



DC TO MMWAVE

Product Catalog

2021

 **Mini-Circuits®**

7,500+ products
across 27 product lines

400+ new products
every year

Minimal end-of-life
and low returns

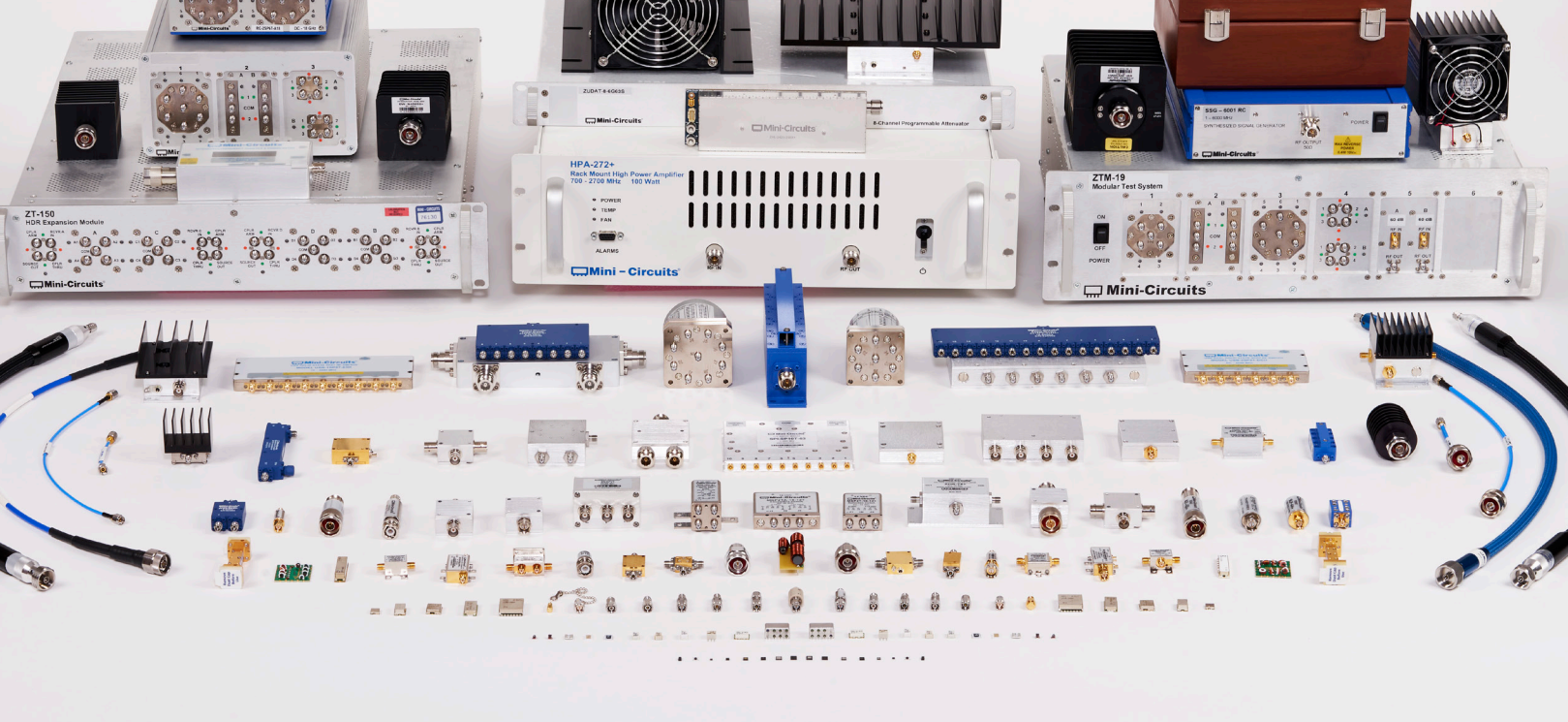

The World's Preferred Supplier from DC to mmWave

Selection Meets Solutions

Mini-Circuits is the only supplier in the industry that gives you the in-stock selection and convenience of a catalog company with the technical capabilities of a custom house and leading manufacturer. With 27 product lines comprising 7,500+ models in stock and growing, chances are we have the right part for your needs. For everything else, we put the full capability of our world-class design and manufacturing facilities to work for you. From special screening requirements to fully custom components and integrated assemblies, our engineers work with you every step of the way with competitive pricing and fast turnaround.

Constant Innovation

For over 50 years, we've grown with the industry by adapting to your needs. With hundreds of new catalog releases each year, a growing portfolio of active patents, and recent investments in new design facilities and world-class technical talent, we're not just keeping up with the pace of innovation—we're setting it.

Service Beyond Normal

When you choose Mini-Circuits, you're getting more than the right part for your system. You're getting the right partner for your long-term success. Our commitment to you means same-day shipping with on-time delivery, short lead times, easy access to knowledgeable engineering support, local reps and service anywhere in the world—everything you expect from a good partner. With 20,000+ customers, we know that every customer's needs are unique, so we go beyond normal expectations to collaborate with our customers in solving problems and getting results.

Peace of Mind

Quality and reliability are in our DNA. That's why the world's largest and most innovative technology companies recognize Mini-Circuits as a top supplier year after year. When failure isn't an option, customers trust us because they know our products perform as expected. They also know that no supplier does more than we do to protect them from supply chain disruptions and product obsolescence. We've built a reputation with our policy to provide product support through the life of your system and minimize end-of-life for every product in active use. That trust, and the peace of mind that comes with it, sets us apart from the rest.

THE MINI-CIRCUITS DIFFERENCE

20-23

- Partner Program
- EZ-Samples
- Buy It Your Way
- Global Presence, Local Service
- Application Engineering
- Custom Designs
- In-House Upscreening

ENGINEERING RESOURCES

24-27

- Microwave Calculator
- Yoni2 Advanced Search
- The Mini-Circuits Blog
- Modelithics
- X-Microwave

CORE TECHNOLOGIES

28-31

- Amplifier Technologies
- Filter Technologies
- Low Temperature Co-Fired Ceramic (LTCC)
- Magnetic Core & Wire
- MMIC

MARKETS

32-37

- Aerospace & Defense
- CATV & Broadband
- Education
- Industrial
- Medical & Diagnostic
- Space & SatCom
- Telecom
- Test & Measurement

PRODUCTS

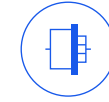

ADAPTERS

40-43

Impedance: 50Ω | Frequency Range: DC-67000 MHz 40-43



AMPLIFIERS

44-73

CATV Coaxial
Impedance: 75Ω | Frequency Range: 50-1000 MHz 45-45

CATV Surface Mount
Impedance: 75Ω | Frequency Range: 5-2150 MHz 45-45

Custom Systems
Impedance: 50Ω | Frequency Range: DC-40000 MHz 333-333

Dual-Matched Coaxial
Impedance: 50Ω | Frequency Range: 4-2000 MHz 46-46

Dual-Matched Surface Mount
Impedance: 50Ω | Frequency Range: DC-5200 MHz 46-46

Gain Blocks Bare Die
Impedance: 50Ω | Frequency Range: DC-22000 MHz 51-51

Gain Blocks Coaxial
Impedance: 50Ω | Frequency Range: 0.0025-43500 MHz 52-56

Gain Blocks Plug-In
Impedance: 50Ω | Frequency Range: 0.5-500 MHz 56-56

Gain Blocks Rack
Impedance: 50Ω | Frequency Range: 10-21000 MHz 57-57

Gain Blocks Surface Mount
Impedance: 50Ω | Frequency Range: DC-43500 MHz 47-50

High-Power Coaxial
Impedance: 50Ω | Frequency Range: 0.1-18000 MHz 57-59

High-Power Rack
Impedance: 75Ω | Frequency Range: 5-2150 MHz 60-60

Amplifiers Continued

Attenuators Continued

Linear Bare Die Impedance: 50Ω Frequency Range: 30-6000 MHz	61-61
Linear Surface Mount Impedance: 50Ω Frequency Range: 30-6000 MHz	60-60
Low Noise Bare Die Impedance: 50Ω Frequency Range: DC-18000 MHz	64-65
Low Noise Coaxial Impedance: 50Ω Frequency Range: 0.1-43500 MHz	65-68
Low Noise Plug-In Impedance: 50Ω Frequency Range: 5-2400 MHz	68-68
Low Noise Surface Mount Impedance: 50Ω Frequency Range: DC-18000 MHz	61-64
Pulse Coaxial Impedance: 50Ω Frequency Range: 0.0025-700 MHz	68-68
RF Transistors Bare Die Impedance: 50Ω Frequency Range: 50-10000 MHz	69-69
RF Transistors Surface Mount Impedance: 50Ω Frequency Range: 10-10000 MHz	69-69
Variable Gain Coaxial Impedance: 50Ω Frequency Range: 10-2000 MHz	70-70
Variable Gain Surface Mount Impedance: 50Ω Frequency Range: 50-3000 MHz	70-70
74-100	
Custom Rack Mount Impedance: 50Ω Frequency Range: DC-40000 MHz	336-336
Digital Step Coaxial Impedance: 50Ω Frequency Range: DC-6000 MHz	76-76
Digital Step Plug-In Impedance: 50Ω Frequency Range: 10-1000 MHz	77-77
Digital Step Surface Mount Impedance: 75Ω Frequency Range: 1-2500 MHz	75-76

Digital Step Surface Mount Impedance: 50Ω Frequency Range: DC-4000 MHz	75-75
Fixed Bare Die Impedance: 50Ω Frequency Range: DC-43500 MHz	82-83
Fixed Coaxial Impedance: 75Ω Frequency Range: DC-2000 MHz	90-90
Fixed Coaxial Impedance: 50Ω Frequency Range: DC-65000 MHz	83-90
Fixed Surface Mount Impedance: 50Ω Frequency Range: DC-50000 MHz	77-81
Programmable Impedance: 50Ω Frequency Range: 1-40000 MHz	91-92
Voltage Variable Coaxial Impedance: 50Ω Frequency Range: 0.1-12000 MHz	93-93
Voltage Variable Surface Mount Impedance: 75Ω Frequency Range: 10-2500 MHz	93-93
Voltage Variable Surface Mount Impedance: 50Ω Frequency Range: 10-7000 MHz	92-92

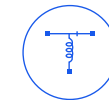

BIAS TEES

102-105

Bare Die Impedance: 50Ω Frequency Range: 1500-28000 MHz	103-103
Coaxial Impedance: 50Ω Frequency Range: 0.1-12000 MHz	103-104
Mux-Tees Coaxial Impedance: 50Ω Frequency Range: 10-2150 MHz	105-105
Plug-In Impedance: 50Ω Frequency Range: 0.1-3000 MHz	104-104
Surface Mount Impedance: 50Ω Frequency Range: 0.1-28000 MHz	103-103



ATTENUATORS

74-100



CABLES

106-131

Interconnect

Impedance: 50/75Ω | Frequency Range: DC-40000 MHz 110-121

Test

Impedance: 50Ω | Frequency Range: DC-67000 MHz 121-128

VNA

Impedance: 50Ω | Frequency Range: DC-67000 MHz 128-129

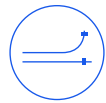

COUPLERS

132-154

Bi-Directional Bare Die

Impedance: 50Ω | Frequency Range: 5000-43500 MHz 150-150

Bi-Directional Coaxial

Impedance: 75Ω | Frequency Range: 700-2500 MHz 151-151

Bi-Directional Coaxial

Impedance: 50Ω | Frequency Range: 0.4-9000 MHz 150-151

Bi-Directional Plug-In

Impedance: 50Ω | Frequency Range: 0.2-400 MHz 151-151

Bi-Directional Surface Mount

Impedance: 50Ω | Frequency Range: 1.5-10500 MHz 146-149

Directional Bare Die

Impedance: 50Ω | Frequency Range: 4-43500 MHz 140-140

Directional Coaxial

Impedance: 75Ω | Frequency Range: 1-1750 MHz 145-145

Directional Coaxial

Impedance: 50Ω | Frequency Range: 0.005-2000 MHz 140-145

Directional Plug-In

Impedance: 75Ω | Frequency Range: 1-150 MHz 146-146

Directional Plug-In

Impedance: 50Ω | Frequency Range: 0.005-2000 MHz 146-146

Directional Surface Mount

Impedance: 75Ω | Frequency Range: 2-2000 MHz 137-139

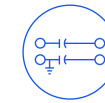

DC BLOCKS

156-156

Coaxial

Impedance: 50Ω | Frequency Range: 0.1-65000 MHz 157-157



EQUALIZERS

158-165

Fixed Slope Bare Die

Impedance: 50Ω | Frequency Range: DC-45000 MHz 160-161

Fixed Slope Coaxial

Impedance: 50Ω | Frequency Range: DC-20000 MHz 161-161

Fixed Slope Surface Mount

Impedance: 50Ω | Frequency Range: DC-45000 MHz 159-160

Voltage Variable Surface Mount

Impedance: 50Ω | Frequency Range: 50-2150 MHz 162-162



FILTERS

166-235

Band Pass + Balun Surface Mount

Impedance: 50Ω | Frequency Range: 690-5875 MHz 204-204

Band Pass Bare Die

Impedance: 50Ω | Frequency Range: 3800-32000 MHz 205-205

Couplers Continued

Directional Surface Mount

Impedance: 50Ω | Frequency Range: 1.5-10500 MHz 134-137

Dual Directional Coaxial

Impedance: 50Ω | Frequency Range: 500-40000 MHz 151-151

RF Tap Bare Die

Impedance: 50Ω | Frequency Range: DC-50000 MHz 152-152

RF Tap Coaxial

Impedance: 50Ω | Frequency Range: 20-6000 MHz 152-152

RF Tap Surface Mount

Impedance: 50Ω | Frequency Range: DC-50000 MHz 152-152

Filters Continued

Band Pass Coaxial Impedance: 75Ω Frequency Range: 12.3-13.8 MHz	211-211
Band Pass Coaxial Impedance: 50Ω Frequency Range: 0.063-43500 MHz	205-211
Band Pass Plug-In Impedance: 50Ω Frequency Range: 9.5-82 MHz	211-212
Band Pass Surface Mount Impedance: 75Ω Frequency Range: 5-2250 MHz	204-204
Band Pass Surface Mount Impedance: 50Ω Frequency Range: 2-29500 MHz	193-204
Band Pass Waveguide Impedance: 50Ω Frequency Range: 27500-86000 MHz	212-212
Band Stop Coaxial Impedance: 50Ω Frequency Range: DC-1000 MHz	225-225
Band Stop Surface Mount Impedance: 50Ω Frequency Range: DC-1200 MHz	224-224
Diplexer Coaxial Impedance: 75Ω Frequency Range: DC-1700 MHz	229-229
Diplexer Coaxial Impedance: 50Ω Frequency Range: DC-7500 MHz	228-229
Diplexer Plug-In Impedance: 75Ω Frequency Range: DC-1225 MHz	229-230
Diplexer Surface Mount Impedance: 75Ω Frequency Range: DC-1220 MHz	227-228
Diplexer Surface Mount Impedance: 50Ω Frequency Range: DC-6500 MHz	226-227
Dual Passband Surface Mount Impedance: 50Ω Frequency Range: 470-960 MHz	225-225
High Pass Bare Die Impedance: 50Ω Frequency Range: 2010-40000 MHz	217-218
High Pass Coaxial Impedance: 50Ω Frequency Range: 0.07-40000 MHz	218-223

Filters Continued

High Pass Plug-In Impedance: 50Ω Frequency Range: 13-720 MHz	223-224
High Pass Surface Mount Impedance: 50Ω Frequency Range: 2-30000 MHz	213-217
Low Pass Dual Differential Surface Mount Impedance: 50Ω Frequency Range: DC-1750 MHz	180-180
Low Pass Flat Time Delay Coax Impedance: 50Ω Frequency Range: 23-1870 MHz	191-191
Low Pass Flat Time Delay Plug-In Impedance: 50Ω Frequency Range: 23-200 MHz	192-193
Low Pass Bare Die Impedance: 50Ω Frequency Range: DC-17000 MHz	180-181
Low Pass Coaxial Impedance: 75Ω Frequency Range: 7-640 MHz	191-191
Low Pass Coaxial Impedance: 50Ω Frequency Range: DC-24000 MHz	182-190
Low Pass Plug-In Impedance: 75Ω Frequency Range: 7-640 MHz	193-193
Low Pass Plug-In Impedance: 50Ω Frequency Range: 1.9-1200 MHz	192-192
Low Pass Surface Mount Impedance: 75Ω Frequency Range: 5-700 MHz	179-179
Low Pass Surface Mount Impedance: 50Ω Frequency Range: DC-17000 MHz	169-179
Triplexers Coaxial Impedance: 50Ω Frequency Range: DC-7000 MHz	231-231
Triplexers Surface Mount Impedance: 50Ω Frequency Range: 1-2700 MHz	230-230



HYBRIDS 90 / 180° **236-242**

Bare Die
Impedance: 50Ω | Frequency Range: 5000-14000 MHz 240-240

Coaxial
Impedance: 50Ω | Frequency Range: 0.01-4200 MHz 241-242

Plug-In
Impedance: 50Ω | Frequency Range: 3.5-600 MHz 242-242

Surface Mount
Impedance: 75Ω | Frequency Range: 5-1250 MHz 240-240

Surface Mount
Impedance: 50Ω | Frequency Range: 1-14500 MHz 237-240



IMPEDANCE MATCHING PADS **244-245**

Coaxial
Impedance: 50Ω | Frequency Range: DC-3000 MHz 245-245

Surface Mount
Impedance: 50Ω | Frequency Range: DC-3000 MHz 245-245



LIMITERS **246-247**

Coaxial
Impedance: 50Ω | Frequency Range: 0.2-8200 MHz 247-247

Plug-In
Impedance: 50Ω | Frequency Range: 0.1-900 MHz 247-247

Surface Mount
Impedance: 50Ω | Frequency Range: 0.2-8200 MHz 246-247



MIXERS **248-271**

Bare Die
Impedance: 50Ω | Frequency Range: 2200-65000 MHz 261-261

Coaxial
Impedance: 50Ω | Frequency Range: 0.0005-40000 MHz 261-266



MODULATORS & DEMODULATORS **272-275**

Bi-Phase Coaxial
Impedance: 50Ω | Frequency Range: 1-2000 MHz 275-275

Bi-Phase Plug-In
Impedance: 50Ω | Frequency Range: 1-2000 MHz 275-275

Bi-Phase Surface Mount
Impedance: 50Ω | Frequency Range: 2-1000 MHz 274-274

I&Q Demodulators Coaxial
Impedance: 50Ω | Frequency Range: 66-73 MHz 274-274

I&Q Demodulators Plug-In
Impedance: 50Ω | Frequency Range: 23-23 MHz 274-274

I&Q Demodulators Surface Mount
Impedance: 50Ω | Frequency Range: 104-176 MHz 273-273

I&Q Modulators Coaxial
Impedance: 50Ω | Frequency Range: 66-73 MHz 273-273

I&Q Modulators Plug-In
Impedance: 50Ω | Frequency Range: 20-23 MHz 273-273

I&Q Modulators Surface Mount
Impedance: 50Ω | Frequency Range: 52-176 MHz 273-273



MULTIPLIERS **276-280**

Bare Die
Impedance: 50Ω | Frequency Range: 0.05-1500 MHz 279-279

Multipliers Continued

Coaxial Impedance: 50Ω Frequency Range: 0.1-20000MHz	279-279
Plug-In Impedance: 50Ω Frequency Range: 0.1-3000 MHz	280-280
Surface Mount Impedance: 50Ω Frequency Range: 20-40000 MHz	277-278



PHASE DETECTORS 282-284

Coaxial Impedance: 50Ω Frequency Range: 1-100 MHz	283-283
Plug-In Impedance: 50Ω Frequency Range: 1-400 MHz	283-283
Surface Mount Impedance: 50Ω Frequency Range: 1-650 MHz	283-283



PHASE SHIFTERS 286-287

Coaxial 360° Impedance: 50Ω Frequency Range: 250-430 MHz	287-287
Surface Mount 180° Impedance: 50Ω Frequency Range: 36-2484 MHz	287-287
Surface Mount 360° Impedance: 50Ω Frequency Range: 210-1500 MHz	287-287

POWER DETECTORS 288-289

Coaxial Impedance: 50Ω Frequency Range: 10-43500 MHz	289-289
------------------------------------------------------------------	---------



POWER SENSORS & FREQUENCY COUNTERS 338-338

Frequency Counter Impedance: 50Ω Frequency Range: 1-6000 MHz	338-338
Power Sensors Impedance: 50Ω Frequency Range: 0.009-8000 MHz	338-338
Power Sensor Frequency Counter Impedance: 50Ω Frequency Range: 1-6000 MHz	338-338

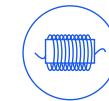

RF CHOKES 290-290

Surface Mount Impedance: 50Ω Frequency Range: 5-10000 MHz	290-290
-----------------------------------------------------------------------	---------

SIGNAL GENERATORS 337-337

Coaxial Impedance: 50Ω Frequency Range: 1-15000 MHz	337-337
-----------------------------------------------------------------	---------

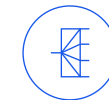

SPLITTERS & COMBINERS 292-316

Bare Die Impedance: 50Ω Frequency Range: DC-43500 MHz	302-302
Coaxial Impedance: 75Ω Frequency Range: 0.002-2500 MHz	313-314
Coaxial Impedance: 50Ω Frequency Range: DC-65000 MHz	303-313
Plug-In Impedance: 50Ω Frequency Range: 0.004-2000 MHz	315-315
Surface Mount Impedance: 75Ω Frequency Range: 1-2750 MHz	300-302
Surface Mount Impedance: 50Ω Frequency Range: DC-43500 MHz	294-300



SWITCHES

318-324

Bare Die

Impedance: 50Ω | Frequency Range: DC-6000 MHz 323-323

Custom Switch Systems

Impedance: 50Ω | Frequency Range: DC-50000 MHz 340-342

Electromechanical Coaxial

Impedance: 50Ω | Frequency Range: DC-18000 MHz 319-319

MMIC Surface Mount

Impedance: 75Ω | Frequency Range: 5-3000 MHz 322-322

MMIC Surface Mount

Impedance: 50Ω | Frequency Range: DC-6000 MHz 321-322

MMIC Surface Mount Low Video Leakage

Impedance: 50Ω | Frequency Range: DC-2000 MHz 322-322

Pin Diode Coaxial

Impedance: 50Ω | Frequency Range: 10-3000 MHz 324-324

Pin Diode Plug-In

Impedance: 50Ω | Frequency Range: 10-3000 MHz 324-324

Solid State Coaxial TTL

Impedance: 50Ω | Frequency Range: DC-6000 MHz 23-324

USB Ethernet Mechanical Modules

Impedance: 50Ω | Frequency Range: DC-50000 MHz 319-320

USB Ethernet Solid State Modules

Impedance: 50Ω | Frequency Range: DC-8000 MHz 323-323



SYNTHESIZERS

326-327

Surface Mount

Impedance: 50Ω | Frequency Range: 1520-2346 MHz 327-327



TERMINATIONS

328-330

Coaxial

Impedance: 50Ω | Frequency Range: 65000 MHz 329-330

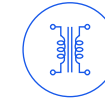

TRANSFORMERS & BALUNS

344-365

Bare Die

Impedance: 50Ω | Frequency Range: 2000-24000 MHz 361-361

Coaxial

Impedance: 50/75Ω | Frequency Range: 0.004-24000 MHz 359-359

Plug-In

Impedance: 50Ω | Frequency Range: 0.1-800 MHz 359-361

Surface Mount

Impedance: 75Ω | Frequency Range: 0.3-3000 MHz 357-358

Surface Mount

Impedance: 50Ω | Frequency Range: 0.005-24000 MHz 345-357



VOLTAGE CONTROLLED OSCILLATORS

366-379

Dual Output Coaxial

Impedance: 50Ω | Frequency Range: 37.7-1025 MHz 379-379

Linear Tuning Wideband Plug-In

Impedance: 50Ω | Frequency Range: 37.5-2120 MHz 378-378

Linear Tuning Wideband Surface Mount

Impedance: 50Ω | Frequency Range: 37.5-6840 MHz 374-377

5V Tuning for PLLs Surface Mount

Impedance: 50Ω | Frequency Range: 35-6520 MHz 370-373



TEST SOLUTIONS

332-342

Custom Test Systems

Impedance: 50Ω | Frequency Range: DC-65000 MHz 333-333

Instrumentation Amplifiers

Impedance: 50Ω | Frequency Range: 0.0025-43500 MHz 333-333

Mesh Network Simulation Racks

Impedance: 50Ω | Frequency Range: 30-6000 MHz 333-334

Modular Test Systems

Impedance: 50Ω | Frequency Range: DC-40000 MHz 334-334

Test Solutions Continued

Patch Panel Systems

Impedance: 50Ω | Frequency Range: DC-67000 MHz 335-335

Signal Conditioning & Attenuation, Custom

Impedance: 50Ω | Frequency Range: DC-40000 MHz 336-336

Signal Distribution

Impedance: 50Ω | Frequency Range: DC-65000 MHz 339-339

Signal Generation & Measurement

Impedance: 50Ω | Frequency Range: 0.009-15000 MHz 337-337

Power Sensors & Frequency Counters

Impedance: 50Ω | Frequency Range: 0.009-8000 MHz 338-338

Switching & Routing

Impedance: 50Ω | Frequency Range: DC-50000 MHz 340-341



RESEARCH & EDUCATION

380-381

4D Imaging Kit

Impedance: 50Ω | Frequency Range: 62000-69000 MHz 381-381

DIY VNA Kit

Impedance: 50Ω | Frequency Range: DC-6000 MHz 381-381

RESEARCH & EDUCATION

382-383



Partner Program
PRICE ASSURANCE



Partner Program

Preferred Pricing and Long-Term Savings

Nothing matters more to us than building and maintaining strong, long-term relationships with our customers. We established Mini-Circuits' Partner Program to reward your loyalty with preferred pricing based on cumulative purchases for each model you buy.

Here's how it works:

- You're automatically enrolled in the program when you make a purchase from us
- Your preferred pricing is based on the volume pricing at the accumulated total of all purchases of a model while enrolled in the program
- This rewards all subsequent orders, large or small, with higher volume pricing
- You remain enrolled in the program for each model as long as you purchase at least 2% of the prior year's cumulative total



[*See minicircuits.com/partners/partners for terms and conditions](https://minicircuits.com/partners/partners)

[See full program terms](#)

EZ-Sample

Try It Before You Buy It

EZ-Sample is Mini-Circuits' free, online sample request program for RF components. We offer a wide selection of our surface mount parts in small-quantity samples to support your product selection and design validation efforts, so you can make an informed decision at no cost.

- 1300+ models available to sample for free*
- Free shipping to 200+ countries
- Choose from a wide selection of amplifiers, attenuators, bias tees, couplers, equalizers, filters, limiters, mixers, multipliers, RF chokes, switches, splitter/combiners and transformers

*Additional models may be available on request. Check with your Mini-Circuits sales rep or account manager



[Browse free sample parts](#)

Buy It Your Way

Ship from Mini-Circuits or Mouser

Mini-Circuits is your preferred supplier from DC to mmWave for components, custom assemblies and test solutions. We've partnered with Mouser to give customers the flexibility to choose their point of sale for our products, expand the availability of parts from stock and accelerate delivery times across the globe.

- 1300+ Mini-Circuits components and growing
- Same-day shipping to 200+ countries*
- Approved vendor for many of our customers

*Shipping times and product availability may vary by location



[Shop Mini-Circuits on Mouser](#)

Global Presence, Local Service

Corporate Offices and Authorized Reps Worldwide

Being the world's preferred supplier means personal, locally accessible service and technical support wherever you're doing business. Whether you need help with logistics or technical support from a qualified engineer, almost anywhere in the world, there's a Mini-Circuits team member nearby to help you meet your goals.

- 14 corporate locations in 8 countries
- 300+ authorized sales rep offices and distributors worldwide
- Company-owned warehouses and shipping hubs in the U.S., Europe and Asia-Pacific regions



[Find a Mini-Circuits rep in your area](#)



Applications Engineering

Engineer-to-Engineer Technical Support

First and foremost, we're a company of RF engineers supporting other RF engineers. We're committed to making the technical expertise of our organization a resource to the industry and collaborating at the engineering level with all customers, small and large, from the early stages of product selection through integration and troubleshooting long after your order ships.

- Dedicated staff of qualified RF engineers
- Product selection assistance
- Custom designs and special requirements
- Integration support
- Technical troubleshooting

Contact Our Engineers: apps@minicircuits.com

Custom Designs

Components and Integrated Assemblies

Our offering goes way beyond the catalog. Put the full capability of our 50+ years of design and manufacturing experience to work for you. Whether you need a modification of an existing part or a fully custom component or integrated sub-system, our engineers work closely with you to realize innovative solutions from definition to delivery.

- 50+ years design and manufacturing experience
- Broad range of design capabilities across 27 product categories
- 7 design centers and 8 company-owned manufacturing facilities

In-House Upscreening

Hi-Rel and Space Applications

Mini-Circuits has decades of experience supporting hi-rel military applications and space missions with a wide range of upscreening requirements. Most of our catalog and custom components can be upscreened in-house for Mil-Spec or equivalent qualification in as little as 90 days.

Hi-Rel

- Qualification for the toughest operating environments
- Broad selection off-the-shelf + custom designs
- MMICs in ceramic, plastic and bare die formats

Capable of meeting MIL requirements for:

Gross leak, fine leak, thermal shock, vibration, acceleration, mechanical shock and HTOL. Additional screening available on request.



Space Flight Launch Prep

- Mil-Spec or equivalent qualifications
- 30+ years of space-level screening and testing heritage
- In-stock and custom components
- EEE-INST-002 compliant workflows

Standard capabilities:

Burn-in, thermal cycling and shock, vibration*, radiographic inspection*, destructive physical analysis (DPA)*, mechanical shock, hermeticity with accompanying acceptance test procedure (ATP).

*While Mini-Circuits performs most of its testing and upscreening in-house, we use specialist partners for a limited selection of tests.

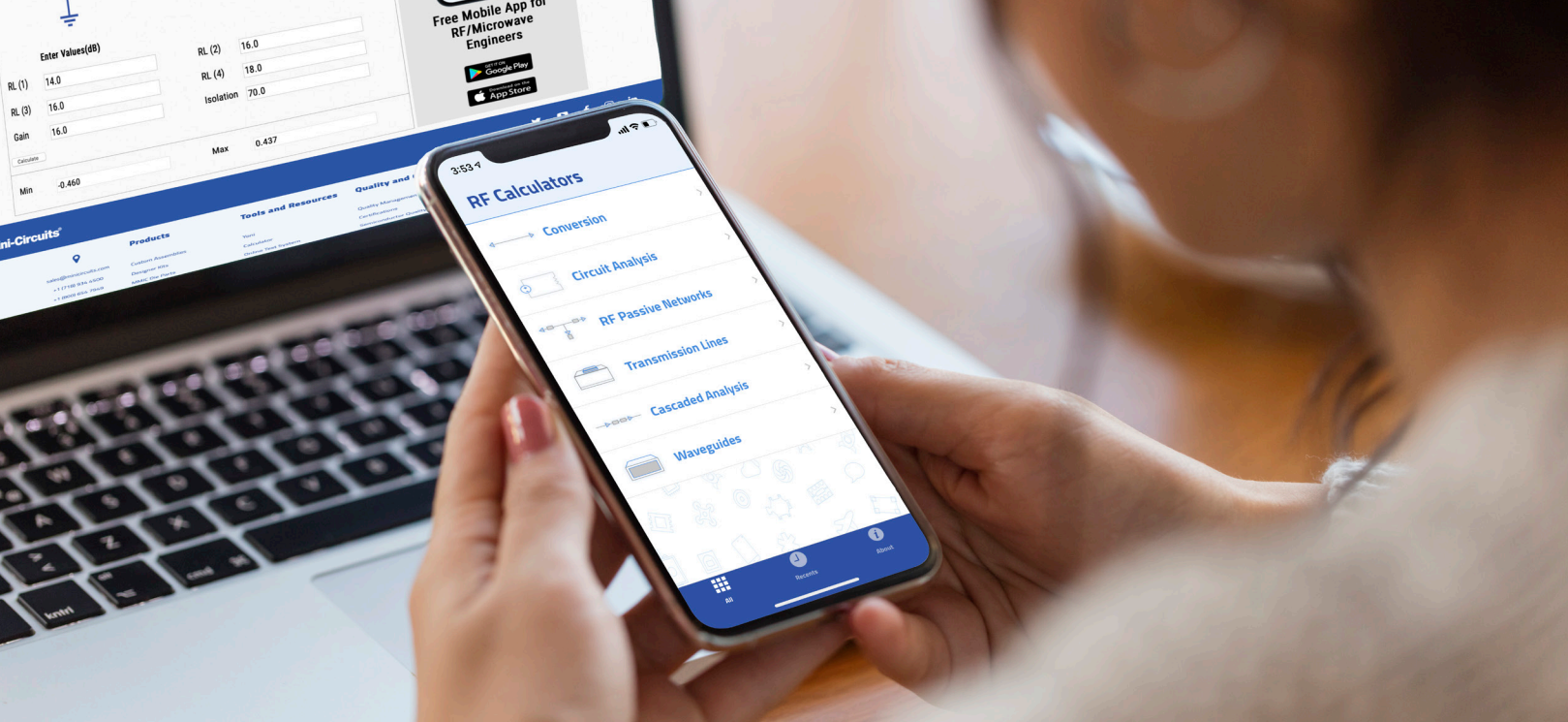

Engineering Resources

Microwave Calculator App

Common RF Calculations in the Lab or On the Fly

Mini-Circuits' Microwave Calculator app for iOS® and Android® devices performs 31 calculations commonly used by professional RF engineers. It's the perfect tool to help you solve problems and save time, whether you're working in the classroom, the lab or in the field. The new and improved version features a redesigned user interface and several new calculations including frequency to wavelength conversion, voltage divider circuit analysis, Ohm's Law circuit analysis and much more.

- 31 common RF engineering calculations
- Free for all our friends in the RF community
- Available for iOS devices from the App Store® and for Android from Google Play®



Yoni2®

The World's Most Advanced Component Search Engine

Most parametric search engines use product specs to find models that meet your requirements. But everyone knows performance is a function of frequency, and specs alone aren't realistic representations of actual response. The Yoni2 search engine is different. By searching based on characteristic performance versus frequency from a database comprising millions of points of actual measured test data, Yoni2 is less prone to false positive and false negative results inherent to spec-based searches, giving you a better likelihood of finding that needle in the haystack.

- Searches characteristic performance data within your exact bandwidth
- Results include catalog models in stock and engineering designs with fast turnaround
- Allows prioritization of parameters for searches with several requirements

The Mini-Circuits Blog

Knowledge, Insights and Mini-Circuits Life

The Mini-Circuits blog is our knowledge hub for engineering reference content, executive thought leadership and stories about the people, culture and values that make Mini-Circuits unique. New articles, videos and other media are added regularly to keep you up to date with information relevant to your work and your personal interests.

- 160+ technical articles and application notes on a wide range of RF engineering topics
- Articles and interviews on industry trends from Mini-Circuits top executives
- Real-world applications of Mini-Circuits products
- Stories about the impact of RF/microwave technology on society

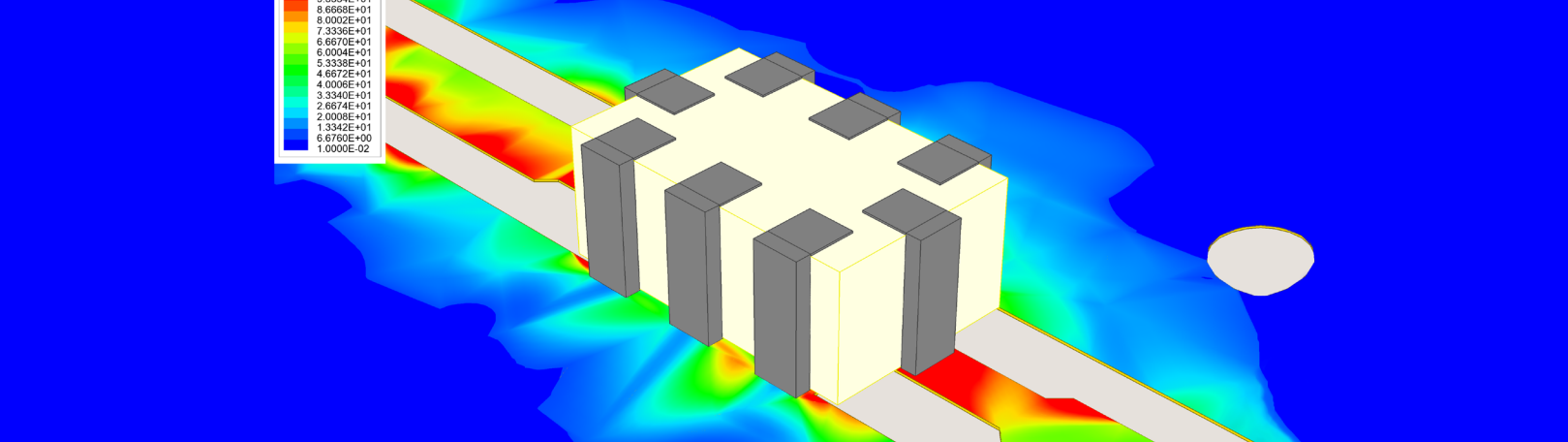

Modelithics

Superior Simulations for Design Confidence

Mini-Circuits has partnered with modeling and measurement experts at Modelithics to give you free high-accuracy simulation models for Mini-Circuits components. This enhanced simulation capability helps achieve faster agreement between simulation and measured performance, permitting faster design cycles, lower design cost, and greater likelihood of first pass success. The Modelithics library gives designers a valuable addition to their tool kit, and Mini-Circuits is pleased to sponsor these simulation models as part of our commitment to provide best-in-class engineering tools for our customers.

- X-Parameters[®]-based non-linear models for Keysight ADS[®]
- Substrate scalable and substrate selectable models for Keysight ADS[®]
- Full 3D models for Ansys HFSS[®]



[Download the models for free from the Mini-Circuits partner page on the Modelithics website](#)

X-Microwave

Modular Building Blocks to Test, Align and Integrate Your Assembly

We're proud to extend availability of Mini-Circuits products through the X-Microwave component ecosystem as an innovative integration tool for customers designing our parts into their systems. X-Microwave offers the industry's first truly modular design system of physically compatible drop-in building blocks, called X-MWBlocks[®], which can be configured on a solderless prototyping plate to build integrated microwave assemblies for testing, design validation and production. The X-MWSystem[®] approach eliminates the need for custom evaluation board layouts, dramatically shortening design cycles and accelerating time to market.

- 1000+ X-MWBlock drop-in modules for 800+ Mini-Circuits components and growing
- Physically compatible with thousands of parts from other leading manufacturers
- Blocks come fully characterized and modeled with X-Parameters[®], S-Parameters and Sys-Parameters
- Free, online tools for non-linear simulation and mechanical layout



[Browse the full selection of X-MWBlocks for Mini-Circuits parts](#)

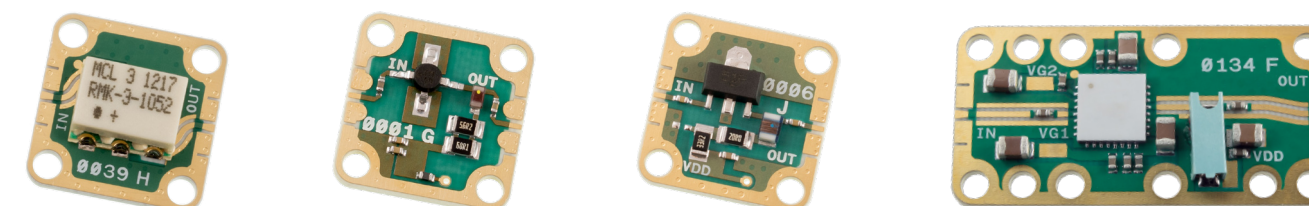

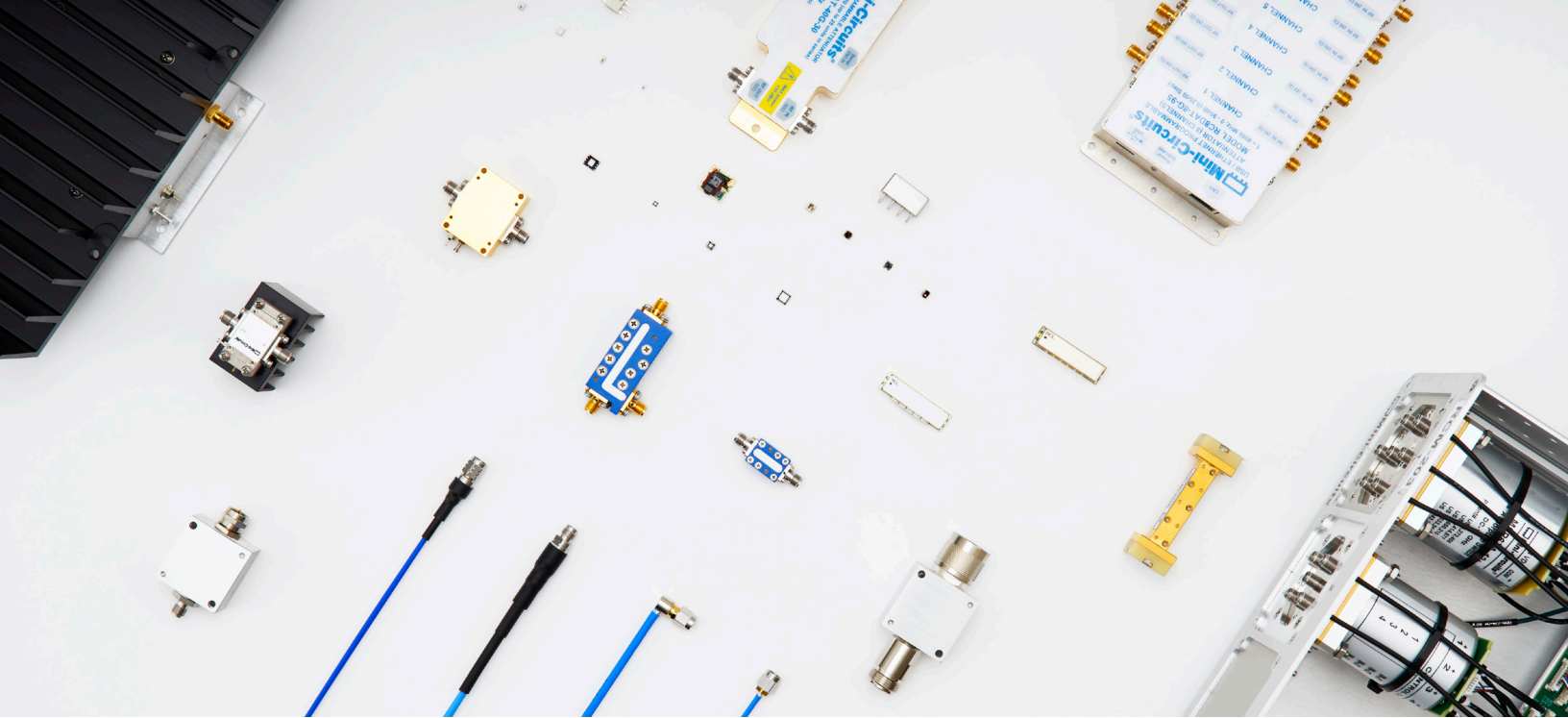

Core Technologies

The diversity of design expertise across our global engineering organization gives us the flexibility to design components for virtually any requirement. From tiny MMICs and LTCCs to instrument-grade waveguides, wideband or narrow-band-optimized, high frequency or high power, chances are if you can define it, we can design it.



DC TO 43.5 GHZ

Amplifier Technologies

Extending Bandwidth, Power, Linearity and Noise Performance

We employ a variety of design methods and transistor types to develop amplifiers for a wide range of application requirements. We've recently expanded our design capabilities with dedicated design teams and facilities to extend our SSPA portfolio into the kW range and develop high-frequency models reaching 100 GHz and beyond.

- LDMOS, GaAs and GaN pHEMT (high power)
- E- and D-Mode GaAs pHEMT (low noise)
- GaAs HBT, InGaP HBT (Low phase noise)

DC TO 43.5 GHZ

Filter Technologies

For Every Application

Mini-Circuits offers one of the industry's broadest and most advanced design and manufacturing capabilities for RF filters spanning multiple technologies to support almost every application requirement.

Response types: Low pass, band pass, high pass, band stop, diplexers and triplexers

- Microstrip, stripline, suspended substrate
- Substrate Integrated Waveguide (SIW)
- Lumped element
- Ceramic resonator
- LTCC
- Cavity
- Thin film on alumina
- Waveguide

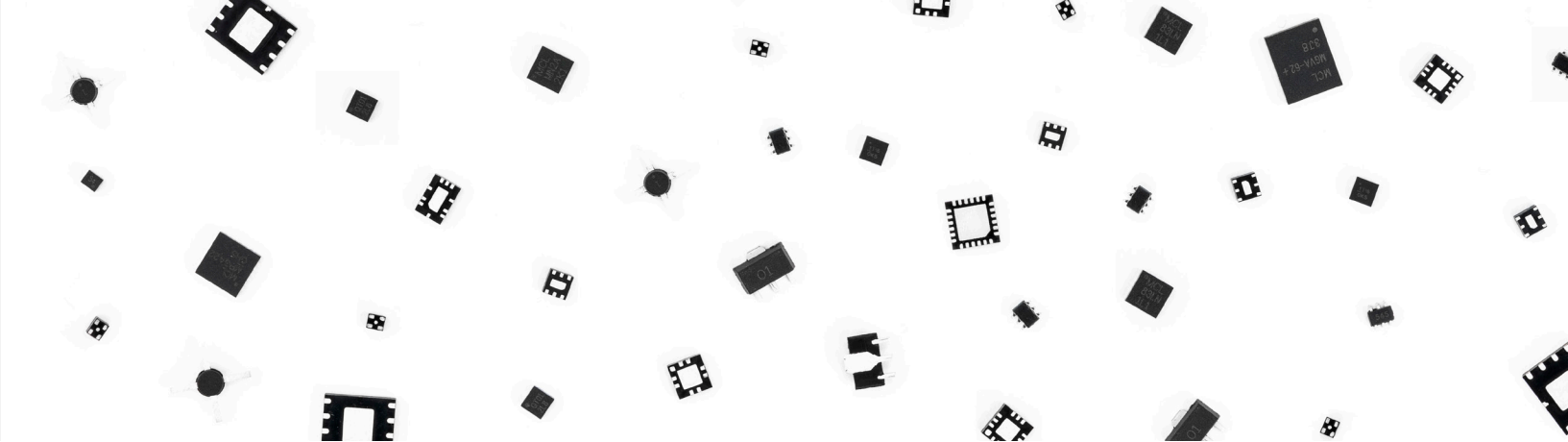
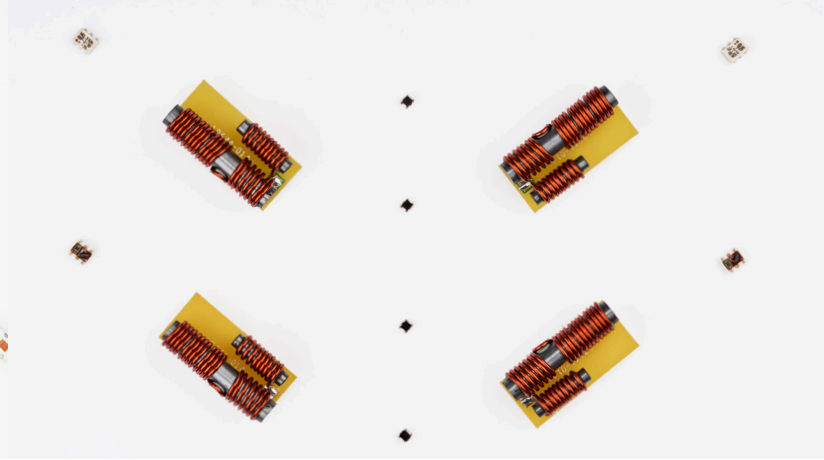

DC TO 60 GHZ

Low Temperature Co-Fired Ceramic (LTCC)

Industry-Leading Design Capability

LTCC devices are fabricated with capacitors, inductors and distributed structures embedded in multi-layered ceramic substrate and sintered into a single monolithic component. Our design team has the most advanced knowledge of LTCC technology in the industry building on 20+ years of R&D and multiple active patents.

Product lines: Couplers, filters, power splitters, transformers and baluns

- The world's broadest portfolio
- 750+ in-stock models
- Custom designs with fast turnaround
- Packages as small as 0202
- Patented mmWave surface mount packaging solutions

DC TO 8 GHZ

Magnetic Core & Wire

Quality and Repeatability
You Can Count On

Core and wire designs consist of twisted wire-coupled structures wound around toroidal ferrite cores utilizing inductive coupling between conductors to achieve a desired function. Mini-Circuits performs all wire twisting, winding and welding in-house with tight process control to ensure the highest quality and repeatability.

Product lines: Directional couplers, filters, power splitters, transformers and baluns

- Footprint as small as 0.15 x 0.15"
- Top Hat® feature improves speed and accuracy of pick-and-place assembly
- Outstanding repeatability, unit-to-unit and lot-to-lot
- In-house wire twisting and winding
- All welded connections

DC TO 50 GHZ

MMIC

In-House Design and Packaging

MMICs are integrated circuits fabricated from semiconductor material and enclosed in a surface-mount package or sold as bare die for chip-and-wire assembly. Mini-Circuits MMICs utilize PHEMT, HBT and IPD fabrication processes on gallium arsenide (GaAs), designed and packaged in our own facilities.

Product lines: Amplifiers, attenuators, bias tees, couplers, equalizers, reflectionless filters, mixers, multipliers, power splitters, transformers and baluns

- 700+ models in stock and growing
- Wideband and band-optimized designs
- Industry-leading quality and reliability
- All models available in QFN or bare die format

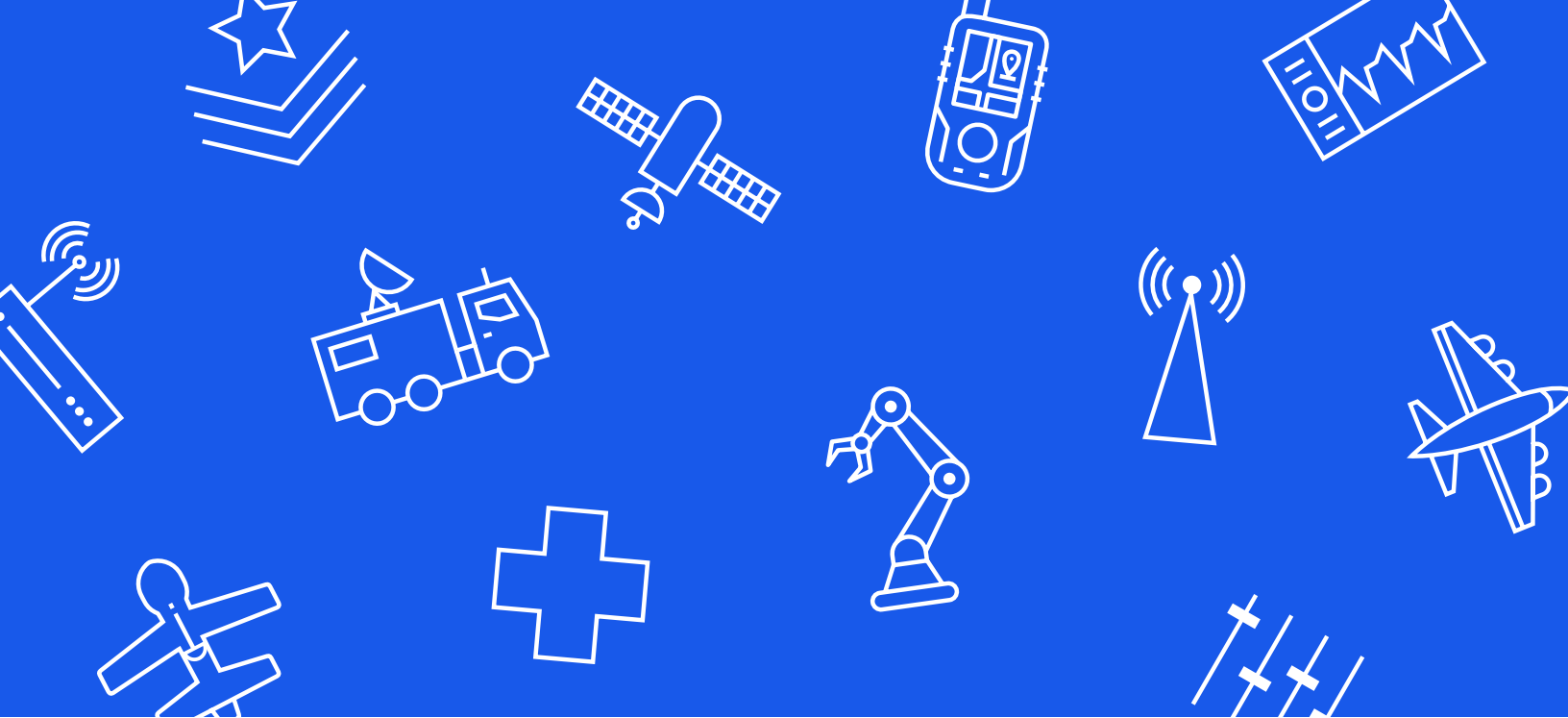

Key Markets

Mini-Circuits serves 20,000+ customers worldwide encompassing virtually every corner of the wireless world. That diversity of our customer base and our product line makes us unique in the RF industry. The wide distribution of our business across markets gives stability through business cycles and enables our continuous growth. It also gives us the experience and flexibility to work with our customers on almost any problem. Below are just some of the major industries we serve, but whatever you're working on, if it relies on wireless connectivity, we have a solution for you.

Aerospace & Defense

Our products enable advanced solutions that governments and private enterprise depend on to keep the world safe and connected. From aviation to defense communications, radar, electronic warfare and more, we're proud to be a trusted partner to government agencies and industry leaders in solving tomorrow's biggest challenges.

- COTS and custom solutions
- Hi-rel products for the toughest environments
- In-house upscreening capabilities
- ITAR registered
- Best-in-industry supply chain security—no EOL target

CATV & Broadband

As consumer demand for higher data speed and capacity continues to intensify, network operators deploying optical and hybrid fiber-coaxial (HFC) infrastructure are pushing the limits of their equipment under the DOCSIS® 3.1 and 4.0 standards. Many Mini-Circuits products have been successfully designed into these applications from the head end to subscriber premises, and we're continuously expanding our portfolio of parts developed specifically for the broadband market.

- Hundreds of models supporting DOCSIS 3.0, 3.1 and 4.0 bandwidth requirements
- State-of-the-art, in-house testing and characterization for 75Ω products
- Amplifiers, couplers, filters and diplexers, splitter/combiners, switches, transformers, voltage variable attenuators, voltage variable equalizers, matching pads and test cables



Education

University programs, educators, researchers and students aren't just customers. They're at the forefront of the advances revolutionizing the RF and microwave field, and they're cultivating the future generations of engineering talent to keep our industry growing. We're proud of our track record supporting the academic community in their mission to prepare bright minds to be the innovators and leaders we need to solve tomorrow's toughest problems and build a smarter, more sustainable world.

- Academic discounts for educators and university staff
- Hands-on project kits to connect classroom theory with practical, real-world applications (see Research & Education section on p. 380)
- Annual equipment donations to university labs
- Career development opportunities for students including research partnerships, summer internships and campus visits from our engineers

Industrial

From the industrial IoT to the next generation of applications for RF energy, Mini-Circuits offers innovative solutions you need to redefine what's possible with the guaranteed quality, service and dependability you expect from a strategic partner. We offer an extensive selection of products in-stock for all the primary ISM bands as well as cost-effective custom designs for special requirements. Our dedicated in-house design team for RF power products is setting a new standard for flexible, turnkey solid-state power amplifiers to simplify and accelerate your design process.

- Broad selection of in-stock products covering ISM bands
- Dedicated in-house PA design expertise
- 50+ years of manufacturing, supply chain and quality management experience

Medical & Diagnostic

Whether for advanced diagnostic imaging, minimally invasive surgical techniques or other life-saving technologies, the unique requirements of applications in the medical field make RF component selection especially challenging. Mini-Circuits has decades of experience working with customers developing medical and diagnostic systems to choose the right components, meet special screening requirements and develop custom designs with fast turnaround.

- Wide selection of standard catalog parts
- Non-magnetic parts successfully designed into MRI systems
- Turnkey PA solutions for RF energy
- In-house capability for additional screening and custom designs
- Product support through the life of your system
- Second-sourcing and replacements for EOL models from other manufacturers

Space & SatCom

Mini-Circuits' space heritage spans some of the earliest government missions all the way through to modern, independent enterprises. We offer an extensive selection of off-the-shelf components from L-Band to Ka Band, suitable for earth station and spaceborne systems with in-house custom design capabilities and upscreening services to meet special requirements.

- 30+ years of experience supporting commercial and government applications
- Extensive selection of COTS components
- Custom components and integrated subassemblies
- In-house space-level screening and testing workflows IAW EEE-INST-002

Learn more about our space heritage and upscreening services on p. 23



Telecom

From the earliest days of cellular communications to the rollout of the 5G revolution, Mini-Circuits is built into the history and the future of the global telecom industry. We offer industry-leading performance for all the established telecom bands, and we've rapidly expanded our product line to support ongoing development in the millimeter-wave range. Mini-Circuits products support everything from R&D and design verification testing in the lab all the way through to macro base stations, small cells and optical backhaul in the field.

- Outstanding RF performance covering all telecom application bands
- Rapidly expanding mmWave portfolio in surface mount and connectorized formats
- Innovative solutions for R&D, design verification and high-throughput production testing
- Competitive pricing
- Short lead times of your system
- Second-sourcing and replacements for EOL models from other manufacturers

Test & Measurement

Mini-Circuits partners closely with leading manufacturers of the world's most sophisticated electronic measurement instrumentation. Our strategic design approach of developing high-performance, wideband products aligns naturally with the demanding requirements of test and measurement applications, and the breadth of our product line provides a complete solution set, covering more of the signal chain than other suppliers in the industry.

- Design focus on high performance over ultra-wide bandwidths from DC to mmWave
- Single source for most active and passive elements in the signal chain
- Long-term supply chain security and minimization of product change

7,500+ STOCKED COMPONENTS

Catalog Products

Custom solutions available

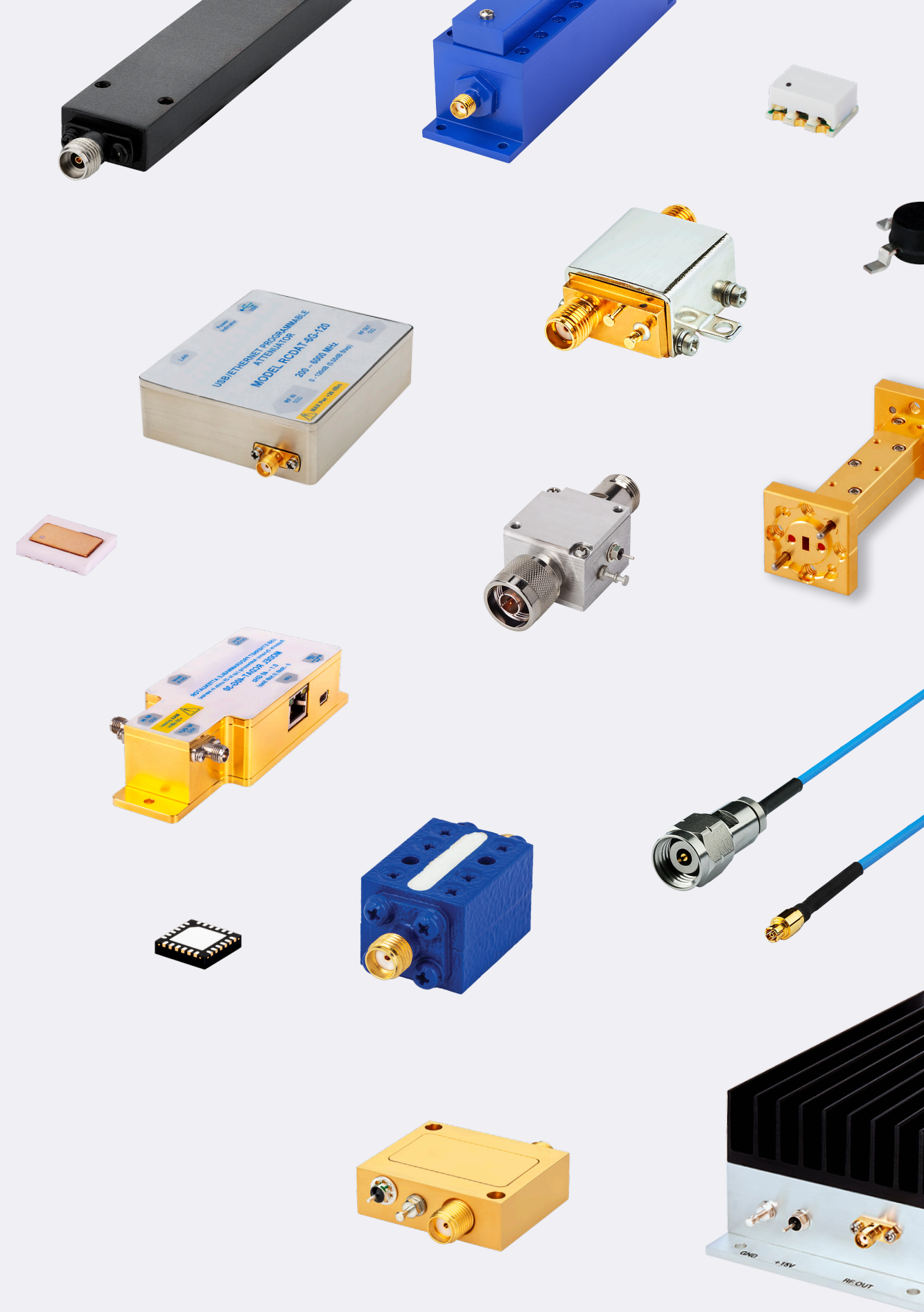



DC TO 67 GHZ

Adapters

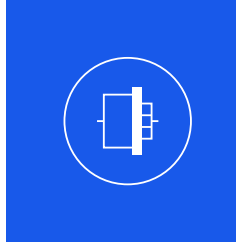

- Wide variety of connector options
- All gender combinations
- Straight, right-angle, bulkhead and NMD formats

- Low loss and excellent VSWR
- Rugged construction

Adapters

Model Number	Connector 1	Connector 2	Frequency Range (GHz)	VSWR (:1)
185F-185F+	1.85mm-F	1.85mm-F	DC-67	1.05
185M-185F+	1.85mm-M	1.85mm-F	DC-67	1.04
185M-185M+	1.85mm-M	1.85mm-M	DC-67	1.04
24F-24F+	2.4mm-F	2.4mm-F	DC-50	1.03
24F-24M+	2.4mm-F	2.4mm-M	DC-50	1.06
24M-24M+	2.4mm-M	2.4mm-M	DC-50	1.04

Adapters Continued

Model Number	Connector 1	Connector 2	Frequency Range (GHz)	VSWR (:1)
24FPM-24F+	2.4mm-F	2.4mm-F	DC-50	1.04
185F-24F+	1.85mm-F	2.4mm-F	DC-50	1.08
185F-24M+	1.85mm-F	2.4mm-M	DC-50	1.08
185M-24F+	1.85mm-M	2.4mm-F	DC-50	1.06
185M-24M+	1.85mm-M	2.4mm-M	DC-50	1.04
24B-KB+	2.92mm-F	2.4mm-F	DC-40	1.05
185F-KF+	1.85mm-F	2.92mm-F	DC-40	1.05
185F-KM+	1.85mm-F	2.92mm-M	DC-40	1.04
185M-KF+	1.85mm-M	2.92mm-F	DC-40	1.04
185M-KM+	1.85mm-M	2.92mm-M	DC-40	1.03
KB-KB50+	2.92mm-F	2.92mm-F	DC-40	1.03
KF-24F+	2.92mm-F	2.4mm-F	DC-40	1.1
KF-24M+	2.92mm-F	2.4mm-M	DC-40	1.1
KF-24MNMD+	2.92mm-F	2.4mm NMD-M	DC-40	1.06
KF-KF50+	2.92mm-F	2.92mm-F	DC-40	1.03
KF-KM50+	2.92mm-F	2.92mm-M	DC-40	1.04
KFFL-KF50+	2.92mm-F	2.92mm-F	DC-40	1.05
KFNMD-24MNMD+	2.92mm NMD-F	2.4mm NMD-M	DC-40	1.08
KFNMD-KM+	2.92mm NMD-F	2.92mm-M	DC-40	1.06
KFNMD-KMNMD+	2.92mm NMD-F	2.92mm NMD-M	DC-40	1.05
KFPM-KF50+	2.92mm-F	2.92mm-F	DC-40	1.08
KFR-KM50+	2.92mm-M	2.92mm-F Right Angle	DC-40	1.07
KM-24F+	2.92mm-M	2.4mm-F	DC-40	1.1
KM-24M+	2.92mm-M	2.4mm-M	DC-40	1.1
KM-24MNMD+	2.92mm-M	2.4mm NMD-M	DC-40	1.04
KM-KM50+	2.92mm-M	2.92mm-M	DC-40	1.02
KMNMD-24MNMD+	2.92mm NMD-M	2.4mm NMD-M	DC-40	1.06
KMR-24F+	2.4mm-F	2.92mm-M Right Angle	DC-40	1.09

Adapters Continued

Model Number	Connector 1	Connector 2	Frequency Range (GHz)	VSWR (:1)
KMR-KM50+	2.92mm-M	2.92mm-M Right Angle	DC-40	1.06
SMPM-24M+	SMP-M	2.4mm-M	DC-40	1.1
35F-35F50+	3.5mm-Female	3.5mm-Female	DC-34	1.07
35F-35M50+	3.5mm-Female	3.5mm-Male	DC-34	1.07
35M-35M50+	3.5mm-Male	3.5mm-Male	DC-34	1.02
35FFL-35F50+	3.5mm-Female	3.5mm-Female	DC-33	1.07
SF-35M50+	SMA-Female	3.5mm-Male	DC-26.5	1.1
SMPMR-SM50+	SMP-Male	SMA-M Right Angle	DC-26.5	1.1
NF-NMR50-18+	N-Female	N-Male Right Angle	DC-18	1.06
NF-SF50+	N-Female	SMA-Female	DC-18	1.2
NF-SM50+	N-Female	SMA-Male	DC-18	1.2
NFFL-SF50+	N-Female	SMA-Female	DC-18	1.2
NFFL-SM50+	N-Female	SMA-Male	DC-18	1.08
NM-NM50-18+	N-Male	N-Male	DC-18	1.04
NM-SF50+	N-Male	SMA-Female	DC-18	1.25
NM-SM50+	N-Male	SMA-Male	DC-18	1.2
SF-MQK50+	SMA-Female	SMA-Male Quick Connect	DC-18	1.25
SF-SF50+	SMA-Female	SMA-Female	DC-18	1.25
SF-SM50+	SMA-Female	SMA-Male	DC-18	1.28
SFFL-SF50+	SMA-Female	SMA-Female	DC-18	1.13
SFR-KF50+	SMA-Female	2.92mm-F Right Angle	DC-18	1.11
SFR-NM50+	SMA-Female	N-Male	DC-18	1.13
SFR-SM50+	SMA-Female	SMA-M Right Angle	DC-18	1.09
SM-SM50+	SMA-Male	SMA-Male	DC-18	1.3
SMPF-SF50+	SMP-F	SMA-F	DC-18	1.07
SMPF-SM50+	SMP-F	SMA-M	DC-18	1.07
SF-SFRP50+	SMA-Female	SMA-FRP	DC-12	1.2
SF-SMRP50+	SMA-Female	SMA-MRP	DC-12	1.2

Adapters Continued

Model Number	Connector 1	Connector 2	Frequency Range (GHz)	VSWR (:1)
SMRP-SM50+	SMA-MRP	SMA-Male	DC-12	1.22
NFFL-NF50+	N-Female	N-Female	DC-9	1.07
NF-NF50+	N-Female	N-Female	DC-6	1.2
NF-NMR50+	N-Female	N-Male Right Angle	DC-6	1.02
NM-NM50+	N-Male	N-Male	DC-6	1.03
NF-BM50+	N-Female	BNC-Male	DC-2	1.15
SF-BF50+	SMA-Female	BNC-Female	DC-2	1.2
SF-BM50+	SMA-Female	BNC-Male	DC-2	1.2
SM-BF50+	SMA-Male	BNC-Female	DC-2	1.2
SM-BM50+	SMA-Male	BNC-Male	DC-2	1.2



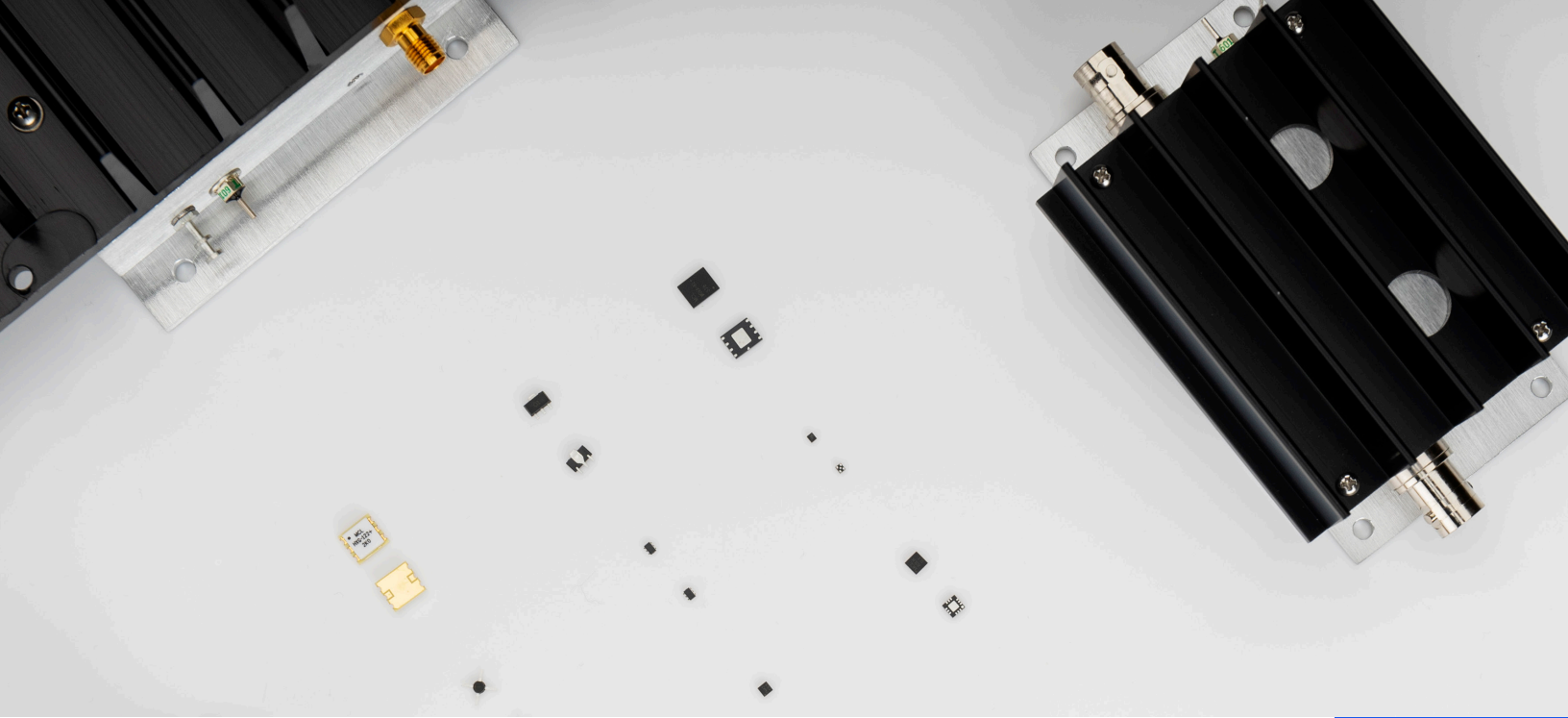

DC TO 43.5 GHz

Amplifiers

570+ Wideband Models & Growing

- Connectorized, MMIC surface mount and bare die interfaces
- In-house design and manufacturing
- Industry-leading quality and reliability
- Cost-effective custom solutions (see *Test Solutions* section)

Broad selection:

Noise figure as low as 0.38 dB, high power up to 100W, class A/AB linear amplifiers, 75Ω for CATV, RF transistors, variable gain, dual-matched, pulse amplifiers and more.

CATV Amplifiers (75Ω)

- Covering 5 to 2150 MHz, supporting bandwidth requirements for DOCSIS® systems and equipment
- MMIC surface mount and BNC connectorized formats
- Flat gain
- Noise figure as low as 2.8 dB
- OIP3 up to +48.8 dBm

CATV Amplifiers – Surface Mount 75Ω

Model Number	Frequency Range (MHz)	Gain (dB)	NF (dB)	P1dB (dBm)	OIP3 (dBm)	Input VSWR (:1)	Output VSWR (:1)	Voltage (V)	DC Current (mA)
PGA-106W-75+	950-2150	15.9	3.6	19.5	35.6	1.4	1.5	5	116
PGA-106-75+	50-1500	16.9	3.3	20.1	36.2	1.4	1.5	5	116
PGA-122-75+	5-1500	15.5	2.8	23.8	41.4	1.26	1.36	9	115
MPGA-122-75+	40-1250	15.3	3.2	30.6	48.8	1.21	1.36	9	391
ZHL-1010-75+	50-1000	9.5	3.5	26	47	1.5	1.5	12	525
PGA-32-75+	5-300	15.6	2.9	23.7/18.7	43.3/39.1	1.16	1.08	9.0/5.0	110/55
PGA-106R-75+	5-250	17.9	3.3	19.5	34.4	1.4	1.25	5	116

CATV Amplifiers – Coaxial 75Ω

Model Number	Frequency Range (MHz)	Gain (dB)	NF (dB)	P1dB (dBm)	OIP3 (dBm)	Input VSWR (:1)	Output VSWR (:1)	Voltage (V)	DC Current (mA)	Connector Type
ZHL-1010-75+	50-1000	9.5	3.5	26	47	1.5	1.5	12	525	BNC

Dual-Matched Amplifiers

- Two well-matched die in a single package
- Ideal for push-pull and balanced amplifier configurations
- Outstanding IP2 and IP3 performance
- Noise figure as low as 1.9 dB

Dual-Matched Amplifiers — Surface Mount

Model Number	Frequency Range (MHz)	Gain (dB)	NF (dB)	P1dB (dBm)	OIP3 (dBm)	Input VSWR (:1)	Output VSWR (:1)	Voltage (V)	DC Current (mA)
MGVA-82+	DC-5200	14.1	7	20.2	36	1.3	1.7	5	100
MERA-533+	DC-4000	18.8	3.5	17.5	33	1.4	1.5	4.9	65
MGVA-62+	40-3000	15.7	4.8	19.6	37.9	1.65	1.24	5	82
MGVA-63+	40-3000	21.4	3.6	19.4	34.3	1.35	1.32	5	69
MPGA-105+	40-3000	14.4	1.9	21	37.8	1.2	1.4	5	63
PHA-11+	50-3000	15	2.3	21.4	41.5	2.1	2.1	5	146
PHA-22H+	50-3000	16	2	22.2	39	1.3	1.28	5	141
MERA-556+	DC-2200	19	3.5	17.6	35.5	1.2	1.4	4.9	65
MPGA-152+	30-1500	14.6	3.2	29.6	43.6	1.21	1.23	9	407
PHA-22+	50-1500	16	1.9	22	41	1.5	1.5	5	146
MERA-7433+	DC-1000	19	2.7	18.3	35	1.25	1.8	4.8	80
MERA-7456+	DC-1000	18.6	2.7	18.2	35	1.3	2	4.8	80

Dual-Matched Amplifiers — Coaxial

Model Number	Frequency Range (MHz)	Gain (dB)	NF (dB)	P1dB (dBm)	OIP3 (dBm)	Input VSWR (:1)	Output VSWR (:1)	Voltage (V)	DC Current (mA)	Connector
ZX60-23LM-S+	500-2000	18.9	4	19.5	35	1.5	1.4	12	125	SMA
ZHL-122LM+	40-1200	12.3	3.9	23	40	1.5	1.5	6	260	SMA

Gain Blocks

- Ultra-wideband from DC to 43.5 GHz
- Excellent gain flatness
- Input/output VSWR as low as 1.1/1.04
- Variety of operating voltages from 2.9 to 15.0V
- Connectorized, surface mount and bare die formats

Gain Blocks — Surface Mount

Model Number	Frequency Range (MHz)	Gain (dB)	NF (dB)	P1dB (dBm)	OIP3 (dBm)	Input VSWR (:1)	Output VSWR (:1)	Voltage (V)	DC Current (mA)
TSS-44+	22000-43500	17.6	3.2	6.9	12.7	1.37	1.28	4	22
AVM-273HP+	13000-26500	14	8.4	26.9	32.1	1.4	1.5	5	559
AVM-273HPK+	13000-26500	14	8.4	26.9	32.1	1.4	1.5	6	559
AVA-24A+	5000-20000	11.8	5.7	18.4	25	1.38	1.7	5	120
EHC-24L+	DC-20000	15.1	5.2	7	19.2	1.28	1.43	5	19.1
AVA-183A+	5000-18000	14	5	19	26	1.9	1.9	5	131
AVA-183P+	500-18000	8.1	4.8	11.7	21.5	1.67	1.92	5	46
TSS-183A+	5000-18000	14.2	4.4	17.9	28.9	1.37	1.28	5	145
EHA-163L+	DC-16000	15.3	5.2	6.5	15.6	1.67	1.57	5	20.9
GVA-123+	10-12000	16.9	4	16.2	30	1.2	1.2	5	52
LVA-123+	10-12000	17.3	3.9	15.6	28.2	1.2	1.35	5	52
PSA-14+	10-10000	16.5	3.9	16.3	29.4	1.25	1.04	5	47
GVA-93+	10-9000	16.9	4	16.2	30	1.2	1.2	5	52
ERA-1+	DC-8000	10.9	4.3	12	26	1.5	1.5	3.4	40
ERA-1SM+	DC-8000	10.9	4.3	12	26	1.5	1.5	3.4	40
ERA-9SM+	DC-8000	8.3	5.3	14.1	31.3	1.2	1.2	4	50
ERA-21SM+	DC-8000	12.2	4.7	12.6	26	1.1	1.3	3.5	40
GALI-1+	DC-8000	11.8	4.5	10.5	27	1.3	1.4	3.4	40
GALI-2+	DC-8000	14.8	4.6	11	27	1.6	1.6	3.5	40
GALI-21+	DC-8000	13.1	4	10.5	27	1.1	1.3	3.5	40
LEE-9+	DC-8000	8.4	5.3	13.9	29.7	1.2	1.2	4	50
LEE-19+	DC-8000	12	6.5	10.2	24.5	1.5	1.4	3.6	40
LEE-29+	DC-8000	15.4	5.5	10.9	25.5	1.4	1.3	3.6	40
LHA-83W+	50-8000	16.8	3.1	23.3	35.1	1.14	1.21	5/9	40/105

Gain Blocks — Surface Mount Continued

Model Number	Frequency Range (MHz)	Gain (dB)	NF (dB)	P1dB (dBm)	OIP3 (dBm)	Input VSWR (:1)	Output VSWR (:1)	Voltage (V)	DC Current (mA)
PHA-83W+	50-8000	15.7	3.3	23.3	35.5	1.57	1.28	5.0/9.0	41/110
CMA-82+	DC-7000	14.1	6.7	20.6	36.4	1.4	1.9	5	106
CMA-84+	DC-7000	20.2	5.5	21	34.5	1.4	3	5	108
GALI-19+	DC-7000	11.6	6.5	9	23.7	1.6	1.5	3.6	40
GALI-29+	DC-7000	19.7	6	10	24.7	1.5	1.5	3.6	40
GVA-82+	DC-7000	13.8	6.6	20.6	36	1.3	1.6	5	106
GVA-83+	DC-7000	17.1	6.2	18.6	31.5	1.3	1.8	5	72
GVA-84+	DC-7000	16	5.5	20.6	35.8	1.3	2.6	5	108
LHY-84+	DC-7000	20	5.4	21	33.1	1.43	2.1	5	111
CMA-62+	10-6000	15.4	5.1	19.2	33	1.5	1.8	5	82
CMA-63+	10-6000	20.3	3.9	18.4	32	1.1	1.4	5	69
CMA-81+	DC-6000	10	7.4	19.6	34	1.3	1.6	5	103
ERA-2+	DC-6000	14.4	4	13	26	1.3	1.2	3.4	40
ERA-2SM+	DC-6000	14.4	4	13	26	1.3	1.2	3.4	40
GALI-24+	DC-6000	16.6	4.3	19.3	35.3	1.4	2	5.8	80
GALI-84+	DC-6000	16.7	4.4	21	37.4	1.4	2.1	5.8	100
GVA-62+	10-6000	15.4	5.1	19.2	33.6	1.5	1.3	5	82
GVA-63+	10-6000	20	3.7	18.6	32.2	1.1	1.35	5	69
GVA-81+	DC-6000	10	7.4	19.7	36.6	1.3	1.3	5	103
MNA-7A+	1500-6000	17.7	5.7	17.1	28.5	1.8	1.2	2.8/5.0	77/82
GALI-49+	DC-5000	13.6	4.4	16.4	33.3	1.2	1.2	4.5	65
GALI-59+	DC-5000	18.3	4.3	17.6	33.3	1.6	1.5	4.8	65
GVA-60+	10-5000	19.8	4	19.5	35.6	1.4	1.9	5	92
LEE-49+	DC-5000	14	5.5	16.4	33	1.6	1.4	4.9	65
LEE-59+	DC-5000	19.7	4.5	17.3	33	1.5	1.5	4.8	65
MNA-2W+	500-4500	14.7	5.4	17.5	29	1.3	1.5	2.8/5.0	79/84
MNA-4W+	500-4500	17	4.5	16.8	27.9	1.5	1.5	2.8/5.0	70.6/75
MNA-5W+	500-4500	19.2	3.2	8.7	19.1	1.3	1.6	5	34

Gain Blocks — Surface Mount Continued

Model Number	Frequency Range (MHz)	Gain (dB)	NF (dB)	P1dB (dBm)	OIP3 (dBm)	Input VSWR (:1)	Output VSWR (:1)	Voltage (V)	DC Current (mA)
ERA-4+	DC-4000	13.4	4.2	17.3	34	1.2	1.3	4.5	65
ERA-4SM+	DC-4000	13.4	4.2	17.3	34	1.2	1.3	4.5	65
ERA-5+	DC-4000	18.5	4.3	18.4	32.5	1.3	1.2	4.9	65
ERA-5SM+	DC-4000	17.6	4.3	18.4	32.5	1.3	1.2	4.9	65
ERA-6+	DC-4000	12.2	4.5	17.9	36	1.3	1.6	5	70
ERA-6SM+	DC-4000	12.2	4.5	17.9	36	1.3	1.6	5	70
ERA-51SM+	DC-4000	16.1	4.1	18.1	33	1.1	1.2	4.5	65
GALI-4+	DC-4000	13.5	4	16	34	1.2	1.4	4.6	65
GALI-4F+	DC-4000	13.4	4	13.8	32	1.2	1.5	4.4	50
GALI-5+	DC-4000	17.5	3.5	16	35	1.2	1.4	4.4	65
GALI-5F+	DC-4000	17.4	3.5	14.2	31.5	1.2	1.4	4.3	50
GALI-6+	DC-4000	11.3	4.5	18.2	35.5	1.5	1.8	5	70
GALI-6F+	DC-4000	11.6	4.5	15.8	35.5	1.5	1.9	4.8	50
GALI-33+	DC-4000	17.5	3.9	11.4	28	1.6	1.2	4.3	40
GALI-51+	DC-4000	16.1	3.5	16.5	35	1.3	1.5	4.5	65
GALI-51F+	DC-4000	15.9	3.5	14.4	32	1.2	1.5	4.4	50
GALI-55+	DC-4000	18.5	3.3	15.5	28.5	1.25	1.3	4.3	50
ERA-3+	DC-3000	18.7	3.5	12.5	25	1.5	1.4	3.2	35
ERA-3SM+	DC-3000	18.7	3.5	12.5	25	1.5	1.4	3.2	35
ERA-33SM+	DC-3000	17.4	3.9	13.5	28.5	1.6	1.25	4.3	40
GALI-3+	DC-3000	19.1	3.5	10.5	25	1.5	1.2	3.3	35
MNA-2A+	500-2500	15	5.3	17.9	29	1.3	1.4	2.8/5.0	79/84
MNA-3A+	500-2500	16.5	4	9.5	21	1.24	1.22	2.8/5.0	32.6/34.3
MNA-4A+	500-2500	17.8	4.4	18.6	30.8	1.5	1.1	2.8/5.0	70.6/75
MNA-5A+	500-2500	22.8	3	10.4	21.3	1.2	1.7	5	34
VNA-25+	500-2500	18.6	5.5	18.2	29	1.5	1.6	5	85
YSF-2151+	900-2150	20	3.1	20	35	1.9	1.2	5	118
ERA-8SM+	DC-2000	19	3.1	12.5	25	1.4	1.8	3.7	36

Gain Blocks — Surface Mount Continued

Model Number	Frequency Range (MHz)	Gain (dB)	NF (dB)	P1dB (dBm)	OIP3 (dBm)	Input VSWR (:1)	Output VSWR (:1)	Voltage (V)	DC Current (mA)
ERA-50SM+	DC-2000	19.4	3.5	17.2	32.5	1.3	1.2	4.4	60
MAR-2SM+	DC-2000	12	3.7	7	22	1.3	1.3	5	25
MAR-3+	DC-2000	12	6	10	23	1.5	1.7	5	35
MAR-3SM+	DC-2000	12	3.7	10	28	1.3	1.3	5	35
MAR-6+	DC-2000	20	3	3	14.5	1.7	1.7	3.5	16
MAR-7SM+	DC-2000	12.5	5	3.5	19	1.3	1.3	4	22
RAM-2+	DC-2000	11.8	6.5	4.5	17	1.2	1.4	5	25
RAM-3+	DC-2000	12	6	10	23	1.6	1.7	5	35
RAM-7+	DC-2000	12.5	4.5	5.5	19	2	1.8	4	22
VAM-3+	DC-2000	11	6	9	22	1.5	1.7	4.7	35
VAM-6+	DC-2000	15	3	2	14	1.6	1.5	3.3	16
VAM-7+	DC-2000	12	5	5.5	18	1.5	1.5	3.8	22
YSF-162+	1200-1600	20.1	3.2	20	35	1.8	1.2	5	118
YSF-122+	800-1200	20.4	3.4	20.5	36	1.8	1.4	5	118
MAR-1+	DC-1000	16.5	3.5	2.5	14	1.3	1.2	5	17
MAR-1SM+	DC-1000	16.5	3.3	2.5	14	1.3	1.2	5	17
MAR-4+	DC-1000	8	7	12.5	25.5	1.5	1.9	5.25	50
MAR-4SM+	DC-1000	8	6	12.5	25.5	1.6	2	5.3	50
MAR-8A+	DC-1000	25	3.1	12.5	25	1.4	1.8	3.7	36
MAR-8ASM+	DC-1000	25	3.1	12.5	25	1.4	1.8	3.7	36
MAV-11BSM+	50-1000	11.3	4.4	18	34	1.2	1.2	5.5	60
MAV-11SM+	50-1000	12.7	3.6	17.5	30	1.5	1.7	5.5	60
RAM-1+	DC-1000	15.5	5.5	1.5	14	1.3	1.3	5	17
RAM-4+	DC-1000	8	6.5	12.5	25.5	1.4	1.9	5.3	50

Gain Blocks — Bare Die

Model Number	Frequency Range (MHz)	Gain (dB)	NF (dB)	P1dB (dBm)	OIP3 (dBm)	Input VSWR (:1)	Output VSWR (:1)	Voltage (V)	DC Current (mA)
LTA-M1109-D+	DC-50000	16.1	4	19.3	26.9	1.32	1.37	5	160
TSS-44-D+	22000-43500	17.6	3.2	6.9	12.7	1.37	1.28	4	22
AVA-24A-D+	5000-22000	13	5.8	19.2	25	1.3	1.9	5	126
AVA-183A-D+	5000-20000	14.5	4.3	18.2	25	1.6	1.7	5	131
EHA-24L-D+	DC-20000	13.4	5.1	6.8	16.6	1.433	1.377	5	19.1
AVA-183P-D+	500-18000	8.1	4.8	11.7	21.5	1.67	1.92	5	46
LTA-5R183-D+	500-18000	13.3	3.3	18.6	27.4	1.33	1.119	5	85
LTA-183M-D+	DC-18000	14.5	2.8	23.2	29.5	1.49	1.25	8	160
LTA-2183-D+	2000-18000	16.6	5.5	19.6	27.4	1.49	1.25	4	210
GVA-123-D+	10-12000	16.7	3.9	15.9	29.1	1.2	1.2	5	48
PHA-83W-D+	50-8000	15.7	3.3	23.3	35.5	1.57	1.28	5.0/9.0	41/110
GALI-39-D+	DC-7000	19.7	2.4	10.5	22.9	1.79	2.3	3.5	35
GVA-84-D+	DC-7000	16	5.5	21	35.8	1.28	2.58	5	108
GVA-60-D+	10-6000	19.3	3.9	18.2	29	1.45	2.2	5	93
GVA-62-D+	10-6000	15.7	5	19.4	32.8	1.4	1.4	5	82
GVA-63-D+	10-6000	20.5	3.7	18.2	31.9	1.18	1.5	5	69
MNA-7A-D+	1500-6000	17.7	5.7	17.1	28.5	1.8	1.2	2.8/5.0	77/82
MNA-2A-D+	500-4500	14.7	5.4	17.5	29	1.3	1.5	2.8/5.0	79/84
MNA-4A-D+	500-4500	17	4.5	16.8	27.9	1.5	1.5	2.8/5.0	70.6/75
MNA-5A-D+	500-4500	19.2	3.2	8.7	19.1	1.3	1.6	2.8/5.0	32/34
MNA-3A-D+	500-2500	16.8	3.9	10.3	22	1.3	1.2	2.8/5.0	32.6/34.3
MAR-8A-D+	DC-1000	31.5	3.1	12.5	25	1.4	1.79	3.7	36

Gain Blocks — Coaxial

Model Number	Frequency Range (MHz)	Gain (dB)	NF (dB)	P1dB (dBm)	OIP3 (dBm)	Input VSWR (:1)	Output VSWR (:1)	Voltage (V)	DC Current (mA)	Connector	Option
ZVA-443HGX+	10-43500	33	5	9	18	1.5	1.8	15	170	2.92mm	-
ZVA-443X+	0.05-43500	11	4.5	10	22	1.8	1.9	5	80	2.4mm	-
ZVA-02443HP+	2000-43500	37	5	17	25	1.5	2.5	15	280	2.92mm	Heat Sink
ZVA-403GX+	0.05-40000	11	4.5	11	21	1.45	1.6	5	100	2.92mm	-
ZVE-403-K+	26000-40000	22	9	19	21	2	2	12	300	2.92mm	Heat Sink
ZVM-273HP+	13000-26500	14.5	9	25	34	1.1	1.5	12	559	2.92mm	Heat Sink
ZVM-273HPX+	13000-26500	14.5	9	25	34	1.1	1.5	12	559	2.92mm	-
ZVA-01243+	1000-22000	12.8	5	21.6	27.5	1.7	1.4	8	170	2.92mm	-
ZVA-213-S+	800-21000	26	3	24	33	1.35	1.25	12	400	SMA	Heat Sink
ZVA-213X-S+	800-21000	26	3	24	33	1.35	1.25	12	400	SMA	-
ZVA-213UWX+	100-20000	14	3	16	29	1.3	1.4	+12, -5	84	2.92mm	-
ZX60-24-S+	5000-20000	24	6.8	18	27	1.4	1.4	5	260	SMA	-
ZX60-24A-S+	5000-20000	24	6.4	18.3	25.4	1.2	1.6	5	270	SMA	-
ZX60-02203+	2000-20000	21.5	6.5	14.6	28	1.75	1.55	5	154	SMA	-
ZX60-02203LPN+	2000-20000	16	5	17	31	1.92	1.67	5	79	SMA	-
ZVA-183-S+	700-18000	26	3	24	33	1.35	1.25	12	400	SMA	Heat Sink
ZVA-183G-S+	500-18000	38	3	25	36	1.9	2	15	770	SMA	Heat Sink
ZVA-183W-S+	100-18000	28	3	26	34.5	1.3	1.6	15	625	SMA	Heat Sink
ZVA-183X-S+	700-18000	26	3	24	33	1.35	1.25	12	400	SMA	-
ZVA-183GX-S+	500-18000	38	3	25	36	1.9	2	15	770	SMA	-
ZVA-183WX-S+	100-18000	28	3	26	34.5	1.3	1.6	15	625	SMA	-
ZX60-183-S+	6000-18000	23.5	6.9	18.1	27.2	1.4	1.4	5	260	SMA	-
ZX60-183A-S+	6000-18000	28	5	18	27	1.4	1.4	5	260	SMA	-
ZJL-153+	5000-15000	13	6	18	23	1.7	1.7	5	180	SMA	-
ZVE-143-S+	8000-14000	19	4.5	28	35	1.5	1.5	12	450	SMA	Heat Sink
ZVE-143X-S+	8000-14000	19	4.5	28	35	1.5	1.5	12	450	SMA	-
ZX60-14012L-S+	0.3-14000	12	5.5	11	20	1.3	1.7	12	62	SMA	-
ZRON-8G+	2000-8000	20	6	20	30	2	2	15	310	SMA	Heat Sink

Gain Blocks — Coaxial Continued

Model Number	Frequency Range (MHz)	Gain (dB)	NF (dB)	P1dB (dBm)	OIP3 (dBm)	Input VSWR (:1)	Output VSWR (:1)	Voltage (V)	DC Current (mA)	Connector	Option
ZRON-8GX+	2000-8000	20	6	20	30	2	2	15	310	SMA	-
ZVE-8G+	2000-8000	30	4	30	40	2	2	12	1200	SMA	Heat Sink
ZVE-8GX+	2000-8000	30	4	30	40	2	2	12	1200	SMA	-
ZX60-8008E-S+	20-8000	9	4.1	9.3	24	1.4	1.7	12	39	SMA	-
ZJL-7G+	20-7000	10	5	9	24	1.5	1.5	12	50	SMA	-
ZJL-6G+	20-6000	13	4.5	10	24	1.5	1.4	12	50	SMA	-
ZX60-5916MA-S+	1500-6000	18	6.6	16.5	27	1.6	1.7	2.8/5.0	103	SMA	-
ZX60-6013E-S+	20-6000	14	3.3	10.3	28.7	1.5	1.2	12	39	SMA	-
ZX60-V62+	50-6000	15.4	5.1	19	33.4	1.3	1.8	5	82	SMA	-
ZX60-V63+	50-6000	20.3	3.7	17.8	31.2	1.5	1.5	5	69	SMA	-
ZX60-V81-S+	20-6000	9.7	8	18.5	36	1.2	1.25	5	103	SMA	-
ZX60-V82-S+	20-6000	13.5	6.8	20	35.8	1.3	1.5	5	100	SMA	-
ZJL-5G+	20-5000	9	8.5	15	32	1.6	1.3	12	80	SMA	-
ZX60-V83-S+	20-4700	16.8	6	17	31	1.25	1.7	5	72	SMA	-
ZHL-42+	600-4200	34	8	30	38	2.5	2.5	15	1000	SMA	Heat Sink
ZHL-42W+	10-4200	30	8	28	38	2.5	2.5	15	880	SMA	Heat Sink
ZHL-42WX+	10-4200	30	8	28	38	2.5	2.5	15	880	SMA	-
ZHL-42X+	600-4200	34	8	30	38	2.5	2.5	15	1000	SMA	-
ZHL-1042J+	10-4200	25	6	20	30	2.5	2.5	15	330	SMA	Heat Sink
ZHL-1042JX+	10-4200	25	6	20	30	2.5	2.5	15	330	SMA	-
ZHL-4240+	600-4200	42	8	30	38	2.5	2.5	15	1000	SMA	Heat Sink
ZHL-4240W+	10-4200	42	6	30	38	2.5	2.5	15	1000	SMA	Heat Sink
ZHL-4240WX+	10-4200	42	6	30	38	2.5	2.5	15	1000	SMA	-
ZHL-4240X+	600-4200	42	8	30	38	2.5	2.5	15	1000	SMA	-
ZJL-4G+	20-4000	12.4	5.5	14	30.5	1.4	1.6	12	75	SMA	-
ZJL-4HG+	20-4000	17	4.5	15	30	1.5	1.4	12	75	SMA	-
ZX60-43-S+	0.5-4000	17	5.4	17.3	33	1.2	2	5	110	SMA	-
ZX60-4016E-S+	20-4000	18	3.9	16.5	30	1.3	1.3	12	65	SMA	-



Gain Blocks – Coaxial Continued

Model Number	Frequency Range (MHz)	Gain (dB)	NF (dB)	P1dB (dBm)	OIP3 (dBm)	Input VSWR (:1)	Output VSWR (:1)	Voltage (V)	DC Current (mA)	Connector	Option
ZJL-3G+	20-3000	14	3.8	8	22	1.4	1.6	12	45	SMA	-
ZFL-272VH+	30-2700	16.9	3.4	24.5	47.2	1.13	1.31	15	350	SMA	-
ZKL-2R7+	10-2700	24	5	13	30	1.3	1.4	12	120	SMA	-
ZFL-2500+	500-2500	28	8	15	27	2.5	2.5	5	220	SMA	-
ZFL-2500B+	500-2500	28	8	15	27	2.5	2.5	5	220	SMA	Bracket
ZFL-2500VH+	10-2500	20	5.5	23	35	1.7	2	15	300	SMA	-
ZFL-2500VHB+	10-2500	20	5.5	23	35	1.7	2	15	300	SMA	Bracket
ZFL-2500VHX+	10-2500	20	5.5	23	35	1.7	2	15	300	SMA	-
ZKL-2R5+	10-2500	30	5	15	31	1.4	1.4	12	120	SMA	-
ZX60-2510MA-S+	500-2500	15	5.4	20	32	1.4	1.4	2.8/5.0	104	SMA	-
ZX60-2514MA-S+	500-2500	17.8	4.5	19	31	1.4	1.5	2.8/5.0	94	SMA	-
ZX60-2531MA-S+	500-2500	40	3.1	19	26	1.3	1.7	2.8/5.0	130	SMA	-
ZX60-2411BM-S+	800-2400	11.5	3.5	24	46.5	1.2	1.2	5	280	SMA	-
ZX60-H242+	700-2400	14.5	3	23	46	1.4	1.5	5.5	145	SMA	-
ZHL-2150+	950-2150	30	3.5	11	25	1.3	1.3	12	110	SMA	-
ZFL-11AD+	2-2000	8	6.5	-2	14	2.5	2	15	22	SMA	-
ZFL-11ADB+	2-2000	8	6.5	-2	14	2.5	2	15	22	SMA	Bracket
ZFL-2000+	10-2000	20	7	16	25	2	2	15	120	SMA	-
ZFL-2000B+	10-2000	20	7	16	25	2	2	15	120	SMA	Bracket
ZFL-2000X+	10-2000	20	7	16	25	2	2	15	120	SMA	-
ZKL-2+	10-2000	33.5	4	15	31	1.4	1.4	12	120	SMA	-
ZKL-1R5+	10-1500	40	3	15	31	1.4	1.6	12	115	SMA	-
ZHL-2-12+	10-1200	26	5	29	45	2.2	2.2	24	750	SMA	-
ZHL-2-12X+	10-1200	26	5	29	45	2.2	2.2	24	750	SMA	-
ZFL-2AD+	2-1000	9	6.5	-2	14	2	2	15	22	SMA	-
ZFL-2ADB+	2-1000	9	6.5	-2	14	2	2	15	22	SMA	Bracket
ZFL-2HAD+	50-1000	12	6	20	35	1.5	1.5	15	115	SMA	-
ZFL-2HADB+	50-1000	12	6	20	35	1.5	1.5	15	115	SMA	Bracket

Gain Blocks – Coaxial Continued

Model Number	Frequency Range (MHz)	Gain (dB)	NF (dB)	P1dB (dBm)	OIP3 (dBm)	Input VSWR (:1)	Output VSWR (:1)	Voltage (V)	DC Current (mA)	Connector	Option
ZFL-2HADX+	50-1000	12	6	20	35	1.5	1.5	15	115	SMA	-
ZFL-1000+	0.1-1000	17	6	9	18	1.5	2	15	105	SMA	-
ZFL-1000B+	0.1-1000	17	6	9	18	1.5	2	15	105	SMA	Bracket
ZFL-1000H+	10-1000	28	4	20	33	1.4	1.4	15	160	SMA	Heat Sink
ZFL-1000HB+	10-1000	28	4	20	33	1.4	1.4	15	160	SMA	Bracket
ZFL-1000HX+	10-1000	28	4	20	33	1.4	1.4	15	160	SMA	-
ZFL-1000VH+	10-1000	20	4.5	25	38	2	2.5	15	320	SMA	-
ZFL-1000VH2+	10-1000	28	5	25	38	2	2.5	15	320	SMA	-
ZFL-1000VH2X+	10-1000	28	5	25	38	2	2.5	15	320	SMA	-
ZFL-1000VHB+	10-1000	20	4.5	25	38	2	2.5	15	320	SMA	Bracket
ZFL-1000VHX+	10-1000	20	4.5	25	38	2	2.5	15	320	SMA	-
ZHL-2-8-S+	10-1000	34	7	29	42	2	2	24	700	SMA	-
ZHL-2-8X-S+	10-1000	34	7	29	42	2	2	24	700	SMA	-
ZHL-2-S+	10-1000	20	9	29	42	2	2.1	24	600	SMA	-
ZHL-2X-S+	10-1000	20	9	29	42	2	2.1	24	600	SMA	-
ZHL-1010+	50-1000	9.5	3.5	26	46	2	2	12	525	SMA	-
ZHL-2010+	50-1000	20	3.7	26	46	2	2	12	900	SMA	-
ZHL-3010+	50-1000	30	5.5	26	46	2	1.6	12	1000	SMA	-
ZFL-750+	0.2-750	18	6	9	18	1.5	2	15	90	SMA	-
ZFL-750B+	0.2-750	18	6	9	18	1.5	2	15	90	SMA	Bracket
ZFL-500+	0.05-500	20	4.2	9	18	1.9	1.9	15	80	SMA	-
ZFL-500-BNC+	0.05-500	20	4.2	9	18	1.9	1.9	15	80	BNC	-
ZFL-500B+	0.05-500	20	4.2	9	18	1.9	1.9	15	80	SMA	Bracket
ZFL-500HLN+	10-500	19	3.8	16	30	1.5	1.5	15	110	SMA	-
ZFL-500HLNB+	10-500	19	3.8	16	30	1.5	1.5	15	110	SMA	Bracket
ZHL-1-2W+	5-500	29	7	33	44	2.1	2.1	24	900	BNC	-
ZHL-1-2W-N+	5-500	29	7	33	44	2.1	2.1	24	900	N	-
ZHL-1-2W-S+	5-500	29	7	33	44	2.1	2.1	24	900	SMA	-

Gain Blocks — Coaxial Continued

Model Number	Frequency Range (MHz)	Gain (dB)	NF (dB)	P1dB (dBm)	OIP3 (dBm)	Input VSWR (:1)	Output VSWR (:1)	Voltage (V)	DC Current (mA)	Connector	Option
ZHL-1-2WX+	5-500	29	7	33	44	2.1	2.1	24	900	BNC	-
ZHL-1-2WX-S+	5-500	29	7	33	44	2.1	2.1	24	900	SMA	-
ZHL-1A+	2-500	16	11	28	38	2	2	24	600	BNC	-
ZHL-1A-S+	2-500	16	11	28	38	2	2	24	600	SMA	-
ZHL-6A+	0.0025-500	25	9.5	22	34	1.8	2	24	350	BNC	-
ZHL-6A-S+	0.0025-500	25	9.5	22	34	1.8	2	24	350	SMA	-
ZHL-3A+	0.4-150	24	11	29.5	38	2	2	24	600	BNC	-
ZHL-3A-S+	0.4-150	24	11	29.5	38	2	2	24	600	SMA	-
ZHL-32A+	0.05-130	25	10	29	38	2	2	24	600	BNC	-
ZHL-32A-S+	0.05-130	25	10	29	38	2	2	24	600	SMA	-
ZX60-100VH+	0.3-100	36	4	30	43	1.6	1.5	12	370	SMA	Heat Sink
ZX60-100VHX+	0.3-100	36	4	30	43	1.6	1.5	12	370	SMA	-

Gain Blocks — Plug-In

Model Number	Frequency Range (MHz)	Gain (dB)	NF (dB)	P1dB (dBm)	OIP3 (dBm)	Input VSWR (:1)	Output VSWR (:1)	Voltage (V)	DC Current (mA)
AMP-76+	5-500	26	3.1	13.5	28	2	2	15	71
AMP-77+	5-500	15	3.3	16	32	2	2	15	56
MAN-1	0.5-500	28	4.5	8	18	1.8	1.8	12	60
MAN-1HLN+	10-500	10	3.7	15	30	1.8	1.8	12	70
MAN-1LN	0.5-500	28	3	7	18	1.8	1.8	12	60

Gain Blocks — Modules for Test Racks

Model Number	Frequency Range (MHz)	Gain (dB)	NF (dB)	P1dB (dBm)	OIP3 (dBm)	Input VSWR (:1)	Output VSWR (:1)	Voltage (V)	DC Current (mA)
TVA-82-213A+	800-21000	25	3	24	30	1.35	1.4	110/220 AC	SMA
TVA-63-183	6000-18000	23.6	6.9	18	26	1.5	1.25	110/220 AC	SMA
TVA-63-183A+	6000-18000	24	6.4	17	26	1.5	1.25	110/220 AC	SMA
TVA-11-422A+	10-4200	39	10.5	30	40	1.7	1.8	110/220 AC	N

High Power Amplifiers

- P^{OUT} up to 100W
- Wideband up to 18 GHz
- Excellent OIP3 performance, up to +60 dBm
- Rugged designs with built-in protections
- Connectorized and rack mount housings

High Power Amplifiers — Coaxial

Model Number	Frequency Range (MHz)	Gain (dB)	NF (dB)	P1dB (dBm)	OIP3 (dBm)	Input VSWR (:1)	Output VSWR (:1)	Voltage (V)	DC Current (mA)	Connector Type	Option
ZVE-3W-183+	5900-18000	35	5.5	34	44	1.5	1.2	15	2200	SMA	Heat Sink
ZVE-3W-83+	2000-8000	35	5.8	33	42	1.5	1.4	15	1500	SMA	Heat Sink
ZVE-3W-83X+	2000-8000	35	5.8	33	42	1.5	1.4	15	1500	SMA	-
ZVE-6W-83+	2000-8000	33	10	37	40	1.9	1.4	15	5000	SMA	Heat Sink
ZVE-6W-83X+	2000-8000	33	10	37	40	1.9	1.4	15	5000	SMA	-
ZHL-1W-63-S+	600-6000	35	12	30	35	2.5	3.5	15	1000	SMA	Heat Sink
ZHL-1W-63X-S+	600-6000	35	12	30	35	2.5	3.5	15	1000	SMA	-
ZHL-2W-63-S+	600-6000	42	12	33	38	2.5	3.5	28	2000	SMA	Heat Sink
ZHL-2W-63X-S+	600-6000	42	12	33	38	2.5	3.5	28	2000	SMA	-
ZHL-5W-63-S+	600-6000	45	12	37	42	2.5	3.5	28	3500	SMA	Heat Sink
ZHL-5W-63X-S+	600-6000	45	12	37	42	2.5	3.5	28	3500	SMA	-
ZHL-25W-63+	700-6000	53	13	37	45	1.8	2	24	12000	SMA	Heat Sink

High Power Amplifiers — Coaxial Continued

Model Number	Frequency Range (MHz)	Gain (dB)	NF (dB)	P1dB (dBm)	OIP3 (dBm)	Input VSWR (:1)	Output VSWR (:1)	Voltage (V)	DC Current (mA)	Connector Type	Option
ZHL-25W-63X+	700-6000	53	13	37	45	1.8	2	24	12000	SMA	-
ZHL-50W-63+	700-6000	59	11	42	53	1.5	1.5	40	6000	SMA	Heat Sink
ZHL-100W-63+	2500-6000	58	12	43	54	2	1.2	30	8000	SMA-N	Heat Sink
ZHL-4W-422+	500-4200	25	10	34	44	1.6	2.6	28	3000	SMA	Heat Sink
ZHL-4W-422X+	500-4200	25	10	34	44	1.6	2.6	28	3000	SMA	-
ZHL-5W-422+	500-4200	25	7	35	45	1.7	5.47	28	3000	SMA	Heat Sink
ZHL-5W-422X+	500-4200	25	7	35	45	1.7	5.47	28	3000	SMA	-
ZHL-15W-422-S+	600-4200	46	10	39	47	1.7	3.5	28	3500	SMA	Heat Sink
ZHL-15W-422X-S+	600-4200	46	10	39	47	1.7	3.5	28	3500	SMA	-
ZHL-16W-43+	1800-4000	45	6	41	47	1.5	1.3	28	4300	SMA	Heat Sink
ZHL-100W-382+	3250-3850	50	9.5	50	58	1.3	1.3	28	18000	SMA-N	Heat Sink
ZHL-40W-372-S+	3400-3700	50	15	46	52	1.5	1.5	28	6200	SMA	Heat Sink
ZHL-100W-352+	3000-3500	50	7.3	50	55	1.35	1.5	28	20000	SMA-N	Heat Sink
ZHL-25W-272+	20-2700	50	10	40	49	2	3.5	28	3700	SMA	Heat Sink
ZHL-25W-272X+	20-2700	50	10	40	49	2	3.5	28	3700	SMA	-
ZHL-100W-272+	700-2700	48	8.2	49	50	1.5	1.5	30	16000	SMA-N	Heat Sink
ZVE-2W-272+	700-2700	33	9.5	32	39.5	1.9	1.5	15	800	SMA	Heat Sink
ZVE-2W-272X+	700-2700	33	9.5	32	39.5	1.9	1.5	15	800	SMA	-
ZHL-30W-262+	2300-2550	50	7	43	50	1.3	1.3	28	4300	SMA	Heat Sink
ZHL-30W-262X-S+	2300-2550	50	7	43	50	1.3	1.3	28	4300	SMA	-
ZHL-30W-252+	600-2500	50	5.5	44	52	1.3	1.2	28	6300	SMA	Heat Sink
ZHL-30W-252X-S+	600-2500	50	5.5	44	52	1.3	1.2	28	6300	SMA	-
ZHL-100W-242+	2000-2400	50	7.8	49.5	55	1.65	1.25	28	12000	SMA-N	Heat Sink
ZHL-5W-2G+	800-2000	45	8	37	44	1.7	1.5	24	2000	SMA	Heat Sink
ZHL-5W-2GX+	800-2000	45	8	37	44	1.7	1.5	24	2000	SMA	-
ZHL-5W-202-S+	10-2000	50	10	36	45	1.2	2.0	28	3000	SMA	Heat Sink
ZHL-10W-2G+	800-2000	43	7	40	50	1.3	1.3	24	5000	SMA	Heat Sink
ZHL-10W-2GX+	800-2000	43	7	40	50	1.3	1.3	24	5000	SMA	-

High Power Amplifiers — Coaxial Continued

Model Number	Frequency Range (MHz)	Gain (dB)	NF (dB)	P1dB (dBm)	OIP3 (dBm)	Input VSWR (:1)	Output VSWR (:1)	Voltage (V)	DC Current (mA)	Connector Type	Option
ZHL-10W-202-S+	10-2000	50	10	38	45	2.0	2.0	28	5000	SMA	Heat Sink
ZHL-20W-202-S+	20-2000	53	10	39	45	2.0	3.5	28	4000	SMA	Heat Sink
ZHL-20W-202X-S+	20-2000	53	10	39	45	2.0	3.5	28	4000	SMA	-
ZHL-20W-13+	20-1000	50	3.5	41	50	1.7	2.5	24	2800	SMA	Heat Sink
ZHL-20W-13SW+	20-1000	50	3.5	41	50	1.7	2.5	24	2800	SMA	Heat Sink
ZHL-20W-13SWX+	20-1000	50	3.5	41	50	1.7	2.5	24	2800	SMA	-
ZHL-20W-13X+	20-1000	50	3.5	41	50	1.7	2.5	24	2800	SMA	-
ZHL-100W-13+	800-1000	50	7	49	60	1.3	1.4	28	14500	SMA-N	Heat Sink
ZHL-1000-3W+	500-1000	44	3.5	37	45	2	2.5	24	2250	SMA	Heat Sink
ZHL-1000-3WX+	500-1000	44	3.5	37	45	2	2.5	24	2250	SMA	-
ZHL-5W-1+	5-500	45	4	37	49	2	2.5	24	3300	SMA	Heat Sink
ZHL-5W-1X+	5-500	45	4	37	49	2	2.5	24	3300	SMA	-
ZHL-50W-52+	50-500	50	6	47.5	55	1.6	2	24	9300	SMA	Heat Sink
ZHL-100W-52+	50-500	50	6.5	48.5	57	1.45	2.5	24	10500	SMA	Heat Sink
ZHL-100W-GAN+	20-500	42	7	49	60	1.5	2.5	30	9400	SMA	Heat Sink
ZHL-100W-GANX+	20-500	42	7	49	60	1.5	2.5	30	9400	SMA	-
ZHL-03-5WF+	60-300	35	3	36	49	1.4	1.5	24	2800	SMA	Heat Sink
ZHL-03-5WFX+	60-300	35	3	36	49	1.4	1.5	24	2800	SMA	-
ZHL-100W-251-S+	50-250	46	4.5	48	58	1.4	2.5	24	10200	SMA	Heat Sink
LZY-22+	0.1-200	43	8.9	42	52	1.4	4	24	6000	SMA	Heat Sink
LZY-22X+	0.1-200	43	8.9	42	52	1.4	4	24	6000	SMA	-

High Power Amplifiers — Rack Mount

Model Number	Frequency Range (MHz)	Gain (dB)	NF (dB)	P1dB (dBm)	OIP3 (dBm)	Input VSWR (:1)	Output VSWR (:1)	Voltage (V)	Connector
HPA-25W-63+	700-6000	53	13	37	45	1.8	2.0	110/220 AC	N
HPA-50W-63+	700-6000	56	12	43	50	2.5	3	110/220 AC	N
HPA-100W-63+	2500-6000	58	15	43	50	2.5	2.5	110/220 AC	N
TVA-4W-422A+	500-4200	25	10	34	44	1.6	2.5	110/220 AC	N
HPA-25W-272+	20-2700	50	10	38	50	1.3	2.5	110/220 AC	N
HPA-272+	700-2700	48	8.2	49	55	1.3	1.3	110/220 AC	N
TVA-R5-13A+	0.5-1000	38	10	34	42	1.5	2.5	110/220 AC	N

Linear Amplifiers

- Wideband from 30 to 6000 MHz
- OIP3 from +40 to +46.5 dBm
- P1dB up to +30.4 dBm
- MMIC surface mount and bare die formats
- Variety of case styles as small as 2x2mm

Linear Amplifiers — Surface Mount

Model Number	Frequency Range (MHz)	Gain (dB)	NF (dB)	P1dB (dBm)	OIP3 (dBm)	Input VSWR (:1)	Output VSWR (:1)	Voltage (V)	DC Current (mA)
LHA-1+	50-6000	14.1	2.1	22.7	40	1.7	1.4	5	146
LHA-1H+	50-6000	12.2	2.5	22.7	40.9	1.87	1.27	5	145
LHY-1H+	50-6000	14	2.1	22.5	41	1.79	1.26	5/4.5/4	144/116/80
PHA-1+	50-6000	13.5	2.2	22.4	42	1.7	1.3	5	146
PHA-1H+	50-6000	13.8	2.2	22.6	41	1.39	1.23	5	132
PHA-102+	50-6000	14.5	3.4	26.4	50	1.5	1.32	9	192
PHA-202+	30-2700	17	3.5	30.4	46.1	1.23	1.24	11	350
HXG-242+	700-2400	15	2.3	22.8	46.5	1.9	1.4	5	144
GVA-91+	869-2170	20.4	6.4	28.8	40	1.8	1.3	5	147
GVA-92+	869-2170	21.2	6	24.1	42	1.8	2	5	99
PHA-101+	50-1500	15.2	4	25.8	45	1.8	1.9	9	182
HXG-122+	500-1200	15.3	2.2	23	46	1.6	1.8	5	144

Linear Amplifiers — Bare Die

Model Number	Frequency Range (MHz)	Gain (dB)	NF (dB)	P1dB (dBm)	OIP3 (dBm)	Input VSWR (:1)	Output VSWR (:1)	Voltage (V)	DC Current (mA)
PHA-1-D+	50-6000	13.6	2.1	22.5	39	1.6	1.3	5	155
PHA-1H-D+	50-6000	13.8	2.2	22.6	41	1.39	1.23	5	132
PHA-102-D+	50-6000	14.5	3.4	26.4	50	1.5	1.32	9	192
PHA-202-D+	30-2700	17	3.5	30.4	46.1	1.23	1.24	11	350
PHA-101-D+	50-1500	15.2	4	25.8	45	1.824	1.894	9	182

Low Noise Amplifiers

- Noise figure as low as 0.38 dB
- Wide bandwidths spanning DC to 43.5 GHz
- Coaxial, surface mount, bare die and plug-in formats
- Operating current as low as 7.7 mA

Low Noise Amplifiers — Surface Mount

Model Number	Frequency Range (MHz)	Gain (dB)	NF (dB)	P1dB (dBm)	OIP3 (dBm)	Input VSWR (:1)	Output VSWR (:1)	Voltage (V)	DC Current (mA)
PMA-183PLN+	6000-18000	27.3	1.1	9.1	21.7	1.5	1.5	2.6	53
PMA2-183LN+	4000-18000	10.4	2.5	14.2	25.6	1.79	1.43	5	48.2
PMA2-153LN+	500-15000	16.8	2.6	14.8	26.8	1.97	1.15	5.0/6.0	50/66
PMA2-133LN+	10000-13000	15.3	1.3	13.5	28.6	1.24	1.08	3.0/5.0	13/29
PMA2-123LN+	500-12000	16.8	2.6	14.9	27	1.96	1.17	5.0/6.0	51/68
PMA2-123LN5+	500-12000	15.1	1.2	12.2	23.4	1.9	1.3	5	30
CMA-83LN+	500-8000	21.5	1.3	20.3	30.1	1.32	1.31	5.0/6.0	50/62
LEE-39+	DC-8000	20.8	2.4	10.4	23.4	1.3	1.3	3.5	35
PMA3-83LN+	500-8000	22.1	1.3	20.7	35.2	1.38	1.58	5.0/6.0	60/77
PMA3-83LNW+	400-8000	22.6	1.2	21.7	37.0	1.32	1.5	5.0/6.0	58/75
GALI-39+	DC-7000	19.7	2.4	9	22.9	1.6	1.5	3.5	35
LEE2-6+	DC-7000	18.9	2.3	2.8	17.6	1.33	1.54	3.6	16

Low Noise Amplifiers — Surface Mount Continued

Model Number	Frequency Range (MHz)	Gain (dB)	NF (dB)	P1dB (dBm)	OIP3 (dBm)	Input VSWR (:1)	Output VSWR (:1)	Voltage (V)	DC Current (mA)
CMA-545+	50-6000	14.2	0.8	20	35	2.3	1.5	3	80
PGA-102+	50-6000	15.9	2.3	17.4	32.7	1.27	1.27	3.3	83
PGA-1021+	50-6000	15.1	2.3	16.8	26.5	1.35	1.11	3.3	57
PMA-545+	50-6000	14.2	0.8	20.3	36.4	2.3	1.3	3	80
PMA-5451+	50-6000	13.7	0.8	16.8	30.8	2.6	1.3	3	30
PMA-5452+	50-6000	14	0.7	18.3	34.1	2.6	1.3	3	40
PMA-5453+	50-6000	14.3	0.7	19.64	36.8	2.6	1.3	3	60
PMA-5454+	50-6000	13.5	0.9	14.6	28.1	2.9	1.3	5	20
PMA-5455+	50-6000	14	0.8	19.1	32.7	2.6	1.3	5	40
PMA-5456+	50-6000	14.4	0.8	21.5	36	2.6	1.3	5	60
PMA3-63GLN+	1800-6000	27.9	0.7	14.1	26.6	1.78	1.92	5.0	69
PSA-0012+	50-6000	14.2	2.4	22	35	1.7	1.4	5	74
PSA-39+	DC-6000	23	2.2	10.7	23.3	1.28	1.22	5	32
MNA-6W+	500-5500	23.2	2.7	19.2	30	1.4	1.2	2.8/5.0	92/99
TSS-53LNB+	500-5000	21.7	1.4	20.6	33.9	1.46	1.33	5	82
TSS-53LNB3+	500-5000	18.4	1.5	14.9	25	1.63	1.26	3	42
CMA-103+	50-4000	11.0	0.8	23.1	44.8	1.38	1.36	3.0/5.0	60/97
CMA-5043+	50-4000	18.4	0.75	19.8	33.5	1.7	1.5	5	58
PGA-103+	50-4000	11	0.9	22.5	44.6	1.6	1.2	3.0/5.0	60/97
PMA2-43LN+	1100-4000	19.9	0.46	19.9	32.9	1.35	1.64	5	51
PSA-8A+	DC-4000	31	3	12.8	25.8	1.28	1.25	5	36
PSA-545+	50-4000	14.9	1	20.2	36.2	2.1	1.5	3	80
PSA-5451+	50-4000	14	1	16.2	30.2	2.6	1.2	3	30
PSA-5453+	50-4000	14.7	1	19.4	36.8	2.6	1.2	3	60
PSA-5454+	50-4000	13.6	1.1	14	26.3	2.6	1.4	5	20
PSA-5455+	50-4000	14.4	1	18.5	32.2	2.3	1.3	5	40
PSA4-5043+	50-4000	18.4	0.75	18.8	33.5	1.7	1.5	3.0/5.0	33/58
YSF-382+	3300-3800	14.5	2.5	20	36	1.4	1.8	5	118

Low Noise Amplifiers — Surface Mount Continued

Model Number	Frequency Range (MHz)	Gain (dB)	NF (dB)	P1dB (dBm)	OIP3 (dBm)	Input VSWR (:1)	Output VSWR (:1)	Voltage (V)	DC Current (mA)
TAMP-362GLN+	3300-3600	20	0.9	16	29	1.3	1.3	5	100
TAMP-362LN+	3300-3600	12	0.9	11	25	1.3	1.3	5	20
PMA3-352GLN+	2500-3500	28.5	0.7	14.8	27.8	1.78	1.92	5.0	69
YSF-322+	900-3200	19	2.5	20	35	1.4	1.3	5	118
GALI-S66+	DC-3000	18.2	2.4	3.3	19.1	1.1	1.2	3.5	16
PMA2-33LN+	400-3000	19.1	0.38	17.2	34.5	1.9	1.2	3	56
PMA4-33GLN+	700-3000	38.9	0.47	22.6	40.4	1.6	1.9	5	152
RAMP-33LN+	50-3000	13	1.1	16.5	30	2	1.4	5	80
TAMP-272LN+	2300-2700	14	0.85	19.5	30	1.3	1.45	5	70
YSF-272+	2300-2700	19	2.5	20	35	1.4	1.3	5	118
PGA-105+	40-2600	15.1	1.9	20.5	39.3	1.5	1.5	5	63
CMA-252LN+	1500-2500	16.8	1	17.8	30	1.5	1.3	4	57
MNA-6A+	500-2500	25	2.6	20.2	32.4	1.5	1.1	2.8/5.0	92/99
PMA2-252LN+	1500-2500	17.6	0.8	17.8	30	1.3	1.3	4	57
VNA-28B+	500-2500	23	2.9	11.4	22.7	1.31	1.83	2.8/5.0	32/34
TAMP-242GLN+	1710-2400	30	0.85	20	36	1.25	1.4	5	120
TAMP-242LN+	1710-2400	13	0.65	17	33.5	1.6	1.2	5	46
YSF-232+	1700-2300	20	2.8	20	35	1.8	1.2	5	118
CMA-545G1+	400-2200	31.8	0.9	23.3	36.5	1.9	1.4	5	158
PMA-545G1+	400-2200	31.3	1	22.2	33.6	1.6	1.4	5	158
GALI-52+	DC-2000	17.8	2.7	15.5	32	1.35	1.4	4.4	50
LHA-23HLN+	30-2000	21.5	1.3	28.3	44.7	1.9	1.5	8	244
LHA-23LN+	30-2000	21.2	1.2	23.8	36.9	1.9	1.25	5/3	146/75
MAR-6SM+	DC-2000	20.2	2.3	3.7	18.1	1.2	1.2	3.5	16
PHA-23HLN+	30-2000	21.3	1.4	28.4	44.4	1.7	1.48	8	235
PHA-23LN+	30-2000	21	1.2	23.9	37.4	1.7	1.25	5.0/3.0	171/72
RAM-6A+	DC-2000	19.7	2.3	3.2	17.3	1.2	1.2	3.5	16
TSS-23HLN+	30-2000	21.8	1.4	28.5	42.6	1.92	1.67	8	236

Low Noise Amplifiers — Surface Mount Continued

Model Number	Frequency Range (MHz)	Gain (dB)	NF (dB)	P1dB (dBm)	OIP3 (dBm)	Input VSWR (:1)	Output VSWR (:1)	Voltage (V)	DC Current (mA)
TSS-23LN+	30-2000	21.5	1.2	24.1	36.4	1.92	1.67	5/3	139/74
TSY-172LNB+	30-1700	13.1	1.4	17.5	24.7	1.9	1.5	2.7	7.7
CMA-162LN+	700-1600	23.2	0.49	19.9	30.3	1.4	1.2	4	55
PMA-545G2+	1100-1600	30.4	1	22	33.6	1.6	1.4	5	158
PMA2-162LN+	700-1600	22.7	0.5	20	30	1.3	1.3	4	55
TAMP-1521GLN+	1380-1520	35	0.6	13.5	27.5	1.2	1.15	5	50
GALI-74+	DC-1000	21.8	2.7	18.3	38	1.2	1.6	4.8	80
LHA-13HLN+	1-1000	22.7	1.2	28	43.3	1.28	1.32	8	239
LHA-13LN+	1-1000	22.4	1.1	23.3	38.3	1.28	1.28	5/3	143/73
PHA-13HLN+	1-1000	22.7	1.1	28.7	43	1.3	1.3	8	234
PHA-13LN+	1-1000	22.4	1	24.5	39	1.3	1.3	5.0/3/0	138/71
PMA-545G3+	700-1000	31.3	0.9	21.9	33.4	1.6	1.4	5	158
RAM-8A+	DC-1000	28	2.6	12.6	24.4	1.6	1.8	3.7	36
TSS-13HLN+	1-1000	23	1.4	28.4	42.9	1.43	1.37	8	234
TSS-13LN+	1-1000	22.8	1.1	24.5	39.2	1.28	1.32	5/3	142/72
TSY-13LNB+	30-1000	14.7	1.2	17.1	26.4	1.5	1.3	2.7	7.7
TAMP-960LN+	824-960	18	0.55	16.5	30	1.1	1.4	5	45
TAMP-72LN+	400-700	20	1	21.5	36	1.35	1.15	5	90
YSIF-421+	220-380	37.2	1.6	22.2	38.3	1.78	1.08	5	189

Low Noise Amplifiers — Bare Die

Model Number	Frequency Range (MHz)	Gain (dB)	NF (dB)	P1dB (dBm)	OIP3 (dBm)	Input VSWR (:1)	Output VSWR (:1)	Voltage (V)	DC Current (mA)
PMA2-183LN-D+	4000-18000	10.4	2.5	14.2	25.6	1.79	1.43	5	48.2
PMA2-153LN-D+	500-15000	16.8	2.6	14.8	26.8	1.97	1.15	5.0/6.0	50/66
PMA2-133LN-D+	10000-13000	15.3	1.3	13.5	28.6	1.24	1.08	3.0/5.0	13/29
PMA2-123LN5-D+	500-12000	15.1	1.2	12.2	23.4	1.9	1.3	5	30
PMA3-83LN-D+	500-8000	21.9	1.2	21.2	35	1.4	1.8	5.0/6.0	60/77

Low Noise Amplifiers — Bare Die Continued

Model Number	Frequency Range (MHz)	Gain (dB)	NF (dB)	P1dB (dBm)	OIP3 (dBm)	Input VSWR (:1)	Output VSWR (:1)	Voltage (V)	DC Current (mA)
PMA3-83LNW-D+	400-8000	22.6	1.2	21.7	37.0	1.32	1.5	5.0/6.0	58/75
PMA3-63GLN-D+	1800-6000	27.9	0.7	14.1	26.6	1.78	1.92	5.0	69
PSA-0012-D+	50-6000	15.6	2.4	22.2	35	1.51	1.34	5	92
TSS-53LNB-D+	500-6000	21.4	1.3	19.4	35	1.2	1.4	5	82
MNA-6A-D+	500-5500	23.2	2.7	19.2	30	1.4	1.2	2.8/5.0	92/99
PGA-103-D+	50-4000	11.3	0.8	22.3	41.6	1.5	1.4	5	60/97
PMA2-43LN-D+	1100-4000	19.4	0.6	20.4	32.9	1.3	1.7	5	53
PSA4-5043-D+	50-4000	18.4	0.8	19	34	1.7	1.5	5	33/58
GALI-S66-D+	DC-3000	18.2	2.4	3.3	19.1	1.1	1.2	3.5	16
PMA2-33LN-D+	400-3000	18.4	0.47	17.6	33.8	1.5	1.1	3	58
PGA-105-D+	40-2600	15.1	1.9	18.4	36.9	1.2	1.2	5	65
PMA-545G1-D+	400-2200	31.1	1	23.4	36.1	1.92	1.33	5	158
PHA-23HLN-D+	30-2000	21	1.2	19/24/28	31/37/44	1.94	1.48	3.0/5.0/8.0	72/141/235
TSS-23HLN-D+	30-2000	21.8	1.4	28.5	42.6	1.92	1.67	8/5/3	236/139/74
TSY-172LNB-D+	30-1700	13.1	1.4	17.5	24.7	1.9	1.5	2.7	7.7
PMA2-162LN-D+	700-1600	22.7	0.5	20	30	1.3	1.3	4	55
PHA-13HLN-D+	1-1000	23	1.1	19/24/18	33/40/43	1.34	1.3	3.0/5.0/8.0	71/138/234
TSS-13HLN-D+	1-1000	23	1.4	28.4	42.9	1.43	1.37	8/5/3	234/142/72

Low Noise Amplifiers — Coaxial

Model Number	Frequency Range (MHz)	Gain (dB)	NF (dB)	P1dB (dBm)	OIP3 (dBm)	Input VSWR (:1)	Output VSWR (:1)	Voltage (V)	DC Current (mA)	Connector	Option
ZEL-0812LN	24000-43500	45	1.7	20	27	2	2.5	15	160	2.92mm	Heat Sink
ZEL-1217LN+	18000-32000	20	3	10	23	1.9	1.8	12	50	2.92mm	Heat Sink
ZEL-1724LN+	18000-32000	20	3	10	23	1.9	1.8	12	50	2.92mm	-
ZFL-500LN+	1500-21000	29	3	15.5	27.5	1.5	1.6	5	450	2.92mm	-
ZFL-500LN-BNC+	500-15000	16	2.8	15	27	2	1.5	12	82	SMA	-
ZFL-500LNB+	500-12000	17	2.4	16	28	1.45	1.3	12	82	SMA	-

Low Noise Amplifiers – Coaxial Continued

Model Number	Frequency Range (MHz)	Gain (dB)	NF (dB)	P1dB (dBm)	OIP3 (dBm)	Input VSWR (:1)	Output VSWR (:1)	Voltage (V)	DC Current (mA)	Connector	Option
ZFL-500LNB-BNC+	5000-11000	21.4	1.9	13	24.5	1.9	1.5	5	42	SMA	-
ZFL-1000LN+	500-8000	22.1	1.4	20.7	35.2	1.38	1.58	5.0/6.0	60/70	SMA	-
ZFL-1000LNB+	500-8000	22.1	1.4	20.7	35.2	1.38	1.58	12	77	SMA	-
ZHL-0812HLN+	1800-6000	27.8	1.2	13.6	26	1.7	1.7	5	67	SMA	-
ZHL-0812HLNX+	4400-5400	24	1.9	10	23	1.5	1.5	12	80	SMA	-
ZHL-1217HLN+	500-5000	21	1.45	19	32	1.6	1.3	5	80	SMA	-
ZHL-1217HLNX+	500-5000	20	1.45	19.5	32	1.6	1.2	5	105	SMA	-
ZHL-1217MLN+	3300-3800	23	0.9	18	36	1.2	1.4	5	110	SMA	-
ZHL-1724HLN+	3300-3600	20	0.9	16	29	1.2	1.4	5	140	SMA	-
ZHL-1724HLNX+	3300-3600	11.5	0.9	10.5	22	1.4	1.4	5	30	SMA	-
ZHL-1724MLN+	700-3500	21	2.4	24	45	1.4	1.3	12	460	SMA	-
ZQL-900LN+	50-3000	14.1	1.1	19	35	2	1.6	5	80	SMA	-
ZQL-900LNW+	400-3000	11	1.7	21.1	31	1.7	1.6	12	120	SMA	-
ZQL-900MLN+	20-3000	20	2.7	11.8	25	1.3	1.4	12	34	SMA	-
ZQL-900MLNW+	400-3000	14.8	0.4	17.4	35	1.9	1.3	3	67	SMA	-
ZQL-1900LN+	50-3000	13	0.6	22.5	40	1.6	1.6	5	120	SMA	-
ZQL-1900LNW+	2200-2700	25	1.5	25	38	1.25	1.15	15	350	SMA	-
ZQL-2700MLNW+	2300-2700	14	0.8	18.5	31.5	1.2	1.6	5	70	SMA	-
ZRL-400+	40-2600	15	2	20	35	1.5	1.5	5	77	SMA	-
ZRL-700+	500-2500	24	2.6	20.5	32	1.4	1.4	2.8/5.0	110	SMA	-
ZRL-1150LN+	500-2500	43	2.6	19	18	1.6	1.6	2.8/5.0	190	SMA	-
ZRL-1200+	1700-2400	20	1.5	10	22	2.5	2.5	15	70	SMA	-
ZRL-2150+	1700-2400	30	1.5	26	36	1.4	1.6	15	725	SMA	Heat Sink
ZRL-2300+	1700-2400	30	1.5	26	36	1.4	1.6	15	725	SMA	-
ZRL-2400LN+	1700-2400	28	1.1	20	32	1.8	1.8	15	380	SMA	-
ZRL-3500+	1000-2400	30	1	23	39	1.6	1.4	12	520	SMA	-
ZVA-203GX+	1710-2400	30	0.85	20	37	1.4	1.6	5	150	SMA	-
ZVA-24443G1+	1710-2400	13	0.75	16.5	33	1.2	1.6	5	46	SMA	-

Low Noise Amplifiers – Coaxial Continued

Model Number	Frequency Range (MHz)	Gain (dB)	NF (dB)	P1dB (dBm)	OIP3 (dBm)	Input VSWR (:1)	Output VSWR (:1)	Voltage (V)	DC Current (mA)	Connector	Option
ZVE-323LN-K+	1400-2300	29	2.5	26	42	1.2	1.16	12	470	SMA	-
ZVE-323LNX-K+	950-2150	25	1.5	22	34	1.3	1.2	12	300	SMA	-
ZX60-33LNR-S+	1700-2000	14	1.6	18.5	37	1.15	1.25	15	160	SMA	-
ZX60-53LN+	1850-1910	15	1.5	19	37	1.15	1.25	15	160	SMA	-
ZX60-53LNB-S+	1200-1700	20	1.5	10	25	2.5	2.5	15	70	SMA	-
ZX60-63GLN+	1200-1700	36	1.5	26	36	1.4	1.3	15	725	SMA	Heat Sink
ZX60-83LN-S+	1200-1700	36	1.5	26	36	1.4	1.3	15	725	SMA	-
ZX60-83LN12+	1200-1700	35	1.1	22	36	1.4	1.3	15	380	SMA	-
ZX60-112LN+	1217-1620	14	0.5	13.5	30	1.3	1.3	12	50	SMA	-
ZX60-123LN-S+	700-1600	22.5	0.5	19.9	29.9	1.2	1.4	4	60	SMA	-
ZX60-153LN-S+	650-1400	33	1	25	41	1.4	1.3	12	500	SMA	-
ZX60-242GLN-S+	800-1400	16	0.4	12.5	27	1.7	1.4	12	50	SMA	-
ZX60-242LN-S+	800-1200	20	1.5	8	18	2.5	2.5	15	70	SMA	-
ZX60-272LN-S+	800-1200	36	1.5	26	36	1.4	1.3	15	725	SMA	Heat Sink
ZX60-362GLN-S+	800-1200	36	1.5	26	36	1.4	1.3	15	725	SMA	-
ZX60-362LN-S+	650-1200	28	2	23.5	46	1.2	1.2	12	575	SMA	-
ZX60-542LN-S+	500-1200	14.9	2.5	22.8	46.2	1.5	1.7	5.5	145	SMA	-
ZX60-0916LN-S+	400-1100	27	1.2	16.5	30	1.4	1.3	5	190	SMA	-
ZX60-1215LN-S+	0.1-1000	20	2.9	3	14	1.5	2	15	60	SMA	-
ZX60-1614LN-S	0.1-1000	20	2.9	3	14	1.5	2	15	60	SMA	Bracket
ZX60-2522MA-S+	824-960	18	0.55	16.5	30	1.2	1.4	5	45	SMA	-
ZX60-2534MA-S+	800-900	13	1.6	21	35	1.2	1.1	15	160	SMA	-
ZX60-3011+	800-900	22	1.7	23	41	1.3	1.4	15	230	SMA	-
ZX60-3018G-S+	824-849	15	1.3	21	35	1.2	1.1	15	160	SMA	-
ZX60-3800LN-S+	824-849	25.5	1.5	24.5	41	1.3	1.4	15	230	SMA	-
ZX60-05113LN+	250-700	30	2	23.5	46	1.1	1.1	12	575	SMA	-
ZX60-H122+	0.1-500	24	2.9	5	14	1.5	1.6	15	60	SMA	-
ZX60-P33ULN+	0.1-500	24	2.9	5	14	1.5	1.6	15	60	BNC	-

Low Noise Amplifiers – Coaxial Continued

Model Number	Frequency Range (MHz)	Gain (dB)	NF (dB)	P1dB (dBm)	OIP3 (dBm)	Input VSWR (:1)	Output VSWR (:1)	Voltage (V)	DC Current (mA)	Connector	Option
ZX60-P103LN+	0.1-500	24	2.9	5	14	1.5	1.6	15	60	SMA	Bracket
ZX60-P105LN+	0.1-500	24	2.9	5	14	1.5	1.6	15	60	BNC	Bracket
ZX60-P162LN+	150-400	31	2.5	25	42	1.5	1.25	12	450	SMA	-

Low Noise Amplifiers – Plug-In

Model Number	Frequency Range (MHz)	F Low (MHz)	F High (MHz)	Gain (dB)	NF (dB)	P1dB (dBm)	OIP3 (dBm)	Input VSWR (:1)	Output VSWR (:1)	Voltage (V)	DC Current (mA)
TO-1724LN+	1700-2400	1700	2400	20	1.6	10	22	2.5	2.5	15	70
TO-1217LN+	1200-1700	1200	1700	20	1.6	10	25	2.5	2.5	15	70
TAMP-112-2W+	650-1200	650	1200	31	2.8	30	41	1.9	2.1	5	750
AMP-15	5-1000	5	1000	13	2.8	8	22	2	2	15	29
AMP-75+	5-500	5	500	19	2.4	12	28	2	2	15	31

Pulse Amplifiers

- 0.0025 to 700 MHz
- Gain up to 35 dB with excellent flatness, ± 0.6 dB typ.
- Capable of handling pulse widths up to 15 μ s with any kind of modulation
- Fast rise/fall time, 1.1 ns

Pulse Amplifiers – Coaxial

Model Number	Frequency Range (MHz)	Gain (dB)	NF (dB)	P1dB (dBm)	OIP3 (dBm)	Input VSWR (:1)	Output VSWR (:1)	Voltage (V)	DC Current (mA)	Connector
ZHL-72A+	0.0025-700	35	7.7	24	34	2	2	24	350	BNC
ZPUL-30P+	0.0025-700	35	7.7	22	34	2	2	24	400	BNC

RF Transistors

- Wide bandwidths from 10 to 10000 MHz
- Noise figure as low as 0.38 dB
- Multiple case style options, 3 x 3 mm and 1.4 x 1.2 mm QFN, SOT-343 and bare die
- Footprint compatible replacements for EOL Avago parts
- Suitable for medical / MRI applications (non-magnetic)
- Design your own external biasing and matching

RF Transistors – Surface Mount

Model Number	Frequency Range (MHz)	Gain (dB)	NF (dB)	P1dB (dBm)	OIP3 (dBm)	Input VSWR (:1)	Output VSWR (:1)	Voltage (V)	DC Current (mA)
TAV2-14LN+	50-10000	16.4	0.7	18.8	30.9	2.615	1.577	2/4	20/40
SAV-541+	45-6000	23.2	0.5	19.2	33.1	-	-	3	60
SAV-551+	45-6000	20.9	0.5	17.5	24.3	-	-	3	15
SAV-581+	45-6000	22.3	0.5	19	30.6	-	-	3	30
TAV-541+	45-6000	23.8	0.5	19.1	33.6	-	-	3	60
TAV-551+	45-6000	21.3	0.5	17.5	23.5	-	-	3	15
TAV-581+	45-6000	22.9	0.5	18.3	30.3	-	-	3	30
TAV1-541+	45-6000	23.2	0.5	19.2	33.1	-	-	3	60
TAV1-551+	45-6000	21.6	0.5	16	23.9	-	-	3	15
SAV-331+	10-4000	24.1	0.5	19.6	32.3	-	-	4	60
TAV1-331+	10-4000	24.1	0.6	20.1	31.8	-	-	4	60
TAV2-501+	400-3900	15.1	1.3	27.7	42.9	-	-	4.5	280

RF Transistors – Bare Die

Model Number	Frequency Range (MHz)	Gain (dB)	NF (dB)	P1dB (dBm)	OIP3 (dBm)	Input VSWR (:1)	Output VSWR (:1)	Voltage (V)	DC Current (mA)
TAV2-14LN-D+	50-10000	16.4	0.7	18.8	30.9	2.615	1.577	2/4	20/40
SAV-541-D+	450-6000	19.1	0.38	21	33.1	-	-	3/4	15/30/60
TAV2-501-D+	400-3900	15.1	1.3	27.7	42.9	-	-	4.5	280

Variable Gain Amplifiers

- Models covering 10 to 3000 MHz
- MMIC digital variable gain amplifiers with 6-bit serial and parallel control
- Coaxial voltage-controlled variable gain amplifiers
- Gain control range as wide as 60 dB

Digital Variable Gain Amplifiers — Surface Mount

Model Number	Frequency Range (MHz)	Gain Max. (dB)	NF (dB)	P1dB (dBm)	OIP3 (dBm)	Input VSWR (:1)	Output VSWR (:1)	Voltage (V)	DC Current (mA)
DVGA2-33A+	50-3000	18.1	5.3	18	31.3	1.6	1.43	5	91
DVGA2-33APP+	50-3000	19.3	5.3	16.4	31.5	1.53	1.39	3 & 5	91
DVGA1-242A+	450-2400	29.3	2.4	22.9	35.9	2.43	1.66	5	155
DVGA1-242APP+	450-2400	29.5	2.6	22.8	35.5	2.54	1.39	5	158
DVGA3-122+	900-1200	20	0.5	15.6	28	1.92	2.6	5	52.2

Voltage Variable Gain Amplifiers — Coaxial

Model Number	Frequency Range (MHz)	Gain Max. (dB)	NF (dB)	P1dB (dBm)	OIP3 (dBm)	Input VSWR (:1)	Output VSWR (:1)	Voltage (V)	DC Current (mA)	Connector	Option
ZFL-2000G+	10-2000	20	7.5	7	17	1.5	1.5	15	180	SMA	-
ZFL-2000GB+	10-2000	20	7.5	7	17	1.5	1.5	15	180	SMA	Bracket
ZFL-2000GH+	10-2000	27	5.5	14	25	1.4	1.5	15	230	SMA	-
ZFL-2000GHB+	10-2000	27	5.5	14	25	1.4	1.5	15	230	SMA	Bracket
ZFL-1200G+	10-1200	23	6.5	8	22	1.25	1.5	15	180	SMA	-
ZFL-1200GB+	10-1200	23	6.5	8	22	1.25	1.5	15	180	SMA	Bracket
ZFL-1200GH+	10-1200	29	5.5	13	28	1.25	1.5	15	230	SMA	-
ZFL-1200GHB+	10-1200	29	5.5	13	28	1.25	1.5	15	230	SMA	Bracket



TSR Engineering

You guys make some of the best RF components in the world—and always at a fantastic price!...Your staff...have always been on top of it and extremely helpful. It's a pleasure doing business with you.

— ENGINEER



Amplifier Designer Kits

Model Number	Model Series	Description	Package	Models Included in Kit	Qty. Ea.	Total Qty.
K1-ERA+	ERA	DC to 8 GHz Up to 13 dBm Output Power	Micro-X	ERA-1+ -2+ -3+	10	30
K2-ERA+	ERA	DC to 4 GHz Up to 18.4 dBm Output Power	Micro-X	ERA-4+ -5+	10	20
K1-ERASM+	ERA-SM	DC to 8 GHz 18.4 dBm Output Power, Up to 13 dBm Output Power	Mircro-X	ERA-1SM+ -2SM+ -3SM+	10	30
K3-ERASM+	ERA-SM	DC to 4 GHz Up to 18.4 dBm Output Power	Mircro-X	ERA-4SM+ -5SM+ 6SM+	10	30
K3-Gali_GVA+	GVA, GALI	DC to 8G Hz Up to 21.5 dBm Output Power	Mircro-X	GVA-84+ Gali-74+ -24+, -84+	10	40
K4-Gali+	GALI	DC to 8 GHz Up to 18.2 dBm Output Power	SOT-89	Gali-1+ -21+ -2+ -33+ -3+ -4+ -5+ -51+ -6+	10	90
K5-Gali+	GALI	DC to 4 GHz Up to 15.9 dBm Output Power	SOT-89	Gali-4F+ -5F+ -51F+ -55+ -6F+	10	50
K1-GVA+	GVA	DC to 7 GHz Up to 21 dBm Output Power	SOT-89	GVA-81+ -82+ -83+ -84+	10	40

Model Number	Model Series	Description	Package	Models Included in Kit	Qty. Ea.	Total Qty.
K2-LEE+	LEE	DC to 8 GHz Up to 17.3 dBm Output Power	Modified QFN	LEE-19+ -29+ -39+ -49+ -59+	10	50
K-ZFL	ZFL	2.5 kHz to 2000 MHz Up to 22 dBm Output Power	Connectorized	ZHL-6A ZFL-1000 ZFL-2000	1	3
K1-PHA+	PHA	30 MHz to 8 GHz Up to 30 dBm Output Power	SOT-89 MCLP 5x6mm	PHA-1+ -1H+ -83W+ -101+ -202+	5	25
K1-SAV_TAV+	SAV, TAV	0.01 to 10 GHz Up to 20 dBm Output Power	MCLP 1.42x1.18mm MCLP 3x3mm SOT-343	SAV-331+ SAV-541+ SAV-551+ SAV-581+ TAV-541+ TAV-551+ TAV-581+ TAV1-331+ TAV1-541+ TAV2-14LN+	10	100



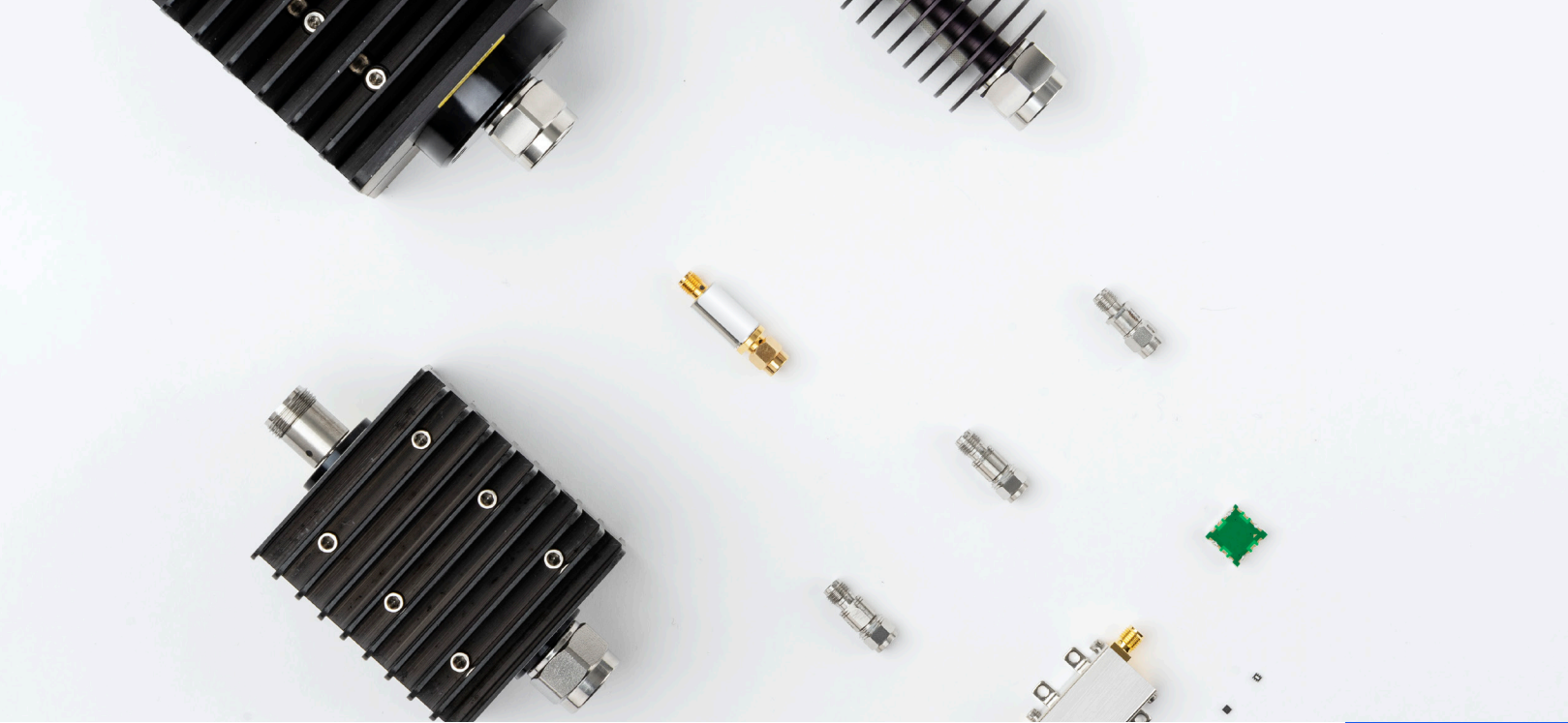

DC TO 65 GHz

Attenuators

400+ Models in Stock

- Fixed, voltage variable, digital step and programmable designs
- Connectorized, MMIC surface mount and bare die formats
- Attenuation values from 0 to 50 dB
- Power handling up to 100W
- Excellent accuracy and repeatability



Digital Step Attenuators

- Models from DC to 6 GHz
- 6-bit serial and parallel control interfaces
- Up to 31.75 dB attenuation control
- Step size as fine as 0.25 dB
- Coaxial and MMIC surface mount formats

Digital Step Attenuators – Surface Mount

Model Number	Frequency Range (MHz)	Attenuation Range (dB)	Attenuation Step (dB)	# of Bits	IP3 (dBm)	Input Power 0.2 dB Compression (dBm)	Input Power (W), Max	Switching Speed (μs)	Supply Voltage (Vdd, Vss)	Control Interface
DAT-31R5A-PN+	DC-4000	31.5	0.5	6	52	24	0.25	1	3, -3.2	Parallel
DAT-31R5A-PP+	DC-4000	31.5	0.5	6	52	24	0.25	1	3	Parallel
DAT-31R5A-SN+	DC-4000	31.5	0.5	6	52	24	0.25	1	3, -3.2	Serial
DAT-31R5A-SP+	DC-4000	31.5	0.5	6	52	24	0.25	1	3	Serial
DAT-31A-PN+	DC-4000	31	1	5	52	24	0.25	1	3, -3.2	Parallel
DAT-31A-PP+	DC-4000	31	1	5	52	24	0.25	1	3	Parallel
DAT-31A-SN+	DC-4000	31	1	5	52	24	0.25	1	3, -3.2	Serial
DAT-31A-SP+	DC-4000	31	1	5	52	24	0.25	1	3	Serial
DAT-15R5A-PN+	DC-4000	15.5	0.5	5	52	24	0.25	1	3, -3.2	Parallel
DAT-15R5A-PP+	DC-4000	15.5	0.5	5	52	24	0.25	1	3	Parallel
DAT-15R5A-SN+	DC-4000	15.5	0.5	5	52	24	0.25	1	3, -3.2	Serial
DAT-15R5A-SP+	DC-4000	15.5	0.5	5	52	24	0.25	1	3	Serial

Digital Step Attenuators – Surface Mount 75Ω

Model Number	Frequency Range (MHz)	Attenuation Range (dB)	Attenuation Step (dB)	# of Bits	IP3 (dBm)	Input Power 0.2 dB Compression (dBm)	Input Power (W), Max	Switching Speed (μs)	Supply Voltage (Vdd, Vss)	Control Interface
DAT-31575A-PN+	31.5	1-2500	0.5	6	57	30	1	0.4	3, -3	Parallel
DAT-31575A-PP+	31.5	1-2500	0.5	6	57	30	1	0.4	3	Parallel
DAT-31575A-SN+	31.5	1-2500	0.5	6	57	30	1	0.4	3, -3	Serial
DAT-31575A-SP+	31.5	1-2500	0.5	6	57	30	1	0.4	3	Serial
DAT-3175A-PN+	31	1-2500	1	5	57	30	1	0.4	3, -3	Parallel
DAT-3175A-PP+	31	1-2500	1	5	57	30	1	0.4	3	Parallel



Digital Step Attenuators — Surface Mount 75Ω Continued

Model Number	Frequency Range (MHz)	Attenuation Range (dB)	Attenuation Step (dB)	# of Bits	IP3 (dBm)	Input Power 0.2 dB Compression (dBm)	Input Power (W), Max	Switching Speed (μs)	Supply Voltage (Vdd, Vss)	Control Interface
DAT-3175A-SN+	31	1-2500	1	5	57	30	1	0.4	3, -3	Serial
DAT-3175A-SP+	31	1-2500	1	5	57	30	1	0.4	3	Serial
DAT-15575A-PN+	15.5	1-2500	0.5	5	57	30	1	0.4	3, -3	Parallel
DAT-15575A-PP+	15.5	1-2500	0.5	5	57	30	1	0.4	3	Parallel
DAT-15575A-SN+	15.5	1-2500	0.5	5	57	30	1	0.4	3, -3	Serial
DAT-15575A-SP+	15.5	1-2500	0.5	5	57	30	1	0.4	3	Serial

Digital Step Attenuators — Coaxial

Model Number	Freq. Range (MHz)	Attenuation Range (dB)	Attenuation Step (dB)	# of Bits	IP3 (dBm)	Input Power 0.2 dB Compression (dBm)	Input Power (W), Max	Switching Speed (μs)	Supply Voltage (Vdd, Vss)	Control Interface	Connector Type
ZX76-31R75PP-S+	0.009-6000	31.75	0.25	7	53	30	1	0.3	3.0-5.5	Parallel	SMA
ZX76-31R5A-PNS+	DC-4000	31.5	0.5	6	52	24	0.25	1	3, -3.3	Parallel	SMA
ZX76-31R5A-PPS+	DC-4000	31.5	0.5	6	52	24	0.25	1	3	Parallel	SMA
ZX76-31R5A-SNS+	DC-4000	31.5	0.5	6	52	24	0.25	1	3, -3.3	Serial	SMA
ZX76-31R5A-SPS+	DC-4000	31.5	0.5	6	52	24	0.25	1	3	Serial	SMA
ZX76-31A-PNS+	DC-4000	31	1	5	52	24	0.25	1	3, -3.3	Parallel	SMA
ZX76-31A-PPS+	DC-4000	31	1	5	52	24	0.25	1	3	Parallel	SMA
ZX76-31A-SNS+	DC-4000	31	1	5	52	24	0.25	1	3, -3.3	Serial	SMA
ZX76-31A-SPS+	DC-4000	31	1	5	52	24	0.25	1	3	Serial	SMA
ZX76-15R5A-PNS+	DC-4000	15.5	0.5	5	52	24	0.25	1	3, -3.3	Parallel	SMA
ZX76-15R5A-PPS+	DC-4000	15.5	0.5	5	52	24	0.25	1	3	Parallel	SMA
ZX76-15R5A-SNS+	DC-4000	15.5	0.5	5	52	24	0.25	1	3, -3.3	Serial	SMA
ZX76-15R5A-SPS+	DC-4000	15.5	0.5	5	52	24	0.25	1	3	Serial	SMA
ZFAT-51020	10-1000	35	5	3	-	-	-	10	5	-	SMA
ZSAT-31R5+	10-1000	31.5	0.5	6	-	-	-	10	5	-	SMA
ZFAT-3610	10-1000	19	3	3	-	-	-	10	5	-	SMA

Digital Step Attenuators — Plug-In

Model Number	Frequency Range (MHz)	Attenuation Range (dB)	Attenuation Step (dB)	# of Bits	Switching Speed (μs)	Supply Voltage (Vdd, Vss)
TOAT-R512+	10-1000	3.5	0.5	3	10	5
TOAT-124+	10-1000	7	1	3	10	5
TOAT-3610+	10-1000	19	3	3	10	5
TOAT-4816+	10-1000	28	4	3	10	5
TOAT-51020+	10-1000	35	5	3	10	5

Fixed Attenuators

- Coaxial models to 65 GHz
- MMIC models to 50 GHz in QFN package
- RF input power up to 100W
- Attenuation values from 0 to 50 dB
- Outstanding accuracy

Fixed Attenuators — Surface Mount

Model Number	Frequency Range (MHz)	Attenuation (dB)	Flatness (dB)	VSWR (:1)	Input Power (W)
QAT-0+	DC-50000	0	-	1.30	2
QAT-1+	DC-50000	1	-	1.16	2
QAT-2+	DC-50000	2	-	1.17	2
QAT-3+	DC-50000	3	-	1.21	2
QAT-4+	DC-50000	4	-	1.16	1.7
QAT-5+	DC-50000	5	-	1.13	1.4
QAT-6+	DC-50000	6	-	1.14	1.6
QAT-7+	DC-50000	7	-	1.15	1.3
QAT-8+	DC-50000	8	-	1.16	1.2
QAT-9+	DC-50000	9	-	1.19	1.1

Fixed Attenuators — Surface Mount Continued

Model Number	Frequency Range (MHz)	Attenuation (dB)	Flatness (dB)	VSWR (:1)	Input Power (W)
QAT-10+	DC-50000	10	-	1.20	1.7
QAT-12+	DC-50000	12	-	1.19	1.1
QAT-15+	DC-50000	15	-	1.20	1.4
QAT-20+	DC-50000	20	-	1.16	0.8
QAT-30+	DC-50000	30	-	1.21	1
KAT-0+	DC-43500	0	0.665	1.71	2
KAT-1+	DC-43500	1	0.27	2.06	2
KAT-2+	DC-43500	2	0.17	1.71	2
KAT-3+	DC-43500	3	0.305	1.62	2
KAT-4+	DC-43500	4	0.25	1.75	1.7
KAT-5+	DC-43500	5	0.3	1.59	1.4
KAT-6+	DC-43500	6	0.3	1.44	1.6
KAT-7+	DC-43500	7	0.38	1.69	1.3
KAT-8+	DC-43500	8	0.38	1.52	1.2
KAT-9+	DC-43500	9	0.28	1.6	1.1
KAT-10+	DC-43500	10	0.16	1.5	1.7
KAT-12+	DC-43500	12	0.185	1.41	1.1
KAT-15+	DC-43500	15	0.2	1.57	1.4
KAT-20+	DC-43500	20	0.155	1.32	0.8
KAT-30+	DC-43500	30	1.13	1.59	1
RCAT-00+	DC-20000	0	0.25	1.67	2
RCAT-01+	DC-20000	1	0.35	1.67	2
RCAT-02+	DC-20000	2	0.35	1.38	2
RCAT-03+	DC-20000	3	0.45	1.50	2
RCAT-04+	DC-20000	4	0.55	1.43	2
RCAT-05+	DC-20000	5	0.6	1.38	2
RCAT-06+	DC-20000	6	0.7	1.43	2
RCAT-07+	DC-20000	7	0.8	1.43	2

Fixed Attenuators — Surface Mount Continued

Model Number	Frequency Range (MHz)	Attenuation (dB)	Flatness (dB)	VSWR (:1)	Input Power (W)
RCAT-08+	DC-20000	8	0.9	1.33	2
RCAT-09+	DC-20000	9	1.05	1.33	2
RCAT-10+	DC-20000	10	1.1	1.43	2
RCAT-12+	DC-20000	12	1.4	1.38	1.8
RCAT-15+	DC-20000	15	1.95	1.43	1.6
RCAT-20+	DC-20000	20	3.45	1.50	1.5
RCAT-30+	DC-20000	30	1	1.58	1.3
YAT-0+	DC-18000	0	0.105	1.6	2
YAT-0A+	DC-18000	0	-	1.52	2
YAT-1+	DC-18000	1	0.15	1.44	2
YAT-1A+	DC-18000	1	-	1.36	2
YAT-2+	DC-18000	2	0.195	1.6	2
YAT-2A+	DC-18000	2	-	1.29	2
YAT-3+	DC-18000	3	0.23	1.54	2
YAT-3A+	DC-18000	3	-	1.37	2
YAT-4+	DC-18000	4	0.25	1.4	2
YAT-4A+	DC-18000	4	-	1.29	1.7
YAT-5+	DC-18000	5	0.25	1.38	2
YAT-5A+	DC-18000	5	-	1.25	1.4
YAT-6+	DC-18000	6	0.325	1.5	2
YAT-6A+	DC-18000	6	-	1.19	1.6
YAT-7+	DC-18000	7	0.3	1.9	2
YAT-7A+	DC-18000	7	-	1.17	1.3
YAT-8+	DC-18000	8	0.35	1.4	2
YAT-8A+	DC-18000	8	-	1.19	1.2
YAT-9+	DC-18000	9	0.2	1.4	2
YAT-9A+	DC-18000	9	-	1.21	1.1
YAT-10+	DC-18000	10	0.4	1.67	2

Fixed Attenuators — Surface Mount Continued

Model Number	Frequency Range (MHz)	Attenuation (dB)	Flatness (dB)	VSWR (:1)	Input Power (W)
YAT-10A+	DC-18000	10	-	1.21	1.7
YAT-12+	DC-18000	12	0.3	1.47	1.8
YAT-12A+	DC-18000	12	-	1.22	1.1
YAT-15+	DC-18000	15	0.35	1.46	1.6
YAT-15A+	DC-18000	15	-	1.24	1.4
YAT-20+	DC-18000	20	0.5	1.65	1.5
YAT-20A+	DC-18000	20	-	1.21	0.8
YAT-30+	DC-18000	30	0.4	1.42	1.3
YAT-30A+	DC-18000	30	-	1.2	1
GAT-0+	DC-8000	0	0.2	1.25	0.5
GAT-1+	DC-8000	1	0.2	1.3	0.5
GAT-2+	DC-8000	2	0.2	1.3	0.5
GAT-3+	DC-8000	3	0.2	1.35	0.5
GAT-4+	DC-8000	4	0.2	1.35	0.5
GAT-5+	DC-8000	5	0.2	1.35	0.5
GAT-6+	DC-8000	6	0.3	1.35	0.5
GAT-7+	DC-8000	7	0.3	1.35	0.5
GAT-8+	DC-8000	8	0.3	1.35	0.5
GAT-9+	DC-8000	9	0.3	1.3	0.5
GAT-10+	DC-8000	10	0.3	1.3	0.5
GAT-12+	DC-8000	12	0.3	1.3	0.5
GAT-15+	DC-8000	15	0.3	1.35	0.5
GAT-20+	DC-8000	20	0.2	1.35	0.5
PAT-0+	DC-5000	0	0.5	1.55	1
PAT-1+	DC-7000	1	0.7	1.4	1
PAT-2+	DC-7000	2	0.9	1.4	1
PAT-3+	DC-7000	3	0.9	1.4	1
PAT-4+	DC-7000	4	0.9	1.4	1

Fixed Attenuators — Surface Mount Continued

Model Number	Frequency Range (MHz)	Attenuation (dB)	Flatness (dB)	VSWR (:1)	Input Power (W)
PAT-5+	DC-7000	5	1	1.4	1
PAT-6+	DC-7000	6	1.1	1.4	1
PAT-7+	DC-7000	7	1.3	1.5	1
PAT-8+	DC-7000	8	1.5	1.5	1
PAT-9+	DC-7000	9	1.7	1.5	1
PAT-10+	DC-7000	10	1.7	1.5	1
PAT-12+	DC-7000	12	1.8	1.5	1
PAT-15+	DC-7000	15	2.4	1.5	1
PAT-20+	DC-7000	20	2.6	1.5	1
PAT-30+	DC-7000	30	2.8	1.5	1
GAT-30+	DC-3000	30	1.2	1.15	0.5
LAT-0+	DC-2500	0	0.6	1.5	0.5
LAT-1+	DC-2500	1	0.7	1.5	0.5
LAT-2+	DC-2500	2	0.7	1.5	0.5
LAT-3+	DC-2500	3	0.7	1.5	0.5
LAT-4+	DC-2500	4	0.7	1.5	0.5
LAT-5+	DC-2500	5	0.7	1.5	0.5
LAT-6+	DC-2500	6	0.7	1.5	0.5
LAT-7+	DC-2500	7	0.7	1.5	0.5
LAT-8+	DC-2500	8	0.8	1.5	0.5
LAT-9+	DC-2500	9	0.8	1.5	0.5
LAT-10+	DC-2500	10	0.8	1.5	0.5
LAT-12+	DC-2500	12	0.8	1.6	0.5
LAT-15+	DC-2500	15	0.8	1.6	0.5
LAT-20+	DC-2500	20	0.8	1.6	0.5
LAT-30+	DC-1000	30	1.2	1.3	0.5



Fixed Attenuators — Bare Die

Model Number	Frequency Range (MHz)	Attenuation (dB)	Flatness (dB)	VSWR (:1)	Input Power (W)
KAT-0-D+	DC-43500	0	0.2	1.5	2
KAT-1-D+	DC-43500	1	0.1	1.3	2
KAT-2-D+	DC-43500	2	0.25	1.3	2
KAT-3-D+	DC-43500	3	0.25	1.3	2
KAT-4-D+	DC-43500	4	0.3	1.2	1.7
KAT-5-D+	DC-43500	5	0.2	1.2	1.4
KAT-6-D+	DC-43500	6	0.15	1.2	1.6
KAT-7-D+	DC-43500	7	0.2	1.2	1.3
KAT-8-D+	DC-43500	8	0.2	1.2	1.2
KAT-9-D+	DC-43500	9	0.2	1.2	1.1
KAT-10-D+	DC-43500	10	0.2	1.2	1.7
KAT-12-D+	DC-43500	12	0.25	1.2	1.1
KAT-15-D+	DC-43500	15	0.4	1.2	1.4
KAT-20-D+	DC-43500	20	0.65	1.2	0.8
KAT-30-D+	DC-43500	30	0.45	1.2	1
YAT-0-D+	DC-26500	0	0.3	1.7	2
YAT-0A-D+	DC-26500	0	-	1.5	2
YAT-1-D+	DC-26500	1	0.25	1.6	2
YAT-1A-D+	DC-26500	1	-	1.3	2
YAT-2-D+	DC-26500	2	0.35	1.7	2
YAT-2A-D+	DC-26500	2	-	1.3	2
YAT-3-D+	DC-26500	3	0.3	1.5	2
YAT-3A-D+	DC-26500	3	-	1.3	2
YAT-4-D+	DC-26500	4	0.25	1.5	2
YAT-4A-D+	DC-26500	4	-	1.2	1.7
YAT-5-D+	DC-26500	5	0.3	1.5	2
YAT-5A-D+	DC-26500	5	-	1.2	1.4
YAT-6-D+	DC-26500	6	0.4	1.5	2

Fixed Attenuators — Bare Die Continued

Model Number	Frequency Range (MHz)	Attenuation (dB)	Flatness (dB)	VSWR (:1)	Input Power (W)
YAT-6A-D+	DC-26500	6	-	1.2	1.6
YAT-7-D+	DC-26500	7	0.25	1.5	2
YAT-7A-D+	DC-26500	7	-	1.2	1.3
YAT-8-D+	DC-26500	8	0.3	1.4	2
YAT-8A-D+	DC-26500	8	-	1.2	1.2
YAT-9-D+	DC-26500	9	0.3	1.4	2
YAT-9A-D+	DC-26500	9	-	1.2	1.1
YAT-10-D+	DC-26500	10	0.2	1.3	2
YAT-10A-D+	DC-26500	10	-	1.2	1.7
YAT-12-D+	DC-26500	12	0.2	1.3	1.8
YAT-12A-D+	DC-26500	12	-	1.2	1.1
YAT-15-D+	DC-26500	15	0.2	1.3	1.6
YAT-15A-D+	DC-26500	15	-	1.2	1.4
YAT-20-D+	DC-26500	20	0.2	1.2	1.5
YAT-20A-D+	DC-26500	20	-	1.2	0.8
YAT-30-D+	DC-26500	30	0.1	1.2	1.3
YAT-30A-D+	DC-26500	30	-	1.2	1

Fixed Attenuators — Coaxial 50Ω

Model Number	Frequency Range (MHz)	Attenuation (dB)	Flatness (dB)	VSWR (:1)	Input Power (W)	Connector Type
BW-E1-1W653+	DC-65000	1	0.65	1.65	1	1.85 mm
BW-E2-1W653+	DC-65000	2	1.5	1.13	1	1.85 mm
BW-E3-1W653+	DC-65000	3	1.5	1.65	1	1.85 mm
BW-E6-1W653+	DC-65000	6	1.5	1.65	1	1.85 mm
BW-E10-1W653+	DC-65000	10	1.5	1.65	1	1.85 mm
BW-E20-1W653+	DC-65000	20	1.5	1.65	1	1.85 mm

Fixed Attenuators — Coaxial 50Ω Continued

Model Number	Frequency Range (MHz)	Attenuation (dB)	Flatness (dB)	VSWR (:1)	Input Power (W)	Connector Type
BW-E30-1W653+	DC-65000	30	1.5	1.65	1	1.85 mm
BW-V3-1W54+	DC-50000	3	1.5	1.1	1	2.4 mm
BW-V6-1W54+	DC-50000	6	1.5	1.2	1	2.4 mm
BW-V10-1W54+	DC-50000	10	1.5	1.5	1	2.4 mm
BW-V20-1W54+	DC-50000	20	1.5	1.1	1	2.4 mm
BW-K1-2W44+	DC-40000	1	0.8	1.5	2	2.92 mm
BW-K2-2W44+	DC-40000	2	0.8	1.5	2	2.92 mm
BW-K3-2W44+	DC-40000	3	0.8	1.5	2	2.92 mm
BW-KM3-2W44+	DC-40000	3	0.4	1.2	2	2.92 mm
BW-K4-2W44+	DC-40000	4	0.8	1.5	2	2.92 mm
BW-K5-2W44+	DC-40000	5	0.8	1.5	2	2.92 mm
BW-K6-2W44+	DC-40000	6	0.8	1.5	2	2.92 mm
BW-KM6-2W44+	DC-40000	6	0.5	1.1	2	2.92 mm
BW-K10-2W44+	DC-40000	10	1	1.5	2	2.92 mm
BW-KM10-2W44+	DC-40000	10	0.4	1.1	2	2.92 mm
BW-K20-2W44+	DC-40000	20	1	1.5	2	2.92 mm
BW-KM20-2W44+	DC-40000	20	0.1	1.1	2	2.92 mm
BW-S1-2W263+	DC-26000	1	0.4	1.4	2	SMA
BW-S3-2W263+	DC-26000	3	0.3	1.4	2	SMA
BW-S6-2W263+	DC-26000	6	0.3	1.4	2	SMA
BW-S10-2W263+	DC-26000	10	0.4	1.35	2	SMA
BW-S20-2W263+	DC-26000	20	0.6	1.35	2	SMA
BW-S0.5W2+	DC-18000	0.5	0.4	1.11	2	SMA
BW-N1W5+	DC-18000	1	0.4	1.3	5	N
BW-S1W2+	DC-18000	1	0.4	1.3	2	SMA
BW-S1W5+	DC-18000	1	0.4	1.3	5	SMA
BW-N2W5+	DC-18000	2	0.4	1.3	5	N
BW-S2W2+	DC-18000	2	0.4	1.3	2	SMA

Fixed Attenuators — Coaxial 50Ω Continued

Model Number	Frequency Range (MHz)	Attenuation (dB)	Flatness (dB)	VSWR (:1)	Input Power (W)	Connector Type
BW-S2W5+	DC-18000	2	0.4	1.3	5	SMA
BW-N3W20+	DC-18000	3	0.5	1.5	20	N
BW-N3W5+	DC-18000	3	0.4	1.3	5	N
BW-S3W20+	DC-18000	3	0.5	1.4	20	SMA
BW-S3W2+	DC-18000	3	0.4	1.3	2	SMA
BW-S3W5+	DC-18000	3	0.4	1.3	5	SMA
BW-N4W5+	DC-18000	4	0.4	1.3	5	N
BW-S4W2+	DC-18000	4	0.4	1.3	2	SMA
BW-S4W5+	DC-18000	4	0.4	1.3	5	SMA
BW-N5W5+	DC-18000	5	0.4	1.3	5	N
BW-S5W2+	DC-18000	5	0.4	1.3	2	SMA
BW-S5W5+	DC-18000	5	0.4	1.3	5	SMA
BW-N6W20+	DC-18000	6	0.5	1.5	20	N
BW-N6W5+	DC-18000	6	0.4	1.3	5	N
BW-S6W20+	DC-18000	6	0.5	1.4	20	SMA
BW-S6W2+	DC-18000	6	0.4	1.3	2	SMA
BW-S6W5+	DC-18000	6	0.4	1.3	5	SMA
BW-N7W5+	DC-18000	7	0.6	1.3	5	N
BW-S7W2+	DC-18000	7	0.6	1.3	2	SMA
BW-S7W5+	DC-18000	7	0.6	1.3	5	SMA
BW-N8W5+	DC-18000	8	0.6	1.3	5	N
BW-S8W2+	DC-18000	8	0.6	1.3	2	SMA
BW-S8W5+	DC-18000	8	0.6	1.3	5	SMA
BW-N9W5+	DC-18000	9	0.6	1.3	5	N
BW-S9W2+	DC-18000	9	0.6	1.3	2	SMA
BW-S9W5+	DC-18000	9	0.6	1.3	5	SMA
BW-N10W20+	DC-18000	10	0.75	1.5	20	N
BW-N10W5+	DC-18000	10	0.6	1.3	5	N

Fixed Attenuators — Coaxial 50Ω Continued

Model Number	Frequency Range (MHz)	Attenuation (dB)	Flatness (dB)	VSWR (:1)	Input Power (W)	Connector Type
BW-N10W50+	DC-18000	10	1	1.4	50	N
BW-S10W20+	DC-18000	10	0.75	1.4	20	SMA
BW-S10W2+	DC-18000	10	0.6	1.3	2	SMA
BW-S10W5+	DC-18000	10	0.6	1.3	5	SMA
BW-N12W5+	DC-18000	12	0.6	1.3	5	N
BW-S12W2+	DC-18000	12	0.6	1.3	2	SMA
BW-S12W5+	DC-18000	12	0.6	1.3	5	SMA
BW-N15W5+	DC-18000	15	0.6	1.3	5	N
BW-S15W2+	DC-18000	15	0.6	1.3	2	SMA
BW-S15W5+	DC-18000	15	0.6	1.3	5	SMA
BW-N20W20+	DC-18000	20	0.5	1.4	20	N
BW-N20W5+	DC-18000	20	0.6	1.3	5	N
BW-N20W50+	DC-18000	20	1	1.4	50	N
BW-S20W20+	DC-18000	20	0.75	1.4	20	SMA
BW-S20W2+	DC-18000	20	0.6	1.3	2	SMA
BW-S20W5+	DC-18000	20	0.6	1.3	5	SMA
BW-N30W20+	DC-18000	30	1	1.65	20	N
BW-N30W5+	DC-18000	30	0.85	1.3	5	N
BW-N30W50+	DC-18000	30	1.25	1.4	50	N
BW-S30W20+	DC-18000	30	1	1.4	20	SMA
BW-S30W2+	DC-18000	30	0.85	1.3	2	SMA
BW-S30W5+	DC-18000	30	0.85	1.3	5	SMA
BW-N40W5+	DC-18000	40	0.85	1.3	5	N
BW-N40W50+	DC-18000	40	1.5	1.4	50	N
BW-S40W20+	DC-18000	40	2	1.4	20	SMA
BW-S40W2+	DC-18000	40	0.85	1.3	2	SMA
BW-S40W5+	DC-18000	40	0.85	1.3	5	SMA
BW-S50W2+	DC-18000	50	1.5	1.25	2	SMA

Fixed Attenuators — Coaxial 50Ω Continued

Model Number	Frequency Range (MHz)	Attenuation (dB)	Flatness (dB)	VSWR (:1)	Input Power (W)	Connector Type
BW-S3W10+	DC-12400	3	0.3	1.15	10	SMA
FW-1+	DC-12000	1	0.225	1.35	1	SMA
FW-2+	DC-12000	2	0.2	1.3	1	SMA
FW-3+	DC-12000	3	0.225	1.3	1	SMA
FW-4+	DC-12000	4	0.225	1.35	1	SMA
FW-5+	DC-12000	5	0.275	1.3	1	SMA
FW-6+	DC-12000	6	0.3	1.3	1	SMA
FW-7+	DC-12000	7	0.275	1.3	1	SMA
FW-8+	DC-12000	8	0.3	1.3	1	SMA
FW-9+	DC-12000	9	0.35	1.35	1	SMA
FW-10+	DC-12000	10	0.375	1.3	1	SMA
FW-12+	DC-12000	12	0.45	1.4	1	SMA
FW-15+	DC-12000	15	0.575	1.3	1	SMA
FW-20+	DC-12000	20	0.8	1.35	1	SMA
UNAT-1+	DC-6000	1	0.45	1.4	1	N
VAT-1+	DC-6000	1	0.6	1.4	1	SMA
VAT-1W2+	DC-6000	1	0.6	1.55	2	SMA
UNAT-2+	DC-6000	2	0.5	1.5	1	N
VAT-2+	DC-6000	2	0.65	1.5	1	SMA
VAT-2W2+	DC-6000	2	0.65	1.5	2	SMA
UNAT-3+	DC-6000	3	0.35	1.5	1	N
VAT-3+	DC-6000	3	0.45	1.4	1	SMA
VAT-3W2+	DC-6000	3	0.45	1.45	2	SMA
UNAT-4+	DC-6000	4	0.4	1.5	1	N
VAT-4+	DC-6000	4	0.55	1.45	1	SMA
VAT-4W2+	DC-6000	4	0.55	1.5	2	SMA
UNAT-5+	DC-6000	5	0.35	1.5	1	N
VAT-5+	DC-6000	5	0.25	1.4	1	SMA

Fixed Attenuators — Coaxial 50Ω Continued

Model Number	Frequency Range (MHz)	Attenuation (dB)	Flatness (dB)	VSWR (:1)	Input Power (W)	Connector Type
VAT-5W2+	DC-6000	5	0.35	1.65	2	SMA
UNAT-6+	DC-6000	6	0.4	1.5	1	N
VAT-6+	DC-6000	6	0.45	1.5	1	SMA
VAT-6W2+	DC-6000	6	0.45	1.5	2	SMA
UNAT-7+	DC-6000	7	0.2	1.5	1	N
VAT-7+	DC-6000	7	0.1	1.4	1	SMA
VAT-7W2+	DC-6000	7	0.45	1.4	2	SMA
UNAT-8+	DC-6000	8	0.1	1.5	1	N
VAT-8+	DC-6000	8	0.2	1.6	1	SMA
VAT-8W2+	DC-6000	8	0.25	1.6	2	SMA
UNAT-9+	DC-6000	9	0.15	1.5	1	N
VAT-9+	DC-6000	9	0.1	1.5	1	SMA
VAT-9W2+	DC-6000	9	0.15	1.5	2	SMA
UNAT-10+	DC-6000	10	0.4	1.5	1	N
VAT-10+	DC-6000	10	0.35	1.6	1	SMA
VAT-10W2+	DC-6000	10	0.35	1.6	2	SMA
UNAT-12+	DC-6000	12	0.35	1.8	1	N
VAT-12+	DC-6000	12	0.3	1.65	1	SMA
VAT-12W2+	DC-6000	12	0.3	1.7	2	SMA
UNAT-15+	DC-6000	15	0.6	1.7	1	N
VAT-15+	DC-6000	15	0.8	1.75	1	SMA
VAT-15W2+	DC-6000	15	0.8	1.75	2	SMA
BW-20N100W+	DC-6000	20	1.5	1.45	100	N
UNAT-20+	DC-6000	20	0.75	1.5	0.5	N
VAT-20+	DC-6000	20	1	1.3	0.5	SMA
VAT-20W2+	DC-6000	20	1.05	1.95	2	SMA
BW-30N100W+	DC-6000	30	1.5	1.45	100	N
UNAT-30+	DC-6000	30	2.3	1.1	0.5	N

Fixed Attenuators — Coaxial 50Ω Continued

Model Number	Frequency Range (MHz)	Attenuation (dB)	Flatness (dB)	VSWR (:1)	Input Power (W)	Connector Type
VAT-30+	DC-6000	30	1.3	1.25	0.5	SMA
VAT-30W2+	DC-6000	30	1.3	1.6	2	SMA
NAT-6DC-1A+	600-4000	6	0.8	1.7	1	N
NAT-10DC-1.5A+	1000-4000	10	0.6	1.6	1	N
NAT-10DC-1A+	600-4000	10	0.6	1.6	1	N
NAT-15DC-1.5A+	950-4000	15	0.6	1.6	1	N
NAT-15DC-1A+	650-4000	15	0.8	1.7	1	N
BW-40N100W+	DC-4000	40	1.4	1.4	100	N
BW-40TMNF100W+	DC-4000	40	-	1.3	100	TNC/N
NAT-6DC-2A+	1000-3750	6	0.8	1.6	1	N
NAT-3DC-1A+	650-3500	3	0.7	1.6	1	N
NAT-3DC-2A+	1000-3500	3	0.8	1.7	1	N
NAT-6DC-3A+	1700-3500	6	0.8	1.5	1	N
NAT-3DC+	200-2500	3	0.8	1.1	0.5	N
NAT-6DC+	200-2500	6	0.8	1.1	0.375	N
NAT-10DC+	200-2500	10	1	1.2	0.6	N
NAT-20DC+	500-2300	20	1.2	1.1	0.4	N
HAT-1+	DC-2000	1	0.15	1.1	1	BNC
HAT-2+	DC-2000	2	0.15	1.1	1	BNC
HAT-3+	DC-2000	3	0.15	1.1	1	BNC
HAT-4+	DC-2000	4	0.15	1.1	1	BNC
HAT-5+	DC-2000	5	0.15	1.1	1	BNC
HAT-6+	DC-2000	6	0.15	1.1	1	BNC
HAT-7+	DC-2000	7	0.15	1.1	1	BNC
HAT-8+	DC-2000	8	0.15	1.1	1	BNC
HAT-9+	DC-2000	9	0.15	1.1	1	BNC
HAT-10+	DC-2000	10	0.1	1.1	1	BNC
SF-BM-10+	DC-2000	10	0.1	1.1	0.5	SMA - BNC

Fixed Attenuators — Coaxial 50Ω Continued

Model Number	Frequency Range (MHz)	Attenuation (dB)	Flatness (dB)	VSWR (:1)	Input Power (W)	Connector Type
SM-BF-10+	DC-2000	10	0.1	1.1	0.5	SMA - BNC
HAT-12+	DC-2000	12	0.1	1.15	1	BNC
HAT-15+	DC-2000	15	0.2	1.15	1	BNC
HAT-20+	DC-2000	20	0.25	1.15	0.5	BNC
HAT-30+	DC-2000	30	0.8	1.15	1	BNC
SAT-3DC-3A+	100-500	3	0.7	1.1	0.01	SMA
SAT-6DC-3A+	100-500	6	0.7	1.1	0.01	SMA
SAT-10DC-3A+	100-500	10	0.6	1.1	0.01	SMA

Fixed Attenuators — Coaxial 75Ω

Model Number	Frequency Range (MHz)	Attenuation (dB)	Flatness (dB)	VSWR (:1)	Input Power (W)	Connector Type
HAT-3-75	DC-2000	3	0.15	1.22	0.5	BNC
HAT-3-75+	DC-2000	3	0.15	1.22	0.5	BNC
HAT-6-75+	DC-2000	6	0.15	1.15	0.5	BNC
HAT-10-75+	DC-2000	10	0.05	1.1	0.5	BNC
HAT-15-75+	DC-2000	15	0.05	1.1	0.5	BNC
HAT-20-75+	DC-2000	20	0.05	1.1	0.5	BNC

Programmable Attenuators

- USB, Ethernet, SPI and RS232 control options
- Models up to 40 GHz
- Attenuation ranges from 0 up to 120 dB
- Step size as small as 0.1 dB
- User-friendly GUI and full API included
- See more details in Test Solutions

Programmable Attenuators — Coaxial, USB / Ethernet / RS232

Model Number	# of Channels	Frequency Range (MHz)	Attenuation Range (dB)	Attenuation Step (dB)	Attenuation Accuracy (dB)	Input Power (dBm), Max	IP3 (dB)	Control Interface	Connector Type
RCDAT-50G-30	1	100-50000	31.5	0.5	1.0	28	50	USB & Ethernet	2.92 mm
RCDAT-40G-30	1	100-40000	30	0.5	1.0	24	38	USB & Ethernet	2.92mm
RUDAT-13G-90	1	10-13000	90	0.5	0.6	23	41	USB, SPI & RS232	SMA
RUDAT-13G-60	1	10-13000	60	0.5	0.5	23	41	USB, SPI & RS232	SMA
RC4DAT-8G-95	4	1-8000	95	0.25	0.8	28	51	USB & Ethernet	SMA
RC8DAT-8G-95	8	1-8000	95	0.25	1.8	28	51	USB & Ethernet	SMA
RCDAT-8000-90	1	1-8000	90	0.25	0.8	28	51	USB & Ethernet	SMA
RCDAT-8000-60	1	1-8000	60	0.25	0.75	28	51	USB & Ethernet	SMA
RCDAT-8000-30	1	1-8000	30	0.25	0.4	28	52	USB & Ethernet	SMA
RCDAT-6G-120H	1	200-6000	120	0.05	1.0	23	51	USB & Ethernet	SMA
RC4DAT-6G-95	4	1-6000	95	0.25	0.4	20	54	USB & Ethernet	SMA
RC4DAT-6G-60	4	1-6000	63	0.25	0.6	23	53	USB & Ethernet	SMA
RC4DAT-6G-30	4	1-6000	30	0.25	0.35	23	53	USB & Ethernet	SMA
RCDAT-6000-110	1	1-6000	110	0.25	0.45	20	53	USB & Ethernet	SMA
RCDAT-6000-90	1	1-6000	90	0.25	0.4	20	54	USB & Ethernet	SMA
RCDAT-6000-60	1	1-6000	60	0.25	0.3	20	55	USB & Ethernet	SMA
RCDAT-6000-30	1	1-6000	30	0.25	0.4	20	56	USB & Ethernet	SMA
RUDAT-6000-110	1	1-6000	110	0.25	0.45	20	53	USB & RS232	SMA



Programmable Attenuators — Coaxial, USB / Ethernet / RS232 Continued

Model Number	# of Channels	Frequency Range (MHz)	Attenuation Range (dB)	Attenuation Step (dB)	Attenuation Accuracy (dB)	Input Power (dBm), Max	IP3 (dB)	Control Interface	Connector Type
RUDAT-6000-90	1	1-6000	90	0.25	0.4	20	50	USB & RS232	SMA
RUDAT-6000-60	1	1-6000	60	0.25	0.3	20	50	USB & RS232	SMA
RUDAT-6000-30	1	1-6000	30	0.25	0.3	20	50	USB & RS232	SMA
RCDAT-4000-120	1	1-4000	120	0.25	0.5	20	53	USB & Ethernet	SMA
RUDAT-4000-120	1	1-4000	120	0.25	0.5	20	53	USB & RS232	SMA
RCDAT-3000-63W2	1	50-3000	63	1	0.4	33	54	USB & Ethernet	SMA
ZVVA-3000	1	20-3000	25	0.1	0.7	23	52	USB & RS232	SMA

Voltage Variable Attenuators — Surface Mount Continued

Model Number	Frequency Range (MHz)	Attenuation (dB)	IP3 (dBm)	Return Loss (dB)	Max Control Voltage (V)	Max Control Voltage (mA)
RVA-2000+	150-2000	35	56	22	17	30
RVA-2000V3+	50-2000	43	49	23	10	20
RVA-2000V35+	50-2000	47	53	19	5	20
SVA-2000+	50-2000	29	44	21	12	5
EVA-1500+	100-1500	30	50	20	5	7
VACC-09+	600-1200	20	48	20	6	10
MVA-1000+	50-1000	13	52	20	5	15
RVA-800+	50-800	9	18	23	5	17
HVA-451+	250-450	32	50	22	6	10
SYVA-30+	16-30	32	48	25	4	4

Voltage Variable Attenuators

- Models from 10 MHz to 7 GHz
- Precise attenuation control up to 47 dB
- Good return loss, up to 25 dB
- High IP3, up to +53 dBm
- Connectorized and surface mount formats

Voltage Variable Attenuators — Surface Mount

Model Number	Frequency Range (MHz)	Attenuation (dB)	IP3 (dBm)	Return Loss (dB)	Max Control Voltage (V)	Max Control Voltage (mA)
HVA-73+	5500-7000	27	48	17	6	10
RVA-6000+	2000-6000	32.7	43	20	12	10
EVA-3000+	50-3000	29	45	22	8	40
RVA-33+	20-3000	45	50	18	5	45
RVA-3000R+	20-3000	44	56	21	17	30
RVA-2500+	10-2500	41	43	20	17	30
VACC-22+	1600-2200	23	42	20	5	10
MVA-2000+	10-2000	28	48	23	12	15

Voltage Variable Attenuators — Surface Mount 75Ω

Model Number	Frequency Range (MHz)	Attenuation (dB)	IP3 (dBm)	Return Loss (dB)	Max Control Voltage (V)	Max Control Voltage (mA)
RVA-2500-75+	10-2500	40	45	15	15	20
EVA-23-75+	10-2000	33	50	16	8	15
EVA-2-75+	50-2000	30	49	25	8	40

Voltage Variable Attenuators — Coaxial

Model Number	Frequency Range (MHz)	Attenuation (dB)	IP3 (dBm)	Return Loss (dB)	Max Control Voltage (V)	Max Control Voltage (mA)
ZX73-123+	6000-12000	20	23	15	0.9	40
ZX73-2500-S+	10-2500	40	43	20	17	30

Attenuator Designer Kits

Model Number	Model Series	Description	Package	Models Included in Kit	Qty. Ea.	Total Qty.
K2-BW1+	BW	DC to 18 GHz 2 Watts	SMA Connectorized	BW-S3W2+ -S6W2+ -S10W2+	2	6
K2-BW2+	BW	DC to 18 GHz 2 Watts	SMA Connectorized	BW-S3W2+ -S6W2+ -S10W2+ -S20W2+ -S30W2+ -S40W2+	1	6
K2-BW3+	BW	DC to 18 GHz 2 Watts	SMA Connectorized	BW-S1W2+ -S2W2+ -S3W2+ -S4W2+ -S5W2+ -S6W2+ -S7W2+ -S8W2+ -S9W2+ -S10W2+	1	10
K5-BW1+	BW	DC to 18 GHz 5 Watts	SMA Connectorized	BW-S1W5+ -S2W5+ -S3W5+ -S4W5+ -S5W5+ -S6W5+ -S8W5+ -S10W5+	1	8
K5-BW2+	BW	DC to 18 GHz 5 Watts	SMA Connectorized	BW-S3W5+ BW-S6W5+ BW-S10W5+	1 2	4
K5N-BW3+	BW	DC to 18 GHz 5 Watts	N Connectorized	BW-N3W5+ BW-N6W5+ BW-N10W5+	1 2	4

Model Number	Model Series	Description	Package	Models Included in Kit	Qty. Ea.	Total Qty.
K1-GAT+	GAT	DC to 8 GHz 0.5 Watts	Modified QFN	GAT-2+ -3+ -4+ -6+ -8+ -10+ -15+ -20+ -30+	5	45
K2-GAT+	GAT	DC to 8 GHz 0.5 Watts	Modified QFN	GAT-3+ -6+ -10+ -15+ -20+	5	25
K3-GAT+	GAT	DC to 8 GHz 0.5 Watts	Modified QFN	GAT-0+ -1+ -2+ -3+ -4+ -5+ -6+ -7+ -8+ -9+ -10+ -12+ -15+ -20+ -30+	5	75
K1-HAT+	HAT	DC to 2 GHz 1 Watts	BNC Connectorized	HAT-3+ -6+ -10+ -20+ -30+	1	5



Designer Kits Continued

Model Number	Model Series	Description	Package	Models Included in Kit	Qty. Ea.	Total Qty.
K2-HAT+	HAT	DC to 2 GHz 1 Watts	BNC Connectorized	HAT-1+ -2+ -3+ -4+ -5+ -6+ -7+ -8+ -9+ -10+	1	10
K1-KAT+	KAT	DC to 43.5 GHz 2 Watts	QFN	KAT-3+ -6+ -10+ -15+ -20+	10	50
K2-KAT+	KAT	DC to 43.5 GHz 2 Watts	QFN	KAT-0+ -1+ -2+ -3+ -4+ -5+ -6+ -7+ -8+ -9+ -10+ -12+ -15+ -20+ -30+	5	75

Model Number	Model Series	Description	Package	Models Included in Kit	Qty. Ea.	Total Qty.
K2-KAT-DG+	KAT	DC to 43.5 GHz 2 Watts	DIE	KAT-0+ -1+ -2+ -3+ -4+ -5+ -6+ -7+ -8+ -9+ -10+ -12+ -15+ -20+ -30+	5	75
K1-LAT+	LAT	DC to 2.5 GHz 0.5 Watts	Leaded SMT	LAT-3+ -6+ -10+ -15+ -20+ LAT-1+ -2+ -4+ -5+ -7+ -8+ -9+ -12+	4 2	36
K1-PAT+	GAT	DC to 7 GHz 1 Watts	QFN	PAT-3+ -6+ -10+ -15+ -20+	4	20



Designer Kits Continued

Model Number	Model Series	Description	Package	Models Included in Kit	Qty. Ea.	Total Qty.
K2-KAT-DG+	KAT	DC to 43.5GHz 2 Watts,	DIE	KAT-0+ -1+ -2+ -3+ -4+ -5+ -6+ -7+ -8+ -9+ -10+ -12+ -15+ -20+ -30+	5	75
K1-LAT+	LAT	DC to 2.5GHz 0.5 Watts	Leaded SMT	LAT-3+ -6+ -10+ -15+ -20+ LAT-1+ -2+ -4+ -5+ -7+ -8+ -9+ -12+	4 2	36
K1-PAT+	GAT	DC to 7GHz 1 Watts	QFN	PAT-3+ -6+ -10+ -15+ -20+	4	20

Model Number	Model Series	Description	Package	Models Included in Kit	Qty. Ea.	Total Qty.
K1-VAT2+	VAT	DC to 6 GHz 2 Watts	SMA Connectorized	VAT-3W2+ -6W2+ -10W2+ -20W2+ -30W2+	1	5
K2-VAT2+	VAT	DC to 6 GHz 2 Watts	SMA Connectorized	VAT-1W2+ -2W2+ -3W2+ -4W2+ -5W2+ -6W2+ -7W2+ -8W2+ -9W2+ -10W2+	1	10
K3-VAT2+	VAT	DC to 6 GHz 2 Watts	SMA Connectorized	VAT-3W2+ -6W2+ -10W2+	2	6
K4-VAT2+	VAT	DC to 6 GHz 2 Watts	SMA Connectorized	VAT-3W2+ -6W2+ -10W2+ -20W2+	1	4
K1-UNAT+	UNAT	DC to 6 GHz 0.5 and 1 Watts	N Connectorized	UNAT-3+ -6+ -10+ -15+ -20+	2	10
K2-UNAT+	UNAT	DC to 6 GHz 0.5 and 1 Watts	N Connectorized	UNAT-1+ -2+ -3+ -4+ -5+ -6+ -7+ -8+ -9+ -10+ -15+ -20+ -30+	1	13



Designer Kits Continued

Model Number	Model Series	Description	Package	Models Included in Kit	Qty. Ea.	Total Qty.
K1-YAT+	YAT	DC to 18 GHz Up to 2 Watts	QFN	YAT-3+ -6+ -10+ -15+ -20+	10	50
K2-YAT+	YAT	DC to 18 GHz Up to 2 Watts	QFN	YAT-0+ -3+ -4+ -6+ -8+ -10+ -12+ -15+ -20+ -30+	10	100
K1-QAT+	QAT	DC to 50 GHz Up to 2 Watts	QFN	QAT-0+ -1+ -2+ -3+ -4+ -5+ -6+ -7+ -8+ -9+ -10+ -12+ -15+ -20+ -30+	5	75



Data Electronics Devices



Quoting, delivery and quality continues to exceed expectations.

— PLANNER / BUYER





100 KHZ TO 28 GHZ

Bias Tees

Wideband, High-Current

- DC current up to 5A
- RF power up to 40W
- Mux-tees (bias tee + diplexers)
- Insertion loss as low as 0.15 dB
- Bandwidth as wide as 1.5 to 28 GHz in a single model

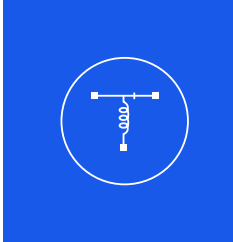

Bias Tees – Surface Mount

Model Number	Frequency Range (MHz)	Insertion Loss (dB)	Input Current (mA) Max.	DC port Isolation (dB)	VSWR (:1)
MBT-283+	1500-28000	0.7	500	47	1.22
TCBT-123+	10-12000	0.3	200	33	1.2
TCBT-14R+	10-10000	0.6	200	33	1.2
TCBT-14+	10-10000	0.35	200	33	1.2
TCBT-6G+	50-6000	0.7	200	28	1.1
RCBT-63+	10-6000	1	500	20	1.25
JEBT-4R2GW+	0.1-4200	0.6	500	40	1.1
JEBT-4R2G+	10-4200	0.6	500	40	1.1
TCBT-2R5G+	20-2500	0.35	200	44	1.05

Bias Tees – Bare Die

Model Number	Frequency Range (MHz)	Insertion Loss (dB)	Input Current (mA) Max.	DC Port Isolation (dB)	VSWR (:1)
MBT-283-283-D+	1500-20000	0.7	500	47	1.22

Bias Tees – Coaxial

Model Number	Frequency Range (MHz)	Input Current (mA) Max.	Insertion Loss (dB)	DC port Isolation (dB)	VSWR (:1)	Connector Type
ZX85-12G-S+	0.2-12000	400	0.6	-	1.2	SMA
ZFBT-6G+	10-6000	500	0.6	40	1.13	SMA
ZFBT-6G-FT+	10-6000	500	0.6	-	1.13	SMA
ZFBT-6GW+	0.1-6000	500	0.6	40	1.13	SMA
ZFBT-6GW-FT+	0.1-6000	500	0.6	-	1.13	SMA
ZNBT-60-1W+	2.5-6000	500	0.6	45	1.1	BNC
ZX85-40W-63-S+	1000-6000	1000	0.5	-	1.4	SMA
ZFBT-4R2G+	10-4200	500	0.6	40	1.13	SMA
ZFBT-4R2G-FT+	10-4200	500	0.6	-	1.13	SMA
ZFBT-4R2GW+	0.1-4200	500	0.6	40	1.13	SMA

Bias Tees — Coaxial Continued

Model Number	Frequency Range (MHz)	Input Current (mA) Max.	Insertion Loss (dB)	DC port Isolation (dB)	VSWR (:1)	Connector Type
ZFBT-4R2GW-FT+	0.1-4200	500	0.6	-	1.13	SMA
ZFBT-352-FT+	300-3500	4000	0.5	23	1.1	SMA
ZFBT-33-75-FT+	10-3000	200	0.15	-	1.13	N
ZFBT-33W-75-FT+	1-3000	200	0.5	-	1.18	N
ZFBT-282-1.5A+	10-2800	1500	0.6	45	1.1	SMA
Z3BT-2R15G+	10-2150	2000	1.4	47	1.6	SMA
ZABT-80W-13-S+	20-1000	5000	0.6	50	1.2	SMA

Bias Tees — Plug-In

Model Number	Frequency Range (MHz)	Input Current (mA) Max.	Insertion Loss (dB)	DC port Isolation (dB)	VSWR (:1)
PBTC-3G+	10-3000	500	0.3	30	1.13
PBTC-3GW+	0.1-3000	500	0.3	30	1.13
PBTC-1GW+	0.1-1000	500	0.3	33	1.06

Coaxial Mux-Tees

- All-in-one bias tee and diplexer
- Ideal for powering satellite up-converters where IF, DC and 10 MHz clock reference are all injected on the same line.
- DC current up to 3A, voltage up to 48V
- Bi-directional operation

Mux-Tees — Coaxial

Model Number	Common Port (MHz)	Output Port Freq. (MHz)	IL/ISO (dB) COM-LP	IL/ISO (dB) COM-HP	IL/ISO (dB) LO-HP	VSWR (:1) COM	VSWR (:1) LP	VSWR (:1) HP	DC Current (ma)
Z4BT-2R15G+	10, 950-2150	10	0.5	65	50	-	1.4	-	2000
Z4BT-2R15G+	10, 950-2150	950-2150	90	0.4	50	-	-	1.2	2000
ZABT-2R15G+	10, 950-2150	10	0.5	65	40	-	1.4	-	3000
ZABT-2R15G+	10, 950-2150	950-2150	90	0.4	50	-	-	1.2	3000



Overview of Connector Types

F-Type

- Impedance: 75Ω
- Frequency range: DC to 4 GHz
- Outer diameter: 11 mm male, 9.5 mm female
- Coupling mechanism: threaded

MMCX

(Micro-Miniature CoaXial)

- Impedance: 50Ω
- Frequency range: DC to 6 GHz
- Outer diameter: 2.4 mm
- Coupling mechanism: snap-on

BNC

(Bayonet Neill-Concelman)

- Impedance: 50 and 75Ω
- Frequency range: DC to 11 GHz
- Outer diameter: 14 mm male, 11.1 mm female
- Coupling mechanism: bayonet coupling

N-Type

(Named after Paul Neill of Bell Labs)

- Impedance: 50 and 75Ω
- Frequency range: DC to 11 GHz (18 GHz in some cases)
- Outer diameter: 20.3 mm male, 15.7 mm female
- Coupling mechanism: threaded

SMA Quick-Connect

- Impedance: 50Ω
- Frequency range: DC to 18 GHz
- Outer diameter: 11 mm male, 9.5 mm female
- Coupling mechanism: push-on

DC TO 67 GHZ

Coaxial Cables

System Interconnect and Precision Test

- 375+ models in stock
- Custom assemblies available on request
- Rugged design and construction

Precision test cables

- Options for every environment: armored, phase stable, temperature stable, ultra-flexible and more

Interconnect cables

- Wide selection of connector options from SMA to 2.4 mm
- 0.141, 0.086 & 0.047" center diameter

VNA cables

- Crush & torque resistant
- Competitive pricing, starting at \$1,795 ea.

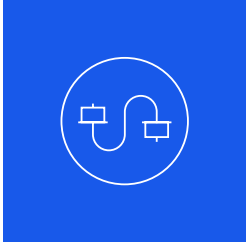

Connector Types Continued

SMA

(Sub-Miniature version A)

- Impedance: 50Ω
- Frequency range: DC to 26.5 GHz
- Outer diameter: 11 mm male, 9.5 mm female
- Coupling mechanism: threaded

SMA-RP

(Sub-Miniature version A—Reversed Polarity)

- Variation of standard SMA connector with the gender of the contact interface reversed
- Male connector has center receptacle
- Female connector has male contact pin
- Widely used in Wi-Fi equipment

SMP

(Sub-Miniature Push-On)

- Impedance: 50Ω
- Frequency range: DC to 40 GHz
- Outer diameter: 3.3 mm
- Coupling mechanism: push-on / snap-on

3.5 mm

- Impedance: 50Ω
- Frequency range: DC to 34 GHz
- Outer diameter: 3.5 mm
- Coupling mechanism: threaded

2.92 mm

("K Connector")

- Impedance: 50Ω
- Frequency range: DC to 40 GHz
- Outer diameter: 2.92 mm
- Coupling mechanism: threaded

2.92 mm (K) Network Measurement Division

(NMD) / Rugged Test Port Connector

- Variant of the 2.92 mm connector designed to mate directly with VNA ports
- Wider connector body stabilizes the cable-connector interface

2.4 mm

- Impedance: 50Ω
- Frequency range: DC to 50 GHz
- Outer diameter: 2.4 mm
- Coupling mechanism: threaded

2.4 mm Network Measurement Device

(NMD) / Rugged Test Port Connector

- Variant of the 2.4 mm connector designed to mate directly with VNA ports
- Wider connector body stabilizes the cable-connector interface

SMPM

(Sub-Miniature Push-On, Micro)

- Impedance: 50Ω
- Frequency range: DC to 65 GHz
- Outer diameter: 2.92 mm male, 2.4 mm female
- Coupling mechanism: push-on

1.85 mm

- Impedance: 50Ω
- Frequency range: DC to 67 GHz
- Outer diameter: 1.85 mm
- Coupling mechanism: threaded

Flexible Interconnect Cables

- Designed for interconnection of coaxial components and sub-systems
- Flexible construction with excellent shielding up to 40 GHz
- 0.141", 0.086" and 0.047" diameters
- N-type, SMA, SMP, 3.5, 2.92 and 2.4 mm connector options

Flexible Interconnect Cables						
Model Number	Connector 1	Connector 2	Diameter (In.)	Length (Ft.)	Frequency High (GHz)	Insertion Loss (dB)
FL47-12VM+	2.4mm Male	2.4mm Male	0.047	1.0	50.0	3.2
FL47-6VM+	2.4mm Male	2.4mm Male	0.047	0.5	50.0	2.36
FL86-12VM+	2.4mm Male	2.4mm Male	0.086	1.0	50.0	1.96
FL47-12KM+	2.92mm Male	2.92mm Male	0.047	1.0	40.0	2.7
FL47-12KMVM+	2.92mm Male	2.4mm Male	0.047	1.0	40.0	2.8
FL47-12SSMP+	SMPM Female	SMPM Female	0.047	1.0	40.0	2.7
FL47-12SSMPKM+	SMPM Female	2.92mm Male	0.047	1.0	40.0	2.7
FL47-12SSMPVM+	SMPM Female	2.4mm Male	0.047	1.0	40.0	2.8
FL47-6KM+	2.92mm Male	2.92mm Male	0.047	0.5	40.0	2.1
FL47-6SSMP+	SMPM Female	SMPM Female	0.047	0.5	40.0	2.5
FL47-6SSMPKM+	SMPM Female	2.92mm Male	0.047	0.5	40.0	2.36
FL47-6SSMPVM+	SMPM Female	2.4mm Male	0.047	0.5	40.0	2.36
FL086-12KM+	2.92mm Male	2.92mm Male	0.086	1.0	40.0	1.5
FL086-3KM+	2.92mm Male	2.92mm Male	0.086	0.25	40.0	0.5
FL086-4KM+	2.92mm Male	2.92mm Male	0.086	0.33	40.0	0.6
FL086-6KM+	2.92mm Male	2.92mm Male	0.086	0.5	40.0	0.8
FL86-12KMVM+	2.92mm Male	2.4mm Male	0.086	1.0	40.0	1.6
FL86-12SSMP+	SMPM Female	SMPM Female	0.086	1.0	40.0	1.86
FL86-12SSMPKM+	SMPM Female	2.92mm Male	0.086	1.0	40.0	1.79
FL86-12SSMPVM+	SMPM Female	2.4mm Male	0.086	1.0	40.0	1.81
FL86-12SMPKM+	SMP Female	2.92mm Male	0.086	1.0	33.0	1.46
FL86-12SMPVM+	SMP Female	2.4mm Male	0.086	1.0	33.0	1.45

Flexible Interconnect Cables Continued

Model Number	Connector 1	Connector 2	Diameter (In.)	Length (Ft.)	Frequency High (GHz)	Insertion Loss (dB)
FL86-12SSMPSMP+	SMPM Female	SMP Female	0.086	1.0	33.0	1.45
FL086-12-35M+	3.5mm Male	3.5mm Male	0.086	1.0	26.5	1.2
FL086-6-35M+	3.5mm Male	3.5mm Male	0.086	0.5	26.5	0.6
FL86-12SMP+	SMP Female	SMP Female	0.086	1.0	26.5	1.45
FL086-12NM+	N-Type Male	N-Type Male	0.086	1.0	18.0	0.6
FL086-12SM+	SMA Male	SMA Male	0.086	1.0	18.0	0.9
FL086-12SMNM+	N-Type Male	SMA Male	0.086	1.0	18.0	0.7
FL086-24NM+	N-Type Male	N-Type Male	0.086	2.0	18.0	1.4
FL086-24SM+	SMA Male	SMA Male	0.086	2.0	18.0	1.5
FL086-24SMNM+	N-Type Male	SMA Male	0.086	2.0	18.0	1.4
FL086-6NM+	N-Type Male	N-Type Male	0.086	0.5	18.0	0.3
FL086-6SM+	SMA Male	SMA Male	0.086	0.5	18.0	0.4
FL086-6SMNM+	N-Type Male	SMA Male	0.086	0.5	18.0	0.3
FL086-9SM+	SMA Male	SMA Male	0.086	0.75	18.0	0.64
FL141-12NM+	N-Type Male	N-Type Male	0.141	1.0	18.0	0.4
FL141-12SM+	SMA Male	SMA Male	0.141	1.0	18.0	0.5
FL141-12SMNM+	N-Type Male	SMA Male	0.141	1.0	18.0	0.4
FL141-24NM+	N-Type Male	N-Type Male	0.141	2.0	18.0	0.9
FL141-24SM+	SMA Male	SMA Male	0.141	2.0	18.0	1.0
FL141-24SMNM+	N-Type Male	SMA Male	0.141	2.0	18.0	0.9
FL141-6NM+	N-Type Male	N-Type Male	0.141	0.5	18.0	0.2
FL141-6SM+	SMA Male	SMA Male	0.141	0.5	18.0	0.3
FL141-6SMNM+	N-Type Male	SMA Male	0.141	0.5	18.0	0.2
FL141-9SM+	SMA Male	SMA Male	0.141	0.75	18.0	0.37

HandFlex® Interconnect Cables

- Flexible, hand-formable construction maintains shape after bending
- Designed for interconnection of coaxial components and sub-systems
- 0.141", 0.086" and 0.047" diameters
- Ideal replacement for semi-rigid cables
- BNC, N-Type, MMCX, SMA, SMP and 2.92 mm connector options
- Straight and right angle (0° and 180° clocked) orientations, bulkhead mountings available

HandFlex® Interconnect Cables						
Model Number	Connector 1	Connector 2	Diameter (In.)	Length (Ft.)	Frequency High (GHz)	Insertion Loss (dB)
086-3KM+	2.92 mm Male Straight	2.92 mm Male Straight Standard	0.086	0.25	40.0	0.49
086-4KM+	2.92 mm Male Straight	2.92 mm Male Straight Standard	0.086	0.33	40.0	0.6
086-6KM+	2.92 mm Male Straight	2.92 mm Male Straight Standard	0.086	0.5	40.0	0.89
086-9KM+	2.92 mm Male Straight	2.92 mm Male Straight Standard	0.086	0.75	40.0	1.4
086-12KM+	2.92 mm Male Straight	2.92 mm Male Straight Standard	0.086	1.0	40.0	1.7
086-15KM+	2.92 mm Male Straight	2.92 mm Male Straight Standard	0.086	1.25	40.0	2.2
086-18KM+	2.92 mm Male Straight	2.92 mm Male Straight Standard	0.086	1.5	40.0	2.4
086-24KM+	2.92 mm Male Straight	2.92 mm Male Straight Standard	0.086	2.0	40.0	3.2
047-3SMP+	SMP Female Straight	SMP Female Straight Standard	0.047	0.25	18.0	0.34
047-3SMPR+	SMP Female Right Angle 0° Clocked	SMP Female Right Angle 0° Clocked Standard	0.047	0.25	18.0	0.39
047-3SMPRC+	SMP Female Right Angle 180° Clocked	SMP Female Right Angle 0° Clocked Standard	0.047	0.25	18.0	0.39
047-3SMPSM+	SMA Male Straight	SMP Female Straight Standard	0.047	0.25	18.0	0.35
047-6SMP+	SMP Female Straight	SMP Female Straight Standard	0.047	0.5	18.0	0.72
047-6SMPR+	SMP Female Right Angle 0° Clocked	SMP Female Right Angle 0° Clocked Standard	0.047	0.5	18.0	0.75
047-6SMPRC+	SMP Female Right Angle 180° Clocked	SMP Female Right Angle 0° Clocked Standard	0.047	0.5	18.0	0.78
047-6SMPSM+	SMA Male Straight	SMP Female Straight Standard	0.047	0.5	18.0	0.75
047-12SMP+	SMP Female Straight	SMP Female Straight Standard	0.047	1.0	18.0	1.51
047-12SMPR+	SMP Female Right Angle 0° Clocked	SMP Female Right Angle 0° Clocked Standard	0.047	1.0	18.0	1.53

HandFlex® Interconnect Cables Continued

Model Number	Connector 1	Connector 2	Diameter (In.)	Length (Ft.)	Frequency High (GHz)	Insertion Loss (dB)
047-12SMPRC+	SMP Female Right Angle 180° Clocked	SMP Female Right Angle 0° Clocked Standard	0.047	1.0	18.0	1.55
047-12SMPSM+	SMA Male Straight	SMP Female Straight Standard	0.047	1.0	18.0	1.51
086-2SM+	SMA Male Straight	SMA Male Straight Standard	0.086	0.17	18.0	0.33
086-2SMR+	SMA Male Right Angle 0° Clocked	SMA Male Right Angle 0° Clocked Standard	0.086	0.17	18.0	0.47
086-2SMRC+	SMA Male Right Angle 180° Clocked	SMA Male Right Angle 0° Clocked Standard	0.086	0.17	18.0	0.47
086-3SBSM+	SMA Male Straight	SMA Female Straight Bulkhead	0.086	0.25	18.0	0.47
086-3SBSMR+	SMA Male Right Angle 0° Clocked	SMA Female Straight Bulkhead	0.086	0.25	18.0	0.36
086-3SM+	SMA Male Straight	SMA Male Straight Standard	0.086	0.25	18.0	0.31
086-3SMR+	SMA Male Right Angle 0° Clocked	SMA Male Right Angle 0° Clocked Standard	0.086	0.25	18.0	0.39
086-3SMRC+	SMA Male Right Angle 180° Clocked	SMA Male Right Angle 0° Clocked Standard	0.086	0.25	18.0	0.45
086-3SMRSM+	SMA Male Straight	SMA Male Right Angle 0° Clocked Standard	0.086	0.25	18.0	0.38
086-4SBSMR+	SMA Male Right Angle 0° Clocked	SMA Female Straight Bulkhead	0.086	0.33	18.0	0.56
086-4SM+	SMA Male Straight	SMA Male Straight Standard	0.086	0.33	18.0	0.34
086-4SMR+	SMA Male Right Angle 0° Clocked	SMA Male Right Angle 0° Clocked Standard	0.086	0.33	18.0	0.59
086-4SMRSM+	SMA Male Straight	SMA Male Right Angle 0° Clocked Standard	0.086	0.33	18.0	0.57
086-5SBSM+	SMA Male Straight	SMA Female Straight Bulkhead	0.086	0.42	18.0	0.42
086-5SBSMR+	SMA Male Right Angle 0° Clocked	SMA Female Straight Bulkhead	0.086	0.42	18.0	0.71
086-5SM+	SMA Male Straight	SMA Male Straight Standard	0.086	0.42	18.0	0.41
086-5SMPR+	SMP Female Right Angle 0° Clocked	SMP Female Right Angle 0° Clocked Standard	0.086	0.42	18.0	0.43
086-5SMR+	SMA Male Right Angle 0° Clocked	SMA Male Right Angle 0° Clocked Standard	0.086	0.42	18.0	0.66
086-5SMRSM+	SMA Male Straight	SMA Male Right Angle 0° Clocked Standard	0.086	0.42	18.0	0.57
086-6SBSM+	SMA Male Straight	SMA Female Straight Bulkhead	0.086	0.5	18.0	0.47
086-6SBSMR+	SMA Male Right Angle 0° Clocked	SMA Female Straight Bulkhead	0.086	0.5	18.0	0.76
086-6SM+	SMA Male Straight	SMA Male Straight Standard	0.086	0.5	18.0	0.52

HandFlex® Interconnect Cables Continued

Model Number	Connector 1	Connector 2	Diameter (In.)	Length (Ft.)	Frequency High (GHz)	Insertion Loss (dB)
086-6SMR+	SMA Male Right Angle 0° Clocked	SMA Male Right Angle 0° Clocked Standard	0.086	0.5	18.0	0.76
086-6SMRC+	SMA Male Right Angle 180° Clocked	SMA Male Right Angle 0° Clocked Standard	0.086	0.5	18.0	0.68
086-6SMRSM+	SMA Male Straight	SMA Male Right Angle 0° Clocked Standard	0.086	0.5	18.0	0.57
086-7SBSM+	SMA Male Straight	SMA Female Straight Bulkhead	0.086	0.58	18.0	0.59
086-7SM+	SMA Male Straight	SMA Male Straight Standard	0.086	0.58	18.0	0.6
086-7SMR+	SMA Male Right Angle 0° Clocked	SMA Male Right Angle 0° Clocked Standard	0.086	0.58	18.0	0.97
086-7SMRSM+	SMA Male Straight	SMA Male Right Angle 0° Clocked Standard	0.086	0.58	18.0	0.88
086-8SBSM+	SMA Male Straight	SMA Female Straight Bulkhead	0.086	0.67	18.0	0.7
086-8SBSMR+	SMA Male Right Angle 0° Clocked	SMA Female Straight Bulkhead	0.086	0.67	18.0	0.56
086-8SM+	SMA Male Straight	SMA Male Straight Standard	0.086	0.67	18.0	0.69
086-8SMPR+	SMP Female Right Angle 0° Clocked	SMP Female Right Angle 0° Clocked Standard	0.086	0.67	18.0	0.9
086-8SMPSM+	SMA Male Straight	SMP Female Straight Standard	0.086	0.67	18.0	0.63
086-8SMR+	SMA Male Right Angle 0° Clocked	SMA Male Right Angle 0° Clocked Standard	0.086	0.67	18.0	0.93
086-8SMRSM+	SMA Male Straight	SMA Male Right Angle 0° Clocked Standard	0.086	0.67	18.0	0.92
086-9SBSM+	SMA Male Straight	SMA Female Straight Bulkhead	0.086	0.75	18.0	0.72
086-9SM+	SMA Male Straight	SMA Male Straight Standard	0.086	0.75	18.0	0.79
086-9SMR+	SMA Male Right Angle 0° Clocked	SMA Male Right Angle 0° Clocked Standard	0.086	0.75	18.0	1.01
086-9SMRC+	SMA Male Right Angle 180° Clocked	SMA Male Right Angle 0° Clocked Standard	0.086	0.75	18.0	1.0
086-9SMRSM+	SMA Male Straight	SMA Male Right Angle 0° Clocked Standard	0.086	0.75	18.0	1.01
086-10SBSM+	SMA Male Straight	SMA Female Straight Bulkhead	0.086	0.83	18.0	0.78
086-10SM+	SMA Male Straight	SMA Male Straight Standard	0.086	0.83	18.0	0.85
086-10SMP+	SMP Female Straight	SMP Female Straight Standard	0.086	0.83	18.0	1.05
086-10SMPR+	SMP Female Right Angle 0° Clocked	SMP Female Right Angle 0° Clocked Standard	0.086	0.83	18.0	0.83
086-10SMR+	SMA Male Right Angle 0° Clocked	SMA Male Right Angle 0° Clocked Standard	0.086	0.83	18.0	1.16

HandFlex® Interconnect Cables Continued

Model Number	Connector 1	Connector 2	Diameter (In.)	Length (Ft.)	Frequency High (GHz)	Insertion Loss (dB)
086-10SMRSM+	SMA Male Straight	SMA Male Right Angle 0° Clocked Standard	0.086	0.83	18.0	1.12
086-11SBSM+	SMA Male Straight	SMA Female Straight Bulkhead	0.086	0.92	18.0	1.1
086-11SM+	SMA Male Straight	SMA Male Straight Standard	0.086	0.92	18.0	1.17
086-11SMR+	SMA Male Right Angle 0° Clocked	SMA Male Right Angle 0° Clocked Standard	0.086	0.92	18.0	1.22
086-11SMRSM+	SMA Male Straight	SMA Male Right Angle 0° Clocked Standard	0.086	0.92	18.0	0.8
086-12SBSM+	SMA Male Straight	SMA Female Straight Bulkhead	0.086	1.0	18.0	0.9
086-12SM+	SMA Male Straight	SMA Male Straight Standard	0.086	1.0	18.0	1.01
086-12SMR+	SMA Male Right Angle 0° Clocked	SMA Male Right Angle 0° Clocked Standard	0.086	1.0	18.0	1.3
086-12SMRC+	SMA Male Right Angle 180° Clocked	SMA Male Right Angle 0° Clocked Standard	0.086	1.0	18.0	1.22
086-12SMRSM+	SMA Male Straight	SMA Male Right Angle 0° Clocked Standard	0.086	1.0	18.0	1.24
086-13SM+	SMA Male Straight	SMA Male Straight Standard	0.086	1.08	18.0	1.0
086-14SBSM+	SMA Male Straight	SMA Female Straight Bulkhead	0.086	1.17	18.0	1.03
086-14SM+	SMA Male Straight	SMA Male Straight Standard	0.086	1.17	18.0	1.13
086-14SMR+	SMA Male Right Angle 0° Clocked	SMA Male Right Angle 0° Clocked Standard	0.086	1.17	18.0	1.49
086-14SMRSM+	SMA Male Straight	SMA Male Right Angle 0° Clocked Standard	0.086	1.17	18.0	1.36
086-15SM+	SMA Male Straight	SMA Male Straight Standard	0.086	1.25	18.0	1.19
086-15SMRSM+	SMA Male Straight	SMA Male Right Angle 0° Clocked Standard	0.086	1.25	18.0	1.43
086-16SBSM+	SMA Male Straight	SMA Female Straight Bulkhead	0.086	1.33	18.0	1.1
086-16SM+	SMA Male Straight	SMA Male Straight Standard	0.086	1.33	18.0	1.33
086-16SMRSM+	SMA Male Straight	SMA Male Right Angle 0° Clocked Standard	0.086	1.33	18.0	1.5
086-18SBSMR+	SMA Male Right Angle 0° Clocked	SMA Female Straight Bulkhead	0.086	1.5	18.0	1.71
086-18SM+	SMA Male Straight	SMA Male Straight Standard	0.086	1.5	18.0	1.41
086-18SMR+	SMA Male Right Angle 0° Clocked	SMA Male Right Angle 0° Clocked Standard	0.086	1.5	18.0	1.9
086-18SMRSM+	SMA Male Straight	SMA Male Right Angle 0° Clocked Standard	0.086	1.5	18.0	1.7

HandFlex® Interconnect Cables Continued

Model Number	Connector 1	Connector 2	Diameter (In.)	Length (Ft.)	Frequency High (GHz)	Insertion Loss (dB)
086-20SM+	SMA Male Straight	SMA Male Straight Standard	0.086	1.67	18.0	1.87
086-22SM+	SMA Male Straight	SMA Male Straight Standard	0.086	1.83	18.0	2.02
086-24SM+	SMA Male Straight	SMA Male Straight Standard	0.086	2.0	18.0	2.02
086-24SMR+	SMA Male Right Angle 0° Clocked	SMA Male Right Angle 0° Clocked Standard	0.086	2.0	18.0	1.7
086-24SMRSM+	SMA Male Straight	SMA Male Right Angle 0° Clocked Standard	0.086	2.0	18.0	2.25
086-36SM+	SMA Male Straight	SMA Male Straight Standard	0.086	3.0	18.0	2.44
141-2SM+	SMA Male Straight	SMA Male Straight Standard	0.141	0.17	18.0	0.15
141-2SMR+	SMA Male Right Angle 0° Clocked	SMA Male Right Angle 0° Clocked Standard	0.141	0.17	18.0	0.14
141-2SMRC+	SMA Male Right Angle 180° Clocked	SMA Male Right Angle 0° Clocked Standard	0.141	0.17	18.0	0.21
141-3NM+	N-Type Male Straight	N-Type Male Straight Standard	0.141	0.25	18.0	0.42
141-3SM+	SMA Male Straight	SMA Male Straight Standard	0.141	0.25	18.0	0.21
141-3SMR+	SMA Male Right Angle 0° Clocked	SMA Male Right Angle 0° Clocked Standard	0.141	0.25	18.0	0.2
141-3SMRC+	SMA Male Right Angle 180° Clocked	SMA Male Right Angle 0° Clocked Standard	0.141	0.25	18.0	0.2
141-3SMRSM+	SMA Male Straight	SMA Male Right Angle 0° Clocked Standard	0.141	0.25	18.0	0.28
141-4SBBSM+	SMA Male Straight	SMA Female Straight Bulkhead	0.141	0.33	18.0	0.21
141-4SM+	SMA Male Straight	SMA Male Straight Standard	0.141	0.33	18.0	0.2
141-4SMNM+	N-Type Male Straight	SMA Male Straight Standard	0.141	0.33	18.0	0.49
141-4SMR+	SMA Male Right Angle 0° Clocked	SMA Male Right Angle 0° Clocked Standard	0.141	0.33	18.0	0.31
141-4SMRC+	SMA Male Right Angle 180° Clocked	SMA Male Right Angle 0° Clocked Standard	0.141	0.33	18.0	0.45
141-4SMRSM+	SMA Male Straight	SMA Male Right Angle 0° Clocked Standard	0.141	0.33	18.0	0.39
141-5SM+	SMA Male Straight	SMA Male Straight Standard	0.141	0.42	18.0	0.29
141-5SMNM+	N-Type Male Straight	SMA Male Straight Standard	0.141	0.42	18.0	0.84
141-5SMR+	SMA Male Right Angle 0° Clocked	SMA Male Right Angle 0° Clocked Standard	0.141	0.42	18.0	0.4
141-5SMRC+	SMA Male Right Angle 180° Clocked	SMA Male Right Angle 0° Clocked Standard	0.141	0.42	18.0	0.56

HandFlex® Interconnect Cables Continued

Model Number	Connector 1	Connector 2	Diameter (In.)	Length (Ft.)	Frequency High (GHz)	Insertion Loss (dB)
141-5SMRSM+	SMA Male Straight	SMA Male Right Angle 0° Clocked Standard	0.141	0.42	18.0	0.31
141-6NM+	N-Type Male Straight	N-Type Male Straight Standard	0.141	0.5	18.0	0.35
141-6SBBSM+	SMA Male Right Angle 0° Clocked	SMA Female Straight Bulkhead	0.141	0.5	18.0	0.28
141-6SM+	SMA Male Straight	SMA Male Straight Standard	0.141	0.5	18.0	0.39
141-6SMNM+	N-Type Male Straight	SMA Male Straight Standard	0.141	0.5	18.0	0.67
141-6SMR+	SMA Male Right Angle 0° Clocked	SMA Male Right Angle 0° Clocked Standard	0.141	0.5	18.0	0.46
141-6SMRC+	SMA Male Right Angle 180° Clocked	SMA Male Right Angle 0° Clocked Standard	0.141	0.5	18.0	0.46
141-6SMRSM+	SMA Male Straight	SMA Male Right Angle 0° Clocked Standard	0.141	0.5	18.0	0.5
141-7NM+	N-Type Male Straight	N-Type Male Straight Standard	0.141	0.58	18.0	0.46
141-7SBBSM+	SMA Male Straight	SMA Female Straight Bulkhead	0.141	0.58	18.0	0.37
141-7SM+	SMA Male Straight	SMA Male Straight Standard	0.141	0.58	18.0	0.47
141-7SMNM+	N-Type Male Straight	SMA Male Straight Standard	0.141	0.58	18.0	0.27
141-7SMR+	SMA Male Right Angle 0° Clocked	SMA Male Right Angle 0° Clocked Standard	0.141	0.58	18.0	0.45
141-7SMRSM+	SMA Male Straight	SMA Male Right Angle 0° Clocked Standard	0.141	0.58	18.0	0.72
141-8NM+	N-Type Male Straight	N-Type Male Straight Standard	0.141	0.67	18.0	1.2
141-8SM+	SMA Male Straight	SMA Male Straight Standard	0.141	0.67	18.0	0.42
141-8SMNM+	N-Type Male Straight	SMA Male Straight Standard	0.141	0.67	18.0	0.86
141-8SMR+	SMA Male Right Angle 0° Clocked	SMA Male Right Angle 0° Clocked Standard	0.141	0.67	18.0	0.51
141-8SMRSM+	SMA Male Straight	SMA Male Right Angle 0° Clocked Standard	0.141	0.67	18.0	0.7
141-9SM+	SMA Male Straight	SMA Male Straight Standard	0.141	0.75	18.0	0.55
141-9SMR+	SMA Male Right Angle 0° Clocked	SMA Male Right Angle 0° Clocked Standard	0.141	0.75	18.0	0.58
141-9SMRC+	SMA Male Right Angle 180° Clocked	SMA Male Right Angle 0° Clocked Standard	0.141	0.75	18.0	0.72
141-9SMRSM+	SMA Male Straight	SMA Male Right Angle 0° Clocked Standard	0.141	0.75	18.0	0.72
141-10NM+	N-Type Male Straight	N-Type Male Straight Standard	0.141	0.83	18.0	0.53

HandFlex® Interconnect Cables Continued

Model Number	Connector 1	Connector 2	Diameter (In.)	Length (Ft.)	Frequency High (GHz)	Insertion Loss (dB)
141-10SM+	SMA Male Straight	SMA Male Straight Standard	0.141	0.83	18.0	0.59
141-10SMNM+	N-Type Male Straight	SMA Male Straight Standard	0.141	0.83	18.0	0.69
141-10SMRNM+	N-Type Male Straight	SMA Male Right Angle 0° Clock Standard	0.141	0.83	18.0	0.5
141-10SMRSM+	SMA Male Straight	SMA Male Right Angle 0° Clock Standard	0.141	0.83	18.0	0.8
141-11SM+	SMA Male Straight	SMA Male Straight Standard	0.141	0.92	18.0	0.57
141-11SMRSM+	SMA Male Straight	SMA Male Right Angle 0° Clock Standard	0.141	0.92	18.0	0.8
141-12NM+	N-Type Male Straight	N-Type Male Straight Standard	0.141	1.0	18.0	0.69
141-12SM+	SMA Male Straight	SMA Male Straight Standard	0.141	1.0	18.0	0.66
141-12SMNM+	N-Type Male Straight	SMA Male Straight Standard	0.141	1.0	18.0	0.77
141-12SMR+	SMA Male Right Angle 0° Clock	SMA Male Right Angle 0° Clock Standard	0.141	1.0	18.0	0.76
141-12SMRC+	SMA Male Right Angle 180° Clock	SMA Male Right Angle 0° Clock Standard	0.141	1.0	18.0	0.72
141-12SMRSM+	SMA Male Straight	SMA Male Right Angle 0° Clock Standard	0.141	1.0	18.0	0.8
141-13SM+	SMA Male Straight	SMA Male Straight Standard	0.141	1.08	18.0	0.5
141-13SMRSM+	SMA Male Straight	SMA Male Right Angle 0° Clock Standard	0.141	1.08	18.0	0.92
141-14SM+	SMA Male Straight	SMA Male Straight Standard	0.141	1.17	18.0	0.73
141-14SMRSM+	SMA Male Straight	SMA Male Right Angle 0° Clock Standard	0.141	1.17	18.0	1.03
141-15SM+	SMA Male Straight	SMA Male Straight Standard	0.141	1.25	18.0	0.85
141-15SMRSM+	SMA Male Straight	SMA Male Right Angle 0° Clock Standard	0.141	1.25	18.0	1.0
141-16SM+	SMA Male Straight	SMA Male Straight Standard	0.141	1.33	18.0	0.9
141-16SMRSM+	SMA Male Straight	SMA Male Right Angle 0° Clock Standard	0.141	1.33	18.0	1.04
141-17SM+	SMA Male Straight	SMA Male Straight Standard	0.141	1.42	18.0	0.96
141-17SMRSM+	SMA Male Straight	SMA Male Right Angle 0° Clock Standard	0.141	1.42	18.0	1.11
141-18SM+	SMA Male Straight	SMA Male Straight Standard	0.141	1.5	18.0	0.89
141-18SMNM+	N-Type Male Straight	SMA Male Straight Standard	0.141	1.5	18.0	1.19

HandFlex® Interconnect Cables Continued

Model Number	Connector 1	Connector 2	Diameter (In.)	Length (Ft.)	Frequency High (GHz)	Insertion Loss (dB)
141-18SMRSM+	SMA Male Straight	SMA Male Right Angle 0° Clock Standard	0.141	1.5	18.0	0.93
141-19SM+	SMA Male Straight	SMA Male Straight Standard	0.141	1.58	18.0	0.86
141-0.5MSM+	SMA Male Straight	SMA Male Straight Standard	0.141	1.64	18.0	0.86
141-20SM+	SMA Male Straight	SMA Male Straight Standard	0.141	1.67	18.0	0.92
141-20SMRSM+	SMA Male Straight	SMA Male Right Angle 0° Clock Standard	0.141	1.67	18.0	1.12
141-22SM+	SMA Male Straight	SMA Male Straight Standard	0.141	1.83	18.0	1.12
141-24NM+	N-Type Male Straight	N-Type Male Straight Standard	0.141	2.0	18.0	1.21
141-24SBSM+	SMA Male Straight	SMA Female Straight Bulkhead	0.141	2.0	18.0	1.1
141-24SM+	SMA Male Straight	SMA Male Straight Standard	0.141	2.0	18.0	1.12
141-24SMNM+	N-Type Male Straight	SMA Male Straight Standard	0.141	2.0	18.0	1.32
141-24SMRSM+	SMA Male Straight	SMA Male Right Angle 0° Clock Standard	0.141	2.0	18.0	1.55
141-26SM+	SMA Male Straight	SMA Male Straight Standard	0.141	2.17	18.0	1.2
141-30SM+	SMA Male Straight	SMA Male Straight Standard	0.141	2.5	18.0	1.27
141-32SM+	SMA Male Straight	SMA Male Straight Standard	0.141	2.67	18.0	1.3
141-36SBSMR+	SMA Male Right Angle 0° Clock	SMA Female Straight Bulkhead	0.141	3.0	18.0	1.6
141-36SM+	SMA Male Straight	SMA Male Straight Standard	0.141	3.0	18.0	1.51
141-36SMRSM+	SMA Male Straight	SMA Male Right Angle 0° Clock Standard	0.141	3.0	18.0	2.19
141-1MSM+	SMA Male Straight	SMA Male Straight Standard	0.141	3.28	18.0	1.67
141-40SM+	SMA Male Straight	SMA Male Straight Standard	0.141	3.33	18.0	1.9
141-50SM+	SMA Male Straight	SMA Male Straight Standard	0.141	4.17	18.0	2.5
141-1.5MSM+	SMA Male Straight	SMA Male Straight Standard	0.141	4.92	18.0	3.53
141-60SM+	SMA Male Straight	SMA Male Straight Standard	0.141	5.0	18.0	2.5
141-72SM+	SMA Male Straight	SMA Male Straight Standard	0.141	6.0	18.0	3.1
141-2MSM+	SMA Male Straight	SMA Male Straight Standard	0.141	6.56	18.0	3.36

HandFlex® Interconnect Cables Continued

Model Number	Connector 1	Connector 2	Diameter (In.)	Length (Ft.)	Frequency High (GHz)	Insertion Loss (dB)
141-6SMNB+	N-Type Female Straight Bulkhead	SMA Male Straight Standard	0.141	0.5	12.5	0.32
141-8SMNB+	N-Type Female Straight Bulkhead	SMA Male Straight Standard	0.141	0.67	12.5	0.32
141-10SMNB+	N-Type Female Straight Bulkhead	SMA Male Straight Standard	0.141	0.83	12.5	0.4
141-12SMNB+	N-Type Female Straight Bulkhead	SMA Male Straight Standard	0.141	1.0	12.5	0.58
141-14SMNB+	N-Type Female Straight Bulkhead	SMA Male Straight Standard	0.141	1.17	12.5	0.64
141-16SMNB+	N-Type Female Straight Bulkhead	SMA Male Straight Standard	0.141	1.33	12.5	0.76
141-18SMNB+	N-Type Female Straight Bulkhead	SMA Male Straight Standard	0.141	1.5	12.5	0.81
141-20SMNB+	N-Type Female Straight Bulkhead	SMA Male Straight Standard	0.141	1.67	12.5	1.01
141-24SMNB+	N-Type Female Straight Bulkhead	SMA Male Straight Standard	0.141	2.0	12.5	1.18
086-6SBMMCR+	MMCX Male Right Angle 0° Clock	SMA Female Straight Bulkhead	0.086	0.5	6.0	0.3
086-6BM+	BNC Male Straight	BNC Male Straight Standard	0.086	0.5	3.0	0.14
086-8BM+	BNC Male Straight	BNC Male Straight Standard	0.086	0.67	3.0	0.18
086-10BM+	BNC Male Straight	BNC Male Straight Standard	0.086	0.83	3.0	0.22
086-12BM+	BNC Male Straight	BNC Male Straight Standard	0.086	1.0	3.0	0.27
086-18BM+	BNC Male Straight	BNC Male Straight Standard	0.086	1.5	3.0	0.39
086-24BM+	BNC Male Straight	BNC Male Straight Standard	0.086	2.0	3.0	0.51
141-6BM+	BNC Male Straight	BNC Male Straight Standard	0.141	0.5	3.0	0.1
141-8BM+	BNC Male Straight	BNC Male Straight Standard	0.141	0.67	3.0	0.12
141-10BM+	BNC Male Straight	BNC Male Straight Standard	0.141	0.83	3.0	0.15
141-12BM+	BNC Male Straight	BNC Male Straight Standard	0.141	1.0	3.0	0.17
141-14BM+	BNC Male Straight	BNC Male Straight Standard	0.141	1.17	3.0	0.2
141-18BM+	BNC Male Straight	BNC Male Straight Standard	0.141	1.5	3.0	0.25
141-24BM+	BNC Male Straight	BNC Male Straight Standard	0.141	2.0	3.0	0.31

Super-Flexible Interconnect Cables, 0.047" Center Diameter

- 0.047" diameter
- Minimum bend radius of just 0.25 inches
- Double-shielded construction
- Excellent stability of performance vs. bend
- Performance qualified to 100,000 bend cycles

Super-Flexible Interconnect Cables, 0.047" Center Diameter

Model Number	Connector 1	Connector 2	Length (Ft.)	Frequency High (GHz)	Insertion Loss (dB)
SLC-2FT-SMSM+	SMA Male	SMA Male	2.0	18.0	2.9
SLC-3FT-SMSM+	SMA Male	SMA Male	3.0	18.0	4.4
SLC-1M-SMSM+	SMA Male	SMA Male	3.28	18.0	4.9
SLC-4FT-SMSM+	SMA Male	SMA Male	4.0	18.0	6.0
SLC-6FT-SMSM+	SMA Male	SMA Male	6.0	18.0	8.8

Armored Test Cables

- 18 GHz (N-Type) and 40 GHz (2.92 mm) models
- Armored construction with strain relief stands up to wear and tear in harsh environments
- Double and triple-shielded construction
- Outstanding stability of insertion loss, VSWR and phase vs. flex

Armored Test Cables

Model Number	Connector 1	Connector 2	Length (Ft.)	Frequency High (GHz)	Insertion Loss (dB)
KBL-1.5FT-LOW+	2.92 mm Male	2.92 mm Male	1.5	40.0	1.41
KBL-2FT-LOW+	2.92 mm Male	2.92 mm Male	2.0	40.0	1.74
KBL-1M-LOW+	2.92 mm Male	2.92 mm Male	3.28	40.0	3.05
KBL-4FT-LOW+	2.92 mm Male	2.92 mm Male	4.0	40.0	3.41

Armored Test Cables Continued

Model Number	Connector 1	Connector 2	Length (Ft.)	Frequency High (GHz)	Insertion Loss (dB)
KBL-2M-LOW+	2.92 mm Male	2.92 mm Male	6.56	40.0	5.46
APC-4FT-SMNM+	N-Type Male	SMA Male	4.0	18.0	2.55
APC-6FT-NMNM+	N-Type Male	N-Type Male	6.0	18.0	3.8
APC-10FT-NMNM+	N-Type Male	N-Type Male	10.0	18.0	6.3
APC-15FT-NMNM+	N-Type Male	N-Type Male	15.0	18.0	9.0

Economy Precision Test Cables

- Cost-effective options for precision measurements up to 67 GHz
- Stable performance in bend radii as tight as 10 mm
- 2.92 mm, 2.4 mm and 1.85 mm connector options

Economy Precision Test Cables

Model Number	Connector 1	Connector 2	Length (Ft.)	Frequency High (GHz)	Insertion Loss (dB)
E67-2FT-EMEM+	1.85 mm Male	1.85 mm Male	2.0	67.0	2.7
E67-3FT-EMEM+	1.85 mm Male	1.85 mm Male	3.0	67.0	4.2
E67-1M-EMEM+	1.85 mm Male	1.85 mm Male	3.28	67.0	5.5
E50-2FT-VMVM+	2.4 mm Male	2.4 mm Male	2.0	50.0	3.5
E50-3FT-VMVM+	2.4 mm Male	2.4 mm Male	3.0	50.0	6.3
E40-2FT-KMKM+	2.92 mm Male	2.92 mm Male	2.0	40.0	3.4
E40-3FT-KMKM+	2.92 mm Male	2.92 mm Male	3.0	40.0	5.1
E40-1M-KMKM+	2.92 mm Male	2.92 mm Male	3.28	40.0	5.4
E40-6FT-KMKM+	2.92 mm Male	2.92 mm Male	6.0	40.0	8.7

Flexible Test Cables

- DC to 26 GHz
- Stable performance in bend radii as tight as 2.4 inches
- SMA and N-Type connector options
- Performance qualified to 20,000 bend cycles

Flexible Test Cables

Model Number	Connector 1	Connector 2	Length (Ft.)	Frequency High (GHz)	Insertion Loss (dB)
FLC-1FT-SMSM+	SMA Male	SMA Male	1.0	26.0	1.1
FLC-1.5FT-SMSM+	SMA Male	SMA Male	1.5	26.0	1.26
FLC-2FT-SMSM+	SMA Male	SMA Male	2.0	26.0	1.61
FLC-3FT-SMSM+	SMA Male	SMA Male	3.0	26.0	2.5
FLC-1M-SMSM+	SMA Male	SMA Male	3.28	26.0	2.62
FLC-4FT-SMSM+	SMA Male	SMA Male	4.0	26.0	3.55
FLC-6FT-SMSM+	SMA Male	SMA Male	6.0	26.0	5.04
FLC-2M-SMSM+	SMA Male	SMA Male	6.56	26.0	5.5
FLC-2M-SMNM+	N-Type Male	SMA Male	6.56	18.0	4.03

Flexible Test Cables, Booted Joints

- DC to 18 GHz
- Stable performance in bend radii as tight as 2.0 inches
- SMA and N-Type connector options
- Molded boot around cable-connector interface protects against damage from handling in demanding lab environments

Flexible Test Cables, Booted Joints					
Model Number	Connector 1	Connector 2	Length (Ft.)	Frequency High (GHz)	Insertion Loss (dB)
ULC-1FT-SMSM+	SMA Male	SMA Male	1.0	18.0	0.7
ULC-1.5FT-SMSM+	SMA Male	SMA Male	1.5	18.0	1.4
ULC-2FT-NMNM+	N-Type Male	N-Type Male	2.0	18.0	1.6
ULC-2FT-SMNM+	N-Type Male	SMA Male	2.0	18.0	1.5
ULC-2FT-SMSM+	SMA Male	SMA Male	2.0	18.0	1.8
ULC-3FT-NMNM+	N-Type Male	N-Type Male	3.0	18.0	2.2
ULC-3FT-SMNM+	N-Type Male	SMA Male	3.0	18.0	2.2
ULC-3FT-SMSM+	SMA Male	SMA Male	3.0	18.0	2.7
ULC-1M-NMNM+	N-Type Male	N-Type Male	3.28	18.0	2.6
ULC-1M-SMNM+	N-Type Male	SMA Male	3.28	18.0	2.5
ULC-1M-SMSM+	SMA Male	SMA Male	3.28	18.0	2.8
ULC-4FT-NMNM+	N-Type Male	N-Type Male	4.0	18.0	4.0
ULC-4FT-SMNM+	N-Type Male	SMA Male	4.0	18.0	3.1
ULC-4FT-SMSM+	SMA Male	SMA Male	4.0	18.0	3.4
ULC-6FT-NMNM+	N-Type Male	N-Type Male	6.0	18.0	4.6
ULC-6FT-SMNM+	N-Type Male	SMA Male	6.0	18.0	4.4
ULC-6FT-SMSM+	SMA Male	SMA Male	6.0	18.0	5.2
ULC-2M-SMSM+	SMA Male	SMA Male	6.56	18.0	5.9
ULC-8FT-SMSM+	SMA Male	SMA Male	8.0	18.0	5.4
ULC-10FT-SMSM+	SMA Male	SMA Male	10.0	18.0	7.5

Precision Test Cables

- Reliable performance for precision measurements up to 50 GHz
- Good stability of insertion loss, VSWR and phase vs. flex
- Triple shielded construction
- SMA, N-Type, 2.92 mm and 2.4 mm connector options

Precision Test Cables					
Model Number	Connector 1	Connector 2	Length (Ft.)	Frequency High (GHz)	Insertion Loss (dB)
T50-2FT-VFVM+	2.4 mm Male	2.4 mm Female	2.0	50.0	2.2
T50-2FT-VMVM+	2.4 mm Male	2.4 mm Male	2.0	50.0	2.7
T50-3FT-VFVM+	2.4 mm Male	2.4 mm Female	3.0	50.0	3.7
T40-2FT-KFKM+	2.92 mm Male	2.92 mm Female	2.0	40.0	2.2
T40-2FT-KMKM+	2.92 mm Male	2.92 mm Male	2.0	40.0	2.2
T40-2FT-VFVM+	2.4 mm Male	2.4 mm Female	2.0	40.0	2.2
T40-3FT-KFKM+	2.92 mm Male	2.92 mm Female	3.0	40.0	3.3
T40-3FT-KMKM+	2.92 mm Male	2.92 mm Male	3.0	40.0	3.3
T40-3FT-VFVM+	2.4 mm Male	2.4 mm Female	3.0	40.0	3.3
CBL-1FT-SMSM+	SMA Male	SMA Male	1.0	18.0	0.75
CBL-1.5FT-SMSM+	SMA Male	SMA Male	1.5	18.0	1.0
CBL1.5SMQ-SM+	SMA Male	SMA Male	1.5	18.0	1.0
CBL-0.5M-NMNM+	N-Type Male	N-Type Male	1.64	18.0	1.2
CBL-0.5M-SMNM+	N-Type Male	SMA Male	1.64	18.0	1.2
CBL-0.5M-SMSM+	SMA Male	SMA Male	1.64	18.0	1.1
CBL-2FT-NMNM+	N-Type Male	N-Type Male	2.0	18.0	1.4
CBL-2FT-SFNM+	N-Type Male	SMA Female	2.0	18.0	1.4
CBL-2FT-SMNM+	N-Type Male	SMA Male	2.0	18.0	1.4
CBL-2FT-SMSM+	SMA Male	SMA Male	2.0	18.0	1.4
CBL2SMQ-NM+	N-Type Male	SMA Male Quick Connect	2.0	18.0	1.4
CBL2SMQ-SM+	SMA Male	SMA Male Quick Connect	2.0	18.0	1.4
CBL-3FT-NMNM+	N-Type Male	N-Type Male	3.0	18.0	1.9

Precision Test Cables Continued

Model Number	Connector 1	Connector 2	Length (Ft.)	Frequency High (GHz)	Insertion Loss (dB)
CBL-3FT-SFNM+	N-Type Male	SMA Female	3.0	18.0	1.9
CBL-3FT-SFSM+	SMA Male	SMA Female	3.0	18.0	1.9
CBL-3FT-SMNM+	N-Type Male	SMA Male	3.0	18.0	1.9
CBL-3FT-SMSM+	SMA Male	SMA Male	3.0	18.0	1.9
CBL3NMQ-NM+	N-Type Male	N-Type Male Quick Connect	3.0	18.0	2.0
CBL3NMQ-SM+	SMA Male	N-Type Male Quick Connect	3.0	18.0	1.9
CBL3NMQ-SMQ+	N-Type Male Quick Connect	SMA Male Quick Connect	3.0	18.0	1.9
CBL3SMQ-SM+	SMA Male	SMA Male Quick Connect	3.0	18.0	1.9
CBL-1M-NMNM+	N-Type Male	N-Type Male	3.28	18.0	2.3
CBL-1M-SMNM+	N-Type Male	SMA Male	3.28	18.0	2.2
CBL-1M-SMSM+	SMA Male	SMA Male	3.28	18.0	2.0
CBL-4FT-SMNM+	N-Type Male	SMA Male	4.0	18.0	2.55
CBL-4FT-SMSM+	SMA Male	SMA Male	4.0	18.0	2.55
CBL-1.5M-NMNM+	N-Type Male	N-Type Male	4.92	18.0	3.4
CBL-1.5M-SMNM+	N-Type Male	SMA Male	4.92	18.0	3.2
CBL-1.5M-SMSM+	SMA Male	SMA Male	4.92	18.0	3.1
CBL-5FT-NMNM+	N-Type Male	N-Type Male	5.0	18.0	2.5
CBL-5FT-SMSM+	SMA Male	SMA Male	5.0	18.0	3.4
CBL-6FT-NMNM+	N-Type Male	N-Type Male	6.0	18.0	3.8
CBL-6FT-SFNM+	N-Type Male	SMA Female	6.0	18.0	3.8
CBL-6FT-SMNM+	N-Type Male	SMA Male	6.0	18.0	3.8
CBL-6FT-SMSM+	SMA Male	SMA Male	6.0	18.0	3.8
CBL6NMQ-NM+	N-Type Male	N-Type Male Quick Connect	6.0	18.0	3.8
CBL6NMQ-SM+	SMA Male	N-Type Male Quick Connect	6.0	18.0	3.8
CBL6SMQ-SM+	SMA Male	SMA Male Quick Connect	6.0	18.0	3.8
CBL-2M-NMNM+	N-Type Male	N-Type Male	6.56	18.0	4.0
CBL-2M-SMNM+	N-Type Male	SMA Male	6.56	18.0	4.2
CBL-2M-SMSM+	SMA Male	SMA Male	6.56	18.0	4.0

Precision Test Cables Continued

Model Number	Connector 1	Connector 2	Length (Ft.)	Frequency High (GHz)	Insertion Loss (dB)
CBL-10FT-NMNM+	N-Type Male	N-Type Male	10.0	18.0	6.3
CBL-10FT-SMNM+	N-Type Male	SMA Male	10.0	18.0	6.06
CBL-10FT-SMSM+	SMA Male	SMA Male	10.0	18.0	6.1
CBL10SMQ-SM+	SMA Male	SMA Male Quick Connect	10.0	18.0	6.1
CBL-12FT-SMSM+	SMA Male	SMA Male	12.0	18.0	7.3
CBL-15FT-NMNM+	N-Type Male	N-Type Male	15.0	18.0	9.2
CBL-15FT-SMNM+	N-Type Male	SMA Male	15.0	18.0	9.2
CBL-15FT-SMSM+	SMA Male	SMA Male	15.0	18.0	9.25
CBL-20FT-NMNM+	N-Type Male	N-Type Male	20.0	18.0	12.0
CBL-20FT-SMSM+	SMA Male	SMA Male	20.0	18.0	12.5
CBL-25FT-NMNM+	N-Type Male	N-Type Male	25.0	18.0	15.0
CBL-25FT-SMSM+	SMA Male	SMA Male	25.0	18.0	15.0
CBL-50FT-SMSM+	SMA Male	SMA Male	50.0	18.0	31.0

75Ω Test Cables

- Perfect for testing 75Ω devices
- Wideband coverage, DC to 3000 covers the primary CATV system bandwidths
- Rugged construction, performance qualified to 20,000 flexures

Test Cables – 75Ω

Model Number	Connector 1	Connector 2	Length (Ft.)	Frequency High (GHz)	Insertion Loss (dB)
CBL-2FM-75+	F-Type Male	F-Type Male	2.0	3.0	0.61
CBL-3FM-75+	F-Type Male	F-Type Male	3.0	3.0	0.77
CBL-3NM-75+	N-Type Male	N-Type Male	3.0	3.0	0.7
CBL-1MFM-75+	F-Type Male	F-Type Male	3.28	3.0	0.89

Test Cables – 75Ω Continued

Model Number	Connector 1	Connector 2	Length (Ft.)	Frequency High (GHz)	Insertion Loss (dB)
CBL-4NM-75+	N-Type Male	N-Type Male	4.0	3.0	0.8
CBL-6FM-75+	F-Type Male	F-Type Male	6.0	3.0	1.43
CBL-6NM-75+	N-Type Male	N-Type Male	6.0	3.0	1.43

Precision VNA Cables

- DC to 67 GHz
- 2.92 mm rugged female connector mates directly with 67 GHz VNA ports
- Rugged construction, crush and torque resistant
- Excellent stability of performance vs. flexure

Precision VNA Cables

Model Number	Connector 1	Connector 2	Length (Ft.)	Frequency High (GHz)	Insertion Loss (dB)
VNAX-2FT-EMERF+	1.85 mm Female Rugged	1.85 mm Male Standard	2.0	67.0	3.7
VNAX-3FT-EMERF+	1.85 mm Female Rugged	1.85 mm Male Standard	3.0	67.0	5.36
VNAX-1M-EMERF+	1.85 mm Female Rugged	1.85 mm Male Standard	3.28	67.0	5.79
VNAX-2FT-VMVRF+	2.4 mm Female Rugged	2.4 mm Male Standard	2.0	50.0	2.4
VNAX-2FT-KMVRF+	2.4 mm Female Rugged	2.92 mm Male Standard	2.0	40.0	2.0
VNAC-2R1-K+	2.92 mm Female Rugged	2.92 mm Male Standard	2.08	40.0	2.3

Temperature Stable Cables

- DC to 40 GHz
- Stable RF performance from -55 to +105 °C
- Good stability of amplitude and phase vs. bend
- Ideal for HTOL and other high-temperature test environments

Temperature Stable Cables

Model Number	Connector 1	Connector 2	Length (Ft.)	Frequency High (GHz)	Insertion Loss (dB)
TMP40-3FT-KMKM+	2.92 mm Male	2.92 mm Male	3.0	40.0	2.4
TMP40-1M-KMKM+	2.92 mm Male	2.92 mm Male	3.28	40.0	2.6
TMP40-6FT-KMKM+	2.92 mm Male	2.92 mm Male	6.0	40.0	4.6

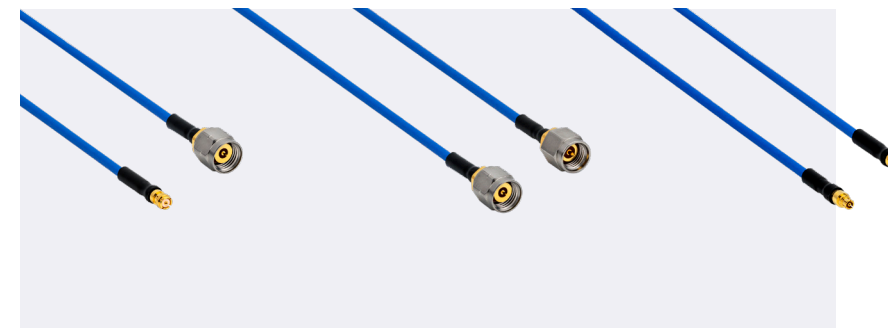

Cable Designer Kits

Model Number	Package	Description	Connector	Models Included in Kit	Qty. Ea.	Total Qty.
KHFC-1+	86 414	DC-18 GHz 3" Hand-Formable Interconnect Cables, SMA Male to SMA Male	SMA Male to SMA Male	086-3SM+	5	10
				141-3SM+		
KHFC1-047+	47	DC-18 GHz 6" Hand-Formable Interconnect Cables, 0.047" Diameter, Varying Connector Types	SMP Female to SMP Female SMP Female Right-Angle to SMP Female Right-Angle SMP Female to SMA Male SMP Female Right-Angle to SMA Male	047-6SMP+	5	20
				047-6SMPR+ 047-6SMPSM 047-6SMPRSM+		
KHFC2-086+	86	DC-18 GHz 2" to 12" Hand-Formable Interconnect Cables, 0.086" Diameter, SMA Male to SMA Male	SMA Male to SMA Male	086-2SM+	5	50
				086-3SM+ 086-4SM+ 086-5SM+ 086-6SM+ 086-7SM+ 086-8SM+ 086-9SM+ 086-10SM+ 086-12SM+		
KHFC3-086+	86	DC-18 GHz 3" to 24" Hand-Formable Interconnect Cables, 0.086" Diameter, SMA Male to SMA Male	SMA Male to SMA Male	086-3SM+	5	25
				086-6SM+ 086-12SM+ 086-18SM+ 086-24SM+		

Model Number	Package	Description	Connector	Models Included in Kit	Qty. Ea.	Total Qty.
KHFC4-086+	86	DC-18 GHz 6" Hand-Formable Interconnect Cables, 0.086" Diameter, Varying Connector Types	SMA Male to SMA Male SMA Female w/Bulkhead to SMA Female w/Bulkhead SMA Female w/Bulkhead to SMA Male SMA Male Right-Angle to SMA Male Right-Angle SMA Male Right-Angle to SMA Male	086-6SM+	3	15
				086-6SB+ 086-6SBSM+ 086-6SMR+ 086-6SMRSM+		
KHFC2-141+	141	DC-18 GHz 2" to 12" Hand-Formable Interconnect Cables, 0.141" Diameter, SMA Male to SMA Male	SMA Male to SMA Male	141-2SM+	5	50
				141-3SM+ 141-4SM+ 141-5SM+ 141-6SM+ 141-7SM+ 141-8SM+ 141-9SM+ 141-10SM+ 141-12SM+		
KHFC3-141+	141	DC-18 GHz 3" to 24" Hand-Formable Interconnect Cables, 0.141" Diameter, SMA Male to SMA Male	SMA Male to SMA Male	141-3SM+	5	25
				141-6SM+ 141-12SM+ 141-18SM+ 141-24SM+		
KTFC1-FL47+	47	DC-50 GHz 12" Flexible Interconnect Cables, 0.047" Diameter, Varying Connector Types	2.92 mm Male to 2.92 mm Male 2.4 mm Male to 2.4 mm Male 2.92 mm Male to 2.4 mm Male SMPM Female to SMPM Female SMPM Female to 2.92 mm Male SMPM Female to 2.4 mm Male	FL47-12KM+	2	12
				FL47-12VM+ FL47-12KMVM+ FL47-12SSMP+ FL47-12SSMPKM+ FL47-12SSMPVM+		

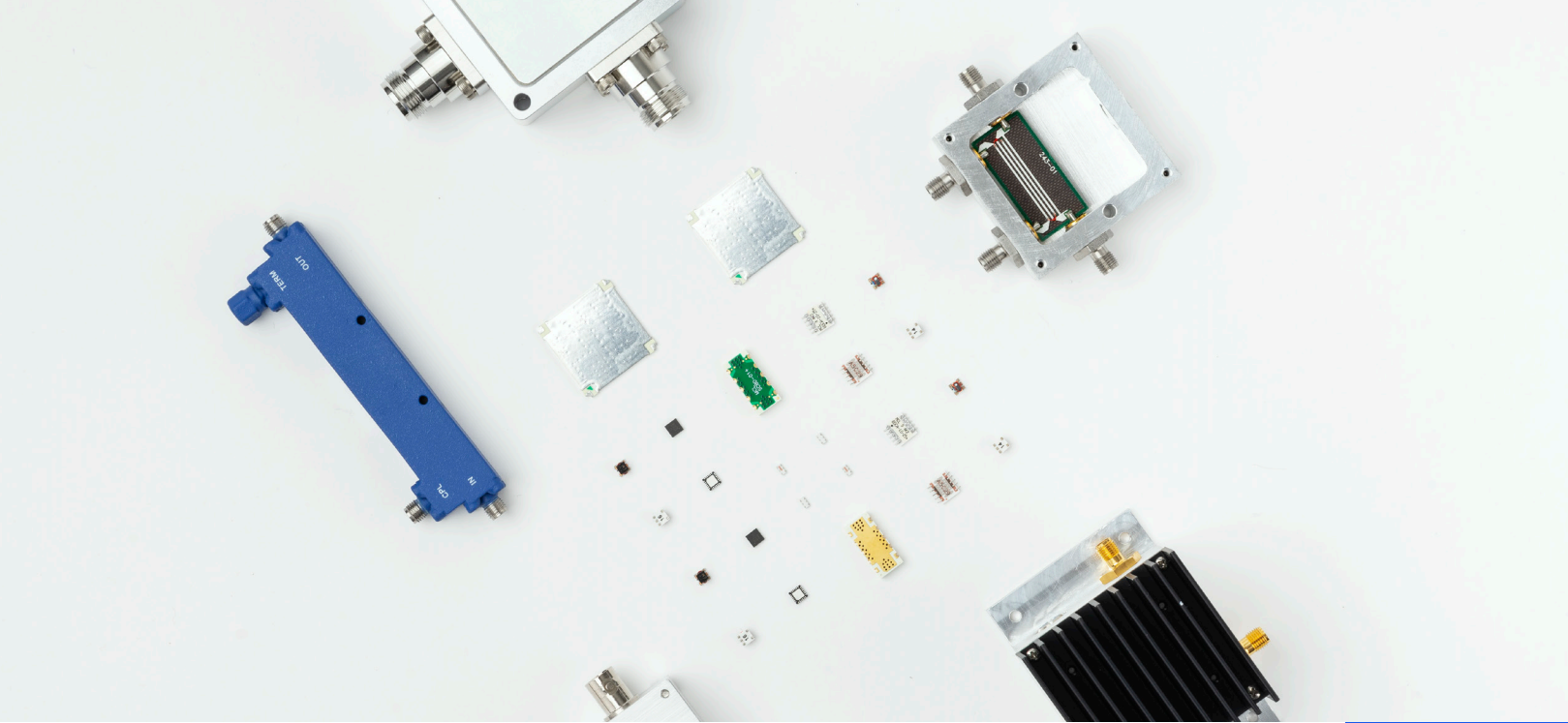

DC TO 65 GHZ

Couplers

Directional, Bi-Directional and RF Tap

- 400+ models in stock
- Power handling up to 250W
- Coupling from 6 to 50 dB
- DC passing and DC blocking

Technology for almost every application:

LTCC, MMIC, transformer/core and wire, microstrip/stripline, bridge

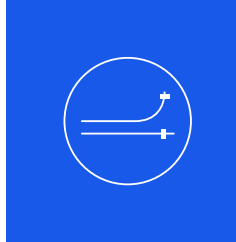

Technology Overview

Bridge

- Low-cost solution for S-parameter measurements, intermodulation measurements and other test applications
- High directivity, up to 32 dB
- Excellent wideband coupling flatness



LTCC

- Rugged ceramic construction
- Surface mount case styles as small as 0603
- Power handling up to 65W
- Excellent flatness vs. frequency
- Operating temperature up to 100° C



Microstrip/Stripline

- Power handling up to 250W
- Insertion loss as low as 0.01 dB
- Bandwidth as wide as 0.5 to 40 GHz in a single mode



MMIC

- Ultra-wide bandwidths up to 50 GHz
- Surface mount and bare die formats available
- Package sizes as small as 3.1 x 3.0 x 1.6 mm
- Excellent repeatability and value pricing for volume production



Transformer

- Excellent coupling flatness over wide bandwidths
- Power handling up to 100W
- 50 and 75Ω options
- Connectorized and surface mount case style



Directional — Surface Mount 50Ω

Model Number	Frequency Range (MHz)	Coupling (dB) Nom.	Mainline Loss (dB)	Directivity (dB)	VSWR (:1)	Power Input Max. (W)	Construction
EDC10-273+	6000-26500	10	1.4	15	1.329	0.63	MMIC
EDC21-24+	4000-20000	21	0.7	19	1.37	1.77	MMIC
EDC10-183+	6000-18000	10	1.3	16	1.329	0.63	MMIC
DCW-6-722+	4400-7200	6	2.5	10	2	2	LTCC
DCW-11-722+	2400-7200	13	0.7	12	1.3	1	LTCC
SEDC-10-63+	50-6000	10	4	27	1.5	1	Transformer
DCW-14-472+	3600-4700	14	0.7	10	2	2	LTCC
DCW-9-432+	2300-4300	9	1.3	14	1.8	2	LTCC
D17W+	700-3500	16-26	0.4	14	1.25	4	MMIC
DCW-6-352+	2300-3500	6	1.9	12	2	2	LTCC
SYD-20-33+	30-3000	20.8	1.6	15	1.2	1	Transformer
DBTC16-282LX+	5-2850	16.8	1.1	18	1.29	1	Transformer
TCD-17-282X+	5-2850	17	1.9	10	1.4	1	Transformer
D17IA+	2300-2600	17.1	0.4	14	1.1	4	MMIC
CPJC-6-252R+	2400-2500	6.5	1.27	18	1.2	2	LTCC
CPJC-10-252R+	2400-2500	10	0.65	19	1.33	2	LTCC
CPJC-17-252R+	2400-2500	17.65	0.14	12	1.06	2	LTCC
CPJC-21-252R+	2400-2500	21	0.3	19	1.1	2	LTCC
CPJC-28-252R+	2400-2500	28	0.3	10	1.05	2	LTCC
TCD-12-222X+	5-2250	12.6	2	10	1.43	1	Transformer
D18PA+	1700-2000	19.3	0.3	16	1.1	4	MMIC
DBTC-17-5+	50-2000	17.2	1	20	1.2	2	Transformer
DBTC-17-5L+	50-2000	17.2	1	20	1.2	2	Transformer
DBTC-17-5LX+	50-2000	17.2	1	20	1.2	2	Transformer
TCD-9-1W+	5-2000	8.9	1.5	17	1.5	1	Transformer
TCD-9-1WX+	5-2000	8.9	1.5	17	1.5	1	Transformer
D19GA+	1400-1700	20.7	0.3	17	1.1	4	MMIC
DBTC-7-152+	10-1500	7	2.2	32	1.4	0.5	Transformer

Directional — Surface Mount 50Ω Continued

Model Number	Frequency Range (MHz)	Coupling (dB) Nom.	Mainline Loss (dB)	Directivity (dB)	VSWR (:1)	Power Input Max. (W)	Construction
DBTC-7-152L+	10-1500	7	2.2	32	1.4	0.5	Transformer
DBTC-7-152LX+	10-1500	7	2.2	32	1.4	0.5	Transformer
DBTC-7-152X+	10-1500	7	2.2	32	1.4	0.5	Transformer
JDC-20-5+	50-1500	20.5	1	22	1.2	0.5	Transformer
ADC-6-13+	200-1300	6.3	1.8	17	1.3	0.5	Transformer
ADC-20-132+	100-1300	20	0.4	22	1.43	4	Transformer
ADC-20-12+	100-1200	20	0.5	26	1.17	1	Transformer
LRDC-20-2+	300-1100	20.5	0.25	17	1.2	2	Transformer
LRDC-20-2J+	300-1100	20.5	0.25	22	1.2	2	Transformer
ADC-10-4+	5-1000	10.5	0.8	40	1.2	1	Transformer
ADC-15-4+	5-1000	15.5	0.6	24	1.2	1	Transformer
ADC-20-4+	5-1000	20	0.5	21	1.1	1	Transformer
ADC-20-13+	450-1000	19.7	0.2	20	1.2	4	Transformer
DBTC-9-4+	5-1000	9	1.2	18	1.3	1	Transformer
DBTC-9-4L+	5-1000	9	1.2	18	1.3	1	Transformer
DBTC-9-4LX+	5-1000	9	1.2	18	1.3	1	Transformer
DBTC-9-4X+	5-1000	9	1.2	18	1.3	1	Transformer
DBTC-10-13+	5-1000	10.3	1.4	18	1.3	1	Transformer
DBTC-10-13L+	5-1000	10.3	1.4	18	1.3	1	Transformer
DBTC-10-13LX+	5-1000	10.3	1.4	18	1.3	1	Transformer
DBTC-10-13X+	5-1000	10.3	1.4	18	1.3	1	Transformer
DBTC-12-4+	5-1000	12.2	0.7	21	1.3	1	Transformer
DBTC-12-4L+	5-1000	12.2	0.7	21	1.3	1	Transformer
DBTC-12-4LX+	5-1000	12.2	0.7	21	1.3	1	Transformer
DBTC-12-4X+	5-1000	12.2	0.7	21	1.3	1	Transformer
DBTC-13-4+	5-1000	13	0.7	18	1.3	1	Transformer
DBTC-13-4L+	5-1000	13	0.7	18	1.3	1	Transformer
DBTC-13-4LX+	5-1000	13	0.7	18	1.3	1	Transformer



Directional — Surface Mount 50Ω Continued

Model Number	Frequency Range (MHz)	Coupling (dB) Nom.	Mainline Loss (dB)	Directivity (dB)	VSWR (:1)	Power Input Max. (W)	Construction
DBTC-13-4X+	5-1000	13	0.7	18	1.3	1	Transformer
DBTC-20-4+	20-1000	20.4	0.7	21	1.2	1	Transformer
DBTC-20-4L+	20-1000	20.4	0.7	21	1.2	1	Transformer
DBTC-20-4LX+	20-1000	20.4	0.7	21	1.2	1	Transformer
DBTC-20-4X+	20-1000	20.4	0.7	21	1.2	1	Transformer
JDC-10-4+	5-1000	10.5	1.3	23	1.15	1	Transformer
SYDC-6-13HP+	50-1000	5.6	0.8	17	1.33	10	Transformer
TCD-13-4+	5-1000	13	0.7	18	1.2	1	Transformer
TCD-13-4X+	5-1000	13	0.7	18	1.2	1	Transformer
TCD-18-4+	5-1000	17.9	0.7	20	1.2	1	Transformer
TCD-18-4X+	5-1000	17.9	0.7	20	1.2	1	Transformer
TCD-20-4+	5-1000	20	0.4	21	1.2	1	Transformer
TCD-20-4X+	5-1000	20	0.4	21	1.2	1	Transformer
D20C+	810-960	19.2	0.3	15	1.1	1	MMIC
ADC-10-1R+	5-900	10.5	0.8	30	1.3	1	Transformer
JDC-20-2+	400-900	20.5	0.2	19	1.15	2	Transformer
JDC-10-2+	5-750	10	1	20	1.13	1	Transformer
JDC-20-1W+	50-750	19.5	0.5	22	1.2	0.5	Transformer
TCD-10-1W+	10-750	10.3	1.2	18	1.3	1	Transformer
TCD-10-1WX+	10-750	10.3	1.2	18	1.3	1	Transformer
SYDC-7-651HP+	10-650	7.3	0.6	21	1.15	10	Transformer
ADC-26-52+	10-500	26	0.2	25	1.1	5	Transformer
JYDC-7-1HP+	30-500	7.3	1.4	20	1.25	5	Transformer
JYDC-23-1HP+	30-500	23.5	0.4	23	1.1	10	Transformer
LRDC-10-1	5-500	10.7	0.9	31	1.2	1	Transformer
LRDC-10-1+	5-500	10.7	0.9	31	1.2	1	Transformer
LRDC-10-1J+	5-500	10.7	1.2	30	1.2	1	Transformer
JDC-6-1+	5-400	6.5	2	25	1.25	0.5	Transformer

Directional — Surface Mount 50Ω Continued

Model Number	Frequency Range (MHz)	Coupling (dB) Nom.	Mainline Loss (dB)	Directivity (dB)	VSWR (:1)	Power Input Max. (W)	Construction
SYDC-10-42HP+	10-400	10	0.4	18	1.1	16	Transformer
ADC-6-1R+	5-200	6.2	1.7	25	1.33	0.5	Transformer
SYDC20-171VHP+	30-174	20	0.19	18	1.1	100	Transformer
SYDC-20-61VHP+	1.5-60	20	0.1	30.5	1.02	40	Transformer

Directional — Surface Mount 750Ω

Model Number	Frequency Range (MHz)	Coupling (dB) Nom.	Mainline Loss (dB)	Directivity (dB)	VSWR (:1)	Power Input Max. (W)	Type	Construction
TCD-9-1W-75+	5-2000	8.9	1.8	15	1.5	1	Directional	Transformer
TCD-9-1W-75X+	5-2000	8.9	1.8	15	1.5	1	Directional	Transformer
TCD-16-23-75X+	5-2000	16.5	1.3	22	1.2	1	Directional	Transformer
RDC-7-182-75X+	5-1800	7.5	2.7	12	1.29	1	Directional	Transformer
RDC-10-182-75X+	5-1800	10	1.3	20	1.2	1	Directional	Transformer
DBTC-13-5-75+	5-1500	13.2	0.7	19	1.3	1	Directional	Transformer
DBTC-13-5-75L+	5-1500	13.2	1.4	19	1.3	1	Directional	Transformer
DBTC-13-5-75LX+	5-1500	13.2	1.4	19	1.3	1	Directional	Transformer
DBTC-13-5-75X+	5-1500	13.2	0.7	19	1.3	1	Directional	Transformer
DBTC-16-5-75+	5-1500	16.3	1.3	21	1.3	1	Directional	Transformer
DBTC-16-5-75L+	5-1500	16.3	1.3	21	1.3	1	Directional	Transformer
DBTC-16-5-75LX+	5-1500	16.3	1.3	21	1.3	1	Directional	Transformer
DBTC-16-5-75X+	5-1500	16.3	1.3	21	1.3	1	Directional	Transformer
ADC-8-4-75+	5-1250	7.9	1.6	17	1.2	1	Directional	Transformer
ADC-10-4-75+	5-1250	10.5	0.9	18	1.2	1	Directional	Transformer
ADC-12-4-75+	20-1250	12.6	0.9	23	1.2	1	Directional	Transformer
ADC-16-4-75+	5-1250	16.2	0.7	30	1.15	1	Directional	Transformer
ADC-17-122-75+	5-1250	17	0.8	12	1.15	1	Directional	Transformer
ADC-20-4-75+	5-1250	19.7	0.5	23	1.15	1	Directional	Transformer
ADC-25-4-75+	5-1250	25	0.1	25	1.2	1	Directional	Transformer



Directional — Surface Mount 750Ω Continued

Model Number	Frequency Range (MHz)	Coupling (dB) Nom.	Mainline Loss (dB)	Directivity (dB)	VSWR (:1)	Power Input Max. (W)	Type	Construction
DBTC-6-4-75+	5-1250	6.8	2.2	17	1.4	1	Directional	Transformer
DBTC-6-4-75L+	5-1250	6.8	2.2	17	1.4	1	Directional	Transformer
DBTC-6-4-75LX+	5-1250	6.8	2.2	17	1.4	1	Directional	Transformer
DBTC-6-4-75X+	5-1250	6.8	2.2	17	1.4	1	Directional	Transformer
DBTC-20-4-75+	5-1250	20.5	0.8	19	1.4	1	Directional	Transformer
DBTC-20-4-75L+	5-1250	20.5	0.8	19	1.4	1	Directional	Transformer
DBTC-20-4-75LX+	5-1250	20.5	0.8	19	1.4	1	Directional	Transformer
DBTC-20-4-75X+	5-1250	20.5	0.8	19	1.4	1	Directional	Transformer
RDC-10-122-75X+	5-1250	10	1.2	20	1.22	1	Directional	Transformer
RDC-17-122-75X+	5-1250	17.6	0.8	20	1.14	1	Directional	Transformer
TCD-6-122-75X+	5-1250	6.7	2.3	12	1.43	0.5	Directional	Transformer
TCD-10-122-75X+	5-1250	10	1.5	15	1.17	1	Directional	Transformer
TCD-13-122-75X+	5-1250	12.7	1	15	1.17	1	Directional	Transformer
TCD-16-122-75X+	5-1250	16.5	1.5	22	1.33	1	Directional	Transformer
TCD-18-122-75X+	5-1250	17.5	1	22	1.17	1	Directional	Transformer
TCD-16-12W-75X+	5-1218	16	0.9	16	1.3	1	Directional	Transformer
DBTC-9-4-75+	5-1200	9.3	1.3	20	1.3	0.7	Directional	Transformer
DBTC-9-4-75L+	5-1200	9.3	1.3	20	1.3	0.7	Directional	Transformer
DBTC-9-4-75LX+	5-1200	9.3	1.3	20	1.3	0.7	Directional	Transformer
DBTC-9-4-75X+	5-1200	9.3	1.3	20	1.3	0.7	Directional	Transformer
DBTC-12-4-75+	5-1200	12	1.1	19	1.3	0.5	Directional	Transformer
DBTC-12-4-75L+	5-1200	12	1.1	19	1.3	0.5	Directional	Transformer
DBTC-12-4-75LX+	5-1200	12	1.1	19	1.3	0.5	Directional	Transformer
DBTC-12-4-75X+	5-1200	12	1.1	19	1.3	0.5	Directional	Transformer
TCD-20-4-75+	40-1200	20	0.6	23	1.15	1	Directional	Transformer
TCD-20-4-75X+	40-1200	20	0.6	23	1.15	1	Directional	Transformer
ADC-6-10-75+	20-1000	6.6	2.1	15	1.3	0.5	Directional	Transformer
ADC-10-4-75R+	5-1000	9.6	1.1	21	1.2	1	Directional	Transformer

Directional — Surface Mount 750Ω Continued

Model Number	Frequency Range (MHz)	Coupling (dB) Nom.	Mainline Loss (dB)	Directivity (dB)	VSWR (:1)	Power Input Max. (W)	Type	Construction
ADC-18-4-75+	20-1000	17.4	0.4	18	1.15	1	Directional	Transformer
ADC-18-4-75R+	20-1000	17.7	0.5	25	1.15	1	Directional	Transformer
ADC-20-4-75R+	40-1000	20.5	0.6	20	1.1	1	Directional	Transformer
DBTC-10-4-75+	5-1000	10.5	0.7	20	1.3	1	Directional	Transformer
DBTC-10-4-75L+	5-1000	10.5	0.7	20	1.3	1	Directional	Transformer
DBTC-10-4-75LX+	5-1000	10.5	0.7	20	1.3	1	Directional	Transformer
DBTC-10-4-75X+	5-1000	10.5	0.7	20	1.3	1	Directional	Transformer
DBTC-18-4-75+	5-1000	18.2	0.8	21	1.3	1	Directional	Transformer
DBTC-18-4-75L+	5-1000	18.2	0.8	21	1.3	1	Directional	Transformer
DBTC-18-4-75LX+	5-1000	18.2	0.8	21	1.3	1	Directional	Transformer
DBTC-18-4-75X+	5-1000	18.2	0.8	21	1.3	1	Directional	Transformer
LRDC-10-2-75+	30-1000	10	1	21	1.3	1	Directional	Transformer
LRDC-10-2-75J+	30-1000	10	1.3	22	1.3	1	Directional	Transformer
TCD-10-4-75+	5-1000	9.9	1.1	20	1.25	1	Directional	Transformer
TCD-10-4-75X+	5-1000	9.9	1.1	20	1.25	1	Directional	Transformer
TCD-13-4-75+	5-1000	13	0.8	15	1.2	1	Directional	Transformer
TCD-13-4-75X+	5-1000	13	0.8	15	1.2	1	Directional	Transformer
TCD-18-4-75+	10-1000	18	0.7	22	1.2	1	Directional	Transformer
TCD-18-4-75X+	10-1000	18	0.7	22	1.2	1	Directional	Transformer
JDC20-1W-75+	50-750	19.5	0.5	23	1.2	0.5	Directional	Transformer
TCD-10-1W-75+	10-750	10.5	1.4	18	1.3	1	Directional	Transformer
TCD-10-1W-75X+	10-750	10.5	1.4	18	1.3	1	Directional	Transformer
JDC-20-3-75+	2-250	19.2	0.4	30	1.1	1	Directional	Transformer



Directional — Bare Die 50Ω

Model Number	Frequency Range (MHz)	Coupling (dB) Nom.	Mainline Loss (dB)	Directivity (dB)	VSWR (:1)	Power Input Max. (W)	Type	Construction
EDC19-KA-D+	5000-43500	18.3	0.5	9.3	1.4	1.47	Directional	MMIC
EDC10-273-D+	6000-26500	10	1.4	15	1.329	0.63	Directional	MMIC
EDC21-24-D+	4000-20000	21	0.7	19	1.37	1.77	Directional	MMIC

Directional — Coaxial 50Ω

Model Number	Frequency Range (MHz)	Coupling (dB) Nom.	Mainline Loss (dB)	Directivity (dB)	VSWR (:1)	Power Input Max. (W)	Type	Construction	Connector Type
ZCDC10-E2653+	2000-65000	10	1.45	22	1.11	11	Directional	Microstrip / Stripline	1.85mm
ZCDC10-E6653+	6000-65000	10	1.2	22	1.12	11	Directional	Microstrip / Stripline	1.85mm
ZCDC10-E40653+	40000-65000	10	1.9	18	1.9	12	Directional	Microstrip / Stripline	1.85mm
ZCDC13-E1653+	1000-65000	13	1.55	21.5	1.12	11	Directional	Microstrip / Stripline	1.85mm
ZCDC20-E18653+	18000-65000	20	0.9	20	1.15	12	Directional	Microstrip / Stripline	1.85mm
ZCDC10-V254+	2000-50000	10	1.3	23	1.08	13	Directional	Microstrip / Stripline	2.4mm
ZCDC10-V654+	6000-50000	10	1.1	21	1.14	13	Directional	Microstrip / Stripline	2.4mm
ZCDC10-V1854+	18000-50000	10	1.2	20	1.14	13	Directional	Microstrip / Stripline	2.4mm
ZCDC10-V2654+	26000-50000	10	1.1	22	1.11	16	Directional	Microstrip / Stripline	2.4mm
ZCDC13-V154+	1000-50000	13	1.4	21	1.14	13	Directional	Microstrip / Stripline	2.4mm
ZCDC20-V1854+	18000-50000	20	0.8	21.5	1.12	16	Directional	Microstrip / Stripline	2.4mm
ZCDC10-V18443+	18000-44000	10	1.2	23	1.11	16	Directional	Microstrip / Stripline	2.4mm
ZCDC10-V24443+	24000-44000	10	1.2	22	1.11	16	Directional	Microstrip / Stripline	2.4mm
ZCDC13-V24443+	24000-44000	13	0.8	18	1.3	16	Directional	Microstrip / Stripline	2.4mm
ZCDC16-V24443+	24000-44000	16	0.8	22	1.2	16	Directional	Microstrip / Stripline	2.4mm
ZCDC10-K5R44W+	500-40000	10	1.3	23	1.12	15	Directional	Microstrip / Stripline	2.92mm
ZCDC10-K0144+	1000-40000	10	2.2	16	1.22	19	Directional	Microstrip / Stripline	2.92mm
ZCDC10-K0244+	2000-40000	10	1.2	23	1.11	15	Directional	Microstrip / Stripline	2.92mm

Directional — Coaxial 50Ω Continued

Model Number	Frequency Range (MHz)	Coupling (dB) Nom.	Mainline Loss (dB)	Directivity (dB)	VSWR (:1)	Power Input Max. (W)	Type	Construction	Connector Type
ZCDC10-K0644+	6000-40000	10	1.0	24	1.12	17	Directional	Microstrip / Stripline	2.92mm
ZCDC10-K1844+	18000-40000	10	1.2	21	1.22	17	Directional	Microstrip / Stripline	2.92mm
ZCDC13-K0144+	1000-40000	13	1.5	19	1.73	13	Directional	Microstrip / Stripline	2.92mm
ZCDC13-K0244+	2000-40000	13	0.95	24	1.11	20	Directional	Microstrip / Stripline	2.92mm
ZCDC13-K1844+	18000-40000	13	0.9	21	1.13	20	Directional	Microstrip / Stripline	2.92mm
ZCDC13-K26344+	26500-40000	13	0.9	21	1.22	20	Directional	Microstrip / Stripline	2.92mm
ZCDC16-K5R44W+	500-40000	16	2.0	19	1.19	20	Directional	Microstrip / Stripline	2.92mm
ZCDC16-K0144+	1000-40000	16	1.3	20	1.22	19	Directional	Microstrip / Stripline	2.92mm
ZCDC16-K0244+	2000-40000	16	1.2	20	1.19	20	Directional	Microstrip / Stripline	2.92mm
ZCDC16-K1844+	18000-40000	16	0.7	23	1.10	20	Directional	Microstrip / Stripline	2.92mm
ZCDC20-K0144+	1000-40000	20	1.2	20	1.20	20	Directional	Microstrip / Stripline	2.92mm
ZCDC20-K0244+	2000-40000	20	1.0	20	1.17	20	Directional	Microstrip / Stripline	2.92mm
ZCDC20-K0644+	6000-40000	20	0.7	22	1.07	20	Directional	Microstrip / Stripline	2.92mm
ZCDC20-K1844+	18000-40000	20	0.7	19	1.17	20	Directional	Microstrip / Stripline	2.92mm
ZCDC30-K0644+	6000-40000	30	0.5	22	1.12	20	Directional	Microstrip / Stripline	2.92mm
ZCDC30-K1844+	18000-40000	30	0.6	22	1.15	20	Directional	Microstrip / Stripline	2.92mm
ZDC10-20403-K+	20000-40000	10.0	1.2	13	1.22	20	Directional	Microstrip / Stripline	2.92mm
ZDC20-20403-K+	18000-40000	20.0	0.9	12	1.25	20	Directional	Microstrip / Stripline	2.92mm
ZDC20-20403-V+	18000-40000	20.0	0.9	12	1.25	20	Directional	Microstrip / Stripline	2.4mm
ZCDC10-5R263-S+	500-26500	10	1.2	22	1.12	20	Directional	Microstrip / Stripline	SMA
ZCDC10-01263-S+	1000-26500	10	0.9	21	1.17	20	Directional	Microstrip / Stripline	SMA
ZCDC10-02263S+	2000-26500	10	0.9	27	1.11	20	Directional	Microstrip / Stripline	SMA
ZCDC10-06263-S+	6000-26500	10	1.0	22	1.17	20	Directional	Microstrip / Stripline	SMA
ZCDC10-18263-S+	18000-26500	10	0.9	24	1.15	20	Directional	Microstrip / Stripline	SMA



Directional — Coaxial 50Ω Continued

Model Number	Frequency Range (MHz)	Coupling (dB) Nom.	Mainline Loss (dB)	Directivity (dB)	VSWR (:1)	Power Input Max. (W)	Type	Construction	Connector Type
ZCDC13-5R263-S+	500-26500	13	1.3	21	1.73	20	Directional	Microstrip / Stripline	SMA
ZCDC13-01263-S+	1000-26500	13	1.2	21	1.17	19	Directional	Microstrip / Stripline	SMA
ZCDC16-5R263-S+	500-26500	16	1.4	23	1.12	20	Directional	Microstrip / Stripline	SMA
ZCDC16-01263-S+	1000-26500	16	0.9	21	1.14	20	Directional	Microstrip / Stripline	SMA
ZCDC16-02263-S+	2000-26500	16	0.6	26	1.09	20	Directional	Microstrip / Stripline	SMA
ZCDC20-5R263-S+	500-26500	20	0.9	25	1.09	20	Directional	Microstrip / Stripline	SMA
ZCDC20-01263-S+	1000-26500	20	0.9	23	1.12	20	Directional	Microstrip / Stripline	SMA
ZCDC20-02263S+	2000-26500	20	0.5	18	1.33	20	Directional	Microstrip / Stripline	SMA
ZCDC20-06263-S+	6000-26500	20	0.5	26	1.14	20	Directional	Microstrip / Stripline	SMA
ZCDC20-18263-S+	18000-26500	20	0.4	24	1.14	20	Directional	Microstrip / Stripline	SMA
ZCDC30-5R263-S+	500-26500	30	0.6	28	1.07	20	Directional	Microstrip / Stripline	SMA
ZCDC30-01263-S+	1000-26500	30	0.8	23	1.14	20	Directional	Microstrip / Stripline	SMA
ZCDC30-02263-S+	2000-26500	30	0.6	23	1.14	20	Directional	Microstrip / Stripline	SMA
ZCDC30-06263-S+	6000-26500	30	0.6	23	1.12	20	Directional	Microstrip / Stripline	SMA
ZCDC30-18263-S+	18000-26500	30	0.6	21	1.14	20	Directional	Microstrip / Stripline	SMA
ZCDC10-01203-S+	1000-20000	10	1.0	23	1.11	20	Directional	Microstrip / Stripline	SMA
ZCDC20-01203-S+	1000-20000	20	0.6	25	1.07	20	Directional	Microstrip / Stripline	SMA
ZUDC10-183+	500-18000	10	1.4	17	1.3	50	Directional	Microstrip / Stripline	SMA
ZUDC10-02183-S+	2000-18000	10	0.3	17	1.43	20	Directional	Microstrip / Stripline	SMA
ZUDC10-06183-S+	6000-18000	10	0.77	21	1.14	50	Directional	Microstrip / Stripline	SMA
ZUDC15-02183-S+	2000-18000	15	0.3	18	1.25	20	Directional	Microstrip / Stripline	SMA
ZUDC20-183+	500-18000	20	0.9	17	1.3	50	Directional	Microstrip / Stripline	SMA
ZUDC20-02183-S+	2000-18000	20	0.5	20	1.22	20	Directional	Microstrip / Stripline	SMA
ZUDC20-06183-S+	6000-18000	20	0.37	21	1.11	50	Directional	Microstrip / Stripline	SMA

Directional — Coaxial 50Ω Continued

Model Number	Frequency Range (MHz)	Coupling (dB) Nom.	Mainline Loss (dB)	Directivity (dB)	VSWR (:1)	Power Input Max. (W)	Type	Construction	Connector Type
ZUDC30-183+	500-18000	30	0.9	16	1.3	50	Directional	Microstrip / Stripline	SMA
ZUDC30-02183-S+	2000-18000	30	0.3	17	1.33	20	Directional	Microstrip / Stripline	SMA
ZX30-14-972HP+	8300-9700	14	0.8	7	2.3	20	Directional	Microstrip / Stripline	SMA
ZGDC35-93HP+	900-9000	35	0.1	19	1.25	250	Directional	Microstrip / Stripline	N
ZUDC10-83-S+	300-8000	10	0.9	24	1.15	20	Directional	Microstrip / Stripline	SMA
ZUDC20-83-S+	300-8000	20	0.7	24	1.15	20	Directional	Microstrip / Stripline	SMA
ZADC-13-73-S+	2600-7000	13	0.8	18	1.2	4	Directional	Microstrip / Stripline	SMA
ZADC-10-63-S+	2500-6000	11.7	0.6	23	1.11	4	Directional	Microstrip / Stripline	SMA
ZHDC-10-63+	50-6000	10.2	4	32	1.2	1	Directional	Bridge	N
ZHDC-10-63-NS+	50-6000	10.2	4	32	1.2	1	Directional	Bridge	N/SMA
ZHDC-16-63+	50-6000	16.7	2	32	1.3	0.5	Directional	Bridge	SMA
ZHDC-16-63-NS+	50-6000	16	2	24	1.3	0.5	Directional	Bridge	N/SMA
ZGDC6-372HP+	380-3700	6	0.2	23	1.09	250	Directional	Microstrip / Stripline	N
ZGDC10-372HP+	380-3700	10	0.17	23	1.09	250	Directional	Microstrip / Stripline	N
ZGDC20-372HP+	300-3700	20	0.15	25	1.06	250	Directional	Microstrip / Stripline	N
ZGDC30-372HP+	380-3700	30	0.16	17	1.07	250	Directional	Microstrip / Stripline	N
ZFDC-20-33+	20-3000	20.5	0.9	15	1.5	1	Directional	Transformer	BNC
ZADC-40-27HP+	1400-2700	40	0.19	25	1.2	40	Directional	Microstrip / Stripline	N
ZADC-15-252+	850-2500	15	0.7	14.5	1.15	8	Directional	LTCC	SMA
ZADC-6-2G-5W-S+	800-2000	6.7	1.6	25	1.15	5	Directional	Microstrip / Stripline	SMA
ZFDC-6-23-S+	20-2000	6	2.7	18	1.3	0.5	Directional	Transformer	SMA
ZFDC-10-5+	1-2000	10.8	1.2	30	1.3	0.5	Directional	Transformer	BNC
ZFDC-20-5+	0.1-2000	19.5	0.7	27	1.2	2	Directional	Transformer	BNC
ZFDC-20-50+	20-2000	19.5	0.7	25	1.25	1	Directional	Transformer	BNC
ZNDC-13-2G-S+	800-2000	13	0.8	20	1.15	3	Directional	Transformer	SMA
ZNDC-15-2G-S+	800-2000	15	0.8	22	1.2	3	Directional	Transformer	SMA



Directional — Coaxial 50Ω Continued

Model Number	Frequency Range (MHz)	Coupling (dB) Nom.	Mainline Loss (dB)	Directivity (dB)	VSWR (:1)	Power Input Max. (W)	Type	Construction	Connector Type
ZNDC-18-2G-S+	800-2000	18.2	0.5	25	1.2	3	Directional	Transformer	SMA
ZNDC-20-2G-S+	800-2000	19.8	0.5	25	1.15	3	Directional	Transformer	SMA
ZNDC-23-2G-S+	800-2000	23	0.5	22	1.2	3	Directional	Transformer	SMA
ZUDC6-5R23-S+	500-2000	6.5	1.3	28	1.07	50	Directional	Microstrip / Stripline	SMA
ZUDC10-5R23-S+	500-2000	10	0.6	32	1.03	50	Directional	Microstrip / Stripline	SMA
ZUDC20-5R23-S+	500-2000	20	0.19	35	1.03	50	Directional	Microstrip / Stripline	SMA
ZUDC30-5R23-S+	500-2000	30	0.15	34	1.04	50	Directional	Microstrip / Stripline	SMA
ZX30-17-5-S+	5-2000	17.5	0.85	18	1.3	1	Directional	Transformer	SMA
ZX30-20-20BD-S+	500-2000	21	0.2	21	1.2	2	Directional	Transformer	SMA
ZADC-10-17W-S+	800-1900	10.2	0.8	24	1.2	5	Directional	Microstrip / Stripline	SMA
ZFDC-10-182+	10-1800	10.4	1	31.7	1.16	0.5	Directional	Transformer	BNC
ZADC-10-17-S+	1000-1700	9.8	0.8	25	1.2	5	Directional	Microstrip / Stripline	SMA
ZADC-17-14HP-S	500-1350	16.4	0.8	29	1.06	10	Directional	LTCC	SMA
ZNDC-6-122-S+	500-1200	6	0.5	25	1.2	2	Directional	Transformer	SMA
ZX30-9-4-S+	5-1200	8.9	1.1	20	1.2	1	Directional	Transformer	SMA
ZX30-13-4-S+	5-1200	13	0.7	19	1.15	1	Directional	Transformer	SMA
ZADC-10-10	800-1000	10	0.85	22	1.16	5	Directional	Microstrip / Stripline	BNC
ZADC-20-10+	800-1000	20	0.4	21	1.18	5	Directional	Microstrip / Stripline	SMA
ZEDC-10-2B	1-1000	11	1.5	30	1.3	3	Directional	Transformer	SMA
ZEDC-15-2B	1-1000	15	0.8	30	1.15	3	Directional	Transformer	SMA
ZFDC-10-2	10-1000	10.75	1.2	30	1.5	3	Directional	Transformer	BNC
ZFDC-10-21	1-1000	11	1.2	25	1.2	2	Directional	Transformer	BNC
ZFDC-15-10+	800-1000	15	0.3	23	1.2	5	Directional	Microstrip / Stripline	SMA
ZFDC-20-4	1-1000	19.5	0.4	27	1.1	2	Directional	Transformer	SMA
ZFDC-20-4+	1-1000	19.5	0.4	27	1.1	2	Directional	Transformer	BNC
ZFDC-20-4L	10-1000	20.2	0.3	30	1.1	1	Directional	Transformer	SMA
ZX30-12-4-S+	5-1000	12	0.85	25	1.15	1	Directional	Transformer	SMA

Directional — Coaxial 50Ω Continued

Model Number	Frequency Range (MHz)	Coupling (dB) Nom.	Mainline Loss (dB)	Directivity (dB)	VSWR (:1)	Power Input Max. (W)	Type	Construction	Connector Type
ZX30-20-4-S+	5-1000	20.5	0.35	22	1.11	1	Directional	Transformer	SMA
ZFDC-10-22	1-750	11	1.2	25	1.25	2	Directional	Transformer	BNC
ZGDC6-521-N+	130-520	6	0.2	26	1.08	60	Directional	Microstrip / Stripline	N
ZDC-10-1+	0.5-500	11.5	0.65	32	1.2	3	Directional	Transformer	BNC
ZFDC-10-1+	1-500	10.5	0.8	33	1.2	3	Directional	Transformer	BNC
ZMDC-10-1+	0.5-500	11.5	0.65	32	1.2	3	Directional	Transformer	SMA
ZDC-20-1+	25-400	20	0.3	35	1.25	5	Directional	Transformer	BNC
ZDC-20-3	0.2-250	19.5	0.25	33	1.2	4	Directional	Transformer	BNC
ZFDC-20-3+	0.2-250	19.5	0.25	33	1.2	4	Directional	Transformer	BNC
ZMDC-20-3+	0.2-250	19.5	0.35	33	1.2	4	Directional	Transformer	SMA
ZMDC-30-1+	0.1-250	30	0.5	20	1.5	3	Directional	Transformer	SMA
ZFDC-15-6+	0.03-35	15	0.2	35	1.15	4	Directional	Transformer	BNC
ZFDC-10-6+	0.005-20	11	0.4	40	1.3	3	Directional	Transformer	BNC

Directional — Coaxial 75Ω

Model Number	Frequency Range (MHz)	Coupling (dB) Nom.	Mainline Loss (dB)	Directivity (dB)	VSWR (:1)	Power Input Max. (W)	Type	Construction	Connector Type
ZADC-20-18-75+	800-1750	19.8	0.4	22	1.2	1	Directional	Transformer	BNC
Z30-16-5-75+	5-1500	16.5	1.1	24	1.3	1	Directional	Transformer	BNC
ZFDC-20-5-75	100-1500	20	0.9	25	1.3	1	Directional	Transformer	BNC
Z30-18-4-75+	5-1000	18.5	0.85	23	1.3	1	Directional	Transformer	BNC
ZFDC-10-1-75	1-400	10.5	1.1	44	1.3	4	Directional	Transformer	BNC
ZDC-10-1-75+	1-250	10.5	1.1	30	2	4	Directional	Transformer	BNC
ZFDC-20-3-75+	10-250	19.3	0.3	29	1.2	2	Directional	Transformer	BNC
ZDC-20-3-75+	1-150	19.5	0.35	25	2	4	Directional	Transformer	BNC
ZDC-2375	50-100	10.5	1.1	35	1.3	4	Directional	Transformer	BNC
ZDC-2375+	50-100	10.5	1.1	35	1.3	4	Directional	Transformer	BNC
ZDC-20-3-75-1+	55-90	18.6	0.4	35	1.2	4	Directional	Transformer	BNC



Directional — Plug-In 50Ω

Model Number	Frequency Range (MHz)	Coupling (dB) Nom.	Mainline Loss (dB)	Directivity (dB)	VSWR (:1)	Power Input Max. (W)	Type	Construction
PDC-10-5+	1-2000	10.5	1.3	30	1.3	0.5	Directional	Transformer
PDC-10-54+	10-1500	10.5	1.3	28	1.3	0.5	Directional	Transformer
P4DC-30A-2+	5-1000	30.5	0.7	32	1.15	2	Directional	Transformer
TDC-10-2+	5-1000	11	1.5	25	1.5	0.5	Directional	Transformer
PDC-20-1W+	10-700	19.2	0.4	27	1.4	2	Directional	Transformer
PDC-10-1+	0.5-500	11.5	0.65	32	1.2	3	Directional	Transformer
PDC-15-21+	1-500	14.7	0.7	35	1.4	2	Directional	Transformer
PDC-20-1+	25-400	21	0.3	35	1.25	5	Directional	Transformer
PDC20-400HP+	40-400	21.5	0.2	30	1.1	10	Directional	Transformer
TDC-6-1+	10-400	6.3	2	30	1.5	2	Directional	Transformer
TDC-10-1+	1-400	10	1	30	1.5	2	Directional	Transformer
PDC-20-3+	0.2-250	19.5	0.25	33	1.2	4	Directional	Transformer
PDC-15-6+	0.01-35	15	0.2	35	1.15	4	Directional	Transformer
PDC-10-6+	0.005-20	11	0.4	40	1.3	3	Directional	Transformer

Directional — Plug-In 75Ω

Model Number	Frequency Range (MHz)	Coupling (dB) Nom.	Mainline Loss (dB)	Directivity (dB)	VSWR (:1)	Power Input Max. (W)	Type	Construction
PDC-20-3-75	1-150	19.5	0.35	25	2	4	Directional	Transformer

Bi-Directional — Surface Mount 50Ω

Model Number	Frequency Range (MHz)	Coupling (dB) Nom.	Mainline Loss (dB)	Directivity (dB)	VSWR (:1)	Power Input Max. (W)	Type	Construction	Connector Type
CPL-20-14+	9200-10500	19.2	0.2	16	1.2	16	Bi-Directional	Microstrip / Stripline	DC Passthrough
BDCH-10-63	2000-6000	10	0.1	22	1.12	100	Bi-Directional	Microstrip / Stripline	DC Passthrough
BDCH-20-63+	2000-6000	19.5	0.15	19	1.2	180	Bi-Directional	Microstrip / Stripline	DC Passthrough
BDCH-20-63A+	2000-6000	18	0.15	29	1.1	140	Bi-Directional	Microstrip / Stripline	DC Passthrough

Bi-Directional — Surface Mount 50Ω Continued

Model Number	Frequency Range (MHz)	Coupling (dB) Nom.	Mainline Loss (dB)	Directivity (dB)	VSWR (:1)	Power Input Max. (W)	Type	Construction	Connector Type
MBD-20-63HP+	5000-6000	20	0.18	20	1.1	20	Bi-Directional	Microstrip / Stripline	DC Passthrough
MBDC-13-63HP+	2000-6000	12.8	0.1	23	1.15	100	Bi-Directional	Microstrip / Stripline	DC Passthrough
MBDC-20-63HP	2000-6000	20.25	0.15	23	1.17	100	Bi-Directional	Microstrip / Stripline	DC Passthrough
SCBD-10-63HP+	50-6000	10	0.9	17	1.22	100	Bi-Directional	Microstrip / Stripline	DC Passthrough
SCBD-16-63HP+	50-6000	16.2	0.45	23	1.22	100	Bi-Directional	Microstrip / Stripline	DC Passthrough
SYBD-10-63HP+	2700-6000	11.8	0.6	20	1.2	25	Bi-Directional	Microstrip / Stripline	DC Passthrough
SYBD-13-63HP+	2700-6000	13.3	0.4	21	1.2	25	Bi-Directional	Microstrip / Stripline	DC Passthrough
SCBD-16-562HP+	2700-5600	16.2	0.4	18	1.29	75	Bi-Directional	Microstrip / Stripline	DC Passthrough
SYBD-16-53HP+	2700-5000	16.3	0.2	18	1.2	25	Bi-Directional	Microstrip / Stripline	DC Passthrough
BDCA-16-30+	1800-4200	15.5	0.4	23	1.3	20	Bi-Directional	LTCC	DC Passthrough
BDCA1-10-40+	1600-4000	10	1.05	21	1.1	12	Bi-Directional	LTCC	DC Passthrough
BDCN-14-342+	1700-3400	14	0.4	14	1.22	16	Bi-Directional	LTCC	-
BDCA1-7-33+	1600-3300	7	1.6	23	1.15	24	Bi-Directional	LTCC	DC Passthrough
DCW-22-332+	1200-3300	22	0.4	12	1.2	2	Bi-Directional	LTCC	-
BDCH-15-33+	500-3000	15.5	0.25	25	1.07	100	Bi-Directional	Microstrip / Stripline	DC Passthrough
BDCH-25-33+	800-3000	25	0.2	28	1.2	150	Bi-Directional	Microstrip / Stripline	DC Passthrough
SCBD-20-272HP+	1750-2750	18.6	0.25	24	1.08	100	Bi-Directional	Microstrip / Stripline	DC Passthrough
BDCH-15-272	700-2700	15	0.25	19	1.13	150	Bi-Directional	Microstrip / Stripline	DC Passthrough
BDCH-20-272	700-2700	21	0.25	21	1.12	150	Bi-Directional	Microstrip / Stripline	DC Passthrough
BDCH-25-272	700-2700	26	0.2	18	1.2	150	Bi-Directional	Microstrip / Stripline	DC Passthrough
BDCH-35-272	700-2700	35	0.2	16	1.3	150	Bi-Directional	Microstrip / Stripline	DC Passthrough
DCW-30-272+	700-2700	30	0.2	14	1.2	2	Bi-Directional	LTCC	-
SYBD-14-272HP+	1750-2700	14.5	0.4	23	1.15	25	Bi-Directional	Microstrip / Stripline	DC Passthrough
SYBD-16-272HP+	1750-2700	17.1	0.18	30	1.2	25	Bi-Directional	Microstrip / Stripline	DC Passthrough



Bi-Directional — Surface Mount 50Ω Continued

Model Number	Frequency Range (MHz)	Coupling (dB) Nom.	Mainline Loss (dB)	Directivity (dB)	VSWR (:1)	Power Input Max. (W)	Type	Construction	Connector Type
SYBD-20-272HP+	1750-2700	19.8	0.12	22	1.15	25	Bi-Directional	Microstrip / Stripline	DC Passthrough
BDCN-7-25+	824-2525	8.2	1.3	20	1.15	15	Bi-Directional	LTCC	-
BDCN-10-25+	824-2525	10.2	1	17	1.2	15	Bi-Directional	LTCC	-
BDCN-15-25+	824-2525	14.5	0.6	13	1.2	16	Bi-Directional	LTCC	DC Passthrough
BDCN-17-25+	824-2525	16.8	0.6	13	1.2	16	Bi-Directional	LTCC	DC Passthrough
BDCA-7-25+	1200-2500	7.1	1.6	22	1.05	35	Bi-Directional	LTCC	DC Passthrough
BDCA-10-25+	800-2500	10.1	1	22	1.05	24	Bi-Directional	LTCC	DC Passthrough
BDCA-15-25+	800-2500	15	0.5	27	1.2	23	Bi-Directional	LTCC	DC Passthrough
BDCA1-6-22+	950-2200	6.5	1.7	25	1.1	37	Bi-Directional	LTCC	DC Passthrough
BDCN-14-22+	1930-2170	13.8	0.05	23	1.25	16	Bi-Directional	LTCC	-
SYDC-18-23+	10-2000	18	0.7	20	1.25	2	Bi-Directional	Transformer	-
SYBD-16-172HP+	1400-1750	17	0.22	23	1.1	50	Bi-Directional	Microstrip / Stripline	DC Passthrough
SYBD-18-172HP+	1400-1750	19	0.1	28	1.1	50	Bi-Directional	Microstrip / Stripline	DC Passthrough
SYBD-22-172HP+	1400-1750	22.3	0.09	23	1.15	50	Bi-Directional	Microstrip / Stripline	DC Passthrough
BDCA-6-16+	800-1600	6.3	1.6	24	1.05	65	Bi-Directional	LTCC	DC Passthrough
SYBD-18-142HP+	960-1400	19.5	0.15	26	1.1	50	Bi-Directional	Microstrip / Stripline	DC Passthrough
SYBD-20-142HP+	960-1400	21	0.8	26	1.1	50	Bi-Directional	Microstrip / Stripline	DC Passthrough
SYBD-24-142HP+	960-1400	24.8	0.04	25	1.15	50	Bi-Directional	Microstrip / Stripline	DC Passthrough
SCBD-25-122HP+	800-1220	25	0.1	23	1.07	100	Bi-Directional	Microstrip / Stripline	DC Passthrough
BDCA1-6-11+	600-1100	6.3	1.8	27	1.08	38	Bi-Directional	LTCC	DC Passthrough
BDCN-20-13+	360-1000	20.7	0.2	12	1.08	16	Bi-Directional	LTCC	-
SYBD-20-13HP+	800-1000	20.8	0.12	24	1.1	100	Bi-Directional	Microstrip / Stripline	DC Passthrough
SYBD-23-13HP+	800-1000	23.5	0.06	27	1.15	100	Bi-Directional	Microstrip / Stripline	DC Passthrough
SYBD-26-13HP+	800-1000	26.8	0.03	29	1.05	100	Bi-Directional	Microstrip / Stripline	DC Passthrough
SYBDC-10-13HP+	50-1000	10	0.95	20	1.23	10	Bi-Directional	Transformer	-
SYBDC-15-13HP+	100-1000	15.8	0.75	20	1.15	10	Bi-Directional	Transformer	-

Bi-Directional — Surface Mount 50Ω Continued

Model Number	Frequency Range (MHz)	Coupling (dB) Nom.	Mainline Loss (dB)	Directivity (dB)	VSWR (:1)	Power Input Max. (W)	Type	Construction	Connector Type
SYDC-20-13HP+	40-1000	20	0.4	28	1.55	10	Bi-Directional	Transformer	-
SCBD-28-82HP+	600-820	28	0.1	23	1.07	100	Bi-Directional	Microstrip / Stripline	DC Passthrough
SYBD-22-82HP+	610-810	22.8	0.1	24	1.05	100	Bi-Directional	Microstrip / Stripline	DC Passthrough
SYBD-25-82HP+	610-810	25.5	0.05	28	1.1	100	Bi-Directional	Microstrip / Stripline	DC Passthrough
SYBD-28-82HP+	610-810	28.1	0.02	33	1.05	100	Bi-Directional	Microstrip / Stripline	DC Passthrough
ADCB-20-82+	1-800	20.2	0.3	24	1.2	1	Bi-Directional	Transformer	-
SCBD-30-62HP+	400-620	31	0.08	23	1.1	100	Bi-Directional	Microstrip / Stripline	DC Passthrough
SYBD-26-62HP+	400-610	27.2	0.08	24	1.05	100	Bi-Directional	Microstrip / Stripline	DC Passthrough
SYBD-28-62HP+	400-610	28.8	0.03	27	1.1	100	Bi-Directional	Microstrip / Stripline	DC Passthrough
SYBD-30-62HP+	400-610	32.5	0.02	30	1.05	100	Bi-Directional	Microstrip / Stripline	DC Passthrough
SYBDC-6-62HP+	30-600	6.7	1.9	20	1.22	10	Bi-Directional	Transformer	-
SYDC-10-62HP+	10-600	9.8	0.9	23	1.2	20	Bi-Directional	Transformer	-
SYBDC-26-52VHP+	30-540	26	0.15	25	1.2	50	Bi-Directional	Transformer	-
SYDC-20-62HP+	10-540	19.8	0.2	28	1.1	25	Bi-Directional	Transformer	-
SYBDC-15-52VHP+	10-520	15	0.5	18	1.06	30	Bi-Directional	Transformer	-
SYDC-10-52VHP+	30-512	10	1	19	1.18	35	Bi-Directional	Transformer	-
SYDC-19-52HP+	30-512	19.5	0.35	25	1.11	50	Bi-Directional	Transformer	-
SYDC-19-52VHP+	30-512	19.5	0.35	25	1.1	60	Bi-Directional	Transformer	-
MBDA-30-451HP	225-450	30.5	0.15	28	1.07	200	Bi-Directional	Microstrip / Stripline	DC Passthrough
SYDC-20-22HP+	3-200	20.1	0.1	24	1.1	25	Bi-Directional	Transformer	-
SYDC-30-12HP+	20-100	29	0.06	30	1.03	55	Bi-Directional	Transformer	-
SYDC-20-61HP+	1.5-60	20	0.1	35	1.05	15	Bi-Directional	Transformer	-
SYDC-20-31HP+	1.5-30	20.5	0.06	33	1.13	50	Bi-Directional	Transformer	-



Bi-Directional — Bare Die 50Ω

Model Number	Frequency Range (MHz)	Coupling (dB) Nom.	Mainline Loss (dB)	Directivity (dB)	VSWR (:1)	Power Input Max. (W)	Type	Construction	Feature
EBDC19-KA-D+	5000-43500	18.7	0.6	10	10	1.45	Bi-Directional	MMIC	-

Bi-Directional — Coaxial 50Ω

Model Number	Frequency Range (MHz)	Coupling (dB) Nom.	Mainline Loss (dB)	Directivity (dB)	VSWR (:1)	Power Input Max. (W)	Type	Construction	Feature
ZGBDC35-93HP+	900-9000	34.5	0.1	19	1.2	250	Bi-Directional	Microstrip / Stripline	DC Passthrough
ZFBDC16-63HP+	700-6000	16	0.55	25	1.22	75	Bi-Directional	Microstrip / Stripline	-
ZX30-20-462HP+	2600-4600	19.3	0.35	25	1.2	40	Bi-Directional	Microstrip / Stripline	DC Passthrough
ZGBDC6-372HP+	380-3700	6	0.29	20	1.135	250	Bi-Directional	Microstrip / Stripline	DC Passthrough
ZGBDC10-372HP+	380-3700	10	0.18	20	1.135	250	Bi-Directional	Microstrip / Stripline	DC Passthrough
ZGBDC20-372HP+	300-3700	20	0.16	18	1.288	250	Bi-Directional	Microstrip / Stripline	DC Passthrough
ZGBDC30-372HP+	380-3700	30	0.2	20	1.222	250	Bi-Directional	Microstrip / Stripline	DC Passthrough
ZABDC20-322H-S+	1700-3200	20.5	0.25	21	1.1	50	Bi-Directional	Microstrip / Stripline	DC Passthrough
ZGBDC20-33H+	300-3000	20.6	0.2	23	1.14	50	Bi-Directional	Microstrip / Stripline	DC Passthrough
ZABDC10-25HP-S	1500-2500	10	0.55	26	1.1	10	Bi-Directional	Microstrip / Stripline	DC Passthrough
ZABDC20-252H+	800-2500	21.7	0.2	28	1.05	50	Bi-Directional	Microstrip / Stripline	DC Passthrough
ZABDC20-2400-S+	1500-2400	19.5	0.3	25	1.2	10	Bi-Directional	Microstrip / Stripline	DC Passthrough
ZABDC20-232H+	800-2300	20.5	0.23	20	1.15	50	Bi-Directional	Microstrip / Stripline	DC Passthrough
ZABDC20-182H-S+	700-1800	20.5	0.2	25	1.08	50	Bi-Directional	Microstrip / Stripline	DC Passthrough
ZFBDC20-13HP+	40-1000	20	0.6	22	1.2	10	Bi-Directional	Transformer	-
ZFBDC20-970HP	860-970	20.4	0.1	28	1.1	10	Bi-Directional	Transformer	-
ZFBDC20-900HP	800-900	20.7	0.1	28	1.1	10	Bi-Directional	Transformer	-
ZFBDC20-62HP+	10-600	20	0.25	25	1.05	25	Bi-Directional	Transformer	-
ZGBDC6-521-N+	130-520	6	0.2	28	1.08	60	Bi-Directional	Microstrip / Stripline	DC Passthrough
ZFDC-20-1H+	30-400	20.5	0.15	30	1.2	25	Bi-Directional	Transformer	-

Bi-Directional — Coaxial 50Ω Continued

Model Number	Frequency Range (MHz)	Coupling (dB) Nom.	Mainline Loss (dB)	Directivity (dB)	VSWR (:1)	Power Input Max. (W)	Type	Construction	Feature
ZFBDC20-61HP+	1-60	20	0.1	30	1.07	15	Bi-Directional	Transformer	-
ZABDC50-51HP+	1-50	50	0.06	20	1.06	100	Bi-Directional	Microstrip / Stripline	DC Passthrough
ZABDC50-150HP+	0.4-15	50	0.01	30	1.03	100	Bi-Directional	Microstrip / Stripline	DC Passthrough

Bi-Directional — Coaxial 75Ω

Model Number	Frequency Range (MHz)	Coupling (dB) Nom.	Mainline Loss (dB)	Directivity (dB)	VSWR (:1)	Power Input Max. (W)	Type	Construction
ZABDC20-25H75+	700-2500	21.5	0.15	25	1.08	25	Bi-Directional	Microstrip / Stripline
ZABDC20-25H75F+	700-2500	20	0.3	25	1.1	25	Bi-Directional	Microstrip / Stripline

Bi-Directional — Plug-In 50Ω

Model Number	Frequency Range (MHz)	F Low (MHz)	F High (MHz)	Coupling (dB) Nom.	Mainline Loss (dB)	Directivity (dB)	VSWR (:1)	Power Input Max. (W)	Type	Construction
PDC-10-1BD+	1-400	1	400	11.5	0.8	35	1.2	4	Bi-Directional	Transformer
PDC-20-3BD+	0.2-250	0.2	250	19.5	0.25	40	1.1	4	Bi-Directional	Transformer
PDC-20-1BD+	0.5-200	0.5	200	19.2	0.3	35	1.1	5	Bi-Directional	Transformer

Dual-Directional — Coaxial 50Ω

Model Number	Frequency Range (MHz)	Coupling (dB) Nom.	Mainline Loss (dB)	Directivity (dB)	VSWR (:1)	Power Input Max. (W)	Type	Construction
ZDDC10-K5R44W+	500-40000	10	2.55	24	1.08	16	Dual-Directional	Microstrip / Stripline
ZDDC20-K0144+	1000-40000	20	0.75	24.5	1.08	20	Dual-Directional	Microstrip / Stripline



RF Tap — Surface Mount 50Ω

Model Number	Frequency Range (MHz)	Coupling (dB) Nom.	Mainline Loss (dB)	Directivity (dB)	VSWR (:1)	Power Input Max. (W)	Type	Construction
RBDC-20-63+	DC-6000	20	1.35	20	1.30	0.25	RF Tap	Microstrip / Stripline

RF Tap — Bare Die 50Ω

Model Number	Frequency Range (MHz)	Coupling (dB) Nom.	Mainline Loss (dB)	Directivity (dB)	VSWR (:1)	Power Input Max. (W)	Type	Construction
HK-PT54-D+	DC-50000	26.5	0.8	-	1.27	1	RF Tap	MMIC

RF Tap — Coaxial 50Ω

Model Number	Frequency Range (MHz)	Coupling (dB) Nom.	Mainline Loss (dB)	Directivity (dB)	VSWR (:1)	Power Input Max. (W)	Type	Construction
ZARC-25-63-S+	2500-6000	25	0.27	20	0	100	RF Tap	Microstrip / Stripline
ZARC-25-252-S+	550-2500	25	0.15	27	0	100	RF Tap	Microstrip / Stripline
ZARC-20-52+	100-550	20	0.9	21	0	16	RF Tap	Microstrip / Stripline
ZARC-25-551-S+	100-550	25	0.12	23	0	100	RF Tap	Microstrip / Stripline
ZARC-26-12-S+	20-100	26	0.06	27	0	100	RF Tap	Microstrip / Stripline

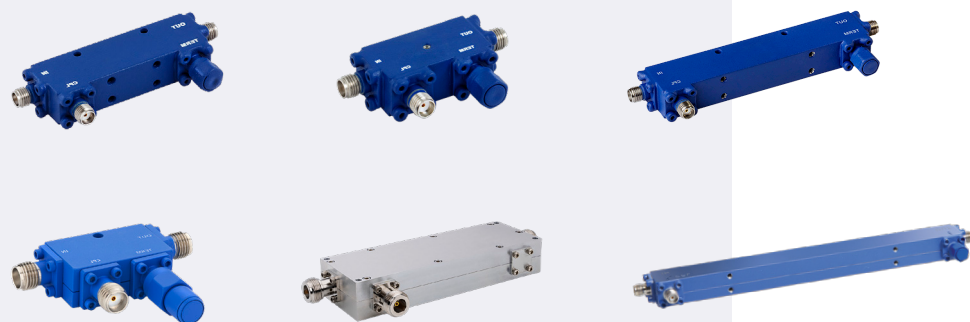

General Dynamics Mission Systems



Mini-Circuits is a terrific partner.

— SR. SUPPLY CHAIN ANALYST



Coupler Designer Kits

Model Number	Model Series	Description	Package	Models Included in Kit	Qty. Ea.	Total Qty.
K2-LTCC-WBZ+	BLNK BLJC BLGE CPJC	2.4 to 2.5 GHz and 4.9 to 5.9 GHz LTCC Couplers and Baluns for WiFi Applications	0402 0603 0805	BLNK1-252R+	5	105
				BLNK2-252R+		
K1-DBTC+	DBTC	5 to 2000 MHz 9 to 20 dB Coupling	Leadless SMT	DBTC-9-4+	5	25
				DBTC-12-4+		
K2-DBTC+	DBTC	75Ω 5 to 1500 MHz	Leadless SMT	DBTC-10-4-75+	5	30
				DBTC-13-5-75+		



// Have I told you lately how much I appreciate working with you and Mini-Circuits?!?!? I do!

— GLOBAL COMMODITY MANAGER

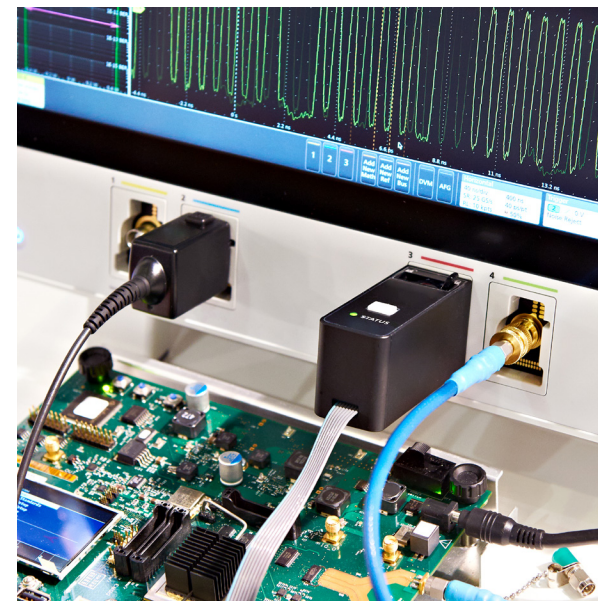

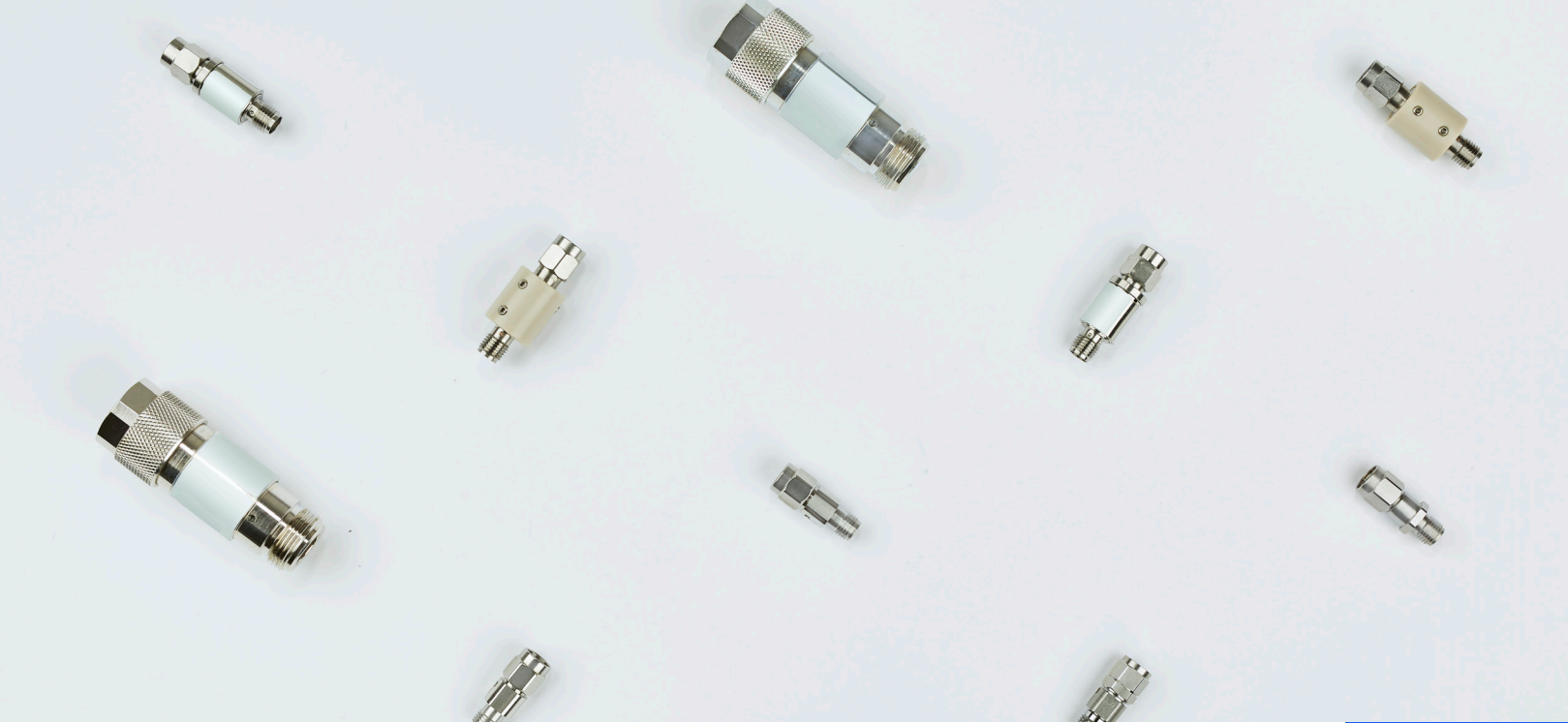

DC Blocks — Coaxial

Model Number	Frequency Range (MHz)	Insertion Loss (dB)	Return Loss (dB)	Connector Type
BLK-E653+	10-65000	0.7	22	1.85mm
BLK-V54+	10-50000	0.51	23	2.4mm
BLK-K44+	10-40000	0.43	25	2.92mm
BLK-18-S+	10-18000	0.15	26	SMA
BLK-18W-S+	10-18000	0.41	23	SMA
BLKD-183-S+	10-18000	0.43	18.52	SMA
BLK-89-S+	0.1-8000	0.1	25	SMA
BLK-6+	10-6000	0.05	45	N
BLK-222+	10-2200	0.2	28	BNC
BLK-222-75+	10-2200	0.1	25	BNC

DC TO 65 GHZ

DC Blocks

Wideband, High-Voltage

- DC input voltage up to 200V
- Low insertion loss
- Excellent return loss

Wide variety of connector types:

N-type, BNC, SMA, 2.92 mm, 2.4 mm, 1.85 mm

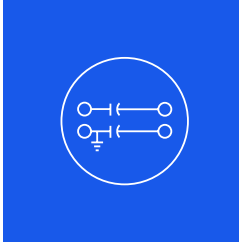



DC TO 45 GHZ

Equalizers

Flatten Negative Gain Slope

- Compensate for frequency-dependent losses in wideband systems
- Fixed slope and voltage variable designs
- Connectorized, MMIC surface mount and bare die formats
- Minimal deviation from linear dB slope



Fixed Slope Equalizers

- SMA and 2.92 mm connectorized, MMIC surface mount and bare die options
- Minimal deviation from linear dB slope
- Good matching over broad bandwidths

Fixed Slope Equalizers – MMIC Surface Mount

Model Number	Frequency Range (MHz)	Slope (dB)	Insertion Loss @ Freq. High (dB)	VSWR (:1)	Max Input Power (dBm)
EQY-3-453+	DC-45000	3.5	0.9	1.24	30
EQY-4-453+	DC-45000	4.1	1.1	1.24	29
EQY-5-453+	DC-45000	5.1	1.1	1.29	28
EQY-6-453+	DC-45000	6.1	1.1	1.29	28
EQY-7-453+	DC-45000	7	1.3	1.23	27
EQY-8-453+	DC-45000	7.9	1.2	1.17	27
EQY-9-453+	DC-45000	8.6	1.5	1.22	28
EQY-10-453+	DC-45000	9.6	1.8	1.27	28
EQY-0-24+	DC-20000	-0.37	0.39	1.1	33
EQY-2-24+	DC-20000	2.1	0.9	1.16	31
EQY-3-24+	DC-20000	3.1	0.7	1.15	34
EQY-5-24+	DC-20000	5.1	0.7	1.24	34
EQY-6-24+	DC-20000	6.3	0.5	1.22	31
EQY-8-24+	DC-20000	8.3	0.8	1.18	34
EQY-10-24+	DC-20000	10.2	0.9	1.18	33
EQY-12-24+	DC-20000	12	1.4	1.09	30
EQY-0-63+	DC-6000	-0.1	0.14	1.07	33
EQY-1-63+	DC-6000	1.2	0.4	1.24	31
EQY-2-63+	DC-6000	2.1	0.4	1.29	31
EQY-3-63+	DC-6000	3.2	0.6	1.29	31
EQY-4-63+	DC-6000	4.2	0.6	1.25	31
EQY-5-63+	DC-6000	5	1	1.24	31



Fixed Slope Equalizers — MMIC Surface Mount Continued

Model Number	Frequency Range (MHz)	Slope (dB)	Insertion Loss @ Freq. High (dB)	VSWR (:1)	Max Input Power (dBm)
EQY-6-63+	DC-6000	6.5	0.5	1.2	32
EQY-8-63+	DC-6000	8.2	0.5	1.21	31
EQY-10-63+	DC-6000	10.2	1	1.12	31
REQ-75-182+	1200-1800	8	2	1.9	20

Fixed Slope Equalizers — Bare Die Continued

Model Number	Frequency Range (MHz)	Slope (dB)	Insertion Loss @ Freq. High (dB)	VSWR (:1)	Max Input Power (dBm)
EQY-6-63-D+	DC-6000	6.5	0.5	1.2	32
EQY-8-63-D+	DC-6000	8.2	0.5	1.21	31
EQY-10-63-D+	DC-6000	10.2	1	1.12	31

Fixed Slope Equalizers — Bare Die

Model Number	Frequency Range (MHz)	Slope (dB)	Insertion Loss @ Freq. High (dB)	VSWR (:1)	Max Input Power (dBm)
EQY-3-453-D+	DC-45000	3.5	1.1	1.22	30
EQY-4-453-D+	DC-45000	4.5	1.1	1.23	29
EQY-5-453-D+	DC-45000	5.5	1.1	1.26	28
EQY-6-453-D+	DC-45000	6.5	1.1	1.25	28
EQY-7-453-D+	DC-45000	7.4	1.3	1.26	27
EQY-8-453-D+	DC-45000	8.2	1.2	1.14	27
EQY-9-453-D+	DC-45000	9	1.6	1.21	28
EQY-10-453-D+	DC-45000	10.2	1.8	1.22	28
EQY-2-24-D+	DC-20000	2.1	0.9	1.26	31
EQY-3-24-D+	DC-20000	3	0.8	1.24	34
EQY-5-24-D+	DC-20000	4.9	0.8	1.34	34
EQY-6-24-D+	DC-20000	6.1	0.7	1.3	31
EQY-8-24-D+	DC-20000	8	1.1	1.31	34
EQY-10-24-D+	DC-20000	10	1.1	1.28	33
EQY-12-24-D+	DC-20000	11.9	1.5	1.17	30
EQY-1-63-D+	DC-6000	1.2	0.4	1.24	31
EQY-2-63-D+	DC-6000	2.1	0.4	1.29	31
EQY-3-63-D+	DC-6000	3.2	0.6	1.29	31
EQY-4-63-D+	DC-6000	4.2	0.6	1.25	31
EQY-5-63-D+	DC-6000	5	1	1.24	31

Fixed Slope Equalizers — Coaxial

Model Number	Frequency Range (MHz)	Slope (dB)	Insertion Loss @ Freq. High (dB)	VSWR (:1)	Max Input Power (dBm)	Connector Type
ZEQ-1-24K+	DC-20000	1.4	1.9	1.3	30	2.92mm
ZEQ-2-24K+	DC-20000	2.4	1.6	1.2	33	2.92mm
ZEQ-4-24K+	DC-20000	4.2	1.7	1.3	33	2.92mm
ZEQ-5-24K+	DC-20000	5.3	1.65	1.3	30	2.92mm
ZEQ-7-24K+	DC-20000	7.4	1.75	1.4	33	2.92mm
ZEQ-9-24K+	DC-20000	9.2	2.1	1.3	33	2.92mm
ZEQ-11-24K+	DC-20000	10.8	2.6	1.4	30	2.92mm
VEQY-1-63+	10-6000	0.9	1	1.13	31	SMA
VEQY-2-63+	10-6000	2.3	0.6	1.18	31	SMA
VEQY-3-63+	10-6000	3	1.2	1.25	31	SMA
VEQY-4-63+	10-6000	4.4	0.8	1.23	31	SMA
VEQY-5-63+	10-6000	4.8	1.6	1.16	31	SMA
VEQY-6-63+	10-6000	6.3	1.1	1.2	31	SMA
VEQY-8-63+	10-6000	7.9	1.1	1.21	31	SMA
VEQY-10-63+	10-6000	9.9	1.6	1.21	31	SMA
ZEQ-5-292-S+	1300-2900	4.7	1.5	1.1	20	SMA
ZEQ-3-222N+	950-2150	4.2	1.7	1.1	20	N
ZEQ-3-222S+	950-2150	4.2	1.7	1.1	20	SMA
ZEQ-8-222N+	950-2150	7.9	6.6	1.1	20	N
ZEQ-8-222S+	950-2150	7.9	6.6	1.1	20	SMA

Voltage Variable Equalizers

- Adjustable attenuation slope up to 13.6 dB
- Ideal for compensating for frequency-dependent cable loss under variable operating conditions
- 50 and 75Ω options

Voltage Variable Equalizers — Surface Mount 50 and 75Ω

Model Number	Freq. Range (MHz)	Impedance (Ω)	Max Slope (dB)	Insertion Loss @ Freq. High (dB)	IP3 (dBm)	P1dB (dBm)	Input Return Loss (dB)	Output Return Loss (dB)	Supply Voltage (V)	Supply Current (mA) Max.	Control Voltage (V)	Control Current (mA) Max.
VAEQ-2150R+	950-2150	50	6.7	5.9	55	30	15	10	3	8	0-5	6
VAEQ-2150R+	950-2150	50	6.5	6.1	55	30	16	11	5	15	0-5	10
VAEQ-1220+	50-1220	50	12.5	2.5	55	30	13	11	5	16	0-7	20
VAEQ-1220-75+	50-1220	75	13.4	1.6	50	30	15	13	5	16	0-7	20
VAEQ-1000+	50-1000	50	13.6	1.6	45	30	17.5	17.5	5	4	0-10	40

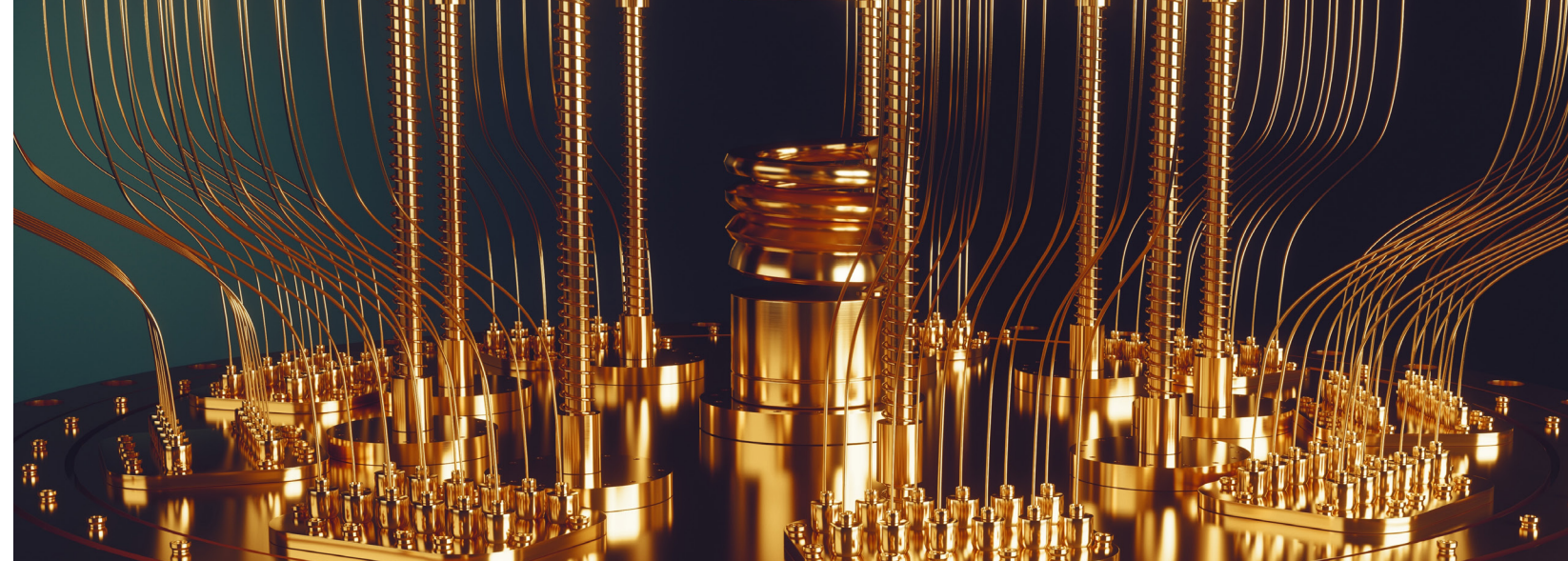

MIT Lincoln Laboratory

Great company to work with!

— ALEXANDREA H

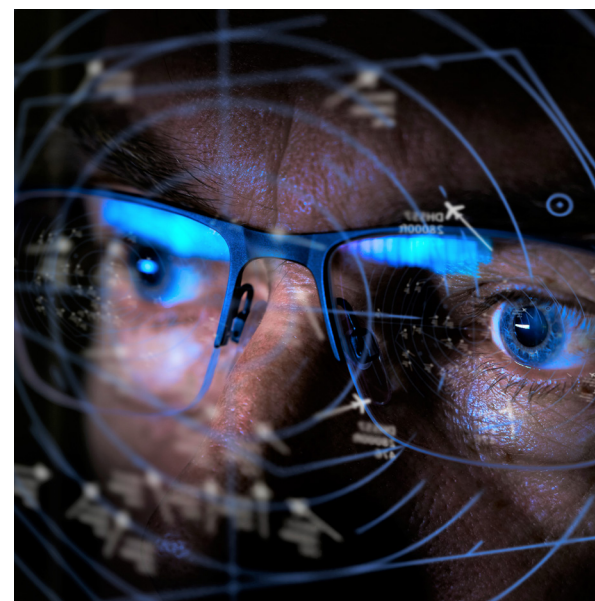

Equalizer Designer Kits

Model Number	Model Series	Description	Package	Models Included in Kit	Qty. Ea.	Total Qty.
K1-EQY24+	EQY	DC to 20 GHz 2-12 dB Gain Slopes	QFN	EQY-2-24+ -3-24+ -5-24+ -6-24+ -8-24+ -10-24+ -12-24+	5	35
K1-EQY24-DG+	EQY	DC to 20 GHz 2-12 dB Gain Slopes	DIE	EQY-2-24-DG+ -3-24-DG+ -5-24-DG+ -6-24-DG+ -8-24-DG+ -10-24-DG+ -12-24-DG+	5	35
K1-EQY63+	EQY	DC to 6 GHz 1-10 dB Gain Slopes	QFN	EQY-1-63+ -2-63+ -3-63+ -4-63+ -5-63+ -6-63+ -8-63+ -10-63+	5	40
K1-EQY63-DG+	EQY	DC to 6 GHz 1-10 dB Gain Slopes	DIE	EQY-1-63-DG+ -2-63-DG+ -3-63-DG+ -4-63-DG+ -5-63-DG+ -6-63-DG+ -8-63-DG+ -10-63-DG+	5	40

Model Number	Model Series	Description	Package	Models Included in Kit	Qty. Ea.	Total Qty.
KVEQY-63+	VEQY	DC to 6 GHz 1-10 dB Gain Slopes	SMA Connectorized	VEQY-1-63+ -2-63+ -3-63+ -4-63+ -5-63+ -6-63+ -8-63+ -10-63+	2	16
K1-EQY453+	EQY	DC to 45 GHz 3-10 dB Gain Slopes	QFN	EQY-3-453+ -4-453+ -5-453+ -6-453+ -7-453+ -8-453+ -9-453+ -10-453+	5	40
K1-ZEQ24+	ZEQ	DC to 20 GHz 1-11 dB Gain Slopes	2.92 mm Connectorized	ZEQ-1-24K+ -2-24K+ -4-24K+ -5-24K+ -7-24K+ -9-24K+ -11-24K+	1	7





DC TO 86 GHz

Filters

For Every Application

- 1500+ in-stock models and custom designs with fast turnaround
- Low pass, high pass, band pass, band stop, diplexers and triplexers
- In-house design and manufacturing capability

Technologies:

LTCC, Lumped L-C, ceramic resonator, reflectionless filters, suspended substrate, microstrip, alumina, cavity and waveguide



Technology Overview

Cavity

- Bandwidths as narrow as 1%
- Passbands to 43.5 GHz, stopbands to 57 GHz
- Wide stopbands with 100+ dB rejection
- Excellent selectivity
- Coaxial and surface mount designs

- Rugged design prevents accidental de-tuning from handling in harsh environments
- Short turnaround on custom designs, 8 to 10 weeks



Ceramic Resonator

- Fractional bandwidth from 0.5 to 40%
- Low insertion loss, 0.5 dB typ.
- Excellent power handling, up to 20W
- Rugged construction for demanding operating conditions

- Good rejection and selectivity
- Multiple compact surface mount package options
- Wide stopband with harmonic suppression > 3 x fc



LTCC

- The industry's widest selection
- New designs achieve deeper rejection in case styles as small as 0202
- New mmWave designs for 5G bands

- Low cost for volume production
- Excellent repeatability
- Stopband rejection up to 40 GHz



Lumped L-C

- Wide catalog selection
- Affordable custom designs with low or no NRE
- Several package options including aqueous wash-proof

- Flexible type and topology
- Excellent repeatability
- Over 100 million shipped!

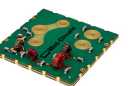

Microstrip

- Passband insertion loss as low as 0.6 dB
- Connectorized designs with 4 to 40% fractional bandwidth
- Power handling up to 10W
- Flat group delay



MMIC Reflectionless

- Patented topology absorbs and internally terminates stopband signals
- Perfect for pairing with amplifiers, mixers and multipliers
- Improves spur-free dynamic range in DACs and ADCs
- Minimizes ripple in optical communication systems
- Cascadable with other filter technologies

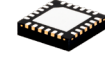

Rectangular Waveguide

- Low passband insertion loss, 1 dB
- High stopband rejection, 40 dB
- WR-12, WR-15 and WR-28 interfaces



Low Pass Filters

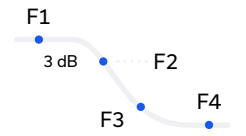

Low Pass – Surface Mount 50Ω

Model Number	Passband (MHz)	Stopband F3 (MHz)	Rejection @ F3 (dB)	Stopband F4 (MHz)	Rejection @ F4 (dB)	Technology
XLF-173+	DC-17000	23900-26000	14	26000-33000	20	Reflectionless
LFCV-1652+	DC -16500	22500-26500	35	26500-40000	30	LTCC
LFCV-1452+	DC -14500	20000-26500	40	26500-40000	20	LTCC
LFCW-143+	DC -14000	19250-25000	31	25000-26500	30	LTCC
LFCW-133+	DC -13250	14910-15410	20	-	-	LTCC
XLF-133+	DC-13100	19500-20000	14	20000-30000	20	Reflectionless
LFCN-1282+	DC -12800	16200-20000	30	16200-20000	30	LTCC
XLF-123+	DC-12200	18100-19000	14	19000-29000	20	Reflectionless
LFCN-123+	DC -12000	15000	20	15500-20000	40	LTCC
LFCW-123+	DC -12000	16300-22000	35	22000-26500	20	LTCC
LFCW-1142+	DC -11400	12860-13860	20	-	-	LTCC
LFCN-113+	DC -11000	14000	20	14500-20000	40	LTCC
LFCW-113+	DC -11000	14800-16000	39	19000-26500	20	LTCC
LFCW-1062+	DC -10600	12160-12860	20	-	-	LTCC
LFCW-103+	DC -10000	13700-18000	38	23000-26500	15	LTCC
XLF-14+	DC-10000	15800-17000	20	17000-24200	20	Reflectionless
XLF-982+	DC-9800	19000-22000	14	22000-32500	20	Reflectionless
XLF-962+	DC-9600	14800-16000	14	16000-25200	20	Reflectionless
LFCN-9170+	DC -9170	11360-19000	20	11630-18770	30	LTCC
LFCN-8440+	DC -8440	10900	20	11500-21850	30	LTCC
LFCN-8400+	DC -8400	10300 - 15000	20	-	-	LTCC
LFCW-8400+	DC -8400	12200-16000	45	16000-26500	15	LTCC
XLF-762+	DC-7600	13100-20000	14	-	-	Reflectionless
LFCW-7500+	DC -7500	9900-15000	42	15000-26500	25	LTCC
XLF-732+	DC-7300	14300-34000	14	-	-	Reflectionless
LFCN-722+	DC -7200	8980	20	9270-10060	30	LTCC

Low Pass — Surface Mount 50Ω Continued

Model Number	Passband (MHz)	Stopband F3 (MHz)	Rejection @ F3 (dB)	Stopband F4 (MHz)	Rejection @ F4 (dB)	Technology
LFCN-7200+	DC -7200	9500	20	8850-9600	30	LTCC
LFCN-7200D+	DC -7200	9500	20	8850-9600	30	LTCC
XLF-73+	DC-7000	11700-21300	14	-	-	Reflectionless
XLF-63H+	DC-6820	14500-16300	30	16300-26000	40	Reflectionless
LFCN-6700+	DC -6700	9300	20	9500-11000	30	LTCC
LFCN-6700D+	DC -6700	9300	20	9500-11000	30	LTCC
LFCN-6400+	DC -6400	8300	20	7770-10200	30	LTCC
LFCN-6400D+	DC -6400	8300	20	7770-10200	30	LTCC
LFCW-6300+	DC -6300	8600-14300	42	14300-26500	25	LTCC
LFCG-612+	4900-6100	8200	20	9800-12200	30	LTCC
LFCW-612+	10-6100	9300-12600	25	-	-	LTCC
LFCN-6000+	DC -6000	8500	20	8700-10500	30	LTCC
LFCN-6000D+	DC -6000	8500	20	8700-10500	30	LTCC
LFCW-6000+	DC -6000	8200-14000	42	14000-26500	15	LTCC
XLF-63+	DC-6000	9600-17800	14	-	-	Reflectionless
XLF-662M+	DC-6000	9200-14000	30	14000-26000	36	Reflectionless
LPJC-592R+	4900-5950	8800-12600	49	-	-	LTCC
LPGE-592R+	4900-5900	9800-11800	42	14700-17700	54	LTCC
LFCN-5850+	DC -5850	7600	20	7100-9900	30	LTCC
LFCN-5850D+	DC -5850	7600	20	7100-9900	30	LTCC
LFCN-5500+	DC -5500	7200	20	6770-9500	30	LTCC
LFCN-5500D+	DC -5500	7200	20	6770-9500	30	LTCC
LFCW-5500+	DC -5500	7500-11500	32	17000-26500	20	LTCC
LFTC-5400+	DC -5400	9000-11000	20	12000	20	LTCC
LFCN-5000+	DC -5000	6850	20	7050-10000	30	LTCC
LFCN-5000D+	DC -5000	6850	20	7050-10000	30	LTCC
LFCW-5000+	DC -5000	7200-11000	40	11000-26500	15	LTCC
LFCG-4800+	DC-4800	7200-9300	42	9300-18000	20	LTCC

Low Pass — Surface Mount 50Ω Continued

Model Number	Passband (MHz)	Stopband F3 (MHz)	Rejection @ F3 (dB)	Stopband F4 (MHz)	Rejection @ F4 (dB)	Technology
LFCN-4400+	DC -4400	6700	20	6280-9800	30	LTCC
LFCN-4400D+	DC -4400	6700	20	6280-9800	30	LTCC
LFTC-4000+	DC -4000	7250	20	9500	20	LTCC
XLF-362H+	DC-3910	9200-10700	30	10700-18500	40	Reflectionless
LFCG-3800+	DC-3900	5800-8400	40	8400-18000	20	LTCC
LFCN-3800+	DC -3900	6000	20	5700-8300	30	LTCC
LFCN-3800D+	DC -3900	6000	20	5700-8300	30	LTCC
XLF-312H+	DC-3530	7900-9300	30	9300-18500	40	Reflectionless
LFCG-3500+	DC-3500	4800-5000	35	8500-15000	25	LTCC
LFCG-3400+	DC-3400	5000-8500	40	8500-15000	25	LTCC
LFCN-3400+	DC -3400	4300	20	4600-7800	30	LTCC
LFCN-3400D+	DC -3400	4300	20	4600-7800	30	LTCC
LFCW-332+	10-3300	4550-8000	25	-	-	LTCC
LFTC-3300+	DC -3300	5600	20	10000	20	LTCC
XLF-332+	DC-3250	5900-17000	14	17000-30000	20	Reflectionless
LFCG-3000+	DC-3000	4550-7000	50	11000-15000	25	LTCC
LFCN-3000+	DC -3000	4550	20	4780-7500	30	LTCC
LFCN-3000D+	DC -3000	4550	20	4780-7500	30	LTCC
LFCG-2850+	DC-2850	3800-4400	20	4400-12000	30	LTCC
LFCN-2850+	DC -2800	4000	20	4200-7400	30	LTCC
LFCN-2850D+	DC -2800	4000	20	4200-7400	30	LTCC
LFCG-2750+	DC-2750	4000-7200	50	7200-16000	25	LTCC
LFCN-2750+	DC -2750	4000	20	4150-6800	30	LTCC
LFCN-2750D+	DC -2750	4000	20	4150-6800	30	LTCC
LFCW-272+	DC -2690	4400	20	4800-5400	30	LTCC
LFCG-2600+	DC-2600	3850-7000	50	7000-15000	25	LTCC
LFCN-2600+	DC -2600	3750	20	3900-6600	30	LTCC
LFCN-2600D+	DC -2600	3750	20	3900-6600	30	LTCC



Low Pass – Surface Mount 50Ω Continued

Model Number	Passband (MHz)	Stopband F3 (MHz)	Rejection @ F3 (dB)	Stopband F4 (MHz)	Rejection @ F4 (dB)	Technology
LFCG-2500+	DC-2500	3500-4000	33	7000-10000	30	LTCC
LFCN-2500+	DC -2500	3675	20	3800-6100	30	LTCC
LFCN-2500D+	DC -2500	3675	20	3800-6100	30	LTCC
LFCO-252+	DC-2500	4400-8500	20	-	-	LTCC
LPGE-252R+	2400-2500	4800-5000	40	7200-7500	37	LTCC
LPJC-252R+	2400-2500	4800-5000	52	7200-7500	34	LTCC
LPNK-252R+	2400-2500	4800-5000	42	7200-7500	40	LTCC
XLF-252+	DC-2500	4550-16000	14	16000-30000	20	Reflectionless
XLF-252H+	DC-2500	7000-17000	40	-	-	Reflectionless
LFCN-2400+	DC -2400	3600	20	3700-4000	30	LTCC
LFCN-2400D+	DC -2400	3600	20	3700-4000	30	LTCC
LFCN-2290+	DC -2290	3110	20	3600-8000	30	LTCC
LFCG-2250+	DC-2250	2800-3600	20	3600-8000	30	LTCC
LFCN-2250D+	DC -2250	2900	20	3000-5000	30	LTCC
LFCN-2250+	DC -2200	2900	20	3000-5000	30	LTCC
LFCG-2000+	DC-2000	3300-7500	52	7500-13500	28	LTCC
LFCN-2000+	DC -2000	3000	20	3100-3500	30	LTCC
LFCN-2000D+	DC -2000	3000	20	3100-3500	30	LTCC
LFTC-2000+	DC -2000	3450	20	4500-5400	40	LTCC
XLF-172H+	DC-2000	3600-3800	30	3800-11000	40	Reflectionless
XLF-192+	DC-1900	3480-11200	14	11200-30000	20	Reflectionless
LFCG-1800+	DC-1800	2450-7000	40	7000-10000	35	LTCC
LFCN-1800+	DC -1800	2425	20	2500-7200	30	LTCC
LFCN-1800D+	DC -1800	2550	20	3000-7200	30	LTCC
LFCG-1700+	DC-1700	2400-2800	20	2800-8000	30	LTCC
LFCN-1700+	DC -1700	2375	20	2500-6500	30	LTCC
LFCN-1700D+	DC -1700	2375	20	2500-6500	30	LTCC
LFTC-1700+	DC -1700	2700	20	3300-3750	40	LTCC

Low Pass – Surface Mount 50Ω Continued

Model Number	Passband (MHz)	Stopband F3 (MHz)	Rejection @ F3 (dB)	Stopband F4 (MHz)	Rejection @ F4 (dB)	Technology
LFCG-1575+	DC-1575	2175-2400	20	2400-7000	40	LTCC
LFCN-1575+	DC -1575	2175	20	2225-6800	30	LTCC
LFCN-1575D+	DC -1575	2275	20	2325-6800	30	LTCC
LFCG-1525+	DC-1525	2125-7000	40	7000-12000	30	LTCC
LFCN-1525+	DC -1525	2040	20	2075-6600	30	LTCC
LFCN-1525D+	DC -1525	2150	20	2425-6600	30	LTCC
RLPF-1520+	0.5-1520	1870-3200	20	-	-	Lumped LC
LFCN-1500+	DC -1500	2100	20	2150-6600	30	LTCC
LFCN-1500D+	DC -1500	2175	20	2300-6600	30	LTCC
LFCN-1450+	DC -1450	2025	20	2050-6600	30	LTCC
LFCV-1450+	DC -1450	1650	20	4000	20	LTCC
LFCG-1400+	DC-1400	2015-6600	50	6600-10000	35	LTCC
LFCN-1400+	DC -1400	2015	20	2050-6600	30	LTCC
LFCN-1400D+	DC -1400	2100	20	2200-6600	30	LTCC
LFTC-1350+	DC -1350	2100	20	2700-4500	30	LTCC
LFCG-1325+	DC-1325	1900-2150	45	6500-11600	35	LTCC
LFCN-1325+	DC -1325	2100	20	2200-2600	30	LTCC
XLF-132H+	DC-1300	2700-3000	30	3000-19000	40	Reflectionless
LFCG-1200+	DC-1200	1865-3700	50	3700-10000	30	LTCC
LFCN-1200+	DC -1200	1850	20	2000-5000	30	LTCC
LFCN-1200D+	DC -1200	1850	20	2000-5000	30	LTCC
XLF-122H+	DC-1200	2300-2500	30	2500-9500	40	Reflectionless
XLF-122+	DC-1150	2190-10000	14	10000-21000	20	Reflectionless
SXLP-1100+	DC -1100	1440-8500	20	-	-	Lumped LC
RLP-1094+	DC -1094	1700-3650	20	-	-	Lumped LC
ULP-1094+	DC -1094	1700-2200	20	2200-3300	30	Lumped LC
XLF-112H+	DC-1050	2000-2200	30	2200-10000	40	Reflectionless
LFCG-1000+	DC-1000	1550-1900	20	1900-6000	30	LTCC



Low Pass — Surface Mount 50Ω Continued

Model Number	Passband (MHz)	Stopband F3 (MHz)	Rejection @ F3 (dB)	Stopband F4 (MHz)	Rejection @ F4 (dB)	Technology
LFCN-1000+	DC -1000	1550	20	1900-5000	30	LTCC
LFCN-1000D+	DC -1000	1600	20	1900-5000	30	LTCC
SCLF-1000+	DC -1000	1620-2100	20	2100-2500	40	Lumped LC
SXLP-1000+	DC -1000	1620-2100	20	2100-2500	40	Lumped LC
XLF-13H+	DC-1000	1850-2500	30	2500-10000	40	Reflectionless
LFCG-92+	DC -990	1700	20	1800-2700	30	LTCC
RLP-900+	DC -900	1300-1750	20	1750-2900	40	Lumped LC
ULP-900+	DC -900	1300-1750	20	1750-2900	30	Lumped LC
SALF-865+	DC -865	1300-1400	20	1400-2550	40	Lumped LC
XLF-861+	DC-860	1700-7500	14	7500-25000	20	Reflectionless
LFCG-900+	DC-850	1300-1600	48	4500-11000	20	LTCC
LFCN-900+	DC -850	1275	20	1350-4850	30	LTCC
LFCN-900D+	DC -850	1275	20	1350-4850	30	LTCC
LFTC-850+	DC -850	1500	20	2000-3500	40	LTCC
LFCG-800+	DC-800	1400-4500	47	4500-10000	24	LTCC
LFCN-800+	DC -800	1400	20	1500-2000	30	LTCC
LFCN-800D+	DC -800	1400	20	1500-2000	30	LTCC
SALF-800+	DC -800	1200-1330	20	1330-2550	40	Lumped LC
SCLF-700+	DC -700	1000-1300	20	1300-2000	40	Lumped LC
SXLP-700+	DC -700	1000-1300	20	1300-2000	40	Lumped LC
SALF-680+	DC -680	1090-1400	20	1400-2200	40	Lumped LC
LFCG-630+	DC-630	1050-1500	48	1500-8500	15	LTCC
LFCN-630+	DC -630	1000	20	1020-3500	40	LTCC
LFCN-630D+	DC -630	1020	20	1020-3500	40	LTCC
SALF-580+	DC -580	1000-1300	20	1300-2100	40	Lumped LC
LFCG-575+	DC-575	1020-2500	30	2500-4400	25	LTCC
LFCN-575	DC -575	900	20	1050-3200	40	LTCC
LFCN-575+	DC -575	900	20	1050-3200	40	LTCC

Low Pass — Surface Mount 50Ω Continued

Model Number	Passband (MHz)	Stopband F3 (MHz)	Rejection @ F3 (dB)	Stopband F4 (MHz)	Rejection @ F4 (dB)	Technology
LFCN-575D+	DC -575	945	20	1050-3200	40	LTCC
SCLF-550+	DC -550	800-1050	20	1050-2000	40	Lumped LC
SXLP-550+	DC -550	800-1050	20	1050-2000	30	Lumped LC
SXLP-550A+	DC -550	600-630	20	630-2300	30	Lumped LC
XLF-551+	DC-550	1140-5800	14	5800-18500	20	Reflectionless
LFCG-530+	DC-530	980-2600	30	2600-4000	25	LTCC
LFCN-530+	DC -530	820	20	945-3000	40	LTCC
LFCN-530D+	DC -530	870	20	945-3000	40	LTCC
LPF-B500+	DC -500	585-4500	20	-	-	Lumped LC
XLF-641M+	DC-500	1100-7800	30	7800-13000	40	Reflectionless
LFCG-490+	DC-490	800-1500	48	1500-8500	15	LTCC
LFCN-490+	DC -490	800	20	880-2500	40	LTCC
LFCN-490D+	DC -490	840	20	880-2500	30	LTCC
SALF-490+	DC -490	800-900	20	900-1600	40	Lumped LC
RLP-470+	DC -470	650-780	20	780-2000	40	Lumped LC
ULP-470+	DC -470	650-780	20	780-2000	30	Lumped LC
SXLP-450+	DC -450	495-545	20	545-3000	40	Lumped LC
LFCG-42+	DC -435	625	20	650-2700	30	LTCC
SCLF-420+	DC -420	750-920	20	920-2000	40	Lumped LC
SXLP-420+	DC -420	740-920	20	920-2000	30	Lumped LC
XLF-421+	DC-420	900-5200	14	5200-18000	20	Reflectionless
LFCG-400+	DC-400	800-2500	30	2500-4500	20	LTCC
LFCN-400+	DC -400	660	20	680-3000	40	LTCC
LFCN-400D+	DC -400	690	20	680-3000	30	LTCC
SXLP-400+	DC -400	500-2400	20	-	-	Lumped LC
SALF-396+	DC -396	570-620	20	620-1430	40	Lumped LC
SCLF-380+	DC -380	580-750	20	750-1800	40	Lumped LC
SXLP-380+	DC -380	580-750	20	750-2200	30	Lumped LC



Low Pass — Surface Mount 50Ω Continued

Model Number	Passband (MHz)	Stopband F3 (MHz)	Rejection @ F3 (dB)	Stopband F4 (MHz)	Rejection @ F4 (dB)	Technology
LFP-B375+	DC -375	440-4500	20	-	-	Lumped LC
RLP-340+	DC -340	475-560	20	560-1500	40	Lumped LC
ULP-340+	DC -340	475-750	20	750-2000	40	Lumped LC
SALF-325+	DC -325	480-580	20	580-1250	40	Lumped LC
LFCG-320+	DC-320	660-2000	33	2000-6000	20	LTCC
LFCN-320+	DC -320	560	20	640-2500	40	LTCC
LFCN-320D+	DC -320	610	20	640-2500	30	LTCC
RLP-320+	DC -320	440-510	20	510-1600	40	Lumped LC
ULP-320+	DC -320	440-510	20	510-1600	40	Lumped LC
XLF-42M+	DC-300	660-6800	30	6800-10000	40	Reflectionless
RLP-290+	DC -290	350-1600	20	-	-	Lumped LC
RLP-288+	DC -288	390-455	20	455-1500	40	Lumped LC
ULP-288+	DC -288	390-700	20	700-1500	40	Lumped LC
SALF-265+	DC -265	390-470	20	470-1100	40	Lumped LC
RLP-264+	DC -264	365-425	20	425-1500	40	Lumped LC
ULP-264+	DC -264	365-600	20	600-1600	40	Lumped LC
LFCN-225+	DC -225	460	20	510-2500	40	LTCC
LFCN-225D+	DC -225	485	20	510-2500	40	LTCC
SCLF-225+	DC -225	340-440	20	440-1200	40	Lumped LC
SXLP-225+	DC -225	340-440	20	440-1600	40	Lumped LC
XLF-221+	DC-220	570-3500	14	3500-12000	20	Reflectionless
RLP-216+	DC -216	295-340	20	340-1300	40	Lumped LC
ULP-216+	DC -216	295-450	20	450-1300	40	Lumped LC
LFCN-190+	DC -190	400	20	510-2850	40	LTCC
RLP-190+	DC -190	264-300	20	300-1300	40	Lumped LC
SCLF-190+	DC -190	290-390	20	390-800	40	Lumped LC
SXLP-190+	DC -190	290-390	20	390-1000	40	Lumped LC
ULP-190+	DC -190	264-300	20	300-1300	40	Lumped LC

Low Pass — Surface Mount 50Ω Continued

Model Number	Passband (MHz)	Stopband F3 (MHz)	Rejection @ F3 (dB)	Stopband F4 (MHz)	Rejection @ F4 (dB)	Technology
LFCN-180+	DC -180	370	20	525-2350	40	LTCC
RLP-176+	DC -176	245-285	20	285-1000	40	Lumped LC
ULP-176+	DC -176	245-285	20	285-1000	40	Lumped LC
LFCN-160+	DC -160	330	20	480-2700	30	LTCC
RLP-158+	DC -158	220-255	20	255-1000	40	Lumped LC
ULP-158+	DC -158	220-255	20	255-1000	40	Lumped LC
XLF-151+	DC-150	460-2800	14	2800-16000	20	Reflectionless
SALF-146+	DC -146	210-240	20	240-850	40	Lumped LC
RLP-137+	DC -137	190-215	20	215-1000	40	Lumped LC
ULP-137+	DC -137	190-215	20	215-1000	40	Lumped LC
SCLF-135+	DC -135	210-300	20	300-600	40	Lumped LC
SXLP-135+	DC -135	210-300	20	300-1600	40	Lumped LC
LFCN-120+	DC -120	280	20	300-1850	40	LTCC
RLP-120+	DC -120	170-205	20	205-1000	40	Lumped LC
ULP-120+	DC -120	170-205	20	205-1000	40	Lumped LC
SALF-116+	DC -116	182-220	20	220-825	40	Lumped LC
LFCN-105+	DC -105	250	20	265-1650	40	LTCC
RLP-105+	DC -105	145-165	20	165-1000	40	Lumped LC
ULP-105+	DC -105	145-165	20	165-1000	40	Lumped LC
LFCN-95+	DC -95	230	20	255-1600	40	LTCC
SCLF-95+	DC -95	146-189	20	189-400	40	Lumped LC
SXLP-95+	DC -95	146-189	20	189-1400	40	Lumped LC
SXLP-90+	DC -90	105-170	20	170-1000	40	Lumped LC
RLP-83+	DC -83	118-135	20	135-850	40	Lumped LC
ULP-83+	DC -83	118-135	20	135-850	40	Lumped LC
LFCN-80+	DC -80	200	20	225-1550	40	LTCC
SALF-78+	DC -78	120-136	20	136-550	40	Lumped LC
RLP-70+	DC -70	100-115	20	115-1000	40	Lumped LC



Low Pass – Surface Mount 50Ω Continued

Model Number	Passband (MHz)	Stopband F3 (MHz)	Rejection @ F3 (dB)	Stopband F4 (MHz)	Rejection @ F4 (dB)	Technology
ULP-70+	DC -70	100-115	20	115-700	40	Lumped LC
SCLF-65+	DC -65	86-96.0	20	96.0-510	40	Lumped LC
SXLP-65+	DC -65	86-96	20	96-710	40	Lumped LC
LFCV-52+	DC -52	140	20	170-1100	40	LTCC
LPF-B50+	DC -50	65-3300	20	-	-	Lumped LC
RLP-50+	DC -50	78-91	20	91-1000	40	Lumped LC
ULP-50+	DC -50	78-91	20	91-700	40	Lumped LC
LFCV-45+	DC -45	120	20	150-910	40	LTCC
SCLF-45+	DC -45	70-90.0	20	90.0-200	40	Lumped LC
SXLP-45+	DC -45	70-90	20	90-1600	40	Lumped LC
SCLF-44+	DC -44	59-65.5	20	66.5-420	40	Lumped LC
SXLP-44+	DC -44	59-65.5	20	65.50-600	40	Lumped LC
RLP-40+	DC -40	70-80	20	80-800	40	Lumped LC
SXLP-40+	DC -40	54-80	20	80-2750	40	Lumped LC
ULP-40+	DC -40	70-80	20	80-600	40	Lumped LC
SCLF-36+	DC -36	50-57.0	20	57.0-390	40	Lumped LC
SXLP-36+	DC -36	50-57	20	57-560	40	Lumped LC
LPF-B35+	DC -35	45-2500	20	-	-	Lumped LC
RLP-30+	DC -30	47-53	20	53-3000	40	Lumped LC
SCLF-30+	DC -30	47-61.0	20	61.0-200	40	Lumped LC
SXLP-30+	DC -30	47-61	20	61-1500	40	Lumped LC
ULP-30+	DC -30	47-53	20	53-3000	40	Lumped LC
SXLP-29+	DC -29	38	20	400-2500	30	Lumped LC
SCLF-27+	DC -27	36.0-41.0	20	41.0-480	40	Lumped LC
SXLP-27+	DC -27	36-41	20	41-810	40	Lumped LC
SCLF-25+	DC -25	36.0-47.0	20	47.0-200	40	Lumped LC
SXLP-25+	DC -25	36-47	20	47-1000	40	Lumped LC
SCLF-23+	DC -23	31.0-34.0	20	34.0-320	40	Lumped LC

Low Pass – Surface Mount 50Ω Continued

Model Number	Passband (MHz)	Stopband F3 (MHz)	Rejection @ F3 (dB)	Stopband F4 (MHz)	Rejection @ F4 (dB)	Technology
SXLP-23+	DC -23	31-34	20	34-500	40	Lumped LC
SCLF-21.4+	DC -22	32.0-41.0	20	41.0-200	40	Lumped LC
SXLP-21.4+	DC -22	32-41	20	41-2000	40	Lumped LC
SXLP-16+	DC -16	22	20	1000-2000	30	Lumped LC
SXLP-13+	DC -13	18.5	20	20-2200	30	Lumped LC
SCLF-10.7+	DC -11	19.0-24.0	20	24.0-200	40	Lumped LC
SXLP-10.7+	DC -11	19-24	20	24-1600	40	Lumped LC
SCLF-10+	DC -10	14.0-16.0	20	16.0-230	40	Lumped LC
SXLP-10+	DC -10	14-16	20	16-230	40	Lumped LC
SCLF-8.4+	DC -8.4	11.4-12.6	20	12.6-210	40	Lumped LC
SXLP-8.4+	DC -8.4	11.6-13.0	20	13.0-400	40	Lumped LC
SCLF-8+	DC -8	12.5-16.5	20	16.5-200	40	Lumped LC
SXLP-8+	DC -8	12.5-16.5	20	16.5-1000	40	Lumped LC
SCLF-5+	DC -5	8.0-10.0	20	10.0-200	40	Lumped LC
SXLP-5+	DC -5	8.0-11	20	11-600	40	Lumped LC
SCLF-4.7+	DC -4.7	6.6-7.4	20	7.4-600	40	Lumped LC
SXLP-4.7+	DC -4.7	6.6-7.4	20	7.4-600	40	Lumped LC
SXLP-3+	DC -3	4.6-800	20	-	-	Lumped LC
LPF-B0R8+	DC -0.8	1.55-1.75	20	1.75-1000	40	Lumped LC
LPF-B0R7+	DC -0.7	1.30-1.46	20	1.46-1000	40	Lumped LC
LPF-B0R6+	DC -0.6	1.08-1.23	20	1.23-1000	40	Lumped LC
LPF-B0R5+	DC -0.5	1.00-1.12	20	1.12-1000	40	Lumped LC
LPF-B0R35+	DC -0.35	0.70-0.79	20	0.79-1000	40	Lumped LC
LPF-B0R3+	DC -0.3	0.56-0.61	20	0.61-1000	40	Lumped LC

Low Pass – Surface Mount 75Ω

Model Number	Passband (MHz)	Stopband F3 (MHz)	Rejection @ F3 (dB)	Stopband F4 (MHz)	Rejection @ F4 (dB)	Technology
LFCV-700-75+	5-700	990-1950	30	1950-2150	25	LTCC



Low Pass Dual Differential — Surface Mount 50Ω

Model Number	Passband (MHz)	Stopband F3 (MHz)	Rejection @ F3 (dB)	Stopband F4 (MHz)	Rejection @ F4 (dB)	Technology
DLFCV-1750+	DC -1750	2500-5000	50	5000-10000	25	LTCC
DLFCV-1600+	DC -1600	2400-4900	50	4900-10000	25	LTCC
DLFCV-1000+	DC -1000	1700-5000	20	-	-	LTCC
DLFCG-540+	DC -540	720-8360	20	-	-	LTCC
DLFCN-290+	DC -290	460	25	600-2000	45	LTCC
LPGD-7080+	DC -80	155-250	20	250-2500	40	Lumped LC
LPGD-7080+	DC -70	135-200	20	200-2500	40	Lumped LC
LPGD-3040+	DC -40	85-130	20	130-2000	40	Lumped LC
LPGD-3040+	DC -30	70-110	20	110-2000	40	Lumped LC

Low Pass — Bare Die

Model Number	Passband (MHz)	Stopband F3 (MHz)	Rejection @ F3 (dB)	Stopband F4 (MHz)	Rejection @ F4 (dB)	Technology
XLF-173-D+	DC-17000	23900-26000	14	26000-33000	20	Reflectionless
XLF-133-D+	DC-13100	19500-20000	14	20000-30000	20	Reflectionless
XLF-123-D+	DC-12200	18100-19000	14	19000-29000	20	Reflectionless
XLF-14-D+	DC-10000	15800-17000	20	17000-24200	20	Reflectionless
XLF-982-D+	DC-9800	19000-22000	14	22000-32500	20	Reflectionless
XLF-962-D+	DC-9600	14800-16000	14	16000-25200	20	Reflectionless
XLF-762-D+	DC-7600	13100-20000	14	-	-	Reflectionless
XLF-63H-D+	DC-6820	14500-16300	30	16300-26000	40	Reflectionless
XLF-73-D+	DC-7000	11700-21300	14	-	-	Reflectionless
XLF-732-D+	DC-7300	14300-34000	14	-	-	Reflectionless
XLF-63-D+	DC-6000	9600-17800	14	-	-	Reflectionless
XLF-662M-D+	DC-6000	9200-18000	31	18000-43500	38	Reflectionless
XLF-362H-D+	DC-3910	9200-10700	30	10700-18500	40	Reflectionless
XLF-312H-D+	DC-3530	7900-9300	30	9300-18500	40	Reflectionless

Low Pass — Bare Die Continued

Model Number	Passband (MHz)	Stopband F3 (MHz)	Rejection @ F3 (dB)	Stopband F4 (MHz)	Rejection @ F4 (dB)	Technology
XLF-332-D+	DC-3250	5900-17000	14	17000-30000	20	Reflectionless
XLF-252H-D+	DC-2500	7000-17000	40	-	-	Reflectionless
XLF-252-D+	DC-2500	4550-16000	14	16000-30000	20	Reflectionless
XLF-192-D+	DC-1900	3480-11200	14	11200-30000	20	Reflectionless
XLF-172H-D+	DC-2000	3600-3800	30	3800-11000	40	Reflectionless
XLF-132H-D+	DC-1300	2700-3000	30	3000-19000	40	Reflectionless
XLF-122-D+	DC-1150	2190-10000	14	10000-21000	20	Reflectionless
XLF-122H-D+	DC-1200	2300-2500	30	2500-9500	40	Reflectionless
XLF-112H-D+	DC-1050	2000-2200	30	2200-10000	40	Reflectionless
XLF-13H-D+	DC-1000	1850-2500	30	2500-10000	40	Reflectionless
XLF-861-D+	DC-860	1700-7500	14	7500-25000	20	Reflectionless
XLF-551-D+	DC-550	1140-5800	14	5800-18500	20	Reflectionless
XLF-421-D+	DC-420	900-5200	14	5200-18000	20	Reflectionless
XLF-221-DG+	DC-220	570-3500	14	3500-12000	20	Reflectionless
XLF-151-D+	DC-150	460-2800	14	2800-16000	20	Reflectionless



Low Pass — Coaxial 50Ω

Model Number	Passband (MHz)	Stopband F3 (MHz)	Rejection @ F3 (dB)	Stopband F4 (MHz)	Rejection @ F4 (dB)	Technology	Connector Type
ZLSS-K24G+	DC-24000	29000-33000	40	33000-40000	70	Suspended Substrate	2.92mm
ZLSS-K21G+	DC-21000	26000-30000	40	30000-40000	70	Suspended Substrate	2.92mm
ZLSS-K18G+	DC-18000	22000-26000	40	26000-40000	70	Suspended Substrate	2.92mm
ZXLF-K173+	DC-17000	25000-35000	25	35000-40000	22	Reflectionless	2.92mm
ZLSS-14G-S+	14000-15100	16500-18000	20	18000-26500	40	Suspended Substrate	SMA
ZLSS-K15G+	DC-15000	21000-27000	40	27000-40000	70	Suspended Substrate	2.92mm
ZXLF-K133+	DC-13000	20000-30000	23	30000-35000	20	Reflectionless	2.92mm
ZXLF-K123+	DC-12000	18100-19000	20	19000-29000	24	Reflectionless	2.92mm
ZLSS-11G-S+	11000-11400	12500-14500	20	14500-26500	40	Suspended Substrate	SMA
ZLSS-K11G+	DC-11000	15500-22000	40	22000-40000	70	Suspended Substrate	2.92mm
ZXLF-K14+	DC-10000	-	-	16500-24200	22	Reflectionless	2.92mm
ZXLF-K982+	DC-9800	19000-22000	15	22000-32500	22	Reflectionless	2.92mm
ZXLF-K962+	DC-9600	14800-16000	20	16000-25200	23	Reflectionless	2.92mm
VLF-8400+	8400-9100	10300	20	10300-15000	30	LTCC	SMA
ZLSS-8G-S+	8000-8600	10800-12500	20	12500-26500	40	Suspended Substrate	SMA
VLF-7200+	7200-8150	9500	20	8850-9600	30	LTCC	SMA
VLF-6700+	6700-7600	9300	20	9500-11000	30	LTCC	SMA
ZXLF-K762+	DC-7600	13100-23000	15	-	-	Reflectionless	2.92mm
ZXLF-K732+	DC-7300	14300-26000	16	-	-	Reflectionless	2.92mm
VLF-6400+	6400-7200	8300	20	7770-10200	30	LTCC	SMA
ZXLF-K73+	DC-7000	11700-21300	15	-	-	Reflectionless	2.92mm
ZXLF-K63H+	DC-6820	14500-16300	29	16300-24000	43	Reflectionless	2.92mm
VLF-6000+	6000-6800	8500	20	8700-10500	30	LTCC	SMA
ZLSS-6G-S+	6000-6600	8200-9600	20	9600-26500	40	Suspended Substrate	SMA
VLF-5850+	5850-6540	7600	20	7100-9900	30	LTCC	SMA
VLP-64	5400-6410	9000	20	-	-	LTCC	SMA
VLF-5500+	5500-6200	7200	20	6770-9500	30	LTCC	SMA
ZXLF-K63+	DC-6000	9600-17800	15	-	-	Reflectionless	2.92mm

Low Pass — Coaxial 50Ω Continued

Model Number	Passband (MHz)	Stopband F3 (MHz)	Rejection @ F3 (dB)	Stopband F4 (MHz)	Rejection @ F4 (dB)	Technology	Connector Type
ZXLF-K662M+	DC-6000	9200-14000	30	14000-22000	36	Reflectionless	2.92mm
VLF-5000+	5000-5580	6850	20	7050-10000	30	LTCC	SMA
VLP-54	4000-5400	7100	20	-	-	LTCC	SMA
VLF-4400+	4400-5290	6700	20	6280-9800	30	LTCC	SMA
VLF-3800+	3900-4850	6000	20	5700-8300	30	LTCC	SMA
ZLSS-4G-S+	4000-4500	5500-6300	20	6300-26500	40	Suspended Substrate	SMA
VLP-41	3300-4100	5600	20	-	-	LTCC	SMA
VLF-3400+	3400-3950	4300	20	-	-	LTCC	SMA
ZXLF-K362H+	DC-3910	9200-10700	28	10700-21000	48	Reflectionless	2.92mm
VLFG-3800+	DC-3900	5800-6200	40	8400-18000	20	LTCC	SMA
VLF-3000+	3000-3600	4550	20	4780-7500	40	LTCC	SMA
ZXLF-K312H+	DC-3530	7900-9300	28	9300-22000	49	Reflectionless	2.92mm
VLFG-3500+	DC-3500	4800-8500	35	8500-15000	25	LTCC	SMA
VLF-2850+	2800-3300	4000	20	4200-7400	40	LTCC	SMA
ZLSS-2R8G-S+	2800-3300	4000-4700	20	4700-26500	40	Suspended Substrate	SMA
ZXLF-K332+	DC-3250	5900-17000	15	17000-25000	19	Reflectionless	2.92mm
VLF-2750+	2750-3150	4000	20	4150-6800	40	LTCC	SMA
VLF-2600+	2600-3125	3750	20	3900-6600	40	LTCC	SMA
VLF-2500+	2500-3075	3675	20	3800-6100	40	LTCC	SMA
VLFX-2500+	2500-3075	3675	20	2800-20000	40	LTCC	SMA
VLFG-3000+	DC-3000	4550-7000	45	7000-15000	25	LTCC	SMA
NLP-2950+	2700-2950	3700-4500	20	4500-6000	40	Lumped LC	N
SLP-2950+	2700-2950	3700-4500	20	4500-6000	40	Lumped LC	SMA
VLFG-2850+	DC-2850	4400-8000	40	8000-14000	30	LTCC	SMA
ZLSS-A2R8G-S+	DC-2800	3350-3600	35	3600-18000	55	Suspended Substrate	SMA
VLFG-2750+	DC-2750	4350-7200	42	10000-16000	25	LTCC	SMA
VLF-2350+	2350-2700	3600	20	3700-4000	40	LTCC	SMA
VLFG-2600+	DC-2600	3850-4200	50	10000-15000	25	LTCC	SMA



Low Pass — Coaxial 50Ω Continued

Model Number	Passband (MHz)	Stopband F3 (MHz)	Rejection @ F3 (dB)	Stopband F4 (MHz)	Rejection @ F4 (dB)	Technology	Connector Type
VLF-2250+	2200-2575	2900	20	2950-5000	40	LTCC	SMA
VLFG-2500+	DC-2500	4000-7000	42	7000-10000	30	LTCC	SMA
ZXLF-K252+	DC-2500	4550-16000	15	16000-25000	18	Reflectionless	2.92mm
VLP-24	2000-2430	3400	20	4400	40	LTCC	SMA
NLP-2400+	2200-2400	3150-4000	20	4000-6000	40	Lumped LC	N
SLP-2400+	2200-2400	3150-4000	20	4000-6000	40	Lumped LC	SMA
VLFG-2250+	DC-2250	3600-8000	40	8000-15000	26	LTCC	SMA
ZLPF-40W-222-S+	DC-2200	2650-3200	29	3200-6300	39	Lumped LC	SMA
VLF-1800+	1800-2125	2425	20	2500-7200	40	LTCC	SMA
ZNFLP-2100-S+	1800-2100	2600-4500	20	-	-	Microstrip	SMA
VLF-1700+	1700-2050	2375	20	2500-6500	40	LTCC	SMA
VLFX-1350+	1350-2050	2425	20	2600-20000	40	LTCC	SMA
VXLF-172H+	DC-2000	3600-3800	28	3800-11000	47	Reflectionless	SMA
ZX75LP-2000-S+	DC-2000	2400-4000	35	4000-10000	90	Lumped LC	SMA
VLFX-1300+	1300-1925	2300	20	2500-20000	40	LTCC	SMA
VXLF-192+	DC-1900	3480-11200	15	-	-	Reflectionless	SMA
ZXLF-K192+	DC-1900	3480-11200	15	11200-25000	22	Reflectionless	2.92mm
VLF-1575+	1575-1875	2175	20	2225-6800	40	LTCC	SMA
VLFX-1125+	1125-1850	2200-20000	20	-	-	LTCC	SMA
VLF-1450+	1450-1825	2025	20	2050-6600	40	LTCC	SMA
VLF-1500+	1500-1825	2100	20	2150-6600	40	LTCC	SMA
VLFG-1800+	DC-1800	2450-7000	40	7000-10000	35	LTCC	SMA
NLP-1750+	1500-1750	2400-3000	20	3000-6000	40	Lumped LC	N
VLF-1525+	1525-1750	2040	20	2120-6600	40	LTCC	SMA
VLFX-1100+	1100-1750	2070	20	2300-20000	40	LTCC	SMA
VLF-1400+	1400-1700	2015	20	2100-6600	40	LTCC	SMA
VLFG-1700+	DC-1700	2800-8000	40	8000-13000	30	LTCC	SMA
VLFX-1050+	1050-1675	1990	20	2275-20000	40	LTCC	SMA

Low Pass — Coaxial 50Ω Continued

Model Number	Passband (MHz)	Stopband F3 (MHz)	Rejection @ F3 (dB)	Stopband F4 (MHz)	Rejection @ F4 (dB)	Technology	Connector Type
SLP-1650+	1400-1650	2300-2900	20	2900-6000	40	Lumped LC	SMA
VLFG-1575+	DC-1575	2400-7000	45	7000-12000	35	LTCC	SMA
VLP-16	1350-1550	2100	20	2700-4500	30	LTCC	SMA
VLF-1200+	1200-1530	1865	20	2000-5000	40	LTCC	SMA
VLFG-1400+	DC-1400	2015-6600	46	6600-10000	35	LTCC	SMA
VLFX-950+	950-1400	1865	20	2250-20000	40	LTCC	SMA
VLF-1000+	1000-1300	1550	20	1900-5000	40	LTCC	SMA
VLFX-825+	825-1275	1550	20	1850-20000	40	LTCC	SMA
BLP-1200+	1000-1200	1620-2100	20	2100-2500	40	Lumped LC	BNC
NLP-1200+	1000-1200	1620-2100	20	2100-2500	40	Lumped LC	N
SLP-1200+	1000-1200	1620-2100	20	2100-2500	40	Lumped LC	SMA
VLFG-1200+	DC-1200	1865-3700	50	7000-10000	30	LTCC	SMA
ZXLF-K122+	DC-1150	2190-10000	14	10000-21000	21	Reflectionless	2.92mm
VLP-11	850-1125	1500	20	2000-3100	40	LTCC	SMA
VLF-800+	800-1075	1275	20	1350-4850	40	LTCC	SMA
ZX75LP-1050-S+	50-1050	1200 - 2500	43	-	-	Lumped LC	SMA
VLFX-650+	650-1025	1275	20	1450-20000	40	LTCC	SMA
VLFG-1000+	DC-1000	1550-3000	29	3000-10000	34	LTCC	SMA
ZX75LP-900-S+	900-1000	1300-2900	20	-	-	Lumped LC	SMA
BLP-1000+	900-990	1340-1750	20	1750-2000	40	Lumped LC	BNC
NLP-1000+	900-990	1340-1750	20	1750-2000	40	Lumped LC	N
SLP-1000+	900-990	1340-1750	20	1750-2000	40	Lumped LC	SMA
VLFX-780+	780-950	1450	20	1600-20000	40	LTCC	SMA
ZXLF-K861+	DC-860	1700-7500	15	7500-20000	24	Reflectionless	2.92mm
BLP-850+	780-850	1100-1400	20	1400-2000	40	Lumped LC	BNC
NLP-850+	780-850	1100-1400	20	1400-2000	40	Lumped LC	N
SLP-850+	780-850	1100-1400	20	1400-2000	40	Lumped LC	SMA
VLFG-900+	DC-850	1300-4500	45	4500-11000	21	LTCC	SMA



Low Pass – Coaxial 50Ω Continued

Model Number	Passband (MHz)	Stopband F3 (MHz)	Rejection @ F3 (dB)	Stopband F4 (MHz)	Rejection @ F4 (dB)	Technology	Connector Type
VLF-630+	630-830	1000	20	1020-3500	40	LTCC	SMA
VLFX-540+	540-810	1000	20	1100-20000	40	LTCC	SMA
BLP-800+	720-800	1080-1400	20	1400-2000	40	Lumped LC	BNC
NLP-800+	720-800	1080-1400	20	1400-2000	40	Lumped LC	N
SLP-800+	720-800	1080-1400	20	1400-2000	40	Lumped LC	SMA
BLP-750+	700-770	1000-1300	20	1300-2000	40	Lumped LC	BNC
NLP-750+	700-770	1000-1300	20	1300-2000	40	Lumped LC	N
SLP-750+	700-770	1000-1300	20	1300-2000	40	Lumped LC	SMA
VLF-575+	575-770	900	20	1050-3200	40	LTCC	SMA
VLFX-500+	500-750	900	20	1100-20000	40	LTCC	SMA
VLF-530+	530-700	820	20	945-3000	40	LTCC	SMA
VLFX-470+	470-675	820	20	1000-20000	40	LTCC	SMA
VLF-490+	490-650	800	20	880-2500	40	LTCC	SMA
BLP-600+	580-640	840-1120	20	1120-2000	40	Lumped LC	BNC
NLP-600+	580-640	840-1120	20	1120-2000	40	Lumped LC	N
SLP-600+	580-640	840-120	20	1120-2000	40	Lumped LC	SMA
VLFX-450+	450-640	800	20	900-20000	40	LTCC	SMA
NLP-500+	500-630	1000	20	1400-4500	40	Lumped LC	N
VLFG-630+	DC-630	1050-1500	50	1500-8500	21	LTCC	SMA
VLFG-575+	DC-575	1020-2500	32	2500-4400	25	LTCC	SMA
BLP-550+	520-570	750-920	20	920-2000	40	Lumped LC	BNC
NLP-550+	520-570	750-920	20	920-2000	40	Lumped LC	N
SLP-550+	520-570	750-920	20	920-2000	40	Lumped LC	SMA
VLF-400+	400-560	660	20	680-3000	40	LTCC	SMA
ZXLF-K551+	DC-550	1140-5800	15	5800-18500	24	Reflectionless	2.92mm
VLFX-400+	400-540	670	20	700-20000	40	LTCC	SMA
VLFG-530+	DC-530	980-2600	31	2600-4000	27	LTCC	SMA
ZX75LP-470-S+	470-510	650-2000	20	-	-	Lumped LC	SMA

Low Pass – Coaxial 50Ω Continued

Model Number	Passband (MHz)	Stopband F3 (MHz)	Rejection @ F3 (dB)	Stopband F4 (MHz)	Rejection @ F4 (dB)	Technology	Connector Type
ZFLP-450-S+	450-505	640-5000	20	-	-	Lumped LC	SMA
ZXLF-K641M+	DC-500	1100-7800	28	7800-11000	38	Reflectionless	2.92mm
VLFG-490+	DC-490	800-1500	52	1500-8500	17	LTCC	SMA
VLF-320+	320-460	560	20	640-2500	40	LTCC	SMA
VLFX-300+	300-450	580	20	650-20000	40	LTCC	SMA
BLP-450+	400-440	580-750	20	750-1800	40	Lumped LC	BNC
NLP-450+	400-440	580-750	20	750-1800	40	Lumped LC	N
SLP-450+	400-440	580-750	20	750-1800	40	Lumped LC	SMA
ZXLF-K421+	DC-420	900-5200	14	5200-18000	24	Reflectionless	2.92mm
VLFG-400+	DC-400	800-2500	31	2500-4500	23	LTCC	SMA
ZX75LP-340-S+	340-365	475-2000	20	-	-	Lumped LC	SMA
VLF-225+	225-350	460	20	510-2500	40	LTCC	SMA
VLFX-225+	225-350	460	20	520-20000	40	LTCC	SMA
ZX75LP-320-S+	320-345	445-1800	20	-	-	Lumped LC	SMA
VLFG-320+	DC-320	660-2000	33	2000-6000	25	LTCC	SMA
ZX75LP-288-S+	288-312	400-1500	20	-	-	Lumped LC	SMA
ZXLF-K42M+	DC-300	660-6800	32	6800-10000	43	Reflectionless	2.92mm
BLP-300+	270-297	410-550	20	550-1200	40	Lumped LC	BNC
NLP-300+	270-297	410-550	20	550-1200	40	Lumped LC	N
SLP-300+	270-297	410-550	20	550-1200	40	Lumped LC	SMA
ZX75LP-264-S+	264-288	365-1500	20	-	-	Lumped LC	SMA
VLF-190+	190-280	400	20	510-2850	40	LTCC	SMA
VLF-180+	180-270	370	20	525-2350	40	LTCC	SMA
BLP-250+	225-250	320-400	20	400-1200	40	Lumped LC	BNC
NLP-250+	225-250	320-400	20	400-1200	40	Lumped LC	N
SLP-250+	225-250	320-400	20	400-1200	40	Lumped LC	SMA
ZX75LP-216-S+	216-232	300-1400	20	-	-	Lumped LC	SMA
VLF-160+	160-230	330	20	480-2700	40	LTCC	SMA



Low Pass — Coaxial 50Ω Continued

Model Number	Passband (MHz)	Stopband F3 (MHz)	Rejection @ F3 (dB)	Stopband F4 (MHz)	Rejection @ F4 (dB)	Technology	Connector Type
ZXLF-K221+	DC-220	570-3500	15	3500-12000	26	Reflectionless	2.92mm
BLP-200+	190-210	290-390	20	390-800	40	Lumped LC	BNC
NLP-200+	190-210	290-390	20	390-800	40	Lumped LC	N
SLP-200+	190-210	290-390	20	390-800	40	Lumped LC	SMA
VLF-120+	120-195	280	20	300-1850	40	LTCC	SMA
ZX75LP-176-S+	176-189	245-1500	20	-	-	Lumped LC	SMA
VLF-105+	105-180	250	20	265-1650	40	LTCC	SMA
ZX75LP-158-S+	158-170	220-1000	20	-	-	Lumped LC	SMA
VLF-95+	95-165	230	20	255-1600	40	LTCC	SMA
VLFX-105+	105-165	250	20	400-20000	40	LTCC	SMA
BLP-150+	140-155	210-300	20	300-600	40	Lumped LC	BNC
NLP-150+	140-155	210-300	20	300-600	40	Lumped LC	N
SLP-150+	140-155	210-300	20	300-600	40	Lumped LC	SMA
ZX75LP-137-S+	137-150	195-1000	20	-	-	Lumped LC	SMA
ZXLF-K151+	DC-150	460-2800	15	2800-16000	24	Reflectionless	2.92mm
VLF-80+	80-145	200	20	225-1550	40	LTCC	SMA
VLFX-80+	80-145	200	20	220-20000	40	LTCC	SMA
ZX75LP-120-S+	120-130	175-2000	20	-	-	Lumped LC	SMA
ZLPF-120+	120-121	125-2000	20	-	-	Lumped LC	SMA
ZX75LP-105-S+	105-115	150-1000	20	-	-	Lumped LC	SMA
BLP-100+	98-108	146-189	20	189-400	40	Lumped LC	BNC
NLP-100+	98-108	146-189	20	189-400	40	Lumped LC	N
SLP-100+	98-108	146-189	20	189-400	40	Lumped LC	SMA
VLF-52+	52-93	140	20	170-1100	30	LTCC	SMA
ZX75LP-83-S+	83-93	119-850	20	-	-	Lumped LC	SMA
BLP-90+	81-90	121-157	20	157-400	40	Lumped LC	BNC
NLP-90+	81-90	121-157	20	157-400	40	Lumped LC	N
SLP-90+	81-90	121-157	20	157-400	40	Lumped LC	SMA

Low Pass — Coaxial 50Ω Continued

Model Number	Passband (MHz)	Stopband F3 (MHz)	Rejection @ F3 (dB)	Stopband F4 (MHz)	Rejection @ F4 (dB)	Technology	Connector Type
ZX75LP-70-S+	70-78	105-4000	20	-	-	Lumped LC	SMA
VLF-45+	45-77	120	20	150-910	30	LTCC	SMA
BLP-70+	60-67	90-117	20	117-300	40	Lumped LC	BNC
NLP-70+	60-67	90-117	20	117-300	40	Lumped LC	N
SLP-70+	60-67	90-117	20	117-300	40	Lumped LC	SMA
ZX75LP-50-S+	50-59	79-4000	20	-	-	Lumped LC	SMA
ZX75LP-40-S+	40-56	71-3000	20	-	-	Lumped LC	SMA
BLP-50+	48-55	70-90	20	90-200	40	Lumped LC	BNC
NLP-50+	48-55	70-90	20	90-200	40	Lumped LC	N
SLP-50+	48-55	70-90	20	90-200	40	Lumped LC	SMA
BLP-44+	44-48.5	59-65.5	30	65.5-600	46	Lumped LC	BNC
SLP-44+	44-48.5	59-65.5	30	65.5-600	46	Lumped LC	SMA
BLP-36+	36-40	50-57	30	57-560	46	Lumped LC	BNC
ZX75LP-30-S+	30-38	48-3000	20	-	-	Lumped LC	SMA
SLP-36+	DC-36	50-57	30	57-560	46	Lumped LC	SMA
BLP-30+	32-35	47-61	20	61-200	40	Lumped LC	BNC
NLP-30+	32-35	47-61	20	61-200	40	Lumped LC	N
SLP-30+	32-35	47-61	20	61-200	40	Lumped LC	SMA
BLP-27+	27-30	36-41	26	41-810	43	Lumped LC	BNC
SLP-27+	27-30	36-41	26	41-810	43	Lumped LC	SMA
BLP-25+	25-28	36-47	25	47-1000	45	Lumped LC	BNC
BLP-23+	23-25	31-34	30	34-500	48	Lumped LC	BNC
SLP-23+	23-25	31-34	30	34-500	48	Lumped LC	SMA
SLP-25+	DC-25	36-47	25	47-1000	45	Lumped LC	SMA
BLP-21.4+	22-24.5	32-41	20	41-200	40	Lumped LC	BNC
NLP-21.4+	22-24.5	32-41	20	41-200	40	Lumped LC	N
SLP-21.4+	22-24.5	32-41	20	41-200	40	Lumped LC	SMA
BLP-15+	15-17	23-32	20	32-200	40	Lumped LC	BNC



Low Pass — Coaxial 50Ω Continued

Model Number	Passband (MHz)	Stopband F3 (MHz)	Rejection @ F3 (dB)	Stopband F4 (MHz)	Rejection @ F4 (dB)	Technology	Connector Type
NLP-15+	15-17	23-32	20	32-200	40	Lumped LC	N
SLP-15+	15-17	23-32	20	32-200	40	Lumped LC	SMA
BLP-10.7+	11-14	19-24	20	24-200	40	Lumped LC	BNC
NLP-10.7+	11-14	19-24	20	24-200	40	Lumped LC	N
SLP-10.7+	11-14	19-24	20	24-200	40	Lumped LC	SMA
BLP-5+	5-6	8-10	20	10-200	40	Lumped LC	BNC
NLP-5+	5-6	8-10	20	10-200	40	Lumped LC	N
SLP-5+	5-6	8-10	20	10-200	40	Lumped LC	SMA
BLP-2.5+	2.5-2.75	3.8-5.0	20	5.0-200	40	Lumped LC	BNC
NLP-2.5+	2.5-2.75	3.8-5.0	20	5.0-200	40	Lumped LC	N
SLP-2.5+	2.5-2.75	3.8-5.0	20	5.0-200	40	Lumped LC	SMA
BLP-1.9+	1.9-2.5	3.4-4.7	20	4.7-200	40	Lumped LC	BNC
NLP-1.9+	1.9-2.5	3.4-4.7	20	4.7-200	40	Lumped LC	N
SLP-1.9+	1.9-2.5	3.4-4.7	20	4.7-200	40	Lumped LC	SMA

Low Pass — Coaxial 75Ω

Model Number	Passband (MHz)	Stopband F3 (MHz)	Rejection @ F3 (dB)	Stopband F4 (MHz)	Rejection @ F4 (dB)	Technology	Connector Type
BLP-600-75+	580-640	840-1120	20	1120-2000	40	Lumped LC	BNC
BLP-100-75+	98-108	146-189	20	189-400	40	Lumped LC	BNC
BLP-70-75+	60-67	90-117	20	117-300	40	Lumped LC	BNC
BLP-50-75+	48-55	70-90	20	90-200	40	Lumped LC	BNC
BLP-30-75+	32-35	47-61	20	61-200	40	Lumped LC	BNC
BLP-21.4-75+	22-24.5	32-41	20	41-200	40	Lumped LC	BNC
BLP-15-75+	15-17	23-32	20	32-200	40	Lumped LC	BNC
BLP-10.7-75+	11-14	19-24	20	24-200	40	Lumped LC	BNC
BLP-7-75+	7-8	11-15	20	15-200	40	Lumped LC	BNC

Low Pass Flat Time Delay — Coaxial 50Ω

Model Number	Passband (MHz)	Stopband F3 (MHz)	Rejection @ F3 (dB)	Stopband F4 (MHz)	Rejection @ F4 (dB)	Technology	Connector Type
SBLP-1870+	850-1870	3740	10	5000	20	Lumped LC	SMA
SBLP-933+	560-933	1866	10	2490	20	Lumped LC	SMA
SBLP-467+	280-467	934	10	1246	20	Lumped LC	SMA
NBLP-300+	180-300	600	10	801	20	Lumped LC	N
SBLP-300+	180-300	600	10	801	20	Lumped LC	SMA
SBLP-200+	120-200	400	10	534	20	Lumped LC	SMA
SBLP-156+	94-156	312	10	416	20	Lumped LC	SMA
SBLP-117+	65-117	234	10	312	20	Lumped LC	SMA
BBLP-39+	23-39	78	10	117	20	Lumped LC	BNC
NBLP-39+	23-39	78	10	117	20	Lumped LC	N
SBLP-39+	23-39	78	10	117	20	Lumped LC	SMA



Low Pass – Plug-In 50Ω

Model Number	Passband (MHz)	Stopband F3 (MHz)	Rejection @ F3 (dB)	Stopband F4 (MHz)	Rejection @ F4 (dB)	Technology
PLP-1200+	1000-1200	1620-2100	20	2100-2500	40	Lumped LC
PLP-1000+	900-990	1340-1750	20	1750-2000	40	Lumped LC
PLP-850+	780-850	1100-1400	20	1400-2000	40	Lumped LC
PLP-800+	720-800	1080-1400	20	1400-2000	40	Lumped LC
PLP-750+	700-770	1000-1300	20	1300-2000	40	Lumped LC
PLP-600+	580-640	840-1120	20	1120-2000	40	Lumped LC
PLP-550+	520-570	750-920	20	920-2000	40	Lumped LC
PLP-450+	400-440	580-750	20	750-1800	40	Lumped LC
PLP-300+	270-297	410-550	20	550-1200	40	Lumped LC
PLP-250+	225-250	320-400	20	400-1200	40	Lumped LC
PLP-200+	190-210	290-390	20	390-800	40	Lumped LC
PLP-150+	140-155	210-300	20	300-600	40	Lumped LC
PLP-100+	98-108	146-189	20	189-400	40	Lumped LC
PLP-90+	81-90	121-157	20	157-400	40	Lumped LC
PLP-70+	60-67	90-117	20	117-300	40	Lumped LC
PLP-50+	48-55	70-90	20	90-200	40	Lumped LC
PLP-30+	32-35	47-61	20	61-200	40	Lumped LC
PLP-21.4+	22-24.5	32-41	20	41-200	40	Lumped LC
PLP-15+	15-17	23-32	20	32-200	40	Lumped LC
PLP-10.7+	11-14	19-24	20	24-200	40	Lumped LC
PLP-5+	5-6	8-10	20	10-200	40	Lumped LC
PLP-2.5+	2.5-2.75	3.8-5	20	5-200	40	Lumped LC
PLP-1.9+	1.9-2.5	3.4-4.7	20	4.7-200	40	Lumped LC

Low Pass – Plug-In 75Ω

Model Number	Passband (MHz)	Stopband F3 (MHz)	Rejection @ F3 (dB)	Stopband F4 (MHz)	Rejection @ F4 (dB)	Technology
PLP-600-75+	580-640	840-1120	20	1120-2000	40	Lumped LC
PLP-70-75+	60-67	90-117	20	117-300	40	Lumped LC
PLP-30-75+	32-35	47-61	20	61-200	40	Lumped LC
PLP-21.4-75+	22-24.5	32-41	20	41-200	40	Lumped LC
PLP-15-75+	15-17	23-32	20	32-200	40	Lumped LC
PLP-10.7-75+	11-14	19-24	20	24-200	40	Lumped LC
PLP-7-75+	7-8	11-15	20	15-200	40	Lumped LC

Low Pass Flat Time Delay – Plug-In 50Ω

Model Number	Passband (MHz)	Stopband F3 (MHz)	Rejection @ F3 (dB)	Stopband F4 (MHz)	Rejection @ F4 (dB)	Technology
PBLP-200+	120-200	400-534	10	534	20	Lumped LC
PBLP-39+	23-39	78-117	10	117	20	Lumped LC

Band Pass



Band Pass – Surface Mount 50Ω

Model Number	Passband (MHz)	Stopband F3 (MHz)	Rejection @ F3 (dB)	Stopband F4 (MHz)	Rejection @ F4 (dB)	Technology
BFHK-2802+	26500-29500	DC-24500	25	32000-44000	33	LTCC
BFHK-2582+	24250-27500	DC-21700	40	29430	30	LTCC
BFCG-1952+	16800-21000	DC-11900	18	26300-38500	18	LTCC
XBF-24+	19500-20500	DC - 10000	66	30000 - 32000	55	Reflectionless
BFCG-1902+	17000-20400	DC-13000	24	24500-39000	28	LTCC
XBF-183+	17500-18500	DC-9000	55	27000-40000	55	Reflectionless
XBF-163+	15500-16500	DC-8000	55	24000-40000	55	Reflectionless
BFCN-1262+	12100-13200	DC-9760	45	15170-25000	30	LTCC

Band Pass — Surface Mount 50Ω Continued

Model Number	Passband (MHz)	Stopband F3 (MHz)	Rejection @ F3 (dB)	Stopband F4 (MHz)	Rejection @ F4 (dB)	Technology
BFCN-1152+	11160-11970	DC-8950	50	13750-20900	35	LTCC
BFCN-1052+	9700-11950	8400	32	14000	28	LTCC
BFCN-8650+	8550-8750	7700	20	9900	20	LTCC
BFCN-8450+	8350-8550	7500	20	9800	20	LTCC
BFCN-8350+	8250-8450	7400	20	9600	20	LTCC
BFCN-7900+	7800-8100	6800	20	9300	20	LTCC
BFCN-8000+	7900-8100	7000	20	9300	20	LTCC
BFCN-7700+	7500-7900	6800	20	9000	20	LTCC
BFCN-7331+	6850-7850	DC-5800	20	9300-13300	20	LTCC
BFCN-7500+	7450-7650	6700	20	8800	20	LTCC
BFCN-7350+	7150-7550	6500	20	8500	20	LTCC
BFCN-7200+	7100-7300	6650	20	8150	20	LTCC
BFCN-5100+	3100-7100	DC-2400	20	9500-17000	20	LTCC
BFCN-5540+	4620-6640	3420	20	8060-10990	20	LTCC
BFCV-5270+	4040-6500	DC-3250	20	8080-14000	20	LTCC
BFCN-5151+	4120-6440	3000	24	8820	32	LTCC
BFCN-5200+	4250-6300	DC-3300	20	7500-9000	20	LTCC
BFCO-552+	4600-6100	DC-2600	22	10200-18000	26	LTCC
BFCW-542+	4700-6000	DC-2500	20	9800-12000	20	LTCC
BFCG-5600+	5150-5990	DC-4200	20	9310-15750	20	LTCC
BPNK-542R+	4900-5950	2400-2500	23	14700-17850	38	LTCC
BFCG-552+	5100-5930	DC-3360	20	8770-11000	20	LTCC
BPGE-542R+	4900-5920	3500	49	14700-17760	30	LTCC
BPJC-542R+	4900-5900	DC-2700	40	9800-12000	34	LTCC
BFCN-5750+	5650-5850	DC-4300	20	8000-9000	20	LTCC
CBP-5800AG+	5725-5825	DC-5100	20	6250-7300	20	Ceramic Resonator
BFCN-4800+	4400-5200	DC-1800	20	7500-12000	20	LTCC
BFCV-4085+	3130-5040	DC-2520	20	6260-8000	20	LTCC

Band Pass — Surface Mount 50Ω Continued

Model Number	Passband (MHz)	Stopband F3 (MHz)	Rejection @ F3 (dB)	Stopband F4 (MHz)	Rejection @ F4 (dB)	Technology
BFCN-4440+	4200-4700	2000	20	6750	20	LTCC
BFCN-3700+	3000-4600	DC-2100	20	5600-8000	20	LTCC
BFCN-4100+	3700-4500	2200	20	6000	20	LTCC
BFCN-3491+	2790-4370	2150	21	5950	30	LTCC
BFCV-3350+	2570-4130	DC-1900	20	5140-8000	20	LTCC
BFCN-3600+	3300-3900	1850	20	5000	20	LTCC
BFCV-3641+	3400-3850	DC-2900	20	4700-12400	20	LTCC
BFCN-3115+	2720-3570	DC-1850	20	4300-8160	20	LTCC
BFCV-2895+	2220-3570	DC-1785	20	4440-7000	20	LTCC
BFCN-2975+	2570-3440	DC-1700	20	4000-7500	20	LTCC
BFCN-3085+	2800-3400	4250	20	7800	20	LTCC
BFCN-3085A+	2800-3400	4210	20	7800	20	LTCC
BFCV-2610+	2000-3220	DC-1550	20	4500-8000	20	LTCC
BFCN-2491+	1950-3190	1440	22	4500	29	LTCC
XBF-282+	2350-3150	DC-1810	14	3800-20000	14	Reflectionless
BFCN-2900+	2700-3100	1850	20	4200	20	LTCC
BFCN-3010+	2920-3100	1530	20	4450	20	LTCC
BFCN-2910+	2850-2970	1600	20	4200	20	LTCC
BFCN-2850+	2750-2950	1500	20	4300	20	LTCC
BFCN-2840+	2750-2930	1550	20	4000	20	LTCC
BFCN-2500+	2100-2900	DC-1600	20	3700-5200	20	LTCC
BFCN-2700+	2600-2800	1500	20	4150	20	LTCC
SYBP-2640+	2500-2780	DC-1780	20	3800-6040	20	Lumped LC
SYBP-2250+	1880-2620	DC-1280	20	3640-5400	20	Lumped LC
BFCN-2555+	2500-2610	1970	20	3200	20	LTCC
CBP-2400A+	2200-2600	DC-1780+	20	3480-4200	20	Ceramic Resonator
BFCN-2450+	2400-2550	DC-2100	20	3400-12000	20	LTCC
BFCN-2435+	2340-2530	1940	20	3850	20	LTCC



Band Pass — Surface Mount 50Ω Continued

Model Number	Passband (MHz)	Stopband F3 (MHz)	Rejection @ F3 (dB)	Stopband F4 (MHz)	Rejection @ F4 (dB)	Technology
BFCG-252+	2400-2500	10-1350	25	3400-3800	23	LTCC
BFCO-252+	2400-2500	DC-1500	30	3200-4500	17	LTCC
BFCW-252+	2400-2500	DC-1860	20	3100-8000	20	LTCC
BPGE-252R+	2400-2500	1200-1300	42	3600-3800	43	LTCC
BPJC-252R+	2400-2500	1910	26	3200	38	LTCC
BPNK-252R+	2400-2500	692-800	40	4800-5000	23	LTCC
CBP-2250A+	2000-2500	DC-1630	20	2900-6000	35	Ceramic Resonator
SYBP-232+	2250-2500	DC-1520	20	3720-4800	20	Lumped LC
BFCN-2360+	2250-2470	1850	20	3600	20	LTCC
BPF-F1950+	1450-2450	DC-1100	35	2750-4000	35	Lumped LC
BFCN-2275+	2170-2380	1800	20	3430	20	LTCC
BFCN-1801+	1400-2320	1000	25	3110	33	LTCC
CBP-2150AN+	2000-2300	DC-1700	27	3200-3620	40	Ceramic Resonator
SXBP-2150+	2050-2250	DC-950	20	2675-5000	20	Lumped LC
BFCG-162W+	950-2200	DC-770	20	3000-5000	20	LTCC
BFCN-1860+	1580-2200	DC-1300	20	2600-4800	20	LTCC
SYBP-1950+	1700-2200	DC-1030	26	2900-4600	20	Lumped LC
SXBP-1940+	1710-2170	DC-145	20	2900-4700	20	Lumped LC
SXBP-1430+	950-2150	575	20	2850	20	Lumped LC
CBP-1953AF+	1858-2048	DC-1500	65	2400-3500	50	Ceramic Resonator
BFCN-1945+	1850-2040	1400	20	2900	20	LTCC
CBP-1905AN+	1785-2025	DC-1525	27	2365-3200	26	Ceramic Resonator
BPF-BD1800+	1600-2000	DC-1400	25	2200-4000	25	Lumped LC
BPNL-1891+	1790-2000	1090	36	2615-5935	33	LTCC
CBP-1880E+	1780-1980	DC-1550+	20	2150-3300	20	Ceramic Resonator
CBP-1950C+	1920-1980	DC-1740	20	2190-4300	20	Ceramic Resonator
CBP-1820F+	1680-1960	DC-1510	20	2170-3000	20	Ceramic Resonator
BFCN-1840+	1750-1930	1480	20	2860	20	LTCC

Band Pass — Surface Mount 50Ω Continued

Model Number	Passband (MHz)	Stopband F3 (MHz)	Rejection @ F3 (dB)	Stopband F4 (MHz)	Rejection @ F4 (dB)	Technology
BFCN-1855+	1790-1920	1510	20	2810	20	LTCC
BFCN-1900+	1893-1920	DC-1687	20	2153-5500	20	LTCC
CSBP-A1843+	1765-1920	DC-1580	20	2095-3300	20	Ceramic Resonator
CBP-1773AF+	1678-1868	DC-1400	65	2150-2700	60	Ceramic Resonator
BFCN-1690+	1570-1810	DC-1200	20	2170-4400	20	LTCC
BPF-A1340+	1000-1800	800	20	2300	20	Lumped LC
BPF-A1600+	1400-1800	DC-1220	20	1980-3300	20	Lumped LC
SXBP-1200+	800-1800	535	20	2220	20	Lumped LC
CBP-1748C+	1710-1785	DC-1580	20	1960-4000	20	Ceramic Resonator
CBP-1630F+	1500-1760	DC-1320	20	1960-2600	20	Ceramic Resonator
CBP-1598AF+	1505.5-1690.5	DC-1264	60	1888-2900	60	Ceramic Resonator
CBP-1645J+	1616-1675	DC-1500	20	1850-3000	20	Ceramic Resonator
SXBP-1500+	1350-1650	DC-75	20	2160-3700	20	Lumped LC
BFCN-1560+	1500-1620	1100	20	2100	20	LTCC
BFCN-1575+	1530-1620	1290	20	2220	20	LTCC
BPF-BD1400+	1200-1600	DC-1000	25	1800-3000	25	Lumped LC
CBP-1555C+	1525-1585	DC-1415	20	1700-3600	20	Ceramic Resonator
CBP-1450F+	1320-1580	DC-1150	20	1775-2350	20	Ceramic Resonator
CBP-1475E+	1375-1575	DC-1230	40	1750-2600	40	Ceramic Resonator
BFCN-1525+	1480-1570	1250	20	2180	20	LTCC
SYBP-1420+	1250-1560	DC-910	20	2000-5000	20	Lumped LC
CBP-1538J+	1518-1559	DC-1390	20	1750-3000	20	Ceramic Resonator
CBP-1476BD+	1427-1525	DC-1340	26	1590-2500	26	Ceramic Resonator
CBP-1490A+	1465-1515	DC-1430	20	1550-3000	20	Ceramic Resonator
CBP-1423AF+	1333-1513	DC-1113	60	1669-2600	55	Ceramic Resonator
CBP-1400F+	1300-1500	DC-1090+	20	1740-2450	20	Ceramic Resonator
CBP-1400BD+	1320-1480	DC-1224	27	1700-2300	55	Ceramic Resonator
CBP-1400E+	1320-1480	DC-1150+	20	1600-2400	20	Ceramic Resonator



Band Pass — Surface Mount 50Ω Continued

Model Number	Passband (MHz)	Stopband F3 (MHz)	Rejection @ F3 (dB)	Stopband F4 (MHz)	Rejection @ F4 (dB)	Technology
BFCN-1445+	1420-1470	1190	20	2050	20	LTCC
BPF-F1250+	1050-1450	DC-960	20	1640-2500	20	Lumped LC
SYBP-1275+	1100-1450	DC-600	28	2050-5000	25	Lumped LC
BPF-A1140+	840-1440	DC-711	20	1577-3000	20	Lumped LC
CBP12-1411AK+	1395-1427	DC-1225	34	1650-2400	30	Ceramic Resonator
CBP-1414A+	1402-1426	1310-1352	30	1480-3000	30	Ceramic Resonator
CBP-1280F+	1160-1400	DC-1000	20	1570-2100	20	Ceramic Resonator
CBP-1300A+	1200-1400	DC-1040	20	1640-3100	20	Ceramic Resonator
CBP-1307C+	1215-1400	DC-1000+	20	1820-2500	20	Ceramic Resonator
CBP-1350C+	1300-1400	DC-1125	20	1665-2700	20	Ceramic Resonator
CBP-1280C+	1170-1390	DC-950+	20	1850-2450	20	Ceramic Resonator
CBP-1320Q+	1280-1360	900-1170	20	1490-20000	20	Ceramic Resonator
CBP-B1230C+	1120-1340	DC-980	20	1750-2350	20	Ceramic Resonator
CBP-1260C+	1200-1320	DC-1025	20	1640-2450	20	Ceramic Resonator
JCBP-900+	480-1320	380	20	1790	20	Lumped LC
CBP-A1230C+	1160-1300	DC-950	20	1670-2400	20	Ceramic Resonator
CBP-1250C+	1215-1285	DC-1055	20	1510-2500	20	Ceramic Resonator
CSBP-D1228+	1203-1253	DC-1020	20	1425-2500	20	Ceramic Resonator
CSBP-D1189+	1130-1246	DC-950	20	1550-2400	20	Ceramic Resonator
CBP-1228C+	1217-1238	DC-1140	20	1330-3000	20	Ceramic Resonator
CBP-1170C+	1110-1230	DC-900	20	1560-2200	20	Ceramic Resonator
CBP-1120F+	1020-1220	DC-880	20	1420-2000	20	Ceramic Resonator
CBP-1183A+	1165-1201	DC-1130	20	1235-2800	20	Ceramic Resonator
BPF-A950+	700-1200	DC-620	20	1310-2500	20	Lumped LC
SXBP-1100+	1000-1200	DC-20	20	1500-2200	20	Lumped LC
CBP-1062C+	960-1164	DC-735	20	1620-1900	20	Ceramic Resonator
CBP-1090C+	1060-1120	DC-955	20	1255-2200	20	Ceramic Resonator
CBP-A1060C+	1015-1105	DC-865	20	1350-2250	20	Ceramic Resonator

Band Pass — Surface Mount 50Ω Continued

Model Number	Passband (MHz)	Stopband F3 (MHz)	Rejection @ F3 (dB)	Stopband F4 (MHz)	Rejection @ F4 (dB)	Technology
CBP-1000F+	900-1100	DC-790	20	1260-1800	20	Ceramic Resonator
CBP12-1090BE+	1087-1093	DC-1000	80	1800-2000	40	Ceramic Resonator
CBP-1034C+	978-1090	DC-790	20	1400-2000	20	Ceramic Resonator
CBP-1060Q+	1030-1090	500-930	20	1190-1400	20	Ceramic Resonator
BPF-V1000+	940-1060	DC-860	35	1140-3000	35	Lumped LC
CBP-1023A+	1005-1041	DC-970	20	1075-2400	20	Ceramic Resonator
CBP12-1030BE+	1027-1033	DC-970	80	1800-2000	40	Ceramic Resonator
BPF-C510+	20-1000	DC-17	20	1150-1800	20	Lumped LC
BPF-C550+	100-1000	DC-80	35	1200-2000	35	Lumped LC
CSBP-A940+	880-1000	DC-800	20	1095-1840	20	Ceramic Resonator
SYBP-92+	800-1000	DC-530	20	1550-3000	20	Lumped LC
CBP6-950BB+	940-960	DC-800	52	1040-1800	52	Ceramic Resonator
CBP-915C+	902.5-927.5	DC-830	20	1005-1800	20	Ceramic Resonator
CBP-893C+	870-915	DC-750	20	1050-1700	20	Ceramic Resonator
CBP-897G+	887-907	DC-850	20	945-2000	20	Ceramic Resonator
CBP-840C+	790-890	DC-665	20	1070-1600	20	Ceramic Resonator
SXBP-820+	769-872	550	20	920	20	Lumped LC
BPF-C670+	470-870	280	20	890	20	Lumped LC
SYBP-820+	770-870	DC-450	20	1420-2500	20	Lumped LC
SYBP-675+	500-850	DC-340	28	1275-4500	22	Lumped LC
CBP-804F+	783-825	DC-750	20	860-1900	20	Ceramic Resonator
BPF-A800+	795-805	700	20	900	20	Lumped LC
BPF-A730+	670-795	610	20	910	20	Lumped LC
BPF-F598+	410-785	DC-385	20	825-1600	20	Lumped LC
BFTC-615+	450-780	1-320	20	970-2400	20	LTCC
BPF-C650+	560-780	DC-365	20	965-2700	20	Lumped LC
CBP-770C+	760-780	DC-705	20	840-1650	20	Ceramic Resonator
BFTC-618+	460-776	1-330	20	980-2400	20	LTCC



Band Pass — Surface Mount 50Ω Continued

Model Number	Passband (MHz)	Stopband F3 (MHz)	Rejection @ F3 (dB)	Stopband F4 (MHz)	Rejection @ F4 (dB)	Technology
SXBP-707+	650-770	450	20	830	20	Lumped LC
MBPA-A693+	663-723	DC-500	55	850-5000	60	Lumped LC
MBPA-693+	673-713	DC-575	60	790-5000	60	Lumped LC
BPF-C587+	470-705	DC-400	20	800-1500	20	Lumped LC
BPF-A587R5+	475-700	DC-390	35	820-3800	30	Lumped LC
BPF-A600+	500-700	DC-380	20	795-1800	20	Lumped LC
CBP-670F+	645-695	DC-613	20	728-1500	20	Ceramic Resonator
RBP-650+	624-680	560	20	760	20	Lumped LC
SXBP-640+	600-680	500	20	750	20	Lumped LC
SXBP-615+	565-670	380	20	720	20	Lumped LC
BPF-A580+	520-640	440	20	720	20	Lumped LC
BPF-A535+	460-610	DC-380	20	700-1600	20	Lumped LC
BFTC-500+	400-600	1-290	20	800-2000	20	LTCC
BPF-A490+	400-600	280	20	680	20	Lumped LC
SXBP-507+	460-560	300	20	615	20	Lumped LC
BPF-A475+	400-550	DC-300	30	650-5000	30	Lumped LC
RBPF-485+	435-535	DC-320	20	700-3700	20	Lumped LC
BPF-C495+	470-520	DC-410	20	625-2600	20	Lumped LC
BPF-B503+	495-510	440	20	565	20	Lumped LC
BPF-C450+	400-510	310	20	700	20	Lumped LC
CBP6-507BG+	504-509	DC-486	52	528-1900	40	Ceramic Resonator
BFTC-415+	330-500	1-240	20	650-1800	20	LTCC
RBP-400+	292-490	230	20	620	20	Lumped LC
JCBP-290+	100-480	65	20	630	20	Lumped LC
RBP-440+	410-470	320	20	650	20	Lumped LC
BPF-A410+	365-455	300	20	515	20	Lumped LC
SXBP-425+	410-440	385	20	470	20	Lumped LC
RBP-415+	404-426	225	20	550	20	Lumped LC

Band Pass — Surface Mount 50Ω Continued

Model Number	Passband (MHz)	Stopband F3 (MHz)	Rejection @ F3 (dB)	Stopband F4 (MHz)	Rejection @ F4 (dB)	Technology
BPF-A400+	390-410	350	20	490	20	Lumped LC
SXBP-404+	398-410	DC-370	20	445-4500	20	Lumped LC
BPF-A355+	310-400	DC-237	20	450-1400	20	Lumped LC
BPHI-370+	350-390	DC-305	30	430-4000	30	Lumped LC
SXBP-350+	330-375	280	20	435	20	Lumped LC
BPF-V300+	230-370	DC-170	20	440-3000	20	Lumped LC
BPF-BC300A+	260-340	DC-220	40	380-4000	25	Lumped LC
RBP-253+	186-340	140	20	440	20	Lumped LC
BPF-A332+	329-335	305	20	365	20	Lumped LC
BPHI-332+	329-335	300-313	20	343-370	20	Lumped LC
BPF-A328+	327-329	305	20	350	20	Lumped LC
SXBP-310+	300-320	DC-280	20	342-2250	20	Lumped LC
BPF-BC300+	290-310	DC-240	50	350-4000	25	Lumped LC
RBP-280+	260-310	205	20	375	20	Lumped LC
SXBP-300+	290-310	DC-200	69	2000-3300	39	Lumped LC
RBP-263+	230-297	140	20	360	20	Lumped LC
RBP-275+	268-282	209	20	350	20	Lumped LC
RBPF-246+	236-256	DC-180	20	315-3400	20	Lumped LC
RBP-220W+	190-250	80	20	310	20	Lumped LC
SXBP-240+	238-242	220	20	260	20	Lumped LC
RBP-188+	138-238	DC-96	20	315-3600	20	Lumped LC
RBP-204+	175-237	135	20	300	20	Lumped LC
RBP-220+	212-228	150	20	290	20	Lumped LC
BPF-F184+	154.32-214.32	DC-139	20	242-2800	20	Lumped LC
RBP-160+	120-210	85	20	280	20	Lumped LC
SXBP-202+	198-206	250	20	2700	20	Lumped LC
BPF-F200+	195-205	177 - 182	40	225 - 1600	45	Lumped LC
BPF-B199+	194-204	DC-179	20	221-2000	20	Lumped LC



Band Pass — Surface Mount 50Ω Continued

Model Number	Passband (MHz)	Stopband F3 (MHz)	Rejection @ F3 (dB)	Stopband F4 (MHz)	Rejection @ F4 (dB)	Technology
BPF-B190+	185-195	170	20	212	20	Lumped LC
SXBP-178+	170-186	150	20	210	20	Lumped LC
BPF-B177+	170-185	150	20	210	20	Lumped LC
RBP-173+	160-185	129	20	230	20	Lumped LC
BPF-A175+	170-180	154	20	200	20	Lumped LC
BPF-C138+	105-180	87	20	201	20	Lumped LC
BPF-C141+	110-180	92	20	213	20	Lumped LC
RBP-130+	95-180	50	20	280	20	Lumped LC
BPF-A176+	175-177	162	20	190	20	Lumped LC
SXBP-176+	175-177	DC-155	20	199-1000	20	Lumped LC
SXBP-161R5+	148-175	DC-130	20	200-2300	20	Lumped LC
TBP-154+	136-175	DC-108	20	220-3000	20	Lumped LC
SXBP-169+	164-174	137	20	205	20	Lumped LC
SXBP-162+	155-169	138	20	200	20	Lumped LC
SXBP-157+	150-164	131	20	187	20	Lumped LC
BPF-B157+	151-163	131	20	187	20	Lumped LC
SXBP-150+	140-160	120	20	190	20	Lumped LC
BPF-F150+	145-155	DC-133	35	170-1400	35	Lumped LC
RBP-135+	120-150	85	20	210	20	Lumped LC
RBP-140+	130-150	DC-100	20	178-3000	20	Lumped LC
SXBP-140+	130-150	110	20	185	20	Lumped LC
BPF-B140W+	135-145	117	20	165	20	Lumped LC
BPF-B140N+	135-143	126	20	154	20	Lumped LC
BPF-A120+	100-140	DC-82	20	170-3000	20	Lumped LC
BPF-A135+	132-138	123	20	148	20	Lumped LC
BPF-A127+	118-137	105	20	155	20	Lumped LC
RBP-98+	75-131	55	20	170	20	Lumped LC
BPF-A122+	119-125	111	20	132	20	Lumped LC

Band Pass — Surface Mount 50Ω Continued

Model Number	Passband (MHz)	Stopband F3 (MHz)	Rejection @ F3 (dB)	Stopband F4 (MHz)	Rejection @ F4 (dB)	Technology
BPF-A113+	108-118	95	20	140	20	Lumped LC
BPF-B113+	108-118	DC-98	20	132-2000	20	Lumped LC
SXBP-100+	87-117	66	20	143	20	Lumped LC
SXBP-101+	94-108	DC-80	20	130-3900	20	Lumped LC
BPF-F100+	95-105	DC-85	35	120-900	35	Lumped LC
BPF-C75+	60-90	46	20	102	20	Lumped LC
RBP-75+	60-90	37	20	122	20	Lumped LC
SXBP-70W+	50-90	DC-2	20	137-1500	20	Lumped LC
BPF-C59+	30-88	DC-22	20	115-4500	20	Lumped LC
BPF-C73+	63-85	45	20	105	20	Lumped LC
BPF-A69+	55-83	40	20	97	20	Lumped LC
BPF-A75+	72-78	65	20	88	20	Lumped LC
BPF-A76+	74-77	65	20	86	20	Lumped LC
SXBP-70+	63-77	50	20	95	20	Lumped LC
SXBP-69+	61.9-76.5	DC-55	20	87-3200	20	Lumped LC
SXBP-72+	68-76	DC-60	20	87-4000	20	Lumped LC
BPF-C70+	69.5-70.5	DC-66	20	75-1000	20	Lumped LC
BPF-C45+	30-70	23	20	95	20	Lumped LC
BPF-A60+	55-65	DC-50	20	75-900	20	Lumped LC
BPF-B63+	61-65	DC-56	20	72-2800	20	Lumped LC
BPF-B59+	57-61	DC-52	20	68-2600	20	Lumped LC
JCBP-43+	26-60	12.5	20	130	20	Lumped LC
BPF-B48+	47-49	41	20	56	20	Lumped LC
SXBP-35W+	24-46	16	20	73	20	Lumped LC
SXBP-35N+	30-40	21	20	60	20	Lumped LC
SXBP-29+	24-35	DC-17	20	48-1600	20	Lumped LC
SXBP-27R5+	24-31	DC-19	20	39-900	20	Lumped LC
BPF-E16+	2-30	DC-1.4	20	35-500	20	Lumped LC



Band Pass — Surface Mount 50Ω Continued

Model Number	Passband (MHz)	Stopband F3 (MHz)	Rejection @ F3 (dB)	Stopband F4 (MHz)	Rejection @ F4 (dB)	Technology
SXBP-20R5+	20-21	DC-17	20	27-400	20	Lumped LC
BPF-C4R5+	2-7	DC-0.6	20	17-2100	20	Lumped LC

Band Pass — Surface Mount 75Ω

Model Number	Passband (MHz)	Stopband F3 (MHz)	Rejection @ F3 (dB)	Stopband F4 (MHz)	Rejection @ F4 (dB)	Technology
BPF-AS1600-75+	950-2250	DC-480	30	3000-3500	20	Lumped LC
SXBP-1430-75+	950-2150	540	20	2950	20	Lumped LC
BFCN-152W-75+	950-1970	630-730	20	2300-3000	20	LTCC
CSBP-B1300-75+	1210-1390	DC-1080	20	1545-2500	20	Ceramic Resonator
SXBP-45-75+	5-85	DC-1	20	116-3000	20	Lumped LC

Band Pass + Balun — Surface Mount 50Ω

Model Number	Passband (MHz)	Stopband F3 (MHz)	Rejection @ F3 (dB)	Stopband F4 (MHz)	Rejection @ F4 (dB)	Technology
BFG2-552R+	4900-5875	3500	49	-	-	LTCC
BBFCG2-532+	5000-5700	DC-3000	30	8200-11000	20	LTCC
BBFCV-492+	4650-5150	50-4000	20	6696-8049	22	LTCC
BBFCV-2250+	1710-2610	10-1240	17	3390-5400	27	LTCC
BBFCQ2-252+	2400-2600	DC-1800	30	4100-7400	20	LTCC
BBFCG1-252+	2400-2500	DC-1800	29	3500-6600	24	LTCC
BFG1-252R+	2400-2500	1000-2000	39	4800-5000	49	LTCC
BFNL2-252R+	2400-2500	1710-1910	38	4800-5000	42	LTCC
BLFCV-1570+	690-1570	2200-6000	20	-	-	LTCC

Band Pass — Bare Die 50Ω

Model Number	Passband (MHz)	Stopband F3 (MHz)	Rejection @ F3 (dB)	Stopband F4 (MHz)	Rejection @ F4 (dB)	Technology
XBF-24-D+	19500-20500	DC - 10000	76	30000 - 32000	49	Reflectionless
XBF-183-D+	17500-18500	DC - 9000	77	27000 - 32000	50	Reflectionless
XBF-163-D+	15500-16500	DC - 8000	77	24000 - 30000	53	Reflectionless
XBF-282-D+	2350-3150	DC-1810	14	3800-20000	14	Reflectionless

Band Pass — Coaxial 50Ω

Model Number	Passband (MHz)	Stopband F3 (MHz)	Rejection @ F3 (dB)	Stopband F4 (MHz)	Rejection @ F4 (dB)	Technology	Connector Type
ZVBP-40600-K+	37700-43500	DC-36600	125	44600-57000	114	Cavity	2.92mm
ZVBP-40600-V+	37700-43500	DC-36600	112	44600-57000	102	Cavity	2.4mm
ZVBP-38500-K+	37000-40000	DC-36500	127	40500-55000	116	Cavity	2.92mm
ZVBP-38500-V+	37000-40000	DC-36500	114	40500-55000	103	Cavity	2.4mm
ZVBP-28000-K+	26500-29500	DC-25000	126	31000-48000	103	Cavity	2.92mm
ZVBP-27925-K+	27500-28350	DC-27325	128	28525-45000	115	Cavity	2.92mm
ZVBP-25875-K+	24250-27500	DC-23875	126	27875-44000	114	Cavity	2.92mm
ZVBP-K26R25G+	25375-27125	DC-24935	63	27565-37000	63	Cavity	2.92mm
ZVBP-13R1G-S+	11700-14500	DC-11000	56	15000-22000	42	Cavity	SMA
ZVBP-11R7G-S+	10700-12750	DC-10200	54	13200-20000	46	Cavity	SMA
ZVBP-11G3-S+	11200-11400	DC-11030	35	11580-20000	35	Cavity	SMA
ZVBP-10R5G-S+	9750-11250	DC-5950	35	15100-18000	35	Cavity	SMA
ZVBP-9R6G-S+	9550-9650	DC-9300	30	9900-20400	33	Cavity	SMA
VBF-8650+	8550-8750	7650	20	10300	20	LTCC	SMA
VBF-8450+	8350-8550	7650	20	10000	20	LTCC	SMA
ZVBP-8250-S+	8025-8475	DC-7650	20	8925-11000	20	Cavity	SMA
VBF-8350+	8250-8450	7300	20	10300	20	LTCC	SMA
ZBSS-7975-S+	7825-8125	DC-6900	35	9350-15000	35	Suspended Substrate	SMA
VBF-7900+	7800-8100	DC-6800	20	9500-15000	20	LTCC	SMA
VBF-8000+	7900-8100	6900	20	10300	20	LTCC	SMA



Band Pass — Coaxial 50Ω Continued

Model Number	Passband (MHz)	Stopband F3 (MHz)	Rejection @ F3 (dB)	Stopband F4 (MHz)	Rejection @ F4 (dB)	Technology	Connector Type
VBF-7700+	7500-7900	DC-6400	20	9200-14800	20	LTCC	SMA
VBF-7331+	6850-7850	10-5600	23	9300-10500	20	LTCC	SMA
VBF-7500+	7450-7650	6400	20	9000	20	LTCC	SMA
VBF-7350+	7150-7550	6325	20	8700	20	LTCC	SMA
VBF-7200+	7100-7300	6500	20	8400	20	LTCC	SMA
ZVBP-7100-S+	7025-7175	DC-6990	36	7224-14000	35	Cavity	SMA
VBFZ-6260-S+	5600-7000	4200	20	9300	20	LTCC	SMA
VBFZ-5500-S+	4900-6200	3600	20	8600	20	LTCC	SMA
ZVBP-5800-S+	5725-5875	DC-5200	35	6400-14000	35	Cavity	SMA
ZVBP-5310-S+	5250-5370	DC-5080	20	5530-8250	20	Cavity	SMA
ZX75BP-4700-S+	4400-5000	DC-2800	40	6300-8000	30	Ceramic Resonator	SMA
ZVBP-4900-S+	4840-4960	DC-4670	20	5100-9000	20	Cavity	SMA
ZVBP-4810-S+	4750-4870	DC-4600	20	5020-8250	20	Cavity	SMA
VBF-4440+	4200-4700	2000	20	6750	20	LTCC	SMA
VBFZ-4000-S+	3500-4500	2550	20	5700	20	LTCC	SMA
ZVBP-4300-S+	4250-4350	DC-4140	20	4480-8000	20	Cavity	SMA
VBFZ-3590-S+	3000-4300	2250	20	5950	20	LTCC	SMA
ZVBP-4000-S+	3997-4003	DC - 3800	70	4200 - 6000	70	Cavity	SMA
ZVBP-3875-S+	3845-3905	DC-3785	35	3970-8500	35	Cavity	SMA
ZAFBP-3200-S+	3100-3300	DC-2800	20	3550-8500	20	Microstrip	SMA
ZXBF-K282+	2350-3150	DC-1810	15	3800-20000	15	Reflectionless	2.92mm
VBF-2900+	2700-3100	1850	20	4200	20	LTCC	SMA
ZAFBP-2793-S+	2600-3000	DC-2300	20	3200-7400	20	Microstrip	SMA
VBFZ-2575-S+	2350-2800	1390	20	3850	20	LTCC	SMA
VBFZ-2340-S+	2020-2660	1450	20	3750	20	LTCC	SMA
VBF-2555+	2500-2610	1970	20	3200	20	LTCC	SMA
VBF-2435+	2340-2530	DC-1830	20	4300-5500	30	LTCC	SMA
ZFBP-2400-S+	2300-2500	DC-1800	20	2800-6000	20	Microstrip	SMA

Band Pass — Coaxial 50Ω Continued

Model Number	Passband (MHz)	Stopband F3 (MHz)	Rejection @ F3 (dB)	Stopband F4 (MHz)	Rejection @ F4 (dB)	Technology	Connector Type
ZVBP-2450-S+	2400-2500	2120-2260	40	2635-2780	40	Cavity	SMA
ZVBP-2450A-S+	2400-2500	DC-2050	57	2850-10000	65	Cavity	SMA
ZX75BP-2250-S+	2000-2500	DC-1630	29	2950-6000	25	Ceramic Resonator	SMA
VBF-2360+	2250-2470	DC-1700	20	4300-6200	30	LTCC	SMA
ZVBP-2400-S+	2375-2425	DC-2250	35	2550-6000	35	Cavity	SMA
ZVBP-2300A-S+	2200-2400	DC-2000	30	2550-8050	30	Cavity	SMA
VBF-2275+	2170-2380	DC-1720	20	4200-6000	30	LTCC	SMA
VBFZ-2000-S+	1730-2270	1210	20	2960	20	LTCC	SMA
VBFZ-2130-S+	2000-2260	1420	20	2950	20	LTCC	SMA
ZX75BP-2150-S+	2050-2250	DC-600	20	2720-4500	20	Lumped LC	SMA
ZX75BP-1940-S+	1710-2170	DC-150	20	2800-4000	20	Lumped LC	SMA
ZAFBP-2100-S+	2050-2150	DC-1800	20	2340-5000	20	Microstrip	SMA
ZVBP-2072R5-S+	2030-2115	DC-1930	48	2220-6000	49	Cavity	SMA
ZVBP-2100-S+	2085-2115	DC-2073	26	2127-5750	26	Cavity	SMA
VBF-1945+	1850-2040	DC-1500	20	3600-5700	30	LTCC	SMA
ZX75BP-1842-S+	1725-1960	1450	20	2350	20	Ceramic Resonator	SMA
VBF-1840+	1750-1930	DC-1460	20	3500-5700	30	LTCC	SMA
VBFZ-1690-S+	1455-1925	930	20	2600	20	LTCC	SMA
VBF-1855+	1790-1920	DC-1400	20	3700-5550	30	LTCC	SMA
ZX75BP-1500-S+	1350-1650	DC-85	20	2030-2800	20	Lumped LC	SMA
NBP-1560+	1500-1620	DC-1060	20	2150-4200	20	Lumped LC	N
VBF-1560+	1500-1620	1100	20	2100	20	LTCC	SMA
VBF-1575+	1530-1620	DC-1200	20	2800-5200	30	LTCC	SMA
ZVBP-1575R42-S+	1550.42-1600.42	DC-1475	68	1675-3000	77	Cavity	SMA
ZX75BP-1450-S+	1320-1580	DC-1100	46	2000-2500	54	Ceramic Resonator	SMA
VBF-1525+	1480-1570	DC-1150	20	2900-5100	30	LTCC	SMA
VBF-1445+	1420-1470	DC-1140	20	2600-4400	30	LTCC	SMA
VBFZ-1400-S+	1350-1450	890	20	1965	20	LTCC	SMA



Band Pass — Coaxial 50Ω Continued

Model Number	Passband (MHz)	Stopband F3 (MHz)	Rejection @ F3 (dB)	Stopband F4 (MHz)	Rejection @ F4 (dB)	Technology	Connector Type
ZVBP-1420-N+	1415-1425	DC-1370	81	1470-3000	79	Cavity	N
ZX75BP-1307-S+	1215-1400	DC-1000	20	1820-3000	20	Lumped LC	SMA
ZX75BP-1350-S+	1300-1400	DC-1125	20	1665-2800	20	Lumped LC	SMA
ZX75BP-B1280-S+	1160-1400	DC-955	40	1700-2200	40	Ceramic Resonator	SMA
ZX75BP-1280-S+	1170-1390	DC-950	20	1850-2550	20	Lumped LC	SMA
ZX75BP-1135-S+	900-1370	DC-500	45	2000-5600	40	Lumped LC	SMA
ZX75BP-B1230-S+	1120-1340	DC-940	25	1750-3500	20	Ceramic Resonator	SMA
ZX75BP-1260-S+	1200-1320	DC-1025	20	1640-2500	20	Lumped LC	SMA
ZX75BP-A1230-S+	1160-1300	DC-950	30	1670-3500	20	Ceramic Resonator	SMA
ZX75BP-1250-S+	1215-1285	DC-1055	20	1510-2500	20	Lumped LC	SMA
ZX75BP-1205-S+	1155-1255	DC-1026	20	1435-4500	20	Lumped LC	SMA
ZVBP-1227R6-S+	1202.6-1252.6	DC-1127	67	1327-2500	74	Cavity	SMA
ZX75BP-1170-S+	1110-1230	DC-900	20	1560-2200	20	Lumped LC	SMA
ZVBP-1176R45-S+	1151.45-1201.45	DC-1076	69	1276-2500	76	Cavity	SMA
ZX75BP-1100-S+	1000-1200	DC-25	20	1500-1900	20	Lumped LC	SMA
ZX75BP-1062-S+	960-1164	DC-735	20	1620-2000	20	Lumped LC	SMA
VBZ-1065-S+	980-1150	630	20	1800	20	LTCC	SMA
ZX75BP-1090-S+	1060-1120	DC-955	20	1255-2200	20	Lumped LC	SMA
ZX75BP-A1060-S+	1015-1105	DC-880	25	1350-4000	30	Ceramic Resonator	SMA
ZX75BP-1034-S+	978-1090	DC-790	20	1400-2000	20	Lumped LC	SMA
VBZ-925-S+	800-1050	530	20	1550	20	LTCC	SMA
ZX75BP-942-S+	875-1010	750	20	1160	20	Ceramic Resonator	SMA
ZABP-510-S+	20-1000	DC-17	20	1150-2500	20	Lumped LC	SMA
ZABP-550-S+	100-1000	DC-80	35	1200-2000	30	Lumped LC	SMA
ZX75BP-915-S+	902.5-927.5	DC-830	20	1005-1900	20	Lumped LC	SMA
ZVBP-909-S+	902-915	10-895	20	925-2300	20	Cavity	SMA
ZVBP-909A-S+	902-915	DC-895	27	923-2300	35	Cavity	SMA
ZX75BP-893-S+	870-915	DC-750	20	1050-1800	20	Lumped LC	SMA

Band Pass — Coaxial 50Ω Continued

Model Number	Passband (MHz)	Stopband F3 (MHz)	Rejection @ F3 (dB)	Stopband F4 (MHz)	Rejection @ F4 (dB)	Technology	Connector Type
ZX75BP-750-S+	600-900	DC-500	30	1000-6000	30	Lumped LC	SMA
ZX75BP-840-S+	790-890	DC-665	20	1070-1650	20	Lumped LC	SMA
ZABP-670-S+	470-870	280-365	20	965-1200	20	Lumped LC	SMA
VBZ-780-S+	710-850	460	20	1300	20	LTCC	SMA
ZABP-598-S+	410-785	DC-385	20	825-1000	20	Lumped LC	SMA
ZABP-650-S+	560-780	185-280	20	890-3500	30	Lumped LC	SMA
ZX75BP-770-S+	760-780	DC-705	20	840-1700	20	Lumped LC	SMA
ZABP-587-S+	470-705	200-400	20	800-1500	20	Lumped LC	SMA
ZABP-495-S+	470-520	300-410	20	625-800	20	Lumped LC	SMA
ZABP-450-S+	400-510	150-310	20	700-760	20	Lumped LC	SMA
BBP-240+	238-242	DC-220	32	260-2000	30	Lumped LC	BNC
SBP-240+	238-242	DC-220	32	260-2000	30	Lumped LC	SMA
ZX75BP-204-S+	175-237	DC-90	60	2500-3500	30	Lumped LC	SMA
ZABP-184-S+	154.32-214.32	DC - 139	20	242 - 750	20	Lumped LC	SMA
ZABP-141-S+	110-180	90-92	20	213-217	20	Lumped LC	SMA
BBP-150+	140-160	DC-120	29	190-2000	30	Lumped LC	BNC
SBP-150+	140-160	DC-120	27	190-2000	32	Lumped LC	SMA
BBP-140+	130-150	DC-110	30	185-2000	30	Lumped LC	BNC
SBP-140+	130-150	DC-110	30	185-2000	30	Lumped LC	SMA
BBP-100+	87-117	DC-66	29	143-1500	28	Lumped LC	BNC
SBP-100+	87-117	DC-66	29	143-1500	28	Lumped LC	SMA
BBP-101+	94-108	DC-80	29	130-2000	28	Lumped LC	BNC
SBP-101+	94-108	DC-80	29	130-3300	28	Lumped LC	SMA
ZABP-59-S+	30-88	16-22	20	115-140	20	Lumped LC	SMA
ZX75BP-B70-S+	52-88	11-29	20	118-200	20	Lumped LC	SMA
ZABP-73-S+	63-85	40-45	20	105-110	20	Lumped LC	SMA
SIF-70+	58-82	4.4	20	490	20	Lumped LC	SMA
ZX75BP-A70-S+	62-78	11-29	20	110-3300	20	Lumped LC	SMA



Band Pass — Coaxial 50Ω Continued

Model Number	Passband (MHz)	Stopband F3 (MHz)	Rejection @ F3 (dB)	Stopband F4 (MHz)	Rejection @ F4 (dB)	Technology	Connector Type
BBP-70+	63-77	51	20	94	20	Lumped LC	BNC
NBP-70+	63-77	51	20	94	20	Lumped LC	N
SBP-70+	63-77	51	20	94	20	Lumped LC	SMA
ZFBP-70HR-S+	69-71	DC-50	85	100-1000	60	Lumped LC	SMA
SIF-60+	50-70	3.8	20	400	20	Lumped LC	SMA
ZABP-45-S+	30-70	21-23	20	95-120	20	Lumped LC	SMA
BBP-60+	55-67	44	20	79	20	Lumped LC	BNC
SBP-60+	55-67	44	20	79	20	Lumped LC	SMA
SIF-50+	41-58	3.1	20	350	20	Lumped LC	SMA
SIF-40+	35-49	2.6	20	300	20	Lumped LC	SMA
BBP-35B+	24-46	DC-16	29	73-1000	27	Lumped LC	BNC
SBP-35B+	24-46	DC-16	29	73-1000	27	Lumped LC	SMA
BBP-35A+	30-40	DC-19	30	65-1350	30	Lumped LC	BNC
SBP-35A+	30-40	DC-21	27	60-1350	30	Lumped LC	SMA
BBP-29+	24-35	DC-18	27	46-1600	27	Lumped LC	BNC
SBP-29+	24-35	DC-18	27	46-1600	27	Lumped LC	SMA
SIF-30+	25-35	1.9	20	210	20	Lumped LC	SMA
BBP-30+	27-33	22	20	40	20	Lumped LC	BNC
SBP-30+	27-33	22	20	40	20	Lumped LC	SMA
BBP-27R5+	24-31	DC-19	30	39-900	30	Lumped LC	BNC
SBP-27R5+	24-31	DC-19	30	39-900	30	Lumped LC	SMA
ZABP-16+	3-30	DC-1.4	20	35-1600	20	Lumped LC	SMA
SIF-21.4+	18-25	1.3	20	150	20	Lumped LC	SMA
BBP-21.4+	19.2-23.6	15.5	20	29	20	Lumped LC	BNC
SBP-21.4+	19.2-23.6	15.5	20	29	20	Lumped LC	SMA
BBP-20R5+	20-21	DC-15.8	40	40-380	40	Lumped LC	BNC
SBP-20R5+	20-21	DC-17	30	27-380	25	Lumped LC	SMA
ZFBP-13.5-S+	12-15	8	20	22	30	Lumped LC	SMA

Band Pass — Coaxial 50Ω Continued

Model Number	Passband (MHz)	Stopband F3 (MHz)	Rejection @ F3 (dB)	Stopband F4 (MHz)	Rejection @ F4 (dB)	Technology	Connector Type
ZX75-12-S+	9-15	7.5	20	18	20	Lumped LC	SMA
BBP-10.7+	9.5-11.5	7.5	20	15	20	Lumped LC	BNC
NBP-10.7+	9.5-11.5	7.5	20	15	20	Lumped LC	N
SBP-10.7+	9.5-11.5	7.5	20	15	20	Lumped LC	SMA
ZABP-4R5-S+	2-7	DC - 0.6	20	17 - 100	20	Lumped LC	SMA
ZFBP-400K-S+	0.35-0.45	0.03	20	0.18	20	Lumped LC	SMA
ZBPF-75-S+	0.063-0.087	DC-0.045	20	0.125-800	20	Lumped LC	SMA

Band Pass — Coaxial 75Ω

Model Number	Passband (MHz)	Stopband F3 (MHz)	Rejection @ F3 (dB)	Stopband F4 (MHz)	Rejection @ F4 (dB)	Technology	Connector Type
ZFBP13-75+	12.3-13.8	10.6	20	16	20	Lumped LC	BNC

Band Pass — Plug-In 50Ω

Model Number	Passband (MHz)	Passband F1 (MHz)	Passband F2 (MHz)	Stopband F3 (MHz)	Rejection @ F3 (dB)	Stopband F4 (MHz)	Rejection @ F4 (dB)	Technology
PIF-70+	58-82	58	82	4.4	20	490	20	Lumped LC
PBP-70+	63-77	63	77	51	20	94	20	Lumped LC
PIF-60+	50-70	50	70	3.8	20	400	20	Lumped LC
PBP-60+	55-67	55	67	44	20	79	20	Lumped LC
PIF-50+	41-58	41	58	3.1	20	350	20	Lumped LC
PIF-40+	35-49	35	49	2.6	20	300	20	Lumped LC
PBP-35W+	25-45	25	45	16	20	70	20	Lumped LC
PBP-35N+	30-40	30	40	21	20	58	20	Lumped LC
PIF-30+	25-35	25	35	1.9	20	210	20	Lumped LC
PBP-30+	27-33	27	33	22	20	40	20	Lumped LC



Band Pass — Plug-In 50Ω Continued

Model Number	Passband (MHz)	Passband F1 (MHz)	Passband F2 (MHz)	Stopband F3 (MHz)	Rejection @ F3 (dB)	Stopband F4 (MHz)	Rejection @ F4 (dB)	Technology
PIF-21.4+	18-25	18	25	1.3	20	150	20	Lumped LC
PBP-21.4+	19.2-23.6	19.2	23.6	15.5	20	29	20	Lumped LC
PBP-10.7+	9.5-11.5	9.5	11.5	7.5	20	15	20	Lumped LC

Band Pass — Waveguide 50Ω

Model Number	Passband (MHz)	Stopband F3 (MHz)	Rejection @ F3 (dB)	Stopband F4 (MHz)	Rejection @ F4 (dB)	Filter Type	Technology	Interface
WVBP-833-WR12+	81000-86000	60000-79000	64	88000-90000	38	Band Pass	Rectangular Waveguide	WR-12
WVBP-783-WR12+	76000-81000	60000-74500	67	82500-90000	48	Band Pass	Rectangular Waveguide	WR-12
WVBP-733-WR12+	71000-76000	60000-69500	56	77500-90000	66	Band Pass	Rectangular Waveguide	WR-12
WVBP-673-WR12+	64000-71000	60000-61500	56	73500-90000	28	Band Pass	Rectangular Waveguide	WR-12
WVBP-613-WR15+	57200-65900	50000-56200	74	66900-75000	65	Band Pass	Rectangular Waveguide	WR-15
WVBP-653-WR15+	63700-65900	50000-62700	59	66900-75000	66	Band Pass	Rectangular Waveguide	WR-15
WVBP-633-WR15+	61500-63800	50000-60500	66	64800-75000	67	Band Pass	Rectangular Waveguide	WR-15
WVBP-64-WR15+	59400-61600	50000-58400	72	62600-75000	72	Band Pass	Rectangular Waveguide	WR-15
WVBP-583-WR15+	57200-59400	50000-56200	56	60400-75000	58	Band Pass	Rectangular Waveguide	WR-15
WVBP-383-WR28+	37000-40000	22000-36000	59	41000-42000	34	Band Pass	Rectangular Waveguide	WR-28
WVBP-283-WR28+	27500-28350	22000-27000	48	28850-38000	34	Band Pass	Rectangular Waveguide	WR-28

High Pass

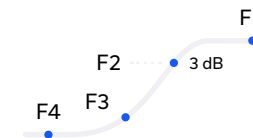

High Pass — Surface Mount 50Ω

Model Number	Passband (MHz)	Stopband F3 (MHz)	Rejection @ F3 (dB)	Stopband F4 (MHz)	Rejection @ F4 (dB)	Technology
XHF2-1832+	18300-30000	DC-14600	14	-	-	Reflectionless
XHF2-153+	15300-30000	DC-12000	14	-	-	Reflectionless
XHF2-1352+	13500-30000	DC-10500	14	-	-	Reflectionless
XHF2-1162+	11600-30000	DC-8700	14	-	-	Reflectionless
XHF2-912+	9100-30000	DC-7100	14	-	-	Reflectionless
XHF-14M+	9900-20000	5000-7000	30	DC-5000	40	Reflectionless
XHF-482M+	4800-19400	2400-3600	36	DC-2400	37	Reflectionless
XHF-143M+	13900-19000	7000-8000	30	DC-7000	40	Reflectionless
XHF-63M+	5900-19000	3000-4100	30	DC-3000	40	Reflectionless
HFCN-1322+	14300-18500	11700	20	11300	30	LTCC
HFCG-4400+	4900-18500	DC-3000	42	3000-3500	38	LTCC
HFCG-3800+	4200-18000	DC-2700	42	2700-3000	34	LTCC
HFCN-9700+	9700-16980	6770-7550	20	DC-6770	30	LTCC
XHF-73M+	7000-16400	4000-5200	30	DC-4000	38	Reflectionless
XHF-652M+	6600-16200	4000-5000	30	DC-4000	38	Reflectionless
HFCG-2750+	2900-16000	DC-1000	36	1000-2000	34	LTCC
HFCN-103+	9700-15000	6500	20	5700	30	LTCC
HFCN-6010+	6300-15000	5200	20	5190	30	LTCC
HFCN-8400+	9000-13000	6000	20	5700	30	LTCC
HFCN-8400D+	9000-13000	6000	20	5700	30	LTCC
HFCN-672+	6700-13000	5500	20	4435	30	LTCC
HFCG-3000+	3400-13000	DC-2350	30	-	-	LTCC
HFCN-7971+	8560-12800	6985	20	5500	30	LTCC
HFCN-5500+	6000-11500	4500	20	4000	30	LTCC
HFCN-5500D+	6000-11500	4500	20	4000	30	LTCC
XHF-392+	3940-11500	DC-2450	14	-	-	Reflectionless

High Pass — Surface Mount 50Ω Continued

Model Number	Passband (MHz)	Stopband F3 (MHz)	Rejection @ F3 (dB)	Stopband F4 (MHz)	Rejection @ F4 (dB)	Technology
HFCN-7150+	7900-11000	6150	20	5100	30	LTCC
HFCN-4600+	5000-11000	3800	20	3700	30	LTCC
XHF-53H+	5000-11000	DC-3100	50	-	-	Reflectionless
XHF-252+	2460-10400	DC-1520	14	-	-	Reflectionless
HFCN-4400+	5000-10100	3500	20	3300	30	LTCC
HFCN-4400D+	5000-10100	3500	20	3300	30	LTCC
XHF-23+	2010-10100	DC-1210	14	-	-	Reflectionless
HFCN-5050+	5500-10000	4200	20	3600	30	LTCC
HFCN-3800	4250-10000	3200	20	3100	30	LTCC
HFCN-3800+	4250-10000	3200	20	3100	30	LTCC
HFCN-3800D+	4250-10000	3200	20	3100	30	LTCC
HFCG-2000+	2100-10000	DC-1100	50	1100-1530	27	LTCC
HFCN-3100+	3400-9900	2450	20	2250	30	LTCC
HFCN-3100D+	3400-9900	2450	20	2250	30	LTCC
HFCN-3500+	3900-9800	2800	20	2600	30	LTCC
HFCN-3500D+	3900-9800	2800	20	2600	30	LTCC
HFCW-422+	4200-9000	10-2600	17.8	-	-	LTCC
HFCN-2700A+	2900-8700	2150	20	2000	30	LTCC
HFCN-2700AD+	2900-8700	2150	20	2000	30	LTCC
XHF-292M+	2900-8700	DC-1950	30	-	-	Reflectionless
HFCE-452+	4500-8500	DC-2500	22	-	-	LTCC
HFCG-1760+	1800-8000	DC-800	38	800-1200	36	LTCC
HFTC-26+	3000-7000	2000	20	1450	30	LTCC
HFCN-2275+	2450-7000	1770	20	1400	30	LTCC
HFCN-2700+	2650-6500	1800	20	1500	30	LTCC
HFCN-2000+	2260-6250	1530	20	1300	30	LTCC
HFCG-2100+	2200-6000	DC-1050	40	DC-1320	20	LTCC
HFCN-2100+	2200-6000	1530	20	1050	30	LTCC

High Pass — Surface Mount 50Ω Continued

Model Number	Passband (MHz)	Stopband F3 (MHz)	Rejection @ F3 (dB)	Stopband F4 (MHz)	Rejection @ F4 (dB)	Technology
HFCN-2100D+	2200-6000	1530	20	1050	30	LTCC
HFCG-1500+	1600-6000	DC-800	40	800-1000	35	LTCC
HPJC-492R+	4900-5850	500-2400	25	2400-2500	36	LTCC
HPSC-492R+	4900-5850	500-2400	25	2400-2500	34	LTCC
HFTC-19+	2300-5500	1650	20	1450	30	LTCC
HFCN-1760+	1900-5500	1230	20	950	30	LTCC
HFCN-1500+	1600-5500	1250	20	1060	30	LTCC
HFCN-1500D+	1600-5500	1250	20	1090	30	LTCC
HFCN-1910+	2000-5200	1400	20	1075	30	LTCC
HFCN-1910D+	2000-5200	1400	20	1100	30	LTCC
HFCN-1600+	1650-5000	1290	20	1090	30	LTCC
HFCN-1600D+	1650-5000	1290	20	1090	30	LTCC
HFCG-1600+	1650-5000	DC-700	53	DC-950	34	LTCC
HFCN-1320+	1400-5000	1060	20	880	30	LTCC
HFCN-1320D+	1400-5000	1060	20	910	30	LTCC
HFCN-1300+	1400-5000	930	20	680	30	LTCC
HFCN-1300D+	1400-5000	930	20	680	30	LTCC
XHF-721M+	700-5000	300-450	20	DC-300	30	Reflectionless
HFCN-1810+	1950-4750	1480	20	1100	30	LTCC
HFCN-1810D+	1950-4750	1480	20	1100	30	LTCC
HFCN-1200+	1220-4600	910	20	750	30	LTCC
HFCN-1200D+	1220-4600	940	20	780	30	LTCC
HFCN-1150+	1220-4500	850	20	650	30	LTCC
HFCN-1080+	1140-4240	700	20	600	30	LTCC
THP-1500+	1500-4000	DC-1030	20	900	30	Lumped LC
HFCN-1000+	1080-4000	740	20	570	30	LTCC
THP-1225+	1225-4000	DC-720	20	675	30	Lumped LC
THP-1050+	1050-4000	DC-620	20	500	30	Lumped LC



High Pass — Surface Mount 50Ω Continued

Model Number	Passband (MHz)	Stopband F3 (MHz)	Rejection @ F3 (dB)	Stopband F4 (MHz)	Rejection @ F4 (dB)	Technology
THP-825+	825-4000	DC-475	20	300	30	Lumped LC
THP-700+	700-4000	DC-395	20	250	30	Lumped LC
HFCN-1100+	1500-3900	700	20	530	30	LTCC
HFCG-1100+	1400-3900	DC-700	20	DC-530	40	LTCC
HFTC-9R5+	1300-3500	750	20	600	30	LTCC
RHP-755+	1200-3400	550	20	350	30	Lumped LC
HFCW-242+	2400-3300	DC-1650	20	-	-	LTCC
HFCN-880+	950-3200	640	20	500	30	LTCC
HFCN-880D+	950-3200	640	20	500	30	LTCC
RHP-305+	420-3200	215	20	160	30	Lumped LC
RHP-290+	430-3100	210	20	150	30	Lumped LC
JCHP-1200+	1400-3000	1040	20	730	30	Lumped LC
RHP-700+	700-3000	DC-500	20	-	-	Lumped LC
RHPF-500+	500-3000	400-430	20	DC-400	30	Lumped LC
XHF-581M+	580-3000	280-330	20	DC-280	30	Reflectionless
RHP-250+	400-3000	180	20	135	30	Lumped LC
RHP-225+	360-3000	165	20	125	30	Lumped LC
RHP-180+	300-3000	135	20	100	30	Lumped LC
RHP-147+	250-3000	105	20	80	30	Lumped LC
RHP-139+	225-3000	100	20	75	30	Lumped LC
RHP-122+	200-3000	85	20	65	30	Lumped LC
HFCN-740+	780-2800	550	20	430	30	LTCC
HFCN-740D+	780-2800	550	20	430	30	LTCC
RHP-395+	650-2750	290	20	210	30	Lumped LC
HFTC-16+	1900-2700	1300	20	1030	30	LTCC
HPJC-252R+	2400-2500	500-1917	35	1917	25	LTCC
HFCN-440+	500-2500	350	20	230	30	LTCC
RHP-110+	185-2500	75	20	60	30	Lumped LC

High Pass — Surface Mount 50Ω Continued

Model Number	Passband (MHz)	Stopband F3 (MHz)	Rejection @ F3 (dB)	Stopband F4 (MHz)	Rejection @ F4 (dB)	Technology
RHP-92+	160-2500	65	20	50	30	Lumped LC
HFCN-650+	710-2490	480	20	390	30	LTCC
HFCN-650D+	710-2490	480	20	390	30	LTCC
RHP-44+	95-2400	32	20	25	30	Lumped LC
RHP-260+	300-2200	190	20	145	30	Lumped LC
RHP-73+	140-2000	55	20	42	30	Lumped LC
RHP-65+	130-2000	48	20	37	30	Lumped LC
SCHF-31+	31-1500	20.5-23.5	20	DC-20.5	30	Lumped LC
SCHF-300	290-1200	190	20	145	30	Lumped LC
HFCV-145+	140-1150	115	20	80	30	LTCC
SXHP-108+	108-1000	DC-85	20	78	30	Lumped LC
SXHP-76+	81-1000	DC-65	20	62	30	Lumped LC
SXHP-48+	54-1000	DC-42	20	40	30	Lumped LC
SCHF-27+	27-1000	17-19	20	DC-17	30	Lumped LC
SXHP-5+	5-400	DC-3.5	20	-	-	Lumped LC
SXHP-2+	2-400	DC-1.3	30	-	-	Lumped LC
SCHF-25	27.5-200	19	20	13	30	Lumped LC
SCHF-17+	18-200	13	20	9	30	Lumped LC

High Pass — Bare Die 50Ω

Model Number	Passband (MHz)	Stopband F3 (MHz)	Rejection @ F3 (dB)	Stopband F4 (MHz)	Rejection @ F4 (dB)	Technology
XHF-153-D+	15000-40000	2400-12000	20	DC-2400	9	Reflectionless
XHF-912-D+	9100-40000	1400-7300	20	DC-1400	9	Reflectionless
XHF-1162-D+	11600-40000	2500-9100	20	DC-2500	9	Reflectionless
XHF-1352-D+	13500-40000	3000-10500	20	DC-3000	9	Reflectionless
XHF-1832-D+	18300-40000	9000-14600	20	DC-9000	9	Reflectionless
XHF-14M-D+	9900-26000	5000 - 7000	32	DC - 5000	41	Reflectionless



High Pass — Bare Die 50Ω Continued

Model Number	Passband (MHz)	Stopband F3 (MHz)	Rejection @ F3 (dB)	Stopband F4 (MHz)	Rejection @ F4 (dB)	Technology
XHF-63M-D+	5900-26000	3000 - 4100	34	DC - 3000	38	Reflectionless
XHF-143M-D+	13900-26000	7000 - 9000	30	DC - 7000	41	Reflectionless
XHF-73M-D+	7000-21700	DC-5200	36	-	-	Reflectionless
XHF-652M-D+	6500-21110	DC-5000	36	-	-	Reflectionless
XHF-482M-D+	4800-17800	DC-3500	37	-	-	Reflectionless
XHF-392-D+	3940-11500	DC-2450	14	-	-	Reflectionless
XHF-53H-D+	5000-11000	DC-3100	50	-	-	Reflectionless
XHF-252-D+	2460-10400	DC-1520	14	-	-	Reflectionless
XHF-23-D+	2010-10100	DC-1210	14	-	-	Reflectionless

High Pass — Coaxial 50Ω

Model Number	Passband (MHz)	Stopband F3 (MHz)	Rejection @ F3 (dB)	Stopband F4 (MHz)	Rejection @ F4 (dB)	Filter Type	Technology	Connector Type
ZHSS-K11G+	11000-40000	DC-6500	80	6500-8500	40	High Pass	Suspended Substrate	2.92mm
ZHSS-K15G+	15000-40000	DC-7000	80	7000-10000	40	High Pass	Suspended Substrate	2.92mm
ZHSS-K18G+	18000-40000	DC-11700	80	11700-13600	40	High Pass	Suspended Substrate	2.92mm
ZHSS-K21G+	21000-40000	DC-13000	80	13000-16000	40	High Pass	Suspended Substrate	2.92mm
ZHSS-K24G+	24000-40000	DC-15000	80	15000-18500	40	High Pass	Suspended Substrate	2.92mm
ZXHF-K153+	15300-30000	DC-2400	6.8	2400-12000	13.7	High Pass	Reflectionless	2.92mm
ZXHF-K912+	9100-30000	DC-1400	6.9	1400-7100	14.3	High Pass	Reflectionless	2.92mm
ZXHF-K1162+	11600-30000	DC-2500	6.9	2500-8700	13.6	High Pass	Reflectionless	2.92mm
ZXHF-K1352+	13500-30000	DC-3000	6.9	3000-10500	13.8	High Pass	Reflectionless	2.92mm
ZXHF-K1832+	18300-30000	DC-9000	6.7	9000-14600	14	High Pass	Reflectionless	2.92mm
ZHSS-8G-S+	8000-24000	5300-5800	20	DC-5300	40	High Pass	Suspended Substrate	SMA
ZHSS-11G-S+	11000-24000	DC-6000	80	6000-9000	30	High Pass	Suspended Substrate	SMA
ZHSS-8G-S+	8000-24000	DC-4000	85	5300-5800	30	High Pass	Suspended Substrate	SMA
ZXHF-K14M+	9900-20000	DC-5000	28	5000-7000	24	High Pass	Reflectionless	2.92mm

High Pass — Coaxial 50Ω Continued

Model Number	Passband (MHz)	Stopband F3 (MHz)	Rejection @ F3 (dB)	Stopband F4 (MHz)	Rejection @ F4 (dB)	Filter Type	Technology	Connector Type
ZXHF-K63M+	5900-19000	DC-3000	27	3000-4100	25	High Pass	Reflectionless	2.92mm
ZXHF-K143M+	13900-19000	DC-7000	27	7000-9000	24	High Pass	Reflectionless	2.92mm
ZXHF-K482M+	4800-19000	2400-3500	30	DC-2400	35	High Pass	Reflectionless	2.92mm
ZXHF-K73M+	7000-16000	4000-5200	25	DC-4000	35	High Pass	Reflectionless	2.92mm
ZXHF-K652M+	6600-16000	4000-5000	30	DC-4000	34	High Pass	Reflectionless	2.92mm
VHF-6010+	6350-15000	5200	20	5190	40	High Pass	LTCC	SMA
ZHSS-2G-S+	2000-14000	DC-500	80	500-1150	30	High Pass	Suspended Substrate	SMA
VHF-8400+	9500-13000	6000	20	5700	40	High Pass	LTCC	SMA
VXHF-392+	3940-11500	DC-2450	12.5	-	-	High Pass	Reflectionless	SMA
ZXHF-K392+	3940-11500	DC-2450	14	-	-	High Pass	Reflectionless	2.92mm
VHF-4600+	5200-10500	3800	20	3700	40	High Pass	LTCC	SMA
VHF-7150+	8500-10500	6150	20	5100	40	High Pass	LTCC	SMA
ZXHF-K252+	2460-10400	DC-1520	13	-	-	High Pass	Reflectionless	2.92mm
VXHF-23+	2010-10100	DC-1210	14	-	-	High Pass	Reflectionless	SMA
ZXHF-K23+	2010-10100	DC-1210	14	-	-	High Pass	Reflectionless	2.92mm
VHF-5500+	6600-10000	4500	20	4000	40	High Pass	LTCC	SMA
VHF-4400+	5000-9900	3500	20	3600	40	High Pass	LTCC	SMA
VHF-5050+	5650-9700	4200	20	3600	40	High Pass	LTCC	SMA
VHF-3100+	3500-9500	2450	20	2500	40	High Pass	LTCC	SMA
VHF-3800+	4500-9000	3200	20	3100	40	High Pass	LTCC	SMA
VXHF-482M+	4800-9000	DC-2400	37	2400-3600	36	High Pass	Reflectionless	SMA
VHF-3500+	4000-8800	2800	20	2900	40	High Pass	LTCC	SMA
VXHF-292M+	2900-8700	DC-1950	36	-	-	High Pass	Reflectionless	SMA
ZXHF-K292M+	2900-8700	DC-1950	32	-	-	High Pass	Reflectionless	2.92mm
VHF-2700A+	3070-8500	2150	20	2270	40	High Pass	LTCC	SMA
ZXHF-K53H+	5000-8000	DC-3100	50	-	-	High Pass	Reflectionless	2.92mm
VHP-26	3000-7000	2000	20	1500	40	High Pass	LTCC	SMA
ZFHP-2100-S+	2500-6800	1925	20	900	40	High Pass	Lumped LC	SMA



High Pass — Coaxial 50Ω Continued

Model Number	Passband (MHz)	Stopband F3 (MHz)	Rejection @ F3 (dB)	Stopband F4 (MHz)	Rejection @ F4 (dB)	Filter Type	Technology	Connector Type
VHF-2275+	2640-6230	1770	20	1400	40	High Pass	LTCC	SMA
ZFHP-3800FF-S+	3800-6000	10-3170	27.3	-	-	High Pass	Lumped LC	SMA
ZX75HP-2400-S+	2400-5925	DC-2025	20	-	40	High Pass	Lumped LC	SMA
VHF-2700+	3000-5700	1800	20	1500	40	High Pass	LTCC	SMA
VHF-2000+	2410-5550	1530	20	1300	40	High Pass	LTCC	SMA
VHP-19	2300-5500	1650	20	1450	40	High Pass	LTCC	SMA
VHF-1760+	2100-5200	1230	20	950	40	High Pass	LTCC	SMA
VHF-1080+	1150-5000	600-750	20	DC-600	40	High Pass	LTCC	SMA
VHF-2100+	2500-5000	1530	20	1050	40	High Pass	LTCC	SMA
ZFHP-3800-S+	3800-5000	DC-3170	20	-	40	High Pass	Lumped LC	SMA
ZXHF-K721M+	700-5000	DC-300	35	300-450	30	High Pass	Reflectionless	2.92mm
VHF-1500+	1850-4400	1250	20	1060	40	High Pass	LTCC	SMA
VHF-1910+	2200-4400	1400	20	1075	40	High Pass	LTCC	SMA
VHF-1200+	1380-4000	910	20	750	40	High Pass	LTCC	SMA
VHF-1300+	1510-4000	930	20	680	40	High Pass	LTCC	SMA
VHF-1600+	1950-4000	1290	20	1090	40	High Pass	LTCC	SMA
VHF-1810+	2250-4000	1480	20	1100	40	High Pass	LTCC	SMA
VHF-1320+	1700-3800	1060	20	880	40	High Pass	LTCC	SMA
VHP-9R5	1300-3500	750	20	600	40	High Pass	LTCC	SMA
ZX75HP-755-S+	1200-3400	DC-540	20	-	40	High Pass	Lumped LC	SMA
BHP-400+	395-3200	290	20	210	40	High Pass	Lumped LC	BNC
BHP-500+	500-3200	365	20	280	40	High Pass	Lumped LC	BNC
NHP-400+	395-3200	290	20	210	40	High Pass	Lumped LC	N
NHP-500+	500-3200	365	20	280	40	High Pass	Lumped LC	N
SHP-400+	395-3200	290	20	210	40	High Pass	Lumped LC	SMA
SHP-500+	500-3200	365	20	280	40	High Pass	Lumped LC	SMA
ZX75HP-305-S+	420-3200	DC-215	20	-	40	High Pass	Lumped LC	SMA
ZX75HP-290-S+	430-3100	DC-200	20	-	40	High Pass	Lumped LC	SMA

High Pass — Coaxial 50Ω Continued

Model Number	Passband (MHz)	Stopband F3 (MHz)	Rejection @ F3 (dB)	Stopband F4 (MHz)	Rejection @ F4 (dB)	Filter Type	Technology	Connector Type
BHP-250+	225-3000	150	20	100	40	High Pass	Lumped LC	BNC
BHP-300+	290-3000	190	20	145	40	High Pass	Lumped LC	BNC
BHP-600+	600-3000	440	20	350	40	High Pass	Lumped LC	BNC
BHP-700+	700-3000	520	20	400	40	High Pass	Lumped LC	BNC
BHP-800+	780-3000	570	20	445	40	High Pass	Lumped LC	BNC
BHP-900+	910-3000	660	20	520	40	High Pass	Lumped LC	BNC
BHP-1000+	1000-3000	720	20	550	40	High Pass	Lumped LC	BNC
NHP-200+	185-3000	116	20	90	40	High Pass	Lumped LC	N
NHP-250+	225-3000	150	20	100	40	High Pass	Lumped LC	N
NHP-300+	290-3000	190	20	145	40	High Pass	Lumped LC	N
NHP-600+	600-3000	440	20	350	40	High Pass	Lumped LC	N
NHP-700+	700-3000	520	20	400	40	High Pass	Lumped LC	N
NHP-800+	780-3000	570	20	445	40	High Pass	Lumped LC	N
NHP-900+	910-3000	660	20	520	40	High Pass	Lumped LC	N
NHP-1000+	1000-3000	720	20	550	40	High Pass	Lumped LC	N
SHP-100A+	110-3000	82	20	77	40	High Pass	Lumped LC	SMA
SHP-200+	185-3000	116	20	90	40	High Pass	Lumped LC	SMA
SHP-250+	225-3000	150	20	100	40	High Pass	Lumped LC	SMA
SHP-300+	290-3000	190	20	145	40	High Pass	Lumped LC	SMA
SHP-600+	600-3000	440	20	350	40	High Pass	Lumped LC	SMA
SHP-700+	700-3000	520	20	400	40	High Pass	Lumped LC	SMA
SHP-800+	780-3000	570	20	445	40	High Pass	Lumped LC	SMA
SHP-900+	910-3000	660	20	520	40	High Pass	Lumped LC	SMA
SHP-1000+	1000-3000	720	20	550	40	High Pass	Lumped LC	SMA
ZX75HP-122-S+	200-3000	DC-85	20	-	40	High Pass	Lumped LC	SMA
ZX75HP-147-S+	250-3000	DC-100	20	-	40	High Pass	Lumped LC	SMA
ZX75HP-225-S+	360-3000	DC-150	20	-	40	High Pass	Lumped LC	SMA
ZX75HP-250-S+	400-3000	DC-178	20	-	40	High Pass	Lumped LC	SMA



High Pass — Coaxial 50Ω Continued

Model Number	Passband (MHz)	Stopband F3 (MHz)	Rejection @ F3 (dB)	Stopband F4 (MHz)	Rejection @ F4 (dB)	Filter Type	Technology	Connector Type
ZX75HP-2000-S+	2000-3000	DC-1600	20	-	40	High Pass	Lumped LC	SMA
ZXHF-K581M+	580-3000	DC-280	35	280-330	27	High Pass	Reflectionless	2.92mm
ZX75HP-395-S+	650-2750	DC-280	20	-	40	High Pass	Lumped LC	SMA
VHP-16	1900-2700	1300	20	1030	40	High Pass	LTCC	SMA
VHF-880+	1060-2500	640	20	500	40	High Pass	LTCC	SMA
ZX75HP-92-S+	160-2500	DC-64	20	-	40	High Pass	Lumped LC	SMA
ZX75HP-110-S+	185-2500	DC-77	20	-	40	High Pass	Lumped LC	SMA
ZX75HP-180-S+	300-2500	DC-130	20	-	40	High Pass	Lumped LC	SMA
ZX75HP-44-S+	95-2400	DC-31	20	-	40	High Pass	Lumped LC	SMA
VHF-740+	900-2200	550	20	430	40	High Pass	LTCC	SMA
ZX75HP-139-S+	225-2200	DC-99	20	-	40	High Pass	Lumped LC	SMA
ZX75HP-260-S+	300-2200	DC-184	20	-	40	High Pass	Lumped LC	SMA
SHP-48+	48-2150	DC-18	20	12	40	High Pass	Lumped LC	SMA
BHP-100+	90-2000	55	20	40	40	High Pass	Lumped LC	BNC
NHP-100+	90-2000	55	20	40	40	High Pass	Lumped LC	N
SHP-100+	90-2000	55	20	40	40	High Pass	Lumped LC	SMA
VHF-650+	850-2000	480	20	390	40	High Pass	LTCC	SMA
ZX75HP-65-S+	130-2000	DC-46	20	-	40	High Pass	Lumped LC	SMA
ZX75HP-73-S+	140-2000	DC-53	20	-	40	High Pass	Lumped LC	SMA
VHF-440+	600-1700	350	20	230	40	High Pass	LTCC	SMA
BHP-175+	160-1200	105	20	70	40	High Pass	Lumped LC	BNC
NHP-175+	160-1200	105	20	70	40	High Pass	Lumped LC	N
SHP-175+	160-1200	105	20	70	40	High Pass	Lumped LC	SMA
VHF-145+	140-1150	115	20	-	-	High Pass	LTCC	SMA
BHP-150+	133-1000	95	20	70	40	High Pass	Lumped LC	BNC
NHP-150+	133-1000	95	20	70	40	High Pass	Lumped LC	N
SHP-20+	20-1000	DC-11	20	9	40	High Pass	Lumped LC	SMA
SHP-150+	133-1000	95	20	70	40	High Pass	Lumped LC	SMA

High Pass — Coaxial 50Ω Continued

Model Number	Passband (MHz)	Stopband F3 (MHz)	Rejection @ F3 (dB)	Stopband F4 (MHz)	Rejection @ F4 (dB)	Filter Type	Technology	Connector Type
ZFHP-0R055-S+	0.07-1000	0.044	20	0.04	40	High Pass	Lumped LC	SMA
ZFHP-0R12-S+	0.12-1000	DC-0.05	20	-	40	High Pass	Lumped LC	SMA
ZFHP-0R23-S+	0.23-1000	DC-0.12	20	-	40	High Pass	Lumped LC	SMA
BHP-25+	27.5-800	19	20	13	40	High Pass	Lumped LC	BNC
BHP-50+	41-800	26	20	20	40	High Pass	Lumped LC	BNC
NHP-25+	27.5-800	19	20	13	40	High Pass	Lumped LC	N
NHP-50+	41-800	26	20	20	40	High Pass	Lumped LC	N
SHP-25+	27.5-800	19	20	13	40	High Pass	Lumped LC	SMA
SHP-50+	41-800	26	20	20	40	High Pass	Lumped LC	SMA
ZFHP-0R60-S+	0.6-800	DC-0.3	20	-	40	High Pass	Lumped LC	SMA
ZFHP-1R2-S+	1.2-800	DC-0.5	20	-	40	High Pass	Lumped LC	SMA
ZFHP-0R50-S+	0.5-750	DC-0.25	20	-	40	High Pass	Lumped LC	SMA
ZFHP-0R75-S+	0.75-500	DC-0.3	20	-	40	High Pass	Lumped LC	SMA

High Pass — Plug-In 50Ω

Model Number	Passband (MHz)	Stopband F3 (MHz)	Rejection @ F3 (dB)	Stopband F4 (MHz)	Rejection @ F4 (dB)	Technology
PHP-1000+	1000-2200	550-720	20	DC -550	40	Lumped LC
PHP-900+	910-2100	490-640	20	DC -490	40	Lumped LC
PHP-400+	395-2000	210-290	20	DC -210	40	Lumped LC
PHP-700+	700-1800	400-520	20	DC -400	40	Lumped LC
PHP-500+	500-1600	260-340	20	DC -260	40	Lumped LC
PHP-600+	600-1600	325-420	20	DC -325	40	Lumped LC
PHP-250+	225-1200	100-150	20	DC -100	40	Lumped LC
PHP-300+	290-1200	145-170	20	DC -145	40	Lumped LC
PHP-175+	160-800	70-105	20	DC -70	40	Lumped LC
PHP-200+	185-800	90-116	20	DC -90	40	Lumped LC



High Pass — Plug-In 50Ω Continued

Model Number	Passband (MHz)	Stopband F3 (MHz)	Rejection @ F3 (dB)	Stopband F4 (MHz)	Rejection @ F4 (dB)	Technology
PHP-150+	133-600	70-95	20	DC -70	40	Lumped LC
PHP-100+	90-400	40-55	20	DC -40	40	Lumped LC
PHP-25+	27.5-200	13-19	20	DC -13	40	Lumped LC
PHP-50+	41-200	20-26	20	DC -20	40	Lumped LC

Band Stop



Band Stop — Surface Mount 50Ω

Model Number	Passband F1 (MHz)	Passband F2 (MHz)	Stopband F3 (MHz)	Rejection @ F3 (dB)	Stopband F4 (MHz)	Rejection @ F4 (dB)	Technology
BSP-255310+	180	400-1000	262	35	295	35	Lumped LC
BSF-C174223+	DC-130	-	174	35	223	35	Lumped LC
BSF-C160+	DC-115	-	150.3	35	169.7	35	Lumped LC
BSF-C140+	DC -96	210 - 1000	127.25	35	152.75	35	Lumped LC
BSF-C125+	DC-84	196-1000	110.25	35	139.75	35	Lumped LC
BSF-C100+	DC-70	146-1500	90.365	35	109.635	35	Lumped LC
BSF-C88108+	DC-66	142-1300	88	35	108	35	Lumped LC
BSF-108+	65	140-1000	90	35	105	35	Lumped LC
BSF-C75+	DC-48	115-1000	65	35	85	35	Lumped LC
BSF-C70+	DC-37	120-1200	56.75	35	83.25	35	Lumped LC
BSF-C4768+	DC-32	95-1200	47	35	68	35	Lumped LC

Band Stop — Coaxial 50Ω

Model Number	Passband F1 (MHz)	Passband F2 (MHz)	Stopband F3 (MHz)	Rejection @ F3 (dB)	Stopband F4 (MHz)	Rejection @ F4 (dB)	Technology	Connector Type
ZX75BS-160-S+	DC-115	230-1000	150.3	35	169.7	35	Lumped LC	SMA
ZX75BS-140-S+	DC-96	210-1000	127.25	35	152.75	35	Lumped LC	SMA
ZX75BS-125-S+	DC-84	196-1000	110.25	35	139.75	35	Lumped LC	SMA
ZX75BS-100-S+	DC-70	146-1000	90.365	35	109.635	35	Lumped LC	SMA
ZX75BS-88108-S+	DC-66	142-1000	88	35	108	35	Lumped LC	SMA
NSBP-108+	65	140-1000	89	35	105	35	Lumped LC	N
ZBSF-95+	DC-60	125-1000	88	35	105	35	Lumped LC	SMA
ZX75BS-75-S+	DC-48	115-1000	65	35	85	35	Lumped LC	SMA
ZX75BS-5468-S+	DC-42	94-1000	54	35	68	35	Lumped LC	SMA
ZX75BS-70-S+	DC-37	120-1000	56.75	35	83.25	35	Lumped LC	SMA
ZX75BS-4768-S+	DC-32	95-1000	47	35	68	35	Lumped LC	SMA

Dual Passband

Dual Passband — Surface Mount 50Ω

Model Number	Passband F1 (MHz)	Passband F2 (MHz)	Stopband F3 (MHz)	Rejection @ F3 (dB)	Stopband F4 (MHz)	Rejection @ F4 (dB)	Technology
B2P-A535950+	470-600	940-960	DC-365	25	710-795/1075-1500	20 / 25	Lumped LC

Diplexers – Surface Mount 50Ω

Model Number	Channel	Passband (MHz)	Passband IL (dB)	Rejection (dB)	Return Loss (dB)	Technology
RDP-6500+	Low Pass	3500-4400	1.2	-	17	Lumped LC
	High Pass	4400-6500	3	-	8	Lumped LC
RDP-632+	Low Pass	DC-2100	1	42 @ 3420-6300	8	Lumped LC
	High Pass	3420-6300	1.1	47 @ DC-2100	8	Lumped LC
LDPW-272-452+	Low Pass	10-2700	1.8	20 @ 5000 - 7700	11	LTCC
	High Pass	4500-6000	1.7	20 @ 10 - 2500	11	LTCC
LDPW-162-242+	Low Pass	DC-1650	0.6	20 @ 2500 - 6000	20	LTCC
	High Pass	2400-6000	0.6	15 @ DC - 1650	16	LTCC
DPJC-252-492R+	Low Pass	2400-2500	0.7	28 @ 4800-6000	18	LTCC
	High Pass	4900-5950	0.7	34 @ 800-2500	26	LTCC
DPGE-252-492R+	Low Pass	2400-2500	0.4	36 @ 4800-6000	33	LTCC
	High Pass	4900-5950	0.5	25 @ 800-2500	25	LTCC
DPNK-252-492R+	Low Pass	2400-2500	0.4	26 @ 4800-6000	31	LTCC
	High Pass	5150-5850	1.2	40 @ 2400-2690	23	LTCC
LDPO-33-53+	Low Pass	DC-3000	0.8	17 @ 5000 - 12000	15	LTCC
	High Pass	5000-5750	2.5	23 @ DC - 3000	11	LTCC
LDPG-272-492+	Low Pass	DC-2700	0.5	30 @ 4800 - 8000	16	LTCC
	High Pass	4900-5750	0.7	23 @ DC - 2700	14	LTCC
LDPG-212-322+	Low Pass	DC-2100	0.5	22 @ 3200 - 5000	16	LTCC
	High Pass	2600-5000	0.8	18 @ DC - 2040	14	LTCC
RDP-6500+	Low Pass	DC-100	1	60 @ 1400-2500, 43 @ 2500-4400, 28 @ 4400-6500	21	Lumped LC
	High Pass	1400-3500	1	75 @ DC-100	20	Lumped LC
LDPQ-132-33+	Low Pass	DC-1280	1	15 @ 1620 - 3000	15	LTCC
	High Pass	1550-3000	1.5	15 @ DC - 1240	15	LTCC
RDP-272+	Low Pass	DC-950	0.7	48 @ 1700-2700	18	Lumped LC
	High Pass	1700-2700	0.7	35 @ DC-950	17	Lumped LC

Diplexers – Surface Mount 50Ω Continued

Model Number	Channel	Passband (MHz)	Passband IL (dB)	Rejection (dB)	Return Loss (dB)	Technology
LDP-1050-252+	Low Pass	1-1050	0.6	31 @ 1650 - 2500	15	LTCC
	High Pass	1650-2500	1	21 @ 1-1050	8	LTCC
RDP-2150+	Low Pass	DC-10	0.5	31 @ 40-2150	29	Lumped LC
	High Pass	40-2150	0.9	61 @ DC-10	16	Lumped LC
RDP-2R15+	Low Pass	DC-20	0.5	58 @ 950-2150	18	Lumped LC
	High Pass	950-2150	0.5	86 @ DC-20	21	Lumped LC
RDP-50-2R15+	Low Pass	DC-50	0.5	53 @ 950-2150	22	Lumped LC
	High Pass	950-2150	0.3	74 @ DC-50	22	Lumped LC
SDP-2R15+	Low Pass	DC-800	0.4	46 @ 1500-2150	19	Lumped LC
	High Pass	1500-2150	0.5	46 @ DC-800	20	Lumped LC
CDPL-1710A+	Low Pass	1176	0.8	50.6 @ 1590	10.9	Ceramic Resonator
	High Pass	1590	0.8	39.7 @ 1176	10.9	Ceramic Resonator
SDP-1R3G+	Low Pass	DC-600	0.8	35 @ 710-1300	15	Lumped LC
	High Pass	710-1300	0.8	35 @ DC-600	15	Lumped LC

Diplexers – Surface Mount 75Ω

Model Number	Passband (MHz)	Passband IL (dB)	Rejection (dB)	Return Loss (dB)	Crossover Isolation (dB)	Technology
DPLB-2025A0+	DC-204	1	50 @ 258-1220	23	40	Lumped LC
	258-1220	1	55 @ DC-204	21	40	Lumped LC
DPLB-4254A0+	DC-42	0.8	50 @ 54-1220	18	-	Lumped LC
	54-1220	0.8	50 @ DC-42	18	-	Lumped LC
DPLB-4254A01+	5-42	1.0	50 @ 54-1220	24	-	Lumped LC
	54-1220	1.0	50 @ 5-42	24	-	Lumped LC
DPLB-6585A0+	5-65	1.0	50 @ 85-1220	24	40	Lumped LC
	85-1220	1.0	55 @ 5-65	24	40	Lumped LC
DPLB-8510A01+	DC-85	1.4	50 @ 102-1220	18	-	Lumped LC
	102-1220	1.4	50 @ DC-85	16	-	Lumped LC

Diplexers — Surface Mount 75Ω Continued

Model Number	Passband (MHz)	Passband IL (dB)	Rejection (dB)	Return Loss (dB)	Crossover Isolation (dB)	Technology
DPLB-8510A04+	5-85	0.7	48 @ 102-1220	24	9	Lumped LC
	102-1220	1	48 @ 5-85	24	9	Lumped LC
DPLB-8510A05+	5-85	1.2	55 @ 5-85	24	41	Lumped LC
	102-1220	1.3	45 @ 102-1220	24	41	Lumped LC
DPLX-4254A0+	DC-42	0.9	50 @ 54-1000	20	-	Lumped LC
	54-1000	0.9	50 @ DC-42	18	-	Lumped LC
DPLX-6588A0+	DC-65	1	50 @ 88-1000	18	-	Lumped LC
	88-1000	1	50 @ DC-65	18	-	Lumped LC

Diplexers — Coaxial 50Ω

Model Number	Channel	Passband (MHz)	Passband IL (dB)	Rejection (dB)	Return Loss (dB)	Technology	Connector Type
ZDSS-3G4G-S+	High Pass	4000-20000	1.5	15 @ DC-3000	10	Suspended Substrate	SMA
	Low Pass	DC-3000	1.5	30 @ 4000-20000	10		
ZDSS-5G6G-S+	High Pass	6000-20000	2.5	50 @ DC-4000	8	Suspended Substrate	SMA
	Low Pass	DC-5000	1.5	80 @ 7200-20000	10		
ZDSS-7G10G-S+	High Pass	10500-20000	1.2	90 @ DC-7500	12	Suspended Substrate	SMA
	Low Pass	DC-7500	0.8	90 @ 13000-20000	12		
ZDSS-2R5G5G-S+	High Pass	5100-7500	0.8	65 @ DC-2500	17	Suspended Substrate	SMA
	Low Pass	DC-2500	0.5	50 @ 5100-7500	20		
ZDPLX-592-S+	High Pass	5100-5900	0.9	40 @ 2400-2500	12	Lumped LC	SMA
	Low Pass	2400-2500	0.8	45 @ 5100-5900	16		
ZDPLX-2150-S+	High Pass	50-2150	0.9	61 @ DC-10	16	Lumped LC	SMA
	Low Pass	DC-10	0.5	44 @ 50-2150	29		
ZX75-2R15-S+	High Pass	950-2150	0.5	91 @ DC-20	26	Lumped LC	SMA
	Low Pass	DC-20	0.4	49 @ 950-2150	26		
ZX75-23-S+	High Pass	650-2000	0.5	52 @ 650-2000	18	Lumped LC	SMA
	Low Pass	9.8-10.2	0.5	90 @ 9.8-10.2	18		

Diplexers — Coaxial 50Ω Continued

Model Number	Channel	Passband (MHz)	Passband IL (dB)	Rejection (dB)	Return Loss (dB)	Technology	Connector Type
ZCDP-1710-S+	High Pass	1590	0.8	40 @ 1176	11	Ceramic Resonator	SMA
	Low Pass	1176	0.8	50 @ 1590	11		

Diplexers — Coaxial 75Ω

Model Number	Channel	Passband (MHz)	Passband IL (dB)	Rejection (dB)	Return Loss (dB)	Crossover Isolation (dB)	Technology
ZDPL-2025-75-F+	High Pass	258-1700	1	50 @ DC-204	20	37	Lumped LC
	Low Pass	DC-204	1	65 @ 258-1700	24	37	
ZDPL-4254-75-F+	High Pass	54-1700	1	50 @ 5-42	22	40	Lumped LC
	Low Pass	5-42	1	50 @ 54-1700	24	40	
ZDPL-6588-75-F+	High Pass	88-1700	1.2	50 @ 5-65	20	35	Lumped LC
	Low Pass	5-65	1	50 @ 88-1700	20	35	
ZDPL-8510-75-F+	High Pass	102-1400	1.6	45 @ 5-85	20	30	Lumped LC
	Low Pass	5-85	1.4	50 @ 102-1400	22	30	

Diplexers — Field Replaceable Plug-In 75Ω

Model Number	Channel	Passband (MHz)	Passband IL (dB)	Rejection (dB)	Return Loss (dB)	Crossover Isolation (dB)	Technology
DPLC-2025A0+	High Pass	258-1220	1	50 @ DC-204	24	40	Lumped LC
	Low Pass	DC-204	1	45 @ 258-1220	24	40	
DPLC-2025A0M+	High Pass	258-1220	1.0	50 @ 5-204	24	40	Lumped LC
	Low Pass	DC-204	1.0	45 @ 258-1220	24	40	
DPLC-4254A0+	High Pass	54-1220	1	50 @ DC-42	24	40	Lumped LC
	Low Pass	DC-42	1	50 @ 54-1220	24	40	
DPLC-4254A0M+	High Pass	54-1220	1.0	50 @ 5-42	24	40	Lumped LC
	Low Pass	5-42	1.0	50 @ 54-1220	24	40	
DPLC-6585A0+	High Pass	85-1220	1.0	55 @ 5-65	24	40	Lumped LC
	Low Pass	5-65	1.0	50 @ 85-1220	24	40	

Diplexers — Field Replaceable Plug-In 75Ω Continued

Model Number	Channel	Passband (MHz)	Passband IL (dB)	Rejection (dB)	Return Loss (dB)	Crossover Isolation (dB)	Technology
DPLC-6585A0M+	High Pass	85-1220	1.5	55 @ 5-65	24	40	Lumped LC
	Low Pass	5-65	1.5	50 @ 85-1220	24	40	
DPLC-8510A0+	High Pass	102-1220	1.4	50 @ DC-85	24	15	Lumped LC
	Low Pass	DC-85	1.1	50 @ 102-1220	24	15	
DPLC-8510A01+	High Pass	102-1225	1.75	48 @ 5-84.9	24	38	Lumped LC
	Low Pass	5-85	1.3	45 @ 105-1225	24	38	
DPLC-8510A01M+	High Pass	102-1225	1.75	48 @ 5-84.9	24	38	Lumped LC
	Low Pass	5-85	1.3	45 @ 105-1225	24	38	

Triplexers

Triplexers — Surface Mount 50Ω

Model Number	Channel	Passband (MHz)	Passband IL (dB)	Rejection (dB)	Return Loss (dB)	Technology
TPLX-F2700+	High Pass	1400-2700	0.8	31 @ 1-512 23 @ 608-1000	14	Lumped LC
	Band Pass	608-1000	1	20 @ 1-512 27 @ 1400-2700	13	Lumped LC
	Low Pass	1-512	1	24 @ 608-2700	14	Lumped LC
TPLX-E2485+	High Pass	1435-2485	0.8	37 @ 1-460 34 @ 610-1150	11	Lumped LC
	Band Pass	610-1150	0.9	29 @ 1-460 54 @ 1435-2485	13	Lumped LC
	Low Pass	1-460	0.9	38 @ 610-1150 26 @ 1435-2485	16	Lumped LC

Triplexers — Coaxial 50Ω

Model Number	Channel	Passband (MHz)	Passband IL (dB)	Rejection (dB)	Return Loss (dB)	Technology	Connector Type
Z3SS-7000-S+	High Pass	7000-15000	2	90 @ DC-3400	8	Suspended Substrate	SMA
	Band Pass	2600-5500	2	40 @ DC-1600 / 90 @ 10000-15000	10	Suspended Substrate	SMA
	Low Pass	DC-1600	1.5	55 @ 3500-4000	10	Suspended Substrate	SMA
ZTPL-4620+	High Pass	9.8-10.2	0.5	33 @ 50-4620	17	Lumped LC	SMA
	Band Pass	852-1872	0.5	35 @ 1-250 29 @ 3300-4620	14	Lumped LC	SMA
	Low Pass	3300-4620	1	26 @ 1-600 23 @ 600-1872	15	Lumped LC	SMA



Filter Designer Kits

Model Number	Model Series	Description	Package	Models Included in Kit	Qty. Ea.	Total Qty.
K1-LTCC-WBZ+	LPNK, LPJC LPGE HPJC HPSC BPNK BPJC BPGE BFNL DPNK DPJC DPGE	2.4 to 2.5 GHz and 4.9 to 5.9 GHz LTCC Filters and Diplexers for WiFi Applications	0402 0603 0805	LPNK-252R+ LPJC-252R+ LPGE-252R+ LPJC-592R+ LPGE-592R+ HPJC-252R+ HPSC-492R+ HPJC-492R+ BPNK-252R+ BPJC-252R+ BPGE-252R+ BPNK-542R+ BPJC-542R+ BPGE-542R+ BFG1-252R+ BFG2-552R+ BFNL2-252R+ DPNK-252-492R+ DPJC-252-492R+ DPGE-252-492R+	5	100
K-SCF+	SCLP	DC to 420 MHz Low Pass	Leaded SMT	SCLF-21.4+ -30+ -45+ -135+ -190+ -380+ -420+	1	7
K-LHP+	SLP SHP	DC to 1800 MHz Low Pass and High Pass	SMA Connectorized	SLP-50+ -100+ -300+ -550+ -1000+ SHP-200+ -400+ -700+	1	8

Model Number	Model Series	Description	Package	Models Included in Kit	Qty. Ea.	Total Qty.
K1-HFCN+	HFCN	710 to 7000 MHz High Pass	1206	HFCN-650+ -740+ -1200+ -1500+ -1760+ -2000+ -2275+ -2700+	5	40
K2-HFCN+	HFCN	950 to 13000 MHz High Pass	1206	HFCN-880+ -1300+ -1320+ -1600+ -1810+ -1910+ -2100+ -3800+ -5500+ -8400+	5	50
K1-LFCN+	LFCN	DC to 630 MHz Low Pass	1206	LFCN-225+ -320+ -400+ -490+ -530+ -575+ -630+	5	35
K2-LFCN+	LFCN	DC to 6700 MHz Low Pass	1206	LFCN-800+ -900+ -1000+ -1200+ -1325+ -1700+ -2000+ -2250+ -2400+ -5000+ -6000+ -6700+	5	60



Designer Kits Continued

Model Number	Model Series	Description	Package	Models Included in Kit	Qty. Ea.	Total Qty.
K3-LFCN+	LFCN	DC to 630 MHz Low Pass	1206	LFCN-80+ -95+ -105+ -120+ -225+ -320+ -400+ -490+ -530+ -575+ -630+	5	55
K4-LFCN+	LFCN	DC to 6700 MHz Low Pass	1206	LFCN-800+ -900+ -1000+ -1200+ -1325+ -1400+ -1450+ -1500+ -1525+ -1575+ -1700+ -1800+ -2000+ -2250+ -2400+ -5000+ -6000+ -6700+	5	90

Model Number	Model Series	Description	Package	Models Included in Kit	Qty. Ea.	Total Qty.
K5-LFCN+	LFCN	DC to 6700 MHz Low Pass	1206	LFCN-2000+ -2250+ -2400+ -2500+ -2600+ -2750+ -2850+ -3000+ -3800+ -4400+ -5000+ -6000+ -6700+	5	65
KWC-LHP	HFCN LFCN	80 MHz to 13 GHz Low Pass and High Pass Made to Order	Wild Card	Any 8 models of your choice from the LFCN and HFCN series	5	40
K1-LFCW+	LFCW	DC to 14 GHz LTCC Low Pass Filters	603	LFCW-103+ LFCW-1062 LFCW-1142+ LFCW-123+ LFCW-133+ LFCW-143+ LFCW-272+ LFCW-5000+ LFCW-6000+ LFCW-8400+	10	100





10 KHZ TO 14 GHZ

90° & 180° Hybrids

Insulate Circuits from Reflective Elements

- 160+ models in stock
- 90°, 180° and quadrifilar phase shifts
- Power handling up to 250W
- Low phase and amplitude unbalance
- Connectorized, surface mount and MMIC die formats

Choose from:

LTCC, MMC, core and wire, microstrip/stripline designs



90° / 180° Hybrids — Surface Mount 50Ω

Model Number	Frequency Range (MHz)	Isolation (dB)	Insertion Loss (dB) above 3 dB	Phase Unbalance (deg)	Amplitude Unbalance (dB)	Input Power, Max. (W)	Technology
QCH-153+	3000-14500	13	1	-	1.5	25	Microstrip / Stripline
EPQ-133+	6000-14000	20	0.6	8.8	1.6	1.58	MMIC
QCH-123+	8000-12000	23	0.25	-	1	50	Microstrip / Stripline
EPQ-113+	5000-11000	19	0.6	8.8	1.5	1.59	MMIC
QCH-83	4000-8000	23	0.15	-	1.3	75	Microstrip / Stripline
QCS-83+	4000-8000	16	0.7	6	1.1	15	LTCC
QCS-722+	4000-7200	23	0.6	10	1.4	15	LTCC
QCH-652+	1000-6500	19	0.6	-	1.8	60	Microstrip / Stripline
QCH-63+	2000-6000	26	0.2	5	1.4	200	Microstrip / Stripline
QCH-63B+	800-6000	20	0.5	-	2.6	70	Microstrip / Stripline
QCS-592+	3100-5900	25	0.7	5	1.4	15	LTCC
QCN-45+	2500-4500	19	0.5	6	2.5	15	LTCC
QCN-45D+	2500-4500	19	0.5	6	2.5	15	LTCC
QCS-442+	2800-4400	23	0.5	7	1.1	15	LTCC
QCH-392+	600-3900	14	0.8	12	2.8	90	Microstrip / Stripline
QCH-382+	800-3800	28	0.25	7.5	1.3	150	Microstrip / Stripline
QCN-34+	2500-3400	32	0.4	4	1.2	15	LTCC
QCN-34D+	2500-3400	32	0.4	4	1.2	15	LTCC
QCS-332+	1800-3300	18	0.5	5	1.2	15	LTCC
QCS-312+	1700-3100	25	0.5	7	1.2	15	LTCC
SYPJ-2-33+	500-3000	16	1.7	4	0.5	0.5	Core & Wire
QCH-272+	700-2700	22	0.3	5	1	200	Microstrip / Stripline
QCN-27+	1700-2700	26	0.4	6	1	15	LTCC
QCN-27D+	1700-2700	26	0.4	6	1	15	LTCC
QCC-22+	1500-2500	28	0.8	4	1.3	17.5	LTCC
QCN-25+	1350-2450	25	0.4	5	1.1	15	LTCC
QCN-25D+	1350-2450	25	0.4	5	1.1	15	LTCC
QBA-24+	1900-2400	21	0.54	6	0.8	20	LTCC

90° / 180° Hybrids — Surface Mount 50Ω Continued

Model Number	Frequency Range (MHz)	Isolation (dB)	Insertion Loss (dB) above 3 dB	Phase Unbalance (deg)	Amplitude Unbalance (dB)	Input Power, Max. (W)	Technology
QBA-24W+	1700-2400	21	0.49	6	1.2	20	LTCC
SCQA-4-232+	1700-2300	24	1.6	5	1.3	1	Core & Wire
SYPJ-2-222+	500-2250	25	1.7	3	0.5	0.5	Core & Wire
QBA-20W+	1500-2200	23	0.4	5	1.2	25	LTCC
QCC-20+	1200-2200	35	0.4	5	1	17.5	LTCC
QCN-19+	1100-1925	25	0.4	4	1.1	15	LTCC
QCN-19D+	1100-1925	25	0.4	4	1.1	15	LTCC
SCQ-4-1650+	1150-1650	22	1.5	3	0.4	1	Core & Wire
QCS-162+	1550-1620	15	0.9	5	1	3	LTCC
QCS-152+	820-1600	20	0.5	6	0.8	15	LTCC
SCQA-4-162+	1200-1600	22	1.5	3	0.6	1	Core & Wire
QCN-12+	800-1375	19	0.4	12	0.9	15	LTCC
QCN-12D+	800-1375	19	0.4	12	0.9	15	LTCC
QCN-13D+	675-1300	20	0.4	8	1.3	15	LTCC
QCN-12A+	800-1250	17	0.3	5	0.8	15	LTCC
QCN-12AD+	800-1250	17	0.3	5	0.8	15	LTCC
QBA-12+	800-1200	23	0.25	6	1.2	50	LTCC
SCQA-4-13+	600-1000	20	1.5	5	0.8	1	Core & Wire
SYPJ-2-13+	10-1000	22	1.5	6	0.3	0.5	Core & Wire
QCS-981+	540-980	20	0.5	4	0.8	15	LTCC
QBA-12N+	800-900	28	0.25	3	1	50	LTCC
SCPJ-2-9+	200-900	24	1	6	0.7	1	Core & Wire
RPQ-820	760-860	22	0.15	4	1	1	Core & Wire
QCN-8+	450-750	16	0.6	8	1	15	LTCC
SBTCJ-1W+	1-750	22	0.6	7	0.4	0.5	Core & Wire
SBTCJ-1WX+	1-750	22	0.6	7	0.4	0.5	Core & Wire
LRPQ-700	500-700	23	0.2	3	1.8	1	Core & Wire
LRPQ-700J+	500-700	23	0.2	3	1.8	1	Core & Wire

90° / 180° Hybrids — Surface Mount 50Ω Continued

Model Number	Frequency Range (MHz)	Isolation (dB)	Insertion Loss (dB) above 3 dB	Phase Unbalance (deg)	Amplitude Unbalance (dB)	Input Power, Max. (W)	Technology
QBA-07+	340-680	22	0.8	7	2	21	LTCC
QCN-7+	425-675	17	0.4	8	1	15	LTCC
QCN-7D+	425-675	17	0.4	8	1	15	LTCC
QCN-5+	330-580	20	0.3	8	1.3	15	LTCC
QCN-5D+	330-580	20	0.3	8	1.3	15	LTCC
SYPJ-2-5W-52+	10-520	23	0.9	2	0.1	5	Core & Wire
QCN-3+	220-470	24	0.6	8	1.7	15	LTCC
SCPQ-400+	250-400	20	0.3	3	1.2	1	Core & Wire
JSPQ-350+	150-350	20	0.5	5	1.5	1	Core & Wire
ADQ-32W+	104-340	20	0.6	8	1.8	0.5	Core & Wire
ADQ-32+	160-327	22	0.3	5	1.6	0.5	Core & Wire
LRPQ-320J	270-320	21	0.3	3	1.2	1	Core & Wire
QCV-271+	150-265	17	0.5	8	1.4	10	LTCC
ADPQ-2-250+	150-250	24	0.2	4	1.4	1	Core & Wire
QCV-211+	130-210	18	0.6	5	1.4	10	LTCC
ADQ-22+	95-200	28	0.3	6	1.6	0.5	Core & Wire
AMT-2+	50-200	35	0.8	2	0.3	0.5	Core & Wire
ADQ-180+	120-180	35	0.2	6	1.5	0.5	Core & Wire
SCPQ-180+	120-180	20	0.3	3	1.2	1	Core & Wire
SYPQ-181+	120-180	20	0.3	3	0.8	1	Core & Wire
JYPQ-160+	105-160	24	0.25	3	1.5	1	Core & Wire
QCV-151+	90-150	15	0.9	5	1.6	10	LTCC
SCPQ-150+	95-150	22	0.3	3	1.2	1	Core & Wire
JSPQW-100+	40-100	24	0.2	3	1.2	1	Core & Wire
JSPQW-100A+	30-100	41	0.5	4	0.6	1	Core & Wire
ADQ-90+	55-90	26	0.2	4	1.2	0.5	Core & Wire
SCPQ-90+	55-90	26	0.2	3	1.2	1	Core & Wire
SCPQ-85C+	55-85	30	0.3	3	0.6	1	Core & Wire

90° / 180° Hybrids — Surface Mount 50Ω Continued

Model Number	Frequency Range (MHz)	Isolation (dB)	Insertion Loss (dB) above 3 dB	Phase Unbalance (deg)	Amplitude Unbalance (dB)	Input Power, Max. (W)	Technology
JSPQ-80+	10-80	44	0.45	6	0.6	1	Core & Wire
LRPQ-70	65-75	30	0.1	3	1	1	Core & Wire
LRPQ-70J	65-75	30	0.1	3	1	1	Core & Wire
SYPQ-70+	65-75	31	0.1	3	1.1	1	Core & Wire
JSPQ-65W+	5-65	33	0.7	5	0.7	1	Core & Wire
SCPQ-60+	30-60	30	0.15	3	1.5	1	Core & Wire
SCPQ-50+	25-50	25	0.15	3	1.5	1	Core & Wire
JYPQ-30+	16-30	28	0.2	3	1.5	1	Core & Wire
SCPQ-21.4+	20-23	32	0.15	2.5	1	1	Core & Wire
SCPQ-10.5+	9-11	31	0.15	3	1.2	1	Core & Wire

90° / 180° Hybrids — Surface Mount 75Ω

Model Number	Frequency Range (MHz)	Isolation (dB)	Insertion Loss (dB) above 3 dB	Phase Unbalance (deg)	Amplitude Unbalance (dB)	Input Power, Max.	Technology
SBTCJ-122-75X+	5-1250	26	1.5	2.7	0.3	1	Core & Wire
SYMT-122-75+	5-1218	20	3.2	7	0.6	0.5	Core & Wire
SBTCJ-13-75+	5-1000	26	1.5	2.8	0.8	1	Core & Wire

90° / 180° Hybrids — Bare Die 50Ω

Model Number	Frequency Range (MHz)	Isolation (dB)	Insertion Loss (dB) above 3 dB	Phase Unbalance (deg)	Amplitude Unbalance (dB)	Input Power, Max.	Technology
EPQ-133-D+	6000-14000	20	0.6	8.8	1.6	1.6	MMIC
EPQ-113-D+	5000-11000	19	0.6	1.4	1.5	1.6	MMIC

90° / 180° Hybrids — Coaxial 50Ω

Model Number	Frequency Range (MHz)	Isolation (dB)	Insertion Loss (dB) above 3 dB	Phase Unbalance (deg)	Amplitude Unbalance (dB)	Input Power, Max.	Connector Type
ZAPDQ-4+	2000-4200	22	0.4	8	1	1	SMA
ZX10Q-2-34-S+	2500-3400	29	0.4	4	1.2	20	SMA
ZX10Q-2-27-S+	1700-2700	23	0.4	3	1	20	SMA
ZX10Q-2-25-S+	1350-2450	25	0.4	5	1.1	20	SMA
ZFSCJ-2-232+	5-2300	4	1.9	3	0.2	1	SMA
ZAPDJ-2-S+	1000-2000	22	1.3	6	0.8	1	SMA
ZAPDQ-2	1000-2000	22	0.4	6	0.8	1	SMA
ZX10Q-2-19-S+	1100-1925	26	0.4	4	1.1	20	SMA
ZX10Q-2-13-S+	675-1300	20	0.4	8	1.3	15	SMA
ZX10Q-2-12-S+	800-1250	17	0.35	5	0.8	25	SMA
ZFSCJ-2-4+	50-1000	25	1.7	6	0.6	1	SMA
ZX10Q-2-7-S+	425-675	17	0.4	8	1	20	SMA
ZX10Q-2-5-S+	330-580	20	0.4	5	1.3	20	SMA
ZAPDJ2-5W-521+	10-520	23	0.9	2	0.1	5	BNC
ZAPDJ2-5W-521N+	10-520	23	0.9	2	0.1	5	N
ZAPDJ2-5W-521S+	10-520	23	0.9	2	0.1	5	SMA
ZFSCJ-2-1	1-500	33	1	4	0.2	1	BNC
ZFSCJ-2-1+	1-500	33	1	4	0.2	1	BNC
ZX10Q-2-3-S+	220-470	24	0.6	8	1.7	15	SMA
ZFSCJ-2-3	5-300	33	1	4	0.2	1	BNC
ZFSCJ-2-3+	5-300	33	1	4	0.2	1	BNC
ZMSCJ-2-1	1-200	35	0.6	2.5	0.15	1	SMA
ZSCJ-2-1+	1-200	35	0.6	2.5	0.15	1	BNC
ZMSCQ-2-180+	120-180	23	0.3	4	1.2	1	SMA
ZMSCQ-2-120+	80-120	21	0.3	3	1.5	1	SMA
ZMSCQ-2-90	55-90	30	0.3	3	1.2	1	SMA
ZSCQ-2-90	55-90	30	0.3	3	1.2	1	BNC
ZMSCQ-2-50+	25-50	27	0.3	3	1.5	1	SMA

90° / 180° Hybrids — Coaxial 50Ω Continued

Model Number	Frequency Range (MHz)	Isolation (dB)	Insertion Loss (dB) above 3 dB	Phase Unbalance (deg)	Amplitude Unbalance (dB)	Input Power, Max.	Connector Type
ZFSCJ-2-2	0.01-20	30	0.2	2	0.1	1	SMA
ZMSCJ-2-2	0.01-20	30	0.2	2	0.1	1	SMA
ZSCJ-2-2+	0.01-20	30	0.2	2	0.1	1	BNC

90° / 180° Hybrids — Plug-In 50Ω

Model Number	Frequency Range (MHz)	Isolation (dB)	Insertion Loss (dB) above 3 dB	Phase Unbalance (deg)	Amplitude Unbalance (dB)
PSCJ-2-1W	100-600	30	1	6	0.5
PSCQ-2-450+	350-450	23	0.5	5	1.5
PSCQ-2-400+	250-400	23	0.5	4	1.5
PQW-2-270+	90-270	20	0.4	4	1.4
PSCQ-2-250+	150-250	30	0.4	4	1.5
PMT-1+	5-200	24	0.9	6	0.2
PSCJ-2-1+	1-200	35	0.5	2.5	0.15
PSCQ-2-180+	120-180	23	0.3	4	1.2
PSCQ-2-120+	80-120	25	0.3	3	1.5
PQW-2-90+	30-90	27	0.3	3	1
PSCQ-2-90+	55-90	30	0.3	3	1.2
PSCQ-2-70N+	66-74	22	0.2	0.8	0.25
PSCQ-2-70+	40-70	30	0.3	3	1.5
PSCQ-2-50+	25-50	30	0.3	3	1.5
PSCQ-2-51W+	5-50	41	0.5	5	0.5
PSCQ-2-40+	23-40	21	0.3	3	1.5
PSCQ-2-26+	14-30	25	0.4	3	1.5
PSCQ-2-21.4+	20-23	30	0.4	3	1.2
PSCQ-2-14+	12-16	30	0.3	3	1.8
PSCQ-2-13+	12-14	29	0.4	3	1.2
PSCQ-2-8+	2-8	36	0.3	6	0.5
PSCQ-2-4+	3.5-4.5	36	0.4	3	1.5



// A true pleasure to deal with and wish more of my suppliers would work and perform as well as Mini-Circuits does.

— SENIOR PROCUREMENT ANALYST





DC TO 3000 MHZ

Impedance Matching Pads

Seamless 50/75Ω Conversion

- Ideal matching solutions for CATV systems, broadband networks, test setups and more
- Excellent VSWR (from 1.05 to 1.3)
- Flat attenuation vs. frequency
- BNC, SMA and N-Type connector options



Impedance Matching Pads — Surface Mount

Model Number	Frequency Range (MHz)	Nom. Attenuation (dB)	Attenuation Flatness (dB), DC - 100 MHz	Attenuation Flatness (dB), 100 - 1000 MHz	Attenuation Flatness (dB), 1000 - 3000 MHz	VSWR (:1), DC - 100 MHz	VSWR (:1), 100 - 1000 MHz	VSWR (:1), 1000 - 3000 MHz
ALMP-5075+	DC-3000	5.7±0.2	0.2	0.4	0.4	1.06	1.4	1.45

Impedance Matching Pads — Coaxial

Model Number	Frequency Range (MHz)	Nom. Attenuation (dB)	Attenuation Flatness (dB)	VSWR (:1)	Connector	Connector, 50 Ohm	Connector, 75 Ohm
SQFM-5075+	DC-3000	5.7	0.2	1.2	SMA-F	SMA-Female	F-Male
UNMP-5075+	DC-3000	5.7±0.15	0.3	1.3	TYPE 'N'	Female	Male
UNMP-5075-33+	DC-3000	5.7±0.15	0.3	1.05	TYPE 'N'	Female	Male
UNMP-5075-33R+	DC-3000	1.7	0.2	1.15	TYPE 'N'	Male	Female
UNMP-R5075-33+	DC-3000	5.7±0.15	0.3	1.05	TYPE 'N'	Male	Female
Z7550R-FMSF+	DC-2500	5.9	-	1.2	SMA-F	SMA-Female	F-Male
BMP-5075+	DC-2000	5.7±0.10	0.3	1.22	BNC	Female	Male
BMP-5075R+	DC-2000	5.7±0.10	0.3	1.22	BNC	Male	Female

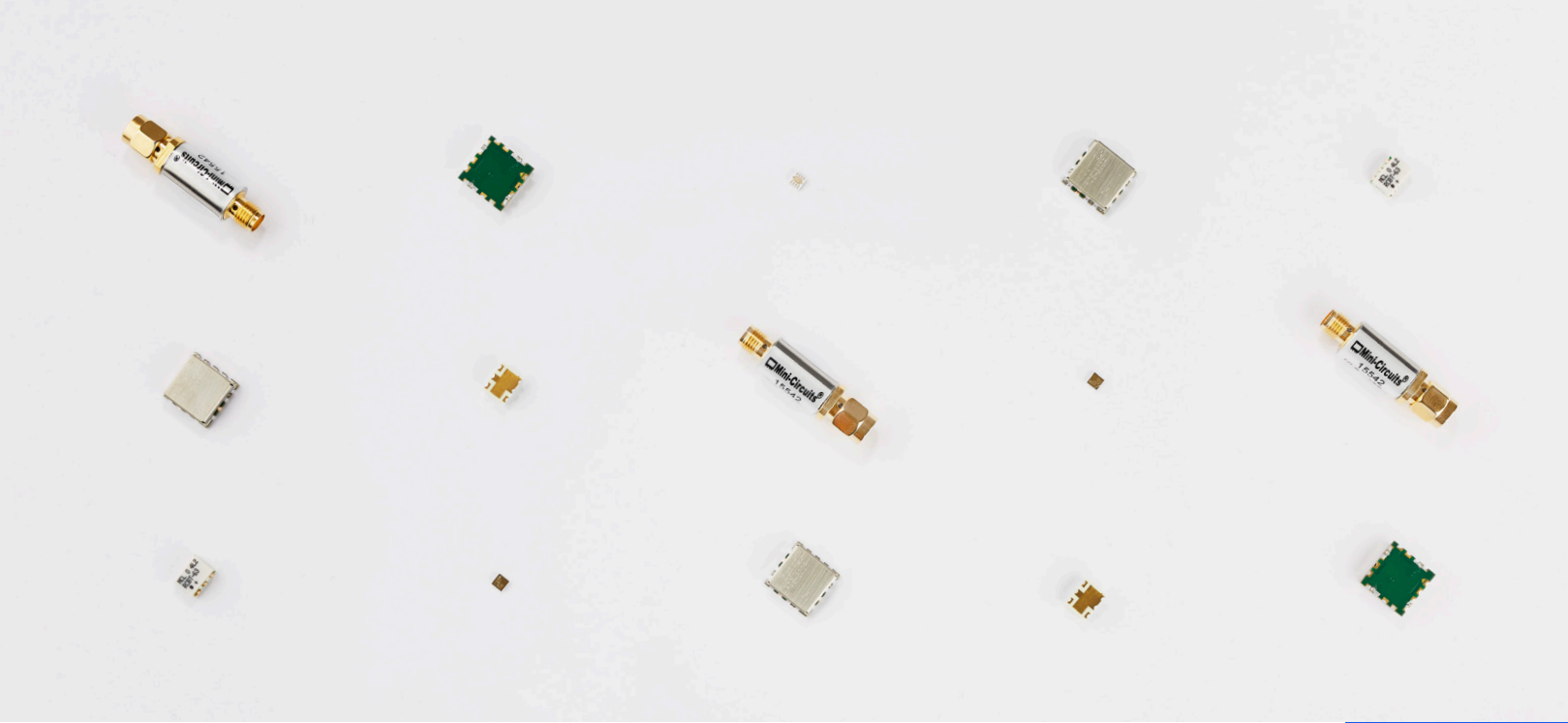

200 KHZ TO 8.2 GHZ

Limiters

Block High-Level Interference

- Reliable protection for sensitive receivers against ESD spikes, power surges and transceiver leakage
- Input power from +5 to +37 dBm
- Fast response and recovery
- Low insertion loss and excellent VSWR
- Connectorized and surface mount models



Limiters – Surface Mount

Model Number	Frequency Range (MHz)	Linear Range Insertion Loss (dB)	Input Power Min.	Input Power Max.	Output Power Limit (dBm)	Limiting Δ Output / Δ 1 dB Input (dB / dB)
CLM-83-2W+	30-8200	0.5	12	32	11.5	0.4
RLM-63-2W+	30-6000	0.3	12	32	11.5	0.4
RLM-43-5W+	20-4000	0.36	10	37	12	0.1
RLM-33+	30-3000	0.23	12	30	11.5	0.2
RLM-33-2W+	0.2-3000	0.25	12	33	13	0.2

Limiters – Surface Mount Continued

Model Number	Frequency Range (MHz)	Linear Range Insertion Loss (dB)	Input Power Min.	Input Power Max.	Output Power Limit (dBm)	Limiting Δ Output / Δ 1 dB Input (dB / dB)
RLM-33H+	30-3000	0.23	17	30	18	0.2
RLM-23-1WL+	100-2500	0.7	5	30	0	0.2
RLM-23+	950-2050	0.7	5	30	0	0.1
RLM-751-2WL+	3-750	0.2	5	33	8	0.3
RLM-521-2WL+	0.5-520	0.2	9	32	7	0.3
RLM-512-4WL+	50-512	0.6	5	36	3	0.23

Limiters – Coaxial

Model Number	Frequency Range (MHz)	Linear Range Insertion Loss (dB)	Input Power Min.	Input Power Max.	Output Power Limit (dBm)	Limiting Δ Output / Δ 1 dB Input (dB / dB)	Connector Type
VLM-83-2W-S+	30-8200	1	12	32	11.5	0.8	SMA
VLM-73-1W-S+	30-7000	0.4	12	30	11.5	0.6	SMA
ULM-63-2W-N+	30-6000	0.5	12	33	13.5	0.6	N
VLM-63-2W-S+	30-6000	0.4	12	33	11.5	0.6	SMA
ZFLM-43-5W+	20-4000	0.5	10	37	13	0.1	SMA
VLM-33-S+	30-3000	0.23	12	30	11.5	0.2	SMA
VLM-33W-2W-S+	0.2-3000	0.2	12	33	13	0.6	SMA
ZFLM-252-1WL-S+	100-2500	0.7	5	30	0	0.1	SMA
VLM-52-S+	10-500	0.5	10	20	9.5	0.2	SMA

Limiters – Plug-In

Model Number	Frequency Range (MHz)	Input Power Min.	Input Power Max.	Output Power Limit (dBm)	Current Control (mA)	Limiting Δ Output / Δ 1 dB Input (dBm)	Limiting Δ Output / Δ 1 dB Input (amp) (dB)	Limiting Δ Output / Δ 1 dB Input (phase) (deg)
PLS-2+	100-900	3	15	-5	5	15-Mar	0.4	2
PLS-1+	0.1-150	6	20	-4	3	20-Jun	0.15	0.8

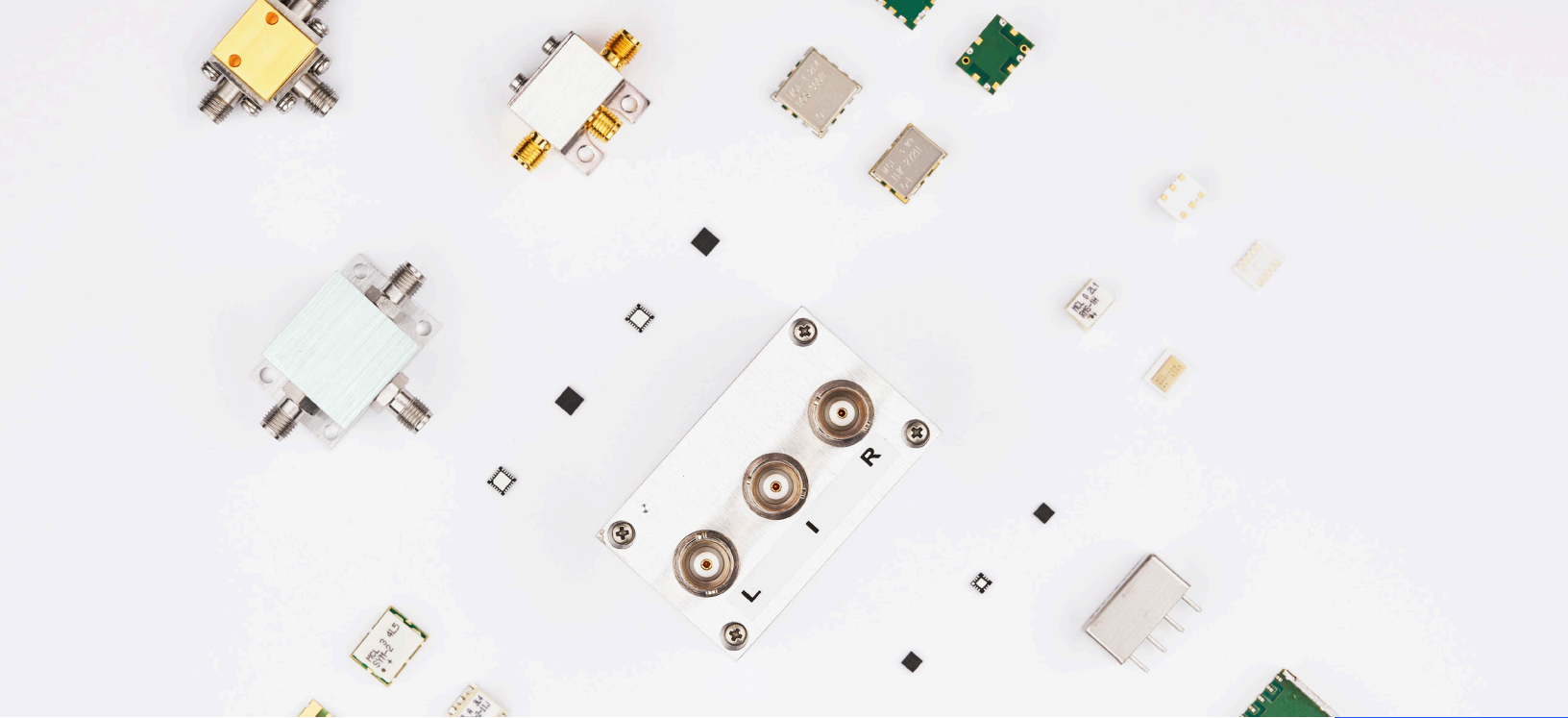

Technology Overview

500 HZ TO 40 GHZ

Frequency Mixers

The Industry's Widest Selection

- 50+ years design and manufacturing experience
- 490+ models in-stock
- LO power from +3 to +27 dBm
- MMIC, core and wire, and LTCC-based models

Designs for every application:

Double balanced, triple balanced, image reject, up-converter, down-converter, active mixers, hi-rel designs and more

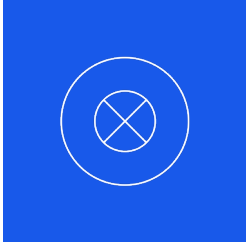

Active Mixers

- Integrated double balanced mixers with LO amplifiers
- Low LO power, -3 to 0 dBm
- Low conversion loss or conversion gain up to 9.1 dB
- MMIC and LTCC designs



Double Balanced Mixers

- Patented FET-based designs achieve high IP3 up to +30 dBm
- High isolation
- Core and wire and LTCC-based implementations



Hi-Rel Mixers

- Double balanced mixer die in ceramic, hermetically sealed case
- Operating temperature from -55 to +125 °C
- Small, low profile case, 0.3 x 0.25 x 0.06"
- Available for up-screening



Image Reject Mixers

- Excellent image rejection, 28 dBc typ.
- Low conversion loss with good flatness
- Reduces need for filtering at mixer output



Triple Balanced Mixers

- Patented FET-based designs achieve high IP3, up to +34 dBm
- High isolation
- High Input P1dB, up to +23 dBm



Up-Converters

- LO power up to +21 dBm
- Low conversion loss
- Designed for use in transmitter signal chains



Frequency Mixers — Surface Mount Passive

Model Number	RF Frequency Range (MHz)	LO Frequency Range (MHz)	IF Frequency Range (MHz)	LO Level (dBm)	Conversion Loss (dB)	L-R Isolation (dB)	L-I Isolation (dB)	Input IP3 (dBm)	P1dB (dBm)	Subcategory	Tech.
MDB-44H+	10000-40000	10000-40000	DC-15000	15	8.4	37	37	20	10	Double Balanced Mixer	MMIC
MDB-24H+	5000-21500	5000-21500	DC-5000	15	7.9	35	44	23	10	Double Balanced Mixer	MMIC
SIM-24MH+	7300-20000	7300-20000	DC-7500	13	8	35	20	16	9	Double Balanced Mixer	LTCC
SIM-193H+	7300-19000	7300-19000	DC-7500	17	8	25	18	18	14	Double Balanced Mixer	LTCC
SIM-153+	3400-15000	3400-15000	DC-4000	7	8	36	30	10	1	Double Balanced Mixer	LTCC
SIM-153LH+	3200-15000	3200-15000	DC-4000	10	7.5	36	20	18	3	Double Balanced Mixer	LTCC
SIM-153MH+	3200-15000	3200-15000	DC-4000	13	7.5	35	19	17	7	Double Balanced Mixer	LTCC
MAC-12G+	3800-12000	3800-12000	DC-1800	7	6.3	26	15	9	1	High Reliability	LTCC
MAC-12GL+	3800-12000	3800-12000	DC-1500	4	6.6	26	15	7	-1	High Reliability	LTCC
MCA1-12G+	3800-12000	3800-12000	DC-1800	7	6.2	36	40	8	1	Double Balanced Mixer	LTCC
MCA1-12GL+	3800-12000	3800-12000	DC-1500	4	6.5	38	40	9	1	Double Balanced Mixer	LTCC
MAC-113H+	3800-11000	3800-11000	DC-1800	17	6.5	28	17	19	14	High Reliability	LTCC
MCA1-113H+	3800-11000	3800-11000	DC-1800	17	6.7	35	32	23	14	Double Balanced Mixer	LTCC
SIM-14+	3700-10000	3700-10000	DC-4000	7	6.3	36	16	13	1	Double Balanced Mixer	LTCC
SIM-14H+	3700-10000	3700-10000	DC-4000	17	7	38	16	25	14	Double Balanced Mixer	LTCC
SIM-14LH+	3700-10000	3700-10000	DC-4000	10	6.7	38	17	19	3	Double Balanced Mixer	LTCC
MAC-85+	2800-8500	2800-8500	DC-1250	7	6.1	31	15	9	1	High Reliability	LTCC
MAC-85L+	2800-8500	2800-8500	DC-1200	4	7	31	15	8	0	High Reliability	LTCC
MCA1-85+	2800-8500	2800-8500	DC-1250	7	5.5	40	13	13	1	Double Balanced Mixer	LTCC
MCA1-85L+	2800-8500	2800-8500	DC-1200	4	6	35	38	11	0	Double Balanced Mixer	LTCC
SIM-852MH+	3700-8500	3700-8500	DC-4000	13	6.9	35	11	20	9	Double Balanced Mixer	LTCC
MAC-80H+	2800-8000	2800-8000	DC-1250	17	6.5	29	17	21	14	High Reliability	LTCC
MAC-80LH+	2800-8000	2800-8000	DC-1250	10	5.8	29	15	12	5	High Reliability	LTCC
MAC-80MH+	2800-8000	2800-8000	DC-1250	13	5.8	29	13	16	9	High Reliability	LTCC

Frequency Mixers — Surface Mount Passive Continued

Model Number	RF Frequency Range (MHz)	LO Frequency Range (MHz)	IF Frequency Range (MHz)	LO Level (dBm)	Conversion Loss (dB)	L-R Isolation (dB)	L-I Isolation (dB)	Input IP3 (dBm)	P1dB (dBm)	Subcategory	Tech.
MCA1-80H+	5000-8000	5000-8000	DC-1250	17	6.3	35	35	24	14	Double Balanced Mixer	LTCC
MCA1-80LH+	2800-8000	2800-8000	DC-1250	10	5.9	35	40	12	5	Double Balanced Mixer	LTCC
MCA1-80MH+	2800-8000	2800-8000	DC-1250	13	5.7	27	20	18	9	Double Balanced Mixer	LTCC
SIM-83+	2300-8000	2300-8000	DC-3000	7	6	32	28	15	1	Double Balanced Mixer	LTCC
SIM-83LH+	1700-8000	1700-8000	DC-3000	10	6	31	28	18	3	Double Balanced Mixer	LTCC
SIM-792LH+	2300-7900	2300-7900	DC-3000	10	5.8	33	22	16	5	Double Balanced Mixer	LTCC
SIM-762H+	2300-7600	2300-7600	DC-3000	17	6	35	21	25	14	Double Balanced Mixer	LTCC
SIM-U742MH+	2300-7400	2300-7400	0.1-3300	13	8	23	17	20	9	Up Converter	LTCC
SIM-722MH+	2300-7200	2300-7200	DC-3000	13	6	30	23	22	9	Double Balanced Mixer	LTCC
SIM-U712H+	2600-7100	10-1780	2600-7100	17	7.3	19	27	27	14	Up Converter	LTCC
MDB-73H+	2200-7000	2200-7000	DC-1600	15	8.2	39	46	24	10	Double Balanced Mixer	MMIC
SIM-73L+	2400-7000	2400-7000	DC-3000	4	6.3	32	26	12	1	Double Balanced Mixer	LTCC
SKY-7G+	2000-7000	2000-7000	DC-1000	7	7	28	20	11	1	Double Balanced Mixer	Core & Wire
MBA-671+	2400-6700	2400-6700	DC-1000	7	6.5	36	26	10	1	Double Balanced Mixer	LTCC
MAC-60+	1600-6000	1600-6000	DC-2000	7	6.4	35	15	10	1	High Reliability	LTCC
MAC-60LH+	1600-6000	1600-6000	DC-2000	10	6.5	35	15	12	5	High Reliability	LTCC
MAC-60MH+	1600-6000	1600-6000	DC-2000	13	6.5	35	17	15	9	High Reliability	LTCC
MCA1-60+	1600-6000	1600-6000	DC-2000	7	6.3	32	17	9	1	Double Balanced Mixer	LTCC
MCA1-60LH+	1700-6000	1700-6000	DC-2000	10	6.4	35	21	13	5	Double Balanced Mixer	LTCC
MCA1-60MH+	1600-6000	1600-6000	DC-2000	13	6.5	28	15	15	9	Double Balanced Mixer	LTCC
SIM-63LH+	750-6000	750-6000	DC-1500	10	6.6	32	22	12	3	Double Balanced Mixer	LTCC
SIM-U63+	3800-6000	3100-5700	1600-2500	7	6.9	39	16	10	1	Up Converter	LTCC
SKY-60+	2500-6000	2500-6000	DC-1500	7	6.2	28	14	11	1	Double Balanced Mixer	Core & Wire
SKY-60H+	2500-6000	2500-6000	DC-1500	17	6.2	28	14	23	14	Double Balanced Mixer	Core & Wire

Frequency Mixers — Surface Mount Passive Continued

Model Number	RF Frequency Range (MHz)	LO Frequency Range (MHz)	IF Frequency Range (MHz)	LO Level (dBm)	Conversion Loss (dB)	L-R Isolation (dB)	L-I Isolation (dB)	Input IP3 (dBm)	P1dB (dBm)	Subcategory	Tech.
SKY-60LH+	2500-6000	2500-6000	DC-1500	10	6.2	28	14	15	5	Double Balanced Mixer	Core & Wire
SKY-60MH+	2500-6000	2500-6000	DC-1500	13	6.2	28	14	19	9	Double Balanced Mixer	Core & Wire
SYM-63LH+	1-6000	1-6000	DC-1000	10	7.5	35	25	14	3	Double Balanced Mixer	Core & Wire
MBA-591+	2800-5900	2800-5900	DC-1000	7	6.5	36	26	10	1	Double Balanced Mixer	LTCC
MBA-591L+	4950-5900	4950-5900	DC-1000	4	7	35	26	15	1	Double Balanced Mixer	LTCC
SKY-53LHR+	2800-5300	2800-5300	DC-500	10	5.7	28	12	14	5	Double Balanced Mixer	Core & Wire
MCA-50H+	1000-5000	1000-5000	10-1500	17	7.3	30	30	23	14	Triple Balanced Mixer	Core & Wire
MCA-50LH+	1000-5000	1000-5000	10-1500	10	7.3	35	32	18	6	Triple Balanced Mixer	Core & Wire
MCA-50MH+	1000-5000	1000-5000	10-1500	13	7.3	34	30	21	9	Triple Balanced Mixer	Core & Wire
LAVI-452VH+	3220-4500	2370-3650	300-1500	23	8.6	36	32	29	20	Triple Balanced Mixer	Core & Wire
ADE-42MH+	5-4200	5-4200	5-3500	13	7.5	29	26	17	9	Double Balanced Mixer	Core & Wire
MAC-42+	1000-4200	1000-4200	DC-1500	7	6.1	35	20	10	1	High Reliability	LTCC
MAC-42LH+	1000-4200	1000-4200	DC-1500	10	6.1	38	20	12	5	High Reliability	LTCC
MAC-42MH+	1000-4200	1000-4200	DC-1500	13	6.1	35	20	16	9	High Reliability	LTCC
MCA1-42+	1000-4200	1000-4200	DC-1500	7	6.1	35	20	10	1	Double Balanced Mixer	LTCC
MCA1-42LH+	1000-4200	1000-4200	DC-1500	10	6	38	20	12	5	Double Balanced Mixer	LTCC
MCA1-42MH+	1000-4200	1000-4200	DC-1500	13	6.2	32	20	16	9	Double Balanced Mixer	LTCC
RMS-42MH+	800-4200	800-4200	DC-800	13	5.3	28	15	19	9	Double Balanced Mixer	Core & Wire
SIM-43+	750-4200	750-4200	DC-1500	7	6.3	37	24	12	1	Double Balanced Mixer	LTCC
SIM-43LH+	824-4200	824-4200	DC-1500	10	6.3	37	24	14	5	Double Balanced Mixer	LTCC
SIM-43MH+	824-4200	824-4200	DC-1500	13	6.3	37	24	20	9	Double Balanced Mixer	LTCC
HJK-412H+	2400-4100	3700-5400	1200-1800	17	10.7	30	35	25	14	Triple Balanced Mixer	Core & Wire
ADE-30W+	300-4000	300-4000	DC-950	7	6.8	35	16	12	1	Double Balanced Mixer	Core & Wire
ADE-R30W+	300-4000	300-4000	DC-950	7	6	38	13	12	1	High Reliability	Core & Wire

Frequency Mixers — Surface Mount Passive Continued

Model Number	RF Frequency Range (MHz)	LO Frequency Range (MHz)	IF Frequency Range (MHz)	LO Level (dBm)	Conversion Loss (dB)	L-R Isolation (dB)	L-I Isolation (dB)	Input IP3 (dBm)	P1dB (dBm)	Subcategory	Tech.
ADE-R30WLH+	300-4000	300-4000	DC-950	10	7.5	40	16	15	5	High Reliability	Core & Wire
SIM-43H+	1000-4000	1000-4000	DC-1500	17	6.5	37	24	22	14	Double Balanced Mixer	LTCC
SIM-U432H+	1100-3900	1100-4250	0.1-800	17	7.5	36	24	26	14	Up Converter	LTCC
HJK-372H+	420-3730	610-3920	100-600	17	7.5	35	33	24	14	Triple Balanced Mixer	Core & Wire
MBA-25LH+	2200-3600	2200-3600	DC-500	10	7	32	20	12	4	Double Balanced Mixer	LTCC
SYM-36H+	1500-3600	1500-3600	DC-600	17	6.3	30	34	25	14	Double Balanced Mixer	Core & Wire
ADE-18W+	1750-3500	1750-3500	DC-700	7	5.4	33	12	11	1	Double Balanced Mixer	Core & Wire
ADE-35+	1600-3500	1600-3500	DC-1500	7	6.3	25	22	11	1	Double Balanced Mixer	Core & Wire
ADE-35MH+	5-3500	5-3500	5-2500	13	6.9	33	28	18	9	Double Balanced Mixer	Core & Wire
MCA-35H+	500-3500	500-3500	10-1500	17	6.9	30	30	24	14	Triple Balanced Mixer	Core & Wire
MCA-35MH+	500-3500	500-3500	10-1500	13	6.9	29	29	20	9	Triple Balanced Mixer	Core & Wire
MBA-18LH+	1600-3200	1600-3200	DC-500	10	5.8	30	22	12	5	Double Balanced Mixer	LTCC
LAVI-362VH+	100-3100	1800-3600	500-2500	22	7.5	40	35	33	20	Triple Balanced Mixer	Core & Wire
ADE-30+	200-3000	200-3000	DC-1000	7	4.5	35	20	14	1	Double Balanced Mixer	Core & Wire
JYM-30H+	2-3000	2-3000	4-1400	17	6	40	30	24	10	Double Balanced Mixer	Core & Wire
LRMS-30J+	200-3000	200-3000	DC-1000	7	6.8	30	27	14	1	Double Balanced Mixer	Core & Wire
MBA-25L+	2000-3000	2000-3000	DC-600	4	6.2	28	15	10	0	Double Balanced Mixer	LTCC
MBA-25MH+	2000-3000	2000-3000	DC-500	13	6.5	36	20	16	8	Double Balanced Mixer	LTCC
RMS-30+	200-3000	200-3000	DC-1000	7	6.5	27	20	11	1	Double Balanced Mixer	Core & Wire
SYM-30DHW+	5-3000	5-3000	5-1500	17	6.5	40	25	29	14	Triple Balanced Mixer	Core & Wire
SYM-30DL-HW+	5-3000	5-3000	5-1500	10	6.5	27	45	19	5	Double Balanced Mixer	Core & Wire
SYM-30DM-HW+	5-3000	5-3000	5-1500	13	6.5	39	42	22	9	Double Balanced Mixer	Core & Wire
ADE-R20+	1500-2800	1500-2800	DC-500	7	5.8	30	28	12	1	High Reliability	Core & Wire
JYM-28H+	400-2800	400-2800	4-700	17	6.3	40	30	23	10	Double Balanced Mixer	Core & Wire

Frequency Mixers — Surface Mount Passive Continued

Model Number	RF Frequency Range (MHz)	LO Frequency Range (MHz)	IF Frequency Range (MHz)	LO Level (dBm)	Conversion Loss (dB)	L-R Isolation (dB)	L-I Isolation (dB)	Input IP3 (dBm)	P1dB (dBm)	Subcategory	Tech.
ADE-3G+	2300-2700	2300-2700	DC-400	7	5.6	36	26	13	1	Double Balanced Mixer	Core & Wire
ADE-R3GLH+	2000-2700	2000-2700	DC-700	10	5.2	35	23	14	4	High Reliability	Core & Wire
ADE-R272MH+	1300-2700	1300-2700	DC-600	13	5.6	34	25	18	9	High Reliability	Core & Wire
HJK-272H+	600-2700	600-2700	10-1000	17	7.7	35	23	25	20	Double Balanced Mixer	Core & Wire
HJK-272MH+	600-2700	600-2700	10-1000	13	7.4	37	27	21	16	Double Balanced Mixer	Core & Wire
ADE-3GL+	2100-2600	2100-2600	DC-600	7	6	34	20	17	1	Double Balanced Mixer	Core & Wire
ADE-25MH+	5-2500	5-2500	5-1500	13	6.9	34	32	18	9	Double Balanced Mixer	Core & Wire
LAVI-25VH+	400-2500	660-2800	70-1500	23	7.8	50	45	32	20	Triple Balanced Mixer	Core & Wire
LAVI-252H+	200-2500	130-2430	50-2000	17	7.8	40	45	25	17	Triple Balanced Mixer	Core & Wire
LAVI-252VH+	1850-2500	1920-2570	60-750	20	7.5	45	40	30	20	Triple Balanced Mixer	Core & Wire
LAVI-U252VH+	1500-2500	1800-2800	10-1300	21	7.8	45	51	30	16	Up Converter	Core & Wire
LRMS-25J+	750-2500	750-2500	DC-600	10	5.2	35	20	18	5	Double Balanced Mixer	Core & Wire
RMS-25MH+	5-2500	5-2500	5-1500	13	7	32	32	17	9	Double Balanced Mixer	Core & Wire
SCM-2500+	500-2500	500-2500	DC-500	7	5.88	35	18	13	1	Double Balanced Mixer	Core & Wire
SCM-2500LH+	500-2500	500-2500	DC-500	10	5.6	35	18	16	5	Double Balanced Mixer	Core & Wire
SYM-11+	1-2500	1-2500	10-600	7	7	40	35	10	1	Double Balanced Mixer	Core & Wire
SYM-25DHW+	80-2500	80-2500	DC-1000	17	6.4	37	33	30	14	Triple Balanced Mixer	Core & Wire
SYM-25DL-HW+	40-2500	40-2500	DC-1000	10	6.3	40	33	22	5	Double Balanced Mixer	Core & Wire
SYM-25DM-HW+	40-2500	40-2500	DC-1000	13	6.6	37	38	26	9	Double Balanced Mixer	Core & Wire
SYM-2500+	1-2500	1-2500	DC-500	7	6.5	50	30	12	1	Double Balanced Mixer	Core & Wire
SYM-R252HW+	10-2500	10-2500	10-500	17	6.5	40	40	23	14	Double Balanced Mixer	Core & Wire
MAC-24+	300-2400	300-2400	DC-700	7	6	40	24	10	1	High Reliability	LTCC
MAC-24LH+	300-2400	300-2400	DC-700	10	6.1	40	24	12	5	High Reliability	LTCC
MAC-24MH+	300-2400	300-2400	DC-700	13	6.1	40	24	14	9	High Reliability	LTCC

Frequency Mixers — Surface Mount Passive Continued

Model Number	RF Frequency Range (MHz)	LO Frequency Range (MHz)	IF Frequency Range (MHz)	LO Level (dBm)	Conversion Loss (dB)	L-R Isolation (dB)	L-I Isolation (dB)	Input IP3 (dBm)	P1dB (dBm)	Subcategory	Tech.
MBA-15L+	1200-2400	1200-2400	DC-600	4	6.5	27	14	10	0	Double Balanced Mixer	LTCC
MBA-15LH+	1200-2400	1200-2400	DC-600	10	5.6	26	22	15	5	Double Balanced Mixer	LTCC
MBA-15MH+	1400-2400	1400-2400	DC-600	13	5.5	28	16	18	8	Double Balanced Mixer	LTCC
MCA1-24+	300-2400	300-2400	DC-700	7	6.1	40	25	10	1	Double Balanced Mixer	LTCC
MCA1-24LH+	300-2400	300-2400	DC-700	10	6.5	40	22	13	5	Double Balanced Mixer	LTCC
MCA1-24MH+	300-2400	300-2400	DC-700	13	6.1	40	25	13	9	Double Balanced Mixer	LTCC
SYM-24DH+	1400-2400	1400-2400	10-250	17	7	32	36	29	14	Triple Balanced Mixer	Core & Wire
HJK-U232H+	1220-2360	370-510	850-1850	17	6.8	46	35	31	20	Up Converter	Core & Wire
LAVI-22VH+	425-2200	525-2400	100-700	21	7.7	50	45	31	20	Triple Balanced Mixer	Core & Wire
ADE-11X+	10-2000	10-2000	5-1000	7	7.1	36	37	9	1	Double Balanced Mixer	Core & Wire
ADE-20+	1500-2000	1500-2000	DC-300	7	5.4	31	28	14	1	Double Balanced Mixer	Core & Wire
ADE-R11X+	10-2000	10-2000	10-1000	7	7.5	40	42	10	1	High Reliability	Core & Wire
ADE-R11XLH+	10-2000	10-2000	10-1000	10	7.5	36	45	11	5	High Reliability	Core & Wire
LAVI-23VH+	1200-2000	1270-2070	50-1000	20	8.4	58	40	30	20	Triple Balanced Mixer	Core & Wire
LRMS-20J+	1500-2000	1500-2000	DC-500	10	5	35	26	18	5	Double Balanced Mixer	Core & Wire
RMS-11F+	350-2000	350-2000	DC-400	7	5.5	36	29	12	1	Double Balanced Mixer	Core & Wire
SYM-11LH+	1-2000	1-2000	10-600	10	7	45	33	14	5	Double Balanced Mixer	Core & Wire
SYM-20DHW+	10-2000	10-2000	10-1800	17	6.2	40	42	27	14	Triple Balanced Mixer	Core & Wire
HJK-212H+	1660-1960	1800-2100	10-270	17	6.5	42	35	32	20	Triple Balanced Mixer	Core & Wire
JMS-11X+	5-1900	5-1900	5-1000	7	6.7	35	37	9	1	Double Balanced Mixer	Core & Wire
RMS-11X+	5-1900	5-1900	5-1000	7	7.1	35	37	10	1	Double Balanced Mixer	Core & Wire
LAVI-U182H+	1560-1800	1490-1730	10-250	19	8.3	53	40	32	15	Up Converter	Core & Wire
SYM-18H+	5-1800	5-1800	10-1500	17	5.8	45	50	30	14	Triple Balanced Mixer	Core & Wire
TUF-18DHSM+	100-1800	100-1800	50-750	17	7.3	41	33	27	10	Triple Balanced Mixer	Core & Wire



Frequency Mixers — Surface Mount Passive Continued

Model Number	RF Frequency Range (MHz)	LO Frequency Range (MHz)	IF Frequency Range (MHz)	LO Level (dBm)	Conversion Loss (dB)	L-R Isolation (dB)	L-I Isolation (dB)	Input IP3 (dBm)	P1dB (dBm)	Subcategory	Tech.
LAVI-17VH+	470-1730	600-1800	70-1000	21	6.8	52	50	32	20	Triple Balanced Mixer	Core & Wire
ADE-17H+	100-1700	100-1700	50-1500	17	7.2	35	32	25	14	Double Balanced Mixer	Core & Wire
HJK-172H+	1250-1700	1850-2300	300-900	17	7.5	42	31	30	20	Triple Balanced Mixer	Core & Wire
HJK-1651H+	1430-1650	1520-1740	10-300	17	7.3	45	32	32	20	Triple Balanced Mixer	Core & Wire
ADE-13+	50-1600	50-1600	50-1000	7	8.1	40	35	11	1	Double Balanced Mixer	Core & Wire
ADE-5+	5-1500	5-1500	DC-1000	7	6.6	40	30	15	1.2	Double Balanced Mixer	Core & Wire
ADE-R5LH+	10-1500	10-1500	DC-1000	10	7.2	55	45	15	5	High Reliability	Core & Wire
JCIR-152H+	1000-1500	1080-1580	68-100	15	7.5	43	32	25		Image Reject	Core & Wire
JMS-5H+	5-1500	5-1500	DC-1000	17	5.9	50	35	22	14	Double Balanced Mixer	Core & Wire
JMS-5MH+	5-1500	5-1500	DC-1000	13	5.7	57	35	19	9	Double Balanced Mixer	Core & Wire
LRMS-5H+	10-1500	10-1500	DC-900	17	6.36	36	30	22	14	Double Balanced Mixer	Core & Wire
LRMS-5HJ+	10-1500	10-1500	DC-900	17	6.36	36	30	22	14	Double Balanced Mixer	Core & Wire
LRMS-5J+	5-1500	5-1500	DC-1000	7	5.92	40	30	12	1	Double Balanced Mixer	Core & Wire
RMS-5+	5-1500	5-1500	DC-1000	7	5.92	40	30	13	1	Double Balanced Mixer	Core & Wire
RMS-5H+	10-1500	10-1500	DC-900	17	6.36	36	30	24	14	Double Balanced Mixer	Core & Wire
RMS-5MH+	10-1500	10-1500	DC-900	13	5.67	40	38	17	9	Double Balanced Mixer	Core & Wire
TUF-5LHSM+	20-1500	20-1500	DC-1000	10	6.9	42	30	14	5	Double Balanced Mixer	Core & Wire
TUF-5SM+	20-1500	20-1500	DC-1000	7	5.7	42	32	12	1	Double Balanced Mixer	Core & Wire
TUF-R5SM+	20-1500	20-1500	DC-1200	7	6.5	48	30	12	1	High Reliability	Core & Wire
RMS-5L+	400-1400	400-1400	DC-800	3	7	22	22	9	-3	Double Balanced Mixer	Core & Wire
SYM-14H+	100-1370	100-1370	10-1000	17	6.5	36	30	30	17	Triple Balanced Mixer	Core & Wire
ADE-12H+	500-1200	500-1200	DC-250	17	6.7	34	28	28	14	Double Balanced Mixer	Core & Wire
ADE-12MH+	10-1200	10-1200	DC-1200	13	6.3	45	42	22	9	Double Balanced Mixer	Core & Wire
ADE-R12MH+	10-1200	10-1200	DC-1200	13	6.8	50	42	22	9	High Reliability	Core & Wire

Frequency Mixers — Surface Mount Passive Continued

Model Number	RF Frequency Range (MHz)	LO Frequency Range (MHz)	IF Frequency Range (MHz)	LO Level (dBm)	Conversion Loss (dB)	L-R Isolation (dB)	L-I Isolation (dB)	Input IP3 (dBm)	P1dB (dBm)	Subcategory	Tech.
JMS-2W+	5-1200	5-1200	DC-500	7	6.8	60	48	17	1	Double Balanced Mixer	Core & Wire
SYM-12+	5-1200	5-1200	DC-1000	7	6.5	50	46	16	1	Double Balanced Mixer	Core & Wire
LAVI-2VH+	2-1100	2-1100	2-1000	23	7.5	48	47	34	23	Triple Balanced Mixer	Core & Wire
ADE-2+	5-1000	5-1000	DC-1000	7	6.67	47	45	20	1	Double Balanced Mixer	Core & Wire
ADE-2ASK+	1-1000	1-1000	DC-1000	7	5.4	45	32	12	1	Double Balanced Mixer	Core & Wire
ADE-2M+	5-1000	5-1000	DC-1000	7	6.67	40	30	17	1	Double Balanced Mixer	Core & Wire
ADE-4+	200-1000	200-1000	DC-800	7	6.8	53	40	15	1	Double Balanced Mixer	Core & Wire
ADE-10H+	400-1000	400-1000	DC-500	17	7	39	25	30	14	Double Balanced Mixer	Core & Wire
ADE-10MH+	800-1000	800-1000	10-200	13	7	34	29	26	9	Double Balanced Mixer	Core & Wire
ADE-12+	50-1000	50-1000	DC-1000	7	7	33	37	17	1	Double Balanced Mixer	Core & Wire
ADE-14+	800-1000	800-1000	DC-200	7	7.4	32	34	17	1	Double Balanced Mixer	Core & Wire
ADE-901+	800-1000	800-1000	DC-200	7	5.9	32	26	13	1	Double Balanced Mixer	Core & Wire
ADE-R2ASK+	2-1000	2-1000	DC-1000	7	5.4	48	32	14	1	High Reliability	Core & Wire
ADE-R2ASK-LH+	2-1000	2-1000	DC-1000	10	5.7	45	32	15	5	High Reliability	Core & Wire
ADE-R901LH+	300-1000	300-1000	DC-800	10	6.4	42	35	18	5	High Reliability	Core & Wire
ADEX-10+	10-1000	10-1000	DC-800	7	6.8	60	33	16	1	Double Balanced Mixer	Core & Wire
ADEX-10H+	10-1000	10-1000	DC-800	17	7	55	32	22	14	Double Balanced Mixer	Core & Wire
ADEX-10L+	10-1000	10-1000	DC-800	4	7.2	60	33	16	1	Double Balanced Mixer	Core & Wire
ADEX-R10LH+	10-1000	10-1000	DC-800	10	7	60	35	16	5	High Reliability	Core & Wire
ASK-2-KK81+	1-1000	1-1000	DC-1000	7	6.79	35	25	12	1	Double Balanced Mixer	Core & Wire
JMS-2+	20-1000	20-1000	DC-1000	7	7	50	47	17	1	Double Balanced Mixer	Core & Wire
JMS-2H+	20-1000	20-1000	DC-1000	17	7	50	47	24	14	Double Balanced Mixer	Core & Wire
JMS-2LH+	20-1000	20-1000	DC-1000	10	6.5	48	35	20	5	Double Balanced Mixer	Core & Wire
JMS-2MH+	20-1000	20-1000	DC-1000	13	7	50	47	22	9	Double Balanced Mixer	Core & Wire

Frequency Mixers — Surface Mount Passive Continued

Model Number	RF Frequency Range (MHz)	LO Frequency Range (MHz)	IF Frequency Range (MHz)	LO Level (dBm)	Conversion Loss (dB)	L-R Isolation (dB)	L-I Isolation (dB)	Input IP3 (dBm)	P1dB (dBm)	Subcategory	Tech.
LAVI-10VH+	300-1000	525-1175	60-875	21	6.3	50	45	33	20	Triple Balanced Mixer	Core & Wire
LRMS-2H+	5-1000	5-1000	DC-900	17	6.98	39	45		14	Double Balanced Mixer	Core & Wire
LRMS-2J+	5-1000	5-1000	DC-1000	7	6.67	40	30	16	1	Double Balanced Mixer	Core & Wire
RMS-2+	5-1000	5-1000	DC-1000	7	6.67	40	30	17	1	Double Balanced Mixer	Core & Wire
RMS-2D+	5-1000	5-1000	DC-1000	7	6.81	40	40	17	1	Double Balanced Mixer	Core & Wire
RMS-2H+	5-1000	5-1000	DC-900	17	6.98	39	45	23	14	Double Balanced Mixer	Core & Wire
RMS-2LH+	5-1000	5-1000	DC-1000	10	6.44	39	30	18	5	Double Balanced Mixer	Core & Wire
RMS-2MH+	5-1000	5-1000	DC-1000	13	6.72	39	30	22	9	Double Balanced Mixer	Core & Wire
SCM-2+	5-1000	5-1000	DC-500	7	5.76	40	40	11	1	Double Balanced Mixer	Core & Wire
SYM-2+	2-1000	2-1000	DC-1000	7	5.4	50	48	17	1	Double Balanced Mixer	Core & Wire
TUF-2HSM+	50-1000	50-1000	DC-1000	17	6.2	47	44	21	14	Double Balanced Mixer	Core & Wire
TUF-2MHSM+	50-1000	50-1000	DC-1000	13	6	47	47	19	9	Double Balanced Mixer	Core & Wire
TUF-2SM+	50-1000	50-1000	DC-1000	7	5.85	47	44	16	1	Double Balanced Mixer	Core & Wire
LAVI-971VH+	270-970	340-1040	10-600	21	7.5	48	36	33	20	Triple Balanced Mixer	Core & Wire
JCIR-4MH+	430-930	500-1000	65-75	18	7.9	55	25	20		Image Reject	Core & Wire
ADE-851FH+	620-850	685-915	10-150	17	7.3	34	36	34	20	Triple Balanced Mixer	Core & Wire
ADE-851FLH+	620-850	685-915	10-150	10	7.5	34	36	28	13	Triple Balanced Mixer	Core & Wire
ADE-1HW+	5-750	5-750	DC-750	17	6	48	40	26	14	Double Balanced Mixer	Core & Wire
ADE-751H+	20-750	50-780	DC-250	17	6.5	42	40	27	9	Double Balanced Mixer	Core & Wire
ADE-751MH+	20-750	50-780	DC-250	13	6.6	42	40	26	9	Double Balanced Mixer	Core & Wire
LRMS-1W+	2-750	2-750	DC-750	7	5.83	45	40	20	1	Double Balanced Mixer	Core & Wire
LAVI-711H+	220-710	250-740	10-500	17	7.3	50	40	30	20	Triple Balanced Mixer	Core & Wire
ADE-1ASK+	2-600	2-600	DC-600	7	5.3	50	45	16	1	Double Balanced Mixer	Core & Wire
ADE-1MHW+	0.5-600	0.5-600	DC-600	13	5.2	53	44	17	9	Double Balanced Mixer	Core & Wire

Frequency Mixers — Surface Mount Passive Continued

Model Number	RF Frequency Range (MHz)	LO Frequency Range (MHz)	IF Frequency Range (MHz)	LO Level (dBm)	Conversion Loss (dB)	L-R Isolation (dB)	L-I Isolation (dB)	Input IP3 (dBm)	P1dB (dBm)	Subcategory	Tech.
ASK-1-KK81+	1-600	1-600	DC-600	7	5.58	35	30	14	1	Double Balanced Mixer	Core & Wire
TUF-1HSM+	2-600	2-600	DC-600	17	5.9	50	48	26	14	Double Balanced Mixer	Core & Wire
TUF-1LHSM+	2-600	2-600	DC-600	10	6	50	50	17	5	Double Balanced Mixer	Core & Wire
TUF-1SM+	2-600	2-600	DC-600	7	5.85	42	47	16	1	Double Balanced Mixer	Core & Wire
TUF-R1M-HSM+	5-600	5-600	DC-600	13	6	45	43	20	9	High Reliability	Core & Wire
HJK-551H+	320-550	275-505	10-150	17	7	53	38	30	20	Triple Balanced Mixer	Core & Wire
HJK-481H+	345-530	395-530	30-150	17	6.5	55	38	32	20	Triple Balanced Mixer	Core & Wire
ADE-1+	0.5-500	0.5-500	DC-500	7	5	55	40	15	1	Double Balanced Mixer	Core & Wire
ADE-1H+	0.5-500	0.5-500	DC-500	17	5.3	52	42	23	14	Double Balanced Mixer	Core & Wire
ADE-1L+	2-500	2-500	DC-500	3	5.2	55	45	16	0	Double Balanced Mixer	Core & Wire
ADE-1LH+	0.5-500	0.5-500	DC-500	10	5	55	45	15	5	Double Balanced Mixer	Core & Wire
ADE-1MH+	2-500	2-500	DC-500	13	5.2	50	45	17	9	Double Balanced Mixer	Core & Wire
ADE-R1+	1-500	1-500	DC-500	7	5	60	45	13	1	High Reliability	Core & Wire
ADE-R1L+	2-500	2-500	DC-500	3	5.6	55	45	14	0	High Reliability	Core & Wire
JMS-1+	2-500	2-500	DC-500	7	5.75	45	45	16	1	Double Balanced Mixer	Core & Wire
JMS-1H+	2-500	2-500	DC-500	17	5.9	50	50	22	14	Double Balanced Mixer	Core & Wire
JMS-1LH+	2-500	2-500	DC-500	10	5.75	55	45	21	5	Double Balanced Mixer	Core & Wire
JMS-1MH+	2-500	2-500	DC-500	13	5.75	60	45	22	9	Double Balanced Mixer	Core & Wire
LRMS-1	0.5-500	0.5-500	DC-500	7	5.94	33	30	15	1	Double Balanced Mixer	Core & Wire
LRMS-1+	0.5-500	0.5-500	DC-500	7	5.94	33	30	15	1	Double Balanced Mixer	Core & Wire
LRMS-1H+	2-500	2-500	DC-500	17	6.25	44	45	25	14	Double Balanced Mixer	Core & Wire
LRMS-1HJ+	2-500	2-500	DC-500	17	6.25	44	45	25	14	Double Balanced Mixer	Core & Wire
LRMS-1J+	0.5-500	0.5-500	DC-500	7	5.94	33	30	15	1	Double Balanced Mixer	Core & Wire
LRMS-1LH+	2-500	2-500	DC-500	10	5.36	45	40		3	Double Balanced Mixer	Core & Wire

Frequency Mixers — Surface Mount Passive Continued

Model Number	RF Frequency Range (MHz)	LO Frequency Range (MHz)	IF Frequency Range (MHz)	LO Level (dBm)	Conversion Loss (dB)	L-R Isolation (dB)	L-I Isolation (dB)	Input IP3 (dBm)	P1dB (dBm)	Subcategory	Tech.
LRMS-1MH+	2-500	2-500	DC-500	13	5.65	44	36	23	9	Double Balanced Mixer	Core & Wire
LRMS-1MHJ+	2-500	2-500	DC-500	13	6.13	44	36	23	9	Double Balanced Mixer	Core & Wire
LRMS-2MH+	5-500	5-500	DC-1000	13	6.72	39	30		9	Double Balanced Mixer	Core & Wire
RMS-1+	0.5-500	0.5-500	DC-500	7	5.94	33	30	20	1	Double Balanced Mixer	Core & Wire
RMS-1H+	2-500	2-500	DC-500	17	6.25	44	45	22	14	Double Balanced Mixer	Core & Wire
RMS-1LH+	2-500	2-500	DC-500	10	5.68	44	40	15	5	Double Balanced Mixer	Core & Wire
RMS-1MH+	2-500	2-500	DC-500	13	6.07	44	36	26	9	Double Balanced Mixer	Core & Wire
SCM-1+	1-500	1-500	DC-500	7	5.72	45	45	10	1	Double Balanced Mixer	Core & Wire
TUF-R1SM+	5-500	5-500	DC-600	7	5.9	50	48	16	1	High Reliability	Core & Wire
HJK-421H+	238-428	268-458	10-150	17	7.2	52	39	31	20	Triple Balanced Mixer	Core & Wire
TUF-3HSM+	0.15-400	0.15-400	DC-400	17	5	50	45	22	14	Double Balanced Mixer	Core & Wire
TUF-3SM+	0.15-400	0.15-400	DC-400	7	4.7	46	47	11	1	Double Balanced Mixer	Core & Wire
TUF-R3LHSM+	0.3-400	0.3-400	DC-400	10	5.2	46	46	15	5	High Reliability	Core & Wire
TUF-R3SM+	0.25-400	0.25-400	DC-400	7	5	60	45	11	1	High Reliability	Core & Wire
HJK-351H+	235-355	177-297	10-150	17	7.1	55	38	30	20	Triple Balanced Mixer	Core & Wire
HJK-261H+	120-260	190-330	10-150	17	7.1	55	37	30	14	Triple Balanced Mixer	Core & Wire
HJK-261MH+	120-260	190-330	10-150	13	7.2	55	37	27	14	Triple Balanced Mixer	Core & Wire
ADE-6+	0.05-250	0.05-250	DC-200	7	4.6	40	45	10	1	Double Balanced Mixer	Core & Wire
ADE-R6+	0.15-250	0.15-250	DC-200	7	4.6	50	45	10	1	High Reliability	Core & Wire
ADE-R6LH+	0.2-250	0.2-250	DC-200	10	4.9	50	45	16	5	High Reliability	Core & Wire
HJK-251H+	40-250	10-220	10-90	17	7	50	45	32	20	Triple Balanced Mixer	Core & Wire
ADE-201FMH+	90-200	154-264	10-150	13	6.4	42	35	30	16	Triple Balanced Mixer	Core & Wire
HJK-U151H+	70-150	140-280	10-130	17	7.6	58	40	28	17	Up Converter	Core & Wire

Frequency Mixers — Active Surface Mount

Model Number	RF Frequency Range (MHz)	LO Frequency Range (MHz)	IF Frequency Range (MHz)	LO Level (dBm)	Conversion Loss (dB)	L-R Isolation (dB)	L-I Isolation (dB)	Input IP3 (dBm)	P1dB (dBm)	DC volt	DC current	Subcategory	Tech.
MDA4-752H+	2200-7500	2200-7500	30-1600	0	-9.1	31	61	15	9	5	141	Active Mixer	MMIC
MACA-63H+	2000-6000	2000-6000	DC-1000	0	6.9	16	35	20	10	5	110	Active Mixer	LTCC
MACA-242H+	750-2400	750-2400	DC-500	-3	6.1	20	55	18	10	5	110	Active Mixer	LTCC
MA3-242LH+	850-1200	850-1200	50-80	0	5.5	25	20	18	14	5	22	Active Mixer	MMIC

Frequency Mixers — Bare Die

Model Number	RF Frequency Range (MHz)	LO Frequency Range (MHz)	IF Frequency Range (MHz)	LO Level (dBm)	Conversion Loss (MHz)	L-R Isolation (dB)	L-I Isolation (dB)	Input IP3 (dBm)	Input P1dB (dBm)	Subcategory	Tech.
MDB-653H-D+	20000-65000	20000-65000	DC-20000	15	11	45	30	20	10	Double Balanced Mixer	MMIC
MDB-44H-D+	10000-40000	10000-40000	DC-15000	15	8.4	37	37	20	10	Double Balanced Mixer	MMIC
MDB-24H-D+	5000-21500	5000-21500	DC-5000	15	7.9	35	44	23	10	Double Balanced Mixer	MMIC
MDB-73H-D+	2200-7000	2200-7000	DC-1600	15	8.5	40	51.6	18.2	10	Double Balanced Mixer	MMIC

Frequency Mixers — Coaxial

Model Number	RF Frequency Range (MHz)	LO Frequency Range (MHz)	IF Frequency Range (MHz)	LO Level (dBm)	Conversion Loss (dB)	L-R Isolation (dB)	L-I Isolation (dB)	Input IP3 (dBm)	P1dB (dBm)	Subcategory	Tech.
ZMDB-44H-K+	10000-40000	10000-40000	DC-15000	15	8.8	35	30	20	10	Double Balanced Mixer	MMIC
ZMDB-24H-K+	5000-21000	5000-21000	DC-5000	15	8.5	30	40	22	10	Double Balanced Mixer	MMIC
ZX05-24MH-S+	7500-20000	7500-20000	DC-7500	13	7	30	15	-	-	Double Balanced Mixer	Core & Wire
ZX05-153-S+	3400-15000	3400-15000	DC-4000	7	7.5	35	25	-	-	Double Balanced Mixer	Core & Wire
ZX05-153LH-S+	3200-15000	3200-15000	DC-4000	10	7	32	20	-	-	Double Balanced Mixer	Core & Wire
ZX05-153MH-S+	3200-15000	3200-15000	DC-4000	13	7	35	20	-	-	Double Balanced Mixer	Core & Wire

Frequency Mixers — Coaxial Continued

Model Number	RF Frequency Range (MHz)	LO Frequency Range (MHz)	IF Frequency Range (MHz)	LO Level (dBm)	Conversion Loss (dB)	L-R Isolation (dB)	L-I Isolation (dB)	Input IP3 (dBm)	P1dB (dBm)	Subcategory	Tech.
ZMX-10G+	3700-10000	3700-10000	DC-2000	7	5	37	17	-	-	Double Balanced Mixer	Core & Wire
ZX05-14-S+	3700-10000	3700-10000	DC-4000	7	6.7	38	17	-	-	Double Balanced Mixer	Core & Wire
ZX05-14H-S+	3700-10000	3700-10000	DC-4000	17	6.8	38	15	-	-	Double Balanced Mixer	Core & Wire
ZX05-14LH-S+	3700-10000	3700-10000	DC-4000	10	6.7	35	17	-	-	Double Balanced Mixer	Core & Wire
ZMX-8GH	3700-8000	3700-8000	DC-2000	17	5.8	40	18	-	-	Double Balanced Mixer	Core & Wire
ZMX-8GLH	3700-8000	3700-8000	DC-2000	10	5.5	40	18	-	-	Double Balanced Mixer	Core & Wire
ZX05-83-S+	2300-8000	2300-8000	DC-3000	7	6	28	24	-	-	Double Balanced Mixer	Core & Wire
ZX05-83LH-S+	1700-8000	1700-8000	DC-3000	10	6	28	23	-	-	Double Balanced Mixer	Core & Wire
ZX05-762H-S+	2300-7600	2300-7600	DC-3000	17	6.2	30	27	-	-	Double Balanced Mixer	Core & Wire
ZX05-U742MH-S+	2300-7400	2300-7400	0.1-3300	13	8.3	25	23	20	9	Up Converter	Core & Wire
ZX05-U712H-S+	2600-7100	10-1780	2600-7100	17	7.5	24	30	27	14	Up Converter	Core & Wire
ZMX-7GR	3700-7000	3700-7000	DC-1000	7	5	30	36	-	-	Double Balanced Mixer	Core & Wire
ZMX-7GHR	3700-7000	3700-7000	DC-1000	17	5.3	33	34	-	-	Double Balanced Mixer	Core & Wire
ZMX-7GMH	3700-7000	3700-7000	DC-2000	13	4.7	37	17	-	-	Double Balanced Mixer	Core & Wire
ZX05-73L-S+	2400-7000	2400-7000	DC-3000	4	6.5	33	20	10	1	Double Balanced Mixer	Core & Wire
ZX05-63LH-S+	750-6000	750-6000	DC-1000	10	6.5	30	20	-	-	Double Balanced Mixer	Core & Wire
ZX05-C60-S+	1600-6000	1600-6000	DC-2000	7	6.1	32	18	-	-	Double Balanced Mixer	Core & Wire
ZX05-C60LH-S+	1600-6000	1600-6000	DC-750	10	5.3	52	28	-	-	Double Balanced Mixer	Core & Wire
ZX05-C60MH-S+	1600-6000	1600-6000	DC-2000	13	6.9	32	17	-	-	Double Balanced Mixer	Core & Wire
ZX05-U63-S+	3800-6000	3100-5700	1600-2500	7	7	40	17	10	1	Up Converter	Core & Wire
ZEM-4300+	300-4300	300-4300	DC-1000	7	6.65	35	15	-	-	Double Balanced Mixer	Core & Wire
ZEM-4300MH+	300-4300	300-4300	DC-1000	13	6.42	40	14	-	-	Double Balanced Mixer	Core & Wire
ZAM-42	1500-4200	1500-4200	DC-500	7	5.67	25	18	-	-	Double Balanced Mixer	Core & Wire
ZFM-4212+	2000-4200	2000-4200	DC-1300	7	5.44	25	18	-	-	Double Balanced Mixer	Core & Wire

Frequency Mixers — Coaxial Continued

Model Number	RF Frequency Range (MHz)	LO Frequency Range (MHz)	IF Frequency Range (MHz)	LO Level (dBm)	Conversion Loss (dB)	L-R Isolation (dB)	L-I Isolation (dB)	Input IP3 (dBm)	P1dB (dBm)	Subcategory	Tech.
ZX05-42MH-S+	5-4200	5-4200	5-3500	13	7.5	29	26	-	-	Double Balanced Mixer	Core & Wire
ZX05-43-S+	750-4200	750-4200	DC-1500	7	6.5	32	22	-	-	Double Balanced Mixer	Core & Wire
ZX05-43LH-S+	824-4200	824-4200	DC-1500	10	6.1	32	22	-	-	Double Balanced Mixer	Core & Wire
ZX05-43MH-S+	824-4200	824-4200	DC-1500	13	6.1	33	24	-	-	Double Balanced Mixer	Core & Wire
ZX05-C42-S+	1000-4200	1000-4200	DC-1500	7	6.1	35	20	-	-	Double Balanced Mixer	Core & Wire
ZX05-C42LH-S+	1000-4200	1000-4200	DC-1500	10	6	38	20	-	-	Double Balanced Mixer	Core & Wire
ZX05-C42MH-S+	1000-4200	1000-4200	DC-1500	13	6.2	35	20	-	-	Double Balanced Mixer	Core & Wire
ZX05-30W-S+	300-4000	300-4000	DC-950	7	6.8	35	16	-	-	Double Balanced Mixer	Core & Wire
ZX05-43H-S+	1000-4000	1000-4000	DC-1500	17	6.5	35	22	-	-	Double Balanced Mixer	Core & Wire
ZX05-U432H-S+	1100-3900	1100-4250	0.1-800	17	7.5	35	24	26	14	Up Converter	Core & Wire
ZAD-11H+	10-3000	10-3000	10-1000	17	6.83	25	25	-	-	Double Balanced Mixer	Core & Wire
ZFM-15+	10-3000	10-3000	10-800	10	6.13	35	30	-	-	Double Balanced Mixer	Core & Wire
ZLW-11H+	10-3000	10-3000	10-1000	17	6.83	25	25	-	-	Double Balanced Mixer	Core & Wire
ZLW-186MH	2-2500	2-2500	2-1000	13	6.9	35	49	-	-	Double Balanced Mixer	Core & Wire
ZX05-25MH-S+	5-2500	5-2500	5-1500	13	6.9	34	32	-	-	Double Balanced Mixer	Core & Wire
ZEM-M2TMH	10-2400	10-2400	10-1000	13	6.9	43	44	-	-	Double Balanced Mixer	Core & Wire
ZEM-M2TMH+	10-2400	10-2400	10-1000	13	6.9	43	44	-	-	Double Balanced Mixer	Core & Wire
ZFY-11	10-2400	10-2400	5-1000	23	7.4	25	26	-	-	Double Balanced Mixer	Core & Wire
ZX05-C24-S+	300-2400	300-2400	DC-700	7	6.1	40	25	-	-	Double Balanced Mixer	Core & Wire
ZX05-C24LH-S+	300-2400	300-2400	DC-700	10	6.5	40	30	-	-	Double Balanced Mixer	Core & Wire
ZX05-C24MH-S+	300-2400	300-2400	DC-700	13	6.1	40	25	-	-	Double Balanced Mixer	Core & Wire
ZAD-11+	5-2000	5-2000	10-600	7	7.12	35	30	-	-	Double Balanced Mixer	Core & Wire
ZFM-11+	1-2000	1-2000	5-600	7	7.03	35	27	-	-	Double Balanced Mixer	Core & Wire
ZFM-150+	10-2000	10-2000	DC-1000	10	6.05	35	30	-	-	Double Balanced Mixer	Core & Wire

Frequency Mixers — Coaxial Continued

Model Number	RF Frequency Range (MHz)	LO Frequency Range (MHz)	IF Frequency Range (MHz)	LO Level (dBm)	Conversion Loss (dB)	L-R Isolation (dB)	L-I Isolation (dB)	Input IP3 (dBm)	P1dB (dBm)	Subcategory	Tech.
ZFM-2000+	100-2000	100-2000	DC-600	7	7.49	37	30	-	-	Double Balanced Mixer	Core & Wire
ZLW-11+	5-2000	5-2000	10-600	7	6.85	35	30	-	-	Double Balanced Mixer	Core & Wire
ZX05-11X-S+	10-2000	10-2000	5-1000	7	7.1	36	37	-	-	Double Balanced Mixer	Core & Wire
ZX05-20H-S+	1500-2000	1500-2000	DC-300	17	5.2	31	34	-	-	Double Balanced Mixer	Core & Wire
ZX05-17H-S+	100-1700	100-1700	50-1500	17	7.2	34	32	-	-	Double Balanced Mixer	Core & Wire
ZFM-5X+	1-1500	1-1500	1-1000	7	5.9	40	45	-	-	Double Balanced Mixer	Core & Wire
ZP-5+	20-1500	20-1500	DC-1000	7	5.7	42	32	-	-	Double Balanced Mixer	Core & Wire
ZP-5H+	20-1500	20-1500	DC-1000	17	7.5	50	29	-	-	Double Balanced Mixer	Core & Wire
ZP-5MH+	20-1500	20-1500	DC-1000	13	7	41	28	-	-	Double Balanced Mixer	Core & Wire
ZP-5X+	1-1500	1-1500	1-1000	7	5.9	40	45	-	-	Double Balanced Mixer	Core & Wire
ZX05-5-S+	5-1500	5-1500	DC-1000	7	6.6	40	30	-	-	Double Balanced Mixer	Core & Wire
ZFM-4-S+	5-1250	5-1250	DC-1250	7	5.7	40	35	-	-	Double Balanced Mixer	Core & Wire
ZFM-4H+	5-1200	5-1200	DC-1200	17	4.97	35	35	-	-	Double Balanced Mixer	Core & Wire
ZX05-12MH-S+	10-1200	10-1200	DC-1200	13	6.3	45	42	-	-	Double Balanced Mixer	Core & Wire
ZAD-2+	1-1000	1-1000	0.5-500	7	5.66	35	35	-	-	Double Balanced Mixer	Core & Wire
ZAY-2	10-1000	10-1000	DC-1000	23	6.89	40	35	-	-	Double Balanced Mixer	Core & Wire
ZEM-2B+	10-1000	10-1000	DC-1000	7	5.74	30	30	-	-	Double Balanced Mixer	Core & Wire
ZFM-2+	1-1000	1-1000	DC-1000	7	5.72	40	35	-	-	Double Balanced Mixer	Core & Wire
ZFY-2	0.1-1000	0.1-1000	0.01-500	23	5.4	40	40	-	-	Double Balanced Mixer	Core & Wire
ZFY-2+	0.1-1000	0.1-1000	0.01-500	23	5.4	40	40	-	-	Double Balanced Mixer	Core & Wire
ZLW-2	1-1000	1-1000	DC-1000	7	5.68	40	40	-	-	Double Balanced Mixer	Core & Wire
ZLW-2H+	2-1000	2-1000	DC-1000	17	6.34	35	30	-	-	Double Balanced Mixer	Core & Wire
ZP-2+	50-1000	50-1000	DC-1000	7	5.85	47	44	-	-	Double Balanced Mixer	Core & Wire
ZP-2MH+	50-1000	50-1000	DC-1000	13	6	47	47	-	-	Double Balanced Mixer	Core & Wire

Frequency Mixers — Coaxial Continued

Model Number	RF Frequency Range (MHz)	LO Frequency Range (MHz)	IF Frequency Range (MHz)	LO Level (dBm)	Conversion Loss (dB)	L-R Isolation (dB)	L-I Isolation (dB)	Input IP3 (dBm)	P1dB (dBm)	Subcategory	Tech.
ZX05-2-S+	5-1000	5-1000	DC-1000	7	6.7	47	45	-	-	Double Balanced Mixer	Core & Wire
ZX05-10-S+	10-1000	10-1000	DC-800	7	6.8	60	30	-	-	Double Balanced Mixer	Core & Wire
ZX05-10H-S+	10-1000	10-1000	DC-800	17	7	55	32	-	-	Double Balanced Mixer	Core & Wire
ZX05-10L-S+	10-1000	10-1000	DC-800	4	7.2	60	37	16	1	Double Balanced Mixer	Core & Wire
ZFM-1W	10-750	10-750	DC-750	7	5.42	45	40	-	-	Double Balanced Mixer	Core & Wire
ZFM-1W+	10-750	10-750	DC-750	7	5.42	45	40	-	-	Double Balanced Mixer	Core & Wire
ZLW-1W+	1-750	1-750	DC-750	7	5.74	45	40	-	-	Double Balanced Mixer	Core & Wire
ZX05-1HW-S+	5-750	5-750	DC-750	17	6	48	40	-	-	Double Balanced Mixer	Core & Wire
ZX05-1LHW-S+	2-750	2-750	DC-750	10	5.3	52	50	-	-	Double Balanced Mixer	Core & Wire
ZP-1+	2-600	2-600	DC-600	7	5.85	42	47	-	-	Double Balanced Mixer	Core & Wire
ZP-1LH-S+	2-600	2-600	DC-600	10	6	50	50	-	-	Double Balanced Mixer	Core & Wire
ZP-1MH+	2-600	2-600	DC-600	13	6.3	50	48	-	-	Double Balanced Mixer	Core & Wire
ZX05-1MHW-S+	0.5-600	0.5-600	DC-600	13	5.2	53	44	-	-	Double Balanced Mixer	Core & Wire
ZAD-1+	0.5-500	0.5-500	DC-500	7	5.24	45	40	-	-	Double Balanced Mixer	Core & Wire
ZAD-1-1+	0.1-500	0.1-500	DC-500	7	4.83	45	40	-	-	Double Balanced Mixer	Core & Wire
ZAD-1H+	0.5-500	0.5-500	DC-500	17	6.16	45	40	-	-	Double Balanced Mixer	Core & Wire
ZFM-1H+	2-500	2-500	DC-500	17	6.14	40	35	-	-	Double Balanced Mixer	Core & Wire
ZFY-1+	0.1-500	0.1-500	0.01-500	23	4.85	46	46	-	-	Double Balanced Mixer	Core & Wire
ZLW-1	0.5-500	0.5-500	DC-500	7	5.81	45	40	-	-	Double Balanced Mixer	Core & Wire
ZLW-1-1+	0.1-500	0.1-500	DC-500	7	4.82	45	40	-	-	Double Balanced Mixer	Core & Wire
ZLW-1H	0.5-500	0.5-500	DC-500	17	6.13	45	40	-	-	Double Balanced Mixer	Core & Wire
ZMY-1+	5-500	5-500	DC-500	23	6.62	40	40	-	-	Double Balanced Mixer	Core & Wire
ZX05-1-S+	0.5-500	0.5-500	DC-500	7	5	55	40	-	-	Double Balanced Mixer	Core & Wire
ZX05-1L-S+	2-500	2-500	DC-500	3	5.2	55	45	16	0	Double Balanced Mixer	Core & Wire



Frequency Mixers — Coaxial Continued

Model Number	RF Frequency Range (MHz)	LO Frequency Range (MHz)	IF Frequency Range (MHz)	LO Level (dBm)	Conversion Loss (dB)	L-R Isolation (dB)	L-I Isolation (dB)	Input IP3 (dBm)	P1dB (dBm)	Subcategory	Tech.
ZFM-3+	0.04-400	0.04-400	DC-400	7	4.78	50	45	-	-	Double Balanced Mixer	Core & Wire
ZP-3+	0.15-400	0.15-400	DC-400	7	4.7	46	47	-	-	Double Balanced Mixer	Core & Wire
ZP-3LH+	0.15-400	0.15-400	DC-400	10	4.8	51	45	-	-	Double Balanced Mixer	Core & Wire
ZP-3MH+	0.15-400	0.15-400	DC-400	13	5	46	42	-	-	Double Balanced Mixer	Core & Wire
ZFM-3H+	0.05-300	0.05-300	DC-300	17	5.18	40	35	-	-	Double Balanced Mixer	Core & Wire
ZAD-3+	0.025-200	0.025-200	DC-200	7	4.61	45	40	-	-	Double Balanced Mixer	Core & Wire
ZAD-3H+	0.05-200	0.05-200	DC-200	17	4.89	45	40	-	-	Double Balanced Mixer	Core & Wire
ZLW-3+	0.025-200	0.025-200	DC-200	7	4.61	45	40	-	-	Double Balanced Mixer	Core & Wire
ZAD-6+	0.003-100	0.003-100	DC-100	7	4.65	45	40	-	-	Double Balanced Mixer	Core & Wire
ZLW-6+	0.003-100	0.003-100	DC-100	7	4.58	45	40	-	-	Double Balanced Mixer	Core & Wire
ZAD-8+	0.0005-10	0.0005-10	DC-10	7	5.79	50	50	-	-	Double Balanced Mixer	Core & Wire

Frequency Mixers — Plug-In

Model Number	RF Frequency Range (MHz)	LO Frequency Range (MHz)	IF Frequency Range (MHz)	LO Level (dBm)	Conversion Loss (dB)	L-R Isolation (dB)	L-I Isolation (dB)	Input IP3 (dBm)	P1dB (dBm)
TFM-4300+	300-4300	300-4300	DC-800	7	5.87	30	15	Double Balanced Mixer	Core & Wire
TFM-42MH+	10-4200	10-4200	10-1000	13	7.46	40	35	Double Balanced Mixer	Core & Wire
SRA-11H+	10-3000	10-3000	10-1000	17	6.83	25	25	Double Balanced Mixer	Core & Wire
TFM-15+	10-3000	10-3000	10-800	10	6.75	35	30	Double Balanced Mixer	Core & Wire
SAY-11+	10-2400	10-2400	5-1000	23	7.4	26	26	Double Balanced Mixer	Core & Wire
SRA-2400+	750-2400	750-2400	DC-400	7	5.95	30	30	Double Balanced Mixer	Core & Wire
TFM-2400+	750-2400	750-2400	DC-400	7	6.65	30	30	Double Balanced Mixer	Core & Wire
SBL-11+	5-2000	5-2000	10-600	7	7.08	35	30	Double Balanced Mixer	Core & Wire

Frequency Mixers — Plug-In Continued

Model Number	RF Frequency Range (MHz)	LO Frequency Range (MHz)	IF Frequency Range (MHz)	LO Level (dBm)	Conversion Loss (dB)	L-R Isolation (dB)	L-I Isolation (dB)	Input IP3 (dBm)	P1dB (dBm)
SRA-11+	5-2000	5-2000	10-600	7	6.72	35	30	Double Balanced Mixer	Core & Wire
SRA-220+	0.05-2000	0.05-2000	0.05-500	10	5.59	40	40	Double Balanced Mixer	Core & Wire
SRA-2000+	100-2000	100-2000	DC-600	7	8.6	37	30	Double Balanced Mixer	Core & Wire
TFM-11+	1-2000	1-2000	5-600	7	7.16	35	27	Double Balanced Mixer	Core & Wire
TFM-12MH+	0.5-2000	0.5-2000	0.2-600	13	6.99	35	30	Double Balanced Mixer	Core & Wire
TFM-150+	10-2000	10-2000	DC-1000	10	6.19	35	30	Double Balanced Mixer	Core & Wire
SIMA-5H	2-1500	2-1500	DC-1000	17	6.94	44	30	Double Balanced Mixer	Core & Wire
TUF-5+	20-1500	20-1500	DC-1000	7	5.7	42	32	Double Balanced Mixer	Core & Wire
TUF-5H+	20-1500	20-1500	DC-1000	17	7.5	50	29	Double Balanced Mixer	Core & Wire
TUF-5LH+	20-1500	20-1500	DC-1000	10	6.9	42	30	Double Balanced Mixer	Core & Wire
TUF-5MH+	20-1500	20-1500	DC-1000	13	7	41	28	Double Balanced Mixer	Core & Wire
TFM-4+	5-1250	5-1250	DC-1250	7	6.47	40	35	Double Balanced Mixer	Core & Wire
TFM-12+	800-1250	800-1250	50-90	7	6.86	35	30	Double Balanced Mixer	Core & Wire
SRA-173H+	5-1200	5-1200	DC-1200	17	5.38	35	35	Double Balanced Mixer	Core & Wire
SBL-12MH+	2-1100	2-1100	DC-500	13	6.63	40	25	Double Balanced Mixer	Core & Wire
SBL-1X+	10-1000	10-1000	5-500	7	5.88	40	40	Double Balanced Mixer	Core & Wire
SBL-2LH+	5-1000	5-1000	DC-1000	10	5.9	61	54	Double Balanced Mixer	Core & Wire
SRA-2+	1-1000	1-1000	0.5-500	7	5.66	35	30	Double Balanced Mixer	Core & Wire
TFM-2+	1-1000	1-1000	DC-1000	7	5.74	40	35	Double Balanced Mixer	Core & Wire
TFM-2H+	5-1000	5-1000	DC-1000	17	6.12	40	35	Double Balanced Mixer	Core & Wire
TUF-2+	50-1000	50-1000	DC-1000	7	5.85	47	44	Double Balanced Mixer	Core & Wire
TUF-2LH+	50-1000	50-1000	DC-1000	10	5.2	44	50	Double Balanced Mixer	Core & Wire
SRA-1W+	1-750	1-750	DC-750	7	5.8	45	40	Double Balanced Mixer	Core & Wire
SRA-1WH+	1-750	1-750	DC-750	17	5.85	45	40	Double Balanced Mixer	Core & Wire

Frequency Mixers — Plug-In Continued

Model Number	RF Frequency Range (MHz)	LO Frequency Range (MHz)	IF Frequency Range (MHz)	LO Level (dBm)	Conversion Loss (dB)	L-R Isolation (dB)	L-I Isolation (dB)	Input IP3 (dBm)	P1dB (dBm)
TAK-1WH+	5-750	5-750	DC-750	17	5.71	40	35	Double Balanced Mixer	Core & Wire
ASK-1+	1-600	1-600	DC-600	7	5.58	35	30	Double Balanced Mixer	Core & Wire
ASK-1-X65+	1-600	1-600	DC-600	7	5.58	35	30	Double Balanced Mixer	Core & Wire
SAM-1+	1-600	1-600	DC-600	7	5.67	45	40	Double Balanced Mixer	Core & Wire
TAK-6+	0.5-600	0.5-600	DC-600	7	5.58	50	45	Double Balanced Mixer	Core & Wire
TUF-1+	2-600	2-600	DC-600	7	5.85	42	47	Double Balanced Mixer	Core & Wire
TUF-1H+	2-600	2-600	DC-600	17	5.9	50	48	Double Balanced Mixer	Core & Wire
TUF-1LH+	2-600	2-600	DC-600	10	6	50	50	Double Balanced Mixer	Core & Wire
TUF-1MH+	2-600	2-600	DC-600	13	6.3	50	48	Double Balanced Mixer	Core & Wire
RAY-1+	5-500	5-500	DC-500	23	6.57	40	40	Double Balanced Mixer	Core & Wire
SAY-1+	0.1-500	0.1-500	0.01-500	23	4.85	46	46	Double Balanced Mixer	Core & Wire
SBL-1+	1-500	1-500	DC-500	7	5.6	45	40	Double Balanced Mixer	Core & Wire
SBL-1MH+	1-500	1-500	DC-500	13	5.73	45	40	Double Balanced Mixer	Core & Wire
SRA-1+	0.5-500	0.5-500	DC-500	7	5.11	45	40	Double Balanced Mixer	Core & Wire
SRA-1-1+	0.1-500	0.1-500	DC-500	7	4.81	45	40	Double Balanced Mixer	Core & Wire
SRA-1H+	0.5-500	0.5-500	DC-500	17	6.01	45	40	Double Balanced Mixer	Core & Wire
SRA-1MH+	0.5-500	0.5-500	DC-500	13	5.65	45	40	Double Balanced Mixer	Core & Wire
TAK-1H+	2-500	2-500	DC-500	17	5.93	40	35	Double Balanced Mixer	Core & Wire
TFM-1H+	2-500	2-500	DC-500	17	6.14	40	35	Double Balanced Mixer	Core & Wire
TFM-1MH+	2-500	2-500	DC-500	13	5.8	40	35	Double Balanced Mixer	Core & Wire
TSM-3+	0.1-500	0.1-500	DC-500	7	4.75	50	45	Double Balanced Mixer	Core & Wire
VAY-1+	0.5-500	0.5-500	0.02-500	27	5.79	46	46	Double Balanced Mixer	Core & Wire
SBL-1-1+	0.1-400	0.1-400	DC-400	7	4.84	45	40	Double Balanced Mixer	Core & Wire
TFM-3+	0.04-400	0.04-400	DC-400	7	4.7	50	45	Double Balanced Mixer	Core & Wire

Frequency Mixers — Plug-In Continued

Model Number	RF Frequency Range (MHz)	LO Frequency Range (MHz)	IF Frequency Range (MHz)	LO Level (dBm)	Conversion Loss (dB)	L-R Isolation (dB)	L-I Isolation (dB)	Input IP3 (dBm)	P1dB (dBm)
TUF-3+	0.15-400	0.15-400	DC-400	7	4.7	46	47	Double Balanced Mixer	Core & Wire
TUF-3LH+	0.15-400	0.15-400	DC-400	10	4.8	51	45	Double Balanced Mixer	Core & Wire
TAK-3H+	0.05-300	0.05-300	DC-300	17	4.82	40	35	Double Balanced Mixer	Core & Wire
TAK-5+	0.01-250	0.01-250	DC-250	7	4.65	50	45	Double Balanced Mixer	Core & Wire
TFM-3H+	0.1-250	0.1-250	DC-250	17	4.58	40	35	Double Balanced Mixer	Core & Wire
TFM-3MH+	1-250	1-250	DC-250	13	4.79	40	35	Double Balanced Mixer	Core & Wire
RAY-3+	0.07-200	0.07-200	DC-200	23	5.53	40	40	Double Balanced Mixer	Core & Wire
SBL-3+	0.025-200	0.025-200	DC-200	7	4.81	45	40	Double Balanced Mixer	Core & Wire
SRA-3+	0.025-200	0.025-200	DC-200	7	4.61	45	40	Double Balanced Mixer	Core & Wire
SRA-3H+	0.05-200	0.05-200	DC-200	17	5.18	40	40	Double Balanced Mixer	Core & Wire
SRA-3MH+	0.025-200	0.025-200	DC-200	13	4.77	45	40	Double Balanced Mixer	Core & Wire
SRA-6+	0.003-100	0.003-100	DC-100	7	4.58	45	40	Double Balanced Mixer	Core & Wire
SRA-8+	0.0005-10	0.0005-10	DC-10	7	5.69	50	50	Double Balanced Mixer	Core & Wire



Frequency Designer Kits

Model Number	Model Series	Description	Package	Models Included in Kit	Qty. Ea.	Total Qty.
K1-ADE+	ADE	2 to 4000 MHz 3 to 17 dBm LO Powers	Leaded SMT	ADE-1L+ -2+ -18W+ -30W+ -35MH+ -17H+ ADEX-10L+ -10H+	5	40
K1-MCA+	MCA	500 to 5000 MHz 10, 13, and 17 dBm LO Powers	Leaded SMT	MCA-35H+ -35LH+ -35MH+ -50H+ -50LH+ -50MH+	5	30
K2-MCA+	MCA	1760 to 3600 MHz 10, 13, and 17 dBm LO Powers	Leaded SMT	MCA-19FH+ -19FLH+ -19FMH+ -30FH+ -30FLH+ -30FMH+ -36FH+ -36FLH+ -36FMH+	2	18
K1-MCA1+	MCA1	300 to 1200 MHz 4 to 17 dBm LO Powers	Leaded SMT	MCA1-12GL+ -24+ -24LH+ -42MH+ -42+ -60+ -60LH+ -80H+ -85L+ -113H+	5	50

Model Number	Model Series	Description	Package	Models Included in Kit	Qty. Ea.	Total Qty.
K1-SIM+	SIM	750 to 15000 MHz 4, 7, and 10 dBm LO Powers	Leadedless SMT	SIM-14+ -43+ -63LH+ -73L+ -83+ -83LH+ -153+ -153LH+	5	40
K1-ZX05+	ZX05	5 to 15000 MHz 7 dBm LO Power	SMA Connectorized	ZX05-5+ -43+ -153+	1	3
K2-ZX05+	ZX05	0.5 to 15000 MHz 10 and 13 dBm LO Powers	SMA Connectorized	ZX05-1MHW+ -12MH+ -63LH+ -153MH+	1	4
K3-ZX05+	ZX05	5 to 10000 MHz 17 dBm LO Power	SMA Connectorized	ZX05-1HW+ -17H+ -43H+ -14H+	1	4



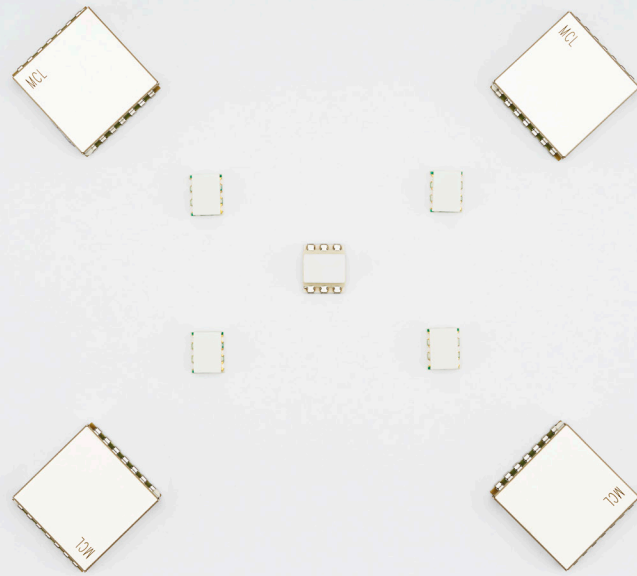

**RF / LO FROM 1 MHZ TO 20 GHZ
I&Q FROM DC TO 10 MHZ**

Modulators & Demodulators

Integrated Frequency Conversion

- I&Q, QPSK and bi-phase designs
- Excellent rejection of carrier, harmonics and sideband
- Low conversion loss
- Connectorized and surface mount models



Modulators

I&Q Modulators — Surface Mount

Model Number	RF/LO Frequency Range (MHz)	I&Q Frequency Range (MHz)	Conv. Loss (dB)	Carrier Rejection (dBc)	Sideband Rejection (dBc)	Harmonic Suppression (dBc), 3XI/Q	Harmonic Suppression (dBc), 5XI/Q
JCIQ-176M+	104-176	DC-5	5.6	35	35	45	65
JCIQ-88M+	52-88	DC-5	5.6	40	35	45	65

I&Q Modulators — Coaxial

Model Number	RF/LO Frequency Range (MHz)	I&Q Frequency Range (MHz)	Conv. Loss (dB)	Carrier Rejection (dBc)	Sideband Rejection (dBc)	Harmonic Suppression (dBc), 3XI/Q	Harmonic Suppression (dBc), 5XI/Q
ZFMIQ-70ML	66-73	DC-5	5.7	38	38	48	58

I&Q Modulators — Plug-In

Model Number	RF/LO Frequency Range (MHz)	I&Q Frequency Range (MHz)	Conv. Loss (dB)	Carrier Rejection (dBc)	Sideband Rejection (dBc)	Harmonic Suppression (dBc), 3XI/Q	Harmonic Suppression (dBc), 5XI/Q
MIQA-21M+	20-23	DC-3	6.2	50	40	48	65

Demodulators

I&Q Demodulators — Surface Mount

Model Number	RF/LO Frequency Range (MHz)	I&Q Frequency Range (MHz)	Conv. Loss (dB)	Carrier Rejection (dBc)	Sideband Rejection (dBc)	Harmonic Suppression (dBc), 3XI/Q	Harmonic Suppression (dBc), 5XI/Q
JCIQ-176D+	104-176	DC-5	5.5	0.15	2	52	65

I&Q Demodulators — Coaxial

Model Number	RF/LO Frequency Range (MHz)	I&Q Frequency Range (MHz)	Conv. Loss (dB)	Carrier Rejection (dBc)	Sideband Rejection (dBc)	Harmonic Suppression (dBc), 3XI/Q	Harmonic Suppression (dBc), 5XI/Q
ZFMIQ-70D	66-73	DC-2	6.2	0.15	0.7	56	58

I&Q Demodulators — Plug-In

Model Number	RF/LO Frequency Range (MHz)	I&Q Frequency Range (MHz)	Conv. Loss (dB)	Carrier Rejection (dBc)	Sideband Rejection (dBc)	Harmonic Suppression (dBc), 3XI/Q	Harmonic Suppression (dBc), 5XI/Q
MIQA-21D+	23-23	DC-3	6.1	0.15	0.7	64	67

Bi-Phase

Bi-Phase — Surface Mount

Model Number	Frequency Range In (MHz)	Frequency Range Con (MHz)	Total Range Insertion Loss (dB) at ±20 mA	Input Power (dBm) at 1 dB Compr., at ±20 mA	No Damage Input Power (dBm) at ±20 mA	In-Out Isolation (dB) at 0 mA, Mid Range	Bi-Phase X (±20 mA), Amp (dB), Total Range	Bi-Phase X (±20 mA), Phase (deg.) deviation from 180, Total Range
LRAS-2-75	10-1000	DC-0.05	4.5	20	25	42	0.3	3
SYAS-860+	600-1000	DC-0.5	2.7	14	25	25	0.5	4
TFAS-2SM+	10-1000	DC-0.5	5	17	25	42	0.2	3
RAS-1+	2-400	DC-0.05	1.6	20	25	45	0.1	2
SYAS-1+	2-400	DC-0.05	1.6	20	25	45	0.1	2
TFAS-1SM+	2-400	DC-0.05	1.6	20	25	45	0.1	2

Bi-Phase — Coaxial

Model Number	Frequency Range (MHz)	Control Frequency Range (MHz)	Total-Band Insertion Loss (dB) at ±20 mA,	Input Pwr @ 1 dB Compr. at ±20 mA	Max. No Damage Input Pwr	In-Out Isolation (dB) at 0 mA, Mid-Range Typ.	Bi-Phase Amp (dB) at ±20 mA, Total Range	Bi-Phase Phase Deviation from 180° at ±20 mA, Total Range
ZFAS-2000+	100-2000	DC-0.5	5.4	19R	25	-	0.4	8
ZMAS-1	5-450	DC-0.05	3.5	20	30	55	0.1	1.2
ZAS-3+	1-200	DC-0.05	1.6	15	30	50	0.1	1
ZMAS-3	1-200	DC-0.05	1.6	15	30	50	0.1	1

Bi-Phase — Plug-In

Model Number	RF Frequency Range (MHz)	Control Frequency Range (MHz)	Total-Band Insertion Loss (dB) at ±20 mA	Input Pwr @ 1 dB Compr. at ±20 mA	Max. No Damage Input Pwr	In-Out Isolation (dB) at 0 mA, Mid-Range	Bi-Phase Amp (dB) at ±20 mA, Total Range	Bi-Phase Phase Deviation from 180° at ±20 mA, Total Range
PAS-2000+	100-2000	DC-0.5	5.4	19	25	-	0.4	8
GAS-2+	10-1000	DC-0.05	5.2	20	25	35	0.3	3
PAS-2+	10-1000	DC-0.05	6.5	20	29	40	0.3	1
TFAS-2+	10-1000	DC-0.5	5	17	25	42	0.2	3
GAS-1+	5-450	DC-0.05	3.5	20	25	45	0.1	1.5
PAS-1+	5-450	DC-0.05	3.5	20	29	45	0.1	1.2
TFAS-1+	2-400	DC-0.05	1.6	20	25	45	0.1	2
PAS-3+	1-200	DC-0.05	1.6	15	29	50	0.1	1

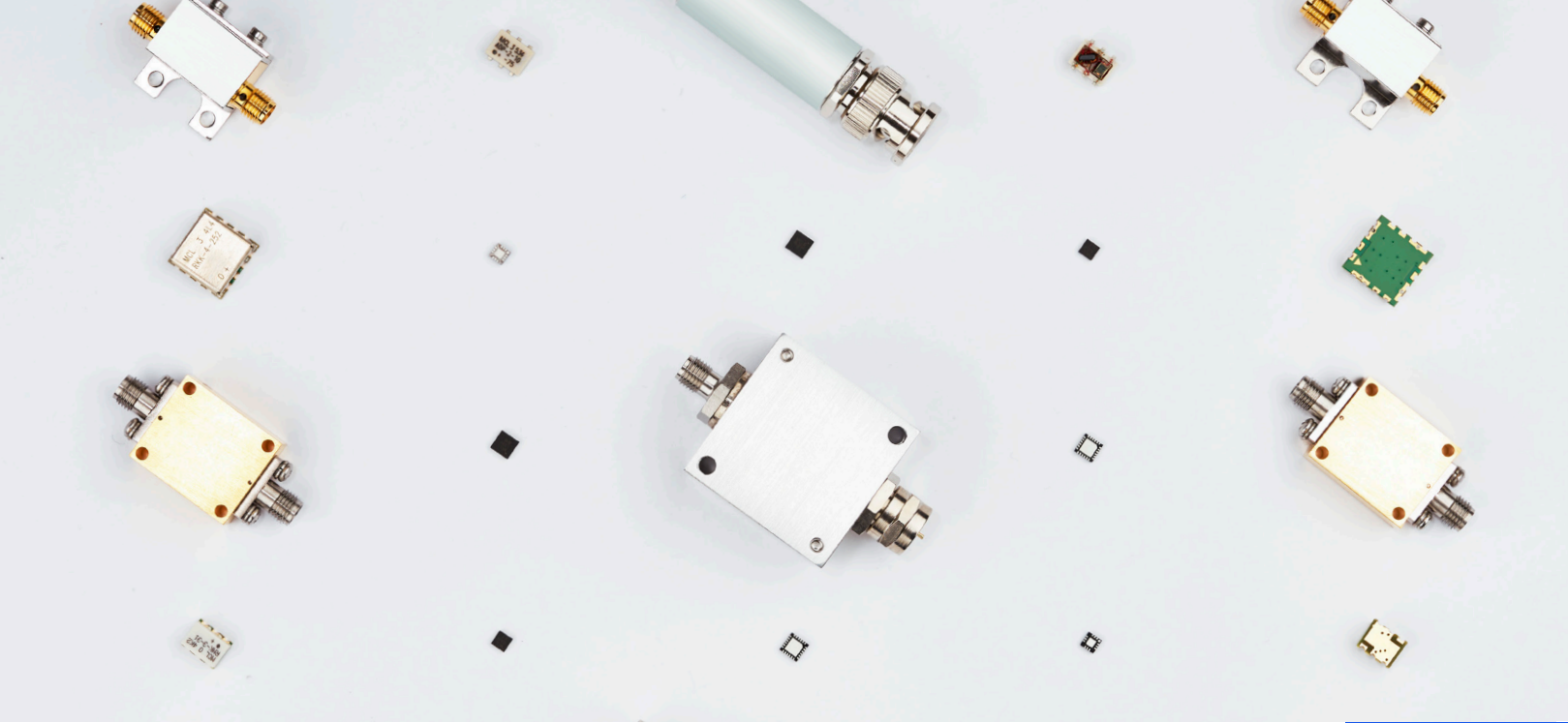

100 KHZ TO 40 GHZ

Frequency Multipliers

From X2 to X12

- Over 80 models in stock
- Coaxial, surface mount and bare die formats
- Conversion loss as low as 6.5 dB
- Excellent fundamental and harmonic suppression



Frequency Multipliers — Surface Mount

Model Number	Multiply Factor [X]	Input Frequency Range (MHz)	Output Frequency Range (MHz)	RF Input Power Range (dBm)	Conv. Loss (dB)	F1 Fundamental Suppression Below F[X] (dBc)	F[X-1] Suppression Below F[X] (dBc)	F[X+1] Suppression Below F[X] (dBc)
CY2-44+	2	6200-20000	12400-40000	12-18	14	26	-	34
CY2-283+	2	3500-14000	7000-28000	12-18	13	34	-	40
KSX2-24+	2	5000-10000	10000-20000	10-16	14	29	-	29
CY2-143+	2	2000-7000	4000-14000	12-18	12	30	-	32
KC2-50+	2	3500-5000	7000-10000	7-12	12.5	15	-	28
KSX2-14+	2	2500-5000	5000-10000	13-17	12	22	-	31
KBA-40	2	2700-4800	5400-9600	10-16	12.3	18	-	26
KBA-40+	2	2700-4800	5400-9600	10-16	12.3	18	-	26
KC2-36+	2	1700-3600	3400-7200	8-13	11	18	-	30
KSX2-722+	2	1300-3600	2600-7200	9-13	12	20	-	28
KBA-20	2	1600-2200	3200-4400	11-15	12	12	-	20
KBA-20+	2	1600-2200	3200-4400	11-15	12	12	-	20
KSX2-442+	2	600-2200	1200-4400	7-15	11	22	-	35
KC2-19+	2	1100-1900	2200-3800	5-10	10.5	24	-	30
LK-3000+	2	70-1500	140-3000	12-15	10.5	27	-	35
SYK-2-33+	2	50-1500	100-3000	11-15	11.5	30	-	33
KC2-11+	2	500-1100	1000-2200	5-10	10.5	27	-	34
SYK-2R	2	10-1000	20-2000	12-16	10.5	35	-	42
SYK-2R+	2	10-1000	20-2000	12-16	10.5	35	-	42
AMK-2-13+	2	10-500	20-1000	4-10	11.4	45	-	45
RMK-3-153+	3	2600-5000	7800-15000	7-11	17	1	48	50
RMK-3-1262+	3	2250-4200	6750-12600	7-11	15.5	5	45	50
RMK-3-123+	3	2200-4000	6600-12000	13-17	15.5	5	33	45
RMK-3-1052+	3	2200-3500	6600-10500	7-11	14.5	6	52	50
RMK-3-14+	3	2200-3335	6600-10005	13-17	14.5	6	40	37
RMK-3-93+	3	1800-3000	5400-9000	7-11	15	6	55	55
RMK-3-812+	3	1800-2700	5400-8100	0-6	16	6	40	37
RMK-3-722+	3	1525-2400	4575-7200	7-11	14	3	55	55



Frequency Multipliers — Surface Mount Continued

Model Number	Multiply Factor [X]	Input Frequency Range (MHz)	Output Frequency Range (MHz)	RF Input Power Range (dBm)	Conv. Loss (dB)	F1 Fundamental Suppression Below F[X] (dBc)	F[X-1] Suppression Below F[X] (dBc)	F[X+1] Suppression Below F[X] (dBc)
RMK-3-662+	3	1600-2200	4800-6600	9-13	15	6	45	38
AMK-3-452+	3	1000-1500	3000-4500	10-14	14.5	-2	55	55
RMK-3-332+	3	700-1100	2100-3300	10-15	15.6	3	40	37
RMK-3-33+	3	700-1000	2100-3000	12-17	17	4.5	47.5	43.5
RMK-3-212+	3	400-700	1200-2100	12-17	17	-1.4	50	53
RMK-3-122+	3	300-400	900-1200	0-6	14.5	6	48	52
RMK-3-31+	3	9-12	27-36	12-17	14	4	60	60
RMK-3-92+	3	150-300	450-900	12-17	14	-1	66	67
RMK-3-451+	3	100-150	300-450	12-17	13.2	4	52	50
RKK-4-442+	4	900-1100	3600-4400	19-23	24.5	27	23	31
RKK-4-252+	4	430-630	1720-2520	16-19	25	33	30	35
RKK-4-23+	4	320-500	1280-2000	11-15	24.5	27	38	30
RKK-4-112+	4	200-275	800-1100	17-23	22.5	36	30	23
RMK-5-83+	5	1000-1600	5000-8000	7-11	28	-3.5	56.2	58.3
RMK-5-472+	5	675-950	3375-4750	10-15	22	4	55	60
RMK-5-352+	5	550-700	2750-3500	17-17	22	6.5	40	40
RMK-5-2751+	5	450-550	2250-2750	17-17	22	4.8	54	57
RMK-5-2251+	5	300-450	1500-2250	17-17	21	5.3	52	56
RMK-5-13+	5	150-200	750-1000	17-17	21.2	2	63	68
RMK-5-751+	5	100-150	500-750	17-17	22	-1	60	67
RMK-5-571+	5	70-115	350-575	22-24	21	2	43	42
RMK-5-52+	5	50-100	250-500	17-17	22	2	56	57
RMK-5-51+	5	7.5-10.5	37.5-52.5	0-5	22.9	-1.3	39	37
RMK-7-81+	7	7.5-11.5	52.5-80.5	8-12	27	3	47	45

Frequency Multipliers — Bare Die

Model Number	Multiply Factor [X]	Input Frequency Range (MHz)	Output Frequency Range (MHz)	RF Input Power Range (dBm)	Conv. Loss (dB)	F1 Fundamental Suppression Below F[X] (dBc)	F[X-1] Suppression Below F[X] (dBc)	F[X+1] Suppression Below F[X] (dBc)
CY2-44-D+	2	7000-20000	14000-40000	12-18	13	30	-	30
CY2-283-D+	2	3500-14000	7000-28000	12-18	13	35	-	34
CY2-143-D+	2	2000-7000	4000-14000	12-18	12	30	-	32

Frequency Multipliers — Coaxial

Model Number	Multiply Factor [X]	Input Frequency Range (MHz)	Output Frequency Range (MHz)	RF Input Power Range (dBm)	Conv. Loss (dB)	F1 Fundamental Suppression Below F[X] (dBc)	F[X-1] Suppression Below F[X] (dBc)	F[X+1] Suppression Below F[X] (dBc)	Connector Type
ZX90-2-24-S+	2	5000-10000	10000-20000	11-16	12	30	-	30	SMA
ZXF90-2-24-K+	2	6000-10000	12000-20000	16-22	17	35	38	20	2.92mm
ZXF90-2-183-K+	2	6000-9000	12000-18000	14-20	17	35	43	20	2.92mm
ZXF90-2-153-K+	2	4500-7500	9000-15000	16-22	15	48	42	23	2.92mm
ZX90-2-50-S+	2	3500-5000	7000-10000	7-12	12.5	15	-	28	SMA
ZX90-2-36-S+	2	1700-3600	3400-7200	8-13	11	28	-	32	SMA
ZX90-2-19-S+	2	1100-1900	2200-3800	5-10	10.5	27	-	30	SMA
FK-3000+	2	70-1500	140-3000	12-15	11	25	-	30	SMA
ZX90-2-11-S+	2	500-1100	1000-2200	5-10	10.5	27	-	34	SMA
FK-5	2	10-1000	20-2000	10-20	13	20	-	20	BNC
MK-5	2	10-1000	20-2000	10-20	13	20	-	26	SMA
FD-2+	2	5-500	10-1000	1-15	13	30	-	40	BNC
MK-2	2	5-500	10-1000	1-15	13	25	-	40	SMA
ZX90-2-13-S+	2	10-500	20-1000	4-10	11	45	-	45	SMA
MK-3	2	0.05-150	0.1-300	0-13	11	35	-	40	SMA
ZX90-3-812-S+	3	2000-2700	6000-8100	0-5	15	30	48	48	SMA
ZX90-3-692-S+	3	1700-2300	5100-6900	9-13	14.7	40	40	40	SMA
ZX90-3-452-S+	3	1000-1500	3000-4500	10-16	14.7	40	55	55	SMA
ZX90-3-122-S+	3	300-400	900-1200	0-6	16	48	60	70	SMA
ZX90-12-63-S+	12	375-500	4500-6000	-4-0	6.5	65	26	26	SMA



Frequency Multipliers — Plug-In

Model Number	Multiply Factor [X]	Input Frequency Range (MHz)	Output Frequency Range (MHz)	RF Input Power Range (dBm)	Conv. Loss (dB)	F1 Fundamental Suppression Below F[X] (dBc)	F[X-1] Suppression Below F[X] (dBc)	F[X+1] Suppression Below F[X] (dBc)
AK-3000+	2	70-1500	140-3000	12-15	10.5	25	-	30
RK-5+	2	10-800	20-1600	10-20	12.5	20	-	30
AK-2+	2	1-500	2-1000	1-10	13.5	30	-	40
RK-2+	2	5-500	10-1000	1-15	13.5	30	-	40
SK-2+	2	1-500	2-1000	1-10	13.5	30	-	40
RK-3+	2	0.05-150	0.1-300	0-13	11	35	-	40



Vendor
Partner Award

Modelithics



Your extensive design data in particular makes it very easy to select and thereafter simulate and evaluate a design. Thank you!

— KENNETH K, ANTRACOM

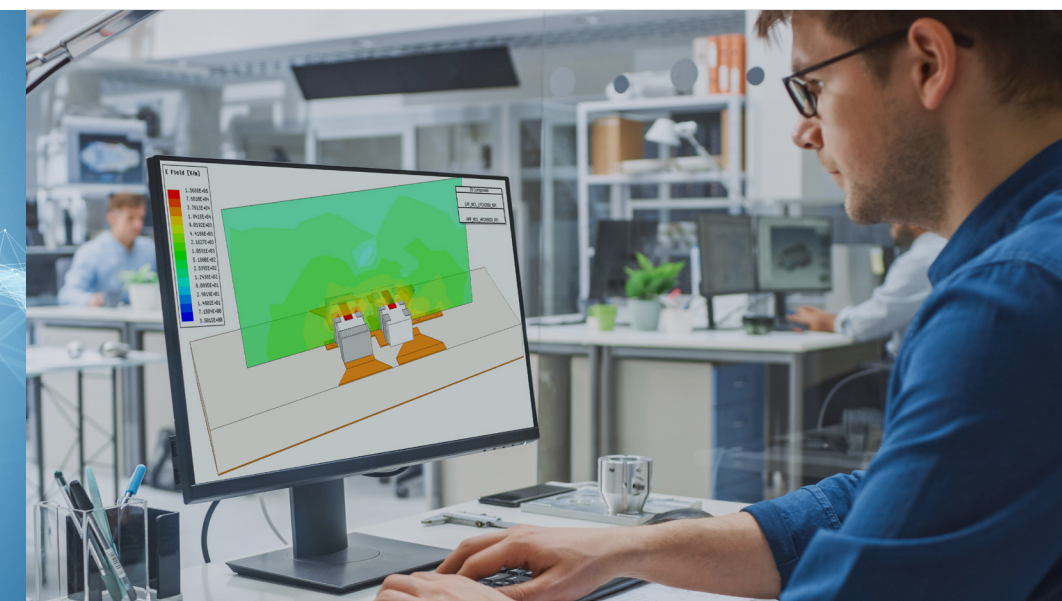

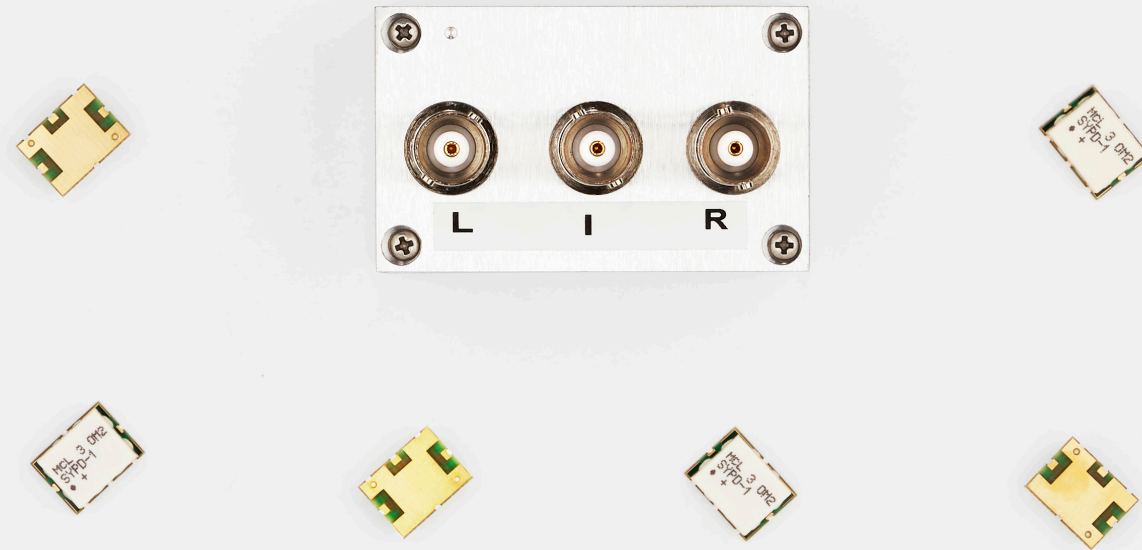

1 TO 650 MHZ

Phase Detectors

For PLLs, Monitoring and Levelling Circuits

- High DC output vs. phase, up to 1V
- Low DC offset
- Connectorized and surface mount designs
- Designer's kits available



Phase Detectors – Surface Mount

Model Number	Frequency Range (MHz)	RF Power In (dBm)	Scale Factor (mV/deg.)	DC Out Impedance (Ω)	RF1 - RF2 Isolation (dB) Min.	Output Polarity with RF in phase	DC Output (mV)	DC Offset (mV)	Figure of Merit M
SYPD-52W+	300-650	7	8	500	28	neg.	900	0.9	129
SYPD-52+	400-500	7	8	500	30	neg.	900	0.7	129
SYPD-2+	10-200	7	8	500	40	neg.	1000	0.3	143
SYPD-1+	1-100	7	8	500	40	neg.	1000	0.2	143

Phase Detectors – Coaxial

Model Number	Frequency Range (MHz)	RF Power In (dBm)	Scale Factor (mV/deg.)	DC Out Impedance (Ω)	RF1 - RF2 Isolation (dB) Min.	Output Polarity with RF in phase	DC Output (mV)	DC Offset (mV)	Figure of Merit M	Connector Type
ZRPD-1+	1-100	7	8	500	40	neg.	1000	0.2	143	BNC

Phase Detectors – Plug-In

Model Number	Frequency Range (MHz)	RF Power In (dBm)	Scale Factor (mV/deg.)	DC Out Impedance (Ω)	RF1 - RF2 Isolation (dB) Min.	Output Polarity with RF in phase	DC Output (mV)	DC Offset (mV)	Figure of Merit M
MPD-21+	50-400	7	7	500	40	neg.	800	0.5	120
MPD-2+	10-200	7	8	500	40	neg.	1000	0.3	143
RPD-2+	5-150	7	8	500	40	neg.	1000	0.3	143
MPD-1+	1-100	7	8	500	40	neg.	1000	0.2	143
RPD-1+	1-100	7	8	500	40	neg.	1000	0.2	143



Phase Detector Designer Kits

Model Number	Model Series	Description	Package	Models Included in Kit	Qty. Ea.	Total Qty.
K-PD	MPD SYPD	1 to 400 MHz	Plug-In, Leadless SMT	MPD-1+ MPD-2+ MPD-21+ SYPD-1+ SYPD-2+	1	5



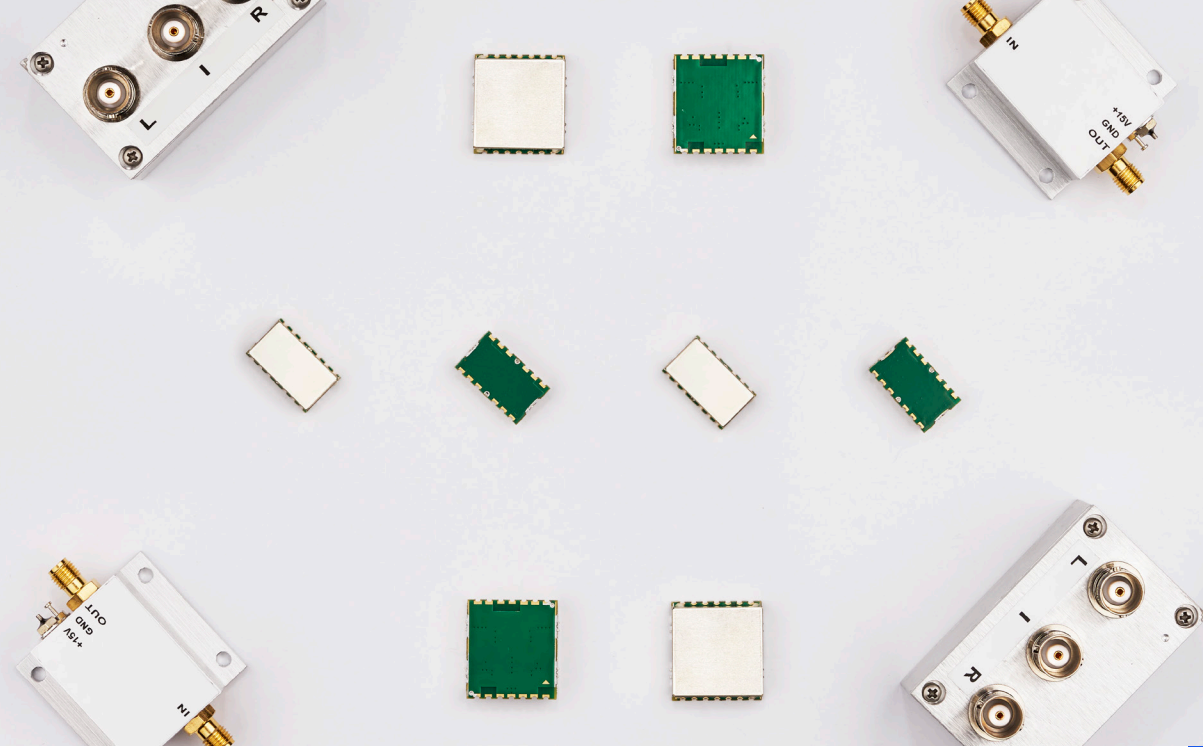

1.8 TO 2484 MHZ

Phase Shifters

Precise Control up to 360°

- 180° and 360° models
- Low insertion loss
- Excellent VSWR
- Connectorized and surface mount interfaces



Phase Shifters — Surface Mount 180°

Model Number	Frequency Range (MHz)	Phase Range (deg.) Min.	Insertion Loss (dB)	Insertion Loss (dB), Max.	Control Voltage (V)	Control Bandwidth (kHz)	VSWR (:1)	PCB Layout
JSPHS-2484+	2150-2484	180	2	5.6	0-15	DC-50	1.5	30
JSPHS-23+	1700-2000	180	2	3.5	0-15	DC-50	1.5	30
JSPHS-1000+	700-1000	160	1.2	2.3	0-15	DC-50	1.2	30
JSPHS-661+	400-660	180	1.2	2.5	0-12	DC-50	1.2	30
JSPHS-446+	366-446	180	1.2	2.5	0-12	DC-50	1.2	214
JSPHS-42+	300-400	180	1.4	2.8	0-12	DC-50	1.3	214
SPHSA-251+	150-250	180	1.5	2.5	0-15	DC-30	1.3	408
JSPHS-150+	100-150	180	1.2	2.5	0-12	DC-30	1.2	214
JSPHS-51+	36-54	180	1.2	2.5	0-12	DC-50	1.2	30

Phase Shifters — Surface Mount 360°

Model Number	Frequency Range (MHz)	Phase Range (deg.) Min.	Insertion Loss (dB)	Insertion Loss (dB), Max.	Control Voltage (V)	Control Bandwidth (kHz)	VSWR (:1)	PCB Layout
SPHSA-152+	800-1500	360	2.8	4.5	0-15	DC-50	1.2	408
SCPHS-51+	25-48	360	2	5	0-15	DC-30	1.3	690
SCPHS-13.6+	10-16	360	2	3.5	0-12	DC-30	1.2	690

Phase Shifters — Coaxial 360°

Model Number	Frequency Range (MHz)	Phase Range (deg.) Min.	Insertion Loss (dB)	Insertion Loss (dB), Max.	Control Voltage (V)	Control Bandwidth (kHz)	VSWR (:1)	Connector Type
ZXPHS-431-S+	250-430	360	3	5.5	0-15	DC-50	1.5	SMA





10 MHZ TO 40 GHZ

Power Detectors

Wide Bandwidth and Dynamic Range

- Input power range spanning -60 to +20 dBm
- Linear response (in dB)
- Fast response time, as little as 400 nsec rise time and 10 nsec fall time
- Low noise
- Single positive supply voltage

Ideal for a wide range of applications:

RF/IF power measurement, transmit/receive power monitoring, RF leakage monitors, fast-feedback levelling circuits, automatic gain control systems and more



Power Detectors — Coaxial

Model Number	Frequency Range (MHz)	Dynamic Range @ ±1 dB Error (dBm)	Output Voltage Range (V)	VSWR (:1)	Pulse Response Rise Time (nsec)	Pulse Response Fall Time (nsec)	Supply Voltage (V)	Supply Current (mA)	Connector Type
ZV47-K44+	500-43500	-30 to +15	0 - 4.30	2.4	4	50	5	3	2.92mm
ZV47-K44RMS+	100-40000	-35 to 0	0 - 1.20	1.6	2900	8100	3.3	30	2.92mm
ZX47-40-S+	10-8000	-40 to +20	0.50 - 2.10	1.2	400	10	4.5	100	SMA
ZX47-40LN-S+	10-8000	-40 to +20	0.50 - 2.10	1.2	800	400	4.5	100	SMA
ZX47-50-S+	10-8000	-45 to +15	0.50 - 2.10	1.2	400	10	4.5	100	SMA
ZX47-50LN-S+	10-8000	-45 to +15	0.50 - 2.10	1.2	800	400	4.5	100	SMA
ZX47-55-S+	10-8000	-50 to +10	0.50 - 2.10	1.4	400	10	4.5	100	SMA
ZX47-55LN-S+	10-8000	-50 to +10	0.50 - 2.10	1.4	800	400	4.5	100	SMA
ZX47-60-S+	10-8000	-60 to +5	0.50 - 2.10	1.7	400	10	5.0	100	SMA
ZX47-60LN-S+	10-8000	-60 to +5	0.50 - 2.10	1.7	800	400	5.0	100	SMA

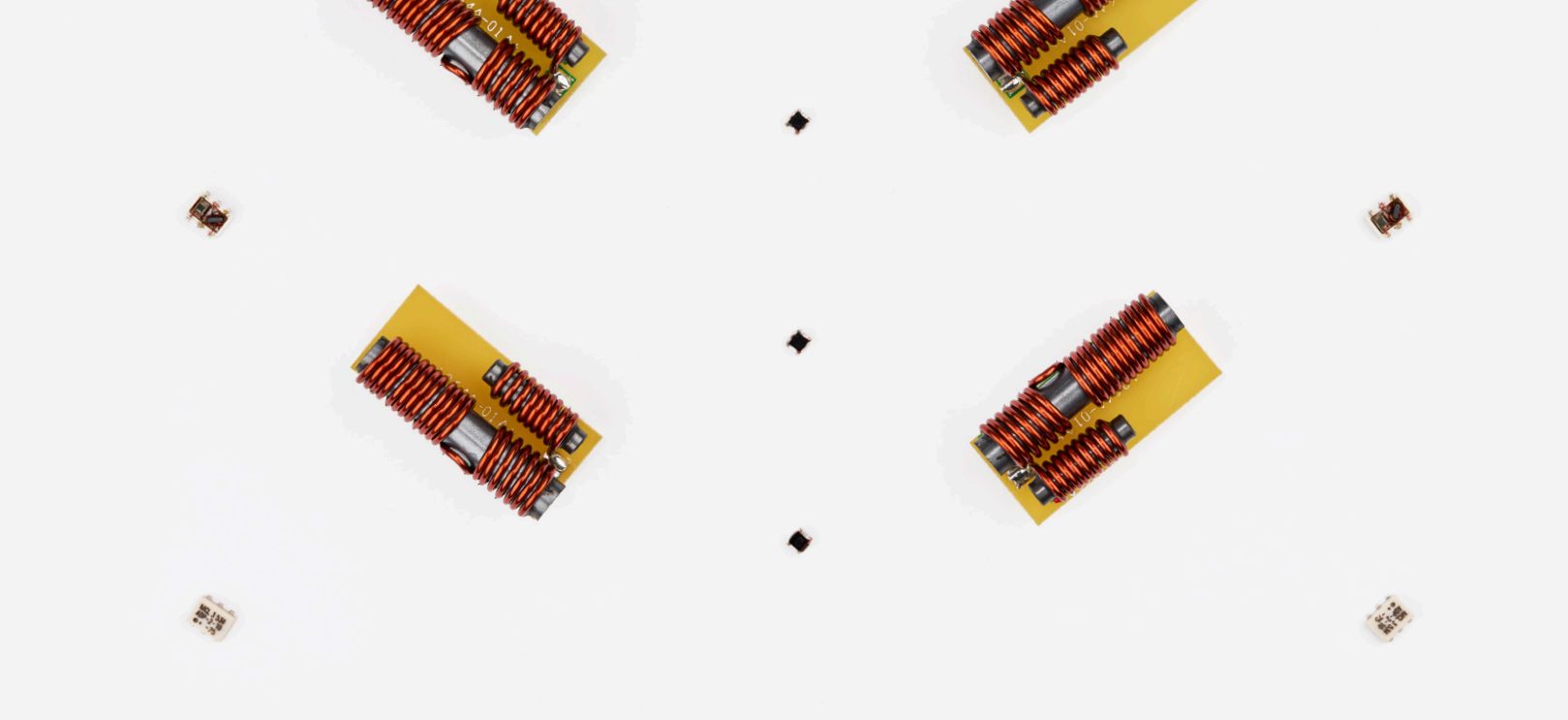

5 MHZ TO 10 GHZ

RF Chokes

Effective Wideband Parallel Resistance

- Low DC resistance
- Low parasitic capacitance
- DC current handling up to 15A
- Tiny surface mount packages as small as 0.5 x 0.15 x 0.15"

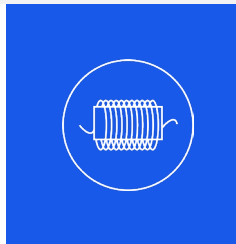

RF Chokes – Surface Mount

Model Number	Frequency Range (MHz)	Insertion Loss (dB)	Insertion Loss (dB), Max.	VSWR (:1)	VSWR (:1), Max.	DC Current (mA)	Inductance (μH) @ 0 mA	Inductance (μH) @ 100 mA	Inductance (μH) @ 200 mA
ADCH-80+	50-10000	0.3	2	1.1	1.6	100	7	1	-
ADCH-80A+	50-10000	0.3	2	1.1	1.6	100	7	1	-
TCCH-80+	50-8200	0.5	1.1	1.1	1.7	200	4	0.9	0.5
TACH-182-75+	5-1800	0.4	0.6	-	1.67	15000	5.4	-	-



// You are all ROCK STARS!

– BUYING SPECIALIST



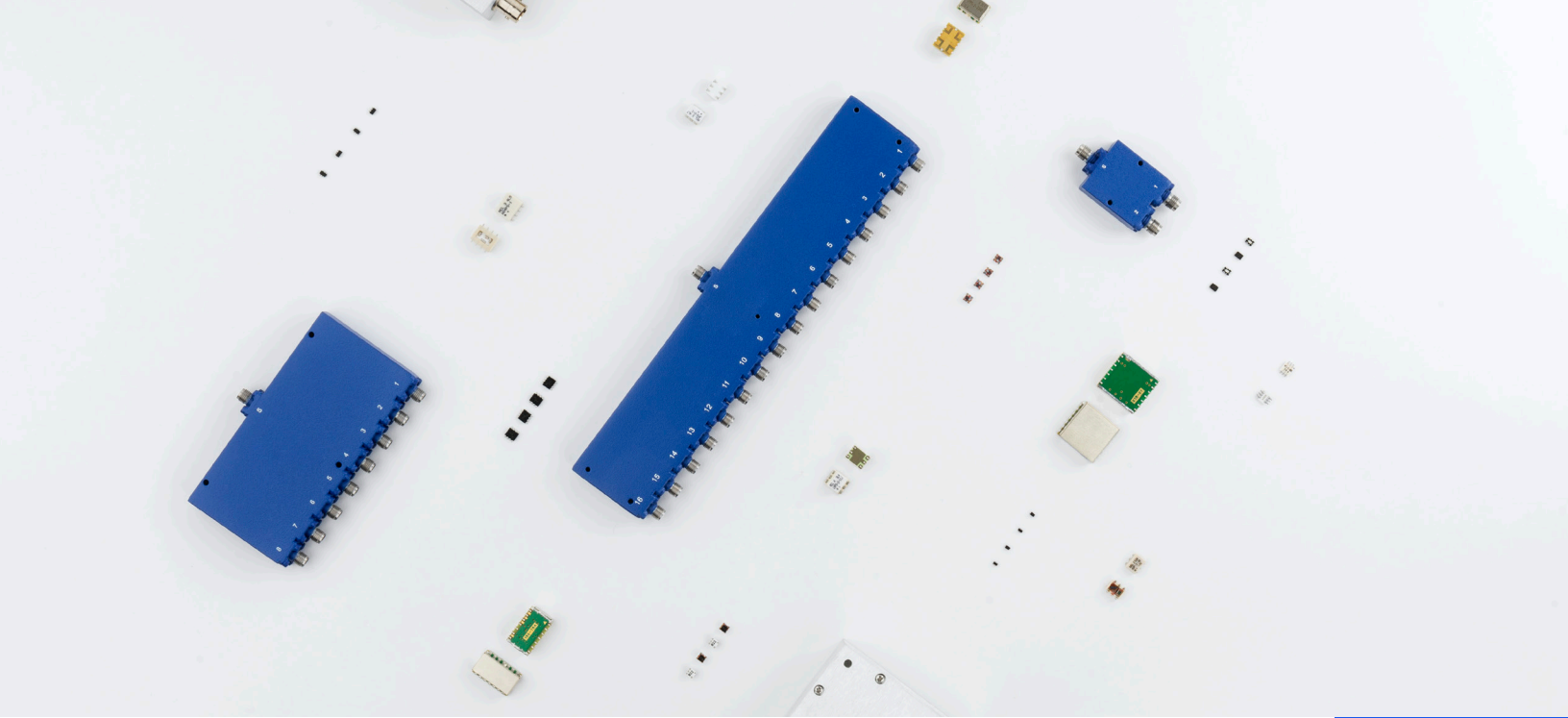

2 KHZ TO 65 GHZ

Power Splitters & Combiners

600+ in Stock

- 2-Way through 24-Way
- RF input power up to 100W
- Low insertion loss
- High isolation
- Connectorized, surface mount and MMIC die formats

Technology for every requiremen:

LTCC, MMIC, stripline, microstrip, core and wire, resistive



Technology Overview

Core & Wire

- Top Hat® feature improves speed and accuracy of pick and place assembly

- Tiny footprint
- Low insertion loss



LTCC

- Case styles as small as 0805
- Low insertion loss

- Power handling up to 20W
- ESD non-sensitive



Microstrip

- Excellent power handling in small, SMT form factor, up to 5W

- Bandwidths > 1 octave

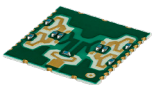

MMIC

- Widest surface mount bandwidths in the industry
- Hybrid architecture designs extend coverage down to DC

- Case styles as small as 1.4 x 2.0 mm
- QFN, SOT-343 and bare die formats

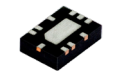

Resistive

- Wideband coverage down to DC
- Low insertion loss

- High isolation



Stripline

- Multi-octave bandwidths up to 65 GHz
- Power handling up to 20W

- Low insertion loss
- High isolation



Power Splitters & Combiners — Surface Mount 50Ω

Model Number	No. of Ways	Frequency Range (MHz)	Isolation (dB)	Insertion Loss (dB) Above Theoretical	Phase Unbalance (deg)	Amplitude Unbalance (dB)	Power Input (W) as Splitter, Max.	Feature	Technology
EP2-5G1+	2	12000-43500	23	1.3	1.7	0.1	0.5	-	MMIC
EP2KA+	2	10000-43500	17	2.2	9.6	0.57	1.25	DC Pass	MMIC
EP2-5G+	2	24000-30000	23	1.3	1.7	0.1	0.5	-	MMIC
EP2K1+	2	2000-26500	20	2.4	5.4	0.3	2.5	DC Pass	MMIC
EP2K+	2	5000-20000	20	2.1	4.2	0.1	2.5	DC Pass	MMIC
EP2RKU+	2	DC-18000	26.1	3.3	1.1	0.02	0.3	-	Resistive, MMIC
EP2C+	2	1800-12500	16	1.1	6	0.2	1.85	DC Pass	MMIC
EP2W1+	2	500-9500	19.4	1.8	1.7	0.1	2.5	DC Pass	MMIC
EP2RCW+	2	DC-8000	23.0	4.8	0.9	0.02	0.3	-	Resistive, MMIC
GP2X1+	2	2800-7200	22	0.8	10	0.4	1.5	-	MMIC
SCRP-2-682W+	2	DC-6800	19	0.8	3	0.3	0.5	-	Resistive
SCN-2-65+	2	5500-6500	17	0.8	2	0.1	4	-	LTCC
GP2X+	2	2900-6200	24	0.6	9	0.3	1.5	-	MMIC
EP2W+	2	700-6000	19.8	1.3	0.9	0.1	2.5	DC Pass	MMIC
SEPS-2-63+	2	680-6000	17	1	1.5	0.2	5	-	Microstrip
SCG-2-592+	2	3800-5900	15	0.8	1.5	0.1	2	-	LTCC
GP2Y1+	2	1550-4400	20	1	6	0.3	1.5	-	MMIC
SCG-2-422+	2	2800-4200	16	0.9	1.5	0.1	2	-	LTCC
SCN-2-45+	2	3700-4200	21	0.7	1.5	0.2	4	-	LTCC
SP-2W1+	2	2875-4200	20	0.8	8	0.2	0.75	DC Pass	MMIC
SP-2L+	2	2700-4000	18	0.75	8	0.3	0.75	DC Pass	MMIC
SP-2W+	2	3300-3800	25	0.5	7	0.2	0.75	DC Pass	MMIC
SCN-2-35	2	2825-3700	25	0.4	1	0.1	4	-	LTCC
SCN-2-35+	2	2825-3700	25	0.4	1	0.1	4	-	LTCC
GP2Y+	2	1600-3300	24	0.8	4	0.2	1.5	-	MMIC
SCG-2-322+	2	1800-3200	15	0.7	1.5	0.1	2	-	LTCC
BP2U1+	2	1750-3000	20	0.5	4	0.4	1.5	DC Pass	MMIC
RPS-2-30+	2	10-3000	22	0.9	4	0.6	0.5	-	Core & Wire

Power Splitters & Combiners — Surface Mount 50Ω Continued

Model Number	No. of Ways	Frequency Range (MHz)	Isolation (dB)	Insertion Loss (dB) Above Theoretical	Phase Unbalance (deg)	Amplitude Unbalance (dB)	Power Input (W) as Splitter, Max.	Feature	Technology
SEPS-2-33+	2	600-3000	22	0.8	1	0.15	5	-	Microstrip
SYPS-2-33+	2	400-3000	21	0.7	1	0.1	0.5	-	Core & Wire
TCP-2-33+	2	1000-3000	18	0.8	5	0.9	0.5	-	Core & Wire
TCP-2-33W+	2	50-3000	21	0.9	1.6	0.4	0.5	-	Core & Wire
TCP-2-33X+	2	1000-3000	18	0.8	5	0.9	0.5	-	Core & Wire
SP-2U2+	2	1720-2850	17	0.5	2	0.2	1.5	DC Pass	MMIC
SCN-2-27+	2	2225-2700	21	0.5	3.5	0.6	20	-	LTCC
TCP-2-272+	2	5-2700	20	0.9	2	0.3	0.5	-	Core & Wire
SBA-2-22+	2	2000-2600	18	0.8	10	0.8	2	-	LTCC
BP2U+	2	2100-2500	30	0.5	2	0.2	1.5	DC Pass	MMIC
GP2S1+	2	500-2500	20	0.9	5	0.2	1.5	DC Pass	MMIC
LRPS-2-25+	2	1700-2500	20	0.8	10	0.9	1	-	Core & Wire
LRPS-2-25J+	2	1700-2500	20	0.8	10	0.9	1	-	Core & Wire
SBTC-2-25+	2	1000-2500	20	1.4	14	1.2	1	-	Core & Wire
SBTC-2-25L+	2	1000-2500	20	1.4	14	1.2	1	-	Core & Wire
SBTC-2-25LX+	2	1000-2500	20	1.4	14	1.2	1	-	Core & Wire
SBTC-2-25X+	2	1000-2500	20	1.4	14	1.2	1	-	Core & Wire
SP-2U1+	2	2300-2500	22	0.5	2	0.2	1.5	DC Pass	MMIC
SYPS-2-252+	2	5-2500	18	0.7	3	0.3	0.5	-	Core & Wire
TCP-2-25+	2	200-2500	18	0.8	6	0.6	0.5	-	Core & Wire
TCP-2-25X+	2	200-2500	18	0.8	6	0.6	0.5	-	Core & Wire
SCG-2-242+	2	1000-2400	15	0.8	1.5	0.1	2	-	LTCC
BP2P1+	2	1400-2350	20	0.5	4	0.3	1.5	DC Pass	MMIC
SBB-2-23+	2	2000-2300	24	0.6	3	0.3	10	-	LTCC
SP-2U+	2	2100-2300	24	0.5	2	0.2	1.5	DC Pass	MMIC
SP-2P1+	2	1350-2250	20	0.5	3	0.2	1.5	DC Pass	MMIC
SBA-2-20+	2	1800-2200	22	0.5	7	0.7	2	-	LTCC
SCN-2-22+	2	1850-2200	22	0.5	2	0.25	20	-	LTCC



Power Splitters & Combiners — Surface Mount 50Ω Continued

Model Number	No. of Ways	Frequency Range (MHz)	Isolation (dB)	Insertion Loss (dB) Above Theoretical	Phase Unbalance (deg)	Amplitude Unbalance (dB)	Power Input (W) as Splitter, Max.	Feature	Technology
SBTC-2-22-75L+	2	500-2150	28	1.9	2	0.7	0.5	-	Core & Wire
GP2S+	2	800-2100	24	0.8	4	0.2	1.5	DC Pass	MMIC
SBB-2-21W+	2	1700-2100	22	0.6	4	0.3	10	-	LTCC
ADP-2-20+	2	20-2000	18	0.7	3	0.3	1	-	Core & Wire
BP2G1+	2	1200-2000	21	0.6	3	0.3	1.5	DC Pass	MMIC
LRPS-2-11+	2	20-2000	21	0.7	3	0.3	1	-	Core & Wire
LRPS-2-11A+	2	20-2000	21	0.7	3	0.3	1	-	Core & Wire
LRPS-2-11J+	2	20-2000	21	0.7	3	0.3	1	-	Core & Wire
SBA-2-18+	2	1600-2000	19	0.4	6	0.6	2	-	LTCC
SBTC-2-20+	2	200-2000	20	0.8	10	0.8	0.5	-	Core & Wire
SBTC-2-20L+	2	200-2000	20	0.8	10	0.8	0.5	-	Core & Wire
SBTC-2-20LX+	2	200-2000	20	0.8	10	0.8	0.5	-	Core & Wire
SBTC-2-20X+	2	20-2000	20	0.8	10	0.8	0.5	-	Core & Wire
SP-2G1+	2	1200-2000	20	0.7	4	0.2	1.5	DC Pass	MMIC
BP2P+	2	1710-1990	30	0.5	3	0.2	1.5	DC Pass	MMIC
SP-2P+	2	1710-1990	28	0.4	2	0.2	1.5	DC Pass	MMIC
NP2G+	2	1150-1950	13	0.4	0.8	0.1	1.5	-	MMIC
SCN-2-19+	2	1425-1900	23	0.5	2.5	0.25	20	-	LTCC
SBB-2-18+	2	1425-1800	22	0.6	4	0.3	10	-	LTCC
BP2G+	2	1420-1660	28	0.6	3	0.2	1.5	DC Pass	MMIC
SP-2G+	2	1420-1660	28	0.4	3	0.2	1.5	DC Pass	MMIC
SBA-2-14+	2	1200-1600	16	0.6	5	0.5	2	-	LTCC
SCN-2-15+	2	1100-1450	23	0.5	1.5	0.25	20	-	LTCC
SBB-2-13+	2	950-1300	24	0.6	3	0.6	10	-	LTCC
SCN-2-11+	2	800-1175	20	0.5	1	0.1	20	-	LTCC
BP2C1+	2	650-1100	20	0.4	3	0.2	1.5	DC Pass	MMIC
SP-2C1+	2	640-1100	20	0.4	2	0.2	1.5	DC Pass	MMIC
ADP-2-4+	2	10-1000	23	0.4	3	0.2	1	-	Core & Wire

Power Splitters & Combiners — Surface Mount 50Ω Continued

Model Number	No. of Ways	Frequency Range (MHz)	Isolation (dB)	Insertion Loss (dB) Above Theoretical	Phase Unbalance (deg)	Amplitude Unbalance (dB)	Power Input (W) as Splitter, Max.	Feature	Technology
ADP-2-10+	2	5-1000	23	0.4	2	0.2	0.5	-	Core & Wire
JPS-2-4+	2	100-1000	22	0.5	5	0.4	1	-	Core & Wire
LRPS-2-4+	2	10-1000	23	0.4	3	0.2	1	-	Core & Wire
LRPS-2-4J+	2	10-1000	23	0.4	3	0.2	1	-	Core & Wire
SBB-2-10+	2	800-1000	24	0.6	3	0.3	10	-	LTCC
SBTC-2-10+	2	5-1000	18	0.3	3	0.5	0.5	-	Core & Wire
SBTC-2-10L+	2	5-1000	18	0.3	3	0.5	0.5	-	Core & Wire
SBTC-2-10LX+	2	5-1000	18	0.3	3	0.5	0.5	-	Core & Wire
SBTC-2-10X+	2	5-1000	18	0.3	3	0.5	0.5	-	Core & Wire
SCN-2-10+	2	600-1000	15	0.5	1.7	0.1	1	-	LTCC
TCP-2-10+	2	5-1000	25	0.5	4	0.6	0.5	-	Core & Wire
TCP-2-10X+	2	5-1000	25	0.5	4	0.6	0.5	-	Core & Wire
LRPS-2-980+	2	800-980	30	0.5	3	0.5	1	-	Core & Wire
LRPS-2-980J+	2	800-980	30	0.5	3	0.5	1	-	Core & Wire
BP2C+	2	810-960	25	0.4	3	0.2	1.5	DC Pass	MMIC
SP-2C+	2	780-960	28	0.4	2	0.2	1.5	DC Pass	MMIC
ADP-2-9+	2	200-900	27	0.4	2	0.3	0.5	-	Core & Wire
JPS-2-900+	2	400-900	24	0.5	3	0.4	1	-	Core & Wire
JPS-2-1W+	2	3-750	28	0.4	2	0.3	1	-	Core & Wire
ADP-2-1W+	2	1-650	30	0.25	2	0.2	2	-	Core & Wire
JPS-2-1N+	2	350-550	30	0.25	3	0.3	1	-	Core & Wire
SCP-2-1A+	2	1-550	25	0.3	2	0.2	1	-	Core & Wire
SYPS-2-52HP+	2	10-540	25	0.3	1.5	0.1	15	-	Core & Wire
JPS-2-1+	2	1-500	30	0.25	2	0.2	1	-	Core & Wire
LRPS-2-1+	2	5-500	33	0.3	2	0.2	1	-	Core & Wire
LRPS-2-1J+	2	5-500	33	0.3	2	0.2	1	-	Core & Wire
SYPS-2-1+	2	2-500	32	0.3	3	0.3	1	-	Core & Wire
ADP-2-1+	2	0.5-400	25	0.3	2	0.2	0.5	-	Core & Wire



Power Splitters & Combiners — Surface Mount 50Ω Continued

Model Number	No. of Ways	Frequency Range (MHz)	Isolation (dB)	Insertion Loss (dB) Above Theoretical	Phase Unbalance (deg)	Amplitude Unbalance (dB)	Power Input (W) as Splitter, Max.	Feature	Technology
SCP-2-1+	2	0.1-400	30	0.2	2	0.2	1	-	Core & Wire
SYPS-2-22HP+	2	2-200	22	0.6	1.5	0.1	5	-	Core & Wire
SCG-3-592+	3	4400-5900	17	1.2	5	0.4	2	-	LTCC
SEPS-3-33+	3	700-3000	18	0.9	2	0.5	4	-	Microstrip
SCN-3-28+	3	1600-2800	12	0.8	5	0.2	15	-	LTCC
SCG-3-272+	3	1800-2700	16	1.1	5	0.4	2	-	LTCC
SCG-3-262+	3	1600-2600	17	1.2	5	0.4	2	-	LTCC
SCG-3-162+	3	900-1600	18	1.2	5	0.2	2	-	LTCC
SCN-3-16+	3	950-1600	15	0.6	3	0.2	15	-	LTCC
SYPS-3-142W+	3	5-1450	19	1.5	5	0.5	1	-	Core & Wire
SCN-3-13+	3	750-1325	12	1	1	0.3	15	-	LTCC
SYPS-3-12W+	3	20-1200	22	1.2	4	0.7	1	-	Core & Wire
SCA-3-11+	3	100-940	20	0.7	7	0.7	0.5	-	Core & Wire
LRPS-3-850+	3	500-850	23	0.7	8	0.9	1	-	Core & Wire
LRPS-3-850J+	3	500-850	23	0.7	8	0.9	1	-	Core & Wire
JPS-3-1W+	3	50-750	26	0.9	7	0.6	1	-	Core & Wire
AD3PS-1+	3	1-300	35	0.4	4	0.3	0.5	-	Core & Wire
JPS-3-1+	3	5-300	33	0.3	4	0.4	1	-	Core & Wire
LRPS-3-1+	3	10-300	25	0.3	3	0.3	1	-	Core & Wire
LRPS-3-1J+	3	10-300	25	0.3	3	0.3	1	-	Core & Wire
SCP-3-1+	3	1-300	25	0.4	2	0.15	1	-	Core & Wire
EP4KA+	4	10700-31000	19.3	0.6	4.7	0.2	0.6	DC Pass	MMIC
EP4RKU+	4	DC-18000	18.8	3.8	1.9	0.2	0.6	-	Resistive , MMIC
WP4A+	4	5100-6500	25	0.9	8	0.5	1.5	-	MMIC
WP4F1+	4	4750-6200	28	1	9	0.6	1.5	-	MMIC
SRSC-4-63+	4	DC-6000	7	0.5	14	1.2	0.2	-	Resistive
WP4F+	4	5150-5875	29	1	7	0.5	1.5	-	MMIC
WP4S+	4	3400-4600	30	0.8	9	0.6	1.5	-	MMIC

Power Splitters & Combiners — Surface Mount 50Ω Continued

Model Number	No. of Ways	Frequency Range (MHz)	Isolation (dB)	Insertion Loss (dB) Above Theoretical	Phase Unbalance (deg)	Amplitude Unbalance (dB)	Power Input (W) as Splitter, Max.	Feature	Technology
WP4W1+	4	3000-4200	26	0.9	9	0.5	1.5	-	MMIC
WP4L+	4	2700-3800	24	0.7	9	0.5	1.5	-	MMIC
WP4W+	4	3300-3800	26	0.8	8	0.4	1.5	-	MMIC
BP4U1+	4	1850-3000	23	0.7	28	1.3	1.5	-	MMIC
SC4PS-33+	4	300-3000	17	1.6	7	0.4	1	-	Core & Wire
WP4R1+	4	2000-3000	24	0.7	7	0.5	1.5	-	MMIC
WP4U1+	4	1875-2800	24	0.7	5	0.5	1.5	-	MMIC
SEPS-4-272+	4	690-2700	20	1.3	4	0.4	5	-	Microstrip
WP4R+	4	2300-2700	26	0.7	6	0.4	1.5	-	MMIC
SBD-4-25+	4	1800-2600	20	1	8	0.7	10	-	LTCC
BP4P1+	4	1500-2500	21	0.8	25	0.8	1.5	-	MMIC
BP4U+	4	2100-2500	23	0.7	20	1.1	1.5	-	MMIC
WP4U+	4	2100-2500	28	0.7	4	0.5	1.5	-	MMIC
WP4P1+	4	1525-2375	26	0.9	4	0.4	1.5	-	MMIC
SEPS-4-222+	4	800-2200	20	1	6	0.6	5	-	Microstrip
WP4P+	4	1710-2025	29	0.7	4	0.4	1.5	-	MMIC
SCA-4-20+	4	1000-2000	15	1	5	0.9	5	-	LTCC
WP4G1+	4	1300-2000	26	0.8	5	0.5	1.5	-	MMIC
BP4P+	4	1710-1990	23	0.8	15	0.5	1.5	-	MMIC
WP4N+	4	1215-1900	23	0.7	5	0.5	1.5	-	MMIC
WP4G+	4	1420-1660	28	0.7	4	0.5	1.5	-	MMIC
SCA-4-132+	4	5-1300	21	1.5	8	0.9	0.5	-	Core & Wire
BP4C1+	4	750-1200	20	0.7	14	0.6	1.5	-	MMIC
WP4C1+	4	800-1150	22	0.7	4	0.5	1.5	-	MMIC
WP4M+	4	720-1125	22	0.7	3	0.5	1.5	-	MMIC
JS4PS-1W+	4	5-1000	26	0.8	5	0.7	0.5	-	Core & Wire
SCA-4-10+	4	5-1000	30	0.8	6	0.8	0.5	-	Core & Wire
SCP-4-4+	4	800-1000	24	0.7	12	1	1	-	Core & Wire



Power Splitters & Combiners — Surface Mount 50Ω Continued

Model Number	No. of Ways	Frequency Range (MHz)	Isolation (dB)	Insertion Loss (dB) Above Theoretical	Phase Unbalance (deg)	Amplitude Unbalance (dB)	Power Input (W) as Splitter, Max.	Feature	Technology
BP4C+	4	810-960	22	0.7	8	0.6	1.5		MMIC
WP4C+	4	810-960	24	0.8	3	0.5	1.5	-	MMIC
SCP-4-1W+	4	10-650	23	0.9	7	0.4	1	-	Core & Wire
SCPS-4-62+	4	1-650	26	1	2	0.3	1	-	Core & Wire
JS4PS-1+	4	80-520	36	0.8	5	0.5	0.75	-	Core & Wire
AD4PS-1+	4	1-500	30	0.5	5	0.5	0.5	-	Core & Wire
SCP-4-1+	4	1-400	26	0.6	4	0.3	1	-	Core & Wire
AD5PS-1+	5	1-400	25	0.3	6	0.4	0.5	-	Core & Wire
SCP-5-1+	5	2-200	29	0.3	3	0.3	1	-	Core & Wire
JCPS-6-3	6	75-425	23	0.9	9	0.7	0.25	-	Core & Wire
AD6PS-1+	6	2-250	30	0.2	6	0.4	0.5	-	Core & Wire
SEPS-8-153+	8	6000-15000	15	1.6	-	1.1	4	DC Pass	Microstrip
SEPS-8-272+	8	700-2700	20	1.8	7	1	5	-	Core & Wire
JCPS-8-10+	8	5-1000	22	1.2	10	0.7	0.5	-	Core & Wire
JCPS-8-850+	8	10-850	25	1	10	0.7	1	-	Core & Wire
JEPS-16-1W+	16	5-1000	23	1.5	13	1.2	0.5	-	Core & Wire

Power Splitters & Combiners — Surface Mount 75Ω

Model Number	No. of Ways	Frequency Range (MHz)	Isolation (dB)	Insertion Loss (dB) Above Theoretical	Phase Unbalance (deg)	Amplitude Unbalance (dB)	Power Input (W) as Splitter, Max.	Feature	Tech.
SYPS-2-282-75+	2	2-2750	20	0.5	2	0.2	0.5	-	Core & Wire
TCP-2-23-75+	2	900-2300	18	0.8	3	0.4	0.5	-	Core & Wire
TRPS2-232-75+	2	5-2300	22	0.8	2	0.1	0.5	-	Core & Wire
ADP-2-20-75+	2	5-2000	16	0.5	4	0.3	0.5	-	Core & Wire
TCP-2-182-75X+	2	10-1800	26	0.8	2	0.15	0.5	-	Core & Wire
SBTC-2-15-75+	2	500-1500	28	0.8	5	0.9	0.5	-	Core & Wire

Power Splitters & Combiners — Surface Mount 75Ω Continued

Model Number	No. of Ways	Frequency Range (MHz)	Isolation (dB)	Insertion Loss (dB) Above Theoretical	Phase Unbalance (deg)	Amplitude Unbalance (dB)	Power Input (W) as Splitter, Max.	Feature	Tech.
SBTC-2-15-75L+	2	500-1500	28	0.8	5	0.9	0.5	-	Core & Wire
SBTC-2-15-75LX+	2	500-1500	28	0.8	5	0.9	0.5	-	Core & Wire
SBTC-2-15-75X+	2	500-1500	28	0.8	5	0.9	0.5	-	Core & Wire
TCP-2-152-75X+	2	5-1500	28	0.8	1.5	0.25	0.5	-	Core & Wire
ADP-2-122-75+	2	5-1250	22	0.9	2	0.2	0.5	-	Core & Wire
CDP-2-122W-75+	2	1-1250	21	0.8	1.5	0.25	1	-	Core & Wire
TCP-2-122-75X+	2	5-1250	24	0.9	1.5	0.4	0.5	-	Core & Wire
ADP-2-10-75M+	2	5-1200	28	0.7	4	0.3	1	-	Core & Wire
CDP-2-122-75+	2	5-1200	25	0.6	2	0.2	1	-	Core & Wire
ADP-2-10-75+	2	50-1000	24	0.7	2	0.2	0.5	-	Core & Wire
ADP-2-10W-75+	2	5-1000	23	0.3	3	0.2	0.5	-	Core & Wire
CDP-2-13-75+	2	5-1000	25	0.6	3	0.3	1	-	Core & Wire
JPS-2-4-75+	2	20-1000	29	0.4	2	0.2	1	-	Core & Wire
JYPS-2-4-75+	2	5-1000	25	0.4	4	0.3	0.5	-	Core & Wire
SBTC-2-10-75+	2	10-1000	28	0.6	3	0.6	0.5	-	Core & Wire
SBTC-2-10-75L+	2	10-1000	28	0.6	3	0.6	0.5	-	Core & Wire
SBTC-2-10-75LX+	2	10-1000	28	0.6	3	0.6	0.5	-	Core & Wire
SBTC-2-10-75X+	2	10-1000	28	0.6	3	0.6	0.5	-	Core & Wire
SBTC-2-10-5075+	2	50-1000	25	0.7	3	0.6	0.5	Impedance matching	Core & Wire
SBTC-2-10-7550+	2	5-1000	24	0.6	3	0.5	0.5	Impedance matching	Core & Wire
SBTC-2-105075X+	2	50-1000	25	0.7	3	0.6	0.5	Impedance matching	Core & Wire
SBTC-2-107550X+	2	5-1000	24	0.6	3	0.5	0.5	Impedance matching	Core & Wire
TCP-2-10-75+	2	5-1000	29	0.3	4	0.6	0.5	-	Core & Wire
TCP-2-10-75X+	2	5-1000	29	0.3	4	0.6	0.5	-	Core & Wire
JPS-2-1-75+	2	5-500	35	0.15	2	0.2	1	-	Core & Wire
LRPS-2-1-75+	2	2-500	35	0.35	2	0.2	1	-	Core & Wire

Power Splitters & Combiners — Surface Mount 75Ω Continued

Model Number	No. of Ways	Frequency Range (MHz)	Isolation (dB)	Insertion Loss (dB) Above Theoretical	Phase Unbalance (deg)	Amplitude Unbalance (dB)	Power Input (W) as Splitter, Max.	Feature	Tech.
LRPS-2-1-75J+	2	2-500	35	0.35	2	0.2	1	-	Core & Wire
SYPS-3-12W-75+	3	20-1200	22	1.2	4	0.7	1	-	Core & Wire
SCA-4-15-75+	4	10-1500	19	1.2	9	0.9	0.5	-	Core & Wire
SXPS-4-13-75+	4	5-1300	22	1.2	1	0.15	0.25	-	Core & Wire
SCA-4-10-75+	4	10-1000	30	1.5	9	0.9	0.5	-	Core & Wire
SCP-4-4-75+	4	10-1000	32	0.65	6	0.4	1	-	Core & Wire
JS4PS-1W-75	4	5-750	35	0.6	5	0.3	0.25	-	Core & Wire
SCP-4-1W-75+	4	10-750	32	0.65	3	0.4	0.5	-	Core & Wire
JCPS-8-850-75+	8	10-850	25	1	-	0.7	1	-	Core & Wire

Power Splitters & Combiners — Bare Die 50Ω

Model Number	No. of Ways	Frequency Range (MHz)	Isolation (dB)	Insertion Loss (dB) Above Theoretical	Phase Unbalance (deg)	Amplitude Unbalance (dB)	Power Input (W) as Splitter, Max.	Feature	Technology
EP2KA-D+	2	10000-43500	22	0.9	6.1	0.22	1.25	DC Pass	MMIC
EP2K-D+	2	2000-26500	18.9	1.6	6	0.2	2.5	DC Pass	MMIC
EP2RKU-D+	2	DC-18000	23	2.9	0.6	0.1	0.6	-	Resistive, MMIC
EP2C-D+	2	1800-12500	19.7	0.9	3.2	0.09	1.85	DC Pass	MMIC
EP2W-D+	2	500-9500	19.4	1.8	1.7	0.1	2.5	DC Pass	MMIC
EP2RCW-D+	2	DC-8000	22.3	4.5	0.1	0.1	0.6	-	Resistive, MMIC
EP4KA-D+	4	10700-31000	18.8	3.8	1.9	0.2	0.6	DC Pass	MMIC
EP4RKU-D+	4	DC-18000	23	4.8	0.9	0.2	0.6	-	Resistive, MMIC
WP4R-D+	4	2000-3000	24	0.7	2	0.1	1.5	-	MMIC
WP4P1-D+	4	1525-2375	26	0.9	2	0.2	1.5	-	MMIC

Power Splitters & Combiners — Coaxial 50Ω

Model Number	No. of Ways	Frequency Range (MHz)	Isolation (dB)	Insertion Loss (dB) Above Theoretical	Phase Unbalance (deg)	Amplitude Unbalance (dB)	Power Input (W) as Splitter, Max.	Feature	Tech.	Connector Type
ZC2PD-E1653+	2	1000-65000	32	1.8	1.3	0.1	12	DC Pass	Stripline	1.85mm
ZC2PD-E2653+	2	2000-65000	30	1.2	1.9	0.1	12	DC Pass	Stripline	1.85mm
ZC2PD-E6653+	2	6000-65000	31	1	1.7	0.06	12	DC Pass	Stripline	1.85mm
ZC2PD-E18653+	2	18000-65000	29	1.2	2.5	0.13	12	DC Pass	Stripline	1.85mm
ZC2PD-E40653+	2	40000-65000	24	1.2	2.5	0.06	12	DC Pass	Stripline	1.85mm
ZN2PD-E653+	2	10000-65000	22	1.2	10.7	0.64	10	DC Pass	-	1.85mm
ZC2PD-E1864+	2	18000-60000	28	1	1.6	0.1	12	DC Pass	Stripline	1.85mm
ZC2PD-V154+	2	1000-50000	32	1.9	1.2	0.11	16	DC Pass	Stripline	2.4mm
ZC2PD-V254+	2	2000-50000	28	1.0	1.3	0.09	16	DC Pass	Stripline	2.4mm
ZC2PD-V654+	2	6000-50000	27	0.9	0.8	0.06	16	DC Pass	Stripline	2.4mm
ZC2PD-V1854+	2	18000-50000	28	0.75	0.71	0.08	16	DC Pass	Stripline	2.4mm
ZC2PD-V2654+	2	26000-50000	26	1.0	1.1	0.06	16	DC Pass	Stripline	2.4mm
ZN2PD-V54+	2	10000-50000	23	1.8	2.7	0.13	10	DC Pass	-	2.4mm
ZC2PD-V18443+	2	18000-44000	29	0.7	0.9	0.04	20	DC Pass	Stripline	2.4mm
ZC2PD-V24443+	2	24000-44000	30	0.9	1.2	0.04	16	DC Pass	Stripline	2.4mm
ZC2PD-K5R44W+	2	500-40000	35	1.9	1	0.1	20	DC Pass	-	2.92mm
ZC2PD-K0144+	2	1000-40000	36	0.9	1.1	0.05	20	DC Pass	-	2.92mm
ZC2PD-K0244+	2	2000-40000	32	0.8	0.5	0.04	20	DC Pass	-	2.92mm
ZC2PD-K0644+	2	6000-40000	29	0.7	1.3	0.03	20	DC Pass	Stripline	2.92mm
ZC2PD-K1844+	2	18000-40000	27	0.8	1.1	0.05	20	DC Pass	-	2.92mm
ZN2PD-44-V+	2	10000-40000	21	1.0	3.9	0.07	10	DC Pass	-	2.4mm
ZN2PD-K44+	2	10000-40000	20	0.9	10	0.6	10	DC Pass	-	2.92mm
ZC2PD-5R263-S+	2	500-26500	35	1.2	0.6	0.05	14	DC Pass	-	SMA
ZC2PD-01263-S+	2	1000-26500	33	0.7	0.7	0.04	14	DC Pass	-	SMA
ZC2PD-02263-S+	2	2000-26500	31	0.6	0.69	0.04	14	DC Pass	-	SMA
ZC2PD-06263-S+	2	6000-26500	27	0.4	0.4	0.03	14	DC Pass	Stripline	SMA
ZC2PD-18263-S+	2	18000-26500	29	0.7	1	0.03	11	DC Pass	Stripline	SMA
ZFRSC-183+	2	DC-18000	6.5	0.7	7	0.5	0.16	-	Resistive	SMA

Power Splitters & Combiners — Coaxial 50Ω Continued

Model Number	No. of Ways	Frequency Range (MHz)	Isolation (dB)	Insertion Loss (dB) Above Theoretical	Phase Unbalance (deg)	Amplitude Unbalance (dB)	Power Input (W) as Splitter, Max.	Feature	Tech.	Connector Type
ZN2PD-183W-S+	2	500-18000	24	0.8	1.1	0.05	20	DC Pass	Stripline	SMA
ZN2PD-02183-S+	2	2000-18000	20	0.5	4	0.3	10	DC Pass	-	SMA
ZX10-2-183-S+	2	1500-18000	20	1	4	0.2	30	DC Pass	-	SMA
ZX10-2-143M-S+	2	4000-14000	20	1.1	6	0.5	2.5	DC Pass	-	SMA
ZX10-2-126-S+	2	7400-12600	23	0.3	10	0.5	1	DC Pass	-	SMA
ZX10-2-1252-S+	2	1800-12500	20	1.1	12	0.9	1.85	DC Pass	-	SMA
ZFRSC-123+	2	DC-12000	19.5	3.5	3	0.25	0.16	-	Resistive	SMA
ZN2PD2-14W-S+	2	500-10500	20	0.9	2	0.1	35	DC Pass	-	SMA
ZFSC-2-10G+	2	2000-10000	20	0.6	12	0.5	1	DC Pass	-	SMA
ZX10R-14-S+	2	DC-10000	6	0.5	3	0.2	0.16	-	Resistive	SMA
ZX10-2-98-S+	2	4750-9800	23	0.3	9	0.5	1	DC Pass	-	SMA
ZFSC-2-9G+	2	3500-9000	20	0.6	10	0.5	1	DC Pass	-	SMA
ZN2PD-9G-S+	2	1700-9000	22	1	2	0.2	30	DC Pass	-	SMA
ZX10-2-852-S+	2	500-8500	20	1.9	8	0.9	2.5	DC Pass	-	SMA
ZN2PD-83W-N+	2	500-8000	24	0.5	1.3	0.04	20	DC Pass	Stripline	N
ZX10-2-722-S+	2	2800-7200	22	0.8	10	0.4	1.5	-	-	SMA
ZX10-2-71-S+	2	2950-7100	23	0.25	3	0.4	1	DC Pass	-	SMA
ZACS622-100W+	2	650-6200	22	0.5	2	0.1	100	DC Pass	-	SMA
ZN2PD-622SMP+	2	350-6200	18	1	2	0.2	10	DC Pass	-	SMP
ZX10-2-622-S+	2	2900-6200	24	0.9	9	0.3	1.5	-	-	SMA
ZAPD-50W+	2	4200-6000	26	0.3	5	0.7	10	DC Pass	-	N
ZB2PD-63+	2	600-6000	19	0.9	2.8	0.2	30	DC Pass	-	N
ZN2PD-63-S+	2	1800-6000	24	0.4	4	0.3	10	DC Pass	-	SMA
ZN2PD1-63+	2	500-6000	18	0.45	1.5	0.1	30	DC Pass	-	SMA
ZN2PD2-63-S+	2	350-6000	20	0.7	1.5	0.2	25	DC Pass	-	SMA
ZN2PD2-63A+	2	350-6000	18	0.8	1	0.2	25	DC Pass	-	SMA
ZAPD-50+	2	4400-5000	26	0.3	5	0.5	10	DC Pass	-	SMA
ZN2PD2-50-S+	2	500-5000	25	0.8	4	0.5	10	DC Pass	-	SMA

Power Splitters & Combiners — Coaxial 50Ω Continued

Model Number	No. of Ways	Frequency Range (MHz)	Isolation (dB)	Insertion Loss (dB) Above Theoretical	Phase Unbalance (deg)	Amplitude Unbalance (dB)	Power Input (W) as Splitter, Max.	Feature	Tech.	Connector Type
ZX10-2-442-S+	2	1500-4400	20	1	6	0.3	1.5	-	-	SMA
ZAPD-4+	2	2000-4200	25	0.4	6	0.4	10	DC Pass	-	SMA
ZFRSC-42+	2	DC-4200	6.5	0.1	3	0.2	0.75	-	Resistive	BNC
ZX10-2-42-S+	2	1900-4200	23	0.2	3	0.3	1	DC Pass	-	SMA
ZFSC-2-372+	2	10-3700	18	0.6	4	0.3	1	-	-	SMA
ZACS362-100W+	2	600-3600	18	0.6	1	0.15	100	DC Pass	-	SMA
ZX10-2-332-S+	2	1600-3300	24	0.8	5	0.2	1.5	-	-	SMA
ZAPD-30-S+	2	20-3000	16	1.1	5	0.4	1	-	-	SMA
ZN2PD-272SMP+	2	600-2750	22	0.4	1	0.1	10	DC Pass	-	SMP
ZAPD-2-272+	2	800-2700	22	0.3	3	0.3	10	-	-	SMA
ZAPD-2-252+	2	5-2500	17	1	3	0.4	1	-	-	BNC
ZFSC-2-2500+	2	10-2500	17	0.6	4	0.3	1	-	-	BNC
ZX10-2-25-S+	2	1000-2500	20	1.2	10	1.2	1	-	-	SMA
ZX10-2-252-S+	2	500-2500	22	0.9	4	0.2	1.5	-	-	SMA
ZACS242-100W+	2	500-2450	22	0.8	2	0.1	100	DC Pass	-	SMA
ZN2PD1-222-S+	2	600-2200	18	0.2	2	0.2	10	DC Pass	-	SMA
ZX10-2-222-S+	2	800-2200	24	0.8	4	0.2	1.5	-	-	SMA
ZAPD-2DC+	2	950-2150	22	0.3	5	0.3	10	DC Pass	-	BNC
ZAPD-2-21-3W+	2	700-2100	25	0.4	0.7	0.05	10	DC Pass	-	SMA
ZAPD-2+	2	1000-2000	25	0.25	2	0.2	10	DC Pass	-	BNC
ZAPD-20+	2	700-2000	30	0.3	3	0.4	10	DC Pass	-	BNC
ZAPD-21+	2	500-2000	25	0.25	3	0.2	10	DC Pass	-	BNC
ZAPD-23-S+	2	700-2000	27	0.4	2	0.2	10	DC Pass	-	SMA
ZESC-2-11+	2	10-2000	18	0.5	3	0.3	1	-	-	SMA
ZFRSC-2050+	2	DC-2000	6.6	0.3	2	0.2	0.75	-	Resistive	BNC
ZFSC-2-11+	2	10-2000	16	1.2	2	0.3	1	-	-	BNC
ZN2PD-20-S+	2	750-2000	25	0.2	4	0.3	5	DC Pass	-	SMA
ZN2PD-1900W+	2	1500-2000	24	0.2	3	0.3	10	DC Pass	-	SMA



Power Splitters & Combiners — Coaxial 50Ω Continued

Model Number	No. of Ways	Frequency Range (MHz)	Isolation (dB)	Insertion Loss (dB) Above Theoretical	Phase Unbalance (deg)	Amplitude Unbalance (dB)	Power Input (W) as Splitter, Max.	Feature	Tech.	Connector Type
ZX10-2-20-S+	2	200-2000	20	0.8	6	0.4	0.5	-	-	SMA
ZAPD-1750+	2	950-1750	30	0.2	4	0.5	10	DC Pass	-	BNC
ZFSC-2-5+	2	10-1500	30	0.5	3	0.2	1	-	-	BNC
ZX10-2-12-S+	2	2-1200	21	0.5	3	0.5	0.5	-	-	SMA
ZN2PD-920W-S+	2	700-1050	22	0.15	3	0.3	10	DC Pass	-	SMA
ZA2CS-10-20W	2	900-1000	38	0.2	0.5	0.11	20	DC Pass	-	SMA
ZAPD-1+	2	500-1000	25	0.25	2	0.2	10	DC Pass	-	BNC
ZFSC-2-2+	2	10-1000	25	0.5	4	0.15	1	-	-	BNC
ZFSC-2-4+	2	0.2-1000	25	0.5	4	0.15	1	-	-	BNC
ZSC-2-4	2	10-1000	35	0.5	4	0.2	1	-	-	BNC
ZSC-2-4+	2	10-1000	35	0.5	4	0.2	1	-	-	BNC
ZN2PD-920-S+	2	800-920	30	0.15	2	0.2	10	DC Pass	-	SMA
ZAPD-900-5W+	2	100-900	23	0.3	3	0.3	5	-	-	N
ZFSC-2-1W+	2	1-750	28	0.4	4	0.15	1	-	-	BNC
ZFSC-2-1WDC-S+	2	1-750	28	0.4	4	0.15	1	DC Pass	-	SMA
ZMSC-2-1W+	2	1-650	35	0.5	3	0.2	1	-	-	SMA
ZSC-2-1W+	2	1-650	35	0.5	3	0.2	1	-	-	BNC
ZB2PD-62-50W+	2	30-610	20	0.7	1	0.15	50	-	-	N
Z99SC-62-S+	2	0.5-600	20	0.5	2	0.3	1	-	-	SMA
ZA2CS-62-40W+	2	100-600	22	0.8	0.9	0.2	40	-	-	BNC
ZA2CS-600-10W	2	100-600	27	0.4	0.4	0.15	10	-	-	BNC
ZA2CS-500-15W	2	200-500	31	0.3	0.3	0.1	15	-	-	BNC
ZFSC-2-1+	2	5-500	28	0.3	4	0.15	1	-	-	BNC
ZMSC-2-1+	2	0.1-400	25	0.4	3	0.2	1	-	-	SMA
ZSC-2-1+	2	0.1-400	25	0.4	3	0.2	1	-	-	BNC
ZA2CS-251-20W+	2	10-250	20	0.25	0.5	0.05	25	-	-	N
ZFSC-2-6+	2	0.002-60	30	0.3	3	0.2	1	-	-	BNC
ZMSC-2-2	2	0.002-60	30	0.3	3	0.25	1	-	-	SMA

Power Splitters & Combiners — Coaxial 50Ω Continued

Model Number	No. of Ways	Frequency Range (MHz)	Isolation (dB)	Insertion Loss (dB) Above Theoretical	Phase Unbalance (deg)	Amplitude Unbalance (dB)	Power Input (W) as Splitter, Max.	Feature	Tech.	Connector Type
ZSC-2-2+	2	0.002-60	30	0.3	3	0.25	1	-	-	BNC
ZC3PD-K1844+	3	18000-40000	31	1.2	3.7	0.15	13.6	DC Pass	-	2.92mm
ZC3PD-18263-S+	3	18000-26500	35	0.9	2.0	0.17	20	DC Pass	Stripline	SMA
ZN3PD-02183-S+	3	2000-18000	22	1.2	4	0.2	25	DC Pass	-	SMA
ZN3PD-622W-S+	3	1800-6200	20	1	3	0.6	10	DC Pass	-	SMA
ZB3PD-63+	3	150-6000	20	1	7	0.7	30	DC Pass	-	SMA
ZF3RSC-542-S+	3	DC-5400	19	1.6	10	0.5	0.1	-	Resistive	SMA
ZA3PD-4+	3	2000-4200	18	0.7	-	0.9	10	DC Pass	-	SMA
ZB3PD-2400W-S+	3	700-2450	25	0.5	8	0.9	10	DC Pass	-	SMA
ZB3PD1-222+	3	500-2200	25	0.3	-	0.7	10	DC Pass	-	N
ZA3PD-2+	3	1000-2000	20	0.3	-	0.3	10	DC Pass	-	SMA
ZA3PD-1.5+	3	750-1500	20	0.3	-	0.4	10	DC Pass	-	SMA
ZN3PD-900W-S	3	650-1050	22	0.3	-	0.8	10	DC Pass	-	SMA
ZA3PD-1+	3	500-1000	20	0.3	-	0.4	10	DC Pass	-	SMA
ZFSC-3-4+	3	1-1000	20	0.7	6	0.4	1	-	-	BNC
ZB3CS-900-6W	3	440-900	24	0.2	3	0.1	20	DC Pass	-	SMA
ZN3PD-900-S	3	800-900	30	0.2	-	0.5	10	DC Pass	-	SMA
ZFSC-3-1W+	3	2-750	30	0.5	5	0.3	1	-	-	BNC
ZFSC-3-1+	3	1-500	30	0.5	3	0.3	1	-	-	BNC
ZA3CS-450-9W	3	100-450	22	0.9	2.5	0.2	12	-	-	SMA
ZA3CS-400-3W+	3	2-400	25	0.5	0.2	0.15	10	-	-	BNC
ZCSC-3-R3+	3	2-300	31	0.4	2	0.3	1	-	-	SMA
ZMSC-3-1+	3	1-200	40	0.4	2	0.2	1	-	-	SMA
ZSC-3-1+	3	1-200	40	0.4	2	0.2	1	-	-	BNC
ZSC-3-2+	3	0.01-30	40	0.15	2	0.3	1	-	-	BNC
ZC4PD-V1854+	4	18000-50000	30	1.6	3.4	0.12	16	DC Pass	Stripline	2.4mm
ZC4PD-K5R44W+	4	500-40000	36	2.7	2.3	0.1	20	DC Pass	Stripline	2.92mm
ZC4PD-K0144+	4	1000-40000	33	1.8	1.5	0.1	20	DC Pass	Stripline	2.92mm

Power Splitters & Combiners — Coaxial 50Ω Continued

Model Number	No. of Ways	Frequency Range (MHz)	Isolation (dB)	Insertion Loss (dB) Above Theoretical	Phase Unbalance (deg)	Amplitude Unbalance (dB)	Power Input (W) as Splitter, Max.	Feature	Tech.	Connector Type
ZC4PD-K0244+	4	2000-40000	28	2.7	2.8	0.14	20	DC Pass	-	2.92mm
ZC4PD-K0644+	4	6000-40000	26	1.5	2.9	0.13	20	DC Pass	Stripline	2.92mm
ZC4PD-K1844+	4	18000-40000	27	1.2	3.5	0.12	20	DC Pass	-	2.92mm
ZN4PD-K44+	4	10000-40000	22	1.5	6	0.3	20	-	-	2.92mm
ZC4PD-5R263-S+	4	500-26500	34	2.7	1.6	0.15	20	DC Pass	Stripline	SMA
ZC4PD-01263-S+	4	1000-26500	33	1.6	1.9	0.06	14	DC Pass	-	SMA
ZC4PD-02263-S+	4	2000-26500	31	1.5	1.5	0.07	14	DC Pass	-	SMA
ZC4PD-06263-S+	4	6000-26500	26	1.5	2.0	0.13	20	DC Pass	Stripline	SMA
ZC4PD-18263-S+	4	18000-26500	28	1.1	2.5	0.1	20	DC Pass	Stripline	SMA
ZN4PD-5R183-S+	4	500-18000	25	1.2	3	0.1	20	DC Pass	Stripline	SMA
ZN4PD-02183-S+	4	2000-18000	20	1	3.5	0.3	30	DC Pass	-	SMA
ZN4PD1-183W-S+	4	4000-18000	22	0.7	3	0.25	30	DC Pass	-	SMA
ZC4PD-153-S+	4	6000-15000	22	1.3	8	0.4	10	DC Pass	-	SMA
ZFRSC-4-842+	4	DC-8400	6.4	0.3	4	0.3	0.16	-	Resistive	SMA
ZN4PD1-842-S+	4	2100-8400	19	1.3	5	0.5	10	DC Pass	-	SMA
ZB4PD-6.4-S+	4	5400-6800	25	0.6	9	0.9	10	DC Pass	-	SMA
ZN4PD-642W-S+	4	1600-6000	23	0.9	4	0.2	10	DC Pass	-	SMA
ZN4PD1-63-S+	4	2000-6000	26	0.7	5	0.4	10	DC Pass	-	SMA
ZN4PD1-63HP-S+	4	250-6000	23	1	2	0.2	30	DC Pass	-	SMA
ZN4PD1-63LW-S+	4	500-6000	23	0.6	2	0.15	30	DC Pass	-	SMA
ZB4PD1-5.8+	4	4600-5800	25	0.4	5	0.4	10	DC Pass	-	BNC
ZB4PD-462W+	4	380-4600	22	0.9	2	0.2	30	DC Pass	-	SMA
ZA4PD-4+	4	2000-4200	25	0.5	16	0.8	10	DC Pass	-	SMA
ZB4PD-4+	4	3700-4200	24	0.6	8	0.8	10	DC Pass	-	SMA
ZB4PD-42+	4	1700-4200	23	0.5	8	0.8	10	DC Pass	-	SMA
ZB4PD-332HP+	4	500-3300	22	1	3	0.2	100	DC Pass	-	N
ZN4PD-33SMP+	4	500-3000	20	0.9	3	0.3	10	DC Pass	-	SMP
ZB4PD-282-50W+	4	500-2750	20	1.8	6	0.4	100	DC Pass	-	N

Power Splitters & Combiners — Coaxial 50Ω Continued

Model Number	No. of Ways	Frequency Range (MHz)	Isolation (dB)	Insertion Loss (dB) Above Theoretical	Phase Unbalance (deg)	Amplitude Unbalance (dB)	Power Input (W) as Splitter, Max.	Feature	Tech.	Connector Type
ZN4PD-272-S+	4	500-2700	22	0.9	3	0.25	10	DC Pass	-	SMA
ZX10-4-27-S+	4	2225-2700	20	1	9	1.2	2.5	-	-	SMA
ZX10-4A-27-S+	4	2225-2600	23	0.9	6	0.8	2.5	-	-	SMA
ZX10-4-24-S+	4	1675-2350	20	0.9	5	0.7	2.5	-	-	SMA
ZB4PD-232-50W+	4	600-2300	19	1.1	0.9	0.05	50	DC Pass	-	SMA
ZX10-4A-24-S+	4	1675-2200	23	0.8	6	0.6	2.5	-	-	SMA
ZA4PD-2+	4	1000-2000	25	0.3	6	0.7	10	DC Pass	-	SMA
ZB4PD1-2000+	4	800-2000	25	0.6	-	0.3	10	DC Pass	-	BNC
ZN4PD-20-S	4	1800-2000	31	0.3	4	0.5	10	DC Pass	-	SMA
ZX10-4-19-S+	4	1425-1900	20	0.75	6	0.9	2.5	-	-	SMA
ZX10-4A-19-S+	4	1425-1900	22	0.75	4	0.7	2.5	-	-	SMA
ZC4PD-18-S+	4	1000-1800	32	0.3	6	0.4	10	DC Pass	-	SMA
ZX10-4-14-S+	4	1100-1450	20	0.8	7	0.8	2.5	-	-	SMA
ZX10-4A-14-S+	4	1100-1450	25	0.6	4	0.7	2.5	-	-	SMA
ZX10-4-11-S+	4	800-1125	20	0.6	3	0.7	2.5	-	-	SMA
ZX10-4A-11-S+	4	800-1125	22	0.6	4	0.6	2.5	-	-	SMA
ZFSC-4-1+	4	1-1000	23	0.6	8	0.4	1	-	-	SMA
ZN4PD-920W-S+	4	670-1000	22	0.3	3	0.2	10	DC Pass	-	SMA
ZN4PD-920-S+	4	800-920	30	0.25	2	0.2	10	DC Pass	-	SMA
ZC4PD-900-S+	4	800-900	30	0.3	3	0.2	10	-	-	SMA
ZB4CS-870-10W	4	570-870	28	0.35	0.6	0.1	20	DC Pass	-	N
ZBSC-413+	4	10-800	18	1	8	0.4	1	-	-	SMA
ZB4CS-700-10W	4	400-700	25	0.35	0.6	0.1	20	DC Pass	-	SMA
ZB4PD-52-20W+	4	10-500	29	0.4	2	0.1	20	-	-	BNC
ZB4PD1-500+	4	5-500	34	0.5	3	0.2	1	-	-	BNC
ZFSC-4-1W	4	10-500	23	0.6	8	0.3	1	-	-	SMA
ZFSC-4-1W+	4	10-500	23	0.6	8	0.3	1	-	-	SMA
ZB4CS-440-12W	4	100-440	27	0.6	0.8	0.15	10	-	-	BNC



Power Splitters & Combiners — Coaxial 50Ω Continued

Model Number	No. of Ways	Frequency Range (MHz)	Isolation (dB)	Insertion Loss (dB) Above Theoretical	Phase Unbalance (deg)	Amplitude Unbalance (dB)	Power Input (W) as Splitter, Max.	Feature	Tech.	Connector Type
ZFSC-4-3+	4	10-300	38	0.6	6	0.1	1	-	-	SMA
ZSC-4-3+	4	0.25-250	30	0.5	6	0.2	1	-	-	BNC
ZMSC-4-1+	4	0.1-200	30	0.5	6	0.2	1	-	-	SMA
ZSC-4-1+	4	0.1-200	30	0.5	6	0.2	1	-	-	BNC
ZMSC-4-2+	4	0.002-20	33	0.3	6	0.2	1	-	-	SMA
ZB5CS-920-10W	5	450-920	26	0.4	2	0.1	20	DC Pass	-	SMA
ZBSC-5-1	5	120-520	25	1	8	0.9	1	-	-	SMA
ZFSC-5-1+	5	1-300	23	0.6	4	0.3	1	-	-	BNC
ZC6PD-K1844+	6	18000-40000	25	1.6	6.2	0.35	20	DC Pass	Stripline	2.92mm
ZC6PD-18263-S+	6	18000-26500	24	1.1	5.2	0.28	20	DC Pass	Stripline	SMA
ZN6PD-02183-S+	6	2000-18000	22	1.4	6	0.4	25	-	-	SMA
ZN6PD-63W-S+	6	1800-6000	20	1	7	0.9	10	DC Pass	-	SMA
ZN6PD1-63-S+	6	600-6000	20	2.5	10	0.8	20	DC Pass	-	SMA
ZN6PD1-63SMP+	6	600-6000	20	2.5	10	0.8	20	-	-	SMP
ZN6PD-272HP+	6	650-2750	25	0.9	4	0.3	100	-	-	SMP
ZB6PD-2+	6	800-2000	27	0.7	-	0.7	10	DC Pass	-	SMA
ZC6PD-1900W-S+	6	1500-2000	30	0.5	-	0.6	10	DC Pass	-	SMA
ZB6PD-17	6	600-1700	25	0.35	7	0.5	10	DC Pass	-	SMA
ZB6PD-1700	6	1500-1700	30	0.5	-	0.6	10	DC Pass	-	SMA
ZC6PD-960W-S	6	700-1000	28	0.4	-	0.6	10	DC Pass	-	SMA
ZB6PD1-960	6	890-960	35	0.3	-	0.6	10	DC Pass	-	SMA
ZB6PD1-900	6	800-900	32	0.3	-	0.5	10	DC Pass	-	SMA
ZBSC-615+	6	1-500	26	0.7	8	0.4	1	-	-	SMA
ZFSC-6-110	6	1-500	26	0.6	6	0.3	1	-	-	BNC
ZBSC-611	6	10-200	26	0.7	5	0.3	1	-	-	SMA
ZFSC-6-1+	6	1-175	26	0.75	6	0.4	1	-	-	BNC
ZC8PD-K5R44W+	8	500-40000	35	4.1	1.9	0.18	20	DC Pass	Stripline	2.92mm
ZC8PD-K0644+	8	6000-40000	28	2.0	2.2	0.12	20	DC Pass	Stripline	2.92mm

Power Splitters & Combiners — Coaxial 50Ω Continued

Model Number	No. of Ways	Frequency Range (MHz)	Isolation (dB)	Insertion Loss (dB) Above Theoretical	Phase Unbalance (deg)	Amplitude Unbalance (dB)	Power Input (W) as Splitter, Max.	Feature	Tech.	Connector Type
ZC8PD-K1844+	8	18000-40000	26	1.8	5.3	0.16	20	DC Pass	Stripline	2.92mm
ZN8PD-K44+	8	10000-40000	20	2	8	0.3	20	-	-	2.92mm
ZC8PD-5R263-S+	8	500-26500	35	4.1	3.1	0.2	20	DC Pass	Stripline	SMA
ZC8PD-01263-S+	8	1000-26500	26	3.2	2.9	0.14	20	DC Pass	Stripline	SMA
ZC8PD-02263-S+	8	2000-26500	31	2.1	2.3	0.11	20	DC Pass	Stripline	SMA
ZC8PD-06263-S+	8	6000-26500	28	1.2	2.6	0.11	20	DC Pass	Stripline	SMA
ZC8PD-18263-S+	8	18000-26500	26	1.7	4.2	0.19	20	DC Pass	Stripline	SMA
ZN8PD-02183-S+	8	2000-18000	20	1.4	5	0.3	20	DC Pass	-	SMA
ZN8PD-113-S+	8	2000-11000	22	1.3	6	0.4	10	DC Pass	-	SMA
ZB8PD-8.4	8	7200-8400	25	0.9	15	0.8	10	DC Pass	-	SMA
ZN8PD-642W-S+	8	1800-6400	25	1.5	5	0.2	10	-	-	SMA
ZB8PD-622+	8	3200-6200	26	0.8	3	0.3	10	DC Pass	-	SMA
ZB8PD-622N+	8	3200-6200	26	0.8	5	0.4	10	DC Pass	-	N
ZN8PD1-63W-S+	8	500-6000	24	1.5	4.5	0.3	10	DC Pass	-	SMA
ZN8PD1-53-S+	8	500-5000	20	1.5	14	0.5	10	DC Pass	-	SMA
ZB8PD-4+	8	2000-4200	23	0.8	10	1.2	10	DC Pass	-	SMA
ZB8PD-362+	8	600-3600	20	1.6	10	0.4	10	DC Pass	-	SMA
ZN8PD-362HP+	8	600-3600	23	1	4	0.2	100	DC Pass	-	SMP
ZN8PD-272SMP+	8	690-2750	28	0.8	2	0.1	10	DC Pass	-	SMP
ZC8SC272-12DL+	8	2450-2700	22	2	7	0.6	5	Dual Channel	-	SMA
ZB8PD-252+	8	1550-2500	25	0.8	3.2	0.3	10	DC Pass	-	F
ZB8PD-2+	8	1000-2000	24	0.8	18	0.8	10	DC Pass	-	SMA
ZB8PD-2000+	8	800-2000	26	0.8	3	0.3	10	DC Pass	-	SMA
ZCSC-8-152-S+	8	0.5-1550	38	2.5	4	0.3	0.5	-	Resistive	SMA
ZC8PD1-10-S+	8	300-1000	27	0.6	6	0.2	10	DC Pass	-	SMA
ZCSC-8-13-S+	8	5-1000	22	1.2	2	0.4	0.5	-	-	SMA
ZFSC-8-43+	8	10-1000	25	1.4	10	0.4	1	-	-	BNC
ZB8PD-1+	8	800-960	30	0.4	8	0.4	10	DC Pass	-	SMA



Power Splitters & Combiners — Coaxial 50Ω Continued

Model Number	No. of Ways	Frequency Range (MHz)	Isolation (dB)	Insertion Loss (dB) Above Theoretical	Phase Unbalance (deg)	Amplitude Unbalance (dB)	Power Input (W) as Splitter, Max.	Feature	Tech.	Connector Type
ZBSC-8-82+	8	10-800	26	0.9	4	0.3	1	-	-	BNC
ZFSC-8-4+	8	5-700	25	1.2	5	0.4	1	-	-	BNC
ZCSC-8-1+	8	2-250	30	0.8	4	0.3	1	-	-	SMA
ZFSC-8-1+	8	0.5-175	30	0.8	2.5	0.2	1	-	-	BNC
ZC8SC272-12DL+	8	1-100	30	0.5	0.2	0.1	0.5	Dual Channel	-	SMA
ZC9PD-172-S+	9	1200-1700	18	0.6	7	0.4	10	-	-	SMA
ZC10PD-26W-S+	10	2250-2800	21	0.9	17	1	10	-	-	SMA
ZC10PD-26-S	10	2300-2600	35	0.7	15	1.1	10	-	-	SMA
ZC10PD-900-S	10	800-900	25	1.5	-	0.8	10	-	-	SMA
ZC10PD-900W	10	750-900	30	0.4	-	0.6	10	-	-	SMA
ZFSC-10-1+	10	0.5-100	30	0.4	6	0.3	1	-	-	BNC
ZN12PD-63-S+	12	600-6000	18	3	10	0.9	20	DC Pass	-	SMA
ZN12PD-63SMP+	12	600-6000	19	3	8	0.8	20	DC Pass	-	SMP
ZN12PD-252-S+	12	800-2450	30	0.5	6	0.6	10	-	-	SMA
ZN12PD-17-S	12	800-1700	30	0.45	14	0.7	10	-	-	SMA
ZFSC-12-11+	12	10-300	33	1.1	4	0.3	1	-	-	BNC
ZFSC-12-1+	12	1-200	35	1.1	8	0.2	1	-	-	BNC
ZC16PD-K0644+	16	6000-40000	26	2.2	6	0.28	20	DC Pass	Stripline	2.92mm
ZC16PD-K1844+	16	18000-40000	22	3.1	5.9	0.2	20	DC Pass	Stripline	2.92mm
ZC16PD-06263-S+	16	6000-26500	24	2.2	3.3	0.2	20	DC Pass	Stripline	SMA
ZC16PD-18263-S+	16	18000-26500	23	3.1	3.8	0.24	20	DC Pass	Stripline	SMA
ZC16PD-02183-S+	16	2000-18000	30	2.2	3.1	0.13	20	DC Pass	Stripline	SMA
ZC16PD-2185-S+	16	1800-2600	30	0.5	6	0.7	10	-	-	SMA
ZC16PD-252-S+	16	10-2500	17	3.2	10	0.7	1	-	-	SMA
ZC16PD-24-S+	16	650-2450	25	0.8	14	0.9	10	-	-	SMA
ZC16PD-23-S	16	1500-2300	32	0.8	11	0.6	10	-	-	SMA
ZC16PD-222-S+	16	10-2200	17	3.2	10	0.7	1	-	-	SMA
ZC16PD-1900W-S+	16	1500-2100	30	0.7	-	0.8	10	-	-	SMA

Power Splitters & Combiners — Coaxial 50Ω Continued

Model Number	No. of Ways	Frequency Range (MHz)	Isolation (dB)	Insertion Loss (dB) Above Theoretical	Phase Unbalance (deg)	Amplitude Unbalance (dB)	Power Input (W) as Splitter, Max.	Feature	Tech.	Connector Type
ZB16PD-13-S+	16	500-1000	30	0.6	6	0.6	10	-	-	SMA
ZC16PD-960-S+	16	890-960	28	0.5	-	0.5	10	-	-	SMA
ZB16PD-72-S+	16	400-700	30	0.7	8	0.6	10	-	-	SMA
ZFSC-16-12+	16	0.1-200	27	0.7	6	0.2	1	-	-	BNC
ZFSC-16-1+	16	0.5-125	25	1.1	3	0.2	1	-	-	BNC
ZFSC-16-3+	16	1-30	45	0.5	2	0.1	1	-	-	BNC
ZC24PD-222-S+	24	650-2200	25	1.8	10	0.5	10	-	-	SMA
ZFSC-24-11	24	1-200	22	1	-	0.8	1	-	-	BNC
ZFSC-24-1	24	0.2-100	25	1	-	0.4	1	-	-	BNC

Power Splitters & Combiners — Coaxial 75Ω

Model Number	No. of Ways	Frequency Range (MHz)	Isolation (dB)	Insertion Loss (dB) Above Theoretical	Phase Unbalance (deg)	Amplitude Unbalance (dB)	Power Input (W) as Splitter, Max.	Feature	Technology	Connector Type
ZAPD-2-252-75+	2	5-2500	26	0.6	3	0.4	0.5	-	-	BNC
ZAPD-232-75+	2	700-2450	25	0.5	1	0.1	10	DC Pass	-	SMA
ZAPD-2-22-75+	2	910-2150	30	0.2	2	0.4	5	DC Pass	-	BNC
ZFRSC-2075+	2	DC-2000	6.6	0.3	2	0.2	0.75	-	Resistive	BNC
ZFSC-2-1W-75+	2	5-600	45	0.27	2	0.3	1	-	-	BNC
ZFSC-2-1-75+	2	0.25-300	30	0.4	3	0.2	1	-	-	BNC
ZSC-2-1-75+	2	0.25-300	30	0.4	3	0.2	1	-	-	BNC
ZSC-2375+	2	55-85	35	0.3	1	0.1	1	-	-	BNC
ZFSC-2-6-75	2	0.004-60	35	0.4	2	0.2	1	-	-	BNC
ZSC-2-2-75+	2	0.002-60	30	0.3	3	0.25	1	-	-	BNC
ZFSC-3-4-75+	3	1-1000	27	0.4	6	0.7	1	-	-	BNC
ZSC-3-1-75+	3	1-200	35	0.4	3	0.2	1	-	-	BNC
ZB4PD-222-75+	4	950-2200	23	0.9	2.7	0.3	10	DC Pass	-	BNC
ZB4PD-1750-75+	4	875-1750	30	0.4	3	0.4	10	DC Pass	-	BNC

Power Splitters & Combiners — Coaxial 75Ω Continued

Model Number	No. of Ways	Frequency Range (MHz)	Isolation (dB)	Insertion Loss (dB) Above Theoretical	Phase Unbalance (deg)	Amplitude Unbalance (dB)	Power Input (W) as Splitter, Max.	Feature	Technology	Connector Type
ZB4PD1-152-75+	4	650-1500	23	0.6	6	0.4	10	DC Pass	-	BNC
ZFSC-4-175+	4	10-1000	38	0.6	-	0.3	1	-	-	BNC
ZFSC-4-175W+	4	5-1000	36	0.5	3	0.2	1	-	-	BNC
ZB4PD1-500-75+	4	5-500	34	0.6	3	0.2	1	-	-	BNC
ZB4PD1-32-75+	4	0.25-300	36	0.3	2	0.2	1	-	-	BNC
ZSC-4-3-75+	4	0.25-250	30	0.3	2	0.2	1	-	-	BNC
ZSC-4-1-75+	4	1-200	25	0.5	6	0.2	1	-	-	BNC
ZFSC-4375+	4	50-90	34	0.3	6	0.15	1	-	-	BNC
ZFSC-6-1-75+	6	1-200	30	0.75	6	0.4	1	-	-	BNC
ZB8PD-242-75+	8	600-2400	27	0.7	3	0.3	10	DC Pass	-	BNC
ZB8PD-242-75-F+	8	600-2400	27	0.7	3	0.3	10	DC Pass	-	F
ZB8PD-22-75+	8	950-2200	24	0.7	-	0.3	10	DC Pass	-	BNC
ZFSC-8-4-75+	8	5-1000	25	0.6	7	0.5	1	-	-	BNC
ZFSC-84-75+	8	1-300	30	0.7	3	0.2	1	-	-	BNC
ZFSC-8-1-75+	8	0.5-175	30	0.6	2.5	0.3	1	-	-	BNC
ZFSC-8375	8	50-90	30	1	2	0.2	1	-	-	BNC
ZFSC-12-175+	12	10-500	24	1	-	0.5	1	-	-	BNC
ZFSC-12-1-75+	12	10-200	27	0.8	-	0.3	1	-	-	BNC
ZFSC-16-1-75+	16	1-150	30	0.7	6	0.2	1	-	-	BNC
ZFSC-24-11-75	24	1-200	33	0.8	-	0.4	1	-	-	BNC

Power Splitters & Combiners — Plug-In 50Ω

Model Number	No. of Ways	Frequency Range (MHz)	Isolation (dB)	Insertion Loss (dB) Above Theoretical	Phase Unbalance (deg)	Amplitude Unbalance (dB)	Power Input (W) as Splitter, Max.	Feature
MSC-2-11+	2	5-2000	20	0.6	3	0.3	1	-
MSC-2-5+	2	5-1500	20	0.6	3	0.3	1	-
MSC-2-1W+	2	2-650	30	0.5	2	0.2	1	-
PSC-2-1W+	2	1-650	35	0.5	3	0.2	1	-
MSC-2-1+	2	0.1-450	30	0.4	3	0.2	1	-
PSC-2-1+	2	0.1-400	25	0.4	3	0.2	1	-
TSC-2-1+	2	1-400	30	0.4	3	0.2	1	-
PSC-2-2+	2	0.004-60	30	0.3	3	0.25	1	-
MSC-3-1W	3	50-750	22	0.9	7	0.7	1	-
PSC-3-1W+	3	5-500	31	0.4	3	0.3	1	-
PSC-3-1+	3	1-200	40	0.4	2	0.2	1	-
PSC-3-13+	3	1-200	45	0.35	3	0.2	1	-
PSC-4-1W+	4	1-500	27	0.5	3	0.3	0.5	-
PSC-4-1+	4	0.1-200	30	0.5	6	0.2	1	-
PSC-5-1+	5	1-300	23	0.6	4	0.3	1	-
PSC-6-1+	6	1-175	26	0.7	6	0.4	1	-

Power Splitter Designer Kits

Model Number	Model Series	Description	Package	Models Included in Kit	Qty. Ea.	Total Qty.
K1-ADP+	ADP	0.5 to 2000 MHz 2-Way 0°	Leaded SMT	ADP-2-1+ -2-1W+ -2-9+ -2-10+ -2-4+ -2-20+	2	12
K1-QCN+	QCN	220 to 4500 MHz 2-Way 90°	1206	QCN-3+ -5+ -7+ -12+ -12A+ -19+ -25+ -27+ -34+ -45+	2	20
K1-SBTC+	SBTC	5 to 2500 MHz 2-Way 0°	Leaded SMT	SBTC-2-10+ -2-20+ -2-25+	5	15
K1-ZX10+	ZX10	2 to 12600 MHz 2-Way 0°	SMA Connectorized	ZX10-2-12+ -2-20+ -2-25+ -2-42+ -2-71+ -2-98+ -2-126+ Free deluxe wood storage case	1	7
K1-SCG+	SCG	900 to 5900 MHz LTCC 2-Way 3-Way 0°	805	SCG-2-242+ SCG-2-322+ SCG-2-422+ SCG-2-592+ SCG-3-162+ SCG-3-262+ SCG-3-592+	7	35

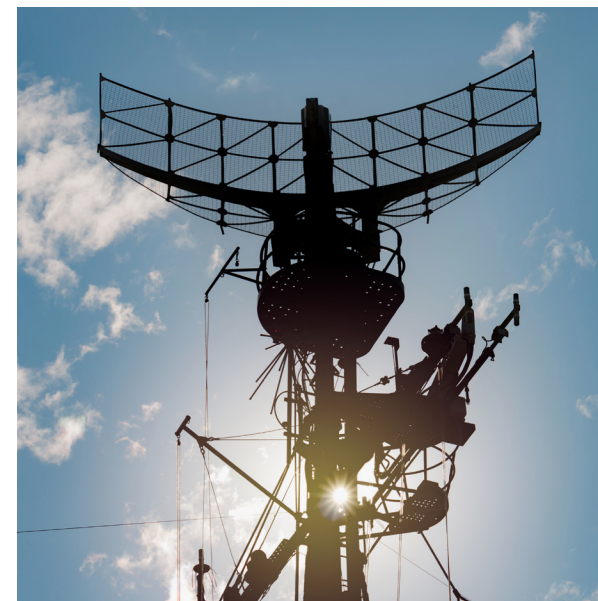

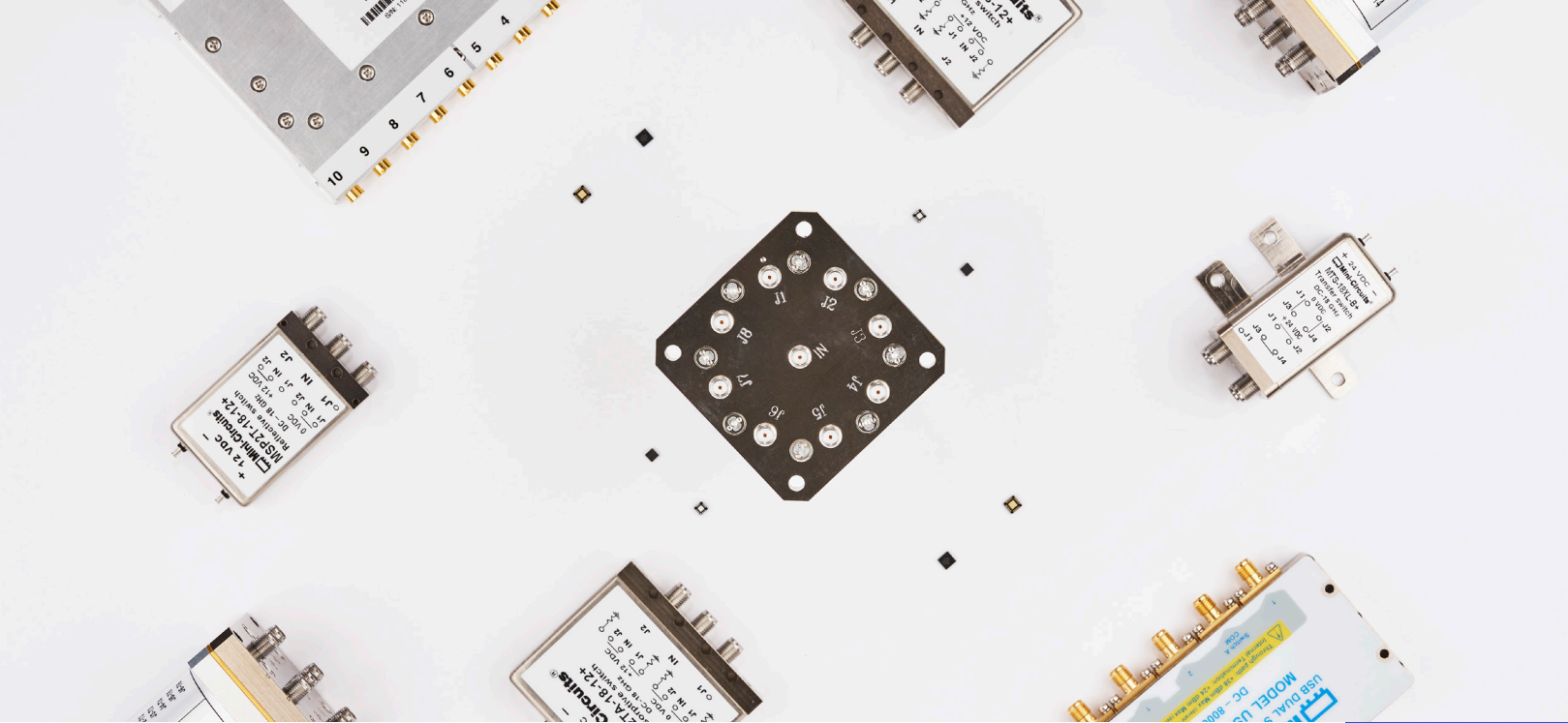

DC TO 50 GHZ

RF/Microwave Switches

Ultra-Reliable

- Switch configurations from SPDT to SP10T
- Patented electromechanical switches capable of 10-million switch cycles without failure
- Solid-state switches with ultra-fast switching time
- Absorptive and reflective designs
- USB, Ethernet and SPI control interfaces available

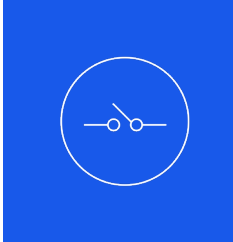

Electromechanical

- SPDT, SP4T, SP6T, SP8T and transfer switch configurations
- Patented design uses magnetics instead of springs and solenoids
- Extra-long switch life, up to 10 million cycles guaranteed
- Low insertion loss and high isolation

Electromechanical – Coaxial 50Ω

Model Number	Switch Type	Frequency Range (GHz)	Config.	Insertion Loss (dB)	Isolation (dB)	VSWR (:1)	DC Current (mA) @ +12V	DC Current (mA) @ +24V	RF Power (W) Max.	Connector Type
MSP2T-18-12+	SPDT	DC-18	Reflective	0.25	80	1.2	180	-	10	SMA
MSP2T-18XL+	SPDT	DC-18	Reflective	0.2	80	1.2	-	80	10	SMA
MSP2TA-18-12+	SPDT	DC-18	Absorptive	0.25	80	1.2	350	-	20	SMA
MSP2TA-18XL+	SPDT	DC-18	Reflective	0.25	80	1.2	-	175	20	SMA
MSP4TA-18+	SP4T	DC-18	Reflective	0.25	85	1.2	-	175	2	SMA
MSP6TA-12+	SP6T	DC-12	Reflective	0.25	90	1.2	-	85	20	SMA
MSP8TA-12D+	SP8T	DC-12	Reflective	0.4	90	1.3	-	85	20	SMA
MTS-18XL-B+	Transfer (DPDT)	DC-18	Reflective	0.25	80	1.15	-	175	10	SMA

Electromechanical – USB / Ethernet Switch Modules

Model Number	Switch Type	Number of Switches	Frequency Range (GHz)	Insertion Loss (dB)	Isolation (dB)	VSWR (:1)	RF Power (W), Max.	Control Interfaces	Connector Type
RC-2SPDT-40	SPDT	2	DC-40	0.6	65	1.5	20	USB & Ethernet	2.92mm
RC-1SPDT-A26	SPDT	1	DC-26.5	0.6	65	1.25	20	USB & Ethernet	SMA
RC-2SPDT-A26	SPDT	2	DC-26.5	0.6	65	1.25	20	USB & Ethernet	SMA
RC-4SPDT-A26	SPDT	4	DC-26.5	0.54	65	1.25	20	USB & Ethernet	SMA
RC-1SPDT-A18	SPDT	1	DC-18	0.25	80	1.2	20	USB & Ethernet	SMA
RC-2SPDT-A18	SPDT	2	DC-18	0.25	80	1.2	20	USB & Ethernet	SMA
RC-4SPDT-A18	SPDT	4	DC-18	0.25	80	1.2	20	USB & Ethernet	SMA
RC-8SPDT-A18	SPDT	8	DC-18	0.25	80	1.2	20	USB & Ethernet	SMA
RC-1SP4T-50	SP4T	1	DC-50	0.4	75	1.3	20	USB & Ethernet	2.4mm
RC-1SP4T-40	SP4T	1	DC-40	0.3	80	1.3	20	USB & Ethernet	2.92mm



Electromechanical – USB / Ethernet Switch Modules Continued

Model Number	Switch Type	Number of Switches	Frequency Range (GHz)	Insertion Loss (dB)	Isolation (dB)	VSWR (:1)	RF Power (W), Max.	Control Interfaces	Connector Type
RC-2SP4T-40	SP4T	2	DC-40	0.3	80	1.3	20	USB & Ethernet	2.92mm
RC-1SP4T-26	SP4T	1	DC-26.5	0.2	80	1.35	20	USB & Ethernet	SMA
RC-2SP4T-26	SP4T	2	DC-26.5	0.2	80	1.35	20	USB & Ethernet	SMA
RC-1SP4T-A18	SP4T	1	DC-18	0.25	80	1.2	20	USB & Ethernet	SMA
RC-2SP4T-A18	SP4T	2	DC-18	0.25	80	1.2	20	USB & Ethernet	SMA
RC-1SP6T-50	SP6T	1	DC-50	0.4	75	1.4	20	USB & Ethernet	2.4mm
RC-1SP6T-40	SP6T	1	DC-40	0.4	80	1.7	20	USB & Ethernet	2.92mm
RC-2SP6T-40	SP6T	2	DC-40	0.4	80	1.7	20	USB & Ethernet	2.92mm
RC-1SP6T-26	SP6T	1	DC-26.5	0.25	90	1.35	20	USB & Ethernet	SMA
RC-2SP6T-26	SP6T	2	DC-26.5	0.25	90	1.35	20	USB & Ethernet	SMA
RC-2SP6T-A18	SP6T	2	DC-18	0.4	100	1.43	20	USB & Ethernet	SMA
RC-1SP6T-A12	SP6T	1	DC-12	0.2	90	1.2	20	USB & Ethernet	SMA
RC-2SP6T-A12	SP6T	2	DC-12	0.2	90	1.2	20	USB & Ethernet	SMA
RC-2MTS-40	Transfer Switch	2	DC-40	0.4	70	1.3	20	USB & Ethernet	2.92mm
RC-2MTS-26	Transfer Switch	2	DC-26.5	0.3	75	1.3	20	USB & Ethernet	SMA
RC-2MTS-18	Transfer Switch	2	DC-18	0.2	86	1.15	10	USB & Ethernet	SMA
RC-3MTS-40	Transfer Switch	3	DC-40	0.5	70	1.5	20	USB & Ethernet	2.92mm
RC-3MTS-26	Transfer Switch	3	DC-26.5	0.5	70	1.7	20	USB & Ethernet	SMA
RC-3MTS-18	Transfer Switch	3	DC-18	0.2	86	1.15	10	USB & Ethernet	SMA

Solid State

- SPDT, SP4T, SP8T, SP10T and SP16T switch configurations
- Extremely fast switching time, down to 250 ns
- Unique designs achieve high isolation
- USB, Ethernet and SPI control options

Solid State – MMIC Surface Mount 50Ω

Model Number	Switch Type	Frequency Range (GHz)	Driver	Config.	Insertion Loss (dB)	1 dB Compression (dBm)	Input IP3 (dBm)	In-Out Isolation (dB)
KSWHA-1-20+	SPST	DC-2	-	Absorptive	1.3	26	-	65
CSWA2-63DR+	SPDT	0.5-6	CMOS	Absorptive	1.1	27	45	50
HSWA2-63DR+	SPDT	0.1-6	CMOS	Absorptive	1	35	65	68
JSW2-63DR+	SPDT	0.005-6	CMOS	Reflective	0.33	35	59	35
JSW2-63VHDRG+	SPDT	0.005-6	CMOS	Reflective	0.36	37	75	33
JSW2-63VHDRP+	SPDT	0.005-6	CMOS	Reflective	0.36	37	75	33
M3SWA2-63DRC+	SPDT	DC-6	CMOS	Absorptive	0.6	26.2	46.3	56
VSWA2-63DR+	SPDT	0.5-6	CMOS	Absorptive	1.2	27	44	46
MSW2-50+	SPDT	DC-5	-	Reflective	0.7	23	54	53
MSWA2-50+	SPDT	DC-5	-	Absorptive	0.7	24	54	53
KSW-2-46+	SPDT	DC-4.6	-	Reflective	1	20	-	50
KSWA-2-46+	SPDT	DC-4.6	-	Absorptive	0.9	20	-	50
M3SW-2-50DRA+	SPDT	DC-4.5	CMOS	Reflective	0.6	25	47.3	48
M3SWA-2-50DRA+	SPDT	0.5-4.5	CMOS	Absorptive	1.2	27	46	51
M3SWA-2-50DRB+	SPDT	DC-4.5	CMOS	Absorptive	0.6	25.4	46.5	56
HSWA2-30DR+	SPDT	DC-3	CMOS	Absorptive	0.9	31	55	55
VSW2-33-10W+	SPDT	0.05-3	-	Reflective	0.5	40	56	26
HSW2-272VHDR+	SPDT	0.03-2.7	CMOS	Reflective	0.4	45.5	85	28
RSW-2-25PA+	SPDT	DC-2.5	-	Reflective	0.7	28	39	44
MSW-2-20+	SPDT	DC-2	-	Reflective	0.5	24	-	34
MSWA-2-20+	SPDT	DC-2	-	Absorptive	0.95	27	-	40
JSW3-272DR+	SP3T	0.005-2.7	CMOS	Reflective	0.6	35	59	30

Solid State — MMIC Surface Mount 50Ω Continued

Model Number	Switch Type	Frequency Range (GHz)	Driver	Config.	Insertion Loss (dB)	1 dB Compression (dBm)	Input IP3 (dBm)	In-Out Isolation (dB)
HSWA4-63DR+	SP4T	0.03-6	CMOS	Absorptive	1.15	35	58	52
JSW4-272DR+	SP4T	0.005-2.7	CMOS	Reflective	0.6	35	59	30
JSW5-272DR+	SP5T	0.005-2.7	CMOS	Reflective	0.6	35	59	30
JSW6-33DR+	SP6T	0.005-2.7	CMOS	Reflect	0.6	35	59	30

Solid State — MMIC Surface Mount 75Ω

Model Number	Switch Type	Frequency Range (GHz)	Driver	Config.	Insertion Loss (dB)	1 dB Compression (dBm)	In-Out Isolation (dB)
JSW2-33DR-75+	SPDT	0.005-3	CMOS	Reflective	0.4	35	35
JSW2-33HDR-75+	SPDT	0.005-3	CMOS	Reflective	0.3	35	35
JSW3-23DR-75+	SP3T	0.005-2	CMOS	Reflective	0.8	35	32
JSW4-23DR-75+	SP4T	0.005-2	CMOS	Reflective	0.8	35	32
JSW5-23DR-75+	SP5T	0.005-2	CMOS	Reflective	0.8	35	32
JSW6-23DR-75+	SP6T	0.005-2	CMOS	Reflective	0.8	35	32

Solid State — MMIC Surface Mount 50Ω Low Video Leakage

Model Number	Switch Type	Frequency Range (GHz)	Driver	Config.	Insertion Loss (dB)	1 dB Compression (dBm)	In-Out Isolation (dB)
MSWT-4-20+	DPDT (Transfer)	DC-2	Absorptive	Tx-J1/J2	1.25	28	26
				J1/J2-RX	1.5	20	29
				TX-RX	-	-	34

Solid State — MMIC Bare Die 50Ω

Model Number	Switch Type	Frequency Range (GHz)	Driver	Config.	Insertion Loss (dB)	1 dB Compression (dBm)	Input IP3 (dBm)	In-Out Isolation (dB)
M3SWA263DRC-D+	SPDT	DC-6	CMOS	Absorptive	0.6	26.2	46.3	56
M3SW-250DRA-D+	SPDT	DC-4.5	CMOS	Reflective	0.6	25	47.3	48
M3SWA-250DRBDG+	SPDT	DC-4.5	CMOS	Absorptive	0.6	25.4	46.5	56

Solid State — USB / Ethernet-Controlled Coaxial 50Ω

Model Number	Switch Type	No. of Switches	Freq. Range (GHz)	Config.	Insertion Loss (dB)	Isolation (dB)	VSWR (:1)	Transition Time (usec)	Supply Voltage (V)	Max Input Power (W)	Control Interface	Connector Type
USB-2SP2T-DCH	SPDT	2	DC-8	Absorptive	1.4	50	1.2	10	USB (5V)	3.15	USB	SMA
U2C-1SP2T-63VH	SPDT	1	0.01-6	Absorptive	4	110	1.3	0.7	USB (5V) or 12-24	2	USB / I ² C / SPI	SMA
USB-4SP2T-63H	SPDT	4	0.01-6	Absorptive	2	80	1.25	0.2	USB (5V)	1	USB	SMA
USB-SP4T-63	SP4T	1	0.001-6	Absorptive	1	50	1.2	3	USB (5V)	0.5	USB	SMA
U2C-1SP4T-63H	SP4T	1	0.002-6	Absorptive	3.7	80	1.25	0.2	5	1	USB / I ² C	SMA
USB-2SP4T-63H	SP4T	2	0.01-6	Absorptive	2.5	85	1.3	5	USB (5V)	1	USB	SMA
SPI-SP8T-6G	SP8T	1	0.001-6	Absorptive	4	90	1.25	6	24-May	0.5	SPI	SMP
USB-1SP8T-63H	SP8T	1	0.01-6	Absorptive	4	80	1.25	0.2	USB (5V)	1	USB	SMA
SPI-SP10T-63	SP10T	1	0.001-6	Absorptive	4	90	1.25	6	24-Dec	0.5	SPI	SMP
USB-1SP16T-83H	SP16T	1	0.001-8	Absorptive	7.5	100	1.3	5	USB (5V)	1	USB / TTL	SMA

Solid State — Coaxial with TTL Drivers 50Ω

Model Number	Switch Type	Frequency Range (GHz)	TTL Driver	Config.	Insertion Loss (dB)	1 dB Compression (dBm)	In-Out Isolation (dB)	Connector Type
ZFSWA-1-20+	SPST	DC-2	-	Absorptive	1.3	26	65	SMA
ZFSWA2-63DR+	SPDT	0.5-6	Y	Absorptive	1.7	27	50	SMA
ZFSWA2R-63DR+	SPDT	0.5-6	Y	Absorptive	1.7	27	50	SMA
ZSW2-63DR+	SPDT	0.005-6	-	Reflective	0.33	35	31	SMA
ZASW-2-50DRA+	SPDT	DC-5	Y	Reflective	2.2	22	65	SMA

Solid State — Coaxial with TTL Drivers 50Ω Continued

Model Number	Switch Type	Frequency Range (GHz)	TTL Driver	Config.	Insertion Loss (dB)	1 dB Compression (dBm)	In-Out Isolation (dB)	Connector Type
ZASWA-2-50DRA+	SPDT	DC-5	Y	Absorptive	2.2	22	70	SMA
ZASWA2-50DR-FA+	SPDT	DC-5	Y	Absorptive	2.2	22	70	SMA
ZYSW-2-50DR+	SPDT	DC-5	Y	Reflective	1.4	22	25	SMA
ZYSWA-2-50DR+	SPDT	DC-5	Y	Absorptive	1.4	22	28	SMA
ZFSW-2-46	SPDT	DC-4.6	-	Reflective	1	17	50	SMA
ZFSWA-2-46	SPDT	DC-4.6	-	Absorptive	0.9	17	50	SMA
ZFSW2-33HDR-75+	SPDT	0.005-3	Y	Reflective	0.85	35	32	F
ZX80-DR230+	SPDT	DC-3	Y	Absorptive	0.9	31	46	SMA
ZSW2-272VHDR+	SPDT	0.03-2.7	Y	Reflective	0.5	45.5	35	SMA
ZSWA4-63DR+	SP4T	0.001-6	Y	Absorptive	1.7	35	57	SMA

Solid State — PIN-Diode Coaxial 50Ω

Model Number	Switch Type	Freq. Range (GHz)	Insertion Loss Low-Band (dB)	Insertion Loss Upper-Band (dB)	In-Out Isolation Low-Band (dB)	In-Out Isolation Mid-Band (dB)	In-Out Isolation Upper Band (dB)	Connector Type
ZMSW-1111	SPST	0.01-2.5	1.1	1.9	50	35	28	SMA
ZSDR-230+	SPDT	0.01-3	1.3	1.8	60	40	35	SMA
ZMSW-1211	SPDT	0.01-2.5	1.1	1.9	50	35	28	SMA
ZSDR-425+	SP4T	0.01-2.5	1.1	1.5	60	40	35	SMA

Solid State — PIN-Diode Plug-In

Model Number	Switch Type	Frequency Range (GHz)	Driver	Config.	Insertion Loss (dB)	1 dB Compression (dBm)	In-Out Isolation (dB)
TOSW-230+	SPDT	0.01-3	1.3	1.8	60	40	35
PSW-1211	SPDT	0.01-2.5	1.1	1.9	50	35	28
TOSW-425+	SP4T	0.01-2.5	1.1	1.5	60	40	35



Intelligent Automation



I have always received excellent customer service from the sales representatives.

— JASON R



160 TO 7800 MHZ

Synthesizers

Industry-Leading Design Capability

- Affordable custom designs with fast turnaround
- Surface-mount and coaxial interfaces
- Fixed-frequency to broadband
- Low phase noise and spurious

Designs for a wide range of system requirements:

Fixed frequency, tunable narrow, medium and wide bandwidth, tunable fast settling time, dual frequency



Synthesizers – Surface Mount (Additional Parameters Below)

Model Number	PLL	Frequency Range (MHz)	Ref Freq. (MHz)	Step Size (kHz)	PLL Power Supply Voltage (V), Nom.	PLL Power Supply, Current (mA), Max.	VCO Power Supply, Voltage (V), Nom.	VCO Power Supply, Current (mA), Max.	Power Output (dBm)
KSN-2346A+	Integer-N	2286-2346	15	1000	5	20	5	30	-0.3
KSN-1620A-119+	Integer-N	1520-1620	10	100	5	15	5	31	2.5

(Additional Parameters)

Model Number	Harmonics (dBc)	Ref. Spurious (dBc)	PFD. Spurious (dBc)	Step Size Spurious (dBc)	Phase Noise (dBc/Hz) @ 100 Hz Offset	Phase Noise (dBc/Hz) @ 1000 Hz Offset	Phase Noise (dBc/Hz) @ 10 kHz Offset	Phase Noise (dBc/Hz) @ 100 kHz Offset	Phase Noise (dBc/Hz) @ 1000 kHz Offset	Settling Time (mSec)
KSN-2346A+	-30	-106	-92	-92	-83	-86	-88	-122	-143	1.1
KSN-1620A-119+	-56	-100	-85	-85	-80	-77	-95	-124	-147	5

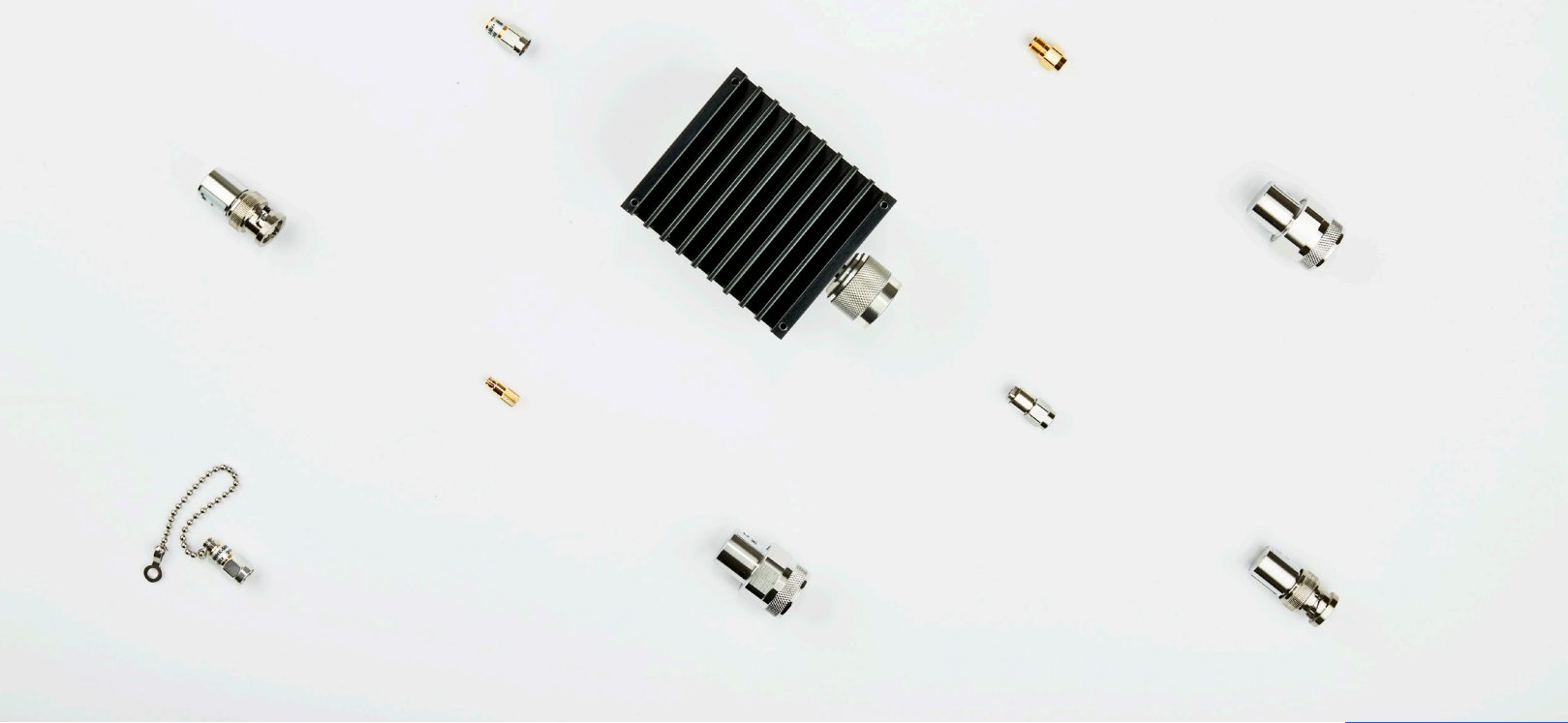

DC TO 65 GHZ

RF Terminations

Absorb and Dissipate Signal Power

- High power up to 500W
- Excellent return loss minimizes signal reflections
- 50 and 75Ω models in stock

Wide variety of connector types:

DIN 1.0/2.3, BNC, TNC, SMB, SMA, SMP, N-Type, 2.92 mm, 2.4 mm, 1.85 mm

RF Terminations — Coaxial 50 and 75Ω (Additional Parameters on the Following Page)

Model Number	Impedance (Ω)	Connector Type	Freq. Range (GHz)	Return Loss (dB) @ 1 GHz	Return Loss (dB) @ 2 GHz	Return Loss (dB) @ 4 GHz	Return Loss (dB) @ 6 GHz
ANNE-50E+	50	1.85mm Male	DC-65	41	38	36	32
ANNEF-50E+	50	1.85mm Female	DC-65	54.5	38	30.6	28.5
ANNE-50V+	50	2.4mm Male	DC-50	43	42	37	35
ANNEF-50V+	50	2.4mm Female	DC-50	45	44	42	43
ANNE-50K+	50	2.92mm Male	DC-40	40	38	35	32
ANNEF-50K+	50	2.92mm Female	DC-40	38	36	32	32
ANNEQ-50K+	50	2.92mm Male Quick-Turn	DC-40	38	36	31	29
ANNE-50X+	50	SMA Male	DC-20	48	46	39	37
ANNEQ-50X+	50	SMA Male Quick-Turn	DC-20	48	46	43	39
ANNE-50+	50	SMA Male	DC-18	50	46	41	40
ANNE-50CN+	50	SMA Male w/Chain	DC-18	50	46	41	40
ANNEF-50+	50	SMA Female	DC-18	46	45	40	40
KARN-50-18+	50	N-Type Male	DC-18	46	44	41	41
SMPF-TERM50+	50	SMP Female	DC-18	47	46	45	35
TERM-25W-183N+	50	N-Type Male	DC-18	33	36	25	31
TERM-25W-183S+	50	SMA Male	DC-18	33	32	32	25
TERM-50W-183N+	50	N-Type Male	DC-18	31	38	29	29
TERM-50W-183S+	50	SMA Male	DC-18	34	31	41	32
ANNE-50L+	50	SMA Male	DC-12	48	46	39	34
KARN-50+	50	N-Type Male	DC-8	46	44	40	37
KARN-50CN+	50	N-Type Male w/chain	DC-8	46	44	40	37
ANNE-50RP+	50	SMA Male Reverse Polarity	DC-6	35	35	35	35
ROSE-50+	50	SMB Female	DC-6	50	49	45	45
TTRM-50+	50	TNC Male	DC-6	24	24	22	21
BTRM-50+	50	BNC Male	DC-4	30	21	20	-
BTRM-50CN+	50	BNC Male	DC-4	41	37	26	-
LOUIS-50	50	DIN 1.0/2.3 Male	DC-2	42	36	-	-
BTRM-75+	75	BNC Male-75 Ohm	DC-1	33	-	-	-

RF Terminations — Coaxial 50 and 75Ω

(Additional Parameters)

Model Number	Return Loss (dB) @ 8 GHz	Return Loss (dB) @ 12 GHz	Return Loss (dB) @ 18 GHz	Return Loss (dB) @ 20 GHz	Return Loss (dB) @ 40 GHz	Return Loss (dB) @ 50 GHz	Return Loss (dB) @ 65 GHz	Power Rating (W), Max.
ANNE-50E+	32	33	31	28	32	22	29	1
ANNEF-50E+	29.5	29.8	26.4	24.2	29.8	25.8	16.1	1
ANNE-50V+	35	38	29	27	26	19	-	1
ANNEF-50V+	45	38	31	30	20	24	-	1
ANNE-50K+	30	30	30	27	20	-	-	1.0
ANNEF-50K+	30	29	26	26	32	-	-	1.0
ANNEQ-50K+	27	26	26	23	25	-	-	1.0
ANNE-50X+	35	35	25	25	-	-	-	1.0
ANNEQ-50X+	33	26	26	31	-	-	-	1.0
ANNE-50+	38	45	30	-	-	-	-	1.0
ANNE-50CN+	38	45	30	-	-	-	-	1.0
ANNEF-50+	41	32	23	-	-	-	-	1.0
KARN-50-18+	41	41	28	-	-	-	-	2.0
SMPF-TERM50+	30	24	22	-	-	-	-	1.0
TERM-25W-183N+	30	36	22	-	-	-	-	25
TERM-25W-183S+	28	24	29	-	-	-	-	25
TERM-50W-183N+	21	44	24	-	-	-	-	50
TERM-50W-183S+	21	30	26	-	-	-	-	50
ANNE-50L+	31	27	-	-	-	-	-	1.0
KARN-50+	35	-	-	-	-	-	-	2.0
KARN-50CN+	35	-	-	-	-	-	-	2.0
ANNE-50RP+	-	-	-	-	-	-	-	1.0
ROSE-50+	-	-	-	-	-	-	-	0.50
TTRM-50+	-	-	-	-	-	-	-	2
BTRM-50+	-	-	-	-	-	-	-	0.50
BTRM-50CN+	-	-	-	-	-	-	-	0.50
LOUIS-50	-	-	-	-	-	-	-	0.125
BTRM-75+	-	-	-	-	-	-	-	0.50



EMLinQ



They are the greatest support staff I've ever worked with. Not just 1 or 2, ALL of them.

— BUYER

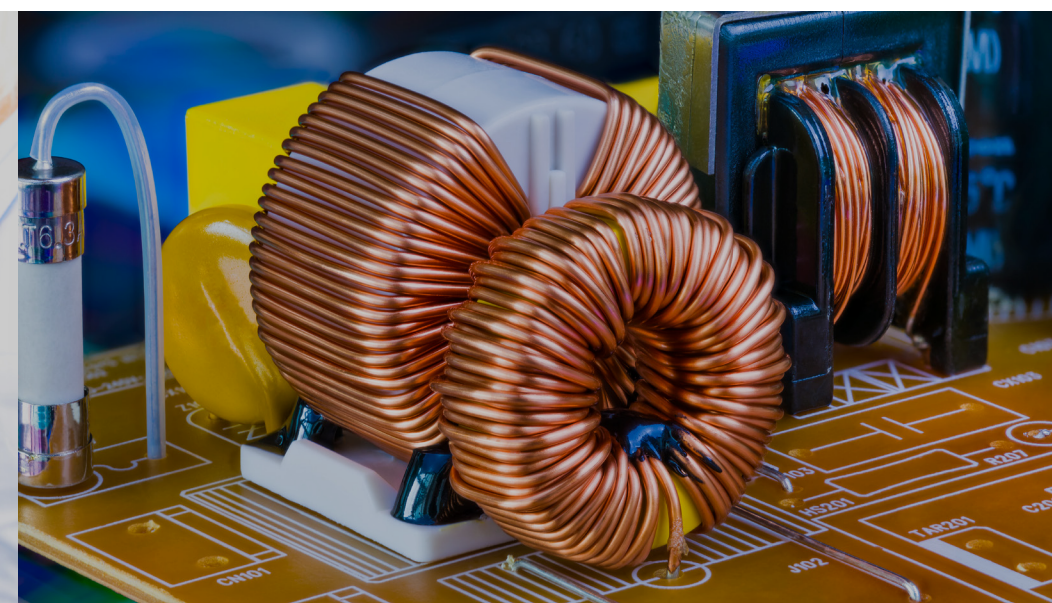
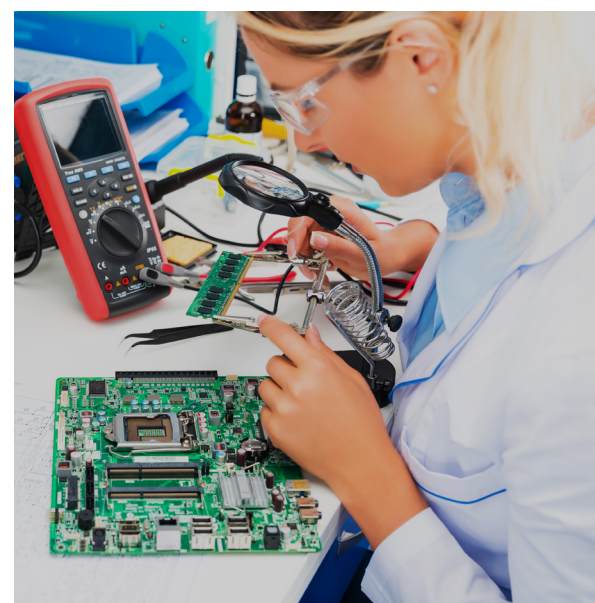



DC TO 50 GHZ

Test Solutions

Components, Systems & Accessories

User-Assembled

Leverage our wide selection of in stock components for total flexibility to build your own system. We'll help you choose the right hardware. You take it from there.

Pre-Built Modular

Configure our flexible, pre-built modular chassis structures with your choice of routing and attenuation hardware for delivery as fast as two weeks.

Custom Systems

Put our full design and manufacturing capability to work for you to build complex, custom systems with bespoke control software tailored to your unique test setup.

Building-Block Functionality:

Signal source and amplification, routing and distribution, level control, measurement and more!



Custom Test Systems

- Typical turnaround of just 8 weeks
- 100% RF tested with Labview based automated test program
- Custom GUI with path control functions
- Full API with programming instructions

Perfect for:

- Complex test setups requiring integration of multiple functions

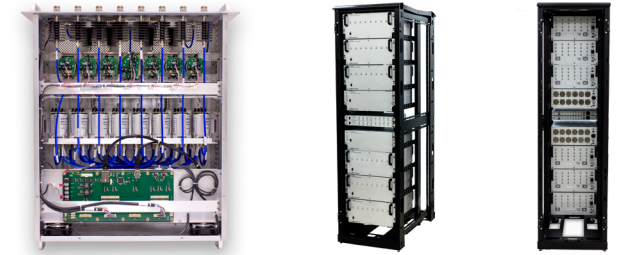

Instrumentation Amplifiers

- Wide selection of amplifier modules from stock
- Custom integration with affordable cost and quick turnaround

Perfect for:

- Signal amplification in unique test setups requiring multiple channels, variable gain and more



Mesh Network Test Systems

- Multi-port networks for interconnecting 3 to n devices or test systems
- Independently controlled attenuation on every path
- Allows simulation of "real-world" mesh communication network in production environments

Perfect for:

- Testing Bluetooth and Zigbee devices, wireless handsets, and Wi-Fi systems

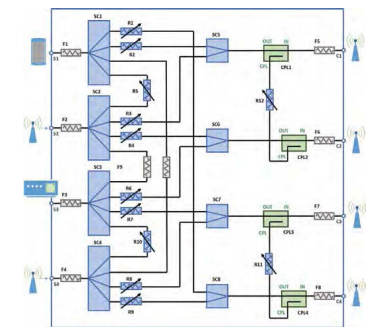

Mesh Network Simulation Racks — Featured Configurations

Model Number	Frequency (MHz)	# of Ports	Atten Range (dB)	Connector
ZTMN-0495AS	350-6000	4	95	SMA
ZTMN-0695A-T	2000-6000	6	95	TNC
ZTMN-0695B-S	600-6000	6	95	SMA
ZTMN-0890A-S	30-3000	8	95	SMA
ZTMN-0895B-S	500-6000	8	95	SMA
ZTMN-0995A-S	500-6000	9	95	SMA

Modular Test Systems

- Your choice of rack mount or bench top structures
- Customizable front panel layout
- USB and Ethernet control interfaces
- Delivery in as little as two weeks!

Perfect for:

- Flexible signal routing and level control in any RF test environment

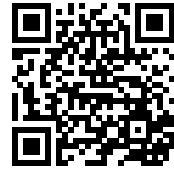

Configure your system online for a fast quote!

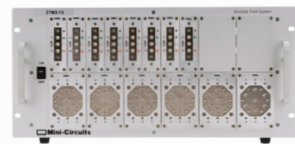

ZTM2 Series



ZTM Series

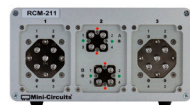

RCM Series

Panel Mounted Structures

- Custom configurations of adapters and splitters in 19-inch rack mount panel

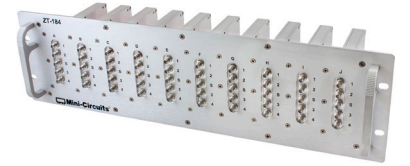

Perfect for:

- Managing and organizing cables and interconnection between different connector types in busy lab environments

Patch Panels — Featured Configurations

Model Number	Frequency (MHz)	Height	Description	Component
ZT-96KFFL-KF50+	DC-40000	5U	96x 2.92-F to 2.92-F Adapter Panel	Adapter
ZT-256	DC-18000	2U	12x 2-Way Splitter Panel, ZFRSC-183-S+	Splitter
ZT-275	DC-18000	2U	10x 30dB Attenuator Panel, BW-S30W20+	Attenuator
ZT-183	DC -18000	4U	48x N-F to SMA-F Adapter Panel	Adapter
ZT-312	DC-18000	1U	12 x N-F to SMA-F Adapter Panel	Adapter
ZT-314D	DC-18000	2U	80 x SMA-F to SMA-F Adapter Panel	Adapter
ZT-182	DC-11000	4U	48x N-F to N-F Adapter Panel	Adapter
ZT-255	500-8500	2U	8x 2-Way Splitter Panel, ZX10-2-852-S+	Splitter
ZT-184	500-6000	3U	10x 4-Way Splitter Panel, ZN4PD1-63LW-S+	Splitter
ZT-222	350-6000	4U	20x 2-Way Splitter Panel, ZN2PD2-63-N+	Splitter
ZT-240	DC-6000	4U	24x N-F to N-F Adapter Panel w/ Special Mounting Bracket	Adapter
ZT-240BK	DC-6000	4U	24x N-F to N-F Adapter Panel w/ Black Anodized Panel	Adapter
ZT-277	600-6000	1U	3x 4-Way Splitter Panel, ZN4PD1-63LW-S+	Splitter
ZT-257	600-6000	1U	4 x 4-Way Splitter Panel	Splitter
ZT-304	500-6000	1U	8 x 2-Way Splitter Panel	Splitter
ZT-299	500-6000	1U	4 x 8-Way Splitter Panel	Splitter
ZT-245	300-1000	1U	1x 8-Way Splitter Panel, ZC8PD1-10-S+	Splitter
ZT-333	100-900	1U	4 x 2-Way Splitter Panel	Splitter
ZT-229B	0.5-600	2U	16x 2-Way Splitter Panel, Z99SC-62-S+	Splitter
ZT-230	1-500	2U	8x 10dB Coupler Panel, ZFDC-10-1-S+	Coupler

Signal Conditioning & Attenuation Systems

- Attenuation range up to 120 dB
- USB, Ethernet, RS232 and SPI control options
- Capable of sweeping, hopping and customized attenuation patterns
- 1, 4 and 8 channel models off-the-shelf (See Page 92)
- Customized multi-channel rack mount systems with fast turnaround

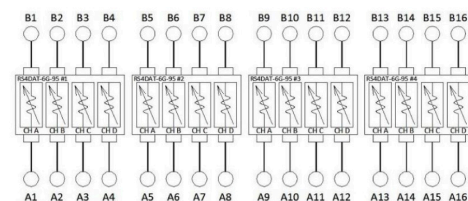

Perfect for:

- Fading simulators
- Handover system evaluation
- Telecom network infrastructure testing
- And more!

Custom Multi-Channel Attenuator Racks Overview

Mini-Circuits' ZTDAT-series attenuator racks cater to test systems where multiple programmable channels are required. With models operating up to 8 GHz and up to 48 channels in a single, self-contained rack, most wireless test applications in the L, S and C bands can be accommodated.



[Learn more about our multi-channel attenuator systems](#)

Signal Generation, Measurement & Control

- Synthesized signal generators
- Power sensors and frequency counters
- Control products

Perfect for:

- General lab use, field testing and remote location monitoring, low-cost alternative to high-end generators and power meters



USB/Ethernet Controlled Synthesized Signal Generators (Additional Parameters Below)

Model Number	Control Interface	Frequency Range (GHz)	Power Range (dBm)	Frequency Resolution (Hz), Min.	Power Resolution (dB), Nom.	Harmonics & Sub-Harmonics (dBc)	Non-Harmonic Spurious (dBc) @ 100 kHz Step
SSG-15G-RC	USB & Ethernet (with SSH)	0.01-15000	-50-15	0.1	0.1	-25	-70
SSG-6000RC	USB & Ethernet	0.025-6000	-65-14	3	0.25	-52	-72
SSG-6001RC	USB & Ethernet	0.001-6000	-70-15	3	0.25	-65	-73

(Additional Parameters)

Model Number	Phase Noise (dBc/Hz) SSB @ 100 Hz Offset	Phase Noise (dBc/Hz) SSB @ 1 kHz Offset	Phase Noise (dBc/Hz) SSB @ 10 kHz Offset	Phase Noise (dBc/Hz) SSB @ 100 kHz Offset	Settling Time (mSec)	Ext. Ref (MHz)	Connector Type
SSG-15G-RC	-83	-103	-112	-112	3.5	10	SMA
SSG-6000RC	-82	-96	-99	-102	1.5	10	N
SSG-6001RC	-92	-108	-112	-119	2	10	N

Power Sensors

Model Number	Control	Sensor Type	Impedance (Ω)	Frequency Range (MHz)	Input Power Range (dBm)	Dynamic Range (dB)	Measurement Speed (ms)	Connector Type
PWR-8P-RC	USB & Ethernet	Peak & Avg.	50	10-8000	-60 to 20	80	0.002	N
PWR-8FS	USB	CW	50	1-8000	-30 to 20	50	10	N
PWR-8GHS	USB	CW	50	1-8000	-30 to 20	50	30	N
PWR-8GHS-RC	USB & Ethernet	CW	50	1-8000	-30 to 20	50	30	N
PWR-6GHS	USB	CW	50	1-6000	-30 to 20	50	30	N
PWR-6LGHS	USB	CW	50	50-6000	-45 to 10	55	30	N
PWR-6LRMS-RC	USB & Ethernet	RMS	50	50-6000	-45 to 10	55	30	N
PWR-6RMS-RC	USB & Ethernet	RMS	50	50-6000	-35 to 20	55	30	N
PWR-4GHS	USB	CW	50	0.009-4000	-30 to 20	50	30	N
PWR-2.5GHS-75	USB	CW	75	0.1-2500	-30 to 20	50	30	N

Integrated Power Sensor – Frequency Counter

Model Number	Control	Sensor Type	Frequency Range (GHz)	Input Power Range (dBm)	Dynamic Range (dB)	Power Meas. Speed (mS)	Freq. Sample Time (S), Min.	Freq. Sample Time (S), Max.
FCPM-6000RC	USB & Ethernet	CW	0.001-6	-30 to 20	50	30	0.1	3

Frequency Counter

Model Number	Control Interface	Freq. Range (MHz)	Frequency Resolution (Hz) @ 1-40 MHz	Frequency Resolution (Hz) @ 40-190 MHz	Frequency Resolution (Hz) @ 190-6000 MHz	Input Power Range (dBm)	Sample Time (Sec) min.	Sample Time (Sec.) Max	Connector Type
UFC-6000	USB	1-6000	1	10	100	-23 to 13	0.1	3	SMA

Signal Distribution

- Splitter/combiner and directional coupler arrays for distribution of test signals through multiple channels
- Rack mounted, panel mounted and benchtop configurations
- Wide range of splitter configurations
- Wideband splitters up to 65 GHz
- High-power splitters up to 100W

Perfect for:

- Distributing test signal through multiple channels to support high-volume testing of multiple DUTs simultaneously

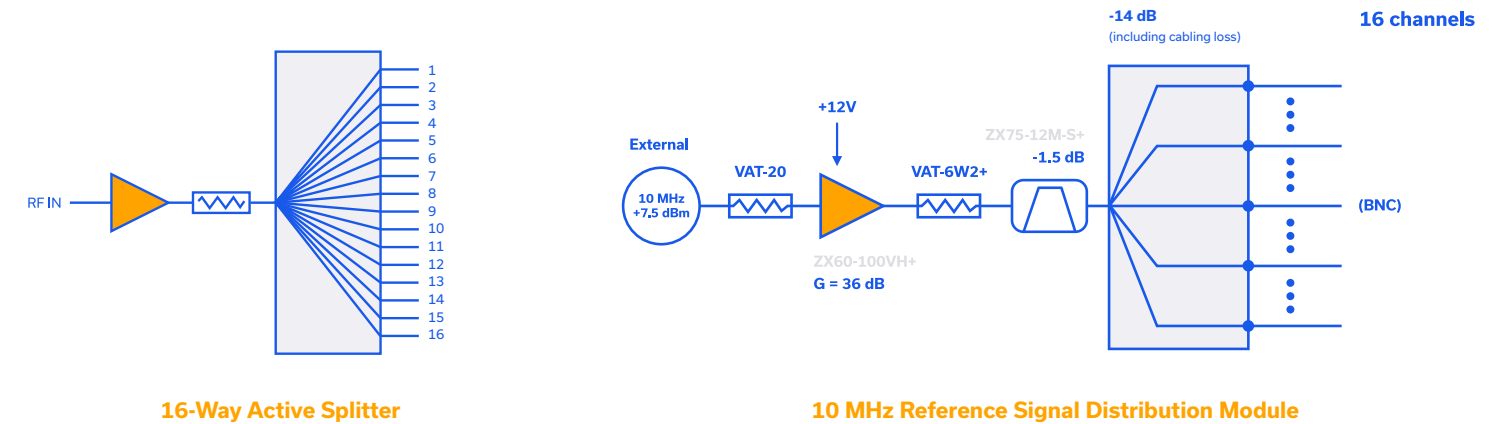

Switching & Signal Routing

Electromechanical Switch Systems

- Compact benchtop modules and custom rack mount systems
- SPDT, SP4T, SP6T, SP8T and transfer switch configurations

Perfect for:

- Automating signal routing for R&D, production test and more

- Extra-long switch life, up to 10 million cycles guaranteed
- USB and Ethernet control options
- Wide selection of models off the shelf (See Page 318)



Custom Electromechanical Switch Systems — Featured Configurations

Model Number	Switch Count					Application	Frequency	Rack Height	Insertion Loss (dB)	
	DPD T	SPD T	SP4 T	SP6 T	SP8 T				Type	Panel
ZTRC-4SPDT-A26	-	4	-	-	-	Switch Rack	DC - 26.5 GHz	1U	SMA	Front
ZTRC-4SPDT-A18	-	4	-	-	-	Switch Rack	DC - 18 GHz	1U	SMA	Front
ZTRC-8SPDT-A18	-	8	-	-	-	Switch Rack	DC - 18 GHz	2U	SMA	Front
ZTRC-8SPDT-A26	-	8	-	-	-	Switch Rack	DC - 26.5 GHz	2U	SMA	Front
ZT-12SP6T-12R	-	-	-	12	-	Switch Rack	DC - 12 GHz	4U	SMA	Rear
ZT-311	-	4	-	8	-	4 x SP12T Switch	DC - 12 GHz	4U	SMA	Rear
ZT-SP36T-12A	-	-	-	-	-	SP36T Switch	DC - 12 GHz	4U	SMA	Front
ZTM2-12SP4T-18	-	-	12	-	-	Switch Rack	DC - 18 GHz	5U	SMA	Front
ZTM2-12SP6T-12	-	-	-	12	-	Switch Rack	DC - 12 GHz	5U	SMA	Front
ZTM2-8SP8T-12	-	-	-	-	8	Switch Rack	DC - 12 GHz	5U	SMA	Front
ZTMX-5SP4T-40	-	-	5	-	-	Switch Rack	DC - 40 GHz	3U	2.92 mm	Front
ZT-1SP8T-26	-	-	-	-	1	Switch Rack	DC - 26.5 GHz	3U	SMA	Front

Electromechanical Switch Systems — Featured Configurations Continued

Model Number	Switch Count					Application	Frequency	Rack Height	Insertion Loss (dB)	
	DPD T	SPD T	SP4 T	SP6 T	SP8 T				Type	Panel
ZTM-6SP6T-26	-	-	-	6	-	Switch Rack	DC - 26.5 GHz	3U	SMA	Front
ZTM-4SP8T-12	-	-	-	-	4	Switch Rack	DC - 12 GHz	3U	SMA	Front
ZT-14SP6T-40	-	-	-	14	-	2 x SP36T Switch	DC - 40 GHz	6U	2.92 mm	Front
ZT-166	-	1	10	-	-	SP32T Switch	DC - 18 GHz	4U	SMA	Front
ZT-297	-	-	-	-	9	Switch Rack	DC - 12 GHz	4U	SMA	Front
ZT-317	-	3	-	-	-	Switch Rack	DC - 18 GHz	1U	N-type	Rear
ZT-310	32	-	-	-	-	Switch Rack	DC - 18 GHz	5U	SMA	Front & Rear
ZT-315	-	-	1*	-	5	SP40T Switch	DC - 18 GHz	3U	SMA	Front
ZT-169	-	4	10	-	-	4 x SP8T & 2 x SPDT	DC - 18 GHz	4U	SMA	Front
ZTM-12MTS-26	12	-	-	-	-	Switch Rack	DC - 26.5 GHz	3U	SMA	Front

Solid State Switch Systems

- Compact switch modules and custom rack mount switch matrices
- Many combinations of SPDT, SP4T, SP8T, SP10T and SP16T switch configurations
- Extremely fast switching time, down to 250 ns

- Unique designs achieve high isolation
- USB, Ethernet and SPI control options
- See full selection of models in stock on page 321

Perfect for:

- Signal routing in systems with high-speed, high-volume signal traffic



Custom Solid State Switch Systems — Featured Configurations

Model Number	Switch Type	Frequency	Switch Count	Rack Height	Connectors	Panel	Control
ZT-24SP2T-63VH	SPDT	600 - 6000 MHz	24	4U	N-type	Front & Rear	USB & Ethernet
ZTS-32SP2T-63VH	SPDT	100 - 6000 MHz	32	5U	SMA	Front	USB & Ethernet
ZTS-16SP4T-63H	SP4T	10 - 6000 MHz	16	2U	SMA	Front	USB & Ethernet & Daisy-Chain
ZTS-6SP8T-63R	SP8T	10 - 6000 MHz	6	3U	SMA	Rear	USB & Ethernet
ZTS-8SP8T-63	SP8T	10 - 6000 MHz	8	4U	SMA	Front	USB & Ethernet
ZT-320	SP8T	1 - 6000 MHz	30	3U	SMA	Rear	USB & Ethernet & Daisy-Chain
ZTS-1SP16T-83R	SP16T	1 - 8000 MHz	1	1U	SMA	Rear	USB & Ethernet
ZTS-1SP80T-63H	SP80T	10 - 6000 MHz	1	2U	SMA	Front & Rear	USB & Ethernet & Daisy-Chain

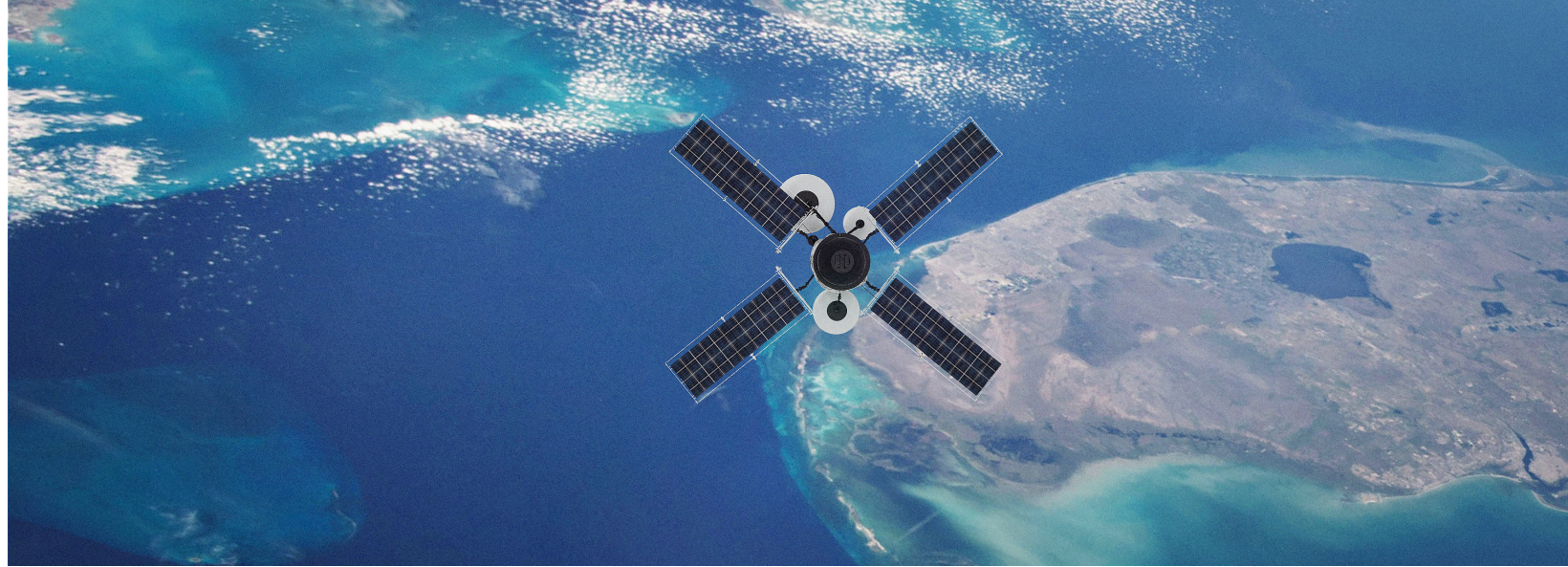

Custom Switch Matrices

Mini-Circuits' integrated switch matrices provide reliable and repeatable signal routing for any application. Blocking, non-blocking and full fan-out switch matrices are available using combinations of high reliability mechanical switches and high-performance solid-state switch technologies.

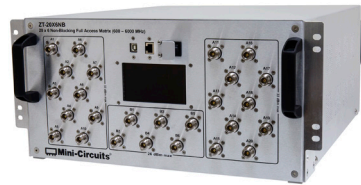

Explore custom switch matrices for your needs

Mission Microwave

// [Mini-Circuits] has provided the best service.

— PLANNER / BUYER

Non-Blocking Switch Matrices

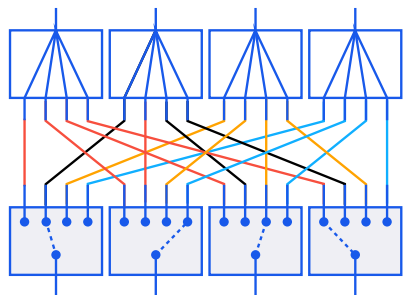

Blocking Switch Matrices

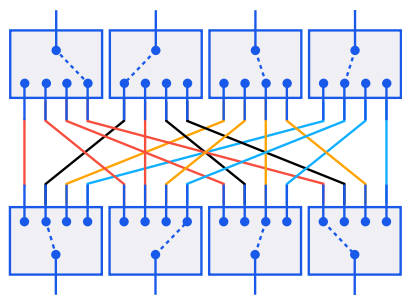

Full Fan-out Matrices

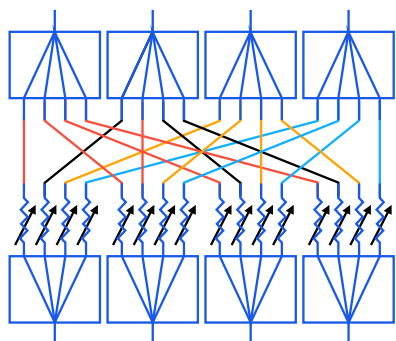

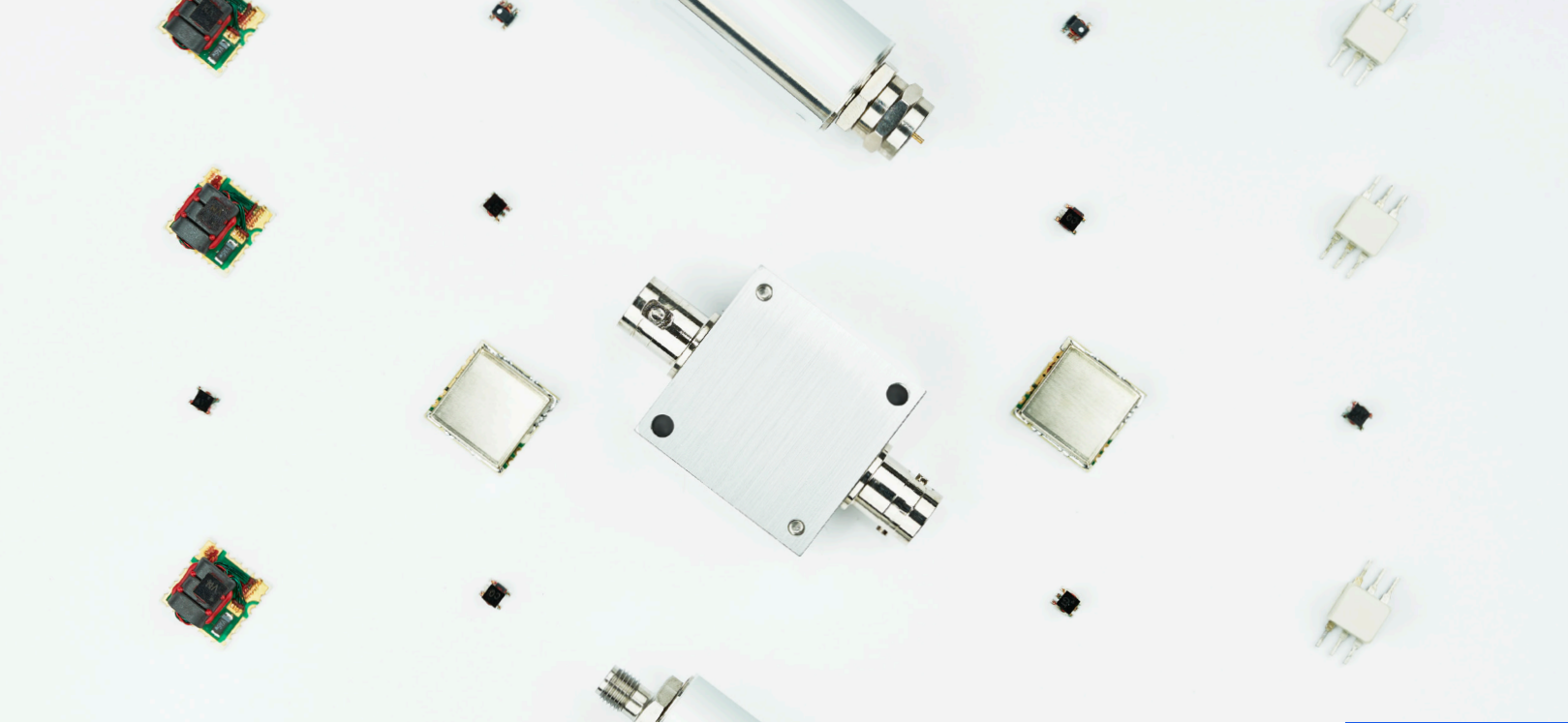

DC TO 24 GHZ

Transformers & Baluns

400+ In Stock

- Wide selection of LTCC, core and wire and MMIC designs
- Step-down and step-up impedance ratios from 0.1 to 36
- Connectorized, surface mount and MMIC die formats

Configurations for almost any circuit:

Single-ended to single-ended, single-ended to balanced, balanced to balanced, DC passing, DC isolated, with and without center taps

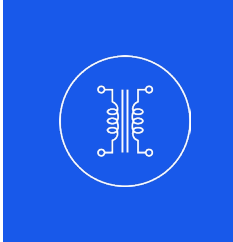

Transformers & Baluns — Surface Mount 50Ω

Model Number	Single-Ended to Single-Ended	Single-Ended to Balanced	Balanced to Balanced	Center Tap	DC Isolation	Freq. Range (MHz)	Impedance	Impedance Ratio	Tech.	Config.
MTY2-243+	N	Y	N	N	Y	10000-24000	50	2	MMIC	J
NCR2-183+	N	Y	N	N	Y	12000-18000	50	2	LTCC	E1
MTX2-143+	N	Y	N	N	Y	5500-13500	50	2	MMIC	J
NCR2-123+	N	Y	N	N	Y	4700-12000	50	2	LTCC	J
NCR2-113+	N	Y	N	N	Y	3500-11000	50	2	LTCC	J
SBTX2-113-2W+	N	Y	N	N	N	2600-11000	50	2	CORE & WIRE	G
SCTX2-93-2W+	N	Y	N	N	N	10-9000	50	2	CORE & WIRE	G
NCS2-83+	N	Y	N	N	Y	3000-8000	50	2	LTCC	R
SCTX1-83-2W+	N	Y	N	N	N	10-8000	50	1	CORE & WIRE	G
TCM1-83X+	N	Y	Y	N	N	10-8000	50	1	CORE & WIRE	K
TCW2-722+	N	Y	N	N	Y	2400-7125	50	2	LTCC	J
MTX2-73+	N	Y	N	N	Y	2000-7000	50	2	MMIC	J
TCM2-672X+	N	Y	Y	N	N	1700-6700	50	2	CORE & WIRE	G
NCS2-622+	N	Y	N	N	Y	5600-6200	50	2	LTCC	R
NCS1-63+	N	Y	N	N	Y	4900-6000	50	1	LTCC	R
NCS4-63+	N	Y	N	N	Y	4500-6000	50	4	LTCC	J
TCM1-63AX+	N	Y	Y	N	N	10-6000	50	1	CORE & WIRE	K
TCM2-63WX+	N	Y	Y	N	N	30-6000	50	2	CORE & WIRE	K
TCW1-6000+	N	Y	N	N	Y	3200-6000	50	1	LTCC	R
TCW2-6000+	N	Y	N	N	Y	3100-6000	50	2	LTCC	R
TTC2-63W+	N	Y	N	N	N	100-6000	50	2	CORE & WIRE	G
BLJC1-542R+	N	Y	N	N	Y	4900-5950	50	1	LTCC	J
BLJC4-542R+	N	Y	N	N	Y	4900-5950	50	4	LTCC	J
BLNK1-542R+	N	Y	N	N	N	4900-5950	50	1	LTCC	G

Transformers & Baluns — Surface Mount 50Ω Continued

Model Number	Single-Ended to Single-Ended	Single-Ended to Balanced	Balanced to Balanced	Center Tap	DC Isolation	Freq. Range (MHz)	Impedance	Impedance Ratio	Tech.	Config.
BLNK2-542R+	N	Y	N	N	N	4900-5950	50	2	LTCC	G
TCO1-462+	N	Y	N	N	N	3300-5900	50	1	LTCC	G
TCO2-532+	N	Y	N	N	N	4600-5900	50	2	LTCC	G
BLGE1-542R+	N	Y	N	N	Y	4900-5875	50	1	LTCC	R
BLGE2-542R+	N	Y	N	N	Y	4900-5875	50	2	LTCC	R
BLGE4-542R+	N	Y	N	N	Y	4900-5875	50	4	LTCC	J
BLJC2-542R+	N	Y	N	N	Y	4900-5875	50	2	LTCC	R
NCS2-592+	N	Y	N	N	Y	4900-5875	50	2	LTCC	R
TCW2-63+	N	Y	N	N	Y	4900-5875	50	2	LTCC	R
TCW4-582+	N	Y	N	N	Y	5000-5800	50	4	LTCC	R
TCM3-452X+	N	Y	Y	Y	N	20-4500	50	3	CORE & WIRE	H
TCM4-452X+	N	Y	Y	Y	N	20-4500	50	4	CORE & WIRE	H
TCN2-45+	N	Y	Y	Y	N	3300-4500	50	2	LTCC	H
NCS4-442+	N	Y	N	N	Y	3300-4200	50	2	LTCC	R
NCS1-422+	N	Y	N	N	Y	3300-4000	50	1	LTCC	R
TC1-1-43+	N	Y	Y	N	N	650-4000	50	1	CORE & WIRE	G
TC1-1-43X+	N	Y	Y	N	N	650-4000	50	1	CORE & WIRE	G
TCM1-43X+	N	Y	Y	N	N	10-4000	50	1	CORE & WIRE	K
TCM2-43X+	N	Y	Y	N	N	10-4000	50	2	CORE & WIRE	K
NCS2-392+	N	Y	N	N	Y	3000-3900	50	2	LTCC	R
TCW1-392+	N	Y	N	N	Y	3300-3900	50	1	LTCC	J
TCW1-3901+	N	Y	Y	N	N	3300-3900	50	1	LTCC	G
TCW2-392+	N	Y	N	N	Y	3300-3900	50	2	LTCC	R
NCS1-332+	N	Y	N	N	Y	700-3300	50	1	LTCC	R

Transformers & Baluns — Surface Mount 50Ω Continued

Model Number	Single-Ended to Single-Ended	Single-Ended to Balanced	Balanced to Balanced	Center Tap	DC Isolation	Freq. Range (MHz)	Impedance	Impedance Ratio	Tech.	Config.
NCS2-33+	N	Y	N	N	Y	1500-3100	50	2	LTCC	J
TC1-1-13M+	N	Y	Y	N	N	4.5-3000	50	1	CORE & WIRE	G
TC1-1-13MG2+	N	Y	Y	N	N	4.5-3000	50	1	CORE & WIRE	G
TC1-1-13MX+	N	Y	Y	N	N	4.5-3000	50	1	CORE & WIRE	G
TCM2-33WX+	N	Y	Y	N	N	10-3000	50	2	CORE & WIRE	N
TCM2-33X+	N	Y	Y	N	N	30-3000	50	2	CORE & WIRE	N
TCW1-33+	N	Y	N	N	Y	2300-3000	50	1	LTCC	R
TTC1-33W+	N	Y	N	N	N	4.5-3000	50	1	CORE & WIRE	G
NCS1-292+	N	Y	N	N	Y	1650-2850	50	1	LTCC	J
NCS2-282+	N	Y	N	N	Y	625-2815	50	2	LTCC	R
TC1.33-282+	N	Y	Y	N	N	5-2800	50	1.33	CORE & WIRE	K
TC1.33-282X+	N	Y	Y	N	N	5-2800	50	1.33	CORE & WIRE	K
TCW2-282+	N	Y	N	N	Y	700-2800	50	2	LTCC	R
NCS3-272+	N	Y	N	N	Y	2250-2725	50	3	LTCC	J
NCS4-272+	N	Y	N	N	Y	2300-2700	50	4	LTCC	J
TCW1-272+	N	Y	Y	N	N	1700-2700	50	1	LTCC	G
TCW1-2700+	N	Y	N	N	Y	700-2700	50	1	LTCC	R
TCW2-272+	N	Y	N	N	Y	2100-2700	50	2	LTCC	J
TCN2-26+	N	Y	Y	N	N	1600-2600	50	2	LTCC	G
TCW4-262+	N	Y	N	N	Y	2300-2600	50	4	LTCC	J
BLGE1-252R+	N	Y	N	N	Y	2400-2500	50	1	LTCC	J
BLGE2-252R+	N	Y	N	N	Y	2400-2500	50	2	LTCC	J
BLGE4-252R+	N	Y	N	N	Y	2400-2500	50	4	LTCC	J
BLJC1-252R+	N	Y	N	N	Y	2400-2500	50	1	LTCC	R

Transformers & Baluns — Surface Mount 50Ω Continued

Model Number	Single-Ended to Single-Ended	Single-Ended to Balanced	Balanced to Balanced	Center Tap	DC Isolation	Freq. Range (MHz)	Impedance	Impedance Ratio	Tech.	Config.
BLJC2-252R+	N	Y	N	N	Y	2400-2500	50	2	LTCC	J
BLJC4-252R+	N	Y	N	N	Y	2400-2500	50	4	LTCC	J
BLNK1-252R+	N	Y	N	N	N	2400-2500	50	1	LTCC	S
BLNK2-252R+	N	Y	N	N	N	2400-2500	50	2	LTCC	S
TC4-25+	N	Y	Y	Y	N	500-2500	50	4	CORE & WIRE	H
TC4-25G2+	N	Y	Y	Y	N	500-2500	50	4	CORE & WIRE	H
TC4-25X+	N	Y	Y	Y	N	500-2500	50	4	CORE & WIRE	H
TCM4-25+	N	Y	Y	Y	N	500-2500	50	4	CORE & WIRE	H
TRS2-252+	Y	N	N	N	N	4-2500	50	2	CORE & WIRE	D
NCS1.5-232+	N	Y	N	N	Y	400-2300	50	1.5	LTCC	J
NCS2-232+	N	Y	N	N	Y	900-2300	50	2	LTCC	R
NCS4-232+	N	Y	N	N	Y	1600-2300	50	4	LTCC	J
TCN1-23+	N	Y	Y	N	N	1300-2300	50	1	LTCC	G
NCS2-222+	N	Y	N	N	Y	1275-2200	50	2	LTCC	J
TC1.5-1+	Y	N	N	N	N	0.5-2200	50	1.5	CORE & WIRE	D
TC1.5-1G2+	Y	N	N	N	N	0.5-2200	50	1.5	CORE & WIRE	D
TC1.5-1X+	Y	N	N	N	N	0.5-2200	50	1.5	CORE & WIRE	D
TCN4-22+	N	Y	N	N	Y	1200-2200	50	4	LTCC	J
NCS1-23+	N	Y	N	N	Y	1300-2000	50	1	LTCC	R
TC4-19+	N	Y	Y	Y	N	10-1900	50	4	CORE & WIRE	H
TC4-19G2+	N	Y	Y	Y	N	10-1900	50	4	CORE & WIRE	H
TC4-19X+	N	Y	Y	Y	N	10-1900	50	4	CORE & WIRE	H
TCL1-19+	N	Y	Y	N	N	800-1900	50	1	CORE & WIRE	G
TCL1-19G2+	N	Y	Y	N	N	800-1900	50	1	CORE & WIRE	G

Transformers & Baluns — Surface Mount 50Ω Continued

Model Number	Single-Ended to Single-Ended	Single-Ended to Balanced	Balanced to Balanced	Center Tap	DC Isolation	Freq. Range (MHz)	Impedance	Impedance Ratio	Tech.	Config.
TCM4-19+	N	Y	Y	Y	N	10-1900	50	4	CORE & WIRE	H
TCML1-19+	N	Y	Y	N	N	800-1900	50	1	CORE & WIRE	G
TCML1-19X+	N	Y	Y	N	N	800-1900	50	1	CORE & WIRE	G
ADTL2-18+	N	Y	Y	N	N	30-1800	50	2	CORE & WIRE	G
TRS1.5-182+	N	Y	Y	N	N	10-1800	50	1.5	CORE & WIRE	K
ADT1.5-17+	Y	N	N	N	N	0.5-1700	50	1.5	CORE & WIRE	D
ADT2-162T+	N	Y	N	N	N	20-1600	50	2	CORE & WIRE	P1
TCN4-162+	N	Y	N	N	Y	720-1600	50	4	LTCC	J
TC1-1T-152X+	N	Y	N	Y	N	5-1500	50	1	CORE & WIRE	M1
TC1-15+	N	Y	Y	N	N	350-1500	50	1	CORE & WIRE	G
TC1-15G2+	N	Y	Y	N	N	350-1500	50	1	CORE & WIRE	G
TC1-15X+	N	Y	Y	N	N	350-1500	50	1	CORE & WIRE	G
TC4-14+	N	Y	Y	Y	Y	200-1400	50	4	CORE & WIRE	A
TC4-14G2+	N	Y	Y	Y	Y	200-1400	50	4	CORE & WIRE	A
TC4-14X+	N	Y	Y	Y	Y	200-1400	50	4	CORE & WIRE	A
TCM4-14+	N	Y	Y	Y	Y	200-1400	50	4	CORE & WIRE	A
TCN2-14+	N	Y	Y	N	N	700-1400	50	2	LTCC	G
TCN4-13+	N	Y	Y	N	N	650-1250	50	4	LTCC	G
ADT1.5-122+	N	Y	Y	N	N	20-1200	50	1.5	CORE & WIRE	K
ADTL1-12+	N	Y	Y	N	N	20-1200	50	1	CORE & WIRE	G
TCN2-122+	N	Y	N	N	Y	600-1200	50	2	LTCC	J
NCS1-112+	N	Y	N	N	Y	700-1100	50	1	LTCC	J
TC2-112G2+	Y	N	N	N	N	2-1100	50	0.5	CORE & WIRE	D
TC4-11+	Y	N	N	N	N	2-1100	50	0.25	CORE & WIRE	D

Transformers & Baluns — Surface Mount 50Ω Continued

Model Number	Single-Ended to Single-Ended	Single-Ended to Balanced	Balanced to Balanced	Center Tap	DC Isolation	Freq. Range (MHz)	Impedance	Impedance Ratio	Tech.	Config.
TC4-11G2+	Y	N	N	N	N	2-1100	50	0.25	CORE & WIRE	D
TC4-11X+	Y	N	N	N	N	2-1100	50	0.25	CORE & WIRE	D
TCL1-11+	N	Y	Y	N	N	600-1100	50	1	CORE & WIRE	G
TCML1-11+	N	Y	Y	N	N	600-1100	50	1	CORE & WIRE	G
TCML1-11X+	N	Y	Y	N	N	600-1100	50	1	CORE & WIRE	G
TCN3-11+	N	Y	Y	N	N	600-1100	50	3	LTCC	G
TCN1-10+	N	Y	Y	N	N	680-1050	50	1	LTCC	G
JTX-4-10T+	N	Y	Y	Y	Y	50-1000	50	4	CORE & WIRE	A
NCS4-102+	N	Y	N	N	Y	700-1000	50	4	LTCC	J
SYTX4-13HP+	N	Y	Y	Y	N	30-1000	50	4	CORE & WIRE	H
TC4-13TX+	N	Y	Y	Y	Y	100-1000	50	4	CORE & WIRE	A
T3-1+	Y	N	N	N	N	0.5-800	50	3	CORE & WIRE	D
T3-1-KK81+	Y	N	N	N	N	0.5-800	50	3	CORE & WIRE	D
TC4-1W+	N	Y	Y	Y	Y	3-800	50	4	CORE & WIRE	A
TC4-1WA+	N	Y	Y	Y	Y	3-800	50	4	CORE & WIRE	A
TC4-1WG2+	N	Y	Y	Y	Y	3-800	50	4	CORE & WIRE	A
TC4-1WX+	N	Y	Y	Y	Y	3-800	50	4	CORE & WIRE	A
TCM4-1W+	N	Y	Y	Y	Y	3-800	50	4	CORE & WIRE	A
TCM4-1WX+	N	Y	Y	Y	Y	3-800	50	4	CORE & WIRE	A
ADT4-1WT+	N	Y	Y	Y	Y	2-775	50	4	CORE & WIRE	A
NCS2-771+	N	Y	N	N	Y	240-770	50	2	LTCC	J
NCS3-72+	N	Y	N	N	Y	250-760	50	3	LTCC	J
TC2-72T+	N	Y	Y	Y	Y	10-700	50	2	CORE & WIRE	A
ADT1.5-1+	N	Y	Y	Y	Y	0.5-650	50	1.5	CORE & WIRE	A

Transformers & Baluns — Surface Mount 50Ω Continued

Model Number	Single-Ended to Single-Ended	Single-Ended to Balanced	Balanced to Balanced	Center Tap	DC Isolation	Freq. Range (MHz)	Impedance	Impedance Ratio	Tech.	Config.
ADT4-1T+	N	Y	Y	Y	Y	9-625	50	4	CORE & WIRE	A
ADT2-1T-1P+	N	Y	Y	Y	Y	8-600	50	2	CORE & WIRE	A
ADT4-6WT+	N	Y	Y	Y	Y	0.5-600	50	4	CORE & WIRE	A
SERT4-62HP-50W+	Y	N	N	N	N	20-600	12.5/50	0.25	CORE & WIRE	D
T2-1+	Y	N	N	N	N	0.05-600	50	2	CORE & WIRE	D
T2-1-KK81+	Y	N	N	N	N	0.05-600	50	2	CORE & WIRE	D
T4-2+	Y	N	N	N	N	0.2-600	50	4	CORE & WIRE	D
T4-2-KK81+	Y	N	N	N	N	0.2-600	50	4	CORE & WIRE	D
TC4-6T+	N	Y	Y	Y	Y	1.5-600	50	4	CORE & WIRE	A
TC4-6TG2+	N	Y	Y	Y	Y	1.5-600	50	4	CORE & WIRE	A
TC4-6TX+	N	Y	Y	Y	Y	1.5-600	50	4	CORE & WIRE	A
TCM4-6T+	N	Y	Y	Y	Y	1.5-600	50	4	CORE & WIRE	A
TX4-62HP+	N	Y	Y	Y	N	20-600	50	4	CORE & WIRE	H
NCS2-62+	N	Y	N	N	Y	390-590	50	2	LTCC	J
TC1.5-52T+	N	Y	Y	Y	Y	0.5-550	50	1.5	CORE & WIRE	A
TC1.5-52TG2+	N	Y	Y	Y	Y	0.5-550	50	1.5	CORE & WIRE	A
TC1.5-52TX+	N	Y	Y	Y	Y	0.5-550	50	1.5	CORE & WIRE	A
NCS1-521+	N	Y	N	N	N	223-520	50	1	LTCC	S
NCS4-521+	N	Y	N	N	Y	223-520	50	4	LTCC	R
SYTX1-52HP-15W+	N	Y	Y	N	N	20-520	50	1	CORE & WIRE	G
SYTX2-52HP-20W+	Y	N	N	N	N	30-520	50	2	CORE & WIRE	D
TXA4-512HP+	N	Y	Y	Y	N	30-512	50	4	CORE & WIRE	H
ADT3-1T+	N	Y	Y	Y	Y	1-500	50	3	CORE & WIRE	A
ADT4-5WT+	N	Y	Y	Y	Y	0.3-500	50	4	CORE & WIRE	A

Transformers & Baluns — Surface Mount 50Ω Continued

Model Number	Single-Ended to Single-Ended	Single-Ended to Balanced	Balanced to Balanced	Center Tap	DC Isolation	Freq. Range (MHz)	Impedance	Impedance Ratio	Tech.	Config.
TC1-1+	N	Y	Y	N	Y	1.5-500	50	1	CORE & WIRE	C
TC1-1G2+	N	Y	Y	N	Y	1.5-500	50	1	CORE & WIRE	C
TC1-1T+	N	Y	Y	Y	Y	0.4-500	50	1	CORE & WIRE	A
TC1-1TG2+	N	Y	Y	Y	Y	0.4-500	50	1	CORE & WIRE	A
TC1-1TX+	N	Y	Y	Y	Y	0.4-500	50	1	CORE & WIRE	A
TC1-1X+	N	Y	Y	N	Y	1.5-500	50	1	CORE & WIRE	C
TC8-1+	N	Y	Y	Y	Y	2-500	50	8	CORE & WIRE	A
TC8-1G2+	N	Y	Y	Y	Y	2-500	50	8	CORE & WIRE	A
TC8-1X+	N	Y	Y	Y	Y	2-500	50	8	CORE & WIRE	A
TCM1-1+	N	Y	Y	N	Y	1.5-500	50	1	CORE & WIRE	C
TCM1-1X+	N	Y	Y	N	Y	1.5-500	50	1	CORE & WIRE	C
TCM3-1T+	N	Y	Y	Y	Y	2-500	50	3	CORE & WIRE	A
TCM3-1TX+	N	Y	Y	Y	Y	2-500	50	3	CORE & WIRE	A
TCM8-1+	N	Y	Y	Y	Y	2-500	50	8	CORE & WIRE	A
TT1.5-1+	N	Y	Y	Y	Y	0.075-500	50	1.5	CORE & WIRE	B
TT1.5-1-KK81+	N	Y	Y	Y	Y	0.075-500	50	1.5	CORE & WIRE	B
TX1-R5+	N	Y	Y	N	Y	0.8-500	50	1	CORE & WIRE	C
ADT2-1T+	N	Y	Y	Y	Y	0.4-450	50	2	CORE & WIRE	A
SYTX2-451-5W+	N	Y	Y	N	Y	10-450	50	2	CORE & WIRE	C
ADT1-1+	N	Y	Y	N	Y	0.15-400	50	1	CORE & WIRE	C
ADT3-6T+	N	Y	Y	Y	Y	0.06-400	50	3	CORE & WIRE	A
T1-1+	N	Y	Y	N	Y	0.15-400	50	1	CORE & WIRE	C
T1-1-KK81+	N	Y	Y	N	Y	0.15-400	50	1	CORE & WIRE	C
TC1-42+	N	Y	Y	N	Y	0.25-400	50	1	CORE & WIRE	C

Transformers & Baluns — Surface Mount 50Ω Continued

Model Number	Single-Ended to Single-Ended	Single-Ended to Balanced	Balanced to Balanced	Center Tap	DC Isolation	Freq. Range (MHz)	Impedance	Impedance Ratio	Tech.	Config.
TC1-42X+	N	Y	Y	N	Y	0.25-400	50	1	CORE & WIRE	C
TTCM4-4+	N	Y	Y	Y	Y	0.5-400	50	4	CORE & WIRE	B
TTCM4-4X+	N	Y	Y	Y	Y	0.5-400	50	4	CORE & WIRE	B
TX1-1+	N	Y	Y	N	Y	0.3-400	50	1	CORE & WIRE	C
T4-1+	N	Y	Y	Y	Y	0.2-350	50	4	CORE & WIRE	A
T4-1-KK81+	N	Y	Y	Y	Y	0.2-350	50	4	CORE & WIRE	A
T4-1H+	N	Y	Y	Y	Y	10-350	50	4	CORE & WIRE	A
T4-1H-KK81+	N	Y	Y	Y	Y	10-350	50	4	CORE & WIRE	A
TC1-6+	N	Y	Y	N	Y	0.15-350	50	1	CORE & WIRE	C
TC1-6X+	N	Y	Y	N	Y	0.15-350	50	1	CORE & WIRE	C
SCTX4-32HP-20W+	Y	N	N	N	N	1-310	50	4	CORE & WIRE	D1
ADT4-6T+	N	Y	Y	Y	Y	0.06-300	50	4	CORE & WIRE	A
ADTT1-1+	N	Y	Y	Y	Y	0.3-300	50	1	CORE & WIRE	B
ADTT1.5-1+	N	Y	Y	Y	Y	0.25-300	50	1.5	CORE & WIRE	B
T1-6T+	N	Y	Y	Y	Y	0.015-300	50	1	CORE & WIRE	A
T1-6T-KK81+	N	Y	Y	Y	Y	0.015-300	50	1	CORE & WIRE	A
T5-1T+	N	Y	Y	Y	Y	0.3-300	50	5	CORE & WIRE	A
T5-1T-KK81+	N	Y	Y	Y	Y	0.3-300	50	5	CORE & WIRE	A
TC2-1T+	N	Y	Y	Y	Y	3-300	50	2	CORE & WIRE	A
TC2-1TG2+	N	Y	Y	Y	Y	3-300	50	2	CORE & WIRE	A
TC2-1TX+	N	Y	Y	Y	Y	3-300	50	2	CORE & WIRE	A
TC3-1T+	N	Y	Y	Y	Y	5-300	50	3	CORE & WIRE	A
TC3-1TG2+	N	Y	Y	Y	Y	5-300	50	3	CORE & WIRE	A
TC3-1TX+	N	Y	Y	Y	Y	5-300	50	3	CORE & WIRE	A

Transformers & Baluns — Surface Mount 50Ω Continued

Model Number	Single-Ended to Single-Ended	Single-Ended to Balanced	Balanced to Balanced	Center Tap	DC Isolation	Freq. Range (MHz)	Impedance	Impedance Ratio	Tech.	Config.
TC4-1T+	N	Y	Y	Y	Y	0.5-300	50	4	CORE & WIRE	A
TC4-1TG2+	N	Y	Y	Y	Y	0.5-300	50	4	CORE & WIRE	A
TC4-1TX+	N	Y	Y	Y	Y	0.5-300	50	4	CORE & WIRE	A
TC16-1T+	N	Y	Y	Y	Y	20-300	50	16	CORE & WIRE	A
TC16-1TG2+	N	Y	Y	Y	Y	20-300	50	16	CORE & WIRE	A
TC16-1TX+	N	Y	Y	Y	Y	20-300	50	16	CORE & WIRE	A
TCM2-1T+	N	Y	Y	Y	Y	3-300	50	2	CORE & WIRE	A
TT1-6+	N	Y	Y	Y	Y	0.004-300	50	1	CORE & WIRE	B
TT1-6-KK81+	N	Y	Y	Y	Y	0.004-300	50	1	CORE & WIRE	B
TT4-1A+	N	Y	Y	Y	Y	0.1-300	50	4	CORE & WIRE	B
TT4-1A-KK81+	N	Y	Y	Y	Y	0.1-300	50	4	CORE & WIRE	B
TX1.5-1+	N	Y	Y	N	Y	0.25-300	50	1.5	CORE & WIRE	C
TX16-R3T+	N	Y	Y	Y	Y	40-300	50	16	CORE & WIRE	A
TCM9-1+	N	Y	Y	Y	Y	2-280	50	9	CORE & WIRE	A
ADT4-6+	N	Y	Y	N	Y	0.07-250	50	4	CORE & WIRE	C
ADT9-1T+	N	Y	Y	Y	Y	1-250	50	9	CORE & WIRE	A
T3-1T+	N	Y	Y	Y	Y	0.05-250	50	3	CORE & WIRE	A
T3-1T-KK81+	N	Y	Y	Y	Y	0.05-250	50	3	CORE & WIRE	A
T4-1-2W+	N	Y	Y	N	Y	10-250	50	4	CORE & WIRE	C
T4-1-2W-KK81+	N	Y	Y	N	Y	10-250	50	4	CORE & WIRE	C
T4-6T+	N	Y	Y	Y	Y	0.02-250	50	4	CORE & WIRE	A
T4-6T-KK81+	N	Y	Y	Y	Y	0.02-250	50	4	CORE & WIRE	A
T8-1+	Y	N	N	N	N	0.15-250	50	8	CORE & WIRE	D
T8-1-KK81+	Y	N	N	N	N	0.15-250	50	8	CORE & WIRE	D

Transformers & Baluns — Surface Mount 50Ω Continued

Model Number	Single-Ended to Single-Ended	Single-Ended to Balanced	Balanced to Balanced	Center Tap	DC Isolation	Freq. Range (MHz)	Impedance	Impedance Ratio	Tech.	Config.
ADT1.5-2+	N	Y	Y	N	Y	0.3-225	50	1.5	CORE & WIRE	C
ADTT3-2+	N	Y	Y	Y	Y	0.2-210	50	3	CORE & WIRE	B
T-622+	Y	Y	Y	Y	Y	0.1-200	50	0.0423726851851852	CORE & WIRE	F
T-622-KK81+	Y	Y	Y	Y	Y	0.1-200	50	0.0423726851851852	CORE & WIRE	F
T1-1T+	N	Y	Y	Y	Y	0.08-200	50	1	CORE & WIRE	A
T1-1T-KK81+	N	Y	Y	Y	Y	0.08-200	50	1	CORE & WIRE	A
T2-1T+	N	Y	Y	Y	Y	0.07-200	50	2	CORE & WIRE	A
T2-1T-KK81+	N	Y	Y	Y	Y	0.07-200	50	2	CORE & WIRE	A
T2-613-1+	Y	Y	Y	Y	Y	0.07-200	50	0.0423842592592593	CORE & WIRE	F
T2-613-1-KK81+	Y	Y	Y	Y	Y	0.07-200	50	0.0423842592592593	CORE & WIRE	F
T4-6+	N	Y	Y	N	Y	0.02-200	50	4	CORE & WIRE	C
T4-6-KK81+	N	Y	Y	N	Y	0.02-200	50	4	CORE & WIRE	C
T9-1+	N	Y	Y	N	Y	0.15-200	50	9	CORE & WIRE	C
T9-1-KK81+	N	Y	Y	N	Y	0.15-200	50	9	CORE & WIRE	C
TC9-1+	N	Y	Y	Y	Y	2-200	50	9	CORE & WIRE	A
TC9-1G2+	N	Y	Y	Y	Y	2-200	50	9	CORE & WIRE	A
TC9-1X+	N	Y	Y	Y	Y	2-200	50	9	CORE & WIRE	A
TT4-1+	N	Y	Y	Y	Y	0.05-200	50	3	CORE & WIRE	B
TT4-1-KK81+	N	Y	Y	Y	Y	0.05-200	50	3	CORE & WIRE	B
TX9-1+	N	Y	Y	N	Y	1-200	50	9	CORE & WIRE	C
ADT16-1T+	N	Y	Y	Y	Y	1.5-160	50	16	CORE & WIRE	A
TC16-161T+	N	Y	Y	Y	Y	0.6-160	50	16	CORE & WIRE	A
TC16-161TG2+	N	Y	Y	Y	Y	0.6-160	50	16	CORE & WIRE	A
TC16-161TX+	N	Y	Y	Y	Y	0.6-160	50	16	CORE & WIRE	A

Transformers & Baluns — Surface Mount 50Ω Continued

Model Number	Single-Ended to Single-Ended	Single-Ended to Balanced	Balanced to Balanced	Center Tap	DC Isolation	Freq. Range (MHz)	Impedance	Impedance Ratio	Tech.	Config.
T1-6+	N	Y	Y	N	Y	0.01-150	50	1	CORE & WIRE	C
T1-6-KK81+	N	Y	Y	N	Y	0.01-150	50	1	CORE & WIRE	C
T14-1+	Y	N	N	N	N	0.2-150	50	14	CORE & WIRE	D
T14-1-KK81+	Y	N	N	N	N	0.2-150	50	14	CORE & WIRE	D
T8-1T+	N	Y	Y	Y	Y	0.3-140	50	8	CORE & WIRE	A
T8-1T-KK81+	N	Y	Y	Y	Y	0.3-140	50	8	CORE & WIRE	A
TC4-1W-7A+	N	Y	Y	Y	Y	125-135	50	4	CORE & WIRE	A
ADT8-1T+	N	Y	Y	Y	Y	0.1-130	50	8	CORE & WIRE	A
ADT1-6T+	N	Y	Y	Y	Y	0.03-125	50	1	CORE & WIRE	A
ADTT4-1+	N	Y	Y	Y	Y	0.2-120	50	4	CORE & WIRE	B
T2-1-2W+	N	Y	Y	N	Y	5-120	50	2	CORE & WIRE	C
T2-1-2W-KK81+	N	Y	Y	N	Y	5-120	50	2	CORE & WIRE	C
T13-1T+	N	Y	Y	Y	Y	0.3-120	50	13	CORE & WIRE	A
T13-1T-KK81+	N	Y	Y	Y	Y	0.3-120	50	13	CORE & WIRE	A
T16-1+	N	Y	Y	N	Y	0.3-120	50	16	CORE & WIRE	C
T16-1-KK81+	N	Y	Y	N	Y	0.3-120	50	16	CORE & WIRE	C
ADT16-6+	N	Y	Y	N	Y	0.25-105	50	16	CORE & WIRE	C
ADTT1-6+	N	Y	Y	Y	Y	0.015-100	50	1	CORE & WIRE	B
T1.5-6+	N	Y	Y	N	Y	0.02-100	50	1.5	CORE & WIRE	C
T1.5-6-KK81+	N	Y	Y	N	Y	0.02-100	50	1.5	CORE & WIRE	C
T2.5-6-KK81+	N	Y	Y	N	Y	0.01-100	50	2.5	CORE & WIRE	C
T2.5-6T+	N	Y	Y	Y	Y	0.01-100	50	2.5	CORE & WIRE	A
T2.5-6T-KK81+	N	Y	Y	Y	Y	0.01-100	50	2.5	CORE & WIRE	A
JT-1975+	N	Y	Y	Y	Y	0.04-80	50	2.5	CORE & WIRE	A

Transformers & Baluns — Surface Mount 50Ω Continued

Model Number	Single-Ended to Single-Ended	Single-Ended to Balanced	Balanced to Balanced	Center Tap	DC Isolation	Freq. Range (MHz)	Impedance	Impedance Ratio	Tech.	Config.
T16-6T+	N	Y	Y	Y	Y	0.03-75	50	16	CORE & WIRE	A
T16-6T-KK81+	N	Y	Y	Y	Y	0.03-75	50	16	CORE & WIRE	A
ADT16-6T+	N	Y	Y	Y	Y	0.1-70	50	16	CORE & WIRE	A
SYTX2-61HP+	N	Y	Y	N	Y	10-60	50	0.5	CORE & WIRE	C
TT2.5-6+	N	Y	Y	Y	Y	0.01-50	50	2.5	CORE & WIRE	B
TT2.5-6-KK81+	N	Y	Y	Y	Y	0.01-50	50	2.5	CORE & WIRE	B
TT16-1-KK81+	N	Y	Y	Y	Y	0.1-45	50	16	CORE & WIRE	B
TT25-1+	N	Y	Y	Y	Y	0.02-30	50	25	CORE & WIRE	B
TT25-1-KK81+	N	Y	Y	Y	Y	0.02-30	50	25	CORE & WIRE	B
T36-1+	N	Y	Y	N	Y	0.03-20	50	36	CORE & WIRE	C
T36-1-KK81+	N	Y	Y	N	Y	0.03-20	50	36	CORE & WIRE	C
T-626+	Y	Y	Y	Y	Y	0.01-10	50	0.0423726851851852	CORE & WIRE	F
T-626-KK81+	Y	Y	Y	Y	Y	0.01-10	50	0.0423726851851852	CORE & WIRE	F
T-626-X65+	Y	Y	Y	Y	Y	0.01-10	50	0.0423726851851852	CORE & WIRE	F

Transformers & Baluns — Surface Mount 75Ω

Model Number	Single-Ended to Single-Ended	Single-Ended to Balanced	Balanced to Balanced	Center Tap	DC Isolation	Freq. Range (MHz)	Impedance Ratio	Technology	Configuration
SCTX1.33-33-2W+	N	Y	N	N	N	10-3000	1.33	CORE & WIRE	G
TC1-1-13M-75+	N	Y	Y	N	N	4.5-3000	1	CORE & WIRE	G
TC1-1-13M-75X+	N	Y	Y	N	N	4.5-3000	1	CORE & WIRE	G
TC1-33-75G2+	N	Y	Y	N	N	5-3000	1	CORE & WIRE	K
TTC1-33W-75+	N	Y	N	N	N	30-3000	1	CORE & WIRE	G
NCS1-222-75+	N	Y	N	N	Y	950-2200	1	LTCC	R
TRS1-23-75+	N	Y	Y	N	N	10-2200	1	CORE & WIRE	G
ADTL1-18-75+	N	Y	Y	N	N	5-1800	1	CORE & WIRE	G

Transformers & Baluns — Surface Mount 75Ω Continued

Model Number	Single-Ended to Single-Ended	Single-Ended to Balanced	Balanced to Balanced	Center Tap	DC Isolation	Freq. Range (MHz)	Impedance Ratio	Technology	Configuration
TC1.33-182X-75+	N	Y	N	Y	N	5-1800	1.33	CORE & WIRE	M1
TRS1-182-75+	N	Y	Y	N	N	10-1800	1	CORE & WIRE	K
ADTL1-15-75+	N	Y	Y	N	N	10-1500	1	CORE & WIRE	K
TCN1-152-75+	N	Y	N	N	Y	950-1450	1	LTCC	J
TCM2-142-75X+	N	Y	Y	N	N	10-1400	2	CORE & WIRE	K
TRS1.33-132-75+	N	Y	N	N	N	25-1300	1.33	CORE & WIRE	P
TC4-122-75X+	N	Y	Y	Y	N	40-1250	4	CORE & WIRE	H
TRC1-1-122-75+	N	Y	N	N	N	5-1250	1	CORE & WIRE	G
TRC1-1K122-75+	N	Y	Y	N	N	20-1250	1	CORE & WIRE	K
TX-2-5-1+	N	Y	Y	Y	Y	20-1250	2	CORE & WIRE	A
TRS2-1T-75+	N	Y	N	N	N	5-1200	2	CORE & WIRE	P1
ADTL1-4-75+	N	Y	Y	N	N	0.5-1000	1	CORE & WIRE	G
JTX-2-10T+	N	Y	Y	Y	Y	50-1000	2	CORE & WIRE	A
JTX-2-10TA+	N	Y	Y	Y	Y	50-1000	2	CORE & WIRE	A
ADT1-1WT+	N	Y	Y	Y	Y	0.4-800	1	CORE & WIRE	A
NCS2-771-75+	N	Y	N	N	Y	240-770	2	LTCC	J
TC4-6T-75X+	N	Y	Y	Y	Y	0.6-600	4	CORE & WIRE	A
ADT3-1T-75+	N	Y	Y	Y	Y	1-500	3	CORE & WIRE	A
TC1.33-1T-75+	N	Y	Y	Y	Y	3-500	1.33	CORE & WIRE	A
TC1.33-1T-75X+	N	Y	Y	Y	Y	3-500	1.33	CORE & WIRE	A
TC9-1-75+	Y	N	N	N	N	0.3-475	0.11	CORE & WIRE	D
TC9-1-75G2+	Y	N	N	N	N	0.3-475	0.11	CORE & WIRE	D
TC9-1-75X+	Y	N	N	N	N	0.3-475	0.11	CORE & WIRE	D
ADT1-1WT-1+	N	Y	Y	Y	Y	1-400	1	CORE & WIRE	A
TRS1.33-1T-75+	N	Y	Y	Y	Y	1-400	1.33	CORE & WIRE	A
TRS2-32-75+	N	Y	N	N	Y	1-300	0.5	CORE & WIRE	J1
TC1-1T-75X+	N	Y	Y	Y	Y	5-120	1	CORE & WIRE	A

Transformers & Baluns — Coaxial 50Ω / 75Ω

Model Number	Single-Ended to Single-Ended	Single-Ended to Balanced	Balanced to Balanced	Center Tap	DC Isolation	Freq. Range (MHz)	Impedance	Impedance Ratio	Tech.	Config.	Connector Type
SFMP-5075+	Y	N	N	N	N	DC-2500	50/75	1.5	CORE & WIRE	D	SMA/F
Z7550-BFNF+	Y	N	N	N	N	DC-2500	50/75	1.5	CORE & WIRE	Q	BNC/N
Z7550-BMNF+	Y	N	N	N	N	DC-2500	50/75	1.5	CORE & WIRE	Q	BNC/N
Z7550-FFSF+	Y	N	N	N	N	DC-2500	50/75	1.5	CORE & WIRE	Q	F/SMA
Z7550-FMSFDC+	Y	N	N	N	Y	1-2500	50/75	1.5	CORE & WIRE	Q	F/SMA
FT-1.5-232+	Y	N	N	N	N	0.5-2350	50	1.5	CORE & WIRE	D	BNC
Z7550-BMBF+	Y	N	N	N	N	DC-2300	50/75	1.5	CORE & WIRE	D1	BNC
Z7550-FFNM+	Y	N	N	N	N	DC-2300	50/75	1.5	CORE & WIRE	Q	F/N
Z7550-FMSF+	Y	N	N	N	N	DC-2300	50/75	1.5	CORE & WIRE	Q	F/SMA
Z7550-NMNF+	Y	N	N	N	N	DC-2300	50/75	1.5	CORE & WIRE	Q	N
FTB-1-1+	N	Y	N	N	Y	0.2-500	50	1	CORE & WIRE	E	BNC
FTB-1-1-75	N	Y	N	N	Y	0.5-500	75	1	CORE & WIRE	E	BNC
FTB-1-1-75+	N	Y	N	N	Y	0.5-500	75	1	CORE & WIRE	E	BNC
FT-1.5-1+	Y	N	N	N	N	0.1-400	50	1.5	CORE & WIRE	D	BNC
FTB-1-6+	N	Y	N	N	Y	0.01-125	50	1	CORE & WIRE	E	BNC

Transformers & Baluns — Plug-In 50Ω

Model Number	Single-Ended to Single-Ended	Single-Ended to Balanced	Balanced to Balanced	Center Tap	DC Isolation	Freq. Range (MHz)	Impedance	Impedance Ratio	Tech.	Config.
T3-1-X65+	Y	N	N	N	N	0.5-800	50	3	CORE & WIRE	D
TMO-1-02+	N	Y	Y	N	Y	1-800	50	1	CORE & WIRE	C
T2-1-X65+	Y	N	N	N	N	0.05-600	50	2	CORE & WIRE	D
T4-2-X65+	Y	N	N	N	N	0.2-600	50	4	CORE & WIRE	D
TMO-2-1+	Y	N	N	N	N	0.05-600	50	2	CORE & WIRE	D
TMO-4-2+	Y	N	N	N	N	0.2-600	50	4	CORE & WIRE	D

Transformers & Baluns — Plug-In 50Ω Continued

Model Number	Single-Ended to Single-Ended	Single-Ended to Balanced	Balanced to Balanced	Center Tap	DC Isolation	Freq. Range (MHz)	Impedance	Impedance Ratio	Tech.	Config.
TO-75+	N	Y	Y	N	Y	10-500	50	1	CORE & WIRE	C
TT1.5-1-X65+	N	Y	Y	Y	Y	0.075-500	50	1.5	CORE & WIRE	B
T1-1-X65+	N	Y	Y	N	Y	0.15-400	50	1	CORE & WIRE	C
TMO-1-1+	N	Y	Y	N	Y	0.15-400	50	1	CORE & WIRE	C
T4-1-X65+	N	Y	Y	Y	Y	0.2-350	50	4	CORE & WIRE	A
TMO-4-1+	N	Y	Y	Y	Y	0.2-350	50	4	CORE & WIRE	A
T1-6T-X65+	N	Y	Y	Y	Y	0.015-300	50	1	CORE & WIRE	A
T5-1T-X65+	N	Y	Y	Y	Y	0.3-300	50	5	CORE & WIRE	A
TMO-5-1T+	N	Y	Y	Y	Y	0.3-300	50	5	CORE & WIRE	A
TT1-6-X65+	N	Y	Y	Y	Y	0.004-300	50	1	CORE & WIRE	B
TT4-1A-X65+	N	Y	Y	Y	Y	0.1-300	50	4	CORE & WIRE	B
TTMO-4-1A+	N	Y	Y	Y	Y	0.1-300	50	4	CORE & WIRE	B
T3-1T-X65+	N	Y	Y	Y	Y	0.05-250	50	3	CORE & WIRE	A
T4-1-2W-X65+	N	Y	Y	N	Y	10-250	50	4	CORE & WIRE	C
T4-6T-X65+	N	Y	Y	Y	Y	0.02-250	50	4	CORE & WIRE	A
T8-1-X65+	Y	N	N	N	N	0.15-250	50	8	CORE & WIRE	D
TMO-3-1T+	N	Y	Y	Y	Y	0.05-250	50	3	CORE & WIRE	A
T-622-X65+	Y	Y	Y	Y	Y	0.1-200	50	1:1:1	CORE & WIRE	F
T1-1T-X65+	N	Y	Y	Y	Y	0.08-200	50	1	CORE & WIRE	A
T2-1T-X65+	N	Y	Y	Y	Y	0.07-200	50	2	CORE & WIRE	A
T2-613-1-X65+	Y	Y	Y	Y	Y	0.07-200	50	1:1:2	CORE & WIRE	F
T4-6-X65+	N	Y	Y	N	Y	0.02-200	50	4	CORE & WIRE	C
T9-1-X65+	N	Y	Y	N	Y	0.15-200	50	9	CORE & WIRE	C
TMO-1-1T+	N	Y	Y	Y	Y	0.05-200	50	1	CORE & WIRE	A
TMO-2-1T+	N	Y	Y	Y	Y	0.07-200	50	2	CORE & WIRE	A
TMO-4-6+	N	Y	Y	N	Y	0.02-200	50	4	CORE & WIRE	C
TMO-9-1+	N	Y	Y	N	Y	0.15-200	50	9	CORE & WIRE	C
TT4-1-X65+	N	Y	Y	Y	Y	0.05-200	50	3	CORE & WIRE	B

Transformers & Baluns — Plug-In 50Ω Continued

Model Number	Single-Ended to Single-Ended	Single-Ended to Balanced	Balanced to Balanced	Center Tap	DC Isolation	Freq. Range (MHz)	Impedance	Impedance Ratio	Tech.	Config.
T1-6-X65+	N	Y	Y	N	Y	0.01-150	50	1	CORE & WIRE	C
T14-1-X65+	Y	N	N	N	N	0.2-150	50	14	CORE & WIRE	D
TMO-14-1+	Y	N	N	N	N	0.2-150	50	14	CORE & WIRE	D
T8-1T-X65+	N	Y	Y	Y	Y	0.3-140	50	8	CORE & WIRE	A
T2-1-2W-X65+	N	Y	Y	N	Y	5-120	50	2	CORE & WIRE	C
T13-1T-X65+	N	Y	Y	Y	Y	0.3-120	50	13	CORE & WIRE	A
T16-1-X65+	N	Y	Y	N	Y	0.3-120	50	16	CORE & WIRE	C
TMO-13-1T+	N	Y	Y	Y	Y	0.3-120	50	13	CORE & WIRE	A
TMO-16-1+	N	Y	Y	N	Y	0.3-120	50	16	CORE & WIRE	C
T1.5-6-X65+	N	Y	Y	N	Y	0.02-100	50	1.5	CORE & WIRE	C
T2.5-6T-X65+	N	Y	Y	Y	Y	0.01-100	50	2.5	CORE & WIRE	A
TMO-2.5-6T+	N	Y	Y	Y	Y	0.01-100	50	2.5	CORE & WIRE	A
TMO-2.5-6+	N	Y	Y	N	Y	0.01-100	50	2.5	CORE & WIRE	C
T16-6T-X65+	N	Y	Y	Y	Y	0.03-75	50	16	CORE & WIRE	A
TT2.5-6-X65+	N	Y	Y	Y	Y	0.01-50	50	2.5	CORE & WIRE	B
TT25-1-X65+	N	Y	Y	Y	Y	0.02-30	50	25	CORE & WIRE	B
T36-1-X65+	N	Y	Y	N	Y	0.03-20	50	36	CORE & WIRE	C
T-626-X65+	Y	Y	Y	Y	Y	0.01-10	50	1:1:1	CORE & WIRE	F

Transformers & Baluns — Bare Die 50Ω

Model Number	Single-Ended to Single-Ended	Single-Ended to Balanced	Balanced to Balanced	Center Tap	DC Isolation	Freq. Range (MHz)	Impedance Ratio	Technology	Configuration
MTY2-243-D+	N	Y	N	N	Y	10000-24000	2	MMIC	J
MTX2-143-D+	N	Y	N	N	Y	5500-13500	2	MMIC	J
MTX2-73-D+	N	Y	N	N	Y	2000-7000	2	MMIC	J



RF Transformer Designer Kits

Model Number	Model Series	Description	Package	Models Included in Kit	Qty. Ea.	Total Qty.
K2-LTCC-WBZ+	BLNK BLJC BLGE CPJC	2.4 to 2.5 GHz and 4.9 to 5.9 GHz LTCC Couplers and Baluns for WiFi Applications	0402 0603 0805	BLNK1-252R+ BLJC1-252R+ BLGE1-252R+ BLNK2-252R+ BLJC2-252R+ BLGE2-252R+ BLJC4-252R+ BLGE4-252R+ BLNK1-542R+ BLJC1-542R+ BLGE1-542R+ BLNK2-542R+ BLJC2-542R+ BLGE2-542R+ BLJC4-542R+ BLGE4-542R+ CPJC-6-252R+ CPJC-10-252R+ CPJC-17-252R+ CPJC-21-252R+ CPJC-28-252R+	5	105
K-ADT-1+	ADT	0.15 to 775 MHz Impedance Ratios from 1:1 to 1:9, 50Ω	Leaded SMT	ADT1-1+ ADT2-1T+ ADT3-1T+ ADT4-1WT+ ADT9-1T+	2	10
K1-ADTL+	ADTL	0.5 to 1800 MHz Impedance Ratios of 1:1 and 1:2, 50Ω and 75Ω Models	Leaded SMT	ADTL1-12+ -18-75+ -4-75+ -15-75+ -18+	10	50

Model Number	Model Series	Description	Package	Models Included in Kit	Qty. Ea.	Total Qty.
K1-TCG2+	TCG	0.3 to 3000 MHz Impedance Ratios from 1:9 to 16:1, 50Ω and 75Ω Models	Leaded SMT	TC1-1TG2+ TC1-1G2+ TC1-1-13MG2+ TC1-15G2+ TC1.5-1G2+ TC2-1TG2+ TC3-1TG2+ TC4-1TG2+ TC4-1WG2+ TC4-14G2+ TC8-1G2+ TC9-1G2+ TC16-1TG2+ TC4-11G2+ TC9-1-75G2+	10	150
K1-TCM+	TCM	0.5 to 2500 MHz Impedance Ratios from 1:1 to 9:1 Transformers	Leaded SMT	TCM1-1+ TCML1-11+ TCML1-19+ TCM2-1T+ TCM3-1T+ TCM4-1W+ TCM4-14+ TCM4-6T+ TTCM4-4+ TCM4-19+ TCM4-25+ TCM8-1+ TCM9-1+	10	130
K1-TCN+	TCN	600 to 2600 MHz Impedance Ratios from 1:1 to 4:1, LTCC Construction	1206	TCN1-10+ TCN1-23+ TCN2-14+ TCN2-26+ TCN3-11+ TCN4-13+ TCN4-22+	5	35



Designer Kits Continued

Model Number	Model Series	Description	Package	Models Included in Kit	Qty. Ea.	Total Qty.
TK-5+	TK	0.01 to 350 MHz Impedance Ratios from 1:1 to 16:1	Leaded SMT	T1-1T+ T1-6T+ T2-1T+ T2.5-6T+ T3-1T+ T4-1T+ T4-6T+ T5-1T+ T8-1T+ T13-1T+ T16-6T+	2	22
K1-NCS+	NCS	223 to 8000 MHz Impedance Ratios of 1:1, 1:1.5: 1:2, 1:3, and 1:4 50Ω	805	NCS1-23+ NCS1-292+ NCS1-332+ NCS1-422+ NCS1-521+ NCS1-63+ NCS1.5-232+ NCS2-222+ NCS2-232+ NCS2-282+ NCS2-33+ NCS2-392+ NCS2-592+ NCS2-62+ NCS2-622+ NCS2-771+ NCS2-83+ NCS3-272+ NCS3-72+ NCS4-102+ NCS4-232+ NCS4-272+ NCS4-442+ NCS4-521+ NCS4-63+	5	125

Model Number	Model Series	Description	Package	Models Included in Kit	Qty. Ea.	Total Qty.
K1-TCW+	TCW	700 to 7125 MHz Impedance Ratios from 1:1, 1:2, and 1:4 50Ω	603	TCW1-2700+ TCW1-272+ TCW1-33+ TCW1-3901+ TCW1-392+ TCW1-6000+ TCW2-272+ TCW2-282+ TCW2-392+ TCW2-6000+ TCW2-63+ TCW2-722+ TCW4-262+ TCW4-582+	10	140
K1-TRAN-HP+	SYTX	10 to 1000 MHz Impedance Ratios from 1:2 to 4:1 50Ω	Leadless SMT	SYTX2-61HP+ SYTX1-52HP-15W+ SYTX2-451-5W+ SYTX2-52HP-20W+ SYTX4-13HP+	5	25



3 TO 7000 MHZ

Voltage Controlled Oscillators

The Industry's Widest Selection

- Spot frequency, narrow, medium and wideband (up to 1.5 octaves)
- Connectorized and surface mount case styles
- Superior phase noise to IC oscillators, as low as -111 dBc/Hz @ 1 kHz offset
- Supply chain security—support through the life of your system

Optimized for your needs:

Linear tuning, low phase noise, dual output, dual VCO, separate modulation port, and 5V PLL implementations



Technology Overview

5V Tuning for PLLs

- 5V tuning range
- Linear tuning sensitivity ratio optimal for loop filter design

Dual Output VCOs (ZOS)

- Coupled auxiliary output allows signal monitoring without external couplers, saving space
- Wide bandwidth
- Linear tuning
- Excellent harmonic suppression

Dual VCOs (DROS, AOS, DUOS)

- Two separate VCOs in a single case to save space
- Low power consumption (only one VCO works at a time)
- Two separate frequency bands
- Linear tuning
- Excellent phase noise
- Both VCOs designed for the same sensitivity characteristic, simplifying loop band filter design

Modulation Port VCOs

- Direct modulation port for low frequency modulation without the need for mixers and other peripheral components

Wideband, Linear Tuning

- Low phase noise improves system EVM
- Voltage tunable filter implementation for good harmonic suppression



Overview of Functions & Features by Family

Oscillators — Catalog Model Families

Family	ROS	MOS	SOS	JTOS
Type	SMT	SMT	SMT	SMT
Footprint (Inch)	0.5"x0.5"	0.375"x0.375"	0.3"x0.3"	0.505"x0.8"
Standard heights (Inch)	0.1",0.18",0.22"	0.131", 0.14"	0.07", 0.1"	0.25"
Standard Freq.	3.2-6990 MHz	35-3313 MHz	194-6000 MHz	25-3000 MHz
Special features	Models with Modulation port available	-	Models with Modulation port available	-

Catalog Families Continued

Family	POS	POSA	ZX95*	ZOS
Type	Plug-In	Plug-In	Connectorized (SMA)	Connectorized (SMA)
Footprint(Inch)	0.77"x0.8"	0.71"x0.81"	1.20"x1.18"	3.25"x1.28"
Standard heights (Inch)	0.3"	0.38"	0.46"	1.25"
Standard Freq.	25-2650 MHz	6.75-960 MHz	3.2-6990 MHz	37.5-1025 MHz
Special features	Hermetically sealed case	Hermetically sealed case	Small size connectorized	Coupled auxiliary output

Custom Families

Family	DROS	VOS	WOS	AOS
Type	SMT	SMT	SMT	SMT
Footprint (Inch)	0.5"x0.5"	0.35"x0.35"	0.2"x0.2"	0.563"x0.373"
Standard heights (Inch)	0.1",0.18",0.23"	0.1", 0.15"	0.075"	0.2", 0.14"
Standard Freq.	1445-2088	120-2450	1650-1750	896-1076 MHz
Special features	Dual freq. band VCO, sharing same RF Output	-	Small size	Dual freq. band VCO, sharing same RF Output

Custom Families Continued

Family	IOS	ROSA	DOS	JCOS	DUOS
Type	SMT	SMT	SMT	SMT	SMT
Footprint (Inch)	0.175"x0.175"	0.91"x0.91"	0.25"x0.25"	0.87"x0.8"	0.584"x0.8"
Standard heights (Inch)	0.075"	0.25", 0.305"	0.1"	0.25", 0.4"	0.154"
Standard Freq.	10000-11000 MHz	140-1600 MHz	98-6000 MHz	325-1145 MHz	1000-4055 MHz
Special features	Smallest size VCO	Designed for low Ph. N at low freq.	Small size	-	Dual freq. band VCO, sharing same RF Output

VCO specifications tend to be highly specific to the application. We offer a wide range of models in stock for immediate shipment, but if you don't see what you need in our catalog, we have an extensive library of engineering designs with additional features to meet your needs. For questions regarding engineering designs or custom VCOs, contact apps@minicircuits.com

*Any SMT model with case size 0.5"x0.5" and smaller from ROS-3-1+ (3MHz) to IOS-11-1 (11 GHz) can be housed in ZX95 case on demand.



5V Tuning for PLLs – Surface Mount 50Ω

Model Number	Freq. Range (MHz)	Power Output (dBm)	Phase Noise (dBc/Hz) @ 1 kHz Offset	Phase Noise (dBc/Hz) @ 10 kHz Offset	Phase Noise (dBc/Hz) @ 100kHz Offset	Phase Noise (dBc/Hz) @ 1 MHz Offset	Pulling (MHz) pk - pk @ 12 dBr	Pushing (MHz/V)	Tuning Sensitivity (MHz/V)	Harmonics (dBc)	3 dB Control BW (MHz)	DC Voltage (V)	DC Current (mA)
ROS-6520C-119+	6385-6520	2	-72	-100	-123	-143	2	2.5	77-92	-	260	5	35
ROS-6030C-219R+	5890-6010	3.5	-73	-102	-124	-144	2	1.4	63-73	-30	140	5	28
ROS-5776-119+	5726-5826	1.5	-75	-102	-122	-142	0.5	3	59-78	-30	130	5	33
ROS-5815C-119+	5685-5815	3.5	-74	-102	-125	-145	1.5	1.5	70-80	-	100	5	32
ROS-5580-119+	5440-5580	-0.5	-75	-101	-123	-143	0.3	0.8	68-72	-34	180	5	35
ROS-5490C-119+	5340-5490	0.5	-74	-102	-122	-142	0.5	1.5	58-76	-34	150	5	35
ROS-5363C-119+	5223-5363	0	-75	-102	-122	-140	0.5	1	55-70	-15	180	5	35
ROS-5150-119+	4880-5150	3.5	-69	-95	-116	-136	2	2.5	65-103	-28	200	5	53
ROS-5150-319+	5020-5145	3.5	-73	-103	-126	-146	1.5	2.5	75-90	-35	120	5	32
ROS-4725-119+	4585-4725	1.5	-74	-104	-125	-145	2	3.5	70-97	-25	110	5	30
ROS-4303-119+	4195-4415	5	-68	-95	-118	-138	3	2.5	80-92	-25	150	5	50
ROS-39702PH19R+	3790-3970	3.5	-70	-98	-119	-139	6	0.6	48-63	-23	180	5	37
ROS-3146-119+	3000-3110	9	-73	-102	-123	-144	4.5	2.5	56-64	-25	200	5	43
SOS-3065-119+	2800-3100	6	-56	-85	-107	-128	10	5	155-180	-25	10	4	36
ROS-3000-619+	2800-2970	10	-74	-102	-123	-144	4	1.5	55-68	-25	150	5	36
ROS-2920-219+	2820-2920	4	-74	-101	-123	-143	1	1	53-56	-23	200	5	30
ROS-2650-519+	2450-2650	0.5	-69	-97	-118	-138	3	2	111-125	-25	80	5	30
ROS-2566C-119+	2566-2566	8	-94	-121	-141	-161	0.7	0.1	4.3	-27	50	8	36
ROS-2536C-119+	2315-2536	6	-75	-105	-128	-148	2.5	2.5	55-77	-18	70	5	45
ROS-2500-2319+	2200-2495	4.5	-68	-96	-119	-139	6	2	130	-25	100	5	35
ROS-2488C-119+	2488-2488	8.5	-92	-118	-140	-160	1.5	0.05	4.4	-25	50	5	33
ROS-2470-119+	2430-2470	9.5	-80	-106	-126	-146	2	0.5	28-40	-22	100	8	43

5V Tuning for PLLs – Surface Mount 50Ω Continued

Model Number	Freq. Range (MHz)	Power Output (dBm)	Phase Noise (dBc/Hz) @ 1 kHz Offset	Phase Noise (dBc/Hz) @ 10 kHz Offset	Phase Noise (dBc/Hz) @ 100kHz Offset	Phase Noise (dBc/Hz) @ 1 MHz Offset	Pulling (MHz) pk - pk @ 12 dBr	Pushing (MHz/V)	Tuning Sensitivity (MHz/V)	Harmonics (dBc)	3 dB Control BW (MHz)	DC Voltage (V)	DC Current (mA)
ROS-2435+	2425-2435	7	-87	-115	-135	-156	1	0.04	16	-20	130	8	32
ROS-2390+	2320-2390	4.5	-80	-106	-127	-147	1	0.5	30-36	-22	180	5	43
MOS-2360-119R+	2299-2360	5.5	-73	-101	-123	-143	1	1.5	31-39	-25	100	5	38
ROS-2310+	2290-2310	6.5	-89	-115	-136	-156	0.7	0.3	8-10	-20	120	5	35
ROS-2243C+	2185-2243	4.8	-86	-114	-135	-154	0.7	0.1	21	-29	85	4.75	39
ROS-2168-119+	2112-2168	2.5	-82	-107	-128	-148	1.5	1	30-35	-32	170	5	35
ROS-2082-119+	1780-2082	6.5	-69	-97	-118	-139	9	2	96-120	-24	50	5	27
ROS-2015+	1975-2015	7.5	-85	-108	-129	-149	0.6	1	16-18	-30	110	5	35
ROS-2045-219R+	1900-2000	6.5	-74	-101	-122	-143	6	1	42-56	-25	60	5	35
ROS-1960-219+	1960-1966	5	-93	-121	-141	-161	0.5	0.05	8	-26	190	5	40
ROS-1910-419+	1855-1910	3.5	-83	-107	-127	-147	0.5	1	25-29	-27	160	5	30
MOS-1890-119R+	1800-1890	4	-77	-104	-126	-146	0.2	1.5	30-50	-22	100	5	44
ROS-1836+	1824-1836	4	-86	-112	-132	-152	0.2	0.2	18	-30	90	5	40
MOS-1797-119+	1618-1797	2.5	-70	-98	-121	-141	2.5	2	88-94	-20	90	5	33
MOS-1739-219R+	1690-1760	1	-74	-103	-124	-144	0.1	1.4	26-30	-25	300	5	37
ROS-1700-819R+	1690-1740	1	-82	-108	-130	-150	0.7	0.2	22	-20	100	5	40
MOS-1632-119+	1556-1632	4.5	-83	-110	-130	-150	1	0.3	31-35	-19	60	5	36
MOS-1510C+	1510-1510	2.5	-88	-115	-136	-156	0.5	0.1	7	-20	50	5	35
ROS-1357+	1338-1357	0	-86	-110	-131	-151	0.3	0.4	12	-22	50	5	37
ROS-13301PH19R+	1210-1330	3.5	-80	-106	-128	-145	2.5	0.5	35-43	-18	100	5	35
ROS-1280-819+	1280-1280	6.5	-90	-116	-136	-156	1.2	0.2	12-14	-24	35	5	37
ROS-1215-119+	1205-1260	3	-84	-108	-129	-149	0.7	0.5	24	-28	100	5	30
ROS-1200+	1110-1170	11	-84	-113	-136	-156	1.5	0.3	19-24	-29	50	5	46
SOS-1000-519+	980-1050	-6.3	-74	-99	-120	-140	0.5	0.5	57-60	-35	335	3	14



5V Tuning for PLLs — Surface Mount 50Ω Continued

Model Number	Freq. Range (MHz)	Power Output (dBm)	Phase Noise (dBc/Hz) @ 1 kHz Offset	Phase Noise (dBc/Hz) @ 10 kHz Offset	Phase Noise (dBc/Hz) @ 100kHz Offset	Phase Noise (dBc/Hz) @ 1 MHz Offset	Pulling (MHz) pk - pk @ 12 dBr	Pushing (MHz/V)	Tuning Sensitivity (MHz/V)	Harmonics (dBc)	3 dB Control BW (MHz)	DC Voltage (V)	DC Current (mA)
ROS-1012-1PH19+	925-1012	4.5	-76	-104	-126	-146	2	1.5	55	-24	80	5	35
ROS-1000PV+	900-1000	6	-80	-104	-124	-144	2	0.7	27-38	-33	1	5	22
ROS-1000C-519R+	1000-1000	-1	-98	-125	-145	-164	0.06	0.01	5	-22	80	5	35
ROS-1000C-319R+	1000-1000	1	-96	-126	-146	-165	0.1	0.04	4	-22	150	6	38
ROS-995-119+	965-995	4.5	-87	-111	-132	-152	0.8	0.5	16	-24	90	5	32
ROS-970R+	830-970	5	-80	-107	-128	-148	1	1.5	39-44	-26	80	5	35
ROS-933C-119+	933-933	0	-97	-123	-144	-163	0.1	0.05	3.8	-23	10	5	35
ROS-900PV+	810-900	1	-80	-102	-122	-142	3	2	26-30	-25	1	4.5	12
ROS-850+	800-850	7	-86	-110	-130	-150	1	0.7	20	-24	100	5	27
ROS-835+	800-835	-0.4	-89	-110	-130	-150	1	0.5	12-13	-21	60	5	15
ROS-800-719R+	797-806	-0.5	-93	-118	-140	-162	0.2	0.2	7	-24	115	5	35
ROS-800-719+	797-806	0.5	-93	-118	-140	-162	0.2	0.2	7	-24	115	5	35
ROS-800C-119R+	798-803	5.3	-97	-124	-145	-165	0.2	0.02	3.5	-28	60	5	35
ROS-809C-119+	768-798	4	-89	-119	-142	-162	0.5	0.6	9-13	-23	50	5	30
ROS-785-419+	755-785	3	-90	-115	-136	-156	0.3	0.5	10-14	-33	50	5	36
ROS-766+	730-766	0.4	-91	-113	-134	-154	0.6	0.1	13-Dec	-23	80	5	18
ROS-750+	670-750	3	-82	-107	-128	-148	0.3	1	27-32	-30	110	5	26
ROS-745+	710-745	1.2	-88	-113	-133	-153	0.8	0.3	12	-22	60	5	17
ROS-715+	680-715	-0.5	-90	-113	-133	-152	0.5	0.2	12-13	-22	60	5	16
ROS-690+	655-690	-1	-89	-111	-131	-151	0.4	0.4	12-13	-24	50	5	17
ROS-665+	630-665	0.2	-90	-113	-133	-153	0.4	0.1	12-13	-24	60	5	18
ROS-630+	595-630	0.1	-90	-113	-133	-153	0.4	0.1	11-12	-23	80	5	18
ROS-615R+	580-615	-1	-87	-111	-132	-153	0.3	0.2	12-13	-21	52	5	17
ROS-550+	515-550	-1	-90	-112	-133	-151	0.2	0.2	12-13	-23	60	5	17

5V Tuning for PLLs — Surface Mount 50Ω Continued

Model Number	Freq. Range (MHz)	Power Output (dBm)	Phase Noise (dBc/Hz) @ 1 kHz Offset	Phase Noise (dBc/Hz) @ 10 kHz Offset	Phase Noise (dBc/Hz) @ 100kHz Offset	Phase Noise (dBc/Hz) @ 1 MHz Offset	Pulling (MHz) pk - pk @ 12 dBr	Pushing (MHz/V)	Tuning Sensitivity (MHz/V)	Harmonics (dBc)	3 dB Control BW (MHz)	DC Voltage (V)	DC Current (mA)
ROS-498-119R+	449-499	5	-91	-118	-138	-158	0.5	0.3	13	-20	22	5	22
ROS-485-119R+	450-485	4.5	-89	-119	-139	-159	0.2	0.4	11-12	-20	20	5	28
ROS-470-519+	340-470	6	-78	-102	-123	-143	2	0.5	38-58	-35	30	5	35
MOS-465+	420-465	0.5	-85	-110	-130	-150	0.3	0.5	20-24	-13	15	3	18
ROS-445+	410-445	-0.2	-91	-115	-135	-155	0.4	0.2	44512	-20	60	5	16
ROS-404-219+	375-410	2	-87	-113	-133	-153	0.1	0.5	18	-23	80	5	25
ROS-369-319R+	370-400	3	-90	-117	-138	-159	0.3	1	15	-25	70	5	25
ROS-365-119R+	335-365	6.5	-92	-119	-140	-159	0.5	0.2	10-12	-21	12	5	30
ROS-355-219+	318-355	5	-87	-113	-133	-153	0.2	0.5	20	-23	3	5	22
ROS-258-119+	258-258	4.5	-97	-120	-141	-160	0.15	0.1	5.3	-23	45	5	25
ROS-200-619+	155-200	1	-90	-114	-134	-154	0.07	0.3	12-16	-17	4	5	21
JTOS-300P+	148-174	10	-82	-102	-122	-142	1	0.2	10-12	-27	0.12	12	20
JTOS-200P+	95-120	8.8	-84	-105	-124	-145	1	0.2	7-10	-30	0.11	12	20
ROS-102-919+	96-102	2	-98	-123	-143	-162	0.01	0.2	4.5	-21	35	5	21
ROS-95-419+	91-95	5	-97	-125	-146	-162	0.01	0.3	4	-19	7	5	25
JTOS-150P+	72-91	9.5	-82	-106	-127	-147	0.8	0.3	6-9	-30	0.11	12	20
JTOS-100P+	48-59	9	-83	-108	-128	-140	0.6	0.2	3.5-4	-30	0.1	12	18
ROS-43-119+	43-43	2	-105	-130	-150	-170	0.002	0.1	1	-18	3	5	30
JTOS-75P+	35-43	8	-94	-114	-135	-156	0.02	0.11	2.7-3.6	-37	0.1	12	20



Linear Tuning Wideband – Surface Mount 50Ω

Model Number	Freq. Range (MHz)	Power Output (dBm)	Tune Voltage Range (V)	Phase Noise (dBc/Hz) @ 1 kHz Offset	Phase Noise (dBc/Hz) @ 10 kHz Offset	Phase Noise (dBc/Hz) @ 100 kHz Offset	Phase Noise (dBc/Hz) @ 1 MHz Offset	Pulling (MHz) @ 12 dBr	Pushing (MHz/V)	Tuning Sensitivity (MHz/V)	Harmonics (dBc), Typ.	3 dB Control BW (MHz)	DC Voltage (V)	DC Current (mA)
ROS-6840C-119+	6740-6840	1	0.5-4.5	-69	-95	-119	-139	1	6	3.0-5.0	-22	125	5	38
ROS-4861C-119+	4859-4861	7.5	0.5-8	-80	-108	-132	-153	1.5	0.3	2.7-3.4	-23	200	8	37
ROS-4650-119+	4130-4650	0	0.25-15	-71	-96	-117	-137	0.4	2	5.8-6.7	-25	85	8	48
ROS-4415-119R+	4214-4415	5	1-10	-69	-95	-118	-138	2.5	4.5	15-80	-27	150	5	45
ROS-4000-419R+	3850-4000	5	0.5-10	-74	-99	-120	-140	5	1.5	20-45	-26	13	5	42
ROS-3900-419+	3650-3900	4.5	0.5-12	-72	-96	-118	-138	2	4	50-90	-20	100	5	40
ROS-3800-119R+	1900-3700	6	0.5-20	-61	-88	-110	-130	2	6	8	-22	10	6	55
ROS-3600-419R+	3300-3605	8.5	0.5-8	-71	-97	-118	-138	3.5	2.5	5	-20	130	5	46
ROS-3570-319+	3230-3570	6	0.5-16	-75	-99	-120	-140	6.5	0.7	5-10	-22	100	5	40
ROS-3555+	3000-3555	5.5	0.5-15	-71	-97	-118	-138	1.5	3	7-17	-25	55	5	41
ROS-3360R+	2120-3360	9	0.5-18	-64	-93	-116	-136	9	1.5	5.0-7.0	-20	170	12	45
ROS-3323C-119+	3192-3323	1	1-13	-81	-106	-127	-147	0.7	0.2	6	-19	300	6	40
ROS-3250-519+	2550-3250	3	0.5-24	-73	-98	-119	-139	0.6	3	10	-20	160	5	42
ROS-3200C-1419+	3200-3200	2	0.5-9.5	-93	-119	-141	-160	0.1	0.1	5-6	-20	50	8	40
ROS-3150R+	2650-3150	5	0.5-12	-67	-95	-117	-137	1.5	3.5	6	-22	40	5	45
ROS-3060C-119+	2920-3060	3.2	0.25-18	-85	-112	-132	-152	1.2	0.5	8-12	-18	70	8	36
ROS-3050-819+	2150-3050	7	0.5-11.5	-67	-94	-115	-135	2	1.7	14-30	-20	200	5	49
ROS-3050C+	2635-3050	6.5	0.5-16	-77	-104	-125	-145	4.5	0.2	5-14	-22	100	8	40
ROS-3000-819+	2000-3000	5.5	0.5-14	-71	-96	-117	-138	13.5	1.5	11-14	-22	140	12	35
ROS-2960C-119+	2500-2920	7	0.5-16	-79	-107	-128	-147	2	0.2	5	-25	150	8	38
ROS-2950-119+	2700-2890	5	0.5-16	-80	-106	-126	-146	3	0.7	7-15	-25	170	5	40
ROS-2800-719R+	1400-2800	3.5	0.5-25	-63	-91	-113	-134	6	4	26-68	-15	10	5	30

Linear Tuning Wideband – Surface Mount 50Ω Continued

Model Number	Freq. Range (MHz)	Power Output (dBm)	Tune Voltage Range (V)	Phase Noise (dBc/Hz) @ 1 kHz Offset	Phase Noise (dBc/Hz) @ 10 kHz Offset	Phase Noise (dBc/Hz) @ 100 kHz Offset	Phase Noise (dBc/Hz) @ 1 MHz Offset	Pulling (MHz) @ 12 dBr	Pushing (MHz/V)	Tuning Sensitivity (MHz/V)	Harmonics (dBc), Typ.	3 dB Control BW (MHz)	DC Voltage (V)	DC Current (mA)
ROS-2770R+	1970-2770	5	0.5-25	-72	-100	-123	-142	3.5	2	8-13	-16	45	8	38
ROS-2760C-119R+	2600-2760	4	0.5-18	-85	-113	-133	-153	0.8	0.3	38-45	-16	60	8	37
ROS-2750+	2350-2750	5.7	0.5-14.5	-78	-105	-127	-146	2	0.3	3	-23	120	6	35
ROS-2700-819+	1950-2705	8.5	0.5-10	-64	-90	-112	-132	18	3	42-62	-29	300	8.5	30
ROS-2700-1819+	1300-2700	3.3	0.15-25	-69	-93	-114	-136	6	1.6	50-80	-23	25	5	35
ROS-2650+	2165-2650	5	0.5-19	-95	-101	-122	-142	7	1.4	35-42	-25	28	12	27
ROS-2600-1119+	1650-2600	6	0.3-28	-75	-102	-122	-142	2.5	1	35-58	-18	30	10	53
ROS-2600C+	2130-2600	6.7	0.5-16	-78	-105	-126	-147	1.5	0.5	26-43	-26	75	8	40
ROS-2500+	1600-2500	7.5	0.5-14	-62	-89	-111	-131	18	2	26-65	-16	20	12	28
ROS-2490+	2280-2490	8	0.5-10	-80	-104	-124	-144	1	1	32-59	-20	140	5	38
ROS-2490C+	2020-2490	7.2	0.25-16	-79	-107	-128	-149	2.5	0.4	33-47	-32	45	8	40
ROS-2450C+	2120-2450	7	0-15	-80	-107	-128	-148	3	0.3	71-103	-23	150	6	34
ROS-2432-119+	1662-2432	5.5	1-28	-73	-100	-123	-143	6.5	1	19	-18	230	10	30
ROS-2420+	1220-2420	5	0.5-20	-70	-95	-117	-138	1.5	1.5	1.5	-20	90	5	47
ROS-2400C-319+	2400-2400	7	0.5-9.5	-93	-121	-144	-164	0.4	0.1	22-34	-13	50	8	37
ROS-2500W-319+	1000-2400	3.5	0.5-25	-65	-93	-116	-138	1	4.5	0.7	-13	20	5	48
ROS-2360WR+	1430-2360	8	0.5-20	-73	-100	-122	-142	9	0.7	57-105	-19	95	5	35
ROS-2350-519+	1960-2350	7	0.5-15	-80	-106	-126	-146	5	0.3	46-72	-18	115	5	40
ROS-2250W-119+	1220-2250	3.5	0-20	-73	-99	-121	-141	5	1	25-80	-18	70	5	25
ROS-2170-1319R+	1730-2170	7.5	0.5-12	-76	-103	-124	-144	4	0.3	30-80	-17	30	12	34
ROS-2160W+	1160-2160	5	0.5-20	-70	-97	-117	-137	10	1.5	52-60	-11	12	10	30
ROS-2150VWR+	970-2150	4	0.5-25	-71	-99	-122	-142	5	1	50-75	-22	15	5	27
ROS-2100-119+	1350-2100	8.5	0.5-18.5	-76	-102	-123	-143	8.5	0.5	34-37	-18	60	8	35
ROS-2001C-119+	2000-2000	7	0.5-9.5	-100	-126	-148	-165	0.2	0.1	41-74	-16	50	8	38



Linear Tuning Wideband — Surface Mount 50Ω Continued

Model Number	Freq. Range (MHz)	Power Output (dBm)	Tune Voltage Range (V)	Phase Noise (dBc/Hz) @ 1 kHz Offset	Phase Noise (dBc/Hz) @ 10 kHz Offset	Phase Noise (dBc/Hz) @ 100 kHz Offset	Phase Noise (dBc/Hz) @ 1 MHz Offset	Pulling (MHz) pk - pk @ 12 dBr	Pushing (MHz/V)	Tuning Sensitivity (MHz/V)	Harmonics (dBc), Typ.	3 dB Control BW (MHz)	DC Voltage (V)	DC Current (mA)
ROS-2050-719+	1020-1980	4.5	0.5-15	-71	-99	-121	-141	0.4	0.3	3	-17	15	10	37
ROS-1900+	1450-1900	7	0.5-20	-80	-106	-126	-146	7	0.7	50-82	-15	100	10	25
ROS-1801C-119+	1800-1800	6	0.5-9.5	-101	-126	-147	-166	0.2	0.1	23-49	-16	50	8	37
ROS-1790-519R+	1640-1790	6.5	0.5-12	-82	-107	-127	-147	4	0.7	28-35	-28	50	5	36
ROS-1750W-619+	950-1750	6	0.5-12	-71	-99	-121	-143	0.3	0.2	30-37	-20	50	10	35
ROS-1745C-219+	1445-1745	6.5	1-20	-81	-107	-127	-147	2.5	0.3	30-40	-20	45	8	34
ROS-1707-119+	1033-1707	8	0.5-24	-74	-100	-121	-142	10.5	2	70-118	-15	100	10	35
ROS-1700W+	770-1700	9	1-24	-72	-99	-120	-141	7	0.7	40-96	-25	50	12	35
JTOS-1650+	1200-1650	7	1-13	-70	-95	-115	-135	15	1.5	25-60	-20	1	12	30
ROS-1645W-119+	1200-1645	8	0.5-16	-79	-106	-127	-147	4	0.2	35-49	-19	80	10	30
ROS-1600W+	800-1600	9	0.5-24	-72	-99	-122	-143	10	0.3	37-46	-22	90	11.5	35
JTOS-1550+	1150-1550	9	0.5-18	-72	-100	-122	-142	14	1.2	98-161	-18	100	12	32
ROS-1445-219+	1145-1445	8	1-20	-78	-106	-129	-149	5	0.5	42-49	-12	60	10	30
ROS-1410+	850-1410	7	0.5-11	-73	-99	-119	-138	15	1	32-42	-8	1	12	25
ROS-1200WR+	612-1200	9	0.5-18	-71	-97	-119	-139	9	0.45	12-16	-20	20	12	35
ROS-1150C-119R+	1146-1154	3	0.5-11	-96	-121	-141	-161	0.2	0.1	36-65	-22	45	5	35
ROS-1150-519+	750-1150	6.5	0.5-13.5	-75	-99	-121	-141	5	1	42-107	-20	70	5	35
ROS-1121V+	1060-1121	2.5	1-11	-88	-111	-131	-149	0.7	0.7	22-36	-11	10	5	30
ROS-1120-119+	610-1120	13	0.5-18	-71	-97	-119	-139	9	0.45	34-42	-18	20	12	40
ROS-1015-119+	750-1010	6	0.5-28	-85	-113	-134	-154	1	1.5	84-125	-20	35	5	35
MOS-975-119+	900-975	0.8	0.5-14	-90	-114	-135	-154	0.3	0.3	98-122	-25	70	5	40
ROS-890CR+	875-890	6.2	0.5-11	-97	-125	-145	-165	0.3	0.2	35-47	-19	60	8	35
JTOS-850VW+	400-850	6	0.5-18	-74	-96	-116	-136	6	1.5	8-14	-20	0.18	5	20
ROS-780R+	720-780	10	0.5-12	-87	-112	-133	-154	1	0.7	63-90	-21	20	12	26

Linear Tuning Wideband — Surface Mount 50Ω Continued

Model Number	Freq. Range (MHz)	Power Output (dBm)	Tune Voltage Range (V)	Phase Noise (dBc/Hz) @ 1 kHz Offset	Phase Noise (dBc/Hz) @ 10 kHz Offset	Phase Noise (dBc/Hz) @ 100 kHz Offset	Phase Noise (dBc/Hz) @ 1 MHz Offset	Pulling (MHz) pk - pk @ 12 dBr	Pushing (MHz/V)	Tuning Sensitivity (MHz/V)	Harmonics (dBc), Typ.	3 dB Control BW (MHz)	DC Voltage (V)	DC Current (mA)
ROS-675-219R+	500-750	6	0.5-28	-88	-113	-136	-156	0.8	1.5	3	-20	25	5	37
ROS-625-219+	280-625	6.4	0.3-18	-78	-104	-125	-146	1	0.8	22-44	-24	25	10	30
ROS-480+	386-480	9.5	3-16	-88	-115	-137	-158	0.25	0.45	19-27	-20	30	12	31
ROS-470-319+	460-470	5	1-10	-94	-118	-138	-157	0.1	0.1	77-123	-21	100	5	22
ROS-435-119+	425-435	2.5	0.5-10	-93	-118	-139	-159	0.2	0.1	65-74	-22	50	5	30
ROS-386-119+	295-386	9.5	4-16	-90	-117	-138	-158	0.2	0.4	27-33	-23	18	12	31
ROS-368-119+	360-380	2.5	0.5-10	-96	-120	-141	-160	0.1	0.03	57-78	-20	50	5	23
ROS-310-519+	240-305	6	0.5-17	-89	-112	-133	-153	0.5	0.7	60-150	-24	40	5	30
ROS-300R+	150-280	9	1-16	-80	-102	-122	-142	0.5	0.6	34-40	-28	0.1	12	20
ROS-244R+	170-244	10	2-16	-94	-120	-140	-160	0.2	0.1	24-36	-18	50	12	34
ROS-200-719R+	144-200	9	0.5-16	-95	-122	-142	-161	0.1	0.1	52-57	-20	50	12	33
JCOS-175LN	125-175	3.7	1-17	-95	-118	-138	-158	0.08	0.05	45-60	-25	2.9	12	20
JTOS-150+	75-150	9.5	1-16	-82	-106	-127	-147	0.8	0.3	5-6	-23	0.11	12	20
JTOS-75+	37.5-75	8	1-16	-90	-111	-131	-152	0.05	0.11	85-100	-32	0.1	12	20



Linear Tuning Wideband — Plug-In 50Ω

Model Number	Freq. Range (MHz)	Power Output (dBm)	Tune Voltage Range (V)	Phase Noise (dBc/Hz) @ 1 kHz Offset	Phase Noise (dBc/Hz) @ 10 kHz Offset	Phase Noise (dBc/Hz) @ 100kHz Offset	Phase Noise (dBc/Hz) @ 1MHz Offset	Pulling (MHz) pk - pk @ 12 dBr	Pushing (MHz/V)	Tuning Sensitivity (MHz/V)	Harmonics (dBc), Typ.	3 dB Control BW (KHz)	DC Voltage (V)	DC Current (mA)
POS-2120W+	1060-2120	7	0.5-20	-63	-93	-117	-139	20	2	25-108	-15	2000	12	28
POS-1025+	685-1025	9	1-16	-65	-84	-104	-124	5	0.6	21-36	-23	100	12	22
POS-535+	300-525	8.5	1-16	-72	-97	-120	-145	0.6	0.6	17-23	-32	100	12	20
POS-400+	200-380	9.5	1-16	-76	-98	-120	-140	1.8	0.3	13.7-16.9	-28	100	12	20
POS-300+	150-280	10	1-16	-78	-100	-120	-140	1.8	0.3	9.5-13	-30	100	12	20
POS-200+	100-200	10	1-16	-80	-102	-122	-142	1	0.2	7.1-8.6	-24	100	12	20
POSA-158+	138-158	5	1-16	-100	-125	-145	-163	0.07	0.03	2.4	-40	2000	12	25
POS-150+	75-150	9.5	1-16	-80	-103	-127	-147	0.8	0.3	5.8-6.7	-23	100	12	20
POSA-138+	118-138	5	1-16	-100	-125	-145	-163	0.07	0.03	2.3	-40	2000	12	25
POS-100+	50-100	8.3	10-16	-83	-107	-130	-150	0.6	0.2	4.2-4.8	-23	100	12	20
POS-75+	37.5-75	8	1-16	-87	-110	-130	-150	0.15	0.11	3.1-3.8	-27	100	12	20

Dual Output

Dual Output — Coaxial 50Ω

Model Number	Freq. Range (MHz)	Power Output (dBm) Typ., Max.	Power Output (dBm) Typ., Aux.	Tuning Voltage Range (V)	Phase Noise (dBc/Hz) @ 1 kHz Offset	Phase Noise (dBc/Hz) @ 100kHz Offset	Phase Noise (dBc/Hz) @ 1 MHz Offset	Pulling (MHz) pk - pk @ 12 dBr	Pushing (MHz/V)	Tuning Sensitivity (MHz/V)	Harmonics (dBc)	3 dB Control BW (KHz)	DC Voltage (V)	DC Current (mA)	Connector Type
ZOS-1025+	685-1025	8	-13	1-16	-92	-112	-136	0.051	1	30	-25	100	12	140	SMA
ZOS-765+	485-765	8.5	-14	1-16	-96	-117	-132	0.033	0.72	22	-27	100	12	140	SMA
ZOS-535+	300-525	9	-13	1-16	-96	-118	-131	0.018	0.5	18	-27	100	12	140	SMA
ZOS-400+	200-380	10	-13	1-16	-100	-120	-136	0.021	0.5	15	-24	100	12	140	SMA
ZOS-300+	150-280	9	-13	1-16	-103	-123	-142	0.017	0.5	11	-27	100	12	140	SMA
ZOS-200+	100-200	10	-11	1-16	-106	-126	-141	0.015	0.42	7.7	-25	100	12	140	SMA
ZOS-150+	75-150	9	-12	1-16	-107	-127	-142	0.017	0.39	5.8	-23	100	12	140	SMA
ZOS-100+	50-100	9	-12	1-16	-111	-131	-143	0.026	0.25	4.5	-29	100	12	140	SMA
ZOS-75+	37.5-75	9	-12	1-16	-110	-128	-142	0.016	0.15	3.5	-26	100	12	140	SMA



HANDS-ON TOOLS

Research & Education

Infinite Potential

Mini-Circuits has partnered with RFIC pioneers at Vayyar to put cutting edge technology into the hands of students, educators and researchers around the world. Our research and education kits give the next generation of technical talent the hardware they need to connect theory with practice, and to innovate new applications for high-resolution radar.

IMAGEVK-73 4D mmWave Imaging and Sensing Kit

Explore 4D mmWave imaging without the high-cost of mmWave hardware

Incorporating Vayyar's revolutionary RFIC technology and radar IP, Mini-Circuits mmWave imaging and sensing kit gives researchers around the world the advanced to realize new applications with a full API to put the industry's most advanced mmWave transceiver IC to work.

- 20 Tx and 20 Rx on-board antennas that can be configured to transmit and receive signals anywhere within the 62 to 69 GHz range
- 3 levels of transmit configuration and direct access to the radar returns (IQ and/or phasor)
- Impeccably accurate calculations. Operates on Windows. Compatible with Python or Matlab®
- University discounts available

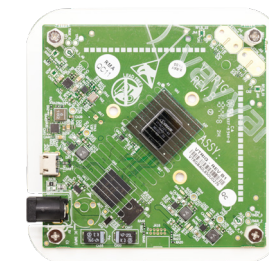

UVNA-63 DIY Vector Network Analyzer Kit

Bridge the gap between the classroom and the real world

Mini-Circuits' DIY vector network analyzer kit includes everything students need to build a fully functioning vector network analyzer, program their own algorithms, and perform actual measurements of RF components.

- Hands-on learning tool for EM course work
- Build your own fully functioning vector network analyzer with RF transceiver board, RF and microwave components, cables and calibration standards
- Open access to the entire VNA RF chain
- Develop real time S-parameter measurements with Python® or Matlab®
- University discounts available

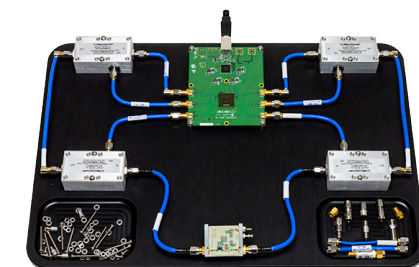

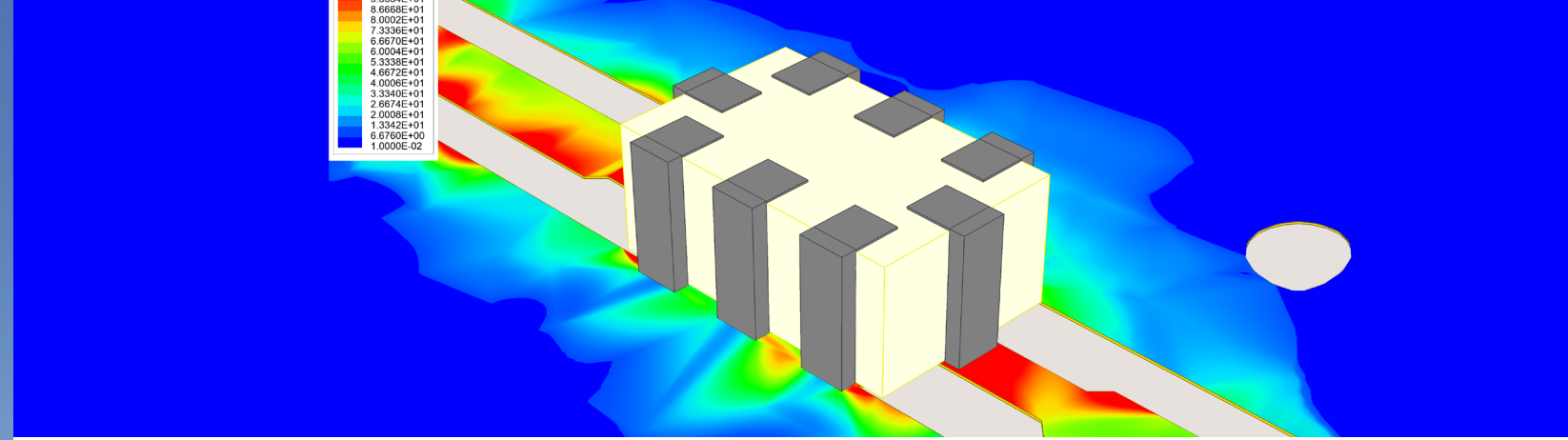

Company News

We have big plans for 2021, so keep a look out for news and announcements from Mini-Circuits throughout the year.

Here are some of the latest headlines from our newsroom:

Patent Awarded for Novel mmWave SMT Packaging

The new packaging technology, which supports both wire-bonding and flip-chip assembly methods, gives chipmakers and system designers an option to build millimeter-wave systems at production volume without compromising on electrical performance.

New Shipping Hub in Penang

Expansion of Malaysia facility will allow Mini-Circuits to offer many customers shorter lead times and lower freight costs.

Free 3D Models for Ansys® HFSS™

Mini-Circuits has partnered with modelling and simulation leader, Modelithics to offer free full 3D models for Ansys HFSS for over 40 of Mini-Circuits' most popular LTCC filters.

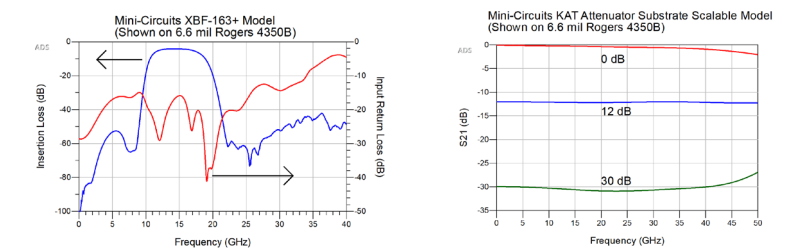

Ordering through Mouser Now Available in 200+ Countries

Mini-Circuits is pleased to announce an expansion of its distribution agreement with Mouser Electronics, Inc., making Mouser an authorized distributor of Mini-Circuits' product line in 206 countries.

Mini-Circuits Among Keysight's Top 100 Suppliers

Mini-Circuits has been recognized by Keysight Technologies as one of its top 100 suppliers at the Keysight Supplier Conference in Penang, Malaysia.

10th Consecutive 4-Star Supplier Excellence Award from Raytheon

Raytheon (now Raytheon Technologies, RTX) has again recognized Mini-Circuits for outstanding service and partnership in exceeding customer requirements.



[Browse additional news and events](#)

Direct Sales

Brooklyn, NY

sales@minicircuits.com
+1 (718) 934 4500

Missouri

sales@uk.minicircuits.com
+1 (417) 335-5935

Europe

sales@uk.minicircuits.com
+44 1252-832600

Taiwan

robert@min-kai.com.tw
+886 3 318 4450

Japan and South Korea

thomasj@minicircuits.com
+81 45 548 5058

Technical Support

North America

apps@minicircuits.com
+1 (718) 934-4500

Southeast Asia

foxfoo@minicircuits.com.my
+604 646-2828

Taiwan and Philippines

robert@min-kai.com.tw
+886 3 318 4450

Europe

apps@uk.minicircuits.com
+44 1252-832600

India

apps@minicircuits.com
+91 44 2 2622575

Israel

app@ravon.co.il
+972 4 8749100

China

yuanzhong@minicircuits.com
+86 020-8734 0992

Japan and South Korea

thomasj@minicircuits.com
+81 45 548 5058

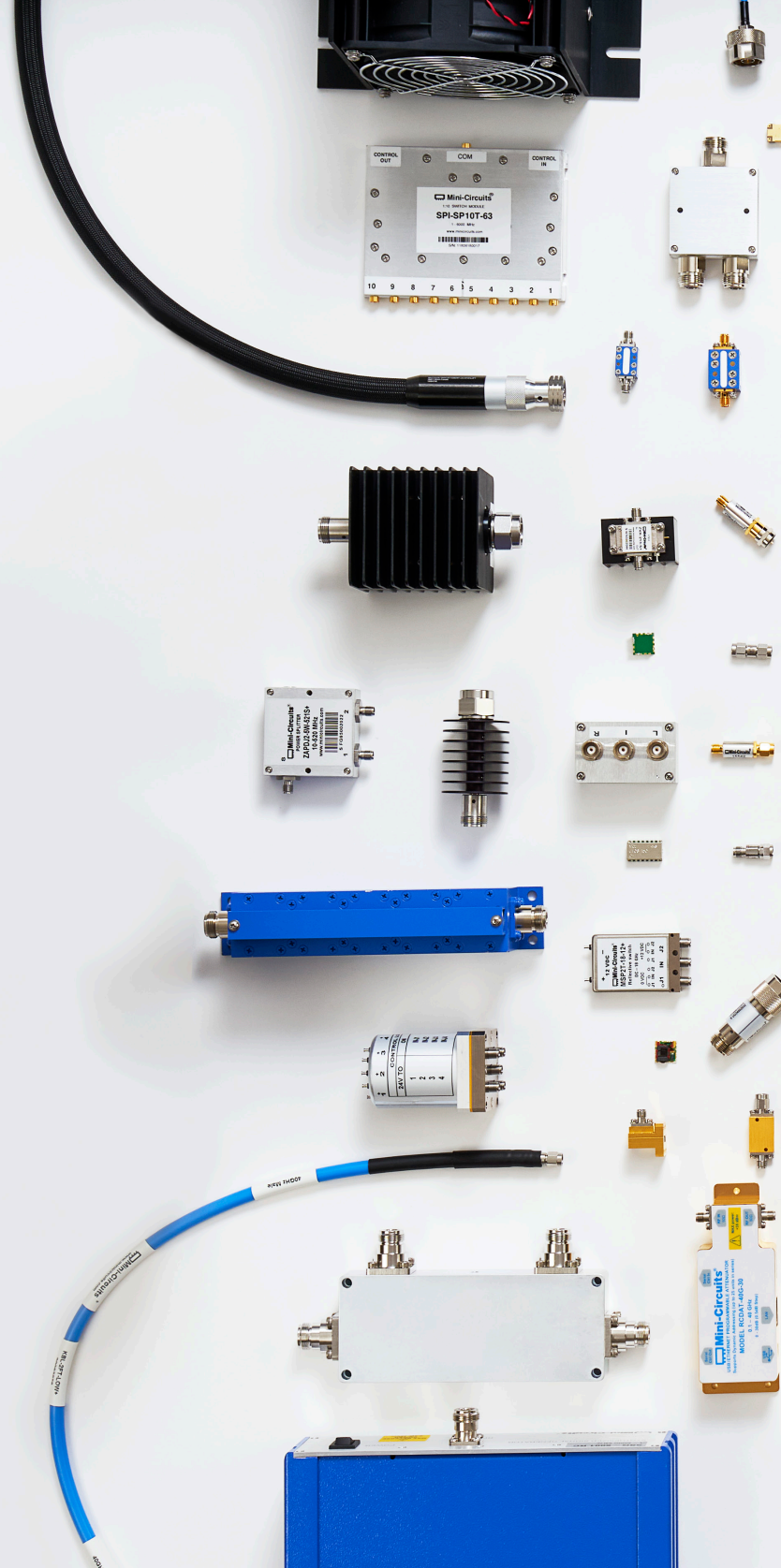

All product information herein is current and accurate as of the date of publication. Product availability and specifications may change. Please consult the Mini-Circuits website, an authorized sales representative or your Mini-Circuits account manager for the most up-to-date information.

minicircuits.com

 Mini-Circuits®