

MERITOR FRICTION PRODUCTS



MERITOR

PRODUITS DE FRICTION MERITOR
MERITOR REIBBELÄGE
PRODOTTI FRENANTI MERITOR
MERITOR REMPRODUCTEN
PRODUCTOS DE FRICCIÓN MERITOR
ELEMENTY CIERNE UKŁADU HAMULCOWEGO
ТОРМОЗНЫЕ НАКЛАДКИ, БАРАБАНЫ И
ДИСКИ MERITOR
PRODUTOS DE FRICÇÃO MERITOR
منتجات الاحتكاك ميريتور



December 2016



CONTENT

CONTENU · INHALT · CONTENUTO · INHOUD · CONTENIDO · ZAWARTOŚĆ · СОДЕРЖАНИЕ · CONTEÚDO · المحتويات



1.	GLOSSARY	2
	Vocabulaire · Glossar · Vocabolario · Verklarende woordenlijst · Glosario · Słownictwo · Глоссарий · Glossário · قائمة المصطلحات	
2.	PAD AND DISC APPLICATIONS	9
	Plaquettes et disques · Bremsscheiben und Beläge · Pastiglie e dischi freno · Remblokken & Remschijven · Pastillas y Discos · Zastosowanie klocków i tarcz hamulcowych · применение накладок и дисков · Aplicações para calço e discos de travões · قطع غيار لوسائد الفرامل والثقراص	
3.	PAD AND DISC BUYERS GUIDES	65
	Guide Acheteurs · Teileverwendung · Guida degli Acquisti · Kopersgids · Guía de compras · Zastosowanie części · Инструкции для покупателя · Guia do comprador · دليل المشتري	
4.	PAD AND DISC CROSS REFERENCES	75
	Liste d'Equivalences · Umcodierungen · Trascodifica · Kruisverwijzing · Referencia cruzada · Zamienniki · Таблицы соответствия · Referència cruzada · الإسناد الترافقي	
5.	DRUM AND LINING APPLICATIONS	87
	Tambours et garnitures de frein · Bremsscheiben und Beläge · Tamburi freno e guarnizioni frenanti · Remtrommels & Remvoeringen · Tambores de freno y forros · Zastosowanie bębnow i okładzin hamulcowych · применение накладок и барабанных тормозов · Aplicações para tambor e guarnição · قطع غيار جرن وبطانة الفرامل	
6.	DRUM AND LINING BUYERS GUIDES	167
	Guide Acheteurs · Teileverwendung · Guida degli Acquisti · Kopersgids · Guía de compras · Zastosowanie części · Инструкции для покупателя · Guia do comprador · دليل المشتري	
7.	DRUM AND LINING CROSS REFERENCES	179
	Liste d'Equivalences · Umcodierungen · Trascodifica · Kruisverwijzing · Referencia cruzada · Zamienniki · Таблицы соответствия · Referència cruzada · الإسناد الترافقي	

1



2



3



4



5



6



7



1



2



3



4



5



6



7



	(GB)	(F)	(D)	(I)	(NL)
	Bus	Autobus	Autobus	Bus urbano	Bus
	Dust Cart	Benne à ordures ménagères	Müllwagen	Camion dei rifiuti	Vuilniswagen
	Fire Engine	Camion de Pompiers	Feuerwehrgewagen	Camion dei Pompieri	Brandweerauto
	Trailer	Remorque	Anhänger	Rimorchio	Aanhangwagen
	Truck	Porteur	LKW	Motrice	Vrachtauto
	Van	Camionnette	Kastenwagen	Furgone	Bestelwagen
	Front	Avant	Vorne	Anteriore	Voor
	Rear	Arrière	Hinten	Posteriore	Achter
	Front / Rear	Avant / Arrière	Vorne / Hinten	Anteriore / Posteriore	Voor / Achter
	OE Part	Equipement d'origine	OE Nummern	Codice di primo equipaggiamento	OE Part
	AllFitt Part	AllFitt Pièce	AllFitt Teil	AllFitt Pezzo	AllFitt Onderdeel
	Solid Disc	Disque Plein	Nicht Belüftete Scheibe	Disco No Ventilato	Volle Remschijf
	Vented Disc	Disque Ventilé	Belüftete Scheibe	Disco Ventilato	Geventileerde Remschijf
	Brake Diameter	Diamètre de frein	Bremsdurchmesser	Diametro freno	Remdiameter
N/A	Not Applicable	Non applicable	nicht anwendbar	Non applicabile	Non applicabile
▶ 2.1	All Dimensions are in mm	Toutes les dimensions sont en mm	Alle Dimensionen in mm	Tutte le dimensioni sono in mm	Alle afmetingen zijn in mm
▶ 2.2	Manufacturers' numbers are for reference only	Les références constructeurs sont indiquées pour information uniquement	Die Fahrzeughersteller-Angaben dienen nur zu Vergleichszwecken	I dati della casa costruttrice servono solo a scopo comparativo	Fabrieksnummers dienen alleen ter informatie



	(E)	(PL)	(RU)	(P)	(UAE)
	Autobus	Autobus	Автобус	Autocarro	حافلة
	Camion de residuos	Ciężarówka do wywozu śmieci	мусоровоз	Carro do lixo	شاحنة النفايات
	Camión de bomberos	Wóz straży pożarnej	пожарный автомобиль	Carro de bombeiros	عربة إطفاء
	Remolque	naczepa	Прицеп	Reboque	مقطورة
	Camion	samochód ciężarowy	Грузовой автомобиль	Camião	شاحنة
	Furgoneta	Samochód dostawczy	Микроавтобус	Camionete	شاحنة صغيرة
	Delantero	Lewa strona	Левая сторона	Frente	الأمام
	Trasero	Prawa strona	Правая сторона	Traseira	الخلف
	Delantero / Trasero	Lewa strona / Prawa strona	Левая сторона / Правая сторона	Frente / Traseira	الأمام / الخلف
	Referencia del fabricante	Część oryginalna (OE)	части OE	Equipamento original	المعدات الأصلية
	AllFitt Pieza	AllFitt Część	AllFitt деталь	AllFitt Peça	قطعة AllFitt
	Disco No Ventilado	Pełna Tarcza Hamulcowa	Диск, Цельный	Disco completo	الأسطوانة الصلبة
	Disco Ventilado	Wentylowana Tarcza Hamulcowa	Диск, Оборудованный Воздушным Лапанам	Disco ventilado	الأسطوانة المهواة
	Diámetro del freno	Średnica hamulca	Диаметр тормозов	Diâmetro do travão	قطر الفرامل
N/A	no aplicable	Brak zastosowania	Не применимо	Não aplicável	غير قابل للتطبيق
▶ 2.1	Las dimensiones están en mm	Wszystkie wymiary w mm	Все размеры в	Todas as dimensões estão em mm	جميع الأبعاد بالملم
▶ 2.2	Las referencias de los fabricantes son para consulta únicamente	Podane numery oryginalne służą tylko do celów porównawczych	Номера производителя служат только для сравнения	As referências construtor são dadas unicamente a título informativo	أرقام المصنِّعين مدرجة كمرجع استرشادي فقط

1



2



3



4



5



6



7



MERITOR BRAKE PADS

MERITOR BRAKE PADS · PLAQUETTES DE FREIN MERITOR · MERITOR BREMSBELÄGE · PASTIGLIE FRENO MERITOR

1



MDP5000 / 9000 OE series:
OE quality friction material specifically designed for each OE Meritor brakes application (Truck, Trailer & Buses), increase life and eliminate noise / judder.



Séries d'origine MDP5000/9000 :
Matériau de friction de qualité d'origine spécialement conçu pour chaque application de freins Meritor d'origine (camion, remorque et bus) pour une durée de vie plus élevée et une suppression du bruit/brouetement.



MDP5000/9000:
OES-Reibbeläge mit Originalausrüster-Material, speziell konzipiert für jede Erstausrüster-Bremsanwendung von Meritor (LKW, Anhänger und Busse). Längere Lebensdauer, weniger Geräusche und Bremsrubbeln.



Serie MDP5000 / 9000 OE:
Materiale d'attrito di qualità OE appositamente progettato per ciascuna delle applicazioni freni Meritor OE (autocarri, rimorchi e autobus) con incremento di durata e riduzione di rumore e/o tremolio

2

3



Premium Brake pads (MAX) :
M550 friction material for high demand, high inertia disc pad material for city-bus and super heavy duty applications. Suited for applications where two piece rotors feature. (flat disc).



Plaquettes de frein de qualité supérieure (MAX) :
Matériau de friction M550 pour plaquettes de frein à disque à forte inertie subissant d'importantes sollicitations, destiné aux bus urbains et aux super poids-lourds. Convient pour des applications avec disques deux pièces (disque plat).



Premium-Bremsbeläge (MAX):
Reibmaterial M550 für anspruchsvolle Bremsanwendungen wie Stadtbusse und schwere Nutzfahrzeuge. Besonders geeignet für Anwendungen mit zweiteiligen Brems scheiben.



Pastiglie freno premium (MAX):
Materiale d'attrito M550 per pastiglie disco ad alto grado di inerzia per applicazioni con alta esigenza per autobus urbani e mezzi super pesanti. Ideale per applicazioni con due pezzi rotori (disco piatto).

4

5



MDP3000 series:
M520 Friction material outstanding for heavy vehicle brake pad with a low metallic and organic base. Designed to operate in premium trailer and premium truck applications.



Séries MDP3000 :
Matériau de friction M520 de plaque de frein de haute qualité avec base organique à faible concentration métallique, destiné aux véhicules lourds. Conçu pour des applications sur remorques et camions de qualité supérieure.



MDP3000-Serie:
Reibmaterial M520 für hervorragende Bremsbeläge für Schwerlastfahrzeuge auf niedrig-metallischer, organischer Basis. Für Premium-Anhänger- und LKW-Anwendungen.



Serie MDP3000:
Materiale d'attrito M520 di altissima qualità per pastiglie freno per mezzi pesanti con base organica a basso contenuto di metallo. Progettato per il funzionamento su applicazioni per rimorchi e autocarri di prima qualità

7

MERITOR BRAKE PADS

MERITOR REMBLOKKEN · PASTILLAS DE FRENO MERITOR · KLOCKI HAMULCOWE MERITOR · ТОРМОЗНЫЕ КОЛОДКИ MERITOR



MDP5000 / 9000 OE-serie:
OE kwaliteit frictiemateriaal dat specifiek is ontworpen voor elke OE Meritor remtoepassing (truck, trailer en bussen), verhoogt de levensduur en vermindert lawaai/trillingen



Serie MDP5000 / 9000 OE:
El material de fricción de calidad de equipo original diseñado específicamente para cada aplicación de frenos Meritor originales (camioneros, tráileres y autobuses) alarga la vida útil y elimina ruidos y vibraciones



Seria MDP5000 / 9000 OE:
Materiał czarny o jakości OE zaprojektowany z myślą o każdym zastosowaniu hamulców OE Meritor (pojazd ciężarowy, naczepa i autobusy), zwiększa trwałość i eliminuje hałas / drgania



Серия MDP5000/9000 OE:
фрикционный материал качества оригинального оборудования, специально разработанный для каждой из сфер применения тормозов Meritor (грузовики, трейлеры и автобусы), повышающий срок службы изделия и снижающий шум и вибрацию



Premium remblokken (MAX):
M550 frictiemateriaal voor veeleisende, hoge inertie schijf blok materiaal voor stadsbussen en zeer zware gebruikstoepassingen. Geschikt voor toepassingen met tweeledige rotors (vlakke schijf)



Pastillas de freno de primera calidad (MAX):
Material de fricción M550 para pastillas de freno sometidas a condiciones exigentes y con un alto nivel de inercia en aplicaciones de autobuses urbanos y muy reforzadas. Apropriadadas para aplicaciones con rotores de dos piezas (disco plano).



Klocki hamulcowe Premium (MAX):
Materiał czarny M550 to spełniający wysokie wymagania materiał klocków do hamulców tarczowych o wysokiej bezwładności przeznaczony do zastosowań w autobusach miejskich oraz pojazdach eksploatowanych w bardzo trudnych warunkach. Nadaje się do zastosowań w pojazdach z tarczami dwuczęściowymi. (tarcza płaska).



Тормозные колодки премиум-класса (MAX):
фрикционный материал M550, рассчитанный на высокие нагрузки; материал для высокоинерционных тормозных систем городских автобусов и сверхмощных видах транспорта. Подходит для применений с двухэлементным ротором (плоский диск).



MDP3000 serie:
M520 Frictiemateriaal: hoogwaardig remblok frictiemateriaal voor zware voertuigen met een lage metalen, organische basis. Ontworpen om te functioneren in premium trailer- en premium trucktoepassingen



Serie MDP3000:
Material de fricción M520 sobresaliente para pastillas de frenos para vehículos pesados con una base orgánica y de bajo contenido metálico. Diseñadas para funcionar en aplicaciones para tráileres de primera calidad y camiones de primera calidad



Seria MDP3000:
Materiał czarny M520: znakomity materiał czarny klocków hamulcowych do pojazdów ciężkich o małej zawartości metali i substancji organicznych. Przeznaczony do pracy w pojazdach ciężarowych i naczepach klasy premium



Серия MDP3000:
Фрикционный материал M520: превосходный фрикционный материал для тормозных дисков тяжелых автомобилей на основе низкометаллических органических соединений. Разработан для использования в трейлерах и грузовых автомобилях премиум-класса

1



2



3



4



5



6















7

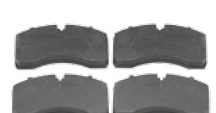
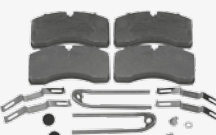

MERITOR MDP3000 BRAKE PADS RANGE EXTENSION

ÉLARGISSEMENT GAMME DE PLAQUETTES DE FREIN MERITOR MDP3000 · MERITOR MDP3000 BREMSBELÄGE, ERWEITERTES PRODUKTANGEBOT · GAMMA AGGIUNTIVA DI PASTIGLIE FRENO MERITOR MDP3000 · UITBREIDING GAMMA MERITOR MDP3000 REMBLOKKEN · AMPLIACIÓN DE LA GAMA DE PASTILLAS DE FRENO MERITOR MDP3000 · POSZERZONA GAMA KLOCKÓW HAMULCOWYCH MERITOR MDP3000 · РАСШИРЕНИЕ АССОРТИМЕНТА ТОРМОЗНЫХ КОЛОДОК MERITOR MDP3000

Meritor	Description	WVA	OE Ref	Brake Application	OEM Application	Current Kit Reference	NEW Kit Reference
MDP3087KP	Brake pad kit (including Retainer plate)	29042 29059 29087 29106 29108 29109 29163 29179 29202 29253	0034203520 4214310 81508205104	Knorr SN / SB7	BPW DAF Dennis Iveco Mercedes Neoplan SAF Scania Schmitz SMB	 MDP3087K	 MDP3087KP
MDP3088K	Brake pad kit	29088	5010848607 81508206042	Wabco Pan 17	DAF Iveco MAN Renault	 MDP3088	 MDP3088K
MDP3126K	Brake pad kit	29126 29159	12182192 1628064	Wabco Pan 19-1	DAF SAF	 MDP3126	 MDP3126K
MDP3141K	Brake pad kit	29141 29119	1440504 5001855902	Wabco Pan 19-2	DAF Dennis	 MDP3141	 MDP3141K
MDP3142K	Brake pad kit	29142	1440504 5001855902	Wabco Pan 19-2	Renault	 MDP3142	 MDP3142K
MDP3162K	Brake pad kit	29162	3057008400	Wabco Pan 22-1	SAF SMB	 MDP3162	 MDP3162K
MDP3244K	Brake pad kit	29244	006420120 0064205320 A0064201520 A0064205320	Knorr SL7	Mercedes Actros MP4	 MDP3244K no other option	
MDP3246K	Brake pad kit	29246	64201420 64205220 A0064201420 A0064205220	Knorr SM7	Mercedes Actros MP4	 MDP3246K no other option	

MERITOR BRAKE DISCS ECE R90 CERTIFIED

DISQUES DE FREINS MERITOR CERTIFIÉS ECE R90 · MERITOR BREMSSCHEIBEN MIT ZERTIFIZIERUNG NACH ECE R90 · CERTIFICAZIONE ECE R90 PER DISCHI FRENO MERITOR · MERITOR REMSCHIJVEN ECE R90 GECERTIFICEERD · DISCOS DE FRENO MERITOR CON CERTIFICACIÓN ECE R90 · TARCZE HAMULCOWE MERITOR Z CERTYFIKATEM ECE R90 · СЕРТИФИКАЦИЯ ECE R90 ТОРМОЗНЫХ ШАЙБ MERITOR

R90 Certification 90R-02C0888-13917

MBR5012, MBR5013, MBR5066, MBR5070,
MBR5092, MBR5097, MBR5100, MBR6025

R90 Certification E1190R-02C0986 - 18127

MBR5015, MBR5016HD, MBR5025,
MBR5032, MBR5046, MBR5048, MBR5057,
MBR5063, MBR5064, MBR5068, MBR5074,
MBR5076, MBR5105, MBR5128, MBR5143,
MBR5171, MBR5179, MBR5183, MBR5184,
MBR6036, MBR6037

R90 Certification 90R-02C0986-19006

MBR5056, MBR5124

R90 Certification 90R-02C0986-19010

MBR5073

R90 Certification 90R-02C0986-19008

MBR5014, MBR5049, MBR5059, MBR5060,
MBR5061, MBR5062, MBR5071, MBR5072,
MBR5077, MBR5096, MBR5099, MBR5102,
MBR5104, MBR5106, MBR5113, MBR5116,
MBR6026, MBR6028, MBR6029



1



2



3



4



5



6



7





- 1
- 2



- 3

- 4

- 5

- 6

- 7



1	Alexander	11
	Aüwarter (Neoplan)	11
	AWD	11
	Ayats	11
	Berkhof	11
	Beulas	12
	BMC	12
	Bova	12
2	BPW	12
	Caetano	13
	DAF	14
	Dennis	15
	ERF	15
	Esker	17
3	Foden	17
	Fruehauf	17
	Gigant	17
	Granning	17
	Hendrickson	17
	Ikarus	18
	Irizar	18
4	Iveco	18
	Kässbohrer	24
	Lecinena Trailer	25
	Leyland	25
	Liaz	25
	MAN	25
5	MCI	38
	MCW	38
	Mercedes	38
	Nissan	49
	Noge	50
	Optare	50
	Orion	50
6	Renault Trucks	50
	ROR	55
	SAF	55
	Scania	56
	Schmitz	58
	Seddon Atkinson	58
7	Sitcar	58
	SMB	58
	SOR	58
	Timoney/Teledyne	58
	Van Hool	59
	Volvo	60



Alexander									
ALX100 8.1 - 8.5m	B Frame	97 - 99		MDP5040	MDP3835K	MBA106	MBA007		MBR5039
				MDP5040	MDP3835K	MBA106	MBA007		MBR5040
ALX400 10.5m		00 →			MDP3090K/ MAX090K	MBA101			MBR5108
Aüwarter (Neoplan)									
Centroliner	Knorr SB7000			MDP9005	MDP3087K / MAX087K	MBA110 / MBA120	N/A		MBR5032
Cityliner N116, N116H, N116/3, N116/3H	Knorr SB7000	01/92 →		MDP9005	MDP3087K / MAX087K	MBA110 / MBA120	N/A		MBR5032
				MDP9005	MDP3087K / MAX087K	MBA110 / MBA120	N/A		
Clubstar SB6000	Knorr SB6000	01/98 →		MDP9002	MDP3095K / MAX095K	MBA110 / MBA121	N/A		MBR5077
				MDP9002	MDP3095K / MAX095K	MBA110 / MBA121	N/A		MBR5071
Economy	B Frame	01/98 →		MDP5040	MDP3835K	MBA106	MBA007		MBR1589
Euroliner SB7000	Knorr SB7000	01/92 →		MDP9005	MDP3087K / MAX087K	MBA110 / MBA120	N/A		MBR5032
				MDP9005	MDP3087K / MAX087K	MBA110 / MBA120	N/A		MBR5032
Eurostar	D3	10/91 →		MDP5017	MDP3030K / MAX030K	MBA108	MBA007		MBR5015
				MDP5017	MDP3030K / MAX030K	MBA108	MBA007		MBR5015
Jetliner N212H, N213H, N213SHD, N214H, N214SHD	Knorr SB7000	01/92 →		MDP9005	MDP3087K / MAX087K	MBA110 / MBA120	N/A		MBR5032
N Series N4008 - N4026	Knorr SB7000	01/92 →		MDP9005	MDP3087K / MAX087K	MBA110 / MBA120	N/A		MBR5032
Skyliner N122/3	Knorr SB6000	→ 92		MDP9002	MDP3095K / MAX095K	MBA110 / MBA121	N/A		MBR5026
	Knorr SB7000	01/92 →		MDP9005	MDP3087K / MAX087K	MBA110 / MBA120	N/A		MBR5032
Spaceliner N117/2, N117/3	Knorr SB7000	01/92 →		MDP9005	MDP3087K / MAX087K	MBA110 / MBA120	N/A		MBR5032
Starliner SB7000	Knorr SB7000	01/92 →		MDP9005	MDP3087K / MAX087K	MBA110 / MBA120	N/A		MBR5032
Transliner N312, N316	Knorr SB7000	01/92 →		MDP9005	MDP3087K / MAX087K	MBA110 / MBA120	N/A		MBR5032
AWD									
Mini-Bus Rockwell Axles	B Frame	07/92 →		MDP5030	N/A	N/A	N/A		
				MDP5030	N/A	N/A	N/A		
Ayats									
Bravo I, II, III - Scania Chassis	Knorr SB7000	01/96 →		MDP9005	MDP3087K / MAX087K	MBA110 / MBA120	N/A		MBR5025
				MDP9005	MDP3087K / MAX087K	MBA110 / MBA120	N/A		MBR5025
Berkhof									
Axial 50 12m Coach	D2	91 - 96		MDP5027	MDP3043K	MBA109	MBA006		
	D Lisa	97 →		MDP5061	MDP3090K / MAX090K	MBA101			





- 1
- 2
- 3
- 4
- 5
- 6
- 7

				OE	ALLFIT			OE	ALLFIT
...Berkhof									
Axial 50 12m Coach - Dennis Chassis	D2	91 – 96		MDP5027	MDP3043K	MBA109	MBA006		MBR5122
	D Lisa	97 →			MDP3090K / MAX090K	MBA101	MBA015	MBR9010	MBR5118
Excellence 3000HD - Scania Chassis	Knorr SB7000	96 →		MDP9005	MDP3087K / MAX087K	MBA110 / MBA120	N/A		MBR5025
				MDP9005	MDP3087K / MAX087K	MBA110 / MBA120	N/A		MBR5025
Radial 12m Coach - Dennis Chassis	D2	91 – 96		MDP5027	MDP3043K	MBA109	MBA006		MBR5122
	D Lisa	97 →			MDP3090K / MAX090K	MBA101	MBA015	MBR9010	MBR5118
Beulas									
Midi Star	Brembo (bframe)	00 →		N/A	MDP3122	MBA117			
				N/A	MDP3122	MBA117			
BMC									
Falcon 1100 City Bus	Knorr SB6000	03 →		MDP9002	MDP3095K / MAX095K	MBA110 / MBA121	N/A		
Bova									
Axial DD 138-430XE	Knorr SB7000	97 →		MDP9005	MDP3087K / MAX087K	MBA110 / MBA120	N/A		MBR5032
				MDP9005	MDP3087K / MAX087K	MBA110 / MBA120	N/A		MBR5032
Futura FHD	Knorr K85	86 – 94		N/A	MDP3747	N/A	N/A		MBR2695
Futura FHD - All models Exc 12.370	Knorr SB7000	95 →		MDP9005	MDP3087K / MAX087K	MBA110 / MBA120	N/A		MBR5032
Futura FHD 12.370A	Knorr SB6000	95 →		MDP9002	MDP3095K / MAX095K	MBA110 / MBA121	N/A		MBR5026
Futura FHD 14 Magnum		04/01 →							MBR5184
FLD 15 Magnum		04/01 →							MBR5184
Magiq HD 120-430XE	Knorr SB7000	94 →		MDP9005	MDP3087K / MAX087K	MBA110 / MBA120	N/A		MBR5032
				MDP9005	MDP3087K / MAX087K	MBA110 / MBA120	N/A		MBR5032
ZF Axle	Knorr SB7000	01/90 →		MDP9001	MDP3087K / MAX087K	MBA110 / MBA120	N/A		MBR5032
BPW									
Eco Plus SB6000 (with ABS)	Knorr SB6000	98 →		MDP9003	MDP3095K	MBA110 / MBA121	N/A		MBR5061
Eco Plus SB6000 (non ABS)	Knorr SB6000	01/98 →		MDP9003	MDP3095K	MBA110 / MBA121	N/A		MBR5048
Eco Plus SB7000 (without ABS)	Knorr SB7000	98 →		MDP9001	MDP3087K	MBA110 / MBA120	N/A		MBR5048
Eco Plus (with ABS)	Knorr SB7000	98 →		MDP9001	MDP3087K	MBA110 / MBA120	N/A		MBR5047
SH Series (no ABS location)	Knorr SB6000	→ 04/03		MDP9003	MDP3095K	MBA110 / MBA121	N/A		MBR5048
	Knorr SB7000 (Stepped)	05/03 →		MDP9006	MDP3167K*	MBA110 / MBA120	N/A		MBR5048

* MDP3165K, MDP3167K & MDP3171K - NOT AVAILABLE IN GERMANY

* MDP3165K, MDP3167K & MDP3171K - IN DEUTSCHLAND NICHT VERFÜGBAR



...BPW									
SH Series with ABS location	Knorr SB7000	→ 04/03		MDP9001	MDP3087K	MBA110 / MBA120	N/A		MBR5047
	Knorr SB7000 (Stepped)	05/03 →		MDP9006	MDP3167K*	MBA110 / MBA120	N/A		MBR5047
SH Series SK7000	Knorr SK7000	05/03 →		N/A	MDP3171K*	MBA110 / MBA121	N/A		MBR5105
	SB4309								MBR5180
	SB4345								MBR5180
SKH Series	Knorr SB6000	→ 04/03		MDP9003	MDP3095K	MBA110 / MBA121	N/A		MBR5060
				MDP9003	MDP3095K	MBA110 / MBA121	N/A		MBR5062
				MDP9003	MDP3095K	MBA110 / MBA121	N/A		MBR5099
				MDP9003	MDP3095K	MBA110 / MBA121	N/A		MBR5113
SKH Series With ABS	Knorr SB6000	→ 04/03		MDP9003	MDP3095K	MBA110 / MBA121	N/A		MBR5061
				MDP9003	MDP3095K	MBA110 / MBA121	N/A		MBR5062
				MDP9003	MDP3095K	MBA110 / MBA121	N/A		MBR5102
SKH Series	Knorr SB6000 (Stepped)	05/03 →		MDP9007	MDP3165K*	MBA110 / MBA121	N/A		MBR5060
				MDP9007	MDP3165K*	MBA110 / MBA121	N/A		MBR5062
				MDP9007	MDP3165K*	MBA110 / MBA121	N/A		MBR5099
				MDP9007	MDP3165K*	MBA110 / MBA121	N/A		MBR5113
SKH Series With ABS	Knorr SB6000 (Stepped)	05/03 →		MDP9007	MDP3165K*	MBA110 / MBA121	N/A		MBR5061
				MDP9007	MDP3165K*	MBA110 / MBA121	N/A		MBR5062
				MDP9007	MDP3165K*	MBA110 / MBA121	N/A		MBR5102
Caetano									
Cutlass	D2	91 – 96		MDP5027	MDP3043K	MBA109	MBA006		MBR5122
	D Lisa	97 →		MDP5061	MDP3090K / MAX090K	MBA101		MBR9010	MBR5118
Enigma MAN Chassis	Elsa 1	01/01 →		MDP5065	MDP3030K / MAX030K	MBA108	MBA019		MBR5068
Enigma 12m - Dennis Chassis	D2	91 – 96		MDP5027	MDP3043K	MBA109	MBA006		MBR5122
	D Lisa	97 →			MDP3090K / MAX090K	MBA101	MBA015	MBR9010	MBR5118
Enigma Dennis Chassis	Knorr SB7000	01/01 →		MDP9005	MDP3087K / MAX087K	MBA110 / MBA120	N/A		
Enigma Volvo Chassis	D Duco	12/99 →		MDP5057	MDP3125K / MAX125K	MBA104	N/A		
		12/01 →							MBR5183
Porto Volvo Chassis	D Duco	00 →		MDP5057	MDP3125K / MAX125K	MBA104	N/A		
Porto Dennis Chassis	D2	91 – 96		MDP5027	MDP3043K	MBA109	MBA006		MBR5122
	D Lisa	97 →			MDP3090K / MAX090K	MBA101	MBA015	MBR9010	MBR5118

* MDP3165K, MDP3167K & MDP3171K - NOT AVAILABLE IN GERMANY

* MDP3165K, MDP3167K & MDP3171K - IN DEUTSCHLAND NICHT VERFÜGBAR





- 1
- 2
- 3
- 4
- 5
- 6
- 7

DAF									
MB 220	Knorr K85	89 →		N/A	MDP3747	N/A	N/A		MBR2695
MB 230	Knorr K85	89 →		N/A	MDP3747	N/A	N/A		MBR2695
SB 120 Pan 19 19.5" wheels	Knorr SB6000	02 →		MDP9002	MDP3095K / MAX095K	MBA110 / MBA121	N/A		
SB 200 Pan 19 19.5" wheels	Knorr SB6000	02 →		MDP9002	MDP3095K / MAX095K	MBA110 / MBA121	N/A		
SB 2300	Knorr K85	86 →		N/A	MDP3747	N/A	N/A		MBR2695
SB 2305	Knorr K85	87 →		N/A	MDP3747	N/A	N/A		MBR2695
SB 3000	Knorr K85	89 →		N/A	MDP3747	N/A	N/A		MBR2695
	Knorr SB7000	89 →		MDP9005	MDP3087K / MAX087K	MBA110 / MBA120	N/A		MBR5032
SB 4000	Knorr SB7000	01/99 →		MDP9005	MDP3087K / MAX087K	MBA110 / MBA120	N/A		
SBG 220	Knorr K85	89 →		N/A	MDP3747	N/A	N/A		MBR2695
SBR 3000	Knorr K85	89 →		N/A	MDP3747	N/A	N/A		MBR2695
	Knorr SB7000	89 →		MDP9005	MDP3087K / MAX087K	MBA110 / MBA120	N/A		MBR5032
SKB 3000	Knorr K85	89 →		N/A	MDP3747	N/A	N/A		MBR2695
	Knorr SB7000	89 →		MDP9005	MDP3087K / MAX087K	MBA110 / MBA120	N/A		MBR5032
DAF									
45 Series FA45.120 - FA45.210 6.2t to 7.7t	Wabco 456	91 →		N/A	MDP3024	N/A	N/A		MBR1832
45 Series FA45.130 - FA45.210 10t to 11t	Wabco 456	91 →		N/A	MDP3024	N/A	N/A		MBR5006
55 Series FA55.150 - FA55.230	Wabco 1600	95 →		N/A	MDP3077	N/A	N/A		MBR5049
CF Series 65, 75, 85, 95	Knorr SB7000	09/00 →		MDP9000	MDP3087K / MAX087K	MBA110 / MBA120	N/A		
CF Series CF 65.180, CF 65.220, CF 65.250		00 - 06		MDP9000	MDP3087K / MAX087K				
CF Series CF 65.220, CF 65.250, CF 65.280, CF 65.300		06 →		MDP9000	MDP3087K / MAX087K				
CF Series CF 75.250, CF 75.310, CF 75.360		00 →		MDP9000	MDP3087K / MAX087K				
CF Series CF 85.340, CF 85.380, CF 85.430, CF 85.480		00 - 07		MDP9000	MDP3087K / MAX087K				
CF Series CF 85.360, CF 85.410, CF 85.460, CF 85.510		06 →		MDP9000	MDP3087K / MAX087K				
F Series FA1000, FA1005	Wabco 456	87 →		N/A	MDP3024	N/A	N/A		MBR5006
FA45 Series FA45		96 - 00			MDP3077				MBR5049
									MBR5006
FA55 Series FA55		96 - 00			MDP3077				MBR5049
									MBR5006
LF 45 Series 12t - Pan 17	Wabco Pan17	01/01 →		N/A	MDP3088 / MAX088K	N/A	N/A		MBR5103
				N/A	MDP3088 / MAX088K	N/A	N/A		MBR5097
LF 45 Series exc12t - Pan 17	Wabco Pan17	01/01 →		N/A	MDP3088 / MAX088K	N/A	N/A		MBR5100
				N/A	MDP3088 / MAX088K	N/A	N/A		MBR5097



...DAF									
LF Series LF 45.130, LF 45.150, LF 45.170, LF 45.180, LF 45.220		01 – 06			MDP3088 / MAX088K				MBR5100 MBR5103
					MDP3088 / MAX088K				MBR5100 MBR5097
LF Series LF 55.170, LF 55.180, LF 55.220, LF 55.250		01 – 06		MDP9000	MDP3087K / MAX087K				MBR5104
					MDP3141				MBR5104
					MDP3126				MBR5104
				MDP9000	MDP3087K / MAX087K				MBR5106
					MDP3141				MBR5106
					MDP3126				MBR5106
LF Series LF 45.140, LF 45.160, LF 45.180, LF 45.210, LF 45.220, LF 45.250		06 →			MDP3088 / MAX088K				MBR5100
									MBR5103
					MDP3088 / MAX088K				MBR5100
									MBR5097
LF Series LF 55.160, LF 55.180, LF 55.210, LF 55.220, LF 55.250, LF 55.280, LF 55.290, LF 55.300		06 →		MDP9000	MDP3087K / MAX087K				MBR5104
					MDP3141				MBR5104
					MDP3126				MBR5104
				MDP9000	MDP3087K / MAX087K				MBR5106
					MDP3141				MBR5106
					MDP3126				MBR5106
LF 55 Series 12t - 18t - Pan 19-2	Wabco Pan19-1	01/02 – 02/03		N/A	MDP3126	N/A	N/A		MBR5104
				N/A	MDP3126	N/A	N/A		MBR5106
LF 55 Series 12t - 18t - Pan 19-1 plus	Wabco Pan19-2	02/03 →		N/A	MDP3141	N/A	N/A		MBR5104
				N/A	MDP3141	N/A	N/A		MBR5106
LF 55 Series 21t	Knorr SB7000	01/02 →		MDP9000	MDP3087K / MAX087K	MBA110 / MBA120	N/A		
XF 95 Series	Knorr SB7000	09/00 →		MDP9000	MDP3087K / MAX087K	MBA110 / MBA120	N/A		
XF 105 Series	Knorr SB7000	09/00 →		MDP9000	MDP3087K / MAX087K	MBA110 / MBA120	N/A		
XF Series 95XF 380, 95XF 430, 95XF 480, 95XF 530		97 – 01		MDP9000	MDP3087K / MAX087K				
XF Series XF 95.380, XF 95.430, XF 95.480, XF 95.530		02 – 06		MDP9000	MDP3087K / MAX087K				
XF Series XF 95.560		02 – 06		MDP9000	MDP3087K / MAX087K				
XF Series XF 105.410, XF 105.460, XF 105.510		05 →		MDP9000	MDP3087K / MAX087K				





- 1
- 2
- 3
- 4
- 5
- 6
- 7

Dennis									
Arrow	D Lisa	95 →		MDP5061	MDP3090K / MAX090K	MBA101		MBR9010	MBR5118
Javelin	D2	91 – 96		MDP5027	MDP3043K	MBA109	MBA006		MBR5122
Javelin	D Lisa	97 – 00			MDP3090K / MAX090K	MBA101	MBA015	MBR9010	MBR5118
Javelin	Wabco Pan19-1	01 →		N/A	MDP3126	N/A	N/A		
Lance Low Floor - ZF Axle.	D3	04/92 →		MDP5000	MDP3030K / MAX030K	MBA108	MBA010		
R Series R300, R345, R420	Knorr SB7000	01/01 →		MDP9005	MDP3087K / MAX087K	MBA110 / MBA120	N/A		
Trident II	Knorr SB7000	01/01 →		MDP9005	MDP3087K / MAX087K	MBA110 / MBA120	N/A		
Enviro 200	Wabco Pan19-1	03 →		N/A	MDP3126	N/A	N/A		
Enviro 300	Wabco Pan19-1	01 →		N/A	MDP3126	N/A	N/A		
Enviro 400	Wabco Pan19-1	04 →		N/A	MDP3126	N/A	N/A		
Enviro 500	Wabco Pan19-1	02 →		N/A	MDP3126	N/A	N/A		
Dart		06/02 →							MBR5185
									MBR5186
Enviro 200 Dart		04/06 →							MBR5185
									MBR5186
Enviro 300		04/06 →							MBR5185
									MBR5186
Enviro 400		06/04 →							MBR5183
Enviro 500		06/02 →							MBR5183
Elite 2	D Lisa	00 →		MDP5071	MDP3090K / MAX090K	MBA101	MBA015	MBR9010	MBR5118
Dagger	Knorr SB5000	00 →		N/A	MDP3148K	MBA110	N/A		
				N/A	MDP3148K	MBA110	N/A		
Rapier		91 →		N/A	MDP3013	N/A	Fitted		
Sabre	D Lisa	01/95 →			MDP3090K	MBA101	MBA015	MBR9010	MBR5118
ERF									
E Series ECL, ECM, ECS, ECT, ECX	Elsa 1	11/99 – 08/00		MDP5038	MDP3030K / MAX030K	MBA108	MBA018	MBR9006	
				MDP5038	MDP3030K / MAX030K	MBA108	MBA018	MBR9005	
	Elsa 2	08/00 →		MDP5059	MDP3131K / MAX131K	MBA105	N/A	MBR9006	
				MDP5059	MDP3131K / MAX131K	MBA105	N/A	MBR9005	



Vehicle Type	Brake Model	Year Range	Air Line	Air Line				Brake Type	
				OE	ALLFIT	Wabco	Knorr	Wabco	Knorr
Esker									
Touring 19.5" Wheels	Knorr SB6000	96 →	☐	MDP9002	MDP3095K / MAX095K	MBA110 / MBA121	N/A		MBR5077
			☐	MDP9002	MDP3095K / MAX095K	MBA110 / MBA121	N/A		MBR5071
Foden									
Alpha 2000, 3000	Knorr SB7000	05/01 →	☐	MDP9000	MDP3087K / MAX087K	MBA110 / MBA120	N/A		
Fruehauf									
Knorr Brakes	Knorr SB6000		☐	MDP9003	MDP3095K	MBA110 / MBA121	N/A		MBR5096
	Knorr SB7000		☐	MDP9001	MDP3087K	MBA110 / MBA120	N/A		MBR5064
Wabco Brakes	Wabco Pan19		☐		N/A				MBR5096
	Wabco Pan19-1		☐	N/A	MDP3126	N/A	N/A		MBR5096
	Wabco Pan19-1 plus		☐		N/A				MBR5096
	Wabco Pan19-2		☐	N/A	MDP3141	N/A	N/A		MBR5096
	Wabco Pan22		☐		N/A				MBR5064
	Wabco Pan22-1		☐		N/A				MBR5064
Gigant									
Hallex Brakes	Hallex DB22	01/99 →	☐	N/A	MDP3143K	MBA116	N/A		
Knorr Brakes	Knorr SB5000	01/99 →	☐	N/A	MDP3148K	MBA110 / MBA120	N/A		
	Knorr SB6000	01/99 →	☐	MDP9003	MDP3095K	MBA110 / MBA121	N/A		
	Knorr SB7000	01/99 →	☐	MDP9001	MDP3087K	MBA110 / MBA120	N/A		
Wabco Brakes	Wabco Pan22-1	01/99 →	☐	N/A	MDP3162	N/A	N/A		
Granning									
Knorr Brakes 17.5" wheels	Knorr SB5000	01/00 →	☐	N/A	MDP3148K	MBA110 / MBA120	N/A		
Knorr Brakes 19.5" wheels	Knorr SB6000	01/00 →	☐	MDP9003	MDP3095K	MBA110 / MBA121	N/A		
Knorr Brakes 22.5" wheels	Knorr SB7000	01/00 →	☐	MDP9001	MDP3087K	MBA110 / MBA120	N/A		
Hendrickson									
Knorr Brakes 17.5" Wheels	Knorr SB5000		☐	N/A	MDP3148K	MBA110 / MBA120	N/A		
Knorr Brakes 19.5" Wheels	Knorr SB6000		☐	MDP9003	MDP3095K	MBA110 / MBA121	N/A		
Knorr Brakes 22.5" Wheels	Knorr SB7000		☐	MDP9001	MDP3087K	MBA110 / MBA120	N/A		





- 1
- 2
- 3
- 4
- 5
- 6
- 7

Ikarus												
Bus Raba Axle		01/93 – 10/93		MDP5031	MDP3030K / MAX030K	MBA108	MBA010					
		11/93 →		MDP5033	MDP3030K / MAX030K	MBA108	MBA010					
Irizar												
Century Club	Knorr SB7000	96 →		MDP9005	MDP3087K / MAX087K	MBA110 / MBA120	N/A					MBR5025
					N/A							MBR5025
Century Style	Knorr SB7000	96 →		MDP9005	MDP3087K / MAX087K	MBA110 / MBA120	N/A					MBR5025
					N/A							MBR5025
Century Topline	Knorr SB7000	96 →		MDP9005	MDP3087K / MAX087K	MBA110 / MBA120	N/A					MBR5025
					N/A							MBR5025
Intercountry	Knorr SB7000	96 →		MDP9005	MDP3087K / MAX087K	MBA110 / MBA120	N/A					MBR5025
					N/A							MBR5025
PB	Knorr SB7000	96 →		MDP9005	MDP3087K / MAX087K	MBA110 / MBA120	N/A					MBR5025
					N/A							MBR5025
S-Kool	Knorr SB7000	96 →		MDP9005	MDP3087K / MAX087K	MBA110 / MBA120	N/A					MBR5025
					N/A							MBR5025
Iveco												
Breda Menarini Bus												MBR5147
Breda Menarini Bus Strepavava	Meritor DX225			MDP5083								MBR5129
Cityclass 491,591		98 →										MBR5146
Euroclass		92 →										MBR5146
Eurorider		92 →										MBR5146
Irisbus - Access Bus 127 5880 Bus 4x2 17,30	Elsa 2	03 – 06		MDP5056	MDP3131K / MAX131K							
Irisbus Agora 18m 7790 Bus 4x2 19,00	Elsa 2			MDP5056	MDP3131K / MAX131K							
Irisbus - Arway - 10.6M, 12M., 12.8M 7790 Bus 4x2 18,00	Elsa 2			MDP5056	MDP3131K / MAX131K							
Iveco												MBR5145
Myway 393.35		99 →										MBR5146
Iveco												
Cargo 0608, 0609, 0611	Brembo (bframe)	03/87 →		MDP5429	MDP3122	MBA107	N/A					MBR1762
Cargo 0708, 0709, 0712, 0713	Brembo (bframe)	03/87 →		MDP5429	MDP3122	MBA107	N/A					MBR1762
Cargo 0808, 0809, 0811, 0813, 0815	Brembo (bframe)	03/87 →		MDP5429	MDP3122	MBA107	N/A					MBR1762
Cargoplus 18T	Brembo (bframe)	02/02 →		MDP5020	MDP3122	MBA107	MBA001					MBR2649



Truck Model	Brake System	Date Range	Air System	Brake Components				Other	
				MDP	MBA	MBA002	OE	ALLFIT	
...Iveco									
Cargoplus 7.5T		02/02 →		MDP3122	MBA117				MBR2648
EuroCargo	Brembo (bframe)			MDP3122					MBR5131
EuroCargo 60E12, 60E14, 65E12, 65E14, 75E12, 75E14, TECTOR	Brembo (bframe)	09/91 – 94		MDP5842	MDP3122	MBA106	MBA002		MBR2648
		94 – 08/00			MDP3122	MBA117			MBR2648
EuroCargo 75E.13, 75E.13P, 75E.14, 75E.15, 75E.15P, 75E.17, 75E.17P, 75E.18, 75E.18P		00 – 07			MDP3122				MBR2648
					MDP3122				
EuroCargo 75E.14P, 75E.16, 75E.16P, 75E.18, 75E.18P		05 – 07			MDP3122				MBR2648
				MDP9000	MDP3087K / MAX087K				MBR2648
					MDP3122				MBR5131
				MDP9000	MDP3087K / MAX087K				MBR5131
EuroCargo 75E.14, 75E.14P, 75E.16, 75E.16P, 75E.18, 75E.18P		07 →		MDP9000	MDP3087K / MAX087K				
				MDP9000	MDP3087K / MAX087K				MBR5131
EuroCargo 80E15, 80E15R, 100E15, 100E18, 100E21, 109E14 & ZETA 95.14	Brembo (bframe)	06/91 – 06/94		MDP5453	MDP3122	MBA107	MBA002		MBR2649
		05/97 – 98		MDP5020	MDP3122	MBA107	MBA001		MBR2649
	Wabco Pan17	99 →		N/A	MDP3088 / MAX088K	N/A	N/A		MBR2649
EuroCargo 100E.17, 100E.17P, 100E.17FP, 100E.18, 100E.18FP, 100E.18P, 100E.21, 100E.21FP, 100E.21P	B Frame	00 – 07		MDP5020	MDP3122	MBA107	MBA001		MBR2649
				MDP5020	MDP3122	MBA107	MBA001		MBR2649
EuroCargo 100E.18, 100E.18FP, 100E.18P, 100E.22, 100E.22FP, 100E.22P	B Frame	05 – 07		MDP5020	MDP3122	MBA107	MBA001		MBR2649
				MDP5020	MDP3122	MBA107	MBA001		MBR5131
EuroCargo 110E15, E18, E23	Knorr	09/91 – 08/00		N/A	MDP3032K	MBA111	N/A		MBR5002
EuroCargo 110E15, EL17, E18, EL21, E23, E24, E28	Knorr	09/91 – 08/00		N/A	MDP3032K	MBA111	N/A		MBR5002
EuroCargo 110EL Tector	Wabco Pan17	09/00 →		N/A	MDP3088 / MAX088K	N/A	N/A		
EuroCargo 120E.17, 120E.17P, 120E.18, 120E.18P, 120E.21, 120E.21P, 120E.22, 120E.22P		00 – 07			MDP3088 / MAX088K				MBR6025
EuroCargo 120E.18, 120E.18P, 120E.20, 120E.20P, 120E.22, 120E.22P		07 →			MDP3088 / MAX088K				MBR6025
EuroCargo 120EL Tector	Wabco Pan17	09/00 →		N/A	MDP3088 / MAX088K	N/A	N/A		
Eurocargo 130E, 140E, 160E (+ABS) SB6 4x2	Knorr SB6000				MDP3095K / MAX095K				MBR6029
EuroCargo 130E.18, 130E.18FP, 130E.18P, 130E.21, 130E.21P, 130E.24, 130E.24FP, 130E.24P, 130E.28, 130E.28FP, 130E.28P		00 – 07			MDP3095K / MAX095K				MBR5116
					MDP3095K / MAX095K				MBR6027
EuroCargo 130E15, E18, E23, E24, E28	Knorr	91 – 00		N/A	MDP3032K	MBA111	N/A		MBR5002
EuroCargo 130E18, E21, E24, E28 TECTOR	Knorr SB6000	09/00 →		MDP9002	MDP3095K / MAX095K	MBA110 / MBA121	N/A		MBR5116
EuroCargo 135E18, E23	Knorr	09/91 – 08/00		N/A	MDP3032K	MBA111	N/A		MBR5002
EuroCargo 140E18, E21, E23, E24, E27	Knorr	09/91 – 08/00		N/A	MDP3032K	MBA111	N/A		MBR5002
	Knorr SB6000	09/00 →		MDP9002	MDP3095K / MAX095K	MBA110 / MBA121	N/A		MBR5116





- 1
- 2
- 3
- 4
- 5
- 6
- 7

...Iveco									
EuroCargo 140E.18		02 – 07			MDP3095K / MAX095K				MBR6029
					MDP3095K / MAX095K				MBR6028
EuroCargo 140E.18		07 →			MDP3095K / MAX095K				MBR6029
					MDP3095K / MAX095K				MBR6028
EuroCargo 150E15, E18, E23, E24, E27, E28	Knorr	09/91 – 08/00		N/A	MDP3032K	MBA111	N/A		MBR5001
	Knorr SB6000	09/00 →		MDP9002	MDP3095K / MAX095K	MBA110 / MBA121	N/A		
EuroCargo 150E.18, 150E.18P, 320E.28T, 320E.28TP		00 – 02			MDP3095K / MAX095K				MBR6026
EuroCargo 150E.21, 150E.21FP, 150E.21P		02 – 07			MDP3095K / MAX095K				MBR6026
					MDP3095K / MAX095K				MBR6028
EuroCargo 150E.24		00 – 07			MDP3095K / MAX095K				MBR6026
					MDP3032K				MBR6026
									MBR5001
					MDP3095K / MAX095K				MBR6028
EuroCargo 150E.24FP, 150E.24P, 150E.28, 150E.28FP, 150E.28P		00 – 07			MDP3095K / MAX095K				MBR6026
					MDP3095K / MAX095K				MBR6028
Eurocargo 150E Rear (+ABS) SB6 4x2	Knorr SB6000				MDP3095K / MAX095K				MBR6028
EuroCargo 170E18, E23, E23R		91 – 98		N/A	MDP3011K	MBA111	N/A		MBR2711
	Knorr SB7000	98 →		MDP9000	MDP3087K / MAX087K	MBA110 / MBA120	N/A		MBR5063
EuroCargo 175E24, E27	Knorr	91 – 98		N/A	MDP3011K	MBA111	N/A		MBR2711
EuroCargo 175E24, E27 TECTOR	Knorr SB7000	98 →		MDP9000	MDP3087K / MAX087K	MBA110 / MBA120	N/A		MBR5063
EuroCargo 176E30, E34	Knorr	91 – 98		N/A	MDP3011K	MBA111	N/A		MBR2711
EuroCargo 176E30, E34 TECTOR	Knorr SB7000	98 →		MDP9000	MDP3087K / MAX087K	MBA110 / MBA120	N/A		MBR5063
EuroCargo 179E24, E27, E30	Knorr	91 – 98		N/A	MDP3011K	MBA111	N/A		MBR2711
EuroCargo 179E24, E27, E30 TECTOR	Knorr SB7000	98 →		MDP9000	MDP3087K / MAX087K	MBA110 / MBA120	N/A		MBR5063
EuroCargo 180E21, EL21, E23, E24, EL24, E28, EL28	Knorr	91 – 00		N/A	MDP3011K	MBA111	N/A		MBR2711
EuroCargo 180E21, E24, E28 Tector	Knorr SB7000	00 →		MDP9000	MDP3087K / MAX087K	MBA110 / MBA120	N/A		
EuroCargo 180E.21, 180E.21P, 180E.24, 180E.24P, 180E.28, 180E.28P		00 – 07		MDP9000	MDP3087K / MAX087K				MBR5063
									MBR6036
				MDP9000	MDP3087K / MAX087K				MBR6036
									MBR6037
EuroCargo 180E.25, 180E.25P, 180E.28, 180E.30, 180E.30P		07 →		MDP9000	MDP3087K / MAX087K				MBR6036
				MDP9000	MDP3087K / MAX087K				MBR6037
EuroCargo 180E.28P		07 →		MDP9000	MDP3087K / MAX087K				MBR6036
									MBR6037



Truck Model	Brake System	Year Range	Icon	Brake Components				Other	
				MDP9000	MDP3087K / MAX087K	MBA110 / MBA120	N/A	OE	ALLFIT
...Iveco									
EuroCargo 180E Stralis Plataform C 4x2	Knorr SB7000			MDP9000	MDP3087K / MAX087K				MBR6037
EuroCargo 260E23, E28 TECTOR	Knorr SB7000	09/00 →		MDP9000	MDP3087K / MAX087K	MBA110 / MBA120	N/A		
EuroCargo 260E.28		02 – 07		MDP9000	MDP3087K / MAX087K				MBR6036
EuroCargo 260E.28KE		02 – 07		MDP9000	MDP3087K / MAX087K				MBR6036
EuroCargo 325E27	Knorr	91 – 98		N/A	MDP3011K	MBA111	N/A		MBR2711
	Knorr SB7000	98 →		MDP9000	MDP3087K / MAX087K	MBA110 / MBA120	N/A		MBR5063
EuroCargo 390E30, E34	Knorr	91 – 98		N/A	MDP3011K	MBA111	N/A		MBR2711
EuroCargo E210E23		09/91 →			N/A				MBR5001
EuroCargo E250E23		09/91 →			N/A				MBR5001
EuroCargo E260E23, E28	Knorr	09/91 →		N/A	MDP3032K	MBA111	N/A		MBR5002
EuroCargo E280E23		09/91 →			N/A				MBR5001
EuroCargo E320E23, E27, E28		09/91 →			N/A				MBR5001
Eurofire 130E, 150E	Knorr	09/91 →		N/A	MDP3032K	MBA111	N/A		MBR5002
Euromover					N/A				MBR5063
Eurostar All Models 190-520E	Knorr	93 – 96		N/A	MDP3011K	MBA111	N/A		MBR2711
Eurostar All Models 190-520E	Knorr SB7000	97 →		MDP9000	MDP3087K / MAX087K	MBA110 / MBA120	N/A		MBR5063
Eurotech All Models 180-440	Knorr	93 – 97		N/A	MDP3011K	MBA111	N/A		MBR2711
	Knorr SB7000	98 →		MDP9000	MDP3087K / MAX087K	MBA110 / MBA120	N/A		MBR5063
EuroTrakker 190E24, 190E27, 190E31, 190E35, 190E38, 190E44, 260E27, 260E31, 260E31P, 260E35, 260E35P, 260E38, 260E44, 260E44P, 260E48, 340E35, 340E35P, 340E38, 340E38P, 340E44, 380E35, 380E38, 380E44, 380E48, 400E35, 400E38, 400E44, 410E35, 410E38, 410E44, 410E48, 44		00 – 04		MDP9000	MDP3087K / MAX087K				MBR5063
									MBR6036
Eurotrakker Brake Discs	Knorr SB7000	99 →		MDP9000	MDP3087K / MAX087K	MBA110 / MBA120	N/A		MBR5063
Euroturbo (U.S.A.)	Brembo (bframe)	07/94 →		MDP5020	MDP3122	MBA107	MBA001		
		→ 06/94		MDP5453	MDP3122	MBA107	MBA002		
Stergo E		00 →			N/A				MBR5064
Stralis 260S40, S43, S48, S54	Knorr SB7000	02/02 →		MDP9000	MDP3087K / MAX087K	MBA110 / MBA120	N/A		MBR5063
Stralis 440E40, E43, E44, E54	Knorr SB7000	02/02 →		MDP9000	MDP3087K / MAX087K	MBA110 / MBA120	N/A		MBR5063
Stralis 440E40, S43, S44, S54	Knorr SB7000	02/02 →		MDP9000	MDP3087K / MAX087K	MBA110 / MBA120	N/A		MBR5063
Stralis AD , AS, AS, AT Plataform C 4x2	Knorr SB7000			MDP9000	MDP3087K / MAX087K				MBR6036
Stralis AD190S27		02 – 07		MDP9000	MDP3087K / MAX087K				MBR6036
									MBR6037





1



2



3



4



5



6



7



...Iveco								
Stralis AD190S27P, AD260S27FP, AD260S35P, AS260S40FP, AS260S40P, AS440S48TP, AT260S31FP, AT260S35P, AT260S40P, AT440S40TP	02 – 07		MDP9000	MDP3087K / MAX087K				
			MDP9000	MDP3087K / MAX087K				
Stralis AD190S27P	07 →		MDP9000	MDP3087K / MAX087K				MBR6036
Stralis AD190S30, AD190S30P, AT190S35	02 – 07		MDP9000	MDP3087K / MAX087K				MBR6036
			MDP9000	MDP3087K / MAX087K				MBR6037
Stralis AD190S31, AD190S31FP, AD190S31P, AD260S31, AD260S31FP, AD260S31P, AT190S31, AT190S31FP, AT190S31P, AT260S31P	02 – 07		MDP9000	MDP3087K / MAX087K				MBR6036
								MBR6037
Stralis AD190S33	06 →		MDP9000	MDP3087K / MAX087K				MBR6036
			MDP9000	MDP3087K / MAX087K				MBR6037
Stralis AD190S35FP, AD190S40FP, AD190S43, AD260S40, AD260S43, AT190S40P, AT260S27FP, AT440S40TFP, AT440S43TFP	02 – 07		MDP9000	MDP3087K / MAX087K				MBR6036
			MDP9000	MDP3087K / MAX087K				MBR6036
Stralis AD190S42FP, AD190S45, AD440S33TP, AD440S48TP, AT190S33, AT190S45, AT440S33TP, AT440S48TFP, AT440S48TP	07 →		MDP9000	MDP3087K / MAX087K				MBR6036
			MDP9000	MDP3087K / MAX087K				MBR6037
Stralis AD260S27FP, AD260S35P, AS260S40P, AT260S31FP, AT260S35P, AT260S40P, AT440S40TP	02 →							MBR6037
Stralis AD260S27FP, AD260S33	06 →		MDP9000	MDP3087K / MAX087K				MBR6036
								MBR6037
Stralis AD260S35P, AT260S35P, AT260S40P, AT440S40TP	02 – 07							MBR6037
Stralis AD260S45FP, AD260S45P, AS260S50TP, AT260S36, AT260S45	06 – 07		MDP9000	MDP3087K / MAX087K				MBR6036
								MBR6037
Stralis AD440S45TP	06 →		MDP9000	MDP3087K / MAX087K				MBR6036
								MBR6037
			MDP9000	MDP3087K / MAX087K				MBR6037
Stralis AS260S40FP, AS260S40P, AS440S48TP	02 →							MBR6036
Stralis AS260S40FP, AS440S48TP	02 →							MBR6036
Stralis AS260S40FP, AS440S48TP	02 →							MBR6037
Stralis AS260S43FP, AS260S48FP, AS260S48P, AS260S54P, AS440S40TP, AS440S43TFP, AS440S43TP, AS440S54TP	02 – 07		MDP9000	MDP3087K / MAX087K				MBR5063
								MBR6036
								MBR6037
Stralis AS260S44P, AS440S40TFP, AS440S44TP, AS440S48TFP	02 – 07		MDP9000	MDP3087K / MAX087K				MBR5063
								MBR6036



Icon 1	Icon 2	Icon 3	Icon 4	Icon 5				Icon 6	
				OE	ALLFIT	Icon 7	Icon 8	OE	ALLFIT
...Iveco									
Stralis AS440S48TP		02 – 07							MBR6036
									MBR6037
Stralis AT260S33FP		06 →		MDP9000	MDP3087K / MAX087K				MBR6036
									MBR6037
		06 – 07							MBR6037
Stralis AT260S40		02 – 07		MDP9000	MDP3087K / MAX087K				MBR6036
SuperCargo	Knorr	93 – 00		N/A	MDP3011K	MBA111	N/A		MBR2711
SuperCargo	Knorr SB7000	00 →		MDP9000	MDP3087K / MAX087K	MBA110 / MBA120	N/A		MBR5063
Trakker AD180T27W		04 – 07		MDP9000	MDP3087K / MAX087K				MBR6037
Trakker AD190T27, AD190T31, AD190T35, AD190T38, AD190T44, AD400T35, AD400T38, AD400T44, AT180T27, AT190T27, AT190T35, AT190T38, AT190T44, AT400T38, AT440T41P		04 – 07		MDP9000	MDP3087K / MAX087K				MBR6036
				MDP9000	MDP3087K / MAX087K				MBR6037
Trakker AD190T31W, AD190T31WP, AD190T33W, AD190T33WP, AD190T45W, AD400T45W, AT190T31W, AT190T36W, AT190T36WP, AT190T41W, AT190T45W, AT400T45W		04 →		MDP9000	MDP3087K / MAX087K				MBR6037
Trakker AD190T36W, AD190T36WP, AD400T41W, AT190T33W, AT190T33WP, AT190T41WP, AT190T45WP, AT400T41W		07 →		MDP9000	MDP3087K / MAX087K				MBR6037
Trakker AD190T41W, AD260T45W, AD380T36, AD380T45, AT260T44, AT440T41		04 – 07		MDP9000	MDP3087K / MAX087K				
Trakker AD190T45, AT190T31, AT190T36, AT190T38, AT190T41, AT400T36, AT400T41, AT400T41P, AT400T50		07 →		MDP9000	MDP3087K / MAX087K				MBR6036
				MDP9000	MDP3087K / MAX087K				MBR6037
Trakker AD260T31, AD260T33		04 – 07		MDP9000	MDP3087K / MAX087K				MBR6036
									MBR6037
Trakker AD260T35W, AD260T36W, AD260T41W, AD380T36W, AD380T41W, AD380T45W, AD410T45W, AD720T41W, AD720T45W, AT260T41W, AT260T45W, AT380T45W, AT720T45W		04 – 07		MDP9000	MDP3087K / MAX087K				MBR6036
									MBR6037
Trakker AD260T38		07 →		MDP9000	MDP3087K / MAX087K				MBR6036
									MBR6037
Trakker AD260T45W, AD380T36, AD380T45, AT260T44, AT440T41		04 – 07							MBR6037
Trakker AD380T36, AD380T45, AT260T44, AT440T41		04 – 07		MDP9000	MDP3087K / MAX087K				MBR6036
Trakker AD380T41W, AD380T45W, AD410T45W, AT380T41W, AT380T45W		07 →		MDP9000	MDP3087K / MAX087K				MBR6036
									MBR6037
Zeta 65.12 - 79.14	Wabco 456	83 →		N/A	MDP3024	N/A	N/A		MBR1761





- 1
- 2
- 3
- 4
- 5
- 6
- 7

...Iveco									
Daily 28.8, 30.8, 32.8, 32.9, 35.8, 35.8T, 35.10, 35.10TD, 40.8 Turbo Diesel		82 – 90							MBR5144
Kässbohrer									
S130 ES		82 – 86		N/A	MDP3498	N/A	N/A		MBR5110
S140		83 →		N/A	MDP3498	N/A	N/A		MBR5110
	Knorr K85	83 →		N/A	MDP3747	N/A	N/A		MBR5003
S210		83 →		N/A	MDP3498	N/A	N/A		MBR5110
	Knorr K85	83 →		N/A	MDP3747	N/A	N/A		MBR5003
S211		83 →		N/A	MDP3498	N/A	N/A		MBR5110
	Knorr K85	83 →		N/A	MDP3747	N/A	N/A		MBR5003
S212		76 →		N/A	MDP3498	N/A	N/A		MBR5110
	Knorr K85	76 →		N/A	MDP3747	N/A	N/A		MBR5003
S213		76 →		N/A	MDP3498	N/A	N/A		MBR5110
	Knorr K85	76 →		N/A	MDP3747	N/A	N/A		MBR5003
S214		83 →		N/A	MDP3498	N/A	N/A		MBR5110
	Knorr K85	83 →		N/A	MDP3747	N/A	N/A		MBR5003
S215		83 – 90		N/A	MDP3498	N/A	N/A		MBR5110
	Knorr K85	83 – 90		N/A	MDP3747	N/A	N/A		MBR5003
	D3	91 →		MDP5000	MDP3030K / MAX030K	MBA108	MBA010		MBR5076
	D3	91 →		MDP5031	MDP3030K / MAX030K	MBA108	MBA010		MBR5076
S216		80 →		N/A	MDP3747	N/A	N/A		MBR5003
	Knorr K85	80 →		N/A	MDP3747	N/A	N/A		MBR5003
S228		83 – 89		N/A	MDP3747	N/A	N/A		MBR5003
		89 →		N/A	MDP3498	N/A	N/A		MBR5110
S300		91 →		MDP5000	MDP3030K / MAX030K	MBA108	MBA010		MBR5076
		91 →		MDP5033	MDP3030K / MAX030K	MBA108	MBA010		MBR5076
S313		91 →		MDP5033	MDP3030K / MAX030K	MBA108	MBA010		MBR5076
S315		91 →		MDP5000	MDP3030K / MAX030K	MBA108	MBA010		MBR5076
S317		91 →		MDP5033	MDP3030K / MAX030K	MBA108	MBA010		MBR5076
S319		91 →		MDP5033	MDP3030K / MAX030K	MBA108	MBA010		MBR5076
S321		91 →		MDP5033	MDP3030K / MAX030K	MBA108	MBA010		MBR5076
S328	Knorr SB7000	95 →		MDP9005	MDP3087K / MAX087K	MBA110 / MBA120	N/A		MBR5032



Icon	Icon	Icon	Icon	Icon				Icon	
				Icon	Icon	Icon	Icon	Icon	Icon
...Kässbohrer									
S415	Knorr SB7000	04/01 →		MDP9005	MDP3087K / MAX087K	MBA110 / MBA120	N/A		MBR5032
S417	Knorr SB7000	04/01 →		MDP9005	MDP3087K / MAX087K	MBA110 / MBA120	N/A		MBR5032
Lecinena Trailer									
FD22/120	Knorr SB7000			MDP9001	MDP3087K	MBA110 / MBA120	N/A		
FD22/0	Knorr SB7000			MDP9001	MDP3087K	MBA110 / MBA120	N/A		
Leyland									
Swift	Wabco 456	87 →		N/A	MDP3024	N/A	Fitted		MBR5006
Liaz									
400 Series	Knorr SB7000	98 →		MDP9005	MDP3087K / MAX087K	MBA110 / MBA120	N/A		MBR5016HD
MAN									
City Bus 19.5" Wheels	Knorr SB6000	96 →		MDP9002	MDP3095K / MAX095K	MBA110 / MBA121	N/A		MBR5077
				MDP9002	MDP3095K / MAX095K	MBA110 / MBA121	N/A		MBR5071
City Bus 22.5" Wheels	Elsa 1	96 →		MDP5065	MDP3030K / MAX030K	MBA108	MBA018		MBR5068
				MDP5065	MDP3030K / MAX030K	MBA108	MBA018		MBR5078
				MDP5065	MDP3030K / MAX030K	MBA108	MBA018		MBR5068
Lion's Coach (without ABS)	Elsa 1	89 – 96		MDP5038	MDP3030K / MAX030K	MBA108	MBA018		MBR5068
Lion's Coach (with ABS)	Elsa 1	89 – 96		MDP5054	MDP3030K / MAX030K	MBA108	st1189		MBR5078
Lion's Comfort (without ABS)	Elsa 1	89 – 96		MDP5054	MDP3030K / MAX030K	MBA108	st1189		MBR5068
Lion's Comfort (with ABS)	Elsa 1	89 – 96		MDP5054	MDP3030K / MAX030K	MBA108	st1189		MBR5078
Lion's Star Knorr Brake	Knorr K85	94 →		N/A	MDP3747	N/A	N/A		MBR5011
Lion's Star Meritor Brake	Elsa 1	94 →		MDP5038	MDP3030K / MAX030K	MBA108	MBA018		MBR5011
				MDP5054	MDP3030K / MAX030K	MBA108	st1189		MBR5011
NG262, NG263, NG272, NG312, NG313	Elsa 1	3/95 – 7/98		MDP5065	MDP3030K / MAX030K	MBA108	MBA019		MBR5011
NG262, NG263, NG312, NG313	Elsa 1	98 →		MDP5065	MDP3030K / MAX030K	MBA108	MBA019		MBR5057
NG262, NG263, NG312, NG313 (without ABS)	Elsa 1	98 →		MDP5065	MDP3030K / MAX030K	MBA108	MBA019		MBR5068
NG262, NG263, NG312, NG313 (with ABS)	Elsa 1	98 →		MDP5065	MDP3030K / MAX030K	MBA108	MBA019		MBR5078
NL202, NL222, NL223	Elsa 1	98 →		MDP5065	MDP3030K / MAX030K	MBA108	MBA019		MBR5068
NL312	Elsa 1	95 – 98		MDP5065	MDP3030K / MAX030K	MBA108	MBA019		MBR5011
		98 →		MDP5065	MDP3030K / MAX030K	MBA108	MBA019		MBR5057
NL313 (without ABS)	Elsa 1	98 →		MDP5065	MDP3030K / MAX030K	MBA108	MBA019		MBR5068





- 1
- 2
- 3
- 4
- 5
- 6
- 7

				OE	ALLFIT			OE	ALLFIT
...MAN									
NL313 (with ABS)	Elsa 1	98 →		MDP5065	MDP3030K / MAX030K	MBA108	MBA019		MBR5078
NM222, NM223	Elsa 1	98 →		MDP5065	MDP3030K / MAX030K	MBA108	MBA019		MBR5011
NU263, NU313, NU353	Elsa 1	96 – 02		MDP5065	MDP3030K / MAX030K	MBA108	MBA019		MBR5057
				MDP5065	MDP3030K / MAX030K	MBA108	MBA019		MBR5068
NU313	Elsa 2	02 →		MDP5097	MDP3131K / MAX131K	MBA105	N/A		MBR5057
				MDP5097	MDP3131K / MAX131K	MBA105	N/A		MBR5068
SG150 - 750, SL150 - 750	Brembo (bframe)	93 – 96		N/A	MDP3122	N/A	N/A		MBR5010
				N/A	MDP3088 / MAX088K	N/A	N/A		MBR5012
				N/A	MDP3088 / MAX088K	N/A	N/A		MBR5013
SU210	Brembo (bframe)	93 – 96		N/A	MDP3122	N/A	N/A		MBR5010
				N/A	MDP3088 / MAX088K	N/A	N/A		MBR5012
				N/A	MDP3088 / MAX088K	N/A	N/A		MBR5012
MAN									
E2000 19.314, 19.364, 19.414, 19.464	D3 + D Elsa 1	95 – 05		MDP5038	MDP3030K / MAX030K	MBA108	MCK1070		MBR5057
				MDP5039					MBR5057
	D Elsa 2	95 – 05		MDP5060	MDP3131K / MAX131K	MBA105			MBR5057
									MBR5068
E2000 24.273, 26.273, 26.293, 26.323, 26.343, 27.273, 27.293, 27.323, 27.343, 28.273, 28.293, 28.323, 28.343, 33.273, 33.293, 33.323, 33.343	D3 + D Elsa 1	96 – 00		MDP5038	MDP3030K / MAX030K	MBA108	MCK1070		MBR5057
				MDP5039					MBR5057
		96 – 00							MBR5068
									MBR5057
E2000 26.414, 26.464	D3 + D Elsa 1	95 – 05		MDP5038	MDP3030K / MAX030K	MBA108	MCK1070		MBR5057
				MDP5039					MBR5057
	D Elsa 2	95 – 05		MDP5060	MDP3131K / MAX131K	MBA105		MBR5057	
E2000 28.233, 28.314, 28.364, 28.414, 28.464	D3 + D Elsa 1	96 – 05		MDP5039					MBR5057
				MDP5060	MDP3131K / MAX131K	MBA105		MBR5057	
	D Elsa 2	96 – 05			MDP3030K / MAX030K				MBR5057
									MBR5068
E2000 30.314, 30.364, 30.414, 30.464, 33.364, 33.414, 33.464	D3 + D Elsa 1	97 – 05		MDP5038	MDP3030K / MAX030K	MBA108	MCK1070		MBR5057
				MDP5039					MBR5057
	D Elsa 2	97 – 05		MDP5060	MDP3131K / MAX131K	MBA105		MBR5057	
									MBR5068
E2000 32.314, 32.364, 35.414, 35.464		96 – 05			MDP3030K / MAX030K				MBR5011
									MBR5011



...MAN									
E2000 32.414, 32.464	D Elsa 2	97 – 05		MDP5060	MDP3131K / MAX131K	MBA105			MBR5011
		97 – 05			MDP3030K / MAX030K				MBR5011
E2000 41.464, 41.604, 50.414, 50.464		96 – 04			MDP3030K / MAX030K				MBR5011
F90 without ABS	Elsa 1	89 – 96		MDP5038	MDP3030K / MAX030K	MBA108	MBA018		MBR5068
F90 with ABS	Elsa 1	89 – 96		MDP5038	MDP3030K / MAX030K	MBA108	MBA018		MBR5078
F2000 18.273, 19.603, 19.604	D3 + D Elsa 1	94 – 01		MDP5038	MDP3030K / MAX030K	MBA108	MCK1070		MBR5057
				MDP5039					MBR5057
	D3	94 – 01		MDP5032					MBR5057
				MDP5054	MDP3030K / MAX030K	MBA108			MBR5057
	D Elsa 1	94 – 01		MDP5065	MDP3030K / MAX030K	MBA108			MBR5057
				MDP5066					MBR5057
		94 – 01			MDP3122				MBR5057
				MDP5055					MBR5057
									MBR5068
									MBR5011
F2000 18.314, 18.373, 18.403, 18.423, 18.463, 19.233, 19.314, 19.364, 19.373, 19.403, 19.414, 19.423, 19.463, 19.464, 26.314, 26.364, 26.373, 26.403, 26.414, 26.423, 26.463, 26.464	D3 + D Elsa 1	94 – 05		MDP5038	MDP3030K / MAX030K	MBA108	MCK1070		MBR5057
				MDP5039					MBR5057
	D3	94 – 05		MDP5054	MDP3030K / MAX030K	MBA108			MBR5057
				MDP5032					MBR5057
	D Elsa 1	94 – 05		MDP5065	MDP3030K / MAX030K	MBA108			MBR5057
				MDP5066					MBR5057
	D Elsa 2	94 – 05		MDP5060	MDP3131K / MAX131K	MBA105			MBR5057
		94 – 05			MDP3122				MBR5057
				MDP5055					MBR5057
									MBR5068
									MBR5011
F2000 22.273, 22.293, 22.314, 22.323, 22.364, 22.373, 22.403, 22.414, 22.423, 22.463, 22.464, 23.273, 23.293, 23.323, 23.343, 23.344, 26.233, 28.273, 28.293, 28.323, 28.343	D3 + D Elsa 1	94 – 05		MDP5038	MDP3030K / MAX030K	MBA108	MCK1070		MBR5011
				MDP5039					MBR5011
	D3	94 – 05		MDP5054	MDP3030K / MAX030K	MBA108			MBR5011
				MDP5032					MBR5011
	D Elsa 1	94 – 05		MDP5065	MDP3030K / MAX030K	MBA108			MBR5011
				MDP5066					MBR5011
		94 – 05			MDP3122				MBR5011
				MDP5055					MBR5011





- 1
- 2
- 3
- 4
- 5
- 6
- 7

...MAN											
F2000 23.314, 23.364, 23.403, 23.414, 23.463, 23.464, 26.314, 26.364, 26.373, 26.403, 26.414, 26.423, 26.463, 26.464	D3 + D Elsa 1	94 – 04		MDP5038	MDP3030K / MAX030K	MBA108	MCK1070			MBR5057	
				MDP5039					MBR5057		
	D3	94 – 04		MDP5054	MDP3030K / MAX030K	MBA108				MBR5057	
				MDP5032					MBR5057		
	D Elsa 1	94 – 04		MDP5065	MDP3030K / MAX030K	MBA108				MBR5057	
				MDP5066					MBR5057		
	D Elsa 2	94 – 04		MDP5060	MDP3131K / MAX131K	MBA105				MBR5057	
					MDP3122					MBR5057	
		94 – 04								MBR5057	
				MDP5055						MBR5057	
										MBR5068	
										MBR5011	
F2000 26.603, 26.604, 28.603	D3 + D Elsa 1	96 – 01		MDP5038	MDP3030K / MAX030K	MBA108	MCK1070			MBR5057	
				MDP5039						MBR5057	
	D3	96 – 01		MDP5054	MDP3030K / MAX030K	MBA108				MBR5057	
				MDP5032						MBR5057	
	D Elsa 1	96 – 01		MDP5065	MDP3030K / MAX030K	MBA108				MBR5057	
				MDP5066						MBR5057	
		96 – 01			MDP3122					MBR5057	
				MDP5055						MBR5057	
										MBR5068	
										MBR5011	
	F2000 27.314, 27.364, 27.414, 27.464	D3 + D Elsa 1	94 – 05		MDP5038	MDP3030K / MAX030K	MBA108	MCK1070			MBR5057
					MDP5039						MBR5057
D3		94 – 05		MDP5054	MDP3030K / MAX030K	MBA108				MBR5057	
				MDP5032						MBR5057	
D Elsa 1		94 – 05		MDP5065	MDP3030K / MAX030K	MBA108				MBR5057	
				MDP5066						MBR5057	
D Elsa 2		94 – 05		MDP5060	MDP3131K / MAX131K	MBA105				MBR5057	
					MDP3122					MBR5057	
		94 – 05								MBR5057	
				MDP5055						MBR5057	
										MBR5068	
										MBR5011	



...MAN										
F2000 27.603, 33.604	D3 + D Elsa 1	96 – 01		MDP5038	MDP3030K / MAX030K	MBA108	MCK1070		MBR5057	
				MDP5039				MBR5057		
	D3	96 – 01		MDP5054	MDP3030K / MAX030K	MBA108			MBR5057	
				MDP5032				MBR5057		
	D Elsa 1	96 – 01		MDP5065	MDP3030K / MAX030K	MBA108			MBR5057	
				MDP5066				MBR5057		
		96 – 01			MDP3122				MBR5057	
								MBR5068		
								MBR5011		
	F2000 28.314, 28.364, 28.414, 28.464	D3 + D Elsa 1	94 – 01		MDP5038	MDP3030K / MAX030K	MBA108	MCK1070		MBR5057
					MDP5039				MBR5057	
		D3	94 – 01		MDP5054	MDP3030K / MAX030K	MBA108			MBR5057
				MDP5032				MBR5057		
D Elsa 1		94 – 01		MDP5065	MDP3030K / MAX030K	MBA108			MBR5057	
				MDP5066				MBR5057		
		94 – 01			MDP3122				MBR5057	
				MDP5055				MBR5057		
								MBR5068		
							MBR5011			
F2000 32.293, 32.323, 32.343		D3 + D Elsa 1	95 – 00		MDP5039					MBR5011
			95 – 01		MDP5038	MDP3030K / MAX030K	MBA108	MCK1070		MBR5011
	D3	95 – 00		MDP5054	MDP3030K / MAX030K	MBA108			MBR5011	
				MDP5032				MBR5011		
	D Elsa 1	95 – 00		MDP5065	MDP3030K / MAX030K	MBA108			MBR5011	
		95 – 01		MDP5066				MBR5011		
		95 – 00			MDP3122				MBR5011	
		95 – 01		MDP5055				MBR5011		
	F2000 32.314, 32.364, 32.373, 32.403, 32.414, 32.423, 32.464, 35.293, 35.323, 35.343, 35.364, 35.373, 35.403, 35.414, 35.423, 35.463, 35.464, 37.314, 37.323, 37.343, 37.364, 37.414, 37.464, 41.323, 41.343, 41.364, 41.373, 41.403, 41.414, 41.423, 41.463, 41.464	D3 + D Elsa 1	95 – 03		MDP5038	MDP3030K / MAX030K	MBA108	MCK1070		MBR5011
					MDP5039				MBR5011	
D3		95 – 03		MDP5054	MDP3030K / MAX030K	MBA108			MBR5011	
				MDP5032				MBR5011		
D Elsa 1		95 – 03		MDP5065	MDP3030K / MAX030K	MBA108			MBR5011	
				MDP5066				MBR5011		
		95 – 03			MDP3122				MBR5011	
				MDP5055				MBR5011		





- 1
- 2
- 3
- 4
- 5
- 6
- 7

...MAN											
F2000 Inner Ø 131mm	Elsa 1	94 →		MDP5038	MDP3030K / MAX030K	MBA108	MBA018				MBR5057
F2000 Inner Ø 200mm	Elsa 1	94 →		MDP5054	MDP3030K / MAX030K	MBA108	st1189				MBR5011
F2000 Inner Ø 208mm	Elsa 1	94 →		MDP5038	MDP3030K / MAX030K	MBA108	MBA018				MBR5068
F2000 Elsa 2	Elsa 2	04/02 →		MDP5060	MDP3131K / MAX131K	MBA105	N/A				
L2000 6.103 - 10.224 (without ABS)	Brembo (bframe)	10/93 - 12/95		N/A	MDP3122	N/A	N/A				MBR5010
L2000 6.103 - 10.224 (with ABS)	Brembo (bframe)	10/93 - 12/95		N/A	MDP3122	N/A	N/A				MBR5013
L2000 6.103 - 10.224 (10 hole disc without ABS)	Wabco Pan17	01/96 - 00		N/A	MDP3088 / MAX088K	N/A	N/A				MBR5012
L2000 6.103 - 10.224 (12 hole disc with ABS)	Wabco Pan17	01/96 - 00		N/A	MDP3088 / MAX088K	N/A	N/A				MBR5013
L2000 6.103 - 10.224 (optional 8 hole disc)	Wabco Pan17	01/96 - 00		N/A	MDP3088 / MAX088K	N/A	N/A				MBR5092
LE2000 Series LE2000 LE110C, LE140C, LE150C, LE160C, LE220C 8 -12 tonne - (10 hole without ABS)	Wabco Pan17	00 →		N/A	MDP3088 / MAX088K	N/A	N/A				MBR5012
LE2000 Series LE2000 LE110C, LE140C, LE150C, LE160C, LE220C 8 -12 tonne - (12 hole with ABS)	Wabco Pan17	00 →		N/A	MDP3088 / MAX088K	N/A	N/A				MBR5013
LE2000 Series LE2000 LE110C, LE140C, LE150C, LE160C, LE220C 8 -12 tonne - (optional 8 hole disc)	Wabco Pan17	00 →		N/A	MDP3088 / MAX088K	N/A	N/A				MBR5092
LE2000 Series LE2000 LE220B, LE250B, LE280B 14-18 tonne (Knorr SB6000)	Knorr SB6000	00 →		MDP9002	MDP3095K / MAX095K	MBA110 / MBA121	N/A				MBR5014
LE2000 Series LE2000 LE220B, LE250B, LE280B 14-18 tonne (10 hole disc)	Elsa 1	00 →		MDP5038	MDP3030K / MAX030K	MBA108	MBA018				MBR5011
LE2000 Series LE2000 LE220B, LE250B, LE280B 14-18 tonne (12 hole disc)	Elsa 1	00 →		MDP5038	MDP3030K / MAX030K	MBA108	MBA018				MBR5057
M2000 L 11.145, 11.163, 11.223, 11.224, 11.225, 12.145, 12.224		95 - 06			MDP3088 / MAX088K						MBR5012
					MDP3088 / MAX088K						MBR5013
M2000 L 12.163, 12.185, 12.225		95 - 07			MDP3095K / MAX095K						MBR5012
					MDP3088 / MAX088K						MBR5012
											MBR5014
					MDP3095K / MAX095K						MBR5013
					MDP3088 / MAX088K						MBR5013
M2000 L 12.255, 12.285, 14.224, 14.225, 14.255, 14.263, 14.264, 14.284, 14.285		95 - 07			MDP3095K / MAX095K						MBR5014
					MDP3095K / MAX095K						
M2000 L 13.163, 13.185, 13.225, 13.255, 13.285, 15.163, 13.284, 14.163		95 - 05			MDP3095K / MAX095K						MBR5014
					MDP3095K / MAX095K						



...MAN									
M2000 L 15.224, 15.225, 15.255, 15.263, 15.264, 15.284, 15.285, 20.224, 20.225, 20.255, 20.264, 20.284, 20.285		95 – 06			MDP3095K / MAX095K				MBR5014
					MDP3095K / MAX095K				
M2000 L 18.224, 18.225, 18.255, 18.263, 18.264, 18.284, 18.285	D3 + D Elsa 1	95 – 07		MDP5038	MDP3030K / MAX030K	MBA108	MCK1070		MBR5057
	D3	95 – 07		MDP5054	MDP3030K / MAX030K	MBA108			MBR5057
	D Elsa 1	95 – 07		MDP5065	MDP3030K / MAX030K	MBA108			MBR5057
	D Elsa 2	95 – 07		MDP5060	MDP3131K / MAX131K	MBA105			MBR5057
		95 – 07							MBR5011
M2000 L 19.224, 19.225, 19.255, 19.264, 19.284, 19.285, 26.224, 26.225, 26.255, 26.274, 26.275, 26.284, 26.285	D3 + D Elsa 1	95 – 07		MDP5038	MDP3030K / MAX030K	MBA108	MCK1070		MBR5057
	D3	95 – 07		MDP5054	MDP3030K / MAX030K	MBA108			MBR5057
	D Elsa 1	95 – 07		MDP5065	MDP3030K / MAX030K	MBA108			MBR5057
	D Elsa 2	95 – 07		MDP5060	MDP3131K / MAX131K	MBA105			MBR5057
M2000 M 18.224, 18.225, 18.255, 18.264, 18.284, 18.285, 23.224, 23.225, 23.255, 23.264, 23.284, 23.285, 25.224, 25.225, 25.255, 25.264, 25.284, 25.285	D3 + D Elsa 1	95 – 07		MDP5038	MDP3030K / MAX030K	MBA108	MCK1070		MBR5057
	D3	95 – 07		MDP5054	MDP3030K / MAX030K	MBA108			MBR5057
	D Elsa 1	95 – 07		MDP5065	MDP3030K / MAX030K	MBA108			MBR5057
	D Elsa 2	95 – 07		MDP5060	MDP3131K / MAX131K	MBA105			MBR5057
M2000 M 26.224, 26.225, 26.255, 26.284, 26.285	D3 + D Elsa 1	95 – 04		MDP5038	MDP3030K / MAX030K	MBA108	MCK1070		MBR5011
	D3	95 – 04		MDP5054	MDP3030K / MAX030K	MBA108			MBR5011
	D Elsa 1	95 – 04		MDP5065	MDP3030K / MAX030K	MBA108			MBR5011
M2000 L Series 12.163, 12.164, 12.224	Wabco Pan17	96 – 00		N/A	MDP3088 / MAX088K	N/A	N/A		MBR5012
				N/A	MDP3088 / MAX088K	N/A	N/A		MBR5013
M2000 L Series 14.163, 14.224, 14.264, 14.284, 15.163, 15.264, 15.284	Knorr SB6000	8/95 – 9/00		MDP9002	MDP3095K / MAX095K	MBA110 / MBA121	N/A		MBR5014
				MDP9002	MDP3095K / MAX095K	MBA110 / MBA121	N/A		MBR5014
M2000 L Series 18.224, 18.264, 18.294 (10 hole disc)	Elsa 1	8/95 – 9/00		MDP5038	MDP3030K / MAX030K	MBA108	MBA018		MBR5011
M2000 L Series 18.224, 18.264, 18.294 (12 hole disc)	Elsa 1	8/95 – 9/00		MDP5038	MDP3030K / MAX030K	MBA108	MBA018		MBR5057
M2000 M Series 14.224, 14.264, 14.284	Knorr SB6000	8/95 – 9/00		MDP9002	MDP3095K / MAX095K	MBA110 / MBA121	N/A		MBR5014
M2000 M Series 18.224, 18.264, 18.284, 25.224, 25.264 (10 hole disc)	Elsa 1	8/95 – 9/00		MDP5038	MDP3030K / MAX030K	MBA108	MBA018		MBR5011
M2000 M Series 18.224, 18.264, 18.284, 25.224, 25.264 (12 hole disc)	Elsa 1	8/95 – 9/00		MDP5038	MDP3030K / MAX030K	MBA108	MBA018		MBR5057
M90 17.192 - 24.272 (without ABS)	Elsa 1	89 – 96		MDP5038	MDP3030K / MAX030K	MBA108	MBA018		MBR5068
M90 17.192 - 24.272 (with ABS)	Elsa 1	90 – 97		MDP5038	MDP3030K / MAX030K	MBA108	MBA018		MBR5078
ME2000 12 Series	Wabco Pan17	96 →		N/A	MDP3088 / MAX088K	N/A	N/A		MBR5012
				N/A	MDP3088 / MAX088K	N/A	N/A		MBR5013





- 1
- 2
- 3
- 4
- 5
- 6
- 7

...MAN													
ME2000 14 Series	Knorr SB6000	96 →		MDP9002	MDP3095K / MAX095K	MBA110 / MBA121	N/A					MBR5014	
ME2000 15 - 26 Series	Elsa 1	96 →		MDP5038	MDP3030K / MAX030K	MBA108	MBA018					MBR5011	
				MDP5038	MDP3030K / MAX030K	MBA108	MBA018					MBR5057	
TGA	Elsa 1	→ 00		MDP5038	MDP3030K / MAX030K	MBA108	MBA018						
			(without ABS)	Elsa 2	03/00 →		MDP5060	MDP3131K / MAX131K	MBA105	N/A			MBR5057
				Elsa 2	03/00 →		MDP5060	MDP3131K / MAX131K	MBA105	N/A			MBR5068
				(with ABS)	Elsa 2	03/00 →		MDP5060	MDP3131K / MAX131K	MBA105	N/A		
TGA-Series 18.280, 18.310, 18.320, 18.330, 18.350, 18.360, 18.390, 18.400, 18.410, 18.430, 18.440, 18.460, 18.480, 18.510, 18.530, 18.540	D3 + D Elsa 1	99 - 09		MDP5038	MDP3030K / MAX030K	MBA108	MCK1070					MBR5057	
	D Elsa 2	99 - 09		MDP5060	MDP3131K / MAX131K	MBA105						MBR5057	
	D3 + D Elsa 1	99 - 09		MDP9000	MDP3087K / MAX087K							MBR5057	
				MDP5038	MDP3030K / MAX030K	MBA108	MCK1070					MBR5068	
	D3 + D Elsa 1	99 - 09		MDP5039									MBR5068
				MDP5032									MBR5068
	D Elsa 1	99 - 09		MDP5066									MBR5068
	D Elsa 2	99 - 09		MDP5060	MDP3131K / MAX131K	MBA105							MBR5068
				MDP9000	MDP3087K / MAX087K								MBR5068
	D Elsa 2	99 - 09			MDP3122								MBR5068
												MBR5068	
TGA-Series 18.680	D3 + D Elsa 1	07 - 08		MDP9000	MDP3087K / MAX087K							MBR5057	
				MDP5038	MDP3030K / MAX030K	MBA108	MCK1070					MBR5068	
	D3	07 - 08		MDP5039								MBR5068	
				MDP5032									MBR5068
D3	07 - 08		MDP9000	MDP3087K / MAX087K								MBR5068	
				MDP3122								MBR5068	
TGA-Series 19.350, 19.360, 19.390, 19.410, 19.400, 19.430, 19.440, 19.460, 19.480	D3 + D Elsa 1	03 - 11		MDP9000	MDP3087K / MAX087K							MBR5057	
				MDP5038	MDP3030K / MAX030K	MBA108	MCK1070					MBR5068	
	D3 + D Elsa 1	03 - 11		MDP5039								MBR5068	
				MDP5032									MBR5068
	D Elsa 1	03 - 11		MDP5066								MBR5068	
	D Elsa 2	03 - 11		MDP5060	MDP3131K / MAX131K	MBA105							MBR5068
			MDP9000	MDP3087K / MAX087K								MBR5068	
D Elsa 2	03 - 11			MDP3122								MBR5068	
												MBR5068	



...MAN									
TGA-Series 24.350, 24.360, 24.390, 24.400, 24.430, 24.440, 24.480, 24.530, 24.540, 26.280, 26.310, 26.320, 26.330, 26.360, 26.400, 26.410, 26.430, 26.440, 26.460, 26.480, 26.510, 26.530, 35.390, 35.400, 35.430, 35.440, 35.480, 33.510, 33.530	D3 + D Elsa 1	00 – 11		MDP5038	MDP3030K / MAX030K	MBA108	MCK1070		MBR5057
	D Elsa 2	00 – 11		MDP5060	MDP3131K / MAX131K	MBA105			MBR5057
		00 – 11		MDP9000	MDP3087K / MAX087K				MBR5057
	D3 + D Elsa 1	00 – 11		MDP5038	MDP3030K / MAX030K	MBA108	MCK1070		MBR5057
				MDP5039					MBR5057
	D3	00 – 11		MDP5032					MBR5057
	D Elsa 2	00 – 11		MDP5060	MDP3131K / MAX131K	MBA105			MBR5057
	D Elsa 1	00 – 11		MDP5066					MBR5057
				MDP9000	MDP3087K / MAX087K				MBR5057
					MDP3122				MBR5057
				MDP3095K / MAX095K				MBR5057	
								MBR5068	
TGA-Series 24.410, 24.460, 24.510	D3 + D Elsa 1	01 – 06		MDP5038	MDP3030K / MAX030K	MBA108	MCK1070		MBR5057
	D Elsa 2	01 – 06		MDP5060	MDP3131K / MAX131K	MBA105			MBR5057
		01 – 06		MDP9000	MDP3087K / MAX087K				MBR5057
	D3 + D Elsa 1	01 – 06		MDP5038	MDP3030K / MAX030K	MBA108	MCK1070		MBR5057
				MDP5039					MBR5057
	D3	01 – 06		MDP5032					MBR5057
	D Elsa 1	01 – 06		MDP5066					MBR5057
	D Elsa 2	01 – 06		MDP5060	MDP3131K / MAX131K	MBA105			MBR5057
				MDP9000	MDP3087K / MAX087K				MBR5057
					MDP3122				MBR5057
								MBR5068	
TGA-Series 26.540		03 – 08		MDP9000	MDP3087K / MAX087K				MBR5057
	D3 + D Elsa 1	03 – 08		MDP5038	MDP3030K / MAX030K	MBA108	MCK1070		MBR5057
				MDP5039					MBR5057
	D3	03 – 08		MDP5032					MBR5057
	D Elsa 1	03 – 08		MDP5066					MBR5057
	D Elsa 2	03 – 08		MDP5060	MDP3131K / MAX131K	MBA105			MBR5057
				MDP9000	MDP3087K / MAX087K				MBR5057
					MDP3122				MBR5057
									MBR5068





- 1
- 2
- 3
- 4
- 5
- 6
- 7

...MAN									
TGA-Series 28.310, 28.320, 28.350, 28.360, 28.390, 28.400, 28.410, 28.430, 28.440, 28.460, 28.480, 28.510, 28.530, 28.540, 33.310, 33.360, 33.410, 33.460, 33.480, 33.510, 33.530	D3 + D Elsa 1	00 – 08		MDP5038	MDP3030K / MAX030K	MBA108	MCK1070		MBR5057
	D Elsa 2	00 – 08		MDP5060	MDP3131K / MAX131K	MBA105			MBR5057
		00 – 08		MDP9000	MDP3087K / MAX087K				MBR5057
	D3 + D Elsa 1	00 – 08		MDP5038	MDP3030K / MAX030K	MBA108	MCK1070		MBR5057
				MDP5039					MBR5057
	D3	00 – 08		MDP5032					MBR5057
	D Elsa 1	00 – 08		MDP5066					MBR5057
	D Elsa 2	00 – 08		MDP5060	MDP3131K / MAX131K	MBA105			MBR5057
			MDP9000	MDP3087K / MAX087K				MBR5057	
				MDP3122				MBR5068	
TGA-Series 32.310, 32.360, 32.410, 32.460, 32.480, 33.360, 33.410, 33.460, 33.480, 35.310, 37.310, 37.360, 37.410, 37.460, 37.480, 37.530, 41.410, 41.460, 41.480, 41.530, 50.410, 50.460, 50.480, 50.530	D3 + D Elsa 1	01 – 07		MDP5038	MDP3030K / MAX030K	MBA108	MCK1070		MBR5057
	D Elsa 2	01 – 07		MDP5060	MDP3131K / MAX131K	MBA105			MBR5057
		01 – 07		MDP9000	MDP3087K / MAX087K				MBR5057
	D3 + D Elsa 1	01 – 07		MDP5038	MDP3030K / MAX030K	MBA108	MCK1070		MBR5068
				MDP5039					MBR5068
	D3	01 – 07		MDP5032					MBR5068
	D Elsa 1	01 – 07		MDP5066					MBR5068
	D Elsa 2	01 – 07		MDP5060	MDP3131K / MAX131K	MBA105			MBR5068
			MDP9000	MDP3087K / MAX087K				MBR5068	
				MDP3030K / MAX030K				MBR5068	
TGA-Series 32.400, 32.430, 32.440		04 – 08		MDP9000	MDP3087K / MAX087K				MBR5057
				MDP9000	MDP3087K / MAX087K				MBR5068
TGA-Series 33.350, 33.390, 33.400, 33.430, 33.440	D Elsa 2	01 – 11		MDP5060	MDP3131K / MAX131K	MBA105			MBR5057
		01 – 11		MDP9000	MDP3087K / MAX087K				MBR5057
					MDP3030K / MAX030K				MBR5057
	D3 + D Elsa 1	01 – 11		MDP5038	MDP3030K / MAX030K	MBA108	MCK1070		MBR5068
				MDP5039					MBR5068
	D3	01 – 11		MDP5032					MBR5068
	D Elsa 1	01 – 11		MDP5066					MBR5068
	D Elsa 2	01 – 11		MDP5060	MDP3131K / MAX131K	MBA105			MBR5068
			MDP9000	MDP3087K / MAX087K				MBR5068	
				MDP3030K / MAX030K				MBR5068	
					MDP3122			MBR5068	



...MAN									
TGA-Series 33.680	D Elsa 2	07 – 08		MDP5060	MDP3131K / MAX131K	MBA105			MBR5057
		07 – 08		MDP9000	MDP3087K / MAX087K				MBR5057
	D Elsa 2	07 – 08		MDP5060	MDP3131K / MAX131K	MBA105			MBR5068
		07 – 08		MDP9000	MDP3087K / MAX087K				MBR5068
TGA-Series 35.320, 37.310, 37.320, 37.350, 37.360, 37.390, 37.400, 37.430, 37.440, 37.480, 50.350, 50.360, 50.390, 50.400, 50.430, 50.440, 50.480		03 – 08		MDP9000	MDP3087K / MAX087K				MBR5057
	D3 + D Elsa 1	03 – 08		MDP5038	MDP3030K / MAX030K	MBA108	MCK1070		MBR5068
				MDP5039					MBR5068
	D3	03 – 08		MDP5032					MBR5068
	D Elsa 1	03 – 08		MDP5066					MBR5068
	D Elsa 2	03 – 08		MDP5060	MDP3131K / MAX131K	MBA105			MBR5068
				MDP9000	MDP3087K / MAX087K				MBR5068
					MDP3122				MBR5068
TGA-Series 35.350, 35.360, 35.410, 35.460, 35.480, 35.530	D Elsa 2	01 – 08		MDP5060	MDP3131K / MAX131K	MBA105			MBR5057
		01 – 08		MDP9000	MDP3087K / MAX087K				MBR5057
					MDP3030K / MAX030K				MBR5057
	D3 + D Elsa 1	01 – 08		MDP5038	MDP3030K / MAX030K	MBA108	MCK1070		MBR5057
				MDP5039					MBR5057
	D3	01 – 08		MDP5032					MBR5057
	D Elsa 1	01 – 08		MDP5066					MBR5057
	D Elsa 2	01 – 08		MDP5060	MDP3131K / MAX131K	MBA105			MBR5057
				MDP9000	MDP3087K / MAX087K				MBR5057
					MDP3122				MBR5057
								MBR5068	
TGA-Series 39.390, 39.400, 39.430, 39.440, 39.480		05 – 08		MDP9000	MDP3087K / MAX087K				MBR5057
	D3 + D Elsa 1	05 – 08		MDP5038	MDP3030K / MAX030K	MBA108	MCK1070		MBR5057
				MDP5039					MBR5057
	D3	05 – 08		MDP5032					MBR5057
	D Elsa 1	05 – 08		MDP5066					MBR5057
	D Elsa 2	05 – 08		MDP5060	MDP3131K / MAX131K	MBA105			MBR5057
				MDP9000	MDP3087K / MAX087K				MBR5057
					MDP3122				MBR5068





- 1
- 2
- 3
- 4
- 5
- 6
- 7

...MAN									
TGA-Series 41.350, 41.360, 41.390, 41.400, 41.430, 41.440, 41.480	D3 + D Elsa 1	03 – 11		MDP9000	MDP3087K / MAX087K				MBR5057
		03 – 11		MDP5038	MDP3030K / MAX030K	MBA108	MCK1070		MBR5068
				MDP5039					MBR5068
	D3	03 – 11		MDP5032					MBR5068
	D Elsa 1	03 – 11		MDP5066					MBR5068
	D Elsa 2	03 – 11		MDP5060	MDP3131K / MAX131K	MBA105			MBR5068
		03 – 11		MDP9000	MDP3087K / MAX087K				MBR5068
					MDP3122				MBR5068
TGA-Series 41.530, 41.540		02 – 08		MDP9000	MDP3087K / MAX087K				MBR5057
	D3 + D Elsa 1	02 – 08		MDP5038	MDP3030K / MAX030K	MBA108	MCK1070		MBR5057
	D Elsa 2	02 – 08		MDP5060	MDP3131K / MAX131K	MBA105			MBR5057
		02 – 08		MDP9000	MDP3087K / MAX087K				MBR5057
TGA-Series 41.660	D3 + D Elsa 1	01 – 07		MDP5038	MDP3030K / MAX030K	MBA108	MCK1070		MBR5057
	D Elsa 2	01 – 07		MDP5060	MDP3131K / MAX131K	MBA105			MBR5057
		01 – 07		MDP9000	MDP3087K / MAX087K				MBR5057
	D3 + D Elsa 1	01 – 07		MDP5038	MDP3030K / MAX030K	MBA108	MCK1070		MBR5057
	D Elsa 2	01 – 07		MDP5060	MDP3131K / MAX131K	MBA105			MBR5057
		01 – 07		MDP9000	MDP3087K / MAX087K				MBR5057
TGA-Series 50.510		03 – 09		MDP9000	MDP3087K / MAX087K				MBR5057
TGL-Series 7.150, 7.180, 8.150, 8.180, 8.210, 8.220, 8.240, 8.250, 10.180, 10.210, 10.220, 10.240, 10.250, 12.180, 12.210, 12.220, 12.240, 12.250,	D Elsa 2	04 →		MDP5060	MDP3131K / MAX131K	MBA105			MBR5068
		04 →			MDP3148k				MBR5068
	D Elsa 2	04 →		MDP5060	MDP3131K / MAX131K	MBA105			
		04 →			MDP3148k				
TGM-Series 12.240, 12.280, 16.240, 16.280		05 →			MDP3095K / MAX095K				MBR5068
					MDP3095K / MAX095K				MBR5014
TGM-Series 12.250, 12.290, 16.250, 16.290		08 →			MDP3095K / MAX095K				MBR5068
					MDP3095K / MAX095K				MBR5014
TGM-Series 15.240, 15.250, 15.280, 15.290		04 →		MDP9000	MDP3087K / MAX087K				MBR5057
					MDP3095K / MAX095K				MBR5057
									MBR5068
				MDP9000	MDP3087K / MAX087K				MBR5068
					MDP3095K / MAX095K				MBR5068
									MBR5014



...MAN									
TGM-Series 15.330, 15.340		04 →	MDP9000 MDP9000 MDP9000	MDP3087K / MAX087K					MBR5057 MBR5068 MBR5068
TGM-Series 18.240, 18.250, 18.280, 18.330, 18.340		04 →	MDP9000 MDP9000 MDP9000	MDP3087K / MAX087K MDP3095K / MAX095K MDP3087K / MAX087K					MBR5057 MBR5057 MBR5068 MBR5068
TGM-Series 22.240, 22.250, 22.280, 22.290		06 →	MDP9000 MDP9000	MDP3095K / MAX095K MDP3095K / MAX095K					MBR5014
TGM-Series 26.280, 26.290, 26.330, 26.340		06 →	MDP9000 MDP9000 MDP9000	MDP3087K / MAX087K MDP3087K / MAX087K					MBR5057 MBR5057 MBR5068
TGS-Series 18.320, 18.360, 18.400, 18.440, 18.480, 18.540		06 →	MDP9000 MDP9000	MDP3087K / MAX087K MDP3087K / MAX087K					MBR5057 MBR5068
TGS-Series 19.350, 19.360, 19.390, 19.400, 19.430, 19.480, 19.540, 21.360, 21.400, 21.440, 21.480, 33.350, 33.390, 33.430		09 →	MDP9000 MDP9000	MDP3087K / MAX087K MDP3087K / MAX087K					MBR5057 MBR5068
TGS-Series 19.440		09 →	MDP9000 MDP9000	MDP3087K / MAX087K MDP3087K / MAX087K					MBR5057 MBR5068
	D3 + D Elsa 1	09 →	MDP5038	MDP3030K / MAX030K	MBA108	MCK1070			MBR5068
	D Elsa 2	09 →	MDP5060	MDP3131K / MAX131K	MBA105				MBR5068
TGS-Series 24.320, 24.360, 24.400, 24.440, 24.480, 24.540		06 →	MDP9000 MDP9000 MDP9000 MDP9000	MDP3087K / MAX087K MDP3087K / MAX087K MDP3095K / MAX095K					MBR5057 MBR5057 MBR5057 MBR5068
TGS-Series 26.320, 26.350, 26.360, 26.390, 26.400, 26.430, 26.440, 26.480, 26.540, 28.320, 28.350, 28.360, 28.390, 28.400, 28.430, 28.440, 28.480, 28.540, 35.320, 35.360, 35.400, 35.440, 35.480, 35.540		07 →	MDP9000 MDP9000	MDP3087K / MAX087K					MBR5057 MBR5068
TGS-Series 32.540, 33.320, 33.360, 33.400, 33.440, 33.480, 35.320, 35.360, 35.400, 35.440, 35.480, 35.540, 37.320, 37.360, 37.400, 37.440, 37.480, 41.320, 41.360, 41.400, 41.440, 41.480		07 →	MDP9000 MDP9000	MDP3087K / MAX087K MDP3087K / MAX087K					MBR5057 MBR5068
TGS-Series 41.350, 41.390, 41.430, 41.540		09 →	MDP9000	MDP3087K / MAX087K					MBR5057
TGX-Series 18.360, 18.400, 18.440, 18.480, 18.520, 18.540, 18.560, 18.680, 28.520, 28.560, 33.360, 33.400, 33.440, 33.480, 33.520, 33.540, 33.560		06 →	MDP9000 MDP9000	MDP3087K / MAX087K MDP3087K / MAX087K					MBR5057 MBR5068





- 1
- 2
- 3
- 4
- 5
- 6
- 7

...MAN											
TGX-Series 24.360, 24.400, 24.440, 24.480, 24.540, 26.360, 26.400, 26.440, 26.480, 26.540		06 →		MDP9000	MDP3087K / MAX087K						MBR5057
				MDP9000	MDP3087K / MAX087K						MBR5057
					MDP3095K / MAX095K						MBR5057
											MBR5068
TGX-Series 24.360, 24.400, 24.440, 24.480, 24.540, 26.360, 26.400, 26.440, 26.480, 26.540, 35.360, 35.400, 35.440, 35.480, 35.540		07 →		MDP9000	MDP3087K / MAX087K						MBR5057
				MDP9000	MDP3087K / MAX087K						MBR5057
											MBR5068
TGX-Series 24.520, 24.560, 26.520, 26.560		14 →		MDP9000	MDP3087K / MAX087K						MBR5057
				MDP9000	MDP3087K / MAX087K						MBR5057
					MDP3095K / MAX095K						MBR5057
											MBR5068
TGX-Series 26.320		06 →		MDP9000	MDP3087K / MAX087K						MBR5057
				MDP9000	MDP3087K / MAX087K						MBR5057
											MBR5068
TGX-Series 27.440		11 →		MDP9000	MDP3087K / MAX087K						MBR5068
TGX-Series 28.360, 28.400, 28.440, 28.480, 28.540, 33.360, 33.400, 33.440, 33.480, 35.520, 33.540, 35.560		07 →		MDP9000	MDP3087K / MAX087K						MBR5057
				MDP9000	MDP3087K / MAX087K						MBR5068
TGX-Series 33.680		07 →		MDP9000	MDP3087K / MAX087K						MBR5057
				MDP9000	MDP3087K / MAX087K						
TGX-Series 41.540, 41.560, 41.640, 41.680		06 →		MDP9000	MDP3087K / MAX087K						MBR5057
				MDP9000	MDP3087K / MAX087K						MBR5057
ERF - ECL - 7.28 RD3 / TP3 6871 Platform / C 6x4	Elsa 2	04/04 →		MDP5099	MDP3131K / MAX131K						
MCI											
'E' Series Renaissance Coach	D Lisa			MDP5044	MDP3090K / MAX090K	MBA101	N/A				
MCW											
Metrorider Optional Disc Brake	Brembo (bframe)	87 →		MDP5429	MDP3122	MBA107	N/A				MBR1831
Mercedes											
0404	D3	10/91 →		MDP5033	MDP3030K / MAX030K	MBA108	MBA010				MBR5015
0409	B Frame	86 →		MDP5040	MDP3835K	MBA106	MBA007				MBR1588
0606D, 0609D, 0611D, 0614D	B Frame	87 →		MDP5481	MDP3835K	MBA106	MBA007				MBR1589
0709D, 0711D	B Frame	87 →		MDP5481	MDP3835K	MBA106	MBA007				MBR1589



...Mercedes										
0811D, 0814D	B Frame	87 →		MDP5481	MDP3835K	MBA106	MBA007		MBR1589	
814DA	B Frame	88 →		MDP5481	MDP3835K	MBA106	MBA007			
Citaro 0530	Knorr SB7000	00 →		MDP9005	MDP3087K / MAX087K	MBA110 / MBA120	N/A		MBR5016HD	
Cito 0520	Knorr SB7000	00 →		MDP9005	MDP3087K / MAX087K	MBA110 / MBA120	N/A		MBR5016HD	
Integro 0550	Knorr SB7000	00 →		MDP9005	MDP3087K / MAX087K	MBA110 / MBA120	N/A		MBR5016HD	
Tourino	Knorr SB7000	02 →		MDP9005	MDP3087K / MAX087K	MBA110 / MBA120	N/A		MBR5016HD	
Tourismo	D3	08/95 →		MDP5017	MDP3030K / MAX030K	MBA108	MBA007		MBR5015	
Touro	Knorr SB7000	02 →		MDP9005	MDP3087K / MAX087K	MBA110 / MBA120	N/A			
Vario 512, 612, 614 - 16" Wheels	B Frame	96 →		MDP5040	MDP3835K	MBA106	MBA007		MBR5037	
				MDP5040	MDP3835K	MBA106	MBA007		MBR5038	
				MDP5040	MDP3835K	MBA106	MBA007		MBR5093	
Vario 810, 812, 814 - 17.5" Wheels	B Frame	96 →		MDP5040	MDP3835K	MBA106	MBA007		MBR5039	
				MDP5040	MDP3835K	MBA106	MBA007		MBR5040	
				MDP5040	MDP3835K	MBA106	MBA007		MBR5075	
Mercedes										
Actros 1831-3357	Knorr SB7000	09/96 →		MDP9000	MDP3087K / MAX087K	MBA110 / MBA120	N/A		MBR5016HD	
Actros MP2 / MP3 1831K Dump Truck Actros MP2 / MP3 1831 L,LL Plataforma C Actros MP2 / MP3 1831 LS Truck Tracto Actros MP2 / MP3 1835 K Dump Truck	Knorr SB7000	04/03 →		MDP9000	MDP3087K / MAX087K				MBR5128	
Actros-Series 1824 L		11 →			MDP3246K / MAX246K					
					MDP3244K / MAX244K				MBR5016HD	
				MDP9000	MDP3087K / MAX087K				MBR5016HD	
Actros-Series 1831		96 - 02			MDP3246K / MAX246K				MBR5016HD	
				MDP9000	MDP3087K / MAX087K				MBR5016HD	
									MBR5046	
								MBR5128		
			MDP9000	MDP3087K / MAX087K				MBR5016HD		
		02 →			MDP3246K / MAX246K					MBR5016HD
				MDP9000	MDP3087K / MAX087K					MBR5016HD
										MBR5046
										MBR5128
			MDP3244K / MAX244K					MBR5016HD		
	MDP9000		MDP3087K / MAX087K					MBR5016HD		





- 1
- 2
- 3
- 4
- 5
- 6
- 7

...Mercedes									
Actros-Series 1831 K, 1835 K, 1840 K, 1843 K, 1846 K, 1848 K, 1853 K, 1857 K, 2031 K, 2040 K		96 - 02			MDP3246K / MAX246K				MBR5016HD
				MDP9000	MDP3087K / MAX087K				MBR5016HD
									MBR5046
									MBR5128
Actros-Series 1853 L		96 - 02			MDP3246K / MAX246K				MBR5016HD
				MDP9000	MDP3087K / MAX087K				MBR5016HD
									MBR5046
									MBR5128
					MDP3244K / MAX244K				MBR5016HD
Actros-Series 2024 LS, 2027 LS, 2030 LS, 2032 LS, 2033 LS, 2035 LS, 2036 LS, 2040 LS, 2042 LS, 2043 LS, 2048 LS, 2051 LS, 2052 LS, 2058 LS, 2063 LS, 2445 LS		12 →			MDP3246K / MAX246K				
				MDP9000	MDP3087K / MAX087K				MBR5016HD
Actros-Series 2031		02 →			MDP3246K / MAX246K				MBR5016HD
				MDP9000	MDP3087K / MAX087K				MBR5016HD
									MBR5046
									MBR5128
				MDP9000	MDP3087K / MAX087K				MBR5016HD
Actros-Series 2427 LS, 2430 LS, 2432 LS, 2433 LS, 2435 LS, 2436 LS, 2440 LS, 2443 LS, 2445 LS, 2448 LS, 2451 LS, 2452 LS, 2458 LS, 2463 LS		11 →			MDP3246K / MAX246K				
					MDP3244K / MAX244K				MBR5066
				MDP9000	MDP3087K / MAX087K				MBR5066
					MDP3148K				MBR5066
									MBR5016HD
Actros-Series 2432 LS, 2436 LS, 2441 LS, 2444 LS, 2446 LS, 2448 LS, 2451 LS, 2455 LS, 2460 LS		02 →			MDP3246K / MAX246K				MBR5016HD
				MDP9000	MDP3087K / MAX087K				MBR5016HD
									MBR5046
									MBR5128
					MDP3244K / MAX244K				MBR5066
				MDP9000	MDP3087K / MAX087K				MBR5066
					MDP3148K				MBR5066
						MBR5016HD			



...Mercedes										
Actros-Series 2442 LS		11 →			MDP3246K / MAX246K					
					MDP3244K / MAX244K					MBR5016HD
				MDP9000	MDP3087K / MAX087K					MBR5016HD
					MDP3148K					MBR5016HD
										MBR5066
Actros-Series 2527 L		11 →			MDP3246K / MAX246K					
					MDP3246K / MAX246K					MBR5016HD
					MDP3244K / MAX244K					MBR5016HD
				MDP9000	MDP3087K / MAX087K					MBR5016HD
										MBR5128
Actros-Series 2531 L, 2535 L, 2540 L, 2543 L, 2548 L, 2553 L, 2557 L		96 – 02			MDP3246K / MAX246K					MBR5016HD
				MDP9000	MDP3087K / MAX087K					MBR5016HD
										MBR5046
										MBR5128
					MDP3246K / MAX246K					MBR5016HD
				MDP9000	MDP3087K / MAX087K					MBR5016HD
										MBR5046
										MBR5128
Actros-Series 2531 L		02 →			MDP3246K / MAX246K					MBR5016HD
				MDP9000	MDP3087K / MAX087K					MBR5016HD
										MBR5046
										MBR5128
					MDP3246K / MAX246K					MBR5016HD
					MDP3244K / MAX244K					MBR5016HD
				MDP9000	MDP3087K / MAX087K					MBR5016HD
										MBR5046
Actros-Series 2531 LS, 2535 LS, 2540 LS, 2543 LS, 2546 LS, 2548 LS, 2553 LS		96 – 02		MDP9000	MDP3087K / MAX087K					MBR5016HD
										MBR5046
										MBR5128
				MDP9000	MDP3087K / MAX087K					MBR5016HD
										MBR5046
							MBR5128			





Truck Icon	Truck Model Icon	Truck Model	Axle	Brake Type				Other	
				OE	ALLFIT	900	MAX	OE	ALLFIT
...Mercedes									
Antos-Series 2527 L		12 →			MDP3246K / MAX246K				
					MDP3246K / MAX246K			MBR5016HD	
					MDP3244K / MAX244K			MBR5016HD	
				MDP9000	MDP3087K / MAX087K			MBR5016HD	
								MBR5128	
Antos-Series 3333 L, 3336 L, 3340 L, 3342 L, 3343 L, 3345 L, 3348 L, 3351 L, 3352 L, 3358 L, 3363 L		11 →			MDP3246K / MAX246K				
					MDP3244K / MAX244K			MBR5016HD	
				MDP9000	MDP3087K / MAX087K			MBR5016HD	
Arocs-Series 1824		13 →			MDP3246K / MAX246K				
					MDP3244K / MAX244K			MBR5016HD	
Arocs-Series 1824 L		13 →			MDP3246K / MAX246K				
					MDP3244K / MAX244K			MBR5016HD	
				MDP9000	MDP3087K / MAX087K			MBR5016HD	
Arocs-Series 1827 A		13 →			MDP3246K / MAX246K				
Arocs-Series 2527 L, 2530 L, 2532 L, 2533 L, 2533 LS, 2535 L, 2536 L, 2540 L, 2542 L, 2543 L, 2545 L, 2548 L, 2551 L, 2552 L, 2558 L, 2563 L		13 →			MDP3246K / MAX246K				
					MDP3246K / MAX246K			MBR5016HD	
					MDP3244K / MAX244K			MBR5016HD	
				MDP9000	MDP3087K / MAX087K			MBR5016HD	
								MBR5128	
Arocs-Series 2527 LS		13 →			MDP3246K / MAX246K				
					MDP3244K / MAX244K			MBR5016HD	
				MDP9000	MDP3087K / MAX087K			MBR5016HD	
								MBR5128	
Arocs-Series 3227 L, 3227 LB, 3227 LK, 3230 L, 3232 L, 3233 L, 3235 L, 3236 L, 3240 L, 3242 L, 3243 L, 3245 L, 3248 L, 3251 L, 3252 L, 3258 L, 3263 L		13 →			MDP3246K / MAX246K				
					MDP3246K / MAX246K			MBR5016HD	
					MDP3244K / MAX244K			MBR5016HD	
				MDP9000	MDP3087K / MAX087K			MBR5016HD	
Atego-Series 1015, 1017, 1017 K, 1018, 1018 K, 1023, 1023 K, 917, 917 K, 917 KO, 918, 918 K, 923, 923 K		98 – 04			MDP3148K			MBR5066	
					MDP1329			MBR5066	
								MBR5077	
					MDP3148K			MBR5070	
Atego-Series 1015		04 →			MDP3148K			MBR5066	
					MDP1329			MBR5066	
								MBR5077	
					MDP3148K			MBR5070	





- 1
- 2
- 3
- 4
- 5
- 6
- 7

...Mercedes									
Atego-Series 1015 L, 1016 L, 1017 L, 1018 L, 1022 L, 1023 L, 1024 L		04 →			MDP3148K				MBR5066
					MDP3148K				
Atego-Series 1016		13 →			MDP3148K				MBR5066
					MDP3148K				MBR5070
Atego-Series 1016 L, 1018 L, 1021 L, 1023 L, 1024 L, 1216, 1216 L		13 →			MDP3148K				MBR5066
Atego 1215-1528 - 19.5" Wheels	Knorr SB6000	98 →		MDP9002	MDP3095K / MAX095K	MBA110 / MBA121	N/A		MBR5077
Atego-Series 1016 L, 1018 L, 1021 L, 1023 L, 1024 L, 1216, 1216 L		13 →			MDP3148K				
Atego-Series 1017 KO		98 – 04			MDP1329				MBR5077
					MDP1329				MBR5071
Atego-Series 1017 L, 1018 L, 1023 L, 823 L		98 – 04			MDP3148K				MBR5066
					MDP3148K				
Atego-Series 1214 K, 1215 K, 1217 K, 1218 K, 1223 K, 1317 K, 1318 K, 1323 K, 1517 K, 1518 K, 1523 K, 1528 K		98 – 04			MDP1329				MBR5077
Atego-Series 1214 K		04 →			MDP1329				MBR5077
					MDP1329				MBR5077
					MDP1329				MBR5071
Atego-Series 1215, 1215 L, 1216, 1216 L, 1217, 1217 L, 1218, 1218 L, 1222, 1222 L, 1223, 1223 L, 1224, 1224 L		04 →			MDP3148K				MBR5066
					MDP1329				MBR5066
									MBR5077
					MDP3148K				MBR5071
					MDP1329				MBR5071
Atego-Series 1216 K		13 →			MDP1329				MBR5077
Atego-Series 1217, 1217 L, 1218, 1218 L, 1223, 1223 L		98 – 04			MDP3148K				MBR5066
					MDP1329				MBR5066
									MBR5077
					MDP3148K				MBR5071
					MDP1329				MBR5071
Atego-Series 1218, 1218 L, 1221, 1223, 1224		13 →			MDP3148K				MBR5066
					MDP1329				MBR5066
									MBR5077
					MDP3148K				MBR5070
					MDP1329				MBR5070



...Mercedes									
Atego-Series 1221 L		13 →			MDP1329				MBR5077
					MDP1329				MBR5070
Atego-Series 1317 A, 1318 A, 1323 A		98 – 04			MDP1329				MBR5071
Atego-Series 1317 A, 1318 A, 1318 AE, 1322 A, 1322 AE, 1323 A, 1323 AE, 1324 A, 1324 AE, 1517 A, 1518 A, 1522 A, 1523 A, 1524 A		14 →			MDP1329				MBR5071
Atego-Series 1317 L, 1318 L, 1322 L, 1323 L, 1328 L		14 →			MDP1329				MBR5077
Atego-Series 1318 LKO, 1321 LKO, 1323 LKO, 1324 LKO		13 →			MDP1329				MBR5077
					MDP1329				MBR5071
Atego-Series 1823		98 – 04			MDP3246K / MAX246K				MBR5016HD
				MDP9000	MDP3087K / MAX087K				MBR5016HD
									MBR5046
									MBR5128
					MDP3244K / MAX244K				MBR5016HD
				MDP9000	MDP3087K / MAX087K				MBR5016HD
Atego-Series 1823 LL, 1824 LL, 1826 LL, 1828 LL, 1829 LL, 1833 LL		98 – 04		MDP9000	MDP3087K / MAX087K				MBR5016HD
									MBR5046
									MBR5128
					MDP3244K / MAX244K				MBR5016HD
				MDP9000	MDP3087K / MAX087K				MBR5016HD
					MDP3244K / MAX244K				MBR5016HD
				MDP9000	MDP3087K / MAX087K				MBR5016HD
Atego-Series 2523 L		98 – 04							MBR5046
									MBR5128
Atego-Series 2528 L, 2529 L, 2533 L		98 – 04			MDP3246K / MAX246K				MBR5016HD
				MDP9000	MDP3087K / MAX087K				MBR5016HD
									MBR5046
									MBR5128
					MDP3246K / MAX246K				MBR5016HD
					MDP3244K / MAX244K				MBR5016HD
				MDP9000	MDP3087K / MAX087K				MBR5016HD
									MBR5046
									MBR5128

1

2

3

4

5

6

7



...Mercedes									
Axor-Series 2523 K, 2528 K, 2529 K		02 – 04		MDP9000	MDP3087K / MAX087K				
Axor-Series 2523 L, 2528 L, 2528 LL, 2529 L, 2529 LL, 2533 L, 2533 LL, 2535 L, 2536 L, 2540 L, 2543 L		04 →			MDP3246K / MAX246K				MBR5016HD
				MDP9000	MDP3087K / MAX087K				MBR5016HD
									MBR5046
									MBR5128
					MDP3246K / MAX246K				MBR5016HD
					MDP3244K / MAX244K				MBR5016HD
				MDP9000	MDP3087K / MAX087K				MBR5016HD
									MBR5046
									MBR5128
Axor-Series 2535 LS, 2540 LS, 2543 LS		02 – 04			MDP3246K / MAX246K				MBR5016HD
				MDP9000	MDP3087K / MAX087K				MBR5016HD
									MBR5128
				MDP9000	MDP3087K / MAX087K				MBR5016HD
Axor-Series 2536 LS		04 →			MDP3246K / MAX246K				MBR5016HD
				MDP9000	MDP3087K / MAX087K				MBR5016HD
									MBR5046
									MBR5128
					MDP3246K / MAX246K				MBR5066
					MDP3244K / MAX244K				MBR5066
				MDP9000	MDP3087K / MAX087K				MBR5066
					MDP3148K				MBR5066
									MBR5016HD
						MBR5128			
Axor-Series 2623 L, 2624 L, 2628 L, 2629 L		02 – 04		MDP9000	MDP3087K / MAX087K				
					MDP3244K / MAX244K				MBR5016HD
				MDP9000	MDP3087K / MAX087K				MBR5016HD
									MBR5046
									MBR5128
Axor-Series 2628, 2629, 2633		04 →			MDP3246K / MAX246K				MBR5016HD
				MDP9000	MDP3087K / MAX087K				MBR5016HD
									MBR5046
									MBR5128
				MDP9000	MDP3087K / MAX087K				MBR5016HD





- 1
- 2
- 3
- 4
- 5
- 6
- 7

...Mercedes									
Axor-Series 3228, 3229		02 – 04			MDP3246K / MAX246K				MBR5016HD
				MDP9000	MDP3087K / MAX087K				MBR5016HD
									MBR5128
					MDP3244K / MAX244K				MBR5016HD
				MDP9000	MDP3087K / MAX087K				MBR5016HD
Axor-Series 3235 B, 3235 K, 3236 B, 3236 K, 3240 B, 3240 K, 3243 B, 3243 K, 4135 B, 4135 K, 4136 B, 4136 K, 4140 B, 4140 K, 4143 B, 4143 K		04 →			MDP3246K / MAX246K				MBR5016HD
				MDP9000	MDP3087K / MAX087K				MBR5016HD
									MBR5128
					MDP3244K / MAX244K				MBR5016HD
				MDP9000	MDP3087K / MAX087K				MBR5016HD
Atego 1215-1528 - 19.5" Wheels	Knorr SB6000	98 →		MDP9002	MDP3095K / MAX095K	MBA110 / MBA121	N/A	MBR5071	
Atego 1823-2628 - 22.5" Wheels	Knorr SB6000	96 →		MDP9002	MDP3095K / MAX095K	MBA110 / MBA121	N/A	MBR5016HD	
				MDP9002	MDP3095K / MAX095K	MBA110 / MBA121	N/A	MBR5016HD	
Atego 712-823 - 17.5" Wheels	Knorr SB5000	98 →		N/A	MDP3148K	MBA110 / MBA120	N/A	MBR5066	
				N/A	MDP3148K	MBA110 / MBA120	N/A	MBR5070	
				N/A	MDP3148K	MBA110 / MBA120	N/A	MBR5091	
Atego 917-1023 - 17.5" Wheels	Knorr SB5000	98 →		N/A	MDP3148K	MBA110 / MBA120	N/A	MBR5066	
				N/A	MDP3148K	MBA110 / MBA120	N/A	MBR5070	
Atego 917-1023 - 19.5" Wheels	Knorr SB6000	98 →		MDP9002	MDP3095K / MAX095K	MBA110 / MBA121	N/A	MBR5077	
				MDP9002	MDP3095K / MAX095K	MBA110 / MBA121	N/A	MBR5071	
Axor 1831- 2557	Knorr SB7000	09/96 →		MDP9000	MDP3087K / MAX087K	MBA110 / MBA120	N/A	MBR5016HD	
				MDP9000	MDP3087K / MAX087K	MBA110 / MBA120	N/A	MBR5016HD	
Econic Refuse & Specialist Fire chassis	Knorr SB7000	09/96 →		MDP9000	MDP3087K / MAX087K	MBA110 / MBA120	N/A	MBR5016HD	
		09/96 →		MDP9000	MDP3087K / MAX087K	MBA110 / MBA120	N/A	MBR5016HD	
Econic-Series 1823 LL		98 – 13			MDP3246K / MAX246K			MBR5016HD	
				MDP9000	MDP3087K / MAX087K			MBR5016HD	
								MBR5046	
								MBR5128	
								MBR5128	
Econic-Series 1824 LL, 1828 LL, 1828 LS, 1829 LL, 1829 LS, 1833 LL, 1833 LS, 3233 LL		98 – 13			MDP3246K / MAX246K			MBR5016HD	
				MDP9000	MDP3087K / MAX087K			MBR5016HD	
								MBR5046	
								MBR5128	



Icon	Icon	Icon	Icon	Icon				Icon	
				OE	ALLFIT	Icon	Icon	OE	ALLFIT
...Mercedes									
Econic-Series 2628 LL, 2629 LL, 2633 LL		98 – 13			MDP3246K / MAX246K				MBR5016HD
				MDP9000	MDP3087K / MAX087K				MBR5016HD
									MBR5046
									MBR5128
T1 Series L207, L208, L209, L210		77 – 95			N/A				MBR1577
T1 Series L307, L308, L309 D, L310		77 – 95			N/A				MBR1577
T2 Series 508D, 510, 511D, 608D, 609D	B Frame	86 →		MDP5040	MDP3835K	MBA106	MBA007		MBR1588
T2 Series 809D, 811D, 814D - 16" wheels	B Frame	86 – 98		MDP5040	MDP3835K	MBA106	MBA007		MBR1588
T2 Series 809D, 811D, 814D - 17.5" wheels	B Frame	86 – 98		MDP5040	MDP3835K	MBA106	MBA007		MBR1589
T2 Series 814DA	B Frame	88 →		MDP5040	MDP3835K	MBA106	MBA007		
T2 Series L709 - 16" wheels	B Frame	86 →		MDP5040	MDP3835K	MBA106	MBA007		MBR1588
T2 Series L711 - 16" wheels	B Frame	86 →		MDP5040	MDP3835K	MBA106	MBA007		MBR1588
Vario 512, 612, 614 - 16" Wheels	B Frame	96 →		MDP5040	MDP3835K	MBA106	MBA007		MBR5037
				MDP5040	MDP3835K	MBA106	MBA007		MBR5038
				MDP5040	MDP3835K	MBA106	MBA007		MBR5093
Vario 810, 812, 814 - 17.5" Wheels	B Frame	96 →		MDP5040	MDP3835K	MBA106	MBA007		MBR5039
				MDP5040	MDP3835K	MBA106	MBA007		MBR5040
				MDP5040	MDP3835K	MBA106	MBA007		MBR5075
Mercedes									
19.5" brake, trailer TE4-TE5	Knorr SB6000				MDP3095K				MBR5132
Mercedes									
Optare Soroco		04/06 →							MBR6045
Sitcar Gamma Sprinter Trend		06/06 →							MBR6045
Sprinter 516CDi		04/06 →							MBR6045
Sprinter		06/06 →							MBR6045
Vito Van (W639)		06/03 →							MBR6053
Volkswagen Crafter CR30, CR35, CR50		04/06 →							MBR6045
Nissan									
Eco T M140 - 15t	M140	04/96 →		MDP5035	N/A		N/A		
Motor Iberica, Ebro L60 & L80 Range	Brembo (bframe)	01/92 – 12/95		MDP5429	MDP3122	MBA107	N/A		
Motor Iberica, Ebro L60 & L80 Range	B Frame	01/96 – 08/99		MDP5030	N/A		N/A		





- 1
- 2
- 3
- 4
- 5
- 6
- 7

Noge											
Catalan 320		98 →			N/A						MBR5077
					N/A						MBR5071
Catalan 350 & 370	D3	98 →		MDP5017	MDP3030K / MAX030K	MBA108	MBA007				MBR5068
Catalan 350 & 370 (with ABS)	D3	98 →		MDP5017	MDP3030K / MAX030K	MBA108	MBA007				MBR5078
Optare											
Metrorider	Brembo (bframe)	98 →		MDP5429	MDP3122	MBA107	N/A				MBR1831
Nouvelle	B Frame	96 →		MDP5040	MDP3835K	MBA106	MBA007				MBR5039
				MDP5040	MDP3835K	MBA106	MBA007				MBR5040
				MDP5040	MDP3835K	MBA106	MBA007				MBR5075
Sigma	D3	94 – 96		MDP5000	MDP3030K / MAX030K	MBA108	MBA010				
Solera SR	Knorr SB6000	01/02 →		MDP9002	MDP3095K / MAX095K	MBA110 / MBA121	N/A				MBR5077
				MDP9002	MDP3095K / MAX095K	MBA110 / MBA121	N/A				MBR5071
Solo	B Frame	88 – 02		MDP5049	MDP3122	MBA107	N/A				MBR1831
Solo Pan 17 brake	Wabco Pan17	03/02 →		N/A	MDP3088 / MAX088K	N/A	N/A				
Solo 02	Wabco Pan17				MDP3088 / MAX088K						MBR5130
Star Rider	B Frame	87 →		MDP5481	MDP3835K	MBA106	MBA007				MBR1589
Orion											
Transit Bus ZF Axle	D3	→ 06/93		MDP5031	MDP3030K / MAX030K	MBA108	MBA010				
Renault Truck											
Agora	Elsa 1	95 – 98		MDP5090	MDP3030K / MAX030K	MBA108	MBA017	MBR9008			MBR5056
Agora	D Lisa	98 →		MDP5042	MDP3090K / MAX090K	MBA101	MBA015	MBR9008			MBR5056
Illiade	Elsa 1	98 →		MDP5090	MDP3030K / MAX030K	MBA108	MBA017	MBR9008			MBR5056
Midliner PP160	B Frame 60mm	01/92 – 05/93		MDP5005	MDP3122	MBA107	MBA009				MBR2693
R312	Brembo (bframe)	01/89 →		N/A	N/A	N/A	N/A				
		01/89 →		N/A	N/A	N/A	N/A				
Renault Truck											
C C250, C280, C320	Elsa 225-3	13 →		MDP5101						MBR9008	MBR5056
	Elsa 225-1	13 →		MDP5102						MBR9008	MBR5056
C C380, C430, C440, C460, C480, C520	Elsa 225-3	13 →		MDP5101							
	Elsa 225-1	13 →		MDP5106							



Truck Model	Elsa Code	Axle Config	Icon	Brake System				Other	
				OE	ALLFIT	Icon	Icon	OE	ALLFIT
...Renault Truck									
D D210, D240	Elsa 225-1	13 →		MDP5102					MBR5080
D D250, D280	Elsa 225-1	13 →		MDP5102				MBR9008	MBR5056
	Elsa 225-3	13 →		MDP5101				MBR9008	MBR5056
		13 →							MBR5080
D D320	Elsa 225-3	13 →		MDP5101				MBR9008	MBR5056
	Elsa 225-1	13 →		MDP5102				MBR9008	MBR5056
K K380, K430, K440, K460, K480, K520	Elsa 225-3	13 →		MDP5101					
Magnum 390.18, 390.19, 430.18, 430.19, 470.18, 470.19, 560.18, 560.19	D3	96 – 00		MDP5050	MDP3030K / MAX030K	MBA108	MBA011	MBR9008	MBR5056
	D Lisa	96 – 00		MDP5042	MDP3090K / MAX090K	MBA101	MBA015	MBR9008	MBR5056
	D Elsa 2	96 – 00		MDP5056	MDP3131K / MAX131K	MBA105	MBA016		MBR5101
Magnum 390.24, 390.26, 430.22, 430.24, 430.26, 470.22, 470.24, 470.26	D3	96 – 00		MDP5050	MDP3030K / MAX030K	MBA108	MBA011	MBR9008	MBR5056
	D Lisa	96 – 00		MDP5042	MDP3090K / MAX090K	MBA101	MBA015	MBR9008	MBR5056
		96 – 00						MBR9008	
	D Elsa 2	96 – 00		MDP5056	MDP3131K / MAX131K	MBA105	MBA016		MBR5101
Magnum 400.18, 400.19	D3	99 – 05		MDP5050	MDP3030K / MAX030K	MBA108	MBA011	MBR9008	MBR5056
	D Lisa	99 – 05		MDP5042	MDP3090K / MAX090K	MBA101	MBA015	MBR9008	MBR5056
	D Elsa 2	99 – 05		MDP5056	MDP3131K / MAX131K	MBA105	MBA016	MBR9008	MBR5056
		99 – 05			MDP3030K / MAX030K			MBR9008	MBR5056
	D Elsa 2	99 – 05		MDP5056	MDP3131K / MAX131K	MBA105	MBA016		MBR5101
		99 – 05						MBR9011	
Magnum 400.24, 400.26, 440.18, 440.19, 440.22, 440.24, 440.26, 480.18, 480.19, 480.22, 480.24, 480.26	D Lisa	99 – 05		MDP5042	MDP3090K / MAX090K	MBA101	MBA015	MBR9008	MBR5056
	D Elsa 2	99 – 05		MDP5056	MDP3131K / MAX131K	MBA105	MBA016	MBR9008	MBR5056
	D Elsa 2	99 – 05		MDP5056	MDP3131K / MAX131K	MBA105	MBA016		MBR5101
		99 – 05						MBR9011	
Magnum 420.18, 420.19	D3	96 – 96		MDP5050	MDP3030K / MAX030K	MBA108	MBA011	MBR9008	MBR5056
	D Lisa	96 – 96		MDP5042	MDP3090K / MAX090K	MBA101	MBA015	MBR9008	MBR5056
	D Elsa 2	96 – 96		MDP5056	MDP3131K / MAX131K	MBA105	MBA016		MBR5101
Magnum 420.24, 420.26	D3	96 – 96		MDP5050	MDP3030K / MAX030K	MBA108	MBA011	MBR9008	MBR5056
	D Lisa	96 – 96		MDP5042	MDP3090K / MAX090K	MBA101	MBA015	MBR9008	MBR5056
		96 – 96						MBR9008	
	D Elsa 2	96 – 96		MDP5056	MDP3131K / MAX131K	MBA105	MBA016		MBR5101





- 1
- 2
- 3
- 4
- 5
- 6
- 7

...Renault Truck									
Magnum 440.18, 440.19, 480.18, 480.19	D3	96 – 05		MDP5050	MDP3030K / MAX030K	MBA108	MBA011	MBR9008	MBR5056
	D Lisa	96 – 05		MDP5042	MDP3090K / MAX090K	MBA101	MBA015	MBR9008	MBR5056
	D Elsa 2	96 – 05		MDP5056	MDP3131K / MAX131K	MBA105	MBA016	MBR9008	MBR5056
	D Elsa 2	96 – 05		MDP5056	MDP3131K / MAX131K	MBA105	MBA016		MBR5101
		96 – 05						MBR9011	
	Elsa 225-3	05 – 06		MDP5101					
Magnum 440.18, 440.19, 480.18, 480.19, 520.18, 520.19	Elsa 225-3	09 – 13		MDP5101					
Magnum 440.24, 440.25, 440.26, 480.24, 480.25, 480.26	Elsa 225-3	05 – 13		MDP5101					
	Elsa 225-1	05 – 13		MDP5106					
	Elsa 195 VGT	05 – 13		MDP5108					
Magnum 460.18, 460.19, 500.18, 500.19	Elsa 225-3	06 – 09		MDP5101					
Magnum 460.24, 460.25, 460.26, 500.24, 500.25, 500.26, 520.24, 520.25, 520.26	Elsa 225-3	06 – 09		MDP5101					
	Elsa 225-1	06 – 09		MDP5106					
	Elsa 195 VGT	06 – 09		MDP5108					
Magnum 560.22, 560.24, 560.26	D3	96 – 00		MDP5050	MDP3030K / MAX030K	MBA108	MBA011	MBR9008	MBR5056
	D Lisa	96 – 00		MDP5042	MDP3090K / MAX090K	MBA101	MBA015	MBR9008	MBR5056
		96 – 00						MBR9008	
	D Elsa 2	96 – 00		MDP5056	MDP3131K / MAX131K	MBA105	MBA016		MBR5101
Magnum AE380, AE385, AE390	D2	90 – 93		MDP5008	MDP3043K	MBA109	MBA014		MBR2694
					MDP3043K	MBA109	MBA006		MBR2694
Magnum AE380, AE385, AE390, AE420, AE430, AE520, AE560	D Lisa	93 – 00		MDP5042	MDP3090K / MAX090K	MBA101	MBA015	MBR9008	MBR5056
Magnum E Tech 400, 440, 480 - D3	D3	01/02 →		MDP5050	MDP3030K / MAX030K	MBA108	MBA011	MBR9008	MBR5056
				MDP5050	MDP3030K / MAX030K	MBA108	MBA011	MBR9007	MBR5101
	Elsa 2	01/02 →		MDP5056	MDP3131K / MAX131K	MBA105	MBA016	MBR9008	MBR5056
				MDP5056	MDP3131K / MAX131K	MBA105	MBA016	MBR9007	MBR5101
Major	D2	90 – 93		MDP5008	MDP3043K	MBA109	MBA014		MBR2694
	D3	93 – 00		MDP5050	MDP3030K / MAX030K	MBA108	MBA011	MBR9008	MBR5056
Manager	D2	90 – 93		MDP5008	MDP3043K	MBA109	MBA014		MBR2694
	D3	93 – 00		MDP5050	MDP3030K / MAX030K	MBA108	MBA011	MBR9008	MBR5056
Midliner M120 - M250		89 – 95		N/A	MDP3013	N/A	N/A		MBR2693
	C Lisa	95 – 01		MDP5037	N/A	N/A	N/A		MBR2693
Midliner S12, S13		87 – 95		N/A	MDP3013	N/A	N/A		



...Renault Truck									
Midliner S120-S210	B Frame 60mm	90 – 95		MDP5004	MDP3122	MBA106	MBA009		MBR2693
		01/95 →		MDP5004	MDP3122	MBA106	MBA009		MBR5095
				MDP5005	MDP3122	MBA107	MBA009		MBR5109
Midlum	Elsa 225-1	06 →		MDP5102					
Midlum 17.5" Wheels	Wabco Pan17	11/99 →		N/A	MDP3088 / MAX088K	N/A	N/A		MBR5117
				N/A	MDP3088 / MAX088K	N/A	N/A		MBR5112
Midlum 19.5" Wheels - Meritor brakes	C Lisa	11/99 →		MDP5037	N/A	N/A	N/A		MBR5107
				MDP5037	N/A	N/A	N/A		MBR5080
				MDP5037	N/A	N/A	N/A		MBR5119
				MDP5037	N/A	N/A	N/A		MBR5115
Midlum 19.5" Wheels - Wabco PAN19 - 1 plus brakes	Wabco Pan19-1	03 →		N/A	MDP3126	N/A	N/A		MBR5107
				N/A	MDP3126	N/A	N/A		MBR5080
				N/A	MDP3126	N/A	N/A		MBR5119
				N/A	MDP3126	N/A	N/A		MBR5115
Midlum 19.5" Wheels - Wabco PAN19 - 2 brakes	Wabco Pan19-2	99 – 03		N/A	MDP3142	N/A	N/A		MBR5107
				N/A	MDP3142	N/A	N/A		MBR5080
				N/A	MDP3142	N/A	N/A		MBR5119
				N/A	MDP3142	N/A	N/A		MBR5115
Midlum 160.08, 160.09, 160.10, 160.12, 190.08, 190.09, 190.10, 190.12, 220.08, 220.10, 220.12		06 – 09			MDP3088 / MAX088K				
Midlum 180.08, 180.10, 180.12, 220.08, 220.10, 220.12		09 →			MDP3088 / MAX088K				
Midlum 240.18, 280.18	Elsa 225-1	06 – 09		MDP5102					
		09 →		MDP5102					
Premium	D3	96 – 97		MDP5051	MDP3030K / MAX030K	MBA108	MBA013	MBR9008	MBR5056
	D Lisa	96 – 02		MDP5042	MDP3090K / MAX090K	MBA101	MBA015	MBR9008	MBR5056
	Elsa 2	02 →		MDP5056	MDP3131K / MAX131K	MBA105	MBA016	MBR9008	MBR5056
	Elsa 2	02 →		MDP5056	MDP3131K / MAX131K	MBA105	MBA016	MBR9007	MBR5101
Premium 210.16	D3	96 – 01		MDP5050	MDP3030K / MAX030K	MBA108	MBA011	MBR9008	MBR5056
	D Lisa	96 – 01		MDP5042	MDP3090K / MAX090K	MBA101	MBA015	MBR9008	MBR5056
	D Elsa 2	96 – 01		MDP5056	MDP3131K / MAX131K	MBA105	MBA016	MBR9008	MBR5056
Premium 220.16, 220.18, 270.16, 270.18, 270.19, 320.16	D Elsa 2	00 – 06		MDP5056	MDP3131K / MAX131K	MBA105	MBA016	MBR9008	MBR5056
Premium 240.16 D	Elsa 225-3	05 – 09		MDP5101				MBR9008	MBR5056
				MDP5101					





- 1
- 2
- 3
- 4
- 5
- 6
- 7

...Renault Truck									
Premium 240.26, 280.26 D, 320.24 D, 320.25 D, 320.26 D, 320.26	Elsa 225-3	05 – 09		MDP5101				MBR9008	MBR5056
	Elsa 225-3	05 – 09		MDP5101					
	Elsa 225-1	05 – 09		MDP5102					
Premium 260.26	D3	96 – 99		MDP5050	MDP3030K / MAX030K	MBA108	MBA011	MBR9008	MBR5056
	D Lisa	96 – 99		MDP5042	MDP3090K / MAX090K	MBA101	MBA015	MBR9008	MBR5056
Premium 270.16	Elsa 225-3	09 →		MDP5101				MBR9008	MBR5056
				MDP5101					
Premium 300.16, 300.18, 300.19, 300.26, 340.18, 340.19, 340.18, 340.19, 385.18, 385.19, 385.24, 420.18, 420.19	D3	96 – 01		MDP5050	MDP3030K / MAX030K	MBA108	MBA011	MBR9008	MBR5056
	D Lisa	96 – 01		MDP5042	MDP3090K / MAX090K	MBA101	MBA015	MBR9008	MBR5056
	D Elsa 2	96 – 01		MDP5056	MDP3131K / MAX131K	MBA105	MBA016	MBR9008	MBR5056
Premium 300.26	D3	96 – 99		MDP5050	MDP3030K / MAX030K	MBA108	MBA011	MBR9008	MBR5056
	D Lisa	96 – 99		MDP5042	MDP3090K / MAX090K	MBA101	MBA015	MBR9008	MBR5056
Premium 310.24, 310.25, 310.26, 340.24, 340.25, 340.26, 340.26	Elsa 225-3	09 →		MDP5101				MBR9008	MBR5056
	Elsa 225-3	09 →		MDP5101					
	Elsa 225-1	09 →		MDP5102					
Premium 320.18	D Elsa 2	00 – 06		MDP5056	MDP3131K / MAX131K	MBA105	MBA016	MBR9008	MBR5056
	D Elsa 2	00 – 06		MDP5056	MDP3131K / MAX131K	MBA105	MBA016		MBR5101
		00 – 06						MBR9011	
Premium 320.24, 320.26, 370.24, 370.26, 320.26, 370.24, 370.26, 420.24, 420.25, 420.26	D Elsa 2	00 – 06		MDP5056	MDP3131K / MAX131K	MBA105	MBA016	MBR9008	MBR5056
Premium 330.18	Elsa 225-3	05 →		MDP5101					
Premium 330.26, 380.26, 440.26	Elsa 225-3	05 →		MDP5101					
	Elsa 225-1	05 →		MDP5106					
	Elsa 195 VGT	05 →		MDP5108					
Premium 370.18 D	Elsa 225-3	05 – 09		MDP5101					
Premium 370.26 D, 410.26 D, 370.26, 410.26, 450.26, 370.26, 410.24, 450.24	Elsa 225-3	05 – 09		MDP5101					
	Elsa 225-1	05 – 09		MDP5106					
Premium 385.18, 385.19	D3	96 – 03		MDP5050	MDP3030K / MAX030K	MBA108	MBA011	MBR9008	MBR5056
	D Lisa	96 – 03		MDP5042	MDP3090K / MAX090K	MBA101	MBA015	MBR9008	MBR5056
		96 – 03			MDP3030K / MAX030K			MBR9008	MBR5056
Premium 400.18, 400.19, 400.24	D Elsa 2	98 – 03		MDP5056	MDP3131K / MAX131K	MBA105	MBA016	MBR9008	MBR5056
	D Lisa	98 – 03		MDP5042	MDP3090K / MAX090K	MBA101	MBA015	MBR9008	MBR5056
		98 – 03			MDP3030K / MAX030K			MBR9008	MBR5056



...Renault Truck									
Premium 400.26	D Lisa	98 – 01		MDP5042	MDP3090K / MAX090K	MBA101	MBA015	MBR9008	MBR5056
	D Elsa 2	98 – 01		MDP5056	MDP3131K / MAX131K	MBA105	MBA016	MBR9008	MBR5056
Premium 410.25, 410.26, 450.25, 450.26	Elsa 225-3	05 – 09		MDP5101					
	Elsa 225-1	05 – 09		MDP5106					
	Elsa 195 VGT	05 – 09		MDP5108					
Premium 430.18, 430.19	Elsa 225-3	09 →		MDP5101					
Premium 430.24, 430.25, 430.26, 460.24, 460.25, 460.26	Elsa 225-3	09 →		MDP5101					
	Elsa 225-1	09 →		MDP5106					
	Elsa 195 VGT	09 →		MDP5108					
T T380, T430, T440, T460, T480, T520	Elsa 225-3	13 →		MDP5101					
	Elsa 225-1	13 →		MDP5106					
	Elsa 195 VGT	13 →		MDP5108					
ROR									
LM D Duco Axial (M20)	D Duco	02/00 – 06/01		MDP5057	MDP3125K	MBA104	N/A	MBR9004	MBR5124
LM DX195 (8 stud w/o pole wheel)	DX195	98 →		MDP5076	MDP3124K	MBA100	N/A	MBR9017	MBR5079
LM DX195 (8 stud with pole wheel)	DX195	98 →		MDP5076	MDP3124K	MBA100	N/A	MBR9014	
LM DX195 (10 stud ABS & Non ABS)	DX195	98 →		MDP5076	MDP3124K	MBA100	N/A	MBR9018	MBR5073
LM Elsa 195 (8 stud w/o pole wheel)	Elsa 195	01/03 – 06/04		MDP5093	MDP3169K	MBA112	N/A	MBR9017	MBR5079
LM Elsa 195 (8 stud with pole wheel)	Elsa 195	01/03 – 06/04		MDP5093	MDP3169K	MBA112	N/A	MBR9014	
LM Elsa 195 (10 stud ABS & Non ABS)	Elsa 195	01/03 – 06/04		MDP5093	MDP3169K	MBA112	N/A	MBR9018	MBR5073
LM Elsa 2	Elsa 2	07/01 →		MDP5073	MDP3131K	MBA105	N/A	MBR9004	MBR5124
TA D Duco Axial (M20)	D Duco	02/00 – 06/01		MDP5057	MDP3125K	MBA104	N/A	MBR9004	
		06/01 – 01/02		MDP5057	MDP3125K	MBA104	N/A	MBR9004	MBR5124
TA Elsa 2	Elsa 2	07/01 →		MDP5073	MDP3131K	MBA105	N/A	MBR9004	MBR5124
TM DX195 (8 stud w/o pole wheel)	DX195	98 →		MDP5076	MDP3124K	MBA100	N/A	MBR9017	MBR5079
TM DX195 (8 stud with pole wheel)	DX195	98 →		MDP5076	MDP3124K	MBA100	N/A	MBR9014	
TM Elsa 195	Elsa 195	01/03 – 06/04		MDP5093	MDP3169K	MBA112	N/A	MBR9018	MBR5073
TM Elsa 195 (8 stud w/o pole wheel)	Elsa 195	01/03 – 06/04		MDP5093	MDP3169K	MBA112	N/A	MBR9017	MBR5079
TM Elsa 195 (8 stud with pole wheel)	Elsa 195	01/03 – 06/04		MDP5093	MDP3169K	MBA112	N/A	MBR9014	
SAF									
Haldex 22.5" wheels	Haldex DB22			N/A	MDP3143K	MBA116	N/A		MBR5046
Haldex 22.5" wheels	Haldex DB22			N/A	MDP3143K	MBA116	N/A		MBR5074





- 1
- 2
- 3
- 4
- 5
- 6
- 7

...SAF									
Knorr SB6000 19.5" wheels	Knorr SB6000			MDP9003	MDP3095K	MBA110 / MBA121	N/A		MBR5072
Knorr SB7000 22.5" wheels	Knorr SB7000			MDP9001	MDP3087K	MBA110 / MBA120	N/A		MBR5046
Knorr SB7000 22.5" wheels	Knorr SB7000			MDP9001	MDP3087K	MBA110 / MBA120	N/A		MBR5074
SAF (Sauer)	SK RB 9019								MBR5139
SKRB 9022 K1	SN7								MBR5125
Wabco Pan 19 19.5" wheels	Wabco Pan19-1			N/A	MDP3126	N/A	N/A		MBR5059
Wabco Pan 22-1 22.5" wheels	Wabco Pan22-1	03 →		N/A	MDP3162	N/A	N/A		MBR5046
Scania									
Omnidecker Knorr caliper	Knorr SB7000	96 →		MDP9005	MDP3087K / MAX087K	MBA110 / MBA120	N/A		MBR5025
Series 4 94, 124, 144 - Haldex caliper	Haldex DB22	01/96 →		N/A	MDP3143K	MBA116	N/A		MBR5025
Series 4 94, 124, 144 - Knorr caliper	Knorr SB7000	01/96 →		MDP9005	MDP3087K / MAX087K	MBA110 / MBA120	N/A		MBR5025
Scania									
4-Serie 94C 220, 94C 230, 94C 260, 94C 300, 94C 310, 94D 230, 94D 300, 94G 230, 94G 300, 94L 230, 94L 300, 114C 260, 114C 340, 114G 260, 114L 260		00 – 05		MDP9000	MDP3087K / MAX087K				MBR5025
4-Serie 114C 330, 114C 340, 114C 380, 114G 330, 114L 330, 124C 360, 124C 400, 124C 420, 124C 440, 124C 470, 124G 440, 124G 470, 124L 440, 124L 470, 144C 460, 144C 530, 164C 480, 164C 580, 94G 300, 94L 300		99 – 04		MDP9000	MDP3087K / MAX087K				MBR5025
4-Serie 124C 360, 124G 360, 124L 360, 94C 220, 94C 310, 94D 220, 94D 310, 94G 220, 94G 310, 94L 220, 94L 310		96 – 99		MDP9000	MDP3087K / MAX087K				MBR5025
G-Serie G310 18, G310 26, G310 32, G340 18, G340 26, G340 32, G380 18, G380 26, G380 32, G420 18, G420 26, G420 32, G440 18, G440 26, G440 32		04 →		MDP9000	MDP3087K / MAX087K				MBR5025
G-Serie G270 26, G270 32, G310 18, G310 26, G310 32, G340 18, G340 26, G340 32, G380 18, G380 26, G380 32, G420 18, G420 26, G420 32, G480 18, G480 26, G480 32		05 →		MDP9000	MDP3087K / MAX087K				MBR5025
G-Serie G230 18, G230 26, G230 32, G250 18, G250 26, G250 32, G280 18, G280 26, G280 32, G320 18, G320 26, G320 32, G360 18, G360 26, G360 32, G400 18, G400 26, G400 32, G420 18, G420 26, G420 32, G440 18, G440 26, G440 32, G480 18, G480 26, G480 32		07 →		MDP9000	MDP3087K / MAX087K				MBR5025
G-Serie G370 18, G370 26, G370 32, G410 18, G410 26, G410 32, G450 18, G450 26, G450 32, G490 18, G490 26, G490 32		12 →		MDP9000	MDP3087K / MAX087K				MBR5025



...Scania									
P-Serie P230 18, P230 26, P230 32, P270 18, P270 26, P270 32, P310 18, P310 26, P310 32, P340 18, P340 26, P340 32, P380 18, P380 26, P380 32, P420 18, P420 26, P420 32		04 →		MDP9000	MDP3087K / MAX087K				MBR5025
P-Serie P230 18, P230 26, P230 32, P280 18, P280 26, P280 32, P320 18, P320 26, P320 32, P360 18, P360 26, P360 32, P400 18, P400 26, P400 32, P420 18, P420 26, P420 32		07 →		MDP9000	MDP3087K / MAX087K				MBR5025
P-Serie P230 26, P230 32, P270 18, P270 26, P270 32, P310 26, P310 32, P340 18, P340 26, P340 32, P380 18, P380 26, P380 32, P380 44, P420 18, P420 26, P420 32		05 →		MDP9000	MDP3087K / MAX087K				MBR5025
P-Serie P250 18, P250 26, P250 32, P270 18, P270 26, P270 32, P310 18, P310 26, P310 32, P360 18, P360 32, P410 18, P410 26, P410 32, P440 18, P440 26, P440 32		11 →		MDP9000	MDP3087K / MAX087K				MBR5025
P-Serie P270 18, P270 26, P270 32		08 →		MDP9000	MDP3087K / MAX087K				MBR5025
P-Serie P280 18, P280 26, P280 32, P340 18, P340 26, P340 32, P370 18, P370 26, P370 32, P450 18, P450 26, P450 32		12 →		MDP9000	MDP3087K / MAX087K				MBR5025
P-Serie P310 18, P310 26, P310 32		09 →		MDP9000	MDP3087K / MAX087K				MBR5025
R-Serie R230 18		04 →		MDP9000	MDP3087K / MAX087K				MBR5025
R-Serie R230 26, R230 32, R270 18, R270 26, R270 32, R360 18, R360 26, R360 32, R400 18, R400 26, R400 32, R420 18, R420 26, R420 32, R440 18, R440 26, R440 32, R470 18, R470 26, R470 32, R480 18, R480 26, R480 32		07 →		MDP9000	MDP3087K / MAX087K				MBR5025
R-Serie R370 18, R370 26, R370 32, R410 18, R410 26, R410 32, R450 18, R450 26, R450 32, R490 18, R490 26, R490 32, R520 18, R520 26, R520 32, R580 18, R580 26, R580 32		12 →		MDP9000	MDP3087K / MAX087K				MBR5025
R-Serie R460 18, R460 26, R460 32		11 →		MDP9000	MDP3087K / MAX087K				MBR5025
R-Serie R580 32, R730 18, R730 26, R730 32		09 →		MDP9000	MDP3087K / MAX087K				MBR5025
T-Serie T230 18, T230 26, T230 32, T270 18, T270 26, T270 32, T310 18, T310 26, T310 32, T340 18, T340 26, T340 32, T380 18, T380 26, T380 32, T420 18, T420 26, T420 32, T470 18, T470 26, T470 32, T500 18, T500 26, T500 32, T580 18, T580 26, T580 32		04 →		MDP9000	MDP3087K / MAX087K				MBR5025
T-Serie T230 18, T230 26, T230 32, T420 18, T420 26, T420 32, T470 18, T470 26, T470 32		07 →		MDP9000	MDP3087K / MAX087K				MBR5025
T-Serie T270 18, T270 26, T270 32, T340 18, T340 26, T340 32		05 →		MDP9000	MDP3087K / MAX087K				MBR5025





- 1
- 2
- 3
- 4
- 5
- 6
- 7

Schmitz											
Schmitz Cargo 35886											MBR5143
Seddon Atkinson											
Euromover			97 →			N/A					MBR5063
Sitcar											
PSV		B Frame	00 →		MDP5040	MDP3835K	MBA106	MBA007			MBR5039
					MDP5040	MDP3835K	MBA106	MBA007			MBR5040
					MDP5040	MDP3835K	MBA106	MBA007			MBR5075
SMB											
Haldex DB22		Haldex DB22			N/A	MDP3143K	MBA116	N/A			MBR5064
Knorr D1 axle		Knorr SB7000			MDP9001	MDP3087K	MBA110 / MBA120	N/A			MBR5064
Knorr H1 axle		Knorr SB7000			MDP9001	MDP3087K	MBA110 / MBA120	N/A			MBR5064
Knorr K1 axle		Knorr SB7000			MDP9001	MDP3087K	MBA110 / MBA120	N/A			MBR5064
Knorr K5 axle		Knorr SB6000			MDP9003	MDP3095K	MBA110 / MBA121	N/A			MBR5096
Knorr SB6000		Knorr SB6000			MDP9003	MDP3095K	MBA110 / MBA121	N/A			MBR5096
Wabco Pan 19		Wabco Pan19-1			N/A	MDP3126	N/A	N/A			MBR5096
Wabco Pan 19-1		Wabco Pan19-1			N/A	MDP3126	N/A	N/A			MBR5096
Wabco Pan 19-1 plus		Wabco Pan19-1			N/A	MDP3126	N/A	N/A			MBR5096
Wabco Pan 19-2		Wabco Pan19-2			N/A	MDP3141	N/A	N/A			MBR5096
Wabco Pan 22		Haldex DB22			N/A	MDP3143K	MBA116	N/A			MBR5064
Wabco Pan 22-1		Wabco Pan22-1			N/A	MDP3162	N/A	N/A			MBR5064
SOR											
9.5 Series Citybus B9.5 Intercity C9.5 Tourist Bus LC9.5		C Duco	04/02 →		MDP5053	MDP3137K	MBA103	N/A			MBR9001
10.5 Series Citybus B10.5 Intercity Bus C10.5 Tourist Bus LH10.5		C Duco	04/02 →		MDP5053	MDP3137K	MBA103	N/A			MBR9001
Timoney/Teledyne											
P23 Crash Fire Tender (8 x 8)		D2	08/92 →			MDP3043K	MBA109	N/A			



Van Hool									
913CL 915CL, 915TL	Elsa 2	06/04 →		MDP5060	MDP3131K / MAX131K	MBA105			
				MDP5111	MDP3131K / MAX131K	MBA105		MBR9016	
A300 URBAIN	Knorr K85			N/A	MDP3747	N/A	N/A		MBR5026
A300, A300CNG, A300T A308 A320, A320CNG A330, A330CNG	Elsa 2	04/04 →		MDP5097	MDP3131K / MAX131K	MBA105	MCK1141		
				MDP5097	MDP3131K / MAX131K	MBA105	MCK1141	MBR9013	
A320	Elsa 1	03 →		MDP5065	MDP3030K / MAX030K	MBA108	MBA019	MBR9013	
A360, A600	Elsa 2	04/04 →		MDP5097	MDP3131K / MAX131K	MBA105	MCK1141		
AA42, AA440 AA42, AA440	Knorr K85			N/A	MDP3747	N/A	N/A		MBR5026
AG300, AG300CNG, AG300T AG500	Elsa 2	04/04 →		MDP5097	MDP3131K / MAX131K	MBA105	MCK1141		
				MDP5097	MDP3131K / MAX131K	MBA105	MCK1141	MBR9013	
AGG300	Elsa 2	04/04 →		MDP5097	MDP3131K / MAX131K	MBA105	MCK1141		
AGG300 Trailer 1 & Trailer 2	Elsa 2	04/04 →		MDP5097	MDP3131K / MAX131K	MBA105	MCK1141	MBR9013	
Alicron MAN Chassis	Elsa 1			MDP5038	MDP3030K / MAX030K	MBA108	MBA018		MBR5011
Alizee 12m - Scania Chassis	Knorr SB7000	06/96 →		MDP9005	MDP3087K / MAX087K	MBA110	N/A		MBR5025
Alizee 12m - Volvo Chassis	D Lisa	95 – 98		MDP5061	MDP3090K / MAX090K	MBA101			MBR5108
Astron T917	Elsa 1			MDP5038	MDP3030K / MAX030K	MBA108	MBA018		MBR5011
EOS 200	Knorr K85			N/A	MDP3747	N/A	N/A		MBR5003
EOS 80	Knorr K85			N/A	MDP3747	N/A	N/A		MBR5026
EOS 90, 100, 200, 230, 233	Knorr SB6000			MDP9002	MDP3095K / MAX095K	MBA110	N/A		MBR5026
EOS 90, 100, 200, 230, 233 Scania Chassis	Knorr SB7000			MDP9005	MDP3087K / MAX087K	MBA110	N/A		MBR5025
T911 Alicron T915 Alicron T915 Acron	Elsa 2	06/04 →		MDP5060	MDP3131K / MAX131K	MBA105	MCK1141		
				MDP5111	MDP3131K / MAX131K	MBA105	MCK1141	MBR9016	
T915, T917, T918	Elsa 1			MDP5038	MDP3030K / MAX030K	MBA108	MBA018		MBR5011
T916 Altano T917 Acron T917 Altano T917 Astron T918 Altano T924 Astromega DD T927 Astromega DD	Elsa 2	06/04 →		MDP5060	MDP3131K	MBA105	MCK1141		
T916 Altano Centre (Drive Axle) T917 Acron Centre (Drive Axle) T917 Altano Centre (Drive Axle) T917 Astron Centre (Drive Axle) T918 Altano Centre (Drive Axle) T924 Astromega DD Centre (Drive Axle) T927 Astromega DD Centre (Drive Axle)	Elsa 2	06/04 →		MDP5111	MDP3131K	MBA105	MCK1141	MBR9016	





- 1
- 2
- 3
- 4
- 5
- 6
- 7

Volvo										
B7	D Lisa	95 – 00		MDP5061	MDP3090K	MBA101	MBA015			MBR5108
	D Duco	00 →		MDP5057	MDP3125K	MBA104	N/A			
B10B	D Lisa	95 →		MDP5061	MDP3090K	MBA101	MBA015			MBR5108
B10L	D Lisa	95 – 98		MDP5061	MDP3090K	MBA101	MBA015			MBR5108
	D Duco	01/99 →		MDP5057	MDP3125K	MBA104	N/A			MBR5108
B12	D Lisa	95 – 00		MDP5061	MDP3090K	MBA101	MBA015			MBR5108
	D Duco	00 →		MDP5057	MDP3125K	MBA104	N/A			
Merit Pan 19-2	Wabco Pan19-2	01/02 →		N/A	MDP3141	N/A	N/A			
Volvo										
FE 240 -18	Elsa 225-3	05/06 →		MDP5119						
FE Series 240, 260, 280, 300, 320, 340	Elsa 225-1	06 – 12		MDP5106						
	Elsa 225-3	06 – 12		MDP5104						
FE Series 240, 250, 260, 280, 300, 320, 340		13 →			MDP3174K / MAX174K					
	Elsa 225-1	13 →		MDP5106						
FH Series	D Duco	05/00 →		MDP5057	MDP3125K / MAX125K	MBA104	N/A			
FH Series 16 540, 16 580, 16 660, 400, 420, 440, 460, 480, 500, 520, 540	D Duco	05 →		MDP5057	MDP3125K / MAX125K	MBA104	N/A			
	Elsa 225-1	05 →		MDP5106						
		05 →			MDP3174K / MAX174K					
	Duco LE	05 →		MDP5072						
FH Series 16 540, 16 600, 16 700, 420, 460, 500, 540	Elsa 195	05 →		MDP5093	MDP3169K	MBA112	N/A			
		12 →			MDP3174K / MAX174K					
	Elsa 225-1	12 →		MDP5106						
FH Series 16 550, 16 610	Elsa 195	12 →		MDP5093	MDP3169K	MBA112	N/A			
	D Duco	03 →		MDP5057	MDP3125K / MAX125K	MBA104	N/A			
		03 →			MDP3174K / MAX174K					
FH Series 16 550, 16 650	Elsa 225-1	03 →		MDP5106						
	Duco LE	03 →		MDP5072						
	Elsa 195	03 →		MDP5093	MDP3169K	MBA112	N/A			
		12 →			MDP3174K / MAX174K					
FH Series 16 550, 16 650	Elsa 225-1	12 →		MDP5106						
		14 →			MDP3174K / MAX174K					
FH Series 16 550, 16 650, 16 750	Elsa 225-1	14 →		MDP5106						
	Elsa 195	14 →		MDP5093	MDP3169K	MBA112	N/A			



				OE	ALLFIT			OE	ALLFIT
...Volvo									
FH Series 16 600, 16 700, 16 750	D Duco	08 →		MDP5057	MDP3125K / MAX125K	MBA104	N/A		
	Elsa 225-1	08 →		MDP5106					
		08 →			MDP3174K / MAX174K				
	Duco LE	08 →		MDP5072					
	Elsa 195	08 →		MDP5093	MDP3169K	MBA112	N/A		
FH Series	D Duco	05/00 →		MDP5057	MDP3125K / MAX125K	MBA104	N/A		
FL Series 180, 205, 220, 250	D Duco	00 – 06		MDP5057	MDP3125K / MAX125K	MBA104	N/A	MBR9002	
	B Duco	00 – 06		MDP5052	MDP3136K	MBA102	N/A	MBR9002	
		00 – 06						MBR9000	
	D Duco	00 – 06		MDP5057	MDP3125K / MAX125K	MBA104	N/A	MBR9003	
	B Duco	00 – 06		MDP5052	MDP3136K	MBA102	N/A	MBR9003	
FL Series 180, 205, 220, 250		00 – 06						MBR9001	
FL Series 210, 240, 250, 260, 280, 290, 300, 320, 340	Elsa 225-1	06 →		MDP5106					
FL4 Series FL4.06, 4.08, 4.11	Brembo (bframe)	87 – 02/90		MDP5429	MDP3122	MBA107	N/A		MBR5029
				MDP5429	MDP3122	MBA107	N/A		MBR5098
FL6 Series FL6.08, 6.09, 6.10, 6.11	Brembo (bframe)	87 – 02/90		MDP5429	MDP3122	MBA107	N/A		MBR5021
				MDP5429	MDP3122	MBA107	N/A		MBR5031
				MDP5429	MDP3122	MBA107	N/A		
FL Series 17.5" Wheels - B Duco Caliper	B Duco	05/00 →		MDP5052	MDP3136K	MBA102	N/A	MBR9002	
				MDP5052	MDP3136K	MBA102	N/A	MBR9003	
FL Series 19.5" Wheels - C Duco Caliper	C Duco	05/00 →		MDP5053	MDP3137K	MBA103	N/A	MBR9000	
				MDP5053	MDP3137K	MBA103	N/A	MBR9001	
FL Series 22.5" Wheels - D Duco Caliper	D Duco	05/00 →		MDP5057	MDP3125K / MAX125K	MBA104	N/A		
FL6 Series FL6.18	D Duco	00 →		MDP5057	MDP3125K / MAX125K	MBA104	N/A		
FLC Series FLC5	Brembo (bframe)	97 – 99		MDP5429	MDP3122	MBA107	N/A		MBR5029
				MDP5429	MDP3122	MBA107	N/A		MBR5098
FLC Series FLC7	Brembo (bframe)	97 – 99		MDP5429	MDP3122	MBA107	N/A		MBR5021
				MDP5429	MDP3122	MBA107	N/A		MBR5031
				MDP5429	MDP3122	MBA107	N/A		
FLC Series FLC8	Brembo (bframe)	97 – 99		MDP5429	MDP3122	MBA107	N/A		MBR5021
				MDP5429	MDP3122	MBA107	N/A		MBR5031
				MDP5429	MDP3122	MBA107	N/A		
FLC Series 140	B Frame	96 – 00		MDP5453					
				MDP5761					





- 1
- 2
- 3
- 4
- 5
- 6
- 7

...Volvo									
FM Series	D Duco	05/00 →		MDP5057	MDP3125K / MAX125K	MBA104	N/A		
FM Series 7 250, 7 290, 7 310	D Duco	98 – 01		MDP5057	MDP3125K / MAX125K	MBA104	N/A		
FM Series 9 260, 9 300, 9 340, 9 380	D Duco	02 – 05		MDP5057	MDP3125K / MAX125K	MBA104	N/A		
FM Series 10 320, 10 360	D Duco	99 – 01		MDP5057	MDP3125K / MAX125K	MBA104	N/A		
FM Series 12 340, 12 380, 12 420, 12 460	D Duco	98 – 08		MDP5057	MDP3125K / MAX125K	MBA104	N/A		
FM Series 12 500	D Duco	01 – 08		MDP5057	MDP3125K / MAX125K	MBA104	N/A		
FM Series 300, 330, 340, 360, 370, 380, 390, 400, 410, 420, 430, 450, 460, 480, 500	D Duco	05 →		MDP5057	MDP3125K / MAX125K	MBA104	N/A		
	Elsa 225-1	05 →		MDP5106					
		05 →			MDP3174K / MAX174K				
	Duco LE	05 →		MDP5072					
FM Series FMX 330, FMX 370, FMX 380, FMX 410, FMX 420, FMX 450, FMX 460, FMX 500	D Duco	10 →		MDP5057	MDP3125K / MAX125K	MBA104	N/A		
	Elsa 225-1	10 →		MDP5106					
		10 →			MDP3174K / MAX174K				
	Duco LE	10 →		MDP5072					
FM Series FMX 350, FMX 390, FMX 400, FMX 440, FMX 480	D Duco	10 →		MDP5057	MDP3125K / MAX125K	MBA104	N/A		
	Elsa 225-1	10 →		MDP5106					
		10 →			MDP3174K / MAX174K				
	Duco LE	10 →		MDP5072					
FM Series FMX 430	D Duco	10 →		MDP5057	MDP3125K / MAX125K	MBA104	N/A		
	Elsa 225-1	10 →		MDP5106					
		10 →			MDP3174K / MAX174K				
	Duco LE	10 →		MDP5072					
FS Series FS7.16, 7.17, 7.18, 7.19	Brembo (bframe)	10/91 →		MDP5429	MDP3122	MBA107	N/A		MBR5021



.....

.....

.....

.....

.....

.....

.....

.....

.....

.....



A large area of horizontal dashed lines for writing, with a large red silhouette of a running bull in the center.

1

2

3

4

5

6

7



1



2



3



4



5



6



7





1



2



3



4



5



6



7





OE							ABS
MBR1577	280	16	14	78.7	5 x Ø12.6 + 5 x Ø18		
MBR1588	303.8	30	26	140	6		
MBR1589	324	30	26	91	6 x M12 x 1.5		
MBR1761	315	26	23	164.5	6 x Ø18.2 + 2 x M10 x 1.5		
MBR1762	322	30	28	125.8	6 x Ø21 + 3 x M8 x 1.25		
MBR1831	322	30	28	110	12 x M12 x 1.75		
MBR1832	315	26	25	121.7	10 x M12 x 1.75		
MBR2648	304	30	28	128.5	6 x Ø18.15 + 2 x M10 x 1.5		
MBR2649	322	30	28	133.9	8 x Ø20.15 + 2 x M10 x 1.5		
MBR2693	354	30	26	82	10 x Ø12.3		
MBR2694	439.5	44.5	35	100	5 x Ø16.8 + 2 x M14 x 2		
MBR2695	460	48	38	119	10 x M16 x 2		
MBR2711	430	50	46	101.7	12 x M16 x 2		
MBR5001	370	45	41	243.5	8 x Ø22.15 + 2 x M10 x 1.5		
MBR5002	370	45	41	209.3	8 x Ø20.15 + 2 x M10 x 1.5		
MBR5003	406	48	36	175	10 x M16 x 1.5		
MBR5006	312	30	28	137	12 x M12 x 1.75		
MBR5010	324	30	26	102	10 x M14 x 1.5		
MBR5011	434	45	35	135	10 x M16 x 1.5		
MBR5012	330	34	30	104	10 x M14 x 1.5		
MBR5013	330	34	28	124	12 x M12 x 1.5		ABS ring
MBR5014	377	45	38	128	10 x M14 x 1.5		
MBR5015	434	45	41	135	10 x M14 x 1.5		
MBR5016HD	430	45	41	132.5	10 x M14 x 1.5		
MBR5021	322	30	27	90	8 x M14 x 2		
MBR5025	430	45	41	131	10 x M16 x 1.5		
MBR5026	410	48	38	120	12		
MBR5029	322	30	27	90	6 x M14 x 2		
MBR5031	322.2	30	27	138.1	8 x Ø13.1		
MBR5032	430	45	37	131	10 x M16 x 1.5		
MBR5037	303.8	30	26	140	6		
MBR5038	304	29.9	26	120.6	6 x M12 x 1.5		
MBR5039	324	30	26	91	6 x M12 x 1.5		
MBR5040	323.8	30	26	120.5	6 x M12 x 1.5		
MBR5046	430	45	37	130	12 x Ø19.1 + 3 x M12 x 1.5		
MBR5047	430	45	37	160	10		
MBR5048	430	45	37	159.5	10 x Ø23 + 2 x Ø10		
MBR5049	375	44	38	128	10 x M14 x 1.5		
MBR5056	434	45	41	96.75	5 x Ø17.1 + 5 x Ø17.1 + 2 x M14 x 2		
MBR5057	432	45	37	130	12 x Ø19 + 3 x M12 x 1.5		
MBR5059	377	45	37	139.5	12 x Ø19 + 3 x M12 x 1.5		
MBR5060	383	45	40	169.5	10 x Ø23 + 2 x Ø10		



OE		MAX	MIN				ABS
MBR5061	380	45	37	159.5	10 x Ø23 + 2 x Ø10 + 5 x M6 x 1		ABS ring seat
MBR5062	377	45	37	159.5	8 x Ø23 + 2 x Ø10.5		ABS ring seat
MBR5063	432	45	41	138.5	12 x M16 x 2		
MBR5064	430	45	39	155	10 x Ø26.1		ABS ring
MBR5066	334.5	34	28	102.4	10 x Ø14.5		
MBR5068	432	45	35	135	10 x M16 x 1.5		
MBR5070	335	34	28	111	8 x M12 x 1.5		
MBR5071	377	45	37	138.4	8 x M14 x 1.5		
MBR5072	377	45	37	157.5	8 x Ø23		
MBR5073	376	45	37	150	10 x M16 x 2		ABS ring
MBR5074	430	45	37	160.5	10 x Ø22.75		
MBR5075	324	30	27	120.5	6 x M12 x 1.5		
MBR5076	432	45	35	135	10 x M16 x 1.5		
MBR5077	377	45	37	134	14 x Ø14.5		
MBR5078	432	45	35	135	10 x M16 x 1.5		ABS ring
MBR5079	378	45	41	150	8 x Ø24.25 + 2 x M12 x 1.75		
MBR5080	375	45	38	166	10		
MBR5092	330	34	26	129.5	8 x M12 x 1.5		
MBR5093	304	30	27	120.5	6 x M12 x 1.5		
MBR5095	322	30	26	140	6 x Ø21		
MBR5096	377	45	37	138.5	8 x M14 x 1.5		ABS ring
MBR5097	330	34	31	119	6 x M12 x 1.75		ABS ring
MBR5098	322	30	28	115	6 x M12 x 1.5		
MBR5099	380	45	41	159.5	10 x Ø22.5		
MBR5100	329.5	34	31	123	12 x M12 x 1.75		ABS ring
MBR5101	434	45	41	96.75	5 x Ø17.1 + 5 x Ø17.1 + 2 x M14 x 2		
MBR5102	380	45	41	159.5	10 x Ø22.5		ABS ring seat
MBR5103	329.8	34	30	143.5	16 x M12 x 1.75		ABS ring
MBR5104	375	45	40	99	10 x Ø15 + 2 x M14 x 2		
MBR5105	430	45	40	159.5	10 x Ø22.5		
MBR5106	375	45	40	146.1	10 x M14 x 1.5		ABS ring
MBR5107	380	45	40	85.5	10 x Ø15 + 2 x M14 x 2		
MBR5108	438	38	45	127.1	10 x M16 x 1.5		
MBR5109	304	30	28	135	6 x Ø21		
MBR5110	396	48	45	119	10 x M16 x 1.5		
MBR5112	329.5	34	28	137	6 x Ø21		ABS ring
MBR5113	377	45	37	164.5	10 x Ø23		ABS ring seat
MBR5115	375	45	38	166.5	8 x Ø22.6		
MBR5116	377	45	37	223	8 x Ø20 + 2 x M10 x 1.5		ABS ring
MBR5117	330	34	28	80	10 x Ø15 + 2 x M12 x 1.75		
MBR5118	434	45	40	130.3	10 x Ø17.2		
MBR5119	375	45	38	99	10 x Ø15 + 2 x M14 x 2		











OE							ABS
MBR5122	440	45	41	135.35	10 x M16 x 1.5		
MBR5124	430	45	40	150	10 x M16 x 2		ABS ring
MBR5125	430	45	39	48	10 x Ø13.5		
MBR5128	430	37	45	199	10 x 21 + 2 x M12 x 1.5		Integrated bearing
MBR5129	436	45	39	131	12		
MBR5130	330	30	34	95	8 x 14.7 + 2 x M14 x 1.5		
MBR5132	377	45	37	131.5	10 x M14 x 1.5		
MBR5143	430	45	37	169	10		
MBR5183	430	45	37	105	14		
MBR5184	430	45	39	131	10 x M16 x 1.5		
MBR6045	300	28	26	130	6 + 1		
MBR5144	266.5	14.2	13	111	6		
MBR6053	296	10	8	112	5 + 1		
MBR5145	425	45	41	170.5	10		
MBR5139	375.5	45	39	57.5	10 x Ø13.5		
MBR5146	416	28	26	67	10		
MBR5147	425	45	38	159	10		
MBR5185	375	45	37	108	10 x 14.7		
MBR5186	375	45	37	138.5	8 x M14 x 1.5		ABS ring
MBR5180	377	45	37	159.5	10		
MBR6000	254	24	22	43	5		
MBR6001	270	24	22	43	5		
MBR6002	276	25	22	43	5		
MBR6003	294	24	22	43	5		
MBR6004	290	25	23	199.5	6 x Ø12.5 + 6 x M18 x 1.5		
MBR6005	276	22	19	72.5	5 x Ø15.6 + 2 x Ø8.6		
MBR6006	276	16	13	69.5	5 x Ø15.6 + 2 x Ø8.6		
MBR6007	276	16	13	69.5	5 x Ø15.6 + 2 x Ø8.6		ABS ring
MBR6008	290	26	23	53	9 x Ø12.5		
MBR6009	290	22	19	141.5	6 x Ø12.5 + 6 x M18 x 1.5		
MBR6010	289	22	19	84.5	8 x Ø10.5		
MBR6011	275	22	19	76.8	5 + 1 + 1		
MBR6012	272	15.9	14	96.6	5 + 1 + 1		
MBR6013	285	22	19	145	6 Hub + 6		
MBR6014	258	12	10	130	5 + 1 + 1		
MBR6015	305.3	28	26	130	5 + 1		
MBR6016	280	24	21	110	6		
MBR6017	304.7	12	11	130	5 + 2 + 1		
MBR6018	305	28	24	50	5 + 1 + 1		
MBR6021	280	24	22	118	5 + 2		
MBR6022	277.9	24	22	108	5		
MBR6024	280	16	13	160	5		









OE		 MAX	 MIN				ABS
MBR6025	330	34	31	141	8 x Ø20 + 2 x M10 x 1.5		ABS ring
MBR6026	377	45	37	223	8 x Ø20 + 2 x M10 x 1.5		
MBR6027	377	45	37	223	8 x Ø20 + 2 x M10 x 1.5		ABS ring
MBR6028	377	45	37	151	8		ABS ring
MBR6029	377	45	37	107	14 x Ø15.3		
MBR6030	296	16	13	69.5	6 x Ø15.6 + Ø8.6		ABS ring
MBR6031	296	16	13	69.5	6		ABS ring
MBR6032	294	24	21	83.5	8		
MBR6033	294	24	21	87.5	8 x Ø10.5		
MBR6034	290	28	25	46	9 x Ø12.5		
MBR6035	300	28	25	74.5	6 x Ø15.5 + Ø8.6		
MBR6036	432	45	41	138.5	12 x M16 x 2		
MBR6037	432	45	37	154.5	12 x M16 x 2		ABS ring
MBR6039	276	22	19	72.5	5 x Ø15.6 + 2 x Ø8.6		
MBR6040	306	22	19	136.5	6 x M10 x 1.25		
MBR6041	290	22	19	140	6 x Ø12.5 + 6 x M18 x 1.5		
MBR6042	290	22	19	78	8 x Ø10.7		
MBR9000	375	45		116	14 x Ø14.6 + 2 x M10 x 1.5		
MBR9001	374.7	45		150	8 x Ø20.15 + 2 x M10 x 1.5		
MBR9002	336.8	30		100.5	10 x Ø14.6 + 2 x M10 x 2.0		
MBR9003	336	30		139	8 x Ø20.15 + 2 x M10 x 1.5		
MBR9004	434	45		150	10 x M16 x 2.0		
MBR9005	434	45		150	12		
MBR9006	434	45		145	12 x M16		
MBR9007	434	45		160	12 x M14 x 1.5		
MBR9008	434	45		97	10 x Ø17.15 + 2 x M14 x 2.0		
MBR9010	438	45		130.5	10		
MBR9011	434	45		162.9	10 x Ø32.9		
MBR9012	434	45		170	10 x Ø32.9		
MBR9013	434	45		130	10 x M16 x 1.5		
MBR9014	377	45		150	8 x Ø24.5		
MBR9015	377	45		150	10 x Ø24.5		
MBR9016	434	45		135	10 x M16 x 1.5		
MBR9017	377	44		150	8		
MBR9018	377	45		150	10		
MBR9020	434	45		108	10 x Ø17.15 + 2 x M14		
MBR9025	377	45		150	8 x Ø20.25 + 2 x M10 x 1.5		



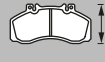

				WVA		
MDP5000	250	118	28	29030	D3	Evobus GmbH
MDP5004	175	85	22	29065	Lucas B2x60	Renault
MDP5005	176	78	22	29067	B Frame	Renault
MDP5008	204	96	24	29043	D2	Renault
MDP5017	250	118	28	29083	D3	Evobus GmbH
MDP5019	250	114	28	29090	D Lisa	Alexander Dennis Ltd
MDP5020	175	77	22	29067	B Frame	Iveco SPA
MDP5027	204	96	24	29043	D2	Alexander Dennis Limited
MDP5030	176	78	22	29039	Lucas B2x68	Nissan / Volvo
MDP5031	250	118	28	29030	D3	Evobus GmbH
MDP5032	250	118	30	29053	D3	Evobus GmbH
MDP5033	250	118	28	29030	D3	Evobus GmbH
MDP5034	250	118	30	29053	D3	Evobus GmbH
MDP5035	214	112	25	29100	M140	Nissan
MDP5037	204	96	24	29100	C Lisa	DAF Trucks NV
MDP5038	250	118	28	29113 / 29030	D3 + Elsa 1	MAN Nutzfahrzeuge AG
MDP5039	250	118	30	29114	D3 + Elsa 1	MAN Nutzfahrzeuge AG
MDP5040	175	85	22	29835	B Frame	Daimler Chrysler AG
MDP5042	250	114	28	29090	D Lisa	Renault
MDP5045	250	118	28	29083	D3	MAN / Mercedes
MDP5049	175	78	22	29039	B Frame	Volvo
MDP5050	250	118	28	29030	D3	Renault
MDP5051	250	118	28	29030	D3	Renault
MDP5052	176	89	29	29136	B Duco	Volvo Parts
MDP5053	210	102	30	29137	C Duco	Volvo Parts
MDP5054	250	118	28	29113	D3	MAN Nutzfahrzeuge AG
MDP5056	250	118	30	29131	Elsa 2	Renault / Irisbus
MDP5057	250	110	30	29125	D Duco	Volvo Parts Corp
MDP5059	250	118	30	29131	Elsa 2	MAN ERF UK Ltd
MDP5060	250	118	30	29131	D2	MAN Nutzfahrzeuge AG
MDP5061	250	114	28	29090	D Lisa	Volvo Bus
MDP5065	250	118	28	29113 / 29030	Elsa 1	MAN Nutzfahrzeuge AG
MDP5066	250	118	30	29114	Elsa 1	MAN Nutzfahrzeuge AG
MDP5071	250	114	28	29090	D Lisa	Dennis
MDP5072	215	97	29	29151	Duco LE	Volvo Parts Corp
MDP5073	250	118	30	29131	Elsa 2	ROR
MDP5076	205	100	27	29124	DX195	ROR
MDP5083	249	118	30	29150	DX225	Bredamenarinibus SPA , Iveco
MDP5083K	249	118	30	29150	DX225	Bredamenarinibus SPA , Iveco
MDP5088	250	118	28	29030	D3	MAN / Mercedes
MDP5090	250	118	28	29030	D3	MAN / Mercedes
MDP5091	250	107	28	29030	D3 / Elsa 1	MAN / Mercedes



				WVA		
MDP5092	175	69	21	29835	B Frame	Mercedes
MDP5093	210	104	30	29169 / 29177	Elsa 195	ROR / Renault / Volvo
MDP5097	250	118	30	29131	Elsa 2	MAN Nutzfahrzeuge AG
MDP5099	250	118	30	29131	Elsa 2	MAN / Volvo
MDP5101	250	106	29	29174 / 29273	Elsa 225-3	Renault
MDP5102	215	97	29	29173	Elsa 225-1	Renault
MDP5103	210	96	29	29177	Elsa 195 VGT	Renault
MDP5104	256	110	29	29174	Elsa 225-3	Volvo
MDP5106	215	97	29	29173 / 29203 / 29272	Elsa 225-1	Volvo
MDP5108	210	97	29	29177	Elsa 195 VGT	Volvo Parts Corp
MDP5110	250	118	29	29030	D3 / Elsa 1	Van Hool / Mercedes / Kässbohrer
MDP5111	250	118	30	29131 / 29156	Elsa 2	Irisbus / Optare
MDP5112	250	118	30	29131	Elsa 2	MAN
MDP5115	250	118	30	29131	Elsa 2	Renault / Volvo
MDP5116	249	118	30	29131 / 29156	Elsa 2	Irisbus
MDP5117	216	96	29	29211	Elsa 225L	ROR
MDP5119	250	107	29	29174	Elsa 225-3	Volvo
MDP5120	250	118	30	29053	D3 / Elsa 1	MAN
MDP5121	250	118	30	29131 / 29156	Elsa 2	MAN
MDP5122	250	114	29	29187	EX225H2	Optare
MDP5125	250	114	28	29090	D Lisa	Alexander Dennis Ltd
MDP5429	175	78	22	29302	B Frame	Volvo Parts
MDP5453	176	78	22	29302	B Frame	DAF Trucks NV
MDP5481	175	85	22	29835	B Frame	Daimler Chrysler AG
MDP5761	177	78	22	29039	B Frame	Volvo Parts
MDP5842	175	86	22	29065	B Frame	DAF Trucks NV, Iveco Euro Cargo
MDP9000	248	108	30	29061 / 29179 / 29087	Knorr SB7 / SN7	Mercedes Truck
MDP9001	246	108	30	29061	Knorr SB7 / SN7	Mercedes Trailer
MDP9002	211	90	30	29095	Knorr SB6 / SN6	MAN / Iveco Truck
MDP9004	248	108	30	29105	Knorr SB7000	Iveco Truck
MDP9005	248	108	30	29061 / 29087	Knorr SB/SN7	Mercedes Bus
MDP9006	246	108	30	29167	Knorr SB7000	BPW
MDP9007	210	90	30	29165	Knorr SB7000	BPW





				WVA		
MDP3011K	241	125	25	29011	Bendix ADB4300	Iveco
MDP3030K / MAX030K	249.6	118.4	27.5	29030, 29083, 29113	Meritor D3 / Elsa 1	MAN, Mercedes, Renault
MDP3032K	206	107	25	29032	Bendix ADB3700	Iveco
MDP3043K	204	97	24	29043	Meritor D2	Dennis, Renault
MDP3087K / MAX087K	243.5	99.9	29.5	29087, 29042, 29106, 29108, 29109, 29163, 29179, 29202, 29253, 29059	Knorr SN / SB7	BPM, DAF, Dennis, Iveco, Mercedes, Neoplan, SAF, Scania, Schmitz, SMB
MDP3090K / MAX090K	249.6	114	28	29090	Meritor D Lisa	Auwärter, Dennis, Renault
MDP3095K / MAX095K	210.4	92	30	29095, 29197	Knorr SN / SB6	BPM, DAF, MAN, Mercedes, SAF, SMB
MDP3124K	205.4	102	27	29124, 29155	Meritor DX195	ROR
MDP3125K / MAX125K	248.5	110.5	29.5	29125, 29277	Meritor D Duco	ROR, Volvo
MDP3131K / MAX131K	249.5	118	30	29131	Meritor Elsa 2	ERF, MAN, Renault, ROR
MDP3136K	175.5	89	29	29136	Meritor B Duco	Volvo
MDP3137K	210	102	29	29137	Meritor C Duco	Volvo
MDP3143K	248	105	30	29120, 29143, 29185	Haldex DB22	SAF, Scania, SMB
MDP3148K	173.6	84	27	29148, 29115, 29116, 29183	Knorr SN / SB5	Mercedes
MDP3165K*	211	92	30	29165	Knorr SN / SB6	BPW
MDP3167K*	248	109.5	30	29167	Knorr SN / SB7	BPW
MDP3169K	210.5	99.75	30	29169, 29177	Meritor Elsa 195	ROR, Volvo
MDP3171K*	211	108	30	29171, 29158	Knorr SK7	BPW, SAF, Schmitz
MDP3173K / MAX173K	216.2	96.52	29	29173, 29203	Meritor Elsa 225-1	Renault Volvo
MDP3174K / MAX174K	249.3	107	29.2	29174, 29218, 29273	Meritor Elsa 225-3	Renault Volvo
MDP3835K	175	85	22	29835	Meritor B Frame	Alexander PSV, Auwärter, Mercedes, Optare
MDP3013	183	87	21	29013, 29014	SEE 2X67	Dennis, MAN, Renault
MDP3017	191	89	23	29017	Wabco 456 F-Ö	DAF, Iveco, Leyland
MDP3024	191	89	23	29024	Wabco 456 F-Ö	DAF, Iveco
MDP3077	205	106	27	29077	Wabco 1600 V-G	DAF
MDP3088 / MAX088K	175.4	81.9	25	29088	Wabco Pan 17	DAF, Iveco, MAN, Renault
MDP3122	175	86	22	29122	Brembo 2x60	Auwärter, AWD, Ford, Iveco, Mercedes, Optare, Renault, Volvo,
MDP3126	211	93	30	29126, 29159	Wabco Pan 19-1	SAF
MDP3141	205	100	30	29141, 29119	Wabco Pan 19-2	DAF, Dennis
MDP3142	205	100	30	29142	Wabco Pan 19-2	Renault
MDP3162	210	110	31	29162	Wabco Pan 22-1	SAF, SMB
MDP3498	180	114	20	29498	Knorr 2V20	Kässbohrer, Setra
MDP3747	140	121	32	29747	Knorr K85	DAF, Iveco, Leyland
MDP3244K / MAX244K	207.16	111	34.5	29244	Knorr SL7	Mercedes
MDP3246K / MAX246K	244.2	111	34.5	29246	Knorr SM7	Mercedes

* MDP3165K, MDP3167K & MDP3171K - NOT AVAILABLE IN GERMANY

* MDP3165K, MDP3167K & MDP3171K - IN DEUTSCHLAND NICHT VERFÜGBAR



Handwriting practice lines consisting of a solid top line, a dashed midline, and a solid bottom line, spanning the width of the page.



1



2



3



4



5



6



7





1



2



3



4



5



6



7



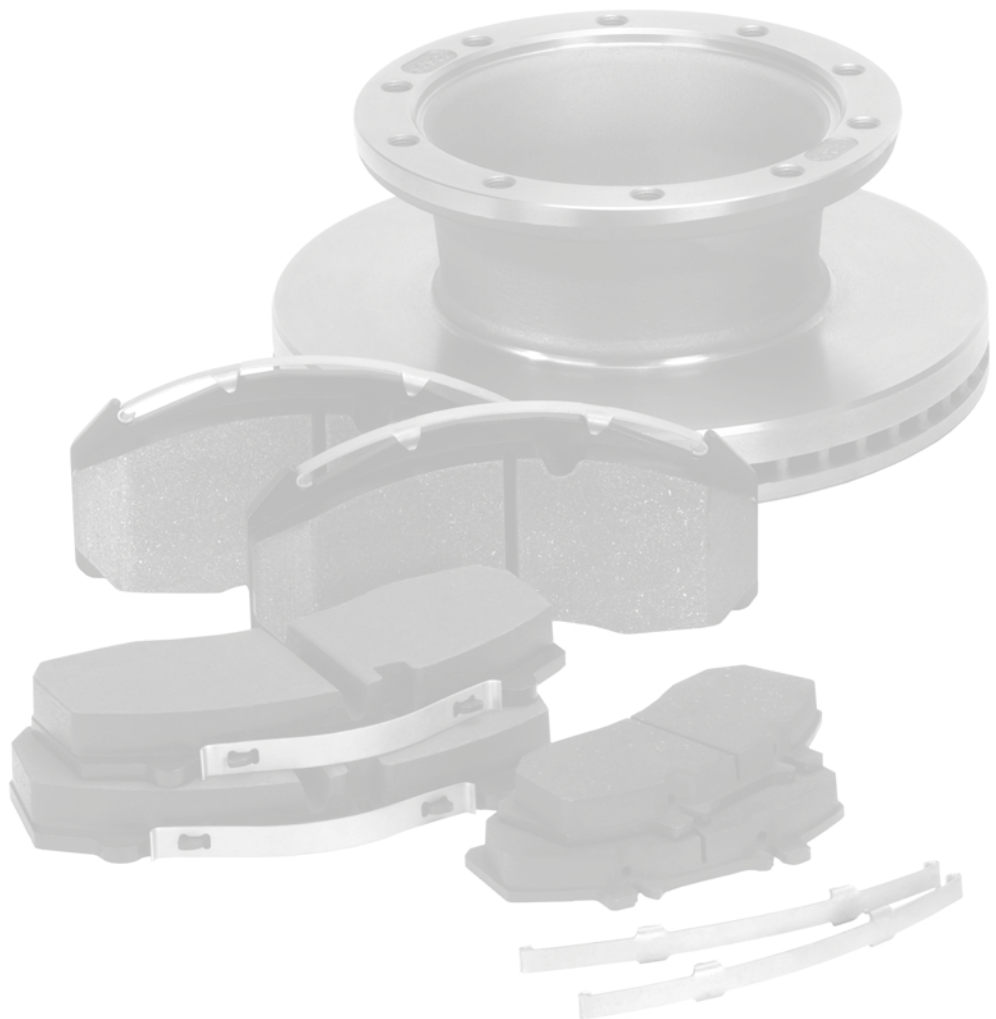

1



2



3



4



5



6



7





	OE	
Bova		
	8285472000	MBR5032
BPW		
	03.088.34.01.7	MBR5047
	03.088.34.02.0	MBR5061
	03.088.34.03.0	MBR5062
	03.088.34.04.0	MBR5061
	03.088.34.04.7	MBR5061
	03.088.34.06.0	MBR5061
	03.088.34.08.0	MBR5060
	03.088.34.08.7	MBR5060
	03.088.34.10.0	MBR5099
	03.088.34.13.0	MBR5102
	03.088.35.01.0	MBR5047
	03.088.35.03.0	MBR5048
	03.088.35.05.0	MBR5105
	03.088.35.05.7	MBR5105
	0308834020	MBR5180
	0308834037	MBR5062
	0308834040	MBR5061
	0308834067	MBR5180
	0308834070	MBR5113
	0308834130	MBR5102
	308834020	MBR5180
	308834037	MBR5062
	308834040	MBR5061
	308834067	MBR5180
	308834070	MBR5113
	308834130	MBR5102
	SB3745	MBR5180
DAF		
	1238372	MBR2695
	1400069	MBR5104
	1400163	MBR5100
	1400273	MBR5097
	1400284	MBR5106
	1403758	MBR5103
	1408253	MBR5103
	1525365	MBR5184
	299095	MBR2695
	352281	MBR2695
	AMPA014	MBR5049

	OE	
	AMPB860	MBR5049
	AMPB887	MBR5006
	MAK2487	MBR5006
	MAK2578	MBR5006
	NJK2785	MBR5049
	PAK3545	MBR1832
	PAK3546	MBR5006
	PAK5513	MBR5006
Dennis		
	13162046	MBR5185
	13162047	MBR5186
	655750	MBR5118
	655750	MBR9010
	657303	MBR5183
	658439	MBR5183
	658470	MBR5183
	658621	MBR5185
	658622	MBR5186
	DE1050	MBR5183
ERF		
	306815-8	MBR9005
	306908-0	MBR9006
Fiat		
	51728377	MBR6021
Ford		
	1361298	MBR6022
	1387152	MBR6024
	1451161	MBR6024
	4041427	MBR6002
	4041428	MBR6003
	4395257	MBR6002
	5022610	MBR6000
	5025610	MBR6000
	5025611	MBR6001
	5029815	MBR6000
	5029816	MBR6001
	1C1W1125AA	MBR6002
	1C1W1125AB	MBR6002
	92VX1125BA	MBR6001
	95VX1125BA	MBR6001
	YC1W1125BA	MBR6003

	OE	
Fruehauf		
	M069018	MBR5064
	M200135	MBR5064
	M20013501	MBR5064
Iveco		
	13162006	MBR5147
	1904529	MBR5144
	1904532	MBR1761
	1904693	MBR6004
	1904696	MBR6004
	1906461	MBR5063
	1906466	MBR6025
	1907526	MBR2649
	1907528	MBR2648
	1907529	MBR2648
	1907568	MBR5002
	1907569	MBR5001
	1907631	MBR2711
	1907725	MBR2648
	1907726	MBR2649
	1907764	MBR5145
	1908577	MBR2648
	1908578	MBR2649
	1908614	MBR2711
	1908772	MBR6009
	1908773	MBR6010
	1908793	MBR6010
	2991646	MBR6006
	2991979	MBR2711
	2992271	MBR5116
	2992291	MBR6026
	2992470	MBR5063
	2992477	MBR6036
	2992635	MBR6027
	2992636	MBR6028
	2994031	MBR5129
	2995702	MBR6029
	2995812	MBR6037
	2995894	MBR6029
	2996027	MBR6030
	2996028	MBR6031
	2996033	MBR6032



	OE	
...Iveco		
2996043		MBR6033
2996121		MBR6034
2996131		MBR6035
2996327		MBR6036
2996328		MBR6037
42470836		MBR6005
42470836		MBR6039
42470842		MBR6009
42471034		MBR6007
4247111		MBR6010
42471111		MBR6010
42471150		MBR6040
42471214		MBR6008
42546401		MBR6041
5001092		MBR5147
500306590		MBR6005
5010216437		MBR9008
5010422363		MBR9008
5010422593		MBR9008
7171274		MBR1761
7173036		MBR2648
7180256		MBR6010
7182299		MBR6006
7182300		MBR6007
7183632		MBR6025
7183776		MBR6026
7183804		MBR5116
7183805		MBR6026
7184077		MBR6027
7184078		MBR6028
7184136		MBR6036
7185503		MBR6037
7186309		MBR6030
7187541		MBR6029
7188080		MBR6031
7189476		MBR6037
93161407		MBR5146
93814402		MBR6004
93821918		MBR6009
Iveco Ford		
6172906		MBR1762



	OE	
A4038860		MBR1762
Kässbohrer		
17924111111		MBR5003
17924111130		MBR5110
1.79241E+11		MBR5003
1.79241E+11		MBR5110
8284000147		MBR5110
8284000208		MBR5003
828539000		MBR5076
11350103		MBR5110
11351605		MBR5003
Kögl Traax Axle		
6604915		MBR9020
MAN		
81508030009		MBR5011
81508030014		MBR5011
81508030021		MBR5068
81508030022		MBR5013
81508030023		MBR5057
81508030027		MBR5014
81508030028		MBR5078
81508030031		MBR5057
81508030038		MBR5057
81508030040		MBR5057
81508030041		MBR5068
81508030048		MBR5078
81508030057		MBR5014
81508030061		MBR5013
81508030010		MBR5010
81508030026		MBR5012
81508030039		MBR5092
N1.01101.5508		MBR5184
MCW		
X1857658		MBR1831
X2057948		MBR1831
Mercedes Benz		
3564210312		MBR5015
3564211012		MBR5015
3564211212		MBR5015
5010216932		MBR5095
5010260102		MBR5095
6014200272		MBR1577



	OE	
6014215112		MBR1577
6384210112		MBR5066
6394230112		MBR6053
6684210112		MBR5037
6684210212		MBR5039
6684230012		MBR5038
6684230012		MBR5040
6684230212		MBR5093
6684230412		MBR5093
6684230512		MBR5075
6694210112		MBR1588
6703560312		MBR1589
6703560312		MBR5039
6704210112		MBR1589
6704210312		MBR1589
6754210012		MBR5132
9014210312		MBR6011
9014210612		MBR6011
9014230412		MBR6014
9014230612		MBR6014
9014230812		MBR6014
9024210312		MBR6011
9024210612		MBR6011
9024210712		MBR6011
9024210912		MBR6011
9024210912/04		MBR6011
9024230112		MBR6012
9024230312		MBR6012
9024230412		MBR6012
9024230512		MBR6012
9024234312		MBR6012
9044230212		MBR6013
9044230312		MBR6013
9064210012		MBR6045
9424210912		MBR5016HD
9424211012		MBR5016HD
9424211112		MBR5016HD
9424211212		MBR5016HD
9424212112		MBR5016HD
9424230012		MBR5016HD
9434210312		MBR5128
9704210012		MBR5066





	OE	
...Mercedes Benz		
9704210112		MBR5066
9704210212		MBR5066
9704210612		MBR5066
9704230412		MBR5070
9754210112		MBR5077
9754210212		MBR5077
9754230012		MBR5071
9754230312		MBR5071
9754230612		MBR5071
2D0615301A		MBR6011
2D0615301B		MBR6011
2D0615601A		MBR6012
2D0615601B		MBR6013
A2D0615301A		MBR6011
A2D0615301B		MBR6011
A2D0615601A		MBR6012
A2D0615601B		MBR6013
A3564210312		MBR5015
A3564211012		MBR5015
A3564211212		MBR5015
A5010216932		MBR5095
A5010260102		MBR5095
A6014200272		MBR1577
A6014215112		MBR1577
A6384210112		MBR5066
A6394230112		MBR6053
A6684210112		MBR5037
A6684210212		MBR5039
A6684230012		MBR5038
A6684230012		MBR5040
A6684230212		MBR5093
A6684230412		MBR5093
A6684230512		MBR5075
A6694210112		MBR1588
A6703560312		MBR1589
A6703560312		MBR5039
A6704210112		MBR1589
A6704210312		MBR1589
A6754210012		MBR5132
A9014210312		MBR6011
A9014210612		MBR6011

	OE	
A9014230412		MBR6014
A9014230612		MBR6014
A9014230812		MBR6014
A9024210312		MBR6011
A9024210612		MBR6011
A9024210712		MBR6011
A9024210912		MBR6011
A9024210912/04		MBR6011
A9024230112		MBR6012
A9024230312		MBR6012
A9024230412		MBR6012
A9024230512		MBR6012
A9024234312		MBR6012
A9044230212		MBR6013
A9044230312		MBR6013
A9064210012		MBR6045
A9424210912		MBR5016HD
A9424211012		MBR5016HD
A9424211112		MBR5016HD
A9424211212		MBR5016HD
A9424212112		MBR5016HD
A9424230012		MBR5016HD
A9434210312		MBR5128
A9704210012		MBR5066
A9704210112		MBR5066
A9704210212		MBR5066
A9704210612		MBR5066
A9704230412		MBR5070
A9754210112		MBR5077
A9754210212		MBR5077
A9754230012		MBR5071
A9754230312		MBR5071
A9754230612		MBR5071
Neoplan		
0 801 621 00		MBR5026
1415147		MBR5032
351032		MBR5026
67792085		MBR5029
82135830		MBR5032
Opel		
4403038		MBR6015
4500098		MBR6016

	OE	
9111038		MBR6015
9111045		MBR6017
9160398		MBR6016
Optare		
24240014		MBR5130
Renault		
5000297808		MBR2693
5000450158		MBR2693
5000545242		MBR2693
5000792539		MBR2694
5001864712		MBR6042
5010216437		MBR9008
5010216548		MBR2694
5010216931		MBR5109
5010260101		MBR5109
5010260218		MBR5107
5010260609		MBR6042
5010422262		MBR5117
5010422263		MBR5112
5010422363		MBR5056
5010422363		MBR9008
5010422364		MBR5101
5010422364		MBR9007
5010422593		MBR5056
5010422593		MBR9008
5010525014		MBR5119
5010525308		MBR5117
5010525326		MBR9011
5010525362		MBR5115
5010525364		MBR5080
5010525508		MBR9012
5021180772		MBR9018
5021200858		MBR9014
5021210521		MBR9017
7700302128		MBR6016
7700314064		MBR6015
7700314107		MBR6017
7701206845		MBR6018
7701260845		MBR6018
ROR		
21225115		MBR5073
21227349		MBR5073



	OE	
...ROR		
	21224263	MBR5079
	3218R1500	MBR9025
	68323825	MBR5124
SAF		
	4079000300	MBR5074
	4079000400	MBR5072
	4079000500	MBR5046
	4079000501	MBR5046
	4079000700	MBR5059
	4079000701	MBR5059
	4079001000	MBR5139
	4079001001	MBR5139
	4079001003	MBR5139
	4079001300	MBR5125
	4079001301	MBR5125
Scania		
	1402272	MBR5025
	1415147	MBR5032



	OE	
	1852817	MBR5025
Schimtz		
	017870	MBR5143
	17870	MBR5143
SMB		
	103836	MBR5096
	M069018	MBR5064
	M078157	MBR5096
	M200135	MBR5064
	M20013501	MBR5064
Van Hool		
	351032	MBR5026
	52E908472	MBR5026
Van Hool/Volvo		
	20564467	MBR9013
	20995144	MBR9013
Volvo		
	3095672	MBR9000
	22591141183	MBR5029



	OE	
	22591141184	MBR5021
	3095652	MBR9002
	3095653	MBR9003
	3095673	MBR9001
	3112965	MBR5108
	6774686	MBR5021
	67746867	MBR5021
	6775227	MBR5031
	67752273	MBR5031
	67752279	MBR5031
	6779208	MBR5029
	6779209	MBR5098
	67792093	MBR5098
	68323232	MBR9000
	68323233	MBR9001
VW		
	2D0615601	MBR6014
	2D0615601C	MBR6014



A series of horizontal dotted lines for handwritten notes or comments.

1



2



3



4



5



6



7





OE	MDP
Alexander Dennis Ltd	
655377-1	MDP5019
653563-7	MDP5027
655377-1	MDP5125
Bova	
204552	MDP3087K
BPW	
02.0312.14.00	MDP3087K
02.0312.17.00	MDP3087K
05.362.70.01.0	MDP3087K
05.362.70.02.0	MDP3087K
09.801.02.20.0	MDP3087K
09.801.02.57.0	MDP3087K
09.801.02.92.0	MDP3087K
09.801.06.20.0	MDP3087K
09.801.06.36.0	MDP3087K
310687090	MBD2004
509290040	MDP3165K*
509290050	MDP3165K*
509290070	MDP3167K*
509290090	MDP3167K*
509290100	MDP3165K*
536270020	MDP3087K
536270020	MDP3167K*
980102570	MDP3087K
980102570	MDP3167K*
980102750	MDP3165K*
980102920	MDP3087K
980102920	MDP3167K*
980102930	MDP3165K*
980106200	MDP3087K
980106200	MDP3167K*
980106210	MDP3165K*
980106350	MDP3165K*
980106360	MDP3167K*
980106430	MDP3165K*
980106450	MDP3167K*
980106960	MDP3167K*
980107090	MDP3165K*
DAF	
1436901	MDP3088
1439324	MDP3087K

OE	MDP
1617343	MDP3087K
DAF Trucks NV	
1522191	MDP5037
1522203	MDP5453
DAF Trucks NV, Iveco Euro Cargo	
1522201	MDP5842
Daimler Chrysler AG	
A0024206220	MDP5481
A0034201520005	MDP5040
A0034207720	MDP5040
A6694200120	MDP5481
Dennis	
1519449	MDP5071
616441	MDP5071
Evobus GmbH	
8285408532	MDP5034
8285408534	MDP5033
82854084630	MDP5031
8.285.388.435	MDP5000
8 285 388 533 0	MDP5000
8 285 408 464 0	MDP5032
A 002 420 55.20	MDP5017
Irisbus	
5006028410	MDP5056
Irisbus / Optare	
28060035	MDP5111
Iveco	
1906416	MDP3122
1906467	MDP3088
1907527	MBR2649
254625	MDP5083
2992336	MDP3095K
2992348	MDP3087K
2992476	MDP3087K
2992669	MDP5083K
2995552	MDP5083
2995637	MDP3087K
2996065	MDP5116
2996068	MDP5116
2996378	MDP3087K
2996468	MDP3095K
2996515	MDP3087K

OE	MDP
2996518	MDP3087K
41211278	MDP3087K
42555669	MDP3122
5006028410	MDP5116
504079365	MBR6041
504121605	MBR6035
504121612	MBR6034
7172880	MBR5002
7172881	MBR5002
7172882	MBR5001
7182681	MBR2648
7182682	MBR2649
7185410	MBR6007
7186485	MBR6033
7188210	MBR6032
7189475	MBR6036
93800492	MBR5144
Iveco Spa	
1906297	MDP5020
1906298	MDP5021
Kässbohrer	
8285408463	MDP5110
8285408534	MDP5110
8285515573	MDP3087K
MAN	
8150805005	MDP5090
8150805005	MDP5091
81508045088	MDP5120
81508205023	MDP3088
81508205025	MDP3088
81508205029	MDP3088
81508205066	MDP5045
81508205072	MDP5099
81508205072	MDP5121
81508205072	MDP3131K
81508205073	MDP5112
81508205080	MDP5121
81508205080	MDP3131K
81508205091	MDP3030K
81508205099	MDP3087K
81508206006	MDP3088
81508206020	MDP3088

* MDP3165K, MDP3167K & MDP3171K - NOT AVAILABLE IN GERMANY

* MDP3165K, MDP3167K & MDP3171K - IN DEUTSCHLAND NICHT VERFÜGBAR





	OE	
...MAN		
81508206024		MDP5045
81508206026		MDP5120
81508206030		MDP3087K
81508206032		MDP3087K
81508206033		MDP3087K
81508206041		MDP5099
81508206041		MDP3131K
81508206042		MDP3088
81508206044		MDP3030K
81508206045		MDP5120
81508206046		MDP5088
81508206046		MDP3030K
81508206051		MDP5099
81508206051		MDP5121
81508206051		MDP3131K
81508206052		MDP3131K
81508206055		MDP3087K
81508206056		MDP3087K
8158206052		MDP5112
MAN ERF UK Ltd		
35503084795		MDP5059
MAN Nutzfahrzeuge AG		
81508205064		MDP5065
81508206016		MDP5038
81508206017		MDP5039
81508206025		MDP5054
81508206031		MDP5060
81508206034		MDP5038
81508206035		MDP5039
81508206036		MDP5065
81508206037		MDP5066
81508206038		MDP5054
81508206041		MDP5060
81508206044		MDP5065
81508206045		MDP5039
81508206045		MDP5066
81508206046		MDP5038
81508206051		MDP5060
81508206052		MDP5097
81.50820.6014		MDP5038
81.50820.6015		MDP5039

	OE	
Mercedes		
24200820		MDP5088
24205520		MDP5110
24205720		MDP5092
34205520		MDP5110
34205520		MDP5090
34205520		MDP5091
4200276		MDP5045
6694200020		MDP5092
6704202820		MDP5092
Mercedes-Benz		
000 421 05 10		MDP3087K
000 421 18 10		MDP3087K
000 421 43 10		MDP3087K
000 423 66 10		MDP3087K
002 420 49 20		MDP3087K
002 420 70 20		MDP3087K
003 420 10 20		MDP3087K
003 420 16 20		MDP3087K
003 420 20 20		MDP3087K
003 420 22 20		MDP3087K
003 420 35 20		MDP3087K
004 420 22 20		MDP3087K
006 420 14 20		MDP3246K
006 420 15 20		MDP3244K
006 420 52 20		MDP3246K
006 420 53 20		MDP3244K
14211710		MDP3095K
2420222010		MDP3087K
24204920		MDP3087K
24207820		MDP3095K
24207920		MDP3095K
34201620		MDP3087K
34202020		MDP3087K
34202220		MDP3087K
34203520		MDP3087K
4210510		MDP3087K
4210710		MDP3095K
4214310		MDP3087K
44202220		MDP3087K
54202320		MDP3095K
64201420		MDP3246K

	OE	
64201520		MDP3244K
64205220		MDP3246K
64205320		MDP3244K
A0004210510		MDP3087K
A0004210710		MDP3095K
A0004211810		MDP3087K
A0004214310		MDP3087K
A0004236610		MDP3087K
A0014211710		MDP3095K
A0024204920		MDP3087K
A0024207020		MDP3087K
A0024207820		MDP3095K
A0024207920		MDP3095K
A0034201020		MDP3087K
A0034201620		MDP3087K
A0034202020		MDP3087K
A0034202220		MDP3087K
A0034203520		MDP3087K
A0044202220		MDP3087K
A0054202320		MDP3095K
A006 420 14 20		MDP3246K
A006 420 15 20		MDP3244K
A006 420 52 20		MDP3246K
A006 420 53 20		MDP3244K
A0064201420		MDP3246K
A0064201520		MDP3244K
A0064205220		MDP3246K
A0064205320		MDP3244K
Neoplan		
82135100		MDP3087K
Nissan		
06902964-0		MDP5030
06902970-0		MDP5035
06903006-0		MDP5035
Optare		
28060035#B		MDP5122
Renault		
5001014694		MDP5004
5001014704		MDP5005
5001822987		MDP5008
5001825638		MDP5004
5001831161		MDP5042

1

2

3

4

5

6

7



	OE	
...Renault		
	5001833114	MDP5042
	5001846034	MDP5042
	5001854341	MDP5051
	5001854342	MDP5050
	5001855646	MDP5056
	5001864363	MDP5101
	5001864363	MDP5115
	5001864364	MDP5101
	5001864364	MDP5115
	5001864365	MDP5102
	5001864380	MDP5103
	7421399929	MDP5101
	7421496555	MDP5101
Renault Trucks		
	5001855646	MDP3131K
	5010848607	MDP3088
ROR / MAN		
	35503112160	MDP5073
	N2508206022	MDP5076
ROR / Paccar		
	906245	MDP5117
ROR / Renault		
	5021139271	MDP5076
	5021174771	MDP5073
ROR / Renault / Volvo		
	20568713	MDP5093
	20765963 5	MDP5093
	5001864380	MDP5093
	68324665	MDP5093
ROR / Scania		
	2114543	MDP5117
SAE		
	9317202	MDP3087K



	OE	
	9317-202	MDP3087K
SAF		
	3057007700	MDP3087K
	3057007800	MDP3095K
	3057007900	MDP3087K
	4057427700	MDP3087K
	4079001302	MBR5125
	5317002300	MDP3087K
	5317002400	MDP3095K
Scania		
	1390428	MDP3087K
	1521979	MDP3087K
	1734529	MDP3087K
	1856 08	MDP3087K
	1890861	MDP3087K
Setra		
	8 285 388 435	MDP3030K
SMB		
	M100669	MDP3087K
Volvo		
	20526568	MDP5104
	20535922	MDP5099
	20560412	MDP5104
	20560414	MDP5106
	20568711	MDP5104
	20568711	MDP5115
	20568712	MDP5106
	20568715	MDP5106
	270530	MDP5049
	20768092	MDP3125K
	20918891	MDP3125K
	20931343	MDP3125K
	209313430	MDP3125K
	20932682	MDP3125K



	OE	
	20976509	MDP3131K
	20976509	MDP5099
	21024701	MDP5119
	21024702	MDP5119
	21309468	MDP3131K
	21309468	MDP5099
	21352573	MDP5106
	21496551	MDP5106
	276147-6	MDP5030
	3090048-4	MDP5049
	3095396	MDP3125K
	5001864365	MDP5106
	6779999	MDP5049
	85107768	MDP3131K
	85107768	MDP5099
Volvo Bus		
	3093919	MDP5061
	8550611	MDP5061
Volvo Parts		
	276147	MDP5761
	309048	MDP5429
	3093531	MDP5052
	3093532	MDP5053
Volvo Parts Corp		
	20526570	MDP5108
	20560415	MDP5108
	20568713	MDP5108
	20768092	MDP5057
	20768101	MDP5072
	20918891	MDP5057
	3095396	MDP5057
	3099533	MDP5072
	3198394	MDP5072





1



2



3



4



5



6



7





	WVA
MAX030K	29030
MAX030K	29113
MAX030K	29083
MAX087K	29042
MAX087K	29059
MAX087K	29087
MAX087K	29106
MAX087K	29108
MAX087K	29109
MAX087K	29163
MAX087K	29179
MAX087K	29202
MAX087K	29253
MAX088K	29088
MAX090K	29090
MAX095K	29095
MAX095K	29197
MAX125K	29125
MAX125K	29277
MAX131K	29131
MAX173K	29173
MAX174K	29174
MAX244K	29244
MAX246K	29246
MDP3011K	29011
MDP3013	29013
MDP3013	29014
MDP3017	29017
MDP3024	29024
MDP3030K	29030
MDP3030K	29083,
MDP3030K	29113
MDP3032K	29032
MDP3043K	29043
MDP3077	29077
MDP3087K	29087
MDP3087K	29042
MDP3087K	29106
MDP3087K	29108
MDP3087K	29109
MDP3087K	29163
MDP3087K	29179

	WVA
MDP3087K	29202
MDP3087K	29253
MDP3087K	29059
MDP3088	29088
MDP3090K	29090
MDP3095K	29095
MDP3095K	29197
MDP3122	29122
MDP3124K	29124
MDP3124K	29155
MDP3125K	29125
MDP3125K	29277
MDP3126	29126
MDP3126	29159
MDP3131K	29131
MDP3136K	29136
MDP3137K	29137
MDP3141	29141
MDP3141	29119,
MDP3142	29142
MDP3143K	29120
MDP3143K	29143
MDP3143K	29185
MDP3148K	29148
MDP3148K	29115
MDP3148K	29116
MDP3148K	29183
MDP3162	29162
MDP3165K*	29165
MDP3165K*	29306
MDP3167K*	29167
MDP3167K*	29307
MDP3169K	29169
MDP3169K	29177
MDP3171K*	29171
MDP3171K*	29158
MDP3171K*	29308
MDP3173K	29173
MDP3173K	29203
MDP3174K	29174
MDP3174K	29218
MDP3174K	29273

	WVA
MDP3244K	29244
MDP3246K	29246
MDP3498	29498
MDP3747	29747
MDP3835K	29835
MDP5000	29030
MDP5004	29065
MDP5005	29067
MDP5008	29043
MDP5017	29083
MDP5019	29090
MDP5020	29067
MDP5021	29065
MDP5027	29043
MDP5030	29039
MDP5031	29030
MDP5032	29053
MDP5033	29030
MDP5034	29053
MDP5035	29100
MDP5037	29100
MDP5038	29113
MDP5038	29030
MDP5039	29114
MDP5040	29835
MDP5042	29090
MDP5045	29083
MDP5049	29039
MDP5050	29030
MDP5051	29030
MDP5052	29136
MDP5053	29137
MDP5054	29113
MDP5056	29131
MDP5057	29125
MDP5059	29131
MDP5060	29131
MDP5061	29090
MDP5065	29030
MDP5065	29113
MDP5066	29114
MDP5071	29090

* MDP3165K, MDP3167K & MDP3171K - NOT AVAILABLE IN GERMANY

* MDP3165K, MDP3167K & MDP3171K - IN DEUTSCHLAND NICHT VERFÜGBAR





	WVA
MDP5072	29151
MDP5073	29131
MDP5076	29124
MDP5083	29150
MDP5083K	29150
MDP5088	29030
MDP5090	29030
MDP5091	29030
MDP5092	29835
MDP5093	29177
MDP5093	29169
MDP5097	29131
MDP5099	29131
MDP5101	29174
MDP5101	29273
MDP5102	29173
MDP5103	29177

	WVA
MDP5104	29174
MDP5106	29173
MDP5106	29203
MDP5106	29272
MDP5108	29177
MDP5110	29030
MDP5111	29131
MDP5111	29156
MDP5112	29131
MDP5115	29131
MDP5116	29131
MDP5116	29156
MDP5117	29211
MDP5119	29174
MDP5120	29053
MDP5121	29131
MDP5121	29156

	WVA
MDP5122	29187
MDP5125	29090
MDP5429	29302
MDP5453	29302
MDP5481	29835
MDP5761	29039
MDP5842	29065
MDP9000	29061
MDP9000	29179
MDP9001	29061
MDP9002	29095
MDP9004	29105
MDP9005	29087
MDP9005	29061
MDP9006	29167
MDP9007	29165



Handwriting practice area with horizontal dotted lines.

1 

2   

3   

4   

5   

6   

7   



OE		
DAF		
1522062		ST1189
Hyundai		
5817487500		MCK1006
Iveco		
1908407		MBA027
1906462		MBA020
1908231		MBA021
1903651		MBA022
29918554		MBA029
2992304		MBA030
2992393		MBA025
42530550		MBA023
42530606		MBA023
42532204		MBA024
42548195		MBA025
42548196		MBA026
42548208		MBA027
42548209		MBA029
42549196		MBA030
42555634		MBA028
42556205		MBA029
42559616		MBA030
5001834075		MCK1328
503137964		MCK1328

OE		
Kässbohrer Setra		
82823884510		MBA010
MAN		
81508110004		MBA010
81508226013		ST1189
81508226012		MBA019
81508226016		MBA018
81508226016		MCK1070
81508226017		MBA019
81508226017		MCK1071
81508226018		MCK1141
81508226018		MCK1141.MA
Mercedes		
3565400017		MBA007
5021200657		MBA007
82853884510		MBA010
6695400917		MBA033
9015400017		MBA033
Paccar		
1527462		MCK1358
1527463		MBA015
5001831161		MBA015
Renault		
5001822987		MBA011
5001834075		MBA016

OE		
5001834075		MAKE2WI2
5001848363		MBA017
5001872604		MCK1372.RI
5010848607		MBA032
5021200651		MBA001
5021200652		MBA002
5021200653		MBA003
5021200654		MBA004
5021200655		MBA005
5021200656		MBA006
5021200658		MBA008
5021200659		MBA009
5021200660		MBA010
5021200660		MBA011
5021200662		MBA012
5021200663		MBA013
5021200664		MBA014
5001872603		MCK1373.RI
Volvo		
21392592		MCK1370
21392592		MCK1370.VT
85110419		MCK1358.VT



A series of horizontal dotted lines for taking notes or making corrections.

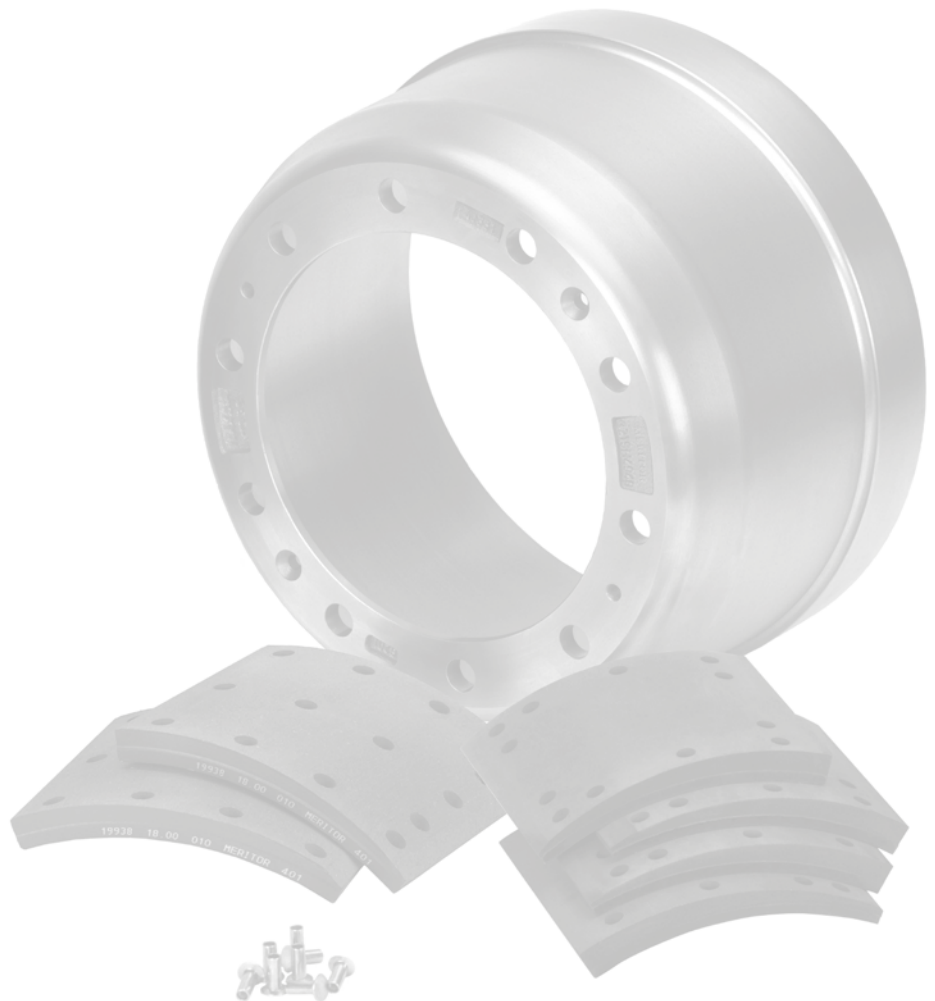



Alexander PSV	89
Aüwarter (Neoplan)	89
AWD	89
Bedford	90
Berkhof	90
Bova	90
BPW	90
Bristol	91
Caetano	91
Cardi	91
DAF	91
Dennis	97
ERF	98
Foden	99
Ford	100
Fruehauf	100
Gorica	100
Hendrickson	100
Heuliez	100
Iveco	100
Kaiser	108
Karosa	108
Kässbohrer	108
King	109
Leyland Daf	109
Löhr	109
MAN	109
Mercedes	119
Merriworth	141
Optare	141
Pegaso	141
Renault Truck	142
ROR	149
SAE	149
SAF	150
Scammell	150
Scania	150
Seddon Atkinson	155
Sisu	157
SMB	157
Steyr	157
Tatra (CZ)	157
Trailor	157
Van Hool	157
Viberti	158
Volvo	158
York	165
ZF	165



Alexander PSV				
AXL200 – 9.5m - 10.8m	92 →		MBLK1210	MBD1027
AXL300 – 12m	97 – 00		MBLK1190	MBD1161
			MBLK1200	MBD1021
AXL300 – 12m	97 →		MBLK2190	MBD1106
			MBLK2200	MBD1104
			MBLK2210	MBD1105
AXL300 – 12m - Low Floor	97 – 00		MBLK2070	MBD1018
AXL500 – DB220	95 →		MBLK2070	MBD1062
AXL500 – Ultra 12m	95 →		MBLK1200	MBD1021
Aüwarter (Neoplan)				
Cityliner – N116, N116/3	74 – 91			MBD1010
				MBD1004
	92 →		MBLK2230	MBD1130
Cityliner – N116/3H, N116H	92 →		MBLK2230	MBD1130
Jetliner – N314	74 – 82			MBD1111
				MBD1010
Jetliner – N316, N326	74 – 82			MBD1111
Jetliner – N416	83 – 91			MBD2070
				MBD1010
	92 →		MBLK2230	MBD1130
Jetliner – N426	74 – 82			MBD1112
			MBLK2230	MBD1130
Kneel bus – N4007LNF, N4007NF, N4009LNF, N4009NF, N4014NF, N4016NF, N4021NF	88 – 91			MBD2070
			MBLK2230	MBD1130
Metroliner – MIC 4012, MIC 4017	90 →			MBD2070
				MBD1130
Metroliner – N Series	88 →			MBD2070
				MBD1130
Skyliner – N122	74 – 92			MBD1010
Transliner – N312, N316	92 →		MBLK2230	MBD1130
Transliner – SHD 12M MAN AXLE	92 →		MBLK2200	MBD1104
			MBLK2210	MBD1105
AWD				
MTL Series – MTL33.27	91 – 06/92		MBLK1190	
			MBLK1190	MBD5013
TL Series – TL17.27	91 – 06/92		MBLK1190	
			MBLK1190	MBD5013
TL Series – TL24.27	91 – 06/92		MBLK1190	
			MBLK1190	MBD5013





- 1
- 2
- 3
- 4
- 5
- 6
- 7

Bedford				
KM – KM	66 – 87		MBLK1090	
			MBLK1100	
TK-Series – TK1630 / DOV	77 – 87		MBLK1090	
			MBLK1100	
TL Series – TL1630 DMY8	80 – 87		MBLK1100	
			MBLK1100	
TL Series – TL24-27	93 →		MBLK1180	
			MBLK1190	
TM-Series – TM1500	74 – 87		MBLK1090	
TM-Series – TM1700	74 – 87		MBLK1090	
			MBLK1100	
TM-Series – TM2250	74 – 87		MBLK1090	
			MBLK1100	
TM-Series – TM2300	74 – 87		MBLK1080	
			MBLK1080	
TM-Series – TM2500	74 – 87		MBLK1100	
TM-Series – TM2600	74 – 87		MBLK1090	
			MBLK1100	
TM-Series – TM3250	74 – 87		MBLK1100	
Berkhof				
Axial 50 – 12m Coach	91 →		MBLK2380	MBD1030
			MBLK2390	MBD2057
Excellence – 3000HD			MBLK1190	MBD1161
			MBLK1200	MBD1021
			MBLK1170	
			MBLK2360	MBD2071
Radial – 12m Coach	91 →		MBLK2380	MBD1030
			MBLK2390	MBD2057
Bova				
Futura FHM – 12.29	83 →			MBD1010
				MBD1111
				MBD1112
BPW				
300 x 200 mm			MBLK2430 / MBSK2430-4	MBD1050
			MBLK2430 / MBSK2430-4	MBD1052
			MBLK2430 / MBSK2430-4	
360 x 200 mm			MBLK2430 / MBSK2430-4	MBD1044
			MBLK2430 / MBSK2430-4	MBD1049



...BPW					
360 x 200 mm – SN3620				MBLK2440 / MBSK2440-4	
420 x 180 mm				MBLK2000 / MBSK2000-4	MBD1041
				MBLK2000 / MBSK2000-4	MBD1048
				MBLK2000 / MBSK2000-4	MBD1053
				MBLK2000 / MBSK2000-4	MBD1034
420 x 200 mm				MBLK2010 / MBSK2010-4	MBD1019
				MBLK2010 / MBSK2010-4	MBD1040
				MBLK2010 / MBSK2010-4	
420 x 200 mm – ECOMAX				MBLK2010 / MBSK2010-4	MBD1029
				MBLK2010 / MBSK2010-4	
420 x 200 mm – ECOMAX 10/11 Ton Low model				MBLK2010 / MBSK2010-4	MBD1054
Bristol					
LHL, LHS	68 – 81			MBLK1220	
Caetano					
Algarve 2	92 – 97			MBLK2380	MBD1030
				MBLK2390	MBD2057
Enigma	01 →			MBLK2210	MBD1105
Enigma – 12m	→ 99			MBLK2380	MBD1030
				MBLK2390	MBD2057
Porto	→ 99			MBLK2380	MBD1030
				MBLK2390	MBD2057
Cardi					
300 x 200 – S Cam				MBLK2430 / MBSK2430-4	
420 x 180 – S Cam				MBLK2000 / MBSK2000-4	
420 x 200 – S Cam				MBLK2010 / MBSK2010-4	
DAF					
MB Series – MB201	74 – 80			MBLK2620	MBD2006
SB 3000 Series – SB3000, SBR3000, SKB3000 TAG	89 →				MBD1018
SB Series – SB 201	74 – 80			MBLK2040	
SB Series – SB 210	74 – 80			MBLK2040	
SB Series – SB 220	75 – 80			MBLK2040	
SB Series – SB 220, LD, LC	87 – 89			MBLK2050	
				MBLK2040	
SB Series – SB 2300, DHTD	87 →			MBLK2010 / MBSK2010-4	
				MBLK2040	
SB Series – SB 2305 DHS, DHTD	87 →			MBLK2010 / MBSK2010-4	
				MBLK2040	





- 1
- 2
- 3
- 4
- 5
- 6
- 7















































...DAF				
SB Series – SB 2705	83 →		MBLK2010 / MBSK2010-4	
			MBLK2040	
SB Series – SB 3000 DKSB, DSKB	84 – 89		MBLK2040	
SB Series – SB 3000 DKV	87 →		MBLK2010 / MBSK2010-4	
SB Series – SB200	74 →			MBD2006
SB Series – SB220	87 – 89			MBD1018
	89 →		MBLK2070	
			MBLK2090	MBD1018
SB Series – SB220, SBG220	11/89 →			MBD1018
SB Series – SB2300	82 – 86			MBD2006
SB Series – SB3000	84 – 89			MBD2006
SB Series – SBG 220	89 →		MBLK2070	
			MBLK2090	MBD1018
	11/89 →			MBD2006
SB Series – SBR 3000 DKSB, SBR 3000 DKZ	84 – 89		MBLK2010 / MBSK2010-4	
TB2100 – TB 2100			MBLK2090	
XF 95 Series	01/98 →			MBD1060
DAF				
30.23, 30.25, 30.26, 30.27, 30.30	90 →		MBLK1130	
50 Series – FA50.150	03/92 →		MBLK2240	MBD2009
50 Series – FA50.160	92 →		MBLK2240	
50 Series – FA50.180	10/94 →		MBLK2240	
			MBLK2240	MBD2009
55 Series – FA55.150, FA55.180, FA55.210, FA55.230	06/95 →		MBLK2240	
			MBLK2240	MBD2009
			MBLK2070	MBD1060
65 CF Series – FA 65 CF 180, FA 65 CF 210, FA 65 CF 240	06/93 →		MBLK2070	MBD1018
			MBLK2090	MBD1061
65 CF Series – FAV 65 CF 180, FAV 65 CF 210	06/93 →		MBLK2070	MBD1018
			MBLK2090	MBD1061
65 CF Series – FAV 65.210	03/93 – 02/98		MBLK2090	MBD1061
75 CF Series – FA 75 CF 250	92 – 02/98		MBLK2070	MBD1018
			MBLK2080	MBD1060
			MBLK2070	MBD1060
			MBLK2090	MBD1061
			MBLK2080	MBD1062
75 CF Series – FA 75 CF 250 (4x2)	92 – 02/98		MBLK2070	MBD1018
			MBLK2070	MBD1060
			MBLK2090	MBD1061
			MBLK2080	MBD1062







































...DAF				
75 CF Series – FA 75 CF 250,290,320	92 – 02/98		MBLK2080	MBD1060
75 CF Series – FA 75 CF 320	92 – 02/98		MBLK2070	MBD1018
			MBLK2070	MBD1060
			MBLK2090	MBD1061
			MBLK2080	MBD1062
75 CF Series – FAG, FAN 75 CF 2500 (6x2/4)	92 – 02/98		MBLK2070	MBD1018
			MBLK2080	MBD1060
			MBLK2070	MBD1060
			MBLK2090	MBD1061
			MBLK2080	MBD1062
75 CF Series – FAG, FAN 75 CF 290 (6x2/4) FAG, FAN 75 CF 320 (6x2/4)	92 – 02/98		MBLK2070	MBD1018
			MBLK2070	MBD1060
			MBLK2090	MBD1061
			MBLK2080	MBD1062
75 CF Series – FAR, FAS 75 CF 250 (6x2)	92 – 02/98		MBLK2070	MBD1018
			MBLK2080	MBD1060
			MBLK2070	MBD1060
			MBLK2090	MBD1061
			MBLK2080	MBD1062
75 CF Series – FAR, FAS 75 CF 290 (6x2) FAR, FAS 75 CF 320 (6x2)	92 – 02/98		MBLK2070	MBD1018
			MBLK2070	MBD1060
			MBLK2090	MBD1061
			MBLK2080	MBD1062
75 CF Series – FAT 75 CF 250 FAT 75 CF 290 (6x4) FAT 75 CF 320 (6x4)	92 – 02/98		MBLK2070	MBD1018
			MBLK2070	MBD1060
			MBLK2090	MBD1061
			MBLK2080	MBD1062
75 CF Series – FT 75 CF 250, 290, 320 (4x2)	92 – 02/98		MBLK2080	MBD1060
75 CF Series – FT 75 CF 250 (4x2) FT 75 CF 290 (4x2) FT 75 CF 320 (4x2)	92 – 02/98		MBLK2070	MBD1018
			MBLK2070	MBD1060
			MBLK2090	MBD1061
75 Series – FA, FT & Ati 75.240, 75.270, FA, FT 75.300	92 →		MBLK2070	MBD1018
			MBLK2090	MBD1061
75 Series – FAG 75.240 & Ati, FAG 75.270, FAG 75.300	92 →		MBLK2080	MBD1062
75 Series – FAG 75.240 & Ati, FAG 75.270, FAG 75.300	92 →		MBLK2070	MBD1060
			1 MBLK2070	MBD1060
			2 MBLK2090	MBD1061
75 Series – FAS 75.240/M, FAS 75.270 & Ati, FAR, FA 75.270 & Ati, FAR, FAS, FAT 75.300M & Ati	92 →		MBLK2070	MBD1018
			1 MBLK2090	MBD1061
			2 MBLK2080	MBD1062





				
...DAF				
				
80 Series Constructor – FAD 80.250	→ 94		MBLK2070	
85 Series Constructor – FA, FT 85.330 & Ati	93 →		MBLK2070	MBD1018
85 Series Constructor – FA, FT 85.360/400 & Ati	93 →		MBLK2070	MBD1018
			MBLK2090	MBD1061
85 Series Constructor – FA, FT85.330 & Ati	93 →		MBLK2090	MBD1061
85 Series Constructor – FA, FAG, FAR, FAS, FTG 85.330, 85.360, 85.400 & Ati	93 →		MBLK2070	MBD1060
			MBLK2080	MBD1062
		 1	MBLK2070	MBD1060
		 2	MBLK2090	MBD1061
85 Series Constructor – FAD85.300, 330, 360, 400	93 →	 1	MBLK2070	MBD1060
		 1	MBLK2080	MBD1062
		 1	MBLK2090	MBD1061
		 2	MBLK2070	MBD1018
		 2	MBLK2080	MBD1062
85 Series Constructor – FAT,FTT 85.330/360/400	93 →		MBLK2080	MBD1062
		 1	MBLK2090	MBD1061
		 2	MBLK2090	MBD1061
CF Series – CF 65.180, CF 65.220, CF 65.250	00 – 06		MBLK1190	MBD5036
			MBLK2090	MBD1061
CF Series – CF 65.220, CF 65.250, CF 65.280, CF 65.300	06 →		MBLK1190	MBD5036
			MBLK2090	MBD1061
CF Series – CF 75.250, CF 75.310, CF 75.360	00 →		MBLK1190	MBD5036
			MBLK2081	
			MBLK2090	MBD1061
			MBLK1190	MBD5036
CF Series – CF 85.340, CF 85.380, CF 85.430, CF 85.480	00 – 07		MBLK1190	MBD5036
			MBLK2081	
			MBLK2090	MBD1061
CF Series – CF 85.360, CF 85.410, CF 85.460, CF 85.510	06 →		MBLK1190	MBD5036
			MBLK2081	
			MBLK2090	MBD1061
Chieftain – 12/13.5 ton rigid	75 – 82		MBLK1220	
Chieftain – Tractor	74 – 82		MBLK1220	
F 65 Series – FA 65.180 (4x2), FA 65.210, FA 65.210	03/93 – 02/98		MBLK2070	MBD1018
			MBLK2090	MBD1061
F 65 Series – FAV 65.180 (4x4), FAV 65.210	03/93 – 02/98		MBLK2070	MBD1018
			MBLK2090	MBD1061
F 75 Series – FA 75.240 Ati (4x2) FA 75.270 Ati (4x2) FA 75.300 (4x2)	07/92 – 02/98		MBLK2070	MBD1018
			MBLK2090	MBD1061
			MBLK2080	MBD1062



		 	 	 
...DAF				
				
F 75 Series – FAG 75.240 ATi (6x2/4)	07/92 – 02/98	 	MBLK2070 MBLK2090 MBLK2080	MBD1018 MBD1061 MBD1062
F 75 Series – FAG 75.270, FAN 75.270 (6x2/4) FAG 75.300, FAN 75.300 (6x2/4)	07/92 – 02/98	 	MBLK2070 MBLK2090 MBLK2080	MBD1018 MBD1061 MBD1062
F 75 Series – FAN 75.240 (6x2/4)	07/92 – 02/98	 	MBLK2070 MBLK2080 MBLK2090	MBD1018 MBD1062 MBD1061
F 75 Series – FAR 75.240 (6x2) FAR 75.270, FAS 75.270 (6x2) FAR 75.300 (6x2)	07/92 – 02/98	 	MBLK2070 MBLK2090 MBLK2080	MBD1018 MBD1061 MBD1062
F 75 Series – FAS 75.240 (6x2) FAS 75.300 (6x2)	07/92 – 02/98	 	MBLK2070 MBLK2080 MBLK2090	MBD1018 MBD1062 MBD1061
F 75 Series – FAT 75.270 (6x4)	07/92 – 02/98	 	MBLK2070 MBLK2090 MBLK2080	MBD1018 MBD1061 MBD1062
F 75 Series – FAV 75.240 (4x4) FAV 75.270 (6x4)	07/92 – 02/98	 	MBLK2070 MBLK2090 MBLK2080	MBD1018 MBD1061 MBD1062
F 75 Series – FT 75.240 ATi (4x2) FT 75.270 (4x2) FT 75.300 (4x2)	07/92 – 02/98	 	MBLK2070 MBLK2090 MBLK2080	MBD1018 MBD1061 MBD1062
F 85 CF Series – FA 85 CF 340 (4x2) FA 85 CF 380 (4x2) FA 85 CF 430 (4x2)	07/92 →	  	MBLK2070 MBLK2080 MBLK2070 MBLK2090 MBLK2080	MBD1018 MBD1060 MBD1060 MBD1061 MBD1062
F 85 CF Series – FT 85 CF 340 (4x2) FT 85 CF 380 (4x2) FT 85 CF 430 (4x2)	07/92 →	  	MBLK2070 MBLK2080 MBLK2070 MBLK2090 MBLK2080	MBD1018 MBD1060 MBD1060 MBD1061 MBD1062
F 85 Series – FA 85.330 ATi (4x2)	07/92 – 02/98	 	MBLK2070 MBLK2090	MBD1018 MBD1061
F 85 Series – FA 85.360 ATi (4x2)	07/92 – 02/98	 	MBLK2070 MBLK2090	MBD1018 MBD1061
F 85 Series – FA 85.400 ATi (4x2)	03/95 – 02/98	 	MBLK2070 MBLK2090	MBD1018 MBD1061





				
...DAF				
F 85 Series – FAD 85.330 ATi (8x4) FAD 85.360 ATi (8x4)	07/92 – 02/98	  	MBLK2070 MBLK2080 MBLK2090 MBLK2080	MBD1018 MBD1060 MBD1061 MBD1062
F 85 Series – FAD 85.400 ATi (8x4)	03/95 – 02/98	   	MBLK2070 MBLK2080 MBLK2090 MBLK2080	MBD1018 MBD1060 MBD1061 MBD1062
F 85 Series – FAG 85.330 (6x2/2/4) FAG 85.360 (6x2/2/4)	07/92 – 02/98	  	MBLK2080 MBLK2070 MBLK2090	MBD1060 MBD1060 MBD1061
F 85 Series – FAG 85.400 (6x2/2/4)	03/95 – 02/98	  	MBLK2080 MBLK2070 MBLK2090	MBD1060 MBD1060 MBD1061
F 85 Series – FAR 85.330 (6x2/2/4) FAR 85.360 (6x2/2/4)	07/92 – 02/98	  	MBLK2080 MBLK2070 MBLK2090	MBD1060 MBD1060 MBD1061
F 85 Series – FAR 85.400 (6x2/2/4)	03/95 – 02/98	  	MBLK2080 MBLK2070 MBLK2090	MBD1060 MBD1060 MBD1061
F 85 Series – FAS 85.330 (6x2/2/4) FAS 85.360 (6x2/2/4)	07/92 – 02/98	  	MBLK2080 MBLK2070 MBLK2090	MBD1060 MBD1060 MBD1061
F 85 Series – FAS 85.400 (6x2/2/4)	03/95 – 02/98	  	MBLK2080 MBLK2070 MBLK2090	MBD1060 MBD1060 MBD1061
F 85 Series – FAT 85.330 ATi (6x4) FAT 85.360 ATi (6x4)	07/92 – 02/98	 	MBLK2080 MBLK2090	MBD1060 MBD1061
F 85 Series – FAT 85.400 ATi (6x4)	03/95 – 02/98	 	MBLK2080 MBLK2090	MBD1060 MBD1061
F 85 Series – FT 85.330 ATi (4x2) FT 85.360 ATi (4x2)	07/92 – 02/98	 	MBLK2070 MBLK2090	MBD1018 MBD1061
F 85 Series – FT 85.400 ATi (4x2)	03/95 – 02/98	 	MBLK2070 MBLK2090	MBD1018 MBD1061
F 85 Series – FTG 85.330 (6x2/2/4) FTG 85.360 (6x2/2/4)	07/92 – 02/98	  	MBLK2080 MBLK2070 MBLK2090	MBD1060 MBD1060 MBD1061
F 85 Series – FTG 85.400 (6x2/2/4)	03/95 – 02/98	  	MBLK2080 MBLK2070 MBLK2090	MBD1060 MBD1060 MBD1061



...DAF				
F 85 Series – FTT 85.330 (6x4) FTT 85.360 ATi (6x4)	07/92 – 02/98		MBLK2080	MBD1060
			MBLK2090	MBD1061
F 85 Series – FTT 85.400 ATi (6x4)	03/95 – 02/98		MBLK2080	MBD1060
			MBLK2090	MBD1061
F 800 - Series – FA 800	12/86 – 08/91		MBLK2220	
F Series – F2100	80 – 86		MBLK2620	
F Series – F2100, F2300, F2500, F2700, F2900	11/89 →		MBLK2045	MBD1023
F Series – F2800, F3300	86 – 89		MBLK2045	MBD1023
F Series – F3300	80 – 86		MBLK2610	MBD1059
F Series – F3600	87 – 89		MBLK2045	MBD1023
F Series – FA 1900 DNS, Topsleeper	87 – 89		MBLK2050	
			MBLK2060	
F Series – FA 1900 DNT	87 – 89		MBLK2050	
			MBLK2060	
F Series – FA 1905, FT 1905	87 – 89		MBLK2050	
	11/89 – 09/93		MBLK2070	MBD1018
	87 – 89		MBLK2060	
	11/89 – 09/93		MBLK2080	MBD1062
F Series – FA 2100, FAR 2100	87 – 89		MBLK2050	
			MBLK2060	
F Series – FA 2105, FA 2505	11/89 →		MBLK2080	MBD1062
F Series – FA 600	87 – 91		MBLK2220	
F Series – FA1300 DNT FA1700 DNT	87 – 89		MBLK2240	
			MBLK2240	MBD2009
F Series – FT 1900	11/89 – 09/93		MBLK2070	MBD1018
			MBLK2080	MBD1062
F Series – FT 2500	87 →		MBLK2050	
			MBLK2060	
XF 95 Series	01/98 →			MBD1060
XF Series – XF 105.410, XF 105.460, XF 105.510	05 →		MBLK1190	MBD5036
			MBLK2090	MBD1061
Dennis				
DB15, DB15.5	70 →		MBLK1220	
DB20, DB21	70 →		MBLK1220	
DB24T Defiant	71 – 72		MBLK1220	
Dominant	70 →		MBLK1220	
Pax V	68 – 69		MBLK1220	
Refuse collectors – Bulkmaster 70	71 →		MBLK1220	
Refuse collectors – Paxit 50, 70	70 →		MBLK1220	



















































- 1
- 2
- 3
- 4
- 5
- 6
- 7

...Dennis				
R Series	76 →		MBLK1090	
			MBLK1100	
S Series	76 →		MBLK1090	
			MBLK1100	
Self steer 20 ton	70 →		MBLK1220	
ERF				
C Series – C36, C38, C40	82 – 86		MBLK1100	
CP Series – CP28.250 CP32.250, CP32.290, CP32.290 4x2 CP38.250 TwinS, CP38.250, CP38.290 4x2, CP38.290 TwinS	84 – 86		MBLK1100	
E Series – E 6.18, E 6.18 DROPFRAME	91 – 09/93		MBLK1190	
			MBLK1190	MBD5013
E Series – E 6.18 E16	87 – 90		MBLK1100	
E Series – E 6.18 M16			MBLK1090	
E Series – E 6.21	91 – 09/93		MBLK1190	
			MBLK1190	MBD5013
E Series – E 8.26, E 8.27 E 10.25	91 – 09/93		MBLK1190	
			MBLK1190	MBD5013
E Series – E 10.25 4x2, E 10.25 ST 4x2, E 10.25 D5, E 10.25 T2	86 – 90		MBLK1100	
E Series – E 10.27	91 – 09/93		MBLK1190	
			MBLK1190	MBD5013
E Series – E 10.29 4x2, E 10.29 ST 4x2, E 10.29 D5, E 10.29 TT	86 – 90		MBLK1100	
E Series – E 10.32, E 10.32 DT, E 10.32 TT	91 – 09/93		MBLK1190	
			MBLK1190	MBD5013
E Series – E 12.26 ST, E 12.27 ST	86 – 90		MBLK1100	
E Series – E 12.30, E 12.32, E 12.32 ST, E 12.32 TT	91 – 09/93		MBLK1190	
			MBLK1190	MBD5013
E Series – E 12.34 DT	86 – 90		MBLK1100	
E Series – E 12.37 ST, E 12.37 TT, E 12.40 ST, E 12.40 TT, E 14.32 ST, E 14.32 TT	91 – 09/93		MBLK1190	
			MBLK1190	MBD5013
E Series – E 14.35 DT	86 – 90		MBLK1100	
E Series – E 14.36 ST, E 14.36 TT E 14.41 DT, E 14.41 ST, E 14.46 DT, E 14.46 ST	91 – 09/93		MBLK1190	
			MBLK1190	MBD5013
E Series – EP 6	91 – 09/93		MBLK1190	MBD5013
E Series – ES 6.18	91 – 09/93		MBLK1190	MBD5013
E Series – ES 6.18 (Euro1)	09/93 – 04/96		MBLK1155	
	05/96 →		MBLK1155	
	95 →		MBLK1190	MBD5013
E Series – ES 6.19	89 – 09/93		MBLK1190	MBD5013



				
				
...ERF				
				
E Series – ES 6.21 (Euro2)	09/93 – 04/96		MBLK1155	
	05/96 →		MBLK1155	
E Series – ES 8.24 (Euro1)	09/93 – 04/96		MBLK1155	
	05/96 →		MBLK1155	
E Series – ES 8.27 (Euro2)	09/93 – 04/96		MBLK1155	
	05/96 →		MBLK1155	
E Series – Rockwell Brakes	95 →		MBLK1155	
EC 11 Series – EC 11.305 EC 11.340 EC 11.380	95 – 04/96		MBLK1155	
	05/96 →		MBLK1155	
	95 →		MBLK1190	
EC Series – EC 6.18	95 – 04/96		MBLK1155	
	05/96 →		MBLK1155	
	95 →		MBLK1190	
EC Series – EC 6.21	09/93 – 04/96		MBLK1155	
	05/96 →		MBLK1155	
EC Series – EC 8.24, EC 8.27 EC 10.30, EC 10.32, EC 10.35 EC 12.33, EC 12.37, EC 12.40 EC 14.34, EC 14.38, EC 14.41, EC 14.50, EC 14.52	09/93 – 04/96		MBLK1155	
	05/96 →		MBLK1155	
	09/93 →		MBLK1190	
EC Series – ES 6.18	95 →		MBLK1190	
			MBLK1190	
EC Series – ES 8.24, ES 8.27	95 →			
Pre 1974 range – 54G 16 Ton & Tractor 20 ton	64 – 67		MBLK1220	
Pre 1974 range – 64G 16 ton & tractor 24 ton	65 – 68		MBLK1220	
Pre 1974 range – 64GX tractor 28/30 ton	66 – 68		MBLK1220	
Pre 1974 range – 64GXB tractor 30/32 ton	67 – 68		MBLK1220	
Pre 1974 range – 64P 16 ton & tractor 20 ton	65 – 68		MBLK1220	
Pre 1974 range – 64R205 tractor 30/32 ton	66 – 68		MBLK1220	
Pre 1974 range – 66G/66GX 20/22 ton	65 – 68		MBLK1220	
Pre 1974 range – 68G/68GX 24/26 ton	65 – 68		MBLK1220	
	65 – 68		MBLK1220	
Foden				
				
2000 Series – 2180,	90 – 06/92		MBLK1130	
2000 Series – 2200	90 →		MBLK1130	
	90 – 06/92		MBLK1130	
	91 →		MBLK1120	
2000 Series – 2210	90 – 06/92		MBLK1130	
2000 Series – 2250	90 – 06/92		MBLK1130	
3000 Series – 3049, 3053, 3063, 3250, 3300	88 →		MBLK1130	
	91 →		MBLK1120	









































- 1
- 2
- 3
- 4
- 5
- 6
- 7

...Foden				
3000 Series – 3210, 3265	88 – 06/92		MBLK1130	
	90 – 06/92		MBLK1130	
3000 Series – 3275, 3300, 3325	88 →		MBLK1130	
4000 Series – 4250	87 – 06/92		MBLK1130	
4000 Series – 4250, 4300, 4350, 4400, 4500	82 →		MBLK1130	
			MBLK1120	
4000 Series – 4275, 4300, 4325, 4350, 4375, 4380, 4400, 4410, 4465	87 →		MBLK1130	
4000 Series – 4465	87 – 06/92		MBLK1130	
4000 Series – 4500	87 →		MBLK1130	
	87 – 06/92		MBLK1130	
Haulmaster	79 – 83		MBLK1150	
S104	83 – 87		MBLK1130	
S104/S106/S108	82 – 87		MBLK1130	
			MBLK1120	
			MBLK1190	
S106	83 – 87		MBLK1130	
S106L4	87 – 06/92		MBLK1130	
S108	83 – 87		MBLK1130	
S4	87 – 06/92		MBLK1130	
Ford				
R Series – R1010, R1011, R1111	71 – 82		MBLK1220	
R Series – R1014 45 Seats	71 – 82		MBLK1220	
R Series – R1114 53 Seats	71 – 77		MBLK1220	
Ford				
Cargo – (4x2) Rigid 13.300 kgs GVW (4x2) Tipper 13.300 kgs GVW	82 →		MBLK1070	
			MBLK1060	
Cargo – (4x2) Rigid 15.000 kgs GVW	82 →		MBLK1070	
Cargo – (4x2) Tipper 15.000 & 17.500 kgs GVW	82 →		MBLK1070	
Cargo – (4x2) Tractor 15.000 & 16.250 kgs GVW	82 →		MBLK1070	
Cargo – (4x2) Rigid 16.250 kgs GVW (4x2) Tipper 16.250 kgs GVW	82 →		MBLK1070	
			MBLK1060	
Cargo – (4x2) Rigid 17.500 kgs GVW	82 →		MBLK1070	
Cargo – (6x2) Rigid 24.500 kgs GVW (6x2) Tipper 24.500 kgs GVW	82 →		MBLK1070	
			MBLK1060	
Cargo – (6x4) Rigid 24.500 kgs GVW (6x4) Tipper 24.500 kgs GVW	82 →		MBLK1070	
			MBLK1060	
Cargo – 1411, 1413, 1415, 1417 C	87 →		MBLK1090	
Cargo – 1417 P	87 – 88		MBLK1090	
Cargo – 1418 C, 1513, 1515			MBLK1090	



				
				
...Ford				
				
Cargo – 1424 C	87 →		MBLK1070	
Cargo – 1512, 1514, 1517 C, 1517 P	81 – 86		MBLK1090	
Cargo – 1517 C, 1517 P	87 →		MBLK1090	
Cargo – 1614	87 – 87		MBLK1090	
Cargo – 1614, 1617 C, 1617 P	81 – 86		MBLK1090	
Cargo – 1615	81 – 86		MBLK1090	
Cargo – 1617 C, 1617 P	81 – 86		MBLK1090	
Cargo – 1617 C, P	87 – 87		MBLK1090	
Cargo – 1620	83 – 86		MBLK1090	
Cargo – 1620, 1624	87 →		MBLK1070	
			MBLK1060	
Cargo – 1624	82 →		MBLK1070	
			MBLK1060	
Cargo – 1713, 1714, 1717	87 →		MBLK1070	
Cargo – 1713, 1715, 1718, 1721	88 →		MBLK1070	
			MBLK1060	
Cargo – 1720, 1724, 1728	87 →		MBLK1070	
Cargo – 1724 C, 1728 C	88 →		MBLK1070	
			MBLK1060	
Cargo – 2118 C	89 →		MBLK1070	
			MBLK1070	
Cargo – 2147 C, 2417 P	81 – 86		MBLK1090	
Cargo – 2417	87 →		MBLK1070	
			MBLK1060	
Cargo – 2417 C	87 – 88		MBLK1090	
Cargo – 2417 P	87 →		MBLK1090	
Cargo – 2424	87 →		MBLK1070	
			MBLK1060	
Cargo – 2428 C, 2517 C	89 →		MBLK1070	
Cargo – 2517 P, 2817 P	87 – 89		MBLK1070	
Cargo – 2521 C, 2817 C	87 →		MBLK1070	
Cargo – 2820 D, P	87 →		MBLK1070	
Cargo – 2824	87 – 89		MBLK1070	
Cargo – 2921 C	89 →		MBLK1070	
Cargo – 3224	84 →		MBLK1070	
Cargo – 3224 C	87 →		MBLK1070	
Cargo – 3424	87 →		MBLK1070	
D Series – D1000 24ton GVW	67 – 71		MBLK1220	
D Series – D1210	72 – 81		MBLK1220	
D Series – D1311, 1314	72 – 81		MBLK1220	
D Series – D750, 800 Turbo	65 – 71		MBLK1220	



















































- 1
- 2
- 3
- 4
- 5
- 6
- 7

...Ford				
D Series – DA1007	72 – 81		MBLK1220	
D Series – DA1710, 1911	72 – 81		MBLK1220	
D Series – DA2011, 2114	72 – 81		MBLK1220	
D Series – DA2417, 2418	72 – 81		MBLK1220	
D Series – DT1400	69 – 71		MBLK1220	
D Series – DT1711, 2014	72 – 81		MBLK1220	
D Series – DT800	65 – 69		MBLK1220	
Fruehauf				
311 x 190 mm – MER-Axle			BLKAR	
391 x 177.8 mm			MBLK1050	
419 x 178 mm			BLKQR / MBSK1000-4	
419 x 178 mm – MM Axle SMB C 2			MBLK2490 / MBSK2490-4	MBD1071
419 X 178 mm – Propar P, PS, P13S			BLKAR	MBD1002
419 X 178 mm – Propar PSL			BLKAR	MBD1000
419 x 203 mm			MBLK1115	
419 x 203 mm – SMB C1			MBLK2500 / MBSK2500-4	
Gorica				
Jumbo – 360 x 200 mm			MBLK2440 / MBSK2440-4	
Hendrickson				
160 & 800 Series – 419 x 178 mm	→ 93		BLKQR / MBSK1000-4	MBD1076
H2000 Series – 419 x 178 mm	93 →		BLKQR / MBSK1000-4	MBD1072
Heuliez				
GX317 – Renault chassis	01/96 →		MBLK2290	
GX57 – Volvo chassis			MBLK2380	
			MBLK2750	
			MBLK2380	
			MBLK2390	
GX77 – DAF chassis			MBLK2750	
GX87 – Renault chassis - articulated			MBLK2380	
			1 MBLK2390	
			2 MBLK2730	
Iveco				
571.12.20	83 →		MBLK1050	
Magirus Coach – M 2000 (R 119 I)	78 →		MBLK1050	
Magirus Coach – M 2000 (R 119 II)	04/80 →		MBLK1050	



				
Iveco				
				
85 Series – FAT, FTT 85.330/360/	93 →			MBD1060
Eurocargo – 110E, 120E, 130E	01/91 →		MBLK2240	
Eurocargo – 130E.18	00 – 07		MBLK2240	MBD2015
Eurocargo – 150E, 170E, 320E	07/98 →		MBLK2240	
Eurocargo – 150E, 210E, 250E, 280E, 320E	01/91 →		MBLK2240	
Eurocargo – 150E.18, 150E.18P, 320E.28TP	00 – 02		MBLK2240	MBD2015
Eurocargo – 150E.21	02 – 07		MBLK1050	
Eurocargo – 150E.24	00 – 07		MBLK1050	
			MBLK2240	MBD2015
Eurocargo – 170E, 180E	01/94 →		MBLK1050	
Eurocargo – 180E.21, 180E.24, 180E.24P, 180E.28, 180E.28P	00 – 07		MBLK1050	MBD2015
Eurocargo – 260E.28	02 – 07		MBLK1050	MBD2015
Eurocargo – 260E.28KE	00 – 02		MBLK1050	MBD2015
Eurostar – 470E	93 →		MBLK1050	MBD2015
Eurostar – From Chass C053915, from 9/98 only	09/98 →		MBLK2540	
Eurostar – LD 190E38 P (4x2)	93 →		MBLK2540	
Eurostar – LD 190E42 (4x2)	93 →		MBLK2540	
Eurostar – LD 190E47 (4x2)	95 →		MBLK2540	
Eurostar – LD 190E52 (4x2)	94 →		MBLK2540	
Eurostar – LD 240E38 (6x2/2/4)	93 →		MBLK2540	
Eurostar – LD 240E42 (6x2/2/4)	93 →		MBLK2540	
Eurostar – LD 240E47 (6x2/2/4)	95 →		MBLK2540	
Eurostar – LD 240E52 (6x2/2/4)	93 →		MBLK2540	
Eurostar – LD 260E38 (6x4)	94 →		MBLK2540	
Eurostar – LD 260E42 P (6x4)	94 →		MBLK2540	
Eurostar – LD 260E47 (6x4)	95 →		MBLK2540	
Eurostar – LD 260E52 (6x4)	95 →		MBLK2540	
Eurostar – LD 400E42 TXP (6x2/4)	01/94 →		MBLK2540	
Eurostar – LD 440E38 T (4x2)	01/93 →		MBLK2540	
Eurostar – LD 440E38 TX (6x2/4)	01/94 →		MBLK2540	
Eurostar – LD 440E38 TZ (6x4)	01/94 →		MBLK2540	
Eurostar – LD 440E42 (6x4)	01/93 →		MBLK2540	
Eurostar – LD 440E42 T (4x2)	01/93 →		MBLK2540	
Eurostar – LD 440E42 TX (6x2/4)	01/94 →		MBLK2540	
Eurostar – LD 440E47 T (4x2)	01/95 →		MBLK2540	
Eurostar – LD 440E52 T (4x2)	01/95 →		MBLK2540	
Eurostar – LD 440R52 TZ (6x4)	01/93 →		MBLK2540	
Eurostar – LD190E, LD240E, LD260E, LD400E, LD440E, LD440R	93 – 04/96		MBLK1155	
Eurostar – LD190E, LD260E, LD440E, LD440R	05/96 – 08/98		MBLK1155	
Eurostar – LD400E42 TXP (6x2/4)	01/94 →		MBLK2540	
Eurostar – Wabco/ Perrot Brakes			MBLK2540	

1



2



3



4



5



6



7





- 1
- 2
- 3
- 4
- 5
- 6
- 7

...Iveco				
Eurotech – 150E52	92 →		MBLK2540	
Eurotech – 190E52	91 →		MBLK2540	
Eurotech – 240E52 (6x2)	92 →		MBLK2540	
Eurotech – 400E52, 440E34, 440E52	92 →		MBLK2540	
Eurotech – From Chass. 4206701	98 →	2	MBLK2540	
Eurotech – MP 180E, 180E52, MP 190E, 190E52 (- chassis 4206700)	05/96 – 08/98		MBLK1155	
Eurotech – MP 180E34 (4x2), MP 180E38 (4x2), MP 180E42 (4x2)	01/92 – 12/93		MBLK2540	
Eurotech – MP 190E34 (4x2), MP 190E38 (4x2), MP 190E42 (4x2)	01/93 →		MBLK2540	
Eurotech – MP 240E, MP 240E52, MP 260, MP 260E53	05/96 – 08/98		MBLK1155	
Eurotech – MP 240E, MP 240E52, MP 260, MP 260E53 (Rear Axle)	05/96 – 08/98		MBLK1155	
Eurotech – MP 240E30 (6x2)	01/97 →		MBLK2540	
Eurotech – MP 240E34 (6x2)	09/95 – 12/96		MBLK2540	
Eurotech – MP 240E38 (6x2), MP 240E42 (6x2)	01/92 →		MBLK2540	
Eurotech – MP 400E34, MP 400E38, MP 400E42, MP 400E52, MP 440E34, MP 440E38, MP 440E42	05/96 – 08/98		MBLK1155	
Eurotech – MP 400E34 (4x2), MP 400E38 (4x2), MP 400E42 (4x2)	01/92 →		MBLK2540	
Eurotech – MP 400E34 (6x2 twinsteer)	09/92 →	2	MBLK2540	
Eurotech – MP 400E34 (6x4)	09/92 →	2	MBLK2540	
Eurotech – MP 400E38 (6x2 Tractors)	11/93 – 12/96		MBLK2540	
Eurotech – MP 400E38 (6x2 Twinsteer)	11/93 – 12/96	2	MBLK2540	
Eurotech – MP 400E38 (6x4)	11/93 – 12/96	2	MBLK2540	
Eurotech – MP 400E42 (6x2 Tractors)	09/92 →		MBLK2540	
Eurotech – MP 440E34, MP 440E38, MP 440E42	92 →		MBLK2540	
Eurotech – MP 440E38 (6x2 tractors)	01/93 →		MBLK2540	
Eurotech – MP 440E38, MP440E42	09/92 →		MBLK1050	MBD2015
Eurotech – MT 180E, MT 190E	01/92 →		MBLK1050	MBD2015
Eurotech – MT 325E27, MT400E30, MT400E34	01/92 – 08/98		MBLK1050	MBD2015
EuroTrakker – 400E29	93 →		MBLK2540	MBD1090
EuroTrakker – from Chass. C50897	07/98 →		MBLK2540	
		2	MBLK2540	
			MBLK2540	MBD1090
		2	MBLK2540	
EuroTrakker – MP 260E37 (6x4/6x6) MP 260E42 (6x4/6x6)	01/93 →		MBLK2540	
		2	MBLK2540	
			MBLK2540	
		2	MBLK2540	
EuroTrakker – MP 340E34 (8x4/4) MP 340E37 (8x4/4)	01/94 →		MBLK2540	
		2	MBLK2540	
			MBLK2540	MBD1090
		2	MBLK2540	MBD1090



...Iveco				
EuroTrakker – MP 340E42 (8x4/4)	01/95 →		MBLK2540	
		2	MBLK2540	
			MBLK2540	MBD1090
		2	MBLK2540	MBD1090
EuroTrakker – MP 380E34 (6x4)	01/93 →		MBLK2540	
		2	MBLK2540	
			MBLK2540	
		2	MBLK2540	
EuroTrakker – MP 380E37 (6x4/6x6) MP 380E42 (6x4/6x6)	01/93 →		MBLK2540	
		2	MBLK2540	
			MBLK2540	
		2	MBLK2540	
EuroTrakker – MP 400E34 (4x2)	01/93 →		MBLK2540	
		2	MBLK2540	
			MBLK2540	
		2	MBLK2540	
EuroTrakker – MP 400E37 (4x2/4x4)	01/93 →		MBLK2540	
		2	MBLK2540	
			MBLK2540	
		2	MBLK2540	
EuroTrakker – MP 400E42 (4x2/4x4)	01/95 →		MBLK2540	
		2	MBLK2540	
			MBLK2540	MBD1090
		2	MBLK2540	MBD1090
EuroTrakker – MP 410E37 (8x4/4)	01/94 →		MBLK2540	
		2	MBLK2540	
			MBLK2540	MBD1090
		2	MBLK2540	MBD1090
EuroTrakker – MP 410E42 (8x4/4 & 8x8/4)	01/94 →		MBLK2540	
		2	MBLK2540	
			MBLK2540	MBD1090
		2	MBLK2540	MBD1090
EuroTrakker – MP 440E34 (6x4)	01/94 →		MBLK2540	
		2	MBLK2540	
			MBLK2540	MBD1090
		2	MBLK2540	MBD1090
EuroTrakker – MP 440E37 (6x4)	01/93 →		MBLK2540	
		2	MBLK2540	
			MBLK2540	MBD1090
		2	MBLK2540	MBD1090

















































- 1
- 2
- 3
- 4
- 5
- 6
- 7

...Iveco				
EuroTrakker – MP 440E42 (6x4)	01/97 →		MBLK2540	
		2	MBLK2540	
			MBLK2540	MBD1090
		2	MBLK2540	MBD1090
EuroTrakker – MP 720E37 (6x4/6x6)	01/94 →		MBLK2540	
		2	MBLK2540	
			MBLK2540	MBD1090
		2	MBLK2540	MBD1090
EuroTrakker – MP 720E42 (6x4/6x6)	01/97 →		MBLK2540	
		2	MBLK2540	
			MBLK2540	MBD1090
		2	MBLK2540	MBD1090
EuroTrakker – MP 720E47 (6x4)	01/98 →		MBLK2540	
		2	MBLK2540	
			MBLK2540	MBD1090
		2	MBLK2540	MBD1090
EuroTrakker – MP 190E, MP 260E, MP 340E, MP 380E, MP 400E, MP 410E, MP 440E, MP 720E	05/96 →		MBLK1155	
			MBLK1155	
EuroTrakker – Z cam brakes	94 →		MBLK2539	MBD1090
EuroTrakker 2 – MP 190E30 (4x2/4x4) MP 190E34 (4x2/4x4) MP 190E37 (4x2/4x4) MP 190E42 (4x2/4x4)	01/93 →		MBLK2540	
		2	MBLK2540	
			MBLK2540	
		2	MBLK2540	
EuroTrakker 2 – MP 260E30 (6x4)	01/93 →		MBLK2540	
		2	MBLK2540	
			MBLK2540	
		2	MBLK2540	
EuroTrakker 2 – MP 260E34 (6x4/6x6)	01/93 →		MBLK2540	
		2	MBLK2540	
			MBLK2540	
		2	MBLK2540	
M Series – 130 NR, NT	73 →		MBLK1080	
M Series – 130 NT/14 & NT/20	78 →		MBLK1050	
M Series – 135.14 (4x2)	84 →		MBLK1050	
M Series – 150.16 AN Turbo, ANW Turbo	87 →		MBLK1050	
M Series – 159.17 (4x2)	84 – 90		MBLK1050	
M Series – 159.20, 159.20 R, 159.20 T	80 – 90		MBLK1050	
M Series – 165.24	80 – 90		MBLK1050	
M Series – 175.17 (4x2), 175.24 (4x2)	87 – 92		MBLK1050	
T / P / PA Series	79 – 91		MBLK1050	
T / P / PA Series – 170 F 26, T26, F 35 T	81 – 91		MBLK1050	



				
				
...Iveco				
				
T / P / PA Series – 170 F 30 Turbo	81 – 91		MBLK1050	
T / P / PA Series – 190 F 26, FT 26, F 35, F 35 T	→ 91		MBLK1050	
T / P / PA Series – 190 PAC 20 & 26	78 – 92		MBLK1050	
T / P / PA Series – 190 PAT 26	→ 91		MBLK1050	
T / P / PA Series – 190 PC 26 (4x2), PT 26 (4x2)	→ 91		MBLK1050	
T / P / PA Series – 190 PC 26 (4x4)	→ 91		MBLK1050	
T / P / PA Series – 190 PC 35, PT 35 (4x2)	→ 91		MBLK1050	
T / P / PA Series – 190.25 (4x2)	87 – 91		MBLK1050	
T / P / PA Series – 190.29 Turbo (4x2)	87 – 91		MBLK1050	
T / P / PA Series – 190.30 Turbo (6x2, 6x4)	82 – 92		MBLK1050	
T / P / PA Series – 190.30 Turbo, T Turbo	82 – 92		MBLK1050	
T / P / PA Series – 190.32 (4x2)	89 – 92		MBLK1050	
T / P / PA Series – 190.33 T Turbo Star	84 – 92		MBLK1050	
T / P / PA Series – 190.36 TurboStar	87 – 92		MBLK1050	
T / P / PA Series – 190.38 Turbo, T Turbo	82 – 91		MBLK1050	
T / P / PA Series – 190.42 Turbostar	84 – 92		MBLK1050	
T / P / PA Series – 190.44 T, Turbostar	86 – 92		MBLK1050	
T / P / PA Series – 190.48 TurboStar	89 – 92		MBLK1050	
T / P / PA Series – 220 F 35 T (6x2, 6x4)	79 – 91		MBLK1050	
T / P / PA Series – 220.30 Turbo (6x2, 6x4)	82 – 91		MBLK1050	
T / P / PA Series – 220.32 (6x2)	89 – 92		MBLK1050	
T / P / PA Series – 220.36 (6x2)	87 – 92		MBLK1050	
T / P / PA Series – 220.38 P (6x2)	82 – 91		MBLK1050	
T / P / PA Series – 220.38 T Turbo	86 – 91		MBLK1050	
T / P / PA Series – 240 F 26	78 – 91		MBLK1050	
T / P / PA Series – 240 F 35	78 – 91		MBLK1050	
T / P / PA Series – 240.30/38 Turbo	→ 91		MBLK1050	
T / P / PA Series – 240.38 P (6x2)	82 – 92		MBLK1050	
T / P / PA Series – 260 F 26	78 – 91		MBLK1050	
T / P / PA Series – 260 F 35	78 – 91		MBLK1050	
T / P / PA Series – 260 PAC 26	78 – 91		MBLK1050	
T / P / PA Series – 260 PC 26 (6x6)	→ 91		MBLK1050	
T / P / PA Series – 260 PC 26, PT 26 (6x4)	→ 91		MBLK1050	
T / P / PA Series – 260 PC 35 (6x6)	→ 91		MBLK1050	
T / P / PA Series – 260 PC 35, PT 35 (6x4)	79 – 91		MBLK1050	
T / P / PA Series – 260.25 AN (6x4)	→ 91		MBLK1050	
T / P / PA Series – 260.48	87 – 92		MBLK1050	
T / P / PA Series – 300.23 (8x4)	84 →		MBLK1050	
T / P / PA Series – 300.25 (8x4)	86 →		MBLK1050	
T / P / PA Series – 300.30 (8x4)	87 →		MBLK1050	
T / P / PA Series – 300.32 (8x4)	89 →		MBLK1050	

















































- 1
- 2
- 3
- 4
- 5
- 6
- 7

















































...Iveco				
T / P / PA Series – 300.34 (8x4)	89 →		MBLK1050	
T / P / PA Series – 330 F 26	→ 91		MBLK1050	
T / P / PA Series – 330 F P, PT (6x4)	79 – 91		MBLK1050	
T / P / PA Series – 330 PC 26, 35 (6x4)	→ 91		MBLK1050	
T / P / PA Series – 330 PT 35 (6x4), PC 35 (6x6)	→ 91		MBLK1050	
Z Series – 135 to 360			MBLK1050	MBD1031
Kaiser				
420 x 177 mm – SAF, SNF Axles			MBLK2450 / MBSK2450-4	
420 x 177 mm – SAF, SNF Axles			MBLK2450 / MBSK2450-4	
420 x 203 mm – SAF, SNF Axles			MBLK2460 / MBSK2460-4	
420 x 203 mm – SAF, SNF Axles			MBLK2460 / MBSK2460-4	
Karosa				
Citybus	98 – 01		MBLK2290	
Kässbohrer				
S 110, S 120, S 130	12/79 →		MBLK2230	MBD1036
S 130 S	84 – 89		MBLK2230	MBD1036
S 140	83 →		MBLK2230	MBD1036
S 150, S 200	12/79 →		MBLK2230	MBD1036
S 210 HD, HDV	80 →		MBLK2230	MBD1036
S 211	83 – 89		MBLK2230	MBD1036
	89 →		MBLK2230	MBD1036
S 212 HUE	83 – 89		MBLK2230	MBD1036
S 213	83 – 89		MBLK2230	MBD1036
	89 →		MBLK2230	MBD1036
S 214	83 – 89		MBLK2230	MBD1036
	89 →		MBLK2230	MBD1036
S 215	89 →		MBLK2230	MBD1036
S 215 HDS	89 →		MBLK2230	MBD1036
S 215 NR	91 →		MBLK2230	MBD1036
S 215 UL, SL	83 – 89		MBLK2230	MBD1036
S 216 HDS	80 – 83		MBLK2230	MBD1036
	09/83 – 89		MBLK2230	MBD1036
	89 →		MBLK2230	MBD1036
S 216 HDSI	89 →		MBLK2230	MBD1036
S 228 DT	84 – 88		MBLK2230	MBD1036
	89 →		MBLK2230	MBD1036
S 300 N	89 →		MBLK2230	MBD1036
S 309 HD – Comfort Class (Series 300)	91 →		MBLK2230	MBD1036



				
				
...Kässbohrer				
				
S 312 HD – Comfort Class (Series 300)	91 →		MBLK2230	MBD1036
S 312/315HD Series	89 →			MBD2013
S 313 UL – Multi Class (Series300)	91 →		MBLK2230	MBD1036
S 315 GT – Comfort Class (Series 300)	91 →		MBLK2230	MBD1036
S 315 GT-HD – Comfort Class (Series 300)	91 →		MBLK2230	MBD1036
S 315 H – Multi Class (Series300)	91 →		MBLK2230	MBD1036
S 315 HD – Comfort Class (Series 300)	91 →		MBLK2230	MBD1036
S 315 HDH – Comfort Class (Series 300)	91 →		MBLK2230	MBD1036
S 315 HDH-3 – Comfort Class (Series 300)	91 →		MBLK2230	MBD1036
S 315 UL – Multi Class (Series300)	91 →		MBLK2230	MBD1036
S 316 HDS – Comfort Class (Series 300)	91 →		MBLK2230	MBD1036
S 317 GT-HD – Comfort Class (Series 300)	91 →		MBLK2230	MBD1036
S 317 HDH-3 – Comfort Class (Series 300)	91 →		MBLK2230	MBD1036
S 319 GT-HD – Comfort Class (Series 300)	91 →		MBLK2230	MBD1036
SG 219 SL	84 →		MBLK2230	MBD1036
SG 221 UL	84 →		MBLK2230	MBD1036
SG 321 UL – Multi Class (Series300)	91 →		MBLK2230	MBD1036
Kässbohrer				
				
300 x 200 mm – S Cam			MBLK2430 / MBSK2430-4	
420 x 180 mm			MBLK2000 / MBSK2000-4	
420 x 200 mm			MBLK2010 / MBSK2010-4	MBD1093
King				
				
394 x 178 mm			MBLK2400	
394 x 210 mm			MBLK2410	
M90-series (17t)			MBLK2400	
Leyland Daf				
				
Cruiser – 16.18, 16.21, 16.23	81 – 90		MBLK1090	
			MBLK1100	
Roadrunner – 6.10-8.15	01/86 – 12/91		MBLK2220	
Löhr				
				
305 x 200 mm – SAE Axle S3320			MBLK2510	MBD1007
MAN				
				
Citybus – All models			MBLK2200	MBD1104
			MBLK2210	MBD1105
SG – SL 150-750	93 – 96			MBD2016
	96 →			MBD2016





		 	 	 
MAN				
				
14t Series – 14.22	02/82 – 89		MBLK2185	
14t Series – 14.220	04/78 – 90		MBLK2200	
14t Series – 14.24	04/78 – 90		MBLK2185	
14t Series – 14.240	04/78 – 90		MBLK2210	
15t Series – 15.168	83 – 89		MBLK2185	
17t Series – 17.220	06/81 – 90		MBLK2200	
			MBLK2210	
19t Series – 19.240, 19.281, 19.291, 19.321, 19.331, 19.361	01/79 – 90		MBLK2210	
20/22t Series – 20.240, 20.280, 20.331	05/78 – 90		MBLK2200	
			MBLK2210	
24t Series – 23.361, 24.192, 24.240, 24.291, 24.331	02/80 – 90		MBLK2200	
			MBLK2210	
EL Series – EL202, EL222	01/96 – 06/97		MBLK2210	
EL Series – EL262	04/94 – 06/97		MBLK2210	
	07/98 →		MBLK2210	
F2000 – 32.464, 33.273, 33.293, 33.323, 33.343, 33.364, 33.373, 33.403, 33.414, 33.423, 33.463, 33.464, 33.604, 35.293, 35.314, 35.323, 35.343, 35.364, 35.373, 35.403, 35.414, 35.423, 35.463, 35.464, 37.314, 37.323, 37.343, 37.364, 37.414, 37.464, 38.364, 38.414,	94 – 05		MBLK2190	MBD1108
			MBLK2200	MBD1107
			MBLK2200	MBD1108
			MBLK2185	
			MBLK2200	MBD1103
			MBLK2210	MBD1105
F90 Series - 19t – 19.262 F, FL, FLL 19t – 19.262 FS, FLS, FK	01/88 – 02/90		MBLK2200	MBD1107
			MBLK2210	MBD1105
F90 Series - 19t – 19.272 F, FL, FLL 19t – 19.272 FS, FLS, FK	02/90 – 05/95		MBLK2200	MBD1107
			MBLK2210	MBD1105
F90 Series - 19t – 19.292 F, FL, FLL 19t – 19.292 FS, FLS, FK	07/86 – 05/95		MBLK2200	MBD1107
			MBLK2210	MBD1105
F90 Series - 19t – 19.322 F, FL, FLL 19t – 19.322 FS, FLS, FK	02/90 – 05/95		MBLK2200	MBD1107
			MBLK2210	MBD1105
F90 Series - 19t – 19.322 U, ULL	02/90 – 05/94		MBLK2200	MBD1107
			MBLK2210	MBD1105
F90 Series - 19t – 19.322 U, ULL	07/86 – 02/90		MBLK2200	MBD1107
			MBLK2210	MBD1105
F90 Series - 19t – 19.332 F, FL, FLL	02/90 – 05/94		MBLK2200	MBD1107
			MBLK2210	MBD1105
F90 Series - 19t – 19.332 FS, FLS, FK 19t – 19.342 F, FL, FLL	07/86 – 02/90		MBLK2200	MBD1107
			MBLK2210	MBD1105
F90 Series - 19t – 19.342 FS, FLS, FK 19t – 19.362 F, FK, FL, FLL	05/94 – 05/95		MBLK2200	MBD1107
			MBLK2210	MBD1105
F90 Series - 19t – 19.362 FS, FLS, U, ULL 19t – 19.372 F, FL, FLL, U, ULL	07/86 – 02/90		MBLK2200	MBD1107
			MBLK2210	MBD1105



...MAN				
F90 Series - 19t – 19.402 F, FL, C3484FLL 19t – 19.422 FS, FLS, FK, U, ULL	02/90 – 05/95		MBLK2200	MBD1107
			MBLK2210	MBD1105
F90 Series - 19t – 19.402 FS, FLS, FK 19t – 19.422 F, FL, FLL	05/94 – 05/95		MBLK2200	MBD1107
			MBLK2210	MBD1105
F90 Series - 19t – 19.462 F, FL, FS, FLS, FK	05/87 – 02/90		MBLK2200	MBD1107
			MBLK2210	MBD1105
F90 Series - 19t – 19.502 F, FL, FLL 19t – 19.502 FS, FLS	02/90 – 06/96		MBLK2200	MBD1107
			MBLK2210	MBD1105
F90 Series - 19t – 19.502 FK	08/89 →		MBLK2200	MBD1107
			MBLK2210	MBD1105
F90 Series - 23t – 23.272 FNL 23t – 23.322 FNL 23t – 23.372 FNL 23t – 23.422 FNL	09/86 – 94		MBLK2200	MBD1107
			MBLK2185	
			MBLK2210	MBD1105
F90 Series - 24t – 24.242 FNL, FNLL	01/88 – 06/96		MBLK2200	MBD1107
			MBLK2210	MBD1105
	01/88 – 02/90		MBLK2185	
F90 Series - 24t – 24.262 DF, DFS, DFSL, DFK	01/88 – 02/90		MBLK2200	MBD1107
			MBLK2210	MBD1105
F90 Series - 24t – 24.262 FNL, FNLL	01/88 – 02/90		MBLK2200	MBD1107
			MBLK2210	MBD1105
	01/88 – 06/96		MBLK2185	
F90 Series - 24t – 24.272 DF, DFS, DFSL, DFK	02/90 – 12/90		MBLK2200	MBD1107
			MBLK2210	MBD1105
F90 Series - 24t – 24.272 FNL, FNLL 24t – 24.272 FNLS, FVLS	02/90 – 05/95		MBLK2200	MBD1107
			MBLK2210	MBD1105
			MBLK2185	
F90 Series - 24t – 24.292 DF, DFS, DFSL, DFK	04/87 – 02/90		MBLK2200	MBD1107
			MBLK2210	MBD1105
F90 Series - 24t – 24.292 FNL, FNLL 24t – 24.292 FNLS, FVLS	10/86 – 02/90		MBLK2200	MBD1107
			MBLK2210	MBD1105
			MBLK2185	
F90 Series - 24t – 24.302 DF, DFS, DFSL, DFK	05/90 – 04/95		MBLK2200	MBD1107
			MBLK2210	MBD1105
F90 Series - 24t – 24.302 FNL, FNLL	05/90 – 10/90		MBLK2200	MBD1107
			MBLK2210	MBD1105
	02/90 – 10/90		MBLK2185	
F90 Series - 24t – 24.322 DF, DFS, DFSL, DFK	02/90 – 12/90		MBLK2200	MBD1107
			MBLK2210	MBD1105





- 1
- 2
- 3
- 4
- 5
- 6
- 7













































...MAN				
F90 Series - 24t – 24.322 FNL, FNLL 24t – 24.322 FNLS, FLS	02/90 – 05/95		MBLK2200	MBD1107
			MBLK2210	MBD1105
			MBLK2185	
F90 Series - 24t – 24.322 UNL, UNLL	02/90 – 12/90		MBLK2200	MBD1107
			MBLK2210	MBD1105
			MBLK2185	
F90 Series - 24t – 24.332 DF, DFS, DFLS, DFK 24t – 24.362 DF, DFS, DFLS, DFK	04/87 – 02/90		MBLK2200	MBD1107
			MBLK2210	MBD1105
F90 Series - 24t – 24.332 FNL, FNLL 24t – 24.332 FNLS, FVLS 24t – 24.332 UNL, UNLL	10/86 – 02/90		MBLK2200	MBD1107
			MBLK2210	MBD1105
			MBLK2185	
F90 Series - 24t – 24.342 FNL, FNLL	05/94 – 05/95		MBLK2200	MBD1107
			MBLK2210	MBD1105
			MBLK2185	
F90 Series - 24t – 24.362 FNL, FNLL 24t – 24.362 FNLS, FVL 24t – 24.362 UNL, UNLL	10/86 – 02/90		MBLK2200	MBD1107
			MBLK2210	MBD1105
			MBLK2185	
F90 Series - 24t – 24.372 DF, DFS, DFLS, DFK	02/90 – 04/95		MBLK2200	MBD1107
			MBLK2210	MBD1105
F90 Series - 24t – 24.372 FNL, FNLL 24t – 24.372 FNLS, FVLS	02/90 – 05/95		MBLK2200	MBD1107
			MBLK2210	MBD1105
			MBLK2185	
F90 Series - 24t – 24.372 FVL, FVLS 24t – 24.372 UNL, UNLL	02/90 – 12/90		MBLK2200	MBD1107
			MBLK2210	MBD1105
			MBLK2185	
F90 Series - 24t – 24.402 FNL, FNLL	05/94 – 05/95		MBLK2200	MBD1107
			MBLK2210	MBD1105
			MBLK2185	
F90 Series - 24t – 24.422 DF, DFS, DFLS, DFK 24t – 24.462 DF, DFS, DFLS, DFK	02/90 – 12/90		MBLK2200	MBD1107
			MBLK2210	MBD1105
F90 Series - 24t – 24.422 FNL, FNLL	02/90 – 05/95		MBLK2200	MBD1107
			MBLK2210	MBD1105
			MBLK2185	
F90 Series - 24t – 24.422 UNL, UNLL	02/90 – 12/90		MBLK2200	MBD1107
			MBLK2185	
			MBLK2210	MBD1105
F90 Series - 24t – 24.462 FNL	04/89 – 02/90		MBLK2200	MBD1107
			MBLK2210	MBD1105
			MBLK2185	



		 	 	 
...MAN				
				
F90 Series - 24t – 24.462 FVLS	05/87 – 07/87	 	MBLK2200 MBLK2210 MBLK2185	MBD1107 MBD1105
F90 Series - 24t – 24.502 DF	02/90 – 12/90	 	MBLK2200 MBLK2210	MBD1107 MBD1105
F90 Series - 24t – 24.502 FNL	02/90 – 12/90	 	MBLK2200 MBLK2210 MBLK2185	MBD1107 MBD1105
F90 Series - 25t – 25.272 DF, DFS, DFSL, DFK	09/90 – 12/92	 	MBLK2200 MBLK2210	MBD1107 MBD1105
F90 Series - 25t – 25.272 FNL, FNLL	09/90 – 10/93	 	MBLK2200 MBLK2210 MBLK2185	MBD1107 MBD1105
F90 Series - 25t – 25.302 DF, DFS, DFSL, DFK 25t – 25.322 DF, DFS, DFSL, DFK 25t – 25.372 DF, DFS, DFSL, DFK	09/90 – 12/92	 	MBLK2200 MBLK2210	MBD1107 MBD1105
F90 Series - 25t – 25.302 FNL, FNLL 25t – 25.302 FNLS, FVLS	09/90 – 12/91	 	MBLK2200 MBLK2210 MBLK2185	MBD1107 MBD1105
F90 Series - 25t – 25.322 FNL, FNLL 25t – 25.322 FNLS, FVLS	09/90 – 12/92	 	MBLK2200 MBLK2210 MBLK2185	MBD1107 MBD1105
F90 Series - 25t – 25.322 UNL, UNLL 25t – 25.372 UNL, UNLL	09/90 – 12/92	 	MBLK2200 MBLK2210	MBD1107 MBD1105
F90 Series - 25t – 25.372 FNLS, FVLS 25t – 25.372 FVLS, FNL, FNLL	09/90 – 10/93	 	MBLK2200 MBLK2210 MBLK2185	MBD1107 MBD1105
F90 Series - 25t – 25.422 DF, DFS, DFSL, DFK	09/90 – 12/92	 	MBLK2200 MBLK2210	MBD1107 MBD1105
F90 Series - 25t – 25.422 FNL, FNLL 25t – 25.422 FNLS, FVLS	09/90 – 12/92	 	MBLK2200 MBLK2210 MBLK2185	MBD1107 MBD1105
F90 Series - 25t – 25.422 UNL, UNLL	09/90 – 12/92	 	MBLK2200 MBLK2210	MBD1107 MBD1105
F90 Series - 25t – 25.502 DF, DFS	09/90 – 12/92	 	MBLK2200 MBLK2210	MBD1107 MBD1105
F90 Series - 25t – 25.502 FNL	09/90 – 12/92	 	MBLK2200 MBLK2210 MBLK2185	MBD1107 MBD1105
F90 Series - 26t – 25.502 DF, DFS	01/89 →		MBLK2210	MBD1105
F90 Series - 26t – 26.262 DF, DFS DFK	01/88 – 02/90		MBLK2210	MBD1105





				
...MAN				
				
F90 Series - 26t – 26.262 DFA, DFAS, DFAK	02/89 – 02/90		MBLK2210	MBD1105
F90 Series - 26t – 26.272 DF, DFS, DFLS, DFK	02/90 – 06/96		MBLK2210	MBD1105
F90 Series - 26t – 26.272 DFA, DFAS, DFAK	02/90 – 12/92		MBLK2210	MBD1105
F90 Series - 26t – 26.272 FNL, FNLL, FNLS, FVLS	09/90 – 12/95		MBLK2200	MBD1107
			MBLK2210	MBD1105
			MBLK2185	
F90 Series - 26t – 26.292 DF, DFS, DFK	09/87 – 02/90		MBLK2210	MBD1105
F90 Series - 26t – 26.292 DFA, DFAS, DFAK	05/88 – 02/90		MBLK2210	MBD1105
F90 Series - 26t – 26.302 DF, DFS, DFK	05/90 – 12/91		MBLK2210	MBD1105
F90 Series - 26t – 26.302 DFA, DFAS, DFAK	05/90 – 12/91		MBLK2210	MBD1105
F90 Series - 26t – 26.302 FNL, FNLL, FNLS, FVLS	09/90 – 12/91		MBLK2200	MBD1107
			MBLK2210	MBD1105
			MBLK2185	
F90 Series - 26t – 26.322 DF, DFS, DFLS, DFK	02/90 – 06/96		MBLK2210	MBD1105
F90 Series - 26t – 26.322 DFA, DFAS, DFAK	02/90 – 12/90		MBLK2210	MBD1105
F90 Series - 26t – 26.322 FNL, FNLL, FNLS, FVLS	09/90 – 12/95		MBLK2200	MBD1107
			MBLK2210	MBD1105
			MBLK2185	
F90 Series - 26t – 26.322 UNL, 26.322 UNLL	09/90 – 05/94		MBLK2210	MBD1105
F90 Series - 26t – 26.332 DF, DFS, DFK	09/87 – 02/90		MBLK2210	MBD1105
F90 Series - 26t – 26.332 DFA, DFAS, DFAK	05/88 – 02/90		MBLK2210	MBD1105
F90 Series - 26t – 26.342 DF, DFL, DFS, DFK, DFLK	04/94 – 06/96		MBLK2210	MBD1105
F90 Series - 26t – 26.372 DFA, DFAS, DFAK	01/89 – 94		MBLK2210	MBD1105
F90 Series - 26t – 26.372 DFN, FVL, FVLS, FNL, FN	01/89 – 94		MBLK2200	MBD1107
			MBLK2185	
			MBLK2210	MBD1105
F90 Series - 26t – 26.422 D, DFS DFK	01/89 – 94		MBLK2210	MBD1105
F90 Series - 26t – 26.422 DFA, DFAK, DFAS	01/89 – 94		MBLK2210	MBD1105
F90 Series - 26t – 26.422 DFN, FVL, FVLS, FNL, FN	01/89 – 94		MBLK2200	MBD1107
			MBLK2185	
			MBLK2210	MBD1105
F90 Series - 26t – 26.502 DFA, DFAS	01/89 →		MBLK2210	MBD1105
F90 Series - 26t – 26.502 FNL	01/89 →		MBLK2200	MBD1107
			MBLK2185	
			MBLK2210	MBD1105
F90 Series - 26t – 26.732 DF, DFS, DFK	01/89 – 94		MBLK2210	MBD1105
F90 Series - 27t – 27.272, 27.322, 27.372, 27.422	01/89 – 94		MBLK2210	MBD1105
F90 Series - 27t – 27.502 DF, DFS	01/89 →		MBLK2210	MBD1105
F90 Series - 27t – 27.502 DFA, DFAS	01/89 →		MBLK2210	MBD1105



...MAN				
F90 Series - 30t – 30.292	88 – 94		MBLK2200	MBD1107
	88 – 97		MBLK2210	MBD1105
F90 Series - 30t – 30.332 VFNL (8x2)	88 – 94		MBLK2200	MBD1107
			MBLK2210	MBD1105
F90 Series - 32t – 32.242 32t – 32.262	88 – 94		MBLK2200	MBD1107
			MBLK2210	MBD1105
F90 Series - 32t – 32.272 VF, VFK 32t – 32.322 VF, VFK 32t – 32.372 VF, VFK 32t – 32.422 VF, VFK	01/89 – 94		MBLK2200	MBD1107
			MBLK2210	MBD1105
F90 Series - 32t – 32.292 VFNL (8x2) 32t – 32.332 VFNL (8x2) 32t – 32.362 VFNL (8x2)	88 – 94		MBLK2200	MBD1107
			MBLK2210	MBD1105
F90 Series - 33t – 33.242	09/87 – 94		MBLK2200	MBD1107
			MBLK2210	MBD1105
F90 Series - 33t – 33.262 DF, DFK, DFS 33t – 33.272 DF, DFK, DFS 33t – 33.292 DF, DFK, DFS 33t – 33.322 DF, DFK, DFS 33t – 33.332 DF, DFK, DFS 33t – 33.362 DF, DFK, DFS 33t – 33.372 DF, DFK, DFS 33t – 33.422 DF, DFK, DFS	01/89 – 94		MBLK2200	MBD1107
			MBLK2210	MBD1105
F90 Series - 33t – 33.262 DFA, DFAK, DFAS 33t – 33.272 DFA, DFAK, DFAS 33t – 33.292 DFA, DFAK, DFAS 33t – 33.322 DFA, DFAK, DFAS 33t – 33.332 DFA, DFAK, DFAS 33t – 33.362 DFA, DFAK, DFAS 33t – 33.372 DFA, DFAK, DFAS 33t – 33.422 DFA, DFAK, DFAS	01/89 – 94		MBLK2210	MBD1105
F90 Series - 33t – 33.462 DF, DFS	01/89 – 94		MBLK2200	MBD1107
			MBLK2210	MBD1105
F90 Series - 33t – 33.462 DFA, DFAS	01/89 – 94		MBLK2210	MBD1105
F90 Series - 33t – 33.502 DF, DFS	01/89 →		MBLK2200	MBD1107
			MBLK2210	MBD1105
			MBLK2185	
F90 Series - 33t – 33.502 DFA, DFAS	01/89 →		MBLK2210	MBD1105
F90 Series - 35t – 35.262 VF 35t – 35.292 VF 35t – 35.332 VF 35t – 35.362 VF	01/89 – 94		MBLK2200	MBD1107
			MBLK2210	MBD1105





- 1
- 2
- 3
- 4
- 5
- 6
- 7

...MAN				
F90 Series - 35t – 35.262 VFAK 35t – 35.272 VFAK 35t – 35.292 VFAK 35t – 35.332 VFAK 35t – 35.362 VFAK	01/89 – 94		MBLK2210	MBD1105
F90 Series - 35t – 35.272 VF, VFK 35t – 35.322 VF, VFK 35t – 35.372 VF, VFK 35t – 35.422 VF, VFK	01/89 – 94		MBLK2200	MBD1107
F90 Series - 35t – 35.322 VFA, VFAK 35t – 35.372 VFA, VFAK 35t – 35.422 VFA, VFAK	01/89 – 94		MBLK2210	MBD1105
F90 Series - 40t – 40.242, 40.262, 40.292, 40.332, 40.362	87 →		MBLK2200	MBD1107
F90 Series - 40t – 40.372 DFAK, DFAS 40t – 40.422 DFAK, DFAS 40t – 40.462 DFAK, DFAS	01/89 – 94		MBLK2210	MBD1105
F90 Series - 40t – 40.372 DFS, DFK 40t – 40.422 DFS, DFK	01/89 – 94		MBLK2200	MBD1107
F90 Series - 40t – 40.502 (6x6) 40t – 40.502 (8x8)	01/89 →		MBLK2200	MBD1105
F90 Series - 41t – 41.262 VF, VFK 41t – 41.292 VF, VFK 41t – 41.322 VF, VFK 41t – 41.332 VF, VFK 41t – 41.362 VF, VFK 41t – 41.372 VF, VFK 41t – 41.422 VF, VFK	01/89 – 94		MBLK2200	MBD1107
F90 Series - 41t – 41.262 VFAK 41t – 41.292 VFAK 41t – 41.322 VFAK 41t – 41.332 VFAK 41t – 41.362 VFAK 41t – 41.372 VFAK 41t – 41.422 VFAK	01/89 – 94		MBLK2210	MBD1105
F90 Series - 48t – 48.292 VFA, VFAK 48t – 48.322 VFA, VFAK 48t – 48.332 VFA, VFAK 48t – 48.362 VFA, VFAK 48t – 48.372 VFA, VFAK 48t – 48.422 VFA, VFAK 48t – 48.462 VFA, VFAK	01/89 – 94		MBLK2210	MBD1105
F90 Series - 48t – 48.322 VF 48t – 48.372 VF 48t – 48.422 VF	01/89 – 94		MBLK2200	MBD1107



...MAN				
F90 Series - 48t – 48.502 VF	01/89 →		MBLK2200	MBD1107
			MBLK2210	MBD1105
F90 Series - 48t – 48.502 VFA, VFAK	01/89 →		MBLK2210	MBD1105
F90 Series – All Models	73 →		MBLK2190	MBD1106
			MBLK2190	
			MBLK2200	MBD1104
F90 Series 4x4 - 19t – 19.262 FA, FAK, FAS	02/89 – 02/90		MBLK2210	MBD1105
F90 Series 4x4 - 19t – 19.272 FA, FAK, FAS	02/90 – 05/95		MBLK2210	MBD1105
F90 Series 4x4 - 19t – 19.292 FA, FAK, FAS	05/88 – 02/90		MBLK2210	MBD1105
F90 Series 4x4 - 19t – 19.322 FA, FAK, FAS	02/90 – 06/96		MBLK2210	MBD1105
F90 Series 4x4 - 19t – 19.332 FA, FAK, FAS	05/88 – 02/90		MBLK2210	MBD1105
F90 Series 4x4 - 19t – 19.342 FA, FAK, FAS	05/94 – 06/96		MBLK2210	MBD1105
F90 Series 4x4 - 19t – 19.362 FA, FAK, FAS	05/88 – 02/90		MBLK2210	MBD1105
F90 Series 4x4 - 19t – 19.372 FA, FAK, FAS	02/90 – 06/96		MBLK2210	MBD1105
F90 Series 4x4 - 19t – 19.402 FA, FAK, FAS	05/94 – 06/96		MBLK2210	MBD1105
F90 Series 4x4 - 19t – 19.422 FA, FAK, FAS	02/90 – 06/96		MBLK2210	MBD1105
G90 Series – 6.100 - 9.170	78 – 93			MBD2016
				MBD2016
L2000 and M90 Series – 25.224, 25.264	08/95 →		MBLK2200	MBD1104
			MBLK2210	MBD1105
L2000 Series – 6.103 to 10.224	93 – 99			MBD2016
M2000 Series – 15.163 LC, LLC 15.224 LC, LLC, LL 18.224 LC, LLC, LL	08/95 →		MBLK2200	MBD1104
			MBLK2210	MBD1105
M2000 Series – 15.163 LK 15.224 LK	08/95 →		MBLK2200	MBD1104
M2000 Series – 18.224 LK, LLK, LAK	08/95 →		MBLK2200	MBD1104
M2000 Series – 18.224 MC, MLC, ML, MLS 18.264 MC, MLC, ML, MLS	08/95 →		MBLK2200	MBD1104
			MBLK2210	MBD1105
M2000 Series – 18.224 MK, MLK, MAK 18.264 MK, MLK, MAK	08/95 →		MBLK2200	MBD1104
M2000 Series – 25.224, 25.264	08/95 →		MBLK2200	MBD1104
			MBLK2210	MBD1105
M2000 Series – 25.224 MNLC, MNLLC 25.264 MNLC, MNLL	08/95 →		MBLK2200	MBD1104
			MBLK2210	MBD1105
M90 Series - 15t – 15.168, 15.200, 15.232, 15.240			MBLK2190	MBD1106
M90 Series - 16t – 16.168			MBLK2190	MBD1106
M90 Series - 17t – 17.192	08/88 – 06/96		MBLK2190	MBD1106
M90 Series - 17t – 17.222	05/94 – 06/96		MBLK2190	MBD1106
			MBLK2210	MBD1105
	08/88 – 06/96		MBLK2210	MBD1105

















































...MAN				
M90 Series - 17t - 17.232	08/88 - 06/96		MBLK2190	MBD1106
			MBLK2210	MBD1105
M90 Series - 17t - 17.272	09/91 - 05/95		MBLK2190	MBD1106
			MBLK2210	MBD1105
M90 Series - 17t - 17.322, 17.332, 17.373, 17.422, 17.502	90 - 06/96		MBLK2190	MBD1106
			MBLK2210	MBD1105
M90 Series - 18t - 18.192	09/90 - 06/96		MBLK2200	MBD1104
M90 Series - 18t - 18.222	05/94 - 06/96		MBLK2200	MBD1104
M90 Series - 18t - 18.232	09/90 - 06/96		MBLK2200	MBD1104
M90 Series - 18t - 18.262	08/95 - 06/96		MBLK2200	MBD1104
M90 Series - 18t - 18.272	09/91 - 06/96		MBLK2200	MBD1104
M90 Series - 24t - 24.192	07/89 - 06/96		MBLK2200	MBD1104
			MBLK2185	
M90 Series - 24t - 24.222	05/92 - 06/96		MBLK2185	
M90 Series - 24t - 24.222	05/94 - 06/96		MBLK2200	MBD1104
M90 Series - 24t - 24.232	07/89 - 06/96		MBLK2200	MBD1104
			MBLK2185	
M90 Series - 24t - 24.272	07/91 - 06/96		MBLK2185	
	09/91 - 06/96		MBLK2200	MBD1104
M90 Series - Non ABS/ABS	89 - 96		MBLK2200	MBD1104
			MBLK2210	MBD1105
TGA-Series - 18.280, 18.310, 18.320, 18.330, 18.350, 18.360, 18.390, 18.400, 18.410, 18.430, 18.440, 18.460, 18.480, 18.510, 18.530, 18.540, 18.680, 19.350, 19.360, 19.390, 19.400, 19.410, 19.430, 19.440, 19.460, 19.480, 24.350, 24.360, 24.390, 24.400, 24.410, 24.430,	99 →		MBLK2190	MBD1108
			MBLK2200	MBD1107
			MBLK2200	MBD1003
			MBLK2210	MBD1105
TGS-Series - 18.320, 18.350, 18.360, 18.390, 18.400, 18.430, 18.440, 18.480, 18.540, 19.350, 19.360, 19.390, 19.400, 19.430, 19.440, 19.480, 19.540, 21.360, 21.400, 21.440, 21.480, 24.320, 24.360, 24.400, 24.440, 24.480, 24.540, 26.320, 26.350, 26.360, 26.390, 26.400,	05 →		MBLK2190	MBD1108
			MBLK2200	MBD1107
			MBLK2200	MBD1103
			MBLK2210	MBD1105
TGX-Series - 18.360, 18.400, 18.440, 18.480, 18.540, 41.540	06 →		MBLK2210	MBD1105
TGX-Series - 18.520, 18.560, 41.560, 41.640	14 →		MBLK2210	MBD1105
TGX-Series - 26.360, 26.400, 26.440, 26.480, 26.540, 33.360, 33.400, 33.440, 33.480, 33.540	06 →		MBLK2200	MBD1107
			MBLK2210	
			MBLK2210	MBD1105
TGX-Series - 26.360, 26.400, 26.440, 26.480, 26.540, 33.360, 33.400, 33.440, 33.480, 33.540	07 →		MBLK2200	MBD1107
			MBLK2210	
			MBLK2210	MBD1105
TGX-Series - 26.520, 26.560, 33.520, 33.560	14 →		MBLK2200	MBD1107
			MBLK2210	
			MBLK2210	MBD1105



...MAN				
TGX-Series – 28.440, 28.480, 28.540	09 →		MBLK2200	MBD1107
			MBLK2210	
			MBLK2210	MBD1105
TGX-Series – 41.680	07 →		MBLK2210	MBD1105
U90 Series – 14.272 U 19.322 U, UL 19.372 U, UL 19.422 U, UL	05/89 →		MBLK2200	MBD1104
			MBLK2210	MBD1105
U90 Series – 24.332 U, UL 24.362 U, UL	86 →		MBLK2200	MBD1104
			MBLK2210	MBD1105
			MBLK2185	
U90 Series – 26.322 UNL 26.372 UNL 26.422 UNL	05/89 →		MBLK2200	MBD1104
			MBLK2210	MBD1105
			MBLK2185	
Mercedes				
809, 811, 814 D	86 – 08/96		MBLK2160	
O 301	10/88 →			MBD1028
O 303 – 13R, 14R & 15R	74 – 91		MBLK2190	MBD1126
O 303, O 305, O 307, O 309 – Evobus	70 →			MBD1010
				MBD1004
				MBD1111
				MBD1112
				MBD1126
O 305 – G	77 – 87		MBLK2190	MBD1126
O 402	10/88 →			MBD1028
				MBD1028
O 404, O 405, O 407	84 →			MBD1111
				MBD1112
O 405 – City Bus	89 →		MBLK2190	MBD1126
O 405 – G Bus	89 →		MBLK2190	MBD1126
O 814 – 8/8.6t	84 →		MBLK2170	
O 817 – BM 676	84 →		MBLK2170	
Mercedes				
1017 – 1017	76 – 86		MBLK2190	MBD1111
1120 – 1120 FBM677	89 →			MBD1028
1120 – 1120 FBM677	89 →			MBD1028
114 – 114 A, L BM675	85 – 88			MBD1028
1313 – 1313 EBM675	10/88 →			MBD1028
1314 – 1314 BM675				MBD1028





				
...Mercedes				
				
1317	76 – 83	 	 MBLK2190	MBD1111 MBD1115
1413	75 – 86	 	MBLK2190	MBD1115 MBD1111
1424 – 1424	75 – 86	 	MBLK2190 MBLK2190	MBD1111 MBD1115
1426 – 1426	84 →	 	MBLK2190 MBLK2190	MBD1116 MBD1126
1426 – 1426	84 →	   	MBLK2190 MBLK2190 MBLK2190	MBD1111 MBD1115 MBD1116 MBD1126
1613 – 1613 BM385	73 – 84	  	MBLK2190 MBLK2190 MBLK2190	MBD1010 MBD1111 MBD1126
1614 – 1614 BM617	04/84 – 03/91	  	MBLK2190 MBLK2190 MBLK2190	MBD1126 MBD1115 MBD1116
1617 – 1617 C, K, L, S	89 →	     	MBLK2190 MBLK2190 MBLK2190 MBLK2190 MBLK2190	MBD1010 MBD1111 MBD1126 MBD1115 MBD1116 MBD1126
1623 – 1623 K, L, S, AK, AS	73 →	     	MBLK2190 MBLK2190 MBLK2190 MBLK2210 MBLK2190 MBLK2190	MBD1010 MBD1111 MBD1126 MBD1112 MBD1115 MBD1116 MBD1126
1624 – 1624 L, LS, K, S	75 – 91	   	MBLK2190 MBLK2190 MBLK2190 MBLK2190	MBD1010 MBD1111 MBD1126 MBD1115 MBD1116
1625 – 1625 AK BM617	83 – 91	  	MBLK2190 MBLK2190 MBLK2190	MBD1010 MBD1111 MBD1115 MBD1116



...Mercedes					
1626 – 1626 K, L, AL, AS	73 – 91		MBLK2190	MBD1010	
			MBLK2190	MBD1111	
			MBLK2190	MBD1126	
			MBLK2190	MBD1115	
			MBLK2190	MBD1116	
			MBLK2190	MBD1126	
1632 – 1632 K, AK, AS, S, L	73 – 91		MBLK2190	MBD1010	
			MBLK2190	MBD1111	
			MBLK2190	MBD1126	
			MBLK2210	MBD1112	
			MBLK2190	MBD1115	
			MBLK2190	MBD1116	
1719 – 1719 S, AS, K	09/89 – 08/94		MBLK2190	MBD1010	
			MBLK2190	MBD1111	
			MBLK2190	MBD1126	
			MBLK2210	MBD1112	
			MBLK2190	MBD1115	
			MBLK2190	MBD1116	
1919 – 1919 AK, AS, K, S	73 – 89		MBLK2190	MBD1126	
			MBLK2190	MBD1010	
			MBLK2200	MBD1104	
			MBLK2190	MBD1126	
			MBLK2190	MBD1115	
			MBLK2190	MBD1116	
1922 – 1922 BM656	89 →		MBLK2200	MBD1012	
			MBLK2200	MBD1124	
			MBLK2210	MBD1004	
			MBLK2210	MBD1112	
1924 – 1924 K, S BM397	73 – 89		MBLK2190	MBD1010	
			MBLK2190	MBD1126	
			MBLK2200	MBD1104	
			MBLK2190	MBD1126	
			MBLK2190	MBD1115	
			MBLK2190	MBD1116	
1926 – 1926 A, AK, K, S	73 – 89		MBLK2190	MBD1010	
			MBLK2190	MBD1126	
			MBLK2200	MBD1104	
			MBLK2190	MBD1126	
			MBLK2190	MBD1115	
			MBLK2190	MBD1116	

1

2

3

4

5

6

7



- 1
- 2
- 3
- 4
- 5
- 6
- 7

...Mercedes				
1928 – 1928 AK, K, L, LS, S	80 – 89		MBLK2190	MBD1010
			MBLK2190	MBD1126
			MBLK2200	MBD1104
			MBLK2190	MBD1126
			MBLK2190	MBD1115
			MBLK2190	MBD1116
1932 – 1932 A, AK, AS, K, LS	73 – 89		MBLK2190	MBD1010
			MBLK2190	MBD1126
			MBLK2200	MBD1104
			MBLK2190	MBD1126
			MBLK2190	MBD1115
			MBLK2190	MBD1116
1944 – 1944 LS, S	80 – 89		MBLK2190	MBD1010
			MBLK2190	MBD1126
			MBLK2200	MBD1104
			MBLK2190	MBD1126
			MBLK2190	MBD1115
			MBLK2190	MBD1116
2026 – 2026 BM391	76 – 91		MBLK2190	MBD1010
			MBLK2190	MBD1126
			MBLK2210	MBD1004
			MBLK2200	MBD1104
			MBLK2190	MBD1126
2032 – 2032 S	75 – 91		MBLK2190	MBD1010
			MBLK2190	MBD1126
			MBLK2210	MBD1004
			MBLK2200	MBD1104
			MBLK2190	MBD1126
2033 – 2033 S, LS BM622	76 – 91		MBLK2190	MBD1010
			MBLK2190	MBD1126
			MBLK2210	MBD1004
			MBLK2200	MBD1104
			MBLK2190	MBD1126
2219 – 2219 C BM619	84 – 86		MBLK2190	MBD1012
			MBLK2190	MBD1111
				MBD1124
			MBLK2210	MBD1112
			MBLK2210	MBD1004
			MBLK2190	MBD1115
			MBLK2190	MBD1116
			MBLK2190	MBD1126
			MBLK2200	



...Mercedes				
2226 – 2226 BM619	→ 88		MBLK2190	MBD1012
				MBD1124
			MBLK2210	MBD1004
			MBLK2210	MBD1112
			MBLK2190	MBD1013
2226 – 2226 L, LP	89 →		MBLK2190	MBD1126
			MBLK2190	MBD1126
			MBLK2210	MBD1004
			MBLK2200	MBD1104
2232 – 2232 (6x4)	73 – 91		MBLK2190	MBD1010
			MBLK2190	MBD1013
			MBLK2190	MBD1126
2232 – 2232 L, LP	74 →		MBLK2190	MBD1010
			MBLK2190	MBD1126
			MBLK2210	MBD1004
			MBLK2200	MBD1104
			MBLK2190	MBD1126
2233 – 2233 L (6x2)	80 – 91		MBLK2190	MBD1010
				MBD1122
			MBLK2190	MBD1013
			MBLK2200	MBD1104
2235 – 2235 K, S (6x4) BM648	87 – 91		MBLK2190	MBD1010
			MBLK2190	MBD1013
			MBLK2190	MBD1126
2235 – 2235 LS (6x2) BM648	87 – 91		MBLK2190	MBD1010
				MBD1122
			MBLK2190	MBD1013
			MBLK2200	MBD1104
2421 – 2421 (6x4)	82 →		MBLK2190	MBD1010
			MBLK2190	MBD1013
			MBLK2190	MBD1126
2624 – 2624 A, AK (6x6)	73 – 89		MBLK2190	MBD1010
				MBD1122
			MBLK2190	MBD1013
2624 – 2624 K, S (6x4)	73 – 89		MBLK2190	MBD1010
				MBD1122
			MBLK2190	MBD1013
2626 – 2626 A, AB, AK, AS, LAK (6x6)	73 – 89		MBLK2190	MBD1010
				MBD1122
			MBLK2190	MBD1013

















































- 1
- 2
- 3
- 4
- 5
- 6
- 7

...Mercedes				
2626 – 2626 B, K, AK, S (6x4)	73 – 89		MBLK2190	MBD1010
				MBD1122
2628 – 2628 A, AK, AS (6x6)	82 – 89		MBLK2190	MBD1013
				MBD1122
2628 – 2628 B, S, K (6x4)	80 – 89		MBLK2190	MBD1013
				MBD1122
2632 – 2632 AK, AS, LAK (6x6)	73 →		MBLK2190	MBD1010
				MBD1122
2632 – 2632 K, S, LK (6x4)	77 – 89		MBLK2190	MBD1013
				MBD1122
2633 – 2633 S (6x4)	82 – 89		MBLK2190	MBD1010
				MBD1122
2636 – 2636 K, S (6x4/6x6)	81 →		MBLK2190	MBD1013
				MBD1122
2638 – 2638 S (6x4)	→ 91		MBLK2190	MBD1010
				MBD1122
2644 – 2644 S (6x4)	09/91 →		MBLK2190	MBD1013
				MBD1122
3025 – 3025 (8x4) BM625	85 →		MBLK2200	MBD1012
				MBD1124
3028 – 3028 B, K (8x4) BM625	→ 87		MBLK2190	MBD1013
				MBD1104
3229 – 3229 B, K (6x4/4)	91 →		MBLK2190	MBD1010
				MBD1124
3229 – 3229 B, K (8x4/4)	→ 89		MBLK2200	MBD1104
				MBD1012
			MBLK2190	MBD1010
				MBD1124
			MBLK2190	MBD1010
				MBD1124



		 	 	 
...Mercedes				
				
3250 – 3250 A (6x6) BM625	89 →	 	MBLK2200 MBLK2190 MBLK2190	MBD1012 MBD1111 MBD1013
3250 – 3250 AF (6x6) BM625	89 →	   	MBLK2190 MBLK2190 MBLK2190 MBLK2190	MBD1010 MBD1111 MBD1122 MBD1013
3328 – 3328 (8x4/2) BM625	83 – 89	 	MBLK2190 MBLK2190 MBLK2190	MBD1010 MBD1013
3328 – 3328 B, K (8x4/4)	83 – 89	  	MBLK2190 MBLK2190 MBLK2190	MBD1010 MBD1013
3328 – 3328 K (8x4/4) BM624	83 – 89	  	MBLK2190 MBLK2190 MBLK2190	MBD1010 MBD1013
3336 – 3336 (8x4/4) BM625	83 – 89	  	MBLK2190 MBLK2190 MBLK2190	MBD1010 MBD1013
3528 – 3528 B, K (8x4/4)	→ 91	  	MBLK2190 MBLK2190 MBLK2190	MBD1010 MBD1013
3536 – 3536 (8x4/4) BM625	84 – 89	  	MBLK2190 MBLK2190 MBLK2190	MBD1010 MBD1013
3824 – 3824 (6x4) BM625	84 →	    	MBLK2190 MBLK2190 MBLK2190 MBLK2190 MBLK2190	MBD1010 MBD1111 MBD1122 MBD1013
3824 – 3824 (6x6) BM625	84 →	    	MBLK2190 MBLK2190 MBLK2190 MBLK2190 MBLK2190	MBD1010 MBD1111 MBD1122 MBD1013
4050 – 4050 A (8x8) BM625	84 – 89	   	MBLK2190 MBLK2190 MBLK2190 MBLK2190	MBD1111 MBD1122 MBD1010 MBD1013





































































- 1
- 2
- 3
- 4
- 5
- 6
- 7







































...Mercedes				
410 x 160/163 mm			MBLK2190	
410 x 180/183 mm			MBLK2200	
410 x 220/223 mm – Mini bus			MBLK2210	
4850 – 4850 A (8x8) BM625	84 – 89		MBLK2190	MBD1010
			MBLK2190	MBD1111
				MBD1122
			MBLK2190	MBD1013
			MBLK2190	
914 – 914 EBM678	10/88 →			MBD1028
914 – 914 EBM678	85 – 09/88			MBD1028
Actros-Series – 1831	96 – 02		MBLK2200	MBD1012
			MBLK2190	MBD1104
			MBLK2200	MBD1104
			MBLK2210	MBD1104
Actros-Series – 1831	02 →		MBLK2200	MBD1012
			MBLK2190	MBD1104
			MBLK2200	MBD1104
			MBLK2210	MBD1104
Actros-Series – 1831 AK	96 – 02		MBLK2200	MBD2025
			MBLK2190	MBD1104
			MBLK2200	MBD1104
			MBLK2210	MBD1104
Actros-Series – 1831 AK	02 →		MBLK2200	MBD2025
			MBLK2190	MBD1004
			MBLK2200	MBD1004
			MBLK2210	MBD1004
Actros-Series – 1832	02 →		MBLK2200	MBD1012
			MBLK2190	MBD1004
			MBLK2200	MBD1004
			MBLK2210	MBD1004
Actros-Series – 1835 AK, 1848 AK, 3348 AK	02 →		MBLK2200	MBD2025
			MBLK2190	MBD1104
			MBLK2200	MBD1104
			MBLK2210	MBD1104
Actros-Series – 2531, 2540, 2543, 2548, 2553	96 – 02		MBLK2200	MBD1012
Actros-Series – 2631 L, 2632 L, 2635 L, 2636 L, 2641 L, 2643 L, 2644 L, 2646 L, 2648 L, 2650 L, 2653 L, 2654 L, 2655 L, 2658 L, 2660 L, 3231 B, 3232 B, 3235 B, 3236 B, 3240 B, 3241, 3241 B, 3243, 3243 B, 3244, 3244 B, 3246, 3246 B, 3248, 3248 B	02 →		MBLK2190	MBD1104
			MBLK2200	MBD1104
			MBLK2210	MBD1104
Actros-Series – 2640 L, 2651 L	02 →		MBLK2190	MBD1004
			MBLK2200	MBD1004
			MBLK2210	MBD1004



		 	 	 
...Mercedes				
				
Actros-Series – 4140 K, 4141 K, 4143 K, 4146 K	02 →	  	  	MBD2025 MBD1012 MBD1004 MBD1004 MBD1004
Actros-Series – 4144 K, 4148 K, 4150 K, 4151 K	02 →	  	  	MBD2025 MBD1012 MBD1104 MBD1104 MBD1104
Actros-Series – 5041 AK, 5044 AK, 5048 AK	08 →	  	  	MBD2025 MBD1104 MBD1104 MBD1104
Actros-Series – 5041 B, 5044 K	08 →	  	  	MBD1012 MBD1004 MBD1004 MBD1004
Actros-Series – 5041 K, 5044 B, 5046 B, 5046 K	08 →	  	  	MBD1012 MBD1104 MBD1104 MBD1104
Actros-Series – 5046 AK	08 →	  	  	MBD2025 MBD1004 MBD1004 MBD1004
Atego-Series – 1017 A, 1018 A, 1022 A, 1023 A, 1024 A, 1324 A, 1326 A, 1329 A	04 →			MBD2026
Atego-Series – 1017 A, 1018 A, 1023 A	98 – 04			MBD2026
Atego-Series – 1214 K	04 →			MBD1028
Atego-Series – 1214, 1214 K, 1215, 1215 K, 1215 L, 1217, 1217 K, 1217 L, 1218, 1218 K, 1218 L, 1223, 1223 K, 1223 L, 1225 F, 1228, 1228 L, 1317, 1317 K, 1317 L, 1318, 1318 K, 1318 L, 1323, 1323 K, 1323 L, 1325 F, 1328, 1328 F, 1328 L, 1517 K, 1518 K, 1523 K, 1528 K	98 – 04			MBD1028
Atego-Series – 1222 AF	04 →	 	 	MBLK2190 MBD1028 MBD2026
Atego-Series – 1222 AF, 1225 AF, 1225 AFE, 1317 A, 1317 AK, 1318 A, 1318 AK, 1323 A, 1323 AK, 1325 AF, 1328 AF, 1517 A, 1518 A, 1523 A, 1523 AK, 1525 AF, 1528 AF, 1528 AK	98 – 04	 	 	MBLK2190 MBD1028 MBD2026
Atego-Series – 1823 AK, 1824 AK, 1826 AK, 1828 A, 1828 AK, 1829 A, 1829 AK, 1833 A, 1833 AK	98 – 04	 	 	MBD2025 MBD1004 MBD1104











































		 	 	 
...Mercedes				
				
Atego-Series – 1823 K, 1828 K	98 – 04	 	MBLK2200 MBLK2190 MBLK2210	MBD1012 MBD1004 MBD1104
Atego-Series – 1823 L, 1828 L	98 – 04	  	MBLK2185 MBLK2190 MBLK2200 MBLK2210	MBD1012 MBD1004 MBD1004 MBD1104
Atego-Series – 1823 LS, 1824 LS, 1826 LS, 1828 LS, 1829 LS, 1833 LS, 2628 B, 2629, 2629 K, 2633, 2633 B, 2633 K	98 – 04	  	MBLK2200 MBLK2190 MBLK2200 MBLK2210	MBD1012 MBD1104 MBD1104 MBD1104
Atego-Series – 1823, 1824, 1826, 1828, 1829, 1833	98 – 04	   	MBLK2185 MBLK2200 MBLK2190 MBLK2200 MBLK2210	MBD1012 MBD1012 MBD1104 MBD1104 MBD1104
Atego-Series – 1824 K, 1826 K, 1829 K, 1833 K	98 – 04	 	MBLK2200 MBLK2190 MBLK2210	MBD1012 MBD1004 MBD1104
Atego-Series – 1824 L, 1826 L, 1829 L, 1833 L	98 – 04	  	MBLK2185 MBLK2190 MBLK2200 MBLK2210	MBD1004 MBD1004 MBD1004 MBD1104
Atego-Series – 2523 L, 2528 L, 2529 L, 2533 L	98 – 04	 	MBLK2190 MBLK2200 MBLK2210	MBD1104 MBD1104 MBD1104
Atego-Series – 2628, 2628 K, 2629 B	04 →	  	MBLK2200 MBLK2190 MBLK2200 MBLK2210	MBD1012 MBD1004 MBD1004 MBD1104
Atego-Series – 915 K, 916 K, 917 K, 918 K, 922 K, 923 K, 924 K, 926 K, 929 K	04 →			MBD2026
Atego-Series – 915, 916, 917, 918, 922, 923, 924, 1015, 1015 K, 1016, 1016 K, 1017, 1017 K, 1018, 1018 K, 1022, 1022 K, 1023, 1023 K, 1024, 1024 K, 1026, 1026 K, 1029, 1029 K	04 →	 		MBD1028 MBD2026
Atego-Series – 917 AF, 918 AF, 922 AF, 925 AF, 926 AF, 1017 AK, 1018 AK, 1022 AFE, 1022 AK, 1022 AKE, 1023 AK, 1023 AKE, 1024 AK, 1024 AKE, 1025 AFE, 1026 AFE, 1026 AK, 1029 AK	04 →	 		MBD2026 MBD1028 MBD2026
Atego-Series – 917, 917 K, 918, 918 K, 923, 923 K, 1015, 1017, 1017 K, 1018, 1018 K, 1023, 1023 K	98 – 04			MBD1028 MBD2026
Atego-Series – 918 AF, 918 AFE, 925 AF, 925 AFE, 1017 AK, 1018 AK, 1023 AK	98 – 04	 		MBD2026 MBD1028 MBD2026































...Mercedes				
LK/LN2 Series - 8t/8.6t – 809 K BM367	03/84 →		MBLK2160	
LK/LN2 Series - 8t/8.6t – 811 K	03/84 →		MBLK2160	
LK/LN2 Series - 8t/8.6t – 814 F	03/84 →		MBLK2160	
	07/87 →		MBLK2170	
LK/LN2 Series - 8t/8.6t – 814 L, K, S	03/84 →		MBLK2160	
LK/LN2 Series - 8t/8.6t – 817 F	03/96 →		MBLK2160	
LK/LN2 Series - 8t/8.6t – 817 L, K, S, LS	01/86 →		MBLK2160	
	07/87 →		MBLK2170	
MK Series - 14t – 1417 A, AK, K	07/89 →		MBLK2190	
MK Series - 14t – 1420, L, LS	84 →		MBLK2190	MBD1111
			MBLK2190	MBD1115
			MBLK2190	MBD1116
			MBLK2190	MBD1126
MK Series - 14t – 1422	02/93 – 08/94		MBLK2190	
MK Series - 14t – 1422 F	07/89 – 09/93		MBLK2190	
MK Series - 14t – 1422 L, S, LS	02/93 – 08/94		MBLK2190	
MK Series - 14t – 1427 F	02/93 →		MBLK2190	
MK/SK Series - 17t – 1717 AK	09/89 – 08/94		MBLK2190	MBD1010
			MBLK2200	MBD1003
			MBLK2210	MBD1004
			MBLK2210	MBD1112
MK/SK Series - 17t – 1717 L, K	09/89 – 08/94		MBLK2200	MBD1012
			MBLK2200	MBD1003
			MBLK2210	MBD1004
			MBLK2210	MBD1112
MK/SK Series - 17t – 1717AK, 1722AK, 1726AK	09/89 – 08/94		MBLK2190	MBD1010
MK/SK Series - 17t – 1720 L	02/90 →		MBLK2200	MBD1012
			MBLK2200	MBD1003
			MBLK2210	MBD1004
			MBLK2210	MBD1112
MK/SK Series - 17t – 1720 S	02/90 – 08/94		MBLK2200	MBD1012
			MBLK2200	MBD1003
			MBLK2210	MBD1004
			MBLK2210	MBD1112
MK/SK Series - 17t – 1722 AK	12/88 – 08/94		MBLK2190	MBD1010
			MBLK2200	MBD1003
			MBLK2210	MBD1004
			MBLK2210	MBD1112





































		 	 	 
...Mercedes				
				
MK/SK Series - 17t – 1722 L, S, K	12/88 – 08/94	 	MBLK2200 MBLK2200 MBLK2210 MBLK2210	MBD1012 MBD1003 MBD1004 MBD1112
MK/SK Series - 17t – 1726 AK	06/89 – 08/94	  	MBLK2190 MBLK2200 MBLK2210 MBLK2210	MBD1010 MBD1003 MBD1004 MBD1112
MK/SK Series - 17t – 1726 L, S, LS, K	12/88 – 08/94	  	MBLK2200 MBLK2200 MBLK2210 MBLK2210	MBD1012 MBD1003 MBD1004 MBD1112
MK/SK Series - 17t – 1729 AK	07/88 – 09/93	  	MBLK2190 MBLK2210 MBLK2200 MBLK2210	MBD1010 MBD1112 MBD1003 MBD1004
MK/SK Series - 17t – 1729 L, S, LS, K	07/88 – 08/94	  	MBLK2200 MBLK2200 MBLK2210 MBLK2210	MBD1012 MBD1003 MBD1004 MBD1112
MK/SK Series - 17t – 1733 L, S, LS	01/89 – 07/92	  	MBLK2200 MBLK2200 MBLK2210 MBLK2210	MBD1012 MBD1003 MBD1004 MBD1112
MK/SK Series - 18t – 1820 AK	07/93 →	  	MBLK2190 MBLK2200 MBLK2210 MBLK2210	MBD1010 MBD1003 MBD1004 MBD1112
MK/SK Series - 18t – 1820 L	01/94 →	  	MBLK2200 MBLK2200 MBLK2210 MBLK2210	MBD1012 MBD1003 MBD1004 MBD1112
MK/SK Series - 18t – 1824 AK	01/94 →	  	MBLK2190 MBLK2200 MBLK2210 MBLK2210	MBD1010 MBD1003 MBD1004 MBD1112
MK/SK Series - 18t – 1824 K	08/92 →	  	MBLK2190 MBLK2200 MBLK2210 MBLK2210	MBD1010 MBD1003 MBD1004 MBD1112



		 	 	 
...Mercedes				
				
MK/SK Series - 18t – 1824 L	08/92 →	 	MBLK2200 MBLK2200 MBLK2210 MBLK2210	MBD1012 MBD1003 MBD1004 MBD1112
MK/SK Series - 18t – 1827 L, S, LS	12/90 →	 	MBLK2200 MBLK2200 MBLK2210 MBLK2210	MBD1012 MBD1003 MBD1004 MBD1112
MK/SK Series - 18t – 1831 K	07/92 →	 	MBLK2190 MBLK2200 MBLK2210 MBLK2210	MBD1010 MBD1003 MBD1004 MBD1112
MK/SK Series - 18t – 1831 L, S, LS	12/90 →	 	MBLK2200 MBLK2200 MBLK2210 MBLK2210	MBD1012 MBD1003 MBD1004 MBD1112
MK/SK Series - 18t – 1834 L, S, LS	01/91 →	 	MBLK2200 MBLK2200 MBLK2210 MBLK2210	MBD1012 MBD1003 MBD1004 MBD1112
MK/SK Series - 19t – 1922 AK, K, S BM621	82 – 89	 	MBLK2190 MBLK2190 MBLK2200 MBLK2190 MBLK2190 MBLK2190	MBD1010 MBD1126 MBD1104 MBD1126 MBD1115 MBD1116
MK/SK Series - 19t – 1929 K, LS BM656	89 →	 	MBLK2200 MBLK2200 MBLK2210 MBLK2210	MBD1012 MBD1124 MBD1004 MBD1112
MK/SK Series - 19t – 1935 AK, AS, LS, K, S	81 – 89	 	MBLK2190 MBLK2190 MBLK2200 MBLK2190 MBLK2190 MBLK2190	MBD1010 MBD1126 MBD1104 MBD1126 MBD1115 MBD1116
MK/SK Series - 19t – 1935 S BM656	89 →	 	MBLK2200 MBLK2200 MBLK2210 MBLK2210	MBD1012 MBD1124 MBD1004 MBD1112
MK/SK Series - 22t – 2220 L	89 →		MBLK2200	





				
...Mercedes				
				
MK/SK Series - 24t – 2420 (6x2)	02/90 →	  	MBLK2200 MBLK2190 MBLK2210 MBLK2190	MBD1012 MBD1124 MBD1004 MBD1010
MK/SK Series - 24t – 2420 L	02/90 →	  	MBLK2200 MBLK2190 MBLK2210 MBLK2190	MBD1012 MBD1124 MBD1004 MBD1010
MK/SK Series - 24t – 2420 L (6x2/2/4)	89 →	  	MBLK2200 MBLK2190 MBLK2210 MBLK2200	MBD1012 MBD1124 MBD1004 MBD1104
MK/SK Series - 24t – 2422 B, K (6x4)	08/89 →	  	MBLK2200 MBLK2190 MBLK2210 MBLK2190 MBLK2200	MBD1012 MBD1124 MBD1004 MBD1013 MBD1104
MK/SK Series - 24t – 2422 L	02/90 →	  	MBLK2200 MBLK2190 MBLK2210 MBLK2190	MBD1012 MBD1124 MBD1004 MBD1010
MK/SK Series - 24t – 2426 B 6x4	08/89 →	  	MBLK2200 MBLK2190 MBLK2210 MBLK2190 MBLK2200	MBD1012 MBD1124 MBD1004 MBD1013 MBD1104
MK/SK Series - 24t – 2426 L (6x2/4)	02/90 – 08/94	  	MBLK2200 MBLK2190 MBLK2210 MBLK2190	MBD1012 MBD1124 MBD1004 MBD1010
MK/SK Series - 24t – 2429 L (6x2) BM658	89 →	  	MBLK2200 MBLK2190 MBLK2210 MBLK2190 MBLK2200	MBD1012 MBD1124 MBD1004 MBD1013 MBD1104
MK/SK Series - 24t – 2429 S, LS (6x2/4) BM658	89 →	  	MBLK2200 MBLK2190 MBLK2210 MBLK2190 MBLK2200	MBD1012 MBD1124 MBD1004 MBD1013 MBD1104



...Mercedes				
MK/SK Series - 24t – 2433 6x2	02/90 →		MBLK2200	MBD1012
			MBLK2190	MBD1124
			MBLK2210	MBD1004
			MBLK2190	MBD1010
MK/SK Series - 24t – 2433 S, LS (6x2/4)	05/89 →		MBLK2200	MBD1012
			MBLK2190	MBD1124
			MBLK2210	MBD1004
			MBLK2200	MBD1104
MK/SK Series - 24t – 2435 K, S (6x4)	05/89 →		MBLK2200	MBD1012
MK/SK Series - 24t – 2435 L (6x2) BM658	05/89 →		MBLK2200	MBD1012
			MBLK2190	MBD1124
			MBLK2190	MBD1124
			MBLK2210	MBD1004
			MBLK2190	MBD1013
			MBLK2200	MBD1104
			MBLK2200	MBD1104
MK/SK Series - 25t – 2524 K, L (6x2/2/4)	06/92 →		MBLK2200	MBD1012
			MBLK2190	MBD1124
			MBLK2210	MBD1004
			MBLK2190	MBD1013
			MBLK2200	MBD1104
MK/SK Series - 25t – 2527 B, K, L (6x2/2/4)	89 →		MBLK2200	MBD1012
			MBLK2190	MBD1124
			MBLK2200	MBD1104
MK/SK Series - 25t – 2531 L (6x2) BM653	12/90 →		MBLK2200	MBD1012
			MBLK2190	MBD1124
			MBLK2210	MBD1004
MK/SK Series - 25t – 2534 K (6x4)	01/91 →		MBLK2200	MBD1012
			MBLK2200	MBD1003
MK/SK Series - 25t – 2534 L (6x2)	01/91 →		MBLK2200	
			MBLK2190	
			MBLK2210	
MK/SK Series - 25t – 2534 S, LS (6x2/4)	01/91 →		MBLK2210	
MK/SK Series - 26t – 2629 A, AK, AS (6x4)	89 →		MBLK2200	MBD1012
			MBLK2190	MBD1124
			MBLK2210	MBD1004
			MBLK2200	
MK/SK Series - 26t – 2629 B, K, S (6x4)	89 →		MBLK2200	MBD1012
			MBLK2190	MBD1124
			MBLK2210	MBD1004
			MBLK2200	





























- 1
- 2
- 3
- 4
- 5
- 6
- 7

...Mercedes				
MK/SK Series - 26t – 2635 A, AK, K, S (6x4)	81 – 89		MBLK2190	MBD1010
				MBD1122
			MBLK2190	MBD1013
MK/SK Series - 26t – 2635 A, AS, AK (6x6)	02/90 →		MBLK2190	MBD1010
				MBD1122
			MBLK2190	MBD1013
MK/SK Series - 26t – 2638 S (6x4)	09/91 →		MBLK2200	MBD1012
			MBLK2190	MBD1124
			MBLK2210	MBD1004
			MBLK2200	
MK/SK Series - 26t – 2644 (6x4)	09/91 →		MBLK2190	MBD1010
				MBD1122
			MBLK2190	MBD1013
MK/SK Series - 32t – 3228 B, K (8x4/4) BM625	89 →		MBLK2190	MBD1010
			MBLK2190	MBD1013
			MBLK2190	
MK/SK Series - 32t – 3236 A (6x6) BM625	89 →		MBLK2200	MBD1012
			MBLK2190	MBD1013
MK/SK Series - 38t – 3850 A (6x6) BM625	89 →		MBLK2190	MBD1010
			MBLK2190	MBD1111
				MBD1122
			MBLK2190	MBD1013
			MBLK2190	
MK/SK Series - 38t – 3850 AS (6x6) BM625	89 →		MBLK2190	MBD1010
			MBLK2190	MBD1111
				MBD1122
			MBLK2190	MBD1013
			MBLK2190	
NG Series - 10t – 1013 A, AK, KO	74 – 86		MBLK2190	MBD1111
NG Series - 12t – 1214 A	86 – 88		MBLK2185	
				MBD1115
				MBD1116
	83 →		MBLK2190	MBD1126
			MBLK2190	
			MBLK2190	
NG Series - 12t – 1217 CA	86 – 88		MBLK2185	MBD1111
	89 →		MBLK2190	MBD1111
	83 →		MBLK2190	
			MBLK2185	
			MBLK2190	MBD1111
		MBLK2190	MBD1115	
		MBLK2190	MBD1116	
		MBLK2190	MBD1126	
83 – 88		MBLK2185		



		 	 	 
...Mercedes				
				
NG Series - 12t – 1219 A	09/75 – 12/84		MBLK2185	
			MBLK2185	
			MBLK2190	MBD1111
			MBLK2190	MBD1115
			MBLK2190	MBD1116
			MBLK2190	MBD1126
NG Series - 12t – 1219 AK	09/75 – 12/84		MBLK2185	
			MBLK2185	
			MBLK2190	MBD1111
			MBLK2190	MBD1115
			MBLK2190	MBD1116
			MBLK2190	MBD1126
NG Series - 12t – 1219 S, F, AF, K	09/75 – 09/84		MBLK2185	
			MBLK2185	
			MBLK2190	MBD1111
			MBLK2190	MBD1115
			MBLK2190	MBD1116
			MBLK2190	MBD1126
NG Series - 12t – 1222 A, AF, F, S	05/82 – 10/90		MBLK2185	
			MBLK2185	
			MBLK2190	MBD1111
			MBLK2190	MBD1115
			MBLK2190	MBD1116
			MBLK2190	MBD1126
NG Series - 12t – 1225 AF	83 – 88		MBLK2185	
	83 →		MBLK2190	MBD1111
			MBLK2190	MBD1115
			MBLK2190	MBD1116
			MBLK2190	MBD1126
	83 – 88		MBLK2185	
NG Series - 12t – 1226 AF	83 →		MBLK2190	MBD1111
			MBLK2190	MBD1115
			MBLK2190	MBD1116
			MBLK2190	MBD1126
NG Series - 14t – 1414 K	04/84 – 03/91		MBLK2185	
	84 – 88		MBLK2190	MBD1111
			MBLK2190	MBD1115
			MBLK2190	MBD1116
			MBLK2190	MBD1126
	04/84 – 03/91		MBLK2185	





- 1
- 2
- 3
- 4
- 5
- 6
- 7

...Mercedes				
NG Series - 14t – 1417 C, CA, CK, CAK	04/84 – 03/91		MBLK2185	
			MBLK2185	
NG Series - 14t – 1419 C, CL	05/83 – 06/85		MBLK2185	
			MBLK2185	
NG Series - 14t – 1419 C, CL	84 →		MBLK2190	MBD1111
			MBLK2190	MBD1115
			MBLK2190	MBD1116
			MBLK2190	MBD1126
NG Series - 14t – 1420 L	07/85 – 03/91		MBLK2185	
			MBLK2185	
NG Series - 14t – 1422	84 – 86		MBLK2190	MBD1111
			MBLK2190	MBD1115
			MBLK2190	MBD1116
			MBLK2190	MBD1126
NG Series - 14t – 1422 L, S, LS, F	05/82 – 10/90		MBLK2185	
			MBLK2185	
NG Series - 14t – 1425 S, LS	11/82 – 03/91		MBLK2185	
			MBLK2185	
NG Series - 16t – 1614 BM617	04/84 – 03/91		MBLK2190	MBD1010
			MBLK2190	MBD1111
NG Series - 16t – 1617	04/84 – 03/91		MBLK2190	MBD1010
			MBLK2190	MBD1111
			MBLK2190	MBD1126
			MBLK2190	MBD1115
			MBLK2190	MBD1116
NG Series - 16t – 1619 C, CL	06/83 – 06/85		MBLK2185	
NG Series - 16t – 1620 L	07/85 – 03/91		MBLK2190	MBD1010
			MBLK2190	MBD1111
			MBLK2190	MBD1126
			MBLK2190	MBD1115
			MBLK2190	MBD1116
NG Series - 16t – 1621 S	82 – 91		MBLK2190	MBD1010
			MBLK2190	MBD1111
			MBLK2190	MBD1126
			MBLK2190	MBD1115
			MBLK2190	MBD1116
NG Series - 16t – 1622 L, K, KA, S	05/82 – 03/91		MBLK2190	MBD1010
			MBLK2190	MBD1111
			MBLK2190	MBD1126
			MBLK2190	MBD1115
			MBLK2190	MBD1116



...Mercedes				
NG Series - 16t – 1625 AK	10/80 – 11/89		MBLK2185	
NG Series - 16t – 1625 L, S, LS, K 16t – 1628 LS, S	73 – 91		MBLK2190	MBD1010
			MBLK2190	MBD1111
			MBLK2190	MBD1126
			MBLK2210	MBD1112
			MBLK2190	MBD1115
			MBLK2190	MBD1116
			MBLK2190	MBD1126
NG Series - 16t – 1633 S, L, LS, K, B 16t – 1635 S, LS, K, LB	80 – 91		MBLK2190	MBD1010
			MBLK2190	MBD1111
			MBLK2190	MBD1126
			MBLK2210	MBD1112
			MBLK2190	MBD1115
			MBLK2190	MBD1116
			MBLK2190	MBD1126
NG Series - 16t – 1636 S, LS 16t – 1638 S, SL	84 →		MBLK2190	MBD1010
			MBLK2190	MBD1111
			MBLK2190	MBD1126
			MBLK2210	MBD1112
			MBLK2190	MBD1115
			MBLK2190	MBD1116
			MBLK2190	MBD1126
NG Series - 16t – 1644 LS, S	85 – 91		MBLK2190	MBD1010
			MBLK2190	MBD1111
			MBLK2190	MBD1126
			MBLK2210	MBD1112
			MBLK2190	MBD1115
			MBLK2190	MBD1116
			MBLK2190	MBD1126
NG Series - 16t – 1922 S, K, AK	10/81 – 10/90		MBLK2190	
			MBLK2200	
NG Series - 19t – 1928 A, S, LS, AS. K, AK	01/80 – 03/91		MBLK2190	
NG Series - 19t – 1933 S, LS BM621	11/80 – 03/91		MBLK2200	
			MBLK2190	MBD1010
			MBLK2190	MBD1126
			MBLK2200	MBD1104
			MBLK2190	MBD1115
			MBLK2190	MBD1116
			MBLK2190	MBD1126
NG Series - 19t – 1935 AK	09/87 – 03/91		MBLK2190	
			MBLK2200	























































- 1
- 2
- 3
- 4
- 5
- 6
- 7

...Mercedes				
NG Series - 19t – 1936 S, LS, AS, K, AK	10/81 – 03/91		MBLK2190	MBD1010
			MBLK2190	MBD1126
			MBLK2200	MBD1104
			MBLK2190	MBD1115
			MBLK2190	MBD1116
			MBLK2190	MBD1126
NG Series - 19t – 1938 S, LS BM621	80 – 89		MBLK2190	MBD1010
			MBLK2190	MBD1126
			MBLK2200	MBD1104
			MBLK2190	MBD1115
			MBLK2190	MBD1116
			MBLK2190	MBD1126
NG Series - 20t – 2025 S BM619	08/83 – 03/91		MBLK2190	MBD1010
			MBLK2190	MBD1126
			MBLK2210	MBD1004
			MBLK2200	MBD1104
			MBLK2190	MBD1126
NG Series - 20t – 2028 A (6x6)	80 – 91		MBLK2190	MBD1126
			MBLK2190	MBD1126
NG Series - 20t – 2036 LS BM622	03/84 – 91		MBLK2190	MBD1010
			MBLK2190	MBD1126
			MBLK2210	MBD1004
			MBLK2200	MBD1104
			MBLK2190	MBD1126
NG Series - 22t – 2219 CL BM619.4	84 – 86		MBLK2190	MBD1012
			MBLK2190	MBD1111
				MBD1124
			MBLK2200	
			MBLK2210	MBD1004
			MBLK2210	MBD1112
			MBLK2190	MBD1115
			MBLK2190	MBD1116
			MBLK2190	MBD1126
NG Series - 22t – 2220 L	07/85 – 03/91		MBLK2190	MBD1111
			MBLK2200	
			MBLK2190	MBD1115
			MBLK2190	MBD1116
			MBLK2190	MBD1126
NG Series - 22t – 2222 (6x4) BM619	83 – 91		MBLK2190	MBD1010
			MBLK2190	MBD1115
			MBLK2190	MBD1116



		 	 	 
...Mercedes				
				
NG Series - 22t – 2222 B, K, L BM619	05/82 – 03/91		MBLK2190	MBD1012
			MBLK2190	MBD1111
				MBD1124
			MBLK2210	MBD1004
			MBLK2190	MBD1115
			MBLK2190	MBD1116
			MBLK2190	MBD1126
NG Series - 22t – 2222 L	05/82 – 03/91		MBLK2185	
NG Series - 22t – 2225 B	08/83 – 03/91		MBLK2190	MBD1010
			MBLK2190	MBD1115
			MBLK2190	MBD1116
	04/85 – 03/91		MBLK2185	
NG Series - 22t – 2228 L	12/79 – 03/91		MBLK2190	MBD1010
				MBD1122
			MBLK2190	MBD1013
			MBLK2200	MBD1104
NG Series - 22t – 2236 S (6x4) BM623	09/82 – 03/91		MBLK2190	MBD1010
			MBLK2190	MBD1013
			MBLK2190	MBD1126
NG Series - 22t – 2244 L (6x2) BM648	87 – 97		MBLK2190	MBD1010
				MBD1122
			MBLK2190	MBD1013
			MBLK2200	MBD1104
NG Series - 22t – 2244 S (6x4) BM648	87 – 97		MBLK2190	MBD1010
			MBLK2190	MBD1013
			MBLK2190	MBD1126
NG Series - 24t – 2419 K	79 →		MBLK2190	MBD1010
			MBLK2190	MBD1013
			MBLK2190	MBD1126
NG Series - 24t – 2419 K (6x4)	75 →		MBLK2190	
			MBLK2185	
NG Series - 24t – 2421 K (6x4)	82 →		MBLK2185	
NG Series - 26t – 2632			MBLK2190	
NG Series - 26t – 2635 S, AS, AK	09/87 – 03/91		MBLK2190	
NG Series - 26t – 2636 A, S, K	11/81 – 03/91		MBLK2190	
NG Series - 26t – 2644 S	10/85 – 02/90		MBLK2190	
NG Series - 26t – 2828 S, K	02/80 – 03/91		MBLK2190	
NG Series - 30t – 3025 B	12/85 – 07/87		MBLK2185	
NG Series - 30t – 3038 S (6x4)	89 – 91		MBLK2200	
NG Series - 32t – 3228 B	07/87 – 03/91		MBLK2190	
			MBLK2185	















































- 1
- 2
- 3
- 4
- 5
- 6
- 7

...Mercedes				
NG Series - 32t – 3228 K	07/87 – 03/91		MBLK2190	
NG Series - 32t – 3229 B, K (8x4/4)	89 – 91		MBLK2190	
NG Series - 32t – 3235, K (8x4/4)	89 – 91		MBLK2200	
NG Series - 32t – 3236 A (8x8)	89 – 91		MBLK2190	
NG Series - 32t – 3250 A	09/85 – 08/94		MBLK2190	
NG Series - 32t – 3250 AF	09/85 – 08/94		MBLK2190	
			MBLK2200	
NG Series - 33t – 3336 AK	09/86 – 11/91		MBLK2190	
NG Series - 33t – 3336, S, K	12/82 – 11/91		MBLK2190	
NG Series - 35t – 3535 AK	09/87 – 02/90		MBLK2200	
NG Series - 38t – 3824 (6x4, 6x6)	84 →		MBLK2190	
NG Series - 38t – 3850 A	09/85 – 08/94		MBLK2200	
Powerliner – 1717	89 →		MBLK2200	MBD1012
			MBLK2200	MBD1124
			MBLK2210	MBD1004
Powerliner – 1717 AK BM655	89 →		MBLK2190	MBD1010
			MBLK2210	MBD1004
Powerliner – 1720	89 →		MBLK2200	MBD1012
			MBLK2200	MBD1124
			MBLK2210	MBD1004
Powerliner – 1722	89 →		MBLK2200	MBD1012
			MBLK2200	MBD1124
			MBLK2210	MBD1004
Powerliner – 1722 AK	89 →		MBLK2190	MBD1010
			MBLK2210	MBD1004
Powerliner – 1726	89 →		MBLK2200	MBD1012
			MBLK2200	MBD1124
			MBLK2210	MBD1004
Powerliner – 1726 AK BM652	89 →		MBLK2190	MBD1010
			MBLK2210	MBD1004
Powerliner – 1729 AK BM655	08/89 →		MBLK2190	MBD1010
			MBLK2210	MBD1004
Powerliner – 1732	89 →		MBLK2200	MBD1012
			MBLK2200	MBD1124
			MBLK2210	MBD1004
Powerliner – 1733	89 →		MBLK2200	MBD1012
			MBLK2200	MBD1124
			MBLK2210	MBD1004
Powerliner – 1734	89 →		MBLK2200	MBD1012
			MBLK2200	MBD1124
			MBLK2210	MBD1004



				
...Mercedes				
				
Powerliner – 1735	89 →		MBLK2200	MBD1012
			MBLK2200	MBD1124
			MBLK2210	MBD1004
Powerliner – 1735 AK BM655	89 →		MBLK2190	MBD1010
			MBLK2210	MBD1004
Powerliner – 1735 S, L, LS, K (4x2) BM655	88 →		MBLK2200	MBD1012
			MBLK2200	MBD1104
			MBLK2210	MBD1004
			MBLK2200	MBD1003
Powerliner – 1820	91 →		MBLK2200	MBD1124
			MBLK2200	MBD1012
Powerliner – 1827	91 →			MBD1112
Powerliner – 1831	91 →		MBLK2210	MBD1004
Powerliner – 301	86 – 09/88			MBD1028
Powerliner – 402	86 – 09/88			MBD1028
T2 Series - 7.5t – 809 D	06/95 – 08/96		MBLK2160	
T2 Series - 7.5t – 811 D	06/95 – 08/96		MBLK2160	
T2 Series - 7.5t – 814	06/95 – 08/96		MBLK2160	
Merriworth				
				
394 x 178 mm			MBLK2400	
394 x 178 mm			MBLK2400	
Optare				
				
Delta – 11.5m	88 →		MBLK2070	MBD1018
Excel	96 →		MBLK2190	
			MBLK1130	
Pegaso				
				
1061 A, 1063 A, 1064 A	87 →		MBLK2250	
1135	87 →		MBLK2260	
			MBLK2250	
2011 A	87 →		MBLK2250	
2135, 2180, 2181, 2182	87 →		MBLK2260	
			MBLK2250	
5030 L, 5074 A, 5076 N	87 →		MBLK2250	
5317 Minibus	87 →		MBLK2260	
			MBLK2260	
6038, 6420	87 →		MBLK2250	



















- 1
- 2
- 3
- 4
- 5
- 6
- 7

Pegaso				
1214.14, 1214.17, 1217.17	87 →		MBLK2260	
1217.20, 1223.20, 1231 R, 1234 R	87 →		MBLK2260	
			MBLK2250	
1323.26	87 →		MBLK2260	
			MBLK2250	
			MBLK2260	
1331.26, 1331.38 R, 1343.38 1436.38 G	87 →		MBLK2260	
			MBLK2250	
2323.26 K, 2331.26 K, 2331.38 R, 2331.38 T, 2334.38 T	87 →		MBLK2250	
			MBLK2260	
2431.36 K, 2434.36 K	87 →		MBLK2250	
			MBLK2250	
			MBLK2260	
3060 D, 3060 Turbo	87 →		MBLK1090	
5030 L, 5074 A, 5076 N	87 →		MBLK2250	
5317 Minibus	87 →		MBLK2260	
6038, 6420	87 →		MBLK2250	
Troner – 1234.38 T, 1234.39 R	87 →		MBLK2250	
Troner – 1236.38 R, 1236.38 T	87 →		MBLK2260	
			MBLK2250	
Renault Truck				
Agora	95 →		MBLK2290	MBD1131
FR – FR 1 - T 1, T 2, GT1 - GT2, TX - GTX,	05/84 – 12/92		MBLK2280	
FR – FR1	01/93 →		MBLK2280	
Iliade	97 →		MBLK2290	MBD1131
PR – PR 100.3	94 →		MBLK2280	
	89 →		MBLK2270	
			MBLK2270	
			MBLK2280	
PR – PR 180.3	94 →		MBLK2280	
PSV – FR1 (6.20-L1)			MBLK2290	MBD1131
Special Vehicles	11/93 →		MBLK2290	
	12/92 →		MBLK2290	
Tracer	92 →		MBLK2280	
Renault Truck				
C & G Series – C290.26 Ti (6x4)	09/86 →		MBLK2280	MBD1001
C & G Series – CBH 340 Ti	03/87 →		MBLK2280	MBD1001
C & G Series – G Maxter			MBLK2280	MBD1001
C & G Series – G280.17TD	90 →		MBLK2280	MBD1001



				
...Renault Truck				
				
C & G Series – G290.23 T (6x2, 6x4)	87 →		MBLK2280	MBD1001
C & G Series – G290.30D Turbo (4 Axle Rigid)	88 →		MBLK2280	MBD1001
C & G Series – G310 Turbo Injection	88 →		MBLK2280	MBD1001
C & G Series – G330.22TD	91 →		MBLK2280	MBD1001
C Series – C 210.19	03/89 →		MBLK2270	
			MBLK2280	MBD1001
C Series – C 230 TI 19	06/88 →		MBLK2270	
			MBLK2280	MBD1001
C Series – C 260	84 →		MBLK2270	MBD1033
C Series – C 260.19	03/89 →		MBLK2270	
	06/88 →		MBLK2270	
			MBLK2280	MBD1001
C Series – C 280.19	03/89 →		MBLK2270	
			MBLK2280	MBD1001
C Series – C 290.19	06/88 →		MBLK2270	
			MBLK2280	MBD1001
C Series – C 300 PM, C 300.19, C 319, C 340 TI	06/88 →		MBLK2270	
			MBLK2280	MBD1001
C Series – CBH 280	06/88 →		MBLK2270	
			MBLK2280	MBD1001
C Series – CBH 320 (6x6)	→05/97		MBLK2280	
			MBLK2280	MBD1001
	06/88 →		MBLK2270	
			MBLK2280	MBD1001
C Series – CBH 340, CBH 350, CBH 380	06/88 →		MBLK2270	
			MBLK2280	MBD1001
C Series – CBH 385 (6x4)	→05/97		MBLK2280	
			MBLK2280	MBD1001
C Series – CBH 385 (6x6)	06/88 →		MBLK2270	
			MBLK2280	MBD1001
C Series – CCH 300, CCH 300.26	06/88 →		MBLK2270	
			MBLK2280	MBD1001
C Series – CLM 280, CLM 320, CLM 340, CLM 350, CLM 380, CLM 380 T, CLM 385	06/88 →		MBLK2270	
			MBLK2280	MBD1001
C Series – CLR 220	03/89 →		MBLK2270	
			MBLK2280	MBD1001
Commando – G 13, G 15	86 – 90		MBLK1080	
Commando – G 16	86 – 90		MBLK1090	
Commando – G 24	86 – 90		MBLK1090	
Commando – G 26	86 – 90		MBLK1090	
Commando – G11 overload	74 – 81		MBLK1220	





















































- 1
- 2
- 3
- 4
- 5
- 6
- 7

...Renault Truck				
Commando – G12	81 – 90		MBLK1220	
Commando – G13	81 – 90		MBLK1220	
Commando – G13 (6Cyl inline Eng.)	86 – 90		MBLK1220	
Commando – G13 6cyl	81 – 90		MBLK1220	
Commando – G20	76 – 81		MBLK1220	
	86 – 88		MBLK1220	
	81 – 90		MBLK1220	
Commer Medium Range – CC15	66 – 69		MBLK1220	
Commer Medium Range – CEB, VC8	68 – 73		MBLK1220	
G Series – G160.17D	90 →		MBLK2270	MBD1033
G Series – G260.24D	88 →		MBLK2270	MBD1033
Kerax Series – 260.18/B, 300.18/B, 300.26/A/B, 340.18/B, 340.26/A/B, 340.32/A, 385.18/B, 385.18T, 385.26/A/B/C, 385.26/B, 385.26T, 385.32A/B/C	06/97 →		MBLK2280	
			MBLK2280	MBD1001
Magnum Series – AE 380	90 →		MBLK2280	MBD1001
	90 – 12/92		MBLK2280	MBD1001
Magnum Series – AE 380, 385ti, 390	01/93 – 12/95		MBLK2290	MBD1131
	01/96 →		MBLK2290	MBD1131
Magnum Series – AE 380, 385 Ti, 390 (6x2)	01/93 – 12/95		1 MBLK2290	MBD1131
			2 MBLK2290	MBD1131
	01/96 →		1 MBLK2290	MBD1131
			2 MBLK2290	MBD1131
Magnum Series – AE 380.19 TD	90 – 12/92		MBLK2280	MBD1001
Magnum Series – AE 380.22 TD	90 – 12/92		MBLK2280	MBD1001
	90 →		MBLK2280	MBD1001
Magnum Series – AE 385 Ti	90 – 12/92		MBLK2280	MBD1001
Magnum Series – AE 420 Ti	01/93 →		MBLK2290	MBD1131
Magnum Series – AE 420 Ti.26T	06/00 →		MBLK2270	
			MBLK2280	
Magnum Series – AE 420 Ti, 430, 470	01/93 – 12/95		MBLK2290	MBD1131
	01/96 →		MBLK2290	MBD1131
Magnum Series – AE 420 Ti, 430, 470 (6x2)	01/93 – 12/95		1 MBLK2290	MBD1131
			2 MBLK2290	MBD1131
	01/96 →		1 MBLK2290	MBD1131
			2 MBLK2290	MBD1131
Magnum Series – AE 430.26T, AE 470.26T	06/00 →		MBLK2270	
			MBLK2280	
Magnum Series – AE 50.22 TD	90 – 12/92		MBLK2280	MBD1001
Magnum Series – AE 500	90 – 12/92		MBLK2280	MBD1001
Magnum Series – AE 500, 520, 560	01/93 – 12/95		MBLK2290	MBD1131
	01/96 →		MBLK2290	MBD1131



		 	 	 
...Renault Truck				
				
Magnum Series – AE 500, 520, 560 (6x2)	01/93 – 12/95	 1	MBLK2290	MBD1131
		 2	MBLK2290	MBD1131
	01/96 →	 1	MBLK2290	MBD1131
		 2	MBLK2290	MBD1131
Magnum Series – AE 500.19 TD	90 – 12/92		MBLK2280	MBD1001
Magnum Series – AE 500.22TD	90 →		MBLK2280	MBD1001
Magnum Series – AE 520	01/93 – 96		MBLK2290	MBD1131
Magnum Series – AE 520.26T	06/00 →		MBLK2270	
			MBLK2280	
Magnum Series – AE 550	10/92 →		MBLK2280	MBD1001
Magnum Series – AE 560.26T	06/00 →		MBLK2270	
			MBLK2280	
Major Series			MBLK2270	MBD1033
Major Series – G 160	90 →		MBLK2280	
Major Series – G 170	04/86 – 10/88		MBLK2270	
Major Series – G 210.15/17 T	04/86 – 10/88		MBLK2270	
Major Series – G 230.15/17 T	04/86 – 10/88		MBLK2270	
Major Series – G 230.SPn Turbo	04/86 – 10/88		MBLK2270	
Major Series – G 260.15	→10/88		MBLK2270	
Major Series – G 260.17 Turbo	→10/88		MBLK2270	
Major Series – G 290.17	→10/88		MBLK2270	
Major Series – R 310	09/84 →		MBLK2270	
			MBLK2280	
Major Series – R 310.26 T (6x4)	09/84 →		MBLK2270	
Major Series – R 310.33 T (6x4)	09/84 →		MBLK2270	
			MBLK2280	
Major Series – R 330, R 340	89 →		MBLK2270	
			MBLK2280	
Major Series – R 340 Ti	05/93 →		MBLK2280	
			MBLK2280	MBD1001
Major Series – R 340 Ti (Porteur 6x2)	11/93 →		MBLK2280	
			MBLK2280	MBD1001
	90 – 10/93		MBLK2280	
			MBLK2280	MBD1001
Major Series – R 340 TI (Tracteur)	90 – 04/93		MBLK2270	
			MBLK2280	MBD1001
Major Series – R 340.26 T (6x4)	01/89 →		MBLK2270	
			MBLK2280	MBD1001
	85 – 12/88		MBLK2270	
			MBLK2270	



































- 1
- 2
- 3
- 4
- 5
- 6
- 7

...Renault Truck				
Major Series – R 340.33 T (6x4)	85 →		MBLK2270	
			MBLK2280	MBD1001
Major Series – R 350			MBLK2270	
	90 →		MBLK2280	
			MBLK2280	MBD1001
Major Series – R 365	10/87 →		MBLK2270	
			MBLK2280	MBD1001
Major Series – R 365.26 T (6x4)	01/89 →		MBLK2270	
			MBLK2280	MBD1001
	10/87 – 12/88		MBLK2270	
			MBLK2270	
Major Series – R 365.33 T (6x4)	87 →		MBLK2270	
			MBLK2280	MBD1001
Major Series – R 370	09/84 →		MBLK2270	
			MBLK2280	MBD1001
Major Series – R 370.26 T (6x4)	09/84 →		MBLK2270	
			MBLK2270	
Major Series – R 370.33 T (6x4)	09/84 →		MBLK2270	
			MBLK2280	MBD1001
Major Series – R 380	90 →		MBLK2280	
	89 →		MBLK2270	
			MBLK2280	MBD1001
Major Series – R 380 (6x4)	90 →		MBLK2270	
			MBLK2280	MBD1001
Major Series – R 385 Ti	05/93 →		MBLK2280	
			MBLK2280	MBD1001
Major Series – R 385 TI (6x4)	11/93 →		MBLK2280	
			MBLK2280	MBD1001
	90 – 10/93		MBLK2270	
			MBLK2280	MBD1001
Major Series – R 385 Ti (Porteur 6x2)	90 – 10/93		MBLK2280	
			MBLK2280	MBD1001
Major Series – R 385 TI (Tracteur)	90 – 10/93		MBLK2270	
			MBLK2280	MBD1001
Major Series – R 390	10/85 →		MBLK2270	
			MBLK2280	
Major Series – R 390.26 T (6x4)	05/85 →		MBLK2270	
			MBLK2270	
Major Series – R 390.33 T (6x4)	→05/85		MBLK2270	
			MBLK2280	



				
...Renault Truck				
				
Major Series – R 420 (Porteur)	89 →	 	MBLK2270 MBLK2280	
Major Series – R 420 (Tracteur)	89 – 12/92		MBLK2280	MBD1001
Major Series – R 420 Ti	05/93 →	 	MBLK2280 MBLK2280	MBD1001
		90 – 04/93	 	MBLK2270 MBLK2280
Major Series – R 420.26 T (6x4)	→01/89	 	MBLK2270 MBLK2280	
		88 – 12/88	 	MBLK2270 MBLK2270
Major Series – R 420.33 T (6x4)	→88	 	MBLK2270 MBLK2280	
Manager Series – G 170	10/88 →	 	MBLK2270 MBLK2280	
		→04/90	 	MBLK2270 MBLK2280
Manager Series – G 200317/18	04/90 →		 	MBLK2280
Manager Series – G 210 17t	10/88 →	 	MBLK2270 MBLK2280	MBD1001
		04/86 →	 	MBLK2270 MBLK2280
Manager Series – G 210.19 Turbo	04/86 →		 	MBLK2270 MBLK2280
Manager Series – G 220.19 BOM	92 →	 	MBLK2280	MBD1001
Manager Series – G 230 17t	10/88 →	 	MBLK2270 MBLK2280	MBD1001
		→04/90	 	MBLK2270 MBLK2280
Manager Series – G 230.17	04/90 →		 	MBLK2280
Manager Series – G 230.18	04/90 →	 	MBLK2280	
Manager Series – G 230.19	04/90 →	 	MBLK2280	
Manager Series – G 230.19 Turbo	04/86 →	 	MBLK2270 MBLK2280	MBD1001
		10/88 →	 	MBLK2270 MBLK2280
Manager Series – G 260 17t	07/86 →		 	MBLK2270 MBLK2280
		94 →	 	MBLK2280 MBLK2270
Manager Series – G 280	→04/90		 	MBLK2270 MBLK2280





- 1
- 2
- 3
- 4
- 5
- 6
- 7

...Renault Truck				
Manager Series – G 280.17, G 280.18, G 280.19	04/90 →		MBLK2280	
Manager Series – G 290 17t	10/88 →		MBLK2270	
			MBLK2280	
Manager Series – G 290.19 A Turbo Intercooler			MBLK2270	
			MBLK2280	
Manager Series – G 290.19 GT Turbo Intercooler G 290.19 T Turbo Intercooler G 290.19 Turbo Intercooler	04/86 →		MBLK2270	
			MBLK2280	
Manager Series – G 290.24 (6x2)	7/87 →		MBLK2270	
			MBLK2280	
Manager Series – G 290.26 (6x2, 6x4)			MBLK2270	
			MBLK2280	
Manager Series – G 290.30	7/87 →		MBLK2270	
			MBLK2280	
Manager Series – G 300			MBLK2270	
			MBLK2280	
Manager Series – G 300	→04/90		MBLK2270	
			MBLK2280	
Manager Series – G 300.17, G 300.18, G 300.18, G 300.19, G 300.24, G 300.26	04/90 →		MBLK2280	
			MBLK2280	MBD1001
Manager Series – G 320.19 (6x2)	88 →		MBLK2270	
			MBLK2280	
Manager Series – G 320.24 (6x2), G 320.26 (6x2)	88 →		MBLK2270	
			MBLK2280	
Manager Series – G 330	→04/90		MBLK2270	
			MBLK2280	
Manager Series – G 330.17, G 330.18, G 330.19	04/90 →		MBLK2280	
			MBLK2280	MBD1001
Manager Series – G 330.19 (6x2), G 330.24 (6x2), G 330.26 (6x2)	88 →		MBLK2270	
			MBLK2280	
Manager Series – G 340 Ti	→04/90		MBLK2270	
			MBLK2280	
Manager Series – G 340.18	04/90 →		MBLK2280	
			MBLK2280	MBD1001
Manager Series – G 340.19 (6x2), G 340.24 (6x2), G 340.26 (6x2)	88 →		MBLK2270	
			MBLK2280	
Manager Series – Turbo Intercooler	7/87 →		MBLK2270	
			MBLK2280	
Maxter Series – G 230 Ti, G 235, G 270, G 280, G 300, G 340 Ti	90 →		MBLK2280	
			MBLK2280	MBD1001



...Renault Truck				
Midliner Series – M 150.14, M 160.15, M 180.15, M 180.16, M 200.15, M 200.16, M 210.14, M 210.15, M 210.16, M 220.16, M 230.15, M 230.16, M 250.15	89 →		MBLK2270	
			MBLK2270	
			MBLK2280	MBD1001
Premium – 210.16, 210.18, 220.16, 220.18, 240.16 D, 240.18 D, 240.19, 240.19 D, 240.26, 240.26, 250.16, 250.18, 250.19, 260.16, 260.18, 260.19, 260.26, 270.16, 270.18, 270.18, 270.19, 270.19, 280.16 D, 280.18 D, 280.19, 280.19 D, 280.26, 280.26 D, 300.16, 300.16, 3	96 – 06		MBLK2280	
			MBLK2270	MBD1131
			MBLK2280	MBD1131
			MBLK2290	MBD1131
Saviem – SM10	→78		MBLK2185	
Saviem – SM170PE	→77		MBLK2185	
Saviem – SM21/180, 240	→79		MBLK2185	
Saviem – SM260TPE	→79		MBLK2185	
ROR				
12.1/4 x 7"			MBLK1110	
16.1/2 x 8"			MBLK1120	
311 x 177.8 mm			MBLK1110	
381 x 177.8 mm			MBLK1050	
419 x 203 mm			MBLK1120	
LC – 9000 Series - 420 x 180 mm 10 Bolt			BLKQ+R / MBSK1040-4	21220183V / MBD1172
LC – Q+ Brake - 420 x 180 mm	06/97 →		BLKQ+R / MBSK1040-4	21220183V / MBD1172
LM – 9000 Series - 420 x 180 mm 10 Bolt			BLKQ+R / MBSK1040-4	21220183V / MBD1172
LM – Q+ Brake - 420 x 180 mm	06/97 →		BLKQ+R / MBSK1040-4	21220183V / MBD1172
TA – Q Brake - 420 x 180 mm 10 Bolt			BLKQR / MBSK1000-4	21018986V / MBD1171
TA – Z Brake - 420 x 220 mm 10 Bolt			BLKZR / MBSK1010-4	21021114AV / MBD1170
TC – Q Brake - 420 x 180 mm 10 Bolt			BLKQR / MBSK1000-4	21018986V / MBD1171
TC – Z Brake - 420 x 220 mm 10 Bolt			BLKZR / MBSK1010-4	21021114AV / MBD1170
TE – 9000 Series - 420 x 180 mm 10 Bolt			BLKQR / MBSK1000-4	21220183V / MBD1172
TM – 33000 - 420 x 220 mm 10 Bolt			BLKZR / MBSK1010-4	21021114AV / MBD1170
TM – 9000 Series - 420 x 180 mm 10 Bolt			BLKQR / MBSK1000-4	21220183V / MBD1172
TM – AC Brake - 310 x 190 mm 10 Bolt			BLKAR	21209723S / MBD1174
TM – AC Brake - 310 x 190 mm 8 Bolt			BLKAR	21020448S
TM – B Brake - 350 x 200 mm 10 Bolt			BLKBR	21211030S / MBD1173
TM – B Brake - 350 x 200 mm 8 Bolt			BLKBR	21211966S / MBD1175
TM – Q Brake 420 x 180 mm 10 Bolt			BLKQR / MBSK1000-4	21018986V / MBD1171
TM – Z Brake 420 x 220 mm 10 Bolt			BLKZR / MBSK1010-4	21021114AV / MBD1170
TM - QE Axle – Q Brake 420 x 180 mm 10 Bolt			BLKQR / MBSK1000-4	21220183V / MBD1172
SAE				
305 x 200 mm			MBLK2510	MBD1007
306 x 200 mm			MBLK2510	MBD1011
355 x 200 mm – S3520			MBLK2310	





- 1
- 2
- 3
- 4
- 5
- 6
- 7

SAE					
419 x 203 mm			MBLK2500 / MBSK2500-4		
420 x 178 mm – SKRS 9042			MBLK2450 / MBSK2450-4		
420 x 178 mm – SKRS 9042			MBLK2450 / MBSK2450-4		
420 x 200 mm – S4420			MBLK2010 / MBSK2010-4		
420 x 203 mm – 420 x203mm SKRS			MBLK2460 / MBSK2460-4		
421 x 203 mm – 420 x203mm SKRS			MBLK2460 / MBSK2460-4		
SAF					
300 x 200 mm – WEZ6030, 8030, 10030			MBLK2300		MBD1137
300 x 200 mm – WEZ6030, 8030, 10031			MBLK2300		MBD2031
355 x 200 mm			MBLK2310		MBD2028
			MBLK2310		MBD1136
			MBLK2310		MBD2028
			MBLK2310		MBD2029
			MBLK2310		MBD2028
367 x 180 mm – SNK			MBLK2770		
	MBLK2770				
367 x 200 mm – SNK			MBLK2780		MBD2032
			MBLK2780		
420 x 180 mm – SNF			MBLK2000 / MBSK2000-4		MBD1009
			MBLK2450 / MBSK2450-4		MBD1138
420 x 200 mm			MBLK2010 / MBSK2010-4		MBD1008
			MBLK2460 / MBSK2460-4		MBD1039
Scammel					
394 x 127 mm			MBLK1220		
Scania					
B 112 A	79 →		MBLK2330		MBD2041
			MBLK2720		MBD1035
B 116	78 – 82		MBLK2710		MBD2038
			MBLK2330		MBD2041
			MBLK2720		MBD1035
BF 110	72 →		MBLK2710		MBD2038
			MBLK2720		MBD1035
			MBLK2710		MBD2038
			MBLK2720		MBD1035
BR 111 DH	72 →		MBLK2710		
			MBLK2330		MBD2041
BR 111 M	75 →		MBLK2710		
			MBLK2330		MBD2041



...Scania				
BR 112, BR 112 A	72 →		MBLK2710	
			MBLK2330	MBD2041
BR 116	78 →		MBLK2710	MBD2038
			MBLK2330	MBD2041
			MBLK2720	MBD1035
BR 85	→74		MBLK2710	MBD2038
			MBLK2720	MBD1035
BR 86	79 →		MBLK2710	MBD2038
			MBLK2720	MBD1035
				MBD1035
C 50 – Metropol			MBLK2710	
C 76	72 →		MBLK2710	
			MBLK2710	MBD2038
			MBLK2720	MBD1035
			MBLK2330	
CN 112	08/88 →		MBLK2350	
			MBLK2370	MBD2041
CR 110 – Metro-Scania	72 →		MBLK2710	
			MBLK2330	MBD2041
CR 111 M	75 →		MBLK2710	
			MBLK2330	MBD2041
CR 112	08/88 →		MBLK2350	
			MBLK2370	MBD2041
CR76	72 →		MBLK2710	
			MBLK2710	MBD2038
			MBLK2720	MBD1035
			MBLK2330	
K 112 CL, K 112 T	82 – 88		MBLK2710	
K 112 T	82 – 88		MBLK2710	
K 112 TR	82 – 88			MBD2040
			MBLK2330	MBD2041
K 113 CRB, K 113 DRB, K 113 TRS	08/88 →		MBLK2350	MBD1016
			MBLK2350	MBD1142
			MBLK2330	MBD2041
K 82	82 →		MBLK2720	MBD2040
			MBLK2330	MBD1035
K 93 CRB	88 →		MBLK2350	MBD1016
			MBLK2350	MBD1142
			MBLK2330	MBD2041





- 1
- 2
- 3
- 4
- 5
- 6
- 7

...Scania				
N 112 AL, N 112 CLB	08/88 →		MBLK2350	MBD1016
			MBLK2350	MBD1142
			MBLK2330	MBD2041
N 112 CR	83 – 88			MBD2040
			MBLK2330	MBD2041
N 114	88 →		MBLK2350	
			MBLK2360	MBD2071
			MBLK2360	MBD2071
N 114 – 413 x 203 mm	88 →			MBD2071
N 124	88 →		MBLK2350	
			MBLK2360	MBD2071
			MBLK2360	MBD2071
N 124 – 413 x 203 mm	88 →			MBD2071
N 94	88 →		MBLK2350	
			MBLK2360	MBD2071
			MBLK2360	MBD2071
N 94 – 413 x 203 mm	88 →			MBD2071
Scania				
2 Series – G 82 M (4x2), G 82 M (6x2), G 82 MD (4x2) G 112 H, G 112 M (4x2), G 112H TYPE F FINNED	81 – 88		MBLK2320	MBD1139
			MBLK2710	MBD2038
			MBLK2320	MBD2040
			MBLK2720	MBD1035
			MBLK2330	MBD2041
			MBLK2340	MBD1144
			MBLK2710	MBD2038
2 Series – G 92 M (4x2), G 92 M (6x2), G 92 MD (4x2)	84 – 88		MBLK2320	MBD1139
			MBLK2710	MBD2038
			MBLK2320	MBD2040
			MBLK2720	MBD1035
			MBLK2330	MBD2041
			MBLK2340	MBD1144
			MBLK2710	MBD2038
2 Series – P 82 H (4x2), P 82 H (6x2), P 82 M (4x2), P 82 M (6x2), P 82 MA (4x2) P 112 E (6x4), P 112 H, P 112 H (4x2), P 112 H (6x2), P 112 M (6x2), P 112 M (6x4) P 112 MA (4x2), P 112 M, MA (4x2)	81 – 88		MBLK2710	MBD2038
			MBLK2320	MBD1139
			MBLK2320	MBD2040
			MBLK2720	MBD1035
			MBLK2330	MBD2041
			MBLK2710	MBD2038
			MBLK2340	MBD1144
2 Series – P 112 M (4x2)	81 – 88		MBLK2710	MBD2038



...Scania				
2 Series – P 92 (6x2), P 92 (6x4), P 92 H (4x2), P 92 H (6x2), P 92 M (4x2), P 92 M (6x2), P 92 MA (4x2)	85 – 88	 	MBLK2710 MBLK2320 MBLK2320 MBLK2720 MBLK2330 MBLK2710 MBLK2340	MBD2038 MBD1139 MBD2040 MBD1035 MBD2041 MBD2038 MBD1144
2 Series – R 112 E (4x2), R 112 E (6x2), R 112 H (4x2), R 112 H (6x2), R 112 H (6x4), R 112 M (4x2), R 112 M (6x2), R 112 M (6x4), R 112 MA (4x2), R 142 E (6x4), R 142 H (4x2), R 142 H (6x2), R 142 H (6x4), R 142 M (4x2), R 142 M (6x2), R 142 M (6x4), R 142 MA (4x2)	81 – 88	 	MBLK2710 MBLK2320 MBLK2320 MBLK2720 MBLK2330 MBLK2710 MBLK2340	MBD2038 MBD1139 MBD2040 MBD1035 MBD2041 MBD2038 MBD1144
2 Series – T 82 (6x4), T 82 H (4x2), T 82 M (4x2), T 82 T 92 H (4x2), T 92 H (6x2), T 112 E (4x2), T 112 E (6x2), T 112 H (4x2), T 112 H (6x2), T 142 H (6x2)	81 – 88	 	MBLK2710 MBLK2320 MBLK2320 MBLK2720 MBLK2330 MBLK2710 MBLK2340	MBD2038 MBD1139 MBD2040 MBD1035 MBD2041 MBD2038 MBD1144
2 Series – T 112 M (4x2), T 112 MA (4x2), T 142 E (6x4)	80 – 88	 	MBLK2710 MBLK2320 MBLK2320 MBLK2720 MBLK2330 MBLK2710 MBLK2340	MBD2038 MBD1139 MBD2040 MBD1035 MBD2041 MBD2038 MBD1144
3 Series – 93 E, 93 H, 93 M 113 E, 113 H, 113 M 143 E, 143 H, 143 M	88 →	 	MBLK2340 MBLK2350 MBLK2350 MBLK2370 MBLK2360 MBLK2340 MBLK2340	MBD1016 MBD1142 MBD2041 MBD1035 MBD1144 MBD2038
3 Series – G 93 ML (4x2), G 93 MLR 210 (4x2), G 93 MLR 250 (4x2)	88 →	 	MBLK2340 MBLK2350 MBLK2350 MBLK2370 MBLK2360 MBLK2340 MBLK2340	MBD1016 MBD1142 MBD2041 MBD1035 MBD1144 MBD2038



1

2

3













































4

5

6

7



				
...Scania				
3 Series – P 93 HLR 250 (6x2), P 93 MAR 230 (4x2), P 93 MAR 280 (4x2), P 93 MAR 280 (6x2), P 93 MAR 280 (6x4), P 93 ML 230 (4x2), P 93 MLR 280 (8x4), P 93 MTR 230 (4x2), P 113 MA 130 (4x2), P 113 MAR 320, P 113 MAR 320 (6x2), P 113 MAR 320 (6x4), P 113 ML 310 (4x2), P 113 MLR 320 (6x2), P 113 MLR 320 (8x4)	88 →	      	MBLK2340 MBLK2350 MBLK2350 MBLK2370 MBLK2360 MBLK2340 MBLK2340	 MBD1016 MBD1142 MBD2041 MBD1035 MBD1144 MBD2038
3 Series – R 113 HLR 360 (6x4), R 113 MA 320, R 113 MA 320 (4x2), R 113 MA 320 (6x2), R 113 MAR 320 (4x2), R 113 MAR 360 (4x2), R 113 MAR 360 (6x2), R 143 EL 450 (6x4), R 143 MA 450, R 143 MA 450 (6x2), R 143 MA Intercooler, R 143 MAR 470 (4x2), R 143 MAR 470 (6x2), R 143 MAR 470 (6x4), R 143HL 450 (6x2)	88 →	      	MBLK2340 MBLK2350 MBLK2350 MBLK2370 MBLK2360 MBLK2340 MBLK2340	 MBD1016 MBD1142 MBD2041 MBD1035 MBD1144 MBD2038
4 Series – 94C 220, 94C 230, 94C 260, 94C 300, 94C 310, 94D 220, 94D 230, 94D 260, 94D 300, 94D 310, 94G 220, 94G 230, 94G 260, 94G 300, 94G 310, 94L 220, 94L 230, 94L 260, 94L 300, 94L 310, 114C 260, 114C 330, 114C 340, 114C 380, 114G 260, 114G 330, 114G 340, 114G	99 – 05	     	MBLK2350 MBLK2360 MBLK2340 MBLK2350 MBLK2360 MBLK2370	 MBD2042 MBD2071 MBD1144 MBD2040 MBD2071
80, 81, 85, 86 – 413 x 178 mm				MBD2034
93, 113, 143 – Series 1		     	MBLK2350 MBLK2350 MBLK2360 MBLK2330 MBLK2330	 MBD1016 MBD1142 MBD2040 MBD1035 MBD2041
93, 113, 143 – Series 2		 		MBD2042 MBD2071
G-Series – G230 18, G230 26, G230 32, G250 18, G250 26, G250 32, G270 18, G270 26, G270 32, G280 18, G280 26, G280 32, G310 18, G310 26, G310 32, G320 18, G320 26, G320 32, G340 18, G340 26, G340 32, G360 18, G360 26, G360 32, G370 18, G370 26, G370 32, G380 18, G38	04 →	     	MBLK2350 MBLK2360 MBLK2340 MBLK2350 MBLK2360 MBLK2370	 MBD2042 MBD1144 MBD2042 MBD2071
P-Series – P230 18, P230 26, P230 32, P250 18, P250 26, P250 32, P270 18, P270 26, P270 32, P280 18, P280 26, P280 32, P310 18, P310 26, P310 32, P320 18, P320 26, P320 32, P340 18, P340 26, P340 32, P360 18, P360 26, P360 32, P370 18, P370 26, P370 32, P380 18, P38	04 →	    	MBLK2350 MBLK2360 MBLK2340 MBLK2350 MBLK2360 MBLK2370	 MBD2042 MBD1144 MBD2042 MBD2071



...Scania				
R-Series – R230 18, R230.26, R230.32, R270 18, R270 26, R270 32, R280 18, R280 26, R280 32, R310 18, R310 26, R310 32, R340 18, R340 26, R340 32, R360 18, R360.26, R360 32, R370 18, R370 26, R370.32, R380 18, R380 26, R380 32, R400 18, R400.26, R400.32, R410.18, R41	05 →		MBLK2350	MBD2042
			MBLK2360	MBD2071
			MBLK2340	MBD1144
			MBLK2350	MBD2042
			MBLK2360	MBD2071
			MBLK2370	
R-Series – R730 18	10 →		MBLK2350	MBD2042
			MBLK2360	MBD2071
			MBLK2360	MBD2071
			MBLK2370	
R-Series – R730 26, R730 32	10 →		MBLK2350	
			MBLK2360	MBD2071
			MBLK2340	MBD1144
			MBLK2350	MBD2042
			MBLK2360	MBD2071
			MBLK2370	
T-Series – T230 18, T230 26, T230 32, T270 18, T270 26, T270 32, T310 18, T310 26, T310 32, T340 18, T340 26, T340 32, T380 18, T380 26, T380 32, T420 18, T420 26, T420 32, T470 18, T470 26, T470 32, T500 18, T500 26, T500 32, T580 18, T580 26, T580 32	04 →		MBLK2350	MBD2042
			MBLK2360	MBD2071
			MBLK2340	MBD1144
			MBLK2350	MBD2042
			MBLK2360	MBD2071
			MBLK2370	
Seddon Atkinson				
211 Series – 2.11	88 – 09/92		MBLK1130	
300 Series – R24 M466 (6 X 4)	79 – 82		MBLK1100	
300 Series – R30 M466 (8X4 Rigid), R30 M466i	79 – 81		MBLK1130	
300 Series – T17L25, T17L29, T22L29, T24L29	82 – 86		MBLK1130	
311 Series – 3.11	11/90 →		MBLK1130	
	86 – 01/93		MBLK1130	
	91 →		MBLK1120	
400 Series – R24 C220	75 – 83		MBLK1100	
400 Series – R30 M466 (IHRA-472 Axle)	79 →		MBLK1130	
400 Series – T38 G8XB	75 – 83		MBLK1100	
401 Series – T17C24, T17C29, T17G20, T17G25, T17R26, T17R29, T17R32	80 – 86		MBLK1130	
401 Series – T22C29, T22C32, T22R30, T24C32	82 – 86		MBLK1130	
	80 – 86		MBLK1130	
401 Series – T24R30	82 – 86		MBLK1130	





- 1
- 2
- 3
- 4
- 5
- 6
- 7

...Seddon Atkinson				
411 Series – 4.11	86 – 88		MBLK1130	
	86 – 08/91		MBLK1130	
	86 →		MBLK1130	
	91 →		MBLK1120	
Pacer, Strato – 17.30L	88 →		MBLK1130	
Strato – 17.21P	90 – 94		MBLK1130	
Strato – 17.21P	90 – 94		MBLK1130	
Strato – 17.275L	12/93 →		MBLK1130	
Strato – 17.27L	09/90 →		MBLK1130	
Strato – 17.30L	10/88 →		MBLK1130	
Strato – 17.325L	12/93 →		MBLK1130	
Strato – 17.32C	08/88 – 12/93		MBLK1130	
Strato – 17.33L	10/88 →		MBLK1130	
Strato – 17.33P	10/88 →		MBLK1130	
Strato – 17.340C	04/94 →		MBLK1130	
Strato – 17.350L	05/94 →		MBLK1130	
Strato – 17.35C	08/88 – 07/89		MBLK1130	
Strato – 17.37C	06/89 – 12/91		MBLK1130	
Strato – 17.380C	04/94 →		MBLK1130	
Strato – 17.38C	03/92 →		MBLK1130	
Strato – 17.38P	03/92 →		MBLK1130	
Strato – 17.40C	08/88 →		MBLK1130	
Strato – 17.40P	08/88 →		MBLK1130	
Strato – 17.410C	04/94 →		MBLK1130	
Strato – 17.41C	01/92 →		MBLK1130	
Strato – 17.47C	01/91 – 08/93		MBLK1130	
Strato – 22.30L	90 →		MBLK1130	
Strato – 22.32C	04/89 →		MBLK1130	
Strato – 22.33L	04/89 →		MBLK1130	
Strato – 22.33P	04/89 →		MBLK1130	
Strato – 22.37C	04/89 – 12/91		MBLK1130	
Strato – 22.38C	03/92 →		MBLK1130	
Strato – 22.38P	03/92 →		MBLK1130	
Strato – 22.40C	04/89 →		MBLK1130	
Strato – 22.40P	04/89 →		MBLK1130	
Strato – 22.41C	01/92 →		MBLK1130	
Strato – 22.47C	09/90 – 02/93		MBLK1130	
Strato – 23.325L	02/94 →		MBLK1130	
Strato – 23.340C	02/94 →		MBLK1130	
Strato – 23.350L	02/94 →		MBLK1130	
Strato – 23.380C	02/94 →		MBLK1130	



...Seddon Atkinson					
Strato – 23.410C	02/94 →		MBLK1130		
Strato – TC17.28L	09/90 →		MBLK1130		
Strato – TC17.32C	08/88 – 12/93		MBLK1130		
Strato – TC17.37C	06/89 – 12/91		MBLK1130		
Strato – TC17.41C	01/92 →		MBLK1130		
Strato – TC22.32C	04/89 →		MBLK1130		
Strato – TC22.33L	04/89 →		MBLK1130		
Strato – TC22.33P	04/89 →		MBLK1130		
Strato – TC22.38C	03/92 →		MBLK1130		
Strato – TC22.38P	03/92 →		MBLK1130		
Strato – TC22.40P	04/89 →		MBLK1130		
Strato – TC22.41C	01/92 →		MBLK1130		
Sisu					
Various models – 394 x 178 mm			MBLK1090		
Various models – 410 x 150 mm			MBLK2560		
Various models – 410 x 180 mm			MBLK2570		MBD1145
Various models – 410 x 210 mm			MBLK2580		MBD1146
SMB					
SMB C1 – 419 x 203 mm			MBLK2500 / MBSK2500-4		
SMB C2 – 419 x 178 mm			MBLK2490 / MBSK2490-4		MBD1071
Steyr					
19 S to 42 S – with Eaton/ MAN Rear Axle	94 →		MBLK2200		
19 S to 42 S – with Eaton/ MAN Rear Axle	94 →		MBLK2210		
19 S to 42 S – without 4 wheel drive	94 →		MBLK2200		
Tatra (CZ)					
Jamal – 410 x 180mm	00 →		MBLK2540		
Trailer					
L200 TEM – 419 x 178 mm			BLKQR / MBSK1000-4		MBD1037
N400 TEM – 419 x 203 mm			MBLK1115		MBD1006
SMB C1 – 419 X 203 mm			MBLK2500 / MBSK2500-4		
SMB C2 – 419 x 178 mm			MBLK2490 / MBSK2490-4		
Van Hool					
A Series – A 308	80 →		MBLK1050		
A Series – A 420	80 →		MBLK2040		
A Series – A 440	80 →		MBLK2040		



















































- 1
- 2
- 3
- 4
- 5
- 6
- 7

...Van Hool				
A Series – A 508	80 →		MBLK1050	
A Series – A 600 Urbain	80 →		MBLK2040	
Acron				MBD1130
AG700 – AG700				MBD1130
Alizee – 10m			MBLK2380	MBD1030
			MBLK2390	MBD2057
Alizee – 12m			MBLK2350	
			MBLK2360	MBD2071
			MBLK2380	MBD1030
			MBLK2360	MBD2071
Aststrobel – 12m			MBLK1190	MBD1161
			MBLK1200	MBD1021
			MBLK1160	
			MBLK1170	
EOS – Models 80-223			MBLK2230	
G280 – G 280.2 Urbain			MBLK2190	
G280 – G 280.3 Urbain			MBLK2190	
G280 – G 280.4 Urbain			MBLK2190	
T Series – T 811, T 812, T 813	80 →		MBLK1050	
			MBLK2200	
T Series – T 814, T 815	80 →		MBLK1050	
			MBLK2200	
Van Hool				
BPW Axle – 420 x 200 mm			MBLK2010 / MBSK2010-4	
Viberti				
BPW Axle – 420 x 200 mm			MBLK2010 / MBSK2010-4	
Volvo				
B 6 Series – B6	92 →		MBLK1210	MBD1027
B 6 Series – B6 FA	83 →		MBLK1050	
B 7 Series – B 7	87 →		MBLK1170	
			MBLK1190	MBD1161
			MBLK1200	
			MBLK1180	MBD1156
B 7 Series – B 7R	97 →		MBLK2380	MBD1030
	87 →		MBLK2390	MBD2057
B 9 Series – B 9 M	83 →		MBLK2740	
			MBLK2750	
			MBLK2380	



				
...Volvo				
				
B 10 Series – B 10 B	92 →		MBLK2380	MBD1030
			MBLK2390	MBD2057
	92 – 95		MBLK1190	MBD1161
			MBLK1200	MBD1021
			MBLK1160	
	→95		MBLK1160	
	95 →		MBLK1190	
			MBLK2790	
B 10 Series – B 10 H	79 →		MBLK2380	MBD1030
			MBLK2390	MBD2057
B 10 Series – B 10 L	95 →		MBLK2790	
B 10 Series – B 10 M	79 →		MBLK2380	MBD1030
			MBLK2740	
			MBLK2380	MBD1030
			MBLK2390	MBD2057
			MBLK2380	MBD1030
B 10 Series – B 10 M Articulated	79 →		MBLK2740	
			MBLK2390	MBD2057
B 10 Series – B 10 M Coach	79 →		MBLK2390	MBD2057
B 10 Series – B 10 M DL	93 →		MBLK2380	MBD1030
B 10 Series – B 10 M GLE	93 →		MBLK2380	MBD1030
			MBLK2390	MBD2057
B 10 Series – B 10 M SE, GL	96 →		MBLK2380	MBD1030
			MBLK2390	MBD2057
B 10 Series – B 10 MD	79 →		MBLK2380	MBD1030
			MBLK2390	MBD2057
B 10 Series – B 10 MT	93 →		MBLK2380	MBD1030
			MBLK2390	MBD2057
B 10 Series – B 10 R	79 →		MBLK2380	MBD1030
			MBLK2740	
			MBLK2390	MBD2057
B 12 Series – B 12	86 – 95		MBLK1190	MBD1161
			MBLK1160	
			MBLK1200	MBD1021
	01/96 →		MBLK1190	
			MBLK1160	
			MBLK1170	
			MBLK1200	MBD1158
B 12 Series – B 12 L	95 →		MBLK1200	
C 10 Series – Highliner	78 →		MBLK2380	MBD1030
Citybus – B57	77 – 82		MBLK2750	



















































- 1
- 2
- 3
- 4
- 5
- 6
- 7

...Volvo				
Citybus – B58	73 →		MBLK2750	
Citybus – B59	70 →		MBLK2380	
Citybus – BB57	70 – 77		MBLK2740	
	78 – 82		MBLK2740	
D 10 Series – D10M	79 →		MBLK2390	MBD2057
Olympian MK2	93 →		MBLK1180	
			MBLK1200	
Volvo				
F 7 Series – F 7	77 – 84		MBLK2750	
			MBLK2740	
			MBLK2380	
			MBLK2730	
	78 – 85		MBLK1050	
F 12 Series – (4x2) 17-18t (6x2) 24-25t	01/87 – 12/94		MBLK1180	MBD1020
			MBLK1170	MBD1157
			MBLK1190	MBD1161
			MBLK1190	MBD1017
			MBLK1200	MBD1021
			MBLK1180	MBD1156
F 12 Series – (6x4) 24t	01/87 – 12/94		MBLK1180	MBD1020
			MBLK1190	MBD1161
			MBLK1190	MBD1017
F 12 Series – (8x2)	86 →		MBLK1170	MBD1157
			MBLK1180	MBD1020
			MBLK1190	MBD1161
			MBLK1180	MBD1156
			MBLK1190	MBD1017
			MBLK1200	MBD1021
			MBLK1160	
			MBLK1170	
F 12 Series – F 12 Intercooler (4x2)	80 – 85		MBLK2740	
			MBLK2750	
			MBLK2380	
			MBLK2390	
F 12 Series – F 12 Intercooler (6x2) 38t	80 – 85		MBLK2740	
			MBLK2750	
			MBLK2390	
			MBLK2380	
			MBLK2760	



				
Volvo				
				
F 12 Series – F 12 Intercooler(6x2)	80 – 85		MBLK2740	
			MBLK2750	
			MBLK2380	
			MBLK2390	
F 12 Series – FAT 6.5	80 – 85		MBLK2740	
			MBLK2750	
			MBLK2390	
			MBLK2380	
			MBLK2760	
F 12 Series – FAT 7.5	80 – 85		MBLK2740	
			MBLK2750	
			MBLK2390	
			MBLK2380	
F 16 Series – (4x2) 17-18t (6x2) 24-25t	01/87 – 12/94		MBLK1180	MBD1020
			MBLK1170	MBD1157
			MBLK1190	MBD1161
			MBLK1190	MBD1017
			MBLK1200	MBD1021
			MBLK1180	MBD1156
F 16 Series – (6x4) 24t	01/87 – 12/94		MBLK1180	MBD1020
			MBLK1190	MBD1161
			MBLK1190	MBD1017
F 16 Series – (8x2)	86 →		MBLK1170	MBD1157
			MBLK1180	MBD1020
			MBLK1190	MBD1161
			MBLK1180	MBD1156
			MBLK1190	MBD1017
			MBLK1200	MBD1021
			MBLK1160	
			MBLK1170	
F Series – F10	77 – 84		MBLK2750	
	85 →		MBLK1190	MBD1161
			MBLK1200	MBD1021
			MBLK1180	MBD1156
F Series – F10 (4x2), F10 (6x2)	77 – 84		MBLK2750	
F Series – F12 (4x2)	77 – 80		MBLK2740	
F Series – F12 (4x2)	81 – 85		MBLK2750	
F Series – F12 (6x4)	77 – 80		MBLK2380	
F Series – F615	79 – 86		MBLK1050	
F Series – F616	79 – 86		MBLK1050	
F Series – F617	79 – 86		MBLK1050	





- 1
- 2
- 3
- 4
- 5
- 6
- 7

...Volvo				
F Series – F86	74 →		MBLK2750	
F Series – F89	70 – 77		MBLK2750	
F Series – F89 (4x2)	70 – 77		MBLK2380	
F Series – F89 (6x2)	70 – 77		MBLK2750	
F Series – F89 (6x4)	70 – 77		MBLK2380	
FH Series – FH 12, FH 16	93 – 96		MBLK1180	MBD1020
			MBLK1170	MBD1157
			MBLK1190	MBD1161
			MBLK1190	MBD1017
			MBLK1200	MBD1021
			MBLK1180	MBD1156
	96 →		MBLK1170	
			MBLK1190	
			MBLK1180	MBD1162
			MBLK1200	MBD1158
			MBLK1180	MBD1162
			MBLK1190	MBD1163
			MBLK1160	
			MBLK1170	
FL 6 Series – FL 615	86 – 94		MBLK1050	
		MBLK1140		
FL 6 Series – FL 616	86 – 10/91		MBLK1050	
		MBLK1140		
FL 6 Series – FL 617	86 →		MBLK1050	
		MBLK1140		
FL 6 Series – FL 618	90 →		MBLK1140	
			MBLK1150	
FL 6 Series – FL 619	94 →		MBLK1050	MBD2064
			MBLK1140	
	90 →		MBLK1150	
FL 7 Series – (4x2)	09/85 →		MBLK1180	MBD1020
			MBLK1170	MBD1157
			MBLK1190	MBD1017
FL 7 Series – (6x2 & 6x2/2/4)	09/85 →		MBLK1170	MBD1157
			MBLK1180	MBD1156
			MBLK1160	
			MBLK1190	MBD1017
			MBLK1160	
			MBLK1190	MBD1017



...Volvo				
FL 7 Series – (6x2)	09/85 →		MBLK1170	MBD1157
			MBLK1180	MBD1156
			MBLK1160	
			MBLK1180	MBD1156
FL 7 Series – (8x4)	09/85 →		MBLK1170	MBD1157
			MBLK1160	
			MBLK1180	MBD1156
			MBLK1200	MBD1021
FL 10 Series – (4x2)	09/85 →		MBLK1170	MBD1157
FL 10 Series – (6x2) (6x2/2/4)			MBLK1180	MBD1020
FL 10 Series – (6x4) Models FAT6.5, T-Ride 20t			MBLK1190	MBD1161
FL 10 Series – (8x4) Models			MBLK1180	MBD1156
			MBLK1190	MBD1017
			MBLK1200	MBD1021
			MBLK1160	
			MBLK1170	
FL Series			MBLK1180	MBD1020
			MBLK1190	
			MBLK1190	
			MBLK1180	MBD1020
			MBLK1160	
			MBLK1180	MBD1156
			MBLK1160	
			MBLK1180	MBD1156
FL Series – 618, 619	93 →		MBLK1150	MBD2064
FL Series – FL 6.08 / 9 / 10 / 11 / 13	87 →		MBLK1210	MBD1027
FL Series – FL 612	86 →		MBLK1210	MBD1027
FL Series – FL 613	86 →		MBLK1210	MBD1027
FL Series – FL 616	86 →		MBLK1050	
FL Series – FL 617	86 →		MBLK1050	
FL Series – FL 618	93 →		MBLK1150	MBD2064
FL Series – FL 619	93 →		MBLK1150	MBD2064
FL Series – FL7	01/96 →		MBLK1170	
			MBLK1180	MBD1162
			MBLK1190	
			MBLK1200	MBD1158
			MBLK1190	MBD1163
			MBLK1180	
FL Series – FL7 PA (6x2)	85 →		MBLK1170	MBD1157
			MBLK1190	MBD1017
			MBLK1170	





- 1
- 2
- 3
- 4
- 5
- 6
- 7

...Volvo				
FL Series – FL7, FL10	85 →		MBLK1170	MBD1157
			MBLK1180	MBD1020
			MBLK1180	MBD1156
			MBLK1180	MBD1156
FL Series – FL7, FL10 (4x2)	85 →		MBLK1170	MBD1157
			MBLK1180	MBD1020
			MBLK1190	MBD1017
FL Series – FL7, FL10 (6x2)	85 →		MBLK1170	MBD1157
FL Series – FL10, FL12	01/96 →		MBLK1170	
			MBLK1180	MBD1162
			MBLK1190	
			MBLK1180	
			MBLK1190	MBD1163
			MBLK1200	MBD1158
FL7, FH7, N7 – 410 x 200 mm			MBLK1190	MBD1161
FM Series	01/96 →		MBLK1180	MBD1162
			MBLK1170	
			MBLK1190	
			MBLK1180	
			MBLK1190	MBD1163
			MBLK1200	MBD1158
FS Series – FS 716, FS 717, FS 718, FS 719	92 →		MBLK1050	
			MBLK1150	MBD2064
N Series – 8" Drive axle			MBLK2380	
N Series – N10 (4x2)	74 – 79		MBLK2750	
N Series – N10 (6x2)	80 – 85		MBLK2380	
			MBLK2730	
N Series – N10 (6x4)	74 – 80		MBLK2750	
N Series – N10 and N12 Models	85 →		MBLK1180	MBD1020
				MBD1157
			MBLK1170	
			MBLK1190	MBD1017
			MBLK1200	MBD1021
N Series – N10 Mk2 (6x2)	80 – 85		MBLK2740	
N Series – N12 (4x2)	80 – 85		MBLK2750	
			MBLK2390	MBD2057
	74 – 79		MBLK2380	
N Series – N12 (6x4)	74 – 80		MBLK2380	
N Series – N12 Mk2 (6x2)	80 – 85		MBLK2740	
			MBLK2750	
	81 – 85		MBLK2380	



1



2



3



4



5



6



7



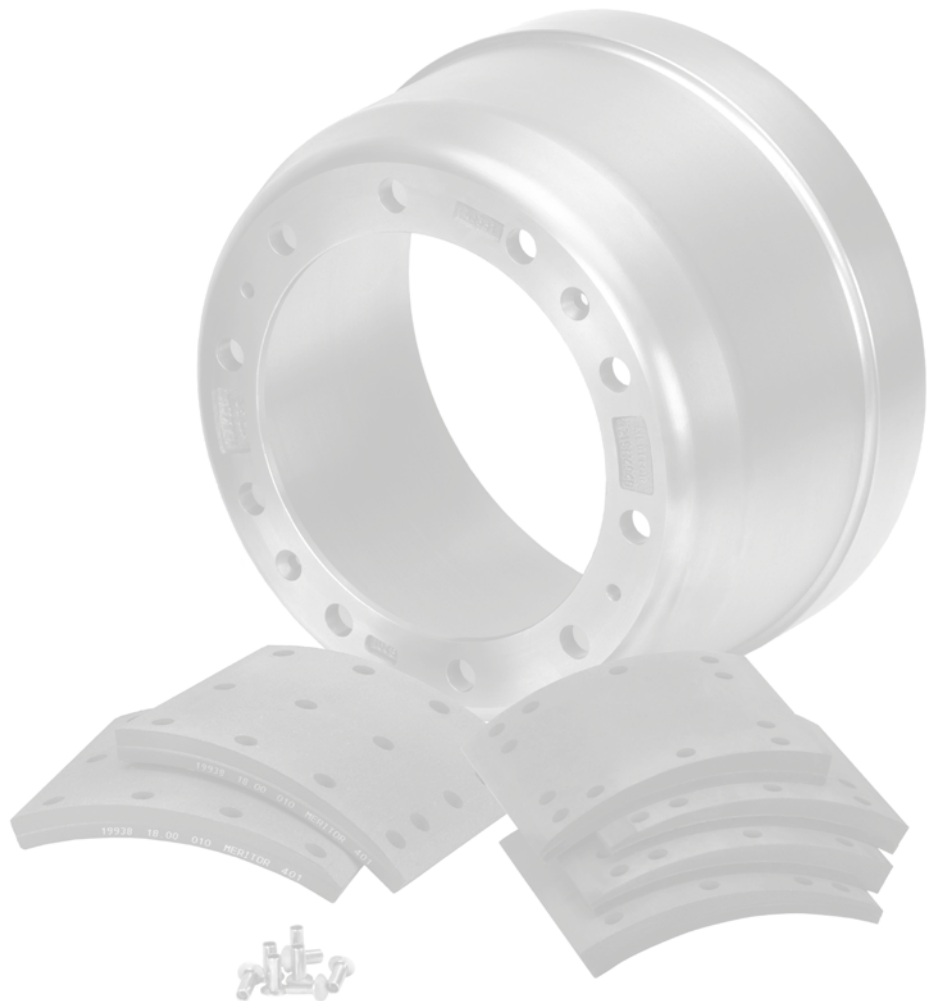

- 1
- 2
- 3
- 4
- 5
- 6
- 7



MBD1000	419	188	288	229	335	10 x 26.6
MBD1001	414	180	281	231	335	10 x 25.2
MBD1002	419	191	288	271.5	335	10 x 26
MBD1003	410	192	298	280	335	10 x 23
MBD1004	410	238	298	306	335	10 x 23
MBD1007	305	210	176	256	225	10 x 26
MBD1008	420	215	290	256	335	10 x 23
MBD1009	420	178	290	227	335	10 x 23
MBD1010	410	167	213	213	335	10 x 23
MBD1011	305	203	175	286	225	10 x 23
MBD1012	410	181	298	237	335	10 x 23
MBD1013	410	178	270	270	335	10 x 23
MBD1016	413	190	295	254	335	10 x 23.5
MBD1017	410	217	282	295	335	10 x 28
MBD1018	420	166	285	228	335	10 x 24
MBD1019	420	209	290	259	335	10 x 23
MBD1020	410	190	282	261	335	10 x 28
MBD1021	410	230	282	307	335	10 x 28
MBD1023	420	216	285	288	335	10 x 24
MBD1027	360	184	228	247	275	8 x 21.5
MBD1028	364	172	238	210	275	8 x 21
MBD1029	420	215	290	284	335	10 x 23
MBD1030	394	218	282	269	335	10 x 28
MBD1033	414	180	281	231	335	10 x 25.2
MBD1034	420	191	290	226	335	10 x 23
MBD1035	413	210	295	296	335	10 x 23.5
MBD1036	410	230	290	281	335	10 x 23
MBD1037	419	182	290	225	335	10 x 27
MBD1039	420	215	300	256	335	10 x 23
MBD1040	420	215	290	275	335	10 x 23
MBD1041	420	194	290	246	335	10 x 23
MBD1044	360	200	190	263	225	10 x 23
MBD1048	420	191	290	250	335	10 x 23
MBD1049	360	208	230	263	275	8 x 23
MBD1050	300	206	190	260	225	10 x 23
MBD1052	300	214	190	295	225	10 x 23
MBD1053	420	191	290	226	335	10 x 23
MBD1054	420	208	290	259	335	10 x 23
MBD1060	420	185	285	240	335	10 x 24
MBD1061	420	216	285	287.5	335	10 x 24
MBD1062	420	188	285	252	335	10 x 24
MBD1071	419	199	244	288	335	10 x 26



MBD1090	410	206	285	282	335	10 x 23
MBD1093	400	215	290	266	335	10 x 23
MBD1104	410	190	298	280	335	10 x 23
MBD1105	410	232	298	300	335	10 x 23
MBD1106	410	167	298	401	335	10 x 23
MBD1107	410	187	298	232	335	10 x 23
MBD1108	410	176	298	250	335	10 x 23
MBD1111	410	178	228	228	335	10 x 23
MBD1112	410	238	298	306	335	10 x 23
MBD1115	410	172	298	248	335	10 x 23
MBD1116	410	172	298	290	335	10 x 23
MBD1122	410	172	298	250	335	10 x 23
MBD1124	410	181	298	237	335	10 x 23
MBD1130	410	235	282	275	335	10 x 23
MBD1131	414	233	281	227	335	10 x 25.2
MBD1136	420	192	290	227	335	10 x 23
MBD1137	300	212	190	280	225	10 x 23
MBD1138	420	190	300	227	335	10 x 23
MBD1142	413	189	295	263	335	10 x 23.5
MBD1144	413	143	295	263	335	10 x 23.5
MBD1145	413	226	285	268	335	10 x 23.5
MBD1146	410	241	285	283	335	10 x 25.5
MBD1156	410	202	282	282	335	10 x 28
MBD1157	410	181	282	249	335	10 x 28
MBD1158	410	230	282	306	335	10 x 28
MBD1161	410	205	282	274	335	10 x 28
MBD1162	410	200	282	261	335	10 x 28
MBD1163	410	218	282	294	335	10 x 28
MBD1170	419	229	282	271	335	10 x 24.5
MBD1171	419	200	282	248	335	10 x 24
MBD1172	419	187	282	238	335	10 x 24.5
MBD1173	350	210	183	263	225	10 x 24.5
MBD1174	311	202	183	260	225	10 x 25
MBD1175	350	214	225	263	275	8 x 24.5
MBD2016	325	156	204	192	245	6 x 20
MBD2025	410	193	298	260	335	10 x 23, 5 x 24, 3 x M12
MBD2029	355	211	190	279	225	10 x 23
MBD2031	300	212	190	280	225	10 x 23
MBD2032	367	210	240	260	275	8 x 23
MBD2041	413	266	295	320	335	10 x 23.5
MBD2042	413	190	195	263	335	10 x 23.5, 3 x M12
MBD2057	394	265	282	314	335	10 x 28





1



2



3



4



5



6



7



MBD2064	381	237	286	255	335	10 x 24.5
MBD2071	413	210	295	275	335	10 x 23.5
MBD2076	419	215	288	256	335	10 x 26.5
MBD2077	406	163	282	220	335	10 x 26
MBD2078	406	227	282	284	335	10 x 26
MBD2079	300	210	190	260	225	10 x 23
MBD5013	410	207	285	268	382	10 x 23
21018986V	419	200	282	248	335	10 x 24
21021114AV	419	229	282	271	335	10 x 24.5
21209723S	311	202	183	260	225	10 x 25
21211030S	350	210	183	263	225	10 x 24.5
21211966S	350	214	225	263	275	8 x 24.5
21220183V	419	187	282	238	335	10 x 24.5



Series of horizontal dotted lines for writing.



Handwriting practice area with horizontal lines and a large red silhouette of a running bull in the center.

1



2



3



4



5



6









7





	BFMC	WVA						
MBLK1050	CW 4/2	19384	8	Std	381	178	96	L9
MBLK1060	CW 10/1	19905	8	Std	394	152	64	L9
MBLK1070	CW 11/1	19887	8	Std	394	178	128	L9
MBLK1080	GG 83/1	19072	4	Std	394	152	48	L9
MBLK1090	GG 92/1	19111	4	Std	394	178	72	L9
MBLK1100	GG 142/1	19371	4	Std	394	203	48	L9
MBLK1110	MQ 3 / MQ 4	19783 / 19784	4 + 4	Std	311	178	96	L9
MBLK1115	RW 1 / RW 2/3	19365 / 19366	4 + 4	Std	419	203	96	L9
MBLK1120	RW 1 / RW 2/5	19365 / 19366	4 + 4	Std	419	203	128	L9
MBLK1121	RW 1 / RW 2/5	19365 / 19366	4 + 4	Std + 1mm	421	203	128	L9
MBLK1130	RW 5 / RW 6/4	19613 / 19614	4 + 4	Std	419	178	128	L9
MBLK1140	RW 24/1	19492	8	Std	380	180	96	L9
MBLK1141	RW 24/1	19492	8	Std + 1mm	380	180	96	L9
MBLK1150	RW 25/1	19542	8	Std	374	200	96	L9
MBLK1155	RW 29 / 32 / 33	19553 / 716 / 17	4 + 2 + 2	Std	410	200	96	8 x 15
MBLK1160	VL 85/1	17992	8	Std	410	123	64	L9
MBLK1170	VL 86/1	19941	8	Std	410	150	96	L9
MBLK1180	VL 87/2	19090	8	Std	410	175	112	L9
MBLK1182	VL 87/2	19090	8	Std + 2mm	414	175	112	L9
MBLK1190	VL 88/2	19071	8	Std	410	200	112	L9
MBLK1192	VL 88/2	19071	8	Std + 2mm	414	200	112	L9
MBLK1200	VL 89/2	19068	8	Std	410	225	112	L9
MBLK1202	VL 89/2	19940	8	Std + 2mm	414	225	112	L9
MBLK1210	GG 235 / GG 236	19758 / 19759	4 + 4	Std	360	170	72	L9
MBLK1220	GG 118/1	17546	4	Std	394	127	48	L8
MBLK1245	RW 28 /30 / 31	19556 / 714/715	4 + 2 + 2	Std	410	180	96	8 x 15
MBLK2000	BC 36 / BC 98/1	19032	8	Std	420	180	80	8 x 15
MBLK2001	BC 36 / BC 98/1	19032	8	Std + 1mm	422	180	80	8 x 15
MBLK2002	BC 36 / BC 98/1	19032	8	Std + 2mm	424	180	80	8 x 15
MBLK2010	BC 37 / BC 97/1	19094	8	Std	420	200	80	8 x 15
MBLK2011	BC 37 / BC 97/1	19094	8	Std + 1mm	422	200	80	8 x 15
MBLK2012	BC 37 / BC 97/1	19094	8	Std + 2mm	424	200	80	8 x 15
MBLK2015	BC 81/1	19591	8	Std	420	220	80	8 x 15
MBLK2045	DF 32 / DF 33	19890 / 19891	4 + 4	Std	420	200	112	L10
MBLK2046	DF 32 / DF 33	19890 / 19891	4 + 4	Std + 1mm	422	200	112	L10
MBLK2050	DF 34 / DF 35/1	19900 / 19901	4 + 4	Std	420	150	64	L9
MBLK2060	DF 36 / DF 37	19888 / 19889	4 + 4	Std	420	175	96	L9
MBLK2065	DF 38 / DF 39	19914 / 19915	4 + 4	Std	420	240	128	L10
MBLK2070	DF 44 / DF 45/1	19011 / 19010	4 + 4	Std	420	150	64	L10
MBLK2071	DF 44 / DF 45/1	19011 / 19010	4 + 4	Std + 1mm	422	150	64	L10
MBLK2080	DF 46 / DF 47/1	19052 / 19055	4 + 4	Std	420	175	96	L10
MBLK2081	DF 46 / DF 47/1	19052 / 19055	4 + 4	Std + 1mm	422	175	96	L10









	BFMC	WVA						
MBLK2090	DF 48 / DF 49/1	19063 / 19064	4 + 4	Std	420	200	128	L10
MBLK2100	FI 124/1	19918	8	Std	360	170	14.1	8 x 18
MBLK2160	MB 97	17928	4	Std	304	120	40	8 x 15
MBLK2170	MB 110	17280	4	Std	308	120	40	8 x 18
MBLK2180	MB 117 / MB118	17351 / 17975	2 + 2	Std	300	122.5	52	6 x 10
MBLK2185	MP 30/2	17238	8	Std	410	140	64	8 x 20
MBLK2190	MP 31/2	19494	8	Std	410	160	64	8 x 20
MBLK2191	MP 31/2	19494	8	Std + 1mm	412	160	64	8 x 15
MBLK2192	MP 31/2	19494	8	Std + 2mm	414	160	64	8 x 15
MBLK2200	MP 32/2	19495	8	Std	410	180	64	8 x 20
MBLK2201	MP 32/2	19495	8	Std + 1mm	410	180	64	8 x 15
MBLK2202	MP 32/2	19495	8	Std + 2mm	414	180	64	8 x 15
MBLK2210	MP 36/2	19496	8	Std	410	220	64	8 x 15
MBLK2211	MP 36/2	19496	8	Std + 1mm	410	220	64	8 x 15
MBLK2230	PB 18 / PB 19/1	19847 / 19848	4 + 4	Std	410	220	96	10 x 18
MBLK2231	PB 18 / PB 19/1	19847 / 19848	4 + 4	Std + 2mm	414	220	96	10 x 18
MBLK2240	PB 22	19503	4	Std	360	170	72	8 x 15
MBLK2245	PD 3 / PD 4/1	19879 / 19881	4 + 4	Std	410	200	104	6 x 15
MBLK2246	PD 3 / PD 4/1	19879 / 19881	4 + 4	Std + 1mm	412	200	104	6 x 15
MBLK2260	PD 7 / PD 8/1	19877 / 19878	4 + 4	Std	410	160	104	6 x 15
MBLK2270	RN 100/1	19934	8	Std	414	150	64	8 x 18
MBLK2271	RN 100/2	19934	8	Std + 1mm	414	150	64	8 x 19
MBLK2280	RN 101/1	19935	8	Std	414	175	64	8 x 18
MBLK2290	RN 104/1	19187	8	Std	413	220	64	8 x 18
MBLK2291	RN 104/1	19187	8	Std + 1mm	415	220	64	8 x 18
MBLK2300	SJ 22 / SJ 23/1	19516 / 19515	4 + 4	Std	300	200	64	8 x 18
MBLK2301	SJ 22 / SJ 23/1	19516 / 19515	4 + 4	Std + 1mm	300	200	64	8 x 18
MBLK2310	SJ 26 / SJ 27/1	19892 / 19893	4 + 4	Std	355	200	80	8 x 18
MBLK2312	SJ 26 / SJ 27/1	19892 / 19893	4 + 4	Std + 2mm	359	200	80	8 x 18
MBLK2320	SV 8/1	19075	8	Std	413	178	96	L12
MBLK2321	SV 8/2	19075	8	Std + 1mm	413	178	96	L12
MBLK2330	SV 34/1	19647	8	Std	413	254	96	L12
MBLK2331	SV 34/1	19647	8	Std + 1mm	413	254	96	L12
MBLK2340	SV 39/2	17991	4	Std	413	127	32	L12
MBLK2350	SV 40/2	19931	4	Std	413	178	64	S38
MBLK2351	SV 40/2	19931	4	Std + 1mm	415	178	64	S38
MBLK2360	SV 41/2	19932	4	Std	413	200	64	N22
MBLK2361	SV 41/2	19932	4	Std + 1mm	415	200	64	S38
MBLK2370	SV 42/2	19933	4	Std	413	254	64	N22
MBLK2371	SV 42/2	19933	4	Std + 1mm	415	254	64	S38
MBLK2380	VL 76 / VL 77/1	19562 / 19563	4 + 4	Std	394	203	84	L11
MBLK2390	VL 81 / VL 82/1	19800 / 19799	4 + 4	Std	394	254	84	L11





	BFMC	WVA						
MBLK2400	YK 6 / YK 7	19334 / 19333	4 + 4	Std	394	178	96	L8.5
MBLK2410	YK 8 / YK 9	19462 / 19461	4 + 4	Std	394	210	128	L8.5
MBLK2420	YK 12	19700	8	Std	335	210	128	L9
MBLK2421	YK 12	19700	8	Std + 1mm	337	150	128	L9
MBLK2425	YK13	17362	8	Std	335	150	64	L9
MBLK2430	BC 80/1	19574	8	Std	300	200	64	8 x 18
MBLK2431	BC 80/1	19574	8	Std + 1mm	300	200	64	8 x 18
MBLK2432	BC 80/1	19574	8	Std + 2mm	304	200	64	8 x 18
MBLK2440	BC 100 / BC 101/1	19902 / 19903	4 + 4	std	360	200	72	8 x 15
MBLK2450	SJ 28 / SJ 29/1	19283 / 19284	4 + 4	Std	420	178	64	8 x 15
MBLK2451	SJ 28 / SJ 29/1	19283 / 19284	4 + 4	Std + 1mm	420	178	64	8 x 15
MBLK2460	SJ 30 / SJ 31/1	19477 / 19478	4 + 4	Std	420	203	64	8 x 15
MBLK2480	BC 120 / BC 121	19718 / 19719	4 + 4	Std	360	200	88	5 x 16
MBLK2490	FT 11 / FT 12	19614 / 19613	4 + 4	Std	419	179	128	5 x 16
MBLK2491	FT 11 / FT 12	19614 / 19613	4 + 4	Std + 1 mm	421	179	128	5 x 16
MBLK2500	FT 6 / FT 7	19606 / 19557	4 + 4	Std	419	204	128	5 x 16
MBLK2501	FT 6 / FT 7	19606 / 19557	4 + 4	Std + 1mm	421	204	128	5 x 16
MBLK2510	LZ2 / LZ3/1	19762 / 19763	4 + 4	Std	305	200	64	8 x 18
MBLK2540	PB 24/1	19263	8	Std	410	200	112	8 x 18
MBLK2550	PB 25/2	19342	8	Std	410	180	112	8 x 20
MBLK2560	SV 43 / SV 44/1	N/A	4 + 4	Std	413	150	96	L
MBLK2570	SV 45 / SV 46/1	N/A	4 + 4	Std	420	180	96	L
MBLK2580	SV 47 / SV 48/1	N/A	4 + 4	Std	420	210	96	L
MBLK2610	DF 16 / DF17	19256 / 19260	4 + 4	Std	420	178	112	L10
MBLK2620	DF 20 / DF 21	19150 / 19151	4 + 4	Std	420	152	80	L10
MBLK2680	NN 62	N/A	8	Std	406	150	96	L9
MBLK2690	NN 63	N/A	8	Std	406	220	96	L9
MBLK2710	SV 26/1	17161	8	Std	413	125	64	L12
MBLK2720	SV 27/1	19393	8	Std	413	203	96	L12
MBLK2730	VL 70 / VL 71/1	17665 / 17664	4 + 4	Std	413	127	72	L11
MBLK2740	VL 72 / VL 73/1	19468 / 19467	4 + 4	Std	394	178	84	L11
MBLK2750	VL 74 / VL 75/1	19560 / 19561	4 + 4	Std	413	152	88	L11
MBLK2760	VL 83 / VL 84/1	19885 / 19886	4 + 4	Std	394	240	84	L
MBLK2770	SJ 32 / SJ 33	19479 / 19480	4 + 4	Std	367	180	64	8 x 15
MBLK2780	SJ 34 / SJ 35	19490 / 19491	4 + 4	Std	367	200	64	8 x 15
MBLK2790	VL 100 / 101/1	19975	4 + 4	Std	394	229	84	L11
MBLK2800	FI 115	19754	4 + 4	Std	410	199.5	96	L
MBLK2810	PB 34	19786	8	Std	410	200	80	L
RMBLK1180	VL 87/2	19090	8	Std	410	175	112	L9
RMBLK1182	VL 87/2	19090	8	Std + 2mm	414	175	112	L9
RMBLK1190	VL 88/2	19071	8	Std	410	200	112	L9
RMBLK1200	VL 89/2	19068	8	Std	410	225	112	L9



	BFMC	WVA						
RMBLK2000	BC 36 / BC 98/1	19032	8	Std	420	180	80	8 x 15
RMBLK2001	BC 36 / BC 98/1	19032	8	Std + 1mm	422	180	80	8 x 15
RMBLK2002	BC 36 / BC 98/1	19032	8	Std + 2mm	424	180	80	8 x 15
RMBLK2010	BC 37 / BC 97/1	19094	8	Std	420	200	80	8 x 15
RMBLK2011	BC 37 / BC 97/1	19094	8	Std + 1mm	422	200	80	8 x 15
RMBLK2012	BC 37 / BC 97/1	19094	8	Std + 2mm	424	200	80	8 x 15
RMBLK2090	DF 48 / DF 49/1	19063 / 19064	4 + 4	Std	420	200	128	L10
RMBLK2200	MP 32/2	19495	8	Std	410	180	64	8 x 20
RMBLK2210	MP 36/2	19496	8	Std	410	220	64	8 x 15
RMBLK2211	MP 36/2	19496	8	Std + 1mm	410	220	64	8 x 15
RMBLK2290	RN 104/1	19187	8	Std	413	220	64	8 x 18
RMBLK2350	SV 40/2	19931	4	Std	413	178	64	S38
RMBLK2360	SV 41/2	19932	4	Std	413	200	64	N22
RMBLK2370	SV 42/2	19933	4	Std	413	254	64	N22
RMBLK2430	BC 80/1	19574	8	Std	300	200	64	8 x 18
RMBLK2440	BC 100 / BC 101/1	19902 / 19903	4 + 4	std	360	200	72	8 x 15
RMBLK2450	SJ 28 / SJ 29/1	19283 / 19284	4 + 4	Std	420	178	64	8 x 15
RMBLK2460	SJ 30 / SJ 31/1	19477 / 19478	4 + 4	Std	420	203	64	8 x 15
RMBLK2500	FT 6 / FT 7	19606 / 19557	4 + 4	Std	419	204	128	5 x 16
RMBLK2501	FT 6 / FT 7	19606 / 19557	4 + 4	Std + 1mm	421	204	128	5 x 16





Series of horizontal dotted lines for writing or drawing.

Vertical sidebar with numbered sections 1 through 7 and corresponding icons:

- 1: Document icon
- 2: Map icon, Bird icon, Bird icon
- 3: Map icon, Bird icon, Bird icon
- 4: Map icon, Bird icon, Bird icon
- 5: Map icon, Bird icon, Bird icon
- 6: Bird icon, Bird icon, Bird icon
- 7: Map icon, Bird icon, Bird icon



	BFMC	WVA					
MBSK1000-4	IL66/67	19036 / 19037	ROR	419	178	Q	TM, TE
MBSK1010-4	FU4/5	19370	ROR	419	220	Z	TM
MBSK1040-4	RW34/35	19030 / 19033	ROR	419	178	Q+	LM, LMC
MBSK2000-4	BC98	19032	BPW	420	180	SN4218	H, R ECO 95
MBSK2010-4	BC97	19094	BPW	420	200	SN4220	H, R ECO 95
MBSK2015-4	BC81	19591	BPW	420	220	BPW	420x220
MBSK2430-4	BC80	19574	BPW	300	200	BPW	SN3020
MBSK2440-4	BC100/101	19902 / 19903	BPW	360	200	BPW	SN3620
MBSK2450-4	SJ28/29	19283 / 19284	SAF	420	180	SAF	SK RZ 9042
MBSK2460-4	SJ30/31	19477 / 19478	SAF	420	200	SAF	SK RZ 11242
MBSK2490-4	FT11/12	19613 / 19614	SMB	419	178	SMB	C2
MBSK2500-4	FT6/7	19557 / 19606	SMB	419	203	SMB	C1/L1





	BFMC	WVA									
BLKAR	RW 13/3	19605/19604	8 {	4	158	190	40	L10	ROR AC Brake - (310 x 190mm)	Fruehauf, ROR	
	RW 9/2	19605/19604		4	126	190	40	L10			
BLKAR+1	RW 13/3 / RW 9/2	19605/19604							ROR AC Brake - (310 x 190mm)	Fruehauf, ROR	
BLKA	RW 13/3 / RW 9/2	19605/19604							ROR AC Brake - (310 x 190mm)	Fruehauf, ROR	
BLKBR	RW 21/1	19908	8 {	4	151	200	40	L10	ROR B Brake - (350 x 200mm)	ROR	
	RW 22/1	19909		4	151	200	40	L10			
BLKBR+1	RW 21 / RW 22/1	19908/19909							ROR B Brake - (350 x 200mm)	ROR	
BLKB	RW 21 / RW 22/1	19908/19909							ROR B Brake - (350 x 200mm)	ROR	
BLKQ+R	RW 34/1	19030	8 {	4	189	177	48	L9	ROR Q+ Brake - 16.1/2 x 7" (419 x 178mm)	ROR	
	RW 35/1	19033		4	195	177	48	L9			
BLKQ+R+1	RW 34 / RW 35/1	19030/19033							ROR Q+ Brake - 16.1/2 x 7" (419 x 178mm)	ROR	
BLKQ+	RW 34 / RW 35/1	19030/19033							ROR Q+ Brake - 16.1/2 x 7" (419 x 178mm)	ROR	
BLKQR	IL 66/67								ROR Q Brake - 16.1/2 x 7" (419 x 178mm)	Fruehauf, Hendrickson, ROR, TRALOR, York	
BLKQR	IL 66/3	19036	8 {	4	188	177	48	L10	ROR Q Brake - 16.1/2 x 7" (419 x 178mm)	Fruehauf, Hendrickson, ROR, TRALOR, York	
	IL 67/3	19037		4	194	177	48	L10			
BLKQR+1	IL 66 / IL 67/3	19036/19037							ROR Q Brake - 16.1/2 x 7" (419 x 178mm)	Fruehauf, Hendrickson, ROR, TRALOR, York	
BLKQR+2	RW 9 / RW 13/2	19604/19605							ROR Q Brake - 16.1/2 x 7" (419 x 178mm)	Fruehauf, Hendrickson, ROR, TRALOR, York	
BLKZR	FU 4 / FU 5/3	19370	8 {	4	189	219	48	L10	ROR Z Brake - 16.1/2 x 8.5/8" (419 x 219mm)	ROR, York	
	FU 4 / FU 5/3	19369		4	192	219	48	L10			
BLKZR+1	FU 4 / FU 5/3	19370/19369							ROR Z Brake - 16.1/2 x 8.5/8" (419 x 219mm)	ROR, York	
BLKZ	FU 4 / FU 5/3	19370/19369							ROR Z Brake - 16.1/2 x 8.5/8" (419 x 219mm)	ROR, York	





- 1
- 2
- 3
- 4
- 5
- 6
- 7

MBLR1003	RIVET L9 SEMI TUBULAR - 14KG PACK	4000 rivets	BRITISH STANDARD TYPE
MBLR1004	RIVET L10 SEMI TUBULAR - 14KG PACK	3500 rivets	BRITISH STANDARD TYPE
MBLR1005	RIVET L11 SEMI TUBULAR - 14KG PACK	3500 rivets	BRITISH STANDARD TYPE
MBLR1006	RIVET L12 SEMI TUBULAR - 14KG PACK	3000 rivets	BRITISH STANDARD TYPE
MBLR1009	RIVET 8 x 15 SEMI TUBULAR - 12KG PACK	2500 rivets	METRIC TYPE
MBLR1011	RIVET 8 x 15 FULLY TUBULAR - 12KG PACK	2500 rivets	METRIC TYPE
MBLR1012	RIVET 8 x 18 FULLY TUBULAR - 12KG PACK	2000 rivets	METRIC TYPE





- 1
- 2
- 3
- 4
- 5
- 6
- 7





	OE	
BPW		
	0310546200	MBD1052
	0310546290	MBD1050
	0310667120	MBD1041
	0310667620	MBD1034
	0310677040	MBD1040
	0310677520	MBD1029
	0310946060	MBD2079
	0310946490	MBD1050
	0310967130	MBD1034
	0310967190	MBD1053
	0310967740	MBD1048
	0310967790	MBD1053
	0310967820	MBD1034
	0310977170	MBD1054
	0310977720	MBD1029
	0310990220	MBD1049
	0310990240	MBD1044
	310546290	MBD1050
	310667620	MBD1034
	310677570	MBD1019
	310946490	MBD1050
	310967130	MBD1034
	310967790	MBD1053
	310967820	MBD1034
	310977160	MBD1019
	310977720	MBD1029
	310977770	MBD1019
DAF		
	0090500	MBD1060
	01232806	MBD1062
	01233462	MBD1018
	01488338	21018986V
	01488338	MBD1171
	01488714	21220183V
	01488714	MBD1172
	0284620	MBD1018
	0365579	MBD1023
	0595225	MBD1018
	0754397	MBD1061
	1232806	MBD1062
	1233462	MBD1018

	OE	
	1488338	21018986V
	1488338	MBD1171
	1488714	21220183V
	1488714	MBD1172
	284620	MBD1018
	365579	MBD1023
	595225	MBD1018
	754397	MBD1061
Fruehauf		
	AJA0489001	MBD1002
	AJB0026001	MBD1000
Hino		
	43512-4090	MBD2077
	43512-4100	MBD2078
Iveco		
	42118427	MBD1090
Kässbohrer		
	015268511115B	MBD1093
MAN		
	3464230601	MBD1013
	81501100101	MBD1003
	81501100144	MBD1105
	81501100175	MBD2016
	81501100195	MBD2016
	81501100213	MBD1108
	81501100231	MBD1106
	81501100232	MBD1107
Mercedes-Benz		
	3014230801	MBD1112
	3054210001	MBD1111
	3054210401	MBD1010
	3054230401	MBD1004
	3464210301	MBD1122
	3464230101	MBD1104
	3464230501	MBD1104
	3854230301	MBD1115
	3854230501	MBD1116
	3874210001	MBD1122
	3874210201	MBD2025
	6244210201	MBD1012
	6584210001	MBD1124
	6774210101	MBD1028

	OE	
	6774210201	MBD1028
	6774210501	MBD1028
	6774230001	MBD1028
	6774230501	MBD1028
	A3014230801	MBD1112
	A3054210001	MBD1111
	A3054210401	MBD1010
	A3054230401	MBD1004
	A3464210301	MBD1122
	A3464230101	MBD1104
	A3464230501	MBD1104
	A3854230301	MBD1115
	A3854230501	MBD1116
	A3874210001	MBD1122
	A3874210201	MBD2025
	A6244210201	MBD1012
	A6584210001	MBD1124
	A6774210101	MBD1028
	A6774210201	MBD1028
	A6774210501	MBD1028
	A6774230001	MBD1028
	A6774230501	MBD1028
Neoplan		
	8252019174	MBD1130
Renault		
	189923	MBD1033
	5000737768	MBD1001
	5001826771	21209723S
	5001826771	MBD1174
	5010098949	MBD1131
	5021138663	21021114AV
	5021138663	MBD1170
	5021138818	21211966S
	5021138818	MBD1175
SAE - Dupellier		
	730397	MBD1011
	790160	MBD1007
SAF		
	1064006002	MBD1009
	1064010801	MBD1008
	1064019700	MBD1137
	1064022300	MBD2029



SAF	OE	MBD
1064023600		MBD1136
1064023601		MBD1136
1064027000		MBD1039
1064027300		MBD2031
1064027700		MBD2032
1064026001		MBD1138
Scania	OE	MBD
0360572		MBD1035
1034079		21211030S
1034079		MBD1173
1414152		MBD2042
1414153		MBD2071
360567		MBD1144
360573		MBD2041
392390		MBD1016

392391	OE	MBD
Seddon Atkinson	OE	MBD
179252011411		MBD1036
Sisu	OE	MBD
1463117200		MBD1146
1463117210		MBD1145
SMB	OE	MBD
M003176		MBD2076
M006166		MBD1071
Trailer	OE	MBD
6502796E		MBD1037
Volvo	OE	MBD
1075306		MBD1162
1075309		MBD1163
1075310		MBD1158
1134817		MBD1030

1590313/1	OE	MBD
1599009		MBD1020
1599010		MBD1161
1599011		MBD1017
1599012		MBD1021
1599678		MBD1157
1599679		MBD1156
3171744		MBD1162
3171747		MBD1163
3171748		MBD1158
6772133		MBD1027
6798892		MBD2064
6798897		MBD2064
1590313/1		MBD2057



Handwriting practice area with horizontal dotted lines.

Vertical sidebar with numbered steps 1 through 7 and corresponding icons:

- 1: Document icon
- 2: Navigation icons (book, bull, arrows)
- 3: Navigation icons (book, bull, arrows)
- 4: Navigation icons (book, bull, arrows)
- 5: Navigation icons (book, bull, arrows)
- 6: Navigation icons (book, bull, arrows)
- 7: Navigation icons (book, bull, arrows)



	BFMC	WVA
MBLK1050	CW 4/2	19384
MBLK1060	CW 10/1	19905
MBLK1070	CW 11/1	19887
MBLK1080	GG 83/1	19072
MBLK1090	GG 92/1	19111
MBLK1100	GG 142/1	19371
MBLK1110	MQ 3 / MQ4	19783 / 19784
MBLK1115	RW 1 / RW 2/3	19365 / 19366
MBLK1120	RW 1 / RW 2/5	19365 / 19366
MBLK1121	RW 1 / RW 2/5	19365 / 19366
MBLK1130	RW 5 / RW 6/4	19613 / 19614
MBLK1140	RW24/1	19492
MBLK1141	RW24/1	19492
MBLK1150	RW 25/1	19542
MBLK1155	RW 29 / 32 / 33	19553 / 716 / 17
MBLK1160	VL 85/1	17992
MBLK1170	VL 86/1	19941
MBLK1180	VL 87/2	19090
MBLK1182	VL 87/2	19090
MBLK1190	VL 88/2	19071
MBLK1192	VL 88/2	19071
MBLK1200	VL 89/2	19068
MBLK1202	VL 89/2	19940
MBLK1210	GG 235 / GG 236	19758 / 19759
MBLK1220	GG118/1	17546
MBLK1245	RW 28 / 3 0/ 31	19556 / 714 / 715
MBLK2000	BC 36 / BC 98/1	19032
MBLK2001	BC 36 / BC 98/1	19032
MBLK2002	BC 36 / BC 98/1	19032
MBLK2010	BC 37 / BC 97/1	19094
MBLK2011	BC 37 / BC 97/1	19094
MBLK2012	BC 37 / BC 97/1	19094
MBLK2015	BC81/1	19591
MBLK2045	DF32/DF33	19890 / 19891
MBLK2046	DF32/DF33	19890 / 19891
MBLK2050	DF 34 / DF 35/1	19900 / 19901
MBLK2060	DF36/DF37	19888 / 19889
MBLK2065	DF38/DF39	19914 / 19915
MBLK2070	DF 44 / DF 45/1	19011 / 19010
MBLK2071	DF 44 / DF 45/1	19011 / 19010
MBLK2080	DF 46 / DF 47/1	19052 / 19055
MBLK2081	DF 46 / DF 47/1	19052 / 19055

	BFMC	WVA
MBLK2090	DF 48 / DF 49/1	19063 / 19064
MBLK2100	FI1 24/1	19918
MBLK2160	MB 97	17928
MBLK2170	MB 110	17280
MBLK2180	MB 117 / MB 118	17351 / 17975
MBLK2185	MP 30/2	17238
MBLK2190	MP 31/2	19494
MBLK2191	MP 31/2	19494
MBLK2192	MP 31/2	19494
MBLK2200	MP 32/2	19495
MBLK2201	MP 32/2	19495
MBLK2202	MP 32/2	19495
MBLK2210	MP 36/2	19496
MBLK2211	MP 36/2	19496
MBLK2230	PB 18 / PB 19/1	19847 / 19848
MBLK2231	PB 18 / PB 19/1	19847 / 19848
MBLK2240	PB 22	19503
MBLK2245	PD 3 / PD 4/1	19879 / 19881
MBLK2246	PD 3 / PD 4/1	19879 / 19881
MBLK2260	PD 7 / PD 8/1	19877 / 19878
MBLK2270	RN 100/1	19934
MBLK2271	RN 100/2	19934
MBLK2280	RN 101/1	19935
MBLK2290	RN 104/1	19187
MBLK2291	RN 104/1	19187
MBLK2300	SJ 22 / SJ 23/1	19516 / 19515
MBLK2301	SJ 22 / SJ 23/1	19516 / 19515
MBLK2310	SJ 26 / SJ 27/1	19892 / 19893
MBLK2312	SJ 26 / SJ 27/1	19892 / 19893
MBLK2320	SV 8/1	19075
MBLK2321	SV 8/2	19075
MBLK2330	SV 34/1	19647
MBLK2331	SV 34/1	19647
MBLK2340	SV 39/2	17991
MBLK2350	SV 40/2	19931
MBLK2351	SV 40/2	19931
MBLK2360	SV 41/2	19932
MBLK2361	SV 41/2	19932
MBLK2370	SV 42/2	19933
MBLK2371	SV 42/2	19933
MBLK2380	VL 76 / VL 77/1	19562 / 19563
MBLK2390	VL 81 / VL 82/1	19800 / 19799

	BFMC	WVA
MBLK2400	YK 6 / YK 7	19334 / 19333
MBLK2410	YK 8 / YK 9	19462 / 19461
MBLK2420	YK 12	19700
MBLK2421	YK 12	19700
MBLK2425	YK 13	17362
MBLK2430	BC 80/1	19574
MBLK2431	BC 80/1	19574
MBLK2432	BC 80/1	19574
MBLK2440	BC100 / BC101/1	19902 / 19903
MBLK2450	SJ 28 / SJ 29/1	19283 / 19284
MBLK2451	SJ 28 / SJ 29/1	19283 / 19284
MBLK2460	SJ 30 / SJ 31/1	19477 / 19478
MBLK2480	BC 120 / BC 121	19718 / 19719
MBLK2490	FT 11 / FT 12	19614 / 19613
MBLK2491	FT 11 / FT 12	19614 / 19613
MBLK2500	FT 6 / FT 7	19606 / 19557
MBLK2501	FT 6 / FT 7	19606 / 19557
MBLK2510	LZ 2 / LZ 3/1	19762 / 19763
MBLK2540	PB 24/1	19263
MBLK2550	PB 25/2	19342
MBLK2560	SV 43 / SV 44/1	N/A
MBLK2570	SV 45 / SV 46/1	N/A
MBLK2580	SV 47 / SV 48/1	N/A
MBLK2610	DF 16 / DF17	19256 / 19260
MBLK2620	DF 20 / DF 21	19150 / 19151
MBLK2680	NN62	N/A
MBLK2690	NN63	N/A
MBLK2710	SV 26/1	17161
MBLK2720	SV 27/1	19393
MBLK2730	VL 70 / VL 71/1	17665 / 17664
MBLK2740	VL 72 / VL 73/1	19468 / 19467
MBLK2750	VL 74 / VL 75/1	19560 / 19561
MBLK2760	VL 83 / VL 84/1	19885 / 19886
MBLK2770	SJ 32 / SJ33	19479 / 19480
MBLK2780	SJ 34 / SJ35	19490 / 19491
MBLK2790	VL 100 / 101/1	19975
MBLK2800	FI 115	19754
MBLK2810	PB 34	19786
MBSK1000-4	IL 66 / 67	19036 / 19037
MBSK1010-4	FU 4/5	19370
MBSK1040-4	RW 34 / 35	19030 / 19033
MBSK2000-4	BC98	19032



1



2



3



4



5



6



7





Handwriting practice area with horizontal lines and a large red silhouette of a running bull in the center.

1



2



3



4



5



6



7





1



2



3



4



5



6



7





1



2



3



4



5



6



7



DISCLAIMER

DISCLAIMER · AVIS DE NON-RESPONSABILITÉ · ABLEHNUNG · ESCLUSIONE DI RESPONSABILITÀ · DISCLAIMER · DESCARGO DE RESPONSABILIDAD · WYŁĄCZENIE ODPOWIEDZIALNOŚCI · ОТКАЗ ОТ ОТВЕТСТВЕННОСТИ · EXONERAÇÃO DE RESPONSABILIDADE · إخلاء المسؤولية القانونية

1
1
GB

The designated trademarks are registered marks of their respective owners and Meritor and its affiliates are not commercially connected, affiliated, or associated with any of the owners of such marks. The Meritor products presented herein are not endorsed or authorized by any of the trademark owners.

2
F

Les marques désignées sont des marques déposées par leurs propriétaires respectifs. Meritor et ses filiales ne sont en aucun cas liés, affiliés ou associés aux propriétaires de ces marques. Les produits d'Meritor présentés dans ce document ne sont ni recommandés ni autorisés par les propriétaires de ces marques.

3
D

Die genannten Handelsmarken sind geschützte Marken ihrer jeweiligen Eigentümer und Meritor und seine unterschiedlichen Tochtergesellschaften sind mit keinem der Eigentümer dieser Marken gewerbsmäßig verbunden, eine Filiale der Marke oder der Marke angegliedert. Die hier präsentierten Produkte von Meritor werden von den Eigentümern der Handelsmarken anderweitig weder empfohlen noch konzessioniert.

4
I

I marchi specificati sono marchi registrati che appartengono ai relativi proprietari. Meritor e le sue società affiliate non hanno alcun legame commerciale, affiliazione o associazione con i proprietari di tali marchi. I prodotti Meritor qui presentati non sono raccomandati o autorizzati da nessuno dei proprietari di tali marchi.

5
NL

De vermelde handelsmerken zijn geregistreerde merken van de respectievelijke eigenaren en de onderneming Meritor en haar filialen zijn niet commercieel verbonden aan, aangesloten bij of geassocieerd met de eigenaren van dergelijke merken. De hier gepresenteerde Meritor producten worden door geen van deze eigenaren van handelsmerken aanbevolen of goedgekeurd.

6
E

Las marcas designadas son marcas registradas de sus propietarios respectivos y Meritor y sus filiales no están conectados, afiliados o asociados comercialmente con ninguno de los propietarios de dichas marcas. Los productos Meritor presentados aquí no están aprobados o autorizados por ninguno de los propietarios de las marcas registradas.

7
PL

Wskazane znaki handlowe są zastrzeżonymi znakami handlowymi odpowiednich właścicieli. Firma Meritor i spółki z nią powiązane nie podjęły żadnej współpracy handlowej z właścicielami tych znaków. Przedstawione tu produkty firmy Meritor nie mają rekomendacji ani autoryzacji właścicieli wymienionych znaków handlowych.

RU

Указываемые торговые марки являются зарегистрированными торговыми марками их соответствующих владельцев и компания Meritor и ее дочерние структуры не имеют каких-либо коммерческих отношений, не аффилированы и не ассоциированы с какими-либо владельцами таких торговых марок. Представленные здесь изделия компании Meritor не являются переданными или санкционированными любыми владельцами торговых марок.

P

As marcas comerciais designadas são marcas registradas de seus respetivos proprietários e a Meritor e suas filiais não estão ligadas, afiliadas ou associadas comercialmente com quaisquer dos proprietários das referidas marcas. Os produtos da Meritor aqui apresentados não são apoiados ou autorizados por quaisquer dos proprietários de marcas comerciais.

UAE

العلامات التجارية المختارة مسجلة لمالكها وأرفين ميريتور وشركاتها التابعة غير مرتبطة تجارياً أو تابعة أو متصلة بملاك هذه العلامات. ومنتجات أرفين ميريتور المقدمة هنا غير مدعومة أو مصرح بها من قبل أي من ملاك هذه العلامات.



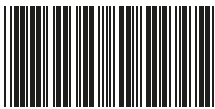

MC3001

Distributed by



Meritor Aftermarket Switzerland AG
Neugutstrasse 89,
8600 Dübendorf, Switzerland
Telephone Number: +41 (0) 44 824 8200

Meritor Aftermarket UK Limited
Unit 1 Broad Ground Road, Lakeside Industrial Estate,
Redditch, Worcestershire, B98 8YS, U.K.
Telephone Number: +44 (0) 1527 50 3950

www.meritor.com

©2016 Meritor, Inc. All rights reserved.
Issued 12-16 Publication MC3001

Descriptions and specifications were
in effect at the time of publication and
are subject to change without notice
or liability