



AT-FS201

AT-FS202

AT-FS202SC/FS1

AT-FS202SC/FS2

AT-FS202SC/FS3

AT-FS202SC/FS4

Fast Ethernet Switches

Installation Guide

Copyright © 2002 Allied Telesyn, Inc.
960 Stewart Drive, Suite B, Sunnyvale CA 94085 USA

All rights reserved. No part of this publication may be reproduced without prior written permission from Allied Telesyn, Inc.

Ethernet is a registered trademark of Xerox Corporation. All other product names, company names, logos or other designations mentioned herein are trademarks or registered trademarks of their respective owners.

Allied Telesyn, Inc. reserves the right to make changes in specifications and other information contained in this document without prior written notice. The information provided herein is subject to change without notice. In no event shall Allied Telesyn, Inc. be liable for any incidental, special, indirect, or consequential damages whatsoever, including but not limited to lost profits, arising out of or related to this manual or the information contained herein, even if Allied Telesyn, Inc. has been advised of, known, or should have known, the possibility of such damages.

Electrical Safety and Emission Compliance Statement

Standards: This product meets the following standards.

U.S. Federal Communications Commission

Radiated Energy

Note: This equipment has been tested and found to comply with the limits for a Class A digital device pursuant to Part 15 of FCC Rules. These limits are designed to provide reasonable protection against harmful interference when the equipment is operated in a commercial environment. This equipment generates, uses, and can radiate radio frequency energy and, if not installed and used in accordance with this instruction manual, may cause harmful interference to radio communications. Operation of this equipment in a residential area is likely to cause harmful interference in which case the user will be required to correct the interference at his own expense.

Note: Modifications or changes not expressly approved of by the manufacturer or the FCC, can void your right to operate this equipment.

Industry Canada

This Class A digital apparatus meets all requirements of the Canadian Interference-Causing Equipment Regulations.

Cet appareil numérique de la classe A respecte toutes les exigences du Règlement sur le matériel brouilleur du Canada.

RFI Emission

EN55022 Class A  1



Warning: In a domestic environment this product may cause radio interference in which case the user may be required to take adequate measures.  2

Immunity

EN55024  3

Warning: This product requires shielded cables to comply with emission and immunity standards. If it is used with unshielded cables, the user may be required to take measures to correct the interference problem at their own expense.  4

Electrical Safety

EN60950, UL1950, CSA 950  5



Laser

EN60825  6

Warning Class 1 Laser product.  7

Warning Do not stare into the Laser beam.  8

At time of installation, the Fiber Optic Lasers comply with FDA Radiation Performance Standard 21CFR Subchapter J, applicable at date of manufacture.

This is a "Class 1 LED Product" (AT-FS201, AT-FS202 models)  9

Important: Appendix B contains translated safety statements for installing this equipment. When you see the , go to Appendix B for the translated safety statement in your language.

Wichtig: Anhang B enthält übersetzte Sicherheitshinweise für die Installation dieses Geräts. Wenn Sie  sehen, schlagen Sie in Anhang B den übersetzten Sicherheitshinweis in Ihrer Sprache nach.

Vigtigt: Tillæg B indeholder oversatte sikkerhedsadvarsler, der vedrører installation af dette udstyr. Når De ser symbolet , skal De slå op i tillæg B og finde de oversatte sikkerhedsadvarsler i Deres eget sprog.

Belangrijk: Appendix B bevat vertaalde veiligheidsopmerkingen voor het installeren van deze apparatuur. Wanneer u de  ziet, raadpleeg Appendix B voor vertaalde veiligheidsinstructies in uw taal.

Important: L'annexe B contient les instructions de sécurité relatives à l'installation de cet équipement. Lorsque vous voyez le symbole , reportez-vous à l'annexe B pour consulter la traduction de ces instructions dans votre langue.

Tärkeää: Liite B sisältää tämän laitteen asentamiseen liittyvät käännetyt turvaohjeet. Kun näet -symbolin, katso käännettyä turvaohjetta liitteestä B.

Importante: l'Appendice B contiene avvisi di sicurezza tradotti per l'installazione di questa apparecchiatura. Il simbolo , indica di consultare l'Appendice B per l'avviso di sicurezza nella propria lingua.

Viktig: Tillegg B inneholder oversatt sikkerhetsinformasjon for installering av dette utstyret. Når du ser , åpner du til Tillegg B for å finne den oversatte sikkerhetsinformasjonen på ønsket språk.

Importante: O Anexo B contém advertências de segurança traduzidas para instalar este equipamento. Quando vir o símbolo , leia a advertência de segurança traduzida no seu idioma no Anexo B.

Importante: El Apéndice B contiene mensajes de seguridad traducidos para la instalación de este equipo. Cuando vea el símbolo , vaya al Apéndice B para ver el mensaje de seguridad traducido a su idioma.

Obs! Bilaga B innehåller översatta säkerhetsmeddelanden avseende installationen av denna utrustning. När du ser , skall du gå till Bilaga B för att läsa det översatta säkerhetsmeddelandet på ditt språk.

Table of Contents

Electrical Safety and Emission Compliance Statement	iii
Welcome to Allied Telesyn	vii
Where to Find Web-based Guides	vii
Document Conventions	vii
Contacting Allied Telesyn Technical Support	viii
Online Support	viii
Telephone Support	viii
Technical Support E-mail Addresses	viii
Returning Products	ix
FTP Server	ix
For Sales or Corporate Information	ix
Tell Us What You Think	x
Chapter 1	
Description	1
Key Features	3
Status LEDs	4
Twisted Pair Port	5
Port Speed	5
Duplex Mode	5
Auto MDI/MDI-X	6
Fiber Optic Port	6
Port Speed	6
Duplex Mode	6
Switch Performance	7
DIP Switches	7
MAC Address Table	7
Store and Forward	8
External AC/DC Power Adapter	8
Network Topologies	9

Chapter 2

Installing the Switch 11
Verifying Package Contents 11
Planning the Installation 12
 Selecting a Site 14
Installing the Switch 15
Warranty Registration 16

Chapter 3

Troubleshooting 17

Appendix A

Technical Specifications 19
Physical 19
Temperature 19
Electrical Rating 19
Agency Certifications 20
Fiber Optic Port Specifications 20
Pinout Assignments 22

Appendix B

Translated Safety and Emission Information 25

Welcome to Allied Telesyn

This guide contains instructions on how to install the AT-FS20x and AT-FS202SC/FSx Series Fast Ethernet Switches.

Where to Find Web-based Guides

The Allied Telesyn web site at www.alliedtelesyn.com offers you an easy way to access the most recent documentation, software, and technical information for all of our products. For product guides, select “Support & Services” from our web site.

Document Conventions

This guide uses the following conventions:

Note

Notes provides additional information.

**Caution**

Cautions indicate that performing or omitting a specific action may result in equipment damage or loss of data.

**Warning**

Warnings indicates that performing or omitting a specific action may result in bodily injury.

Contacting Allied Telesyn Technical Support

You can contact Allied Telesyn technical support online or by telephone, or e-mail.

Online Support

You can request technical support online by accessing the Knowledge Base at **http://kb.alliedtelesyn.com**. You can use the Knowledge Base to submit questions to our technical support staff and review answers to previously asked questions.

Telephone Support

For Technical Support by telephone, contact Allied Telesyn at one of the following locations:

Americas

United States, Canada, Mexico,
Central America, South America
Tel: 1 (800) 428-4835

Germany

Switzerland, Austria, Eastern Europe
Tel: (+49) 30-435-900-126

Asia

Singapore, Taiwan, Thailand,
Malaysia, Indonesia, Korea,
Philippines, China, India, Hong Kong
Tel: (+65) 3815-612

Italy

Spain, Portugal, Greece, Turkey, Israel
Tel: (+39) 02-41-30-41

Australia

Tel: 1 (800) 000-880

Japan

Tel: (+81) 3-3443-5640

France

Belgium, Luxembourg, The
Netherlands, Middle East, Africa
Tel: (+33) 0-1-60-92-15-25

United Kingdom

Denmark, Norway, Sweden, Finland,
Iceland
Tel: (+0044) 1235-442500

Technical Support E-mail Addresses

Latin America, Mexico, Puerto Rico, Caribbean, and Virgin Islands
latin_america@alliedtelesyn.com

United Kingdom, Sweden, Norway, Denmark, and Finland
support_europe@alliedtelesyn.com

Returning Products

Products for return or repair must first be assigned a Return Materials Authorization (RMA) number. A product sent to Allied Telesyn without a RMA number will be returned to the sender at the sender's expense.

To obtain an RMA number, contact Allied Telesyn's Technical Support at one of the following locations:

North America

Toll-free: 1-800-762-1664

Fax: 1-425-806-1050

Europe, Africa, and the Middle East

Tel: +44-1793-501401

Fax: +44-1793-431099

Latin America, the Caribbean, Virgin Islands

Tel: international code + 425-481-3852

Fax: international code + 425-481-3895

Asia and Southeast Asia

Tel: +65-381-5612

Fax: +65-383-3830

Mexico

Toll-free: 1-800-424-5012, ext 3852

Fax: international code + 425-481-3895

Puerto Rico

Toll-free: 1-800-424-5012, ext 3852
or 1-800-424-4284, ext 3852

Australia

Toll-free: 1-800-000-880

Fax: + 61-2-9438-4966

New Zealand

Toll-free: 0800-45-5782

Fax: +65-383-3830

FTP Server

If you need management software for an Allied Telesyn managed device and you know the file name of the software, you can download the software by connecting directly to our FTP server at **ftp.alliedtelesyn.com**. At login, enter 'anonymous' as the user name and your e-mail address for the password.

For Sales or Corporate Information

You can contact Allied Telesyn for sales or corporate information at the location below:

Allied Telesyn, Inc.

19800 North Creek Parkway, Suite 200

Bothell, WA 98011

Tel: 1 (425) 487-8880

Fax: 1 (425) 489-9191

Welcome to Allied Telesyn

Tell Us What You Think

If you have any comments or suggestions on how we might improve this or other Allied Telesyn documents, please fill out the General Enquiry Form online. This form can be accessed by selecting “Contact Us” from **www.alliedtelesyn.com**.

Chapter 1

Description

The AT-FS20x and AT-FS202SC/FSx Series Fast Ethernet Switches include the following models:

- AT-FS201
- AT-FS202
- AT-FS202SC/FS1
- AT-FS202SC/FS2
- AT-FS202SC/FS3
- AT-FS202SC/FS4

The AT-FS20x and AT-FS202SC/FSx Series Switches are designed to extend the distance of your network by converting Fast Ethernet data between twisted pair cabling and either multimode or single-mode fiber optic cabling. These dual-port switches can also be used to improve the performance of your network by dividing it into smaller, more manageable segments.

Each switch features a 100Base-FX fiber optic port and a 10Base-T/100Base-TX twisted pair port. The fiber optic port has either a SC or ST connector and a maximum operating distance of 2 kilometers (1.2 miles) to 100 kilometers (62 miles), depending on the model. The twisted pair port has a RJ-45 connector with a maximum operating distance of 100 meters (328 feet).

The fiber optic port operates at 100 Mbps, while the twisted pair port operates at 10 Mbps or 100 Mbps. Both ports feature half- and full-duplex operation.

AT-FS20x and AT-FS202SC/FSx Series Switches can be installed on a desktop or in an AT-MCR12 chassis. These switches are easy to install and do not require software configuration or management.

Figure 1 illustrates the front panel of an AT-FS20x Series Switch.

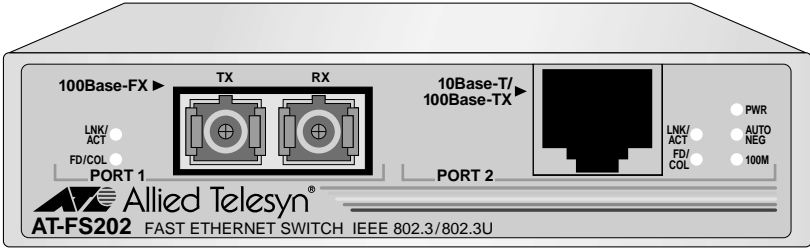

Figure 1 AT-FS20x Series Front Panel (AT-FS202 Model)

Figure 2 illustrates a front panel of an AT-FS202SC/FSx Series Switch.

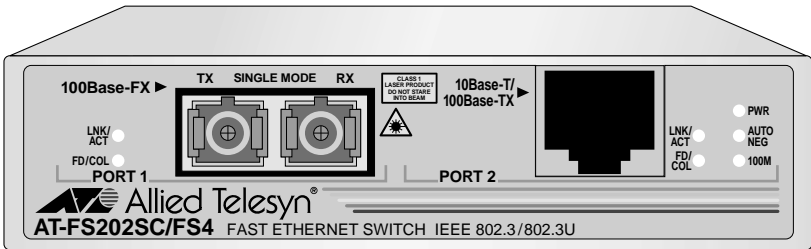

Figure 2 AT-FS202SC/FSx Series Front Panel (AT-FS202SC/FS4 Model)

The back panel of the AT-FS20x and AT-FS202SC/FSx Series Switches features a power adapter connector and DIP switches for manually configuring the ports. Figure 3 illustrates the back panel.

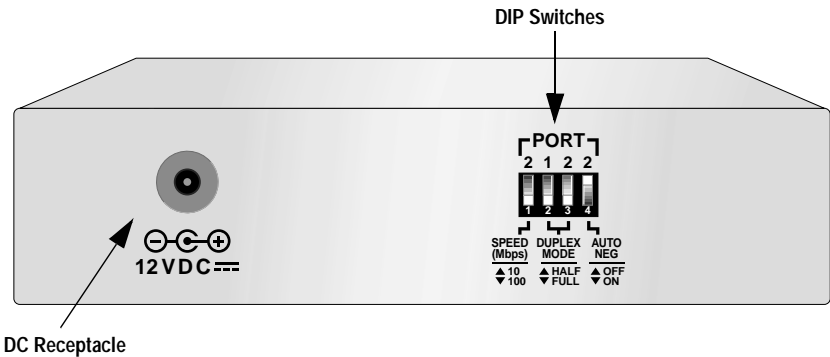

Figure 3 Back Panel of the AT-FS20x and AT-FS202SC/FSx Series Switches

Table 1 lists the maximum operating distances for the switches.

Table 1 Maximum Operating Distances

Model	100Base-FX		10/100Base-TX	
	Connector	Maximum Operating Distance ¹	Connector	Maximum Operating Distance ²
AT-FS201	ST	2 km (1.2 mi)	RJ-45	100 m (328 ft)
AT-FS202	SC	2 km (1.2 mi)	RJ-45	100 m (328 ft)
AT-FS202SC/FS1	SC	15 km (9.3 mi)	RJ-45	100 m (328 ft)
AT-FS202SC/FS2	SC	40 km (24.8 mi)	RJ-45	100 m (328 ft)
AT-FS202SC/FS3	SC	75 km (46.5 mi)	RJ-45	100 m (328 ft)
AT-FS202SC/FS4	SC	100 km (62 mi)	RJ-45	100 m (328 ft)

1. Maximum distance for 100 Mbps optical datalinks is dependent on the following factors: type of optical fiber, duplex mode of both end-nodes, and maximum optical loss budget for each of the optical fiber at the operating optical wavelength.
2. Maximum distance can only be obtained when the UTP/STP cabling is installed and verified to TIA/EIA 568A Commercial Building Telecommunications Cabling Standard.

Key Features

The AT-FS20x and AT-FS202SC/FSx Series Switches have the following features:

- LEDs for unit and port status
- Auto MDI/MDI-X
- DIP switches for configuring the ports
- Half- or full-duplex operation on both ports
- RJ-45 twisted pair connector
- SC or ST fiber optic connector

Description

- Data packet forwarding and filtering at full wire speed (10 Mbps to 100 Mbps, 100 Mbps to 100 Mbps, and 10 Mbps to 10 Mbps)
- Store and forward switching mode
- Automatic address learning and aging
- IEEE 802.3u compliant auto-negotiation
- External AC/DC power adapters (North America, Continental Europe, or United Kingdom)
- For use on a desktop or in an AT-MCR12 chassis

Status LEDs

Table 2 defines the LEDs for the switches.

Table 2 Status LEDs

LED	Color	Description
PWR	Green	Power is applied to the switch.
LNK/ACT	Green Blinking	A valid link has been established on the port. Data is being received or transmitted on the port.
100M	Green OFF	The twisted pair port is operating at 100 Mbps. The twisted pair port is operating at 10 Mbps.
FD/COL	Green OFF Blinking	The switch is operating in full-duplex mode. The switch is operating in half-duplex mode. A collision has been detected on the port.
AUTO NEG	Green OFF	Auto-negotiation on the twisted pair port is enabled. Auto-negotiation on the twisted pair port is disabled.

Twisted Pair Port

The AT-FS20x and AT-FS202SC/FSx Series Switches have one 10Base-T/100Base-TX twisted pair port. The twisted pair port features a RJ-45 connector.

Port Speed

The twisted pair port is compliant with the 10Base-T and 10Base-TX standards and is capable of either 10 Mbps or 100 Mbps operation. You can set the port speed manually or, since the port is IEEE 802.3u auto-negotiation compliant, you can allow the switch to set the port speed automatically. With auto-negotiation, the speed of the port is set automatically by the switch after it determines the speed of the end-node connected to the port. Auto-negotiation is designed to ensure that the port on the switch and the end-node are operating at the same speed and that they are communicating at the highest possible common speed of the devices.

Duplex Mode

Duplex mode refers to the way an end-node sends and receives data on the network. An end-node can operate in either half- or full-duplex mode, depending on its capabilities. An end-node that is operating in half-duplex mode can either send data or receive data, but it cannot do both at the same time. An end-node that is operating in full-duplex mode can send and receive data simultaneously. The best network performance is achieved when an end-node can operate at full-duplex, since the end-node is able to send and receive data simultaneously.

The twisted pair port on the switch can operated in either half- or full-duplex mode. You can set the duplex mode manually or allow the switch to set it automatically through auto-negotiation. With auto-negotiation, if the end-node is capable of full-duplex, the twisted pair port is set automatically to full-duplex mode. If the end-node is capable of half-duplex, the port is set automatically to half-duplex mode.

Auto MDI/MDI-X

An RJ-45 twisted pair port on a 10 Mbps or 100 Mbps Ethernet network device can have one of two possible wiring configurations: MDI or MDI-X. The RJ-45 port on a PC, router, or bridge is typically wired as MDI, while the twisted pair port on a switch or hub is usually MDI-X.

To connect two 10 Mbps or 100 Mbps network devices together that have dissimilar port wiring configurations, such as MDI to MDI-X, you would usually use a straight-through twisted pair cable. To connect two network devices that have the same wiring configuration, such as MDI to MDI, you would usually use a crossover cable.

The AT-FS20x and AT-FS202SC/FSx Series Switches feature automatic MDI/MDI-X. The RJ-45 port automatically determines the configuration of the port on the device to which it is connected and then configures itself appropriately. For example, if a port on a switch is connected to a port on a bridge, which is typically wired as MDI, the port on the switch automatically configures itself as MDI-X. This feature allows you to use either crossover cables or straight-through cable when connecting a device to the twisted pair port.

Fiber Optic Port

The AT-FS20x and AT-FS202SC/FSx Series Switches have one 100Base-FX fiber optic port. The fiber optic port features either an SC or ST connector.

Port Speed

The fiber optic port is compliant with the 100Base-FX standard and has a fixed operating speed of 100 Mbps. The end-node connected to the fiber optic port on the switch must also be able to operate at 100 Mbps.

Duplex Mode

The fiber optic port on the switch can operate in half- or full-duplex mode. You must set the duplex mode manually using the DIP switches on the back of the unit.

Switch Performance

The switches perform at:

- ❑ 148,800 pps for 100 Mbps and 14,880 pps for 10 Mbps for full wire speed forwarding and filtering
- ❑ 200 Mbps maximum throughput in 100 Mbps, full-duplex mode
- ❑ 20 Mbps maximum throughput in 10 Mbps, full-duplex mode
- ❑ Storage for up to 4,000 MAC addresses
- ❑ 280 kib bytes (per port) packet buffer
- ❑ Low latency 15.6 μ s (64-byte packet, 100 Mbps full-duplex)

DIP Switches

The DIP switches are used to manually configure the operating characteristics of the ports. These characteristics include the port speed, duplex mode, and auto-negotiation.

On the 100Base-FX fiber optic port, you can manually set the duplex mode to either half- or full-duplex.

On the 10Base-T/100Base-TX twisted pair port, you can manually set the speed of the port to either 10 Mbps or 100 Mbps, set the duplex mode to either half- or full-duplex and enable or disable auto-negotiation. Enabling auto-negotiation will automatically set the port's speed and duplex mode.

MAC Address Table

Up to 4,000 MAC addresses can be stored in the switch's MAC address table. The switch's self-learning feature will learn all new addresses in real-time after power-up. If the source address of an incoming packet is not found in the MAC address table, the switch will update the table with the new address.

The switch also has an automatic address aging feature that will delete a source address from the table if it has not seen a frame from the end-node with that address within five minutes. This prevents the table from becoming filled with addresses of end-nodes that are no longer active.

The switch forwards all multicast, broadcast, and unicast packets when the MAC address table has exceeded its storage limit.

Store and Forward

The AT-FS20x and AT-FS202SC/FSx Series Switches support store and forward switching at Fast Ethernet full-wire speed in 100 Mbps, half- or full-duplex mode. Packets entering each port are stored in buffers. Once the full packet is received, the switch will forward or discard the packet, depending on its destination address and error status. This ensures that only error-free packets destined for another segment will be transferred across the switch, reducing network load. For example, if the packet entering from Port 1 is destined for an end-node on Port 2, the switch forwards the frame if the frame does not contain any errors. If the packet from Port 1 is destined for an end-node also connected to Port 1, the packet is discarded.

The switch will discard CRC errors, misaligned, runt, and under-oversized packets. When the packet has dribble bits at the end, the switch will truncate to octet boundary and check for a good FCS before forwarding.

External AC/DC Power Adapter

The power adapter supplies 12V DC to the switch. Allied Telesyn supplies an approved safety compliant AC power adapter for the 100 and 240V AC versions with an unregulated output of 12V DC.

Network Topologies

Figure 4 illustrates a topology using one AT-FS201 switch to interconnect two small networks of stackable hubs. Network 1 has an AT-FH812u with an AT-FH807u switching module connected to the 100Base-FX port on the AT-FS201. Network 2 has an AT-3624TR hub connected to the 10Base-T/100Base-TX port on the AT-FS201.

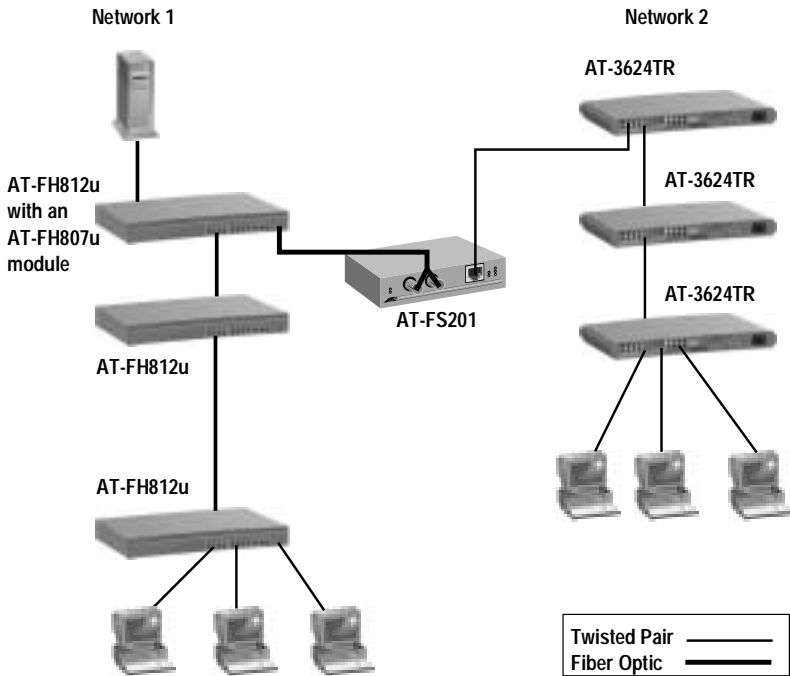

Figure 4 Network Topology

Chapter 2

Installing the Switch

This chapter explains how to install an AT-FS20x or AT-FS202SC/FSx Series Switch. These switches can be installed on a desktop or in an AT-MCR12 chassis.

Verifying Package Contents

Make sure the following items are included in your package. If any item is missing or damaged, contact your Allied Telesyn sales representative for assistance.

- One AT-FS20x or AT-FS202SC/FSx Series Switch
- Four protective feet (for desktop use only)
- External AC/DC power adapter (North America, Continental Europe, or United Kingdom)
- This installation guide
- Warranty card

Planning the Installation

Be sure to observe the following guidelines when planning the installation of your switch.

- The end-node connected to the 100Base-FX fiber optic port must be able to operate at 100 Mbps.
- The end-node connected to the 10Base-T/100Base-TX twisted pair port can operate at either 10 Mbps or 100 Mbps.
- The end-node connected to a port on the switch can be a network adapter card, repeater, router, hub, or another switch.
- The twisted pair cabling must be kept away from sources of electrical noise, such as radios, transmitters, power lines, broadband amplifiers, electrical motor, and fluorescent fixtures.
- Refer to Table 3 for the cabling specifications for the twisted pair port.

Table 3 10Base-T/100Base-TX Twisted Pair Cabling Specifications

Operating Mode	Cable Type	Maximum Operating Distance
10Base-T	Shielded or unshielded Category 3 or better	100 m (328 ft)
100Base-TX	Shielded or unshielded Category 5 or better	100 m (328 ft)

- ❑ Refer to Table 4 for the cabling specifications for the fiber optic port operating in full-duplex mode.

Table 4 100Base-FX Fiber Optic Cabling Specifications (Full-duplex)

Model	Cable Type	Maximum Operating Distance ¹	Maximum Allowable Loss Budget
AT-FS201	50/125 or 62.5/125 micron multimode	2 km (1.2 mi)	13 dB at 1310 nm
AT-FS202	50/125 or 62.5/125 micron multimode	2 km (1.2 mi)	13 dB at 1310 nm
AT-FS202SC/FS1	50/125 or 62.5/125 multimode	2 km (1.2 mi)	13 dB at 1310 nm
	9/125 micron single-mode	15 km (9.3 mi)	16 dB at 1310 nm
AT-FS202SC/FS2	9/125 micron single-mode	40 km (24.8 mi)	30 dB at 1310 nm
AT-FS202SC/FS3	9/125 micron single-mode	75 km (46.5 mi)	33 dB at 1310 nm
AT-FS202SC/FS4 ²	9/125 micron single-mode	100 km (62 mi)	34 dB at 1550 nm

1. Maximum distance for 100 Mbps optical datalinks is dependent on the following factors: type of optical fiber, duplex mode of both end-nodes, and maximum optical loss budget for each of the optical fiber at the operating optical wavelength.
2. The cable must be non-dispersion-shifted, dispersion-shifted, or non-zero dispersion-shifted single-mode fiber optic cable.

Note

Refer to “Fiber Optic Port Specifications” on page 20 for additional information on the fiber optic port.

- Refer to Table 5 for the cabling specifications for the fiber optic port operating in half-duplex mode.

Table 5 100Base-FX Fiber Optic Ports (Half-duplex)¹

Number of Media Converters	Connected Devices	Maximum Operating Distance
One Media Converter Inline	Switch to switch	372 m (1,221 ft)
	Workstation to switch	372 m (1,221 ft)
	Switch to Class I repeater	137 m (450 ft)
	Switch to Class II repeater	185 m (607 ft)
Two Media Converters Inline	Switch to switch	332 m (1,089 ft)
	Workstation to switch	322 m (1,089 ft)
	Switch to Class I repeater	97 m (318 ft)
	Switch to Class II repeater	145 m (476 ft)

1. The total distance of the fiber optic lengths cannot exceed the limits stated in the table. Each media converter used inline within a single collision domain reduces the overall segment length by 40 meters (131 feet).

Selecting a Site

Be sure to observe the following guidelines when selecting a site for your switch.

- Select a site that is dust-free and moisture-free.
- Select a site that will allow you to easily access the data cables and power cord.
- Use dedicated power circuits or power conditioners to supply reliable power to the device.

Installing the Switch

To install an AT-FS20x or AT-FS202SC/FSx Series Switches, perform the following procedures:

1. Remove all equipment from the package and store the packaging material in a safe place.

Note

Do not remove the dust cover from the fiber optic port until you are ready to connect the fiber optic cable. Dust contamination can adversely impact the operating performance of the port and the switch.

2. Attach the four protective feet (provided) to each corner of the bottom of the unit. **Do not attach the protective feet if you are installing the switch in an AT-MCR12 chassis.**
3. Configure the DIP switches. Refer to Figure 3 on page 2 for the location of the DIP switches and Table 6 for the possible settings.

Table 6 DIP Switch Settings

DIP Switch Number	Port	Setting	Position	Description
1	2	Speed (Mbps)	Up Down	The twisted pair port is operating at 10 Mbps. The twisted pair port is operating at 100 Mbps.
2	1	Duplex Mode	Up Down	The fiber optic port is operating at half-duplex mode. The fiber optic is operating at full-duplex mode.
3	2	Duplex Mode	Up Down	The twisted pair port is operating at half-duplex mode. The twisted pair port is operating at full-duplex mode.
4	2	Auto Neg	Up Down	Auto-negotiation on the twisted pair port is OFF. Auto-negotiation on the twisted pair port is ON.

When setting the DIP switches, consider the following:

- ❑ Setting the Auto Neg DIP switch for the twisted pair port to ON or OFF enables or disables auto-negotiation for the port. If you disable auto-negotiation, be sure to set the DIP switches for the port's speed and duplex mode to match the speed and duplex mode of the end-node.
 - ❑ For the fiber optic port, set the port's duplex mode using the appropriate Duplex Mode DIP switch. This setting must match the duplex mode capability of the end-node to be connected to the port.
4. If you are installing the switch in an AT-MCR12 chassis, download the *AT-MCR12 Chassis Installation Guide* from our web site for instructions on how to install the switch, then proceed to Step 7.
 5. Place the switch on a secure, level surface, leaving ample space around the switch for ventilation.
 6. Plug the AC/DC power adapter into an appropriate AC power outlet and insert the power plug into the DC receptacle located on the back of the switch. **This step does not apply if you are installing the switch in an AT-MCR12 chassis.**
 7. Verify that the PWR LED is green. If the LED is OFF, refer to "Troubleshooting" on page 17 for instructions.
 8. Remove the dust cover from the fiber optic port and connect the fiber optic cable to the 100Base-FX port.
 9. Connect the twisted pair cable to the 10Base-T/100Base-TX port.
 10. Power ON the end-nodes.
 11. Verify that the LNK/ACT LEDs for both the fiber optic port and the twisted pair port are green. If either LED is OFF, refer to "Troubleshooting" on page 17 for instructions.
 12. The switch is now ready for use.

Warranty Registration

When you have finished installing the product, register your product by completing the enclosed warranty card and sending it in. You can also fill out the registration online by selecting "Warranties" under "Support & Services" from www.alliedtelesyn.com.

Chapter 3

Troubleshooting

Follow the guidelines below to test and troubleshoot the installation in the event a problem occurs.

Note

Whenever the speed and/or duplex mode are changed during or after power ON, power OFF then power back ON the switch to load the new configuration.

If the PWR LED is OFF, do the following:

- If the switch is installed on a desktop, check to be sure that the power adapter is securely connected to a power outlet and that the power adapter cable is securely connected to the back of the switch.
- If the switch is installed in an AT-MCR12 chassis, check that the unit is fully seated in the slot.
- Verify that the power outlet has power by connecting another device to it.
- Try using another power adapter.

If the LNK/ACT LED for the twisted pair port is OFF, do the following:

- Check that the end-node connected to the port is powered ON and is operating properly.
- Check that the twisted pair cable is securely connected to the twisted pair port on the switch and on the end-node.
- Check to be sure that the end-nodes connected to the switch are operating at the same duplex mode.
- Make sure that the twisted pair cable does not exceed 100 meters (328 feet) and that you are using a Category 3 or better cable for 10Base-T operation or a Category 5 or better cable for 100Base-TX operation.

If the LNK/ACT LED for the fiber optic port is OFF, do the following:

- Verify that the end-node connected to the port is ON and is operating properly.
- Check that the fiber optic cable is securely connected to the fiber optic port on the switch and on the end-node.
- Check to be sure that the end-node connected to the port is operating at 100 Mbps.
- Check to be sure that the end-nodes connected to the switch are operating at the same duplex mode.
- Make sure that the cable connected to the switch's receiver port (RX) is connected to the end-node's transmitter port (TX) and that the switch's transmitter port (TX) is connected to the end-node's receiver port (RX).
- Test the attenuation on the fiber cable to ensure that it does not exceed acceptable values.
- Verify that you are using the appropriate type of fiber optic cables and that you have not exceeded the maximum operating distances. For the maximum operating distances, refer to Table 1 on page 3 and for the cable types, refer to Table 4 on page 13.
- Check that the operating specifications of the fiber optic port on the end-node are compatible with the operating specifications of the fiber optic port on the switch. For the fiber optic port specifications, refer to "Fiber Optic Port Specifications" on page 20.

If you are still experiencing problems after testing and troubleshooting the installation, contact Allied Telesyn Technical Support for assistance. Refer to "Contacting Allied Telesyn Technical Support" on page viii or visit our web site at **www.alliedtelesyn.com** for support information.

Appendix A

Technical Specifications

Physical

Dimensions: W x D x H
10.5 cm x 9.5 cm x 2.5 cm
(4.12 in x 3.75 in x 1.0 in)

Weight: 294 g (10.4 oz)

Temperature

Maximum Operating: 0° C to 40° C (32° F to 104° F)

Maximum Storage: -25° C to 70° C (-13° F to 158° F)

Relative Humidity: 5% to 95% non-condensing

Operating Altitude: Up to 3,048 meters (10,000 feet)

Electrical Rating

Input Supply Voltage: 12 V DC

Maximum Current: 500 mA

Power Consumption: 6 W

Agency Certifications

Safety	Conforms to all standards normally supported by Allied Telesyn products including safety standards UL 1950, CSA 22.2 No. 950, TUV EN60950, EN60825 CE Compliant
Standard	CE Compliant IEEE 802.3, IEEE 802.3u
Immunity	Conforms to EN55024 immunity standard
EMI/RFI	Meets all applicable requirements for emissions including but not limited to FCC Class A, IC Class A, EN55022 Class A

Fiber Optic Port Specifications

Table 7 through Table 10 lists the specifications for the fiber optic port.

Table 7 Fiber Optic Transmitter

Model	Fiber Type ¹	Fiber Optic Diameter (microns)	Optical Wavelength	Launch Power (dBm) ²		
				Max.	Avg.	Min.
AT-FS201 & AT-FS202	MMF	50/125	1310 nm	-14.0	-20.3	-22.5
	MMF	62.5/125	1310 nm	-14.0	-16.8	-19.0
AT-FS202SC/FS1	SMF	9/125	1310 nm	-8.0	-11.5	-15.0
AT-FS202SC/FS2	SMF	9/125	1310 nm	0.0	-3.0	-5.0
AT-FS202SC/FS3	SMF	9/125	1310 nm	0.0	-2.0	-4.0
AT-FS202SC/FS4	SMF	9/125	1550 nm	0.0	-1.5	-3.0

1. MMF = Multimode Fiber / SMF = Single-mode Fiber.
2. The launch power is measured at one meter from the transmitter.

Table 8 Fiber Optic Receiver

Model	Fiber Type ¹	Fiber Optic Diameter (microns)	Optical Wavelength	Receiver Sensitivity (dBm)		
				Min.	Avg.	Saturation
AT-FS201 & AT-FS202	MMF	50/125	1310 nm	-31.8	-34.5	-14.5
	MMF	62.5/125	1310 nm	-31.8	-34.5	-14.0
AT-FS202SC/FS1	SMF	9/125	1310 nm	-31.0	-31.0	-8.0
AT-FS202SC/FS2	SMF	9/125	1310 nm	-35.0	-38.0	0.0
AT-FS202SC/FS3	SMF	9/125	1310 nm	-37.0	-37.0	-3.0
AT-FS202SC/FS4	SMF	9.125	1550 nm	-37.0	-37.0	-3.0

1. MMF = Multimode Fiber / SMF = Single-mode Fiber.

Table 9 Fiber Optic Datalink

Model	Fiber Type ¹	Minimum Power/Link Budget	Average Signal Loss (dB)	Minimum Distance Specs. ²	Maximum Distance Specs.
AT-FS201 & AT-FS202	50/125 MMF	13.00 dB	18.70 dB	0	2 km (1.25 mi)
	62.5/125 MMF	16.80 dB	22.50 dB	0	2 km (1.25 mi)
AT-FS202SC/FS1	9/125 SMF	16.00 dB	19.50 dB	0	15 km (9.4 mi)
AT-FS202SC/FS2	9/125 SMF	30.00 dB	35.00 dB	0	40 km (25 mi)
AT-FS202SC/FS3	9/125 SMF	33.00 dB	35.00 dB	15 km (9.4 mi)	75 km (46 mi)
AT-FS202SC/FS4	9/125 SMF	34.0	35.5 dB	40 km (24.8 mi)	100 km (62 mi)

1. MMF = Multimode Fiber / SMF = Single-mode Fiber.

2. The recommended minimum range is stated in all cases where the maximum transmitter output power exceeds the receivers saturation level. This is to prevent blinding or burning out of the optical receiver on the far-end node.

Table 10 Fiber Optic Loss Specification (Benchmark)

Fiber Type ¹	Fiber Optic Diameter	Optical Wavelength	Typical Loss Factor	Worst Case Loss Factor	Bandwidth
MMF	50/125 microns	1310 nm	1.00 dB/km	1.50 dB/km	400 Mhz-km
	62.5/125 microns	1310 nm	1.00 dB/km	1.50 dB/km	500 Mhz-km
SMF	9/125 microns	1310 nm	0.40 dB/km	1.00 dB/km	Not applicable
SMF	9/125	1550 nm	0.30 dB/km	0.75 dB/km	Not applicable

1. MMF = Multimode Fiber / SMF = Single-mode Fiber.

Pinout Assignments

Figure 5 shows the pin assignments of the RJ-45 connector.

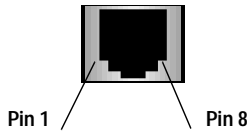

Figure 5 RJ-45 Pin Assignments

Table 5 lists the 10Base-T/100Base-TX connector pins and their signals when the port is operating in either MDI or MDI-X configuration.

Table 11 RJ-45 Pinouts

MDI-X (Default)	Signal	MDI	Signal
1	RX+	1	TX+
2	RX-	2	TX-
3	TX+	3	RX+
4	-	4	-
5	-	5	-

Table 11 RJ-45 Pinouts *(Continued)*

MDI-X (Default)	Signal	MDI	Signal
6	TX-	6	RX-
7	-	7	-
8	-	8	-

Appendix B

Translated Safety and Emission Information

Important: This appendix contains multiple-language translations for the safety statements in this guide.

Wichtig: Dieser Anhang enthält Übersetzungen der in diesem Handbuch enthaltenen Sicherheitshinweise in mehreren Sprachen.

Vigtigt: Dette tillæg indeholder oversættelser i flere sprog af sikkerhedsadvarselene i denne håndbog.

Belangrijk: Deze appendix bevat vertalingen in meerdere talen van de veiligheidsopmerkingen in deze gids.

Important: Cette annexe contient la traduction en plusieurs langues des instructions de sécurité figurant dans ce guide.

Tärkeää: Tämä liite sisältää tässä oppaassa esiintyvät turvaohjeet usealla kielellä.

Importante: questa appendice contiene traduzioni in più lingue degli avvisi di sicurezza di questa guida.

Viktig: Dette tillegget inneholder oversettelser til flere språk av sikkerhetsinformasjonen i denne veiledningen.

Importante: Este anexo contém traduções em vários idiomas das advertências de segurança neste guia.

Importante: Este apéndice contiene traducciones en múltiples idiomas de los mensajes de seguridad incluidos en esta guía.

Obs! Denna bilaga innehåller flerspråkiga översättningar av säkerhetsmeddelandena i denna handledning.

Standards: This product meets the following standards.

U.S. Federal Communications Commission

Radiated Energy



Note: This equipment has been tested and found to comply with the limits for a Class A digital device pursuant to Part 15 of FCC Rules. These limits are designed to provide reasonable protection against harmful interference when the equipment is operated in a commercial environment. This equipment generates, uses, and can radiate radio frequency energy and, if not installed and used in accordance with this instruction manual, may cause harmful interference to radio communications. Operation of this equipment in a residential area is likely to cause harmful interference in which case the user will be required to correct the interference at his own expense.

Note: Modifications or changes not expressly approved of by the manufacturer or the FCC, can void your right to operate this equipment.

Industry Canada

This Class A digital apparatus meets all requirements of the Canadian Interference-Causing Equipment Regulations.

Cet appareil numérique de la classe A respecte toutes les exigences du Règlement sur le matériel brouilleur du Canada.

- 🌀 1 **RFI Emission** EN55022 Class A
- 🌀 2  **Warning:** In a domestic environment this product may cause radio interference in which case the user may be required to take adequate measures.
- 🌀 3 **Immunity** EN55024
- 🌀 4 **Warning:** This product requires shielded cables to comply with emission and immunity standards. If it is used with unshielded cables, the user may be required to take measures to correct the interference problem at their own expense.
- 🌀 5 **Electrical Safety** EN60950, UL1950, CSA 950
- 🌀 6  **Laser** EN60825
- 🌀 7 **Warning** Class 1 Laser product.
- 🌀 8 **Warning** Do not stare into the Laser beam.
At time of installation, the Fiber Optic Lasers comply with FDA Radiation Performance Standard 21CFR Subchapter J, applicable at date of manufacture.
- 🌀 9 This is a “Class 1 LED Product” (AT-FS201, AT-FS202, AT-FS203 models)
- Safety**
- 🌀 10  **Lightning Danger**
Danger: Do not work on equipment or cables during periods of lightning activity.
- 🌀 11 Do not block air vents.
- 🌀 12 Power to the hub must be sourced only from the adapter.

USA/Canada

Use a UL Listed/CSA Certified AC adapter of DC 12V, 500mA.

Europe - EU



Use TÜV licensed AC adapter of DC 12V, 500mA.

UK



Use a UK Safety Approved AC adapter of DC 12V, minimum 500mA.

- 🌀 **13** **Operating Temperature:** This product is designed for a maximum ambient temperature of 40 degrees C.
- 🌀 **14** **All Countries:** Install product in accordance with local and National Electrical Codes.



Normen: Dieses Produkt erfüllt die Anforderungen der nachfolgenden Normen.

- 🌀 **1** **Hochfrequenzstörung** EN55022 Klasse A
- 🌀 **2**  **Warnung:** Bei Verwendung zu Hause kann dieses Produkt Funkstörungen hervorrufen. In diesem Fall müßte der Anwender angemessene Gegenmaßnahmen ergreifen.
- 🌀 **3** **Störsicherheit** EN55024
- 🌀 **4** **Achtung:** Für dieses Produkt sind abgeschirmte Kabel erforderlich, damit den Richtlinien für Emission und Interferenzschutz entsprochen wird. Falls das Produkt mit nicht abgeschirmten Kabeln verwendet wird, können weitergehende Maßnahmen für die Korrektur von Interferenzproblemen auf Kosten des Benutzers notwendig werden.
- 🌀 **5** **Elektrische Sicherheit** EN60950, UL1950, CSA 950
- 🌀 **6**  **Laser** EN60825
- 🌀 **7** **Warnung** Laserprodukt der Klasse 1.
- 🌀 **8** **Warnung** Nicht direkt in den Strahl blicken.
- 🌀 **9** Das ist ein "LED Produkt der Klasse 1"
- 🌀 **10**  **Gefahr Durch Blitzschla**
Gefahr: Keine Arbeiten am Gerät oder an den Kabeln während eines Gewitters ausführen
- 🌀 **11** Entlüftungsöffnungen nicht versperren.
- 🌀 **12** Der Buchse darf nur aus dem Adapter Strom zugeführt werden.
- 🌀 **13** **Europe - EU**
Gebrauchen Sie einen von TÜV zugelassenen Wechselstromadapter für Gleichstrom 12 V, 500 mA.
- 🌀 **13** **Betriebstemperatur**
Dieses Produkt wurde für den Betrieb in einer Umgebungstemperatur von nicht mehr als 40° C entworfen.
- 🌀 **14** **Alle Länder:** Installation muß örtlichen und nationalen elektrischen Vorschriften entsprechen.

Standarder: Dette produkt tilfredsstiller de følgende standarder.

- 🌀 1 **Radiofrekvens forstyrrelsesemission** EN55022 Klasse A
- 🌀 2  **Advarsel:** I et hjemligt miljø kunne dette produkt forårsage radio forstyrrelse. Bliver det tilfældet, påkræves brugeren muligvis at tage tilstrækkelige foranstaltninger.
- 🌀 3 **Immunitet** EN55024
- 🌀 4 **Advarsel:** Dette produkt skal bruges med afskærmede kabler for at overholde bestemmelserne vedrørende udstråling og støjimmunitet. Hvis det bruges med uafskærmede kabler, kan det blive påkrævet af brugeren at korrigere interferensproblemer for egen regning.
- 🌀 5 **Elektrisk sikkerhed.** EN60950, UL1950, CSA 950
- 🌀 6  **Laser** EN60825
- 🌀 7 **Advarsel** Laserprodukt av klasse 1.
- 🌀 8 **Advarsel** Stirr ikke på strålen.
- 🌀 9 Dette er et "Produkt under Klasse 1 LED"
Sikkerhed
- 🌀 10  **Fare Under Uvejr**
Fare: Undlad at arbejde på udstyr eller kabler i perioder med lynaktivitet.
- 🌀 11 Ventilationsåbningerne må ikke blokeres.
- 🌀 12 Strømforsyningen til apparatet må udelukkende tages fra tilpasningstransformatoren.
Europe - EU
Brug kun TÜV godkendt vekselstrømstransformator på 12 V jævnstrøm, 500 mA.
- 🌀 13 **Betjeningsstemperatur**
Dette apparat er konstrueret til en omgivende temperatur på maksimum 40 grader C.
- 🌀 14 **Alle Lande:** Installation af produktet skal ske i overensstemmelse med lokal og national lovgivning for elektriske installationer.

Eisen: Dit product voldoet aan de volgende eisen.

- 🌀 1 **RFI Emissie** EN55022 Klasse A
- 🌀 2  **Waarschuwing:** Binnenshuis kan dit product radiostoring veroorzaken, in welk geval de gebruiker verplicht kan worden om gepaste maatregelen te nemen.
- 🌀 3 **Immunitet** EN55024
- 🌀 4 **Waarschuwing:** Om te voldoen aan de emissie- en immunitetsnormen dient dit apparaat te zijn voorzien van afgeschermdes kabels. Als het met niet-afgeschermdes kabels wordt gebruikt, kan het zijn dat de gebruiker maatregelen moet treffen om interferentieproblemen voor eigen rekening op te lossen.
- 🌀 5 **Electrische Veiligheid** EN60950, UL1950, CSA 950
- 🌀 6  **Laser** EN60825

🌀 7 **Waarschuwing** Klasse-1 laser produkt.

🌀 8 **Waarchuwing** Neit in de straal staren.

🌀 9 Dit is een "Klasse 1 LED-produkt"

Veiligheid

🌀 10  **Gevaar Voor Blikseminslag**
Gevaar: Niet aan toestellen of kabels werken bij bliksem.

🌀 11 Ventilatiegaten niet blokkeren.

🌀 12 Stroom mag alleen via de adapter naar het apparaat toegevoerd worden.

Europe - EU

Gebruik een door TÜV gekeurde wisselstroomadapter van 12 Volt gelijkstroom, 500 milliamperes.

🌀 13 **Bedrijfstemperatuur**

De omgevingstemperatuur voor dit produkt mag niet meer bedragen dan 40 graden Celsius.

🌀 14 **Alle Landen:** het toestel installeren overeenkomstig de lokale en nationale elektrische voorschriften.

Normes: Ce produit est conforme aux normes de suivantes.

🌀 1 **Emission d'interférences radioélectriques** EN55022 Classe A

🌀 2  **Mise En Garde:** Dans un environnement domestique, ce produit peut provoquer des interférences radioélectriques. Auquel cas, l'utilisateur devra prendre les mesures adéquates.

🌀 3 **Immunité** EN55024

🌀 4 **Avertissement :** Il faut utiliser des câbles blindés pour ce produit afin de respecter les normes d'émission et d'immunité. Si l'utilisateur choisit d'utiliser des câbles non blindés, il sera peut-être contraint de prendre les mesures nécessaires pour corriger les problèmes d'interférences, ainsi que d'assumer le coût correspondant.

🌀 5 **Sécurité électrique** EN60950, UL1950, CSA 950

🌀 6  **Laser** EN60825

🌀 7 **Attention** Produit laser di classe 1.

🌀 8 **Attention** Ne pas fixer le faisceau des yeux.

🌀 9 Ce matériel est un "Produit a diode lectroluminescente de Classe 1"

Sécurité



🌀 10  **Danger De Foudre**
Danger: Ne pas manier le matériel ou les câbles lors d'activité orageuse.

🌀 11 Ne pas bloquer les fentes d'aération.

















🌀 12 L'alimentation du concentrateur doit être uniquement fournie par l'adaptateur.

Europe - EU



Utiliser un adaptateur secteur conforme TÜV de 12 V, 500 mA en courant continu.

-  **13** **Température De Fonctionnement**
Ce matériel est capable de tolérer une température ambiante maximum de 40 degrés Celsius.
-  **14** **Pour Tous Pays:** Installer le matériel conformément aux normes électriques nationales et locales.
-

Standardit: Tämä tuote on seuraavien standardien mukainen.

-  **1** **Radioaaltojen häirintä** EN55022 Luokka A
-  **2**  **Varoitus:** Kotiolosuhteissa tämä laite voi aiheuttaa radioaaltojen häirintää, missä tapauksessa laitteen käyttäjän on mahdollisesti ryhdyttävä tarpeellisiin toimenpiteisiin.
-  **3** **Kestävyys** EN55024
-  **4** **Varoitus:** Tämä tuote vaatii suojattuja kaapeleita toimiakseen emissio- ja häiriönsietostandardien mukaisesti. Jos tuotetta käytetään ilman suojattuja kaapeleita, käyttäjä voi joutua korjaamaan häirinnän aiheuttaman ongelman omalla kustannuksellaan.
-  **5** **Sähköturvallisuus** EN60950, UL1950, CSA 950
-  **6**  **Laser** EN60825
-  **7** **Varoitus** Luokan 1 Lasertuote.
-  **8** **Variotus** Älä katso säteeseen.
-  **9** Tämä on "Ensimmäisen luokan valodiodituote"
- Turvallisuus**
-  **10**  **Salamaniskuvaara**
Engenvaara: Älä työskentele laitteiden tai kaapeleiden kanssa salamoinnin aikana.
-  **11** Älä tuki ilmareikiä.
-  **12** Tähtipisteeseen (hub) syötettävän virran pitää tulla ainoastaan sovittimesta.
- Europe - EU**
Käytä TÜV-lisenssillä valmistettua verkkosovitinta, jonka tasajännitteen nimellisarvot ovat DC 12 V, 500 mA (milliampeeria).
-  **13** **Käyttölämpötila**
Tämä tuote on suunniteltu ympäröivän ilman maksimilämpötilalle 40° C.
-  **14** **Kaikki Maat:** Asenna tuote paikallisten ja kansallisten sähköturvallisuusmääräysten mukaisesti.

Standard: Questo prodotto è conforme ai seguenti standard.

- 🔌 1 **Emissione RFI (interferenza di radiofrequenza)** EN55022 Classe A
 - 🔌 2  **Avvertenza:** in ambiente domestico questo prodotto potrebbe causare radio interferenza. In questo caso potrebbe richiedersi all'utente di prendere gli adeguati provvedimenti.
 - 🔌 3 **Immunità** EN55024
 - 🔌 4 **Avvertenza:** questo prodotto, se utilizzato con cavi schermati, è conforme alle norme sulle emissioni e sull'immunità. In caso di uso senza cavi schermati, l'utente può dover adottare a proprie spese misure correttive contro le interferenze.
 - 🔌 5 **Sicurezza elettrica** EN60950, UL1950, CSA 950
 - 🔌 6  **Laser** EN60825
 - 🔌 7 **Avvertenza** Prodotto laser di Classe 1.
 - 🔌 8 **Avvertenza** Non fissare il raggio con gli occhi.
 - 🔌 9 Questo è un "Prodotto con LED di Classe 1"
- Norme Di Sicurezza**
- 🔌 10  **Pericolo Di Fulmini**
Pericolo: Non lavorare sul dispositivo o sui cavi durante precipitazioni temporalesche.
 - 🔌 11 Non ostruire le prese d'aria.
 - 🔌 12 Questo dispositivo deve essere alimentato solo mediante l'adattatore.
- Europe - EU**
Utilizzare l'adattatore per c.a. da 12 V c.c. e 500 mA conforme alla normativa TÜV.
- 🔌 13 **Temperatura Di Funzionamento**
Questo prodotto è concepito per una temperatura ambientale massima di 40 gradi centigradi.
 - 🔌 14 **Tutti I Paesi:** installare il prodotto in conformità delle vigenti normative elettriche nazionali.

Sikkerhetsnormer: Dette produktet tilfredsstiller følgende sikkerhetsnormer.

- 🔌 1 **RFI stråling** EN55022 Klasse A
- 🔌 2  **Advarsel:** Hvis dette produktet benyttes til privat bruk, kan produktet forårsake radioforstyrrelse. Hvis dette skjer, må brukeren ta de nødvendige forholdsregler.
- 🔌 3 **Immunitet** EN55024
- 🔌 4 **Advarsel:** Dette produktet må brukes med vernet kabler for å tilfredsstille emisjons- og fritakelsesstandarder. Dersom produktet brukes med uvernet kabler, må brukeren muligens rette forstyrrelsesproblemene for egen regning.
- 🔌 5 **Elektrisk sikkerhet** EN60950, UL1950, CSA 950

6  **Laser** EN60825

7  **Advarsel** Laserprodukt av klasse 1.

8 **Advarsal** Stirr ikke på strålen.

9 Dette er et "Klasse 1 LED produkt"

Sikkerhet

10  **Fare For Lynnedslag**
Fare: Arbeid ikke på utstyr eller kabler i tordenvær.

11 Blokker Ikke Luftventilene

12 All strømtilførsel må komme fra adapteren.

Europe - EU

Benytt TÜV-godkjent AC-adapter på 12V DC, 500mA (millismpere)

13 **Driftstemperatur**

Dette produktet er konstruert for bruk i maksimum romtemperatur på 40 grader celsius.

14 **Alle Land:** Produktet må installeres i samsvar med de lokale og nasjonale elektriske koder.

Padrões: Este produto atende aos seguintes padrões.

1 **Emissão De Interferência De Radiofrequência** EN55022 Classe A

2  **Aviso:** Num ambiente doméstico este produto pode causar interferência na radiorrecepção e, neste caso, pode ser necessário que o utente tome as medidas adequadas.

3 **Imunidade** EN55024

4 **Advertência:** Este produto requer a utilização de cabos blindados para cumprimento dos standards de limites de emissão e imunidade. Se o produto for utilizado com cabos não blindados, o utilizador poderá necessitar de tomar medidas para correção de problemas de interferência, por sua própria conta.

5 **Segurança Eléctrica** TUV-EN60950, UL1950, CSA 950

6  **Laser** EN60825

7 **Aviso** Produto laser de classe 1.

8 **Aviso** Não olhe fixamente para o raio.

9 Este é um "Produto Classe 1 LED"

Segurança



















10  **Perigo De Choque Causado Por Raio**
Perigo: Não trabalhe no equipamento ou nos cabos durante períodos suscetíveis a quedas de raio.

11 Não Bloqueie As Aberturas De Ventilação





12 Use somente o adaptador fornecido para alimentação elétrica do hub.

Europe - EU

Use um adaptador de corrente alternada com saída DC de 12V e 500mA em conformidade com as especificações da TÜV.

-  **13 Temperatura De Funcionamento**
Este produto foi projetado para uma temperatura ambiente máxima de 40 graus centígrados.
-  **14 Todos Os Países:** Instale o produto de acordo com as normas nacionais e locais para instalações elétricas.
Estándares: Este producto cumple con los siguientes estándares.
-  **1 Emisión RFI** EN55022 Clase A
-  **2  Advertencia:** en un entorno doméstico, este producto puede causar radiointerferencias, en cuyo caso, puede requerirse del usuario que tome las medidas que sean convenientes al respecto.
-  **3 Inmunidad** EN55024
-  **4 Advertencia:** Este producto exige cables protectores para ajustarse a las normas de emisión e inmunidad. Si se utiliza con cables sin protección, el usuario tendrá que correr con los gastos por las medidas a tomar en caso de problemas de interferencias.
-  **5 Seguridad eléctrica** TUV-EN60950, UL1950, CSA 950
-  **6  Laser** EN60825
-  **7 ¡Advertencia!** Producto láser Clase 1.
-  **8 ¡Advertencia!** No mirat fijamente el haz.
-  **9** Este es un "Producto de diodo luminiscente (LED) Clase 1"
- Seguridad**
-  **10  Peligro De Rayos**
Eligro: No realice ningun tipo de trabajo o conexion en los equipos o en los cables durante tormentas electricas.
-  **11** No bloquee las aberturas para ventilacion.
-  **12** La energía para el dispositivo central o "hub" debe provenir únicamente del adaptador.
Europe - EU
Utilizar un adaptador de corriente alterna autorizado TÜV de 12 voltios de corriente continua y 500 miliamperios.
-  **13 Temperatura Requerida Para La Operación**
Este producto está diseñado para una temperatura ambiental máxima de 40 grados C.
-  **14 Para Todos Los Países:** Monte el producto de acuerdo con los Códigos Eléctricos locales y nacionales.

Standarder: Denna produkt uppfyller följande standarder.

-  **1 Radiostörning** EN55022 Klass A
-  **2  Varning:** Denna produkt kan ge upphov till radiostörningar i hemmet, vilket kan tvinga användaren till att vidtaga erforderliga åtgärder.
-  **3 Immunitet** EN55024
-  **4 Varning!** Denna produkt kräver skärmade kablar för att uppfylla standardkraven för emission och immunitet. Om den används med oskärmade kablar kan användaren vara tvungen att vidta åtgärder på egen bekostnad för att åtgärda störningsproblemet.

5 **Elsäkerhet** TUV-EN60950, UL1950, CSA 950

6  **Laser** EN60825

7 **Varning!** Laserprodukt av klass 1.

8 **Varning!** Laserstrålning när enheten är öppen.

9 Detta är en "Klass 1 lysdiodprodukt"

Säkerhet

10  **Fara För Blixtnedslag**
Fara: Arbeta ej på utrustningen eller kablarna vid åskväder.

11 Blockera Inte Luftventilerna.

12 Endast anslutningsenheten får vara kraftkälla till centralen.

Europe - EU

Använd en växelströmsanslutningsenhet licensierad av TÜV. Likström 12V, 500mA.

13 **Driftstemperatur**
Denna produkt är konstruerad för rumstemperatur ej överstigande 40 grader Celsius.

14 **Alla Länder:** Installera produkten i enlighet med lokala och statliga bestämmelser för elektrisk utrustning.