

Lab Validation Report

QLogic Enhanced Gen 5 (16Gb) Fibre Channel Adapters with StorFusion Technology for Lenovo

Designed to Simplify Deployment and Increase Performance in the Data
Center with Application aware Services

By Tony Palmer, Senior Lab Analyst

July 2016

Contents

Introduction	3
Background	3
QLogic Enhanced Gen 5 FC	4
QLogic Integration with Brocade Fabric	5
ESG Lab Validation	6
Simplified Deployment and SAN Provisioning	6
Reliability and Diagnostics	11
Performance and Scalability	16
ESG Lab Validation Highlights	20
Issues to Consider	20
The Bigger Truth	22
Appendix	23

ESG Lab Reports

The goal of ESG Lab reports is to educate IT professionals about data center technology products for companies of all types and sizes. ESG Lab reports are not meant to replace the evaluation process that should be conducted before making purchasing decisions, but rather to provide insight into these emerging technologies. Our objective is to go over some of the more valuable feature/functions of products, show how they can be used to solve real customer problems and identify any areas needing improvement. ESG Lab's expert third-party perspective is based on our own hands-on testing as well as on interviews with customers who use these products in production environments. This ESG Lab report was sponsored by QLogic.

All trademark names are property of their respective companies. Information contained in this publication has been obtained by sources The Enterprise Strategy Group (ESG) considers to be reliable but is not warranted by ESG. This publication may contain opinions of ESG, which are subject to change from time to time. This publication is copyrighted by The Enterprise Strategy Group, Inc. Any reproduction or redistribution of this publication, in whole or in part, whether in hard-copy format, electronically, or otherwise to persons not authorized to receive it, without the express consent of The Enterprise Strategy Group, Inc., is in violation of U.S. copyright law and will be subject to an action for civil damages and, if applicable, criminal prosecution. Should you have any questions, please contact ESG Client Relations at 508.482.0188.

Introduction

ESG Lab recently tested [QLogic](#) Enhanced Gen 5 (16Gb) Fibre Channel (FC) Adapters ([Lenovo part numbers 01CV750/01CV760](#)) with a goal of validating how QLogic Enhanced Gen 5 FC technology can be used to reduce data center complexity by enabling a storage network infrastructure that supports fabric pre-provisioning, powerful virtualization features, granular quality of service (QoS), and simplified management leveraging key integration points with [Brocade](#) Fabric and QLogic StorFusion. QLogic has long been recognized as a market leader in Fibre Channel Host Bus Adapters (HBAs).

Background

ESG recently asked 633 IT professionals and managers to identify their most important considerations in justifying IT investments, and more than one-third (35%) flagged return on investment, while nearly as many (32%) indicated business process improvement and 27% cited reducing operational expenditures, as shown in Figure 1.¹ The continuing usage of ROI as a metric for IT investment validation nearly mirrors the pattern of organizations purchasing technologies with improved ROI as a means of cost mitigation, cited by 30% of organizations in the same report. Increasing the use of server virtualization was cited by 20% of respondents in the same survey as one of their most important IT priorities over the next 12 months.

Figure 1. Most Important Considerations in Justifying IT Investments in 2016

Which of the following considerations do you believe will be most important in justifying IT investments to your organization’s business management team over the next 12 months? (Percent of respondents, N=633, three responses accepted)

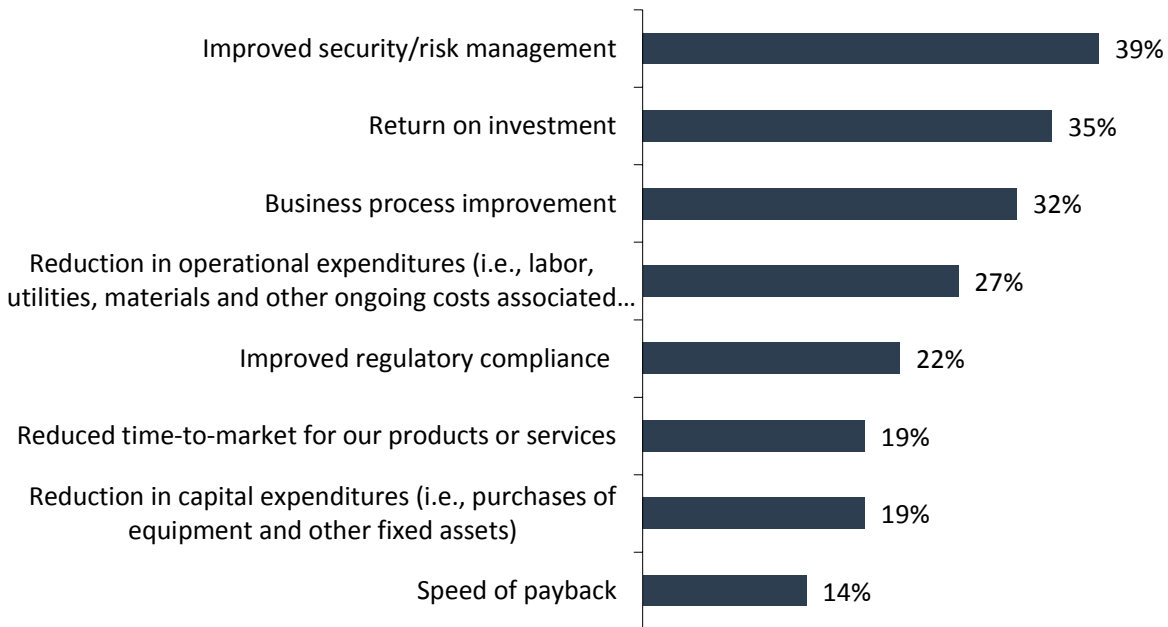

Source: Enterprise Strategy Group, 2016.

Clearly, IT organizations are looking for ways to optimize the efficiency of their infrastructure, extracting as much value as possible from the technology they implement. In the enterprise, where Fibre Channel continues to be widely deployed in support of densely populated virtual servers, solid-state arrays, and high performance applications, finding ways to simplify deployment, management and day-to-day processes is critical.

¹ Source: ESG Research Survey, 2016 IT Spending Intentions Survey, to be published.

QLogic Enhanced Gen 5 FC

QLogic Enhanced Gen 5 FC enterprise-class HBAs deliver up to 16Gbps per port for high-performance storage area network (SAN) applications. Based on recently announced QLogic technology, these new adapters are designed for enterprise data centers that require the ultimate in Fibre Channel performance, power efficiency, reliability, and investment protection for demanding virtualized and private cloud environments. The Enhanced Gen 5 FC for Lenovo (01CV750 and 01CV760) adapters are available as low-profile cards that utilize the PCI Express (PCIe) 3.0 bus. The small form factor enables efficient operation with low power requirements and heat dissipation. The following table includes a complete list of QLogic Enhanced Gen 5 FC model numbers.

Table 1. QLogic Enhanced Gen 5 FC Model Numbers

Lenovo Part Number	Description	PCIe Connector	Ports
01CV750	Single-port PCIe 3.0 x8 to 16Gb Fibre Channel Adapter – SFP+	X8	1
01CV760	Dual-port PCIe 3.0 x8 to 16Gb Fibre Channel Adapter – SFP+	X8	2

QLogic Enhanced Gen 5 FC adapters for Lenovo feature StorFusion technology for advanced SAN fabric management and performance, enhanced network resiliency, advanced diagnostic and troubleshooting capabilities, quicker SAN deployment, and enriched QoS. New features that were developed in conjunction with Brocade and integrated with QLogic management tools include the QLogic QConvergeConsole (QCC), VMware vCenter Server plug-in, and Brocade Network Advisor integration.

Figure 2. QLogic Enhanced Gen 5 Fibre Channel Adapter Port Isolation Architecture

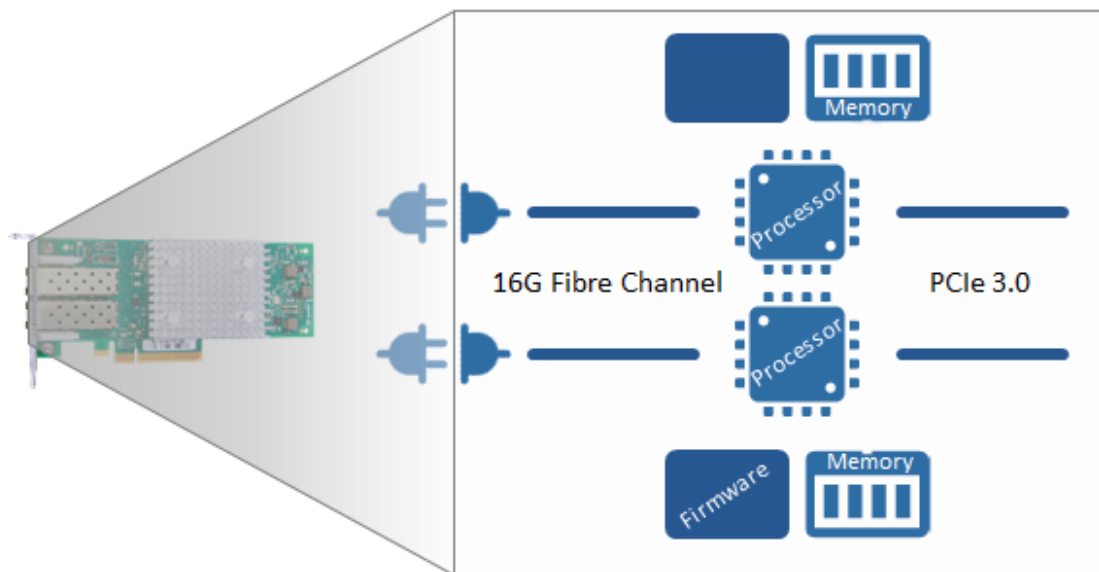

Key QLogic Enhanced Gen 5 FC technology features include:

- Support for 16Gb, 8Gb, and 4Gb Fibre Channel devices.
- Higher per-port performance than earlier Gen 5 FC technology with up to 650K IOPS per port (up to 1.3 million IOPS for dual-port adapters).

- Higher per-port throughput (maximum 12000MB/s for Enhanced Gen 5 FC) for high bandwidth SAN traffic and low latency to maximize the potential of all-flash array (AFA) technology.
- Industry standard N_Port ID Virtualization (NPIV) and Virtual Fibre Channel (vFC) for increased scalability and performance in virtual server environments.
- QLogic Port Isolation Architecture (see Figure 2), which features a single ASIC design and a dedicated processor, memory, and firmware for each port to ensure performance, security, and availability.
- Lower operational expenditures (OpEx) with 75% lower power requirements and 75% greater power efficiency.
- Improvements in total cost of ownership (TCO) with QLogic StorFusion technology, offering streamlined deployment, end-to-end diagnostics, and QoS optimizations when used in conjunction with supported Brocade switches.

QLogic Integration with Brocade Fabric

QLogic Enhanced Gen 5 FC adapters support StorFusion technology, offering comprehensive port diagnostics, rapid provisioning, and guaranteed performance service level agreements (SLAs) when used in conjunction with Brocade's Gen 5 FC fabric.



Key capabilities enabled by StorFusion include:

- Fabric-assigned Port World Wide Name (FA-WWN) and Fabric-based Boot LUN Discovery (F-BLD) to accelerate server deployments by enabling administrators to pre-provision SAN fabrics.
- Brocade ClearLink Diagnostic Port (D_Port) for fast and efficient end-to-end diagnostics.
- Industry standard N_Port ID Virtualization (NPIV), Virtual Fibre Channel (vFC), and Class-specific Control (CS_CTL)-based QoS technologies to prioritize virtual workloads for optimized network performance.
- FC Ping, FC Traceroute, and Fabric Device Management Interface (FDMI) for enhanced configuration, management, and performance.
- Read Diagnostics Parameter (RDP) and Link Cable Beaconsing (LCB) for greater network reliability.
- Forward Error Correction (FEC) and Buffer-to-Buffer Credit Recovery (BB-CR) to improve network resiliency and performance.

Figure 3. QLogic Enhanced Gen 5 FC Adapter Integration with Brocade Fabric

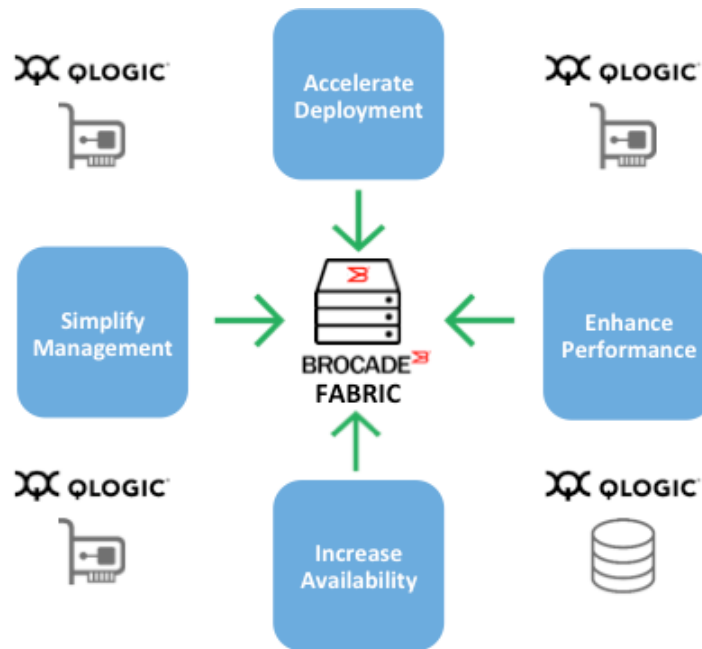

ESG Lab Validation

ESG Lab performed hands-on evaluation and testing of the QLogic 2690 Series Enhanced Gen 5 16Gb Fibre Channel HBA Model QLE2692 (equivalent to the 01CV760 dual-port 16Gb Fibre Channel Adapter for Lenovo) at QLogic's facilities in Mountain View, CA. Testing was designed to demonstrate simplified deployment and management of fifth and sixth generation Fibre Channel solutions. Also of interest was an evaluation of this adapter's impact on reliability and cost of operations, as well as on overall system performance and scalability.

Simplified Deployment and SAN Provisioning

Traditional server deployment methods rely on multiple administrative teams to manage servers, storage, and networks, all of whom must coordinate with each other in order to configure the systems, create zones in the fabric, and perform LUN mapping and masking on the storage devices. These activities cannot begin until the physical server arrives on site, since the physical port World Wide Name (PWWN) for the server is needed. The process consists of many sequential tasks that span multiple IT teams. As a result, deploying servers into a Fibre Channel SAN can take many days or weeks when traditional methods are utilized.

QLogic Enhanced Gen 5 FC HBAs have been designed to integrate with Brocade's Fibre Channel switches to automate and simplify SAN deployment by using dynamic fabric provisioning via FA-WWN and F-BLD. Integrating these two features—which can be enabled prior to installing the OS with minimal pre-boot configuration needed—empowers administrators to pre-provision SAN fabrics, eliminating tedious and repetitive manual steps and processes. As a result, when the new server is powered on, the HBA is automatically configured, and the server boots directly to the operating system.

In addition, QCC enables centralized administration of all QLogic HBAs within local or remote systems in a multiprotocol, heterogeneous environment. QCC provides detailed insight into the adapter for configuration,

diagnostics, monitoring, and statistics to help optimize SAN network performance from the host, through the network fabric, to the storage. QCC also includes a plug-in for VMware vCenter Server, which provides administrators with a real-time view of the storage network infrastructure mappings from the physical adapter all the way to the individual virtual machine.

ESG Lab Testing

ESG Lab tested the adapter’s simplified deployment and management using QCC. ESG Lab launched the console using a standard web browser. By default, QCC showed the configuration information for the first adapter attached to the local host, as shown in Figure 4. (Note: The QLE2692 is equivalent to the 01CV760.)

Figure 4. Factory-assigned Worldwide Port Name

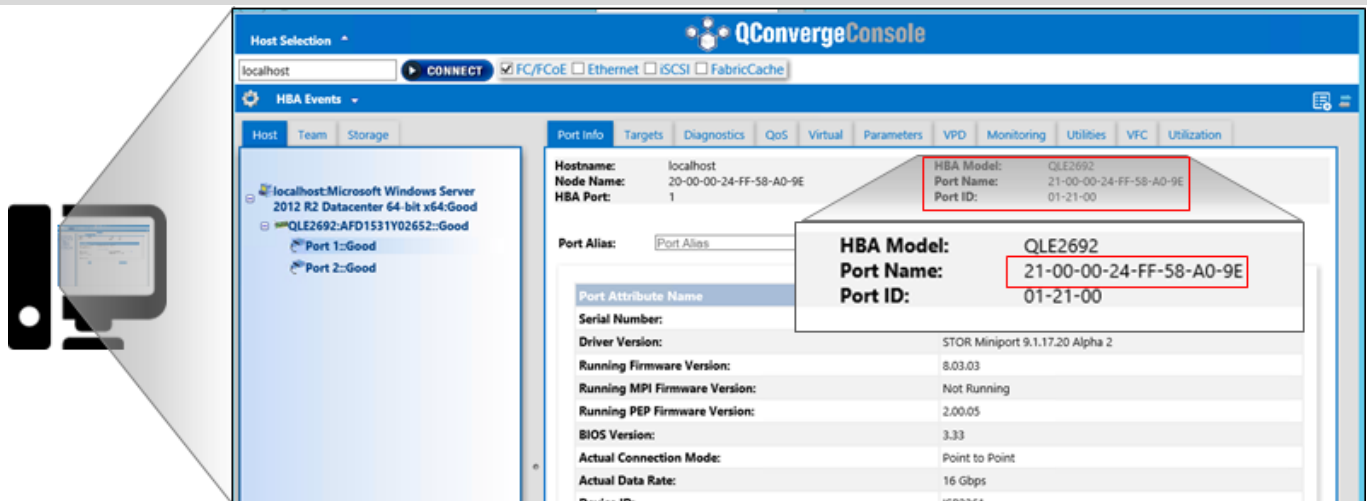

In addition to the usual information, such as serial number, driver, firmware, and BIOS versions, QCC displayed the factory assigned worldwide port name.

Next, ESG Lab selected the parameters tab, which opened up the HBA configurable parameters pane. Selecting advanced HBA parameters opened up the advanced configuration pane. ESG Lab clicked on the box to enable FA-WWN, then clicked save to save the configuration, and then rebooted the server (see Figure 5).

Figure 5. Configuring Fabric-assigned Worldwide Port Name

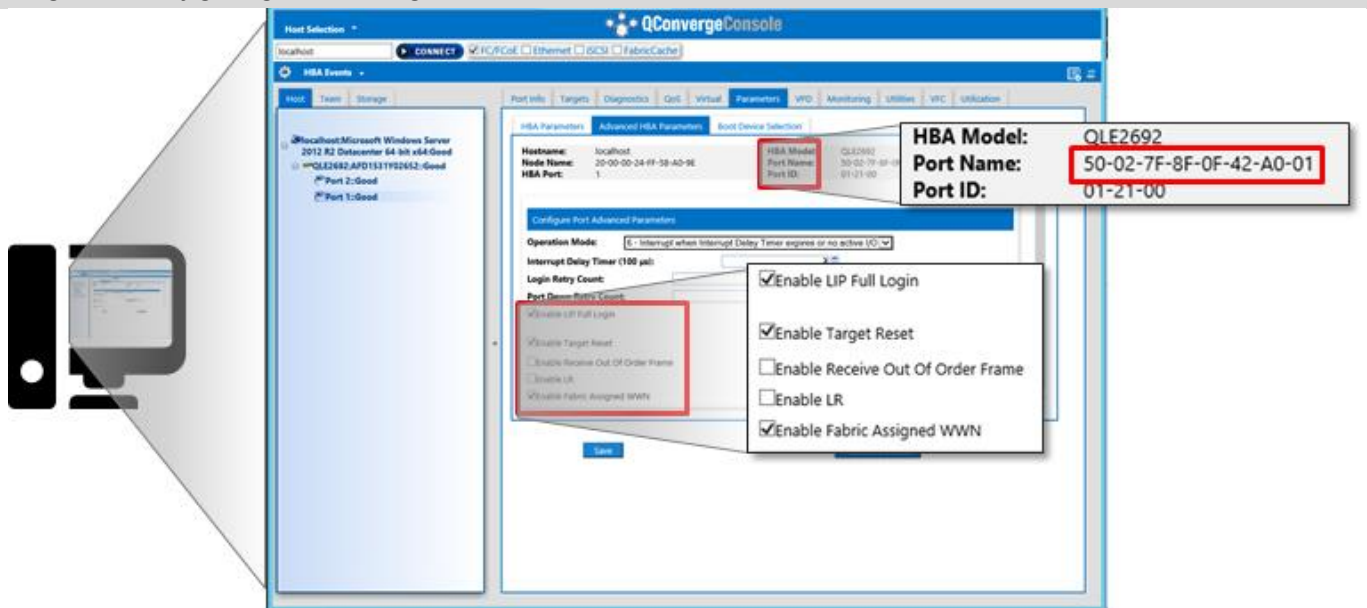

Once the server booted, ESG Lab viewed the QCC, and validated that the HBA was now using the fabric-assigned worldwide name, which had been pre-configured in the Brocade Gen 5 FC switch.

Next, ESG Lab configured F-BLD. First, ESG logged into the Brocade switch using Brocade Fabric OS (FOS), Brocade’s switch management application. Selecting new zone, a zone was created for the boot LUN configuration. A second zone was created containing the device’s port WWN and specification information about the target WWN and LUN to be booted from, as shown in Figure 6.

Figure 6. Brocade Switch Configuration for Fabric-assigned Boot LUN Discovery

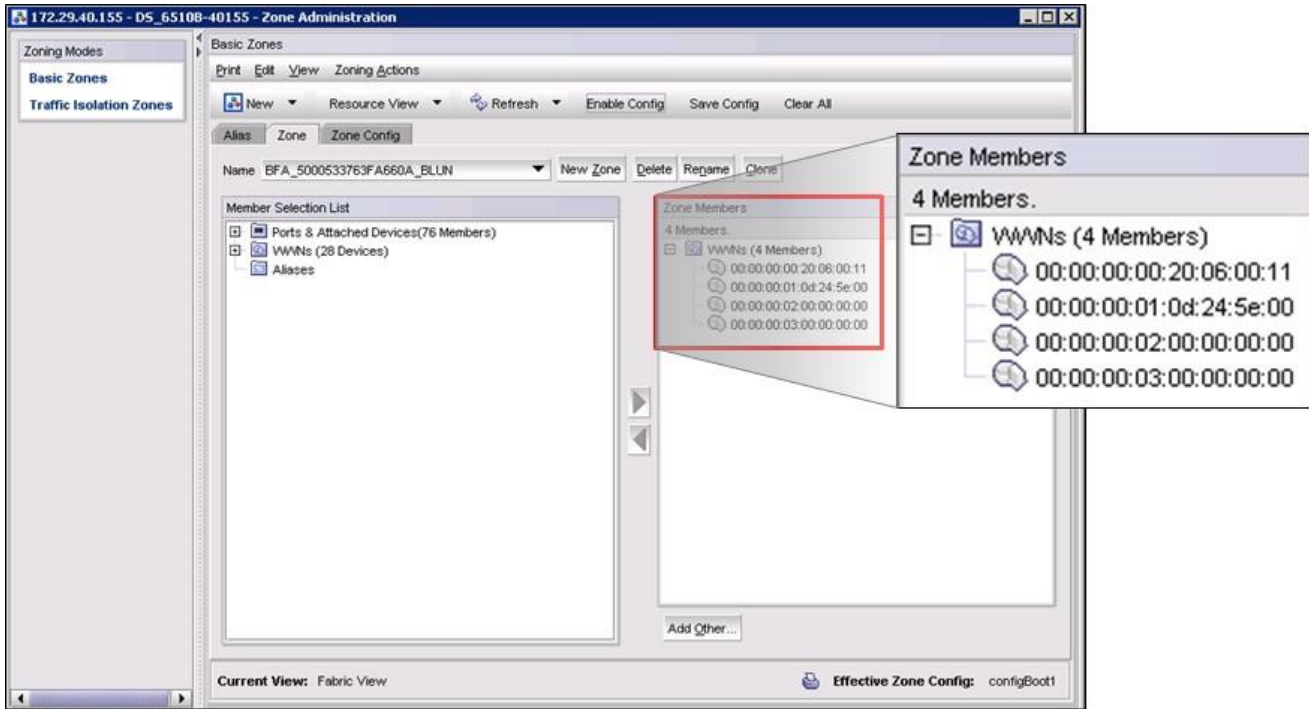

Specifically, the name of the zone contained the HBA port WWN: BFA_5000533763FA660A_BLUN. The zone included four members, with WWNs defined as seen in Table 3.

Table 2. Fabric-assigned Boot LUN Discovery Zone Member Configuration

Zone Member	First 4 Octets	Last 4 Octets	Description
1st member	00:00:00:00:	20:06:00:11	Target’s PWWN, first 4 octets
2nd member	00:00:00:01:	0d:24:5e:00	Target’s PWWN, last 4 octets
3rd member	00:00:00:02:	00:00:00:00	Target’s LUN, first 4 octets
4th member	00:00:00:03:	00:00:00:00	Target’s LUN, last 4 octets

Next, ESG Lab configured the HBA, enabling F-BLD. First, ESG Lab used the QCC to open up the pane showing the HBA parameters. On the basic parameters pane, enable HBA port BIOS was selected. This parameter installs the HBA BIOS into the server system BIOS on server boot, ensuring that the server can boot from a LUN using the HBA. In the next step, ESG Lab selected the boot device and rebooted the server.

Figure 7. Booting from Fabric-assigned Boot LUN Discovery

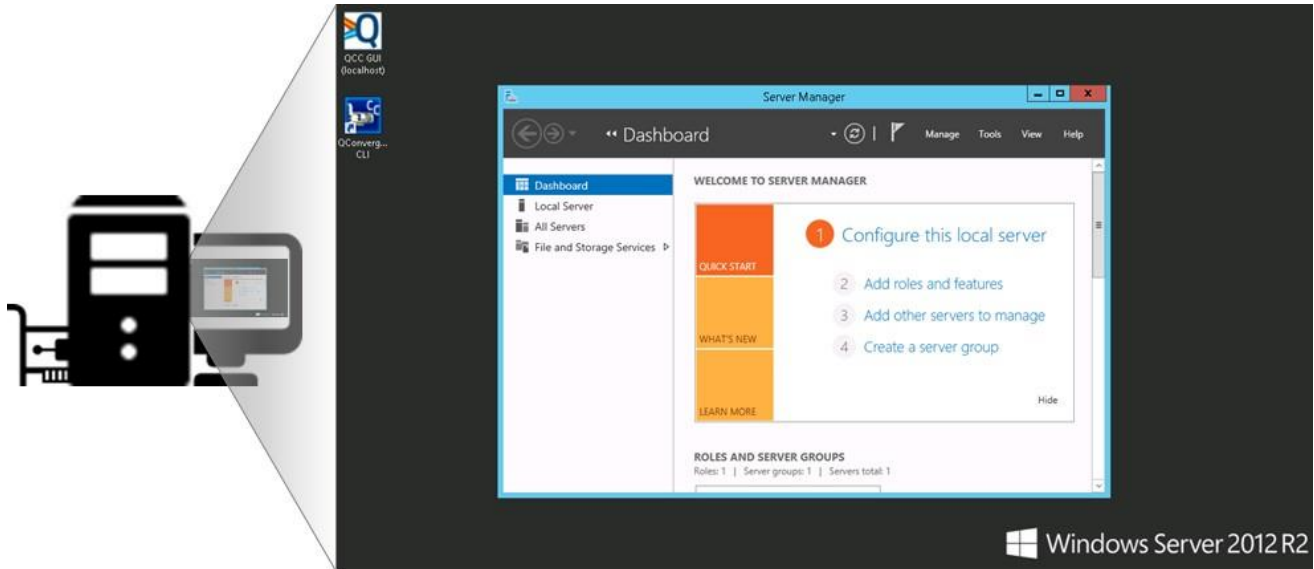

As shown in Figure 7, since the server was using F-BLD, the server booted directly to Microsoft Server 2012, which was the OS preinstalled on the boot LUN.

ESG Lab evaluated all the steps necessary to deploy servers into production, from ordering through provisioning, configuration, establishing connectivity, and booting. Figure 8 shows a comparison of the time and effort of the traditional process and the new process using FA-WWN and F-BLD enabled by StorFusion for a hypothetical deployment of 100 servers.

Figure 8. Server Deployment: Traditional vs. QLogic StorFusion with Fabric Pre-provisioning for 100 Servers

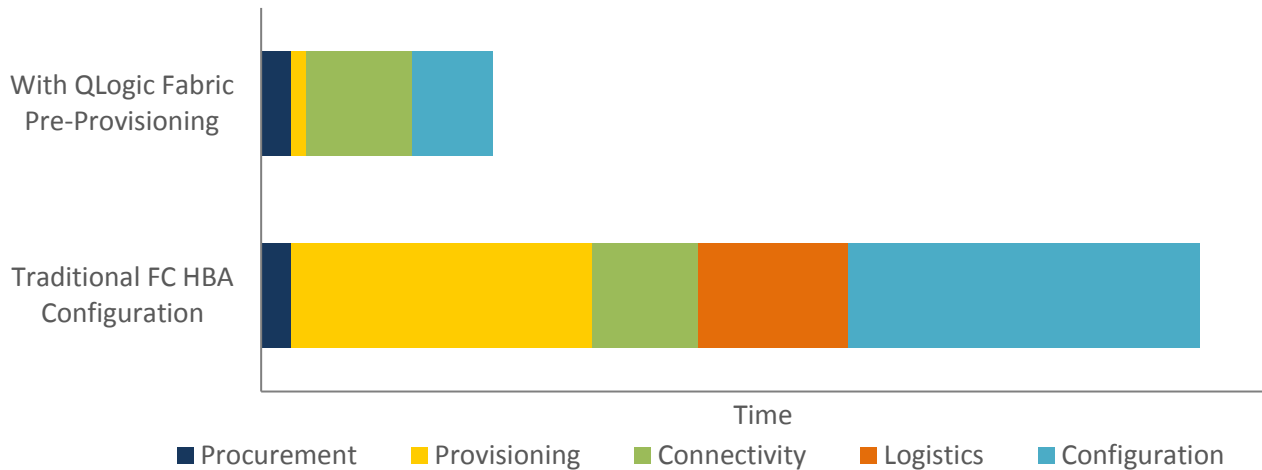

With the traditional FC HBA deployment process, while new servers are in transit from the vendor, boot images can be provisioned. Once the servers arrive on site, the administrator must visually inspect the HBAs to obtain the preprogrammed WWNs. The servers are physically installed and connected to the FC fabric. Using the FC HBA WWNs, zones and targets are configured on the FC switches. The servers are booted to the QLogic BIOS, and configured with the server-specific boot LUN. Finally, the servers can be booted into the OS, validated, and put into production.

Using QLogic Enhanced Gen 5 FC HBAs in conjunction with Brocade Fibre Channel switches enables administrators to pre-provision fabrics using FA-WWN and F-BLD. While new servers are in transit, the FC fabric is pre-provisioned

with WWNs and zones, and boot images are created for each new server. Once servers arrive on site, they are physically installed and connected to the FC fabric. The servers are booted into the QLogic BIOS, and FA-WWN and F-BLD are enabled. The servers are rebooted, are automatically assigned WWNs and boot LUNs from the fabric, and then boot into the OS. It is the opinion of ESG Lab, based on hands-on experience deploying physical and virtual servers in real data centers, that leveraging QLogic fabric pre-provisioning (FA-WWN and FA-BLD) with Brocade Fibre Channel switches can reduce the number of steps required to deploy servers by up to 30%, saving organizations a significant amount of time and effort, approximately 75% in large server deployments.

Pre-provisioning is useful both with initial server deployment and with server or HBA replacement, since replacements can be booted into production without having to make additional changes in fabric configurations. This eliminates time-consuming manual processes, and accelerates and simplifies server deployments.

Why This Matters

IT organizations are looking for ways to optimize the efficiency of their infrastructures, extracting as much value as possible from the technology they implement. In the enterprise, where Fibre Channel is widely deployed in support of densely populated virtual servers, solid-state arrays, and high performance applications, finding ways to simplify deployment and management and streamline day-to-day processes is critical.

ESG Lab confirmed that QLogic Enhanced Gen 5 FC HBAs can be quickly and easily configured to use dynamic fabric provisioning via FA-WWN and F-BLD using the QCC. Deploying QLogic HBAs with Brocade Fibre Channel switches enables administrators to leverage the power of pre-provisioning fabrics, eliminating manual steps. Not only does pre-provisioning simplify server deployment, but it also streamlines server maintenance and replacement. ESG Lab found that organizations could potentially reduce the steps required to deploy servers by 30%, saving approximately 75% of the time and effort required for large server deployments.

Reliability and Diagnostics

QLogic has included a long list of advanced reliability, availability, and serviceability features in the QLogic Enhanced Gen 5 FC HBAs, supporting the ever increasing pace of business and reducing the cost of operations. Key features and capabilities provided by QLogic include:

- **Brocade ClearLink Diagnostics**—supports D_Port, which enables administrators to quickly run a battery of automated diagnostic tests in a single step, across multiple adapters, servers, and fabric components to assess connectivity. Optics and cable problems are quickly identified and resolved, significantly reducing fabric deployment time and ensuring reliable connections.
- **FC Ping**— provides the ability to ping an FC N_Port or end device, validating configurations prior to deployment or during troubleshooting.
- **FC Traceroute**—obtains path information between two FC Ports, ensuring correct switch and multi-path configuration, especially useful in complex SAN environments. A topology routing map can be easily viewed via QCC.
- **FDMI**—provides rapid access to hardware configuration and counters through a centralized management system for rapid troubleshooting and performance tuning.
- **RDP**—enables one-click identification of network and media issues.
- **LCB**—simplifies cable identification and eliminates human errors.

ESG Lab Testing

In a typical SAN environment, a link-level component failure, such as a broken cable as shown with the leftmost server in the SAN diagram in Figure 9, can halt operation of applications. However, marginal cabling or intermittent failures may not manifest themselves so obviously, and troubleshooting is complicated and time consuming, especially after a deployment has moved into production. To evaluate the effort of troubleshooting link-level issues, ESG Lab reviewed QLogic’s support for ClearLink Diagnostics (D_Port).

Figure 9. QLogic Enhanced Gen 5 FC with ClearLink Diagnostics (D_Port)

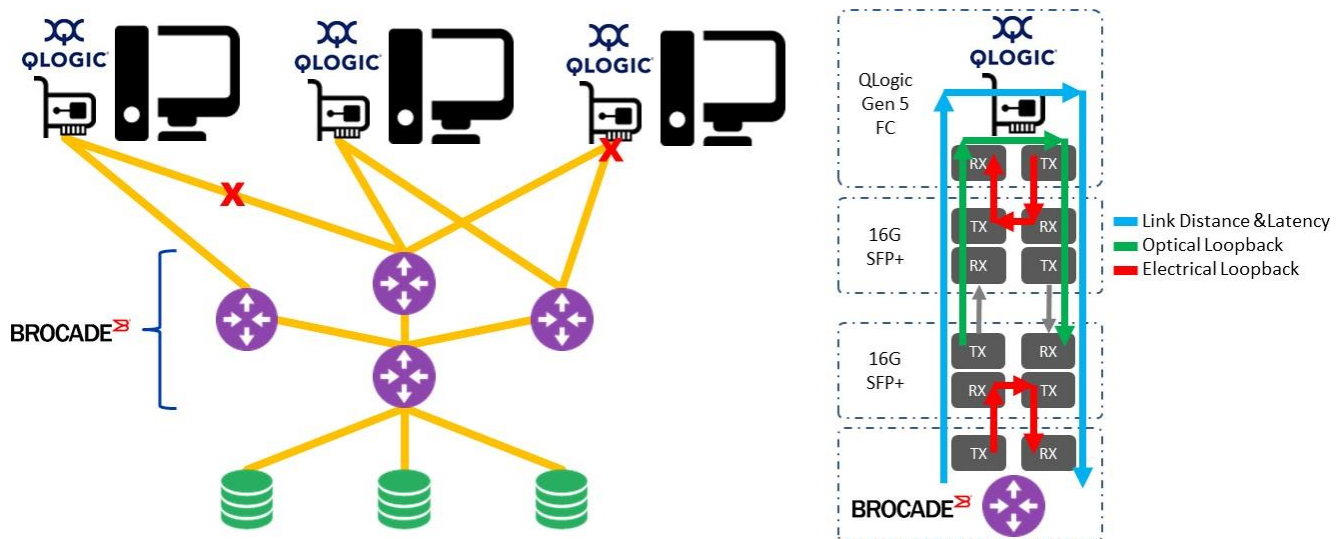

ClearLink diagnostics are started from the Brocade switch, and run electrical and optical loopback tests. In the first step, the switch sends frames to the switch SFP, which electrically loops the data back to the switch. If this test passes, the switch sends frames through the switch SFP, across the optical cable to the SFP on the QLogic HBA, which optically loops the frames back to the switch. If this test passes, the switch sends frames to the QLogic HBA,

which receives and returns the frames to the switch. The switch uses the round-trip time to calculate the cable length.

ESG Lab logged into the Brocade switch and initiated Clearlink diagnostics (D_Port) on port 22 of the switch using the command line interface. The results are shown in Figure 10.

Figure 10. ClearLink Diagnostics - D_Port Information Screen

```

D-Port Information:
=====
Port:                22
Remote WWPN:         21:00:00:0e:1e:08:cb:10
Mode:                Automatic
No. of test frames:  1 Million
Test frame size:     1024 Bytes
FEC (enabled/option/active): Yes/No/No
CR (enabled/option/active): Yes/No/No
Start time:          Wed Mar 18 00:32:24 2015
End time:            Wed Mar 18 00:33:12 2015
Status:              PASSED
=====
Test                 Start time      Result          EST(HH:MM:SS)    Comments
=====
Electrical loopback  00:32:51       PASSED          -----          -----
Optical loopback    00:33:02       PASSED          -----          -----
Link traffic test   -----        SKIPPED         -----          -----
=====
Roundtrip link latency: 265 nano-seconds
Estimated cable distance: 14 meters
Buffers required:     1 (for 2112 byte frames at 16Gbps speed)
DS 6510B-40155:admin>
  
```

The output from ClearLink diagnostics provides a wealth of information, enhancing the ability of the administrator to troubleshoot and resolve issues. At the top, the D-Port Information screen shows the HBA’s WWN and additional data regarding the testing. The bottom of the screen shows the test results. In this case, both electrical and optical loopback tests passed, indicating all components were operating correctly. The round trip time for frames was calculated at 265 nanoseconds. The diagnostics calculated that the cable length was 14 meters. ESG Lab verified that the optical cable was indeed a 14 meter cable.

Next, ESG Lab used the FC Ping tool to validate connectivity between two nodes in the SAN. ESG Lab used the QCC to initiate a ping between a QLogic HBA and the Brocade switch. The General Diagnostics tab was selected, opening up the ping configuration frame, as shown in Figure 11.

Figure 11. FC Ping

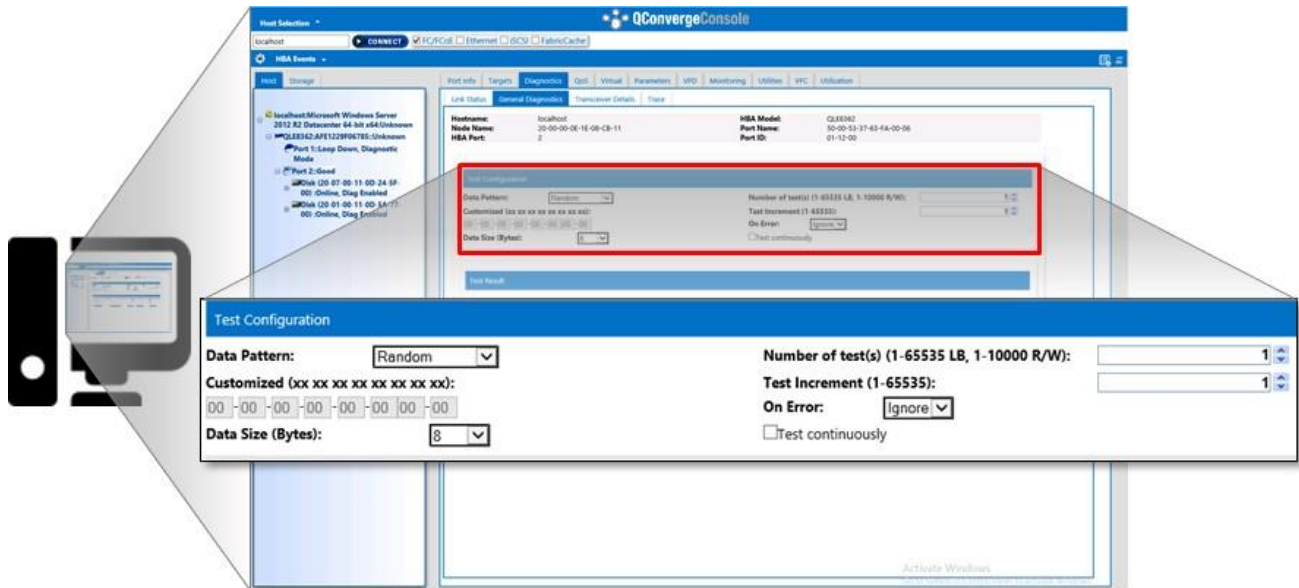

The ping capability can be configured to loop continuously or to run for a specified number of tests. The data sent with each frame can be random or a specific pattern selected by the user. ESG Lab chose to run one test with random data, and the results were successful, indicating full data connectivity between the QLogic HBA and the Brocade switch.

In a complex SAN environment with multiple paths between nodes (see Figure 9), it can be difficult for an administrator to know the path a frame takes between nodes. QLogic FC Traceroute traces the route an individual frame will take across the SAN. Using QLogic QCC, ESG Lab selected the Topology tab, which opened up a frame displaying the entire SAN topology, as shown in Figure 12. A right-click on the QLogic HBA opened a context-sensitive menu with an option for FC Traceroute, which was selected. A pop-up window opened, with a list of all endpoints in the SAN fabric.

Figure 12. FC Traceroute

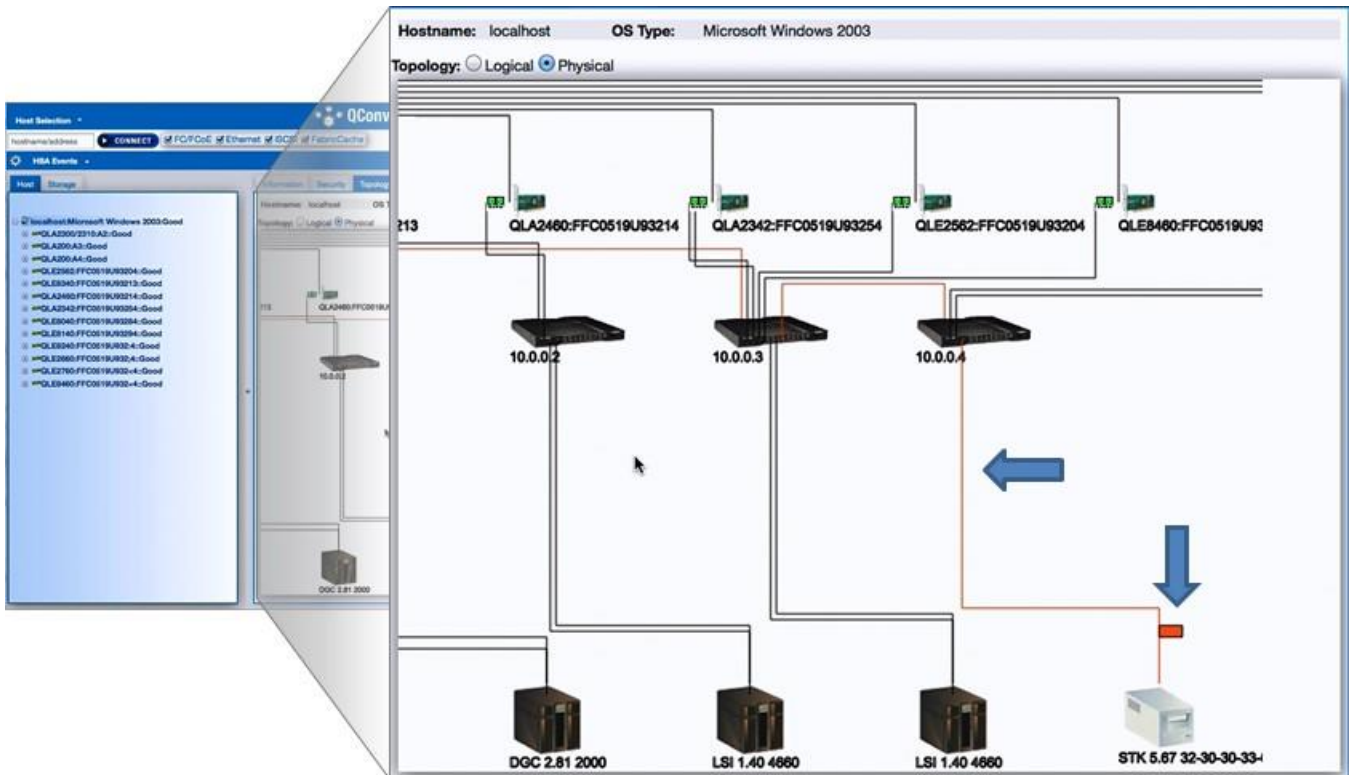

ESG Lab selected a storage node, and clicked on the trace button to initiate FC Traceroute between the HBA and the storage node. The path the frame was to travel between the HBA and the storage node was highlighted in red. The QCC animated the movement of the frame between the nodes. The frame was highlighted as a small red box, and moved between the nodes, entering and leaving switches on the correct switch port, and providing a visual trace of the route.

Finally, ESG Lab reviewed the information available to administrators through the FDMI. Logging into the Brocade switch, ESG used the command line interface to query the QLogic HBA's FDMI. A portion of the information returned is shown in Figure 13.

Figure 13. Fabric Device Management Interface (FDMI)

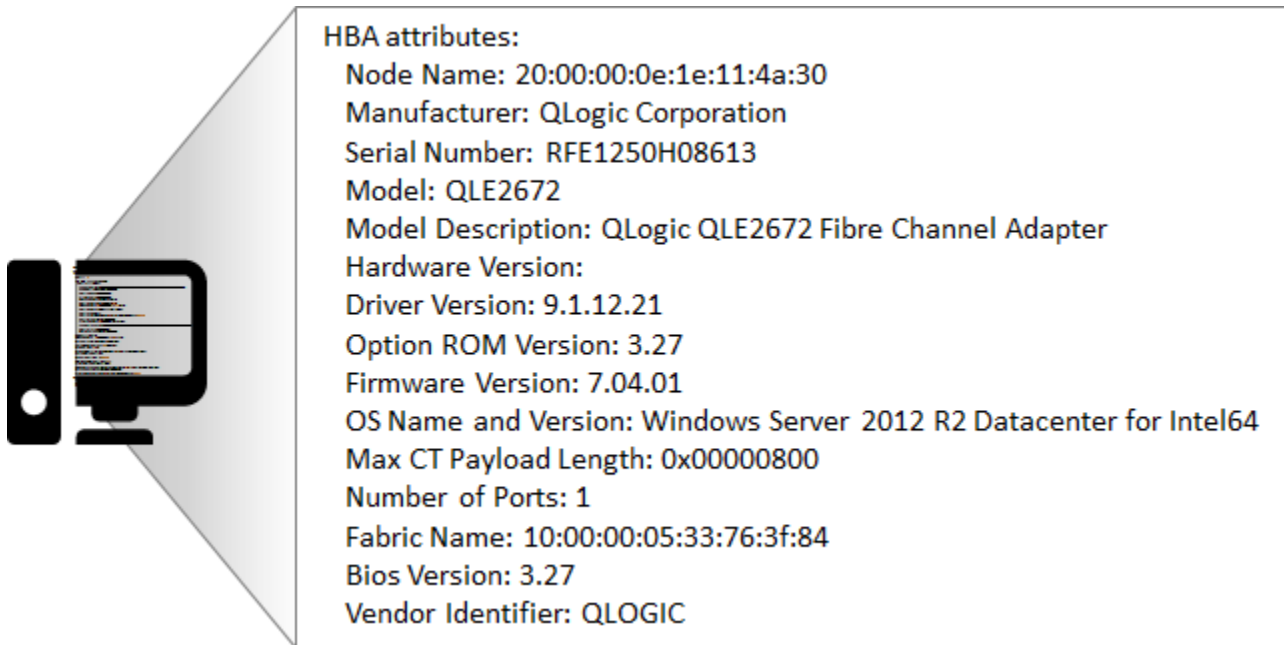

In addition to Fibre Channel configuration information (i.e., node name, port name, port type, port symbolic name, class of service, fabric name, port state, and number of ports), FDMI provides HBA-specific details including hardware, BIOS, firmware, and ROM versions along with the OS name and version. This information enhances the administrator's ability to correctly identify adapters and ensure that all components are up to date.

Why This Matters

As storage environments grow in size and complexity, so too does the impact of data outages. Since lack of application availability can result in missed business opportunities, reduced productivity, lost revenue, dissatisfied customers, damage to the company's reputation, and even legal liability, it follows that maintaining uptime and data access are crucial for business productivity.

Global operations demand 24x7 data access, leaving no window for planned or unplanned downtime. Server and storage consolidation magnify the need for high availability and reliability because a hardware outage will affect many systems and applications, not just one.

ESG Lab confirmed that using ClearLink diagnostics (D_Port) with QLogic Enhanced Gen 5 FC HBAs and Brocade switches enables rapid detection and identification of component issues affecting link-level connectivity. D_Port enables administrators to check fabric health and resolve issues before moving a new deployment into production.

The ability of administrators to understand connectivity is equally enhanced with FC Ping and FC Traceroute, ensuring correct configurations in complex SAN environments, especially when multi-path comes into play. ESG Lab also confirmed that FDMI provides key information about QLogic HBAs. The combination of diagnostic tools and device-specific data provided by QLogic empowers administrators to rapidly configure and troubleshoot complex environments, enhancing reliability, reducing troubleshooting and downtime, and improving total cost of operations.

Performance and Scalability

To meet the performance and scalability needs of the enterprise virtualized data center, workloads need independent, reliable, and portable connections to the SAN. QLogic architected the Enhanced Gen 5 FC HBAs to include port virtualization and QoS. Port virtualization allows multiple virtual ports (vPorts) to share a single physical port, enabling each virtual machine (VM) to be assigned its own FC port. Once assigned, each vPort can be configured to have a guaranteed minimum performance.

QLogic’s implementation of NPIV provides administrators with the ability to configure 255 vPorts for each physical port. NPIV works in conjunction with both Microsoft Hyper-V and VMware, whereby administrators can assign a unique WWN to each guest VM. QoS levels are implemented using industry-standard CS_CTL-based frame prioritization and are enforced at the adapter, extending QoS from the fabric to the host. End-to-end QoS requires all components in the SAN fabric to support CS_CTL-based QoS.

Additionally, the FEC feature improves performance and link integrity to support higher end-to-end data rates by automatically recovering from transmission errors. FEC automatically detects and recovers from bit errors, which results in higher availability and performance.

Combined, port virtualization, CS_CTL-based QoS, FEC and BB-CR enable administrators to isolate VMs, applications, and workloads, ensuring no compromises in security and performance. Critical workloads can be assigned the highest priority, so that the data center can scale without compromising SLAs. Virtual ports and QoS can be changed on the fly, simplifying management in dynamic environments.

ESG Lab Testing

ESG Lab tested port virtualization and QoS using QLogic’s QCC to configure a dual-port Enhanced Gen 5 FC HBA (equivalent to O1CV760). In addition to the graphical user interface, the QCC also provides a command line interface. ESG Lab launched the graphical QCC and selected the HBA from the menu on the left-hand pane, and then clicked on the virtual tab, opening up the port virtualization configuration panel, as shown in Figure 14.

Figure 14. Configuring NPIV

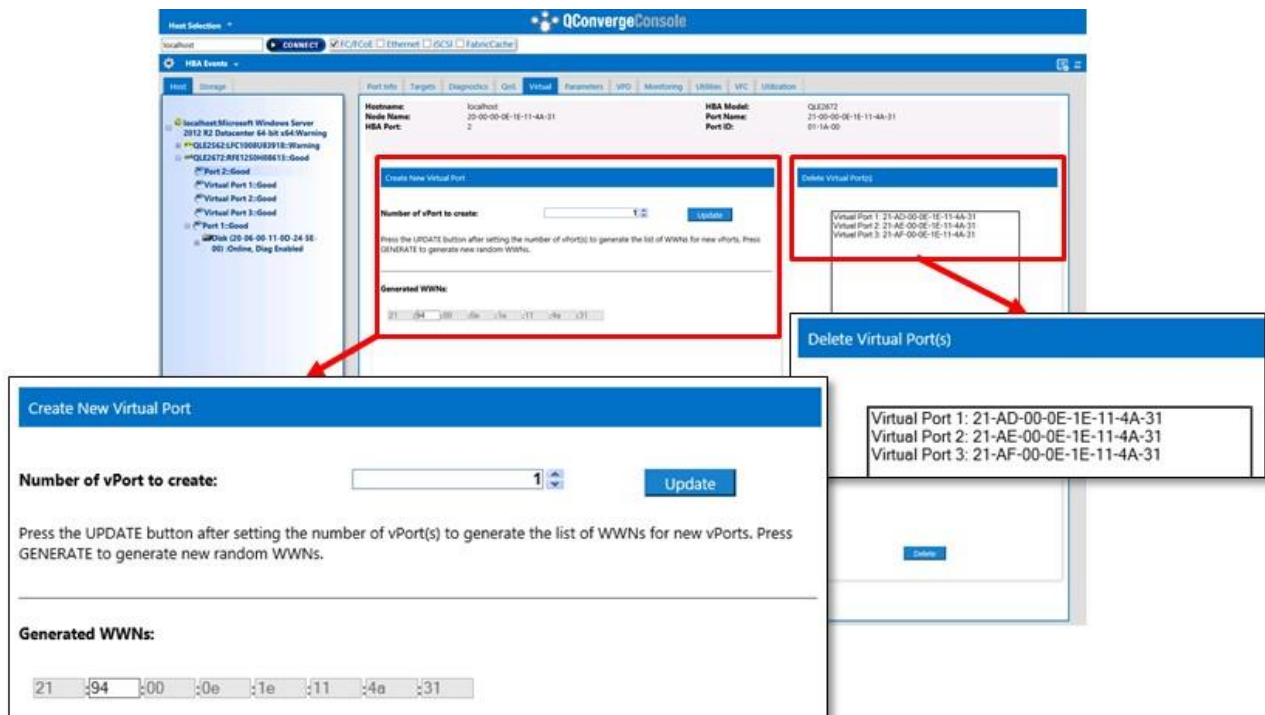

Virtual ports are configured on the left-hand side of the tab. Administrators can select the number of ports to create, from one to 255. Each vPort is assigned a new WWN based on the adapter’s existing WWN, by automatically incrementing the second octet of the WWN. The initial value of the octet can be set by entering a new value in the WWN field. ESG Lab entered three for the number of ports and AD for the initial value of the WWN octet for creating unique WWNs, and then clicked update to create the new vPorts.

The QCC then updated the list of active vPorts in a box on the right-hand side of the pane. As can be seen, the new vPorts’ WWNs start with the values 21-AD, 21-AE, and 21-AF. From this section, one or multiple vPorts can be selected and then deleted.

Once configured, the vPorts automatically register with the Fibre Channel fabric. ESG Lab next logged into the Brocade fabric switch using Brocade’s web interface. Clicking on the Name Server tab opened up the list of all nodes registered with the fabric (see Figure 15).

Figure 15. Nodes Registered in Fabric (NPIV)

Domain	User Port #	Port ID	Device Node WWN	Sequence N.	Tag	Device Type	Model	WWN Company ID	Port Type	Device Port WWN
1(0x1)	0	0x010000	10:00:00:20:c2:11:a6:65					TEXAS MEMORY SYSTEMS, INC	N	20:00:00:20:c2:11:a6:65
1(0x1)	1	0x010100	10:00:00:20:c2:11:a6:65					TEXAS MEMORY SYSTEMS, INC	N	20:04:00:20:c2:11:a6:65
1(0x1)	2	0x010200	10:00:00:20:c2:11:a6:65					TEXAS MEMORY SYSTEMS, INC	N	20:10:00:20:c2:11:a6:65
1(0x1)	3	0x010300	10:00:00:20:c2:11:a6:65					TEXAS MEMORY SYSTEMS, INC	N	20:0c:00:20:c2:11:a6:65
1(0x1)	4	0x010400	20:04:00:11:0d:2a:a0:00					SANBlaze Technology, Inc.	N	20:04:00:11:0d:2a:a0:00
1(0x1)	5	0x010500	20:06:00:11:0d:2a:4a:00					SANBlaze Technology, Inc.	N	20:06:00:11:0d:2a:4a:00
1(0x1)	6	0x010600	20:00:00:11:0d:5a:76:00					SANBlaze Technology, Inc.	N	20:00:00:11:0d:5a:76:00
1(0x1)	7	0x010700	20:08:00:11:0d:2b:0a:00					SANBlaze Technology, Inc.	N	20:08:00:11:0d:2b:0a:00
1(0x1)	8	0x010800	20:05:00:11:0d:2a:a1:00					SANBlaze Technology, Inc.	N	20:05:00:11:0d:2a:a1:00
1(0x1)	9	0x010900	20:01:00:11:0d:5a:77:00					SANBlaze Technology, Inc.	N	20:01:00:11:0d:5a:77:00
1(0x1)	10	0x010A00	20:03:00:11:0d:51:5d:00					SANBlaze Technology, Inc.	N	20:03:00:11:0d:51:5d:00
1(0x1)	11	0x010B00	20:02:00:11:0d:51:5c:00					SANBlaze Technology, Inc.	N	20:02:00:11:0d:51:5c:00
1(0x1)	12	0x010C00	20:07:00:11:0d:24:51:00					SANBlaze Technology, Inc.	N	20:07:00:11:0d:24:51:00
1(0x1)	13	0x010D00	20:05:00:11:0d:10:49:00					SANBlaze Technology, Inc.	N	20:05:00:11:0d:10:49:00
1(0x1)	14	0x010E00	20:02:00:11:0d:10:54:00					SANBlaze Technology, Inc.	N	20:02:00:11:0d:10:54:00
1(0x1)	15	0x010F00	20:03:00:11:0d:10:55:00					SANBlaze Technology, Inc.	N	20:03:00:11:0d:10:55:00
1(0x1)	16	0x011000	20:09:00:11:0d:2b:0b:00					SANBlaze Technology, Inc.	N	20:09:00:11:0d:2b:0b:00
1(0x1)	26	0x011A02	21:ae:00:0e:1e:11:4a:31					QLogic Corporation	NPIV	21:ae:00:0e:1e:11:4a:31
1(0x1)	26	0x011A01	21:ad:00:0e:1e:11:4a:31					QLogic Corporation	NPIV	21:ad:00:0e:1e:11:4a:31
1(0x1)	26	0x011A03	21:af:00:0e:1e:11:4a:31					QLogic Corporation	NPIV	21:af:00:0e:1e:11:4a:31
1(0x1)	26	0x011A00	20:00:00:0e:1e:11:4a:31					QLogic Corporation	Physical	21:00:00:0e:1e:11:4a:31
1(0x1)	27	0x011B00	20:00:00:0e:1e:11:55:e1					QLogic Corporation	N	21:00:00:0e:1e:11:55:e1
1(0x1)	28	0x011C00	20:06:00:11:0d:24:5e:00					SANBlaze Technology, Inc.	N	20:06:00:11:0d:24:5e:00
1(0x1)	29	0x011D00	20:00:00:11:0d:10:4c:00					SANBlaze Technology, Inc.	N	20:00:00:11:0d:10:4c:00
1(0x1)	30	0x011E00	20:04:00:11:0d:10:48:00					SANBlaze Technology, Inc.	N	20:04:00:11:0d:10:48:00
1(0x1)	31	0x011F00	20:08:00:11:0d:12:5c:00					SANBlaze Technology, Inc.	N	20:08:00:11:0d:12:5c:00

The physical port and the three vPorts and their associated WWNs appear in the fabric’s list of registered nodes. The fabric identifies the three vPorts as NPIV ports.

Next, ESG Lab configured QoS for the ports. Switching back to the QCC, ESG Lab selected QoS, opening up the quality of service configuration panel. At the top of the panel is a pulldown box, enabling the administrator to select between configuring QoS based on priority or bandwidth. By default, QoS is configured for transaction priority, as shown in Figure 16.

Figure 16. Quality of Service—Priority

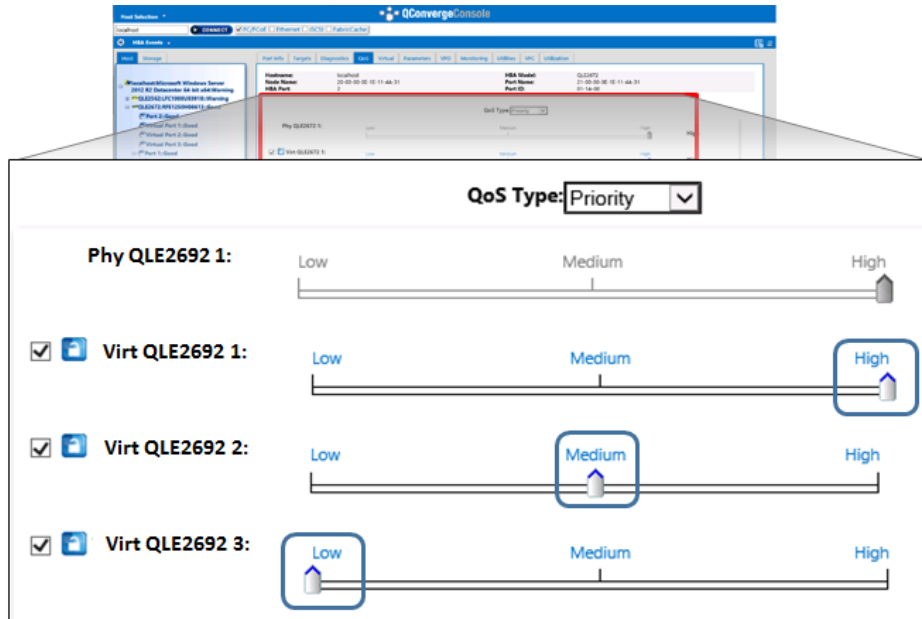

The configuration pane lists all available vPorts. Beside each port is a checkbox, which enables QoS for the port, and a slider, which configures the QoS level for the port (high, medium, low). The physical port always has high priority regardless of the priority or bandwidth scheme chosen for vPorts. For ports where QoS is not enabled, the default is low priority, also considered “best effort.”

ESG Lab enabled QoS for each vPort, and then used the slider to configure vPort 1 as high priority, vPort 2 as medium priority, and vPort 3 as low priority. Clicking the save button saved and applied the QoS configuration to the vPorts.

Next, ESG Lab used the pulldown to switch the QoS mode from priority to bandwidth, resulting in the configuration pane as shown in Figure 17.

Figure 17. Quality of Service—Bandwidth

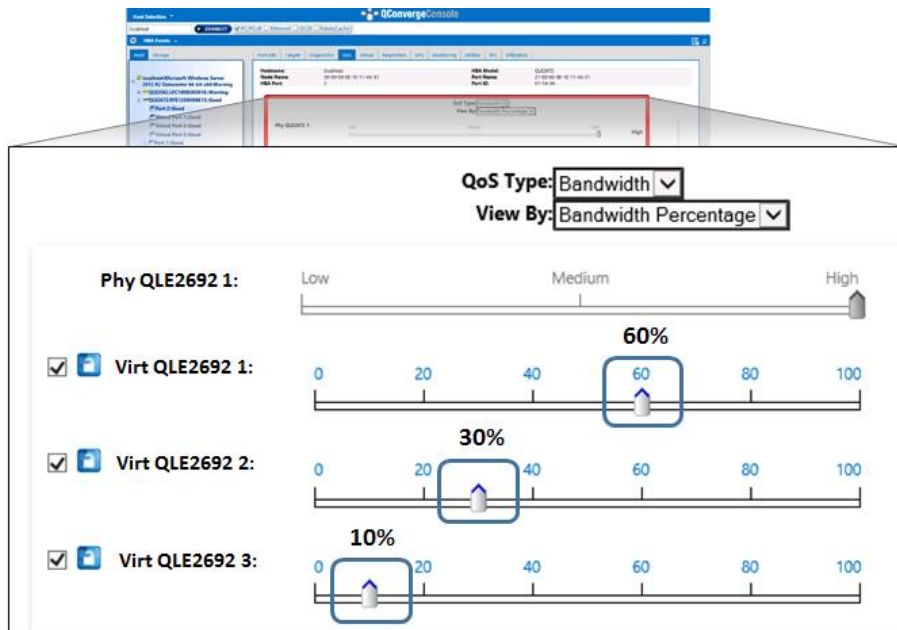

As with configuring QoS by priority, when configuring QoS by bandwidth, QoS can be individually enabled for each port. QoS levels can be configured by absolute values or by a percentage of total bandwidth available. The bandwidth method of providing QoS provides a minimum bandwidth guarantee, and bandwidth is not reserved in advance for a specific vPort. Instead, unused bandwidth is shared among all ports. If the application associated with the vPort requires more bandwidth and the physical port has available bandwidth, the application receives the additional bandwidth. Bandwidth limiting is only applied when there is contention.

ESG Lab used the view by pulldown to view and configure QoS by percentage. Using the sliders, vPort 1 was configured with a minimum guarantee of 60% of available bandwidth, vPort 2 was guaranteed 30%, and vPort 3 was guaranteed 10% of available bandwidth. Next, ESG Lab clicked the save button to save and apply the configuration to the vPorts.

Why This Matters

Because server virtualization touches the entire technology stack, all parts have to work in concert for the effective delivery of IT services. IT organizations are challenged to ensure virtual machine isolation and performance in the modern virtualized data center, where the number of VMs per host is rapidly increasing, and Fibre Channel is still the primary storage technology.

QLogic Enhanced Gen 5 FC HBAs embody technology advances that deliver improved performance and scalability capabilities for highly virtualized environments. This includes the ability to support 255 NPIV vPorts per physical port and to provide flexible QoS levels for every vPort. As a result, administrators can assign unique vPorts and WWNs to each VM, providing isolation and separation. QoS, in combination with vPorts, enables guaranteed performance to meet SLAs and support greater VM densities as workloads and environments scale with the business.

ESG Lab verified that administrators can use QLogic's QCC to rapidly and easily create and delete NPIV vPorts on the QLogic Enhanced Gen 5 FC HBA (01CV760). Once vPorts were configured, ESG Lab was able to assign and change QoS for each vPort, using either low/medium/high priority or percentage of available bandwidth. ESG Lab confirmed that QLogic Enhanced Gen 5 FC HBAs (01CV750/01CV760) empower organizations to support application and server QoS and SLAs while simultaneously providing isolation and the ability to scale.

ESG Lab Validation Highlights

- ☑ ESG Lab was able to easily pre-provision an Enhanced Gen 5 FC Adapter and quickly deploy it into an existing Brocade SAN environment by using dynamic fabric provisioning via Fabric-assigned Port Worldwide Name (FA-WWN) and Fabric-based Boot LUN Discovery (F-BLD).
- ☑ For large server deployments, FA-WWN and F-BLD can reduce the steps required to deploy servers by 30%, potentially reducing administrator time and effort by approximately 75%, freeing them to work on other projects.
- ☑ ESG Lab found that the reliability and diagnostic capabilities provided by ClearLink Diagnostics (D_Port), FC Ping, FC Traceroute, and Fabric Device Management Interface (FDMI) enabled fast identification and diagnosis of common, yet often hard to pinpoint SAN issues.
- ☑ Administrators can quickly identify network issues with Link Cable Beacons (LCB) and troubleshoot failing components faster with Read Diagnostic Parameters (RDP)—new QLogic StorFusion features that were not available at the time of this lab validation.
- ☑ Using QConvergeConsole (QCC) provided intuitive SAN topology views from link-level to device-specific.
- ☑ N_Port ID virtualization (NPIV) enabled the ability to configure up to 255 vPorts for each physical port and the ability to assign a unique WWN to each guest VM for security and performance.
- ☑ Using Class-specific Control (CS_CTL) QoS-enabled per-VM priority classification, it took just seconds to designate QoS levels for individual VMs, set either by priority of traffic, or allocated bandwidth.
- ☑ Forward Error Correction (FEC) automatically detects and recovers from bit errors, and Buffer-to-Buffer Credit Recovery (BB-CR) automatically recovers from loss of buffer credits, which can occur on long distance and lossy connections. Both of these StorFusion features result in higher availability and performance. (These are new StorFusion features that were not available at the time of this lab validation.)

Issues to Consider

- ☑ In order to take full advantage of the massive throughput provided by QLogic Enhanced Gen 5 FC, users should take care to size their server PCI bandwidth accordingly. A single 01CV760 dual-port HBA could drive more than 16Gb per second (16Gbps) of bidirectional throughput. This needs to be installed in a slot that is PCIe 2.0 x8-capable or PCIe 3.0 x4-capable to accommodate its full bandwidth.
- ☑ While RDP and LCB were not enabled during ESG Lab testing, you can learn more about these powerful features in this informative [technology brief](#).
- ☑ The FEC and BB-CR features were not enabled during ESG Lab testing, but you can learn more about how to enhanced performance and harness the power of QoS in this [technology brief](#).
- ☑ StorFusion features, as tested in this report, require Brocade Gen 5 FC switches with QLogic Enhanced Gen 5 FC (01CV750/01CV760) . Table 4 outlines each StorFusion feature with the compatible QLogic adapter and Brocade technical requirements.

Table 4. QLogic StorFusion/Brocade Compatibility Matrix

StorFusion Feature	Description	Lenovo Part Number	Brocade Requirements	Other Requirements
D_Port	ClearLink Diagnostic port support integration with Brocade	01CV750 01CV760	FOS 7.3.0a or higher; Brocade Fabric Vision License	Qualified 16Gb FC transceivers on both ends (server and switch)
FDMI Enhancements	Fabric Device Management Interface attributes	01CV750 01CV760	FOS 7.3.0a or higher	
FC Ping	Allows users to ping a		FOS 7.3.0a or higher	

	Fibre Channel N port or end device	01CV750 01CV760		
FC Traceroute	Obtains the path information between two F_Ports from the Fabric Configuration Server	01CV750 01CV760	FOS 7.3.0a or higher	
RDP	Read Diagnostic Parameters – provides additional diagnostic data	01CV750 01CV760	FOS 7.4x or higher	Qualified 16Gb FC transceivers on both ends (server and switch)
LCB	Link Cable Beaconsing – blink LEDs on both ends of the wire between HBA and switch	01CV750 01CV760	FOS 7.4x or higher	Qualified 16Gb FC transceivers on both ends (server and switch)
FA-WWN	Fabric-assigned Port World Wide Name	01CV750 01CV760	FOS 7.3.0a or higher	
F-BLD	Fabric-based Boot LUN Discovery	01CV750 01CV760	FOS 7.3.0a or higher	
QoS CS-CTL	Class-specific Control – Frames are prioritized depending on the value of the CS_CTL field in the FC frame header	01CV750 01CV760	FOS 7.3.0a or higher; CS_CTL-based QoS-enabled	
FEC	Forward Error Correction – improves performance & link integrity to support higher end-to-end data rates by auto recovering transmission errors	01CV750 01CV760	FOS 7.4x or higher	
BB-CR	Buffer-to-Buffer Credit Recovery – Improves performance and resiliency by automatically recovering from loss of buffer credits.	01CV750 01CV760	FOS 7.4x or higher	

The Bigger Truth

Increasing the use of server virtualization is still a strong IT priority in organizations surveyed by ESG. While server virtualization penetration continues to gain momentum, IT organizations still have numerous hurdles to overcome in order to deploy it more widely and move closer to a fully virtualized data center. When asked to identify their most important considerations when justifying IT investments, IT professionals and managers cited return on investment, business process improvement, and reduction of operational expenditures.²

As virtualized server environments continue to mature and VM densities increase, simplicity of deployment and management becomes as critical as performance. Fibre Channel solutions need to be virtualization-aware while delivering predictable performance.

ESG Lab hands-on testing has confirmed that the QLogic Enhanced Gen 5 FC HBAs can be pre-provisioned using FA-WWN and F-BLD to speed and simplify server and storage deployments. Identification and diagnosis of issues at the adapter and on the SAN were simplified using D_Port, FC Ping/Traceroute, and FDMI technology. Management was simple and straightforward for physical and virtual servers, whether using the standalone QLogic QConvergeConsole or Brocade Network Advisor.

ESG Lab was able to easily configure multiple vPorts for each physical port and set QoS levels that prioritized traffic for each vPort based on priority classification or network bandwidth. Implementing QoS in combination with vPorts enables guaranteed SLAs and the ability to support greater VM densities as workloads and environments scale over time.

QLogic has recognized the need to reduce complexity to better support highly virtualized and cloud environments and is accomplishing this by leveraging its partnership with Brocade to provide fabric-based pre-provisioning, advanced troubleshooting and diagnostics, and virtualization-aware SAN quality of service.

QLogic Enhanced Gen 5 FC HBAs are designed to take advantage of the latest I/O virtualization techniques while providing the rock-solid reliability and performance that has made Fibre Channel the mainstay of the enterprise data center. ESG Lab found that deploying QLogic HBAs with Brocade Fibre Channel switches enables administrators to implement fabric pre-provisioning (FA-WWN and F-BLD), which significantly streamlines deployment and management of data center Fibre Channel environments. The solution is also engineered to address the parallel IT concerns of reducing operational expenses, process improvement, and overall ROI. Organizations that are deploying or managing Fibre Channel SANs would be well served to take a closer look at the QLogic Enhanced Gen 5 FC HBAs (Lenovo part numbers 01CV750/01CV760.)

² Source: ESG Research Report, [2016 IT Spending Intentions Survey](#), to be published.

Appendix

Table 5. ESG Lab Test Bed

Hardware	
Server	Industry Standard X64 Server
Storage	IBM FlashSystem RamSan, SANBlaze GLF
HBA	(1) QLogic 2690 Series 16Gb Enhanced Gen 5 Fibre Channel HBA (dual-port model QLE2692)
SAN	Brocade 6510 48-port Gen 5 Fibre Channel Switch, Fabric OS 7.3.1b/7.4.0a and higher
Software	
OS	Windows Server 2012, Standard Edition (64-bit)



Enterprise Strategy Group | **Getting to the bigger truth.**