



**MANTAGUA**  
Led Lighting Innovations



**2022**



## CONCEPTEUR ET FABRICANT D'ÉCLAIRAGES À LED POUR BATEAUX BOATS LED LIGHTING DESIGNER AND MANUFACTURER

Constructeur historique d'électronique fondé en 1974, BREIZELEC conçoit et fabrique depuis 2005 des feux de navigation et de l'éclairage à LED sous la marque MANTAGUA. Nous appliquons notre expérience et notre savoir-faire pour équiper de la tête de mât aux coursives les chalutiers, les navires militaires, les bateaux de compétition ou de plaisance. Proche de nos clients et à leur écoute, nos équipes développent de nouveaux produits et assurent un service après-vente réactif. Retrouvez toute notre gamme chez nos revendeurs partenaires partout en France, à l'international et sur [www.MANTAGUA.fr](http://www.MANTAGUA.fr).

Historic electronics manufacturer founded in 1974, BREIZELEC designs and manufactures navigation lights and LED lighting under the brand MANTAGUA since 2005. We apply our experience and know-how to equip trawlers, military vessels, competition or pleasure boats from masthead to gangways. Close to our customers and attentive to their needs, our teams develop new products and provide a reactive after-sales service. You can find our full range of products in our dealerships in France and abroad and on our website [www.MANTAGUA.fr](http://www.MANTAGUA.fr).



La conception et fabrication des produits Mantagua a été certifiée ISO 9001 par DNV-GL en 2018  
Design & manufacturing of Mantagua's product has been certified ISO 9001 by DNV-GL in 2018.



Nos feux de mât ne perturbent pas l'AIS et la VHF. Ils ont été certifiés CE en 2016 par un laboratoire indépendant et répondent à la norme IEC 60945 4e Édition 2002-08 selon le rapport 204009 EMC Ed. 1.2  
Our mast navigation lights don't interfere with VHF and AIS. They have been CE certified in 2016 by an independent laboratory and comply to the IEC 60945 4th Edition 2002-08 as per the report 204009 EMC Ed. 1.2.



SUIVEZ NOUS SUR



FOLLOW US ON

[www.mantagua.fr](http://www.mantagua.fr)



## PROFESSIONNEL / PROFESSIONAL

Réglettes étanches / Waterproof slim luminaires.....	5
Tubes LED étanches / Waterproof LED Tubes .....	6
Panneaux à LED / LED panels.....	7
Plafonniers salle machine & coursive / Technical luminaires .....	8
Projecteurs étanches / Waterproof floodlights.....	12
Projecteurs de recherche / Searchlights.....	16
STARCOM amplificateur NMEA / NMEA buffer STARCOM.....	17



## NAVIGATION / NAVIGATION

Feux NAVIPRO avec pied / NAVIPRO with foot.....	21
Feux NAVIPRO superposés / Double lens NAVIPRO .....	22
Feux NAVIPRO plat pont/ Horizontal deck NAVIPRO.....	24
Feux NAVIPRO voile/ Sailing NAVIPRO .....	25
Feux résinés / Epoxy resin navigation lights.....	26
Feux de compétition résinés / Racing epoxy resin navigation lights ....	30
Feux classiques / Classical navigation lights.....	31
Ampoules de feux de navigation / Navigation lights bulbs.....	32



## EXTÉRIEUR / EXTERNAL

Lampes de courtoisie / Courtesy lights .....	34
Réglettes de Bôme ou Bimini / Lighting for Boom or Bimini.....	35
Eclairages autonomes / Wireless lightings .....	35
Projecteurs de Barre de Flèche / Spreader spotlights.....	36
Projecteurs Pont & Cockpit / Deck & Cockpit floodlights .....	37
Combinés Hune et Pont / Combined Masthead & Deck lights.....	38



## INTÉRIEUR / CABIN

Spots et plafonniers / Ceiling lights.....	41
Liseuses / Adjustable spotlights.....	46
Lampes de table à cartes / Chart Table Lamp.....	50
Réglettes / Tube lights .....	51
Ampoules / Light bulbs .....	53
Profils pour ruban / Profiles for led strip.....	57
Rubans à LED / LED Strips.....	58
Accessoires électriques / Electrical accessories .....	61





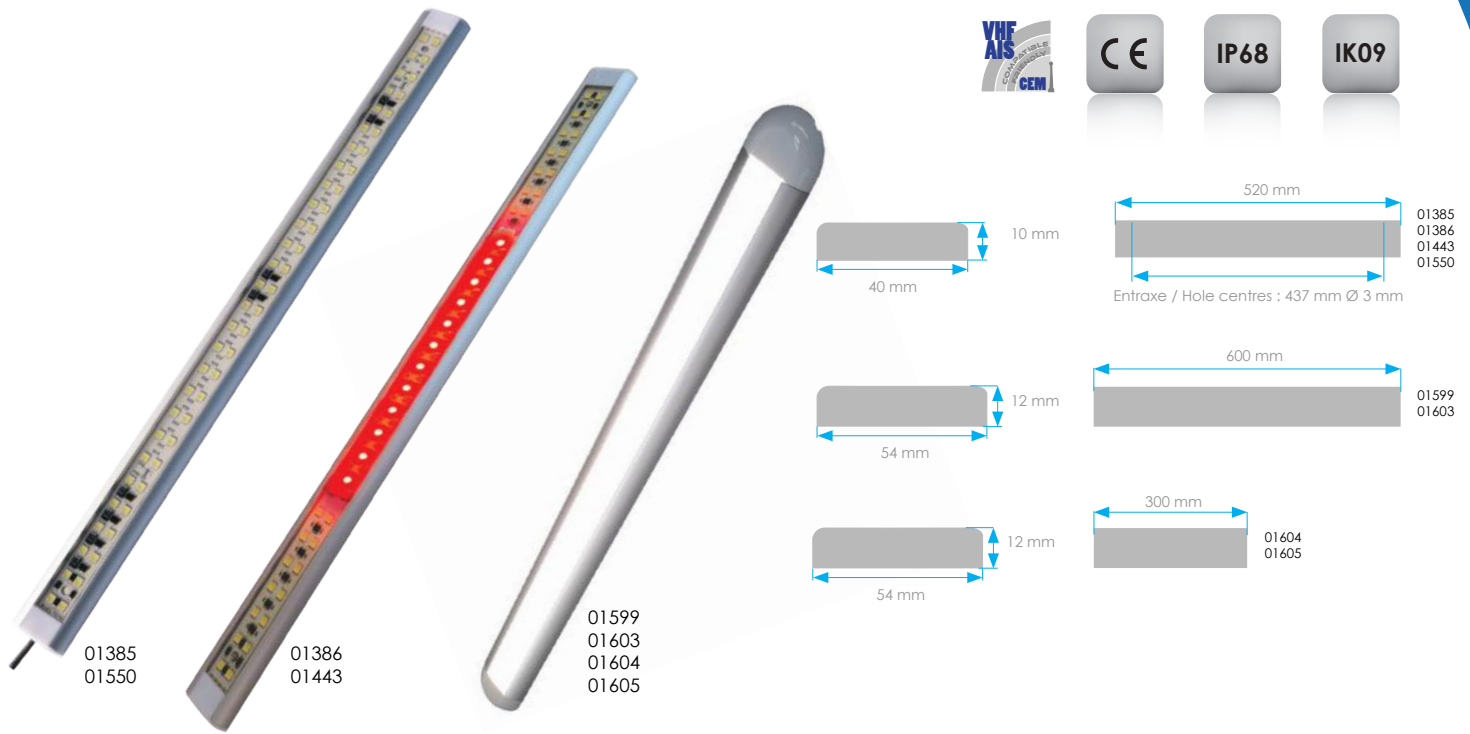

### Descriptif technique :

Forte puissance dans un faible encombrement, idéal pour l'éclairage des zones étroites. En version rouge et blanche, avec ou sans interrupteur, Kerguelen est idéale pour l'éclairage de votre passerelle. Fixation par 2 vis en face avant. Polarité électrique indifférente. Faible consommation électrique. Supporte les températures de -20°C à +55°C. Fixation en saillie. Livré avec 1m de fil électrique dénudé\*.

\*(sauf 1599,1603, 01604 et 01605)

### Description:

High power for a slim waterproof appliance, ideal for narrow areas lighting. In its red & white version, with or without switch, Kerguelen is ideal to illuminate your deck at night. Fastening by 2 screws. Reverse polarity protected. Low consumption. Withstands temperatures from -20°C to +55°C. External mounting. Supplied with 1m of electrical wire\*.

\*(except 01599,01603,01604,01605)

	Description Description	Alim. Voltage	Puissance Power	Couleur Colour	Matériau Material	Poids Weight	Angle Angle	Conso. Cons.	Réf. Ref.
4500 K	Sans inter. - Blanc White - No switch	10-30 VDC	800 lm	4500 K Blanc neutre 4500 K Neutral White	Alu.+ PMMA Alu.& PMMA	450 g	120°	13,5 W	01599
4500 K	Avec inter.- Blanc White With switch	10-30 VDC	800 lm	4500 K Blanc neutre 4500 K Neutral White	Alu.+ PMMA Alu.& PMMA	450 g	120°	13,5 W	01603
4500 K	Sans inter. - Blanc White - No switch	10-30 VDC	550 lm	4500 K Blanc neutre 4500 K Neutral White	Alu.+ PMMA Alu.& PMMA	225 g	120°	9 W	01604
4500 K	Avec inter.- Blanc White With switch	10-30 VDC	550 lm	4500 K Blanc neutre 4500 K Neutral White	Alu.+ PMMA Alu.& PMMA	225 g	120°	9 W	01605
4500 K	Sans inter. - Blanc White - No switch	24-30 VDC	800 lm	4500 K Blanc neutre 4500 K Neutral White	Alu.+ PMMA Alu.& PMMA	715 g	120°	7 W	01385
3100 K	Sans inter. - Blanc White - No switch	12 VDC	800 lm	3100 K Blanc chaud 3100 K Warm White	Alu.+ PMMA Alu.& PMMA	715 g	120°	7 W	01550
4500 K	Sans inter. - Blanc et rouge White & Red No switch	24-30 VDC	800 lm	4500 K Blanc neutre + Rouge 4500 K Neutral White + Red	Alu.+ PMMA Alu.& PMMA	715 g	120°	7 W	01386
3100 K	Sans inter. - Blanc et rouge White & Red No switch	24-30 VDC	800 lm	3100 K Blanc chaud + Rouge 3100 K Warm White + Red	Alu.+ PMMA Alu.& PMMA	715 g	120°	7 W	01443

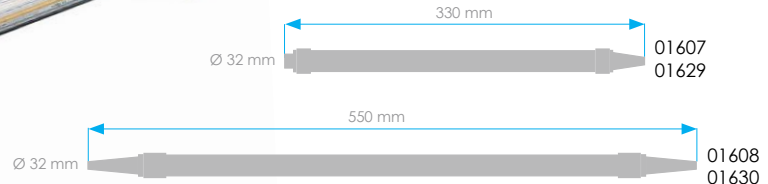

	Description Description	Alim. Voltage	Puissance Power	Couleur Colour	Matériau Material	Dimensions Dimensions	Angle Angle	Conso. Cons.	Temp. Temp.	Réf. Ref.
4000 K	Tube LED 330 mm 330 mm LED Tube	22-30 VDC	500 lm	4000 K Blanc neutre 4000 K Neutral white	PMMA + POM PMMA + POM	Ø 32 mm L 330 mm	120°	4 W	- 25°C + 55°C	01607
4000 K	Tube LED 550 mm 550 mm LED Tube	22-30 VDC	850 lm	4000 K Blanc neutre 4000 K Neutral white	PMMA + POM PMMA + POM	Ø 32 mm L 550 mm	120°	7,7 W	- 25°C + 55°C	01608
4000 K	Tube LED 550 mm 550 mm LED Tube	230 VAC	850 lm	4000 K Blanc neutre 4000 K Neutral white	PMMA + POM PMMA + POM	Ø 32 mm L 550 mm	120°	7,7 W	- 25°C + 55°C	01630
4000 K	Tube LED 550 mm 550 mm LED Tube	230 VAC	1200 lm	4000 K Blanc neutre 4000 K Neutral white	PMMA + POM PMMA + POM	Ø 32 mm L 550 mm	120°	7,7 W	- 25°C + 55°C	01642
4000 K	Option secours Emergency lighting	22-30 VDC	140 lm	4000 K Blanc neutre 4000 K Neutral white	-	-	-	-	-	01611

### Descriptif technique :

Forte puissance dans un faible encombrement. Idéal pour l'éclairage de votre passerelle ou de grandes longueurs par raccordement en guirlande\*. Fixation par 2 colliers (vis M5 non fournies). Polarité électrique indifférente. Faible consommation électrique. Borner à vis étanche pour câbles de 6mm à 9mm de diamètre.

\* jusqu'à 5 tubes successifs, au delà nous contacter.

### Description:

Compact, high powered and space saving. Ideal to illuminate your deck or long halls by daisy chaining\*. Fastening by 2 brackets (M5 screws not supplied). Reverse polarity protected. Low consumption. Waterproof connector for 6mm to 9mm diameter cables.

\* Up to 5 tubes in series, above please call us.



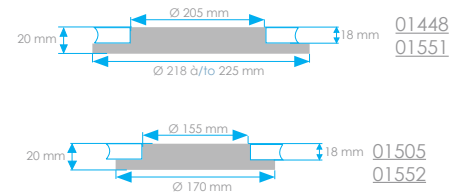
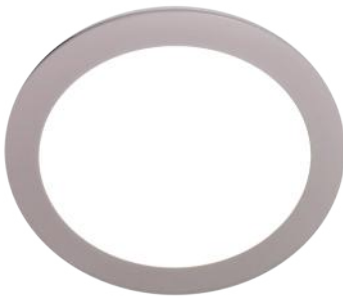

**Descriptif technique :**

PENFRET est un plafonnier rond **encastré** conçu pour l'éclairage intérieur des **coursives et pièces de vie** sur les navires de commerce. Fourni avec driver. Montage encastré aisé par 2 ressorts.

**Description :**

PENFRET is a circular **recessed** downlight ideal for the internal area lighting like merchant ships **gangways and dining rooms**. Supplied with its led driver. Easy recessed mounting with the 2 springs.

	Description Description	Alim. Voltage	Puissance Power	Couleur Colour	Matériau Material	Poids Weight	Angle Angle	Conso. Cons.	Temp. Temp.	Réf. Ref.
4000 K	Plafonnier rond 18W 18W Downlight	225-260 VAC	1500 lm	4000 K Blanc neutre 4000 K Neutral white	Aluminium + PMMA	450 g	120°	18 W	- 25°C + 55°C	01448
4000 K	Plafonnier rond 18W 18W Downlight	24 VDC	1500 lm	4000 K Blanc neutre 4000 K Neutral white	Aluminium + PMMA	450 g	120°	18 W	- 25°C + 55°C	01551
4000 K	Plafonnier rond 12W 12W Downlight	225-260 VAC	800 lm	4000 K Blanc neutre 4000 K Neutral white	Aluminium + PMMA	300 g	120°	12 W	- 25°C + 55°C	01505
4000 K	Plafonnier rond 12W 12W Downlight	24 VDC	800 lm	4000 K Blanc neutre 4000 K Neutral white	Aluminium + PMMA	300 g	120°	12 W	- 25°C + 55°C	01552



Ultra fin 9mm (\*sauf 01616 & 01661)  
Ultra thin 9mm (\*except 01616 & 01661)

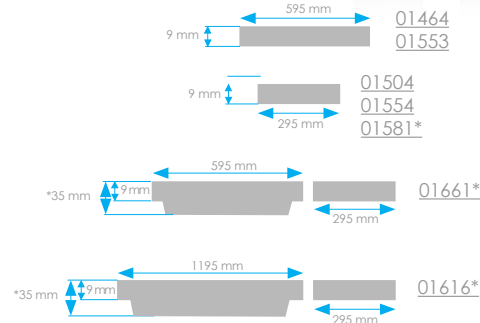

**Descriptif technique :**

CHAUSEY est un plafonnier carré monté **en saillie ou encastré** conçu pour l'éclairage intérieur des **coursives et pièces de vie** sur les navires de commerce. Fourni avec driver. Fixation par 4 vis à tête plate et 4 capuchons fournis. \*\*01581 est la version dimmable de 01504.

**Description:**

CHAUSEY is a square **surface mounted or recessed** downlight ideal for the internal area lighting like merchant ships **gangways and dining rooms**. Supplied with its led driver. Easy to install with 4 screws and 4 supplied covering taps. \*\*01504 can be dimmed by ordering 01581 instead.

	Description Description	Alim. Voltage	Puissance Power	Couleur Colour	Matériau Material	Poids Weight	Angle Angle	Conso. Cons.	Temp. Temp.	Réf. Ref.
4000 K	Plafonnier carré 40W 40W square Downlight	115-260 VAC	3000 lm	4000 K Blanc neutre 4000 K Neutral white	ABS + PMMA	450 g	120°	40 W	- 25°C + 55°C	01464
4000 K	Plafonnier carré 40W 40W square Downlight	24 VDC	3000 lm	4000 K Blanc neutre 4000 K Neutral white	ABS + PMMA	450 g	120°	40 W	- 25°C + 55°C	01553
4000 K	Plafonnier carré 20W 20W square Downlight	115-260 VAC	1500 lm	4000 K Blanc neutre 4000 K Neutral white	ABS + PMMA	350 g	120°	20 W	- 25°C + 55°C	01504 (01581*)
4000 K	Plafonnier carré 20W 20W square Downlight	24 VDC	1500 lm	4000 K Blanc neutre 4000 K Neutral white	ABS + PMMA	350 g	120°	20 W	- 25°C + 55°C	01554
4000 K	Plafonnier rectangle 40W 40W Downlight	115-260 VAC	3000 lm	4000 K Blanc neutre 4000 K Neutral white	ABS + PMMA	450 g	120°	40 W	- 25°C + 55°C	01616*
4000 K	Plafonnier rectangle 24W 24W Downlight	115-260 VAC	2000 lm	4000 K Blanc neutre 4000 K Neutral white	ABS + PMMA	450 g	120°	24 W	- 25°C + 55°C	01661*



Interrupteur variateur rotatif  
Rotary dimmer switch

01582

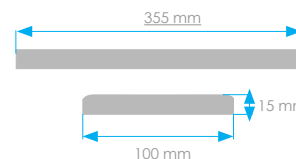

Facile à installer  
Easy to install

**Descriptif technique :**

**Robuste et économe en énergie, le JERSEY est idéal pour l'éclairage des salles machine de moyenne taille.** Fixation arrière par vis. Matière : PC et ABS classés UL94 V0 certifiant la non inflammabilité des matériaux. Étanche IP67. Interrupteur et gradateur possibles (01653). Fourni avec 4 vis de fixation et 1 mètre de câble. Longueur de câble supplémentaire disponible en option (rèf. 01720). Eclairage de secours 24 VDC disponible (01685, 01686, 01693). Supporte les températures de -25°C à +70°C.

**Description :**

**Its very low consumption and robustness make JERSEY the perfect light for the medium size engine room.** Rear fixing by screws. Made in PC and ABS, UL94 V0 very low flammability classified. IP67 waterproof. Switch and dimmer available (01653). Supplied with 4 mounting screws and 1 meter cable. Additional cable length available as an option (ref. 01720). Emergency lighting in 24 VDC available (01685, 01686, 01693). Withstands temperatures from -25°C to +70°C.

	Alim. Voltage	Hertz Hertz	Description Description	Puissance Power	Couleur Colour	Matériau Material	Poids Weight	Angle Angle	Conso. Cons.	Réf. Ref.
	24-30 VDC	-	Plafonnier 10W 10W Downlight	1600 lm	4500 K Blanc neutre 4500 K Neutral white	PC+ ABS PC & ABS	290 g	120°	10W	01644
	24-30 VDC	-	Plafonnier 10W avec inter.+gradateur 10W Downlight with switch & dimmer	1600 lm	4500 K Blanc neutre 4500 K Neutral white	PC+ ABS PC & ABS	290 g	120°	10W	01653
	24-30 VDC	-	Plafonnier 10W avec secours 10W Downlight with backup	1600 lm	4500 K Blanc neutre 4500 K Neutral white	PC+ ABS PC & ABS	290 g	120°	10W	01686
	225-260 VAC	50Hz	Plafonnier 10W 10W Downlight	1600 lm	4500 K Blanc neutre 4500 K Neutral white	PC+ ABS PC & ABS	290 g	120°	10W	01643
	225-260 VAC	50Hz	Plafonnier 10W avec secours 10W Downlight with backup	1600 lm	4500 K Blanc neutre 4500 K Neutral white	PC+ ABS PC & ABS	290 g	120°	10W	01685
	225-260 VAC	60Hz	Plafonnier 10W 10W Downlight	1600 lm	4500 K Blanc neutre 4500 K Neutral white	PC+ ABS PC & ABS	290 g	120°	10W	01692
	225-260 VAC	60Hz	Plafonnier 10W avec secours 10W Downlight with backup	1600 lm	4500 K Blanc neutre 4500 K Neutral white	PC+ ABS PC & ABS	290 g	120°	10W	01693





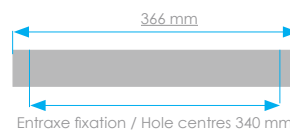

### Descriptif technique :

**Robuste et économe en énergie, le KELLER est idéal pour l'éclairage des salles machine de moyenne taille.** Fixation arrière par vis extérieures au bâti. Matière : PC et ABS classés UL94 V0 certifiant la non inflammabilité des matériaux. Fourni avec 2 presse-étoupe et 2 vis de fixation. Disponible avec éclairage de secours blanc neutre 24 VDC avec presse-étoupe supplémentaire (01721, 01722, 01723, 01724, 01725, 01726). Supporte les températures de -25°C à +70°C.

### Description :

**Its very low consumption and robustness make KELLER the perfect light for the medium size engine room.** Fitting by 2 holes outside the light body. Made in PC and ABS UL94 V0 very low flammability classified. Supplied with 2 cable glands and 2 mounting screws. Available with emergency lighting in 24 VDC with additional cable gland (01721, 01722, 01723, 01724, 01725, 01726). Withstands temperatures from -25°C to +70°C..

	Alim. Voltage	Hertz Hertz	Description Description	Puissance Power	Couleur Colour	Matériau Material	Poids Weight	Angle Angle	Conso. Cons.	Réf. Ref.
	24-30 VDC	-	Plafonnier 28W 28W Downlight	2000 lm	4500 K Blanc neutre 4500 K Neutral white	PC+ ABS PC & ABS	625 g	120°	15W	01358
	24-30 VDC	-	Plafonnier 28W avec secours 28W Downlight with backup	2000 lm	4500 K Blanc neutre 4500 K Neutral white	PC+ ABS PC & ABS	625 g	120°	15W	01722
	225-260 VAC	50Hz	Plafonnier 28W 28W Downlight	2000 lm	4500 K Blanc neutre 4500 K Neutral white	PC+ ABS PC & ABS	625 g	120°	13W	01357
	225-260 VAC	50Hz	Plafonnier 28W avec secours 28W Downlight with backup	2000 lm	4500 K Blanc neutre 4500 K Neutral white	PC+ ABS PC & ABS	625 g	120°	13W	01721
	225-260 VAC	60Hz	Plafonnier 28W 28W Downlight	2000 lm	4500 K Blanc neutre 4500 K Neutral white	PC+ ABS PC & ABS	625 g	120°	13W	01680
	225-260 VAC	60Hz	Plafonnier 28W avec secours 28W Downlight with backup	2000 lm	4500 K Blanc neutre 4500 K Neutral white	PC+ ABS PC & ABS	625 g	120°	13W	01725
	24-30 VDC	-	Plafonnier Rouge Red Downlight	1000 lm	Rouge / Red	PC+ ABS PC & ABS	625 g	120°	15W	01376
	24-30 VDC	-	Plafonnier Rouge avec secours Red Downlight with backup	1000 lm	Rouge / Red	PC+ ABS PC & ABS	625 g	120°	15W	01724
	225-260 VAC	50Hz	Plafonnier Rouge Red Downlight	1000 lm	Rouge / Red	PC+ ABS PC & ABS	625 g	120°	22W	01359
	225-260 VAC	50Hz	Plafonnier Rouge avec secours Red Downlight with backup	1000 lm	Rouge / Red	PC+ ABS PC & ABS	625 g	120°	22W	01723
	225-260 VAC	60Hz	Plafonnier Rouge Red Downlight	1000 lm	Rouge / Red	PC+ ABS PC & ABS	625 g	120°	22W	01681
	225-260 VAC	60Hz	Plafonnier Rouge avec secours Red Downlight with backup	1000 lm	Rouge / Red	PC+ ABS PC & ABS	625 g	120°	22W	01726

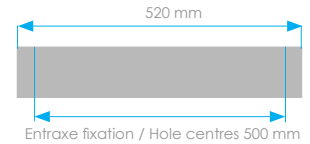
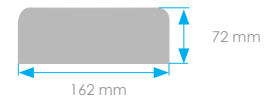

**Descriptif technique :**

Robuste et économe en énergie, le CARN est idéal pour l'éclairage des salles machine de moyenne et grande taille ou des coursives. Fixation arrière par vis extérieures au bâti (fournies). Matière: PC et ABS classés UL94 V0 certifiant la non inflammabilité des matériaux. Fourni avec 2 presse-étoupes. Disponible avec éclairage de secours blanc neutre 24 VDC et presse-étoupe supplémentaire (01727, 01728, 01729, 01730, 01731, 01732). Supporte les températures de -25°C à +80°C.

**Description :**

Its very low consumption and robustness make CARN the perfect light for the medium and large engine rooms and gangways. Fitting by 2 holes outside the light body (screws supplied). Made in PC and ABS UL94 V0 very low flammability classified. Supplied with 2 cable glands. Available with emergency lighting in 24 VDC with additional cable gland (01727, 01728, 01729, 01730, 01731, 01732). Withstands temperatures from -25°C to +80°C

	Alim. Voltage	Hertz Hertz	Description Description	Puissance Power	Couleur Colour	Matériau Material	Poids Weight	Angle Angle	Conso. Cons.	Réf. Ref.
	24-30 VDC	-	Plafonnier 36 W 36 W Downlight	3000 lm	4500 K Blanc neutre 4500 K Neutral white	PC+ ABS PC & ABS	890 g	120°	23 W	01589
	24-30 VDC	-	Plafonnier 36 W avec secours 36 W Downlight with backup	3000 lm	4500 K Blanc neutre 4500 K Neutral white	PC+ ABS PC & ABS	890 g	120°	23 W	01727
	225-260 VAC	50Hz	Plafonnier 36 W 36 W Downlight	3000 lm	4500 K Blanc neutre 4500 K Neutral white	PC+ ABS PC & ABS	890 g	120°	18 W	01590
	225-260 VAC	50Hz	Plafonnier 36 W avec secours 36 W Downlight with backup	3000 lm	4500 K Blanc neutre 4500 K Neutral white	PC+ ABS PC & ABS	890 g	120°	18 W	01728
	225-260 VAC	60Hz	Plafonnier 36 W 36 W Downlight	3000 lm	4500 K Blanc neutre 4500 K Neutral white	PC+ ABS PC & ABS	890 g	120°	18 W	01678
	225-260 VAC	60Hz	Plafonnier 36 W avec secours 36 W Downlight with backup	3000 lm	4500 K Blanc neutre 4500 K Neutral white	PC+ ABS PC & ABS	890 g	120°	18 W	01731
	225-260 VAC	50Hz	Plafonnier 36 W 36 W Downlight	3000 lm	3000 K Blanc chaud 3000 K Warm white	PC+ ABS PC & ABS	890 g	120°	18 W	01675
	225-260 VAC	50Hz	Plafonnier 36 W avec secours 36 W Downlight with backup	3000 lm	3000 K Blanc chaud 3000 K Warm white	PC+ ABS PC & ABS	890 g	120°	18 W	01730
	225-260 VAC	60Hz	Plafonnier 36 W (60 Hz) 36 W (60 Hz) Downlight	3000 lm	3000 K Blanc chaud 3000 K Warm white	PC+ ABS PC & ABS	890 g	120°	18 W	01679
	225-260 VAC	60Hz	Plafonnier 36 W (60 Hz) avec secours 36 W (60 Hz) Downlight with backup	3000 lm	3000 K Blanc chaud 3000 K Warm white	PC+ ABS PC & ABS	890 g	120°	18 W	01732
	110-230 VAC	50/60 Hz	Plafonnier Dimmable 36 W (50/60 Hz) 36 W (50/60 Hz) Dimmable Downlight	3000 lm	4500 K Blanc neutre 4500 K Neutral white	PC+ ABS PC & ABS	890 g	120°	18 W	01671
	110-230 VAC	50/60 Hz	Plafonnier Dimmable 36 W (50/60 Hz) avec secours 36 W (50/60 Hz) Dimmable Downlight with backup	3000 lm	4500 K Blanc neutre 4500 K Neutral white	PC+ ABS PC & ABS	890 g	120°	18 W	01729

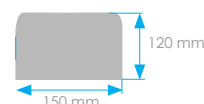
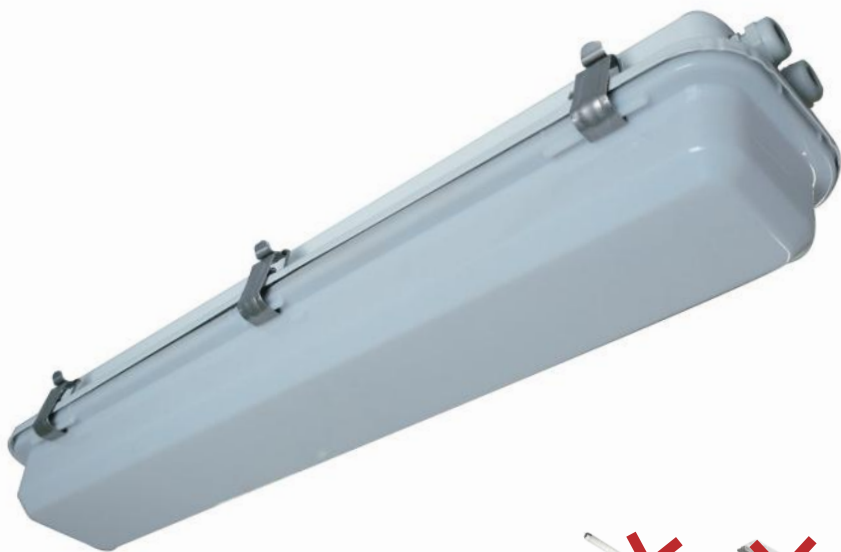

**Descriptif technique :**

Avec son corps INOX 316L peint et ses ferrures inox, SIECK est notre plafonnier conçu pour l'éclairage extérieur ou sous ponts couverts. Grâce à sa verrière blanche transparente, l'éclairage est uniforme et les points lumineux des leds sont masqués. Fixation intérieure par 2 vis (non fournies). Matière : INOX 316L et PMMA blanc transparent. Fourni avec 2 presses-étoupe. Eclairage de secours 24 VDC ou 230 VAC disponible en option. Supporte les températures de -25°C à +70°C.

**Description:**

With its 316L Stainless Steel Body and fastenings, SIECK is ideal for the external area lighting of gangways or semi-open decks. The transparent white cover provides a uniform lighting and hides the leds. Fitting by 2 holes inside the light body (screws not supplied). Made in Stainless Steel and transparent white PMMA. Supplied with 2 cable glands. Optional backup lighting in 24 VDC or 230 VAC available. Withstands temperatures from -25°C to +70°C

	Alim. Voltage	Hertz Hertz	Description Description	Puissance Power	Couleur Colour	Matériau Material	Poids Weight	Angle Angle	Conso. Cons.	Réf. Ref.
	24-30 VDC	-	Plafonnier INOX 36W 36W S/S Downlight	3000 lm	4500 K Blanc neutre 4500 K Neutral white	Inox + PMMA Stainless Steel & PMMA	1900 g	120°	23 W	01406
	225-260 VAC	50 Hz	Plafonnier INOX 36W 36W S/S Downlight	3000 lm	4500 K Blanc neutre 4500 K Neutral white	Inox + PMMA Stainless Steel & PMMA	1900 g	120°	18 W	01407
	225-260 VAC	60 Hz	Plafonnier INOX 36W 36W S/S Downlight	3000 lm	4500 K Blanc neutre 4500 K Neutral white	Inox + PMMA Stainless Steel & PMMA	1900 g	120°	18 W	01682
	24-30 VDC	-	Option secours Backup lighting option	140 lm	4500 K Blanc neutre 4500 K Neutral white	-	-	-	3,9 W	01341





Ref. 01534  
Ref. 01535



Ref. 01743  
Ref. 01744

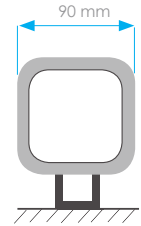
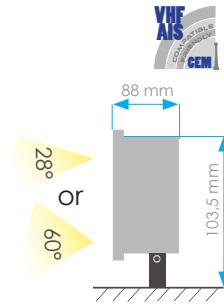

24 W

Ref. 01536  
Ref. 01537



Ref. 01676  
Ref. 01677

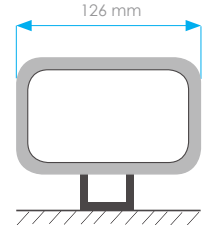
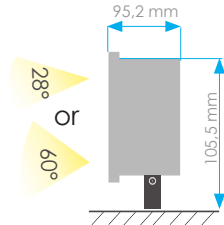

36 W

Ref. 01538  
Ref. 01539



Ref. 01745  
Ref. 01746

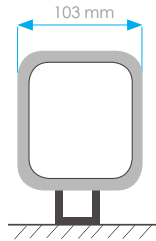
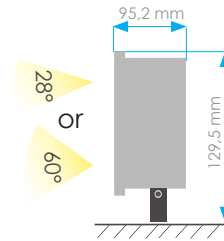

43 W

Ref. 01540  
Ref. 01541



Ref. 01747  
Ref. 01748

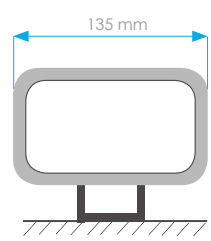
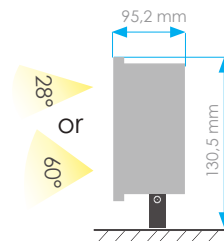

55 W

	Description Description	Alim. Voltage	Puissance Power	Couleur Colour	Matériau Material	Angle Angle	Conso. Cons.	Blanc White	Noir Black
	Projecteur Floodlight	9-30 VDC	2500 lm	4000 K Blanc neutre 4000 K Neutral white	Aluminium + Inox Aluminium + S.S	28°	24 W	01534	01743
	Projecteur Floodlight	9-30 VDC	2500 lm	4000 K Blanc neutre 4000 K Neutral white	Aluminium + Inox Aluminium + S.S	60 °	24 W	01535	01744
	Projecteur Floodlight	9-30 VDC	3800 lm	4000 K Blanc neutre 4000 K Neutral white	Aluminium + Inox Aluminium + S.S	28°	36 W	01536	01676
	Projecteur Floodlight	9-30 VDC	3800 lm	4000 K Blanc neutre 4000 K Neutral white	Aluminium + Inox Aluminium + S.S	60 °	36 W	01537	01677
	Projecteur Floodlight	9-30 VDC	4100 lm	4000 K Blanc neutre 4000 K Neutral white	Aluminium + Inox Aluminium + S.S	28°	43 W	01538	01745
	Projecteur Floodlight	9-30 VDC	4100 lm	4000 K Blanc neutre 4000 K Neutral white	Aluminium + Inox Aluminium + S.S	60 °	43 W	01539	01746
	Projecteur Floodlight	9-30 VDC	5200 lm	4000 K Blanc neutre 4000 K Neutral white	Aluminium + Inox Aluminium + S.S	28°	55 W	01540	01747
	Projecteur Floodlight	9-30 VDC	5200 lm	4000 K Blanc neutre 4000 K Neutral white	Aluminium + Inox Aluminium + S.S	60 °	55 W	01541	01748

**Descriptif technique :**

Projecteur en aluminium peint en blanc ou noir, PMMA et équerre inox A4. Livré avec 0,5 mètre de câble et gaine thermorétractable adhésivée. Supporte les températures de -40°C à +85°C. Longueur de câble supplémentaire disponible en option (rèf. 01720).

**Description :**

White or black painted aluminium, PMMA & 316L stainless steel fastenings LED floodlight. Supplied with 0.5 meter of cable & adhesive line heat shrink tubing. Withstands temperatures from -40°C to +85°C. Additional cable length available as an option (ref. 01720).



**400 W**  
Ref. 01381  
Ref. 01361  
Ref. 01683

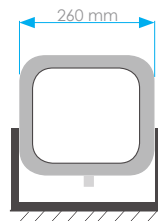
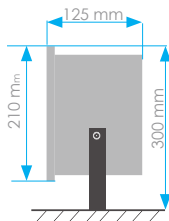

**1200 W**  
Ref. 01408  
Ref. 01409  
Ref. 01684

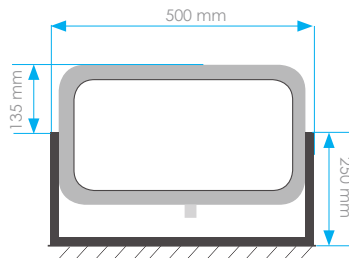
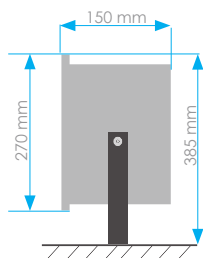
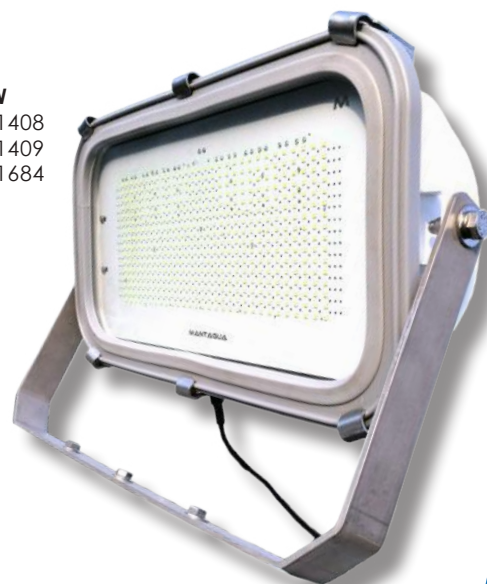

Fourni avec 5 mètres de câble marin. Longueur de câble supplémentaire disponible en option (rèf. 01720)  
Supplied with 5 meters of marine cable. Additional cable length available as an option (ref. 01720)

	Alim. Voltage	Hertz Hertz	Puissance Power	Couleur Colour	Matériau Material	Poids Weight	Angle Angle	Consommation Consumption	Références References
	24-30 VDC	-	3000 lm	6000 K Blanc froid 6000 K Cool white	Inox 316 L S. S. 316 L	3150 g	120°	16 W	01381
	225-260 VAC	50 Hz	3000 lm	6000 K Blanc froid 6000 K Cool white	Inox 316 L S. S. 316 L	3150 g	120°	18 W	01361
	225-260 VAC	60 Hz	3000 lm	6000 K Blanc froid 6000 K Cool white	Inox 316 L S. S. 316 L	3150 g	120°	18 W	01683
	24-30 VDC	-	9000 lm	6000 K Blanc froid 6000 K Cool white	Inox 316 L S. S. 316 L	6250 g	120°	52 W	01408
	225-260 VAC	50 Hz	9000 lm	6000 K Blanc froid 6000 K Cool white	Inox 316 L S. S. 316 L	6250 g	120°	42 W	01409
	225-260 VAC	60 Hz	9000 lm	6000 K Blanc froid 6000 K Cool white	Inox 316 L S. S. 316 L	6250 g	120°	42 W	01684

**Descriptif technique :**

Projecteur conçu pour l'éclairage extérieur avec son corps INOX 316L peint et ses ferrures inox. Contrairement aux projecteurs à 1 led centrale, il offre un faisceau de diffusion très large idéal pour éclairer sous un portique. Fixation par 3 vis (non fournies). Matière : INOX 316L et verre. Fourni avec 5 mètres de câble marin. Etanchéité du presse étoupe par gaine thermorétractable adhésivée. Supporte les températures de -25°C à +55°C

**Description :**

Ideal floodlight for external area lighting with its Stainless Steel 316L Body and fastenings. Unlike floodlights with a central led, it offers a very wide beam, perfect to illuminate below a trawler gantry. Fitting by 3 screws (not supplied). Made in 316L Stainless Steel and glass. Supplied with 5 meters of marine cable. Sealing of the cable gland by adhesive Lined Heat Shrink Tubing. Withstands temperatures from -25°C to +55°C.



Ref. 01450

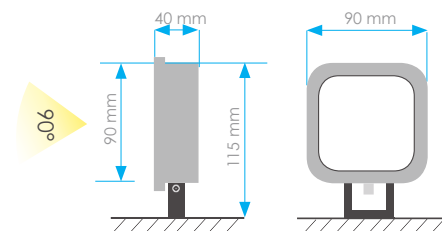

Ref. 01453  
Ref. 01454

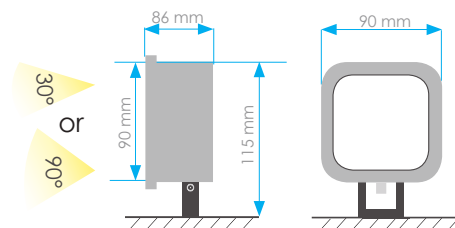

Ref. 01624  
Ref. 01639

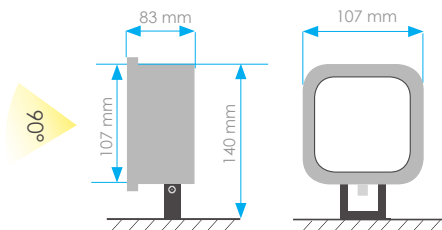

Ref. 01625

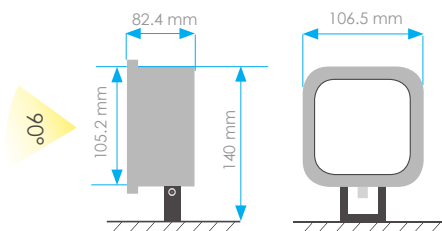

	Alimentation Voltage	Description Description	Puissance Power	Couleur Colour	Matériau Material	Poids Weight	Angle Angle	Conso. Cons.	Références References
	9-32 VDC	Projecteur 14 W 14 W Floodlight	750 lm	5700 K Blanc froid 5700 K Cool white	Aluminium + PMMA + A4	350 g	90°	14 W	01450
	18-32 VDC	Projecteur 22 W 22 W Floodlight	1400 lm	5700 K Blanc froid 5700 K Cool white	Aluminium + PMMA + A4	700 g	90°	22 W	01453
	18-32 VDC	Projecteur 22 W 22 W Floodlight	1400 lm	5700 K Blanc froid 5700 K Cool white	Aluminium + PMMA + A4	700 g	30°	22 W	01454
	9-32 VDC	Projecteur 38 W 38 W Floodlight	2800 lm	5700 K Blanc froid 5700 K Cool white	Aluminium + PMMA + A4	1200 g	90°	38 W	01624
	100-305 VAC	Projecteur 43 W 43 W Floodlight	2800 lm	5700 K Blanc froid 5700 K Cool white	Aluminium + PMMA + A4	2200 g	90°	43 W	01639
	9-30 VDC	Projecteur 14 W 14 W Floodlight	240 lm	Rouge Red	Aluminium + PMMA + A4	1200 g	90°	14 W	01625

Descriptif technique :

Projecteur en aluminium, PMMA et équerre en inox A4. Livré avec 5 mètres de câble et gaine thermorétractable adhésive. Longueur de câble supplémentaire disponible en option (réf. 01720). Supporte les températures de -40°C à +85°C. Garantie 5 ans.

Description:

Aluminium, PMMA & 316 stainless steel fastenings LED floodlight. Supplied with 5 meters of cable & adhesive line heat shrink tubing. Additional cable length available as an option (ref. 01720). Withstands temperatures from -40°C to +85°C. 5 years warranty.



Ref. 01455  
Ref. 01463  
Ref. 01640  
Ref. 01641

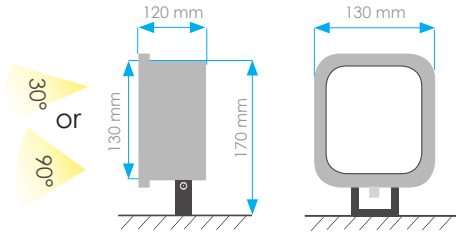

Ref. 01451  
Ref. 01452

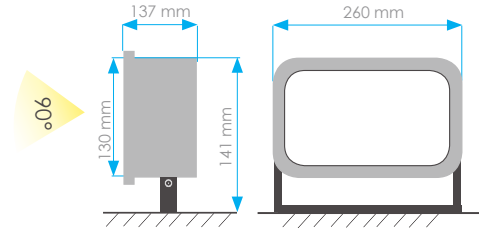

	Alimentation Voltage	Description Description	Puissance Power	Couleur Colour	Matériau Material	Poids Weight	Angle Angle	Conso. Cons.	Références References
	9-32 VDC	Projecteur 82 W 82 W Floodlight	7000 lm	5700 K Blanc froid 5700 K Cool white	Aluminium + PMMA + A4	1900 g	90°	82 W	01455
	100-305 VAC	Projecteur 92 W 92 W Floodlight	7000 lm	5700 K Blanc froid 5700 K Cool white	Aluminium + PMMA + A4	2900 g	90°	92 W	01640
	9-32 VDC	Projecteur 82 W 82 W Floodlight	7000 lm	5700 K Blanc froid 5700 K Cool white	Aluminium + PMMA + A4	1900 g	30°	82 W	01463
	100-305 VAC	Projecteur 92 W 92 W Floodlight	7000 lm	5700 K Blanc froid 5700 K Cool white	Aluminium + PMMA + A4	2900 g	30°	92 W	01641
	18-32 VDC	Projecteur 150 W 150 W Floodlight	13500 lm	4000 K Blanc neutre 4000 K Neutral white	Aluminium + PMMA + A4	5000 g	90°	150 W	01451
	100-277 VAC	Projecteur 150W 150W Floodlight	13500 lm	4000 K Blanc neutre 4000 K Neutral white	Aluminium + PMMA + A4	5000 g	90°	150 W	01452



Professional / Professional



12 W ≈ 100 W



Mode deux vitesses (rapide/lent)  
Dual speed mode (fast/slow)

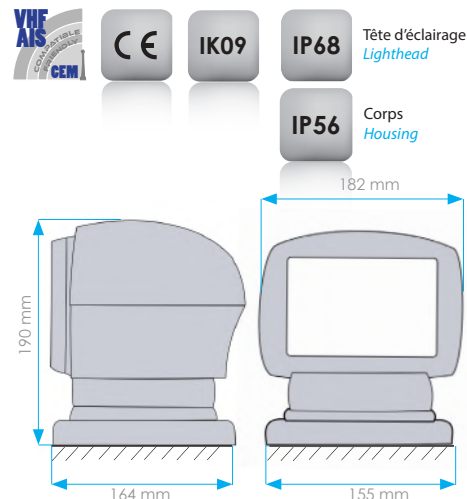

Description Description	Alimentation Power supply	Int. lumineuse Lighting intensity	Couleur Colour	Matériau Material	Angle Angle	Conso. Cons.	Temp. Temp.	Références References
Projecteur blanc White floodlight	10-30 VDC	460 000 cd	5700 K Blanc froid 5700 K Cool white	Aluminium+ASA+ PC Aluminium+ASA+ PC	8°	36W	- 30°C + 70°C	01613
Projecteur noir Black floodlight	10-30 VDC	460 000 cd	5700 K Blanc froid 5700 K Cool white	Aluminium+ASA+ PC Aluminium+ASA+ PC	8°	36W	- 30°C + 70°C	01614
Rallonge pour télécommande filaire Cable extension for wired remote control						5 mètres de câble 5 meters cable length		01628

**Descriptif technique :**

Projecteur en ASA blanc ou noir & PC. Portée: 1000 mètres. Intensité lumineuse 460.000 cd. Livré avec une télécommande sans fil et sa pile, et une télécommande filaire avec 5 mètres de câble.

**Description :**

White or black ASA & PC. Beam span at 1000 meters. Lighting intensity 460.000 cd. Supplied with a wireless remote command and its battery, plus a wired remote control command with 5 meters cable length.

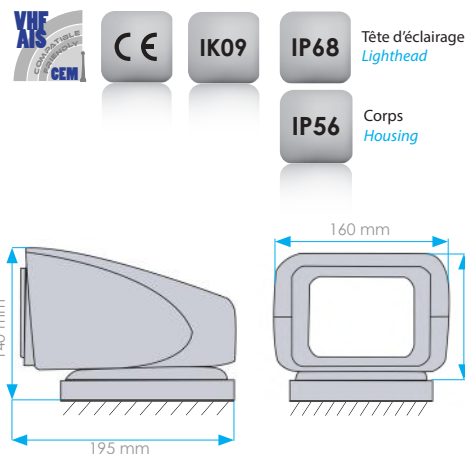

Description Description	Alimentation Power supply	Int. lumineuse Lighting intensity	Couleur Colour	Matériau Material	Angle Angle	Conso. Cons.	Temp. Temp.	Références References
Projecteur blanc White floodlight	10-30 VDC	70 000 cd	5700 K Blanc froid 5700 K Cool white	Aluminium+ASA+ PC Aluminium+ASA+ PC	8°	22W	- 30°C + 70°C	01621
Projecteur noir Black floodlight	10-30 VDC	70 000 cd	5700 K Blanc froid 5700 K Cool white	Alluminium+ASA+ PC Aluminium+ASA+ PC	8°	22W	- 30°C + 70°C	01622

**Descriptif technique :**

Projecteur en ASA blanc ou noir & PC. Portée: 550 mètres. Livré avec une télécommande filaire avec 7 mètres de câble.

**Description :**

White or black ASA & PC. Beam span at 550 meters. Supplied with a wired remote control command with 7 meters cable length.



# KIT D' ADAPTATION LED POUR DHR

## DHR LED ADAPTATION KIT

PROJECTEUR RECHERCHE LED / LED SEARCH LIGHT



DHR 150  
Ø 150 mm  
01734



DHR 180  
Ø 180 mm  
01735



DHR 220  
Ø 220 mm  
01753



	Description Description	Alimentation Power supply	Int. lumineuse Lighting intensity	Couleur Colour	Matériau Material	Angle Angle	Conso. Cons.	Temp. Temp.	Références References
	KIT DHR 150	10-30 VDC	26 500 cd	5700 K Blanc froid 5700 K Cool white	Aluminium+ASA+ PC Aluminium+ASA+ PC	12°	12W	- 30°C + 70°C	01734
	KIT DHR 180	10-30 VDC	50 000 cd	5700 K Blanc froid 5700 K Cool white	Aluminium+ASA+ PC Aluminium+ASA+ PC	12°	20W	- 30°C + 70°C	01735
	KIT DHR 220	20-30 VDC	65 000 cd	5700 K Blanc froid 5700 K Cool white	Aluminium+ASA+ PC Aluminium+ASA+ PC	12°	25W	- 30°C + 70°C	01753

### Descriptif technique :

Kit d'adaptation pour projecteur de recherche DHR en ASA blanc & PC. Intensité lumineuse de 26 500 cd, 50 000 cd ou 65 000 cd. L'angle de diffusion est identique à celui d'un éclairage halogène.

### Description :

DHR Searchlight adaptation kit made in white ASA & PC. 26,500 cd, 50,000 cd or 65,000 cd light intensity. Beam angle is same as an halogen searchlight.

# STARCOM NMEA

AMPLIFICATEUR NMEA / NMEA BUFFER

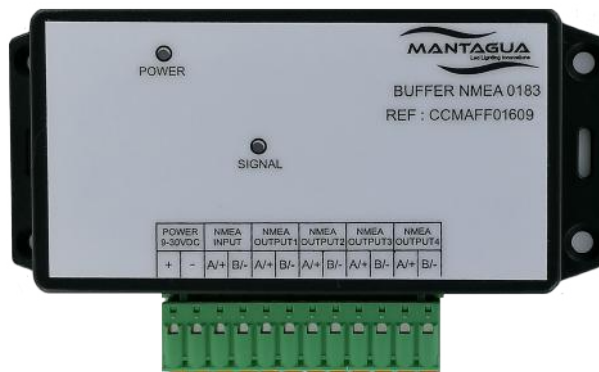

### Descriptif technique :

Amplifie et isole le signal NMEA reçu et l'envoie vers 4 sorties indépendantes, ce qui permet de connecter un émetteur NMEA (par ex : GPS) vers 4 récepteurs sans détérioration du signal dû à une surcharge du bus. L'entrée NMEA est opto-isolée permettant d'éviter tout problème de aux boucles de masse ou à des alimentations différentes. Ces sorties indépendantes et isolées peuvent être utilisées avec n'importe quel récepteur NMEA. Il fonctionne jusqu'à une vitesse de 115200 bauds. La LED présente sur le dessus du produit permet une visualisation de la présence du signal d'entrée.

### Description :

Amplifies and isolates the received NMEA signal and sends it to 4 independent outputs, allowing a NMEA transmitter (e.g. GPS) to be connected to 4 receivers without signal degradation due to bus overload. The NMEA input is opto-isolated to avoid problems due to ground loops or different power supplies. These independent and isolated outputs can be used with any NMEA receiver. It operates up to 115200 baud. The LED on the top of the product displays the presence of the input signal.

	Alimentation Power supply	Débit Throughput	Dimensions Dimensions	Référence Reference
Starcom amplificateur NMEA NMEA buffer Starcom	10 - 30 VDC	De 4800 à 115200 bauds From 4800 to 115200 bauds	130 x 64 x 30mm	01609

# FEUX DE NAVIGATION

## NAVIGATION LIGHTS

### NAVIPRO



### NAVIPRO VOILE SAILING NAVIPRO



### FEUX RÉSINÉS EPOXY RESIN LIGHTS

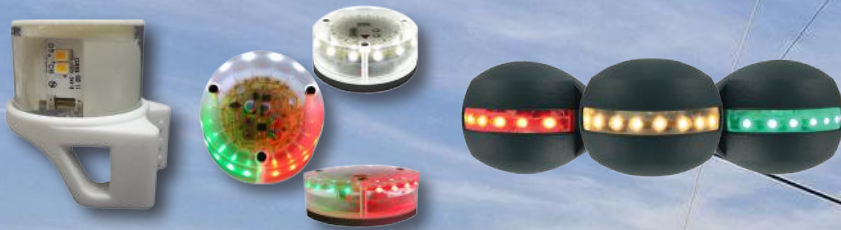

### AMPOULES FEUX NAVIGATION LIGHT BULBS



Navigation / Navigation



## Type d'embarcation / Boat type

Moteur < 7m  
Power < 23ft



Moteur < 12m  
Power < 39ft



Moteur < 20m  
Power < 65ft



Moteur < 50m  
Power < 164ft



Moteur > 50m  
Power > 164ft



Voiliers < 7m  
Sailboat < 7m



Voiliers < 12m  
Sailboat < 39ft



Voiliers < 20m  
Sailboat < 65ft



Voiliers > 20m et < 50m  
Sailboat > 65ft and < 164ft

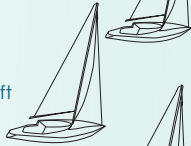

Voiliers > 50m  
Sailboat > 164ft

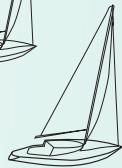

## Combinaisons de feux Navigation lights combinations

360° 2NM									
1NM 		1NM 		2NM 		2NM 		2NM 	
2NM 		2NM 		2NM 		2NM 		2NM 	
360° 2NM* 2NM* 2NM* 2NM* 5NM 2NM* 2NM* 2NM 2NM*									
360° 3NM 3NM 3NM 3NM 6NM 3NM* 3NM* 3NM* 3NM*									
360° 2NM*									
1NM 		1NM 		2NM 		2NM 		2NM 	
2NM 		2NM 		2NM 		2NM 		2NM 	
2NM 2NM 2NM 2NM 3NM 2NM 2NM 2NM 3NM 2NM 2NM 3NM									
2NM 2NM 2NM 2NM 2NM* 2NM* 5NM									
3NM 3NM 3NM 3NM 3NM* 3NM* 6NM									

\* Optionnel / Optional



Nos feux de mât ne perturbent pas l'AIS ni la VHF. Ils ont été certifiés CE en 2014 par un laboratoire indépendant et répondent à la norme IEC 60945 4th Edition 2002-08 selon le rapport 204009 EMC Ed. 1.2.

Our mast navigation lights don't interfere with VHF and AIS. They have been CE certified in 2014 by an independent laboratory and comply to the IEC 60945 4th Edition 2002-08 as per the report 204009 EMC Ed. 1.2.





**HUNE  
MASTHEAD**



**TRIBORD  
STARBOARD**



**BABORD  
PORT**



# NAVIPRO AVEC PIED / NAVIPRO WITH FOOT



10/30  
VDC



IP 67

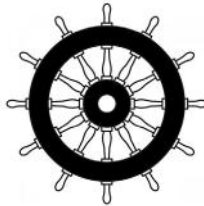

FEU CERTIFIÉ  
WHEELMARK  
CERTIFIED

60427/A0 MED



Navipro 5 MN (00147 et 00193)  
5 NM Navipro (00147 & 00193)

## Déscriptif technique :

Régulés 10-30 VDC (\*5 MN 20-30 VDC), faible consommation électrique. **Étanches IP67**. Réalisés en PC et ASA traités UV. Livré avec un mètre de câble. Longueur de câble supplémentaire disponible en option (rèf. 01720).

**Certifié WHEELMARK 60427/A0 MED.**

## Description :

Regulated 10-30VDC (\*5NM 20-30 VDC), very low power consumption. **IP67 waterproof**. Made of UV proof ASA and PC. Supplied with 5 meters of cable. Additional cable length available as an option (ref. 01720).







**WHEELMARK approved 60427/A0 MED.**

Type / Product description	Portée Visibility	Intensité lumineuse Lighting intensity	Consommation Consumption	Dimensions Dimensions	Poids Weight	Réf. Ref.
Babord Rouge 112,5° Port Red 112,5°	2 MN 2 NM	> 5,4 Cd	1,08 W	H 95 mm - Ø 69 mm	170 g	00122
Tribord Vert 112,5° Starboard Green 112,5°	2 MN 2 NM	> 5,4 Cd	1,08 W	H 95 mm - Ø 69 mm	170 g	00123
Bicolore Vert/Rouge 112,5° Combined Green/red 112,5°	2 MN 2 NM	> 5,4 Cd	2,76 W	H 95 mm - Ø 69 mm	170 g	00121
Poupe Blanc 135° Stern White 135°	2 MN 2 NM	> 5,4 Cd	1,08 W	H 95 mm - Ø 69 mm	170 g	00124
Mouillage Blanc 360° Anchor White 360°	2 MN 2 NM	> 5,4 Cd	2,76 W	H 95 mm - Ø 69 mm	170 g	00119
Hune ou de mâât Blanc 225° Masthead White 225°	2 MN 2 NM	> 5,4 Cd	2,16 W	H 95 mm - Ø 69 mm	170 g	00126
Hune ou de mâât Blanc 225° Masthead White 225°	3 MN 3 NM	> 15 Cd	4,32 W	H 95 mm - Ø 69 mm	170 g	00128
Hune ou de mâât Blanc 225° Masthead White 225°	5 MN 5 NM	> 65 Cd	7,50 W	H 110 mm - Ø 69 mm	510 g	00147*
Hune + Mouillage Masthead with Anchor light	2 MN 2 NM	> 5,4 Cd	2,76 W	H 95 mm - Ø 69 mm	170 g	00127
Hune 3 MN + Mouillage 2 MN Masthead 3NM with Anchor light 2 MN	3 MN 3 NM	> 15 Cd	4,32 W	H 95 mm - Ø 69 mm	170 g	00129
Hune 5 MN + Mouillage 2MN Masthead 5NM & Anchor 2NM	5 MN 5 NM	> 65 Cd	7,50 W	H 110 mm - Ø 69 mm	510 g	00193*
Remorquage Jaune 135° Towing Yellow 135°	2 MN 2 NM	> 5,4 Cd	1,08 W	H 95 mm - Ø 69 mm	170 g	00130
Vert 360° Green 360°	2 MN 2 NM	> 5,4 Cd	3,24 W	H 95 mm - Ø 69 mm	170 g	00131
Rouge 360° Red 360°	2 MN 2 NM	> 5,4 Cd	3,24 W	H 95 mm - Ø 69 mm	170 g	00132
Jaune 360° Yellow 360°	2 MN 2 NM	> 5,4 Cd	3,24 W	H 95 mm - Ø 69 mm	170 g	00165
Bleu 360° Blue 360°	2 MN 2 NM	> 5,4 Cd	3,24 W	H 95 mm - Ø 69 mm	170 g	00166
Suez rouge 135° Red Suez 135°	2 MN 2 NM	> 5,4 Cd	3,24 W	H 95 mm - Ø 69 mm	170 g	00152

\* Tension alimentation = 20 - 30 VDC / Power supply = 20 - 30 VDC

Suite à la page 22  
Continued on page 22

# NAVIPRO AVEC PIED / NAVIPRO WITH FOOT

Type / Product description	Portée Visibility	Intensité lumineuse Lighting intensity	Consommation Consumption	Dimensions Dimensions	Poids Weight	Réf. Ref.
 Babord Rouge 180° Red port 180°	2 MN 2 NM	> 5,4 Cd	3,24 W	H 95 mm - Ø 69 mm	170 g	00154
 Tribord Rouge 180° Red starboard 180°	2 MN 2 NM	> 5,4 Cd	3,24 W	H 95 mm - Ø 69 mm	170 g	00155
 Babord Vert 180° Green port 180°	2 MN 2 NM	> 5,4 Cd	3,24 W	H 95 mm - Ø 69 mm	170 g	00161
 Tribord Vert 180° Green starboard 180°	2 MN 2 NM	> 5,4 Cd	3,24 W	H 95 mm - Ø 69 mm	170 g	00162
 Babord Blanc 180° White port 180°	2 MN 2 NM	> 5,4 Cd	3,24 W	H 95 mm - Ø 69 mm	170 g	00186
 Tribord Blanc 180° White starboard 180°	2 MN 2 NM	> 5,4 Cd	3,24 W	H 95 mm - Ø 69 mm	170 g	00187
 Flash Bleu 360° Blue Flash 360°	2 MN 2 NM	> 5,4 Cd	3,24 W	H 95 mm - Ø 69 mm	170 g	00181

# NAVIPRO SUPERPOSÉ / DOUBLE LENS NAVIPRO

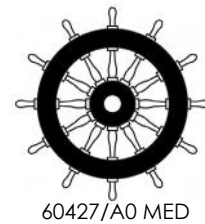

FEU CERTIFIÉ  
WHEELMARK  
CERTIFIED

60427/A0 MED



## Déscriptif technique :







Réglés 10-30 VDC (\*5 MN 20-30 VDC), faible consommation électrique. **Étanches IP67**. Réalisés en PC et ASA traités UV. Livrés avec un mètre de câble. Longueur de câble supplémentaire disponible en option (rèf. 01720).

**Certifié WHEELMARK 60427/A0 MED.**

## Description :

Regulated 10-30VDC (\*5NM 20-30 VDC), very low power consumption. **IP67 waterproof**. Made of UV proof ASA and PC. Supplied with 5 meters of cable. Additional cable length available as an option (ref. 01720).

**WHEELMARK approved 60427/A0 MED.**















Type / Product description	Portée Visibility	Intensité lumineuse Lighting intensity	Consommation Consumption	Dimensions Dimensions	Poids max Max weight	Réf. Ref.
 Babord Rouge 112,5° Port Red 112,5°	2 MN 2 NM	> 5,4 Cd	1,08 W	H 150 mm - Ø 69 mm	380 g	00148
 Tribord Vert 112,5° Starboard Green 112,5°	2 MN 2 NM	> 5,4 Cd	1,08 W	H 150 mm - Ø 69 mm	380 g	00149
 Poupe Blanc 135° Stern White 135°	2 MN 2 NM	> 5,4 Cd	1,08 W	H 150 mm - Ø 69 mm	380 g	00150
 Hune ou de mât Blanc 225° Masthead White 225°	3 MN 3 NM	> 15 Cd	4,32 W	H 150 mm - Ø 69 mm	380 g	00157
 Hune ou de mât Blanc 225° Masthead White 225°	5 MN 5 NM	> 65 Cd	7,5 W	H mm - Ø 69 mm	950 g	00156*
 Rouge 360° Red 360°	2 MN 2 NM	> 5,4 Cd	3,24 W	H 150 mm - Ø 69 mm	380 g	00167
 Rouge 360° sur Blanc 360° Red 360° over White 360°	2 MN 2 NM	> 5,4 Cd	3,24 W	H 150 mm - Ø 69 mm	380 g	00173
 Rouge 360° sur Vert 360° Red 360° over Green 360°	2 MN 2 NM	> 5,4 Cd	3,24 W	H 150 mm - Ø 69 mm	380 g	00171

\* Tension alimentation = 20 - 30 VDC / Power supply = 20 - 30 VDC

Suite à la page 23  
Continued on page 23



# NAVIPRO SUPERPOSÉ / DOUBLE LENS NAVIPRO

Type / Product description	Portée Visibility	Intensité lumineuse Lighting intensity	Consommation Consumption	Dimensions Dimensions	Poids max Max weight	Réf. Ref.
 Vert 360° Green 360°	2 MN 2 NM	> 5,4 Cd	3,24 W	H 150 mm - Ø 69 mm	380 g	00168
 Vert 360° sur Blanc 360° Green 360° over White 360°	2 MN 2 NM	> 5,4 Cd	3,24 W	H 150 mm - Ø 69 mm	380 g	00175
 Vert 360° sur Rouge 360° Green 360° over Red 360°	2 MN 2 NM	> 5,4 Cd	3,24 W	H 150 mm - Ø 69 mm	380 g	00170
 Mouillage Blanc 360° Anchor White 360°	2 MN 2 NM	> 5,4 Cd	2,76 W	H 150 mm - Ø 69 mm	380 g	00160
 Blanc 360° sur Rouge 360° White 360° over Red 360°	2 MN 2 NM	> 5,4 Cd	3,24 W	H 150 mm - Ø 69 mm	380 g	00172
 Blanc 360° sur Vert 360° White 360° over Green 360°	2 MN 2 NM	> 5,4 Cd	3,24 W	H 150 mm - Ø 69 mm	380 g	00174
 Babord Rouge 180° Red port 180°	2 MN 2 NM	> 5,4 Cd	3,24 W	H 150 mm - Ø 69 mm	380 g	00182
 Tribord Rouge 180° Red starboard 180°	2 MN 2 NM	> 5,4 Cd	3,24 W	H 150 mm - Ø 69 mm	380 g	00183
 Babord Vert 180° Green port 180°	2 MN 2 NM	> 5,4 Cd	3,24 W	H 150 mm - Ø 69 mm	380 g	00184
 Tribord Vert 180° Green starboard 180°	2 MN 2 NM	> 5,4 Cd	3,24 W	H 150 mm - Ø 69 mm	380 g	00185
 Babord Blanc 180° White port 180°	2 MN 2 NM	> 5,4 Cd	3,24 W	H 150 mm - Ø 69 mm	380 g	00190
 Tribord Blanc 180° White starboard 180°	2 MN 2 NM	> 5,4 Cd	3,24 W	H 150 mm - Ø 69 mm	380 g	00191
 Remorquage Jaune 135° Towing Yellow 135°	2 MN 2 NM	> 5,4 Cd	3,24 W	H 150 mm - Ø 69 mm	380 g	00169
 Rouge 360° sur Blanc 360° sur Vert 360° Red 360° over White 360° over Green 360°	2 MN 2 NM	> 5,4 Cd	3,24 W	H 150 mm - Ø 69 mm	380 g	00192



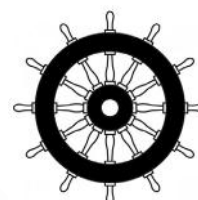

# NAVIPRO HISSABLE / HOISTABLE NAVIPRO



FEU CERTIFIÉ  
WHEELMARK  
CERTIFIED

60427/A0 MED



Type / Product description	Portée Visibility	Intensité lumineuse Lighting intensity	Consommation Consumption	Dimensions Dimensions	Poids max Max weight	Réf. Ref.
 Blanc 360° White 360°	2 MN 2 NM	> 5,4 Cd	3,24 W	H 155 mm - Ø 70 mm	855 g	00176
 Rouge 360° Red 360°	2 MN 2 NM	> 5,4 Cd	3,24 W	H 155 mm - Ø 70 mm	855 g	00177
 Vert 360° Green 360°	2 MN 2 NM	> 5,4 Cd	3,24 W	H 155 mm - Ø 70 mm	855 g	00178
 Jaune 360° Yellow 360°	2 MN 2 NM	> 5,4 Cd	3,24 W	H 155 mm - Ø 70 mm	855 g	00179
 Bleu 360° Blue 360°	2 MN 2 NM	> 5,4 Cd	3,24 W	H 155 mm - Ø 70 mm	855 g	00180

# NAVIPRO PLAT PONT / HORIZONTAL DECK NAVIPRO

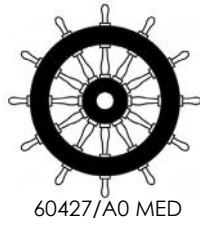









FEU CERTIFIÉ  
WHEELMARK  
CERTIFIED

60427/A0 MED



Navipro 5 MN (00146)  
5 NM Navipro (00146)

Navigation / Navigation

Type / Product description	Portée Visibility	Intensité lumineuse Lighting intensity	Consommation Consumption	Dimensions Dimensions	Poids max Max weight	Réf. Ref.
 Tricolore Tricolor	2 MN 2 NM	> 5, 4 Cd	3,24 W	H 50 mm - Ø 69 mm	190 g	00151
 Bicolore Vert/Rouge 112,5° Combined Green/red 112,5°	2 MN 2 NM	> 5, 4 Cd	2,76 W	H 50 mm - Ø 69 mm	190 g	00139
 Babord Rouge 112,5° Port Red 112,5°	2 MN 2 NM	> 5, 4 Cd	1,08 W	H 50 mm - Ø 69 mm	190 g	00140
 Tribord Vert 112,5° Starboard Green 112,5°	2 MN 2 NM	> 5, 4 Cd	1,08 W	H 50 mm - Ø 69 mm	190 g	00141
 Poupe Blanc 135° Stern White 135°	2 MN 2 NM	> 5, 4 Cd	1,08 W	H 50 mm - Ø 69 mm	190 g	00142
 Hune ou de mât Blanc 225° Masthead White 225°	2 MN 2 NM	> 5, 4 Cd	2,16 W	H 50 mm - Ø 69 mm	190 g	00143
 Hune ou de mât Blanc 225° Masthead White 225°	3 MN 3 NM	> 15 Cd	4,32 W	H 50 mm - Ø 69 mm	190 g	00144
 Hune ou de mât Blanc 225° Masthead White 225°	5 MN 5 NM	> 65 Cd	7,50 W	H 65 mm - Ø 69 mm	530 g	00146*
 Mouillage Blanc 360° Anchor White 360°	2 MN 2 NM	> 5, 4 Cd	2,76 W	H 50 mm - Ø 69 mm	190 g	00145
 Suez Rouge 135° Red Suez 135°	2 MN 2 NM	> 5, 4 Cd	3,24 W	H 50 mm - Ø 69 mm	190 g	00152
 Babord Rouge 180° Red port 180°	2 MN 2 NM	> 5, 4 Cd	3,24 W	H 50 mm - Ø 69 mm	190 g	00158
 Tribord Rouge 180° Red starboard 180°	2 MN 2 NM	> 5, 4 Cd	3,24 W	H 50 mm - Ø 69 mm	190 g	00159
 Babord Vert 180° Green port 180°	2 MN 2 NM	> 5, 4 Cd	3,24 W	H 50 mm - Ø 69 mm	190 g	00163
 Tribord Vert 180° Green starboard 180°	2 MN 2 NM	> 5, 4 Cd	3,24 W	H 50 mm - Ø 69 mm	190 g	00164
 Babord Blanc 180° White port 180°	2 MN 2 NM	> 5, 4 Cd	3,24 W	H 50 mm - Ø 69 mm	190 g	00188
 Tribord Blanc 180° White starboard 180°	2 MN 2 NM	> 5, 4 Cd	3,24 W	H 50 mm - Ø 69 mm	190 g	00189

\* Tension alimentation = 20 - 30 VDC / Power supply = 20 - 30 VDC

## Déscriptif technique :

Régulés 10-30 VDC (\*5 MN 20-30 VDC), faible consommation électrique. **Étanches IP67**. Réalisés en PC et ASA traités UV. Livré avec un mètre de câble. Longueur de câble supplémentaire disponible en option (réf. 01720).

**Certifié WHEELMARK 60427/A0 MED.**

## Description :

Regulated 10-30VDC (\*5NM 20-30 VDC), very low power consumption. **IP67 waterproof**. Made of UV proof ASA and PC. Supplied with 5 meters of cable. Additional cable length available as an option (ref. 01720).

**WHEELMARK approved 60427/A0 MED.**





# NAVIPRO VOILE / SAILING NAVIPRO



10/30  
VDC



IP 67

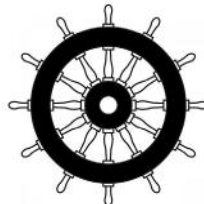

FEU CERTIFIÉ  
WHEELMARK  
CERTIFIED

60427/A0 MED



Type / Product description

Portée  
Visibility

Intensité lumineuse  
Lighting intensity

Consommation  
Consumption

Dimensions  
Dimensions

Poids max  
Max weight

Réf.  
Ref.

	Tricolore + Mouillage Tricolor with Anchor	2 MN 2 NM	> 5,4 Cd	3,24 W	H 95 mm - Ø 69 mm	170 g	00116
	Tricolore Tricolor	2 MN 2 NM	> 5,4 Cd	3,24 W	H 95 mm - Ø 69 mm	170 g	00118
	Mouillage Blanc 360° Anchor White 360°	2 MN 2 NM	> 5,4 Cd	2,76 W	H 95 mm - Ø 69 mm	170 g	00119
	Mouillage Blanc 360° - Jour / Nuit* Anchor White 360° - Night & Day*	2 MN 2 NM	> 5,4 Cd	2,76 W	H 95 mm - Ø 69 mm	170 g	00120
	Tricolore + Mouillage - Stroboscopique + Jour / Nuit* Tricolor with Anchor - Stroboscopic + Night & Day*	2 MN 2 NM	> 5,4 Cd	3,24 W	H 95 mm - Ø 69 mm	170 g	00117



\*Mode Jour / Nuit - Night & Day mode

Ceux qui passent de nombreuses nuits au mouillage connaissent l'importance de maîtriser au mieux sa consommation d'énergie. Le mode JOUR/NUIT sur le mouillage, qui prend 1 mesure de luminosité chaque quart d'heure, permet de s'assurer que le feu de mouillage ne se mettra en route que si nécessaire et s'éteindra dès l'aube sans intervention de votre part.

Those who spend many nights anchoring know the importance of controlling their energy consumption. The Night & Day mode on the anchor function, which measures the light every 15mn, will guarantee that the light goes ON only if necessary, and goes OFF automatically in the morning whilst you're still asleep.

# NAVIPRO MÂT / MASTHEAD NAVIPRO



20/30  
VDC



IP 67

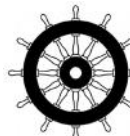

FEU CERTIFIÉ  
WHEELMARK  
CERTIFIED

60427/A0 MED

Patte de protection  
Protective tab

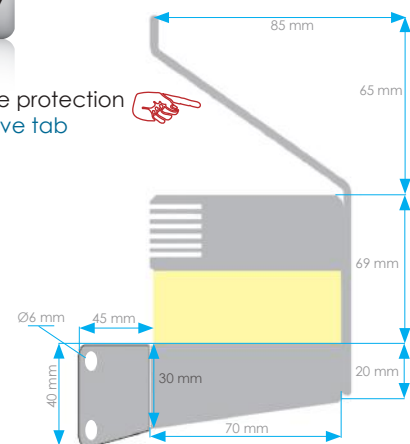

Type / Product description

Portée  
Visibility

Intensité lumineuse  
Lighting intensity

Consommation  
Consumption

Dimensions  
Dimensions

Poids max  
Max weight

Réf.  
Ref.

	Hune ou de mât Blanc 225° Masthead White 225°	5 MN 5 NM	> 65 Cd	7,50 W	H 164 mm - Ø 69 mm	560 g	00196
--	--	--------------	---------	--------	--------------------	-------	-------

# FEUX DE NAVIGATION RÉSINÉS EPOXY RESIN NAVIGATION LIGHTS

Feu tête de mat **TINY TRI** <12 m / Mast head light **TINY TRI** <12 m (39 ft)



La gamme TINY est pensée pour répondre aux problématiques des régatiers et des petits bateaux qui souhaitent avoir des feux compacts et légers.  
Livré avec 15 mètres de câble.

*The Tiny range has been developed to answer the needs of those racing or with a small boat, who are looking for compact and lightweight navigation lights.*  
Supplied with 15 meters of cable.

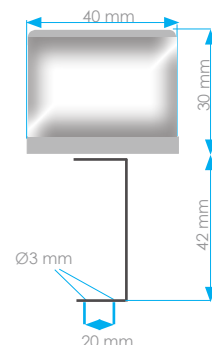

Type / Product description

Portée  
Visibility

Intensité lumineuse  
Lighting intensity

Conso.  
Cons.

Dimensions  
Dimensions

Poids  
Weight

Réf.  
Ref.

	Tricolore - Mouillage Tricolor with anchor	1 & 2 MN 1 & 2 NM	> 1,1 Candela	1,8 W	H 30 + 42 mm Ø 40 mm	70 + 15 g	00094
	Tricolore - tête de mât Tricolor	1 & 2 MN 1 & 2 NM	> 1,1 Candela	1,7 W	H 30 + 42 mm Ø 40 mm	45 + 15 g	00085
	Mouillage - Blanc 360° Anchor - White 360°	2 MN 2 NM	> 5,4 Candela	1,8 W	H 30 + 42 mm Ø 40 mm	45 + 15 g	00093

**TINY BALCON** < 12 m / Vertical mount **TINY** < 12 m (39 ft)



Livré avec 10 mètres de câble  
Option : Câble aviation sur demande

Supplied with 10 meters of cable.  
Option : Aviation cable on demand



Type / Product description

Portée  
Visibility

Intensité lumineuse  
Lighting intensity

Conso.  
Cons.

Dimensions  
Dimensions

Poids  
Weight

Réf.  
Ref.

	Babord (Rouge 112,5°) Port (Red 112,5°)	1 MN 1 NM	> 1,1 Candela	0,6 W	H 30 + 42 mm Ø 40 mm	50 + 15 g	00133
	Tribord (Vert 112,5°) Starboard (Green 112,5°)	1 MN 1 NM	> 1,1 Candela	0,6 W	H 30 + 42 mm Ø 40 mm	50 + 15 g	00134
	Poupe (Blanc 135°) Stern (White 135°)	2 MN 2 NM	> 5,4 Candela	0,6 W	H 30 + 42 mm Ø 40 mm	50 + 15 g	00135
	Poupe & babord (Blanc 135°/Rouge 112,5°) Stern & Port (White 135°/Red 112,5°)	2 & 1 MN 2 & 1 NM	> 1,1 Candela	1,2 W	H 30 + 42 mm Ø 40 mm	50 + 15 g	00136

Feu de hune **TINY HUNE 225°** / Mast light **TINY MAST 225°**



Livré avec 15 mètres de câble  
Option : Câble aviation sur demande

Supplied with 15 meters of cable.  
Option : Aviation cable on demand

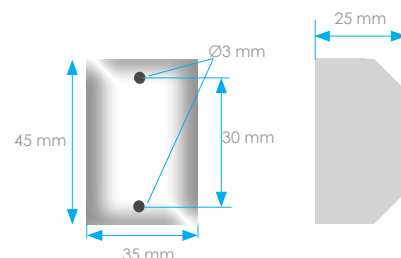

Type / Product description

Portée  
Visibility

Intensité lumineuse  
Lighting intensity

Conso.  
Cons.

Dimensions  
Dimensions

Poids  
Weight

Réf.  
Ref.

	Tiny Hune 225° Tiny Mast Light 225°	2 MN 2 NM	> 5,4 Candela	1,2 W	45 x 35 x 27 mm	60 g	00086
	Tiny Hune 225° Tiny Mast Light 225°	3 MN 3 NM	> 15 Candela	2,4 W	45 x 35 x 27 mm	60 g	00087

## Caractéristiques techniques :

Régulés en 12 VDC, polarisés. Faible consommation électrique.  
Étanche IP67 et résistant aux vibrations car totalement résiné epoxy. Fourni avec câble de 1 mètre.

## Specifications:

Regulated 12 VDC, polarized. Very low power consumption, IP67 waterproof and vibrations proof as totally sealed in epoxy resin. Supplied with 1 meter cable.

# FEUX DE NAVIGATION RÉSINÉS EPOXY RESIN NAVIGATION LIGHTS

Feux tête de mat - Montage horizontal < 20 mètres  
Mast head light - Horizontal fitting < 20 meters



## Caractéristiques techniques :

Régulés 9-30VDC, faible consommation électrique. **Étanches IP67 et incassables**. Réalisés en aluminium 6082 anodisé et epoxy (sans pied) ou ASA et epoxy (avec pied). **Complètement résinés**, les feux à LEDS Mantagua offrent une **visibilité maximale**, sont **économés en énergie**, **insensibles aux vibrations**, hyper **étanches** et très **résistants**.

## Specifications :

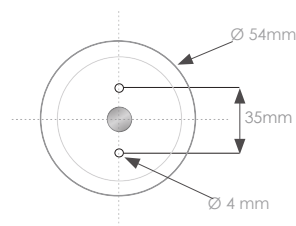
Regulated 9-30VDC, very low power consumption. **IP67 waterproof, unbreakable**. Made of aluminium and epoxy (without foot) or ASA plastic and epoxy resin (with foot). **Totally encapsulated in resin**, Mantagua LED Navigation lights offer a **maximum visibility**. They are **energy efficient, unaffected by vibrations**, highly **resistant** and **waterproof**



Type / Product description	Portée Visibility	Intensité lumineuse Lighting intensity	Conso. Cons.	Dimensions Dimensions	Poids Weight	Réf. Ref.
 Mouillage (Blanc 360°) Anchor (White 360°)	2 MN 2 NM	> 5,4 Cd	1,2 W	H 79 mm - Ø 70 mm	160 g	00081
 Tricolore - Tête de mât Tricolor	2 MN 2 NM	> 5,4 Cd	1,2 W	H 79 mm - Ø 70 mm	160 g	00082
 Tricolore + Mouillage - Tête de mât Tricolor with Anchor	2 MN 2 NM	> 5,4 Cd	2,4 W	H 89 mm - Ø 70 mm	240 g	00075

TROPHÉE JULES VERNE

GITANA



Sodebo



+X

MAXI BANQUE POPULAIRE XI



Photo : Sébastien Destremau / Vendée Globe 2020

vendéeglobe  
Les Sables d'Olonne

ALEX THOMPSON  
RACING

BOSS



CHARAL



+X





# FEUX DE NAVIGATION RÉSINÉS

## EPOXY RESIN NAVIGATION LIGHTS











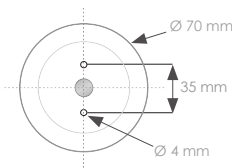

Mode Jour / Nuit - Night & Day mode



Type / Product description	Portée Visibility	Intensité lumineuse Lighting intensity	Conso. Cons.	Dimensions Dimensions	Poids Weight	Réf. Ref.
 360° Mouillage (Blanc 360°) - Jour / Nuit Anchor (White 360°) - Night & Day	2 MN 2 NM	> 5,4 Cd	1,2 W	H 79 mm - Ø 70 mm	160 g	00084
 360° Tricolore + Mouillage - Stroboscopique + éclairage Windex Jour / Nuit Tricolor with Anchor - Stroboscopic + Windex lighting Night & Day	2 MN 2 NM	> 5,4 Cd	2,4 W	H 89 mm - Ø 70 mm	240 g	00083

### Feux plats Pont / Horizontal Deck fitting Navigation lights



Type / Product description	Portée Visibility	Intensité lumineuse Lighting intensity	Conso. Cons.	Dimensions Dimensions	Poids Weight	Réf. Ref.
 112,5° Babord (Rouge 112,5°) Port (Red 112,5°)	2 MN 2 NM	> 5,4 Candela	0,8 W	H 29 mm - Ø 70 mm	155 g	00011
 112,5° Tribord (Vert 112,5°) Starboard (Green 112,5°)	2 MN 2 NM	> 5,4 Candela	0,8 W	H 29 mm - Ø 70 mm	155 g	00012
 135° Poupe (Blanc 135°) Stern (White 135°)	2 MN 2 NM	> 5,4 Candela	0,8 W	H 29 mm - Ø 70 mm	155 g	00013
 112,5° Bicolore (Vert/Rouge 112,5°) Combined (Green/Red 112,5°)	2 MN 2 NM	> 5,4 Candela	1,6 W	H 29 mm - Ø 70 mm	155 g	00014
 225° Hune ou de mât (Blanc 225°) Masthead (White 225°)	2 MN 2 NM	> 5,4 Candela	1,6 W	H 29 mm - Ø 70 mm	155 g	00019
 225° Hune ou de mât (Blanc 225°) Masthead (White 225°)	3 MN 3 NM	> 15 Candela	3,2 W	H 39 mm - Ø 70 mm	230 g	00015
 112,5° Babord (Rouge 112,5°) Port (Red 112,5°)	3 MN 3 NM	> 15 Candela	3,2 W	H 39 mm - Ø 70 mm	230 g	00076
 112,5° Tribord (vert 112,5°) Starboard (Green 112,5°)	3 MN 3 NM	> 15 Candela	3,2 W	H 39 mm - Ø 70 mm	230 g	00077
 135° Poupe (Blanc 135°) Stern (White 135°)	3 MN 3 NM	> 15 Candela	3,2 W	H 39 mm - Ø 70 mm	230 g	00078

Info / Info



Pour les feux de Hune, pensez aux combinés Feu de Hune / Projecteur de Pont p. 39

Retrouver nos feux de compétition sur [www.mantagua.fr](http://www.mantagua.fr)

For mast lights, also look at our Combined Masthead / Deck lights p. 39









For racing navigation lights, please visit [www.mantagua.fr](http://www.mantagua.fr)

# FEUX DE NAVIGATION RÉSINÉS

## EPOXY RESIN NAVIGATION LIGHTS

Feux avec pied - Horizontal / Navigation lights with foot - Horizontal



Type / Product description	Portée Visibility	Intensité lumineuse Lighting intensity	Conso. Cons.	Dimensions Dimensions	Poids Weight	Réf. Ref.
 Tricolore + Stroboscopique Tricolor + Flashing	2 MN 2 NM	> 5,4 Candela	2,4 W	H 39 mm - Ø 70 mm	230 g	00055
 Mouillage (Blanc 360°) Anchor (White 360°)	3 MN 3 NM	> 15 Candela	3,2 W	H 39 mm - Ø 70 mm	230 g	00062
 Rouge 360° (NUC) Red 360° (NUC)	2 MN 2 NM	> 5,4 Candela	2,4 W	H 29 mm - Ø 70 mm	155 g	00066
 Rouge 360° (NUC) Red 360° (NUC)	3 MN 3 NM	> 15 Candela	3,2 W	H 39 mm - Ø 70 mm	230 g	00065
 Vert 360° Green 360°	2 MN 2 NM	> 5,4 Candela	2,4 W	H 29 mm - Ø 70 mm	155 g	00069
 Vert 360° Green 360°	3 MN 3 NM	> 15 Candela	3,2 W	H 39 mm - Ø 70 mm	230 g	00070
 Stroboscopique (Blanc 360°) Flashing (White 360°)	2 MN 2 NM	> 5,4 Candela	0,8 W	H 29 mm - Ø 70 mm	155 g	00046
 Stroboscopique + Mouillage Flashing + Anchor	2 MN 2 NM	> 5,4 Candela	2,4 W	H 39 mm - Ø 70 mm	240 g	00048

### Accessoires / Accessories







Options / Options	Dimensions Dimensions	Poids Weight	Réf. Ref.
 Support de champ inox Stainless steel side support	L 73 x l 45 x H 40 mm	100 g	00009
 Support Windex Windex support	H 17 mm x Ø 70 mm	45 g	00068
 Cache supérieur pour montage plat pont Top cover for deck mounting	H 5 mm x Ø 70 mm	45 g	00079
 Pied pour feu horizontal Foot for horizontal light	H 50 mm x Ø 70 mm	60 g	00074



Photo: Alubat ovni-365

### Gyrophares / Beacons



Type / Product description	Portée Visibility	Intensité lumineuse Lighting intensity	Conso. Cons.	Dimensions Dimensions	Poids Weight	Réf. Ref.
 Gyrophare bleu (360°) Police - Flashing - blue color (360°)	2 MN 2 NM	> 5,4 Candela	2,4 W	H 89 mm - Ø 70 mm	230 g	00054
 Gyrophare orange (360°) Orange - Flashing beacon (360°)	1 MN 1 NM	> 1,1 Candela	0,7 W	H 39 mm - Ø 70 mm	230 g	00080

# FEUX DE NAVIGATION RÉSINÉS EPOXY RESIN NAVIGATION LIGHTS

## Feux latéraux / Vertical mount navigation lights



### Descriptif technique :

Ces feux à LEDs Mantagua sont conçus pour le montage latéral sur les balcons ou le tableau arrière. Parce que très exposés, ils sont totalement résinés pour être ultra-résistants. Livré avec un cache lumière pour éviter l'éblouissement.

### Description:

These vertical mount navigation lights are made for fitting on the balconies or directly on the stern. As they very exposed, they are totally sealed in resin to resist to the assaults of the sea. Supplied with a light shield to avoid glare.

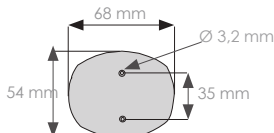

### Type / Product description

### Portée Visibility

### Intensité lumineuse Lighting intensity

### Conso. Cons.

### Dimensions Dimensions

### Poids Weight

### Réf. Ref.

	Babord (Rouge 112,5°) + cache Port (Red 112,5°) & cover cap	2 MN 2 NM	> 5,4 Candela	0,8 W	L 68 x l 55 x H 34 mm	90 g	00031
	Tribord (Vert 112,5°) + cache Starboard (Green 112,5°) & cover cap	2 MN 2 NM	> 5,4 Candela	0,8 W	L 68 x l 55 x H 34 mm	90 g	00032
	Poupe (Blanc 135°) + cache Stern (White 135°) & cover cap	2 MN 2 NM	> 5,4 Candela	0,8 W	L 68 x l 55 x H 34 mm	90 g	00033
	Bicolore (Vert/Rouge 112,5°) Combined (Green/Red 112,5°)	2 MN 2 NM	> 5,4 Candela	1,6 W	L 68 x l 55 x H 39 mm	100 g	00034
	Rouge 180° x 2 Red 180° x 2	2 MN 2 NM	> 5,4 Candela	0,8 W	L 68 x l 55 x H 34 mm	90 g	00071
	Vert 180° x 2 Green 180° x 2	2 MN 2 NM	> 5,4 Candela	0,8 W	L 68 x l 55 x H 34 mm	90 g	00072
	Blanc 180° x 2 White 180° x 2	2 MN 2 NM	> 5,4 Candela	0,8 W	L 68 x l 55 x H 34 mm	90 g	00073
	Hune ou de mât (Blanc 225°) Masthead (White 225°)	2 MN 2 NM	> 5,4 Candela	1,6 W	L 68 x l 55 x H 39 mm	100 g	00035
	Hune ou de mât (Blanc 225°) Masthead (White 225°)	3 MN 3 NM	> 15 Candela	3,2 W	L 68 x l 55 x H 39 mm	155 g	00047
	Hune ou de mât (Blanc 225°) Masthead (White 225°)	5 MN 5 NM	> 65 Candela	6,4 W	L 100 x l 78 x H 172 mm		00063
	Hune ou de mât (Blanc 225°) Masthead (White 225°)	6 MN 6 NM	> 118 Candela	12,8 W	L 100 x l 78 x H 214 mm		00064
	Cache lumière noir pour feux 00031, 00032 & 00033 Black light shield for navigation lights 00031, 00032 & 00033				L 70 x l 56 x H 40 mm	5 g	00137

## Feux de compétition / Racing navigation lights

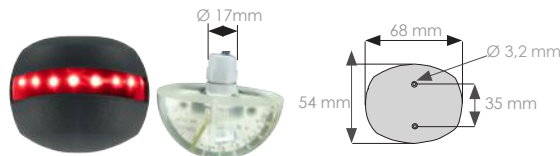

### Type / Product description

### Portée Visibility

### Intensité lumineuse Lighting intensity

### Conso. Cons.

### Dimensions Dimensions

### Poids Weight

### Réf. Ref.

	Babord (Rouge 112,5°) Port (Red 112,5°)	2 MN 2 NM	> 5,4 Candela	0,8 W	L 68 x l 55 x H 34 mm	140 g	00049
	Tribord (Vert 112,5°) Starboard (Green 112,5°)	2 MN 2 NM	> 5,4 Candela	0,8 W	L 68 x l 55 x H 34 mm	140 g	00050
	Poupe (Blanc 135°) Stern (White 135°)	2 MN 2 NM	> 5,4 Candela	0,8 W	L 68 x l 55 x H 34 mm	140 g	00051
	Bicolore (Vert/Rouge 112,5°) Combined (Green/Red 112,5°)	2 MN 2 NM	> 5,4 Candela	1,6 W	L 68 x l 55 x H 34 mm	160 g	00052
	Hune ou de mât (Blanc 225°) Masthead (White 225°)	2 MN 2 NM	> 5,4 Candela	1,6 W	L 68 x l 55 x H 39 mm	100 g	00058

# FEUX CLASSIQUES AVEC LEDS

## LED CLASSICAL NAVIGATION LIGHTS



Nos feux de mât ne perturbent pas l'AIS ni la VHF. Ils ont été certifiés CE en 2016 par un laboratoire indépendant et répondent à la norme IEC 60945 4th Edition 2002-08 selon le rapport 204009 EMC Ed. 1.2.

Our mast navigation lights don't interfere with VHF and AIS. They have been CE certified in 2016 by an independent laboratory and comply to the IEC 60945 4th edition 2002-08 as per the report 204009 EMC Ed. 1.2.



### Descriptif technique :

Ces feux classiques sont équipés de nos ampoules à LEDS Mantagua. Vous divisez ainsi par 8 votre consommation électrique.

### Description :

We fit these classical navigation lights with our Mantagua led bulbs. Low power consumption : up to 8 times less than usual bulb.

## Horizontal < 12 mètres / Horizontal mount < 39 feet



Type Product description	Portée Visibility	Intensité lumineuse Lighting intensity	Conso. Cons.	Dimensions Dimensions	Poids Weight	Réf. Ref.
Mouillage (Blanc 360°) Anchor (White 360°)	2MN	> 5,4 Candela	1,2W	H 75 x Ø 55 mm	85 g	00101
Tricolore - tête de mât Tricolor	1MN	> 1,1 Candela	1,2W	H 75 x Ø 55 mm	85 g	00100
Feu blanc 360° sur pied orientable All-around white 360° on foldable pole	2MN	> 5,4 Candela	1,2W	H 230 x l 60 mm	140 g	00115

## Horizontal < 20 mètres / Horizontal mount < 65 feet



Type Product description	Portée Visibility	Intensité lumineuse Lighting intensity	Conso. Cons.	Dimensions Dimensions	Poids Weight	Réf. Ref.
Mouillage (Blanc 360°) Anchor (White 360°)	2 MN	> 5,4 Candela	2,4 W	L 85 x l 85 x H 105 mm	250 g	00103
Tricolore - tête de mât Tricolor	2 MN	> 5,4 Candela	2,4 W	L 85 x l 85 x H 105 mm	260 g	00102
Tricolore + Mouillage - tête de mât Tricolor with Anchor	2 MN	> 5,4 Candela	2,4 W	L 85 x l 85 x H 200 mm	450 g	00104

## Latéral < 12 mètres / Vertical mount < 39 feet



Type Product description	Portée Visibility	Intensité lumineuse Lighting intensity	Conso. Cons.	Dimensions Dimensions	Poids Weight	Réf. Ref.
Babord (Rouge 112,5°) Port (Red 112,5°)	2 MN	> 1,1 Candela	1,2 W	L 60 x l 55x H 70 mm	105 g	00105
Tribord (Vert 112,5°) Starboard (Green 112,5°)	2 MN	> 1,1 Candela	1,2 W	L 60 x l 55x H 70 mm	105 g	00106
Poupe (Blanc 135°) Stern (White 135°)	2 MN	> 5,4 Candela	1,2 W	L 60 x l 55x H 70 mm	105 g	00107
Bicolore (Vert / Rouge 112,5°) Combined (Green / Red 112,5°)	2 MN	> 1,1 Candela	1,2 W	L 60 x l 55x H 70 mm	110 g	00108
Hune ou tête de mât (Blanc 225°) Masthead (White 225°)	2 MN	> 5,4 Candela	1,2 W	L 60 x l 55x H 70 mm	110 g	00109



# AMPOULES DE FEUX / NAVIGATION LIGHT BULBS



## Caractéristiques techniques :

Ampoule régulée : pas de variation d'intensité et grande longévité de la led.  
 Polarité électrique indifférente : installation électrique simplifiée.  
 Faible consommation électrique : divisée par 10.  
 Longue durée : 50.000 heures.  
**Ont été homologuées 2 MN COLREG et 3MN Marine Marchande.**  
 Diamètre réduit à 33 mm : peut être montée dans les feux de petites dimensions.  
 Navette : l'enlèvement de l'entretoise permet de réduire sa longueur de 42 à 38 mm.

## Specifications:

Regulated leds : no intensity variations and very long expected life.  
 Easy to install : reverse polarity protected.  
 Low power consumption : divided by up to 10.  
 Expected life : 50.000 hours.  
**Have been 2 NM COLREG and 3 NM IMO certified.**  
 Diameter reduced to 33 mm : fits small navigation lights.  
 Festoon : taking off the spacer reduces its length from 42 to 38 mm.

Navigation / Navigation

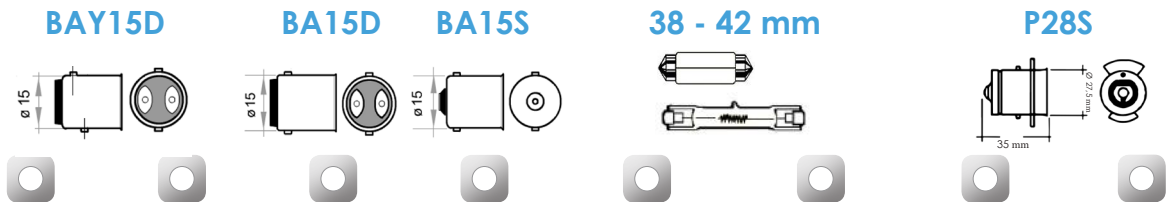

Longueur Navire Boat length	< 12 m	< 20 m	< 12 m	< 12 m	< 12 m	< 20 m	> 50 m	> 50 m
Angle de diffusion Beam angle	50° x 360°	50° x 360°	50° x 360°	50° x 360°	50° x 360°	50° x 360°	50° x 360°	50° x 360°
Consommation Consumption	0,8 W	1,5 W	0,8 W	0,8 W	0,8 W	1,5 W	7 W (65 W)	7 W (40 W)
Dimensions Dimensions	Ø 33 x H 41mm	Ø 33 x H 46mm	Ø 33 x H 41mm	Ø 33 x H 41mm	Ø 33 x L 38/42mm	Ø 33 x L 38/42mm	Ø 38 x H 110mm	Ø 38 x H 110mm
Alimentation Power supply	9 - 30 VDC	9 - 30 VDC	9 - 30 VDC	9 - 30 VDC	9 - 30 VDC	9 - 30 VDC	230 VAC	10 - 30 VDC
Références References	01029	01030	01032	01033	01017	01626	01645	01646



P28S 110 VAC ref. 01658  
sur demande / on request

Les ampoules de navigation à LED les plus éprouvées du marché depuis 2008.  
 Since 2008, the most experienced LED navigation bulbs on the market.



Nos ampoules de navigation ne perturbent pas l'AIS ni la VHF. Elles ont été certifiées CE en 2016 par un laboratoire indépendant et répondent à la norme IEC 60945 4th Edition 2002-08 selon le rapport 204009 EMC Ed. 1.2.  
 Our navigation light bulbs don't interfere with VHF and AIS. They have been CE certified in 2016 by an independant laboratory and comply to the IEC 60945 4th Edition 2002-08 as per the report 204009 EMC Ed. 1.2.



# ÉCLAIRAGES EXTERIEUR À LED

## LED WATERPROOF LIGHTINGS



Extérieur / External

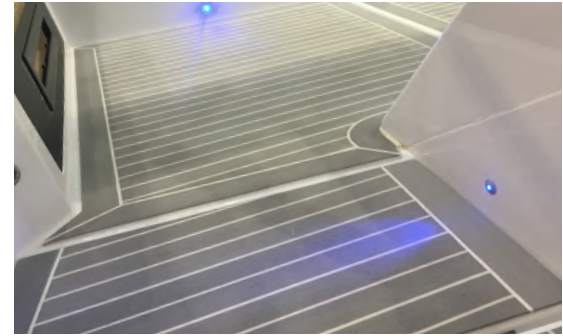
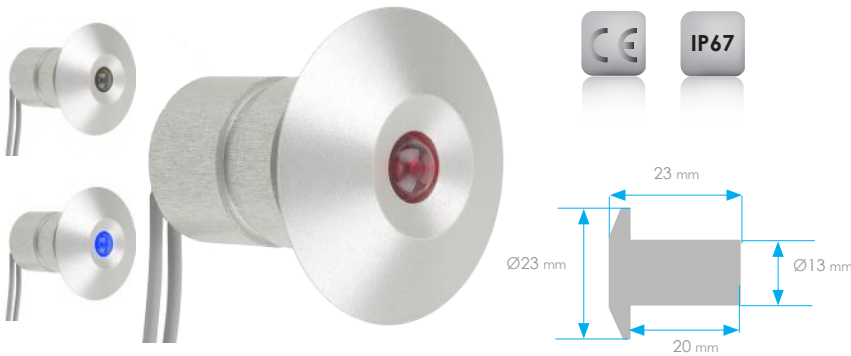

**Descriptif technique :**

Idéales pour l'éclairage bas comme sur des marches de catamaran, les Houat sont ultra-robustes car réalisées en aluminium anodisé et l'électronique est totalement résinée. Non polarisées. Livrées avec 10 cm de fil électrique dénudé. Etanchéité IP67.

**Description :**

Ideal for low onboard areas such as catamaran steps. The Houat courtesy lights are extremely robust thanks to their aluminium anodized body in which the electronics is encapsulated in resin. Reverse polarity protected. Supplied with 10 cm of electrical wire. IP67 waterproof.

	Alimentation Voltage	Puissance Power	Couleur Colour	Matériau Material	Poids Weight	Angle diffusion Beam angle	Consommation Consumption	Références References
	9-30 VDC	5 Cd	3100 K Blanc chaud 3100 K Warm white	Aluminium + résine Aluminium & resin	20 g	50°	0.4 W	01129
	9-30 VDC	3 Cd	Rouge Red	Aluminium + résine Aluminium & resin	20 g	50°	0.4 W	01130
	9-30 VDC	1 Cd	Bleu Blue	Aluminium + résine Aluminium & resin	20 g	50°	0.4 W	01131



Eclairage horizontal / Horizontal lighting

	Alimentation Voltage	Puissance Power	Couleur Colour	Matériau Material	Poids Weight	Angle diffusion Beam angle	Consommation Consumption	Références References
	9-30 VDC	12 Cd	4500 K Blanc neutre 4500 K Neutral white	Inox + résine Stainless + resin	30 g	120°	0.8 W	01413
	9-30 VDC	4 Cd	Bleu Blue	Inox + résine Stainless + resin	30 g	120°	0.8 W	01414

Eclairage vertical / Vertical lighting

	9-30 VDC	12 Cd	4500 K Blanc neutre 4500 K Neutral white	Inox + résine Stainless + resin	30 g	120°	0.8 W	01415
	9-30 VDC	4 Cd	Bleu Blue	Inox + résine Stainless + resin	30 g	120°	0.8 W	01416

**Descriptif technique :**

Idéales pour l'éclairage bas extérieur, les Wight sont réalisées en inox et l'électronique est totalement résinée. Non polarisées. Livré avec 10 cm de fil électrique dénudé. Etanchéité IP67.

**Description:**

Ideal for low level external lighting, the Wight courtesy lights have a stainless steel bezel and electronics is encapsulated in resin. Reverse polarity protected. Supplied with 10 cm of electrical wire. IP67 waterproof.



Photo: Axon



15W Gavrinis on Bimini Tube

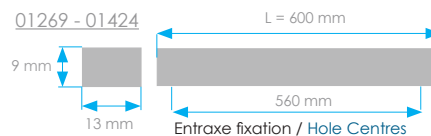
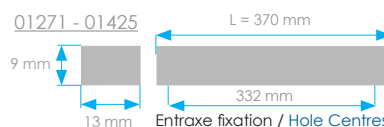

Screw

clip

**Caracteristiques techniques :**

Conçues pour être logées dans la ralingue d'une bôme, les réglottes à leds Gavrinis sont fournies avec deux clips de fixation qui permettent de les monter également sur un tube de bimini de diamètre 25 mm. Fournies avec 5 m de câble pour pouvoir réaliser la connection à l'intérieur du bateau. Polarité électrique indifférente. Étanche IP68.

**Specifications:**

Designed to be fitted in the luff of a boom, the Gavrinis led strips are also supplied with 2 clips to be fitted on a 25 mm bimini tube. They are supplied with 5 m cable to connect to the ship's power inside the boat. Regulated leds, reverse polarity protected. IP68 waterproof.

**Réglotte à brancher / Wired rigid LED strip**

	Alimentation Voltage	Dimension Length	Puissance Power	Couleur Colour	Matériau Material	Poids Weight	Angle Angle	Consommation Consumption	Références References
	9-30 VDC	370 mm	140 lm	3100 K Blanc chaud 3100 K Warm white	Alu. + résine Alu. & resin	145 g	50°	4,2 W	01271
	9-30 VDC	600 mm	280 lm	3100 K Blanc chaud 3100 K Warm white	Alu. + résine Alu. & resin	190 g	50°	8,4 W	01269
	9-30 VDC	370 mm	140 lm	Rouge Red	Alu. + résine Alu. & resin	145 g	50°	4,2 W	01425
	9-30 VDC	600 mm	280 lm	Rouge Red	Alu. + résine Alu. & resin	190 g	50°	8,4 W	01424

Dimmables avec gradateur Mantagua (ref. 01159 voir p.61) / Dimmables with Mantagua dimmer (Ref. 01159 see p.61)

**ÉCLAIRAGE AUTONOME / WIRELESS LIGHTING**

Réglotte rigide ou ruban étanche IP68. Fournie seule ou avec power bank. La réglotte est fournie avec une rallonge USB de 1 m. IP68 waterproof rigid led strip or led ribbon. Supplied alone or with power bank. The rigid led strip is supplied with a 1 m USB extension cable.

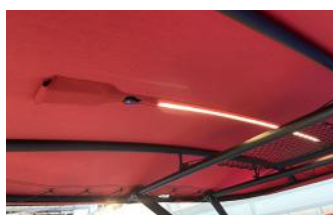

**Ruban 1 mètre / LED strip ribbon 1m**

	Autonomie Autonomy	Puissance Power	Couleur Colour	Matériau Material	Poids Weight	Angle Angle	Consommation Consumption	Références References
	8 heures 8 hours	190 lm	3100 K Blanc chaud 3100 K Warm white	1m ruban étanche IP68 1m IP68 waterproof strip	145 g	120°	4 W	01500
	3 heures 3 hours	190 lm	3100 K Blanc chaud 3100 K Warm white	1m ruban étanche IP68 1m IP68 waterproof strip	145 g	120°	4 W	01571
	Sans powerbank W/O powerbank	190 lm	3100 K Blanc chaud 3100 K Warm white	1m ruban étanche IP68 1m IP68 waterproof strip	145 g	120°	4 W	01579

**Réglotte rigide / Rigid strip**

	8 heures 8 hours	200 lm	3100 K Blanc chaud Warm white	0,6 m Aluminium + résine 0,6 m Aluminium & resin	190 g	50°	2,4 W	01547
	Sans powerbank W/O powerbank	100 lm	3100 K Blanc chaud Warm white	0,3 m Aluminium + résine 0,3 m Aluminium & resin	80 g	50°	1,2 W	01580



clip

# PROJECTEURS DE BARRE DE FLÈCHE À LED LED SPREADER FLOODLIGHTS

Extérieur / External



## Info

Les projecteurs de barre de flèche ont au départ été conçus pour illuminer le pont, mais aujourd'hui, en jouant sur les optiques et les couleurs, on les utilise de plus en plus comme élément de signalisation ou de décoration, par exemple en éclairant vers le haut, en couleur, pour illuminer un grand mât. Gradable avec la ref. 01159, page 61

## Product info

A spreader floodlight was originally developed to permit the lighting of the deck from above, but today, playing with the optical lenses and the colors, they are more and more used as signalling or decorating elements to illuminate a big mast. Dimmable with our ref. 01159, page 61.

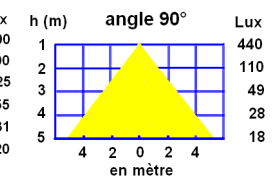
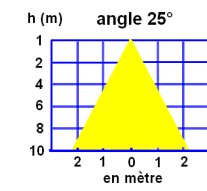
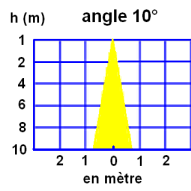
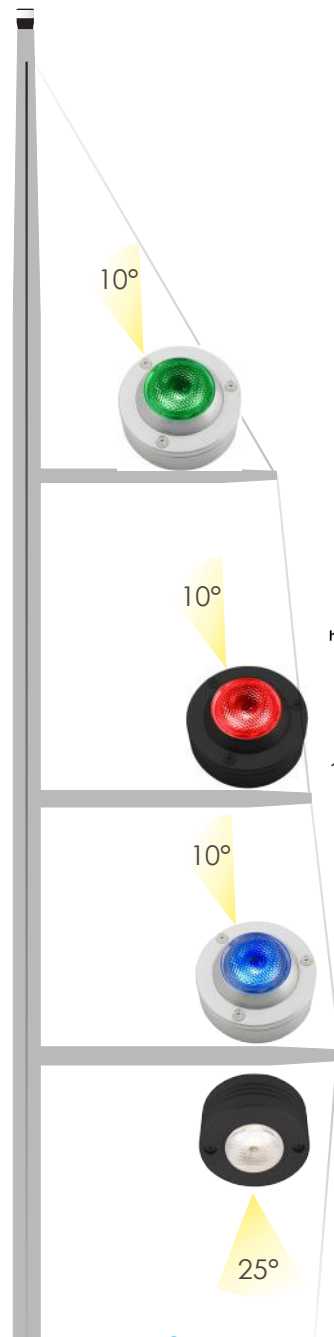

Un projecteur se définit par sa puissance lumineuse et aussi par son angle. Le fait d'avoir une optique va permettre d'allonger la portée du faisceau, en concentrant son faisceau, mais cela réduit sa largeur d'éclairage. Il convient donc de bien choisir son modèle en fonction de la position du projecteur et de ce que l'on veut éclairer.

A floodlight is defined by its lighting power and also by the beam angle. Having an optical lens will permit to concentrate the light and increase the range, but that reduces the width of lighting. You shall then carefully select your model according to the unit position and what you want to enlight.

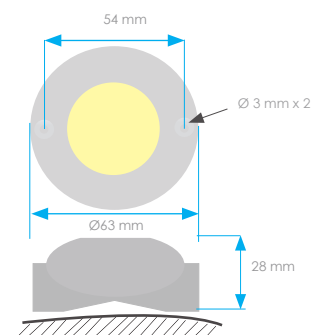

Orientable / Adjustable



	Alimentation Voltage	Puissance Power	Couleur Colour	Matériau Material	Poids Weight	Angle Angle	Consommation Consumption	Aluminium Aluminium	Noir Black
	9-30 VDC	370 lm - 900 Cd	6500 K Blanc froid 6500 K Cool white	Alu. anodisé Anodised alu.	156 g	25°	4.4 W	01301	01558
	9-30 VDC	370 lm - 900 Cd	3000 K Blanc chaud 3000 K Warm white	Alu. anodisé Anodised alu.	156 g	25°	4.4 W	01597	01598
	9-30 VDC	30 lm	Au choix To select	Alu. anodisé Anodised alu.	156 g	25°	2 W	01384	01559
	9-30 VDC	30 lm	Au choix To select	Alu. anodisé Anodised alu.	156 g	10°	2 W	01423	01560

# PROJECTEURS BARRE DE FLÈCHE, PONT & COCKPIT LED SPREADER, DECK & COCKPIT FLOODLIGHTS



Longueur de câble supplémentaire disponible en option (réf. 01720)  
Additional cable length available as an option (ref. 01720)

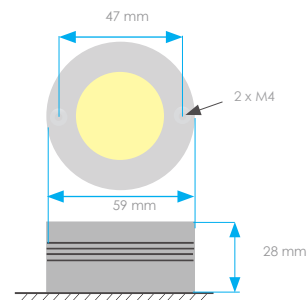

## Saillie / Surface mounted

	Alimentation Voltage	Puissance Power	Couleur Colour	Matériau Material	Poids Weight	Angle Angle	Consommation Consumption	Aluminium Aluminium	Noir Black
	9-30 VDC	370 lm - 900 Cd	6500 K Blanc froid 6500 K Cool white	Alu. anodisé Anodised alu.	165 g	25°	4.4 W	01074	01561
	9-30 VDC	370 lm - 900 Cd	3000 K Blanc chaud 3000 K Warm white	Alu. anodisé Anodised alu.	165 g	25°	4.4 W	01595	01596
	9-30 VDC	370 lm - 820 Cd	6500 K Blanc froid 6500 K Cool white	Inox Sainless steel	436 g	40°	4.4 W	01287	-



Longueur de câble supplémentaire disponible en option (réf. 01720)  
Additional cable length available as an option (ref. 01720)

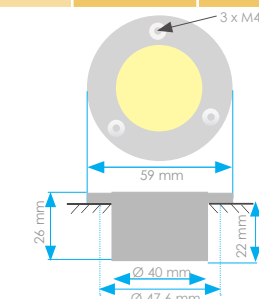

## Encastré 1 LED / Recessed SINGLE LED

	Alimentation Voltage	Puissance Power	Couleur Colour	Matériau Material	Poids Weight	Angle Angle	Consommation Consumption	Aluminium Aluminium	Noir Black
	9-30 VDC	370 lm - 1500 Cd	6500 K Blanc froid 6500 K Cool white	Alu. anodisé Anodised alu.	85 g	10°	4.4 W	01444	01562
	9-30 VDC	370 lm - 900 Cd	6500 K Blanc froid 6500 K Cool white	Alu. anodisé Anodised alu.	85 g	25°	4.4 W	01184	01563
	9-30 VDC	370 lm - 900 Cd	3000 K Blanc chaud 3000 K Warm white	Alu. anodisé Anodised alu.	85 g	25°	4.4 W	01542	01564
	9-30 VDC	370 lm - 820 Cd	6500 K Blanc froid 6500 K Cool white	Alu. anodisé Anodised alu.	85 g	40°	4.4 W	01285	01565
	9-30 VDC	370 lm - 820 Cd	3000 K Blanc chaud 3000 K Warm white	Alu. anodisé Anodised alu.	85 g	40°	4.4 W	01655	01656
	9-30 VDC	370 lm - 900 Cd	6500 K Blanc froid 6500 K Cool white	Inox Sainless steel	220 g	25°	4.4 W	01288	-



Longueur de câble supplémentaire disponible en option (réf. 01720)  
Additional cable length available as an option (ref. 01720)

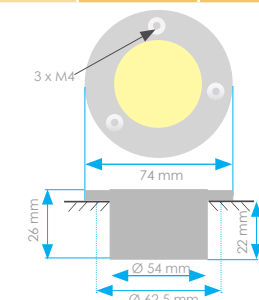

## Encastré Tri LEDs / Recessed TRIPLE LEDS

	Alimentation Voltage	Puissance Power	Couleur Colour	Matériau Material	Poids Weight	Angle Angle	Consommation Consumption	Aluminium Aluminium	Noir Black
	9-30 VDC	600 lm - 2400 Cd	6500 K Blanc froid 6500 K Cool white	Alu. anodisé Anodised alu.	140 g	10°	6.8 W	01446	01566
	9-30 VDC	600 lm - 1000 Cd	6500 K Blanc froid 6500 K Cool white	Alu. anodisé Anodised alu.	140 g	25°	6.8 W	01445	01567
	9-30 VDC	600 lm - 850 Cd	6500 K Blanc froid 6500 K Cool white	Alu. anodisé Anodised alu.	140 g	40°	6.8 W	01447	01568
	12 VDC	-	RVBB RGBW	Alu. anodisé Anodised alu.	140 g	10°	2 W	01632	01631



Télécommande + contrôleur RVBB (voir Page 58)  
RGBW Remote & controller (see page 58)  
Réf. 01633

Support saillie  
Surface mount holder

01635 01634

# PROJECTEURS DE PONT & COCKPIT COMBINED MASTHEAD & DECK LIGHTS

Mini projecteur / Mini spotlight

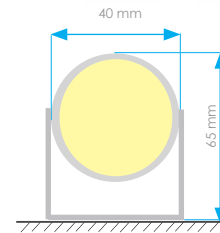

	Alimentation Voltage	Puissance Power	Couleur Colour	Matériau Material	Poids Weight	Angle Angle	Consommation Consumption	Références References
6500 K	9-30 VDC	370 lm - 660 Cd	6500 K Blanc froid 6500 K Cool white	Alu. anodisé Anodised alu.	100 g	40°	4.4 W	01144

Projecteur de pont et feu de hune / Combined masthead & deck light

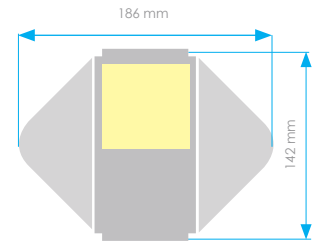

	Alimentation Voltage	Puissance Power	Couleur Colour	Matériau Material	Poids Weight	Angle Angle	Consommation Consumption	Références References
2700 K	9-30 VDC	2 MN / 210 lm	2700 K Blanc chaud 2700 K Warm white	ABS & PMMA.	270 g	90°	0,8 W / 3 W	01179
2700 K	9-30 VDC	3 MN / 210 lm	2700 K Blanc chaud 2700 K Warm white	ABS & PMMA.	280 g	90°	1,5 W / 3 W	01627

Extérieur / External



# PROJECTEURS DE PONT & COCKPIT COMBINED MASTHEAD & DECK LIGHTS

Projecteur de pont 4.4 W et feu de hune / Combined masthead & 4.4 W deck light

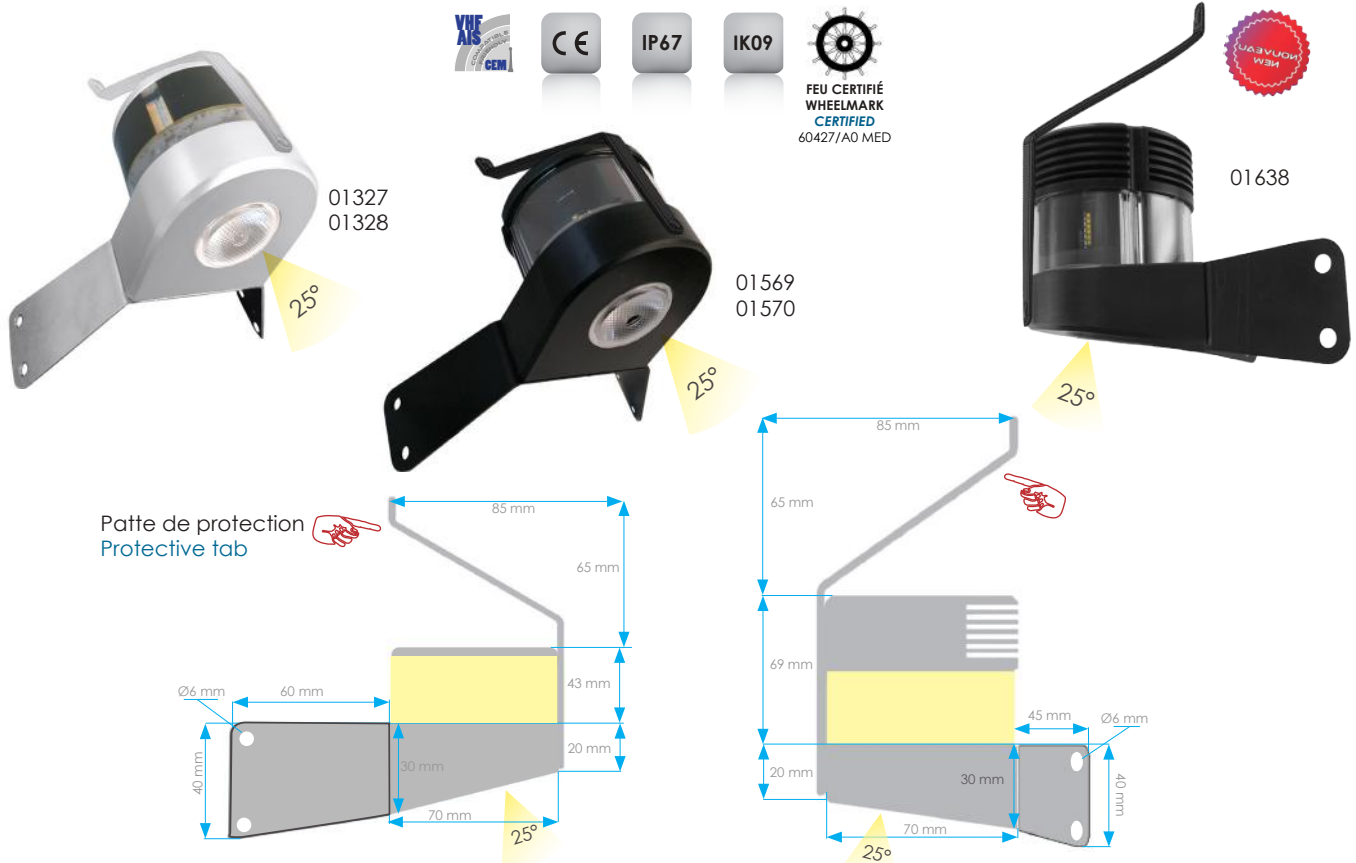

	Alimentation Voltage	Puissance Power	Couleur Colour	Matériau Material	Poids Weight	Angle Angle	Consommation Consumption	Aluminium Aluminium	Noir Black
	9-30 VDC	2 MN / 370 lm	6000 K Blanc froid 6000 K Cool white	Alu. anodisé Anodised alu.	430 g	25°	1,6 W / 4.4 W	01327*	01569
	9-30 VDC	3 MN / 370 lm	6000 K Blanc froid 6000 K Cool white	Alu. anodisé Anodised alu.	470 g	25°	3,2 W / 4.4 W	01328*	01570
	20-30 VDC	5 MN / 370 lm	6000 K Blanc froid 6000 K Cool white	Alu. anodisé Anodised alu.	520 g	25°	11 W / 4.4 W	-	01638

Livré avec 15 mètres de câble / Supplied with 15 meters of cable

\* Non certifié Wheelmark / Not Wheelmark certified

## Projecteur de pont 6.8 W Tri LEDs / TRIPLE LED 6.8 W deck light

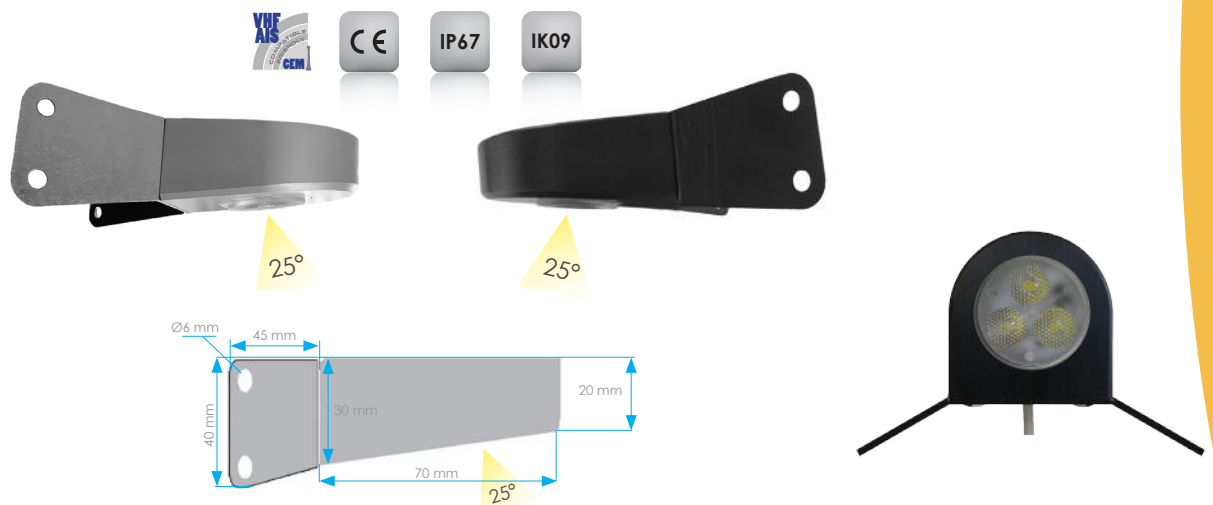

	Alimentation Voltage	Puissance Power	Couleur Colour	Matériau Material	Poids Weight	Angle Angle	Consommation Consumption	Aluminium Aluminium	Noir Black
	9-30 VDC	600 lm	6500 K Blanc froid 6500 K Cool white	Alu. anodisé Anodised alu.	430 g	25°	6.8 W	01751	01752

Livré avec 15 mètres de câble / Supplied with 15 meters of cable

**SPOTS / LISEUSES / LAMPES TABLE À CARTES /  
REGLETTES**

**LED CEILING LIGHTS / DOWNLIGHTS / CABIN LAMPS /  
CHART TABLE LAMPS / STRIPS**

Intérieur / Cabin





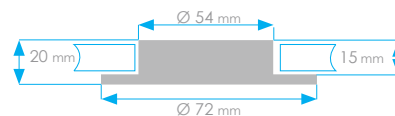

LED 1,9 W ≈ 10 W



Cache Cover	Alimentation Voltage	Puissance Power	Couleur Colour	Matériau Material	Poids Weight	Angle Angle	Conso. Consumption	Sans inter. No switch	Avec inter. With switch
Inox poli Polished S.S	9-30 VDC	140 lm	3000 K Blanc chaud 3000 K Warm white	inox +ABS S/S + ABS	54 g	120°	1,9 W	01437	01438
Inox brossé Brushed S.S	9-30 VDC	140 lm	3000 K Blanc chaud 3000 K Warm white	inox +ABS S/S + ABS	54 g	120°	1,9 W	01521	01522
Blanc White	9-30 VDC	140 lm	3000 K Blanc chaud 3000 K Warm white	inox blanc white S/S	54 g	120°	1,9 W	01489	01490

LED 2,4 W ≈ 20 W



Cache Cover	Alimentation Voltage	Puissance Power	Couleur Colour	Matériau Material	Poids Weight	Angle Angle	Conso. Consumption	Sans inter. No switch	Avec inter. With switch
Inox poli Polished S.S	9-30 VDC	250 lm	3000 K Blanc chaud 3000 K Warm white	inox +ABS S/S + ABS	54 g	120°	2,4 W	01439	01440
Inox brossé Brushed S.S	9-30 VDC	250 lm	3000 K Blanc chaud 3000K Warm white	inox +ABS S/S + ABS	54 g	120°	2,4 W	01523	01524
Blanc White	9-30 VDC	250 lm	3000 K Blanc chaud 3000K Warm white	inox blanc white S/S	54 g	120°	2,4 W	01548	01549

### Descriptif technique :

**Spot de cabine en ABS et cache inox poli ou brossé ou blanc.** Diffusion large. Montage encastré aisé par 2 ressorts (inclus). Livré avec 10 cm de fil électrique dénudé. En version avec ou sans interrupteur, le spot est ETANCHE IP67. 01437, 01489 et 01521 sont dimmables avec gradateur Mantagua (ref. 01159). Peut être fourni avec joint isolant permettant un montage inox sur aluminium.

### Description:

**Cabin spotlight made of ABS and mirror polished or brushed or white painted Stainless Steel cover.** Large beam. Easy recessed mounting with 2 springs (included). Comes with 10 cm of electrical wire. With or without switch the spotlight is IP67 WATERPROOF. 01437, 01489 et 01521 are dimmable with Mantagua dimmer (ref. 01159). Can be supplied with plastic sealing allowing stainless steel mounting on aluminium base.

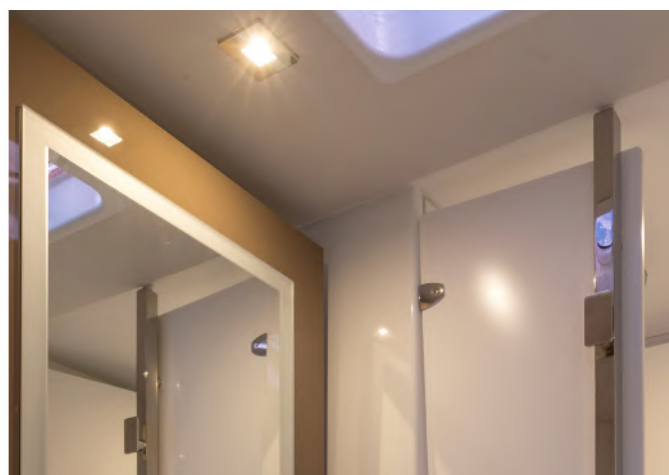

Totalement étanches, Tudy et Nividic sont idéals pour un éclairage extérieur ou dans une salle de bain.  
Fully waterproof, Tudy and Nividic are ideal for outdoor or bathroom lighting.

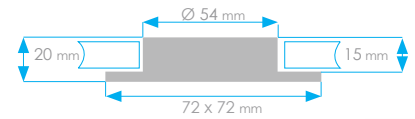

LED 1,9 W ≈ 10 W



	Cache Cover	Cache Cover	Puissance Power	Couleur Colour	Matériau Material	Poids Weight	Angle Angle	Conso. Consumption	Sans inter. No switch	Avec inter. With switch
	Inox poli Polished S.S	9-30 VDC	140 lm	3000 K Blanc chaud 3000 K Warm white	inox + ABS S/S + ABS	54 g	120°	1,9 W	01432	01433
	Inox brossé Brushed S.S	9-30 VDC	140 lm	3000 K Blanc chaud 3000 K Warm white	inox + ABS S/S + ABS	54 g	120°	1,9 W	01525	01526
	Blanc White	9-30 VDC	140 lm	3000 K Blanc chaud 3000 K Warm white	inox blanc white S/S	54 g	120°	1,9 W	01514	01515

LED 2,4 W ≈ 20 W



	Cache Cover	Cache Cover	Puissance Power	Couleur Colour	Matériau Material	Poids Weight	Angle Angle	Conso. Consumption	Sans inter. No switch	Avec inter. With switch
	Inox poli Polished S.S	9-30 VDC	250 lm	3000 K Blanc chaud 3000 K Warm white	inox+ABS S/S + ABS	54 g	120°	2,4 W	01434	01435
	Inox brossé Brushed S.S	9-30 VDC	250 lm	3000 K Blanc chaud 3000 K Warm white	inox+ABS S/S + ABS	54 g	120°	2,4 W	01527	01528
	Blanc White	9-30 VDC	250 lm	3000 K Blanc chaud 3000 K Warm white	inox blanc white S/S	54 g	120°	2,4 W	01529	01530

**Descriptif technique :**

**Spot de cabine en ABS et cache inox poli ou brossé ou blanc.** Diffusion large. Montage encastré aisé par 2 ressorts (inclus). Livré avec 10 cm de fil électrique dénudé. En version avec ou sans interrupteur, le spot est ETANCHE IP67. 01432, 01514 et 01525 sont dimmables avec gradateur Mantagua (Ref. 01159). Peut être fourni avec joint isolant permettant un montage inox sur aluminium.

**Description:**

**Cabin spotlight made of ABS and mirror polished or brushed or white Stainless Steel cover.** Large beam. Easy recessed mounting with the 2 springs (included). Comes with 10 cm of electrical wire. With or without switch the spotlight is IP67 WATERPROOF. 01432, 01514 and 01525 are dimmable with Mantagua dimmer (Ref. 01159). Can be supplied with plastic sealing allowing stainless steel mounting on aluminium base.



Support saillié (avec vis)  
Surface mount holder (with screws)



Dimensions : L 98 x l 98 x H 17 mm  
Dimensions : L 98 x W 98 x H 17 mm

Rehausse inox poli Polished stainless steel mounting holder	01441
Rehausse inox brossé Brushed stainless steel mounting holder	01531
Réhausse blanc White mounting holder	01491

LED 2,8 W ≈ 10 W

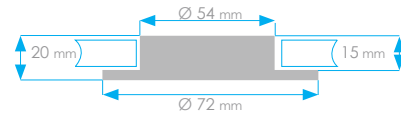

## Descriptif technique :

Spot de cabine Rouge et/ou Blanc avec gradateur intégré, fonctionnement Maître/Esclave, étanche IP67. Diffusion large. Finition inox poli miroir, interrupteur poussoir. Montage encastré aisé par 2 ressorts (inclus). Livré avec 10 cm de fil électrique dénudé.

## Description:

Cabin spotlight Red and/or White lighting with built-in dimmer module, Master & Slave system, IP67 waterproof. Large beam. Mirror polished Stainless Steel, pushed button. Easy recessed mounting with 2 springs (included). Comes with 10 cm of electrical wire.

	Description Description	Alim. Voltage	Puissance Power	Couleur Colour	Matériau Material	Poids Weight	Angle Angle	Conso. Cons.	Réf. Ref.
	Rouzig standard (avec inter.) Stand alone Rouzig (with switch)	9-30 VDC	135 lm	3000 K Blanc 3000 K White	Inox + PMMA S. S. + PMMA	47 g	120°	2,8 W	01481
	Rouzig maître (avec inter.) Rouzig master (with switch)	9-30 VDC	135 lm	3000 K Blanc 3000 K White	Inox + PMMA S. S. + PMMA	47 g	120°	2,8 W	01477
	Rouzig maître (sans inter.) Rouzig master (without switch)	9-30 VDC	135 lm	3000 K Blanc 3000 K White	Inox + PMMA S. S. + PMMA	47 g	120°	2,8 W	01478
	Rouzig esclave (avec inter.) Rouzig slave (with switch)	9-30 VDC	135 lm	3000 K Blanc 3000 K White	Inox + PMMA S. S. + PMMA	47 g	120°	2,8 W	01479
	Rouzig esclave (sans inter.) Rouzig slave (no switch)	9-30 VDC	135 lm	3000 K Blanc 3000 K White	Inox + PMMA S. S. + PMMA	47 g	120°	2,8 W	01480
	Rouzig standard (avec inter.) Stand alone Rouzig (with switch)	9-30 VDC	135 lm	3000 K Blanc + Rouge 3000 K White + Red	Inox + PMMA S. S. + PMMA	47 g	120°	2,8 W	01476
	Rouzig maître (avec inter.) Rouzig master (with switch)	9-30 VDC	135 lm	3000 K Blanc + Rouge 3000 K White + Red	Inox + PMMA S. S. + PMMA	47 g	120°	2,8 W	01472
	Rouzig maître (sans inter.) Rouzig master (without switch)	9-30 VDC	135 lm	3000 K Blanc + Rouge 3000 K White + Red	Inox + PMMA S. S. + PMMA	47 g	120°	2,8 W	01473
	Rouzig esclave (avec inter.) Rouzig slave (with switch)	9-30 VDC	135 lm	3000 K Blanc + Rouge 3000 K White + Red	Inox + PMMA S. S. + PMMA	47 g	120°	2,8 W	01474
	Rouzig esclave (sans inter.) Rouzig slave (no switch)	9-30 VDC	135 lm	3000 K Blanc + Rouge 3000 K White + Red	Inox + PMMA S. S. + PMMA	47 g	120°	2,8 W	01475

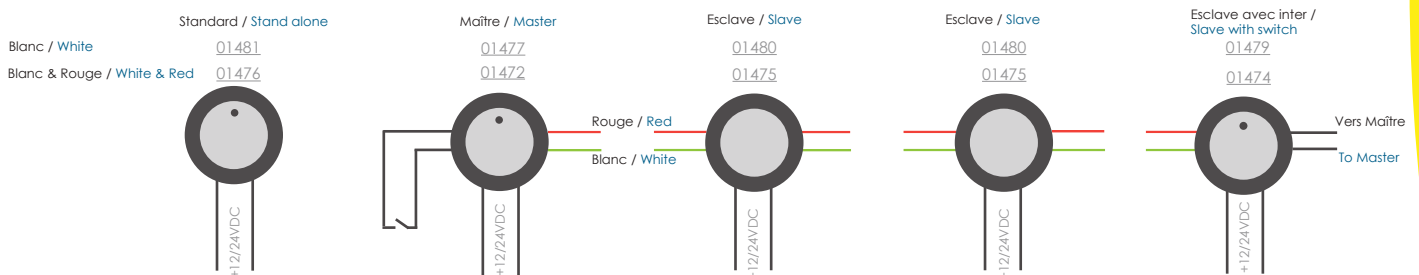

## Système Maître/Esclave Rouzig et Tristan :

Pour pouvoir illuminer une timonerie de manière homogène en rouge ou blanc en faisant varier l'intensité, nous avons conçu un système Maître/Esclave qui permet de chaîner jusqu'à 20 spots et les commander depuis différents endroits de la timonerie / passerelle.

## Rouzig & Tristan Master & Slave system:

To illuminate a complete boat deck with an homogenous red or white lighting whilst dimming the lights, we developed a daisy chain system up to 20 spotlights that can be managed from various points of the wheelbridge.

# TRISTAN

SPOT LED / LED CEILING LIGHT

LED 2,8 W ≈ 10 W

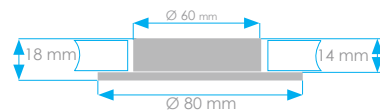

## Descriptif technique :

Fonctionnement Maître/Esclave identique au Rouzic (voir page précédente). Corps en aluminium anodisé, brossé. Diffusion large. Interrupteur en ABS blanc sur 01227, 01266, 01375 et 01456. Montage encastré aisé par 2 ressorts. Livré avec 10 cm de fil électrique dénudé.

## Description:

Master & Slave (see system description on previous page). Body made with brushed anodises aluminium. Large beam. Switch in white ABS on 01227, 01266, 01375 et 01456. Easy recessed mounting with the 2 springs. Comes with 10 cm of electrical wire.

	Description Description	Alim. Voltage	Puissance Power	Couleur Colour	Matériau Material	Poids Weight	Angle Angle	Conso. Cons.	Référence Reference
	Tristan standard(avec inter.) Stand alone Tristan (with switch)	9-30 VDC	135 lm	3000 K Blanc 3000 K White	Alu + PMMA Alu + PMMA	47g	120°	2,8 W	01266
	Tristan standard (avec inter.) Stand alone Tristan (with switch)	9-30 VDC	135 lm	3000 K Blanc + Rouge 3000 K White + Red	Alu + PMMA Alu + PMMA	47g	120°	2,8 W	01227
	Tristan maître (avec inter.) Tristan master (with switch)	9-30 VDC	135 lm	3000 K Blanc + Rouge 3000 K White + Red	Alu + PMMA Alu + PMMA	47g	120°	2,8 W	01375
	Tristan maître (sans inter.) Tristan master (without switch)	9-30 VDC	135 lm	3000 K Blanc + Rouge 3000 K White + Red	Alu + PMMA Alu + PMMA	47g	120°	2,8 W	01471
	Tristan esclave (avec inter.) Tristan slave (with switch)	9-30 VDC	135 lm	3000 K Blanc + Rouge 3000 K White + Red	Alu + PMMA Alu + PMMA	47g	120°	2,8 W	01456
	Tristan esclave (sans inter.) Tristan slave (no switch)	9-30 VDC	135 lm	3000 K Blanc + Rouge 3000 K White + Red	Alu + PMMA Alu + PMMA	47g	120°	2,8 W	01362

# QUIBERON

SPOT LED / LED CEILING LIGHT

LED 2,2 W ≈ 10 W



SAMSUNG

	Alimentation Voltage	Puissance Power	Couleur Colour	Matériau Material	Poids Weight	Angle Angle	Consommation Consumption	Sans inter. No switch	Avec inter. With switch
	9-30 VDC	220 lm	3100 K Blanc chaud 3100 K Warm white	Aluminium + verre Aluminium + glass	120 g	120°	2,2 W	01293	01294

## Descriptif technique :

Idéal pour les salles de bains et pièces humides, ce spot plastique est fourni avec kit encastrément et collerette bleue ou blanche, livré avec 10 cm de fil dénudé.

## Description:

Idéal for bathrooms and wet areas in general, this plastic body spotlight is supplied with recessed assembly kit and blue or white external ring, supplied with 10 cm of electrical wire.

# MOLENE

## PLAFONNIER LED / LED CABIN DOWNLIGHTLIGHT

LED 1,5 W ≈ 20 W    LED 2,2 W ≈ 30 W

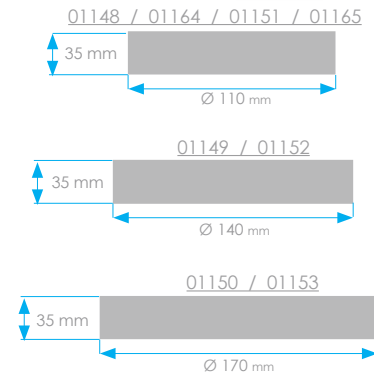

	Alimentation Voltage	Puissance Power	Couleur Colour	Matériau Material	Poids Weight	Angle Angle	Consommation Consumption	Référence Reference
	9-30 VDC	130 lm	3100 K Blanc 3100 K White	Inox poli Stainless steel	126 g	90°	1,5 W	01148
	9-30 VDC	30 lm	Rouge chaud Warm red	Inox poli Stainless steel	126 g	90°	1,3 W	01164
	9-30 VDC	130 lm	3100 K Blanc 3100 K White	Inox poli Stainless steel	175 g	120°	1,5 W	01149
	9-30 VDC	220 lm	3100 K Blanc 3100 K White	Inox poli Stainless steel	226 g	120°	2,2 W	01150
	9-30 VDC	130 lm	3100 K Blanc 3100 K White	Laiton Brass	126 g	90°	1,5 W	01151
	9-30 VDC	30 lm	Rouge chaud Warm red	Laiton Brass	126 g	90°	1,3 W	01165
	9-30 VDC	130 lm	3100 K Blanc 3100 K White	Laiton Brass	175 g	120°	1,5 W	01152
	9-30 VDC	220 lm	3100 K Blanc 3100 K White	Laiton Brass	226 g	120°	2,2 W	01153

# SARK

## PLAFONNIER LED / LED CABIN DOWNLIGHT

LED 1,5 W ≈ 20 W

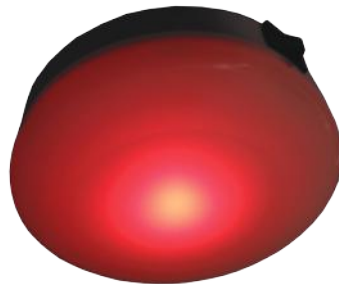

	Alimentation Voltage	Puissance Power	Couleur Colour	Matériau Material	Poids Weight	Angle Angle	Consommation Consumption	Référence Reference
	9-30 VDC	130 lm	3100 K Blanc chaud + Rouge 3100 K Warm white + Red	Nylon Nylon	120 g	120°	1,5 W	01419

### Descriptif technique :

**Plafonnier éclairage bicolore : rouge et blanc.** Diffusion large. Corps en plastique nylon. Fixation aisée par 2 vis fournies. Livré avec 10 cm de fil électrique dénudé.

### Description:

**Red & White downlight with a large light diffusion.** Plastic body. Easy to install with the 2 supplied screws. Comes with 10 cm of electrical wire.

# BELLE ILE

LED 1 W ≈ 15 W

LISEUSE LED / LED CABIN LAMP

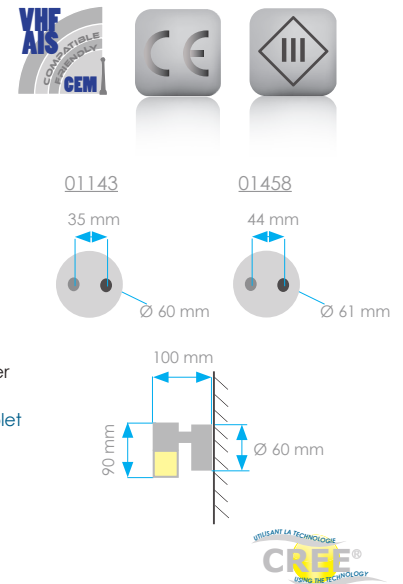

Le port USB permet de charger tablette et portable. 2 A max.  
The USB port can charge tablet and cellphone. 2 A. max

Alimentation Voltage	Puissance Power	Couleur Colour	Matériau Material	Poids Weight	Angle	Consommation Consumption	Avec inter. With switch	Inter+USB Switch+USB
9-30 VDC	100 lm	3100 K Blanc chaud 3100 K Warm white	Verre + Zamak Zamak + Glass	140 g	115°	1 W	01143	01458

## Descriptif technique :

**Lampe de cabine d'ambiance.** Diffusion large. Finition inox brossé verni et interrupteur en ABS noir. Fixation aisée par 2 vis fournies. Livré avec 10 cm de fil électrique dénudé.

## Description:

**Cabin lamp with a large light diffusion.** Brushed stainless steel finish and switch in black ABS. Easy to install with the 2 supplied screws. Comes with 10 cm of electrical wire.

# HOEDIC

LED 1 W ≈ 15 W

LISEUSE LED / LED CABIN LAMP

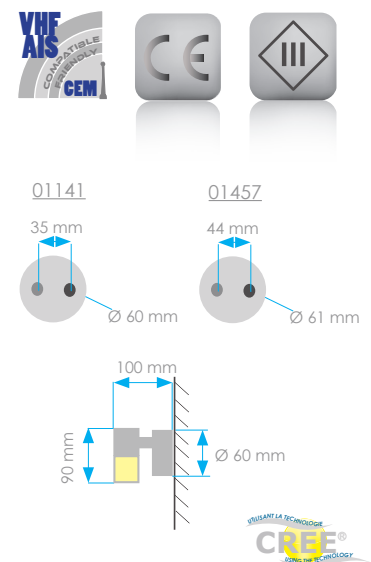

Le port USB permet de charger tablette et portable. 2 A max.  
The USB port can charge tablet and cellphone. 2 A max.

Alimentation Voltage	Puissance Power	Couleur Colour	Matériau Material	Poids Weight	Angle	Consommation Consumption	Avec inter. With switch	Inter+USB Switch+USB
9-30 VDC	100 lm	3100 K Blanc chaud 3100 K Warm white	Verre + Zamak Zamak + Glass	140 g	40°	1 W	01141	01457

## Descriptif technique :

**Lampe de cabine DIRECTIONNELLE.** Faisceau 40° idéal pour la lecture. Finition aspect inox brossé avec interrupteur. Fixation aisée par 2 vis fournies. Livré avec 10 cm de fil électrique dénudé.

## Description:

**Cabin lamp with a DIRECTIONAL light 40° beam ideal for reading.** Stainless steel finish, with switch. Easy to install with the 2 supplied screws. Comes with 10 cm of electrical wire.

LED 1,3 W ≈ 10 W

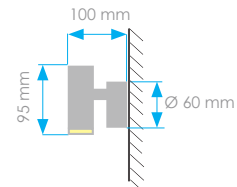
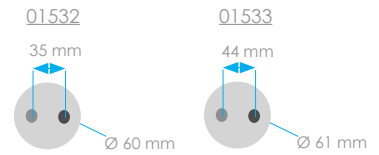

Le port USB permet de charger tablette et portable. 2 A max.  
The USB port can charge tablet and cellphone. 2 A max.

Alimentation Voltage	Puissance Power	Couleur Colour	Matériau Material	Poids Weight	Angle Angle	Consommation Consumption	Avec inter. With switch	Inter+USB Switch+USB
9-30 VDC	90 lm	3100 K Blanc chaud 3100 K Warm white	Zamak Zamak	170 g	40°	1,3 W	01532	01533

### Descriptif technique :

**Lampe de cabine orientable avec faisceau étroit idéal pour la lecture.** Finition inox poli et interrupteur en ABS noir. Fixation aisée par 2 vis fournies. Livré avec 10 cm de fil électrique dénudé.

### Description:

**Cabin lamp adjustable with a narrow beam ideal for reading.** Polished stainless steel finish and switch in black ABS. Easy to install with the 2 supplied screws. Comes with 10 cm of electrical wire.



LED 1,5 W ≈ 20 W



01411

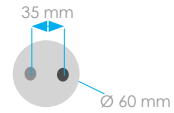

01452

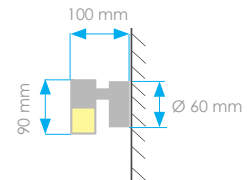
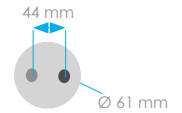

Le port USB permet de charger tablette et portable. 2 A max.  
The USB port can charge tablet and cellphone. 2 A max.

Alimentation Voltage	Puissance Power	Couleur Colour	Matériau Material	Poids Weight	Angle Angle	Consommation Consumption	Avec inter. With switch	Inter+USB Switch+USB
9-30 VDC	110 lm	3100 K Blanc chaud 3100 K Warm white	Verre + Zamak Zamak + Glass	225 g	120°	1,5 W	01411	01459

### Descriptif technique :

**Lampe de cabine d'ambiance.** Diffusion large. Finition inox brossé verni et interrupteur en ABS noir. Fixation aisée par 2 vis fournies. Livré avec 10 cm de fil électrique dénudé.

### Description:

**Cabin lamp with a large light diffusion.** Brushed stainless steel finish and switch in black ABS. Easy to install with the 2 supplied screws. Comes with 10 cm of electrical wire.





LED 1 W ≈ 10 W

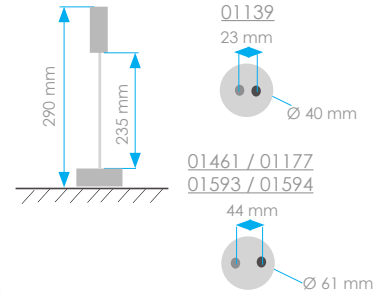

Le port USB permet de charger tablette et portable. 2 A max.  
The USB port can charge tablet and cellphone. 2 A max.

	Alim. Voltage	Puissance Power	Couleur Colour	Matériau Material	Poids Weight	Angle Angle	Conso. Consumption	Sans inter. No switch	Avec inter. With switch	Inter+USB Switch+USB
	12-24 VDC	100 lm	3100 K Blanc chaud 3100 K Warm white	Aluminium argent Silver aluminium	120g	10°	1 W	01139	01177	01461
	12-24 VDC	100 lm	3100 K Blanc chaud 3100 K Warm white	Aluminium noir Matt black aluminium	120g	10°	1 W		01593	01594
	Option Optional		Noire Black	Marron Brown						
	Gaine néoprène pour flexible Flex arm neoprene tubing		01689	01690						

**Descriptif technique :**

**Lampe de cabine flexible avec faisceau très étroit idéal pour la lecture.** Finition aluminium brossé argent ou noir mat. Fixation aisée par 2 vis fournies. Livré avec 10 cm de fil électrique dénudé.

**Description:**

**Flexible cabin lamp with a very narrow beam ideal for reading.** Chrome brushed aluminium or matt black finish. Easy to install with the 2 supplied screws. Comes with 10 cm of electrical wire.

LED 1 W ≈ 10 W

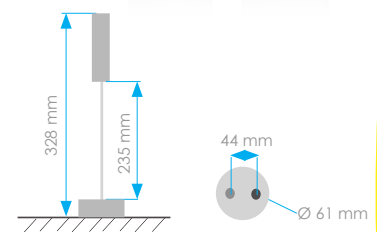
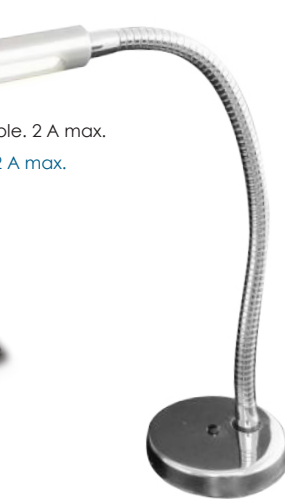

Le port USB permet de charger tablette et portable. 2 A max.  
The USB port can charge tablet and cellphone. 2 A max.

	Alim. Voltage	Puissance Power	Couleur Colour	Matériau Material	Poids Weight	Angle Angle	Conso. Consumption	Avec inter. With switch	Inter+USB Switch+USB
	12-24 VDC	100 lm	3100 K Blanc chaud 3100 K Warm white	Aluminium argent Silver aluminium	150g	120°	1,2 W	01649	01650
	12-24 VDC	100 lm	3100 K Blanc chaud 3100 K Warm white	Aluminium noir Matt black aluminium	150g	120°	1,2 W	01647	01648
	Option Optional		Noire Black	Marron Brown					
	Gaine néoprène pour flexible Flex arm neoprene tubing		01689	01690					

**Descriptif technique :**

**Lampe de cabine flexible avec faisceau large.** Finition aluminium brossé argent ou noir mat. Fixation aisée par 2 vis fournies. Livré avec 10 cm de fil électrique dénudé.

**Description:**

**Flexible cabin lamp with a large beam.** Chrome brushed aluminium or matt black finish. Easy to install with the 2 supplied screws. Comes with 10 cm of electrical wire.

LED 2,8 W ≈ 20 W

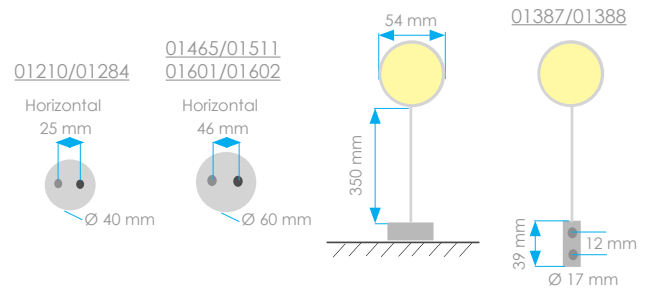

Intérieur / Cabin



### Fixation horizontale / Horizontal fitting

	Description Description	Alim. Voltage	Puissance Power	Couleur Colour	Matériau Material	Poids Weight	Conso. Cons.	Sans USB No USB	Avec USB With USB	
	Glénan Alu brossé fixation horizontale Glenan Brushed alu horizontal fitting	9-30 VDC	135 lm/80 lm	Blanc 3100 K+Rouge White 3100 K+Red	Alu+PMMA Alu+PMMA	170 g	2,8 W	01210	01601	01465
	Glénan noire fixation horizontale Glenan black horizontal fitting	9-30 VDC	135 lm/80 lm	Blanc 3100 K+Rouge White 3100 K+Red	Alu+PMMA Alu+PMMA	170g	2,8 W	01284	01602	01511



**ZOOM**

Le pied pour fixation verticale offre une meilleure résistance aux mouvements du bateau avec le départ du flexible vertical comme quand il est monté contre une cloison.  
The vertical mount fitting ensures a better resistance with the start of the arm being always vertical as when mounted against a bulkhead.

Le port USB permet de charger tablette et portable. 2 A max.  
The USB port can charge tablet and cellphone. 2 A max.

### Fixation verticale / Vertical fitting

	Description Description	Alim. Voltage	Puissance Power	Couleur Colour	Matériau Material	Poids Weight	Angle Angle	Conso. Cons.	Référence Reference
	Glénan Alu brossé fixation verticale Glenan Brushed alu vertical fitting	9-30 VDC	135 lm/80 lm	Blanc 3100 K+Rouge White 3100 K+Red	Alu+PMMA Alu+PMMA	170 g	120°	2,8 W	01387
	Glénan noire fixation verticale Glenan black vertical fitting	9-30 VDC	135 lm/80 lm	Blanc 3100 K+Rouge White 3100 K+Red	Alu+PMMA Alu+PMMA	170 g	120°	2,8 W	01388

#### Descriptif technique :

**Lampe de table à cartes Rouge et Blanc. Diffusion large.**  
Flexible ultra rigide. Gradateur intégré, mémorisation du réglage d'intensité lumineuse. S'allume en rouge en premier, on peut grader l'intensité par un appui prolongé sur le bouton central ou passer au blanc qui est aussi gradable par appui prolongé. Disponible en montage horizontal ou vertical en finition argent ou noir mat. Facile à installer avec 2 vis fournies. Livré avec 10cm de fils électrique dénudé.

#### Description:

**Chart table lamp Red & White. Large light diffusion.**  
Ultra rigid flex arm. Built-in dimmer. Memorization of last intensity settings. Switches on in red, dimmable by a prolonged push on the central button or you switch to white which is also dimmable. Available in horizontal or vertical fitting versions, proposed in silver or black matt finish. Easy to install with the 2 supplied screws. Comes with 10 cm of electrical wire.

LED 4,8 W ≈ 30 W



01277 - 01383

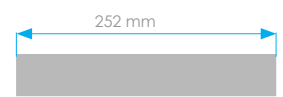
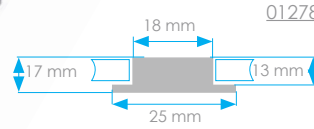
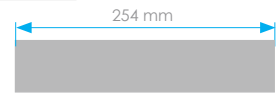
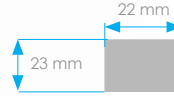

	Montage Mounting	Alim. Voltage	Puissance Power	Couleur Colour	Matériau Material	Poids Weight	Angle Angle	Consommation Consumption	Référence Reference
	Saillie Deck Mount	9-30 VDC	180 lm	3100 K Blanc chaud 3100 K Warm white	Alu + PMMA Alu + PMMA	85 g	120°	4,8 W	01277
	Saillie Deck Mount	9-30 VDC	140 lm / 28 lm	Blanc 3000 K + Rouge White 3000 k + Red	Alu + PMMA Alu + PMMA	85 g	120°	4,8 W	01383
	Encastrée Flush Mount	9-30 VDC	180 lm	3100 K Blanc chaud 3100 K Warm white	Alu + PMMA Alu + PMMA	85 g	120°	4,8 W	01278

**ZOOM**

Enez est maintenant disponible en version éclairage rouge / blanc.

Enez is now available in red & white lighting version.

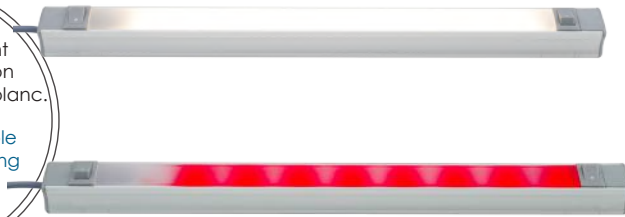

## GUERNESEY

### REGLETTE ORIENTABLE À LED / ROTATING LED STRIP

LED 2 W ≈ 10 W

LED 4 W ≈ 20 W



Lampe de cabine rotative  
Rotative cabin lamp

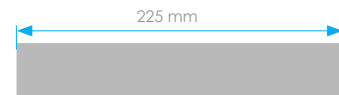
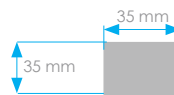

	Alim. Voltage	Puissance Power	Couleur Colour	Matériau Material	Poids Weight	Angle Angle	Consommation Consumption	Références References
	9-30 VDC	80 lm	3100 K Blanc chaud 3100 K Warm white	ABS + PMMA ABS + PMMA	120 g	120°	2 W	01157
	9-30 VDC	160 lm	3100 K Blanc chaud 3100 K Warm white	ABS + PMMA ABS + PMMA	120 g	120°	4 W	01158
	230 VAC	160 lm	3100 K Blanc chaud 3100 K Warm white	ABS + PMMA ABS + PMMA	120 g	120°	4 W	01637

#### Descriptif technique :

**Lampe de cabine rotative.** En ABS et PMMA, avec interrupteur. Fixation aisée par 2 vis fournies. Livré avec 10 cm de fil électrique dénudé.

#### Description:

**Rotating cabin lamp.** ABS and PMMA finish, includes a switch. Easy to install with the 2 supplied screws. Comes with 10 cm of electrical wire.

LED 3,5 W ≈ 30 W

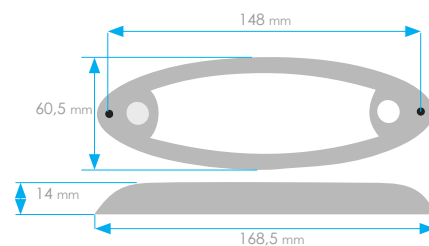

Interrupteur tactile bleu  
Blue touch switch

Alim.  
Voltage

Puissance  
Power

Couleur  
Colour

Poids  
Weight

Angle  
Angle

Consommation  
Consumption

Avec interrupteur  
With switch

 4000 K	10-30 VDC	300 lm	4000 K Blanc neutre 4000 K Neutral white	110 g	120°	3,5 W	01572
--	-----------	--------	---	-------	------	-------	-------

### Descriptif technique :

Réglète éclairage blanc neutre, étanche IP67. Extra plate, avec interrupteur tactile. Livré avec 10 cm de câble et 2 vis.

### Description:

Neutral white cabin downlight, IP67 waterproof. Very thin, with touch switch. Easy to install with 10 cm of electrical wire and 2 supplied screws.



QUALITY CHOICE

Pour vous assurer une qualité de lumière constante, Mantagua utilise des LED de grandes marques.  
To ensure consistent light quality, Mantagua uses LEDs from leading brands.

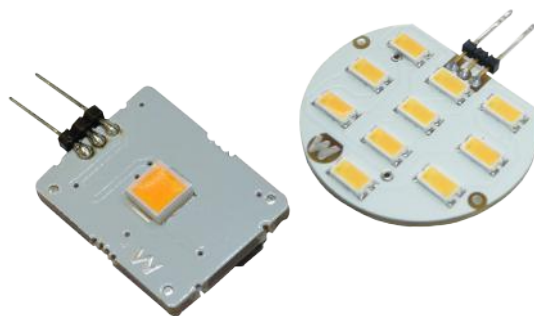

### G4 Horizontale / Horizontal G4

Gamme premium  
Premium range

LED G4 1,3 W ≈ 10 W

LED G4 2,2 W ≈ 20 W



Puissance lumineuse Lighting power	10 W (100 lm)	10 W (100 lm)	5 W (40 lm)	3 W (30 lm)	20 W (220 lm)
Couleur Lighting colour	6000 K	3000 K			3100 K
Angle de diffusion Beam angle	90°	90°	90°	100°	120°
Consommation Consumption	1,3 W	1,3 W	1,3 W	1,3 W	2,2 W
Dimensions Dimensions	L 24 x l 19 x H 10 mm	L 24 x l 19 x H 10 mm	L 24 x l 19 x H 10 mm	L 24 x l 19 x H 10 mm	L 40 x l 38 x H 4 mm
Références References	01020	01021	01022	01023	01368



Éco pack  
Pack de 2  
Pack of 2

LED G4 1,3 W ≈ 10 W

LED G4 1,3 W ≈ 15 W

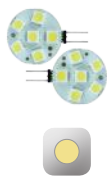

Puissance lumineuse Lighting power	10 W (74 lm)	15 W (110 lm)
Couleur Lighting colour	2700 K	3000 K
Angle de diffusion Beam angle	120°	330°
Consommation Consumption	1,3 W	1,2 W
Dimensions Dimensions	Ø 25 x H 37 mm	Ø 9.6 x H 30 mm
Références References	01283	01420

#### Caractéristiques techniques :

Toutes nos ampoules sont non polarisées, elles offrent une grande longévité (50.000 h) et permettent de diviser la consommation par 8 par rapport à l'halogène.

#### Specifications:

All our bulbs are reverse polarity protected, they have long life (50.000 hr) and permit to divide the consumption by 8 compared to halogen bulbs.

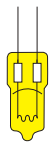

### G4 Verticale / Vertical G4



LED G4 1,3 W ≈ 10 W

LED G4 2,6 W ≈ 20 W



Puissance lumineuse Lighting power	10 W (74 lm)	10 W (74 lm)	10 W (74 lm)	10 W (74 lm)	20 W (140 lm)
Couleur Lighting colour	6000 K	3000 K	3000 K	3100 K	3100 K
Angle de diffusion Beam angle	90°	90°	90°	120°	120°
Consommation Consumption	1,3 W	1,3 W	1 W	1,3 W	2,6 W
Dimensions Dimensions	L 24 x l 19 x H 8 mm	L 24 x l 19 x H 10 mm	L 20 x l 10 x H 9 mm	Ø 25 x H 20 mm	Ø 44 x H 20 mm
Références References	01025	01026	01092	01279	01268



### Adaptateurs pour culot G4 / Adaptor for G4 bulb

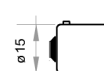
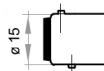
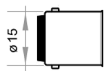

Désignation Designation	Adaptateur G4 / BA15D Adaptor G4 / BA15D	Adaptateur G4 / BAY15D Adaptor G4 / BAY15D	Adaptateur G4 / BA15S Adaptor G4 / BA15S
Références References	01369	01370	01371



Crédit photo : Fontaine Pajot

# AMPOULES LED / LED BULBS

## Navette S8.5 / Festoon S8.5



31mm



38mm



42mm



Puissance lumineuse Lighting power	15 W (110 lm)	15 W (110 lm)	15 W (110 lm)
Angle de diffusion Beam angle	120°	120°	120°
Consommation Consumption	1,5 W	1,5 W	1,5 W
Dimensions Dimensions	18 mm x 31 mm	18 mm x 38 mm	18 mm x 42 mm
Références References	01494	01400	01401



## Ampoules 15 W 360° / 15 W 360° Bulbs

LED 2,2W ≈ 10W



BA15D

BAY15D

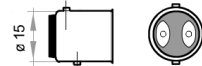
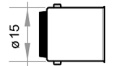

Culot  
Socket

Puissance lumineuse Lighting power	15W (110 lm)	15W (110 lm)
Angle de diffusion Beam angle	360°	360°
Consommation Consumption	2,2 W	2,2 W
Dimensions Dimensions	Ø 20 x H 45 mm	Ø 20 x H 45 mm
Références References	01295	01296

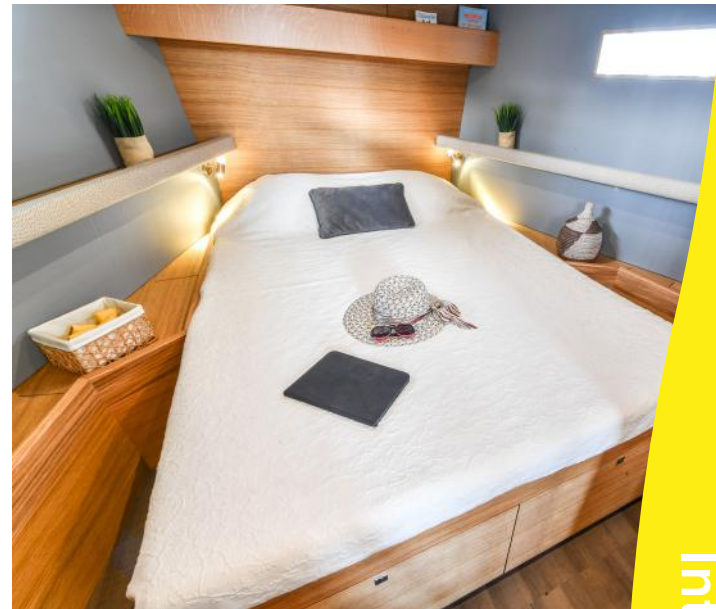

Alubat OVNI 450

## Ampoules 25 W 360° / 25 W 360° Bulbs

LED 5 W ≈ 25 W

BA15D

BAY15D

B22

E14

E27

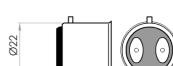

Culot  
Socket

Puissance lumineuse Lighting power	25 W (210 lm)	25W (210 lm)	25 W (210 lm)	25 W (210 lm)	25 W (210 lm)
Angle de diffusion Beam angle	360°	360°	360°	360°	360°
Consommation Consumption	5 W	5 W	5 W	5 W	5 W
Dimensions Dimensions	Ø 32 x H 63 mm	Ø 32 x H 63 mm	Ø 32 x H 70 mm	Ø 32 x H 70 mm	Ø 32 x H 70 mm
Références References	01305	01306	01105	01108	01104

# AMPOULES LED / LED BULBS

## Ampoules axiales / Axial bulbs



LED G4 1W ≈ 15 W

BA9S



BA15S



BAY15D



Puissance lumineuse Lighting power	10 W (74 lm)	10 W (74 lm)	10 W (74 lm)	10 W (74 lm)	10 W (74 lm)
Angle de diffusion Beam angle	90°	40°	90°	40°	90°
Consommation Consumption	0,7 W	1 W	1 W	1 W	1 W
Dimensions Dimensions	Ø 9 x H 34 mm	Ø 35 x H 40 mm	Ø 26 x H 28 mm	Ø 35 x H 40 mm	Ø 26 x H 28 mm
Références References	01001	01003	01004	01009	01010

B22



BA 15D



Puissance lumineuse Lighting power	10 W (74 lm)	10 W (74 lm)	10 W (74 lm)	10 W (74 lm)
Angle de diffusion Beam angle	40°	90°	40°	90°
Consommation Consumption	1 W	1 W	1 W	1 W
Dimensions Dimensions	Ø 35 x H 40 mm	Ø 26 x H 28 mm	Ø 35 x H 40 mm	Ø 26 x H 28 mm
Références References	01011	01012	01006	01007

E14



Puissance lumineuse Lighting power	10 W (74 lm)	10 W (74 lm)
Angle de diffusion Beam angle	40°	90°
Consommation Consumption	1 W	1 W
Dimensions Dimensions	Ø 35 x H 46 mm	Ø 26 x H 34 mm
Références References	01015	01016



Pogo Structures



# AMPOULES LED / LED BULBS

## Ampoules type Dichroïque / Dichroic bulbs

### MR11 - GU4



Puissance lumineuse Lighting power	15W (100lm)
Angle de diffusion Beam angle	40°
Consommation Consumption	1W
Dimensions Dimensions	Ø 35 x H 35 mm
Référence Reference	01018

### MR16 - GU5.3

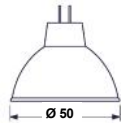

Puissance lumineuse Lighting power	40 W (300 lm)
Angle de diffusion Beam angle	40°
Consommation Consumption	5W
Dimensions Dimensions	Ø 50 x H 60 mm
Référence Reference	01308



Puissance lumineuse Lighting power	20 W (210 lm)
Angle de diffusion Beam angle	90°
Consommation Consumption	3 W
Dimensions Dimensions	Ø 50 x H 52 mm
Référence Reference	01107 <i>Gradable Dimmable</i>

L'ampoule 01107 est gradable avec le gradateur ref. 01159. Voir p.62  
The bulb 01107 can be dimmed with the dimmer ref. 01159. See p.62

## PROFILÉS LED / LED PROFILES ÉCLAIRAGE INDIRECT / INDIRECT LIGHTING

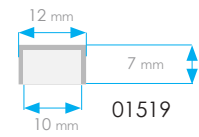
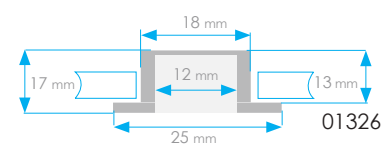
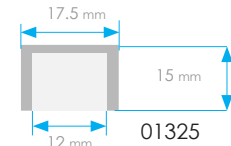
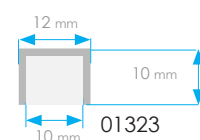
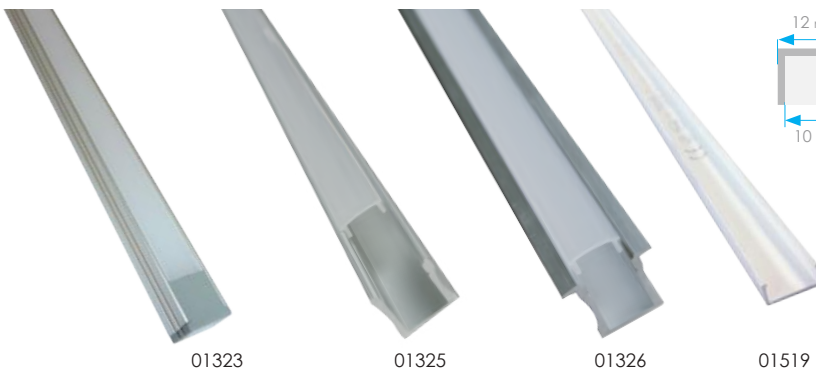

01323

01325

01326

01519

Saillie / Surface

Saillie / Surface

Encastré / Recessed

Saillie / Surface

Angle de diffusion Beam angle	90°	90°	90°	90°
Matériau Material	Aluminium & PMMA	Aluminium & PMMA	Aluminium & PMMA	PVC blanc sans verrine
Dimensions Dimensions	L 1 m x l 12 mm x H 10 mm	L 1 m x l 17,5 mm x H 15 mm	L 1 m x l 25 mm x H 17 mm	L 1 m x l 12 mm x H 7 mm
Références References	01323	01325	01326	01519
Types ruban Led Strip models	Non étanche / Non waterproof	Tous types / Any models	Tous types / Any models	Étanche IP68 / IP68 Waterproof

### Caractéristiques techniques :

Profilé aluminium avec verrine translucide en PMMA ou PVC blanc sans verrine, compatible avec ruban à leds pour réalisation de réglettes sur mesure. 2 embouts fournis (sauf 01519).

### Specifications:

Aluminium profile with semi-transparent cover in PMMA or white PVC without cover for use with led strip to make custom led bars lightings. 2 end caps supplied (except 01519).

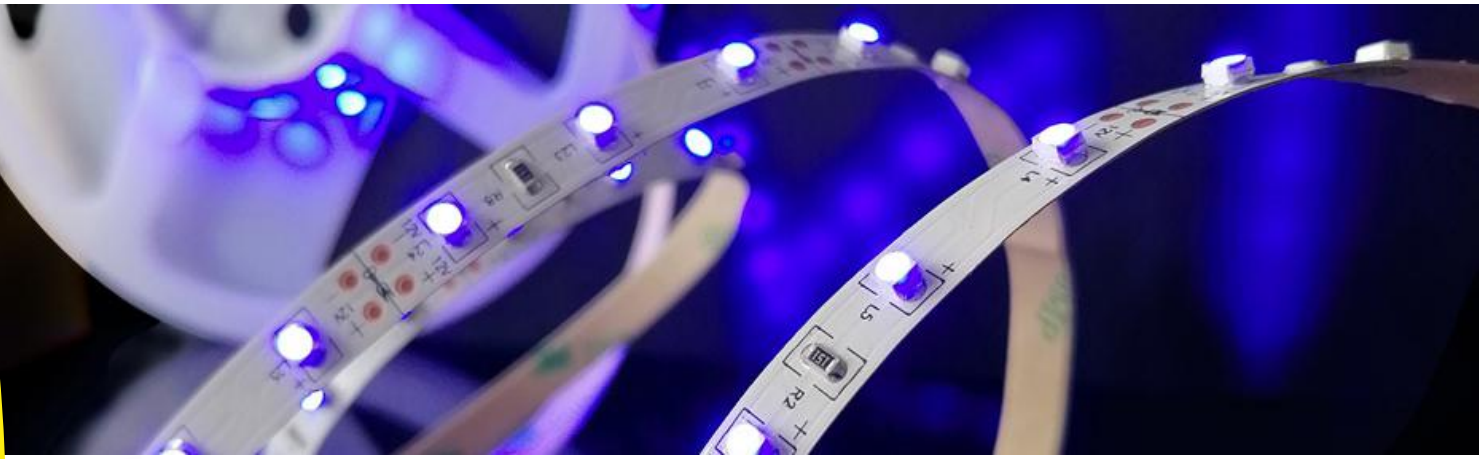

Info

Pensez à la régulation DC/DC, voir p. 62 / Best to use with DC/DC regulation, see p. 62

Pour intérieur / Indoor

Couleur Color	Puissance Power	Conso. Cons.	Nbr leds/m Led nbr/m	12 VDC			24 VDC		
				Longueur : 1 m Length : 1 m	Longueur : 5 m Length : 5 m	✂	Longueur : 1 m Length : 1 m	Longueur : 5 m Length : 5 m	✂
3100 K Leds 3528	190 lm/m	3,6 W/m	60	01134	01201	5 cm	01145	01203	10 cm
3100 K Leds 3528	300 lm/m	6 W/m	120	01486	01636	2,5 cm	-	-	-
6000 K Leds 3528	190 lm/m	3,6 W/m	60	01449		5 cm	01410	-	10 cm
Leds 3528	75 lm/m	3,6 W/m	60	01135	01202	5 cm	01146	01204	10 cm

Dimensions / Dimensions : 8 x 5000 max x 3 mm

Pour intérieur - Étanche IP65 / Indoor - IP65 waterproof



Couleur Color	Puissance Power	Conso. Cons.	Nbr leds/m Led nbr/m	Tension Voltage	Longueur : 1 m Length : 1 m	✂	Longueur : 5 m Length : 5 m	✂
3100 K Leds 3528	190 lm/m	3,6 W/m	60	12 VDC	01391	5 cm	01396	10 cm

Dimensions / Dimensions : 8 x 5000 max x 3 mm

Pour extérieur - Étanche IP68 / Outdoor - IP68 waterproof



Couleur Color	Puissance Power	Conso. Cons.	Nbr leds/m Led nbr/m	12 VDC			24 VDC		
				Longueur : 1 m Length : 1 m	Longueur : 5 m Length : 5 m	✂	Longueur : 1 m Length : 1 m	Longueur : 5 m Length : 5 m	✂
3100 K Leds 3528	190 lm/m	3,6 W/m	60	01136	01205	5 cm	01180	01207	10 cm
3100 K Leds 5050	500 lm/m	7,2 W/m	60	01224	01380	5 cm	01379	01378	10 cm
Leds 3528	75 lm/m	3,6 W/m	60	01137	01206	5 cm	01181	01208	10 cm
Leds 3528	75 lm/m	3,6 W/m	60	01185	-	5 cm	-	-	-

Dimensions Leds 3528 / Dimensions Leds 3528 : 10 x 5000 max x 4 mm  
Dimensions Leds 5050 / Dimensions Leds 5050 : 12 x 5000 max x 5 mm

Caractéristiques techniques :

Tension d'alimentation : 12VDC ou 24VDC. Longue durée : 50.000 heures avec régulation DC-DC. Fixation en saillie par adhésif. Vendu au mètre ou par rouleau de 5 mètres. Peut être coupé (✂). Angle de diffusion : 120°. Polarité à respecter. Livré avec 10 cm de fil électrique aux deux extrémités du ruban.

Specifications:

Power source : 12VDC or 24VDC. Expected life : 50.000 hours with DC-DC power supply. Self adhesive. Sold per meter or reel of 5 meters. Cutable (✂). Beam angle : 120°. Polarity must be respected. Supplied with 10 cm of electrical wires at each end of the strip.

Ruban RVB + Blanc / RGB + White Led Strip

Étanche IP68 / IP68 waterproof

Couleur Color	Puissance Power	Conso. Cons.	Tension Voltage		Longueur : 1 m Length : 1 m	Longueur : 5 m Length : 5 m
Leds 5050 RVBB / RGBW	500 lm/m	7,2 W/m	12 VDC	10 cm	01365	01366
Leds 5050 RVBB / RGBW	500 lm/m	7,2 W/m	24 VDC	15 cm	01687	01688

Dimensions / Dimensions : 12 x 5000 max x 5 mm



Description Description	Puissance Power	Conso. Cons.	Tension Voltage	Réf. Ref.
Contrôleur RVB RGB Controller	190 W/12 V 380 W/24 V	0,6 W	12-24 VDC	01367
Télécommande + contrôleur RVBB RGBW Remote & controller	240 W	-	12-24 VDC	01633

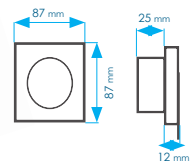

RUBANS À ENCASTRER / STRIPS TO BE EMBEDDED



**Intérêts techniques:** Le ruban à encastrer évite la pose de profilé aluminium pour son installation. 5 m maxi.

**Technical benefits:** Led strip to be embedded does not require aluminium profile for its setup. 5 m max.

Ruban latéral à encastrer / lateral strip to be embedded

Étanche IP68 / IP68 waterproof

Couleur Color	Puissance Power	Conso. Cons.	Nbr leds/m Led nbr/m	Tension Voltage		Longueur : 1 m Length : 1 m
Leds 335 3100 K - Blanc chaud 3100 K - Warm white	300 lm/m	6 W/m	60	12 VDC	5 cm	01484
Leds 335 6000 K - Blanc froid 6000 K - Cold white	300 lm/m	6 W/m	60	12 VDC	5 cm	01485
Leds 335 Rouge / Red	300 lm/m	4,8 W/m	60	12 VDC	5 cm	01546

IP68

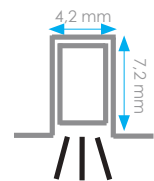

Ruban néon à encastrer / neon strip to be embedded

Étanche IP68 / IP68 waterproof

PHOTO PAGE 59 ->

Couleur Color	Puissance Power	Conso. Cons.	Nbr leds/m Led nbr/m	Tension Voltage		Longueur : 1 m Length : 1 m
Leds 3100 K 3100 K - Blanc chaud 3100 K - Warm White	600 lm/m	20 W/m	120	12 VDC	5 cm	01556
Leds 3100 K 3100 K - Blanc chaud 3100 K - Warm White	600 lm/m	20 W/m	120	24 VDC	5 cm	01575

IP68

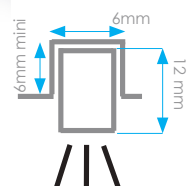

Intérieur / Cabin



01556 / 01575

Le ruban néon ou COB présente l'avantage d'offrir un éclairage uniforme et homogène masquant les leds.

Flexible neon or COB strip offers a uniformed and homogeneous lighting that hides led chips.

## Ruban néon / Flexible neon strip

Étanche IP67 / IP67 waterproof

IP67

	Couleur Color	Puissance Power	Conso. Cons.	Nbr leds/m Led nbr/m	Tension Voltage		Longueur : 1 m Length : 1 m
	3000 K - Blanc chaud 3000 K - Warm White	1000 lm/m	12 W/m	240	12 VDC	2,5 cm	01674
	3000 K - Blanc chaud 3000 K - Warm White	1000 lm/m	12 W/m	240	24 VDC	2,5 cm	01555

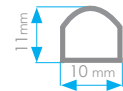

Uniquement en 1 mètre, pour les longueurs sur mesure nous contacter  
1 meter only, for custom lengths please contact us

## Ruban néon / Flexible neon strip

Étanche IP68 / IP68 waterproof

IP68

	Couleur Color	Puissance Power	Conso. Cons.	Nbr leds/m Led nbr/m	Tension Voltage		Longueur : 1 m Length : 1 m	Longueur : 5 m Length : 5 m
	3000 K - Blanc chaud 3000 K - Warm White	600 lm/m	12 W/m	140	12 VDC	-	01584	01695
	3000 K - Blanc chaud 3000 K - Warm White	600 lm/m	12 W/m	140	24 VDC	-	01585	-
	RVB RGB	600 lm/m	12 W/m	140	24 VDC	6 cm	01586	-

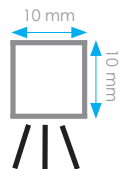

Uniquement en 1 mètre (5m pour 01695), pour les longueurs sur mesure nous contacter  
1 meter only (5m for 01695), for custom lengths please contact us

## Ruban COB étanche / Waterproof COB flexible strip

Étanche IP68 / IP68 waterproof

IP68

	Couleur Color	Puissance Power	Conso. Cons.	Nbr leds/m Led nbr/m	Tension Voltage		Longueur : 1 m Length : 1 m
	3100 K - Blanc chaud 3100 K - Warm White	600 lm/m	12 W/m	384	12 VDC	1,8 cm	01587
	3100 K - Blanc chaud 3100 K - Warm White	600 lm/m	12 W/m	384	24 VDC	3,6 cm	01588

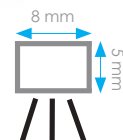

## Ruban COB intérieur / Indoor COB flexible strip

IP20

	Couleur Color	Puissance Power	Conso. Cons.	Nbr leds/m Led nbr/m	Tension Voltage		Longueur : 1 m Length : 1 m	Longueur : 5 m Length : 5 m
	3100 K - Blanc chaud 3100 K - Warm White	1200 lm/m	14 W/m	384	24 VDC	4,5 cm	01738	
	3100 K - Blanc chaud 3100 K - Warm White	1200 lm/m	14 W/m	384	24 VDC	4,5 cm	-	01739

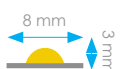



## Caractéristiques techniques

Tension d'alimentation : 9 - 30 VDC.  
Taille réduite pour intégration aisée dans les navires.

## Specifications

Input from 9 to 30 VDC.  
Reduced size, ideal for integration on vessels.

## INTERRUPTEURS / SWITCHES

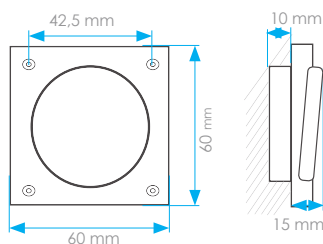

	Dimensions (mm)	Encastrement (mm) Embedding (mm)	Poids Weight	Réf. Chrome Mat Matt chrome Ref.	Réf. Blanc White Ref.
Bouton poussoir Push button	L 60 x l 60 x H 13	Ø 45 x H 10	30 g	01275	01335
Interrupteur Switch	L 60 x l 60 x H 13	Ø 45 x H 10	30 g	01313	01337
Double Interrupteur Double Switch	L 60 x l 60 x H 13	Ø 45 x H 10	30 g	01333	01431
Prise 230 V 230V socket	L 60 x l 60 x H 13	Ø 45 x H 10	30 g	01334	01339



	Dimensions (mm)	Encastrement (mm) Embedding (mm)	Poids Weight	Référence Reference
Bouton poussoir Push button	Ø 18 mm x H 37	Ø 15 x H 37	15 g	01543



Design : P.FORGIA / Finot Conq

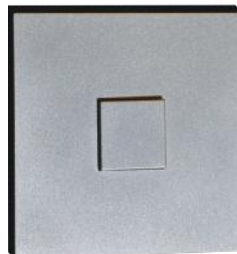
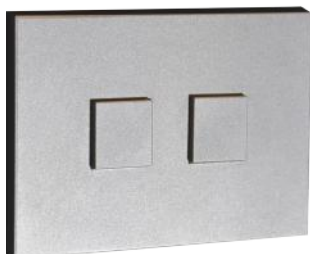

	Dimensions (mm)	Encastrement (mm) Embedding (mm)	Poids Weight	Réf. Inox brossé Brushed s. s.
Interrupteur 1 bouton poussoir Switch 1 push button	L 62 x l 62 x H 13	L 60 x l 60 x H 10	100 g	01466
Interrupteur 2 boutons poussoir Switch 2 push buttons	L 92 x l 62 x H 13	L 85 x l 60 x H 10	100 g	01467
Interrupteur 3 boutons poussoir Switch 3 push buttons	L 122 x l 62 x H 13	L 110 x l 60 x H 10	100 g	01468
Prise 230 V 230V socket	L 62 x l 62 x H 13	L 60 x l 60 x H 10	100 g	01469



## GRADATEUR / DIMMER

Modèle Model	50 W
Tension d'alimentation Input voltage	9-30 VDC
Tension de sortie Output voltage	9-30 VDC
Consommation électrique Power consumption	0,5 W max
Dimensions (mm) Dimensions (mm)	90 x 55 x 17
Poids en gramme Weight in gramme	65
Référence Reference	01159

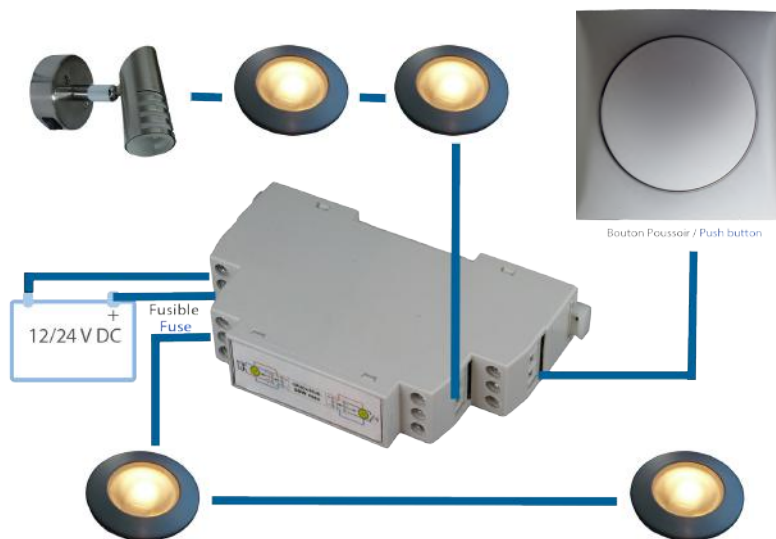

POWERSAVER

CONFORT VISUEL ET ECONOMIES D'ENERGIE  
COMFORT & POWER SAVINGS

### Descriptif technique :

**Gradateur piloté par bouton poussoir.** Allumage/extinction progressif de l'éclairage (soft start). Mémorisation de la dernière puissance lumineuse. Fixation sur rail DIN. Puissance max : 50 W. Convient pour des éclairages à filament ou LED. Plusieurs gradateurs en parallèle peuvent être commandés par le même interrupteur. Le gradateur peut faire office de télérupteur en câblant plusieurs boutons poussoirs en parallèle. Faible consommation : 0,5 W max

### Description:

**Dimmer controlled via a push button.** Progressive light at start/switch off (soft start). Memorises the last light intensity choosen. Din rail fitting. Maximum power 50 W. Suitable for halogen or LED bulbs. Dimmers connected in parallel can be controlled by the same button. The dimmer can be used as a telebreaker by connecting other buttons in parallel. Low consumption : 0,5 W max.

## ALIMENTATION / POWER SUPPLY



### Alimentation / Power supply

### Régulateurs / Converters

Modèle Model	24 W	50 W	150 W	350 W	350 W	36 W (3 Amp)	72 W (6 Amp)	72 W (3 Amp)
Tension d'entrée Input voltage	110/230 VAC	110/230 VAC	110/230 VAC	110/230 VAC	110/230 VAC	8,4 - 15,6 VDC	10 - 32 VDC	17 - 32 VDC
Tension de sortie Output voltage	12 VDC	12 VDC	12 VDC	12 VDC	24 VDC	12 VDC	12 VDC	24 VDC
Intensité maximum Maximum intensity	2 A	4 A	12,5 A	30 A	15 A	0,3 W <sup>(2)</sup>	0,3 W <sup>(2)</sup>	0,3 W <sup>(2)</sup>
Dimensions (mm) Dimensions (mm)	90 x 55 x 17	110 x 78 x 38	199 x 98 x 50	215 x 115 x 50	215 x 115 x 50	89 x 87 x 50	127 x 87 x 50	127 x 87 x 50
Références References	01167	01168	01169	01171	01354	01189	01190	01226

<sup>(1)</sup> Utilisation intérieure seulement  
Alimentation étanche : nous consulter.  
Interior use only. Waterproof power supply : on request

<sup>(2)</sup> Consommation à vide  
Minimum consumption

### Régulateurs :

Lors de la charge sur un bateau, le chargeur de batteries débite 14.4 V ou 27.2 V en général alors que le ruban à leds est prévu pour 12 ou 24V. Si on n'utilise pas de régulateur, on prend le risque d'endommager à terme les leds du ruban qui seraient sur-sollicitées. Tension de sortie : 12 ou 24 VDC. Intensité max : 3 ou 6 Amp. Fixation par vis fournies. Rendement : 75%. Régulation en tension.

### Converters:

When charging on a boat, the charger delivers 14.4 or 27.2 VDC instead of the 12 or 24V required by the led strips. If you don't use a DC/DC regulator, you may damage the leds of the led strip as they are over-powered. Output voltage : 12 or 24 VDC. Maximum current : 3 or 6 Amp. Easy to install with 3 supplied screws. Efficiency : 75%. Voltage regulated.





01512



01310

Type / Product description	Dimensions (mm) / Dimensions (mm)	USHIP	AD
Présentoir de vente comptoir 2021 2021 shop counter point of sale	H 441 x L 330 x W 96	01512	01513
Présentoir de vente comptoir Shop counter point of sale	H 685 x L 352 x W 220	01310	-

## CONTACTS



**Christophe QUENOT - France**  
Mobile : 06 23 28 54 60  
e-mail : christophe@breizelec.fr

**Yvon BERTIN - Export sales**  
Mobile : +33 6 29 67 02 62  
e-mail : yvon@breizelec.fr

**Administration des Ventes / Orders**  
Tél. : +33 2 21 58 05 55  
e-mail : orders@mantagua.fr

## INTERNATIONAL DISTRIBUTION NETWORK

### Italie / Italy

**NEEA**  
Tel. +39 0184513161  
www.neeasrl.com  
info@neeasrl.com

**Battagli**  
Tel. +39 0187512783  
www.battagli.it  
info@battagli.it

### Grèce / Greece

**Waypoint Sailing**  
Tel. +30 2645021461  
www.waypointsails.com  
info@waypointsails.com

**Sail Aegean Services**  
Tel. +30 2645021461  
www.sailaegean.eu  
chandlery@sailaegean.eu

### Norvège / Norway

**Strøm**  
Tel. +47 23233970  
www.stroem.no  
mail@stroem.no

**Southern Cross Spars**  
Tel. +47 41350626  
www.southerncross.no  
info@southerncross.no

### Suisse / Swiss

**Bucher + Walt SA**  
Tel. +41 327559500  
www.bucher-walt.ch  
info@bucher-walt.ch

### Suède / Sweden

**Riggarna**  
Tel. +46 31222010  
www.riggarna.se  
mathias@riggarna.se

### Gibraltar / Gibraltar

**EMS**  
Tel. +350 56000106  
www.emsgib.com  
sales@emsgib.com

### Hollande / Netherlands

**Rake Rigging BV**  
Tel. +31 653604628  
www.rakerigging.nl  
info@rakerigging.nl

### Irlande / Ireland

**Masts & Rigging**  
Tel. +353 18168633  
www.masts-rigging-ireland.ie  
info@riggers.ie

### Canada / Canada

**WPG**  
Tel. +1 8198783018  
www.wpgcanada.com  
info@wpgcanada.com

### Belgique / Belgium

**Radio Holland Belgium**  
Tel. +32 50559860  
www.radioholland.com  
frederick.danneels@radioholland.com

### Grande Bretagne / United Kingdom

**Technical Marine Supplies**  
Tel. +44 1752600454  
www.technicalmarinesupplies.co.uk  
contact@technicalmarinesupplies.co.uk

### Turquie / Turkey

**Raventec**  
Tel. +90 5366535351  
http://raventec.com.tr  
sales@raventec.com.tr

# MANTAGUA



**ÉCLAIRAGE BATEAUX PROS**  
**PROFESSIONAL LED LIGHTING**



**PROJECTEURS ÉTANCHES**  
**WATERPROOF FLOODLIGHTS**



**ÉCLAIRAGE MÂT & PONT**  
**SPOTLIGHT & MASTHEAD**



**FEUX DE NAVIGATION**  
**NAVIGATION LIGHTS**



**ÉCLAIRAGE INTÉRIEUR**  
**CABIN LED LIGHTING**



**BREIZELEC - MANTAGUA**  
23, Z.A Penn ar Roz  
29150 Châteaulin  
France

+33 2 21 58 05 55  
info@mantagua.fr  
www.mantagua.fr

