

Professionals Choose Woodworking Tooling and Supplies From

MAGNATE™

2019 Catalog

Magnate Router Bits,
Legacy Ornamental Mills
and a Woodworker with Vision.
The possibilities are endless.

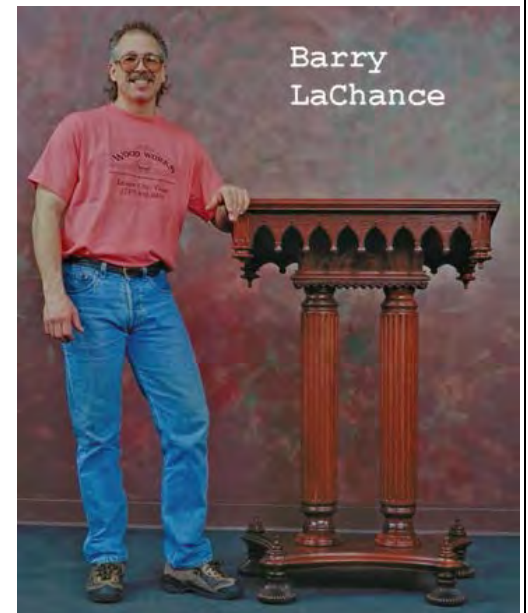
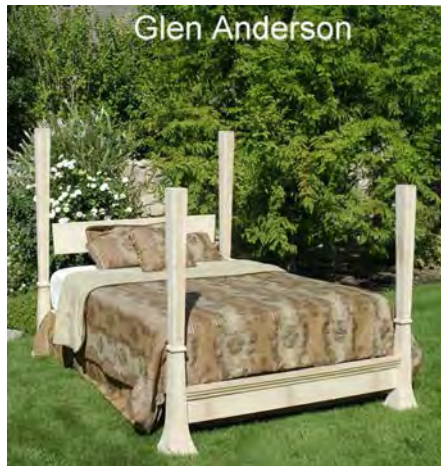

**Safety Information : www.P65Warnings.ca.gov/wood
[Warning/Advertencia](http://www.P65Warnings.ca.gov/wood)**



**Cancer. Avoid Inhaling Wood Dust.
Cancer. Evite Inhalar Polvo De Madera.**

**Warning : Cancer and Reproductive Harm -
www.p65warnings.ca.gov/search/abrasives
www.p65warnings.ca.gov**

20639 Lycoming Street, B-6, Walnut, CA 91789 USA Web Site : www.magnate.net
(Tel) 909-468-5747 (Fax) 909-468-5745

Table of Contents

General Information

vii-viii

MAGNATE™ Solid Carbide Router Bits

7 Degree Bevel Trim, 2 Flute.....	A-14	O-Flute Spiral, Slow 2-Flute Up-Cut	A-11
7 Degree Bevel Trim, Double Ended 2 Flute	A-14	O-Flute Straight Edge Rounding, 1 Flute	A-12
7 Degree Bevel Trim, Left Rotation 2 Flute.....	A-14	O-Flute Straight Edge Rounding, 2 Flute	A-12
7.5 Degree Dovetail For Inkra/Omni Jig	A-14	O-Flute Straight, 1 Flute.....	A-11
Compression Spiral, 1+1, PCD	A-6	O-Flute Straight, 2 Flute For Medium Plastic	A-12
Compression Spiral, 1+1.....	A-6	O-Flute Straight, Polished 1 Flute Left Hand	A-12
Compression Spiral, 1+1 Left Hand	A-6	Ripping & Slotting	A-13
Compression Spiral, 2+2.....	A-6	Round Bottom Veining, 1 Flute	A-13
Compression Spiral, 2+2 Left Hand	A-7	Round Bottom Veining, 2 Flute	A-13
Compression Spiral, 3+3.....	A-7	Spiral, 1 Flute Down-Cut	A-1
Compression Spiral, 4+4.....	A-7	Spiral, 1 Flute Up-Cut.....	A-1
Compression Spiral, Chipbreaker 2+2.....	A-10	Spiral, 2 Flute Down-Cut	A-2
Compression Spiral, Chipbreaker 3+3.....	A-10	Spiral, 2 Flute Down-Cut, Left Hand	A-1
Compression Spiral, Flush Trim 2+2	A-7	Spiral, 2 Flute Up-Cut	A-2
Compression Spiral, MFC 2+2.....	A-6	Spiral, 2 Flute Up-Cut Left Hand	A-1
Compression Spiral, MFC 3+3.....	A-6	Spiral, 3 Flute Down-Cut	A-3
Compression Spiral, MFC Mortise 2+2	A-8	Spiral, 3 Flute Up-Cut	A-3
Compression Spiral, MFC Mortise 3+3	A-7	Spiral, Ball Nose 2 Flute Up-Cut	A-3
Compression Spiral, MFC+ 2+2	A-8	Spiral, Chipbreaker 2 Flute Down-Cut	A-4
Compression Spiral, MFC+ 2+2, Enduro Coated	A-8	Spiral, Chipbreaker 2 Flute Up-Cut.....	A-4
Compression Spiral, MFC+ 3+3	A-8	Spiral, Chipbreaker 3 Flute Down-Cut	A-4
Compression Spiral, MFC+ 3+3, Enduro Coated	A-8	Spiral, Chipbreaker 3 Flute Up-Cut.....	A-4
Compression Spiral, MFC+ Mortise 2+2	A-9	Spiral, Dovetail For OMEC, 2 Flute.....	A-2
Compression Spiral, MFC+ Mortise 3+3	A-9	Spiral, Flat-End 2 Flute Down-Cut.....	A-1
Compression Spiral, MFC+ Mortise 3+3, Enduro Coated.....	A-9	Spiral, Flat-End 2 Flute Up-Cut	A-1
Compression Spiral, Mortise 1+1.....	A-7	Spiral, Flush Trim 2 Flute Down-Cut.....	A-1
Compression Spiral, Mortise 2+2.....	A-7	Spiral, Flush Trim 2 Flute Up-Cut.....	A-1
Compression Spiral, Mortise 3+3.....	A-7	Spiral, MFC 2 Flute Down-Cut	A-4
Compression Spiral, Mortise Chipbreaker 2+2	A-7	Spiral, MFC 2 Flute Down-Cut, Enduro Coated	A-4
Compression Spiral, Ruffer 2+2.....	A-10	Spiral, MFC 2 Flute Up-Cut.....	A-4
Compression Spiral, Ruffer 3+3.....	A-10	Spiral, MFC 2 Flute Up-Cut, Enduro coated	A-4
Compression Spiral, Ruffer/Finisher 4+4.....	A-10	Spiral, MFC 3 Flute Down-Cut	A-4
Compression Spiral, Ruffer 2+2.....	A-10	Spiral, MFC 3 Flute Up-Cut.....	A-4
Dovetail For CNC, PCD, 2F	A-2	Spiral, Ruffer 2 Flute Down-Cut	A-5
Dovetail For OMEC, PCD, 3F.....	A-2	Spiral, Ruffer 2 Flute Up-Cut.....	A-5
Fiberglass, End Mill	A-14	Spiral, Ruffer 3 Flute Down-Cut	A-5
Fiberglass, V-Point Plunge.....	A-13	Spiral, Ruffer 3 Flute Up-Cut.....	A-5
Flush & 7 Degree Bevel Trim	A-14	Spiral, Ruffer/Finisher 4 Flute Down-Cut	A-6
Flush Trim Double-Ended, 2 Flute.....	A-14	Spiral, Ruffer/Finisher 4 Flute Up-Cut.....	A-5
Flush Trim, 2 Flute.....	A-14	Spiral, Slow 2 Flute Down-Cut	A-6
Hole & Flush Trim, 2 Flute.....	A-14	Spiral, Slow 2 Flute Up-Cut.....	A-6
Liner/Veining 1 Flute.....	A-13	Spiral, Slow 3 Flute Down-Cut	A-6
O-Flute Spiral Up-Cut Edge Rounding	A-12	Spiral, Slow 3 Flute Up-Cut.....	A-6
O-Flute Spiral, 1 Flute Down-Cut	A-10	Spiral, Slow Chipbreaker 3 Flute Up-Cut.....	A-6
O-Flute Spiral, 1 Flute Up-Cut.....	A-10	Spiral, Tapered Ball Nose 3 Flute Up-Cut.....	A-3
O-Flute Spiral, 2 Flute Down-Cut	A-11	V-Grooving	A-13
O-Flute Spiral, 2 Flute Up-Cut.....	A-11	Z Flute Straight, 1 Flute	A-13
O-Flute Spiral, Polished 1 Flute Down-Cut.....	A-11	Z Flute Straight, 2 Flute	A-13
O-Flute Spiral, Polished 1 Flute Up-Cut	A-11	Z-Flute Straight Flat Bottom Veining.....	A-13
O-Flute Spiral, Slow 2-Flute Down-Cut.....	A-11		

MAGNATE™ Carbide Tipped Router Bit

14 Degree Butterfly Spline, 2-Flute.....	B-9	Barley Twist, 2-Flute	B-29
14 Degree Plunge Bevel with Top Bearing, 2-Flute	B-9	Bead & Cove, 2-Flute, 1/2" Shank	B-12
15-Piece Router Bit Set	B-34	Bearing - For Router Bits, Steel Ball	B-34
25 Degree Bevel - 2-Flute.....	B-7	Bearing - For Router Bits, Teflon	B-34
45 Degree Bevel Spiral, 2-Flute	B-7	Bearing Locking Collars For Router Bit	B-34
45 Degree Corner Lock Mitre, 2-Flute	B-32	Bevel & Flush Trimming, 2-Flute.....	B-7
45 Degree Undercut Bevel Trim.....	B-7	Bevel Trim With Bearing.....	B-7
5/16" Spindle Arbor.....	B-5	Bevel Undermount Bowl, 2-Flute	B-8
60 Degree Lettering, 2 Flute.....	B-9	Bird Mouth (Bird Beak), 8-Sided.....	B-33
90 Degree V-Shaped Edge Banding	B-32	Boat Planking, 2-Flute	B-11
Adjustable Box Joint, 2-Flute	B-32	Bowl & Tray Plunge with Top Bearing, 2-Flute	B-28
Adjustable Double Round Over.....	B-17	Bowl & Tray Plunge, 2-Flute.....	B-27
Adjustable Finger Joint, 2-Flute	B-32	Brick Molding, 2-Flute	B-30
Arbor for Screw Type Cutters	B-4	Bull Nose (Half Round) With Bearing.....	B-12
Ball End, Extended Shank	B-19		

MAGNATE™ 20639 Lycoming Street #B-6, Walnut, CA 91789 USA

i



email : info@magnate.net Online Shop : www.magnate.net
 (TEL) 800-827-2316, 909-468-5747 (FAX) 909-468-5745

MAGNATE™ Table of Contents

<p>Bull Nose (Half Round), 2-Flute B-12</p> <p>Bull Nose (Half Round, 2-Flute..... B-12</p> <p>Casing Molding, 1/2" Shank..... B-31</p> <p>Chamfer, 2-Flute B-7</p> <p>Classic Astragal, 2-Flute..... B-17</p> <p>Classic Combination, 2-Flute B-18</p> <p>Classic Cove, 2-Flute..... B-18</p> <p>Classic Double Round Over B-17</p> <p>Classic Multi-Form, 2-Flute B-19</p> <p>Classic Plunge Beading, 2-Flute..... B-10</p> <p>Classic Plunge Cutting, 2-Flute B-19</p> <p>Classic Spiral, 2-Flute..... B-10</p> <p>Classic Triple Round Over, 2-Flute B-17</p> <p>Classic with Step Edges, 2-Flute B-19</p> <p>Classic, 2-Flute..... B-19</p> <p>Classical Ogee Plunge, 2-Flute..... B-18</p> <p>Combination Barley Twist, 2-Flute B-29</p> <p>Combination Rope Molding, 2-Flute..... B-28</p> <p>Core Box, 2 Flute B-20</p> <p>Corner Rounding (Round Over), 2-Flute B-15</p> <p>Cove & Bead Plunge, 2-Flute..... B-10</p> <p>Cove & Bead, 2-Flute..... B-14, B-15</p> <p>Cove, 2-Flute..... B-19</p> <p>Crown Molding 1/2" Shank B-31</p> <p>Deep Classic Point, 2-Flute B-15</p> <p>Door Lip (Finger Pull), 2-Flute..... B-24</p> <p>Door Pull, 2-Flute, 1/2" Shank B-24</p> <p>Double Bead Flat Plunge, 2-Flute..... B-13</p> <p>Double Bead Point Plunge, 2-Flute B-13</p> <p>Double Easing, 2 Flute, 1/2" Shank B-13</p> <p>Double Easing, 2-Flute, 1/4" Shank..... B-13</p> <p>Double Round Over Molding, 2-Flute..... B-15</p> <p>Double Round Over, 2-Flute B-16</p> <p>Double-Beading, 2-Flute B-13</p> <p>Dovetail - 10 Degree, 2-Flute B-8</p> <p>Dovetail - 10 Degree, 1-Flute For Continuous Dovetail Machine B-8</p> <p>Dovetail - 14 Degree, 2-Flute B-9</p> <p>Dovetail - 18 Degree, 2-Flute B-9</p> <p>Dovetail - 25 Degree Half Blind, 2-Flute..... B-9</p> <p>Dovetail - 7 Degree Left Rotation, 2 Flute B-8</p> <p>Dovetail - 7 Degree, 2-Flute B-8</p> <p>Dovetail - 8 Degree 2-Flute B-8</p> <p>Dovetail - 9 Degree, 2-Flute B-8</p> <p>Dovetail With Top Bearing B-8</p> <p>Drawer Lock, 2-Flute B-32</p> <p>Drawer/Finger Pull, 2-Flute..... B-24</p> <p>Drawing Line, 2-Flute B-14</p> <p>Dyna Plus, Tri-Bountry Dry-Lubricant & Cleaning Conditioner..... B-35</p> <p>Edge Beading, 2-Flute..... B-12, B-13</p> <p>Eliminator RC Quick Change Chuck..... B-35</p> <p>Extra Deep Core Box, 1/2" Shank B-20</p> <p>Extra Deep Core Box, 1/4" Shank B-20</p> <p>Face Molding, 2-Flute 1/2" Shank..... B-31</p> <p>Face Molding, 2-Flute 1/4" Shank..... B-31</p> <p>Face-Inlay Extended Shank, 2-Flute..... B-6</p> <p>Face-Inlay, 2-Flute B-6</p> <p>Finger Joint, 2-Flute B-32</p> <p>Finger Nail with Center Bearing..... B-13</p> <p>Finger Nail, 2-Flute B-13</p> <p>Flat Roundover Plunge, 2-Flute..... B-11</p> <p>Flush Trim with Double Bearing..... B-3</p> <p>Flush Trim with Glue Space, 2-Flute..... B-3</p> <p>Flush Trim, 2-Flute..... B-2</p> <p>Flush Trim, 3 Degree Down Shear, 2-Flute..... B-2</p> <p>Flush Trim, 3-Flute..... B-3</p> <p>Flush Trim, with Top and Bottom Bearings B-3</p> <p>Flute Cutter with Top Bearing, 2-Flute..... B-11</p> <p>Flute Cutting, 2-Flute B-11</p> <p>Fluting Extended Shank, 2-Flute B-11</p> <p>French Provincial, 1/2" Shank B-31</p> <p>Glue Joint, 2-Flute..... B-33</p> <p>Hand Grip Plunge, 2-Flute..... B-14</p> <p>Handrail, 1/2" Shank B-30</p>	<p>Horizontal Crown Molding, 2-Flute B-32</p> <p>Key Hole..... B-7</p> <p>Large Cove Classic Plunge, 2-Flute..... B-10</p> <p>Leaf Edge Beading, 2-Flute B-12</p> <p>Matching Corner Round/Cove, 2-Flute..... B-16</p> <p>Mortising, 2-Flute B-4</p> <p>Multi-Bead Forming, 2-Flute..... B-13</p> <p>Multi-Beading, 2-Flute B-14</p> <p>Multi-Edge Beading, 2-Flute B-14</p> <p>Multi-Fluting, 2-Flute B-11</p> <p>No-Drip Edge, 2-Flute B-18</p> <p>Ogee No-Drip, 2-Flute B-17</p> <p>Ogee with Fillet, 2-Flute B-17</p> <p>Ogee, 2-Flute, 1/2" Shank..... B-17</p> <p>Ogee, 2-Flute, 1/4" Shank..... B-17</p> <p>One Piece Stile and Rail, 2 Flute B-25</p> <p>Overhang Bowl..... B-3</p> <p>Overhang Pattern, 1/4" Shank..... B-4</p> <p>Overhang Trim, 2-Flute B-3</p> <p>Palace Pattern, 1/2" Shank B-31</p> <p>Panel Pilot..... B-6</p> <p>Panel Pilot with 2 Pilots & Drill Point B-6</p> <p>Pattern Extended Shank, 2-Flute..... B-3</p> <p>Pattern, 2-Flute B-3</p> <p>Plunge Ball End, 2-Flute..... B-20</p> <p>Plunge Button, 2-Flute..... B-28</p> <p>Plunge Ogee, 1/2" Shank B-18</p> <p>Plunge Ogee, 1/4" Shank B-18</p> <p>Plunge Roman Ogee, 2-Flute..... B-18</p> <p>Plunge Roundover, 2-Flute B-15</p> <p>Point Cutting Roundover, 2-Flute..... B-16</p> <p>Provincial Plunge, 2-Flute B-28</p> <p>Rabbeting, 2-Flute B-4</p> <p>Raised Panel 12 Degree Face-Cut With Quarter Round..... B-21</p> <p>Raised Panel Groove..... B-10</p> <p>Raised Panel Under Cutter, 2-Flute B-23</p> <p>Raised Panel, 12 Degree Face-Cut..... B-21</p> <p>Raised Panel, 15 Degree Face Cut B-21</p> <p>Raised Panel, 15 Degree Face-Cut..... B-21</p> <p>Raised Panel, 18 Degree Face-Cut..... B-21</p> <p>Raised Panel, 25 Degree Face Cut B-22</p> <p>Raised Panel, 5 Degree Face-Cut..... B-20</p> <p>Raised Panel, Classical..... B-23</p> <p>Raised Panel, Convex B-22</p> <p>Raised Panel, Ogee B-22</p> <p>Raised Panel, Vertical 12 Degree Face-Cut B-23</p> <p>Raised Panel, Vertical 15 Degree Face-Cut B-23</p> <p>Raised Panel, Vertical 18 Degree Face-Cut B-23</p> <p>Raised Panel, Vertical 5 Degree Face-Cut B-23</p> <p>Raised Panel, Vertical Convex 2-Flute B-23</p> <p>Raised Panel, Vertical Ogee 2-Flute B-23</p> <p>Reeding Extended Shank with Bearing..... B-14</p> <p>Reeding Extended Shank, 2-Flute..... B-14</p> <p>Reversible Glue Joint, 2-Flute B-33</p> <p>Reversible Stile & Rail, 2 Flute B-25</p> <p>Roman Ogee, 2-Flute..... B-17</p> <p>Rope Molding, 2-Flute..... B-28</p> <p>Rope Pen, 2-Flute B-29</p> <p>Roundover Undermount Bowl, 2-Flute..... B-16</p> <p>Screw Type Mortising Cutter..... B-4</p> <p>Shallow Classic Point, 2-Flute..... B-14</p> <p>Shallow Flute Extended Shank B-12</p> <p>Shallow Flute, 2-Flute..... B-11</p> <p>Shear Under Roundover, 2-Flute B-16</p> <p>Side V-Grooving Extended Shank B-10</p> <p>Side V-Grooving, 2-Flute B-10</p> <p>Slot Cutter For Demountable Hinge B-4</p> <p>Slot Cutter with Top Bearing, 2-Flute..... B-5</p> <p>Slot Cutter, 2-Flute B-5, B-26</p> <p>Slotting Cutter with 5/16" Bore B-5</p> <p>Special Cove, 2-Flute..... B-19</p> <p>Stagger Tooth Panel With Center Pilot..... B-6</p> <p>Stagger Tooth Pilot Panel, 2-Flute B-6</p>
---	---

MAGNATE™ 20639 Lycoming Street #B-6, Walnut, CA 91789 USA



email : info@magnate.net Online Shop : www.magnate.net
 (TEL) 800-827-2316, 909-468-5747 (FAX) 909-468-5745

MAGNATE™ Table of Contents

Stagger Tooth Plunge, 2-Flute.....	B-6	Table Top Edge, Thumb Nail With Bead.....	B-30
Steel Router Collet Reducer.....	B-34	Table Top Edge, Thumbnail 2-Flute.....	B-29
Stile or Rail, For 1" to 1-3/8" Material.....	B-27	Table Top Edge, Traditional 2-Flute.....	B-30
Stile or Rail, For 3/4" to 7/8" Material.....	B-26	Thread Cutting 90-Degree, 2-Flute.....	B-10
Straight Plunge, 2-Flute.....	B-2	Triple Classic Plunge, 2-Flute.....	B-19
Straight Plunge, 2-Flute Left Hand.....	B-2	T-Slot, Bevel-Edge 2-Flute.....	B-6
Straight, 1-Flute.....	B-1	T-Slot, Straight-Edge 2-Flute.....	B-5
Straight, 2-Flute, 1/2" Shank Diameter.....	B-1	V Trim (Face Frame), 2-Flute.....	B-3
Straight, 2-Flute, 1/4" Shank Diameter.....	B-1	V-Grooving & Carving, 3-Flute.....	B-9
Straight, 2-Flute, 3/4" Shank Diameter.....	B-1	V-Grooving With Top Bearing, 2 Flute.....	B-9
Straight, 2-Flute, Metric Shank.....	B-1	V-Grooving, 2-Flute.....	B-9
Straight, 5 Degree Tapered.....	B-1	V-Matching Tongue & Groove, 2-Flute.....	B-33
Surface Planing (Bottom Cleaning), 2-Flute.....	B-2	Wavy Edge, 2-Flute.....	B-18
Table Top Edge, Classic Ogee 2-Flute.....	B-30	Wedge Tongue & Groove.....	B-33
Table Top Edge, French Baroque 2-Flute.....	B-30	Window Sash, 2-Flute Reversible.....	B-18
Table Top Edge, Ogee 2-Flute.....	B-29	Window Sill Edge, 2-Flute.....	B-24

MAGNATE™ Carbide Tipped Shaper Cutters

Ball Bearing Rub Collar.....	C-5	Quarter Round, 3 Wing.....	C-1
Bead & Corner Round, 3-Wing.....	C-1	Raised Panel Back Cutter.....	C-3
Bead & Cove, 3-Wing.....	C-1	Raised Panel, 12 Degree Face-Up.....	C-2
Bead (Concave), 3-Wing.....	C-1	Raised Panel, 15 Degree Face-Up.....	C-3
Bevel, 30 Degree 3-Wing.....	C-5	Raised Panel, 5 Degree Face-Up.....	C-2
Cabinet Stile & Rail Set.....	C-4	Raised Panel, 6 Degree Face-Up.....	C-3
Concave Stile & Rail Set.....	C-4	Raised Panel, Convex.....	C-3
Convex Stile & Rail Set.....	C-4	Raised Panel, Ogee.....	C-3
Corner Round, 3-Wing.....	C-2	Reversible 45 Degree Lock Mitre, 3-Wing.....	C-3
Cove & Bead Stile & Rail Set.....	C-4	Reversible Bead & Cove, 3-Wing.....	C-3
Cove & Quarter Round, 3-Wing.....	C-1	Reversible Drawer Joint, 3-Wing.....	C-3
Door Lip, Corner Round & Ogee, 3-Wing.....	C-2	Reversible Glue Joint, 3-Wing.....	C-3
Door Lip, Corner Round & Taper Rabbet.....	C-2	Sash, 3-Wing.....	C-3
Door Lip, Ogee & Bead, 3-Wing.....	C-2	Spacers.....	C-5
Door Lip, Ogee & Cove, 3-Wing.....	C-2	Stair Tread Nose, 3-Wing.....	C-1
Double T-Bushing, Both Sides 3/8.....	C-5	Straight Bushing.....	C-5
Flute (Convex), 3-Wing.....	C-1	Straight, 3-Wing.....	C-1
Long T-Bushing.....	C-5	T-Bushing.....	C-5
Molding, 3-Wing.....	C-4	Triple Bead & Flute, 3-Wing.....	C-2
Ogee Stile & Rail Set.....	C-4	V-Groove, 3-Wing.....	C-4
Ogee, 3-Wing.....	C-4	Wedge Groove, 3-Wing.....	C-4

MAGNATE™ End Mills

Cobalt M42 Roughing, Ball Nose end.....	D-1	Solid Carbide, 2-Flute, Regular Length.....	D-3
Cobalt M42 Roughing, Coarse Pitch.....	D-2	Solid Carbide, 2-Flute, Stub Length.....	D-2
Cobalt M42, 2 Flute Double End.....	D-1	Solid Carbide, 4-Flute, Double End.....	D-4
Cobalt M42, 2 Flute, Single End.....	D-1	Solid Carbide, 4-Flute, Long Length.....	D-3
Cobalt M42, 4 Flute Double End.....	D-1	Solid Carbide, 4-Flute, Metric.....	D-4
Cobalt M42, 4 Flute, Single End.....	D-1	Solid Carbide, 4-Flute, Regular Length.....	D-3
Cobalt M42, 6 Flute, Single End.....	D-1	Solid Carbide, 4-Flute, Stub Length.....	D-3
Solid Carbide, 2-Flute, Double End.....	D-4	Solid Carbide, Ball Nose, 2-Flute.....	D-2
Solid Carbide, 2-Flute, Long Length.....	D-3	Solid Carbide, Ball Nose, 4-Flute.....	D-2
Solid Carbide, 2-Flute, Metric.....	D-3	Solid Carbide, Tapered End Mills.....	D-5,D-6,D-7,D-8,D-9

MAGNATE™ Solid Carbide Insert Knives

2 Cutting Edges, 1 Hole.....	E-1	4 Cutting Radius Edges, 1 Hole.....	E-2
2 Cutting Edges, 2 Holes.....	E-1	Double Radius, 3mm Hole, 10 Knives/Pack.....	E-2
4 Cutting Edges, 1 Hole.....	E-1	End Angle, 1 Hole.....	E-1
4 Cutting Edges, 2 Holes For Plunge.....	E-1	End Angle, 2 Holes.....	E-2
4 Cutting Edges, 3 Holes.....	E-1		

MAGNATE™ 20639 Lycoming Street #B-6, Walnut, CA 91789 USA

iii



email : info@magnate.net Online Shop : www.magnate.net
(TEL) 800-827-2316, 909-468-5747 (FAX) 909-468-5745

MAGNATE™ Solid Carbide Insert Knives

Face Groove, 4-Sided, 10 Knives/Pack	E-2	Radius Knives, 10 Knives/Pack	E-2
Radius Knife, 3mm Radius, 1 Knife/Pack	E-2	Scraper, 1 Knife/Pack	E-2
		Straight Spoilboard Surfacing Cutter	E-1

MAGNATE™ Planer/Joiner, Molder Cutterheads/Knives

Molder Knife, 25" HSS	F-4	Tersa™ R2000 Knives, Chrome	F-5
Molder Cutterheads	F-4	Tersa™ R2000 Knives, High Speed Steel	F-5
Planer-Jointer Knife Set, High Speed Steel (HSS)	F-1, F-2	Tersa™ R2000 Knives, M42 HSS	F-5
Planer-Jointer Knife Set, Carbide Tipped	F-3	Tersa™ R2000 Knives, Solid Carbide	F-6

MAGNATE™ Rosette Cutters, Forstner, Boring, Drill bits and Counterbores, Countersinks

Adjustable Counterbore	G-7	Hinge Boring Bit	G-2
Adjustable Counterbores	G-7	Multi-Spur Bit	G-2
Adjustable Countersink	G-8	Pocket Hole Brad Point Drill Bit for Cast Machine	G-6
Brad Point Boring Bit	G-3, G-4	Rosette Cutter, Carbide Tipped	G-1
Brad Point Center Drill Bit	G-6	Taper Shell Countersink	G-8
Brad Point Drill Bit	G-5, G-6	Thru-Bore Boring Bit	G-4, G-5
Chuck Adaptor, Straight to 7/16" Thread	G-8	V-Point Center Drill	G-6
Countersink	G-7, G-8	V-Point Drill Bit	G-6
Door Drill Bit - 3-wing, carbide Tipped	G-1	Yo-Yo Rosette Cutter	G-1
Forstner Bit	G-2		

MAGNATE™ Hole Saws

Carbide Grit-Edge Hole Saw	H-1	Cobalt Bi-Metal Hole Saw	H-1
Carbide Tipped Hole Saw	H-1, H-2	Hole Saw Arbor	H-2
Carbide Tipped Hole Saw, 10mm Shank	H-2		

MAGNATE™ Carbide Tipped Circular Saw Blades

Anti-Kickback Rip Saw Blade	I-1	Nail Saw Blade, TC/TC Grind	I-7
Arbor for Plastic Cutting Saw Blades	I-8	Non-Ferrous Metal Cutting Saw Blade	I-7
Hobbyist Portable Machine Saw Blades	I-8	Panel Saw Blade	I-6, I-7
Combination Saw Blade	I-2	Plastic Cutting Saw Blade, 16-Wing	I-8
Conical Scoring Saw Blade	I-5, I-6	Special Cut-Off Saw Blades	I-2, I-3
Double Face Laminate Saw Blade	I-3	Split Scoring Saw Blade, 20mm Bore	I-4
Double Face Melamine	I-4	Split Scoring Saw Blade, 22mm Bore	I-4
General Purpose Saw Blades	I-3	Split Scoring Saw Blade, 3/4" Bore	I-4
Glue Line Rip Saw Blade	I-1	Split Scoring Saw Blade, 50mm Bore	I-4
Heavy Duty Rip Saw Blade	I-1	Stackable Dado Set, 5/8" Bore	I-5
Hollow Face Saw Blade, V-Hollow Grind	I-5	Standard Cut-Off Saw Blade	I-2
Mitre Saw Blade, 4ATB+R Grind	I-5	Steel Cutting Saw Blade, 1" Bore	I-7
		Thin Kerf Saw Blade, ATB Grind	I-1
		Thin Kerf Saw Blade, TC Grind	I-1

MAGNATE™ M2 Cold Saw Blades With Universal Pin Holes – Metal Cutting

200mm Diameter, 32mm Bore	J-1	300mm Diameter, 40mm Bore	J-8
225mm Diameter, 32mm Bore	J-1, J-2	315mm Diameter, 32mm Bore	J-9
225mm Diameter, 40mm Bore	J-2	315mm Diameter, 40mm Bore	J-9, J-10
250mm Diameter, 32mm Bore	J-3	325mm Diameter, 40mm Bore	J-10
250mm Diameter, 40mm Bore	J-4	350mm Diameter, 32mm Bore	J-11
275mm Diameter, 32mm Bore	J-5	350mm Diameter, 40mm Bore	J-11, J-12
275mm Diameter, 40mm Bore	J-6	370mm Diameter, 32mm Bore	J-12
300mm Diameter, 32mm Bore	J-7	370mm Diameter, 40mm Bore	J-13
300mm Diameter, 38mm Bore	J-7, J-8	370mm Diameter, 50mm Bore	J-13, J-14

MAGNATE™ 20639 Lycoming Street #B-6, Walnut, CA 91789 USA

iv



email : info@magnate.net Online Shop : www.magnate.net
 (TEL) 800-827-2316, 909-468-5747 (FAX) 909-468-5745

MAGNATE™ Diamond Circular Saw Blades

Asphalt Cutting Diamond Blade.....	K-1
General Purpose Diamond Blade.....	K-1, K-2
Granite Cutting Sintered Blade.....	K-2

SKARPAZ® Carbide Tipped Saw Blades

Biscuit Jointer Saw Blades	L-6	Precision Trim Saw Blades.....	L-3
Combination/Planer Style Saw Blades	L-3	Radial Arm/Miter Saw Blades	L-5
Edge Banding Saw Blades.....	L-6	Replacement Chippers	L-7
Finish Trim Saw Blades	L-4	Rip with Chip Guides Saw Blades	L-2
General Purpose Saw Blades	L-2	Saw Stabilizers	L-7
Glue Line Rip Saw Blades, Straight Line Rip	L-1	Standard Cross Cut Saw Blades.....	L-3
Heavy Duty Rip Saw Blades, Flat Top Grind.....	L-1	Standard Rip Saw Blades, Flat Top Grind	L-1
High Production Rip Saw Blades	L-1	Stellite Tipped Resaw Bandsaw Blade.....	L-7
Industrial Dado Set, 2 Tooth Chippers.....	L-6	Thin Kerf Beam Saw Blades.....	L-6
Laminates & Veneer Saw Blades, Double Sided, NSLRRCR grind.....	L-4	Ultra Thin Rip Saw Blades	L-2
Portable Miter/Table Saw Saw Blades.....	L-5		

Bandsaw Blades (Non-Food Processing)

Band Saw Blades (Non-Food Processing)	M-3-M-92
Band Saw Blades Introduction (Magnate)	M-1

Food Processing Blades

Band Saw Blades - Meat Cutting.....	N-1-N-9
Bread Slicing Blades	N-9



Bandsaw Blades Accessories				Legacy® Ornamental
Bandsaw Blade Cleaner	52			Legacy CNC Projects, Tips, Techniques and List of Most Commonly Used Router Bits For Legacy Ornamental Machines
Bandsaw Lubricant	52			
Bandsaw Release Agent	52			
Bandsaw Tires	52			
Abrasives				
9" x 11" Sheets	O-21			
Buffing Wheelers	O-22 to O-23			
Flap Discs	O-4			
Flange & Nut	O-23			
Graphite Coated Canvas Roll	O-1			
Quick Change Pads/Discs	O-2			
Sanding Belts	O-5 to O-21			
Sanding Discs	O-2 to O-4			
Sanding Roll	O-1 to O-2			
Sanding Star	O-21			
Spiral Band	O-21			
Fasteners				
Nailer Kit/Nails	180			
Staple Gun Kit/Staples	181			
Dust Collection				
Dust Collector	190			
Dust Collector Accessories	191			
Sharpening				
Sharpening	204			
Custom Made Tools				
Instruction	200			
Drawing Sheet	201			
Freeborn Tools				
All Items	Call			
		Glare Car/Aircraft Detailing	192-195	
		Amana® Tools		
		All Items Call	Call	
		Edge Banding Tapes		
		Edge Banding Tape – PVC Preglued	206	
		Edge Banding Tape – PVC Unglued	205	
		Edge Banding Tape – PVC Paintable	205	
		Edge Banding Tape – Wood Veneer	206	
		Misc.		
		16-Wing Plastic Saws + Arbor	199	
		Abrasive Belt Cleaner	198	
		Carving Pod Bit	198	
		Carving Rougher Bit	198	
		CNC Collet Nut Wrenches	199	
		ER Collet Nuts	198	
		ER Precision Collets	196	
		HSK 63F Collet Toolholders	198	
		Lube Tube Band Saw Lubricant	199	
		Panel Pilot Spiral (HSS)	198	
		Panel Pilot Straight (HSS)	198	
		SYOZ CNC Collets	197	
		SYOZ Clamping Nuts	197	
		SYOZ Spanner Wrenches	197	
		TG CNC Collets	197	

From After Page 206
To Last Page



MAGNATE™ General Information

Office

Customers are welcome to visit our office during normal office hours, 8:00 A.M. to 5:00 P.M. PST Monday through Friday, except holidays. Please call first to schedule an appointment if you wish to visit us on weekends or holidays. Our address is 20639 Lycoming Street, Suite B-6, Walnut CA 91789. Our office is located northwest of the intersection of the 57 and 60 freeways. The cross streets are "Lemon Street" and "Brea Canyon Road". A map and driving directions are provided on our website under "Contact Us".

How to Order

Online Orders: To order online, visit www.magnate.net and search for each item by its tool number. Add each item along with its quantity to the shopping cart until you have added all the items required on your purchase list.

After you have selected all items you wish to purchase, you can Calculate Shipping Rates by entering your Country, State, and ZIP/Postal Code. Our shopping cart will automatically calculate the shipping charge for your order.

To ship with UPS, under "Shipping Rates", will see options for the UPS shipping methods. (UPS Ground, UPS 2nd Day Air, Next Day Air, etc)

To ship with US Postal Service (by mail), under "Shipping Rates", will see options for the USPS shipping methods. (Priority Mail, Priority Mail Express)

On regular business days, all orders will be processed on the same day if placed before 12:00 PM Pacific Standard Time.

Phone Orders: To place an order simply call our toll free number, **(800) 827-2316, or (909) 468-5747**. List the tool number and quantity of each item, along with the preferred method of shipment. Our 800 number will work anywhere in Canada and in the U.S.A., including Hawaii and Alaska. When calling in from outside the U.S.A. or Canada call us at **(909) 468-5747**.

Mail In/Fax or Email Orders: To mail in an order, simply write down your name, company name (if applicable), shipping address, contact phone number, fax or e-mail address, the tool number and the quantity of each item. If paying by credit card, please include your credit card number with CVV code, expiration date, and your signature. If paying by check, please enclose a check issued by a USA domestic bank, made payable to "Magnate, Inc.". If placing an order by fax, fax the completed order sheet to our 24 hour fax service at (909) 468-5745. If ordering by e-mail, send the order to sales@magnate.net. Please be sure to include all applicable shipping charges. **You may need to take special care of your credit card information if ordering through email – call for details.**

International Orders

All international orders are shipped by US Postal Service unless otherwise requested. The cost will be determined according to the current postage rates plus insurance. Please call or e-mail to confirm the actual shipping charges. All payments must be made in U.S. Dollars.

Price

Please note that all prices in this catalog or from our web site, www.Magnate.net, are deemed reliable but not guaranteed. All prices are subject to change without notice. Feel free to contact us if in doubt.

Shipping

Small parcels and packages can be shipped via UPS or US Postal Service and the shipping charges will be calculated accordingly. Bulky items exceeding UPS and USPS limitations, i.e. woodworking machinery, may need a special arrangement or may be shipped via UPS Freight.

California Sales Tax

Any customers whose orders are shipped to California must include sales tax in the total purchase price.

Warranty

Magnate™ warrants its cutting tools (router bits and shaper cutters) to be free of defects from materials and workmanship for a period of 90 days from date of original purchase. This warranty does not apply to defects caused by customer misuse or accidents caused by the customer themselves. To take advantage of this warranty, freight must be prepaid and proof of purchase must accompany the merchandise. Magnate's liability will also not exceed the purchase value of the merchandise in question. As far as the fastening equipment, the limited warranty covers the housing for one year and the main parts for 45 days. The limited warranty covers defects on materials & workmanship if they occur during the duration of the warranty period. Merchandise other than the Magnate™ brand is warranted by their own manufacturers. All pricing, specifications, dimensions, and design characteristics in this catalogue are subject to change without prior notice.

Note

Picture shown may not reflect the actual item. Sometimes our vendors may unexpectedly change item material, color, packaging, etc. without notifying us. However, if this were to occur, the product given to the customer will be of the same quality/grade as the item ordered.

Return Policy

In order to return an item, an RMA (Returned Merchandise Authorization) number must be obtained. All items must be unused and returned in the original packaging within 30 days from the date the RMA number is obtained. Please include a copy of the original invoice. All items will be inspected and subject to a 15% restocking fee unless the merchandise has a manufacturer's defect. There is no return for custom made cutters except when there is a proven defect. All returned merchandise must be shipped to our headquarters prepaid. Call if you have any further questions.

**Cancer and Reproductive Harm - www.p65warnings.ca.gov/search/abrasives
www.p65warnings.ca.gov**

 **Some dust created by power sanding, sawing, grinding, drilling, and other construction activities contains chemicals known to the State of California to cause cancer and birth defects or other reproductive harm.**

Your risk from exposure to these chemicals varies, depending on how often you do this type of work. To reduce your exposure, work in a well-ventilated area and with approved safety equipment, such as dust masks that are specially designed to filter out microscopic particles. 

Routers, shapers, machinery, and all tools can be dangerous when used improperly so it is important to strictly comply with all operation and safety procedures. Always strictly follow the safety rules stipulated in the operation manual of your tools/machines.

First and foremost, always wear eye and hearing protection and keep all loose clothing away from machines. It is also important to keep the machines unplugged when changing bits, cutters, blades, etc. and to make sure everything is properly secured before turning on the machines. To avoid slippage, keep all collets clean.

Use of these products will produce dust of potentially hazardous ingredients. Coolant mist from wet grinding may also contain dust. The dust produced can cause throat, nose, skin and eye irritation, and respiratory disease.

Following these safety guidelines (but not limited to) are suggestions to help reduce the possible hazards to your health:

- Maintaining adequate ventilation to keep dust levels below OSHA and ACGIH levels is required all the times.
- Use protective devices (i.e. dust mask etc.) to avoid breathing dust or mist.
- Avoid direct skin contact with dust or mist.
- Before eating, drinking or smoking, wash hands thoroughly.
- When disposing of materials, comply with local, state, and/or federal regulation codes.



20639 Lycoming Street #B-6, Walnut, CA 91789 USA

email : info@magnate.net Online Shop : www.magnate.net

(TEL) 800-827-2316, 909-468-5747 (FAX) 909-468-5745



vii

MAGNATE™ General Information

Custom Bits/Cutters

Magnate™ can custom make cutters to fit your specifications.

Sharpening Service

Magnate™ provides a sharpening service. Tools can be shipped to or dropped off in person at Magnate's office. After the tools are sharpened, they can be picked up in person or be shipped back at the customer's expense.

Router Bit Speed Guideline

Always first refer to the operation manual of your router to select the ideal router bit speed. In the event that a router bit doesn't come with a speed chart, you may start at about 2,000 rpm slower than the maximum speed described in the chart below. Maximum speed below is for reference only. The actual best performance speed varies depending on a number of factors. (size of the router bit, material to be cut, etc)

Overall Dia.	Max. (rpm)	Overall Dia.	Max. (rpm)
1"	24,000	2-1/2"	16,000
1-1/2"	20,000	3"	12,000
2"	18,000	3-1/2"	10,000

Shaper Cutter Speed Guideline

Always first refer to the operation manual of your shaper. If a shaper cutter doesn't come with a speed chart, you may start at about 1,000 rpm slower than the maximum speed described in the chart below. Maximum speed below is for reference only. The actual best performance speed varies depending on a number of factors. (size of the cutter, material to be cut, etc)

Overall Dia.	Max. (rpm)	Overall Dia.	Max. (rpm)
3"	12,000	5"	8,000
3-1/2"	11,000	5-1/2"	7,000
4"	10,000	6"	6,000
4-1/2"	9,000		

Bandsaw Blades

All Magnate™ bandsaw blades are welded and fabricated in the USA. The coils/material are USA brands but may not be made in the USA. All band saw blades' pictures depict a general bandsaw blade and thus may look different from each particular item.

Warning: For packaging purposes, this blade is folded into a coiled position which is similar to a spring and may pop open when being coiled or uncoiled. Wear heavy duty leather gloves and eye/body protection while using extreme care when coiling or uncoiling a blade. Failure to exercise the proper care could result in serious bodily injury. See your bandsaw owner's manual for further safety instructions.

Upon request, Magnate™ makes blades of any length and of any type available to fit your bandsaw brand and model.

Always disconnect power plug before mounting, unmounting blades or measuring blade length. If in doubt when determining your bandsaw blade length, please refer the instructions below:

- 1 - Check the owner's manual of your bandsaw machine for specifications. Check not only the length, but also the range of the width and of the thickness.
- 2 - If the owner's manual is not available, refer to your previous invoices.
- 3 - Uncoil your blade and use a soft cloth measuring tape and accurately measure the length by pressing tape tightly at the back end of your old blade.
- 4 - Mark a starting point on the floor and on your blade. Line up the starting point on your blade with the starting point on the floor. Roll the blade along the floor in a straight line until the starting point on the blade reaches the ground for the second time. Measure the length from the start point to the end point on the floor.
- 5 - Cut your old blade in half so that it lies flat and flush on a leveled surface and measure its length.

Choose A Width : How Tight Do You Need To Turn

Horizontal metalcutting bandsaws are typically designed to use only one width of blade. Vertical metalcutting bandsaws and woodcutting bandsaws have the capacity to run a wide range of widths. Here are some minimum turning circle diameters for our most common blades.

Blade	Minimum Circle Diameter
1/8" x 14 Raker Carbon	3/16"
3/16" x 4 Skip Carbon	3/8"
3/16" x 10 Raker Carbon	7/16"
3/16" x 8 Hook Three Wheeler	9/16"
1/4" x 6 Hook Premium Gold Carbide	3/4"
1/4" x 6 Hook Carbon and Bimetal	13/16"
1/4" x 6 Hook Three Wheeler	1-1/2"
3/8" x 4 Hook Premium Gold Carbide	1-3/4"
3/8" x 4 Hook Carbon & Bimetal	2-1/4"
3/8" x 6 Hook Three Wheeler	2-5/8"
1/2" x 3 Hawc Pro Resaw	3-1/8"
1/2" x 3 Hook Premium Gold Carbide	3-5/8"
1/2" x 3 Hook Carbon & Bimetal	6-1/2"
3/4" x 3 Hook Carbon	9-1/4"

METALCUTTING BANDSAWS:

The correct tooth pattern for metalcutting is determined by the thickness (cross-section) of material you are cutting. There should be between 2 and approximately 10 teeth in contact with the material at all times. Generally, choose fewer teeth per inch for thicker materials and more teeth per inch for thinner materials. The chart below will give you some basic guidelines for choosing the correct number of teeth per inch.

Carbon Tool Steel (Teeth Per Inch)	Material Thickness	Premium Bimetal (Teeth Per Inch)
24 Raker	1/16" to 1/4"	20-24 Variable
18 Raker	1/8" to 3/8"	14-18 Raker
14 Raker	3/16" to 7/16"	10-14 Variable
10 Raker	1/4" to 1/2"	8-12 Variable
10 Raker	5/16" to 5/8"	6-10 Variable / 6 Hook
6 Hook	3/8" to 1"	5-8 Variable / 6 Hook
6 Hook	1/2" to 2"	4-6 Variable / 6 Hook
4 Hook	3/4" to 4-1/2"	3-4 Variable / 4 Hook
3 Hook	1" to 6"	3 Hook
2 Hook	2" to 12"	2 Hook

Tooth patterns of Carbon Tool Steel Blades

All Carbon Tool Steel Blades feature a standard set, which is a recurring sequence of teeth – one set right, one set left, and one not set.

Raker – Raker (also called "Standard") is a good general purpose tooth design with a zero degree tooth angle. It works well on structural shapes and thinner materials in wood and metal.

Skip – Skip is available in limited sizes, but works well on thick cutting of paper and wood products. It features widely spaced teeth with a zero degree tooth angle.

Hook – Hook is an excellent positive angle tooth design for fast cutting of thicker materials such as wood, plastics, and soft metals.

Variable – Variable Pitch Bimetal Blades combine teeth of different gullet depth, pitches, and set angles. This results in smoother cuts, faster sawing, improved chip clearance, and longer blade life. A constant-pitch blade can increase undesirable harmonic vibrations that negatively affect a cut. Variable pitch improves chip evacuation, interrupts sawing rhythm, and reduces harmonic vibrations.

Magnate - Cold Saw Order Form

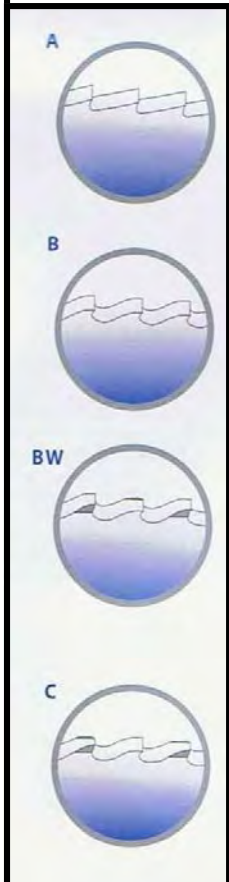
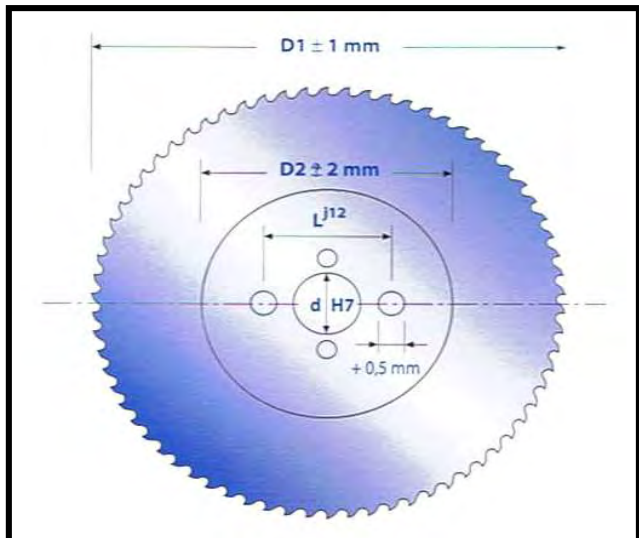
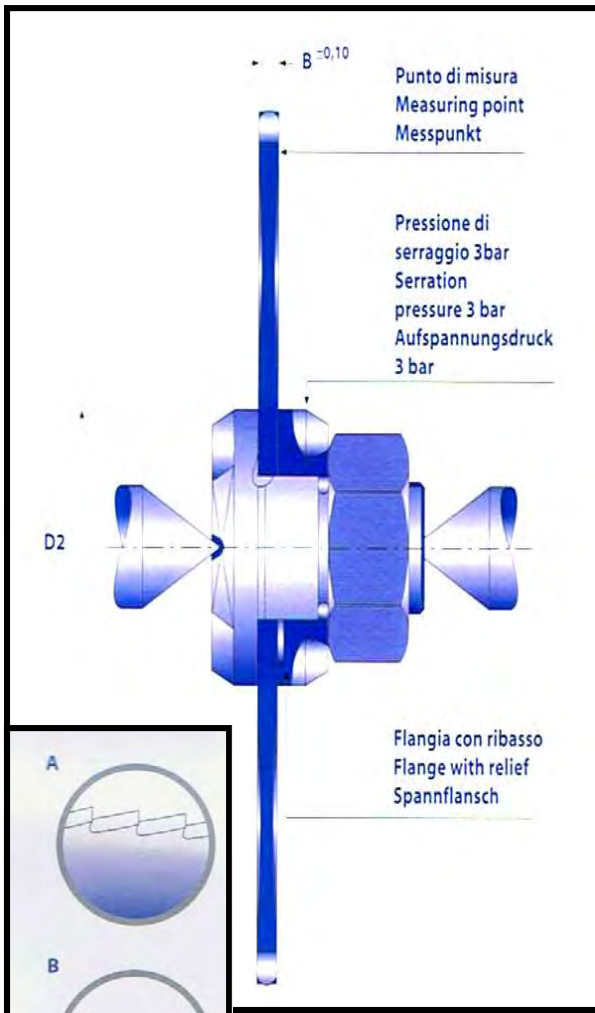

- Tooth Patterns:**
- A. Very fine tooth, jewelry and screw slots.
 - B. Thin wall pipe, chip control is not required
 - BW. Thin wall, chip control required. AKA ATB
 - C. Most common, bar and solid stock. AKA – triple chip

Please Provide the Following:

D1 (diameter) _____

d (arbor hole) _____

B (thickness) _____

Number of teeth _____

Tooth style _____

Material _____
(Stainless, Cast, Brass, Aluminum)

Product _____
(tube, pipe, bar stock, solid)

Wall thickness _____

Quantity Ordered _____

FAX or E-mail to: **MAGNATE™**
Magnate Inc.

FAX: 909-468-5745
E-mail: sales@magnate.net

Spiral, 1 Flute Up-Cut



This one flute spiral bit is designed for solid woods, wood composites and some plastics. It is for use with low power routers.

Tool No.	Cutting Dia.	Cutting Length	Shank Dia.	Overall Length	Price
9401	1/4"	1"	1/4"	2-1/2"	\$19.81
9402	5/16"	1"	5/16"	3"	\$28.43
9403	3/8"	1"	3/8"	3"	\$29.78
9407	3/8"	1-1/4"	3/8"	3"	\$32.50
9404	1/2"	1-3/8"	1/2"	3-1/2"	\$48.74

Spiral, 1 Flute Down-Cut



This one flute spiral bit is designed for solid woods, wood composites and some plastics. It is for use with low power routers.

Tool No.	Cutting Dia.	Cutting Length	Shank Dia.	Overall Length	Price
9411	1/4"	1"	1/4"	2-1/2"	\$19.81
9412	5/16"	1"	5/16"	3"	\$28.43
9413	3/8"	1"	3/8"	3"	\$29.78
9417	3/8"	1-1/4"	3/8"	3"	\$32.50
9414	1/2"	1-3/8"	1/2"	3-1/2"	\$48.74

Spiral, Flush Trim 2 Flute Up-Cut



This two flute flush trim spiral bit comes with double bearings to enhance stability for laminate, template or pattern work. It is designed for solid woods, wood composites and some plastics.

Tool No.	Cutting Dia.	Cutting Length	Shank Dia.	Overall Length	Price
2272	1/4"	1"	1/4"	3"	\$39.56
2275	1/2"	1-1/4"	1/2"	4"	\$77.02
2276	1/2"	2"	1/2"	4-1/2"	\$94.12

Spiral, Flush Trim 2 Flute Down-Cut



This two flute flush trim spiral bit comes with double bearings to enhance stability for laminate, template or pattern work. It is designed for solid woods, wood composites and some plastics.

Tool No.	Cutting Dia.	Cutting Length	Shank Dia.	Overall Length	Price
2292	1/4"	1"	1/4"	3"	\$39.36
2295	1/2"	1-1/4"	1/2"	4"	\$77.02
2296	1/2"	2"	1/2"	4-1/2"	\$94.12

Spiral, Flat-End 2 Flute Up-Cut



This two flute spiral bit is designed for solid woods, wood composites and some plastics.

This bit is used when creating dadoes without machine marks.

Tool No.	Cutting Dia.	Cutting Length	Shank Dia.	Overall Length	Price
9631	1/8"	1/2"	1/4"	2"	\$16.23
9635	1/4"	1"	1/4"	2-1/2"	\$18.70
9632	1/4"	1-1/4"	1/4"	2-1/2"	\$18.80
9636	5/16"	1-1/8"	5/16"	3"	\$27.67
9637	3/8"	1-1/4"	3/8"	3"	\$26.45
9638	1/2"	1-1/4"	1/2"	3"	\$42.77
9639	1/2"	1-5/8"	1/2"	3-1/2"	\$44.05
9630	1/2"	2-1/8"	1/2"	4"	\$47.32

Spiral, Flat-End 2 Flute Down-Cut



This two flute spiral bit is designed for solid woods, wood composites and some plastics.

This bit is used when creating dadoes without machine marks.

Tool No.	Cutting Dia.	Cutting Length	Shank Dia.	Overall Length	Price
9681	1/4"	3/8"	1/4"	2-1/2"	\$18.70
9685	1/4"	1"	1/4"	2-1/2"	\$18.70
9689	1/4"	1-1/4"	1/4"	2-1/2"	\$18.80
9682	1/4"	1-1/4"	1/4"	3-1/2"	\$31.97
9683	3/8"	1/2"	3/8"	2-1/2"	\$21.42
9687	3/8"	1-1/4"	3/8"	3"	\$26.45
9684	1/2"	1-1/4"	1/2"	3"	\$42.77
9686	1/2"	1-5/8"	1/2"	3-1/2"	\$47.13
9688	1/2"	2-1/4"	1/2"	4"	\$50.63

Spiral, 2 Flute Up-Cut Left Hand



This two flute spiral bit is designed for solid woods, wood composites and some plastics.

Tool No.	Cutting Dia.	Cutting Length	Shank Dia.	Overall Length	Price
2901	1/8"	1/2"	1/4"	2"	\$23.10
2903	3/16"	3/4"	1/4"	2"	\$23.10
2920	7/32"	3/4"	1/4"	2"	\$23.96
2905	1/4"	1"	1/4"	2-1/2"	\$21.39
2927	5/16"	1"	5/16"	3"	\$41.93
2923	3/8"	1"	3/8"	3"	\$41.93
2921	7/16"	1-1/4"	1/2"	3"	\$76.67
2909	1/2"	1-1/4"	1/2"	3"	\$53.91
2910	1/2"	1-1/2"	1/2"	3-1/2"	\$72.73
2911	1/2"	2"	1/2"	4"	\$75.30
2926	5/8"	1-1/2"	5/8"	3-1/2"	\$158.30
2912	5/8"	2"	5/8"	4"	\$205.37
2917	3/4"	1-1/2"	3/4"	4"	\$158.30
2913	3/4"	2"	3/4"	4"	\$166.86

Spiral, 2 Flute Down-Cut, Left Hand



This two flute spiral bit is designed for solid woods, wood composites and some plastics.

Tool No.	Cutting Dia.	Cutting Length	Shank Dia.	Overall Length	Price
2971	1/8"	1/2"	1/4"	2"	\$23.10
2973	3/16"	3/4"	1/4"	2"	\$23.10
2990	7/32"	3/4"	1/4"	2"	\$23.96
2975	1/4"	1"	1/4"	2-1/2"	\$21.39
2997	5/16"	1"	5/16"	3"	\$41.93
2993	3/8"	1"	3/8"	3"	\$41.93
2991	7/16"	1-1/4"	1/2"	3"	\$76.67
2979	1/2"	1-1/4"	1/2"	3"	\$53.91
2980	1/2"	1-1/2"	1/2"	3-1/2"	\$72.73
2981	1/2"	2"	1/2"	4"	\$75.30
2996	5/8"	1-1/2"	5/8"	3-1/2"	\$158.30
2982	5/8"	2"	5/8"	4"	\$205.37
2987	3/4"	1-1/2"	3/4"	4"	\$158.30
2983	3/4"	2"	3/4"	4"	\$166.86



MAGNATE™ Solid Carbide/PCD Router Bits

Spiral, 2 Flute Up-Cut



This two flute spiral bit is designed for solid woods, wood composites and some plastics.

Tool No.	Cutting Dia.	Cutting Length	Shank Dia.	Overall Length	Price
9450	1/16"	1/4"	1/8"	1-1/2"	\$17.92
2000	3/32"	1/2"	1/4"	2"	\$14.23
2001	1/8"	1/2"	1/4"	2"	\$14.13
9478	1/8"	3/4"	1/4"	2"	\$20.90
9477	1/8"	3/4"	1/4"	2-1/2"	\$17.25
9453	1/8"	7/8"	1/8"	2"	\$23.00
9462	1/8"	1"	1/4"	2-1/2"	\$23.77
2002	5/32"	3/4"	1/4"	2"	\$14.41
9460	3/16"	5/8"	1/4"	2"	\$15.44
2003	3/16"	3/4"	1/4"	2"	\$15.44
9463	3/16"	1"	1/4"	2-1/2"	\$22.89
9461	5.0mm	3/4"	1/4"	2"	\$26.91
2020	7/32"	3/4"	1/4"	2-1/2"	\$17.05
2004	1/4"	3/4"	1/4"	2-1/2"	\$16.26
9472	1/4"	7/8"	1/4"	2-1/2"	\$16.26
2005	1/4"	1"	1/4"	2-1/2"	\$18.40
2024	1/4"	1-1/4"	1/4"	2-1/2"	\$16.35
2025	1/4"	1-1/4"	1/4"	3"	\$20.89
9451	1/4"	1-1/4"	1/4"	4"	\$29.17
9452	1/4"	1-1/2"	1/4"	3"	\$28.96
9479	1/4"	1-1/2"	1/4"	3-1/2"	\$29.13
9392	1/4"	2"	1/4"	4"	\$32.97
2019	9/32"	1"	1/2"	3"	\$60.88
2027	5/16"	1"	5/16"	3"	\$24.68
9465	5/16"	1-1/8"	5/16"	3"	\$27.66
9466	5/16"	1-1/4"	5/16"	3"	\$26.18
2006	5/16"	1-1/4"	1/2"	3"	\$50.98
2023	3/8"	1"	3/8"	3"	\$26.41
9467	3/8"	1-1/8"	3/8"	3"	\$26.97
2007	3/8"	1-1/4"	3/8"	3"	\$27.58
2008	3/8"	1-1/4"	1/2"	3"	\$40.57
9475	3/8"	1-3/8"	1/2"	3-1/2"	\$40.13
9468	7/16"	1"	1/2"	3"	\$39.97
2021	7/16"	1-1/4"	1/2"	3"	\$40.71
9476	7/16"	1-3/4"	1/2"	4"	\$56.65
2022	1/2"	1"	1/2"	3"	\$39.40
2009	1/2"	1-1/4"	1/2"	3"	\$41.29
2010	1/2"	1-1/2"	1/2"	3-1/2"	\$44.05
9469	1/2"	1-3/4"	1/2"	4"	\$55.06
2011	1/2"	2"	1/2"	4"	\$47.31
2028	1/2"	2-1/8"	1/2"	4"	\$47.31
9464	1/2"	2-1/2"	1/2"	5"	\$68.00
9444	1/2"	3"	1/2"	6"	\$85.83
9470	17/32"	1"	1/2"	3"	\$95.03
9471	17/32"	1-1/4"	1/2"	3-1/2"	\$124.24
2029	9/16"	1-1/4"	1/2"	3"	\$118.24
2026	5/8"	1-5/8"	5/8"	3-1/2"	\$97.07
2012	5/8"	2"	5/8"	4"	\$105.23
2017	3/4"	1-1/2"	3/4"	4"	\$121.55
2013	3/4"	2"	3/4"	4"	\$127.26
9473	3/4"	2-1/8"	3/4"	4"	\$170.06
9474	3/4"	2-1/2"	3/4"	5"	\$197.60
2014	3/4"	3"	3/4"	6"	\$150.91
2015	3/4"	3-1/4"	3/4"	6"	\$245.99
2016	3/4"	3-1/2"	3/4"	6"	\$235.35

Spiral, 2 Flute Down-Cut



This two flute spiral bit is designed for solid woods, wood composites and some plastics.

Tool No.	Cutting Dia.	Cutting Length	Shank Dia.	Overall Length	Price
9395	1/16"	1/4"	1/4"	2"	\$18.67
2100	3/32"	1/2"	1/4"	2"	\$16.23
9396	1/8"	1/2"	1/4"	1-1/2"	\$19.83
2101	1/8"	1/2"	1/4"	2"	\$16.23
9498	1/8"	3/4"	1/4"	2"	\$19.73
9497	1/8"	3/4"	1/4"	2-1/2"	\$22.82
9482	1/8"	1"	1/4"	2-1/2"	\$27.50
9398	1/8"	1-1/4"	1/8"	3"	\$31.73
2102	5/32"	3/4"	1/4"	2"	\$16.72
9480	3/16"	5/8"	1/4"	2"	\$17.75
2103	3/16"	3/4"	1/4"	2"	\$17.75
9483	3/16"	1"	1/4"	2-1/2"	\$26.32
9481	5.0mm	3/4"	1/4"	2"	\$25.85
2120	7/32"	3/4"	1/4"	2-1/2"	\$20.37
2104	1/4"	3/4"	1/4"	2-1/2"	\$18.70
9492	1/4"	7/8"	1/4"	2-1/2"	\$18.70
2105	1/4"	1"	1/4"	2-1/2"	\$18.70
2124	1/4"	1-1/4"	1/4"	2-1/2"	\$18.80
2125	1/4"	1-1/4"	1/4"	3"	\$24.03
9456	1/4"	1-1/4"	1/4"	4"	\$29.17
9499	1/4"	1-1/2"	1/4"	3-1/2"	\$33.50
9397	1/4"	2"	1/4"	4"	\$37.92
9484	9/32"	1"	5/16"	2-1/2"	\$60.62
9485	9/32"	1"	3/8"	2-1/2"	\$46.83
2119	9/32"	1"	1/2"	3"	\$63.32
2127	5/16"	1"	5/16"	3"	\$25.75
9486	5/16"	1-1/4"	5/16"	3"	\$25.92
2106	5/16"	1-1/4"	1/2"	3"	\$48.00
2123	3/8"	1"	3/8"	3"	\$24.98
9487	3/8"	1-1/8"	3/8"	3"	\$25.72
2107	3/8"	1-1/4"	3/8"	3"	\$26.45
2108	3/8"	1-1/4"	1/2"	3"	\$42.77
9495	3/8"	1-3/8"	1/2"	3-1/2"	\$34.90
9488	7/16"	1"	1/2"	3"	\$42.77
2121	7/16"	1-1/4"	1/2"	3"	\$43.20
9496	7/16"	1-3/4"	1/2"	4"	\$56.65
2122	1/2"	1"	1/2"	3"	\$41.82
2109	1/2"	1-1/4"	1/2"	3"	\$42.77
2110	1/2"	1-5/8"	1/2"	3-1/2"	\$47.13
9489	1/2"	1-3/4"	1/2"	4"	\$49.85
2111	1/2"	2"	1/2"	4"	\$50.63
2128	1/2"	2-1/8"	1/2"	4"	\$50.63
2118	1/2"	2-1/2"	1/2"	5"	\$60.62
9490	17/32"	1"	1/2"	3"	\$101.68
9491	17/32"	1-1/4"	1/2"	3-1/2"	\$129.22
2129	9/16"	1-1/4"	1/2"	3"	\$119.34
2126	5/8"	1-5/8"	5/8"	3-1/2"	\$100.60
2112	5/8"	2"	5/8"	4"	\$110.50
2117	3/4"	1-1/2"	3/4"	4"	\$127.63
2113	3/4"	2"	3/4"	4"	\$133.62
9493	3/4"	2-1/8"	3/4"	4"	\$176.86
9494	3/4"	2-1/2"	3/4"	5"	\$205.51
2114	3/4"	3"	3/4"	6"	\$158.47
2115	3/4"	3-1/4"	3/4"	6"	\$252.74
2116	3/4"	3-1/2"	3/4"	6"	\$247.53

Spiral Dovetail Bit for OMEC Solid Carbide, 14mm Cutting Diameter 2 Flute, 14mm+Flat Shank 20 inclusive Degree, 60mm Overall Length



This two flute spiral bit is designed for solid woods, wood composites and some plastics.

Specifically designed for use on OMEC dovetail machines. Tools work well for routing solid wood and wood composites.

Tool No.	Cut	Cutting Height	Small Dia.	Rotation	Price
4512	UP	9mm	10.8mm	Right	\$216.90
4514	Up	10mm	10.8mm	Right	\$198.87
4516	Down	10mm	10.4mm	Right	\$198.87
4518	Up	15.8mm	8.4mm	Right	\$184.22

Dovetail Bit for CNC, 2-Flute PCD 20 inclusive Degree (10 Degree) 1/2" Shank Dia. 2" Overall Length



Dovetail tool allows for use on CNC machines. For use with material thicknesses of 3/8 to 1/2. Mating dovetail joint is cut with 1/4 straight spiral.

Tool No.	Cutting Dia.	Small Dia.	Cutting Height	Price
2310	15mm	10mm	8.99mm	\$303.57

Dovetail PCD Bit for OMEC, 3 Flute 20 inclusive Degree (10 Degree) 14mm+Flat Shank 60mm Overall Length



Dovetail tool for use on Dodds dovetail machines. PCD cutting edge provides superior life over carbide. 3-flute chip breaker helps eliminate tearing and furring in plywood and solid wood.

Tool No.	Cutting Dia.	Small Dia.	Cutting Height	Price
2312	14mm	11.3mm	7.7mm	\$384.55
2313	14mm	10.6mm	9.8mm	\$384.55



MAGNATE™ Solid Carbide/PCD Router Bits

Spiral, 3 Flute Up-Cut



This three flute bit is designed for higher feed rates, to produce extremely smooth finishes on natural woods and man made composites.

Tool No.	Cutting Dia.	Cutting Length	Shank Dia.	Overall Length	Price
2086	1/4"	3/4"	1/4"	2-1/2"	\$31.01
2087	3/8"	1-1/4"	3/8"	3"	\$35.94
2089	1/2"	1-1/4"	1/2"	3"	\$48.78
2090	1/2"	1-5/8"	1/2"	3-1/2"	\$65.55
2091	1/2"	2"	1/2"	4"	\$64.61
2082	5/8"	1-5/8"	5/8"	3-1/2"	\$121.55
2092	5/8"	2"	5/8"	4"	\$128.35
2097	3/4"	1-1/2"	3/4"	4"	\$127.59
2093	3/4"	2"	3/4"	4"	\$132.63
2094	3/4"	3"	3/4"	6"	\$174.63
2098	3/4"	3-1/2"	3/4"	6"	\$212.41

Spiral, Ball Nose 2 Flute Up-Cut



A ball end spiral bit is designed for round bottom cuts, carving, fluting, and 3D modeling. This bit is designed for natural wood, plastic, and aluminum.

Tool No.	Cutting Dia.	Cutting Length	Shank Dia.	Overall Length	Price
1965	1/8"	1/2"	1/4"	2"	\$23.68
1967	3/16"	3/4"	1/4"	2-1/2"	\$27.23
1960	1/4"	3/4"	1/4"	2-1/2"	\$23.76
1968	1/4"	1"	1/4"	2-1/2"	\$24.91
1975	5/16"	1"	5/16"	3"	\$36.05
1961	3/8"	1"	3/8"	3"	\$38.63
1964	3/8"	1-1/8"	3/8"	3"	\$39.73
1962	1/2"	1-1/4"	1/2"	3"	\$63.72
1969	1/2"	1-1/2"	1/2"	3-1/2"	\$57.68
1978	1/2"	2"	1/2"	5"	\$72.76
1966	5/8"	1-5/8"	5/8"	3-1/2"	\$121.34
1963	3/4"	2"	3/4"	4"	\$147.63

Spiral, MFC 2 Flute Up-Cut



MFC (Melamine Faced Chipboard) grade spiral bit is designed for difficult materials such as MDF (Medium Density Fiberboard), particle board and products with melamine laminate; double sided laminated or veneered material. It is also suitable for wood composite that contains vinyl or glue.

Tool No.	Cutting Dia.	Cutting Length	Shank Dia.	Overall Length	Price
2262	1/4"	1"	1/4"	2-1/2"	\$22.43
2282	3/8"	1"	3/8"	3"	\$26.85
2263	3/8"	1-1/4"	3/8"	3"	\$28.43
2283	1/2"	1-1/4"	1/2"	3"	\$43.97
2284	1/2"	1-5/8"	1/2"	3-1/2"	\$48.45
2260	1/2"	1-3/4"	1/2"	4"	\$52.04
2264	1/2"	2-1/8"	1/2"	4"	\$58.24

Spiral, 3 Flute Down-Cut



This three flute bit is designed for higher feed rates, to produce extremely smooth finishes on natural woods and man made composites.

Tool No.	Cutting Dia.	Cutting Length	Shank Dia.	Overall Length	Price
2186	1/4"	3/4"	1/4"	2-1/2"	\$31.01
2187	3/8"	1-1/4"	3/8"	3"	\$35.94
2189	1/2"	1-1/4"	1/2"	3"	\$48.78
2190	1/2"	1-5/8"	1/2"	3-1/2"	\$65.55
2191	1/2"	2"	1/2"	4"	\$64.61
2182	5/8"	1-5/8"	5/8"	3-1/2"	\$121.55
2192	5/8"	2"	5/8"	4"	\$128.35
2197	3/4"	1-1/2"	3/4"	4"	\$127.59
2193	3/4"	2"	3/4"	4"	\$132.63
2194	3/4"	3"	3/4"	6"	\$174.63
2198	3/4"	3-1/2"	3/4"	6"	\$212.41

Spiral, Tapered Ball Nose 3 Flute Up-Cut



A ball end spiral bit is designed for round bottom cuts, carving, fluting, and 3D modeling. This bit is designed for natural wood, plastic, and aluminum.

Tool No.	Cutting Dia.	Degree	Cutting Height	Shank Dia.	Overall Length	Price
2681	1/16"	3	3/4"	1/4"	3"	\$55.75
2682	1/8"	1	1-1/2"	1/4"	3"	\$48.36
2683	1/8"	3	1"	1/4"	3"	\$48.36
2684	1/8"	3	3"	1/2"	5"	\$110.03
2685	1/8"	5	3/4"	1/4"	3"	\$41.40
2686	1/8"	7	1/2"	1/4"	3"	\$48.95
2687	1/4"	3	2"	1/2"	4"	\$81.52
2688	1/4"	5	1-3/8"	1/2"	4"	\$112.58
2689	1/4"	7	1"	1/2"	4"	\$112.58
2680	1/4"	3	2-1/4"	1/2"	5"	\$94.74

Spiral, MFC 2 Flute Down-Cut



MFC (Melamine Faced Chipboard) grade spiral bit is designed for difficult materials such as MDF (Medium Density Fiberboard), particle board and products with melamine laminate; double sided laminated or veneered material. It is also suitable for wood composite that contains vinyl or glue.

Tool No.	Cutting Dia.	Cutting Length	Shank Dia.	Overall Length	Price
2267	1/4"	1"	1/4"	2-1/2"	\$22.43
2287	3/8"	1"	3/8"	3"	\$26.85
2268	3/8"	1-1/4"	3/8"	3"	\$28.43
2288	1/2"	1-1/4"	1/2"	3"	\$43.97
2289	1/2"	1-5/8"	1/2"	3-1/2"	\$48.45
2265	1/2"	1-3/4"	1/2"	4"	\$52.04
2269	1/2"	2-1/8"	1/2"	4"	\$58.24



Spiral, MFC 2 Flute UP-Cut Enduro Coated



MFC (Melamine Faced Chipboard) grade spiral bit is designed for difficult materials such as MDF (Medium Density Fiberboard), particle board and products with melamine laminate; double sided laminated or veneered material. It is also suitable for wood composite that contains vinyl or glue.

Enduro Coat is an ultra thin PVD coating that offers many benefits for CNC applications. The Ultra-hard layer resists heat and abrasion, thus reducing cutting edge breakdown. Added lubricity results in better chip evacuation. Up to 4 times the life of non-coated equivalent tools and can be re-coated after service.

Tool No.	Cutting Dia.	Cutting Length	Shank Dia.	Overall Length	Price
7903	1/4"	1"	1/4"	2-1/2"	\$27.90
7905	3/8"	1-1/4"	3/8"	3"	\$37.05
7907	1/2"	1-1/4"	1/2"	3"	\$55.77

Spiral, MFC 2 Flute Down-Cut Enduro Coated



MFC (Melamine Faced Chipboard) grade spiral bit is designed for difficult materials such as MDF (Medium Density Fiberboard), particle board and products with melamine laminate; double sided laminated or veneered material. It is also suitable for wood composite that contains vinyl or glue.

Enduro Coat is an ultra thin PVD coating that offers many benefits for CNC applications. The Ultra-hard layer resists heat and abrasion, thus reducing cutting edge breakdown. Added lubricity results in better chip evacuation. Up to 4 times the life of non-coated equivalent tools and can be re-coated after service.

Tool No.	Cutting Dia.	Cutting Length	Shank Dia.	Overall Length	Price
7913	1/4"	1"	1/4"	2-1/2"	\$27.90
7915	3/8"	1-1/4"	3/8"	3"	\$37.05
7917	1/2"	1-1/4"	1/2"	3"	\$55.77

Spiral, MFC 3 Flute Up-Cut



MFC (Melamine Faced Chipboard) grade spiral bit is designed for difficult materials such as MDF (Medium Density Fiberboard), particle board and products with melamine laminate; double sided laminated or veneered material. It is also suitable for wood composite that contains vinyl or glue.

Tool No.	Cutting Dia.	Cutting Length	Shank Dia.	Overall Length	Price
9541	3/8"	1"	3/8"	3"	\$49.13
9543	1/2"	1"	1/2"	3"	\$75.37
9545	1/2"	1-5/8"	1/2"	3-1/2"	\$79.41

Spiral, MFC 3 Flute Down-Cut



It is used where faster feed rates need to be achieved.

MFC (Melamine Faced Chipboard) grade spiral bit is designed for difficult materials such as MDF (Medium Density Fiberboard), particle board and products with melamine laminate; double sided laminated or veneered material. It is also suitable for wood composite that contains vinyl or glue.

Tool No.	Cutting Dia.	Cutting Length	Shank Dia.	Overall Length	Price
9561	3/8"	1"	3/8"	3"	\$49.13
9563	1/2"	1"	1/2"	3"	\$75.37
9565	1/2"	1-5/8"	1/2"	3-1/2"	\$79.41

Spiral, Chipbreaker 2 Flute Up-Cut



This three flute chipbreaker spiral bit is designed for higher feed rates, to produce smooth cuts in hardwoods, plywoods and dense materials.

Tool No.	Cutting Dia.	Overall Length	Shank Dia.	Cutting Length	Price
2052	3/8"	3"	3/8"	1-1/4"	\$37.53
2053	1/2"	3"	1/2"	1-1/4"	\$52.21
2054	1/2"	3-1/2"	1/2"	1-5/8"	\$54.65
2055	1/2"	4"	1/2"	2"	\$66.89
2059	1/2"	4"	1/2"	2-1/8"	\$67.98
2051	5/8"	3-1/2"	5/8"	1-5/8"	\$110.13
2056	5/8"	4"	5/8"	2"	\$117.47
2050	3/4"	4"	3/4"	1-1/2"	\$130.68
2057	3/4"	4"	3/4"	2"	\$135.44
2058	3/4"	6"	3/4"	3"	\$164.91

Spiral, Chipbreaker 2 Flute Down-Cut



This three flute chipbreaker spiral bit is designed for higher feed rates, to produce smooth cuts in hardwoods, plywoods and dense materials.

Tool No.	Cutting Dia.	Overall Length	Shank Dia.	Cutting Length	Price
2152	3/8"	3"	3/8"	1-1/4"	\$37.53
2153	1/2"	3"	1/2"	1-1/4"	\$52.21
2154	1/2"	3-1/2"	1/2"	1-5/8"	\$54.65
2155	1/2"	4"	1/2"	2"	\$66.89
2159	1/2"	4"	1/2"	2-1/8"	\$67.98
2151	5/8"	3-1/2"	5/8"	1-5/8"	\$110.13
2156	5/8"	4"	5/8"	2"	\$117.47
2150	3/4"	4"	3/4"	1-1/2"	\$130.68
2157	3/4"	4"	3/4"	2"	\$135.44
2158	3/4"	6"	3/4"	3"	\$164.91

Spiral, Chipbreaker 3 Flute Up-Cut



This two flute chipbreaker spiral bit is designed for higher feed rates, to produce smooth cuts in hardwoods, plywood and dense materials.

Tool No.	Cutting Dia.	Cutting Length	Shank Dia.	Overall Length	Price
2062	3/8"	1-1/4"	3/8"	3"	\$53.14
2063	1/2"	1-1/4"	1/2"	3"	\$64.83
2064	1/2"	1-5/8"	1/2"	3-1/2"	\$74.21
2065	1/2"	2"	1/2"	4"	\$76.66
2060	5/8"	1-5/8"	5/8"	3-1/2"	\$132.15
2066	5/8"	2"	5/8"	4"	\$142.68
2069	3/4"	1-1/2"	3/4"	4"	\$141.85
2067	3/4"	2"	3/4"	4"	\$153.71
2068	3/4"	3"	3/4"	6"	\$242.11

Spiral, Chipbreaker 3 Flute Down-Cut



This two flute chipbreaker spiral bit is designed for higher feed rates, to produce smooth cuts in hardwoods, plywood and dense materials.

Tool No.	Cutting Dia.	Cutting Length	Shank Dia.	Overall Length	Price
2162	3/8"	1-1/4"	3/8"	3"	\$53.14
2163	1/2"	1-1/4"	1/2"	3"	\$64.83
2164	1/2"	1-5/8"	1/2"	3-1/2"	\$74.21
2165	1/2"	2"	1/2"	4"	\$76.66
2160	5/8"	1-5/8"	5/8"	3-1/2"	\$132.15
2166	5/8"	2"	5/8"	4"	\$142.68
2169	3/4"	1-1/2"	3/4"	4"	\$141.85
2167	3/4"	2"	3/4"	4"	\$153.71
2168	3/4"	3"	3/4"	6"	\$242.11



Spiral, Ruffer 2 Flute Up-Cut



This two flute ruffer (rougher or hoggers) spiral router bit is designed for solid woods, plywoods, and wood composites. This bit is used for fast routing or hogging with high speed rates.

Tool No.	Cutting Dia.	Cutting Length	Shank Dia.	Overall Length	Price
9501	3/8"	1-1/4"	3/8"	3"	\$58.33
9502	1/2"	1-1/4"	1/2"	3"	\$72.28
9503	1/2"	1-1/4"	1/2"	3-1/2"	\$75.30
9504	1/2"	1-5/8"	1/2"	3-1/2"	\$77.30
9505	1/2"	2-1/8"	1/2"	4"	\$96.50
9506	5/8"	2"	5/8"	4"	\$129.87
9507	3/4"	2"	3/4"	4"	\$181.37

Spiral, Ruffer 2 Flute Down-Cut



This two flute ruffer (rougher or hoggers) spiral router bit is designed for solid woods, plywoods, and wood composites. This bit is used for fast routing or hogging with high speed rates.

Tool No.	Cutting Dia.	Overall Length	Shank Dia.	Cutting Length	Price
9521	3/8"	3"	3/8"	1-1/4"	\$58.33
9522	1/2"	3"	1/2"	1-1/4"	\$72.28
9523	1/2"	3-1/2"	1/2"	1-1/4"	\$75.29
9524	1/2"	3-1/2"	1/2"	1-5/8"	\$77.29
9525	1/2"	4"	1/2"	2-1/8"	\$96.50
9526	5/8"	4"	5/8"	2"	\$129.87
9527	3/4"	4"	3/4"	2"	\$181.37

Spiral, Ruffer 3 Flute Up-Cut



This Three flute ruffer (rougher or hoggers) spiral router bit is designed for solid woods and wood composites. This bit is used for fast routing or hogging with high feed rates.

Tool No.	Cutting Dia.	Cutting Length	Shank Dia.	Overall Length	Price
2040*	3/8"	7/8"	3/8"	2-1/2"	\$49.76
4350	3/8"	1"	3/8"	2-1/2"	\$70.56
4351	3/8"	1"	3/8"	3"	\$72.60
2030	3/8"	1-1/4"	3/8"	3"	\$53.91
2035	3/8"	1-3/4"	3/8"	3-1/2"	\$89.54
2036	1/2"	1-1/4"	1/2"	3"	\$68.53
2031	1/2"	1-5/8"	1/2"	3-1/2"	\$88.92
4358	1/2"	1-7/8"	1/2"	4"	\$94.65
2037	1/2"	2-1/8"	1/2"	4"	\$101.36
4355	1/2"	2-1/4"	1/2"	4"	\$133.80
2032	5/8"	2"	5/8"	4"	\$134.60
4359	5/8"	2-1/8"	5/8"	5"	\$155.33
4353	5/8"	3"	5/8"	5-1/2"	\$214.17
2033	3/4"	2"	3/4"	4"	\$156.81
2038	3/4"	2-1/4"	3/4"	4-1/2"	\$181.35
4356	3/4"	2-1/2"	3/4"	4"	\$177.61
2034	3/4"	3"	3/4"	6"	\$235.32
2039	3/4"	3-1/4"	3/4"	6"	\$235.32
4357	3/4"	3-1/2"	3/4"	6"	\$256.67

* For Castle Machine

Spiral, Ruffer 3 Flute Down-Cut



This Three flute ruffer (rougher or hoggers) spiral router bit is designed for solid woods and wood composites. This bit is used for fast routing or hogging with high feed rates.

Tool No.	Cutting Dia.	Cutting Length	Shank Dia.	Overall Length	Price
2140*	3/8"	7/8"	3/8"	2-1/2"	\$51.75
4370	3/8"	1"	3/8"	2-1/2"	\$70.57
4371	3/8"	1"	3/8"	3"	\$72.60
2130	3/8"	1-1/4"	3/8"	3"	\$56.06
2135	3/8"	1-3/4"	3/8"	3-1/2"	\$93.12
2136	1/2"	1-1/4"	1/2"	3"	\$68.53
2131	1/2"	1-5/8"	1/2"	3-1/2"	\$88.92
4378	1/2"	1-7/8"	1/2"	4"	\$97.48
2137	1/2"	2-1/8"	1/2"	4"	\$101.35
4375	1/2"	2-1/4"	1/2"	4"	\$139.15
4372	1/2"	2-1/2"	1/2"	5"	\$128.93
2132	5/8"	2"	5/8"	4"	\$134.60
4379	5/8"	2-1/8"	5/8"	5"	\$155.33
4373	5/8"	3"	5/8"	5-1/2"	\$214.17
2133	3/4"	2"	3/4"	4"	\$156.82
2138	3/4"	2-1/4"	3/4"	4-1/2"	\$181.35
4376	3/4"	2-1/2"	3/4"	4"	\$177.60
2134	3/4"	3"	3/4"	6"	\$243.33
2139	3/4"	3-1/4"	3/4"	6"	\$244.74
4377	3/4"	3-1/2"	3/4"	6"	\$256.67

* For Castle Machine

Spiral, Ruffer/Finisher 4 Flute Up-Cut



This four flute finisher/ruffer (hoggers) spiral router bit is designed for solid woods, wood composites, and some plastics. This bit is used for applications that require superior finishes and extremely fast feed rates.

Tool No.	Cutting Dia.	Cutting Length	Shank Dia.	Overall Length	Price
9602	1/2"	1-1/4"	1/2"	3"	\$104.09
9603	1/2"	1-5/8"	1/2"	3-1/2"	\$112.49
9605	1/2"	2-1/8"	1/2"	4-1/2"	\$177.42
9606	5/8"	2"	5/8"	4"	\$157.03
9608	3/4"	2"	3/4"	4"	\$193.33
9609	3/4"	2-1/8"	3/4"	5"	\$244.38



Spiral, Ruffer/Finisher 4 Flute Down-Cut



This four flute finisher/ruffer (hoggers) spiral router bit is designed for solid woods, wood composites, and some plastics. This bit is used for applications that require superior finishes and extremely fast feed rates.

Tool No.	Cutting Dia.	Cutting Length	Shank Dia.	Overall Length	Price
9622	1/2"	1-1/4"	1/2"	3"	\$104.09
9623	1/2"	1-5/8"	1/2"	3-1/2"	\$112.49
9625	1/2"	2-1/8"	1/2"	4-1/2"	\$177.42
9626	5/8"	2"	5/8"	4"	\$157.03
9628	3/4"	2"	3/4"	4"	\$193.33
9629	3/4"	2-1/8"	3/4"	5"	\$244.38

Spiral, Slow 2 Flute Up-Cut



This two flute slow spiral bit is designed for hardwoods, acrylics and phenolics.

Tool No.	Cutting Dia.	Cutting Length	Shank Dia.	Overall Length	Price
9421	1/4"	3/8"	1/4"	2-1/2"	\$15.44
9423	1/4"	3/4"	1/4"	2-1/2"	\$16.39
9424	1/4"	1-1/4"	1/4"	2-1/2"	\$17.26
9425	3/8"	1"	3/8"	3"	\$24.33
9426	1/2"	1-1/4"	1/2"	3"	\$40.79
9427	1/2"	1-5/8"	1/2"	3-1/2"	\$44.87
9428	1/2"	2"	1/2"	4"	\$47.73

Spiral, Slow 2 Flute Down-Cut



This two flute slow spiral bit is designed for hardwoods, acrylics and phenolics.

Tool No.	Cutting Dia.	Cutting Length	Shank Dia.	Overall Length	Price
9431	1/4"	3/8"	1/4"	2-1/2"	\$17.75
9433	1/4"	3/4"	1/4"	2-1/2"	\$18.85
9434	1/4"	1-1/4"	1/4"	3"	\$21.60
9435	3/8"	1"	3/8"	3"	\$26.03
9436	1/2"	1-1/4"	1/2"	3"	\$43.63
9437	1/2"	1-5/8"	1/2"	3-1/2"	\$48.00
9438	1/2"	2"	1/2"	4"	\$47.73

Spiral, Slow Chipbreaker 3 Flute Up-Cut, Right Hand



This three flute slow chipbreaker spiral bit is designed for faster and smoother feed rates, creating excellent finishes on dense hardwoods, solid surface and hard plastics.

Tool No.	Cutting Dia.	Cutting Length	Shank Dia.	Overall Length	Price
9552	1/4"	5/8"	1/4"	2-1/2"	\$23.83
9557	1/4"	1-1/8"	1/4"	2-1/2"	\$46.35

Spiral, Slow 3 Flute Up-Cut



This three flute slow spiral bit is designed for faster feed rates, creating excellent finishes on dense hardwoods, solid surface and hard plastics.

Tool No.	Cutting Dia.	Cutting Length	Shank Dia.	Overall Length	Price
2074	1/4"	1"	1/4"	2-1/2"	\$27.80
2076	3/8"	3/4"	3/8"	3"	\$38.45
2075	3/8"	1-1/4"	3/8"	3"	\$43.20
2077	1/2"	3/4"	1/2"	3"	\$66.17
2078	1/2"	1-1/8"	1/2"	3"	\$64.08
2070	1/2"	1-1/4"	1/2"	3-1/2"	\$49.97
2071	1/2"	1-5/8"	1/2"	4"	\$60.58
9573	1/2"	1-1/2"	1/2"	4"	\$64.85
2072	3/4"	2"	3/4"	4"	\$163.23
2073	3/4"	2"	3/4"	6"	\$185.85

Spiral, Slow 3 Flute Down-Cut



This three flute slow spiral bit is designed for faster feed rates, creating excellent finishes on dense hardwoods, solid surface and hard plastics.

Tool No.	Cutting Dia.	Cutting Length	Shank Dia.	Overall Length	Price
2174	1/4"	1"	1/4"	2-1/2"	\$26.73
2176	3/8"	1"	3/8"	3-1/2"	\$40.00
2175	3/8"	1-1/4"	3/8"	3"	\$42.38
2179	1/2"	1-1/8"	1/2"	3-1/2"	\$61.61
2170	1/2"	1-1/4"	1/2"	3-1/2"	\$43.77
2171	1/2"	1-5/8"	1/2"	4"	\$58.25
2172	3/4"	2"	3/4"	4"	\$155.47

Compression Spiral, 1+1 PCD



PCD (Polycrystalline Diamond) bits perform exceptionally well in CNC woodworking applications even when used on plastics and non-ferrous metals. Some examples of uses include those with panel saw blades, router bits and cutter heads, and many more.

PCD tooling is not recommended for hand operated tools.

Tool No.	Cutting Dia.	Cutting Height	Shank Dia.	Overall Length	Price
2342*	3/8"	7/8"	3/8"	2-3/4"	\$163.94
2344	1/2"	1"	1/2"	3"	\$172.62
2345	1/2"	1-3/8"	1/2"	3-1/2"	\$212.86
2347	5/8"	1-1/16"	5/8"	2-3/4"	\$242.74
2349	3/4"	1-3/8"	3/4"	4"	\$305.53

* no guarantee against breakage due to small diameter

Compression Spiral, 1+1



This compression spiral bit is designed for MDF and products with melamine laminate.

Tool No.	Cutting Dia.	Cutting Length	Shank Dia.	Overall Length	Price
2210	1/4"	7/8"	1/4"	2-1/2"	\$37.53
2211	1/4"	1"	1/4"	2-1/2"	\$38.17
2217	3/8"	1"	3/8"	3"	\$45.68
2212	3/8"	1-1/4"	3/8"	3"	\$50.24
2218	1/2"	1-1/8"	1/2"	3"	\$80.75
2213	1/2"	1-1/4"	1/2"	3"	\$68.07
2214	1/2"	1-3/8"	1/2"	3-1/2"	\$82.15
2215	1/2"	1-5/8"	1/2"	3-1/2"	\$71.17
2219	5/8"	2"	5/8"	4"	\$137.87
2216	5/8"	2-1/8"	5/8"	4"	\$195.78
2209	3/4"	2"	3/4"	4"	\$203.13

Compression Spiral, 1+1 Left Hand



This compression spiral bit is designed for MDF (Medium Density Fiberboard) and products with melamine laminate.

Tool No.	Cutting Dia.	Cutting Length	Shank Dia.	Overall Length	Price
2931	1/4"	1"	1/4"	2-1/2"	\$44.49
2932	3/8"	1-1/4"	3/8"	3"	\$59.91
2933	1/2"	1-1/4"	1/2"	3"	\$88.07

Compression Spiral, 2+2



This compression spiral bit is designed for MDF (Medium Density Fiberboard) and products with melamine laminate.

Tool No.	Cutting Dia.	Cutting Length	Shank Dia.	Overall Length	Price
9371	1/4"	7/8"	1/4"	2-1/2"	\$45.60
2221	1/4"	1"	1/4"	2-1/2"	\$47.13
9372	1/4"	1-1/4"	1/4"	3"	\$53.00
9383	5/16"	1"	5/16"	3"	\$54.95
9384	5/16"	1-1/4"	5/16"	3"	\$55.77
2222	3/8"	1-1/4"	3/8"	3"	\$57.60
9374	1/2"	1-1/8"	1/2"	3"	\$66.33
2223	1/2"	1-1/4"	1/2"	3"	\$68.08
9375	1/2"	1-3/8"	1/2"	3"	\$71.57
2224	1/2"	1-3/8"	1/2"	3-1/2"	\$75.07
2225	1/2"	1-5/8"	1/2"	3-1/2"	\$76.82
9376	1/2"	1-7/8"	1/2"	4"	\$80.30
2220	1/2"	2"	1/2"	4"	\$83.80
9378	1/2"	2-1/8"	1/2"	4"	\$83.80
9385	1/2"	2-5/16"	1/2"	4-1/2"	\$92.95
9386	1/2"	2-1/2"	1/2"	5"	\$101.03
2226	5/8"	1-5/8"	5/8"	3-1/2"	\$152.47
2227	5/8"	2"	5/8"	4"	\$161.88
2228	3/4"	1-1/2"	3/4"	4"	\$201.25
2229	3/4"	2"	3/4"	4"	\$207.07
9381	3/4"	2-1/2"	3/4"	5"	\$249.07
9382	3/4"	3"	3/4"	6"	\$276.50



MAGNATE™ Solid Carbide/PCD Router Bits

Compression Spiral, 2+2 Left Hand



This compression spiral bit is designed for MDF (Medium Density Fiberboard) and products with melamine laminate.

Tool No.	Cutting Dia.	Cutting Length	Shank Dia.	Overall Length	Price
2951	1/4"	1"	1/4"	2-1/2"	\$38.54
2952	3/8"	1-1/4"	3/8"	3"	\$77.02
2953	1/2"	1-1/4"	1/2"	3"	\$94.12
2955	1/2"	1-5/8"	1/2"	3-1/2"	\$102.68
2950	1/2"	2"	1/2"	4"	\$119.80
2957	5/8"	2"	5/8"	4"	\$191.68
2958	3/4"	1-1/2"	3/4"	4"	\$213.92
2959	3/4"	2"	3/4"	4"	\$248.15
2954	3/4"	2-1/2"	3/4"	5"	\$271.25

Compression Spiral, Flush Trim 2+2



This compression spiral bit is designed for MDF (Medium Density Fiberboard) and products with melamine laminate.

This two flute flush trim compression spiral bit comes with double bearing to enhance stability for laminate, template or pattern work.

Tool No.	Cutting Dia.	Cutting Length	Shank Dia.	Overall Length	Price
2252	1/2"	1-1/4"	1/2"	4"	\$115.52

Compression Spiral, Mortise 3+3 3/16" Up-Cut



This compression spiral bit is designed for MDF (Medium Density Fiberboard) and products with melamine laminate.

It is used where an excellent finish on top and bottom with short up-cut to allow mortise cut when down-cut is required.

Tool No.	Cutting Dia.	Cutting Length	Shank Dia.	Overall Length	Price
9751	3/8"	1-1/4"	3/8"	3"	\$65.03
9752	1/2"	1-1/4"	1/2"	3"	\$80.27
9753	1/2"	1-3/8"	1/2"	3"	\$86.15
9754	1/2"	1-5/8"	1/2"	3-1/2"	\$83.61
9755	5/8"	2"	5/8"	4"	\$159.07

Compression Spiral, 3+3



This compression spiral bit is designed for MDF (Medium Density Fiberboard) and products with melamine laminate.

It is used where faster feed rates need to be achieved.

Tool No.	Cutting Dia.	Cutting Length	Shank Dia.	Overall Length	Price
2232	3/8"	1-1/4"	3/8"	3"	\$65.03
2234	1/2"	1"	1/2"	3"	\$79.33
2233	1/2"	1-1/4"	1/2"	3"	\$80.27
2236	1/2"	1-3/8"	1/2"	3"	\$82.75
2235	1/2"	1-5/8"	1/2"	3-1/2"	\$83.61
2239	1/2"	2-1/8"	1/2"	4"	\$101.97
2237	5/8"	2"	5/8"	4"	\$159.07
2238	3/4"	2"	3/4"	4"	\$209.33
2231	3/4"	2-1/2"	3/4"	5"	\$241.67
2230	3/4"	3"	3/4"	6"	\$250.00

Compression Spiral, Mortise 1+1



This mortise compression bit is designed for double sided laminated or veneered material.

It is used where an excellent finish on top and bottom with short up-cut to allow mortise cut when down-cut is required.

Tool No.	Cutting Dia.	Cutting Length	Shank Dia.	Overall Length	Price
2201	1/4"	1"	1/4"	2-1/2"	\$46.43
2202	3/8"	1-1/4"	3/8"	3"	\$51.07
2203	1/2"	1-1/4"	1/2"	3"	\$68.08
2204	1/2"	1-3/8"	1/2"	3-1/2"	\$71.35
2205	1/2"	1-5/8"	1/2"	3-1/2"	\$73.32

Compression Spiral, Mortise Chipbreaker 2+2, 3/16" Up-Cut



It is used where higher feed rate is required.

It is used where an excellent finish on top and bottom with short up-cut to allow mortise cut when down-cut is required.

Tool No.	Cutting Dia.	Cutting Length	Shank Dia.	Overall Length	Price
9731	1/4"	1"	1/4"	2-1/2"	\$48.11
9732	3/8"	1-1/4"	3/8"	3"	\$60.50
9733	3/8"	1-5/8"	3/8"	3-1/2"	\$72.75
9734	1/2"	1"	1/2"	3"	\$91.38
9735	1/2"	1-1/4"	1/2"	3"	\$91.52
9736	1/2"	1-5/8"	1/2"	3-1/2"	\$96.54

Compression Spiral, Mortise 2+2 3/16" Up-Cut



This mortise compression bit is designed for double sided laminated or veneered material.

It is used where an excellent finish on top and bottom with short up-cut to allow mortise cut when down-cut is required.

Tool No.	Cutting Dia.	Cutting Length	Shank Dia.	Overall Length	Price
2255	3/16"	7/8"	1/4"	2-1/2"	\$50.16
2240	1/4"	1"	1/4"	2-1/2"	\$38.25
2249	1/4"	1-1/4"	1/4"	3"	\$46.09
2241	5/16"	1"	5/16"	3"	\$49.63
2244	5/16"	1-1/4"	5/16"	3"	\$49.63
2242	3/8"	1-1/4"	3/8"	3"	\$53.84
2247	3/8"	1-5/8"	3/8"	3"	\$68.45
2246	1/2"	1"	1/2"	3"	\$63.00
2243	1/2"	1-1/4"	1/2"	3"	\$63.63
2248	1/2"	1-3/8"	1/2"	3-1/2"	\$70.15
2245	1/2"	1-5/8"	1/2"	3-1/2"	\$71.79

Compression Spiral, MFC 2+2



MFC (Melamine Faced Chipboard) grade spiral bit is designed for difficult materials such as MDF (Medium Density Fiberboard), particle board and products with melamine laminate; double sided laminated or veneered material. It is also suitable for wood composite that contains vinyl or glue.

It is for use where standard feed rate is required.

Tool No.	Cutting Dia.	Cutting Length	Shank Dia.	Overall Length	Price
9590	3/8"	1"	3/8"	3"	\$54.91
9591	3/8"	1-1/4"	3/8"	3"	\$57.50
9592	1/2"	1-1/8"	1/2"	3"	\$66.21
9593	1/2"	1-1/4"	1/2"	3"	\$67.95
9594	1/2"	1-3/8"	1/2"	3-1/2"	\$71.44
9595	1/2"	1-5/8"	1/2"	3-1/2"	\$76.67
9597	1/2"	2-1/8"	1/2"	4"	\$83.17
9598	5/8"	2-1/8"	5/8"	4"	\$163.33

Compression Spiral, 4+4



This compression spiral bit is designed for MDF (Medium Density Fiberboard) and products with melamine laminate.

This bit is used where an extremely high feed rate is required.

Tool No.	Cutting Dia.	Cutting Length	Shank Dia.	Overall Length	Price
9791	1/2"	7/8"	1/2"	3"	\$131.78
9792	1/2"	1"	1/2"	3"	\$140.57
9793	1/2"	1-1/8"	1/2"	3"	\$124.23
9794	1/2"	1-3/8"	1/2"	3-1/2"	\$151.07
9795	1/2"	1-5/8"	1/2"	4"	\$162.06
9796	3/4"	1-7/8"	3/4"	4"	\$287.52
9798	3/4"	2-1/2"	3/4"	5"	\$299.39

MAGNATE™ 20639 Lycoming Street #B-6, Walnut, CA 91789 USA

A-7



email : info@magnate.net Online Shop : www.magnate.net
(TEL) 800-827-2316, 909-468-5747 (FAX) 909-468-5745

Compression Spiral, MFC+ 2+2



MFC (Melamine Faced Chipboard) grade spiral bit is designed for difficult materials such as MDF (Medium Density Fiberboard), particle board and products with melamine laminate; double sided laminated or veneered material. It is also suitable for wood composite that contains vinyl or glue.

The MFC+ solid carbide bit comes with harder carbide yet than the MFC grade and will provide longer life between tool changes.

Tool No.	Cutting Dia.	Cutting Length	Shank Dia.	Overall Length	Price
9650	3/8"	7/8"	3/8"	3"	\$58.35
9652	3/8"	1"	3/8"	3"	\$59.51
9653	3/8"	1-1/4"	3/8"	3"	\$63.52
9654	1/2"	1-1/4"	1/2"	3-1/2"	\$70.33
9656	1/2"	1-3/8"	1/2"	3-1/2"	\$73.93
9657	1/2"	1-5/8"	1/2"	3-1/2"	\$79.35
9658	1/2"	1-7/8"	1/2"	4"	\$84.69

Compression Spiral, MFC 3+3



MFC (Melamine Faced Chipboard) grade spiral bit is designed for difficult materials such as MDF (Medium Density Fiberboard), particle board and products with melamine laminate; double sided laminated or veneered material. It is also suitable for wood composite that contains vinyl or glue.

It is used when higher feed rates are required.

It is used where an excellent finish on top and bottom with short up-cut to allow mortise cut when down-cut is required.

Tool No.	Cutting Dia.	Cutting Length	Shank Dia.	Overall Length	Price
9741	3/8"	1-1/4"	3/8"	3"	\$69.52
9742	1/2"	1-1/4"	1/2"	3"	\$85.73
9743	1/2"	1-3/8"	1/2"	3-1/2"	\$92.00
9744	1/2"	1-5/8"	1/2"	3-1/2"	\$91.98
9745	5/8"	2"	5/8"	4"	\$169.89

Compression Spiral, MFC+ Mortise 2+2 3/16" Up-Cut, Enduro Coated



MFC (Melamine Faced Chipboard) grade spiral bit is designed for difficult materials such as MDF (Medium Density Fiberboard), particle board and products with melamine laminate; double sided laminated or veneered material. It is also suitable for wood composite that contains vinyl or glue.

The MFC+ solid carbide bit comes with harder carbide yet than the MFC grade and will provide longer life between tool changes.

It is used where an excellent finish on top and bottom with short up-cut to allow mortise cut when down-cut is required.

EnduroCoat is an ultra thin PVD coating that offers many benefits for CNC applications. The Ultra-hard layer resists heat and abrasion, thus reducing cutting edge breakdown. Added lubricity results in better chip evacuation. Up to 4 times the life of non-coated equivalent tools and can be re-coated after service.

Tool No.	Cutting Dia.	Cutting Length	Shank Dia.	Overall Length	Price
7961	3/8"	1"	3/8"	3"	\$68.29
7962	3/8"	1-1/4"	3/8"	3"	\$69.10
7960	1/2"	7/8"	1/2"	3"	\$80.67
7963	1/2"	1-1/4"	1/2"	3"	\$82.00
7964	1/2"	1-3/8"	1/2"	3-1/2"	\$85.33
7965	1/2"	1-5/8"	1/2"	3-1/2"	\$91.09

Compression Spiral MFC+ Enduro Coated 2+2



MFC (Melamine Faced Chipboard) grade spiral bit is designed for difficult materials such as MDF (Medium Density Fiberboard), particle board and products with melamine laminate; double sided laminated or veneered material. It is also suitable for wood composite that contains vinyl or glue.

The MFC+ solid carbide bit comes with harder carbide yet than the MFC grade and will provide longer life between tool changes.

Enduro Coat is an ultra thin PVD coating that offers many benefits for CNC applications. The Ultra-hard layer resists heat and abrasion, thus reducing cutting edge breakdown. Added lubricity results in better chip evacuation. Up to 4 times the life of non-coated equivalent tools and can be re-coated after service.

Tool No.	Cutting Dia.	Cutting Length	Shank Dia.	Overall Length	Price
7951	1/4"	1"	1/4"	2-1/2"	\$58.95
7953	3/8"	1-1/4"	3/8"	3"	\$69.10
7954	1/2"	1-1/4"	1/2"	3-1/2"	\$82.00
7956	1/2"	1-3/8"	1/2"	3-1/2"	\$85.34
7957	1/2"	1-5/8"	1/2"	3-1/2"	\$91.03

Compression Spiral, MFC Mortise 2+2 3/16" Up-Cut



MFC (Melamine Faced Chipboard) grade spiral bit is designed for difficult materials such as MDF (Medium Density Fiberboard), particle board and products with melamine laminate; double sided laminated or veneered material. It is also suitable for wood composite that contains vinyl or glue.

It is used where standard feed rate is required.

Tool No.	Cutting Dia.	Cutting Length	Shank Dia.	Overall Length	Price
9671	3/8"	1-1/4"	3/8"	3"	\$57.50
9672	1/2"	1"	1/2"	3"	\$65.00
9673	1/2"	1-1/4"	1/2"	3"	\$66.21
9674	1/2"	1-3/8"	1/2"	3-1/2"	\$71.44
9675	1/2"	1-5/8"	1/2"	3-1/2"	\$76.67
9677	3/4"	2"	3/4"	4"	\$216.93

Compression Spiral, MFC Mortise 3+3 3/16" Up-Cut



MFC (Melamine Faced Chipboard) grade spiral bit is designed for difficult materials such as MDF (Medium Density Fiberboard), particle board and products with melamine laminate; double sided laminated or veneered material. It is also suitable for wood composite that contains vinyl or glue.

It is used where an excellent finish on top and bottom with short up-cut to allow mortise cut when down-cut is required.

Tool No.	Cutting Dia.	Cutting Length	Shank Dia.	Overall Length	Price
9691	3/8"	7/8"	3/8"	3"	\$67.83
9692	3/8"	1-1/4"	3/8"	3"	\$69.52
9693	1/2"	1-1/4"	1/2"	3"	\$85.73
9694	1/2"	1-3/8"	1/2"	3-1/2"	\$92.00
9695	1/2"	1-5/8"	1/2"	3-1/2"	\$89.30
9696	5/8"	2"	5/8"	4"	\$169.89



Compression Spiral, MFC+ 3+3



The MFC+ solid carbide bit comes with harder carbide yet than the MFC grade and will provide longer life between tool changes.

MFC (Melamine Faced Chipboard) grade spiral bit is designed for difficult materials such as MDF (Medium Density Fiberboard), particle board and products with melamine laminate; double sided laminated or veneered material. It is also suitable for wood composite that contains vinyl or glue.

It is used when higher feed rates are required.

Tool No.	Cutting Dia.	Cutting Length	Shank Dia.	Overall Length	Price
9860	3/8"	1"	3/8"	3"	\$70.38
9861	3/8"	1-1/4"	3/8"	3"	\$70.38
9862	1/2"	1-1/4"	1/2"	3"	\$85.73
9863	1/2"	1-3/8"	1/2"	3-1/2"	\$92.00
9864	1/2"	1-5/8"	1/2"	3-1/2"	\$89.30
9867	1/2"	1-7/8"	1/2"	4"	\$89.30
9865	5/8"	2"	5/8"	4"	\$169.89

Compression Spiral, MFC+ 3+3 Enduro Coated



This 3 flute up-down spiral bit is designed for MDF and products with melamine laminate. This bit is used where an excellent finish on the top and bottom and higher feed rate is required.

MFC (Melamine Faced Chipboard) grade spiral bit is designed for difficult materials such as MDF (Medium Density Fiberboard), particle board and products with melamine laminate; double sided laminated or veneered material. It is also suitable for wood composite that contains vinyl or glue.

The MFC+ solid carbide bit comes with harder carbide yet than the MFC grade and will provide longer life between tool changes.

It is used when higher feed rates are required.

EnduroCoat is an ultra thin PVD coating that offers many benefits for CNC applications. The Ultra-hard layer resists heat and abrasion, thus reducing cutting edge breakdown. Added lubricity results in better chip evacuation. Up to 4 times the life of non-coated equivalent tools and can be re-coated after service.

Tool No.	Cutting Dia.	Cutting Length	Shank Dia.	Overall Length	Price
7972	1/2"	1-1/4"	1/2"	3"	\$100.40
7974	1/2"	1-5/8"	1/2"	3-1/2"	\$108.67

Compression Spiral, MFC+ Mortise 2+2 3/16" Up-Cut



The MFC+ solid carbide bit comes with harder carbide yet than the MFC grade and will provide longer life between tool changes.

MFC (Melamine Faced Chipboard) grade spiral bit is designed for difficult materials such as MDF (Medium Density Fiberboard), particle board and products with melamine laminate; double sided laminated or veneered material. It is also suitable for wood composite that contains vinyl or glue.

It is used where an excellent finish on top and bottom with short up-cut to allow mortise cut when down-cut is required.

Tool No.	Cutting Dia.	Cutting Length	Shank Dia.	Overall Length	Price
9661	3/8"	1"	3/8"	3"	\$58.71
9662	3/8"	1-1/4"	3/8"	3"	\$59.51
9663	1/2"	1-1/4"	1/2"	3"	\$70.33
9664	1/2"	1-3/8"	1/2"	3-1/2"	\$73.93
9665	1/2"	1-5/8"	1/2"	3-1/2"	\$79.35
9667	1/2"	1-7/8"	1/2"	4"	\$84.69

Compression Spiral, MFC+ Mortise 3+3 3/16" Up-Cut



The MFC+ solid carbide bit comes with harder carbide yet than the MFC grade and will provide longer life between tool changes.

MFC (Melamine Faced Chipboard) grade spiral bit is designed for difficult materials such as MDF (Medium Density Fiberboard), particle board and products with melamine laminate; double sided laminated or veneered material. It is also suitable for wood composite that contains vinyl or glue.

It is used when higher feed rates are required.

It is used where an excellent finish on top and bottom with short up-cut to allow mortise cut when down-cut is required.

Tool No.	Cutting Dia.	Cutting Length	Shank Dia.	Overall Length	Price
9870	3/8"	7/8"	3/8"	3"	\$69.51
9871	3/8"	1"	3/8"	3"	\$70.38
9872	3/8"	1-1/4"	3/8"	3"	\$71.95
9876	1/2"	7/8"	1/2"	3"	\$87.39
9873	1/2"	1-1/4"	1/2"	3"	\$88.73
9874	1/2"	1-3/8"	1/2"	3-1/2"	\$95.22
9875	1/2"	1-5/8"	1/2"	3-1/2"	\$96.07
9878	1/2"	1-3/4"	1/2"	4"	\$101.13

Compression Spiral, MFC+ Mortise 3+3 3/16" Up-Cut, Enduro Coated



MFC (Melamine Faced Chipboard) grade spiral bit is designed for difficult materials such as MDF (Medium Density Fiberboard), particle board and products with melamine laminate; double sided laminated or veneered material. It is also suitable for wood composite that contains vinyl or glue.

The MFC+ solid carbide bit comes with harder carbide yet than the MFC grade and will provide longer life between tool changes.

It is used when higher feed rates are required.

It is used where an excellent finish on top and bottom with short up-cut to allow mortise cut when down-cut is required.

EnduroCoat is an ultra thin PVD coating that offers many benefits for CNC applications. The Ultra-hard layer resists heat and abrasion, thus reducing cutting edge breakdown. Added lubricity results in better chip evacuation. Up to 4 times the life of non-coated equivalent tools and can be re-coated after service.

Tool No.	Cutting Dia.	Cutting Length	Shank Dia.	Overall Length	Price
7981	3/8"	1"	3/8"	3"	\$79.97
7982	3/8"	1-1/4"	3/8"	3"	\$81.53
7984	1/2"	1-3/8"	1/2"	3-1/2"	\$105.78
7985	1/2"	1-5/8"	1/2"	3-1/2"	\$107.73



Compression Spiral, Chipbreaker 2+2



Designed for plywood, solid wood, and MDF (Medium Density Fiberboard), this bit is used where excellent finish and higher feed rate is required.

Tool No.	Cutting Dia.	Cutting Length	Shank Dia.	Overall Length	Price
9701	5/16"	1"	5/16"	3"	\$62.93
9702	3/8"	1-1/4"	3/8"	3"	\$57.92
9704	1/2"	1-1/8"	1/2"	3"	\$66.07
9705	1/2"	1-1/4"	1/2"	3"	\$67.71
9706	1/2"	1-3/8"	1/2"	3-1/2"	\$74.67
9708	1/2"	1-5/8"	1/2"	3-1/2"	\$75.53
9710	1/2"	1-7/8"	1/2"	4"	\$79.13
9712	1/2"	2"	1/2"	4"	\$82.30
9711	1/2"	2-1/8"	1/2"	4"	\$83.33
9707	1/2"	2-5/16"	1/2"	4-1/2"	\$95.83
9713	5/8"	1-5/8"	5/8"	3-1/2"	\$149.29
9714	5/8"	2"	5/8"	4"	\$158.26
9715	3/4"	1-1/2"	3/4"	4"	\$185.78
9716	3/4"	2"	3/4"	4"	\$189.22
9717	3/4"	2-1/2"	3/4"	5"	\$244.15
9718	3/4"	3"	3/4"	6"	\$252.58

Compression Spiral, Chipbreaker 3+3



Designed for plywood, solid wood, and MDF. This bit is used where excellent finish and very high feed rate is required.

Tool No.	Cutting Dia.	Cutting Length	Shank Dia.	Overall Length	Price
9761	3/8"	1-1/4"	3/8"	3"	\$70.81
9762	1/2"	1-1/4"	1/2"	3"	\$85.98
9763	1/2"	1-5/8"	1/2"	3-1/2"	\$89.33
9767	1/2"	2-1/8"	1/2"	4"	\$107.64
9764	5/8"	2"	5/8"	4"	\$167.23
9765	3/4"	2"	3/4"	4"	\$214.87

Compression Spiral, Ruffer 2+2



Where finish is not important, but high feed rates and extensive life are required, this two flute up-down ruffer (rougher or hoggers) spiral bit is designed for solid wood and MDF (Medium Density Fiberboard).

Tool No.	Cutting Dia.	Cutting Length	Shank Dia.	Overall Length	Price
9640	3/8"	1-1/4"	3/8"	3"	\$62.45
9641	1/2"	1-1/8"	1/2"	3"	\$75.07
9642	1/2"	1-1/4"	1/2"	3"	\$76.82
9647	1/2"	1-5/8"	1/2"	3-1/2"	\$85.30
9643	1/2"	2"	1/2"	4"	\$91.53
9644	5/8"	2"	5/8"	4"	\$170.45
9645	3/4"	2"	3/4"	4"	\$257.38

Compression Spiral, Ruffer 3+3



Where an extremely high feed rate is required, this three flute up-down ruffer (rougher or hoggers) spiral bit is designed for MDF (Medium Density Fiberboard) and products with melamine laminate.

Tool No.	Cutting Dia.	Cutting Length	Shank Dia.	Overall Length	Price
9782	1/2"	1-1/4"	1/2"	3"	\$98.12
9783	1/2"	1-5/8"	1/2"	3-1/2"	\$101.68
9787	1/2"	1-3/4"	1/2"	5"	\$113.15
9784	5/8"	2"	5/8"	4"	\$184.15
9785	3/4"	2"	3/4"	4"	\$235.60

Compression Spiral, Ruffer/Finisher 4+4



This compression spiral bit is designed for MDF (Medium Density Fiberboard) and products with melamine laminate.

This four flute ruffer (rougher or hoggers) compression spiral bit is used for applications that require superior finishes and extremely fast feed rates.

Tool No.	Cutting Dia.	Cutting Length	Shank Dia.	Overall Length	Price
9801	1/2"	1"	1/2"	3"	\$145.92
9802	1/2"	1-1/8"	1/2"	3"	\$145.92
9803	1/2"	1-3/8"	1/2"	3-1/2"	\$168.36
9804	1/2"	1-5/8"	1/2"	4"	\$175.09
9805	3/4"	1-7/8"	3/4"	4"	\$264.90
9806	3/4"	2-1/2"	3/4"	5"	\$325.85

O-Flute Spiral, 1 Flute Up-Cut For Rigid Plastic, Acrylics & Nylons



Designed for general hard and soft plastic applications.

Tool No.	Cutting Dia.	Cutting Length	Shank Dia.	Overall Length	Price
1921	1/8"	3/8"	1/4"	2-1/2"	\$17.92
2881	1/8"	1/2"	1/4"	2"	\$18.13
2880	3/16"	3/8"	1/4"	2"	\$18.49
1922	3/16"	1/2"	1/4"	2-1/2"	\$21.02
2882	3/16"	5/8"	1/4"	2"	\$19.83
1923	1/4"	3/4"	1/4"	2-1/2"	\$22.24
2887	1/4"	1"	1/4"	2-1/2"	\$23.13
1924	1/4"	1-1/4"	1/4"	3"	\$24.82
2888	1/4"	1-1/2"	1/4"	3"	\$25.90
2889	5/16"	7/8"	5/16"	2-1/2"	\$23.45
2883	3/8"	1"	3/8"	3"	\$26.43
2884	3/8"	1-1/8"	3/8"	3"	\$28.75
2885	3/8"	1-5/8"	3/8"	3-1/2"	\$44.68
2886	1/2"	1-1/8"	1/2"	3"	\$41.19
1920	1/2"	1-5/8"	1/2"	3-1/2"	\$62.82

O-Flute Spiral, 1 Flute Down-Cut For Rigid Plastic, Acrylics & Nylons



Designed for general hard and soft plastic applications.

Tool No.	Cutting Dia.	Cutting Length	Shank Dia.	Overall Length	Price
1925	1/8"	3/8"	1/4"	2-1/2"	\$17.92
2891	1/8"	1/2"	1/4"	2"	\$18.13
2890	3/16"	3/8"	1/4"	2"	\$18.49
1926	3/16"	1/2"	1/4"	2-1/2"	\$21.02
2892	3/16"	5/8"	1/4"	2"	\$19.83
1927	1/4"	3/4"	1/4"	2-1/2"	\$22.24
2897	1/4"	1"	1/4"	2-1/2"	\$23.13
1928	1/4"	1-1/4"	1/4"	3"	\$24.82
2898	1/4"	1-1/2"	1/4"	3"	\$25.90
2899	5/16"	7/8"	5/16"	2-1/2"	\$23.45
2893	3/8"	1"	3/8"	3"	\$26.43
2894	3/8"	1-1/8"	3/8"	3"	\$28.75
2895	3/8"	1-5/8"	3/8"	3-1/2"	\$44.68
2896	1/2"	1-1/8"	1/2"	3"	\$41.82
1929	1/2"	1-5/8"	1/2"	3-1/2"	\$62.82



MAGNATE™ Solid Carbide/PCD Router Bits

O-Flute Spiral, Polished 1 Flute Up-Cut For Hard Plastics and Solid Surface



This one flute O flute polished spiral bit creates curled chips to enhance evacuation and minimize chips welding to the cutting edge of the bit while improving surface finish. The end grinds improve bottom cut finishes.

Tool No.	Cutting Dia.	Cutting Length	Shank Dia.	Overall Length	Price
2568	1/8"	1/4"	1/8"	2"	\$23.94
2569	1/8"	1/2"	1/8"	2"	\$23.95
2560	1/8"	1/4"	1/4"	2"	\$23.96
2561	1/8"	1/2"	1/4"	2"	\$23.97
2570	1/8"	3/4"	1/4"	2-1/2"	\$31.44
2562	3/16"	3/8"	1/4"	2"	\$23.98
2563	3/16"	5/8"	1/4"	2"	\$25.61
2571	7/32"	3/4"	1/4"	2-1/2"	\$31.44
2564	1/4"	3/8"	1/4"	2"	\$23.99
2565	1/4"	3/4"	1/4"	2-1/2"	\$24.01
2567	1/4"	1-1/4"	1/4"	3"	\$26.35
2573	1/4"	1-1/2"	1/4"	3"	\$32.34
2572	3/8"	5/8"	3/8"	2-1/2"	\$39.71
2574	3/8"	1-1/8"	3/8"	3"	\$48.52
2577	3/8"	1-5/8"	3/8"	3-1/2"	\$36.97
2578	1/2"	1-5/8"	1/2"	3-1/2"	\$77.87
2579	1/2"	2-1/8"	1/2"	4"	\$68.31

O-Flute Spiral, Polished 1 Flute Up-Cut For Soft Plastics, Aluminum and Solid Surface



This one flute O flute polished spiral bit creates curled chips to enhance evacuation and minimize chips welding to the cutting edge of the bit while improving surface finish. The end grinds improve bottom cut finishes.

Tool No.	Cutting Dia.	Cutting Length	Shank Dia.	Overall Length	Price
2646	1/16"	1/4"	1/4"	2"	\$31.44
2648	1/8"	1/4"	1/8"	2"	\$23.10
2649	1/8"	1/2"	1/8"	2"	\$23.11
2640	1/8"	1/4"	1/4"	2"	\$23.96
2641	1/8"	1/2"	1/4"	2"	\$23.97
2650	1/8"	3/4"	1/4"	2-1/2"	\$31.44
2642	3/16"	3/8"	1/4"	2"	\$23.98
2643	3/16"	5/8"	1/4"	2"	\$25.61
2644	1/4"	3/8"	1/4"	2"	\$23.99
2653	1/4"	3/4"	1/4"	2-1/2"	\$24.01
2645	1/4"	1"	1/4"	2-1/2"	\$31.44
2647	1/4"	1-1/4"	1/4"	3"	\$27.03
2656	1/4"	1-1/2"	1/4"	3"	\$32.34
2652	3/8"	5/8"	3/8"	2-1/2"	\$38.51
2654	3/8"	1-1/8"	3/8"	3"	\$36.97
2657	3/8"	1-5/8"	3/8"	3-1/2"	\$55.62
2658	1/2"	1-5/8"	1/2"	3-1/2"	\$77.87

O-Flute Spiral, 2 Flute Up-Cut For Harder Plastics and Aluminum



Tool No.	Cutting Dia.	Cutting Length	Shank Dia.	Overall Length	Price
2621	3/16"	5/8"	1/4"	2"	\$16.86
2622	1/4"	1"	1/4"	2-1/2"	\$15.07
2623	1/4"	1-1/4"	1/4"	3"	\$15.07
2624	5/16"	1"	5/16"	3"	\$23.01
2625	3/8"	1"	3/8"	3"	\$25.49
2627	1/2"	1"	1/2"	3"	\$42.91
2628	1/2"	1-5/8"	1/2"	3-1/2"	\$47.52
2629	1/2"	2-1/8"	1/2"	4"	\$54.49

O-Flute Spiral, 2 Flute Down-Cut For Harder Plastics and Aluminum

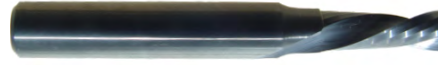

Tool No.	Cutting Dia.	Cutting Length	Shank Dia.	Overall Length	Price
2632	1/4"	1"	1/4"	2-1/2"	\$15.07
2633	1/4"	1-1/4"	1/4"	3"	\$15.08
2634	5/16"	1"	5/16"	3"	\$23.01
2635	3/8"	1"	3/8"	3"	\$25.49
2630	1/2"	1-1/4"	1/2"	3"	\$42.35
2638	1/2"	1-5/8"	1/2"	3-1/2"	\$47.52

O-Flute Spiral, Polished 1 Flute Down-Cut For Hard Plastics and Solid Surface



This one flute O flute polished spiral bit creates curled chips to enhance evacuation and minimize chips welding to the cutting edge of the bit while improving surface finish. The end grinds improve bottom cut finishes.

Tool No.	Cutting Dia.	Cutting Length	Shank Dia.	Overall Length	Price
2581	1/8"	1/2"	1/4"	2"	\$26.16
2583	3/16"	5/8"	1/4"	2"	\$26.17
2585	1/4"	7/8"	1/4"	2-1/2"	\$26.38
2587	1/4"	1-1/4"	1/4"	3"	\$31.44
2584	3/8"	1-1/8"	3/8"	3"	\$44.09
2588	1/2"	1-5/8"	1/2"	3-1/2"	\$89.80

O-Flute Spiral, Polished 1 Flute Down-Cut For Soft Plastics, Aluminum & Solid Surface



This one flute O flute polished spiral bit creates curled chips to enhance evacuation and minimize chips welding to the cutting edge of the bit while improving surface finish. The end grinds improve bottom cut finishes.

Tool No.	Cutting Dia.	Cutting Length	Shank Dia.	Overall Length	Price
2661	1/8"	1/2"	1/4"	2"	\$28.52
2663	3/16"	5/8"	1/4"	2"	\$28.53
2665	1/4"	3/4"	1/4"	2-1/2"	\$28.75
2667	1/4"	1-1/4"	1/4"	3"	\$34.26
2674	3/8"	1-1/8"	3/8"	3"	\$49.35
2678	1/2"	1-5/8"	1/2"	3-1/2"	\$97.87

O-Flute Spiral, Slow 2-Flute Up-Cut For Plastics and Solid Surface



This 2 flute O flute slow spiral bit is designed to achieve smooth finishes in plastic. It is suitable for soft plastic, hard plastic, solid surface and general purpose applications.

Tool No.	Cutting Dia.	Cutting Length	Shank Dia.	Overall Length	Price
2045	1/4"	3/4"	1/4"	2-1/2"	\$23.10

O-Flute Spiral, Slow 2-Flute Down-Cut For Plastics and Solid Surface



This 2 flute O flute slow spiral bit is designed to achieve smooth finishes in plastic. It is suitable for soft plastic, hard plastic, solid surface and general purpose applications.

Tool No.	Cutting Dia.	Cutting Length	Shank Dia.	Overall Length	Price
2145	1/4"	3/4"	1/4"	2-1/2"	\$23.10



MAGNATE™ Solid Carbide/PCD Router Bits

O-Flute Straight, 1 Flute For Soft Plastics



This one flute O-flute straight bit is designed for soft plastics. This bit is used where requires a good finish without chipping or tearing the plastics.

Tool No.	Cutting Dia.	Cutting Length	Shank Dia.	Overall Length	Price
1901	1/8"	3/8"	1/4"	2-1/2"	\$19.68
1909	1/8"	1/2"	1/4"	2"	\$18.90
1911	1/8"	5/8"	1/4"	4"	\$22.25
1902	5/32"	1/2"	1/4"	2-1/2"	\$19.68
1903	3/16"	1/2"	1/4"	2-1/2"	\$19.68
1910	3/16"	5/8"	1/4"	2"	\$18.91
1913	3/16"	1"	1/4"	4"	\$25.67
1904	7/32"	5/8"	1/4"	2-1/2"	\$24.82
1912	1/4"	1/2"	1/4"	2-1/2"	\$19.08
1905	1/4"	3/4"	1/4"	2-1/2"	\$19.35
1906	1/4"	1"	1/4"	2-1/2"	\$19.58
1916	1/4"	1-1/4"	1/4"	4"	\$27.09
1918	3/8"	7/8"	3/8"	2-1/2"	\$26.51
1907	3/8"	1"	3/8"	3"	\$29.25
1919	3/8"	1-5/8"	3/8"	6"	\$65.03
1908	1/2"	1"	1/2"	3"	\$43.21
1914	1/2"	1-5/8"	1/2"	3-1/2"	\$48.37
1900	1/2"	2-1/8"	1/2"	6"	\$100.68

O-Flute Straight, Polished 1 Flute Left Hand For Hard and Soft Plastics



Polished 1 Flute O flute straight tools produce curled chips to enhance evacuation and minimize chips welding to the the cutting edge of the tool. Use when upcut or downcut forces are not required. Used for routing hard and soft plastic material.

Tool No.	Cutting Dia.	Cutting Length	Shank Dia.	Overall Length	Price
2821	1/8"	3/8"	1/4"	2-1/2"	\$28.26
2826	5/32"	1/2"	1/4"	2-1/2"	\$29.30
2823	3/16"	1/2"	1/4"	2-1/2"	\$28.26
2825	1/4"	3/4"	1/4"	2-1/2"	\$28.26

O-Flute Straight, 2 Flute For Medium Plastic



Tool No.	Cutting Dia.	Cutting Length	Shank Dia.	Overall Length	Price
2941	1/8"	1/2"	1/4"	2"	\$16.53
2961	1/8"	5/8"	1/4"	4"	\$27.38
2942	5/32"	1/2"	1/4"	2-1/2"	\$22.88
2943	3/16"	3/8"	1/4"	2"	\$21.19
2963	3/16"	5/8"	1/4"	2"	\$16.53
2944	3/16"	1"	1/4"	4"	\$29.95
2964	1/4"	1/2"	1/4"	2-1/2"	\$16.53
2945	1/4"	1"	1/4"	2-1/2"	\$17.21
2946	1/4"	1"	1/4"	3-1/2"	\$28.24
2965	1/4"	1-1/4"	1/4"	3"	\$24.09
2947	3/8"	7/8"	3/8"	2-1/2"	\$27.41
2949	3/8"	1"	3/8"	3"	\$30.51
2967	3/8"	1"	3/8"	4"	\$48.15
2948	1/2"	1"	1/2"	3"	\$45.15
2968	1/2"	1"	1/2"	4"	\$68.45
2969	1/2"	1-5/8"	1/2"	3-1/2"	\$51.88

O-Flute Spiral Up-Cut Edge Rounding 1 Flute, 1/4" Shank Diameter Polished For Plastic and Solid Surface



This one flute O flute polished spiral bit creates curled chips to enhance evacuation and minimize chips welding to the cutting edge of the bit while improving surface finish. The end grinds improve bottom cut finishes.

Tool No.	Opening	Small Dia.	Cutting Length	Radius	Overall Length	Price
2693	5/32"	0.195"	3/8"	1/8"	2-1/2"	\$35.21
2695	7/32"	0.180"	3/8"	3/16"	2-1/2"	\$35.32
2697	9/32"	0.163"	3/8"	1/4"	2-1/2"	\$35.33

O-Flute Straight Edge Rounding, 1 Flute 1/4" Shank Diameter, 1/4" Cutting Diameter Polished For Plastic and Solid Surface



This 1 Flute O flute polished rounding edge straight solid carbide bit is recommended for hard plastic, soft plastic and solid surface materials.

Tool No.	Opening	Cutting Length	Small Dia.	Radius	Overall Length	Price
1981	5/32"	3/8"	0.195"	1/8"	2-1/2"	\$30.81
1982	7/32"	3/8"	0.180"	3/16"	2-1/2"	\$30.82
1983	9/32"	3/8"	0.163"	1/4"	2-1/2"	\$30.83

O-Flute Straight Edge Rounding, 2 Flute 1/4" Shank Diameter, 1/4" Cutting Diameter For Plastic Sheets or Parts



This 2 flute O flute edge rounding straight solid carbide bit improves edge polish. It is designed for rounding edge of plastic sheets or parts.

Tool No.	Opening	Cutting Length	Small Dia.	Radius	Overall Length	Price
1991	5/32"	3/8"	0.195"	1/8"	2-1/2"	\$34.23
1992	7/32"	3/8"	0.180"	3/16"	2-1/2"	\$34.24
1993	9/32"	3/8"	0.163"	1/4"	2-1/2"	\$34.25

O-Flute Straight Edge Rounding, 2 Flute 3/8" Shank Diameter, 3/8" Cutting Diameter For Plastic Sheets or Parts



This 2 flute O flute edge rounding straight solid carbide bit improves edge polish. It is designed for rounding edge of plastic sheets or parts.

Tool No.	Opening	Cutting Length	Small Dia.	Radius	Overall Length	Price
1994	5/32"	3/8"	0.320"	1/8"	2-1/2"	\$57.01
1995	9/32"	3/8"	0.288"	1/4"	2-1/2"	\$57.02

O-Flute Straight Edge Rounding, 2 Flute 1/2" Shank Diameter For Plastic Sheets or Parts



This 2 flute O flute edge rounding straight solid carbide bit improves edge polish. It is designed for rounding edge of plastic sheets or parts.

Tool No.	Opening	Cutting Length	Small Dia.	R.	Overall Length	Price
1997*	5/32"	3/8"	0.445"	1/8"	3"	\$75.84
1996^	1/4"	14mm	0.2675"	4mm	3-1/2"	\$61.12
1999*	9/32"	3/8"	0.413"	1/4"	3"	\$75.84
1990*	27/64"	5/8"	0.370"	3/8"	3"	\$75.86

* 1/2" Cutting Diameter
^ 10mm Cutting Diameter



MAGNATE™ Solid Carbide/PCD Router Bits

Z Flute Straight, 1 Flute For Plastic or Solid Woods



Designed for solid woods, wood composites, acrylics, plastics, and solid surface. This bit is to provide fast, free cutting and long edge life.

Tool No.	Cutting Dia.	Cutting Length	Shank Dia.	Overall Length	Price
1956	1/16"	1/4"	1/4"	1-1/2"	\$16.44
1972	3/32"	1/2"	1/4"	2"	\$15.44
1950	1/8"	3/8"	1/4"	1-1/2"	\$15.69
1952	1/8"	1/2"	1/4"	2"	\$15.72
1973	5/32"	5/8"	1/4"	2"	\$15.81
1954	3/16"	5/8"	1/4"	2"	\$15.90
1955	3/16"	3/4"	1/4"	2"	\$16.10
1951	1/4"	7/8"	1/4"	2-1/2"	\$16.22
1953	1/4"	1"	1/4"	2-1/2"	\$19.47
1958	3/8"	1"	3/8"	3"	\$27.63
1959	1/2"	1"	1/2"	3"	\$40.95
1957	1/2"	1-3/4"	1/2"	4"	\$56.29

Z-Flute Straight Flat Bottom Veining For Plastic or Solid Woods, 2 Flute



This bit provides fast, free cutting and long edge life in harder materials like solid woods, wood composites, acrylics, plastics and solid surface.

Tool No.	Cutting Dia.	Shank Dia.	Cutting Length	Overall Length	Price
1949	3/32"	1/4"	3/16"	1-1/2"	\$16.26
1948	1/8"	1/4"	1/4"	2"	\$14.28

Z Flute Straight, 2 Flute For Plastic or Solid Woods



This bit provides fast, free cutting and long edge life in harder materials like solid woods, wood composites, acrylics, plastics and solid surface.

Tool No.	Cutting Dia.	Cutting Length	Shank Dia.	Overall Length	Price
1931	1/8"	3/8"	1/4"	1-1/2"	\$14.56
1930	1/8"	3/8"	1/4"	2"	\$14.56
5300	1/8"	1/2"	1/4"	2"	\$16.26
1933	5/32"	3/8"	1/4"	1-1/2"	\$14.18
1932	5/32"	3/8"	1/4"	2"	\$16.26
1934	3/16"	1/2"	1/4"	2"	\$15.72
1935	3/16"	1/2"	1/4"	1-1/2"	\$14.98
5301	3/16"	5/8"	1/4"	2"	\$16.26
5302	3/16"	3/4"	1/4"	2"	\$16.26
1936	7/32"	3/4"	1/4"	2"	\$16.26
1937	1/4"	3/4"	1/4"	2"	\$16.26
1947	1/4"	3/4"	1/4"	2-1/2"	\$17.08
5303	1/4"	7/8"	1/4"	2-1/2"	\$17.08
1938	1/4"	1"	1/4"	2-1/2"	\$18.55
1939	1/4"	1"	1/4"	3"	\$18.55
5304	1/4"	1-1/4"	1/4"	3"	\$20.49
1940	5/16"	1"	5/16"	2-1/2"	\$31.02
1941	3/8"	1"	3/8"	2-1/2"	\$32.78
5305	3/8"	1"	3/8"	3"	\$29.33
1942	3/8"	1-1/4"	3/8"	3"	\$30.43
5306	1/4"	3/4"	1/2"	3"	\$57.74
5307	5/16"	1"	1/2"	3"	\$57.74
5308	3/8"	1"	1/2"	3"	\$64.18
1943	1/2"	1"	1/2"	3"	\$43.11
5309	1/2"	1-1/8"	1/2"	3"	\$43.90
1944	1/2"	1-1/4"	1/2"	3"	\$43.95
1945	1/2"	1-5/8"	1/2"	3-1/2"	\$55.07
5310	1/2"	1-3/4"	1/2"	4"	\$54.95
1946	1/2"	2"	1/2"	4"	\$61.11

V-Grooving, 1/4" Shank Diameter



Tool No.	Flute	Degree	Cutting Dia.	Cutting Height	Overall Length	Price
5164	2	90	1/4"	1/8"	1-1/2"	\$17.28
5161	2	60	1/4"	7/32"	1-1/2"	\$14.78
5163	2	60	1/4"	7/32"	2-1/2"	\$22.45
765	3	90	1/4"	1/8"	1-1/2"	\$13.61
768	2	60	1/4"	7/32"	2"	\$13.16

Liner/Veining 1 Flute 1/4" Shank Diameter, For Carving Machine



Designed for solid woods, wood composites, plastics, and laminated or veneered materials. This bit used for engraving or creating decorative cuts in materials.

Tool No.	Tip Degree	Cutting Height	Overall Length	Price
1970	1/16" 20	1/2"	2"	\$15.94
1971*	1/16" 20	1/2"	2"	\$20.83
1972	1/16" 15	1/2"	2-1/2"	\$30.76

* Left Hand Rotation

Round Bottom Veining, 1 Flute 1/4" Shank Diameter



Tool No.	Radius	Cutting Dia.	Cutting Length	Overall Length	Price
5196	1/16"	1/8"	1/4"	1-1/2"	\$18.55
5192	1/8"	1/4"	1/4"	2"	\$18.55

Round Bottom Veining, 2 Flute 1/4" Shank Diameter



Tool No.	Radius	Cutting Dia.	Cutting Length	Overall Length	Price
5136	1/16"	1/8"	5/16"	2"	\$17.12
5134	3/32"	3/16"	3/8"	2"	\$17.32
5132	1/8"	1/4"	3/8"	2"	\$17.32

Fiberglass, V-Point Plunge



Tool No.	Cutting Dia.	Cutting Length	Shank Dia.	Overall Length	Price
5172	1/4"	3/4"	1/4"	2-1/2"	\$21.00
5174	3/8"	7/8"	3/8"	2-1/2"	\$52.25
5176	1/2"	1"	1/2"	3"	\$69.58

Ripping & Slotting



Tool No.	Cutting Dia.	Cutting Length	Shank Dia.	Overall Length	Price
5156	1/4"	3/8"	1/4"	1-1/2"	\$11.86



Flush Trim, 2 Flute



5101



5102



5103



5181

These bits produce flush, square corners on plastic laminates and veneers.

Tool No.	Cutting Dia.	Cutting Length	Shank Dia.	Overall Length	Price
5101	1/4"	1/4"	1/4"	1-1/2"	\$8.68
5102	1/4"	3/8"	1/4"	2"	\$9.93
5103	1/4"	3/8"	1/4"	1-1/2"	\$10.27
5181*	1/4"	1/4"	1/4"	1-1/2"	\$8.99

* AKA DADO Trim Bit, comes with Small Pilot for Shallow Dado

7 Degree Bevel Trim, Left Rotation 2 Flute



This bit creates seven degree bevel edges on sink tops and cabinets.

Tool No.	Cutting Dia.	Cutting Length	Shank Dia.	Overall Length	Price
5231	1/4"	1/4"	1/4"	1-1/2"	\$10.95

7 Degree Bevel Trim, Double Ended 2 Flute



This bit creates seven degree bevel edges on sink tops and cabinets.

Tool No.	Cutting Dia.	Cutting Length	Shank Dia.	Overall Length	Price
5206	1/4"	1/4"	1/4"	2"	\$15.65

7 Degree Bevel Trim, 2 Flute Small Pilot for Shallow Dado



Tool No.	Cutting Dia.	Cutting Length	Shank Dia.	Overall Length	Price
5281^	1/4"	1/4"	1/4"	1-1/2"	\$14.63

Flush Trim Double-Ended, 2 Flute



These bits produce flush, square corners on plastic laminates and veneers.

Tool No.	Cutting Dia.	Cutting Length	Shank Dia.	Overall Length	Price
5106	1/4"	1/4"	1/4"	2"	\$14.98

Flush & 7 Degree Bevel Trim



Tool No.	Cutting Dia.	Cutting Length	Shank Dia.	Overall Length	Price
5211	1/4"	1/4"	1/4"	1-1/2"	\$11.17

Hole & Flush Trim, 2 Flute



Tool No.	Cutting Dia.	Cutting Length	Shank Dia.	Overall Length	Price
5241	1/4"	5/16"	1/4"	2"	\$11.17
5242	1/4"	3/8"	1/4"	1-1/2"	\$12.38
5243	1/4"	1/4"	1/4"	1-1/2"	\$14.26

7.5 Degree Dovetail For Incra/Omni Jig 2 Flute



Tool No.	Degree	Cutting Dia.	Cutting Height	Shank Dia.	Overall Length	Price
5264	7.5	1/4"	5/16"	1/4"	2"	\$19.17

7 Degree Bevel Trim, 2 Flute



This bit creates seven degree bevel edges on sink tops and cabinets.

Tool No.	Cutting Dia.	Cutting Length	Shank Dia.	Overall Length	Price
5201	1/4"	1/4"	1/4"	1-1/2"	\$9.93

Fiberglass, End Mill



Tool No.	Cutting Dia.	Cutting Length	Shank Dia.	Overall Length	Price
5171	1/4"	3/4"	1/4"	2-1/2"	\$20.54
5173	3/8"	7/8"	3/8"	2-1/2"	\$53.25
5175	1/2"	1"	1/2"	3"	\$69.58



MAGNATE™ Carbide Tipped Router Bits

In order to avoid vibration and for maximum cutting quality, always choose a router bit with the shortest cutting edge and the shortest overall length available that is able to fit your project application. Excessive overall length may cause tool damage.

Straight, 1-Flute



Straight router bits are probably the most commonly used bits for various woodworking applications such as planing edges and cutting rabbets, dadoes, grooves, or slots.

A single flute bit has a faster cut speed than a multiple flute bit and should be used where cut speed is more important than cut finish. Though a single flute bit has a rougher cut than a multiple flute bit, it allows for faster chip clearance and maximum stock removal. Single flute bits are typically more suitable for being used on a lower horsepower router.

Tool No.	Cutting Dia.	Cutting Length	Shank Dia.	Shank Length	Price
101	1/8"	1/2"	1/4"	1-1/4"	\$7.41
102	3/16"	1/2"	1/4"	1-1/4"	\$7.46
103	1/4"	3/4"	1/4"	1-1/4"	\$7.49
104	1/4"	1"	1/4"	1-1/4"	\$7.56
123	1/4"	3/4"	1/2"	1-1/2"	\$8.05
124	5/16"	1"	1/2"	1-1/2"	\$8.38
125	3/8"	1"	1/2"	1-1/2"	\$8.93
126	1/2"	1-1/4"	1/2"	1-1/2"	\$9.52
127	1/2"	1-1/2"	1/2"	1-1/2"	\$12.02
128	1/2"	2"	1/2"	1-1/2"	\$13.59

Straight, 2-Flute, Metric Shank



Straight router bits are probably the most commonly used bits for various woodworking applications such as planing edges and cutting rabbets, dadoes, grooves, or slots.

Tool No.	Cutting Dia.	Cutting Height	Shank Dia.	Shank Length	Price
212	5/16"	1"	8mm	1-1/4"	\$9.01

Straight, 2-Flute, 1/2" Shank Diameter



Straight router bits are probably the most commonly used bits for various woodworking applications such as planing edges and cutting rabbets, dadoes, grooves, or slots.

When used on the Legacy Ornamental Mill these bits can mill grooves and mortises, or mill contoured profiles when following a template; simulating a copy lathe.

Tool No.	Cutting Dia.	Cutting Length	Shank Dia.	Shank Length	Price
231U	7/32"	1/2"	1/2"	1-1/2"	\$8.62
231	1/4"	3/4"	1/2"	1-1/2"	\$8.68
232	5/16"	1"	1/2"	1-1/2"	\$9.32
223	3/8"	3/4"	1/2"	1-3/4"	\$8.95
233	3/8"	1"	1/2"	1-1/2"	\$9.37
233L	3/8"	1-1/2"	1/2"	2"	\$12.39
245	13/32"	1"	1/2"	1-1/2"	\$10.60
234A	7/16"	3/4"	1/2"	1-1/2"	\$9.33
234	7/16"	1"	1/2"	1-1/2"	\$9.37
234D	15/32"	1-1/4"	1/2"	1-1/2"	\$9.91
235U	31/64"	1"	1/2"	1-1/2"	\$10.84
235	1/2"	1"	1/2"	1-1/2"	\$10.24
235A	1/2"	1-1/4"	1/2"	1-1/2"	\$12.02
235L	1/2"	1-1/2"	1/2"	1-1/2"	\$12.87
235B	1/2"	2"	1/2"	2"	\$15.91
235C	1/2"	2-1/2"	1/2"	2"	\$18.11
236U	17/32"	1-1/4"	1/2"	1-1/2"	\$12.03
236	9/16"	1"	1/2"	1-1/2"	\$11.28
237U	19/32"	1-1/4"	1/2"	1-1/2"	\$12.62
237K	5/8"	1"	1/2"	1-1/2"	\$11.51
237	5/8"	1-1/4"	1/2"	1-1/2"	\$13.35
237A	5/8"	1-1/2"	1/2"	1-1/2"	\$14.01
237L	5/8"	2"	1/2"	1-1/2"	\$16.50
237D	21/32"	1-1/4"	1/2"	1-1/2"	\$13.30
238R	11/16"	1"	1/2"	1-1/2"	\$13.78
238U	23/32"	1"	1/2"	1-1/2"	\$14.16
238	3/4"	1-1/4"	1/2"	1-1/2"	\$14.56
238B	3/4"	2"	1/2"	1-1/2"	\$17.06
238D	25/32"	1-1/4"	1/2"	1-1/2"	\$15.64
239R	13/16"	1"	1/2"	1-1/2"	\$16.09
239A	27/32"	1"	1/2"	1-1/2"	\$16.42
239	7/8"	1-1/4"	1/2"	1-1/2"	\$16.73
240	1"	1-1/4"	1/2"	1-1/2"	\$17.99
241	1"	2"	1/2"	2"	\$20.43
244	1-1/8"	1-1/2"	1/2"	1-1/2"	\$21.38
242	1-1/4"	1-1/2"	1/2"	1-1/2"	\$21.04
243	1-1/2"	1-1/2"	1/2"	1-1/2"	\$23.18

Straight, 2-Flute, 1/4" Shank Diameter



Straight router bits are probably the most commonly used bits for various woodworking applications such as planing edges and cutting rabbets, dadoes, grooves, or slots.

Tool No.	Cutting Dia.	Cutting Length	Shank Dia.	Shank Length	Price
201U	7/32"	3/4"	1/4"	1-1/4"	\$8.04
201R	15/64"	3/4"	1/4"	1-1/4"	\$8.32
201	1/4"	3/4"	1/4"	1-1/4"	\$8.38
201L	1/4"	1"	1/4"	1-1/4"	\$8.42
201D	9/32"	3/4"	1/4"	1-1/4"	\$8.46
202	5/16"	1"	1/4"	1-1/4"	\$8.49
203	3/8"	1"	1/4"	1-1/4"	\$8.54
204	7/16"	1"	1/4"	1-1/4"	\$8.57
205U	31/64"	1"	1/4"	1-1/4"	\$8.65
205	1/2"	1"	1/4"	1-1/4"	\$8.70
205D	17/32"	3/4"	1/4"	1-1/4"	\$8.75
206	9/16"	1"	1/4"	1-1/4"	\$8.82
207	5/8"	3/4"	1/4"	1-1/4"	\$9.47
208R	11/16"	3/4"	1/4"	1-1/4"	\$9.41
208U	23/32"	1"	1/4"	1-1/4"	\$10.55
208	3/4"	3/4"	1/4"	1-1/4"	\$10.23
209R	13/16"	3/4"	1/4"	1-1/4"	\$11.47
209	7/8"	3/4"	1/4"	1-1/4"	\$12.09
210	1"	3/4"	1/4"	1-1/4"	\$12.73

Straight, 5 Degree Tapered for Castle Pocket machine, 2-Flute



This bit is designed for the Castle Pocket machine. It comes with 2 flute tapered carbide tipped cutters which can cut high-pressure laminates, MDF, and solid surface materials.

Tool No.	Cutting Dia.	Cutting Length	Shank Dia.	Overall Length	Price
178	3/8"	5/16"	3/8"	2-1/2"	\$11.45

Straight, 2-Flute, 3/4" Shank Diameter



Straight router bits are probably the most commonly used bits for various woodworking applications such as planing edges and cutting rabbets, dadoes, grooves, or slots.

Tool No.	Rotation	Cutting Dia.	Cutting Length	Overall Length	Shank Dia.	Price
151	Right	3/4"	1-1/4"	3-1/4"	3/4"	\$18.03
152	Right	3/4"	2"	4"	3/4"	\$22.50
153	Left	3/4"	2"	5"	3/4"	\$25.87
154	Left	3/4"	2-1/2"	5-1/2"	3/4"	\$29.22



MAGNATE™ Carbide Tipped Router Bits

Straight Plunge, 2-Flute



Straight router bits are probably the most commonly used bits for various woodworking applications such as planing edges and cutting rabbets, dadoes, grooves, or slots.

Straight router bits are probably the most commonly used bits for various woodworking applications such as planing edges and cutting rabbets, dadoes, grooves, or slots.

This 2-flute plunge straight bit feature an extra carbide cutter at bottom for faster and cleaner plunging and mortising.

Tool No.	Cutting Dia.	Cutting Length	Shank Dia.	Shank Length	Price
261	1/4"	3/4"	1/4"	1-1/4"	\$9.41
262	5/16"	3/4"	1/4"	1-1/4"	\$9.50
263	3/8"	3/4"	1/4"	1-1/4"	\$10.12
265	1/2"	1"	1/4"	1-1/4"	\$10.32
267	5/8"	3/4"	1/4"	1-1/4"	\$10.59
268	3/4"	3/4"	1/4"	1-1/4"	\$11.51
269	7/8"	3/4"	1/4"	1-1/4"	\$13.83
270	1"	3/4"	1/4"	1-1/4"	\$14.69
281	1/4"	3/4"	1/2"	1-1/2"	\$10.15
282	5/16"	3/4"	1/2"	1-1/2"	\$10.32
283	3/8"	1-1/4"	1/2"	1-1/2"	\$10.81
284	7/16"	1"	1/2"	1-1/2"	\$11.44
284D	15/32"	1-1/4"	1/2"	1-1/2"	\$12.10
285	1/2"	1"	1/2"	1-1/2"	\$12.39
285L	1/2"	1-1/2"	1/2"	1-1/2"	\$14.40
285B	1/2"	2"	1/2"	1-1/2"	\$16.15
287K	5/8"	1"	1/2"	1-1/2"	\$12.45
295	5/8"	2"	1/2"	1-1/2"	\$19.12
288U	23/32"	1"	1/2"	1-1/2"	\$15.58
288	3/4"	1-1/4"	1/2"	1-1/2"	\$16.13
289	7/8"	1-1/4"	1/2"	1-1/2"	\$17.99
290	1"	1"	1/2"	1-1/2"	\$19.25
293	1-1/2"	1-1/2"	1/2"	1-1/2"	\$24.12

Straight Plunge, 2-Flute Left Hand



Straight router bits are probably the most commonly used bits for various woodworking applications such as planing edges and cutting rabbets, dadoes, grooves, or slots.

Straight router bits are probably the most commonly used bits for various woodworking applications such as planing edges and cutting rabbets, dadoes, grooves, or slots.

This 2-flute plunge straight bit feature an extra carbide cutter at bottom for faster and cleaner plunging and mortising.

Tool No.	Cutting Dia.	Cutting Height	Shank Dia.	Overall Length	Price
251	1/4"	3/4"	1/4"	2-1/2"	\$9.78
253	3/8"	1"	1/2"	2-5/8"	\$10.64
255	1/2"	1"	1/2"	2-5/8"	\$10.87

Surface Planing (Bottom Cleaning), 2-Flute

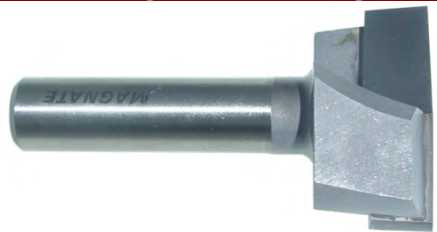

Good for cleaning out dadoes and cutting wide square grooves. Leaves a smooth clean finished surface. Also perfect for milling round, square, or flat stock on the Legacy Ornamental Mill.

Tool No.	Cutting Dia.	Shank Dia.	Cutting Length	Shank Length	Price
2700	3/4"	1/4"	3/8"	1-1/4"	\$16.40
2712	7/8"	1/4"	3/8"	1-1/2"	\$18.67
2713	1"	1/4"	3/8"	1-1/2"	\$21.34
2714	1-1/4"	1/4"	3/8"	1-1/2"	\$24.54
2715	1-1/2"	1/4"	3/8"	1-1/2"	\$25.95
2701	3/4"	1/2"	15/32"	2"	\$16.76
2702	7/8"	1/2"	15/32"	2"	\$18.80
2703	1"	1/2"	15/32"	2"	\$21.52
2723	1-3/16"	1/2"	15/32"	2"	\$23.80
2704	1-1/4"	1/2"	15/32"	2"	\$24.70
2724	1-3/8"	1/2"	15/32"	2"	\$25.40
2705	1-1/2"	1/2"	15/32"	2"	\$26.13
2725	40mm	1/2"	15/32"	2"	\$29.07
2706	2"	1/2"	15/32"	2"	\$38.92
2708	2-1/2"	1/2"	15/32"	2"	\$43.38
2707	2-3/4"	1/2"	15/32"	2"	\$49.69
2709	3"	1/2"	15/32"	2"	\$55.94

Flush Trim, 2-Flute



This flush trim bit is used for laminate, template, or pattern work.

Tool No.	Cutting Dia.	Cutting Length	Shank Dia.	Shank Length	Bearing	Price
318	1/4"	1/2"	1/4"	1-1/4"	BR-00	\$10.69
319	1/4"	1"	1/4"	1-1/4"	BR-00	\$11.59
301	3/8"	1/2"	1/4"	1-1/4"	BR-02	\$9.79
302	3/8"	1"	1/4"	1-1/4"	BR-02	\$9.98
303	1/2"	1/2"	1/4"	1-1/4"	BR-03	\$10.38
304	1/2"	1"	1/4"	1-1/4"	BR-03	\$11.30
305	1/2"	1-1/4"	1/4"	1-1/4"	BR-03	\$11.92
309	5/8"	5/8"	1/4"	1-1/4"	BR-05	\$13.00
306	1/2"	1"	3/8"	1-1/2"	BR-03	\$12.42
307	1/2"	1/2"	1/2"	1-1/2"	BR-03	\$10.70
308	1/2"	1"	1/2"	1-1/2"	BR-03	\$12.77
311	1/2"	1-1/2"	1/2"	1-1/2"	BR-03	\$15.28
312	1/2"	2"	1/2"	1-1/2"	BR-03	\$16.75
310	5/8"	1-1/2"	1/2"	1-1/2"	BR-05	\$15.79
313	3/4"	1"	1/2"	1-1/2"	BR-08	\$14.69
314	3/4"	2"	1/2"	1-1/2"	BR-08	\$18.60

Flush Trim, 3 Degree Down Shear, 2-Flute



This flush trim bit is used for laminate, template, or pattern work. This bits down shear cutting edges offer improved cutting speed and excellent finish.

Tool No.	Cutting Dia.	Cutting Length	Shank Dia.	Shank Length	Bearing	Price
322	1/4"	1/2"	1/4"	1-1/4"	BR-00	\$11.12
323	1/4"	1"	1/4"	1-1/4"	BR-00	\$12.09
331	3/8"	1/2"	1/4"	1-1/4"	BR-02	\$11.19
332	3/8"	1"	1/4"	1-1/4"	BR-02	\$12.33
320	1/2"	1"	1/4"	1-1/4"	BR-03	\$12.51
321	1/2"	1-3/16"	1/4"	1-1/4"	BR-03	\$13.13
329	5/8"	5/8"	1/4"	1-1/4"	BR-05	\$14.01
324	1/2"	1"	1/2"	1-1/2"	BR-03	\$13.76
325	1/2"	1-3/16"	1/2"	1-1/2"	BR-03	\$14.36
326	1/2"	1-1/2"	1/2"	1-1/2"	BR-03	\$15.79
327	1/2"	2"	1/2"	1-1/2"	BR-03	\$17.08
341	3/4"	1"	1/2"	1-1/2"	BR-08	\$16.71
342	3/4"	1-1/2"	1/2"	1-1/2"	BR-08	\$17.68
343	3/4"	2"	1/2"	1-1/2"	BR-08	\$18.90



MAGNATE™ Carbide Tipped Router Bits

Flush Trim, with Top and Bottom Bearings 3 Degree Down Shear, 2-Flute



This bit features double bearings at both ends of the 3 degree down-shear cutters. It is designed to be used with the template mounted on either side of material.

Tool No.	Overall Dia.	Cutting Length	Shank Dia.	Shank Length	Bearing	Price
360	1/2"	5/8"	1/4"	1-1/2"	BR-03	\$15.21
361	1/2"	1"	1/4"	1-1/2"	BR-03	\$16.04
367	3/4"	1-1/4"	1/2"	2"	BR-08	\$20.17
368	3/4"	2"	1/2"	2"	BR-08	\$21.82

Flush Trim with Double Bearing



This bit comes with double bearings (Magnate BR-03) that offers better stability and contact with the template guide.

Tool No.	Flute	Overall Dia.	Cutting Length	Shank Dia.	Shank Length	Overall Price
381	2	1/2"	1-1/2"	1/2"	3-7/8"	\$17.68
382	2	1/2"	2"	1/2"	4-1/4"	\$19.15
381TF	3	1/2"	1-1/2"	1/2"	3-7/8"	\$19.84
382TF	3	1/2"	2"	1/2"	4-1/4"	\$22.86

Flush Trim with Glue Space, 2-Flute



Designed to reduce glue buildup around the bearing area.

Tool No.	Overall Dia.	Cutting Length	Glue Space	Shank Dia.	Shank Length	Price
371*	3/8"	1/2"	1/4"	1/4"	1-1/4"	\$10.65
373^	1/2"	1/2"	1/4"	1/4"	1-1/4"	\$11.92
374^	1/2"	1"	5/16"	1/4"	1-1/4"	\$12.78
378^	1/2"	1"	5/16"	1/2"	1-1/2"	\$13.98

* Use Magnate BR-02 bearing

^ Use Magnate BR-03 bearing

Flush Trim, 3-Flute



Used for laminate, template, or pattern work. This flush trim bit comes with 3 flutes for application when chipping removal is more important than feed rate. This bit lasts longer than its 2 flute rivals.

Tool No.	Overall Dia.	Cutting Length	Shank Dia.	Shank Length	Bearing	Price
303TF	1/2"	1/2"	1/4"	1-1/4"	BR-03	\$11.90
304TF	1/2"	1"	1/4"	1-1/4"	BR-03	\$13.44
308TF	1/2"	1"	1/2"	1-1/2"	BR-03	\$14.28
311TF	1/2"	1-1/2"	1/2"	1-1/2"	BR-03	\$17.60
312TF	1/2"	2"	1/2"	1-1/2"	BR-03	\$19.56

V Trim (Face Frame), 2-Flute



Used for joining frame and cabinet sides. Removes excessive overhang and creates decorative V shape detail.

Tool No.	Overall Dia.	Cutting Length	Shank Dia.	Shank Length	Bearing	Price
7001	5/8"	1-3/16"	1/4"	1-1/4"	BR-03	\$15.86
S7001	5/8"	1-3/16"	1/2"	1-1/2"	BR-03	\$16.30

Overhang Trim, 2-Flute 1/2" Cutting Length



This bit is designed to leave a small overhang in laminate or template work.

Tool No.	Overhang	Overall Dia.	Shank Dia.	Shank Length	Bearing	Price
7021	1/16"	3/8"	1/4"	1-1/4"	BR-03	\$10.55
7023	1/8"	3/8"	1/4"	1-1/4"	BR-10	\$10.76
7025	1/16"	1/2"	1/4"	1-1/4"	BR-10	\$11.30
7026	1/16"	1/2"	1/2"	1-1/2"	BR-10	\$11.47

Overhang Bowl 2-Flute with a 10 degree tapered bearing



This overhang bit comes with a 10 degree tapered bearing (Magnate BR-52) designed to match the bowls side.

Tool No.	Overhang	Overall Dia.	Cutting Length	Shank Dia.	Shank Length	Overall Price
3058	1/16"	3/4"	7/8"	1/2"	3-3/8"	\$15.73

Pattern Extended Shank, 2-Flute



Originally designed for the Legacy Ornamental Milling machine, this bit allows you to follow a template when milling a contoured profile. It works on turnings up to 10" in diameter, square turnings up to 5", and square or flat stock up to 5" thick. The router follows the template as you make approximately 1/4" deep cuts for 2 to 3 passes. The bearing will follow the previous cut and support the router bit to eliminate chatter. This bit can also be used in a traditional router table like a pattern cutting router bit.

4-1/2" shank length is measured from middle of the knife to the end of the shank.

Tool No.	Cutting Dia.	Cutting Length	Shank Dia.	Shank Length	Bearing	Price
7621	1/2"	1/2"	1/2"	4-1/2"	BR-04	\$29.19
7623	3/4"	3/4"	1/2"	4-1/2"	BR-09	\$31.30

Pattern, 2-Flute



To be used for pattern routing and template work by placing a template above the piece of wood to be cut. The router can glide against the template creating a multitude of interesting patterns.

Tool No.	Cutting Dia.	Cutting Length	Shank Dia.	Shank Length	Bearing	Price
7601R*	1/2"	1/4"	1/4"	1-1/2"	BR-04	\$11.90
7601D*	1/2"	3/8"	1/4"	1-1/2"	BR-04	\$12.24
7601C	1/2"	1/2"	1/4"	1-1/2"	BR-04	\$13.27
7601X	1/2"	3/4"	1/4"	1-1/2"	BR-04	\$14.04
7601	1/2"	1"	1/4"	1-1/2"	BR-04	\$15.54
7612	9/16"	3/4"	1/4"	1-1/2"	BR-29	\$16.02
7602D*	5/8"	3/8"	1/4"	1-1/2"	BR-05	\$12.51
7602	5/8"	1"	1/4"	1-1/2"	BR-05	\$17.08
7603D*	3/4"	3/8"	1/4"	1-1/2"	BR-08	\$16.01
7603	3/4"	1"	1/4"	1-1/2"	BR-08	\$20.71
S7603	3/4"	1"	1/2"	1-3/4"	BR-09	\$21.92
S7613	3/4"	1-1/4"	1/2"	1-3/4"	BR-09	\$23.13
S7614	3/4"	1-1/2"	1/2"	1-3/4"	BR-09	\$24.33
S7609	3/4"	1-3/4"	1/2"	1-3/4"	BR-09	\$25.61
7617	3/4"	2"	1/2"	1-3/4"	BR-09	\$27.61
S7610	7/8"	1"	1/2"	1-3/4"	BR-30	\$22.55
S7605	1"	1"	1/2"	1-3/4"	BR-15	\$23.10
S7615	1"	1-1/4"	1/2"	1-3/4"	BR-15	\$24.35
S7616	1"	1-1/2"	1/2"	1-3/4"	BR-15	\$25.91
S7606	1"	1-3/4"	1/2"	1-3/4"	BR-15	\$27.41
7618	1-1/8"	1"	1/2"	1-3/4"	BR-07	\$24.81
S7604	1-1/8"	1-1/2"	1/2"	1-3/4"	BR-07	\$28.68
7619	1-1/8"	2"	1/2"	1-3/4"	BR-07	\$30.06
S7607	1-1/4"	1-1/2"	1/2"	1-3/4"	BR-16	\$32.45
S7611	1-1/2"	5/8"	1/2"	1-3/4"	BR-17	\$27.06
S7608	1-1/2"	1-3/4"	1/2"	1-3/4"	BR-17	\$34.66

* Cutting edges are designed for dado clean-out



Overhang Pattern, 1/4" Shank 2-Flute



This bit is designed to leave a small overhang in laminate or template work.

Tool No. Overhang Cutting Dia. Cutting Length Overall Length Bearing Price

7031	3/32"	5/16"	3/4"	2-3/4"	BR-04	\$13.76
7033	1/16"	1/2"	1/4"	1-7/8"	BR-05	\$12.03
7035	1/8"	1/2"	1/4"	1-7/8"	BR-08	\$12.32
7036	1/32"	9/16"	3/4"	2 1/4"	BR-05	\$16.07

Mortising, 2-Flute



Good for creating mortises for projects using mortises and tenons. Also for mortising hinges and hardware recesses when used in conjunction with a square corner chisel. Leaves a smooth finish and ideal for surfacing work

Tool No. Cutting Dia. Cutting Height Shank Dia. Shank Length Price

3301	1/2"	13/32"	1/4"	1-1/4"	\$9.79
3311	1/2"	3/4"	1/4"	1-1/4"	\$10.62
3302	5/8"	9/16"	1/4"	1-1/4"	\$11.01
3312	5/8"	3/4"	1/4"	1-1/4"	\$12.12
3303	3/4"	3/4"	1/4"	1-1/4"	\$12.25
3304	1"	3/4"	1/4"	1-1/4"	\$13.42
3305	1-1/4"	1/2"	1/4"	1-1/4"	\$13.08
3315	1-1/4"	1/2"	1/2"	1-1/2"	\$14.33
3306	1-1/4"	3/4"	1/2"	1-1/2"	\$15.98
3316	1-1/4"	1-1/4"	1/2"	1-1/2"	\$17.29

Arbor for Screw Type Cutters 1/4" Thread Length



These arbors are designed to work with screw type cutters. Ideally for Magnate screw type mortising cutters.

Tool No. Thread Shank Dia. Overall Length Price

3351	1/4"-28	1/4"	1-3/4"	\$5.17
3352	1/4"-28	1/2"	1-3/4"	\$5.27
3354	1/4"-28	1/2"	2-5/8"	\$6.89
3356	5/16"-24	1/4"	1-3/4"	\$5.19
3357	5/16"-24	1/2"	1-3/4"	\$5.29

Screw Type Mortising Cutter 1/4"-28 Thread, 2-Flute



Designed for 1/4"-28 thread mortising jigs.

Tool No. Cutting Dia. Cutting Height Price

3340	1/2"	17/32"	\$9.24
3341	5/8"	17/32"	\$9.82
3343	3/4"	17/32"	\$10.42
3344	13/16"	17/32"	\$11.08
3345	7/8"	17/32"	\$11.65
3346	15/16"	17/32"	\$12.35
3347	1"	17/32"	\$12.28
3348	1-1/8"	9/16"	\$12.67
3349	1-1/4"	5/8"	\$13.02

Screw Type Mortising Cutter 5/16"-24 Thread, 2-Flute



Designed for 5/16"-24 thread mortising jigs.

Tool No. Cutting Dia. Cutting Height Price

3370	1/2"	17/32"	\$9.24
3371	5/8"	17/32"	\$9.82
3373	3/4"	17/32"	\$10.42
3374	13/16"	17/32"	\$11.08
3375	7/8"	17/32"	\$11.65
3376	15/16"	17/32"	\$12.35
3377	1"	17/32"	\$12.48
3378	1-1/8"	9/16"	\$12.67
3379	1-1/4"	5/8"	\$13.07

Rabbeting, 2-Flute



It is designed for easy wood joining. Shearing cut brazed at an angle assures smooth, clean cutting results. It can also be used for lap joints and biscuit joining.

By replacing the original bearing, the rabbet depth varies as following:

Rabbet Depth						
Tool No	BR-02	BR-10	BR-11	BR-12	BR-13	BR-14
3501	7/16"	5/16"	1/4"	3/16"	1/8"	1/16"
3507	9/16"	7/16"	3/8"	5/16"	1/4"	3/16"
3503	9/16"	7/16"	3/8"	5/16"	1/4"	3/16"
3502	7/16"	5/16"	1/4"	3/16"	1/8"	1/16"
3508	9/16"	7/16"	3/8"	5/16"	1/8"	3/16"
3504	9/16"	7/16"	3/8"	5/16"	1/4"	3/16"

Rabbet Depth of Magnate 3505						
BR-18	BR-29	BR-05	BR-08	BR-26	BR-19	BR-28
13/16"	23/32"	11/16"	5/8"	9/16"	1/2"	7/16"

Tool No. Rabbet Depth Cutting Height Shank Dia. Overall Dia. Bearing Price

3501	3/8"	1/2"	1/4"	1-1/4"	BR-03	\$17.42
3507	1/2"	3/8"	1/4"	1-1/2"	BR-03	\$18.07
3503	1/2"	1/2"	1/4"	1-1/2"	BR-03	\$19.09
3502	3/8"	1/2"	1/2"	1-1/4"	BR-03	\$17.58
3508	1/2"	3/8"	1/2"	1-1/2"	BR-03	\$18.59
3504	1/2"	1/2"	1/2"	1-1/2"	BR-03	\$19.61
3505	3/4"	7/8"	1/2"	2"	BR-04	\$35.67

Slot Cutter For Demountable Hinge 2-Flute, 21/32" Cutting Height



Designed for easy demountable hinge installation. Will cut a T-slot fit for Amerock hinges

Tool No. Large Diameter Shank Dia. Radius Small Shank Dia. Length Price

6062	1-1/8"	3/8"	5/64"	3/8"	1-1/2"	\$22.73
6067	1-1/8"	1/2"	5/64"	3/8"	1-1/2"	\$23.30
6069	1-19/32"	1/2"	5/64"	3/8"	1-1/2"	\$27.59



Slot Cutter, 2-Flute

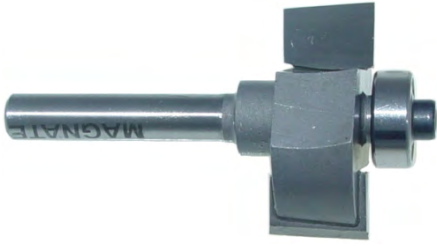

This bit is designed for rabbeting and for making lap joints and for tongue & groove jointing. Relieved on top and bottom for chip free use.

Comes with a Magnate BR-03 replacement bearing.

Tool No.	Cutting Length	Shank Dia.	Cutting Depth	Shank Length	Overall Dia.	Price
1101*	1/8"	1/4"	3/8"	1-1/4"	1-1/4"	\$15.25
1114^	5/32"	1/4"	3/8"	1-1/4"	1-1/4"	\$15.35
1102	3/16"	1/4"	3/8"	1-1/4"	1-1/4"	\$15.50
1103	1/4"	1/4"	3/8"	1-1/4"	1-1/4"	\$16.18
1104	5/16"	1/4"	3/8"	1-1/4"	1-1/4"	\$16.50
1105	3/8"	1/4"	3/8"	1-1/4"	1-1/4"	\$17.06
1106	1/2"	1/4"	3/8"	1-1/4"	1-1/4"	\$17.88
1107*	1/8"	1/2"	3/8"	1-1/2"	1-1/4"	\$15.53
1118^	5/32"	1/2"	3/8"	1-1/2"	1-1/4"	\$15.74
1108	3/16"	1/2"	3/8"	1-1/2"	1-1/4"	\$15.93
1109	1/4"	1/2"	3/8"	1-1/2"	1-1/4"	\$16.48
1110	5/16"	1/2"	3/8"	1-1/2"	1-1/4"	\$17.36
1111	3/8"	1/2"	3/8"	1-1/2"	1-1/4"	\$18.11
1112	1/2"	1/2"	3/8"	1-1/2"	1-1/4"	\$19.50

* For biscuit H-9 slot cutting

^ For biscuit #0, #10, #20 slot cutting

Slot Cutter with Top Bearing, 2-Flute



Good for remodeling jobs or any other slot cutting applications where a slot cutter with a top mounted bearing is preferred.

Replacing original Magnate bearing BR-05 by Magnate BR-04 will increase the cutting depth by 1/16.

Replacing original Magnate bearing BR-05 by Magnate BR-08 will decrease the cutting depth by 1/16.

Tool No.	Cutting Length	Cutting Depth	Shank Dia.	Shank Length	Overall Dia.	Price
1142	1/8"	5/16"	1/4"	1-1/2"	1-1/4"	\$19.50
1145	5/32"	5/16"	1/4"	1-1/2"	1-1/4"	\$20.01
1146	3/16"	5/16"	1/4"	1-1/2"	1-1/4"	\$20.63
1141	7/32"	5/16"	1/4"	1-1/2"	1-1/4"	\$21.04
1147	1/4"	7/16"	1/4"	1-1/2"	1-1/2"	\$21.34
1143	1/4"	7/16"	1/2"	1-3/4"	1-1/2"	\$22.08

Slotting Cutter with 5/16" Bore



2-wing design is most popular and economically priced. 3-wing and 4-wing design is sturdy and is commonly used for slotting plywood and composition boards to make T-moldings, box joints, spline joints and biscuit jointing. All slotting cutters can be interchangeable and stacked on the same 5/16" spindle arbor for various applications. Must be used with arbors with 5/16" spindle, such as Magnate Tool No. 4301, 4302, and 4303. By replacing the original bearing, Magnate BR-06, the cut depth varies as follows:

Original Bearing	Cutting Depth Matrix				
	BR-20	BR-21	BR-22	BR-23	BR-31
1/2"	7/16"	3/8"	5/16"	1/4"	3/16"

Tool No.	Kerf	Wing	Cutting Depth	Overall Dia.	Price
4000	1/16"	2	1/2"	1-7/8"	\$7.92
4001	5/64"	2	1/2"	1-7/8"	\$8.00
4002	3/32"	2	1/2"	1-7/8"	\$8.09
4003	1/10"	2	1/2"	1-7/8"	\$8.16
4004*	1/8"	2	1/2"	1-7/8"	\$8.24
4006^	5/32"	2	1/2"	1-7/8"	\$8.34
4007	3/16"	2	1/2"	1-7/8"	\$8.54
4008	7/32"	2	1/2"	1-7/8"	\$8.75
4005	1/4"	2	1/2"	1-7/8"	\$8.93
4009	9/32"	2	1/2"	1-7/8"	\$9.25
4100	1/16"	3	1/2"	1-7/8"	\$9.77
4101	5/64"	3	1/2"	1-7/8"	\$9.90
4102	3/32"	3	1/2"	1-7/8"	\$10.02
4103	1/10"	3	1/2"	1-7/8"	\$10.15
4104*	1/8"	3	1/2"	1-7/8"	\$10.27
4106^	5/32"	3	1/2"	1-7/8"	\$10.41
4107	3/16"	3	1/2"	1-7/8"	\$10.53
4108	7/32"	3	1/2"	1-7/8"	\$10.66
4105	1/4"	3	1/2"	1-7/8"	\$10.78
4109	9/32"	3	1/2"	1-7/8"	\$10.91
4200	1/16"	4	1/2"	1-7/8"	\$11.30
4201	5/64"	4	1/2"	1-7/8"	\$11.47
4202	3/32"	4	1/2"	1-7/8"	\$11.65
4203	1/10"	4	1/2"	1-7/8"	\$11.81
4204*	1/8"	4	1/2"	1-7/8"	\$11.98
4206^	5/32"	4	1/2"	1-7/8"	\$12.13
4207	3/16"	4	1/2"	1-7/8"	\$12.30
4208	7/32"	4	1/2"	1-7/8"	\$12.46
4205	1/4"	4	1/2"	1-7/8"	\$12.62
4209	9/32"	4	1/2"	1-7/8"	\$12.78

* For biscuit H-9 slot cutting

^ For biscuit #0, #10, #20 slot cutting

T-Slot, Straight-Edge 2-Flute



This bit is designed to cut a horizontal T-slot in wall panels for hanging brackets or accepting the head of a bolt.

Tool No.	Kerf	Large Diameter	Small Dia.	Shank Dia.	Cutting Length	Price
6106	1/8"	5/8"	3/8"	1/4"	5/8"	\$15.19
6105	3/16"	5/8"	3/8"	1/4"	11/16"	\$19.32
6104	1/4"	3/4"	3/8"	1/4"	3/4"	\$20.13
6102	5/16"	1-1/8"	3/8"	1/2"	13/16"	\$23.67
6103	3/8"	1"	3/8"	1/2"	7/8"	\$21.93
6101	3/8"	1-3/8"	1/2"	1/2"	7/8"	\$24.46

5/16" Spindle Arbors



4301, 4302 are used with the slotting cutters. 4303, 4304 are for the stile and rail cutters. 4305 is used with the adjustable finger joint or box joint cutters. All include a Magnate BR-06 bearing, a nut, and shims.

Tool No.	Arbor Length	Shank Dia.	Shank Length	Price
4301*	7/8"	1/4"	1-1/4"	\$7.30
4302*	7/8"	1/2"	1-1/2"	\$7.35
4303^	1-3/8"	1/4"	1-1/4"	\$7.88
4304^	1-3/8"	1/2"	1-1/2"	\$7.95
4305#	2"	1/2"	1-1/2"	\$9.17

* Fits Magnate slotting cutters

^ Fits Magnate reversible stile & rail cutters.

Fits Magnate adjustable finger joint or box joint cutters.



T-Slot, Bevel-Edge 2-Flute



This bit is designed to cut a horizontal T-slot in wall panels for hanging brackets or accepting the head of a bolt.

Tool No.	Kerf	Large Diameter	Small Dia.	Shank Dia.	Cutting Length	Price
6124	1/4"	1-3/16"	3/8"	1/2"	5/8"	\$22.84

Face-Inlay Extended Shank, 2-Flute



It is designed to work with Legacy Ornamental Milling machines. Used for inlaying wood veneer, and other materials i.e. brass on either spindle stock up to 8" in diameter, or flat stock up to 4" wide that has a curved profile i.e. bow front drawer.

Its extended shank allows milling on the side of a larger diameter material while following a curved profile.

5" Shank length is measured from the middle of the knife to the end of the shank.

The cutting depth is 1/8". By replacing the original Magnate bearing BR-05, the rabbet depth varies as follows:

Original Bearing	Cutting Depth		
	BR-08	BR-05	BR-04
BR-05	1/8"	1/16"	1/8"

Tool No.	Cutting Height	Shank Length	Shank Dia.	Overall Dia.	Price
1171	1/8"	5"	1/2"	7/8"	\$22.41
1173	1/4"	5"	1/2"	7/8"	\$25.30

Face-Inlay, 2-Flute



Used for inlaying wood veneer, and other material i.e. brass.

The cutting depth is 1/8". By replacing the original Magnate BR-05 bearing, the rabbet depth varies as follows:

Original Bearing	Cutting Depth Matrix		
	BR-08	BR-05	BR-04
BR-05	1/8"	1/16"	1/8"

Tool No.	Cutting Height	Shank Dia.	Overall Dia.	Overall Length	Price
1151	1/8"	1/2"	7/8"	3"	\$12.74
1153	1/4"	1/2"	7/8"	3"	\$14.66
1155	3/8"	1/2"	7/8"	3"	\$15.61
1157	1/2"	1/2"	7/8"	3-1/2"	\$16.97
1159	3/4"	1/2"	7/8"	3-1/2"	\$18.26

Stagger Tooth Panel With Center Pilot 1/2" Shank, 2 Flute



This stagger tooth panel bit comes with a solid pilot that offers a fast and clean cut.

Tool No.	Cutting Dia.	Flute Height	Cutting Length	Overall Length	Price
564	1/2"	1-1/8" & 1-1/8"	2-3/4"	4-1/4"	\$16.16

Stagger Tooth Plunge, 2-Flute



Good for materials that are normally hard to work with like particle boards, chip boards, and high resin materials. Performs plunge cutting tasks quickly and effortlessly.

Tool No.	Cutting Dia.	Cutting Length	Shank Dia.	Overall Length	Price
608	1/4"	1"	1/4"	2 1/4"	\$9.47
601	3/8"	1-1/2"	3/8"	2-3/4"	\$12.11
602	3/8"	1-1/2"	1/2"	2-3/4"	\$12.52
603	1/2"	1-1/2"	1/2"	3"	\$13.84
604	1/2"	2"	1/2"	3-1/4"	\$15.53
612*	1/2"	2"	1/2"	4"	\$15.73
605	1/2"	2-1/2"	1/2"	4"	\$18.57
614*	1/2"	2-5/8"	1/2"	5-1/2"	\$19.75

* Opposite Shear

Stagger Tooth Pilot Panel, 2-Flute



This Stagger Tooth Panel Pilot With Drill Point bit provides great stock removal.

Tool No.	Cutting Dia.	Cutting Length	Shank Dia.	Shank Length	Price
543	3/8"	7/8"	3/8"	1-1/4"	\$13.37
547	5/8"	2-1/4"	1/2"	1-1/2"	\$16.03

Panel Pilot, 1 Flute



For composition materials, hard or soft wood. Used for installing paneling, drywall, or siding. The sharp point plunges quickly while the carbide edges create a clean even interior surface.

Tool No.	Cutting Dia.	Cutting Length	Shank Dia.	Shank Length	Overall Length	Price
501	1/4"	3/4"	1/4"	1-1/4"	2-15/32"	\$9.16
502	3/8"	1"	3/8"	1-1/4"	2-7/8"	\$10.03
503	1/2"	1"	1/2"	1-1/2"	3-13/32"	\$10.12
504	1/2"	1-3/16"	1/2"	1-1/2"	3-17/32"	\$11.56
500	1/2"	1-1/4"	1/2"	1-27/32"	4"	\$12.47

Panel Pilot, 2 Flute



For composition materials, hard or soft wood. Used for installing paneling, drywall, or siding. The sharp point plunges quickly while the carbide edges create a clean even interior surface.

Tool No.	Cutting Dia.	Cutting Length	Shank Dia.	Shank Length	Overall Length	Price
521	1/4"	3/4"	1/4"	1-1/4"	2-15/32"	\$10.43
505	3/8"	1"	3/8"	1-1/2"	2-19/32"	\$11.40
506	1/2"	1"	1/2"	1-1/2"	2-19/32"	\$12.22
507	1/2"	1-3/16"	1/2"	1-1/2"	3-17/32"	\$13.67
509	1/2"	1-1/4"	1/2"	1-27/32"	4"	\$14.58
508	1/2"	2"	1/2"	1-1/2"	4-13/32"	\$15.56

Panel Pilot with 2 Pilots & Drill Point 2-Flute



This carbide tipped bit comes with 2 pilots and a drill/plunge point for thicker material. Fast cutting.

Tool No.	Cutting Dia.	Cutting Height	Shank Dia.	Overall Length	Price
536	3/8"	1-25/32"	3/8"	3 5/8"	\$16.06



MAGNATE™ Carbide Tipped Router Bits

Key Hole



Perfect for artists or interior decorators- the key hole bit allows you to mount pictures or plaques flush to the wall. First, the bit is plunge cut perpendicular to the wood face. Once the bit has reached the desired depth, the smaller cutting surface creates a thin slot while the larger cutting surface makes a larger slot. Perfect for holding the head of a nail or screw.

Tool No.	Under-Cut	Shank Dia.	Flute	Cutting Length	Cutting Dia.	Price
5001	3/16	1/4"	1	3/8"	3/8"	\$8.56
5002	1/8	1/4"	2	3/8"	3/8"	\$9.21
\$5001	3/16	1/2"	1	3/8"	3/8"	\$8.84
\$5002	1/8	1/2"	2	3/8"	3/8"	\$9.54
C5004	5/16	1/4"	2	1/2"	1/2"	\$10.32

Chamfer, 2-Flute



This chamfer bit creates bevel edges and miters with the same angle as the bit's cutter angle.

Comes with a Magnate BR-03 replacement bearing.

A chamfer bit with different angle is also used to make a box with different number of sides :

Number of Sides	4	6	8	12	16
Degree of Bit	45	30	22.5	15	11.25

Tool No.	Degree	Cutting Height	Shank Dia.	Shank Length	Overall Dia.	Price
952	11.25	13/16"	1/2"	1-1/2"	1-1/4"	\$25.29
911	15	5/8"	1/4"	1-1/4"	1"	\$21.26
951	15	7/8"	1/2"	1-1/2"	1"	\$21.95
910	22.5	7/8"	1/2"	1-1/2"	1-3/16"	\$25.27
909	30	7/8"	1/4"	1-1/4"	1-3/8"	\$26.47
949	30	7/8"	1/2"	1-1/2"	1-3/8"	\$26.51
901	45	3/8"	1/4"	1-1/4"	1"	\$15.30
902	45	1/2"	1/4"	1-1/4"	1-3/16"	\$16.42
903	45	9/16"	1/4"	1-1/4"	1-7/16"	\$18.87
943	45	9/16"	1/2"	1-1/2"	1-7/16"	\$19.60
904	45	11/16"	1/2"	1-1/2"	1-5/8"	\$21.95
905	45	3/4"	1/2"	1-1/2"	1-3/4"	\$25.30
906	45	7/8"	1/2"	1-1/2"	1-7/8"	\$26.79
907	45	1"	1/2"	1-1/2"	2"	\$29.13
908	45	1-3/16"	1/2"	1-1/2"	2-5/8"	\$34.53

25 Degree Bevel - 2-Flute



Tool No.	Small Cutting Dia.	Cutting Dia.	Height	Shank Dia.	Shank Length	Price
941	5/8"	1-11/16"	1-1/4"	1/2"	2"	\$28.27

45 Degree Bevel Spiral, 2-Flute



This bit is designed for the Legacy Ornamental milling machine. It creates spiral screws, and chamfered grooves on flat stock. It will work with the following pitches: 1-1/2", 3", 4-1/2", 6", 7-1/2", 9", 12" & 15".

It can be also used as a chamfer, bevel, or flush trim bit.

Tool No.	Small Cutting Dia.	Cutting Dia.	Height	Shank Dia.	Shank Length	Price
935	1/2"	1-1/2"	1"	1/2"	2"	\$29.13

14° Plunge Bevel with Top Bearing - 2-Flute



Tool No.	Cutting Dia.	Cutting Height	Shank Dia.	Small Dia.	Overall Length	Price
940	1-1/8"	1-1/16"	1/2"	5/8"	3-5/16"	\$28.32

45 Degree Undercut Bevel Trim, 4 Flute For Laminate Miter Joint



This 4-flute bit is also known as Laminate Miter Joint Bit. It is designed to cut 45 degree miter joints & eliminate dark line at the edge of laminated surfaces.

Tool No.	Cutting Height	Shank Dia.	Overall Dia.	Overall Length	Bearing	Price
3241	1/4"	1/4"	1-3/8"	2-3/8"	BR-23	\$18.25
3245	1/4"	1/2"	1-3/8"	2-3/8"	BR-23	\$18.54

Bevel & Flush Trimming, 2-Flute



This bit is designed to perform flush or bevel trimming; more specifically for trim and bevel cut by one pass. It can be used with a laminate trimmer.

Use with router guide attachment.

Tool No.	Degree	Cutting Dia.	Cutting Height	Shank Dia.	Shank Length	Price
3022	22	15/32"	1/2"	1/4"	1-1/4"	\$8.68
3030	30	5/8"	1/2"	1/4"	1-1/4"	\$10.95
3045	45	5/8"	1/2"	1/4"	1-1/4"	\$10.86

Bevel Trim With Bearing

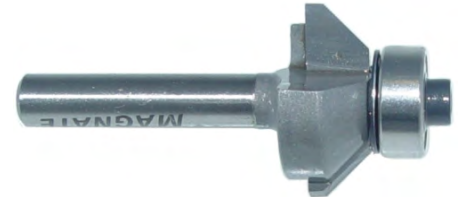

Creates bevel edges on cabinets and furniture. Assembly includes ball bearing, arbor and replaceable cutters.

Tool No.	Degree	Flute	Cutting Height	Shank Dia.	Shank Length	Price
3101*	15	2	1/4"	1/4"	1-1/4"	\$14.32
3102*	25	2	1/4"	1/4"	1-1/4"	\$14.65
3105*	25	2	7/16"	1/4"	1-1/4"	\$16.46
3103*	45	2	1/4"	1/4"	1-1/4"	\$15.04
3201*	7	3	3/8"	1/4"	1-1/4"	\$15.59
3205^	15	3	7/16"	1/4"	1-1/4"	\$16.16
3202^	22	3	3/8"	1/4"	1-1/4"	\$15.97
3203^	30	3	7/16"	1/4"	1-1/4"	\$16.50
3204#	45	4	1/4"	1/2"	1-1/2"	\$17.80

* Comes with a Magnate BR-03 bearing
^ Comes with a Magnate BR-04 bearing
Comes with a Magnate BR-06 bearing

Bevel Trim With Bearing 1/16" Overhang, 3 Flute



Creates bevel edges on cabinets and furniture. Assembly includes ball bearing, arbor and replaceable cutters.

Tool No.	Degree	Cutting Height	Shank Dia.	Shank Length	Bearing	Price
3202B	22	3/8"	1/4"	1-1/4"	BR-08	\$19.20

MAGNATE™ 20639 Lycoming Street #B-6, Walnut, CA 91789 USA

B-7



email : info@magnate.net Online Shop : www.magnate.net
(TEL) 800-827-2316, 909-468-5747 (FAX) 909-468-5745

Bevel Undermount Bowl, 2-Flute 1/2" Shank Diameter



This bevel bit trims the sink cut-out flush for a bevel-mount bowl.

Tool No.	Degree	Cutting Height	Overall Dia.	Shank Length	Bearing	Price
3121	10	1"	1-7/32"	1-3/4"	BR-56	\$23.36
3122	10	1-1/4"	1-5/16"	1-3/4"	BR-56	\$27.25
3123	10	1-3/4"	1-1/2"	1-3/4"	BR-56	\$32.79
3124	12	1"	1-5/16"	1-3/4"	BR-50	\$25.26
3125	12	1-1/4"	1-13/32"	1-3/4"	BR-50	\$28.90
3126	12	1-3/4"	1-5/8"	1-3/4"	BR-50	\$34.32
3127	15	1"	1-13/32"	1-3/4"	BR-54	\$27.50

Dovetail - 7 Degree, 2-Flute



This bit is designed for creating drawer box joints and for French dovetailing.

This bit can also be used with the Legacy Ornamental Mill to create unique indexed dovetail slots at 90 degree or 120 degree spacing for furniture legs and three legged pedestals.

Tool No.	Cutting Dia.	Cutting Height	Shank Dia.	Overall Length	Price
427*	17/32"	3/4"	1/4"	2-1/2"	\$10.77
417	5/8"	7/8"	1/4"	2-5/8"	\$11.80
467^	5/8"	7/8"	1/2"	2-5/8"	\$12.01
418^	3/4"	7/8"	1/4"	2-5/8"	\$12.18
468^	3/4"	7/8"	1/2"	2-5/8"	\$12.74
428	7/8"	7/8"	1/2"	2-1/2"	\$13.20
429	1"	7/8"	1/2"	2-1/2"	\$13.52

*Compatible with Porter-Cable Jig 4210 & 4212
^ Compatible with Inkra & JoinTech dovetail machines.

Dovetail With Top Bearing 7 Degree, 2-Flute



This bit is designed for creating drawer box joints and for French dovetailing.

This 7 degree dovetail bit is mounted with a bearing on the shank for creating dovetail joints along with template guides.

Tool No.	Cutting Dia.	Cutting Height	Shank Dia.	Overall Length	Bearing	Price
483	5/8"	1"	1/4"	2-5/8"	BR-05	\$14.42
484	3/4"	7/8"	1/4"	2-5/8"	BR-08	\$14.70

Dovetail - 7 Degree Left Rotation, 2 Flute



This bit is designed for creating drawer box joints and for French dovetailing.

Tool No.	Cutting Dia.	Cutting Height	Shank Dia.	Overall Length	Price
496	3/4"	7/8"	1/2"	2-5/8"	\$12.04
497	7/8"	7/8"	1/2"	2-1/2"	\$12.28
498	1"	7/8"	1/2"	2-1/2"	\$13.90

Dovetail - 7.5 Degree, 2-Flute



This bit is designed for creating drawer box joints and for French dovetailing.

Tool No.	Cutting Dia.	Cutting Height	Shank Dia.	Overall Length	Price
408*	1/4"	5/16"	1/4"	2-1/2"	\$9.20
458	1/4"	5/16"	1/2"	2-1/2"	\$9.78

* Compatible with Leigh Dovetail.

Dovetail - 8 Degree 2-Flute

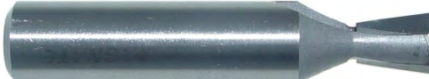

This bit is designed for creating drawer box joints and for French dovetailing.

Tool No.	Cutting Dia.	Cutting Height	Shank Dia.	Overall Length	Price
409*	1/4"	1/4"	1/4"	2-1/2"	\$9.29
410*	5/16"	3/8"	1/4"	2 1/4"	\$10.14
440*	5/16"	3/8"	8mm	2 1/4"	\$11.09
412*	3/8"	1/2"	1/4"	2-3/8"	\$10.75
442*	3/8"	1/2"	8mm	2-3/8"	\$11.35
462	3/8"	1/2"	1/2"	2-3/8"	\$11.17
423*	7/16"	5/8"	1/4"	2-3/8"	\$11.14
453*	7/16"	5/8"	8mm	2-3/8"	\$12.10
414*	1/2"	13/16"	1/4"	2-3/4"	\$11.44
454*	1/2"	13/16"	8mm	2-3/4"	\$11.65
464*	1/2"	13/16"	1/2"	2-3/4"	\$11.47
470*	11/16"	1"	1/2"	3"	\$13.21
471*	13/16"	1-1/4"	1/2"	3-1/4"	\$14.59

* Compatible with Leigh Dovetail

Dovetail - 9 Degree, 2-Flute



This bit is designed for creating drawer box joints and for French dovetailing.

Tool No.	Cutting Dia.	Cutting Height	Shank Dia.	Overall Length	Price
411*	5/16"	3/8"	1/4"	2 1/4"	\$9.53
461	5/16"	3/8"	1/2"	2 1/4"	\$10.19
401*	3/8"	3/8"	1/4"	2"	\$9.81
451	3/8"	3/8"	1/2"	2-1/2"	\$11.01

* Compatible with Inkra, JoinTech dovetail.

Dovetail - 10 Degree, 2-Flute



This bit is designed for creating drawer box joints and for French dovetailing.

Tool No.	Cutting Dia.	Cutting Height	Shank Dia.	Overall Length	Price
415*^	1/2"	5/8"	1/4"	2-1/2"	\$10.84
455*	1/2"	5/8"	8mm	2-1/2"	\$12.46
465^	1/2"	5/8"	1/2"	2-1/2"	\$11.41

* Compatible with Leigh Dovetail
^ Compatible with Inkra, JoinTech Dovetail

Dovetail - 10 Degree, 1-Flute For Continuous Dovetail Machine



Designed to be used with continuous dovetail machines, i.e. Grizzly G0610 & G0611X, Powermatic 1791305.

Tool No.	Cutting Dia.	Cutting Height	Shank Dia.	Overall Length	Price
475	14mm	18mm	12mm	60mm	\$16.27

Dovetail With Top Bearing 14 Degree, 2-Flute



This bit is designed for creating drawer box joints and for French dovetailing.

This 14 degree dovetail bit is mounted with a bearing on the shank for creating dovetail joints along with template guides.

Tool No.	Cutting Dia.	Cutting Height	Shank Dia.	Overall Length	Bearing	Price
486	3/4"	7/8"	1/4"	2-5/8"	BR-08	\$16.86
489	1-1/8"	1-1/4"	1/2"	3"	BR-07	\$26.87



MAGNATE™ Carbide Tipped Router Bits

Dovetail - 14 Degree, 2-Flute



This bit is designed for creating drawer box joints and for French dovetailing.

This 14 degree dovetail bit can be used in conjunction with 14 degree Butterfly Spline bits to make a butterfly spline glue joint.

Magnate dovetail bits 407, 403, 404, 469, 405 and 406 are commonly used with Legacy Ornamental Mill machines to create unique indexed dovetail slots at 90 degree or 120 degree spacing for furniture legs and three legged pedestals.

Tool No.	Cutting Dia.	Cutting Height	Shank Dia.	Overall Length	Price
413	3/8"	3/8"	1/4"	2"	\$10.66
402*	1/2"	1/2"	1/4"	2-3/8"	\$11.22
432*	1/2"	1/2"	8mm	2-3/8"	\$12.62
407^#	1/2"	1/2"	1/2"	2-1/2"	\$11.80
426	17/32"	1/2"	1/4"	2"	\$11.90
403	5/8"	5/8"	1/2"	2-7/8"	\$12.45
404#	3/4"	3/4"	1/2"	3"	\$13.18
419	3/4"	7/8"	1/4"	2-5/8"	\$13.71
469	3/4"	7/8"	1/2"	2-1/2"	\$13.87
405	7/8"	7/8"	1/2"	3"	\$13.99
406	1"	7/8"	1/2"	3"	\$14.30

* Compatible with Leigh Dovetail
 ^ Compatible with Inkra, JoinTech Dovetail
 # Compatible with OmniJig

14 Degree Butterfly Spline, 2-Flute



This bit is designed to be used in conjunction with the Magnate 14 degree dovetail router bits. It is suitable to make butterfly spline glue joints, decorative inlays, and sliding dovetails. Recommended for use in a router table with a fence.

Tool No.	Cutting Dia.	Cutting Height	Shank Dia.	Overall Length	Price
5401	3/4"	1-1/8"	1/2"	2-5/8"	\$21.56
5402	1-1/4"	2"	1/2"	3-3/8"	\$29.47

Dovetail - 18 Degree, 2-Flute



This bit is designed for creating drawer box joints and for French dovetailing.

Compatible with Leigh(TM) Dovetail.

Tool No.	Cutting Dia.	Cutting Height	Shank Dia.	Overall Length	Price
416	1/2"	3/8"	1/4"	2 1/4"	\$12.00
446	1/2"	3/8"	8mm	2 1/4"	\$12.60

Dovetail - 25 Degree Half Blind, 2-Flute 1/2" Shank



This 25 degree bit is most commonly used for creating 1/2" half blind drawer box joints. It can be also used to create a bee hive box.

It can be used with a 3-axis CNC machine.

Tool No.	Radius	Cutting Dia.	Profile Height	Cutting Height	Overall Length	Price
479	1/8"	3/8"	3/8"	1/2"	2-1/2"	\$14.75

V-Grooving & Carving, 3-Flute



It is designed for professional sign making and lettering.

Tool No.	Degree	Cutting Dia.	Shank Dia.	Cutting Length	Shank Length	Price
767	45	5/8"	1/2"	3/4"	2"	\$23.45
761	60	5/8"	1/4"	5/8"	1-1/4"	\$18.40
763	60	5/8"	1/2"	5/8"	2"	\$19.76

60 Degree Lettering, 2 Flute



This bit is designed for quick removal of excess material during sign making and lettering.

Tool No.	Cutting Dia.	Cutting Height	Shank Dia.	Radius	Shank Length	Price
781	1"	3/4"	1/4"	1/8"	1-1/4"	\$19.16
784	1-1/8"	3/4"	1/2"	1/8"	1-1/2"	\$21.33
794*	1-1/8"	3/4"	1/2"	1/8"	1-1/2"	\$25.05

* Comes with a Magnate BR-07 bearing at shank.

V-Grooving, 2-Flute



These bits make both shallow and deep grooves in solid wood and composition boards. Can be used for decorative veining of drawers and cabinets. Also good for sign lettering.

When used with the Legacy Ornamental Mill, this bit can be used to chamfer square to round transitions. It can also be used to mill a diamond pattern on flat or spindle stock.

Tool No.	Degree	Cutting Dia.	Shank Dia.	Cutting Length	Shank Length	Price
710	60	1/4"	1/4"	3/8"	1-1/4"	\$11.34
711	60	1/2"	1/4"	5/8"	1-1/4"	\$11.63
712	60	3/4"	1/4"	13/16"	1-1/4"	\$14.76
716	60	1"	1/4"	1"	1-1/4"	\$19.51
717	60	1"	1/2"	1-3/32"	1-1/2"	\$20.80
700	90	1/4"	1/4"	3/8"	1-1/4"	\$10.01
701	90	3/8"	1/4"	1/2"	1-1/4"	\$10.14
702	90	1/2"	1/4"	1/2"	1-1/4"	\$11.35
703	90	5/8"	1/4"	5/8"	1-1/4"	\$14.94
704	90	3/4"	1/2"	5/8"	1-1/2"	\$16.37
705	90	7/8"	1/2"	3/4"	1-1/2"	\$19.90
706	90	1"	1/2"	3/4"	2"	\$23.13
718	90	1-1/4"	1/4"	7/8"	1-1/4"	\$21.92
707	90	1-1/4"	1/2"	7/8"	2"	\$26.77
708	90	1-1/2"	1/2"	1"	2"	\$30.42
709	90	2"	1/2"	1-1/4"	2"	\$36.85
721	120	3/4"	1/4"	1/2"	1-1/4"	\$16.34
723	120	1"	1/4"	15/32"	1-1/4"	\$21.31
726	120	1"	1/2"	15/32"	1-1/2"	\$21.92
724	120	1-1/4"	1/4"	21/32"	1-1/4"	\$24.38
727	120	1-1/4"	1/2"	21/32"	1-1/2"	\$24.58
728	120	2"	1/2"	11/16"	1-1/2"	\$28.04

V-Grooving With Top Bearing, 90 Degree 2 Flute



Tool No.	Cutting Dia.	Shank Dia.	Cutting Length	Shank Length	Bearing	Price
731	3/8"	1/4"	1/2"	1-1/4"	BR-18	\$12.58
732	1/2"	1/4"	1/2"	1-1/4"	BR-05	\$13.86
733	5/8"	1/4"	5/8"	1-1/4"	BR-09	\$18.28
734	3/4"	1/2"	5/8"	1-1/2"	BR-07	\$19.54

V-Grooving With Top Bearing, 60 Degree 2 Flute



Tool No.	Cutting Dia.	Shank Dia.	Cutting Length	Shank Length	Bearing	Price
741	1/2"	1/4"	5/8"	1-1/4"	BR-04	\$13.97

MAGNATE™ 20639 Lycoming Street #B-6, Walnut, CA 91789 USA

B-9



email : info@magnate.net Online Shop : www.magnate.net
 (TEL) 800-827-2316, 909-468-5747 (FAX) 909-468-5745

MAGNATE™ Carbide Tipped Router Bits

Thread Cutting 90-Degree, 2-Flute



This cutter is used to cut internal and external threads i.e. a wooden bolt and nut. The 90 degree angle produces a stronger wooden thread that is less likely to chip out. The depth of cut is 3/16". The 3/8" dimension refers to the size of the v section measured parallel to the shank.

Legacy's CCAM software will automatically generate the G Code for both parts.

Tool No.	Cutting Height	Shank Dia.	Shank Length	Overall Dia.	Price
796	3/8"	1/4"	1-1/2"	5/8"	\$18.02

Classic Plunge Beading, 2-Flute



Designed to create a bead-sided groove with flat bottom.

Tool No.	Radius	Cutting Dia.	Cutting Height	Shank Dia.	Shank Length	Price
1291	5/64"	1/2"	3/8"	1/4"	1-1/4"	\$15.86
1292	1/4"	7/8"	7/16"	1/4"	1-1/4"	\$18.30
1293	1/4"	7/8"	7/16"	1/2"	1-1/2"	\$18.88

3-Bit Classic Spiral Set - 3950



Tool No.: 3950 Price: 133.34

This package comes with 3 Classic Spiral bits - 3951, 3952, 3953 at 15% discounted price.

Side V-Grooving, 2-Flute



This side cutting v-grooving router bit is designed to make clean v-shaped grooves and chamfer edges. The bearing allows the bit to follow template whichever is applicable. It comes with a Magnate BR-05 bearing.

Tool No.	Degree	Cutting Height	Shank Dia.	Shank Length	Overall Dia.	Price
771	90	1/4"	1/4"	1-1/2"	7/8"	\$21.04
773	90	1/2"	1/4"	1-1/2"	1-1/8"	\$24.35
776	90	1/4"	1/2"	2"	7/8"	\$21.35
778	90	1/2"	1/2"	2"	1-1/8"	\$24.75
779	90	3/4"	1/2"	2"	1-3/8"	\$28.18
775	90	1"	1/2"	2"	1-5/8"	\$34.78

Cove & Bead Plunge, 2-Flute
1/4" Shank Diameter, 1-1/4" Shank Length



Features an extra 1/2" wide cutter at bottom for fast and clean plunge.

Tool No.	Radius (Bead, Cove)	Cutting Height	Cutting Dia.	Price
3641	1/8", 1/8"	7/16"	1"	\$19.45
3642	3/16", 3/16"	9/16"	1-1/4"	\$21.69

Large Cove Classic Plunge, 2-Flute
1/2" Shank Diameter, 2" Shank Length



Tool No.	Cutting Dia.	Profile Height	Radius (Bead, Cove)	Price
3941	1"	1/4"	1/8", 1/2"	\$36.18
3944	1-1/2"	3/8"	3/16", 3/4"	\$44.56
3942	2"	1/2"	1/4", 1"	\$52.22

Side V-Grooving Extended Shank 2-Flute



Designed for the Legacy Ornamental Milling machines. These bits are for milling v style flutes on spindles up to 8" in diameter or for cutting v style flutes or chamfer cuts on the face or a curved piece of flat stock i.e. bow front drawer.

Comes with a Magnate BR-05 replacement bearing.

5" Shank length is measured from the middle of the knife to the end of the shank.

Tool No.	Degree	Cutting Height	Shank Dia.	Shank Length	Overall Dia.	Price
751	90	1/4"	1/2"	5"	7/8"	\$31.89
753	90	1/2"	1/2"	5"	1-1/8"	\$34.32
756	90	3/4"	1/2"	5"	1-3/8"	\$36.88

Classic Spiral, 2-Flute
1/2" Shank Diameter, 2" Shank Length



Designed for the Legacy Ornamental Mill. A cross between the classic plunge and the barley twist bit. Creates a more stylized bead and cove or a beautiful single start spiral.

Can also be used to create a decorative groove with a half-rounded bottom.

Tool No.	Cutting Dia.	Radius	Price
3951	1"	1/2" + 3/32"	\$40.49
3954	1-1/2"	3/4" + 9/64"	\$46.68
3952	2"	1" + 3/16"	\$53.08
3953	3"	1-1/2" + 9/32"	\$71.81

Raised Panel Groove
25 Degree Face-Cut, 2-Flute



Tool No.	Overall Dia.	Profile Height	Small Dia.	Cutting Height	Shank Dia.	Price
3851	1"	0.146"	3/8"	0.4"	1/4"	\$22.23
3856	1-1/8"	0.16"	3/8"	1/2"	1/2"	\$27.02
3858	1.575"	1/4"	1/2"	9/16"	1/2"	\$34.33

MAGNATE™ 20639 Lycoming Street #B-6, Walnut, CA 91789 USA

B-10



email : info@magnate.net Online Shop : www.magnate.net
(TEL) 800-827-2316, 909-468-5747 (FAX) 909-468-5745

MAGNATE™ Carbide Tipped Router Bits

Flat Roundover Plunge, 2-Flute



When used with the Legacy ornamental machines, these bits make transitions from flat surfaces to beads on round or flat stock, i.e. astragal on columns or table legs.

Tool No.	Radius	Small Shank Dia.	Shank Dia.	Cutting Length	Shank Length	Price
1251	3/32"	3/16"	1/4"	5/16"	1-1/4"	\$14.03
1252	1/8"	1/4"	1/4"	3/8"	1-1/4"	\$15.93
1262	1/8"	1/2"	1/4"	3/8"	1-1/4"	\$17.07
1253	3/16"	1/4"	1/4"	7/16"	1-1/4"	\$17.28
1256	1/4"	1/8"	1/4"	1/2"	1-1/4"	\$19.04
1254	1/4"	1/4"	1/4"	1/2"	1-1/4"	\$19.39
1255	5/16"	1/4"	1/4"	1/2"	1-1/4"	\$20.08
1265	5/16"	1/2"	1/4"	1/2"	1-1/4"	\$21.77
1257	11/32"	3/16"	1/4"	9/16"	1-1/4"	\$22.48
1272	1/8"	1/4"	1/2"	3/8"	2"	\$17.02
1282	1/8"	1/2"	1/2"	3/8"	2"	\$18.28
1273	3/16"	1/4"	1/2"	7/16"	2"	\$19.32
1268	1/4"	1/8"	1/2"	1/2"	2"	\$19.43
1274	1/4"	1/4"	1/2"	1/2"	2"	\$20.25
1284	1/4"	7/16"	1/2"	1/2"	2"	\$23.18
1275	5/16"	1/4"	1/2"	9/16"	2"	\$23.51
1285	5/16"	1/2"	1/2"	1/2"	2"	\$23.25
1269	11/32"	3/16"	1/2"	9/16"	2"	\$24.30
1276	3/8"	1/4"	1/2"	5/8"	2"	\$25.61
1278	1/2"	1/4"	1/2"	3/4"	2"	\$28.09

Flute Cutter with Top Bearing, 2-Flute



Comes with a Magnate BR-05 bearing.

Tool No.	Radius	Cutting Length	Shank Dia.	Overall Dia.	Shank Length	Price
6023	1/8"	1/4"	1/4"	1-1/4"	1-1/4"	\$17.52

Boat Planking, 2-Flute

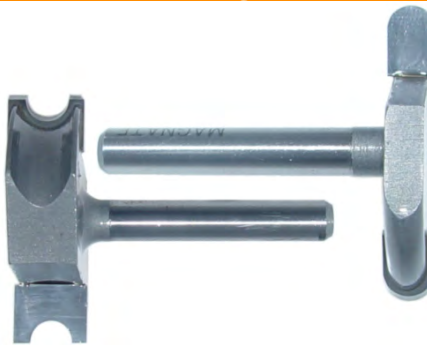

These 2 bits are used for slats of hot tub walls, circular planters, canoes, etc.

Tool No.	Profile	Radius	Shank Dia.	Cutting Length	Overall Dia.	Price
6011B	Bead	1/8"	1/4"	7/16"	1-1/2"	\$18.39
6011F	Flute	1/8"	1/4"	1/4"	1-1/2"	\$17.44
6013B	Bead	5/32"	1/4"	9/16"	1-1/2"	\$19.44
6013F	Flute	5/32"	1/4"	5/16"	1-1/2"	\$18.57
6012B	Bead	3/16"	1/4"	5/8"	1-1/2"	\$20.15
6012F	Flute	3/16"	1/4"	3/8"	1-1/2"	\$19.51

Multi-Fluting, 2-Flute



Comes with a Magnate BR-05 bearing.

Tool No.	Radius	Cutting Length	Shank Dia.	Overall Dia.	Shank Length	Price
6041	1/8"	1"	1/4"	7/8"	1-1/4"	\$29.95
6042	1/8"	1"	1/2"	7/8"	1-1/2"	\$31.21
6045	3/32"	11/16"	1/2"	13/16"	2"	\$30.38

Fluting Extended Shank, 2-Flute



Designed for Legacy. These bits are for milling fluted columns and spindles up to 8 in diameter. Extended shaft allows for milling on the side of a larger diameter while following a curved profile.

Note : 5" shank length is measured from middle of the knife to the end of the shank.

Tool No.	Flute Height	Shank Dia.	Shank Length	Radius	Bearing	Price
6053	3/16"	1/2"	5"	3/32"	BR-05	\$36.64
6051	1/4"	1/2"	5"	1/8"	BR-05	\$39.19
6054	3/8"	1/2"	5"	3/16"	BR-05	\$43.91
6052	1/2"	1/2"	5"	1/4"	BR-05	\$48.62
6056	5/8"	1/2"	5"	5/16"	BR-05	\$53.88
6058	3/4"	1/2"	5"	3/8"	BR-05	\$58.58

Shallow Flute, 2-Flute



A male counterpart of the Magnate 1300 series, Finger Nail router bits. For decorative edging.

Tool No.	Flute Height	Shank Dia.	Shank Length	Overall Dia.	Bearing	Price
2421	5/16"	1/4"	1-1/2"	7/8"	BR-03	\$13.74
2422	3/8"	1/4"	1-1/2"	7/8"	BR-03	\$14.96
2423	1/2"	1/4"	1-1/2"	7/8"	BR-03	\$15.86
2424	5/8"	1/4"	1-1/2"	15/16"	BR-03	\$19.84
2425	3/4"	1/4"	1-1/2"	1"	BR-03	\$21.25
2401	5/16"	1/2"	1-1/2"	7/8"	BR-05	\$14.41
2402	3/8"	1/2"	1-1/2"	7/8"	BR-05	\$15.71
2403	1/2"	1/2"	1-1/2"	7/8"	BR-05	\$16.91
2404	5/8"	1/2"	1-1/2"	15/16"	BR-05	\$20.53
2405	3/4"	1/2"	1-1/2"	1"	BR-05	\$21.93
2406	7/8"	1/2"	1-1/2"	1"	BR-05	\$24.84
2407	1"	1/2"	1-1/2"	1"	BR-05	\$26.09
2408	1-1/8"	1/2"	1-1/2"	1-1/8"	BR-05	\$28.77
2409	1-1/4"	1/2"	1-1/2"	1-1/8"	BR-05	\$29.84
2410	1-1/2"	1/2"	1-1/2"	1-1/8"	BR-05	\$34.08

Flute Cutting, 2-Flute



Good for making single or multiple flute designs on moldings and small diameter spindles.

Comes with a Magnate BR-05 bearing.

Tool No.	Radius	Cutting Depth	Shank Dia.	Shank Length	Cutting Length	Price
6001	1/8"	1/8"	1/4"	1-1/2"	1/4"	\$18.25
6002	3/16"	3/16"	1/4"	1-1/2"	3/8"	\$20.80
6003	1/4"	1/4"	1/4"	1-3/4"	1/2"	\$22.98
6004	5/16"	5/16"	1/4"	1-3/4"	5/8"	\$25.86
6005	3/8"	3/8"	1/4"	1-3/4"	3/4"	\$29.37



MAGNATE™ Carbide Tipped Router Bits

Shallow Flute Extended Shank 2-Flute



Designed for the Legacy Ornamental Milling machines. These bits are for milling fluted columns and spindles up to 8" in diameter. Extended shaft allow for milling on the side of a larger diameter while following a curved profile.

Note : 5" shank length is measured from middle of the knife to the end of the shank.

Tool No.	Flute Height	Shank Dia.	Shank Length	Overall Dia.	Bearing	Price
2451	1/4"	1/2"	5"	13/16"	BR-05	\$34.36
2453	3/8"	1/2"	5"	7/8"	BR-05	\$36.70
2455	1/2"	1/2"	5"	7/8"	BR-05	\$41.45
2456	5/8"	1/2"	5"	15/16"	BR-05	\$46.19
2457	3/4"	1/2"	5"	1"	BR-05	\$51.56
2459	1"	1/2"	5"	1"	BR-05	\$54.89

Bead & Cove, 2-Flute, 1/2" Shank Diameter



Tool No.	Cutting Height	Radius (Bead, Cove)	Overall Dia.	Shank Length	Bearing	Price
4823	1"	3/8", 3/8"	1"	1-1/2"	BR-03	\$27.16
4824	1"	9/64", 5/8"	1"	1-1/2"	BR-03	\$29.79
4828	1-7/16"	3/8", 3/8"	1-1/4"	1-1/2"	BR-03	\$38.29

Bull Nose (Half Round), 2-Flute 1/2" Shank Diameter, 1-1/2" Shank Length



For bead cutting and edge rounding on picture frames, stair threads, window sills, etc.

Tool No.	Bead Diameter	Radius	Overall Dia.	Price
1701	1/4"	1/8"	15/16"	\$14.09
1702	3/8"	3/16"	1-1/16"	\$17.14
1703	1/2"	1/4"	1-3/16"	\$19.67
1704	5/8"	5/16"	1-5/16"	\$22.78
1705	3/4"	3/8"	1-7/16"	\$26.20
1706	7/8"	7/16"	1-9/16"	\$28.72
1707	1"	1/2"	1 11/16"	\$32.85
1711	1-1/8"	9/16"	1-13/16"	\$35.02
1708	1-1/4"	5/8"	1-15/16"	\$38.08
1709	1-1/2"	3/4"	2-3/16"	\$40.23

Bull Nose (Half Round, 2-Flute 1/4" Shank Diameter, 1-1/4" Shank Length



For bead cutting and edge rounding on picture frames, stair threads, window sills, etc.

Tool No.	Bead Diameter	Radius	Overall Dia.	Price
1721	1/4"	1/8"	15/16"	\$13.86
1722	3/8"	3/16"	1-1/16"	\$16.46
1723	1/2"	1/4"	1-3/16"	\$18.95
1724	5/8"	5/16"	1-5/16"	\$21.97
1725	3/4"	3/8"	1-7/16"	\$25.82

Bull Nose (Half Round) With Bearing 1/2" Shank Diameter, 1-1/2" Shank Length 2-Flute



For bead cutting and edge rounding on picture frames, stair threads, window sills, etc.

Tool No.	Bead Diameter	Radius	Overall Dia.	Bearing	Price
5821	1/4"	1/8"	15/16"	BR-05	\$16.47
5822	3/8"	3/16"	1-1/16"	BR-05	\$19.75
5823	1/2"	1/4"	1-3/16"	BR-05	\$21.15
5824	5/8"	5/16"	1-5/16"	BR-05	\$25.27
5825	3/4"	3/8"	1-7/16"	BR-05	\$27.52
5826	7/8"	7/16"	1-9/16"	BR-05	\$30.54
5827	1"	1/2"	1 11/16"	BR-05	\$35.71
5831	1-1/8"	9/16"	1-15/16"	BR-05	\$38.32
5828	1-1/4"	5/8"	1-15/16"	BR-05	\$41.13
5829	1-1/2"	3/4"	2-3/16"	BR-05	\$42.91

Bull Nose (Half Round) With Bearing 1/4" Shank Diameter 2-Flute



For bead cutting and edge rounding on picture frames, stair threads, window sills, etc.

Tool No.	Bead Diameter	Radius	Shank Length	Overall Dia.	Bearing	Price
5811	1/4"	1/8"	1-1/4"	15/16"	BR-05	\$16.17
5812	3/8"	3/16"	1-1/4"	1-1/16"	BR-05	\$19.46
5813	1/2"	1/4"	1-1/4"	1-3/16"	BR-05	\$20.78
5814	5/8"	5/16"	1-1/4"	1-5/16"	BR-05	\$23.12
5815	3/4"	3/8"	1-1/4"	1-7/16"	BR-05	\$27.02

Variable Beading, 2-Flute 1" Cutting Length, 7/8" Overall Diameter



This bit is used to create multiple beads with different radii.

Tool No.	Radius	Shank Dia.	Shank Length	Price
5912	1/16", 7/64", 5/32"	1/4"	1-1/4"	\$23.44
5917	1/16", 7/64", 5/32"	1/2"	1-1/2"	\$23.78

Leaf Edge Beading, 2-Flute



It takes 2 cut passes to create a leaf-shape corner bead profile. The first pass cut is to create a round-edged groove near the corner of the material. The second pass cut is on the adjacent side and it forms the desired leaf shape.

Tool No.	Radius	Cutting Length	Shank Dia.	Shank Length	Overall Dia.	Price
7651*	1/8"	3/8"	1/4"	1-1/2"	7/8"	\$24.71
7652*	3/16"	1/2"	1/4"	1-1/2"	1"	\$27.08
7653*	1/4"	5/8"	1/4"	1-1/2"	1-1/8"	\$28.46
7657^	5/16"	3/4"	1/4"	1-1/2"	1-1/4"	\$29.48
7654*	3/8"	7/8"	1/4"	1-1/2"	1-3/8"	\$32.87
S7651#	1/8"	3/8"	1/2"	1-3/4"	7/8"	\$24.73
S7652#	3/16"	1/2"	1/2"	1-3/4"	1"	\$27.10
S7653#	1/4"	5/8"	1/2"	1-3/4"	1-1/8"	\$28.50
S7657#	5/16"	3/4"	1/2"	1-3/4"	1-1/4"	\$29.66
S7654#	3/8"	7/8"	1/2"	1-3/4"	1-3/8"	\$33.33
S7656#	1/2"	1"	1/2"	1-3/4"	1-3/8"	\$38.13

* Comes with 2 Magnate BR-05 bearings.
^ Comes with 2 Magnate BR-08 bearings.
Comes with a Magnate BR-09 and BR-08 bearings.

Edge Beading, 2-Flute 1/4" Shank Diameter, 1-1/4" Shank Length



Decorative edge forming design.

Tool No.	Bead Diameter	Cutting Length	Radius	Overall Dia.	Bearing	Price
5808	1/8"	7/16"	1/16"	3/4"	BR-03	\$17.09
5809	3/16"	1/2"	3/32"	13/16"	BR-03	\$17.74
5801	1/4"	9/16"	1/8"	7/8"	BR-03	\$18.43
5803	3/8"	11/16"	3/16"	1"	BR-03	\$20.69
5805	1/2"	15/16"	1/4"	1-1/8"	BR-03	\$23.42

MAGNATE™ 20639 Lycoming Street #B-6, Walnut, CA 91789 USA

B-12



email : info@magnate.net Online Shop : www.magnate.net
(TEL) 800-827-2316, 909-468-5747 (FAX) 909-468-5745

Edge Beading, 2-Flute 1/2" Shank Diameter, 1-1/2" Shank Length



Decorative edge forming design.

Tool No.	Bead Dia.	Cutting Length	Radius	Overall Dia.	Bearing	Price
5802	1/4"	9/16"	1/8"	7/8"	BR-03	\$19.10
5804	3/8"	11/16"	3/16"	1"	BR-03	\$21.26
5800	1/2"	15/16"	1/4"	1-1/8"	BR-03	\$23.94
5806	5/8"	1"	5/16"	1-3/8"	BR-03	\$27.81
5807	3/4"	1-1/8"	3/8"	1-1/2"	BR-03	\$30.06

Finger Nail with Center Bearing 1/2" Shank Diameter 2-Flute



These bits are designed for finish jobs on contoured edges such as plywood tops, stair treads, window sills, etc.

Comes with a Magnate BR-35 bearing.

Tool No.	Profile Height	Cutting Depth	Overall Dia.	Radius	Shank Length	Price
5864	1"	3/16"	1"	3/4"	1-1/2"	\$26.68
5865	1-1/4"	3/16"	1"	1"	1-1/2"	\$27.96
5867	1-1/2"	1/4"	1-1/8"	1-1/4"	1-1/2"	\$35.11
5869	1-3/4"	1/4"	1-1/8"	1-1/2"	1-1/2"	\$42.63

Double Bead Point Plunge Set - 3480



Tool No.: 3480

Price: 102.77

This package comes with 3 Double Bead Point Plunge bits - 3481, 3482, 3484 at 15% discounted price.

Finger Nail, 2-Flute

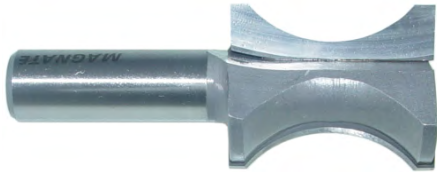

Good for cutting finger nail shaped edgings and for making moldings for table tops and other furniture. Cuts oval an shape. Female counterpart of Shallow Flute router bits - Magnate 2400 series, .

Tool No.	Bead Height	Cutting Depth	Shank Dia.	Overall Dia.	Shank Length	Price
1321	5/16"	1/8"	1/4"	7/8"	1-1/4"	\$15.85
1322	3/8"	1/8"	1/4"	7/8"	1-1/4"	\$17.06
1323	1/2"	1/8"	1/4"	7/8"	1-1/4"	\$17.78
1324	5/8"	5/32"	1/4"	15/16"	1-1/4"	\$18.50
1325	3/4"	3/16"	1/4"	1"	1-1/4"	\$19.53
1301	5/16"	1/8"	1/2"	7/8"	1-1/2"	\$16.20
1302	3/8"	1/8"	1/2"	7/8"	1-1/2"	\$17.31
1303	1/2"	1/8"	1/2"	7/8"	1-1/2"	\$18.17
1304	5/8"	5/32"	1/2"	15/16"	1-1/2"	\$19.60
1305	3/4"	3/16"	1/2"	1"	1-1/2"	\$20.46
1306	7/8"	3/16"	1/2"	1"	1-1/2"	\$20.99
1307	1"	3/16"	1/2"	1"	1-1/2"	\$21.95
1308	1-1/8"	1/4"	1/2"	1-1/8"	1-1/2"	\$24.39
1309	1-1/4"	1/4"	1/2"	1-1/8"	1-1/2"	\$29.61
1310	1-1/2"	1/4"	1/2"	1-1/8"	1-1/2"	\$33.30

Double Bead Flat Plunge, 2-Flute 1/2" Shank Diameter, 2" Shank Length



Tool No.	Small Dia.	Cutting Dia.	Radius	Cutting Height	Price
3495	1/2"	1-1/2"	1/4"	3/4"	\$37.17

Double Bead Point Plunge, 2-Flute

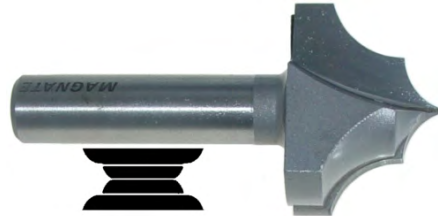

These bits create double bead profiles for decorative edges and bead & cove details. The above illustration depicts a wood column milled by the Legacy Ornamental Milling machines.

Tool No.	Radius	Cutting Dia.	Shank Dia.	Shank Length	Price
3481	5/16"	1"	1/2"	2"	\$34.17
3484	9/16"	1-1/2"	1/2"	2"	\$41.23
3482	5/8"	2"	1/2"	2"	\$50.01

Double-Beading, 2-Flute



Comes with a Magnate BR-05 bearing.

Tool No.	Radius	Cutting Length	Shank Dia.	Shank Length	Overall Dia.	Price
6071	1/8"	13/16"	1/4"	1-1/4"	7/8"	\$24.26
6072	1/8"	13/16"	1/2"	1-1/2"	7/8"	\$24.39

Double Easing, 2-Flute, 1/4" Shank Diameter



Tool No.	Opening	Cutting Depth	Radius	Shank Length	Overall Dia.	Price
5981	25/64"	9/64"	1/8"	1-1/4"	7/8"	\$15.55
5982	33/64"	9/64"	1/8"	1-1/4"	7/8"	\$17.69
5983	49/64"	9/64"	1/8"	1-1/4"	7/8"	\$20.82

Double Easing, 2 Flute, 1/2" Shank Diameter



Tool No.	Opening	Cutting Depth	Radius	Shank Length	Overall Dia.	Price
5985	1-1/64"	9/64"	1/8"	1-1/2"	1-1/32"	\$22.88
5986	1-17/64"	9/64"	1/8"	1-1/2"	1-1/32"	\$25.55
5987	49/64"	9/32"	1/4"	1-1/2"	1-5/16"	\$29.95
5989	1-33/64"	9/32"	1/4"	1-1/2"	1-5/16"	\$32.79

Multi-Bead Forming, 2-Flute



This bit can create unusual mouldings with either a single pass, multiple passes, or an edge beading profile.

Tool No.	Radius	Shank Dia.	Cutting Length	Overall Dia.	Shank Length	Price
5901	5/32"	1/4"	1"	7/8"	1-1/4"	\$23.87
S5901	5/32"	1/2"	1"	7/8"	1-1/2"	\$24.18



MAGNATE™ Carbide Tipped Router Bits

Multi-Beading, 2-Flute



Comes with a Magnate BR-05 bearing.

Tool No.	Radius	Cutting Length	Shank Dia.	Shank Length	Overall Dia.	Price
6031	1/8"	1"	1/4"	1-1/4"	7/8"	\$29.81
6032	1/8"	1"	1/2"	1-1/2"	7/8"	\$30.53

**Reeding Extended Shank, 2-Flute
5" Shank Length**



Designed for the Legacy Ornamental machines..

Note : 5" shank length is measured from middle of the knife to the end of the shank.

Tool No.	Bead Height	Cutting Height	Shank Dia.	Radius	Price
7696	1/4"	1"	1/2"	1/8"	\$39.57
7691	3/8"	1-1/8"	1/2"	3/16"	\$43.23
7692	1/2"	1-1/4"	1/2"	1/4"	\$49.13
7693	3/4"	1-1/2"	1/2"	3/8"	\$55.06
7697	1"	1-3/4"	1/2"	1/2"	\$62.27

Shallow Classic Point, 2-Flute



Multi-Edge Beading, 2-Flute



Comes with 2 Magnate BR-05 bearings.

Tool No.	Radius	Cutting Length	Shank Dia.	Shank Length	Overall Dia.	Price
5851	3/16"	7/8"	1/4"	1-1/4"	15/16"	\$23.82

**Reeding Extended Shank with Bearing
5" Shank Length, 2-Flute**



Designed for the Legacy. These bits are for milling reeding columns and spindles up to 8" in diameter. Extended shaft allow for milling on the side of a larger diameter while following a curved profile.

Designed for the Legacy Ornamental Mill. These bits are similar to our Classic Plunge Cutting bits except that they have a shallow point instead of a round tip. They create decorative bead and cove edge details. The illustration depicts a wood column milled by the Legacy using these bits.

Tool No.	Radius	Cutting Dia.	Shank Dia.	Cutting Height	Shank Length	Price
7566	3/16"	3/4"	1/2"	3/8"	2"	\$31.75
7561	1/4"	1"	1/2"	1/2"	2"	\$36.65
7564	3/8"	1-1/2"	1/2"	3/4"	2"	\$43.80
7562	1/2"	2"	1/2"	1"	2"	\$49.81
7563	3/4"	3"	1/2"	1-1/2"	2"	\$65.49

**Hand Grip Plunge, 2-Flute
1/2" Shank Diameter, 7/8" Opening,**



5876



5879

Tool No.	Cutting Height	Cutting Depth	Cutting Dia.	Shank Length	Radius	Price
5876	1-5/8"	1/4"	1-1/8"	2"	1/2"	\$25.36
5879*	1-5/8"	1/4"	1-1/8"	1-3/4"	1/2"	\$29.45

* Comes with Magnate BR-07 bearing at shank.

Note : 5" shank length is measured from middle of the knife to the end of the shank.

Tool No.	Bead Height	Shank Dia.	Radius	Bearing	Price
7678	3/16"	1/2"	3/32"	BR-05	\$36.55
7676	1/4"	1/2"	1/8"	BR-05	\$39.03
7671	3/8"	1/2"	3/16"	BR-05	\$42.69
7672	1/2"	1/2"	1/4"	BR-05	\$48.72
7675	5/8"	1/2"	5/16"	BR-05	\$51.49
7673	3/4"	1/2"	3/8"	BR-05	\$55.24

**Cove & Bead, 2-Flute
1/2" Shank Diameter, 1-1/2" Shank Length**



Drawing Line, 2-Flute



Good for decorative moldings.

Tool No.	Bead Height	Cutting Height	Shank Dia.	Shank Length	Bearing	Price
1401	1/8"	7/8"	1/2"	1-1/2"	BR-03	\$17.80
1402	3/16"	7/8"	1/2"	1-1/2"	BR-03	\$19.42
1403	1/4"	7/8"	1/2"	1-1/2"	BR-03	\$20.71
1404	5/16"	7/8"	1/2"	1-1/2"	BR-03	\$21.96
1405	3/8"	7/8"	1/2"	1-1/2"	BR-03	\$23.32

Shallow Classic Point Set - 7560



Tool No.: 7560 Price: 122.47

The time-honored French provincial design is good for decorative edge forming, picture frames, windows sills etc.

Tool No.	Radius (Bead, Cove)	Cutting Height	Overall Dia.	Bearing	Price
3602	3/16", 1/4"	5/8"	1-5/16"	BR-03	\$26.85
3608	1/4", 1/4"	11/16"	1-1/2"	BR-03	\$29.81
3604	3/16", 5/16"	3/4"	1-1/2"	BR-03	\$31.64
3609	3/8", 3/8"	1"	2"	BR-03	\$36.61

This package comes with 3 Shallow Classic Point bits - 7561, 7562, 7563 at 15% discounted price.



Cove & Bead, 2-Flute 1/4" Shank Diameter, 1-1/4" Shank Length



The time-honored French provincial design is good for decorative edge forming, picture frames, windows sills etc.

Tool No.	Radius (Bead, Cove)	Cutting Height	Overall Dia.	Bearing	Price
3605	1/8", 1/8"	7/16"	1"	BR-03	\$19.59
3603	5/32", 5/32"	1/2"	1-1/8"	BR-03	\$21.25
3606	3/16", 3/16"	9/16"	1-1/4"	BR-03	\$23.00
3601	3/16", 1/4"	5/8"	1-5/16"	BR-03	\$26.11
3607	1/4", 1/4"	11/16"	1-1/2"	BR-03	\$29.81

Corner Rounding (Round Over), 2-Flute



Designed for decorative edge rounding. Good for making drop leaf table joints.

It comes with a Magnate BR-03 bearing.

By replacing original bearing (Magnate BR-03) by a Magnate BR-02, It creates a round edge with stepped bead.

Tool No.	Radius	Cutting Length	Shank Dia.	Overall Dia.	Shank Length	Price
1220	1/16"	5/16"	1/4"	5/8"	1-1/4"	\$14.64
1200	1/8"	3/8"	1/4"	3/4"	1-1/4"	\$15.90
1231	5/32"	3/8"	1/4"	13/16"	1-1/4"	\$16.42
1201	3/16"	3/8"	1/4"	7/8"	1-1/4"	\$16.96
1202	1/4"	7/16"	1/4"	1"	1-1/4"	\$17.28
1203	5/16"	1/2"	1/4"	1-1/8"	1-1/4"	\$18.80
1204	3/8"	5/8"	1/4"	1-1/4"	1-1/4"	\$19.71
1234	7/16"	5/8"	1/4"	1-3/8"	1-1/4"	\$21.62
1205	1/2"	3/4"	1/4"	1-1/2"	1-1/4"	\$22.24
1240	1/16"	5/16"	1/2"	5/8"	1-1/2"	\$15.80
1242	1/8"	3/8"	1/2"	3/4"	1-1/2"	\$16.28
1236	5/32"	3/8"	1/2"	13/16"	1-1/2"	\$17.02
1206	3/16"	3/8"	1/2"	7/8"	1-1/2"	\$17.45
1207	1/4"	7/16"	1/2"	1"	1-1/2"	\$18.15
1208	5/16"	1/2"	1/2"	1-1/8"	1-1/2"	\$20.93
1209	3/8"	5/8"	1/2"	1-1/4"	1-1/2"	\$22.10
1239	7/16"	11/16"	1/2"	1-3/8"	1-1/2"	\$23.43
1210	1/2"	3/4"	1/2"	1-1/2"	1-1/2"	\$24.94
1244	9/16"	13/16"	1/2"	1-5/8"	1-1/2"	\$27.07
1211	5/8"	7/8"	1/2"	1-3/4"	1-1/2"	\$29.17
1212	3/4"	1"	1/2"	2"	1-1/2"	\$34.56
1246	7/8"	1-1/8"	1/2"	2-1/4"	1-1/2"	\$37.42
1213	1"	1-1/4"	1/2"	2-1/2"	1-1/2"	\$39.63
1214	1-1/8"	1-3/8"	1/2"	2-3/4"	1-1/2"	\$42.94
1215	1-1/4"	1-1/2"	1/2"	3"	1-1/2"	\$46.07
1249	1-3/8"	1-5/8"	1/2"	3-1/4"	1-1/2"	\$51.77
1216	1-1/2"	1-3/4"	1/2"	3-1/2"	1-1/2"	\$59.33

Plunge Roundover, 2-Flute



Combination cutters for plunging through boards and for rounding corners as well as edge forming.

Tool No.	Radius	Small Shank Dia.	Shank Dia.	Cutting Length	Shank Length	Price
3910	1/8"	1/8"	1/4"	1/4"	1-1/4"	\$13.93
3911	3/16"	1/4"	1/4"	5/16"	1-1/4"	\$15.76
3912	1/4"	1/4"	1/4"	3/8"	1-1/4"	\$17.56
3913	5/16"	1/4"	1/4"	7/16"	1-1/4"	\$20.04
3914	3/8"	1/4"	1/4"	1/2"	1-1/4"	\$23.54
3915	1/2"	3/8"	1/4"	3/4"	1-1/4"	\$27.68
3916	1/2"	1/2"	1/4"	7/8"	1-1/4"	\$28.59
3917	3/16"	1/4"	1/2"	3/8"	1-1/2"	\$16.21
3918	1/4"	1/4"	1/2"	3/8"	1-1/2"	\$19.43
3919	5/16"	1/4"	1/2"	7/16"	1-1/2"	\$21.90
3920	3/8"	1/4"	1/2"	1/2"	1-1/2"	\$24.41
3921	1/2"	3/8"	1/2"	3/4"	1-1/2"	\$27.91
3924	9/16"	1/2"	1/2"	15/16"	1-1/2"	\$30.46
3922	5/8"	1/2"	1/2"	1"	1-1/2"	\$34.38
3923	3/4"	1/2"	1/2"	1-1/8"	1-1/2"	\$39.47
3927	1"	1/2"	1/2"	1-3/8"	1-1/2"	\$46.00

Deep Classic Point, 2-Flute



Designed for the Legacy Ornamental Mill..These bits are similar to our Classic Plunge Cutting bits except that they have a deep point instead of a round tip. They create decorative bead and cove edge details. The illustration depicts a wood column milled by the Legacy using these bits.

Tool No.	Radius	Cutting Dia.	Shank Dia.	Cutting Height	Shank Length	Price
7536	3/16"	3/4"	1/2"	5/8"	2"	\$32.14
7531	1/4"	1"	1/2"	3/4"	2"	\$41.42
7534	3/8"	1-1/2"	1/2"	1"	2"	\$47.78
7532	1/2"	2"	1/2"	1-3/8"	2"	\$53.59
7533	3/4"	3"	1/2"	2"	2"	\$71.98

Deep Classic Point Set - 7530



Tool No.: 7530

Price: 134.60

This package comes with 3 Deep Classic Point bits - 7531, 7532, 7533 at 15% discounted price.

Double Round Over Molding, 2-Flute 1/2" Shank Diameter, 1-1/2" Shank Length



Tool No.	Radius	Bead Height	Cutting Length	Overall Dia.	Bearing	Price
1364	3/16"	1"	1-1/4"	1-5/8"	BR-05	\$34.83



MAGNATE™ Carbide Tipped Router Bits

Matching Corner Round/Cove, 2-Flute



This bit is used to create both corner round and cove profiles which match each other. To create either profile, simply shift the bit to corresponding profile knife.

Comes with 2 Magnate BR-05 bearings.

Tool No.	Radius	Shank Dia.	Cutting Length	Overall Dia.	Shank Length	Price
1287	1/4"	1/4"	17/32"	1-1/8"	1-1/2"	\$25.62
1288	5/16"	1/4"	21/32"	1-1/4"	1-1/2"	\$29.21
1289	3/8"	1/4"	25/32"	1-3/8"	1-1/2"	\$34.20

Point Cutting Roundover, 2-Flute



These bits can be used with the Legacy Ornamental Mill to create indexed beads and reeds on flat or spindle stock.

Tool No.	Radius	Shank Dia.	Cutting Length	Shank Length	Price
7508	1/16"	1/4"	1/4"	1-1/4"	\$12.34
7507	1/8"	1/4"	3/8"	1-1/4"	\$13.71
7504	3/16"	1/4"	7/16"	1-1/4"	\$15.16
7503	1/4"	1/4"	1/2"	1-1/4"	\$17.35
7509	5/16"	1/4"	9/16"	1-1/4"	\$20.25
7506	3/8"	1/4"	5/8"	1-1/4"	\$22.24
7505	1/2"	1/4"	3/4"	1-1/4"	\$24.23
7513	5/16"	1/2"	9/16"	2"	\$20.58
7502	3/8"	1/2"	5/8"	2"	\$23.03
7514	7/16"	1/2"	11/16"	2"	\$24.70
7501	1/2"	1/2"	3/4"	2"	\$26.40
7515	9/16"	1/2"	13/16"	2"	\$29.61
7516	5/8"	1/2"	7/8"	2"	\$32.18
7517	3/4"	1/2"	1"	2"	\$36.33

* Left Hand Rotation

Roundover Undermount Bowl, 2-Flute 1/2" Shank Diameter, 1-1/2" Shank Length



Designed for the Legacy Ornamental Mill. Great for milling 2" and 3" diameter balls on posts or large beads on column bases. Can also be used for large diameter rope columns with a very pronounced rope design.

Tool No.	Cutting Dia.	Radius	Price
7592	2"	1" + 1/16"	\$44.29
7593	3"	1-1/2" + 1/8"	\$65.68

Tool No.	Degree	Cutting Height	Radius	Overall Dia.	Bearing	Price
3971	10	1-1/4"	7/16"	2-1/4"	BR-57	\$41.50
3976	18	1"	1/2"	2-1/8"	BR-74	\$43.88
3978	18	1-1/4"	9/16"	2-1/4"	BR-74	\$47.10

Shear Under Roundover, 2-Flute 1/2" Shank Diameter

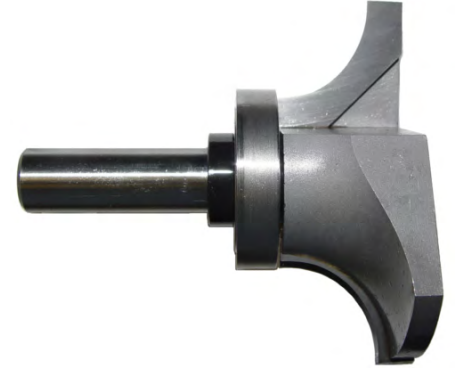

Without turning over the heavy material, these bits create a round edge under the solid surface countertop.

Tool No.	Radius	Cutting Length	Shank Length	Overall Dia.	Bearing	Price
1294	3/8"	5/8"	1-3/4"	2-1/8"	BR-27	\$29.66
1295	1/2"	3/4"	1-3/4"	2-3/8"	BR-27	\$33.94
1298	5/8"	7/8"	1-3/4"	2-5/8"	BR-27	\$42.43
1296	3/4"	1"	1-3/4"	2-7/8"	BR-27	\$49.48

Double Round Over, 2-Flute 1/2" Shank Diameter, 1-1/2" Shank Length



This unique bit enables you to round over the top and bottom corners of wood stock in one pass.

Tool No.	Material Thickness	Radius	Cutting Length	Overall Dia.	Bearing	Price
7701	3/4"	3/16"	1-1/8"	1-1/4"	BR-06	\$38.47
7702	7/8"	1/4"	1-1/4"	1-5/8"	BR-07	\$44.48
7703	1-1/8"	3/8"	1-1/2"	1-7/8"	BR-07	\$49.23
7704	1-3/8"	1/2"	1-3/4"	2-1/8"	BR-07	\$57.62



MAGNATE™ Carbide Tipped Router Bits

Adjustable Double Round Over 1/2" Shank Diameter, 2-Flute



These cutters allow you to round or bead. Both profile cutters are interchangeable. Each bit includes 2 profile cutters, 1 bearing, 1 1/2"-shank arbor and 1 nut and shims.

Tool No.	Radius	Cutting Length	Overall Dia.	Shank Length	Bearing	Price
7731	1/8"	1-5/8"	1"	1-1/2"	BR-32	\$39.01
7732	3/16"	1-5/8"	1-1/8"	1-1/2"	BR-32	\$42.66
7733	1/4"	1-5/8"	1-1/4"	1-1/2"	BR-32	\$46.20
7734	3/8"	1-5/8"	1-1/2"	1-1/2"	BR-32	\$49.90

Classic Double Round Over 2-Flute with a Magnate BR-03 Bearing

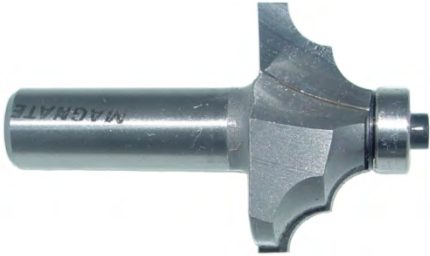

Tool No.	R.	Cutting Length	Shank Dia.	Shank Length	Overall Dia.	Price
3451	5/32"	1/2"	1/4"	1-1/4"	1-1/8"	\$24.37
3452	7/32"	5/8"	1/4"	1-1/4"	1-3/8"	\$26.32
3453	1/4"	11/16"	1/4"	1-1/4"	1-1/2"	\$29.25
3456	5/32"	1/2"	1/2"	1-1/2"	1-1/8"	\$25.19
3457	7/32"	5/8"	1/2"	1-1/2"	1-3/8"	\$27.72
3458	1/4"	11/16"	1/2"	1-1/2"	1-1/2"	\$30.17
3459	3/8"	7/8"	1/2"	1-1/2"	1-1/2"	\$32.82

Classic Triple Round Over, 2-Flute



Comes with a Magnate BR-03 bearing.

Tool No.	Radius	Shank Dia.	Cutting Length	Overall Dia.	Shank Length	Price
3471	3/16"	1/2"	3/4"	1-3/4"	1-1/2"	\$31.39

Classic Astragal, 2-Flute 1/2" Shank Diameter, 1-1/2" Shank Length



Tool No.	Cutting Length	Radius	Overall Dia.	Bearing	Price
1342	1"	1/8" + 1/4"	1-1/8"	BR-05	\$34.09
1343	1-3/16"	5/32" + 5/16"	1-1/4"	BR-05	\$37.07
1344	1-1/2"	3/16" + 1/2"	1-3/8"	BR-05	\$43.69

Roman Ogee, 2-Flute



Distinctive design used for decorative moldings. The two radii are precision ground to match perfectly. Complete with totally enclosed ball bearing guide.

Tool No.	Cutting Height	Shank Dia.	Radius	Overall Dia.	Shank Length	Price
1601*	15/32"	1/4"	5/32"	1-1/16"	1-1/4"	\$19.62
1605*	5/8"	1/4"	3/16"	1-1/8"	1-1/4"	\$27.17
1602*	21/32"	1/4"	1/4"	1-3/8"	1-1/4"	\$28.19
1603*	15/32"	1/2"	5/32"	1-1/16"	1-1/2"	\$20.21
1606*	5/8"	1/2"	3/16"	1-1/8"	1-1/2"	\$27.73
1604*	21/32"	1/2"	1/4"	1-3/8"	1-1/2"	\$29.13
1608^	1"	1/2"	3/8"	2"	2"	\$34.13
1609^	1-1/4"	1/2"	1/2"	2-1/2"	2"	\$37.75

* Comes with a Magnate BR-02 bearing
^ Comes with a Magnate BR-03 bearing

Ogee with Fillet, 2-Flute



This bit can make a graceful ogee style cut with a standard edge profile.

Comes with a Magnate BR-03 bearing.

Tool No.	Cutting Height	Shank Dia.	Overall Length	Radius	Overall Dia.	Price
3701	9/16"	1/4"	2 1/4"	3/16"	1-3/8"	\$23.11
3702	9/16"	1/2"	2-1/2"	3/16"	1-3/8"	\$23.43
3703	11/16"	1/2"	2-11/16"	1/4"	1-5/8"	\$27.86

Ogee, 2-Flute, 1/4" Shank Diameter 1-1/4" Shank Length



This edge forming bit creates a decorative edge of a S-shaped curve to projects like shelving and furniture moldings.

Tool No.	Cutting Height	Radius (Bead, Cove)	Overall Dia.	Bearing	Price
3724	1/2"	5/32", 5/32"	1-1/8"	BR-03	\$18.48
3725	5/8"	3/16", 1/4"	1-3/8"	BR-03	\$25.30
3721	5/8"	3/16", 3/16"	1-1/4"	BR-03	\$22.15
3723	7/8"	9/32", 9/32"	1-5/8"	BR-03	\$29.88

Ogee, 2-Flute, 1/2" Shank Diameter 1-1/2" Shank Length

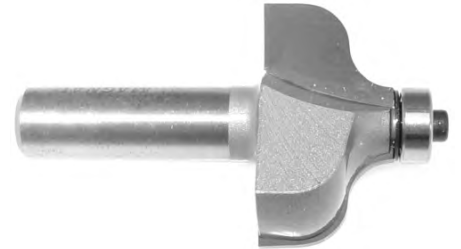

This edge forming bit creates a decorative edge of a S-shaped curve to projects like shelving and furniture moldings.

Tool No.	Cutting Height	Radius (Bead, Cove)	Overall Dia.	Bearing	Price
3726	1/2"	5/32", 5/32"	1-1/8"	BR-03	\$18.51
3728	5/8"	3/16", 1/4"	1-3/8"	BR-03	\$25.40
3727	7/8"	9/32", 9/32"	1-5/8"	BR-03	\$30.35

Ogee No-Drip, 2-Flute



Cuts a No-Drip Edge on a countertop.

Tool No.	Cutting Dia.	Cutting Height	Shank Dia.	Shank Length	Price
4652	1"	1/2"	1/4"	1-1/4"	\$24.04
4657	1"	1/2"	1/2"	1-1/2"	\$24.26



MAGNATE™ Carbide Tipped Router Bits

Plunge Ogee, 1/4" Shank Diameter 2-Flute



Tool No.	Cutting Dia.	Small Dia.	Height	Radius	Shank Length	Price
3740	3/8"	1/8"	5/16"	1/16"	1-1/4"	\$13.48
3744	1/2"	5/32"	3/8"	5/64"	1-1/4"	\$15.28
3741	3/4"	1/4"	7/16"	1/8"	1-1/4"	\$17.17
3742	1"	3/8"	9/16"	3/16"	1-1/4"	\$19.79
3743	1-1/4"	1/2"	5/8"	3/16"	1-1/4"	\$24.41

Plunge Ogee, 1/2" Shank Diameter 2-Flute



Tool No.	Cutting Dia.	Small Dia.	Height	Radius	Shank Length	Price
3745	3/4"	1/4"	7/16"	1/8"	1-1/2"	\$17.59
3746	1"	3/8"	9/16"	3/16"	1-1/2"	\$21.89
3747	1-3/16"	1/2"	5/8"	1/4"	1-1/2"	\$25.34
3748	1-1/2"	1/2"	3/4"	1/4"	1-1/2"	\$31.91

Plunge Roman Ogee, 2-Flute 1/4" Shank Diameter, 1-1/4" Shank Length

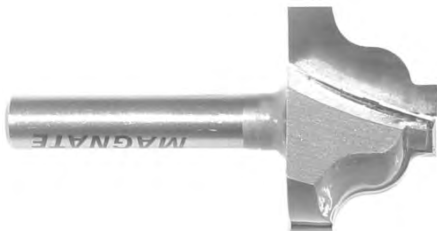

Tool No.	Cutting Dia.	Small Dia.	Cutting Height	Radius	Price
1621	13/16"	9/32"	1/2"	1/8"	\$15.90
1625	1"	9/32"	21/32"	5/32"	\$20.70

Classical Ogee Plunge, 2-Flute



This bit is designed for the Legacy to create the classic ogee shape in a plunge style cut.

Tool No.	Cutting Dia.	Cutting Height	Shank Dia.	Radius	Shank Length	Price
3674	2"	3/4"	1/2"	1/4"	2"	\$47.62

Wavy Edge, 2-Flute



Unique design with soft, rounded corners.

Comes with a Magnate BR-03 bearing.

Tool No.	Cutting Height	Shank Dia.	Overall Length	Radius	Overall Dia.	Price
3904	9/16"	1/4"	2-1/8"	1/8"	1-1/8"	\$22.81
3901	11/16"	1/4"	2-3/16"	3/16"	1-1/4"	\$25.62
3902	11/16"	1/2"	2-1/2"	3/16"	1-1/4"	\$26.37
3906	7/8"	1/2"	2-3/4"	1/4"	1-3/4"	\$32.09

Window Sash, 1/8" Radius 2-Flute

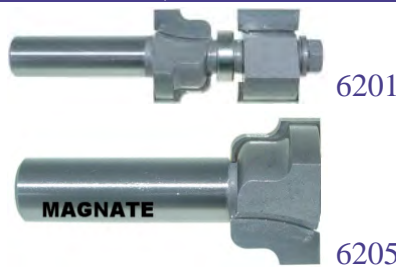

To create a complete stile and rail ogee window sash profiles for 1-1/8" to 1-5/8" sash stock requires both of Magnate bits 6201 and 6205.

Tool No.	Cutting Height	Shank Dia.	Overall Length	Overall Dia.	Price
6201*	1-3/4"	1/2"	3-3/4"	1-3/8"	\$54.62
6205	5/8"	1/2"	2-5/8"	1-3/8"	\$22.43

* Reversible, comes with a BR-06 bearing

No-Drip Edge, 2-Flute 1/2" Shank Diameter, 1" Overall Diameter



No-Drip Edge bits cut a slightly raised edge on a countertop.

Tool No.	Radius	Cutting Height	Shank Length	Bearing	Price
4621	3/8" + 1/4"	7/8"	1-1/2"	BR-58	\$24.22
4622	3/8" + 1/4"	1-1/8"	1-1/2"	BR-58	\$27.85

Classic Combination, 2-Flute 1/2" Shank Diameter



Tool No.	Cutting Length	Overall Dia.	Radius	Shank Length	Price
5701	1-3/16"	2"	3/16"	1-1/2"	\$47.62

Classic Cove, 2-Flute

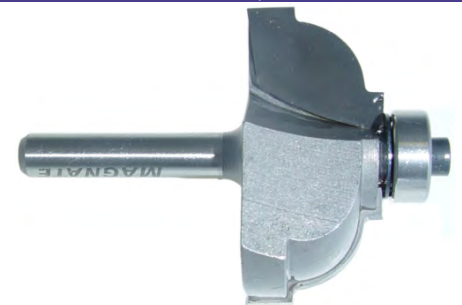

Cove design with a small fillet on top & bottom for decorative edge forming and molding.

Comes with a Magnate BR-03 bearing..

Tool No.	Radius	Shank Dia.	Cutting Length	Overall Dia.	Shank Length	Price
4701	5/32"	1/4"	1/2"	1-1/8"	1-1/4"	\$20.76
4702	1/4"	1/4"	5/8"	1-3/8"	1-1/4"	\$25.33
4703	5/16"	1/4"	11/16"	1-1/2"	1-1/4"	\$26.35
4704	3/8"	1/4"	3/4"	1-5/8"	1-1/4"	\$28.91
\$4701	5/32"	1/2"	1/2"	1-1/8"	1-1/2"	\$21.45
\$4702	1/4"	1/2"	5/8"	1-3/8"	1-1/2"	\$26.00
\$4703	5/16"	1/2"	11/16"	1-1/2"	1-1/2"	\$26.80
\$4704	3/8"	1/2"	3/4"	1-5/8"	1-1/2"	\$29.55
\$4705	1/2"	1/2"	7/8"	1-3/4"	1-1/2"	\$33.63



MAGNATE™ Carbide Tipped Router Bits

Classic Plunge Cutting, 2-Flute



For decorative edge grooving on cabinet faces and for picture and mirror frames.

Tool No.	Radius	Cutting Dia.	Shank Dia.	Cutting Height	Shank Length	Price
3931	3/32"	1/2"	1/4"	3/8"	1-1/4"	\$18.17
3932	5/32"	3/4"	1/4"	1/2"	1-1/4"	\$21.05
3933	5/32"	3/4"	1/2"	1/2"	1-1/2"	\$21.65
3934	15/64"	1"	1/2"	5/8"	1-1/2"	\$27.23
3935	3/8"	1-1/2"	1/2"	3/4"	1-1/2"	\$33.44

Triple Classic Plunge, 2-Flute



Designed for the Legacy Ornamental Mill. Use the profile of the classic plunge cutting bit 3 times for creating decorative edges, bead, and cove details.

Tool No.	Cutting Dia.	Cutting Height	Shank Dia.	Radius	Shank Length	Price
3982	2"	7/8"	1/2"	3/16"	2"	\$50.40
3983	3"	1-5/8"	1/2"	5/16"	2"	\$69.89

Cove, 2-Flute

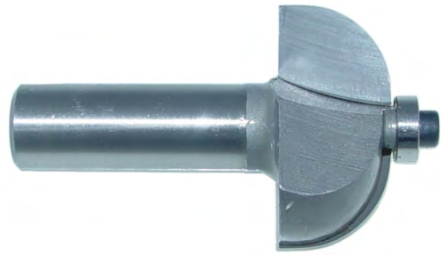

Good for decorative edge forming on doors and furniture. Can also be used to make drop leaf tables when used in conjunction with a round over bit with an equivalent radius.

Tool No.	Radius	Shank Dia.	Cutting Length	Overall Dia.	Shank Length	Price
1022*	1/8"	1/4"	3/8"	5/8"	1-1/4"	\$12.35
1023*	3/16"	1/4"	3/8"	3/4"	1-1/4"	\$13.85
1001*	1/4"	1/4"	3/8"	7/8"	1-1/4"	\$15.73
1021*	5/16"	1/4"	1/2"	1"	1-1/4"	\$18.50
1002*	3/8"	1/4"	1/2"	1-1/8"	1-1/4"	\$19.72
1003*	1/2"	1/4"	5/8"	1-3/8"	1-1/4"	\$21.66
1004*	1/4"	1/2"	3/8"	7/8"	1-1/2"	\$16.52
1005*	3/8"	1/2"	1/2"	1-1/8"	1-1/2"	\$20.36
1006*	1/2"	1/2"	5/8"	1-3/8"	1-1/2"	\$23.55
1007*	5/8"	1/2"	3/4"	1-5/8"	1-1/2"	\$28.56
1008^	3/4"	1/2"	7/8"	2"	1-1/2"	\$35.02
1024^	7/8"	1/2"	1"	2-1/4"	1-1/2"	\$40.35
1009^	1"	1/2"	1-1/8"	2-1/2"	1-1/2"	\$46.10

* Comes with a Magnate BR-02 bearing.
^ Comes with a Magnate BR-03 bearing.

Classic, 2-Flute



Traditional design for edge forming. It adds a touch of class to cabinets, architectural moldings, and picture frames.

Tool No.	Radius	Cutting Length	Shank Dia.	Shank Length	Overall Dia.	Price
3401^	5/32"	1/2"	1/4"	1-1/4"	1-1/4"	\$27.10
3403^	7/32"	5/8"	1/4"	1-1/4"	1-1/2"	\$29.45
3405*	1/4"	3/4"	1/4"	1-1/4"	1-1/2"	\$30.86
3402^	5/32"	1/2"	1/2"	1-1/2"	1-1/4"	\$27.74
3404^	7/32"	5/8"	1/2"	1-1/2"	1-1/2"	\$30.11
3406*	1/4"	3/4"	1/2"	1-1/2"	1-1/2"	\$31.39

* Comes with a Magnate BR-02 bearing.
^ Comes with a Magnate BR-03 bearing.

Classic Multi-Form, 2-Flute



Over 40 different profiles can be made with 2 or more passes of this multi-purpose cutter.

Tool No.	Cutting Length	Cutting Depth	Shank Dia.	Radius	Shank Length	Price
5603*	1-1/16"	1/2"	1/4"	1/8"	1-1/4"	\$36.52
5602^#	1-7/8"	13/16"	1/2"	15/64"	1-1/2"	\$54.02
5601^#	2-1/4"	1"	1/2"	5/16"	1-1/2"	\$63.22

* Comes with a Magnate BR-02 bearing.
^ Comes with a Magnate BR-03 bearing
Make use of your router table

Special Cove, 2-Flute



Comes with a Magnate BR-03 bearing.

Classic with Step Edges, 2-Flute



A 1/16" x 1/16" step edge is added to traditional design for edge forming. It adds a touch of class to cabinets, architectural moldings, and picture frames.

Comes with a Magnate BR-02 bearing.

Tool No.	Radius	Cutting Length	Shank Dia.	Shank Length	Overall Dia.	Price
3416	1/4"	13/16"	1/2"	1-1/2"	1-5/8"	\$33.30

Ball End, Extended Shank 4" Shank Length, 2-Flute



Designed for the Legacy Ornamental Milling machines. Used to mill spiral or index flutes on contoured spindles i.e. pineapple pattern on a finial.

Note : Shank length is measured from middle of the knife to the end of the shank.

Tool No.	Cutting Dia.	Small Dia.	Shank Dia.	Radius	Price
2553	1/2"	1/4"	1/2"	1/4"	\$31.76
2554	5/8"	5/16"	1/2"	5/16"	\$36.36
2556	3/4"	3/8"	1/2"	3/8"	\$43.42

Tool No.	Radius	Shank Dia.	Cutting Length	Overall Dia.	Shank Length	Price
4761	3/16"	1/4"	1/2"	1-1/8"	1-1/2"	\$21.97
4763	5/16"	1/4"	5/8"	1-3/8"	1-1/2"	\$25.66
4766	3/16"	1/2"	1/2"	1-1/8"	1-3/4"	\$23.22
4768	5/16"	1/2"	5/8"	1-3/8"	1-3/4"	\$27.14



Core Box, 2 Flute



For use in decorative fluting and sign making. Up shear cutting angle clears chips out fast for accurate and chatter free performance. Can be used with the Legacy Ornamental Mill[®] to cut indexed flutes and coves on spindle stock or parallel flutes on flat stock.

817 is designed for Nevada style gaming table chip trays.

Tool No.	Cutting Dia.	Shank Dia.	Cutting Length	Radius	Shank Length	Price
800	1/8"	1/4"	1/8"	1/16"	1-1/4"	\$9.44
801	1/4"	1/4"	1/4"	1/8"	1-1/4"	\$10.77
811	5/16"	1/4"	5/16"	5/32"	1-1/4"	\$11.50
802	3/8"	1/4"	3/8"	3/16"	1-1/4"	\$12.09
803	1/2"	1/4"	3/8"	1/4"	1-1/4"	\$14.36
804	5/8"	1/4"	5/8"	5/16"	1-1/4"	\$17.17
805	3/4"	1/2"	5/8"	3/8"	1-1/2"	\$18.85
806	7/8"	1/2"	3/4"	7/16"	1-1/2"	\$20.96
807	1"	1/2"	3/4"	1/2"	2"	\$23.30
812	1-1/8"	1/2"	13/16"	9/16"	2"	\$24.66
809	1-1/4"	1/2"	7/8"	5/8"	2"	\$27.25
814	1-3/8"	1/2"	15/16"	11/16"	2"	\$27.98
810	1-1/2"	1/2"	1"	3/4"	2"	\$32.25
817*	1-9/16"	1/2"	1-1/32"	25/32"	2"	\$34.57
819	1-3/4"	1/2"	1-1/8"	7/8"	2"	\$36.69
808	2"	1/2"	1-1/4"	1"	2"	\$42.48
818	2-1/4"	1/2"	1-3/8"	1-1/8"	2"	\$45.27

* for Nevada style gaming table chip trays

Extra Deep Core Box, 1/2" Shank Diameter



Tool No.	Cutting Dia.	Cutting Length	Radius	Shank Length	Price
1508	3/8"	1"	3/16"	1-1/2"	\$19.46
1509	1/2"	1"	1/4"	1-1/2"	\$20.30
1510	5/8"	1"	5/16"	1-1/2"	\$21.52
1520	5/8"	1-1/4"	5/16"	1-1/2"	\$23.71
1511	3/4"	1-1/4"	3/8"	1-1/2"	\$25.67
1521	3/4"	1-1/2"	3/8"	1-1/2"	\$27.09
1519	7/8"	1-1/4"	7/16"	1-1/2"	\$28.46
1512	1"	1-1/4"	1/2"	1-1/2"	\$29.72
1522	1"	1-3/4"	1/2"	1-1/2"	\$33.99
1513	1-1/4"	1-1/4"	5/8"	1-1/2"	\$31.41
1514	1-1/2"	1-1/2"	3/4"	1-1/2"	\$37.28
1515	2"	1-3/4"	1"	1-1/2"	\$46.65

Extra Deep Core Box, 1/4" Shank Diameter



Tool No.	Cutting Dia.	Cutting Length	Radius	Shank Length	Flute	Price
1501	1/8"	5/16"	1/16"	1-1/4"	1	\$9.26
1502	3/16"	5/16"	3/32"	1-1/4"	1	\$11.18
1503	1/4"	3/8"	1/8"	1-1/4"	2	\$12.67
1525	5/16"	3/8"	5/32"	1-1/4"	2	\$13.38
1504	3/8"	1/2"	3/16"	1-1/4"	2	\$13.88
1505	1/2"	5/8"	1/4"	1-1/4"	2	\$15.16
1506	5/8"	3/4"	5/16"	1-1/4"	2	\$17.41
1507	3/4"	3/4"	3/8"	1-1/2"	2	\$19.73

Plunge Ball End, 2-Flute



This bit creates a rounded inside edge on a slot that makes drawer opening easy.

Tool No.	Cutting Dia.	Cutting Length	Shank Dia.	Radius	Shank Length	Price
2521	3/8"	3/8"	1/4"	3/16"	1-1/4"	\$15.49
2522	1/2"	1/2"	1/4"	1/4"	1-1/4"	\$16.84
2523	5/8"	5/8"	1/4"	5/16"	1-1/4"	\$19.39
2501	3/8"	3/8"	1/2"	3/16"	1-1/2"	\$16.01
2502	1/2"	1/2"	1/2"	1/4"	1-1/2"	\$17.37
2503	5/8"	5/8"	1/2"	5/16"	1-1/2"	\$20.36
2504	3/4"	3/4"	1/2"	3/8"	1-1/2"	\$23.58
2505	7/8"	7/8"	1/2"	7/16"	1-1/2"	\$26.80
2506	1"	1"	1/2"	1/2"	1-1/2"	\$29.58
2507	1-1/8"	1-1/8"	1/2"	9/16"	1-1/2"	\$32.14
2508	1-1/4"	1-1/4"	1/2"	5/8"	1-1/2"	\$34.98
2509	1-1/2"	1-1/2"	1/2"	3/4"	1-1/2"	\$39.92

Raised Panel, 5 Degree Face-Cut 2-Flute Horizontal



Comes with a Magnate BR-03 bearing.

Tool No.	Reveal	Overall Dia.	Shank Dia.	Radius	Shank Length	Price
3823	3/4"	2"	1/4"	3/32"	1-1/4"	\$31.08
3803	1-1/16"	2-5/8"	1/2"	1/8"	1-1/2"	\$36.70
3843	1-1/4"	3"	1/2"	1/8"	1-1/2"	\$46.38
3803B	1-1/2"	3-1/2"	1/2"	1/8"	1-1/2"	\$56.84

Raised Panel, 5 Degree Face-Cut with Under Cutter, 2-Flute Horizontal 1/2" Shank Diameter, 1-1/2" Shank Length

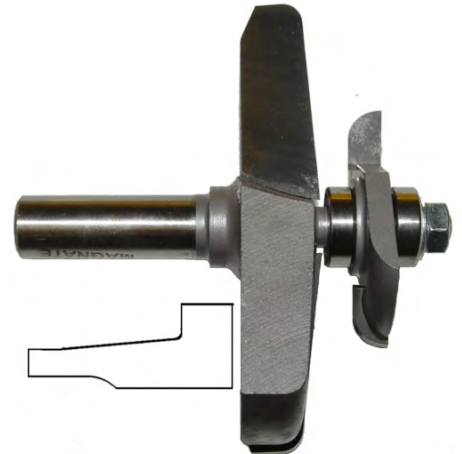

Designed for 3/4" or 7/8" wood, leaves a 1/4" tongue.

Tool No.	Reveal	Overall Dia.	Radius	Bearing	Price
3863	15/16"	2-5/8"	3/32"	BR-40	\$49.94
3803C	1-3/8"	3-1/2"	1/8"	BR-05	\$68.23



MAGNATE™ Carbide Tipped Router Bits

Raised Panel, 12 Degree Face-Cut With Quarter Round, 2-Flute Horizontal

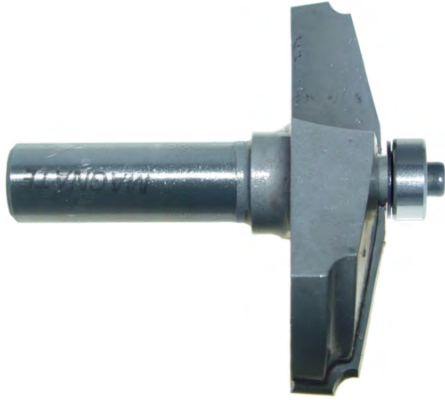

Comes with a Magnate BR-03 bearing.

Tool No.	Reveal	Overall Dia.	Shank Dia.	Radius	Shank Length	Price
3826	3/4"	2"	1/4"	3/32"	1-1/4"	\$31.76
3806	1-1/16"	2-5/8"	1/2"	1/8"	1-1/2"	\$37.32
3846	1-1/4"	3"	1/2"	5/32"	1-1/2"	\$47.10
3806B	1-1/2"	3-1/2"	1/2"	5/32"	1-1/2"	\$56.61

Raised Panel, 15 Degree Face Cut 2-Flute Horizontal



Comes with a Magnate BR-03 bearing.

Tool No.	Reveal	Overall Dia.	Shank Dia.	Shank Length	Price
3824	3/4"	2"	1/4"	1-1/4"	\$31.22
3804	1-1/16"	2-5/8"	1/2"	1-1/2"	\$36.82
3844	1-1/4"	3"	1/2"	1-1/2"	\$46.53
3804B	1-1/2"	3-1/2"	1/2"	1-1/2"	\$57.02

Raised Panel, 18 Degree Face-Cut 2-Flute Horizontal



Comes with a Magnate BR-03 bearing.

Tool No.	Reveal	Overall Dia.	Shank Dia.	Radius	Shank Length	Price
3829	3/4"	2"	1/4"	3/32"	1-1/4"	\$31.36
3809	1-1/16"	2-5/8"	1/2"	1/8"	1-1/2"	\$36.95
3849	1-1/4"	3"	1/2"	1/8"	1-1/2"	\$46.66
3809B	1-1/2"	3-1/2"	1/2"	1/8"	1-1/2"	\$57.12

Raised Panel, 12 Degree Face-Cut With Quarter Round with Under Cutter, 2-Flute Horizontal 1/2" Shank Diameter, 1-1/2" Shank Length

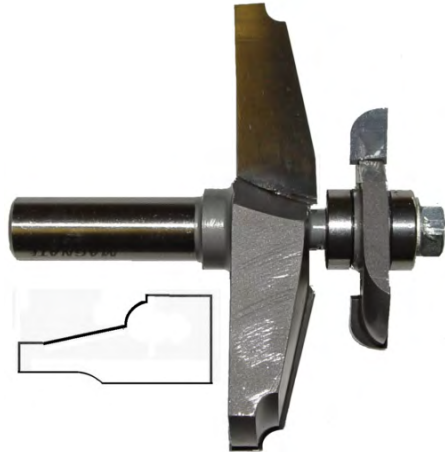

Designed for 3/4" or 7/8" wood, leaves a 1/4" tongue.

Tool No.	Reveal	Overall Dia.	Radius	Bearing	Price
3866	15/16"	2-5/8"	1/8"	BR-40	\$50.79
3806C	1-3/8"	3-1/2"	5/32"	BR-05	\$69.15

Raised Panel, 15 Degree Face-Cut with Under Cutter, 2-Flute Horizontal 1/2" Shank Diameter, 1-1/2" Shank Length

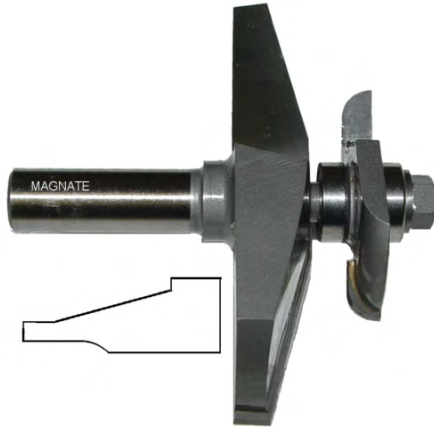

Designed for 3/4" or 7/8" wood, leaves a 1/4" tongue.

Tool No.	Reveal	Overall Dia.	Bearing	Price
3864	15/16"	2-5/8"	BR-40	\$50.16
3804C	1-3/8"	3-1/2"	BR-05	\$68.43

Raised Panel, 18 Degree Face-Cut with Under Cutter, 2-Flute Horizontal

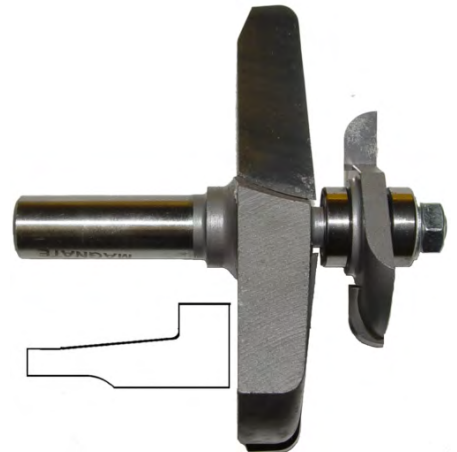

Designed for 3/4" or 7/8" wood, leaves a 1/4" tongue.

Tool No.	Reveal	Overall Dia.	Shank Dia.	Radius	Shank Length	Price
3869	1"	2-5/8"	1/2"	1/8"	1-1/2"	\$50.38
3809C	1-3/8"	3-1/2"	1/2"	1/8"	1-1/2"	\$68.63



Raised Panel, 25 Degree Face Cut 2-Flute Horizontal



3802



3801



3892



3894

Tool No.	Reveal	Overall Dia.	Shank Dia.	Shank Length	Bearing	Price
3802	9/16"	1-5/8"	1/4"	1-1/4"	BR-03	\$24.61
3801	9/16"	1-5/8"	1/2"	1-1/2"	BR-03	\$24.94
3892	1"	2-1/2"	1/2"	1-1/2"	BR-03	\$35.52
3894	1-7/32"	2-31/32"	1/2"	1-1/2"	BR-03	\$44.45

Raised Panel, Ogee 2-Flute Horizontal



Comes with a Magnate BR-03 bearing.

Tool No.	Reveal	Overall Dia.	Shank Dia.	Shank Length	Price
3835	5/8"	1-3/4"	1/4"	1-1/4"	\$26.80
3825	3/4"	2"	1/4"	1-1/4"	\$31.66
3805	1-1/16"	2-5/8"	1/2"	1-1/2"	\$37.20
3845	1-1/4"	3"	1/2"	1-1/2"	\$46.97
3805B	1-1/2"	3-1/2"	1/2"	1-1/2"	\$57.56

Raised Panel, Ogee with Under Cutter, 2-Flute Horizontal 1/2" Shank Diameter, 1-1/2" Shank Length

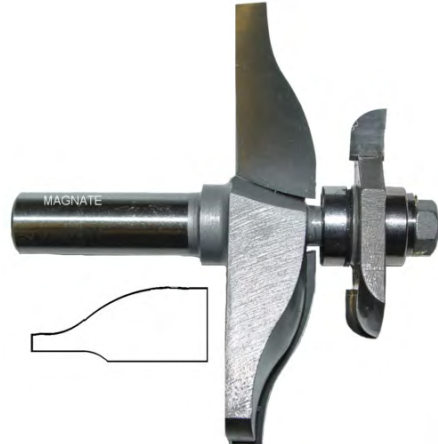

Designed for 3/4" or 7/8" wood, leaves a 1/4" tongue.

Tool No.	Reveal	Overall Dia.	Bearing	Price
3865	15/16"	2-5/8"	BR-40	\$50.69
3805C	1-3/8"	3-1/2"	BR-05	\$69.00

Raised Panel, Convex 2-Flute Horizontal



Comes with a Magnate BR-03 bearing.

Tool No.	Reveal	Overall Dia.	Shank Dia.	Shank Length	Price
3837	5/8"	1-3/4"	1/4"	1-1/4"	\$26.70
3827	3/4"	2"	1/4"	1-1/4"	\$31.52
3807	1-1/16"	2-5/8"	1/2"	1-1/2"	\$37.07
3847	1-1/4"	3"	1/2"	1-1/2"	\$46.79
3807B	1-1/2"	3-1/2"	1/2"	1-1/2"	\$57.38

Raised Panel, Convex with Under Cutter, 2-Flute Horizontal 1/2" Shank Diameter, 1-1/2" Shank Length

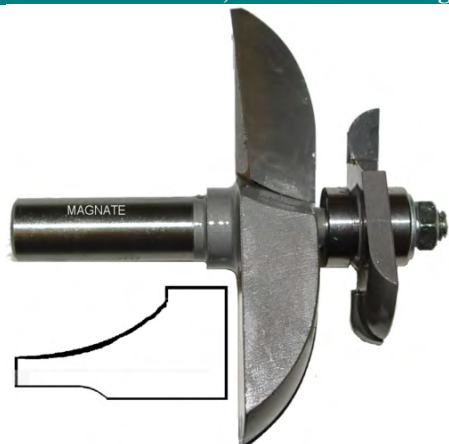

Designed for 3/4" or 7/8" wood, leaves a 1/4" tongue.

Tool No.	Reveal	Overall Dia.	Bearing	Price
3867	15/16"	2-5/8"	BR-40	\$50.50
3807C	1-3/8"	3-1/2"	BR-05	\$68.82



Raised Panel, Classical 2-Flute Horizontal

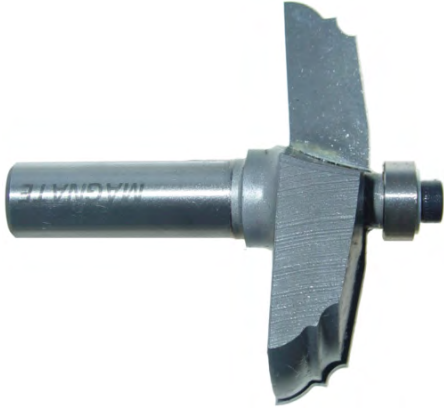

Comes with a Magnate BR-03 bearing.

Tool No.	Reveal	Overall Dia.	Shank Dia.	Radius	Shank Length	Price
3808	1-1/16"	2-5/8"	1/2"	1-1/8"	1-1/2"	\$37.46

Raised Panel Under Cutter, 2-Flute



Use this under cutter to create a tongue with desired panel profiles. Designed for 3/4" or 7/8" wood, leaves a 1/4" tongue.

This bit is designed to be used with raised panel bits without an under cutter.

Comes with a Magnate BR-03 bearing.

Tool No.	Reveal	Overall Dia.	Cutting Height	Shank Dia.	Shank Length	Price
3800	5/8"	1-3/4"	3/8"	1/2"	1-1/2"	\$27.85

Raised Panel, Vertical 15 Degree Face-Cut 2-Flute

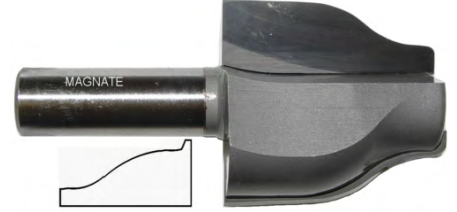

Tool No.	Cutting Height	Shank Dia.	Overall Dia.	Shank Length	Price
3814	1-5/8"	1/2"	1-1/8"	1-1/2"	\$33.81

Raised Panel, Vertical 18 Degree Face-Cut 2-Flute

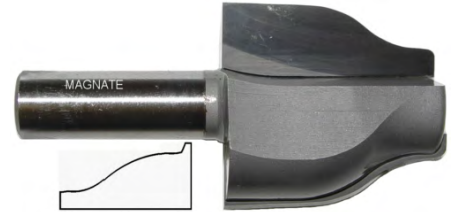

Tool No.	Cutting Height	Shank Dia.	Overall Dia.	Radius	Shank Length	Price
3819	1-5/8"	1/2"	1-1/8"	1/8"	1-1/2"	\$34.09

Raised Panel, Classical with Under Cutter, 2-Flute Horizontal 1/2" Shank Diameter, 1-1/2" Shank Length



Designed for 3/4" or 7/8" wood, leaves a 1/4" tongue.

Tool No.	Reveal	Overall Dia.	Radius	Bearing	Price
3868	15/16"	2-5/8"	1/8"	BR-40	\$50.63

Raised Panel, Vertical 5 Degree Face-Cut 2-Flute



Tool No.	Cutting Height	Shank Dia.	Overall Dia.	Radius	Shank Length	Price
3813	1-5/8"	1/2"	1-1/8"	1/8"	1-1/2"	\$33.69

Raised Panel, Vertical 12 Degree Face-Cut With Quarter Round, 2-Flute

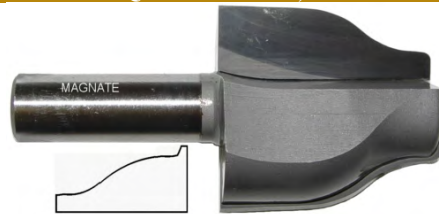

Tool No.	Cutting Height	Shank Dia.	Overall Dia.	Radius	Shank Length	Price
3816	1-5/8"	1/2"	1-1/8"	5/32"	1-1/2"	\$34.95

Raised Panel, Vertical Ogee 2-Flute

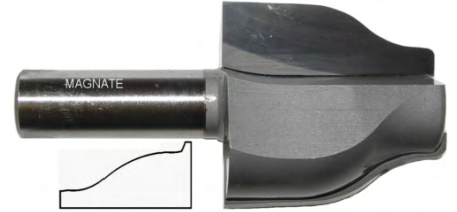

Tool No.	Cutting Height	Shank Dia.	Overall Dia.	Shank Length	Price
3815	1-5/8"	1/2"	1-1/8"	1-1/2"	\$33.12

Raised Panel, Vertical Convex 2-Flute

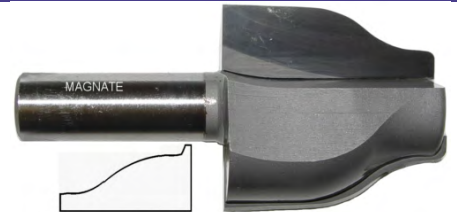

Tool No.	Cutting Height	Shank Dia.	Overall Dia.	Shank Length	Price
3817	1-5/8"	1/2"	1-1/8"	1-1/2"	\$34.18



**Door Lip (Finger Pull), 2-Flute
1/2" Shank Diameter**

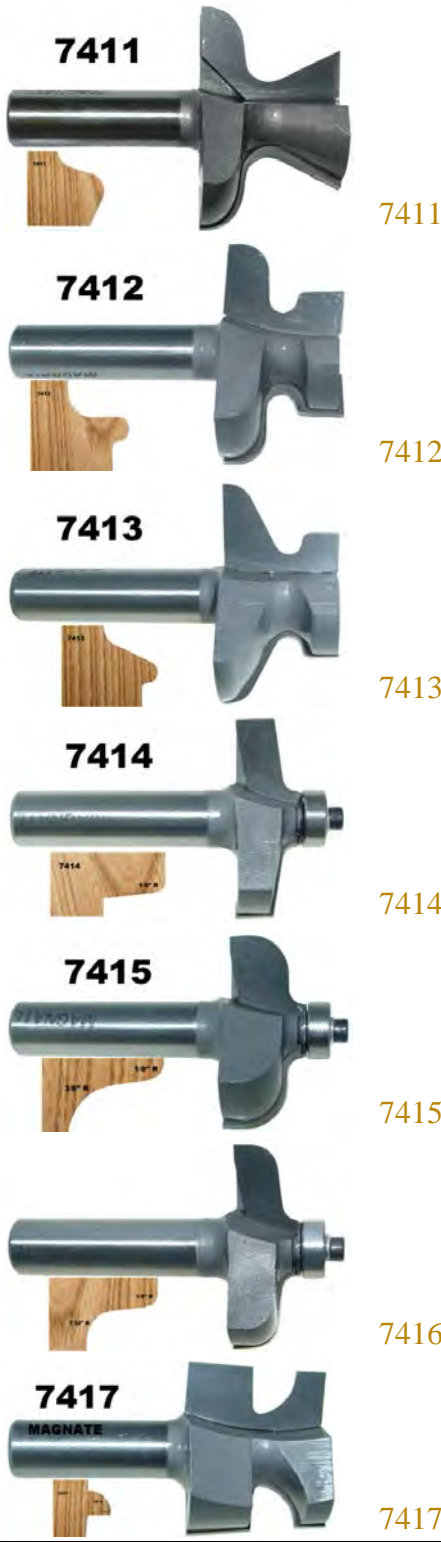

Tool No.	Overall Dia.	Cutting Length	Small Dia.	Radius	Price
7411	2"	1-1/4"	3/4"	1/4"	\$31.16
7412	2"	1"	23/32"	1/8"	\$31.15
7413	2-1/4"	1"	3/4"	1/8"	\$33.21
7414	1-3/4"	9/16"	1/2"	1/8"	\$28.69
7415	1-3/4"	11/16"	1/2"	1/8" + 3/8"	\$28.76
7416	1-3/4"	9/16"	1/2"	1/8" + 7/32"	\$26.33
7417	1-1/2"	1-3/32"	5/8"	1/16" + 3/8"	\$25.56
7418	1-5/8"	1-3/16"	3/4"	9/32" + 7/16"	\$26.09
7419	1-1/2"	1"	3/4"	1/4" + 11/32"	\$25.25
7431	1-9/16"	1"	3/4"	3/8"	\$26.30

* Comes with a Magnate BR-03 bearing.

**Drawer/Finger Pull, 2-Flute
1/2" Shank Diameter**



Used in making hand holds and drawer pulls for cabinets, dressers, and other projects.

Tool No.	Overall Dia.	Cutting Length	Small Dia.	Shank Length	Price
7402	1"	1/2"	3/4"	2"	\$24.40
7401	1-3/8"	5/8"	3/4"	2"	\$29.72

Door Pull, 2-Flute, 1/2" Shank Diameter

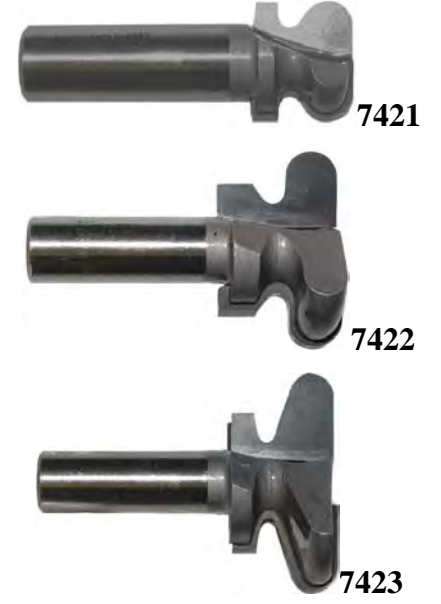

Tool No.	Overall Dia.	Cutting Length	Radius	Price
7421	3/4"	3/4"	3/32" + 3/16"	\$22.28
7422	1-1/2"	7/8"	5/64" + 15/64"	\$27.12
7423	1-3/4"	7/8"	3/32" + 3/16"	\$31.89

**Window Sill Edge, 2-Flute
1/2" Shank Diameter, 2" Shank Length**

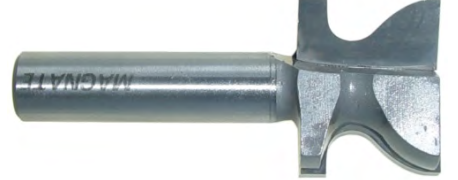

These bits are designed to cut the front edge of window sills. Can be used for drawer pulls.

Tool No.	Overall Dia.	Profile Height	Radius	Small Dia.	Price
7425	1-1/4"	13/16"	7/32"	5/8"	\$25.75
7426	1-7/16"	1-1/8"	3/8"	3/4"	\$29.80



MAGNATE™ Carbide Tipped Router Bits

A reversible stile and rail bit comes with a Magnate 4303 (1/2" shank arbor assembly), a profile cutter and one Magnate 9000 (1/4" height x 3/8" deep slot cutter). It can be used to make both stile and rail cuts. In order to make glass doors of up to 1-1/8" stock, just stack one additional Magnate 9000 cutter next to the other.

Following are instructions how to cut both stile and rail cut by using a stile and rail reversible bit:

Stile Cut :

1. Set up router bit for stile cut (Profile Cutter, Straight Cutter, Bearing, Nut)
2. Rip door sides to desired with. (typically 2" to 4")
3. Set up router bit for stile cut. (Make sure the nut is secure by tightening in router)
4. Set height of bit and make test cuts for desire pattern.
5. Make all the stile cuts at one time to insure they are all the same.
6. Cut a 6" length and save as a set up example.
7. Cut length for desired door width.
8. For **Rail Length**, it equals **Door Height + 3/4" - Stile Width * 2**

Rail Cut :

1. Set up router bit for rail cut (Straight Cutter, Bearing, Profile Cutter, Nut)
2. Adjust the height of the bit for the bearing spacing even with the slot on the rail cut. Make final adjustments using test cuts and matching to be flush when placed together with rail.
3. Cut three 6" squares of material to be used as guides for rail cuts. Make a rail cut on one side of one square. (rail guide).
4. Fit rail to be cut into the rail guide so the ends are flush. This is done to avoid frayed edges on the rail at the overlap end.
5. Place the second square on the opposite side of the stile cut and flush with the end. Place the third square over the first two squares and the rail and secure with screws to make a Rail Cutting Jig. Save for future use.
6. Cut rails on both ends using Rail cutting Jig to avoid end fray.
7. Panel will be 3/4" wider than inside of frame.

Reversible Stile & Rail, 2 Flute
1/2" Shank Diameter, 1-1/2" Shank Length
1-5/8" Overall Diameter



Tool No.	Profile	Cutting Height	Bearing	Price
S9001	Ogee	7/8"	BR-06	\$41.93
S9002	Classic	7/8"	BR-06	\$42.55
S9003	Traditional	7/8"	BR-06	\$42.03
S9004	14 Degree Bevel	7/8"	BR-06	\$41.78
S9005	Tongue & Groove	3/4"	BR-06	\$38.10
S9006	V-Groove	3/4"	BR-06	\$47.86
S9009	Cove & Bead	7/8"	BR-06	\$42.16

Reversible Stile & Rail, 2 Flute
1/4" Shank Diameter, 1-1/4" Shank Length
1-5/8" Overall Diameter

Tool No.	Profile	Cutting Height	Bearing	Price
9001	Ogee	7/8"	BR-06	\$41.90
9002	Classic	7/8"	BR-06	\$42.48
9003	Traditional	7/8"	BR-06	\$41.94
9004	14 Degree Bevel	7/8"	BR-06	\$41.69
9005	Tongue & Groove	3/4"	BR-06	\$37.93
9006	V-Groove	3/4"	BR-06	\$47.78
9009	Cove & Bead	7/8"	BR-06	\$42.08

One Piece Stile and Rail
2 Flute For 3/4 to 7/8 Material
1/2" Shank Diameter, 1-1/8" Cutting Height

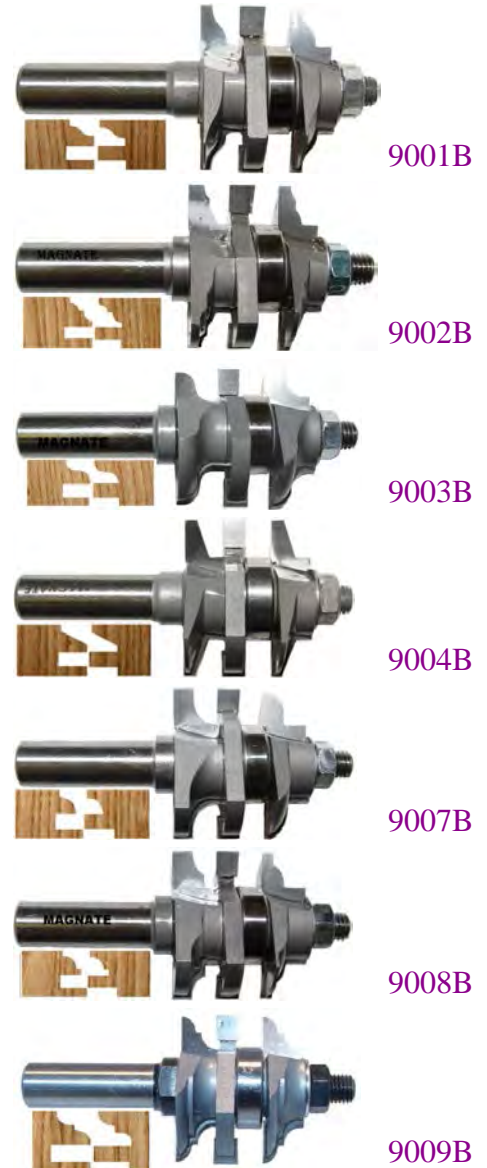

This design allows the woodworker to use only one bit to do both stile and rail cuts without having to disassemble and reassemble the parts as you do with the reversible bit. The groove created is 1/4 wide x 3/8 depth.

Tool No.	Profile	Overall Dia.	Shank Length	Bearing	Price
9001B	Ogee	1-5/8"	1-1/2"	BR-06	\$57.61
9002B	Classic	1-5/8"	1-1/2"	BR-06	\$56.97
9003B	Traditional	1-5/8"	1-1/2"	BR-06	\$57.11
9004B	14 Degree Bevel	1-5/8"	1-1/2"	BR-06	\$56.75
9007B	Concave	1-5/8"	1-1/2"	BR-06	\$57.06
9008B	Bead	1-5/8"	1-1/2"	BR-06	\$57.04
9009B	Cove & Bead	1-5/8"	1-1/2"	BR-06	\$56.60



MAGNATE™ Carbide Tipped Router Bits

Stile or Rail, For 3/4" to 7/8" Material
1/2" Shank Diameter, 1-1/2" Shank Length
2 Flute, 15/16" Cutting Height
1-5/8" Overall Diameter

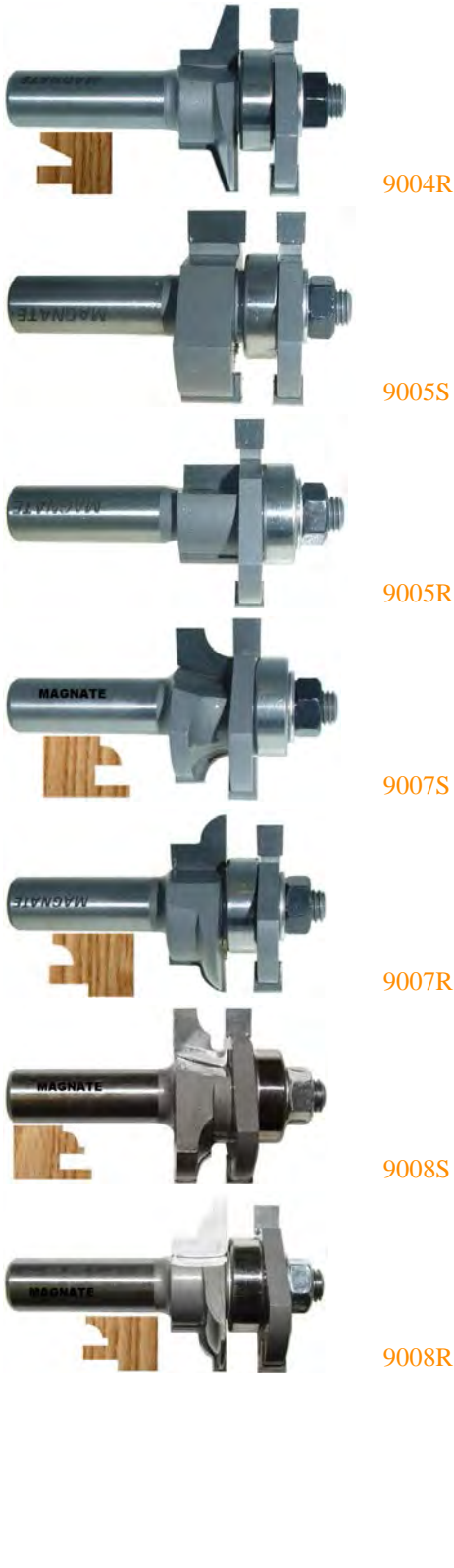
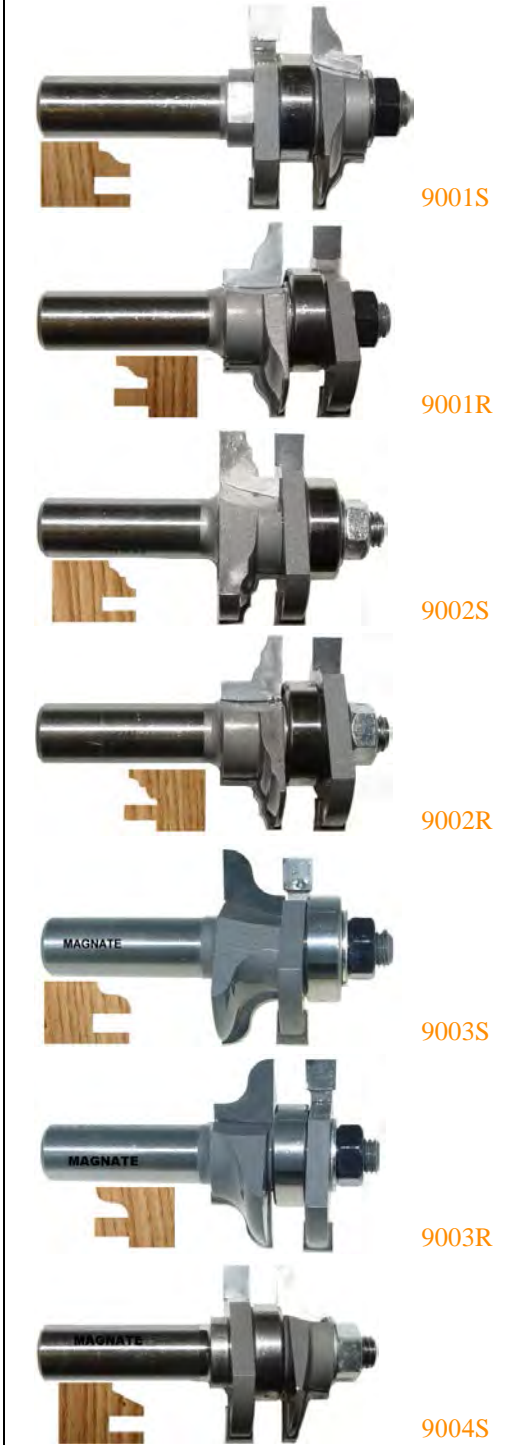

To create precision stile and rail joints without having to disassemble and reassemble the parts as you do with the reversible bit. By using two bits, both stile and rail cuts can be made at the same time.

The groove created is 1/4" wide x 3/8" depth.

Tool No.	Profile	Cut	Bearing	Price
9001S	Ogee	Stile	BR-06	\$42.16
9001R	Ogee	Rail	BR-06	\$42.24
9002S	Classic	Stile	BR-06	\$42.72
9002R	Classic	Rail	BR-06	\$42.76
9003S	Traditional	Stile	BR-06	\$42.01
9003R	Traditional	Rail	BR-06	\$42.08
9004S	14 Degree Bevel	Stile	BR-06	\$41.78
9004R	14 Degree Bevel	Rail	BR-06	\$41.82
9005S	Tongue	Stile	BR-06	\$38.12
9005R	Groove	Rail	BR-06	\$35.24
9007S	Concave	Stile	BR-06	\$42.81
9007R	Concave	Rail	BR-06	\$42.86
9008S	Bead	Stile	BR-06	\$42.36
9008R	Bead	Rail	BR-06	\$42.42

Slot Cutter, 2-Flute For Reversible Stile and Rail Bit



This 2-flute slot cutter is designed to work with Magnate 9000 series Reversible Stile & Rail cutters.

Tool No.	Bore	Cutting Height	Overall Dia.	Price
9000	5/16"	1/4"	1-5/8"	\$12.32



MAGNATE™ Carbide Tipped Router Bits

Stile or Rail, 1" to 1-3/8" Material, 2 Flute
1/2" Shank Diameter, 3-1/8" Overall Height
1-3/4" Overall Diameter



9021S



9021R



9022S



9022R



9023S



9023R



9024S



9024R



9025S



9025R



9026S



9026R



9027S



9027R



9028S



9028R

To create precision stile and rail joints without having to disassemble and reassemble the parts as you do with the reversible design. By using two bits, both stile and rail cuts can be made at the same time.

The groove created is 1/4" wide x 7/16" depth.

Tool No.	Profile	Cut	Bearing	Price
9021S	Ogee	Stile	BR-06	\$56.91
9021R	Ogee	Rail	BR-06	\$56.95
9022S	Classic	Stile	BR-06	\$57.68
9022R	Classic	Rail	BR-06	\$57.72
9023S	Traditional	Stile	BR-06	\$56.86
9023R	Traditional	Rail	BR-06	\$56.89
9024S	Bevel	Stile	BR-06	\$56.74
9024R	Bevel	Rail	BR-06	\$56.78
9025S	Groove	Stile	BR-06	\$48.46
9025R	Tongue	Rail	BR-06	\$41.77
9026S	V-Groove	Stile	BR-06	\$51.76
9026R	V-Groove	Rail	BR-06	\$48.09
9027S	Concave	Stile	BR-06	\$56.62
9027R	Concave	Rail	BR-06	\$56.66
9028S	Bead	Stile	BR-06	\$56.62
9028R	Bead	Rail	BR-06	\$56.66
9029S	Cove & Bead	Stile	BR-06	\$48.47
9029R	Cove & Bead	Rail	BR-06	\$48.51

Bowl & Tray Plunge, 2-Flute



This bit is designed to create a flat bottom, two square sides and two bottom radii in only one pass. Ideal for making dishes or serving trays.

Tool No.	Radius	Cutting Dia.	Cutting Height	Shank Dia.	Shank Length	Price
7800	1/8"	1/2"	1/2"	1/4"	1-1/4"	\$18.33
7801	1/4"	3/4"	5/8"	1/4"	1-1/4"	\$22.80
7802	1/4"	1"	5/8"	1/4"	1-1/4"	\$24.10
S7801	1/4"	3/4"	5/8"	1/2"	1-1/2"	\$23.08
S7802	1/4"	1"	5/8"	1/2"	1-1/2"	\$24.30
S7804	1/4"	1-1/8"	5/8"	1/2"	1-1/2"	\$25.62
S7803	1/4"	1-1/4"	5/8"	1/2"	1-1/2"	\$28.47

MAGNATE™ 20639 Lycoming Street #B-6, Walnut, CA 91789 USA

B-27



email : info@magnate.net Online Shop : www.magnate.net
(TEL) 800-827-2316, 909-468-5747 (FAX) 909-468-5745

Bowl & Tray Plunge with Top Bearing 1/4" Radius, 2-Flute



This bit is designed to create a flat bottom, two square sides and two bottom radii in only one pass. Ideal for making dishes or serving trays.

Tool No. Cutting Dia. Height Shank Dia. Length Bearing Price

Tool No.	Cutting Dia.	Height	Shank Dia.	Length	Bearing	Price
7821	3/4"	5/8"	1/4"	1-3/4"	BR-08	\$26.38
7822	1"	5/8"	1/4"	1-3/4"	BR-19	\$27.75
7831	3/4"	5/8"	1/2"	2"	BR-09	\$27.45
7832	1"	5/8"	1/2"	2"	BR-15	\$29.30
7834	1-1/8"	5/8"	1/2"	2"	BR-07	\$31.15
7833	1-1/4"	5/8"	1/2"	2"	BR-16	\$32.89

Plunge Button, 2-Flute



Designed for the Legacy Ornamental Milling machines. Plunge to mill buttons and fine details on flat mouldings and/or around the circumference of a spindle or leg. Adds just the right touch for those details that give style to any project.

Tool No. Cutting Dia. Button Diameter Shank Dia. Radius Shank Length Price

Tool No.	Cutting Dia.	Button Diameter	Shank Dia.	Radius	Shank Length	Price
358	3/8"	1/4"	1/4"	1/8"	1-3/8"	\$17.42
350	1/2"	3/8"	1/2"	1/4"	2"	\$19.59
351	5/8"	5/16"	1/2"	3/16"	2"	\$21.97
352	1"	1/2"	1/2"	3/10"	2"	\$26.99
353	5/8"	1/2"	1/2"	3/10"	2"	\$24.35

Provincial Plunge, 2-Flute 1/2" Shank Diameter, 2" Cutting Diameter



This bit is designed for the Legacy to create a plunge version of French Provincial (without bearing)

Tool No.	Cutting Length	Radius	Shank Length	Price
3654	7/8"	1/2" + 1" + 1/4"	2"	\$48.00

Rope Molding, 2-Flute

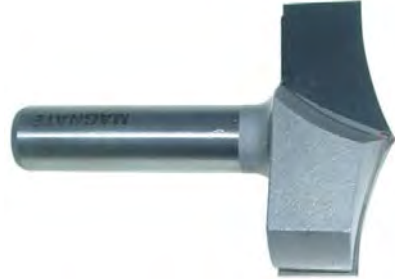

Designed for the Legacy Ornamental Mill. Used to mill rope and pillowed diamond designs on spindle and columns up to 10" diameter. These bits can also be used for other unusual groove/bead forming applications i.e. flat moldings or indexed rosettes.

#7584, #7585 and #7586 can be used in conjunction with the Combination Barley Twist bits to create big diameter barley twist profiles.

Tool No. Cutting Dia. Shank Length Shank Dia. Radius Profile Height Price

Tool No.	Cutting Dia.	Shank Length	Shank Dia.	Radius	Profile Height	Price
7588	3/4"	2"	1/2"	51/64"	3/32"	\$26.72
7581	1"	2"	1/2"	1-1/16"	1/8"	\$31.21
7582	1-1/2"	2"	1/2"	1-19/32"	3/16"	\$39.79
7584	2"	2"	1/2"	2-1/8"	1/4"	\$48.60
7585	2-1/2"	2"	1/2"	2-21/32"	5/16"	\$59.65
7586	3"	2"	1/2"	3-3/16"	3/8"	\$71.74

3-Bit Rope Molding Set - 7580



Tool No.: 7580 Price: 149.88

This package comes with 3 Rope Molding bits - 7584, 7585, 7586 at 15% discounted price.

3-Bit Rope Molding Set - 7570



Tool No.: 7570 Price: 94.78

This package comes with 3 Rope Molding bits - 7581, 7582, 7584 at 15% discounted price.

7-Bit Rope Molding Set - 7579



Tool No.: 7579 Price: 236.05

This package comes with 7 Rope Molding bits - 7581, 7582, 7584, 7585, 7586, 7588, 7591 at 15% discounted price.

Combination Rope Molding, 2-Flute 1/2" Shank Diameter, 2" Shank Length



Designed for the Legacy Ornamental Mill. #7521 (1st Cut) and #7522 (2nd cut) are used conjunctionally to create 4" diameter rope molding profiles while #7524 and #7525 are used for 5" diameter rope molding; #7527 and #7528 for 6" diameter rope molding.

Tool No. Cutting Dia. Radius Profile Height Price

Tool No.	Cutting Dia.	Radius	Profile Height	Price
7521	2"	4-1/4"	1/2"	\$52.14
7522	2"	4-1/4"	0.1193	\$48.84
7524	2-1/2"	5-5/16"	5/8"	\$60.73
7525	2-1/2"	5-5/16"	0.1492"	\$57.41
7527	3"	6-3/8"	3/4"	\$72.90
7528	3"	6-3/8"	0.179"	\$68.64



MAGNATE™ Carbide Tipped Router Bits

Rope Pen, 2-Flute



Designed for the Legacy. This bit creates rope pens using a standard 7mm twist pen kit. The above illustration depicts a wood pen milled by the Legacy Ornamental Mill using this bit.

Tool No.	Radius	Cutting Dia.	Shank Dia.	Cutting Height	Shank Length	Price
7597	0.65"	1/2"	1/4"	3/8"	1-1/2"	\$19.69
7591	0.65"	1/2"	1/2"	3/8"	2"	\$19.94

6-Bit Barley Twist Set - 7559



Tool No.: 7559 Price: 244.22

This package comes with 6 barley twist bits - 7551, 7552, 7553, 7554, 7556, 7558 at 15% discounted price.

Combination Barley Twist Set - 7540



Tool No.: 7540 Price: 158.25

This package comes with 3 Combination Barley Twist bits - 7544, 7545, 7546 at 15% discounted price.

Barley Twist, 2-Flute



This bit is designed to work with Legacy Ornamental machine to create traditional style barley twist. When combined with a upcut spiral bit they also form a beautiful hollow spiral. Can also be used for general grooving or flat moldings.

Tool No.	Cutting Dia.	Profile Height	Shank Dia.	Shank Length	Radius	Price
7557*	3/4"	3/32"	1/4"	1-1/2"	3/32" + 3/8"	\$28.50
7558	3/4"	3/32"	1/2"	2"	3/32" + 3/8"	\$29.40
7551	1"	1/4"	1/2"	2"	1/8" + 1/2"	\$36.10
7554	1-1/2"	3/8"	1/2"	2"	3/16" + 3/4"	\$41.80
7552	2"	1/2"	1/2"	2"	1/4" + 1"	\$49.60
7556	2-1/2"	5/16"	1/2"	2"	5/16" + 1-1/4"	\$58.72
7553	3"	3/4"	1/2"	2"	3/8" + 1-1/2"	\$71.69

* Spiral pen making for Legacy

Combination Barley Twist, 2-Flute 1/2" Shank Diameter, 2" Shank Length

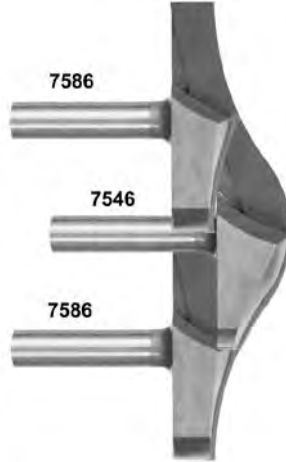

Designed for the Legacy. These bits are create traditional style barley twist profiles with diameters over 3".

For example, to create a 6" diameter barley twist profile, first start by using a 3" diameter Rope Molding bit # 7586, to make a 2-start rope with 6" pitch. Next, plunge on the top of one of the rope heads to create a cove using the 3" Combination Barley Twist bit #7546. To attain the desired depth, 3-5 passes are required. When completed, the final pass should match up with the edge of the bead on each of the sections of rope.

These bits can be also used separately to form cove detail for turnings or moldings.

Tool No.	Cutting Dia.	Radius	Profile Height	Price
7544	2"	0.9167" & 2-1/8"	1/2"	\$52.70
7545	2-1/2"	1.1458" + 2-21/32"	5/8"	\$61.71
7546	3"	1-3/8" + 3-3/16"	3/4"	\$71.77

Table Top Edge, Thumbnail 2-Flute



These large profile cutters make handsome edge accents for table tops, cabinet tips, window sills, chair rails, and picture frames. They may be used with handrail side profiles.

Comes with a Magnate BR-03 bearing.

Tool No.	Cutting Depth	Cutting Height	Shank Dia.	Shank Length	Overall Dia.	Price
4611	7/16"	3/8"	1/4"	1-1/2"	1-3/8"	\$26.35
4614	7/16"	3/8"	1/2"	2"	1-3/8"	\$28.31
4615	3/4"	5/8"	1/2"	2"	2"	\$34.20
4601	1"	3/4"	1/2"	2"	2-1/2"	\$41.34

Table Top Edge, Ogee 2-Flute



These large profile cutters make handsome edge accents for table tops, cabinet tips, window sills, chair rails, and picture frames. They may be used with handrail side profiles.

Comes with a Magnate BR-03 bearing.

Tool No.	Cutting Depth	Cutting Height	Shank Dia.	Shank Length	Overall Dia.	Price
4602	1"	3/4"	1/2"	2"	2-1/2"	\$41.58

3-Bit Barley Twist Set - 7550



Tool No.: 7550 Price: 131.32

This package comes with 3 barley twist bits - 7551, 7552, 7553 at 15% discounted price.



MAGNATE™ Carbide Tipped Router Bits

Table Top Edge, French Baroque 2-Flute



These large profile cutters make handsome edge accents for table tops, cabinet tips, window sills, chair rails, and picture frames. They may be used with handrail side profiles.

Comes with a Magnate BR-03 bearing.

Tool No.	Cutting Depth	Cutting Height	Shank Dia.	Shank Length	Overall Dia.	Price
4604	1"	1"	1/2"	2"	2-1/2"	\$43.84

Table Top Edge, Traditional 2-Flute



These large profile cutters make handsome edge accents for table tops, cabinet tips, window sills, chair rails, and picture frames. They may be used with handrail side profiles.

Comes with a Magnate BR-03 bearing.

Tool No.	Cutting Depth	Cutting Height	Shank Dia.	Shank Length	Overall Dia.	Price
4635	9/16"	5/8"	1/2"	2"	1-5/8"	\$30.58
4605	1"	3/4"	1/2"	2"	2-1/2"	\$41.48

Handrail, 1/2" Shank Diameter 2-Flute



4901

4902

4903

4903L

4904

Designed for the lower portion of a handrail. Can be used in combination with other edge forming bits, i.e. Table Top Edge bits.

Tool No.	Cutting Length	Cutting Radius	Overall Shank Dia.	Shank Length	Bearing	Price
4901	1-1/2"	1/8"	1-3/8"	1-1/2"	BR-03	\$40.71
4902	1-1/2"	3/8"	1-1/4"	1-1/2"	BR-05	\$41.10
4903	1-1/2"	1/8"	1-3/8"	1-1/2"	BR-03	\$41.34
4903L	2"	1/8"	1-1/4"	1-1/2"	BR-03	\$50.60
4904	1-1/2"	3/8"	1-1/4"	1-1/2"	BR-05	\$41.48

Table Top Edge, Classic Ogee 2-Flute



These large profile cutters make handsome edge accents for table tops, cabinet tips, window sills, chair rails, and picture frames. They may be used with handrail side profiles.

Comes with a Magnate BR-03 bearing..

Tool No.	Cutting Depth	Cutting Height	Shank Dia.	Shank Length	Overall Dia.	Price
4603	1"	3/4"	1/2"	2"	2-1/2"	\$41.83

Table Top Edge, Thumb Nail With Bead 1/2" Shank Diameter, 2-Flute



These large profile cutters make handsome edge accents for table tops, cabinet tips, window sills, chair rails, and picture frames. They may be used with handrail side profiles.

Comes with a Magnate BR-03 bearing.

Tool No.	Cutting Depth	Cutting Height	Shank Length	Overall Dia.	Price
4606	1"	3/4"	2"	2-1/2"	\$41.61

Brick Molding, 2-Flute



Designed for the Legacy Ornamental Mill to make rosettes (as seen on the wainscot project of Legacy demo video) and a decorative trim. Can also be used for traditional mouldings.

Tool No.	Cutting Dia.	Cutting Height	Shank Dia.	Shank Radius	Shank Length	Price
3961	1-1/4"	3/8"	1/2"	0.35"	2"	\$27.16



MAGNATE™ Carbide Tipped Router Bits

Casing Molding, 1/2" Shank Diameter 2-Flute



5521

5523

Tool No.	Cutting Length	Overall Dia.	Radius	Shank Length	Bearing	Price
5521	2"	1-3/8"	1/8"	1-1/2"	BR-03	\$41.94
5523	2"	1-3/8"	1"	1-1/2"	BR-03	\$42.19

Crown Molding 1/2" Shank Diameter 1-1/2" Shank Length, 2 Flute

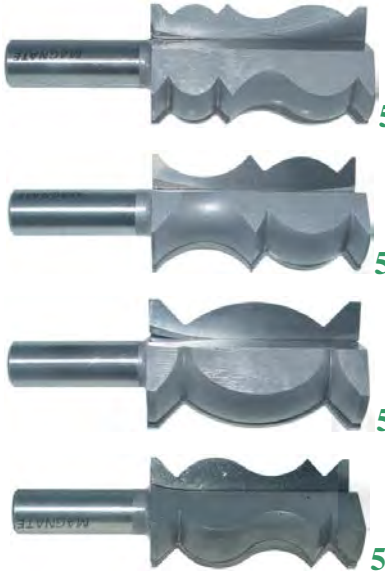

5512

5513

5514

5516

Tool No.	Cutting Length	Overall Dia.	Radius	Price
5512	2-1/4"	1-1/4"	1-3/16"	\$47.63
5513	2-1/4"	1-1/4"	1/2" + 3/4"	\$47.39
5514	2-1/4"	1-1/4"	1-3/16"	\$46.12
5516	2-1/4"	1-1/4"	17/32"	\$46.52

Face Molding, 2-Flute 1/4" Shank Diameter



5501

5502

5503

5504

5505

Tool No.	Cutting Length	Bead Diameter	Overall Dia.	Shank Length	Bearing	Price
5501	1"	5/16"	11/16"	1-1/4"	BR-02	\$23.83
5502	1"	5/16"	11/16"	1-1/4"	BR-02	\$24.04
5503	1"	1/4"	3/4"	1-1/4"	BR-02	\$24.36
5504	1"	5/16"	11/16"	1-1/4"	BR-02	\$24.64
5505	1"	1/4"	3/4"	1-1/4"	BR-02	\$25.09

French Provincial, 1/2" Shank Diameter 1-1/2" Shank Length 2-Flute



Good for antique style furniture design. For panel molding or decorative edging. Shank length: 1-1/2"

Tool No.	Cutting Length	Radius	Overall Dia.	Price
4804	7/8"	3/16"+5/16"+3/32"	1-1/2"	\$35.75
4801	1-1/8"	1/4"+3/8"+1/8"	1-3/4"	\$41.02

Face Molding, 2-Flute 1/2" Shank Diameter



S5501

S5502

S5503

S5504

S5505

Tool No.	Cutting Length	Bead Diameter	Overall Dia.	Shank Length	Bearing	Price
S5501	1-1/2"	5/16"	7/8"	1-1/2"	BR-03	\$31.74
S5502	1-1/2"	5/16"	7/8"	1-1/2"	BR-03	\$32.14
S5503	1-5/8"	1/4"	1-1/8"	1-1/2"	BR-03	\$32.56
S5504	1-3/8"	5/16"	7/8"	1-1/2"	BR-03	\$32.84
S5505	1-5/8"	1/4"	1"	1-1/2"	BR-03	\$33.64

Palace Pattern, 1/2" Shank Diameter 1-1/2" Shank Length, 2-Flute



For decorative edging. Adds oriental flavor to your products

Tool No.	Cutting Length	Cutting Depth	Radius	Price
2603	3/4"	1/4"	3/16" + 1/8"	\$24.49
2602	7/8"	3/8"	1/4" + 3/16"	\$27.67
2601	1"	1/2"	3/8" + 1/4"	\$30.29



Horizontal Crown Molding, 2-Flute



This bit can also be used with the Legacy Ornamental Mill and/or overhead router to create linear mouldings. It can be used to create turnings between centers on the Legacy Ornamental Mill.

Tool No.	Cutting Dia.	Cutting Depth	Cutting Height	Shank Dia.	Radius	Price
5561	1-3/4"	5/16"	3/8"	1/4"	1-1/2"	\$34.24
5563	1-3/4"	5/16"	3/8"	1/2"	1-1/2"	\$36.74
5562	2"	3/8"	5/8"	1/2"	1-19/32"	\$38.15
5564	2-1/8"	3/8"	5/8"	1/2"	1-5/8"	\$40.21
5566	2-1/4"	3/8"	5/8"	1/2"	1-7/8"	\$42.72
5565	2-1/2"	3/8"	5/8"	1/2"	2-1/4"	\$44.32
5567	2-3/4"	3/8"	5/8"	1/2"	2-3/4"	\$51.92
5568	3"	7/16"	11/16"	1/2"	3-3/16"	\$60.51

45 Degree Corner Lock Mitre, 2-Flute



For creating strong corners on cabinets and other types of furniture. First piece is cut flat (horizontally) and second piece is cut perpendicular (vertically).

It is recommended that the cutting length (height) of the bit is 1/8" to 1/4" longer than the thickness of the material you intend to work on.

Tool No.	Cutting Length	Shank Dia.	Cutting Dia.	Shank Length	Price
7204	5/8"	1/4"	1-1/2"	1-1/4"	\$34.02
7203	7/8"	1/4"	2"	1-1/4"	\$40.68
7202	7/8"	1/2"	2"	1-1/2"	\$41.34
7201	1"	1/2"	3"	1-1/2"	\$53.63
7205	1-5/8"	1/2"	3-1/2"	1-1/2"	\$64.94

90 Degree V-Shaped Edge Banding For 1" Thick Material, 2-Flute



To add a banding to plywood or table tops.

Use 7124A to create a concave V shaped profile and use 7124B to create a convex V shaped match.

Comes with a Magnate BR-11 bearing..

Tool No.	Cutting Height	Shank Dia.	Overall Dia.	Shank Length	Price
7124A	1-1/32"	1/2"	1-25/32"	1-1/2"	\$35.44
7124B	1-1/4"	1/2"	1-25/32"	1-1/2"	\$37.93

Adjustable Box Joint, 2-Flute



This Box Joint cutter consists of 5 Magnate 4106 (3-wing 5/32" kerf) slotting cutters, 1 Magnate BR-06 bearing, 1 Magnate 4305 arbor assembly (1/2" shank arbor, 1 nut and shims).

It will cut stock from 3/4" through 1-5/8", with 1/2" deep cut. For material over 1-5/8", two pass cut will accomplish joints up to 3".

Tool No.	Cutting Length	Shank Dia.	Overall Dia.	Shank Length	Price
7391	1-5/8"	1/2"	1-7/8"	1-1/2"	\$59.69

Adjustable Finger Joint, 2-Flute

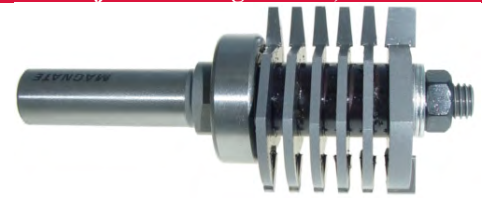

This assembly includes 5 finger cutters, 1 straight cutter, 1 Magnate BR-37 bearing (8mm x 28 mm), 1 Magnate 4305 arbor assembly (1/2" shank arbor and 1 nut and shims).

By adjusting the number of finger cutters, this bit can be used on :

- 1 cutter for 7/16" to 5/8" wood
- 2 cutters for 5/8" to 13/16" wood
- 3 cutters for 13/16" to 1" wood
- 4 cutters for 1" to 1-3/16" wood
- 5 cutters for 1-3/16" to 1-3/8" wood

Tool No.	Cutting Length	Shank Dia.	Overall Dia.	Shank Length	Price
7381	1-3/8"	1/2"	1-9/16"	1-1/2"	\$65.65

Drawer Lock, 2-Flute

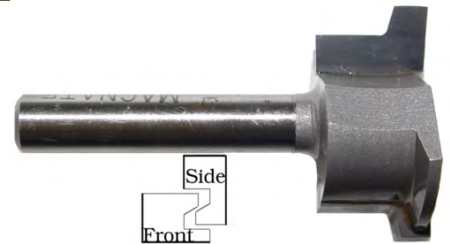

Tool No.	Cutting Height	Shank Dia.	Shank Length	Overall Dia.	Price
7321	1/2"	1/4"	1-1/4"	1"	\$17.62
\$7321	1/2"	1/2"	1-1/2"	1"	\$18.17

Finger Joint, 2-Flute



Tool No.	Cutting Length	Shank Dia.	Overall Dia.	Shank Length	Bearing	Price
7371	1-1/2"	1/2"	1-3/8"	1-1/2"	BR-05	\$51.24



Bird Mouth (Bird Beak) 12-Sided 1/2" Shank 2-Flute



These 30 & 60 degree Bird Mouth bits allow you to easily glue up 12-sided hollow columns. They create a nesting joint that is stronger and easier to glue up without shifting than the traditional miter joint. Material thickness can be up to 2" thick, allowing for deep cut profiles such as turnings, fluting, and spirals on the Legacy Ornamental Mill.

Tool No.	Long Diagonal Edge	Cutting Height	Shank Dia.	Overall Dia.	Small Dia.	Price
5481	1	1-1/8"	1/2"	1-9/16"	1/8"	\$26.32
5482	1-1/2"	1-5/8"	1/2"	1-3/4"	1/8"	\$42.76
5483	2	2-1/8"	1/2"	2-1/8"	1/8"	\$57.07

Bird Mouth (Bird Beak), 8-Sided 1/2" Shank 2-Flute



These 45 Bird Mouth bits allow you to easily glue up 8-sided hollow columns. They create a nesting joint that is stronger and easier to glue up without shifting than the traditional miter joint. Material thickness can be up to 2" thick, allowing for deep cut profiles such as turnings, fluting, and spirals on the Legacy Ornamental Mill.

Tool No.	Long Diagonal Edge	Cutting Height	Overall Dia.	Small Dia.	Price
5461	1	1-1/8"	1.539"	1/8"	\$28.52
5462	1-1/2"	1-5/8"	1.857"	1/8"	\$45.29
5463	2	2-1/8"	2-1/8"	1/8"	\$62.27

Glue Joint, 2-Flute

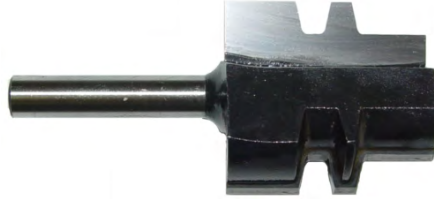

By cutting one piece and then cutting a second piece upside-down in relation to the first piece, a strong joint is easily created.

Tool No.	Cutting Length	Shank Dia.	Shank Length	Overall Dia.	Price
7301	1-1/4"	1/4"	1-1/4"	1-1/8"	\$33.50
7302	1-1/4"	1/2"	1-1/2"	1-1/8"	\$33.97

Reversible Glue Joint, 2-Flute

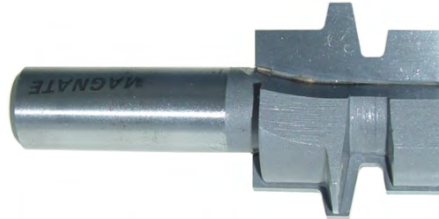

Adjust the bit according to the thickness of the wood. Line up the cut edge of the wood to the center point of the bit. Make the 1st cut face up, then turn the wood upside down to make the reverse matching cut.

Tool No.	Cutting Length	Shank Dia.	Shank Length	Overall Dia.	Price
7361	1"	1/4"	1-1/4"	1-1/4"	\$34.54
7362	1"	1/2"	1-1/2"	1-1/4"	\$35.24
7363	1-1/8"	1/2"	1-1/2"	1-1/2"	\$38.82

V-Matching Tongue & Groove, 2-Flute 1/2" Shank Diameter, 1-1/2" Shank Length



7102A



7102B



7103A



7103B

The V-match set is for making custom paneling and wainscoting.

Comes with a Magnate BR-05 bearing.

Tool No.	Profile	Material Thickness	Overall Dia.	Price
7102A	Tongue	3/4" to 1"	1-7/16"	\$39.19
7102B	Groove	3/4" to 1"	1-7/16"	\$39.75
7103A	Tongue	1" to 1-1/4"	1-7/16"	\$40.80
7103B	Groove	1" to 1-1/4"	1-7/16"	\$42.71

Wedge Tongue & Groove 1/2" Shank Diameter 2-Flute



7101A



7101B

The Wedge set is good to use when creating a non-glued edge joint. Good for paneling cabinet doors, and flooring applications.

Tool No.	Profile	Material Thickness	Overall Dia.	Shank Length	Price
7101A	Groove	5/8" to 7/8"	1-7/16"	1-1/2"	\$36.78
7101B	Tongue	5/8" to 7/8"	1-7/16"	1-1/2"	\$38.94



MAGNATE™ Carbide Tipped Router Bits

15-Piece Router Bit Set 2-Flute 1/4" Shank Diameter



Comes in 1/4" shank size in attractive varnished wooden box. Contains a variety of different bits good for a whole array of woodworking jobs. A perfect gift for the home woodworker. (Not recommended for Industrial purposes) The set contains one of each which is equivalent to the following Magnate router bits:

Tool No.	Description	Tool No.	Description
201	1/4" Straight	1003	1/2" Cove
205	1/2" Straight	1105	3/8" Slot Cutter
208	3/4" Straight	1204	3/8" Corner Round
303	1/2" Flush Trim	1601	5/32" Roman Ogee
402	1/2" Dovetail	3301	1/2" Mortising
501	1/4" Panel Pilot	5101	Solid Flush Trim
702	1/2" V-Grooving	5201	Solid 7 degree Bevel Trim t
902	1/2" 45 degree Chamfer		

Tool No.	Shank Dia.	Price
WB-15	1/4"	\$34.95

Bearing, Teflon - For Router Bits



Tool No.	Degree	Inside Diameter	Outside Dia.	Thickness	Price
BR-52	10	1/4"	7/8"	3/16"	\$5.37
BR-50	12	1/4"	1-13/16"	3/16"	\$5.12

Bearing, Steel Ball - For Router Bits



This fully enclosed steel replacement bearing can also be used for adjusting the cutting depth.

Tool No.	Inside Dia.	Outside Dia.	Thickness	Price
BR-00	1/8"	1/4"	7/64"	\$3.15
BR-01	1/8"	3/8"	5/32"	\$3.41
BR-02	3/16"	3/8"	1/8"	\$3.68
BR-03	3/16"	1/2"	3/16"	\$3.94
BR-10	3/16"	5/8"	3/16"	\$4.20
BR-11	3/16"	3/4"	3/16"	\$4.20
BR-12	3/16"	7/8"	3/16"	\$4.20
BR-13	3/16"	1"	3/16"	\$4.46
BR-14	3/16"	1-1/8"	3/16"	\$4.74
BR-25	3/16"	1-1/4"	3/16"	\$5.20
BR-18	1/4"	3/8"	1/8"	\$4.22
BR-04	1/4"	1/2"	3/16"	\$4.18
BR-29	1/4"	9/16"	3/16"	\$4.28
BR-05	1/4"	5/8"	3/16"	\$4.34
BR-08	1/4"	3/4"	1/4"	\$4.96
BR-26	1/4"	7/8"	1/4"	\$4.98
BR-19	1/4"	1"	3/16"	\$5.14
BR-28	1/4"	1-1/8"	1/4"	\$5.75
BR-35	5/16"	5/8"	1/4"	\$4.30
BR-24	5/16"	3/4"	1/4"	\$4.30
BR-06	5/16"	7/8"	1/4"	\$4.56
BR-20	5/16"	1"	1/4"	\$4.98
BR-21	5/16"	1-1/8"	1/4"	\$5.25
BR-22	5/16"	1-1/4"	1/4"	\$5.54
BR-23	5/16"	1-3/8"	1/4"	\$6.43
BR-31	5/16"	1-1/2"	1/4"	\$6.93
BR-09	1/2"	3/4"	3/16"	\$4.60
BR-30	1/2"	7/8"	3/16"	\$4.98
BR-15	1/2"	1"	3/16"	\$5.34
BR-07	1/2"	1-1/8"	5/16"	\$5.76
BR-16	1/2"	1-1/4"	5/16"	\$6.04
BR-27	1/2"	1-3/8"	5/16"	\$6.57
BR-17	1/2"	1-1/2"	5/16"	\$6.94

Bearing Lock Collars For Router Bit



This retaining collar is used when bearings are added to the shank of a router bit to follow templates.

Tool No.	Inside Diameter	Outside Dia.	Pairs per Package	Price
LC12	1/2"	11/16"	10	\$10.00
LC14	1/4"	7/16"	10	\$10.00

Steel Router Collet Reducers



This adaptor is designed for use with a 1/2" collet router. It comes with 1" collet height and a flange for easy removal.

Tool No.	Inside Dia.	Outside Dia.	Overall Length	Price
SCK18	1/8"	1/2"	1-1/8"	\$6.38
SCK36	3/16"	1/2"	1-3/16"	\$6.38
SCK14	1/4"	1/2"	1-3/16"	\$6.38
SCK56	5/16"	1/2"	1-3/16"	\$6.38
SCK08	8mm	1/2"	1-3/16"	\$6.38
SCK38	3/8"	1/2"	1-3/16"	\$6.38
SCK10	10mm	1/2"	1-3/16"	\$6.38



Eliminator RC Quick Change Chuck



SHA0002



SHA0101



SHA0102



SHA0201

Change Bits in 5-10 Seconds; One-Handed Bit Change with T-Handle Allen Wrench (Not Included); No Need for 2 Large Wrenches; No More Nicking of Fingers and Hands;

Tool No.	Router	Price
SHA0002	All Porter-Cable 1/2" except the 800 series	\$60.18
SHA0101*	Dewalt 616; 618 and 621	\$60.42
SHA0102^	DeWalt 625	\$61.19
SHA0201	All Bosch 1/2" and Makita 3612C	\$60.28

* It also fits Hitach M-8V, M-12VC, M-12SC and M-12VS

^ Also fits all Festool, ELU 177, Trend, Freud, Fein and Matabo 1612

Porter Cable and DeWalt are registered trademarks of the Stanley Black & Decker Corp.

Bosch is the registered trademark of the Robert Bosch Corp.

dynaGlide Plus, Tri-Bountry Dry-Lubricant & Cleaning Conditioner



WARNING: Reproductive Harm
www.P65Warnings.ca.gov

Use on Woodworking & Metalworking Tools, any Metals.

dynaGLIDE Plus will not stain, discolor, or transfer. dynaGLIDE penetrates instantly and dries within minutes, leaving behind extremely tough pressure film. Can be used for storage of tools, all router bearings, table beds, scroll-saw, ban-saw, cutters, lathe tools, all cutting /drilling/routing blades, etc. Will not stain wood or other material.

Replaces all other lubricants for any purpose.

Note : Ground Shipping Only

Tool No.	Bottle	Price
A12WT	10 oz	\$15.95



MAGNATE™ Carbide Tipped Shaper Cutters

Straight, 3-Wing

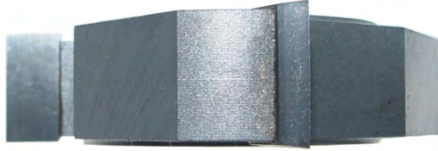

Listed rub collars by Magnate tool number are merely for information and not included.

Tool No.	Cutting Height	Bore	Outside Dia.	Rub Collar	Price
M055	1/4"	3/4"	2-5/8"	M1122	\$27.89
M045	3/8"	3/4"	2-5/8"	M1122	\$29.47
M046	1/2"	3/4"	2-5/8"	M1122	\$32.53
M020	3/4"	3/4"	2-5/8"	M1122	\$37.52
M047	1"	3/4"	2-5/8"	M1122	\$40.51
M049	1-1/4"	3/4"	2-5/8"	M1122	\$45.10
M048	1-1/2"	3/4"	2-5/8"	M1122	\$50.10
M050	1-3/4"	3/4"	2-5/8"	M1122	\$55.14
M051	2"	3/4"	2-5/8"	M1122	\$59.53
M055L	1/4"	1-1/4"	3-1/4"	M1128	\$30.33
M045L	3/8"	1-1/4"	3-1/4"	M1128	\$32.33
M046L	1/2"	1-1/4"	3-1/4"	M1128	\$37.20
M020L	3/4"	1-1/4"	3-1/4"	M1128	\$42.73
M047L	1"	1-1/4"	3-1/4"	M1128	\$47.68
M049L	1-1/4"	1-1/4"	3-1/4"	M1128	\$53.65
M048L	1-1/2"	1-1/4"	3-1/4"	M1128	\$56.87
M050L	1-3/4"	1-1/4"	3-1/4"	M1128	\$61.47
M051L	2"	1-1/4"	3-1/4"	M1128	\$68.60

Bead (Concave), 3-Wing



Listed rub collars by Magnate tool number are merely for information and not included.

Tool No.	Openin g	Radi us	Bore	Outside Dia.	Rub Collar	Price
M043	1/4"	1/8"	3/4"	2-5/8"	M1135	\$29.65
M044	3/8"	3/16"	3/4"	2-5/8"	M1133	\$33.51
M003	1/2"	1/4"	3/4"	2-5/8"	M1120	\$38.35
M060	5/8"	5/16"	3/4"	2-5/8"	M1119	\$41.97
M002	3/4"	3/8"	3/4"	2-5/8"	M1118	\$46.67
M061	7/8"	7/16"	3/4"	2-5/8"	M1116	\$54.22
M001	1"	1/2"	3/4"	2-5/8"	M1114	\$65.79
M043L	1/4"	1/8"	1-1/4"	3-1/4"	M1127	\$35.88
M044L	3/8"	3/16"	1-1/4"	3-1/4"	M1109	\$39.55
M003L	1/2"	1/4"	1-1/4"	3-1/4"	M1126	\$44.87
M060L	5/8"	5/16"	1-1/4"	3-1/4"	M1108	\$48.51
M002L	3/4"	3/8"	1-1/4"	3-1/4"	M1125	\$51.32
M061L	7/8"	7/16"	1-1/4"	3-1/4"	M1107	\$59.10
M001L	1"	1/2"	1-1/4"	3-1/4"	M1124	\$69.43
M062L	1-1/4"	5/8"	1-1/4"	3-5/8"	M1107	\$80.01
M063L	1-1/2"	3/4"	1-1/4"	4-1/8"	M1108	\$91.79

Bead & Corner Round, 3-Wing



Tool No.	Bore	Radius	Cutting Height	Overall Dia.	Price
M010	3/4"	1/4" + 1/8" + 3/8"	1"	2-5/8"	\$43.12
M010L	1-1/4"	1/4" + 1/8" + 3/8"	1"	3-1/4"	\$48.20

Bead & Cove, 3-Wing



Tool No.	Radius	Cutting Height	Bore	Overall Dia.	Price
M011	5/32" + 3/8"	1"	3/4"	2-5/8"	\$45.12
M011L	5/32" + 3/8"	1"	1-1/4"	3-1/4"	\$50.35

Quarter Round, 3 Wing

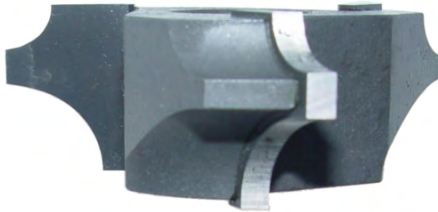

Tool No.	Bore	Radius	Cutting Height	Overall Dia.	Price
M017	3/4"	1/4" + 1/2"	1"	2-5/8"	\$49.78
M017L	1-1/4"	1/4" + 1/2"	1"	3-1/4"	\$58.24

Flute (Convex), 3-Wing



Listed rub collars by Magnate tool number are merely for information and not included.

Tool No.	Flute Height	Radius	Bore	Outside Dia.	Rub Collar	Price
M041	1/4"	1/8"	3/4"	2-5/8"	M1135	\$25.74
M042	3/8"	3/16"	3/4"	2-5/8"	M1133	\$27.14
M006	1/2"	1/4"	3/4"	2-5/8"	M1120	\$31.44
M070	5/8"	5/16"	3/4"	2-5/8"	M1119	\$33.57
M005	3/4"	3/8"	3/4"	2-5/8"	M1118	\$37.30
M071	7/8"	7/16"	3/4"	2-5/8"	M1116	\$50.82
M004	1"	1/2"	3/4"	2-5/8"	M1114	\$59.30
M041L	1/4"	1/8"	1-1/4"	3-1/4"	M1127	\$30.29
M042L	3/8"	3/16"	1-1/4"	3-1/4"	M1109	\$34.46
M006L	1/2"	1/4"	1-1/4"	3-1/4"	M1126	\$39.32
M070L	5/8"	5/16"	1-1/4"	3-1/4"	M1108	\$43.61
M005L	3/4"	3/8"	1-1/4"	3-1/4"	M1125	\$47.33
M071L	7/8"	7/16"	1-1/4"	3-1/4"	M1107	\$58.22
M004L	1"	1/2"	1-1/4"	3-1/4"	M1124	\$69.24
M072L	1-1/4"	5/8"	1-1/4"	3-5/8"	M1107	\$80.79
M073L	1-1/2"	3/4"	1-1/4"	4-1/8"	M1108	\$90.81

Stair Tread Nose, 3-Wing

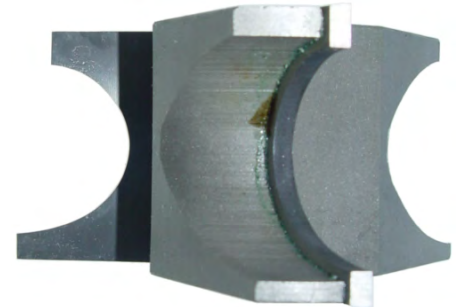

Tool No.	Bore	Radius	Cutting Height	Overall Dia.	Price
M016	3/4"	11/16" + 1/2"	1-1/2"	3-3/8"	\$69.52
M016L	1-1/4"	11/16" + 1/2"	1-1/2"	4"	\$75.57

Cove & Quarter Round, 3-Wing



Tool No.	Radius	Cutting Height	Bore	Overall Dia.	Price
M009	5/16" + 1/2"	1"	3/4"	2-5/8"	\$51.43
M009L	5/16" + 1/2"	1"	1-1/4"	3-1/4"	\$58.73



Triple Bead & Flute, 3-Wing



M095(L)

M096(L)

Tool No.	Profile	Bore	Radius	Cutting Height	Overall Dia.	Price
M095	Flute	3/4"	1/8"	1"	2-3/4"	\$55.94
M096	Bead	3/4"	1/8"	1"	2-3/4"	\$56.44
M095L	Flute	1-1/4"	1/8"	1"	3-1/4"	\$60.47
M096L	Bead	1-1/4"	1/8"	1"	3-1/4"	\$60.69

Corner Round, 3-Wing



Listed rub collars by Magnate tool number are merely for information and not included.

Tool No.	Radius	Bore	Carbide Height	Outside Dia.	Rub Collar	Price
M081	1/8"	3/4"	3/8"	2-5/8"	M1135	\$28.26
M082	3/16"	3/4"	7/16"	2-5/8"	M1133	\$31.21
M083	1/4"	3/4"	1/2"	2-5/8"	M1120	\$33.51
M084	5/16"	3/4"	9/16"	2-5/8"	M1119	\$37.12
M085	3/8"	3/4"	5/8"	2-5/8"	M1118	\$40.38
M086	1/2"	3/4"	3/4"	2-5/8"	M1116	\$45.21
M087	5/8"	3/4"	7/8"	3"	M1116	\$50.63
M034	3/4"	3/4"	1"	3-5/8"	M1120	\$61.83
M089	1"	3/4"	1-1/4"	4-1/8"	M1120	\$83.91
M090	1-1/4"	3/4"	1-1/2"	4-5/8"	M1120	\$97.59
M091	1-1/2"	3/4"	1-3/4"	5-1/8"	M1120	\$115.37
M081L	1/8"	1-1/4"	3/8"	3-1/4"	M1127	\$31.07
M082L	3/16"	1-1/4"	7/16"	3-1/4"	M1109	\$33.38
M083L	1/4"	1-1/4"	1/2"	3-1/4"	M1126	\$38.01
M084L	5/16"	1-1/4"	9/16"	3-1/4"	M1108	\$41.61
M085L	3/8"	1-1/4"	5/8"	3-1/4"	M1125	\$43.41
M086L	1/2"	1-1/4"	3/4"	3-3/8"	M1107	\$48.69
M087L	5/8"	1-1/4"	7/8"	3-5/8"	M1109	\$53.42
M034L	3/4"	1-1/4"	1"	4-1/8"	M1108	\$68.20
M089L	1"	1-1/4"	1-1/4"	4-5/8"	M1108	\$90.67
M090L	1-1/4"	1-1/4"	1-1/2"	5-1/8"	M1108	\$104.04
M091L	1-1/2"	1-1/4"	1-3/4"	5-5/8"	M1108	\$122.17

Door Lip, Ogee & Bead, 3-Wing



Tool No.	Cutting Height	Bore	Overall Dia.	Price
M037	1"	3/4"	2-5/8"	\$45.12
M037L	1"	1-1/4"	3-1/4"	\$48.44

Door Lip, Corner Round & Ogee, 3-Wing

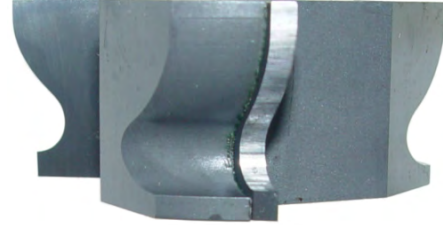

Tool No.	Bore	Cutting Height	Overall Dia.	Price
M027	3/4"	1"	2-5/8"	\$49.32
M027L	1-1/4"	1"	3-1/4"	\$52.92

Door Lip, Corner Round & Taper Rabbet 3-Wing



M026(L)

M015(L)

M015A(L)

Tool No.	Bore	Cutting Height	Overall Dia.	Price
M026^	3/4"	1"	2-5/8"	\$48.81
M026L^	1-1/4"	1"	3-1/4"	\$52.51
M015*	3/4"	1-1/4"	2-5/8"	\$49.64
M015L*	1-1/4"	1-1/4"	3-1/4"	\$53.86
M015A^	3/4"	1-1/4"	2-5/8"	\$50.14
M015AL^	1-1/4"	1-1/4"	3-1/4"	\$54.04

* Rabbet Down/Face Down
^ Rabbet Up/Face Up

Door Lip, Ogee & Cove, 3-Wing



Tool No.	Bore	Cutting Height	Overall Dia.	Price
M028	3/4"	1"	2-5/8"	\$48.77
M028L	1-1/4"	1"	3-1/4"	\$52.34

Raised Panel, 5 Degree Face-Cut 1-5/8" Cutting Depth 1/8" Radius, 3-Wing Horizontal



Listed rub collars by Magnate tool number are merely for information and not included.

Cutting depth shown is measured when working without a rub collar or with a rub collar on the list.

Cutting depth can be reduced to 1-1/2" if the cutter is used with Magnate rub collar M1119 (3/4" ID x 2" OD) for 3/4" bore cutter, or M1127 (1-1/4" ID x 3" OD) for 1-1/4" bore cutter.

Tool No.	Bore	Overall Dia.	Cutting Height	Rub Collar	Price
M029	3/4"	5"	5/8"	M1116	\$75.32
M029L	1-1/4"	5-1/2"	5/8"	M1126	\$81.18

Raised Panel, 12 Degree Face-Cut with 5/32" Radius Quarter Round 1-5/8" Cutting Depth, 3-Wing Horizontal



Listed rub collars by Magnate tool number are merely for information and not included.

Cutting depth shown is measured when working without a rub collar or with a rub collar on the list.

Cutting depth can be reduced to 1-1/2" if the cutter is used with Magnate rub collar M1119 (3/4" ID x 2" OD) for 3/4" bore cutter, or M1127 (1-1/4" ID x 3" OD) for 1-1/4" bore cutter.

Tool No.	Bore	Overall Dia.	Cutting Height	Price
M032	3/4"	5"	21/32"	\$75.80
M032L	1-1/4"	5-1/2"	21/32"	\$81.71



Raised Panel, 15 Degree Face-Cut 1-5/8" Cutting Depth 3-Wing Horizontal



Listed rub collars by Magnate tool number are merely for information and not included.

Cutting depth shown is measured when working without a rub collar or with a rub collar on the list.

Cutting depth can be reduced to 1-1/2" if the cutter is used with Magnate rub collar M1119 (3/4" ID x 2" OD) for 3/4" bore cutter, or M1127 (1-1/4" ID x 3" OD) for 1-1/4" bore cutter.

Tool No.	Bore	Overall Dia.	Cutting Height	Price
M030	3/4"	5"	21/32"	\$75.47
M030L	1-1/4"	5-1/2"	21/32"	\$81.29

Raised Panel, Ogee 1-5/8" Cutting Depth 3-Wing Horizontal



Listed rub collars by Magnate tool number are merely for information and not included.

Cutting depth shown is measured when working without a rub collar or with a rub collar on the list.

Cutting depth can be reduced to 1-1/2" if the cutter is used with Magnate rub collar M1119 (3/4" ID x 2" OD) for 3/4" bore cutter, or M1127 (1-1/4" ID x 3" OD) for 1-1/4" bore cutter.

Tool No.	Bore	Overall Dia.	Cutting Height	Price
M031	3/4"	5"	25/32"	\$75.61
M031L	1-1/4"	5-1/2"	25/32"	\$81.44

Raised Panel Back Cutter 3 Wing, Horizontal



Tool No.	Profile	Cutting Height	Bore	Overall Dia.	Price
M057	3/16" Radius	3/8"	3/4"	3-1/2"	\$37.40
M057L	3/16" Radius	3/8"	1-1/4"	4"	\$42.44
M058	45 Degree	1/2"	3/4"	3-3/4"	\$37.32
M058L	45 Degree	3/8"	1-1/4"	4-1/4"	\$42.18

Raised Panel, Convex 1-5/8" Cutting Depth 3-Wing Horizontal



Listed rub collars by Magnate tool number are merely for information and not included.

Cutting depth shown is measured when working without a rub collar or with a rub collar on the list.

Cutting depth can be reduced to 1-1/2" if the cutter is used with Magnate rub collar M1119 (3/4" ID x 2" OD) for 3/4" bore cutter, or M1127 (1-1/4" ID x 3" OD) for 1-1/4" bore cutter.

Tool No.	Bore	Overall Dia.	Cutting Height	Price
M033	3/4"	5"	21/32"	\$75.80
M033L	1-1/4"	5-1/2"	21/32"	\$81.71

Raised Panel, 6 Degree Face-Up 1-1/2" Cutting Height 3/32" Radius, 3-Wing Vertical



Tool No.	Bore	Overall Dia.	Price
M014	3/4"	2-5/8"	\$37.24
M014L	1-1/4"	3-1/4"	\$42.08

Reversible 45 Degree Lock Mitre, 3-Wing



Tool No.	Cutting Height	Bore	Overall Dia.	Price
M038	1-3/16"	3/4"	4-1/2"	\$71.82
M038L	1-3/16"	1-1/4"	5"	\$81.10

Reversible Drawer Joint, 3-Wing

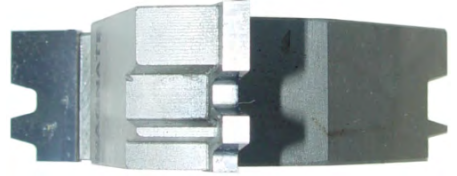

Tool No.	Cutting Height	Bore	Overall Dia.	Price
M007	3/4"	3/4"	2-5/8"	\$40.17
M007L	3/4"	1-1/4"	3-1/4"	\$45.07

Reversible Glue Joint, 3-Wing

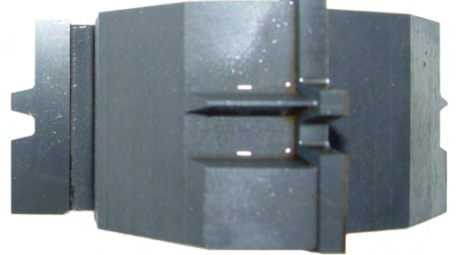

Tool No.	Cutting Height	Bore	Overall Dia.	Price
M019	1-1/4"	3/4"	2-5/8"	\$43.97
M019L	1-1/4"	1-1/4"	3-1/4"	\$51.68

Reversible Bead & Cove, 3-Wing



Tool No.	Radius	Cutting Height	Bore	Overall Dia.	Price
M054	(1/4", 1/4")	15/16"	3/4"	3"	\$49.98
M054L	(1/4", 1/4")	15/16"	1-1/4"	3-5/8"	\$57.09

Sash, 3-Wing

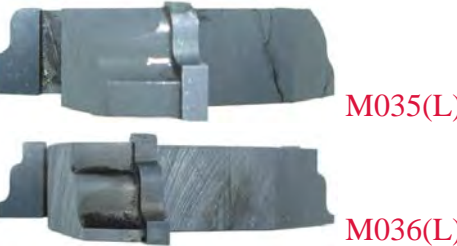

Tool No.	Profile	Cutting Height	Bore	Overall Dia.	Price
M035	Female	11/16"	3/4"	2-5/8"	\$37.48
M036	Male	3/4"	3/4"	3-1/4"	\$37.62
M035L	Female	11/16"	1-1/4"	3-1/4"	\$44.64
M036L	Male	3/4"	1-1/4"	3-3/4"	\$44.89



Cabinet Stile & Rail Set 3-Wing 6 Pieces

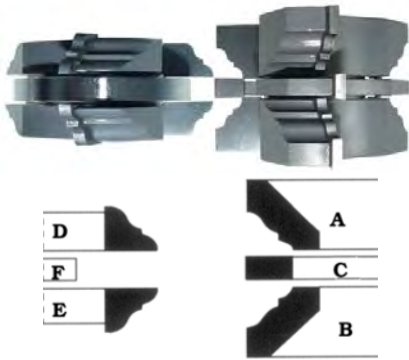

D : R. H. Male 3/8" **A** : R. H. Female 11/16"
F : Spacer 1/4" **C** : Straight 1/4"
E : L. H. Male 3/8" **B** : L. H. Female 11/16"

Tool No.	Cutting Height	Bore	Overall Dia.	Price
M021	1-5/8"	3/4"	2-5/8"	\$173.69
M021L	1-5/8"	1-1/4"	3-1/4"	\$195.65

Cove & Bead Stile & Rail Set 3-Wing 6 Pieces

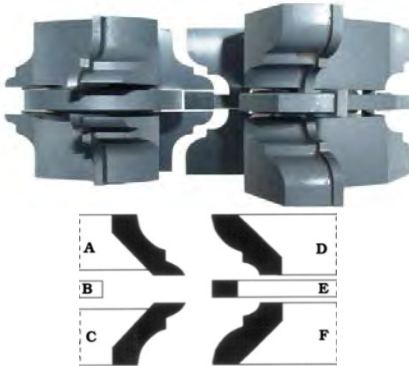

A : R. H. Male 3/4" **D** : R. H. Female 3/4"
B : Spacer 1/4" **E** : Straight 1/4"
C : L. H. Male 3/4" **F** : L. H. Female 3/4"

Tool No.	Cutting Height	Bore	Overall Dia.	Price
M022	1-3/4"	3/4"	2-5/8"	\$174.14
M022L	1-3/4"	1-1/4"	3-5/8"	\$195.96

V-Groove, 3-Wing



Tool No.	Degree	Cutting Height	Bore	Overall Dia.	Price
M039	90	1"	3/4"	2-5/8"	\$47.81
M039L	90	1"	1-1/4"	3-1/4"	\$55.00

Concave Stile & Rail Set 3-Wing 6 Pieces

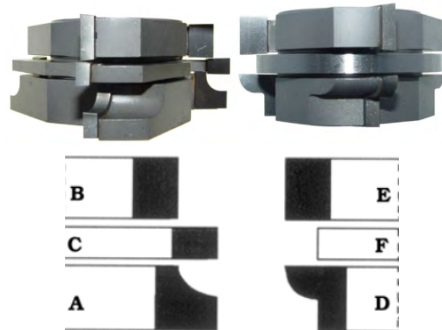

B : Straight 1/2" **E** : Straight 1/2"
C : Straight 1/4" **F** : Spacer 1/4"
A : Stile 1/2" **D** : Rail 1/2"

Tool No.	Cutting Height	Bore	Overall Dia.	Price
M023	1-1/4"	3/4"	2-5/8"	\$173.23
M023L	1-1/4"	1-1/4"	3-1/4"	\$195.30

Convex Stile & Rail Set 3-Wing 6 Pieces

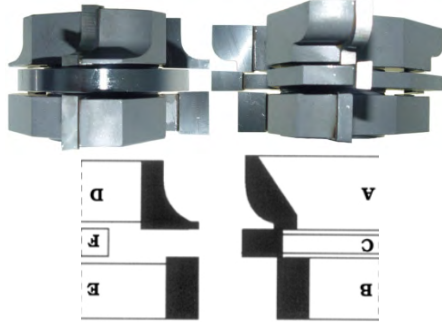

D : Rail 9/16" **A** : Stile 1/2"
F : Spacer 1/4" **C** : Straight 1/4"
E : Straight 1/2" **B** : Straight 1/2"

Tool No.	Cutting Height	Bore	Overall Dia.	Price
M024	1-5/16"	3/4"	2-5/8"	\$173.46
M024L	1-5/16"	1-1/4"	3-1/4"	\$195.40

Molding, 3-Wing

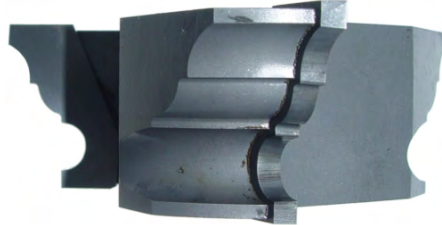

Tool No.	Cutting Height	Bore	Overall Dia.	Price
M008	1-3/16"	3/4"	3-1/4"	\$54.01
M008L	1-3/16"	1-1/4"	3-3/4"	\$66.97

Ogee Stile & Rail Set 3-Wing 6 Pieces

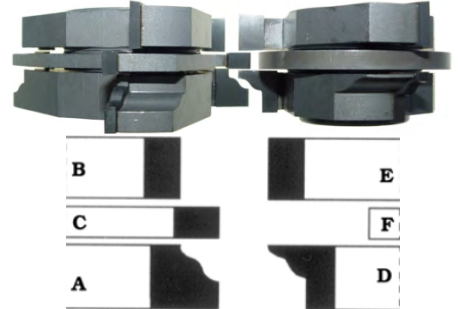

B : Straight 1/2" **E** : Straight 1/2"
C : Straight 1/4" **F** : Spacer 1/4"
A : Stile 1/2" **D** : Rail 1/2"

Tool No.	Cutting Height	Bore	Overall Dia.	Price
M025	1-1/4"	3/4"	2-5/8"	\$173.09
M025L	1-1/4"	1-1/4"	3-1/4"	\$195.23

Ogee, 3-Wing



Tool No.	Cutting Height	Bore	Radius	Overall Dia.	Price
M018	13/16"	3/4"	(1/4", 1/4")	2-5/8"	\$45.79
M018L	13/16"	1-1/4"	(1/4", 1/4")	3-1/4"	\$53.63

Wedge Tongue & Groove, 3-Wing



M012(L)



M013(L)

The opening is 3/8", the two straight edges are 3/8" each, the depth is 5/16", the indentation is 10 degrees.

Tool No.	Profile	Cutting Height	Bore	Overall Dia.	Price
M012	Tongue	1-1/8"	3/4"	2-5/8"	\$43.85
M013	Groove	1-1/8"	3/4"	2-5/8"	\$43.88
M012L	Tongue	1-1/8"	1-1/4"	3-1/4"	\$51.41
M013L	Groove	1-1/8"	1-1/4"	3-1/4"	\$51.45



Bevel, 30 Degree 3-Wing

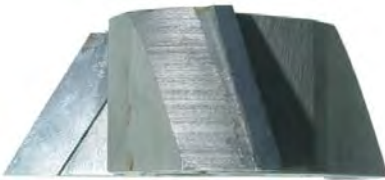

Tool No.	Cutting Height	Bore	Overall Dia.	Price
M040	1"	3/4"	2-5/8"	\$34.83
M040L	1"	1-1/4"	3-1/4"	\$38.32

Spacers



Spacers are used for positioning shaper cutters on the shaper spindle. In some cases, when a spacer is placed in between two stacked shapers, a tongue profile can be formed.

Tool No.	Inside Dia.	Outside Dia.	Height	Price
M1159	1/2"	1"	1/4"	\$2.47
M1160	1/2"	1"	3/8"	\$2.48
M1161	1/2"	1"	1/2"	\$2.71
M1162	1/2"	1"	3/4"	\$2.86
M1163	1/2"	1"	1"	\$3.05
M1164	3/4"	1-1/4"	1/4"	\$3.06
M1165	3/4"	1-1/4"	3/8"	\$3.08
M1166	3/4"	1-1/4"	1/2"	\$3.44
M1167	3/4"	1-1/4"	3/4"	\$3.45
M1168	3/4"	1-1/4"	1"	\$3.48
M1169	1"	1-1/2"	1/4"	\$3.61
M1170	1"	1-1/2"	3/8"	\$3.63
M1171	1"	1-1/2"	1/2"	\$3.65
M1172	1"	1-1/2"	3/4"	\$3.79
M1173	1"	1-1/2"	1"	\$3.98
M1174	1-1/4"	1-3/4"	1/4"	\$4.36
M1175	1-1/4"	1-3/4"	3/8"	\$4.40
M1176	1-1/4"	1-3/4"	1/2"	\$4.43
M1177	1-1/4"	1-3/4"	3/4"	\$4.65
M1178	1-1/4"	1-3/4"	1"	\$4.86

T-Bushing, 2/Pack



Reduces the bore size of the shaper cutter. T-Bushings come with a flange for easy removal.

In the situation where the bore size of a shaper cutter is larger than the size of the shaper spindle, two T-bushings can be placed at the top and bottom of the shaper cutter to secure its position by tightening spindle nut.

Tool No.	Inside Dia.	Outside Dia.	Price
M1151	1"	1-1/4"	\$5.25
M1152	3/4"	1-1/4"	\$7.12
M1153	3/4"	1"	\$5.01
M1154	1/2"	3/4"	\$3.92

Straight Bushing



Straight bushings reduce the bore size of the shaper cutter. When the bore size of a shaper cutter is larger than the size of the shapers spindle, multiple straight bushings can be placed in the bore of the shaper cutters.

Tool No.	Inside Dia.	Outside Dia.	Height	Price
M1155	1"	1-1/4"	3/8"	\$2.86
M1156	3/4"	1-1/4"	3/8"	\$2.88
M1157	3/4"	1"	3/8"	\$2.66
M1158	1/2"	3/4"	3/8"	\$2.48

Double T-Bushing, 3/8" Height Both Sides



The Double T-Bushing is designed to be placed in between two stacked shaper cutters with bore sizes larger than the size of the shaper spindle.

Tool No.	Inside Dia.	Outside Dia.	Price
M1179	1"	1-1/4"	\$5.03
M1180	3/4"	1-1/4"	\$5.07
M1181	3/4"	1"	\$4.81
M1182	1/2"	3/4"	\$4.48

Long T-Bushing



Reduces the bore size of the shaper cutter. Long T-bushings come with a flange for easy removal.

When the bore sizes of multiple stacked shaper cutters are larger than the size of the shaper spindle, place two long T-bushings at the top and bottom of the stacked shaper cutters. This will eliminate the number of straight bushings.

Tool No.	Inside Dia.	Outside Dia.	Height	Price
M1150	1/2"	3/4"	1-3/16"	\$5.60
M1149	3/4"	1"	1-3/16"	\$5.79
M1146	3/4"	1-1/4"	3/4"	\$5.87
M1148	3/4"	1-1/4"	1-3/16"	\$6.12
M1147	1"	1-1/4"	1-3/16"	\$6.07

Ball Bearing Rub Collar For Shaper Cutters



Placing on the top, bottom or between shaper cutters, this ball bearing rub collar is used to follow templates. It can also be used like a spacer.

Tool No.	Bore	Outside Dia.	Height	Price
M1110	1/2"	1-1/8"	5/16"	\$8.88
M1111	1/2"	1-1/4"	5/16"	\$9.86
M1112	1/2"	1-3/8"	5/16"	\$12.85
M1113	1/2"	1-1/2"	5/16"	\$13.86
M1114	3/4"	1-5/8"	7/16"	\$14.40
M1115	3/4"	1-11/16"	7/16"	\$16.22
M1116	3/4"	1-3/4"	7/16"	\$16.24
M1117	3/4"	1-27/32"	7/16"	\$16.26
M1118	3/4"	1-7/8"	7/16"	\$16.28
M1119	3/4"	2"	7/16"	\$17.12
M1132	3/4"	2-1/16"	7/16"	\$16.56
M1120	3/4"	2-1/8"	7/16"	\$16.58
M1121	3/4"	2-3/16"	7/16"	\$17.33
M1133	3/4"	2-1/4"	7/16"	\$17.96
M1134	3/4"	2-5/16"	7/16"	\$17.98
M1135	3/4"	2-3/8"	7/16"	\$18.00
M1136	3/4"	2-7/16"	7/16"	\$18.02
M1137	3/4"	2-1/2"	7/16"	\$18.04
M1138	3/4"	2-9/16"	7/16"	\$18.84
M1122	3/4"	2-5/8"	7/16"	\$18.04
M1139	3/4"	2-11/16"	7/16"	\$18.86
M1140	3/4"	2-3/4"	7/16"	\$18.88
M1143	3/4"	2-13/16"	7/16"	\$18.90
M1144	3/4"	2-7/8"	7/16"	\$18.92
M1123	3/4"	2-15/16"	7/16"	\$18.94
M1078	1"	1-3/4"	7/16"	\$16.64
M1079	1"	1-7/8"	7/16"	\$17.23
M1080	1"	2"	7/16"	\$17.84
M1081	1"	2-1/8"	7/16"	\$18.49
M1082	1"	2-1/4"	7/16"	\$19.02
M1083	1"	2-3/8"	7/16"	\$19.58
M1084	1"	2-1/2"	7/16"	\$20.21
M1085	1"	2-5/8"	7/16"	\$20.83
M1086	1"	2-3/4"	7/16"	\$21.58
M1087	1"	2-7/8"	7/16"	\$22.34
M1088	1"	3"	7/16"	\$23.17
M1090	1"	3-1/4"	7/16"	\$24.63
M1124	1-1/4"	2-1/4"	7/16"	\$24.63
M1107	1-1/4"	2-3/8"	7/16"	\$25.13
M1125	1-1/4"	2-1/2"	7/16"	\$25.63
M1108	1-1/4"	2-5/8"	7/16"	\$25.85
M1126	1-1/4"	2-3/4"	7/16"	\$25.65
M1109	1-1/4"	2-7/8"	7/16"	\$26.18
M1127	1-1/4"	3"	7/16"	\$26.08
M1128	1-1/4"	3-1/4"	7/16"	\$26.10
M1129	1-1/4"	3-3/8"	7/16"	\$26.90
M1130	1-1/4"	3-1/2"	7/16"	\$28.34
M1131	1-1/4"	4"	7/16"	\$29.61



MAGNATE™ End Mills

These cobalt M42 uncoated end mill bits are designed for tougher cutting assignments on high strength, hi-temp steel and exotic materials or extended production runs in conventional and N/C milling operations.

Used for general purpose milling including profiling, slotting, keyways, pockets and plunge cutting.

TiAIN coated end mills are also available, details upon request.

Cobalt M42, 2 Flute, Single End Right Hand, 30° Helix, Weldon Shank



Tool No.	Mill Dia.	Shank Dia.	Flute Height	Overall Length	Price
EM2602	1/8"	3/8"	3/8"	2-5/16"	\$21.00
EM2604	3/16"	3/8"	7/16"	2-5/16"	\$19.33
EM2606	1/4"	3/8"	1/2"	2-5/16"	\$21.07
EM2608	5/16"	3/8"	9/16"	2-5/16"	\$19.43
EM2610	3/8"	3/8"	9/16"	2-5/16"	\$22.58
EM2612	7/16"	3/8"	13/16"	2-1/2"	\$31.53
EM2614	1/2"	3/8"	13/16"	2-1/2"	\$27.07
EM2616	1/2"	1/2"	1"	3"	\$34.00
EM2618	9/16"	1/2"	1-1/8"	3-1/8"	\$31.58
EM2620	5/8"	1/2"	1-1/8"	3-1/8"	\$35.43
EM2622	5/8"	5/8"	1-5/16"	3-7/16"	\$35.20
EM2630	3/4"	5/8"	1-5/16"	3-7/16"	\$35.20
EM2632	3/4"	3/4"	1-5/16"	3-9/16"	\$40.17
EM2636	7/8"	5/8"	1-1/2"	3 5/8"	\$52.70
EM2640	7/8"	7/8"	1-1/2"	3-3/4"	\$59.35
EM2642	1"	5/8"	1-1/2"	3 5/8"	\$57.27
EM2644	1"	3/4"	1-1/2"	3-3/4"	\$70.60
EM2646	1"	1"	1-5/8"	4-1/8"	\$70.07
EM2656	1-1/4"	1-1/4"	1-5/8"	4-1/8"	\$89.32
EM2664	1-1/2"	1-1/4"	1-5/8"	4-1/8"	\$116.65
EM2678	2"	1-1/4"	1-5/8"	4-1/8"	\$184.38

Cobalt M42, 4 Flute, Single End Right Hand, 30° Helix, Weldon Shank



Tool No.	Mill Dia.	Shank Dia.	Flute Height	Overall Length	Price
EM2702	1/8"	3/8"	3/8"	2-5/16"	\$19.98
EM2704	3/16"	3/8"	1/2"	2-3/8"	\$19.98
EM2706	1/4"	3/8"	5/8"	2-7/16"	\$22.88
EM2708	5/16"	3/8"	3/4"	2-1/2"	\$24.20
EM2710	3/8"	3/8"	3/4"	2-1/2"	\$22.88
EM2711	3/8"	3/8"	1-1/2"	3-1/4"	\$26.63
EM2714	1/2"	1/2"	1-1/4"	3-1/4"	\$30.20
EM2715	1/2"	1/2"	2"	4"	\$42.48
EM2718	5/8"	5/8"	1-5/8"	3-3/4"	\$46.82
EM2719	5/8"	5/8"	2-1/2"	4-5/8"	\$48.07
EM2722	3/4"	3/4"	1-5/8"	3-7/8"	\$57.18
EM2723	3/4"	3/4"	3"	5-1/4"	\$54.53
EM2724	7/8"	7/8"	1-7/8"	4-1/8"	\$56.55
EM2728	1"	1"	2"	4-1/2"	\$80.60
EM2729	1"	1"	4"	6-1/2"	\$97.07
EM2730	1-1/4"	1-1/4"	2"	4-1/2"	\$109.77
EM2731	1-1/4"	1-1/4"	4"	6-1/2"	\$146.63
EM2734	1-1/2"	1-1/4"	2"	4-1/2"	\$136.22

Cobalt M42, 6 Flute, Single End Right Hand, 30° Helix, Weldon Shank



Tool No.	Mill Dia.	Shank Dia.	Flute Height	Overall Length	Price
EM2732	1-1/4"	1-1/4"	2"	4-1/2"	\$105.78
EM2733	1-1/4"	1-1/4"	4"	6-1/2"	\$146.63
EM2736	1-1/2"	1-1/4"	2"	4-1/2"	\$128.80
EM2738	2"	1-1/4"	2"	4-1/2"	\$195.33

Cobalt M42, 2 Flute Double End Right Hand, 30° Helix, Weldon Shank



Tool No.	Mill Dia.	Shank Dia.	Flute Height	Overall Length	Price
EM2402	1/8"	3/8"	3/8"	3-1/16"	\$26.50
EM2404	5/32"	3/8"	7/16"	3-1/8"	\$28.72
EM2406	3/16"	3/8"	7/16"	3-1/8"	\$27.70
EM2408	7/32"	3/8"	1/2"	3-1/8"	\$31.18
EM2410	1/4"	3/8"	1/2"	3-1/8"	\$27.22
EM2412	9/32"	3/8"	9/16"	3-1/8"	\$29.88
EM2414	5/16"	3/8"	9/16"	3-1/8"	\$27.65
EM2418	3/8"	3/8"	9/16"	3-1/8"	\$28.08
EM2420	13/32"	1/2"	13/16"	3-3/4"	\$43.35
EM2422	7/16"	1/2"	13/16"	3-3/4"	\$43.80
EM2426	1/2"	1/2"	13/16"	3-3/4"	\$43.98
EM2428	9/16"	5/8"	1-1/8"	4-1/2"	\$49.67
EM2430	5/8"	5/8"	1-1/8"	4-1/2"	\$55.67
EM2432	3/4"	3/4"	1-5/16"	5"	\$60.68
EM2436	7/8"	7/8"	1-9/16"	5-1/2"	\$77.27
EM2442	1"	1"	1-5/8"	5-7/8"	\$80.75

Cobalt M42, 4 Flute Double End Right Hand, 30° Helix, Weldon Shank



Tool No.	Mill Dia.	Shank Dia.	Flute Height	Overall Length	Price
EM2502	1/8"	3/8"	3/8"	3-1/16"	\$36.07
EM2506	3/16"	3/8"	1/2"	3-1/4"	\$36.37
EM2510	1/4"	3/8"	5/8"	3-3/8"	\$29.35
EM2514	5/16"	3/8"	3/4"	3-1/2"	\$29.67
EM2518	3/8"	3/8"	3/4"	3-1/2"	\$32.02
EM2526	1/2"	1/2"	1"	4-1/8"	\$47.72
EM2530	5/8"	5/8"	1-3/8"	5"	\$68.30
EM2532	3/4"	3/4"	1-5/8"	5-5/8"	\$73.00

These roughing end mills have a sinusoidal chip breaker form which produce small chips, allowing them to run at faster speed rate than conventional tools, resulting in high material removal rates.

Designed to machine difficult and abrasive materials, ranging from medium to highest hardness level machinable by High Speed steel. The 8% cobalt content assures high edge hardness at elevated temperature levels. The large core diameter provides rigidity and reduces deflection.

They can be used for general purpose rough milling including profiling and open ended slots.

Cobalt M42 Roughing, Ball Nose Center Cutting Coarse Pitch, Sinusoidal Tooth Right-Hand, 30° Helix



Tool No.	Mill Dia.	Shank Dia.	Flute Height	Flute	Overall Length	Price
EM2112	1/2"	1/2"	1-1/4"	4	3-1/4"	\$91.28
EM2114	1/2"	1/2"	2"	4	4"	\$122.30
EM2116	5/8"	5/8"	1-5/8"	4	3-3/4"	\$122.30
EM2118	5/8"	5/8"	2-1/2"	4	4-5/8"	\$152.45
EM2120	3/4"	3/4"	1-5/8"	4	3-7/8"	\$132.80
EM2122	3/4"	3/4"	3"	4	5-1/4"	\$164.82
EM2124	1"	1"	2"	5	4-1/2"	\$223.33
EM2126	1"	1"	4"	5	6-1/2"	\$256.98
EM2128	1-1/4"	1-1/4"	2"	6	4-1/2"	\$280.03
EM2130	1-1/4"	1-1/4"	4"	6	6-1/2"	\$340.30
EM2132	1-1/2"	1-1/4"	2"	6	4-1/2"	\$354.47
EM2134	1-1/2"	1-1/4"	4"	6	6-1/2"	\$398.75



MAGNATE™ End Mills

Cobalt M42 Roughing, Coarse Pitch Non-Center Cutting Right Hand, 30° Helix, Sinusoidal Tooth



These micro-grain solid carbide, uncoated end mill bits provides outstanding performance and allows optimum cutting speeds and feeds, high rigidity and minimum tool deflection. It is designed for aggressive milling of most materials. TiAlN coated end mills are also available, details upon request.

For wood cutting applications, spiral bits may be more suitable than these end mills.

Tool No.	Mill Dia.	Shank Dia.	Flute Height	Flute	Overall Length	Price
EM2006	1/4"	3/8"	5/8"	3	2-7/16"	\$35.40
EM2008	5/16"	3/8"	3/4"	3	2-1/2"	\$37.97
EM2010	3/8"	3/8"	3/4"	4	2-1/2"	\$39.15
EM2015	1/2"	1/2"	2"	4	4"	\$66.20
EM2018	5/8"	5/8"	1-5/8"	4	3-3/4"	\$53.18
EM2019	5/8"	5/8"	2-1/2"	4	4-5/8"	\$89.53
EM2022	3/4"	3/4"	1-5/8"	4	3-7/8"	\$64.07
EM2021	3/4"	3/4"	3"	4	5-1/4"	\$81.53
EM2024	7/8"	3/4"	1-7/8"	5	4-1/8"	\$90.93
EM2025	7/8"	3/4"	3-1/2"	5	5-3/4"	\$105.73
EM2032	1"	1"	2"	5	4-1/2"	\$102.27
EM2029	1"	1"	4"	5	6-1/2"	\$135.27
EM2034	1-1/8"	1"	2"	6	4-1/2"	\$128.75
EM2036	1-1/4"	1-1/4"	2"	6	4-1/2"	\$146.13
EM2037	1-1/4"	1-1/4"	4"	6	6-1/2"	\$177.03
EM2038	1-1/2"	1-1/4"	2"	6	4-1/2"	\$176.02
EM2039	1-1/2"	1-1/4"	4"	6	6-1/2"	\$264.53
EM2040	2"	1-1/4"	2"	8	4-1/2"	\$238.72
EM2041	2"	1-1/4"	4"	8	6-1/2"	\$305.47
EM2042	2"	2"	4"	8	7-3/4"	\$362.67
EM2045	2"	2"	8"	8	11-3/4"	\$537.77
EM2047	2"	2"	10"	8	13-3/4"	\$672.22
EM2049	2"	2"	12"	8	15-3/4"	\$806.65

Solid Carbide, Ball Nose, 2-Flute Single End, Right Hand, 30° Helix



Ball nose geometry for inside corner radius and CNC contouring.

Tool No.	Mill Dia.	Shank Dia.	Flute Height	Overall Length	Price
EM1562	1/32"	1/8"	3/32"	1-1/2"	\$14.27
EM1564	3/64"	1/8"	1/8"	1-1/2"	\$12.58
EM1566	1/16"	1/8"	1/4"	1-1/2"	\$12.77
EM1568	5/64"	1/8"	1/4"	1-1/2"	\$10.72
EM1570	3/32"	1/8"	3/8"	1-1/2"	\$13.70
EM1572	7/64"	1/8"	3/8"	1-1/2"	\$10.72
EM1502	1/8"	1/8"	1/2"	1-1/2"	\$10.83
EM1504	5/32"	3/16"	9/16"	2"	\$16.32
EM1506	3/16"	3/16"	5/8"	2"	\$16.07
EM1508	7/32"	1/4"	5/8"	2-1/2"	\$21.05
EM1510	1/4"	1/4"	3/4"	2-1/2"	\$19.73
EM1512	9/32"	5/16"	7/8"	2-1/2"	\$29.82
EM1514	5/16"	5/16"	7/8"	2-1/2"	\$27.60
EM1516	3/8"	3/8"	7/8"	2-1/2"	\$30.62
EM1518	7/16"	7/16"	1"	2-1/2"	\$48.62
EM1520	1/2"	1/2"	1"	3"	\$57.37
EM1522	9/16"	9/16"	1-1/4"	3-1/2"	\$95.23
EM1524	5/8"	5/8"	1-1/4"	3-1/2"	\$102.17
EM1526	3/4"	3/4"	1-1/2"	4"	\$148.72
EM1528	7/8"	7/8"	1-1/2"	4"	\$232.10
EM1530	1"	1"	1-1/2"	4"	\$246.55

Solid Carbide, Ball Nose, 4-Flute Single End, Right Hand, 30° Helix



Ball nose geometry for inside corner radius and CNC contouring.

Tool No.	Mill Dia.	Shank Dia.	Flute Height	Overall Length	Price
EM1563	1/32"	1/8"	3/32"	1-1/2"	\$14.27
EM1565	3/64"	1/8"	1/8"	1-1/2"	\$12.58
EM1567	1/16"	1/8"	1/4"	1-1/2"	\$12.77
EM1569	5/64"	1/8"	1/4"	1-1/2"	\$10.72
EM1571	3/32"	1/8"	3/8"	1-1/2"	\$12.77
EM1573	7/64"	1/8"	3/8"	1-1/2"	\$10.72
EM1503	1/8"	1/8"	1/2"	1-1/2"	\$10.83
EM1507	3/16"	3/16"	5/8"	2"	\$16.07
EM1511	1/4"	1/4"	3/4"	2-1/2"	\$19.73
EM1515	5/16"	5/16"	7/8"	2-1/2"	\$27.60
EM1517	3/8"	3/8"	7/8"	2-1/2"	\$30.62
EM1519	7/16"	7/16"	1"	2-1/2"	\$48.62
EM1521	1/2"	1/2"	1"	3"	\$57.37
EM1525	5/8"	5/8"	1-1/4"	3-1/2"	\$102.17
EM1527	3/4"	3/4"	1-1/2"	4"	\$148.72
EM1531	1"	1"	1-1/2"	4"	\$246.55

Solid Carbide, 2-Flute, Stub Length Single End, Right Hand, 30° Helix



Tool No.	Mill Dia.	Shank Dia.	Flute Height	Overall Length	Price
EM1105	1/16"	1/8"	1/8"	1-1/2"	\$8.95
EM1107	3/32"	1/8"	3/16"	1-1/2"	\$6.05
EM1109	1/8"	1/8"	1/4"	1-1/2"	\$7.93
EM1117	5/32"	3/16"	5/16"	2"	\$11.50
EM1119	3/16"	3/16"	3/8"	2"	\$12.63
EM1125	7/32"	1/4"	7/16"	2"	\$13.55
EM1127	1/4"	1/4"	1/2"	2"	\$15.78
EM1133	5/16"	5/16"	1/2"	2"	\$20.25
EM1135	3/8"	3/8"	5/8"	2"	\$23.35
EM1143	7/16"	7/16"	5/8"	3"	\$32.57
EM1149	1/2"	1/2"	5/8"	2-1/2"	\$40.22
EM1159	5/8"	5/8"	3/4"	3"	\$70.42
EM1169	3/4"	3/4"	1"	3"	\$100.77



MAGNATE™ End Mills

Solid Carbide, 2-Flute, Regular Length Single End, Right Hand, 30° Helix



Tool No.	Mill Dia.	Shank Dia.	Flute Height	Overall Length	Price
EM1098	1/32"	1/8"	3/32"	1-1/2"	\$8.55
EM1100	3/64"	1/8"	1/8"	1-1/2"	\$8.55
EM1102	1/16"	1/8"	1/4"	1-1/2"	\$8.95
EM1104	5/64"	1/8"	1/4"	1-1/2"	\$8.95
EM1106	3/32"	1/8"	3/8"	1-1/2"	\$8.95
EM1108	7/64"	1/8"	3/8"	1-1/2"	\$8.95
EM1110	1/8"	1/8"	1/2"	1-1/2"	\$7.93
EM1112	9/64"	3/16"	9/16"	2"	\$12.90
EM1114	5/32"	3/16"	9/16"	2"	\$12.90
EM1116	11/64"	3/16"	9/16"	2"	\$12.90
EM1118	3/16"	3/16"	5/8"	2"	\$12.63
EM1120	13/64"	1/4"	5/8"	2-1/2"	\$15.30
EM1122	7/32"	1/4"	5/8"	2-1/2"	\$17.62
EM1124	15/64"	1/4"	3/4"	2-1/2"	\$15.30
EM1126	1/4"	1/4"	3/4"	2-1/2"	\$16.28
EM1128	17/64"	5/16"	7/8"	2-1/2"	\$22.03
EM1130	9/32"	5/16"	7/8"	2-1/2"	\$23.22
EM1132	19/64"	5/16"	7/8"	2-1/2"	\$22.03
EM1134	5/16"	5/16"	7/8"	2-1/2"	\$21.00
EM1136	21/64"	3/8"	7/8"	2-1/2"	\$25.67
EM1138	11/32"	3/8"	7/8"	2-1/2"	\$26.18
EM1140	23/64"	3/8"	7/8"	2-1/2"	\$25.67
EM1142	3/8"	3/8"	7/8"	2-1/2"	\$24.00
EM1144	25/64"	7/16"	7/8"	2-3/4"	\$37.50
EM1146	13/32"	7/16"	7/8"	2-3/4"	\$39.63
EM1148	27/64"	7/16"	7/8"	2-3/4"	\$37.50
EM1150	7/16"	7/16"	1"	2-3/4"	\$35.40
EM1152	29/64"	1/2"	1"	3"	\$44.52
EM1154	15/32"	1/2"	1"	3"	\$45.48
EM1156	31/64"	1/2"	1"	3"	\$44.52
EM1158	1/2"	1/2"	1"	3"	\$44.18
EM1160	9/16"	9/16"	1-1/4"	3-1/2"	\$74.12
EM1162	5/8"	5/8"	1-1/4"	3-1/2"	\$81.05
EM1164	11/16"	3/4"	1-1/2"	4"	\$124.15
EM1166	3/4"	3/4"	1-1/2"	4"	\$122.30
EM1168	7/8"	7/8"	1-1/2"	4"	\$195.13
EM1170	1"	1"	1-1/2"	4"	\$209.55

Solid Carbide, 2-Flute, Metric Single End, Right Hand, 30° Helix



Tool No.	Mill Dia.	Shank Dia.	Flute Height	Overall Length	Price
EM1172	2mm	3mm	6mm	38mm	\$10.83
EM1174	2.5mm	3mm	7mm	38mm	\$10.83
EM1176	3mm	3mm	12mm	38mm	\$10.83
EM1178	3.5mm	4mm	12mm	50mm	\$14.75
EM1180	4mm	4mm	14mm	50mm	\$14.17
EM1182	4.5mm	5mm	14mm	50mm	\$14.75
EM1184	5mm	5mm	16mm	50mm	\$15.90
EM1186	6mm	6mm	19mm	63mm	\$20.23
EM1188	7mm	8mm	19mm	63mm	\$26.45
EM1190	8mm	8mm	19mm	63mm	\$25.45
EM1192	9mm	10mm	22mm	70mm	\$36.87
EM1194	10mm	10mm	22mm	70mm	\$32.52
EM1181	11mm	11mm	25mm	70mm	\$47.38
EM1196	12mm	12mm	25mm	75mm	\$46.25
EM1183	14mm	14mm	30mm	88mm	\$69.68
EM1185	16mm	16mm	32mm	88mm	\$92.88
EM1187	18mm	18mm	36mm	100mm	\$106.15
EM1189	20mm	20mm	38mm	100mm	\$127.40
EM1191	22mm	22mm	38mm	100mm	\$156.58

Solid Carbide, 4-Flute, Stub Length Single End, Right Hand, 30° Helix



Tool No.	Mill Dia.	Shank Dia.	Flute Height	Overall Length	Price
EM1205	1/16"	1/8"	1/8"	1-1/2"	\$8.95
EM1207	3/32"	1/8"	3/16"	1-1/2"	\$8.95
EM1209	1/8"	1/8"	1/4"	1-1/2"	\$7.93
EM1217	5/32"	3/16"	5/16"	2"	\$12.90
EM1219	3/16"	3/16"	3/8"	2"	\$12.63
EM1225	7/32"	1/4"	7/16"	2"	\$16.43
EM1227	1/4"	1/4"	1/2"	2"	\$15.78
EM1233	5/16"	5/16"	1/2"	2"	\$20.25
EM1235	3/8"	3/8"	5/8"	2"	\$23.35
EM1243	7/16"	7/16"	5/8"	3"	\$32.57
EM1249	1/2"	1/2"	5/8"	2-1/2"	\$40.22
EM1259	5/8"	5/8"	3/4"	3"	\$70.42
EM1269	3/4"	3/4"	1"	3"	\$100.77

Solid Carbide, 4-Flute, Regular Length Single End, Right Hand, 30° Helix



Tool No.	Mill Dia.	Shank Dia.	Flute Height	Overall Length	Price
EM12001	1/32"	1/8"	3/32"	1-1/2"	\$10.13
EM1200	3/64"	1/8"	1/8"	1-1/2"	\$10.13
EM1202	1/16"	1/8"	1/4"	1-1/2"	\$9.27
EM1204	5/64"	1/8"	1/4"	1-1/2"	\$9.27
EM1206	3/32"	1/8"	3/8"	1-1/2"	\$9.27
EM1208	7/64"	1/8"	3/8"	1-1/2"	\$9.27
EM1210	1/8"	1/8"	1/2"	1-1/2"	\$8.22
EM1212	9/64"	3/16"	9/16"	2"	\$13.37
EM1214	5/32"	3/16"	9/16"	2"	\$13.37
EM1216	11/64"	3/16"	9/16"	2"	\$13.37
EM1218	3/16"	3/16"	5/8"	2"	\$13.08
EM1220	13/64"	1/4"	5/8"	2-1/2"	\$18.25
EM1222	7/32"	1/4"	5/8"	2-1/2"	\$18.25
EM1224	15/64"	1/4"	3/4"	2-1/2"	\$18.25
EM1226	1/4"	1/4"	3/4"	2-1/2"	\$16.87
EM1228	17/64"	5/16"	7/8"	2-1/2"	\$24.05
EM1230	9/32"	5/16"	7/8"	2-1/2"	\$24.05
EM1232	19/64"	5/16"	7/8"	2-1/2"	\$24.05
EM1234	5/16"	5/16"	7/8"	2-1/2"	\$21.75
EM1236	21/64"	3/8"	7/8"	2-1/2"	\$27.12
EM1238	11/32"	3/8"	7/8"	2-1/2"	\$27.12
EM1240	23/64"	3/8"	7/8"	2-1/2"	\$27.12
EM1242	3/8"	3/8"	7/8"	2-1/2"	\$24.85
EM1244	25/64"	7/16"	7/8"	2-1/2"	\$41.05
EM1246	13/32"	7/16"	7/8"	2-1/2"	\$41.05
EM1248	27/64"	7/16"	7/8"	2-1/2"	\$41.05
EM1250	7/16"	7/16"	1"	2-1/2"	\$36.67
EM1252	29/64"	1/2"	1"	3"	\$47.12
EM1254	15/32"	1/2"	1"	3"	\$47.12
EM1256	31/64"	1/2"	1"	3"	\$47.12
EM1258	1/2"	1/2"	1"	3"	\$45.63
EM1260	9/16"	9/16"	1-1/4"	3-1/2"	\$76.75
EM1262	5/8"	5/8"	1-1/4"	3-1/2"	\$83.83
EM1264	11/16"	3/4"	1-1/2"	4"	\$128.60
EM1266	3/4"	3/4"	1-1/2"	4"	\$126.65
EM1268	7/8"	7/8"	1-1/2"	4"	\$202.10
EM1270	1"	1"	1-1/2"	4"	\$217.03

Solid Carbide, 2-Flute, Long Length Single End, Right Hand, 30° Helix



Tool No.	Mill Dia.	Shank Dia.	Flute Height	Overall Length	Price
EM1111	1/8"	1/8"	3/4"	2"	\$13.82
EM1115	3/16"	3/16"	1-1/8"	3"	\$18.57
EM1123	1/4"	1/4"	1-1/2"	4"	\$31.45
EM1131	5/16"	5/16"	1-5/8"	4"	\$37.05
EM1139	3/8"	3/8"	2"	4"	\$46.63
EM1151	7/16"	7/16"	2"	4"	\$59.80
EM1157	1/2"	1/2"	3"	6"	\$108.23
EM1163	5/8"	5/8"	3"	6"	\$148.08
EM1167	3/4"	3/4"	3"	6"	\$209.42
EM1173	1"	1"	3"	6"	\$382.57

Solid Carbide, 4-Flute, Long Length Single End, Right Hand, 30° Helix



Tool No.	Mill Dia.	Shank Dia.	Flute Height	Overall Length	Price
EM1211	1/8"	1/8"	3/4"	2"	\$13.82
EM1215	3/16"	3/16"	1-1/8"	3"	\$22.37
EM1223	1/4"	1/4"	1-1/2"	4"	\$31.45
EM1231	5/16"	5/16"	1-5/8"	4"	\$37.05
EM1239	3/8"	3/8"	2"	4"	\$46.63
EM1251	7/16"	7/16"	2"	4"	\$59.80
EM1257	1/2"	1/2"	3"	6"	\$108.23
EM1263	5/8"	5/8"	3"	6"	\$148.08
EM1267	3/4"	3/4"	3"	6"	\$209.42
EM1273	1"	1"	3"	6"	\$382.57

MAGNATE™ 20639 Lycoming Street #B-6, Walnut, CA 91789 USA

D-3



email : info@magnate.net Online Shop : www.magnate.net
(TEL) 800-827-2316, 909-468-5747 (FAX) 909-468-5745

MAGNATE™ End Mills

Solid Carbide, 4-Flute, Metric Single End, Right Hand, 30° Helix



Tool No.	Mill Dia.	Shank Dia.	Flute Height	Overall Length	Price
EM1272	2mm	3mm	6mm	38mm	\$10.83
EM1274	2.5mm	3mm	7mm	38mm	\$10.83
EM1276	3mm	3mm	12mm	38mm	\$10.83
EM1278	3.5mm	4mm	12mm	50mm	\$14.75
EM1280	4mm	4mm	14mm	50mm	\$14.17
EM1282	4.5mm	5mm	14mm	50mm	\$14.75
EM1284	5mm	5mm	16mm	50mm	\$15.90
EM1286	6mm	6mm	19mm	63mm	\$20.23
EM1288	7mm	8mm	19mm	63mm	\$26.45
EM1290	8mm	8mm	19mm	63mm	\$25.45
EM1292	9mm	10mm	22mm	70mm	\$36.87
EM1294	10mm	10mm	22mm	70mm	\$32.52
EM1295	11mm	11mm	25mm	70mm	\$44.50
EM1296	12mm	12mm	25mm	75mm	\$46.25
EM1281	14mm	14mm	30mm	88mm	\$65.43
EM1283	16mm	16mm	32mm	88mm	\$87.27
EM1285	18mm	18mm	36mm	100mm	\$99.73
EM1287	20mm	20mm	38mm	100mm	\$119.67
EM1289	22mm	22mm	38mm	100mm	\$147.08

Solid Carbide, 4-Flute, Double End Right Hand, 30° Helix



Tool No.	Mill Dia.	Shank Dia.	Flute Height	Overall Length	Price
EM1401	1/32"	1/8"	1/16"	1-1/2"	\$12.58
EM1402	1/32"	1/8"	3/32"	2"	\$13.07
EM1403	3/64"	1/8"	3/32"	1-1/2"	\$12.58
EM1404	3/64"	1/8"	1/8"	2"	\$12.82
EM1405	1/16"	1/8"	1/8"	1-1/2"	\$12.10
EM1406	1/16"	1/8"	3/16"	2"	\$13.98
EM1407	3/32"	1/8"	3/16"	1-1/2"	\$10.88
EM1408	3/32"	1/8"	1/4"	2"	\$11.13
EM1409	1/8"	1/8"	1/4"	1-1/2"	\$10.65
EM1410	1/8"	1/8"	3/8"	2"	\$60.45
EM1417	5/32"	3/16"	5/16"	2"	\$16.33
EM1414	5/32"	3/16"	7/16"	2-1/2"	\$17.67
EM1419	3/16"	3/16"	3/8"	2"	\$15.73
EM1418	3/16"	3/16"	1/2"	2-1/2"	\$60.45
EM1425	7/32"	1/4"	1/2"	2-1/2"	\$18.38
EM1422	7/32"	1/4"	9/16"	2-1/2"	\$18.38
EM1427	1/4"	1/4"	1/2"	2-1/2"	\$17.90
EM1426	1/4"	1/4"	1/2"	2-1/2"	\$69.88
EM1433	5/16"	5/16"	1/2"	2-1/2"	\$21.53
EM1434	5/16"	5/16"	1/2"	3-1/2"	\$69.88
EM1435	3/8"	3/8"	1/2"	2-1/2"	\$27.83
EM1442	3/8"	3/8"	1/2"	3-1/2"	\$61.22
EM1443	7/16"	7/16"	1/2"	2-1/2"	\$43.32
EM1450	7/16"	7/16"	1/2"	4"	\$92.70
EM1449	1/2"	1/2"	5/8"	3"	\$48.52
EM1458	1/2"	1/2"	5/8"	4"	\$89.23

Solid Carbide, 2-Flute, Double End Right Hand, 30° Helix



Tool No.	Mill Dia.	Shank Dia.	Flute Height	Overall Length	Price
EM1301	1/32"	1/8"	1/16"	1-1/2"	\$12.58
EM1302	1/32"	1/8"	3/32"	2"	\$13.07
EM1303	3/64"	1/8"	3/32"	1-1/2"	\$12.58
EM1304	3/64"	1/8"	1/8"	2"	\$12.82
EM1305	1/16"	1/8"	1/8"	1-1/2"	\$12.10
EM1306	1/16"	1/8"	3/16"	2"	\$12.33
EM1307	3/32"	1/8"	3/16"	1-1/2"	\$10.88
EM1308	3/32"	1/8"	1/4"	2"	\$11.13
EM1309	1/8"	1/8"	1/4"	1-1/2"	\$10.65
EM1310	1/8"	1/8"	3/8"	2"	\$10.88
EM1317	5/32"	3/16"	5/16"	2"	\$16.33
EM1314	5/32"	3/16"	7/16"	2-1/2"	\$17.67
EM1319	3/16"	3/16"	3/8"	2"	\$15.73
EM1318	3/16"	3/16"	1/2"	2-1/2"	\$16.93
EM1325	7/32"	1/4"	1/2"	2-1/2"	\$18.38
EM1322	7/32"	1/4"	9/16"	2-1/2"	\$18.38
EM1327	1/4"	1/4"	1/2"	2-1/2"	\$17.90
EM1326	1/4"	1/4"	5/8"	2-1/2"	\$17.90
EM1333	5/16"	5/16"	1/2"	2-1/2"	\$21.53
EM1334	5/16"	5/16"	3/4"	3-1/2"	\$25.28
EM1335	3/8"	3/8"	1/2"	2-1/2"	\$27.83
EM1342	3/8"	3/8"	3/4"	3-1/2"	\$34.37
EM1343	7/16"	7/16"	1/2"	2-1/2"	\$43.32
EM1350	7/16"	7/16"	7/8"	4"	\$54.57
EM1349	1/2"	1/2"	5/8"	3"	\$48.52
EM1358	1/2"	1/2"	1"	4"	\$57.72

MAGNATE™ 20639 Lycoming Street #B-6, Walnut, CA 91789 USA

D-4



email : info@magnate.net Online Shop : www.magnate.net
 (TEL) 800-827-2316, 909-468-5747 (FAX) 909-468-5745

MAGNATE™ Tapered End Mills – Solid Sub-Micrograin Carbide

All tapered end mills are produced from a premium grade of super submicrograin carbide to give you the maximum hardness and toughness. This means longer cutting life with less breakage.

All flutes are hollow ground with double clearance angles. The flute face is also hollow ground and polished to assure free cutting actions with minimum of heat generation. All tools have end cutting teeth. Special grinding procedures and equipment assures a high degree on concentricity between shank and cutting flutes.

Taper angles constant to +/- .001 per inch of flute length. Tip diameter tolerances are held at +/- .002. Shank diameter tolerances are .0002 to -.0005.

1/2° 3-Flute Tapered										1° 3-Flute Tapered									
Flat-End	Price	Tip Dia.	Flute Length	Shank Dia.	Overall Length	Large Dia.	Ball-End	Price		Flat-End	Price	Tip Dia.	Flute Length	Shank Dia.	Overall Length	Large Dia.	Ball-End	Price	
FE0-0001	\$30.98	1/32"	1/4"	1/8"	2"	.03561"	BE0-0001	\$38.99		FE1-0001	\$31.38	1/32"	1/4"	1/8"	2"	.03998"	BE1-0001	\$39.40	
FE0-0002	\$33.12	1/32"	1/2"	1/8"	2"	.03998"	BE0-0002	\$41.13		FE1-0002	\$33.59	1/32"	1/2"	1/8"	2"	.0487"	BE1-0002	\$41.60	
FE0-0501	\$31.38	3/64"	1/4"	1/8"	2"	.05124"	BE0-0501	\$39.40		FE1-0501	\$31.85	3/64"	1/4"	1/8"	2"	.0556"	BE1-0501	\$39.86	
FE0-0502	\$33.59	3/64"	1/2"	1/8"	2"	.05560"	BE0-0502	\$41.60		FE1-0502	\$31.78	3/64"	1/2"	1/8"	2"	.06433"	BE1-0502	\$39.79	
FE0-002	\$35.72	1/16"	1/2"	1/8"	2"	.07123"	BE0-002	\$43.73		FE1-002	\$33.92	1/16"	1/2"	1/8"	2"	.07995"	BE1-002	\$41.93	
FE0-003	\$29.51	1/16"	3/4"	1/8"	2-1/2"	.07559"	BE0-003	\$37.53		FE1-003	\$31.85	1/16"	3/4"	1/8"	2-1/2"	.08868"	BE1-003	\$39.86	
FE0-004	\$45.93	1/16"	1"	1/8"	3"	.07995"	BE0-004	\$55.15		FE1-004	\$46.34	1/16"	1"	1/8"	3"	.0974"	BE1-004	\$55.62	
FE0-052	\$36.59	5/64"	1/2"	1/8"	2"	.08685"	BE0-052	\$44.60		FE1-052	\$36.98	5/64"	1/2"	1/8"	2"	.09558"	BE1-052	\$45.00	
FE0-053	\$35.72	5/64"	3/4"	1/8"	2-1/2"	.09121"	BE0-053	\$43.73		FE1-053	\$36.18	5/64"	3/4"	1/8"	2-1/2"	.1043"	BE1-053	\$44.20	
FE0-054	\$46.34	5/64"	1"	1/8"	3"	.09558"	BE0-054	\$55.62		FE1-054	\$46.81	5/64"	1"	1/8"	3"	.11303"	BE1-054	\$56.15	
FE0-102	\$25.03	3/32"	1/2"	1/8"	2"	.10248"	BE0-102	\$31.72		FE1-102	\$29.98	3/32"	1/2"	1/8"	2"	.11120"	BE1-102	\$37.99	
FE0-103	\$29.78	3/32"	3/4"	1/8"	2-1/2"	.10684"	BE0-103	\$37.80		FE1-103	\$27.58	3/32"	3/4"	3/16"	2-1/2"	.11993"	BE1-103	\$34.25	
FE0-105	\$35.99	3/32"	1-1/4"	1/8"	3"	.11556"	BE0-105	\$44.00		FE1-104	\$30.38	3/32"	1"	3/16"	3"	.12865"	BE1-104	\$38.39	
FE0-201	\$26.65	1/8"	1/4"	3/16"	2-1/2"	.12936"	BE0-201	\$33.32		FE1-105	\$33.39	3/32"	1-1/4"	3/16"	3"	.13738"	BE1-105	\$41.40	
FE0-2015	\$28.05	1/8"	3/8"	3/16"	2-1/2"	.13154"	BE0-2015	\$34.72		FE1-106	\$49.48	3/32"	1-1/2"	1/4"	3-1/2"	.14610"	BE1-106	\$59.36	
FE0-202	\$27.58	1/8"	1/2"	3/16"	2-1/2"	.13373"	BE0-202	\$34.25		FE1-201	\$26.65	1/8"	1/4"	3/16"	2"	.13373"	BE1-201	\$33.32	
FE0-203	\$29.91	1/8"	3/4"	3/16"	2-1/2"	.13809"	BE0-203	\$37.92		FE1-2015	\$28.05	1/8"	3/8"	3/16"	2"	.13809"	BE1-2015	\$36.06	
FE0-204	\$37.99	1/8"	1"	3/16"	3"	.14245"	BE0-204	\$46.01		FE1-202	\$31.38	1/8"	1/2"	3/16"	2"	.14245"	BE1-202	\$39.40	
FE0-205	\$33.78	1/8"	1-1/4"	3/16"	3"	.14681"	BE0-205	\$41.80		FE1-203	\$31.72	1/8"	3/4"	1/4"	2"	.15118"	BE1-203	\$39.73	
FE0-206	\$33.92	1/8"	1-1/2"	3/16"	3"	.15118"	BE0-206	\$40.73		FE1-204	\$33.72	1/8"	1"	1/4"	3"	.15990"	BE1-204	\$41.74	
FE0-303	\$31.38	3/16"	3/4"	1/4"	2-1/2"	.20059"	BE0-303	\$39.40		FE1-205	\$34.25	1/8"	1-1/4"	1/4"	3"	.16863"	BE1-205	\$42.26	
FE0-305	\$36.46	3/16"	1-1/4"	1/4"	3"	.20931"	BE0-305	\$44.47		FE1-206	\$36.65	1/8"	1-1/2"	1/4"	3"	.17735"	BE1-206	\$44.66	
FE0-307	\$48.87	3/16"	1-3/4"	1/4"	3-1/2"	.21804"	BE0-307	\$58.70		FE1-208	\$46.74	1/8"	2"	1/4"	4"	.19480"	BE1-208	\$56.09	
FE0-313	\$85.46	3/16"	3-1/4"	3/8"	6"	.24421"	BE0-313	\$102.56		FE1-303	\$35.99	3/16"	3/4"	1/4"	2-1/2"	.21368"	BE1-303	\$44.00	
FE0-403	\$44.33	1/4"	3/4"	3/8"	2-1/2"	.26309"	BE0-403	\$48.81		FE1-305	\$36.73	3/16"	1-1/4"	1/4"	3"	.23113"	BE1-305	\$44.74	
FE0-405	\$41.60	1/4"	1-1/4"	3/8"	3"	.27181"	BE0-405	\$49.61		FE1-307	\$53.75	3/16"	1-3/4"	1/4"	4"	.24858"	BE1-307	\$64.50	
FE0-409	\$61.96	1/4"	2-1/4"	3/8"	4-1/2"	.28926"	BE0-409	\$74.38		FE1-308	\$50.88	3/16"	2"	5/16"	4"	.25730"	BE1-308	\$61.10	
FE0-413	\$80.12	1/4"	3-1/4"	3/8"	6"	.30671"	BE0-413	\$96.15		FE1-309	\$56.09	3/16"	2-1/4"	3/8"	4-1/2"	.26603"	BE1-309	\$67.30	
FE0-605	\$56.89	3/8"	1-1/4"	1/2"	3-1/2"	.39681"	BE0-605	\$68.31		FE1-310	\$68.11	3/16"	2-1/2"	3/8"	5"	.27475"	BE1-310	\$81.72	
FE0-609	\$77.32	3/8"	2-1/4"	1/2"	5"	.41426"	BE0-609	\$92.81		FE1-313	\$85.46	3/16"	3-1/4"	3/8"	6"	.30093"	BE1-313	\$102.56	
FE0-613	\$102.83	3/8"	3-1/4"	1/2"	6"	.43171"	BE0-613	\$123.38		FE1-403	\$36.26	1/4"	3/4"	3/8"	2-1/2"	.27618"	BE1-403	\$44.27	
FE0-805	\$66.77	1/2"	1-1/4"	9/16"	4"	.52181"	BE0-805	\$80.12		FE1-405	\$43.40	1/4"	1-1/4"	3/8"	3"	.29363"	BE1-405	\$52.09	
FE0-809	\$96.15	1/2"	2-1/4"	9/16"	5"	.53926"	BE0-809	\$115.37		FE1-408	\$67.90	1/4"	2"	3/8"	4"	.31980"	BE1-408	\$81.53	
FE0-813	\$186.95	1/2"	3-1/4"	5/8"	6"	.55671"	BE0-813	\$224.34		FE1-409	\$62.36	1/4"	2-1/4"	3/8"	4-1/2"	.32853"	BE1-409	\$74.84	
FE0-1009	\$153.58	5/8"	2-1/4"	3/4"	5"	.66426"	BE0-1009	\$184.28		FE1-413	\$88.14	1/4"	3-1/4"	3/8"	6"	.36343"	BE1-413	\$105.76	
FE0-1013	\$193.64	5/8"	3-1/4"	3/4"	6"	.68171"	BE0-1013	\$232.36		FE1-605	\$57.62	3/8"	1-1/4"	1/2"	3-1/2"	.41863"	BE1-605	\$69.17	
FE0-1017	\$267.08	5/8"	4-1/4"	3/4"	7"	.69916"	BE0-1017	\$320.49		FE1-609	\$78.19	3/8"	2-1/4"	1/2"	5"	.45353"	BE1-609	\$93.81	
FE0-1209	\$186.95	3/4"	2-1/4"	7/8"	5"	.78926"	BE0-1209	\$224.34		FE1-613	\$96.15	3/8"	3-1/4"	1/2"	6"	.48843"	BE1-613	\$115.37	
FE0-1213	\$240.37	3/4"	3-1/4"	7/8"	6"	.80671"	BE0-1213	\$283.10		FE1-803	\$68.11	1/2"	3/4"	5/8"	3"	.52618"	BE1-803	\$81.72	
FE0-1217	\$320.49	3/4"	4-1/4"	1"	7"	.82416"	BE0-1217	\$384.59		FE1-805	\$74.78	1/2"	1-1/4"	9/16"	4"	.54363"	BE1-805	\$89.74	
FE0-1221	\$367.24	3/4"	5-1/4"	1"	8"	.84161"	BE0-1221	\$440.68		FE1-809	\$98.82	1/2"	2-1/4"	5/8"	5"	.57853"	BE1-809	\$118.58	
										FE1-813	\$145.56	1/2"	3-1/4"	5/8"	6"	.61343"	BE1-813	\$174.67	
										FE1-1009	\$153.58	5/8"	2-1/4"	3/4"	5"	.70353"	BE1-1009	\$184.28	
										FE1-1013	\$186.95	5/8"	3-1/4"	3/4"	6"	.73843"	BE1-1013	\$224.34	
										FE1-1017	\$253.72	5/8"	4-1/4"	1"	7"	.77333"	BE1-1017	\$304.47	
										FE1-1209	\$173.60	3/4"	2-1/4"	7/8"	5"	.82853"	BE1-1209	\$208.32	
										FE1-1213	\$240.37	3/4"	3-1/4"	7/8"	6"	.86343"	BE1-1213	\$283.10	
										FE1-1217	\$333.85	3/4"	4-1/4"	1"	7"	.89833"	BE1-1217	\$400.62	
										FE1-1221	\$400.62	3/4"	5-1/4"	1"	8"	.93323"	BE1-1221	\$480.74	

MAGNATE™ Tapered End Mills – Solid Sub-Micrograin Carbide

1.5° 3-Flute Tapered							
Flat-End	Price	Tip Dia.	Flute Length	Shank Dia.	Overall Length	Large Dia.	Ball-End Price
FE1.5-0001	\$31.85	1/32"	1/4"	1/8"	2"	.04434"	BE1.5-0001 \$39.86
FE1.5-0002	\$33.92	1/32"	1/2"	1/8"	2"	.05743"	BE1.5-0002 \$41.93
FE1.5-0501	\$32.25	3/64"	1/4"	1/8"	2"	.05997"	BE1.5-0501 \$40.26
FE1.5-0502	\$34.39	3/64"	1/2"	1/8"	2"	.07306"	BE1.5-0502 \$42.40
FE1.5-002	\$30.92	1/16"	1/2"	1/8"	2"	.08868"	BE1.5-002 \$38.93
FE1.5-003	\$38.26	1/16"	3/4"	1/8"	2-1/2"	.10177"	BE1.5-003 \$46.28
FE1.5-004	\$31.25	1/16"	1"	1/8"	3"	.11486"	BE1.5-004 \$39.26
FE1.5-052	\$37.39	5/64"	1/2"	1/8"	2"	.10431"	BE1.5-052 \$45.40
FE1.5-053	\$36.59	5/64"	3/4"	1/8"	2-1/2"	.1174"	BE1.5-053 \$47.94
FE1.5-054	\$47.27	5/64"	1"	1/8"	3"	.13049"	BE1.5-054 \$56.75
FE1.5-102	\$24.17	3/32"	1/2"	3/16"	2-1/2"	.11993"	BE1.5-102 \$30.84
FE1.5-103	\$31.11	3/32"	3/4"	1/4"	2-1/2"	.13302"	BE1.5-103 \$39.13
FE1.5-104	\$31.64	3/32"	1"	1/4"	3"	.14611"	BE1.5-104 \$39.66
FE1.5-105	\$31.52	3/32"	1-1/4"	3/16"	3"	.15920"	BE1.5-105 \$38.19
FE1.5-106	\$34.45	3/32"	1-1/2"	1/4"	3"	.17229"	BE1.5-106 \$41.33
FE1.5-154	\$29.38	7/64"	1"	3/16"	3"	.16136"	BE1.5-154 \$36.06
FE1.5-202	\$26.04	1/8"	1/2"	3/16"	2-1/2"	.15118"	BE1.5-202 \$32.71
FE1.5-203	\$35.99	1/8"	3/4"	1/4"	2-1/2"	.16427"	BE1.5-203 \$44.00
FE1.5-204	\$32.71	1/8"	1"	3/16"	3"	.17736"	BE1.5-204 \$40.73
FE1.5-205	\$36.18	1/8"	1-1/4"	1/4"	3"	.19045"	BE1.5-205 \$43.40
FE1.5-206	\$38.66	1/8"	1-1/2"	1/4"	3"	.20354"	BE1.5-206 \$46.67
FE1.5-208	\$46.74	1/8"	2"	1/4"	4"	.22972"	BE1.5-208 \$56.09
FE1.5-209	\$50.74	1/8"	2-1/4"	5/16"	4"	.24281"	BE1.5-209 \$60.90
FE1.5-212	\$65.44	1/8"	3"	3/8"	5"	.28208"	BE1.5-212 \$78.52
FE1.5-253	\$33.78	5/32"	3/4"	1/4"	2-1/2"	.19552"	BE1.5-253 \$40.53
FE1.5-254	\$35.66	5/32"	1"	1/4"	3"	.20861"	BE1.5-254 \$42.73
FE1.5-255	\$36.73	5/32"	1-1/4"	1/4"	3"	.22170"	BE1.5-255 \$44.07
FE1.5-256	\$41.40	5/32"	1-1/2"	1/4"	3"	.23479"	BE1.5-256 \$49.67
FE1.5-258	\$50.74	5/32"	2"	5/16"	4"	.26097"	BE1.5-258 \$60.90
FE1.5-303	\$38.19	3/16"	3/4"	3/8"	2-1/2"	.22677"	BE1.5-303 \$46.20
FE1.5-304	\$38.52	3/16"	1"	1/4"	3"	.23986"	BE1.5-304 \$46.20
FE1.5-305	\$38.86	3/16"	1-1/4"	3/8"	3"	.25295"	BE1.5-305 \$46.87
FE1.5-307	\$49.28	3/16"	1-3/4"	3/8"	3-1/2"	.27913"	BE1.5-307 \$59.16
FE1.5-309	\$56.09	3/16"	2-1/4"	3/8"	4-1/2"	.30531"	BE1.5-309 \$67.30
FE1.5-313	\$86.81	3/16"	3-1/4"	3/8"	6"	.35767"	BE1.5-313 \$104.16
FE1.5-403	\$44.33	1/4"	3/4"	3/8"	2-1/2"	.28927"	BE1.5-403 \$53.22
FE1.5-405	\$43.53	1/4"	1-1/4"	3/8"	3"	.31545"	BE1.5-405 \$52.28
FE1.5-406	\$62.77	1/4"	1-1/2"	3/8"	3-1/2"	.32854"	BE1.5-406 \$75.31
FE1.5-409	\$72.11	1/4"	2-1/4"	3/8"	4-1/2"	.36781"	BE1.5-409 \$86.54
FE1.5-413	\$93.48	1/4"	3-1/4"	1/2"	6"	.42017"	BE1.5-413 \$112.17
FE1.5-605	\$58.62	3/8"	1-1/4"	1/2"	3"	.44045"	BE1.5-605 \$70.38
FE1.5-609	\$77.92	3/8"	2-1/4"	1/2"	5"	.49281"	BE1.5-609 \$93.54
FE1.5-613	\$102.83	3/8"	3-1/4"	9/16"	6"	.54517"	BE1.5-613 \$123.38
FE1.5-805	\$85.46	1/2"	1-1/4"	5/8"	3-1/2"	.56545"	BE1.5-805 \$102.56
FE1.5-806	\$90.14	1/2"	1-1/2"	5/8"	3-1/2"	.57855"	BE1.5-806 \$108.17
FE1.5-809	\$98.82	1/2"	2-1/4"	5/8"	5"	.61781"	BE1.5-809 \$118.58
FE1.5-813	\$186.95	1/2"	3-1/4"	3/4"	6"	.67017"	BE1.5-813 \$224.34
FE1.5-1009	\$153.58	5/8"	2-1/4"	3/4"	5"	.74281"	BE1.5-1009 \$184.28
FE1.5-1013	\$240.37	5/8"	3-1/4"	7/8"	6"	.79517"	BE1.5-1013 \$283.10
FE1.5-1017	\$253.72	5/8"	4-1/4"	1"	7"	.84753"	BE1.5-1017 \$304.47
FE1.5-1209	\$173.60	3/4"	2-1/4"	7/8"	5"	.86781"	BE1.5-1209 \$208.32
FE1.5-1213	\$233.70	3/4"	3-1/4"	1"	6"	.92017"	BE1.5-1213 \$280.43

2° 3-Flute Tapered							
Flat-End	Price	Tip Dia.	Flute Length	Shank Dia.	Overall Length	Large Dia.	Ball-End Price
FE2-0001	\$32.25	1/32"	1/4"	1/8"	2"	.04871"	BE2-0001 \$40.26
FE2-0002	\$30.65	1/32"	1/2"	1/8"	2"	.06617"	BE2-0002 \$38.66
FE2-0501	\$32.71	3/64"	1/4"	1/8"	2"	.06434"	BE2-0501 \$40.73
FE2-0502	\$30.98	3/64"	1/2"	1/8"	2"	.0818"	BE2-0502 \$38.99
FE2-002	\$31.18	1/16"	1/2"	1/8"	2"	.09742"	BE2-002 \$39.19
FE2-003	\$38.73	1/16"	3/4"	1/8"	2-1/2"	.11488"	BE2-003 \$46.74
FE2-004	\$47.67	1/16"	1"	1/8"	3"	.13234"	BE2-004 \$57.22
FE2-052	\$37.86	5/64"	1/2"	1/8"	2"	.11305"	BE2-052 \$45.87
FE2-053	\$40.86	5/64"	3/4"	1/8"	2-1/2"	.13051"	BE2-053 \$49.07
FE2-054	\$47.67	5/64"	1"	1/8"	3"	.14797"	BE2-054 \$57.22
FE2-102	\$31.31	3/32"	1/2"	3/16"	2-1/2"	.12867"	BE2-102 \$39.32
FE2-103	\$31.64	3/32"	3/4"	1/4"	2-1/2"	.14613"	BE2-103 \$39.66
FE2-104	\$37.19	3/32"	1"	1/4"	3"	.16359"	BE2-104 \$45.21
FE2-105	\$32.05	3/32"	1-1/4"	1/4"	3"	.18105"	BE2-105 \$40.06
FE2-202	\$31.85	1/8"	1/2"	3/16"	2-1/2"	.15992"	BE2-202 \$39.86
FE2-203	\$32.38	1/8"	3/4"	1/4"	2-1/2"	.17738"	BE2-203 \$40.39
FE2-204	\$32.92	1/8"	1"	1/4"	3"	.19484"	BE2-204 \$40.94
FE2-205	\$38.86	1/8"	1-1/4"	1/4"	3"	.21230"	BE2-205 \$46.87
FE2-206	\$40.94	1/8"	1-1/2"	1/4"	3-1/2"	.22976"	BE2-206 \$49.14
FE2-208	\$50.74	1/8"	2"	5/16"	3-1/2"	.26468"	BE2-208 \$60.90
FE2-210	\$54.76	1/8"	2-1/2"	5/16"	4"	.29960"	BE2-210 \$65.70
FE2-303	\$33.39	3/16"	3/4"	1/4"	2-1/2"	.23988"	BE2-303 \$41.40
FE2-305	\$40.59	3/16"	1-1/4"	3/8"	3"	.27480"	BE2-305 \$48.74
FE2-307	\$47.47	3/16"	1-3/4"	3/8"	3-1/2"	.30972"	BE2-307 \$57.02
FE2-309	\$60.10	3/16"	2-1/4"	1/2"	5"	.34464"	BE2-309 \$72.11
FE2-313	\$93.48	3/16"	3-1/4"	1/2"	6"	.41448"	BE2-313 \$112.17
FE2-403	\$38.86	1/4"	3/4"	3/8"	2-1/2"	.30238"	BE2-403 \$46.87
FE2-405	\$43.94	1/4"	1-1/4"	3/8"	3"	.33730"	BE2-405 \$52.75
FE2-408	\$67.90	1/4"	2"	1/2"	4"	.38968"	BE2-408 \$81.53
FE2-409	\$70.71	1/4"	2-1/4"	1/2"	5"	.40714"	BE2-409 \$83.53
FE2-413	\$96.15	1/4"	3-1/4"	1/2"	6"	.47698"	BE2-413 \$115.37
FE2-605	\$62.70	3/8"	1-1/4"	1/2"	3-1/2"	.46230"	BE2-605 \$75.25
FE2-609	\$86.81	3/8"	2-1/4"	9/16"	5"	.53214"	BE2-609 \$104.16
FE2-613	\$154.90	3/8"	3-1/4"	5/8"	6"	.60198"	BE2-613 \$185.88
FE2-805	\$89.48	1/2"	1-1/4"	5/8"	3-1/2"	.58730"	BE2-805 \$107.36
FE2-809	\$153.58	1/2"	2-1/4"	3/4"	5"	.65714"	BE2-809 \$184.28
FE2-813	\$197.64	1/2"	3-1/4"	3/4"	6"	.72698"	BE2-813 \$237.17
FE2-1009	\$173.60	5/8"	2-1/4"	7/8"	5"	.78214"	BE2-1009 \$208.32
FE2-1013	\$240.37	5/8"	3-1/4"	7/8"	6"	.85198"	BE2-1013 \$283.10
FE2-1017	\$474.07	5/8"	4-1/4"	1"	7"	.92182"	BE2-1017 \$568.87
FE2-1209	\$208.32	3/4"	2-1/4"	1"	5"	.90714"	BE2-1209 \$249.98
FE2-1213	\$307.14	3/4"	3-1/4"	1"	6"	.97698"	BE2-1213 \$368.57

3° 3-Flute Tapered							
Flat-End	Price	Tip Dia.	Flute Length	Shank Dia.	Overall Length	Large Dia.	Ball-End Price
FE3-0001	\$32.71	1/32"	1/4"	1/8"	2"	.05746"	BE3-0001 \$40.73
FE3-0002	\$34.86	1/32"	1/2"	1/8"	2"	.08366"	BE3-0002 \$42.87
FE3-0501	\$33.12	3/64"	1/4"	1/8"	2"	.07308"	BE3-0501 \$41.13
FE3-0502	\$35.25	3/64"	1/2"	1/8"	2"	.09929"	BE3-0502 \$43.26
FE3-002	\$31.64	1/16"	1/2"	1/8"	2"	.11491"	BE3-002 \$39.66
FE3-003	\$39.19	1/16"	3/4"	3/16"	2-1/2"	.14112"	BE3-003 \$47.20
FE3-004	\$32.71	1/16"	1"	3/16"	3"	.16732"	BE3-004 \$40.73
FE3-006	\$42.73	1/16"	1-1/2"	1/4"	3"	.21973"	BE3-006 \$51.27
FE3-052	\$38.26	5/64"	1/2"	3/16"	2"	.13054"	BE3-052 \$46.28
FE3-053	\$41.27	5/64"	3/4"	3/16"	2-1/2"	.15674"	BE3-053 \$49.54
FE3-054	\$48.14	5/64"	1"	3/16"	3"	.18295"	BE3-054 \$57.10
FE3-103	\$32.92	3/32"	3/4"	3/16"	2-1/2"	.17237"	BE3-103 \$39.59
FE3-104	\$32.85	3/32"	1"	1/4"	3"	.19857"	BE3-104 \$40.86

MAGNATE™ Tapered End Mills – Solid Sub-Micrograin Carbide

3° 3-Flute Tapered (Continued)



Flat-End Price	Tip Dia.	Flute Length	Shank Dia.	Overall Length	Large Dia.	Ball-End Price		
FE3-105	\$36.59	3/32"	1-1/4"	1/4"	3"	.22478"	BE3-105	\$43.86
FE3-106	\$38.79	3/32"	1-1/2"	1/4"	3"	.25000"	BE3-106	\$46.81
FE3-107	\$47.27	3/32"	1-3/4"	3/8"	3-1/2"	.27719"	BE3-107	\$55.29
FE3-108	\$48.81	3/32"	2"	5/16"	4"	.30339"	BE3-108	\$58.56
FE3-110	\$61.43	3/32"	2-1/2"	3/8"	4-1/2"	.35580"	BE3-110	\$73.71
FE3-154	\$33.85	7/64"	1"	1/4"	3"	.21382"	BE3-154	\$41.40
FE3-155	\$36.06	7/64"	1-1/4"	1/4"	3"	.24003"	BE3-155	\$43.26
FE3-156	\$39.66	7/64"	1-1/2"	5/16"	3"	.26623"	BE3-156	\$47.61
FE3-158	\$49.54	7/64"	2"	3/8"	4"	.31864"	BE3-158	\$59.42
FE3-203	\$32.85	1/8"	3/4"	1/4"	2-1/2"	.20362"	BE3-203	\$40.86
FE3-204	\$33.65	1/8"	1"	1/4"	3"	.22982"	BE3-204	\$41.66
FE3-205	\$41.99	1/8"	1-1/4"	3/8"	3"	.25603"	BE3-205	\$50.41
FE3-206	\$43.00	1/8"	1-1/2"	3/8"	3-1/2"	.28223"	BE3-206	\$51.62
FE3-208	\$60.16	1/8"	2"	3/8"	4"	.33464"	BE3-208	\$72.25
FE3-209	\$61.16	1/8"	2-1/4"	3/8"	4-1/2"	.36085"	BE3-209	\$73.45
FE3-210	\$68.11	1/8"	2-1/2"	7/16"	4-1/2"	.38705"	BE3-210	\$81.72
FE3-212	\$80.12	1/8"	3"	1/2"	5"	.43946"	BE3-212	\$96.15
FE3-216	\$118.86	1/8"	4"	9/16"	6"	.54428"	BE3-216	\$142.62
FE3-253	\$32.46	5/32"	3/4"	1/4"	2-1/2"	.23487"	BE3-253	\$39.13
FE3-254	\$37.26	5/32"	1"	3/8"	3"	.26107"	BE3-254	\$45.27
FE3-255	\$36.06	5/32"	1-1/4"	3/8"	3"	.28728"	BE3-255	\$43.26
FE3-256	\$44.47	5/32"	1-1/2"	3/8"	3-1/2"	.31348"	BE3-256	\$53.35
FE3-257	\$59.22	5/32"	1-3/4"	3/8"	3-1/2"	.33969"	BE3-257	\$71.11
FE3-258	\$49.54	5/32"	2"	3/8"	4"	.36589"	BE3-258	\$59.42
FE3-303	\$36.65	3/16"	3/4"	3/8"	2-1/2"	.26612"	BE3-303	\$44.66
FE3-304	\$42.60	3/16"	1"	3/8"	3"	.29232"	BE3-304	\$51.08
FE3-305	\$42.73	3/16"	1-1/4"	3/8"	3"	.31853"	BE3-305	\$51.27
FE3-306	\$48.07	3/16"	1-1/2"	3/8"	3-1/2"	.34473"	BE3-306	\$57.69
FE3-308	\$56.09	3/16"	2"	1/2"	4"	.39714"	BE3-308	\$67.30
FE3-310	\$70.78	3/16"	2-1/2"	1/2"	5"	.44955"	BE3-310	\$83.59
FE3-313	\$97.49	3/16"	3-1/4"	9/16"	6"	.52817"	BE3-313	\$116.98
FE3-316	\$186.95	3/16"	4"	5/8"	6"	.60678"	BE3-316	\$224.34
FE3-320	\$300.47	3/16"	5"	3/4"	7"	.71160"	BE3-320	\$360.55
FE3-403	\$39.86	1/4"	3/4"	3/8"	2-1/2"	.32862"	BE3-403	\$47.88
FE3-404	\$42.87	1/4"	1"	3/8"	3"	.35482"	BE3-404	\$51.41
FE3-405	\$44.20	1/4"	1-1/4"	3/8"	3"	.37500"	BE3-405	\$53.08
FE3-408	\$67.90	1/4"	2"	1/2"	4"	.45964"	BE3-408	\$81.53
FE3-409	\$66.17	1/4"	2-1/4"	1/2"	5"	.48585"	BE3-409	\$79.38
FE3-413	\$160.25	1/4"	3-1/4"	5/8"	6"	.59067"	BE3-413	\$192.30
FE3-416	\$213.66	1/4"	4"	3/4"	6"	.66928"	BE3-416	\$256.39
FE3-420	\$320.49	1/4"	5"	1"	7"	.77410"	BE3-420	\$384.59
FE3-504	\$56.02	5/16"	1"	1/2"	3"	.41782"	BE3-504	\$67.24
FE3-507	\$59.50	5/16"	1-3/4"	1/2"	4"	.49644"	BE3-507	\$71.37
FE3-604	\$59.03	3/8"	1"	1/2"	3"	.47982"	BE3-604	\$71.51
FE3-605	\$66.77	3/8"	1-1/4"	1/2"	3-1/2"	.50000"	BE3-605	\$80.12
FE3-609	\$101.49	3/8"	2-1/4"	5/8"	5"	.61085"	BE3-609	\$121.78
FE3-613	\$186.95	3/8"	3-1/4"	3/4"	6"	.71567"	BE3-613	\$224.34
FE3-616	\$267.08	3/8"	4"	7/8"	6"	.79428"	BE3-616	\$315.15
FE3-620	\$333.85	3/8"	5"	1"	8"	.89910"	BE3-620	\$400.62
FE3-805	\$146.89	1/2"	1-1/4"	3/4"	4"	.63103"	BE3-805	\$176.27
FE3-809	\$166.93	1/2"	2-1/4"	3/4"	5"	.73585"	BE3-809	\$200.31
FE3-813	\$283.10	1/2"	3-1/4"	7/8"	6"	.84067"	BE3-813	\$339.72
FE3-816	\$333.85	1/2"	4"	1"	7"	.91928"	BE3-816	\$400.62
FE3-1009	\$193.64	5/8"	2-1/4"	7/8"	5"	.86085"	BE3-1009	\$232.36
FE3-1013	\$233.70	5/8"	3-1/4"	1"	6"	.95567"	BE3-1013	\$280.43
FE3-1209	\$233.96	3/4"	2-1/4"	1"	5"	.98585"	BE3-1209	\$280.70

4° 3-Flute Tapered





Flat-End Price	Tip Dia.	Flute Length	Shank Dia.	Overall Length	Large Dia.	Ball-End Price		
FE4-0004	\$34.66	1/32"	1"	3/16"	3"	.17111"	BE4-0004	\$41.33
FE4-004	\$33.85	1/16"	1"	1/4"	3"	.20236"	BE4-004	\$41.86
FE4-103	\$32.38	3/32"	3/4"	1/4"	2-1/2"	.19865"	BE4-103	\$39.06
FE4-104	\$33.59	3/32"	1"	1/4"	3"	.23361"	BE4-104	\$41.60
FE4-203	\$35.66	1/8"	3/4"	1/4"	2-1/2"	.22990"	BE4-203	\$43.67
FE4-204	\$33.92	1/8"	1"	3/8"	3"	.26486"	BE4-204	\$41.93
FE4-206	\$43.53	1/8"	1-1/2"	3/8"	3-1/2"	.33479"	BE4-206	\$52.21
FE4-208	\$51.48	1/8"	2"	1/2"	4"	.40472"	BE4-208	\$61.76
FE4-210	\$93.48	1/8"	2-1/2"	1/2"	5"	.47465"	BE4-210	\$112.17
FE4-303	\$37.19	3/16"	3/4"	3/8"	2-1/2"	.29240"	BE4-303	\$45.21
FE4-305	\$44.47	3/16"	1-1/4"	3/8"	3"	.36233"	BE4-305	\$53.35
FE4-313	\$156.25	3/16"	3-1/4"	3/4"	6"	.64205"	BE4-313	\$185.62
FE4-316	\$202.98	3/16"	4"	3/4"	6"	.74694"	BE4-316	\$110.03
FE4-403	\$44.33	1/4"	3/4"	3/8"	2-1/2"	.35490"	BE4-403	\$53.22
FE4-405	\$50.81	1/4"	1-1/4"	1/2"	3-1/2"	.42483"	BE4-405	\$61.02
FE4-409	\$101.49	1/4"	2-1/4"	5/8"	5"	.56469"	BE4-409	\$121.78
FE4-413	\$166.93	1/4"	3-1/4"	3/4"	6"	.70455"	BE4-413	\$200.31
FE4-416	\$240.37	1/4"	4"	1"	7"	.80944"	BE4-416	\$288.44
FE4-605	\$64.10	3/8"	1-1/4"	9/16"	4"	.54983"	BE4-605	\$76.92
FE4-609	\$166.93	3/8"	2-1/4"	3/4"	5"	.68969"	BE4-609	\$200.31
FE4-613	\$240.37	3/8"	3-1/4"	7/8"	6"	.82955"	BE4-613	\$283.10
FE4-616	\$313.82	3/8"	4"	1"	7"	.93444"	BE4-616	\$376.58
FE4-805	\$153.58	1/2"	1-1/4"	3/4"	3-1/2"	.67483"	BE4-805	\$184.28
FE4-809	\$180.28	1/2"	2-1/4"	7/8"	5"	.81469"	BE4-809	\$216.33
FE4-813	\$293.78	1/2"	3-1/4"	1"	6"	.95455"	BE4-813	\$352.54



5° 3-Flute Tapered





Flat-End Price	Tip Dia.	Flute Length	Shank Dia.	Overall Length	Large Dia.	Ball-End Price		
FE5-0001	\$33.12	1/32"	1/4"	1/8"	2"	.075"	BE5-0001	\$41.13
FE5-0002	\$32.38	1/32"	1/2"	3/16"	2"	.11874"	BE5-0002	\$40.39
FE5-0003	\$38.26	1/32"	3/4"	3/16"	2-1/2"	.16249"	BE5-0003	\$46.28
FE5-0501	\$33.59	3/64"	1/4"	1/8"	2"	.09062"	BE5-0501	\$41.60
FE5-0502	\$35.72	3/64"	1/2"	3/16"	2"	.13437"	BE5-0502	\$43.73
FE5-002	\$33.18	1/16"	1/2"	1/4"	2-1/2"	.14999"	BE5-002	\$41.19
FE5-003	\$39.59	1/16"	3/4"	1/4"	2-1/2"	.19374"	BE5-003	\$47.61
FE5-004	\$35.19	1/16"	1"	1/4"	3"	.23748"	BE5-004	\$43.20
FE5-006	\$43.67	1/16"	1-1/2"	3/8"	3"	.28123"	BE5-006	\$52.42
FE5-052	\$38.73	5/64"	1/2"	3/16"	2"	.16562"	BE5-052	\$46.74
FE5-053	\$41.74	5/64"	3/4"	1/4"	2-1/2"	.20936"	BE5-053	\$50.08
FE5-054	\$56.15	5/64"	1"	3/8"	3"	.25311"	BE5-054	\$67.37
FE5-102	\$33.32	3/32"	1/2"	1/4"	2-1/2"	.18124"	BE5-102	\$41.33
FE5-103	\$37.66	3/32"	3/4"	1/4"	2-1/2"	.22499"	BE5-103	\$45.67
FE5-104	\$38.99	3/32"	1"	3/8"	3"	.26873"	BE5-104	\$47.00
FE5-105	\$41.86	3/32"	1-1/4"	3/8"	3"	.31248"	BE5-105	\$50.28
FE5-106	\$43.86	3/32"	1-1/2"	3/8"	3-1/2"	.35622"	BE5-106	\$52.68
FE5-108	\$53.08	3/32"	2"	1/2"	4"	.44371"	BE5-108	\$63.69
FE5-155	\$39.73	7/64"	1-1/4"	3/8"	3"	.32773"	BE5-155	\$47.74
FE5-203	\$33.39	1/8"	3/4"	1/4"	2-1/2"	.25000"	BE5-203	\$41.40
FE5-204	\$39.32	1/8"	1"	3/8"	3"	.29998"	BE5-204	\$47.34
FE5-205	\$43.26	1/8"	1-1/4"	3/8"	3"	.34373"	BE5-205	\$51.95
FE5-206	\$44.14	1/8"	1-1/2"	3/8"	3-1/2"	.37500"	BE5-206	\$52.95
FE5-207	\$53.69	1/8"	1-3/4"	1/2"	4"	.43122"	BE5-207	\$64.43
FE5-208	\$56.55	1/8"	2"	1/2"	4"	.47496"	BE5-208	\$67.90
FE5-210	\$90.81	1/8"	2-1/2"	5/8"	5"	.56245"	BE5-210	\$108.97
FE5-212	\$166.93	1/8"	3"	3/4"	5"	.64994"	BE5-212	\$200.31
FE5-253	\$33.78	5/32"	3/4"	3/8"	2-1/2"	.28749"	BE5-253	\$41.80
FE5-254	\$40.94	5/32"	1"	3/8"	3"	.33123"	BE5-254	\$49.14
FE5-255	\$47.08	5/32"	1-1/4"	3/8"	3"	.37498"	BE5-255	\$62.30

MAGNATE™ Tapered End Mills – Solid Sub-Micrograin Carbide

5° 3-Flute Tapered (Continued)									
									
		Tip Dia.	Flute Length	Shank Dia.	Overall Length	Large			
Flat-End	Price	Dia.	Length	Dia.	Length	Dia.	Ball-End	Price	
FE5-256	\$55.02	5/32"	1-1/2"	1/2"	3-1/2"	.41872"	BE5-256	\$62.89	
FE5-257	\$57.88	5/32"	1-3/4"	1/2"	4"	.46247"	BE5-257	\$69.44	
FE5-258	\$60.82	5/32"	2"	1/2"	4"	.50000"	BE5-258	\$72.98	
FE5-303	\$39.66	3/16"	3/4"	3/8"	2-1/2"	.31874"	BE5-303	\$47.67	
FE5-304	\$47.41	3/16"	1"	3/8"	3"	.36248"	BE5-304	\$56.89	
FE5-305	\$50.88	3/16"	1-1/4"	1/2"	3-1/2"	.40623"	BE5-305	\$61.10	
FE5-306	\$56.55	3/16"	1-1/2"	1/2"	3-1/2"	.44997"	BE5-306	\$67.90	
FE5-307	\$64.10	3/16"	1-3/4"	1/2"	4"	.49372"	BE5-307	\$76.98	
FE5-308	\$65.30	3/16"	2"	5/8"	4"	.53746"	BE5-308	\$78.33	
FE5-310	\$101.49	3/16"	2-1/2"	5/8"	5"	.62495"	BE5-310	\$121.78	
FE5-312	\$166.93	3/16"	3"	3/4"	5"	.71244"	BE5-312	\$200.31	
FE5-313	\$240.37	3/16"	3-1/4"	7/8"	6"	.75619"	BE5-313	\$283.10	
FE5-316	\$474.07	3/16"	4"	1"	7"	.88742"	BE5-316	\$568.87	
FE5-403	\$43.73	1/4"	3/4"	1/2"	3"	.38124"	BE5-403	\$52.48	
FE5-404	\$54.08	1/4"	1"	1/2"	3"	.42498"	BE5-404	\$64.90	
FE5-405	\$50.41	1/4"	1-1/4"	1/2"	3-1/2"	.46873"	BE5-405	\$60.49	
FE5-406	\$58.42	1/4"	1-1/2"	9/16"	3-1/2"	.51247"	BE5-406	\$70.10	
FE5-407	\$70.10	1/4"	1-3/4"	5/8"	4"	.55622"	BE5-407	\$84.14	
FE5-408	\$80.46	1/4"	2"	5/8"	4"	.59996"	BE5-408	\$96.55	
FE5-409	\$140.22	1/4"	2-1/4"	3/4"	5"	.64371"	BE5-409	\$168.26	
FE5-410	\$160.25	1/4"	2-1/2"	3/4"	5"	.68745"	BE5-410	\$192.30	
FE5-413	\$213.66	1/4"	3-1/4"	7/8"	6"	.81869"	BE5-413	\$283.10	
FE5-416	\$474.07	1/4"	4"	1"	7"	.94992"	BE5-416	\$568.87	
FE5-504	\$54.22	5/16"	1"	1/2"	3"	.48798"	BE5-504	\$65.10	
FE5-507	\$101.49	5/16"	1-3/4"	5/8"	4"	.61872"	BE5-507	\$121.78	
FE5-509	\$160.25	5/16"	2-1/4"	3/4"	5"	.70671"	BE5-509	\$192.30	
FE5-604	\$54.68	3/8"	1"	5/8"	3-1/2"	.54998"	BE5-604	\$65.64	
FE5-605	\$81.19	3/8"	1-1/4"	5/8"	4"	.59373"	BE5-605	\$97.42	
FE5-609	\$180.28	3/8"	2-1/4"	7/8"	5"	.76871"	BE5-609	\$216.33	
FE5-613	\$325.83	3/8"	3-1/4"	1"	6"	.94369"	BE5-613	\$391.00	
FE5-805	\$146.89	1/2"	1-1/4"	3/4"	4"	.71873"	BE5-805	\$176.27	
FE5-806	\$165.59	1/2"	1-1/2"	7/8"	4"	.76247"	BE5-806	\$198.71	
FE5-809	\$233.70	1/2"	2-1/4"	1"	5"	.89371"	BE5-809	\$280.43	

6° 3-Flute Tapered									
									
		Tip Dia.	Flute Length	Shank Dia.	Overall Length	Large			
Flat-End	Price	Dia.	Length	Dia.	Length	Dia.	Ball-End	Price	
FE6-004	\$38.26	1/16"	1"	5/16"	3"	.27271"	BE6-004	\$45.87	
FE6-104	\$42.20	3/32"	1"	5/16"	3"	.30396"	BE6-104	\$50.61	
FE6-204	\$43.73	1/8"	1"	3/8"	3"	.33521"	BE6-204	\$52.48	

7° 3-Flute Tapered									
									
		Tip Dia.	Flute Length	Shank Dia.	Overall Length	Large			
Flat-End	Price	Dia.	Length	Dia.	Length	Dia.	Ball-End	Price	
FE7-0003	\$44.74	1/32"	3/4"	1/4"	2-1/2"	.21542"	BE7-0003	\$53.69	
FE7-0004	\$46.07	1/32"	1	3/8"	3"	.27656"	BE7-0004	\$55.29	
FE7-001	\$34.06	1/16"	1/4"	1/4"	2"	.12389"	BE7-001	\$42.07	
FE7-002	\$35.25	1/16"	1/2"	1/4"	2-1/2"	.18528"	BE7-002	\$43.26	
FE7-003	\$38.39	1/16"	3/4"	3/8"	3"	.24667"	BE7-003	\$46.07	
FE7-004	\$43.34	1/16"	1"	3/8"	3"	.30806"	BE7-004	\$52.01	
FE7-054	\$45.87	5/64"	1"	3/8"	3"	.32356"	BE7-054	\$55.02	
FE7-102	\$36.73	3/32"	1/2"	1/4"	2-1/2"	.21653"	BE7-102	\$44.07	
FE7-104	\$44.00	3/32"	1"	3/8"	3"	.33931"	BE7-104	\$52.81	
FE7-106	\$53.08	3/32"	1-1/2"	1/2"	3-1/2"	.46209"	BE7-106	\$63.69	
FE7-202	\$42.73	1/8"	1/2"	3/8"	2-1/2"	.24778"	BE7-202	\$51.27	

7° 3-Flute Tapered (Continued)									
									
		Tip Dia.	Flute Length	Shank Dia.	Overall Length	Large			
Flat-End	Price	Dia.	Length	Dia.	Length	Dia.	Ball-End	Price	
FE7-203	\$41.19	1/8"	3/4"	3/8"	2-1/2"	.30917"	BE7-203	\$49.48	
FE7-204	\$43.94	1/8"	1"	3/8"	3"	.37056"	BE7-204	\$52.75	
FE7-206	\$52.48	1/8"	1-1/2"	1/2"	3-1/2"	.49334"	BE7-206	\$62.97	
FE7-208	\$101.49	1/8"	2"	5/8"	4"	.61612"	BE7-208	\$121.78	
FE7-212	\$229.69	1/8"	3"	7/8"	5"	.86168"	BE7-212	\$272.42	
FE7-253	\$45.93	5/32"	3/4"	3/8"	2-1/2"	.34042"	BE7-253	\$55.15	
FE7-305	\$58.89	3/16"	1-1/4"	1/2"	3-1/2"	.49445"	BE7-305	\$70.71	
FE7-403	\$51.48	1/4"	3/4"	1/2"	3"	.43417"	BE7-403	\$61.76	
FE7-404	\$62.03	1/4"	1"	1/2"	3"	.49556"	BE7-404	\$74.45	
FE7-405	\$74.72	1/4"	1-1/4"	5/8"	3-1/2"	.55695"	BE7-405	\$89.67	
FE7-409	\$213.66	1/4"	2-1/4"	7/8"	5"	.80251"	BE7-409	\$256.39	
FE7-605	\$126.87	3/8"	1-1/4"	3/4"	4"	.68195"	BE7-605	\$152.23	
FE7-609	\$213.66	3/8"	2-1/4"	1"	5"	.92751"	BE7-609	\$256.39	
FE7-805	\$146.89	1/2"	1-1/4"	7/8"	4"	.80695"	BE7-805	\$176.27	
FE7-808	\$240.37	1/2"	2"	1"	5"	.99112"	BE7-808	\$288.44	

10° 3-Flute Tapered									
									
		Tip Dia.	Flute Length	Shank Dia.	Overall Length	Large			
Flat-End	Price	Dia.	Length	Dia.	Length	Dia.	Ball-End	Price	
FE10-0002	\$37.26	1/32"	1/2"	1/4"	2-1/2"	.20758"	BE10-0002	\$45.27	
FE10-0003	\$52.68	1/32"	3/4"	3/8"	2-1/2"	.29575"	BE10-0003	\$63.22	
FE10-002	\$37.80	1/16"	1/2"	3/8"	2-1/2"	.23883"	BE10-002	\$45.81	
FE10-003	\$40.86	1/16"	3/4"	3/8"	2-1/2"	.32700"	BE10-003	\$49.07	
FE10-004	\$48.07	1/16"	1"	1/2"	3"	.41516"	BE10-004	\$57.69	
FE10-005	\$49.42	1/16"	1-1/4"	1/2"	3-1/2"	.50000"	BE10-005	\$59.29	
FE10-102	\$37.99	3/32"	1/2"	3/8"	2-1/2"	.27008"	BE10-102	\$46.01	
FE10-102A	\$37.99	3/32"	1/2"	1/4"	2-1/2"	.25000"	BE10-102A	\$46.01	
FE10-103	\$42.54	3/32"	3/4"	3/8"	2-1/2"	.35825"	BE10-103	\$51.08	
FE10-106	\$74.72	3/32"	1-1/2"	5/8"	3-1/2"	.62274"	BE10-106	\$89.67	
FE10-203	\$40.86	1/8"	3/4"	3/8"	2-1/2"	.37500"	BE10-203	\$49.07	
FE10-204	\$51.27	1/8"	1"	1/2"	3"	.47766"	BE10-204	\$61.56	
FE10-205	\$74.72	1/8"	1-1/4"	5/8"	4"	.56583"	BE10-205	\$89.67	
FE10-206	\$146.89	1/8"	1-1/2"	3/4"	4"	.65399"	BE10-206	\$176.27	
FE10-254	\$51.88	5/32"	1"	1/2"	3"	.50000"	BE10-254	\$62.23	
FE10-258	\$173.60	5/32"	2"	7/8"	4"	.86132"	BE10-258	\$208.32	
FE10-303	\$49.07	3/16"	3/4"	1/2"	3"	.45199"	BE10-303	\$58.89	
FE10-305	\$81.53	3/16"	1-1/4"	5/8"	3-1/2"	.62500"	BE10-305	\$97.82	
FE10-309	\$233.70	3/16"	2-1/4"	1"	5"	.98099"	BE10-309	\$280.43	
FE10-403	\$56.69	1/4"	3/4"	5/8"	3"	.51450"	BE10-403	\$68.04	
FE10-404	\$75.99	1/4"	1"	5/8"	3"	.60266"	BE10-404	\$91.21	
FE10-405	\$146.89	1/4"	1-1/4"	3/4"	4"	.69083"	BE10-405	\$176.27	
FE10-605	\$162.92	3/8"	1-1/4"	7/8"	4"	.81583"	BE10-605	\$195.50	
FE10-805	\$169.33	1/2"	1-1/4"	1"	4"	.94083"	BE10-805	\$203.18	

10° 4-Flute Tapered									
									
		Tip Dia.	Flute Length	Shank Dia.	Overall Length	Large			
Flat-End	Price	Dia.	Length	Dia.	Length	Dia.	Ball-End	Price	
FE10-408	\$233.70	1/4"	2"	1"	5"	.95532"	BE10-408	\$280.43	

15° 4-Flute Tapered									
									
		Tip Dia.	Flute Length	Shank Dia.	Overall Length	Large			
Flat-End	Price	Dia.	Length	Dia.	Length	Dia.	Ball-End	Price	
FE15-606	\$347.08	3/8"	1-1/2"	3/4"	4"	1.17855"	BE15-606	\$396.31	
FE15-805	\$306.46	1/2"	1-1/4"	3/4"	3-1/2"	1.16988"	BE15-805	\$355.69	

MAGNATE Tapered End Mills – Solid Sub-Micrograin Carbide

All tapered end mills are produced from a premium grade of super submicrograin carbide to give you the maximum hardness and toughness. This means longer cutting life with less breakage.

All flutes are hollow ground with double clearance angles. The flute face is also hollow ground and polished to assure free cutting actions with minimum of heat generation. All tools have end cutting teeth. Special grinding procedures and equipment assures a high degree on concentricity between shank and cutting flutes.

Taper angles constant to +/- .001 per inch of flute length. Tip diameter tolerances are held at +/- .002. Shank diameter tolerances are .0002 to -.0005.

15° 3-Flute Tapered



Tip Flute Shank Overall Large

Flat-End Price	Tip Dia.	Flute Length	Shank Dia.	Shank Length	Overall Length	Large Dia.	Ball-End Price
FE15-0001	\$36.46	1/32"	1/4"	1/4"	2"	.16523"	BE15-0001 \$44.47
FE15-0003	\$69.44	1/32"	3/4"	1/2"	2-1/2"	.43318"	BE15-0003 \$83.32
FE15-001	\$37.66	1/16"	1/4"	1/4"	2"	.19648"	BE15-001 \$45.67
FE15-003	\$62.63	1/16"	3/4"	1/2"	2-1/2"	.46443"	BE15-003 \$75.19
FE15-101	\$37.72	3/32"	1/4"	1/4"	2"	.22773"	BE15-101 \$45.74
FE15-102	\$39.73	3/32"	1/2"	3/8"	2-1/2"	.36170"	BE15-102 \$47.67
FE15-103	\$52.21	3/32"	3/4"	1/2"	3"	.49568"	BE15-103 \$62.70
FE15-104	\$127.20	3/32"	1"	3/4"	3"	.62965"	BE15-104 \$152.64
FE15-106	\$213.66	3/32"	1-1/2"	1"	4"	.89760"	BE15-106 \$256.39
FE15-202	\$44.33	1/8"	1/2"	1/2"	2-1/2"	.39295"	BE15-202 \$53.22
FE15-203	\$54.41	1/8"	3/4"	9/16"	3"	.52693"	BE15-203 \$65.30
FE15-204	\$130.46	1/8"	1"	3/4"	3"	.66090"	BE15-204 \$156.58
FE15-206	\$238.36	1/8"	1-1/2"	1"	4"	.92885"	BE15-206 \$286.04
FE15-206A	\$244.31	1/8"	1-1/2"	1/2"	4"	.92885"	BE15-206A \$268.92
FE15-304	\$159.37	3/16"	1"	3/4"	3"	.72340"	BE15-304 \$191.30
FE15-304A	\$171.69	3/16"	1"	1/2"	3"	.72340"	BE15-304A \$206.03
FE15-305	\$180.28	3/16"	1-1/4"	7/8"	4"	.85738"	BE15-305 \$216.33
FE15-404	\$166.12	1/4"	1"	3/4"	3"	.75000"	BE15-404 \$199.37
FE15-404A	\$178.42	1/4"	1"	1/2"	3"	.78590"	BE15-404A \$214.10
FE15-405	\$187.89	1/4"	1-1/4"	1"	4"	.91988"	BE15-405 \$225.48
FE15-405A	\$200.20	1/4"	1-1/4"	1/2"	3-1/2"	.91988"	BE15-405A \$240.23
FE15-504	\$186.42	5/16"	1"	7/8"	4"	.84890"	BE15-504 \$223.68

20° 4-Flute Tapered



Tip Flute Shank Overall Large

Flat-End Price	Tip Dia.	Flute Length	Shank Dia.	Shank Length	Overall Length	Large Dia.	Ball-End Price
FE20-204	\$179.26	1/8"	1"	1/2"	3-1/2"	.85294"	BE20-204 \$215.11
FE20-304	\$190.65	3/16"	1"	1/2"	3-1/2"	.91594"	BE20-304 \$227.57
FE20-404	\$224.86	1/4"	1"	1/2"	3-1/2"	.97794"	BE20-404 \$269.83

20° 3-Flute Tapered



Tip Flute Shank Overall Large

Flat-End Price	Tip Dia.	Flute Length	Shank Dia.	Shank Length	Overall Length	Large Dia.	Ball-End Price
FE20-0001	\$37.12	1/32"	1/4"	1/4"	2"	.21324"	BE20-0001 \$45.13
FE20-0002	\$69.44	1/32"	1/2"	1/2"	2-1/2"	.39522"	BE20-0002 \$86.54
FE20-001	\$39.40	1/16"	1/4"	1/4"	2"	.24449"	BE20-001 \$47.94
FE20-002	\$51.21	1/16"	1/2"	1/2"	2-1/2"	.42647"	BE20-002 \$61.49
FE20-102	\$53.61	3/32"	1/2"	1/2"	2-1/2"	.45772"	BE20-102 \$64.37
FE20-103	\$129.66	3/32"	3/4"	3/4"	3"	.63971"	BE20-103 \$155.57
FE20-202	\$60.43	1/8"	1/2"	1/2"	2-1/2"	.48897"	BE20-202 \$72.52

25° 3-Flute Tapered



Tip Flute Shank Overall Large

Flat-End Price	Tip Dia.	Flute Length	Shank Dia.	Shank Length	Overall Length	Large Dia.	Ball-End Price
FE25-001	\$56.09	1/16"	1/4"	3/8"	2-1/2"	.29566"	BE25-001 \$67.30
FE25-002	\$104.86	1/16"	1/2"	3/8"	2-1/2"	.52881"	BE25-002 \$125.83
FE25-101	\$53.42	3/32"	1/4"	3/8"	2-1/2"	.32691"	BE25-101 \$64.10
FE25-103	\$171.94	3/32"	3/4"	1/2"	3"	.79322"	BE25-103 \$206.33
FE25-201	\$60.10	1/8"	1/4"	1/2"	2-1/2"	.35816"	BE25-201 \$72.11

25° 4-Flute Tapered



Tip Flute Shank Overall Large

Flat-End Price	Tip Dia.	Flute Length	Shank Dia.	Shank Length	Overall Length	Large Dia.	Ball-End Price
FE25-202	\$131.08	1/8"	1/2"	1/2"	2-1/2"	.59131"	BE25-202 \$157.29
FE25-204	\$200.74	1/8"	1"	1/2"	3"	1.05762"	BE25-204 \$240.89

30° 3-Flute Tapered



Tip Flute Shank Overall Large

Flat-End Price	Tip Dia.	Flute Length	Shank Dia.	Shank Length	Overall Length	Large Dia.	Ball-End Price
FE30-0001	\$50.34	1/32"	1/4"	3/8"	2-1/2"	.31993"	BE30-001 \$60.43
FE30-001	\$50.34	1/16"	1/4"	3/8"	2-1/2"	.35118"	BE30-001 \$60.43
FE30-002	\$114.71	1/16"	1/2"	3/8"	2-1/2"	.63985"	BE30-002 \$137.65
FE30-101	\$52.81	3/32"	1/4"	3/8"	2-1/2"	.37500"	BE30-101 \$63.36
FE30-103	\$207.57	3/32"	3/4"	1/2"	3"	.95978"	BE30-103 \$249.08
FE30-201	\$60.69	1/8"	1/4"	1/2"	2-1/2"	.41368"	BE30-201 \$72.85
FE30-202	\$131.26	1/8"	1/2"	1/2"	2-1/2"	.70235"	BE30-202 \$157.51

30° 4-Flute Tapered



Tip Flute Shank Overall Large

Flat-End Price	Tip Dia.	Flute Length	Shank Dia.	Shank Length	Overall Length	Large Dia.	Ball-End Price
FE30-204	\$236.80	1/8"	1"	1/2"	3"	1.27970"	BE30-204 \$284.16
FE30-404	\$281.85	1/4"	1"	3/4"	3"	1.40470"	BE30-404 \$338.22

45° 4-Flute Tapered



Tip Flute Shank Overall Large

Flat-End Price	Tip Dia.	Flute Length	Shank Dia.	Shank Length	Overall Length	Large Dia.	Ball-End Price
FE45-2015	\$172.31	1/8"	5/16"	1/2"	2-1/2"	.75000"	BE45-2015 \$206.77
FE45-202	\$215.38	1/8"	1/2"	1/2"	2-5/8"	1.12500"	BE45-202 \$258.46

MAGNATE™ Solid Carbide Insert Knives

Straight Spoilboard Surfacing Cutter For MDF and Particleboard



This straight spoil board surfacing Cutter comes with solid carbide insert knives. Use replacement insert knives that are compatible with Magnate tool no. 8203. (4 cutting edges 1 hole, 14mm x 14mm x 2.0mm)

Tool No.	Cutting Dia.	Cutting Length	Shank Dia.	Wing	Price
SBC178W2	1-7/8"	1/2"	1/2"	3	\$287.13
SBC212W2	2-1/2"	1/2"	1/2"	3	\$297.12
SBC4W2	4"	1/2"	3/4"	2	\$303.74
SBC4W3	4"	1/2"	3/4"	3	\$326.04

2 Cutting Edges, 2 Holes 10 Knives/Pack, Reversible



Tool No.	Length	Width	Thickness	CTC	Price
8219	25mm	12mm	1.5mm	14mm	\$39.28
8207	30mm	12mm	1.5mm	14mm	\$27.36
8217	30mm	12mm	1.5mm	16mm	\$62.01
8216	35mm	12mm	1.5mm	16mm	\$59.13
8211	40mm	12mm	1.5mm	26mm	\$41.03
8209	50mm	12mm	1.5mm	26mm	\$41.03
8218	60mm	12mm	1.5mm	26mm	\$59.03
8231	80mm	13mm	2.0mm	60mm	\$183.15
8232	100mm	13mm	2.0mm	60mm	\$233.49
8234	120mm	13mm	2.0mm	60mm	\$257.41

4 Cutting Edges, 2 Holes For Plunge 10 Knives/Pack, Reversible



Tool No.	Length	Width	Thickness	CTC	Price
8220	29.5mm	7mm	1.5mm	14mm	\$75.64
8221	29.5mm	7.5mm	1.5mm	14mm	\$75.64
8222	29.5mm	8mm	1.5mm	14mm	\$70.23
8223	29.5mm	9mm	1.5mm	14mm	\$58.02
8224	29.5mm	10mm	1.5mm	14mm	\$68.75
8225	29.5mm	11mm	1.5mm	14mm	\$68.75
8226	29.5mm	12mm	1.5mm	14mm	\$58.03
8227	30mm	12mm	1.5mm	14mm	\$58.02
8260	39.5mm	12mm	1.5mm	26mm	\$70.55
8261	49.5mm	8mm	1.5mm	26mm	\$90.21
8262	49.5mm	9mm	1.5mm	26mm	\$81.55
8263	49.5mm	10mm	1.5mm	26mm	\$88.29
8264	49.5mm	11mm	1.5mm	26mm	\$88.29
8265	49.5mm	12mm	1.5mm	26mm	\$81.55
8268	59.5mm	12mm	1.5mm	26mm	\$90.94

4 Cutting Edges, 1 Hole 10 Knives/Pack, Reversible

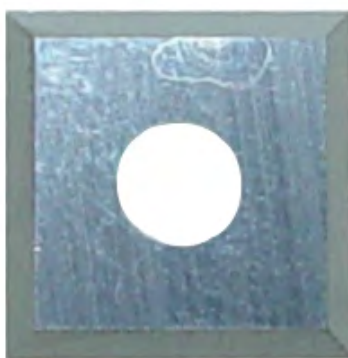

Tool No.	Length	Width	Thickness	Price
8201	12mm	12mm	1.5mm	\$25.76
8253	13mm	13mm	2.5mm	\$67.66
8243	13.6mm	13.6mm	2.0mm	\$28.32
8202	14mm	14mm	1.2mm	\$27.04
8203	14mm	14mm	2.0mm	\$22.82
8244#	14mm	14mm	2.0mm	\$61.32
8254	14.3mm	14.3mm	2.5mm	\$50.86
8246	14.6mm	14.6mm	2.5mm	\$51.71
8210^	15mm	15mm	2.5mm	\$48.13
8247*	17mm	17mm	2.0mm	\$69.90
8257+	17mm	17mm	2.0mm	\$73.75
8249+	19mm	19mm	2.0mm	\$77.49
8240	19.5mm	7mm	1.5mm	\$63.84
8250	19.5mm	7.5mm	1.5mm	\$63.84
8241	19.5mm	8mm	1.5mm	\$63.84
8251	19.5mm	9mm	1.5mm	\$48.39
8248	19.5mm	10mm	1.5mm	\$58.72
8258	19.5mm	11mm	1.5mm	\$58.72
8259	19.5mm	12mm	1.5mm	\$46.17

4 Cutting Edges, 3 Holes 10 Knives/Pack, Reversible



Tool No.	Length	Width	Thickness	CTC	Price
8351	50mm	10mm	1.7mm	37mm	\$93.00
8352	50mm	12mm	1.7mm	37mm	\$76.50



Tool No.	Length	Width	Thickness	Price
8282	7.5mm	12mm	1.5mm	\$22.30
8284	8.6mm	12mm	1.5mm	\$53.48
8286	9.0mm	12mm	1.5mm	\$36.48
8288	9.6mm	12mm	1.5mm	\$37.99
8289	10.5mm	10.5mm	1.5mm	\$34.11
8293	13mm	12mm	1.5mm	\$62.49
8295	15mm	12mm	1.5mm	\$20.45
8296	18mm	12mm	1.5mm	\$55.65
8298	20mm	12mm	1.5mm	\$23.57
8299	25mm	12mm	1.5mm	\$39.28

End Angle, 1 Hole 10 Knives/Pack, Reversible

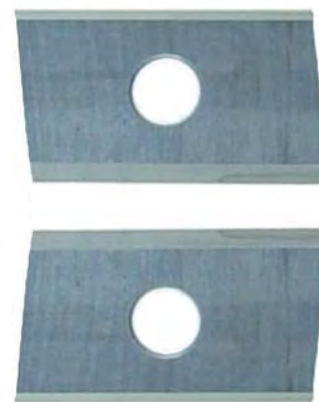

Tool No.	Length	Width	Thickness	Angle	Price
8321	20mm	12mm	1.5mm	Right	\$50.81
8326	20mm	12mm	1.5mm	Left	\$50.81

MAGNATE™ 20639 Lycoming Street #B-6, Walnut, CA 91789 USA

E-1



email : info@magnate.net Online Shop : www.magnate.net
(TEL) 800-827-2316, 909-468-5747 (FAX) 909-468-5745

MAGNATE™ Solid Carbide Insert Knives

End Angle, 2 Holes 10 Knives/Pack, Reversible



8331

8341

Tool No.	Length	Width	Thickness	Angle	Price
8331*	30mm	12mm	1.5mm	Right	\$54.69
8341*	30mm	12mm	1.5mm	Left	\$54.69
8332^	40mm	12mm	1.5mm	Right	\$74.21
8342^	40mm	12mm	1.5mm	Left	\$74.21
8334^	50mm	12mm	1.5mm	Right	\$74.21
8344^	50mm	12mm	1.5mm	Left	\$74.21

Face Groove, 4-Sided, 10 Knives/Pack



Tool No.	Length	Width	Thickness	CTC	Price
8241	20mm	5.5mm	1.1"	14mm	\$68.93
8243	25mm	5.5mm	1.1"	14mm	\$72.21
8246	30mm	5.5mm	1.1"	16mm	\$75.81
8247	35mm	5.5mm	1.1"	16mm	\$80.36
8248	40mm	5.5mm	1.1"	26mm	\$76.46
8249	50mm	5.5mm	1.1"	26mm	\$81.70

Double Radius, 3mm Hole, 10 Knives/Pack



Tool No.	Length	Width	Thickness	Radius	Price
8371	16mm	17.5mm	2.0mm	2mm	\$190.25
8373	16mm	17.5mm	2.0mm	3mm	\$190.25
8375	16mm	17.5mm	2.0mm	4mm	\$190.25
8378	16mm	17.5mm	2.0mm	5mm	\$190.25

Radius Knives, 10 Knives/Pack



Right



Left

Tool No.	Length	Width	Thickness	Side	Price
8271*	12mm	14.5mm	2.0mm	Right	\$183.77
8276*	12mm	14.5mm	2.0mm	Left	\$183.77
8272^	12mm	14.5mm	2.0mm	Right	\$183.77
8277^	12mm	14.5mm	2.0mm	Left	\$183.77
8273#	12mm	14.5mm	2.0mm	Right	\$173.26
8278#	12mm	14.5mm	2.0mm	Left	\$173.26
8301*	15mm	14.5mm	2.0mm	Right	\$191.46
8306*	15mm	14.5mm	2.0mm	Left	\$191.46
8302^	15mm	14.5mm	2.0mm	Right	\$191.46
8307^	15mm	14.5mm	2.0mm	Left	\$191.46
8303#	15mm	14.5mm	2.0mm	Right	\$170.51
8308#	15mm	14.5mm	2.0mm	Left	\$170.51
8311*	19.6mm	15.2mm	2.0mm	Right	\$203.25
8316*	19.6mm	15.2mm	2.0mm	Left	\$203.25
8313#	19.6mm	15.2mm	2.0mm	Right	\$203.25
8318#	19.6mm	15.2mm	2.0mm	Left	\$203.25

* 2mm radius
^ 2.5mm radius
3.0mm radius

Radius Knife, 3mm Radius, 1 Knife/Pack

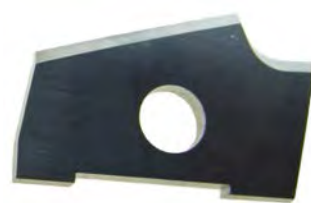

8374

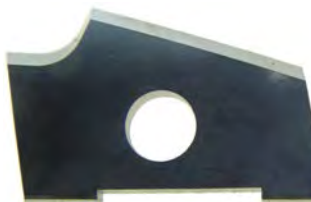

8379

Tool No.	Length	Width	Thickness	Side	Price
8374	22.3mm	14mm	2.0mm	Right	\$46.11
8379	22.3mm	14mm	2.0mm	Left	\$46.12

Scraper, 1 Knife/Pack



Tool No.	Length	Width	Thickness	Radius	Price
8361	12.7mm	12.7mm	3.0mm	3mm	\$40.69
8364	20mm	12mm	2.0mm	2mm	\$31.92
8365	20mm	12mm	2.0mm	3mm	\$31.93
8368	20mm	12mm	2.0mm	5mm	\$38.23

4 Cutting Radius Edges, 1 Hole 10 Knives/Pack, Reversible



Tool No.	Length	Width	Thickness	Radius	Price
8208	15mm	15mm	2.5mm	50mm	\$60.51
8200	15mm	15mm	2.5mm	100mm	\$48.87
8206	15mm	15mm	2.5mm	115mm	\$48.87
8205*	15mm	15mm	2.5mm	150mm	\$52.13

* With 30° bevel



MAGNATE™ Planer-Jointer, Molder Cutterhead/Knife

Planer-Jointer Knife Set, High Speed Steel (HSS)



Tool No.	Length	Width	Thickness	Knives/Pkg	Machine	Price
PK0401H	4"	5/8"	1/8"	3	Atlas, Boice Crane, Old Craftsman, Jet JJ-4	\$12.25
PK0603H	6"	5/8"	1/8"	3	Delta 6", Jet JJ-6, Boice, Crane, Craftsman, TTL	\$16.99
PK0605H	6"	5/8"	1/8"	4	Boice Crane	\$22.68
PK0609H	6"	16.5mm	2.7mm	3	Delta 37-195, 37-275, 190	\$27.72
PK0612H	6"	3/4"	1/8"	3	Powermatic 50, Crescent, Atlas	\$20.26
PK0618H	6"	1"	1/8"	3	Grizzly G6697	\$26.86
PK0632H	6-1/16"	5/8"	1/8"	3	Powermatic 54A (No Holes), Jet JJ-6	\$17.45
PK0635H	6-1/16"	3/4"	1/8"	3	Delta, Walker-Tuner, Wallace	\$22.81
PK0638H	6-1/16"	13/16"	1/8"	3	Delta DJ-15, 37-154 & Similar 6" Jointers	\$22.24
PK0670H	6-1/8"	5/8"	3/32	3	Delta 37-658, 37-205, 37-220, 37-195, 37-190	\$17.52
PK0676H	6-1/8"	5/8"	1/8"	3	Craftsman	\$17.52
PK0679H	6-1/8"	11/16"	1/8"	3	Jet, Ridgid JP0610	\$18.82
PK0803H	8"	5/8"	1/8"	3	Delta 8", Jet JJ-8, Boice Crane, Powermatic 60	\$24.00
PK0806H	8"	3/4"	1/8"	3	Jet JJ-8 Jointer, Powermatic 60, Pryor, Sunhill	\$27.11
PK0809H	8"	3/4"	1/8"	4	Bridgewood, Grizzly 8"	\$36.10
PK0812H	8"	7/8"	1/8"	3	Powermatic 50	\$31.02
PK0815H	8"	1"	1/8"	3	Grizzly G6698, Oliver	\$35.94
PK0832H	8-1/16"	5/8"	3/32	3	Delta 37-315, Yates, J-Line	\$23.10
PK0835H	8-1/16"	5/8"	1/8"	3	Delta	\$23.10
PK0838H	8-1/16"	3/4"	1/8"	3	Sunhill	\$27.48
PK0841H	8-1/16"	13/16"	1/8"	3	Delta DJ-20, 37-365 & Similar	\$29.70
PK1201H*	12"	15/32"	1/16"	2	Craftsman 21722	\$36.96
PK1205H	12"	3/4"	1/8"	3	Grizzly G6700	\$40.56
PK1207H	12"	7/8"	1/8"	3	Powermatic 100, Parks, Woodtek	\$46.30
PK1209H	12"	1"	1/8"	3	Craftsman	\$53.75
PK1213H	12"	1-1/4"	1/8"	3	Northfield, Oliver	\$56.75
PK1232H	12-1/4"	3/4"	1/8"	3	Boice Crane, Reliant, Wilke	\$41.34
PK1235H	12-1/4"	7/8"	1/8"	3	Powermatic 100	\$47.50
PK1237H	12-1/4"	1"	1/8"	3	Parks, Boice, Most European Combo	\$54.92
PK1260H**	12-1/2"	15/32"	1/16"	2	Delta 22-560, TP305 & Ryobi AP-12	\$55.44
PK1264H	12-1/2"	5/8"	1/8"	3	Boice Crane	\$35.49
PK1268H	12-1/2"	11/16"	1/8"	3	RBI Model 812, Foley-Belsaw, Woodmaster 712, Jet	\$38.33
PK1272H	12-1/2"	3/4"	1/8"	3	Jet, Grizzly G1195, Wilke, Reliant, Most 12" Imports	\$35.69
PK1276H*	12-1/2"	7/8"	1/16"	3	DeWalt DW734	\$70.23
PK1279H	12-1/2"	1-1/16"	1/8"	2	DeWalt DW733	\$62.84
PK1302H*	13 in.	1/2"	1/16"	2	Ryobi AP1300	\$33.25
PK1304H*	13 in.	3/4"	1/16"	2	Ryobi TP1300	\$51.75
PK1306H*	13 in.	3/4"	1/16"	2	Ryobi AP1301	\$51.75
PK1308H*	13 in.	7/8"	1/16"	3	DeWalt DW735	\$80.59
PK1320H	13-1/16"	5/8"	1/8"	3	Jet	\$37.48
PK1326H^	13-1/8"	11/16"	5/32"	3	Delta 22-401	\$49.89
PK1328H	13-1/8"	1"	1/8"	3	Delta RC-33 & DC-33 13" Planer, Rockwell	\$58.82
PK1503H	15"	1"	1/8"	3	Delta DC-380, Grizzly G6701, Powermatic 15, Jet, TLL	\$67.29
PK1514H	15-1/16"	1"	1/8"	3	Delta 22-677	\$67.57
PK1542H	15-3/4"	30mm	3mm	4	SCMI	\$111.07
PK1602H	16"	1"	1/8"	3	Jet JWP 16	\$71.67
PK1604H	16"	1-1/8"	1/8"	4	Bridgewd, Crescent, Grizzly 16"	\$106.65
PK1610H	16"	1-1/4"	1/8"	3	Northfield 16HD	\$88.80
PK1634H	16-3/16"	30mm	3mm	4	SCMI	\$114.20
PK1624H	16-1/4"	1-1/4"	5/32"	3	Powermatic 160	\$106.41
PK1641H	16-1/2"	11/16"	1/8"	4	RBI 816	\$67.03
PK1803H	18"	1-1/4"	5/32"	3	Powermatic	\$119.39
PK1814H	18-1/8"	1-1/8"	5/32"	3	Rockwell, Delta 22-212, Yates J180	\$106.87
PK1825H	18-1/4"	1-1/4"	5/32"	3	Powermatic 180	\$119.39

MAGNATE™ 20639 Lycoming Street #B-6, Walnut, CA 91789 USA

F-1



email : info@magnate.net Online Shop : www.magnate.net
 (TEL) 800-827-2316, 909-468-5747 (FAX) 909-468-5745

MAGNATE™ Planer-Jointer, Molder Cutterhead/Knife

PK1850H	18-1/2"	11/16"	1/8"	3	Woodmaster 718	\$56.29
PK2003H	20"	1"	1/8"	3	Grizzly, Northwood	\$88.96
PK2004H	20"	1"	1/8"	4	Parks, TLL 20", Jet 208, Northstate, Grizzly G6702	\$118.53
PK2012H	20"	1-1/8"	1/8"	4	Delta 20x9 Crescent, Many European Macihnes	\$133.46
PK2013H	20"	1-3/16"	1/8"	4	Delta 20" Planer, Grizzly 20" H7269, Many Imports	\$140.44
PK2014H	20"	1-1/4"	1/8"	3	Woodtek 20"	\$111.03
PK2032H	20-3/16"	1-3/16"	1/8"	4	Delta DC-580	\$141.00
PK2035H	20-3/16"	1-3/8"	1/8"	4	Delta RC-51, 22-460	\$157.49
PK2040H	20-1/4"	1-1/4"	5/32"	3	Powermatic 221	\$132.59
PK2051H	20-1/2"	11/16"	1/8"	4	RBI Model 820	\$83.31
PK2054H	20-1/2"	30mm	3mm	4	SCMI 520, 550, 552	\$142.68
PK2217H	22-1/8 in.	1"	1/8"	4	Powermatic 201	\$131.10
PK2403H	24"	1-1/4"	5/32"	4	Powermatic, Northfield	\$209.51
PK2415H	24-1/8"	1-3/16"	1/8"	4	Grizzly G6705	\$167.98
PK2431H	24-1/4"	1-1/8"	1/8"	3	Delta 22-470	\$121.58
PK2436H	24-1/4"	1-1/8"	1/8"	4	Crescent (Delta)	\$162.06
PK2437H	24-3/4"	1-1/8"	1/8"	3	Jet 24H	\$123.98
PK2451H	24-13/16"	1-3/8"	1/8"	4	Delta RC-63, 22-610	\$190.08
PK2501H	25"	11/16"	1/8"	3	Woodmaster 725	\$163.39
PK2504H	25"	1-1/4"	1/8"	4	Powermatic	\$191.33
PK2507H	25"	1-3/8"	1/8"	4	Pinheiro	\$195.31
PK2528H	25-3/16"	35mm	1/8"	4	SCMI F630 & F535	\$197.37

* Double Edged

^ No Slots in Knife

Fits Porter Cable PC305TP

MAGNATE™ 20639 Lycoming Street #B-6, Walnut, CA 91789 USA

F-2



email : info@magnate.net Online Shop : www.magnate.net
 (TEL) 800-827-2316, 909-468-5747 (FAX) 909-468-5745

MAGNATE™ Planer-Jointer, Molder Cutterhead/Knife

Planer-Jointer Knife Set, Carbide Tipped



This carbide tipped planer/jointer knife set can last up to 10 times longer than its high speed steel (HSS) rivals . It offers precision cuts and fine finishing.

Tool No.	Length	Width	Thickness	Knives/Pkg	Machine	Price
PK0401T	4"	5/8"	1/8"	3	Atlas, Boice Crane, Old Craftsman, Jet JJ-4	\$63.73
PK0603T	6"	5/8"	1/8"	3	Delta 6",Jet JJ-6,Boice,Crane,Craftsman,TTL	\$95.95
PK0612T	6"	3/4"	1/8"	3	Powermatic 50, Crescent, Atlas	\$96.61
PK0618T	6"	1"	1/8"	3	Grizzly G6697	\$97.68
PK0632T	6-1/16"	5/8"	1/8"	3	Powermatic 54A (No Holes), Jet JJ-6	\$97.41
PK0635T	6-1/16"	3/4"	1/8"	3	Delta, Walker-Tuner, Wallace	\$96.61
PK0638T	6-1/16"	13/16"	1/8"	3	Delta DJ-15, 37-154 & Similar 6" Jointers	\$97.68
PK0679T	6-1/8"	11/16"	1/8"	3	Jet, Ridgid JP0610	\$102.15
PK0803T	8"	5/8"	1/8"	3	Delta 8",Jet JJ-8,Boice Crane,Powermatic 60	\$127.80
PK0806T	8"	3/4"	1/8"	3	Jet JJ-8 Jointer, Powermatic 60, Pryor, Sunhill	\$128.50
PK0809T	8"	3/4"	1/8"	4	Bridgewood, Grizzly 8"	\$173.19
PK0812T	8"	7/8"	1/8"	3	Powermatic 50	\$129.19
PK0815T	8"	1"	1/8"	3	Grizzly G6698, Oliver	\$129.90
PK0838T	8-1/16"	3/4"	1/8"	3	Sunhill	\$130.66
PK0841T	8-1/16"	13/16"	1/8"	3	Delta DJ-20, 37-365 & Similar	\$129.90
PK1207T	12"	7/8"	1/8"	3	Powermatic 100, Parks, Woodtek	\$193.60
PK1209T	12"	1"	1/8"	3	Craftsman	\$195.02
PK1213T	12"	1-1/4"	1/8"	3	Northfield, Oliver	\$261.60
PK1235T	12-1/4"	7/8"	1/8"	3	Powermatic 100	\$197.80
PK1237T	12-1/4"	1"	1/8"	3	Parks, Boice, Most European Combo	\$198.91
PK1268T	12-1/2"	11/16"	1/8"	3	RBI Model 812, Foley-Belsaw, Woodmaster 712, Jet	\$199.93
PK1272T	12-1/2"	3/4"	1/8"	3	Jet,Grizzly G1195,Wilke,Reliant,Most 12" Imports	\$133.74
PK1308T	13 in.	7/8"	1/16"	3	DeWalt DW735	\$222.15
PK1320T	13-1/16"	5/8"	1/8"	3	Jet	\$208.32
PK1328T	13-1/8"	1"	1/8"	3	Delta RC-33 & DC-33 13" Planer, Rockwell	\$213.21
PK1503T	15"	1"	1/8"	3	Delta DC-380,Grizzly G6701,Powermatic 15,Jet,TLL	\$243.69
PK1542T	15-3/4"	30mm	3mm	4	SCMI	\$339.29
PK1610T	16"	1-1/4"	1/8"	3	Northfield 16HD	\$262.93
PK1634T	16-3/16"	30mm	3mm	4	SCMI	\$350.14
PK1624T	16-1/4"	1-1/4"	5/32"	3	Powermatic 160	\$270.65
PK1641T	16-1/2"	11/16"	1/8"	4	RBI 816	\$349.09
PK1803T	18"	1-1/4"	5/32"	3	Powermatic	\$303.57
PK1814T	18-1/8"	1-1/8"	5/32"	3	Rockwell, Delta 22-212, Yates J180	\$290.94
PK1825T	18-1/4"	1-1/4"	5/32"	3	Powermatic 180	\$303.57
PK1850T	18-1/2"	11/16"	1/8"	3	Woodmaster 718	\$295.53
PK2003T	20"	1"	1/8"	3	Grizzly, Northwood	\$325.97
PK2004T	20"	1"	1/8"	4	Parks, TLL 20", Jet 208, Northstate, Grizzly G6702	\$429.25
PK2012T	20"	1-1/8"	1/8"	4	Delta 20x9 Crescent, Many European Machines	\$431.01
PK2013T	20"	1-3/16"	1/8"	4	Delta 20" Planer, Grizzly 20" H7269, Many Imports	\$432.05
PK2032T	20-3/16"	1-3/16"	1/8"	4	Delta DC-580	\$434.86
PK2035T	20-3/16"	1-3/8"	1/8"	4	Delta RC-51, 22-460	\$437.68
PK2040T	20-1/4"	1-1/4"	5/32"	3	Powermatic 221	\$338.24
PK2051T	20-1/2"	11/16"	1/8"	4	RBI Model 820	\$434.86
PK2054T	20-1/2"	30mm	3mm	4	SCMI 520, 550, 552	\$442.54
PK2403T	24"	1-1/4"	5/32"	4	Powermatic, Northfield	\$523.77
PK2415T	24-1/8"	1-3/16"	1/8"	4	Grizzly G6705	\$519.59
PK2431T	24-1/4"	1-1/8"	1/8"	3	Delta 22-470	\$395.97
PK2436T	24-1/4"	1-1/8"	1/8"	4	Crescent (Delta)	\$520.99
PK2437T	24-3/4"	1-1/8"	1/8"	3	Jet 24H	\$404.04
PK2451T	24-13/16"	1-3/8"	1/8"	4	Delta RC-63, 22-610	\$546.90
PK2501T	25"	11/16"	1/8"	3	Woodmaster 725	\$399.84
PK2504T	25"	1-1/4"	1/8"	4	Powermatic	\$540.76
PK2507T	25"	1-3/8"	1/8"	4	Pinheiro	\$541.71
PK2528T	25-3/16"	35mm	1/8"	4	SCMI F630 & F535	\$546.90

MAGNATE™ 20639 Lycoming Street #B-6, Walnut, CA 91789 USA

F-3



email : info@magnate.net Online Shop : www.magnate.net

(TEL) 800-827-2316, 909-468-5747 (FAX) 909-468-5745

Molder Knife, M2 HSS
25" Long, 1 Knife/Package
60° Corrugated Back
40° Bevel Edged



This 60 degree corrugated, 40 degree sharp edged, M2 High Speed Steel corrugated back molder knife offers long life in hardwoods and softwoods. It provides excellent cuts and easy grinding.

Tool No.	Width	Thickness	Price
CS25410	1-1/4"	1/4"	\$82.57
CS25412	1-1/2"	1/4"	\$92.20
CS25414	1-3/4"	1/4"	\$101.83
CS25416	2"	1/4"	\$114.80
CS25418	2-1/4"	1/4"	\$127.87
CS25420	2-1/2"	1/4"	\$137.05
CS25422	2-3/4"	1/4"	\$153.82
CS25424	3"	1/4"	\$181.62
CS25510	1-1/4"	5/16"	\$88.95
CS25512	1-1/2"	5/16"	\$103.78
CS25514	1-3/4"	5/16"	\$113.05
CS25516	2"	5/16"	\$124.17
CS25518	2-1/4"	5/16"	\$142.70
CS25520	2-1/2"	5/16"	\$153.82
CS25522	2-3/4"	5/16"	\$161.23
CS25524	3"	5/16"	\$194.58
CS25526	3-1/2"	5/16"	\$294.58

Molder Straight Cutterhead
137mm Diameter, 1-13/16" Bore
Knives are not included





Standard for American, European and Japanese Machines.

Tool No.	Length	Knives	Price
MH137L50F2S1-1316	50mm	2	\$295.20
MH137L50F4S1-1316	50mm	4	\$347.33
MH137L100F2S1-1316	100mm	2	\$323.47
MH137L100F4S1-1316	100mm	4	\$378.13
MH137L150F2S1-1316	150mm	2	\$452.67
MH137L150F4S1-1316	150mm	4	\$532.53
MH137L180F2S1-1316	180mm	2	\$522.13
MH137L180F4S1-1316	180mm	4	\$614.27
MH137L230F2S1-1316	230mm	2	\$596.93
MH137L230F4S1-1316	230mm	4	\$702.27



MAGNATE™ Planer-Jointer, Molder Cutterhead/Knife

Tersa R2000 Knives Chrome Steel 2 Knives/Package	1940440	440mm	\$35.66	Tersa R2000 Knives High Speed Steel 2 Knives/Package	1950430	430mm	\$57.85	Tersa R2000 Knives M42 2 Knives/Package	1956370	370mm	\$54.25
 <p>These genuine Tersa R2000 Chrome Steel replacement knives are best for general wood material i.e. birch, spruce and pine.</p>	1940450	450mm	\$36.34	 <p>These genuine Tersa R2000 High Speed Steel (HSS) replacement knives are best for general wood material i.e. pine, oak, maple, cherry and etc.</p>	1950440	440mm	\$59.02	 <p>These genuine Tersa R2000 M42 replacement knives are in better high speed steel quality, will often result in a longer lifetime and a better surface compared to standard HSS knives. Just like standard HSS knives, these M42 knives are suitable for general wood material pine, oak, maple, cherry and etc.</p>	1956380	380mm	\$55.63
	1940460	460mm	\$36.92		1950450	450mm	\$60.15		1956390	390mm	\$56.74
	1940470	470mm	\$37.32		1950460	460mm	\$61.29		1956400	400mm	\$57.85
	1940480	480mm	\$38.12		1950470	470mm	\$62.49		1956410	410mm	\$59.29
	1940490	490mm	\$38.58		1950480	480mm	\$63.54		1956420	420mm	\$60.34
	1940500	500mm	\$39.32		1950490	490mm	\$64.92		1956430	430mm	\$61.78
	1940510	510mm	\$39.82		1950500	500mm	\$66.09		1956440	440mm	\$62.89
	1940520	520mm	\$40.52		1950510	510mm	\$67.23		1956450	450mm	\$64.03
	1940530	530mm	\$40.98		1950520	520mm	\$68.37		1956460	460mm	\$65.32
	1940540	540mm	\$41.69		1950530	530mm	\$69.48		1956470	470mm	\$66.55
1940550	550mm	\$42.31	1950540	540mm	\$70.58	1956480	480mm	\$67.85			
1940560	560mm	\$42.68	1950550	550mm	\$72.15	1956490	490mm	\$69.02			
1940570	570mm	\$43.45	1950560	560mm	\$72.83	1956500	500mm	\$70.22			
1940580	580mm	\$43.94	1950570	570mm	\$74.28	1956510	510mm	\$72.15			
1940590	590mm	\$44.74	1950580	580mm	\$75.75	1956520	520mm	\$72.83			
1940600	600mm	\$45.17	1950590	590mm	\$76.43	1956530	530mm	\$74.28			
1940610	610mm	\$45.88	1950600	600mm	\$77.91	1956580	580mm	\$80.71			
1940620	620mm	\$46.37	1950610	610mm	\$78.58	1956590	590mm	\$81.45			
1940625	625mm	\$46.62	1950620	620mm	\$80.00	1956600	600mm	\$82.86			
1940630	630mm	\$47.17	1950625	625mm	\$80.71	1956610	610mm	\$84.34			
1940635	635mm	\$47.35	1950630	630mm	\$81.45	1956620	620mm	\$85.02			
1940640	640mm	\$47.63	1950635	635mm	\$81.78	1956625	625mm	\$85.72			
			1950640	640mm	\$82.18	1956630	630mm	\$86.46	1956635	635mm	\$87.17
			1950050	50mm	\$14.58	1956640	640mm	\$87.91			
			1950060	60mm	\$15.72						
			1950070	70mm	\$16.86						
			1950080	80mm	\$17.97						
			1950085	85mm	\$18.55						
			1950090	90mm	\$19.20						
			1950100	100mm	\$20.28						
			1950110	110mm	\$21.42						
			1950115	115mm	\$21.85						
			1950120	120mm	\$22.55						
			1950125	125mm	\$23.05						
			1950130	130mm	\$23.75						
			1950140	140mm	\$24.89						
			1950150	150mm	\$26.06						
			1950155	155mm	\$26.58						
			1950160	160mm	\$27.11						
			1950170	170mm	\$28.31						
			1950180	180mm	\$29.45						
			1950185	185mm	\$29.91						
			1950190	190mm	\$30.62						
			1950200	200mm	\$31.63						
			1950210	210mm	\$32.74						
			1950220	220mm	\$33.97						
			1950230	230mm	\$35.08						
			1950240	240mm	\$36.22						
			1950250	250mm	\$37.35						
			1950260	260mm	\$38.46						
			1950265	265mm	\$39.20						
			1950270	270mm	\$39.69						
			1950280	280mm	\$40.83						
			1950290	290mm	\$41.88						
			1950300	300mm	\$43.08						
			1950305	305mm	\$43.75						
			1950310	310mm	\$44.22						
			1950315	315mm	\$44.80						
			1950320	320mm	\$45.38						
			1950330	330mm	\$46.49						
			1950340	340mm	\$47.72						
			1950350	350mm	\$48.77						
			1950360	360mm	\$49.85						
			1950370	370mm	\$51.05						
			1950380	380mm	\$52.12						
			1950390	390mm	\$53.26						
			1950400	400mm	\$54.43						
			1950410	410mm	\$55.63						
			1950420	420mm	\$56.74						

MAGNATE™ 20639 Lycoming Street #B-6, Walnut, CA 91789 USA

F-5



email : info@magnate.net Online Shop : www.magnate.net
(TEL) 800-827-2316, 909-468-5747 (FAX) 909-468-5745

MAGNATE™ Planer-Jointer, Molder Cutterhead/Knife

Tersa R2000 Knives Solid Carbide 2 Knives/Package



These genuine Tersa R2000 micrograin solid carbide replacement knives are most durable and recommended for laminated wood, hardwood like hickory and abrasive material.

Tool No. Length Price

1961050	50mm	\$70.58
1961060	60mm	\$82.09
1961070	70mm	\$93.35
1961080	80mm	\$104.52
1961085	85mm	\$110.15
1961090	90mm	\$115.78
1961100	100mm	\$128.15
1961110	110mm	\$139.29
1961115	115mm	\$144.15
1961120	120mm	\$150.37
1961125	125mm	\$156.52
1961130	130mm	\$161.45
1961140	140mm	\$172.58
1961150	150mm	\$183.63
1961155	155mm	\$189.78
1961160	160mm	\$194.74
1961170	170mm	\$207.08
1961180	180mm	\$218.18
1961185	185mm	\$223.08
1961190	190mm	\$229.23
1961200	200mm	\$240.34
1961210	210mm	\$251.45
1961220	220mm	\$262.49
1961230	230mm	\$274.77
1961240	240mm	\$285.94
1961250	250mm	\$297.05
1961260	260mm	\$308.09
1961265	265mm	\$314.25
1961270	270mm	\$319.23
1961280	280mm	\$330.31
1961290	290mm	\$341.38
1961300	300mm	\$353.69
1961305	305mm	\$359.88
1961310	310mm	\$364.80
1961315	315mm	\$369.72
1961320	320mm	\$375.91
1961330	330mm	\$387.02
1961340	340mm	\$398.09
1961350	350mm	\$409.14
1961360	360mm	\$421.54
1961370	370mm	\$432.58
1961380	380mm	\$443.69
1961390	390mm	\$454.77
1961400	400mm	\$465.88
1961410	410mm	\$476.95

1961420	420mm	\$489.32
1961430	430mm	\$500.37
1961440	440mm	\$511.45
1961450	450mm	\$522.58
1961460	460mm	\$533.66
1961470	470mm	\$544.77
1961480	480mm	\$557.05
1961490	490mm	\$568.18
1961500	500mm	\$579.26
1961510	510mm	\$590.34
1961520	520mm	\$601.42
1961530	530mm	\$612.55
1961540	540mm	\$623.66
1961550	550mm	\$635.97
1961560	560mm	\$647.02
1961570	570mm	\$658.15
1961580	580mm	\$669.26
1961590	590mm	\$680.28
1961600	600mm	\$691.42
1961610	610mm	\$703.72
1961620	620mm	\$714.86
1961625	625mm	\$719.75
1961630	630mm	\$725.88
1961640	640mm	\$725.88

MAGNATE™ 20639 Lycoming Street #B-6, Walnut, CA 91789 USA

F-6



email : info@magnate.net Online Shop : www.magnate.net
(TEL) 800-827-2316, 909-468-5747 (FAX) 909-468-5745

**Rosette Cutter, Carbide Tipped
2-Flute, Woodworking**

This rosette cutter is designed for use only with a variable speed drill press or lathe under 1,000 rpm; In general, at slow controlled feed speed with 300-500 rpm.

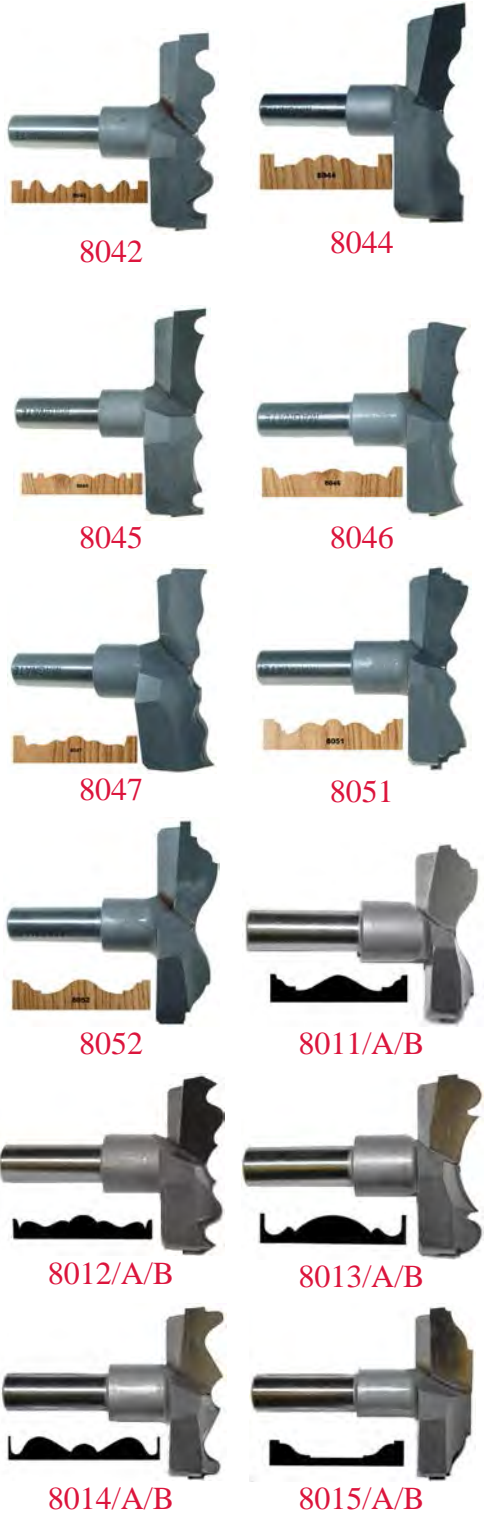

Tool No.	Cutting Dia.	Shank Dia.	Cutting Height	Shank Length	Price
8042	2-3/4"	1/2"	3/4"	1-1/2"	\$58.85
8044	3-1/8"	1/2"	3/4"	1-1/2"	\$64.81
8045	3-1/8"	1/2"	3/4"	1-1/2"	\$64.83
8046	2-3/4"	1/2"	3/4"	1-1/2"	\$47.25
8047	2-3/4"	1/2"	3/4"	1-1/2"	\$54.80
8051	2-5/8"	1/2"	3/4"	1-1/2"	\$50.40
8052	2-1/2"	1/2"	3/4"	1-1/2"	\$53.38
8011	2-1/8"	1/2"	3/4"	1-1/2"	\$52.67
8011A	2-5/8"	1/2"	3/4"	1-1/2"	\$58.99
8011B	3-5/16"	1/2"	3/4"	1-1/2"	\$71.28
8012	2-1/8"	1/2"	3/4"	1-1/2"	\$53.38
8012A	2-5/8"	1/2"	3/4"	1-1/2"	\$59.09
8012B	3-5/16"	1/2"	3/4"	1-1/2"	\$71.80
8013	2-1/8"	1/2"	3/4"	1-1/2"	\$52.71
8013A	2-5/8"	1/2"	3/4"	1-1/2"	\$58.91
8013B	3-5/16"	1/2"	3/4"	1-1/2"	\$71.34
8014	2-1/8"	1/2"	3/4"	1-1/2"	\$52.92
8014A	2-5/8"	1/2"	3/4"	1-1/2"	\$59.12
8014B	3-5/16"	1/2"	3/4"	1-1/2"	\$71.42
8015	2-1/8"	1/2"	3/4"	1-1/2"	\$52.52
8015A	2-5/8"	1/2"	3/4"	1-1/2"	\$58.84
8015B	3-5/16"	1/2"	3/4"	1-1/2"	\$71.06
8016	2-1/8"	1/2"	3/4"	1-1/2"	\$53.61
8016A	2-5/8"	1/2"	3/4"	1-1/2"	\$59.41
8016B	3-5/16"	1/2"	3/4"	1-1/2"	\$72.29
8017	2-1/8"	1/2"	3/4"	1-1/2"	\$53.63
8017A	2-5/8"	1/2"	3/4"	1-1/2"	\$59.46
8017B	3-5/16"	1/2"	3/4"	1-1/2"	\$72.33
8018	2-1/8"	1/2"	3/4"	1-1/2"	\$53.95
8018A	2-5/8"	1/2"	3/4"	1-1/2"	\$59.78
8018B	3-5/16"	1/2"	3/4"	1-1/2"	\$72.57
8019	2-1/8"	1/2"	3/4"	1-1/2"	\$53.70
8019A	2-5/8"	1/2"	3/4"	1-1/2"	\$59.47
8019B	3-5/16"	1/2"	3/4"	1-1/2"	\$72.41
8020	2-1/8"	1/2"	3/4"	1-1/2"	\$53.76
8020A	2-5/8"	1/2"	3/4"	1-1/2"	\$59.71
8020B	3-5/16"	1/2"	3/4"	1-1/2"	\$72.43

**Yo-Yo Rosette Cutter
2-Flute Carbide Tipped**



Use Magnate 1638 metric brad point boring bit (10mm x 10mm x 57mm) , to make 2-1/4" x 5/8" yo-yo halves with a 10mm hole.

This cutter is designed for use only with a variable speed drill press or lathe under 1,000 rpm; In general, at slow controlled feed speed with 300-500 rpm.

Tool No.	Profile Dia.	Profile Height	Profile	Overall Length	Price
8096	2-1/4"	5/8"	Round	4-1/2"	\$58.62
8097	2-1/4"	5/8"	Ogee	4-1/2"	\$59.73

**Door Drill Bit, 3-Wing Carbide Tipped
1/2" Shank Diameter x 6" OAL**



It comes with a tool steel 1/8" cutting diameter x 2" long center drill bit. Designed to be used with a drill press, milling machine or boring machine only.

Tool No.	Cutting Dia.	Price
DR3012	1/2"	\$108.17
DR30916	9/16"	\$108.17
DR3058	5/8"	\$104.83
DR301116	11/16"	\$104.83
DR3034	3/4"	\$108.17
DR301316	13/16"	\$112.70
DR3078	7/8"	\$104.83
DR301516	15/16"	\$117.93
DR3100	1"	\$104.83
DR31116	1-1/16"	\$117.93
DR3118	1-1/8"	\$117.93
DR3114	1-1/4"	\$131.05
DR3138	1-3/8"	\$136.28
DR3112	1-1/2"	\$149.38
DR3158	1-5/8"	\$152.02
DR3134	1-3/4"	\$157.25
DR3178	1-7/8"	\$170.35
DR3200	2"	\$170.35
DR3218	2-1/8"	\$172.97
DR3214	2-1/4"	\$209.67
DR3238	2-3/8"	\$209.67
DR3212	2-1/2"	\$209.67
DR321516	2-15/16"	\$406.23
DR3300	3"	\$458.65
DR3314	3-1/4"	\$511.07
DR3334	3-3/4"	\$537.27



Brad Point Boring Bit 10mm Shank 57mm OAL 27mm Cutting Length Right Rotation Dowel Carbide Tipped			Brad Point Boring Bit 10mm Shank 57mm OAL 27mm Cutting Length Left Rotation Dowel Carbide Tipped			Brad Point Boring Bit 10mm Shank 57mm OAL Right Rotation Dowel 27mm Cutting Length Solid Carbide			Brad Point Boring Bit 10mm Shank 70mm OAL Right Rotation Dowel 35mm Cutting Length Carbide Tipped			Brad Point Boring Bit 10mm Shank 70mm OAL Left Rotation Dowel 35mm Cutting Length Carbide Tipped			Brad Point Boring Bit 10mm Shank 70mm OAL Right Rotation Dowel 40mm Cutting Length Solid Carbide		
Tool No.	Cutting Dia.	Price	Tool No.	Cutting Dia.	Price	Tool No.	Cutting Dia.	Price	Tool No.	Cutting Dia.	Price	Tool No.	Cutting Dia.	Price	Tool No.	Cutting Dia.	Price
1330	3.0mm	\$9.59	1390	3.0mm	\$9.59	2461	3.0mm	\$17.96	1430	3.0mm	\$10.77	1460	3.0mm	\$10.77	4861	3.0mm	\$19.36
1630	4.0mm	\$9.59	1650	4.0mm	\$9.59	2460	3.2mm	\$20.82	1671	4.0mm	\$10.59	1691	4.0mm	\$10.59	4860	3.2mm	\$21.34
1631	4.5mm	\$9.92	1651	4.5mm	\$9.92	2462	4.0mm	\$20.09	1670	4.5mm	\$10.92	1690	4.5mm	\$10.92	4866	3.5mm	\$21.34
1660	3/16"	\$9.92	1665	3/16"	\$9.92	2463	5.0mm	\$18.76	1680	3/16"	\$10.76	1685	3/16"	\$10.76	4862	4.0mm	\$21.62
1632	5.0mm	\$8.26	1652	5.0mm	\$8.26	2464	6.0mm	\$21.86	1672	5.0mm	\$9.26	1692	5.0mm	\$9.26	4863	5.0mm	\$23.39
1635	5.1mm	\$9.92	1655	5.1mm	\$9.92	2466	1/4"	\$23.17	1679	5.1mm	\$11.09	1699	5.1mm	\$11.09	4864	6.0mm	\$24.61
1661	5.2mm	\$9.92	1666	5.2mm	\$9.92	2467	7mm	\$26.79	1626	5.2mm	\$11.09	1628	5.2mm	\$11.09	4868	1/4"	\$35.14
1633	5.5mm	\$9.92	1653	5.5mm	\$9.92	2465	8mm	\$25.01	1673	5.5mm	\$11.09	1693	5.5mm	\$11.09	4869	6.5mm	\$35.14
1634	6.0mm	\$9.92	1654	6.0mm	\$9.92	2469	8.2mm	\$36.36	1674	6.0mm	\$10.26	1694	6.0mm	\$10.26	4865	8mm	\$32.49
1662	1/4"	\$11.42	1667	1/4"	\$11.42	2468	10mm	\$36.36	1682	1/4"	\$12.26	1687	1/4"	\$12.26	4880	8.2mm	\$36.42
1331	6.5mm	\$12.42	1391	6.5mm	\$12.42				1677	6.5mm	\$13.09	1697	6.5mm	\$13.09	4867	10mm	\$50.86
1332	6.7mm	\$12.61	1392	6.7mm	\$12.61	Brad Point Boring Bit 10mm Shank 57mm OAL Left Rotation Dowel 27mm Cutting Length Solid Carbide			1431	6.7mm	\$13.09	1461	6.7mm	\$13.09	Brad Point Boring Bit 10mm Shank 70mm OAL Left Rotation Dowel 40mm Cutting Length Solid Carbide		
1334	7mm	\$11.42	1394	7mm	\$11.42				1432	7.1mm	\$14.94	1462	7.1mm	\$14.94			
1333	7.5mm	\$15.86	1393	7.5mm	\$15.86				1433	7.5mm	\$15.42	1463	7.5mm	\$15.42			
1636	8mm	\$10.92	1656	8mm	\$10.92				1444	7.75mm	\$15.42	1474	7.75mm	\$15.42			
1337	8.2mm	\$12.42	1397	8.2mm	\$12.42				1676	8mm	\$11.26	1696	8mm	\$11.26			
1338	8.5mm	\$13.01	1398	8.5mm	\$13.01				1437	8.2mm	\$13.26	1467	8.2mm	\$13.26			
1339	9.0mm	\$13.26	1399	9.0mm	\$13.26				1438	8.5mm	\$15.42	1468	8.5mm	\$15.42			
1664	3/8"	\$15.42	1669	3/8"	\$15.42				1439	9.0mm	\$14.09	1469	9.0mm	\$14.09			
1638	10mm	\$13.09	1658	10mm	\$13.09				1684	3/8"	\$15.09	1689	3/8"	\$15.09			
1641	11mm	\$18.59	1371	11mm	\$18.59				1678	10mm	\$13.92	1698	10mm	\$13.92			
1335	7/16"	\$18.59	1395	7/16"	\$18.59	1434	10.4mm	\$22.19	1464	10.4mm	\$22.19	4871	3.0mm	\$19.36			
1643	12mm	\$15.92	1373	12mm	\$15.92	2471	3.0mm	\$17.96	1441	11mm	\$19.59	1471	11mm	\$19.59	4870	3.2mm	\$21.34
1663	1/2"	\$23.76	1668	1/2"	\$23.76	2470	3.2mm	\$20.82	1435	7/16"	\$20.92	1465	7/16"	\$20.92	4876	3.5mm	\$21.34
1645	13mm	\$21.92	1375	13mm	\$21.92	2472	4.0mm	\$20.09	1443	12mm	\$17.09	1473	12mm	\$17.09	4872	4.0mm	\$21.62
1647	14mm	\$24.92	1377	14mm	\$24.92	2473	5.0mm	\$18.76	1683	1/2"	\$24.92	1688	1/2"	\$24.92	4873	5.0mm	\$23.39
1649	15mm	\$28.26	1379	15mm	\$28.26	2474	6.0mm	\$21.86	1445	13mm	\$22.92	1475	13mm	\$22.92	4874	6.0mm	\$24.61
1681	5/8"	\$11.09	1686	5/8"	\$11.09	2476	1/4"	\$23.17	1447	14mm	\$25.59	1477	14mm	\$25.59	4878	1/4"	\$35.14
1351	16mm	\$30.42	1381	16mm	\$30.42	2477	7mm	\$26.79	1436	9/16"	\$25.84	1466	9/16"	\$25.84	4879	6.5mm	\$35.14
1353	17mm	\$38.76	1383	17mm	\$38.76	2475	8mm	\$25.01	1449	15mm	\$28.92	1479	15mm	\$28.92	4875	8mm	\$32.49
1355	18mm	\$38.76	1385	18mm	\$38.76	2479	8.2mm	\$36.36	1448	5/8"	\$31.59	1478	5/8"	\$31.59	4885	8.2mm	\$36.42
1357	19mm	\$44.42	1387	19mm	\$44.42	2478	10mm	\$36.36	1451	16mm	\$31.59	1481	16mm	\$31.59	4877	10mm	\$50.86
1359	20mm	\$44.42	1389	20mm	\$44.42				1440	16.5mm	\$34.02	1470	16.5mm	\$34.02			
									1453	17mm	\$39.26	1483	17mm	\$39.26			
									1455	18mm	\$39.26	1485	18mm	\$39.26			
									1457	19mm	\$44.92	1487	19mm	\$44.92			
									1459	20mm	\$44.92	1489	20mm	\$44.92			
									1442	25mm	\$63.99	1472	25mm	\$63.99			



Brad Point Boring Bit 10mm Shank 77mm OAL 45mm Cutting Length Right Rotation Dowel Carbide Tipped			Brad Point Boring Bit 10mm Shank 85mm OAL 55mm Cutting Length Right Rotation Dowel Carbide Tipped			Brad Point Boring Bit Carbide Tipped M8x1.25 Thread Shank 100mm OAL Right Rotation Dowel			Brad Point Boring Bit M10x1.25 Thread Shank 100mm OAL Left Rotation Dowel Carbide Tipped			Thru-Bore Boring Bit 10mm Shank 58mm OAL 60 Degree V-point 35mm Cutting Length Left Rotation Carbide Tipped			Thru-Bore Boring Bit 10mm Shank 58mm OAL Left Rotation 60 Degree V-point 28mm Cutting Length Solid Carbide					
Tool No.	Cutting Dia.	Price	Tool No.	Cutting Dia.	Price	Tool No.	Cutting Dia.	Price	Tool No.	Cutting Dia.	Price	Tool No.	Cutting Dia.	Price	Tool No.	Cutting Dia.	Price			
1029	4.0mm	\$11.52	2435	5.0mm	\$19.92	4881	5.0mm	\$18.72	2791	5.0mm	\$17.69	1160	3.0mm	\$16.26	2765	3.0mm	\$18.69			
1025	5.0mm	\$10.76	2438	8mm	\$23.26	4882	6.0mm	\$19.39	2792	6.0mm	\$18.37	1750	4.0mm	\$14.81	2766	3.2mm	\$20.82			
1026	6.0mm	\$11.31	2439	3/8"	\$27.09	4883	8mm	\$21.43	2793	8mm	\$20.41	1765	3/16"	\$14.99	2767	5.0mm	\$19.66			
1031	1/4"	\$13.25	2430	1/2"	\$34.17	4884	10mm	\$23.13	2794	10mm	\$22.10	1752	5.0mm	\$12.32	2768	8mm	\$26.72			
1027	7mm	\$13.42	Brad Point Boring Bit 10mm Shank 85mm OAL 55mm Cutting Length Left Rotation Dowel Carbide Tipped			4885	12mm	\$25.17	2795	12mm	\$24.15	1167	5.05mm	\$15.92	Thru-Bore Boring Bit 10mm Shank 70mm OAL Right Rotation 60 Degree V-point 47mm Cutting Length Carbide Tipped					
1035	7.5mm	\$13.07				4886	15mm	\$36.08	2796	15mm	\$35.05	1757	5.2mm	\$15.92						
1028	8mm	\$12.61				Brad Point Boring Bit M8x1.25 Thread Shank 100mm OAL Left Rotation Dowel Carbide Tipped			Thru-Bore Boring Bit 10mm Shank 58mm OAL 60 Degree V-point 35mm Cutting Length Right Rotation Carbide Tipped			1753	5.5mm	\$15.70						
1036	9.0mm	\$16.23										4891	5.0mm	\$18.72				1130	3.0mm	\$16.26
1033	3/8"	\$16.25										4892	6.0mm	\$19.39				1730	4.0mm	\$14.81
1030	10mm	\$15.09	4893	8mm	\$21.43							1760	3/16"	\$14.99						
1034	7/16"	\$22.46	4894	10mm	\$23.13							1732	5.0mm	\$12.32						
1032	12mm	\$17.34	Brad Point Boring Bit 1/4" Shank Diameter 63.5mm OAL Right Rotation Dowel Carbide Tipped			4895	12mm	\$25.17	1137	5.05mm	\$15.92	1754	6.0mm	\$14.31						
1037	1/2"	\$24.47				4896	15mm	\$36.08	1737	5.2mm	\$15.92	1767	1/4"	\$15.70						
1038	15mm	\$33.26				Brad Point Boring Bit Carbide Tipped M10x1.25 Thread Shank 100mm OAL Right Rotation Dowel			1733	5.5mm	\$15.70	1161	6.5mm	\$17.24						
Brad Point Boring Bit 10mm Shank 77mm OAL 45mm Cutting Length Left Rotation Dowel Carbide Tipped									1738	7/32"	\$15.92	1162	7.9mm	\$16.81	1756	8mm	\$16.84			
									1069	4.0mm	\$11.52	1734	6.0mm	\$14.31	1164	7mm	\$15.40	1757	9.0mm	\$21.37
			1065	5.0mm	\$10.76				1762	1/4"	\$15.70	1166	7.9mm	\$16.81	1758	10mm	\$22.87			
			1066	6.0mm	\$11.31				1131	6.5mm	\$17.24	1169	9.0mm	\$25.02	1191	11mm	\$28.14			
			1071	1/4"	\$13.25	1134	7mm	\$15.40	1758	10mm	\$22.87	1193	12mm	\$27.16						
1067	7mm	\$13.42	Brad Point Boring Bit 1/4" Shank Diameter 63.5mm OAL Left Rotation Dowel Carbide Tipped			1132	7.9mm	\$16.81	1768	1/2"	\$33.48	1163	7/16"	\$29.09						
1075	7.5mm	\$13.07				1139	9.0mm	\$21.37	1175	13mm	\$33.48	1769	3/8"	\$25.02						
1068	8mm	\$12.61				1764	3/8"	\$25.02	1177	14mm	\$34.44	1778	10mm	\$24.92						
1076	9.0mm	\$16.23				1738	10mm	\$22.87	1179	15mm	\$39.41	1772	5.0mm	\$13.95						
1073	3/8"	\$16.25				2481	11mm	\$28.14	1181	16mm	\$42.15	1557	5.05mm	\$16.42						
1070	10mm	\$15.09	Brad Point Boring Bit 1/4" Shank Diameter 63.5mm OAL Right Rotation Dowel Carbide Tipped			1133	7/16"	\$29.09	1165	18mm	\$47.39	1558	5.2mm	\$16.42						
1074	7/16"	\$22.46				2483	12mm	\$27.16	Thru-Bore Boring Bit 10mm Shank 58mm OAL 60 Degree V-point 28mm Cutting Length Right Rotation Solid Carbide			1773	5.5mm	\$17.94						
1072	12mm	\$17.34				2484	1/2"	\$33.48				1559	7/32"	\$16.92						
1077	1/2"	\$24.47				2485	13mm	\$33.48				1774	6.0mm	\$15.26						
1078	15mm	\$33.26				2487	14mm	\$34.44				1777	6.5mm	\$19.61						
Brad Point Boring Bit 10mm Shank 85mm OAL 55mm Cutting Length Left Rotation Dowel Carbide Tipped			2488	15mm	\$39.41	2760	3.0mm	\$18.69				1775	7mm	\$16.92						
			1746	5.0mm	\$16.68	2489	15mm	\$39.41	2761	3.2mm	\$20.82	1542	7.1mm	\$21.82						
			1747	1/4"	\$17.73	2486	16mm	\$42.15	2762	5.0mm	\$19.66	1776	8mm	\$18.26						
			Brad Point Boring Bit 10mm Shank 85mm OAL 55mm Cutting Length Left Rotation Dowel Carbide Tipped			1135	18mm	\$47.39	2763	8mm	\$26.72	1544	8.2mm	\$21.07						
						1548	10.4mm	\$27.89	Thru-Bore Boring Bit 10mm Shank 58mm OAL 60 Degree V-point 28mm Cutting Length Right Rotation Solid Carbide			1778	10mm	\$24.92						
1541	11mm	\$30.26				1546	10.2mm	\$29.44												
1550	7/16"	\$30.26				1548	10.4mm	\$27.89												
1543	12mm	\$29.92				1541	11mm	\$30.26												
1783	1/2"	\$34.42	1550	7/16"	\$30.26															
1545	13mm	\$34.56	1543	12mm	\$29.92	1547	14mm	\$36.67												
1547	14mm	\$36.67	1783	1/2"	\$34.42	1552	9/16"	\$36.64												
1552	9/16"	\$36.64	1545	13mm	\$34.56	1549	15mm	\$40.59												
1549	15mm	\$40.59	1547	14mm	\$36.67	1551	16mm	\$50.31												
1551	16mm	\$50.31	1552	9/16"	\$36.64	1538	16.5mm	\$58.26												
1538	16.5mm	\$58.26	1549	15mm	\$40.59	1553	17mm	\$56.71												
1553	17mm	\$56.71	1551	16mm	\$50.31	1554	18mm	\$61.07												
1554	18mm	\$61.07	1538	16.5mm	\$58.26	1555	19mm	\$66.89												
1555	19mm	\$66.89	1553	17mm	\$56.71															



MAGNATE™ Rosette Cutters, Forstner, Boring, Drill bits and Counterbores, Countersinks

<p>Brad Point Drill Bit 7/16"-14 Threaded Shank 3" Cutting Length 4-1/2" OAL Right Rotation Carbide Tipped</p> <p>Recommended for use in any wood product containing glue, or long production runs in hardwood. Performs well in many plastics, as well as in several composite materials, including fiberglass.</p> <table border="1" style="width: 100%; border-collapse: collapse;"> <thead> <tr> <th>Tool No.</th> <th>Cutting Dia.</th> <th>Price</th> </tr> </thead> <tbody> <tr><td>C316</td><td>3/16"</td><td>\$62.47</td></tr> <tr><td>C62103</td><td>1/4"</td><td>\$78.68</td></tr> <tr><td>C1764</td><td>17/64"</td><td>\$96.17</td></tr> <tr><td>C62104</td><td>5/16"</td><td>\$78.68</td></tr> <tr><td>C62105</td><td>3/8"</td><td>\$82.17</td></tr> <tr><td>C62106</td><td>25/64"</td><td>\$83.92</td></tr> <tr><td>C62107</td><td>7/16"</td><td>\$85.67</td></tr> <tr><td>C62108</td><td>1/2"</td><td>\$85.67</td></tr> <tr><td>C58RH</td><td>5/8"</td><td>\$115.38</td></tr> <tr><td>C34RH</td><td>3/4"</td><td>\$116.87</td></tr> <tr><td>C875RH</td><td>7/8"</td><td>\$120.63</td></tr> <tr><td>C1516X</td><td>15/16"</td><td>\$120.63</td></tr> </tbody> </table>	Tool No.	Cutting Dia.	Price	C316	3/16"	\$62.47	C62103	1/4"	\$78.68	C1764	17/64"	\$96.17	C62104	5/16"	\$78.68	C62105	3/8"	\$82.17	C62106	25/64"	\$83.92	C62107	7/16"	\$85.67	C62108	1/2"	\$85.67	C58RH	5/8"	\$115.38	C34RH	3/4"	\$116.87	C875RH	7/8"	\$120.63	C1516X	15/16"	\$120.63	<p>Brad Point Drill Bit 7/16"-14 Threaded Shank 4-1/2" Cutting Length 6" OAL Right Rotation Carbide Tipped</p> <p>Recommended for use in any wood product containing glue, or long production runs in hardwood. Performs well in many plastics, as well as in several composite materials, including fiberglass.</p> <table border="1" style="width: 100%; border-collapse: collapse;"> <thead> <tr> <th>Tool No.</th> <th>Cutting Dia.</th> <th>Price</th> </tr> </thead> <tbody> <tr><td>C1516E</td><td>15/16"</td><td>\$124.13</td></tr> <tr><td>C62119E</td><td>1"</td><td>\$120.01</td></tr> </tbody> </table>	Tool No.	Cutting Dia.	Price	C1516E	15/16"	\$124.13	C62119E	1"	\$120.01	<p>Brad Point Drill Bit 55mm OAL Right Rotation Solid Carbide Dowel</p> <table border="1" style="width: 100%; border-collapse: collapse;"> <thead> <tr> <th>Tool No.</th> <th>Cutting Dia.</th> <th>Price</th> </tr> </thead> <tbody> <tr><td>C020DSR</td><td>2.0mm</td><td>\$11.26</td></tr> <tr><td>C024DSR</td><td>2.4mm</td><td>\$12.09</td></tr> <tr><td>C025DSR</td><td>2.5mm</td><td>\$12.11</td></tr> <tr><td>C028DSR</td><td>2.8mm</td><td>\$12.14</td></tr> <tr><td>C030DSR</td><td>3.0mm</td><td>\$12.92</td></tr> <tr><td>C032DSR</td><td>3.2mm</td><td>\$12.94</td></tr> <tr><td>C035DSR</td><td>3.5mm</td><td>\$14.42</td></tr> <tr><td>C040DSR</td><td>4.0mm</td><td>\$14.92</td></tr> <tr><td>C050DSR</td><td>5.0mm</td><td>\$19.59</td></tr> <tr><td>C060DSR</td><td>6.0mm</td><td>\$24.17</td></tr> </tbody> </table>	Tool No.	Cutting Dia.	Price	C020DSR	2.0mm	\$11.26	C024DSR	2.4mm	\$12.09	C025DSR	2.5mm	\$12.11	C028DSR	2.8mm	\$12.14	C030DSR	3.0mm	\$12.92	C032DSR	3.2mm	\$12.94	C035DSR	3.5mm	\$14.42	C040DSR	4.0mm	\$14.92	C050DSR	5.0mm	\$19.59	C060DSR	6.0mm	\$24.17	<p>Brad Point Center Drill Bit Straight Shank 2-1/4" Cutting Length 6" OAL Left Rotation HSS Dowel</p> <table border="1" style="width: 100%; border-collapse: collapse;"> <thead> <tr> <th>Tool No.</th> <th>Cutting Dia.</th> <th>Price</th> </tr> </thead> <tbody> <tr><td>H62394</td><td>3/16"</td><td>\$15.83</td></tr> <tr><td>H62395</td><td>7/32"</td><td>\$15.83</td></tr> <tr><td>H62396</td><td>1/4"</td><td>\$24.17</td></tr> <tr><td>H62393LH</td><td>3/8"</td><td>\$36.58</td></tr> </tbody> </table>	Tool No.	Cutting Dia.	Price	H62394	3/16"	\$15.83	H62395	7/32"	\$15.83	H62396	1/4"	\$24.17	H62393LH	3/8"	\$36.58	<p>V-Point Center Drill Straight Shank 2-1/4" Cutting Length 6" OAL Right Rotation HSS</p> <table border="1" style="width: 100%; border-collapse: collapse;"> <thead> <tr> <th>Tool No.</th> <th>Cutting Dia.</th> <th>Price</th> </tr> </thead> <tbody> <tr><td>H62426</td><td>3/32"</td><td>\$16.58</td></tr> <tr><td>H62427</td><td>1/8"</td><td>\$11.58</td></tr> <tr><td>H62428</td><td>5/32"</td><td>\$18.25</td></tr> <tr><td>H62429</td><td>11/64"</td><td>\$18.75</td></tr> <tr><td>H62430</td><td>3/16"</td><td>\$11.58</td></tr> <tr><td>H62431</td><td>7/32"</td><td>\$13.25</td></tr> <tr><td>H62432</td><td>1/4"</td><td>\$13.25</td></tr> <tr><td>H62433</td><td>9/32"</td><td>\$24.17</td></tr> <tr><td>H62434</td><td>5/16"</td><td>\$27.75</td></tr> <tr><td>H62416</td><td>11/32"</td><td>\$28.75</td></tr> <tr><td>H62435</td><td>3/8"</td><td>\$32.92</td></tr> </tbody> </table>	Tool No.	Cutting Dia.	Price	H62426	3/32"	\$16.58	H62427	1/8"	\$11.58	H62428	5/32"	\$18.25	H62429	11/64"	\$18.75	H62430	3/16"	\$11.58	H62431	7/32"	\$13.25	H62432	1/4"	\$13.25	H62433	9/32"	\$24.17	H62434	5/16"	\$27.75	H62416	11/32"	\$28.75	H62435	3/8"	\$32.92	<p>Brad Point Drill Bit For Spur Machine 1/2" x 2" Shank 3" Cutting Length 5" OAL Right Rotation Carbide Tipped</p> <table border="1" style="width: 100%; border-collapse: collapse;"> <thead> <tr> <th>Tool No.</th> <th>Cutting Dia.</th> <th>Price</th> </tr> </thead> <tbody> <tr><td>C62189</td><td>1/4"</td><td>\$75.01</td></tr> <tr><td>C62190</td><td>5/16"</td><td>\$75.01</td></tr> <tr><td>C62191</td><td>3/8"</td><td>\$78.34</td></tr> <tr><td>C62192</td><td>7/16"</td><td>\$80.01</td></tr> <tr><td>C62193</td><td>1/2"</td><td>\$81.67</td></tr> <tr><td>C62194</td><td>5/8"</td><td>\$98.34</td></tr> <tr><td>C62195</td><td>3/4"</td><td>\$115.01</td></tr> </tbody> </table>	Tool No.	Cutting Dia.	Price	C62189	1/4"	\$75.01	C62190	5/16"	\$75.01	C62191	3/8"	\$78.34	C62192	7/16"	\$80.01	C62193	1/2"	\$81.67	C62194	5/8"	\$98.34	C62195	3/4"	\$115.01																																																																		
Tool No.	Cutting Dia.	Price																																																																																																																																																																																																																																	
C316	3/16"	\$62.47																																																																																																																																																																																																																																	
C62103	1/4"	\$78.68																																																																																																																																																																																																																																	
C1764	17/64"	\$96.17																																																																																																																																																																																																																																	
C62104	5/16"	\$78.68																																																																																																																																																																																																																																	
C62105	3/8"	\$82.17																																																																																																																																																																																																																																	
C62106	25/64"	\$83.92																																																																																																																																																																																																																																	
C62107	7/16"	\$85.67																																																																																																																																																																																																																																	
C62108	1/2"	\$85.67																																																																																																																																																																																																																																	
C58RH	5/8"	\$115.38																																																																																																																																																																																																																																	
C34RH	3/4"	\$116.87																																																																																																																																																																																																																																	
C875RH	7/8"	\$120.63																																																																																																																																																																																																																																	
C1516X	15/16"	\$120.63																																																																																																																																																																																																																																	
Tool No.	Cutting Dia.	Price																																																																																																																																																																																																																																	
C1516E	15/16"	\$124.13																																																																																																																																																																																																																																	
C62119E	1"	\$120.01																																																																																																																																																																																																																																	
Tool No.	Cutting Dia.	Price																																																																																																																																																																																																																																	
C020DSR	2.0mm	\$11.26																																																																																																																																																																																																																																	
C024DSR	2.4mm	\$12.09																																																																																																																																																																																																																																	
C025DSR	2.5mm	\$12.11																																																																																																																																																																																																																																	
C028DSR	2.8mm	\$12.14																																																																																																																																																																																																																																	
C030DSR	3.0mm	\$12.92																																																																																																																																																																																																																																	
C032DSR	3.2mm	\$12.94																																																																																																																																																																																																																																	
C035DSR	3.5mm	\$14.42																																																																																																																																																																																																																																	
C040DSR	4.0mm	\$14.92																																																																																																																																																																																																																																	
C050DSR	5.0mm	\$19.59																																																																																																																																																																																																																																	
C060DSR	6.0mm	\$24.17																																																																																																																																																																																																																																	
Tool No.	Cutting Dia.	Price																																																																																																																																																																																																																																	
H62394	3/16"	\$15.83																																																																																																																																																																																																																																	
H62395	7/32"	\$15.83																																																																																																																																																																																																																																	
H62396	1/4"	\$24.17																																																																																																																																																																																																																																	
H62393LH	3/8"	\$36.58																																																																																																																																																																																																																																	
Tool No.	Cutting Dia.	Price																																																																																																																																																																																																																																	
H62426	3/32"	\$16.58																																																																																																																																																																																																																																	
H62427	1/8"	\$11.58																																																																																																																																																																																																																																	
H62428	5/32"	\$18.25																																																																																																																																																																																																																																	
H62429	11/64"	\$18.75																																																																																																																																																																																																																																	
H62430	3/16"	\$11.58																																																																																																																																																																																																																																	
H62431	7/32"	\$13.25																																																																																																																																																																																																																																	
H62432	1/4"	\$13.25																																																																																																																																																																																																																																	
H62433	9/32"	\$24.17																																																																																																																																																																																																																																	
H62434	5/16"	\$27.75																																																																																																																																																																																																																																	
H62416	11/32"	\$28.75																																																																																																																																																																																																																																	
H62435	3/8"	\$32.92																																																																																																																																																																																																																																	
Tool No.	Cutting Dia.	Price																																																																																																																																																																																																																																	
C62189	1/4"	\$75.01																																																																																																																																																																																																																																	
C62190	5/16"	\$75.01																																																																																																																																																																																																																																	
C62191	3/8"	\$78.34																																																																																																																																																																																																																																	
C62192	7/16"	\$80.01																																																																																																																																																																																																																																	
C62193	1/2"	\$81.67																																																																																																																																																																																																																																	
C62194	5/8"	\$98.34																																																																																																																																																																																																																																	
C62195	3/4"	\$115.01																																																																																																																																																																																																																																	
<p>Brad Point Drill Bit 7/16"-14 Threaded Shank 3" Cutting Length 4-1/2" Overall Length Left Rotation Carbide Tipped</p> <p>Recommended for use in any wood product containing glue, or long production runs in hardwood. Performs well in many plastics, as well as in several composite materials, including fiberglass.</p> <table border="1" style="width: 100%; border-collapse: collapse;"> <thead> <tr> <th>Tool No.</th> <th>Cutting Dia.</th> <th>Price</th> </tr> </thead> <tbody> <tr><td>H316</td><td>3/16"</td><td>\$33.25</td></tr> <tr><td>H62095</td><td>3/8"</td><td>\$33.54</td></tr> <tr><td>H62096</td><td>7/16"</td><td>\$33.87</td></tr> <tr><td>H1732</td><td>17/32"</td><td>\$35.84</td></tr> <tr><td>H2132</td><td>21/32"</td><td>\$43.34</td></tr> </tbody> </table>	Tool No.	Cutting Dia.	Price	H316	3/16"	\$33.25	H62095	3/8"	\$33.54	H62096	7/16"	\$33.87	H1732	17/32"	\$35.84	H2132	21/32"	\$43.34	<p>V-Point Drill Bit 7/16"-14 Threaded Shank 3" Cutting Length 4-1/2" OAL Left Rotation HSS</p> <table border="1" style="width: 100%; border-collapse: collapse;"> <thead> <tr> <th>Tool No.</th> <th>Cutting Dia.</th> <th>Price</th> </tr> </thead> <tbody> <tr><td>H316LH</td><td>3/16"</td><td>\$33.25</td></tr> <tr><td>H62097</td><td>3/8"</td><td>\$33.54</td></tr> </tbody> </table>	Tool No.	Cutting Dia.	Price	H316LH	3/16"	\$33.25	H62097	3/8"	\$33.54	<p>Brad Point Drill Bit 55mm OAL Left Rotation Solid Carbide Dowel</p> <table border="1" style="width: 100%; border-collapse: collapse;"> <thead> <tr> <th>Tool No.</th> <th>Cutting Dia.</th> <th>Price</th> </tr> </thead> <tbody> <tr><td>C020DSL</td><td>2.0mm</td><td>\$11.26</td></tr> <tr><td>C024DSL</td><td>2.4mm</td><td>\$12.09</td></tr> <tr><td>C025DSL</td><td>2.5mm</td><td>\$12.11</td></tr> <tr><td>C028DSL</td><td>2.8mm</td><td>\$12.14</td></tr> <tr><td>C030DSL</td><td>3.0mm</td><td>\$12.92</td></tr> <tr><td>C032DSL</td><td>3.2mm</td><td>\$12.94</td></tr> <tr><td>C035DSL</td><td>3.5mm</td><td>\$14.42</td></tr> <tr><td>C040DSL</td><td>4.0mm</td><td>\$14.92</td></tr> <tr><td>C050DSL</td><td>5.0mm</td><td>\$19.59</td></tr> <tr><td>C060DSL</td><td>6.0mm</td><td>\$24.17</td></tr> </tbody> </table>	Tool No.	Cutting Dia.	Price	C020DSL	2.0mm	\$11.26	C024DSL	2.4mm	\$12.09	C025DSL	2.5mm	\$12.11	C028DSL	2.8mm	\$12.14	C030DSL	3.0mm	\$12.92	C032DSL	3.2mm	\$12.94	C035DSL	3.5mm	\$14.42	C040DSL	4.0mm	\$14.92	C050DSL	5.0mm	\$19.59	C060DSL	6.0mm	\$24.17	<p>Brad Point Center Drill Bit Straight Shank 3-1/2" Cutting Length 8" OAL Right Rotation HSS Dowel</p> <table border="1" style="width: 100%; border-collapse: collapse;"> <thead> <tr> <th>Tool No.</th> <th>Cutting Dia.</th> <th>Price</th> </tr> </thead> <tbody> <tr><td>H62382</td><td>3/16"</td><td>\$13.92</td></tr> <tr><td>H62383</td><td>7/32"</td><td>\$15.83</td></tr> <tr><td>H62384</td><td>1/4"</td><td>\$14.92</td></tr> </tbody> </table>	Tool No.	Cutting Dia.	Price	H62382	3/16"	\$13.92	H62383	7/32"	\$15.83	H62384	1/4"	\$14.92	<p>Brad Point Drill Bit For Spur Machine 1/2" x 2" Shank 4" Cutting Length 6" OAL Right Rotation HSS Dowel</p> <table border="1" style="width: 100%; border-collapse: collapse;"> <thead> <tr> <th>Tool No.</th> <th>Cutting Dia.</th> <th>Price</th> </tr> </thead> <tbody> <tr><td>H62132</td><td>1/8"</td><td>\$33.26</td></tr> <tr><td>H62134</td><td>3/16"</td><td>\$33.26</td></tr> <tr><td>H62135</td><td>7/32"</td><td>\$33.26</td></tr> <tr><td>H62172</td><td>1/4"</td><td>\$34.59</td></tr> <tr><td>H62137</td><td>17/64"</td><td>\$36.12</td></tr> <tr><td>H62173</td><td>9/32"</td><td>\$34.59</td></tr> <tr><td>H62174</td><td>5/16"</td><td>\$34.59</td></tr> <tr><td>H62175</td><td>11/32"</td><td>\$34.59</td></tr> <tr><td>H62176</td><td>3/8"</td><td>\$34.59</td></tr> <tr><td>H62143</td><td>25/64"</td><td>\$50.42</td></tr> <tr><td>H62177</td><td>13/32"</td><td>\$36.09</td></tr> <tr><td>H62178</td><td>7/16"</td><td>\$36.09</td></tr> <tr><td>H62146</td><td>29/64"</td><td>\$37.09</td></tr> <tr><td>H62147</td><td>15/32"</td><td>\$37.09</td></tr> <tr><td>H62179</td><td>1/2"</td><td>\$37.09</td></tr> <tr><td>H3364</td><td>33/64"</td><td>\$50.42</td></tr> <tr><td>H62180</td><td>17/32"</td><td>\$41.26</td></tr> <tr><td>H62181</td><td>9/16"</td><td>\$46.26</td></tr> <tr><td>H62151</td><td>19/32"</td><td>\$50.42</td></tr> <tr><td>H62182</td><td>5/8"</td><td>\$50.42</td></tr> <tr><td>H62153</td><td>21/32"</td><td>\$50.42</td></tr> <tr><td>H62183</td><td>11/16"</td><td>\$54.59</td></tr> <tr><td>H62184</td><td>3/4"</td><td>\$61.26</td></tr> <tr><td>H62185</td><td>13/16"</td><td>\$66.61</td></tr> <tr><td>H62186</td><td>7/8"</td><td>\$75.42</td></tr> <tr><td>H62187</td><td>15/16"</td><td>\$80.42</td></tr> <tr><td>H62188</td><td>1"</td><td>\$88.76</td></tr> <tr><td>H62161</td><td>1-1/16"</td><td>\$108.34</td></tr> </tbody> </table>	Tool No.	Cutting Dia.	Price	H62132	1/8"	\$33.26	H62134	3/16"	\$33.26	H62135	7/32"	\$33.26	H62172	1/4"	\$34.59	H62137	17/64"	\$36.12	H62173	9/32"	\$34.59	H62174	5/16"	\$34.59	H62175	11/32"	\$34.59	H62176	3/8"	\$34.59	H62143	25/64"	\$50.42	H62177	13/32"	\$36.09	H62178	7/16"	\$36.09	H62146	29/64"	\$37.09	H62147	15/32"	\$37.09	H62179	1/2"	\$37.09	H3364	33/64"	\$50.42	H62180	17/32"	\$41.26	H62181	9/16"	\$46.26	H62151	19/32"	\$50.42	H62182	5/8"	\$50.42	H62153	21/32"	\$50.42	H62183	11/16"	\$54.59	H62184	3/4"	\$61.26	H62185	13/16"	\$66.61	H62186	7/8"	\$75.42	H62187	15/16"	\$80.42	H62188	1"	\$88.76	H62161	1-1/16"	\$108.34	<p>Brad Point Drill Bit For Spur Machine 1/2" x 2" Shank 4" Cutting Length 6" OAL Right Rotation Carbide Tipped</p> <table border="1" style="width: 100%; border-collapse: collapse;"> <thead> <tr> <th>Tool No.</th> <th>Cutting Dia.</th> <th>Price</th> </tr> </thead> <tbody> <tr><td>C62196</td><td>1/4"</td><td>\$75.01</td></tr> <tr><td>C62197</td><td>5/16"</td><td>\$75.01</td></tr> <tr><td>C62198</td><td>3/8"</td><td>\$78.34</td></tr> <tr><td>C62199</td><td>7/16"</td><td>\$80.01</td></tr> <tr><td>C62146</td><td>29/64"</td><td>\$81.28</td></tr> <tr><td>C62200</td><td>1/2"</td><td>\$81.67</td></tr> <tr><td>C62201</td><td>5/8"</td><td>\$98.34</td></tr> <tr><td>C62202</td><td>3/4"</td><td>\$115.01</td></tr> <tr><td>C875</td><td>7/8"</td><td>\$115.01</td></tr> <tr><td>C1516</td><td>15/16"</td><td>\$115.01</td></tr> <tr><td>C62188</td><td>1"</td><td>\$120.01</td></tr> </tbody> </table>	Tool No.	Cutting Dia.	Price	C62196	1/4"	\$75.01	C62197	5/16"	\$75.01	C62198	3/8"	\$78.34	C62199	7/16"	\$80.01	C62146	29/64"	\$81.28	C62200	1/2"	\$81.67	C62201	5/8"	\$98.34	C62202	3/4"	\$115.01	C875	7/8"	\$115.01	C1516	15/16"	\$115.01	C62188	1"	\$120.01																											
Tool No.	Cutting Dia.	Price																																																																																																																																																																																																																																	
H316	3/16"	\$33.25																																																																																																																																																																																																																																	
H62095	3/8"	\$33.54																																																																																																																																																																																																																																	
H62096	7/16"	\$33.87																																																																																																																																																																																																																																	
H1732	17/32"	\$35.84																																																																																																																																																																																																																																	
H2132	21/32"	\$43.34																																																																																																																																																																																																																																	
Tool No.	Cutting Dia.	Price																																																																																																																																																																																																																																	
H316LH	3/16"	\$33.25																																																																																																																																																																																																																																	
H62097	3/8"	\$33.54																																																																																																																																																																																																																																	
Tool No.	Cutting Dia.	Price																																																																																																																																																																																																																																	
C020DSL	2.0mm	\$11.26																																																																																																																																																																																																																																	
C024DSL	2.4mm	\$12.09																																																																																																																																																																																																																																	
C025DSL	2.5mm	\$12.11																																																																																																																																																																																																																																	
C028DSL	2.8mm	\$12.14																																																																																																																																																																																																																																	
C030DSL	3.0mm	\$12.92																																																																																																																																																																																																																																	
C032DSL	3.2mm	\$12.94																																																																																																																																																																																																																																	
C035DSL	3.5mm	\$14.42																																																																																																																																																																																																																																	
C040DSL	4.0mm	\$14.92																																																																																																																																																																																																																																	
C050DSL	5.0mm	\$19.59																																																																																																																																																																																																																																	
C060DSL	6.0mm	\$24.17																																																																																																																																																																																																																																	
Tool No.	Cutting Dia.	Price																																																																																																																																																																																																																																	
H62382	3/16"	\$13.92																																																																																																																																																																																																																																	
H62383	7/32"	\$15.83																																																																																																																																																																																																																																	
H62384	1/4"	\$14.92																																																																																																																																																																																																																																	
Tool No.	Cutting Dia.	Price																																																																																																																																																																																																																																	
H62132	1/8"	\$33.26																																																																																																																																																																																																																																	
H62134	3/16"	\$33.26																																																																																																																																																																																																																																	
H62135	7/32"	\$33.26																																																																																																																																																																																																																																	
H62172	1/4"	\$34.59																																																																																																																																																																																																																																	
H62137	17/64"	\$36.12																																																																																																																																																																																																																																	
H62173	9/32"	\$34.59																																																																																																																																																																																																																																	
H62174	5/16"	\$34.59																																																																																																																																																																																																																																	
H62175	11/32"	\$34.59																																																																																																																																																																																																																																	
H62176	3/8"	\$34.59																																																																																																																																																																																																																																	
H62143	25/64"	\$50.42																																																																																																																																																																																																																																	
H62177	13/32"	\$36.09																																																																																																																																																																																																																																	
H62178	7/16"	\$36.09																																																																																																																																																																																																																																	
H62146	29/64"	\$37.09																																																																																																																																																																																																																																	
H62147	15/32"	\$37.09																																																																																																																																																																																																																																	
H62179	1/2"	\$37.09																																																																																																																																																																																																																																	
H3364	33/64"	\$50.42																																																																																																																																																																																																																																	
H62180	17/32"	\$41.26																																																																																																																																																																																																																																	
H62181	9/16"	\$46.26																																																																																																																																																																																																																																	
H62151	19/32"	\$50.42																																																																																																																																																																																																																																	
H62182	5/8"	\$50.42																																																																																																																																																																																																																																	
H62153	21/32"	\$50.42																																																																																																																																																																																																																																	
H62183	11/16"	\$54.59																																																																																																																																																																																																																																	
H62184	3/4"	\$61.26																																																																																																																																																																																																																																	
H62185	13/16"	\$66.61																																																																																																																																																																																																																																	
H62186	7/8"	\$75.42																																																																																																																																																																																																																																	
H62187	15/16"	\$80.42																																																																																																																																																																																																																																	
H62188	1"	\$88.76																																																																																																																																																																																																																																	
H62161	1-1/16"	\$108.34																																																																																																																																																																																																																																	
Tool No.	Cutting Dia.	Price																																																																																																																																																																																																																																	
C62196	1/4"	\$75.01																																																																																																																																																																																																																																	
C62197	5/16"	\$75.01																																																																																																																																																																																																																																	
C62198	3/8"	\$78.34																																																																																																																																																																																																																																	
C62199	7/16"	\$80.01																																																																																																																																																																																																																																	
C62146	29/64"	\$81.28																																																																																																																																																																																																																																	
C62200	1/2"	\$81.67																																																																																																																																																																																																																																	
C62201	5/8"	\$98.34																																																																																																																																																																																																																																	
C62202	3/4"	\$115.01																																																																																																																																																																																																																																	
C875	7/8"	\$115.01																																																																																																																																																																																																																																	
C1516	15/16"	\$115.01																																																																																																																																																																																																																																	
C62188	1"	\$120.01																																																																																																																																																																																																																																	
<p>Brad Point Drill Bit 7/16"-14 Threaded Shank 3" Cutting Length 4-1/2" OAL Left Rotation Carbide Tipped</p> <p>Recommended for use in any wood product containing glue, or long production runs in hardwood. Performs well in many plastics, as well as in several composite materials, including fiberglass.</p> <table border="1" style="width: 100%; border-collapse: collapse;"> <thead> <tr> <th>Tool No.</th> <th>Cutting Dia.</th> <th>Price</th> </tr> </thead> <tbody> <tr><td>C62109</td><td>1/4"</td><td>\$75.01</td></tr> <tr><td>C62110</td><td>5/16"</td><td>\$75.01</td></tr> <tr><td>C62111</td><td>3/8"</td><td>\$78.34</td></tr> <tr><td>C62112</td><td>25/64"</td><td>\$80.01</td></tr> <tr><td>C62113</td><td>7/16"</td><td>\$81.67</td></tr> <tr><td>C62114</td><td>1/2"</td><td>\$81.67</td></tr> <tr><td>C58LH</td><td>5/8"</td><td>\$110.01</td></tr> <tr><td>C34LH</td><td>3/4"</td><td>\$116.86</td></tr> <tr><td>C875LH</td><td>7/8"</td><td>\$117.69</td></tr> </tbody> </table>	Tool No.	Cutting Dia.	Price	C62109	1/4"	\$75.01	C62110	5/16"	\$75.01	C62111	3/8"	\$78.34	C62112	25/64"	\$80.01	C62113	7/16"	\$81.67	C62114	1/2"	\$81.67	C58LH	5/8"	\$110.01	C34LH	3/4"	\$116.86	C875LH	7/8"	\$117.69	<p>V-Point Drill Bit 7/16"-14 Threaded Shank 3" Cutting Length 4-1/2" OAL Left Rotation HSS</p> <table border="1" style="width: 100%; border-collapse: collapse;"> <thead> <tr> <th>Tool No.</th> <th>Cutting Dia.</th> <th>Price</th> </tr> </thead> <tbody> <tr><td>H316LH</td><td>3/16"</td><td>\$33.25</td></tr> <tr><td>H62097</td><td>3/8"</td><td>\$33.54</td></tr> </tbody> </table>	Tool No.	Cutting Dia.	Price	H316LH	3/16"	\$33.25	H62097	3/8"	\$33.54	<p>Brad Point Center Drill Bit Straight Shank 2-1/4" Cutting Length 6" OAL Right Rotation HSS Dowel</p> <table border="1" style="width: 100%; border-collapse: collapse;"> <thead> <tr> <th>Tool No.</th> <th>Cutting Dia.</th> <th>Price</th> </tr> </thead> <tbody> <tr><td>H62385</td><td>1/8"</td><td>\$11.58</td></tr> <tr><td>H62386</td><td>5/32"</td><td>\$12.08</td></tr> <tr><td>H62387</td><td>3/16"</td><td>\$11.58</td></tr> <tr><td>H62388</td><td>7/32"</td><td>\$13.25</td></tr> <tr><td>H62389</td><td>1/4"</td><td>\$13.25</td></tr> <tr><td>H62392</td><td>5/16"</td><td>\$13.75</td></tr> <tr><td>H62393</td><td>3/8"</td><td>\$14.92</td></tr> </tbody> </table>	Tool No.	Cutting Dia.	Price	H62385	1/8"	\$11.58	H62386	5/32"	\$12.08	H62387	3/16"	\$11.58	H62388	7/32"	\$13.25	H62389	1/4"	\$13.25	H62392	5/16"	\$13.75	H62393	3/8"	\$14.92	<p>Brad Point Center Drill Bit Straight Shank 3-1/2" Cutting Length 8" OAL Right Rotation HSS Dowel</p> <table border="1" style="width: 100%; border-collapse: collapse;"> <thead> <tr> <th>Tool No.</th> <th>Cutting Dia.</th> <th>Price</th> </tr> </thead> <tbody> <tr><td>H62164</td><td>3/16"</td><td>\$31.67</td></tr> <tr><td>H62118</td><td>7/32"</td><td>\$31.67</td></tr> <tr><td>H62165</td><td>1/4"</td><td>\$33.09</td></tr> <tr><td>H62166</td><td>9/32"</td><td>\$33.09</td></tr> <tr><td>H62167</td><td>5/16"</td><td>\$33.09</td></tr> <tr><td>H62168</td><td>11/32"</td><td>\$33.09</td></tr> <tr><td>H62169</td><td>3/8"</td><td>\$33.09</td></tr> <tr><td>H62126</td><td>13/32"</td><td>\$34.59</td></tr> <tr><td>H62170</td><td>7/16"</td><td>\$32.51</td></tr> <tr><td>H62128</td><td>15/32"</td><td>\$35.59</td></tr> <tr><td>H62171</td><td>1/2"</td><td>\$35.59</td></tr> </tbody> </table>	Tool No.	Cutting Dia.	Price	H62164	3/16"	\$31.67	H62118	7/32"	\$31.67	H62165	1/4"	\$33.09	H62166	9/32"	\$33.09	H62167	5/16"	\$33.09	H62168	11/32"	\$33.09	H62169	3/8"	\$33.09	H62126	13/32"	\$34.59	H62170	7/16"	\$32.51	H62128	15/32"	\$35.59	H62171	1/2"	\$35.59	<p>Brad Point Drill Bit For Spur Machine 1/2" x 2" Shank 4" Cutting Length 6" OAL Right Rotation HSS Dowel</p> <table border="1" style="width: 100%; border-collapse: collapse;"> <thead> <tr> <th>Tool No.</th> <th>Cutting Dia.</th> <th>Price</th> </tr> </thead> <tbody> <tr><td>H62132</td><td>1/8"</td><td>\$33.26</td></tr> <tr><td>H62134</td><td>3/16"</td><td>\$33.26</td></tr> <tr><td>H62135</td><td>7/32"</td><td>\$33.26</td></tr> <tr><td>H62172</td><td>1/4"</td><td>\$34.59</td></tr> <tr><td>H62137</td><td>17/64"</td><td>\$36.12</td></tr> <tr><td>H62173</td><td>9/32"</td><td>\$34.59</td></tr> <tr><td>H62174</td><td>5/16"</td><td>\$34.59</td></tr> <tr><td>H62175</td><td>11/32"</td><td>\$34.59</td></tr> <tr><td>H62176</td><td>3/8"</td><td>\$34.59</td></tr> <tr><td>H62143</td><td>25/64"</td><td>\$50.42</td></tr> <tr><td>H62177</td><td>13/32"</td><td>\$36.09</td></tr> <tr><td>H62178</td><td>7/16"</td><td>\$36.09</td></tr> <tr><td>H62146</td><td>29/64"</td><td>\$37.09</td></tr> <tr><td>H62147</td><td>15/32"</td><td>\$37.09</td></tr> <tr><td>H62179</td><td>1/2"</td><td>\$37.09</td></tr> <tr><td>H3364</td><td>33/64"</td><td>\$50.42</td></tr> <tr><td>H62180</td><td>17/32"</td><td>\$41.26</td></tr> <tr><td>H62181</td><td>9/16"</td><td>\$46.26</td></tr> <tr><td>H62151</td><td>19/32"</td><td>\$50.42</td></tr> <tr><td>H62182</td><td>5/8"</td><td>\$50.42</td></tr> <tr><td>H62153</td><td>21/32"</td><td>\$50.42</td></tr> <tr><td>H62183</td><td>11/16"</td><td>\$54.59</td></tr> <tr><td>H62184</td><td>3/4"</td><td>\$61.26</td></tr> <tr><td>H62185</td><td>13/16"</td><td>\$66.61</td></tr> <tr><td>H62186</td><td>7/8"</td><td>\$75.42</td></tr> <tr><td>H62187</td><td>15/16"</td><td>\$80.42</td></tr> <tr><td>H62188</td><td>1"</td><td>\$88.76</td></tr> <tr><td>H62161</td><td>1-1/16"</td><td>\$108.34</td></tr> </tbody> </table>	Tool No.	Cutting Dia.	Price	H62132	1/8"	\$33.26	H62134	3/16"	\$33.26	H62135	7/32"	\$33.26	H62172	1/4"	\$34.59	H62137	17/64"	\$36.12	H62173	9/32"	\$34.59	H62174	5/16"	\$34.59	H62175	11/32"	\$34.59	H62176	3/8"	\$34.59	H62143	25/64"	\$50.42	H62177	13/32"	\$36.09	H62178	7/16"	\$36.09	H62146	29/64"	\$37.09	H62147	15/32"	\$37.09	H62179	1/2"	\$37.09	H3364	33/64"	\$50.42	H62180	17/32"	\$41.26	H62181	9/16"	\$46.26	H62151	19/32"	\$50.42	H62182	5/8"	\$50.42	H62153	21/32"	\$50.42	H62183	11/16"	\$54.59	H62184	3/4"	\$61.26	H62185	13/16"	\$66.61	H62186	7/8"	\$75.42	H62187	15/16"	\$80.42	H62188	1"	\$88.76	H62161	1-1/16"	\$108.34	<p>Brad Point Drill Bit For Spur Machine 1/2" x 2" Shank 4" Cutting Length 6" OAL Right Rotation Carbide Tipped</p> <table border="1" style="width: 100%; border-collapse: collapse;"> <thead> <tr> <th>Tool No.</th> <th>Cutting Dia.</th> <th>Price</th> </tr> </thead> <tbody> <tr><td>C62196</td><td>1/4"</td><td>\$75.01</td></tr> <tr><td>C62197</td><td>5/16"</td><td>\$75.01</td></tr> <tr><td>C62198</td><td>3/8"</td><td>\$78.34</td></tr> <tr><td>C62199</td><td>7/16"</td><td>\$80.01</td></tr> <tr><td>C62146</td><td>29/64"</td><td>\$81.28</td></tr> <tr><td>C62200</td><td>1/2"</td><td>\$81.67</td></tr> <tr><td>C62201</td><td>5/8"</td><td>\$98.34</td></tr> <tr><td>C62202</td><td>3/4"</td><td>\$115.01</td></tr> <tr><td>C875</td><td>7/8"</td><td>\$115.01</td></tr> <tr><td>C1516</td><td>15/16"</td><td>\$115.01</td></tr> <tr><td>C62188</td><td>1"</td><td>\$120.01</td></tr> </tbody> </table>	Tool No.	Cutting Dia.	Price	C62196	1/4"	\$75.01	C62197	5/16"	\$75.01	C62198	3/8"	\$78.34	C62199	7/16"	\$80.01	C62146	29/64"	\$81.28	C62200	1/2"	\$81.67	C62201	5/8"	\$98.34	C62202	3/4"	\$115.01	C875	7/8"	\$115.01	C1516	15/16"	\$115.01	C62188	1"	\$120.01
Tool No.	Cutting Dia.	Price																																																																																																																																																																																																																																	
C62109	1/4"	\$75.01																																																																																																																																																																																																																																	
C62110	5/16"	\$75.01																																																																																																																																																																																																																																	
C62111	3/8"	\$78.34																																																																																																																																																																																																																																	
C62112	25/64"	\$80.01																																																																																																																																																																																																																																	
C62113	7/16"	\$81.67																																																																																																																																																																																																																																	
C62114	1/2"	\$81.67																																																																																																																																																																																																																																	
C58LH	5/8"	\$110.01																																																																																																																																																																																																																																	
C34LH	3/4"	\$116.86																																																																																																																																																																																																																																	
C875LH	7/8"	\$117.69																																																																																																																																																																																																																																	
Tool No.	Cutting Dia.	Price																																																																																																																																																																																																																																	
H316LH	3/16"	\$33.25																																																																																																																																																																																																																																	
H62097	3/8"	\$33.54																																																																																																																																																																																																																																	
Tool No.	Cutting Dia.	Price																																																																																																																																																																																																																																	
H62385	1/8"	\$11.58																																																																																																																																																																																																																																	
H62386	5/32"	\$12.08																																																																																																																																																																																																																																	
H62387	3/16"	\$11.58																																																																																																																																																																																																																																	
H62388	7/32"	\$13.25																																																																																																																																																																																																																																	
H62389	1/4"	\$13.25																																																																																																																																																																																																																																	
H62392	5/16"	\$13.75																																																																																																																																																																																																																																	
H62393	3/8"	\$14.92																																																																																																																																																																																																																																	
Tool No.	Cutting Dia.	Price																																																																																																																																																																																																																																	
H62164	3/16"	\$31.67																																																																																																																																																																																																																																	
H62118	7/32"	\$31.67																																																																																																																																																																																																																																	
H62165	1/4"	\$33.09																																																																																																																																																																																																																																	
H62166	9/32"	\$33.09																																																																																																																																																																																																																																	
H62167	5/16"	\$33.09																																																																																																																																																																																																																																	
H62168	11/32"	\$33.09																																																																																																																																																																																																																																	
H62169	3/8"	\$33.09																																																																																																																																																																																																																																	
H62126	13/32"	\$34.59																																																																																																																																																																																																																																	
H62170	7/16"	\$32.51																																																																																																																																																																																																																																	
H62128	15/32"	\$35.59																																																																																																																																																																																																																																	
H62171	1/2"	\$35.59																																																																																																																																																																																																																																	
Tool No.	Cutting Dia.	Price																																																																																																																																																																																																																																	
H62132	1/8"	\$33.26																																																																																																																																																																																																																																	
H62134	3/16"	\$33.26																																																																																																																																																																																																																																	
H62135	7/32"	\$33.26																																																																																																																																																																																																																																	
H62172	1/4"	\$34.59																																																																																																																																																																																																																																	
H62137	17/64"	\$36.12																																																																																																																																																																																																																																	
H62173	9/32"	\$34.59																																																																																																																																																																																																																																	
H62174	5/16"	\$34.59																																																																																																																																																																																																																																	
H62175	11/32"	\$34.59																																																																																																																																																																																																																																	
H62176	3/8"	\$34.59																																																																																																																																																																																																																																	
H62143	25/64"	\$50.42																																																																																																																																																																																																																																	
H62177	13/32"	\$36.09																																																																																																																																																																																																																																	
H62178	7/16"	\$36.09																																																																																																																																																																																																																																	
H62146	29/64"	\$37.09																																																																																																																																																																																																																																	
H62147	15/32"	\$37.09																																																																																																																																																																																																																																	
H62179	1/2"	\$37.09																																																																																																																																																																																																																																	
H3364	33/64"	\$50.42																																																																																																																																																																																																																																	
H62180	17/32"	\$41.26																																																																																																																																																																																																																																	
H62181	9/16"	\$46.26																																																																																																																																																																																																																																	
H62151	19/32"	\$50.42																																																																																																																																																																																																																																	
H62182	5/8"	\$50.42																																																																																																																																																																																																																																	
H62153	21/32"	\$50.42																																																																																																																																																																																																																																	
H62183	11/16"	\$54.59																																																																																																																																																																																																																																	
H62184	3/4"	\$61.26																																																																																																																																																																																																																																	
H62185	13/16"	\$66.61																																																																																																																																																																																																																																	
H62186	7/8"	\$75.42																																																																																																																																																																																																																																	
H62187	15/16"	\$80.42																																																																																																																																																																																																																																	
H62188	1"	\$88.76																																																																																																																																																																																																																																	
H62161	1-1/16"	\$108.34																																																																																																																																																																																																																																	
Tool No.	Cutting Dia.	Price																																																																																																																																																																																																																																	
C62196	1/4"	\$75.01																																																																																																																																																																																																																																	
C62197	5/16"	\$75.01																																																																																																																																																																																																																																	
C62198	3/8"	\$78.34																																																																																																																																																																																																																																	
C62199	7/16"	\$80.01																																																																																																																																																																																																																																	
C62146	29/64"	\$81.28																																																																																																																																																																																																																																	
C62200	1/2"	\$81.67																																																																																																																																																																																																																																	
C62201	5/8"	\$98.34																																																																																																																																																																																																																																	
C62202	3/4"	\$115.01																																																																																																																																																																																																																																	
C875	7/8"	\$115.01																																																																																																																																																																																																																																	
C1516	15/16"	\$115.01																																																																																																																																																																																																																																	
C62188	1"	\$120.01																																																																																																																																																																																																																																	
					<p>Pocket Hole Drill Bit For Cast Machine Brad-Point 1/4" Shank 1" Cutting Length 2-1/2" OAL Right Rotation HSS Dowel 5 Bits/Pack</p> <table border="1" style="width: 100%; border-collapse: collapse;"> <thead> <tr> <th>Tool No.</th> <th>Cutting Dia.</th> <th>Price</th> </tr> </thead> <tbody> <tr><td>29102B</td><td>9/64"</td><td>\$43.74</td></tr> </tbody> </table>	Tool No.	Cutting Dia.	Price	29102B	9/64"	\$43.74																																																																																																																																																																																																																								
Tool No.	Cutting Dia.	Price																																																																																																																																																																																																																																	
29102B	9/64"	\$43.74																																																																																																																																																																																																																																	

MAGNATE™ 20639 Lycoming Street #B-6, Walnut, CA 91789 USA

G-6



email : info@magnate.net Online Shop : www.magnate.net
(TEL) 800-827-2316, 909-468-5747 (FAX) 909-468-5745

Face Frame Counterbore
Adjustable
3/8" Shank Diameter
9/32" Carbide Height
4" OAL
Carbide Tipped

Adjustable Counterbore
1/2" x 2" Shank
2-1/2" Cutting length
4-1/2" OAL
Right Rotation
HSS

Adjustable Counterbores
7/16"-14 Threaded Shank
2-1/2" Cutting Length
4-1/2" OAL
Right Rotation
HSS

Countersink
Mount on Shank
Right Rotation
Carbide Tipped



One central drill included

Tool No.	Outside Dia.	Drill Dia.	Price
H624	3/8"	0.136"	\$16.43



Tool No.	Outside Dia.	Inside Dia.	Price
H62261	3/8"	1/8"	\$36.59
H62262	3/8"	5/32"	\$36.59
H62263	3/8"	3/16"	\$36.59
H62264	7/16"	3/16"	\$36.59
H62265	7/16"	7/32"	\$36.59
H62268	1/2"	3/16"	\$36.59
H62269	1/2"	7/32"	\$36.59
H62270	1/2"	1/4"	\$39.92
H62273	5/8"	3/16"	\$54.92
H62274	5/8"	1/4"	\$54.92
H62276	5/8"	5/16"	\$56.59
H62277	3/4"	3/16"	\$56.50
H62280	3/4"	5/16"	\$58.36
H62281	3/4"	3/8"	\$58.26



Tool No.	Outside Dia.	Inside Dia.	Price
H62249	3/8"	3/16"	\$36.59
H716	7/16"	3/16"	\$41.59
H62250	1/2"	3/16"	\$36.59
H62251	1/2"	7/32"	\$36.59
H62252	1/2"	1/4"	\$36.59



Adjustable Counterbores
2" OAL, HSS

Adjustable Counterbores
7/16"-14 Threaded Shank
2-1/2" Cutting Length
4-1/2" OAL
Left Rotation
HSS

Adjustable Counterbores
7/16"-14 Threaded Shank
2-1/2" Cutting Length
4-1/2" OAL
Left Rotation
HSS

Countersink
Mount on Shank
Left Rotation
Carbide Tipped



Tool No.	Outside Dia.	Inside Dia.	Price
H62301	3/8"	3/16"	\$29.92
H62302	1/2"	3/16"	\$34.88
H62307	3/4"	1/4"	\$43.75
H62308	3/4"	5/16"	\$43.75
H62309	7/8"	5/16"	\$46.25
H62310	7/8"	3/8"	\$46.67
H62311	7/8"	7/16"	\$46.67
H62312	1"	5/16"	\$52.50
H62313	1"	3/8"	\$52.50
H62313-7/16	1"	7/16"	\$52.50
H62314	1"	1/2"	\$52.50
H62316	1-1/4"	1/2"	\$77.50
H62318	1-1/2"	1/2"	\$83.25



Tool No.	Outside Dia.	Inside Dia.	Price
H62253	3/8"	3/16"	\$41.59
H62254	1/2"	3/16"	\$44.17
H62255	1/2"	7/32"	\$44.01
H62256	1/2"	1/4"	\$47.51

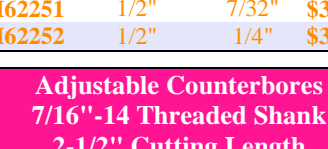

Tool No.	Outside Dia.	Inside Dia.	Price
H62253	3/8"	3/16"	\$41.59
H62254	1/2"	3/16"	\$44.17
H62255	1/2"	7/32"	\$44.01
H62256	1/2"	1/4"	\$47.51



Adjustable Counterbores
2" OAL, Carbide Tipped

Adjustable Counterbore
1/2" x 2" Shank
2-1/2" Cutting length
4-1/2" OAL
Right Rotation
Carbide Tipped

Face Frame Countersink
Adjustable
9/32" Carbide Height
4" OAL
45 Degree Carbide Tipped

Countersink
Mount on Spiral
Right Rotation
Carbide Tipped



Tool No.	Outside Dia.	Inside Dia.	Price
C62312	1"	5/16"	\$61.67
C62312-1	1"	3/16"	\$58.33
C62313	1"	3/8"	\$65.01
C62312-2	1"	7/16"	\$65.02

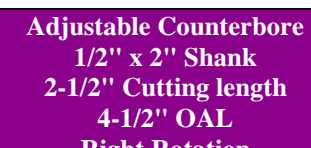

Tool No.	Outside Dia.	Inside Dia.	Price
H62263LH	7/16"	3/16"	\$36.59
C62292	3/8"	3/16"	\$47.07
C62293	1/2"	3/16"	\$47.07



One right-hand drill (#29) is included.

Tool No.	Drill Dia.	Outside Dia.	Price
8634	0.136"	3/8"	\$16.45

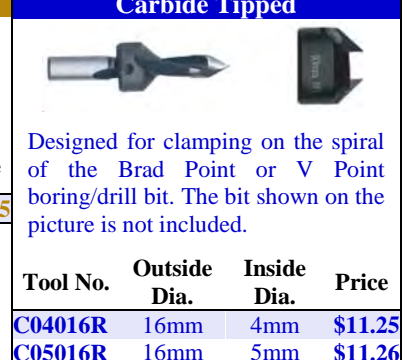

**Countersink
Mount on Spiral
Left Rotation
Carbide Tipped**



Designed for clamping on the spiral of the Brad Point or V Point boring/drill bit. The bit shown on the picture is not included.

Tool No.	Outside Dia.	Inside Dia.	Price
C04016L	16mm	4mm	\$11.25
C05016L	16mm	5mm	\$11.26
C06016L	16mm	6mm	\$11.27
C63516L	16mm	6.35mm	\$11.28
C07016L	16mm	7mm	\$11.29
C08016L	16mm	8mm	\$11.95
C09016L	18mm	9mm	\$12.26
C10020L	20mm	10mm	\$12.95
C12020L	20mm	12mm	\$12.96

**Taper Shell Countersink
3/8" Shank Length
1/2" Shank Diameter
1-1/4" OAL
HSS**



This high speed steel tapered shell countersink is designed for use in wood product containing glue or long production runs in hardwood. It also performs well in many plastics, composite materials and fiberglass. Drill (not included) is held in the center with a set of screws.

Tool No.	Drill Dia.	Price
8640	1/8"	\$14.35
8641	3/16"	\$14.41
8642	1/8"	\$15.27
8646	3/16"	\$15.43
8649	1/4"	\$15.89

**Adjustable Countersink
1/2" x 2" Shank
2-1/2" Cutting length
4-1/2" OAL
Right Rotation
HSS**



Tool No.	Outside Dia.	Inside Dia.	Price
H62282	3/8"	1/8"	\$38.38
H62283	3/8"	5/32"	\$38.38
H62284	3/8"	3/16"	\$38.38
H62286	7/16"	7/32"	\$38.38
H62289	1/2"	3/16"	\$38.38
H62290	1/2"	7/32"	\$38.38
H62291	1/2"	1/4"	\$38.38

**Adjustable Countersink
1/2" x 2" Shank
2-1/2" Cutting length
4-1/2" OAL
Right Rotation
Carbide Tipped**



Tool No.	Outside Dia.	Inside Dia.	Price
C62297	1/2"	3/16"	\$54.92

**Adjustable Countersinks
7/16"-14 Threaded Shank
2-1/2" Cutting Length
4-1/2" OAL
Right Rotation
HSS**



Tool No.	Outside Dia.	Inside Dia.	Price
H62257	3/8"	3/16"	\$44.12
H62258	1/2"	3/16"	\$48.13

**Adjustable Countersink
For Wood Screws
7/16" Carbide Height
1-1/4" OAL, 2 Wing
45 Degree Carbide Tipped**



Accept drills from 3/32" to 9/32". (Wood screw sizes from #2 to #18). Drills not included.

Tool No.	Overall Dia.	Price
8654	7/16" - 19/32"	\$15.51

**Chuck Adaptor
Straight To 7/16-14" Threaded**



Tool No.	Inside Dia.	Outside Dia.	Rotation	Price
H62473	1/8"	5/8"	Right	\$24.54
H62475	3/16"	5/8"	Right	\$24.56
H62476	7/32"	5/8"	Right	\$24.59
H62477	1/4"	5/8"	Right	\$25.01
H62478	9/32"	5/8"	Right	\$25.03
H62479	5/16"	5/8"	Right	\$25.91
H62480	3/8"	5/8"	Right	\$25.93
H62481	7/16"	7/8"	Right	\$34.40
H62482	1/2"	1"	Right	\$27.73
H62483	10mm	5/8"	Right	\$24.54
H62484	10mm	5/8"	Left	\$24.68



MAGNATE™ Hole Saw

Carbide Grit-Edge Hole Saw 1-1/2" Cutting Depth



It comes with 3/16" thick heavy duty backing plate. Snagging resistant Tungsten carbide cutting edge with no teeth to dull or chip and resistant to high heat and abrasion. Cuts extremely hard abrasive materials. Recommended for cutting fiberglass, cast iron, laminates, ceramic tile, marble, slate, and composites. Used for plumbing, construction, marine and aircraft applications. The need for a drive plate is eliminated.

Tool No.	Cutting Dia.	Pipe Tap	Pipe Entrance	Thread	Price
HSG034*	3/4"	----	3/8"	1/2"-20	\$25.56
HSG078*	7/8"	3/4"	1/2"	1/2"-20	\$25.56
HSG100*	1"	----	----	1/2"-20	\$27.91
HSG118*	1-1/8"	1"	3/4"	1/2"-20	\$27.91
HSG114^	1-1/4"	----	----	5/8"-18	\$28.64
HSG138^	1-3/8"	----	1"	5/8"-18	\$28.87
HSG112^	1-1/2"	1-1/4"	----	5/8"-18	\$28.87
HSG134^	1-3/4"	1-1/2"	1-1/4"	5/8"-18	\$35.41
HSG178^	1-7/8"	----	----	5/8"-18	\$35.41
HSG200^	2"	----	1-1/2"	5/8"-18	\$35.41
HSG218^	2-1/8"	----	----	5/8"-18	\$41.89
HSG214^	2-1/4"	2"	----	5/8"-18	\$41.89
HSG238^	2-3/8"	----	----	5/8"-18	\$41.89
HSG212^	2-1/2"	----	2"	5/8"-18	\$47.22
HSG234^	2-3/4"	----	----	5/8"-18	\$47.22
HSG300^	3"	----	2-1/2"	5/8"-18	\$57.21
HSG314^	3-1/4"	3"	----	5/8"-18	\$57.21
HSG338^	3-3/8"	----	----	5/8"-18	\$57.21
HSG334^	3-3/4"	3-1/2"	----	5/8"-18	\$70.86
HSG400^	4"	----	----	5/8"-18	\$75.44
HSG412^	4-1/2"	----	4"	5/8"-18	\$92.99
HSG638^	6-3/8"	----	----	5/8"-18	\$120.31
HSG658^	6-5/8"	----	----	5/8"-18	\$120.31
HSG678^	6-7/8"	----	----	5/8"-18	\$120.31

* Works with Magnate hole saw arbor - HSAA12R
^ Works with Magnate hole saw arbor - HSAB716H

Cobalt Bi-Metal Hole Saw 1-1/2" Cutting Depth M3 Cutting Edge, Made in USA



Electron beam welded M3 high-speed cobalt steel teeth have a positive rake and 4-6 variable pitch. These features provide fatigue resistance, better chip clearance, less vibration, and less heat. This hole saw cutter is designed to cut holes in plastic, fiberboard, wood, plywood, or any machinable metal including: stainless steel, pipe, nail-embedded wood, etc. High alloy steel body design offers superior durability and is shatter resistant.

Tool No.	Cutting Dia.	Pipe Tap	Pipe Entrance	Thread	Price
HSM058*	5/8"	----	----	1/2"-20	\$6.77
HSM034*	3/4"	1/2"	3/8"	1/2"-20	\$6.81
HSM078*	7/8"	3/4"	1/2"	1/2"-20	\$6.85
HSM100*	1"	----	----	1/2"-20	\$7.12
HSM118*	1-1/8"	1"	3/4"	1/2"-20	\$7.16
HSM114^	1-1/4"	----	----	5/8"-18	\$7.21
HSM138^	1-3/8"	----	1"	5/8"-18	\$7.69
HSM112^	1-1/2"	1-1/4"	----	5/8"-18	\$7.73
HSM158^	1-5/8"	----	----	5/8"-18	\$7.78
HSM134^	1-3/4"	1-1/2"	1-1/4"	5/8"-18	\$9.46
HSM178^	1-7/8"	----	----	5/8"-18	\$9.51
HSM200^	2"	----	1-1/2"	5/8"-18	\$9.56
HSM218^	2-1/8"	----	----	5/8"-18	\$11.74
HSM214^	2-1/4"	2"	----	5/8"-18	\$11.79
HSM238^	2-3/8"	----	----	5/8"-18	\$11.84
HSM212^	2-1/2"	----	2"	5/8"-18	\$12.62
HSM258^	2-5/8"	2-1/2"	----	5/8"-18	\$12.67
HSM234^	2-3/4"	----	----	5/8"-18	\$12.71
HSM278^	2-7/8"	----	----	5/8"-18	\$12.76
HSM300^	3"	----	2-1/2"	5/8"-18	\$12.99
HSM314^	3-1/4"	3"	----	5/8"-18	\$13.06
HSM312^	3-1/2"	----	----	5/8"-18	\$13.12
HSM334^	3-3/4"	3-1/2"	----	5/8"-18	\$17.99
HSM400^	4"	----	----	5/8"-18	\$19.76
HSM412^	4-1/2"	----	4"	5/8"-18	\$38.91
HSM500^	5"	----	----	5/8"-18	\$47.94
HSM512^	5-1/2"	----	----	5/8"-18	\$57.17
HSM600^	6"	----	----	5/8"-18	\$66.99

* Works with Magnate hole saw arbor - HSAA14R
^ Works with Magnate hole saw arbor - HSAB716H

Carbide Tipped Hole Saw 1-7/8" Cutting Depth



Tungsten Carbide Tipped teeth for long life and highest wear resistance. 3 Teeth per Inch for superior chip clearance and fast cuts. Designed for sawing holes in ceramic tile, particle board, cast iron, fiberglass, abrasive materials, asbestos board, and formica.

Tool No.	Cutting Dia.	Pipe Tap	Pipe Entrance	Thread	Price
HSE034*	3/4"	----	3/8"	1/2"-20	\$14.77
HSE078*	7/8"	3/4"	1/2"	1/2"-20	\$14.94
HSE100*	1"	----	----	1/2"-20	\$15.91
HSE118*	1-1/8"	1"	3/4"	1/2"-20	\$16.87
HSE114^	1-1/4"	----	----	5/8"-18	\$17.57
HSE138^	1-3/8"	----	1"	5/8"-18	\$17.84
HSE112^	1-1/2"	1-1/4"	----	5/8"-18	\$18.29
HSE158^	1-5/8"	----	----	5/8"-18	\$19.41
HSE134^	1-3/4"	1-1/2"	1-1/4"	5/8"-18	\$20.31
HSE178^	1-7/8"	----	----	5/8"-18	\$21.19
HSE200^	2"	----	1-1/2"	5/8"-18	\$21.79
HSE218^	2-1/8"	----	----	5/8"-18	\$25.64
HSE214^	2-1/4"	2"	----	5/8"-18	\$26.52
HSE238^	2-3/8"	----	----	5/8"-18	\$27.37
HSE212^	2-1/2"	----	2"	5/8"-18	\$28.66
HSE258^	2-5/8"	2-1/2"	----	5/8"-18	\$29.57
HSE234^	2-3/4"	----	----	5/8"-18	\$30.47
HSE278^	2-7/8"	----	----	5/8"-18	\$31.37
HSE300^	3"	----	2-1/2"	5/8"-18	\$32.27
HSE314^	3-1/4"	3"	----	5/8"-18	\$39.89
HSE312^	3-1/2"	----	----	5/8"-18	\$42.92
HSE334^	3-3/4"	3-1/2"	----	5/8"-18	\$45.09
HSE400^	4"	----	----	5/8"-18	\$47.92
HSE414^	4-1/4"	----	4"	5/8"-18	\$69.26
HSE412^	4-1/2"	----	4"	5/8"-18	\$70.19
HSE434^	4-3/4"	4-1/2"	----	5/8"-18	\$76.42
HSE500^	5"	----	----	5/8"-18	\$78.67
HSE512^	5-1/2"	----	----	5/8"-18	\$82.82
HSE600^	6"	----	----	5/8"-18	\$86.81

* Works with Magnate hole saw arbor - HSAA12R
^ Works with Magnate hole saw arbor - HSAB716H



Hole Saw Arbor Made in USA



HSAA14R



HSAB716H



HSAE38H



HSAF38H

Heavy duty steel. Several shank sizes available.
Pilot drill included with arbor.

Tool No.	Shank Dia.	Thread	Chuck	Price
HSAA14R*	1/4"-Round	1/2"-20	1/4"	\$5.69
HSAB716H*	7/16"-Hex	5/8"-18	1/2"	\$14.76
HSAE38H^	3/8"-Hex	1/2"-20	3/8"-1/2"	\$8.01
HSAF38H^	3/8"-Hex	5/8"-18	3/8"-1/2"	\$14.76

* It comes with a HSS 1/4" pilot drill bit
^ It comes with a carbide tipped 1/4" pilot drill bit

Carbide Tipped Hole Saw, 10mm Shank 10 Shank Diameter with 1/4" Hollow Hole



This carbide tipped hole saw cutter comes with specially strengthened carbide that is designed to be used on hardwoods, plastic, marble, concrete, and metals. Apply liquid coolant or lubrication during application in order to extend the working life of this blade. Applying coolant is especially recommended when cutting ferrous and non-ferrous metals.

Tool No.	Cutting Dia.	Cutting Depth	Shank Length	Overall Length	Price
HSC1020T	20mm	2"	30mm	3-1/2"	\$18.69
HSC1024T	24mm	2"	30mm	3-1/2"	\$20.98

Rip Saw Blade, ATB Grind 20° Hook

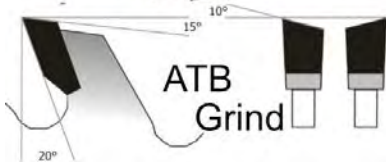

For ripping and cross-cutting of solid wood and board materials on table saws, special sawing machines, etc.

Tool No.	Dia.	Tooth	Bore	Kerf	Plate	Price
R105	10"	24	5/8"	.126"	.087"	\$43.73
R121	12"	28	1"	.126"	.087"	\$53.37
R141	14"	32	1"	.138"	.098"	\$67.55

Anti-Kickback Rip Saw Blade ATB Grind, 20° Hook

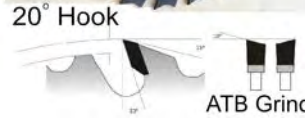

For ripping and cross-cutting of solid wood and board materials on table saws, special sawing machines, with chip limiter to reduce kickbacks.

Tool No.	Dia.	Tooth	Bore	Kerf	Plate	Price
AK105	10"	24	5/8"	.126"	.087"	\$44.33
AK121	12"	28	1"	.126"	.087"	\$54.13
AK141	14"	32	1"	.138"	.098"	\$68.48

Glue Line Rip Saw Blade TC Grind, 20° Hook

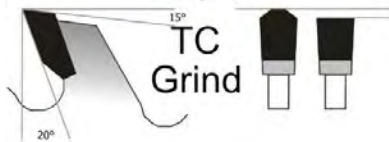

The clearest cutting rip blades for all glue line applications.

Tool No.	Dia.	Tooth	Bore	Kerf	Plate	Price
GR105	10"	30	5/8"	.145"	.095"	\$62.27
GR121	12"	36	1"	.160"	.110"	\$79.15
GR123*^	12"	36	3-1/8"	.126"	.083"	\$96.58
GR124*	12"	36	3-1/8"	.150"	.110"	\$99.27
GR125*	12"	36	3-1/8"	.160"	.110"	\$102.15
GR141	14"	40	1"	.170"	.120"	\$104.60
GR142#	14"	36	2"	.169"	.120"	\$106.50
GR161	16"	36	1"	.170"	.120"	\$120.78
GR327	300mm	36	70mm	4.2mm	2.8mm	\$106.87

* For Mereen Johnson machine

^ Keyway 1/4 x 1/4 round

For Diehl machine, Pin hole 9/16 on 5 b/c

Thin Kerf Saw Blade, ATB Grind



For fine crust cutting of expensive material where savings is an important matter.

ATB Grind for cutting solid wood, plywood, and veneers.

Tool No.	Dia.	Tooth	Bore	Hook	Kerf	Plate	Price
T0856	8"	60	5/8"	10°	.090"	.063"	\$79.85
T1052	10"	24	5/8"	20°	.098"	.071"	\$52.88
T1054	10"	40	5/8"	15°	.090"	.063"	\$64.10
T1058	10"	80	5/8"	5°	.090"	.063"	\$96.17
T1216	12"	100	1"	5°	.090"	.063"	\$132.52

Thin Kerf Saw Blade, TC Grind

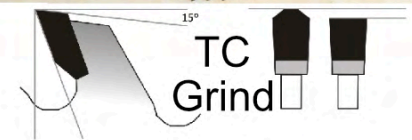

For fine crust cutting of expensive material where savings is an important matter.

TC Grind for cutting plastic, PVC, and plexiglass.

Tool No.	Dia.	Tooth	Bore	Hook	Kerf	Plate	Price
K0856	8"	60	5/8"	10°	.090"	.063"	\$88.27
K1058	10"	80	5/8"	5°	.090"	.063"	\$106.45
K1216	12"	100	1"	5°	.090"	.063"	\$151.72

Heavy Duty Rip Saw Blade F Grind, 20° Hook

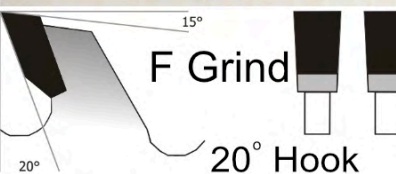

Specially designed for heavy duty ripping in hard or soft woods.

Tool No.	Dia.	Tooth	Bore	Kerf	Plate	Price
HR105	10"	24	5/8"	.145"	.095"	\$51.63
HR121	12"	28	1"	.160"	.110"	\$66.57
HR141	14"	32	1"	.170"	.120"	\$83.85
HR161	16"	36	1"	.170"	.120"	\$118.77
HR181	18"	40	1"	.184"	.134"	\$165.15



MAGNATE™ Carbide Tipped Circular Saw Blades

Combination Saw Blade 4ATB+R Grind, 15° Hook



This blade is specially designed for ripping and cross-cutting in solid wood, plywood and particle boards. The best solution where one blade can be used in different types of cutting.

Tool No.	Dia.	Tooth	Bore	Kerf	Plate	Price
CB105	10"	50	5/8"	.126"	.087"	\$76.55
CB121	12"	60	1"	.155"	.110"	\$105.78
CB141	14"	70	1"	.155"	.110"	\$158.62
CB161	16"	80	1"	.165"	.120"	\$222.05

Standard Cut-Off Saw Blade 1" Bore, ATB Grind



Universal application for cutting along and across the grain in solid wood and board materials.

Tool No.	Dia.	Tooth	Hook	Kerf	Plate	Price
C0814	8"	40	15°	.110"	.070"	\$52.55
C1014	10"	40	15°	.126"	.087"	\$55.42
C1016	10"	60	10°	.126"	.087"	\$64.38
C1214	12"	48	15°	.126"	.087"	\$66.12
C1216	12"	60	10°	.126"	.087"	\$76.97
C1217	12"	72	10°	.126"	.087"	\$87.82
C1211	12"	100	5°	.126"	.087"	\$101.83
C1416	14"	60	10°	.155"	.109"	\$110.70
C1418	14"	80	5°	.150"	.109"	\$118.78
C1411	14"	100	5°	.150"	.109"	\$145.25
C1614	16"	40	15°	.155"	.110"	\$111.28
C1616	16"	60	15°	.155"	.110"	\$137.77
C1618	16"	80	10°	.155"	.110"	\$166.82
C1816	18"	60	10°	.180"	.134"	\$198.82
C1818	18"	80	10°	.180"	.134"	\$218.08
C1811	18"	100	10°	.180"	.134"	\$253.78

Special Cut-Off Saw Blades 5/8" Bore, TC Grind



For the best sizing and finishing; cuts in plywood, veneer, plastic laminated board material, on table saws and vertical sizing saws.

Tool No.	Dia.	Tooth	Hook	Kerf	Plate	Price
SC0854	8"	40	15°	.110"	.070"	\$57.62
SC0856	8"	60	10°	.118"	.078"	\$67.92
SC1054	10"	40	15°	.126"	.087"	\$62.28
SC1056	10"	60	10°	.126"	.087"	\$70.73
SC1058	10"	80	5°	.126"	.087"	\$83.72

Standard Cut-Off Saw Blade 5/8" Bore, ATB Grind



Universal application for cutting along and across the grain in solid wood and board materials.

Tool No.	Dia.	Tooth	Hook	Kerf	Plate	Price
C0854	8"	40	15°	.110"	.070"	\$52.55
C0856	8"	60	10°	.118"	.078"	\$64.55
C0956	9"	60	10°	.128"	.087"	\$66.83
C1054	10"	40	15°	.126"	.087"	\$55.42
C1056	10"	60	10°	.126"	.087"	\$64.38
C1058	10"	80	5°	.126"	.087"	\$76.13

Standard Cut-Off Saw Blade ATB Grind, 30mm Bore

Pin Holes - 2/7/42mm, 2/9/46mm, 2/10/60mm



Universal application for cutting along and across the grain in solid wood and board materials.

Tool No.	Dia.	Tooth	Hook	Kerf	Plate	Price
C3036	300mm	60	10°	3.2mm	2.1mm	\$83.63
C3037	300mm	72	10°	3.2mm	2.2mm	\$95.02

Special Cut-Off Saw Blades 1" Bore, TC Grind



For the best sizing and finishing; cuts in plywood, veneer, plastic laminated board material, on table saws and vertical sizing saws.

Tool No.	Dia.	Tooth	Hook	Kerf	Plate	Price
SC1216	12"	60	10°	.126"	.087"	\$89.58
SC1217	12"	72	10°	.126"	.087"	\$96.52
SC1211	12"	100	5°	.135"	.095"	\$117.63
SC1416	14"	60	10°	.155"	.110"	\$123.33
SC1418	14"	80	5°	.150"	.109"	\$130.47
SC1411	14"	100	5°	.150"	.109"	\$174.33
SC1618	16"	80	15°	.155"	.110"	\$180.80
SC1818	18"	80	10°	.180"	.134"	\$245.87
SC1811	18"	100	10°	.180"	.134"	\$265.12

MAGNATE™ 20639 Lycoming Street #B-6, Walnut, CA 91789 USA

I-2



email : info@magnate.net Online Shop : www.magnate.net
(TEL) 800-827-2316, 909-468-5747 (FAX) 909-468-5745

Special Cut-Off Saw Blades 30mm Bore, TC Grind



For the best sizing and finishing; cuts in plywood, veneer, plastic laminated board material, on table saws and vertical sizing saws.

Tool No. Dia. Tooth Hook Kerf Plate Price

SC2236^	220mm	64	10°	3.2mm	2.2mm	\$76.32
SC2538*	250mm	80	5°	3.2mm	2.2mm	\$98.50
SC3036*	300mm	60	10°	3.2mm	2.2mm	\$94.05
SC3037*	300mm	72	10°	3.2mm	2.2mm	\$98.10
SC3039*	300mm	96	5°	3.2mm	2.2mm	\$137.38
SC3538*	350mm	84	10°	3.5mm	2.5mm	\$129.27

* 2 combi pin holes 2/7/42mm - 2/9/46mm - 2/10/60mm

^ 2 pin holes 7/42mm

Saw Blades, General Purpose For Portable Machines Carbide Tipped, TC Grind, 12° Hook



Manufactured to work in portable machines with all the technical features high industrial quality saw blades.

Tool No. Dia. Tooth Bore Kerf Plate Price

GP44	7-1/4"	40	5/8"	.102"	.072"	\$54.63
------	--------	----	------	-------	-------	---------

Double Face Laminate Saw Blade 1" Bore, ATB Grind

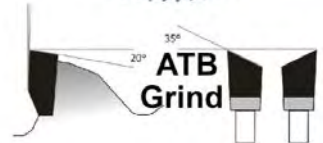

For fine cuts in laminated board materials on both sides with melamine, formica, veneer, etc. On table saws without scoring unit, vertical panel sizing saws, radial arm saws, mitre-and chop saws. Extra hard sub-micro grain carbide tips for long edge life.

Tool No. Dia. Tooth Hook Kerf Plate Price

L1219	12"	96	Neg 5°	.126"	.087"	\$115.47
L1411	14"	100	Neg 2°	.148"	.118"	\$186.28

Saw Blades, General Purpose For Portable Machines Carbide Tipped, ATB Grind

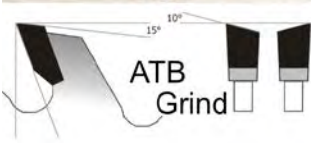

Manufactured to work in portable machines with all the technical features high industrial quality saw blades.

Tool No. Dia. Tooth Bore Kerf Plate Price

GP52*	7-1/4"	24	5/8"	.102"	.072"	\$35.05
GP54*	7-1/4"	40	5/8"	.102"	.072"	\$49.68
GP56*	7-1/4"	60	5/8"	.102"	.072"	\$62.40
GP12^	160mm	48	20mm	2.2mm	1.6mm	\$54.37

* 12° Hook

^ 8° Hook

Double Face Laminate Saw Blade 5/8" Bore, ATB Grind

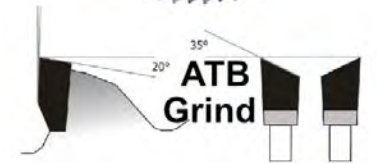

For fine cuts in laminated board materials on both sides with melamine, formica, veneer, etc. On table saws without scoring unit, vertical panel sizing saws, radial arm saws, mitre-and chop saws. Extra hard sub-micro grain carbide tips for long edge life.

Tool No. Dia. Tooth Hook Kerf Plate Price

L1058	10"	80	Neg 5°	.126"	.087"	\$94.15
-------	-----	----	--------	-------	-------	---------

Double Face Laminate Saw Blade 30mm Bore, ATB Grind, Neg 5° Hook

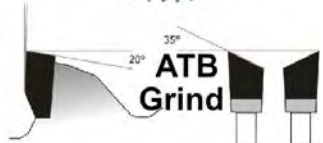

For fine cuts in laminated board materials on both sides with melamine, formica, veneer, etc. On table saws without scoring unit, vertical panel sizing saws, radial arm saws, mitre-and chop saws. Extra hard sub-micro grain carbide tips for long edge life.

Tool No. Dia. Tooth Kerf Plate Price

L2236^	220mm	64	3.2mm	2.2mm	\$86.40
L2538*	250mm	80	3.2mm	2.2mm	\$103.62
L3039*	303mm	96	3.2mm	2.2mm	\$118.23

* 2 Combi Pin Holes - 2/7/42, 2/9/46, 2/10/60mm

^ 2 Pin Holes - 7/42mm



Double Face Melamine & Solid Surface Saw Blade 5/8" Bore, D-TC Grind

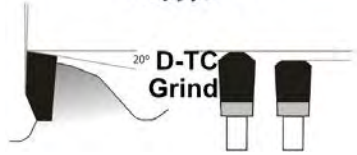

The best option for chip-free top & bottom, cuts in double sided materials such as melamine, double faced high and low pressure laminates. To use in radial or table saws.

Tool No.	Dia.	Tooth	Hook	Kerf	Plate	Price
DM0756	7-1/4"	60	0°	.112".072"		\$81.87
DM0856	8"	60	0°	.106".072"		\$86.03
DM1058	10"	80	Neg 5°	.115".085"		\$96.60
DM1068	10"	80	0°	.115".085"		\$96.60

Double Face Melamine & Solid Surface Saw Blade 1" Bore, D-TC Grind



The best option for chip-free top & bottom, cuts in double sided materials such as melamine, double faced high and low pressure laminates. To use in radial or table saws.

Tool No.	Dia.	Tooth	Hook	Kerf	Plate	Price
DM1211	12"	100	Neg 5°	.126" .095"		\$124.12
DM1221	12"	100	0°	.126" .095"		\$124.12
DM1411	14"	100	Neg 2°	.150" .110"		\$187.45
DM1611	16"	120	Neg 2°	.150" .110"		\$244.73

Double Face Melamine & Solid Surface Saw Blade 30mm Bore, D-TC Grind 2 Combi Pin Holes-2/7/42, 2/9/46, 2/10/60mm

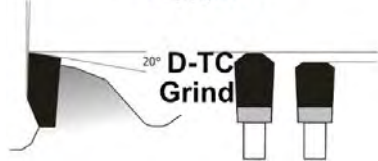

The best option for chip-free top & bottom, cuts in double sided materials such as melamine, double faced high and low pressure laminates. To use in radial or table saws.

Tool No.	Dia.	Tooth	Kerf	Plate	Hook	Price
DM2538	250mm	80	2.9mm	2.2mm	Neg 2°	\$100.58
DM3039	303mm	96	3.2mm	2.2mm	Neg 5°	\$135.35
DM3139	303mm	96	3.2mm	2.2mm	0°	\$135.35

Split Scoring Saw Blade, 20mm Bore ATB Grind, 12° Hook



For scoring of plastic laminated board materials in conjunction with panel sizing saw blades TC on table saws.

Tool No.	Dia.	Tooth	Kerf	Plate	Price
SS0820	80mm	2x10	2.8-3.6mm	2.0mm	\$98.08
SS1020	100mm	2x12	2.8-3.6mm	2.0mm	\$93.88
SS1220	120mm	2x12	2.8-3.6mm	2.0mm	\$93.88

Split Scoring Saw Blade, 22mm Bore ATB Grind, 12° Hook



For scoring of plastic laminated board materials in conjunction with panel sizing saw blades TC on table saws.

Tool No.	Dia.	Tooth	Kerf	Plate	Price
SS1022	100mm	2x12	2.8-3.6mm	2.0mm	\$93.88
SS1222	120mm	2x12	2.8-3.6mm	2.0mm	\$93.88
SS1252	125mm	2x12	2.8-3.8mm	2.2mm	\$93.88

Split Scoring Saw Blade, 3/4" Bore ATB Grind, 12° Hook



For scoring of plastic laminated board materials in conjunction with panel sizing saw blades TC on table saws.

Tool No.	Dia.	Tooth	Kerf	Plate	Price
SS1234	120mm	2x12	2.8-3.6mm	2.0mm	\$93.88

Split Scoring Saw Blade, 50mm Bore ATB Grind, 12° Hook



For scoring of plastic laminated board materials in conjunction with panel sizing saw blades TC on table saws.

Tool No.	Dia.	Tooth	Kerf	Plate	Price
SS1250	120mm	2x12	2.8-3.8mm	2.2mm	\$101.47



Mitre Saw Blade, 4ATB+R Grind



For smooth cuts on wood moldings and the least possible grabbing of materials.

Tool No.	Dia.	Tooth	Bore	Kerf	Plate	Price
MR1056	10"	60	5/8"	.110"	.080"	\$84.62
MR1058	10"	80	5/8"	.102"	.072"	\$92.65
MR1068	10"	80	5/8"	.102"	.072"	\$92.65
MR1216	12"	60	1"	.102"	.080"	\$88.58
MR1218	12"	80	1"	.102"	.080"	\$101.53
MR1228	12"	80	1"	.122"	.095"	\$112.95
MR1251	12"	100	5/8"	.128"	.098"	\$121.55
MR1211	12"	100	1"	.128"	.098"	\$121.55
MR1261	12"	100	5/8"	.128"	.098"	\$121.55
MR1451^	14"	100	5/8"	.150"	.120"	\$190.22
MR1511*	15"	100	1"	.120"	.098"	\$182.75

* For Hitachi mitre saw
^ For Pistorius mitre saw

Stackable Dado Set, 5/8" Bore



This dado set consists of a right-hand and left-hand saw blades, one 1/16" square chipper, two 1/8" square chippers, one 1/4" square chipper, and shims that allow fine adjustment.

The complete cutter set is supplied in a plywood box. Clean cutting for cross-cut or ripping.

Tool No.	Dia.	Tooth	Kerf	Range	Price
DS0824	203mm	24	1/8" - 13/16"	\$283.78	
DS1036	250mm	36	1/8" - 13/16"	\$357.32	

Conical Scoring Saw Blade With Holzma Panel Saw 45mm Bore, ATB Grind



For scoring of double sided laminated boards with Holzma panel saw.

Tool No.	Dia.	Tooth	Kerf	Plate	Price
CN3367	180mm	36	4.8/5.8mm	3.6mm	\$161.32
CN3462	200mm	36	4.8/5.8mm	3.6mm	\$178.10
CN3466	200mm	34	5.8/6.8mm	4.2mm	\$245.77

Conical Scoring Saw Blade With Selco Machine 65mm Bore, ATB Grind Pin Holes - 2/9/110mm



For scoring of double sided laminated boards with Selco panel saw.

Tool No.	Dia.	Tooth	Kerf	Plate	Price
CN6407	200mm	34	4.4/5.4mm	3.2mm	\$182.50
CN6447	200mm	34	4.8/5.8mm	3.6mm	\$192.98

Conical Scoring Saw Blade With SCMI Panel Saw 1-1/4" Bore, ATB Grind



For scoring of double sided laminated boards with SCMI panel saw.

Tool No.	Dia.	Tooth	Kerf	Plate	Price
CN5337	150mm	24	4.4/5.4mm	3.0mm	\$104.90

Hollow Face Saw Blade, V-Hollow Grind 30mm Bore, 12° Hook



For perfect cutting quality in melamine-faced board materials on both sides up to 30 mm cutting height. For use on table saws and vertical panel sizing saws.

Tool No.	Dia.	Tooth	Kerf	Plate	Price
H2234^	220mm	40	3.2mm	2.2mm	\$87.75
H2534*	250mm	48	3.2mm	2.2mm	\$97.87
H3036*	303mm	60	3.2mm	2.2mm	\$120.17

* 2 combi pin holes 2/7/42mm - 2/9/46mm - 2/10/60mm

^ 2 pin holes 7/42mm



**Conical Scoring Saw Blade
With SCM SIGMA, GABBIANI Panel Saw
55mm Bore, ATB Grind
Pin Holes - 3/7/66mm**



For scoring of double sided laminated boards with SCM SIGMA, GABBIANI panel saw.

Tool No.	Dia.	Tooth	Kerf	Plate	Price
CN5387	160mm	36	4.4/5.4mm	3.2mm	\$153.22

**Conical Scoring Saw Blade
With Schelling Panel Saw
20mm Bore, ATB Grind**



For scoring of double sided laminated boards with Schelling panel saw

Tool No.	Dia.	Tooth	Kerf	Plate	Price
CN4337	200mm	34	4.4/5.4mm	3.0mm	\$163.98

**Conical Scoring Saw Blade
For Giben Panel Saw
45mm Bore, ATB Grind**



For scoring of double sided laminated boards with Giben panel saw.

Tool No.	Dia.	Tooth	Kerf	Plate	Price
CN2377	125mm	24	4.4/5.4mm	3.2mm	\$98.78
CN2479*	160mm	28	4.4/5.2mm	3.2mm	\$131.18

* Pin Holes-3/11/70

**Panel Saw Blade
With Holzma Panel Saw
60mm Bore, TC Grind**



For sizing of laminated board materials on either side.

Tool No.	Dia.	Tooth	Kerf	Plate	Price
PS3546*	350mm	72	4.4mm	3.2mm	\$203.65
PS3846*	380mm	72	4.8mm	3.4mm	\$209.37
PS4266^	420mm	72	4.8mm	3.6mm	\$251.15
PS4566^	450mm	72	4.8mm	3.6mm	\$251.15
PS5066#	500mm	72	4.8mm	3.6mm	\$326.63

* Pin Holes - 2/14/100mm
^ Pin Holes - 2/14/125mm
Pin Holes - 2/11/115mm

**Panel Saw Blade
With Selco Panel Saw
80mm Bore, TC Grind
Pin Holes - 2/8.4/130mm, 4/19/120mm**



For sizing of laminated board materials on either side.

Tool No.	Dia.	Tooth	Kerf	Plate	Price
PS4528	450mm	72	4.4mm	3.2mm	\$233.02
PS4568	450mm	72	4.8mm	3.6mm	\$258.65

**Panel Saw Blade
With SCMI Panel Saw
1-1/4" Bore, TC Grind
Pin Holes - 4/9/100mm**



For sizing of laminated board materials on either side.

Tool No.	Dia.	Tooth	Kerf	Plate	Price
PS3501	350mm	72	4.4mm	3.0mm	\$202.85

**Panel Saw Blade
With SCM SIGMA, GABBIANI Panel Saw
72 Tooth, TC Grind**



For sizing of laminated board materials on either side.

Pin Holes :

PS3008: 2/14/100-2/7/110-4/9/100;
PS3508: 2/7/110-4/9/100-2/14/110;
PS4026: 2/14/100;
PS4028: 4/9/100-2/14/110;

Tool No.	Dia.	Bore	Kerf	Plate	Price
PS3008	300mm	80mm	4.4mm	3.0mm	\$194.65
PS3506	350mm	60mm	4.4mm	3.0mm	\$203.67
PS3508	350mm	80mm	4.4mm	3.0mm	\$203.65
PS4028	400mm	80mm	4.4mm	3.2mm	\$223.95



Panel Saw Blade With Schelling Panel Saw 30mm Bore, TC Grind



For sizing of laminated board materials on either side.

Tool No.	Dia.	Tooth	Kerf	Plate	Price
PS3523	350mm	72	4.4mm	3.0mm	\$177.23
PS3723	370mm	72	4.4mm	3.2mm	\$192.80
PS4023	400mm	72	4.4mm	3.2mm	\$203.55

Panel Saw Blade With Giben Panel Saw 75mm Bore, TC Grind



For sizing of laminated board materials on either side.

Tool No.	Dia.	Tooth	Kerf	Plate	Price
PS3507	355mm	72	4.4mm	3.0mm	\$202.03
PS4027	400mm	72	4.4mm	3.2mm	\$203.55

Steel Cutting Saw Blade, 1" Bore ATB + EXTRA 30° Bevel Grind

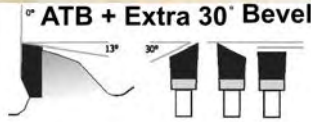

For dry cutting of mild steel type S237, metal-clad work pieces i.e. sandwich panels, Angle irons, pipes, cable ducts, sheet metal, brass, copper.

Tool No.	Dia.	Tooth	Hook	Kerf	Plate	Price
SL2024	205mm	40	0°	2.2mm	1.8mm	\$77.55
SL2524	255mm	48	0°	2.4mm	2.0mm	\$98.25
SL3026	305mm	60	0°	2.4mm	2.0mm	\$123.35
SL3028	305mm	84	0°	2.4mm	2.0mm	\$156.68
SL3528	355mm	84	0°	2.6mm	2.2mm	\$165.65
SL3521	355mm	102	0°	2.6mm	2.2mm	\$201.22

Non-Ferrous Metal Cutting Saw Blade 5/8" Bore



For profiles and sheets of aluminum and plastics on chop-mitre saws and special machines. The negative tooth shape prevents filling up of the gullet. Use coolant or lubricant and clamp the material firmly.

Tool No.	Dia.	Tooth	Hook	Kerf	Plate	Price
NF0756	7-1/4"	60	Neg 5°	.112".087"		\$81.60
NF1056	10"	60	Neg 5°	.126".102"		\$91.60
NF1058	10"	80	Neg 5°	.126".102"		\$104.58
NF1051	10"	100	Neg 5°	.126".102"		\$122.15
NF1251	12"	100	Neg 5°	.128".102"		\$138.45
NF1451*	14"	100	Neg 5°	.150".126"		\$190.23

* For Pistorius mitre saw

Non-Ferrous Metal Cutting Saw Blade 1" Bore



For profiles and sheets of aluminum and plastics on chop-mitre saws and special machines. The negative tooth shape prevents filling up of the gullet. Use coolant or lubricant and clamp the material firmly.

Tool No.	Dia.	Tooth	Hook	Kerf	Plate	Price
NF1217	12"	72	Neg 5°	.128".102"		\$111.20
NF1218	12"	80	Neg 5°	.128".102"		\$119.27
NF1211	12"	100	Neg 5°	.128".102"		\$138.45
NF1411	14"	108	Neg 5°	.138".110"		\$153.93
NF1511^	15"	100	Neg 2°	.120".098"		\$187.93
NF1611	16"	100	Neg 2°	.150".126"		\$215.13
NF1811	18"	100	Neg 2°	.165".134"		\$269.28
NF2011	20"	100	0°	.174".134"		\$308.10
NF2012	20"	120	0°	.174".134"		\$343.63
NF2014	20"	140	0°	.174".134"		\$383.60

* For Hitachi mitre saw

Nail Saw Blade, TC/TC Grind, Neg 5° Hook



For all materials used on building sites, such as wood with nails, clips, concrete residues, tubes and familiar wood inclusions.

Tool No.	Dia.	Tooth	Bore	Kerf	Plate	Price
NL1052	10"	20	5/8"	.126".087"		\$45.33
NL1212	12"	24	1"	.126".087"		\$55.28
NL1412	14"	28	1"	.137".098"		\$71.08
NL1813	18"	36	1"	.165".110"		\$147.93



Arbor for Plastic Cutting Saw Blades



This arbor is specifically designed to work with plastic cutting saw blades that come with 5/8" bore and compatible with Magnate tool numbers: P1531, P1532, P1533, P1534.

Tool No.	Shank Dia.	Overall Length	Price
P1521	1/2"	3-1/4"	\$81.73
P1522	1/2"	4-1/2"	\$87.57
P1523	5/8"	3-1/4"	\$81.73

Plastic Cutting Saw Blade, 16-Wing 5/8" Bore, 0° Hook, TC Grind



It works with Magnate arbors specially designed for plastic saw blade, Tool Numbers of these arbors : P1521, P1522, P1523, P1524. Suggested feed speed at 125 to 175 ipm. (inch per minute)

Tool No.	Dia.	RPM	Kerf	Price
P1531	2"	18,000	.095"	\$106.12
P1532	2-1/2"	16,000	.095"	\$106.12
P1533	3"	14,000	.095"	\$102.03
P1534	3-1/2"	12,000	.095"	\$102.03

Saw Blades for Hobbyist For Portable Machines Carbide Tipped, ATB Grind



Tool No.	Dia.	Tooth	Bore	Price
HB0752	7-1/4"	20	5/8"	\$11.53
HB0754	7-1/4"	40	5/8"	\$19.12
HB0756	7-1/4"	60	5/8"	\$29.80
HB0852	8-1/4"	20	5/8"	\$13.82
HB0856	8-1/4"	60	5/8"	\$34.82
HB1052	10"	24	5/8"	\$21.80
HB1056	10"	60	5/8"	\$33.33
HB1216*	12"	60	1"	\$43.33

* Negative Grind, Standard Cut-Off Blade

Saw Blades for Hobbyist For Portable Machines Carbide Tipped, TC Grind



Tool No.	Dia.	Tooth	Bore	Price
HC0751^	7-1/4"	18	5/8"	\$17.70
HC0854*	8-1/4"	48	5/8"	\$28.67
HC0856*	8-1/4"	60	5/8"	\$34.82
HC1056*	10"	60	5/8"	\$34.88
HC1058*	10"	80	5/8"	\$40.12

* Negative Grind, Non-Ferrous Metal Cutting
^ Demolition





200mm Diameter, 32mm Bore For Cutting Non-Ferrous Metal Pipes/Tubes				200mm Diameter, 32mm Bore For Cutting Ferrous Metal, Mild Steel Solids/Bars/Rebars				225mm Diameter, 32mm Bore For Cutting Non-Ferrous Metal Pipes/Tubes			
Tool No.	Tooth Pattern	Thickness	Price	Tool No.	Tooth Pattern	Thickness	Price	Tool No.	Tooth Pattern	Thickness	Price
HA082032T060ATB	60-BW	2.0mm	\$71.77	HC082032T060TC	60C	2.0mm	\$71.77	HA092032T060ATB	60-BW	2.0mm	\$78.39
HA082032T070ATB	70-BW	2.0mm	\$71.77	HC082032T070TC	70-C	2.0mm	\$71.77	HA092032T070ATB	70-BW	2.0mm	\$78.39
HA082032T080ATB	80-BW	2.0mm	\$71.77	HC082032T080TC	80-C	2.0mm	\$71.77	HA092032T080ATB	80-BW	2.0mm	\$78.39
HA082032T090ATB	90-BW	2.0mm	\$71.77	HC082032T090TC	90-C	2.0mm	\$71.77	HA092032T090ATB	90-BW	2.0mm	\$78.39
HA082032T100ATB	100-BW	2.0mm	\$71.77	HC082032T100TC	100-C	2.0mm	\$71.77	HA092032T100ATB	100-BW	2.0mm	\$78.39
HA082032T120ATB	120-BW	2.0mm	\$71.77	HC082032T120TC	120-C	2.0mm	\$71.77	HA092032T120ATB	120-BW	2.0mm	\$78.39
HA082032T140ATB	140-BW	2.0mm	\$71.77	HC082032T140TC	140-C	2.0mm	\$71.77	HA092032T140ATB	140-BW	2.0mm	\$78.39
HA082032T160ATB	160-BW	2.0mm	\$71.77	HC082032T160TC	160-C	2.0mm	\$71.77	HA092032T160ATB	160-BW	2.0mm	\$78.39
HA082032T180ATB	180-BW	2.0mm	\$71.77	HC082032T180TC	180-C	2.0mm	\$71.77	HA092032T180ATB	180-BW	2.0mm	\$78.39
200mm Diameter, 32mm Bore For Cutting Non-Ferrous Metal Solids/Bars/Rebars				200mm Diameter, 32mm Bore For Cutting Stainless Steel Pipes/Tubes				225mm Diameter, 32mm Bore For Cutting Non-Ferrous Metal Solids/Bars/Rebars			
Tool No.	Tooth Pattern	Thickness	Price	Tool No.	Tooth Pattern	Thickness	Price	Tool No.	Tooth Pattern	Thickness	Price
HA082032T060TC	60C	2.0mm	\$71.77	HE082032T060ATB	60-BW	2.0mm	\$71.77	HA092032T060TC	60C	2.0mm	\$78.39
HA082032T070TC	70-C	2.0mm	\$71.77	HE082032T070ATB	70-BW	2.0mm	\$71.77	HA092032T070TC	70-C	2.0mm	\$78.39
HA082032T080TC	80-C	2.0mm	\$71.77	HE082032T080ATB	80-BW	2.0mm	\$71.77	HA092032T080TC	80-C	2.0mm	\$78.39
HA082032T090TC	90-C	2.0mm	\$71.77	HE082032T090ATB	90-BW	2.0mm	\$71.77	HA092032T090TC	90-C	2.0mm	\$78.39
HA082032T100TC	100-C	2.0mm	\$71.77	HE082032T100ATB	100-BW	2.0mm	\$71.77	HA092032T100TC	100-C	2.0mm	\$78.39
HA082032T120TC	120-C	2.0mm	\$71.77	HE082032T120ATB	120-BW	2.0mm	\$71.77	HA092032T120TC	120-C	2.0mm	\$78.39
HA082032T140TC	140-C	2.0mm	\$71.77	HE082032T140ATB	140-BW	2.0mm	\$71.77	HA092032T140TC	140-C	2.0mm	\$78.39
HA082032T160TC	160-C	2.0mm	\$71.77	HE082032T160ATB	160-BW	2.0mm	\$71.77	HA092032T160TC	160-C	2.0mm	\$78.39
HA082032T180TC	180-C	2.0mm	\$71.77	HE082032T180ATB	180-BW	2.0mm	\$71.77	HA092032T180TC	180-C	2.0mm	\$78.39
200mm Diameter, 32mm Bore For Cutting Ferrous Metal, Mild Steel Pipes/Tubes				200mm Diameter, 32mm Bore For Cutting Stainless Steel Solids/Bars/Rebars				225mm Diameter, 32mm Bore For Cutting Ferrous Metal, Mild Steel Pipes/Tubes			
Tool No.	Tooth Pattern	Thickness	Price	Tool No.	Tooth Pattern	Thickness	Price	Tool No.	Tooth Pattern	Thickness	Price
HC082032T060ATB	60-BW	2.0mm	\$71.77	HE082032T060TC	60C	2.0mm	\$71.77	HC092032T060ATB	60-BW	2.0mm	\$78.39
HC082032T070ATB	70-BW	2.0mm	\$71.77	HE082032T070TC	70-C	2.0mm	\$71.77	HC092032T070ATB	70-BW	2.0mm	\$78.39
HC082032T080ATB	80-BW	2.0mm	\$71.77	HE082032T080TC	80-C	2.0mm	\$71.77	HC092032T080ATB	80-BW	2.0mm	\$78.39
HC082032T090ATB	90-BW	2.0mm	\$71.77	HE082032T090TC	90-C	2.0mm	\$71.77	HC092032T090ATB	90-BW	2.0mm	\$78.39
HC082032T100ATB	100-BW	2.0mm	\$71.77	HE082032T100TC	100-C	2.0mm	\$71.77	HC092032T100ATB	100-BW	2.0mm	\$78.39
HC082032T120ATB	120-BW	2.0mm	\$71.77	HE082032T120TC	120-C	2.0mm	\$71.77	HC092032T120ATB	120-BW	2.0mm	\$78.39
HC082032T140ATB	140-BW	2.0mm	\$71.77	HE082032T140TC	140-C	2.0mm	\$71.77	HC092032T140ATB	140-BW	2.0mm	\$78.39
HC082032T160ATB	160-BW	2.0mm	\$71.77	HE082032T160TC	160-C	2.0mm	\$71.77	HC092032T160ATB	160-BW	2.0mm	\$78.39
HC082032T180ATB	180-BW	2.0mm	\$71.77	HE082032T180TC	180-C	2.0mm	\$71.77	HC092032T180ATB	180-BW	2.0mm	\$78.39





225mm Diameter, 32mm Bore For Cutting Ferrous Metal, Mild Steel Solids/Bars/Rebars				225mm Diameter, 40mm Bore For Cutting Non-Ferrous Metal Pipes/Tubes				225mm Diameter, 40mm Bore For Cutting Ferrous Metal, Mild Steel Solids/Bars/Rebars			
Tool No.	Tooth Pattern	Thickness	Price	Tool No.	Tooth Pattern	Thickness	Price	Tool No.	Tooth Pattern	Thickness	Price
HC092032T060TC	60C	2.0mm	\$78.39	HA091640T060ATB	60-BW	1.6mm	\$74.28	HC091640T060TC	60C	1.6mm	\$74.28
HC092032T070TC	70-C	2.0mm	\$78.39	HA091640T070ATB	70-BW	1.6mm	\$74.28	HC091640T070TC	70-C	1.6mm	\$74.28
HC092032T080TC	80-C	2.0mm	\$78.39	HA091640T080ATB	80-BW	1.6mm	\$74.28	HC091640T080TC	80-C	1.6mm	\$74.28
HC092032T090TC	90-C	2.0mm	\$78.39	HA091640T090ATB	90-BW	1.6mm	\$74.28	HC091640T090TC	90-C	1.6mm	\$74.28
HC092032T100TC	100-C	2.0mm	\$78.39	HA091640T100ATB	100-BW	1.6mm	\$74.28	HC091640T100TC	100-C	1.6mm	\$74.28
HC092032T120TC	120-C	2.0mm	\$78.39	HA091640T120ATB	120-BW	1.6mm	\$74.28	HC091640T120TC	120-C	1.6mm	\$74.28
HC092032T140TC	140-C	2.0mm	\$78.39	HA091640T140ATB	140-BW	1.6mm	\$74.28	HC091640T140TC	140-C	1.6mm	\$74.28
HC092032T160TC	160-C	2.0mm	\$78.39	HA091640T160ATB	160-BW	1.6mm	\$74.28	HC091640T160TC	160-C	1.6mm	\$74.28
HC092032T180TC	180-C	2.0mm	\$78.39	HA091640T180ATB	180-BW	1.6mm	\$74.28	HC091640T180TC	180-C	1.6mm	\$74.28

225mm Diameter, 32mm Bore For Cutting Stainless Steel Pipes/Tubes				225mm Diameter, 40mm Bore For Cutting Non-Ferrous Metal Solids/Bars/Rebars				225mm Diameter, 40mm Bore For Cutting Stainless Steel Pipes/Tubes			
Tool No.	Tooth Pattern	Thickness	Price	Tool No.	Tooth Pattern	Thickness	Price	Tool No.	Tooth Pattern	Thickness	Price
HE092032T060ATB	60-BW	2.0mm	\$78.39	HA091640T060TC	60C	1.6mm	\$74.28	HE091640T060ATB	60-BW	1.6mm	\$74.28
HE092032T070ATB	70-BW	2.0mm	\$78.39	HA091640T070TC	70-C	1.6mm	\$74.28	HE091640T070ATB	70-BW	1.6mm	\$74.28
HE092032T080ATB	80-BW	2.0mm	\$78.39	HA091640T080TC	80-C	1.6mm	\$74.28	HE091640T080ATB	80-BW	1.6mm	\$74.28
HE092032T090ATB	90-BW	2.0mm	\$78.39	HA091640T090TC	90-C	1.6mm	\$74.28	HE091640T090ATB	90-BW	1.6mm	\$74.28
HE092032T100ATB	100-BW	2.0mm	\$78.39	HA091640T100TC	100-C	1.6mm	\$74.28	HE091640T100ATB	100-BW	1.6mm	\$74.28
HE092032T120ATB	120-BW	2.0mm	\$78.39	HA091640T120TC	120-C	1.6mm	\$74.28	HE091640T120ATB	120-BW	1.6mm	\$74.28
HE092032T140ATB	140-BW	2.0mm	\$78.39	HA091640T140TC	140-C	1.6mm	\$74.28	HE091640T140ATB	140-BW	1.6mm	\$74.28
HE092032T160ATB	160-BW	2.0mm	\$78.39	HA091640T160TC	160-C	1.6mm	\$74.28	HE091640T160ATB	160-BW	1.6mm	\$74.28
HE092032T180ATB	180-BW	2.0mm	\$78.39	HA091640T180TC	180-C	1.6mm	\$74.28	HE091640T180ATB	180-BW	1.6mm	\$74.28

225mm Diameter, 32mm Bore For Cutting Stainless Steel Solids/Bars/Rebars				225mm Diameter, 40mm Bore For Cutting Ferrous Metal, Mild Steel Pipes/Tubes				225mm Diameter, 40mm Bore For Cutting Stainless Steel Solids/Bars/Rebars			
Tool No.	Tooth Pattern	Thickness	Price	Tool No.	Tooth Pattern	Thickness	Price	Tool No.	Tooth Pattern	Thickness	Price
HE092032T060TC	60C	2.0mm	\$78.39	HC091640T060ATB	60-BW	1.6mm	\$74.28	HE091640T060TC	60C	1.6mm	\$74.28
HE092032T070TC	70-C	2.0mm	\$78.39	HC091640T070ATB	70-BW	1.6mm	\$74.28	HE091640T070TC	70-C	1.6mm	\$74.28
HE092032T080TC	80-C	2.0mm	\$78.39	HC091640T080ATB	80-BW	1.6mm	\$74.28	HE091640T080TC	80-C	1.6mm	\$74.28
HE092032T090TC	90-C	2.0mm	\$78.39	HC091640T090ATB	90-BW	1.6mm	\$74.28	HE091640T090TC	90-C	1.6mm	\$74.28
HE092032T100TC	100-C	2.0mm	\$78.39	HC091640T100ATB	100-BW	1.6mm	\$74.28	HE091640T100TC	100-C	1.6mm	\$74.28
HE092032T120TC	120-C	2.0mm	\$78.39	HC091640T120ATB	120-BW	1.6mm	\$74.28	HE091640T120TC	120-C	1.6mm	\$74.28
HE092032T140TC	140-C	2.0mm	\$78.39	HC091640T140ATB	140-BW	1.6mm	\$74.28	HE091640T140TC	140-C	1.6mm	\$74.28
HE092032T160TC	160-C	2.0mm	\$78.39	HC091640T160ATB	160-BW	1.6mm	\$74.28	HE091640T160TC	160-C	1.6mm	\$74.28
HE092032T180TC	180-C	2.0mm	\$78.39	HC091640T180ATB	180-BW	1.6mm	\$74.28	HE091640T180TC	180-C	1.6mm	\$74.28





250mm Diameter, 32mm Bore For Cutting Non-Ferrous Metal Pipes/Tubes				250mm Diameter, 32mm Bore For Cutting Ferrous Metal, Mild Steel Pipes/Tubes				250mm Diameter, 32mm Bore For Cutting Stainless Steel Pipes/Tubes			
Tool No.	Tooth Pattern	Thickness	Price	Tool No.	Tooth Pattern	Thickness	Price	Tool No.	Tooth Pattern	Thickness	Price
HA102032T060ATB	60-BW	2.0mm	\$83.98	HC102032T060ATB	60-BW	2.0mm	\$83.98	HE102032T060ATB	60-BW	2.0mm	\$83.98
HA102532T060ATB	60-BW	2.5mm	\$90.59	HC102532T060ATB	60-BW	2.5mm	\$90.59	HE102532T060ATB	60-BW	2.5mm	\$90.59
HA102032T070ATB	70-BW	2.0mm	\$83.98	HC102532T070ATB	70-BW	2.0mm	\$83.98	HE102032T070ATB	70-BW	2.0mm	\$83.98
HA102532T070ATB	70-BW	2.5mm	\$90.59	HC102032T070ATB	70-BW	2.5mm	\$90.59	HE102532T070ATB	70-BW	2.5mm	\$90.59
HA102032T080ATB	80-BW	2.0mm	\$83.98	HC102532T080ATB	80-BW	2.0mm	\$83.98	HE102032T080ATB	80-BW	2.0mm	\$83.98
HA102532T080ATB	80-BW	2.5mm	\$90.59	HC102032T080ATB	80-BW	2.5mm	\$90.59	HE102532T080ATB	80-BW	2.5mm	\$90.59
HA102032T090ATB	90-BW	2.0mm	\$83.98	HC102532T090ATB	90-BW	2.0mm	\$83.98	HE102032T090ATB	90-BW	2.0mm	\$83.98
HA102532T090ATB	90-BW	2.5mm	\$90.59	HC102032T090ATB	90-BW	2.5mm	\$90.59	HE102532T090ATB	90-BW	2.5mm	\$90.59
HA102032T100ATB	100-BW	2.0mm	\$83.98	HC102532T100ATB	100-BW	2.0mm	\$83.98	HE102032T100ATB	100-BW	2.0mm	\$83.98
HA102532T100ATB	100-BW	2.5mm	\$90.59	HC102032T100ATB	100-BW	2.5mm	\$90.59	HE102532T100ATB	100-BW	2.5mm	\$90.59
HA102032T120ATB	120-BW	2.0mm	\$83.98	HC102532T120ATB	120-BW	2.0mm	\$83.98	HE102032T120ATB	120-BW	2.0mm	\$83.98
HA102532T120ATB	120-BW	2.5mm	\$90.59	HC102032T120ATB	120-BW	2.5mm	\$90.59	HE102532T120ATB	120-BW	2.5mm	\$90.59
HA102032T140ATB	140-BW	2.0mm	\$83.98	HC102532T140ATB	140-BW	2.0mm	\$83.98	HE102032T140ATB	140-BW	2.0mm	\$83.98
HA102532T140ATB	140-BW	2.5mm	\$90.59	HC102032T140ATB	140-BW	2.5mm	\$90.59	HE102532T140ATB	140-BW	2.5mm	\$90.59
HA102032T160ATB	160-BW	2.0mm	\$83.98	HC102532T160ATB	160-BW	2.0mm	\$83.98	HE102032T160ATB	160-BW	2.0mm	\$83.98
HA102532T160ATB	160-BW	2.5mm	\$90.59	HC102032T160ATB	160-BW	2.5mm	\$90.59	HE102532T160ATB	160-BW	2.5mm	\$90.59
HA102032T180ATB	180-BW	2.0mm	\$83.98	HC102532T180ATB	180-BW	2.0mm	\$83.98	HE102032T180ATB	180-BW	2.0mm	\$83.98
HA102532T180ATB	180-BW	2.5mm	\$90.59	HC102032T180ATB	180-BW	2.5mm	\$90.59	HE102532T180ATB	180-BW	2.5mm	\$90.59
				HC102532T180ATB	180-BW	2.5mm	\$90.59				
250mm Diameter, 32mm Bore For Cutting Non-Ferrous Metal Solids/Bars/Rebars				250mm Diameter, 32mm Bore For Cutting Ferrous Metal, Mild Steel Solids/Bars/Rebars				250mm Diameter, 32mm Bore For Cutting Stainless Steel Solids/Bars/Rebars			
Tool No.	Tooth Pattern	Thickness	Price	Tool No.	Tooth Pattern	Thickness	Price	Tool No.	Tooth Pattern	Thickness	Price
HA102032T060TC	60C	2.0mm	\$83.98	HC102032T060TC	60C	2.0mm	\$83.98	HE102032T060TC	60C	2.0mm	\$83.98
HA102532T060TC	60C	2.5mm	\$90.59	HC102532T060TC	60C	2.5mm	\$90.59	HE102532T060TC	60C	2.5mm	\$90.59
HA102032T070TC	70-C	2.0mm	\$83.98	HC102532T070TC	70-C	2.0mm	\$83.98	HE102032T070TC	70-C	2.0mm	\$83.98
HA102532T070TC	70-C	2.5mm	\$90.59	HC102032T070TC	70-C	2.5mm	\$90.59	HE102532T070TC	70-C	2.5mm	\$90.59
HA102032T080TC	80-C	2.0mm	\$83.98	HC102532T080TC	80-C	2.0mm	\$83.98	HE102032T080TC	80-C	2.0mm	\$83.98
HA102532T080TC	80-C	2.5mm	\$90.59	HC102032T080TC	80-C	2.5mm	\$90.59	HE102532T080TC	80-C	2.5mm	\$90.59
HA102032T090TC	90-C	2.0mm	\$83.98	HC102532T090TC	90-C	2.0mm	\$83.98	HE102032T090TC	90-C	2.0mm	\$83.98
HA102532T090TC	90-C	2.5mm	\$90.59	HC102032T090TC	90-C	2.5mm	\$90.59	HE102532T090TC	90-C	2.5mm	\$90.59
HA102032T100TC	100-C	2.0mm	\$83.98	HC102532T100TC	100-C	2.0mm	\$83.98	HE102032T100TC	100-C	2.0mm	\$83.98
HA102532T100TC	100-C	2.5mm	\$90.59	HC102032T100TC	100-C	2.5mm	\$90.59	HE102532T100TC	100-C	2.5mm	\$90.59
HA102032T120TC	120-C	2.0mm	\$83.98	HC102532T120TC	120-C	2.0mm	\$83.98	HE102032T120TC	120-C	2.0mm	\$83.98
HA102532T120TC	120-C	2.5mm	\$90.59	HC102032T120TC	120-C	2.5mm	\$90.59	HE102532T120TC	120-C	2.5mm	\$90.59
HA102032T140TC	140-C	2.0mm	\$83.98	HC102532T140TC	140-C	2.0mm	\$83.98	HE102032T140TC	140-C	2.0mm	\$83.98
HA102532T140TC	140-C	2.5mm	\$90.59	HC102032T140TC	140-C	2.5mm	\$90.59	HE102532T140TC	140-C	2.5mm	\$90.59
HA102032T160TC	160-C	2.0mm	\$83.98	HC102532T160TC	160-C	2.0mm	\$83.98	HE102032T160TC	160-C	2.0mm	\$83.98
HA102532T160TC	160-C	2.5mm	\$90.59	HC102032T160TC	160-C	2.5mm	\$90.59	HE102532T160TC	160-C	2.5mm	\$90.59
HA102032T180TC	180-C	2.0mm	\$83.98	HC102532T180TC	180-C	2.0mm	\$83.98	HE102032T180TC	180-C	2.0mm	\$83.98
HA102532T180TC	180-C	2.5mm	\$90.59	HC102032T180TC	180-C	2.5mm	\$90.59	HE102532T180TC	180-C	2.5mm	\$90.59
				HC102532T180TC	180-C	2.5mm	\$90.59				





250mm Diameter, 40mm Bore For Cutting Non-Ferrous Metal Pipes/Tubes				250mm Diameter, 40mm Bore For Cutting Ferrous Metal, Mild Steel Pipes/Tubes				250mm Diameter, 40mm Bore For Cutting Stainless Steel Pipes/Tubes			
Tool No.	Tooth Pattern	Thickness	Price	Tool No.	Tooth Pattern	Thickness	Price	Tool No.	Tooth Pattern	Thickness	Price
HA102040T060ATB	60-BW	2.0mm	\$83.98	HC102040T060ATB	60-BW	2.0mm	\$83.98	HE102040T060ATB	60-BW	2.0mm	\$83.98
HA102540T060ATB	60-BW	2.5mm	\$90.59	HC102540T060ATB	60-BW	2.5mm	\$90.59	HE102540T060ATB	60-BW	2.5mm	\$90.59
HA102040T070ATB	70-BW	2.0mm	\$83.98	HC102040T070ATB	70-BW	2.0mm	\$83.98	HE102040T070ATB	70-BW	2.0mm	\$83.98
HA102540T070ATB	70-BW	2.5mm	\$90.59	HC102040T070ATB	70-BW	2.5mm	\$90.59	HE102540T070ATB	70-BW	2.5mm	\$90.59
HA102040T080ATB	80-BW	2.0mm	\$83.98	HC102540T070ATB	70-BW	2.5mm	\$90.59	HE102040T080ATB	80-BW	2.0mm	\$83.98
HA102540T080ATB	80-BW	2.5mm	\$90.59	HC102040T080ATB	80-BW	2.0mm	\$83.98	HE102540T080ATB	80-BW	2.5mm	\$90.59
HA102040T090ATB	90-BW	2.0mm	\$83.98	HC102540T080ATB	80-BW	2.5mm	\$90.59	HE102040T090ATB	90-BW	2.0mm	\$83.98
HA102540T090ATB	90-BW	2.5mm	\$90.59	HC102040T090ATB	90-BW	2.0mm	\$83.98	HE102540T090ATB	90-BW	2.5mm	\$90.59
HA102040T100ATB	100-BW	2.0mm	\$83.98	HC102540T090ATB	90-BW	2.5mm	\$90.59	HE102040T100ATB	100-BW	2.0mm	\$83.98
HA102540T100ATB	100-BW	2.5mm	\$90.59	HC102040T100ATB	100-BW	2.0mm	\$83.98	HE102540T100ATB	100-BW	2.5mm	\$90.59
HA102040T120ATB	120-BW	2.0mm	\$83.98	HC102540T100ATB	100-BW	2.5mm	\$90.59	HE102040T120ATB	120-BW	2.0mm	\$83.98
HA102540T120ATB	120-BW	2.5mm	\$90.59	HC102040T120ATB	120-BW	2.0mm	\$83.98	HE102540T120ATB	120-BW	2.5mm	\$90.59
HA102040T140ATB	140-BW	2.0mm	\$83.98	HC102540T120ATB	120-BW	2.5mm	\$90.59	HE102040T140ATB	140-BW	2.0mm	\$83.98
HA102540T140ATB	140-BW	2.5mm	\$90.59	HC102040T140ATB	140-BW	2.0mm	\$83.98	HE102540T140ATB	140-BW	2.5mm	\$90.59
HA102040T160ATB	160-BW	2.0mm	\$83.98	HC102540T140ATB	140-BW	2.5mm	\$90.59	HE102040T160ATB	160-BW	2.0mm	\$83.98
HA102540T160ATB	160-BW	2.5mm	\$90.59	HC102040T160ATB	160-BW	2.0mm	\$83.98	HE102540T160ATB	160-BW	2.5mm	\$90.59
HA102040T180ATB	180-BW	2.0mm	\$83.98	HC102540T160ATB	160-BW	2.5mm	\$90.59	HE102040T180ATB	180-BW	2.0mm	\$83.98
HA102540T180ATB	180-BW	2.5mm	\$90.59	HC102040T180ATB	180-BW	2.0mm	\$83.98	HE102540T180ATB	180-BW	2.5mm	\$90.59
				HC102540T180ATB	180-BW	2.5mm	\$90.59				

250mm Diameter, 40mm Bore For Cutting Non-Ferrous Metal Solids/Bars/Rebars				250mm Diameter, 40mm Bore For Cutting Ferrous Metal, Mild Steel Solids/Bars/Rebars				250mm Diameter, 40mm Bore For Cutting Stainless Steel Solids/Bars/Rebars			
Tool No.	Tooth Pattern	Bore	Price	Tool No.	Tooth Pattern	Thickness	Price	Tool No.	Tooth Pattern	Thickness	Price
HA102040T060TC	60C	40mm	\$83.98	HC102040T060TC	60C	2.0mm	\$83.98	HE102040T060TC	60C	2.0mm	\$83.98
HA102540T060TC	60C	40mm	\$90.59	HC102540T060TC	60C	2.5mm	\$90.59	HE102540T060TC	60C	2.5mm	\$90.59
HA102040T070TC	70-C	40mm	\$83.98	HC102040T070TC	70-C	2.0mm	\$83.98	HE102040T070TC	70-C	2.0mm	\$83.98
HA102540T070TC	70-C	40mm	\$90.59	HC102540T070TC	70-C	2.5mm	\$90.59	HE102540T070TC	70-C	2.5mm	\$90.59
HA102040T080TC	80-C	40mm	\$83.98	HC102040T080TC	80-C	2.0mm	\$83.98	HE102040T080TC	80-C	2.0mm	\$83.98
HA102540T080TC	80-C	40mm	\$90.59	HC102540T080TC	80-C	2.5mm	\$90.59	HE102540T080TC	80-C	2.5mm	\$90.59
HA102040T090TC	90-C	40mm	\$83.98	HC102040T090TC	90-C	2.0mm	\$83.98	HE102040T090TC	90-C	2.0mm	\$83.98
HA102540T090TC	90-C	40mm	\$90.59	HC102540T090TC	90-C	2.5mm	\$90.59	HE102540T090TC	90-C	2.5mm	\$90.59
HA102040T100TC	100-C	40mm	\$83.98	HC102040T100TC	100-C	2.0mm	\$83.98	HE102040T100TC	100-C	2.0mm	\$83.98
HA102540T100TC	100-C	40mm	\$90.59	HC102540T100TC	100-C	2.5mm	\$90.59	HE102540T100TC	100-C	2.5mm	\$90.59
HA102040T120TC	120-C	40mm	\$83.98	HC102040T120TC	120-C	2.0mm	\$83.98	HE102040T120TC	120-C	2.0mm	\$83.98
HA102540T120TC	120-C	40mm	\$90.59	HC102540T120TC	120-C	2.5mm	\$90.59	HE102540T120TC	120-C	2.5mm	\$90.59
HA102040T140TC	140-C	40mm	\$83.98	HC102040T140TC	140-C	2.0mm	\$83.98	HE102040T140TC	140-C	2.0mm	\$83.98
HA102540T140TC	140-C	40mm	\$90.59	HC102540T140TC	140-C	2.5mm	\$90.59	HE102540T140TC	140-C	2.5mm	\$90.59
HA102040T160TC	160-C	40mm	\$83.98	HC102040T160TC	160-C	2.0mm	\$83.98	HE102040T160TC	160-C	2.0mm	\$83.98
HA102540T160TC	160-C	40mm	\$90.59	HC102540T160TC	160-C	2.5mm	\$90.59	HE102540T160TC	160-C	2.5mm	\$90.59
HA102040T180TC	180-C	40mm	\$83.98	HC102040T180TC	180-C	2.0mm	\$83.98	HE102040T180TC	180-C	2.0mm	\$83.98
HA102540T180TC	180-C	40mm	\$90.59	HC102540T180TC	180-C	2.5mm	\$90.59	HE102540T180TC	180-C	2.5mm	\$90.59





**275mm Diameter, 32mm Bore
For Cutting Non-Ferrous Metal Pipes/Tubes**

It comes with additional 4/9/50 pin holes so it also fits Kasto/Wagner cold saw machine

Tool No.	Tooth Pattern	Thickness	Price
HA112032T060ATB	60-BW	2.0mm	\$96.48
HA112532T060ATB	60-BW	2.5mm	\$103.83
HA112032T070ATB	70-BW	2.0mm	\$96.48
HA112532T070ATB	70-BW	2.5mm	\$103.83
HA112032T080ATB	80-BW	2.0mm	\$96.48
HA112532T080ATB	80-BW	2.5mm	\$103.83
HA112032T090ATB	90-BW	2.0mm	\$96.48
HA112532T090ATB	90-BW	2.5mm	\$103.83
HA112032T100ATB	100-BW	2.0mm	\$96.48
HA112532T100ATB	100-BW	2.5mm	\$103.83
HA112032T120ATB	120-BW	2.0mm	\$96.48
HA112532T120ATB	120-BW	2.5mm	\$103.83
HA112032T140ATB	140-BW	2.0mm	\$96.48
HA112532T140ATB	140-BW	2.5mm	\$103.83
HA112032T160ATB	160-BW	2.0mm	\$96.48
HA112532T160ATB	160-BW	2.5mm	\$103.83
HA112032T180ATB	180-BW	2.0mm	\$96.48
HA112532T180ATB	180-BW	2.5mm	\$103.83
HA112032T200ATB	200-BW	2.0mm	\$96.48
HA112532T200ATB	200-BW	2.5mm	\$103.83

**275mm Diameter, 32mm Bore
For Cutting Ferrous Metal, Mild Steel
Pipes/Tubes**

It comes with additional 4/9/50 pin holes so it also fits Kasto/Wagner cold saw machine

Tool No.	Tooth Pattern	Thickness	Price
HC112032T060ATB	60-BW	2.0mm	\$96.48
HC112532T060ATB	60-BW	2.5mm	\$103.83
HC112032T070ATB	70-BW	2.0mm	\$96.48
HC112532T070ATB	70-BW	2.5mm	\$103.83
HC112032T080ATB	80-BW	2.0mm	\$96.48
HC112532T080ATB	80-BW	2.5mm	\$103.83
HC112032T090ATB	90-BW	2.0mm	\$96.48
HC112532T090ATB	90-BW	2.5mm	\$103.83
HC112032T100ATB	100-BW	2.0mm	\$96.48
HC112532T100ATB	100-BW	2.5mm	\$103.83
HC112032T120ATB	120-BW	2.0mm	\$96.48
HC112532T120ATB	120-BW	2.5mm	\$103.83
HC112032T140ATB	140-BW	2.0mm	\$96.48
HC112532T140ATB	140-BW	2.5mm	\$103.83
HC112032T160ATB	160-BW	2.0mm	\$96.48
HC112532T160ATB	160-BW	2.5mm	\$103.83
HC112032T180ATB	180-BW	2.0mm	\$96.48
HC112532T180ATB	180-BW	2.5mm	\$103.83
HC112032T200ATB	200-BW	2.0mm	\$96.48
HC112532T200ATB	200-BW	2.5mm	\$103.83

**275mm Diameter, 32mm Bore
For Cutting Stainless Steel Pipes/Tubes**

It comes with additional 4/9/50 pin holes so it also fits Kasto/Wagner cold saw machine.

Tool No.	Tooth Pattern	Thickness	Price
HE112032T060ATB	60-BW	2.0mm	\$96.48
HE112532T060ATB	60-BW	2.5mm	\$103.83
HE112032T070ATB	70-BW	2.0mm	\$96.48
HE112532T070ATB	70-BW	2.5mm	\$103.83
HE112032T080ATB	80-BW	2.0mm	\$96.48
HE112532T080ATB	80-BW	2.5mm	\$103.83
HE112032T090ATB	90-BW	2.0mm	\$96.48
HE112532T090ATB	90-BW	2.5mm	\$103.83
HE112032T100ATB	100-BW	2.0mm	\$96.48
HE112532T100ATB	100-BW	2.5mm	\$103.83
HE112032T120ATB	120-BW	2.0mm	\$96.48
HE112532T120ATB	120-BW	2.5mm	\$103.83
HE112032T140ATB	140-BW	2.0mm	\$96.48
HE112532T140ATB	140-BW	2.5mm	\$103.83
HE112032T160ATB	160-BW	2.0mm	\$96.48
HE112532T160ATB	160-BW	2.5mm	\$103.83
HE112032T180ATB	180-BW	2.0mm	\$96.48
HE112532T180ATB	180-BW	2.5mm	\$103.83
HE112032T200ATB	200-BW	2.0mm	\$96.48
HE112532T200ATB	200-BW	2.5mm	\$103.83

**275mm Diameter, 32mm Bore
For Cutting Non-Ferrous Metal
Solids/Bars/Rebars**

It comes with additional 4/9/50 pin holes so it also fits Kasto/Wagner cold saw machine.

Tool No.	Tooth Pattern	Thickness	Price
HA112032T060TC*	60C	2.0mm	\$96.48
HA112532T060TC*	60C	2.5mm	\$103.83
HA112032T070TC*	70-C	2.0mm	\$96.48
HA112532T070TC*	70-C	2.5mm	\$103.83
HA112032T080TC*	80-C	2.0mm	\$96.48
HA112532T080TC*	80-C	2.5mm	\$103.83
HA112032T090TC*	90-C	2.0mm	\$96.48
HA112532T090TC*	90-C	2.5mm	\$103.83
HA112032T100TC*	100-C	2.0mm	\$96.48
HA112532T100TC*	100-C	2.5mm	\$103.83
HA112032T120TC*	120-C	2.0mm	\$96.48
HA112532T120TC*	120-C	2.5mm	\$103.83
HA112032T140TC*	140-C	2.0mm	\$96.48
HA112532T140TC*	140-C	2.5mm	\$103.83
HA112032T160TC*	160-C	2.0mm	\$96.48
HA112532T160TC*	160-C	2.5mm	\$103.83
HA112032T180TC*	180-C	2.0mm	\$96.48
HA112532T180TC*	180-C	2.5mm	\$103.83
HA112032T200TC*	200-C	2.0mm	\$96.48
HA112532T200TC*	200-C	2.5mm	\$103.83

**275mm Diameter, 32mm Bore
For Cutting Ferrous Metal, Mild Steel
Solids/Bars/Rebars**

It comes with additional 4/9/50 pin holes so it also fits Kasto/Wagner cold saw machine.

Tool No.	Tooth Pattern	Thickness	Price
HC112032T060TC	60C	2.0mm	\$96.48
HC112532T060TC	60C	2.5mm	\$103.83
HC112032T070TC	70-C	2.0mm	\$96.48
HC112532T070TC	70-C	2.5mm	\$103.83
HC112032T080TC	80-C	2.0mm	\$96.48
HC112532T080TC	80-C	2.5mm	\$103.83
HC112032T090TC	90-C	2.0mm	\$96.48
HC112532T090TC	90-C	2.5mm	\$103.83
HC112032T100TC	100-C	2.0mm	\$96.48
HC112532T100TC	100-C	2.5mm	\$103.83
HC112032T120TC	120-C	2.0mm	\$96.48
HC112532T120TC	120-C	2.5mm	\$103.83
HC112032T140TC	140-C	2.0mm	\$96.48
HC112532T140TC	140-C	2.5mm	\$103.83
HC112032T160TC	160-C	2.0mm	\$96.48
HC112532T160TC	160-C	2.5mm	\$103.83
HC112032T180TC	180-C	2.0mm	\$96.48
HC112532T180TC	180-C	2.5mm	\$103.83
HC112032T200TC	200-C	2.0mm	\$96.48
HC112532T200TC	200-C	2.5mm	\$103.83

**275mm Diameter, 32mm Bore
For Cutting Stainless Steel
Solids/Bars/Rebars**

It comes with additional 4/9/50 pin holes so it also fits Kasto/Wagner cold saw machine.

Tool No.	Tooth Pattern	Thickness	Price
HE112032T060TC	60C	2.0mm	\$96.48
HE112532T060TC	60C	2.5mm	\$103.83
HE112032T070TC	70-C	2.0mm	\$96.48
HE112532T070TC	70-C	2.5mm	\$103.83
HE112032T080TC	80-C	2.0mm	\$96.48
HE112532T080TC	80-C	2.5mm	\$103.83
HE112032T090TC	90-C	2.0mm	\$96.48
HE112532T090TC	90-C	2.5mm	\$103.83
HE112032T100TC	100-C	2.0mm	\$96.48
HE112532T100TC	100-C	2.5mm	\$103.83
HE112032T120TC	120-C	2.0mm	\$96.48
HE112532T120TC	120-C	2.5mm	\$103.83
HE112032T140TC	140-C	2.0mm	\$96.48
HE112532T140TC	140-C	2.5mm	\$103.83
HE112032T160TC	160-C	2.0mm	\$96.48
HE112532T160TC	160-C	2.5mm	\$103.83
HE112032T180TC	180-C	2.0mm	\$96.48
HE112532T180TC	180-C	2.5mm	\$103.83
HE112032T200TC	200-C	2.0mm	\$96.48
HE112532T200TC	200-C	2.5mm	\$103.83





275mm Diameter, 40mm Bore For Cutting Non-Ferrous Metal Pipes/Tubes				275mm Diameter, 40mm Bore For Cutting Ferrous Metal, Mild Steel Pipes/Tubes				275mm Diameter, 40mm Bore For Cutting Stainless Steel Pipes/Tubes			
Tool No.	Tooth Pattern	Thickness	Price	Tool No.	Tooth Pattern	Thickness	Price	Tool No.	Tooth Pattern	Thickness	Price
HA112040T060ATB	60-BW	2.0mm	\$96.48	HC112040T060ATB	60-BW	2.0mm	\$96.48	HE112040T060ATB*	60-BW	2.0mm	\$96.48
HA112540T060ATB	60-BW	2.5mm	\$103.83	HC112540T060ATB	60-BW	2.5mm	\$103.83	HE112540T060ATB*	60-BW	2.5mm	\$103.83
HA112040T070ATB	70-BW	2.0mm	\$96.48	HC112040T070ATB	70-BW	2.0mm	\$96.48	HE112040T070ATB*	70-BW	2.0mm	\$96.48
HA112540T070ATB	70-BW	2.5mm	\$103.83	HC112540T070ATB	70-BW	2.5mm	\$103.83	HE112540T070ATB*	70-BW	2.5mm	\$103.83
HA112040T080ATB	80-BW	2.0mm	\$96.48	HC112040T080ATB	80-BW	2.0mm	\$96.48	HE112040T080ATB*	80-BW	2.0mm	\$96.48
HA112540T080ATB	80-BW	2.5mm	\$103.83	HC112540T080ATB	80-BW	2.5mm	\$103.83	HE112540T080ATB*	80-BW	2.5mm	\$103.83
HA112040T090ATB	90-BW	2.0mm	\$96.48	HC112040T090ATB	90-BW	2.0mm	\$96.48	HE112040T090ATB*	90-BW	2.0mm	\$96.48
HA112540T090ATB	90-BW	2.5mm	\$103.83	HC112540T090ATB	90-BW	2.5mm	\$103.83	HE112540T090ATB*	90-BW	2.5mm	\$103.83
HA112040T100ATB	100-BW	2.0mm	\$96.48	HC112040T100ATB	100-BW	2.0mm	\$96.48	HE112040T100ATB*	100-BW	2.0mm	\$96.48
HA112540T100ATB	100-BW	2.5mm	\$103.83	HC112540T100ATB	100-BW	2.5mm	\$103.83	HE112540T100ATB*	100-BW	2.5mm	\$103.83
HA112040T120ATB	120-BW	2.0mm	\$96.48	HC112040T120ATB	120-BW	2.0mm	\$96.48	HE112040T120ATB*	120-BW	2.0mm	\$96.48
HA112540T120ATB	120-BW	2.5mm	\$103.83	HC112540T120ATB	120-BW	2.5mm	\$103.83	HE112540T120ATB*	120-BW	2.5mm	\$103.83
HA112040T140ATB	140-BW	2.0mm	\$96.48	HC112040T140ATB	140-BW	2.0mm	\$96.48	HE112040T140ATB*	140-BW	2.0mm	\$96.48
HA112540T140ATB	140-BW	2.5mm	\$103.83	HC112540T140ATB	140-BW	2.5mm	\$103.83	HE112540T140ATB*	140-BW	2.5mm	\$103.83
HA112040T160ATB	160-BW	2.0mm	\$96.48	HC112040T160ATB	160-BW	2.0mm	\$96.48	HE112040T160ATB*	160-BW	2.0mm	\$96.48
HA112540T160ATB	160-BW	2.5mm	\$103.83	HC112540T160ATB	160-BW	2.5mm	\$103.83	HE112540T160ATB*	160-BW	2.5mm	\$103.83
HA112040T180ATB	180-BW	2.0mm	\$96.48	HC112040T180ATB	180-BW	2.0mm	\$96.48	HE112040T180ATB*	180-BW	2.0mm	\$96.48
HA112540T180ATB	180-BW	2.5mm	\$103.83	HC112540T180ATB	180-BW	2.5mm	\$103.83	HE112540T180ATB*	180-BW	2.5mm	\$103.83
HA112040T200ATB	200-BW	2.0mm	\$96.48	HC112040T200ATB	200-BW	2.0mm	\$96.48	HE112040T200ATB*	200-BW	2.0mm	\$96.48
HA112540T200ATB	200-BW	2.5mm	\$103.83	HC112540T200ATB	200-BW	2.5mm	\$103.83	HE112540T200ATB*	200-BW	2.5mm	\$103.83

275mm Diameter, 40mm Bore For Cutting Non-Ferrous Metal Solids/Bars/Rebars				275mm Diameter, 40mm Bore For Cutting Ferrous Metal, Mild Steel Solids/Bars/Rebars				275mm Diameter, 40mm Bore For Cutting Stainless Steel Solids/Bars/Rebars			
Tool No.	Tooth Pattern	Thickness	Price	Tool No.	Tooth Pattern	Thickness	Price	Tool No.	Tooth Pattern	Thickness	Price
HA112040T060TC	60C	2.0mm	\$96.48	HC112040T060TC	60C	2.0mm	\$96.48	HE112040T060TC	60C	2.0mm	\$96.48
HA112540T060TC	60C	2.5mm	\$103.83	HC112540T060TC	60C	2.5mm	\$103.83	HE112540T060TC	60C	2.5mm	\$103.83
HA112040T070TC	70-C	2.0mm	\$96.48	HC112040T070TC	70-C	2.0mm	\$96.48	HE112040T070TC	70-C	2.0mm	\$96.48
HA112540T070TC	70-C	2.5mm	\$103.83	HC112540T070TC	70-C	2.5mm	\$103.83	HE112540T070TC	70-C	2.5mm	\$103.83
HA112040T080TC	80-C	2.0mm	\$96.48	HC112040T080TC	80-C	2.0mm	\$96.48	HE112040T080TC	80-C	2.0mm	\$96.48
HA112540T080TC	80-C	2.5mm	\$103.83	HC112540T080TC	80-C	2.5mm	\$103.83	HE112540T080TC	80-C	2.5mm	\$103.83
HA112040T090TC	90-C	2.0mm	\$96.48	HC112040T090TC	90-C	2.0mm	\$96.48	HE112040T090TC	90-C	2.0mm	\$96.48
HA112540T090TC	90-C	2.5mm	\$103.83	HC112540T090TC	90-C	2.5mm	\$103.83	HE112540T090TC	90-C	2.5mm	\$103.83
HA112040T100TC	100-C	2.0mm	\$96.48	HC112040T100TC	100-C	2.0mm	\$96.48	HE112040T100TC	100-C	2.0mm	\$96.48
HA112540T100TC	100-C	2.5mm	\$103.83	HC112540T100TC	100-C	2.5mm	\$103.83	HE112540T100TC	100-C	2.5mm	\$103.83
HA112040T120TC	120-C	2.0mm	\$96.48	HC112040T120TC	120-C	2.0mm	\$96.48	HE112040T120TC	120-C	2.0mm	\$96.48
HA112540T120TC	120-C	2.5mm	\$103.83	HC112540T120TC	120-C	2.5mm	\$103.83	HE112540T120TC	120-C	2.5mm	\$103.83
HA112040T140TC	140-C	2.0mm	\$96.48	HC112040T140TC	140-C	2.0mm	\$96.48	HE112040T140TC	140-C	2.0mm	\$96.48
HA112540T140TC	140-C	2.5mm	\$103.83	HC112540T140TC	140-C	2.5mm	\$103.83	HE112540T140TC	140-C	2.5mm	\$103.83
HA112040T160TC	160-C	2.0mm	\$96.48	HC112040T160TC	160-C	2.0mm	\$96.48	HE112040T160TC	160-C	2.0mm	\$96.48
HA112540T160TC	160-C	2.5mm	\$103.83	HC112540T160TC	160-C	2.5mm	\$103.83	HE112540T160TC	160-C	2.5mm	\$103.83
HA112040T180TC	180-C	2.0mm	\$96.48	HC112040T180TC	180-C	2.0mm	\$96.48	HE112040T180TC	180-C	2.0mm	\$96.48
HA112540T180TC	180-C	2.5mm	\$103.83	HC112540T180TC	180-C	2.5mm	\$103.83	HE112540T180TC	180-C	2.5mm	\$103.83
HA112040T200TC	200-C	2.0mm	\$96.48	HC112040T200TC	180-C	2.0mm	\$96.48	HE112040T200TC	200-C	2.0mm	\$96.48
HA112540T200TC	200-C	2.5mm	\$103.83	HC112540T200TC	180-C	2.5mm	\$103.83	HE112540T200TC	200-C	2.5mm	\$103.83





300mm Diameter, 32mm Bore For Cutting Non-Ferrous Metal Pipes/Tubes				300mm Diameter, 32mm Bore For Cutting Ferrous Metal, Mild Steel Solids/Bars/Rebars				300mm Diameter, 38mm Bore For Cutting Non-Ferrous Metal Pipes/Tubes			
Tool No.	Tooth Pattern	Thickness	Price	Tool No.	Tooth Pattern	Thickness	Price	Tool No.	Tooth Pattern	Thickness	Price
HA122532T080ATB	80-BW	2.5mm	\$126.18	HC122532T080TC	80-C	2.5mm	\$126.18	HA122538T080ATB	80-BW	2.5mm	\$132.51
HA122532T090ATB	90-BW	2.5mm	\$126.18	HC122532T090TC	90-C	2.5mm	\$126.18	HA122538T090ATB	90-BW	2.5mm	\$132.51
HA122532T100ATB	100-BW	2.5mm	\$126.18	HC122532T100TC	100-C	2.5mm	\$126.18	HA122538T100ATB	100-BW	2.5mm	\$132.51
HA122532T120ATB	120-BW	2.5mm	\$126.18	HC122532T120TC	120-C	2.5mm	\$126.18	HA122538T120ATB	120-BW	2.5mm	\$132.51
HA122532T140ATB	140-BW	2.5mm	\$126.18	HC122532T140TC	140-C	2.5mm	\$126.18	HA122538T140ATB	140-BW	2.5mm	\$132.51
HA122532T160ATB	160-BW	2.5mm	\$126.18	HC122532T160TC	160-C	2.5mm	\$126.18	HA122538T160ATB	160-BW	2.5mm	\$132.51
HA122532T180ATB	180-BW	2.5mm	\$126.18	HC122532T180TC	180-C	2.5mm	\$126.18	HA122538T180ATB	180-BW	2.5mm	\$132.51
HA122532T200ATB	200-BW	2.5mm	\$126.18	HC122532T200TC	200-C	2.5mm	\$126.18	HA122538T200ATB	200-BW	2.5mm	\$132.51
HA122532T220ATB	220-BW	2.5mm	\$126.18	HC122532T220TC	220-C	2.5mm	\$126.18	HA122538T220ATB	220-BW	2.5mm	\$132.51
HA122532T240ATB	240-BW	2.5mm	\$126.18	HC122532T240TC	240-C	2.5mm	\$126.18	HA122538T240ATB	240-BW	2.5mm	\$132.51
HA122532T260ATB	260-BW	2.5mm	\$126.18	HC122532T260TC	260-C	2.5mm	\$126.18	HA122538T260ATB	260-BW	2.5mm	\$132.51
HA122532T280ATB	280-BW	2.5mm	\$126.18	HC122532T280TC	280-C	2.5mm	\$126.18	HA122538T280ATB	280-BW	2.5mm	\$132.51
HA122532T300ATB	300-BW	2.5mm	\$126.18	HC122532T300TC	300-C	2.5mm	\$126.18	HA122538T300ATB	300-BW	2.5mm	\$132.51
300mm Diameter, 32mm Bore For Cutting Non-Ferrous Metal Solids/Bars/Rebars				300mm Diameter, 32mm Bore For Cutting Stainless Steel Pipes/Tubes				300mm Diameter, 38mm Bore For Cutting Non-Ferrous Metal Solids/Bars/Rebars			
Tool No.	Tooth Pattern	Thickness	Price	Tool No.	Tooth Pattern	Thickness	Price	Tool No.	Tooth Pattern	Thickness	Price
HA122532T080TC	80-C	2.5mm	\$126.18	HE122532T080ATB	80-BW	2.5mm	\$126.18	HA122538T080TC	80-C	2.5mm	\$132.51
HA122532T090TC	90-C	2.5mm	\$126.18	HE122532T090ATB	90-BW	2.5mm	\$126.18	HA122538T090TC	90-C	2.5mm	\$132.51
HA122532T100TC	100-C	2.5mm	\$126.18	HE122532T100ATB	100-BW	2.5mm	\$126.18	HA122538T100TC	100-C	2.5mm	\$132.51
HA122532T120TC	120-C	2.5mm	\$126.18	HE122532T120ATB	120-BW	2.5mm	\$126.18	HA122538T120TC	120-C	2.5mm	\$132.51
HA122532T140TC	140-C	2.5mm	\$126.18	HE122532T140ATB	140-BW	2.5mm	\$126.18	HA122538T140TC	140-C	2.5mm	\$132.51
HA122532T160TC	160-C	2.5mm	\$126.18	HE122532T160ATB	160-BW	2.5mm	\$126.18	HA122538T160TC	160-C	2.5mm	\$132.51
HA122532T180TC	180-C	2.5mm	\$126.18	HE122532T180ATB	180-BW	2.5mm	\$126.18	HA122538T180TC	180-C	2.5mm	\$132.51
HA122532T200TC	200-C	2.5mm	\$126.18	HE122532T200ATB	200-BW	2.5mm	\$126.18	HA122538T200TC	200-C	2.5mm	\$132.51
HA122532T220TC	220-C	2.5mm	\$126.18	HE122532T220ATB	220-BW	2.5mm	\$126.18	HA122538T220TC	220-C	2.5mm	\$132.51
HA122532T240TC	240-C	2.5mm	\$126.18	HE122532T240ATB	240-BW	2.5mm	\$126.18	HA122538T240TC	240-C	2.5mm	\$132.51
HA122532T260TC	260-C	2.5mm	\$126.18	HE122532T260ATB	260-BW	2.5mm	\$126.18	HA122538T260TC	260-C	2.5mm	\$132.51
HA122532T280TC	280-C	2.5mm	\$126.18	HE122532T280ATB	280-BW	2.5mm	\$126.18	HA122538T280TC	280-C	2.5mm	\$132.51
HA122532T300TC	300-C	2.5mm	\$126.18	HE122532T300ATB	300-BW	2.5mm	\$126.18	HA122538T300TC	300-C	2.5mm	\$132.51
300mm Diameter, 32mm Bore For Cutting Ferrous Metal, Mild Steel Pipes/Tubes				300mm Diameter, 32mm Bore For Cutting Stainless Steel Solids/Bars/Rebars				300mm Diameter, 38mm Bore For Cutting Ferrous Metal, Mild Steel Pipes/Tubes			
Tool No.	Tooth Pattern	Thickness	Price	Tool No.	Tooth Pattern	Thickness	Price	Tool No.	Tooth Pattern	Thickness	Price
HC122532T080ATB	80-BW	2.5mm	\$126.18	HE122532T080TC	80-C	2.5mm	\$126.18	HC122538T080ATB	80-BW	2.5mm	\$132.51
HC122532T090ATB	90-BW	2.5mm	\$126.18	HE122532T090TC	90-C	2.5mm	\$126.18	HC122538T090ATB	90-BW	2.5mm	\$132.51
HC122532T100ATB	100-BW	2.5mm	\$126.18	HE122532T100TC	100-C	2.5mm	\$126.18	HC122538T100ATB	100-BW	2.5mm	\$132.51
HC122532T120ATB	120-BW	2.5mm	\$126.18	HE122532T120TC	120-C	2.5mm	\$126.18	HC122538T120ATB	120-BW	2.5mm	\$132.51
HC122532T140ATB	140-BW	2.5mm	\$126.18	HE122532T140TC	140-C	2.5mm	\$126.18	HC122538T140ATB	140-BW	2.5mm	\$132.51
HC122532T160ATB	160-BW	2.5mm	\$126.18	HE122532T160TC	160-C	2.5mm	\$126.18	HC122538T160ATB	160-BW	2.5mm	\$132.51
HC122532T180ATB	180-BW	2.5mm	\$126.18	HE122532T180TC	180-C	2.5mm	\$126.18	HC122538T180ATB	180-BW	2.5mm	\$132.51
HC122532T200ATB	200-BW	2.5mm	\$126.18	HE122532T200TC	200-C	2.5mm	\$126.18	HC122538T200ATB	200-BW	2.5mm	\$132.51
HC122532T220ATB	220-BW	2.5mm	\$126.18	HE122532T220TC	220-C	2.5mm	\$126.18	HC122538T220ATB	220-BW	2.5mm	\$132.51
HC122532T240ATB	240-BW	2.5mm	\$126.18	HE122532T240TC	240-C	2.5mm	\$126.18	HC122538T240ATB	240-BW	2.5mm	\$132.51
HC122532T260ATB	260-BW	2.5mm	\$126.18	HE122532T260TC	260-C	2.5mm	\$126.18	HC122538T260ATB	260-BW	2.5mm	\$132.51
HC122532T280ATB	280-BW	2.5mm	\$126.18	HE122532T280TC	280-C	2.5mm	\$126.18	HC122538T280ATB	280-BW	2.5mm	\$132.51
HC122532T300ATB	300-BW	2.5mm	\$126.18	HE122532T300TC	300-C	2.5mm	\$126.18	HC122538T300ATB	300-BW	2.5mm	\$132.51





300mm Diameter, 38mm Bore For Cutting Ferrous Metal, Mild Steel Solids/Bars/Rebars				300mm Diameter, 40mm Bore For Cutting Non-Ferrous Metal Pipes/Tubes				300mm Diameter, 40mm Bore For Cutting Ferrous Metal, Mild Steel Solids/Bars/Rebars			
Tool No.	Tooth Pattern	Thickness	Price	Tool No.	Tooth Pattern	Thickness	Price	Tool No.	Tooth Pattern	Thickness	Price
HC122538T080TC	80-C	2.5mm	\$132.51	HA122540T080ATB	80-BW	2.5mm	\$126.18	HC122540T080TC	80-C	2.5mm	\$126.18
HC122538T090TC	90-C	2.5mm	\$132.51	HA122540T090ATB	90-BW	2.5mm	\$126.18	HC122540T090TC	90-C	2.5mm	\$126.18
HC122538T100TC	100-C	2.5mm	\$132.51	HA122540T100ATB	100-BW	2.5mm	\$126.18	HC122540T100TC	100-C	2.5mm	\$126.18
HC122538T120TC	120-C	2.5mm	\$132.51	HA122540T120ATB	120-BW	2.5mm	\$126.18	HC122540T120TC	120-C	2.5mm	\$126.18
HC122538T140TC	140-C	2.5mm	\$132.51	HA122540T140ATB	140-BW	2.5mm	\$126.18	HC122540T140TC	140-C	2.5mm	\$126.18
HC122538T160TC	160-C	2.5mm	\$132.51	HA122540T160ATB	160-BW	2.5mm	\$126.18	HC122540T160TC	160-C	2.5mm	\$126.18
HC122538T180TC	180-C	2.5mm	\$132.51	HA122540T180ATB	180-BW	2.5mm	\$126.18	HC122540T180TC	180-C	2.5mm	\$126.18
HC122538T200TC	200-C	2.5mm	\$132.51	HA122540T200ATB	200-BW	2.5mm	\$126.18	HC122540T200TC	200-C	2.5mm	\$126.18
HC122538T220TC	220-C	2.5mm	\$132.51	HA122540T220ATB	220-BW	2.5mm	\$126.18	HC122540T220TC	220-C	2.5mm	\$126.18
HC122538T240TC	240-C	2.5mm	\$132.51	HA122540T240ATB	240-BW	2.5mm	\$126.18	HC122540T240TC	240-C	2.5mm	\$126.18
HC122538T260TC	260-C	2.5mm	\$132.51	HA122540T260ATB	260-BW	2.5mm	\$126.18	HC122540T260TC	260-C	2.5mm	\$126.18
HC122538T280TC	280-C	2.5mm	\$132.51	HA122540T280ATB	280-BW	2.5mm	\$126.18	HC122540T280TC	280-C	2.5mm	\$126.18
HC122538T300TC	300-C	2.5mm	\$132.51	HA122540T300ATB	300-BW	2.5mm	\$126.18	HC122540T300TC	300-C	2.5mm	\$126.18
300mm Diameter, 38mm Bore For Cutting Stainless Steel Pipes/Tubes				300mm Diameter, 40mm Bore For Cutting Non-Ferrous Metal Solids/Bars/Rebars				300mm Diameter, 40mm Bore For Cutting Stainless Steel Pipes/Tubes			
Tool No.	Tooth Pattern	Thickness	Price	Tool No.	Tooth Pattern	Thickness	Price	Tool No.	Tooth Pattern	Thickness	Price
HE122538T080ATB	80-BW	2.5mm	\$126.18	HA122540T080TC	80-C	2.5mm	\$126.18	HE122540T080ATB	80-BW	2.5mm	\$126.18
HE122538T090ATB	90-BW	2.5mm	\$126.18	HA122540T090TC	90-C	2.5mm	\$126.18	HE122540T090ATB	90-BW	2.5mm	\$126.18
HE122538T100ATB	100-BW	2.5mm	\$126.18	HA122540T100TC	100-C	2.5mm	\$126.18	HE122540T100ATB	100-BW	2.5mm	\$126.18
HE122538T120ATB	120-BW	2.5mm	\$126.18	HA122540T120TC	120-C	2.5mm	\$126.18	HE122540T120ATB	120-BW	2.5mm	\$126.18
HE122538T140ATB	140-BW	2.5mm	\$126.18	HA122540T140TC	140-C	2.5mm	\$126.18	HE122540T140ATB	140-BW	2.5mm	\$126.18
HE122538T160ATB	160-BW	2.5mm	\$126.18	HA122540T160TC	160-C	2.5mm	\$126.18	HE122540T160ATB	160-BW	2.5mm	\$126.18
HE122538T180ATB	180-BW	2.5mm	\$126.18	HA122540T180TC	180-C	2.5mm	\$126.18	HE122540T180ATB	180-BW	2.5mm	\$126.18
HE122538T200ATB	200-BW	2.5mm	\$126.18	HA122540T200TC	200-C	2.5mm	\$126.18	HE122540T200ATB	200-BW	2.5mm	\$126.18
HE122538T220ATB	220-BW	2.5mm	\$126.18	HA122540T220TC	220-C	2.5mm	\$126.18	HE122540T220ATB	220-BW	2.5mm	\$126.18
HE122538T240ATB	240-BW	2.5mm	\$126.18	HA122540T240TC	240-C	2.5mm	\$126.18	HE122540T240ATB	240-BW	2.5mm	\$126.18
HE122538T260ATB	260-BW	2.5mm	\$126.18	HA122540T260TC	260-C	2.5mm	\$126.18	HE122540T260ATB	260-BW	2.5mm	\$126.18
HE122538T280ATB	280-BW	2.5mm	\$126.18	HA122540T280TC	280-C	2.5mm	\$126.18	HE122540T280ATB	280-BW	2.5mm	\$126.18
HE122538T300ATB	300-BW	2.5mm	\$126.18	HA122540T300TC	300-C	2.5mm	\$126.18	HE122540T300ATB	300-BW	2.5mm	\$126.18
300mm Diameter, 38mm Bore For Cutting Stainless Steel Solids/Bars/Rebars				300mm Diameter, 40mm Bore For Cutting Ferrous Metal, Mild Steel Pipes/Tubes				300mm Diameter, 40mm Bore For Cutting Stainless Steel Solids/Bars/Rebars			
Tool No.	Tooth Pattern	Thickness	Price	Tool No.	Tooth Pattern	Thickness	Price	Tool No.	Tooth Pattern	Thickness	Price
HE122538T080TC	80-C	2.5mm	\$126.18	HC122540T080ATB	80-BW	2.5mm	\$126.18	HE122540T080TC	80-C	2.5mm	\$126.18
HE122538T090TC	90-C	2.5mm	\$126.18	HC122540T090ATB	90-BW	2.5mm	\$126.18	HE122540T090TC	90-C	2.5mm	\$126.18
HE122538T100TC	100-C	2.5mm	\$126.18	HC122540T100ATB	100-BW	2.5mm	\$126.18	HE122540T100TC	100-C	2.5mm	\$126.18
HE122538T120TC	120-C	2.5mm	\$126.18	HC122540T120ATB	120-BW	2.5mm	\$126.18	HE122540T120TC	120-C	2.5mm	\$126.18
HE122538T140TC	140-C	2.5mm	\$126.18	HC122540T140ATB	140-BW	2.5mm	\$126.18	HE122540T140TC	140-C	2.5mm	\$126.18
HE122538T160TC	160-C	2.5mm	\$126.18	HC122540T160ATB	160-BW	2.5mm	\$126.18	HE122540T160TC	160-C	2.5mm	\$126.18
HE122538T180TC	180-C	2.5mm	\$126.18	HC122540T180ATB	180-BW	2.5mm	\$126.18	HE122540T180TC	180-C	2.5mm	\$126.18
HE122538T200TC	200-C	2.5mm	\$126.18	HC122540T200ATB	200-BW	2.5mm	\$126.18	HE122540T200TC	200-C	2.5mm	\$126.18
HE122538T220TC	220-C	2.5mm	\$126.18	HC122540T220ATB	220-BW	2.5mm	\$126.18	HE122540T220TC	220-C	2.5mm	\$126.18
HE122538T240TC	240-C	2.5mm	\$126.18	HC122540T240ATB	240-BW	2.5mm	\$126.18	HE122540T240TC	240-C	2.5mm	\$126.18
HE122538T260TC	260-C	2.5mm	\$126.18	HC122540T260ATB	260-BW	2.5mm	\$126.18	HE122540T260TC	260-C	2.5mm	\$126.18
HE122538T280TC	280-C	2.5mm	\$126.18	HC122540T280ATB	280-BW	2.5mm	\$126.18	HE122540T280TC	280-C	2.5mm	\$126.18
HE122538T300TC	300-C	2.5mm	\$126.18	HC122540T300ATB	300-BW	2.5mm	\$126.18	HE122540T300TC	300-C	2.5mm	\$126.18





315mm Diameter, 32mm Bore For Cutting Non-Ferrous Metal Pipes/Tubes				315mm Diameter, 32mm Bore For Cutting Ferrous Metal, Mild Steel Solids/Bars/Rebars				315mm Diameter, 40mm Bore For Cutting Non-Ferrous Metal Pipes/Tubes			
Tool No.	Tooth Pattern	Bore	Price	Tool No.	Tooth Pattern	Thickness	Price	Tool No.	Tooth Pattern	Thickness	Price
HA12.42532T080ATB	80-BW	32mm	\$140.30	HC12.42532T080TC	80-C	2.5mm	\$140.30	HA12.42540T080ATB	80-BW	2.5mm	\$140.30
HA12.42532T090ATB	90-BW	32mm	\$140.30	HC12.42532T090TC	90-C	2.5mm	\$140.30	HA12.42540T090ATB	90-BW	2.5mm	\$140.30
HA12.42532T100ATB	100-BW	32mm	\$140.30	HC12.42532T100TC	100-C	2.5mm	\$140.30	HA12.42540T100ATB	100-BW	2.5mm	\$140.30
HA12.42532T120ATB	120-BW	32mm	\$140.30	HC12.42532T120TC	120-C	2.5mm	\$140.30	HA12.42540T120ATB	120-BW	2.5mm	\$140.30
HA12.42532T140ATB	140-BW	32mm	\$140.30	HC12.42532T140TC	140-C	2.5mm	\$140.30	HA12.42540T140ATB	140-BW	2.5mm	\$140.30
HA12.42532T160ATB	160-BW	32mm	\$140.30	HC12.42532T160TC	160-C	2.5mm	\$140.30	HA12.42540T160ATB	160-BW	2.5mm	\$140.30
HA12.42532T180ATB	180-BW	32mm	\$140.30	HC12.42532T180TC	180-C	2.5mm	\$140.30	HA12.42540T180ATB	180-BW	2.5mm	\$140.30
HA12.42532T200ATB	200-BW	32mm	\$140.30	HC12.42532T200TC	200-C	2.5mm	\$140.30	HA12.42540T200ATB	200-BW	2.5mm	\$140.30
HA12.42532T220ATB	220-BW	32mm	\$140.30	HC12.42532T220TC	220-C	2.5mm	\$140.30	HA12.42540T220ATB	220-BW	2.5mm	\$140.30
HA12.42532T240ATB	240-BW	32mm	\$140.30	HC12.42532T240TC	240-C	2.5mm	\$140.30	HA12.42540T240ATB	240-BW	2.5mm	\$140.30
HA12.42532T260ATB	260-BW	32mm	\$140.30	HC12.42532T260TC	260-C	2.5mm	\$140.30	HA12.42540T260ATB	260-BW	2.5mm	\$140.30
HA12.42532T280ATB	280-BW	32mm	\$140.30	HC12.42532T280TC	280-C	2.5mm	\$140.30	HA12.42540T280ATB	280-BW	2.5mm	\$140.30
HA12.42532T300ATB	300-BW	32mm	\$140.30	HC12.42532T300TC	300-C	2.5mm	\$140.30	HA12.42540T300ATB	300-BW	2.5mm	\$140.30
315mm Diameter, 32mm Bore For Cutting Non-Ferrous Metal Solids/Bars/Rebars				315mm Diameter, 32mm Bore For Cutting Stainless Steel Pipes/Tubes				315mm Diameter, 40mm Bore For Cutting Non-Ferrous Metal Solids/Bars/Rebars			
Tool No.	Tooth Pattern	Thickness	Price	Tool No.	Tooth Pattern	Thickness	Price	Tool No.	Tooth Pattern	Thickness	Price
HA12.42532T080TC	80-C	2.5mm	\$140.30	HE12.42532T080ATB	80-BW	2.5mm	\$140.30	HA12.42540T080TC	80-C	2.5mm	\$140.30
HA12.42532T090TC	90-C	2.5mm	\$140.30	HE12.42532T090ATB	90-BW	2.5mm	\$140.30	HA12.42540T090TC	90-C	2.5mm	\$140.30
HA12.42532T100TC	100-C	2.5mm	\$140.30	HE12.42532T100ATB	100-BW	2.5mm	\$140.30	HA12.42540T100TC	100-C	2.5mm	\$140.30
HA12.42532T120TC	120-C	2.5mm	\$140.30	HE12.42532T120ATB	120-BW	2.5mm	\$140.30	HA12.42540T120TC	120-C	2.5mm	\$140.30
HA12.42532T140TC	140-C	2.5mm	\$140.30	HE12.42532T140ATB	140-BW	2.5mm	\$140.30	HA12.42540T140TC	140-C	2.5mm	\$140.30
HA12.42532T160TC	160-C	2.5mm	\$140.30	HE12.42532T160ATB	160-BW	2.5mm	\$140.30	HA12.42540T160TC	160-C	2.5mm	\$140.30
HA12.42532T180TC	180-C	2.5mm	\$140.30	HE12.42532T180ATB	180-BW	2.5mm	\$140.30	HA12.42540T180TC	180-C	2.5mm	\$140.30
HA12.42532T200TC	200-C	2.5mm	\$140.30	HE12.42532T200ATB	200-BW	2.5mm	\$140.30	HA12.42540T200TC	200-C	2.5mm	\$140.30
HA12.42532T220TC	220-C	2.5mm	\$140.30	HE12.42532T220ATB	220-BW	2.5mm	\$140.30	HA12.42540T220TC	220-C	2.5mm	\$140.30
HA12.42532T240TC	240-C	2.5mm	\$140.30	HE12.42532T240ATB	240-BW	2.5mm	\$140.30	HA12.42540T240TC	240-C	2.5mm	\$140.30
HA12.42532T260TC	260-C	2.5mm	\$140.30	HE12.42532T260ATB	260-BW	2.5mm	\$140.30	HA12.42540T260TC	260-C	2.5mm	\$140.30
HA12.42532T280TC	280-C	2.5mm	\$140.30	HE12.42532T280ATB	280-BW	2.5mm	\$140.30	HA12.42540T280TC	280-C	2.5mm	\$140.30
HA12.42532T300TC	300-C	2.5mm	\$140.30	HE12.42532T300ATB	300-BW	2.5mm	\$140.30	HA12.42540T300TC	300-C	2.5mm	\$140.30
315mm Diameter, 32mm Bore For Cutting Ferrous Metal, Mild Steel Pipes/Tubes				315mm Diameter, 32mm Bore For Cutting Stainless Steel Solids/Bars/Rebars				315mm Diameter, 40mm Bore For Cutting Ferrous Metal, Mild Steel Pipes/Tubes			
Tool No.	Tooth Pattern	Thickness	Price	Tool No.	Tooth Pattern	Thickness	Price	Tool No.	Tooth Pattern	Thickness	Price
HC12.42532T080ATB	80-BW	2.5mm	\$140.30	HE12.42532T080TC	80-C	2.5mm	\$140.30	HC12.42540T080ATB	80-BW	2.5mm	\$140.30
HC12.42532T090ATB	90-BW	2.5mm	\$140.30	HE12.42532T090TC	90-C	2.5mm	\$140.30	HC12.42540T090ATB	90-BW	2.5mm	\$140.30
HC12.42532T100ATB	100-BW	2.5mm	\$140.30	HE12.42532T100TC	100-C	2.5mm	\$140.30	HC12.42540T100ATB	100-BW	2.5mm	\$140.30
HC12.42532T120ATB	120-BW	2.5mm	\$140.30	HE12.42532T120TC	120-C	2.5mm	\$140.30	HC12.42540T120ATB	120-BW	2.5mm	\$140.30
HC12.42532T140ATB	140-BW	2.5mm	\$140.30	HE12.42532T140TC	140-C	2.5mm	\$140.30	HC12.42540T140ATB	140-BW	2.5mm	\$140.30
HC12.42532T160ATB	160-BW	2.5mm	\$140.30	HE12.42532T160TC	160-C	2.5mm	\$140.30	HC12.42540T160ATB	160-BW	2.5mm	\$140.30
HC12.42532T180ATB	180-BW	2.5mm	\$140.30	HE12.42532T180TC	180-C	2.5mm	\$140.30	HC12.42540T180ATB	180-BW	2.5mm	\$140.30
HC12.42532T200ATB	200-BW	2.5mm	\$140.30	HE12.42532T200TC	200-C	2.5mm	\$140.30	HC12.42540T200ATB	200-BW	2.5mm	\$140.30
HC12.42532T220ATB	220-BW	2.5mm	\$140.30	HE12.42532T220TC	220-C	2.5mm	\$140.30	HC12.42540T220ATB	220-BW	2.5mm	\$140.30
HC12.42532T240ATB	240-BW	2.5mm	\$140.30	HE12.42532T240TC	240-C	2.5mm	\$140.30	HC12.42540T240ATB	240-BW	2.5mm	\$140.30
HC12.42532T260ATB	260-BW	2.5mm	\$140.30	HE12.42532T260TC	260-C	2.5mm	\$140.30	HC12.42540T260ATB	260-BW	2.5mm	\$140.30
HC12.42532T280ATB	280-BW	2.5mm	\$140.30	HE12.42532T280TC	280-C	2.5mm	\$140.30	HC12.42540T280ATB	280-BW	2.5mm	\$140.30
HC12.42532T300ATB	300-BW	2.5mm	\$140.30	HE12.42532T300TC	300-C	2.5mm	\$140.30	HC12.42540T300ATB	300-BW	2.5mm	\$140.30





315mm Diameter, 40mm Bore For Cutting Ferrous Metal, Mild Steel Solids/Bars/Rebars				325mm Diameter, 40mm Bore For Cutting Non-Ferrous Metal Pipes/Tubes				325mm Diameter, 40mm Bore For Cutting Ferrous Metal, Mild Steel Solids/Bars/Rebars			
Tool No.	Tooth Pattern	Thickness	Price	Tool No.	Tooth Pattern	Bore	Price	Tool No.	Tooth Pattern	Bore	Price
HC12.42540T080TC	80-C	2.5mm	\$140.30	HA132540T080ATB	80-BW	40mm	\$164.27	HC132540T080TC	80-C	40mm	\$164.27
HC12.42540T090TC	90-C	2.5mm	\$140.30	HA132540T090ATB	90-BW	40mm	\$164.27	HC132540T090TC	90-C	40mm	\$164.27
HC12.42540T100TC	100-C	2.5mm	\$140.30	HA132540T100ATB	100-BW	40mm	\$164.27	HC132540T100TC	100-C	40mm	\$164.27
HC12.42540T120TC	120-C	2.5mm	\$140.30	HA132540T120ATB	120-BW	40mm	\$164.27	HC132540T120TC	120-C	40mm	\$164.27
HC12.42540T140TC	140-C	2.5mm	\$140.30	HA132540T140ATB	140-BW	40mm	\$164.27	HC132540T140TC	140-C	40mm	\$164.27
HC12.42540T160TC	160-C	2.5mm	\$140.30	HA132540T160ATB	160-BW	40mm	\$164.27	HC132540T160TC	160-C	40mm	\$164.27
HC12.42540T180TC	180-C	2.5mm	\$140.30	HA132540T180ATB	180-BW	40mm	\$164.27	HC132540T180TC	180-C	40mm	\$164.27
HC12.42540T200TC	200-C	2.5mm	\$140.30	HA132540T200ATB	200-BW	40mm	\$164.27	HC132540T200TC	200-C	40mm	\$164.27
HC12.42540T220TC	220-C	2.5mm	\$140.30	HA132540T220ATB	220-BW	40mm	\$164.27	HC132540T220TC	220-C	40mm	\$164.27
HC12.42540T240TC	240-C	2.5mm	\$140.30	HA132540T240ATB	240-BW	40mm	\$164.27	HC132540T240TC	240-C	40mm	\$164.27
HC12.42540T260TC	260-C	2.5mm	\$140.30	HA132540T260ATB	260-BW	40mm	\$164.27	HC132540T260TC	260-C	40mm	\$164.27
HC12.42540T280TC	280-C	2.5mm	\$140.30	HA132540T280ATB	280-BW	40mm	\$164.27	HC132540T280TC	280-C	40mm	\$164.27
HC12.42540T300TC	300-C	2.5mm	\$140.30	HA132540T300ATB	300-BW	40mm	\$164.27	HC132540T300TC	300-C	40mm	\$164.27
315mm Diameter, 40mm Bore For Cutting Stainless Steel Pipes/Tubes				325mm Diameter, 40mm Bore For Cutting Non-Ferrous Metal Solids/Bars/Rebars				325mm Diameter, 40mm Bore For Cutting Stainless Steel Pipes/Tubes			
Tool No.	Tooth Pattern	Thickness	Price	Tool No.	Tooth Pattern	Bore	Price	Tool No.	Tooth Pattern	Bore	Price
HE12.42540T080ATB	80-BW	2.5mm	\$140.30	HA132540T080TC	80-C	40mm	\$164.27	HE132540T080ATB	80-BW	40mm	\$164.27
HE12.42540T090ATB	90-BW	2.5mm	\$140.30	HA132540T090TC	90-C	40mm	\$164.27	HE132540T090ATB	90-BW	40mm	\$164.27
HE12.42540T100ATB	100-BW	2.5mm	\$140.30	HA132540T100TC	100-C	40mm	\$164.27	HE132540T100ATB	100-BW	40mm	\$164.27
HE12.42540T120ATB	120-BW	2.5mm	\$140.30	HA132540T120TC	120-C	40mm	\$164.27	HE132540T120ATB	120-BW	40mm	\$164.27
HE12.42540T140ATB	140-BW	2.5mm	\$140.30	HA132540T140TC	140-C	40mm	\$164.27	HE132540T140ATB	140-BW	40mm	\$164.27
HE12.42540T160ATB	160-BW	2.5mm	\$140.30	HA132540T160TC	160-C	40mm	\$164.27	HE132540T160ATB	160-BW	40mm	\$164.27
HE12.42540T180ATB	180-BW	2.5mm	\$140.30	HA132540T180TC	180-C	40mm	\$164.27	HE132540T180ATB	180-BW	40mm	\$164.27
HE12.42540T200ATB	200-BW	2.5mm	\$140.30	HA132540T200TC	200-C	40mm	\$164.27	HE132540T200ATB	200-BW	40mm	\$164.27
HE12.42540T220ATB	220-BW	2.5mm	\$140.30	HA132540T220TC	220-C	40mm	\$164.27	HE132540T220ATB	220-BW	40mm	\$164.27
HE12.42540T240ATB	240-BW	2.5mm	\$140.30	HA132540T240TC	240-C	40mm	\$164.27	HE132540T240ATB	240-BW	40mm	\$164.27
HE12.42540T260ATB	260-BW	2.5mm	\$140.30	HA132540T260TC	260-C	40mm	\$164.27	HE132540T260ATB	260-BW	40mm	\$164.27
HE12.42540T280ATB	280-BW	2.5mm	\$140.30	HA132540T280TC	280-C	40mm	\$164.27	HE132540T280ATB	280-BW	40mm	\$164.27
HE12.42540T300ATB	300-BW	2.5mm	\$140.30	HA132540T300TC	300-C	40mm	\$164.27	HE132540T300ATB	300-BW	40mm	\$164.27
315mm Diameter, 40mm Bore For Cutting Stainless Steel Solids/Bars/Rebars				325mm Diameter, 40mm Bore For Cutting Ferrous Metal, Mild Steel Pipes/Tubes				325mm Diameter, 40mm Bore For Cutting Stainless Steel Solids/Bars/Rebars			
Tool No.	Tooth Pattern	Thickness	Price	Tool No.	Tooth Pattern	Bore	Price	Tool No.	Tooth Pattern	Bore	Price
HE12.42540T080TC	80-C	2.5mm	\$140.30	HC132540T080ATB	80-BW	40mm	\$164.27	HE132540T080TC	80-C	40mm	\$164.27
HE12.42540T090TC	90-C	2.5mm	\$140.30	HC132540T090ATB	90-BW	40mm	\$164.27	HE132540T090TC	90-C	40mm	\$164.27
HE12.42540T100TC	100-C	2.5mm	\$140.30	HC132540T100ATB	100-BW	40mm	\$164.27	HE132540T100TC	100-C	40mm	\$164.27
HE12.42540T120TC	120-C	2.5mm	\$140.30	HC132540T120ATB	120-BW	40mm	\$164.27	HE132540T120TC	120-C	40mm	\$164.27
HE12.42540T140TC	140-C	2.5mm	\$140.30	HC132540T140ATB	140-BW	40mm	\$164.27	HE132540T140TC	140-C	40mm	\$164.27
HE12.42540T160TC	160-C	2.5mm	\$140.30	HC132540T160ATB	160-BW	40mm	\$164.27	HE132540T160TC	160-C	40mm	\$164.27
HE12.42540T180TC	180-C	2.5mm	\$140.30	HC132540T180ATB	180-BW	40mm	\$164.27	HE132540T180TC	180-C	40mm	\$164.27
HE12.42540T200TC	200-C	2.5mm	\$140.30	HC132540T200ATB	200-BW	40mm	\$164.27	HE132540T200TC	200-C	40mm	\$164.27
HE12.42540T220TC	220-C	2.5mm	\$140.30	HC132540T220ATB	220-BW	40mm	\$164.27	HE132540T220TC	220-C	40mm	\$164.27
HE12.42540T240TC	240-C	2.5mm	\$140.30	HC132540T240ATB	240-BW	40mm	\$164.27	HE132540T240TC	240-C	40mm	\$164.27
HE12.42540T260TC	260-C	2.5mm	\$140.30	HC132540T260ATB	260-BW	40mm	\$164.27	HE132540T260TC	260-C	40mm	\$164.27
HE12.42540T280TC	280-C	2.5mm	\$140.30	HC132540T280ATB	280-BW	40mm	\$164.27	HE132540T280TC	280-C	40mm	\$164.27
HE12.42540T300TC	300-C	2.5mm	\$140.30	HC132540T300ATB	300-BW	40mm	\$164.27	HE132540T300TC	300-C	40mm	\$164.27





350mm Diameter, 32mm Bore For Cutting Non-Ferrous Metal Pipes/Tubes				350mm Diameter, 32mm Bore For Cutting Ferrous Metal, Mild Steel Solids/Bars/Rebars				350mm Diameter, 40mm Bore For Cutting Non-Ferrous Metal Pipes/Tubes			
Tool No.	Tooth Pattern	Thickness	Price	Tool No.	Tooth Pattern	Thickness	Price	Tool No.	Tooth Pattern	Thickness	Price
HA143032T100ATB	100-BW	3.0mm	\$183.39	HC143032T100TC	100-C	3.0mm	\$183.39	HA143040T100ATB	100-BW	3.0mm	\$183.39
HA143032T120ATB	120-BW	3.0mm	\$183.39	HC143032T120TC	120-C	3.0mm	\$183.39	HA143040T120ATB	120-BW	3.0mm	\$183.39
HA143032T140ATB	140-BW	3.0mm	\$183.39	HC143032T140TC	140-C	3.0mm	\$183.39	HA143040T140ATB	140-BW	3.0mm	\$183.39
HA143032T160ATB	160-BW	3.0mm	\$183.39	HC143032T160TC	160-C	3.0mm	\$183.39	HA143040T160ATB	160-BW	3.0mm	\$183.39
HA143032T180ATB	180-BW	3.0mm	\$183.39	HC143032T180TC	180-C	3.0mm	\$183.39	HA143040T180ATB	180-BW	3.0mm	\$183.39
HA143032T200ATB	200-BW	3.0mm	\$183.39	HC143032T200TC	200-C	3.0mm	\$183.39	HA143040T200ATB	200-BW	3.0mm	\$183.39
HA143032T220ATB	220-BW	3.0mm	\$183.39	HC143032T220TC	220-C	3.0mm	\$183.39	HA143040T220ATB	220-BW	3.0mm	\$183.39
HA143032T240ATB	240-BW	3.0mm	\$183.39	HC143032T240TC	240-C	3.0mm	\$183.39	HA143040T240ATB	240-BW	3.0mm	\$183.39
HA143032T260ATB	260-BW	3.0mm	\$183.39	HC143032T260TC	260-C	3.0mm	\$183.39	HA143040T260ATB	260-BW	3.0mm	\$183.39
HA143032T280ATB	280-BW	3.0mm	\$183.39	HC143032T280TC	280-C	3.0mm	\$183.39	HA143040T280ATB	280-BW	3.0mm	\$183.39
HA143032T300ATB	300-BW	3.0mm	\$183.39	HC143032T300TC	300-C	3.0mm	\$183.39	HA143040T300ATB	300-BW	3.0mm	\$183.39
350mm Diameter, 32mm Bore For Cutting Non-Ferrous Metal Solids/Bars/Rebars				350mm Diameter, 32mm Bore For Cutting Stainless Steel Pipes/Tubes				350mm Diameter, 40mm Bore For Cutting Non-Ferrous Metal Solids/Bars/Rebars			
Tool No.	Tooth Pattern	Thickness	Price	Tool No.	Tooth Pattern	Thickness	Price	Tool No.	Tooth Pattern	Thickness	Price
HA143032T100TC	100-C	3.0mm	\$183.39	HE143032T100ATB	100-BW	3.0mm	\$183.39	HA143040T100TC	100-C	3.0mm	\$183.39
HA143032T120TC	120-C	3.0mm	\$183.39	HE143032T120ATB	120-BW	3.0mm	\$183.39	HA143040T120TC	120-C	3.0mm	\$183.39
HA143032T140TC	140-C	3.0mm	\$183.39	HE143032T140ATB	140-BW	3.0mm	\$183.39	HA143040T140TC	140-C	3.0mm	\$183.39
HA143032T160TC	160-C	3.0mm	\$183.39	HE143032T160ATB	160-BW	3.0mm	\$183.39	HA143040T160TC	160-C	3.0mm	\$183.39
HA143032T180TC	180-C	3.0mm	\$183.39	HE143032T180ATB	180-BW	3.0mm	\$183.39	HA143040T180TC	180-C	3.0mm	\$183.39
HA143032T200TC	200-C	3.0mm	\$183.39	HE143032T200ATB	200-BW	3.0mm	\$183.39	HA143040T200TC	200-C	3.0mm	\$183.39
HA143032T220TC	220-C	3.0mm	\$183.39	HE143032T220ATB	220-BW	3.0mm	\$183.39	HA143040T220TC	220-C	3.0mm	\$183.39
HA143032T240TC	240-C	3.0mm	\$183.39	HE143032T240ATB	240-BW	3.0mm	\$183.39	HA143040T240TC	240-C	3.0mm	\$183.39
HA143032T260TC	260-C	3.0mm	\$183.39	HE143032T260ATB	260-BW	3.0mm	\$183.39	HA143040T260TC	260-C	3.0mm	\$183.39
HA143032T280TC	280-C	3.0mm	\$183.39	HE143032T280ATB	280-BW	3.0mm	\$183.39	HA143040T280TC	280-C	3.0mm	\$183.39
HA143032T300TC	300-C	3.0mm	\$183.39	HE143032T300ATB	300-BW	3.0mm	\$183.39	HA143040T300TC	300-C	3.0mm	\$183.39
350mm Diameter, 32mm Bore For Cutting Ferrous Metal, Mild Steel Pipes/Tubes				350mm Diameter, 32mm Bore For Cutting Stainless Steel Solids/Bars/Rebars				350mm Diameter, 40mm Bore For Cutting Ferrous Metal, Mild Steel Pipes/Tubes			
Tool No.	Tooth Pattern	Thickness	Price	Tool No.	Tooth Pattern	Thickness	Price	Tool No.	Tooth Pattern	Thickness	Price
HC143032T100ATB	100-BW	3.0mm	\$183.39	HE143032T100TC	100-C	3.0mm	\$183.39	HC143040T100ATB	100-BW	3.0mm	\$183.39
HC143032T120ATB	120-BW	3.0mm	\$183.39	HE143032T120TC	120-C	3.0mm	\$183.39	HC143040T120ATB	120-BW	3.0mm	\$183.39
HC143032T140ATB	140-BW	3.0mm	\$183.39	HE143032T140TC	140-C	3.0mm	\$183.39	HC143040T140ATB	140-BW	3.0mm	\$183.39
HC143032T160ATB	160-BW	3.0mm	\$183.39	HE143032T160TC	160-C	3.0mm	\$183.39	HC143040T160ATB	160-BW	3.0mm	\$183.39
HC143032T180ATB	180-BW	3.0mm	\$183.39	HE143032T180TC	180-C	3.0mm	\$183.39	HC143040T180ATB	180-BW	3.0mm	\$183.39
HC143032T200ATB	200-BW	3.0mm	\$183.39	HE143032T200TC	200-C	3.0mm	\$183.39	HC143040T200ATB	200-BW	3.0mm	\$183.39
HC143032T220ATB	220-BW	3.0mm	\$183.39	HE143032T220TC	220-C	3.0mm	\$183.39	HC143040T220ATB	220-BW	3.0mm	\$183.39
HC143032T240ATB	240-BW	3.0mm	\$183.39	HE143032T240TC	240-C	3.0mm	\$183.39	HC143040T240ATB	240-BW	3.0mm	\$183.39
HC143032T260ATB	260-BW	3.0mm	\$183.39	HE143032T260TC	260-C	3.0mm	\$183.39	HC143040T260ATB	260-BW	3.0mm	\$183.39
HC143032T280ATB	280-BW	3.0mm	\$183.39	HE143032T280TC	280-C	3.0mm	\$183.39	HC143040T280ATB	280-BW	3.0mm	\$183.39
HC143032T300ATB	300-BW	3.0mm	\$183.39	HE143032T300TC	300-C	3.0mm	\$183.39	HC143040T300ATB	300-BW	3.0mm	\$183.39





350mm Diameter, 40mm Bore For Cutting Ferrous Metal, Mild Steel Solids/Bars/Rebars				370mm Diameter, 32mm Bore For Cutting Non-Ferrous Metal Pipes/Tubes				370mm Diameter, 32mm Bore For Cutting Ferrous Metal, Mild Steel Solids/Bars/Rebars			
Tool No.	Tooth Pattern	Thickness	Price	Tool No.	Tooth Pattern	Thickness	Price	Tool No.	Tooth Pattern	Thickness	Price
HC143040T100TC	100-C	3.0mm	\$183.39	HA14.63032T120ATB	120-BW	3.0mm	\$243.83	HC14.63032T120TC	120-C	3.0mm	\$243.83
HC143040T120TC	120-C	3.0mm	\$183.39	HA14.63032T140ATB	140-BW	3.0mm	\$243.83	HC14.63032T140TC	140-C	3.0mm	\$243.83
HC143040T140TC	140-C	3.0mm	\$183.39	HA14.63032T160ATB	160-BW	3.0mm	\$243.83	HC14.63032T160TC	160-C	3.0mm	\$243.83
HC143040T160TC	160-C	3.0mm	\$183.39	HA14.63032T180ATB	180-BW	3.0mm	\$243.83	HC14.63032T180TC	180-C	3.0mm	\$243.83
HC143040T180TC	180-C	3.0mm	\$183.39	HA14.63032T200ATB	200-BW	3.0mm	\$243.83	HC14.63032T200TC	200-C	3.0mm	\$243.83
HC143040T200TC	200-C	3.0mm	\$183.39	HA14.63032T220ATB	220-BW	3.0mm	\$243.83	HC14.63032T220TC	220-C	3.0mm	\$243.83
HC143040T220TC	220-C	3.0mm	\$183.39	HA14.63032T240ATB	240-BW	3.0mm	\$243.83	HC14.63032T240TC	240-C	3.0mm	\$243.83
HC143040T240TC	240-C	3.0mm	\$183.39	HA14.63032T260ATB	260-BW	3.0mm	\$243.83	HC14.63032T260TC	260-C	3.0mm	\$243.83
HC143040T260TC	260-C	3.0mm	\$183.39	HA14.63032T280ATB	280-BW	3.0mm	\$243.83	HC14.63032T280TC	280-C	3.0mm	\$243.83
HC143040T280TC	280-C	3.0mm	\$183.39	HA14.63032T300ATB	300-BW	3.0mm	\$243.83	HC14.63032T300TC	300-C	3.0mm	\$243.83
HC143040T300TC	300-C	3.0mm	\$183.39								
350mm Diameter, 40mm Bore For Cutting Stainless Steel Pipes/Tubes				370mm Diameter, 32mm Bore For Cutting Non-Ferrous Metal Solids/Bars/Rebars				370mm Diameter, 32mm Bore For Cutting Stainless Steel Pipes/Tubes			
Tool No.	Tooth Pattern	Thickness	Price	Tool No.	Tooth Pattern	Thickness	Price	Tool No.	Tooth Pattern	Thickness	Price
HE143040T100ATB	100-BW	3.0mm	\$183.39	HA14.63032T120TC	120-C	3.0mm	\$243.83	HE14.63032T120ATB	120-BW	3.0mm	\$243.83
HE143040T120ATB	120-BW	3.0mm	\$183.39	HA14.63032T140TC	140-C	3.0mm	\$243.83	HE14.63032T140ATB	140-BW	3.0mm	\$243.83
HE143040T140ATB	140-BW	3.0mm	\$183.39	HA14.63032T160TC	160-C	3.0mm	\$243.83	HE14.63032T160ATB	160-BW	3.0mm	\$243.83
HE143040T160ATB	160-BW	3.0mm	\$183.39	HA14.63032T180TC	180-C	3.0mm	\$243.83	HE14.63032T180ATB	180-BW	3.0mm	\$243.83
HE143040T180ATB	180-BW	3.0mm	\$183.39	HA14.63032T200TC	200-C	3.0mm	\$243.83	HE14.63032T200ATB	200-BW	3.0mm	\$243.83
HE143040T200ATB	200-BW	3.0mm	\$183.39	HA14.63032T220TC	220-C	3.0mm	\$243.83	HE14.63032T220ATB	220-BW	3.0mm	\$243.83
HE143040T220ATB	220-BW	3.0mm	\$183.39	HA14.63032T240TC	240-C	3.0mm	\$243.83	HE14.63032T240ATB	240-BW	3.0mm	\$243.83
HE143040T240ATB	240-BW	3.0mm	\$183.39	HA14.63032T260TC	260-C	3.0mm	\$243.83	HE14.63032T260ATB	260-BW	3.0mm	\$243.83
HE143040T260ATB	260-BW	3.0mm	\$183.39	HA14.63032T280TC	280-C	3.0mm	\$243.83	HE14.63032T280ATB	280-BW	3.0mm	\$243.83
HE143040T280ATB	280-BW	3.0mm	\$183.39	HA14.63032T300TC	300-C	3.0mm	\$243.83	HE14.63032T300ATB	300-BW	3.0mm	\$243.83
HE143040T300ATB	300-BW	3.0mm	\$183.39								
350mm Diameter, 40mm Bore For Cutting Stainless Steel Solids/Bars/Rebars				370mm Diameter, 32mm Bore For Cutting Ferrous Metal, Mild Steel Pipes/Tubes				370mm Diameter, 32mm Bore For Cutting Stainless Steel Solids/Bars/Rebars			
Tool No.	Tooth Pattern	Thickness	Price	Tool No.	Tooth Pattern	Thickness	Price	Tool No.	Tooth Pattern	Thickness	Price
HE143040T100TC	100-C	3.0mm	\$183.39	HC14.63032T120ATB	120-BW	3.0mm	\$243.83	HE14.63032T120TC	120-C	3.0mm	\$243.83
HE143040T120TC	120-C	3.0mm	\$183.39	HC14.63032T140ATB	140-BW	3.0mm	\$243.83	HE14.63032T140TC	140-C	3.0mm	\$243.83
HE143040T140TC	140-C	3.0mm	\$183.39	HC14.63032T160ATB	160-BW	3.0mm	\$243.83	HE14.63032T160TC	160-C	3.0mm	\$243.83
HE143040T160TC	160-C	3.0mm	\$183.39	HC14.63032T180ATB	180-BW	3.0mm	\$243.83	HE14.63032T180TC	180-C	3.0mm	\$243.83
HE143040T180TC	180-C	3.0mm	\$183.39	HC14.63032T200ATB	200-BW	3.0mm	\$243.83	HE14.63032T200TC	200-C	3.0mm	\$243.83
HE143040T200TC	200-C	3.0mm	\$183.39	HC14.63032T220ATB	220-BW	3.0mm	\$243.83	HE14.63032T220TC	220-C	3.0mm	\$243.83
HE143040T220TC	220-C	3.0mm	\$183.39	HC14.63032T240ATB	240-BW	3.0mm	\$243.83	HE14.63032T240TC	240-C	3.0mm	\$243.83
HE143040T240TC	240-C	3.0mm	\$183.39	HC14.63032T260ATB	260-BW	3.0mm	\$243.83	HE14.63032T260TC	260-C	3.0mm	\$243.83
HE143040T260TC	260-C	3.0mm	\$183.39	HC14.63032T280ATB	280-BW	3.0mm	\$243.83	HE14.63032T280TC	280-C	3.0mm	\$243.83
HE143040T280TC	280-C	3.0mm	\$183.39	HC14.63032T300ATB	300-BW	3.0mm	\$243.83	HE14.63032T300TC	300-C	3.0mm	\$243.83
HE143040T300TC	300-C	3.0mm	\$183.39								





370mm Diameter, 40mm Bore For Cutting Non-Ferrous Metal Pipes/Tubes				370mm Diameter, 40mm Bore For Cutting Ferrous Metal, Mild Steel Solids/Bars/Rebars				370mm Diameter, 50mm Bore For Cutting Non-Ferrous Metal Pipes/Tubes			
Tool No.	Tooth Pattern	Thickness	Price	Tool No.	Tooth Pattern	Thickness	Price	Tool No.	Tooth Pattern	Thickness	Price
HA14.63040T120ATB	120-BW	3.0mm	\$243.85	HC14.63040T120TC	120-C	3.0mm	\$243.85	HA14.63050T120ATB	120-BW	3.0mm	\$243.83
HA14.63040T140ATB	140-BW	3.0mm	\$243.83	HC14.63040T140TC	140-C	3.0mm	\$243.83	HA14.63050T140ATB	140-BW	3.0mm	\$243.83
HA14.63040T160ATB	160-BW	3.0mm	\$243.83	HC14.63040T160TC	160-C	3.0mm	\$243.83	HA14.63050T160ATB	160-BW	3.0mm	\$243.83
HA14.63040T180ATB	180-BW	3.0mm	\$243.83	HC14.63040T180TC	180-C	3.0mm	\$243.83	HA14.63050T180ATB	180-BW	3.0mm	\$243.83
HA14.63040T200ATB	200-BW	3.0mm	\$243.83	HC14.63040T200TC	200-C	3.0mm	\$243.83	HA14.63050T200ATB	200-BW	3.0mm	\$243.83
HA14.63040T220ATB	220-BW	3.0mm	\$243.83	HC14.63040T220TC	220-C	3.0mm	\$243.83	HA14.63050T220ATB	220-BW	3.0mm	\$243.83
HA14.63040T240ATB	240-BW	3.0mm	\$243.83	HC14.63040T240TC	240-C	3.0mm	\$243.83	HA14.63050T240ATB	240-BW	3.0mm	\$243.83
HA14.63040T260ATB	260-BW	3.0mm	\$243.83	HC14.63040T260TC	260-C	3.0mm	\$243.83	HA14.63050T260ATB	260-BW	3.0mm	\$243.83
HA14.63040T280ATB	280-BW	3.0mm	\$243.83	HC14.63040T280TC	280-C	3.0mm	\$243.83	HA14.63050T280ATB	280-BW	3.0mm	\$243.83
HA14.63040T300ATB	300-BW	3.0mm	\$243.83	HC14.63040T300TC	300-C	3.0mm	\$243.83	HA14.63050T300ATB	300-BW	3.0mm	\$243.83
370mm Diameter, 40mm Bore For Cutting Non-Ferrous Metal Solids/Bars/Rebars				370mm Diameter, 40mm Bore For Cutting Stainless Steel Pipes/Tubes				370mm Diameter, 50mm Bore For Cutting Non-Ferrous Metal Solids/Bars/Rebars			
Tool No.	Tooth Pattern	Thickness	Price	Tool No.	Tooth Pattern	Thickness	Price	Tool No.	Tooth Pattern	Thickness	Price
HA14.63040T120TC	120-C	3.0mm	\$243.85	HE14.63040T120ATB	120-BW	3.0mm	\$243.85	HA14.63050T120TC	120-C	3.0mm	\$243.83
HA14.63040T140TC	140-C	3.0mm	\$243.83	HE14.63040T140ATB	140-BW	3.0mm	\$243.83	HA14.63050T140TC	140-C	3.0mm	\$243.83
HA14.63040T160TC	160-C	3.0mm	\$243.83	HE14.63040T160ATB	160-BW	3.0mm	\$243.83	HA14.63050T160TC	160-C	3.0mm	\$243.83
HA14.63040T180TC	180-C	3.0mm	\$243.83	HE14.63040T180ATB	180-BW	3.0mm	\$243.83	HA14.63050T180TC	180-C	3.0mm	\$243.83
HA14.63040T200TC	200-C	3.0mm	\$243.83	HE14.63040T200ATB	200-BW	3.0mm	\$243.83	HA14.63050T200TC	200-C	3.0mm	\$243.83
HA14.63040T220TC	220-C	3.0mm	\$243.83	HE14.63040T220ATB	220-BW	3.0mm	\$243.83	HA14.63050T220TC	220-C	3.0mm	\$243.83
HA14.63040T240TC	240-C	3.0mm	\$243.83	HE14.63040T240ATB	240-BW	3.0mm	\$243.83	HA14.63050T240TC	240-C	3.0mm	\$243.83
HA14.63040T260TC	260-C	3.0mm	\$243.83	HE14.63040T260ATB	260-BW	3.0mm	\$243.83	HA14.63050T260TC	260-C	3.0mm	\$243.83
HA14.63040T280TC	280-C	3.0mm	\$243.83	HE14.63040T280ATB	280-BW	3.0mm	\$243.83	HA14.63050T280TC	280-C	3.0mm	\$243.83
HA14.63040T300TC	300-C	3.0mm	\$243.83	HE14.63040T300ATB	300-BW	3.0mm	\$243.83	HA14.63050T300TC	300-C	3.0mm	\$243.83
370mm Diameter, 40mm Bore For Cutting Ferrous Metal, Mild Steel Pipes/Tubes				370mm Diameter, 40mm Bore For Cutting Stainless Steel Solids/Bars/Rebars				370mm Diameter, 50mm Bore For Cutting Ferrous Metal, Mild Steel Pipes/Tubes			
Tool No.	Tooth Pattern	Thickness	Price	Tool No.	Tooth Pattern	Thickness	Price	Tool No.	Tooth Pattern	Thickness	Price
HC14.63040T120ATB	120-BW	3.0mm	\$243.85	HE14.63040T120TC	120-C	3.0mm	\$243.85	HC14.63050T120ATB	120-BW	3.0mm	\$243.83
HC14.63040T140ATB	140-BW	3.0mm	\$243.83	HE14.63040T140TC	140-C	3.0mm	\$243.83	HC14.63050T140ATB	140-BW	3.0mm	\$243.83
HC14.63040T160ATB	160-BW	3.0mm	\$243.83	HE14.63040T160TC	160-C	3.0mm	\$243.83	HC14.63050T160ATB	160-BW	3.0mm	\$243.83
HC14.63040T180ATB	180-BW	3.0mm	\$243.83	HE14.63040T180TC	180-C	3.0mm	\$243.83	HC14.63050T180ATB	180-BW	3.0mm	\$243.83
HC14.63040T200ATB	200-BW	3.0mm	\$243.83	HE14.63040T200TC	200-C	3.0mm	\$243.83	HC14.63050T200ATB	200-BW	3.0mm	\$243.83
HC14.63040T220ATB	220-BW	3.0mm	\$243.83	HE14.63040T220TC	220-C	3.0mm	\$243.83	HC14.63050T220ATB	220-BW	3.0mm	\$243.83
HC14.63040T240ATB	240-BW	3.0mm	\$243.83	HE14.63040T240TC	240-C	3.0mm	\$243.83	HC14.63050T240ATB	240-BW	3.0mm	\$243.83
HC14.63040T260ATB	260-BW	3.0mm	\$243.83	HE14.63040T260TC	260-C	3.0mm	\$243.83	HC14.63050T260ATB	260-BW	3.0mm	\$243.83
HC14.63040T280ATB	280-BW	3.0mm	\$243.83	HE14.63040T280TC	280-C	3.0mm	\$243.83	HC14.63050T280ATB	280-BW	3.0mm	\$243.83
HC14.63040T300ATB	300-BW	3.0mm	\$243.83	HE14.63040T300TC	300-C	3.0mm	\$243.83	HC14.63050T300ATB	300-BW	3.0mm	\$243.83





**370mm Diameter, 50mm Bore
For Cutting Ferrous Metal, Mild Steel
Solids/Bars/Rebars**

Tool No.	Tooth Pattern	Thickness	Price
HC14.63050T120TC	120-C	3.0mm	\$243.83
HC14.63050T140TC	140-C	3.0mm	\$243.83
HC14.63050T160TC	160-C	3.0mm	\$243.83
HC14.63050T180TC	180-C	3.0mm	\$243.83
HC14.63050T200TC	200-C	3.0mm	\$243.83
HC14.63050T220TC	220-C	3.0mm	\$243.83
HC14.63050T240TC	240-C	3.0mm	\$243.83
HC14.63050T260TC	260-C	3.0mm	\$243.83
HC14.63050T280TC	280-C	3.0mm	\$243.83
HC14.63050T300TC	300-C	3.0mm	\$243.83

**370mm Diameter, 50mm Bore
For Cutting Stainless Steel Pipes/Tubes**

Tool No.	Tooth Pattern	Thickness	Price
HE14.63050T120ATB	120-BW	3.0mm	\$243.83
HE14.63050T140ATB	140-BW	3.0mm	\$243.83
HE14.63050T160ATB	160-BW	3.0mm	\$243.83
HE14.63050T180ATB	180-BW	3.0mm	\$243.83
HE14.63050T200ATB	200-BW	3.0mm	\$243.83
HE14.63050T220ATB	220-BW	3.0mm	\$243.83
HE14.63050T240ATB	240-BW	3.0mm	\$243.83
HE14.63050T260ATB	260-BW	3.0mm	\$243.83
HE14.63050T280ATB	280-BW	3.0mm	\$243.83
HE14.63050T300ATB	300-BW	3.0mm	\$243.83

**370mm Diameter, 50mm Bore
For Cutting Stainless Steel
Solids/Bars/Rebars**

Tool No.	Tooth Pattern	Thickness	Price
HE14.63050T120TC	120-C	3.0mm	\$243.83
HE14.63050T140TC	140-C	3.0mm	\$243.83
HE14.63050T160TC	160-C	3.0mm	\$243.83
HE14.63050T180TC	180-C	3.0mm	\$243.83
HE14.63050T200TC	200-C	3.0mm	\$243.83
HE14.63050T220TC	220-C	3.0mm	\$243.83
HE14.63050T240TC	240-C	3.0mm	\$243.83
HE14.63050T260TC	260-C	3.0mm	\$243.83
HE14.63050T280TC	280-C	3.0mm	\$243.83
HE14.63050T300TC	300-C	3.0mm	\$243.83



MAGNATE™ Diamond Blades

General Purpose Diamond Blade, Laser Welded

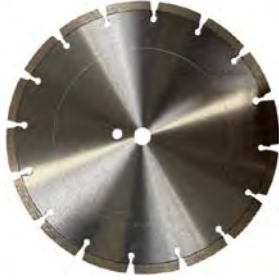

This diamond blade is designed to cut general construction materials i.e. concrete, brick, roof tile, clay paving and etc.

Tool No.	Dia.	Bore	Segment Height	Width	Price
DGL0485S78	4"	7/8"	8.5mm	0.080"	\$14.28
DGL0485S20	4"	20mm	8.5mm	0.080"	\$14.28
DGL4585S78	4-1/2"	7/8"	8.5mm	0.080"	\$15.86
DGL0585S78	5"	7/8"	8.5mm	0.080"	\$17.45
DGL0685S78	6"	7/8"	8.5mm	.090"	\$25.38
DGL0785SDM	7"	DM	8.5mm	.090"	\$34.90
DGL0885SDM	8"	DM	8.5mm	.090"	\$38.07
DGL0985SDM	9"	DM	8.5mm	.090"	\$42.83
DGL1085SDM	10"	DM	8.5mm	.090"	\$49.17
DGL1285S1	12"	1"	8.5mm	.125"	\$74.55
DGL1285S20	12"	20mm	8.5mm	.125"	\$74.55
DGL1485S1	14"	1"	8.5mm	.125"	\$88.83
DGL1485S20	14"	20mm	8.5mm	.125"	\$88.83
DGL1685S1	16"	1"	8.5mm	.142"	\$109.45
DGL2085S1	20"	1"	8.5mm	.142"	\$157.03

General Purpose Diamond Blade, Laser Welded For Faster Cutting General Constructions Materials

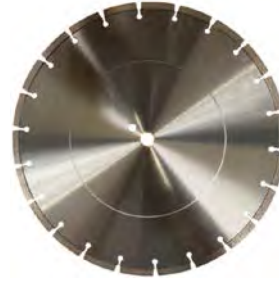

This diamond blade is designed to cut general construction materials i.e. concrete, brick, roof tile, clay paving and etc. This laser welded diamond blade is for faster cutting and longer life.

Tool No.	Dia.	Bore	Segment Height	Width	Price
DGF1210L120	12"	1"-20mm	10mm	.125"	\$41.29
DGF1210L20	12"	20mm	10mm	.125"	\$41.29
DGF1212L120	12"	1"-20mm	12mm	.125"	\$44.87
DGF1410L120	14"	1"-20mm	10mm	.125"	\$47.64
DGF1410L20	14"	20mm	10mm	.125"	\$47.64
DGF1412L120	14"	1"-20mm	12mm	.125"	\$52.40
DGF1610L120	16"	1"-20mm	10mm	.125"	\$63.53
DGF1610L20	16"	20mm	10mm	.125"	\$63.53
DGF1612L120	16"	1"-20mm	12mm	.125"	\$69.88
DGF1812L120	18"	1"-20mm	12mm	.142"	\$101.64
DGF2012L120	20"	1"-20mm	12mm	.142"	\$122.72

Asphalt Cutting Diamond Blade, Laser Dry Cutting, Slant Protection

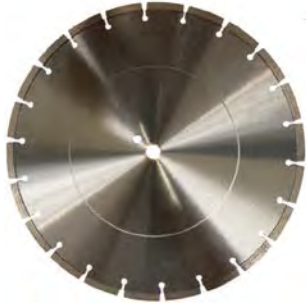

This diamond blade is designed to cut general construction materials i.e. concrete, brick, roof tile, clay paving and etc.

This blade is used when cutting asphalt, asphalt over concrete and green concrete at high speed typically on a low horsepower walk-behind machine.

Tool No.	Dia.	Bore	Segment Height	Width	Price
DAP1210L120	12"	1"-20mm	10mm	.125"	\$41.29
DAP1210L20	12"	20mm	10mm	.125"	\$41.29
DAP1212L120	12"	1"-20mm	12mm	.125"	\$44.87
DAP1410L120	14"	1"-20mm	10mm	.125"	\$47.64
DAP1410L20	14"	20mm	10mm	.125"	\$47.64
DAP1412L120	14"	1"-20mm	12mm	.125"	\$52.40
DAP1610L120	16"	1"-20mm	10mm	.125"	\$63.53
DAP1610L20	16"	20mm	10mm	.125"	\$63.53
DAP1612L120	16"	1"-20mm	12mm	.125"	\$69.88
DAP1812L120	18"	1"-20mm	12mm	.142"	\$101.64
DAP2012L120	20"	1"-20mm	12mm	.142"	\$122.72

General Purpose Diamond Blade, Cold Pressed Sintered For Cutting General Construction Materials

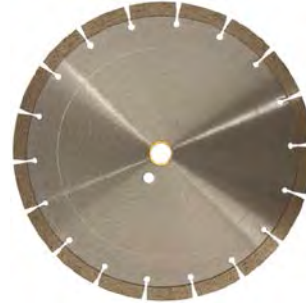

This diamond blade is designed to cut general construction materials i.e. concrete, brick, roof tile, clay paving and etc.

Tool No.	Dia.	Bore	Segment Height	Width	Price
DGS0410S78	4"	7/8"	10mm	0.080"	\$3.57
DGS4510S78	4-1/2"	7/8"	10mm	0.080"	\$4.11
DGS0510S78	5"	7/8"	10mm	0.080"	\$5.01
DGS0610S78	6"	7/8"	10mm	0.080"	\$6.78
DGS0710SDM	7"	DM	10mm	.090"	\$8.92
DGS0810SDM	8"	DM	10mm	.090"	\$9.99
DGS0910SDM	9"	DM	10mm	.100"	\$14.81
DGS1010SDM	10"	DM	10mm	.100"	\$17.13
DGS1210S1	12"	1"	10mm	.125"	\$25.21
DGS1212S1	12"	1"	12mm	.125"	\$33.33
DGS1210S20	12"	20mm	10mm	.125"	\$25.21
DGS1212S20	12"	20mm	12mm	.125"	\$33.33
DGS1410S1	14"	1"	10mm	.125"	\$31.15
DGS1412S1	14"	1"	12mm	.125"	\$39.99
DGS1410S20	14"	20mm	10mm	.125"	\$31.15
DGS1412S20	14"	20mm	12mm	.125"	\$39.99
DGS1612S1	16"	1"	12mm	.125"	\$64.99

MAGNATE™ 20639 Lycoming Street #B-6, Walnut, CA 91789 USA

K-1



email : info@magnate.net Online Shop : www.magnate.net
(TEL) 800-827-2316, 909-468-5747 (FAX) 909-468-5745

MAGNATE™ Diamond Blades

General Purpose Diamond Blade Hot Pressed Sintered For Cutting General Construction Materials



This diamond blade is designed to cut general construction materials i.e. concrete, brick, roof tile, clay paving and etc.

This hot pressed sintered diamond blade is designed for cutting various kinds of cured concrete, i.e. reinforced concrete, concrete slab, concrete block and etc.

Tool No.	Dia.	Bore	Segment Height	Width	Price
DGR0410S78	4"	7/8"	10mm	0.080"	\$7.93
DGR0410S20	4"	20mm	10mm	0.080"	\$7.93
DGR4510S78	4-1/2"	7/8"	10mm	0.080"	\$9.52
DGR0510S78	5"	7/8"	10mm	0.080"	\$11.11
DGR0610S78	6"	7/8"	10mm	0.080"	\$12.69
DGR0710SDM	7"	DM	10mm	.090"	\$17.45
DGR0810SDM	8"	DM	10mm	.090"	\$22.21
DGR0910SDM	9"	DM	10mm	.100"	\$26.97
DGR1010SDM	10"	DM	10mm	.100"	\$34.91
DGR1010S1	10"	1"	10mm	.100"	\$34.91
DGR1210S1	12"	1"	10mm	.125"	\$47.59
DGR1210S20	12"	20mm	10mm	.125"	\$47.59
DGR1410S1	14"	1"	10mm	.125"	\$60.28
DGR1410S20	14"	20mm	10mm	.125"	\$60.28

Granite Cutting Sintered Blade Continuous Rim Turbo With Pro.-teeth

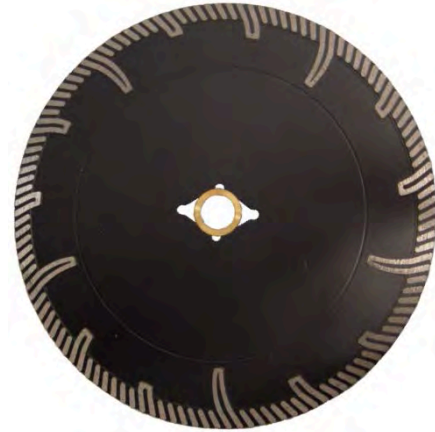

Continuous Rim Turbo blades are suitable for use on small power tools such as angle grinders and circular saws.

Tool No.	Dia.	Bore	Segment Height	Width	Price
DGP0408S78*	4"	7/8"	8mm	0.080"	\$10.31
DGP0408S20*	4"	20mm	8mm	0.080"	\$10.31
DGP4508S78*	4-1/2"	7/8"	8mm	0.080"	\$11.10
DGP0508S78*	5"	7/8"	8mm	0.080"	\$12.69
DGP0608S78*	6"	7/8"	8mm	.090"	\$19.03
DGP0708SDM*	7"	7/8"	8mm	.090"	\$23.79
DGP0808SDM	8"	DM	8mm	.090"	\$28.55
DGP0908SDM	9"	DM	8mm	.090"	\$34.90
DGP1008SDM	10"	DM	8mm	.090"	\$44.41

* It comes with mounting holes for flush cutting adapters.



Standard Rip Saw Blades, Flat Top Grind



Ripping of hard and soft woods. Suitable for both hand and power feed applications.

Tool No.	Dia.	Tooth	Bore	Grind	Plate	Kerf	Price
R824	8"	24	5/8"	20ST	.085"	.125"	\$61.67
R924	9"	24	5/8"	20ST	.085"	.125"	\$64.17
R1024	10"	24	5/8"	20ST	.085"	.125"	\$59.17
R3030^	300mm	30	30mm	20ST	2.2mm	3.2mm	\$92.67
R1224	12"	24	1"	20ST	.085"	.125"	\$77.08
R1230	12"	30	1"	20ST	.085"	.125"	\$82.08
R1236	12"	36	1"	20ST	.085"	.125"	\$85.83
R1640	16"	40	1"	20ST	.120"	.165"	\$140.33
R1824	18"	24	1"	20ST	.134"	.184"	\$191.67
R18361	18"	36	1"	20ST	.134"	.184"	\$165.42
R18362*	18"	36	2"	20ST	.134"	.184"	\$176.25
R20242*	20"	24	2"	20ST	.134"	.184"	\$208.33
R2040	20"	40	1"	20ST	.134"	.184"	\$217.08

* Come standard with 9/16 pinhole - 5" circle.

^ Come with universal pinholes

High Production Rip Saw Blades



Ripping of hard and soft woods. Suitable for both hand and power feed applications.

Tool No.	Dia.	Tooth	Bore	Grind	Plate	Kerf	Price
HP1224	12"	24	1"	20ST	.110"	.160"	\$84.17
HP1230	12"	30	1"	20ST	.134"	.184"	\$113.75
HP1430	14"	30	1"	20ST	.134"	.184"	\$124.58
HP1640	16"	40	1"	20ST	.134"	.184"	\$148.33

Glue Line Rip Saw Blades, Straight Line Rip



These are the cleanest cutting rip blades to be used where a glue joint is required. Triple Chip Grind (TCG) is recommended for hardwoods and composite boards. Alternate Top Bevel (ATB) is recommended for softer woods.

Tool No.	Dia.	Tooth	Bore	Grind	Plate	Kerf	Price
G1024A-125	10"	24	5/8"	20ATB	.085"	.125"	\$61.42
G1030T	10"	30	5/8"	20TCG	.095"	.145"	\$70.42
G1230T	12"	30	1"	20TCG	.110"	.160"	\$89.25
G1236T-160	12"	36	1"	20TCG	.110"	.160"	\$94.92
G1236T-170	12"	36	1"	20TCG	.120"	.170"	\$100.00
G1248A	12"	48	1"	20ATB	.120"	.160"	\$111.67
G1436T	14"	36	1"	20TCG	.120"	.165"	\$114.33
G1436T-112	14"	36	1-1/2"	20TCG	.120"	.165"	\$138.83
G1436T-2*	14"	36	2"	20TCG	.120"	.165"	\$138.83
G1440T	14"	40	1"	20TCG	.110"	.160"	\$115.17
G1440A	14"	40	1"	20ATB	.110"	.160"	\$113.58
G1636T	16"	36	1"	20TCG	.120"	.170"	\$140.00
G1636T-2	16"	36	2"	20TCG	.120"	.170"	\$166.33
G1836T	18"	36	1"	20TCG	.134"	.184"	\$174.17
G1836T-2*	18"	36	2"	20TCG	.134"	.184"	\$199.17
G2040T-2*	20"	40	2"	20TCG	.134"	.184"	\$216.67
G3036T-30^	300mm	36	30mm	20TCG	2.8mm	4.0mm	\$101.58
G3536T-30^	350mm	36	30mm	20TCG	2.8mm	4.0mm	\$138.83

* Come standard with 9/16 pinhole - 5" circle.

^ Come with universal pinholes

Heavy Duty Rip Saw Blades, Flat Top Grind



Ideal for ripping on under powered saws. A thinner kerf allows for less feed effort and saves wood! For maximum performance use with saw stabilizers.

Tool No.	Dia.	Bore	Tooth	Grind	Plate	Kerf	Price
HD1010	10"	5/8"	10	20ST	.095"	.145"	\$57.50
HD1024	10"	5/8"	24	20ST	.095"	.145"	\$65.83
HD1212	12"	1"	12	20ST	.110"	.160"	\$65.83
HD1224	12"	1"	24	20ST	.095"	.145"	\$74.17
HD1236	12"	1"	36	20ST	.095"	.145"	\$90.83
HD1420	14"	1"	20	20ST	.120"	.160"	\$113.33
HD1430	14"	1"	30	20ST	.110"	.160"	\$118.33
HD1440	14"	1"	40	20ST	.110"	.160"	\$123.33
HD1630	16"	1"	30	20ST	.120"	.165"	\$135.00



Ultra Thin Rip Saw Blades



Ideal for ripping on under powered saws. A thinner kerf allows for less feed effort and saves wood! For maximum performance use with saw stabilizers.

Tool No.	Dia.	Tooth	Bore	Grind	Plate	Kerf	Price
U824	8"	24	5/8"	20ST	.059"	.090"	\$62.50
U1024	10"	24	5/8"	20ATB	.059"	.090"	\$77.50
U1224	12"	24	1"	20ST	.060"	.090"	\$88.33
U1436	14"	36	1"	20ST	.085"	.125"	\$113.33

General Purpose Saw Blades



A good compromise between equal ripping and cross cutting duty where frequent blade changes are unacceptable.

Tool No.	Dia.	Tooth	Bore	Grind	Plate	Kerf	Price
GP7A	7-1/4"	24	5/8"	15ATB	.085"	.125"	\$50.83
GP840A	8"	40	5/8"	10ATB	.085"	.125"	\$60.42
GP840T	8"	40	5/8"	10TCG	.085"	.125"	\$67.33
GP940A	9"	40	5/8"	10ATB	.085"	.125"	\$62.08
GP940T	9"	40	5/8"	10TCG	.085"	.125"	\$69.13
GP1040A	10"	40	5/8"	10ATB	.085"	.125"	\$56.00
GP1040T	10"	40	5/8"	10TCG	.085"	.125"	\$57.83
GP1240A	12"	40	1"	10ATB	.095"	.135"	\$86.08
GP1240T	12"	40	1"	10TCG	.095"	.135"	\$83.63
GP1248A	12"	48	1"	10ATB	.095"	.135"	\$90.00
GP1440A	14"	40	1"	10ATB	.110"	.160"	\$119.50
GP1440T	14"	40	1"	10TCG	.110"	.160"	\$121.17
GP1448A	14"	48	1"	10ATB	.095"	.138"	\$123.83
GP1640A	16"	40	1"	10ATB	.120"	.165"	\$132.67
GP1640T	16"	40	1"	10TCG	.120"	.165"	\$134.33
GP1848A	18"	48	1"	10ATB	.134"	.184"	\$191.67
GP2260A	22"	60	1"	15ATB	.150"	.200"	\$307.50
GP2460A-184	24"	60	1"	15ATB	.134"	.184"	\$341.67
GP2460A-200	24"	60	1"	15ATB	.150"	.200"	\$350.00

Rip with Chip Guides Saw Blades



Specially designed for hand feed applications. The unique shoulder design aids in reducing possible "kickback" of material.

Tool No.	Dia.	Tooth	Bore	Grind	Plate	Kerf	Price
SR1024A	10"	24	5/8"	20ATB-S	.085"	.125"	\$64.10
SR1224A-145	12"	24	1"	20ATB-S	.095"	.145"	\$90.80



Standard Cross Cut Saw Blades



Ideal all around cabinet maker blade. Clean cross cutting of all types of wood, particle board, plywood, and plastic laminated(single sided) panels. ATB recommended for most solid woods. TCG recommended for hardwoods, plywood, particleboard, and other abrasive material.

Tool No.	Dia.	Tooth	Bore	Grind	Plate	Kerf	Price
SC740A	7-1/4"	40	5/8"	10ATB	.085"	.125"	\$57.08
SC740T	7-1/4"	40	5/8"	10TCG	.085"	.125"	\$58.75
SC860A	8"	60	5/8"	10ATB	.085"	.125"	\$78.75
SC860T	8"	60	5/8"	10TCG	.085"	.125"	\$80.42
SC960A	9"	60	5/8"	5ATB	.085"	.125"	\$82.92
SC1060A	10"	60	5/8"	10ATB	.085"	.125"	\$65.00
SC1060A-1	10"	60	1"	10ATB	.085"	.125"	\$80.00
SC1060T	10"	60	5/8"	10TCG	.085"	.125"	\$65.83
SC1060T-1	10"	60	1"	10TCG	.085"	.125"	\$81.67
SC1260A	12"	60	1"	10ATB	.095"	.135"	\$106.67
SC1260T	12"	60	1"	10TCG	.095"	.135"	\$107.92
SC1460A-138	14"	60	1"	10ATB	.098"	.138"	\$129.50
SC1460A-160	14"	60	1"	10ATB	.110"	.160"	\$132.75
SC1460T-138	14"	60	1"	10TCG	.098"	.138"	\$129.50
SC1460T-160	14"	60	1"	10TCG	.110"	.160"	\$130.42
SC1560A	15"	60	1"	5ATB	.110"	.160"	\$176.67
SC1660A-165	16"	60	1"	10ATB	.120"	.165"	\$173.83
SC1660A-184	16"	60	1"	10ATB	.134"	.184"	\$180.50
SC1660T	16"	60	1"	10TCG	.120"	.165"	\$173.83
SC1860T	18"	60	1"	5TCG	.134"	.184"	\$213.33
SC1861A	18"	60	1"	10ATB	.134"	.184"	\$210.00
SC2060A	20"	60	1"	5ATB	.134"	.184"	\$273.33
SC2060T	20"	60	1"	5TCG	.134"	.184"	\$275.00
SC2280A	22"	60	1"	10ATB	.150"	.210"	\$323.33
SC2480A	24"	80	1"	10ATB	.150"	.210"	\$366.67

Combination/Planer Style Saw Blades



One blade that is designed to rip and cross cut. The best compromise when one blade needs to do both jobs.

Tool No.	Dia.	Tooth	Bore	Grind	Plate	Kerf	Price
CM850	8"	50	5/8"	15CMB	.085"	.125"	\$67.08
CM950	9"	50	5/8"	15CMB	.085"	.125"	\$71.25
CM1050	10"	50	5/8"	15CMB	.095"	.135"	\$63.33
CM1260	12"	60	1"	15CMB	.095"	.135"	\$106.25
CM1470	14"	70	1"	15CMB	.120"	.165"	\$150.00
CM1680	16"	80	1"	15CMB	.120"	.165"	\$171.67

Precision Trim Saw Blades



Finer cutting than the Standard Cross Cut, these blades are ideal for thinner sheets of material. Use ATB for solid wood, Use TCG for chipboard, plywood, particleboard & other abrasive materials.

Tool No.	Dia.	Tooth	Bore	Grind	Plate	Kerf	Price
PT1085A	10"	80	5/8"	5ATB	.085"	.125"	\$93.75
PT1085T	10"	80	5/8"	5TCG	.085"	.125"	\$98.33
PT1272A	12"	72	5/8"	10ATB	.134"	.177"	\$149.17
PT1280A	12"	80	1"	10ATB	.095"	.135"	\$117.50
PT1280T	12"	80	1"	10TCG	.095"	.135"	\$126.67
PT1481A-138	14"	80	1"	10ATB	.098"	.138"	\$156.00
PT1481A-160	14"	80	1"	10ATB	.110"	.160"	\$156.67
PT1481A-176	14"	80	1"	10ATB	.120"	.176"	\$161.17
PT1481A-184	14"	80	1"	10ATB	.134"	.184"	\$172.42
PT1480T-138	14"	80	1"	10TCG	.098"	.138"	\$156.00
PT1480T-165	14"	80	1"	10TCG	.120"	.165"	\$161.17
PT1680A-165	16"	80	1"	10ATB	.120"	.165"	\$197.67
PT1680A-184	16"	80	1"	10ATB	.134"	.184"	\$201.00
PT1680T	16"	80	1"	10TCG	.120"	.165"	\$198.47
PT1880T	18"	80	1"	10TCG	.134"	.184"	\$246.67
PT1881A	18"	80	1"	10ATB	.134"	.184"	\$243.33
PT2080A-184	20"	80	1"	10ATB	.134"	.184"	\$310.00
PT2080A-200	20"	80	1"	10ATB	.150"	.200"	\$326.67



Finish Trim Saw Blades



When the finest cut is required on thin material, these excel in miter applications or sizing thin sheets of stock.

Tool No.	Dia.	Tooth	Bore	Grind	Plate	Kerf	Price
FT100A	10"	100	5/8"	0ATB	.085"	.115"	\$124.50
FT105A	10"	100	5/8"	5ATB	.085"	.125"	\$129.42
FT105T	10"	100	5/8"	5TCG	.085"	.125"	\$133.17
FT121A	12"	100	1"	5ATB	.095"	.125"	\$136.25
FT122A	12"	120	1"	5ATB	.085"	.118"	\$176.17
FT125T	12"	100	1"	5TCG	.095"	.125"	\$139.58
FT141A	14"	100	1"	10ATB	.098"	.138"	\$165.08
FT141A-165	14"	100	1"	10ATB	.120"	.165"	\$172.67
FT141T-138	14"	100	1"	10TCG	.098"	.138"	\$165.08
FT141T-165	14"	100	1"	10TCG	.120"	.165"	\$172.67
FT142A	14"	120	1"	0ATB	.110"	.150"	\$202.33
FT145A	14"	100	1"	5ATB	.110"	.156"	\$170.17
FT155A	15"	100	1"	5ATB	.110"	.160"	\$204.67
FT1625A	16"	120	1"	5ATB	.120"	.165"	\$224.58
FT162A	16"	120	1"	N5ATB	.120"	.165"	\$232.00
FT162T	16"	120	1"	5TCG	.120"	.150"	\$232.00
FT165A	16"	100	1"	5ATB	.120"	.165"	\$202.75
FT165T	16"	100	1"	5TCG	.120"	.165"	\$202.75
FT181A	18"	100	1"	5ATB	.134"	.177"	\$275.00
FT181T	18"	100	1"	5TCG	.134"	.177"	\$278.33
FT182A	18"	120	1"	5ATB	.134"	.173"	\$305.00
FT182NA	18"	120	1"	N5ATB	.134"	.177"	\$316.67
FT201T	20"	100	1"	5TCG	.134"	.177"	\$344.92
FT202A	20"	120	1"	10ATB	.134"	.177"	\$361.67
FT202T	20"	120	1"	5TCG	.134"	.177"	\$361.67
FT202NA	20"	120	1"	N5ATB	.134"	.173"	\$375.83
FT205A	20"	100	1"	5ATB	.134"	.173"	\$336.67
FT221A	22"	120	1"	10ATB	.150"	.200"	\$406.67
FT241A	24"	100	1"	10ATB	.150"	.200"	\$434.92
FT4510A	450mm	100	30mm	10ATB	3.4mm	4.0mm	\$275.00
FT4512AR	455mm	120	1"	10ATB+R	.110"	.134"	\$300.00

Laminates & Veneer Saw Blades, N5LRCR Grind



Designed to Cut Single & double sided laminates, fine veneers and plywood chip free without a scoring saw. A negative hook angle plus a "high" alternate top are featured in this design. LXT carbide is used to prolong edge life between sharpening.

Tool No.	Dia.	Tooth	Bore	Plate	Kerf	Price
LR860	8"	60	5/8"	.085"	.115"	\$99.58
LR1080	10"	80	5/8"	.085"	.115"	\$124.58
LR1210	12"	100	1"	.095"	.125"	\$160.00
LR1410	14"	100	1"	.098"	.138"	\$189.58
LR1610	16"	120	1"	.120"	.160"	\$227.50
LR18108	18"	108	1"	.134"	.173"	\$333.33
LR220*	220mm	64	30mm	2.2mm	2.9mm	\$125.42
LR250^	250mm	80	30mm	2.2mm	2.9mm	\$131.67
LR3096^	300mm	96	30mm	2.4mm	3.2mm	\$164.17
LR3596^	350mm	96	30mm	2.5mm	3.5mm	\$188.79

* Pin holes: 2/7/42
^ Universal pin holes

**LXT Carbide Tipped Saw Blades, 10° TCG Grind
Universal Pin Holes**



These blades are tipped with Skarpaz LXT carbide which substantially increases edge holding ability when cutting MDF, fiberboard, particleboards, and other abrasive materials. Recommended for high volume cutting applications.

Tool No.	Dia.	Tooth	Bore	Plate	Kerf	Price
LX1280T-30	305mm	80	30mm	2.4mm	3.5mm	\$153.75
LX3072	300mm	72	30mm	2.2mm	3.2mm	\$136.67



Radial Arm/Miter Saw Blades



Neutral Hook angle prevents saw from grabbing material. Select less teeth for thicker material. ATB grind is not suitable for non ferrous metals.

Tool No.	Dia.	Tooth	Bore	Grind	Plate	Kerf	Price
RA860	8"	60	5/8"	0ATB	.085"	.115"	\$78.75
RA980	9"	80	5/8"	0ATB	.085"	.115"	\$117.08
RA1060	10"	60	5/8"	0ATB	.085"	.125"	\$78.33
RA1080	10"	80	5/8"	0ATB	.085"	.125"	\$93.75
RA1260	12"	60	5/8"	0ATB	.085"	.125"	\$123.33
RA1280-1	12"	80	1"	0ATB	.095"	.135"	\$126.67
RA1280-58	12"	80	5/8"	0ATB	.095"	.135"	\$139.17
RA1411	14"	100	1"	0ATB	.098"	.138"	\$174.11
RA1436	14"	36	1"	N5ATB	.085"	.125"	\$126.00
RA1460-SKZ	14"	60	1"	0ATB	.120"	.160"	\$154.67
RA1480	14"	80	1"	0ATB	.110"	.156"	\$166.33
RA1640-SKZ	16"	40	1"	0ATB	.134"	.184"	\$158.33
RA1660	16"	60	1"	0ATB	.120"	.165"	\$182.83
RA1680	16"	80	1"	0ATB	.120"	.165"	\$195.50
RA1860	18"	60	1"	0ATB	.134"	.184"	\$210.67
RA1880	18"	80	1"	0ATB	.134"	.184"	\$243.33

Portable Miter/Table Saw Saw Blades



Extensive selection of blades to maximize the performance of your saw. Use negative and neutral hook angles for miter applications. Positive hook blades for most table saw applications.

Tool No.	Dia.	Tooth	Bore	Grind	Plate	Kerf	Price
U860A	8"	60	5/8"	5ATB	.059"	.090"	\$79.17
U860T	8"	60	5/8"	5TCG	.059"	.090"	\$80.00
PS840A	8-1/4"	40	5/8"	10ATB	.070"	.095"	\$64.58
PS860A	8-1/4"	60	5/8"	10ATB	.070"	.095"	\$75.01
PU860A	8-1/4"	60	5/8"	0ATB	.059"	.090"	\$75.02
PS861T	8-1/4"	60	5/8"	10TCG	.070"	.095"	\$76.67
P86NA	8-1/2"	60	5/8"	N5ATB	.070"	.095"	\$75.04
P860A	8-1/2"	60	5/8"	0ATB	.059"	.090"	\$75.03
U1040A	10"	40	5/8"	10ATB	.059"	.090"	\$69.17
U1040T	10"	40	5/8"	10TCG	.059"	.090"	\$72.50
P1060A	10"	60	5/8"	0ATB	.059"	.090"	\$80.01
U1060A	10"	60	5/8"	10ATB	.059"	.090"	\$85.83
U1060T	10"	60	5/8"	10TCG	.059"	.090"	\$86.67
P1080A	10"	80	5/8"	0ATB	.059"	.090"	\$111.67
P108NA	10"	80	5/8"	N5ATB	.085"	.120"	\$108.75
U1081A	10"	80	5/8"	10ATB	.059"	.090"	\$111.67
U1081T	10"	80	5/8"	10TCG	.059"	.090"	\$113.75
P124NA	12"	40	1"	N5ATB	.085"	.115"	\$94.17
U1260A	12"	60	1"	10ATB	.059"	.090"	\$128.33
P126NA	12"	60	1"	N5ATB	.085"	.115"	\$113.75
U1280A	12"	80	1"	10ATB	.059"	.090"	\$143.33
P1280A	12"	80	1"	0ATB	.059"	.090"	\$130.83
P128NA	12"	80	1"	N5ATB	.085"	.115"	\$126.67
P128NAR	12"	80	1"	N5ATB	.080"	.110"	\$126.68
P1280A-095	12"	80	1"	0ATB	.070"	.095"	\$120.01
U1280T	12"	80	1"	5TCG	.059"	.090"	\$145.00
U1210A	12"	100	1"	5ATB	.059"	.090"	\$150.83
U1210T	12"	100	1"	5TCG	.059"	.090"	\$153.33
U1215T	12"	100	1"	15TCG	.070"	.100"	\$153.33
P148NA	14"	80	1"	N5ATB	.085"	.095"	\$156.67
U1410A	14"	100	1"	10ATB	.070"	.110"	\$190.01
P141NA	14"	100	1"	N5ATB	.085"	.120"	\$182.51
P146NA	14"	60	1"	N5ATB	.085"	.120"	\$105.01
P1560A	15"	60	1"	0ATB	.070"	.110"	\$149.58
P1580A	15"	80	1"	0ATB	.070"	.110"	\$163.75
P1510A-115	15"	100	1"	0ATB	.085"	.115"	\$185.83
U2660AR*	260mm	60	30mm	N2ATB+R	1.8mm	2.5mm	\$91.67
U2680AR*	260mm	80	30mm	N2ATB+R	1.8mm	2.5mm	\$108.33

* For FesTool Kapex Miter saw.



Thin Kerf Beam Saw Blades
For Makita 5402NA & Skilsaw SPT70V-11 Super Sawquatch



Tool No.	Dia.	Bore	Tooth	Grind	Kerf	Plate	Price
U1625*	16"	25mm	60	20ATB	.110"	.070"	\$189.17
U1636	16"	25mm	36	20ATB-S	.110"	.070"	\$165.00

* anti-kickback style

Biscuit Jointer Saw Blades



Fits most popular makes of plate jointer machines. Chip limiting style.

Tool No.	Dia.	Tooth	Kerf	Plate	Price
BJ100	100mm	6	4.0mm	3.0mm	\$62.08
BJ100-2*	100mm	6	4.0mm	3.0mm	\$75.01

* Comes with 4 countersunk pinholes for Lamello Top 20SF machine

Edge Banding Saw Blades



Tool No.	Dia.	Tooth	Bore	Grind	Plate	Kerf	Price
EB1002020	100mm	20	20mm	10ATB	2.2mm	3.2mm	\$81.33
EB1003030	100mm	30	30mm	10ATB	1.8mm	2.4mm	\$81.33
EB1004032	100mm	40	32mm	10ATB	1.8mm	2.4mm	\$119.51
EB1102022	110mm	20	22mm	10ATB	2.5mm	3.6mm	\$81.33
EB1102032	110mm	20	32mm	10ATB	2.5mm	3.6mm	\$81.33
EB1152430	110mm	24	30mm	15ATB	1.6mm	2.6mm	\$101.86
EB1202032	120mm	20	32mm	10ATB	2.2mm	3.2mm	\$84.20
EB1203640P	120mm	36	40mm	10ATB	2.8mm	3.6mm	\$106.79
EB1252420	125mm	24	20mm	10ATB	2.2mm	3.2mm	\$105.97
EB1254L20*	125mm	40	20mm	0Left	2.0mm	3.2mm	\$105.97
EB1254R20^	125mm	40	20mm	0Right	2.0mm	3.2mm	\$105.97
EB1502L30*	150mm	24	30mm	5Left	2.2mm	3.2mm	\$116.64
EB1502R30^	150mm	24	30mm	5Right	2.2mm	3.2mm	\$116.64
EB1503L114*	150mm	30	1-1/4"	5Left	2.2mm	3.2mm	\$139.64
EB1503R114^	150mm	30	1-1/4"	5Right	2.2mm	3.2mm	\$139.64
EB1602430	160mm	24	30mm	15ATB	2.2mm	3.2mm	\$111.30
EB1604822	160mm	48	22mm	N5ATB	2.2mm	3.0mm	\$132.66
EB1703L30*	170mm	36	30mm	5Left	2.1mm	3.1mm	\$127.33
EB1703R30^	170mm	36	30mm	5Right	2.1mm	3.1mm	\$127.33

* Teeth are beveled in left position only

^ Teeth are beveled in right position only

Dado Set For Industrial Applications



Each set consists of 2 outside blades, one 2-wing 1/4" thick chipper two 2-wing 1/8" thick chippers and one 2-wing 1/16" thick chipper.

These stackable dado sets have built their own reputation for reliability and accuracy. Extra large carbide tips are used to the outside blades and cheaper teeth. Precision grinding ensures a perfect flat bottom cut dado with slight scribes on both sides of the dado.

Tool No.	Dia.	Tooth	Bore	Kerf	Price
D630	6"	30	5/8"	Max. 13/16"	\$190.42
D824	8"	24	5/8"	Max. 13/16"	\$191.25
D8241	8"	24	1"	Max. 13/16"	\$242.51
D8240	8"	40	5/8"	Max. 13/16"	\$251.67
D82401	8"	40	1"	Max. 13/16"	\$302.51
D8240N*	8"	40	5/8"	Max. 13/16"-1/64"	\$251.68
D1024	10"	24	5/8"	Max. 13/16"	\$271.25
D10241	10"	24	1"	Max. 13/16"	\$294.17
D1040	10"	40	5/8"	Max. 13/16"	\$307.51
D10401	10"	40	1"	Max. 13/16"	\$342.52
D1224	12"	24	1"	Max. 13/16"	\$408.34
D1240	12"	40	1"	Max. 13/16"	\$466.68

* Negative hook outside dado blades-1/64" undersize



Replacement Chippers, 2-Wing For Industrial Applications



Tool No.	Dia.	Thickness	Bore	Price
CP618	6"	1/8"	5/8"	\$24.58
CP816	8"	1/16"	5/8"	\$23.75
CP818	8"	1/8"	5/8"	\$23.79
CP814	8"	1/4"	5/8"	\$39.17
CP1016	10"	1/16"	5/8"	\$29.17
CP1018	10"	1/8"	5/8"	\$29.19
CP1014	10"	1/4"	5/8"	\$44.16
CP10161	10"	1/16"	1"	\$29.21
CP10181	10"	1/8"	1"	\$29.22
CP10141	10"	1/4"	1"	\$39.18
CP1216	12"	1/16"	1"	\$41.68
CP1218	12"	1/8"	1"	\$41.69
CP1214	12"	1/4"	1"	\$58.35

* Negative hook outside dado blades-1/64" undersize

Saw Stabilizers

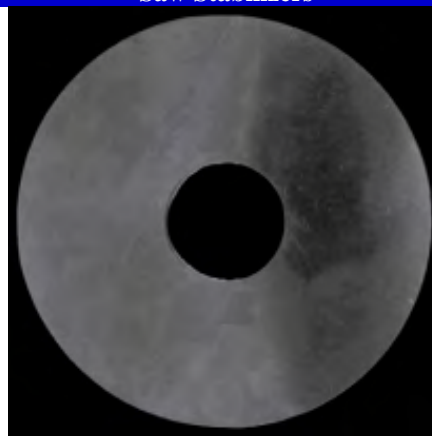

Helps stabilize blades which can result in better cuts and lower blade noise. Sold in pairs for optimum performance.

Tool No.	Dia.	Bore	Thickness	Counts Per Package	Price
ST4	4"	5/8"	.102"	2	\$20.42
ST61	6"	1"	.102"	2	\$30.83
ST81	8"	1"	.102"	2	\$40.83

Stellite Tipped Resaw Bandsaw Blade



Tool No.	Length	Width	Pitch	Gauge	Machine	Price
ST11221-A^	112"	2-7/16"	3/4"	23	Makita 2116	\$141.65
ST11131*#	110-3/4"	3"	3/4"	23	Hitachi CB 75F	\$383.35
ST11131A^#	110-3/4"	3"	3/4"	23	Hitachi CB 75F	\$283.35
ST174114*#	174"	4"	1-1/4"	20	Hitachi CB 100F	\$633.35

* Tipped every tooth
 ^ Tipped alternate tooth
 # Sold as 2 blades/package



MAGNATE Band Saw Blades Introduction

Magnate™ Carbon Tool Steel BandSaw Blade

Carbon tool steel bandsaw blades are designed to work with a woodcutting saw to cut all types of woods at a range of 800-3,500 fpm; especially ideal for soft woods, i.e. pine, polar, fir and spruce. If used with a good release agent, it can cut plastics at a range of 200-800 fpm, or non-ferrous metal (i.e. aluminum, copper and brass) at a range of 200-1,000 fpm. However, to cut ferrous metals or mild steel (don't cut hard steel), you must only use a metal-cutting saw at a range of 40-200 fpm. Having liquid coolant running along the back of the blade yields the best results is highly recommended.

Magnate™ Bi-Metal Bandsaw Blade

Bi-Metal band saw blades are designed to work with a woodworking saw at a speed range of 800-3,500 fpm to cut plastics, all types of woods (especially ideal for hard woods i.e. oak, maple, walnut or cherry), plastics, and non-ferrous metals (aluminum, copper, brass, etc). To cut ferrous metal (i.e. carbon steels, light alloy steels, mold steels, and tool steels), you must only use a metal-cutting bandsaw, at a speed range of 40 - 200 fpm.

Magnate™ Carbide Grit Bandsaw Blade

This blade is NOT used for woodcutting, but it MUST be used with a wood cutting band saw. DO NOT use a metal-cutting band saw with it. It cuts abrasive and hardened materials such as wire-reinforced rubber, steel belted radial tires, ceramics, fiberglass, composites, hardened steel, cast iron (grey with voids), graphite, and case-hardened materials.

A gullet edge carbide particle grit bandsaw blade is ideal for cutting applications involving materials with a cross section thickness of greater than 1/4" (6.4mm); while a continuous carbide particle grit bandsaw blade is ideal for cutting applications involving materials with a cross section thickness of 1/4" (6.4mm) or thinner.

Magnate™ Carbide Tipped Bandsaw Blade

This carbide tipped bandsaw blade is designed with precision triple chip ground teeth for smooth cuts and an excellent finish. The new high performance steel back offers excellent fatigue life. A carbide tipped blade outlasts carbon steel and bi-metal blades when cutting abrasive non-ferrous materials, wood; especially tropical hardwoods i.e. ebony, koa or cocobolo.

When using a metal cutting bandsaw, it is also ideal to cut ferrous metal materials at least 1 inch thick, i.e. alloy steels, tool steels, bearing steel, carbon steels, stainless steels, and mold steels.

Magnate carbide tipped bandsaw blades application notes:

- 1) Use blades of 1/2" wide x 3 TPI, 3/4" wide x 3 TPI, or 1" wide x 3 TPI; To cut up to 6" (taller if fed slow) wood or 1" – 4" steel.
- 2) Use blades of 1" wide x 2-3 variable tooth or 1-1/4" wide x 2-3 variable tooth; To cut up to 6" (taller if fed slow) wood or 3" – 11" steel.
- 3) Use blades of 1-1/4" wide x 3-4 variable tooth; To cut up to 4" (taller if fed slow) wood or 1" – 6" steel.
- 4) Use blades of 1" wide x 1.3 TPI for Woodcutting Only; To cut wood up to 3" and taller.
- 5) Use blades of 1" wide x 2 TPI for Woodcutting Only; To cut wood 2" to 6" wood.

Magnate™ Scallop Edged Bandsaw Blade

These single-edge scallop blades are made from carbon steel, have a double bevel, 1/2" pitch, and feature a hollow ground cutting edge. The 5/8" wide blades are designed to be used on a meat-cutting band saw for clean cutting of boneless (bone-out) meat, bread, vegetables, and more. The 1/2" wide x 0.020" thick scallop blades can be used on a regular woodcutting band saw for cutting materials such as light to medium foams. The 1" wide x 0.035" thick blades can be used to cut tires, though it depends on the machine.

Magnate™ Meat Cutting Bandsaw Blade

A Magnate™ meat cutting bandsaw blade is made from special high carbon steel. The hardened teeth are precision sharpened. These blades are designed for fast bone-in beef, pork, lamb, fish, or frozen meat cutting.

Note

Upon request, Magnate™ makes blades of any length and of any type available to fit your bandsaw brand and model. Please refer to your owner's/operation manual to make sure the blade's length, width and thickness can fit your band saw machine.





Band Saw Blades Introduction

SuperCut™ 3-Wheeler Bandsaw Blade

Blade breakage and poor blade performance are common problems with small 2 or 3 tabletop bandsaws. These problems are caused by the extreme flexing of the blade caused by the small size of the wheels that the blade runs on and the high speeds normally used. This blade is made of special material that is thinner (0.014") to withstand the sharp flexing encountered on the small wheels of these bandsaws.

SuperCut™ Gold Carbide Impregnated Bandsaw Blade

This premium blade was designed with the professional and serious woodworker in mind. It is truly a unique blade featuring many new advances in blade design. Made from the toughest alloys, the teeth are precision ground and razor sharp, not punched or milled like traditional blades. During the manufacture of this blade, the teeth are impregnated with Carbide particles which greatly improve the cutting life of the blade. The teeth also feature a new aggressive tooth design and set. The sides of the blade are polished smooth and the back of the blade is rounded to allow it to feed and turn with less heat and chatter. This blade is manufactured to the industry's highest standards. No less than 30 inspections and tests insure this is the best blade for the discriminating woodworker. It comes with 0.025" Thickness x 0.030" Kerf.

SuperCut™ Hawc Pro Resaw Bandsaw Blade (WoodCutting)

This high silicon content resaw blade with an aggressive set and modified gullet to increase speed, extend life, and improve the straightness of cut. This blade improves on sawdust removal in a long or thick cut. Hawc Pro is the best all around blade for resawing up to 1/2" thick. It will last longer and cut straighter than conventional bandsaw blades due to its special design and induction hardened teeth. It comes with 0.025" Thickness x 0.045" Kerf.

SuperCut™ WoodSaver Carbide Impregnated Resaw Bandsaw Blade (Woodcutting)

This precision ground, thin kerf resaw blade is designed for reduced waste when cutting expensive hardwoods. During the manufacturing of this blade, The teeth are impregnated with carbide particles, making this a very durable blade which retains its sharpness even resawing the hardest and toughest woods. This blade is especially designed for resawing wood, particularly the hardwoods and other difficult to cut wood species. The narrow kerf conserves these expensive woods, giving you more yield from a block of lumber. It comes with 0.025" thickness x 0.035" kerf.

SuperCut™ WoodSaver Plus Carbide Impregnated Resaw Bandsaw Blade (WoodCutting)

This WoodSaver Plus band saw blade is an improved version of WoodSaver blade. The precision ground teeth have a variable 3-4 tooth design which cuts smoother, because it reduces chatter and vibration. The blade saves even more of your expensive woods being lost to sawdust. The sides of the blade are polished to provide a smoother running blade. The back of the blade is polished round to help eliminate marring of the wood. The carbide impregnated tooth technology gives the blade incredible life. All 0.025" thickness x 0.030" kerf.

SuperCut™ Meat Cutting Bandsaw Blade

A SuperCut™ meat cutting bandsaw blade is made from a high quality, stain resistant steel with easy-cleaning polished sides. It features precision ground, heat-treated teeth that are razor sharp and have a tooth profile designed for cutting meat and bone, i.e. Bone-in beef, pork, lamb; fish cutting.

Note

Upon request, Magnate™ makes blades of any length and of any type available to fit your bandsaw brand and model. Please refer to your owner's/operation manual to make sure the blade's length, width and thickness can fit your band saw machine.





MAGNATE™ Band Saw Blades (Non-Food Processing)

Bi-metal Bandsaw Blade 44-7/8" (3' 8-7/8") Long				
				
Tool No.	Width	Tooth	Thickness	Price
M44.875M14H6	1/4"	6H	.025"	\$29.72
M44.875M14V10	1/4"	10-14V	.025"	\$29.72
M44.875M14V14	1/4"	14-18V	.025"	\$29.72
M44.875M38H4	3/8"	4H	.025"	\$29.72
M44.875M38V10	3/8"	10-14V	.025"	\$29.72
M44.875M38V14	3/8"	14-18V	.025"	\$29.72
M44.875M12H3	1/2"	3H	.025"	\$29.72
M44.875M12H4	1/2"	4H	.025"	\$29.72
M44.875M12H6	1/2"	6H	.025"	\$29.72
M44.875M12V6	1/2"	6-10V	.025"	\$29.72
M44.875M12V8	1/2"	8-12V	.025"	\$29.72
M44.875M12V10	1/2"	10-14V	.025"	\$29.72
M44.875M12V12	1/2"	12-16V	.020"	\$12.57
M44.875M12T14	1/2"	14	.025"	\$29.72
M44.875M12V14	1/2"	14-18V	.025"	\$29.72
M44.875M12T18	1/2"	18	.025"	\$29.72

Bi-metal Bandsaw Blade 52-1/2" (4' 4-1/4") Long				
				
Tool No.	Width	Tooth	Thickness	Price
M52.25M14H6	1/4"	6H	.025"	\$29.72
M52.25M14V10	1/4"	10-14V	.025"	\$29.72
M52.25M14V14	1/4"	14-18V	.025"	\$29.72
M52.25M38H4	3/8"	4H	.025"	\$29.72
M52.25M38V10	3/8"	10-14V	.025"	\$29.72
M52.25M38V14	3/8"	14-18V	.025"	\$29.72
M52.25M12H3	1/2"	3H	.025"	\$29.72
M52.25M12H4	1/2"	4H	.025"	\$29.72
M52.25M12H6	1/2"	6H	.025"	\$29.72
M52.25M12V6	1/2"	6-10V	.025"	\$29.72
M52.25M12V8	1/2"	8-12V	.025"	\$29.72
M52.25M12V10	1/2"	10-14V	.025"	\$29.72
M52.25M12T14	1/2"	14	.025"	\$29.72
M52.25M12V14	1/2"	14-18V	.025"	\$29.72
M52.25M12T18	1/2"	18	.025"	\$29.72

Bi-metal Bandsaw Blade 52-3/4" (4' 4-3/4") Long				
				
Tool No.	Width	Tooth	Thickness	Price
M52.75M14H6	1/4"	6H	.025"	\$29.72
M52.75M14V10	1/4"	10-14V	.025"	\$29.72
M52.75M14V14	1/4"	14-18V	.025"	\$29.72
M52.75M38H4	3/8"	4H	.025"	\$29.72
M52.75M38V10	3/8"	10-14V	.025"	\$29.72
M52.75M38V14	3/8"	14-18V	.025"	\$29.72
M52.75M12H3	1/2"	3H	.025"	\$29.72
M52.75M12H4	1/2"	4H	.025"	\$29.72
M52.75M12H6	1/2"	6H	.025"	\$29.72
M52.75M12V6	1/2"	6-10V	.025"	\$29.72
M52.75M12V8	1/2"	8-12V	.025"	\$29.72
M52.75M12V10	1/2"	10-14V	.025"	\$29.72
M52.75M12T14	1/2"	14	.025"	\$29.72
M52.75M12V14	1/2"	14-18V	.025"	\$29.72
M52.75M12T18	1/2"	18	.025"	\$29.72

Carbon Steel Bandsaw Blade 44-7/8" (3' 8-7/8") Long				
				
Tool No.	Width	Tooth	Thickness	Price
M44.875C316S4	3/16"	4S	.025"	\$9.03
M44.875C316S6	3/16"	6S	.025"	\$10.34
M44.875C316R10	3/16"	10R	.025"	\$9.03
M44.875C316R14	3/16"	14R	.025"	\$9.03
M44.875C316R18	3/16"	18R	.025"	\$9.03
M44.875C316R24	3/16"	24R	.025"	\$9.03
M44.875C14H4	1/4"	4H	.025"	\$8.45
M44.875C14H6	1/4"	6H	.025"	\$8.45
M44.875C14R10	1/4"	10R	.025"	\$8.45
M44.875C14R14	1/4"	14R	.025"	\$8.45
M44.875C14R18	1/4"	18R	.025"	\$8.45
M44.875C14R24	1/4"	24R	.025"	\$8.45
M44.875C38H3	3/8"	3H	.025"	\$9.05
M44.875C38H4	3/8"	4H	.025"	\$9.05
M44.875C38H6	3/8"	6H	.025"	\$9.05
M44.875C38R8	3/8"	8R	.025"	\$9.05
M44.875C38R10	3/8"	10R	.025"	\$9.05
M44.875C38R14	3/8"	14R	.025"	\$9.05
M44.875C38R18	3/8"	18R	.025"	\$9.05
M44.875C38R24	3/8"	24R	.025"	\$10.64
M44.875C12H3	1/2"	3H	.025"	\$9.83
M44.875C12H4	1/2"	4H	.025"	\$10.34
M44.875C12H6	1/2"	6H	.025"	\$9.83
M44.875C12R10	1/2"	10R	.025"	\$9.83
M44.875C12R14	1/2"	14R	.025"	\$9.83
M44.875C12R18	1/2"	18R	.025"	\$9.83
M44.875C12R24	1/2"	24R	.025"	\$9.83

Carbon Steel Bandsaw Blade 52-1/2" (4' 4-1/4") Long				
				
Tool No.	Width	Tooth	Thickness	Price
M52.25C316S4	3/16"	4S	.025"	\$9.03
M52.25C316S6	3/16"	6S	.025"	\$10.34
M52.25C316R10	3/16"	10R	.025"	\$9.03
M52.25C316R14	3/16"	14R	.025"	\$9.03
M52.25C316R18	3/16"	18R	.025"	\$9.03
M52.25C316R24	3/16"	24R	.025"	\$9.03
M52.25C14H4	1/4"	4H	.025"	\$8.45
M52.25C14H6	1/4"	6H	.025"	\$8.45
M52.25C14R10	1/4"	10R	.025"	\$8.45
M52.25C14R14	1/4"	14R	.025"	\$8.45
M52.25C14R18	1/4"	18R	.025"	\$8.45
M52.25C14R24	1/4"	24R	.025"	\$8.45
M52.25C38H3	3/8"	3H	.025"	\$9.05
M52.25C38H4	3/8"	4H	.025"	\$9.05
M52.25C38H6	3/8"	6H	.025"	\$9.05
M52.25C38R8	3/8"	8R	.025"	\$9.05
M52.25C38R10	3/8"	10R	.025"	\$9.05
M52.25C38R14	3/8"	14R	.025"	\$9.05
M52.25C38R18	3/8"	18R	.025"	\$9.05
M52.25C38R24	3/8"	24R	.025"	\$10.64
M52.25C12H3	1/2"	3H	.025"	\$9.83
M52.25C12H4	1/2"	4H	.025"	\$10.34
M52.25C12H6	1/2"	6H	.025"	\$9.83
M52.25C12R10	1/2"	10R	.025"	\$9.83
M52.25C12R14	1/2"	14R	.025"	\$9.83
M52.25C12R18	1/2"	18R	.025"	\$9.83
M52.25C12R24	1/2"	24R	.025"	\$9.83

Carbon Steel Bandsaw Blade 52-3/4" (4' 4-3/4") Long				
				
Tool No.	Width	Tooth	Thickness	Price
M52.75C316S4	3/16"	4S	.025"	\$9.03
M52.75C316S6	3/16"	6S	.025"	\$10.34
M52.75C316R10	3/16"	10R	.025"	\$9.03
M52.75C316R14	3/16"	14R	.025"	\$9.03
M52.75C316R18	3/16"	18R	.025"	\$9.03
M52.75C316R24	3/16"	24R	.025"	\$9.03
M52.75C14H4	1/4"	4H	.025"	\$8.45
M52.75C14H6	1/4"	6H	.025"	\$8.45
M52.75C14R10	1/4"	10R	.025"	\$8.45
M52.75C14R14	1/4"	14R	.025"	\$8.45
M52.75C14R18	1/4"	18R	.025"	\$8.45
M52.75C14R24	1/4"	24R	.025"	\$8.45
M52.75C38H3	3/8"	3H	.025"	\$9.05
M52.75C38H4	3/8"	4H	.025"	\$9.05
M52.75C38H6	3/8"	6H	.025"	\$9.05
M52.75C38R8	3/8"	8R	.025"	\$9.05
M52.75C38R10	3/8"	10R	.025"	\$9.05
M52.75C38R14	3/8"	14R	.025"	\$9.05
M52.75C38R18	3/8"	18R	.025"	\$9.05
M52.75C38R24	3/8"	24R	.025"	\$10.64
M52.75C12H3	1/2"	3H	.025"	\$9.83
M52.75C12H4	1/2"	4H	.025"	\$10.34
M52.75C12H6	1/2"	6H	.025"	\$9.83
M52.75C12R10	1/2"	10R	.025"	\$9.83
M52.75C12R14	1/2"	14R	.025"	\$9.83
M52.75C12R18	1/2"	18R	.025"	\$9.83
M52.75C12R24	1/2"	24R	.025"	\$9.83

MAGNATE™ 20639 Lycoming Street #B-6, Walnut, CA 91789 USA

M-3



email : info@magnate.net Online Shop : www.magnate.net
(TEL) 800-827-2316, 909-468-5747 (FAX) 909-468-5745

MAGNATE™ Band Saw Blades (Non-Food Processing)

Three Wheeler Bandsaw Blades 52-3/4" (4' 4-3/4") Long



Tool No.	Width	Tooth	Thickness	Price
B52.75W316H8	3/16"	8H	.014"	\$11.91
B52.75W14H6	1/4"	6H	.014"	\$11.91
B52.75W14R14	1/4"	14R	.014"	\$11.91
B52.75W14R24	1/4"	24R	.014"	\$11.91
B52.75W38H6	3/8"	6H	.014"	\$11.91
B52.75W38R14	3/8"	14R	.014"	\$11.91
B52.75W38R24	3/8"	24R	.014"	\$11.91

Carbon Steel Bandsaw Blade 53-3/4" (4' 5-3/4") Long



MAGNATE

Tool No.	Width	Tooth	Thickness	Price
M53.75C316S4	3/16"	4S	.025"	\$9.03
M53.75C316S6	3/16"	6S	.025"	\$10.34
M53.75C316R10	3/16"	10R	.025"	\$9.03
M53.75C316R14	3/16"	14R	.025"	\$9.03
M53.75C316R18	3/16"	18R	.025"	\$9.03
M53.75C316R24	3/16"	24R	.025"	\$9.03
M53.75C14H4	1/4"	4H	.025"	\$8.45
M53.75C14H6	1/4"	6H	.025"	\$8.45
M53.75C14R10	1/4"	10R	.025"	\$8.45
M53.75C14R14	1/4"	14R	.025"	\$8.45
M53.75C14R18	1/4"	18R	.025"	\$8.45
M53.75C14R24	1/4"	24R	.025"	\$8.45
M53.75C38H3	3/8"	3H	.025"	\$9.05
M53.75C38H4	3/8"	4H	.025"	\$9.05
M53.75C38H6	3/8"	6H	.025"	\$9.05
M53.75C38R8	3/8"	8R	.025"	\$9.05
M53.75C38R10	3/8"	10R	.025"	\$9.05
M53.75C38R14	3/8"	14R	.025"	\$9.05
M53.75C38R18	3/8"	18R	.025"	\$9.05
M53.75C38R24	3/8"	24R	.025"	\$10.64
M53.75C12H3	1/2"	3H	.025"	\$9.83
M53.75C12H4	1/2"	4H	.025"	\$10.34
M53.75C12H6	1/2"	6H	.025"	\$9.83
M53.75C12R10	1/2"	10R	.025"	\$9.83
M53.75C12R14	1/2"	14R	.025"	\$9.83
M53.75C12R18	1/2"	18R	.025"	\$9.83
M53.75C12R24	1/2"	24R	.025"	\$9.83

Bi-metal Bandsaw Blade 53-3/4" (4' 5-3/4") Long



MAGNATE

Tool No.	Width	Tooth	Thickness	Price
M53.75M14H6	1/4"	6H	.025"	\$29.72
M53.75M14V10	1/4"	10-14V	.025"	\$29.72
M53.75M14V14	1/4"	14-18V	.025"	\$29.72
M53.75M38H4	3/8"	4H	.025"	\$29.72
M53.75M38V10	3/8"	10-14V	.025"	\$29.72
M53.75M38V14	3/8"	14-18V	.025"	\$29.72
M53.75M12H3	1/2"	3H	.025"	\$29.72
M53.75M12H4	1/2"	4H	.025"	\$29.72
M53.75M12H6	1/2"	6H	.025"	\$29.72
M53.75M12V6	1/2"	6-10V	.025"	\$29.72
M53.75M12V8	1/2"	8-12V	.025"	\$29.72
M53.75M12V10	1/2"	10-14V	.025"	\$29.72
M53.75M12T14	1/2"	14	.025"	\$29.72
M53.75M12V14	1/2"	14-18V	.025"	\$29.72
M53.75M12T18	1/2"	18	.025"	\$29.72

Carbon Steel Bandsaw Blade 56-1/8" (4' 8-1/8") Long



MAGNATE

Tool No.	Width	Tooth	Thickness	Price
M56.125C316S4	3/16"	4S	.025"	\$9.98
M56.125C316S6	3/16"	6S	.025"	\$10.34
M56.125C316R10	3/16"	10R	.025"	\$9.98
M56.125C316R14	3/16"	14R	.025"	\$9.98
M56.125C316R18	3/16"	18R	.025"	\$9.98
M56.125C316R24	3/16"	24R	.025"	\$9.98
M56.125C14H4	1/4"	4H	.025"	\$8.88
M56.125C14H6	1/4"	6H	.025"	\$8.88
M56.125C14R10	1/4"	10R	.025"	\$8.88
M56.125C14R14	1/4"	14R	.025"	\$8.88
M56.125C14R18	1/4"	18R	.025"	\$8.88
M56.125C14R24	1/4"	24R	.025"	\$8.88
M56.125C38H3	3/8"	3H	.025"	\$9.57
M56.125C38H4	3/8"	4H	.025"	\$9.57
M56.125C38H6	3/8"	6H	.025"	\$9.57
M56.125C38R8	3/8"	8R	.025"	\$9.57
M56.125C38R10	3/8"	10R	.025"	\$9.57
M56.125C38R14	3/8"	14R	.025"	\$9.57
M56.125C38R18	3/8"	18R	.025"	\$9.57
M56.125C38R24	3/8"	24R	.025"	\$10.64
M56.125C12H3	1/2"	3H	.025"	\$10.34
M56.125C12H4	1/2"	4H	.025"	\$10.34
M56.125C12H6	1/2"	6H	.025"	\$10.34
M56.125C12R10	1/2"	10R	.025"	\$10.34
M56.125C12R14	1/2"	14R	.025"	\$10.34
M56.125C12R18	1/2"	18R	.025"	\$10.34
M56.125C12R24	1/2"	24R	.025"	\$10.34

Bi-metal Bandsaw Blade 56-1/8" (4' 8-1/8") Long



MAGNATE

Tool No.	Width	Tooth	Thickness	Price
M56.125M14H6	1/4"	6H	.025"	\$29.72
M56.125M14V10	1/4"	10-14V	.025"	\$29.72
M56.125M14V14	1/4"	14-18V	.025"	\$29.72
M56.125M38H4	3/8"	4H	.025"	\$29.72
M56.125M38V10	3/8"	10-14V	.025"	\$29.72
M56.125M38V14	3/8"	14-18V	.025"	\$29.72
M56.125M12H3	1/2"	3H	.025"	\$29.72
M56.125M12H4	1/2"	4H	.025"	\$29.72
M56.125M12H6	1/2"	6H	.025"	\$29.72
M56.125M12V6	1/2"	6-10V	.025"	\$29.72
M56.125M12V8	1/2"	8-12V	.025"	\$29.72
M56.125M12V10	1/2"	10-14V	.025"	\$29.72
M56.125M12T14	1/2"	14	.025"	\$29.72
M56.125M12V14	1/2"	14-18V	.025"	\$29.72
M56.125M12T18	1/2"	18	.025"	\$29.72

Three Wheeler Bandsaw Blades 56-1/8" (4' 8-1/8") Long

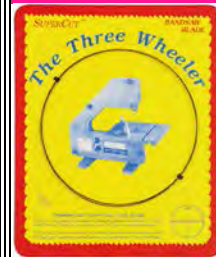

Tool No.	Width	Tooth	Thickness	Price
B56.125W14H6	1/4"	6H	.014"	\$11.91
B56.125W14R14	1/4"	14R	.014"	\$11.91
B56.125W14R24	1/4"	24R	.014"	\$11.91
B56.125W38H6	3/8"	6H	.014"	\$11.91
B56.125W38R14	3/8"	14R	.014"	\$11.91
B56.125W38R24	3/8"	24R	.014"	\$11.91

Three Wheeler Bandsaw Blades 56-1/2" (4' 8-1/2") Long



Tool No.	Width	Tooth	Thickness	Price
B56.5W14H6	1/4"	6H	.014"	\$11.91
B56.5W14R14	1/4"	14R	.014"	\$11.91
B56.5W14R24	1/4"	24R	.014"	\$11.91
B56.5W38H6	3/8"	6H	.014"	\$11.91
B56.5W38R14	3/8"	14R	.014"	\$11.91
B56.5W38R24	3/8"	24R	.014"	\$11.91

MAGNATE™ 20639 Lycoming Street #B-6, Walnut, CA 91789 USA

M-4



email : info@magnate.net Online Shop : www.magnate.net
(TEL) 800-827-2316, 909-468-5747 (FAX) 909-468-5745

MAGNATE™ Band Saw Blades (Non-Food Processing)

Three Wheeler Bandsaw Blades
56-7/8" (4' 8-7/8") Long



Tool No.	Width	Tooth	Thickness	Price
B56.875W14H6	1/4"	6H	.014"	\$11.91
B56.875W14R14	1/4"	14R	.014"	\$11.91
B56.875W14R24	1/4"	24R	.014"	\$11.91
B56.875W38H6	3/8"	6H	.014"	\$11.91
B56.875W38R14	3/8"	14R	.014"	\$11.91
B56.875W38R24	3/8"	24R	.014"	\$11.91

Bi-metal Bandsaw Blade
57" (4' 9") Long



Tool No.	Width	Tooth	Thickness	Price
M57M14H6	1/4"	6H	.025"	\$29.72
M57M14V10	1/4"	10-14V	.025"	\$29.72
M57M14V14	1/4"	14-18V	.025"	\$29.72
M57M38H4	3/8"	4H	.025"	\$29.72
M57M38V10	3/8"	10-14V	.025"	\$29.72
M57M38V14	3/8"	14-18V	.025"	\$29.72
M57M12H3	1/2"	3H	.025"	\$29.72
M57M12H4	1/2"	4H	.025"	\$29.72
M57M12H6	1/2"	6H	.025"	\$29.72
M57M12V6	1/2"	6-10V	.025"	\$29.72
M57M12V8	1/2"	8-12V	.025"	\$29.72
M57M12V10	1/2"	10-14V	.025"	\$29.72
M57M12T14	1/2"	14	.025"	\$29.72
M57M12V14	1/2"	14-18V	.025"	\$29.72
M57M12T18	1/2"	18	.025"	\$29.72

Carbon Steel Bandsaw Blade
57" (4' 9") Long



Tool No.	Width	Tooth	Thickness	Price
M57C316S4	3/16"	4S	.025"	\$9.98
M57C316S6	3/16"	6S	.025"	\$10.34
M57C316R10	3/16"	10R	.025"	\$9.98
M57C316R14	3/16"	14R	.025"	\$9.98
M57C316R18	3/16"	18R	.025"	\$9.98
M57C316R24	3/16"	24R	.025"	\$9.98
M57C14H4	1/4"	4H	.025"	\$8.88
M57C14H6	1/4"	6H	.025"	\$8.88
M57C14R10	1/4"	10R	.025"	\$8.88
M57C14R14	1/4"	14R	.025"	\$8.88
M57C14R18	1/4"	18R	.025"	\$8.88
M57C14R24	1/4"	24R	.025"	\$8.88
M57C38H3	3/8"	3H	.025"	\$9.57
M57C38H4	3/8"	4H	.025"	\$9.57
M57C38H6	3/8"	6H	.025"	\$9.57
M57C38R8	3/8"	8R	.025"	\$9.57
M57C38R10	3/8"	10R	.025"	\$9.57
M57C38R14	3/8"	14R	.025"	\$9.57
M57C38R18	3/8"	18R	.025"	\$9.57
M57C38R24	3/8"	24R	.025"	\$10.64
M57C12H3	1/2"	3H	.025"	\$10.34
M57C12H4	1/2"	4H	.025"	\$10.34
M57C12H6	1/2"	6H	.025"	\$10.34
M57C12R10	1/2"	10R	.025"	\$10.34
M57C12R14	1/2"	14R	.025"	\$10.34
M57C12R18	1/2"	18R	.025"	\$10.34
M57C12R24	1/2"	24R	.025"	\$10.34

Three Wheeler Bandsaw Blades
57" (4' 9") Long



Tool No.	Width	Tooth	Thickness	Price
B57W14H6	1/4"	6H	.014"	\$11.91
B57W14R14	1/4"	14R	.014"	\$11.91
B57W14R24	1/4"	24R	.014"	\$11.91
B57W38H6	3/8"	6H	.014"	\$11.91
B57W38R14	3/8"	14R	.014"	\$11.91
B57W38R24	3/8"	24R	.014"	\$11.91

Bi-metal Bandsaw Blade
57-1/2" (4' 9-1/2") Long



Tool No.	Width	Tooth	Thickness	Price
M57.5M14H6	1/4"	6H	.025"	\$29.72
M57.5M14V10	1/4"	10-14V	.025"	\$29.72
M57.5M14V14	1/4"	14-18V	.025"	\$29.72
M57.5M38H4	3/8"	4H	.025"	\$29.72
M57.5M38V10	3/8"	10-14V	.025"	\$29.72
M57.5M38V14	3/8"	14-18V	.025"	\$29.72
M57.5M12H3	1/2"	3H	.025"	\$29.72
M57.5M12H4	1/2"	4H	.025"	\$29.72
M57.5M12H6	1/2"	6H	.025"	\$29.72
M57.5M12V6	1/2"	6-10V	.025"	\$29.72
M57.5M12V8	1/2"	8-12V	.025"	\$29.72
M57.5M12V10	1/2"	10-14V	.025"	\$29.72
M57.5M12T14	1/2"	14	.025"	\$29.72
M57.5M12V14	1/2"	14-18V	.025"	\$29.72
M57.5M12T18	1/2"	18	.025"	\$29.72

Carbon Steel Bandsaw Blade
57-1/2" (4' 9-1/2") Long



Tool No.	Width	Tooth	Thickness	Price
M57.5C316S4	3/16"	4S	.025"	\$9.98
M57.5C316S6	3/16"	6S	.025"	\$10.34
M57.5C316R10	3/16"	10R	.025"	\$9.98
M57.5C316R14	3/16"	14R	.025"	\$9.98
M57.5C316R18	3/16"	18R	.025"	\$9.98
M57.5C316R24	3/16"	24R	.025"	\$9.98
M57.5C14H4	1/4"	4H	.025"	\$8.88
M57.5C14H6	1/4"	6H	.025"	\$8.88
M57.5C14R10	1/4"	10R	.025"	\$8.88
M57.5C14R14	1/4"	14R	.025"	\$8.88
M57.5C14R18	1/4"	18R	.025"	\$8.88
M57.5C14R24	1/4"	24R	.025"	\$8.88
M57.5C38H3	3/8"	3H	.025"	\$9.57
M57.5C38H4	3/8"	4H	.025"	\$9.57
M57.5C38H6	3/8"	6H	.025"	\$9.57
M57.5C38R8	3/8"	8R	.025"	\$9.57
M57.5C38R10	3/8"	10R	.025"	\$9.57
M57.5C38R14	3/8"	14R	.025"	\$9.57
M57.5C38R18	3/8"	18R	.025"	\$9.57
M57.5C38R24	3/8"	24R	.025"	\$10.64
M57.5C12H3	1/2"	3H	.025"	\$10.34
M57.5C12H4	1/2"	4H	.025"	\$10.34
M57.5C12H6	1/2"	6H	.025"	\$10.34
M57.5C12R10	1/2"	10R	.025"	\$10.34
M57.5C12R14	1/2"	14R	.025"	\$10.34
M57.5C12R18	1/2"	18R	.025"	\$10.34
M57.5C12R24	1/2"	24R	.025"	\$10.34

MAGNATE™ 20639 Lycoming Street #B-6, Walnut, CA 91789 USA

M-5



email : info@magnate.net Online Shop : www.magnate.net
(TEL) 800-827-2316, 909-468-5747 (FAX) 909-468-5745

MAGNATE™ Band Saw Blades (Non-Food Processing)

Three Wheeler Bandsaw Blades 57-1/2" (4' 9-1/2") Long.



Tool No.	Width	Tooth	Thickness	Price
B57.5W14H6	1/4"	6H	.014"	\$11.91
B57.5W14R14	1/4"	14R	.014"	\$11.91
B57.5W14R24	1/4"	24R	.014"	\$11.91
B57.5W38H6	3/8"	6H	.014"	\$11.91
B57.5W38R14	3/8"	14R	.014"	\$11.91
B57.5W38R24	3/8"	24R	.014"	\$11.91

Bi-Metal Bandsaw Blade 59-1/4" (4' 11-1/4") Long



Tool No.	Width	Tooth	Thickness	Price
M59.25M14H6	1/4"	6H	.025"	\$29.72
M59.25M14V10	1/4"	10-14V	.025"	\$29.72
M59.25M14V14	1/4"	14-18V	.025"	\$29.72
M59.25M38H4	3/8"	4H	.025"	\$29.72
M59.25M38V10	3/8"	10-14V	.025"	\$29.72
M59.25M38V14	3/8"	14-18V	.025"	\$29.72
M59.25M12H3	1/2"	3H	.025"	\$29.72
M59.25M12H4	1/2"	4H	.025"	\$29.72
M59.25M12H6	1/2"	6H	.025"	\$29.72
M59.25M12V6	1/2"	6-10V	.025"	\$29.72
M59.25M12V8	1/2"	8-12V	.025"	\$29.72
M59.25M12V10	1/2"	10-14V	.025"	\$29.72
M59.25M12T14	1/2"	14	.025"	\$29.72
M59.25M12V14	1/2"	14-18V	.025"	\$29.72
M59.25M12T18	1/2"	18	.025"	\$29.72

Carbon Steel Bandsaw Blade 59-1/4" (4' 11-1/4") Long



Tool No.	Width	Tooth	Thickness	Price
M59.25C316S4	3/16"	4S	.025"	\$9.98
M59.25C316S6	3/16"	6S	.025"	\$10.34
M59.25C316R10	3/16"	10R	.025"	\$9.98
M59.25C316R14	3/16"	14R	.025"	\$9.98
M59.25C316R18	3/16"	18R	.025"	\$9.98
M59.25C316R24	3/16"	24R	.025"	\$9.98
M59.25C14H4	1/4"	4H	.025"	\$8.88
M59.25C14H6	1/4"	6H	.025"	\$8.88
M59.25C14R10	1/4"	10R	.025"	\$8.88
M59.25C14R14	1/4"	14R	.025"	\$8.88
M59.25C14R18	1/4"	18R	.025"	\$8.88
M59.25C14R24	1/4"	24R	.025"	\$8.88
M59.25C38H3	3/8"	3H	.025"	\$9.57
M59.25C38H4	3/8"	4H	.025"	\$9.57
M59.25C38H6	3/8"	6H	.025"	\$9.57
M59.25C38R8	3/8"	8R	.025"	\$9.57
M59.25C38R10	3/8"	10R	.025"	\$9.57
M59.25C38R14	3/8"	14R	.025"	\$9.57
M59.25C38R18	3/8"	18R	.025"	\$9.57
M59.25C38R24	3/8"	24R	.025"	\$10.64
M59.25C12H3	1/2"	3H	.025"	\$10.34
M59.25C12H4	1/2"	4H	.025"	\$10.34
M59.25C12H6	1/2"	6H	.025"	\$10.34
M59.25C12R10	1/2"	10R	.025"	\$10.34
M59.25C12R14	1/2"	14R	.025"	\$10.34
M59.25C12R18	1/2"	18R	.025"	\$10.34
M59.25C12R24	1/2"	24R	.025"	\$10.34

Three Wheeler Bandsaw Blades 59-1/4" (4' 11-1/4") Long

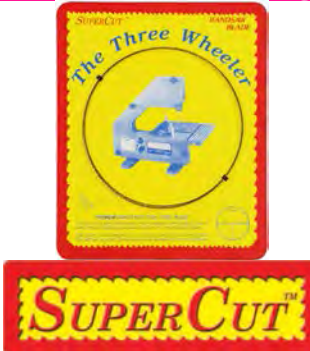

Tool No.	Width	Tooth	Kerf	Price
B59.25W14H6	1/4"	6H	.014"	\$11.91
B59.25W14R14	1/4"	14R	.014"	\$11.91
B59.25W14R24	1/4"	24R	.014"	\$11.91
B59.25W38H6	3/8"	6H	.014"	\$11.91
B59.25W38R14	3/8"	14R	.014"	\$11.91
B59.25W38R24	3/8"	24R	.014"	\$11.91

Bi-metal Bandsaw Blade 59-1/2" (4' 11-1/2") Long



Tool No.	Width	Tooth	Thickness	Price
M59.5M14H6	1/4"	6H	.025"	\$29.72
M59.5M14V10	1/4"	10-14V	.025"	\$29.72
M59.5M14V14	1/4"	14-18V	.025"	\$29.72
M59.5M38H4	3/8"	4H	.025"	\$29.72
M59.5M38V10	3/8"	10-14V	.025"	\$29.72
M59.5M38V14	3/8"	14-18V	.025"	\$29.72
M59.5M12H3	1/2"	3H	.025"	\$29.72
M59.5M12H4	1/2"	4H	.025"	\$29.72
M59.5M12H6	1/2"	6H	.025"	\$29.72
M59.5M12V6	1/2"	6-10V	.025"	\$29.72
M59.5M12V8	1/2"	8-12V	.025"	\$29.72
M59.5M12V10	1/2"	10-14V	.025"	\$29.72
M59.5M12T14	1/2"	14	.025"	\$29.72
M59.5M12V14	1/2"	14-18V	.025"	\$29.72
M59.5M12T18	1/2"	18	.025"	\$29.72

Carbon Steel Bandsaw Blade 59-1/2" (4' 11-1/2") Long



Tool No.	Width	Tooth	Thickness	Price
M59.5C316S4	3/16"	4S	.025"	\$9.98
M59.5C316S6	3/16"	6S	.025"	\$10.34
M59.5C316R10	3/16"	10R	.025"	\$9.98
M59.5C316R14	3/16"	14R	.025"	\$9.98
M59.5C316R18	3/16"	18R	.025"	\$9.98
M59.5C316R24	3/16"	24R	.025"	\$9.98
M59.5C14H4	1/4"	4H	.025"	\$8.88
M59.5C14H6	1/4"	6H	.025"	\$8.88
M59.5C14R10	1/4"	10R	.025"	\$8.88
M59.5C14R14	1/4"	14R	.025"	\$8.88
M59.5C14R18	1/4"	18R	.025"	\$8.88
M59.5C14R24	1/4"	24R	.025"	\$8.88
M59.5C38H3	3/8"	3H	.025"	\$9.57
M59.5C38H4	3/8"	4H	.025"	\$9.57
M59.5C38H6	3/8"	6H	.025"	\$9.57
M59.5C38R8	3/8"	8R	.025"	\$9.57
M59.5C38R10	3/8"	10R	.025"	\$9.57
M59.5C38R14	3/8"	14R	.025"	\$9.57
M59.5C38R18	3/8"	18R	.025"	\$9.57
M59.5C38R24	3/8"	24R	.025"	\$10.64
M59.5C12H3	1/2"	3H	.025"	\$10.34
M59.5C12H4	1/2"	4H	.025"	\$10.34
M59.5C12H6	1/2"	6H	.025"	\$10.34
M59.5C12R10	1/2"	10R	.025"	\$10.34
M59.5C12R14	1/2"	14R	.025"	\$10.34
M59.5C12R18	1/2"	18R	.025"	\$10.34
M59.5C12R24	1/2"	24R	.025"	\$10.34

MAGNATE™ 20639 Lycoming Street #B-6, Walnut, CA 91789 USA

M-6



email : info@magnate.net Online Shop : www.magnate.net
(TEL) 800-827-2316, 909-468-5747 (FAX) 909-468-5745

MAGNATE™ Band Saw Blades (Non-Food Processing)

Three Wheeler Bandsaw Blades 59-1/2" (4' 11-1/2") Long



Tool No.	Width	Tooth	Thickness	Price
B59.5W14H6	1/4"	6H	.014"	\$11.91
B59.5W14R14	1/4"	14R	.014"	\$11.91
B59.5W14R24	1/4"	24R	.014"	\$11.91
B59.5W38H6	3/8"	6H	.014"	\$11.91
B59.5W38R14	3/8"	14R	.014"	\$11.91
B59.5W38R24	3/8"	24R	.014"	\$11.91

Carbon Steel Bandsaw Blade 60" (5') Long



MAGNATE

Tool No.	Width	Tooth	Thickness	Price
M60C316S4	3/16"	4S	.025"	\$9.98
M60C316S6	3/16"	6S	.025"	\$10.34
M60C316R10	3/16"	10R	.025"	\$9.98
M60C316R14	3/16"	14R	.025"	\$9.98
M60C316R18	3/16"	18R	.025"	\$9.98
M60C316R24	3/16"	24R	.025"	\$9.98
M60C14H4	1/4"	4H	.025"	\$8.88
M60C14H6	1/4"	6H	.025"	\$8.88
M60C14R10	1/4"	10R	.025"	\$8.88
M60C14R14	1/4"	14R	.025"	\$8.88
M60C14R18	1/4"	18R	.025"	\$8.88
M60C14R24	1/4"	24R	.025"	\$8.88
M60C38H3	3/8"	3H	.025"	\$9.57
M60C38H4	3/8"	4H	.025"	\$9.57
M60C38H6	3/8"	6H	.025"	\$9.57
M60C38R8	3/8"	8R	.025"	\$9.57
M60C38R10	3/8"	10R	.025"	\$9.57
M60C38R14	3/8"	14R	.025"	\$9.57
M60C38R18	3/8"	18R	.025"	\$9.57
M60C38R24	3/8"	24R	.025"	\$10.64
M60C12H3	1/2"	3H	.025"	\$10.34
M60C12H4	1/2"	4H	.025"	\$10.34
M60C12H6	1/2"	6H	.025"	\$10.34
M60C12R10	1/2"	10R	.025"	\$10.34
M60C12R14	1/2"	14R	.025"	\$10.34
M60C12R18	1/2"	18R	.025"	\$10.34
M60C12R24	1/2"	24R	.025"	\$10.34

Bi-Metal Bandsaw Blade 62" (5' 2") Long



MAGNATE

Tool No.	Width	Tooth	Thickness	Price
M62M14H6	1/4"	6H	.025"	\$31.86
M62M14V10	1/4"	10-14V	.025"	\$31.86
M62M14V14	1/4"	14-18V	.025"	\$31.86
M62M38H4	3/8"	4H	.025"	\$31.86
M62M38V10	3/8"	10-14V	.025"	\$31.86
M62M38V14	3/8"	14-18V	.025"	\$31.86
M62M12H3	1/2"	3H	.025"	\$31.86
M62M12H4	1/2"	4H	.025"	\$31.86
M62M12H6	1/2"	6H	.025"	\$31.86
M62M12V6	1/2"	6-10V	.025"	\$31.86
M62M12V8	1/2"	8-12V	.025"	\$31.86
M62M12V10	1/2"	10-14V	.025"	\$31.86
M62M12T14	1/2"	14	.025"	\$31.86
M62M12V14	1/2"	14-18V	.025"	\$31.86
M62M12T18	1/2"	18	.025"	\$31.86

Bi-Metal Bandsaw Blade 60" (5') Long



MAGNATE

Tool No.	Width	Tooth	Thickness	Price
M60M14H6	1/4"	6H	.025"	\$29.72
M60M14V10	1/4"	10-14V	.025"	\$29.72
M60M14V14	1/4"	14-18V	.025"	\$29.72
M60M38H4	3/8"	4H	.025"	\$29.72
M60M38V10	3/8"	10-14V	.025"	\$29.72
M60M38V14	3/8"	14-18V	.025"	\$29.72
M60M12H3	1/2"	3H	.025"	\$29.72
M60M12H4	1/2"	4H	.025"	\$29.72
M60M12H6	1/2"	6H	.025"	\$29.72
M60M12V6	1/2"	6-10V	.025"	\$29.72
M60M12V8	1/2"	8-12V	.025"	\$29.72
M60M12V10	1/2"	10-14V	.025"	\$29.72
M60M12T14	1/2"	14	.025"	\$29.72
M60M12V14	1/2"	14-18V	.025"	\$29.72
M60M12T18	1/2"	18	.025"	\$29.72

Three Wheeler Bandsaw Blades 60" (5') Long



Tool No.	Width	Tooth	Thickness	Price
B60W14H6	1/4"	6H	.014"	\$11.91
B60W14R14	1/4"	14R	.014"	\$11.91
B60W14R24	1/4"	24R	.014"	\$11.91
B60W38H6	3/8"	6H	.014"	\$11.91
B60W38R14	3/8"	14R	.014"	\$11.91
B60W38R24	3/8"	24R	.014"	\$11.91

Carbon Steel Bandsaw Blade 62" (5' 2") Long



MAGNATE

Tool No.	Width	Tooth	Thickness	Price
M62C316S4	3/16"	4S	.025"	\$11.79
M62C316S6	3/16"	6S	.025"	\$10.95
M62C316R10	3/16"	10R	.025"	\$11.79
M62C316R14	3/16"	14R	.025"	\$11.79
M62C316R18	3/16"	18R	.025"	\$11.79
M62C316R24	3/16"	24R	.025"	\$11.79
M62C14H4	1/4"	4H	.025"	\$9.34
M62C14H6	1/4"	6H	.025"	\$9.34
M62C14R10	1/4"	10R	.025"	\$9.34
M62C14R14	1/4"	14R	.025"	\$9.34
M62C14R18	1/4"	18R	.025"	\$9.34
M62C14R24	1/4"	24R	.025"	\$9.34
M62C38H3	3/8"	3H	.025"	\$10.10
M62C38H4	3/8"	4H	.025"	\$10.10
M62C38H6	3/8"	6H	.025"	\$10.10
M62C38R8	3/8"	8R	.025"	\$10.10
M62C38R10	3/8"	10R	.025"	\$10.10
M62C38R14	3/8"	14R	.025"	\$10.10
M62C38R18	3/8"	18R	.025"	\$10.10
M62C38R24	3/8"	24R	.025"	\$11.05
M62C12H3	1/2"	3H	.025"	\$10.95
M62C12H4	1/2"	4H	.025"	\$10.95
M62C12H6	1/2"	6H	.025"	\$10.95
M62C12R10	1/2"	10R	.025"	\$10.95
M62C12R14	1/2"	14R	.025"	\$10.95
M62C12R18	1/2"	18R	.025"	\$10.95
M62C12R24	1/2"	24R	.025"	\$10.95

MAGNATE™ 20639 Lycoming Street #B-6, Walnut, CA 91789 USA

M-7



email : info@magnate.net Online Shop : www.magnate.net
(TEL) 800-827-2316, 909-468-5747 (FAX) 909-468-5745

MAGNATE™ Band Saw Blades (Non-Food Processing)

Three Wheeler Bandsaw Blades 62" (5' 2") Long



SUPER CUT™

Tool No.	Width	Tooth	Thickness	Price
B62W14H6	1/4"	6H	.014"	\$11.91
B62W14R14	1/4"	14R	.014"	\$11.91
B62W14R24	1/4"	24R	.014"	\$11.91
B62W38H6	3/8"	6H	.014"	\$11.91
B62W38R14	3/8"	14R	.014"	\$11.91
B62W38R24	3/8"	24R	.014"	\$11.91

Three Wheeler Bandsaw Blades 63-1/2" (5' 3-1/2") Long



SUPER CUT™

Tool No.	Width	Tooth	Thickness	Price
B63.5W14H6	1/4"	6H	.014"	\$11.91
B63.5W14R14	1/4"	14R	.014"	\$11.91
B63.5W14R24	1/4"	24R	.014"	\$11.91
B63.5W38H6	3/8"	6H	.014"	\$11.91
B63.5W38R14	3/8"	14R	.014"	\$11.91
B63.5W38R24	3/8"	24R	.014"	\$11.91

Bi-Metal Bandsaw Blade 64" (5' 4") Long



Tool No.	Width	Tooth	Thickness	Price
M64M14H6	1/4"	6H	.025"	\$31.86
M64M14V10	1/4"	10-14V	.025"	\$31.86
M64M14V14	1/4"	14-18V	.025"	\$31.86
M64M38H4	3/8"	4H	.025"	\$31.86
M64M38V10	3/8"	10-14V	.025"	\$31.86
M64M38V14	3/8"	14-18V	.025"	\$31.86
M64M12H3	1/2"	3H	.025"	\$31.86
M64M12H4	1/2"	4H	.025"	\$31.86
M64M12H6	1/2"	6H	.025"	\$31.86
M64M12V6	1/2"	6-10V	.025"	\$31.86
M64M12V8	1/2"	8-12V	.025"	\$31.86
M64M12V10	1/2"	10-14V	.025"	\$31.86
M64M12T14	1/2"	14	.025"	\$31.86
M64M12V14	1/2"	14-18V	.025"	\$31.86
M64M12T18	1/2"	18	.025"	\$31.86

Carbon Steel Bandsaw Blade 64" (5' 4") Long



Tool No.	Width	Tooth	Thickness	Price
M64C316S4	3/16"	4S	.025"	\$11.79
M64C316S6	3/16"	6S	.025"	\$10.95
M64C316R10	3/16"	10R	.025"	\$11.79
M64C316R14	3/16"	14R	.025"	\$11.79
M64C316R18	3/16"	18R	.025"	\$11.79
M64C316R24	3/16"	24R	.025"	\$11.79
M64C14H4	1/4"	4H	.025"	\$9.34
M64C14H6	1/4"	6H	.025"	\$9.34
M64C14R10	1/4"	10R	.025"	\$9.34
M64C14R14	1/4"	14R	.025"	\$9.34
M64C14R18	1/4"	18R	.025"	\$9.34
M64C14R24	1/4"	24R	.025"	\$9.34
M64C38H3	3/8"	3H	.025"	\$10.10
M64C38H4	3/8"	4H	.025"	\$10.10
M64C38H6	3/8"	6H	.025"	\$10.10
M64C38R8	3/8"	8R	.025"	\$10.10
M64C38R10	3/8"	10R	.025"	\$10.10
M64C38R14	3/8"	14R	.025"	\$10.10
M64C38R18	3/8"	18R	.025"	\$10.10
M64C38R24	3/8"	24R	.025"	\$11.05
M64C12H3	1/2"	3H	.025"	\$10.95
M64C12H4	1/2"	4H	.025"	\$10.95
M64C12H6	1/2"	6H	.025"	\$10.95
M64C12R10	1/2"	10R	.025"	\$10.95
M64C12R14	1/2"	14R	.025"	\$10.95
M64C12R18	1/2"	18R	.025"	\$10.95
M64C12R24	1/2"	24R	.025"	\$10.95

Three Wheeler Bandsaw Blades 64" (5' 4") Long



SUPER CUT™

Tool No.	Width	Tooth	Thickness	Price
B64W14H6	1/4"	6H	.014"	\$11.91
B64W14R14	1/4"	14R	.014"	\$11.91
B64W14R24	1/4"	24R	.014"	\$11.91
B64W38H6	3/8"	6H	.014"	\$11.91
B64W38R14	3/8"	14R	.014"	\$11.91
B64W38R24	3/8"	24R	.014"	\$11.91

Bi-Metal Bandsaw Blade 64-1/2" (5' 4-1/2") Long



Tool No.	Width	Tooth	Thickness	Price
M64.5M14H6	1/4"	6H	.025"	\$31.86
M64.5M14V10	1/4"	10-14V	.025"	\$31.86
M64.5M14V14	1/4"	14-18V	.025"	\$31.86
M64.5M38H4	3/8"	4H	.025"	\$31.86
M64.5M38V10	3/8"	10-14V	.025"	\$31.86
M64.5M38V14	3/8"	14-18V	.025"	\$31.86
M64.5M12H3	1/2"	3H	.025"	\$31.86
M64.5M12H4	1/2"	4H	.025"	\$31.86
M64.5M12H6	1/2"	6H	.025"	\$31.86
M64.5M12V6	1/2"	6-10V	.025"	\$31.86
M64.5M12V8	1/2"	8-12V	.025"	\$31.86
M64.5M12V10	1/2"	10-14V	.025"	\$31.86
M64.5M12T14	1/2"	14	.025"	\$31.86
M64.5M12V14	1/2"	14-18V	.025"	\$31.86
M64.5M12T18	1/2"	18	.025"	\$31.86

Carbon Steel Bandsaw Blade 64-1/2" (5' 4-1/2") Long



Tool No.	Width	Tooth	Thickness	Price
M64.5C316S4	3/16"	4S	.025"	\$11.79
M64.5C316S6	3/16"	6S	.025"	\$10.95
M64.5C316R10	3/16"	10R	.025"	\$11.79
M64.5C316R14	3/16"	14R	.025"	\$11.79
M64.5C316R18	3/16"	18R	.025"	\$11.79
M64.5C316R24	3/16"	24R	.025"	\$11.79
M64.5C14H4	1/4"	4H	.025"	\$9.34
M64.5C14H6	1/4"	6H	.025"	\$9.34
M64.5C14R10	1/4"	10R	.025"	\$9.34
M64.5C14R14	1/4"	14R	.025"	\$9.34
M64.5C14R18	1/4"	18R	.025"	\$9.34
M64.5C14R24	1/4"	24R	.025"	\$9.34
M64.5C38H3	3/8"	3H	.025"	\$10.10
M64.5C38H4	3/8"	4H	.025"	\$10.10
M64.5C38H6	3/8"	6H	.025"	\$10.10
M64.5C38R8	3/8"	8R	.025"	\$10.10
M64.5C38R10	3/8"	10R	.025"	\$10.10
M64.5C38R14	3/8"	14R	.025"	\$10.10
M64.5C38R18	3/8"	18R	.025"	\$10.10
M64.5C38R24	3/8"	24R	.025"	\$11.05
M64.5C12H3	1/2"	3H	.025"	\$10.95
M64.5C12H4	1/2"	4H	.025"	\$10.95
M64.5C12H6	1/2"	6H	.025"	\$10.95
M64.5C12R10	1/2"	10R	.025"	\$10.95
M64.5C12R14	1/2"	14R	.025"	\$10.95
M64.5C12R18	1/2"	18R	.025"	\$10.95
M64.5C12R24	1/2"	24R	.025"	\$10.95

MAGNATE™ 20639 Lycoming Street #B-6, Walnut, CA 91789 USA

M-8



email : info@magnate.net Online Shop : www.magnate.net
(TEL) 800-827-2316, 909-468-5747 (FAX) 909-468-5745

MAGNATE™ Band Saw Blades (Non-Food Processing)

Carbide Tipped Bandsaw Blade 64-1/2" (5' 4-1/2") Long



MAGNATE

Tool No.	Width	Tooth	Thickness	Price
M64.5E12T3	1/2"	3	.025"	\$119.38

Carbon Steel Bandsaw Blade 65-1/2" (5' 5-1/2") Long



MAGNATE

Tool No.	Width	Tooth	Thickness	Price
M65.5C316S4	3/16"	4S	.025"	\$11.79
M65.5C316S6	3/16"	6S	.025"	\$10.95
M65.5C316R10	3/16"	10R	.025"	\$11.79
M65.5C316R14	3/16"	14R	.025"	\$11.79
M65.5C316R18	3/16"	18R	.025"	\$11.79
M65.5C316R24	3/16"	24R	.025"	\$11.79
M65.5C14H4	1/4"	4H	.025"	\$9.34
M65.5C14H6	1/4"	6H	.025"	\$9.34
M65.5C14R10	1/4"	10R	.025"	\$9.34
M65.5C14R14	1/4"	14R	.025"	\$9.34
M65.5C14R18	1/4"	18R	.025"	\$9.34
M65.5C14R24	1/4"	24R	.025"	\$9.34
M65.5C38H3	3/8"	3H	.025"	\$10.10
M65.5C38H4	3/8"	4H	.025"	\$10.10
M65.5C38H6	3/8"	6H	.025"	\$10.10
M65.5C38R8	3/8"	8R	.025"	\$10.10
M65.5C38R10	3/8"	10R	.025"	\$10.10
M65.5C38R14	3/8"	14R	.025"	\$10.10
M65.5C38R18	3/8"	18R	.025"	\$10.10
M65.5C38R24	3/8"	24R	.025"	\$11.05
M65.5C12H3	1/2"	3H	.025"	\$10.95
M65.5C12H4	1/2"	4H	.025"	\$10.95
M65.5C12H6	1/2"	6H	.025"	\$10.95
M65.5C12R10	1/2"	10R	.025"	\$10.95
M65.5C12R14	1/2"	14R	.025"	\$10.95
M65.5C12R18	1/2"	18R	.025"	\$10.95
M65.5C12R24	1/2"	24R	.025"	\$10.95

Carbide Tipped Bandsaw Blade 65-1/2" (5' 5-1/2") Long



MAGNATE

Tool No.	Width	Tooth	Thickness	Price
M65.5E12T3	1/2"	3	.025"	\$119.38

Bi-Metal Bandsaw Blade 65-1/2" (5' 5-1/2") Long



MAGNATE

Tool No.	Width	Tooth	Thickness	Price
M65.5M14H6	1/4"	6H	.025"	\$31.86
M65.5M14V10	1/4"	10-14V	.025"	\$31.86
M65.5M14V14	1/4"	14-18V	.025"	\$31.86
M65.5M38H4	3/8"	4H	.025"	\$31.86
M65.5M38V10	3/8"	10-14V	.025"	\$31.86
M65.5M38V14	3/8"	14-18V	.025"	\$31.86
M65.5M12H3	1/2"	3H	.025"	\$31.86
M65.5M12H4	1/2"	4H	.025"	\$31.86
M65.5M12H6	1/2"	6H	.025"	\$31.86
M65.5M12V6	1/2"	6-10V	.025"	\$31.86
M65.5M12V8	1/2"	8-12V	.025"	\$31.86
M65.5M12V10	1/2"	10-14V	.025"	\$31.86
M65.5M12T14	1/2"	14	.025"	\$31.86
M65.5M12V14	1/2"	14-18V	.025"	\$31.86
M65.5M12T18	1/2"	18	.025"	\$31.86

Carbide Tipped Bandsaw Blade 65-3/4" (5' 5-3/4") Long



MAGNATE

Tool No.	Width	Tooth	Thickness	Price
M65.75E12T3	1/2"	3	.025"	\$119.38

Bi-metal Bandsaw Blade 65-3/4" (5' 5-3/4") Long



MAGNATE

Tool No.	Width	Tooth	Thickness	Price
M65.75M14H6	1/4"	6H	.025"	\$31.86
M65.75M14V10	1/4"	10-14V	.025"	\$31.86
M65.75M14V14	1/4"	14-18V	.025"	\$31.86
M65.75M38H4	3/8"	4H	.025"	\$31.86
M65.75M38V10	3/8"	10-14V	.025"	\$31.86
M65.75M38V14	3/8"	14-18V	.025"	\$31.86
M65.75M12H3	1/2"	3H	.025"	\$31.86
M65.75M12H4	1/2"	4H	.025"	\$31.86
M65.75M12H6	1/2"	6H	.025"	\$31.86
M65.75M12V6	1/2"	6-10V	.025"	\$31.86
M65.75M12V8	1/2"	8-12V	.025"	\$31.86
M65.75M12V10	1/2"	10-14V	.025"	\$31.86
M65.75M12T14	1/2"	14	.025"	\$31.86
M65.75M12V14	1/2"	14-18V	.025"	\$31.86
M65.75M12T18	1/2"	18	.025"	\$31.86

Carbon Steel Bandsaw Blade 65-3/4" (5' 5-3/4") Long



MAGNATE

Tool No.	Width	Tooth	Thickness	Price
M65.75C316S4	3/16"	4S	.025"	\$9.98
M65.75C316S6	3/16"	6S	.025"	\$10.95
M65.75C316R10	3/16"	10R	.025"	\$9.98
M65.75C316R14	3/16"	14R	.025"	\$9.98
M65.75C316R18	3/16"	18R	.025"	\$9.98
M65.75C316R24	3/16"	24R	.025"	\$9.98
M65.75C14H4	1/4"	4H	.025"	\$9.34
M65.75C14H6	1/4"	6H	.025"	\$9.34
M65.75C14R10	1/4"	10R	.025"	\$9.34
M65.75C14R14	1/4"	14R	.025"	\$9.34
M65.75C14R18	1/4"	18R	.025"	\$9.34
M65.75C14R24	1/4"	24R	.025"	\$9.34
M65.75C38H3	3/8"	3H	.025"	\$10.10
M65.75C38H4	3/8"	4H	.025"	\$10.10
M65.75C38H6	3/8"	6H	.025"	\$10.10
M65.75C38R8	3/8"	8R	.025"	\$10.10
M65.75C38R10	3/8"	10R	.025"	\$10.10
M65.75C38R14	3/8"	14R	.025"	\$10.10
M65.75C38R18	3/8"	18R	.025"	\$10.10
M65.75C38R24	3/8"	24R	.025"	\$10.64
M65.75C12H3	1/2"	3H	.025"	\$10.95
M65.75C12H4	1/2"	4H	.025"	\$10.95
M65.75C12H6	1/2"	6H	.025"	\$10.95
M65.75C12R10	1/2"	10R	.025"	\$10.95
M65.75C12R14	1/2"	14R	.025"	\$10.95
M65.75C12R18	1/2"	18R	.025"	\$10.95
M65.75C12R24	1/2"	24R	.025"	\$10.95

Bi-metal Bandsaw Blade 67" (5' 7") Long



MAGNATE

Tool No.	Width	Tooth	Thickness	Price
M67M14H6	1/4"	6H	.025"	\$31.86
M67M14V10	1/4"	10-14V	.025"	\$31.86
M67M14V14	1/4"	14-18V	.025"	\$31.86
M67M38H4	3/8"	4H	.025"	\$31.86
M67M38V10	3/8"	10-14V	.025"	\$31.86
M67M38V14	3/8"	14-18V	.025"	\$31.86
M67M12H3	1/2"	3H	.025"	\$31.86
M67M12H4	1/2"	4H	.025"	\$31.86
M67M12H6	1/2"	6H	.025"	\$31.86
M67M12V6	1/2"	6-10V	.025"	\$31.86
M67M12V8	1/2"	8-12V	.025"	\$31.86
M67M12V10	1/2"	10-14V	.025"	\$31.86
M67M12T14	1/2"	14	.025"	\$31.86
M67M12V14	1/2"	14-18V	.025"	\$31.86
M67M12T18	1/2"	18	.025"	\$31.86

MAGNATE™ 20639 Lycoming Street #B-6, Walnut, CA 91789 USA

M-9





email : info@magnate.net Online Shop : www.magnate.net
(TEL) 800-827-2316, 909-468-5747 (FAX) 909-468-5745

MAGNATE™ Band Saw Blades (Non-Food Processing)

Carbon Steel Bandsaw Blade 67" (5' 7") Long				
 MAGNATE				
Tool No.	Width	Tooth	Thickness	Price
M67C18R14	1/8"	14R	.025"	\$13.69
M67C18R18	1/8"	18R	.025"	\$13.69
M67C316S4	3/16"	4S	.025"	\$11.79
M67C316S6	3/16"	6S	.025"	\$11.55
M67C316R10	3/16"	10R	.025"	\$11.79
M67C316R14	3/16"	14R	.025"	\$11.79
M67C316R18	3/16"	18R	.025"	\$11.79
M67C316R24	3/16"	24R	.025"	\$11.79
M67C14H4	1/4"	4H	.025"	\$9.79
M67C14H6	1/4"	6H	.025"	\$9.79
M67C14R10	1/4"	10R	.025"	\$9.79
M67C14R14	1/4"	14R	.025"	\$9.79
M67C14R18	1/4"	18R	.025"	\$9.79
M67C14R24	1/4"	24R	.025"	\$9.79
M67C38H3	3/8"	3H	.025"	\$10.62
M67C38H4	3/8"	4H	.025"	\$10.62
M67C38H6	3/8"	6H	.025"	\$10.62
M67C38R8	3/8"	8R	.025"	\$10.62
M67C38R10	3/8"	10R	.025"	\$10.62
M67C38R14	3/8"	14R	.025"	\$10.62
M67C38R18	3/8"	18R	.025"	\$10.62
M67C38R24	3/8"	24R	.025"	\$11.05
M67C12H3	1/2"	3H	.025"	\$11.55
M67C12H4	1/2"	4H	.025"	\$11.55
M67C12H6	1/2"	6H	.025"	\$11.55
M67C12R10	1/2"	10R	.025"	\$11.55
M67C12R14	1/2"	14R	.025"	\$11.55
M67C12R18	1/2"	18R	.025"	\$11.55
M67C12R24	1/2"	24R	.025"	\$11.55

Three Wheeler Bandsaw Blades 67" (5' 7") Long				
 SUPERCUT™				
Tool No.	Width	Tooth	Thickness	Price
B67W14H6	1/4"	6H	.014"	\$11.91
B67W14R14	1/4"	14R	.014"	\$11.91
B67W14R24	1/4"	24R	.014"	\$11.91
B67W38H6	3/8"	6H	.014"	\$11.91
B67W38R14	3/8"	14R	.014"	\$11.91
B67W38R24	3/8"	24R	.014"	\$11.91

Carbide Tipped Bandsaw Blade 67" (5' 7") Long				
 MAGNATE				
Tool No.	Width	Tooth	Thickness	Price
M67E12T3	1/2"	3	.025"	\$119.38

Carbide Tipped Bandsaw Blade 67-1/2" (5' 7-1/2") Long				
 MAGNATE				
Tool No.	Width	Tooth	Thickness	Price
M67.5E12T3	1/2"	3	.025"	\$119.38

Carbon Steel Bandsaw Blade 67-1/2" (5' 7-1/2") Long				
 MAGNATE				
Tool No.	Width	Tooth	Thickness	Price
M67.5C18R14	1/8"	14R	.025"	\$13.69
M67.5C18R18	1/8"	18R	.025"	\$13.69
M67.5C316S4	3/16"	4S	.025"	\$12.31
M67.5C316S6	3/16"	6S	.025"	\$11.55
M67.5C316R10	3/16"	10R	.025"	\$12.31
M67.5C316R14	3/16"	14R	.025"	\$12.31
M67.5C316R18	3/16"	18R	.025"	\$12.31
M67.5C316R24	3/16"	24R	.025"	\$12.31
M67.5C14H4	1/4"	4H	.025"	\$9.79
M67.5C14H6	1/4"	6H	.025"	\$9.79
M67.5C14R10	1/4"	10R	.025"	\$9.79
M67.5C14R14	1/4"	14R	.025"	\$9.79
M67.5C14R18	1/4"	18R	.025"	\$9.79
M67.5C14R24	1/4"	24R	.025"	\$9.79
M67.5C38H3	3/8"	3H	.025"	\$10.62
M67.5C38H4	3/8"	4H	.025"	\$10.62
M67.5C38H6	3/8"	6H	.025"	\$10.62
M67.5C38R8	3/8"	8R	.025"	\$10.62
M67.5C38R10	3/8"	10R	.025"	\$10.62
M67.5C38R14	3/8"	14R	.025"	\$10.62
M67.5C38R18	3/8"	18R	.025"	\$10.62
M67.5C38R24	3/8"	24R	.025"	\$11.05
M67.5C12H3	1/2"	3H	.025"	\$11.55
M67.5C12H4	1/2"	4H	.025"	\$11.55
M67.5C12H6	1/2"	6H	.025"	\$11.55
M67.5C12R10	1/2"	10R	.025"	\$11.55
M67.5C12R14	1/2"	14R	.025"	\$11.55
M67.5C12R18	1/2"	18R	.025"	\$11.55
M67.5C12R24	1/2"	24R	.025"	\$11.55

Bi-metal Bandsaw Blade 67-1/2" (5' 7-1/2") Long				
 MAGNATE				
Tool No.	Width	Tooth	Thickness	Price
M67.5M14H6	1/4"	6H	.025"	\$31.86
M67.5M14V10	1/4"	10-14V	.025"	\$31.86
M67.5M14V14	1/4"	14-18V	.025"	\$31.86
M67.5M38H4	3/8"	4H	.025"	\$31.86
M67.5M38V10	3/8"	10-14V	.025"	\$31.86
M67.5M38V14	3/8"	14-18V	.025"	\$31.86
M67.5M12H3	1/2"	3H	.025"	\$31.86
M67.5M12H4	1/2"	4H	.025"	\$31.86
M67.5M12H6	1/2"	6H	.025"	\$31.86
M67.5M12V6	1/2"	6-10V	.025"	\$31.86
M67.5M12V8	1/2"	8-12V	.025"	\$31.86
M67.5M12V10	1/2"	10-14V	.025"	\$31.86
M67.5M12T14	1/2"	14	.025"	\$31.86
M67.5M12V14	1/2"	14-18V	.025"	\$31.86
M67.5M12T18	1/2"	18	.025"	\$31.86

Carbon Steel Bandsaw Blade 68-1/2" (5' 8-1/2") Long				
 MAGNATE				
Tool No.	Width	Tooth	Thickness	Price
M68.5C18R14	1/8"	14R	.025"	\$13.69
M68.5C18R18	1/8"	18R	.025"	\$13.69
M68.5C316S4	3/16"	4S	.025"	\$12.31
M68.5C316S6	3/16"	6S	.025"	\$11.55
M68.5C316R10	3/16"	10R	.025"	\$12.31
M68.5C316R14	3/16"	14R	.025"	\$12.31
M68.5C316R18	3/16"	18R	.025"	\$12.31
M68.5C316R24	3/16"	24R	.025"	\$12.31
M68.5C14H4	1/4"	4H	.025"	\$9.79
M68.5C14H6	1/4"	6H	.025"	\$9.79
M68.5C14R10	1/4"	10R	.025"	\$9.79
M68.5C14R14	1/4"	14R	.025"	\$9.79
M68.5C14R18	1/4"	18R	.025"	\$9.79
M68.5C14R24	1/4"	24R	.025"	\$9.79
M68.5C38H3	3/8"	3H	.025"	\$10.62
M68.5C38H4	3/8"	4H	.025"	\$10.62
M68.5C38H6	3/8"	6H	.025"	\$10.62
M68.5C38R8	3/8"	8R	.025"	\$10.62
M68.5C38R10	3/8"	10R	.025"	\$10.62
M68.5C38R14	3/8"	14R	.025"	\$10.62
M68.5C38R18	3/8"	18R	.025"	\$10.62
M68.5C38R24	3/8"	24R	.025"	\$11.05
M68.5C12H3	1/2"	3H	.025"	\$11.55
M68.5C12H4	1/2"	4H	.025"	\$11.55
M68.5C12H6	1/2"	6H	.025"	\$11.55
M68.5C12R10	1/2"	10R	.025"	\$11.55
M68.5C12R14	1/2"	14R	.025"	\$11.55
M68.5C12R18	1/2"	18R	.025"	\$11.55
M68.5C12R24	1/2"	24R	.025"	\$11.55

MAGNATE™ 20639 Lycoming Street #B-6, Walnut, CA 91789 USA

M-10



email : info@magnate.net Online Shop : www.magnate.net
(TEL) 800-827-2316, 909-468-5747 (FAX) 909-468-5745

MAGNATE™ Band Saw Blades (Non-Food Processing)

Bi-metal Bandsaw Blade 68-1/2" (5' 8-1/2") Long



MAGNATE

Tool No.	Width	Tooth	Thickness	Price
M68.5M14H6	1/4"	6H	.025"	\$31.86
M68.5M14V10	1/4"	10-14V	.025"	\$31.86
M68.5M14V14	1/4"	14-18V	.025"	\$31.86
M68.5M38H4	3/8"	4H	.025"	\$31.86
M68.5M38V10	3/8"	10-14V	.025"	\$31.86
M68.5M38V14	3/8"	14-18V	.025"	\$31.86
M68.5M12H3	1/2"	3H	.025"	\$31.86
M68.5M12H4	1/2"	4H	.025"	\$31.86
M68.5M12H6	1/2"	6H	.025"	\$31.86
M68.5M12V6	1/2"	6-10V	.025"	\$31.86
M68.5M12V8	1/2"	8-12V	.025"	\$31.86
M68.5M12V10	1/2"	10-14V	.025"	\$31.86
M68.5M12T14	1/2"	14	.025"	\$31.86
M68.5M12V14	1/2"	14-18V	.025"	\$31.86
M68.5M12T18	1/2"	18	.025"	\$31.86

Carbide Tipped Bandsaw Blade 68-1/2" (5' 8-1/2") Long



MAGNATE

Tool No.	Width	Tooth	Thickness	Price
M68.5E12T3	1/2"	3	.025"	\$119.38

Carbide Impregnated Bandsaw Blade 70" (5' 10") Long



SUPER CUT™

Tool No.	Width	Tooth	Thickness	Price
B70G14H6	1/4"	6H	.025"	\$26.33
B70G38H4	3/8"	4H	.025"	\$24.62
B70G12H3	1/2"	3H	.025"	\$25.50

Carbide Tipped Bandsaw Blade 70" (5' 10") Long



MAGNATE

Tool No.	Width	Tooth	Thickness	Price
M70E12T3	1/2"	3	.025"	\$119.38

Carbon Steel Bandsaw Blade 70" (5' 10") Long



MAGNATE

Tool No.	Width	Tooth	Thickness	Price
M70C18R14	1/8"	14R	.025"	\$13.69
M70C18R18	1/8"	18R	.025"	\$13.69
M70C316S4	3/16"	4S	.025"	\$12.31
M70C316S6	3/16"	6S	.025"	\$11.55
M70C316R10	3/16"	10R	.025"	\$12.31
M70C316R14	3/16"	14R	.025"	\$12.31
M70C316R18	3/16"	18R	.025"	\$12.31
M70C316R24	3/16"	24R	.025"	\$12.31
M70C14H4	1/4"	4H	.025"	\$9.79
M70C14H6	1/4"	6H	.025"	\$9.79
M70C14R10	1/4"	10R	.025"	\$9.79
M70C14R14	1/4"	14R	.025"	\$9.79
M70C14R18	1/4"	18R	.025"	\$9.79
M70C14R24	1/4"	24R	.025"	\$9.79
M70C38H3	3/8"	3H	.025"	\$10.62
M70C38H4	3/8"	4H	.025"	\$10.62
M70C38H6	3/8"	6H	.025"	\$10.62
M70C38R8	3/8"	8R	.025"	\$10.62
M70C38R10	3/8"	10R	.025"	\$10.62
M70C38R14	3/8"	14R	.025"	\$10.62
M70C38R18	3/8"	18R	.025"	\$10.62
M70C38R24	3/8"	24R	.025"	\$11.05
M70C12H3	1/2"	3H	.025"	\$11.55
M70C12H4	1/2"	4H	.025"	\$11.55
M70C12H6	1/2"	6H	.025"	\$11.55
M70C12R10	1/2"	10R	.025"	\$11.55
M70C12R14	1/2"	14R	.025"	\$11.55
M70C12R18	1/2"	18R	.025"	\$11.55
M70C12R24	1/2"	24R	.025"	\$11.55

Hawc Pro Resaw Bandsaw Blade 70" (5' 10") Long



SUPER CUT™

Tool No.	Width	Tooth	Thickness	Price
B70H12T3	1/2"	3	.025"	\$17.07

Three Wheeler Bandsaw Blades 70" (5' 10") Long



SUPER CUT™

Tool No.	Width	Tooth	Thickness	Price
B70W316H8	3/16"	8H	.014"	\$11.91
B70W316R14	3/16"	14R	.014"	\$11.91
B70W14H6	1/4"	6H	.014"	\$11.91
B70W14R14	1/4"	14R	.014"	\$11.91
B70W14R24	1/4"	24R	.014"	\$11.91
B70W38H6	3/8"	6H	.014"	\$11.91
B70W38R14	3/8"	14R	.014"	\$11.91
B70W38R24	3/8"	24R	.014"	\$11.91

Bi-metal Bandsaw Blade 70" (5' 10") Long



MAGNATE

Tool No.	Width	Tooth	Thickness	Price
M70M14H6	1/4"	6H	.025"	\$31.86
M70M14V10	1/4"	10-14V	.025"	\$31.86
M70M14V14	1/4"	14-18V	.025"	\$31.86
M70M38H4	3/8"	4H	.025"	\$31.86
M70M38V10	3/8"	10-14V	.025"	\$31.86
M70M38V14	3/8"	14-18V	.025"	\$31.86
M70M12H3	1/2"	3H	.025"	\$31.86
M70M12H4	1/2"	4H	.025"	\$31.86
M70M12H6	1/2"	6H	.025"	\$31.86
M70M12V6	1/2"	6-10V	.025"	\$31.86
M70M12V8	1/2"	8-12V	.025"	\$31.86
M70M12V10	1/2"	10-14V	.025"	\$31.86
M70M12T14	1/2"	14	.025"	\$31.86
M70M12V14	1/2"	14-18V	.025"	\$31.86
M70M12T18	1/2"	18	.025"	\$31.86

Carbide Tipped Bandsaw Blade 70-1/2" (5' 10-1/2") Long



MAGNATE

Tool No.	Width	Tooth	Thickness	Price
M70.5E12T3	1/2"	3	.025"	\$119.38

MAGNATE™ 20639 Lycoming Street #B-6, Walnut, CA 91789 USA

M-11



email : info@magnate.net Online Shop : www.magnate.net
(TEL) 800-827-2316, 909-468-5747 (FAX) 909-468-5745

MAGNATE™ Band Saw Blades (Non-Food Processing)

Bi-metal Bandsaw Blade
70-1/2" (5' 10-1/2") Long



MAGNATE

Tool No.	Width	Tooth	Thickness	Price
M70.5M14H6	1/4"	6H	.025"	\$31.86
M70.5M14V10	1/4"	10-14V	.025"	\$31.86
M70.5M14V14	1/4"	14-18V	.025"	\$31.86
M70.5M38H4	3/8"	4H	.025"	\$31.86
M70.5M38V10	3/8"	10-14V	.025"	\$31.86
M70.5M38V14	3/8"	14-18V	.025"	\$31.86
M70.5M12H3	1/2"	3H	.025"	\$31.86
M70.5M12H4	1/2"	4H	.025"	\$31.86
M70.5M12H6	1/2"	6H	.025"	\$31.86
M70.5M12V6	1/2"	6-10V	.025"	\$31.86
M70.5M12V8	1/2"	8-12V	.025"	\$31.86
M70.5M12V10	1/2"	10-14V	.025"	\$31.86
M70.5M12T14	1/2"	14	.025"	\$31.86
M70.5M12V14	1/2"	14-18V	.025"	\$31.86
M70.5M12T18	1/2"	18	.025"	\$31.86

Carbon Steel Bandsaw Blade
70-1/2" (5' 10-1/2") Long



MAGNATE

Tool No.	Width	Tooth	Thickness	Price
M70.5C18R14	1/8"	14R	.025"	\$13.69
M70.5C18R18	1/8"	18R	.025"	\$13.69
M70.5C316S4	3/16"	4S	.025"	\$12.31
M70.5C316S6	3/16"	6S	.025"	\$11.55
M70.5C316R10	3/16"	10R	.025"	\$12.31
M70.5C316R14	3/16"	14R	.025"	\$12.31
M70.5C316R18	3/16"	18R	.025"	\$12.31
M70.5C316R24	3/16"	24R	.025"	\$12.31
M70.5C14H4	1/4"	4H	.025"	\$9.79
M70.5C14H6	1/4"	6H	.025"	\$9.79
M70.5C14R10	1/4"	10R	.025"	\$9.79
M70.5C14R14	1/4"	14R	.025"	\$9.79
M70.5C14R18	1/4"	18R	.025"	\$9.79
M70.5C14R24	1/4"	24R	.025"	\$9.79
M70.5C38H3	3/8"	3H	.025"	\$10.62
M70.5C38H4	3/8"	4H	.025"	\$10.62
M70.5C38H6	3/8"	6H	.025"	\$10.62
M70.5C38R8	3/8"	8R	.025"	\$10.62
M70.5C38R10	3/8"	10R	.025"	\$10.62
M70.5C38R14	3/8"	14R	.025"	\$10.62
M70.5C38R18	3/8"	18R	.025"	\$10.62
M70.5C38R24	3/8"	24R	.025"	\$11.05
M70.5C12H3	1/2"	3H	.025"	\$11.55
M70.5C12H4	1/2"	4H	.025"	\$11.55
M70.5C12H6	1/2"	6H	.025"	\$11.55
M70.5C12R10	1/2"	10R	.025"	\$11.55
M70.5C12R14	1/2"	14R	.025"	\$11.55
M70.5C12R18	1/2"	18R	.025"	\$11.55
M70.5C12R24	1/2"	24R	.025"	\$11.55

Bi-metal Bandsaw Blade
71-3/4" (5' 11-3/4") Long



MAGNATE

Tool No.	Width	Tooth	Thickness	Price
M71.75M14H6	1/4"	6H	.025"	\$31.86
M71.75M14V10	1/4"	10-14V	.025"	\$31.86
M71.75M14V14	1/4"	14-18V	.025"	\$31.86
M71.75M38H4	3/8"	4H	.025"	\$31.86
M71.75M38V10	3/8"	10-14V	.025"	\$31.86
M71.75M38V14	3/8"	14-18V	.025"	\$31.86
M71.75M12H3	1/2"	3H	.025"	\$31.86
M71.75M12H4	1/2"	4H	.025"	\$31.86
M71.75M12H6	1/2"	6H	.025"	\$31.86
M71.75M12V6	1/2"	6-10V	.025"	\$31.86
M71.75M12V8	1/2"	8-12V	.025"	\$31.86
M71.75M12V10	1/2"	10-14V	.025"	\$31.86
M71.75M12T14	1/2"	14	.025"	\$31.86
M71.75M12V14	1/2"	14-18V	.025"	\$31.86
M71.75M12T18	1/2"	18	.025"	\$31.86

Carbide Impregnated Bandsaw Blade
70-1/2" (5' 10-1/2") Long



SUPER CUT™

Tool No.	Width	Tooth	Thickness	Price
B70.5G14H6	1/4"	6H	.025"	\$26.33
B70.5G38H4	3/8"	4H	.025"	\$24.62
B70.5G12H3	1/2"	3H	.025"	\$25.50

Three Wheeler Bandsaw Blades
70-1/2" (5' 10-1/2") Long



SUPER CUT™

Tool No.	Width	Tooth	Thickness	Price
B70.5W14H6	1/4"	6H	.014"	\$11.91
B70.5W14R14	1/4"	14R	.014"	\$11.91
B70.5W14R24	1/4"	24R	.014"	\$11.91
B70.5W38H6	3/8"	6H	.014"	\$11.91
B70.5W38R14	3/8"	14R	.014"	\$11.91
B70.5W38R24	3/8"	24R	.014"	\$11.91

Carbide Impregnated Bandsaw Blade
71-3/4" (5' 11-3/4") Long



SUPER CUT™

Tool No.	Width	Tooth	Thickness	Price
B71.75G14H6	1/4"	6H	.025"	\$26.33
B71.75G38H4	3/8"	4H	.025"	\$24.62
B71.75G12H3	1/2"	3H	.025"	\$25.50

Hawc Pro Resaw Bandsaw Blade
70-1/2" (5' 10-1/2") Long



SUPER CUT™

Tool No.	Width	Tooth	Thickness	Price
B70.5H12T3	1/2"	3	.025"	\$17.07

Three Wheeler Bandsaw Blades
70-1/2" (5' 10-1/2") Long



SUPER CUT™

Tool No.	Width	Tooth	Thickness	Price
B70.5W14H6	1/4"	6H	.014"	\$11.91
B70.5W14R14	1/4"	14R	.014"	\$11.91
B70.5W14R24	1/4"	24R	.014"	\$11.91
B70.5W38H6	3/8"	6H	.014"	\$11.91
B70.5W38R14	3/8"	14R	.014"	\$11.91
B70.5W38R24	3/8"	24R	.014"	\$11.91

Carbide Tipped Bandsaw Blade
71-3/4" (5' 11-3/4") Long



MAGNATE

Tool No.	Width	Tooth	Thickness	Price
M71.75E12T3	1/2"	3	.025"	\$119.38

MAGNATE™ 20639 Lycoming Street #B-6, Walnut, CA 91789 USA

M-12



email : info@magnate.net Online Shop : www.magnate.net
(TEL) 800-827-2316, 909-468-5747 (FAX) 909-468-5745

MAGNATE™ Band Saw Blades (Non-Food Processing)

Carbon Steel Bandsaw Blade 71-3/4" (5' 11-3/4") Long



MAGNATE

Tool No.	Width	Tooth	Thickness	Price
M71.75C18R14	1/8"	14R	.025"	\$13.69
M71.75C18R18	1/8"	18R	.025"	\$13.69
M71.75C316S4	3/16"	4S	.025"	\$12.31
M71.75C316S6	3/16"	6S	.025"	\$11.55
M71.75C316R10	3/16"	10R	.025"	\$12.31
M71.75C316R14	3/16"	14R	.025"	\$12.31
M71.75C316R18	3/16"	18R	.025"	\$12.31
M71.75C316R24	3/16"	24R	.025"	\$12.31
M71.75C14H4	1/4"	4H	.025"	\$9.79
M71.75C14H6	1/4"	6H	.025"	\$9.79
M71.75C14R10	1/4"	10R	.025"	\$9.79
M71.75C14R14	1/4"	14R	.025"	\$9.79
M71.75C14R18	1/4"	18R	.025"	\$9.79
M71.75C14R24	1/4"	24R	.025"	\$9.79
M71.75C38H3	3/8"	3H	.025"	\$10.62
M71.75C38H4	3/8"	4H	.025"	\$10.62
M71.75C38H6	3/8"	6H	.025"	\$10.62
M71.75C38R8	3/8"	8R	.025"	\$10.62
M71.75C38R10	3/8"	10R	.025"	\$10.62
M71.75C38R14	3/8"	14R	.025"	\$10.62
M71.75C38R18	3/8"	18R	.025"	\$10.62
M71.75C38R24	3/8"	24R	.025"	\$11.05
M71.75C12H3	1/2"	3H	.025"	\$11.55
M71.75C12H4	1/2"	4H	.025"	\$11.55
M71.75C12H6	1/2"	6H	.025"	\$11.55
M71.75C12R10	1/2"	10R	.025"	\$11.55
M71.75C12R14	1/2"	14R	.025"	\$11.55
M71.75C12R18	1/2"	18R	.025"	\$11.55
M71.75C12R24	1/2"	24R	.025"	\$11.55

Three Wheeler Bandsaw Blades 71-3/4" (5' 11-3/4") Long



Tool No.	Width	Tooth	Thickness	Price
B71.75W14H6	1/4"	6H	.014"	\$11.91
B71.75W14R14	1/4"	14R	.014"	\$11.91
B71.75W14R24	1/4"	24R	.014"	\$11.91
B71.75W38H6	3/8"	6H	.014"	\$11.91
B71.75W38R14	3/8"	14R	.014"	\$11.91
B71.75W38R24	3/8"	24R	.014"	\$11.91

WoodSaver Plus Resaw Bandsaw Blades 71-3/4" (5' 11-3/4") Long



Tool No.	Width	Tooth	Thickness	Price
B71.75P58V3	5/8"	3-4V	.025"	\$54.92

Hawc Pro Resaw Bandsaw Blade 71-3/4" (5' 11-3/4") Long



Tool No.	Width	Tooth	Thickness	Price
B71.75H12T3	1/2"	3	.025"	\$17.07

WoodSaver Resaw Bandsaw Blades 71-3/4" (5' 11-3/4") Long



Tool No.	Width	Tooth	Thickness	Price
B71.75S58T3	5/8"	3	.025"	\$46.92

Bi-metal Bandsaw Blade 72" (6') Long



MAGNATE

Tool No.	Width	Tooth	Thickness	Price
M72M14H6	1/4"	6H	.025"	\$31.86
M72M14V10	1/4"	10-14V	.025"	\$31.86
M72M14V14	1/4"	14-18V	.025"	\$31.86
M72M38H4	3/8"	4H	.025"	\$31.86
M72M38V10	3/8"	10-14V	.025"	\$31.86
M72M38V14	3/8"	14-18V	.025"	\$31.86
M72M12H3	1/2"	3H	.025"	\$31.86
M72M12H4	1/2"	4H	.025"	\$31.86
M72M12H6	1/2"	6H	.025"	\$31.86
M72M12V6	1/2"	6-10V	.025"	\$31.86
M72M12V8	1/2"	8-12V	.025"	\$31.86
M72M12V10	1/2"	10-14V	.025"	\$31.86
M72M12T14	1/2"	14	.025"	\$31.86
M72M12V14	1/2"	14-18V	.025"	\$31.86
M72M12T18	1/2"	18	.025"	\$31.86

Carbide Impregnated Bandsaw Blade 72" (6') Long



Tool No.	Width	Tooth	Thickness	Price
B72G14H6	1/4"	6H	.025"	\$26.33
B72G38H4	3/8"	4H	.025"	\$24.62
B72G12H3	1/2"	3H	.025"	\$25.50

Carbide Tipped Bandsaw Blade 72" (6') Long



MAGNATE

Tool No.	Width	Tooth	Thickness	Price
M72E12T3	1/2"	3	.025"	\$119.38

MAGNATE™ 20639 Lycoming Street #B-6, Walnut, CA 91789 USA

M-13



email : info@magnate.net Online Shop : www.magnate.net
(TEL) 800-827-2316, 909-468-5747 (FAX) 909-468-5745

MAGNATE™ Band Saw Blades (Non-Food Processing)

Carbon Steel Bandsaw Blade 72" (6') Long



MAGNATE

Tool No.	Width	Tooth	Thickness	Price
M72C18R14	1/8"	14R	.025"	\$13.69
M72C18R18	1/8"	18R	.025"	\$13.69
M72C316S4	3/16"	4S	.025"	\$12.31
M72C316S6	3/16"	6S	.025"	\$11.55
M72C316R10	3/16"	10R	.025"	\$12.31
M72C316R14	3/16"	14R	.025"	\$12.31
M72C316R18	3/16"	18R	.025"	\$12.31
M72C316R24	3/16"	24R	.025"	\$12.31
M72C14H4	1/4"	4H	.025"	\$9.79
M72C14H6	1/4"	6H	.025"	\$9.79
M72C14R10	1/4"	10R	.025"	\$9.79
M72C14R14	1/4"	14R	.025"	\$9.79
M72C14R18	1/4"	18R	.025"	\$9.79
M72C14R24	1/4"	24R	.025"	\$9.79
M72C38H3	3/8"	3H	.025"	\$10.62
M72C38H4	3/8"	4H	.025"	\$10.62
M72C38H6	3/8"	6H	.025"	\$10.62
M72C38R8	3/8"	8R	.025"	\$10.62
M72C38R10	3/8"	10R	.025"	\$10.62
M72C38R14	3/8"	14R	.025"	\$10.62
M72C38R18	3/8"	18R	.025"	\$10.62
M72C38R24	3/8"	24R	.025"	\$11.05
M72C12H3	1/2"	3H	.025"	\$11.55
M72C12H4	1/2"	4H	.025"	\$11.55
M72C12H6	1/2"	6H	.025"	\$11.55
M72C12R10	1/2"	10R	.025"	\$11.55
M72C12R14	1/2"	14R	.025"	\$11.55
M72C12R18	1/2"	18R	.025"	\$11.55
M72C12R24	1/2"	24R	.025"	\$11.55
M72C58H3	5/8"	3H	.032"	\$13.31
M72C58H4	5/8"	4H	.032"	\$13.31
M72C58R10	5/8"	10R	.032"	\$13.31
M72C58R14	5/8"	14R	.032"	\$13.31

Hawc Pro Resaw Bandsaw Blade 72" (6') Long



SUPER CUT™

Tool No.	Width	Tooth	Thickness	Price
B72H12T3	1/2"	3	.025"	\$17.07

Three Wheeler Bandsaw Blades 72" (6') Long



SUPER CUT™

Tool No.	Width	Tooth	Thickness	Price
B72W14H6	1/4"	6H	.014"	\$11.91
B72W14R14	1/4"	14R	.014"	\$11.91
B72W14R24	1/4"	24R	.014"	\$11.91
B72W38H6	3/8"	6H	.014"	\$11.91
B72W38R14	3/8"	14R	.014"	\$11.91
B72W38R24	3/8"	24R	.014"	\$11.91

WoodSaver Plus Resaw Bandsaw Blades 72" (6') Long



SUPER CUT™

Tool No.	Width	Tooth	Thickness	Price
B72P58V3	5/8"	3-4V	.025"	\$54.92

WoodSaver Resaw Bandsaw Blades 72" (6') Long



SUPER CUT™

Tool No.	Width	Tooth	Thickness	Price
B72S58T3	5/8"	3	.025"	\$46.92

Bi-metal Bandsaw Blade 72-1/2" (6' 1/2') Long



MAGNATE

Tool No.	Width	Tooth	Thickness	Price
M72.5M14H6	1/4"	6H	.025"	\$36.12
M72.5M14V10	1/4"	10-14V	.025"	\$36.12
M72.5M14V14	1/4"	14-18V	.025"	\$36.12
M72.5M38H4	3/8"	4H	.025"	\$36.12
M72.5M38V10	3/8"	10-14V	.025"	\$36.12
M72.5M38V14	3/8"	14-18V	.025"	\$36.12
M72.5M12H3	1/2"	3H	.025"	\$36.12
M72.5M12H4	1/2"	4H	.025"	\$36.12
M72.5M12H6	1/2"	6H	.025"	\$36.12
M72.5M12V6	1/2"	6-10V	.025"	\$36.12
M72.5M12V8	1/2"	8-12V	.025"	\$36.12
M72.5M12V10	1/2"	10-14V	.025"	\$36.12
M72.5M12T14	1/2"	14	.025"	\$36.12
M72.5M12V14	1/2"	14-18V	.025"	\$36.12
M72.5M12T18	1/2"	18	.025"	\$36.12

Carbide Impregnated Bandsaw Blade 72-1/2" (6' 1/2') Long



SUPER CUT™

Tool No.	Width	Tooth	Thickness	Price
B72.5G14H6	1/4"	6H	.025"	\$27.08
B72.5G38H4	3/8"	4H	.025"	\$25.73
B72.5G12H3	1/2"	3H	.025"	\$26.57

Carbide Tipped Bandsaw Blade 72-1/2" (6' 1/2') Long



MAGNATE

Tool No.	Width	Tooth	Thickness	Price
M72.5E12T3	1/2"	3	.025"	\$129.47

MAGNATE™ 20639 Lycoming Street #B-6, Walnut, CA 91789 USA

M-14



email : info@magnate.net Online Shop : www.magnate.net
(TEL) 800-827-2316, 909-468-5747 (FAX) 909-468-5745

MAGNATE™ Band Saw Blades (Non-Food Processing)

Carbon Steel Bandsaw Blade 72-1/2" (6' 1/2") Long



MAGNATE

Tool No.	Width	Tooth	Thickness	Price
M72.5C18R14	1/8"	14R	.025"	\$13.69
M72.5C18R18	1/8"	18R	.025"	\$13.69
M72.5C316S4	3/16"	4S	.025"	\$12.83
M72.5C316S6	3/16"	6S	.025"	\$12.16
M72.5C316R10	3/16"	10R	.025"	\$12.83
M72.5C316R14	3/16"	14R	.025"	\$12.83
M72.5C316R18	3/16"	18R	.025"	\$12.83
M72.5C316R24	3/16"	24R	.025"	\$12.83
M72.5C14H4	1/4"	4H	.025"	\$10.26
M72.5C14H6	1/4"	6H	.025"	\$10.26
M72.5C14R10	1/4"	10R	.025"	\$10.26
M72.5C14R14	1/4"	14R	.025"	\$10.26
M72.5C14R18	1/4"	18R	.025"	\$10.26
M72.5C14R24	1/4"	24R	.025"	\$10.26
M72.5C38H3	3/8"	3H	.025"	\$11.16
M72.5C38H4	3/8"	4H	.025"	\$11.16
M72.5C38H6	3/8"	6H	.025"	\$11.16
M72.5C38R8	3/8"	8R	.025"	\$11.16
M72.5C38R10	3/8"	10R	.025"	\$11.16
M72.5C38R14	3/8"	14R	.025"	\$11.16
M72.5C38R18	3/8"	18R	.025"	\$11.16
M72.5C38R24	3/8"	24R	.025"	\$11.57
M72.5C12H3	1/2"	3H	.025"	\$12.16
M72.5C12H4	1/2"	4H	.025"	\$12.16
M72.5C12H6	1/2"	6H	.025"	\$12.16
M72.5C12R10	1/2"	10R	.025"	\$12.16
M72.5C12R14	1/2"	14R	.025"	\$12.16
M72.5C12R18	1/2"	18R	.025"	\$12.16
M72.5C12R24	1/2"	24R	.025"	\$12.16
M72.5C58H3	5/8"	3H	.032"	\$14.07
M72.5C58H4	5/8"	4H	.032"	\$14.07
M72.5C58R10	5/8"	10R	.032"	\$14.07
M72.5C58R14	5/8"	14R	.032"	\$14.07

Three Wheeler Bandsaw Blades 72-1/2" (6' 1/2") Long



Tool No.	Width	Tooth	Thickness	Price
B72.5W14H6	1/4"	6H	.014"	\$11.91
B72.5W14R14	1/4"	14R	.014"	\$11.91
B72.5W14R24	1/4"	24R	.014"	\$11.91
B72.5W38H6	3/8"	6H	.014"	\$11.91
B72.5W38R14	3/8"	14R	.014"	\$11.91
B72.5W38R24	3/8"	24R	.014"	\$11.91

WoodSaver Plus Resaw Bandsaw Blades 72-1/2" (6' 1/2") Long



Tool No.	Width	Tooth	Thickness	Price
B72.5P58V3	5/8"	3-4V	.025"	\$58.60

WoodSaver Resaw Bandsaw Blades 72-1/2" (6' 1/2") Long



Tool No.	Width	Tooth	Thickness	Price
B72.5S58T3	5/8"	3	.025"	\$50.12

Hawc Pro Resaw Bandsaw Blade 72-1/2" (6' 1/2") Long



Tool No.	Width	Tooth	Thickness	Price
B72.5H12T3	1/2"	3	.025"	\$17.68

Carbon Steel Bandsaw Blade 72-5/8" (6' 5/8") Long



MAGNATE

Tool No.	Width	Tooth	Thickness	Price
M72.625C18R14	1/8"	14R	.025"	\$13.69
M72.625C18R18	1/8"	18R	.025"	\$13.69
M72.625C316S4	3/16"	4S	.025"	\$12.83
M72.625C316S6	3/16"	6S	.025"	\$12.16
M72.625C316R10	3/16"	10R	.025"	\$12.83
M72.625C316R14	3/16"	14R	.025"	\$12.83
M72.625C316R18	3/16"	18R	.025"	\$12.83
M72.625C316R24	3/16"	24R	.025"	\$12.83
M72.625C14H4	1/4"	4H	.025"	\$10.26
M72.625C14H6	1/4"	6H	.025"	\$10.26
M72.625C14R10	1/4"	10R	.025"	\$10.26
M72.625C14R14	1/4"	14R	.025"	\$10.26
M72.625C14R18	1/4"	18R	.025"	\$10.26
M72.625C14R24	1/4"	24R	.025"	\$10.26
M72.625C38H3	3/8"	3H	.025"	\$11.16
M72.625C38H4	3/8"	4H	.025"	\$11.16
M72.625C38H6	3/8"	6H	.025"	\$11.16
M72.625C38R8	3/8"	8R	.025"	\$11.16
M72.625C38R10	3/8"	10R	.025"	\$11.16
M72.625C38R14	3/8"	14R	.025"	\$11.16
M72.625C38R18	3/8"	18R	.025"	\$11.16
M72.625C38R24	3/8"	24R	.025"	\$11.57
M72.625C12H3	1/2"	3H	.025"	\$12.16
M72.625C12H4	1/2"	4H	.025"	\$12.16
M72.625C12H6	1/2"	6H	.025"	\$12.16
M72.625C12R10	1/2"	10R	.025"	\$12.16
M72.625C12R14	1/2"	14R	.025"	\$12.16
M72.625C12R18	1/2"	18R	.025"	\$12.16
M72.625C12R24	1/2"	24R	.025"	\$12.16
M72.625C58H3	5/8"	3H	.032"	\$14.07
M72.625C58H4	5/8"	4H	.032"	\$14.07
M72.625C58R10	5/8"	10R	.032"	\$14.07
M72.625C58R14	5/8"	14R	.032"	\$14.07

Carbide Tipped Bandsaw Blade 72-5/8" (6' 5/8") Long



MAGNATE

Tool No.	Width	Tooth	Thickness	Price
M72.625E12T3	1/2"	3	.025"	\$129.47

MAGNATE™ 20639 Lycoming Street #B-6, Walnut, CA 91789 USA

M-15



email : info@magnate.net Online Shop : www.magnate.net
(TEL) 800-827-2316, 909-468-5747 (FAX) 909-468-5745

MAGNATE™ Band Saw Blades (Non-Food Processing)

Bi-metal Bandsaw Blade
72-5/8" (6' 5/8") Long



MAGNATE

Tool No.	Width	Tooth	Thickness	Price
M72.625M14H6	1/4"	6H	.025"	\$36.12
M72.625M14V10	1/4"	10-14V	.025"	\$36.12
M72.625M14V14	1/4"	14-18V	.025"	\$36.12
M72.625M38H4	3/8"	4H	.025"	\$36.12
M72.625M38V10	3/8"	10-14V	.025"	\$36.12
M72.625M38V14	3/8"	14-18V	.025"	\$36.12
M72.625M12H3	1/2"	3H	.025"	\$36.12
M72.625M12H4	1/2"	4H	.025"	\$36.12
M72.625M12H6	1/2"	6H	.025"	\$36.12
M72.625M12V6	1/2"	6-10V	.025"	\$36.12
M72.625M12V8	1/2"	8-12V	.025"	\$36.12
M72.625M12V10	1/2"	10-14V	.025"	\$36.12
M72.625M12T14	1/2"	14	.025"	\$36.12
M72.625M12V14	1/2"	14-18V	.025"	\$36.12
M72.625M12T18	1/2"	18	.025"	\$36.12

Carbon Steel Bandsaw Blade
79" (6' 7") Long



MAGNATE

Tool No.	Width	Tooth	Thickness	Price
M79C18R14	1/8"	14R	.025"	\$13.69
M79C18R18	1/8"	18R	.025"	\$13.69
M79C316S4	3/16"	4S	.025"	\$13.28
M79C316S6	3/16"	6S	.025"	\$12.16
M79C316R10	3/16"	10R	.025"	\$13.28
M79C316R14	3/16"	14R	.025"	\$13.28
M79C316R18	3/16"	18R	.025"	\$13.28
M79C316R24	3/16"	24R	.025"	\$13.28
M79C14H4	1/4"	4H	.025"	\$10.26
M79C14H6	1/4"	6H	.025"	\$10.26
M79C14R10	1/4"	10R	.025"	\$10.26
M79C14R14	1/4"	14R	.025"	\$10.26
M79C14R18	1/4"	18R	.025"	\$10.26
M79C14R24	1/4"	24R	.025"	\$10.26
M79C38H3	3/8"	3H	.025"	\$11.16
M79C38H4	3/8"	4H	.025"	\$11.16
M79C38H6	3/8"	6H	.025"	\$11.16
M79C38R8	3/8"	8R	.025"	\$11.16
M79C38R10	3/8"	10R	.025"	\$11.16
M79C38R14	3/8"	14R	.025"	\$11.16
M79C38R18	3/8"	18R	.025"	\$11.16
M79C38R24	3/8"	24R	.025"	\$11.95
M79C12H3	1/2"	3H	.025"	\$12.16
M79C12H4	1/2"	4H	.025"	\$12.16
M79C12H6	1/2"	6H	.025"	\$12.16
M79C12R10	1/2"	10R	.025"	\$12.16
M79C12R14	1/2"	14R	.025"	\$12.16
M79C12R18	1/2"	18R	.025"	\$12.16
M79C12R24	1/2"	24R	.025"	\$12.16
M79C58H3	5/8"	3H	.032"	\$14.07
M79C58H4	5/8"	4H	.032"	\$14.07
M79C58R10	5/8"	10R	.032"	\$14.07
M79C58R14	5/8"	14R	.032"	\$14.07

Bi-metal Bandsaw Blade
79" (6' 7") Long



MAGNATE

Tool No.	Width	Tooth	Thickness	Price
M79M14H6	1/4"	6H	.025"	\$38.26
M79M14V10	1/4"	10-14V	.025"	\$38.26
M79M14V14	1/4"	14-18V	.025"	\$38.26
M79M38H4	3/8"	4H	.025"	\$38.26
M79M38V10	3/8"	10-14V	.025"	\$38.26
M79M38V14	3/8"	14-18V	.025"	\$38.26
M79M12H3	1/2"	3H	.025"	\$38.26
M79M12H4	1/2"	4H	.025"	\$38.26
M79M12H6	1/2"	6H	.025"	\$38.26
M79M12V6	1/2"	6-10V	.025"	\$38.26
M79M12V8	1/2"	8-12V	.025"	\$38.26
M79M12V10	1/2"	10-14V	.025"	\$38.26
M79M12T14	1/2"	14	.025"	\$38.26
M79M12V14	1/2"	14-18V	.025"	\$38.26
M79M12T18	1/2"	18	.025"	\$38.26
M79M58V10	5/8"	10-14V	.032"	\$40.62
M79M34H3	3/4"	3H	.035"	\$40.62
M79M34V4	3/4"	4-6V	.035"	\$40.62
M79M34V5	3/4"	5-8V	.035"	\$40.62
M79M34V6	3/4"	6-10V	.035"	\$40.62
M79M34V8	3/4"	8-12V	.035"	\$40.62
M79M34V10	3/4"	10-14V	.035"	\$40.62
M79M34W14	3/4"	14W	.035"	\$40.62
M79M34W18	3/4"	18W	.035"	\$40.62

Carbide Impregnated Bandsaw Blade
79" (6' 7") Long



SUPER CUT™

Tool No.	Width	Tooth	Thickness	Price
B79G14H6	1/4"	6H	.025"	\$28.22
B79G38H4	3/8"	4H	.025"	\$26.57
B79G12H3	1/2"	3H	.025"	\$27.53

Hawc Pro Resaw Bandsaw Blade
79" (6' 7") Long



SUPER CUT™

Tool No.	Width	Tooth	Thickness	Price
B79H12T3	1/2"	3	.025"	\$18.30

WoodSaver Plus Resaw Bandsaw Blades
79" (6' 7") Long



SUPER CUT™

Tool No.	Width	Tooth	Thickness	Price
B79P58V3	5/8"	3-4V	.025"	\$62.27

Carbide Tipped Bandsaw Blade
79" (6' 7") Long



MAGNATE

Tool No.	Width	Tooth	Thickness	Price
M79E12T3	1/2"	3	.025"	\$139.53

Hawc Pro Resaw Bandsaw Blade
79" (6' 7") Long



SUPER CUT™

Tool No.	Width	Tooth	Thickness	Price
B79H12T3	1/2"	3	.025"	\$18.30

WoodSaver Resaw Bandsaw Blades
79" (6' 7") Long



SUPER CUT™

Tool No.	Width	Tooth	Thickness	Price
B79S58T3	5/8"	3	.025"	\$53.20

MAGNATE™ 20639 Lycoming Street #B-6, Walnut, CA 91789 USA

M-16



email : info@magnate.net Online Shop : www.magnate.net
(TEL) 800-827-2316, 909-468-5747 (FAX) 909-468-5745

MAGNATE™ Band Saw Blades (Non-Food Processing)

Bi-metal Bandsaw Blade 80" (6' 8") Long



Tool No.	Width	Tooth	Thickness	Price
M80M14H6	1/4"	6H	.025"	\$38.26
M80M14V10	1/4"	10-14V	.025"	\$38.26
M80M14V14	1/4"	14-18V	.025"	\$38.26
M80M38H4	3/8"	4H	.025"	\$38.26
M80M38V10	3/8"	10-14V	.025"	\$38.26
M80M38V14	3/8"	14-18V	.025"	\$38.26
M80M12H3	1/2"	3H	.025"	\$38.26
M80M12H4	1/2"	4H	.025"	\$38.26
M80M12H6	1/2"	6H	.025"	\$38.26
M80M12V6	1/2"	6-10V	.025"	\$38.26
M80M12V8	1/2"	8-12V	.025"	\$38.26
M80M12V10	1/2"	10-14V	.025"	\$38.26
M80M12T14	1/2"	14	.025"	\$38.26
M80M12V14	1/2"	14-18V	.025"	\$38.26
M80M12T18	1/2"	18	.025"	\$38.26
M80M58V10	5/8"	10-14V	.032"	\$40.62
M80M34H3	3/4"	3H	.035"	\$40.62
M80M34V4	3/4"	4-6V	.035"	\$40.62
M80M34V5	3/4"	5-8V	.035"	\$40.62
M80M34V6	3/4"	6-10V	.035"	\$40.62
M80M34V8	3/4"	8-12V	.035"	\$40.62
M80M34V10	3/4"	10-14V	.035"	\$40.62
M80M34W14	3/4"	14W	.035"	\$40.62
M80M34W18	3/4"	18W	.035"	\$40.62

Carbide Grit Bandsaw Blade 80" (6' 8") Long



Tool No.	Width	Tooth	Thickness	Price
M80G12MC	1/2"	Med-Coarse	.025"	\$180.78

Carbide Impregnated Bandsaw Blade 80" (6' 8") Long



Tool No.	Width	Tooth	Thickness	Price
B80G14H6	1/4"	6H	.025"	\$28.22
B80G38H4	3/8"	4H	.025"	\$26.57
B80G12H3	1/2"	3H	.025"	\$27.53

Carbon Steel Bandsaw Blade 80" (6' 8") Long



Tool No.	Width	Tooth	Thickness	Price
M80C18R14	1/8"	14R	.025"	\$13.69
M80C18R18	1/8"	18R	.025"	\$13.69
M80C316S4	3/16"	4S	.025"	\$13.28
M80C316S6	3/16"	6S	.025"	\$12.16
M80C316R10	3/16"	10R	.025"	\$13.28
M80C316R14	3/16"	14R	.025"	\$13.28
M80C316R18	3/16"	18R	.025"	\$13.28
M80C316R24	3/16"	24R	.025"	\$13.28
M80C14H4	1/4"	4H	.025"	\$10.26
M80C14H6	1/4"	6H	.025"	\$10.26
M80C14R10	1/4"	10R	.025"	\$10.26
M80C14R14	1/4"	14R	.025"	\$10.26
M80C14R18	1/4"	18R	.025"	\$10.26
M80C14R24	1/4"	24R	.025"	\$10.26
M80C38H3	3/8"	3H	.025"	\$11.16
M80C38H4	3/8"	4H	.025"	\$11.16
M80C38H6	3/8"	6H	.025"	\$11.16
M80C38R8	3/8"	8R	.025"	\$11.16
M80C38R10	3/8"	10R	.025"	\$11.16
M80C38R14	3/8"	14R	.025"	\$11.16
M80C38R18	3/8"	18R	.025"	\$11.16
M80C38R24	3/8"	24R	.025"	\$11.95
M80C12H3	1/2"	3H	.025"	\$12.16
M80C12H4	1/2"	4H	.025"	\$12.16
M80C12H6	1/2"	6H	.025"	\$12.16
M80C12R10	1/2"	10R	.025"	\$12.16
M80C12R14	1/2"	14R	.025"	\$12.16
M80C12R18	1/2"	18R	.025"	\$12.16
M80C12R24	1/2"	24R	.025"	\$12.16
M80C58H3	5/8"	3H	.032"	\$14.07
M80C58H4	5/8"	4H	.032"	\$14.07
M80C58R10	5/8"	10R	.032"	\$14.07
M80C58R14	5/8"	14R	.032"	\$14.07

Carbide Tipped Bandsaw Blade 80" (6' 8") Long



Tool No.	Width	Tooth	Thickness	Price
M80E12T3	1/2"	3	.025"	\$139.53

Hawc Pro Resaw Bandsaw Blade 80" (6' 8") Long



Tool No.	Width	Tooth	Thickness	Price
B80H12T3	1/2"	3	.025"	\$18.30

Three Wheeler Bandsaw Blades 80" (6' 8") Long



Tool No.	Width	Tooth	Thickness	Price
B80W14H6	1/4"	6H	.014"	\$11.91
B80W14R14	1/4"	14R	.014"	\$11.91
B80W14R24	1/4"	24R	.014"	\$11.91
B80W38H6	3/8"	6H	.014"	\$11.91
B80W38R14	3/8"	14R	.014"	\$11.91
B80W38R24	3/8"	24R	.014"	\$11.91

WoodSaver Plus Resaw Bandsaw Blades 80" (6' 8") Long



Tool No.	Width	Tooth	Thickness	Price
B80P58V3	5/8"	3-4V	.025"	\$62.27

MAGNATE™ 20639 Lycoming Street #B-6, Walnut, CA 91789 USA

M-17



email : info@magnate.net Online Shop : www.magnate.net
(TEL) 800-827-2316, 909-468-5747 (FAX) 909-468-5745

MAGNATE™ Band Saw Blades (Non-Food Processing)

WoodSaver Resaw Bandsaw Blades
80" (6' 8") Long



SUPER CUT™

Tool No.	Width	Tooth	Thickness	Price
B80S58T3	5/8"	3	.025"	\$53.20

Carbon Steel Bandsaw Blade
82" (6' 10") Long



MAGNATE

Tool No.	Width	Tooth	Thickness	Price
M82C18R14	1/8"	14R	.025"	\$13.69
M82C18R18	1/8"	18R	.025"	\$13.69
M82C316S4	3/16"	4S	.025"	\$13.28
M82C316S6	3/16"	6S	.025"	\$12.16
M82C316R10	3/16"	10R	.025"	\$13.28
M82C316R14	3/16"	14R	.025"	\$13.28
M82C316R18	3/16"	18R	.025"	\$13.28
M82C316R24	3/16"	24R	.025"	\$13.28
M82C14H4	1/4"	4H	.025"	\$10.26
M82C14H6	1/4"	6H	.025"	\$10.26
M82C14R10	1/4"	10R	.025"	\$10.26
M82C14R14	1/4"	14R	.025"	\$10.26
M82C14R18	1/4"	18R	.025"	\$10.26
M82C14R24	1/4"	24R	.025"	\$10.26
M82C38H3	3/8"	3H	.025"	\$11.16
M82C38H4	3/8"	4H	.025"	\$11.16
M82C38H6	3/8"	6H	.025"	\$11.16
M82C38R8	3/8"	8R	.025"	\$11.16
M82C38R10	3/8"	10R	.025"	\$11.16
M82C38R14	3/8"	14R	.025"	\$11.16
M82C38R18	3/8"	18R	.025"	\$11.16
M82C38R24	3/8"	24R	.025"	\$11.95
M82C12H3	1/2"	3H	.025"	\$12.16
M82C12H4	1/2"	4H	.025"	\$12.16
M82C12H6	1/2"	6H	.025"	\$12.16
M82C12R10	1/2"	10R	.025"	\$12.16
M82C12R14	1/2"	14R	.025"	\$12.16
M82C12R18	1/2"	18R	.025"	\$12.16
M82C12R24	1/2"	24R	.025"	\$12.16
M82C58H3	5/8"	3H	.032"	\$14.07
M82C58H4	5/8"	4H	.032"	\$14.07
M82C58R10	5/8"	10R	.032"	\$14.07
M82C58R14	5/8"	14R	.032"	\$14.07

Bi-metal Bandsaw Blade
82" (6' 10") Long



MAGNATE

Tool No.	Width	Tooth	Thickness	Price
M82M14H6	1/4"	6H	.025"	\$38.26
M82M14V10	1/4"	10-14V	.025"	\$38.26
M82M14V14	1/4"	14-18V	.025"	\$38.26
M82M38H4	3/8"	4H	.025"	\$38.26
M82M38V10	3/8"	10-14V	.025"	\$38.26
M82M38V14	3/8"	14-18V	.025"	\$38.26
M82M12H3	1/2"	3H	.025"	\$38.26
M82M12H4	1/2"	4H	.025"	\$38.26
M82M12H6	1/2"	6H	.025"	\$38.26
M82M12V6	1/2"	6-10V	.025"	\$38.26
M82M12V8	1/2"	8-12V	.025"	\$38.26
M82M12V10	1/2"	10-14V	.025"	\$38.26
M82M12T14	1/2"	14	.025"	\$38.26
M82M12V14	1/2"	14-18V	.025"	\$38.26
M82M12T18	1/2"	18	.025"	\$38.26
M82M58V10	5/8"	10-14V	.032"	\$40.62
M82M34H3	3/4"	3H	.035"	\$40.62
M82M34V4	3/4"	4-6V	.035"	\$40.62
M82M34V5	3/4"	5-8V	.035"	\$40.62
M82M34V6	3/4"	6-10V	.035"	\$40.62
M82M34V8	3/4"	8-12V	.035"	\$40.62
M82M34V10	3/4"	10-14V	.035"	\$40.62
M82M34W14	3/4"	14W	.035"	\$40.62
M82M34W18	3/4"	18W	.035"	\$40.62

Carbide Grit Bandsaw Blade
82" (6' 10") Long



MAGNATE

Tool No.	Width	Tooth	Thickness	Price
M82G12MC	1/2"	Med-Coarse	.025"	\$180.78

Carbide Impregnated Bandsaw Blade
82" (6' 10") Long



SUPER CUT™

Tool No.	Width	Tooth	Thickness	Price
B82G14H6	1/4"	6H	.025"	\$28.22
B82G38H4	3/8"	4H	.025"	\$26.57
B82G12H3	1/2"	3H	.025"	\$27.53

Carbide Tipped Bandsaw Blade
82" (6' 10") Long



MAGNATE

Tool No.	Width	Tooth	Kerf	Price
M82E12T3	1/2"	3	.025"	\$139.53

Hawc Pro Resaw Bandsaw Blade
82" (6' 10") Long



SUPER CUT™

Tool No.	Width	Tooth	Thickness	Price
B82H12T3	1/2"	3	.025"	\$18.30

Three Wheeler Bandsaw Blades
82" (6' 10") Long



SUPER CUT™

Tool No.	Width	Tooth	Thickness	Price
B82W14H6	1/4"	6H	.014"	\$11.91
B82W14R14	1/4"	14R	.014"	\$11.91
B82W14R24	1/4"	24R	.014"	\$11.91
B82W38H6	3/8"	6H	.014"	\$11.91
B82W38R14	3/8"	14R	.014"	\$11.91
B82W38R24	3/8"	24R	.014"	\$11.91

WoodSaver Plus Resaw Bandsaw Blades
82" (6' 10") Long



SUPER CUT™

Tool No.	Width	Tooth	Thickness	Price
B82P58V3	5/8"	3-4V	.025"	\$62.27

MAGNATE™ 20639 Lycoming Street #B-6, Walnut, CA 91789 USA

M-18



email : info@magnate.net Online Shop : www.magnate.net
(TEL) 800-827-2316, 909-468-5747 (FAX) 909-468-5745

MAGNATE™ Band Saw Blades (Non-Food Processing)

WoodSaver Resaw Bandsaw Blades
82" (6' 10") Long



Tool No.	Width	Tooth	Thickness	Price
B82S58T3	5/8"	3	.025"	\$53.20

Bi-metal Bandsaw Blade
85" (7' 1") Long





Tool No.	Width	Tooth	Thickness	Price
M85M14H6	1/4"	6H	.025"	\$40.40
M85M14V10	1/4"	10-14V	.025"	\$40.40
M85M14V14	1/4"	14-18V	.025"	\$40.40
M85M38H4	3/8"	4H	.025"	\$40.40
M85M38V10	3/8"	10-14V	.025"	\$40.40
M85M38V14	3/8"	14-18V	.025"	\$40.40
M85M12H3	1/2"	3H	.025"	\$40.40
M85M12H4	1/2"	4H	.025"	\$40.40
M85M12H6	1/2"	6H	.025"	\$40.40
M85M12V6	1/2"	6-10V	.025"	\$40.40
M85M12V8	1/2"	8-12V	.025"	\$40.40
M85M12V10	1/2"	10-14V	.025"	\$40.40
M85M12T14	1/2"	14	.025"	\$40.40
M85M12V14	1/2"	14-18V	.025"	\$40.40
M85M12T18	1/2"	18	.025"	\$40.40
M85M58V10	5/8"	10-14V	.032"	\$42.84
M85M34H3	3/4"	3H	.035"	\$42.84
M85M34V4	3/4"	4-6V	.035"	\$42.84
M85M34V5	3/4"	5-8V	.035"	\$42.84
M85M34V6	3/4"	6-10V	.035"	\$42.84
M85M34V8	3/4"	8-12V	.035"	\$42.84
M85M34V10	3/4"	10-14V	.035"	\$42.84
M85M34W14	3/4"	14W	.035"	\$42.84
M85M34W18	3/4"	18W	.035"	\$42.84

Carbide Grit Bandsaw Blade
85" (7' 1") Long



Tool No.	Width	Tooth	Thickness	Price
M85G12MC	1/2"	Med-Coarse	.025"	\$193.09

Carbon Steel Bandsaw Blade
85" (7' 1") Long



Tool No.	Width	Tooth	Thickness	Price
M85C18R24	1/8"	14R	.025"	\$15.72
M85C18R18	1/8"	18R	.025"	\$15.72
M85C316S4	3/16"	4S	.025"	\$13.71
M85C316S6	3/16"	6S	.025"	\$13.36
M85C316R10	3/16"	10R	.025"	\$13.71
M85C316R14	3/16"	14R	.025"	\$13.71
M85C316R18	3/16"	18R	.025"	\$13.71
M85C316R24	3/16"	24R	.025"	\$13.71
M85C14H4	1/4"	4H	.025"	\$11.17
M85C14H6	1/4"	6H	.025"	\$11.17
M85C14R10	1/4"	10R	.025"	\$11.17
M85C14R14	1/4"	14R	.025"	\$11.17
M85C14R18	1/4"	18R	.025"	\$11.17
M85C14R24	1/4"	24R	.025"	\$11.17
M85C38H3	3/8"	3H	.025"	\$12.21
M85C38H4	3/8"	4H	.025"	\$12.21
M85C38H6	3/8"	6H	.025"	\$12.21
M85C38R8	3/8"	8R	.025"	\$12.21
M85C38R10	3/8"	10R	.025"	\$12.21
M85C38R14	3/8"	14R	.025"	\$12.21
M85C38R18	3/8"	18R	.025"	\$12.21
M85C38R24	3/8"	24R	.025"	\$12.33
M85C12H3	1/2"	3H	.025"	\$13.36
M85C12H4	1/2"	4H	.025"	\$13.36
M85C12H6	1/2"	6H	.025"	\$13.36
M85C12R10	1/2"	10R	.025"	\$13.36
M85C12R14	1/2"	14R	.025"	\$13.36
M85C12R18	1/2"	18R	.025"	\$13.36
M85C12R24	1/2"	24R	.025"	\$13.36
M85C58H3	5/8"	3H	.032"	\$15.57
M85C58H4	5/8"	4H	.032"	\$15.57
M85C58R10	5/8"	10R	.032"	\$15.57
M85C58R14	5/8"	14R	.032"	\$15.57
M85C34H2	3/4"	2H	.032"	\$15.57
M85C34H3	3/4"	3H	.032"	\$15.57
M85C34H4	3/4"	4H	.032"	\$15.57
M85C34H6	3/4"	6H	.032"	\$15.57
M85C34R6	3/4"	6R	.032"	\$15.57
M85C34R10	3/4"	10R	.032"	\$15.57
M85C34R14	3/4"	14R	.032"	\$15.57
M85C34R18	3/4"	18R	.032"	\$15.57

Carbide Tipped Bandsaw Blade
85" (7' 1") Long



Tool No.	Width	Tooth	Thickness	Price
M85E12T3	1/2"	3	.025"	\$159.65

Carbide Impregnated Bandsaw Blade
85" (7' 1") Long

Tool No.	Width	Tooth	Thickness	Price
B85G14H6	1/4"	6H	.025"	\$29.13
B85G38H4	3/8"	4H	.025"	\$27.40
B85G12H3	1/2"	3H	.025"	\$28.73

Hawc Pro Resaw Bandsaw Blade
85" (7' 1") Long



Tool No.	Width	Tooth	Thickness	Price
B85H12T3	1/2"	3	.025"	\$19.07

WoodSaver Plus Resaw Bandsaw Blades
85" (7' 1") Long



Tool No.	Width	Tooth	Thickness	Price
B85P58V3	5/8"	3-4V	.025"	\$65.88

WoodSaver Resaw Bandsaw Blades
85" (7' 1") Long



Tool No.	Width	Tooth	Thickness	Price
B85S58T3	5/8"	3	.025"	\$56.30

MAGNATE™ 20639 Lycoming Street #B-6, Walnut, CA 91789 USA

M-19



email : info@magnate.net Online Shop : www.magnate.net
(TEL) 800-827-2316, 909-468-5747 (FAX) 909-468-5745

MAGNATE™ Band Saw Blades (Non-Food Processing)

Bi-metal Bandsaw Blade 89-1/2" (7' 5-1/2") Long



Tool No.	Width	Tooth	Thickness	Price
M89.5M14H6	1/4"	6H	.025"	\$40.40
M89.5M14V10	1/4"	10-14V	.025"	\$40.40
M89.5M14V14	1/4"	14-18V	.025"	\$40.40
M89.5M38H4	3/8"	4H	.025"	\$40.40
M89.5M38V10	3/8"	10-14V	.025"	\$40.40
M89.5M38V14	3/8"	14-18V	.025"	\$40.40
M89.5M12H3	1/2"	3H	.025"	\$40.40
M89.5M12H4	1/2"	4H	.025"	\$40.40
M89.5M12H6	1/2"	6H	.025"	\$40.40
M89.5M12V6	1/2"	6-10V	.025"	\$40.40
M89.5M12V8	1/2"	8-12V	.025"	\$40.40
M89.5M12V10	1/2"	10-14V	.025"	\$40.40
M89.5M12T14	1/2"	14	.025"	\$40.40
M89.5M12V14	1/2"	14-18V	.025"	\$40.40
M89.5M12T18	1/2"	18	.025"	\$40.40
M89.5M58V10	5/8"	10-14V	.032"	\$42.84
M89.5M34H3	3/4"	3H	.035"	\$42.84
M89.5M34V4	3/4"	4-6V	.035"	\$42.84
M89.5M34V5	3/4"	5-8V	.035"	\$42.84
M89.5M34V6	3/4"	6-10V	.035"	\$42.84
M89.5M34V8	3/4"	8-12V	.035"	\$42.84
M89.5M34V10	3/4"	10-14V	.035"	\$42.84
M89.5M34W14	3/4"	14W	.035"	\$42.84
M89.5M34W18	3/4"	18W	.035"	\$42.84

Carbide Grit Bandsaw Blade 89-1/2" (7' 5-1/2") Long



Tool No.	Width	Tooth	Thickness	Price
M89.5G12MC	1/2"	Med-Coarse	.025"	\$193.09

Carbide Impregnated Bandsaw Blade 89-1/2" (7' 5-1/2") Long



Tool No.	Width	Tooth	Thickness	Price
B89.5G14H6	1/4"	6H	.025"	\$29.13
B89.5G38H4	3/8"	4H	.025"	\$27.40
B89.5G12H3	1/2"	3H	.025"	\$28.73

Carbide Tipped Bandsaw Blade 89-1/2" (7' 5-1/2") Long



Tool No.	Width	Tooth	Thickness	Price
M89.5E12T3	1/2"	3	.025"	\$159.65

Carbon Steel Bandsaw Blade 89-1/2" (7' 5-1/2") Long



Tool No.	Width	Tooth	Thickness	Price
M89.5C18R14	1/8"	14R	.025"	\$15.72
M89.5C18R18	1/8"	18R	.025"	\$15.72
M89.5C316S4	3/16"	4S	.025"	\$13.71
M89.5C316S6	3/16"	6S	.025"	\$13.36
M89.5C316R10	3/16"	10R	.025"	\$13.71
M89.5C316R14	3/16"	14R	.025"	\$13.71
M89.5C316R18	3/16"	18R	.025"	\$13.71
M89.5C316R24	3/16"	24R	.025"	\$13.71
M89.5C14H4	1/4"	4H	.025"	\$11.17
M89.5C14H6	1/4"	6H	.025"	\$11.17
M89.5C14R10	1/4"	10R	.025"	\$11.17
M89.5C14R14	1/4"	14R	.025"	\$11.17
M89.5C14R18	1/4"	18R	.025"	\$11.17
M89.5C14R24	1/4"	24R	.025"	\$11.17
M89.5C38H3	3/8"	3H	.025"	\$12.21
M89.5C38H4	3/8"	4H	.025"	\$12.21
M89.5C38H6	3/8"	6H	.025"	\$12.21
M89.5C38R8	3/8"	8R	.025"	\$12.21
M89.5C38R10	3/8"	10R	.025"	\$12.21
M89.5C38R14	3/8"	14R	.025"	\$12.21
M89.5C38R18	3/8"	18R	.025"	\$12.21
M89.5C38R24	3/8"	24R	.025"	\$12.33
M89.5C12H3	1/2"	3H	.025"	\$13.36
M89.5C12H4	1/2"	4H	.025"	\$13.36
M89.5C12H6	1/2"	6H	.025"	\$13.36
M89.5C12R10	1/2"	10R	.025"	\$13.36
M89.5C12R14	1/2"	14R	.025"	\$13.36
M89.5C12R18	1/2"	18R	.025"	\$13.36
M89.5C12R24	1/2"	24R	.025"	\$13.36
M89.5C58H3	5/8"	3H	.032"	\$15.57
M89.5C58H4	5/8"	4H	.032"	\$15.57
M89.5C58R10	5/8"	10R	.032"	\$15.57
M89.5C58R14	5/8"	14R	.032"	\$15.57
M89.5C34H2	3/4"	2H	.032"	\$15.57
M89.5C34H3	3/4"	3H	.032"	\$15.57
M89.5C34H4	3/4"	4H	.032"	\$15.57
M89.5C34H6	3/4"	6H	.032"	\$15.57
M89.5C34R6	3/4"	6R	.032"	\$15.57
M89.5C34R10	3/4"	10R	.032"	\$15.57
M89.5C34R14	3/4"	14R	.032"	\$15.57
M89.5C34R18	3/4"	18R	.032"	\$15.57

Hawc Pro Resaw Bandsaw Blade 89-1/2" (7' 5-1/2") Long



Tool No.	Width	Tooth	Thickness	Price
B89.5H12T3	1/2"	3	.025"	\$19.07

WoodSaver Plus Resaw Bandsaw Blades 89-1/2" (7' 5-1/2") Long



Tool No.	Width	Tooth	Thickness	Price
B89.5P58V3	5/8"	3-4V	.025"	\$65.88

WoodSaver Resaw Bandsaw Blades 89-1/2" (7' 5-1/2") Long



Tool No.	Width	Tooth	Thickness	Price
B89.5S58T3	5/8"	3	.025"	\$56.30

Carbide Grit Bandsaw Blade 90" (7' 6") Long



Tool No.	Width	Tooth	Thickness	Price
M90G12MC	1/2"	Med-Coarse	.025"	\$193.09
M90G34MC	3/4"	Med-Coarse	.032"	\$205.83

MAGNATE™ 20639 Lycoming Street #B-6, Walnut, CA 91789 USA

M-20



email : info@magnate.net Online Shop : www.magnate.net
(TEL) 800-827-2316, 909-468-5747 (FAX) 909-468-5745

MAGNATE™ Band Saw Blades (Non-Food Processing)

Bi-metal Bandsaw Blade 90" (7' 6") Long



Tool No.	Width	Tooth	Thickness	Price
M90M14H6	1/4"	6H	.025"	\$40.40
M90M14V10	1/4"	10-14V	.025"	\$40.40
M90M14V14	1/4"	14-18V	.025"	\$40.40
M90M38H4	3/8"	4H	.025"	\$40.40
M90M38V10	3/8"	10-14V	.025"	\$40.40
M90M38V14	3/8"	14-18V	.025"	\$40.40
M90M12H3	1/2"	3H	.025"	\$40.40
M90M12H4	1/2"	4H	.025"	\$40.40
M90M12H6	1/2"	6H	.025"	\$40.40
M90M12V6	1/2"	6-10V	.025"	\$40.40
M90M12V8	1/2"	8-12V	.025"	\$40.40
M90M12V10	1/2"	10-14V	.025"	\$40.40
M90M12T14	1/2"	14	.025"	\$40.40
M90M12V14	1/2"	14-18V	.025"	\$40.40
M90M12T18	1/2"	18	.025"	\$40.40
M90M58V10	5/8"	10-14V	.032"	\$42.84
M90M34H3	3/4"	3H	.035"	\$42.84
M90M34V4	3/4"	4-6V	.035"	\$42.84
M90M34V5	3/4"	5-8V	.035"	\$42.84
M90M34V6	3/4"	6-10V	.035"	\$42.84
M90M34V8	3/4"	8-12V	.035"	\$42.84
M90M34V10	3/4"	10-14V	.035"	\$42.84
M90M34W14	3/4"	14W	.035"	\$42.84
M90M34W18	3/4"	18W	.035"	\$42.84

Carbide Impregnated Bandsaw Blade 90" (7' 6") Long



Tool No.	Width	Tooth	Thickness	Price
B90G14H6	1/4"	6H	.025"	\$29.13
B90G38H4	3/8"	4H	.025"	\$27.40
B90G12H3	1/2"	3H	.025"	\$28.73

Carbide Tipped Bandsaw Blade 90" (7' 6") Long



Tool No.	Width	Tooth	Thickness	Price
M90E12T3	1/2"	3	.025"	\$159.65
M90E34T3	3/4"	3	.035"	\$175.18

Carbon Steel Bandsaw Blade 90" (7' 6") Long



Tool No.	Width	Tooth	Thickness	Price
M90C18R14	1/8"	14R	.025"	\$15.72
M90C18R18	1/8"	18R	.025"	\$15.72
M90C316S4	3/16"	4S	.025"	\$13.71
M90C316S6	3/16"	6S	.025"	\$13.36
M90C316R10	3/16"	10R	.025"	\$13.71
M90C316R14	3/16"	14R	.025"	\$13.71
M90C316R18	3/16"	18R	.025"	\$13.71
M90C316R24	3/16"	24R	.025"	\$13.71
M90C14H4	1/4"	4H	.025"	\$11.17
M90C14H6	1/4"	6H	.025"	\$11.17
M90C14R10	1/4"	10R	.025"	\$11.17
M90C14R14	1/4"	14R	.025"	\$11.17
M90C14R18	1/4"	18R	.025"	\$11.17
M90C14R24	1/4"	24R	.025"	\$11.17
M90C38H3	3/8"	3H	.025"	\$12.21
M90C38H4	3/8"	4H	.025"	\$12.21
M90C38H6	3/8"	6H	.025"	\$12.21
M90C38R8	3/8"	8R	.025"	\$12.21
M90C38R10	3/8"	10R	.025"	\$12.21
M90C38R14	3/8"	14R	.025"	\$12.21
M90C38R18	3/8"	18R	.025"	\$12.21
M90C38R24	3/8"	24R	.025"	\$12.33
M90C12H3	1/2"	3H	.025"	\$13.36
M90C12H4	1/2"	4H	.025"	\$13.36
M90C12H6	1/2"	6H	.025"	\$13.36
M90C12R10	1/2"	10R	.025"	\$13.36
M90C12R14	1/2"	14R	.025"	\$13.36
M90C12R18	1/2"	18R	.025"	\$13.36
M90C12R24	1/2"	24R	.025"	\$13.36
M90C58H3	5/8"	3H	.032"	\$15.57
M90C58H4	5/8"	4H	.032"	\$15.57
M90C58R10	5/8"	10R	.032"	\$15.57
M90C58R14	5/8"	14R	.032"	\$15.57
M90C34H2	3/4"	2H	.032"	\$15.57
M90C34H3	3/4"	3H	.032"	\$15.57
M90C34H4	3/4"	4H	.032"	\$15.57
M90C34H6	3/4"	6H	.032"	\$15.57
M90C34R6	3/4"	6R	.032"	\$15.57
M90C34R10	3/4"	10R	.032"	\$15.57
M90C34R14	3/4"	14R	.032"	\$15.57
M90C34R18	3/4"	18R	.032"	\$15.57

Hawc Pro Resaw Bandsaw Blade 90" (7' 6") Long



Tool No.	Width	Tooth	Thickness	Price
B90H12T3	1/2"	3	.025"	\$19.07

WoodSaver Plus Resaw Bandsaw Blades 90" (7' 6") Long



Tool No.	Width	Tooth	Thickness	Price
B90P58V3	5/8"	3-4V	.025"	\$65.88

WoodSaver Resaw Bandsaw Blades 90" (7' 6") Long



Tool No.	Width	Tooth	Thickness	Price
B90S58T3	5/8"	3	.025"	\$56.30

Carbide Grit Bandsaw Blade 91" (7' 7") Long



Tool No.	Width	Tooth	Thickness	Price
M91G12MC	1/2"	Med-Coarse	.025"	\$205.40
M91G34MC	3/4"	Med-Coarse	.032"	\$218.93

Carbide Impregnated Bandsaw Blade 91" (7' 7") Long



Tool No.	Width	Tooth	Thickness	Price
B91G14H6	1/4"	6H	.025"	\$30.03
B91G38H4	3/8"	4H	.025"	\$28.45
B91G12H3	1/2"	3H	.025"	\$29.65

MAGNATE™ 20639 Lycoming Street #B-6, Walnut, CA 91789 USA

M-21



email : info@magnate.net Online Shop : www.magnate.net
(TEL) 800-827-2316, 909-468-5747 (FAX) 909-468-5745

MAGNATE™ Band Saw Blades (Non-Food Processing)

Carbide Tipped Bandsaw Blade
91" (7' 7") Long



MAGNATE

Tool No.	Width	Tooth	Thickness	Price
M91E12T3	1/2"	3	.025"	\$169.70
M91E34T3	3/4"	3	.035"	\$186.20

Carbon Steel Bandsaw Blade
91" (7' 7") Long



MAGNATE

Tool No.	Width	Tooth	Thickness	Price
M91C18R14	1/8"	14R	.025"	\$16.29
M91C18R18	1/8"	18R	.025"	\$16.29
M91C316S4	3/16"	4S	.025"	\$14.19
M91C316S6	3/16"	6S	.025"	\$13.97
M91C316R10	3/16"	10R	.025"	\$14.19
M91C316R14	3/16"	14R	.025"	\$14.19
M91C316R18	3/16"	18R	.025"	\$14.19
M91C316R24	3/16"	24R	.025"	\$14.19
M91C14H4	1/4"	4H	.025"	\$11.62
M91C14H6	1/4"	6H	.025"	\$11.62
M91C14R10	1/4"	10R	.025"	\$11.62
M91C14R14	1/4"	14R	.025"	\$11.62
M91C14R18	1/4"	18R	.025"	\$11.62
M91C14R24	1/4"	24R	.025"	\$11.62
M91C38H3	3/8"	3H	.025"	\$12.72
M91C38H4	3/8"	4H	.025"	\$12.72
M91C38H6	3/8"	6H	.025"	\$12.72
M91C38R8	3/8"	8R	.025"	\$12.72
M91C38R10	3/8"	10R	.025"	\$12.72
M91C38R14	3/8"	14R	.025"	\$12.72
M91C38R18	3/8"	18R	.025"	\$12.72
M91C38R24	3/8"	24R	.025"	\$12.81
M91C12H3	1/2"	3H	.025"	\$13.97
M91C12H4	1/2"	4H	.025"	\$13.97
M91C12H6	1/2"	6H	.025"	\$13.97
M91C12R10	1/2"	10R	.025"	\$13.97
M91C12R14	1/2"	14R	.025"	\$13.97
M91C12R18	1/2"	18R	.025"	\$13.97
M91C12R24	1/2"	24R	.025"	\$13.97
M91C58H3	5/8"	3H	.032"	\$16.31
M91C58H4	5/8"	4H	.032"	\$16.31
M91C58R10	5/8"	10R	.032"	\$16.31
M91C58R14	5/8"	14R	.032"	\$16.31
M91C34H2	3/4"	2H	.032"	\$16.31
M91C34H3	3/4"	3H	.032"	\$16.31
M91C34H4	3/4"	4H	.032"	\$16.31
M91C34H6	3/4"	6H	.032"	\$16.31
M91C34R6	3/4"	6R	.032"	\$16.31
M91C34R10	3/4"	10R	.032"	\$16.31
M91C34R14	3/4"	14R	.032"	\$16.31
M91C34R18	3/4"	18R	.032"	\$16.31

Bi-metal Bandsaw Blade
91" (7' 7") Long



MAGNATE

Tool No.	Width	Tooth	Thickness	Price
M91M14H6	1/4"	6H	.025"	\$42.52
M91M14V10	1/4"	10-14V	.025"	\$42.52
M91M14V14	1/4"	14-18V	.025"	\$42.52
M91M38H4	3/8"	4H	.025"	\$42.52
M91M38T10	3/8"	10	.025"	\$42.52
M91M38V10	3/8"	10-14V	.025"	\$42.52
M91M38V14	3/8"	14-18V	.025"	\$42.52
M91M12H3	1/2"	3H	.025"	\$42.52
M91M12H4	1/2"	4H	.025"	\$42.52
M91M12H6	1/2"	6H	.025"	\$42.52
M91M12V6	1/2"	6-10V	.025"	\$42.52
M91M12V8	1/2"	8-12V	.025"	\$42.52
M91M12V10	1/2"	10-14V	.025"	\$42.52
M91M12T14	1/2"	14	.025"	\$42.52
M91M12V14	1/2"	14-18V	.025"	\$42.52
M91M12T18	1/2"	18	.025"	\$42.52
M91M58V10	5/8"	10-14V	.032"	\$45.09
M91M34H3	3/4"	3H	.035"	\$45.09
M91M34V4	3/4"	4-6V	.035"	\$45.09
M91M34V5	3/4"	5-8V	.035"	\$45.09
M91M34V6	3/4"	6-10V	.035"	\$45.09
M91M34V8	3/4"	8-12V	.035"	\$45.09
M91M34V10	3/4"	10-14V	.035"	\$45.09
M91M34W14	3/4"	14W	.035"	\$45.09
M91M34W18	3/4"	18W	.035"	\$45.09

WoodSaver Resaw Bandsaw Blades
91" (7' 7") Long



SUPER CUT™

Tool No.	Width	Tooth	Thickness	Price
B91S58T3	5/8"	3	.025"	\$59.47

Bi-metal Bandsaw Blade
92" (7' 8") Long



MAGNATE

Tool No.	Width	Tooth	Thickness	Price
M92M14H6	1/4"	6H	.025"	\$42.52
M92M14V10	1/4"	10-14V	.025"	\$42.52
M92M14V14	1/4"	14-18V	.025"	\$42.52
M92M38H4	3/8"	4H	.025"	\$42.52
M92M38V10	3/8"	10-14V	.025"	\$42.52
M92M38V14	3/8"	14-18V	.025"	\$42.52
M92M12H3	1/2"	3H	.025"	\$42.52
M92M12H4	1/2"	4H	.025"	\$42.52
M92M12H6	1/2"	6H	.025"	\$42.52
M92M12V6	1/2"	6-10V	.025"	\$42.52
M92M12V8	1/2"	8-12V	.025"	\$42.52
M92M12V10	1/2"	10-14V	.025"	\$42.52
M92M12T14	1/2"	14	.025"	\$42.52
M92M12V14	1/2"	14-18V	.025"	\$42.52
M92M12T18	1/2"	18	.025"	\$42.52
M92M58V10	5/8"	10-14V	.032"	\$42.52
M92M34H3	3/4"	3H	.035"	\$45.09
M92M34W14	3/4"	14W	.035"	\$45.09
M92M34W18	3/4"	18W	.035"	\$45.09
M92M34V4	3/4"	4-6V	.035"	\$45.09
M92M34V5	3/4"	5-8V	.035"	\$45.09
M92M34V6	3/4"	6-10V	.035"	\$45.09
M92M34V8	3/4"	8-12V	.035"	\$45.09
M92M34V10	3/4"	10-14V	.035"	\$45.09

Hawc Pro Resaw Bandsaw Blade
91" (7' 7") Long



SUPER CUT™

Tool No.	Width	Tooth	Thickness	Price
B91H12T3	1/2"	3	.025"	\$19.77

WoodSaver Plus Resaw Bandsaw Blades
91" (7' 7") Long



SUPER CUT™

Tool No.	Width	Tooth	Thickness	Price
B91P58V3	5/8"	3-4V	.025"	\$69.58

Carbide Tipped Bandsaw Blade
92" (7' 8") Long



MAGNATE

Tool No.	Width	Tooth	Thickness	Price
M92E12T3	1/2"	3	.025"	\$169.70
M92E34T3	3/4"	3	.035"	\$186.20

MAGNATE™ 20639 Lycoming Street #B-6, Walnut, CA 91789 USA

M-22



email : info@magnate.net Online Shop : www.magnate.net
(TEL) 800-827-2316, 909-468-5747 (FAX) 909-468-5745

MAGNATE™ Band Saw Blades (Non-Food Processing)

Carbon Steel Bandsaw Blade 92" (7' 8") Long



MAGNATE

Tool No.	Width	Tooth	Thickness	Price
M92C18R14	1/8"	14R	.025"	\$16.29
M92C18R18	1/8"	18R	.025"	\$16.29
M92C316S4	3/16"	4S	.025"	\$14.19
M92C316S6	3/16"	6S	.025"	\$13.97
M92C316R10	3/16"	10R	.025"	\$14.19
M92C316R14	3/16"	14R	.025"	\$14.19
M92C316R18	3/16"	18R	.025"	\$14.19
M92C316R24	3/16"	24R	.025"	\$14.19
M92C14H4	1/4"	4H	.025"	\$11.62
M92C14H6	1/4"	6H	.025"	\$11.62
M92C14R10	1/4"	10R	.025"	\$11.62
M92C14R14	1/4"	14R	.025"	\$11.62
M92C14R18	1/4"	18R	.025"	\$11.62
M92C14R24	1/4"	24R	.025"	\$11.62
M92C38H3	3/8"	3H	.025"	\$12.72
M92C38H4	3/8"	4H	.025"	\$12.72
M92C38H6	3/8"	6H	.025"	\$12.72
M92C38R8	3/8"	8R	.025"	\$12.72
M92C38R10	3/8"	10R	.025"	\$12.72
M92C38R14	3/8"	14R	.025"	\$12.72
M92C38R18	3/8"	18R	.025"	\$12.72
M92C38R24	3/8"	24R	.025"	\$12.81
M92C12H3	1/2"	3H	.025"	\$13.97
M92C12H4	1/2"	4H	.025"	\$13.97
M92C12H6	1/2"	6H	.025"	\$13.97
M92C12R10	1/2"	10R	.025"	\$13.97
M92C12R14	1/2"	14R	.025"	\$13.97
M92C12R18	1/2"	18R	.025"	\$13.97
M92C12R24	1/2"	24R	.025"	\$13.97
M92C58H3	5/8"	3H	.032"	\$16.31
M92C58H4	5/8"	4H	.032"	\$16.31
M92C58R10	5/8"	10R	.032"	\$16.31
M92C58R14	5/8"	14R	.032"	\$16.31
M92C34H2	3/4"	2H	.032"	\$16.31
M92C34H3	3/4"	3H	.032"	\$16.31
M92C34H4	3/4"	4H	.032"	\$16.31
M92C34H6	3/4"	6H	.032"	\$16.31
M92C34R6	3/4"	6R	.032"	\$16.31
M92C34R10	3/4"	10R	.032"	\$16.31
M92C34R14	3/4"	14R	.032"	\$16.31
M92C34R18	3/4"	18R	.032"	\$16.31

Carbide Grit Bandsaw Blade 92" (7' 8") Long



MAGNATE

Tool No.	Width	Tooth	Thickness	Price
M92G12MC	1/2"	Med-Coarse	.025"	\$205.40
M92G34MC	3/4"	Med-Coarse	.032"	\$218.93

Carbide Impregnated Bandsaw Blade 92" (7' 8") Long



SUPER CUT™

Tool No.	Width	Tooth	Thickness	Price
B92G14H6	1/4"	6H	.025"	\$30.03
B92G38H4	3/8"	4H	.025"	\$28.45
B92G12H3	1/2"	3H	.025"	\$29.65

Hawc Pro Resaw Bandsaw Blade 92" (7' 8") Long



SUPER CUT™

Tool No.	Width	Tooth	Thickness	Price
B92H12T3	1/2"	3	.025"	\$19.77

WoodSaver Plus Resaw Bandsaw Blades 92" (7' 8") Long



SUPER CUT™

Tool No.	Width	Tooth	Thickness	Price
B92P58V3	5/8"	3-4V	.025"	\$69.58

WoodSaver Resaw Bandsaw Blades 92" (7' 8") Long



SUPER CUT™

Tool No.	Width	Tooth	Thickness	Price
B92S58T3	5/8"	3	.025"	\$59.47

Bi-metal Bandsaw Blade 92-1/2" (7' 8-1/2") Long



MAGNATE

Tool No.	Width	Tooth	Thickness	Price
M92.5M14H6	1/4"	6H	.025"	\$45.09
M92.5M14V10	1/4"	10-14V	.025"	\$42.52
M92.5M14V14	1/4"	14-18V	.025"	\$42.52
M92.5M38H4	3/8"	4H	.025"	\$42.52
M92.5M38V10	3/8"	10-14V	.025"	\$42.52
M92.5M38V14	3/8"	14-18V	.025"	\$42.52
M92.5M12H3	1/2"	3H	.025"	\$42.52
M92.5M12H4	1/2"	4H	.025"	\$42.52
M92.5M12H6	1/2"	6H	.025"	\$42.52
M92.5M12V6	1/2"	6-10V	.025"	\$42.52
M92.5M12V8	1/2"	8-12V	.025"	\$42.52
M92.5M12V10	1/2"	10-14V	.025"	\$42.52
M92.5M12T14	1/2"	14	.025"	\$42.52
M92.5M12V14	1/2"	14-18V	.025"	\$42.52
M92.5M12T18	1/2"	18	.025"	\$42.52
M92.5M58V10	5/8"	10-14V	.032"	\$45.09
M92.5M34H3	3/4"	3H	.035"	\$45.09
M92.5M34V4	3/4"	4-6V	.035"	\$45.09
M92.5M34V5	3/4"	5-8V	.035"	\$45.09
M92.5M34V6	3/4"	6-10V	.035"	\$45.09
M92.5M34V8	3/4"	8-12V	.035"	\$45.09
M92.5M34V10	3/4"	10-14V	.035"	\$45.09
M92.5M34W14	3/4"	14W	.035"	\$45.09
M92.5M34W18	3/4"	18W	.035"	\$45.09



MAGNATE™ Band Saw Blades (Non-Food Processing)

Carbon Steel Bandsaw Blade 92-1/2" (7' 8-1/2") Long



Tool No.	Width	Tooth	Thickness	Price
M92.5C18R14	1/8"	14R	.025"	\$16.29
M92.5C18R18	1/8"	18R	.025"	\$16.29
M92.5C316S4	3/16"	4S	.025"	\$14.19
M92.5C316S6	3/16"	6S	.025"	\$13.97
M92.5C316R10	3/16"	10R	.025"	\$14.19
M92.5C316R14	3/16"	14R	.025"	\$14.19
M92.5C316R18	3/16"	18R	.025"	\$14.19
M92.5C316R24	3/16"	24R	.025"	\$14.19
M92.5C14H4	1/4"	4H	.025"	\$11.62
M92.5C14H6	1/4"	6H	.025"	\$11.62
M92.5C14R10	1/4"	10R	.025"	\$11.62
M92.5C14R14	1/4"	14R	.025"	\$11.62
M92.5C14R18	1/4"	18R	.025"	\$11.62
M92.5C14R24	1/4"	24R	.025"	\$11.62
M92.5C38H3	3/8"	3H	.025"	\$12.72
M92.5C38H4	3/8"	4H	.025"	\$12.72
M92.5C38H6	3/8"	6H	.025"	\$12.72
M92.5C38R8	3/8"	8R	.025"	\$12.72
M92.5C38R10	3/8"	10R	.025"	\$12.72
M92.5C38R14	3/8"	14R	.025"	\$12.72
M92.5C38R18	3/8"	18R	.025"	\$12.72
M92.5C38R24	3/8"	24R	.025"	\$12.81
M92.5C12H3	1/2"	3H	.025"	\$13.97
M92.5C12H4	1/2"	4H	.025"	\$13.97
M92.5C12H6	1/2"	6H	.025"	\$13.97
M92.5C12R10	1/2"	10R	.025"	\$13.97
M92.5C12R14	1/2"	14R	.025"	\$13.97
M92.5C12R18	1/2"	18R	.025"	\$13.97
M92.5C12R24	1/2"	24R	.025"	\$13.97
M92.5C58H3	5/8"	3H	.032"	\$16.31
M92.5C58H4	5/8"	4H	.032"	\$16.31
M92.5C58R10	5/8"	10R	.032"	\$16.31
M92.5C58R14	5/8"	14R	.032"	\$16.31
M92.5C34H2	3/4"	2H	.032"	\$16.31
M92.5C34H3	3/4"	3H	.032"	\$16.31
M92.5C34H4	3/4"	4H	.032"	\$16.31
M92.5C34H6	3/4"	6H	.032"	\$16.31
M92.5C34R6	3/4"	6R	.032"	\$16.31
M92.5C34R10	3/4"	10R	.032"	\$16.31
M92.5C34R14	3/4"	14R	.032"	\$16.31
M92.5C34R18	3/4"	18R	.032"	\$16.31

Carbide Grit Bandsaw Blade 92-1/2" (7' 8-1/2") Long



Tool No.	Width	Tooth	Thickness	Price
M92.5G12MC	1/2"	Med-Coarse	.025"	\$205.40
M92.5G34MC	3/4"	Med-Coarse	.032"	\$218.93

Carbide Impregnated Bandsaw Blade 92-1/2" (7' 8-1/2") Long



Tool No.	Width	Tooth	Thickness	Price
B92.5G14H6	1/4"	6H	.025"	\$30.03
B92.5G38H4	3/8"	4H	.025"	\$28.45
B92.5G12H3	1/2"	3H	.025"	\$29.65

Carbide Tipped Bandsaw Blade 92-1/2" (7' 8-1/2") Long



Tool No.	Width	Tooth	Thickness	Price
M92.5E12T3	1/2"	3	.025"	\$169.70
M92.5E34T3	3/4"	3	.035"	\$186.20

Hawc Pro Resaw Bandsaw Blade 92-1/2" (7' 8-1/2") Long



Tool No.	Width	Tooth	Thickness	Price
B92.5H12T3	1/2"	3	.025"	\$19.77

WoodSaver Plus Resaw Bandsaw Blades 92-1/2" (7' 8-1/2") Long



Tool No.	Width	Tooth	Thickness	Price
B92.5P58V3	5/8"	3-4V	.025"	\$69.58

WoodSaver Resaw Bandsaw Blades 92-1/2" (7' 8-1/2") Long



Tool No.	Width	Tooth	Thickness	Price
B92.5S58T3	5/8"	3	.025"	\$59.47

Carbide Grit Bandsaw Blade 93" (7' 9") Long



Tool No.	Width	Tooth	Thickness	Price
M93G12MC	1/2"	Med-Coarse	.025"	\$205.40
M93G34MC	3/4"	Med-Coarse	.032"	\$218.93

Carbide Impregnated Bandsaw Blade 93" (7' 9") Long



Tool No.	Width	Tooth	Thickness	Price
B93G14H6	1/4"	6H	.025"	\$30.03
B93G38H4	3/8"	4H	.025"	\$28.45
B93G12H3	1/2"	3H	.025"	\$29.65



MAGNATE™ Band Saw Blades (Non-Food Processing)

Carbon Steel Bandsaw Blade 93" (7' 9") Long



Tool No.	Width	Tooth	Thickness	Price
M93C18R14	1/8"	14R	.025"	\$16.29
M93C18R18	1/8"	18R	.025"	\$16.29
M93C316S4	3/16"	4S	.025"	\$14.19
M93C316S6	3/16"	6S	.025"	\$13.97
M93C316R10	3/16"	10R	.025"	\$14.19
M93C316R14	3/16"	14R	.025"	\$14.19
M93C316R18	3/16"	18R	.025"	\$14.19
M93C316R24	3/16"	24R	.025"	\$14.19
M93C14H4	1/4"	4H	.025"	\$11.62
M93C14H6	1/4"	6H	.025"	\$11.62
M93C14R10	1/4"	10R	.025"	\$11.62
M93C14R14	1/4"	14R	.025"	\$11.62
M93C14R18	1/4"	18R	.025"	\$11.62
M93C14R24	1/4"	24R	.025"	\$11.62
M93C38H3	3/8"	3H	.025"	\$12.72
M93C38H4	3/8"	4H	.025"	\$12.72
M93C38H6	3/8"	6H	.025"	\$12.72
M93C38R8	3/8"	8R	.025"	\$12.72
M93C38R10	3/8"	10R	.025"	\$12.72
M93C38R14	3/8"	14R	.025"	\$12.72
M93C38R18	3/8"	18R	.025"	\$12.72
M93C38R24	3/8"	24R	.025"	\$12.81
M93C12H3	1/2"	3H	.025"	\$13.97
M93C12H4	1/2"	4H	.025"	\$13.97
M93C12H6	1/2"	6H	.025"	\$13.97
M93C12R10	1/2"	10R	.025"	\$13.97
M93C12R14	1/2"	14R	.025"	\$13.97
M93C12R18	1/2"	18R	.025"	\$13.97
M93C12R24	1/2"	24R	.025"	\$13.97
M93C58H3	5/8"	3H	.032"	\$16.31
M93C58H4	5/8"	4H	.032"	\$16.31
M93C58R10	5/8"	10R	.032"	\$16.31
M93C58R14	5/8"	14R	.032"	\$16.31
M93C34H2	3/4"	2H	.032"	\$16.31
M93C34H3	3/4"	3H	.032"	\$16.31
M93C34H4	3/4"	4H	.032"	\$16.31
M93C34H6	3/4"	6H	.032"	\$16.31
M93C34R6	3/4"	6R	.032"	\$16.31
M93C34R10	3/4"	10R	.032"	\$16.31
M93C34R14	3/4"	14R	.032"	\$16.31
M93C34R18	3/4"	18R	.032"	\$16.31

Bi-metal Bandsaw Blade 93" (7' 9") Long



Tool No.	Width	Tooth	Thickness	Price
M93M14H6	1/4"	6H	.025"	\$45.09
M93M14V10	1/4"	10-14V	.025"	\$42.52
M93M14V14	1/4"	14-18V	.025"	\$42.52
M93M38H4	3/8"	4H	.025"	\$42.52
M93M38V10	3/8"	10-14V	.025"	\$42.52
M93M38V14	3/8"	14-18V	.025"	\$42.52
M93M12H3	1/2"	3H	.025"	\$42.52
M93M12H4	1/2"	4H	.025"	\$42.52
M93M12H6	1/2"	6H	.025"	\$42.52
M93M12V6	1/2"	6-10V	.025"	\$42.52
M93M12V8	1/2"	8-12V	.025"	\$42.52
M93M12V10	1/2"	10-14V	.025"	\$42.52
M93M12T14	1/2"	14	.025"	\$42.52
M93M12V14	1/2"	14-18V	.025"	\$42.52
M93M12T18	1/2"	18	.025"	\$42.52
M93M58V10	5/8"	10-14V	.032"	\$45.09
M93M34H3	3/4"	3H	.035"	\$45.09
M93M34V4	3/4"	4-6V	.035"	\$45.09
M93M34V5	3/4"	5-8V	.035"	\$45.09
M93M34V6	3/4"	6-10V	.035"	\$45.09
M93M34V8	3/4"	8-12V	.035"	\$45.09
M93M34V10	3/4"	10-14V	.035"	\$45.09
M93M34W14	3/4"	14W	.035"	\$45.09
M93M34W18	3/4"	18W	.035"	\$45.09

Carbide Tipped Bandsaw Blade 93" (7' 9") Long



Tool No.	Width	Tooth	Thickness	Price
M93E12T3	1/2"	3	.025"	\$169.70
M93E34T3	3/4"	3	.035"	\$186.20

Hawe Pro Resaw Bandsaw Blade 93" (7' 9") Long



Tool No.	Width	Tooth	Thickness	Price
B93H12T3	1/2"	3	.025"	\$19.77

WoodSaver Plus Resaw Bandsaw Blades 93" (7' 9") Long



Tool No.	Width	Tooth	Thickness	Price
B93P58V3	5/8"	3-4V	.030"	\$69.58

WoodSaver Resaw Bandsaw Blades 93" (7' 9") Long



Tool No.	Width	Tooth	Thickness	Price
B93S58T3	5/8"	3	.025"	\$59.47

Carbide Grit Bandsaw Blade 93-1/2" (7' 9-1/2") Long



Tool No.	Width	Tooth	Thickness	Price
M93.5G12MC	1/2"	Med-Coarse	.025"	\$205.40
M93.5G34MC	3/4"	Med-Coarse	.032"	\$218.93

Carbide Tipped Bandsaw Blade 93-1/2" (7' 9-1/2") Long



Tool No.	Width	Tooth	Thickness	Price
M93.5E12T3	1/2"	3	.025"	\$169.70
M93.5E34T3	3/4"	3	.035"	\$186.20



MAGNATE™ Band Saw Blades (Non-Food Processing)

Carbon Steel Bandsaw Blade 93-1/2" (7' 9-1/2") Long



Tool No.	Width	Tooth	Thickness	Price
M93.5C18R14	1/8"	14R	.025"	\$16.29
M93.5C18R18	1/8"	18R	.025"	\$16.29
M93.5C316S4	3/16"	4S	.025"	\$14.19
M93.5C316S6	3/16"	6S	.025"	\$13.97
M93.5C316R10	3/16"	10R	.025"	\$14.19
M93.5C316R14	3/16"	14R	.025"	\$14.19
M93.5C316R18	3/16"	18R	.025"	\$14.19
M93.5C316R24	3/16"	24R	.025"	\$14.19
M93.5C14H4	1/4"	4H	.025"	\$11.62
M93.5C14H6	1/4"	6H	.025"	\$11.62
M93.5C14R10	1/4"	10R	.025"	\$11.62
M93.5C14R14	1/4"	14R	.025"	\$11.62
M93.5C14R18	1/4"	18R	.025"	\$11.62
M93.5C14R24	1/4"	24R	.025"	\$11.62
M93.5C38H3	3/8"	3H	.025"	\$12.72
M93.5C38H4	3/8"	4H	.025"	\$12.72
M93.5C38H6	3/8"	6H	.025"	\$12.72
M93.5C38R8	3/8"	8R	.025"	\$12.72
M93.5C38R10	3/8"	10R	.025"	\$12.72
M93.5C38R14	3/8"	14R	.025"	\$12.72
M93.5C38R18	3/8"	18R	.025"	\$12.72
M93.5C38R24	3/8"	24R	.025"	\$12.81
M93.5C12H3	1/2"	3H	.025"	\$13.97
M93.5C12H4	1/2"	4H	.025"	\$13.97
M93.5C12H6	1/2"	6H	.025"	\$13.97
M93.5C12R10	1/2"	10R	.025"	\$13.97
M93.5C12R14	1/2"	14R	.025"	\$13.97
M93.5C12R18	1/2"	18R	.025"	\$13.97
M93.5C12R24	1/2"	24R	.025"	\$13.97
M93.5C58H3	5/8"	3H	.032"	\$16.31
M93.5C58H4	5/8"	4H	.032"	\$16.31
M93.5C58R10	5/8"	10R	.032"	\$16.31
M93.5C58R14	5/8"	14R	.032"	\$16.31
M93.5C34H2	3/4"	2H	.032"	\$16.31
M93.5C34H3	3/4"	3H	.032"	\$16.31
M93.5C34H4	3/4"	4H	.032"	\$16.31
M93.5C34H6	3/4"	6H	.032"	\$16.31
M93.5C34R6	3/4"	6R	.032"	\$16.31
M93.5C34R10	3/4"	10R	.032"	\$16.31
M93.5C34R14	3/4"	14R	.032"	\$16.31
M93.5C34R18	3/4"	18R	.032"	\$16.31

Bi-metal Bandsaw Blade 93-1/2" (7' 9-1/2") Long



Tool No.	Width	Tooth	Thickness	Price
M93.5M14H6	1/4"	6H	.025"	\$45.09
M93.5M14V10	1/4"	10-14V	.025"	\$42.52
M93.5M14V14	1/4"	14-18V	.025"	\$42.52
M93.5M38H4	3/8"	4H	.025"	\$42.52
M93.5M38V10	3/8"	10-14V	.025"	\$42.52
M93.5M38V14	3/8"	14-18V	.025"	\$42.52
M93.5M12H3	1/2"	3H	.025"	\$42.52
M93.5M12H4	1/2"	4H	.025"	\$42.52
M93.5M12H6	1/2"	6H	.025"	\$42.52
M93.5M12V6	1/2"	6-10V	.025"	\$42.52
M93.5M12V8	1/2"	8-12V	.025"	\$42.52
M93.5M12V10	1/2"	10-14V	.025"	\$42.52
M93.5M12T14	1/2"	14	.025"	\$42.52
M93.5M12V14	1/2"	14-18V	.025"	\$42.52
M93.5M12T18	1/2"	18	.025"	\$42.52
M93.5M58V10	5/8"	10-14V	.032"	\$45.09
M93.5M34H3	3/4"	3H	.035"	\$45.09
M93.5M34V4	3/4"	4-6V	.035"	\$45.09
M93.5M34V5	3/4"	5-8V	.035"	\$45.09
M93.5M34V6	3/4"	6-10V	.035"	\$45.09
M93.5M34V8	3/4"	8-12V	.035"	\$45.09
M93.5M34V10	3/4"	10-14V	.035"	\$45.09
M93.5M34W14	3/4"	14W	.035"	\$45.09
M93.5M34W18	3/4"	18W	.035"	\$45.09

Hawc Pro Resaw Bandsaw Blade 93-1/2" (7' 9-1/2") Long



Tool No.	Width	Tooth	Thickness	Price
B93.5H12T3	1/2"	3	.025"	\$19.77

Carbide Impregnated Bandsaw Blade 93-1/2" (7' 9-1/2") Long



Tool No.	Width	Tooth	Thickness	Price
B93.5G14H6	1/4"	6H	.025"	\$30.03
B93.5G38H4	3/8"	4H	.025"	\$28.45
B93.5G12H3	1/2"	3H	.025"	\$29.65

WoodSaver Plus Resaw Bandsaw Blades 93-1/2" (7' 9-1/2") Long



Tool No.	Width	Tooth	Thickness	Price
B93.5P58V3	5/8"	3-4V	.025"	\$69.58

WoodSaver Resaw Bandsaw Blades 93-1/2" (7' 9-1/2") Long



Tool No.	Width	Tooth	Thickness	Price
B93.5S58T3	5/8"	3	.025"	\$59.47

Carbide Grit Bandsaw Blade 95" (7' 11") Long



Tool No.	Width	Tooth	Thickness	Price
M95G12MC	1/2"	Med-Coarse	.025"	\$205.40
M95G34MC	3/4"	Med-Coarse	.032"	\$218.93

Carbide Impregnated Bandsaw Blade 95" (7' 11") Long



Tool No.	Width	Tooth	Thickness	Price
B95G14H6	1/4"	6H	.025"	\$30.03
B95G38H4	3/8"	4H	.025"	\$28.45
B95G12H3	1/2"	3H	.025"	\$29.65

MAGNATE™ 20639 Lycoming Street #B-6, Walnut, CA 91789 USA

M-26



email : info@magnate.net Online Shop : www.magnate.net
(TEL) 800-827-2316, 909-468-5747 (FAX) 909-468-5745

MAGNATE™ Band Saw Blades (Non-Food Processing)

Carbide Tipped Bandsaw Blade
95" (7' 11") Long



MAGNATE

Tool No.	Width	Tooth	Thickness	Price
M95E12T3	1/2"	3	.025"	\$169.70
M95E34T3	3/4"	3	.035"	\$186.20

Carbon Steel Bandsaw Blade
95" (7' 11") Long



MAGNATE

Tool No.	Width	Tooth	Thickness	Price
M95C18R14	1/8"	14R	.025"	\$16.29
M95C18R18	1/8"	18R	.025"	\$16.29
M95C316S4	3/16"	4S	.025"	\$14.19
M95C316S6	3/16"	6S	.025"	\$13.97
M95C316R10	3/16"	10R	.025"	\$14.19
M95C316R14	3/16"	14R	.025"	\$14.19
M95C316R18	3/16"	18R	.025"	\$14.19
M95C316R24	3/16"	24R	.025"	\$14.19
M95C14H4	1/4"	4H	.025"	\$11.62
M95C14H6	1/4"	6H	.025"	\$11.62
M95C14R10	1/4"	10R	.025"	\$11.62
M95C14R14	1/4"	14R	.025"	\$11.62
M95C14R18	1/4"	18R	.025"	\$11.62
M95C14R24	1/4"	24R	.025"	\$11.62
M95C38H3	3/8"	3H	.025"	\$12.72
M95C38H4	3/8"	4H	.025"	\$12.72
M95C38H6	3/8"	6H	.025"	\$12.72
M95C38R8	3/8"	8R	.025"	\$12.72
M95C38R10	3/8"	10R	.025"	\$12.72
M95C38R14	3/8"	14R	.025"	\$12.72
M95C38R18	3/8"	18R	.025"	\$12.72
M95C38R24	3/8"	24R	.025"	\$12.81
M95C12H3	1/2"	3H	.025"	\$13.97
M95C12H4	1/2"	4H	.025"	\$13.97
M95C12H6	1/2"	6H	.025"	\$13.97
M95C12R10	1/2"	10R	.025"	\$13.97
M95C12R14	1/2"	14R	.025"	\$13.97
M95C12R18	1/2"	18R	.025"	\$13.97
M95C12R24	1/2"	24R	.025"	\$13.97
M95C58H3	5/8"	3H	.032"	\$16.31
M95C58H4	5/8"	4H	.032"	\$16.31
M95C58R10	5/8"	10R	.032"	\$16.31
M95C58R14	5/8"	14R	.032"	\$16.31
M95C34H2	3/4"	2H	.032"	\$16.31
M95C34H3	3/4"	3H	.032"	\$16.31
M95C34H4	3/4"	4H	.032"	\$16.31
M95C34H6	3/4"	6H	.032"	\$16.31
M95C34R6	3/4"	6R	.032"	\$16.31
M95C34R10	3/4"	10R	.032"	\$16.31
M95C34R14	3/4"	14R	.032"	\$16.31
M95C34R18	3/4"	18R	.032"	\$16.31

Bi-metal Bandsaw Blade
95" (7' 11") Long



MAGNATE

Tool No.	Width	Tooth	Thickness	Price
M95M14H6	1/4"	6H	.025"	\$45.09
M95M14V10	1/4"	10-14V	.025"	\$42.52
M95M14V14	1/4"	14-18V	.025"	\$42.52
M95M38H4	3/8"	4H	.025"	\$42.52
M95M38V10	3/8"	10-14V	.025"	\$42.52
M95M38V14	3/8"	14-18V	.025"	\$42.52
M95M12H3	1/2"	3H	.025"	\$42.52
M95M12H4	1/2"	4H	.025"	\$42.52
M95M12H6	1/2"	6H	.025"	\$42.52
M95M12V6	1/2"	6-10V	.025"	\$42.52
M95M12V8	1/2"	8-12V	.025"	\$42.52
M95M12V10	1/2"	10-14V	.025"	\$42.52
M95M12T14	1/2"	14	.025"	\$42.52
M95M12V14	1/2"	14-18V	.025"	\$42.52
M95M12T18	1/2"	18	.025"	\$42.52
M95M58V10	5/8"	10-14V	.032"	\$45.09
M95M34H3	3/4"	3H	.035"	\$45.09
M95M34V4	3/4"	4-6V	.035"	\$45.09
M95M34V5	3/4"	5-8V	.035"	\$45.09
M95M34V6	3/4"	6-10V	.035"	\$45.09
M95M34V8	3/4"	8-12V	.035"	\$45.09
M95M34V10	3/4"	10-14V	.035"	\$45.09
M95M34W14	3/4"	14W	.035"	\$45.09
M95M34W18	3/4"	18W	.035"	\$45.09

WoodSaver Resaw Bandsaw Blades
95" (7' 11") Long



SUPER CUT™

Tool No.	Width	Tooth	Thickness	Price
B95S58T3	5/8"	3	.025"	\$59.47

Carbide Grit Bandsaw Blade
96" (8') Long



MAGNATE

Tool No.	Width	Tooth	Thickness	Price
M96G12MC	1/2"	Med-Coarse	.025"	\$205.40
M96G34MC	3/4"	Med-Coarse	.032"	\$218.93

Hawc Pro Resaw Bandsaw Blade
95" (7' 11") Long



SUPER CUT™

Tool No.	Width	Tooth	Thickness	Price
B95H12T3	1/2"	3	.025"	\$19.77

Carbide Tipped Bandsaw Blade
96" (8') Long



MAGNATE

Tool No.	Width	Tooth	Thickness	Price
M96E12T3	1/2"	3	.025"	\$169.70
M96E34T3	3/4"	3	.035"	\$186.20

WoodSaver Plus Resaw Bandsaw Blades
95" (7' 11") Long



SUPER CUT™

Tool No.	Width	Tooth	Thickness	Price
B95P58V3	5/8"	3-4V	.025"	\$69.58

MAGNATE™ 20639 Lycoming Street #B-6, Walnut, CA 91789 USA

M-27



email : info@magnate.net Online Shop : www.magnate.net
(TEL) 800-827-2316, 909-468-5747 (FAX) 909-468-5745

MAGNATE™ Band Saw Blades (Non-Food Processing)

Carbon Steel Bandsaw Blade 96" (8') Long



Tool No.	Width	Tooth	Thickness	Price
M96C18R14	1/8"	14R	.025"	\$16.29
M96C18R18	1/8"	18R	.025"	\$16.29
M96C316S4	3/16"	4S	.025"	\$14.19
M96C316S6	3/16"	6S	.025"	\$13.97
M96C316R10	3/16"	10R	.025"	\$14.19
M96C316R14	3/16"	14R	.025"	\$14.19
M96C316R18	3/16"	18R	.025"	\$14.19
M96C316R24	3/16"	24R	.025"	\$14.19
M96C14H4	1/4"	4H	.025"	\$11.62
M96C14H6	1/4"	6H	.025"	\$11.62
M96C14R10	1/4"	10R	.025"	\$11.62
M96C14R14	1/4"	14R	.025"	\$11.62
M96C14R18	1/4"	18R	.025"	\$11.62
M96C14R24	1/4"	24R	.025"	\$11.62
M96C38H3	3/8"	3H	.025"	\$12.72
M96C38H4	3/8"	4H	.025"	\$12.72
M96C38H6	3/8"	6H	.025"	\$12.72
M96C38R8	3/8"	8R	.025"	\$12.72
M96C38R10	3/8"	10R	.025"	\$12.72
M96C38R14	3/8"	14R	.025"	\$12.72
M96C38R18	3/8"	18R	.025"	\$12.72
M96C38R24	3/8"	24R	.025"	\$12.81
M96C12H3	1/2"	3H	.025"	\$13.97
M96C12H4	1/2"	4H	.025"	\$13.97
M96C12H6	1/2"	6H	.025"	\$13.97
M96C12R10	1/2"	10R	.025"	\$13.97
M96C12R14	1/2"	14R	.025"	\$13.97
M96C12R18	1/2"	18R	.025"	\$13.97
M96C12R24	1/2"	24R	.025"	\$13.97
M96C58H3	5/8"	3H	.032"	\$16.31
M96C58H4	5/8"	4H	.032"	\$16.31
M96C58R10	5/8"	10R	.032"	\$16.31
M96C58R14	5/8"	14R	.032"	\$16.31
M96C34H2	3/4"	2H	.032"	\$16.31
M96C34H3	3/4"	3H	.032"	\$16.31
M96C34H4	3/4"	4H	.032"	\$16.31
M96C34H6	3/4"	6H	.032"	\$16.31
M96C34R6	3/4"	6R	.032"	\$16.31
M96C34R10	3/4"	10R	.032"	\$16.31
M96C34R14	3/4"	14R	.032"	\$16.31
M96C34R18	3/4"	18R	.032"	\$16.31

Bi-metal Bandsaw Blade 96" (8') Long



Tool No.	Width	Tooth	Thickness	Price
M96M14H6	1/4"	6H	.025"	\$45.09
M96M14V10	1/4"	10-14V	.025"	\$42.52
M96M14V14	1/4"	14-18V	.025"	\$42.52
M96M38H4	3/8"	4H	.025"	\$42.52
M96M38V10	3/8"	10-14V	.025"	\$42.52
M96M38V14	3/8"	14-18V	.025"	\$42.52
M96M12H3	1/2"	3H	.025"	\$42.52
M96M12H4	1/2"	4H	.025"	\$42.52
M96M12H6	1/2"	6H	.025"	\$42.52
M96M12V6	1/2"	6-10V	.025"	\$42.52
M96M12V8	1/2"	8-12V	.025"	\$42.52
M96M12V10	1/2"	10-14V	.025"	\$42.52
M96M12T14	1/2"	14	.025"	\$42.52
M96M12V14	1/2"	14-18V	.025"	\$42.52
M96M12T18	1/2"	18	.025"	\$42.52
M96M58V10	5/8"	10-14V	.032"	\$45.09
M96M34H3	3/4"	3H	.035"	\$45.09
M96M34V4	3/4"	4-6V	.035"	\$45.09
M96M34V5	3/4"	5-8V	.035"	\$45.09
M96M34V6	3/4"	6-10V	.035"	\$45.09
M96M34V8	3/4"	8-12V	.035"	\$45.09
M96M34V10	3/4"	10-14V	.035"	\$45.09
M96M34W14	3/4"	14W	.035"	\$45.09
M96M34W18	3/4"	18W	.035"	\$45.09

Carbide Tipped Bandsaw Blade 97" (8' 1") Long



Tool No.	Width	Tooth	Thickness	Price
M97E12T3	1/2"	3	.025"	\$179.78
M97E34T3	3/4"	3	.035"	\$197.25
M97E1T1.3	1"	1.3	.035"	\$197.25
M97E1T2	1"	2	.035"	\$197.25
M97E1T3	1"	3	.035"	\$197.25
M97E1V2	1"	2-3V	.035"	\$193.68

Carbide Impregnated Bandsaw Blade 97" (8' 1") Long



Tool No.	Width	Tooth	Thickness	Price
B97G14H6	1/4"	6H	.025"	\$31.17
B97G38H4	3/8"	4H	.025"	\$29.33
B97G12H3	1/2"	3H	.025"	\$30.48

Bi-metal Bandsaw Blade 97" (8' 1") Long



Tool No.	Width	Tooth	Thickness	Price
M97M14H6	1/4"	6H	.025"	\$44.66
M97M14V10	1/4"	10-14V	.025"	\$44.66
M97M14V14	1/4"	14-18V	.025"	\$44.66
M97M38H4	3/8"	4H	.025"	\$44.66
M97M38V10	3/8"	10-14V	.025"	\$44.66
M97M38V14	3/8"	14-18V	.025"	\$44.66
M97M12H3	1/2"	3H	.025"	\$44.66
M97M12H4	1/2"	4H	.025"	\$44.66
M97M12H6	1/2"	6H	.025"	\$44.66
M97M12V6	1/2"	6-10V	.025"	\$44.66
M97M12V8	1/2"	8-12V	.025"	\$44.66
M97M12V10	1/2"	10-14V	.025"	\$44.66
M97M12T14	1/2"	14	.025"	\$44.66
M97M12V14	1/2"	14-18V	.025"	\$44.66
M97M12T18	1/2"	18	.025"	\$47.31
M97M58V10	5/8"	10-14V	.032"	\$47.31
M97M34H3	3/4"	3H	.035"	\$47.31
M97M34V4	3/4"	4-6V	.035"	\$47.31
M97M34V5	3/4"	5-8V	.035"	\$47.31
M97M34V6	3/4"	6-10V	.035"	\$47.31
M97M34V8	3/4"	8-12V	.035"	\$47.31
M97M34V10	3/4"	10-14V	.035"	\$47.31
M97M34W14	3/4"	14W	.035"	\$47.31
M97M34W18	3/4"	18W	.035"	\$47.31
M97M1V2*	1"	2-3V	.035"	\$54.05
M97M1H3*	1"	3H	.035"	\$54.05
M97M1V3*	1"	3-4V	.035"	\$54.05
M97M1V4*	1"	4-6V	.035"	\$54.05
M97M1V5*	1"	5-8V	.035"	\$54.05
M97M1V6*	1"	6-10V	.035"	\$54.05
M97M1V8*	1"	8-12V	.035"	\$54.05
M97M1V10*	1"	10-14V	.035"	\$54.05

* This 1" wide blade may wear out faster than usual due to its relatively short length



MAGNATE™ Band Saw Blades (Non-Food Processing)

Carbon Steel Bandsaw Blade 97" (8' 1") Long



Tool No.	Width	Tooth	Thickness	Price
M97C18R14	1/8"	14R	.025"	\$16.93
M97C18R18	1/8"	18R	.025"	\$16.93
M97C316S4	3/16"	4S	.025"	\$14.79
M97C316S6	3/16"	6S	.025"	\$14.57
M97C316R10	3/16"	10R	.025"	\$14.79
M97C316R14	3/16"	14R	.025"	\$14.79
M97C316R18	3/16"	18R	.025"	\$14.79
M97C316R24	3/16"	24R	.025"	\$14.79
M97C14H4	1/4"	4H	.025"	\$12.09
M97C14H6	1/4"	6H	.025"	\$12.09
M97C14R10	1/4"	10R	.025"	\$12.09
M97C14R14	1/4"	14R	.025"	\$12.09
M97C14R18	1/4"	18R	.025"	\$12.09
M97C14R24	1/4"	24R	.025"	\$12.09
M97C38H3	3/8"	3H	.025"	\$13.26
M97C38H4	3/8"	4H	.025"	\$13.26
M97C38H6	3/8"	6H	.025"	\$13.26
M97C38R8	3/8"	8R	.025"	\$13.26
M97C38R10	3/8"	10R	.025"	\$13.26
M97C38R14	3/8"	14R	.025"	\$13.26
M97C38R18	3/8"	18R	.025"	\$13.26
M97C38R24	3/8"	24R	.025"	\$13.17
M97C12H3	1/2"	3H	.025"	\$14.57
M97C12H4	1/2"	4H	.025"	\$14.57
M97C12H6	1/2"	6H	.025"	\$14.57
M97C12R10	1/2"	10R	.025"	\$14.57
M97C12R14	1/2"	14R	.025"	\$14.57
M97C12R18	1/2"	18R	.025"	\$14.57
M97C12R24	1/2"	24R	.025"	\$14.57
M97C58H3	5/8"	3H	.032"	\$17.07
M97C58H4	5/8"	4H	.032"	\$17.07
M97C58R10	5/8"	10R	.032"	\$17.07
M97C58R14	5/8"	14R	.032"	\$17.07
M97C34H2	3/4"	2H	.032"	\$17.07
M97C34H3	3/4"	3H	.032"	\$17.07
M97C34H4	3/4"	4H	.032"	\$17.07
M97C34H6	3/4"	6H	.032"	\$17.07
M97C34R6	3/4"	6R	.032"	\$17.07
M97C34R10	3/4"	10R	.032"	\$17.07
M97C34R14	3/4"	14R	.032"	\$17.07
M97C34R18	3/4"	18R	.032"	\$17.07

Carbide Grit Bandsaw Blade 97" (8' 1") Long



Tool No.	Width	Tooth	Thickness	Price
M97G12MC	1/2"	Med-Coarse	.025"	\$217.71
M97G34MC	3/4"	Med-Coarse	.032"	\$232.02

Bi-metal Bandsaw Blade 97-1/2" (8' 1-1/2") Long



Tool No.	Width	Tooth	Thickness	Price
M97.5M14H6	1/4"	6H	.025"	\$44.66
M97.5M14V10	1/4"	10-14V	.025"	\$44.66
M97.5M14V14	1/4"	14-18V	.025"	\$44.66
M97.5M38H4	3/8"	4H	.025"	\$44.66
M97.5M38V10	3/8"	10-14V	.025"	\$44.66
M97.5M38V14	3/8"	14-18V	.025"	\$44.66
M97.5M12H3	1/2"	3H	.025"	\$44.66
M97.5M12H4	1/2"	4H	.025"	\$44.66
M97.5M12H6	1/2"	6H	.025"	\$44.66
M97.5M12V6	1/2"	6-10V	.025"	\$44.66
M97.5M12V8	1/2"	8-12V	.025"	\$44.66
M97.5M12V10	1/2"	10-14V	.025"	\$44.66
M97.5M12T14	1/2"	14	.025"	\$44.66
M97.5M12V14	1/2"	14-18V	.025"	\$44.66
M97.5M12T18	1/2"	18	.025"	\$47.31
M97.5M58V10	5/8"	10-14V	.032"	\$47.31
M97.5M34H3	3/4"	3H	.035"	\$47.31
M97.5M34V4	3/4"	4-6V	.035"	\$47.31
M97.5M34V5	3/4"	5-8V	.035"	\$47.31
M97.5M34V6	3/4"	6-10V	.035"	\$47.31
M97.5M34V8	3/4"	8-12V	.035"	\$47.31
M97.5M34V10	3/4"	10-14V	.035"	\$47.31
M97.5M34W14	3/4"	14W	.035"	\$47.31
M97.5M34W18	3/4"	18W	.035"	\$47.31
M97.5M1V2*	1"	2-3V	.035"	\$54.05
M97.5M1H3*	1"	3H	.035"	\$54.05
M97.5M1V3*	1"	3-4V	.035"	\$54.05
M97.5M1V4*	1"	4-6V	.035"	\$54.05
M97.5M1V5*	1"	5-8V	.035"	\$54.05
M97.5M1V6*	1"	6-10V	.035"	\$54.05
M97.5M1V8*	1"	8-12V	.035"	\$54.05
M97.5M1V10*	1"	10-14V	.035"	\$54.05

* This 1" wide blade may wear out faster than usual due to its relatively short length

Hawc Pro Resaw Bandsaw Blade 97" (8' 1") Long



Tool No.	Width	Tooth	Thickness	Price
B97H12T3	1/2"	3	.025"	\$20.30

WoodSaver Plus Resaw Bandsaw Blades 97" (8' 1") Long



Tool No.	Width	Tooth	Thickness	Price
B97P58V3	5/8"	3-4V	.025"	\$73.27

WoodSaver Resaw Bandsaw Blades 97" (8' 1") Long



Tool No.	Width	Tooth	Thickness	Price
B97S58T3	5/8"	3	.025"	\$62.62
B97S1T3	1"	3	.025"	\$72.35

Carbide Grit Bandsaw Blade 97-1/2" (8' 1-1/2") Long



Tool No.	Width	Tooth	Thickness	Price
M97.5G12MC	1/2"	Med-Coarse	.025"	\$217.71
M97.5G34MC	3/4"	Med-Coarse	.032"	\$232.02



MAGNATE™ Band Saw Blades (Non-Food Processing)

Carbon Steel Bandsaw Blade 97-1/2" (8' 1-1/2") Long



Tool No.	Width	Tooth	Thickness	Price
M97.5C18R14	1/8"	14R	.025"	\$16.93
M97.5C18R18	1/8"	18R	.025"	\$16.93
M97.5C316S4	3/16"	4S	.025"	\$14.79
M97.5C316S6	3/16"	6S	.025"	\$14.57
M97.5C316R10	3/16"	10R	.025"	\$14.79
M97.5C316R14	3/16"	14R	.025"	\$14.79
M97.5C316R18	3/16"	18R	.025"	\$14.79
M97.5C316R24	3/16"	24R	.025"	\$14.79
M97.5C14H4	1/4"	4H	.025"	\$12.09
M97.5C14H6	1/4"	6H	.025"	\$12.09
M97.5C14R10	1/4"	10R	.025"	\$12.09
M97.5C14R14	1/4"	14R	.025"	\$12.09
M97.5C14R18	1/4"	18R	.025"	\$12.09
M97.5C14R24	1/4"	24R	.025"	\$12.09
M97.5C38H3	3/8"	3H	.025"	\$13.26
M97.5C38H4	3/8"	4H	.025"	\$13.26
M97.5C38H6	3/8"	6H	.025"	\$13.26
M97.5C38R8	3/8"	8R	.025"	\$13.26
M97.5C38R10	3/8"	10R	.025"	\$13.26
M97.5C38R14	3/8"	14R	.025"	\$13.26
M97.5C38R18	3/8"	18R	.025"	\$13.26
M97.5C38R24	3/8"	24R	.025"	\$13.17
M97.5C12H3	1/2"	3H	.025"	\$14.57
M97.5C12H4	1/2"	4H	.025"	\$14.57
M97.5C12H6	1/2"	6H	.025"	\$14.57
M97.5C12R10	1/2"	10R	.025"	\$14.57
M97.5C12R14	1/2"	14R	.025"	\$14.57
M97.5C12R18	1/2"	18R	.025"	\$14.57
M97.5C12R24	1/2"	24R	.025"	\$14.57
M97.5C58H3	5/8"	3H	.032"	\$17.07
M97.5C58H4	5/8"	4H	.032"	\$17.07
M97.5C58R10	5/8"	10R	.032"	\$17.07
M97.5C58R14	5/8"	14R	.032"	\$17.07
M97.5C34H2	3/4"	2H	.032"	\$17.07
M97.5C34H3	3/4"	3H	.032"	\$17.07
M97.5C34H4	3/4"	4H	.032"	\$17.07
M97.5C34H6	3/4"	6H	.032"	\$17.07
M97.5C34R6	3/4"	6R	.032"	\$17.07
M97.5C34R10	3/4"	10R	.032"	\$17.07
M97.5C34R14	3/4"	14R	.032"	\$17.07
M97.5C34R18	3/4"	18R	.032"	\$17.07

Carbide Tipped Bandsaw Blade 97-1/2" (8' 1-1/2") Long



Tool No.	Width	Tooth	Thickness	Price
M97.5E12T3	1/2"	3	.025"	\$179.78
M97.5E34T3	3/4"	3	.035"	\$197.25
M97.5E1T1.3	1"	1.3	.035"	\$197.25
M97.5E1T2	1"	2	.035"	\$197.25
M97.5E1T3	1"	3	.035"	\$197.25
M97.5E1V2	1"	2-3V	.035"	\$193.68

Bi-metal Bandsaw Blade 98" (8' 2") Long



Tool No.	Width	Tooth	Thickness	Price
M98M14H6	1/4"	6H	.025"	\$44.66
M98M14V10	1/4"	10-14V	.025"	\$44.66
M98M14V14	1/4"	14-18V	.025"	\$44.66
M98M38H4	3/8"	4H	.025"	\$44.66
M98M38V10	3/8"	10-14V	.025"	\$44.66
M98M38V14	3/8"	14-18V	.025"	\$44.66
M98M12H3	1/2"	3H	.025"	\$44.66
M98M12H4	1/2"	4H	.025"	\$44.66
M98M12H6	1/2"	6H	.025"	\$44.66
M98M12V6	1/2"	6-10V	.025"	\$44.66
M98M12V8	1/2"	8-12V	.025"	\$44.66
M98M12V10	1/2"	10-14V	.025"	\$44.66
M98M12T14	1/2"	14	.025"	\$44.66
M98M12V14	1/2"	14-18V	.025"	\$44.66
M98M12T18	1/2"	18	.025"	\$47.31
M98M58V10	5/8"	10-14V	.032"	\$47.31
M98M34H3	3/4"	3H	.035"	\$47.31
M98M34V4	3/4"	4-6V	.035"	\$47.31
M98M34V5	3/4"	5-8V	.035"	\$47.31
M98M34V6	3/4"	6-10V	.035"	\$47.31
M98M34V8	3/4"	8-12V	.035"	\$47.31
M98M34V10	3/4"	10-14V	.035"	\$47.31
M98M34W14	3/4"	14W	.035"	\$47.31
M98M34W18	3/4"	18W	.035"	\$47.31
M98M1V2*	1"	2-3V	.035"	\$54.05
M98M1H3*	1"	3H	.035"	\$54.05
M98M1V3*	1"	3-4V	.035"	\$54.05
M98M1V4*	1"	4-6V	.035"	\$54.05
M98M1V5*	1"	5-8V	.035"	\$54.05
M98M1V6*	1"	6-10V	.035"	\$54.05
M98M1V8*	1"	8-12V	.035"	\$54.05
M98M1V10*	1"	10-14V	.035"	\$54.05

* This 1" wide blade may wear out faster than usual due to its relatively short length

Carbon Steel Bandsaw Blade 98" (8' 2") Long



Tool No.	Width	Tooth	Thickness	Price
M98C18R14	1/8"	14R	.025"	\$16.93
M98C18R18	1/8"	18R	.025"	\$16.93
M98C316S4	3/16"	4S	.025"	\$14.79
M98C316S6	3/16"	6S	.025"	\$14.57
M98C316R10	3/16"	10R	.025"	\$14.79
M98C316R14	3/16"	14R	.025"	\$14.79
M98C316R18	3/16"	18R	.025"	\$14.79
M98C316R24	3/16"	24R	.025"	\$14.79
M98C14H4	1/4"	4H	.025"	\$12.09
M98C14H6	1/4"	6H	.025"	\$12.09
M98C14R10	1/4"	10R	.025"	\$12.09
M98C14R14	1/4"	14R	.025"	\$12.09
M98C14R18	1/4"	18R	.025"	\$12.09
M98C14R24	1/4"	24R	.025"	\$12.09
M98C38H3	3/8"	3H	.025"	\$13.26
M98C38H4	3/8"	4H	.025"	\$13.26
M98C38H6	3/8"	6H	.025"	\$13.26
M98C38R8	3/8"	8R	.025"	\$13.26
M98C38R10	3/8"	10R	.025"	\$13.26
M98C38R14	3/8"	14R	.025"	\$13.26
M98C38R18	3/8"	18R	.025"	\$13.26
M98C38R24	3/8"	24R	.025"	\$13.17
M98C12H3	1/2"	3H	.025"	\$14.57
M98C12H4	1/2"	4H	.025"	\$14.57
M98C12H6	1/2"	6H	.025"	\$14.57
M98C12R10	1/2"	10R	.025"	\$14.57
M98C12R14	1/2"	14R	.025"	\$14.57
M98C12R18	1/2"	18R	.025"	\$14.57
M98C12R24	1/2"	24R	.025"	\$14.57
M98C58H3	5/8"	3H	.032"	\$17.07
M98C58H4	5/8"	4H	.032"	\$17.07
M98C58R10	5/8"	10R	.032"	\$17.07
M98C58R14	5/8"	14R	.032"	\$17.07
M98C34H2	3/4"	2H	.032"	\$17.07
M98C34H3	3/4"	3H	.032"	\$17.07
M98C34H4	3/4"	4H	.032"	\$17.07
M98C34H6	3/4"	6H	.032"	\$17.07
M98C34R6	3/4"	6R	.032"	\$17.07
M98C34R10	3/4"	10R	.032"	\$17.07
M98C34R14	3/4"	14R	.032"	\$17.07
M98C34R18	3/4"	18R	.032"	\$17.07



MAGNATE™ Band Saw Blades (Non-Food Processing)

Carbide Grit Bandsaw Blade
98" (8' 2") Long



MAGNATE

Tool No.	Width	Tooth	Thickness	Price
M98G12MC	1/2"	Med-Coarse	.025"	\$217.71
M98G34MC	3/4"	Med-Coarse	.032"	\$232.02

WoodSaver Plus Resaw Bandsaw Blades
98" (8' 2") Long



SUPER CUT™

Tool No.	Width	Tooth	Thickness	Price
B98P58V3	5/8"	3-4V	.025"	\$73.27

Carbon Steel Bandsaw Blade
99" (8' 3") Long



MAGNATE

Tool No.	Width	Tooth	Thickness	Price
M99C18R14	1/8"	14R	.025"	\$16.93
M99C18R18	1/8"	18R	.025"	\$16.93
M99C316S4	3/16"	4S	.025"	\$14.79
M99C316S6	3/16"	6S	.025"	\$14.57
M99C316R10	3/16"	10R	.025"	\$14.79
M99C316R14	3/16"	14R	.025"	\$14.79
M99C316R18	3/16"	18R	.025"	\$14.79
M99C316R24	3/16"	24R	.025"	\$14.79
M99C14H4	1/4"	4H	.025"	\$12.09
M99C14H6	1/4"	6H	.025"	\$12.09
M99C14R10	1/4"	10R	.025"	\$12.09
M99C14R14	1/4"	14R	.025"	\$12.09
M99C14R18	1/4"	18R	.025"	\$12.09
M99C14R24	1/4"	24R	.025"	\$12.09
M99C38H3	3/8"	3H	.025"	\$13.26
M99C38H4	3/8"	4H	.025"	\$13.26
M99C38H6	3/8"	6H	.025"	\$13.26
M99C38R8	3/8"	8R	.025"	\$13.26
M99C38R10	3/8"	10R	.025"	\$13.26
M99C38R14	3/8"	14R	.025"	\$13.26
M99C38R18	3/8"	18R	.025"	\$13.26
M99C38R24	3/8"	24R	.025"	\$13.17
M99C12H3	1/2"	3H	.025"	\$14.57
M99C12H4	1/2"	4H	.025"	\$14.57
M99C12H6	1/2"	6H	.025"	\$14.57
M99C12R10	1/2"	10R	.025"	\$14.57
M99C12R14	1/2"	14R	.025"	\$14.57
M99C12R18	1/2"	18R	.025"	\$14.57
M99C12R24	1/2"	24R	.025"	\$14.57
M99C58H3	5/8"	3H	.032"	\$17.07
M99C58H4	5/8"	4H	.032"	\$17.07
M99C58R10	5/8"	10R	.032"	\$17.07
M99C58R14	5/8"	14R	.032"	\$17.07
M99C34H2	3/4"	2H	.032"	\$17.07
M99C34H3	3/4"	3H	.032"	\$17.07
M99C34H4	3/4"	4H	.032"	\$17.07
M99C34H6	3/4"	6H	.032"	\$17.07
M99C34R6	3/4"	6R	.032"	\$17.07
M99C34R10	3/4"	10R	.032"	\$17.07
M99C34R14	3/4"	14R	.032"	\$17.07
M99C34R18	3/4"	18R	.032"	\$17.07

Carbide Impregnated Bandsaw Blade
98" (8' 2") Long



SUPER CUT™

Tool No.	Width	Tooth	Thickness	Price
B98G14H6	1/4"	6H	.025"	\$31.17
B98G38H4	3/8"	4H	.025"	\$29.33
B98G12H3	1/2"	3H	.025"	\$30.48

WoodSaver Resaw Bandsaw Blades
98" (8' 2") Long



SUPER CUT™

Tool No.	Width	Tooth	Thickness	Price
B98S58T3	5/8"	3	.025"	\$62.62
B98S1T3	1"	3	.025"	\$72.35

Carbide Tipped Bandsaw Blade
98" (8' 2") Long



MAGNATE

Tool No.	Width	Tooth	Thickness	Price
M98E12T3	1/2"	3	.025"	\$179.78
M98E34T3	3/4"	3	.035"	\$197.25
M98E1T1.3	1"	1.3	.035"	\$197.25
M98E1T2	1"	2	.035"	\$197.25
M98E1T3	1"	3	.035"	\$197.25
M98E1V2	1"	2-3V	.035"	\$193.68

Carbide Grit Bandsaw Blade
99" (8' 3") Long



MAGNATE

Tool No.	Width	Tooth	Thickness	Price
M99G12MC	1/2"	Med-Coarse	.025"	\$217.71
M99G34MC	3/4"	Med-Coarse	.032"	\$232.02

Hawc Pro Resaw Bandsaw Blade
98" (8' 2") Long



SUPER CUT™

Tool No.	Width	Tooth	Thickness	Price
B98H12T3	1/2"	3	.025"	\$20.30

Carbide Impregnated Bandsaw Blade
99" (8' 3") Long



SUPER CUT™

Tool No.	Width	Tooth	Thickness	Price
B99G14H6	1/4"	6H	.025"	\$31.17
B99G38H4	3/8"	4H	.025"	\$29.33
B99G12H3	1/2"	3H	.025"	\$30.48

MAGNATE™ 20639 Lycoming Street #B-6, Walnut, CA 91789 USA

M-31



email : info@magnate.net Online Shop : www.magnate.net
(TEL) 800-827-2316, 909-468-5747 (FAX) 909-468-5745

MAGNATE™ Band Saw Blades (Non-Food Processing)

Bi-metal Bandsaw Blade 99" (8' 3") Long



MAGNATE

Tool No.	Width	Tooth	Thickness	Price
M99M14H6	1/4"	6H	.025"	\$44.66
M99M14V10	1/4"	10-14V	.025"	\$44.66
M99M14V14	1/4"	14-18V	.025"	\$44.66
M99M38H4	3/8"	4H	.025"	\$44.66
M99M38V10	3/8"	10-14V	.025"	\$44.66
M99M38V14	3/8"	14-18V	.025"	\$44.66
M99M12H3	1/2"	3H	.025"	\$44.66
M99M12H4	1/2"	4H	.025"	\$44.66
M99M12H6	1/2"	6H	.025"	\$44.66
M99M12V6	1/2"	6-10V	.025"	\$44.66
M99M12V8	1/2"	8-12V	.025"	\$44.66
M99M12V10	1/2"	10-14V	.025"	\$44.66
M99M12T14	1/2"	14	.025"	\$44.66
M99M12V14	1/2"	14-18V	.025"	\$44.66
M99M12T18	1/2"	18	.025"	\$47.31
M99M58V10	5/8"	10-14V	.032"	\$47.31
M99M34H3	3/4"	3H	.032"	\$47.31
M99M34V4	3/4"	4-6V	.035"	\$47.31
M99M34V5	3/4"	5-8V	.035"	\$47.31
M99M34V6	3/4"	6-10V	.035"	\$47.31
M99M34V8	3/4"	8-12V	.035"	\$47.31
M99M34V10	3/4"	10-14V	.035"	\$47.31
M99M34W14	3/4"	14W	.035"	\$47.31
M99M34W18	3/4"	18W	.035"	\$47.31
M99M1V2	1"	2-3V	.035"	\$54.05
M99M1H3	1"	3H	.035"	\$54.05
M99M1V3	1"	3-4V	.035"	\$54.05
M99M1V4	1"	4-6V	.035"	\$54.05
M99M1V5	1"	5-8V	.035"	\$54.05
M99M1V6	1"	6-10V	.035"	\$54.05
M99M1V8	1"	8-12V	.035"	\$54.05
M99M1V10	1"	10-14V	.035"	\$54.05

Hawc Pro Resaw Bandsaw Blade 99" (8' 3") Long



Tool No.	Width	Tooth	Thickness	Price
B99H12T3	1/2"	3	.025"	\$20.30

WoodSaver Plus Resaw Bandsaw Blades 99" (8' 3") Long



Tool No.	Width	Tooth	Thickness	Price
B99P58V3	5/8"	3-4V	.025"	\$73.27

WoodSaver Resaw Bandsaw Blades 99" (8' 3") Long



Tool No.	Width	Tooth	Thickness	Price
B99S58T3	5/8"	3	.025"	\$62.62
B99S1T3	1"	3	.025"	\$72.35

Bi-metal Bandsaw Blade 99-3/4" (8' 3-3/4") Long



MAGNATE

Tool No.	Width	Tooth	Thickness	Price
M99.75M14H6	1/4"	6H	.025"	\$44.66
M99.75M14V10	1/4"	10-14V	.025"	\$44.66
M99.75M14V14	1/4"	14-18V	.025"	\$44.66
M99.75M38H4	3/8"	4H	.025"	\$44.66
M99.75M38V10	3/8"	10-14V	.025"	\$44.66
M99.75M38V14	3/8"	14-18V	.025"	\$44.66
M99.75M12H3	1/2"	3H	.025"	\$44.66
M99.75M12H4	1/2"	4H	.025"	\$44.66
M99.75M12H6	1/2"	6H	.025"	\$44.66
M99.75M12V6	1/2"	6-10V	.025"	\$44.66
M99.75M12V8	1/2"	8-12V	.025"	\$44.66
M99.75M12V10	1/2"	10-14V	.025"	\$44.66
M99.75M12T14	1/2"	14	.025"	\$44.66
M99.75M12V14	1/2"	14-18V	.025"	\$44.66
M99.75M12T18	1/2"	18	.025"	\$47.31
M99.75M58V10	5/8"	10-14V	.032"	\$47.31
M99.75M34H3	3/4"	3H	.035"	\$47.31
M99.75M34V4	3/4"	4-6V	.035"	\$47.31
M99.75M34V5	3/4"	5-8V	.035"	\$47.31
M99.75M34V6	3/4"	6-10V	.035"	\$47.31
M99.75M34V8	3/4"	8-12V	.035"	\$47.31
M99.75M34V10	3/4"	10-14V	.035"	\$47.31
M99.75M34W14	3/4"	14W	.035"	\$47.31
M99.75M34W18	3/4"	18W	.035"	\$47.31
M99.75M1V2	1"	2-3V	.035"	\$54.05
M99.75M1H3	1"	3H	.035"	\$54.05
M99.75M1V3	1"	3-4V	.035"	\$54.05
M99.75M1V4	1"	4-6V	.035"	\$54.05
M99.75M1V5	1"	5-8V	.035"	\$54.05
M99.75M1V6	1"	6-10V	.035"	\$54.05
M99.75M1V8	1"	8-12V	.035"	\$54.05
M99.75M1V10	1"	10-14V	.035"	\$54.05

Carbide Tipped Bandsaw Blade 99" (8' 3") Long



MAGNATE

Tool No.	Width	Tooth	Thickness	Price
M99E12T3	1/2"	3	.025"	\$179.78
M99E34T3	3/4"	3	.035"	\$197.25
M99E1T1.3	1"	1.3	.035"	\$197.25
M99E1T2	1"	2	.035"	\$197.25
M99E1T3	1"	3	.035"	\$197.25
M99E1V2	1"	2-3V	.035"	\$193.68

Carbide Grit Bandsaw Blade 99-3/4" (8' 3-3/4") Long



MAGNATE

Tool No.	Width	Tooth	Thickness	Price
M99.75G12MC	1/2"	Med-Coarse	.025"	\$217.71
M99.75G34MC	3/4"	Med-Coarse	.032"	\$232.02

Carbide Impregnated Bandsaw Blade 99-3/4" (8' 3-3/4") Long



Tool No.	Width	Tooth	Thickness	Price
B99.75G14H6	1/4"	6H	.025"	\$31.17
B99.75G38H4	3/8"	4H	.025"	\$29.33
B99.75G12H3	1/2"	3H	.025"	\$30.48

MAGNATE™ 20639 Lycoming Street #B-6, Walnut, CA 91789 USA

M-32



email : info@magnate.net Online Shop : www.magnate.net
(TEL) 800-827-2316, 909-468-5747 (FAX) 909-468-5745

MAGNATE™ Band Saw Blades (Non-Food Processing)

Carbon Steel Bandsaw Blade 99-3/4" (8' 3-3/4") Long



MAGNATE

Tool No.	Width	Tooth	Thickness	Price
M99.75C18R14	1/8"	14R	.025"	\$16.93
M99.75C18R18	1/8"	18R	.025"	\$16.93
M99.75C316S4	3/16"	4S	.025"	\$14.79
M99.75C316S6	3/16"	6S	.025"	\$14.57
M99.75C316R10	3/16"	10R	.025"	\$14.79
M99.75C316R14	3/16"	14R	.025"	\$14.79
M99.75C316R18	3/16"	18R	.025"	\$14.79
M99.75C316R24	3/16"	24R	.025"	\$14.79
M99.75C14H4	1/4"	4H	.025"	\$12.09
M99.75C14H6	1/4"	6H	.025"	\$12.09
M99.75C14R10	1/4"	10R	.025"	\$12.09
M99.75C14R14	1/4"	14R	.025"	\$12.09
M99.75C14R18	1/4"	18R	.025"	\$12.09
M99.75C14R24	1/4"	24R	.025"	\$12.09
M99.75C38H3	3/8"	3H	.025"	\$13.26
M99.75C38H4	3/8"	4H	.025"	\$13.26
M99.75C38H6	3/8"	6H	.025"	\$13.26
M99.75C38R8	3/8"	8R	.025"	\$13.26
M99.75C38R10	3/8"	10R	.025"	\$13.26
M99.75C38R14	3/8"	14R	.025"	\$13.26
M99.75C38R18	3/8"	18R	.025"	\$13.26
M99.75C38R24	3/8"	24R	.025"	\$13.17
M99.75C12H3	1/2"	3H	.025"	\$14.57
M99.75C12H4	1/2"	4H	.025"	\$14.57
M99.75C12H6	1/2"	6H	.025"	\$14.57
M99.75C12R10	1/2"	10R	.025"	\$14.57
M99.75C12R14	1/2"	14R	.025"	\$14.57
M99.75C12R18	1/2"	18R	.025"	\$14.57
M99.75C12R24	1/2"	24R	.025"	\$14.57
M99.75C58H3	5/8"	3H	.032"	\$17.07
M99.75C58H4	5/8"	4H	.032"	\$17.07
M99.75C58R10	5/8"	10R	.032"	\$17.07
M99.75C58R14	5/8"	14R	.032"	\$17.07
M99.75C34H2	3/4"	2H	.032"	\$17.07
M99.75C34H3	3/4"	3H	.032"	\$17.07
M99.75C34H4	3/4"	4H	.032"	\$17.07
M99.75C34H6	3/4"	6H	.032"	\$17.07
M99.75C34R6	3/4"	6R	.032"	\$17.07
M99.75C34R10	3/4"	10R	.032"	\$17.07
M99.75C34R14	3/4"	14R	.032"	\$17.07
M99.75C34R18	3/4"	18R	.032"	\$17.07

Carbide Tipped Bandsaw Blade 99-3/4" (8' 3-3/4") Long



MAGNATE

Tool No.	Width	Tooth	Thickness	Price
M99.75E12T3	1/2"	3	.025"	\$179.78
M99.75E34T3	3/4"	3	.035"	\$197.25
M99.75E1T1.3	1"	1.3	.035"	\$197.25
M99.75E1T2	1"	2	.035"	\$197.25
M99.75E1T3	1"	3	.035"	\$197.25
M99.75E1V2	1"	2-3V	.035"	\$193.68

Hawc Pro Resaw Bandsaw Blade 99-3/4" (8' 3-3/4") Long



SUPER CUT™

Tool No.	Width	Tooth	Thickness	Price
B99.75H12T3	1/2"	3	.025"	\$20.30

WoodSaver Plus Resaw Bandsaw Blades 99-3/4" (8' 3-3/4") Long



SUPER CUT™

Tool No.	Width	Tooth	Thickness	Price
B99.75P58V3	5/8"	3-4V	.025"	\$73.27

WoodSaver Resaw Bandsaw Blades 99-3/4" (8' 3-3/4") Long



SUPER CUT™

Tool No.	Width	Tooth	Thickness	Price
B99.75S58T3	5/8"	3	.025"	\$62.62
B99.75S1T3	1"	3	.025"	\$72.35

Carbon Steel Bandsaw Blade 100-3/4" (8' 4-3/4") Long



MAGNATE

Tool No.	Width	Tooth	Thickness	Price
M100.75C18R14	1/8"	14R	.025"	\$16.93
M100.75C18R18	1/8"	18R	.025"	\$16.93
M100.75C316S4	3/16"	4S	.025"	\$14.79
M100.75C316S6	3/16"	6S	.025"	\$14.57
M100.75C316R10	3/16"	10R	.025"	\$14.79
M100.75C316R14	3/16"	14R	.025"	\$14.79
M100.75C316R18	3/16"	18R	.025"	\$14.79
M100.75C316R24	3/16"	24R	.025"	\$14.79
M100.75C14H4	1/4"	4H	.025"	\$12.09
M100.75C14H6	1/4"	6H	.025"	\$12.09
M100.75C14R10	1/4"	10R	.025"	\$12.09
M100.75C14R14	1/4"	14R	.025"	\$12.09
M100.75C14R18	1/4"	18R	.025"	\$12.09
M100.75C14R24	1/4"	24R	.025"	\$12.09
M100.75C38H3	3/8"	3H	.025"	\$13.26
M100.75C38H4	3/8"	4H	.025"	\$13.26
M100.75C38H6	3/8"	6H	.025"	\$13.26
M100.75C38R8	3/8"	8R	.025"	\$13.26
M100.75C38R10	3/8"	10R	.025"	\$13.26
M100.75C38R14	3/8"	14R	.025"	\$13.26
M100.75C38R18	3/8"	18R	.025"	\$13.26
M100.75C38R24	3/8"	24R	.025"	\$13.17
M100.75C12H3	1/2"	3H	.025"	\$14.57
M100.75C12H4	1/2"	4H	.025"	\$14.57
M100.75C12H6	1/2"	6H	.025"	\$14.57
M100.75C12R10	1/2"	10R	.025"	\$14.57
M100.75C12R14	1/2"	14R	.025"	\$14.57
M100.75C12R18	1/2"	18R	.025"	\$14.57
M100.75C12R24	1/2"	24R	.025"	\$14.57
M100.75C58H3	5/8"	3H	.032"	\$17.07
M100.75C58H4	5/8"	4H	.032"	\$17.07
M100.75C58R10	5/8"	10R	.032"	\$17.07
M100.75C58R14	5/8"	14R	.032"	\$17.07
M100.75C34H2	3/4"	2H	.032"	\$17.07
M100.75C34H3	3/4"	3H	.032"	\$17.07
M100.75C34H4	3/4"	4H	.032"	\$17.07
M100.75C34H6	3/4"	6H	.032"	\$17.07
M100.75C34R6	3/4"	6R	.032"	\$17.07
M100.75C34R10	3/4"	10R	.032"	\$17.07
M100.75C34R14	3/4"	14R	.032"	\$17.07
M100.75C34R18	3/4"	18R	.032"	\$17.07



MAGNATE™ Band Saw Blades (Non-Food Processing)

Carbide Grit Bandsaw Blade
100-3/4" (8' 4-3/4") Long



MAGNATE

Tool No.	Width	Tooth	Thickness	Price
M100.75G12MC	1/2"	Med-Coarse	.025"	\$217.71
M100.75G34MC	3/4"	Med-Coarse	.032"	\$232.02

WoodSaver Resaw Bandsaw Blades
100-3/4" (8' 4-3/4") Long



Tool No.	Width	Tooth	Thickness	Price
B100.75S58T3	5/8"	3	.025"	\$62.62
B100.75S1T3	1"	3	.025"	\$72.35



Carbide Tipped Bandsaw Blade
100-3/4" (8' 4-3/4") Long



MAGNATE

Tool No.	Width	Tooth	Thickness	Price
M100.75E12T3	1/2"	3	.025"	\$179.78
M100.75E34T3	3/4"	3	.035"	\$197.25
M100.75E1T1.3	1"	1.3	.035"	\$197.25
M100.75E1T2	1"	2	.035"	\$197.25
M100.75E1T3	1"	3	.035"	\$197.25
M100.75E1V2	1"	2-3V	.035"	\$193.68

Carbide Impregnated Bandsaw Blade
100-3/4" (8' 4-3/4") Long

Tool No.	Width	Tooth	Thickness	Price
B100.75G14H6	1/4"	6H	.025"	\$31.17
B100.75G38H4	3/8"	4H	.025"	\$29.33
B100.75G12H3	1/2"	3H	.025"	\$30.48

Bi-metal Bandsaw Blade
100-3/4" (8' 4-3/4") Long



MAGNATE

Tool No.	Width	Tooth	Thickness	Price
M100.75M14H6	1/4"	6H	.025"	\$44.66
M100.75M14V10	1/4"	10-14V	.025"	\$44.66
M100.75M14V14	1/4"	14-18V	.025"	\$44.66
M100.75M38H4	3/8"	4H	.025"	\$44.66
M100.75M38V10	3/8"	10-14V	.025"	\$44.66
M100.75M38V14	3/8"	14-18V	.025"	\$44.66
M100.75M12H3	1/2"	3H	.025"	\$44.66
M100.75M12H4	1/2"	4H	.025"	\$44.66
M100.75M12H6	1/2"	6H	.025"	\$44.66
M100.75M12V6	1/2"	6-10V	.025"	\$44.66
M100.75M12V8	1/2"	8-12V	.025"	\$44.66
M100.75M12V10	1/2"	10-14V	.025"	\$44.66
M100.75M12T14	1/2"	14	.025"	\$44.66
M100.75M12V14	1/2"	14-18V	.025"	\$44.66
M100.75M12T18	1/2"	18	.025"	\$44.66
M100.75M58V10	5/8"	10-14V	.032"	\$47.31
M100.75M34H3	3/4"	3H	.035"	\$47.31
M100.75M34V4	3/4"	4-6V	.035"	\$47.31
M100.75M34V5	3/4"	5-8V	.035"	\$47.31
M100.75M34V6	3/4"	6-10V	.035"	\$47.31
M100.75M34V8	3/4"	8-12V	.035"	\$47.31
M100.75M34V10	3/4"	10-14V	.035"	\$47.31
M100.75M34W14	3/4"	14W	.035"	\$47.31
M100.75M34W18	3/4"	18W	.035"	\$47.31
M100.75M1V2	1"	2-3V	.035"	\$54.05
M100.75M1H3	1"	3H	.035"	\$54.05
M100.75M1V3	1"	3-4V	.035"	\$54.05
M100.75M1V4	1"	4-6V	.035"	\$54.05
M100.75M1V5	1"	5-8V	.035"	\$54.05
M100.75M1V6	1"	6-10V	.035"	\$54.05
M100.75M1V8	1"	8-12V	.035"	\$54.05
M100.75M1V10	1"	10-14V	.035"	\$54.05

Bi-metal Bandsaw Blade
101" (8' 5") Long



MAGNATE

Tool No.	Width	Tooth	Thickness	Price
M101M14H6	1/4"	6H	.025"	\$44.66
M101M14V10	1/4"	10-14V	.025"	\$44.66
M101M14V14	1/4"	14-18V	.025"	\$44.66
M101M38H4	3/8"	4H	.025"	\$44.66
M101M38V10	3/8"	10-14V	.025"	\$44.66
M101M38V14	3/8"	14-18V	.025"	\$44.66
M101M12H3	1/2"	3H	.025"	\$44.66
M101M12H4	1/2"	4H	.025"	\$44.66
M101M12H6	1/2"	6H	.025"	\$44.66
M101M12V6	1/2"	6-10V	.025"	\$44.66
M101M12V8	1/2"	8-12V	.025"	\$44.66
M101M12V10	1/2"	10-14V	.025"	\$44.66
M101M12T14	1/2"	14	.025"	\$44.66
M101M12V14	1/2"	14-18V	.025"	\$44.66
M101M12T18	1/2"	18	.025"	\$47.31
M101M58V10	5/8"	10-14V	.032"	\$47.31
M101M34H3	3/4"	3H	.035"	\$47.31
M101M34V4	3/4"	4-6V	.035"	\$47.31
M101M34V5	3/4"	5-8V	.035"	\$47.31
M101M34V6	3/4"	6-10V	.035"	\$47.31
M101M34V8	3/4"	8-12V	.035"	\$47.31
M101M34V10	3/4"	10-14V	.035"	\$47.31
M101M34W14	3/4"	14W	.035"	\$47.31
M101M34W18	3/4"	18W	.035"	\$47.31
M101M1V2	1"	2-3V	.035"	\$54.05
M101M1H3	1"	3H	.035"	\$54.05
M101M1V3	1"	3-4V	.035"	\$54.05
M101M1V4	1"	4-6V	.035"	\$54.05
M101M1V5	1"	5-8V	.035"	\$54.05
M101M1V6	1"	6-10V	.035"	\$54.05
M101M1V8	1"	8-12V	.035"	\$54.05
M101M1V10	1"	10-14V	.035"	\$54.05

Hawc Pro Resaw Bandsaw Blade
100-3/4" (8' 4-3/4") Long



Tool No.	Width	Tooth	Thickness	Price
B100.75H12T3	1/2"	3	.025"	\$20.30

WoodSaver Plus Resaw Bandsaw Blades
100-3/4" (8' 4-3/4") Long



Tool No.	Width	Tooth	Thickness	Price
B100.75P58V3	5/8"	3-4V	.025"	\$73.27

MAGNATE™ 20639 Lycoming Street #B-6, Walnut, CA 91789 USA

M-34



email : info@magnate.net Online Shop : www.magnate.net
(TEL) 800-827-2316, 909-468-5747 (FAX) 909-468-5745

MAGNATE™ Band Saw Blades (Non-Food Processing)

Carbon Steel Bandsaw Blade 101" (8' 5") Long



MAGNATE

Tool No.	Width	Tooth	Thickness	Price
M101C18R14	1/8"	14R	.025"	\$16.93
M101C18R18	1/8"	18R	.025"	\$16.93
M101C316S4	3/16"	4S	.025"	\$14.79
M101C316S6	3/16"	6S	.025"	\$14.57
M101C316R10	3/16"	10R	.025"	\$14.79
M101C316R14	3/16"	14R	.025"	\$14.79
M101C316R18	3/16"	18R	.025"	\$14.79
M101C316R24	3/16"	24R	.025"	\$14.79
M101C14H4	1/4"	4H	.025"	\$12.09
M101C14H6	1/4"	6H	.025"	\$12.09
M101C14R10	1/4"	10R	.025"	\$12.09
M101C14R14	1/4"	14R	.025"	\$12.09
M101C14R18	1/4"	18R	.025"	\$12.09
M101C14R24	1/4"	24R	.025"	\$12.09
M101C38H3	3/8"	3H	.025"	\$13.26
M101C38H4	3/8"	4H	.025"	\$13.26
M101C38H6	3/8"	6H	.025"	\$13.26
M101C38R8	3/8"	8R	.025"	\$13.26
M101C38R10	3/8"	10R	.025"	\$13.26
M101C38R14	3/8"	14R	.025"	\$13.26
M101C38R18	3/8"	18R	.025"	\$13.26
M101C38R24	3/8"	24R	.025"	\$13.17
M101C12H3	1/2"	3H	.025"	\$14.57
M101C12H4	1/2"	4H	.025"	\$14.57
M101C12H6	1/2"	6H	.025"	\$14.57
M101C12R10	1/2"	10R	.025"	\$14.57
M101C12R14	1/2"	14R	.025"	\$14.57
M101C12R18	1/2"	18R	.025"	\$14.57
M101C12R24	1/2"	24R	.025"	\$14.57
M101C58H3	5/8"	3H	.032"	\$17.07
M101C58H4	5/8"	4H	.032"	\$17.07
M101C58R10	5/8"	10R	.032"	\$17.07
M101C58R14	5/8"	14R	.032"	\$17.07
M101C34H2	3/4"	2H	.032"	\$17.07
M101C34H3	3/4"	3H	.032"	\$17.07
M101C34H4	3/4"	4H	.032"	\$17.07
M101C34H6	3/4"	6H	.032"	\$17.07
M101C34R6	3/4"	6R	.032"	\$17.07
M101C34R10	3/4"	10R	.032"	\$17.07
M101C34R14	3/4"	14R	.032"	\$17.07
M101C34R18	3/4"	18R	.032"	\$17.07

Carbide Grit Bandsaw Blade 101" (8' 5") Long



MAGNATE

Tool No.	Width	Tooth	Thickness	Price
M101G12MC	1/2"	Med-Coarse	.025"	\$217.71
M101G34MC	3/4"	Med-Coarse	.032"	\$232.02

Carbide Impregnated Bandsaw Blade 101" (8' 5") Long



SUPER CUT™

Tool No.	Width	Tooth	Thickness	Price
B101G12H3	1/2"	3H	.025"	\$31.17
B101G14H6	1/4"	6H	.025"	\$29.33
B101G38H4	3/8"	4H	.025"	\$30.48

Carbide Tipped Bandsaw Blade 101" (8' 5") Long



MAGNATE

Tool No.	Width	Tooth	Thickness	Price
M101E12T3	1/2"	3	.025"	\$179.78
M101E34T3	3/4"	3	.035"	\$197.25
M101E1T1.3	1"	1.3	.035"	\$197.25
M101E1T2	1"	2	.035"	\$197.25
M101E1T3	1"	3	.035"	\$197.25
M101E1V2	1"	2-3V	.035"	\$193.68

Hawc Pro Resaw Bandsaw Blade 101" (8' 5") Long



SUPER CUT™

Tool No.	Width	Tooth	Thickness	Price
B101H12T3	1/2"	3	.025"	\$20.30

WoodSaver Plus Resaw Bandsaw Blades 101" (8' 5") Long



SUPER CUT™

Tool No.	Width	Tooth	Thickness	Price
B101P58V3	5/8"	3-4V	.025"	\$73.27

WoodSaver Resaw Bandsaw Blades 101" (8' 5") Long



SUPER CUT™

Tool No.	Width	Tooth	Thickness	Price
B101S58T3	5/8"	3	.025"	\$62.62
B101S1T3	1"	3	.025"	\$72.35

Carbide Grit Bandsaw Blade 103" (8' 7") Long



MAGNATE

Tool No.	Width	Tooth	Thickness	Price
M103G12MC	1/2"	Med-Coarse	.025"	\$229.83
M103G34MC	3/4"	Med-Coarse	.032"	\$245.10

Carbide Impregnated Bandsaw Blade 103" (8' 7") Long



SUPER CUT™

Tool No.	Width	Tooth	Thickness	Price
B103G14H6	1/4"	6H	.025"	\$32.03
B103G38H4	3/8"	4H	.025"	\$30.22
B103G12H3	1/2"	3H	.025"	\$31.67



MAGNATE™ Band Saw Blades (Non-Food Processing)

Carbon Steel Bandsaw Blade 103" (8' 7") Long



Tool No.	Width	Tooth	Thickness	Price
M103C18R14	1/8"	14R	.025"	\$17.64
M103C18R18	1/8"	18R	.025"	\$17.64
M103C316S4	3/16"	4S	.025"	\$15.26
M103C316S6	3/16"	6S	.025"	\$15.17
M103C316R10	3/16"	10R	.025"	\$15.26
M103C316R14	3/16"	14R	.025"	\$15.26
M103C316R18	3/16"	18R	.025"	\$15.26
M103C316R24	3/16"	24R	.025"	\$15.26
M103C14H4	1/4"	4H	.025"	\$12.53
M103C14H6	1/4"	6H	.025"	\$12.53
M103C14R10	1/4"	10R	.025"	\$12.53
M103C14R14	1/4"	14R	.025"	\$12.53
M103C14R18	1/4"	18R	.025"	\$12.53
M103C14R24	1/4"	24R	.025"	\$12.53
M103C38H3	3/8"	3H	.025"	\$13.78
M103C38H4	3/8"	4H	.025"	\$13.78
M103C38H6	3/8"	6H	.025"	\$13.78
M103C38R8	3/8"	8R	.025"	\$13.78
M103C38R10	3/8"	10R	.025"	\$13.78
M103C38R14	3/8"	14R	.025"	\$13.78
M103C38R18	3/8"	18R	.025"	\$13.78
M103C38R24	3/8"	24R	.025"	\$13.59
M103C12H3	1/2"	3H	.025"	\$15.17
M103C12H4	1/2"	4H	.025"	\$15.17
M103C12H6	1/2"	6H	.025"	\$15.17
M103C12R10	1/2"	10R	.025"	\$15.17
M103C12R14	1/2"	14R	.025"	\$15.17
M103C12R18	1/2"	18R	.025"	\$15.17
M103C12R24	1/2"	24R	.025"	\$15.17
M103C58H3	5/8"	3H	.032"	\$17.81
M103C58H4	5/8"	4H	.032"	\$17.81
M103C58R10	5/8"	10R	.032"	\$17.81
M103C58R14	5/8"	14R	.032"	\$17.81
M103C34H2	3/4"	2H	.032"	\$17.81
M103C34H3	3/4"	3H	.032"	\$17.81
M103C34H4	3/4"	4H	.032"	\$17.81
M103C34H6	3/4"	6H	.032"	\$17.81
M103C34R6	3/4"	6R	.032"	\$17.81
M103C34R10	3/4"	10R	.032"	\$17.81
M103C34R14	3/4"	14R	.032"	\$17.81
M103C34R18	3/4"	18R	.032"	\$17.81

Bi-metal Bandsaw Blade 103" (8' 7") Long



Tool No.	Width	Tooth	Thickness	Price
M103M14H6	1/4"	6H	.025"	\$46.79
M103M14V10	1/4"	10-14V	.025"	\$46.79
M103M14V14	1/4"	14-18V	.025"	\$46.79
M103M38H4	3/8"	4H	.025"	\$46.79
M103M38V10	3/8"	10-14V	.025"	\$46.79
M103M38V14	3/8"	14-18V	.025"	\$46.79
M103M12H3	1/2"	3H	.025"	\$46.79
M103M12H4	1/2"	4H	.025"	\$46.79
M103M12H6	1/2"	6H	.025"	\$46.79
M103M12V6	1/2"	6-10V	.025"	\$46.79
M103M12V8	1/2"	8-12V	.025"	\$46.79
M103M12V10	1/2"	10-14V	.025"	\$46.79
M103M12T14	1/2"	14	.025"	\$46.79
M103M12V14	1/2"	14-18V	.025"	\$46.79
M103M12T18	1/2"	18	.025"	\$46.79
M103M58V10	5/8"	10-14V	.032"	\$49.55
M103M34H3	3/4"	3H	.035"	\$49.55
M103M34V4	3/4"	4-6V	.035"	\$49.55
M103M34V5	3/4"	5-8V	.035"	\$49.55
M103M34V6	3/4"	6-10V	.035"	\$49.55
M103M34V8	3/4"	8-12V	.035"	\$49.55
M103M34V10	3/4"	10-14V	.035"	\$49.55
M103M34W14	3/4"	14W	.035"	\$49.55
M103M34W18	3/4"	18W	.035"	\$49.55
M103M1H3	1"	3H	.035"	\$56.69
M103M1V2	1"	2-3V	.035"	\$56.69
M103M1V3	1"	3-4V	.035"	\$56.69
M103M1V4	1"	4-6V	.035"	\$56.69
M103M1V5	1"	5-8V	.035"	\$56.69
M103M1V6	1"	6-10V	.035"	\$56.69
M103M1V8	1"	8-12V	.035"	\$56.69
M103M1V10	1"	10-14V	.035"	\$56.69

Carbide Tipped Bandsaw Blade 103" (8' 7") Long



Tool No.	Width	Tooth	Thickness	Price
M103E12T3	1/2"	3	.025"	\$189.85
M103E34T3	3/4"	3	.035"	\$208.27
M103E1T1.3	1"	1.3	.035"	\$208.27
M103E1T2	1"	2	.035"	\$208.27
M103E1T3	1"	3	.035"	\$208.27
M103E1V2	1"	2-3V	.035"	\$204.52

Hawc Pro Resaw Bandsaw Blade 103" (8' 7") Long



Tool No.	Width	Tooth	Thickness	Price
B103H12T3	1/2"	3	.025"	\$21.07

WoodSaver Plus Resaw Bandsaw Blades 103" (8' 7") Long



Tool No.	Width	Tooth	Thickness	Price
B103P58V3	5/8"	3-4V	.025"	\$76.98

WoodSaver Resaw Bandsaw Blades 103" (8' 7") Long



Tool No.	Width	Tooth	Thickness	Price
B103S58T3	5/8"	3	.025"	\$65.78
B103S1T3	1"	3	.025"	\$76.07

Carbide Tipped Bandsaw Blade 104-1/2" (8' 8-1/2") Long



Tool No.	Width	Tooth	Thickness	Price
M104.5E12T3	1/2"	3	.025"	\$189.85
M104.5E34T3	3/4"	3	.035"	\$208.27
M104.5E1T1.3	1"	1.3	.035"	\$208.27
M104.5E1T2	1"	2	.035"	\$208.27
M104.5E1T3	1"	3	.035"	\$208.27
M104.5E1V2	1"	2-3V	.035"	\$204.52

MAGNATE™ 20639 Lycoming Street #B-6, Walnut, CA 91789 USA

M-36



email : info@magnate.net Online Shop : www.magnate.net
(TEL) 800-827-2316, 909-468-5747 (FAX) 909-468-5745

MAGNATE™ Band Saw Blades (Non-Food Processing)

Carbon Steel Bandsaw Blade 104-1/2" (8' 8-1/2") Long



MAGNATE

Tool No.	Width	Tooth	Thickness	Price
M104.5C18R14	1/8"	14R	.025"	\$17.64
M104.5C18R18	1/8"	18R	.025"	\$17.64
M104.5C316S4	3/16"	4S	.025"	\$15.26
M104.5C316S6	3/16"	6S	.025"	\$15.17
M104.5C316R10	3/16"	10R	.025"	\$15.26
M104.5C316R14	3/16"	14R	.025"	\$15.26
M104.5C316R18	3/16"	18R	.025"	\$15.26
M104.5C316R24	3/16"	24R	.025"	\$15.26
M104.5C14H4	1/4"	4H	.025"	\$12.53
M104.5C14H6	1/4"	6H	.025"	\$12.53
M104.5C14R10	1/4"	10R	.025"	\$12.53
M104.5C14R14	1/4"	14R	.025"	\$12.53
M104.5C14R18	1/4"	18R	.025"	\$12.53
M104.5C14R24	1/4"	24R	.025"	\$12.53
M104.5C38H3	3/8"	3H	.025"	\$13.78
M104.5C38H4	3/8"	4H	.025"	\$13.78
M104.5C38H6	3/8"	6H	.025"	\$13.78
M104.5C38R8	3/8"	8R	.025"	\$13.78
M104.5C38R10	3/8"	10R	.025"	\$13.78
M104.5C38R14	3/8"	14R	.025"	\$13.78
M104.5C38R18	3/8"	18R	.025"	\$13.78
M104.5C38R24	3/8"	24R	.025"	\$13.59
M104.5C12H3	1/2"	3H	.025"	\$15.17
M104.5C12H4	1/2"	4H	.025"	\$15.17
M104.5C12H6	1/2"	6H	.025"	\$15.17
M104.5C12R10	1/2"	10R	.025"	\$15.17
M104.5C12R14	1/2"	14R	.025"	\$15.17
M104.5C12R18	1/2"	18R	.025"	\$15.17
M104.5C12R24	1/2"	24R	.025"	\$15.17
M104.5C58H3	5/8"	3H	.032"	\$17.81
M104.5C58H4	5/8"	4H	.032"	\$17.81
M104.5C58R10	5/8"	10R	.032"	\$17.81
M104.5C58R14	5/8"	14R	.032"	\$17.81
M104.5C34H2	3/4"	2H	.032"	\$17.81
M104.5C34H3	3/4"	3H	.032"	\$17.81
M104.5C34H4	3/4"	4H	.032"	\$17.81
M104.5C34H6	3/4"	6H	.032"	\$17.81
M104.5C34R6	3/4"	6R	.032"	\$17.81
M104.5C34R10	3/4"	10R	.032"	\$17.81
M104.5C34R14	3/4"	14R	.032"	\$17.81
M104.5C34R18	3/4"	18R	.032"	\$17.81

Bi-metal Bandsaw Blade 104-1/2" (8' 8-1/2") Long



MAGNATE

Tool No.	Width	Tooth	Thickness	Price
M104.5M14H6	1/4"	6H	.025"	\$46.79
M104.5M14V10	1/4"	10-14V	.025"	\$46.79
M104.5M14V14	1/4"	14-18V	.025"	\$46.79
M104.5M38H4	3/8"	4H	.025"	\$46.79
M104.5M38V10	3/8"	10-14V	.025"	\$46.79
M104.5M38V14	3/8"	14-18V	.025"	\$46.79
M104.5M12H3	1/2"	3H	.025"	\$46.79
M104.5M12H4	1/2"	4H	.025"	\$46.79
M104.5M12H6	1/2"	6H	.025"	\$46.79
M104.5M12V6	1/2"	6-10V	.025"	\$46.79
M104.5M12V8	1/2"	8-12V	.025"	\$46.79
M104.5M12V10	1/2"	10-14V	.025"	\$46.79
M104.5M12T14	1/2"	14	.025"	\$46.79
M104.5M12V14	1/2"	14-18V	.025"	\$46.79
M104.5M12T18	1/2"	18	.025"	\$46.79
M104.5M58V10	5/8"	10-14V	.032"	\$49.55
M104.5M34H3	3/4"	3H	.035"	\$49.55
M104.5M34V4	3/4"	4-6V	.035"	\$49.55
M104.5M34V5	3/4"	5-8V	.035"	\$49.55
M104.5M34V6	3/4"	6-10V	.035"	\$49.55
M104.5M34V8	3/4"	8-12V	.035"	\$49.55
M104.5M34V10	3/4"	10-14V	.035"	\$49.55
M104.5M34T14	3/4"	14W	.035"	\$49.55
M104.5M34T18	3/4"	18W	.035"	\$49.55
M104.5M1H3	1"	3H	.035"	\$56.69
M104.5M1V2	1"	2-3V	.035"	\$56.69
M104.5M1V3	1"	3-4V	.035"	\$56.69
M104.5M1V4	1"	4-6V	.035"	\$56.69
M104.5M1V5	1"	5-8V	.035"	\$56.69
M104.5M1V6	1"	6-10V	.035"	\$56.69
M104.5M1V8	1"	8-12V	.035"	\$56.69
M104.5M1V10	1"	10-14V	.035"	\$56.69

Carbide Grit Bandsaw Blade 104-1/2" (8' 8-1/2") Long



MAGNATE

Tool No.	Width	Tooth	Thickness	Price
M104.5G12MC	1/2"	Med-Coarse	.025"	\$229.83
M104.5G34MC	3/4"	Med-Coarse	.032"	\$245.10

Carbon Steel Bandsaw Blade 105" (8' 9") Long



MAGNATE

Tool No.	Width	Tooth	Thickness	Price
M105C18R14	1/8"	14R	.025"	\$17.64
M105C18R18	1/8"	18R	.025"	\$17.64
M105C316S4	3/16"	4S	.025"	\$15.26
M105C316S6	3/16"	6S	.025"	\$15.17
M105C316R10	3/16"	10R	.025"	\$15.26
M105C316R14	3/16"	14R	.025"	\$15.26
M105C316R18	3/16"	18R	.025"	\$15.26
M105C316R24	3/16"	24R	.025"	\$15.26
M105C14H4	1/4"	4H	.025"	\$12.53
M105C14H6	1/4"	6H	.025"	\$12.53
M105C14R10	1/4"	10R	.025"	\$12.53
M105C14R14	1/4"	14R	.025"	\$12.53
M105C14R18	1/4"	18R	.025"	\$12.53
M105C14R24	1/4"	24R	.025"	\$12.53
M105C38H3	3/8"	3H	.025"	\$13.78
M105C38H4	3/8"	4H	.025"	\$13.78
M105C38H6	3/8"	6H	.025"	\$13.78
M105C38R8	3/8"	8R	.025"	\$13.78
M105C38R10	3/8"	10R	.025"	\$13.78
M105C38R14	3/8"	14R	.025"	\$13.78
M105C38R18	3/8"	18R	.025"	\$13.78
M105C38R24	3/8"	24R	.025"	\$13.59
M105C12H3	1/2"	3H	.025"	\$15.17
M105C12H4	1/2"	4H	.025"	\$15.17
M105C12H6	1/2"	6H	.025"	\$15.17
M105C12R10	1/2"	10R	.025"	\$15.17
M105C12R14	1/2"	14R	.025"	\$15.17
M105C12R18	1/2"	18R	.025"	\$15.17
M105C12R24	1/2"	24R	.025"	\$15.17
M105C58H3	5/8"	3H	.032"	\$17.81
M105C58H4	5/8"	4H	.032"	\$17.81
M105C58R10	5/8"	10R	.032"	\$17.81
M105C58R14	5/8"	14R	.032"	\$17.81
M105C34H2	3/4"	2H	.032"	\$17.81
M105C34H3	3/4"	3H	.032"	\$17.81
M105C34H4	3/4"	4H	.032"	\$17.81
M105C34H6	3/4"	6H	.032"	\$17.81
M105C34R6	3/4"	6R	.032"	\$17.81
M105C34R10	3/4"	10R	.032"	\$17.81
M105C34R14	3/4"	14R	.032"	\$17.81
M105C34R18	3/4"	18R	.032"	\$17.81



MAGNATE™ Band Saw Blades (Non-Food Processing)

Bi-metal Bandsaw Blade 105" (8' 9") Long



Tool No.	Width	Tooth	Thickness	Price
M105M14H6	1/4"	6H	.025"	\$46.79
M105M14V10	1/4"	10-14V	.025"	\$46.79
M105M14V14	1/4"	14-18V	.025"	\$46.79
M105M38H4	3/8"	4H	.025"	\$46.79
M105M38V10	3/8"	10-14V	.025"	\$46.79
M105M38V14	3/8"	14-18V	.025"	\$46.79
M105M12H3	1/2"	3H	.025"	\$46.79
M105M12H4	1/2"	4H	.025"	\$46.79
M105M12H6	1/2"	6H	.025"	\$46.79
M105M12V6	1/2"	6-10V	.025"	\$46.79
M105M12V8	1/2"	8-12V	.025"	\$46.79
M105M12V10	1/2"	10-14V	.025"	\$46.79
M105M12T14	1/2"	14	.025"	\$46.79
M105M12V14	1/2"	14-18V	.025"	\$46.79
M105M12T18	1/2"	18	.025"	\$46.79
M105M58V10	5/8"	10-14V	.032"	\$49.55
M105M34H3	3/4"	3H	.035"	\$49.55
M105M34V4	3/4"	4-6V	.035"	\$49.55
M105M34V5	3/4"	5-8V	.035"	\$49.55
M105M34V6	3/4"	6-10V	.035"	\$49.55
M105M34V8	3/4"	8-12V	.035"	\$49.55
M105M34V10	3/4"	10-14V	.035"	\$49.55
M105M34W14	3/4"	14W	.035"	\$49.55
M105M34W18	3/4"	18W	.035"	\$49.55
M105M1V2	1"	2-3V	.035"	\$56.69
M105M1H3	1"	3H	.035"	\$56.69
M105M1V3	1"	3-4V	.035"	\$56.69
M105M1V4	1"	4-6V	.035"	\$56.69
M105M1V5	1"	5-8V	.035"	\$56.69
M105M1V6	1"	6-10V	.035"	\$56.69
M105M1V8	1"	8-12V	.035"	\$56.69
M105M1V10	1"	10-14V	.035"	\$56.69

Carbide Grit Bandsaw Blade 105" (8' 9") Long



Tool No.	Width	Tooth	Thickness	Price
M105G12MC	1/2"	Med-Coarse	.025"	\$229.83
M105G34MC	3/4"	Med-Coarse	.032"	\$245.10

Carbide Impregnated Bandsaw Blade 105" (8' 9") Long



Tool No.	Width	Tooth	Thickness	Price
B105G14H6	1/4"	6H	.025"	\$32.03
B105G38H4	3/8"	4H	.025"	\$30.22
B105G12H3	1/2"	3H	.025"	\$31.67

Carbide Tipped Bandsaw Blade 105" (8' 9") Long



Tool No.	Width	Tooth	Thickness	Price
M105E12T3	1/2"	3	.025"	\$189.85
M105E34T3	3/4"	3	.035"	\$208.27
M105E1T1.3	1"	1.3	.035"	\$208.27
M105E1T2	1"	2	.035"	\$208.27
M105E1T3	1"	3	.035"	\$208.27
M105E1V2	1"	2-3V	.035"	\$204.52

Hawc Pro Resaw Bandsaw Blade 105" (8' 9") Long



Tool No.	Width	Tooth	Thickness	Price
B105H12T3	1/2"	3	.025"	\$21.07

WoodSaver Plus Resaw Bandsaw Blades 105" (8' 9") Long



Tool No.	Width	Tooth	Thickness	Price
B105P58V3	5/8"	3-4V	.025"	\$76.98

WoodSaver Resaw Bandsaw Blades 105" (8' 9") Long



Tool No.	Width	Tooth	Thickness	Price
B105S58T3	5/8"	3	.025"	\$65.78
B105S1T3	1"	3	.025"	\$76.07

Bi-metal Bandsaw Blade 106" (8' 10") Long



Tool No.	Width	Tooth	Thickness	Price
M106M14H6	1/4"	6H	.025"	\$46.79
M106M14V10	1/4"	10-14V	.025"	\$46.79
M106M14V14	1/4"	14-18V	.025"	\$46.79
M106M38H4	3/8"	4H	.025"	\$46.79
M106M38V10	3/8"	10-14V	.025"	\$46.79
M106M38V14	3/8"	14-18V	.025"	\$46.79
M106M12H3	1/2"	3H	.025"	\$46.79
M106M12H4	1/2"	4H	.025"	\$46.79
M106M12H6	1/2"	6H	.025"	\$46.79
M106M12V6	1/2"	6-10V	.025"	\$46.79
M106M12V8	1/2"	8-12V	.025"	\$46.79
M106M12V10	1/2"	10-14V	.025"	\$46.79
M106M12T14	1/2"	14	.025"	\$46.79
M106M12V14	1/2"	14-18V	.025"	\$46.79
M106M12T18	1/2"	18	.025"	\$46.79
M106M58V10	5/8"	10-14V	.032"	\$49.55
M106M34H3	3/4"	3H	.035"	\$49.55
M106M34V4	3/4"	4-6V	.035"	\$49.55
M106M34V5	3/4"	5-8V	.035"	\$49.55
M106M34V6	3/4"	6-10V	.035"	\$49.55
M106M34V8	3/4"	8-12V	.035"	\$49.55
M106M34V10	3/4"	10-14V	.035"	\$49.55
M106M34W14	3/4"	14W	.035"	\$49.55
M106M34W18	3/4"	18W	.035"	\$49.55
M106M1V2	1"	2-3V	.035"	\$56.69
M106M1H3	1"	3H	.035"	\$56.69
M106M1V3	1"	3-4V	.035"	\$56.69
M106M1V4	1"	4-6V	.035"	\$56.69
M106M1V5	1"	5-8V	.035"	\$56.69
M106M1V6	1"	6-10V	.035"	\$56.69
M106M1V8	1"	8-12V	.035"	\$56.69
M106M1V10	1"	10-14V	.035"	\$56.69



MAGNATE™ Band Saw Blades (Non-Food Processing)

Carbon Steel Bandsaw Blade 106" (8' 10") Long



MAGNATE

Tool No.	Width	Tooth	Thickness	Price
M106C18R14	1/8"	14R	.025"	\$17.64
M106C18R18	1/8"	18R	.025"	\$17.64
M106C316S4	3/16"	4S	.025"	\$15.26
M106C316S6	3/16"	6S	.025"	\$15.17
M106C316R10	3/16"	10R	.025"	\$15.26
M106C316R14	3/16"	14R	.025"	\$15.26
M106C316R18	3/16"	18R	.025"	\$15.26
M106C316R24	3/16"	24R	.025"	\$15.26
M106C14H4	1/4"	4H	.025"	\$12.53
M106C14H6	1/4"	6H	.025"	\$12.53
M106C14R10	1/4"	10R	.025"	\$12.53
M106C14R14	1/4"	14R	.025"	\$12.53
M106C14R18	1/4"	18R	.025"	\$12.53
M106C14R24	1/4"	24R	.025"	\$12.53
M106C38H3	3/8"	3H	.025"	\$13.78
M106C38H4	3/8"	4H	.025"	\$13.78
M106C38H6	3/8"	6H	.025"	\$13.78
M106C38R8	3/8"	8R	.025"	\$13.78
M106C38R10	3/8"	10R	.025"	\$13.78
M106C38R14	3/8"	14R	.025"	\$13.78
M106C38R18	3/8"	18R	.025"	\$13.78
M106C38R24	3/8"	24R	.025"	\$13.59
M106C12H3	1/2"	3H	.025"	\$15.17
M106C12H4	1/2"	4H	.025"	\$15.17
M106C12H6	1/2"	6H	.025"	\$15.17
M106C12R10	1/2"	10R	.025"	\$15.17
M106C12R14	1/2"	14R	.025"	\$15.17
M106C12R18	1/2"	18R	.025"	\$15.17
M106C12R24	1/2"	24R	.025"	\$15.17
M106C58H3	5/8"	3H	.032"	\$17.81
M106C58H4	5/8"	4H	.032"	\$17.81
M106C58R10	5/8"	10R	.032"	\$17.81
M106C58R14	5/8"	14R	.032"	\$17.81
M106C34H2	3/4"	2H	.032"	\$17.81
M106C34H3	3/4"	3H	.032"	\$17.81
M106C34H4	3/4"	4H	.032"	\$17.81
M106C34H6	3/4"	6H	.032"	\$17.81
M106C34R6	3/4"	6R	.032"	\$17.81
M106C34R10	3/4"	10R	.032"	\$17.81
M106C34R14	3/4"	14R	.025"	\$17.81
M106C34R18	3/4"	18R	.025"	\$17.81

Carbide Grit Bandsaw Blade 106" (8' 10") Long



MAGNATE

Tool No.	Width	Tooth	Thickness	Price
M106G12MC	1/2"	Med-Coarse	.025"	\$229.83
M106G34MC	3/4"	Med-Coarse	.032"	\$245.10

Carbide Impregnated Bandsaw Blade 106" (8' 10") Long



SUPER CUT™

Tool No.	Width	Tooth	Thickness	Price
B106G14H6	1/4"	6H	.025"	\$32.03
B106G38H4	3/8"	4H	.025"	\$30.22
B106G12H3	1/2"	3H	.025"	\$31.67

Carbide Tipped Bandsaw Blade 106" (8' 10") Long



MAGNATE

Tool No.	Width	Tooth	Thickness	Price
M106E12T3	1/2"	3	.025"	\$189.85
M106E34T3	3/4"	3	.035"	\$208.27
M106E1T1.3	1"	1.3	.035"	\$208.27
M106E1T2	1"	2	.035"	\$208.27
M106E1T3	1"	3	.035"	\$208.27
M106E1V2	1"	2-3V	.035"	\$204.52

Hawc Pro Resaw Bandsaw Blade 106" (8' 10") Long



SUPER CUT™

Tool No.	Width	Tooth	Thickness	Price
B106H12T3	1/2"	3	.025"	\$21.07

WoodSaver Plus Resaw Bandsaw Blades 106" (8' 10") Long



SUPER CUT™

Tool No.	Width	Tooth	Thickness	Price
B106PS8V3	5/8"	3-4V	.025"	\$76.98

WoodSaver Resaw Bandsaw Blades 106" (8' 10") Long



SUPER CUT™

Tool No.	Width	Tooth	Thickness	Price
B106S58T3	5/8"	3	.025"	\$65.78
B106S1T3	1"	3	.025"	\$76.07

Carbide Grit Bandsaw Blade 107" (8' 11") Long



MAGNATE

Tool No.	Width	Tooth	Thickness	Price
M107G12MC	1/2"	Med-Coarse	.025"	\$229.83
M107G34MC	3/4"	Med-Coarse	.032"	\$245.10

Carbide Impregnated Bandsaw Blade 107" (8' 11") Long



SUPER CUT™

Tool No.	Width	Tooth	Thickness	Price
B107G14H6	1/4"	6H	.025"	\$32.03
B107G38H4	3/8"	4H	.025"	\$30.22
B107G12H3	1/2"	3H	.025"	\$31.67

MAGNATE™ 20639 Lycoming Street #B-6, Walnut, CA 91789 USA

M-39



email : info@magnate.net Online Shop : www.magnate.net
(TEL) 800-827-2316, 909-468-5747 (FAX) 909-468-5745

MAGNATE™ Band Saw Blades (Non-Food Processing)

Carbon Steel Bandsaw Blade 107" (8' 11") Long



Tool No.	Width	Tooth	Thickness	Price
M107C18R14	1/8"	14R	.025"	\$17.64
M107C18R18	1/8"	18R	.025"	\$17.64
M107C316S4	3/16"	4S	.025"	\$15.26
M107C316S6	3/16"	6S	.025"	\$15.17
M107C316R10	3/16"	10R	.025"	\$15.26
M107C316R14	3/16"	14R	.025"	\$15.26
M107C316R18	3/16"	18R	.025"	\$15.26
M107C316R24	3/16"	24R	.025"	\$15.26
M107C14H4	1/4"	4H	.025"	\$12.53
M107C14H6	1/4"	6H	.025"	\$12.53
M107C14R10	1/4"	10R	.025"	\$12.53
M107C14R14	1/4"	14R	.025"	\$12.53
M107C14R18	1/4"	18R	.025"	\$12.53
M107C14R24	1/4"	24R	.025"	\$12.53
M107C38H3	3/8"	3H	.025"	\$13.78
M107C38H4	3/8"	4H	.025"	\$13.78
M107C38H6	3/8"	6H	.025"	\$13.78
M107C38R8	3/8"	8R	.025"	\$13.78
M107C38R10	3/8"	10R	.025"	\$13.78
M107C38R14	3/8"	14R	.025"	\$13.78
M107C38R18	3/8"	18R	.025"	\$13.78
M107C38R24	3/8"	24R	.025"	\$13.59
M107C12H3	1/2"	3H	.025"	\$15.17
M107C12H4	1/2"	4H	.025"	\$15.17
M107C12H6	1/2"	6H	.025"	\$15.17
M107C12R10	1/2"	10R	.025"	\$15.17
M107C12R14	1/2"	14R	.025"	\$15.17
M107C12R18	1/2"	18R	.025"	\$15.17
M107C12R24	1/2"	24R	.025"	\$15.17
M107C58H3	5/8"	3H	.032"	\$17.81
M107C58H4	5/8"	4H	.032"	\$17.81
M107C58R10	5/8"	10R	.032"	\$17.81
M107C58R14	5/8"	14R	.032"	\$17.81
M107C34H2	3/4"	2H	.032"	\$17.81
M107C34H3	3/4"	3H	.032"	\$17.81
M107C34H4	3/4"	4H	.032"	\$17.81
M107C34H6	3/4"	6H	.032"	\$17.81
M107C34R6	3/4"	6R	.032"	\$17.81
M107C34R10	3/4"	10R	.032"	\$17.81
M107C34R14	3/4"	14R	.032"	\$17.81
M107C34R18	3/4"	18R	.032"	\$17.81

Bi-metal Bandsaw Blade 107" (8' 11") Long



Tool No.	Width	Tooth	Thickness	Price
M107M14H6	1/4"	6H	.025"	\$46.79
M107M14V10	1/4"	10-14V	.025"	\$46.79
M107M14V14	1/4"	14-18V	.025"	\$46.79
M107M38H4	3/8"	4H	.025"	\$46.79
M107M38V10	3/8"	10-14V	.025"	\$46.79
M107M38V14	3/8"	14-18V	.025"	\$46.79
M107M12H3	1/2"	3H	.025"	\$46.79
M107M12H4	1/2"	4H	.025"	\$46.79
M107M12H6	1/2"	6H	.025"	\$46.79
M107M12V6	1/2"	6-10V	.025"	\$46.79
M107M12V8	1/2"	8-12V	.025"	\$46.79
M107M12V10	1/2"	10-14V	.025"	\$46.79
M107M12T14	1/2"	14	.025"	\$46.79
M107M12V14	1/2"	14-18V	.025"	\$46.79
M107M12T18	1/2"	18	.025"	\$46.79
M107M58V10	5/8"	10-14V	.032"	\$49.55
M107M34H3	3/4"	3H	.035"	\$49.55
M107M34V4	3/4"	4-6V	.035"	\$49.55
M107M34V5	3/4"	5-8V	.035"	\$49.55
M107M34V6	3/4"	6-10V	.035"	\$49.55
M107M34V8	3/4"	8-12V	.035"	\$49.55
M107M34V10	3/4"	10-14V	.035"	\$49.55
M107M34W14	3/4"	14W	.035"	\$49.55
M107M34W18	3/4"	18W	.035"	\$49.55
M107M1V2	1"	2-3V	.042"	\$56.69
M107M1H3	1"	3H	.042"	\$56.69
M107M1V3	1"	3-4V	.042"	\$56.69
M107M1V4	1"	4-6V	.042"	\$56.69
M107M1V5	1"	5-8V	.042"	\$56.69
M107M1V6	1"	6-10V	.042"	\$56.69
M107M1V8	1"	8-12V	.042"	\$56.69
M107M1V10	1"	10-14V	.042"	\$56.69

Carbide Tipped Bandsaw Blade 107" (8' 11") Long



Tool No.	Width	Tooth	Thickness	Price
M107E12T3	1/2"	3	.025"	\$189.85
M107E34T3	3/4"	3	.035"	\$208.27
M107E1T1.3	1"	1.3	.035"	\$208.27
M107E1T2	1"	2	.035"	\$208.27
M107E1T3	1"	3	.035"	\$208.27
M107E1V2	1"	2-3V	.035"	\$204.52

Hawc Pro Resaw Bandsaw Blade 107" (8' 11") Long



Tool No.	Width	Tooth	Thickness	Price
B107H12T3	1/2"	3	.025"	\$21.07

WoodSaver Plus Resaw Bandsaw Blades 107" (8' 11") Long



Tool No.	Width	Tooth	Thickness	Price
B107P58V3	5/8"	3-4V	.025"	\$76.98

WoodSaver Resaw Bandsaw Blades 107" (8' 11") Long



Tool No.	Width	Tooth	Thickness	Price
B107S58T3	5/8"	3	.025"	\$65.78
B107S1T3	1"	3	.025"	\$76.07

Carbide Grit Bandsaw Blade 108" (9') Long



Tool No.	Width	Tooth	Thickness	Price
M108G12MC	1/2"	Med-Coarse	.025"	\$229.83
M108G34MC	3/4"	Med-Coarse	.032"	\$245.10

MAGNATE™ 20639 Lycoming Street #B-6, Walnut, CA 91789 USA

M-40



email : info@magnate.net Online Shop : www.magnate.net
(TEL) 800-827-2316, 909-468-5747 (FAX) 909-468-5745

MAGNATE™ Band Saw Blades (Non-Food Processing)

Carbon Steel Bandsaw Blade 108" (9') Long



Tool No.	Width	Tooth	Thickness	Price
M108C18R14	1/8"	14R	.025"	\$17.64
M108C18R18	1/8"	18R	.025"	\$17.64
M108C316S4	3/16"	4S	.025"	\$15.26
M108C316S6	3/16"	6S	.025"	\$15.17
M108C316R10	3/16"	10R	.025"	\$15.26
M108C316R14	3/16"	14R	.025"	\$15.26
M108C316R18	3/16"	18R	.025"	\$15.26
M108C316R24	3/16"	24R	.025"	\$15.26
M108C14H4	1/4"	4H	.025"	\$12.53
M108C14H6	1/4"	6H	.025"	\$12.53
M108C14R10	1/4"	10R	.025"	\$12.53
M108C14R14	1/4"	14R	.025"	\$12.53
M108C14R18	1/4"	18R	.025"	\$12.53
M108C14R24	1/4"	24R	.025"	\$12.53
M108C38H3	3/8"	3H	.025"	\$13.78
M108C38H4	3/8"	4H	.025"	\$13.78
M108C38H6	3/8"	6H	.025"	\$13.78
M108C38R8	3/8"	8R	.025"	\$13.78
M108C38R10	3/8"	10R	.025"	\$13.78
M108C38R14	3/8"	14R	.025"	\$13.78
M108C38R18	3/8"	18R	.025"	\$13.78
M108C38R24	3/8"	24R	.025"	\$13.59
M108C12H3	1/2"	3H	.025"	\$15.17
M108C12H4	1/2"	4H	.025"	\$15.17
M108C12H6	1/2"	6H	.025"	\$15.17
M108C12R10	1/2"	10R	.025"	\$15.17
M108C12R14	1/2"	14R	.025"	\$15.17
M108C12R18	1/2"	18R	.025"	\$15.17
M108C12R24	1/2"	24R	.025"	\$15.17
M108C58H3	5/8"	3H	.032"	\$17.81
M108C58H4	5/8"	4H	.032"	\$17.81
M108C58R10	5/8"	10R	.032"	\$17.81
M108C58R14	5/8"	14R	.032"	\$17.81
M108C34H2	3/4"	2H	.032"	\$17.81
M108C34H3	3/4"	3H	.032"	\$17.81
M108C34H4	3/4"	4H	.032"	\$17.81
M108C34H6	3/4"	6H	.032"	\$17.81
M108C34R6	3/4"	6R	.032"	\$17.81
M108C34R10	3/4"	10R	.032"	\$17.81
M108C34R14	3/4"	14R	.032"	\$17.81
M108C34R18	3/4"	18R	.032"	\$17.81

Bi-metal Bandsaw Blade 108" (9') Long



Tool No.	Width	Tooth	Thickness	Price
M108M14H6	1/4"	6H	.025"	\$46.79
M108M14V10	1/4"	10-14V	.025"	\$46.79
M108M14V14	1/4"	14-18V	.025"	\$46.79
M108M38H4	3/8"	4H	.025"	\$46.79
M108M38T10	3/8"	10	.025"	\$46.79
M108M38V10	3/8"	10-14V	.025"	\$46.79
M108M38V14	3/8"	14-18V	.025"	\$46.79
M108M12H3	1/2"	3H	.025"	\$46.79
M108M12H4	1/2"	4H	.025"	\$46.79
M108M12H6	1/2"	6H	.025"	\$46.79
M108M12V6	1/2"	6-10V	.025"	\$46.79
M108M12V8	1/2"	8-12V	.025"	\$46.79
M108M12V10	1/2"	10-14V	.025"	\$46.79
M108M12T14	1/2"	14	.025"	\$46.79
M108M12V14	1/2"	14-18V	.025"	\$46.79
M108M12T18	1/2"	18	.025"	\$49.55
M108M58V10	5/8"	10-14V	.032"	\$49.55
M108M34H3	3/4"	3H	.035"	\$49.55
M108M34V4	3/4"	4-6V	.035"	\$49.55
M108M34V5	3/4"	5-8V	.035"	\$49.55
M108M34V6	3/4"	6-10V	.035"	\$49.55
M108M34V8	3/4"	8-12V	.035"	\$49.55
M108M34V10	3/4"	10-14V	.035"	\$49.55
M108M34W14	3/4"	14W	.035"	\$49.55
M108M34W18	3/4"	18W	.035"	\$56.69
M108M1V2	1"	2-3V	.035"	\$56.69
M108M1H3	1"	3H	.035"	\$56.69
M108M1V3	1"	3-4V	.035"	\$56.69
M108M1V4	1"	4-6V	.035"	\$56.69
M108M1V5	1"	5-8V	.035"	\$56.69
M108M1V6	1"	6-10V	.035"	\$56.69
M108M1V8	1"	8-12V	.035"	\$56.69
M108M1V10	1"	10-14V	.035"	\$56.69

Carbide Impregnated Bandsaw Blade 108" (8' 12") Long



Tool No.	Width	Tooth	Thickness	Price
B108G14H6	1/4"	6H	.025"	\$32.03
B108G38H4	3/8"	4H	.025"	\$30.22
B108G12H3	1/2"	3H	.025"	\$31.67

Carbide Tipped Bandsaw Blade 108" (9') Long



Tool No.	Width	Tooth	Thickness	Price
M108E12T3	1/2"	3	.025"	\$189.85
M108E34T3	3/4"	3	.035"	\$208.27
M108E1T1.3	1"	1.3	.035"	\$208.27
M108E1T2	1"	2	.035"	\$208.27
M108E1T3	1"	3	.035"	\$208.27
M108E1V2	1"	2-3V	.035"	\$204.52

Hawc Pro Resaw Bandsaw Blade 108" (8' 12") Long



Tool No.	Width	Tooth	Thickness	Price
B108H12T3	1/2"	3	.025"	\$21.07

WoodSaver Plus Resaw Bandsaw Blades 108" (8' 12") Long



Tool No.	Width	Tooth	Thickness	Price
B108P58V3	5/8"	3-4V	.025"	\$76.98

WoodSaver Resaw Bandsaw Blades 108" (8' 12") Long



Tool No.	Width	Tooth	Thickness	Price
B108S58T3	5/8"	3	.025"	\$65.78
B108S1T3	1"	3	.025"	\$76.07



MAGNATE™ Band Saw Blades (Non-Food Processing)

Carbon Steel Bandsaw Blade 111" (9' 3") Long



Tool No.	Width	Tooth	Thickness	Price
M111C18R14	1/8"	14R	.025"	\$18.28
M111C18R18	1/8"	18R	.025"	\$18.28
M111C316S4	3/16"	4S	.025"	\$15.90
M111C316S6	3/16"	6S	.025"	\$15.78
M111C316R10	3/16"	10R	.025"	\$15.26
M111C316R14	3/16"	14R	.025"	\$15.26
M111C316R18	3/16"	18R	.025"	\$15.26
M111C316R24	3/16"	24R	.025"	\$15.26
M111C14H4	1/4"	4H	.025"	\$13.00
M111C14H6	1/4"	6H	.025"	\$13.00
M111C14R10	1/4"	10R	.025"	\$13.00
M111C14R14	1/4"	14R	.025"	\$13.00
M111C14R18	1/4"	18R	.025"	\$13.00
M111C14R24	1/4"	24R	.025"	\$13.00
M111C38H3	3/8"	3H	.025"	\$14.31
M111C38H4	3/8"	4H	.025"	\$14.31
M111C38H6	3/8"	6H	.025"	\$14.31
M111C38R8	3/8"	8R	.025"	\$14.31
M111C38R10	3/8"	10R	.025"	\$14.31
M111C38R14	3/8"	14R	.025"	\$14.31
M111C38R18	3/8"	18R	.025"	\$14.31
M111C38R24	3/8"	24R	.025"	\$14.07
M111C12H3	1/2"	3H	.025"	\$15.78
M111C12H4	1/2"	4H	.025"	\$15.78
M111C12H6	1/2"	6H	.025"	\$15.78
M111C12R10	1/2"	10R	.025"	\$15.78
M111C12R14	1/2"	14R	.025"	\$15.78
M111C12R18	1/2"	18R	.025"	\$15.78
M111C12R24	1/2"	24R	.025"	\$15.78
M111C58H3	5/8"	3H	.032"	\$18.57
M111C58H4	5/8"	4H	.032"	\$18.57
M111C58R10	5/8"	10R	.032"	\$18.57
M111C58R14	5/8"	14R	.032"	\$18.57
M111C34H2	3/4"	2H	.032"	\$18.57
M111C34H3	3/4"	3H	.032"	\$18.57
M111C34H4	3/4"	4H	.032"	\$18.57
M111C34H6	3/4"	6H	.032"	\$18.57
M111C34R6	3/4"	6R	.032"	\$18.57
M111C34R10	3/4"	10R	.032"	\$18.57
M111C34R14	3/4"	14R	.032"	\$18.57
M111C34R18	3/4"	18R	.032"	\$18.57

Bi-metal Bandsaw Blade 111" (9' 3") Long



Tool No.	Width	Tooth	Thickness	Price
M111M14H6	1/4"	6H	.025"	\$48.91
M111M14V10	1/4"	10-14V	.025"	\$48.91
M111M14V14	1/4"	14-18V	.025"	\$48.91
M111M38H4	3/8"	4H	.025"	\$48.91
M111M38V10	3/8"	10-14V	.025"	\$48.91
M111M38V14	3/8"	14-18V	.025"	\$48.91
M111M12H3	1/2"	3H	.025"	\$48.91
M111M12H4	1/2"	4H	.025"	\$48.91
M111M12H6	1/2"	6H	.025"	\$48.91
M111M12V6	1/2"	6-10V	.025"	\$48.91
M111M12V8	1/2"	8-12V	.025"	\$48.91
M111M12V10	1/2"	10-14V	.025"	\$48.91
M111M12T14	1/2"	14	.025"	\$48.91
M111M12V14	1/2"	14-18V	.025"	\$48.91
M111M12T18	1/2"	18	.025"	\$48.91
M111M58V10	5/8"	10-14V	.032"	\$51.78
M111M34H3	3/4"	3H	.035"	\$51.78
M111M34V4	3/4"	4-6V	.035"	\$51.78
M111M34V5	3/4"	5-8V	.035"	\$51.78
M111M34V6	3/4"	6-10V	.035"	\$51.78
M111M34V8	3/4"	8-12V	.035"	\$51.78
M111M34V10	3/4"	10-14V	.035"	\$51.78
M111M34W14	3/4"	14W	.035"	\$51.78
M111M34W18	3/4"	18W	.035"	\$51.78
M111M1V2	1"	2-3V	.035"	\$59.33
M111M1H3	1"	3H	.035"	\$59.33
M111M1V3	1"	3-4V	.035"	\$59.33
M111M1V4	1"	4-6V	.035"	\$59.33
M111M1V5	1"	5-8V	.035"	\$59.33
M111M1V6	1"	6-10V	.035"	\$59.33
M111M1V8	1"	8-12V	.035"	\$59.33
M111M1V10	1"	10-14V	.035"	\$59.33

Carbide Grit Bandsaw Blade 111" (9' 3") Long



Tool No.	Width	Tooth	Thickness	Price
M111G12MC	1/2"	Med-Coarse	.025"	\$242.31
M111G34MC	3/4"	Med-Coarse	.032"	\$258.21

Carbide Impregnated Bandsaw Blade 111" (9' 3") Long



Tool No.	Width	Tooth	Thickness	Price
B111G14H6	1/4"	6H	.025"	\$32.85
B111G38H4	3/8"	4H	.025"	\$31.30
B111G12H3	1/2"	3H	.025"	\$32.62

Carbide Tipped Bandsaw Blade 111" (9' 3") Long



Tool No.	Width	Tooth	Thickness	Price
M111E12T3	1/2"	3	.025"	\$199.90
M111E34T3	3/4"	3	.035"	\$219.32
M111E1T1.3	1"	1.3	.035"	\$219.32
M111E1T2	1"	2	.035"	\$219.32
M111E1T3	1"	3	.035"	\$219.32
M111E1V2	1"	2-3V	.035"	\$215.32

Hawc Pro Resaw Bandsaw Blade 111" (9' 3") Long



Tool No.	Width	Tooth	Thickness	Price
B111H12T3	1/2"	3	.025"	\$21.70

WoodSaver Plus Resaw Bandsaw Blades 111" (9' 3") Long



Tool No.	Width	Tooth	Thickness	Price
B111P58V3	5/8"	3-4V	.025"	\$80.67



MAGNATE™ Band Saw Blades (Non-Food Processing)

WoodSaver Resaw Bandsaw Blades 111" (9' 3") Long



Tool No.	Width	Tooth	Thickness	Price
B111S58T3	5/8"	3	.025"	\$68.93
B111S1T3	1"	3	.025"	\$79.73

Bi-metal Bandsaw Blade 112" (9' 4") Long



Tool No.	Width	Tooth	Thickness	Price
M112M14H6	1/4"	6H	.025"	\$48.91
M112M14V10	1/4"	10-14V	.025"	\$48.91
M112M14V14	1/4"	14-18V	.025"	\$48.91
M112M38H4	3/8"	4H	.025"	\$48.91
M112M38V10	3/8"	10-14V	.025"	\$48.91
M112M38V14	3/8"	14-18V	.025"	\$48.91
M112M12H3	1/2"	3H	.025"	\$48.91
M112M12H4	1/2"	4H	.025"	\$48.91
M112M12H6	1/2"	6H	.025"	\$48.91
M112M12V6	1/2"	6-10V	.025"	\$48.91
M112M12V8	1/2"	8-12V	.025"	\$48.91
M112M12V10	1/2"	10-14V	.025"	\$48.91
M112M12T14	1/2"	14	.025"	\$48.91
M112M12V14	1/2"	14-18V	.025"	\$48.91
M112M12T18	1/2"	18	.025"	\$48.91
M112M58V10	5/8"	10-14V	.032"	\$51.78
M112M34H3	3/4"	3H	.035"	\$51.78
M112M34V4	3/4"	4-6V	.035"	\$51.78
M112M34V5	3/4"	5-8V	.035"	\$51.78
M112M34V6	3/4"	6-10V	.035"	\$51.78
M112M34V8	3/4"	8-12V	.035"	\$51.78
M112M34V10	3/4"	10-14V	.035"	\$51.78
M112M34W14	3/4"	14W	.035"	\$51.78
M112M34W18	3/4"	18W	.035"	\$51.78
M112M1V2	1"	2-3V	.035"	\$59.33
M112M1H3	1"	3H	.035"	\$59.33
M112M1V3	1"	3-4V	.035"	\$59.33
M112M1V4	1"	4-6V	.035"	\$59.33
M112M1V5	1"	5-8V	.035"	\$59.33
M112M1V6	1"	6-10V	.035"	\$59.33
M112M1V8	1"	8-12V	.035"	\$59.33
M112M1V10	1"	10-14V	.035"	\$59.33

Carbon Steel Bandsaw Blade 112" (9' 4") Long



Tool No.	Width	Tooth	Thickness	Price
M112C18R14	1/8"	14R	.025"	\$18.28
M112C18R18	1/8"	18R	.025"	\$18.28
M112C316S4	3/16"	4S	.025"	\$15.90
M112C316S6	3/16"	6S	.025"	\$15.78
M112C316R10	3/16"	10R	.025"	\$15.90
M112C316R14	3/16"	14R	.025"	\$15.90
M112C316R18	3/16"	18R	.025"	\$15.90
M112C316R24	3/16"	24R	.025"	\$15.90
M112C14H4	1/4"	4H	.025"	\$13.00
M112C14H6	1/4"	6H	.025"	\$13.00
M112C14R10	1/4"	10R	.025"	\$13.00
M112C14R14	1/4"	14R	.025"	\$13.00
M112C14R18	1/4"	18R	.025"	\$13.00
M112C14R24	1/4"	24R	.025"	\$13.00
M112C38H3	3/8"	3H	.025"	\$14.31
M112C38H4	3/8"	4H	.025"	\$14.31
M112C38H6	3/8"	6H	.025"	\$14.31
M112C38R8	3/8"	8R	.025"	\$14.31
M112C38R10	3/8"	10R	.025"	\$14.31
M112C38R14	3/8"	14R	.025"	\$14.31
M112C38R18	3/8"	18R	.025"	\$14.31
M112C38R24	3/8"	24R	.025"	\$14.07
M112C12H3	1/2"	3H	.025"	\$15.78
M112C12H4	1/2"	4H	.025"	\$15.78
M112C12H6	1/2"	6H	.025"	\$15.78
M112C12R10	1/2"	10R	.025"	\$15.78
M112C12R14	1/2"	14R	.025"	\$15.78
M112C12R18	1/2"	18R	.025"	\$15.78
M112C12R24	1/2"	24R	.025"	\$15.78
M112C58H3	5/8"	3H	.032"	\$18.57
M112C58H4	5/8"	4H	.032"	\$18.57
M112C58R10	5/8"	10R	.032"	\$18.57
M112C58R14	5/8"	14R	.032"	\$18.57
M112C34H2	3/4"	2H	.032"	\$18.57
M112C34H3	3/4"	3H	.032"	\$18.57
M112C34H4	3/4"	4H	.032"	\$18.57
M112C34H6	3/4"	6H	.032"	\$18.57
M112C34R6	3/4"	6R	.032"	\$18.57
M112C34R10	3/4"	10R	.032"	\$18.57
M112C34R14	3/4"	14R	.032"	\$18.57
M112C34R18	3/4"	18R	.032"	\$18.57

Carbide Grit Bandsaw Blade 112" (9' 4") Long



Tool No.	Width	Tooth	Thickness	Price
M112G12MC	1/2"	Med-Coarse	.025"	\$242.31
M112G34MC	3/4"	Med-Coarse	.032"	\$258.21

Carbide Tipped Bandsaw Blade 112" (9' 4") Long



Tool No.	Width	Tooth	Thickness	Price
M112E12T3	1/2"	3	.025"	\$199.90
M112E34T3	3/4"	3	.035"	\$219.32
M112E1T1.3	1"	1.3	.035"	\$219.32
M112E1T2	1"	2	.035"	\$219.32
M112E1T3	1"	3	.035"	\$219.32
M112E1V2	1"	2-3V	.035"	\$215.32

Carbide Grit Bandsaw Blade 113" (9' 5") Long



Tool No.	Width	Tooth	Thickness	Price
M113G12MC	1/2"	Med-Coarse	.025"	\$242.31
M113G34MC	3/4"	Med-Coarse	.032"	\$258.21

Carbide Impregnated Bandsaw Blade 113" (9' 5") Long



Tool No.	Width	Tooth	Thickness	Price
B113G14H6	1/4"	6H	.025"	\$32.85
B113G38H4	3/8"	4H	.025"	\$31.30
B113G12H3	1/2"	3H	.025"	\$32.62

MAGNATE™ 20639 Lycoming Street #B-6, Walnut, CA 91789 USA

M-43



email : info@magnate.net Online Shop : www.magnate.net
(TEL) 800-827-2316, 909-468-5747 (FAX) 909-468-5745

MAGNATE™ Band Saw Blades (Non-Food Processing)

Carbon Steel Bandsaw Blade 113" (9' 5") Long



Tool No.	Width	Tooth	Thickness	Price
M113C18R14	1/8"	14R	.025"	\$18.28
M113C18R18	1/8"	18R	.025"	\$18.28
M113C316S4	3/16"	4S	.025"	\$15.90
M113C316S6	3/16"	6S	.025"	\$15.78
M113C316R10	3/16"	10R	.025"	\$15.90
M113C316R14	3/16"	14R	.025"	\$15.90
M113C316R18	3/16"	18R	.025"	\$15.90
M113C316R24	3/16"	24R	.025"	\$15.90
M113C14H4	1/4"	4H	.025"	\$13.00
M113C14H6	1/4"	6H	.025"	\$13.00
M113C14R10	1/4"	10R	.025"	\$13.00
M113C14R14	1/4"	14R	.025"	\$13.00
M113C14R18	1/4"	18R	.025"	\$13.00
M113C14R24	1/4"	24R	.025"	\$13.00
M113C38H3	3/8"	3H	.025"	\$14.31
M113C38H4	3/8"	4H	.025"	\$14.31
M113C38H6	3/8"	6H	.025"	\$14.31
M113C38R8	3/8"	8R	.025"	\$14.31
M113C38R10	3/8"	10R	.025"	\$14.31
M113C38R14	3/8"	14R	.025"	\$14.31
M113C38R18	3/8"	18R	.025"	\$14.31
M113C38R24	3/8"	24R	.025"	\$14.07
M113C12H3	1/2"	3H	.025"	\$15.78
M113C12H4	1/2"	4H	.025"	\$15.78
M113C12H6	1/2"	6H	.025"	\$15.78
M113C12R10	1/2"	10R	.025"	\$15.78
M113C12R14	1/2"	14R	.025"	\$15.78
M113C12R18	1/2"	18R	.025"	\$15.78
M113C12R24	1/2"	24R	.025"	\$15.78
M113C58H3	5/8"	3H	.032"	\$18.57
M113C58H4	5/8"	4H	.032"	\$18.57
M113C58R10	5/8"	10R	.032"	\$18.57
M113C58R14	5/8"	14R	.032"	\$18.57
M113C34H2	3/4"	2H	.032"	\$18.57
M113C34H3	3/4"	3H	.032"	\$18.57
M113C34H4	3/4"	4H	.032"	\$18.57
M113C34H6	3/4"	6H	.032"	\$18.57
M113C34R6	3/4"	6R	.032"	\$18.57
M113C34R10	3/4"	10R	.032"	\$18.57
M113C34R14	3/4"	14R	.032"	\$18.57
M113C34R18	3/4"	18R	.032"	\$18.57

Carbide Tipped Bandsaw Blade 113" (9' 5") Long



Tool No.	Width	Tooth	Thickness	Price
M113E12T3	1/2"	3	.025"	\$199.90
M113E34T3	3/4"	3	.035"	\$219.32
M113E1T1.3	1"	1.3	.035"	\$219.32
M113E1T2	1"	2	.035"	\$219.32
M113E1T3	1"	3	.035"	\$219.32
M113E1V2	1"	2-3V	.035"	\$215.32

Bi-metal Bandsaw Blade 113" (9' 5") Long



Tool No.	Width	Tooth	Thickness	Price
M113M14H6	1/4"	6H	.025"	\$48.91
M113M14V10	1/4"	10-14V	.025"	\$48.91
M113M14V14	1/4"	14-18V	.025"	\$48.91
M113M38H4	3/8"	4H	.025"	\$48.91
M113M38V10	3/8"	10-14V	.025"	\$48.91
M113M38V14	3/8"	14-18V	.025"	\$48.91
M113M12H3	1/2"	3H	.025"	\$48.91
M113M12H4	1/2"	4H	.025"	\$48.91
M113M12H6	1/2"	6H	.025"	\$48.91
M113M12V6	1/2"	6-10V	.025"	\$48.91
M113M12V8	1/2"	8-12V	.025"	\$48.91
M113M12V10	1/2"	10-14V	.025"	\$48.91
M113M12T14	1/2"	14	.025"	\$48.91
M113M12V14	1/2"	14-18V	.025"	\$48.91
M113M12T18	1/2"	18	.025"	\$48.91
M113M58V10	5/8"	10-14V	.032"	\$51.78
M113M34H3	3/4"	3H	.035"	\$51.78
M113M34V4	3/4"	4-6V	.035"	\$51.78
M113M34V5	3/4"	5-8V	.035"	\$51.78
M113M34V6	3/4"	6-10V	.035"	\$51.78
M113M34V8	3/4"	8-12V	.035"	\$51.78
M113M34V10	3/4"	10-14V	.035"	\$51.78
M113M34W14	3/4"	14W	.035"	\$51.78
M113M34W18	3/4"	18W	.035"	\$51.78
M113M1V2	1"	2-3V	.035"	\$59.33
M113M1H3	1"	3H	.035"	\$59.33
M113M1V3	1"	3-4V	.035"	\$59.33
M113M1V4	1"	4-6V	.035"	\$59.33
M113M1V5	1"	5-8V	.035"	\$59.33
M113M1V6	1"	6-10V	.035"	\$59.33
M113M1V8	1"	8-12V	.035"	\$59.33
M113M1V10	1"	10-14V	.035"	\$59.33

Hawc Pro Resaw Bandsaw Blade 113" (9' 5") Long



Tool No.	Width	Tooth	Thickness	Price
B113H12T3	1/2"	3	.025"	\$21.70

WoodSaver Plus Resaw Bandsaw Blades 113" (9' 5") Long



Tool No.	Width	Tooth	Thickness	Price
B113P58V3	5/8"	3-4V	.025"	\$80.67

WoodSaver Resaw Bandsaw Blades 113" (9' 5") Long



Tool No.	Width	Tooth	Thickness	Price
B113S58T3	5/8"	3	.025"	\$68.93
B113S1T3	1"	3	.025"	\$79.73

Carbide Grit Bandsaw Blade 113-1/2" (9' 5-1/2") Long



Tool No.	Width	Tooth	Thickness	Price
M113.5G12MC	1/2"	Med-Coarse	.025"	\$242.31
M113.5G34MC	3/4"	Med-Coarse	.032"	\$258.21

MAGNATE™ 20639 Lycoming Street #B-6, Walnut, CA 91789 USA

M-44



email : info@magnate.net Online Shop : www.magnate.net
(TEL) 800-827-2316, 909-468-5747 (FAX) 909-468-5745

MAGNATE™ Band Saw Blades (Non-Food Processing)

Carbon Steel Bandsaw Blade 113-1/2" (9' 5-1/2") Long



MAGNATE

Tool No.	Width	Tooth	Thickness	Price
M113.5C18R14	1/8"	14R	.025"	\$18.28
M113.5C18R18	1/8"	18R	.025"	\$18.28
M113.5C316S4	3/16"	4S	.025"	\$15.90
M113.5C316S6	3/16"	6S	.025"	\$15.78
M113.5C316R10	3/16"	10R	.025"	\$15.90
M113.5C316R14	3/16"	14R	.025"	\$15.90
M113.5C316R18	3/16"	18R	.025"	\$15.90
M113.5C316R24	3/16"	24R	.025"	\$15.90
M113.5C14H4	1/4"	4H	.025"	\$13.00
M113.5C14H6	1/4"	6H	.025"	\$13.00
M113.5C14R10	1/4"	10R	.025"	\$13.00
M113.5C14R14	1/4"	14R	.025"	\$13.00
M113.5C14R18	1/4"	18R	.025"	\$13.00
M113.5C14R24	1/4"	24R	.025"	\$13.00
M113.5C38H3	3/8"	3H	.025"	\$14.31
M113.5C38H4	3/8"	4H	.025"	\$14.31
M113.5C38H6	3/8"	6H	.025"	\$14.31
M113.5C38R8	3/8"	8R	.025"	\$14.31
M113.5C38R10	3/8"	10R	.025"	\$14.31
M113.5C38R14	3/8"	14R	.025"	\$14.31
M113.5C38R18	3/8"	18R	.025"	\$14.31
M113.5C38R24	3/8"	24R	.025"	\$14.07
M113.5C12H3	1/2"	3H	.025"	\$15.78
M113.5C12H4	1/2"	4H	.025"	\$15.78
M113.5C12H6	1/2"	6H	.025"	\$15.78
M113.5C12R10	1/2"	10R	.025"	\$15.78
M113.5C12R14	1/2"	14R	.025"	\$15.78
M113.5C12R18	1/2"	18R	.025"	\$15.78
M113.5C12R24	1/2"	24R	.025"	\$15.78
M113.5C58H3	5/8"	3H	.032"	\$18.57
M113.5C58H4	5/8"	4H	.032"	\$18.57
M113.5C58R10	5/8"	10R	.032"	\$18.57
M113.5C58R14	5/8"	14R	.032"	\$18.57
M113.5C34H2	3/4"	2H	.032"	\$18.57
M113.5C34H3	3/4"	3H	.032"	\$18.57
M113.5C34H4	3/4"	4H	.032"	\$18.57
M113.5C34H6	3/4"	6H	.032"	\$18.57
M113.5C34R6	3/4"	6R	.032"	\$18.57
M113.5C34R10	3/4"	10R	.032"	\$18.57
M113.5C34R14	3/4"	14R	.032"	\$18.57
M113.5C34R18	3/4"	18R	.032"	\$18.57

Bi-metal Bandsaw Blade 113-1/2" (9' 5-1/2") Long



MAGNATE

Tool No.	Width	Tooth	Thickness	Price
M113.5M14H6	1/4"	6H	.025"	\$48.91
M113.5M14V10	1/4"	10-14V	.025"	\$48.91
M113.5M14V14	1/4"	14-18V	.025"	\$48.91
M113.5M38H4	3/8"	4H	.025"	\$48.91
M113.5M38V10	3/8"	10-14V	.025"	\$48.91
M113.5M38V14	3/8"	14-18V	.025"	\$48.91
M113.5M12H3	1/2"	3H	.025"	\$48.91
M113.5M12H4	1/2"	4H	.025"	\$48.91
M113.5M12H6	1/2"	6H	.025"	\$48.91
M113.5M12V6	1/2"	6-10V	.025"	\$48.91
M113.5M12V8	1/2"	8-12V	.025"	\$48.91
M113.5M12V10	1/2"	10-14V	.025"	\$48.91
M113.5M12T14	1/2"	14	.025"	\$48.91
M113.5M12V14	1/2"	14-18V	.025"	\$48.91
M113.5M12T18	1/2"	18	.025"	\$48.91
M113.5M58V10	5/8"	10-14V	.032"	\$51.78
M113.5M34H3	3/4"	3H	.035"	\$51.78
M113.5M34V4	3/4"	4-6V	.035"	\$51.78
M113.5M34V5	3/4"	5-8V	.035"	\$51.78
M113.5M34V6	3/4"	6-10V	.035"	\$51.78
M113.5M34V8	3/4"	8-12V	.035"	\$51.78
M113.5M34V10	3/4"	10-14V	.035"	\$51.78
M113.5M34W14	3/4"	14W	.035"	\$51.78
M113.5M34W18	3/4"	18W	.035"	\$51.78
M113.5M1V2	1"	2-3V	.035"	\$59.33
M113.5M1H3	1"	3H	.035"	\$59.33
M113.5M1V3	1"	3-4V	.035"	\$59.33
M113.5M1V4	1"	4-6V	.035"	\$59.33
M113.5M1V5	1"	5-8V	.035"	\$59.33
M113.5M1V6	1"	6-10V	.035"	\$59.33
M113.5M1V8	1"	8-12V	.035"	\$59.33
M113.5M1V10	1"	10-14V	.035"	\$59.33

Carbide Impregnated Bandsaw Blade 113-1/2" (9' 5-1/2") Long



SUPER CUT™

Tool No.	Width	Tooth	Thickness	Price
B113.5G14H6	1/4"	6H	.025"	\$32.85
B113.5G38H4	3/8"	4H	.025"	\$31.30
B113.5G12H3	1/2"	3H	.025"	\$32.62

Carbide Tipped Bandsaw Blade 113-1/2" (9' 5-1/2") Long



MAGNATE

Tool No.	Width	Tooth	Thickness	Price
M113.5E12T3	1/2"	3	.025"	\$199.90
M113.5E34T3	3/4"	3	.035"	\$219.32
M113.5E1T1.3	1"	1.3	.035"	\$219.32
M113.5E1T2	1"	2	.035"	\$219.32
M113.5E1T3	1"	3	.035"	\$219.32
M113.5E1V2	1"	2-3V	.035"	\$215.32

Bi-metal Bandsaw Blade 114" (9' 6") Long



MAGNATE

Tool No.	Width	Tooth	Thickness	Price
M114M14H6	1/4"	6H	.025"	\$48.91
M114M14V10	1/4"	10-14V	.025"	\$48.91
M114M14V14	1/4"	14-18V	.025"	\$48.91
M114M38H4	3/8"	4H	.025"	\$48.91
M114M38V10	3/8"	10-14V	.025"	\$48.91
M114M38V14	3/8"	14-18V	.025"	\$48.91
M114M12H3	1/2"	3H	.025"	\$48.91
M114M12H4	1/2"	4H	.025"	\$48.91
M114M12H6	1/2"	6H	.025"	\$48.91
M114M12V6	1/2"	6-10V	.025"	\$48.91
M114M12V8	1/2"	8-12V	.025"	\$48.91
M114M12V10	1/2"	10-14V	.025"	\$48.91
M114M12T14	1/2"	14	.025"	\$48.91
M114M12V14	1/2"	14-18V	.025"	\$48.91
M114M12T18	1/2"	18	.025"	\$48.91
M114M58V10	5/8"	10-14V	.032"	\$51.78
M114M34H3	3/4"	3H	.035"	\$51.78
M114M34V4	3/4"	4-6V	.035"	\$51.78
M114M34V5	3/4"	5-8V	.035"	\$51.78
M114M34V6	3/4"	6-10V	.035"	\$51.78
M114M34V8	3/4"	8-12V	.035"	\$51.78
M114M34V10	3/4"	10-14V	.035"	\$51.78
M114M34W14	3/4"	14W	.035"	\$51.78
M114M34W18	3/4"	18W	.035"	\$51.78
M114M1V2	1"	2-3V	.035"	\$59.33
M114M1H3	1"	3H	.035"	\$59.33
M114M1V3	1"	3-4V	.035"	\$59.33
M114M1V4	1"	4-6V	.035"	\$59.33
M114M1V5	1"	5-8V	.035"	\$59.33
M114M1V6	1"	6-10V	.035"	\$59.33
M114M1V8	1"	8-12V	.035"	\$59.33
M114M1V10	1"	10-14V	.035"	\$59.33
M114M114V2	1-1/4"	2-3V	.042"	\$67.17
M114M114V3	1-1/4"	3-4V	.042"	\$67.17
M114M114V4	1-1/4"	4-6V	.042"	\$67.17
M114M114V5	1-1/4"	5-8V	.042"	\$67.17
M114M114V6	1-1/4"	6-10V	.042"	\$67.17
M114M114V8	1-1/4"	8-12V	.042"	\$67.17

MAGNATE™ 20639 Lycoming Street #B-6, Walnut, CA 91789 USA

M-45





email : info@magnate.net Online Shop : www.magnate.net
(TEL) 800-827-2316, 909-468-5747 (FAX) 909-468-5745

MAGNATE™ Band Saw Blades (Non-Food Processing)

Carbon Steel Bandsaw Blade 114" (9' 6") Long				
				
MAGNATE				
Tool No.	Width	Tooth	Thickness	Price
M114C18R14	1/8"	14R	.025"	\$18.28
M114C18R18	1/8"	18R	.025"	\$18.28
M114C316S4	3/16"	4S	.025"	\$15.90
M114C316S6	3/16"	6S	.025"	\$15.78
M114C316R10	3/16"	10R	.025"	\$15.90
M114C316R14	3/16"	14R	.025"	\$15.90
M114C316R18	3/16"	18R	.025"	\$15.90
M114C316R24	3/16"	24R	.025"	\$15.90
M114C14H4	1/4"	4H	.025"	\$13.00
M114C14H6	1/4"	6H	.025"	\$13.00
M114C14R10	1/4"	10R	.025"	\$13.00
M114C14R14	1/4"	14R	.025"	\$13.00
M114C14R18	1/4"	18R	.025"	\$13.00
M114C14R24	1/4"	24R	.025"	\$13.00
M114C38H3	3/8"	3H	.025"	\$14.31
M114C38H4	3/8"	4H	.025"	\$14.31
M114C38H6	3/8"	6H	.025"	\$14.31
M114C38R8	3/8"	8R	.025"	\$14.31
M114C38R10	3/8"	10R	.025"	\$14.31
M114C38R14	3/8"	14R	.025"	\$14.31
M114C38R18	3/8"	18R	.025"	\$14.31
M114C38R24	3/8"	24R	.025"	\$14.07
M114C12H3	1/2"	3H	.025"	\$15.78
M114C12H4	1/2"	4H	.025"	\$15.78
M114C12H6	1/2"	6H	.025"	\$15.78
M114C12R10	1/2"	10R	.025"	\$15.78
M114C12R14	1/2"	14R	.025"	\$15.78
M114C12R18	1/2"	18R	.025"	\$15.78
M114C12R24	1/2"	24R	.025"	\$15.78
M114C58H3	5/8"	3H	.032"	\$18.57
M114C58H4	5/8"	4H	.032"	\$18.57
M114C58R10	5/8"	10R	.032"	\$18.57
M114C58R14	5/8"	14R	.032"	\$18.57
M114C34H2	3/4"	2H	.032"	\$18.57
M114C34H3	3/4"	3H	.032"	\$18.57
M114C34H4	3/4"	4H	.032"	\$18.57
M114C34H6	3/4"	6H	.032"	\$18.57
M114C34R6	3/4"	6R	.032"	\$18.57
M114C34R10	3/4"	10R	.032"	\$18.57
M114C34R14	3/4"	14R	.032"	\$18.57
M114C34R18	3/4"	18R	.032"	\$18.57

Carbide Grit Bandsaw Blade 114" (9' 6") Long				
				
MAGNATE				
Tool No.	Width	Tooth	Thickness	Price
M114G12MC	1/2"	Med-Coarse	.025"	\$242.31
M114G34MC	3/4"	Med-Coarse	.032"	\$258.21

Carbide Impregnated Bandsaw Blade 114" (9' 6") Long				
				
SUPER CUT™				
Tool No.	Width	Tooth	Thickness	Price
B114G14H6	1/4"	6H	.025"	\$32.85
B114G38H4	3/8"	4H	.025"	\$31.30
B114G12H3	1/2"	3H	.025"	\$32.62

Carbide Tipped Bandsaw Blade 114" (9' 6") Long				
				
MAGNATE				
Tool No.	Width	Tooth	Thickness	Price
M114E12T3	1/2"	3	.025"	\$199.90
M114E34T3	3/4"	3	.035"	\$219.32
M114E1T1.3	1"	1.3	.035"	\$219.32
M114E1T2	1"	2	.035"	\$219.32
M114E1T3	1"	3	.035"	\$219.32
M114E1V2	1"	2-3V	.035"	\$215.32

Hawc Pro Resaw Bandsaw Blade 114" (9' 6") Long				
				
SUPER CUT™				
Tool No.	Width	Tooth	Thickness	Price
B114H12T3	1/2"	3	.025"	\$21.70

WoodSaver Plus Resaw Bandsaw Blades 114" (9' 6") Long				
				
SUPER CUT™				
Tool No.	Width	Tooth	Thickness	Price
B114P58V3	5/8"	3-4V	.025"	\$80.67

WoodSaver Resaw Bandsaw Blades 114" (9' 6") Long				
				
SUPER CUT™				
Tool No.	Width	Tooth	Thickness	Price
B114S58T3	5/8"	3	.025"	\$68.93
B114S1T3	1"	3	.025"	\$79.73

Carbide Grit Bandsaw Blade 114-1/2" (9' 6-1/2") Long				
				
MAGNATE				
Tool No.	Width	Tooth	Thickness	Price
M114.5G12MC	1/2"	Med-Coarse	.025"	\$254.62
M114.5G34MC	3/4"	Med-Coarse	.032"	\$271.29

Carbide Impregnated Bandsaw Blade 114-1/2" (9' 6-1/2") Long				
				
SUPER CUT™				
Tool No.	Width	Tooth	Thickness	Price
B114.5G14H6	1/4"	6H	.025"	\$34.03
B114.5G38H4	3/8"	4H	.025"	\$32.18
B114.5G12H3	1/2"	3H	.025"	\$33.60

MAGNATE™ 20639 Lycoming Street #B-6, Walnut, CA 91789 USA

M-46



email : info@magnate.net Online Shop : www.magnate.net
(TEL) 800-827-2316, 909-468-5747 (FAX) 909-468-5745

MAGNATE™ Band Saw Blades (Non-Food Processing)

Carbide Tipped Bandsaw Blade
114-1/2" (9' 6-1/2") Long



MAGNATE

Tool No.	Width	Tooth	Thickness	Price
M114.5E12T3	1/2"	3	.025"	\$209.97
M114.5E34T3	3/4"	3	.035"	\$230.33
M114.5E1T1.3	1"	1.3	.035"	\$230.33
M114.5E1T2	1"	2	.035"	\$230.33
M114.5E1T3	1"	3	.035"	\$230.33
M114.5E1V2	1"	2-3V	.035"	\$226.15

Bi-metal Bandsaw Blade
114-1/2" (9' 6-1/2") Long



MAGNATE

Tool No.	Width	Tooth	Thickness	Price
M114.5M14H6	1/4"	6H	.025"	\$51.05
M114.5M14V10	1/4"	10-14V	.025"	\$51.05
M114.5M14V14	1/4"	14-18V	.025"	\$51.05
M114.5M38H4	3/8"	4H	.025"	\$51.05
M114.5M38V10	3/8"	10-14V	.025"	\$51.05
M114.5M38V14	3/8"	14-18V	.025"	\$51.05
M114.5M12H3	1/2"	3H	.025"	\$51.05
M114.5M12H4	1/2"	4H	.025"	\$51.05
M114.5M12H6	1/2"	6H	.025"	\$51.05
M114.5M12V6	1/2"	6-10V	.025"	\$51.05
M114.5M12V8	1/2"	8-12V	.025"	\$51.05
M114.5M12V10	1/2"	10-14V	.025"	\$51.05
M114.5M12T14	1/2"	14	.025"	\$51.05
M114.5M12V14	1/2"	14-18V	.025"	\$51.05
M114.5M12T18	1/2"	18	.025"	\$51.05
M114.5M58V10	5/8"	10-14V	.032"	\$54.02
M114.5M34H3	3/4"	3H	.035"	\$54.02
M114.5M34V4	3/4"	4-6V	.035"	\$54.02
M114.5M34V5	3/4"	5-8V	.035"	\$54.02
M114.5M34V6	3/4"	6-10V	.035"	\$54.02
M114.5M34V8	3/4"	8-12V	.035"	\$54.02
M114.5M34V10	3/4"	10-14V	.035"	\$54.02
M114.5M34W14	3/4"	14W	.035"	\$54.02
M114.5M34W18	3/4"	18W	.035"	\$54.02
M114.5M1V2	1"	2-3V	.035"	\$61.98
M114.5M1H3	1"	3H	.035"	\$61.98
M114.5M1V3	1"	3-4V	.035"	\$61.98
M114.5M1V4	1"	4-6V	.035"	\$61.98
M114.5M1V5	1"	5-8V	.035"	\$61.98
M114.5M1V6	1"	6-10V	.035"	\$61.98
M114.5M1V8	1"	8-12V	.035"	\$61.98
M114.5M1V10	1"	10-14V	.035"	\$61.98
M114.5M114V2	1-1/4"	2-3V	.042"	\$74.40
M114.5M114V3	1-1/4"	3-4V	.042"	\$74.40
M114.5M114V4	1-1/4"	4-6V	.042"	\$74.40
M114.5M114V5	1-1/4"	5-8V	.042"	\$74.40
M114.5M114V6	1-1/4"	6-10V	.042"	\$74.40
M114.5M114V8	1-1/4"	8-12V	.042"	\$74.40

Carbon Steel Bandsaw Blade
114-1/2" (9' 6-1/2") Long



MAGNATE

Tool No.	Width	Tooth	Thickness	Price
M114.5C18R14	1/8"	14R	.025"	\$18.86
M114.5C18R18	1/8"	18R	.025"	\$18.86
M114.5C316S4	3/16"	4S	.025"	\$16.45
M114.5C316S6	3/16"	6S	.025"	\$16.38
M114.5C316R10	3/16"	10R	.025"	\$15.90
M114.5C316R14	3/16"	14R	.025"	\$15.90
M114.5C316R18	3/16"	18R	.025"	\$15.90
M114.5C316R24	3/16"	24R	.025"	\$15.90
M114.5C14H4	1/4"	4H	.025"	\$13.45
M114.5C14H6	1/4"	6H	.025"	\$13.45
M114.5C14R10	1/4"	10R	.025"	\$13.45
M114.5C14R14	1/4"	14R	.025"	\$13.45
M114.5C14R18	1/4"	18R	.025"	\$13.45
M114.5C14R24	1/4"	24R	.025"	\$13.45
M114.5C38H3	3/8"	3H	.025"	\$14.83
M114.5C38H4	3/8"	4H	.025"	\$14.83
M114.5C38H6	3/8"	6H	.025"	\$14.83
M114.5C38R8	3/8"	8R	.025"	\$14.83
M114.5C38R10	3/8"	10R	.025"	\$14.83
M114.5C38R14	3/8"	14R	.025"	\$14.83
M114.5C38R18	3/8"	18R	.025"	\$14.83
M114.5C38R24	3/8"	24R	.025"	\$14.48
M114.5C12H3	1/2"	3H	.025"	\$16.38
M114.5C12H4	1/2"	4H	.025"	\$16.38
M114.5C12H6	1/2"	6H	.025"	\$16.38
M114.5C12R10	1/2"	10R	.025"	\$16.38
M114.5C12R14	1/2"	14R	.025"	\$16.38
M114.5C12R18	1/2"	18R	.025"	\$16.38
M114.5C12R24	1/2"	24R	.025"	\$16.38
M114.5C58H3	5/8"	3H	.032"	\$19.31
M114.5C58H4	5/8"	4H	.032"	\$19.31
M114.5C58R10	5/8"	10R	.032"	\$19.31
M114.5C58R14	5/8"	14R	.032"	\$19.31
M114.5C34H2	3/4"	2H	.032"	\$19.31
M114.5C34H3	3/4"	3H	.032"	\$19.31
M114.5C34H4	3/4"	4H	.032"	\$19.31
M114.5C34H6	3/4"	6H	.032"	\$19.31
M114.5C34R6	3/4"	6R	.032"	\$19.31
M114.5C34R10	3/4"	10R	.032"	\$19.31
M114.5C34R14	3/4"	14R	.032"	\$19.31
M114.5C34R18	3/4"	18R	.032"	\$19.31
M114.5C1H1.3	1"	1.3H	.035"	\$25.26
M114.5C1H2	1"	2H	.035"	\$25.26
M114.5C1H3	1"	3H	.035"	\$25.26
M114.5C1H4	1"	4H	.035"	\$25.26
M114.5C1H6	1"	6H	.035"	\$25.26
M114.5C1R6	1"	6R	.035"	\$25.26
M114.5C1R8	1"	8R	.035"	\$25.26
M114.5C1R10	1"	10R	.035"	\$25.26
M114.5C1R14	1"	14R	.035"	\$25.26

Hawc Pro Resaw Bandsaw Blade
114-1/2" (9' 6-1/2") Long



Tool No.	Width	Tooth	Thickness	Price
B114.5H12T3	1/2"	3	.025"	\$22.33

WoodSaver Plus Resaw Bandsaw Blades
114-1/2" (9' 6-1/2") Long



Tool No.	Width	Tooth	Thickness	Price
B114.5P58V3	5/8"	3-4V	.025"	\$84.32

WoodSaver Resaw Bandsaw Blades
114-1/2" (9' 6-1/2") Long



Tool No.	Width	Tooth	Thickness	Price
B114.5S58T3	5/8"	3	.025"	\$72.05
B114.5S1T3	1"	3	.025"	\$83.47

Carbide Grit Bandsaw Blade
115" (9' 7") Long



MAGNATE

Tool No.	Width	Tooth	Thickness	Price
M115G12MC	1/2"	Med-Coarse	.025"	\$254.62
M115G34MC	3/4"	Med-Coarse	.032"	\$271.29

MAGNATE™ 20639 Lycoming Street #B-6, Walnut, CA 91789 USA

M-47



email : info@magnate.net Online Shop : www.magnate.net
(TEL) 800-827-2316, 909-468-5747 (FAX) 909-468-5745

MAGNATE™ Band Saw Blades (Non-Food Processing)

Carbon Steel Bandsaw Blade 115" (9' 7") Long



MAGNATE

Tool No.	Width	Tooth	Thickness	Price
M115C18R14	1/8"	14R	.025"	\$18.86
M115C18R18	1/8"	18R	.025"	\$18.86
M115C316S4	3/16"	4S	.025"	\$16.45
M115C316S6	3/16"	6S	.025"	\$16.38
M115C316R10	3/16"	10R	.025"	\$16.45
M115C316R14	3/16"	14R	.025"	\$16.45
M115C316R18	3/16"	18R	.025"	\$16.45
M115C316R24	3/16"	24R	.025"	\$16.45
M115C14H4	1/4"	4H	.025"	\$13.45
M115C14H6	1/4"	6H	.025"	\$13.45
M115C14R10	1/4"	10R	.025"	\$13.45
M115C14R14	1/4"	14R	.025"	\$13.45
M115C14R18	1/4"	18R	.025"	\$13.45
M115C14R24	1/4"	24R	.025"	\$13.45
M115C38H3	3/8"	3H	.025"	\$14.83
M115C38H4	3/8"	4H	.025"	\$14.83
M115C38H6	3/8"	6H	.025"	\$14.83
M115C38R8	3/8"	8R	.025"	\$14.83
M115C38R10	3/8"	10R	.025"	\$14.83
M115C38R14	3/8"	14R	.025"	\$14.83
M115C38R18	3/8"	18R	.025"	\$14.83
M115C38R24	3/8"	24R	.025"	\$14.48
M115C12H3	1/2"	3H	.025"	\$16.38
M115C12H4	1/2"	4H	.025"	\$16.38
M115C12H6	1/2"	6H	.025"	\$16.38
M115C12R10	1/2"	10R	.025"	\$16.38
M115C12R14	1/2"	14R	.025"	\$16.38
M115C12R18	1/2"	18R	.025"	\$16.38
M115C12R24	1/2"	24R	.025"	\$16.38
M115C58H3	5/8"	3H	.032"	\$19.31
M115C58H4	5/8"	4H	.032"	\$19.31
M115C58R10	5/8"	10R	.032"	\$19.31
M115C58R14	5/8"	14R	.032"	\$19.31
M115C34H2	3/4"	2H	.032"	\$19.31
M115C34H3	3/4"	3H	.032"	\$19.31
M115C34H4	3/4"	4H	.032"	\$19.31
M115C34H6	3/4"	6H	.032"	\$19.31
M115C34R6	3/4"	6R	.032"	\$19.31
M115C34R10	3/4"	10R	.032"	\$19.31
M115C34R14	3/4"	14R	.032"	\$19.31
M115C34R18	3/4"	18R	.032"	\$19.31
M115C1H1.3	1"	1.3H	.035"	\$25.26
M115C1H2	1"	2H	.035"	\$25.26
M115C1H3	1"	3H	.035"	\$25.26
M115C1H4	1"	4H	.035"	\$25.26
M115C1H6	1"	6H	.035"	\$25.26
M115C1R6	1"	6R	.035"	\$25.26
M115C1R8	1"	8R	.035"	\$25.26
M115C1R10	1"	10R	.035"	\$25.26
M115C1R14	1"	14R	.035"	\$25.26

Bi-metal Bandsaw Blade 115" (9' 7") Long



MAGNATE

Tool No.	Width	Tooth	Thickness	Price
M115M14H6	1/4"	6H	.025"	\$51.05
M115M14V10	1/4"	10-14V	.025"	\$51.05
M115M14V14	1/4"	14-18V	.025"	\$51.05
M115M38H4	3/8"	4H	.025"	\$51.05
M115M38V10	3/8"	10-14V	.025"	\$51.05
M115M38V14	3/8"	14-18V	.025"	\$51.05
M115M12H3	1/2"	3H	.025"	\$51.05
M115M12H4	1/2"	4H	.025"	\$51.05
M115M12H6	1/2"	6H	.025"	\$51.05
M115M12V6	1/2"	6-10V	.025"	\$51.05
M115M12V8	1/2"	8-12V	.025"	\$51.05
M115M12V10	1/2"	10-14V	.025"	\$51.05
M115M12T14	1/2"	14	.025"	\$51.05
M115M12V14	1/2"	14-18V	.025"	\$51.05
M115M12T18	1/2"	18	.025"	\$51.05
M115M58V10	5/8"	10-14V	.032"	\$54.02
M115M34H3	3/4"	3H	.035"	\$54.02
M115M34V4	3/4"	4-6V	.035"	\$54.02
M115M34V5	3/4"	5-8V	.035"	\$54.02
M115M34V6	3/4"	6-10V	.035"	\$54.02
M115M34V8	3/4"	8-12V	.035"	\$54.02
M115M34V10	3/4"	10-14V	.035"	\$54.02
M115M34W14	3/4"	14W	.035"	\$54.02
M115M34W18	3/4"	18W	.035"	\$54.02
M115M1V2	1"	2-3V	.035"	\$61.98
M115M1H3	1"	3H	.035"	\$61.98
M115M1V3	1"	3-4V	.035"	\$61.98
M115M1V4	1"	4-6V	.035"	\$61.98
M115M1V5	1"	5-8V	.035"	\$61.98
M115M1V6	1"	6-10V	.035"	\$61.98
M115M1V8	1"	8-12V	.035"	\$61.98
M115M1V10	1"	10-14V	.035"	\$61.98
M115M114V2	1-1/4"	2-3V	.042"	\$74.40
M115M114V3	1-1/4"	3-4V	.042"	\$74.40
M115M114V4	1-1/4"	4-6V	.042"	\$74.40
M115M114V5	1-1/4"	5-8V	.042"	\$74.40
M115M114V6	1-1/4"	6-10V	.042"	\$74.40
M115M114V8	1-1/4"	8-12V	.042"	\$74.40

Hawc Pro Resaw Bandsaw Blade 115" (9' 7") Long



SUPER CUT™

Tool No.	Width	Tooth	Thickness	Price
B115H12T3	1/2"	3	.025"	\$22.33

Carbide Impregnated Bandsaw Blade 115" (9' 7") Long



SUPER CUT™

Tool No.	Width	Tooth	Thickness	Price
B115G14H6	1/4"	6H	.025"	\$34.03
B115G38H4	3/8"	4H	.025"	\$32.18
B115G12H3	1/2"	3H	.025"	\$33.60

Carbide Tipped Bandsaw Blade 115" (9' 7") Long



MAGNATE

Tool No.	Width	Tooth	Thickness	Price
M115E12T3	1/2"	3	.025"	\$209.97
M115E34T3	3/4"	3	.035"	\$230.33
M115E1T1.3	1"	1.3	.035"	\$230.33
M115E1T2	1"	2	.035"	\$230.33
M115E1T3	1"	3	.035"	\$230.33
M115E1V2	1"	2-3V	.035"	\$226.15

WoodSaver Plus Resaw Bandsaw Blades 115" (9' 7") Long



SUPER CUT™

Tool No.	Width	Tooth	Thickness	Price
B115P58V3	5/8"	3-4V	.025"	\$84.32

WoodSaver Resaw Bandsaw Blades 115" (9' 7") Long



SUPER CUT™

Tool No.	Width	Tooth	Thickness	Price
B115S58T3	5/8"	3	.025"	\$72.05
B115S1T3	1"	3	.025"	\$83.47

MAGNATE™ 20639 Lycoming Street #B-6, Walnut, CA 91789 USA

M-48



email : info@magnate.net Online Shop : www.magnate.net
(TEL) 800-827-2316, 909-468-5747 (FAX) 909-468-5745

MAGNATE™ Band Saw Blades (Non-Food Processing)

Carbon Steel Bandsaw Blade 116-1/4" (9' 8-1/4") Long



Tool No.	Width	Tooth	Thickness	Price
M116.25C18R14	1/8"	14R	.025"	\$18.86
M116.25C18R18	1/8"	18R	.025"	\$18.86
M116.25C316S4	3/16"	4S	.025"	\$16.45
M116.25C316S6	3/16"	6S	.025"	\$16.38
M116.25C316R10	3/16"	10R	.025"	\$16.45
M116.25C316R14	3/16"	14R	.025"	\$16.45
M116.25C316R18	3/16"	18R	.025"	\$16.45
M116.25C316R24	3/16"	24R	.025"	\$16.45
M116.25C14H4	1/4"	4H	.025"	\$13.45
M116.25C14H6	1/4"	6H	.025"	\$13.45
M116.25C14R10	1/4"	10R	.025"	\$13.45
M116.25C14R14	1/4"	14R	.025"	\$13.45
M116.25C14R18	1/4"	18R	.025"	\$13.45
M116.25C14R24	1/4"	24R	.025"	\$13.45
M116.25C38H3	3/8"	3H	.025"	\$14.83
M116.25C38H4	3/8"	4H	.025"	\$14.83
M116.25C38H6	3/8"	6H	.025"	\$14.83
M116.25C38R8	3/8"	8R	.025"	\$14.83
M116.25C38R10	3/8"	10R	.025"	\$14.83
M116.25C38R14	3/8"	14R	.025"	\$14.83
M116.25C38R18	3/8"	18R	.025"	\$14.83
M116.25C38R24	3/8"	24R	.025"	\$14.48
M116.25C12H3	1/2"	3H	.025"	\$16.38
M116.25C12H4	1/2"	4H	.025"	\$16.38
M116.25C12H6	1/2"	6H	.025"	\$16.38
M116.25C12R10	1/2"	10R	.025"	\$16.38
M116.25C12R14	1/2"	14R	.025"	\$16.38
M116.25C12R18	1/2"	18R	.025"	\$16.38
M116.25C12R24	1/2"	24R	.025"	\$16.38
M116.25C58H3	5/8"	3H	.032"	\$19.31
M116.25C58H4	5/8"	4H	.032"	\$19.31
M116.25C58R10	5/8"	10R	.032"	\$19.31
M116.25C58R14	5/8"	14R	.032"	\$19.31
M116.25C34H2	3/4"	2H	.032"	\$19.31
M116.25C34H3	3/4"	3H	.032"	\$19.31
M116.25C34H4	3/4"	4H	.032"	\$19.31
M116.25C34H6	3/4"	6H	.032"	\$19.31
M116.25C34R6	3/4"	6R	.032"	\$19.31
M116.25C34R10	3/4"	10R	.032"	\$19.31
M116.25C34R14	3/4"	14R	.032"	\$19.31
M116.25C34R18	3/4"	18R	.032"	\$19.31
M116.25C1H1.3	1"	1.3H	.035"	\$25.26
M116.25C1H2	1"	2H	.035"	\$25.26
M116.25C1H3	1"	3H	.035"	\$25.26
M116.25C1H4	1"	4H	.035"	\$25.26
M116.25C1H6	1"	6H	.035"	\$25.26
M116.25C1R6	1"	6R	.035"	\$25.26
M116.25C1R8	1"	8R	.035"	\$25.26
M116.25C1R10	1"	10R	.035"	\$25.26
M116.25C1R14	1"	14R	.035"	\$25.26

Bi-metal Bandsaw Blade 116-1/4" (9' 8-1/4") Long



Tool No.	Width	Tooth	Thickness	Price
M116.25M14H6	1/4"	6H	.025"	\$51.05
M116.25M14V10	1/4"	10-14V	.025"	\$51.05
M116.25M14V14	1/4"	14-18V	.025"	\$51.05
M116.25M38H4	3/8"	4H	.025"	\$51.05
M116.25M38V10	3/8"	10-14V	.025"	\$51.05
M116.25M38V14	3/8"	14-18V	.025"	\$51.05
M116.25M12H3	1/2"	3H	.025"	\$51.05
M116.25M12H4	1/2"	4H	.025"	\$51.05
M116.25M12H6	1/2"	6H	.025"	\$51.05
M116.25M12V6	1/2"	6-10V	.025"	\$51.05
M116.25M12V8	1/2"	8-12V	.025"	\$51.05
M116.25M12V10	1/2"	10-14V	.025"	\$51.05
M116.25M12T14	1/2"	14	.025"	\$51.05
M116.25M12V14	1/2"	14-18V	.025"	\$51.05
M116.25M12T18	1/2"	18	.025"	\$51.05
M116.25M58V10	5/8"	10-14V	.032"	\$54.02
M116.25M34H3	3/4"	3H	.035"	\$54.02
M116.25M34V4	3/4"	4-6V	.035"	\$54.02
M116.25M34V5	3/4"	5-8V	.035"	\$54.02
M116.25M34V6	3/4"	6-10V	.035"	\$54.02
M116.25M34V8	3/4"	8-12V	.035"	\$54.02
M116.25M34V10	3/4"	10-14V	.035"	\$54.02
M116.25M34W14	3/4"	14W	.035"	\$54.02
M116.25M34W18	3/4"	18W	.035"	\$54.02
M116.25M1V2	1"	2-3V	.035"	\$61.98
M116.25M1H3	1"	3H	.035"	\$61.98
M116.25M1V3	1"	3-4V	.035"	\$61.98
M116.25M1V4	1"	4-6V	.035"	\$61.98
M116.25M1V5	1"	5-8V	.035"	\$61.98
M116.25M1V6	1"	6-10V	.035"	\$61.98
M116.25M1V8	1"	8-12V	.035"	\$61.98
M116.25M1V10	1"	10-14V	.035"	\$61.98
M116.25M114V2	1-1/4"	2-3V	.042"	\$74.40
M116.25M114V3	1-1/4"	3-4V	.042"	\$74.40
M116.25M114V4	1-1/4"	4-6V	.042"	\$74.40
M116.25M114V5	1-1/4"	5-8V	.042"	\$74.40
M116.25M114V6	1-1/4"	6-10V	.042"	\$74.40
M116.25M114V8	1-1/4"	8-12V	.042"	\$74.40

Carbide Grit Bandsaw Blade 116-1/4" (9' 8-1/4") Long



Tool No.	Width	Tooth	Thickness	Price
M116.25G12MC	1/2"	Med-Coarse	.025"	\$254.62
M116.25G34MC	3/4"	Med-Coarse	.032"	\$271.29

Carbide Impregnated Bandsaw Blade 116-1/4" (9' 8-1/4") Long



Tool No.	Width	Tooth	Thickness	Price
B116.25G14H6	1/4"	6H	.025"	\$34.03
B116.25G38H4	3/8"	4H	.025"	\$32.18
B116.25G12H3	1/2"	3H	.025"	\$33.60

Carbide Tipped Bandsaw Blade 116-1/4" (9' 8-1/4") Long



Tool No.	Width	Tooth	Thickness	Price
M116.25E12T3	1/2"	3	.025"	\$209.97
M116.25E34T3	3/4"	3	.035"	\$230.33
M116.25E1T1.3	1"	1.3	.035"	\$230.33
M116.25E1T2	1"	2	.035"	\$230.33
M116.25E1T3	1"	3	.035"	\$230.33
M116.25E1V2	1"	2-3V	.035"	\$226.15

WoodSaver Plus Resaw Bandsaw Blades 116-1/4" (9' 8-1/4") Long



Tool No.	Width	Tooth	Thickness	Price
B116.25P58V3	5/8"	3-4V	.025"	\$84.32

WoodSaver Resaw Bandsaw Blades 116-1/4" (9' 8-1/4") Long



Tool No.	Width	Tooth	Thickness	Price
B116.25S58T3	5/8"	3	.025"	\$72.05
B116.25S1T3	1"	3	.025"	\$83.47

MAGNATE™ 20639 Lycoming Street #B-6, Walnut, CA 91789 USA

M-49



email : info@magnate.net Online Shop : www.magnate.net
(TEL) 800-827-2316, 909-468-5747 (FAX) 909-468-5745

MAGNATE™ Band Saw Blades (Non-Food Processing)

Hawc Pro Resaw Bandsaw Blade 116-1/4" (9' 8-1/4") Long



Tool No.	Width	Tooth	Thickness	Price
B116.25H12T3	1/2"	3	.025"	\$22.33

Carbide Grit Bandsaw Blade 119" (9' 11") Long



MAGNATE

Tool No.	Width	Tooth	Thickness	Price
M119G12MC	1/2"	Med-Coarse	.025"	\$254.62
M119G34MC	3/4"	Med-Coarse	.032"	\$271.29

Carbide Impregnated Bandsaw Blade 119" (9' 11") Long



Tool No.	Width	Tooth	Thickness	Price
B119G14H6	1/4"	6H	.025"	\$34.03
B119G38H4	3/8"	4H	.025"	\$32.18
B119G12H3	1/2"	3H	.025"	\$33.60

Carbide Tipped Bandsaw Blade 119" (9' 11") Long



MAGNATE

Tool No.	Width	Tooth	Thickness	Price
M119E12T3	1/2"	3	.025"	\$209.97
M119E34T3	3/4"	3	.035"	\$230.33
M119E1T1.3	1"	1.3	.035"	\$230.33
M119E1T2	1"	2	.035"	\$230.33
M119E1T3	1"	3	.035"	\$230.33
M119E1V2	1"	2-3V	.035"	\$226.15

Carbon Steel Bandsaw Blade 119" (9' 11") Long



MAGNATE

Tool No.	Width	Tooth	Thickness	Price
M119C18R14	1/8"	14R	.025"	\$18.86
M119C18R18	1/8"	18R	.025"	\$18.86
M119C316S4	3/16"	4S	.025"	\$16.45
M119C316S6	3/16"	6S	.025"	\$16.38
M119C316R10	3/16"	10R	.025"	\$16.45
M119C316R14	3/16"	14R	.025"	\$16.45
M119C316R18	3/16"	18R	.025"	\$16.45
M119C316R24	3/16"	24R	.025"	\$16.45
M119C14H4	1/4"	4H	.025"	\$13.45
M119C14H6	1/4"	6H	.025"	\$13.45
M119C14R10	1/4"	10R	.025"	\$13.45
M119C14R14	1/4"	14R	.025"	\$13.45
M119C14R18	1/4"	18R	.025"	\$13.45
M119C14R24	1/4"	24R	.025"	\$13.45
M119C38H3	3/8"	3H	.025"	\$14.83
M119C38H4	3/8"	4H	.025"	\$14.83
M119C38H6	3/8"	6H	.025"	\$14.83
M119C38R8	3/8"	8R	.025"	\$14.83
M119C38R10	3/8"	10R	.025"	\$14.83
M119C38R14	3/8"	14R	.025"	\$14.83
M119C38R18	3/8"	18R	.025"	\$14.83
M119C38R24	3/8"	24R	.025"	\$14.48
M119C12H3	1/2"	3H	.025"	\$16.38
M119C12H4	1/2"	4H	.025"	\$16.38
M119C12H6	1/2"	6H	.025"	\$16.38
M119C12R10	1/2"	10R	.025"	\$16.38
M119C12R14	1/2"	14R	.025"	\$16.38
M119C12R18	1/2"	18R	.025"	\$16.38
M119C12R24	1/2"	24R	.025"	\$16.38
M119C58H3	5/8"	3H	.032"	\$19.31
M119C58H4	5/8"	4H	.032"	\$19.31
M119C58R10	5/8"	10R	.032"	\$19.31
M119C58R14	5/8"	14R	.032"	\$19.31
M119C34H2	3/4"	2H	.032"	\$19.31
M119C34H3	3/4"	3H	.032"	\$19.31
M119C34H4	3/4"	4H	.032"	\$19.31
M119C34H6	3/4"	6H	.032"	\$19.31
M119C34R6	3/4"	6R	.032"	\$19.31
M119C34R10	3/4"	10R	.032"	\$19.31
M119C34R14	3/4"	14R	.032"	\$19.31
M119C34R18	3/4"	18R	.032"	\$19.31
M119C1H1.3	1"	1.3H	.035"	\$25.26
M119C1H2	1"	2H	.035"	\$25.26
M119C1H3	1"	3H	.035"	\$25.26
M119C1H4	1"	4H	.035"	\$25.26
M119C1H6	1"	6H	.035"	\$25.26
M119C1R6	1"	6R	.035"	\$25.26
M119C1R8	1"	8R	.035"	\$25.26
M119C1R10	1"	10R	.035"	\$25.26
M119C1R14	1"	14R	.035"	\$25.26

Bi-metal Bandsaw Blade 119" (9' 11") Long



MAGNATE

Tool No.	Width	Tooth	Thickness	Price
M119M14H6	1/4"	6H	.025"	\$51.05
M119M14V10	1/4"	10-14V	.025"	\$51.05
M119M14V14	1/4"	14-18V	.025"	\$51.05
M119M38H4	3/8"	4H	.025"	\$51.05
M119M38V10	3/8"	10-14V	.025"	\$51.05
M119M38V14	3/8"	14-18V	.025"	\$51.05
M119M12H3	1/2"	3H	.025"	\$51.05
M119M12H4	1/2"	4H	.025"	\$51.05
M119M12H6	1/2"	6H	.025"	\$51.05
M119M12V6	1/2"	6-10V	.025"	\$51.05
M119M12V8	1/2"	8-12V	.025"	\$51.05
M119M12V10	1/2"	10-14V	.025"	\$51.05
M119M12T14	1/2"	14	.025"	\$51.05
M119M12V14	1/2"	14-18V	.025"	\$51.05
M119M12T18	1/2"	18	.025"	\$51.05
M119M58V10	5/8"	10-14V	.032"	\$54.02
M119M34H3	3/4"	3H	.035"	\$54.02
M119M34V4	3/4"	4-6V	.035"	\$54.02
M119M34V5	3/4"	5-8V	.035"	\$54.02
M119M34V6	3/4"	6-10V	.035"	\$54.02
M119M34V8	3/4"	8-12V	.035"	\$54.02
M119M34V10	3/4"	10-14V	.035"	\$54.02
M119M34W14	3/4"	14W	.035"	\$54.02
M119M34W18	3/4"	18W	.035"	\$54.02
M119M1V2	1"	2-3V	.035"	\$61.98
M119M1H3	1"	3H	.035"	\$61.98
M119M1V3	1"	3-4V	.035"	\$61.98
M119M1V4	1"	4-6V	.035"	\$61.98
M119M1V5	1"	5-8V	.035"	\$61.98
M119M1V6	1"	6-10V	.035"	\$61.98
M119M1V8	1"	8-12V	.035"	\$61.98
M119M1V10	1"	10-14V	.035"	\$61.98
M119M114V2	1-1/4"	2-3V	.042"	\$74.40
M119M114V3	1-1/4"	3-4V	.042"	\$74.40
M119M114V4	1-1/4"	4-6V	.042"	\$74.40
M119M114V5	1-1/4"	5-8V	.042"	\$74.40
M119M114V6	1-1/4"	6-10V	.042"	\$74.40
M119M114V8	1-1/4"	8-12V	.042"	\$74.40

Hawc Pro Resaw Bandsaw Blade 119" (9' 11") Long



Tool No.	Width	Tooth	Thickness	Price
B119H12T3	1/2"	3	.025"	\$22.33

MAGNATE™ 20639 Lycoming Street #B-6, Walnut, CA 91789 USA

M-50



email : info@magnate.net Online Shop : www.magnate.net
(TEL) 800-827-2316, 909-468-5747 (FAX) 909-468-5745

MAGNATE™ Band Saw Blades (Non-Food Processing)

WoodSaver Plus Resaw Bandsaw Blades 119" (9' 11") Long



Tool No.	Width	Tooth	Thickness	Price
B119P58V3	5/8"	3-4V	.025"	\$84.32

WoodSaver Resaw Bandsaw Blades 119" (9' 11") Long



Tool No.	Width	Tooth	Thickness	Price
B119S58T3	5/8"	3	.025"	\$72.05
B119S1T3	1"	3	.025"	\$83.47

Carbide Impregnated Bandsaw Blade 119-1/2" (9' 11-1/2") Long



Tool No.	Width	Tooth	Thickness	Price
B119.5G14H6	1/4"	6H	.025"	\$34.03
B119.5G38H4	3/8"	4H	.025"	\$32.18
B119.5G12H3	1/2"	3H	.025"	\$33.60

Carbide Tipped Bandsaw Blade 119-1/2" (9' 11-1/2") Long



MAGNATE

Tool No.	Width	Tooth	Thickness	Price
M119.5E12T3	1/2"	3	.025"	\$209.97
M119.5E34T3	3/4"	3	.035"	\$230.33
M119.5E1T1.3	1"	1.3	.035"	\$230.33
M119.5E1T2	1"	2	.035"	\$230.33
M119.5E1T3	1"	3	.035"	\$230.33
M119.5E1V2	1"	2-3V	.035"	\$226.15

Carbon Steel Bandsaw Blade 119-1/2" (9' 11-1/2") Long



MAGNATE

Tool No.	Width	Tooth	Thickness	Price
M119.5C18R14	1/8"	14R	.025"	\$18.86
M119.5C18R18	1/8"	18R	.025"	\$18.86
M119.5C316S4	3/16"	4S	.025"	\$16.45
M119.5C316S6	3/16"	6S	.025"	\$16.38
M119.5C316R10	3/16"	10R	.025"	\$16.45
M119.5C316R14	3/16"	14R	.025"	\$16.45
M119.5C316R18	3/16"	18R	.025"	\$16.45
M119.5C316R24	3/16"	24R	.025"	\$16.45
M119.5C14H4	1/4"	4H	.025"	\$13.45
M119.5C14H6	1/4"	6H	.025"	\$13.45
M119.5C14R10	1/4"	10R	.025"	\$13.45
M119.5C14R14	1/4"	14R	.025"	\$13.45
M119.5C14R18	1/4"	18R	.025"	\$13.45
M119.5C14R24	1/4"	24R	.025"	\$13.45
M119.5C38H3	3/8"	3H	.025"	\$14.83
M119.5C38H4	3/8"	4H	.025"	\$14.83
M119.5C38H6	3/8"	6H	.025"	\$14.83
M119.5C38R8	3/8"	8R	.025"	\$14.83
M119.5C38R10	3/8"	10R	.025"	\$14.83
M119.5C38R14	3/8"	14R	.025"	\$14.83
M119.5C38R18	3/8"	18R	.025"	\$14.83
M119.5C38R24	3/8"	24R	.025"	\$14.48
M119.5C12H3	1/2"	3H	.025"	\$16.38
M119.5C12H4	1/2"	4H	.025"	\$16.38
M119.5C12H6	1/2"	6H	.025"	\$16.38
M119.5C12R10	1/2"	10R	.025"	\$16.38
M119.5C12R14	1/2"	14R	.025"	\$16.38
M119.5C12R18	1/2"	18R	.025"	\$16.38
M119.5C12R24	1/2"	24R	.025"	\$16.38
M119.5C58H3	5/8"	3H	.032"	\$19.31
M119.5C58H4	5/8"	4H	.032"	\$19.31
M119.5C58R10	5/8"	10R	.032"	\$19.31
M119.5C58R14	5/8"	14R	.032"	\$19.31
M119.5C34H2	3/4"	2H	.032"	\$19.31
M119.5C34H3	3/4"	3H	.032"	\$19.31
M119.5C34H4	3/4"	4H	.032"	\$19.31
M119.5C34H6	3/4"	6H	.032"	\$19.31
M119.5C34R6	3/4"	6R	.032"	\$19.31
M119.5C34R10	3/4"	10R	.032"	\$19.31
M119.5C34R14	3/4"	14R	.032"	\$19.31
M119.5C34R18	3/4"	18R	.032"	\$19.31
M119.5C1H1.3	1"	1.3H	.035"	\$25.26
M119.5C1H2	1"	2H	.035"	\$25.26
M119.5C1H3	1"	3H	.035"	\$25.26
M119.5C1H4	1"	4H	.035"	\$25.26
M119.5C1H6	1"	6H	.035"	\$25.26
M119.5C1R6	1"	6R	.035"	\$25.26
M119.5C1R8	1"	8R	.035"	\$25.26
M119.5C1R10	1"	10R	.035"	\$25.26
M119.5C1R14	1"	14R	.035"	\$25.26

Bi-metal Bandsaw Blade 119-1/2" (9' 11-1/2") Long



MAGNATE

Tool No.	Width	Tooth	Thickness	Price
M119.5M14H6	1/4"	6H	.025"	\$51.05
M119.5M14V10	1/4"	10-14V	.025"	\$51.05
M119.5M14V14	1/4"	14-18V	.025"	\$51.05
M119.5M38H4	3/8"	4H	.025"	\$51.05
M119.5M38V10	3/8"	10-14V	.025"	\$51.05
M119.5M38V14	3/8"	14-18V	.025"	\$51.05
M119.5M12H3	1/2"	3H	.025"	\$51.05
M119.5M12H4	1/2"	4H	.025"	\$51.05
M119.5M12H6	1/2"	6H	.025"	\$51.05
M119.5M12V6	1/2"	6-10V	.025"	\$51.05
M119.5M12V8	1/2"	8-12V	.025"	\$51.05
M119.5M12V10	1/2"	10-14V	.025"	\$51.05
M119.5M12T14	1/2"	14	.025"	\$51.05
M119.5M12V14	1/2"	14-18V	.025"	\$51.05
M119.5M12T18	1/2"	18	.025"	\$51.05
M119.5M58V10	5/8"	10-14V	.032"	\$54.02
M119.5M34H3	3/4"	3H	.035"	\$54.02
M119.5M34V4	3/4"	4-6V	.035"	\$54.02
M119.5M34V5	3/4"	5-8V	.035"	\$54.02
M119.5M34V6	3/4"	6-10V	.035"	\$54.02
M119.5M34V8	3/4"	8-12V	.035"	\$54.02
M119.5M34V10	3/4"	10-14V	.035"	\$54.02
M119.5M34W14	3/4"	14W	.035"	\$54.02
M119.5M34W18	3/4"	18W	.035"	\$54.02
M119.5M1V2	1"	2-3V	.035"	\$61.98
M119.5M1H3	1"	3H	.035"	\$61.98
M119.5M1V3	1"	3-4V	.035"	\$61.98
M119.5M1V4	1"	4-6V	.035"	\$61.98
M119.5M1V5	1"	5-8V	.035"	\$61.98
M119.5M1V6	1"	6-10V	.035"	\$61.98
M119.5M1V8	1"	8-12V	.035"	\$61.98
M119.5M1V10	1"	10-14V	.035"	\$61.98
M119.5M114V2	1-1/4"	2-3V	.042"	\$74.40
M119.5M114V3	1-1/4"	3-4V	.042"	\$74.40
M119.5M114V4	1-1/4"	4-6V	.042"	\$74.40
M119.5M114V5	1-1/4"	5-8V	.042"	\$74.40
M119.5M114V6	1-1/4"	6-10V	.042"	\$74.40
M119.5M114V8	1-1/4"	8-12V	.042"	\$74.40

Hawc Pro Resaw Bandsaw Blade 119-1/2" (9' 11-1/2") Long



Tool No.	Width	Tooth	Thickness	Price
B119.5H12T3	1/2"	3	.025"	\$22.33

MAGNATE™ 20639 Lycoming Street #B-6, Walnut, CA 91789 USA

M-51



email : info@magnate.net Online Shop : www.magnate.net
(TEL) 800-827-2316, 909-468-5747 (FAX) 909-468-5745

MAGNATE™ Band Saw Blades (Non-Food Processing)

Carbide Grit Bandsaw Blade
119-1/2" (9' 11-1/2") Long



MAGNATE

Tool No.	Width	Tooth	Thickness	Price
M119.5G12MC	1/2"	Med-Coarse	.025"	\$254.62
M119.5G34MC	3/4"	Med-Coarse	.032"	\$271.29

Carbon Steel Bandsaw Blade
120" (10') Long



MAGNATE

Tool No.	Width	Tooth	Thickness	Price
M120C18R14	1/8"	14R	.025"	\$18.86
M120C18R18	1/8"	18R	.025"	\$18.86
M120C316S4	3/16"	4S	.025"	\$16.45
M120C316S6	3/16"	6S	.025"	\$16.38
M120C316R10	3/16"	10R	.025"	\$16.45
M120C316R14	3/16"	14R	.025"	\$16.45
M120C316R18	3/16"	18R	.025"	\$16.45
M120C316R24	3/16"	24R	.025"	\$16.45
M120C14H4	1/4"	4H	.025"	\$13.45
M120C14H6	1/4"	6H	.025"	\$13.45
M120C14R10	1/4"	10R	.025"	\$13.45
M120C14R14	1/4"	14R	.025"	\$13.45
M120C14R18	1/4"	18R	.025"	\$13.45
M120C14R24	1/4"	24R	.025"	\$13.45
M120C38H3	3/8"	3H	.025"	\$14.83
M120C38H4	3/8"	4H	.025"	\$14.83
M120C38H6	3/8"	6H	.025"	\$14.83
M120C38R8	3/8"	8R	.025"	\$14.83
M120C38R10	3/8"	10R	.025"	\$14.83
M120C38R14	3/8"	14R	.025"	\$14.83
M120C38R18	3/8"	18R	.025"	\$14.83
M120C38R24	3/8"	24R	.025"	\$14.48
M120C12H3	1/2"	3H	.025"	\$16.38
M120C12H4	1/2"	4H	.025"	\$16.38
M120C12H6	1/2"	6H	.025"	\$16.38
M120C12R10	1/2"	10R	.025"	\$16.38
M120C12R14	1/2"	14R	.025"	\$16.38
M120C12R18	1/2"	18R	.025"	\$16.38
M120C12R24	1/2"	24R	.025"	\$16.38
M120C58H3	5/8"	3H	.032"	\$19.31
M120C58H4	5/8"	4H	.032"	\$19.31
M120C58R10	5/8"	10R	.032"	\$19.31
M120C58R14	5/8"	14R	.032"	\$19.31
M120C34H2	3/4"	2H	.032"	\$19.31
M120C34H3	3/4"	3H	.032"	\$19.31
M120C34H4	3/4"	4H	.032"	\$19.31
M120C34H6	3/4"	6H	.032"	\$19.31
M120C34R6	3/4"	6R	.032"	\$19.31
M120C34R10	3/4"	10R	.032"	\$19.31
M120C34R14	3/4"	14R	.032"	\$19.31
M120C34R18	3/4"	18R	.032"	\$19.31
M120C1H1.3	1"	1.3H	.035"	\$25.26
M120C1H2	1"	2H	.035"	\$25.26
M120C1H3	1"	3H	.035"	\$25.26
M120C1H4	1"	4H	.035"	\$25.26
M120C1H6	1"	6H	.035"	\$25.26
M120C1R6	1"	6R	.035"	\$25.26
M120C1R8	1"	8R	.035"	\$25.26
M120C1R10	1"	10R	.035"	\$25.26
M120C1R14	1"	14R	.035"	\$25.26

Carbide Grit Bandsaw Blade
120" (10') Long



MAGNATE

Tool No.	Width	Tooth	Thickness	Price
M120G12MC	1/2"	Med-Coarse	.025"	\$254.62
M120G34MC	3/4"	Med-Coarse	.032"	\$271.29
M120G1MC	1"	Med-Coarse	.035"	\$285.97

WoodSaver Plus Resaw Bandsaw Blades
119-1/2" (9' 11-1/2") Long



SUPER CUT™

Tool No.	Width	Tooth	Thickness	Price
B119.5P58V3	5/8"	3-4V	.025"	\$84.32

WoodSaver Plus Resaw Bandsaw Blades
120" (10') Long



SUPER CUT™

Tool No.	Width	Tooth	Thickness	Price
B120P58V3	5/8"	3-4V	.025"	\$84.32

WoodSaver Resaw Bandsaw Blades
120" (10') Long



SUPER CUT™

Tool No.	Width	Tooth	Thickness	Price
B120S58T3	5/8"	3	.025"	\$72.05
B120S1T3	1"	3	.025"	\$83.47

WoodSaver Resaw Bandsaw Blades
119-1/2" (9' 11-1/2") Long



SUPER CUT™

Tool No.	Width	Tooth	Thickness	Price
B119.5S58T3	5/8"	3	.025"	\$72.05
B119.5S1T3	1"	3	.025"	\$83.47

WoodSaver Resaw Bandsaw Blades
120" (10') Long



SUPER CUT™

Tool No.	Width	Tooth	Thickness	Price
B120S58T3	5/8"	3	.025"	\$72.05
B120S1T3	1"	3	.025"	\$83.47

Carbide Impregnated Bandsaw Blade
120" (10') Long



SUPER CUT™

Tool No.	Width	Tooth	Thickness	Price
B120G14H6	1/4"	6H	.025"	\$34.03
B120G38H4	3/8"	4H	.025"	\$32.18
B120G12H3	1/2"	3H	.025"	\$33.60

Hawc Pro Resaw Bandsaw Blade
120" (10') Long



SUPER CUT™

Tool No.	Width	Tooth	Thickness	Price
B120H12T3	1/2"	3	.025"	\$22.33

Carbide Impregnated Bandsaw Blade
120" (10') Long



SUPER CUT™

Tool No.	Width	Tooth	Thickness	Price
B120G14H6	1/4"	6H	.025"	\$34.03
B120G38H4	3/8"	4H	.025"	\$32.18
B120G12H3	1/2"	3H	.025"	\$33.60

Carbide Impregnated Bandsaw Blade
120" (10') Long



SUPER CUT™

Tool No.	Width	Tooth	Thickness	Price
B120G14H6	1/4"	6H	.025"	\$34.03
B120G38H4	3/8"	4H	.025"	\$32.18
B120G12H3	1/2"	3H	.025"	\$33.60

MAGNATE™ 20639 Lycoming Street #B-6, Walnut, CA 91789 USA

M-52



email : info@magnate.net Online Shop : www.magnate.net
(TEL) 800-827-2316, 909-468-5747 (FAX) 909-468-5745

MAGNATE™ Band Saw Blades (Non-Food Processing)

Bi-metal Bandsaw Blade 120" (10') Long



Tool No.	Width	Tooth	Thickness	Price
M120M14H6	1/4"	6H	.025"	\$51.05
M120M14V10	1/4"	10-14V	.025"	\$51.05
M120M14V14	1/4"	14-18V	.025"	\$51.05
M120M38H4	3/8"	4H	.025"	\$51.05
M120M38V10	3/8"	10-14V	.025"	\$51.05
M120M38V14	3/8"	14-18V	.025"	\$51.05
M120M12H3	1/2"	3H	.035"	\$51.05
M120M12H4	1/2"	4H	.025"	\$51.05
M120M12H6	1/2"	6H	.025"	\$51.05
M120M12V6	1/2"	6-10V	.025"	\$51.05
M120M12V8	1/2"	8-12V	.025"	\$51.05
M120M12V10	1/2"	10-14V	.025"	\$51.05
M120M12T14	1/2"	14	.025"	\$51.05
M120M12V14	1/2"	14-18V	.025"	\$51.05
M120M12T18	1/2"	18	.025"	\$51.05
M120M58V10	5/8"	10-14V	.032"	\$54.02
M120M34H3	3/4"	3H	.035"	\$54.02
M120M34V4	3/4"	4-6V	.035"	\$54.02
M120M34V5	3/4"	5-8V	.035"	\$54.02
M120M34V6	3/4"	6-10V	.035"	\$54.02
M120M34V8	3/4"	8-12V	.035"	\$54.02
M120M34V10	3/4"	10-14V	.035"	\$54.02
M120M34W14	3/4"	14W	.035"	\$54.02
M120M34W18	3/4"	18W	.035"	\$54.02
M120M1V2	1"	2-3V	.035"	\$61.98
M120M1H3	1"	3H	.035"	\$61.98
M120M1V3	1"	3-4V	.035"	\$61.98
M120M1V4	1"	4-6V	.035"	\$61.98
M120M1V5	1"	5-8V	.035"	\$61.98
M120M1V6	1"	6-10V	.035"	\$61.98
M120M1V8	1"	8-12V	.035"	\$61.98
M120M1V10	1"	10-14V	.035"	\$61.98
M120M114V2	1-1/4"	2-3V	.042"	\$74.40
M120M114V3	1-1/4"	3-4V	.042"	\$74.40
M120M114V4	1-1/4"	4-6V	.042"	\$74.40
M120M114V5	1-1/4"	5-8V	.042"	\$74.40
M120M114V6	1-1/4"	6-10V	.042"	\$74.40
M120M114V8	1-1/4"	8-12V	.042"	\$74.40

Carbide Tipped Bandsaw Blade 120" (10') Long



Tool No.	Width	Tooth	Thickness	Price
M120E12T3	1/2"	3	.025"	\$209.97
M120E34T3	3/4"	3	.035"	\$230.33
M120E1T1.3	1"	1.3	.035"	\$230.33
M120E1T2	1"	2	.035"	\$230.33
M120E1T3	1"	3	.035"	\$230.33
M120E1V2	1"	2-3V	.035"	\$226.15

Carbon Steel Bandsaw Blade 121-1/2" (10' 1-1/2") Long



Tool No.	Width	Tooth	Thickness	Price
M121.5C18R14	1/8"	14R	.025"	\$19.33
M121.5C18R18	1/8"	18R	.025"	\$19.33
M121.5C316S4	3/16"	4S	.025"	\$16.84
M121.5C316S6	3/16"	6S	.025"	\$16.98
M121.5C316R10	3/16"	10R	.025"	\$16.45
M121.5C316R14	3/16"	14R	.025"	\$16.45
M121.5C316R18	3/16"	18R	.025"	\$16.45
M121.5C316R24	3/16"	24R	.025"	\$16.45
M121.5C14H4	1/4"	4H	.025"	\$13.91
M121.5C14H6	1/4"	6H	.025"	\$13.91
M121.5C14R10	1/4"	10R	.025"	\$13.91
M121.5C14R14	1/4"	14R	.025"	\$13.91
M121.5C14R18	1/4"	18R	.025"	\$13.91
M121.5C14R24	1/4"	24R	.025"	\$13.91
M121.5C38H3	3/8"	3H	.025"	\$15.36
M121.5C38H4	3/8"	4H	.025"	\$15.36
M121.5C38H6	3/8"	6H	.025"	\$15.36
M121.5C38R8	3/8"	8R	.025"	\$15.36
M121.5C38R10	3/8"	10R	.025"	\$15.36
M121.5C38R14	3/8"	14R	.025"	\$15.36
M121.5C38R18	3/8"	18R	.025"	\$15.36
M121.5C38R24	3/8"	24R	.025"	\$14.83
M121.5C12H3	1/2"	3H	.025"	\$16.98
M121.5C12H4	1/2"	4H	.025"	\$16.98
M121.5C12H6	1/2"	6H	.025"	\$16.98
M121.5C12R10	1/2"	10R	.025"	\$16.98
M121.5C12R14	1/2"	14R	.025"	\$16.98
M121.5C12R18	1/2"	18R	.025"	\$16.98
M121.5C12R24	1/2"	24R	.025"	\$16.98
M121.5C58H3	5/8"	3H	.032"	\$20.07
M121.5C58H4	5/8"	4H	.032"	\$20.07
M121.5C58R10	5/8"	10R	.032"	\$20.07
M121.5C58R14	5/8"	14R	.032"	\$20.07
M121.5C34H2	3/4"	2H	.032"	\$20.07
M121.5C34H3	3/4"	3H	.032"	\$20.07
M121.5C34H4	3/4"	4H	.032"	\$20.07
M121.5C34H6	3/4"	6H	.032"	\$20.07
M121.5C34R6	3/4"	6R	.032"	\$20.07
M121.5C34R10	3/4"	10R	.032"	\$20.07
M121.5C34R14	3/4"	14R	.032"	\$20.07
M121.5C34R18	3/4"	18R	.032"	\$20.07
M121.5C1H1.3	1"	1.3H	.035"	\$26.24
M121.5C1H2	1"	2H	.035"	\$26.24
M121.5C1H3	1"	3H	.035"	\$26.24
M121.5C1H4	1"	4H	.035"	\$26.24
M121.5C1H6	1"	6H	.035"	\$26.24
M121.5C1R6	1"	6R	.035"	\$26.24
M121.5C1R8	1"	8R	.035"	\$26.24
M121.5C1R10	1"	10R	.035"	\$26.24
M121.5C1R14	1"	14R	.035"	\$26.24

Hawc Pro Resaw Bandsaw Blade 121-1/2" (10' 1-1/2") Long



Tool No.	Width	Tooth	Thickness	Price
B121.5H12T3	1/2"	3	.025"	\$23.12

Bi-metal Bandsaw Blade 121-1/2" (10' 1-1/2") Long



Tool No.	Width	Tooth	Thickness	Price
M121.5M14H6	1/4"	6H	.025"	\$53.19
M121.5M14V10	1/4"	10-14V	.025"	\$53.19
M121.5M14V14	1/4"	14-18V	.025"	\$53.19
M121.5M38H4	3/8"	4H	.025"	\$53.19
M121.5M38V10	3/8"	10-14V	.025"	\$53.19
M121.5M38V14	3/8"	14-18V	.025"	\$53.19
M121.5M12H3	1/2"	3H	.035"	\$53.19
M121.5M12H4	1/2"	4H	.025"	\$53.19
M121.5M12H6	1/2"	6H	.025"	\$53.19
M121.5M12V6	1/2"	6-10V	.025"	\$53.19
M121.5M12V8	1/2"	8-12V	.025"	\$53.19
M121.5M12V10	1/2"	10-14V	.025"	\$53.19
M121.5M12T14	1/2"	14	.025"	\$53.19
M121.5M12V14	1/2"	14-18V	.025"	\$53.19
M121.5M12T18	1/2"	18	.025"	\$53.19
M121.5M58V10	5/8"	10-14V	.032"	\$56.24
M121.5M34H3	3/4"	3H	.035"	\$56.24
M121.5M34V4	3/4"	4-6V	.035"	\$56.24
M121.5M34V5	3/4"	5-8V	.035"	\$56.24
M121.5M34V6	3/4"	6-10V	.035"	\$56.24
M121.5M34V8	3/4"	8-12V	.035"	\$56.24
M121.5M34V10	3/4"	10-14V	.035"	\$56.24
M121.5M34W14	3/4"	14W	.035"	\$56.24
M121.5M34W18	3/4"	18W	.035"	\$56.24
M121.5M1V2	1"	2-3V	.035"	\$60.93
M121.5M1H3	1"	3H	.035"	\$60.93
M121.5M1V3	1"	3-4V	.035"	\$60.93
M121.5M1V4	1"	4-6V	.035"	\$60.93
M121.5M1V5	1"	5-8V	.035"	\$60.93
M121.5M1V6	1"	6-10V	.035"	\$60.93
M121.5M1V8	1"	8-12V	.035"	\$60.93
M121.5M1V10	1"	10-14V	.035"	\$60.93
M121.5M114V2	1-1/4"	2-3V	.042"	\$83.00
M121.5M114V3	1-1/4"	3-4V	.042"	\$83.00
M121.5M114V4	1-1/4"	4-6V	.042"	\$83.00
M121.5M114V5	1-1/4"	5-8V	.042"	\$83.00
M121.5M114V6	1-1/4"	6-10V	.042"	\$83.00
M121.5M114V8	1-1/4"	8-12V	.042"	\$83.00

MAGNATE™ 20639 Lycoming Street #B-6, Walnut, CA 91789 USA

M-53



email : info@magnate.net Online Shop : www.magnate.net
(TEL) 800-827-2316, 909-468-5747 (FAX) 909-468-5745

MAGNATE™ Band Saw Blades (Non-Food Processing)

Carbide Grit Bandsaw Blade
121-1/2" (10' 1-1/2") Long



MAGNATE

Tool No.	Width	Tooth	Thickness	Price
M121.5G12MC	1/2"	Med-Coarse	.025"	\$266.93
M121.5G34MC	3/4"	Med-Coarse	.032"	\$284.38
M121.5G1MC	1"	Med-Coarse	.035"	\$299.79

WoodSaver Resaw Bandsaw Blades
121-1/2" (10' 1-1/2") Long



Tool No.	Width	Tooth	Thickness	Price
B121.5S58T3	5/8"	3	.025"	\$75.20
B121.5S1T3	1"	3	.025"	\$87.17



Carbide Grit Bandsaw Blade
123" (10' 3") Long



MAGNATE

Tool No.	Width	Tooth	Thickness	Price
M123G12MC	1/2"	Med-Coarse	.025"	\$266.93
M123G34MC	3/4"	Med-Coarse	.032"	\$284.38
M123G1MC	1"	Med-Coarse	.035"	\$299.79

Carbide Impregnated Bandsaw Blade
121-1/2" (10' 1-1/2") Long

Tool No.	Width	Tooth	Thickness	Price
B121.5G14H6	1/4"	6H	.025"	\$34.88
B121.5G38H4	3/8"	4H	.025"	\$33.00
B121.5G12H3	1/2"	3H	.025"	\$34.72



Bi-metal Bandsaw Blade
123" (10' 3") Long



MAGNATE

Tool No.	Width	Tooth	Thickness	Price
M123M14H6	1/4"	6H	.025"	\$53.19
M123M14V10	1/4"	10-14V	.025"	\$53.19
M123M14V14	1/4"	14-18V	.025"	\$53.19
M123M38H4	3/8"	4H	.025"	\$53.19
M123M38V10	3/8"	10-14V	.025"	\$53.19
M123M38V14	3/8"	14-18V	.025"	\$53.19
M123M12H3	1/2"	3H	.035"	\$53.19
M123M12H4	1/2"	4H	.025"	\$53.19
M123M12H6	1/2"	6H	.025"	\$53.19
M123M12V6	1/2"	6-10V	.025"	\$53.19
M123M12V8	1/2"	8-12V	.025"	\$53.19
M123M12V10	1/2"	10-14V	.025"	\$53.19
M123M12T14	1/2"	14	.025"	\$53.19
M123M12V14	1/2"	14-18V	.025"	\$53.19
M123M12T18	1/2"	18	.025"	\$53.19
M123M58V10	5/8"	10-14V	.032"	\$56.24
M123M34H3	3/4"	3H	.035"	\$56.24
M123M34V4	3/4"	4-6V	.035"	\$56.24
M123M34V5	3/4"	5-8V	.035"	\$56.24
M123M34V6	3/4"	6-10V	.035"	\$56.24
M123M34V8	3/4"	8-12V	.035"	\$56.24
M123M34V10	3/4"	10-14V	.035"	\$56.24
M123M34W14	3/4"	14W	.035"	\$56.24
M123M34W18	3/4"	18W	.035"	\$56.24
M123M1V2	1"	2-3V	.035"	\$60.93
M123M1H3	1"	3H	.035"	\$60.93
M123M1V3	1"	3-4V	.035"	\$60.93
M123M1V4	1"	4-6V	.035"	\$60.93
M123M1V5	1"	5-8V	.035"	\$60.93
M123M1V6	1"	6-10V	.035"	\$60.93
M123M1V8	1"	8-12V	.035"	\$60.93
M123M1V10	1"	10-14V	.035"	\$60.93
M123M114V2	1-1/4"	2-3V	.042"	\$83.00
M123M114V3	1-1/4"	3-4V	.042"	\$83.00
M123M114V4	1-1/4"	4-6V	.042"	\$83.00
M123M114V5	1-1/4"	5-8V	.042"	\$83.00
M123M114V6	1-1/4"	6-10V	.042"	\$83.00
M123M114V8	1-1/4"	8-12V	.042"	\$83.00

Carbide Impregnated Bandsaw Blade
123" (10' 3") Long

Tool No.	Width	Tooth	Thickness	Price
B123G14H6	1/4"	6H	.025"	\$34.88
B123G38H4	3/8"	4H	.025"	\$33.00
B123G12H3	1/2"	3H	.025"	\$34.72

Carbide Tipped Bandsaw Blade
121-1/2" (10' 1-1/2") Long



MAGNATE

Tool No.	Width	Tooth	Thickness	Price
M121.5E12T3	1/2"	3	.025"	\$220.03
M121.5E34T3	3/4"	3	.035"	\$241.38
M121.5E1T1.3	1"	1.3	.035"	\$241.38
M121.5E1T2	1"	2	.035"	\$241.38
M121.5E1T3	1"	3	.035"	\$241.38
M121.5E1V2	1"	2-3V	.035"	\$236.98

Carbide Tipped Bandsaw Blade
123" (10' 3") Long

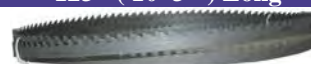

MAGNATE

Tool No.	Width	Tooth	Thickness	Price
M123E12T3	1/2"	3	.025"	\$220.03
M123E34T3	3/4"	3	.035"	\$241.38
M123E1T1.3	1"	1.3	.035"	\$241.38
M123E1T2	1"	2	.035"	\$241.38
M123E1T3	1"	3	.035"	\$241.38
M123E1V2	1"	2-3V	.035"	\$236.98

WoodSaver Plus Resaw Bandsaw Blades
121-1/2" (10' 1-1/2") Long



Tool No.	Width	Tooth	Thickness	Price
B121.5P58V3	5/8"	3-4V	.025"	\$88.00

Hawc Pro Resaw Bandsaw Blade
123" (10' 3") Long



Tool No.	Width	Tooth	Thickness	Price
B123H12T3	1/2"	3	.025"	\$23.12

MAGNATE™ 20639 Lycoming Street #B-6, Walnut, CA 91789 USA

M-54



email : info@magnate.net Online Shop : www.magnate.net
(TEL) 800-827-2316, 909-468-5747 (FAX) 909-468-5745

MAGNATE™ Band Saw Blades (Non-Food Processing)

Carbon Steel Bandsaw Blade 123" (10' 3") Long



MAGNATE

Tool No.	Width	Tooth	Thickness	Price
M123C18R14	1/8"	14R	.025"	\$19.33
M123C18R18	1/8"	18R	.025"	\$19.33
M123C316S4	3/16"	4S	.025"	\$16.84
M123C316S6	3/16"	6S	.025"	\$16.98
M123C316R10	3/16"	10R	.025"	\$16.84
M123C316R14	3/16"	14R	.025"	\$16.84
M123C316R18	3/16"	18R	.025"	\$16.84
M123C316R24	3/16"	24R	.025"	\$16.84
M123C14H4	1/4"	4H	.025"	\$13.91
M123C14H6	1/4"	6H	.025"	\$13.91
M123C14R10	1/4"	10R	.025"	\$13.91
M123C14R14	1/4"	14R	.025"	\$13.91
M123C14R18	1/4"	18R	.025"	\$13.91
M123C14R24	1/4"	24R	.025"	\$13.91
M123C38H3	3/8"	3H	.025"	\$15.36
M123C38H4	3/8"	4H	.025"	\$15.36
M123C38H6	3/8"	6H	.025"	\$15.36
M123C38R8	3/8"	8R	.025"	\$15.36
M123C38R10	3/8"	10R	.025"	\$15.36
M123C38R14	3/8"	14R	.025"	\$15.36
M123C38R18	3/8"	18R	.025"	\$15.36
M123C38R24	3/8"	24R	.025"	\$14.83
M123C12H3	1/2"	3H	.025"	\$16.98
M123C12H4	1/2"	4H	.025"	\$16.98
M123C12H6	1/2"	6H	.025"	\$16.98
M123C12R10	1/2"	10R	.025"	\$16.98
M123C12R14	1/2"	14R	.025"	\$16.98
M123C12R18	1/2"	18R	.025"	\$16.98
M123C12R24	1/2"	24R	.025"	\$16.98
M123C58H3	5/8"	3H	.032"	\$20.07
M123C58H4	5/8"	4H	.032"	\$20.07
M123C58R10	5/8"	10R	.032"	\$20.07
M123C58R14	5/8"	14R	.032"	\$20.07
M123C34H2	3/4"	2H	.032"	\$20.07
M123C34H3	3/4"	3H	.032"	\$20.07
M123C34H4	3/4"	4H	.032"	\$20.07
M123C34H6	3/4"	6H	.032"	\$20.07
M123C34R6	3/4"	6R	.032"	\$20.07
M123C34R10	3/4"	10R	.032"	\$20.07
M123C34R14	3/4"	14R	.032"	\$20.07
M123C34R18	3/4"	18R	.032"	\$20.07
M123C1H1.3	1"	1.3H	.035"	\$26.24
M123C1H2	1"	2H	.035"	\$26.24
M123C1H3	1"	3H	.035"	\$26.24
M123C1H4	1"	4H	.035"	\$26.24
M123C1H6	1"	6H	.035"	\$26.24
M123C1R6	1"	6R	.035"	\$26.24
M123C1R8	1"	8R	.035"	\$26.24
M123C1R10	1"	10R	.035"	\$26.24
M123C1R14	1"	14R	.035"	\$26.24

WoodSaver Plus Resaw Bandsaw Blades 123" (10' 3") Long



Tool No.	Width	Tooth	Thickness	Price
B123P58V3	5/8"	3-4V	.025"	\$88.00

WoodSaver Resaw Bandsaw Blades 123" (10' 3") Long



Tool No.	Width	Tooth	Thickness	Price
B123S58T3	5/8"	3	.025"	\$75.20
B123S1T3	1"	3	.025"	\$87.17

Carbide Grit Bandsaw Blade 123-1/2" (10' 3-1/2") Long



MAGNATE

Tool No.	Width	Tooth	Thickness	Price
M123.5G12MC	1/2"	Med-Coarse	.025"	\$266.93
M123.5G34MC	3/4"	Med-Coarse	.032"	\$284.38
M123.5G1MC	1"	Med-Coarse	.035"	\$299.79

Carbide Tipped Bandsaw Blade 123-1/2" (10' 3-1/2") Long



MAGNATE

Tool No.	Width	Tooth	Thickness	Price
M123.5E12T3	1/2"	3	.025"	\$220.03
M123.5E34T3	3/4"	3	.035"	\$241.38
M123.5E1T1.3	1"	1.3	.035"	\$241.38
M123.5E1T2	1"	2	.035"	\$241.38
M123.5E1T3	1"	3	.035"	\$241.38
M123.5E1V2	1"	2-3V	.035"	\$236.98

Carbon Steel Bandsaw Blade 123-1/2" (10' 3-1/2") Long



MAGNATE

Tool No.	Width	Tooth	Thickness	Price
M123.5C18R14	1/8"	14R	.025"	\$19.33
M123.5C18R18	1/8"	18R	.025"	\$19.33
M123.5C316S4	3/16"	4S	.025"	\$16.84
M123.5C316S6	3/16"	6S	.025"	\$16.98
M123.5C316R10	3/16"	10R	.025"	\$16.84
M123.5C316R14	3/16"	14R	.025"	\$16.84
M123.5C316R18	3/16"	18R	.025"	\$16.84
M123.5C316R24	3/16"	24R	.025"	\$16.84
M123.5C14H4	1/4"	4H	.025"	\$13.91
M123.5C14H6	1/4"	6H	.025"	\$13.91
M123.5C14R10	1/4"	10R	.025"	\$13.91
M123.5C14R14	1/4"	14R	.025"	\$13.91
M123.5C14R18	1/4"	18R	.025"	\$13.91
M123.5C14R24	1/4"	24R	.025"	\$13.91
M123.5C38H3	3/8"	3H	.025"	\$15.36
M123.5C38H4	3/8"	4H	.025"	\$15.36
M123.5C38H6	3/8"	6H	.025"	\$15.36
M123.5C38R8	3/8"	8R	.025"	\$15.36
M123.5C38R10	3/8"	10R	.025"	\$15.36
M123.5C38R14	3/8"	14R	.025"	\$15.36
M123.5C38R18	3/8"	18R	.025"	\$15.36
M123.5C38R24	3/8"	24R	.025"	\$14.83
M123.5C12H3	1/2"	3H	.025"	\$16.98
M123.5C12H4	1/2"	4H	.025"	\$16.98
M123.5C12H6	1/2"	6H	.025"	\$16.98
M123.5C12R10	1/2"	10R	.025"	\$16.98
M123.5C12R14	1/2"	14R	.025"	\$16.98
M123.5C12R18	1/2"	18R	.025"	\$16.98
M123.5C12R24	1/2"	24R	.025"	\$16.98
M123.5C58H3	5/8"	3H	.032"	\$20.07
M123.5C58H4	5/8"	4H	.032"	\$20.07
M123.5C58R10	5/8"	10R	.032"	\$20.07
M123.5C58R14	5/8"	14R	.032"	\$20.07
M123.5C34H2	3/4"	2H	.032"	\$20.07
M123.5C34H3	3/4"	3H	.032"	\$20.07
M123.5C34H4	3/4"	4H	.032"	\$20.07
M123.5C34H6	3/4"	6H	.032"	\$20.07
M123.5C34R6	3/4"	6R	.032"	\$20.07
M123.5C34R10	3/4"	10R	.032"	\$20.07
M123.5C34R14	3/4"	14R	.032"	\$20.07
M123.5C34R18	3/4"	18R	.032"	\$20.07
M123.5C1H1.3	1"	1.3H	.035"	\$26.24
M123.5C1H2	1"	2H	.035"	\$26.24
M123.5C1H3	1"	3H	.035"	\$26.24
M123.5C1H4	1"	4H	.035"	\$26.24
M123.5C1H6	1"	6H	.035"	\$26.24
M123.5C1R6	1"	6R	.035"	\$26.24
M123.5C1R8	1"	8R	.035"	\$26.24
M123.5C1R10	1"	10R	.035"	\$26.24
M123.5C1R14	1"	14R	.035"	\$26.24

MAGNATE™ 20639 Lycoming Street #B-6, Walnut, CA 91789 USA

M-55



email : info@magnate.net Online Shop : www.magnate.net
(TEL) 800-827-2316, 909-468-5747 (FAX) 909-468-5745

MAGNATE™ Band Saw Blades (Non-Food Processing)

Bi-metal Bandsaw Blade 123-1/2" (10' 3-1/2") Long



MAGNATE

Tool No.	Width	Tooth	Thickness	Price
M123.5M14H6	1/4"	6H	.025"	\$53.19
M123.5M14V10	1/4"	10-14V	.025"	\$53.19
M123.5M14V14	1/4"	14-18V	.025"	\$53.19
M123.5M38H4	3/8"	4H	.025"	\$53.19
M123.5M38V10	3/8"	10-14V	.025"	\$53.19
M123.5M38V14	3/8"	14-18V	.025"	\$53.19
M123.5M12H3	1/2"	3H	.035"	\$53.19
M123.5M12H4	1/2"	4H	.025"	\$53.19
M123.5M12H6	1/2"	6H	.025"	\$53.19
M123.5M12V6	1/2"	6-10V	.025"	\$53.19
M123.5M12V8	1/2"	8-12V	.025"	\$53.19
M123.5M12V10	1/2"	10-14V	.025"	\$53.19
M123.5M12T14	1/2"	14	.025"	\$53.19
M123.5M12V14	1/2"	14-18V	.025"	\$53.19
M123.5M12T18	1/2"	18	.025"	\$53.19
M123.5M58V10	5/8"	10-14V	.032"	\$56.24
M123.5M34H3	3/4"	3H	.035"	\$56.24
M123.5M34V4	3/4"	4-6V	.035"	\$56.24
M123.5M34V5	3/4"	5-8V	.035"	\$56.24
M123.5M34V6	3/4"	6-10V	.035"	\$56.24
M123.5M34V8	3/4"	8-12V	.035"	\$56.24
M123.5M34V10	3/4"	10-14V	.035"	\$56.24
M123.5M34W14	3/4"	14W	.035"	\$56.24
M123.5M34W18	3/4"	18W	.035"	\$56.24
M123.5M1V2	1"	2-3V	.035"	\$60.93
M123.5M1H3	1"	3H	.035"	\$60.93
M123.5M1V3	1"	3-4V	.035"	\$60.93
M123.5M1V4	1"	4-6V	.035"	\$60.93
M123.5M1V5	1"	5-8V	.035"	\$60.93
M123.5M1V6	1"	6-10V	.035"	\$60.93
M123.5M1V8	1"	8-12V	.035"	\$60.93
M123.5M1V10	1"	10-14V	.035"	\$60.93
M123.5M114V2	1-1/4"	2-3V	.042"	\$83.00
M123.5M114V3	1-1/4"	3-4V	.042"	\$83.00
M123.5M114V4	1-1/4"	4-6V	.042"	\$83.00
M123.5M114V5	1-1/4"	5-8V	.042"	\$83.00
M123.5M114V6	1-1/4"	6-10V	.042"	\$83.00
M123.5M114V8	1-1/4"	8-12V	.042"	\$83.00

Hawc Pro Resaw Bandsaw Blade 124" (10' 4") Long



SUPER CUT™

Tool No.	Width	Tooth	Thickness	Price
B124H12T3	1/2"	3	.025"	\$23.12

Carbon Steel Bandsaw Blade 124" (10' 4") Long



MAGNATE

Tool No.	Width	Tooth	Thickness	Price
M124C18R14	1/8"	14R	.025"	\$19.33
M124C18R18	1/8"	18R	.025"	\$19.33
M124C316S4	3/16"	4S	.025"	\$16.84
M124C316S6	3/16"	6S	.025"	\$16.98
M124C316R10	3/16"	10R	.025"	\$16.84
M124C316R14	3/16"	14R	.025"	\$16.84
M124C316R18	3/16"	18R	.025"	\$16.84
M124C316R24	3/16"	24R	.025"	\$16.84
M124C14H4	1/4"	4H	.025"	\$13.91
M124C14H6	1/4"	6H	.025"	\$13.91
M124C14R10	1/4"	10R	.025"	\$13.91
M124C14R14	1/4"	14R	.025"	\$13.91
M124C14R18	1/4"	18R	.025"	\$13.91
M124C14R24	1/4"	24R	.025"	\$13.91
M124C38H3	3/8"	3H	.025"	\$15.36
M124C38H4	3/8"	4H	.025"	\$15.36
M124C38H6	3/8"	6H	.025"	\$15.36
M124C38R8	3/8"	8R	.025"	\$15.36
M124C38R10	3/8"	10R	.025"	\$15.36
M124C38R14	3/8"	14R	.025"	\$15.36
M124C38R18	3/8"	18R	.025"	\$15.36
M124C38R24	3/8"	24R	.025"	\$14.83
M124C12H3	1/2"	3H	.025"	\$16.98
M124C12H4	1/2"	4H	.025"	\$16.98
M124C12H6	1/2"	6H	.025"	\$16.98
M124C12R10	1/2"	10R	.025"	\$16.98
M124C12R14	1/2"	14R	.025"	\$16.98
M124C12R18	1/2"	18R	.025"	\$16.98
M124C12R24	1/2"	24R	.025"	\$16.98
M124C58H3	5/8"	3H	.032"	\$20.07
M124C58H4	5/8"	4H	.032"	\$20.07
M124C58R10	5/8"	10R	.032"	\$20.07
M124C58R14	5/8"	14R	.032"	\$20.07
M124C34H2	3/4"	2H	.032"	\$20.07
M124C34H3	3/4"	3H	.032"	\$20.07
M124C34H4	3/4"	4H	.032"	\$20.07
M124C34H6	3/4"	6H	.032"	\$20.07
M124C34R6	3/4"	6R	.032"	\$20.07
M124C34R10	3/4"	10R	.032"	\$20.07
M124C34R14	3/4"	14R	.032"	\$20.07
M124C34R18	3/4"	18R	.032"	\$20.07
M124C1H1.3	1"	1.3H	.035"	\$26.24
M124C1H2	1"	2H	.035"	\$26.24
M124C1H3	1"	3H	.035"	\$26.24
M124C1H4	1"	4H	.035"	\$26.24
M124C1H6	1"	6H	.035"	\$26.24
M124C1R6	1"	6R	.035"	\$26.24
M124C1R8	1"	8R	.035"	\$26.24
M124C1R10	1"	10R	.035"	\$26.24
M124C1R14	1"	14R	.035"	\$26.24

Carbide Grit Bandsaw Blade 124" (10' 4") Long



MAGNATE

Tool No.	Width	Tooth	Thickness	Price
M124G12MC	1/2"	Med-Coarse	.025"	\$266.93
M124G34MC	3/4"	Med-Coarse	.032"	\$284.38
M124G1MC	1"	Med-Coarse	.035"	\$299.79

Carbide Tipped Bandsaw Blade 124" (10' 4") Long



MAGNATE

Tool No.	Width	Tooth	Thickness	Price
M124E12T3	1/2"	3	.025"	\$220.03
M124E34T3	3/4"	3	.035"	\$241.38
M124E1T1.3	1"	1.3	.035"	\$241.38
M124E1T2	1"	2	.035"	\$241.38
M124E1T3	1"	3	.035"	\$241.38
M124E1V2	1"	2-3V	.035"	\$236.98

WoodSaver Plus Resaw Bandsaw Blades 124" (10' 4") Long



SUPER CUT™

Tool No.	Width	Tooth	Thickness	Price
B124P58V3	5/8"	3-4V	.025"	\$88.00

WoodSaver Resaw Bandsaw Blades 124" (10' 4") Long



SUPER CUT™

Tool No.	Width	Tooth	Kerf	Price
B124S58T3	5/8"	3	.025"	\$75.20
B124S1T3	1"	3	.025"	\$87.17

MAGNATE™ 20639 Lycoming Street #B-6, Walnut, CA 91789 USA

M-56



email : info@magnate.net Online Shop : www.magnate.net
(TEL) 800-827-2316, 909-468-5747 (FAX) 909-468-5745

MAGNATE™ Band Saw Blades (Non-Food Processing)

Bi-metal Bandsaw Blade 124" (10' 4") Long



Tool No.	Width	Tooth	Thickness	Price
M124M14H6	1/4"	6H	.025"	\$53.19
M124M14V10	1/4"	10-14V	.025"	\$53.19
M124M14V14	1/4"	14-18V	.025"	\$53.19
M124M38H4	3/8"	4H	.025"	\$53.19
M124M38V10	3/8"	10-14V	.025"	\$53.19
M124M38V14	3/8"	14-18V	.025"	\$53.19
M124M12H3	1/2"	3H	.035"	\$53.19
M124M12H4	1/2"	4H	.025"	\$53.19
M124M12H6	1/2"	6H	.025"	\$53.19
M124M12V6	1/2"	6-10V	.025"	\$53.19
M124M12V8	1/2"	8-12V	.025"	\$53.19
M124M12V10	1/2"	10-14V	.025"	\$53.19
M124M12T14	1/2"	14	.025"	\$53.19
M124M12V14	1/2"	14-18V	.025"	\$53.19
M124M12T18	1/2"	18	.025"	\$53.19
M124M58V10	5/8"	10-14V	.032"	\$56.24
M124M34H3	3/4"	3H	.035"	\$56.24
M124M34V4	3/4"	4-6V	.035"	\$56.24
M124M34V5	3/4"	5-8V	.035"	\$56.24
M124M34V6	3/4"	6-10V	.035"	\$56.24
M124M34V8	3/4"	8-12V	.035"	\$56.24
M124M34V10	3/4"	10-14V	.035"	\$56.24
M124M34W14	3/4"	14W	.035"	\$56.24
M124M34W18	3/4"	18W	.035"	\$56.24
M124M1V2	1"	2-3V	.035"	\$60.93
M124M1H3	1"	3H	.035"	\$60.93
M124M1V3	1"	3-4V	.035"	\$60.93
M124M1V4	1"	4-6V	.035"	\$60.93
M124M1V5	1"	5-8V	.035"	\$60.93
M124M1V6	1"	6-10V	.035"	\$60.93
M124M1V8	1"	8-12V	.035"	\$60.93
M124M1V10	1"	10-14V	.035"	\$60.93
M124M114V2	1-1/4"	2-3V	.042"	\$83.00
M124M114V3	1-1/4"	3-4V	.042"	\$83.00
M124M114V4	1-1/4"	4-6V	.042"	\$83.00
M124M114V5	1-1/4"	5-8V	.042"	\$83.00
M124M114V6	1-1/4"	6-10V	.042"	\$83.00
M124M114V8	1-1/4"	8-12V	.042"	\$83.00

Carbide Impregnated Bandsaw Blade 124" (10' 4") Long



Tool No.	Width	Tooth	Thickness	Price
B124G14H6	1/4"	6H	.025"	\$34.88
B124G38H4	3/8"	4H	.025"	\$33.00
B124G12H3	1/2"	3H	.025"	\$34.72

Carbon Steel Bandsaw Blade 125" (10' 5") Long



Tool No.	Width	Tooth	Thickness	Price
M125C18R14	1/8"	14R	.025"	\$19.33
M125C18R18	1/8"	18R	.025"	\$19.33
M125C316S4	3/16"	4S	.025"	\$16.84
M125C316S6	3/16"	6S	.025"	\$16.98
M125C316R10	3/16"	10R	.025"	\$16.84
M125C316R14	3/16"	14R	.025"	\$16.84
M125C316R18	3/16"	18R	.025"	\$16.84
M125C316R24	3/16"	24R	.025"	\$16.84
M125C14H4	1/4"	4H	.025"	\$13.91
M125C14H6	1/4"	6H	.025"	\$13.91
M125C14R10	1/4"	10R	.025"	\$13.91
M125C14R14	1/4"	14R	.025"	\$13.91
M125C14R18	1/4"	18R	.025"	\$13.91
M125C14R24	1/4"	24R	.025"	\$13.91
M125C38H3	3/8"	3H	.025"	\$15.36
M125C38H4	3/8"	4H	.025"	\$15.36
M125C38H6	3/8"	6H	.025"	\$15.36
M125C38R8	3/8"	8R	.025"	\$15.36
M125C38R10	3/8"	10R	.025"	\$15.36
M125C38R14	3/8"	14R	.025"	\$15.36
M125C38R18	3/8"	18R	.025"	\$15.36
M125C38R24	3/8"	24R	.025"	\$14.83
M125C12H3	1/2"	3H	.025"	\$16.98
M125C12H4	1/2"	4H	.025"	\$16.98
M125C12H6	1/2"	6H	.025"	\$16.98
M125C12R10	1/2"	10R	.025"	\$16.98
M125C12R14	1/2"	14R	.025"	\$16.98
M125C12R18	1/2"	18R	.025"	\$16.98
M125C12R24	1/2"	24R	.025"	\$16.98
M125C58H3	5/8"	3H	.032"	\$20.07
M125C58H4	5/8"	4H	.032"	\$20.07
M125C58R10	5/8"	10R	.032"	\$20.07
M125C58R14	5/8"	14R	.032"	\$20.07
M125C34H2	3/4"	2H	.032"	\$20.07
M125C34H3	3/4"	3H	.032"	\$20.07
M125C34H4	3/4"	4H	.032"	\$20.07
M125C34H6	3/4"	6H	.032"	\$20.07
M125C34R6	3/4"	6R	.032"	\$20.07
M125C34R10	3/4"	10R	.032"	\$20.07
M125C34R14	3/4"	14R	.032"	\$20.07
M125C34R18	3/4"	18R	.032"	\$20.07
M125C1H1.3	1"	1.3H	.035"	\$26.24
M125C1H2	1"	2H	.035"	\$26.24
M125C1H3	1"	3H	.035"	\$26.24
M125C1H4	1"	4H	.035"	\$26.24
M125C1H6	1"	6H	.035"	\$26.24
M125C1R6	1"	6R	.035"	\$26.24
M125C1R8	1"	8R	.035"	\$26.24
M125C1R10	1"	10R	.035"	\$26.24
M125C1R14	1"	14R	.035"	\$26.24

Hawc Pro Resaw Bandsaw Blade 125" (10' 5") Long



Tool No.	Width	Tooth	Thickness	Price
B125H12T3	1/2"	3	.025"	\$23.12

Bi-metal Bandsaw Blade 125" (10' 5") Long



Tool No.	Width	Tooth	Thickness	Price
M125M14H6	1/4"	6H	.025"	\$53.19
M125M14V10	1/4"	10-14V	.025"	\$53.19
M125M14V14	1/4"	14-18V	.025"	\$53.19
M125M38H4	3/8"	4H	.025"	\$53.19
M125M38V10	3/8"	10-14V	.025"	\$53.19
M125M38V14	3/8"	14-18V	.025"	\$53.19
M125M12H3	1/2"	3H	.035"	\$53.19
M125M12H4	1/2"	4H	.025"	\$53.19
M125M12H6	1/2"	6H	.025"	\$53.19
M125M12V6	1/2"	6-10V	.025"	\$53.19
M125M12V8	1/2"	8-12V	.025"	\$53.19
M125M12V10	1/2"	10-14V	.025"	\$53.19
M125M12T14	1/2"	14	.025"	\$53.19
M125M12V14	1/2"	14-18V	.025"	\$53.19
M125M12T18	1/2"	18	.025"	\$53.19
M125M58V10	5/8"	10-14V	.032"	\$56.24
M125M34H3	3/4"	3H	.035"	\$56.24
M125M34V4	3/4"	4-6V	.035"	\$56.24
M125M34V5	3/4"	5-8V	.035"	\$56.24
M125M34V6	3/4"	6-10V	.035"	\$56.24
M125M34V8	3/4"	8-12V	.035"	\$56.24
M125M34V10	3/4"	10-14V	.035"	\$56.24
M125M34W14	3/4"	14W	.035"	\$56.24
M125M34W18	3/4"	18W	.035"	\$56.24
M125M1V2	1"	2-3V	.035"	\$60.93
M125M1H3	1"	3H	.035"	\$60.93
M125M1V3	1"	3-4V	.035"	\$60.93
M125M1V4	1"	4-6V	.035"	\$60.93
M125M1V5	1"	5-8V	.035"	\$60.93
M125M1V6	1"	6-10V	.035"	\$60.93
M125M1V8	1"	8-12V	.035"	\$60.93
M125M1V10	1"	10-14V	.035"	\$60.93
M125M114V2	1-1/4"	2-3V	.042"	\$83.00
M125M114V3	1-1/4"	3-4V	.042"	\$83.00
M125M114V4	1-1/4"	4-6V	.042"	\$83.00
M125M114V5	1-1/4"	5-8V	.042"	\$83.00
M125M114V6	1-1/4"	6-10V	.042"	\$83.00
M125M114V8	1-1/4"	8-12V	.042"	\$83.00

MAGNATE™ 20639 Lycoming Street #B-6, Walnut, CA 91789 USA

M-57



email : info@magnate.net Online Shop : www.magnate.net
(TEL) 800-827-2316, 909-468-5747 (FAX) 909-468-5745

MAGNATE™ Band Saw Blades (Non-Food Processing)

Carbide Grit Bandsaw Blade
125" (10' 5") Long



MAGNATE

Tool No.	Width	Tooth	Thickness	Price
M125G12MC	1/2"	Med-Coarse	.025"	\$266.93
M125G34MC	3/4"	Med-Coarse	.032"	\$284.38
M125G1MC	1"	Med-Coarse	.035"	\$299.79

WoodSaver Resaw Bandsaw Blades
125" (10' 5") Long



Tool No.	Width	Tooth	Thickness	Price
B125S58T3	5/8"	3	.025"	\$75.20
B125S1T3	1"	3	.025"	\$87.17



Carbon Steel Bandsaw Blade
127-7/8" (10' 7-7/8") Long



MAGNATE

Tool No.	Width	Tooth	Thickness	Price
M127.875C18R14	1/8"	14R	.025"	\$20.00
M127.875C18R18	1/8"	18R	.025"	\$20.00
M127.875C316S4	3/16"	4S	.025"	\$17.40
M127.875C316S6	3/16"	6S	.025"	\$17.59
M127.875C316R10	3/16"	10R	.025"	\$16.84
M127.875C316R14	3/16"	14R	.025"	\$16.84
M127.875C316R18	3/16"	18R	.025"	\$16.84
M127.875C316R24	3/16"	24R	.025"	\$16.84
M127.875C14H4	1/4"	4H	.025"	\$14.36
M127.875C14H6	1/4"	6H	.025"	\$14.36
M127.875C14R10	1/4"	10R	.025"	\$14.36
M127.875C14R14	1/4"	14R	.025"	\$14.36
M127.875C14R18	1/4"	18R	.025"	\$14.36
M127.875C14R24	1/4"	24R	.025"	\$14.36
M127.875C38H3	3/8"	3H	.025"	\$15.88
M127.875C38H4	3/8"	4H	.025"	\$15.88
M127.875C38H6	3/8"	6H	.025"	\$15.88
M127.875C38R8	3/8"	8R	.025"	\$15.88
M127.875C38R10	3/8"	10R	.025"	\$15.88
M127.875C38R14	3/8"	14R	.025"	\$15.88
M127.875C38R18	3/8"	18R	.025"	\$15.88
M127.875C38R24	3/8"	24R	.025"	\$15.31
M127.875C12H3	1/2"	3H	.025"	\$17.59
M127.875C12H4	1/2"	4H	.025"	\$17.59
M127.875C12H6	1/2"	6H	.025"	\$17.59
M127.875C12R10	1/2"	10R	.025"	\$17.59
M127.875C12R14	1/2"	14R	.025"	\$17.59
M127.875C12R18	1/2"	18R	.025"	\$17.59
M127.875C12R24	1/2"	24R	.025"	\$17.59
M127.875C58H3	5/8"	3H	.032"	\$20.81
M127.875C58H4	5/8"	4H	.032"	\$20.81
M127.875C58R10	5/8"	10R	.032"	\$20.81
M127.875C58R14	5/8"	14R	.032"	\$20.81
M127.875C34H2	3/4"	2H	.032"	\$20.81
M127.875C34H3	3/4"	3H	.032"	\$20.81
M127.875C34H4	3/4"	4H	.032"	\$20.81
M127.875C34H6	3/4"	6H	.032"	\$20.81
M127.875C34R6	3/4"	6R	.032"	\$20.81
M127.875C34R10	3/4"	10R	.032"	\$20.81
M127.875C34R14	3/4"	14R	.032"	\$20.81
M127.875C34R18	3/4"	18R	.032"	\$20.81
M127.875C1H1.3	1"	1.3H	.035"	\$27.22
M127.875C1H2	1"	2H	.035"	\$27.22
M127.875C1H3	1"	3H	.035"	\$27.22
M127.875C1H4	1"	4H	.035"	\$27.22
M127.875C1H6	1"	6H	.035"	\$27.22
M127.875C1R6	1"	6R	.035"	\$27.22
M127.875C1R8	1"	8R	.035"	\$27.22
M127.875C1R10	1"	10R	.035"	\$27.22
M127.875C1R14	1"	14R	.035"	\$27.22
M127.875C114H1.3	1-1/4"	1.3H	.042"	\$34.05
M127.875C112H1.15	1-1/2"	1.15H	.045"	\$38.03

Carbide Impregnated Bandsaw Blade
125" (10' 5") Long

Tool No.	Width	Tooth	Thickness	Price
B125G14H6	1/4"	6H	.025"	\$34.88
B125G38H4	3/8"	4H	.025"	\$33.00
B125G12H3	1/2"	3H	.025"	\$34.72

Bi-metal Bandsaw Blade
127-7/8" (10' 7-7/8") Long



MAGNATE

Tool No.	Width	Tooth	Thickness	Price
M127.875M14H6	1/4"	6H	.025"	\$55.33
M127.875M14V10	1/4"	10-14V	.025"	\$55.33
M127.875M14V14	1/4"	14-18V	.025"	\$55.33
M127.875M38H4	3/8"	4H	.025"	\$55.33
M127.875M38V10	3/8"	10-14V	.025"	\$55.33
M127.875M38V14	3/8"	14-18V	.025"	\$55.33
M127.875M12H3	1/2"	3H	.035"	\$55.33
M127.875M12H4	1/2"	4H	.025"	\$55.33
M127.875M12H6	1/2"	6H	.025"	\$55.33
M127.875M12V6	1/2"	6-10V	.025"	\$55.33
M127.875M12V8	1/2"	8-12V	.025"	\$55.33
M127.875M12V10	1/2"	10-14V	.025"	\$55.33
M127.875M12T14	1/2"	14	.025"	\$55.33
M127.875M12V14	1/2"	14-18V	.025"	\$55.33
M127.875M12T18	1/2"	18	.025"	\$55.33
M127.875M58V10	5/8"	10-14V	.032"	\$58.48
M127.875M34H3	3/4"	3H	.035"	\$58.48
M127.875M34V4	3/4"	4-6V	.035"	\$58.48
M127.875M34V5	3/4"	5-8V	.035"	\$58.48
M127.875M34V6	3/4"	6-10V	.035"	\$58.48
M127.875M34V8	3/4"	8-12V	.035"	\$58.48
M127.875M34V10	3/4"	10-14V	.035"	\$58.48
M127.875M34W14	3/4"	14W	.035"	\$58.48
M127.875M34W18	3/4"	18W	.035"	\$58.48
M127.875M1H3	1"	3H	.035"	\$67.21
M127.875M1V2	1"	2-3V	.035"	\$67.21
M127.875M1V3	1"	3-4V	.035"	\$67.21
M127.875M1V4	1"	4-6V	.035"	\$67.21
M127.875M1V5	1"	5-8V	.035"	\$67.21
M127.875M1V6	1"	6-10V	.035"	\$67.21
M127.875M1V8	1"	8-12V	.035"	\$67.21
M127.875M1V10	1"	10-14V	.035"	\$67.21
M127.875M114V2	1-1/4"	2-3V	.042"	\$80.72
M127.875M114V3	1-1/4"	3-4V	.042"	\$80.72
M127.875M114V4	1-1/4"	4-6V	.042"	\$80.72
M127.875M114V5	1-1/4"	5-8V	.042"	\$80.72
M127.875M114V6	1-1/4"	6-10V	.042"	\$80.72
M127.875M114V8	1-1/4"	8-12V	.042"	\$80.72

Carbide Tipped Bandsaw Blade
125" (10' 5") Long



MAGNATE

Tool No.	Width	Tooth	Thickness	Price
M125E12T3	1/2"	3	.025"	\$220.03
M125E34T3	3/4"	3	.035"	\$241.38
M125E1T1.3	1"	1.3	.035"	\$241.38
M125E1T2	1"	2	.035"	\$241.38
M125E1T3	1"	3	.035"	\$241.38
M125E1V2	1"	2-3V	.035"	\$236.98

WoodSaver Plus Resaw Bandsaw Blades
125" (10' 5") Long



Tool No.	Width	Tooth	Thickness	Price
B125P58V3	5/8"	3-4V	.025"	\$88.00

MAGNATE™ 20639 Lycoming Street #B-6, Walnut, CA 91789 USA

M-58



email : info@magnate.net Online Shop : www.magnate.net
(TEL) 800-827-2316, 909-468-5747 (FAX) 909-468-5745

MAGNATE™ Band Saw Blades (Non-Food Processing)

Carbide Grit Bandsaw Blade
127-7/8" (10' 7-7/8") Long



MAGNATE

Tool No.	Width	Tooth	Thickness	Price
M127.875G12MC	1/2"	Med-Coarse	.025"	\$279.22
M127.875G34MC	3/4"	Med-Coarse	.032"	\$297.48
M127.875G1MC	1"	Med-Coarse	.035"	\$313.62

WoodSaver Plus Resaw Bandsaw Blades
127-7/8" (10' 7-7/8") Long



SUPER CUT™

Tool No.	Width	Tooth	Thickness	Price
B127.875P58V3	5/8"	3-4V	.025"	\$91.65

Carbon Steel Bandsaw Blade
128" (10' 8") Long



MAGNATE

Tool No.	Width	Tooth	Thickness	Price
M128C18R14	1/8"	14R	.025"	\$20.00
M128C18R18	1/8"	18R	.025"	\$20.00
M128C316S4	3/16"	4S	.025"	\$17.40
M128C316S6	3/16"	6S	.025"	\$17.59
M128C316R10	3/16"	10R	.025"	\$17.40
M128C316R14	3/16"	14R	.025"	\$17.40
M128C316R18	3/16"	18R	.025"	\$17.40
M128C316R24	3/16"	24R	.025"	\$17.40
M128C14H4	1/4"	4H	.025"	\$14.36
M128C14H6	1/4"	6H	.025"	\$14.36
M128C14R10	1/4"	10R	.025"	\$14.36
M128C14R14	1/4"	14R	.025"	\$14.36
M128C14R18	1/4"	18R	.025"	\$14.36
M128C14R24	1/4"	24R	.025"	\$14.36
M128C38H3	3/8"	3H	.025"	\$15.88
M128C38H4	3/8"	4H	.025"	\$15.88
M128C38H6	3/8"	6H	.025"	\$15.88
M128C38R8	3/8"	8R	.025"	\$15.88
M128C38R10	3/8"	10R	.025"	\$15.88
M128C38R14	3/8"	14R	.025"	\$15.88
M128C38R18	3/8"	18R	.025"	\$15.88
M128C38R24	3/8"	24R	.025"	\$15.31
M128C12H3	1/2"	3H	.025"	\$17.59
M128C12H4	1/2"	4H	.025"	\$17.59
M128C12H6	1/2"	6H	.025"	\$17.59
M128C12R10	1/2"	10R	.025"	\$17.59
M128C12R14	1/2"	14R	.025"	\$17.59
M128C12R18	1/2"	18R	.025"	\$17.59
M128C12R24	1/2"	24R	.025"	\$17.59
M128C58H3	5/8"	3H	.032"	\$20.81
M128C58H4	5/8"	4H	.032"	\$20.81
M128C58R10	5/8"	10R	.032"	\$20.81
M128C58R14	5/8"	14R	.032"	\$20.81
M128C34H2	3/4"	2H	.032"	\$20.81
M128C34H3	3/4"	3H	.032"	\$20.81
M128C34H4	3/4"	4H	.032"	\$20.81
M128C34H6	3/4"	6H	.032"	\$20.81
M128C34R6	3/4"	6R	.032"	\$20.81
M128C34R10	3/4"	10R	.032"	\$20.81
M128C34R14	3/4"	14R	.032"	\$20.81
M128C34R18	3/4"	18R	.032"	\$20.81
M128C1H1.3	1"	1.3H	.035"	\$27.22
M128C1H2	1"	2H	.035"	\$27.22
M128C1H3	1"	3H	.035"	\$27.22
M128C1H4	1"	4H	.035"	\$27.22
M128C1H6	1"	6H	.035"	\$27.22
M128C1R6	1"	6R	.035"	\$27.22
M128C1R8	1"	8R	.035"	\$27.22
M128C1R10	1"	10R	.035"	\$27.22
M128C1R14	1"	14R	.035"	\$27.22
M128C114H1.3	1-1/4"	1.3H	.042"	\$34.05
M128C112H1.15	1-1/2"	1.15H	.045"	\$38.03

Carbide Impregnated Bandsaw Blade
127-7/8" (10' 7-7/8") Long



SUPER CUT™

Tool No.	Width	Tooth	Thickness	Price
B127.875G14H6	1/4"	6H	.025"	\$35.75
B127.875G38H4	3/8"	4H	.025"	\$34.07
B127.875G12H3	1/2"	3H	.025"	\$35.68

WoodSaver Resaw Bandsaw Blades
127-7/8" (10' 7-7/8") Long



SUPER CUT™

Tool No.	Width	Tooth	Thickness	Price
B127.875S58T3	5/8"	3	.025"	\$78.32
B127.875S1T3	1"	3	.025"	\$90.88

Carbide Tipped Bandsaw Blade
127-7/8" (10' 7-7/8") Long



MAGNATE

Tool No.	Width	Tooth	Thickness	Price
M127.875E12T3	1/2"	3	.025"	\$230.08
M127.875E34T3	3/4"	3	.035"	\$252.40
M127.875E1T1.3	1"	1.3	.035"	\$252.40
M127.875E1T2	1"	2	.035"	\$252.40
M127.875E1T3	1"	3	.035"	\$252.40
M127.875E1V2	1"	2-3V	.035"	\$247.80

Carbide Impregnated Bandsaw Blade
128" (10' 8") Long



SUPER CUT™

Tool No.	Width	Tooth	Thickness	Price
B128G14H6	1/4"	6H	.025"	\$35.75
B128G38H4	3/8"	4H	.025"	\$34.07
B128G12H3	1/2"	3H	.025"	\$35.68

Hawc Pro Resaw Bandsaw Blade
127-7/8" (10' 7-7/8") Long



SUPER CUT™

Tool No.	Width	Tooth	Thickness	Price
B127.875H12T3	1/2"	3	.025"	\$23.73

Carbide Tipped Bandsaw Blade
128" (10' 8") Long



MAGNATE

Tool No.	Width	Tooth	Thickness	Price
M128E12T3	1/2"	3	.025"	\$230.08
M128E34T3	3/4"	3	.035"	\$252.40
M128E1T1.3	1"	1.3	.035"	\$252.40
M128E1T2	1"	2	.035"	\$252.40
M128E1T3	1"	3	.035"	\$252.40
M128E1V2	1"	2-3V	.035"	\$247.80

MAGNATE™ 20639 Lycoming Street #B-6, Walnut, CA 91789 USA

M-59



email : info@magnate.net Online Shop : www.magnate.net
(TEL) 800-827-2316, 909-468-5747 (FAX) 909-468-5745

MAGNATE™ Band Saw Blades (Non-Food Processing)

Hawc Pro Resaw Bandsaw Blade
128" (10' 8") Long



Tool No.	Width	Tooth	Thickness	Price
B128H12T3	1/2"	3	.025"	\$23.73

Carbide Grit Bandsaw Blade
128" (10' 8") Long



MAGNATE

Tool No.	Width	Tooth	Thickness	Price
M128G12MC	1/2"	Med-Coarse	.025"	\$279.22
M128G34MC	3/4"	Med-Coarse	.032"	\$297.48
M128G1MC	1"	Med-Coarse	.035"	\$313.62

Hawc Pro Resaw Bandsaw Blade
130" (10' 10") Long



Tool No.	Width	Tooth	Thickness	Price
B130H12T3	1/2"	3	.025"	\$23.73

Bi-metal Bandsaw Blade
128" (10' 8") Long



MAGNATE

Tool No.	Width	Tooth	Thickness	Price
M128M14H6	1/4"	6H	.025"	\$55.33
M128M14V10	1/4"	10-14V	.025"	\$55.33
M128M14V14	1/4"	14-18V	.025"	\$55.33
M128M38H4	3/8"	4H	.025"	\$55.33
M128M38V10	3/8"	10-14V	.025"	\$55.33
M128M38V14	3/8"	14-18V	.025"	\$55.33
M128M12H3	1/2"	3H	.035"	\$55.33
M128M12H4	1/2"	4H	.025"	\$55.33
M128M12H6	1/2"	6H	.025"	\$55.33
M128M12V6	1/2"	6-10V	.025"	\$55.33
M128M12V8	1/2"	8-12V	.025"	\$55.33
M128M12V10	1/2"	10-14V	.025"	\$55.33
M128M12T14	1/2"	14	.025"	\$55.33
M128M12V14	1/2"	14-18V	.025"	\$55.33
M128M12T18	1/2"	18	.025"	\$55.33
M128M58V10	5/8"	10-14V	.032"	\$58.48
M128M34H3	3/4"	3H	.035"	\$58.48
M128M34V4	3/4"	4-6V	.035"	\$58.48
M128M34V5	3/4"	5-8V	.035"	\$58.48
M128M34V6	3/4"	6-10V	.035"	\$58.48
M128M34V8	3/4"	8-12V	.035"	\$58.48
M128M34V10	3/4"	10-14V	.035"	\$58.48
M128M34W14	3/4"	14W	.035"	\$58.48
M128M34W18	3/4"	18W	.035"	\$58.48
M128M1H3	1"	3H	.035"	\$67.21
M128M1V2	1"	2-3V	.035"	\$67.21
M128M1V3	1"	3-4V	.035"	\$67.21
M128M1V4	1"	4-6V	.035"	\$67.21
M128M1V5	1"	5-8V	.035"	\$67.21
M128M1V6	1"	6-10V	.035"	\$67.21
M128M1V8	1"	8-12V	.035"	\$67.21
M128M1V10	1"	10-14V	.035"	\$67.21
M128M114V2	1-1/4"	2-3V	.042"	\$80.72
M128M114V3	1-1/4"	3-4V	.042"	\$80.72
M128M114V4	1-1/4"	4-6V	.042"	\$80.72
M128M114V5	1-1/4"	5-8V	.042"	\$80.72
M128M114V6	1-1/4"	6-10V	.042"	\$80.72
M128M114V8	1-1/4"	8-12V	.042"	\$80.72

WoodSaver Plus Resaw Bandsaw Blades
128" (10' 8") Long





Tool No.	Width	Tooth	Thickness	Price
B128P58V3	5/8"	3-4V	.025"	\$91.65

WoodSaver Resaw Bandsaw Blades
128" (10' 8") Long



Tool No.	Width	Tooth	Thickness	Price
B128S58T3	5/8"	3	.025"	\$78.32
B128S1T3	1"	3	.025"	\$90.88

Carbide Impregnated Bandsaw Blade
130" (10' 10") Long

Tool No.	Width	Tooth	Thickness	Price
B130G14H6	1/4"	6H	.025"	\$35.75
B130G38H4	3/8"	4H	.025"	\$34.07
B130G12H3	1/2"	3H	.025"	\$35.68

Bi-metal Bandsaw Blade
130" (10' 10") Long



MAGNATE

Tool No.	Width	Tooth	Thickness	Price
M130M14H6	1/4"	6H	.025"	\$55.33
M130M14V10	1/4"	10-14V	.025"	\$55.33
M130M14V14	1/4"	14-18V	.025"	\$55.33
M130M38H4	3/8"	4H	.025"	\$55.33
M130M38V10	3/8"	10-14V	.025"	\$55.33
M130M38V14	3/8"	14-18V	.025"	\$55.33
M130M12H3	1/2"	3H	.035"	\$55.33
M130M12H4	1/2"	4H	.025"	\$55.33
M130M12H6	1/2"	6H	.025"	\$55.33
M130M12V6	1/2"	6-10V	.025"	\$55.33
M130M12V8	1/2"	8-12V	.025"	\$55.33
M130M12V10	1/2"	10-14V	.025"	\$55.33
M130M12T14	1/2"	14	.025"	\$55.33
M130M12V14	1/2"	14-18V	.025"	\$55.33
M130M12T18	1/2"	18	.025"	\$55.33
M130M58V10	5/8"	10-14V	.032"	\$58.48
M130M34H3	3/4"	3H	.035"	\$58.48
M130M34V4	3/4"	4-6V	.035"	\$58.48
M130M34V5	3/4"	5-8V	.035"	\$58.48
M130M34V6	3/4"	6-10V	.035"	\$58.48
M130M34V8	3/4"	8-12V	.035"	\$58.48
M130M34V10	3/4"	10-14V	.035"	\$58.48
M130M34W14	3/4"	14W	.035"	\$58.48
M130M34W18	3/4"	18W	.035"	\$58.48
M130M1V2	1"	2-3V	.035"	\$67.21
M130M1H3	1"	3H	.035"	\$67.21
M130M1V3	1"	3-4V	.035"	\$67.21
M130M1V4	1"	4-6V	.035"	\$67.21
M130M1V5	1"	5-8V	.035"	\$67.21
M130M1V6	1"	6-10V	.035"	\$67.21
M130M1V8	1"	8-12V	.035"	\$67.21
M130M1V10	1"	10-14V	.035"	\$67.21
M130M114V2	1-1/4"	2-3V	.042"	\$80.72
M130M114V3	1-1/4"	3-4V	.042"	\$80.72
M130M114V4	1-1/4"	4-6V	.042"	\$80.72
M130M114V5	1-1/4"	5-8V	.042"	\$80.72
M130M114V6	1-1/4"	6-10V	.042"	\$80.72
M130M114V8	1-1/4"	8-12V	.042"	\$80.72

MAGNATE™ 20639 Lycoming Street #B-6, Walnut, CA 91789 USA

M-60



email : info@magnate.net Online Shop : www.magnate.net
(TEL) 800-827-2316, 909-468-5747 (FAX) 909-468-5745

MAGNATE™ Band Saw Blades (Non-Food Processing)

Carbon Steel Bandsaw Blade 130" (10' 10") Long



Tool No.	Width	Tooth	Thickness	Price
M130C18R14	1/8"	14R	.025"	\$20.00
M130C18R18	1/8"	18R	.025"	\$20.00
M130C316S4	3/16"	4S	.025"	\$17.40
M130C316S6	3/16"	6S	.025"	\$17.59
M130C316R10	3/16"	10R	.025"	\$17.40
M130C316R24	3/16"	24R	.025"	\$22.95
M130C316R18	3/16"	18R	.025"	\$22.95
M130C316R14	3/16"	14R	.025"	\$17.40
M130C14H4	1/4"	4H	.025"	\$14.36
M130C14H6	1/4"	6H	.025"	\$14.36
M130C14R10	1/4"	10R	.025"	\$14.36
M130C14R14	1/4"	14R	.025"	\$14.36
M130C14R18	1/4"	18R	.025"	\$14.36
M130C14R24	1/4"	24R	.025"	\$14.36
M130C38H3	3/8"	3H	.025"	\$15.88
M130C38H4	3/8"	4H	.025"	\$15.88
M130C38H6	3/8"	6H	.025"	\$15.88
M130C38R8	3/8"	8R	.025"	\$15.88
M130C38R10	3/8"	10R	.025"	\$15.88
M130C38R14	3/8"	14R	.025"	\$15.88
M130C38R18	3/8"	18R	.025"	\$15.88
M130C38R24	3/8"	24R	.025"	\$15.31
M130C12H3	1/2"	3H	.025"	\$17.59
M130C12H4	1/2"	4H	.025"	\$17.59
M130C12H6	1/2"	6H	.025"	\$17.59
M130C12R10	1/2"	10R	.025"	\$17.59
M130C12R14	1/2"	14R	.025"	\$17.59
M130C12R18	1/2"	18R	.025"	\$17.59
M130C12R24	1/2"	24R	.025"	\$17.59
M130C58H3	5/8"	3H	.032"	\$20.81
M130C58H4	5/8"	4H	.032"	\$20.81
M130C58R10	5/8"	10R	.032"	\$20.81
M130C58R14	5/8"	14R	.032"	\$20.81
M130C34H2	3/4"	2H	.032"	\$20.81
M130C34H3	3/4"	3H	.032"	\$20.81
M130C34H4	3/4"	4H	.032"	\$20.81
M130C34H6	3/4"	6H	.032"	\$20.81
M130C34R6	3/4"	6R	.032"	\$20.81
M130C34R10	3/4"	10R	.032"	\$20.81
M130C34R14	3/4"	14R	.032"	\$20.81
M130C34R18	3/4"	18R	.032"	\$20.81
M130C1H1.3	1"	1.3H	.035"	\$27.22
M130C1H2	1"	2H	.035"	\$27.22
M130C1H3	1"	3H	.035"	\$27.22
M130C1H4	1"	4H	.035"	\$27.22
M130C1H6	1"	6H	.035"	\$27.22
M130C1R6	1"	6R	.035"	\$27.22
M130C1R8	1"	8R	.035"	\$27.22
M130C1R10	1"	10R	.035"	\$27.22
M130C1R14	1"	14R	.035"	\$27.22
M130C114H1.3	1-1/4"	1.3H	.042"	\$34.05
M130C112H1.15	1-1/2"	1.15H	.045"	\$38.03

Carbide Tipped Bandsaw Blade 130" (10' 10") Long



Tool No.	Width	Tooth	Thickness	Price
M130E12T3	1/2"	3	.025"	\$230.08
M130E34T3	3/4"	3	.035"	\$252.40
M130E1T1.3	1"	1.3	.035"	\$252.40
M130E1T2	1"	2	.035"	\$252.40
M130E1T3	1"	3	.035"	\$252.40
M130E1V2	1"	2-3V	.035"	\$247.80

Carbide Grit Bandsaw Blade 130" (10' 10") Long



Tool No.	Width	Tooth	Thickness	Price
M130G12MC	1/2"	Med-Coarse	.025"	\$279.22
M130G34MC	3/4"	Med-Coarse	.032"	\$297.48
M130G1MC	1"	Med-Coarse	.035"	\$313.62

WoodSaver Plus Resaw Bandsaw Blades 130" (10' 10") Long



Tool No.	Width	Tooth	Kerf	Price
B130P58V3	5/8"	3-4V	.025"	\$91.65

WoodSaver Resaw Bandsaw Blades 130" (10' 10") Long



Tool No.	Width	Tooth	Thickness	Price
B130S58T3	5/8"	3	.025"	\$78.32
B130S1T3	1"	3	.025"	\$90.88

Carbon Steel Bandsaw Blade 130-1/2" (10' 10-1/2") Long



Tool No.	Width	Tooth	Thickness	Price
M130.5C18R14	1/8"	14R	.025"	\$20.00
M130.5C18R18	1/8"	18R	.025"	\$20.00
M130.5C316S4	3/16"	4S	.025"	\$17.40
M130.5C316S6	3/16"	6S	.025"	\$17.59
M130.5C316R10	3/16"	10R	.025"	\$17.40
M130.5C316R14	3/16"	14R	.025"	\$17.40
M130.5C316R18	3/16"	18R	.025"	\$17.40
M130.5C316R24	3/16"	24R	.025"	\$17.40
M130.5C14H4	1/4"	4H	.025"	\$14.36
M130.5C14H6	1/4"	6H	.025"	\$14.36
M130.5C14R10	1/4"	10R	.025"	\$14.36
M130.5C14R14	1/4"	14R	.025"	\$14.36
M130.5C14R18	1/4"	18R	.025"	\$14.36
M130.5C14R24	1/4"	24R	.025"	\$14.36
M130.5C38H3	3/8"	3H	.025"	\$15.88
M130.5C38H4	3/8"	4H	.025"	\$15.88
M130.5C38H6	3/8"	6H	.025"	\$15.88
M130.5C38R8	3/8"	8R	.025"	\$15.88
M130.5C38R10	3/8"	10R	.025"	\$15.88
M130.5C38R14	3/8"	14R	.025"	\$15.88
M130.5C38R18	3/8"	18R	.025"	\$15.88
M130.5C38R24	3/8"	24R	.025"	\$15.31
M130.5C12H3	1/2"	3H	.025"	\$17.59
M130.5C12H4	1/2"	4H	.025"	\$17.59
M130.5C12H6	1/2"	6H	.025"	\$17.59
M130.5C12R10	1/2"	10R	.025"	\$17.59
M130.5C12R14	1/2"	14R	.025"	\$17.59
M130.5C12R18	1/2"	18R	.025"	\$17.59
M130.5C12R24	1/2"	24R	.025"	\$17.59
M130.5C58H3	5/8"	3H	.032"	\$20.81
M130.5C58H4	5/8"	4H	.032"	\$20.81
M130.5C58R10	5/8"	10R	.032"	\$20.81
M130.5C58R14	5/8"	14R	.032"	\$20.81
M130.5C34H2	3/4"	2H	.032"	\$20.81
M130.5C34H3	3/4"	3H	.032"	\$20.81
M130.5C34H4	3/4"	4H	.032"	\$20.81
M130.5C34H6	3/4"	6H	.032"	\$20.81
M130.5C34R6	3/4"	6R	.032"	\$20.81
M130.5C34R10	3/4"	10R	.032"	\$20.81
M130.5C34R14	3/4"	14R	.032"	\$20.81
M130.5C34R18	3/4"	18R	.032"	\$20.81
M130.5C1H1.3	1"	1.3H	.035"	\$27.22
M130.5C1H2	1"	2H	.035"	\$27.22
M130.5C1H3	1"	3H	.035"	\$27.22
M130.5C1H4	1"	4H	.035"	\$27.22
M130.5C1H6	1"	6H	.035"	\$27.22
M130.5C1R6	1"	6R	.035"	\$27.22
M130.5C1R8	1"	8R	.035"	\$27.22
M130.5C1R10	1"	10R	.035"	\$27.22
M130.5C1R14	1"	14R	.035"	\$27.22
M130.5C114H1.3	1-1/4"	1.3H	.042"	\$34.05
M130.5C112H1.15	1-1/2"	1.15H	.045"	\$38.03

MAGNATE™ 20639 Lycoming Street #B-6, Walnut, CA 91789 USA

M-61



email : info@magnate.net Online Shop : www.magnate.net
(TEL) 800-827-2316, 909-468-5747 (FAX) 909-468-5745

MAGNATE™ Band Saw Blades (Non-Food Processing)

Bi-metal Bandsaw Blade 130-1/2" (10' 10-1/2") Long



Tool No.	Width	Tooth	Thickness	Price
M130.5M14H6	1/4"	6H	.025"	\$55.33
M130.5M14V10	1/4"	10-14V	.025"	\$55.33
M130.5M14V14	1/4"	14-18V	.025"	\$55.33
M130.5M38H4	3/8"	4H	.025"	\$55.33
M130.5M38V10	3/8"	10-14V	.025"	\$55.33
M130.5M38V14	3/8"	14-18V	.025"	\$55.33
M130.5M12H3	1/2"	3H	.035"	\$55.33
M130.5M12H4	1/2"	4H	.025"	\$55.33
M130.5M12H6	1/2"	6H	.025"	\$55.33
M130.5M12V6	1/2"	6-10V	.025"	\$55.33
M130.5M12V8	1/2"	8-12V	.025"	\$55.33
M130.5M12V10	1/2"	10-14V	.025"	\$55.33
M130.5M12T14	1/2"	14	.025"	\$55.33
M130.5M12V14	1/2"	14-18V	.025"	\$55.33
M130.5M12T18	1/2"	18	.025"	\$55.33
M130.5M58V10	5/8"	10-14V	.032"	\$58.48
M130.5M34H3	3/4"	3H	.035"	\$58.48
M130.5M34V4	3/4"	4-6V	.035"	\$58.48
M130.5M34V5	3/4"	5-8V	.035"	\$58.48
M130.5M34V6	3/4"	6-10V	.035"	\$58.48
M130.5M34V8	3/4"	8-12V	.035"	\$58.48
M130.5M34V10	3/4"	10-14V	.035"	\$58.48
M130.5M34W14	3/4"	14W	.035"	\$58.48
M130.5M34W18	3/4"	18W	.035"	\$58.48
M130.5M1V2	1"	2-3V	.035"	\$67.21
M130.5M1H3	1"	3H	.035"	\$67.21
M130.5M1V3	1"	3-4V	.035"	\$67.21
M130.5M1V4	1"	4-6V	.035"	\$67.21
M130.5M1V5	1"	5-8V	.035"	\$67.21
M130.5M1V6	1"	6-10V	.035"	\$67.21
M130.5M1V8	1"	8-12V	.035"	\$67.21
M130.5M1V10	1"	10-14V	.035"	\$67.21
M130.5M114V2	1-1/4"	2-3V	.042"	\$80.72
M130.5M114V3	1-1/4"	3-4V	.042"	\$80.72
M130.5M114V4	1-1/4"	4-6V	.042"	\$80.72
M130.5M114V5	1-1/4"	5-8V	.042"	\$80.72
M130.5M114V6	1-1/4"	6-10V	.042"	\$80.72
M130.5M114V8	1-1/4"	8-12V	.042"	\$80.72

Carbide Grit Bandsaw Blade 130-1/2" (10' 10-1/2") Long



Tool No.	Width	Tooth	Thickness	Price
M130.5G12MC	1/2"	Med-Coarse	.025"	\$279.22
M130.5G34MC	3/4"	Med-Coarse	.032"	\$297.48
M130.5G1MC	1"	Med-Coarse	.035"	\$313.62

Carbide Tipped Bandsaw Blade 130-1/2" (10' 10-1/2") Long



Tool No.	Width	Tooth	Thickness	Price
M130.5E12T3	1/2"	3	.025"	\$230.08
M130.5E34T3	3/4"	3	.035"	\$252.40
M130.5E1T1.3	1"	1.3	.035"	\$252.40
M130.5E1T2	1"	2	.035"	\$252.40
M130.5E1T3	1"	3	.035"	\$252.40
M130.5E1V2	1"	2-3V	.035"	\$247.80

Carbide Grit Bandsaw Blade 131" (10' 11") Long



Tool No.	Width	Tooth	Thickness	Price
M131G12MC	1/2"	Med-Coarse	.025"	\$279.22
M131G34MC	3/4"	Med-Coarse	.032"	\$297.48
M131G1MC	1"	Med-Coarse	.035"	\$313.62

Carbide Tipped Bandsaw Blade 131" (10' 11") Long



Tool No.	Width	Tooth	Thickness	Price
M131E12T3	1/2"	3	.025"	\$230.08
M131E34T3	3/4"	3	.035"	\$252.40
M131E1T1.3	1"	1.3	.035"	\$252.40
M131E1T2	1"	2	.035"	\$252.40
M131E1T3	1"	3	.035"	\$252.40
M131E1V2	1"	2-3V	.035"	\$247.80

Bi-metal Bandsaw Blade 131" (10' 11") Long



Tool No.	Width	Tooth	Thickness	Price
M131M14H6	1/4"	6H	.025"	\$55.33
M131M14V10	1/4"	10-14V	.025"	\$55.33
M131M14V14	1/4"	14-18V	.025"	\$55.33
M131M38H4	3/8"	4H	.025"	\$55.33
M131M38V10	3/8"	10-14V	.025"	\$55.33
M131M38V14	3/8"	14-18V	.025"	\$55.33
M131M12H3	1/2"	3H	.035"	\$55.33
M131M12H4	1/2"	4H	.025"	\$55.33
M131M12H6	1/2"	6H	.025"	\$55.33
M131M12V6	1/2"	6-10V	.025"	\$55.33
M131M12V8	1/2"	8-12V	.025"	\$55.33
M131M12V10	1/2"	10-14V	.025"	\$55.33
M131M12T14	1/2"	14	.025"	\$55.33
M131M12V14	1/2"	14-18V	.025"	\$55.33
M131M12T18	1/2"	18	.025"	\$55.33
M131M58V10	5/8"	10-14V	.032"	\$58.48
M131M34H3	3/4"	3H	.035"	\$58.48
M131M34V4	3/4"	4-6V	.035"	\$58.48
M131M34V5	3/4"	5-8V	.035"	\$58.48
M131M34V6	3/4"	6-10V	.035"	\$58.48
M131M34V8	3/4"	8-12V	.035"	\$58.48
M131M34V10	3/4"	10-14V	.035"	\$58.48
M131M34W14	3/4"	14W	.035"	\$58.48
M131M34W18	3/4"	18W	.035"	\$58.48
M131M1V2	1"	2-3V	.035"	\$67.21
M131M1H3	1"	3H	.035"	\$67.21
M131M1V3	1"	3-4V	.035"	\$67.21
M131M1V4	1"	4-6V	.035"	\$67.21
M131M1V5	1"	5-8V	.035"	\$67.21
M131M1V6	1"	6-10V	.035"	\$67.21
M131M1V8	1"	8-12V	.035"	\$67.21
M131M1V10	1"	10-14V	.035"	\$67.21
M131M114V2	1-1/4"	2-3V	.042"	\$80.72
M131M114V3	1-1/4"	3-4V	.042"	\$80.72
M131M114V4	1-1/4"	4-6V	.042"	\$80.72
M131M114V5	1-1/4"	5-8V	.042"	\$80.72
M131M114V6	1-1/4"	6-10V	.042"	\$80.72
M131M114V8	1-1/4"	8-12V	.042"	\$80.72





MAGNATE™ Band Saw Blades (Non-Food Processing)

Carbon Steel Bandsaw Blade 131" (10' 11") Long				
 MAGNATE				
Tool No.	Width	Tooth	Thickness	Price
M131C18R14	1/8"	14R	.025"	\$20.00
M131C18R18	1/8"	18R	.025"	\$20.00
M131C316S4	3/16"	4S	.025"	\$17.40
M131C316S6	3/16"	6S	.025"	\$17.59
M131C316R10	3/16"	10R	.025"	\$17.40
M131C316R14	3/16"	14R	.025"	\$17.40
M131C316R18	3/16"	18R	.025"	\$17.40
M131C316R24	3/16"	24R	.025"	\$17.40
M131C14H4	1/4"	4H	.025"	\$14.36
M131C14H6	1/4"	6H	.025"	\$14.36
M131C14R10	1/4"	10R	.025"	\$14.36
M131C14R14	1/4"	14R	.025"	\$14.36
M131C14R18	1/4"	18R	.025"	\$14.36
M131C14R24	1/4"	24R	.025"	\$14.36
M131C38H3	3/8"	3H	.025"	\$15.88
M131C38H4	3/8"	4H	.025"	\$15.88
M131C38H6	3/8"	6H	.025"	\$15.88
M131C38R8	3/8"	8R	.025"	\$15.88
M131C38R10	3/8"	10R	.025"	\$15.88
M131C38R14	3/8"	14R	.025"	\$15.88
M131C38R18	3/8"	18R	.025"	\$15.88
M131C38R24	3/8"	24R	.025"	\$15.31
M131C12H3	1/2"	3H	.025"	\$17.59
M131C12H4	1/2"	4H	.025"	\$17.59
M131C12H6	1/2"	6H	.025"	\$17.59
M131C12R10	1/2"	10R	.025"	\$17.59
M131C12R14	1/2"	14R	.025"	\$17.59
M131C12R18	1/2"	18R	.025"	\$17.59
M131C12R24	1/2"	24R	.025"	\$17.59
M131C58H3	5/8"	3H	.032"	\$20.81
M131C58H4	5/8"	4H	.032"	\$20.81
M131C58R10	5/8"	10R	.032"	\$20.81
M131C58R14	5/8"	14R	.032"	\$20.81
M131C34H2	3/4"	2H	.032"	\$20.81
M131C34H3	3/4"	3H	.032"	\$20.81
M131C34H4	3/4"	4H	.032"	\$20.81
M131C34H6	3/4"	6H	.032"	\$20.81
M131C34R6	3/4"	6R	.032"	\$20.81
M131C34R10	3/4"	10R	.032"	\$20.81
M131C34R14	3/4"	14R	.032"	\$20.81
M131C34R18	3/4"	18R	.032"	\$20.81
M131C1H1.3	1"	1.3H	.035"	\$27.22
M131C1H2	1"	2H	.035"	\$27.22
M131C1H3	1"	3H	.035"	\$27.22
M131C1H4	1"	4H	.035"	\$27.22
M131C1H6	1"	6H	.035"	\$27.22
M131C1R6	1"	6R	.035"	\$27.22
M131C1R8	1"	8R	.035"	\$27.22
M131C1R10	1"	10R	.035"	\$27.22
M131C1R14	1"	14R	.035"	\$27.22
M131C114H1.3	1-1/4"	1.3H	.042"	\$34.05
M131C112H1.15	1-1/2"	1.15H	.045"	\$38.03

Bi-metal Bandsaw Blade 131-1/2" (10' 11-1/2") Long				
 MAGNATE				
Tool No.	Width	Tooth	Thickness	Price
M131.5M14H6	1/4"	6H	.025"	\$55.33
M131.5M14V10	1/4"	10-14V	.025"	\$55.33
M131.5M14V14	1/4"	14-18V	.025"	\$55.33
M131.5M38H4	3/8"	4H	.025"	\$55.33
M131.5M38V10	3/8"	10-14V	.025"	\$55.33
M131.5M38V14	3/8"	14-18V	.025"	\$55.33
M131.5M12H3	1/2"	3H	.035"	\$55.33
M131.5M12H4	1/2"	4H	.025"	\$55.33
M131.5M12H6	1/2"	6H	.025"	\$55.33
M131.5M12V6	1/2"	6-10V	.025"	\$55.33
M131.5M12V8	1/2"	8-12V	.025"	\$55.33
M131.5M12V10	1/2"	10-14V	.025"	\$55.33
M131.5M12T14	1/2"	14	.025"	\$55.33
M131.5M12V14	1/2"	14-18V	.025"	\$55.33
M131.5M12T18	1/2"	18	.025"	\$55.33
M131.5M58V10	5/8"	10-14V	.032"	\$58.48
M131.5M34H3	3/4"	3H	.035"	\$58.48
M131.5M34V4	3/4"	4-6V	.035"	\$58.48
M131.5M34V5	3/4"	5-8V	.035"	\$58.48
M131.5M34V6	3/4"	6-10V	.035"	\$58.48
M131.5M34V8	3/4"	8-12V	.035"	\$58.48
M131.5M34V10	3/4"	10-14V	.035"	\$58.48
M131.5M34W14	3/4"	14W	.035"	\$58.48
M131.5M34W18	3/4"	18W	.035"	\$58.48
M131.5M1V2	1"	2-3V	.035"	\$67.21
M131.5M1H3	1"	3H	.035"	\$67.21
M131.5M1V3	1"	3-4V	.035"	\$67.21
M131.5M1V4	1"	4-6V	.035"	\$67.21
M131.5M1V5	1"	5-8V	.035"	\$67.21
M131.5M1V6	1"	6-10V	.035"	\$67.21
M131.5M1V8	1"	8-12V	.035"	\$67.21
M131.5M1V10	1"	10-14V	.035"	\$67.21
M131.5M114V2	1-1/4"	2-3V	.042"	\$80.72
M131.5M114V3	1-1/4"	3-4V	.042"	\$80.72
M131.5M114V4	1-1/4"	4-6V	.042"	\$80.72
M131.5M114V5	1-1/4"	5-8V	.042"	\$80.72
M131.5M114V6	1-1/4"	6-10V	.042"	\$80.72
M131.5M114V8	1-1/4"	8-12V	.042"	\$80.72

Carbide Grit Bandsaw Blade 131-1/2" (10' 11-1/2") Long				
 MAGNATE				
Tool No.	Width	Tooth	Thickness	Price
M131.5G12MC	1/2"	Med-Coarse	.025"	\$279.22
M131.5G34MC	3/4"	Med-Coarse	.032"	\$297.48
M131.5G1MC	1"	Med-Coarse	.035"	\$313.62

Carbide Impregnated Bandsaw Blade 131-1/2" (10' 11-1/2") Long				
 SUPER CUT™				
Tool No.	Width	Tooth	Thickness	Price
B131.5G14H6	1/4"	6H	.025"	\$35.75
B131.5G38H4	3/8"	4H	.025"	\$34.07
B131.5G12H3	1/2"	3H	.025"	\$35.68

Carbide Tipped Bandsaw Blade 131-1/2" (10' 11-1/2") Long				
 MAGNATE				
Tool No.	Width	Tooth	Thickness	Price
M131.5E12T3	1/2"	3	.025"	\$230.08
M131.5E34T3	3/4"	3	.035"	\$252.40
M131.5E1T1.3	1"	1.3	.035"	\$252.40
M131.5E1T2	1"	2	.035"	\$252.40
M131.5E1T3	1"	3	.035"	\$252.40
M131.5E1V2	1"	2-3V	.035"	\$247.80

MAGNATE™ 20639 Lycoming Street #B-6, Walnut, CA 91789 USA

M-63



email : info@magnate.net Online Shop : www.magnate.net
(TEL) 800-827-2316, 909-468-5747 (FAX) 909-468-5745

MAGNATE™ Band Saw Blades (Non-Food Processing)

Carbon Steel Bandsaw Blade 131-1/2" (10' 11-1/2") Long



Tool No.	Width	Tooth	Thickness	Price
M131.5C18R14	1/8"	14R	.025"	\$20.00
M131.5C18R18	1/8"	18R	.025"	\$20.00
M131.5C316S4	3/16"	4S	.025"	\$17.40
M131.5C316S6	3/16"	6S	.025"	\$17.59
M131.5C316R10	3/16"	10R	.025"	\$17.40
M131.5C316R14	3/16"	14R	.025"	\$17.40
M131.5C316R18	3/16"	18R	.025"	\$17.40
M131.5C316R24	3/16"	24R	.025"	\$17.40
M131.5C14H4	1/4"	4H	.025"	\$14.36
M131.5C14H6	1/4"	6H	.025"	\$14.36
M131.5C14R10	1/4"	10R	.025"	\$14.36
M131.5C14R14	1/4"	14R	.025"	\$14.36
M131.5C14R18	1/4"	18R	.025"	\$14.36
M131.5C14R24	1/4"	24R	.025"	\$14.36
M131.5C38H3	3/8"	3H	.025"	\$15.88
M131.5C38H4	3/8"	4H	.025"	\$15.88
M131.5C38H6	3/8"	6H	.025"	\$15.88
M131.5C38R8	3/8"	8R	.025"	\$15.88
M131.5C38R10	3/8"	10R	.025"	\$15.88
M131.5C38R14	3/8"	14R	.025"	\$15.88
M131.5C38R18	3/8"	18R	.025"	\$15.88
M131.5C38R24	3/8"	24R	.025"	\$15.31
M131.5C12H3	1/2"	3H	.025"	\$17.59
M131.5C12H4	1/2"	4H	.025"	\$17.59
M131.5C12H6	1/2"	6H	.025"	\$17.59
M131.5C12R10	1/2"	10R	.025"	\$17.59
M131.5C12R14	1/2"	14R	.025"	\$17.59
M131.5C12R18	1/2"	18R	.025"	\$17.59
M131.5C12R24	1/2"	24R	.025"	\$17.59
M131.5C58H3	5/8"	3H	.032"	\$20.81
M131.5C58H4	5/8"	4H	.032"	\$20.81
M131.5C58R10	5/8"	10R	.032"	\$20.81
M131.5C58R14	5/8"	14R	.032"	\$20.81
M131.5C34H2	3/4"	2H	.032"	\$20.81
M131.5C34H3	3/4"	3H	.032"	\$20.81
M131.5C34H4	3/4"	4H	.032"	\$20.81
M131.5C34H6	3/4"	6H	.032"	\$20.81
M131.5C34R6	3/4"	6R	.032"	\$20.81
M131.5C34R10	3/4"	10R	.032"	\$20.81
M131.5C34R14	3/4"	14R	.032"	\$20.81
M131.5C34R18	3/4"	18R	.032"	\$20.81
M131.5C1H1.3	1"	1.3H	.035"	\$27.22
M131.5C1H2	1"	2H	.035"	\$27.22
M131.5C1H3	1"	3H	.035"	\$27.22
M131.5C1H4	1"	4H	.035"	\$27.22
M131.5C1H6	1"	6H	.035"	\$27.22
M131.5C1R6	1"	6R	.035"	\$27.22
M131.5C1R8	1"	8R	.035"	\$27.22
M131.5C1R10	1"	10R	.035"	\$27.22
M131.5C1R14	1"	14R	.035"	\$27.22
M131.5C114H1.3	1-1/4"	1.3H	.042"	\$34.05
M131.5C112H1.15	1-1/2"	1.15H	.045"	\$38.03

Hawc Pro Resaw Bandsaw Blade 131-1/2" (10' 11-1/2") Long



Tool No.	Width	Tooth	Thickness	Price
B131.5H12T3	1/2"	3	.025"	\$23.73

WoodSaver Plus Resaw Bandsaw Blades 131-1/2" (10' 11-1/2") Long



Tool No.	Width	Tooth	Thickness	Price
B131.5P58V3	5/8"	3-4V	.025"	\$91.65

WoodSaver Resaw Bandsaw Blades 131-1/2" (10' 11-1/2") Long



Tool No.	Width	Tooth	Thickness	Price
B131.5S58T3	5/8"	3	.025"	\$78.32
B131.5S1T3	1"	3	.025"	\$90.88

Carbide Grit Bandsaw Blade 132" (11') Long



Tool No.	Width	Tooth	Thickness	Price
M132G12MC	1/2"	Med-Coarse	.025"	\$279.22
M132G34MC	3/4"	Med-Coarse	.032"	\$297.48
M132G1MC	1"	Med-Coarse	.035"	\$313.62

Bi-metal Bandsaw Blade 132" (11') Long



Tool No.	Width	Tooth	Thickness	Price
M132M14H6	1/4"	6H	.025"	\$55.33
M132M14V10	1/4"	10-14V	.025"	\$55.33
M132M14V14	1/4"	14-18V	.025"	\$55.33
M132M38H4	3/8"	4H	.025"	\$55.33
M132M38V10	3/8"	10-14V	.025"	\$55.33
M132M38V14	3/8"	14-18V	.025"	\$55.33
M132M12H3	1/2"	3H	.035"	\$55.33
M132M12H4	1/2"	4H	.025"	\$55.33
M132M12H6	1/2"	6H	.025"	\$55.33
M132M12V6	1/2"	6-10V	.025"	\$55.33
M132M12V8	1/2"	8-12V	.025"	\$55.33
M132M12V10	1/2"	10-14V	.025"	\$55.33
M132M12T14	1/2"	14	.025"	\$55.33
M132M12V14	1/2"	14-18V	.025"	\$55.33
M132M12T18	1/2"	18	.025"	\$55.33
M132M58V10	5/8"	10-14V	.032"	\$58.48
M132M34H3	3/4"	3H	.035"	\$58.48
M132M34V4	3/4"	4-6V	.035"	\$58.48
M132M34V5	3/4"	5-8V	.035"	\$58.48
M132M34V6	3/4"	6-10V	.035"	\$58.48
M132M34V8	3/4"	8-12V	.035"	\$58.48
M132M34V10	3/4"	10-14V	.035"	\$58.48
M132M34W14	3/4"	14W	.035"	\$58.48
M132M34W18	3/4"	18W	.035"	\$58.48
M132M1V2	1"	2-3V	.035"	\$67.21
M132M1H3	1"	3H	.035"	\$67.21
M132M1V3	1"	3-4V	.035"	\$67.21
M132M1V4	1"	4-6V	.035"	\$67.21
M132M1V5	1"	5-8V	.035"	\$67.21
M132M1V6	1"	6-10V	.035"	\$67.21
M132M1V8	1"	8-12V	.035"	\$67.21
M132M1V10	1"	10-14V	.035"	\$67.21
M132M114V2	1-1/4"	2-3V	.042"	\$80.72
M132M114V3	1-1/4"	3-4V	.042"	\$80.72
M132M114V4	1-1/4"	4-6V	.042"	\$80.72
M132M114V5	1-1/4"	5-8V	.042"	\$80.72
M132M114V6	1-1/4"	6-10V	.042"	\$80.72
M132M114V8	1-1/4"	8-12V	.042"	\$80.72

MAGNATE™ 20639 Lycoming Street #B-6, Walnut, CA 91789 USA

M-64



email : info@magnate.net Online Shop : www.magnate.net
(TEL) 800-827-2316, 909-468-5747 (FAX) 909-468-5745

MAGNATE™ Band Saw Blades (Non-Food Processing)

Carbon Steel Bandsaw Blade 132" (11') Long				
 MAGNATE				
Tool No.	Width	Tooth	Thickness	Price
M132C18R14	1/8"	14R	.025"	\$20.00
M132C18R18	1/8"	18R	.025"	\$20.00
M132C316S4	3/16"	4S	.025"	\$17.40
M132C316S6	3/16"	6S	.025"	\$17.59
M132C316R10	3/16"	10R	.025"	\$17.40
M132C316R14	3/16"	14R	.025"	\$17.40
M132C316R18	3/16"	18R	.025"	\$17.40
M132C316R24	3/16"	24R	.025"	\$17.40
M132C14H4	1/4"	4H	.025"	\$14.36
M132C14H6	1/4"	6H	.025"	\$14.36
M132C14R10	1/4"	10R	.025"	\$14.36
M132C14R14	1/4"	14R	.025"	\$14.36
M132C14R18	1/4"	18R	.025"	\$14.36
M132C14R24	1/4"	24R	.025"	\$14.36
M132C38H3	3/8"	3H	.025"	\$15.88
M132C38H4	3/8"	4H	.025"	\$15.88
M132C38H6	3/8"	6H	.025"	\$15.88
M132C38R8	3/8"	8R	.025"	\$15.88
M132C38R10	3/8"	10R	.025"	\$15.88
M132C38R14	3/8"	14R	.025"	\$15.88
M132C38R18	3/8"	18R	.025"	\$15.88
M132C38R24	3/8"	24R	.025"	\$15.31
M132C12H3	1/2"	3H	.025"	\$17.59
M132C12H4	1/2"	4H	.025"	\$17.59
M132C12H6	1/2"	6H	.025"	\$17.59
M132C12R10	1/2"	10R	.025"	\$17.59
M132C12R14	1/2"	14R	.025"	\$17.59
M132C12R18	1/2"	18R	.025"	\$17.59
M132C12R24	1/2"	24R	.025"	\$17.59
M132C58H3	5/8"	3H	.032"	\$20.81
M132C58H4	5/8"	4H	.032"	\$20.81
M132C58R10	5/8"	10R	.032"	\$20.81
M132C58R14	5/8"	14R	.032"	\$20.81
M132C34H2	3/4"	2H	.032"	\$20.81
M132C34H3	3/4"	3H	.032"	\$20.81
M132C34H4	3/4"	4H	.032"	\$20.81
M132C34H6	3/4"	6H	.032"	\$20.81
M132C34R6	3/4"	6R	.032"	\$20.81
M132C34R10	3/4"	10R	.032"	\$20.81
M132C34R14	3/4"	14R	.032"	\$20.81
M132C34R18	3/4"	18R	.032"	\$20.81
M132C1H1.3	1"	1.3H	.035"	\$27.22
M132C1H2	1"	2H	.035"	\$27.22
M132C1H3	1"	3H	.035"	\$27.22
M132C1H4	1"	4H	.035"	\$27.22
M132C1H6	1"	6H	.035"	\$27.22
M132C1R6	1"	6R	.035"	\$27.22
M132C1R8	1"	8R	.035"	\$27.22
M132C1R10	1"	10R	.035"	\$27.22
M132C1R14	1"	14R	.035"	\$27.22
M132C114H1.3	1-1/4"	1.3H	.042"	\$34.05
M132C112H1.15	1-1/2"	1.15H	.045"	\$38.03

Bi-metal Bandsaw Blade 133" (11' 1") Long				
 MAGNATE				
Tool No.	Width	Tooth	Thickness	Price
M133M14H6	1/4"	6H	.025"	\$57.45
M133M14V10	1/4"	10-14V	.025"	\$57.45
M133M14V14	1/4"	14-18V	.025"	\$57.45
M133M38H4	3/8"	4H	.025"	\$57.45
M133M38V10	3/8"	10-14V	.025"	\$57.45
M133M38V14	3/8"	14-18V	.025"	\$57.45
M133M12H3	1/2"	3H	.035"	\$57.45
M133M12H4	1/2"	4H	.025"	\$57.45
M133M12H6	1/2"	6H	.025"	\$57.45
M133M12V6	1/2"	6-10V	.025"	\$57.45
M133M12V8	1/2"	8-12V	.025"	\$57.45
M133M12V10	1/2"	10-14V	.025"	\$57.45
M133M12T14	1/2"	14	.025"	\$57.45
M133M12V14	1/2"	14-18V	.025"	\$57.45
M133M12T18	1/2"	18	.025"	\$57.45
M133M58V10	5/8"	10-14V	.032"	\$60.71
M133M34H3	3/4"	3H	.035"	\$60.71
M133M34V4	3/4"	4-6V	.035"	\$60.71
M133M34V5	3/4"	5-8V	.035"	\$60.71
M133M34V6	3/4"	6-10V	.035"	\$60.71
M133M34V8	3/4"	8-12V	.035"	\$60.71
M133M34V10	3/4"	10-14V	.035"	\$60.71
M133M34W14	3/4"	14W	.035"	\$60.71
M133M34W18	3/4"	18W	.035"	\$60.71
M133M1V2	1"	2-3V	.035"	\$69.84
M133M1H3	1"	3H	.035"	\$69.84
M133M1V3	1"	3-4V	.035"	\$69.84
M133M1V4	1"	4-6V	.035"	\$69.84
M133M1V5	1"	5-8V	.035"	\$69.84
M133M1V6	1"	6-10V	.035"	\$69.84
M133M1V8	1"	8-12V	.035"	\$69.84
M133M1V10	1"	10-14V	.035"	\$69.84
M133M114V2	1-1/4"	2-3V	.042"	\$83.90
M133M114V3	1-1/4"	3-4V	.042"	\$83.90
M133M114V4	1-1/4"	4-6V	.042"	\$83.90
M133M114V5	1-1/4"	5-8V	.042"	\$83.90
M133M114V6	1-1/4"	6-10V	.042"	\$83.90
M133M114V8	1-1/4"	8-12V	.042"	\$83.90

Carbon Steel Bandsaw Blade 133" (11' 1") Long				
 MAGNATE				
Tool No.	Width	Tooth	Thickness	Price
M133C18R14	1/8"	14R	.025"	\$20.67
M133C18R18	1/8"	18R	.025"	\$20.67
M133C316S4	3/16"	4S	.025"	\$17.78
M133C316S6	3/16"	6S	.025"	\$18.19
M133C316R10	3/16"	10R	.025"	\$17.40
M133C316R14	3/16"	14R	.025"	\$17.40
M133C316R18	3/16"	18R	.025"	\$17.40
M133C316R24	3/16"	24R	.025"	\$17.40
M133C14H4	1/4"	4H	.025"	\$14.83
M133C14H6	1/4"	6H	.025"	\$14.83
M133C14R10	1/4"	10R	.025"	\$14.83
M133C14R14	1/4"	14R	.025"	\$14.83
M133C14R18	1/4"	18R	.025"	\$14.83
M133C14R24	1/4"	24R	.025"	\$14.83
M133C38H3	3/8"	3H	.025"	\$16.59
M133C38H4	3/8"	4H	.025"	\$16.59
M133C38H6	3/8"	6H	.025"	\$16.59
M133C38R8	3/8"	8R	.025"	\$16.59
M133C38R10	3/8"	10R	.025"	\$16.59
M133C38R14	3/8"	14R	.025"	\$16.59
M133C38R18	3/8"	18R	.025"	\$16.59
M133C38R24	3/8"	24R	.025"	\$15.71
M133C12H3	1/2"	3H	.025"	\$18.19
M133C12H4	1/2"	4H	.025"	\$18.19
M133C12H6	1/2"	6H	.025"	\$18.19
M133C12R10	1/2"	10R	.025"	\$18.19
M133C12R14	1/2"	14R	.025"	\$18.19
M133C12R18	1/2"	18R	.025"	\$18.19
M133C12R24	1/2"	24R	.025"	\$18.19
M133C58H3	5/8"	3H	.032"	\$21.57
M133C58H4	5/8"	4H	.032"	\$21.57
M133C58R10	5/8"	10R	.032"	\$21.57
M133C58R14	5/8"	14R	.032"	\$21.57
M133C34H2	3/4"	2H	.032"	\$21.57
M133C34H3	3/4"	3H	.032"	\$21.57
M133C34H4	3/4"	4H	.032"	\$21.57
M133C34H6	3/4"	6H	.032"	\$21.57
M133C34R6	3/4"	6R	.032"	\$21.57
M133C34R10	3/4"	10R	.032"	\$21.57
M133C34R14	3/4"	14R	.032"	\$21.57
M133C34R18	3/4"	18R	.032"	\$21.57
M133C1H1.3	1"	1.3H	.035"	\$28.21
M133C1H2	1"	2H	.035"	\$28.21
M133C1H3	1"	3H	.035"	\$28.21
M133C1H4	1"	4H	.035"	\$28.21
M133C1H6	1"	6H	.035"	\$28.21
M133C1R6	1"	6R	.035"	\$28.21
M133C1R8	1"	8R	.035"	\$28.21
M133C1R10	1"	10R	.035"	\$28.21
M133C1R14	1"	14R	.035"	\$28.21
M133C114H1.3	1-1/4"	1.3H	.042"	\$35.34
M133C112H1.15	1-1/2"	1.15H	.045"	\$39.47

MAGNATE™ 20639 Lycoming Street #B-6, Walnut, CA 91789 USA

M-65



email : info@magnate.net Online Shop : www.magnate.net
(TEL) 800-827-2316, 909-468-5747 (FAX) 909-468-5745

MAGNATE™ Band Saw Blades (Non-Food Processing)

Carbide Grit Bandsaw Blade
133" (11' 1") Long



MAGNATE

Tool No.	Width	Tooth	Thickness	Price
M133G12MC	1/2"	Med-Coarse	.025"	\$291.53
M133G34MC	3/4"	Med-Coarse	.032"	\$310.57
M133G1MC	1"	Med-Coarse	.035"	\$327.45

WoodSaver Plus Resaw Bandsaw Blades
133" (11' 1") Long



Tool No.	Width	Tooth	Thickness	Price
B133P58V3	5/8"	3-4V	.025"	\$95.33



Carbon Steel Bandsaw Blade
135" (11' 3") Long



MAGNATE

Tool No.	Width	Tooth	Thickness	Price
M135C18R14	1/8"	14R	.025"	\$20.67
M135C18R18	1/8"	18R	.025"	\$20.67
M135C316S4	3/16"	4S	.025"	\$17.78
M135C316S6	3/16"	6S	.025"	\$18.19
M135C316R10	3/16"	10R	.025"	\$17.40
M135C316R14	3/16"	14R	.025"	\$17.40
M135C316R18	3/16"	18R	.025"	\$17.40
M135C316R24	3/16"	24R	.025"	\$17.40
M135C14H4	1/4"	4H	.025"	\$14.83
M135C14H6	1/4"	6H	.025"	\$14.83
M135C14R10	1/4"	10R	.025"	\$14.83
M135C14R14	1/4"	14R	.025"	\$14.83
M135C14R18	1/4"	18R	.025"	\$14.83
M135C14R24	1/4"	24R	.025"	\$14.83
M135C38H3	3/8"	3H	.025"	\$16.59
M135C38H4	3/8"	4H	.025"	\$16.59
M135C38H6	3/8"	6H	.025"	\$16.59
M135C38R8	3/8"	8R	.025"	\$16.59
M135C38R10	3/8"	10R	.025"	\$16.59
M135C38R14	3/8"	14R	.025"	\$16.59
M135C38R18	3/8"	18R	.025"	\$16.59
M135C38R24	3/8"	24R	.025"	\$15.71
M135C12H3	1/2"	3H	.025"	\$18.19
M135C12H4	1/2"	4H	.025"	\$18.19
M135C12H6	1/2"	6H	.025"	\$18.19
M135C12R10	1/2"	10R	.025"	\$18.19
M135C12R14	1/2"	14R	.025"	\$18.19
M135C12R18	1/2"	18R	.025"	\$18.19
M135C12R24	1/2"	24R	.025"	\$18.19
M135C58H3	5/8"	3H	.032"	\$21.57
M135C58H4	5/8"	4H	.032"	\$21.57
M135C58R10	5/8"	10R	.032"	\$21.57
M135C58R14	5/8"	14R	.032"	\$21.57
M135C34H2	3/4"	2H	.032"	\$21.57
M135C34H3	3/4"	3H	.032"	\$21.57
M135C34H4	3/4"	4H	.032"	\$21.57
M135C34H6	3/4"	6H	.032"	\$21.57
M135C34R6	3/4"	6R	.032"	\$21.57
M135C34R10	3/4"	10R	.032"	\$21.57
M135C34R14	3/4"	14R	.032"	\$21.57
M135C34R18	3/4"	18R	.032"	\$21.57
M135C1H1.3	1"	1.3H	.035"	\$28.21
M135C1H2	1"	2H	.035"	\$28.21
M135C1H3	1"	3H	.035"	\$28.21
M135C1H4	1"	4H	.035"	\$28.21
M135C1H6	1"	6H	.035"	\$28.21
M135C1R6	1"	6R	.035"	\$28.21
M135C1R8	1"	8R	.035"	\$28.21
M135C1R10	1"	10R	.035"	\$28.21
M135C1R14	1"	14R	.035"	\$28.21
M135C114H1.3	1-1/4"	1.3H	.042"	\$35.34
M135C112H1.15	1-1/2"	1.15H	.045"	\$39.47

Carbide Impregnated Bandsaw Blade
133" (11' 1") Long

Tool No.	Width	Tooth	Thickness	Price
B133G14H6	1/4"	6H	.025"	\$36.85
B133G38H4	3/8"	4H	.025"	\$34.90
B133G12H3	1/2"	3H	.023"	\$36.65

WoodSaver Resaw Bandsaw Blades
133" (11' 1") Long



Tool No.	Width	Tooth	Thickness	Price
B133S58T3	5/8"	3	.025"	\$81.50
B133S1T3	1"	3	.025"	\$94.62

Carbide Tipped Bandsaw Blade
133" (11' 1") Long



MAGNATE

Tool No.	Width	Tooth	Thickness	Price
M133E12T3	1/2"	3	.025"	\$240.17
M133E34T3	3/4"	3	.035"	\$264.90
M133E1T1.3	1"	1.3	.035"	\$264.90
M133E1T2	1"	2	.035"	\$264.90
M133E1T3	1"	3	.035"	\$264.90
M133E1V2	1"	2-3V	.035"	\$258.62

Carbide Grit Bandsaw Blade
135" (11' 3") Long



MAGNATE

Tool No.	Width	Tooth	Thickness	Price
M135G12MC	1/2"	Med-Coarse	.025"	\$291.53
M135G34MC	3/4"	Med-Coarse	.032"	\$310.57
M135G1MC	1"	Med-Coarse	.035"	\$327.45

Hawc Pro Resaw Bandsaw Blade
133" (11' 1") Long



Tool No.	Width	Tooth	Thickness	Price
B133H12T3	1/2"	3	.025"	\$24.37

Carbide Tipped Bandsaw Blade
135" (11' 3") Long



MAGNATE

Tool No.	Width	Tooth	Thickness	Price
M135E12T3	1/2"	3	.025"	\$240.17
M135E34T3	3/4"	3	.035"	\$264.90
M135E1T1.3	1"	1.3	.035"	\$264.90
M135E1T2	1"	2	.035"	\$264.90
M135E1T3	1"	3	.035"	\$264.90
M135E1V2	1"	2-3V	.035"	\$258.62

MAGNATE™ 20639 Lycoming Street #B-6, Walnut, CA 91789 USA

M-66



email : info@magnate.net Online Shop : www.magnate.net
(TEL) 800-827-2316, 909-468-5747 (FAX) 909-468-5745

MAGNATE™ Band Saw Blades (Non-Food Processing)

Bi-metal Bandsaw Blade 135" (11' 3") Long



MAGNATE

Tool No.	Width	Tooth	Thickness	Price
M135M14H6	1/4"	6H	.025"	\$57.45
M135M14V10	1/4"	10-14V	.025"	\$57.45
M135M14V14	1/4"	14-18V	.025"	\$57.45
M135M38H4	3/8"	4H	.025"	\$57.45
M135M38V10	3/8"	10-14V	.025"	\$57.45
M135M38V14	3/8"	14-18V	.025"	\$57.45
M135M12H3	1/2"	3H	.035"	\$57.45
M135M12H4	1/2"	4H	.025"	\$57.45
M135M12H6	1/2"	6H	.025"	\$57.45
M135M12V6	1/2"	6-10V	.025"	\$57.45
M135M12V8	1/2"	8-12V	.025"	\$57.45
M135M12V10	1/2"	10-14V	.025"	\$57.45
M135M12T14	1/2"	14	.025"	\$57.45
M135M12V14	1/2"	14-18V	.025"	\$57.45
M135M12T18	1/2"	18	.025"	\$57.45
M135M58V10	5/8"	10-14V	.032"	\$60.71
M135M34H3	3/4"	3H	.035"	\$60.71
M135M34V4	3/4"	4-6V	.035"	\$60.71
M135M34V5	3/4"	5-8V	.035"	\$60.71
M135M34V6	3/4"	6-10V	.035"	\$60.71
M135M34V8	3/4"	8-12V	.035"	\$60.71
M135M34V10	3/4"	10-14V	.035"	\$60.71
M135M34W14	3/4"	14W	.035"	\$60.71
M135M34W18	3/4"	18W	.035"	\$60.71
M135M1V2	1"	2-3V	.035"	\$69.84
M135M1H3	1"	3H	.035"	\$69.84
M135M1V3	1"	3-4V	.035"	\$69.84
M135M1V4	1"	4-6V	.035"	\$69.84
M135M1V5	1"	5-8V	.035"	\$69.84
M135M1V6	1"	6-10V	.035"	\$69.84
M135M1V8	1"	8-12V	.035"	\$69.84
M135M1V10	1"	10-14V	.035"	\$69.84
M135M114V2	1-1/4"	2-3V	.042"	\$83.90
M135M114V3	1-1/4"	3-4V	.042"	\$83.90
M135M114V4	1-1/4"	4-6V	.042"	\$83.90
M135M114V5	1-1/4"	5-8V	.042"	\$83.90
M135M114V6	1-1/4"	6-10V	.042"	\$83.90
M135M114V8	1-1/4"	8-12V	.042"	\$83.90

Hawc Pro Resaw Bandsaw Blade 136" (11' 4") Long



SUPER CUT™

Tool No.	Width	Tooth	Thickness	Price
B136H12T3	1/2"	3	.025"	\$24.37

Carbon Steel Bandsaw Blade 136" (11' 4") Long



MAGNATE

Tool No.	Width	Tooth	Thickness	Price
M136C18R14	1/8"	14R	.025"	\$20.67
M136C18R18	1/8"	18R	.025"	\$20.67
M136C316S4	3/16"	4S	.025"	\$17.78
M136C316S6	3/16"	6S	.025"	\$18.19
M136C316R10	3/16"	10R	.025"	\$17.78
M136C316R14	3/16"	14R	.025"	\$17.78
M136C316R18	3/16"	18R	.025"	\$17.78
M136C316R24	3/16"	24R	.025"	\$17.78
M136C14H4	1/4"	4H	.025"	\$14.83
M136C14H6	1/4"	6H	.025"	\$14.83
M136C14R10	1/4"	10R	.025"	\$14.83
M136C14R14	1/4"	14R	.025"	\$14.83
M136C14R18	1/4"	18R	.025"	\$14.83
M136C14R24	1/4"	24R	.025"	\$14.83
M136C38H3	3/8"	3H	.025"	\$16.59
M136C38H4	3/8"	4H	.025"	\$16.59
M136C38H6	3/8"	6H	.025"	\$16.59
M136C38R8	3/8"	8R	.025"	\$16.59
M136C38R10	3/8"	10R	.025"	\$16.59
M136C38R14	3/8"	14R	.025"	\$16.59
M136C38R18	3/8"	18R	.025"	\$16.59
M136C38R24	3/8"	24R	.025"	\$15.71
M136C12H3	1/2"	3H	.025"	\$18.19
M136C12H4	1/2"	4H	.025"	\$18.19
M136C12H6	1/2"	6H	.025"	\$18.19
M136C12R10	1/2"	10R	.025"	\$18.19
M136C12R14	1/2"	14R	.025"	\$18.19
M136C12R18	1/2"	18R	.025"	\$18.19
M136C12R24	1/2"	24R	.025"	\$18.19
M136C58H3	5/8"	3H	.032"	\$21.57
M136C58H4	5/8"	4H	.032"	\$21.57
M136C58R10	5/8"	10R	.032"	\$21.57
M136C58R14	5/8"	14R	.032"	\$21.57
M136C34H2	3/4"	2H	.032"	\$21.57
M136C34H3	3/4"	3H	.032"	\$21.57
M136C34H4	3/4"	4H	.032"	\$21.57
M136C34H6	3/4"	6H	.032"	\$21.57
M136C34R6	3/4"	6R	.032"	\$21.57
M136C34R10	3/4"	10R	.032"	\$21.57
M136C34R14	3/4"	14R	.032"	\$21.57
M136C34R18	3/4"	18R	.032"	\$21.57
M136C1H1.3	1"	1.3H	.035"	\$28.21
M136C1H2	1"	2H	.035"	\$28.21
M136C1H3	1"	3H	.035"	\$28.21
M136C1H4	1"	4H	.035"	\$28.21
M136C1H6	1"	6H	.035"	\$28.21
M136C1R6	1"	6R	.035"	\$28.21
M136C1R8	1"	8R	.035"	\$28.21
M136C1R10	1"	10R	.035"	\$28.21
M136C1R14	1"	14R	.035"	\$28.21
M136C114H1.3	1-1/4"	1.3H	.042"	\$35.34
M136C112H1.15	1-1/2"	1.15H	.045"	\$39.47

Carbide Grit Bandsaw Blade 136" (11' 4") Long



MAGNATE

Tool No.	Width	Tooth	Thickness	Price
M136G12MC	1/2"	Med-Coarse	.025"	\$291.53
M136G34MC	3/4"	Med-Coarse	.032"	\$310.57
M136G1MC	1"	Med-Coarse	.035"	\$327.45

WoodSaver Plus Resaw Bandsaw Blades 136" (11' 4") Long



SUPER CUT™

Tool No.	Width	Tooth	Thickness	Price
B136P58V3	5/8"	3-4V	.025"	\$95.33

WoodSaver Resaw Bandsaw Blades 136" (11' 4") Long



SUPER CUT™

Tool No.	Width	Tooth	Thickness	Price
B136S58T3	5/8"	3	.025"	\$81.50
B136S1T3	1"	3	.025"	\$94.62

MAGNATE™ 20639 Lycoming Street #B-6, Walnut, CA 91789 USA

M-67



email : info@magnate.net Online Shop : www.magnate.net
(TEL) 800-827-2316, 909-468-5747 (FAX) 909-468-5745

MAGNATE™ Band Saw Blades (Non-Food Processing)

Bi-metal Bandsaw Blade 136" (11' 4") Long



Tool No.	Width	Tooth	Thickness	Price
M136M14H6	1/4"	6H	.025"	\$57.45
M136M14V10	1/4"	10-14V	.025"	\$57.45
M136M14V14	1/4"	14-18V	.025"	\$57.45
M136M38H4	3/8"	4H	.025"	\$57.45
M136M38V10	3/8"	10-14V	.025"	\$57.45
M136M38V14	3/8"	14-18V	.025"	\$57.45
M136M12H3	1/2"	3H	.035"	\$57.45
M136M12H4	1/2"	4H	.025"	\$57.45
M136M12H6	1/2"	6H	.025"	\$57.45
M136M12V6	1/2"	6-10V	.025"	\$57.45
M136M12V8	1/2"	8-12V	.025"	\$57.45
M136M12V10	1/2"	10-14V	.025"	\$57.45
M136M12T14	1/2"	14	.025"	\$57.45
M136M12V14	1/2"	14-18V	.025"	\$57.45
M136M12T18	1/2"	18	.025"	\$57.45
M136M58V10	5/8"	10-14V	.032"	\$60.71
M136M34H3	3/4"	3H	.035"	\$60.71
M136M34V4	3/4"	4-6V	.035"	\$60.71
M136M34V5	3/4"	5-8V	.035"	\$60.71
M136M34V6	3/4"	6-10V	.035"	\$60.71
M136M34V8	3/4"	8-12V	.035"	\$60.71
M136M34V10	3/4"	10-14V	.035"	\$60.71
M136M34W14	3/4"	14W	.035"	\$60.71
M136M34W18	3/4"	18W	.035"	\$60.71
M136M1V2	1"	2-3V	.035"	\$69.84
M136M1H3	1"	3H	.035"	\$69.84
M136M1V3	1"	3-4V	.035"	\$69.84
M136M1V4	1"	4-6V	.035"	\$69.84
M136M1V5	1"	5-8V	.035"	\$69.84
M136M1V6	1"	6-10V	.035"	\$69.84
M136M1V8	1"	8-12V	.035"	\$69.84
M136M1V10	1"	10-14V	.035"	\$69.84
M136M114V2	1-1/4"	2-3V	.042"	\$83.90
M136M114V3	1-1/4"	3-4V	.042"	\$83.90
M136M114V4	1-1/4"	4-6V	.042"	\$83.90
M136M114V5	1-1/4"	5-8V	.042"	\$83.90
M136M114V6	1-1/4"	6-10V	.042"	\$83.90
M136M114V8	1-1/4"	8-12V	.042"	\$83.90

Carbide Tipped Bandsaw Blade 136" (11' 4") Long



Tool No.	Width	Tooth	Thickness	Price
M136E12T3	1/2"	3	.025"	\$240.17
M136E34T3	3/4"	3	.035"	\$264.90
M136E1T1.3	1"	1.3	.035"	\$264.90
M136E1T2	1"	2	.035"	\$264.90
M136E1T3	1"	3	.035"	\$264.90
M136E1V2	1"	2-3V	.035"	\$258.62

Carbide Grit Bandsaw Blade 137" (11' 5") Long



Tool No.	Width	Tooth	Thickness	Price
M137G12MC	1/2"	Med-Coarse	.025"	\$291.53
M137G34MC	3/4"	Med-Coarse	.032"	\$310.57
M137G1MC	1"	Med-Coarse	.035"	\$327.45

Carbide Tipped Bandsaw Blade 137" (11' 5") Long



Tool No.	Width	Tooth	Thickness	Price
M137E12T3	1/2"	3	.025"	\$240.17
M137E34T3	3/4"	3	.035"	\$264.90
M137E1T1.3	1"	1.3	.035"	\$264.90
M137E1T2	1"	2	.035"	\$264.90
M137E1T3	1"	3	.035"	\$264.90
M137E1V2	1"	2-3V	.035"	\$258.62

Bi-metal Bandsaw Blade 137" (11' 5") Long



Tool No.	Width	Tooth	Thickness	Price
M137M14H6	1/4"	6H	.025"	\$57.45
M137M14V10	1/4"	10-14V	.025"	\$57.45
M137M14V14	1/4"	14-18V	.025"	\$57.45
M137M38H4	3/8"	4H	.025"	\$57.45
M137M38V10	3/8"	10-14V	.025"	\$57.45
M137M38V14	3/8"	14-18V	.025"	\$57.45
M137M12H3	1/2"	3H	.035"	\$57.45
M137M12H4	1/2"	4H	.025"	\$57.45
M137M12H6	1/2"	6H	.025"	\$57.45
M137M12V6	1/2"	6-10V	.025"	\$57.45
M137M12V8	1/2"	8-12V	.025"	\$57.45
M137M12V10	1/2"	10-14V	.025"	\$57.45
M137M12T14	1/2"	14	.025"	\$57.45
M137M12V14	1/2"	14-18V	.025"	\$57.45
M137M12T18	1/2"	18	.025"	\$57.45
M137M58V10	5/8"	10-14V	.032"	\$60.71
M137M34H3	3/4"	3H	.035"	\$60.71
M137M34V4	3/4"	4-6V	.035"	\$60.71
M137M34V5	3/4"	5-8V	.035"	\$60.71
M137M34V6	3/4"	6-10V	.035"	\$60.71
M137M34V8	3/4"	8-12V	.035"	\$60.71
M137M34V10	3/4"	10-14V	.035"	\$60.71
M137M34W14	3/4"	14W	.035"	\$60.71
M137M34W18	3/4"	18W	.035"	\$60.71
M137M1V2	1"	2-3V	.035"	\$69.84
M137M1H3	1"	3H	.035"	\$69.84
M137M1V3	1"	3-4V	.035"	\$69.84
M137M1V4	1"	4-6V	.035"	\$69.84
M137M1V5	1"	5-8V	.035"	\$69.84
M137M1V6	1"	6-10V	.035"	\$69.84
M137M1V8	1"	8-12V	.035"	\$69.84
M137M1V10	1"	10-14V	.035"	\$69.84
M137M114V2	1-1/4"	2-3V	.042"	\$83.90
M137M114V3	1-1/4"	3-4V	.042"	\$83.90
M137M114V4	1-1/4"	4-6V	.042"	\$83.90
M137M114V5	1-1/4"	5-8V	.042"	\$83.90
M137M114V6	1-1/4"	6-10V	.042"	\$83.90
M137M114V8	1-1/4"	8-12V	.042"	\$83.90

Carbide Impregnated Bandsaw Blade 136" (11' 4") Long



Tool No.	Width	Tooth	Thickness	Price
B136G14H6	1/4"	6H	.025"	\$36.85
B136G38H4	3/8"	4H	.025"	\$34.90
B136G12H3	1/2"	3H	.025"	\$36.65

WoodSaver Plus Resaw Bandsaw Blades 137" (11' 5") Long



Tool No.	Width	Tooth	Thickness	Price
B137P58V3	5/8"	3-4V	.025"	\$95.33

MAGNATE™ 20639 Lycoming Street #B-6, Walnut, CA 91789 USA

M-68



email : info@magnate.net Online Shop : www.magnate.net
(TEL) 800-827-2316, 909-468-5747 (FAX) 909-468-5745

MAGNATE™ Band Saw Blades (Non-Food Processing)

Carbon Steel Bandsaw Blade 137" (11' 5") Long



MAGNATE

Tool No.	Width	Tooth	Thickness	Price
M137C18R14	1/8"	14R	.025"	\$20.67
M137C18R18	1/8"	18R	.025"	\$20.67
M137C316S4	3/16"	4S	.025"	\$17.78
M137C316S6	3/16"	6S	.025"	\$18.19
M137C316R10	3/16"	10R	.025"	\$17.78
M137C316R14	3/16"	14R	.025"	\$17.78
M137C316R18	3/16"	18R	.025"	\$17.78
M137C316R24	3/16"	24R	.025"	\$17.78
M137C14H4	1/4"	4H	.025"	\$14.83
M137C14H6	1/4"	6H	.025"	\$14.83
M137C14R10	1/4"	10R	.025"	\$14.83
M137C14R14	1/4"	14R	.025"	\$14.83
M137C14R18	1/4"	18R	.025"	\$14.83
M137C14R24	1/4"	24R	.025"	\$14.83
M137C38H3	3/8"	3H	.025"	\$16.59
M137C38H4	3/8"	4H	.025"	\$16.59
M137C38H6	3/8"	6H	.025"	\$16.59
M137C38R8	3/8"	8R	.025"	\$16.59
M137C38R10	3/8"	10R	.025"	\$16.59
M137C38R14	3/8"	14R	.025"	\$16.59
M137C38R18	3/8"	18R	.025"	\$16.59
M137C38R24	3/8"	24R	.025"	\$15.71
M137C12H3	1/2"	3H	.025"	\$18.19
M137C12H4	1/2"	4H	.025"	\$18.19
M137C12H6	1/2"	6H	.025"	\$18.19
M137C12R10	1/2"	10R	.025"	\$18.19
M137C12R14	1/2"	14R	.025"	\$18.19
M137C12R18	1/2"	18R	.025"	\$18.19
M137C12R24	1/2"	24R	.025"	\$18.19
M137C58H3	5/8"	3H	.032"	\$21.57
M137C58H4	5/8"	4H	.032"	\$21.57
M137C58R10	5/8"	10R	.032"	\$21.57
M137C58R14	5/8"	14R	.032"	\$21.57
M137C34H2	3/4"	2H	.032"	\$21.57
M137C34H3	3/4"	3H	.032"	\$21.57
M137C34H4	3/4"	4H	.032"	\$21.57
M137C34H6	3/4"	6H	.032"	\$21.57
M137C34R6	3/4"	6R	.032"	\$21.57
M137C34R10	3/4"	10R	.032"	\$21.57
M137C34R14	3/4"	14R	.032"	\$21.57
M137C34R18	3/4"	18R	.032"	\$21.57
M137C1H1.3	1"	1.3H	.035"	\$28.21
M137C1H2	1"	2H	.035"	\$28.21
M137C1H3	1"	3H	.035"	\$28.21
M137C1H4	1"	4H	.035"	\$28.21
M137C1H6	1"	6H	.035"	\$28.21
M137C1R6	1"	6R	.035"	\$28.21
M137C1R8	1"	8R	.035"	\$28.21
M137C1R10	1"	10R	.035"	\$28.21
M137C1R14	1"	14R	.035"	\$28.21
M137C114H1.3	1-1/4"	1.3H	.042"	\$35.34
M137C112H1.15	1-1/2"	1.15H	.045"	\$39.47

Bi-metal Bandsaw Blade 138" (11' 6") Long



MAGNATE

Tool No.	Width	Tooth	Thickness	Price
M138M14H6	1/4"	6H	.025"	\$57.45
M138M14V10	1/4"	10-14V	.025"	\$57.45
M138M14V14	1/4"	14-18V	.025"	\$57.45
M138M38H4	3/8"	4H	.025"	\$57.45
M138M38V10	3/8"	10-14V	.025"	\$57.45
M138M38V14	3/8"	14-18V	.025"	\$57.45
M138M12H3	1/2"	3H	.035"	\$57.45
M138M12H4	1/2"	4H	.025"	\$57.45
M138M12H6	1/2"	6H	.025"	\$57.45
M138M12V6	1/2"	6-10V	.025"	\$57.45
M138M12V8	1/2"	8-12V	.025"	\$57.45
M138M12V10	1/2"	10-14V	.025"	\$57.45
M138M12T14	1/2"	14	.025"	\$57.45
M138M12V14	1/2"	14-18V	.025"	\$57.45
M138M12T18	1/2"	18	.025"	\$57.45
M138M58V10	5/8"	10-14V	.032"	\$60.71
M138M34H3	3/4"	3H	.035"	\$60.71
M138M34V4	3/4"	4-6V	.035"	\$60.71
M138M34V5	3/4"	5-8V	.035"	\$60.71
M138M34V6	3/4"	6-10V	.035"	\$60.71
M138M34V8	3/4"	8-12V	.035"	\$60.71
M138M34V10	3/4"	10-14V	.035"	\$60.71
M138M34W14	3/4"	14W	.035"	\$60.71
M138M34W18	3/4"	18W	.035"	\$60.71
M138M1V2	1"	2-3V	.035"	\$69.84
M138M1H3	1"	3H	.035"	\$69.84
M138M1V3	1"	3-4V	.035"	\$69.84
M138M1V4	1"	4-6V	.035"	\$69.84
M138M1V5	1"	5-8V	.035"	\$69.84
M138M1V6	1"	6-10V	.035"	\$69.84
M138M1V8	1"	8-12V	.035"	\$69.84
M138M1V10	1"	10-14V	.035"	\$69.84
M138M114V2	1-1/4"	2-3V	.042"	\$83.90
M138M114V3	1-1/4"	3-4V	.042"	\$83.90
M138M114V4	1-1/4"	4-6V	.042"	\$83.90
M138M114V5	1-1/4"	5-8V	.042"	\$83.90
M138M114V6	1-1/4"	6-10V	.042"	\$83.90
M138M114V8	1-1/4"	8-12V	.042"	\$83.90

Carbon Steel Bandsaw Blade 138" (11' 6") Long



MAGNATE

Tool No.	Width	Tooth	Thickness	Price
M138C18R14	1/8"	14R	.025"	\$20.67
M138C18R18	1/8"	18R	.025"	\$20.67
M138C316S4	3/16"	4S	.025"	\$17.78
M138C316S6	3/16"	6S	.025"	\$18.19
M138C316R10	3/16"	10R	.025"	\$17.78
M138C316R14	3/16"	14R	.025"	\$17.78
M138C316R18	3/16"	18R	.025"	\$17.78
M138C316R24	3/16"	24R	.025"	\$17.78
M138C14H4	1/4"	4H	.025"	\$14.83
M138C14H6	1/4"	6H	.025"	\$14.83
M138C14R10	1/4"	10R	.025"	\$14.83
M138C14R14	1/4"	14R	.025"	\$14.83
M138C14R18	1/4"	18R	.025"	\$14.83
M138C14R24	1/4"	24R	.025"	\$14.83
M138C38H3	3/8"	3H	.025"	\$16.59
M138C38H4	3/8"	4H	.025"	\$16.59
M138C38H6	3/8"	6H	.025"	\$16.59
M138C38R8	3/8"	8R	.025"	\$16.59
M138C38R10	3/8"	10R	.025"	\$16.59
M138C38R14	3/8"	14R	.025"	\$16.59
M138C38R18	3/8"	18R	.025"	\$16.59
M138C38R24	3/8"	24R	.025"	\$15.71
M138C12H3	1/2"	3H	.025"	\$18.19
M138C12H4	1/2"	4H	.025"	\$18.19
M138C12H6	1/2"	6H	.025"	\$18.19
M138C12R10	1/2"	10R	.025"	\$18.19
M138C12R14	1/2"	14R	.025"	\$18.19
M138C12R18	1/2"	18R	.025"	\$18.19
M138C12R24	1/2"	24R	.025"	\$18.19
M138C58H3	5/8"	3H	.032"	\$21.57
M138C58H4	5/8"	4H	.032"	\$21.57
M138C58R10	5/8"	10R	.032"	\$21.57
M138C58R14	5/8"	14R	.032"	\$21.57
M138C34H2	3/4"	2H	.032"	\$21.57
M138C34H3	3/4"	3H	.032"	\$21.57
M138C34H4	3/4"	4H	.032"	\$21.57
M138C34H6	3/4"	6H	.032"	\$21.57
M138C34R6	3/4"	6R	.032"	\$21.57
M138C34R10	3/4"	10R	.032"	\$21.57
M138C34R14	3/4"	14R	.032"	\$21.57
M138C34R18	3/4"	18R	.032"	\$21.57
M138C1H1.3	1"	1.3H	.035"	\$28.21
M138C1H2	1"	2H	.035"	\$28.21
M138C1H3	1"	3H	.035"	\$28.21
M138C1H4	1"	4H	.035"	\$28.21
M138C1H6	1"	6H	.035"	\$28.21
M138C1R6	1"	6R	.035"	\$28.21
M138C1R8	1"	8R	.035"	\$28.21
M138C1R10	1"	10R	.035"	\$28.21
M138C1R14	1"	14R	.035"	\$28.21
M138C114H1.3	1-1/4"	1.3H	.042"	\$35.34
M138C112H1.15	1-1/2"	1.15H	.045"	\$39.47

MAGNATE™ 20639 Lycoming Street #B-6, Walnut, CA 91789 USA

M-69



email : info@magnate.net Online Shop : www.magnate.net
(TEL) 800-827-2316, 909-468-5747 (FAX) 909-468-5745

MAGNATE™ Band Saw Blades (Non-Food Processing)

Carbide Grit Bandsaw Blade
138" (11' 6") Long



MAGNATE

Tool No.	Width	Tooth	Thickness	Price
M138G12MC	1/2"	Med-Coarse	.025"	\$291.53
M138G34MC	3/4"	Med-Coarse	.032"	\$310.57
M138G1MC	1"	Med-Coarse	.035"	\$327.45

Carbide Tipped Bandsaw Blade
138" (11' 6") Long



MAGNATE

Tool No.	Width	Tooth	Thickness	Price
M138E12T3	1/2"	3	.025"	\$240.17
M138E34T3	3/4"	3	.035"	\$264.90
M138E1T1.3	1"	1.3	.035"	\$264.90
M138E1T2	1"	2	.035"	\$264.90
M138E1T3	1"	3	.035"	\$264.90
M138E1V2	1"	2-3V	.035"	\$258.62

Carbide Grit Bandsaw Blade
140" (11' 8") Long



MAGNATE

Tool No.	Width	Tooth	Thickness	Price
M140G12MC	1/2"	Med-Coarse	.025"	\$303.84
M140G34MC	3/4"	Med-Coarse	.032"	\$323.67
M140G1MC	1"	Med-Coarse	.035"	\$341.28

Carbide Tipped Bandsaw Blade
140" (11' 8") Long



MAGNATE

Tool No.	Width	Tooth	Thickness	Price
M140E12T3	1/2"	3	.025"	\$250.22
M140E34T3	3/4"	3	.035"	\$274.47
M140E1T1.3	1"	1.3	.035"	\$274.47
M140E1T2	1"	2	.035"	\$274.47
M140E1T3	1"	3	.035"	\$274.47
M140E1V2	1"	2-3V	.035"	\$269.45

Bi-metal Bandsaw Blade
140" (11' 8") Long



MAGNATE

Tool No.	Width	Tooth	Thickness	Price
M140M14H6	1/4"	6H	.025"	\$59.59
M140M14V10	1/4"	10-14V	.025"	\$59.59
M140M14V14	1/4"	14-18V	.025"	\$59.59
M140M38H4	3/8"	4H	.025"	\$59.59
M140M38V10	3/8"	10-14V	.025"	\$59.59
M140M38V14	3/8"	14-18V	.025"	\$59.59
M140M12H3	1/2"	3H	.035"	\$59.59
M140M12H4	1/2"	4H	.025"	\$59.59
M140M12H6	1/2"	6H	.025"	\$59.59
M140M12V6	1/2"	6-10V	.025"	\$59.59
M140M12V8	1/2"	8-12V	.025"	\$59.59
M140M12V10	1/2"	10-14V	.025"	\$59.59
M140M12T14	1/2"	14	.025"	\$59.59
M140M12V14	1/2"	14-18V	.025"	\$59.59
M140M12T18	1/2"	18	.025"	\$59.59
M140M58V10	5/8"	10-14V	.032"	\$62.95
M140M34H3	3/4"	3H	.035"	\$62.95
M140M34V4	3/4"	4-6V	.035"	\$62.95
M140M34V5	3/4"	5-8V	.035"	\$62.95
M140M34V6	3/4"	6-10V	.035"	\$62.95
M140M34V8	3/4"	8-12V	.035"	\$62.95
M140M34V10	3/4"	10-14V	.035"	\$62.95
M140M34W14	3/4"	14W	.035"	\$62.95
M140M34W18	3/4"	18W	.035"	\$62.95
M140M1V2	1"	2-3V	.035"	\$72.47
M140M1H3	1"	3H	.035"	\$72.47
M140M1V3	1"	3-4V	.035"	\$72.47
M140M1V4	1"	4-6V	.035"	\$72.47
M140M1V5	1"	5-8V	.035"	\$72.47
M140M1V6	1"	6-10V	.035"	\$72.47
M140M1V8	1"	8-12V	.035"	\$72.47
M140M1V10	1"	10-14V	.035"	\$72.47
M140M114V2	1-1/4"	2-3V	.042"	\$87.05
M140M114V3	1-1/4"	3-4V	.042"	\$87.05
M140M114V4	1-1/4"	4-6V	.042"	\$87.05
M140M114V5	1-1/4"	5-8V	.042"	\$87.05
M140M114V6	1-1/4"	6-10V	.042"	\$87.05
M140M114V8	1-1/4"	8-12V	.042"	\$87.05
M140M112V2	1-1/2"	2-3V	.050"	\$105.52
M140M112V3	1-1/2"	3-4V	.050"	\$105.52
M140M112V4	1-1/2"	4-6V	.050"	\$105.52
M140M112V5	1-1/2"	5-8V	.050"	\$105.52

Carbon Steel Bandsaw Blade
140" (11' 8") Long



MAGNATE

Tool No.	Width	Tooth	Thickness	Price
M140C18R14	1/8"	14R	.025"	\$21.22
M140C18R18	1/8"	18R	.025"	\$21.22
M140C316S4	3/16"	4S	.025"	\$19.48
M140C316S6	3/16"	6S	.025"	\$18.79
M140C316R10	3/16"	10R	.025"	\$17.78
M140C316R14	3/16"	14R	.025"	\$17.78
M140C316R18	3/16"	18R	.025"	\$17.78
M140C316R24	3/16"	24R	.025"	\$17.78
M140C14H4	1/4"	4H	.025"	\$15.28
M140C14H6	1/4"	6H	.025"	\$15.28
M140C14R10	1/4"	10R	.025"	\$15.28
M140C14R14	1/4"	14R	.025"	\$15.28
M140C14R18	1/4"	18R	.025"	\$15.28
M140C14R24	1/4"	24R	.025"	\$15.28
M140C38H3	3/8"	3H	.025"	\$16.59
M140C38H4	3/8"	4H	.025"	\$16.93
M140C38H6	3/8"	6H	.025"	\$16.93
M140C38R8	3/8"	8R	.025"	\$16.93
M140C38R10	3/8"	10R	.025"	\$16.93
M140C38R14	3/8"	14R	.025"	\$16.93
M140C38R18	3/8"	18R	.025"	\$16.93
M140C38R24	3/8"	24R	.025"	\$16.10
M140C12H3	1/2"	3H	.025"	\$18.79
M140C12H4	1/2"	4H	.025"	\$18.79
M140C12H6	1/2"	6H	.025"	\$18.79
M140C12R10	1/2"	10R	.025"	\$18.79
M140C12R14	1/2"	14R	.025"	\$18.79
M140C12R18	1/2"	18R	.025"	\$18.79
M140C12R24	1/2"	24R	.025"	\$18.79
M140C58H3	5/8"	3H	.032"	\$22.31
M140C58H4	5/8"	4H	.032"	\$22.31
M140C58R10	5/8"	10R	.032"	\$22.31
M140C58R14	5/8"	14R	.032"	\$22.31
M140C34H2	3/4"	2H	.032"	\$22.31
M140C34H3	3/4"	3H	.032"	\$22.31
M140C34H4	3/4"	4H	.032"	\$22.31
M140C34H6	3/4"	6H	.032"	\$22.31
M140C34R6	3/4"	6R	.032"	\$22.31
M140C34R10	3/4"	10R	.032"	\$22.31
M140C34R14	3/4"	14R	.032"	\$22.31
M140C34R18	3/4"	18R	.032"	\$22.31
M140C1H1.3	1"	1.3H	.035"	\$29.19
M140C1H2	1"	2H	.035"	\$29.19
M140C1H3	1"	3H	.035"	\$29.19
M140C1H4	1"	4H	.035"	\$29.19
M140C1H6	1"	6H	.035"	\$29.19
M140C1R6	1"	6R	.035"	\$29.19
M140C1R8	1"	8R	.035"	\$29.19
M140C1R10	1"	10R	.035"	\$29.19
M140C1R14	1"	14R	.035"	\$29.19
M140C114H1.3	1-1/4"	1.3H	.042"	\$36.64
M140C112H1.15	1-1/2"	1.15H	.045"	\$40.90

MAGNATE™ 20639 Lycoming Street #B-6, Walnut, CA 91789 USA

M-70



email : info@magnate.net Online Shop : www.magnate.net
(TEL) 800-827-2316, 909-468-5747 (FAX) 909-468-5745

MAGNATE™ Band Saw Blades (Non-Food Processing)

Bi-metal Bandsaw Blade 142" (11' 10") Long



MAGNATE

Tool No.	Width	Tooth	Thickness	Price
M142M14H6	1/4"	6H	.025"	\$59.59
M142M14V10	1/4"	10-14V	.025"	\$59.59
M142M14V14	1/4"	14-18V	.025"	\$59.59
M142M38H4	3/8"	4H	.025"	\$59.59
M142M38V10	3/8"	10-14V	.025"	\$59.59
M142M38V14	3/8"	14-18V	.025"	\$59.59
M142M12H3	1/2"	3H	.035"	\$59.59
M142M12H4	1/2"	4H	.025"	\$59.59
M142M12H6	1/2"	6H	.025"	\$59.59
M142M12V6	1/2"	6-10V	.025"	\$59.59
M142M12V8	1/2"	8-12V	.025"	\$59.59
M142M12V10	1/2"	10-14V	.025"	\$59.59
M142M12V14	1/2"	14-18V	.025"	\$59.59
M142M12T14	1/2"	14	.025"	\$59.59
M142M58V10	5/8"	10-14V	.032"	\$59.59
M142M12T18	1/2"	18	.025"	\$62.95
M142M34H3	3/4"	3H	.035"	\$62.95
M142M34V4	3/4"	4-6V	.035"	\$62.95
M142M34V5	3/4"	5-8V	.035"	\$62.95
M142M34V6	3/4"	6-10V	.035"	\$62.95
M142M34V8	3/4"	8-12V	.035"	\$62.95
M142M34V10	3/4"	10-14V	.035"	\$62.95
M142M34W14	3/4"	14W	.035"	\$62.95
M142M34W18	3/4"	18W	.035"	\$62.95
M142M1V2	1"	2-3V	.035"	\$72.47
M142M1H3	1"	3H	.035"	\$72.47
M142M1V3	1"	3-4V	.035"	\$72.47
M142M1V4	1"	4-6V	.035"	\$72.47
M142M1V5	1"	5-8V	.035"	\$72.47
M142M1V6	1"	6-10V	.035"	\$72.47
M142M1V8	1"	8-12V	.035"	\$72.47
M142M1V10	1"	10-14V	.035"	\$72.47
M142M114V2	1-1/4"	2-3V	.042"	\$87.05
M142M114V3	1-1/4"	3-4V	.042"	\$87.05
M142M114V4	1-1/4"	4-6V	.042"	\$87.05
M142M114V5	1-1/4"	5-8V	.042"	\$87.05
M142M114V6	1-1/4"	6-10V	.042"	\$87.05
M142M114V8	1-1/4"	8-12V	.042"	\$87.05
M142M112V2	1-1/2"	2-3V	.050"	\$105.52
M142M112V3	1-1/2"	3-4V	.050"	\$105.52
M142M112V4	1-1/2"	4-6V	.050"	\$105.52
M142M112V5	1-1/2"	5-8V	.050"	\$105.52

Carbon Steel Bandsaw Blade 142" (11' 10") Long



MAGNATE

Tool No.	Width	Tooth	Thickness	Price
M142C18R14	1/8"	14R	.025"	\$21.22
M142C18R18	1/8"	18R	.025"	\$21.22
M142C316S4	3/16"	4S	.025"	\$18.22
M142C316S6	3/16"	6S	.025"	\$18.79
M142C316R10	3/16"	10R	.025"	\$17.78
M142C316R14	3/16"	14R	.025"	\$17.78
M142C316R18	3/16"	18R	.025"	\$17.78
M142C316R24	3/16"	24R	.025"	\$17.78
M142C14H4	1/4"	4H	.025"	\$15.28
M142C14H6	1/4"	6H	.025"	\$15.28
M142C14R10	1/4"	10R	.025"	\$15.28
M142C14R14	1/4"	14R	.025"	\$15.28
M142C14R18	1/4"	18R	.025"	\$15.28
M142C14R24	1/4"	24R	.025"	\$15.28
M142C38H3	3/8"	3H	.025"	\$16.93
M142C38H4	3/8"	4H	.025"	\$16.93
M142C38H6	3/8"	6H	.025"	\$16.93
M142C38R8	3/8"	8R	.025"	\$16.93
M142C38R10	3/8"	10R	.025"	\$16.93
M142C38R14	3/8"	14R	.025"	\$16.93
M142C38R18	3/8"	18R	.025"	\$16.93
M142C38R24	3/8"	24R	.025"	\$16.10
M142C12H3	1/2"	3H	.025"	\$18.79
M142C12H4	1/2"	4H	.025"	\$18.79
M142C12H6	1/2"	6H	.025"	\$18.79
M142C12R10	1/2"	10R	.025"	\$18.79
M142C12R14	1/2"	14R	.025"	\$18.79
M142C12R18	1/2"	18R	.025"	\$18.79
M142C12R24	1/2"	24R	.025"	\$18.79
M142C58H3	5/8"	3H	.032"	\$22.31
M142C58H4	5/8"	4H	.032"	\$22.31
M142C58R10	5/8"	10R	.032"	\$22.31
M142C58R14	5/8"	14R	.032"	\$22.31
M142C34H2	3/4"	2H	.032"	\$22.31
M142C34H3	3/4"	3H	.032"	\$22.31
M142C34H4	3/4"	4H	.032"	\$22.31
M142C34H6	3/4"	6H	.032"	\$22.31
M142C34R6	3/4"	6R	.032"	\$22.31
M142C34R10	3/4"	10R	.032"	\$22.31
M142C34R14	3/4"	14R	.032"	\$22.31
M142C34R18	3/4"	18R	.032"	\$22.31
M142C1H1.3	1"	1.3H	.035"	\$29.19
M142C1H2	1"	2H	.035"	\$29.19
M142C1H3	1"	3H	.035"	\$29.19
M142C1H4	1"	4H	.035"	\$29.19
M142C1H6	1"	6H	.035"	\$29.19
M142C1R6	1"	6R	.035"	\$29.19
M142C1R8	1"	8R	.035"	\$29.19
M142C1R10	1"	10R	.035"	\$29.19
M142C1R14	1"	14R	.035"	\$29.19
M142C114H1.3	1-1/4"	1.3H	.042"	\$36.64
M142C112H1.15	1-1/2"	1.15H	.045"	\$40.90

Carbide Grit Bandsaw Blade 142" (11' 10") Long



MAGNATE

Tool No.	Width	Tooth	Thickness	Price
M142G12MC	1/2"	Med-Coarse	.025"	\$316.16
M142G34MC	3/4"	Med-Coarse	.032"	\$336.76
M142G1MC	1"	Med-Coarse	.035"	\$355.10

Carbide Tipped Bandsaw Blade 142" (11' 10") Long



MAGNATE

Tool No.	Width	Tooth	Thickness	Price
M142E12T3	1/2"	3	.025"	\$250.22
M142E34T3	3/4"	3	.035"	\$274.47
M142E1T1.3	1"	1.3	.035"	\$274.47
M142E1T2	1"	2	.035"	\$274.47
M142E1T3	1"	3	.035"	\$274.47
M142E1V2	1"	2-3V	.035"	\$269.45
M142E114V2	1-1/4"	2-3V	.042"	\$278.37
M142E114V3	1-1/4"	3-4V	.042"	\$352.42

Carbide Grit Bandsaw Blade 143" (11' 11") Long



MAGNATE

Tool No.	Width	Tooth	Thickness	Price
M143G12MC	1/2"	Med-Coarse	.025"	\$303.84
M143G34MC	3/4"	Med-Coarse	.032"	\$323.67
M143G1MC	1"	Med-Coarse	.035"	\$341.28

MAGNATE™ 20639 Lycoming Street #B-6, Walnut, CA 91789 USA

M-71



email : info@magnate.net Online Shop : www.magnate.net
(TEL) 800-827-2316, 909-468-5747 (FAX) 909-468-5745

MAGNATE™ Band Saw Blades (Non-Food Processing)

Bi-metal Bandsaw Blade 143" (11' 11") Long



MAGNATE

Tool No.	Width	Tooth	Thickness	Price
M143M14H6	1/4"	6H	.025"	\$59.59
M143M14V10	1/4"	10-14V	.025"	\$59.59
M143M14V14	1/4"	14-18V	.025"	\$59.59
M143M38H4	3/8"	4H	.025"	\$59.59
M143M38V10	3/8"	10-14V	.025"	\$59.59
M143M38V14	3/8"	14-18V	.025"	\$59.59
M143M12H3	1/2"	3H	.035"	\$59.59
M143M12H4	1/2"	4H	.025"	\$59.59
M143M12H6	1/2"	6H	.025"	\$59.59
M143M12V6	1/2"	6-10V	.025"	\$59.59
M143M12V8	1/2"	8-12V	.025"	\$59.59
M143M12V10	1/2"	10-14V	.025"	\$59.59
M143M12T14	1/2"	14	.025"	\$59.59
M143M12V14	1/2"	14-18V	.025"	\$59.59
M143M12T18	1/2"	18	.025"	\$59.59
M143M58V10	5/8"	10-14V	.032"	\$62.95
M143M34H3	3/4"	3H	.035"	\$62.95
M143M34V4	3/4"	4-6V	.035"	\$62.95
M143M34V5	3/4"	5-8V	.035"	\$62.95
M143M34V6	3/4"	6-10V	.035"	\$62.95
M143M34V8	3/4"	8-12V	.035"	\$62.95
M143M34V10	3/4"	10-14V	.035"	\$62.95
M143M34W14	3/4"	14W	.035"	\$62.95
M143M34W18	3/4"	18W	.035"	\$62.95
M143M1V2	1"	2-3V	.035"	\$72.47
M143M1H3	1"	3H	.035"	\$72.47
M143M1V3	1"	3-4V	.035"	\$72.47
M143M1V4	1"	4-6V	.035"	\$72.47
M143M1V5	1"	5-8V	.035"	\$72.47
M143M1V6	1"	6-10V	.035"	\$72.47
M143M1V8	1"	8-12V	.035"	\$72.47
M143M1V10	1"	10-14V	.035"	\$72.47
M143M114V2	1-1/4"	2-3V	.042"	\$87.05
M143M114V3	1-1/4"	3-4V	.042"	\$87.05
M143M114V4	1-1/4"	4-6V	.042"	\$87.05
M143M114V5	1-1/4"	5-8V	.042"	\$87.05
M143M114V6	1-1/4"	6-10V	.042"	\$87.05
M143M114V8	1-1/4"	8-12V	.042"	\$87.05
M143M112V2	1-1/2"	2-3V	.050"	\$105.52
M143M112V3	1-1/2"	3-4V	.050"	\$105.52
M143M112V4	1-1/2"	4-6V	.050"	\$105.52
M143M112V5	1-1/2"	5-8V	.050"	\$105.52

Carbide Tipped Bandsaw Blade 143" (11' 11") Long



MAGNATE

Tool No.	Width	Tooth	Thickness	Price
M143E12T3	1/2"	3	.025"	\$250.22
M143E34T3	3/4"	3	.035"	\$274.47
M143E1T1.3	1"	1.3	.035"	\$274.47
M143E1T2	1"	2	.035"	\$274.47
M143E1T3	1"	3	.035"	\$274.47
M143E1V2	1"	2-3V	.035"	\$269.45
M143E114V2	1-1/4"	2-3V	.042"	\$278.37
M143E114V3	1-1/4"	3-4V	.042"	\$352.42

WoodSaver Plus Resaw Bandsaw Blades 143" (11' 11") Long



Tool No.	Width	Tooth	Thickness	Price
B143P58V3	5/8"	3-4V	.025"	\$99.00

WoodSaver Resaw Bandsaw Blades 143" (11' 11") Long



Tool No.	Width	Tooth	Thickness	Price
B143S58T3	5/8"	3	.025"	\$84.58
B143S1T3	1"	3	.025"	\$98.30

Hawc Pro Resaw Bandsaw Blade 143" (11' 11") Long



Tool No.	Width	Tooth	Thickness	Price
B143H12T3	1/2"	3	.025"	\$25.12

Carbon Steel Bandsaw Blade 143" (11' 11") Long



MAGNATE

Tool No.	Width	Tooth	Thickness	Price
M143C18R14	1/8"	14R	.025"	\$21.22
M143C18R18	1/8"	18R	.025"	\$21.22
M143C316S4	3/16"	4S	.025"	\$18.22
M143C316S6	3/16"	6S	.025"	\$18.79
M143C316R10	3/16"	10R	.025"	\$18.22
M143C316R14	3/16"	14R	.025"	\$18.22
M143C316R18	3/16"	18R	.025"	\$18.22
M143C316R24	3/16"	24R	.025"	\$18.22
M143C14H4	1/4"	4H	.025"	\$15.28
M143C14H6	1/4"	6H	.025"	\$15.28
M143C14R10	1/4"	10R	.025"	\$15.28
M143C14R14	1/4"	14R	.025"	\$15.28
M143C14R18	1/4"	18R	.025"	\$15.28
M143C14R24	1/4"	24R	.025"	\$15.28
M143C38H3	3/8"	3H	.025"	\$16.93
M143C38H4	3/8"	4H	.025"	\$16.93
M143C38H6	3/8"	6H	.025"	\$16.93
M143C38R8	3/8"	8R	.025"	\$16.93
M143C38R10	3/8"	10R	.025"	\$16.93
M143C38R14	3/8"	14R	.025"	\$16.93
M143C38R18	3/8"	18R	.025"	\$16.93
M143C38R24	3/8"	24R	.025"	\$16.10
M143C12H3	1/2"	3H	.025"	\$18.79
M143C12H4	1/2"	4H	.025"	\$18.79
M143C12H6	1/2"	6H	.025"	\$18.79
M143C12R10	1/2"	10R	.025"	\$18.79
M143C12R14	1/2"	14R	.025"	\$18.79
M143C12R18	1/2"	18R	.025"	\$18.79
M143C12R24	1/2"	24R	.025"	\$18.79
M143C58H3	5/8"	3H	.032"	\$22.31
M143C58H4	5/8"	4H	.032"	\$22.31
M143C58R10	5/8"	10R	.032"	\$22.31
M143C58R14	5/8"	14R	.032"	\$22.31
M143C34H2	3/4"	2H	.032"	\$22.31
M143C34H3	3/4"	3H	.032"	\$22.31
M143C34H4	3/4"	4H	.032"	\$22.31
M143C34H6	3/4"	6H	.032"	\$22.31
M143C34R6	3/4"	6R	.032"	\$22.31
M143C34R10	3/4"	10R	.032"	\$22.31
M143C34R14	3/4"	14R	.032"	\$22.31
M143C34R18	3/4"	18R	.032"	\$22.31
M143C1H1.3	1"	1.3H	.035"	\$29.19
M143C1H2	1"	2H	.035"	\$29.19
M143C1H3	1"	3H	.035"	\$29.19
M143C1H4	1"	4H	.035"	\$29.19
M143C1H6	1"	6H	.035"	\$29.19
M143C1R6	1"	6R	.035"	\$29.19
M143C1R8	1"	8R	.035"	\$29.19
M143C1R10	1"	10R	.035"	\$29.19
M143C1R14	1"	14R	.035"	\$29.19
M143C114H1.3	1-1/4"	1.3H	.042"	\$36.64
M143C112H1.15	1-1/2"	1.15H	.045"	\$40.90

MAGNATE™ 20639 Lycoming Street #B-6, Walnut, CA 91789 USA

M-72



email : info@magnate.net Online Shop : www.magnate.net
(TEL) 800-827-2316, 909-468-5747 (FAX) 909-468-5745

MAGNATE™ Band Saw Blades (Non-Food Processing)

Carbide Impregnated Bandsaw Blade
143" (11' 11") Long



SUPER CUT™

Tool No.	Width	Tooth	Thickness	Price
B143G14H6	1/4"	6H	.025"	\$37.73
B143G38H4	3/8"	4H	.025"	\$35.77
B143G12H3	1/2"	3H	.025"	\$37.75

Carbide Grit Bandsaw Blade
149" (12' 5") Long



MAGNATE

Tool No.	Width	Tooth	Thickness	Price
M149G12MC	1/2"	Med-Coarse	.025"	\$316.16
M149G34MC	3/4"	Med-Coarse	.032"	\$336.76
M149G1MC	1"	Med-Coarse	.035"	\$355.10

Carbide Impregnated Bandsaw Blade
149" (12' 5") Long



SUPER CUT™

Tool No.	Width	Tooth	Thickness	Price
B149G14H6	1/4"	6H	.025"	\$38.65
B149G38H4	3/8"	4H	.025"	\$36.87
B149G12H3	1/2"	3H	.025"	\$38.62

Hawc Pro Resaw Bandsaw Blade
149" (12' 5") Long



SUPER CUT™

Tool No.	Width	Tooth	Thickness	Price
B149H12T3	1/2"	3	.025"	\$25.70

Bi-metal Bandsaw Blade
149" (12' 5") Long



MAGNATE

Tool No.	Width	Tooth	Thickness	Price
M149M14H6	1/4"	6H	.025"	\$61.72
M149M14V10	1/4"	10-14V	.025"	\$61.72
M149M14V14	1/4"	14-18V	.025"	\$61.72
M149M38H4	3/8"	4H	.025"	\$61.72
M149M38V10	3/8"	10-14V	.025"	\$61.72
M149M38V14	3/8"	14-18V	.025"	\$61.72
M149M12H3	1/2"	3H	.035"	\$61.72
M149M12H4	1/2"	4H	.025"	\$61.72
M149M12H6	1/2"	6H	.025"	\$61.72
M149M12V6	1/2"	6-10V	.025"	\$61.72
M149M12V8	1/2"	8-12V	.025"	\$61.72
M149M12V10	1/2"	10-14V	.025"	\$61.72
M149M12T14	1/2"	14	.025"	\$61.72
M149M12V14	1/2"	14-18V	.025"	\$61.72
M149M12T18	1/2"	18	.025"	\$61.72
M149M58V10	5/8"	10-14V	.032"	\$65.17
M149M34H3	3/4"	3H	.035"	\$65.17
M149M34V4	3/4"	4-6V	.035"	\$65.17
M149M34V5	3/4"	5-8V	.035"	\$65.17
M149M34V6	3/4"	6-10V	.035"	\$65.17
M149M34V8	3/4"	8-12V	.035"	\$65.17
M149M34V10	3/4"	10-14V	.035"	\$65.17
M149M34W14	3/4"	14W	.035"	\$65.17
M149M34W18	3/4"	18W	.035"	\$65.17
M149M1H3	1"	3H	.035"	\$75.10
M149M1V2	1"	2-3V	.035"	\$75.10
M149M1V3	1"	3-4V	.035"	\$75.10
M149M1V4	1"	4-6V	.035"	\$75.10
M149M1V5	1"	5-8V	.035"	\$75.10
M149M1V6	1"	6-10V	.035"	\$75.10
M149M1V8	1"	8-12V	.035"	\$75.10
M149M1V10	1"	10-14V	.035"	\$75.10
M149M114V2	1-1/4"	2-3V	.042"	\$90.21
M149M114V3	1-1/4"	3-4V	.042"	\$90.21
M149M114V4	1-1/4"	4-6V	.042"	\$90.21
M149M114V5	1-1/4"	5-8V	.042"	\$90.21
M149M114V6	1-1/4"	6-10V	.042"	\$90.21
M149M114V8	1-1/4"	8-12V	.042"	\$90.21
M149M112V2	1-1/2"	2-3V	.050"	\$109.45
M149M112V3	1-1/2"	3-4V	.050"	\$109.45
M149M112V4	1-1/2"	4-6V	.050"	\$109.45
M149M112V5	1-1/2"	5-8V	.050"	\$109.45

Carbon Steel Bandsaw Blade
149" (12' 5") Long



MAGNATE

Tool No.	Width	Tooth	Thickness	Price
M149C18R14	1/8"	14R	.025"	\$21.79
M149C18R18	1/8"	18R	.025"	\$21.79
M149C316S4	3/16"	4S	.025"	\$18.79
M149C316S6	3/16"	6S	.025"	\$19.40
M149C316R10	3/16"	10R	.025"	\$18.22
M149C316R14	3/16"	14R	.025"	\$18.22
M149C316R18	3/16"	18R	.025"	\$18.22
M149C316R24	3/16"	24R	.025"	\$18.22
M149C14H4	1/4"	4H	.025"	\$15.74
M149C14H6	1/4"	6H	.025"	\$15.74
M149C14R10	1/4"	10R	.025"	\$15.74
M149C14R14	1/4"	14R	.025"	\$15.74
M149C14R18	1/4"	18R	.025"	\$15.74
M149C14R24	1/4"	24R	.025"	\$15.74
M149C38H3	3/8"	3H	.025"	\$17.47
M149C38H4	3/8"	4H	.025"	\$17.47
M149C38H6	3/8"	6H	.025"	\$17.47
M149C38R8	3/8"	8R	.025"	\$17.47
M149C38R10	3/8"	10R	.025"	\$17.47
M149C38R14	3/8"	14R	.025"	\$17.47
M149C38R18	3/8"	18R	.025"	\$17.47
M149C38R24	3/8"	24R	.025"	\$16.60
M149C12H3	1/2"	3H	.025"	\$19.40
M149C12H4	1/2"	4H	.025"	\$19.40
M149C12H6	1/2"	6H	.025"	\$19.40
M149C12R10	1/2"	10R	.025"	\$19.40
M149C12R14	1/2"	14R	.025"	\$19.40
M149C12R18	1/2"	18R	.025"	\$19.40
M149C12R24	1/2"	24R	.025"	\$19.40
M149C58H3	5/8"	3H	.032"	\$23.07
M149C58H4	5/8"	4H	.032"	\$23.07
M149C58R10	5/8"	10R	.032"	\$23.07
M149C58R14	5/8"	14R	.032"	\$23.07
M149C34H2	3/4"	2H	.032"	\$23.07
M149C34H3	3/4"	3H	.032"	\$23.07
M149C34H4	3/4"	4H	.032"	\$23.07
M149C34H6	3/4"	6H	.032"	\$23.07
M149C34R6	3/4"	6R	.032"	\$23.07
M149C34R10	3/4"	10R	.032"	\$23.07
M149C34R14	3/4"	14R	.032"	\$23.07
M149C34R18	3/4"	18R	.032"	\$23.07
M149C1H1.3	1"	1.3H	.035"	\$30.17
M149C1H2	1"	2H	.035"	\$30.17
M149C1H3	1"	3H	.035"	\$30.17
M149C1H4	1"	4H	.035"	\$30.17
M149C1H6	1"	6H	.035"	\$30.17
M149C1R6	1"	6R	.035"	\$30.17
M149C1R8	1"	8R	.035"	\$30.17
M149C1R10	1"	10R	.035"	\$30.17
M149C1R14	1"	14R	.035"	\$30.17
M149C114H1.3	1-1/4"	1.3H	.042"	\$37.93
M149C112H1.15	1-1/2"	1.15H	.045"	\$42.33

MAGNATE™ 20639 Lycoming Street #B-6, Walnut, CA 91789 USA

M-73



email : info@magnate.net Online Shop : www.magnate.net
(TEL) 800-827-2316, 909-468-5747 (FAX) 909-468-5745

MAGNATE™ Band Saw Blades (Non-Food Processing)

WoodSaver Plus Resaw Bandsaw Blades 149" (12' 5") Long



Tool No.	Width	Tooth	Thickness	Price
B149P58V3	5/8"	3-4V	.025"	\$102.63

WoodSaver Resaw Bandsaw Blades 149" (12' 5") Long



Tool No.	Width	Tooth	Thickness	Price
B149S58T3	5/8"	3	.025"	\$87.63
B149S1T3	1"	3	.025"	\$102.02

Carbide Grit Bandsaw Blade 150" (12' 6") Long



MAGNATE

Tool No.	Width	Tooth	Thickness	Price
M150G12MC	1/2"	Med-Coarse	.025"	\$316.16
M150G34MC	3/4"	Med-Coarse	.032"	\$336.76
M150G1MC	1"	Med-Coarse	.035"	\$355.10

Hawc Pro Resaw Bandsaw Blade 150" (12' 6") Long



Tool No.	Width	Tooth	Thickness	Price
B150H12T3	1/2"	3	.025"	\$26.35

Bi-metal Bandsaw Blade 150" (12' 6") Long



MAGNATE

Tool No.	Width	Tooth	Thickness	Price
M150M14H6	1/4"	6H	.025"	\$61.72
M150M14V10	1/4"	10-14V	.025"	\$61.72
M150M14V14	1/4"	14-18V	.025"	\$61.72
M150M38H4	3/8"	4H	.025"	\$61.72
M150M38V10	3/8"	10-14V	.025"	\$61.72
M150M38V14	3/8"	14-18V	.025"	\$61.72
M150M12H3	1/2"	3H	.035"	\$61.72
M150M12H4	1/2"	4H	.025"	\$61.72
M150M12H6	1/2"	6H	.025"	\$61.72
M150M12V6	1/2"	6-10V	.025"	\$61.72
M150M12V8	1/2"	8-12V	.025"	\$61.72
M150M12V10	1/2"	10-14V	.025"	\$61.72
M150M12T14	1/2"	14	.025"	\$61.72
M150M12V14	1/2"	14-18V	.025"	\$61.72
M150M12T18	1/2"	18	.025"	\$61.72
M150M58V10	5/8"	10-14V	.032"	\$65.17
M150M34H3	3/4"	3H	.035"	\$65.17
M150M34V4	3/4"	4-6V	.035"	\$65.17
M150M34V5	3/4"	5-8V	.035"	\$65.17
M150M34V6	3/4"	6-10V	.035"	\$65.17
M150M34V8	3/4"	8-12V	.035"	\$65.17
M150M34V10	3/4"	10-14V	.035"	\$65.17
M150M34W14	3/4"	14W	.035"	\$65.17
M150M34W18	3/4"	18W	.035"	\$65.17
M150M1V2	1"	2-3V	.035"	\$75.10
M150M1H3	1"	3H	.035"	\$75.10
M150M1V3	1"	3-4V	.035"	\$75.10
M150M1V4	1"	4-6V	.035"	\$75.10
M150M1V5	1"	5-8V	.035"	\$75.10
M150M1V6	1"	6-10V	.035"	\$75.10
M150M1V8	1"	8-12V	.035"	\$75.10
M150M1V10	1"	10-14V	.035"	\$75.10
M150M114V2	1-1/4"	2-3V	.042"	\$90.21
M150M114V3	1-1/4"	3-4V	.042"	\$90.21
M150M114V4	1-1/4"	4-6V	.042"	\$90.21
M150M114V5	1-1/4"	5-8V	.042"	\$90.21
M150M114V6	1-1/4"	6-10V	.042"	\$90.21
M150M114V8	1-1/4"	8-12V	.042"	\$90.21
M150M112V2	1-1/2"	2-3V	.050"	\$109.45
M150M112V3	1-1/2"	3-4V	.050"	\$109.45
M150M112V4	1-1/2"	4-6V	.050"	\$109.45
M150M112V5	1-1/2"	5-8V	.050"	\$109.45

Carbon Steel Bandsaw Blade 150" (12' 6") Long



MAGNATE

Tool No.	Width	Tooth	Thickness	Price
M150C18R14	1/8"	14R	.025"	\$21.79
M150C18R18	1/8"	18R	.025"	\$21.79
M150C316S4	3/16"	4S	.025"	\$18.79
M150C316S6	3/16"	6S	.025"	\$19.40
M150C316R10	3/16"	10R	.025"	\$18.79
M150C316R14	3/16"	14R	.025"	\$18.79
M150C316R18	3/16"	18R	.025"	\$18.79
M150C316R24	3/16"	24R	.025"	\$18.79
M150C14H4	1/4"	4H	.025"	\$15.74
M150C14H6	1/4"	6H	.025"	\$15.74
M150C14R10	1/4"	10R	.025"	\$15.74
M150C14R14	1/4"	14R	.025"	\$15.74
M150C14R18	1/4"	18R	.025"	\$15.74
M150C14R24	1/4"	24R	.025"	\$15.74
M150C38H3	3/8"	3H	.025"	\$17.47
M150C38H4	3/8"	4H	.025"	\$17.47
M150C38H6	3/8"	6H	.025"	\$17.47
M150C38R8	3/8"	8R	.025"	\$17.47
M150C38R10	3/8"	10R	.025"	\$17.47
M150C38R14	3/8"	14R	.025"	\$17.47
M150C38R18	3/8"	18R	.025"	\$17.47
M150C38R24	3/8"	24R	.025"	\$16.60
M150C12H3	1/2"	3H	.025"	\$19.40
M150C12H4	1/2"	4H	.025"	\$19.40
M150C12H6	1/2"	6H	.025"	\$19.40
M150C12R10	1/2"	10R	.025"	\$19.40
M150C12R14	1/2"	14R	.025"	\$19.40
M150C12R18	1/2"	18R	.025"	\$19.40
M150C12R24	1/2"	24R	.025"	\$19.40
M150C58H3	5/8"	3H	.032"	\$23.07
M150C58H4	5/8"	4H	.032"	\$23.07
M150C58R10	5/8"	10R	.032"	\$23.07
M150C58R14	5/8"	14R	.032"	\$23.07
M150C34H2	3/4"	2H	.032"	\$23.07
M150C34H3	3/4"	3H	.032"	\$23.07
M150C34H4	3/4"	4H	.032"	\$23.07
M150C34H6	3/4"	6H	.032"	\$23.07
M150C34R6	3/4"	6R	.032"	\$23.07
M150C34R10	3/4"	10R	.032"	\$23.07
M150C34R14	3/4"	14R	.032"	\$23.07
M150C34R18	3/4"	18R	.032"	\$23.07
M150C1H1.3	1"	1.3H	.035"	\$30.17
M150C1H2	1"	2H	.035"	\$30.17
M150C1H3	1"	3H	.035"	\$30.17
M150C1H4	1"	4H	.035"	\$30.17
M150C1H6	1"	6H	.035"	\$30.17
M150C1R6	1"	6R	.035"	\$30.17
M150C1R8	1"	8R	.035"	\$30.17
M150C1R10	1"	10R	.035"	\$30.17
M150C1R14	1"	14R	.035"	\$30.17
M150C114H1.3	1-1/4"	1.3H	.042"	\$37.93
M150C112H1.15	1-1/2"	1.15H	.045"	\$42.33

MAGNATE™ 20639 Lycoming Street #B-6, Walnut, CA 91789 USA

M-74



email : info@magnate.net Online Shop : www.magnate.net
(TEL) 800-827-2316, 909-468-5747 (FAX) 909-468-5745

MAGNATE™ Band Saw Blades (Non-Food Processing)

Carbide Impregnated Bandsaw Blade 150" (12' 6") Long



Tool No.	Width	Tooth	Thickness	Price
B150G14H6	1/4"	6H	.025"	\$38.65
B150G38H4	3/8"	4H	.025"	\$36.87
B150G12H3	1/2"	3H	.025"	\$38.62

Carbide Tipped Bandsaw Blade 150" (12' 6") Long



MAGNATE

Tool No.	Width	Tooth	Thickness	Price
M150E12T3	1/2"	3	.025"	\$260.28
M150E34T3	3/4"	3	.035"	\$285.52
M150E1T1.3	1"	1.3	.035"	\$285.52
M150E1T2	1"	2	.035"	\$285.52
M150E1T3	1"	3	.035"	\$285.52
M150E1V2	1"	2-3V	.035"	\$280.27
M150E114V2	1-1/4"	2-3V	.042"	\$289.50
M150E114V3	1-1/4"	3-4V	.042"	\$366.62

WoodSaver Plus Resaw Bandsaw Blades 150" (12' 6") Long



Tool No.	Width	Tooth	Thickness	Price
B150P58V3	5/8"	3-4V	.025"	\$102.63

WoodSaver Resaw Bandsaw Blades 150" (12' 6") Long



Tool No.	Width	Tooth	Thickness	Price
B150S58T3	5/8"	3	.025"	\$87.63
B150S1T3	1"	3	.025"	\$102.02

Carbon Steel Bandsaw Blade 154" (12' 10") Long



MAGNATE

Tool No.	Width	Tooth	Thickness	Price
M154C18R14	1/8"	14R	.025"	\$22.34
M154C18R18	1/8"	18R	.025"	\$22.34
M154C316S4	3/16"	4S	.025"	\$19.12
M154C316S6	3/16"	6S	.025"	\$20.00
M154C316R10	3/16"	10R	.025"	\$18.79
M154C316R14	3/16"	14R	.025"	\$18.79
M154C316R18	3/16"	18R	.025"	\$18.79
M154C316R24	3/16"	24R	.025"	\$18.79
M154C14H4	1/4"	4H	.025"	\$16.19
M154C14H6	1/4"	6H	.025"	\$16.19
M154C14R10	1/4"	10R	.025"	\$16.19
M154C14R14	1/4"	14R	.025"	\$16.19
M154C14R18	1/4"	18R	.025"	\$16.19
M154C14R24	1/4"	24R	.025"	\$16.19
M154C38H3	3/8"	3H	.025"	\$17.98
M154C38H4	3/8"	4H	.025"	\$17.98
M154C38H6	3/8"	6H	.025"	\$17.98
M154C38R8	3/8"	8R	.025"	\$17.98
M154C38R10	3/8"	10R	.025"	\$17.98
M154C38R14	3/8"	14R	.025"	\$17.98
M154C38R18	3/8"	18R	.025"	\$17.98
M154C38R24	3/8"	24R	.025"	\$16.98
M154C12H3	1/2"	3H	.025"	\$20.00
M154C12H4	1/2"	4H	.025"	\$20.00
M154C12H6	1/2"	6H	.025"	\$20.00
M154C12R10	1/2"	10R	.025"	\$20.00
M154C12R14	1/2"	14R	.025"	\$20.00
M154C12R18	1/2"	18R	.025"	\$20.00
M154C12R24	1/2"	24R	.025"	\$20.00
M154C58H3	5/8"	3H	.032"	\$23.81
M154C58H4	5/8"	4H	.032"	\$23.81
M154C58R10	5/8"	10R	.032"	\$23.81
M154C58R14	5/8"	14R	.032"	\$23.81
M154C34H2	3/4"	2H	.032"	\$23.81
M154C34H3	3/4"	3H	.032"	\$23.81
M154C34H4	3/4"	4H	.032"	\$23.81
M154C34H6	3/4"	6H	.032"	\$23.81
M154C34R6	3/4"	6R	.032"	\$23.81
M154C34R10	3/4"	10R	.032"	\$23.81
M154C34R14	3/4"	14R	.032"	\$23.81
M154C34R18	3/4"	18R	.032"	\$23.81
M154C1H1.3	1"	1.3H	.035"	\$31.16
M154C1H2	1"	2H	.035"	\$31.16
M154C1H3	1"	3H	.035"	\$31.16
M154C1H4	1"	4H	.035"	\$31.16
M154C1H6	1"	6H	.035"	\$31.16
M154C1R6	1"	6R	.035"	\$31.16
M154C1R8	1"	8R	.035"	\$31.16
M154C1R10	1"	10R	.035"	\$31.16
M154C1R14	1"	14R	.035"	\$31.16
M154C114H1.3	1-1/4"	1.3H	.042"	\$39.22
M154C112H1.15	1-1/2"	1.15H	.045"	\$43.76

Bi-metal Bandsaw Blade 154" (12' 10") Long



MAGNATE

Tool No.	Width	Tooth	Thickness	Price
M154M14H6	1/4"	6H	.025"	\$63.91
M154M14V10	1/4"	10-14V	.025"	\$63.91
M154M14V14	1/4"	14-18V	.025"	\$63.91
M154M38H4	3/8"	4H	.025"	\$63.91
M154M38V10	3/8"	10-14V	.025"	\$63.91
M154M38V14	3/8"	14-18V	.025"	\$63.91
M154M12H3	1/2"	3H	.035"	\$63.91
M154M12H4	1/2"	4H	.025"	\$63.91
M154M12H6	1/2"	6H	.025"	\$63.91
M154M12V6	1/2"	6-10V	.025"	\$63.91
M154M12V8	1/2"	8-12V	.025"	\$63.91
M154M12V10	1/2"	10-14V	.025"	\$63.91
M154M12T14	1/2"	14	.025"	\$63.91
M154M12V14	1/2"	14-18V	.025"	\$63.91
M154M12T18	1/2"	18	.025"	\$63.91
M154M58V10	5/8"	10-14V	.032"	\$67.41
M154M34H3	3/4"	3H	.035"	\$67.41
M154M34V4	3/4"	4-6V	.035"	\$67.41
M154M34V5	3/4"	5-8V	.035"	\$67.41
M154M34V6	3/4"	6-10V	.035"	\$67.41
M154M34V8	3/4"	8-12V	.035"	\$67.41
M154M34V10	3/4"	10-14V	.035"	\$67.41
M154M34W14	3/4"	14W	.035"	\$67.41
M154M34W18	3/4"	18W	.035"	\$67.41
M154M1V2	1"	2-3V	.035"	\$77.72
M154M1H3	1"	3H	.035"	\$77.72
M154M1V3	1"	3-4V	.035"	\$77.72
M154M1V4	1"	4-6V	.035"	\$77.72
M154M1V5	1"	5-8V	.035"	\$77.72
M154M1V6	1"	6-10V	.035"	\$77.72
M154M1V8	1"	8-12V	.035"	\$77.72
M154M1V10	1"	10-14V	.035"	\$77.72
M154M114V2	1-1/4"	2-3V	.042"	\$93.38
M154M114V3	1-1/4"	3-4V	.042"	\$93.38
M154M114V4	1-1/4"	4-6V	.042"	\$93.38
M154M114V5	1-1/4"	5-8V	.042"	\$93.38
M154M114V6	1-1/4"	6-10V	.042"	\$93.38
M154M114V8	1-1/4"	8-12V	.042"	\$93.38
M154M112V2	1-1/2"	2-3V	.050"	\$128.41
M154M112V3	1-1/2"	3-4V	.050"	\$128.41
M154M112V4	1-1/2"	4-6V	.050"	\$128.41
M154M112V5	1-1/2"	5-8V	.050"	\$128.41

MAGNATE™ 20639 Lycoming Street #B-6, Walnut, CA 91789 USA

M-75



email : info@magnate.net Online Shop : www.magnate.net
(TEL) 800-827-2316, 909-468-5747 (FAX) 909-468-5745

MAGNATE™ Band Saw Blades (Non-Food Processing)

Carbide Grit Bandsaw Blade
154" (12' 10") Long



MAGNATE

Tool No.	Width	Tooth	Thickness	Price
M154G12MC	1/2"	Med-Coarse	.025"	\$328.47
M154G34MC	3/4"	Med-Coarse	.032"	\$349.84
M154G1MC	1"	Med-Coarse	.035"	\$368.91

Bi-metal Bandsaw Blade
154-1/2" (12' 10-1/2") Long



MAGNATE

Tool No.	Width	Tooth	Thickness	Price
M154.5M14H6	1/4"	6H	.025"	\$63.91
M154.5M14V10	1/4"	10-14V	.025"	\$63.91
M154.5M14V14	1/4"	14-18V	.025"	\$63.91
M154.5M38H4	3/8"	4H	.025"	\$63.91
M154.5M38V10	3/8"	10-14V	.025"	\$63.91
M154.5M38V14	3/8"	14-18V	.025"	\$63.91
M154.5M12H3	1/2"	3H	.035"	\$63.91
M154.5M12H4	1/2"	4H	.025"	\$63.91
M154.5M12H6	1/2"	6H	.025"	\$63.91
M154.5M12V6	1/2"	6-10V	.025"	\$63.91
M154.5M12V8	1/2"	8-12V	.025"	\$63.91
M154.5M12V10	1/2"	10-14V	.025"	\$63.91
M154.5M12T14	1/2"	14	.025"	\$63.91
M154.5M12V14	1/2"	14-18V	.025"	\$63.91
M154.5M12T18	1/2"	18	.025"	\$63.91
M154.5M58V10	5/8"	10-14V	.032"	\$67.41
M154.5M34H3	3/4"	3H	.035"	\$67.41
M154.5M34V4	3/4"	4-6V	.035"	\$67.41
M154.5M34V5	3/4"	5-8V	.035"	\$67.41
M154.5M34V6	3/4"	6-10V	.035"	\$67.41
M154.5M34V8	3/4"	8-12V	.035"	\$67.41
M154.5M34V10	3/4"	10-14V	.035"	\$67.41
M154.5M34W14	3/4"	14W	.035"	\$67.41
M154.5M34W18	3/4"	18W	.035"	\$67.41
M154.5M1V2	1"	2-3V	.035"	\$77.72
M154.5M1H3	1"	3H	.035"	\$77.72
M154.5M1V3	1"	3-4V	.035"	\$77.72
M154.5M1V4	1"	4-6V	.035"	\$77.72
M154.5M1V5	1"	5-8V	.035"	\$77.72
M154.5M1V6	1"	6-10V	.035"	\$77.72
M154.5M1V8	1"	8-12V	.035"	\$77.72
M154.5M1V10	1"	10-14V	.035"	\$77.72
M154.5M114V2	1-1/4"	2-3V	.042"	\$93.38
M154.5M114V3	1-1/4"	3-4V	.042"	\$93.38
M154.5M114V4	1-1/4"	4-6V	.042"	\$93.38
M154.5M114V5	1-1/4"	5-8V	.042"	\$93.38
M154.5M114V6	1-1/4"	6-10V	.042"	\$93.38
M154.5M114V8	1-1/4"	8-12V	.042"	\$93.38
M154.5M112V2	1-1/2"	2-3V	.050"	\$128.41
M154.5M112V3	1-1/2"	3-4V	.050"	\$128.41
M154.5M112V4	1-1/2"	4-6V	.050"	\$128.41
M154.5M112V5	1-1/2"	5-8V	.050"	\$128.41



Carbon Steel Bandsaw Blade
154-1/2" (12' 10-1/2") Long



MAGNATE

Tool No.	Width	Tooth	Thickness	Price
M154.5C18R14	1/8"	14R	.025"	\$22.34
M154.5C18R18	1/8"	18R	.025"	\$22.34
M154.5C316S4	3/16"	4S	.025"	\$19.12
M154.5C316S6	3/16"	6S	.025"	\$20.00
M154.5C316R10	3/16"	10R	.025"	\$19.12
M154.5C316R14	3/16"	14R	.025"	\$19.12
M154.5C316R18	3/16"	18R	.025"	\$19.12
M154.5C316R24	3/16"	24R	.025"	\$19.12
M154.5C14H4	1/4"	4H	.025"	\$16.19
M154.5C14H6	1/4"	6H	.025"	\$16.19
M154.5C14R10	1/4"	10R	.025"	\$16.19
M154.5C14R14	1/4"	14R	.025"	\$16.19
M154.5C14R18	1/4"	18R	.025"	\$16.19
M154.5C14R24	1/4"	24R	.025"	\$16.19
M154.5C38H3	3/8"	3H	.025"	\$17.98
M154.5C38H4	3/8"	4H	.025"	\$17.98
M154.5C38H6	3/8"	6H	.025"	\$17.98
M154.5C38R8	3/8"	8R	.025"	\$17.98
M154.5C38R10	3/8"	10R	.025"	\$17.98
M154.5C38R14	3/8"	14R	.025"	\$17.98
M154.5C38R18	3/8"	18R	.025"	\$17.98
M154.5C38R24	3/8"	24R	.025"	\$16.98
M154.5C12H3	1/2"	3H	.025"	\$20.00
M154.5C12H4	1/2"	4H	.025"	\$20.00
M154.5C12H6	1/2"	6H	.025"	\$20.00
M154.5C12R10	1/2"	10R	.025"	\$20.00
M154.5C12R14	1/2"	14R	.025"	\$20.00
M154.5C12R18	1/2"	18R	.025"	\$20.00
M154.5C12R24	1/2"	24R	.025"	\$20.00
M154.5C58H3	5/8"	3H	.032"	\$23.81
M154.5C58H4	5/8"	4H	.032"	\$23.81
M154.5C58R10	5/8"	10R	.032"	\$23.81
M154.5C58R14	5/8"	14R	.032"	\$23.81
M154.5C34H2	3/4"	2H	.032"	\$23.81
M154.5C34H3	3/4"	3H	.032"	\$23.81
M154.5C34H4	3/4"	4H	.032"	\$23.81
M154.5C34H6	3/4"	6H	.032"	\$23.81
M154.5C34R6	3/4"	6R	.032"	\$23.81
M154.5C34R10	3/4"	10R	.032"	\$23.81
M154.5C34R14	3/4"	14R	.032"	\$23.81
M154.5C34R18	3/4"	18R	.032"	\$23.81
M154.5C1H1.3	1"	1.3H	.035"	\$31.16
M154.5C1H2	1"	2H	.035"	\$31.16
M154.5C1H3	1"	3H	.035"	\$31.16
M154.5C1H4	1"	4H	.035"	\$31.16
M154.5C1H6	1"	6H	.035"	\$31.16
M154.5C1R6	1"	6R	.035"	\$31.16
M154.5C1R8	1"	8R	.035"	\$31.16
M154.5C1R10	1"	10R	.035"	\$31.16
M154.5C1R14	1"	14R	.035"	\$31.16
M154.5C114H1.3	1-1/4"	1.3H	.042"	\$39.22
M154.5C112H1.15	1-1/2"	1.15H	.045"	\$43.76

Carbide Impregnated Bandsaw Blade
154" (12' 10") Long



Tool No.	Width	Tooth	Thickness	Price
B154G14H6	1/4"	6H	.025"	\$39.77
B154G38H4	3/8"	4H	.025"	\$37.78
B154G12H3	1/2"	3H	.025"	\$39.55

Hawc Pro Resaw Bandsaw Blade
154-1/2" (12' 10-1/2") Long



Tool No.	Width	Tooth	Thickness	Price
B154.5H12T3	1/2"	3	.025"	\$26.35

Carbide Impregnated Bandsaw Blade
154-1/2" (12' 10-1/2") Long

Tool No.	Width	Tooth	Thickness	Price
B154.5G14H6	1/4"	6H	.025"	\$39.77
B154.5G38H4	3/8"	4H	.025"	\$37.78
B154.5G12H3	1/2"	3H	.025"	\$39.55

MAGNATE™ 20639 Lycoming Street #B-6, Walnut, CA 91789 USA

M-76



email : info@magnate.net Online Shop : www.magnate.net
(TEL) 800-827-2316, 909-468-5747 (FAX) 909-468-5745

MAGNATE™ Band Saw Blades (Non-Food Processing)

Carbide Grit Bandsaw Blade
154-1/2" (12' 10-1/2") Long



MAGNATE

Tool No.	Width	Tooth	Thickness	Price
M154.5G12MC	1/2"	Med-Coarse	.025"	\$328.47
M154.5G34MC	3/4"	Med-Coarse	.032"	\$349.84
M154.5G1MC	1"	Med-Coarse	.035"	\$368.91

Bi-metal Bandsaw Blade
155" (12' 11") Long



MAGNATE

Tool No.	Width	Tooth	Thickness	Price
M155M14H6	1/4"	6H	.025"	\$63.91
M155M14V10	1/4"	10-14V	.025"	\$63.91
M155M14V14	1/4"	14-18V	.025"	\$63.91
M155M38H4	3/8"	4H	.025"	\$63.91
M155M38V10	3/8"	10-14V	.025"	\$63.91
M155M38V14	3/8"	14-18V	.025"	\$63.91
M155M12H3	1/2"	3H	.035"	\$63.91
M155M12H4	1/2"	4H	.025"	\$63.91
M155M12H6	1/2"	6H	.025"	\$63.91
M155M12V6	1/2"	6-10V	.025"	\$63.91
M155M12V8	1/2"	8-12V	.025"	\$63.91
M155M12V10	1/2"	10-14V	.025"	\$63.91
M155M12T14	1/2"	14	.025"	\$63.91
M155M12V14	1/2"	14-18V	.025"	\$63.91
M155M12T18	1/2"	18	.025"	\$63.91
M155M58V10	5/8"	10-14V	.032"	\$67.41
M155M34H3	3/4"	3H	.035"	\$67.41
M155M34V4	3/4"	4-6V	.035"	\$67.41
M155M34V5	3/4"	5-8V	.035"	\$67.41
M155M34V6	3/4"	6-10V	.035"	\$67.41
M155M34V8	3/4"	8-12V	.035"	\$67.41
M155M34V10	3/4"	10-14V	.035"	\$67.41
M155M34W14	3/4"	14W	.035"	\$67.41
M155M34W18	3/4"	18W	.035"	\$67.41
M155M1V2	1"	2-3V	.035"	\$77.72
M155M1H3	1"	3H	.035"	\$77.72
M155M1V3	1"	3-4V	.035"	\$77.72
M155M1V4	1"	4-6V	.035"	\$77.72
M155M1V5	1"	5-8V	.035"	\$77.72
M155M1V6	1"	6-10V	.035"	\$77.72
M155M1V8	1"	8-12V	.035"	\$77.72
M155M1V10	1"	10-14V	.035"	\$77.72
M155M114V2	1-1/4"	2-3V	.042"	\$93.38
M155M114V3	1-1/4"	3-4V	.042"	\$93.38
M155M114V4	1-1/4"	4-6V	.042"	\$93.38
M155M114V5	1-1/4"	5-8V	.042"	\$93.38
M155M114V6	1-1/4"	6-10V	.042"	\$93.38
M155M114V8	1-1/4"	8-12V	.042"	\$93.38
M155M112V2	1-1/2"	2-3V	.050"	\$128.41
M155M112V3	1-1/2"	3-4V	.050"	\$128.41
M155M112V4	1-1/2"	4-6V	.050"	\$128.41
M155M112V5	1-1/2"	5-8V	.050"	\$128.41

Carbon Steel Bandsaw Blade
155" (12' 11") Long



MAGNATE

Tool No.	Width	Tooth	Thickness	Price
M155C18R14	1/8"	14R	.025"	\$22.34
M155C18R18	1/8"	18R	.025"	\$22.34
M155C316S4	3/16"	4S	.025"	\$19.12
M155C316S6	3/16"	6S	.025"	\$20.00
M155C316R10	3/16"	10R	.025"	\$19.12
M155C316R14	3/16"	14R	.025"	\$19.12
M155C316R18	3/16"	18R	.025"	\$19.12
M155C316R24	3/16"	24R	.025"	\$19.12
M155C14H4	1/4"	4H	.025"	\$16.19
M155C14H6	1/4"	6H	.025"	\$16.19
M155C14R10	1/4"	10R	.025"	\$16.19
M155C14R14	1/4"	14R	.025"	\$16.19
M155C14R18	1/4"	18R	.025"	\$16.19
M155C14R24	1/4"	24R	.025"	\$16.19
M155C38H3	3/8"	3H	.025"	\$17.98
M155C38H4	3/8"	4H	.025"	\$17.98
M155C38H6	3/8"	6H	.025"	\$17.98
M155C38R8	3/8"	8R	.025"	\$17.98
M155C38R10	3/8"	10R	.025"	\$17.98
M155C38R14	3/8"	14R	.025"	\$17.98
M155C38R18	3/8"	18R	.025"	\$17.98
M155C38R24	3/8"	24R	.025"	\$16.98
M155C12H3	1/2"	3H	.025"	\$20.00
M155C12H4	1/2"	4H	.025"	\$20.00
M155C12H6	1/2"	6H	.025"	\$20.00
M155C12R10	1/2"	10R	.025"	\$20.00
M155C12R14	1/2"	14R	.025"	\$20.00
M155C12R18	1/2"	18R	.025"	\$20.00
M155C12R24	1/2"	24R	.025"	\$20.00
M155C58H3	5/8"	3H	.032"	\$23.81
M155C58H4	5/8"	4H	.032"	\$23.81
M155C58R10	5/8"	10R	.032"	\$23.81
M155C58R14	5/8"	14R	.032"	\$23.81
M155C34H2	3/4"	2H	.032"	\$23.81
M155C34H3	3/4"	3H	.032"	\$23.81
M155C34H4	3/4"	4H	.032"	\$23.81
M155C34H6	3/4"	6H	.032"	\$23.81
M155C34R6	3/4"	6R	.032"	\$23.81
M155C34R10	3/4"	10R	.032"	\$23.81
M155C34R14	3/4"	14R	.032"	\$23.81
M155C34R18	3/4"	18R	.032"	\$23.81
M155C1H1.3	1"	1.3H	.035"	\$31.16
M155C1H2	1"	2H	.035"	\$31.16
M155C1H3	1"	3H	.035"	\$31.16
M155C1H4	1"	4H	.035"	\$31.16
M155C1H6	1"	6H	.035"	\$31.16
M155C1R6	1"	6R	.035"	\$31.16
M155C1R8	1"	8R	.035"	\$31.16
M155C1R10	1"	10R	.035"	\$31.16
M155C1R14	1"	14R	.035"	\$31.16
M155C114H1.3	1-1/4"	1.3H	.042"	\$39.22
M155C112H1.15	1-1/2"	1.15H	.042"	\$43.76

WoodSaver Plus Resaw Bandsaw Blades
154-1/2" (12' 10-1/2") Long



SUPER CUT™

Tool No.	Width	Tooth	Thickness	Price
B154.5P58V3	5/8"	3-4V	.025"	\$106.32

WoodSaver Resaw Bandsaw Blades
154-1/2" (12' 10-1/2") Long



SUPER CUT™

Tool No.	Width	Tooth	Thickness	Price
B154.5S58T3	5/8"	3	.025"	\$90.88
B154.5S1T3	1"	3	.025"	\$105.73

Hawc Pro Resaw Bandsaw Blade
155" (12' 11") Long



SUPER CUT™

Tool No.	Width	Tooth	Thickness	Price
B155H12T3	1/2"	3	.025"	\$26.35

MAGNATE™ 20639 Lycoming Street #B-6, Walnut, CA 91789 USA

M-77



email : info@magnate.net Online Shop : www.magnate.net
(TEL) 800-827-2316, 909-468-5747 (FAX) 909-468-5745

MAGNATE™ Band Saw Blades (Non-Food Processing)

Carbide Grit Bandsaw Blade
155" (12' 11") Long



MAGNATE

Tool No.	Width	Tooth	Thickness	Price
M155G12MC	1/2"	Med-Coarse	.025"	\$328.47
M155G34MC	3/4"	Med-Coarse	.032"	\$349.84
M155G1MC	1"	Med-Coarse	.035"	\$368.91

WoodSaver Resaw Bandsaw Blades
155" (12' 11") Long



Tool No.	Width	Tooth	Thickness	Price
B155S58T3	5/8"	3	.025"	\$90.88
B155S1T3	1"	3	.025"	\$105.73



Bi-metal Bandsaw Blade
156-1/2" (13' 1/2") Long



MAGNATE

Tool No.	Width	Tooth	Thickness	Price
M156.5M14H6	1/4"	6H	.025"	\$65.98
M156.5M14V10	1/4"	10-14V	.025"	\$65.98
M156.5M14V14	1/4"	14-18V	.025"	\$65.98
M156.5M38H4	3/8"	4H	.025"	\$65.98
M156.5M38V10	3/8"	10-14V	.025"	\$65.98
M156.5M38V14	3/8"	14-18V	.025"	\$65.98
M156.5M12H3	1/2"	3H	.035"	\$65.98
M156.5M12H4	1/2"	4H	.025"	\$65.98
M156.5M12H6	1/2"	6H	.025"	\$65.98
M156.5M12V6	1/2"	6-10V	.025"	\$65.98
M156.5M12V8	1/2"	8-12V	.025"	\$65.98
M156.5M12V10	1/2"	10-14V	.025"	\$65.98
M156.5M12T14	1/2"	14	.025"	\$65.98
M156.5M12V14	1/2"	14-18V	.025"	\$65.98
M156.5M12T18	1/2"	18	.025"	\$65.98
M156.5M58V10	5/8"	10-14V	.032"	\$69.64
M156.5M34H3	3/4"	3H	.035"	\$69.64
M156.5M34V4	3/4"	4-6V	.035"	\$69.64
M156.5M34V5	3/4"	5-8V	.035"	\$69.64
M156.5M34V6	3/4"	6-10V	.035"	\$69.64
M156.5M34V8	3/4"	8-12V	.035"	\$69.64
M156.5M34V10	3/4"	10-14V	.035"	\$69.64
M156.5M34W14	3/4"	14W	.035"	\$69.64
M156.5M34W18	3/4"	18W	.035"	\$69.64
M156.5M1H3	1"	3H	.035"	\$80.36
M156.5M1V2	1"	2-3V	.035"	\$80.36
M156.5M1V3	1"	3-4V	.035"	\$80.36
M156.5M1V4	1"	4-6V	.035"	\$80.36
M156.5M1V5	1"	5-8V	.035"	\$80.36
M156.5M1V6	1"	6-10V	.035"	\$80.36
M156.5M1V8	1"	8-12V	.035"	\$80.36
M156.5M1V10	1"	10-14V	.035"	\$80.36
M156.5M114V2	1-1/4"	2-3V	.042"	\$96.53
M156.5M114V3	1-1/4"	3-4V	.042"	\$96.53
M156.5M114V4	1-1/4"	4-6V	.042"	\$96.53
M156.5M114V5	1-1/4"	5-8V	.042"	\$96.53
M156.5M114V6	1-1/4"	6-10V	.042"	\$96.53
M156.5M114V8	1-1/4"	8-12V	.042"	\$96.53
M156.5M112V2	1-1/2"	2-3V	.050"	\$117.33
M156.5M112V3	1-1/2"	3-4V	.050"	\$117.33
M156.5M112V4	1-1/2"	4-6V	.050"	\$117.33
M156.5M112V5	1-1/2"	5-8V	.050"	\$117.33

Carbide Impregnated Bandsaw Blade
155" (12' 11") Long

Tool No.	Width	Tooth	Thickness	Price
B155G14H6	1/4"	6H	.025"	\$39.77
B155G38H4	3/8"	4H	.025"	\$37.78
B155G12H3	1/2"	3H	.025"	\$39.55

Carbide Grit Bandsaw Blade
156-1/2" (13' 1/2") Long



MAGNATE

Tool No.	Width	Tooth	Thickness	Price
M156.5G12MC	1/2"	Med-Coarse	.025"	\$340.76
M156.5G34MC	3/4"	Med-Coarse	.032"	\$362.95
M156.5G1MC	1"	Med-Coarse	.035"	\$382.74

WoodSaver Plus Resaw Bandsaw Blades
155" (12' 11") Long



Tool No.	Width	Tooth	Thickness	Price
B155P58V3	5/8"	3-4V	.025"	\$106.32

Carbide Tipped Bandsaw Blade
156-1/2" (13' 1/2") Long



MAGNATE

Tool No.	Width	Tooth	Thickness	Price
M156.5E12T3	1/2"	3	.025"	\$280.40
M156.5E34T3	3/4"	3	.035"	\$307.58
M156.5E1T1.3	1"	1.3	.035"	\$307.58
M156.5E1T2	1"	2	.035"	\$307.58
M156.5E1T3	1"	3	.035"	\$307.58
M156.5E1V2	1"	2-3V	.035"	\$301.90
M156.5E114V2	1"	2-3V	.042"	\$311.75
M156.5E114V3	1"	3-4V	.042"	\$395.03



MAGNATE™ Band Saw Blades (Non-Food Processing)

Carbon Steel Bandsaw Blade 156-1/2" (13' 1/2") Long



Tool No.	Width	Tooth	Thickness	Price
M156.5C316S4	3/16"	4S	.025"	\$20.00
M156.5C316S6	3/16"	6S	.025"	\$20.60
M156.5C316R10	3/16"	10R	.025"	\$19.12
M156.5C316R14	3/16"	14R	.025"	\$19.12
M156.5C316R18	3/16"	18R	.025"	\$19.12
M156.5C316R24	3/16"	24R	.025"	\$19.12
M156.5C14H4	1/4"	4H	.025"	\$16.66
M156.5C14H6	1/4"	6H	.025"	\$16.66
M156.5C14R10	1/4"	10R	.025"	\$16.66
M156.5C14R14	1/4"	14R	.025"	\$16.66
M156.5C14R18	1/4"	18R	.025"	\$16.66
M156.5C14R24	1/4"	24R	.025"	\$16.66
M156.5C38H3	3/8"	3H	.025"	\$18.52
M156.5C38H4	3/8"	4H	.025"	\$18.52
M156.5C38H6	3/8"	6H	.025"	\$18.52
M156.5C38R8	3/8"	8R	.025"	\$18.52
M156.5C38R10	3/8"	10R	.025"	\$18.52
M156.5C38R14	3/8"	14R	.025"	\$18.52
M156.5C38R18	3/8"	18R	.025"	\$18.52
M156.5C38R24	3/8"	24R	.025"	\$17.34
M156.5C12H3	1/2"	3H	.025"	\$20.60
M156.5C12H4	1/2"	4H	.025"	\$20.60
M156.5C12H6	1/2"	6H	.025"	\$20.60
M156.5C12R10	1/2"	10R	.025"	\$20.60
M156.5C12R14	1/2"	14R	.025"	\$20.60
M156.5C12R18	1/2"	18R	.025"	\$20.60
M156.5C12R24	1/2"	24R	.025"	\$20.60
M156.5C58H3	5/8"	3H	.032"	\$24.57
M156.5C58H4	5/8"	4H	.032"	\$24.57
M156.5C58R10	5/8"	10R	.032"	\$24.57
M156.5C58R14	5/8"	14R	.032"	\$24.57
M156.5C34H2	3/4"	2H	.032"	\$24.57
M156.5C34H3	3/4"	3H	.032"	\$24.57
M156.5C34H4	3/4"	4H	.032"	\$24.57
M156.5C34H6	3/4"	6H	.032"	\$24.57
M156.5C34R6	3/4"	6R	.032"	\$24.57
M156.5C34R10	3/4"	10R	.032"	\$24.57
M156.5C34R14	3/4"	14R	.032"	\$24.57
M156.5C34R18	3/4"	18R	.032"	\$24.57
M156.5C1H1.3	1"	1.3H	.035"	\$32.14
M156.5C1H2	1"	2H	.035"	\$32.14
M156.5C1H3	1"	3H	.035"	\$32.14
M156.5C1H4	1"	4H	.035"	\$32.14
M156.5C1H6	1"	6H	.035"	\$32.14
M156.5C1R6	1"	6R	.035"	\$32.14
M156.5C1R8	1"	8R	.035"	\$32.14
M156.5C1R10	1"	10R	.035"	\$32.14
M156.5C1R14	1"	14R	.035"	\$32.14
M156.5C114H1.3	1-1/4"	1.3H	.042"	\$40.52
M156.5C112H1.15	1-1/2"	1.15H	.045"	\$45.19

Hawc Pro Resaw Bandsaw Blade 156-1/2" (13' 1/2") Long



Tool No.	Width	Tooth	Thickness	Price
B156.5H12T3	1/2"	3	.025"	\$27.08

Carbide Impregnated Bandsaw Blade 156-1/2" (13' 1/2") Long



Tool No.	Width	Tooth	Thickness	Price
B156.5G14H6	1/4"	6H	.025"	\$40.55
B156.5G38H4	3/8"	4H	.025"	\$38.55
B156.5G12H3	1/2"	3H	.025"	\$40.77

WoodSaver Plus Resaw Bandsaw Blades 156-1/2" (13' 1/2") Long



Tool No.	Width	Tooth	Thickness	Price
B156.5P58V3	5/8"	3-4V	.025"	\$109.97

WoodSaver Resaw Bandsaw Blades 156-1/2" (13' 1/2") Long



Tool No.	Width	Tooth	Thickness	Price
B156.5S58T3	5/8"	3	.025"	\$93.97
B156.5S1T3	1"	3	.025"	\$109.47

Bi-metal Bandsaw Blade 158" (13' 2") Long



Tool No.	Width	Tooth	Thickness	Price
M158M14H6	1/4"	6H	.025"	\$65.98
M158M14V10	1/4"	10-14V	.025"	\$65.98
M158M14V14	1/4"	14-18V	.025"	\$65.98
M158M38H4	3/8"	4H	.025"	\$65.98
M158M38V10	3/8"	10-14V	.025"	\$65.98
M158M38V14	3/8"	14-18V	.025"	\$65.98
M158M12H3	1/2"	3H	.035"	\$65.98
M158M12H4	1/2"	4H	.025"	\$65.98
M158M12H6	1/2"	6H	.025"	\$65.98
M158M12V6	1/2"	6-10V	.025"	\$65.98
M158M12V8	1/2"	8-12V	.025"	\$65.98
M158M12V10	1/2"	10-14V	.025"	\$65.98
M158M12T14	1/2"	14	.025"	\$65.98
M158M12V14	1/2"	14-18V	.025"	\$65.98
M158M12T18	1/2"	18	.025"	\$65.98
M158M58V10	5/8"	10-14V	.032"	\$69.64
M158M34H3	3/4"	3H	.035"	\$69.64
M158M34V4	3/4"	4-6V	.035"	\$69.64
M158M34V5	3/4"	5-8V	.035"	\$69.64
M158M34V6	3/4"	6-10V	.035"	\$69.64
M158M34V8	3/4"	8-12V	.035"	\$69.64
M158M34V10	3/4"	10-14V	.035"	\$69.64
M158M34W14	3/4"	14W	.035"	\$69.64
M158M34W18	3/4"	18W	.035"	\$69.64
M158M1V2	1"	2-3V	.035"	\$80.36
M158M1H3	1"	3H	.035"	\$80.36
M158M1V3	1"	3-4V	.035"	\$80.36
M158M1V4	1"	4-6V	.035"	\$80.36
M158M1V5	1"	5-8V	.035"	\$80.36
M158M1V6	1"	6-10V	.035"	\$80.36
M158M1V8	1"	8-12V	.035"	\$80.36
M158M1V10	1"	10-14V	.035"	\$80.36
M158M114V2	1-1/4"	2-3V	.042"	\$96.53
M158M114V3	1-1/4"	3-4V	.042"	\$96.53
M158M114V4	1-1/4"	4-6V	.042"	\$96.53
M158M114V5	1-1/4"	5-8V	.042"	\$96.53
M158M114V6	1-1/4"	6-10V	.042"	\$96.53
M158M114V8	1-1/4"	8-12V	.042"	\$96.53
M158M112V2	1-1/2"	2-3V	.050"	\$117.33
M158M112V3	1-1/2"	3-4V	.050"	\$117.33
M158M112V4	1-1/2"	4-6V	.050"	\$117.33
M158M112V5	1-1/2"	5-8V	.050"	\$117.33



MAGNATE™ Band Saw Blades (Non-Food Processing)

Carbon Steel Bandsaw Blade 158" (13' 2") Long



MAGNATE

Tool No.	Width	Tooth	Thickness	Price
M158C316S4	3/16"	4S	.025"	\$20.00
M158C316S6	3/16"	6S	.025"	\$20.60
M158C316R10	3/16"	10R	.025"	\$20.00
M158C316R14	3/16"	14R	.025"	\$20.00
M158C316R18	3/16"	18R	.025"	\$20.00
M158C316R24	3/16"	24R	.025"	\$20.00
M158C14H4	1/4"	4H	.025"	\$16.66
M158C14H6	1/4"	6H	.025"	\$16.66
M158C14R10	1/4"	10R	.025"	\$16.66
M158C14R14	1/4"	14R	.025"	\$16.66
M158C14R18	1/4"	18R	.025"	\$16.66
M158C14R24	1/4"	24R	.025"	\$16.66
M158C38H3	3/8"	3H	.025"	\$18.52
M158C38H4	3/8"	4H	.025"	\$18.52
M158C38H6	3/8"	6H	.025"	\$18.52
M158C38R8	3/8"	8R	.025"	\$18.52
M158C38R10	3/8"	10R	.025"	\$18.52
M158C38R14	3/8"	14R	.025"	\$18.52
M158C38R18	3/8"	18R	.025"	\$18.52
M158C38R24	3/8"	24R	.025"	\$17.34
M158C12H3	1/2"	3H	.025"	\$20.60
M158C12H4	1/2"	4H	.025"	\$20.60
M158C12H6	1/2"	6H	.025"	\$20.60
M158C12R10	1/2"	10R	.025"	\$20.60
M158C12R14	1/2"	14R	.025"	\$20.60
M158C12R18	1/2"	18R	.025"	\$20.60
M158C12R24	1/2"	24R	.025"	\$20.60
M158C58H3	5/8"	3H	.032"	\$24.57
M158C58H4	5/8"	4H	.032"	\$24.57
M158C58R10	5/8"	10R	.032"	\$24.57
M158C58R14	5/8"	14R	.032"	\$24.57
M158C34H2	3/4"	2H	.032"	\$24.57
M158C34H3	3/4"	3H	.032"	\$24.57
M158C34H4	3/4"	4H	.032"	\$24.57
M158C34H6	3/4"	6H	.032"	\$24.57
M158C34R6	3/4"	6R	.032"	\$24.57
M158C34R10	3/4"	10R	.032"	\$24.57
M158C34R14	3/4"	14R	.032"	\$24.57
M158C34R18	3/4"	18R	.032"	\$24.57
M158C1H1.3	1"	1.3H	.035"	\$32.14
M158C1H2	1"	2H	.035"	\$32.14
M158C1H3	1"	3H	.035"	\$32.14
M158C1H4	1"	4H	.035"	\$32.14
M158C1H6	1"	6H	.035"	\$32.14
M158C1R6	1"	6R	.035"	\$32.14
M158C1R8	1"	8R	.035"	\$32.14
M158C1R10	1"	10R	.035"	\$32.14
M158C1R14	1"	14R	.035"	\$32.14
M158C114H1.3	1-1/4"	1.3H	.042"	\$40.52
M158C112H1.15	1-1/2"	1.15H	.045"	\$45.19

Carbide Grit Bandsaw Blade 158" (13' 2") Long



MAGNATE

Tool No.	Width	Tooth	Thickness	Price
M158G12MC	1/2"	Med-Coarse	.025"	\$340.76
M158G34MC	3/4"	Med-Coarse	.032"	\$362.95
M158G1MC	1"	Med-Coarse	.035"	\$382.74

Carbide Tipped Bandsaw Blade 158" (13' 2") Long



MAGNATE

Tool No.	Width	Tooth	Thickness	Price
M158E12T3	1/2"	3	.025"	\$280.40
M158E34T3	3/4"	3	.035"	\$307.58
M158E1T1.3	1"	1.3	.035"	\$307.58
M158E1T2	1"	2	.035"	\$307.58
M158E1T3	1"	3	.035"	\$307.58
M158E1V2	1"	2-3V	.035"	\$301.90
M158E114V2	1-1/4"	2-3V	.042"	\$311.75
M158E114V3	1-1/4"	3-4V	.042"	\$395.03

Carbide Grit Bandsaw Blade 160" (13' 4") Long



MAGNATE

Tool No.	Width	Tooth	Thickness	Price
M160G12MC	1/2"	Med-Coarse	.025"	\$340.76
M160G34MC	3/4"	Med-Coarse	.032"	\$362.95
M160G1MC	1"	Med-Coarse	.035"	\$382.74

Bi-metal Bandsaw Blade 160" (13' 4") Long



MAGNATE

Tool No.	Width	Tooth	Thickness	Price
M160M14H6	1/4"	6H	.025"	\$65.98
M160M14V10	1/4"	10-14V	.025"	\$65.98
M160M14V14	1/4"	14-18V	.025"	\$65.98
M160M38H4	3/8"	4H	.025"	\$65.98
M160M38V10	3/8"	10-14V	.025"	\$65.98
M160M38V14	3/8"	14-18V	.025"	\$65.98
M160M12H3	1/2"	3H	.035"	\$65.98
M160M12H4	1/2"	4H	.025"	\$65.98
M160M12H6	1/2"	6H	.025"	\$65.98
M160M12V6	1/2"	6-10V	.025"	\$65.98
M160M12V8	1/2"	8-12V	.025"	\$65.98
M160M12V10	1/2"	10-14V	.025"	\$65.98
M160M12T14	1/2"	14	.025"	\$65.98
M160M12V14	1/2"	14-18V	.025"	\$65.98
M160M12T18	1/2"	18	.025"	\$65.98
M160M58V10	5/8"	10-14V	.032"	\$69.64
M160M34H3	3/4"	3H	.035"	\$69.64
M160M34V4	3/4"	4-6V	.035"	\$69.64
M160M34V5	3/4"	5-8V	.035"	\$69.64
M160M34V6	3/4"	6-10V	.035"	\$69.64
M160M34V8	3/4"	8-12V	.035"	\$69.64
M160M34V10	3/4"	10-14V	.035"	\$69.64
M160M34W14	3/4"	14W	.035"	\$69.64
M160M34W18	3/4"	18W	.035"	\$69.64
M160M1V2	1"	2-3V	.035"	\$80.36
M160M1H3	1"	3H	.035"	\$80.36
M160M1V3	1"	3-4V	.035"	\$80.36
M160M1V4	1"	4-6V	.035"	\$80.36
M160M1V5	1"	5-8V	.035"	\$80.36
M160M1V6	1"	6-10V	.035"	\$80.36
M160M1V8	1"	8-12V	.035"	\$80.36
M160M1V10	1"	10-14V	.035"	\$80.36
M160M114V2	1-1/4"	2-3V	.042"	\$96.53
M160M114V3	1-1/4"	3-4V	.042"	\$96.53
M160M114V4	1-1/4"	4-6V	.042"	\$96.53
M160M114V5	1-1/4"	5-8V	.042"	\$96.53
M160M114V6	1-1/4"	6-10V	.042"	\$96.53
M160M114V8	1-1/4"	8-12V	.042"	\$96.53
M160M112V2	1-1/2"	2-3V	.050"	\$117.33
M160M112V3	1-1/2"	3-4V	.050"	\$117.33
M160M112V4	1-1/2"	4-6V	.050"	\$117.33
M160M112V5	1-1/2"	5-8V	.050"	\$117.33

MAGNATE™ 20639 Lycoming Street #B-6, Walnut, CA 91789 USA

M-80



email : info@magnate.net Online Shop : www.magnate.net
(TEL) 800-827-2316, 909-468-5747 (FAX) 909-468-5745

MAGNATE™ Band Saw Blades (Non-Food Processing)

Carbon Steel Bandsaw Blade 160" (13' 4") Long



Tool No.	Width	Tooth	Thickness	Price
M160C316S4	3/16"	4S	.025"	\$20.00
M160C316S6	3/16"	6S	.025"	\$20.60
M160C316R10	3/16"	10R	.025"	\$20.00
M160C316R14	3/16"	14R	.025"	\$20.00
M160C316R18	3/16"	18R	.025"	\$20.00
M160C316R24	3/16"	24R	.025"	\$20.00
M160C14H4	1/4"	4H	.025"	\$16.66
M160C14H6	1/4"	6H	.025"	\$16.66
M160C14R10	1/4"	10R	.025"	\$16.66
M160C14R14	1/4"	14R	.025"	\$16.66
M160C14R18	1/4"	18R	.025"	\$16.66
M160C14R24	1/4"	24R	.025"	\$16.66
M160C38H3	3/8"	3H	.025"	\$18.52
M160C38H4	3/8"	4H	.025"	\$18.52
M160C38H6	3/8"	6H	.025"	\$18.52
M160C38R8	3/8"	8R	.025"	\$18.52
M160C38R10	3/8"	10R	.025"	\$18.52
M160C38R14	3/8"	14R	.025"	\$18.52
M160C38R18	3/8"	18R	.025"	\$18.52
M160C38R24	3/8"	24R	.025"	\$17.34
M160C12H3	1/2"	3H	.025"	\$20.60
M160C12H4	1/2"	4H	.025"	\$20.60
M160C12H6	1/2"	6H	.025"	\$20.60
M160C12R10	1/2"	10R	.025"	\$20.60
M160C12R14	1/2"	14R	.025"	\$20.60
M160C12R18	1/2"	18R	.025"	\$20.60
M160C12R24	1/2"	24R	.025"	\$20.60
M160C58H3	5/8"	3H	.032"	\$24.57
M160C58H4	5/8"	4H	.032"	\$24.57
M160C58R10	5/8"	10R	.032"	\$24.57
M160C58R14	5/8"	14R	.032"	\$24.57
M160C34H2	3/4"	2H	.032"	\$24.57
M160C34H3	3/4"	3H	.032"	\$24.57
M160C34H4	3/4"	4H	.032"	\$24.57
M160C34H6	3/4"	6H	.032"	\$24.57
M160C34R6	3/4"	6R	.032"	\$24.57
M160C34R10	3/4"	10R	.032"	\$24.57
M160C34R14	3/4"	14R	.032"	\$24.57
M160C34R18	3/4"	18R	.032"	\$24.57
M160C1H1.3	1"	1.3H	.035"	\$32.14
M160C1H2	1"	2H	.035"	\$32.14
M160C1H3	1"	3H	.035"	\$32.14
M160C1H4	1"	4H	.035"	\$32.14
M160C1H6	1"	6H	.035"	\$32.14
M160C1R6	1"	6R	.035"	\$32.14
M160C1R8	1"	8R	.035"	\$32.14
M160C1R10	1"	10R	.035"	\$32.14
M160C1R14	1"	14R	.035"	\$32.14
M160C114H1.3	1-1/4"	1.3H	.042"	\$40.52
M160C112H1.15	1-1/2"	1.15H	.045"	\$45.19

WoodSaver Plus Resaw Bandsaw Blades 160" (13' 4") Long



Tool No.	Width	Tooth	Thickness	Price
B160P58V3	5/8"	3-4V	.025"	\$109.07

WoodSaver Resaw Bandsaw Blades 160" (13' 4") Long



Tool No.	Width	Tooth	Thickness	Price
B160S58T3	5/8"	3	.025"	\$93.97
B160S1T3	1"	3	.025"	\$109.47

Carbide Tipped Bandsaw Blade 161" (13' 5") Long



Tool No.	Width	Tooth	Thickness	Price
M161E12T3	1/2"	3	.025"	\$280.40
M161E34T3	3/4"	3	.035"	\$307.58
M161E1T1.3	1"	1.3	.035"	\$307.58
M161E1T2	1"	2	.035"	\$307.58
M161E1T3	1"	3	.035"	\$307.58
M161E1V2	1"	2-3V	.035"	\$301.90
M161E114V2	1"	2-3V	.042"	\$311.75
M161E114V3	1"	3-4V	.042"	\$395.03

Bi-metal Bandsaw Blade 161" (13' 5") Long



Tool No.	Width	Tooth	Thickness	Price
M161M14H6	1/4"	6H	.025"	\$65.98
M161M14V10	1/4"	10-14V	.025"	\$65.98
M161M14V14	1/4"	14-18V	.025"	\$65.98
M161M38H4	3/8"	4H	.025"	\$65.98
M161M38V10	3/8"	10-14V	.025"	\$65.98
M161M38V14	3/8"	14-18V	.025"	\$65.98
M161M12H3	1/2"	3H	.035"	\$65.98
M161M12H4	1/2"	4H	.025"	\$65.98
M161M12H6	1/2"	6H	.025"	\$65.98
M161M12V6	1/2"	6-10V	.025"	\$65.98
M161M12V8	1/2"	8-12V	.025"	\$65.98
M161M12V10	1/2"	10-14V	.025"	\$65.98
M161M12T14	1/2"	14	.025"	\$65.98
M161M12V14	1/2"	14-18V	.025"	\$65.98
M161M12T18	1/2"	18	.025"	\$65.98
M161M58V10	5/8"	10-14V	.032"	\$69.64
M161M34H3	3/4"	3H	.035"	\$69.64
M161M34V4	3/4"	4-6V	.035"	\$69.64
M161M34V5	3/4"	5-8V	.035"	\$69.64
M161M34V6	3/4"	6-10V	.035"	\$69.64
M161M34V8	3/4"	8-12V	.035"	\$69.64
M161M34V10	3/4"	10-14V	.035"	\$69.64
M161M34W14	3/4"	14W	.035"	\$69.64
M161M34W18	3/4"	18W	.035"	\$69.64
M161M1V2	1"	2-3V	.035"	\$80.36
M161M1H3	1"	3H	.035"	\$80.36
M161M1V3	1"	3-4V	.035"	\$80.36
M161M1V4	1"	4-6V	.035"	\$80.36
M161M1V5	1"	5-8V	.035"	\$80.36
M161M1V6	1"	6-10V	.035"	\$80.36
M161M1V8	1"	8-12V	.035"	\$80.36
M161M1V10	1"	10-14V	.035"	\$80.36
M161M114V2	1-1/4"	2-3V	.042"	\$96.53
M161M114V3	1-1/4"	3-4V	.042"	\$96.53
M161M114V4	1-1/4"	4-6V	.042"	\$96.53
M161M114V5	1-1/4"	5-8V	.042"	\$96.53
M161M114V6	1-1/4"	6-10V	.042"	\$96.53
M161M114V8	1-1/4"	8-12V	.042"	\$96.53
M161M112V2	1-1/2"	2-3V	.050"	\$117.33
M161M112V3	1-1/2"	3-4V	.050"	\$117.33
M161M112V4	1-1/2"	4-6V	.050"	\$117.33
M161M112V5	1-1/2"	5-8V	.050"	\$117.33



MAGNATE™ Band Saw Blades (Non-Food Processing)

Carbon Steel Bandsaw Blade 161" (13' 5") Long



Tool No.	Width	Tooth	Thickness	Price
M161C316S4	3/16"	4S	.025"	\$20.00
M161C316S6	3/16"	6S	.025"	\$20.60
M161C316R10	3/16"	10R	.025"	\$20.00
M161C316R14	3/16"	14R	.025"	\$20.00
M161C316R18	3/16"	18R	.025"	\$20.00
M161C316R24	3/16"	24R	.025"	\$20.00
M161C14H4	1/4"	4H	.025"	\$16.66
M161C14H6	1/4"	6H	.025"	\$16.66
M161C14R10	1/4"	10R	.025"	\$16.66
M161C14R14	1/4"	14R	.025"	\$16.66
M161C14R18	1/4"	18R	.025"	\$16.66
M161C14R24	1/4"	24R	.025"	\$16.66
M161C38H3	3/8"	3H	.025"	\$18.52
M161C38H4	3/8"	4H	.025"	\$18.52
M161C38H6	3/8"	6H	.025"	\$18.52
M161C38R8	3/8"	8R	.025"	\$18.52
M161C38R10	3/8"	10R	.025"	\$18.52
M161C38R14	3/8"	14R	.025"	\$18.52
M161C38R18	3/8"	18R	.025"	\$18.52
M161C38R24	3/8"	24R	.025"	\$17.34
M161C12H3	1/2"	3H	.025"	\$20.60
M161C12H4	1/2"	4H	.025"	\$20.60
M161C12H6	1/2"	6H	.025"	\$20.60
M161C12R10	1/2"	10R	.025"	\$20.60
M161C12R14	1/2"	14R	.025"	\$20.60
M161C12R18	1/2"	18R	.025"	\$20.60
M161C12R24	1/2"	24R	.025"	\$20.60
M161C58H3	5/8"	3H	.032"	\$24.57
M161C58H4	5/8"	4H	.032"	\$24.57
M161C58R10	5/8"	10R	.032"	\$24.57
M161C58R14	5/8"	14R	.032"	\$24.57
M161C34H2	3/4"	2H	.032"	\$24.57
M161C34H3	3/4"	3H	.032"	\$24.57
M161C34H4	3/4"	4H	.032"	\$24.57
M161C34H6	3/4"	6H	.032"	\$24.57
M161C34R6	3/4"	6R	.032"	\$24.57
M161C34R10	3/4"	10R	.032"	\$24.57
M161C34R14	3/4"	14R	.032"	\$24.57
M161C34R18	3/4"	18R	.032"	\$24.57
M161C1H1.3	1"	2H	.035"	\$32.14
M161C1H2	1"	2H	.035"	\$32.14
M161C1H3	1"	3H	.035"	\$32.14
M161C1H4	1"	4H	.035"	\$32.14
M161C1H6	1"	6H	.035"	\$32.14
M161C1R6	1"	6R	.035"	\$32.14
M161C1R8	1"	8R	.035"	\$32.14
M161C1R10	1"	10R	.035"	\$32.14
M161C1R14	1"	14R	.035"	\$32.14
M161C114H1.3	1-1/4"	1.3H	.042"	\$40.52
M161C112H1.15	1-1/2"	1.15H	.045"	\$45.19

Carbide Impregnated Bandsaw Blade 161" (13' 5") Long



Tool No.	Width	Tooth	Thickness	Price
B161G14H6	1/4"	6H	.025"	\$40.55
B161G38H4	3/8"	4H	.025"	\$38.55
B161G12H3	1/2"	3H	.025"	\$40.77

Carbide Grit Bandsaw Blade 161" (13' 5") Long



Tool No.	Width	Tooth	Thickness	Price
M161G12MC	1/2"	Med-Coarse	.025"	\$340.76
M161G34MC	3/4"	Med-Coarse	.032"	\$362.95
M161G1MC	1"	Med-Coarse	.035"	\$382.74

Hawc Pro Resaw Bandsaw Blade 161" (13' 5") Long



Tool No.	Width	Tooth	Thickness	Price
B161H12T3	1/2"	3	.025"	\$27.08

WoodSaver Plus Resaw Bandsaw Blades 161" (13' 5") Long



Tool No.	Width	Tooth	Thickness	Price
B161P58V3	5/8"	3-4V	.025"	\$109.97

WoodSaver Resaw Bandsaw Blades 161" (13' 5") Long



Tool No.	Width	Tooth	Thickness	Price
B161S58T3	5/8"	3	.025"	\$93.97
B161S1T3	1"	3	.025"	\$109.47

Carbide Grit Bandsaw Blade 161-1/2" (13' 5-1/2") Long



Tool No.	Width	Tooth	Thickness	Price
M161.5G12MC	1/2"	Med-Coarse	.025"	\$340.76
M161.5G34MC	3/4"	Med-Coarse	.032"	\$362.95
M161.5G1MC	1"	Med-Coarse	.035"	\$382.74

Carbide Tipped Bandsaw Blade 161-1/2" (13' 5-1/2") Long



Tool No.	Width	Tooth	Thickness	Price
M161.5E12T3	1/2"	3	.025"	\$280.40
M161.5E34T3	3/4"	3	.035"	\$307.58
M161.5E1T1.3	1"	1.3	.035"	\$307.58
M161.5E1T2	1"	2	.035"	\$307.58
M161.5E1T3	1"	3	.035"	\$307.58
M161.5E1V2	1"	2-3V	.035"	\$301.90
M161.5E114V2	1-1/4"	2-3V	.042"	\$311.75
M161.5E114V3	1-1/4"	3-4V	.042"	\$395.03

MAGNATE™ 20639 Lycoming Street #B-6, Walnut, CA 91789 USA

M-82



email : info@magnate.net Online Shop : www.magnate.net
(TEL) 800-827-2316, 909-468-5747 (FAX) 909-468-5745

MAGNATE™ Band Saw Blades (Non-Food Processing)

Bi-metal Bandsaw Blade 161-1/2" (13' 5-1/2") Long



MAGNATE

Tool No.	Width	Tooth	Thickness	Price
M161.5M14H6	1/4"	6H	.025"	\$65.98
M161.5M14V10	1/4"	10-14V	.025"	\$65.98
M161.5M14V14	1/4"	14-18V	.025"	\$65.98
M161.5M38H4	3/8"	4H	.025"	\$65.98
M161.5M38V10	3/8"	10-14V	.025"	\$65.98
M161.5M38V14	3/8"	14-18V	.025"	\$65.98
M161.5M12H3	1/2"	3H	.035"	\$65.98
M161.5M12H4	1/2"	4H	.025"	\$65.98
M161.5M12H6	1/2"	6H	.025"	\$65.98
M161.5M12V6	1/2"	6-10V	.025"	\$65.98
M161.5M12V8	1/2"	8-12V	.025"	\$65.98
M161.5M12V10	1/2"	10-14V	.025"	\$65.98
M161.5M12T14	1/2"	14	.025"	\$65.98
M161.5M12V14	1/2"	14-18V	.025"	\$65.98
M161.5M12T18	1/2"	18	.025"	\$65.98
M161.5M58V10	5/8"	10-14V	.032"	\$69.64
M161.5M34H3	3/4"	3H	.035"	\$69.64
M161.5M34V4	3/4"	4-6V	.035"	\$69.64
M161.5M34V5	3/4"	5-8V	.035"	\$69.64
M161.5M34V6	3/4"	6-10V	.035"	\$69.64
M161.5M34V8	3/4"	8-12V	.035"	\$69.64
M161.5M34V10	3/4"	10-14V	.035"	\$69.64
M161.5M34W14	3/4"	14W	.035"	\$69.64
M161.5M34W18	3/4"	18W	.035"	\$69.64
M161.5M1V2	1"	2-3V	.035"	\$80.36
M161.5M1H3	1"	3H	.035"	\$80.36
M161.5M1V3	1"	3-4V	.035"	\$80.36
M161.5M1V4	1"	4-6V	.035"	\$80.36
M161.5M1V5	1"	5-8V	.035"	\$80.36
M161.5M1V6	1"	6-10V	.035"	\$80.36
M161.5M1V8	1"	8-12V	.035"	\$80.36
M161.5M1V10	1"	10-14V	.035"	\$80.36
M161.5M114V2	1-1/4"	2-3V	.042"	\$96.53
M161.5M114V3	1-1/4"	3-4V	.042"	\$96.53
M161.5M114V4	1-1/4"	4-6V	.042"	\$96.53
M161.5M114V5	1-1/4"	5-8V	.042"	\$96.53
M161.5M114V6	1-1/4"	6-10V	.042"	\$96.53
M161.5M114V8	1-1/4"	8-12V	.042"	\$96.53
M161.5M112V2	1-1/2"	2-3V	.050"	\$117.33
M161.5M112V3	1-1/2"	3-4V	.050"	\$117.33
M161.5M112V4	1-1/2"	4-6V	.050"	\$117.33
M161.5M112V5	1-1/2"	5-8V	.050"	\$117.33

Carbon Steel Bandsaw Blade 161-1/2" (13' 5-1/2") Long



MAGNATE

Tool No.	Width	Tooth	Thickness	Price
M161.5C316S4	3/16"	4S	.025"	\$20.00
M161.5C316S6	3/16"	6S	.025"	\$20.60
M161.5C316R10	3/16"	10R	.025"	\$20.00
M161.5C316R14	3/16"	14R	.025"	\$20.00
M161.5C316R18	3/16"	18R	.025"	\$20.00
M161.5C316R24	3/16"	24R	.025"	\$20.00
M161.5C14H4	1/4"	4H	.025"	\$16.66
M161.5C14H6	1/4"	6H	.025"	\$16.66
M161.5C14R10	1/4"	10R	.025"	\$16.66
M161.5C14R14	1/4"	14R	.025"	\$16.66
M161.5C14R18	1/4"	18R	.025"	\$16.66
M161.5C14R24	1/4"	24R	.025"	\$16.66
M161.5C38H3	3/8"	3H	.025"	\$18.52
M161.5C38H4	3/8"	4H	.025"	\$18.52
M161.5C38H6	3/8"	6H	.025"	\$18.52
M161.5C38R8	3/8"	8R	.025"	\$18.52
M161.5C38R10	3/8"	10R	.025"	\$18.52
M161.5C38R14	3/8"	14R	.025"	\$18.52
M161.5C38R18	3/8"	18R	.025"	\$18.52
M161.5C38R24	3/8"	24R	.025"	\$17.34
M161.5C12H3	1/2"	3H	.025"	\$20.60
M161.5C12H4	1/2"	4H	.025"	\$20.60
M161.5C12H6	1/2"	6H	.025"	\$20.60
M161.5C12R10	1/2"	10R	.025"	\$20.60
M161.5C12R14	1/2"	14R	.025"	\$20.60
M161.5C12R18	1/2"	18R	.025"	\$20.60
M161.5C12R24	1/2"	24R	.025"	\$20.60
M161.5C58H3	5/8"	3H	.032"	\$24.57
M161.5C58H4	5/8"	4H	.032"	\$24.57
M161.5C58R10	5/8"	10R	.032"	\$24.57
M161.5C58R14	5/8"	14R	.032"	\$24.57
M161.5C34H2	3/4"	2H	.032"	\$24.57
M161.5C34H3	3/4"	3H	.032"	\$24.57
M161.5C34H4	3/4"	4H	.032"	\$24.57
M161.5C34H6	3/4"	6H	.032"	\$24.57
M161.5C34R6	3/4"	6R	.032"	\$24.57
M161.5C34R10	3/4"	10R	.032"	\$24.57
M161.5C34R14	3/4"	14R	.032"	\$24.57
M161.5C34R18	3/4"	18R	.032"	\$24.57
M161.5C1H1.3	1"	1.3H	.035"	\$32.14
M161.5C1H2	1"	2H	.035"	\$32.14
M161.5C1H3	1"	3H	.035"	\$32.14
M161.5C1H4	1"	4H	.035"	\$32.14
M161.5C1H6	1"	6H	.035"	\$32.14
M161.5C1R6	1"	6R	.035"	\$32.14
M161.5C1R8	1"	8R	.035"	\$32.14
M161.5C1R10	1"	10R	.035"	\$32.14
M161.5C1R14	1"	14R	.035"	\$32.14
M161.5C114H1.3	1-1/4"	1.3H	.042"	\$40.52
M161.5C112H1.15	1-1/2"	1.15H	.045"	\$45.19

Bi-metal Bandsaw Blade 167" (13' 11") Long



MAGNATE

Tool No.	Width	Tooth	Thickness	Price
M167M14H6	1/4"	6H	.025"	\$68.12
M167M14V10	1/4"	10-14V	.025"	\$68.12
M167M14V14	1/4"	14-18V	.025"	\$68.12
M167M38H4	3/8"	4H	.025"	\$68.12
M167M38V10	3/8"	10-14V	.025"	\$68.12
M167M38V14	3/8"	14-18V	.025"	\$68.12
M167M12H3	1/2"	3H	.035"	\$68.12
M167M12H4	1/2"	4H	.025"	\$68.12
M167M12H6	1/2"	6H	.025"	\$68.12
M167M12V6	1/2"	6-10V	.025"	\$68.12
M167M12V8	1/2"	8-12V	.025"	\$68.12
M167M12V10	1/2"	10-14V	.025"	\$68.12
M167M12T14	1/2"	14	.025"	\$68.12
M167M12V14	1/2"	14-18V	.025"	\$68.12
M167M12T18	1/2"	18	.025"	\$68.12
M167M58V10	5/8"	10-14V	.032"	\$71.88
M167M34H3	3/4"	3H	.035"	\$71.88
M167M34V4	3/4"	4-6V	.035"	\$71.88
M167M34V5	3/4"	5-8V	.035"	\$71.88
M167M34V6	3/4"	6-10V	.035"	\$71.88
M167M34V8	3/4"	8-12V	.035"	\$71.88
M167M34V10	3/4"	10-14V	.035"	\$71.88
M167M34W14	3/4"	14W	.035"	\$71.88
M167M34W18	3/4"	18W	.035"	\$71.88
M167M1V2	1"	2-3V	.035"	\$82.98
M167M1H3	1"	3H	.035"	\$82.98
M167M1V3	1"	3-4V	.035"	\$82.98
M167M1V4	1"	4-6V	.035"	\$82.98
M167M1V5	1"	5-8V	.035"	\$82.98
M167M1V6	1"	6-10V	.035"	\$82.98
M167M1V8	1"	8-12V	.035"	\$82.98
M167M1V10	1"	10-14V	.035"	\$82.98
M167M114V2	1-1/4"	2-3V	.042"	\$99.71
M167M114V3	1-1/4"	3-4V	.042"	\$99.71
M167M114V4	1-1/4"	4-6V	.042"	\$99.71
M167M114V5	1-1/4"	5-8V	.042"	\$99.71
M167M114V6	1-1/4"	6-10V	.042"	\$99.71
M167M114V8	1-1/4"	8-12V	.042"	\$99.71
M167M112V2	1-1/2"	2-3V	.050"	\$121.26
M167M112V3	1-1/2"	3-4V	.050"	\$121.26
M167M112V4	1-1/2"	4-6V	.050"	\$121.26
M167M112V5	1-1/2"	5-8V	.050"	\$121.26

MAGNATE™ 20639 Lycoming Street #B-6, Walnut, CA 91789 USA

M-83



email : info@magnate.net Online Shop : www.magnate.net
(TEL) 800-827-2316, 909-468-5747 (FAX) 909-468-5745

MAGNATE™ Band Saw Blades (Non-Food Processing)

Carbide Grit Bandsaw Blade
167" (13' 11") Long



MAGNATE

Tool No.	Width	Tooth	Thickness	Price
M167G12MC	1/2"	Med-Coarse	.025"	\$353.07
M167G34MC	3/4"	Med-Coarse	.032"	\$376.03
M167G1MC	1"	Med-Coarse	.035"	\$396.57

Carbide Impregnated Bandsaw Blade
167" (13' 11") Long



SUPER CUT™

Tool No.	Width	Tooth	Thickness	Price
B167G14H6	1/4"	6H	.025"	\$41.52
B167G38H4	3/8"	4H	.025"	\$39.65
B167G12H3	1/2"	3H	.025"	\$41.70

Carbide Tipped Bandsaw Blade
167" (13' 11") Long



MAGNATE

Tool No.	Width	Tooth	Thickness	Price
M167E12T3	1/2"	3	.025"	\$290.48
M167E34T3	3/4"	3	.035"	\$318.60
M167E1V2	1"	2-3V	.035"	\$318.60
M167E1T1.3	1"	1.3	.035"	\$312.73
M167E1T2	1"	2	.035"	\$312.73
M167E1T3	1"	3	.035"	\$312.73
M167E114V2	1-1/4"	2-3V	.042"	\$322.87
M167E114V3	1-1/4"	3-4V	.042"	\$409.20
M167E112V2	1-1/2"	2-3V	.050"	\$330.92
M167E112V3	1-1/2"	3-4V	.050"	\$431.65

Carbon Steel Bandsaw Blade
167" (13' 11") Long



MAGNATE

Tool No.	Width	Tooth	Thickness	Price
M167C316S4	3/16"	4S	.025"	\$20.33
M167C316S6	3/16"	6S	.025"	\$21.21
M167C316R10	3/16"	10R	.025"	\$20.00
M167C316R14	3/16"	14R	.025"	\$20.00
M167C316R18	3/16"	18R	.025"	\$20.00
M167C316R24	3/16"	24R	.025"	\$20.00
M167C14H4	1/4"	4H	.025"	\$17.10
M167C14H6	1/4"	6H	.025"	\$17.10
M167C14R10	1/4"	10R	.025"	\$17.10
M167C14R14	1/4"	14R	.025"	\$17.10
M167C14R18	1/4"	18R	.025"	\$17.10
M167C14R24	1/4"	24R	.025"	\$17.10
M167C38H3	3/8"	3H	.025"	\$19.03
M167C38H4	3/8"	4H	.025"	\$19.03
M167C38H6	3/8"	6H	.025"	\$19.03
M167C38R8	3/8"	8R	.025"	\$19.03
M167C38R10	3/8"	10R	.025"	\$19.03
M167C38R14	3/8"	14R	.025"	\$19.03
M167C38R18	3/8"	18R	.025"	\$19.03
M167C38R24	3/8"	24R	.025"	\$17.83
M167C12H3	1/2"	3H	.025"	\$21.21
M167C12H4	1/2"	4H	.025"	\$21.21
M167C12H6	1/2"	6H	.025"	\$21.21
M167C12R10	1/2"	10R	.025"	\$21.21
M167C12R14	1/2"	14R	.025"	\$21.21
M167C12R18	1/2"	18R	.025"	\$21.21
M167C12R24	1/2"	24R	.025"	\$21.21
M167C58H3	5/8"	3H	.032"	\$25.31
M167C58H4	5/8"	4H	.032"	\$25.31
M167C58R10	5/8"	10R	.032"	\$25.31
M167C58R14	5/8"	14R	.032"	\$25.31
M167C34H2	3/4"	2H	.032"	\$25.31
M167C34H3	3/4"	3H	.032"	\$25.31
M167C34H4	3/4"	4H	.032"	\$25.31
M167C34H6	3/4"	6H	.032"	\$25.31
M167C34R6	3/4"	6R	.032"	\$25.31
M167C34R10	3/4"	10R	.032"	\$25.31
M167C34R14	3/4"	14R	.032"	\$25.31
M167C34R18	3/4"	18R	.032"	\$25.31
M167C1H1.3	1"	1.3H	.035"	\$33.12
M167C1H2	1"	2H	.035"	\$33.12
M167C1H3	1"	3H	.035"	\$33.12
M167C1H4	1"	4H	.035"	\$33.12
M167C1H6	1"	6H	.035"	\$33.12
M167C1R6	1"	6R	.035"	\$33.12
M167C1R8	1"	8R	.035"	\$33.12
M167C1R10	1"	10R	.035"	\$33.12
M167C1R14	1"	14R	.035"	\$33.12
M167C114H1.3	1-1/4"	1.3H	.042"	\$41.81
M167C112H1.15	1-1/2"	1.15H	.045"	\$46.62

Hawc Pro Resaw Bandsaw Blade
167" (13' 11") Long



SUPER CUT™

Tool No.	Width	Tooth	Thickness	Price
B167H12T3	1/2"	3	.025"	\$27.75

WoodSaver Plus Resaw Bandsaw Blades
167" (13' 11") Long



SUPER CUT™

Tool No.	Width	Tooth	Thickness	Price
B167PS8V3	5/8"	3-4V	.025"	\$112.88

WoodSaver Resaw Bandsaw Blades
167" (13' 11") Long



SUPER CUT™

Tool No.	Width	Tooth	Thickness	Price
B167S58T3	5/8"	3	.025"	\$97.15
B167S1T3	1"	3	.025"	\$113.33

Hawc Pro Resaw Bandsaw Blade
169-1/2" (14' 1-1/2") Long



SUPER CUT™

Tool No.	Width	Tooth	Thickness	Price
B169.5H12T3	1/2"	3	.025"	\$28.33

MAGNATE™ 20639 Lycoming Street #B-6, Walnut, CA 91789 USA

M-84



email : info@magnate.net Online Shop : www.magnate.net
(TEL) 800-827-2316, 909-468-5747 (FAX) 909-468-5745

MAGNATE™ Band Saw Blades (Non-Food Processing)

Bi-metal Bandsaw Blade 169-1/2" (14' 1-1/2") Long



MAGNATE

Tool No.	Width	Tooth	Thickness	Price
M169.5M14H6	1/4"	6H	.025"	\$70.24
M169.5M14V10	1/4"	10-14V	.025"	\$70.24
M169.5M14V14	1/4"	14-18V	.025"	\$70.24
M169.5M38H4	3/8"	4H	.025"	\$70.24
M169.5M38V10	3/8"	10-14V	.025"	\$70.24
M169.5M38V14	3/8"	14-18V	.025"	\$70.24
M169.5M12H3	1/2"	3H	.035"	\$70.24
M169.5M12H4	1/2"	4H	.025"	\$70.24
M169.5M12H6	1/2"	6H	.025"	\$70.24
M169.5M12V6	1/2"	6-10V	.025"	\$70.24
M169.5M12V8	1/2"	8-12V	.025"	\$70.24
M169.5M12V10	1/2"	10-14V	.025"	\$70.24
M169.5M12T14	1/2"	14	.025"	\$70.24
M169.5M12V14	1/2"	14-18V	.025"	\$70.24
M169.5M12T18	1/2"	18	.025"	\$70.24
M169.5M58V10	5/8"	10-14V	.032"	\$74.10
M169.5M34H3	3/4"	3H	.035"	\$74.10
M169.5M34V4	3/4"	4-6V	.035"	\$74.10
M169.5M34V5	3/4"	5-8V	.035"	\$74.10
M169.5M34V6	3/4"	6-10V	.035"	\$74.10
M169.5M34V8	3/4"	8-12V	.035"	\$74.10
M169.5M34V10	3/4"	10-14V	.035"	\$74.10
M169.5M34W14	3/4"	14W	.035"	\$74.10
M169.5M34W18	3/4"	18W	.035"	\$74.10
M169.5M1V2	1"	2-3V	.035"	\$85.62
M169.5M1H3	1"	3H	.035"	\$85.62
M169.5M1V3	1"	3-4V	.035"	\$85.62
M169.5M1V4	1"	4-6V	.035"	\$85.62
M169.5M1V5	1"	5-8V	.035"	\$85.62
M169.5M1V6	1"	6-10V	.035"	\$85.62
M169.5M1V8	1"	8-12V	.035"	\$85.62
M169.5M1V10	1"	10-14V	.035"	\$85.62
M169.5M114V2	1-1/4"	2-3V	.042"	\$102.86
M169.5M114V3	1-1/4"	3-4V	.042"	\$102.86
M169.5M114V4	1-1/4"	4-6V	.042"	\$102.86
M169.5M114V5	1-1/4"	5-8V	.042"	\$102.86
M169.5M114V6	1-1/4"	6-10V	.042"	\$102.86
M169.5M114V8	1-1/4"	8-12V	.042"	\$102.86
M169.5M112V2	1-1/2"	2-3V	.050"	\$125.19
M169.5M112V3	1-1/2"	3-4V	.050"	\$125.19
M169.5M112V4	1-1/2"	4-6V	.050"	\$125.19
M169.5M112V5	1-1/2"	5-8V	.050"	\$125.19

Carbide Grit Bandsaw Blade 169-1/2" (14' 1-1/2") Long



MAGNATE

Tool No.	Width	Tooth	Thickness	Price
M169.5G12MC	1/2"	Med-Coarse	.025"	\$353.07
M169.5G34MC	3/4"	Med-Coarse	.032"	\$376.03
M169.5G1MC	1"	Med-Coarse	.035"	\$396.57

Carbide Impregnated Bandsaw Blade 169-1/2" (14' 1-1/2") Long



Tool No.	Width	Tooth	Thickness	Price
B169.5G14H6	1/4"	6H	.025"	\$42.60
B169.5G38H4	3/8"	4H	.025"	\$40.52
B169.5G12H3	1/2"	3H	.025"	\$42.60

Carbide Tipped Bandsaw Blade 169-1/2" (14' 1-1/2") Long



MAGNATE

Tool No.	Width	Tooth	Thickness	Price
M169.5E12T3	1/2"	3	.025"	\$300.55
M169.5E34T3	3/4"	3	.035"	\$329.65
M169.5E1V2	1"	2-3V	.035"	\$329.65
M169.5E1T1.3	1"	1.3	.035"	\$323.57
M169.5E1T2	1"	2	.035"	\$323.57
M169.5E1T3	1"	3	.035"	\$323.57
M169.5E114V2	1-1/4"	2-3V	.042"	\$333.97
M169.5E114V3	1-1/4"	3-4V	.042"	\$423.43

Carbon Steel Bandsaw Blade 169-1/2" (14' 1-1/2") Long



MAGNATE

Tool No.	Width	Tooth	Thickness	Price
M169.5C316S4	3/16"	4S	.025"	\$20.66
M169.5C316S6	3/16"	6S	.025"	\$21.81
M169.5C316R10	3/16"	10R	.025"	\$20.33
M169.5C316R14	3/16"	14R	.025"	\$20.33
M169.5C316R18	3/16"	18R	.025"	\$20.33
M169.5C316R24	3/16"	24R	.025"	\$20.33
M169.5C14H4	1/4"	4H	.025"	\$17.57
M169.5C14H6	1/4"	6H	.025"	\$17.57
M169.5C14R10	1/4"	10R	.025"	\$17.57
M169.5C14R14	1/4"	14R	.025"	\$17.57
M169.5C14R18	1/4"	18R	.025"	\$17.57
M169.5C14R24	1/4"	24R	.025"	\$17.57
M169.5C38H3	3/8"	3H	.025"	\$19.57
M169.5C38H4	3/8"	4H	.025"	\$19.57
M169.5C38H6	3/8"	6H	.025"	\$19.57
M169.5C38R8	3/8"	8R	.025"	\$19.57
M169.5C38R10	3/8"	10R	.025"	\$19.57
M169.5C38R14	3/8"	14R	.025"	\$19.57
M169.5C38R18	3/8"	18R	.025"	\$19.57
M169.5C38R24	3/8"	24R	.025"	\$18.24
M169.5C12H3	1/2"	3H	.025"	\$21.81
M169.5C12H4	1/2"	4H	.025"	\$21.81
M169.5C12H6	1/2"	6H	.025"	\$21.81
M169.5C12R10	1/2"	10R	.025"	\$21.81
M169.5C12R14	1/2"	14R	.025"	\$21.81
M169.5C12R18	1/2"	18R	.025"	\$21.81
M169.5C12R24	1/2"	24R	.025"	\$21.81
M169.5C58H3	5/8"	3H	.032"	\$26.07
M169.5C58H4	5/8"	4H	.032"	\$26.07
M169.5C58R10	5/8"	10R	.032"	\$26.07
M169.5C58R14	5/8"	14R	.032"	\$26.07
M169.5C34H2	3/4"	2H	.032"	\$26.07
M169.5C34H3	3/4"	3H	.032"	\$26.07
M169.5C34H4	3/4"	4H	.032"	\$26.07
M169.5C34H6	3/4"	6H	.032"	\$26.07
M169.5C34R6	3/4"	6R	.032"	\$26.07
M169.5C34R10	3/4"	10R	.032"	\$26.07
M169.5C34R14	3/4"	14R	.032"	\$26.07
M169.5C34R18	3/4"	18R	.032"	\$26.07
M169.5C1H1.3	1"	1.3H	.035"	\$34.10
M169.5C1H2	1"	2H	.035"	\$34.10
M169.5C1H3	1"	3H	.035"	\$34.10
M169.5C1H4	1"	4H	.035"	\$34.10
M169.5C1H6	1"	6H	.035"	\$34.10
M169.5C1R6	1"	6R	.035"	\$34.10
M169.5C1R8	1"	8R	.035"	\$34.10
M169.5C1R10	1"	10R	.035"	\$34.10
M169.5C1R14	1"	14R	.035"	\$34.10
M169.5C114H1.3	1-1/4"	1.3H	.042"	\$43.10
M169.5C112H1.15	1-1/2"	1.15H	.045"	\$48.05

MAGNATE™ 20639 Lycoming Street #B-6, Walnut, CA 91789 USA

M-85



email : info@magnate.net Online Shop : www.magnate.net
(TEL) 800-827-2316, 909-468-5747 (FAX) 909-468-5745

MAGNATE™ Band Saw Blades (Non-Food Processing)

WoodSaver Plus Resaw Bandsaw Blades
169-1/2" (14' 1-1/2") Long





Tool No.	Width	Tooth	Thickness	Price
B169.5P58V3	5/8"	3-4V	.025"	\$117.35

WoodSaver Resaw Bandsaw Blades
169-1/2" (14' 1-1/2") Long



Tool No.	Width	Tooth	Thickness	Price
B169.5S58T3	5/8"	3	.025"	\$100.30
B169.5S1T3	1"	3	.025"	\$116.83

Carbide Impregnated Bandsaw Blade
170-1/2" (14' 2-1/2") Long

Tool No.	Width	Tooth	Thickness	Price
B170.5G14H6	1/4"	6H	.025"	\$42.60
B170.5G38H4	3/8"	4H	.025"	\$40.52
B170.5G12H3	1/2"	3H	.025"	\$42.60

Hawc Pro Resaw Bandsaw Blade
170-1/2" (14' 2-1/2") Long



Tool No.	Width	Tooth	Thickness	Price
B170.5H12T3	1/2"	3	.025"	\$28.33

Bi-metal Bandsaw Blade
170-1/2" (14' 2-1/2") Long



MAGNATE

Tool No.	Width	Tooth	Thickness	Price
M170.5M14H6	1/4"	6H	.025"	\$70.24
M170.5M14V10	1/4"	10-14V	.025"	\$70.24
M170.5M14V14	1/4"	14-18V	.025"	\$70.24
M170.5M38H4	3/8"	4H	.025"	\$70.24
M170.5M38T10	3/8"	10	.025"	\$70.24
M170.5M38V10	3/8"	10-14V	.025"	\$70.24
M170.5M38V14	3/8"	14-18V	.025"	\$70.24
M170.5M12H3	1/2"	3H	.035"	\$70.24
M170.5M12H4	1/2"	4H	.025"	\$70.24
M170.5M12H6	1/2"	6H	.025"	\$70.24
M170.5M12V6	1/2"	6-10V	.025"	\$70.24
M170.5M12V8	1/2"	8-12V	.025"	\$70.24
M170.5M12V10	1/2"	10-14V	.025"	\$70.24
M170.5M12T14	1/2"	14	.025"	\$70.24
M170.5M12V14	1/2"	14-18V	.025"	\$70.24
M170.5M12T18	1/2"	18	.025"	\$70.24
M170.5M58V10	5/8"	10-14V	.032"	\$74.10
M170.5M34H3	3/4"	3H	.035"	\$74.10
M170.5M34V4	3/4"	4-6V	.035"	\$74.10
M170.5M34V5	3/4"	5-8V	.035"	\$74.10
M170.5M34V6	3/4"	6-10V	.035"	\$74.10
M170.5M34V8	3/4"	8-12V	.035"	\$74.10
M170.5M34V10	3/4"	10-14V	.035"	\$74.10
M170.5M34W14	3/4"	14W	.035"	\$74.10
M170.5M34W18	3/4"	18W	.035"	\$74.10
M170.5M1V2	1"	2-3V	.035"	\$85.62
M170.5M1H3	1"	3H	.035"	\$85.62
M170.5M1V3	1"	3-4V	.035"	\$85.62
M170.5M1V4	1"	4-6V	.035"	\$85.62
M170.5M1V5	1"	5-8V	.035"	\$85.62
M170.5M1V6	1"	6-10V	.035"	\$85.62
M170.5M1V8	1"	8-12V	.035"	\$85.62
M170.5M1V10	1"	10-14V	.035"	\$85.62
M170.5M114V2	1-1/4"	2-3V	.042"	\$102.86
M170.5M114V3	1-1/4"	3-4V	.042"	\$102.86
M170.5M114V4	1-1/4"	4-6V	.042"	\$102.86
M170.5M114V5	1-1/4"	5-8V	.042"	\$102.86
M170.5M114V6	1-1/4"	6-10V	.042"	\$102.86
M170.5M114V8	1-1/4"	8-12V	.042"	\$102.86
M170.5M112V2	1-1/2"	2-3V	.050"	\$125.19
M170.5M112V3	1-1/2"	3-4V	.050"	\$125.19
M170.5M112V4	1-1/2"	4-6V	.050"	\$125.19
M170.5M112V5	1-1/2"	5-8V	.050"	\$125.19

Carbon Steel Bandsaw Blade
170-1/2" (14' 2-1/2") Long



MAGNATE

Tool No.	Width	Tooth	Thickness	Price
M170.5C316S4	3/16"	4S	.025"	\$20.66
M170.5C316S6	3/16"	6S	.025"	\$21.81
M170.5C316R10	3/16"	10R	.025"	\$20.66
M170.5C316R14	3/16"	14R	.025"	\$20.66
M170.5C316R18	3/16"	18R	.025"	\$20.66
M170.5C316R24	3/16"	24R	.025"	\$20.66
M170.5C14H4	1/4"	4H	.025"	\$17.57
M170.5C14H6	1/4"	6H	.025"	\$17.57
M170.5C14R10	1/4"	10R	.025"	\$17.57
M170.5C14R14	1/4"	14R	.025"	\$17.57
M170.5C14R18	1/4"	18R	.025"	\$17.57
M170.5C14R24	1/4"	24R	.025"	\$17.57
M170.5C38H3	3/8"	3H	.025"	\$19.57
M170.5C38H4	3/8"	4H	.025"	\$19.57
M170.5C38H6	3/8"	6H	.025"	\$19.57
M170.5C38R8	3/8"	8R	.025"	\$19.57
M170.5C38R10	3/8"	10R	.025"	\$19.57
M170.5C38R14	3/8"	14R	.025"	\$19.57
M170.5C38R18	3/8"	18R	.025"	\$19.57
M170.5C38R24	3/8"	24R	.025"	\$18.24
M170.5C12H3	1/2"	3H	.025"	\$21.81
M170.5C12H4	1/2"	4H	.025"	\$21.81
M170.5C12H6	1/2"	6H	.025"	\$21.81
M170.5C12R10	1/2"	10R	.025"	\$21.81
M170.5C12R14	1/2"	14R	.025"	\$21.81
M170.5C12R18	1/2"	18R	.025"	\$21.81
M170.5C12R24	1/2"	24R	.025"	\$21.81
M170.5C58H3	5/8"	3H	.032"	\$26.07
M170.5C58H4	5/8"	4H	.032"	\$26.07
M170.5C58R10	5/8"	10R	.032"	\$26.07
M170.5C58R14	5/8"	14R	.032"	\$26.07
M170.5C34H2	3/4"	2H	.032"	\$26.07
M170.5C34H3	3/4"	3H	.032"	\$26.07
M170.5C34H4	3/4"	4H	.032"	\$26.07
M170.5C34H6	3/4"	6H	.032"	\$26.07
M170.5C34R6	3/4"	6R	.032"	\$26.07
M170.5C34R10	3/4"	10R	.032"	\$26.07
M170.5C34R14	3/4"	14R	.032"	\$26.07
M170.5C34R18	3/4"	18R	.032"	\$26.07
M170.5C1H1.3	1"	1.3H	.035"	\$34.10
M170.5C1H2	1"	2H	.035"	\$34.10
M170.5C1H3	1"	3H	.035"	\$34.10
M170.5C1H4	1"	4H	.035"	\$34.10
M170.5C1H6	1"	6H	.035"	\$34.10
M170.5C1R6	1"	6R	.035"	\$34.10
M170.5C1R8	1"	8R	.035"	\$34.10
M170.5C1R10	1"	10R	.035"	\$34.10
M170.5C1R14	1"	14R	.035"	\$34.10
M170.5C114H1.3	1-1/4"	1.3H	.042"	\$43.10
M170.5C112H1.15	1-1/2"	1.15H	.045"	\$48.05

MAGNATE™ 20639 Lycoming Street #B-6, Walnut, CA 91789 USA

M-86



email : info@magnate.net Online Shop : www.magnate.net
(TEL) 800-827-2316, 909-468-5747 (FAX) 909-468-5745

MAGNATE™ Band Saw Blades (Non-Food Processing)

WoodSaver Plus Resaw Bandsaw Blades 170-1/2" (14' 2-1/2") Long



SUPER CUT™

Tool No.	Width	Tooth	Thickness	Price
B170.5P58V3	5/8"	3-4V	.025"	\$117.35

WoodSaver Resaw Bandsaw Blades 170-1/2" (14' 2-1/2") Long



SUPER CUT™

Tool No.	Width	Tooth	Thickness	Price
B170.5S58T3	5/8"	3	.025"	\$100.30
B170.5S1T3	1"	3	.025"	\$116.83

Carbide Impregnated Bandsaw Blade 176" (14' 8") Long



SUPER CUT™

Tool No.	Width	Tooth	Thickness	Price
B176G14H6	1/4"	6H	.025"	\$43.52
B176G38H4	3/8"	4H	.025"	\$41.42
B176G12H3	1/2"	3H	.025"	\$43.77

Hawc Pro Resaw Bandsaw Blade 176" (14' 8") Long



SUPER CUT™

Tool No.	Width	Tooth	Thickness	Price
B176H12T3	1/2"	3	.025"	\$29.13

Bi-metal Bandsaw Blade 176" (14' 8") Long



MAGNATE

Tool No.	Width	Tooth	Thickness	Price
M176M14H6	1/4"	6H	.025"	\$72.38
M176M14V10	1/4"	10-14V	.025"	\$72.38
M176M14V14	1/4"	14-18V	.025"	\$72.38
M176M38H4	3/8"	4H	.025"	\$72.38
M176M38V10	3/8"	10-14V	.025"	\$72.38
M176M38V14	3/8"	14-18V	.025"	\$72.38
M176M12H3	1/2"	3H	.035"	\$72.38
M176M12H4	1/2"	4H	.025"	\$72.38
M176M12H6	1/2"	6H	.025"	\$72.38
M176M12V6	1/2"	6-10V	.025"	\$72.38
M176M12V8	1/2"	8-12V	.025"	\$72.38
M176M12V10	1/2"	10-14V	.025"	\$72.38
M176M12T14	1/2"	14	.025"	\$72.38
M176M12V14	1/2"	14-18V	.025"	\$72.38
M176M12T18	1/2"	18	.025"	\$72.38
M176M58V10	5/8"	10-14V	.032"	\$76.34
M176M34H3	3/4"	3H	.035"	\$76.34
M176M34V4	3/4"	4-6V	.035"	\$76.34
M176M34V5	3/4"	5-8V	.035"	\$76.34
M176M34V6	3/4"	6-10V	.035"	\$76.34
M176M34V8	3/4"	8-12V	.035"	\$76.34
M176M34V10	3/4"	10-14V	.035"	\$76.34
M176M34W14	3/4"	14W	.035"	\$76.34
M176M34W18	3/4"	18W	.035"	\$76.34
M176M1V2	1"	2-3V	.035"	\$88.24
M176M1H3	1"	3H	.035"	\$88.24
M176M1V3	1"	3-4V	.035"	\$88.24
M176M1V4	1"	4-6V	.035"	\$88.24
M176M1V5	1"	5-8V	.035"	\$88.24
M176M1V6	1"	6-10V	.035"	\$88.24
M176M1V8	1"	8-12V	.035"	\$88.24
M176M1V10	1"	10-14V	.035"	\$88.24
M176M114V2	1-1/4"	2-3V	.042"	\$106.03
M176M114V3	1-1/4"	3-4V	.042"	\$106.03
M176M114V4	1-1/4"	4-6V	.042"	\$106.03
M176M114V5	1-1/4"	5-8V	.042"	\$106.03
M176M114V6	1-1/4"	6-10V	.042"	\$106.03
M176M114V8	1-1/4"	8-12V	.042"	\$106.03
M176M112V2	1-1/2"	2-3V	.050"	\$129.12
M176M112V3	1-1/2"	3-4V	.050"	\$129.12
M176M112V4	1-1/2"	4-6V	.050"	\$129.12
M176M112V5	1-1/2"	5-8V	.050"	\$129.12

Carbon Steel Bandsaw Blade 176" (14' 8") Long



MAGNATE

Tool No.	Width	Tooth	Thickness	Price
M176C316S4	3/16"	4S	.025"	\$21.47
M176C316S6	3/16"	6S	.025"	\$22.41
M176C316R10	3/16"	10R	.025"	\$20.66
M176C316R14	3/16"	14R	.025"	\$20.66
M176C316R18	3/16"	18R	.025"	\$20.66
M176C316R24	3/16"	24R	.025"	\$20.66
M176C14H4	1/4"	4H	.025"	\$18.02
M176C14H6	1/4"	6H	.025"	\$18.02
M176C14R10	1/4"	10R	.025"	\$18.02
M176C14R14	1/4"	14R	.025"	\$18.02
M176C14R18	1/4"	18R	.025"	\$18.02
M176C14R24	1/4"	24R	.025"	\$18.02
M176C38H3	3/8"	3H	.025"	\$20.09
M176C38H4	3/8"	4H	.025"	\$20.09
M176C38H6	3/8"	6H	.025"	\$20.09
M176C38R8	3/8"	8R	.025"	\$20.09
M176C38R10	3/8"	10R	.025"	\$20.09
M176C38R14	3/8"	14R	.025"	\$20.09
M176C38R18	3/8"	18R	.025"	\$20.09
M176C38R24	3/8"	24R	.025"	\$18.64
M176C12H3	1/2"	3H	.025"	\$22.41
M176C12H4	1/2"	4H	.025"	\$22.41
M176C12H6	1/2"	6H	.025"	\$22.41
M176C12R10	1/2"	10R	.025"	\$22.41
M176C12R14	1/2"	14R	.025"	\$22.41
M176C12R18	1/2"	18R	.025"	\$22.41
M176C12R24	1/2"	24R	.025"	\$22.41
M176C58H3	5/8"	3H	.032"	\$26.81
M176C58H4	5/8"	4H	.032"	\$26.81
M176C58R10	5/8"	10R	.032"	\$26.81
M176C58R14	5/8"	14R	.032"	\$26.81
M176C34H2	3/4"	2H	.032"	\$26.81
M176C34H3	3/4"	3H	.032"	\$26.81
M176C34H4	3/4"	4H	.032"	\$26.81
M176C34H6	3/4"	6H	.032"	\$26.81
M176C34R6	3/4"	6R	.032"	\$26.81
M176C34R10	3/4"	10R	.032"	\$26.81
M176C34R14	3/4"	14R	.032"	\$26.81
M176C34R18	3/4"	18R	.032"	\$26.81
M176C1H1.3	1"	1.3H	.035"	\$35.09
M176C1H2	1"	2H	.035"	\$35.09
M176C1H3	1"	3H	.035"	\$35.09
M176C1H4	1"	4H	.035"	\$35.09
M176C1H6	1"	6H	.035"	\$35.09
M176C1R6	1"	6R	.035"	\$35.09
M176C1R8	1"	8R	.035"	\$35.09
M176C1R10	1"	10R	.035"	\$35.09
M176C1R14	1"	14R	.035"	\$35.09
M176C114H1.3	1-1/4"	1.3H	.042"	\$44.40
M176C112H1.15	1-1/2"	1.15H	.042"	\$49.48

MAGNATE™ 20639 Lycoming Street #B-6, Walnut, CA 91789 USA

M-87



email : info@magnate.net Online Shop : www.magnate.net
(TEL) 800-827-2316, 909-468-5747 (FAX) 909-468-5745

MAGNATE™ Band Saw Blades (Non-Food Processing)

WoodSaver Plus Resaw Bandsaw Blades 176" (14' 8") Long



Tool No.	Width	Tooth	Thickness	Price
B176P58V3	5/8"	3-4V	.025"	\$121.02

WoodSaver Resaw Bandsaw Blades 176" (14' 8") Long



Tool No.	Width	Tooth	Thickness	Price
B176S58T3	5/8"	3	.025"	\$103.43
B176S1T3	1"	3	.025"	\$120.55

Scallop Edged Bandsaw Blade 176" (14' 8") Long



Tool No.	Width	Pitch	Thickness	Price
M176S12P2	1/2"	1/2"	.020"	\$48.98

Carbide Impregnated Bandsaw Blade 176-3/4" (14' 8-3/4") Long



Tool No.	Width	Tooth	Thickness	Price
B176.75G14H6	1/4"	6H	.025"	\$43.52
B176.75G38H4	3/8"	4H	.025"	\$41.42
B176.75G12H3	1/2"	3H	.025"	\$43.77

Carbon Steel Bandsaw Blade 176-3/4" (14' 8-3/4") Long



Tool No.	Width	Tooth	Thickness	Price
M176.75C316S4	3/16"	4S	.025"	\$23.07
M176.75C316S6	3/16"	6S	.025"	\$22.41
M176.75C316R10	3/16"	10R	.025"	\$21.47
M176.75C316R14	3/16"	14R	.025"	\$21.47
M176.75C316R18	3/16"	18R	.025"	\$21.47
M176.75C316R24	3/16"	24R	.025"	\$21.47
M176.75C14H4	1/4"	4H	.025"	\$18.02
M176.75C14H6	1/4"	6H	.025"	\$18.02
M176.75C14R10	1/4"	10R	.025"	\$18.02
M176.75C14R14	1/4"	14R	.025"	\$18.02
M176.75C14R18	1/4"	18R	.025"	\$18.02
M176.75C14R24	1/4"	24R	.025"	\$18.02
M176.75C38H3	3/8"	3H	.025"	\$20.09
M176.75C38H4	3/8"	4H	.025"	\$20.09
M176.75C38H6	3/8"	6H	.025"	\$20.09
M176.75C38R8	3/8"	8R	.025"	\$20.09
M176.75C38R10	3/8"	10R	.025"	\$20.09
M176.75C38R14	3/8"	14R	.025"	\$20.09
M176.75C38R18	3/8"	18R	.025"	\$20.09
M176.75C38R24	3/8"	24R	.025"	\$18.64
M176.75C12H3	1/2"	3H	.025"	\$22.41
M176.75C12H4	1/2"	4H	.025"	\$22.41
M176.75C12H6	1/2"	6H	.025"	\$22.41
M176.75C12R10	1/2"	10R	.025"	\$22.41
M176.75C12R14	1/2"	14R	.025"	\$22.41
M176.75C12R18	1/2"	18R	.025"	\$22.41
M176.75C12R24	1/2"	24R	.025"	\$22.41
M176.75C58H3	5/8"	3H	.032"	\$26.81
M176.75C58H4	5/8"	4H	.032"	\$26.81
M176.75C58R10	5/8"	10R	.032"	\$26.81
M176.75C58R14	5/8"	14R	.032"	\$26.81
M176.75C34H2	3/4"	2H	.032"	\$26.81
M176.75C34H3	3/4"	3H	.032"	\$26.81
M176.75C34H4	3/4"	4H	.032"	\$26.81
M176.75C34H6	3/4"	6H	.032"	\$26.81
M176.75C34R6	3/4"	6R	.032"	\$26.81
M176.75C34R10	3/4"	10R	.032"	\$26.81
M176.75C34R14	3/4"	14R	.032"	\$26.81
M176.75C34R18	3/4"	18R	.032"	\$26.81
M176.75C1H1.3	1"	1.3H	.035"	\$35.09
M176.75C1H2	1"	2H	.035"	\$35.09
M176.75C1H3	1"	3H	.035"	\$35.09
M176.75C1H4	1"	4H	.035"	\$35.09
M176.75C1H6	1"	6H	.035"	\$35.09
M176.75C1R6	1"	6R	.035"	\$35.09
M176.75C1R8	1"	8R	.035"	\$35.09
M176.75C1R10	1"	10R	.035"	\$35.09
M176.75C1R14	1"	14R	.035"	\$35.09
M176.75C114H1.3	1-1/4"	1.3H	.042"	\$44.40
M176.75C112H1.15	1-1/2"	1.15H	.045"	\$49.48

Hawc Pro Resaw Bandsaw Blade 176-3/4" (14' 8-3/4") Long



Tool No.	Width	Tooth	Thickness	Price
B176.75H12T3	1/2"	3	.025"	\$29.13

WoodSaver Plus Resaw Bandsaw Blades 176-3/4" (14' 8-3/4") Long



Tool No.	Width	Tooth	Thickness	Price
B176.75P58V3	5/8"	3-4V	.025"	\$121.02

WoodSaver Resaw Bandsaw Blades 176-3/4" (14' 8-3/4") Long



Tool No.	Width	Tooth	Thickness	Price
B176.75S58T3	5/8"	3	.025"	\$103.43
B176.75S1T3	1"	3	.025"	\$120.55

MAGNATE™ 20639 Lycoming Street #B-6, Walnut, CA 91789 USA

M-88



email : info@magnate.net Online Shop : www.magnate.net
(TEL) 800-827-2316, 909-468-5747 (FAX) 909-468-5745

MAGNATE™ Band Saw Blades (Non-Food Processing)

Carbon Steel Bandsaw Blade 177" (14' 9") Long



MAGNATE

Tool No.	Width	Tooth	Thickness	Price
M177C316S4	3/16"	4S	.025"	\$21.47
M177C316S6	3/16"	6S	.025"	\$22.41
M177C316R10	3/16"	10R	.025"	\$21.47
M177C316R14	3/16"	14R	.025"	\$21.47
M177C316R18	3/16"	18R	.025"	\$21.47
M177C316R24	3/16"	24R	.025"	\$21.47
M177C14H4	1/4"	4H	.025"	\$18.02
M177C14H6	1/4"	6H	.025"	\$18.02
M177C14R10	1/4"	10R	.025"	\$18.02
M177C14R14	1/4"	14R	.025"	\$18.02
M177C14R18	1/4"	18R	.025"	\$18.02
M177C14R24	1/4"	24R	.025"	\$18.02
M177C38H3	3/8"	3H	.025"	\$20.09
M177C38H4	3/8"	4H	.025"	\$20.09
M177C38H6	3/8"	6H	.025"	\$20.09
M177C38R8	3/8"	8R	.025"	\$20.09
M177C38R10	3/8"	10R	.025"	\$20.09
M177C38R14	3/8"	14R	.025"	\$20.09
M177C38R18	3/8"	18R	.025"	\$20.09
M177C38R24	3/8"	24R	.025"	\$18.64
M177C12H3	1/2"	3H	.025"	\$22.41
M177C12H4	1/2"	4H	.025"	\$22.41
M177C12H6	1/2"	6H	.025"	\$22.41
M177C12R10	1/2"	10R	.025"	\$22.41
M177C12R14	1/2"	14R	.025"	\$22.41
M177C12R18	1/2"	18R	.025"	\$22.41
M177C12R24	1/2"	24R	.025"	\$22.41
M177C58H3	5/8"	3H	.032"	\$26.81
M177C58H4	5/8"	4H	.032"	\$26.81
M177C58R10	5/8"	10R	.032"	\$26.81
M177C58R14	5/8"	14R	.032"	\$26.81
M177C34H2	3/4"	2H	.032"	\$26.81
M177C34H3	3/4"	3H	.032"	\$26.81
M177C34H4	3/4"	4H	.032"	\$26.81
M177C34H6	3/4"	6H	.032"	\$26.81
M177C34R6	3/4"	6R	.032"	\$26.81
M177C34R10	3/4"	10R	.032"	\$26.81
M177C34R14	3/4"	14R	.032"	\$26.81
M177C34R18	3/4"	18R	.032"	\$26.81
M177C1H1.3	1"	1.3H	.035"	\$35.09
M177C1H2	1"	2H	.035"	\$35.09
M177C1H3	1"	3H	.035"	\$35.09
M177C1H4	1"	4H	.035"	\$35.09
M177C1H6	1"	6H	.035"	\$35.09
M177C1R6	1"	6R	.035"	\$35.09
M177C1R8	1"	8R	.035"	\$35.09
M177C1R10	1"	10R	.035"	\$35.09
M177C1R14	1"	14R	.035"	\$35.09
M177C114H1.3	1-1/4"	1.3H	.042"	\$44.40
M177C112H1.15	1-1/2"	1.15H	.045"	\$49.48

Bi-metal Bandsaw Blade 180-1/2" (15' 1/2") Long



MAGNATE

Tool No.	Width	Tooth	Thickness	Price
M180.5M14H6	1/4"	6H	.025"	\$74.52
M180.5M14V10	1/4"	10-14V	.025"	\$74.52
M180.5M14V14	1/4"	14-18V	.025"	\$74.52
M180.5M38H4	3/8"	4H	.025"	\$74.52
M180.5M38V10	3/8"	10-14V	.025"	\$74.52
M180.5M38V14	3/8"	14-18V	.025"	\$74.52
M180.5M12H3	1/2"	3H	.035"	\$74.52
M180.5M12H4	1/2"	4H	.025"	\$74.52
M180.5M12H6	1/2"	6H	.025"	\$74.52
M180.5M12V6	1/2"	6-10V	.025"	\$74.52
M180.5M12V8	1/2"	8-12V	.025"	\$74.52
M180.5M12V10	1/2"	10-14V	.025"	\$74.52
M180.5M12T14	1/2"	14	.025"	\$74.52
M180.5M12V14	1/2"	14-18V	.025"	\$74.52
M180.5M12T18	1/2"	18	.025"	\$74.52
M180.5M58V10	5/8"	10-14V	.032"	\$78.57
M180.5M34H3	3/4"	3H	.035"	\$78.57
M180.5M34V4	3/4"	4-6V	.035"	\$78.57
M180.5M34V5	3/4"	5-8V	.035"	\$78.57
M180.5M34V6	3/4"	6-10V	.035"	\$78.57
M180.5M34V8	3/4"	8-12V	.035"	\$78.57
M180.5M34V10	3/4"	10-14V	.035"	\$78.57
M180.5M34W14	3/4"	14W	.035"	\$78.57
M180.5M34W18	3/4"	18W	.035"	\$78.57
M180.5M1V2	1"	2-3V	.035"	\$90.88
M180.5M1H3	1"	3H	.035"	\$90.88
M180.5M1V3	1"	3-4V	.035"	\$90.88
M180.5M1V4	1"	4-6V	.035"	\$90.88
M180.5M1V5	1"	5-8V	.035"	\$90.88
M180.5M1V6	1"	6-10V	.035"	\$90.88
M180.5M1V8	1"	8-12V	.035"	\$90.88
M180.5M1V10	1"	10-14V	.035"	\$90.88
M180.5M114V2	1-1/4"	2-3V	.042"	\$109.19
M180.5M114V3	1-1/4"	3-4V	.042"	\$109.19
M180.5M114V4	1-1/4"	4-6V	.042"	\$109.19
M180.5M114V5	1-1/4"	5-8V	.042"	\$109.19
M180.5M114V6	1-1/4"	6-10V	.042"	\$109.19
M180.5M114V8	1-1/4"	8-12V	.042"	\$109.19
M180.5M112V2	1-1/2"	2-3V	.050"	\$133.05
M180.5M112V3	1-1/2"	3-4V	.050"	\$133.05
M180.5M112V4	1-1/2"	4-6V	.050"	\$133.05
M180.5M112V5	1-1/2"	5-8V	.050"	\$133.05

Carbon Steel Bandsaw Blade 180-1/2" (15' 1/2") Long



MAGNATE

Tool No.	Width	Tooth	Thickness	Price
M180.5C316S4	3/16"	4S	.025"	\$21.64
M180.5C316S6	3/16"	6S	.025"	\$23.02
M180.5C316R10	3/16"	10R	.025"	\$21.64
M180.5C316R14	3/16"	14R	.025"	\$21.64
M180.5C316R18	3/16"	18R	.025"	\$21.64
M180.5C316R24	3/16"	24R	.025"	\$21.64
M180.5C14H4	1/4"	4H	.025"	\$18.48
M180.5C14H6	1/4"	6H	.025"	\$18.48
M180.5C14R10	1/4"	10R	.025"	\$18.48
M180.5C14R14	1/4"	14R	.025"	\$18.48
M180.5C14R18	1/4"	18R	.025"	\$18.48
M180.5C14R24	1/4"	24R	.025"	\$18.48
M180.5C38H3	3/8"	3H	.025"	\$20.62
M180.5C38H4	3/8"	4H	.025"	\$20.62
M180.5C38H6	3/8"	6H	.025"	\$20.62
M180.5C38R8	3/8"	8R	.025"	\$20.62
M180.5C38R10	3/8"	10R	.025"	\$20.62
M180.5C38R14	3/8"	14R	.025"	\$20.62
M180.5C38R18	3/8"	18R	.025"	\$20.62
M180.5C38R24	3/8"	24R	.025"	\$19.09
M180.5C12H3	1/2"	3H	.025"	\$23.02
M180.5C12H4	1/2"	4H	.025"	\$23.02
M180.5C12H6	1/2"	6H	.025"	\$23.02
M180.5C12R10	1/2"	10R	.025"	\$23.02
M180.5C12R14	1/2"	14R	.025"	\$23.02
M180.5C12R18	1/2"	18R	.025"	\$23.02
M180.5C12R24	1/2"	24R	.025"	\$23.02
M180.5C58H3	5/8"	3H	.032"	\$27.57
M180.5C58H4	5/8"	4H	.032"	\$27.57
M180.5C58R10	5/8"	10R	.032"	\$27.57
M180.5C58R14	5/8"	14R	.032"	\$27.57
M180.5C34H2	3/4"	2H	.032"	\$27.57
M180.5C34H3	3/4"	3H	.032"	\$27.57
M180.5C34H4	3/4"	4H	.032"	\$27.57
M180.5C34H6	3/4"	6H	.032"	\$27.57
M180.5C34R6	3/4"	6R	.032"	\$27.57
M180.5C34R10	3/4"	10R	.032"	\$27.57
M180.5C34R14	3/4"	14R	.032"	\$27.57
M180.5C34R18	3/4"	18R	.032"	\$27.57
M180.5C1H1.3	1"	1.3H	.035"	\$36.07
M180.5C1H2	1"	2H	.035"	\$36.07
M180.5C1H3	1"	3H	.035"	\$36.07
M180.5C1H4	1"	4H	.035"	\$36.07
M180.5C1H6	1"	6H	.035"	\$36.07
M180.5C1R6	1"	6R	.035"	\$36.07
M180.5C1R8	1"	8R	.035"	\$36.07
M180.5C1R10	1"	10R	.035"	\$36.07
M180.5C1R14	1"	14R	.035"	\$36.07
M180.5C114H1.3	1-1/4"	1.3H	.042"	\$45.69
M180.5C112H1.15	1-1/2"	1.15H	.045"	\$50.91

MAGNATE™ 20639 Lycoming Street #B-6, Walnut, CA 91789 USA

M-89



email : info@magnate.net Online Shop : www.magnate.net
(TEL) 800-827-2316, 909-468-5747 (FAX) 909-468-5745

MAGNATE™ Band Saw Blades (Non-Food Processing)

Carbon Steel Bandsaw Blade 183" (15' 3") Long



Tool No.	Width	Tooth	Thickness	Price
M183C316S4	3/16"	4S	.025"	\$21.64
M183C316S6	3/16"	6S	.025"	\$23.02
M183C316R10	3/16"	10R	.025"	\$21.64
M183C316R14	3/16"	14R	.025"	\$21.64
M183C316R18	3/16"	18R	.025"	\$21.64
M183C316R24	3/16"	24R	.025"	\$21.64
M183C14H4	1/4"	4H	.025"	\$18.48
M183C14H6	1/4"	6H	.025"	\$18.48
M183C14R10	1/4"	10R	.025"	\$18.48
M183C14R14	1/4"	14R	.025"	\$18.48
M183C14R18	1/4"	18R	.025"	\$18.48
M183C14R24	1/4"	24R	.025"	\$18.48
M183C38H3	3/8"	3H	.025"	\$20.62
M183C38H4	3/8"	4H	.025"	\$20.62
M183C38H6	3/8"	6H	.025"	\$20.62
M183C38R8	3/8"	8R	.025"	\$20.62
M183C38R10	3/8"	10R	.025"	\$20.62
M183C38R14	3/8"	14R	.025"	\$20.62
M183C38R18	3/8"	18R	.025"	\$20.62
M183C38R24	3/8"	24R	.025"	\$19.09
M183C12H3	1/2"	3H	.025"	\$23.02
M183C12H4	1/2"	4H	.025"	\$23.02
M183C12H6	1/2"	6H	.025"	\$23.02
M183C12R10	1/2"	10R	.025"	\$23.02
M183C12R14	1/2"	14R	.025"	\$23.02
M183C12R18	1/2"	18R	.025"	\$23.02
M183C12R24	1/2"	24R	.025"	\$23.02
M183C58H3	5/8"	3H	.032"	\$27.57
M183C58H4	5/8"	4H	.032"	\$27.57
M183C58R10	5/8"	10R	.032"	\$27.57
M183C58R14	5/8"	14R	.032"	\$27.57
M183C34H2	3/4"	2H	.032"	\$27.57
M183C34H3	3/4"	3H	.032"	\$27.57
M183C34H4	3/4"	4H	.032"	\$27.57
M183C34H6	3/4"	6H	.032"	\$27.57
M183C34R6	3/4"	6R	.032"	\$27.57
M183C34R10	3/4"	10R	.032"	\$27.57
M183C34R14	3/4"	14R	.032"	\$27.57
M183C34R18	3/4"	18R	.032"	\$27.57
M183C1H1.3	1"	1.3H	.035"	\$36.07
M183C1H2	1"	2H	.035"	\$36.07
M183C1H3	1"	3H	.035"	\$36.07
M183C1H4	1"	4H	.035"	\$36.07
M183C1H6	1"	6H	.035"	\$36.07
M183C1R6	1"	6R	.035"	\$36.07
M183C1R8	1"	8R	.035"	\$36.07
M183C1R10	1"	10R	.035"	\$36.07
M183C1R14	1"	14R	.035"	\$36.07
M183C114H1.3	1-1/4"	1.3H	.042"	\$45.69
M183C112H1.15	1-1/2"	1.15H	.045"	\$50.91

Carbon Steel Bandsaw Blade 201" (16' 9") Long



Tool No.	Width	Tooth	Thickness	Price
M201C14H4	1/4"	4H	.025"	\$19.84
M201C14H6	1/4"	6H	.025"	\$19.84
M201C14R10	1/4"	10R	.025"	\$19.84
M201C14R14	1/4"	14R	.025"	\$19.84
M201C14R18	1/4"	18R	.025"	\$19.84
M201C14R24	1/4"	24R	.025"	\$19.84
M201C38H3	3/8"	3H	.025"	\$22.19
M201C38H4	3/8"	4H	.025"	\$22.19
M201C38H6	3/8"	6H	.025"	\$22.19
M201C38R8	3/8"	8R	.025"	\$22.19
M201C38R10	3/8"	10R	.025"	\$22.19
M201C38R14	3/8"	14R	.025"	\$22.19
M201C38R18	3/8"	18R	.025"	\$22.19
M201C38R24	3/8"	24R	.025"	\$20.34
M201C12H3	1/2"	3H	.025"	\$24.83
M201C12H4	1/2"	4H	.025"	\$24.83
M201C12H6	1/2"	6H	.025"	\$24.83
M201C12R10	1/2"	10R	.025"	\$24.83
M201C12R14	1/2"	14R	.025"	\$24.83
M201C12R18	1/2"	18R	.025"	\$24.83
M201C12R24	1/2"	24R	.025"	\$24.83
M201C58H3	5/8"	3H	.032"	\$29.81
M201C58H4	5/8"	4H	.032"	\$29.81
M201C58R10	5/8"	10R	.032"	\$29.81
M201C58R14	5/8"	14R	.032"	\$29.81
M201C34H2	3/4"	2H	.032"	\$29.81
M201C34H3	3/4"	3H	.032"	\$29.81
M201C34H4	3/4"	4H	.032"	\$29.81
M201C34H6	3/4"	6H	.032"	\$29.81
M201C34R6	3/4"	6R	.032"	\$29.81
M201C34R10	3/4"	10R	.032"	\$29.81
M201C34R14	3/4"	14R	.032"	\$29.81
M201C34R18	3/4"	18R	.032"	\$29.81
M201C1H1.3	1"	1.3H	.032"	\$39.02
M201C1H2	1"	2H	.035"	\$39.02
M201C1H3	1"	3H	.035"	\$39.02
M201C1H4	1"	4H	.035"	\$39.02
M201C1H6	1"	6H	.035"	\$39.02
M201C1R6	1"	6R	.035"	\$39.02
M201C1R8	1"	8R	.035"	\$39.02
M201C1R10	1"	10R	.035"	\$39.02
M201C1R14	1"	14R	.035"	\$39.02
M201C114H1.3	1-1/4"	1.3H	.042"	\$49.57
M201C112H1.15	1-1/2"	1.15H	.045"	\$55.21

Carbon Steel Bandsaw Blade 222" (18' 6") Long



Tool No.	Width	Tooth	Thickness	Price
M222C14H4	1/4"	4H	.025"	\$21.22
M222C14H6	1/4"	6H	.025"	\$21.22
M222C14R10	1/4"	10R	.025"	\$21.22
M222C14R14	1/4"	14R	.025"	\$21.22
M222C14R18	1/4"	18R	.025"	\$21.22
M222C14R24	1/4"	24R	.025"	\$21.22
M222C38H3	3/8"	3H	.025"	\$23.78
M222C38H4	3/8"	4H	.025"	\$23.78
M222C38H6	3/8"	6H	.025"	\$23.78
M222C38R8	3/8"	8R	.025"	\$23.78
M222C38R10	3/8"	10R	.025"	\$23.78
M222C38R14	3/8"	14R	.025"	\$23.78
M222C38R18	3/8"	18R	.025"	\$23.78
M222C38R24	3/8"	24R	.025"	\$21.62
M222C12H3	1/2"	3H	.025"	\$26.64
M222C12H4	1/2"	4H	.025"	\$26.64
M222C12H6	1/2"	6H	.025"	\$26.64
M222C12R10	1/2"	10R	.025"	\$26.64
M222C12R14	1/2"	14R	.025"	\$26.64
M222C12R18	1/2"	18R	.025"	\$26.64
M222C12R24	1/2"	24R	.025"	\$26.64
M222C58H3	5/8"	3H	.032"	\$32.07
M222C58H4	5/8"	4H	.032"	\$32.07
M222C58R10	5/8"	10R	.032"	\$32.07
M222C58R14	5/8"	14R	.032"	\$32.07
M222C34H2	3/4"	2H	.032"	\$32.07
M222C34H3	3/4"	3H	.032"	\$32.07
M222C34H4	3/4"	4H	.032"	\$32.07
M222C34H6	3/4"	6H	.032"	\$32.07
M222C34R6	3/4"	6R	.032"	\$32.07
M222C34R10	3/4"	10R	.032"	\$32.07
M222C34R14	3/4"	14R	.032"	\$32.07
M222C34R18	3/4"	18R	.032"	\$32.07
M222C1H1.3	1"	1.3H	.035"	\$41.97
M222C1H2	1"	2H	.035"	\$41.97
M222C1H3	1"	3H	.035"	\$41.97
M222C1H4	1"	4H	.035"	\$41.97
M222C1H6	1"	6H	.035"	\$41.97
M222C1R6	1"	6R	.035"	\$41.97
M222C1R8	1"	8R	.035"	\$41.97
M222C1R10	1"	10R	.035"	\$41.97
M222C1R14	1"	14R	.035"	\$41.97
M222C114H1.3	1-1/4"	1.3H	.042"	\$53.45
M222C112H1.15	1-1/2"	1.15H	.045"	\$59.50

MAGNATE™ 20639 Lycoming Street #B-6, Walnut, CA 91789 USA

M-90



email : info@magnate.net Online Shop : www.magnate.net
(TEL) 800-827-2316, 909-468-5747 (FAX) 909-468-5745

MAGNATE™ Band Saw Blades (Non-Food Processing)

Bi-metal Bandsaw Blade 244" (20' 4") Long				
Tool No.	Width	Tooth	Thickness	Price
M244M38H4	3/8"	4H	.025"	\$95.84
M244M38V10	3/8"	10-14V	.025"	\$95.84
M244M38V14	3/8"	14-18V	.025"	\$95.84
M244M12H3	1/2"	3H	.035"	\$95.84
M244M12H4	1/2"	4H	.025"	\$95.84
M244M12H6	1/2"	6H	.025"	\$95.84
M244M12V6	1/2"	6-10V	.025"	\$95.84
M244M12V8	1/2"	8-12V	.025"	\$95.84
M244M12V10	1/2"	10-14V	.025"	\$95.84
M244M12T14	1/2"	14	.025"	\$95.84
M244M12V14	1/2"	14-18V	.025"	\$95.84
M244M12T18	1/2"	18	.025"	\$95.84
M244M58V10	5/8"	10-14V	.032"	\$100.90
M244M34H3	3/4"	3H	.035"	\$100.90
M244M34V4	3/4"	4-6V	.035"	\$100.90
M244M34V5	3/4"	5-8V	.035"	\$100.90
M244M34V6	3/4"	6-10V	.035"	\$100.90
M244M34V8	3/4"	8-12V	.035"	\$100.90
M244M34V10	3/4"	10-14V	.035"	\$100.90
M244M34W14	3/4"	14W	.035"	\$100.90
M244M34W18	3/4"	18W	.035"	\$100.90
M244M1V2	1"	2-3V	.035"	\$117.17
M244M1H3	1"	3H	.035"	\$117.17
M244M1V3	1"	3-4V	.035"	\$117.17
M244M1V4	1"	4-6V	.035"	\$117.17
M244M1V5	1"	5-8V	.035"	\$117.17
M244M1V6	1"	6-10V	.035"	\$117.17
M244M1V8	1"	8-12V	.035"	\$117.17
M244M1V10	1"	10-14V	.035"	\$117.17
M244M114V2	1-1/4"	2-3V	.042"	\$140.81
M244M114V3	1-1/4"	3-4V	.042"	\$140.81
M244M114V4	1-1/4"	4-6V	.042"	\$140.81
M244M114V5	1-1/4"	5-8V	.042"	\$140.81
M244M114V6	1-1/4"	6-10V	.042"	\$140.81
M244M114V8	1-1/4"	8-12V	.042"	\$140.81
M244M112V2	1-1/2"	2-3V	.050"	\$172.38
M244M112V3	1-1/2"	3-4V	.050"	\$172.38
M244M112V4	1-1/2"	4-6V	.050"	\$172.38
M244M112V5	1-1/2"	5-8V	.050"	\$172.38

Carbon Steel Bandsaw Blade 244" (20' 4") Long				
Tool No.	Width	Tooth	Thickness	Price
M244C38H3	3/8"	3H	.025"	\$25.88
M244C38H4	3/8"	4H	.025"	\$25.88
M244C38H6	3/8"	6H	.025"	\$25.88
M244C38R8	3/8"	8R	.025"	\$25.88
M244C38R10	3/8"	10R	.025"	\$25.88
M244C38R14	3/8"	14R	.025"	\$25.88
M244C38R18	3/8"	18R	.025"	\$25.88
M244C38R24	3/8"	24R	.025"	\$23.24
M244C12H3	1/2"	3H	.025"	\$29.05
M244C12H4	1/2"	4H	.025"	\$29.05
M244C12H6	1/2"	6H	.025"	\$29.05
M244C12R10	1/2"	10R	.025"	\$29.05
M244C12R14	1/2"	14R	.025"	\$29.05
M244C12R18	1/2"	18R	.025"	\$29.05
M244C12R24	1/2"	24R	.025"	\$29.05
M244C58H3	5/8"	3H	.032"	\$35.07
M244C58H4	5/8"	4H	.032"	\$35.07
M244C58R10	5/8"	10R	.032"	\$35.07
M244C58R14	5/8"	14R	.032"	\$35.07
M244C34H2	3/4"	2H	.032"	\$35.07
M244C34H3	3/4"	3H	.032"	\$35.07
M244C34H4	3/4"	4H	.032"	\$35.07
M244C34H6	3/4"	6H	.032"	\$35.07
M244C34R6	3/4"	6R	.032"	\$35.07
M244C34R10	3/4"	10R	.032"	\$35.07
M244C34R14	3/4"	14R	.032"	\$35.07
M244C34R18	3/4"	18R	.032"	\$35.07
M244C1H1.3	1"	1.3H	.035"	\$45.90
M244C1H2	1"	2H	.035"	\$45.90
M244C1H3	1"	3H	.035"	\$45.90
M244C1H4	1"	4H	.035"	\$45.90
M244C1H6	1"	6H	.035"	\$45.90
M244C1R6	1"	6R	.035"	\$45.90
M244C1R8	1"	8R	.035"	\$45.90
M244C1R10	1"	10R	.035"	\$45.90
M244C1R14	1"	14R	.035"	\$45.90
M244C114H1.3	1-1/4"	1.3H	.042"	\$58.62
M244C112H1.15	1-1/2"	1.15H	.045"	\$65.22

Hawc Pro Resaw Bandsaw Blade 244" (20' 4") Long				
Tool No.	Width	Tooth	Thickness	Price
B244H12T3	1/2"	3	.025"	\$36.37

WoodSaver Plus Resaw Bandsaw Blades 244" (20' 4") Long				
Tool No.	Width	Tooth	Thickness	Price
B244P58V3	5/8"	3-4V	.025"	\$161.40

Carbide Impregnated Bandsaw Blade 244" (20' 4") Long				
Tool No.	Width	Tooth	Thickness	Price
B244G14H6	1/4"	6H	.025"	\$54.28
B244G38H4	3/8"	4H	.025"	\$51.68
B244G12H3	1/2"	3H	.025"	\$54.70

WoodSaver Resaw Bandsaw Blades 244" (20' 4") Long				
Tool No.	Width	Tooth	Thickness	Price
B244S58T3	5/8"	3	.025"	\$137.93
B244S1T3	1"	3	.025"	\$161.30

MAGNATE™ 20639 Lycoming Street #B-6, Walnut, CA 91789 USA

M-91



email : info@magnate.net Online Shop : www.magnate.net
(TEL) 800-827-2316, 909-468-5747 (FAX) 909-468-5745

**Carbon Steel Bandsaw Blade
261" (21' 9") Long**



Tool No.	Width	Tooth	Thickness	Price
M261C38H3	3/8"	3H	.025"	\$27.45
M261C38H4	3/8"	4H	.025"	\$27.45
M261C38H6	3/8"	6H	.025"	\$27.45
M261C38R8	3/8"	8R	.025"	\$27.45
M261C38R10	3/8"	10R	.025"	\$27.45
M261C38R14	3/8"	14R	.025"	\$27.45
M261C38R18	3/8"	18R	.025"	\$27.45
M261C38R24	3/8"	24R	.025"	\$24.53
M261C12H3	1/2"	3H	.025"	\$30.86
M261C12H4	1/2"	4H	.025"	\$30.86
M261C12H6	1/2"	6H	.025"	\$30.86
M261C12R10	1/2"	10R	.025"	\$30.86
M261C12R14	1/2"	14R	.025"	\$30.86
M261C12R18	1/2"	18R	.025"	\$30.86
M261C12R24	1/2"	24R	.025"	\$30.86
M261C58H3	5/8"	3H	.032"	\$37.31
M261C58H4	5/8"	4H	.032"	\$37.31
M261C58R10	5/8"	10R	.032"	\$37.31
M261C58R14	5/8"	14R	.032"	\$37.31
M261C34H2	3/4"	2H	.032"	\$37.31
M261C34H3	3/4"	3H	.032"	\$37.31
M261C34H4	3/4"	4H	.032"	\$37.31
M261C34H6	3/4"	6H	.032"	\$37.31
M261C34R6	3/4"	6R	.032"	\$37.31
M261C34R10	3/4"	10R	.032"	\$37.31
M261C34R14	3/4"	14R	.032"	\$37.31
M261C34R18	3/4"	18R	.032"	\$37.31
M261C1H1.3	1"	1.3H	.035"	\$48.84
M261C1H2	1"	2H	.035"	\$48.84
M261C1H3	1"	3H	.035"	\$48.84
M261C1H4	1"	4H	.035"	\$48.84
M261C1H6	1"	6H	.035"	\$48.84
M261C1R6	1"	6R	.035"	\$48.84
M261C1R8	1"	8R	.035"	\$48.84
M261C1R10	1"	10R	.035"	\$48.84
M261C1R14	1"	14R	.035"	\$48.84
M261C114H1.3	1-1/4"	1.3H	.042"	\$62.50
M261C112H1.15	1-1/2"	1.15H	.045"	\$69.52



MAGNATE™ Food Processing Blades

Meat Cutting Bandsaw Blade 60" (5') Long					Meat Cutting Bandsaw Blade 65" (5' 5") Long					Meat Cutting Bandsaw Blade 69" (5' 9") Long				
 MAGNATE					 MAGNATE					 MAGNATE				
Tool No.	Width	Tooth	Thickness	Price	Tool No.	Width	Tooth	Thickness	Price	Tool No.	Width	Tooth	Thickness	Price
M60T58T3	5/8"	3	.022"	\$11.80	M65T58T3	5/8"	3	.022"	\$12.11	M69T58T3	5/8"	3	.022"	\$12.35
M60T58T4	5/8"	4	.025"	\$12.71	M65T58T4	5/8"	4	.025"	\$13.04	M69T58T4	5/8"	4	.025"	\$13.29
Meat Cutting Bandsaw Blade 60" (5') Long					Meat Cutting Bandsaw Blade 65" (5' 5") Long					Meat Cutting Bandsaw Blade 69" (5' 9") Long				
 SUPER CUT™					 SUPER CUT™					 SUPER CUT™				
Tool No.	Width	Tooth	Thickness	Price	Tool No.	Width	Tooth	Thickness	Price	Tool No.	Width	Tooth	Thickness	Price
B60T58T4	5/8"	4H	.025"	\$21.09	B65T58T4	5/8"	4H	.025"	\$21.09	B69T58T4	5/8"	4	.025"	\$21.09
Meat Cutting Bandsaw Blade 63" (5' 3") Long					Meat Cutting Bandsaw Blade 66" (5' 6") Long					Meat Cutting Bandsaw Blade 72" (6') Long				
 MAGNATE					 MAGNATE					 MAGNATE				
Tool No.	Width	Tooth	Thickness	Price	Tool No.	Width	Tooth	Thickness	Price	Tool No.	Width	Tooth	Thickness	Price
M63T58T3	5/8"	3	.022"	\$11.99	M66T58T3	5/8"	3	.022"	\$12.17	M72T58T3	5/8"	3	.022"	\$12.53
M63T58T4	5/8"	4	.025"	\$12.90	M66T58T4	5/8"	4	.025"	\$13.10	M72T58T4	5/8"	4	.025"	\$13.48
Meat Cutting Bandsaw Blade 63" (5' 3") Long					Meat Cutting Bandsaw Blade 66" (5' 6") Long					Meat Cutting Bandsaw Blade 72" (6') Long				
 SUPER CUT™					 SUPER CUT™					 SUPER CUT™				
Tool No.	Width	Tooth	Thickness	Price	Tool No.	Width	Tooth	Thickness	Price	Tool No.	Width	Tooth	Thickness	Price
B63T58T4	5/8"	4H	.025"	\$21.09	B66T58T4	5/8"	4H	.025"	\$21.09	B72T58T4	5/8"	4H	.025"	\$21.09



MAGNATE™ 20639 Lycoming Street B-6, Walnut, CA 91789 USA



N-1



email : info@magnate.net Online Shop : www.magnate.net
(TEL) 800-827-2316, 909-468-5747 (FAX) 909-468-5745

MAGNATE™ Food Processing Blades

Meat Cutting Bandsaw Blade 74" (6' 2") Long					Meat Cutting Bandsaw Blade 77" (6' 5") Long					Meat Cutting Bandsaw Blade 78" (6' 6") Long				
 MAGNATE					 MAGNATE					 MAGNATE				
Tool No.	Width	Tooth	Thickness	Price	Tool No.	Width	Tooth	Thickness	Price	Tool No.	Width	Tooth	Thickness	Price
M74T58T3	5/8"	3	.022"	\$12.64	M77T58T3	5/8"	3	.022"	\$12.82	M78T58T3	5/8"	3	.022"	\$12.88
M74T58T4	5/8"	4	.025"	\$13.62	M77T58T4	5/8"	4	.025"	\$13.81	M78T58T4	5/8"	4	.025"	\$13.87

Meat Cutting Bandsaw Blade 74" (6' 2") Long					Meat Cutting Bandsaw Blade 77" (6' 5") Long					Meat Cutting Bandsaw Blade 78" (6' 6") Long				
 SUPER CUT					 SUPER CUT					 SUPER CUT				
Tool No.	Width	Tooth	Thickness	Price	Tool No.	Width	Tooth	Thickness	Price	Tool No.	Width	Tooth	Thickness	Price
B74T58T4	5/8"	4H	.025"	\$21.09	B77T58T4	5/8"	4H	.025"	\$21.09	B78T58T4	5/8"	4H	.025"	\$21.09

Meat Cutting Bandsaw Blade 76-7/8" (6' 4-7/8") Long					Meat Cutting Bandsaw Blade 77-1/2" (6' 5-1/2") Long					Meat Cutting Bandsaw Blade 79" (6' 7") Long				
 MAGNATE					 MAGNATE					 MAGNATE				
Tool No.	Width	Tooth	Thickness	Price	Tool No.	Width	Tooth	Thickness	Price	Tool No.	Width	Tooth	Thickness	Price
M76.875T58T3	5/8"	3	.022"	\$12.81	M77.5T58T3	5/8"	3	.022"	\$12.85	M79T58T3	5/8"	3	.022"	\$12.94
M76.875T58T4	5/8"	4	.025"	\$13.80	M77.5T58T4	5/8"	4	.025"	\$13.84	M79T58T4	5/8"	4	.025"	\$13.93

Meat Cutting Bandsaw Blade 76-7/8" (6' 4-7/8") Long					Meat Cutting Bandsaw Blade 77-1/2" (6' 5-1/2") Long					Meat Cutting Bandsaw Blade 79" (6' 7") Long				
 SUPER CUT					 SUPER CUT					 SUPER CUT				
Tool No.	Width	Tooth	Thickness	Price	Tool No.	Width	Tooth	Thickness	Price	Tool No.	Width	Tooth	Thickness	Price
B76.875T58T4	5/8"	4H	.025"	\$21.09	B77.5T58T4	5/8"	4H	.025"	\$21.09	B79T58T4	5/8"	4H	.025"	\$21.09

MAGNATE™ 20639 Lycoming Street B-6, Walnut, CA 91789 USA



N-2









email : info@magnate.net Online Shop : www.magnate.net
(TEL) 800-827-2316, 909-468-5747 (FAX) 909-468-5745

MAGNATE™ Food Processing Blades

Meat Cutting Bandsaw Blade 82" (6' 10") Long					Meat Cutting Bandsaw Blade 91" (7' 7") Long					Meat Cutting Bandsaw Blade 96" (8') Long				
 MAGNATE					 MAGNATE					 MAGNATE				
Tool No.	Width	Tooth	Thickness	Price	Tool No.	Width	Tooth	Thickness	Price	Tool No.	Width	Tooth	Thickness	Price
M82T58T3	5/8"	3	.022"	\$13.11	M91T58T3	5/8"	3	.022"	\$13.65	M96T58T3	5/8"	3	.022"	\$13.95
M82T58T4	5/8"	4	.025"	\$14.12	M91T58T4	5/8"	4	.025"	\$14.70	M96T58T4	5/8"	4	.025"	\$15.03

Meat Cutting Bandsaw Blade 82" (6' 10") Long					Meat Cutting Bandsaw Blade 91" (7' 7") Long					Meat Cutting Bandsaw Blade 96" (8') Long				
 SUPER CUT™					 SUPER CUT™					 SUPER CUT™				
Tool No.	Width	Tooth	Thickness	Price	Tool No.	Width	Tooth	Thickness	Price	Tool No.	Width	Tooth	Thickness	Price
B82T58T4	5/8"	4H	.025"	\$21.09	B91T58T4	5/8"	4H	.025"	\$21.09	B96T58T4	5/8"	4H	.025"	\$21.09

Meat Cutting Bandsaw Blade 87" (7' 3") Long					Meat Cutting Bandsaw Blade 93" (7' 9") Long					Meat Cutting Bandsaw Blade 98" (8' 2") Long				
 MAGNATE					 MAGNATE					 MAGNATE				
Tool No.	Width	Tooth	Thickness	Price	Tool No.	Width	Tooth	Thickness	Price	Tool No.	Width	Tooth	Thickness	Price
M87T58T3	5/8"	3	.022"	\$13.42	M93T58T3	5/8"	3	.022"	\$13.78	M98T58T3	5/8"	3	.022"	\$14.07
M87T58T4	5/8"	4	.025"	\$14.45	M93T58T4	5/8"	4	.025"	\$14.84	M98T58T4	5/8"	4	.025"	\$15.15

Meat Cutting Bandsaw Blade 87" (7' 3") Long					Meat Cutting Bandsaw Blade 93" (7' 9") Long					Meat Cutting Bandsaw Blade 98" (8' 2") Long				
 SUPER CUT™					 SUPER CUT™					 SUPER CUT™				
Tool No.	Width	Tooth	Thickness	Price	Tool No.	Width	Tooth	Thickness	Price	Tool No.	Width	Tooth	Thickness	Price
B87T58T4	5/8"	4H	.025"	\$21.09	B93T58T4	5/8"	4H	.025"	\$21.09	B98T58T4	5/8"	4H	.025"	\$21.79

MAGNATE™ 20639 Lycoming Street B-6, Walnut, CA 91789 USA

N-3



email : info@magnate.net Online Shop : www.magnate.net
(TEL) 800-827-2316, 909-468-5747 (FAX) 909-468-5745

MAGNATE™ Food Processing Blades

Meat Cutting Bandsaw Blade 99" (8' 3") Long					Meat Cutting Bandsaw Blade 102" (8' 6") Long					Meat Cutting Bandsaw Blade 106" (8' 10") Long				
 MAGNATE					 MAGNATE					 MAGNATE				
Tool No.	Width	Tooth	Thickness	Price	Tool No.	Width	Tooth	Thickness	Price	Tool No.	Width	Tooth	Thickness	Price
M99T58T3	5/8"	3	.022"	\$14.13	M102T58T3	5/8"	3	.022"	\$14.31	M106T58T3	5/8"	3	.022"	\$14.55
M99T58T4	5/8"	4	.025"	\$15.23	M102T58T4	5/8"	4	.025"	\$15.41	M106T58T4	5/8"	4	.025"	\$15.67
Meat Cutting Bandsaw Blade 99" (8' 3") Long					Meat Cutting Bandsaw Blade 102" (8' 6") Long					Meat Cutting Bandsaw Blade 106" (8' 10") Long				
 SUPER CUT™					 SUPER CUT™					 SUPER CUT™				
Tool No.	Width	Tooth	Thickness	Price	Tool No.	Width	Tooth	Thickness	Price	Tool No.	Width	Tooth	Thickness	Price
B99T58T4	5/8"	4	.025"	\$21.79	B102T58T4	5/8"	4H	.025"	\$21.79	B106T58T4	5/8"	4H	.025"	\$22.51
Meat Cutting Bandsaw Blade 100" (8' 4") Long					Meat Cutting Bandsaw Blade 105" (8' 9") Long					Meat Cutting Bandsaw Blade 107" (8' 11") Long				
 MAGNATE					 MAGNATE					 MAGNATE				
Tool No.	Width	Tooth	Thickness	Price	Tool No.	Width	Tooth	Thickness	Price	Tool No.	Width	Tooth	Thickness	Price
M100T58T3	5/8"	3	.022"	\$14.20	M105T58T3	5/8"	3	.022"	\$14.49	M107T58T3	5/8"	3	.022"	\$14.61
M100T58T4	5/8"	4	.025"	\$15.29	M105T58T4	5/8"	4	.025"	\$15.60	M107T58T4	5/8"	4	.025"	\$15.73
Meat Cutting Bandsaw Blade 100" (8' 4") Long					Meat Cutting Bandsaw Blade 105" (8' 9") Long					Meat Cutting Bandsaw Blade 107" (8' 11") Long				
 SUPER CUT™					 SUPER CUT™					 SUPER CUT™				
Tool No.	Width	Tooth	Thickness	Price	Tool No.	Width	Tooth	Thickness	Price	Tool No.	Width	Tooth	Thickness	Price
B100T58T4	5/8"	4H	.025"	\$21.79	B105T58T4	5/8"	4H	.025"	\$22.51	B107T58T4	5/8"	4H	.025"	\$22.51



MAGNATE™ 20639 Lycoming Street B-6, Walnut, CA 91789 USA



N-4





email : info@magnate.net Online Shop : www.magnate.net
(TEL) 800-827-2316, 909-468-5747 (FAX) 909-468-5745

MAGNATE™ Food Processing Blades

Meat Cutting Bandsaw Blade 108" (9') Long					Meat Cutting Bandsaw Blade 110" (9' 2") Long					Meat Cutting Bandsaw Blade 114" (9' 6") Long				
 MAGNATE					 MAGNATE					 MAGNATE				
Tool No.	Width	Tooth	Thickness	Price	Tool No.	Width	Tooth	Thickness	Price	Tool No.	Width	Tooth	Thickness	Price
M108T58T3	5/8"	3	.022"	\$14.67	M110T58T3	5/8"	3	.022"	\$14.78	M114T58T3	5/8"	3	.022"	\$15.03
M108T58T4	5/8"	4	.025"	\$15.79	M110T58T4	5/8"	4	.025"	\$15.93	M114T58T4	5/8"	4	.025"	\$16.18

Meat Cutting Bandsaw Blade 108" (9') Long					Meat Cutting Bandsaw Blade 110" (9' 2") Long					Meat Cutting Bandsaw Blade 114" (9' 6") Long				
 SUPER CUT					 SUPER CUT					 SUPER CUT				
Tool No.	Width	Tooth	Thickness	Price	Tool No.	Width	Tooth	Thickness	Price	Tool No.	Width	Tooth	Thickness	Price
B108T58T4	5/8"	4H	.025"	\$23.22	B110T58T4	5/8"	4H	.025"	\$23.22	B114T58T4	5/8"	4H	.025"	\$23.22

Meat Cutting Bandsaw Blade 109" (9' 1") Long					Meat Cutting Bandsaw Blade 112" (9' 4") Long					Meat Cutting Bandsaw Blade 115" (9' 7") Long				
 MAGNATE					 MAGNATE					 MAGNATE				
Tool No.	Width	Tooth	Thickness	Price	Tool No.	Width	Tooth	Thickness	Price	Tool No.	Width	Tooth	Thickness	Price
M109T58T3	5/8"	3	.022"	\$14.73	M112T58T3	5/8"	3	.022"	\$14.91	M115T58T3	5/8"	3	.022"	\$15.09
M109T58T4	5/8"	4	.025"	\$15.87	M112T58T4	5/8"	4	.025"	\$16.05	M115T58T4	5/8"	4	.025"	\$16.24

Meat Cutting Bandsaw Blade 109" (9' 1") Long					Meat Cutting Bandsaw Blade 112" (9' 4") Long					Meat Cutting Bandsaw Blade 115" (9' 7") Long				
 SUPER CUT					 SUPER CUT					 SUPER CUT				
Tool No.	Width	Tooth	Thickness	Price	Tool No.	Width	Tooth	Thickness	Price	Tool No.	Width	Tooth	Thickness	Price
B109T58T4	5/8"	4H	.025"	\$23.22	B112T58T4	5/8"	4H	.025"	\$23.22	B115T58T4	5/8"	4H	.025"	\$23.22

MAGNATE™ 20639 Lycoming Street B-6, Walnut, CA 91789 USA

N-5



email : info@magnate.net Online Shop : www.magnate.net
(TEL) 800-827-2316, 909-468-5747 (FAX) 909-468-5745

MAGNATE™ Food Processing Blades

<p style="text-align: center;">Meat Cutting Bandsaw Blade 116" (9' 8") Long</p> <div style="text-align: center;">  <p style="font-size: 2em; font-weight: bold; color: gold;">MAGNATE</p> </div> <table border="1" style="width: 100%; border-collapse: collapse; margin-top: 10px;"> <thead> <tr> <th>Tool No.</th> <th>Width</th> <th>Tooth</th> <th>Thickness</th> <th>Price</th> </tr> </thead> <tbody> <tr> <td>M116T58T3</td> <td>5/8"</td> <td>3</td> <td>.022"</td> <td>\$15.14</td> </tr> <tr> <td>M116T58T4</td> <td>5/8"</td> <td>4</td> <td>.025"</td> <td>\$16.31</td> </tr> </tbody> </table>	Tool No.	Width	Tooth	Thickness	Price	M116T58T3	5/8"	3	.022"	\$15.14	M116T58T4	5/8"	4	.025"	\$16.31	<p style="text-align: center;">Meat Cutting Bandsaw Blade 120" (10') Long</p> <div style="text-align: center;">  <p style="font-size: 2em; font-weight: bold; color: gold;">MAGNATE</p> </div> <table border="1" style="width: 100%; border-collapse: collapse; margin-top: 10px;"> <thead> <tr> <th>Tool No.</th> <th>Width</th> <th>Tooth</th> <th>Thickness</th> <th>Price</th> </tr> </thead> <tbody> <tr> <td>M120T58T3</td> <td>5/8"</td> <td>3</td> <td>.022"</td> <td>\$15.38</td> </tr> <tr> <td>M120T58T4</td> <td>5/8"</td> <td>4</td> <td>.025"</td> <td>\$16.57</td> </tr> </tbody> </table>	Tool No.	Width	Tooth	Thickness	Price	M120T58T3	5/8"	3	.022"	\$15.38	M120T58T4	5/8"	4	.025"	\$16.57	<p style="text-align: center;">Meat Cutting Bandsaw Blade 122" (10' 2") Long</p> <div style="text-align: center;">  <p style="font-size: 2em; font-weight: bold; color: gold;">SUPER CUT</p> </div> <table border="1" style="width: 100%; border-collapse: collapse; margin-top: 10px;"> <thead> <tr> <th>Tool No.</th> <th>Width</th> <th>Tooth</th> <th>Thickness</th> <th>Price</th> </tr> </thead> <tbody> <tr> <td>B122T58T4</td> <td>5/8"</td> <td>4H</td> <td>.025"</td> <td>\$23.93</td> </tr> </tbody> </table>	Tool No.	Width	Tooth	Thickness	Price	B122T58T4	5/8"	4H	.025"	\$23.93
Tool No.	Width	Tooth	Thickness	Price																																						
M116T58T3	5/8"	3	.022"	\$15.14																																						
M116T58T4	5/8"	4	.025"	\$16.31																																						
Tool No.	Width	Tooth	Thickness	Price																																						
M120T58T3	5/8"	3	.022"	\$15.38																																						
M120T58T4	5/8"	4	.025"	\$16.57																																						
Tool No.	Width	Tooth	Thickness	Price																																						
B122T58T4	5/8"	4H	.025"	\$23.93																																						
<p style="text-align: center;">Meat Cutting Bandsaw Blade 116" (9' 8") Long</p> <div style="text-align: center;">  <p style="font-size: 2em; font-weight: bold; color: gold;">SUPER CUT</p> </div> <table border="1" style="width: 100%; border-collapse: collapse; margin-top: 10px;"> <thead> <tr> <th>Tool No.</th> <th>Width</th> <th>Tooth</th> <th>Thickness</th> <th>Price</th> </tr> </thead> <tbody> <tr> <td>B116T58T4</td> <td>5/8"</td> <td>4H</td> <td>.025"</td> <td>\$23.93</td> </tr> </tbody> </table>	Tool No.	Width	Tooth	Thickness	Price	B116T58T4	5/8"	4H	.025"	\$23.93	<p style="text-align: center;">Meat Cutting Bandsaw Blade 120" (10') Long</p> <div style="text-align: center;">  <p style="font-size: 2em; font-weight: bold; color: gold;">SUPER CUT</p> </div> <table border="1" style="width: 100%; border-collapse: collapse; margin-top: 10px;"> <thead> <tr> <th>Tool No.</th> <th>Width</th> <th>Tooth</th> <th>Thickness</th> <th>Price</th> </tr> </thead> <tbody> <tr> <td>B120T58T4</td> <td>5/8"</td> <td>4H</td> <td>.025"</td> <td>\$23.93</td> </tr> </tbody> </table>	Tool No.	Width	Tooth	Thickness	Price	B120T58T4	5/8"	4H	.025"	\$23.93	<p style="text-align: center;">Scallop Edged Bandsaw Blade 122" (10' 2") Long</p> <div style="text-align: center;">  <p style="font-size: 2em; font-weight: bold; color: gold;">MAGNATE</p> </div> <table border="1" style="width: 100%; border-collapse: collapse; margin-top: 10px;"> <thead> <tr> <th>Tool No.</th> <th>Width</th> <th>Pitch</th> <th>Thickness</th> <th>Price</th> </tr> </thead> <tbody> <tr> <td>M122S58P2</td> <td>5/8"</td> <td>1/2"</td> <td>.022"</td> <td>\$32.14</td> </tr> </tbody> </table>	Tool No.	Width	Pitch	Thickness	Price	M122S58P2	5/8"	1/2"	.022"	\$32.14										
Tool No.	Width	Tooth	Thickness	Price																																						
B116T58T4	5/8"	4H	.025"	\$23.93																																						
Tool No.	Width	Tooth	Thickness	Price																																						
B120T58T4	5/8"	4H	.025"	\$23.93																																						
Tool No.	Width	Pitch	Thickness	Price																																						
M122S58P2	5/8"	1/2"	.022"	\$32.14																																						
<p style="text-align: center;">Meat Cutting Bandsaw Blade 118" (9' 10") Long</p> <div style="text-align: center;">  <p style="font-size: 2em; font-weight: bold; color: gold;">MAGNATE</p> </div> <table border="1" style="width: 100%; border-collapse: collapse; margin-top: 10px;"> <thead> <tr> <th>Tool No.</th> <th>Width</th> <th>Tooth</th> <th>Thickness</th> <th>Price</th> </tr> </thead> <tbody> <tr> <td>M118T58T3</td> <td>5/8"</td> <td>3</td> <td>.022"</td> <td>\$15.27</td> </tr> <tr> <td>M118T58T4</td> <td>5/8"</td> <td>4</td> <td>.025"</td> <td>\$16.44</td> </tr> </tbody> </table>	Tool No.	Width	Tooth	Thickness	Price	M118T58T3	5/8"	3	.022"	\$15.27	M118T58T4	5/8"	4	.025"	\$16.44	<p style="text-align: center;">Scallop Edged Bandsaw Blade 120" (10') Long</p> <div style="text-align: center;">  <p style="font-size: 2em; font-weight: bold; color: gold;">MAGNATE</p> </div> <table border="1" style="width: 100%; border-collapse: collapse; margin-top: 10px;"> <thead> <tr> <th>Tool No.</th> <th>Width</th> <th>Pitch</th> <th>Thickness</th> <th>Price</th> </tr> </thead> <tbody> <tr> <td>M120S58P2</td> <td>5/8"</td> <td>1/2"</td> <td>.022"</td> <td>\$31.73</td> </tr> </tbody> </table>	Tool No.	Width	Pitch	Thickness	Price	M120S58P2	5/8"	1/2"	.022"	\$31.73	<p style="text-align: center;">Meat Cutting Bandsaw Blade 124" (10' 4") Long</p> <div style="text-align: center;">  <p style="font-size: 2em; font-weight: bold; color: gold;">MAGNATE</p> </div> <table border="1" style="width: 100%; border-collapse: collapse; margin-top: 10px;"> <thead> <tr> <th>Tool No.</th> <th>Width</th> <th>Tooth</th> <th>Thickness</th> <th>Price</th> </tr> </thead> <tbody> <tr> <td>M124T58T3</td> <td>5/8"</td> <td>3</td> <td>.022"</td> <td>\$15.62</td> </tr> <tr> <td>M124T58T4</td> <td>5/8"</td> <td>4</td> <td>.025"</td> <td>\$16.82</td> </tr> </tbody> </table>	Tool No.	Width	Tooth	Thickness	Price	M124T58T3	5/8"	3	.022"	\$15.62	M124T58T4	5/8"	4	.025"	\$16.82
Tool No.	Width	Tooth	Thickness	Price																																						
M118T58T3	5/8"	3	.022"	\$15.27																																						
M118T58T4	5/8"	4	.025"	\$16.44																																						
Tool No.	Width	Pitch	Thickness	Price																																						
M120S58P2	5/8"	1/2"	.022"	\$31.73																																						
Tool No.	Width	Tooth	Thickness	Price																																						
M124T58T3	5/8"	3	.022"	\$15.62																																						
M124T58T4	5/8"	4	.025"	\$16.82																																						
<p style="text-align: center;">Meat Cutting Bandsaw Blade 118" (9' 10") Long</p> <div style="text-align: center;">  <p style="font-size: 2em; font-weight: bold; color: gold;">SUPER CUT</p> </div> <table border="1" style="width: 100%; border-collapse: collapse; margin-top: 10px;"> <thead> <tr> <th>Tool No.</th> <th>Width</th> <th>Tooth</th> <th>Thickness</th> <th>Price</th> </tr> </thead> <tbody> <tr> <td>B118T58T4</td> <td>5/8"</td> <td>4H</td> <td>.025"</td> <td>\$23.93</td> </tr> </tbody> </table>	Tool No.	Width	Tooth	Thickness	Price	B118T58T4	5/8"	4H	.025"	\$23.93	<p style="text-align: center;">Meat Cutting Bandsaw Blade 122" (10' 2") Long</p> <div style="text-align: center;">  <p style="font-size: 2em; font-weight: bold; color: gold;">MAGNATE</p> </div> <table border="1" style="width: 100%; border-collapse: collapse; margin-top: 10px;"> <thead> <tr> <th>Tool No.</th> <th>Width</th> <th>Tooth</th> <th>Thickness</th> <th>Price</th> </tr> </thead> <tbody> <tr> <td>M122T58T3</td> <td>5/8"</td> <td>3</td> <td>.022"</td> <td>\$15.50</td> </tr> <tr> <td>M122T58T4</td> <td>5/8"</td> <td>4</td> <td>.025"</td> <td>\$16.70</td> </tr> </tbody> </table>	Tool No.	Width	Tooth	Thickness	Price	M122T58T3	5/8"	3	.022"	\$15.50	M122T58T4	5/8"	4	.025"	\$16.70	<p style="text-align: center;">Meat Cutting Bandsaw Blade 124" (10' 4") Long</p> <div style="text-align: center;">  <p style="font-size: 2em; font-weight: bold; color: gold;">SUPER CUT</p> </div> <table border="1" style="width: 100%; border-collapse: collapse; margin-top: 10px;"> <thead> <tr> <th>Tool No.</th> <th>Width</th> <th>Tooth</th> <th>Thickness</th> <th>Price</th> </tr> </thead> <tbody> <tr> <td>B124T58T4</td> <td>5/8"</td> <td>4H</td> <td>.025"</td> <td>\$24.65</td> </tr> </tbody> </table>	Tool No.	Width	Tooth	Thickness	Price	B124T58T4	5/8"	4H	.025"	\$24.65					
Tool No.	Width	Tooth	Thickness	Price																																						
B118T58T4	5/8"	4H	.025"	\$23.93																																						
Tool No.	Width	Tooth	Thickness	Price																																						
M122T58T3	5/8"	3	.022"	\$15.50																																						
M122T58T4	5/8"	4	.025"	\$16.70																																						
Tool No.	Width	Tooth	Thickness	Price																																						
B124T58T4	5/8"	4H	.025"	\$24.65																																						

MAGNATE™ 20639 Lycoming Street B-6, Walnut, CA 91789 USA

N-6



email : info@magnate.net Online Shop : www.magnate.net
(TEL) 800-827-2316, 909-468-5747 (FAX) 909-468-5745

MAGNATE™ Food Processing Blades

Scallop Edged Bandsaw Blade
124" (10' 4") Long



MAGNATE

Tool No.	Width	Pitch	Thickness	Price
M124S58P2	5/8"	1/2"	.022"	\$32.56

Meat Cutting Bandsaw Blade
128" (10' 8") Long



MAGNATE

Tool No.	Width	Tooth	Thickness	Price
M128T58T3	5/8"	3	.022"	\$15.87
M128T58T4	5/8"	4	.025"	\$17.08

Meat Cutting Bandsaw Blade
135" (11' 3") Long



SUPER CUT

Tool No.	Width	Tooth	Thickness	Price
B135T58T4	5/8"	4H	.025"	\$24.65

Meat Cutting Bandsaw Blade
126" (10' 6") Long



MAGNATE

Tool No.	Width	Tooth	Thickness	Price
M126T58T3	5/8"	3	.022"	\$15.74
M126T58T4	5/8"	4	.025"	\$16.95

Meat Cutting Bandsaw Blade
128" (10' 8") Long



SUPER CUT

Tool No.	Width	Tooth	Thickness	Price
B128T58T4	5/8"	4H	.025"	\$24.65

Scallop Edged Bandsaw Blade
135" (11' 3") Long



MAGNATE

Tool No.	Width	Pitch	Thickness	Price
M135S58P2	5/8"	1/2"	.022"	\$34.85

Meat Cutting Bandsaw Blade
126" (10' 6") Long



SUPER CUT

Tool No.	Width	Tooth	Thickness	Price
B126T58T4	5/8"	4H	.025"	\$24.65

Scallop Edged Bandsaw Blade
128" (10' 8") Long



MAGNATE

Tool No.	Width	Pitch	Thickness	Price
M128S58P2	5/8"	1/2"	.022"	\$33.39

Meat Cutting Bandsaw Blade
136" (11' 4") Long



MAGNATE

Tool No.	Width	Tooth	Thickness	Price
M136T58T3	5/8"	3	.022"	\$16.34
M136T58T4	5/8"	4	.025"	\$17.60

Scallop Edged Bandsaw Blade
126" (10' 6") Long



MAGNATE

Tool No.	Width	Pitch	Thickness	Price
M126S58P2	5/8"	1/2"	.022"	\$32.97

Meat Cutting Bandsaw Blade
135" (11' 3") Long



MAGNATE

Tool No.	Width	Tooth	Thickness	Price
M135T58T3	5/8"	3	.022"	\$16.28
M135T58T4	5/8"	4	.025"	\$17.52

Meat Cutting Bandsaw Blade
136" (11' 4") Long



SUPER CUT

Tool No.	Width	Tooth	Thickness	Price
B136T58T4	5/8"	4H	.025"	\$24.65



MAGNATE™ Food Processing Blades

<p style="text-align: center;">Scalloped Bandsaw Blade 136" (11' 4") Long</p>  <p style="text-align: right; font-size: 24px; font-weight: bold;">MAGNATE</p> <table border="1" style="width: 100%; border-collapse: collapse;"> <thead> <tr> <th>Tool No.</th> <th>Width</th> <th>Pitch</th> <th>Thickness</th> <th>Price</th> </tr> </thead> <tbody> <tr> <td>M136S58P2</td> <td>5/8"</td> <td>1/2"</td> <td>.022"</td> <td>\$35.05</td> </tr> </tbody> </table>	Tool No.	Width	Pitch	Thickness	Price	M136S58P2	5/8"	1/2"	.022"	\$35.05	<p style="text-align: center;">Meat Cutting Bandsaw Blade 148" (12' 4") Long</p>  <p style="text-align: right; font-size: 24px; font-weight: bold;">MAGNATE</p> <table border="1" style="width: 100%; border-collapse: collapse;"> <thead> <tr> <th>Tool No.</th> <th>Width</th> <th>Tooth</th> <th>Thickness</th> <th>Price</th> </tr> </thead> <tbody> <tr> <td>M148T58T3</td> <td>5/8"</td> <td>3</td> <td>.022"</td> <td>\$17.05</td> </tr> <tr> <td>M148T58T4</td> <td>5/8"</td> <td>4</td> <td>.025"</td> <td>\$18.36</td> </tr> </tbody> </table>	Tool No.	Width	Tooth	Thickness	Price	M148T58T3	5/8"	3	.022"	\$17.05	M148T58T4	5/8"	4	.025"	\$18.36	<p style="text-align: center;">Meat Cutting Bandsaw Blade 150" (12' 6") Long</p>  <p style="text-align: right; font-size: 24px; font-weight: bold;">MAGNATE</p> <table border="1" style="width: 100%; border-collapse: collapse;"> <thead> <tr> <th>Tool No.</th> <th>Width</th> <th>Tooth</th> <th>Thickness</th> <th>Price</th> </tr> </thead> <tbody> <tr> <td>B150T58T4</td> <td>5/8"</td> <td>4H</td> <td>.025"</td> <td>\$25.26</td> </tr> </tbody> </table>	Tool No.	Width	Tooth	Thickness	Price	B150T58T4	5/8"	4H	.025"	\$25.26
Tool No.	Width	Pitch	Thickness	Price																																	
M136S58P2	5/8"	1/2"	.022"	\$35.05																																	
Tool No.	Width	Tooth	Thickness	Price																																	
M148T58T3	5/8"	3	.022"	\$17.05																																	
M148T58T4	5/8"	4	.025"	\$18.36																																	
Tool No.	Width	Tooth	Thickness	Price																																	
B150T58T4	5/8"	4H	.025"	\$25.26																																	
<p style="text-align: center;">Meat Cutting Bandsaw Blade 142" (11' 10") Long</p>  <p style="text-align: right; font-size: 24px; font-weight: bold;">MAGNATE</p> <table border="1" style="width: 100%; border-collapse: collapse;"> <thead> <tr> <th>Tool No.</th> <th>Width</th> <th>Tooth</th> <th>Thickness</th> <th>Price</th> </tr> </thead> <tbody> <tr> <td>M142T58T3</td> <td>5/8"</td> <td>3</td> <td>.022"</td> <td>\$16.70</td> </tr> <tr> <td>M142T58T4</td> <td>5/8"</td> <td>4</td> <td>.025"</td> <td>\$17.98</td> </tr> </tbody> </table>	Tool No.	Width	Tooth	Thickness	Price	M142T58T3	5/8"	3	.022"	\$16.70	M142T58T4	5/8"	4	.025"	\$17.98	<p style="text-align: center;">Meat Cutting Bandsaw Blade 148" (12' 4") Long</p>  <p style="text-align: right; font-size: 24px; font-weight: bold;">MAGNATE</p> <table border="1" style="width: 100%; border-collapse: collapse;"> <thead> <tr> <th>Tool No.</th> <th>Width</th> <th>Tooth</th> <th>Thickness</th> <th>Price</th> </tr> </thead> <tbody> <tr> <td>B148T58T4</td> <td>5/8"</td> <td>4H</td> <td>.025"</td> <td>\$25.26</td> </tr> </tbody> </table>	Tool No.	Width	Tooth	Thickness	Price	B148T58T4	5/8"	4H	.025"	\$25.26	<p style="text-align: center;">Scalloped Bandsaw Blade 150" (12' 6") Long</p>  <p style="text-align: right; font-size: 24px; font-weight: bold;">MAGNATE</p> <table border="1" style="width: 100%; border-collapse: collapse;"> <thead> <tr> <th>Tool No.</th> <th>Width</th> <th>Pitch</th> <th>Thickness</th> <th>Price</th> </tr> </thead> <tbody> <tr> <td>M150S58P2</td> <td>5/8"</td> <td>1/2"</td> <td>.022"</td> <td>\$37.97</td> </tr> </tbody> </table>	Tool No.	Width	Pitch	Thickness	Price	M150S58P2	5/8"	1/2"	.022"	\$37.97
Tool No.	Width	Tooth	Thickness	Price																																	
M142T58T3	5/8"	3	.022"	\$16.70																																	
M142T58T4	5/8"	4	.025"	\$17.98																																	
Tool No.	Width	Tooth	Thickness	Price																																	
B148T58T4	5/8"	4H	.025"	\$25.26																																	
Tool No.	Width	Pitch	Thickness	Price																																	
M150S58P2	5/8"	1/2"	.022"	\$37.97																																	
<p style="text-align: center;">Meat Cutting Bandsaw Blade 142" (11' 10") Long</p>  <p style="text-align: right; font-size: 24px; font-weight: bold;">MAGNATE</p> <table border="1" style="width: 100%; border-collapse: collapse;"> <thead> <tr> <th>Tool No.</th> <th>Width</th> <th>Tooth</th> <th>Thickness</th> <th>Price</th> </tr> </thead> <tbody> <tr> <td>B142T58T4</td> <td>5/8"</td> <td>4H</td> <td>.025"</td> <td>\$25.26</td> </tr> </tbody> </table>	Tool No.	Width	Tooth	Thickness	Price	B142T58T4	5/8"	4H	.025"	\$25.26	<p style="text-align: center;">Scalloped Bandsaw Blade 148" (12' 4") Long</p>  <p style="text-align: right; font-size: 24px; font-weight: bold;">MAGNATE</p> <table border="1" style="width: 100%; border-collapse: collapse;"> <thead> <tr> <th>Tool No.</th> <th>Width</th> <th>Pitch</th> <th>Thickness</th> <th>Price</th> </tr> </thead> <tbody> <tr> <td>M148S58P2</td> <td>5/8"</td> <td>1/2"</td> <td>.022"</td> <td>\$37.56</td> </tr> </tbody> </table>	Tool No.	Width	Pitch	Thickness	Price	M148S58P2	5/8"	1/2"	.022"	\$37.56	<p style="text-align: center;">Meat Cutting Bandsaw Blade 154" (12' 10") Long</p>  <p style="text-align: right; font-size: 24px; font-weight: bold;">MAGNATE</p> <table border="1" style="width: 100%; border-collapse: collapse;"> <thead> <tr> <th>Tool No.</th> <th>Width</th> <th>Tooth</th> <th>Thickness</th> <th>Price</th> </tr> </thead> <tbody> <tr> <td>M154T58T3</td> <td>5/8"</td> <td>3</td> <td>.022"</td> <td>\$17.41</td> </tr> <tr> <td>M154T58T4</td> <td>5/8"</td> <td>4</td> <td>.025"</td> <td>\$18.75</td> </tr> </tbody> </table>	Tool No.	Width	Tooth	Thickness	Price	M154T58T3	5/8"	3	.022"	\$17.41	M154T58T4	5/8"	4	.025"	\$18.75
Tool No.	Width	Tooth	Thickness	Price																																	
B142T58T4	5/8"	4H	.025"	\$25.26																																	
Tool No.	Width	Pitch	Thickness	Price																																	
M148S58P2	5/8"	1/2"	.022"	\$37.56																																	
Tool No.	Width	Tooth	Thickness	Price																																	
M154T58T3	5/8"	3	.022"	\$17.41																																	
M154T58T4	5/8"	4	.025"	\$18.75																																	
<p style="text-align: center;">Scalloped Bandsaw Blade 142" (11' 10") Long</p>  <p style="text-align: right; font-size: 24px; font-weight: bold;">MAGNATE</p> <table border="1" style="width: 100%; border-collapse: collapse;"> <thead> <tr> <th>Tool No.</th> <th>Width</th> <th>Pitch</th> <th>Thickness</th> <th>Price</th> </tr> </thead> <tbody> <tr> <td>M142S58P2</td> <td>5/8"</td> <td>1/2"</td> <td>.022"</td> <td>\$36.30</td> </tr> </tbody> </table>	Tool No.	Width	Pitch	Thickness	Price	M142S58P2	5/8"	1/2"	.022"	\$36.30	<p style="text-align: center;">Meat Cutting Bandsaw Blade 150" (12' 6") Long</p>  <p style="text-align: right; font-size: 24px; font-weight: bold;">MAGNATE</p> <table border="1" style="width: 100%; border-collapse: collapse;"> <thead> <tr> <th>Tool No.</th> <th>Width</th> <th>Tooth</th> <th>Thickness</th> <th>Price</th> </tr> </thead> <tbody> <tr> <td>M150T58T3</td> <td>5/8"</td> <td>3</td> <td>.022"</td> <td>\$17.17</td> </tr> <tr> <td>M150T58T4</td> <td>5/8"</td> <td>4</td> <td>.025"</td> <td>\$18.49</td> </tr> </tbody> </table>	Tool No.	Width	Tooth	Thickness	Price	M150T58T3	5/8"	3	.022"	\$17.17	M150T58T4	5/8"	4	.025"	\$18.49	<p style="text-align: center;">Meat Cutting Bandsaw Blade 154" (12' 10") Long</p>  <p style="text-align: right; font-size: 24px; font-weight: bold;">MAGNATE</p> <table border="1" style="width: 100%; border-collapse: collapse;"> <thead> <tr> <th>Tool No.</th> <th>Width</th> <th>Tooth</th> <th>Thickness</th> <th>Price</th> </tr> </thead> <tbody> <tr> <td>B154T58T4</td> <td>5/8"</td> <td>4H</td> <td>.025"</td> <td>\$26.60</td> </tr> </tbody> </table>	Tool No.	Width	Tooth	Thickness	Price	B154T58T4	5/8"	4H	.025"	\$26.60
Tool No.	Width	Pitch	Thickness	Price																																	
M142S58P2	5/8"	1/2"	.022"	\$36.30																																	
Tool No.	Width	Tooth	Thickness	Price																																	
M150T58T3	5/8"	3	.022"	\$17.17																																	
M150T58T4	5/8"	4	.025"	\$18.49																																	
Tool No.	Width	Tooth	Thickness	Price																																	
B154T58T4	5/8"	4H	.025"	\$26.60																																	

MAGNATE™ 20639 Lycoming Street B-6, Walnut, CA 91789 USA

N-8



email : info@magnate.net Online Shop : www.magnate.net
(TEL) 800-827-2316, 909-468-5747 (FAX) 909-468-5745

MAGNATE™ Food Processing Blades

Scallop Edged Bandsaw Blade
154" (12' 10") Long



MAGNATE

Tool No.	Width	Pitch	Thickness	Price
M154S58P2	5/8"	1/2"	.022"	\$38.80

Meat Cutting Bandsaw Blade
166" (13' 10") Long



SUPER CUT™

Tool No.	Width	Tooth	Thickness	Price
B166T58T4	5/8"	4H	.025"	\$26.60

Bread Slicing Reciprocating Blades

MAGNATE



BSR303
BSR303S
BSR345

These blades come with a 1/2 pitch scalloped edge but there are several configurations of widths, lengths, mounting hole locations, rivets, and holders for mounting blades into appropriate slicing machines.

Meat Cutting Bandsaw Blade
165" (13' 9") Long



MAGNATE

Tool No.	Width	Tooth	Thickness	Price
M165T58T3	5/8"	3	.022"	\$18.07
M165T58T4	5/8"	4	.025"	\$19.46

Meat Cutting Bandsaw Blade
216" (18') Long



SUPER CUT™

Tool No.	Width	Tooth	Thickness	Price
B216T58T4	5/8"	4H	.025"	\$30.49

Tool No.	Machine	Counts Per Package	Price
BSR303*	Oliver 709, 711, 732, 758, 777, 797	32	\$77.34
BSR303S [^]	Oliver 709, 711, 732, 758, 777, 797	50	\$173.34
BSR345*	Berkel MB	6	\$43.50

* Made of carbon steel
^ Made of stainless steel

Meat Cutting Bandsaw Blade
165" (13' 9") Long



SUPER CUT™

Tool No.	Width	Tooth	Thickness	Price
B165T58T4	5/8"	4H	.025"	\$26.60

Meat Cutting Bandsaw Blade
228" (19') Long



SUPER CUT™

Tool No.	Width	Tooth	Thickness	Price
B228T58T4	5/8"	4H	.025"	\$35.29

Meat Cutting Bandsaw Blade
166" (13' 10") Long



MAGNATE

Tool No.	Width	Tooth	Thickness	Price
M166T58T3	5/8"	3	.022"	\$18.12
M166T58T4	5/8"	4	.025"	\$19.52



Scallop Edged BAND SAW BLADES– Made in USA

◆ Please order the exact length & tooth pattern of saw blades you need. Prices include welding charge.

Length	For Foam **	For Bone-Out Meat	For Tire ***
	1/2" x .020"	5/8" x .022"	1" x .035"
← to 5' 6" (66") →	\$17.72 to \$18.83	\$19.22 to \$20.46	\$25.97 to \$27.83
←5'6"+ to 6' (72") →	\$18.84 to \$19.94	\$20.47 to \$21.71	\$27.84 to \$29.69
←6'+ to 6' 6" (78") →	\$19.95 to \$21.06	\$21.72 to \$22.96	\$29.70 to \$31.56
←6' 6"+ to 7' (84") →	\$21.07 to \$22.17	\$22.97 to \$24.21	\$31.57 to \$33.43
←7'+ to 7' 6" (90") →	\$22.18 to \$23.29	\$24.22 to \$25.46	\$33.43 to \$35.30
←7' 6"+ to 8' (96") →	\$23.30 to \$24.40	\$25.47 to \$26.71	\$35.30 to \$37.15
←8'+ to 8' 6" (102") →	\$24.41 to \$25.52	\$26.72 to \$27.96	\$37.16 to \$39.02
←8' 6"+ to 9' (108") →	\$25.53 to \$26.63	\$27.97 to \$29.22	\$39.03 to \$40.88
←9'+ to 9' 6" (114") →	\$26.64 to \$27.75	\$29.23 to \$30.47	\$40.89 to \$42.75
←9' 6"+ to 10' (120") →	\$27.76 to \$28.86	\$30.48 to \$31.72	\$42.76 to \$44.61
←10'+ to 10' 6" (126") →	\$28.87 to \$29.98	\$31.73 to \$32.97	\$44.62 to \$66.48
←10' 6"+ to 11' (132") →	\$29.99 to \$31.09	\$32.98 to \$34.22	\$46.49 to \$48.34
←11' + to 11' 6" (138") →	\$31.10 to \$32.21	\$34.23 to \$35.47	\$48.35 to \$50.21
←11' 6"+ to 12' (144") →	\$32.22 to \$33.32	\$35.48 to \$36.72	\$50.22 to \$52.07
←12' + to 12' 6" (150") →	\$33.33 to \$34.44	\$36.73 to \$37.97	\$52.08 to \$53.94
←12' 6"+ to 13' (156") →	\$34.45 to \$35.55	\$37.98 to \$39.22	\$53.95 to \$55.80
←13' + to 13' 6" (162") →	\$35.56 to \$36.67	\$39.23 to \$40.48	\$55.81 to \$57.68
←13' 6"+ to 14' (168") →	\$36.68 to \$37.78	\$40.49 to \$41.73	\$57.68 to \$59.54
←14' + to 14' 6" (174") →	\$37.79 to \$38.90	\$41.74 to \$42.98	\$59.54 to \$61.40
←14' 6"+ to 15' (180") →	\$38.91 to \$40.02	\$42.99 to \$44.23	\$61.41 to \$63.27
←15' + to 15' 6" (186") →	\$40.03 to \$41.13	\$44.24 to \$45.48	\$63.28 to \$65.13
←15' 6"+ to 16' (192") →	\$41.14 to \$42.25	\$45.49 to \$46.73	\$65.14 to \$67.00
←16' + to 16' 6" (198") →	\$42.26 to \$43.36	\$46.74 to \$47.98	\$67.01 to \$68.86
←16' 6"+ to 17' (204") →	\$43.37 to \$44.48	\$47.99 to \$49.23	\$68.87 to \$70.73
←17' + to 17' 6" (210") →	\$44.49 to \$45.59	\$49.24 to \$50.48	\$70.74 to \$72.59
←17' 6"+ to 18' (216") →	\$45.60 to \$46.71	\$50.49 to \$51.73	\$72.60 to \$74.46
←18' + to 18' 6" (222") →	\$46.72 to \$47.82	\$51.74 to \$52.99	\$74.47 to \$76.32
←18' 6"+ to 19' (228") →	\$47.83 to \$48.94	\$53.00 to \$54.24	\$76.33 to \$78.19
←19' + to 19' 6" (234") →	\$48.95 to \$50.06	\$54.25 to \$55.49	\$78.20 to \$80.06

Our single-edge scallop blades are made from carbon steel, have a double bevel, 1/2" pitch, and feature a hollow ground cutting edge.

** The 1/2" wide x 0.020" thick scallop blades can be used on a regular woodcutting band saw for cutting materials such as light to medium foams

*** The 1" wide x 0.035" thick blades can be used to cut tires, though it depends on the machine.

A Minimum order of 6 blades is required. For different specifications like double-edged, 1/4" pitch or different materials like stainless steel blades, etc. Please contact us for more details.



20639 Lycoming Street #B-6, Walnut, CA 91789 U.S.A.
 e-mail : info@magnate.net Web Site : www.magnate.net
 (TEL) 800-827-2316, 909-468-5747 (FAX) 909-468-5745



INDUSTRIAL Band/SCROLL SAW BLADES



MAGNATE

Specially formulated rubber that lasts as long as urethane. Undersized for the perfect fit. Glue required.

Tool No.	Wheel	Width	Price
BT-10	10"	3/4"	\$27.25
BT-12	12"	1-1/16"	\$27.25
BT-14	14"	1-1/16"	\$27.25
BT-16	16"	1-5/16"	\$38.56
BT-18	18"	1-1/2"	\$27.25
BT-20	20"	1-5/8"	\$42.04
BT-24	24"	1-3/4"	\$46.43
BT-26	26"	2"	\$57.00
BT-28	28"	2"	\$58.80
BT-30	30"	2"	\$62.37
BT-32	32"	2"	\$65.10
BT-34	34"	2-1/8"	\$70.00
BT-36	36"	2-1/8"	\$71.93



SUPER CUT

SuperCut BladeSaver Bandsaw Blade Cleaner removes pitch and resin buildup for a free cutting blade. It will not damage rubber tires or painted surfaces on the saw. It is biodegradable, non-toxic and non-hazardous.

Tool No.	Bottle	Price
BC4	4 oz.	\$5.80



SUPER CUT

These blocks are self-lubricating and can be run with zero clearance on the blade.

Packaged as a complete set of 4 blocks (2 upper and 2 lower) per package. There are completed instructions on each package for fast and simple instructions.

Tool No.	Router/Band Saw/Machine Model	Price
BG-D	Delta 14	\$20.02
BG-M	Import 14	\$20.02
BG-S	Sears Old 12	\$20.02
BG-N*	Sears New 12	\$20.02

* Angle Head Style after year 2000

OF SO

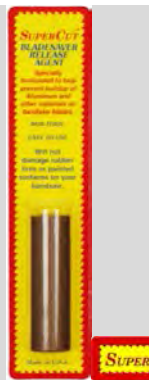

SUPER CUT

SuperCut BladeSaver Release Agent

SuperCut BladeSaver Release Agent is specially formulated to help prevent buildup of aluminum and other materials on bandsaw blades. It is non-toxic and environmentally safe, and will not damage rubber tires or painted surfaces on the saw.

Price : \$4.83/Stick



SuperCut™ Scroll Saw Blades

Specially designed and heat treated for power driven scroll saws, these premium quality blades provide the versatility and performance woodworkers are looking for.. There are 3 styles available –Flat Plain, Round Plain and Pinned End –



Pinned End

6 / pack

Tool No.	Width	Thick	TPI	Price
SSP1	0.066"	0.010"	25	\$5.67
SSP2	0.066"	0.010"	20	\$5.67
SSP3	0.118"	0.020"	18	\$5.67
SSP4	0.118"	0.020"	15	\$5.67
SSP5	0.118"	0.020"	10	\$5.67



Flat Plain End Blister Packed – 12/pack

Tool No.	Width	Thick	TPI	Price
SSF1	0.032"	0.015"	24	\$6.03
SSF2	0.032"	0.016"	22	\$6.03
SSF3	0.040"	0.018"	20	\$6.03
SSF4	0.048"	0.020"	20	\$6.03
SSF5	0.056"	0.023"	16	\$6.03
SSF6	0.062"	0.025"	14	\$6.03
SSF9	2 each of above sizes			\$6.03



Round Plain End Blister Packed – 12/pack

Tool No.	Width	Thick	TPI	Price
SSR1	0.042"	0.016"	48	\$6.03
SSR2	0.046"	0.022"	44	\$6.03
SSR3	0.052"	0.025"	41	\$6.03
SSR4	0.060"	0.028"	37	\$6.03
SSR5	0.066"	0.028"	35	\$6.03
SSR6	0.075"	0.030"	30	\$6.03
SSR9	2 each of above sizes			\$6.03



Lenox Lube Tube Band Saw Lubricant Multi-purpose Lubricating Wax For Industrial Use

This extreme pressure lubricant prevents the buildup of frictional heat on metal surfaces. It is designed to be applied to bandsaw blades and other cutting tools. It improves overall tool life and productivity when sawing, drilling, milling, grinding, threading or tapping. It can be used on ferrous and non-ferrous metals, aluminum gates, risers, plates and extrusions.

WARNING:

Causes serious eye irritation. Causes skin irritation. May cause an allergic skin reaction.

Wear protective gloves. Wear eye or face protection. Avoid breathing dust. Wash hands thoroughly after handling. Contaminated work clothing should not be allowed out of the work place. IF ON SKIN: Wash with plenty of soap and water. Take off contaminated clothing. Wash contaminated clothing before reuse. If skin irritation or rash occurs: Get medical attention.

IF IN EYES: Rinse cautiously with water for several minutes. Remove contact lenses, if present and easy to do. Continue rinsing. If eye irritation persists: Get medical attention. Dispose of contents and container in accordance with all local, regional, national, and international regulations.

Percentage of the mixture consisting of ingredient(s) of unknown toxicity: 44%

Tool No.	Tube	Price
68020LNX	14.5oz	\$15.40



20639 Lycoming Street #B-6, Walnut, CA 91789 U.S.A.
e-mail : info@magnate.net Web Site : www.magnate.net
(TEL) 800-827-2316, 909-468-5747 (FAX) 909-468-5745



If you cannot find what you need on the list below, please contact us. Upon your request, Magnate will make sanding belts of any possible sizes, available material and specs to fit your application.

3" x 25 Yard, Two Rolls Aluminum Oxide



Tool No.	Grit	Weight	Price
KF3X50R6	60	J	\$75.27
KF3X50R8	80	J	\$63.42
KF3X50R10	100	J	\$61.16
KF3X50R12	120	J	\$61.16
KF3X50R15	150	J	\$61.16
KF3X50R18	180	J	\$61.16
KF3X50R22	220	J	\$61.16
KF3X50R32	320	J	\$61.16
KF3X50R40	400	J	\$61.16
K3X50R4	40	X	\$125.76
K3X50R6	60	X	\$111.60
K3X50R8	80	X	\$103.87
K3X50R10	100	X	\$95.02
K3X50R12	120	X	\$95.02
K3X50R15	150	X	\$95.02
K3X50R18	180	X	\$95.02
R3X50R22	220	X	\$95.02
R3X50R32	320	X	\$95.02
R3X50R40	400	X	\$95.02

4-1/2" x 10 Yard Plain Roll Aluminum Oxide, Open Coat Resin Bond Backing



Tool No.	Grit	Weight	Price
PR4.5X30G4	40	E	\$28.89
PR4.5X30G6	60	E	\$24.51
PR4.5X30G8	80	C	\$22.07
PR4.5X30G10	100	C	\$22.07
PR4.5X30G12	120	C	\$22.07
PR4.5X30G15	150	C	\$22.07
PR4.5X30G18	180	C	\$22.07
PR4.5X30G22	220	C	\$22.07
PR4.5X30G32	320	C	\$22.07
PR4.5X30G40	400	C	\$22.07
PR4.5X30G50	500	C	\$22.07
PR4.5X30G60	600	C	\$22.07

4-1/2" x 10 Yard PSA Roll Aluminum Oxide, Open Coat Resin Bond Backing



Tool No.	Grit	Weight	Price
PR4.5X30E4	40	E	\$43.64
PR4.5X30E6	60	E	\$40.93
PR4.5X30E8	80	C	\$25.89
PR4.5X30E10	100	C	\$24.58
PR4.5X30E12	120	C	\$24.58
PR4.5X30E15	150	C	\$24.58
PR4.5X30E18	180	C	\$24.58
PR4.5X30E22	220	C	\$24.58
PR4.5X30E40	400	C	\$24.58
PR4.5X30E50	500	C	\$24.58
PR4.5X30E60	600	C	\$24.58

4" x 25 Yard, Two Rolls Aluminum Oxide



Tool No.	Grit	Weight	Price
KF4X50R6	60	J	\$109.38
KF4X50R8	80	J	\$92.45
KF4X50R10	100	J	\$89.38
KF4X50R12	120	J	\$89.38
KF4X50R15	150	J	\$89.38
KF4X50R18	180	J	\$89.38
KF4X50R22	220	J	\$89.38
KF4X50R32	320	J	\$89.38
KF4X50R40	400	J	\$89.38
K4X50R4	40	X	\$153.22
K4X50R6	60	X	\$134.51
K4X50R8	80	X	\$129.93
K4X50R10	100	X	\$125.31
K4X50R12	120	X	\$125.31
K4X50R15	150	X	\$125.31
K4X50R18	180	X	\$125.31
R4X50R22	220	X	\$125.31
R4X50R32	320	X	\$125.31
R4X50R40	400	X	\$125.31

6" x 25 Yard, Two Rolls Aluminum Oxide



Tool No.	Grit	Weight	Price
KF6X50R6	60	J	\$152.40
KF6X50R8	80	J	\$152.40
KF6X50R10	100	J	\$128.56
KF6X50R12	120	J	\$123.87
KF6X50R15	150	J	\$123.87
KF6X50R18	180	J	\$123.87
KF6X50R22	220	J	\$123.87
KF6X50R32	320	J	\$123.87
KF6X50R40	400	J	\$123.87
K6X50R4	40	X	\$227.80
K6X50R6	60	X	\$199.75
K6X50R8	80	X	\$192.84
K6X50R10	100	X	\$185.96
K6X50R12	120	X	\$185.96
K6X50R15	150	X	\$185.96
K6X50R18	180	X	\$185.96
R6X50R22	220	X	\$185.96
R6X50R32	320	X	\$185.96
R6X50R40	400	X	\$185.96

Graphite Coated Canvas Roll 0.063" Thick, Heavy Duty Grade



This heavy duty graphite coated canvas roll is produced with a special graphite coating, combined with the highest quality binder for tough applications. It has been thoroughly tested by leading wide-belt sanding machines manufacturers, and recommend for use in high heat and pressure applications. Keep graphite coated canvas stored in a warm, dry area. If graphite coated canvas is brittle or partially brittle, preheat to a pliable state before applying to platen. Ideal temperature is 75F or 24C.

Tool No.	Width	Length	Price
G3X5Y	3"	5 Yard	\$34.35
G3X10Y	3"	10 Yard	\$66.46
G4X5Y	4"	5 Yard	\$36.16
G4X10Y	4"	10 Yard	\$69.95
G5X5Y	5"	5 Yard	\$44.39
G5X10Y	5"	10 Yard	\$81.79
G6X5Y	6"	5 Yard	\$48.30
G6X10Y	6"	10 Yard	\$93.45
G8X5Y	8"	5 Yard	\$60.35
G8X10Y	8"	10 Yard	\$116.77
G10X5Y	10"	5 Yard	\$69.98
G10X10Y	10"	10 Yard	\$137.50

2" x 25 Yard, Two Rolls J-weight Aluminum Oxide Open Coat, Resin Bond



Tool No.	Grit	Weight	Price
KF2X50R6	60	J	\$54.53
KF2X50R8	80	J	\$47.73
KF2X50R10	100	J	\$46.38
KF2X50R12	120	J	\$46.38
KF2X50R15	150	J	\$46.38
KF2X50R18	180	J	\$46.38
KF2X50R22	220	J	\$46.38
KF2X50R32	320	J	\$46.38
KF2X50R40	400	J	\$46.38

Quick Change Pad 1/4" Mandrel Medium Density



S-Type



R-Type

This pad for quick-change discs features turn on/turn off fastener which is made of semi-rigid rubber. Its maximum operating speed is 20,000 rpm.

Tool No.	Type	Dia.	Price
Q2S14	S	2"	\$6.34
Q3S14	S	3"	\$7.99
Q2R14	R	2"	\$5.79
Q3R14	R	3"	\$7.67



Type S Quick Change Discs
Aluminum Oxide, 25 Discs/Pack
ResinFibre Backing
Turn-On/Off Metal Clip



Tool No.	Size	Grit	Price
A2QS2	2"	24	\$17.50
A2QS3	2"	36	\$16.67
A2QS4	2"	40	\$16.67
A2QS5	2"	50	\$16.25
A2QS6	2"	60	\$15.83
A2QS8	2"	80	\$15.42
A2QS10	2"	100	\$15.00
A2QS12	2"	120	\$15.00
A2QS15	2"	150	\$15.00
A2QS18	2"	180	\$15.00
A2QS22	2"	220	\$15.00
A2QS24	2"	240	\$15.00
A3QS2	3"	24	\$26.67
A3QS3	3"	36	\$25.83
A3QS4	3"	40	\$25.42
A3QS5	3"	50	\$25.00
A3QS6	3"	60	\$24.58
A3QS8	3"	80	\$24.17
A3QS10	3"	100	\$23.75
A3QS12	3"	120	\$23.75
A3QS15	3"	150	\$23.75
A3QS18	3"	180	\$23.75
A3QS22	3"	220	\$23.75
A3QS24	3"	240	\$23.75

Type R Quick Change Discs
Aluminum Oxide, 25 Discs/Pack
ResinFibre Backing
Roll-On/Roll-Off Threaded



Tool No.	Size	Grit	Price
A2QR2	2"	24	\$17.31
A2QR3	2"	36	\$16.83
A2QR4	2"	40	\$16.36
A2QR5	2"	50	\$15.89
A2QR6	2"	60	\$15.40
A2QR8	2"	80	\$14.93
A2QR10	2"	100	\$14.45
A2QR12	2"	120	\$14.45
A2QR15	2"	150	\$14.45
A2QR18	2"	180	\$14.45
A2QR22	2"	220	\$14.45
A2QR24	2"	240	\$14.45
A3QR2	3"	24	\$22.56
A3QR3	3"	36	\$21.14
A3QR4	3"	40	\$20.18
A3QR5	3"	50	\$19.23
A3QR6	3"	60	\$18.27
A3QR8	3"	80	\$17.31
A3QR10	3"	100	\$16.83
A3QR12	3"	120	\$16.83
A3QR15	3"	150	\$16.83
A3QR18	3"	180	\$16.83
A3QR22	3"	220	\$16.83
A3QR24	3"	240	\$16.83

Hook & Loop 4-1/2" 8 Hole Discs
25 Discs/Pack, Aluminum Oxide
Open Coat, Resin Bond Paper
Backing

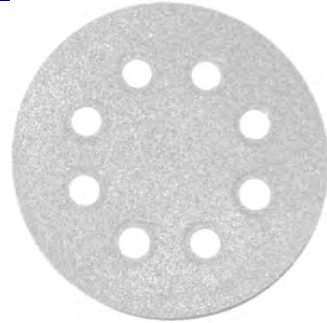

Tool No.	Grit	Weight	Price
V4.58G6	60	C	\$9.58
V4.58G8	80	C	\$8.91
V4.58G10	100	C	\$7.94
V4.58G12	120	B	\$7.92
V4.58G15	150	B	\$7.91
V4.58G18	180	B	\$7.90
V4.58G22	220	B	\$7.89
V4.58G32	320	B	\$7.88
V4.58G40	400	B	\$7.86

Hook & Loop 5" No Hole Discs
50 Discs/Pack
Aluminum Oxide, Open Coat
Resin Bond Paper Backing



Tool No.	Grit	Weight	Price
V5G4	40	C	\$21.68
V5G6	60	C	\$18.42
V5G8	80	C	\$16.71
V5G10	100	C	\$14.57
V5G12	120	C	\$14.56
V5G15	150	C	\$14.56
V5G18	180	C	\$14.55
V5G22	220	C	\$14.54
V5G24	240	C	\$14.53
V5G28	280	C	\$14.53
V5G32	320	C	\$14.52
V5G40	400	C	\$14.51
V5G60	600	C	\$15.08
V5G80	800	C	\$15.58

PSA 5" No Hole Discs
50 Discs/Pack
Aluminum Oxide, Open Coat
Resin Bond Paper Backing



Tool No.	Grit	Weight	Price
P5G4	40	C	\$17.98
P5G6	60	C	\$15.87
P5G8	80	C	\$13.80
P5G10	100	C	\$12.18
P5G12	120	C	\$12.18
P5G15	150	C	\$12.18
P5G18	180	C	\$12.18
P5G22	220	C	\$12.18
P5G32	320	C	\$12.18
P5G40	400	C	\$12.18
P5G50	500	C	\$12.18
P5G60	600	C	\$12.18
P5G80	800	C	\$12.18

PSA 5" 5 Hole Discs
50 Discs/Pack
Aluminum Oxide, Open Coat
Resin Bond Paper Backing



Tool No.	Grit	Weight	Price
P55G4	40	C	\$20.86
P55G6	60	C	\$17.71
P55G8	80	C	\$14.05
P55G10	100	C	\$13.68
P55G12	120	C	\$13.68
P55G15	150	C	\$13.67
P55G18	180	C	\$13.66
P55G22	220	C	\$13.66
P55G32	320	C	\$13.65
P55G40	400	C	\$13.65
P55G50	500	C	\$13.76
P55G60	600	C	\$13.77

Quick Change Discs - Type S
Zirconia Alumina
25 Discs/Pack
ResinFibre Backing
Turn-On/Off Metal Clip



Tool No.	Size	Grit	Price
Z2QS2	2"	24	\$21.67
Z2QS3	2"	36	\$21.25
Z2QS4	2"	40	\$20.42
Z2QS5	2"	50	\$20.00
Z2QS6	2"	60	\$19.58
Z2QS8	2"	80	\$19.17
Z2QS10	2"	100	\$19.17
Z2QS12	2"	120	\$19.17
Z3QS2	3"	24	\$31.67
Z3QS3	3"	36	\$30.83
Z3QS4	3"	40	\$30.42
Z3QS5	3"	50	\$30.00
Z3QS6	3"	60	\$29.58
Z3QS8	3"	80	\$29.17
Z3QS10	3"	100	\$28.75
Z3QS12	3"	120	\$28.75

Quick Change Discs - Type R
Zirconia Alumina
25 Discs/Pack
ResinFibre Backing
Roll-On/Roll-Off Threaded



Tool No.	Size	Grit	Price
Z2QR2	2"	24	\$29.74
Z2QR3	2"	36	\$27.63
Z2QR4	2"	40	\$26.40
Z2QR5	2"	50	\$25.58
Z2QR6	2"	60	\$24.68
Z2QR8	2"	80	\$24.35
Z2QR10	2"	100	\$23.91
Z2QR12	2"	120	\$23.91
Z3QR2	3"	24	\$40.49
Z3QR3	3"	36	\$38.14
Z3QR4	3"	40	\$36.74
Z3QR5	3"	50	\$35.87
Z3QR6	3"	60	\$34.79
Z3QR8	3"	80	\$33.51
Z3QR10	3"	100	\$32.66
Z3QR12	3"	120	\$32.66



Hook & Loop 5" 5 Hole Discs
50 Discs/Pack
Aluminum Oxide, Open Coat
Resin Bond Paper Backing



Tool No.	Grit	Weight	Price
V55G4	40	C	\$21.68
V55G6	60	C	\$18.42
V55G8	80	C	\$16.71
V55G10	100	C	\$14.57
V55G12	120	C	\$14.56
V55G15	150	C	\$14.56
V55G18	180	C	\$14.54
V55G22	220	C	\$14.54
V55G24	240	C	\$14.53
V55G28	280	C	\$14.53
V55G32	320	C	\$14.52
V55G40	400	C	\$14.51
V55G50	500	C	\$15.09
V55G60	600	C	\$15.08

Hook & Loop 5" 8 Hole Discs
50 Discs/Pack
Aluminum Oxide, Open Coat
Resin Bond Paper Backing



Tool No.	Grit	Weight	Price
V58G4	40	C	\$21.68
V58G6	60	C	\$18.42
V58G8	80	C	\$16.71
V58G10	100	C	\$14.57
V58G12	120	C	\$14.56
V58G15	150	C	\$14.56
V58G18	180	C	\$14.54
V58G22	220	C	\$14.54
V58G32	320	C	\$14.52
V58G40	400	C	\$14.51
V58G60	600	C	\$15.08

Hook & Loop 5" Ceramic Discs
Multi-Hole, 50 Discs/Pack

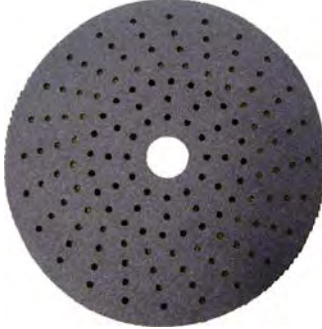

Tool No.	Grit	Price
V5MG8CR	80	\$42.00
V5MG10CR	100	\$40.00

PSA 5" 8 Hole Discs
50 Discs/Pack
Aluminum Oxide, Open Coat
Resin Bond Paper Backing



Tool No.	Grit	Weight	Price
P58G4	40	C	\$17.98
P58G6	60	C	\$16.05
P58G8	80	C	\$14.17
P58G10	100	C	\$12.50
P58G12	120	C	\$12.50
P58G15	150	C	\$12.50
P58G18	180	C	\$12.50
P58G22	220	C	\$12.50
P58G24	240	C	\$12.50
P58G28	280	C	\$12.50
P58G32	320	C	\$12.50
P58G40	400	C	\$12.50
P58G50	500	C	\$12.50
P58G60	600	C	\$12.50

PSA 6" No Hole Discs
50 Discs/Pack
Aluminum Oxide, Open Coat
Resin Bond Paper Backing



Tool No.	Grit	Weight	Price
P6G4	40	C	\$21.33
P6G6	60	C	\$20.61
P6G8	80	C	\$17.92
P6G10	100	C	\$16.22
P6G12	120	C	\$16.22
P6G15	150	C	\$16.22
P6G18	180	C	\$16.22
P6G22	220	C	\$16.22
P6G28	280	C	\$16.22
P6G32	320	C	\$16.22
P6G40	400	C	\$16.22
P6G50	500	C	\$16.22
P6G60	600	C	\$16.22
P6G80	800	C	\$16.22

Hook & Loop 6" No Hole Discs
50 Discs/Pack
Aluminum Oxide, Open Coat
Resin Bond Paper Backing



Tool No.	Grit	Weight	Price
V6G4	40	C	\$32.46
V6G6	60	C	\$27.65
V6G8	80	C	\$21.79
V6G10	100	C	\$21.18
V6G12	120	C	\$21.18
V6G15	150	C	\$21.17
V6G18	180	C	\$21.16
V6G22	220	C	\$21.16
V6G32	320	C	\$21.15
V6G40	400	C	\$21.15
V6G60	600	C	\$21.64

PSA 6" 6 Hole Discs
50 Discs/Pack
Aluminum Oxide, Open Coat
Resin Bond Paper Backing

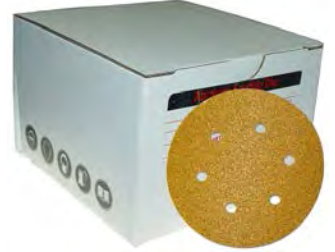

Tool No.	Grit	Weight	Price
P66G4	40	C	\$29.49
P66G6	60	C	\$25.05
P66G8	80	C	\$19.57
P66G10	100	C	\$18.87
P66G12	120	C	\$18.86
P66G15	150	C	\$18.86
P66G18	180	C	\$18.85
P66G22	220	C	\$18.84
P66G32	320	C	\$18.84
P66G40	400	C	\$18.83
P66G60	600	C	\$19.53

Hook & Loop 6" 6 Hole Discs
50 Discs/Pack
Aluminum Oxide, Open Coat
Resin Bond Paper Backing

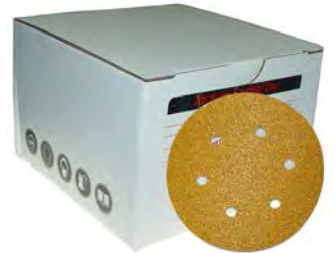

Tool No.	Grit	Weight	Price
V66G4	40	C	\$32.46
V66G6	60	C	\$27.65
V66G8	80	C	\$21.79
V66G10	100	C	\$21.18
V66G12	120	C	\$21.18
V66G15	150	C	\$21.17
V66G18	180	C	\$21.16
V66G22	220	C	\$21.16
V66G32	320	C	\$21.15
V66G40	400	C	\$21.15
V66G60	600	C	\$21.64



PSA 6" 8 Hole Discs
50 Discs/Pack
Aluminum Oxide, Open Coat
Resin Bond Paper Backing



Tool No.	Grit	Weight	Price
P68G4	40	C	\$23.33
P68G6	60	C	\$20.15
P68G8	80	C	\$20.00
P68G10	100	C	\$19.17
P68G12	120	C	\$19.17
P68G15	150	C	\$19.17
P68G18	180	C	\$19.17
P68G22	220	C	\$19.17
P68G32	320	C	\$19.17
P68G40	400	C	\$19.17
P68G60	600	C	\$19.17

Hook & Loop 6" 8 Hole Discs
50 Discs/Pack
Aluminum Oxide, Open Coat
Resin Bond Paper Backing



Tool No.	Grit	Weight	Price
V68G4	40	C	\$32.46
V68G6	60	C	\$27.65
V68G8	80	C	\$21.79
V68G10	100	C	\$21.18
V68G12	120	C	\$21.18
V68G15	150	C	\$21.17
V68G18	180	C	\$21.16
V68G22	220	C	\$21.16
V68G32	320	C	\$21.15
V68G40	400	C	\$21.15
V68G60	600	C	\$21.64

4-1/2" X 7/8" Flap Disc, T-27
10 Discs/Pack, Zirconia Alumina



This zirconia alumina flap disc is designed for weld removing and blending, edge deburring, oxide removal and surface preparation on hard metals, including carbon steel, stainless steel, nickel alloys, aluminum, cast iron and titanium.

Tool No.	Grit	Price
FDZ4.5X78T27P2	24	\$44.98
FDZ4.5X78T27P3	36	\$44.98
FDZ4.5X78T27P4	40	\$44.98
FDZ4.5X78T27P6	60	\$44.98
FDZ4.5X78T27P8	80	\$44.98
FDZ4.5X78T27P12	120	\$44.98

4-1/2" X 7/8" Flap Disc, T-29
10 Discs/Pack, Zirconia Alumina



This zirconia alumina flap disc is designed for weld removing and blending, edge deburring, oxide removal and surface preparation on hard metals, including carbon steel, stainless steel, nickel alloys, aluminum, cast iron and titanium.

Tool No.	Grit	Price
FDZ4.5X78T29P2	24	\$44.98
FDZ4.5X78T29P3	36	\$44.98
FDZ4.5X78T29P4	40	\$44.98
FDZ4.5X78T29P6	60	\$44.98
FDZ4.5X78T29P8	80	\$44.98
FDZ4.5X78T29P12	120	\$44.98

4-1/2" X 7/8" Flap Discs, T-27
10 Discs/Pack, Ceramic



This ceramic flap disc generates lower heat and last longer than zirconia alumina. It is designed for weld removing and blending, edge deburring, scale removal, oxide removal and surface preparation on hard metals, including carbon steel, stainless steel, nickel alloys, aluminum castings and titanium.

Tool No.	Grit	Price
FDC4.5X78T27P2	24	\$68.19
FDC4.5X78T27P3	36	\$68.19
FDC4.5X78T27P4	40	\$68.19
FDC4.5X78T27P6	60	\$68.19
FDC4.5X78T27P8	80	\$68.19
FDC4.5X78T27P12	120	\$68.19

4-1/2" X 7/8" Flap Discs, T-29
10 Discs/Pack, Ceramic



This ceramic flap disc generates lower heat and last longer than zirconia alumina. It is designed for weld removing and blending, edge deburring, scale removal, oxide removal and surface preparation on hard metals, including carbon steel, stainless steel, nickel alloys, aluminum castings and titanium.

Tool No.	Grit	Price
FDC4.5X78T29P2	24	\$68.19
FDC4.5X78T29P3	36	\$68.19
FDC4.5X78T29P4	40	\$68.19
FDC4.5X78T29P6	60	\$68.19
FDC4.5X78T29P8	80	\$68.19
FDC4.5X78T29P12	120	\$68.19

1" x 30" Sanding Belt
10 Belts/Pack, Aluminum Oxide
Closed Coat, 3-mil Film Backing



Tool No.	Grit	Price
R1X30S100	1000	\$11.35
R1X30S120	1200	\$11.35

1" x 30" Sanding Belts
10 Belts/Pack, Aluminum Oxide
X-weight
Resin Bond Poly-Cotton Backing



Tool No.	Grit	Coat	Price
R1X30S2	24	Closed	\$15.00
K1X30S3	36	Open	\$13.22
K1X30S4	40	Open	\$12.68
K1X30S5	50	Open	\$12.16
K1X30S6	60	Open	\$11.62
K1X30S8	80	Open	\$10.82
K1X30S10	100	Open	\$10.23
K1X30S12	120	Open	\$10.22
K1X30S15	150	Open	\$10.20
K1X30S18	180	Open	\$10.19
R1X30S22	220	Closed	\$10.18
R1X30S32	320	Closed	\$10.17
R1X30S40	400	Closed	\$10.15
R1X30S50	500	Closed	\$10.26
R1X30S60	600	Closed	\$10.28
R1X30S80	800	Closed	\$11.34

1" x 30" Sanding Belts
10 Belts/Pack, Zirconia Alumina
Closed Coat, Y-weight
Resin Bond Polyester Backing



Tool No.	Grit	Coat	Price
Z1X30S2	24	Closed	\$25.90
Z1X30S3	36	Closed	\$24.61
Z1X30S4	40	Closed	\$23.88
Z1X30S5	50	Closed	\$23.32
Z1X30S6	60	Closed	\$23.13
Z1X30S8	80	Closed	\$22.77
Z1X30S10	100	Closed	\$22.41
Z1X30S12	120	Closed	\$22.41



1" x 42" Sanding Belts
10 Belts/Pack, Aluminum Oxide
Closed Coat, 3-mil Film Backing



Tool No.	Grit	Price
R1X42S100	1000	\$11.73
R1X42S120	1200	\$11.74

1-1/8" x 21" Sanding Belts
10 Belts/Pack, Silicon Carbide
Closed Coat
Resin Bond Polyester Backing



Tool No.	Grit	Weight	Price
S1.125X21S4	40	Y	\$16.91
S1.125X21S5	50	Y	\$16.17
S1.125X21S6	60	Y	\$15.44
S1.125X21S8	80	Y	\$14.70
S1.125X21S10	100	Y	\$14.04
S1.125X21S12	120	Y	\$14.03
S1.125X21S15	150	Y	\$14.02
S1.125X21S18	180	Y	\$14.01
S1.125X21S22	220	X	\$13.99
S1.125X21S32	320	X	\$13.98
S1.125X21S40	400	X	\$13.97

1" x 42" Sanding Belts
10 Belts/Pack, Aluminum Oxide
X-weight
Resin Bond Poly-Cotton Backing



Tool No.	Grit	Coat	Price
R1X42S2	24	Closed	\$16.50
K1X42S3	36	Open	\$15.83
K1X42S4	40	Open	\$15.00
K1X42S5	50	Open	\$14.67
K1X42S6	60	Open	\$14.17
K1X42S8	80	Open	\$13.17
K1X42S10	100	Open	\$12.50
K1X42S12	120	Open	\$12.50
K1X42S15	150	Open	\$12.50
K1X42S18	180	Open	\$12.50
R1X42S22	220	Closed	\$12.50
R1X42S32	320	Closed	\$12.50
R1X42S40	400	Closed	\$12.50
R1X42S50	500	Closed	\$12.50
R1X42S60	600	Closed	\$12.50
R1X42S80	800	Closed	\$12.50

1-1/2" x 30" Sanding Belts
10 Belts/Pack, Aluminum Oxide
Closed Coat, X-weight
Resin Bond Poly-Cotton Backing



Tool No.	Grit	Price
R1.5X30S2	24	\$30.87
R1.5X30S3	36	\$27.56
R1.5X30S4	40	\$25.27
R1.5X30S5	50	\$22.96
R1.5X30S6	60	\$21.82
R1.5X30S8	80	\$20.67
R1.5X30S10	100	\$19.61
R1.5X30S12	120	\$19.60
R1.5X30S15	150	\$19.59
R1.5X30S18	180	\$19.58
R1.5X30S22	220	\$19.57
R1.5X30S32	320	\$19.56
R1.5X30S40	400	\$19.55
R1.5X30S50	500	\$19.54
R1.5X30S60	600	\$19.53
R1.5X30S80	800	\$21.47

1" x 42" Sanding Belts
10 Belts/Pack, Zirconia Alumina
Closed Coat, Y-weight
Resin Bond Polyester Backing



Tool No.	Grit	Price
Z1X42S2	24	\$27.55
Z1X42S3	36	\$25.55
Z1X42S4	40	\$24.88
Z1X42S5	50	\$24.21
Z1X42S6	60	\$23.37
Z1X42S8	80	\$23.04
Z1X42S10	100	\$22.54
Z1X42S12	120	\$22.54

1-1/2" x 30" Sanding Belts
10 Belts/Pack, Zirconia Alumina
Closed Coat, Y-weight
Resin Bond Polyester Backing



Tool No.	Grit	Coat	Price
Z1.5X30S2	24	Closed	\$38.59
Z1.5X30S3	36	Closed	\$34.45
Z1.5X30S4	40	Closed	\$31.58
Z1.5X30S5	50	Closed	\$28.71
Z1.5X30S6	60	Closed	\$27.28
Z1.5X30S8	80	Closed	\$25.84
Z1.5X30S10	100	Closed	\$24.41
Z1.5X30S12	120	Closed	\$24.40

2" x 48" Sanding Belts
10 Belts/Pack, Aluminum Oxide
X-weight
Resin Bond Poly-Cotton Backing



Tool No.	Grit	Coat	Price
K2X48S3	36	Open	\$23.07
K2X48S4	40	Open	\$22.05
K2X48S5	50	Open	\$20.52
K2X48S6	60	Open	\$18.99
K2X48S8	80	Open	\$17.14
K2X48S10	100	Open	\$16.11
K2X48S12	120	Open	\$16.10
K2X48S15	150	Open	\$16.09
K2X48S18	180	Open	\$16.08
R2X48S22	220	Closed	\$16.07
R2X48S32	320	Closed	\$16.05
R2X48S40	400	Closed	\$16.04

2" x 60" Sanding Belts
10 Belts/Pack, Aluminum Oxide
X-weight
Resin Bond Poly-Cotton Backing



Tool No.	Grit	Coat	Price
K2X60S3	36	Open	\$33.32
K2X60S4	40	Open	\$30.94
K2X60S5	50	Open	\$28.34
K2X60S6	60	Open	\$26.04
K2X60S8	80	Open	\$24.46
K2X60S10	100	Open	\$23.91
K2X60S12	120	Open	\$23.91
K2X60S15	150	Open	\$23.91
K2X60S18	180	Open	\$23.91
R2X60S22	220	Closed	\$23.91
R2X60S32	320	Closed	\$23.91
R2X60S40	400	Closed	\$23.91

2" x 72" Sanding Belts
10 Belts/Pack, Aluminum Oxide
X-weight
Resin Bond Poly-Cotton Backing



Tool No.	Grit	Coat	Price
K2X72S2	24	Open	\$40.77
K2X72S3	36	Open	\$36.76
K2X72S4	40	Open	\$35.57
K2X72S5	50	Open	\$32.81
K2X72S6	60	Open	\$30.91
K2X72S8	80	Open	\$28.50
K2X72S10	100	Open	\$26.94
K2X72S12	120	Open	\$26.93
K2X72S15	150	Open	\$26.92
K2X72S18	180	Open	\$26.91
R2X72S22	220	Closed	\$26.91
R2X72S32	320	Closed	\$26.91
R2X72S40	400	Closed	\$26.91

2" x 132" Sanding Belts
5 Belts/Pack, Aluminum Oxide
J-weight, Closed Coat
Resin Cloth Backing



Tool No.	Grit	Price
R2X132J8	80	\$19.84
R2X132J10	100	\$19.17
R2X132J12	120	\$19.16
R2X132J15	150	\$19.15
R2X132J18	180	\$19.14
R2X132J22	220	\$19.13
R2X132J32	320	\$19.12
R2X132J40	400	\$19.11
R2X132J50	500	\$19.18
R2X132J60	600	\$19.19



3" x 18" Sanding Belt
10 Belts/Pack
Aluminum Oxide, X-weight



Tool No.	Grit	Coat	Price
K3X18S2	24	Open	\$14.69
K3X18S3	36	Open	\$13.23
K3X18S4	40	Open	\$12.71
K3X18S5	50	Open	\$12.31
K3X18S6	60	Open	\$11.77
K3X18S8	80	Open	\$11.25
K3X18S10	100	Open	\$11.19
K3X18S12	120	Open	\$11.18
K3X18S15	150	Open	\$11.17
K3X18S18	180	Open	\$11.16
R3X18S22	220	Closed	\$11.15
R3X18S32	320	Closed	\$11.14
R3X18S40	400	Closed	\$11.11

3" x 21" Sanding Belts
10 Belts/Pack, Aluminum Oxide
X-weight
Resin Bond Poly-Cotton Backing



Tool No.	Grit	Coat	Price
K3X21S2	24	Open	\$17.06
K3X21S3	36	Open	\$15.74
K3X21S4	40	Open	\$15.21
K3X21S5	50	Open	\$14.69
K3X21S6	60	Open	\$14.29
K3X21S8	80	Open	\$13.23
K3X21S10	100	Open	\$13.18
K3X21S12	120	Open	\$13.16
K3X21S15	150	Open	\$13.15
K3X21S18	180	Open	\$13.14
R3X21S22	220	Closed	\$13.13
R3X21S32	320	Closed	\$13.10
R3X21S40	400	Closed	\$13.09

3" x 23-3/4" Sanding Belts
10 Belts/Pack, Aluminum Oxide
X-weight
Resin Bond Poly-Cotton Backing



Tool No.	Grit	Coat	Price
K3X23.75S2	24	Open	\$18.12
K3X23.75S3	36	Open	\$17.06
K3X23.75S4	40	Open	\$16.28
K3X23.75S5	50	Open	\$15.47
K3X23.75S6	60	Open	\$15.21
K3X23.75S8	80	Open	\$14.42
K3X23.75S10	100	Open	\$14.36
K3X23.75S12	120	Open	\$14.35
K3X23.75S15	150	Open	\$14.34
K3X23.75S18	180	Open	\$14.32
R3X23.75S22	220	Closed	\$14.31
R3X23.75S32	320	Closed	\$14.30
R3X23.75S40	400	Closed	\$14.29

3" x 24" Sanding Belts
10 Belts/Pack, Zirconia Alumina
Closed Coat, Y-weight
Resin Bond Polyester Backing



Tool No.	Grit	Price
Z3X24S2	24	\$43.00
Z3X24S3	36	\$40.02
Z3X24S4	40	\$38.70
Z3X24S5	50	\$37.38
Z3X24S6	60	\$36.38
Z3X24S8	80	\$35.06
Z3X24S10	100	\$33.91
Z3X24S12	120	\$33.90

3" x 18" Sanding Belts
10 Belts/Pack, Zirconia Alumina
Closed Coat, Y-weight
Resin Bond Polyester Backing



Tool No.	Grit	Price
Z3X18S2	24	\$39.43
Z3X18S3	36	\$36.98
Z3X18S4	40	\$35.94
Z3X18S5	50	\$35.22
Z3X18S6	60	\$33.50
Z3X18S8	80	\$32.79
Z3X18S10	100	\$32.59
Z3X18S12	120	\$32.57

3" x 21" Sanding Belts
10 Belts/Pack, Zirconia Alumina
Closed Coat, Y-weight
Resin Bond Polyester Backing



Tool No.	Grit	Coat	Price
Z3X21S2	24	Closed	\$41.21
Z3X21S3	36	Closed	\$38.50
Z3X21S4	40	Closed	\$37.32
Z3X21S5	50	Closed	\$36.30
Z3X21S6	60	Closed	\$34.93
Z3X21S8	80	Closed	\$33.93
Z3X21S10	100	Closed	\$33.25
Z3X21S12	120	Closed	\$33.24

3" x 24" Sanding Belt
10 Belts, X-weight/Pack
Aluminum Oxide



Tool No.	Grit	Coat	Price
K3X24S2	24	Open	\$18.24
K3X24S3	36	Open	\$17.16
K3X24S4	40	Open	\$16.36
K3X24S5	50	Open	\$15.55
K3X24S6	60	Open	\$15.29
K3X24S8	80	Open	\$14.50
K3X24S10	100	Open	\$14.45
K3X24S12	120	Open	\$14.43
K3X24S15	150	Open	\$14.42
K3X24S18	180	Open	\$14.40
R3X24S22	220	Closed	\$14.39
R3X24S32	320	Closed	\$14.37
R3X24S40	400	Closed	\$14.67

3" x 24" Sanding Belts
10 Belts/Pack, Silicon Carbide
Closed Coat
Resin Bond Polyester Backing



Tool No.	Grit	Weight	Price
S3X24S4	40	Y	\$19.84
S3X24S5	50	Y	\$18.74
S3X24S6	60	Y	\$17.47
S3X24S8	80	Y	\$16.54
S3X24S10	100	X	\$15.87
S3X24S12	120	X	\$15.86
S3X24S15	150	X	\$15.84
S3X24S18	180	X	\$15.83
S3X24S22	220	X	\$15.82
S3X24S32	320	X	\$15.81
S3X24S40	400	X	\$15.80

3" x 132" Sanding Belts
5 Belts/Pack, Aluminum Oxide
J-weight, Closed Coat
Resin Cloth Backing



Tool No.	Grit	Price
R3X132J8	80	\$27.20
R3X132J10	100	\$26.52
R3X132J12	120	\$26.51
R3X132J15	150	\$26.50
R3X132J18	180	\$26.49
R3X132J22	220	\$26.48
R3X132J32	320	\$26.47
R3X132J40	400	\$26.46
R3X132J50	500	\$26.53
R3X132J60	600	\$26.54



4" x 21" Sanding Belts
10 Belts/Pack, Aluminum Oxide
X-weight
Resin Bond Poly-Cotton Backing



Tool No.	Grit	Coat	Price
K4X21S2	24	Open	\$29.27
K4X21S3	36	Open	\$26.83
K4X21S4	40	Open	\$25.20
K4X21S5	50	Open	\$23.58
K4X21S6	60	Open	\$22.43
K4X21S8	80	Open	\$21.13
K4X21S10	100	Open	\$20.00
K4X21S12	120	Open	\$20.00
K4X21S15	150	Open	\$20.00
K4X21S18	180	Open	\$20.00
R4X21S22	220	Closed	\$20.00
R4X21S32	320	Closed	\$20.00
R4X21S40	400	Closed	\$20.00

4" x 24" Sanding Belts
10 Belts/Pack, Aluminum Oxide
X-weight
Resin Bond Poly-Cotton Backing

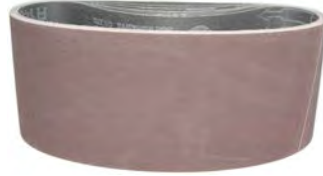

Tool No.	Grit	Coat	Price
K4X24S2	24	Open	\$25.53
K4X24S3	36	Open	\$23.68
K4X24S4	40	Open	\$22.62
K4X24S5	50	Open	\$22.09
K4X24S6	60	Open	\$21.29
K4X24S8	80	Open	\$20.77
K4X24S10	100	Open	\$20.19
K4X24S12	120	Open	\$20.18
K4X24S15	150	Open	\$20.16
K4X24S18	180	Open	\$20.14
R4X24S22	220	Closed	\$20.13
R4X24S32	320	Closed	\$20.12
R4X24S40	400	Closed	\$20.11

4" x 24" Sanding Belts
10 Belts/Pack, Silicon Carbide
Closed Coat
Resin Bond Polyester Backing



Tool No.	Grit	Weight	Price
S4X24S4	40	Y	\$26.46
S4X24S5	50	Y	\$24.81
S4X24S6	60	Y	\$23.34
S4X24S8	80	Y	\$22.05
S4X24S10	100	X	\$21.01
S4X24S12	120	X	\$21.00
S4X24S15	150	X	\$20.99
S4X24S18	180	X	\$20.98
S4X24S22	220	X	\$20.97
S4X24S32	320	X	\$20.96
S4X24S40	400	X	\$20.95

4" x 36" Sanding Belts
1 Belt/Pack, Zirconia Alumina
Closed Coat, Y-weight
Resin Bond Polyester Backing



Tool No.	Grit	Price
Z4X36S2	24	\$7.76
Z4X36S3	36	\$7.14
Z4X36S4	40	\$6.81
Z4X36S5	50	\$6.59
Z4X36S6	60	\$6.32
Z4X36S8	80	\$6.08
Z4X36S10	100	\$5.67
Z4X36S12	120	\$5.67

4" x 21-3/4" Sanding Belts
10 Belts/Pack, Aluminum Oxide
X-weight
Resin Bond Poly-Cotton Backing

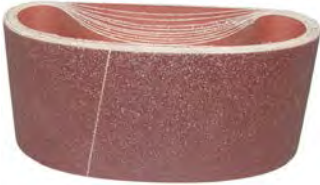

Tool No.	Grit	Coat	Price
K4X21.75S2	24	Open	\$30.00
K4X21.75S3	36	Open	\$27.50
K4X21.75S4	40	Open	\$25.83
K4X21.75S5	50	Open	\$24.17
K4X21.75S6	60	Open	\$23.00
K4X21.75S8	80	Open	\$21.67
K4X21.75S10	100	Open	\$20.50
K4X21.75S12	120	Open	\$20.50
K4X21.75S15	150	Open	\$20.50
K4X21.75S18	180	Open	\$20.50
R4X21.75S22	220	Closed	\$20.50
R4X21.75S32	320	Closed	\$20.50
R4X21.75S40	400	Closed	\$20.50

4" x 24" Sanding Belts
10 Belts/Pack, Zirconia Alumina
Closed Coat, Y-weight
Resin Bond Polyester Backing



Tool No.	Grit	Price
Z4X24S2	24	\$57.23
Z4X24S3	36	\$53.09
Z4X24S4	40	\$50.44
Z4X24S5	50	\$49.44
Z4X24S6	60	\$47.96
Z4X24S8	80	\$46.31
Z4X24S10	100	\$45.48
Z4X24S12	120	\$45.47

4" x 36" Sanding Belts
5 Belts/Pack, Aluminum
Oxide X-weight
Resin Bond Poly-Cotton Backing



Tool No.	Grit	Coat	Price
K4X36S2	24	Open	\$26.44
K4X36S3	36	Open	\$16.60
K4X36S4	40	Open	\$15.88
K4X36S5	50	Open	\$14.74
K4X36S6	60	Open	\$13.69
K4X36S8	80	Open	\$12.37
K4X36S10	100	Open	\$11.64
K4X36S12	120	Open	\$11.63
K4X36S15	150	Open	\$11.62
K4X36S18	180	Open	\$11.61
R4X36S22	220	Closed	\$11.60
R4X36S32	320	Closed	\$11.59
R4X36S40	400	Closed	\$11.58
R4X36S50	500	Closed	\$13.71
R4X36S60	600	Closed	\$13.73
R4X36S80	800	Closed	\$13.76

4" x 48" Sanding Belts
5 Belts/Pack, Aluminum Oxide
X-weight
Resin Bond Poly-Cotton Backing



Tool No.	Grit	Coat	Price
K4X48S2	24	Open	\$35.23
K4X48S3	36	Open	\$33.23
K4X48S4	40	Open	\$31.93
K4X48S5	50	Open	\$29.64
K4X48S6	60	Open	\$27.44
K4X48S8	80	Open	\$24.85
K4X48S10	100	Open	\$23.33
K4X48S12	120	Open	\$23.32
K4X48S15	150	Open	\$23.31
K4X48S18	180	Open	\$23.30
R4X48S22	220	Closed	\$23.29
R4X48S32	320	Closed	\$23.28
R4X48S40	400	Closed	\$23.27

4" x 48" Sanding Belt
1 Belt/Pack, Zirconia Alumina
Closed Coat, Y-weight
Resin Bond Polyester Backing



Tool No.	Grit	Price
Z4X48S2	24	\$9.39
Z4X48S3	36	\$8.59
Z4X48S4	40	\$8.23
Z4X48S5	50	\$7.89
Z4X48S6	60	\$7.51
Z4X48S8	80	\$7.18
Z4X48S10	100	\$6.47
Z4X48S12	120	\$6.47



4" x 80" Sanding Belt
1 Belt/Pack, Aluminum Oxide
X-weight
Resin Bond Poly-Cotton Backing



Tool No.	Grit	Coat	Price
K4X80S2	24	Open	\$8.13
K4X80S3	36	Open	\$7.72
K4X80S4	40	Open	\$7.29
K4X80S5	50	Open	\$6.96
K4X80S6	60	Open	\$6.92
K4X80S8	80	Open	\$6.55
K4X80S10	100	Open	\$6.35
K4X80S12	120	Open	\$6.34
K4X80S15	150	Open	\$6.32
K4X80S18	180	Open	\$6.31
R4X80S22	220	Closed	\$6.30
R4X80S32	320	Closed	\$6.29
R4X80S40	400	Closed	\$6.27

4" x 106" Sanding Belts
5 Belts/Pack, Silicon Carbide
Closed Coat
Resin Bond Polyester Backing



Tool No.	Grit	Weight	Price
S4X106S2	24	Y	\$64.65
S4X106S3	36	Y	\$56.95
S4X106S4	40	Y	\$53.45
S4X106S5	50	Y	\$50.20
S4X106S6	60	Y	\$46.80
S4X106S8	80	Y	\$44.02
S4X106S10	100	X	\$43.60
S4X106S12	120	X	\$43.60
S4X106S15	150	X	\$43.60
S4X106S18	180	X	\$43.60
S4X106S22	220	X	\$43.60
S4X106S32	320	X	\$43.60
S4X106S40	400	X	\$43.60

4" x 132" Sanding Belts
5 Belts/Pack, Aluminum Oxide
X-weight
Resin Bond Poly-Cotton Backing



Tool No.	Grit	Coat	Price
K4X132S2	24	Open	\$46.73
K4X132S3	36	Open	\$43.95
K4X132S4	40	Open	\$42.13
K4X132S5	50	Open	\$39.09
K4X132S6	60	Open	\$36.52
K4X132S8	80	Open	\$34.55
K4X132S10	100	Open	\$33.88
K4X132S12	120	Open	\$33.87
K4X132S15	150	Open	\$33.86
K4X132S18	180	Open	\$33.85
R4X132S22	220	Closed	\$33.83
R4X132S32	320	Closed	\$33.82
R4X132S40	400	Closed	\$33.81

6" x 48" Sanding Belts
5 Belts/Pack, Aluminum Oxide
X-weight
Resin Bond Poly-Cotton Backing



Tool No.	Grit	Coat	Price
K6X48S2	24	Open	\$38.24
K6X48S3	36	Open	\$33.14
K6X48S4	40	Open	\$31.74
K6X48S5	50	Open	\$29.42
K6X48S6	60	Open	\$27.25
K6X48S8	80	Open	\$24.68
K6X48S10	100	Open	\$23.29
K6X48S12	120	Open	\$23.28
K6X48S15	150	Open	\$23.27
K6X48S18	180	Open	\$23.25
K6X48S22	220	Open	\$23.24
R6X48S22	220	Closed	\$23.24
R6X48S32	320	Closed	\$23.23
R6X48S40	400	Closed	\$23.22

4" x 24" Sanding Belts
10 Belts/Pack, Zirconia Alumina
Closed Coat, Y-weight
Resin Bond Polyester Backing



Tool No.	Grit	Price
Z4X80S2	24	\$12.82
Z4X80S3	36	\$11.63
Z4X80S4	40	\$11.21
Z4X80S5	50	\$10.58
Z4X80S6	60	\$9.96
Z4X80S8	80	\$9.49
Z4X80S10	100	\$8.02
Z4X80S12	120	\$8.01

4" x 118" Sanding Belts
5 Belts/Pack, Aluminum Oxide
J-weight, Closed Coat
Resin Cloth Backing



Tool No.	Grit	Price
R4X118J8	80	\$32.34
R4X118J10	100	\$31.68
R4X118J12	120	\$31.67
R4X118J15	150	\$31.66
R4X118J18	180	\$31.65
R4X118J22	220	\$31.63
R4X118J32	320	\$31.62
R4X118J40	400	\$31.61
R4X118J50	500	\$31.69
R4X118J60	600	\$31.70

5" x 73" Sanding Belt
1 Belt/Pack, Aluminum Oxide
X-weight
Resin Bond Poly-Cotton Backing



Tool No.	Grit	Coat	Price
K5X73S2	24	Open	\$10.08
K5X73S3	36	Open	\$9.85
K5X73S4	40	Open	\$9.62
K5X73S5	50	Open	\$9.38
K5X73S6	60	Open	\$9.28
K5X73S8	80	Open	\$8.58
K5X73S10	100	Open	\$8.25
K5X73S12	120	Open	\$8.25
K5X73S15	150	Open	\$8.25
K5X73S18	180	Open	\$8.25
R5X73S22	220	Closed	\$8.25
R5X73S32	320	Closed	\$8.25
R5X73S40	400	Closed	\$8.25

6" x 48" Sanding Belts
1 Belt/Pack, Zirconia Alumina
Closed Coat, Y-weight
Resin Bond Polyester Backing



Tool No.	Grit	Price
Z6X48S2	24	\$14.36
Z6X48S3	36	\$13.02
Z6X48S4	40	\$12.51
Z6X48S5	50	\$11.96
Z6X48S6	60	\$11.38
Z6X48S8	80	\$10.84
Z6X48S10	100	\$10.57
Z6X48S12	120	\$10.57

4" x 84" Sanding Belts
5 Belts/Pack, Silicon Carbide
Closed Coat
Resin Bond Polyester Backing



Tool No.	Grit	Weight	Price
S4X84S4	40	Y	\$40.52
S4X84S5	50	Y	\$38.04
S4X84S6	60	Y	\$35.47
S4X84S8	80	Y	\$33.35
S4X84S10	100	X	\$31.88
S4X84S12	120	X	\$31.87
S4X84S15	150	X	\$31.85
S4X84S18	180	X	\$31.84
S4X84S22	220	X	\$31.83
S4X84S32	320	X	\$31.82
S4X84S40	400	X	\$31.80

4" x 132" Sanding Belts
5 Belts/Pack, Aluminum Oxide
J-weight, Closed Coat
Resin Cloth Backing



Tool No.	Grit	Price
R4X132J8	80	\$34.55
R4X132J10	100	\$33.88
R4X132J12	120	\$33.87
R4X132J15	150	\$33.86
R4X132J18	180	\$33.85
R4X132J22	220	\$33.83
R4X132J32	320	\$33.82
R4X132J40	400	\$33.81
R4X132J50	500	\$33.89
R4X132J60	600	\$33.90



6" x 80" Sanding Belt
1 Belt/Pack, Aluminum Oxide
X-weight
Resin Bond Poly-Cotton Backing



Tool No.	Grit	Coat	Price
K6X80S2	24	Open	\$13.44
K6X80S3	36	Open	\$12.13
K6X80S4	40	Open	\$11.41
K6X80S5	50	Open	\$10.87
K6X80S6	60	Open	\$10.33
K6X80S8	80	Open	\$9.74
K6X80S10	100	Open	\$9.45
K6X80S12	120	Open	\$9.44
K6X80S15	150	Open	\$9.43
K6X80S18	180	Open	\$9.42
R6X80S22	220	Closed	\$9.41
R6X80S32	320	Closed	\$9.40
R6X80S40	400	Closed	\$9.38

6" x 89" Sanding Belt
1 Belt/Pack, Aluminum Oxide
X-weight
Resin Bond Poly-Cotton Backing



Tool No.	Grit	Coat	Price
K6X89S2	24	Open	\$13.91
K6X89S3	36	Open	\$13.13
K6X89S4	40	Open	\$12.39
K6X89S5	50	Open	\$11.76
K6X89S6	60	Open	\$11.18
K6X89S8	80	Open	\$10.54
K6X89S10	100	Open	\$10.17
K6X89S12	120	Open	\$10.16
K6X89S15	150	Open	\$10.15
K6X89S18	180	Open	\$10.14
R6X89S22	220	Closed	\$10.13
R6X89S32	320	Closed	\$10.12
R6X89S40	400	Closed	\$10.10

6" x 89" Sanding Belts
1 Belt/Pack, Zirconia Alumina
Closed Coat, Y-weight
Resin Bond Polyester Backing



Tool No.	Grit	Price
Z6X89S2	24	\$20.40
Z6X89S3	36	\$18.33
Z6X89S4	40	\$17.31
Z6X89S5	50	\$16.40
Z6X89S6	60	\$14.51
Z6X89S8	80	\$13.85
Z6X89S10	100	\$12.25
Z6X89S12	120	\$12.24

6" x 80" Sanding Belts
1 Belt/Pack, Zirconia Alumina
Closed Coat, Y-weight
Resin Bond Polyester Backing



Tool No.	Grit	Price
Z6X80S2	24	\$18.87
Z6X80S3	36	\$16.98
Z6X80S4	40	\$16.08
Z6X80S5	50	\$15.26
Z6X80S6	60	\$13.66
Z6X80S8	80	\$13.03
Z6X80S10	100	\$11.72
Z6X80S12	120	\$11.72

6" x 108" Sanding Belt
1 Belt/Pack, Aluminum Oxide
X-weight
Resin Bond Poly-Cotton Backing



Tool No.	Grit	Coat	Price
K6X108S2	24	Open	\$15.60
K6X108S3	36	Open	\$14.72
K6X108S4	40	Open	\$13.90
K6X108S5	50	Open	\$13.20
K6X108S6	60	Open	\$12.54
K6X108S8	80	Open	\$11.49
K6X108S10	100	Open	\$11.48
K6X108S12	120	Open	\$11.47
K6X108S15	150	Open	\$11.46
K6X108S18	180	Open	\$11.45
R6X108S22	220	Closed	\$11.43
R6X108S32	320	Closed	\$11.42
R6X108S40	400	Closed	\$11.41

6" x 118" Sanding Belt
1 Belt/Pack, Aluminum Oxide
X-weight
Resin Bond Poly-Cotton Backing



Tool No.	Grit	Coat	Price
K6X118S2	24	Open	\$17.25
K6X118S3	36	Open	\$16.28
K6X118S4	40	Open	\$15.37
K6X118S5	50	Open	\$14.58
K6X118S6	60	Open	\$13.87
K6X118S8	80	Open	\$13.07
K6X118S10	100	Open	\$12.62
K6X118S12	120	Open	\$12.62
K6X118S15	150	Open	\$12.62
K6X118S18	180	Open	\$12.62
R6X118S22	220	Closed	\$12.62
R6X118S32	320	Closed	\$12.62
R6X118S40	400	Closed	\$12.62

16" x 48" Sanding Belts
4 Belts/Pack, Aluminum Oxide
F-weight, Open Coat
Resin Paper Backing



Tool No.	Grit	Price
P16X48S8	80	\$32.19
P16X48S10	100	\$30.50
P16X48S12	120	\$30.50
P16X48S15	150	\$30.50
P16X48S18	180	\$30.50
P16X48S22	220	\$30.50
P16X48S32	320	\$30.50

16" x 48" Sanding Belts
4 Belts/Pack, Aluminum Oxide
F-weight, Closed Coat
Resin Paper Backing



Tool No.	Grit	Price
E16X48S8	80	\$32.19
E16X48S10	100	\$30.50
E16X48S12	120	\$30.50
E16X48S15	150	\$30.50
E16X48S18	180	\$30.50
E16X48S22	220	\$30.50
E16X48S32	320	\$30.50



16" x 48" Sanding Belt
4 Belts/Pack, Aluminum Oxide
X-weight, Open Coat
Resin Bond Poly-Cotton Backing



Tool No.	Grit	Price
K16X48S2	24	\$86.43
K16X48S3	36	\$82.35
K16X48S4	40	\$78.42
K16X48S5	50	\$74.70
K16X48S6	60	\$71.12
K16X48S8	80	\$66.47
K16X48S10	100	\$63.40
K16X48S12	120	\$63.40
K16X48S15	150	\$63.40
K16X48S18	180	\$63.40

16" x 48" Sanding Belt
4 Belts/Pack, Aluminum Oxide
Y-weight, Open Coat
Resin Bond Polyester Backing



Tool No.	Grit	Price
W16X48S2	24	\$76.65
W16X48S3	36	\$73.17
W16X48S4	40	\$69.53
W16X48S5	50	\$66.21
W16X48S6	60	\$63.06
W16X48S8	80	\$59.43
W16X48S10	100	\$56.60
W16X48S12	120	\$56.60
W16X48S15	150	\$56.60
W16X48S18	180	\$56.60
W16X48S22	220	\$56.60

16" x 48" Sanding Belts
4 Belts/Pack, Silicon Carbide
Closed Coat
Resin Bond Polyester Backing



Tool No.	Grit	Weight	Price
S16X48S2	24	Y	\$80.13
S16X48S3	36	Y	\$76.49
S16X48S4	40	Y	\$72.69
S16X48S5	50	Y	\$69.23
S16X48S6	60	Y	\$65.93
S16X48S8	80	Y	\$62.13
S16X48S10	100	X	\$59.17
S16X48S12	120	X	\$59.17
S16X48S15	150	X	\$59.17
S16X48S18	180	X	\$59.17
S16X48S22	220	X	\$59.17
S16X48S32	320	X	\$59.17
S16X48S40	400	X	\$59.17
S16X48S60	600	X	\$59.17

18" x 48" Sanding Belts
4 Belts/Pack, Aluminum Oxide
F-weight, Closed Coat
Resin Paper Backing



Tool No.	Grit	Price
E18X48S8	80	\$36.16
E18X48S10	100	\$34.32
E18X48S12	120	\$34.32
E18X48S15	150	\$34.32
E18X48S18	180	\$34.32
E18X48S22	220	\$34.32
E18X48S32	320	\$34.32

16" x 48" Sanding Belts
4 Belts/Pack, Aluminum Oxide
X-weight, Closed Coat
Resin Bond Poly-Cotton Backing



Tool No.	Grit	Price
R16X48S2	24	\$86.43
R16X48S3	36	\$82.35
R16X48S4	40	\$78.42
R16X48S5	50	\$74.70
R16X48S6	60	\$71.12
R16X48S8	80	\$66.47
R16X48S10	100	\$63.40
R16X48S12	120	\$63.40
R16X48S15	150	\$63.40
R16X48S18	180	\$63.40
R16X48S22	220	\$63.40
R16X48S32	320	\$63.40
R16X48S40	400	\$63.40
R16X48S50	500	\$63.40
R16X48S60	600	\$63.40
R16X48S80	800	\$63.40

16" x 48" Sanding Belts
4 Belts/Pack, Zirconia Alumina
Closed Coat, Y-weight
Resin Bond Polyester Backing



Tool No.	Grit	Price
Z16X48S2	24	\$110.87
Z16X48S3	36	\$103.57
Z16X48S4	40	\$100.40
Z16X48S5	50	\$97.66
Z16X48S6	60	\$93.97
Z16X48S8	80	\$91.28
Z16X48S10	100	\$89.45
Z16X48S12	120	\$89.42

18" x 48" Sanding Belts
4 Belts/Pack, Aluminum Oxide
F-weight, Open Coat
Resin Paper Backing

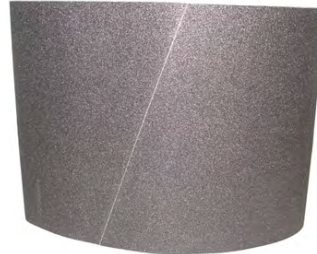

Tool No.	Grit	Price
P18X48S8	80	\$36.16
P18X48S10	100	\$34.32
P18X48S12	120	\$34.32
P18X48S15	150	\$34.32
P18X48S18	180	\$34.32
P18X48S22	220	\$34.32
P18X48S32	320	\$34.32

18" x 48" Sanding Belts
4 Belts/Pack, Aluminum Oxide
X-weight, Open Coat
Resin Bond Poly-Cotton Backing



Tool No.	Grit	Price
K18X48S2	24	\$78.65
K18X48S3	36	\$74.90
K18X48S4	40	\$71.30
K18X48S5	50	\$67.91
K18X48S6	60	\$64.68
K18X48S8	80	\$61.01
K18X48S10	100	\$58.07
K18X48S12	120	\$58.07
K18X48S15	150	\$58.07
K18X48S18	180	\$58.07



18" x 48" Sanding Belts
4 Belts/Pack, Aluminum Oxide
X-weight, Closed Coat
Resin Bond Poly-Cotton Backing

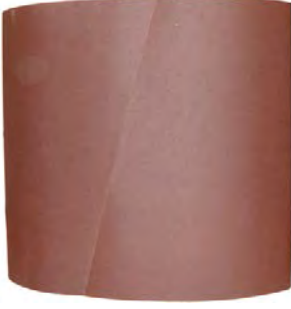

Tool No.	Grit	Price
R18X48S2	24	\$82.58
R18X48S3	36	\$78.65
R18X48S4	40	\$74.87
R18X48S5	50	\$71.31
R18X48S6	60	\$67.91
R18X48S8	80	\$64.06
R18X48S10	100	\$60.97
R18X48S12	120	\$60.97
R18X48S15	150	\$60.97
R18X48S18	180	\$60.97
R18X48S22	220	\$60.97
R18X48S32	320	\$60.97
R18X48S40	400	\$60.97
R18X48S50	500	\$60.97
R18X48S60	600	\$60.97
R18X48S80	800	\$60.97

16" x 48" Sanding Belts
4 Belts/Pack, Silicon Carbide
Closed Coat
Resin Bond Polyester Backing



Tool No.	Grit	Weight	Price
S18X48S2	24	Y	\$90.44
S18X48S3	36	Y	\$86.13
S18X48S4	40	Y	\$81.99
S18X48S5	50	Y	\$78.10
S18X48S6	60	Y	\$74.38
S18X48S8	80	Y	\$70.15
S18X48S10	100	X	\$66.78
S18X48S12	120	X	\$66.78
S18X48S15	150	X	\$66.78
S18X48S18	180	X	\$66.78
S18X48S22	220	X	\$66.78
S18X48S32	320	X	\$66.78
S18X48S40	400	X	\$66.78
S18X48S60	600	X	\$66.78

25" x 48" Sanding Belts
4 Belts/Pack, Aluminum Oxide
F-weight, Closed Coat
Resin Paper Backing



Tool No.	Grit	Price
E25X48S8	80	\$50.27
E25X48S10	100	\$47.78
E25X48S12	120	\$47.78
E25X48S15	150	\$47.78
E25X48S18	180	\$47.78
E25X48S22	220	\$47.78
E25X48S32	320	\$47.78

25" x 48" Sanding Belts
4 Belts/Pack, Aluminum Oxide
X-weight, Closed Coat
Resin Bond Poly-Cotton Backing

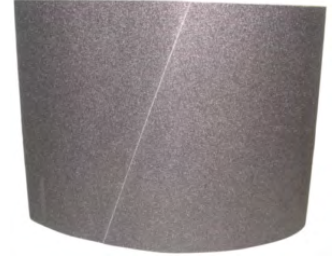

Tool No.	Grit	Price
R25X48S2	24	\$115.84
R25X48S3	36	\$110.37
R25X48S4	40	\$105.12
R25X48S5	50	\$100.10
R25X48S6	60	\$95.31
R25X48S8	80	\$89.13
R25X48S10	100	\$85.12
R25X48S12	120	\$85.12
R25X48S15	150	\$85.12
R25X48S18	180	\$85.12
R25X48S22	220	\$85.12
R25X48S32	320	\$85.12
R25X48S40	400	\$85.12
R25X48S50	500	\$85.12
R25X48S60	600	\$85.12
R25X48S80	800	\$85.12

18" x 48" Sanding Belts
4 Belts/Pack, Aluminum Oxide
Y-weight, Open Coat
Resin Bond Polyester Backing



Tool No.	Grit	Price
W18X48S2	24	\$86.51
W18X48S3	36	\$82.39
W18X48S4	40	\$78.42
W18X48S5	50	\$74.71
W18X48S6	60	\$71.15
W18X48S8	80	\$67.11
W18X48S10	100	\$63.87
W18X48S12	120	\$63.87
W18X48S15	150	\$63.87
W18X48S18	180	\$63.87
W18X48S22	220	\$63.87

25" x 48" Sanding Belts
4 Belts/Pack, Aluminum Oxide
F-weight, Open Coat
Resin Paper Backing



Tool No.	Grit	Price
P25X48S8	80	\$50.27
P25X48S10	100	\$47.78
P25X48S12	120	\$47.78
P25X48S15	150	\$47.78
P25X48S18	180	\$47.78
P25X48S22	220	\$47.78
P25X48S32	320	\$47.78

25" x 48" Sanding Belts
4 Belts/Pack, Aluminum Oxide
X-weight, Open Coat
Resin Bond Poly-Cotton Backing



Tool No.	Grit	Price
K25X48S2	24	\$110.32
K25X48S3	36	\$105.11
K25X48S4	40	\$100.11
K25X48S5	50	\$95.33
K25X48S6	60	\$90.77
K25X48S8	80	\$84.89
K25X48S10	100	\$81.07
K25X48S12	120	\$81.07
K25X48S15	150	\$81.07
K25X48S18	180	\$81.07

25" x 48" Sanding Belts
4 Belts/Pack, Aluminum Oxide
Y-weight, Open Coat
Resin Bond Polyester Backing

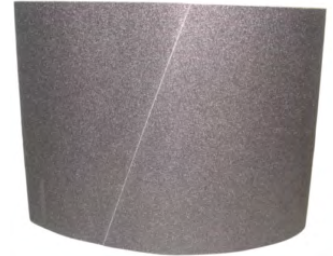

Tool No.	Grit	Price
W25X48S2	24	\$121.35
W25X48S3	36	\$115.62
W25X48S4	40	\$110.11
W25X48S5	50	\$104.86
W25X48S6	60	\$99.86
W25X48S8	80	\$93.39
W25X48S10	100	\$89.18
W25X48S12	120	\$89.18
W25X48S15	150	\$89.18
W25X48S18	180	\$89.18
W25X48S22	220	\$89.18



25" x 48" Sanding Belts
4 Belts/Pack, Zirconia Alumina
Closed Coat, Y-weight
Resin Bond Polyester Backing



Tool No.	Grit	Price
Z25X48S2	24	\$173.23
Z25X48S3	36	\$161.84
Z25X48S4	40	\$156.88
Z25X48S5	50	\$152.59
Z25X48S6	60	\$146.83
Z25X48S8	80	\$142.63
Z25X48S10	100	\$139.77
Z25X48S12	120	\$139.72

25" x 48" Sanding Belts
4 Belts/Pack, Silicon Carbide
Closed Coat
Resin Bond Polyester Backing



Tool No.	Grit	Weight	Price
S25X48S2	24	Y	\$126.87
S25X48S3	36	Y	\$120.87
S25X48S4	40	Y	\$115.12
S25X48S5	50	Y	\$109.63
S25X48S6	60	Y	\$104.38
S25X48S8	80	Y	\$97.63
S25X48S10	100	X	\$93.23
S25X48S12	120	X	\$93.23
S25X48S15	150	X	\$93.23
S25X48S18	180	X	\$93.23
S25X48S22	220	X	\$93.23
S25X48S32	320	X	\$93.23
S25X48S40	400	X	\$93.23
S25X48S60	600	X	\$93.23

25" x 60" Sanding Belts
4 Belts/Pack, Aluminum Oxide
F-weight, Open Coat
Resin Paper Backing

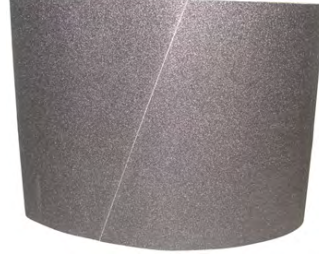

Tool No.	Grit	Price
P25X60S8	80	\$62.84
P25X60S10	100	\$59.76
P25X60S12	120	\$59.76
P25X60S15	150	\$59.76
P25X60S18	180	\$59.76
P25X60S22	220	\$59.76
P25X60S32	320	\$59.76

25" x 60" Sanding Belts
4 Belts/Pack, Aluminum Oxide
F-weight, Closed Coat
Resin Paper Backing



Tool No.	Grit	Price
E25X60S8	80	\$62.84
E25X60S10	100	\$59.76
E25X60S12	120	\$59.76
E25X60S15	150	\$59.76
E25X60S18	180	\$59.76
E25X60S22	220	\$59.76
E25X60S32	320	\$59.76

25" x 60" Sanding Belts
4 Belts/Pack, Aluminum Oxide
X-weight, Open Coat
Resin Bond Poly-Cotton Backing



Tool No.	Grit	Price
K25X60S2	24	\$132.23
K25X60S3	36	\$125.91
K25X60S4	40	\$119.95
K25X60S5	50	\$114.22
K25X60S6	60	\$108.78
K25X60S8	80	\$101.43
K25X60S10	100	\$97.02
K25X60S12	120	\$97.02
K25X60S15	150	\$97.02
K25X60S18	180	\$97.02

25" x 60" Sanding Belts
4 Belts/Pack, Aluminum Oxide
X-weight, Closed Coat
Resin Bond Poly-Cotton Backing



Tool No.	Grit	Price
R25X60S2	24	\$138.84
R25X60S3	36	\$132.21
R25X60S4	40	\$125.95
R25X60S5	50	\$119.93
R25X60S6	60	\$114.22
R25X60S8	80	\$106.50
R25X60S10	100	\$101.87
R25X60S12	120	\$101.87
R25X60S15	150	\$101.87
R25X60S18	180	\$101.87
R25X60S22	220	\$101.87
R25X60S32	320	\$101.87
R25X60S40	400	\$101.87
R25X60S50	500	\$101.87
R25X60S60	600	\$101.87
R25X60S80	800	\$101.87

25" x 60" Sanding Belts
4 Belts/Pack, Aluminum Oxide
Y-weight, Open Coat
Resin Bond Polyester Backing

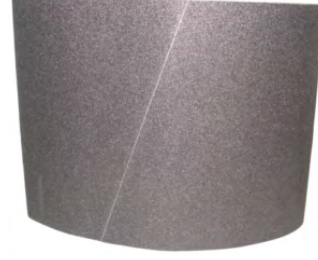

Tool No.	Grit	Price
W25X60S2	24	\$145.46
W25X60S3	36	\$138.50
W25X60S4	40	\$131.94
W25X60S5	50	\$125.64
W25X60S6	60	\$119.66
W25X60S8	80	\$111.57
W25X60S10	100	\$106.72
W25X60S12	120	\$106.72
W25X60S15	150	\$106.72
W25X60S18	180	\$106.72
W25X60S22	220	\$106.72

25" x 60" Sanding Belts
4 Belts/Pack, Silicon Carbide
Closed Coat
Resin Bond Polyester Backing

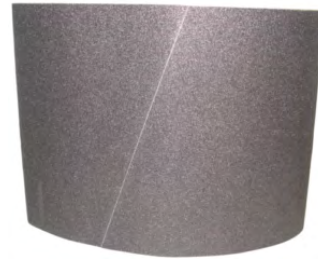

Tool No.	Grit	Weight	Price
S25X60S2	24	Y	\$152.06
S25X60S3	36	Y	\$144.80
S25X60S4	40	Y	\$137.95
S25X60S5	50	Y	\$131.36
S25X60S6	60	Y	\$125.10
S25X60S8	80	Y	\$116.64
S25X60S10	100	X	\$111.57
S25X60S12	120	X	\$111.57
S25X60S15	150	X	\$111.57
S25X60S18	180	X	\$111.57
S25X60S22	220	X	\$111.57
S25X60S32	320	X	\$111.57
S25X60S40	400	X	\$111.57
S25X60S50	500	X	\$111.57
S25X60S60	600	X	\$111.57



25" x 75" Sanding Belts
4 Belts/Pack, Aluminum Oxide
F-weight, Open Coat
Resin Paper Backing



Tool No.	Grit	Price
P25X75S8	80	\$78.50
P25X75S10	100	\$74.38
P25X75S12	120	\$74.38
P25X75S15	150	\$74.38
P25X75S18	180	\$74.38
P25X75S22	220	\$74.38
P25X75S32	320	\$74.38

25" x 75" Sanding Belts
4 Belts/Pack, Aluminum Oxide
X-weight, Open Coat
Resin Bond Poly-Cotton Backing



Tool No.	Grit	Price
K25X75S2	24	\$164.42
K25X75S3	36	\$156.56
K25X75S4	40	\$149.13
K25X75S5	50	\$142.00
K25X75S6	60	\$135.24
K25X75S8	80	\$126.79
K25X75S10	100	\$120.91
K25X75S12	120	\$120.91
K25X75S15	150	\$120.91
K25X75S18	180	\$120.91

25" x 75" Sanding Belts
4 Belts/Pack, Aluminum Oxide
Y-weight, Open Coat
Resin Bond Polyester Backing

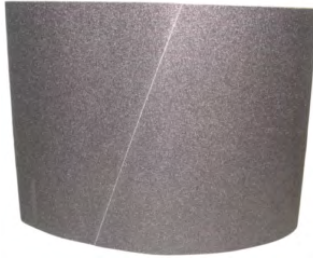

Tool No.	Grit	Price
W25X75S2	24	\$180.86
W25X75S3	36	\$172.21
W25X75S4	40	\$164.04
W25X75S5	50	\$156.20
W25X75S6	60	\$148.76
W25X75S8	80	\$139.47
W25X75S10	100	\$132.99
W25X75S12	120	\$132.99
W25X75S15	150	\$132.99
W25X75S18	180	\$132.99
W25X75S22	220	\$132.99

30" x 103" Sanding Belts
3 Belts/Pack, Aluminum Oxide
X-weight, Open Coat
Resin Bond Poly-Cotton Backing



Tool No.	Grit	Price
K30X103S2	24	\$186.88
K30X103S3	36	\$178.00
K30X103S4	40	\$169.51
K30X103S5	50	\$161.63
K30X103S6	60	\$153.74
K30X103S8	80	\$143.93
K30X103S10	100	\$137.20
K30X103S12	120	\$137.20
K30X103S15	150	\$137.20
K30X103S18	180	\$137.20

25" x 75" Sanding Belts
4 Belts/Pack, Aluminum Oxide
F-weight, Closed Coat
Resin Paper Backing



Tool No.	Grit	Price
E25X75S8	80	\$78.50
E25X75S10	100	\$74.38
E25X75S12	120	\$74.38
E25X75S15	150	\$74.38
E25X75S18	180	\$74.38
E25X75S22	220	\$74.38
E25X75S32	320	\$74.38

25" x 75" Sanding Belts
4 Belts/Pack, Aluminum Oxide
X-weight, Closed Coat
Resin Bond Poly-Cotton Backing

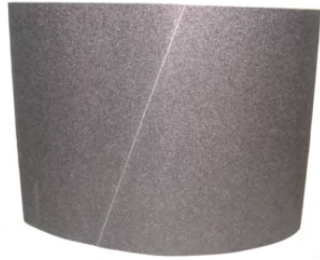

Tool No.	Grit	Price
R25X75S2	24	\$172.64
R25X75S3	36	\$164.39
R25X75S4	40	\$156.59
R25X75S5	50	\$149.10
R25X75S6	60	\$142.00
R25X75S8	80	\$133.13
R25X75S10	100	\$126.96
R25X75S12	120	\$126.96
R25X75S15	150	\$126.96
R25X75S18	180	\$126.96
R25X75S22	220	\$126.96
R25X75S32	320	\$126.96
R25X75S40	400	\$126.96
R25X75S50	500	\$126.96
R25X75S60	600	\$126.96
R25X75S80	800	\$126.96

25" x 75" Sanding Belts
4 Belts/Pack, Silicon Carbide
Closed Coat
Resin Bond Polyester Backing

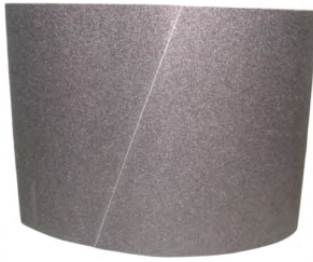

Tool No.	Grit	Weight	Price
S25X75S2	24	Y	\$189.08
S25X75S3	36	Y	\$180.04
S25X75S4	40	Y	\$171.51
S25X75S5	50	Y	\$163.31
S25X75S6	60	Y	\$155.53
S25X75S8	80	Y	\$145.80
S25X75S10	100	X	\$139.05
S25X75S12	120	X	\$139.05
S25X75S15	150	X	\$139.05
S25X75S18	180	X	\$139.05
S25X75S22	220	X	\$139.05
S25X75S32	320	X	\$139.05
S25X75S40	400	X	\$139.05
S25X75S60	600	X	\$139.05

30" x 103" Sanding Belts
3 Belts/Pack, Aluminum Oxide
X-weight, Closed Coat
Resin Bond Poly-Cotton Backing

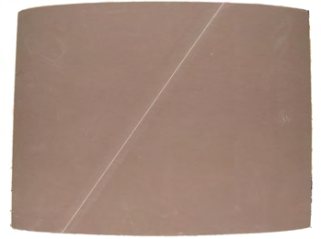

Tool No.	Grit	Price
R30X103S2	24	\$196.22
R30X103S3	36	\$186.90
R30X103S4	40	\$177.99
R30X103S5	50	\$169.71
R30X103S6	60	\$161.43
R30X103S8	80	\$151.13
R30X103S10	100	\$144.06
R30X103S12	120	\$144.06
R30X103S15	150	\$144.06
R30X103S18	180	\$144.06
R30X103S22	220	\$144.06
R30X103S32	320	\$144.06
R30X103S40	400	\$144.06
R30X103S50	500	\$144.06
R30X103S60	600	\$144.06
R30X103S80	800	\$144.06



30" x 103" Sanding Belts
3 Belts/Pack, Aluminum Oxide
Y-weight, Open Coat
Resin Bond Polyester Backing



Tool No.	Grit	Price
W30X103S2	24	\$205.56
W30X103S3	36	\$195.80
W30X103S4	40	\$186.47
W30X103S5	50	\$177.79
W30X103S6	60	\$169.12
W30X103S8	80	\$158.33
W30X103S10	100	\$150.94
W30X103S12	120	\$150.94
W30X103S15	150	\$150.94
W30X103S18	180	\$150.94
W30X103S22	220	\$150.94

36" x 75" Sanding Belts
3 Belts/Pac, Aluminum Oxide
F-weight, Open Coat
Resin Paper Backing



Tool No.	Grit	Price
P36X75S8	80	\$105.01
P36X75S10	100	\$99.17
P36X75S12	120	\$99.17
P36X75S15	150	\$99.17
P36X75S18	180	\$99.17
P36X75S22	220	\$99.17
P36X75S32	320	\$99.17

36" x 75" Sanding Belts
3 Belts/Pack, Aluminum Oxide
X-weight, Open Coat
Resin Bond Poly-Cotton Backing



Tool No.	Grit	Price
K36X75S2	24	\$163.44
K36X75S3	36	\$155.73
K36X75S4	40	\$148.29
K36X75S5	50	\$141.24
K36X75S6	60	\$134.51
K36X75S8	80	\$125.69
K36X75S10	100	\$119.90
K36X75S12	120	\$119.90
K36X75S15	150	\$119.90
K36X75S18	180	\$119.90

36" x 75" Sanding Belts
3 Belts/Pack, Aluminum Oxide
Y-weight, Open Coat
Resin Bond Polyester Backing



Tool No.	Grit	Price
W36X75S2	24	\$179.79
W36X75S3	36	\$171.31
W36X75S4	40	\$163.12
W36X75S5	50	\$155.36
W36X75S6	60	\$147.96
W36X75S8	80	\$138.25
W36X75S10	100	\$131.89
W36X75S12	120	\$131.89
W36X75S15	150	\$131.89
W36X75S18	180	\$131.89
W36X75S22	220	\$131.89

30" x 103" Sanding Belts
3 Belts/Pack, Silicon Carbide
Closed Coat
Resin Bond Polyester Backing



Tool No.	Grit	Weight	Price
S30X103S2	24	Y	\$214.91
S30X103S3	36	Y	\$204.70
S30X103S4	40	Y	\$194.93
S30X103S5	50	Y	\$185.87
S30X103S6	60	Y	\$176.81
S30X103S8	80	Y	\$165.52
S30X103S10	100	Y	\$157.79
S30X103S12	120	Y	\$157.79
S30X103S15	150	X	\$157.79
S30X103S18	180	X	\$157.79
S30X103S22	220	X	\$157.79
S30X103S32	320	X	\$157.79
S30X103S40	400	X	\$157.79
S30X103S60	600	X	\$157.79

36" x 75" Sanding Belts
3 Belts/Pack, Aluminum Oxide
F-weight, Closed Coat
Resin Paper Backing



Tool No.	Grit	Price
E36X75S8	80	\$105.01
E36X75S10	100	\$99.17
E36X75S12	120	\$99.17
E36X75S15	150	\$99.17
E36X75S18	180	\$99.17
E36X75S22	220	\$99.17
E36X75S32	320	\$99.17

36" x 75" Sanding Belts
3 Belts/Pack, Aluminum Oxide
X-weight, Closed Coat
Resin Bond Poly-Cotton Backing



Tool No.	Grit	Price
R36X75S2	24	\$171.61
R36X75S3	36	\$163.52
R36X75S4	40	\$155.70
R36X75S5	50	\$148.30
R36X75S6	60	\$141.24
R36X75S8	80	\$131.97
R36X75S10	100	\$125.90
R36X75S12	120	\$125.90
R36X75S15	150	\$125.90
R36X75S18	180	\$125.90
R36X75S22	220	\$125.90
R36X75S32	320	\$125.90
R36X75S40	400	\$125.90
R36X75S50	500	\$125.90
R36X75S60	600	\$125.90
R36X75S80	800	\$125.90

36" x 75" Sanding Belts
3 Belts/Pack, Zirconia Alumina
Closed Coat, Y-weight
Resin Bond Polyester Backing



Tool No.	Grit	Price
Z36X75S2	24	\$182.38
Z36X75S3	36	\$174.26
Z36X75S4	40	\$167.38
Z36X75S5	50	\$159.43
Z36X75S6	60	\$151.68
Z36X75S8	80	\$142.56
Z36X75S10	100	\$134.97
Z36X75S12	120	\$134.97



36" x 75" Sanding Belts 3 Belts/Pack, Silicon Carbide Closed Coat Resin Bond Polyester Backing			
			
Tool No.	Grit	Weight	Price
S36X75S2	24	Y	\$187.96
S36X75S3	36	Y	\$179.09
S36X75S4	40	Y	\$170.53
S36X75S5	50	Y	\$162.42
S36X75S6	60	Y	\$154.69
S36X75S8	80	Y	\$144.54
S36X75S10	100	X	\$137.88
S36X75S12	120	X	\$137.88
S36X75S15	150	X	\$137.88
S36X75S18	180	X	\$137.88
S36X75S22	220	X	\$137.88
S36X75S32	320	X	\$137.88
S36X75S40	400	X	\$137.88
S36X75S60	600	X	\$137.88

37" x 60" Sanding Belts 3 Belts/Pack, Aluminum Oxide F-weight, Open Coat Resin Paper Backing		
		
Tool No.	Grit	Price
P37X60S8	80	\$86.38
P37X60S10	100	\$81.59
P37X60S12	120	\$81.59
P37X60S15	150	\$81.59
P37X60S18	180	\$81.59
P37X60S22	220	\$81.59
P37X60S32	320	\$81.59

37" x 60" Sanding Belts 3 Belts/Pack, Aluminum Oxide X-weight, Open Coat Resin Bond Poly-Cotton Backing		
		
Tool No.	Grit	Price
K37X60S2	24	\$130.76
K37X60S3	36	\$124.58
K37X60S4	40	\$118.63
K37X60S5	50	\$113.01
K37X60S6	60	\$107.60
K37X60S8	80	\$100.55
K37X60S10	100	\$95.92
K37X60S12	120	\$95.92
K37X60S15	150	\$95.92
K37X60S18	180	\$95.92

37" x 60" Sanding Belts 3 Belts/Pack, Aluminum Oxide, Y-weight, Open Coat Resin Bond Polyester Backing		
		
Tool No.	Grit	Price
W37X60S2	24	\$143.83
W37X60S3	36	\$137.05
W37X60S4	40	\$130.49
W37X60S5	50	\$124.31
W37X60S6	60	\$118.37
W37X60S8	80	\$110.61
W37X60S10	100	\$105.51
W37X60S12	120	\$105.51
W37X60S15	150	\$105.51
W37X60S18	180	\$105.51
W37X60S22	220	\$105.51

37" x 60" Sanding Belts 3 Belts/Pack, Aluminum Oxide F-weight, Closed Coat Resin Paper Backing		
		
Tool No.	Grit	Price
E37X60S8	80	\$86.38
E37X60S10	100	\$81.59
E37X60S12	120	\$81.59
E37X60S15	150	\$81.59
E37X60S18	180	\$81.59
E37X60S22	220	\$81.59
E37X60S32	320	\$81.59

37" x 60" Sanding Belts 3 Belts/Pack, Aluminum Oxide X-weight, Closed Coat Resin Bond Poly-Cotton Backing		
		
Tool No.	Grit	Price
R37X60S2	24	\$137.30
R37X60S3	36	\$130.81
R37X60S4	40	\$124.56
R37X60S5	50	\$118.66
R37X60S6	60	\$112.98
R37X60S8	80	\$105.58
R37X60S10	100	\$100.72
R37X60S12	120	\$100.72
R37X60S15	150	\$100.72
R37X60S18	180	\$100.72
R37X60S22	220	\$100.72
R37X60S32	320	\$100.72
R37X60S40	400	\$100.72
R37X60S50	500	\$100.72
R37X60S60	600	\$100.72
R37X60S80	800	\$100.72

36" x 84" Sanding Belts 3 Belts/Pack, Aluminum Oxide X-weight, Open Coat Resin Bond Poly-Cotton Backing		
		
Tool No.	Grit	Price
K36X84S2	24	\$183.06
K36X84S3	36	\$174.42
K36X84S4	40	\$166.08
K36X84S5	50	\$158.17
K36X84S6	60	\$150.64
K36X84S8	80	\$140.76
K36X84S10	100	\$134.28
K36X84S12	120	\$134.28
K36X84S15	150	\$134.28
K36X84S18	180	\$134.28

16" x 48" Sanding Belts 4 Belts/Pack, Silicon Carbide Closed Coat Resin Bond Polyester Backing			
			
Tool No.	Grit	Weight	Price
S37X60S2	24	Y	\$153.48
S37X60S3	36	Y	\$147.58
S37X60S4	40	Y	\$140.57
S37X60S5	50	Y	\$133.86
S37X60S6	60	Y	\$127.53
S37X60S8	80	Y	\$119.44
S37X60S10	100	X	\$113.81
S37X60S12	120	X	\$113.81
S37X60S15	150	X	\$113.81
S37X60S18	180	X	\$113.81
S37X60S22	220	X	\$113.81
S37X60S32	320	X	\$113.81
S37X60S40	400	X	\$113.81
S37X60S60	600	X	\$113.81



37" x 75" Sanding Belts
3 Belts/Pack, Aluminum Oxide
F-weight, Open Coat
Resin Paper Backing



Tool No.	Grit	Belts/Pkg	Price
P37X75S8	80	3	\$105.29
P37X75S10	100	3	\$99.78
P37X75S12	120	3	\$99.78
P37X75S15	150	3	\$99.78
P37X75S18	180	3	\$99.78
P37X75S22	220	3	\$99.78
P37X75S32	320	3	\$99.78

37" x 75" Sanding Belts
3 Belts/Pack, Aluminum Oxide
X-weight, Open Coat
Resin Bond Poly-Cotton Backing



Tool No.	Grit	Price
K37X75S2	24	\$167.31
K37X75S3	36	\$160.14
K37X75S4	40	\$152.53
K37X75S5	50	\$145.26
K37X75S6	60	\$138.37
K37X75S8	80	\$129.55
K37X75S10	100	\$123.48
K37X75S12	120	\$123.48
K37X75S15	150	\$123.48
K37X75S18	180	\$123.48

37" x 75" Sanding Belts
3 Belts/Pack, Aluminum Oxide
Y-weight, Open Coat
Resin Bond Polyester Backing



Tool No.	Grit	Price
W37X75S2	24	\$184.04
W37X75S3	36	\$176.16
W37X75S4	40	\$167.79
W37X75S5	50	\$159.79
W37X75S6	60	\$152.20
W37X75S8	80	\$142.50
W37X75S10	100	\$135.83
W37X75S12	120	\$135.83
W37X75S15	150	\$135.83
W37X75S18	180	\$135.83
W37X75S22	220	\$135.83

37" x 103" Sanding Belts
3 Belts/Pack, Aluminum Oxide
F-weight, Open Coat
Resin Paper Backing



Tool No.	Grit	Belts/Pkg	Price
P37X103S8	80	3	\$148.34
P37X103S10	100	3	\$140.07
P37X103S12	120	3	\$140.07
P37X103S15	150	3	\$140.07
P37X103S18	180	3	\$140.07
P37X103S22	220	3	\$140.07
P37X103S32	320	3	\$140.07

37" x 75" Sanding Belts
3 Belts/Pack, Aluminum Oxide
F-weight, Closed Coat
Resin Paper Backing



Tool No.	Grit	Price
E37X75S8	80	\$105.29
E37X75S10	100	\$99.78
E37X75S12	120	\$99.78
E37X75S15	150	\$99.78
E37X75S18	180	\$99.78
E37X75S22	220	\$99.78
E37X75S32	320	\$99.78

37" x 75" Sanding Belts
3 Belts/Pack, Aluminum Oxide
X-weight, Closed Coat
Resin Bond Poly-Cotton Backing



Tool No.	Grit	Price
R37X75S2	24	\$175.68
R37X75S3	36	\$168.15
R37X75S4	40	\$160.16
R37X75S5	50	\$152.52
R37X75S6	60	\$145.29
R37X75S8	80	\$136.03
R37X75S10	100	\$129.65
R37X75S12	120	\$129.65
R37X75S15	150	\$129.65
R37X75S18	180	\$129.65
R37X75S22	220	\$129.65
R37X75S32	320	\$129.65
R37X75S40	400	\$129.65
R37X75S50	500	\$129.65
R37X75S60	600	\$129.65
R37X75S80	800	\$129.65

37" x 75" Sanding Belts
3 Belts/Pack, Silicon Carbide
Closed Coat
Resin Bond Polyester Backing



Tool No.	Grit	Weight	Price
S37X75S2	24	Y	\$192.40
S37X75S3	36	Y	\$184.16
S37X75S4	40	Y	\$175.41
S37X75S5	50	Y	\$167.04
S37X75S6	60	Y	\$159.13
S37X75S8	80	Y	\$148.98
S37X75S10	100	X	\$142.00
S37X75S12	120	X	\$142.00
S37X75S15	150	X	\$142.00
S37X75S18	180	X	\$142.00
S37X75S22	220	X	\$142.00
S37X75S32	320	X	\$142.00
S37X75S40	400	X	\$142.00
S37X75S60	600	X	\$142.00

37" x 103" Sanding Belts
3 Belts/Pack, Aluminum Oxide
F-weight, Closed Coat
Resin Paper Backing



Tool No.	Grit	Price
E37X103S8	80	\$148.34
E37X103S10	100	\$140.07
E37X103S12	120	\$140.07
E37X103S15	150	\$140.07
E37X103S18	180	\$140.07
E37X103S22	220	\$140.07
E37X103S32	320	\$140.07



37" x 103" Sanding Belts
3 Belts/Pack, Aluminum Oxide
X-weight, Open Coat
Resin Bond Poly-Cotton Backing



Tool No.	Grit	Price
K37X103S2	24	\$230.48
K37X103S3	36	\$219.51
K37X103S4	40	\$209.09
K37X103S5	50	\$199.11
K37X103S6	60	\$189.63
K37X103S8	80	\$177.50
K37X103S10	100	\$169.24
K37X103S12	120	\$169.24
K37X103S15	150	\$169.24
K37X103S18	180	\$169.24

37" x 103" Sanding Belts
3 Belts/Pack, Aluminum Oxide
Y-weight, Open Coat
Resin Bond Polyester Backing



Tool No.	Grit	Price
W37X103S2	24	\$253.53
W37X103S3	36	\$241.46
W37X103S4	40	\$230.00
W37X103S5	50	\$219.02
W37X103S6	60	\$208.59
W37X103S8	80	\$195.26
W37X103S10	100	\$186.15
W37X103S12	120	\$186.15
W37X103S15	150	\$186.15
W37X103S18	180	\$186.15
W37X103S22	220	\$186.15

42" x 75" Sanding Belts
3 Belts/Pack, Aluminum Oxide
X-weight, Open Coat
Resin Bond Poly-Cotton Backing



Tool No.	Grit	Price
K42X75S2	24	\$190.95
K42X75S3	36	\$181.86
K42X75S4	40	\$173.21
K42X75S5	50	\$164.99
K42X75S6	60	\$157.11
K42X75S8	80	\$146.63
K42X75S10	100	\$140.02
K42X75S12	120	\$140.02
K42X75S15	150	\$140.02
K42X75S18	180	\$140.02

43" x 60" Sanding Belts
3 Belts/Pack, Aluminum Oxide
X-weight, Open Coat
Resin Bond Poly-Cotton Backing



Tool No.	Grit	Price
K43X60S2	24	\$153.97
K43X60S3	36	\$146.68
K43X60S4	40	\$139.67
K43X60S5	50	\$133.04
K43X60S6	60	\$126.69
K43X60S8	80	\$118.40
K43X60S10	100	\$113.18
K43X60S12	120	\$113.18
K43X60S15	150	\$113.18
K43X60S18	180	\$113.18

37" x 103" Sanding Belts
3 Belts/Pack, Aluminum Oxide
X-weight, Closed Coat
Resin Bond Poly-Cotton Backing



Tool No.	Grit	Price
R37X103S2	24	\$242.00
R37X103S3	36	\$230.49
R37X103S4	40	\$219.54
R37X103S5	50	\$209.07
R37X103S6	60	\$199.11
R37X103S8	80	\$186.38
R37X103S10	100	\$177.70
R37X103S12	120	\$177.70
R37X103S15	150	\$177.70
R37X103S18	180	\$177.70
R37X103S22	220	\$177.70
R37X103S32	320	\$177.70
R37X103S40	400	\$177.70
R37X103S50	500	\$177.70
R37X103S60	600	\$177.70
R37X103S80	800	\$177.70

37" x 103" Sanding Belts
3 Belts/Pack, Silicon Carbide
Closed Coat
Resin Bond Polyester Backing



Tool No.	Grit	Weight	Price
S37X103S2	24	Y	\$265.05
S37X103S3	36	Y	\$252.44
S37X103S4	40	Y	\$240.46
S37X103S5	50	Y	\$228.97
S37X103S6	60	Y	\$218.07
S37X103S8	80	Y	\$204.13
S37X103S10	100	Y	\$194.63
S37X103S12	120	Y	\$194.63
S37X103S15	150	X	\$194.63
S37X103S18	180	X	\$194.63
S37X103S22	220	X	\$194.63
S37X103S32	320	X	\$194.63
S37X103S40	400	X	\$194.63
S37X103S60	600	X	\$194.63

42" x 75" Sanding Belts
3 Belts/Pack, Aluminum Oxide
X-weight, Closed Coat
Resin Bond Poly-Cotton Backing



Tool No.	Grit	Price
R42X75S2	24	\$200.50
R42X75S3	36	\$190.95
R42X75S4	40	\$181.87
R42X75S5	50	\$173.24
R42X75S6	60	\$164.97
R42X75S8	80	\$153.96
R42X75S10	100	\$147.02
R42X75S12	120	\$147.02
R42X75S15	150	\$147.02
R42X75S18	180	\$147.02
R42X75S22	220	\$147.02
R42X75S32	320	\$147.02
R42X75S40	400	\$147.02
R42X75S50	500	\$147.02
R42X75S60	600	\$147.02
R42X75S80	800	\$147.02

43" x 60" Sanding Belts
3 Belts/Pack, Aluminum Oxide
X-weight, Closed Coat
Resin Bond Poly-Cotton Backing



Tool No.	Grit	Price
R43X60S2	24	\$153.97
R43X60S3	36	\$146.68
R43X60S4	40	\$139.67
R43X60S5	50	\$133.04
R43X60S6	60	\$126.69
R43X60S8	80	\$118.40
R43X60S10	100	\$113.18
R43X60S12	120	\$113.18
R43X60S15	150	\$113.18
R43X60S18	180	\$113.18
R43X60S22	220	\$113.18
R43X60S32	320	\$113.18
R43X60S40	400	\$113.18



43" x 75" Sanding Belts
3 Belts/Pack, Aluminum Oxide
F-weight, Open Coat
Resin Paper Backing

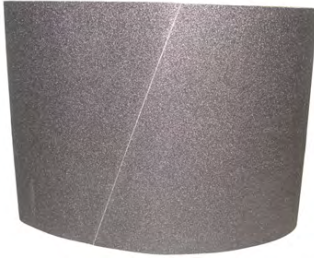

Tool No.	Grit	Price
P43X75S8	80	\$125.63
P43X75S10	100	\$118.58
P43X75S12	120	\$118.58
P43X75S15	150	\$118.58
P43X75S18	180	\$118.58
P43X75S22	220	\$118.58
P43X75S32	320	\$118.58

43" x 75" Sanding Belts
3 Belts/Pack, Aluminum Oxide
X-weight, Open Coat
Resin Bond Poly-Cotton Backing



Tool No.	Grit	Price
K43X75S2	24	\$194.97
K43X75S3	36	\$185.71
K43X75S4	40	\$176.84
K43X75S5	50	\$168.41
K43X75S6	60	\$160.42
K43X75S8	80	\$149.94
K43X75S10	100	\$143.60
K43X75S12	120	\$143.60
K43X75S15	150	\$143.60
K43X75S18	180	\$143.60

43" x 75" Sanding Belts
3 Belts/Pack, Aluminum Oxide
Y-weight, Open Coat
Resin Bond Polyester Backing



Tool No.	Grit	Price
W43X75S2	24	\$214.48
W43X75S3	36	\$204.30
W43X75S4	40	\$194.52
W43X75S5	50	\$185.25
W43X75S6	60	\$176.45
W43X75S8	80	\$164.93
W43X75S10	100	\$157.96
W43X75S12	120	\$157.96
W43X75S15	150	\$157.96
W43X75S18	180	\$157.96
W43X75S22	220	\$157.96

43" x 103" Sanding Belts
3 Belts/Pack, Aluminum Oxide
X-weight, Open Coat
Resin Bond Poly-Cotton Backing



Tool No.	Grit	Price
K43X103S2	24	\$268.02
K43X103S3	36	\$255.23
K43X103S4	40	\$243.11
K43X103S5	50	\$231.53
K43X103S6	60	\$220.50
K43X103S8	80	\$206.17
K43X103S10	100	\$197.07
K43X103S12	120	\$197.07
K43X103S15	150	\$197.07
K43X103S18	180	\$197.07

43" x 75" Sanding Belts
3 Belts/Pack, Aluminum Oxide
F-weight, Closed Coat
Resin Paper Backing



Tool No.	Grit	Price
E43X75S8	80	\$125.63
E43X75S10	100	\$118.58
E43X75S12	120	\$118.58
E43X75S15	150	\$118.58
E43X75S18	180	\$118.58
E43X75S22	220	\$118.58
E43X75S32	320	\$118.58

43" x 75" Sanding Belts
3 Belts/Pack, Aluminum Oxide
X-weight, Closed Coat
Resin Bond Poly-Cotton Backing



Tool No.	Grit	Price
R43X75S2	24	\$204.72
R43X75S3	36	\$195.00
R43X75S4	40	\$185.68
R43X75S5	50	\$176.83
R43X75S6	60	\$168.44
R43X75S8	80	\$157.44
R43X75S10	100	\$150.78
R43X75S12	120	\$150.78
R43X75S15	150	\$150.78
R43X75S18	180	\$150.78
R43X75S22	220	\$150.78
R43X75S32	320	\$150.78
R43X75S40	400	\$150.78
R43X75S50	500	\$150.78
R43X75S60	600	\$150.78
R43X75S80	800	\$150.78

43" x 75" Sanding Belts
3 Belts/Pack, Silicon Carbide
Closed Coat
Resin Bond Polyester Backing

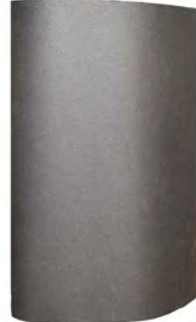

Tool No.	Grit	Weight	Price
S43X75S2	24	Y	\$224.23
S43X75S3	36	Y	\$213.58
S43X75S4	40	Y	\$203.36
S43X75S5	50	Y	\$193.66
S43X75S6	60	Y	\$184.49
S43X75S8	80	Y	\$172.43
S43X75S10	100	X	\$165.14
S43X75S12	120	X	\$165.14
S43X75S15	150	X	\$165.14
S43X75S18	180	X	\$165.14
S43X75S22	220	X	\$165.14
S43X75S32	320	X	\$165.14
S43X75S40	400	X	\$165.14
S43X75S60	600	X	\$165.14

43" x 103" Sanding Belts
3 Belts/Pack, Aluminum Oxide
X-weight, Closed Coat
Resin Bond Poly-Cotton Backing



Tool No.	Grit	Price
R43X103S2	24	\$281.42
R43X103S3	36	\$267.99
R43X103S4	40	\$255.27
R43X103S5	50	\$243.11
R43X103S6	60	\$231.53
R43X103S8	80	\$216.48
R43X103S10	100	\$206.92
R43X103S12	120	\$206.92
R43X103S15	150	\$206.92
R43X103S18	180	\$206.92
R43X103S22	220	\$206.92
R43X103S32	320	\$206.92
R43X103S40	400	\$206.92
R43X103S50	500	\$206.92
R43X103S60	600	\$206.92
R43X103S80	800	\$206.92



52" x 75" Sanding Belts
3 Belts/Pack, Aluminum Oxide
F-weight, Open Coat
Resin Paper Backing



Tool No.	Grit	Price
P52X75S8	80	\$151.98
P52X75S10	100	\$143.33
P52X75S12	120	\$143.33
P52X75S15	150	\$143.33
P52X75S18	180	\$143.33
P52X75S22	220	\$143.33
P52X75S32	320	\$143.33

52" x 75" Sanding Belts
3 Belts/Pack, Aluminum Oxide
X-weight, Open Coat
Resin Bond Poly-Cotton Backing



Tool No.	Grit	Price
K52X75S2	24	\$236.54
K52X75S3	36	\$225.25
K52X75S4	40	\$214.55
K52X75S5	50	\$204.35
K52X75S6	60	\$194.60
K52X75S8	80	\$181.91
K52X75S10	100	\$173.65
K52X75S12	120	\$173.65
K52X75S15	150	\$173.65
K52X75S18	180	\$173.65

52" x 75" Sanding Belts
3 Belts/Pack, Aluminum Oxide
Y-weight, Open Coat
Resin Bond Polyester Backing



Tool No.	Grit	Price
W52X75S2	24	\$260.20
W52X75S3	36	\$247.77
W52X75S4	40	\$236.00
W52X75S5	50	\$224.78
W52X75S6	60	\$214.05
W52X75S8	80	\$200.11
W52X75S10	100	\$191.01
W52X75S12	120	\$191.01
W52X75S15	150	\$191.01
W52X75S18	180	\$191.01
W52X75S22	220	\$191.01

52" x 103" Sanding Belts
3 Belts/Pack, Aluminum Oxide
F-weight, Open Coat
Resin Paper Backing



Tool No.	Grit	Price
P52X103S8	80	\$208.54
P52X103S10	100	\$196.91
P52X103S12	120	\$196.91
P52X103S15	150	\$196.91
P52X103S18	180	\$196.91
P52X103S22	220	\$196.91
P52X103S32	320	\$196.91

52" x 75" Sanding Belts
3 Belts/Pack, Aluminum Oxide
F-weight, Closed Coat
Resin Paper Backing



Tool No.	Grit	Price
E52X75S8	80	\$151.98
E52X75S10	100	\$143.33
E52X75S12	120	\$143.33
E52X75S15	150	\$143.33
E52X75S18	180	\$143.33
E52X75S22	220	\$143.33
E52X75S32	320	\$143.33

52" x 75" Sanding Belts
3 Belts/Pack, Aluminum Oxide
X-weight, Closed Coat
Resin Bond Poly-Cotton Backing

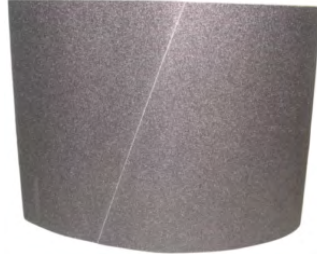

Tool No.	Grit	Price
R52X75S2	24	\$248.37
R52X75S3	36	\$236.51
R52X75S4	40	\$225.28
R52X75S5	50	\$214.57
R52X75S6	60	\$204.33
R52X75S8	80	\$191.01
R52X75S10	100	\$182.33
R52X75S12	120	\$182.33
R52X75S15	150	\$182.33
R52X75S18	180	\$182.33
R52X75S22	220	\$182.33
R52X75S32	320	\$182.33
R52X75S40	400	\$182.33
R52X75S50	500	\$182.33
R52X75S60	600	\$182.33
R52X75S80	800	\$182.33

52" x 75" Sanding Belts
3 Belts/Pack, Silicon Carbide
Closed Coat
Resin Bond Polyester Backing



Tool No.	Grit	Weight	Price
S52X75S2	24	Y	\$272.02
S52X75S3	36	Y	\$259.04
S52X75S4	40	Y	\$246.73
S52X75S5	50	Y	\$235.00
S52X75S6	60	Y	\$223.79
S52X75S8	80	Y	\$209.20
S52X75S10	100	X	\$199.70
S52X75S12	120	X	\$199.70
S52X75S15	150	X	\$199.70
S52X75S18	180	X	\$199.70
S52X75S22	220	X	\$199.70
S52X75S32	320	X	\$199.70
S52X75S40	400	X	\$199.70
S52X75S60	600	X	\$199.70

52" x 103" Sanding Belts
3 Belts/Pack, Aluminum Oxide
F-weight, Closed Coat
Resin Paper Backing



Tool No.	Grit	Price
E52X103S8	80	\$208.54
E52X103S10	100	\$196.91
E52X103S12	120	\$196.91
E52X103S15	150	\$196.91
E52X103S18	180	\$196.91
E52X103S22	220	\$196.91



52" x 103" Sanding Belts
3 Belts/Pack, Aluminum Oxide
X-weight, Open Coat
Resin Bond Poly-Cotton Backing



Tool No.	Grit	Price
K52X103S2	24	\$324.30
K52X103S3	36	\$308.87
K52X103S4	40	\$294.15
K52X103S5	50	\$280.20
K52X103S6	60	\$266.81
K52X103S8	80	\$249.17
K52X103S10	100	\$238.14
K52X103S12	120	\$238.14
K52X103S15	150	\$238.14
K52X103S18	180	\$238.14

52" x 103" Sanding Belts
3 Belts/Pack, Aluminum Oxide
Y-weight, Open Coat
Resin Bond Polyester Backing

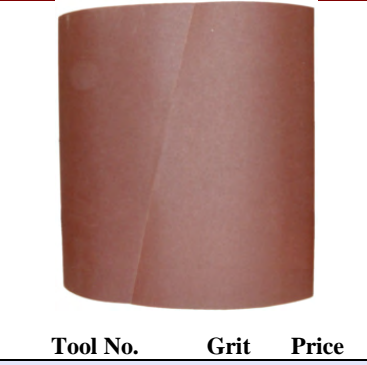

Tool No.	Grit	Price
W52X103S2	24	\$356.74
W52X103S3	36	\$339.76
W52X103S4	40	\$323.56
W52X103S5	50	\$308.23
W52X103S6	60	\$293.49
W52X103S8	80	\$274.08
W52X103S10	100	\$261.95
W52X103S12	120	\$261.95
W52X103S15	150	\$261.95
W52X103S18	180	\$261.95
W52X103S22	220	\$261.95

52" x 128" Sanding Belts
3 Belts/Pack, Aluminum Oxide
F-weight, Open Coat
Resin Paper Backing



Tool No.	Grit	Price
P52X128S8	80	\$214.45
P52X128S10	100	\$202.50
P52X128S12	120	\$202.50
P52X128S15	150	\$202.50
P52X128S18	180	\$202.50
P52X128S22	220	\$202.50
P52X128S32	320	\$202.50

52" x 128" Sanding Belts
3 Belts/Pack, Silicon Carbide
Closed Coat
Resin Bond Polyester Backing



Tool No.	Grit	Belts/Pkg	Price
S52X128S2	24	3	\$457.09
S52X128S3	36	3	\$435.33
S52X128S4	40	3	\$414.60
S52X128S5	50	3	\$394.93
S52X128S6	60	3	\$395.27
S52X128S8	80	3	\$374.74
S52X128S10	100	3	\$355.50
S52X128S12	120	3	\$355.50
S52X128S15	150	3	\$355.50
S52X128S18	180	3	\$355.50
S52X128S22	220	3	\$355.50
S52X128S32	320	3	\$355.50
S52X128S40	400	3	\$355.50
S52X128S60	600	3	\$355.50

52" x 103" Sanding Belts
3 Belts/Pack, Aluminum Oxide
X-weight, Closed Coat
Resin Bond Poly-Cotton Backing



Tool No.	Grit	Price
R52X103S2	24	\$340.52
R52X103S3	36	\$324.31
R52X103S4	40	\$308.86
R52X103S5	50	\$294.21
R52X103S6	60	\$280.15
R52X103S8	80	\$261.63
R52X103S10	100	\$250.05
R52X103S12	120	\$250.05
R52X103S15	150	\$250.05
R52X103S18	180	\$250.05
R52X103S22	220	\$250.05
R52X103S32	320	\$250.05
R52X103S40	400	\$250.05
R52X103S50	500	\$250.05
R52X103S60	600	\$250.05
R52X103S80	800	\$250.05

52" x 103" Sanding Belts
3 Belts/Pack, Silicon Carbide
Closed Coat
Resin Bond Polyester Backing



Tool No.	Grit	Weight	Price
S52X103S2	24	Y	\$372.94
S52X103S3	36	Y	\$355.19
S52X103S4	40	Y	\$338.27
S52X103S5	50	Y	\$329.22
S52X103S6	60	Y	\$322.50
S52X103S8	80	Y	\$305.75
S52X103S10	100	X	\$290.50
S52X103S12	120	X	\$290.50
S52X103S15	150	X	\$290.50
S52X103S18	180	X	\$290.50
S52X103S22	220	X	\$290.50
S52X103S32	320	X	\$290.50
S52X103S40	400	X	\$290.50
S52X103S60	600	X	\$290.50

52" x 128" Sanding Belts
3 Belts/Pack, Aluminum Oxide
F-weight, Closed Coat
Resin Paper Backing



Tool No.	Grit	Price
E52X128S8	80	\$214.45
E52X128S10	100	\$202.50
E52X128S12	120	\$202.50
E52X128S15	150	\$202.50
E52X128S18	180	\$202.50
E52X128S22	220	\$202.50
E52X128S32	320	\$202.50

4" Sanding Stars, 4 Layers
3 Count/Pack, Aluminum Oxide
1/4" Shank Mounted on Mandrel
J-weight



Sanding stars are excellent for wooden parts such as moldings, raised panels, and carvings. They self-dress into moplike wheels and are good for sanding, scuffing, and blending wood or metal. Ideal for all hard to sand areas. Note: 3,200 RPM Maximum.

Tool No.	Grit	Price
SS4X14G8	80	\$57.05
SS4X14G10	100	\$57.05
SS4X14G12	120	\$57.05
SS4X14G15	150	\$57.05
SS4X14G18	180	\$57.05
SS4X14G22	220	\$57.05
SS4X14G32	320	\$57.05
SS4X14G40	400	\$57.05



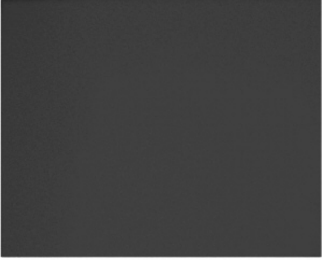

6" x 1/4" Spiral Band 25 Pieces/Pack Aluminum Oxide, X-Weight Resin Bond Cloth Backing			
Tool No.	Grit	Coat	Price
K6X0.25D2	24	Open	\$48.14
K6X0.25D3	36	Open	\$48.13
K6X0.25D4	40	Open	\$48.12
K6X0.25D5	50	Open	\$48.11
K6X0.25D6	60	Open	\$48.10
K6X0.25D8	80	Open	\$48.09
K6X0.25D10	100	Open	\$48.08
K6X0.25D12	120	Open	\$48.07
K6X0.25D15	150	Open	\$48.06
K6X0.25D18	180	Open	\$48.05
K6X0.25D22	220	Closed	\$48.04

9" x 11" Sheets 50 Sheets/Pack, Silicon Carbide Lubricated Stearated with Zinc, Open Coat			
			
This product is treated with a film of zinc stearate which reduces loading material residue on the sheet and provides lubricating effect between the silicon carbide grain and the material being sanded. It is commonly used for sanding / finishing hard surface, i.e. lacquer, enamels and etc. It is also used for fine sanding of primers.			
Tool No.	Grit	Weight	Price
S911L8	80	A	\$26.65
S911L10	100	A	\$23.89
S911L12	120	A	\$23.89
S911L15	150	A	\$23.89
S911L18	180	A	\$23.89
S911L22	220	A	\$23.89
S911L24	240	A	\$23.89
S911L28	280	A	\$23.89
S911L32	320	A	\$23.89
S911L40	400	A	\$23.89

9" x 11" Wet/ Dry Sheets 50 Sheets/Pack, Silicon Carbide Closed Coat, Waterproof			
			
It is most commonly used for metal working applications and final lacquered wood sanding either wet or dry applications, i.e. dry sanding on wood or wet sanding/buffing on automobiles/airplanes.			
Tool No.	Grit	Weight	Price
S911W8	80	C	\$20.21
S911W10	100	C	\$18.38
S911W12	120	C	\$18.38
S911W15	150	C	\$18.38
S911W18	180	C	\$18.38
S911W22	220	A	\$18.38
S911W24	240	A	\$18.38
S911W28	280	A	\$18.38
S911W32	320	A	\$18.38
S911W40	400	A	\$18.38
S911W60	600	A	\$18.38
S911W80	800	A	\$18.38
S911W100	1000	A	\$18.38
S911W120	1200	A	\$18.38
S911W150	1500	A	\$18.38
S911W200	2000	A	\$18.38

Denim Spiral Sewn Buffing Wheel			
			
This denim buffing wheel takes any compound and fits standard buffing applications provided by its rival cotton spiral sewn wheels, and lasts much longer. It is designed for the final cut and initial polish on plastics and most metals i.e. chrome, nickel plate, copper, brass, iron, steel, and stainless steel, but not for gold and silver.			
Tool No.	Dia.	Hole Dia.	Price
DSS0612	6"	1/2"	\$6.75
DSS0658	6"	5/8"	\$6.75
DSS0634	6"	3/4"	\$6.75
DSS0812	8"	1/2"	\$9.49
DSS0858	8"	5/8"	\$9.49
DSS0834	8"	3/4"	\$9.49
DSS1078	10"	7/8"	\$13.56
DSS10114	10"	1-1/4"	\$13.56
DSS12118	12"	1-1/8"	\$15.87

9" x 11" Finishing Paper 100 Sheets/Pack, A-Weight Aluminum Oxide, Open Coat		
		
Tool No.	Grit	Price
F911G8	80	\$20.45
F911G10	100	\$19.02
F911G12	120	\$19.02
F911G15	150	\$19.02
F911G18	180	\$19.02
F911G22	220	\$19.02
F911G32	320	\$19.02
F911G40	400	\$19.02

9" x 11" Sheets, Hook & Loop 10 Sheets/Pack, Aluminum Oxide Open Coat, C-weight			
			
Tool No.	Grit	Price	
V911G6	60	\$9.92	
V911G8	80	\$9.04	
V911G10	100	\$7.95	
V911G12	120	\$7.94	
V911G15	150	\$7.93	
V911G18	180	\$7.92	
V911G22	220	\$7.91	
V911G32	320	\$7.90	
V911G40	400	\$7.90	

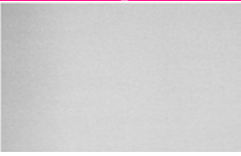
9" x 11" Garnet Paper 50 Sheets/Pack, A-Weight Garnet Open Coat			
			
Tool No.	Grit	Price	
G911G8	80	\$14.76	
G911G10	100	\$13.89	
G911G12	120	\$13.49	
G911G15	150	\$13.21	
G911G18	180	\$13.17	
G911G22	220	\$13.04	

Domet Flannel Airway Buffing Wheel, 16-ply			
			
This domet flannel buffing wheel is constructed in a airway type. It is especially suitable for where an absolute scratch-free finish is required. Its applications includes final finish on brass, aluminum, acrylics, plastics and musical instruments, i.e. guitars.			
Tool No.	Dia.	Hole Dia.	Price
DFA1216034	12"	3/4"	\$19.37
DFA121678	12"	7/8"	\$19.37
DFA1216114	12"	1-1/4"	\$19.37
DFA1516114	15"	1-1/4"	\$26.68
DFA1616034	16"	3/4"	\$33.37
DFA1616114	16"	1-1/4"	\$33.37



Domet Flannel Buffing Wheel



This domet flannel buffing wheel is constructed in an airway type. It is especially suitable for where an absolute scratch-free finish is required. Its applications includes final finish on brass, aluminum, acrylics, plastics and musical instruments, i.e. guitars.

Tool No.	Dia.	Hole Dia.	Ply	Price
DFM103034	10"	3/4"	30	\$13.91
DFM103078	10"	7/8"	30	\$13.91
DFM1030114	10"	1-1/4"	30	\$13.91
DFM123078	12"	7/8"	30	\$20.03
DFM1230114	12"	1-1/4"	30	\$20.03
DFM1516114	15"	1-1/4"	16	\$25.41

Laminated Sisal Buffing Wheel



This wheel gives a fine finish while removing small scratches. Used for the rough cut on copper, brass, iron, steel, and stainless steel.

Tool No.	Dia.	Hole Dia.	Price
BLS0612	6"	1/2"	\$8.41
BLS0658	6"	5/8"	\$8.41
BLS0634	6"	3/4"	\$8.41
BLS0812	8"	1/2"	\$10.01
BLS0858	8"	5/8"	\$10.01
BLS0834	8"	3/4"	\$10.01
BLS1078	10"	7/8"	\$14.56
BLS12118	12"	1-1/8"	\$19.23

Pin Hole Stitched Muslin Buffing Wheel



Soft 1/4" sewing, this buffing wheel contains a fine polishing surface on the outer edge and a soft feathered edge muslin concentrically stitched. Ideal for bringing out a deep lustrous shine. Used on the final polish on musical instruments, plastics, iron, steel, stainless steel as well as soft and delicate metal, i.e. thin plating gold, silver, chrome, nickel plate.

Tool No.	Dia.	Ply	Price
LMP0340	3"	40	\$4.00
LMP0430	4"	30	\$3.10
LMP0440	4"	40	\$4.86
LMP0530	5"	30	\$4.06
LMP0540	5"	40	\$5.20
LMP0560	5"	60	\$5.81
LMP0630	6"	30	\$5.16
LMP0640	6"	40	\$6.89
LMP0660	6"	60	\$10.31
LMP0840	8"	40	\$11.42
LMP0860	8"	60	\$17.14

Hard Airway Buffing Wheel 16-Ply, 100% Cotton Sheet



Ideal for removing light scratches in a variety of metals. Made from 100 percent cotton that's been stiffened through treatment and reinforced by a metal fastener. Pleats hold the compound together. The airway design makes it possible to reach awkward places. This product is used for the rough cut on plastics, soft metals, iron, steel, and stainless steel. This product is also used for the final cut and initial polish on copper, brass, and iron.

Tool No.	Dia.	Hole Dia.	Price
AWH0658	6"	5/8"	\$10.21
AWH0634	6"	3/4"	\$10.21
AWH0858	8"	5/8"	\$11.30
AWH0834	8"	3/4"	\$11.30
AWH1058	10"	5/8"	\$13.03
AWH1034	10"	3/4"	\$13.03
AWH12114*	12"	1-1/4"	\$17.05
AWH14114*	14"	1-1/4"	\$21.98
AWH16114*	16"	1-1/4"	\$25.39

* Safety Flange is mandatory for use with an airway buffing wheel

Soft Airway Buffing Wheel 16-Ply, 100% Cotton Sheet



Made with 100% cotton sheets held together with a steel retainer. The buff is held together with pleats. This wheel brings out a shine in crevices and intricate details. This product is used in the final polish on plastics, soft metals, thin plating gold, silver, chrome, nickel plate, copper, brass, and iron.

Tool No.	Dia.	Hole Dia.	Price
AWS0658	6"	5/8"	\$10.21
AWS0634	6"	3/4"	\$10.21
AWS0858	8"	5/8"	\$11.30
AWS0834	8"	3/4"	\$11.30
AWS1058	10"	5/8"	\$13.03
AWS1034	10"	3/4"	\$13.03
AWS12114*	12"	1-1/4"	\$17.05
AWS1478*	14"	7/8"	\$21.98
AWS14114*	14"	1-1/4"	\$21.98
AWS16114*	16"	1-1/4"	\$25.39

* Safety Flange is mandatory for use with an airway buffing wheel.



Soft Loose Muslin Buffing Wheel



This soft and loose muslin buffing wheel contains a fine polishing surface on the outer edge and a soft feathered edge muslin stitched near the center. Ideal for bringing out a deep lustrous shine. Used on the final polish on musical instruments, plastics, iron, steel, stainless steel as well as soft and delicate metal, i.e. thin plating gold, silver, chrome, nickel plate.

Tool No.	Dia.	Hole Dia.	Ply	Price
LMS033014	3"	1/4"	30	\$4.67
LMS033012	3"	1/2"	30	\$4.67
LMS034014	3"	1/4"	40	\$5.40
LMS034012	3"	1/2"	40	\$5.40
LMS034058	3"	5/8"	40	\$5.40
LMS044014	4"	1/4"	40	\$5.98
LMS043012	4"	1/2"	30	\$5.11
LMS044012	4"	1/2"	40	\$5.98
LMS043058	4"	5/8"	30	\$5.11
LMS044058	4"	5/8"	40	\$5.98
LMS046012	4"	1/2"	60	\$7.73
LMS046058	4"	5/8"	60	\$7.73
LMS053012	5"	1/2"	30	\$5.71
LMS054012	5"	1/2"	40	\$6.96
LMS056012	5"	1/2"	60	\$9.25
LMS053058	5"	5/8"	30	\$5.71
LMS054058	5"	5/8"	40	\$6.96
LMS056058	5"	5/8"	60	\$9.25
LMS063012	6"	1/2"	30	\$6.65
LMS064012	6"	1/2"	40	\$7.95
LMS066012	6"	1/2"	60	\$10.78
LMS063058	6"	5/8"	30	\$6.65
LMS064058	6"	5/8"	40	\$7.95
LMS066058	6"	5/8"	60	\$10.78
LMS064034	6"	3/4"	40	\$7.95
LMS066034	6"	3/4"	60	\$10.78
LMS083012	8"	1/2"	30	\$9.85
LMS084012	8"	1/2"	40	\$11.27
LMS086012	8"	1/2"	60	\$15.51
LMS084058	8"	5/8"	40	\$11.27
LMS086058	8"	5/8"	60	\$15.51
LMS084034	8"	3/4"	40	\$11.27
LMS086034	8"	3/4"	60	\$15.51
LMS103078	10"	7/8"	30	\$13.05
LMS104078	10"	7/8"	40	\$16.25
LMS1040114	10"	1-1/4"	40	\$16.25
LMS1060114	10"	1-1/4"	60	\$21.22
LMS1230114	12"	1-1/4"	30	\$22.49
LMS1240114	12"	1-1/4"	40	\$22.49
LMS1260114	12"	1-1/4"	60	\$26.91

Soft Spiral Sewn Muslin Buffing Wheel



This 1/4" stitching wheel is made up of 100% unbleached cotton sheeting which can be used with any compound. It is designed for the final cut and initial polish on plastics and most metals i.e. chrome, nickel plate, copper, brass, iron, steel, and stainless steel except gold, silver.

Tool No.	Dia.	Hole Dia.	Ply	Price
BSS034014	3"	1/4"	40	\$4.00
BSS034012	3"	1/2"	40	\$4.00
BSS034058	3"	5/8"	40	\$4.00
BSS044014	4"	1/4"	40	\$4.86
BSS043012	4"	1/2"	30	\$3.10
BSS044012	4"	1/2"	40	\$4.86
BSS043058	4"	5/8"	30	\$3.10
BSS044058	4"	5/8"	40	\$4.86
BSS053012	5"	1/2"	30	\$3.85
BSS054012	5"	1/2"	40	\$5.20
BSS056012	5"	1/2"	60	\$7.92
BSS053058	5"	5/8"	30	\$3.85
BSS054058	5"	5/8"	40	\$5.20
BSS056058	5"	5/8"	60	\$7.92
BSS063012	6"	1/2"	30	\$5.16
BSS064012	6"	1/2"	40	\$6.89
BSS066012	6"	1/2"	60	\$10.31
BSS063058	6"	5/8"	30	\$5.16
BSS064058	6"	5/8"	40	\$6.89
BSS066058	6"	5/8"	60	\$10.31
BSS064034	6"	3/4"	40	\$6.89
BSS066034	6"	3/4"	60	\$10.31
BSS084012	8"	1/2"	40	\$11.42
BSS086012	8"	1/2"	60	\$17.14
BSS084058	8"	5/8"	40	\$11.42
BSS086058	8"	5/8"	60	\$17.14
BSS084034	8"	3/4"	40	\$11.42
BSS086034	8"	3/4"	60	\$17.14
BSS105034	10"	3/4"	50	\$20.06
BSS126034	12"	3/4"	60	\$26.93
BSS12601	12"	1"	60	\$26.93

Treated 50-Ply Muslin Buffing Wheel



This treated hard muslin buffing wheel comes with concentric 1/4" stitching offers superb wide-angle buffing action. It is for rough cutting or final cutting steels, brass, aluminum and copper.

Tool No.	Dia.	Hole Dia.	Price
TSS065012	6"	1/2"	\$9.77
TSS065058	6"	5/8"	\$9.77
TSS065034	6"	3/4"	\$9.77
TSS085058	8"	5/8"	\$17.35
TSS085034	8"	3/4"	\$17.35

Lathe Nut



Tool No.	Arbor Dia.	Thickness	Price
LN118	1-1/8"	7/8"	\$23.06

Steel Safety Flange



Safety Flange is mandatory for use with an airway buffing wheel.

Tool No.	Dia.	Arbor Dia.	Counts Per Package	Price
BWF08114	8"	1-1/4"	2	\$91.21



Nail Gun Kits, Nails

18 Gauge Nail Gun Kit

Compatible with **BOSTITCH® BT-35**



Application :

- Shoe Making
- Drawer Assembly
- Picture Frame
- Furniture
- Decoration

15 Gauge Angle Finish Gun Kit

Compatible with **SENCO® SFN40**



Application :

- Furniture & cabinets
- Picture Frames
- Paneling
- Door & Window Construction
- Decoration

Tool No.	Nail Length	Weight	Air Pressure	Height	Length	Prices
UN1832	3/8" to 1-1/4"	2.57 lbs	60 to 100 PSI	8.19"	9.69"	\$69.25
UN1842	3/8" to 1-9/16"	2.86 lbs	70 to 100 PSI	8.74"	9.69"	\$95.64

Tool No.	Nail Length	Weight	Air Pressure	Height	Length	Prices
UN1564	1-1/4" to 2-1/2"	4.84 lbs	70 to 120 PSI	11.81"	13.78"	\$239.95

18 Gauge Brad Nail (5,000 Nails/Box)



Compatibility

Make	Nail	Make	Nail	Make	Nail	Make	Nail
Fasco®	GN®	Bea®	SK300	Omer®	Group 12	Atro®	TI-PIN
		Senco®	AX			Bostitch®	BT13

Tool No.	Length	Price	Tool No.	Length	Price
F10	3/8"	\$5.76	F12	1/2"	\$6.31
F15	5/8"	\$6.83	F20	3/4"	\$7.62
F25	1"	\$8.40	F30	1-3/16"	\$8.93
F32	1-1/4"	\$9.19	F38	1-1/2"	\$10.24
F40	1-9/16"	\$10.77	F45	1-3/4"	\$11.56
F50	2"	\$12.07			

15 Gauge Angle Finish Nail (4,000 Nails/Box)



Compatibility

Make	Nail	Make	Nail	Plain Finish		
Senco®	DA/UA	Fasco®	BA	Tool No.	Length	Price
				UDA13	1"	\$15.92

Galvanized Finish

Tool No.	Length	Price	Tool No.	Length	Price
UDA15G	1-1/4"	\$24.43	UDA17	1-1/2"	\$17.73
UDA17G	1-1/2"	\$28.95	UDA19	1-3/4"	\$20.80
UDA19G	1-3/4"	\$29.86	UDA21	2"	\$22.62
UDA21G	2"	\$30.76	UDA23	2-1/4"	\$28.94
UDA25G	2-1/2"	\$36.19	UDA25	2-1/2"	\$29.85

Staples

16 Gauge Staple – 7/16" Crown (10,000 Staples/Box)

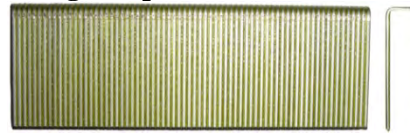

Galvanized

Compatibility

Make	Staple	Make	Staple	Make	Staple	Make	Staple
Fasco®	G	Bea®	155/170	Porter-Cable®		Omer®	M2
Atro®	100	Senco®	N	Stan-Tech®		Bostitch®	B100

Tool No.	Length	Price	Tool No.	Length	Price
N19	3/4"	\$24.60	N25	1"	\$26.78
N32	1-1/4"	\$31.11	N35	1-3/8"	\$31.84
N38	1-1/2"	\$34.74	N40	1-5/8"	\$35.47
N45	1-3/4"	\$39.09	N50	2"	\$43.42

16 Gauge Staple – 1/2" Crown (10,000 Staples/Box)



Galvanized

Compatibility

Make	Staple	Make	Staple	Make	Staple	Make	Staple
Fasco®		Spotnail®		Bostitch®			

Tool No.	Length	Price	Tool No.	Length	Price
BN25	1"	\$31.11	BN32	1-1/4"	\$34.74
BN38	1-1/2"	\$37.64	BN45	1-3/4"	\$39.08
BN50	2"	\$49.21			

16 Gauge Nail Gun Kit

Compatible with **Hitachi® NT65A**



Application :

- Furniture Trim
- Furniture Upholstery
- Picture Frames Assembly
- Door & Window Casing
- Crate and Box Assembly

Tool No.	Nail Length	Weight	Air Pressure	Height	Length	Prices
UN1664	3/4" to 2-1/2"	4.84 lbs	70 to 120 PSI	11.02"	12.60"	\$181.45

16 Gauge Brad Nail (2,500 Nails/Box)



Compatibility

Make	Nail	Make	Nail	Make	Nail	Make	Nail
Fasco®	FN®	Bea®	SK400	Atro®	TIP	Omer®	Group 14
		Paslode®	F-16			Hitachi®	NT65A

Tool No.	Length	Price	Tool No.	Length	Price
T20	3/4"	\$5.86	T25	1"	\$6.32
T32	1-1/4"	\$6.57	T38	1-1/2"	\$7.36
T45	1-3/4"	\$8.13	T50	2"	\$8.67
T57	2-1/4"	\$9.72	T64	2-1/2"	\$10.77



20639 Lycoming Street #B-6, Walnut, CA 91789 U.S.A.

e-mail : info@magnate.net Web Site : www.magnate.net

(TEL) 800-827-2316, 909-468-5747 (FAX) 909-468-5745



Staple Gun Kits & Staples

22 Gauge Staple Gun Kit – 3/8” Crown Compatible with **SENCO® SFT10**



US7116

US7116LN (2" Nose)

Application :

- Furniture Upholstery
- Dust Covers
- Cabinet Backs

- TV/Stereo Screening
- Felt Insulation
- Roofing Felt
- Light Trim Molding

Tool No.	Staple Length	Weight	Air Pressure	Height	Length	Prices
US7116	1/4" to 5/8"	1.98 lbs	60 to 100 PSI	5.71"	8.86"	\$81.45
US7116LN	1/4" to 5/8"	2.20 lbs	60 to 100 PSI	7.78"	8.86"	\$117.65

22 Gauge Staple – 3/8” Crown (10,000 Staples/Box)



Galvanized

Compatibility

Make	Staple	Make	Staple	Make	Staple	Make	Staple
Fasco®	S3G	Bea®	71	Omer®	3G	Bostitch®	7
Atro®	72	Senco®	C	Campbell Hausfeld®		SN162H	

Galvanized

Stainless Steel

Tool No.	Length	Price	Tool No.	Length	Price
C04	5/32"	\$6.82	CS06	1/4"	\$23.96
C06	1/4"	\$4.73	CS10	3/8"	\$25.62
C10	3/8"	\$5.51	CS13	1/2"	\$27.89
C13	1/2"	\$6.32	CS16	5/8"	\$30.34
C16	5/8"	\$6.83			

21 Gauge Staple Gun Kit – 1/2” Crown Compatible with **BEA® 80**



Application :

- Furniture, Upholstery
- TV, Stereo Grille Cloth
- Shoes-Making
- Picture Frame Assembly
- Decoration

Tool No.	Staple Length	Weight	Air Pressure	Height	Length	Prices
US8016	1/4" to 5/8"	2.20 lbs	60 to 100 PSI	5.83"	8.90"	\$81.73

21 Gauge Staple – 1/2” Crown (5,000 Staples/Box)



Galvanized

Compatibility

Make	Staple	Make	Staple	Make	Staple	Make	Staple
Fasco®	80	Bea®	80	Maestri®	80		

Tool No.	Length	Price	Tool No.	Length	Price
B06***	1/4"	\$4.65	B10	3/8"	\$4.21
B13***	1/2"	\$6.48	B16	5/8"	\$6.04

*** 7,000 Staples/Box

18 Gauge Staple Gun Kit – 1/4” Crown Compatible with **SENCO® SLS20/SKS L-Type**



Application :

- Cabinet Making
- Caseback Assembly
- Drawer Assembly
- Insulation Sheathing
- Molding & Trim

Tool No.	Staple Length	Weight	Air Pressure	Height	Length	Prices
US9025	1/2" to 1"	2.71 lbs	60 to 100 PSI	8.19"	9.69"	\$78.49

18 Gauge Staple – 1/4” Crown (5,000 Staples/Box)



Galvanized

Compatibility

Make	Staple	Make	Staple	Make	Staple	Make	Staple
Fasco®	90	Bea®	90/190	Haubold®		Bostitch®	SX5035
Atro®	90	Senco®	L	SpotNail®		Duo-Fast®	
Omer®	90			Poter-Cable®		Hitachi®	

Tool No.	Length	Price	Tool No.	Length	Price
L10	3/8"	\$5.78	L16	5/8"	\$7.88
L13	1/2"	\$6.57	L22	7/8"	\$9.19
L19	3/4"	\$8.67	L29	1-1/8"	\$10.24
L25	1"	\$9.98	L38	1-1/2"	\$11.76
L32	1-1/4"	\$11.02			

16 Gauge Staple Gun Kit – 1” Crown Compatible with **Senco® SPS**



Application :

- Asphalt and fiberglass shingles
- Attachment of lath wire

Tool No.	Staple Length	Weight	Air Pressure	Height	Length	Prices
US1740	5/8" to 1-1/2"	5.06 lbs	65 to 115 PSI	10.6"	12.2"	\$213.35

16 Gauge Staple – 1” Crown (10,000 Staples/Box)



Galvanized

Compatibility

Make	Staple	Make	Staple	Make	Staple	Make	Staple
Senco®	P	Fasco®		Duo-Fast®		Hitachi®	

Tool No.	Length	Price	Tool No.	Length	Price
P16	5/8"	\$31.12	P19	3/4"	\$32.56
P22	7/8"	\$34.74	P25	1"	\$36.91
P32	1-1/4"	\$40.52	P38	1-1/2"	\$44.15
P45***	1-3/4"	\$25.33	P50***	2"	\$28.96

*** 5,000 Satples/Box

**Spoilboard Surfacing, 2+2 Insert Carbide Knife
Rabbeting Flycutter, Leveler & Surface Planer**

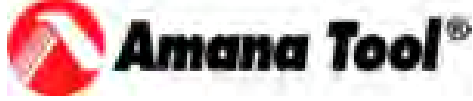

RC-2251



RC-2252

Insert router bit complete with two cutting flutes and two up-shear scorers for fast removal of materials over large surface area. The scorer leaves an improved finish at the bottom of the cut. Utilizes 4-sided carbide inserts. Max cutting depth is 1/4".

Perfect for:

- Resurfacing sPoilboards using CNC• 2+2 Spoilboards contain two bottom scorers for better performance, finer surface finish and better clearance for 90° corners.
- Planing large glued-up panels using CNC
- Surfacing and finishing wood using timber slab machines
- Rabbeting and slotting

Designed for planing & rabbeting the following materials:

- MDF, Plywood/Chipboard, Plastic/Acrylic
- Fiberboard, Balsa Core, High Density Urethane (HOU Board)
- HDF/LDF, EPoxy (EPoxy Resins), Ultra-High-Molecular-Weigh
- Hardwood/Softwood, Polyethylene (UHMWPE)

For optimal results and maximum insert life, replace inserts with optional general purpose knives (sold separately).

Recommendations: For surfacing solid woods, it is recommended to remove both bottom scorers.

replacement knives: use AMANA HMA-12, HCK-40 for MDF, or use AMANA AMA-12, RCK-70 for general purpose.e.

Tool No.	Cutting Dia.	Cutting Height	Shank Dia.	Overall Length	Price
RC-2251*	2-1/2"	15/32"	1/2"	2-1/2"	\$349.35
RC-2252^	3-5/32"	15/32"	3/4"	3-1/2"	\$324.40

* Max 19,000 rpm

^ Used with CNC only. CNC feed and speed available online. Max 18,000 rpm

**Mini Spoilboard Surfacing, 2+2 Insert Carbide Knife
Rabbeting Flycutter, Leveler & Surface Planer**

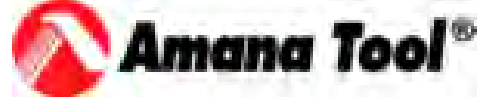

RC-2247



RC-2249



RC-2253



RC-2250

Mini design for tight comers. Exclusive carbide grade for highest quality of cut. Mini insert spoilboard surfacing & rabbeting with scorer utilizes 4-sided carbide inserts. great for cutting tight comers. Features unique 2+2 insert knife design that contains two cutting flutes and two up-shear scorers, which provide a smoother finish at the bottom of the cut than traditional two-knife style router bits. Max cutting depth is 1/4".

Perfect for:

- Resurfacing spoilboards using CNC
- 2+2 spoilboards contain two bottom scorers for better performance, finer surface finish and better clearance for 90° comers
- Planing large glued-up panels using CNC
- Surfacing and finishing wood using timber slab machines
- Rabbeting and slotting

Designed for planing & rabbeting the following materials:

- MDF, Plywood/Chipboard, Plastic/Acrylic.
- Fiberboard, Balsa Core, HOU Board.
- HDF/LDF, Epoxy (Epoxy Resins), UHMWPE
- Hardwood/Softwood

For optimal results and maximum insert life, replace inserts with optional general purpose knives (sold separately). Max. 24,000 rpm.

Tool No.	Cutting Dia.	Cutting Height	Shank Dia.	Overall Length	Price
RC-2247#	1-1/4"	27/64"	1/2"	2-17/64"	\$238.35
RC-2249*^	1-1/2"	1/2"	1/4"	1-3/16"	\$243.15
RC-2253*^	1-1/2"	1/2"	12mm	2-5/16"	\$243.15
RC-2250^	1-1/2"	1/2"	1/2"	2-5/16"	\$226.00

* CNC use only, CNC feed and speed available online

^ replacement knives: use AMANA HMA-12, HCK-40 for MDF, or AMA-12, RCK-70 for general purpose

replacement knives: use AMANA RCK-450, RCK-452 for MDF



**CNC Heavy Duty Spoilboard Surfacing
Planing, Flycutter & Leveler**



RC-2255

RC-2259

Insert carbide spoilboard surfacing & chamfering router bit utilizes 4-sided carbide inserts, great for planing large surface areas. Higher number of teeth allows for a higher feed rate. Featuring solid carbide insert knives with four cutting edges that allow users to rotate the knife when one side becomes dull providing the highest-quality finish available.

- Capable of removing thin layers of material, less than 0.001" per pass
- Tool can plunge up to a maximum depth of 6mm (1/4"), then start resurfacing
- The unique chamfer corner insert design creates a flawless surface
- The 3 wing and 5 wing design results in a more balanced tool while running

Designed for planing & chamfering the following materials:

- MDF, Plywood/Chipboard, Plastic/Acrylic.
- Fiberboard, Balsa Core, HDU Board
- HDF/LDF, Epoxy (Epoxy Resins), UHMWPE
- Hardwood/Softwood

For optimal results and maximum insert life, replace inserts with optional general purpose knives (sold separately).

Perfect for:

- Resurfacing spoilboards using CNC
- Surfacing and finishing wood using timber slab machines
- Planing large glued-up panels using CNC
- Rabbeting and slotting Featuring.
- Exclusive carbide grade for highest quality of cut
- Utilizes 4-sided carbide inserts
- Maximum cutting efficiency
- Faster material removal process

Replacement knives: use AMANA RCK-459 for MDF, or use AMANA RCK-457 for general purpose. CNC feed and speed available online.

Tool No.	Cutting Dia.	Cutting Height	Shank Dia.	Overall Length	Price
RC-2255*	2"	1/4"	1/2"	2-19/32"	\$181.65
RC-2255-M*	2"	1/4"	1/2"	2-19/32"	\$181.65
RC-2259^	3-11/32"	1/4"	12mm	3-25/64"	\$248.80

* 3-wing insert carbide design, 2-1/2" overall diameter

^ 5-wing insert carbide design, 3-25/64" overall diameter

MAGNATE™ 20639 Lycoming Street #B-6, Walnut, CA 91789 U.S.A.

e-mail : info@magnate.net Web Site : www.magnate.net

(TEL) 800-827-2316, 909-468-5747 (FAX) 909-468-5745



Spoilboard Surfacing, 2-Wing Insert Carbide Knife
Rabbeting Flycutter, Leveler & Surface Planer

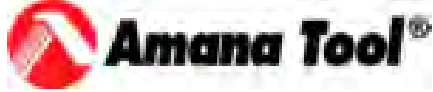

RC-2243

RC-2245



RC-2256

RC-2248



RC-2241

RC-2242



RC-2257

RC-2258

These industrial router bits feature solid carbide insert knives with four cutting edges that allow users to rotate the knife when one side becomes dull, providing the highest-quality finish available on woodworking tools. Used in resurfacing of particleboard, MDF and balsa core material. Optional general purpose knives for chipboard, balsa core, hardwood/softwood and plastic.

Perfect for:

- Resurfacing spoilboards using CNC
- Planing large glued-up panels using CNC
- Surfacing and finishing wood using timber slab machines
- Rabbeting and slotting
- Utilizes 4-sided carbide inserts
- Exclusive carbide grade for highest quality of cut
- Maximum cutting efficiency
- Faster material removal process

Designed for planing & rabbeting the following materials:

- MDF, Plywood/Chipboard, Plastic/Acrylic
- Fiberboard, Balsa Core, HDU Board
- HDF/LDF, Epoxy (Epoxy Resins), UHMWPE
- Hardwood/Softwood

For optimal results and maximum insert life, replace inserts with optional general purpose knives (sold separately))

Tool No.	Cutting Dia.	Cutting Height	Shank Dia.	Overall Length	Price
RC-2243*^	1"	12mm	1/4"	2-1/64"	\$124.40
RC-2245*^	1-1/4"	12mm	1/4"	1-11/16"	\$161.75
RC-2256*^	1-1/2"	12mm	6mm	1-11/16"	\$168.25
RC-2248*^	1-1/2"	12mm	1/4"	1-11/16"	\$168.25
RC-2241^	1-1/2"	12mm	1/2"	2-3/16"	\$168.25
RC-2242#	1-3/4"	12mm	1/2"	1-49/64"	\$199.05
RC-2257#	2-1/2"	1/2"	1/2"	2-1/2"	\$273.64
RC-2258*^	4"	1/2"	3/4"	3"	\$398.10

* CNC use only, CNC feed and speed available online

^ replacement knives: use AMANA HMA-12 for MDF, or AMA-12 for general purpose

replacement knives: use AMANA RCK-344 for MDF



FOR FABRICATING SOLID SURFACE MATERIALS

(Corian®, Surell® (2000X), Fountainhead®, Avonite®, etc.)

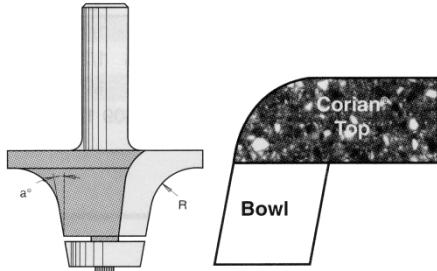

Roundover (57128/57130)

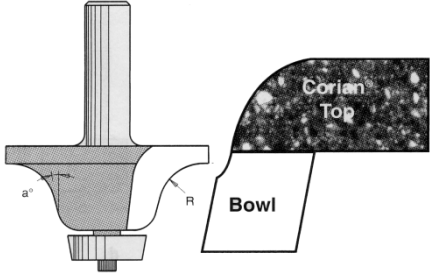

Ogee (57124/57126)

Undermount Bowl

1/2" Shank with Ultra-Glide™ Bearing

Decorative, finished edges for 'undermount' type bowls. Can be used for Corian® sink & bowl#s: 802S, 804S, 805S, 809S, 810S and 871S.

Tool No.	Countertop	Large Carbide				
No.	Angle	r	Thickness	Dia.	Hgt.	Price
57128	18°	1/2"	1/2"	2-1/8"	1"	\$118.76
57130	18°	9/16"	3/4"	2-1/4"	1-1/4"	\$124.76
57124	15°	1/2"	1/2"	2-1/8"	1"	\$120.26
57126	15°	9/16"	3/4"	2-1/4"	1-1/4"	\$98.98

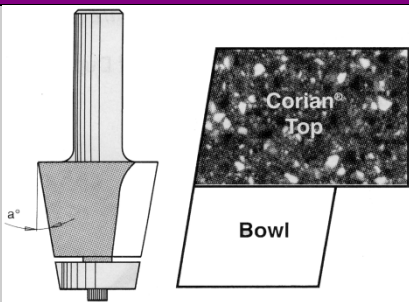

10° Bevel Undermount Bowl

1/2" Shank with Ultra-Glide™ Bearing

It can be used for Corian® sink & bowl#s: 804A, 805A, 830A, 852LA, 852RA and 854RA.

Tool No.	Countertop	Large Carbide			
No.	Thickness	Dia.	Hgt.	Price	
57122	1/2"&3/4"	1"	15/16"	\$109.31	

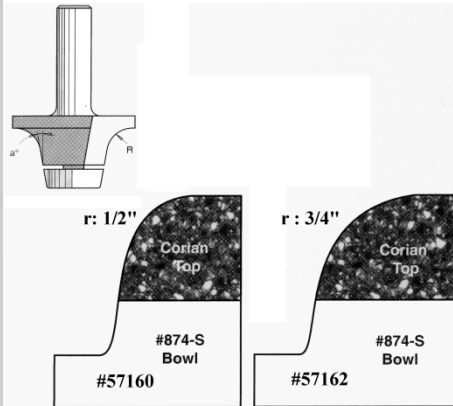
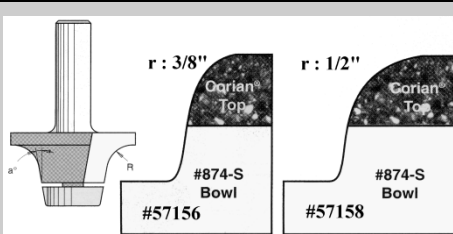

Undermount Bowl
1/2" Shank with Ultra-Glide™ Bearing

Tool No.	Countertop	Large Carbide				
No.	Angle	r	Thickness	Dia.	Hgt.	Price
57156	10°	3/8"	1/2"	1-25/32"	11/16"	\$129.04
57158	14°	1/2"	1/2"	2"	11/16"	\$128.96
57160	10°	1/2"	3/4"	2-1/8"	1"	\$108.00
57162	15°	3/4"	3/4"	2-1/4"	1-1/4"	\$116.70

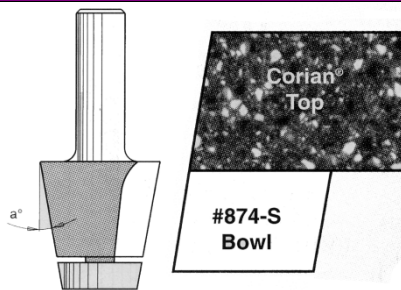

10° Bevel Undermount Bowl
1/2" Shank with Ultra-Glide™ Bearing

Tool No.	Countertop	Large Carbide			
No.	Thickness	Dia.	Hgt.	Price	
57168	1/2"&3/4"	1-1/4"	1"	\$108.34	

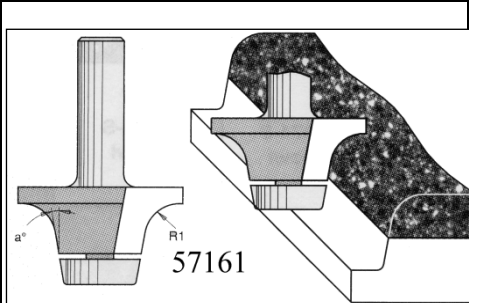

Roundover Wilsonart® SSV® Bowl
1/2" Shank with Ultra-Glide™ Bearing

Tool No.	Countertop	Large Carbide				
No.	Angle	Thickness	Dia.	Hgt.	Price	
57161	12°	1/2" - 3/4"	2-3/8"	7/8"	\$129.94	

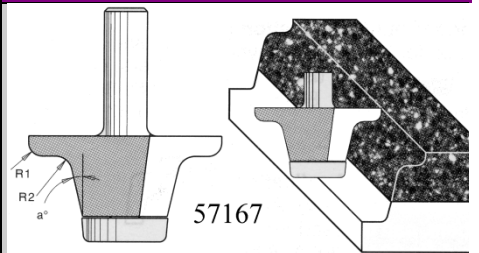

Ogee Wilsonart® SSV® Bowl
1/2" Shank with Ultra-Glide™ Bearing

Tool No.	Countertop	Large Carbide				
No.	Angle	Thickness	Dia.	Hgt.	Price	
57167	13°	1/2" - 3/4"	2-1/4"	15/16"	\$114.28	

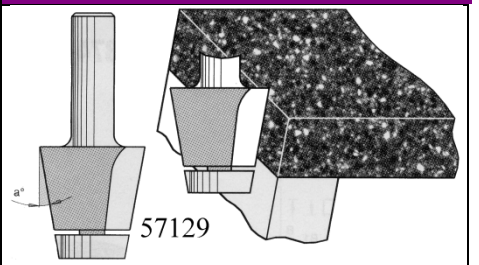

12° Bevel Wilsonart® SSV® Bowl
1/2" Shank with Ultra-Glide™ Bearing

Tool No.	Countertop	Large Carbide	Shank		
No.	Thickness	Dia.	Hgt.	Dia.	Price
57129	1/2" - 1-1/4"	1-1/2"	1-1/4"	1/2"	\$124.50

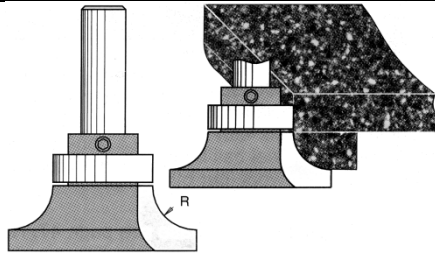

Round Under
with Ultra-Glide™ Bearing

57138 and 57140 can be used with corner rounding bits, 57139 (1/2" radius) or 57141 (3/4" radius) respectively, to cut a full 180° bull nose on 1" or 1-1/2" thick stock **without turning the material over.** (Two 30"x98"x1/2" laminated sheets = 200 lbs+) Also useful for on-site cutting where a conventional round-over can not be used.

Tool No.	Countertop r	Large Carbide Shank Thickness	Dia.	Hgt.	Dia.	Price
57138	1/2"	1"	2-1/8"	3/4"	1/2"	\$133.16
57140	3/4"	1-1/2"	2-5/8"	1"	1/2"	\$142.76
57145	1"	2"	3-1/8"	1-3/8"	1/2"	\$153.93

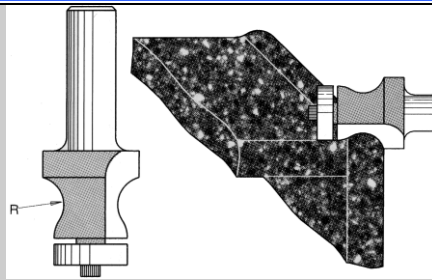

Counter-Top, 'No-Drip' Design

To cut a 'no-drip' edge, in one pass, on kitchen and vanity counter-tops.

Tool No.	Countertop Thickness	Large Carbide Shank Dia.	Hgt.	Dia.	Price
57118	1/2"	1"	7/8"	1/2"	\$75.41
57120	3/4"	1"	1-1/8"	1/2"	\$82.31

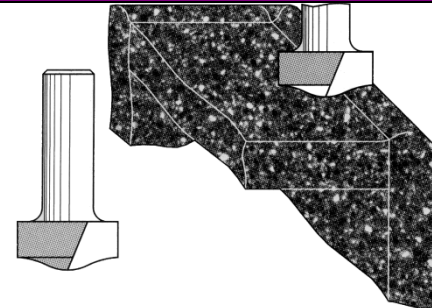

Counter-Top, 'No-Drip' Design

To cut a 'no-drip' edge for kitchen and vanity counter-tops. Use with 5/16" radius corner rounding bits.

Tool No.	Countertop Thickness	Large Carbide Shank Dia.	Hgt.	Dia.	Price
57146	3/4"	1"	1/2"	1/4"	\$34.93
57148	3/4"	1"	1/2"	1/2"	\$44.48

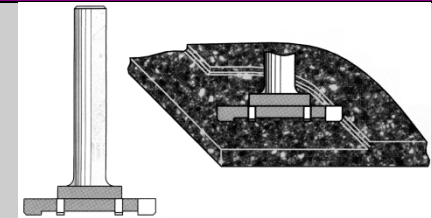

6-Wing Counter-Top Trim

Tool No.	Large Carbide Shank Dia.	Overall Shank Hgt.	Length	Dia.	Price
57136	2-1/16"	1/4"	3-5/16"	1/2"	\$78.56
57137	2-1/16"	1/8"	3-5/16"	1/2"	\$86.24

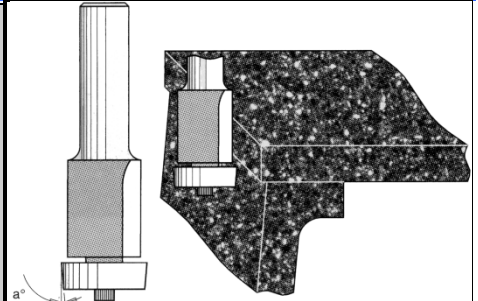

BOWL & SINK TRIM
with Ultra-Glide™ Bearing

Using a template, 57153 (5° 1/16" over-hang) & 57155 (5° 1/8" over-hang) will 'rough out' the sink cut-out. 57154 (flush trim) will finish the cut.

Tool No.	Over- Large Carbide Shank Angle	hang	Dia.	Hgt.	Dia.	Price
57153	5°	1/16"	3/4"	1"	1/2"	\$38.96
57155	5°	1/8"	49/64"	1-1/2"	1/2"	\$51.64
57154	0°	0"	3/4"	1"	1/2"	\$38.96

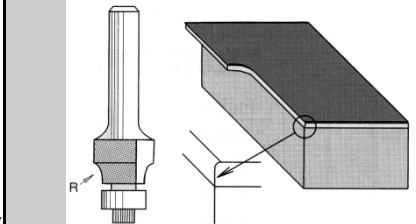

NO-FILE™
(US Patent No. 4,669,923)

These new patented "No-File"™ bits eliminate hand filing of laminates that normally follows trimming. These specially designed tools will flush trim the laminate and "break" the sharp edge all in one pass.

Tool No.	Small Cutting Dia.	Overall Shank R	Length	Length	Dia.	Price
47150	1/2"	0.059"	3/8"	1-7/8"	1/4"	\$27.15
47152	1/2"	0.059"	3/8"	2-1/8"	1/2"	\$27.15
47154*	1/2"	0.015"	3/8"	1-7/8"	1/4"	\$26.51

* - 47154 is for laminates .025-.038 thick.
(.4mm radius) 47150 & 47152 are for laminates .042-.052 thick. (1.5mm radius)

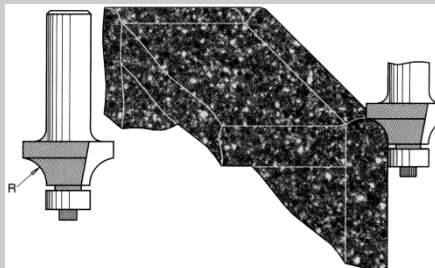

Corner-Rounding
with Ultra-Glide™ Bearing

5/16" radius is used with countertop bit and for general purpose edge ornamentation. The other size can be used for decorative edge treatment or with round under bit to achieve a full 180° bull nose.

Tool No.	Countertop r	Large Carbide Shank Thickness	Dia.	Hgt.	Dia.	Price
57150	5/16"	3/4"	1-1/8"	1/2"	1/4"	\$41.03
57152	5/16"	3/4"	1-1/8"	1/2"	1/2"	\$41.03
57147	1/8"	-----	3/4"	3/8"	1/2"	\$38.10
57149	1/4"	-----	1"	1/2"	1/2"	\$38.10
57139	1/2"	-----	1-1/2"	3/4"	1/2"	\$46.88
57141	3/4"	-----	2"	1"	1/2"	\$64.20

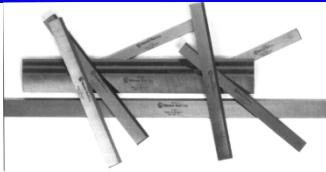

T-1 HSS Planer/Joiner Knife Sets

New grade T-1 high-speed steel with 18% tungsten content. For comparison, this steel is much harder than M-2 HSS which typically has 12% tungsten. Crafted on state-of-the-art equipment in Germany, using German steel, each knife is ground, honed and individually hand-hammered to exacting tolerances. Many standard sizes available individually or in sets. For a nominal charge, knives can be cut to length. Packing : Bulk in flat tubes.

Tool No.	Length	Thickness	Knives/Set	Price
P100	4"	5/8"	1/8"	3 \$23.51
P130	4-3/8"	5/8"	1/8"	3 \$25.65
P150	6"	5/8"	1/8"	3 \$37.50
P160	6"	5/8"	1/8"	4 \$41.51
P165	6"	3/4"	1/8"	3 \$37.50
P170	6"	7/8"	1/8"	3 \$37.50
P190	6-1/16"	5/8"	3/32"	3 \$36.68
P220	6-1/8"	5/8"	1/8"	3 \$36.68
P230	6-1/8"	3/4"	1/8"	3 \$36.68
P250	8"	5/8"	1/16"	4 \$43.43
P270	8"	5/8"	1/8"	3 \$51.34
P280	8"	3/4"	1/16"	3 \$41.93
P290	8"	3/4"	1/8"	3 \$51.34
P300	8"	7/8"	1/8"	3 \$51.34
P310	8"	1"	1/8"	3 \$68.63
P340	8-1/16"	5/8"	3/32"	3 \$54.23
P360	12"	5/8"	1/8"	3 \$73.80
P370	12"	3/4"	1/8"	3 \$75.41
P380	12"	7/8"	1/8"	3 \$79.13
P390	12"	1"	1/8"	3 \$81.19
P395	12"	1-1/4"	1/8"	3 \$81.19
P410	12-1/4"	3/4"	1/8"	3 \$76.84
P430	12-1/2"	7/8"	1/8"	3 \$83.40
P431	12-1/2"	11/16"	1/8"	3 \$83.40
P440	13-1/8"	11/16"	5/32"	3 \$81.49
P443	16-1/4"	1-1/4"	5/32"	3 \$167.10
P444	18"	1-1/4"	5/32"	3 \$165.75
P446	18-1/8"	1-1/8"	5/32"	3 \$88.01
P448	18-1/4"	1-1/8"	5/32"	3 \$168.11
P120	100mm	30mm	3mm	4 \$20.40
P140	130mm	30mm	3mm	4 \$26.03
P180	150mm	30mm	3mm	4 \$29.89
P240	180mm	30mm	3mm	4 \$43.39
P345	230mm	30mm	3mm	4 \$45.23

P445	15"	1"	1/8"	1 \$46.31
P442	16"	1"	1/8"	1 \$36.30
P450	20"	1"	1/8"	1 \$46.31
P455	20"	35mm	1/8"	1 \$59.66
P480	24"	1"	1/8"	1 \$66.23
P490	24"	1-1/4"	1/8"	1 \$66.23
P495	24"	35mm	1/8"	1 \$54.11
P520	24"	11/16"	5/32"	1 \$44.81
P560	25"	3/4"	1/8"	1 \$67.80
P580	25"	1"	1/8"	1 \$63.60
P590	25"	1-1/4"	1/8"	1 \$69.15
P595	25"	35mm	1/8"	1 \$75.23
P650	31"	1"	1/8"	1 \$72.04
P660	31"	1-1/4"	1/8"	1 \$79.54
P700	37"	5/8"	1/8"	1 \$79.46
P710	37"	3/4"	1/8"	1 \$92.74
P715	37"	7/8"	1/8"	1 \$72.75
P720	37"	1"	1/8"	1 \$88.61
P726	37"	1-1/8"	1/8"	1 \$88.95
P730	37"	1-1/4"	1/8"	1 \$93.30
P772	37"	1-1/2"	1/8"	1 \$144.45
P740	37"	5/8"	3/32"	1 \$38.33
P750	37"	3/4"	3/32"	1 \$65.81
P712	37"	3/4"	5/32"	1 \$122.33
P672	37"	1-1/8"	5/32"	1 \$121.61
P774	37"	1-1/2"	5/32"	1 \$173.21
P727	37"	30mm	3mm	1 \$85.46
P725	37"	30mm	1/8"	1 \$70.50
P735	37"	35mm	1/8"	1 \$57.11
P732	400mm	35mm	3mm	1 \$20.36
P734	500mm	35mm	3mm	1 \$52.76
P736	37"	35mm	4mm	1 \$69.98
P461	700mm	35mm	3mm	1 \$52.13
P460	1m	3/4"	3mm	1 \$54.79
P458	1m	35mm	3mm	1 \$52.54

Solid Carbide Portable Planer Knives (1.12mm Thickness)

New solid carbide reversible knives designed for many popular 3-1/4" machines. The ICK-100 will fit many models by AEG, BOSCH, Hitachi, Makita, Metabo, Ryobi, Skil and etc. The ICK-200 will fit many models by Black & Decker. Prices include one pair of 2-sided (reversible) knives.

Tool No.	Length	Width	Price/Each
ICK-100	82.0mm	5.5mm	\$ 8.51
ICK-200	82.7mm	5.5mm	\$14.55

Planer/Molder Heads 4-Wing/125mm Outside Dia.

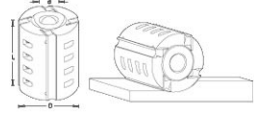

Tool No.	Length	Bore	Price/Each
61700*	100mm	1-1/4"	\$246.45
61702*	100mm	30mm	\$246.45
61704^	130mm	1-1/4"	\$289.76
61706^	130mm	30mm	\$289.76
61708@	150mm	1-1/4"	\$303.79
61710@	150mm	30mm	\$303.79
61712#	180mm	1-1/4"	\$370.46
61716%	230mm	1-1/4"	\$420.41
61718%	230mm	30mm	\$420.41

Carbide Tipped Planer & Joiner Knives

An economical alternative to solid carbide knives. longer tool life than standard HSS knives.

Tool No.	Length	Width	Thickness	Price/Each
CTP-100	4"	3/8"	1/8"	\$25.13
CTP-110	6"	5/8"	1/8"	\$37.61
CTP-120	6"	3/4"	1/8"	\$37.61
CTP-130	8"	5/8"	1/8"	\$49.69
CTP-140	8"	3/4"	1/8"	\$49.69
CTP-150	12"	3/4"	1/8"	\$116.89
CTP-160	15"	3/4"	1/8"	\$132.83
CTP-170	15"	1"	1/8"	\$132.83
CTP-200	20"	1"	1/8"	\$176.89



Solid Carbide Planer & Joiner Knives

Ready to use: fully ground and honed Solid Carbide micrograin planer & joiner knives. All knives are bevel-edged, and are perfectly parallel and flat, with no mounting holes or slots. Mirror finish, ground from 600 grit diamond wheels. One knife/package.

Tool No.	Length	Width	Thickness	Price/Each
PSC-100	4"	5/8"	1/8"	\$50.96
PSC-110	4"	3/4"	1/8"	\$53.59
PSC-130	6"	3/4"	1/8"	\$69.15
PSC-140	8"	5/8"	1/8"	\$101.89
PSC-150	8"	3/4"	1/8"	\$116.44
PSC-160^	12"	3/4"	1/8"	\$201.83
PSC-170*	12-1/2"	3/4"	0.088	\$156.49

* Double-sided for Delta 560
^ Double-sided for Delta 540

25" Long Moulder Steel 60° Corrugated Back M-2 High-Speed Steel 45° Bevel Edged



Tool No.	Width	Thickness	Price/Each
CSK-100	1-1/4"	1/4"	\$89.25
CSK-110	1-1/2"	1/4"	\$95.96
CSK-120	1-3/4"	1/4"	\$104.21
CSK-130	2"	1/4"	\$105.79
CSK-140	2-1/4"	1/4"	\$116.03
CSK-150	2-1/2"	1/4"	\$109.58
CSK-160	2-3/4"	1/4"	\$132.79
CSK-170	3"	1/4"	\$141.23
CSK-300	1-1/4"	5/16"	\$97.09
CSK-310	1-1/2"	5/16"	\$110.06
CSK-320	1-3/4"	5/16"	\$118.13
CSK-330	2"	5/16"	\$122.59
CSK-340	2-1/4"	5/16"	\$125.51
CSK-350	2-1/2"	5/16"	\$131.70
CSK-360	2-3/4"	5/16"	\$131.03
CSK-370	3"	5/16"	\$148.91



'Euro-Rip' Ripping
with cooling slots and anti-kickback feature, 10"-14". 18° Hook Flat Top (FT) Grind

Application: Ripping natural woods, along the grain, anti-kickback fingers maintain safety while limiting chip-thickness, allowing for a faster, quieter cut. Minimal feed effort is required resulting in less operator fatigue. Cooling slots in the saw body prevent excessive heat build-up. Suitable for multiple rip saws. Truly an exceptional blade.

Tool No.	Dia.	Teeth	Kerf	Plate	Bore	Price
RB1020	10"	20	.126"	.087"	5/8"	\$77.70
RB1020-30*	10"	20	.126"	.087"	30mm	\$77.70
RB1224	12"	24	.126"	.087"	1"	\$98.70
RB1224-30	12"	24	.126"	.087"	30mm	\$98.70
RB1428	14"	28	.126"	.087"	1"	\$118.46
RB1428 -30**	14"	28	.126"	.087"	30mm	\$118.46
RB1628	16"	28	.137"	.098"	1"	\$134.48



Multi-Use 10"-20"
20° Hook Alternate Top Bevel Grind

Application: Universal Use; Rip and crosscut natural woods and panel sizing of single and stacked non-laminated chipboard. 18" & 20" blades have cooling slots

Tool No.	Dia.	Teeth	Kerf	Plate	Bore	Price
610300	10"	30	.126"	.087"	5/8"	\$84.41
610300-30*	10"	30	.126"	.087"	30mm	\$84.41
612360	12"	36	.126"	.087"	1"	\$98.29
612360-30**	12"	36	.126"	.087"	30mm	\$98.29
614420	14"	42	.137"	.098"	1"	\$118.88
614420-30**	14"	42	.137"	.098"	30mm	\$118.88
616480	16"	48	.137"	.098"	1"	\$144.23
616480-30**	16"	48	.137"	.098"	30mm	\$144.23
618540	18"	54	.150"	.110"	1"	\$191.03
620600	20"	60	.173"	.110"	1"	\$222.53

* Pin Hole : 2/7/42 & 2/10/60
** Pin Hole : 2/10/60

General Purpose Cut-Off , 8"-20"
10° Hook - Triple Chip(TC) Grind
Application: General trimming and Cross-Cutting of natural woods, plywood, composition material and single or double-sided plastic laminated material.

Tool No.	Dia.	Teeth	Kerf	Plate	Bore	Price
684801	8"	48	.118"	.079"	5/8"	\$93.04
610601 +++	10"	60	.126"	.087"	5/8"	\$78.83
610601-30 *,**	10"	60	.126"	.087"	30mm	\$78.83
612601 +++	12"	60	.126"	.087"	1"	\$133.58
612601-30 **	12"	60	.126"	.087"	30mm	\$133.58
612721	12"	72	.126"	.087"	1"	\$148.61
612721-30***	12"	72	.126"	.087"	30mm	\$148.61
614721	14"	72	.137"	.098"	1"	\$162.38
614721-30 +++	14"	72	.137"	.098"	1"	\$162.38
614841	14"	84	.137"	.098"	1"	\$182.78
616961	16"	96	.137"	.098"	1"	\$216.86
618109 +++	18"	108	.158"	.110"	1"	\$275.51
618109 -30 **	18"	108	.158"	.110"	30mm	\$275.51
620121	20"	120	.173"	.110"	1"	\$333.34



Standard Ripping
10"-18" 18° Hook Flat Top (FT) Grind

Application: Ripping Natural Woods, along the grain.

Tool No.	Dia.	Teeth	Kerf	Plate	Bore	Price
610200	10"	20	.126"	.087"	5/8"	\$73.50
610200-30	10"	20	.126"	.087"	30mm	\$73.50
612240	12"	24	.126"	.087"	1"	\$88.13
612240-30	12"	24	.126"	.087"	30mm	\$88.13
614280	14"	28	.137"	.098"	1"	\$104.18
616320	16"	32	.137"	.098"	1"	\$118.58
616320-30	16"	32	.137"	.098"	30mm	\$118.58
618320	18"	32	.157"	.110"	1"	\$146.63



Combination Ripping & Cross-Cut
8"-16" 10° Hook 4 ATB & 1 Raker Grind

Application: Designed for ripping and cross-cutting natural woods. Teeth consist of 4 ATB followed by one square raker. Large gullets in the saw body allow for deeper cuts & improved chip ejection.

Tool No.	Dia.	Teeth	Kerf	Plate	Bore	Price
684004	8"	40	.126"	.087"	5/8"	\$82.61
694004	9"	40	.126"	.087"	5/8"	\$88.46
610504	10"	50	.135"	.095"	5/8"	\$80.25
612604	12"	60	.150"	.110"	1"	\$135.68
614704	14"	70	.150"	.110"	1"	\$180.34
616804	16"	80	.158"	.118"	1"	\$245.36

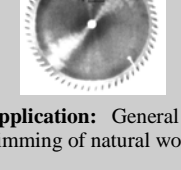

Cut-Off & Cross-Cut, 8"-20"
10° Hook Alternate Top Bevel (ATB) Grind
Application: General Cut-Off, Cross-Cutting and trimming of natural woods.

Tool No.	Dia.	Teeth	Kerf	Plate	Bore	Price
684800	8"	48	.118"	.079"	5/8"	\$88.65
696000	9"	60	.118"	.079"	5/8"	\$101.70
610600	10"	60	.126"	.087"	5/8"	\$73.35
610600-30*,**	10"	60	.126"	.087"	30mm	\$77.66
612600 +++	12"	60	.126"	.087"	1"	\$110.88
612720	12"	72	.126"	.087"	1"	\$138.79
612720-30***	12"	72	.126"	.087"	30mm	\$138.79
614720 +++	14"	72	.137"	.098"	1"	\$151.54
614720 -30	14"	72	.137"	.098"	30mm	\$151.54
614840	14"	84	.137"	.098"	1"	\$172.50
616960	16"	96	.137"	.098"	1"	\$200.51
618108 +++	18"	108	.158"	.110"	1"	\$252.30
618108-30	18"	108	.158"	.110"	30mm	\$252.30
620120	20"	120	.173"	.110"	1"	\$317.81



Heavy-Duty Ripping
10"-20", 18° Hook Flat Top (FT) Grind

Application: Heavy-Duty Production blade featuring increased thickness of kerf and plate. For ripping Natural Woods, along the grain. Suitable for multiple rip saws.

Tool No.	Dia.	Teeth	Kerf	Plate	Bore	Price
710200*	10"	20	.150"	.095"	5/8"	\$90.11
712240	12"	24	.173"	.095"	1"	\$108.83
714280	14"	28	.173"	.110"	1"	\$128.70
714280-30#	14"	28	.173"	.110"	30mm	\$128.70
716320	16"	32	.173"	.118"	1"	\$147.94
716320-30	16"	32	.173"	.118"	30mm	\$147.94

* Pin Hole : 2/7/42 & 2/10/60
Pin Hole : 2/10/60

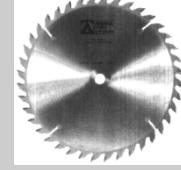

General Purpose Cut-Off
8"-16" 15° Hook Alternate Top Bevel Grind

Application: Universal use; Rip and crosscut natural woods and sizing of plywood.

Tool No.	Dia.	Teeth	Kerf	Plate	Bore	Price
683400	8"	34	.118"	.079"	5/8"	\$72.04
220T340#	220mm	34	.118"	.079"	30mm	\$96.53
692400	9"	24	.118"	.079"	5/8"	\$61.39
694000	9"	40	.118"	.079"	5/8"	\$86.48
612480	12"	48	.126"	.087"	1"	\$108.19
612480-30 *	12"	48	.126"	.087"	30mm	\$108.19
614540	14"	54	.137"	.098"	1"	\$132.86
614540-30 *	14"	54	.137"	.098"	30mm	\$132.86
616600	16"	60	.137"	.098"	1"	\$151.99
616600-30 *	16"	60	.137"	.098"	30mm	\$151.99

* Pin Hole : 2/10/60
For Holz-Her panel saws with Pin Hole 2/7/42

Heavy Duty Cut-off & Cross-Cut, 12"-16", 10"-15"-18° Hook - ATB Grind
Application: Heavy-duty production blade featuring increased thickness of plate & kerf & more aggressive hook angle. For general trimming & cross-cutting of natural woods.

Tool No.	Dia.	Teeth	Kerf	Plate	Bore	Price
712960	12"	96	.173"	.110"	1"	\$189.98
716600	16"	60	.173"	.110"	1"	\$175.20
716800	16"	80	.173"	.110"	1"	\$228.83
716960	16"	96	.173"	.110"	1"	\$258.71

* Pin Hole : 2/7/42 ** Pin Hole : 2/10/60
*** 2/10/60 Pin Hole for Altendorf, Omega, SCMI, and Stiebigh sliding table saws.
+++ 30mm bore with 2/10/60 pin hole available @ same price



Trim
 7"-18", 10° Hook
 Alternate Top
 Bevel (ATB) Grind

Application: Trim and size veneers and laminates in single sheets or stacks. Also for veneer laminated panels.

Tool No.	Dia.	Teeth	Kerf	Plate	Bore	Price
675600	7"	58	.118"	.079"	5/8"	\$90.90
686400	8"	64	.118"	.079"	5/8"	\$100.69
220T640**	220mm	64	.118"	.079"	30mm	\$112.58
610800	10"	80	.126"	.087"	5/8"	\$118.39
610800-30*	10"	80	.126"	.087"	30mm	\$118.39
612960	12"	96	.126"	.087"	1"	\$155.33
612960-30*	12"	96	.126"	.087"	30mm	\$155.33
614108	14"	108	.137"	.098"	1"	\$186.56
614108-30*	14"	108	.137"	.098"	30mm	\$186.56
616128	16"	120	.137"	.098"	1"	\$230.25
618132	18"	132	.157"	.110"	1"	\$297.23

* Pin Holes 2/7/42 & 2/10/60

** For Holzer-Her 220mm panel saws. P.H.2/7/42

Fine Cross-Cut & Cut-Off, 8"-18"

10° Hook - Triple Chip(TC) Grind

Application: Trimming, and single or double-sided veneered and plastic laminated panels.

Tool No.	Dia.	Teeth	Kerf	Plate	Bore	Price
686401	8"	64	.118"	.079"	5/8"	\$106.20
686401-30	8"	64	.118"	.079"	30mm	\$106.20
220T641**	220mm	64	.118"	.079"	30mm	\$118.35
610801	10"	80	.126"	.087"	5/8"	\$124.16
610801-30+	10"	80	.126"	.087"	30mm	\$124.16
612961	12"	96	.126"	.087"	1"	\$161.93
612961-30*	12"	96	.126"	.087"	30mm	\$161.93
614109	14"	108	.137"	.098"	1"	\$190.95
614109-30*	14"	108	.137"	.098"	30mm	\$190.95
616129	16"	120	.137"	.098"	1"	\$231.38
618133	18"	132	.157"	.110"	1"	\$307.36

* 2/10/60 pin holes; + 2/7/42 & 2/10/60 pin holes

** For Holzer-Her 220mm panel saws. P.H. 2/7/42

Radial Arm, 10"-16", Neg 2° Hook

4 ATB&1 Raker Grind - Unless otherwise noted

Application: Designed especially for radial arm saws, sliding compound miter saws and others with the blade above the workpiece. This blade minimizes the blade's tendency to self-feed, thanks to negative 2° hook angle. The blade features a low tooth count and an ATB plus raker grind (typically used on combination blades). Excellent choice for cutting hardwoods and softwoods.

Tool No.	Dia.	Teeth	Kerf	Plate	Bore	Price
RA1024	10"	24	.135"	.095"	5/8"	\$90.34
610720**	10"	72	.126"	.095"	5/8"	\$133.50
RA1236	12"	36	.150"	.110"	1"	\$120.75
RA1236-30*	12"	36	.150"	.110"	30mm	\$120.75
RA1440	14"	40	.165"	.110"	1"	\$152.25
RA1442+	14"	42	.165"	.110"	1"	\$151.43
RA1640	16"	40	.165"	.118"	1"	\$168.08
RA1648+	16"	48	.165"	.118"	1"	\$190.05

* 2/7/42 & 2/10/60 pin holes + TC Grind

** For plywood, ATB Grind



Thin Kerf Miter
 10" - 15", 10° Hook
 Alternative Top Bevel
 (ATB) Grind, or
 Triple Chip (TC)
 Grind.

Application: Thin kerf saws are designed for miter smooth cuts; less drag on bearings and brake and reduces stock loss on expensive woods and veneer plywoods. Not recommended to cut stock over 3/4" without the use of a stabilizer.

Alternative Top Bevel (ATB) Grind

Tool No.	Dia.	Teeth	Kerf	Plate	Bore	Price
610800-TS	10"	80	.090"	.062"	5/8"	\$124.35
612960-TS	12"	96	.090"	.062"	1"	\$147.94
614108-TS	14"	108	.090"	.062"	1"	\$177.71
615100-TS	15"	100	.104"	.079"	1"	\$199.80

Triple Chip (TC) Grind.

Tool No.	Dia.	Teeth	Kerf	Plate	Bore	Price
610801-TS*	10"	80	.090"	.062"	5/8"	\$131.74

* Can also be used for cutting thin plexiglass, masonite and plastics.



Thin Kerf Trim
 8"-14"
 10° Hook
 ATB or TC Grind

Application: Thin kerf blades are designed for miter smooth cuts; less drag on bearings and brake and reduces stock loss on expensive woods and veneer plywoods. Not recommended to cut stock over 3/4" without the use of a stabilizer. TC grind can also be used for cutting thin plexiglas, masonite and plastics.

Alternative Top Bevel (ATB) Grind

Tool No.	Dia.	Teeth	Kerf	Plate	Bore	Price
TB86400	8"	64	.090"	.062"	5/8"	\$101.33
TB10800	10"	80	.090"	.062"	5/8"	\$129.64
TB10100	10"	100	.090"	.062"	5/8"	\$166.61
TB12960	12"	96	.090"	.062"	1"	\$155.33
TB14108	14"	108	.090"	.062"	1"	\$180.98

Triple Chip (TC) Grind

Tool No.	Dia.	Teeth	Kerf	Plate	Bore	Price
TB86401	8"	64	.090"	.062"	5/8"	\$109.46
TB10801	10"	80	.090"	.062"	5/8"	\$138.75
TB10101	10"	100	.090"	.062"	5/8"	\$175.01
TB12961	12"	96	.090"	.062"	1"	\$167.78
TB14109	14"	108	.090"	.062"	1"	\$194.63

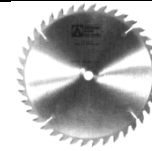

**Thin Kerf
 General
 Purpose**
 8"-15"
 15° Hook, ATB Grind.

Application: General Purpose wood cutting blades; less drag on bearings and brake and reduces stock loss on expensive woods and veneer plywood. Not recommended to cut stock over 3/4" without the use of a stabilizer.

Tool No.	Dia.	Teeth	Kerf	Plate	Bore	Price
TB83400	8"	34	.090"	.062"	5/8"	\$73.01
TB10400	10"	40	.090"	.062"	5/8"	\$81.26
TB12480	12"	48	.090"	.062"	1"	\$105.64
TB14540	14"	54	.090"	.062"	1"	\$131.36
615480	15"	48	.104"	.079"	1"	\$155.48



**Solid Surface &
 Non-Melt**
 10"-16", 0° Hook
 Modified Triple Chip
 (MTC) Grind.

Application: Premium blade for cutting double-sided plastic laminate, plexiglas and solid-surface materials such as Corian® etc. Suitable for radial arm and similar type machines due to 0° hook angle.

Tool No.	Dia.	Teeth	Kerf	Plate	Bore	Price
610721	10"	72	.126"	.095"	5/8"	\$141.71
610721-30*	10"	72	.126"	.095"	30mm	\$141.71
612841	12"	84	.126"	.095"	1"	\$184.39
612841-30**	12"	84	.126"	.095"	30mm	\$184.39
614961	14"	96	.126"	.095"	1"	\$222.30
616109	16"	108	.126"	.095"	1"	\$262.01

* 2/7/42 & 2/10/60 Pin Holes

** 2/10/60 Pin Holes



**Plastic Cutting
 Non-Melt, 10"-14"
 2° Negative Hook
 Modified Triple Chip
 (MTC) Grind.**

Application: Special- application blades for acrylic sheets, Plexiglas®, Lexan®, etc. 2° negative hook angle reduces the tendency of "chip-welding" or "melting" of Material.

Tool No.	Dia.	Teeth	Kerf	Plate	Bore	Price
LB86401	8"	64	.098	.070	5/8"	\$111.76
LB220T641**	220mm	64	.126	.079	30mm	\$117.56
LB10801	10"	80	.100	.074	5/8"	\$147.08
LB10801-30*	10"	80	.100	.074	30mm	\$147.08
LB12961	12"	96	.125	.102	1"	\$172.39
LB12961-30*	12"	96	.125	.102	30mm	\$172.39
LB14108	14"	108	.145	.118	1"	\$232.69
LB16121	16"	120	.145	.118	1"	\$305.96

* 2/7/42 & 2/10/60 pin holes

** For Holz-Her 220mm Panel Saws with 2/7/42 pin holes



Double-Face Melamine & Laminate
8"-16"
6° Negative Hook
25° High Alternative Top Bevel (H-ATB) Grind.

Application: Designed to cut melamine chip-free on both sides provided that your saw fence is square to the blade and the arbor is running true. Features increased thickness of plate for added stability, and special 'High-ATB' grind for extremely smooth cuts. Easily re-sharpened.

Tool No.	Dia.	Teeth	Kerf	Plate	Bore	Price
MB86400**	8"	64	.110".087"	5/8"		\$131.10
MB220T420*	220mm	42	.110".087"	30mm		\$117.53
MB10800	10"	80	.126".102"	5/8"		\$121.01
MB10800-30+	10"	80	.126".102"	30mm		\$121.01
MB12960	12"	96	.126".102"	1"		\$164.48
MB12960-30+	12"	96	.126".102"	30mm		\$164.48
MB14108	14"	108	.126".102"	1"		\$201.83
MB14108-30+	14"	108	.126".102"	30mm		\$181.13
MB16120	16"	120	.150".126"	1"		\$251.63

Double Face Melamine Korton & Veneer Saw Blades
10" TO 12" - 2° Negative Hook
35° 'High-ATB' Grind

Application: Similar to above, but with slightly more acute ATB grind, Thinner plate than our standard melamine blades. Improved results in certain melamine boards.

Tool No.	Dia.	Teeth	Kerf	Plate	Bore	Price
MSB1080	10"	80	.118".087"	5/8"		\$134.81
MSB1080-30+	10"	80	.118".087"	30mm		\$134.81
MSB1296	12"	96	.118".087"	1"		\$164.48
MSB1296-30+	12"	96	.118".087"	30mm		\$164.48

*For Holz-Her 220mm panel saws. 2/7/42 pin holes
**Can be used on vertical type panel saws, i.e. 'Safety Speed Cut' etc.
+ 2/7/42 & 2/10/60 pin holes



Edgebander Trim
150mm & 180mm
10° Hook
Alternative Top Bevel (ATB) Grind

Application: Replacement trim saw blades for edgebanding machines feature alternate bevel grind on the teeth, 10° hook angle, and standard thickness plates. Most machines require two blades.

Tool No.	Dia.	Teeth	Kerf	Plate	Bore	Price
663000*	150mm	30	.126".087"	30mm		\$69.68
663010**	180mm	58	.126".087"	20mm		\$102.04

*For IDM-137 and Ocmac Chica 290 edgebanders and others.
** For Olympic Nova-2 edgebanders, and others.



Non-Ferrous Thick-Walled Metal
8"-18"
6° Negative Hook
Triple Chip (TC) Grind.

Application: Specially designed carbide and blade geometry for cutting aluminum & non-ferrous metal bars, and relatively thick-walled extrusions & profiles. Under certain conditions, these versatile saw blades can also be used to cut other difficult materials such as plastic, PVC tubing and fiber glass. When cutting non-ferrous metals, a coolant should be used and proper clamping devices employed.

Warning: Never attempt to cut ferrous metal (steel, iron etc.) with these saw blades.

Tool No.	Dia.	Teeth	Kerf	Plate	Bore	Price
584801	8"	48	.110".087"	5/8"		\$98.78
510601	10"	60	.126".102"	5/8"		\$124.46
510601-30*	10"	60	.126".102"	30mm		\$124.46
512721	12"	72	.126".102"	1"		\$150.53
512721-30*	12"	72	.126".102"	30mm		\$150.53
514841	14"	84	.150".126"	1"		\$180.53
516961	16"	96	.150".126"	1"		\$211.31
518108	18"	108	.150".126"	1"		\$266.85



Non-Ferrous Thin-Walled Metal
7"-20"
6° Negative Hook
Triple Chip (TC) Grind.

Application: Specially designed carbide and blade geometry for cutting relatively thin-walled aluminum & non-ferrous extrusions & frames. Use a coolant or blade wax and clamp down the work piece when cutting non-ferrous metals.

Warning: Never attempt to cut ferrous metal (steel, iron etc.) with these saw blades.

Tool No.	Dia.	Teeth	Kerf	Plate	Bore	Price
575601	7"	58	.110 .087 5/8"			\$95.25
586401	8"	64	.110 .087 5/8"			\$118.84
596001	9"	60	.110 .087 5/8"			\$121.31
510801	10"	80	.126 .102 5/8"			\$131.06
510801-30 *	10"	80	.126 .102 30mm			\$131.06
510101	10"	100	.126 .102 5/8"			\$164.55
512961	12"	96	.126 .102 1"			\$166.54
512961-30 *	12"	96	.126 .102 30mm			\$166.54
514101-5/8HD#	14"	100	.146 .118 5/8"			\$238.50
514108	14"	108	.126 .102 1"			\$213.30
514108-30	14"	108	.126 .102 30mm			\$203.14
515101 **	15"	100	.120 .098 1"			\$226.61
516121	16"	120	.150 .126 1"			\$254.55
518121	18"	120	.150 .126 1"			\$349.91
520121	20"	120	.174 .134 1"			\$330.49
520121-30*	20"	120	.174 .152 30mm			\$330.49

* 2/7/42 & 2/10/60 pin holes
** For Hitachi Miter Box (Thin Kerf)
Pistorius
++ Makita



General Purpose Trim Saw Blades
Positive Hook
Alternative Top Bevel (ATB) Grind

Application: This carbide tipped trim saw blade is the ideal upgrade or replacement blade for Porter Cable, Makita or other brands of portable trim saws. The ATB grind ensures high quality cross cuts in solid wood and sizing cuts in ply wood.

Tool No.	Dia.	Teeth	Kerf	Plate	Bore	Price
RM-550	5-1/2"	30	.105 .0681/2"	5/8"-10mm		\$29.14

+ RM-550 fits Makita 5-1/2" saw & Others. Use replacement bushing: #BU-110 (5/8" X 3/8") or #BU-125 (5/8" X 10mm)



Nail-Cutting & Demolition
6 1/2" - 7 1/4"
Positive Hook
Flat Top (FT) Grind

Application: This blade is designed especially for renovation and demolition work, where contact with nails, screws, and similar debris has to be expected. The blade is configured - low tooth count and flat-top grind - for ripping. A negative hook angle and strong shoulder design to help prevent the blade's carbide tips from breaking off upon impact against a hidden nail.

Tool No.	Dia.	Teeth	Kerf	Plate	Bore	Price
NC-820	7-1/4"	14	.120".078"	5/8"-Univ.		\$20.18

All blades with '5/8"-Univ.' have a universal bore with 5/8" diameter arbor hole and diamond knock-out. All other blades are as noted.

**Dado Sets
6 & 12"
1/8" to 13/16"
Groove**
**Alternative Top
Bevel (ATB)
and Flat Top
(FT) Grind**

Application: To cut groove and dados from 1/8" through 13/16" or larger than 13/16" with additional chippers. Standard #3 set consists of two outside saw blades and four inside chippers. Outside saw blade feature hollow-ground plates for proper clearance, and alternate top bevel (ATB) grind with every sixth tooth flat ground (FT). See charts below for additional components. All 8" diameter sets now have 5° negative hook angle for smoother cuts.

Dado Combinations	No. of Chippers Required		
Max. Groove Width	1/16	1/8	1/4
13/16	1	2	1
1-1/16	1	2	2
1-9/16	1	2	4
2-1/16	1	2	6
3-1/16	1	2	10
4-1/16	1	2	14

Tool No.	Dia.	Teeth	Hook	Bore	Price
656030	6"	18	15°	5/8"	\$214.16
658030	8"	24	Neg 5°	5/8"	\$264.56
658030-1**	8"	24	Neg 5°	1"	\$264.56
658030-AK*	8"	24	15°	5/8"	\$264.56
658040**	8"	46	Neg 5°	5/8"	\$336.83
658040-1**	8"	46	Neg 5°	1"	\$336.83
651030	10"	24	15°	5/8"	\$325.39
651030-1	10"	24	15°	1"	\$325.39
651230	12"	24	15°	1"	\$456.71

* Anti-Kickback

** for super smooth cuts in cabinet grade plywoods and melamine

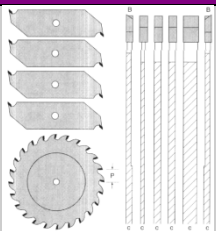
**Outside Saw
Blades
6" to 12"**
**Alternative Top
Bevel (ATB) or
Flat Top(FT)
Grind**

Specify left or right hand. Although each outside saw is sold separately, it is recommended to buy one set of both blades so the O.D. matches. **Kerf : 0.126"**

Tool NO. L/H	Tool NO. R/H	Dia.	Teeth	Bore	Price
656010	656010-R	6"	18	5/8"	\$69.68
658010	658010-R	8"	24	5/8"	\$78.90
658010-AK	658010-AK-R	8"	24	5/8"	\$78.90
658010-1	658010-1-R	8"	24	1"	\$78.90
658020	658020-R	8"	46	5/8"	\$136.80
658020-1	658020-1-R	8"	46	1"	\$136.80
651010	651010-R	10"	24	5/8"	\$133.91
651010-1	651010-1-R	10"	24	1"	\$133.91
651210	651210-R	12"	24	1"	\$124.76

Dado Chippers, FT Grind, 2 teeth per Chipper: Amana Tool has a full range of replacement parts for out dado sets, including chippers and outside blades. This allows you to replace damaged cutters and to expand the range of a standard set. These parts are manufactured to the same exacting standards as the full sets.

Tool No.	Thickness	Dia.	Bore	Price
651660	1/16"	6"	5/8"	\$20.55
651860	1/8"	6"	5/8"	\$29.33
651460	1/4"	6"	5/8"	\$40.80
651680	1/16"	8"	5/8"	\$31.88
651880	1/8"	8"	5/8"	\$37.80
651480	1/4"	8"	5/8"	\$52.58
651280	3/32"	8"	5/8"	\$36.56
651680-AK	1/16"	8"	1"	\$31.88
651880-AK	1/8"	8"	1"	\$37.80
651480-AK	1/4"	8"	1"	\$52.58
651680-1	1/16"	8"	1"	\$31.88
651880-1	1/8"	8"	1"	\$37.80
651480-1	1/4"	8"	1"	\$52.58
651610	1/16"	10"	5/8"	\$41.18
651810	1/8"	10"	5/8"	\$44.59
651610-1	1/16"	10"	1"	\$41.18
651810-1	1/8"	10"	1"	\$44.59
651612	1/16"	12"	1"	\$64.50
651812	1/8"	12"	1"	\$73.39

**Fine-Cutting
For Portable
Machines**
**Positive Hook
Alternative Top
Bevel (ATB)
Grind**

Tool No.	Dia.	Teeth	Kerf	Plate	Bore	Price
FC-500	6-1/2"	40	.120"	.078"	5/8"-Univ.	\$33.38

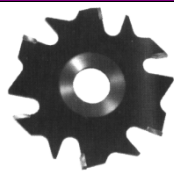
**Plate Jointer
(Biscuit)
Replacement
Blade**

European design with anti-kickback 'fingers' that limit chip-thickness while providing a safer, faster cut. Fits Lamello, Virutex, Freud, Kaiser, Elu, Dewalt and other makes of plate-jointer machines. Packaged in a re-usable protective foam sleeve.

Tool No.	Dia.	Teeth	Kerf	Bore	Price
LAM400T6	100mm	6	4.0mm	22mm	\$76.95

**Plywood & Plastic
Cutting**
**Positive Hook
Triple Chip (TC) Grind**

Tool No.	Dia.	Teeth	Kerf	Plate	Bore	Price
PC-620	7-1/4"	40	.120"	.078"	5/8"-Univ.	\$36.83

**Timberline™
Saw Blades**

Sliding Compound Miter : A 3 Degree Negative hook angle prevents the blade from grabbing the wood. Excellent for cross cutting and trimming crown molding, softwood and hardwood. 5/8" arbor with diamond knockout. Clamshell packed.

Tool No.	Diameter	Teeth	Grind	Bore	Price
235-400	8-1/2"	40	ATB	5/8"	\$27.79
235-600	8-1/2"	60	ATB	5/8"	\$33.60

Aluminum and Non-Ferrous : It is designed for cutting thin non-ferrous products and plastics. Features a negative hook angle. A blade wax and proper clamping is required. 5/8" arbor with diamond knockout. Clamshell packed. TCG Grind

Tool No.	Diameter	Teeth	Kerf	Plate	Bore	Price
185-505	7-1/4"	50	.110	.087	5/8"	\$41.72
240-600*	8-1/2"	60	.087	.083	5/8"	\$27.16

* Denotes 5/8" arbor with diamond knockout

Finishing Blade for Miter or Stationary Table Saw : Excellent for general purpose and crosscutting softwoods and hardwoods. 0° hook angle. Clamshell packed. Perfect blade for Miter Boxes, Table Saw, Radial Arm Saws.

Tool No.	Diameter	Teeth	Grind	Bore	Price
250-400	10"	40	ATB	5/8"	\$30.84
250-600	10"	60	ATB	5/8"	\$41.13
250-800	10"	80	ATB	5/8"	\$50.37
300-400	12"	40	ATB	1"	\$45.43
300-600	12"	60	ATB	1"	\$55.06
300-100	12"	100	ATB	1"	\$71.37

Finishing : This blade was designed for finishing, cross-cutting plastics, double sided melamine and plastic laminated MDF. The 0° hook angle allows for use on a broad range of material as well as machine types. Clamshell packed.

Fits Delta® 33-055 Deluxe Sawbuck® Frame and Trim Saw.

Tool No.	Diameter	Teeth	Grind	Bore	Price
200-401	8"	40	TCG	5/8"	\$32.06
250-601	10"	60	TCG	5/8"	\$41.13
250-801	10"	80	TCG	5/8"	\$50.37

Since 1949
KUFO Dust Collectors

	Model	UFO-40
	Price	\$247.50
	Motor	1 HP, 1ph, 110V
	Bag(s) Volume	1.5 Cubic Feet
	Inlet No. (Dia.)	4" Dia. X 1
	Air Flow	653 cfm
	Packing	17" x 15" x 18"
	Net Weight	41 lbs
	Gross Weight	46 lbs
	Optional	

	Model	UFO-101	UFO-1013
	Price	\$456.25	\$481.25
	Motor	2 HP, 1Ph, 220V	2 HP, 3Ph, 220V
	Bag(s) Volume	5.2 Cubic Feet	5.2 Cubic Feet
	Inlet No. (Dia.)	4" x 2 or 5" x 1	4" x 2 or 5" x 1
	Air Flow	1,312 cfm	1,312 cfm
	Packing	37" x 23" x 23"	37" x 23" x 23"
	Net Weight	134 lbs	134 lbs
	Gross Weight	143 lbs	143 lbs
	Optional	Canister Plastic Bag	Canister Plastic Bag

	Model	UFO-90
	Price	\$272.50
	Motor	1 HP, 1ph, 110V
	Bag(s) Volume	2.5 Cubic Feet
	Inlet No. (Dia.)	4" Dia. X 1
	Air Flow	696 cfm
	Packing	30" x 15" x 18"
	Net Weight	62 lbs
	Gross Weight	70 lbs
Optional	Canister Plastic Bag	

	Model	UFO-102T	UFO-103T
	Price	\$725.00	\$1,600.00
	Motor	3 HP, 3Ph, 220V	5 HP, 3Ph, 220V
	Bag(s) Volume	10.48 Cubic Feet	19.28 Cubic Feet
	Inlet No. (Dia.)	6" x 1 or 4" x 3 5" x 2 (Optional)	7" x 1 or 4" x 4
	Air Flow	1,925 cfm	2,733 cfm
	Packing	70" x 29" x 30"	70" x 29" x 30"
	Net Weight	169 lbs	231 lbs
	Gross Weight	180 lbs	365 lbs
	Optional	Canister Plastic Bag	

	Model	UFO-102B	UFO-102B3	UFO-103B	UFO-103B1
	Price	\$618.75	\$618.75	\$1,600.00	\$1,825.00
	Motor	3 HP, 1Ph, 220V	3 HP, 3Ph, 220V	5 HP, 3Ph, 220V	5 HP, 1Ph, 220V
	Bag(s) Volume	10.48 Cubic Feet	10.48 Cubic Feet	20.97 Cubic Feet	20.97 Cubic Feet
	Inlet No. (Dia.)	6" x 1 or 4" x 3	6" x 1 or 4" x 3	7" x 1 or 4" x 4 5" x 2 (Optional)	7" x 1 or 4" x 4 5" x 2 (Optional)
	Air Flow	1,925 cfm	1,925 cfm	2,733 cfm	2,733 cfm
	Packing	48" x 23" x 23"	48" x 23" x 23"	57" x 30" x 31"	57" x 30" x 31"
	Net Weight	169 lbs	169 lbs	253 lbs	253 lbs
	Gross Weight	180 lbs	180 lbs	365 lbs	365 lbs
	Optional	Canister Plastic Bag	Canister Plastic Bag		

	Model	UFO-103H
	Price	\$1,600.00
	Motor	5 HP, 3ph, 220V
	Bag(s) Volume	15.60 Cubic Feet
	Inlet No. (Dia.)	7" x 1 or 4" x 4 5" x 2 (Optional)
	Air Flow	2,733 cfm
	Packing	60" x 30" x 26"
	Net Weight	253 lbs
	Gross Weight	363 lbs
Optional	Canister Plastic Bag	

	Model	UFO-104D	UFO-105D
	Price	\$2,868.75	\$2,487.50
	Motor	10 HP, 3Ph, 220V	7.5 HP, 3Ph, 220V
	Bag(s) Volume	59.49 Cubic Feet	31.17 Cubic Feet
	Inlet No. (Dia.)	9.5" x 1 or 4" x 6 5" x 5 (Optional)	8.5" x 1 or 4" x 5 5" x 4 (Optional)
	Air Flow	4,257 cfm	3,812 cfm
	Packing	67" x 69" x 33"	60" x 52" x 33"
	Net Weight	728 lbs	440 lbs
	Gross Weight	1,080 lbs	594 lbs

DUST COLLECTION ACCESSORIES

Dust hoods and fittings provide an effective and inexpensive solution to the dust control problem in the workshop. Our hoods are molded in a variety of sizes and shapes to fit the most common woodworking machines and our fittings are specifically designed for assembling a dust collection system.



BLAST GATES

Used to control air flow from one machine to another. We offer plastic and aluminum blast gates. Plastic blast gates feature a textured surface and easy sliding gate action. Our aluminum blast gates are top quality and feature a cast aluminum body with steel gate and locking knob.

◆ ABS Plastic ◆

Tool No.	Dia.	Price
W1006	3"	\$2.67
W1007	4"	\$3.34
W1008	5"	\$6.84
W1009	6"	\$8.51

◆ Aluminum ◆

Tool No.	Dia.	Price
W1141	3"	\$9.01
W1142	4"	\$12.59



JOINTER DUST HOODS

Available in two sizes that fit most jointers on the market today. Model W1001 fits over a 6-1/2" x 6-1/2" chute and the W1002 fits over a 7" x 8-1/2" chute. It can be attached with screw or double-sided tape.

- Material thickness : 3/32"
- Outlet dia. is 4" O.D.
- Flange is 3/4" wide

W1001 ----- \$2.42
 Overall Size: (L x W x H)
 8-1/4" X 8-1/4" X 2-1/2"

W1002 ----- \$2.84
 Overall Size: (L x W x H)
 8-7/16" x 10-1/4" x 2-1/2"



FLOOR SWEEPS

For use in conjunction with our W1007 4" blast gate to clean up floor messes.

W1003 ----- \$6.42
 Overall Size: (L x W x H)
 24" x 7" x 3-1/2"



TABLE SAW DUST HOOD

Available in two sizes, these hoods are designed to fit most 8", 10" and 12" contractor type table saws, foreign and domestic. Mounted face down when in use, they can be adapted to other machines as well as 4" outer Diameter.

W1004 ----- \$5.01
 Overall Size: (L x W x H)
 12-1/4" x 12-1/4" x 2-1/2"

W1005 ----- \$4.92
 Overall Size: (L x W x H)
 14-1/16" x 14-1/16" x 2-1/2"



UNIVERSAL DUST HOODS

W1010 ----- \$1.84
 Fits over 4-1/2" hole on band saws, table saws, shapers, sanders, etc.

Material thickness : 3/32"
 Outlet dia. is 4" O.D.
 Flange is 3/4" wide
 Overall Size: (L x W x H)
 6-1/4" x 6-1/4" x 2-1/2"



ADAPTORS

For use with Shop-Vacs or their equivalent to connect a 3" and 4" line, or to tie into other machines that have 2-1/2" dust ports.

W1041 ----- \$1.42
 Diameter : 3" -> 2-1/2"
 Overall Size: (L x Dia.)
 3-3/16" x 3"

W1044 ----- \$1.67
 Diameter : 4" -> 2-1/2"
 Overall Size: (L x Dia.)
 4-1/2" x 4-1/4"



SPLICES

Designed to connect full sections of hose for longer runs or to utilize short sections.

W1018 ----- \$2.01
 Diameter : 3"
 Overall Size: (L x W x H)
 4-15/16" x 2-15/16" x 2-5/16"

W1019 ----- \$3.51
 Diameter : 4"
 Overall Size: (L x W x H)
 6-1/8" x 3-15/16" x 3-15-16"



T's (Dust Port)

T- allows you the option of adding branches to your system so they can service each machine in the shop.

W1012 ----- \$4.34
 Diameter : 3"
 Overall Size: (L x W x H)
 7-5/8" x 6" x 2-7/8"

W1013 ----- \$7.67
 Diameter : 4"
 Overall Size: (L x W x H)
 9-3/4" x 8" x 4-1/16"



ELBOWS

Elbows are necessary whenever dustwork changes direction, such as from the dust collector to an overhead main line, or when connecting individual machines to branch lines.

Tool No.	Dia.	Price
W1016	3"	\$4.51
W1017	4"	\$6.42



REDUCERS

allow woodworkers to step down from a larger main line to smaller branch lines. This step-down increases air velocity near the machine where it's needed most.

W1020 ----- \$1.42
 Diameter : 3" -> 2"
 Overall Size: (L x W x H)
 4" x 3" x 3"

W1011 ----- \$1.59
 Diameter : 4" -> 3"
 Overall Size: (L x W x H)
 2-7/16" x 4" x 4"



Y's (Dust Port)

Y's are used to attached branch lines to service more than one machine. It increases lateral air flow and efficiency.

W1014 ----- \$4.51
 Diameter : 3"
 Overall Size: (L x W x H)
 7-7/8" x 6-3/4" x 2-7/8"

W1015 ----- \$7.42
 Diameter : 4"
 Overall Size: (L x W x H)
 9-13/16" x 8-1/4" x 4-1/16"



UNIVERSAL DUST PORTS

W1042 ----- \$3.92
 It fits over a 3" hole and is made to the same specifications as our W1041 Adaptor, but with a flange added so you can attach it directly to any machine. Can attach with either double-sided tape or four screws.

- Material thickness : 3/32"
- Outlet dia. is 2-1/2" O.D.
- Flange is 3/4" wide
- Overall Size: (L x W x H)
 4" x 3-5/8" x 3-13/16"



4" Quick Disconnect DISCONTINUED

Designed to attach to the end of a 4" flexible hose and then press-on to any 4" diameter dust hood for a quick and easy friction fit. Ideal for use with smaller capacity, mobile dust collectors to service multiple machines. Eliminates the need to connect and disconnect a hose clamp each time a new woodworking machine is used. Stays secure and airtight.

W1038 ----- \$3.67
 1/8" Material Thickness
 4-1/4" Large O.D. Dia.
 3-7/8" Small O.D. Dia.
 4" Length



HOSE CLAMPS

Used to connect flexible piping to dust hoods, blast gates and fittings. Choose from steel band or wire bail in 2" to 6" sizes.

◆ Steel Clamps

No.	Measurements	Price
W1025	2"	\$0.56
W1313	2-1/2"	\$0.67
W1021	3"	\$0.67
W1022	4"	\$0.76
W1023	5"	\$0.89
W1024	6"	\$0.92



◆ Wire Clamps

Tool No.	Measurements	Price
W1315	2"	\$0.56
W1314	2-1/2"	\$0.56
W1316	3"	\$0.64
W1317	4"	\$0.97
W1318	5"	\$0.97
W1319	6"	\$1.06



HOSE

Tough polythylene hose.

Tool No.	Measurements	Price
W1030	3" x 50'	\$47.51
W1034	4" x 10'	\$54.26
W1035	5" x 10'	\$62.67
W1036	6" x 10'	\$66.42



20639 Lycoming Street #B-6, Walnut, CA 91789 U.S.A.

e-mail : info@magnate.net Web Site : www.magnate.net

(TEL) 800-827-2316, 909-468-5747 (FAX) 909-468-5745



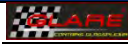

GLARE® PLUS Professional Polish

37411-glr-001



12 oz. Bottle : \$34.95

37411-glr-014



1 Gallon Jug : \$360.00

GLARE® PLUS+ PROFESSIONAL POLISH will make your vehicle's paint shine so bright that you will literally need sunglasses to look at it during the day, and it will look luminescent under artificial light at night. This product provides the highest shine available with a three dimensional depth of gloss not achievable with any other product. This is brand new technology in paint appearance and protection. Now with more Glassplexin®.

NEW GLARE®Plus + PROFESSIONAL POLISH is a non-stick, high gloss, all-weather, temperature- flexible sealant containing a new type of proprietary chemical formulation called Glassplexin. GLARE® was developed by on- staff chemists who have over 100 years of paint-specific chemical experience combined. GLARE® PROFESSIONAL POLISH represents the very latest in paint appearance and protection technology. It contains no waxes, polymers, or resins because those type of ingredients and chemicals in other products have very low melting points and do not filter out UV rays, and do not hold up to regular washing like GLARE®.

GLARE®plus + PROFESSIONAL POLISH will bond to your vehicle's paint through a covalent chemical bond which is not possible with any other product currently available in the world's market. The chemical reaction that occurs between GLARE® and the paint literally transforms the chemical structure of the vehicle's paint and now shares the properties of both the original paint and glass. Micro scratches, swirls, and oxidation are all removed permanently. The end result is a newly created type of paint/glass hybrid "SUPER PAINT" that is harder and more resilient then before.

The GLARE®Plus + treated paint has a much higher surface tension and causes water to sheet off instead of beading. The newly chemically altered paint now has the ability to filter out over 98% of the sun's UVA/UVB rays, the ability to block out air oxidation and corrosion, the ability to expand and contract with temperature variances up to 650 degrees Fahrenheit and down to negative 250 degrees Fahrenheit without cracking fading or peeling, will hold up to regular washing, and will block damage from everyday environmental contaminants that always seem to find their way onto your vehicle. Bugs, bird droppings, and tree sap will not stick to paint treated with GLARE® Plus+. Also, GLARE®Plus + PROFESSIONAL POLISH creates a paint surface so smooth and slick that the Air-Drag Coefficient of your vehicle will be significantly reduced, actually making your vehicle more aerodynamic.

GLARE®Plus + provides all of these benefits while producing the highest three dimensional depth of gloss never before achievable, and this is why GLARE® Plus + is not only used by individual enthusiasts and collectors, but also by vintage car and motorcycle museums and the world's most famous professional custom car and motorcycle painters in the industry. This is the absolute finest gloss enhancing polish/sealant currently available in the world's market for your car, truck, motorcycle, ATV, boat, yacht, personal watercraft, R/V, motorhome, trailer, or aircraft. Never apply carnauba wax, or polymer synthetic wax, on top of your final GLARE® Plus + coat as this will adversely affect the chemical bonding process with the paint and will cause the shine to go down. There is no need to top GLARE® Plus + with anything else because GLARE® provides the highest shine of any other product available. This should always be the final step in any application.

GLARE®Plus + PROFESSIONAL POLISH has been developed to be able to work on a wide variety of car, motorcycle, boat, and aircraft specific paints including Acrylic Enamels, Urethanes, Polyurethane and Polyurethane Clearcoats, and epoxy or polyester resin Gelcoats. GLARE® PLUS + PROFESSIONAL POLISH has been **tested and approved by BOEING** for use on PPG Aircraft Paint. Glare can be used on Fiberglass, Carbon Fiber, Glass, Plexiglass, Plastic, Chrome, Aluminum, and all metal alloys.

GLARE®Plus + is also excellent for exhaust pipes, wheels and rims, headlights and brake lenses, helmets, visors, goggles, eyeglasses and sunglasses, household appliances, marble, tile, porcelain, finished wood, brass, silverware, gold, jewelry, windows, mirrors, crystal, sporting goods, golf clubs, skiing equipment, water sports equipment, musical instruments, and repairs CD's and DVD's. As you can see, GLARE® PLUS + does not need to be stowed away in the garage after you're done treating your car or bike. It can be used around the house and on almost anything and everything that you own. If you think your paint looks good now, just wait until you see it after it has been GLARE'D. **You'll be seeing your vehicle's paint in true HD** for the first time in your life! GLARE® PLUS + PROFESSIONAL POLISH. Beyond wet.



GLARE® MICRO-FINISH

GLARE® MICRO-FINISH is a revolutionary micro compound developed with our exclusive Glassplexin formulation. GLARE® MICRO-FINISH has the smallest and finest abrasive particles added to remove light to moderate levels of oxidation and micro scratches without scratching or harming the applied surface. Just like GLARE® PROFESSIONAL POLISH, GLARE® MICRO-FINISH does not contain any type of waxes, polymers or resins, and can be used on a variety of materials including paint, clear-coat, gel-coat, fiberglass, chrome, glass, carbon fiber, plexiglass, plastic, and all metal alloys. This is the absolute best product available for removing those annoying micro scratches you see in your vehicle's paint, and also excellent for polishing up rims, wheels, and exhaust pipes too! This is not a cover up polymer wax product, but actually and permanently repairs micro scratches and oxidation through physics and chemistry. GLARE® MICRO-FINISH is the most advanced micro compound ever developed.

37411-glr-002



12 oz. Bottle : \$34.95

37411-glr-015



1 Gallon Jug : \$360.00



20639 Lycoming Street #B-6, Walnut, CA 91789 U.S.A.

e-mail : info@magnate.net Web Site : www.magnate.net
(TEL) 800-827-2316, 909-468-5747 (FAX) 909-468-5745



<p align="center"> GLARE® Spider</p> <p>GLARE® SPIDER with Glassplexin® is the most advanced swirl removing product ever created. Utilizing a unique chemical process of ultra pure metal interlinked fusion to Glassplexin® particles, GLARE® SPIDER will physically and chemically remove circular swirls and the appearance of spider webs in the paint, including on black paint even when viewed in direct sunlight. GLARE® SPIDER is not a cover up product, but a technologically advanced swirl removal solution that will permanently correct 99% of the swirls that appear in your paint which are caused by automated carwashes, hard water, dust, and dirt. Unlike other products that are sold as swirl remover products, GLARE® SPIDER actually works and does exactly what the label says it will do. GLARE® SPIDER will correct even the heaviest level of swirls and should always be followed with an application of GLARE® MICRO-FINISH or GLARE® PROFESSIONAL POLISH. GLARE® SPIDER has been designed to also work excellently on plastic too!</p>	<p align="center">37411-glr-003</p> <p align="center"></p> <p align="center">12 oz. Bottle : \$34.95</p>
<p align="center"> GLARE® Knock-Out</p> <p>GLARE® KNOCKOUT is a heavy cutting compound that contains our proprietary Glassplexin® formulation. Again, like all GLARE® products, this is a product that does not contain any type of carnauba wax, synthetic polymer wax, or resins. GLARE® KNOCKOUT is the most aggressive product in the GLARE® line and is designed to remove and repair the heaviest levels of oxidation and scratches in a safe and effective manner through both physical and advanced chemical means. It has been designed to be as aggressive as possible without being overly abrasive. It's balanced. GLARE® KNOCKOUT will not only remove and reverse oxidation, but will also remove stains and repair damage like bird dropping stains and hard water spot damage. GLARE® KNOCKOUT will remove industrial fallout as well. If you have that deep scratch or scuff that you thought could never be fixed outside of repainting, prepare to get knocked out because GLARE® KNOCKOUT can fix it. This product is also great for feathering in touch up paint to blend in with the original paint. GLARE® KNOCK OUT should always be followed with an application of GLARE® MICRO-FINISH.</p>	<p align="center">37411-glr-004</p> <p align="center"></p> <p align="center">12 oz. Bottle : \$29.95</p>
<p align="center"> GLARE® Liqui-Clay</p> <p>"The Clay Bar in a Bottle" Smoothes and removes stubborn blemishes before polishing! Won't re scratch your paint like a regular Clay Bar. Fast and very easy to use. The MOST advanced claying system for your vehicle's finish ever developed! * Restores Color * Picks up Debris. Fallout, Insects, and Dirt Particles like a Magnet! * Smoothes paint like glass * Preps paint before polishing.</p>	<p align="center">37411-glr-005</p> <p align="center"></p> <p align="center">12 oz. Bottle : \$29.95</p>
<p align="center"> GLARE® Ultra Wash</p> <p>"Cleans your vehicle, keeps your shine." The most advanced wash ever developed. A PH balanced concentrated wash. Safe for all paints and finishes including the new clear-coated paints. New technology that leaves your vehicle clean and glossy like no other vehicle wash can. Contains Glassplexin®.</p>	<p align="center">37411-glr-006</p> <p align="center"></p> <p align="center">12 oz. Bottle : \$11.95</p> <p align="center">37411-glr-016</p> <p align="center"></p> <p align="center">1 Gallon Jug : \$110.00</p>
<p align="center"> GLARE® Vinyl – Leather</p> <p>GLARE® Vinyl/Leather all Weather Protectant contains a special blend of natural ingredients and a chemical formulation called SUPPLEXIN which is designed to beautify, soften, deodorize, preserve, and protect against damaging agents found in the everyday usage of your vehicle's interior. This product cleans, conditions, preserves, and protects in one easy step while smelling great at the same time. Contains no harmful silicons, or adverse active ingredients. Blocks harmful UV rays. The finest and most technologically advanced interior product ever unleashed on the car care market, and thus worthy of the GLARE® Name.</p>	<p align="center">37411-glr-007</p> <p align="center"></p> <p align="center">12 oz. Bottle : \$14.95</p>
<p align="center"> GLARE® Rapid Action Spray Polish</p> <p>Bonds molecularly to your paint. The most exciting polish ever developed. Ultimate protection for Cars, Planes, Boats, Motorcycles, Fiberglass, Plastic, Stainless Steel, Chrome, Carbon Graphite & Polished Aluminum. Now in a convenient and easy to use spray formula. Contains Glassplexin® and lasts up to six months. Bonds molecularly to your paint. The most exciting polish ever developed.</p>	<p align="center">37411-glr-008</p> <p align="center"></p> <p align="center">16 oz. Bottle : \$24.95</p>
<p align="center"> GLARE® Turbo Action Wheeler Cleaner</p> <p>Ultimate protection for Cars, Planes, Boats, Motorcycles, Fiberglass, Plastic, Stainless Steel, Chrome, Carbon Graphite & Polished Aluminum. Now in a convenient and easy to use spray formula. Contains Glassplexin and lasts up to six months. Bonds molecularly to your paint. The most exciting polish ever developed.</p>	<p align="center">37411-glr-009</p> <p align="center"></p> <p align="center">16 oz. Bottle : \$12.95</p>



GLARE® Tire Magic

The ultimate all in one tire appearance protection product! Glare Tire Magic will filter out harmful Ultra Violet Rays from the sun. Extreme temperature resistant formula for all climates. Stops tires from cracking and fading. Gives a beautiful rich natural high gloss finish. Splatter resistant formula. Easy to use - just spray and wipe!

37411-GLR-010



16 oz. Bottle : \$14.95

THE CORRECT GLARE APPLICATION PROCEEDURE

GLARE® Winner Circle Pro Kit

1. Knock Out
2. Micro-Finish
3. Spider
4. Glare® Professional Polish (or Air-Glare® Professional Polish)

"Shines so bright, you'll need sunglasses."

This kit includes one of each: GLARE Professional Polish, GLARE Micro-Finish, GLARE Spider, GLARE Knock-Out Compound.



In this order you will apply the products the same. Buffing with a thick Micro Fiber Towel hook and loop design until the product disappears. Turn over the Towel and use the other side to wipe off the excess. Use a new Micro Fiber Towel with each of the products mentioned above. After you finished using the four products as described you will then go over a second coat only with the Glare Pro Polish. Rub in this time but not until the polish disappears. Let it dry to a haze! Do the whole vehicle without buffing the haze off. When you are finished with the vehicle at that time wait 30 min. then buff to a shine with a new Micro Fiber Towel. Do not get water on the Vehicle for 24 hours as it has to cure, and also do not ever put any other products over the Glare® except a Glare® product as the Glassplexin® does not mix with Silicones, Waxes, and Polymers. Very important on this point. If you want to apply another coat of Glare you can do this without any problems to fill in new scratches. As you know when you drive any vehicle on the road the dirt from the highways will make new scratches so we suggest you put on a new coat of Glare every other month. You will not need to go over the 4 step ever again unless your paint got keyed or vandalized etc.

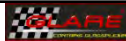

GLARE® Sahara Wash and Detail Spray

GLARE® Sahara Wash and Detail Spray is the only safe solution to washing and detailing your vehicle as an express polish or after care product. This does not replace GLARE® Professional polish. This is a beautiful after care product when your vehicle gets very dirty and you want to clean and maintain the original deep beyond wet look shine you received using the GLARE® Professional Polish.

37411-GLR-011



16 oz. Bottle : \$29.95

37411-GLR-012



32 oz. Refill Bottle : \$59.90

GLARE® Sahara Wash and Detail is a safe and effective wash and detail product rolled into one. This product is the perfect solution when water supply is limited. Do not confuse this product with Glare Rapid Action which has a 6 months lasting protection, and is not a wash. Safe on all exterior materials. The most revolutionary product of this kind on the market. Easy to use on all cars. Clear coat safe and recommended . This is the best spray polish you can buy. Great for use on motorcycles, glass, and polycarbonate as well.

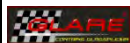

GLARE® Zero

GLARE® ZERO is a revolutionary product, especially developed for the professional in mind. Whether detailing an old finish, or preparing a freshly painted surface for polishing, GLARE® ZERO is a must. After the last coat of clear-coat has cured the professional painter will color sand with fine sandpaper to level any imperfections or ripples in the surface of the paint. After finishing this color-sanding procedure they will proceed to step one of polishing and polish the paint surface with GLARE Knock-Out Compound. Polishing out the scuffs and scrapes left behind from color sanding can be very tedious and take a good amount of work and time requiring countless passes of the high speed buffer.

37411-GLR-013



32 oz. Bottle : \$133.95

GLARE® ZERO was designed to be used after color sanding but before step one (GLARE® Knock-Out) to prepare the painted surface and shorten the time and work of polishing by allowing the GLARE Knockout to be more effective with less effort and with fewer passes of the high speed buffer. GLARE® Zero chemically softens the surface of the clear-coat when activated by heat from friction of the high speed buffer. The surface of the clear-coat turns into semi-fluid state allowing the scuffs and scrapes from color-sanding to blend together right before your very eyes while polishing with GLARE® Knock-Out. This chemical transformation allows the GLARE® Knockout to be twice as effective. Although the clear-coat initially becomes softer, once done polishing with GLARE® Professional Polish, the clear-coat becomes harder, smoother, more resilient and with a higher surface tension then ever before achievable. Detailers may also use GLARE® ZERO without color sanding to make polishing more effective. This is brand new paint prep technology that both the professional painter/body shop as well as the professional detailer will appreciate. Before step one there's ZERO



20639 Lycoming Street #B-6, Walnut, CA 91789 U.S.A.

e-mail : info@magnate.net Web Site : www.magnate.net
(TEL) 800-827-2316, 909-468-5747 (FAX) 909-468-5745





GLARE® Blast

NEW! Glare Blast Quick & Fast Flat Paint Polish Will Adapt to all Paints. We are the only ones with Camo-Adaptive Technology in the World! A Quick Detailer Total all Paint Including Falt Paints Protection Spray!!

GLARE® BLAST is the most technologically advanced spray detailer polish ever developed! This is not just a simple cleaner, but a true polish that blocks UV rays and protects paint against contamination and the environment

This is the only spray detailer polish with Camo-Adaptive Technology™ which allows GLARE BLAST to adapt to whatever surface it is being applied to including Gloss Paint, Flat Paint (Matte or Satin Paint), Clear Coated Paint, ALL types of Polyurethane Paints, Enamel Paint, Nitrocellulose Paint, Gel-Coat, Carbon Fiber, Fiberglass, Glass, Mirrors, Plexiglass, Helmets, Visors, Goggles, Sunglasses, Plastic (smooth or rough), Rubber, Vinyl, Leather, Chrome, Aluminum, All types of Metal Alloys, Powder Coat, and can even be used on outer engine components and casings.

GLARE BLAST's exclusive Camo-Adaptive Technology™ will make flat paint look like brand new flat paint without adding any unwanted sheen or gloss and eliminates and prevents fingerprints. When used on gloss paint it will make the paint pop with added gloss unmatched by any other spray detailer polish. This is the only spray detailer polish in the world with Camo-Adaptive Glassplexin® which allows GLARE BLAST to serve these two totally different and opposite functions for flat and gloss paints. Camo-Adaptive Technology™ makes it possible for this single product to enhance any and all types of paints in existence, and with our Glassplexin® formulation GLARE BLAST will offer you the best paint protection of any spray detailer product on the market. Whether your paint is supposed to shine or not, Camo-Adaptive Technology™ allows GLARE BLAST to know exactly what it's supposed to do. It's easy to use, it will give your paint real protection because it contains our proprietary Glassplexin® formulation, and you can use it on virtually all other materials found on your vehicle besides just the paint. It truly is the most technologically advanced spray detailer polish ever unleashed onto the car care and motorcycle care market. This is cutting edge technology in paint appearance and protection. It sprays on fast and wipes off easy. It's called GLARE BLAST and it's Quick 'N' Fast! Don't drive or ride without it.

37411-glr-020



12 oz. Bottle : \$34.95



Air-GLARE® AIRCRAFT PROFESSIONAL POLISH

AIR-GLARE® PROFESSIONAL AIRCRAFT POLISH is the most technologically advanced aircraft paint polish/sealant ever developed. This is the finest product for your airplane, jet, or helicopter. AIR-GLARE® will protect your expensive aircraft paint from UV ray discoloration, engine exhaust, air oxidation, and degradation which is caused by air molecules constantly bombarding the exterior at extremely high speeds. This product will make cleaning your aircraft a shorter, easier task

AIR-GLARE® PROFESSIONAL AIRCRAFT POLISH will reduce the Air-Drag Coefficient of the aircraft which in turn increases maximum air-speed and fuel economy. AIR-GLARE® will allow for a much easier de-icing of the aircraft as well. AIR-GLARE® has been tested and approved by BOEING® for use on PPG Aircraft Paint, and can be used on a wide variety of aircraft paints and materials. AIR-GLARE® is also excellent for polycarbonate (maintains optical clarity), glass (including instrumentation glass), Carbon Graphite (including helicopter blades), fiberglass, aircraft aluminum, and all metal alloys.

Approved for types of aircraft, Exceeds Boeing® Test D6-17487.

37411-glr-001



12 oz. Bottle : \$44.95

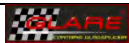

GLARE® Hurricane Folding Bucket

This Glare Bucket is made from the finest Fire-Hose material to give it longevity, and makes extremely sturdy. Will give you many years of use! Handle is made from the finest surgical stainless steel. Folds up in a zippered hat box. After use just fold up and up it your trunk of your car, or store in the garage. Once you use this bucket you will not want to use any other kind! Many uses: Car washing, Holding Golf Balls, Holds Ice for Drinks at the Beach, Fishing!! etc. You will find many more uses for our Glare Foldable 5 gallon Bucket! Makes a Great Unique Gift for anyone!

* This ultra modern bucket holds 5 gallons of Water. * Collapses for easy storage. * Comes in its own storage case.
* The Glare Hurricane Bucket is great for traveling or home. * Fits nicely in any suitcase or trunk of a car. * Glare Hurricane Bucket can be used to wash cars, fishing, golf balls. * Great for holding Ice for parties and keep drinks ice cold.

Made from the same type of materials used in Commercial Fire Hoses. Handle is 100% Stainless Steel - Rust Proof!! Comes with a one year warranty against manufactures defects. We guarantee this is the most practical bucket you have ever seen. Another top notch product brought to you by Ultra 2000 Manufacturing International Inc. the makers of Exclusive Glare Products.

37413-hcn-019



\$29.95



20639 Lycoming Street #B-6, Walnut, CA 91789 U.S.A.

e-mail : info@magnate.net Web Site : www.magnate.net
(TEL) 800-827-2316, 909-468-5747 (FAX) 909-468-5745



MISC. ACCESSORIES

ER11 CNC Collets		
 MAGNATE 18mm (0.708") Length, 11.5mm (0.45") Diameter		
Tool No.	Size	Price
ER11116	1/16"	\$41.28
ER11332	3/32"	\$39.70
ER1118	1/8"	\$33.17
ER11532	5/32"	\$33.17
ER11316	3/16"	\$33.17
ER11732	7/32"	\$33.17
ER1114	1/4"	\$33.17

ER25 CNC Collets		
 MAGNATE 34mm (1.34") Length, 26mm (1.02") Diameter		
Tool No.	Size	Price
ER25332	3/32"	\$47.18
ER2518	1/8"	\$22.50
ER25532	5/32"	\$39.80
ER25316	3/16"	\$22.50
ER25732	7/32"	\$39.80
ER2514	1/4"	\$22.50
ER25932	9/32"	\$39.80
ER25516	5/16"	\$22.50
ER251132	11/32"	\$38.26
ER2538	3/8"	\$22.50
ER251332	13/32"	\$39.80
ER25716	7/16"	\$22.50
ER251532	15/32"	\$38.26
ER2512	1/2"	\$22.50
ER251732	17/32"	\$38.26
ER25916	9/16"	\$22.50
ER251932	19/32"	\$38.26
ER2558	5/8"	\$22.50
ER252	2mm	\$38.26
ER257	7mm	\$39.80
ER258	8mm	\$22.50
ER2510	10mm	\$22.50
ER2512M	12mm	\$39.80
ER2513M	13mm	\$39.80
ER2514M	14mm	\$39.80
ER2516M	16mm	\$39.80

ER16 CNC Collets		
 MAGNATE 27.5mm (1.08") Length, 17mm (0.67") Diameter		
Tool No.	Size	Price
ER16116	1/16"	\$45.70
ER16332	3/32"	\$45.70
ER1618	1/8"	\$33.17
ER16532	5/32"	\$33.17
ER16316	3/16"	\$33.17
ER16732	7/32"	\$33.17
ER1614	1/4"	\$33.17
ER16932	9/32"	\$33.17
ER16516	5/16"	\$33.17
ER161132	11/32"	\$33.17
ER1638	3/8"	\$35.92
ER161332	13/32"	\$33.17
ER167	7mm	\$31.88
ER168	8mm	\$31.88
ER1610	10mm	\$33.17

ER20 CNC Collets		
 MAGNATE 31.5mm (1.24") Length, 21mm (0.83") Diameter		
Tool No.	Size	Price
ER20332	3/32"	\$45.70
ER2018	1/8"	\$19.01
ER20532	5/32"	\$37.62
ER20316	3/16"	\$19.01
ER20732	7/32"	\$37.62
ER2014	1/4"	\$19.01
ER20932	9/32"	\$37.62
ER20516	5/16"	\$19.01
ER201132	11/32"	\$38.27
ER2038	3/8"	\$19.01
ER201332	13/32"	\$36.17
ER20716	7/16"	\$19.01
ER201532	15/32"	\$36.17
ER2012	1/2"	\$19.01
ER207	7mm	\$36.17
ER208	8mm	\$37.62
ER2010	10mm	\$19.01
ER2012M	12mm	\$37.62
ER2013M	13mm	\$36.17

ER32 CNC Collets		
 MAGNATE 40mm (1.57") Length, 33mm (1.31") Diameter		
Tool No.	Size	Price
ER32332	3/32"	\$54.55
ER3218	1/8"	\$22.50
ER32532	5/32"	\$39.80
ER32316	3/16"	\$22.50
ER32732	7/32"	\$39.80
ER3214	1/4"	\$22.50
ER32932	9/32"	\$39.80
ER32516	5/16"	\$22.50
ER321132	11/32"	\$38.35
ER3238	3/8"	\$22.50
ER321332	13/32"	\$39.80
ER32716	7/16"	\$22.50
ER321532	15/32"	\$38.35
ER3212	1/2"	\$22.50
ER321732	17/32"	\$38.35
ER32916	9/16"	\$22.50
ER321932	19/32"	\$38.35
ER3258	5/8"	\$22.50
ER322132	21/32"	\$38.35
ER321116	11/16"	\$22.50
ER322332	23/32"	\$39.80
ER3234	3/4"	\$22.50
ER324	4mm	\$39.80
ER325	5mm	\$39.80
ER326	6mm	\$22.50
ER328	8mm	\$22.50
ER3210	10mm	\$22.50
ER3212M	12mm	\$39.80
ER3213M	13mm	\$39.80
ER3214M	14mm	\$39.80
ER3216M	16mm	\$39.80
ER3218M	18mm	\$38.35
ER3220M	20mm	\$39.80

ER40 CNC Collets		
 MAGNATE 46mm (1.81") Length, 41mm (1.61") Diameter		
Tool No.	Size	Price
ER4018	1/8"	\$25.00
ER40532	5/32"	\$44.23
ER40316	3/16"	\$25.00
ER40732	7/32"	\$44.23
ER4014	1/4"	\$25.00
ER40932	9/32"	\$44.23
ER40516	5/16"	\$25.00
ER401132	11/32"	\$44.23
ER4038	3/8"	\$25.00
ER401332	13/32"	\$44.23
ER40716	7/16"	\$25.00
ER401532	15/32"	\$44.23
ER4012	1/2"	\$25.00
ER401732	17/32"	\$44.23
ER40916	9/16"	\$25.00
ER401932	19/32"	\$44.23
ER4058	5/8"	\$25.00
ER402132	21/32"	\$44.23
ER401116	11/16"	\$25.00
ER402332	23/32"	\$44.23
ER4034	3/4"	\$25.00
ER4078	7/8"	\$25.00
ER401	1"	\$25.00
ER406	6mm	\$25.00
ER407	7mm	\$44.23
ER408	8mm	\$25.00
ER4010	10mm	\$25.00
ER4012M	12mm	\$44.23
ER4013M	13mm	\$44.23
ER4014M	14mm	\$44.23
ER4016M	16mm	\$44.23
ER4018M	18mm	\$44.23
ER4020M	20mm	\$44.23
ER4022M	22mm	\$44.23
ER4025M	25mm	\$44.23



MISC. ACCESSORIES

TG100 CNC Collets



MAGNATE

35mm (1.38") Diameter x 60mm (2.36") Length

Tool No.	Size	Price
TG10018	1/8"	\$33.92
TG10014	1/4"	\$33.92
TG10038	3/8"	\$33.92
TG10012	1/2"	\$33.92
TG10058	5/8"	\$33.92
TG10034	3/4"	\$33.92
TG10078	7/8"	\$32.62
TG1001	1"	\$32.62

TG150 CNC Collets



MAGNATE

76.2mm (3.00") Length x 50.8mm (2.00") Diameter

Tool No.	Size	Price
TG15012	1/2"	\$49.62
TG15058	5/8"	\$49.62
TG15034	3/4"	\$49.62
TG15078	7/8"	\$49.62
TG1501	1"	\$49.62

TG75 CNC Collets



MAGNATE

47mm (1.85") Length x 27mm (1.06") Diameter

Tool No.	Size	Price
TG7518	1/8"	\$32.43
TG75316	3/16"	\$32.43
TG7514	1/4"	\$32.43
TG7538	3/8"	\$32.43
TG7512	1/2"	\$37.15
TG7558	5/8"	\$31.18
TG7534	3/4"	\$32.43
TG7510	10mm	\$32.43

SYOZ 20 CNC Collets



MAGNATE

This collet is used on 6.8HP and 7HP Dual End Perske Motors. It comes with 34mm (1.34") Length x 20mm Diameter (0.78") for RDO 20, SYOZ 20, EOC 12, 407E tool holder.

Tool No.	Size	Price
OZ2018	1/8"	\$35.12
OZ20316	3/16"	\$53.08
OZ2014	1/4"	\$53.08
OZ20516	5/16"	\$53.08
OZ2038	3/8"	\$53.08
OZ2010	10mm	\$53.10
OZ20716	7/16"	\$51.05
OZ2012	1/2"	\$53.08

SYOZ 25 CNC Collets



MAGNATE

This collet is used on 12HP and 15HP Perske motors and 7.5HP Dual End Perske Motors. It comes with 52mm (2.06") Length x 35mm Diameter (1.38") for RDO 35, SYOZ 25, 462E tool holder.

Tool No.	Size	Price
OZ2518	1/8"	\$30.00
OZ25316	3/16"	\$39.82
OZ2514	1/4"	\$30.00
OZ25516	5/16"	\$30.00
OZ2538	3/8"	\$30.00
OZ25716	7/16"	\$39.82
OZ2512	1/2"	\$30.00
OZ25916	9/16"	\$30.00
OZ2558	5/8"	\$30.00
OZ2534	3/4"	\$30.00
OZ2578	7/8"	\$30.00
OZ251	1"	\$30.00
OZ2510	10mm	\$39.82
OZ2516M	16mm	\$39.82
OZ256	6mm	\$39.82
OZ257	7mm	\$39.82
OZ2512M	12mm	\$39.82
OZ2514M	14mm	\$35.12
OZ2520M	20mm	\$39.82
OZ2525M	25mm	\$39.82



SYOZ Ultra High Speed Coated Clamping Nuts

Compatible with RDO and Ortlieb Nuts

Tool No.	Collet	O.D.xI.D.	Price
OZ20HSN	(a)	35x20mm	\$82.69
OZ20HSL	(b)	35x20mm	\$133.83
OZ25HSN	(c)	60x30mm	\$111.56
OZ25HSL	(d)	60x30mm	\$183.76

- (a) For SYOZ 20/RDO 020
- (b) For SYOZ 20/RDO 020, Left Hand
- (c) For SYOZ 25/RDO 035
- (d) For SYOZ 25/RDO 035, Left Hand

Spanner Wrenches For SYOZ 20 and SYOZ 25

Tool No.	Type	Price
OZ20W	SYOZ 20/RDO 020	\$46.49
OZ25W	SYOZ 25/RDO 035	\$26.26



MISC. ACCESSORIES

ER Collet Nuts



MAGNATE

Tool No.	Collet	Outside Dia.	Inside Dia.	Length	Price
ER11HSNER11	19mm	14mmx.75	11.80mm	\$26.00	
ER16HSNER16	32mm	22mmx1.5	18mm	\$26.00	
ER20HSNER20	35mm	25mmx1.5	19.5mm	\$26.00	
ER25HSNER25	42mm	32mmx1.5	20.5mm	\$29.75	
ER32HSNER32	50mm	40mmx1.5	23mm	\$34.65	
ER40HSNER40	63mm	50mmx1.5	26mm	\$44.56	

HSK 63F Collet Toolholder



MAGNATE

Tool No.	Collet	Gauge	Length	Price
ER32-HSK63F-70	ER32	70mm	\$197.50	
ER32-HSK63F-75	ER32	75mm	\$197.50	
ER32-HSK63F-80	ER32	80mm	\$197.50	
ER40-HSK63F-76	ER40	76mm	\$204.17	
ER40-HSK63F-90	ER40	90mm	\$204.17	
OZ25-HSK63F-78	SYOZ25	78mm	\$204.17	



Pro-Stik®

Abrasive Belt & Disc Cleaners

Clearing STIKS : Increase the life of new sanding belts and discs with our quality Pro-Stik® abrasive belt cleaners. Simply press the cleaner lightly against moving sanding belts and discs to remove clogged-up pitch and sawdust. (Not recommended for wide-belt sanders.)

Tool No.	Size	Price
W1307	2"x2"x12"	\$15.75

Panel Pilot Spiral 1 Flute - High Speed Steel



For composition materials, hard or soft wood. Used for installing paneling, drywall, or siding. The sharp point plunges quickly while the carbide edges create a clean even interior surface.

Tool No.	Cutting Dia.	Cutting Length	Shank Dia.	Overall Length	Price
501HSP	1/4"	5/8"	1/4"	2-3/4"	\$8.62
502HSP	3/8"	3/4"	3/8"	3-1/8"	\$10.03
504HSP	1/2"	1"	1/2"	3-1/2"	\$11.56

Panel Pilot Straight 1 Flute - High Speed Steel



For composition materials, hard or soft wood. Used for installing paneling, drywall, or siding. The sharp point plunges quickly while the carbide edges create a clean even interior surface.

Tool No.	Cutting Dia.	Cutting Length	Shank Dia.	Overall Length	Price
501HST	1/4"	3/4"	1/4"	2-3/4"	\$8.62
502HST	3/8"	3/4"	3/8"	3-1/8"	\$10.03
504HST	1/2"	1"	1/2"	3-1/2"	\$11.56



Carving Pod Bits M2 High Speed Steel

Tool No.	Cutting Dia.	Cutting Length	Shank Dia.	Price
2751	1/8"	3/4"	1/4"	\$13.39
2754	3/16"	1"	1/4"	\$13.39
2756	1/4"	1"	1/4"	\$13.39
2758	3/8"	1"	1/4"	\$21.18



Carving Rougher Bits M2 High Speed Steel

Cutting Length : 1-3/16"
Overall Length : 2-1/2"

Tool No.	Cutting Dia.	Shank Dia.	Price
2844	1/2"	1/4"	\$20.65
2845	5/8"	1/4"	\$20.65
2841	5/8"	11mm	\$31.23
2846	3/4"	1/4"	\$22.64
2847	3/4"	1/2"	\$26.69
2842	3/4"	11mm	\$36.00
2848	1"	1/4"	\$46.88

Forstner Bit 3/8" Shank Diameter 3-1/2" OAL Carbon Tool Steel



To be used with drill presses.

Tool No.	Cutting Dia.	Price
FB1001	1/4"	\$2.48
FB1002	3/8"	\$2.88
FB1003	1/2"	\$3.26
FB1004	5/8"	\$3.64
FB1005	3/4"	\$4.02
FB1006	7/8"	\$4.50
FB1007	1"	\$4.88
FB1008	1-1/8"	\$5.64
FB1009	1-1/4"	\$6.50
FB1010	1-3/8"	\$7.45
FB1011	1-1/2"	\$8.03
FB1012	1-5/8"	\$8.50
FB1013	1-3/4"	\$8.88
FB1014	1-7/8"	\$9.47
FB1015	2"	\$11.28
FB1016	2-1/8"	\$12.33

MAGNATE 20639 Lycoming Street #B-6, Walnut, CA 91789 U.S.A.

E-Mail : info@magnate.net Shop Online : <http://www.magnate.net>
(TEL) 800-827-2316, 909-468-5747 (FAX) 909-468-5745



MISC. ACCESSORIES



Arbor for Plastic Saw

Tool No.	Shank Dia.	Overall Length	Prices
P1521	1/2"	3-1/4"	\$53.85
P1522	1/2"	4-1/2"	\$57.69
P1523	5/8"	3-1/4"	\$53.87
P1524	3/4"	3-1/4"	\$53.89



**16-Wing Plastic Saws
Carbide Tipped
(0° Hook TCG)**

Tool No.	Cutting Dia.	Kerf	RPM	Prices
P1531	2"	.095"	18,000	\$87.46
P1532	2-1/2"	.095"	16,000	\$87.46
P1533	3"	.095"	14,000	\$87.46
P1534	3-1/2"	.095"	12,000	\$87.46

Lube Tube Band Saw Lubricant Multi-purpose Lubricating Wax For Industrial Use



This extreme pressure lubricant prevents the buildup of frictional heat on metal surfaces. It is designed to be applied to bandsaw blades and other cutting tools. It improves overall tool life and productivity when sawing, drilling, milling, grinding, threading or tapping. It can be used on ferrous and non-ferrous metals, aluminum gates, risers, plates and extrusions.

It is biodegradable, nontoxic and non staining.

WARNING:

Causes serious eye irritation. Causes skin irritation. May cause an allergic skin reaction.

Wear protective gloves. Wear eye or face protection. Avoid breathing dust. Wash hands thoroughly after handling. Contaminated work clothing should not be allowed out of the work place.

IF ON SKIN: Wash with plenty of soap and water. Take off contaminated clothing. Wash contaminated clothing before reuse. If skin irritation or rash occurs: Get medical attention.

IF IN EYES: Rinse cautiously with water for several minutes. Remove contact lenses, if present and easy to do. Continue rinsing. If eye irritation persists: Get medical attention. Dispose of contents and container in accordance with all local, regional, national, and international regulations.

Percentage of the mixture consisting of ingredient(s) of unknown toxicity: 44%.

Tool No.	Tube	Price
68020LNX	14.5 oz	\$15.40



A (Hex) Wrench

Tool No.	Collet	(mm) Length	(mm) Width	Price
ER11WA	ER11	120	40	\$17.08
ER16WA	ER16	140	53	\$17.74
ER20WA	ER20	180	60	\$26.26



Hook Wrench

Tool No.	Collet	(mm) Length	(mm) Width	Price
TG075WH	TG75	253	46	\$45.00
TG100WH	TG100	260	46	\$26.26
SY20WH	SYOZ25			
	SYOZ20		34	\$46.49



Slotted Wrench

Tool No.	Collet	(mm) Length	(mm) Width	Price
ER16WS	ER16	160	55	\$22.31
ER20WS	ER20	180	60	\$45.94
ER25WS	ER25	206	65	\$20.42
ER32WS	ER32	253	75	\$27.57
ER40WS	ER40	289	90	\$31.52
ER50WS	ER50	351	110	\$65.00



Mini Wrench

Tool No.	Collet	(mm) Length	(mm) Width	Price
ER08WM	ER8	75	13	\$15.75
ER11WM	ER11	95	17	\$15.75
ER16WM	ER16	117	22.5	\$17.08
ER20WM	ER20	129	28.5	\$18.38
ER25WM	ER25	142.5	35.5	\$18.38

Magnate custom makes solid carbide, carbides tipped, diamond and steel cutting tools i.e. router bits, shaper cutters and etc. (thereafter referred to as Cutters) to your specifications. All Cutters are industrial grade carbide tipped and made in USA unless otherwise specified.

The procedure is as follows:

- Please download and fill out our "Custom Made" Tooling Information Sheet" (Please refer to next page). E-mail to info@magnate.net or fax to 909-468-5745 the sheet with the dimensions of the Cutters that you want. Specify the number of wings or flutes and rotation. If the dimensions are not easy to describe, the ACTUAL size of wood sample is desired.
- Upon receiving your drawing or wood sample, Magnate will quote you the pricing usually within 24-48 hours by e-mail, fax or phone whichever you prefer.
- Upon your agreement with the pricing, Magnate will provide you with the CAD-like drawing (see example below) for your approval. Magnate's trained personnel will then discuss the drawing with you if you have any questions.

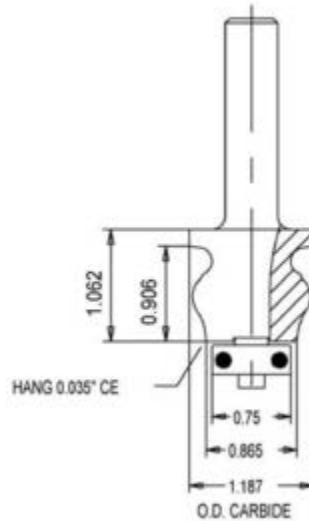

- You will give us written approval or your signature on the final drawing.
- Upon receiving the written approval or your signature, Magnate will make the Cutters according to the final drawing you approved.
- It usually takes 7-10 working days before we can ship the Cutters. Rush orders may require an extra charge.
- You are responsible for providing an accurate drawing. It must be paid in full before Magnate starts making the Cutters. The charge is not refundable UNDER ANY CIRCUMSTANCES. If The Cutter is defective or it does not fit the final drawing you approved, we will re-make it at no extra charge. Beyond this, Magnate is not responsible for any damages caused by any errors of yours, Magnate or any third parties.

Please feel free to contact us if you have further questions.

MAGNATE™ "Custom Made" Tooling Information Sheet

Customer Information

Company name _____
 Contact _____
 Address: _____

 City _____ State _____ Zip _____

Drawing Examples

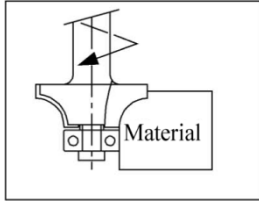

**Clockwise
(Router Bits)**

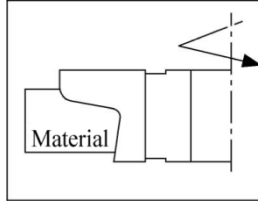

**Counterclockwise
(Shaper Cutter)**

1/8" Squares

Actual Size Drawings only (1 to 1 Scale)

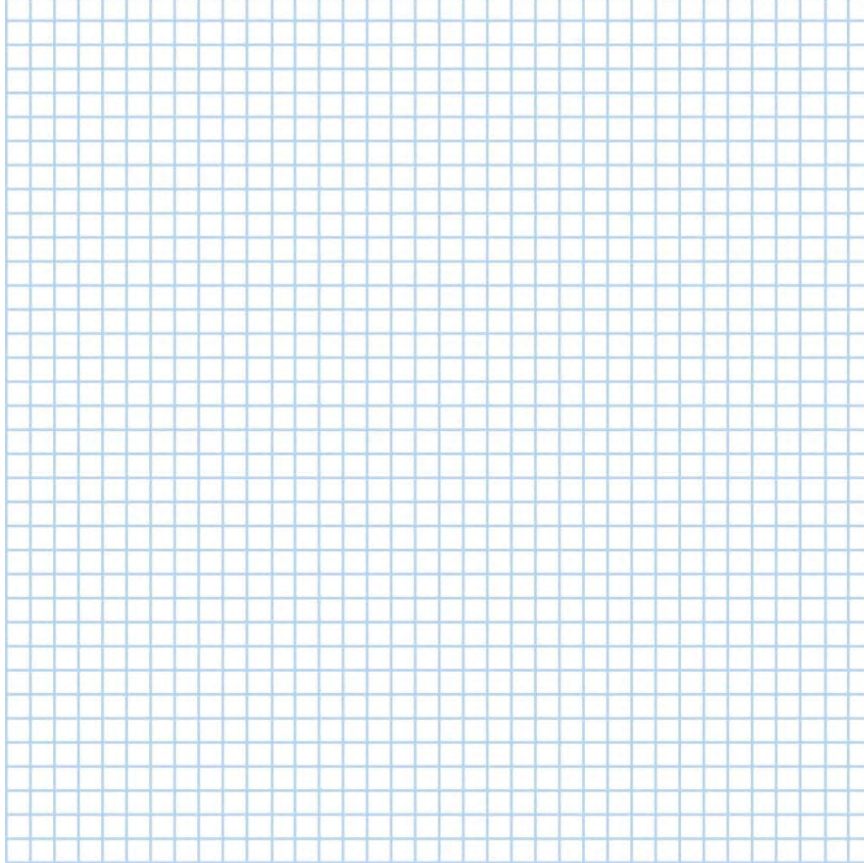

Signature _____ Date _____

Machine Information

Type of Machine _____
 Collect/Spindle Size _____
 Keyway : Yes No
 Quantity _____ Size _____
 RPM _____
 Feed Rate _____
 Minimum Circle : _____
 Maximum Circle : _____
 Comments:

Tool Information

Type of Tool : _____
 Tip Preference :
 Carbide H-Alloy
 Bore/Shank Size _____
 Number of Wings :
 2-Wing 3-Wing 4-Wing
 Rotation :
 Clockwise Counterclockwise
 If Molder :
 Top Head Bottom Head
 Left Head Right Head
 Feed Direction :
 With Grain Against Grain
 Both
 Optional :
 Tool Dia. _____
 Comments:

Material Information

Type of Material Being Cut: _____
 Thickness of Material : _____
 Position of Material :
 Face Up Face Down
 Comments:

Profile Information

Wood Sample
 Scale Drawing Showing Material
 Fax Drawing
 CAD File (.DXF or .DWG format)
 Comments:



MAGNATE™ Professional Sharpening Services

We provide mail order or will call sharpening service. If you wish to have your bits or blades sharpened, send them to Magnate via UPS or US Postal Service or drop them by our office. You may pick up at Magnate's office or we will ship them back via UPS or US Postal Service. Pay by check or credit card. The prices are effective as of Jan 01, 2012 and subject to change without notice. The following are our regular sharpening rates. Please note, due to the various stages of wear of the tooling sent in, it is difficult to give an exact price for sharpening. For example, saw blades may be re-tipped or cutters may need to be repaired. Therefore we may need to contact you by email or phone to adjust the final price accordingly. **Please note that all prices are subject to change without notice.**

PCD Tools – Call For details

Carbide Saw Blades

# of Teeth	Top & Face	# of Teeth	Top & Face	# of Teeth	Top & Face
8	\$9.12	14	\$10.75	20	\$12.83
24	\$14.71	30	\$16.53	36	\$18.11
40	\$19.16	50	\$20.17	60	\$21.24
70	\$22.19	80	\$24.07	90	\$25.45
100	\$26.28	120	\$29.61	130	\$31.05
150	\$32.24				

- * Split or Strobe Saws ---- Add \$3.30
- * Hollow Face Saws ---- Add \$8.80
- * Teeth number falling in between the table, price will be calculated accordingly.

Large Diameter Blades Extra Charge

26".....\$ 14.71	28".....\$ 15.47	30".....\$ 22.00	32".....\$23.57
------------------	------------------	------------------	-----------------

Saw Blades Tip Replacement including siding charge
* First Tip \$4.08, each additional tip \$1.09

Hollow Face

24T-\$27.53	42T-\$30.11	48T-\$32.56	60T-\$36.30	72T-\$40.04
-------------	-------------	-------------	-------------	-------------

Modifications

Bore to 1" - \$ 9.90	Bore over 1" to 2" - \$17.70
Bore over 2" - Quote on Inspection	Plug Expansion Slot - \$ 4.84
Shoulder Replacement - \$9.81	Additional Shoulder - \$ 5.28

Carbide Dado Blades (2)

# of Teeth	Top & Face	# of Teeth	Top & Face	# of Teeth	Top & Face
20	\$14.10	24	\$16.18	30	\$18.18
36	\$19.91	40	\$21.09	50	\$22.20
60	\$23.38				

Carbide Dado Chippers	Carbide Dado Chippers Tip Replacement
* 2-wing ----- \$4.53	
* 4-wing ----- \$4.53	
* 6-wing ----- \$4.53	* Re-Tip ----- \$4.40

Tenoner Heads - High Speed Steel Only

	2-Knife	3-Knife	4-Knife
Thru 2"	\$32.68	\$40.85	\$51.07
2"+ - 5"	\$36.45	\$45.50	\$56.79

Jointer Knives

Thin Knives (Jointer Knives)...\$ 0.66/Inch
Carbide Jointer Knives....\$ 1.54/Inch

Multi-Spur Bits

HIGH SPEED STEEL		CARBIDE TIPPED	
1" to 2-1/2"	\$10.05	Thru 2-1/8"	\$13.57
Over 2-1/2" to 4"	\$13.83	Over 2-1/8" to 4"	\$16.28
		Tips replaced	\$ 5.65/Tip
		Rakers replaced	\$15.84/Tip

Carbide Tipped Router Bits

Spiral, 1 or 2 Flute			Spiral, 3-Flute		
O.D.	1/2"	3/4"	O.D.	1/2"	3/4"
Standard	\$13.20	\$13.20	Standard	\$19.80	\$19.80
Ruffer	\$13.20	\$13.20	Ruffer	\$19.80	\$19.80
Up/Dn	\$26.40	\$26.40	Standard	\$19.80	\$19.80
L/Hand	\$13.20	\$13.20			

Detailed

O.D.	1-2 Flute	3-Flute	O.D.	1-2 Flute	3-Flute
To 1/4"	\$6.36	\$9.54	To 1/4"	\$5.05	\$7.58
1/4"+ - 1/2"	\$6.68	\$10.02	1/4"+ - 1/2"	\$5.35	\$8.02
1/2"+ - 1"	\$10.76	\$16.14	1/2"+ - 1"	\$8.61	\$12.93
1-1/2"+	\$13.51	\$20.26	1-1/2"+	\$10.81	\$16.23

Carbide Tipped Shaper Cutters & Groovers

Wings	1/4"	1/2"	3/4"	1"	1-1/2"	2"
2	\$8.61	\$8.80	\$9.61	\$13.20	\$14.33	\$15.33
3	\$10.49	\$11.69	\$13.57	\$15.21	\$16.65	\$17.72
4	\$10.81	\$12.83	\$14.96	\$16.65	\$18.70	\$20.75
6	\$12.51	\$14.71	\$18.04	\$19.80	\$22.19	\$24.45
10	\$15.77	\$19.80	\$21.88	\$24.20	\$28.48	\$32.93
16	\$18.29	\$19.99	\$25.77	\$28.53	\$34.73	\$43.37
24	\$23.64	\$26.77	\$31.17	\$35.57	\$44.37	\$53.17
32	\$26.33	\$34.25	\$40.41	\$47.71	\$64.05	-----
40	\$27.72	\$39.23	\$47.33	\$55.69	-----	-----
48	\$33.25	\$41.61	\$51.48	-----	-----	-----

Carbide Tipped Shaper Cutters & Groovers (continued)

Wings	2-1/2"	3"	3-1/2"	4"		
2	\$16.35	\$17.41	\$18.01	\$18.92		
3	\$18.23	\$19.73	\$19.99	\$21.88		
4	\$21.63	\$22.63	\$23.39	\$24.45		
6	\$25.65	\$28.60	\$30.61	\$30.87		
10	\$33.88	\$35.45	\$39.60	\$41.73		
16	\$50.16	\$52.92	\$57.30	\$61.04		
24	\$66.51	\$70.21	-----	-----		



**Edge Banding PVC Tape, Unglued Paintable
0.5mm Thick, Pack of Two 300-foot Rolls (600 Feet Total)**

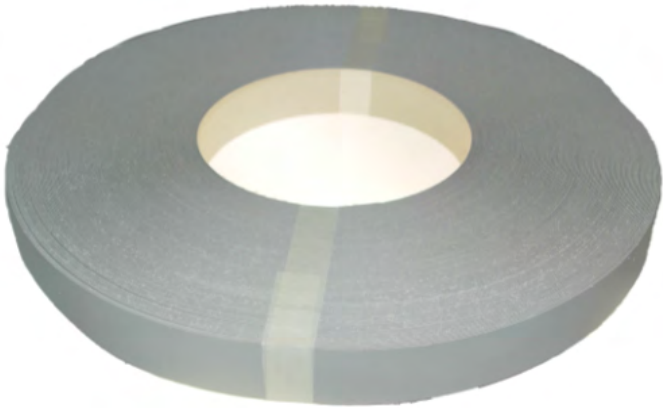

Custom made products of different widths, thickness, colors, textures, and finishes are available.

25% re-stocking charge if items are returned in original condition within 20 days from shipping date. No returns after 20 days from shipping date.

It is recommended that the width of the Edge banding tape is 1/16" to 1/8" wider than the width of the surface you intend to work on.

Tool No.	Width	Color	Price
PVC1516NCUG05-2	15/16"	Paintable	\$80.05

**Edge Banding PVC Tape, Unglued, 0.5mm Thick
Pack of Two 300-foot Rolls (600-foot Total)**

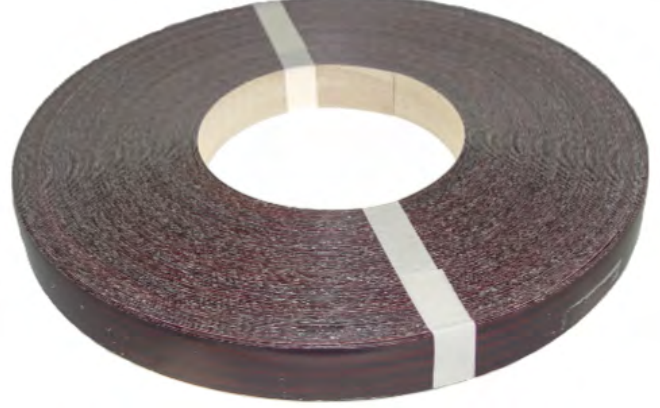

Custom made products of different widths, thickness, colors, textures, and finishes are available.

25% re-stocking charge if items are returned in original condition within 20 days from shipping date. No returns after 20 days from shipping date.

It is recommended that the width of the Edge banding tape is 1/16" to 1/8" wider than the width of the surface you intend to work on.

Tool No.	Width	Color	Price
PVC78G2UG05-2	7/8"	Generic Black	\$45.02
PVC78G1UG05-2	7/8"	Generic White	\$40.03
PVC78W1500UG05-2	7/8"	Matte Gray	\$65.03
PVC1516G1UG05-2	15/16"	Generic White	\$50.02
PVC1516W7909UG05-2	15/16"	Fusion Maple	\$65.03
PVC1516G2UG05-2	15/16"	Generic Black	\$65.04
PVC1516F909UG05-2	15/16"	Matte Black	\$55.02
PVC1516F7759UG05-2	15/16"	Select Cherry	\$70.07
PVC1516F837UG05-2	15/16"	Graphite	\$65.02
PVC1516F9236UG05-2	15/16"	Noble Mahogany	\$70.05
PVC1516W10776UG05-2	15/16"	Kensington Maple	\$65.04
PVC1516F902UG05-2	15/16"	Platinum	\$65.07
PVC1-14F909UG05-2	1-1/4"	Matte Black	\$140.05
PVC1-14F7759UG05-2	1-1/4"	Select Cherry	\$160.09
PVC1-14F837UG05-2	1-1/4"	Graphite	\$140.04
PVC1-146F9236UG05-2	1-1/4"	Noble Mahogany	\$180.05
PVC1-14W10776UG05-2	1-1/4"	Kensington Maple	\$160.06
PVC1-14F902UG05-2	1-1/4"	Platinum	\$150.06

**Edge Banding PVC Unglued Tape, 1.0mm Thick
300-foot Roll**



Custom made products of different widths, thickness, colors, textures, and finishes are available.

25% re-stocking charge if items are returned in original condition within 20 days from shipping date. No returns after 20 days from shipping date.

It is recommended that the width of the Edge banding tape is 1/16" to 1/8" wider than the width of the surface you intend to work on.

Tool No.	Width	Color	Price
PVC78G1UG10	7/8"	Generic White	\$80.03
PVC78G2UG10	7/8"	Generic Black	\$75.02
PVC78W1500UG10	7/8"	Matte Gray	\$90.03



**Edge Banding PVC Tape, Preglued, 0.5mm Thick
Pack of Two 300-foot Rolls (600 Feet Total)**



Custom made products of different widths, thickness, colors, textures, and finishes are available.

It is recommended that the width of the Edge banding tape is 1/16" to 1/8" wider than the width of the surface you intend to work on.

Pre-glued at factory; no return is accepted.

Tool No.	Width	Color	Price
PVC78G1PG05-2	7/8"	Generic White	\$80.03
PVC78G2PG05-2	7/8"	Generic Black	\$85.02
PVC78W1500PG05-2	7/8"	Matte Gray	\$105.03
PVC1516G1PG05-2	15/16"	Generic White	\$90.02
PVC1516W7909PG05-2	15/16"	Fusion Maple	\$105.03
PVC1516G2PG05-2	15/16"	Generic Black	\$95.04
PVC1516F909PG-2	15/16"	Matte Black	\$95.02
PVC1516F7759PG-2	15/16"	Select Cherry	\$110.07
PVC1516F837PG-2	15/16"	Graphite	\$105.02
PVC1516F9236PG-2	15/16"	Noble Mahogany	\$110.05
PVC1516W10776PG-2	15/16"	Kensington Maple	\$105.04
PVC1516F902PG-2	15/16"	Platinum	\$115.04
PVC1-14F909PG-2	1-1/4"	Matte Black	\$180.05
PVC1-14F7759PG-2	1-1/4"	Select Cherry	\$200.09
PVC1-14F837PG-2	1-1/4"	Graphite	\$180.04
PVC1-14F9236PG-2	1-1/4"	Noble Mahogany	\$200.07
PVC1-14W10776PG-2	1-1/4"	Kensington Maple	\$200.06
PVC1-14F902PG-2	1-1/4"	Platinum	\$190.06

**Edge Banding PVC Tape, Preglued 1.0mm Thick
300-foot Roll**



Custom made products of different widths, thickness, colors, textures, and finishes are available.

It is recommended that the width of the Edge banding tape is 1/16" to 1/8" wider than the width of the surface you intend to work on.

Pre-glued at factory; no return is accepted.

Tool No.	Width	Color	Price
PVC78G1PG10	7/8"	Generic White	\$60.03
PVC78G2PG10	7/8"	Generic Black	\$55.02
PVC78W1500PG10	7/8"	Matte Gray	\$70.03

**Edge Banding Wood Veneer Tape, Unglued 0.5mm Thick
Pack of Two 300-foot Rolls (600 Feet Total)**



Custom made products of different widths, thickness, colors, textures, and finishes are available.

25% re-stocking charge if items are returned in original condition within 20 days from shipping date. No returns after 20 days from shipping date.

It is recommended that the width of the Edge banding tape is 1/16" to 1/8" wider than the width of the surface you intend to work on.

Tool No.	Width	Color	Price
WV78G1UG05-2	7/8"	White Maple	\$80.03
WV78WBUG05-2	7/8"	White Birch	\$100.02
WV78CRUG05-2	7/8"	Cherry	\$100.03

**Edge Banding Wood Veneer Tape, Preglued 0.5mm Thick
Pack of Two 300-foot Rolls (600 Feet Total)**



Custom made products of different widths, thickness, colors, textures, and finishes are available.

It is recommended that the width of the Edge banding tape is 1/16" to 1/8" wider than the width of the surface you intend to work on.

Pre-glued at factory; no return is accepted.

Tool No.	Width	Color	Price
WV78G1PG05-2	7/8"	White Maple	\$120.03
WV78WBPG05-2	7/8"	White Birch	\$140.02
WV78CRPG05-2	7/8"	Cherry	\$140.03





In this issue, you will find the following information: the "Run From" feature built into Legacy's CNC control software, programming and cutting wooden threads for the Apple Press project, programming toolpaths using Vectric's CAD CAM software, 2 rail sweeps with multiple cross-sections, and the Wall Clock project demo video.

Welcome to the revolution

TIPS & TECHNIQUES



Run From

Have you ever started running a very long G Code program and wished that you could pause it, shut everything down, and then later resume running the program from the place you left off?

In this Tips & Techniques video, Chris will demonstrate how to execute the Run From feature built right into Legacy's CNC control software.

In the next Tips & Techniques video, Chris will demonstrate how to execute the Run From feature when you encounter an emergency stop.

[Click for more information](#)



Apple Press

In this demonstration video, Harry Tippetts shares how he developed the project and the challenges that were easily overcome using his CNC and Legacy's CCAM software. He also demonstrates how he set up both the turning center and the 3 axis table to machine the internal and external threads.

[Click for more information](#)



Wall Clock

If you haven't seen the video yet, you can check it out on our website by clicking on the button below. Chris demonstrates how he set up and machined all of the parts to complete the wall clock project.

[Click for more information](#)

WEBINAR TRAINING



Vectric Basics

In this weeks webinar we demonstrated how to use the three most commonly used toolpaths in Vectric's V Carve Pro and Aspire software. If you are just getting started programming for CNC, you will want to join the Wednesday webinars or view them in the Class Review on our website. You Can watch Class 13 by clicking on the button.

[Click for more information](#)

LEGACY'S FACEBOOK PAGE



Legacy CNC Woodworking

Check out Legacy's Facebook page where John Hennen post his tips and techniques every Tuesday morning. In this weeks post, John demonstrated how to model using two rail sweeps in Aspire.

Be sure to check out all of the photos, videos and don't forget to Like, Comment, and Share.

[Click for more information](#)

Spiral, Flat-End 2 Flute Down-Cut



This two flute spiral bit is designed for solid woods, wood composites and some plastics.

This bit is used when creating dadoes without machine marks.

Tool No.	Cutting Dia.	Cutting Length	Shank Dia.	Overall Length	Price
9682	1/4"	1-1/4"	1/4"	3-1/2"	\$31.97
9687	3/8"	1-1/4"	3/8"	3"	\$26.45

2-Bit Flat End Spiral Set



Tool No.: 9680

Price: \$48.14

This package comes with 2 Flat End Spiral bits - 9635, 9682 at 5% discounted price.

45 Degree Bevel Spiral, 2-Flute



This bit is designed for the Legacy Ornamental milling machine. It creates spiral screws, and chamfered grooves on flat stock. It will work with the following pitches: 1-1/2", 3", 4-1/2", 6", 7-1/2", 9", 12" & 15".

It can be also used as a chamfer, bevel, or flush trim bit.

Tool No.	Small Cutting Dia.	Cutting Dia.	Height	Shank Dia.	Shank Length	Price
0935	1/2"	1-1/2"	1"	1/2"	2"	\$29.13

Ball End, Extended Shank 4" Shank Length, 2-Flute



Designed for the Legacy Ornamental Milling machines. Used to mill spiral or index flutes on contoured spindles i.e. pineapple pattern on a finial.

Note : Shank length is measured from middle of the knife to the end of the shank.

Tool No.	Cutting Dia.	Degree	Cutting Height	Shank Dia.	Overall Length	Price
2681	1/16"	3	3/4"	1/4"	3"	\$55.75
2682	1/8"	1	1-1/2"	1/4"	3"	\$48.36
2683	1/8"	3	1"	1/4"	3"	\$48.36
2684	1/8"	3	3"	1/2"	5"	\$110.03
2685	1/8"	5	3/4"	1/4"	3"	\$41.40
2686	1/8"	7	1/2"	1/4"	3"	\$48.95
2687	1/4"	3	2"	1/2"	4"	\$81.52
2688	1/4"	5	1-3/8"	1/2"	4"	\$112.58
2689	1/4"	7	1"	1/2"	4"	\$112.58
2680	1/4"	3	2-1/4"	1/2"	5"	\$94.74

Tool No.	Cutting Dia.	Small Dia.	Shank Dia.	R.	Price
2553	1/2"	1/4"	1/2"	1/4"	\$31.76
2554	5/8"	5/16"	1/2"	5/16"	\$36.36
2556	3/4"	3/8"	1/2"	3/8"	\$43.42

Bevel - 2-Flute, 1/2" Shank Dia.



Tool No.	Degree	Cutting Height	Small Dia.	Overall Dia.	Overall Length	Price
0942	15	1-1/8"	31/64"	1"	2-3/4"	\$27.50
0941	25	1-1/4"	5/8"	1 11/16"	3-1/4"	\$28.27

Bird Mouth (Bird Beak) 12-Sided 1/2" Shank 2-Flute



These 30 & 60 degree Bird Mouth bits allow you to easily glue up 12-sided hollow columns. They create a nesting joint that is stronger and easier to glue up without shifting than the traditional miter joint. Material thickness can be up to 2" thick, allowing for deep cut profiles such as turnings, fluting, and spirals on the Legacy Ornamental Mill.

Tool No.	Long Diagonal Edge	Cutting Height	Shank Dia.	Overall Dia.	Small Dia.	Price
5481	1	1-1/8"	1/2"	1-9/16"	1/8"	\$26.32
5482	1-1/2	1-5/8"	1/2"	1-3/4"	1/8"	\$42.76
5483	2	2-1/8"	1/2"	2-1/8"	1/8"	\$57.07

Bird Mouth (Bird Beak), 8-Sided 1/2" Shank 2-Flute



These 45 degree Bird Mouth bits allow you to easily glue up 8-sided hollow columns. They create a nesting joint that is stronger and easier to glue up without shifting than the traditional miter joint. Material thickness can be up to 2" thick, allowing for deep cut profiles such as turnings, fluting, and spirals on the Legacy Ornamental Mill.

Tool No.	Long Diagonal Edge	Cutting Height	Overall Dia.	Small Dia.	Price
5461	1	1-1/8"	1.539"	1/8"	\$28.52
5462	1-1/2	1-5/8"	1.857"	1/8"	\$45.29
5463	2	2-1/8"	2-1/8"	1/8"	\$62.27

Brick Molding, 2-Flute



Designed for the Legacy Ornamental Mill to make rosettes (as seen on the wainscot project of Legacy demo video) and a decorative trim. Can also be used for traditional mouldings.

Tool No.	Cutting Dia.	Cutting Height	Shank Dia.	R.	Shank Length	Price
3961	1-1/4"	3/8"	1/2"	0.35"	2"	\$27.16

Classic Plunge Cutting, 2-Flute



For decorative edge grooving on cabinet faces and for picture and mirror frames.

Tool No.	R.	Cutting Dia.	Shank Dia.	Cutting Height	Shank Length	Price
3931	3/32"	1/2"	1/4"	3/8"	1-1/4"	\$18.17
3932	5/32"	3/4"	1/4"	1/2"	1-1/4"	\$21.05
3933	5/32"	3/4"	1/2"	1/2"	1-1/2"	\$21.65
3934	15/64"	1"	1/2"	5/8"	1-1/2"	\$27.23
3935	3/8"	1-1/2"	1/2"	3/4"	1-1/2"	\$33.44

Classic Spiral, 2-Flute 1/2" Shank Diameter, 2" Shank Length

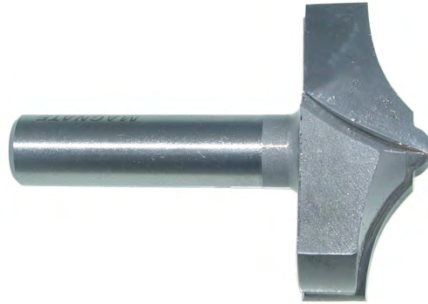

Designed for the Legacy Ornamental Mill. A cross between the classic plunge and the barley twist bit. Creates a more stylized bead and cove or a beautiful single start spiral.

Can also be used to create a decorative groove with a half-rounded bottom.

Tool No.	Cutting Dia.	R.	Price
3951	1"	1/2" + 3/32"	\$40.49
3954	1-1/2"	3/4" + 9/64"	\$46.68
3952	2"	1" + 3/16"	\$53.08
3953	3"	1-1/2" + 9/32"	\$71.81

3-Bit Classic Spiral Set - 3950



Tool No.: 3950 Price: \$133.34

This package comes with 3 Classic Spiral bits - 3951, 3952, 3953 at 15% discounted price.

Classical Ogee Plunge, 2-Flute



This bit is designed for the Legacy to create the classic ogee shape in a plunge style cut.

Tool No.	Cutting Dia.	Cutting Height	Shank Dia.	R.	Shank Length	Price
3674	2"	3/4"	1/2"	1/4"	2"	\$47.62

Combination Rope Molding, 2-Flute 1/2" Shank Diameter, 2" Shank Length



Designed for the Legacy Ornamental Mill. #7521 (1st Cut) and #7522 (2nd cut) are used conjunctionally to create 4" diameter rope molding profiles while #7524 and #7525 are used for 5" diameter rope molding; #7527 and #7528 for 6" diameter rope molding.

Tool No.	Cutting Dia.	R.	Profile Height	Price
7521	2"	4-1/4"	1/2"	\$52.14
7522	2"	4-1/4"	0.1193	\$48.84
7524	2-1/2"	5-5/16"	5/8"	\$60.73
7525	2-1/2"	5-5/16"	0.1492"	\$57.41
7527	3"	6-3/8"	3/4"	\$72.90
7528	3"	6-3/8"	0.179"	\$68.64

Cove & Bead Plunge, 2-Flute 1/4" Shank Diameter, 1-1/4" Shank Length



Features an extra 1/2" wide cutter at bottom for fast and clean plunge.

Tool No.	R. (Bead, Cove)	Cutting Height	Cutting Dia.	Price
3641	1/8", 1/8"	7/16"	1"	\$19.45
3642	3/16", 3/16"	9/16"	1-1/4"	\$21.69

Deep Classic Point, 2-Flute



Designed for the Legacy Ornamental Mill..These bits are similar to our Classic Plunge Cutting bits except that they have a deep point instead of a round tip. They create decorative bead and cove edge details. The illustration depicts a wood column milled by the Legacy using these bits.

Tool No.	R.	Cutting Dia.	Shank Dia.	Cutting Height	Shank Length	Price
7536	3/16"	3/4"	1/2"	5/8"	2"	\$32.14
7531	1/4"	1"	1/2"	3/4"	2"	\$41.42
7534	3/8"	1-1/2"	1/2"	1"	2"	\$47.78
7532	1/2"	2"	1/2"	1-3/8"	2"	\$53.59
7533	3/4"	3"	1/2"	2"	2"	\$71.98

Deep Classic Point Set - 7530



Tool No.: 7530 Price: \$134.60

This package comes with 3 Deep Classic Point bits - 7531, 7532, 7533 at 15% discounted price.

Double Bead Point Plunge, 2-Flute



These bits create double bead profiles for decorative edges and bead & cove details. The above illustration depicts a wood column milled by the Legacy Ornamental Milling machines.

Tool No.	R.	Cutting Dia.	Shank Dia.	Shank Length	Price
3481	5/16"	1"	1/2"	2"	\$34.17
3484	9/16"	1-1/2"	1/2"	2"	\$41.23
3482	5/8"	2"	1/2"	2"	\$50.01

Double Bead Point Plunge Set - 3480



Tool No.: 3480 Price: \$102.77

This package comes with 3 Double Bead Point Plunge bits - 3841, 3842, 3844 at 15% discounted price.

Face-Inlay Extended Shank, 2-Flute



It is designed to work with Legacy Ornamental Milling machines. Used for inlaying wood veneer, and other materials i.e. brass on either spindle stock up to 8" in diameter, or flat stock up to 4" wide that has a curved profile i.e. bow front drawer.

Its extended shank allows milling on the side of a larger diameter material while following a curved profile.

5" Shank length is measured from the middle of the knife to the end of the shank.

The cutting depth is 1/8". By replacing the original Magnate BR-05 bearing, the rabbit depth varies as follows:

Original Bearing	Cutting Depth		
	BR-08	BR-05	BR-04
BR-05	1/8"	1/16"	1/8"
BR-04	1/8"	1/16"	3/16"

Tool No.	Cutting Height	Shank Length	Shank Dia.	Overall Dia.	Price
1171	1/8"	5"	1/2"	7/8"	\$22.41
1173	1/4"	5"	1/2"	7/8"	\$25.30

Fluting Extended Shank, 2-Flute



Designed for Legacy. These bits are for milling fluted columns and spindles up to 8 in diameter. Extended shaft allows for milling on the side of a larger diameter while following a curved profile.

Note : 5" shank length is measured from middle of the knife to the end of the shank.

Tool No.	Flute Height	Shank Dia.	Shank Length	R.	Bearing	Price
6053	3/16"	1/2"	5"	3/32"	BR-05	\$36.64
6051	1/4"	1/2"	5"	1/8"	BR-05	\$39.19
6054	3/8"	1/2"	5"	3/16"	BR-05	\$43.91
6052	1/2"	1/2"	5"	1/4"	BR-05	\$48.62
6056	5/8"	1/2"	5"	5/16"	BR-05	\$53.88
6058	3/4"	1/2"	5"	3/8"	BR-05	\$58.58

Horizontal Crown Molding, 2-Flute



This bit can also be used with the Legacy Ornamental Mill and/or overhead router to create linear mouldings. It can be used to create turnings between centers on the Legacy Ornamental Mill.

Tool No.	Cutting Dia.	Cove Depth	Shank Height	Shank Dia.	R.	Price
5561	1-3/4"	5/16"	3/8"	1/4"	1-1/2"	\$34.24
5563	1-3/4"	5/16"	3/8"	1/2"	1-1/2"	\$36.74
5562	2"	3/8"	5/8"	1/2"	1-19/32"	\$38.15
5564	2-1/8"	3/8"	5/8"	1/2"	1-5/8"	\$40.21
5566	2-1/4"	3/8"	5/8"	1/2"	1-7/8"	\$42.72
5565	2-1/2"	3/8"	5/8"	1/2"	2-1/4"	\$44.32
5567	2-3/4"	3/8"	5/8"	1/2"	2-3/4"	\$51.92
5568	3"	7/16"	11/16"	1/2"	3-3/16"	\$60.51



MAGNATE™ Router Bits For Legacy Ornamental Milling Machinery

Large Cove Classic Plunge, 2-Flute 1/2" Shank Diameter, 2" Shank Length



Tool No.	Cutting Dia.	Profile Height	R. (Bead, Cove)	Price
3941	1"	1/4"	1/8", 1/2"	\$36.18
3944	1-1/2"	3/8"	3/16", 3/4"	\$44.56
3942	2"	1/2"	1/4", 1"	\$52.22

Plunge Button, 2-Flute



Designed for the Legacy Ornamental Milling machines. Plunge to mill buttons and fine details on flat mouldings and/or around the circumference of a spindle or leg. Adds just the right touch for those details that give style to any project.

Tool No.	Cutting Dia.	Button Dia.	Shank Dia.	R.	Shank Length	Price
358	3/8"	1/4"	1/4"	1/8"	1-3/8"	\$17.42
350	1/2"	3/8"	1/2"	1/4"	2"	\$19.59
351	5/8"	5/16"	1/2"	3/16"	2"	\$21.97
352	1"	1/2"	1/2"	3/10"	2"	\$26.99
353	5/8"	1/2"	1/2"	3/10"	2"	\$24.35

Provincial Plunge, 2-Flute 1/2" Shank Diameter, 2" Cutting Diameter



This bit is designed for the Legacy to create a plunge version of French Provincial (without bearing)

Tool No.	Cutting Length	R.	Shank Length	Price
3654	7/8"	1/2" + 1" + 1/4"	2"	\$48.00

Pattern Extended Shank, 2-Flute



Originally designed for the Legacy Ornamental Milling machine, this bit allows you to follow a template when milling a contoured profile. It works on turnings up to 10" in diameter, square turnings up to 5", and square or flat stock up to 5" thick. The router follows the template as you make approximately 1/4" deep cuts for 2 to 3 passes. The bearing will follow the previous cut and support the router bit to eliminate chatter. This bit can also be used in a traditional router table like a pattern cutting router bit.

4-1/2" shank length is measured from middle of the knife to the end of the shank.

Tool No.	Cutting Dia.	Cutting Length	Shank Dia.	Shank Length	Bearing	Price
7621	1/2"	1/2"	1/2"	4-1/2"	BR-04	\$29.19
7623	3/4"	3/4"	1/2"	4-1/2"	BR-09	\$31.30

Plunge Roundover with Radius, 2-Flute 1/2" Shank Diameter, 2" Shank Length



This bit can be also used for the Legacy Ornamental Mill. Great for milling 2" and 3" diameter balls on posts or large beads on column bases. Can also be used for large diameter rope columns with a very pronounced rope design.

Tool No.	Cutting Dia.	R.	Price
7592	2"	1" + 1/16"	\$44.29
7593	3"	1-1/2" + 1/8"	\$65.68

Reeding Extended Shank, 2-Flute 5" Shank Length



Designed for the Legacy Ornamental machines..

Note : 5" shank length is measured from middle of the knife to the end of the shank.

Tool No.	Bead Height	Cutting Height	Shank Dia.	R.	Price
7696	1/4"	1"	1/2"	1/8"	\$39.57
7691	3/8"	1-1/8"	1/2"	3/16"	\$43.23
7692	1/2"	1-1/4"	1/2"	1/4"	\$49.13
7693	3/4"	1-1/2"	1/2"	3/8"	\$55.06
7697	1"	1-3/4"	1/2"	1/2"	\$62.27

Reeding Extended Shank with Bearing 5" Shank Length, 2-Flute



Designed for the Legacy. These bits are for milling reeding columns and spindles up to 8" in diameter. Extended shaft allow for milling on the side of a larger diameter while following a curved profile.

Note : 5" shank length is measured from middle of the knife to the end of the shank.

Tool No.	Bead Height	Shank Dia.	R.	Bearing	Price
7678	3/16"	1/2"	3/32"	BR-05	\$36.55
7676	1/4"	1/2"	1/8"	BR-05	\$39.03
7671	3/8"	1/2"	3/16"	BR-05	\$42.69
7672	1/2"	1/2"	1/4"	BR-05	\$48.72
7675	5/8"	1/2"	5/16"	BR-05	\$51.49
7673	3/4"	1/2"	3/8"	BR-05	\$55.24



Rope Molding, 2-Flute

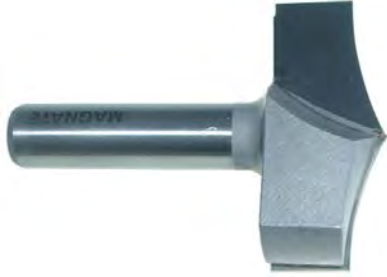

Designed for the Legacy Ornamental Mill. Used to mill rope and pillowed diamond designs on spindle and columns up to 10" diameter. These bits can also be used for other unusual groove/bead forming applications i.e. flat mouldings or indexed rosettes.

#7584, #7585 and #7586 can be used in conjunction with the Combination Barley Twist bits to create big diameter barley twist profiles.

Tool No.	Cutting Dia.	Shank Length	Shank Dia.	R.	Profile Height	Price
7588	3/4"	2"	1/2"	51/64"	3/32"	\$26.72
7581	1"	2"	1/2"	1-1/16"	1/8"	\$31.21
7582	1-1/2"	2"	1/2"	1-19/32"	3/16"	\$39.79
7584	2"	2"	1/2"	2-1/8"	1/4"	\$48.60
7585	2-1/2"	2"	1/2"	2-21/32"	5/16"	\$59.65
7586	3"	2"	1/2"	3-3/16"	3/8"	\$71.74

3-Bit Rope Molding Set - 7570



Tool No.: 7570

Price: \$94.78

This package comes with 3 Rope Molding bits - 7581, 7582, 7584 at 15% discounted price.

3-Bit Rope Molding Set - 7580



Tool No.: 7580

Price: \$149.88

This package comes with 3 Rope Molding bits - 7584, 7585, 7586 at 15% discounted price.

7-Bit Rope Molding Set - 7579



Tool No.: 7579

Price: \$236.05

This package comes with 7 Rope Molding bits - 7581, 7582, 7584, 7585, 7586, 7588, 7591 at 15% discounted price.

Rope Pen, 2-Flute

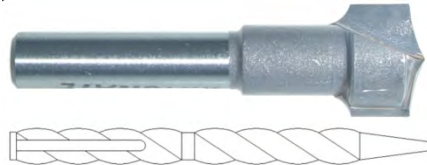

Designed for the Legacy. This bit creates rope pens using a standard 7mm twist pen kit. The above illustration depicts a wood pen milled by the Legacy Ornamental Mill using this bit.

Tool No.	R.	Cutting Dia.	Shank Dia.	Cutting Height	Shank Length	Price
7597	0.65"	1/2"	1/4"	3/8"	1-1/2"	\$19.69
7591	0.65"	1/2"	1/2"	3/8"	2"	\$19.94

Shallow Classic Point, 2-Flute

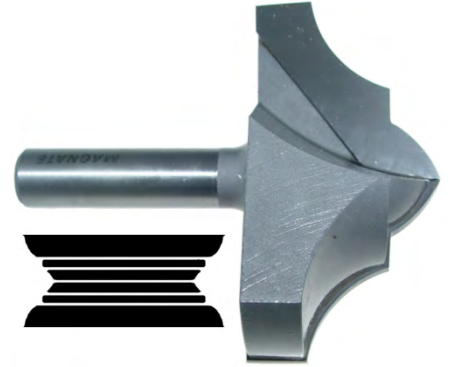

Designed for the Legacy Ornamental Mill. These bits are similar to our Classic Plunge Cutting bits except that they have a shallow point instead of a round tip. They create decorative bead and cove edge details. The illustration depicts a wood column milled by the Legacy using these bits.

Tool No.	R.	Cutting Dia.	Shank Dia.	Cutting Height	Shank Length	Price
7566	3/16"	3/4"	1/2"	3/8"	2"	\$31.75
7561	1/4"	1"	1/2"	1/2"	2"	\$36.65
7564	3/8"	1-1/2"	1/2"	3/4"	2"	\$43.80
7562	1/2"	2"	1/2"	1"	2"	\$49.81
7563	3/4"	3"	1/2"	1-1/2"	2"	\$65.49

Shallow Classic Point Set - 7560



Tool No.: 7560

Price: \$122.47

This package comes with 3 Shallow Classic Point bits - 7561, 7562, 7563 at 15% discounted price.

Shallow Flute Extended Shank 2-Flute



Designed for the Legacy Ornamental Milling machines. These bits are for milling fluted columns and spindles up to 8" in diameter. Extended shaft allow for milling on the side of a larger diameter while following a curved profile.

Note : 5" shank length is measured from middle of the knife to the end of the shank.

Comes with a Magnate BR-05 bearing.

Tool No.	Flute Height	Shank Dia.	Shank Length	Overall Dia.	Bearing	Price
2451	1/4"	1/2"	5"	13/16"	BR-05	\$34.36
2453	3/8"	1/2"	5"	7/8"	BR-05	\$36.70
2455	1/2"	1/2"	5"	7/8"	BR-05	\$41.45
2456	5/8"	1/2"	5"	15/16"	BR-05	\$46.19
2457	3/4"	1/2"	5"	1"	BR-05	\$51.56
2459	1"	1/2"	5"	1"	BR-05	\$54.89

Side V-Grooving Extended Shank 2-Flute



Designed for the Legacy Ornamental Milling machines. These bits are for milling v style flutes on spindles up to 8" in diameter or for cutting v style flutes or chamfer cuts on the face or a curved piece of flat stock i.e. bow front drawer.

Comes with a BR-05 replacement bearing.
5" Shank length is measured from the middle of the knife to the end of the shank.

Tool No.	Degree	Cutting Height	Shank Dia.	Shank Length	Overall Dia.	Price
751	90	1/4"	1/2"	5"	7/8"	\$31.89
753	90	1/2"	1/2"	5"	1-1/8"	\$34.32
756	90	3/4"	1/2"	5"	1-3/8"	\$36.88

Side V-Grooving, 2-Flute



This side cutting v-grooving router bit is designed to make clean v-shaped grooves and chamfer edges. The bearing allows the bit to follow template whichever is applicable.

Comes with a Magnate BR-05 bearing.

Tool No.	Degree	Cutting Height	Shank Dia.	Shank Length	Overall Dia.	Price
771	90	1/4"	1/4"	1-1/2"	7/8"	\$21.04
773	90	1/2"	1/4"	1-1/2"	1-1/8"	\$24.35
776	90	1/4"	1/2"	2"	7/8"	\$21.35
778	90	1/2"	1/2"	2"	1-1/8"	\$24.75
779	90	3/4"	1/2"	2"	1-3/8"	\$28.18
775	90	1"	1/2"	2"	1-5/8"	\$34.78

Surface Planing (Bottom Cleaning), 2-Flute



Good for cleaning out dadoes and cutting wide square grooves. Leaves a smooth clean finished surface. Also perfect for milling round, square, or flat stock on the Legacy Ornamental Mill.

Tool No.	Cutting Dia.	Shank Dia.	Cutting Length	Shank Length	Price
2700	3/4"	1/4"	3/8"	1-1/4"	\$16.40
2712	7/8"	1/4"	3/8"	1-1/2"	\$18.67
2713	1"	1/4"	3/8"	1-1/2"	\$21.34
2714	1-1/4"	1/4"	3/8"	1-1/2"	\$24.54
2715	1-1/2"	1/4"	3/8"	1-1/2"	\$25.95
2701	3/4"	1/2"	15/32"	2"	\$16.76
2702	7/8"	1/2"	15/32"	2"	\$18.80
2703	1"	1/2"	15/32"	2"	\$21.52
2723	1-3/16"	1/2"	15/32"	2"	\$23.80
2704	1-1/4"	1/2"	15/32"	2"	\$24.70
2724	1-3/8"	1/2"	15/32"	2"	\$25.40
2705	1-1/2"	1/2"	15/32"	2"	\$26.13
2725	40mm	1/2"	15/32"	2"	\$29.07
2706	2"	1/2"	15/32"	2"	\$38.92
2708	2-1/2"	1/2"	15/32"	2"	\$43.38
2707	2-3/4"	1/2"	15/32"	2"	\$49.69
2709	3"	1/2"	15/32"	2"	\$55.94

Triple Classic Plunge, 2-Flute



Designed for the Legacy Ornamental Mill. Use the profile of the classic plunge cutting bit 3 times for creating decorative edges, bead, and cove details.

Tool No.	Cutting Dia.	Cutting Height	Shank Dia.	R.	Shank Length	Price
3982	2"	7/8"	1/2"	3/16"	2"	\$50.40
3983	3"	1-5/8"	1/2"	5/16"	2"	\$69.89

V-Grooving & Carving, 3-Flute



It is designed for professional sign making and lettering.

Tool No.	Degree	Cutting Dia.	Shank Dia.	Cutting Length	Shank Length	Price
767	45	5/8"	1/2"	3/4"	2"	\$23.45
761	60	5/8"	1/4"	5/8"	1-1/4"	\$18.40
763	60	5/8"	1/2"	5/8"	2"	\$19.76

Thread Cutting 90-Degree, 2-Flute



This cutter is used to cut internal and external threads i.e. a wooden bolt and nut. The 90 degree angle produces a stronger wooden thread that is less likely to chip out, The depth of cut is 3/16". The 3/8" dimension refers to the size of the V section measured parallel to the shank.

Legacy's CCAM software will automatically generate the G Code for both parts.

Tool No.	Cutting Height	Shank Dia.	Shank Length	Overall Dia.	Price
796	3/8"	1/4"	1-1/2"	5/8"	\$18.02



Barley Twist, 2-Flute



This bit is designed to work with Legacy Ornamental machine to create traditional style barley twist. When combined with an upcut spiral bit they also form a beautiful hollow spiral. Can also be used for general grooving or flat moldings.

Tool Cutting Profile Shank Shank No. Dia. Height Dia. Length R. Price

7557*	3/4"	3/32"	1/4"	1-1/2"	3/32" + 3/8"	\$28.50
7558	3/4"	3/32"	1/2"	2"	3/32" + 3/8"	\$29.40
7551	1"	1/4"	1/2"	2"	1/8" + 1/2"	\$36.10
7554	1-1/2"	3/8"	1/2"	2"	3/16" + 3/4"	\$41.80
7552	2"	1/2"	1/2"	2"	1/4" + 1"	\$49.60
7556	2-1/2"	5/16"	1/2"	2"	5/16" + 1-1/4"	\$58.72
7553	3"	3/4"	1/2"	2"	3/8" + 1-1/2"	\$71.69

* Spiral pen making for Legacy

3-Bit Barley Twist Set - 7550



Tool No.: 7550 Price: \$131.32

This package comes with 3 barley twist bits - 7551, 7552, 7553 at 15% discounted price.

6-Bit Barley Twist Set - 7559



Tool No.: 7559 Price: \$244.22

This package comes with 6 barley twist bits - 7551, 7552, 7553, 7554, 7556, 7558 at 15% discounted price.

Combination Barley Twist Set - 7540



Tool No.: 7540 Price: \$152.40

This package comes with 3 Combination Barley Twist bits - 7544, 7545, 7546 at 15% discounted price.

Combination Barley Twist, 2-Flute 1/2" Shank Diameter, 2" Shank Length

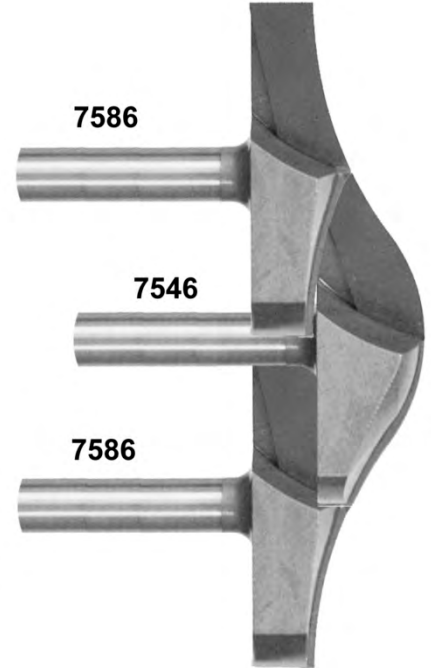

Designed for the Legacy. These bits are created to form traditional style barley twist profiles with diameters over 3".

For example, to create a 6" diameter barley twist profile, first start by using a 3" diameter Rope Molding bit # 7586, to make a 2-start rope with 6" pitch. Next, plunge on the top of one of the rope heads to create a cove using the 3" Combination Barley Twist bit #7546. To attain the desired depth, 3-5 passes are required. When completed, the final pass should match up with the edge of the bead on each of the sections of rope.

These bits can be also used separately to form cove detail for turnings or moldings.

Tool No.	Cutting Dia.	R.	Profile Height	Price
7544	2"	0.9167" & 2-1/8"	1/2"	\$52.70
7545	2-1/2"	1.1458" + 2-21/32"	5/8"	\$61.71
7546	3"	1-3/8" + 3-3/16"	3/4"	\$71.77

MAGNATE™ Router Bits For Legacy Ornamental Milling Machinery

Bowl & Tray Plunge Bits For Legacy Ornamental Mill



This bit is designed to create a flat bottom, two square sides and two bottom radii in only one pass. Ideal for making dishes or serving trays.

Tool No.	R.	Cutting Dia.	Cutting Height	Shank Dia.	Shank Length	Price
S7801	1/4"	3/4"	5/8"	1/2"	1-1/2"	\$23.08
S7802	1/4"	1"	5/8"	1/2"	1-1/2"	\$24.30
S7803	1/4"	1-1/4"	5/8"	1/2"	1-1/2"	\$28.47

Core Box Router Bits For Legacy Ornamental Mill



For use in decorative fluting and sign making. Up shear cutting angle clears chips out fast for accurate and chatter free performance. Can be used with the Legacy Ornamental Mill to cut indexed flutes and coves on spindle stock or parallel flutes on flat stock.

Tool No.	Cutting Dia.	Shank Dia.	Cutting Length	R.	Shank Length	Price
801	1/4"	1/4"	1/4"	1/8"	1-1/4"	\$10.77
802	3/8"	1/4"	3/8"	3/16"	1-1/4"	\$12.09
803	1/2"	1/4"	3/8"	1/4"	1-1/4"	\$14.36
804	5/8"	1/4"	5/8"	5/16"	1-1/4"	\$17.17
805	3/4"	1/2"	5/8"	3/8"	1-1/2"	\$18.85
806	7/8"	1/2"	3/4"	7/16"	1-1/2"	\$20.96
807	1"	1/2"	3/4"	1/2"	2"	\$23.30
812	1-1/8"	1/2"	13/16"	9/16"	2"	\$24.66
809	1-1/4"	1/2"	7/8"	5/8"	2"	\$27.25
814	1-3/8"	1/2"	15/16"	11/16"	2"	\$27.98
810	1-1/2"	1/2"	1"	3/4"	2"	\$32.25
819	1-3/4"	1/2"	1-1/8"	7/8"	2"	\$36.69
808	2"	1/2"	1-1/4"	1"	2"	\$42.48

Classic Plunge Beading Bit For Legacy Ornamental



Designed to create a bead-sided groove with flat bottom.

Tool No.	R.	Cutting Dia.	Cutting Height	Shank Dia.	Shank Length	Price
I293	1/4"	7/8"	7/16"	1/2"	1-1/2"	\$18.88

Corner Rounding Router Bit For Legacy Ornamental



Tool No.	R.	Cutting Length	Shank Dia.	Overall Dia.	Shank Length	Price
1207	1/4"	7/16"	1/2"	1"	1-1/2"	\$18.15
1210	1/2"	3/4"	1/2"	1-1/2"	1-1/2"	\$24.94

Dovetail Router Bits – 7 Degree For Legacy Ornamental Mill



Designed for making drawer fingers and for French dovetailing. These bits can be used with the Legacy Ornamental Mill to create unique indexed dovetail slots at 90 or 120 spacing for furniture legs and three legged pedestals.

Tool No.	Cutting Dia.	Cutting Height	Shank Dia.	Overall Length	Price
467^	5/8"	7/8"	1/2"	2-5/8"	\$12.01
468^	3/4"	7/8"	1/2"	2-5/8"	\$12.74

^ Compatible with Inkra, JoinTech Dovetail

Dovetail Router Bits – 14 Degree For Legacy Ornamental Mill



Designed for making drawer fingers and for French dovetailing. These bits can be used with the Legacy Ornamental Mill to create unique indexed dovetail slots at 90 or 120 spacing for furniture legs and three legged pedestals. 14 dovetail may be used in conjunction with 14 Butterfly Spline bits to make butterfly spline glue joint.

Tool No.	Cutting Dia.	Cutting Height	Shank Dia.	Overall Length	Price
407^#	1/2"	1/2"	1/2"	2-1/2"	\$11.80
403	5/8"	5/8"	1/2"	2-7/8"	\$12.45
404#	3/4"	3/4"	1/2"	3"	\$13.18
469	3/4"	7/8"	1/2"	2-1/2"	\$13.87
405	7/8"	7/8"	1/2"	3"	\$13.99
406	1"	7/8"	1/2"	3"	\$14.30

^ Compatible with Inkra, JoinTech Dovetail
Compatible with OmniJig

Plunge Flat Roundover For Legacy Ornamental Mill



When used with the Legacy ornamental machines, these bits make transitions from flat surfaces to beads on round or flat stock, i.e. astragal on columns or table legs.

Tool No.	R.	Small Dia.	Shank Dia.	Cutting Length	Shank Length	Price
1251	3/32"	3/16"	1/4"	5/16"	1-1/4"	\$14.03
1272	1/8"	1/4"	1/2"	3/8"	2"	\$17.02
1282	1/8"	1/2"	1/2"	3/8"	2"	\$18.28
1273	3/16"	1/4"	1/2"	7/16"	2"	\$19.32
1274	1/4"	1/4"	1/2"	1/2"	2"	\$20.25
1284	1/4"	7/16"	1/2"	1/2"	2"	\$23.18
1275	5/16"	1/4"	1/2"	9/16"	2"	\$23.51
1285	5/16"	1/2"	1/2"	1/2"	2"	\$23.25
1276	3/8"	1/4"	1/2"	5/8"	2"	\$25.61
1278	1/2"	1/4"	1/2"	3/4"	2"	\$28.09

MAGNATE™ Router Bits For Legacy Ornamental Milling Machinery

Plunge Roundover Bit For Legacy Ornamental Mill



Combination cutters for plunging through boards and for rounding corners as well as edge forming.

Tool No.	R.	Small Dia.	Shank Dia.	Cutting Length	Shank Length	Price
3917	3/16"	1/4"	1/2"	3/8"	1-1/2"	\$16.21
3918	1/4"	1/4"	1/2"	3/8"	1-1/2"	\$19.43
3919	5/16"	1/4"	1/2"	7/16"	1-1/2"	\$21.90
3920	3/8"	1/4"	1/2"	1/2"	1-1/2"	\$24.41
3921	1/2"	3/8"	1/2"	3/4"	1-1/2"	\$27.91
3924	9/16"	1/2"	1/2"	15/16"	1-1/2"	\$30.46
3922	5/8"	1/2"	1/2"	1"	1-1/2"	\$34.38
3923	3/4"	1/2"	1/2"	1-1/8"	1-1/2"	\$39.47
3927	1"	1/2"	1/2"	1-3/8"	1-1/2"	\$46.00

Point Cutting Roundover Bits For Ornamental Mill



These bits can be used with the Legacy Ornamental Mill to create indexed beads and reeds on flat or spindle stock.

Tool No.	R.	Shank Dia.	Cutting Length	Shank Length	Price
7507	1/8"	1/4"	3/8"	1-1/4"	\$13.71
7504	3/16"	1/4"	7/16"	1-1/4"	\$15.16
7503	1/4"	1/4"	1/2"	1-1/4"	\$17.35
7513	5/16"	1/2"	9/16"	2"	\$20.58
7502	3/8"	1/2"	5/8"	2"	\$23.03
7514	7/16"	1/2"	11/16"	2"	\$24.70
7501	1/2"	1/2"	3/4"	2"	\$26.40
7515	9/16"	1/2"	13/16"	2"	\$29.61
7516	5/8"	1/2"	7/8"	2"	\$32.18
7517	3/4"	1/2"	1"	2"	\$36.33

Spiral Router Bits UP For Legacy Ornamental Mill



These bits can be used with the Legacy Ornamental Mill to cut mortises, grooves, and hollow spirals. They can also be used when following a template to mill contoured profiles i.e. Queen Ann legs.

Tool No.	Cutting Dia.	Cutting Length	Shank Dia.	Overall Length	Price
2001	1/8"	1/2"	1/4"	2"	\$16.54
2104	1/4"	3/4"	1/4"	2-1/2"	\$18.70
2004	1/4"	3/4"	1/4"	2-1/2"	\$18.70
2005	1/4"	1"	1/4"	2-1/2"	\$19.14
2025	1/4"	1-1/4"	1/4"	3"	\$24.03
2007	3/8"	1-1/4"	3/8"	3"	\$26.45
2008	3/8"	1-1/4"	1/2"	3"	\$42.77
2010	1/2"	1-1/2"	1/2"	3-1/2"	\$47.13
2011	1/2"	2"	1/2"	4"	\$50.62

Straight Plunge Router Bits For Legacy Ornamental



When used on the Legacy Ornamental Mill these bits can mill grooves and mortises, or mill contoured profiles when following a template, simulating to a copy lathe.

Tool No.	Cutting Dia.	Cutting Length	Shank Dia.	Shank Length	Price
265	1/2"	1"	1/4"	1-1/4"	\$10.32
283	3/8"	1-1/4"	1/2"	1-1/2"	\$10.81
285B	1/2"	2"	1/2"	1-1/2"	\$16.15
295	5/8"	2"	1/2"	1-1/2"	\$19.12
290	1"	1"	1/2"	1-1/2"	\$19.25
293	1-1/2"	1-1/2"	1/2"	1-1/2"	\$24.12

Straight Router Bits For Legacy Ornamental Mill



When used on the Legacy Ornamental Mill these bits can mill grooves and mortises, or mill contoured profiles when following a template, simulating to a copy lathe.

Tool No.	Cutting Dia.	Cutting Length	Shank Dia.	Shank Length	Price
231	1/4"	3/4"	1/2"	1-1/2"	\$8.68
233L	3/8"	1-1/2"	1/2"	2"	\$12.39
234	7/16"	1"	1/2"	1-1/2"	\$9.37
235B	1/2"	2"	1/2"	2"	\$15.91
237L	5/8"	2"	1/2"	1-1/2"	\$16.50
239	7/8"	1-1/4"	1/2"	1-1/2"	\$16.73
241	1"	2"	1/2"	2"	\$20.43

V-Grooving & Carving 3-Flute Bit For Legacy Orname

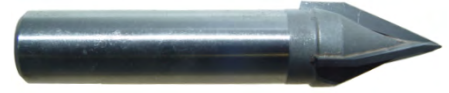

It is designed for professional sign making and lettering.

Tool No.	Degree	Cutting Dia.	Shank Dia.	Cutting Length	Shank Length	Price
767	45	5/8"	1/2"	3/4"	2"	\$23.45
763	60	5/8"	1/2"	5/8"	2"	\$19.76

V-Grooving Router Bits For Legacy Ornamental Mill



These bits make both shallow and deep grooves in solid wood and composition boards. Can be used for decorative veining of drawers and cabinets. Also good for sign lettering.

When used with the Legacy Ornamental Mill, this bit can be used to chamfer square to round transitions. It can also be used to mill a diamond pattern on flat or spindle stock.

Tool No.	Degree	Cutting Dia.	Shank Dia.	Cutting Length	Shank Length	Price
717	60	1"	1/2"	1-3/32"	1-1/2"	\$20.80
704	90	3/4"	1/2"	5/8"	1-1/2"	\$16.37
706	90	1"	1/2"	3/4"	2"	\$23.13
708	90	1-1/2"	1/2"	1"	2"	\$30.42

Steel Router Collet Reducers



This adaptor is designed for use with a 1/2" collet router. It comes with 1" collet height and a flange for easy removal.

Tool No.	Inside Dia.	Outside Dia.	Overall Length	Price
SCK18	1/8"	1/2"	1-1/8"	\$6.38
SCK36	3/16"	1/2"	1-3/16"	\$6.38
SCK14	1/4"	1/2"	1-3/16"	\$6.38
SCK56	5/16"	1/2"	1-3/16"	\$6.38
SCK08	8mm	1/2"	1-3/16"	\$6.38
SCK38	3/8"	1/2"	1-3/16"	\$6.38
SCK10	10mm	1/2"	1-3/16"	\$6.38



3 Leg Pedestal Set



Tool No.: RBPEDESTAL Price: \$84.25

This set includes a total of 4 router bits as follows: 1210, 468, 285B, 708.

This set of router bit includes those used in the milling of Legacy's 3-Leg Pedestal Display Stand. They are demonstrated in the class titled 3-Leg Pedestal 1.

Contemporary Bed Set

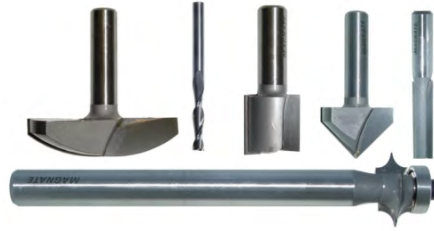

Tool No.: RBPBED Price: \$180.60

This set includes a total of 6 router bits as follows: 5567, 7671, 2025, 285B, 290, 708.

This Contemporary Bed Bit Set consists of those router bits used in creating the 4-poster bed that Legacy designed.

The construction of this bed is demonstrated at Legacy's Woodworking academy web page in the class titled: "4-Poster Bed 1".

Fast Start Set



Tool No.: RBFSTART Price: \$108.99

This set includes a total of 3 router bits as follows: 2704, 3952, 7581.

This is the recommended starter set for the Legacy Ornamental Mill. These three router bits are used to teach the basics of turning, indexing and spiraling in the Fast Start Training DVD. These are very common router bits and that frequently used with the Ornamental Mill.

Bowl Class Set



Tool No.: RBPBOWL01 Price: \$135.67

This set includes a total of 4 router bits as follows: 7592, 241, 808, S7803.

This set of router bits is used to create varying accents when milling various size bowls and trays. Complete router bit set for the 8" Bowl project. You will also need a 2704 surface planning bit, if you do not already have one.

Display Table Set



Tool No.: RBDISPLAYTABLE Price: \$151.41

This set includes a total of 6 router bits as follows: 2105, 1278, 706, 801, 2704, 3954

Fast Start CNC Set



Tool No.: RBFSTARTCNC Price: \$253.63

This set includes a total of 9 router bits as follows: 2704, 7581, 7551, 3952, 810, 706, 717, 285B, 2104.

Flat Stock CNC Set



Tool No.: RBFLATSTOCKCNC Price: \$207.59

This set includes a total of 7 bits as follows: 2104, 285B, 2704, 717, 706, 2681, 2683.

This set is the recommended as one of the starter sets for the Legacy Ornamental Mill users.

Cabinet Maker Set



Tool No.: RBCABINETMAKER Price: \$241.75

This set includes totally 5 router bits, 1 Boring Bit and 1 ER32 CNC collet as following: 9492, 2123, 9521, 2152, 2246, 1025, ER3210.

Hollow Spiral Candlestick Set



Tool No.: RBPCANDLE Price: \$129.06

This includes a total of 5 bits as follows: 7552, 810, 7503, 7507, 285B.

This set of bits is used to create the large candlestick featured in Legacy's online class titled "Candlestick 1" that is part of the "Legacy Woodworking Academy" curriculum.

Note: You will also need a 1/4" Collet reducer (Tool No. SCK14), and a bottom cleaning bit (Tool No. 2704).

Panel Processing Set



Tool No.: RBPANEL Price: \$639.21

This set includes a total of 12 solid carbide bits as follows: 9492, 2123, 9521, 2130, 2140, 4350, 2152, 2162, 2240, 2242, 2246, 7972.

Professional CNC Set



Tool No.: RBCNC Price: \$657.15

This set includes a total of 21 router bits as follows: 2704 x 2 pcs, 285B x 2 pcs, 2104, 706, 717, 7581, 7584, 7551, 7552, 3952, 7503, 7501, 1274, 1278, 807, 810, 808, 2681, 2683.

Professional Set



Tool No.: RBPROFESSIONAL Price: \$500.42

This set includes a total of 16 router bits as follows: 2704, 3952, 7581, 7582, 7554, 290, 285B, 283, 708, 807, 810, 3935, 351, 5567, 7676, 7623.

This set of router bit includes 16 of the most commonly used router bits for the Legacy Ornamental Mill. This set of bits will allow you to create a wide variety of turnings featuring beads, coves, rope twist, barley twist, hollow spiral, diamond, pillowed diamond, Joinery, and contoured profiles. It will also allow you to create simple and specialty moldings featuring beads, coves, buttons, denticulation, and rope inlay. There are also bits for rough and finish cuts for surfacing planing and dimension turning or flat stock.

Wall Clock Set



Tool No.: RBPWALLCLOCK Price: \$291.54

This set includes a total of 12 router bits and one 1/2" to 1/4" collet reducer as follows: 3961, 805, 807, 808, 810, 1207, 7502, 7503, 7564, 2104, 265, 285B, SCK14

dynaGlide Plus, Tri-Bountry Dry-Lubricant & Cleaning Conditioner



WARNING: Reproductive Harm
www.P65Warnings.ca.gov

Use on Woodworking & Metalworking Tools, any Metals.

dynaGLIDE Plus will not stain, discolor, or transfer. dynaGLIDE penetrates instantly and dries within minutes, leaving behind extremely tough pressure film. Can be used for storage of tools, all router bearings, table beds, scroll-saw, ban-saw, cutters, lathe tools, all cutting /drilling/routing blades, etc. Will not stain wood or other material.

Replaces all other lubricants for any purpose.

Note : Ground Shipping Only

Tool No.	Bottle	Price
A12WT	10 oz	\$15.95



Spoilboard Surfacing, 2+2 Insert Carbide Knife Rabbeting Flycutter, Leveler & Surface Planer

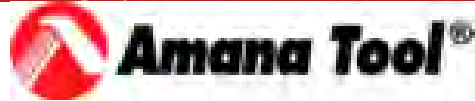

RC-2251

Insert router bit complete with two cutting flutes and two up-shear scorers for fast removal of materials over large surface area. The scorer leaves an improved finish at the bottom of the cut. Utilizes 4-sided carbide inserts. Max cutting depth is 1/4".

Perfect for:

- Resurfacing sPoilboards using CNC• 2+2 Spoilboards contain two bottom scorers for better performance, finer surface finish and better clearance for 90° corners.
- Planing large glued-up panels using CNC
- Surfacing and finishing wood using timber slab machines
- Rabbeting and slotting

Designed for planing & rabbeting the following materials:

- MDF, Plywood/Chipboard, Plastic/Acrylic
- Fiberboard, Balsa Core, High Density Urethane (HOU Board)
- HDF/LDF, EPoxy (EPoxy Resins), Ultra-High-Molecular-Weigh
- Hardwood/Softwood, Polyethylene (UHMWPE)

For optimal results and maximum insert life, replace inserts with optional general purpose knives (sold separately).

Recommendations: For surfacing solid woods, it is recommended to remove both bottom scorers.

replacement knives: use AMANA HMA-12, HCK-40 for MDF, or use AMANA AMA-12, RCK-70 for general purpose.e.

Tool No.	Cutting Dia.	Cutting Height	Shank Dia.	Overall Length	Price
RC-2251*	2-1/2"	15/32"	1/2"	2-1/2"	\$349.35

* Max 19,000 rpm

Mini Spoilboard Surfacing, 2+2 Insert Carbide Knife Rabbeting Flycutter, Leveler & Surface Planer

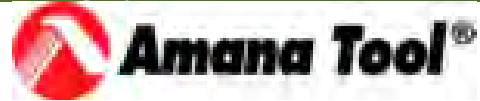

RC-2250

Mini design for tight comers. Exclusive carbide grade for highest quality of cut. Mini insert spoilboard surfacing & rabbeting with scorer utilizes 4-sided carbide inserts. great for cutting tight comers. Features unique 2+2 insert knife design that contains two cutting flutes and two up-shear scorers, which provide a smoother finish at the bottom of the cut than traditional two-knife style router bits. Max cutting depth is 1/4".

Perfect for:

- Resurfacing spoilboards using CNC
- 2+2 spoilboards contain two bottom scorers for better performance, finer surface finish and better clearance for 90° comers
- Planing large glued-up panels using CNC
- Surfacing and finishing wood using timber slab machines
- Rabbeting and slotting

Designed for planing & rabbeting the following materials:

- MDF, Plywood/Chipboard, Plastic/Acrylic.
- Fiberboard, Balsa Core, HOU Board.
- HDF/LDF, Epoxy (Epoxy Resins), UHMWPE
- Hardwood/Softwood

For optimal results and maximum insert life, replace inserts with optional general purpose knives (sold separately). Max. 24,000 rpm.

Tool No.	Cutting Dia.	Cutting Height	Shank Dia.	Overall Length	Price
RC-2250*	1-1/2"	1/2"	1/2"	2-5/16"	\$226.00

* replacement knives: use AMANA HMA-12, HCK-40 for MDF, or AMA-12, RCK-70 for general purpose

