

dwsitepro.com



Dave White's

SiteProTM

EDITION IX



SURVEYING & CONTRACTORS **TOOLS AND ACCESSORIES**

GAMMON REEL®

David White®

SITEGEAR®



**SALAMANDER
SERIES®**



Dave White's

SitePro™

2020 NEW PRODUCTS

APPLICATIONS

- Short to mid-range leveling for building and construction
- Elevation control
- Distance measuring
- Stakeout



11-805-BM barcode leveling rod is compatible with the SDL32



SDL32

32 POWER DIGITAL LEVEL FOR BUILDING CONSTRUCTION

Super fast measurement speed of less than 3 sec. with the simplicity of the one-push measure and store functionality provides faster, more economical workflow.

- Accuracy of $\pm 1.0\text{mm}$ for 1km double-run level
- Memory stores up to 1,000 points; interface: Micro-USB
- Data recorded on the job site can be simply downloaded by connecting the SDL32 with a PC or laptop
- Range up to 100m (330-ft)
- Shock-resistant pendulum magnetic damped compensator ensures durability and precision
- IP 55 water protection
- Horizontal circle- graduated to 1°

sku

SDL 32 /Standard Kit
25-SDL32

what's included?

SDL32 Digital Level, 5m Barcode leveling rod, case, user manual

FOCUS, MEASURE, DISPLAY RESULTS



01-ALHVZ20
P. 30

01-TLS
P. 33

51-B1535
P. 46

51-B1528
P. 46

51-B2617
P. 45

27-RD105
P. 11

28-KS100HV
P. 7

28-RSLT10
P. 11

07-4365
P. 26

07-4602-TM
P. 22

28-KS5PG
P. 9

11-TURL
P. 36

07-4364
P. 25



PRODUCT CATEGORIES

OPTICAL INSTRUMENTS	4
LASER TOOLS & ACCESSORIES	7
PRISM SYSTEMS	13
TRIBRACH SYSTEMS	19
PRISM POLE SYSTEMS	20
GNSS ROVER RODS	23
BIPODS & TRIPODS, GPS TRIPOD	24
ACCESSORIES-PRISM, POLE, BIPOD	27
ACCESSORIES FOR GNSS, RODS	28
TRIPODS FOR INSTRUMENTS	29
LEVELING RODS	34
MEASURING DEVICES	37
MAGNETIC LOCATOR	39
HAND TOOLS	40
WORK GEAR	42
FIELD SUPPLIES	47
BAGS AND CASES	50

SITEPRO GUARANTEE

Dave White's SitePro guarantees all our brands of tools and instruments against any defects in material or workmanship with a limited lifetime warranty.

For details and complete warranty, visit www.dwsitepro.com/guarantee/

APPLICATIONS

- Gravity flow pipe laser setup
- Measure angles, establishing 90-degree reference lines
- Anchor bolt alignment
- Aligning forms, walls

LT8-300LTU
UNIVERSAL LINE TRANSFER UNIT

The LT8-300LTU is versatile and ideal for use with pipe aligning laser or as a level-transit. The 360° telescope design allows direct sight below the instrument for pipe laying applications.

- Powerful 26X optics
- Accuracy: ±3/16-in at 150-ft (4.75mm at 45m)
- Range up to 400-ft (120m)
- Optional laser plummet for quick and easy setup
- Horizontal circle with lock
- Glass reticle with stadia lines for measuring distance (ratio 1:100)
- Plate vial for rough leveling and general plummetering requirements

sku	what's included?
LT8-300LTU /No Plummet 46-D8877	LT8-300LTU Line Transfer Unit, rain hood, objective lens, case, manual
LT8-300LTULP /Laser Plummet 46-D8879 	LT8-300LTULP Line Transfer Unit, rain hood, objective lens, case, manual



APPLICATIONS

- Medium range leveling
- Turning angles, establishing 90° reference lines
- Determine vertical angles, basic grade work
- Checking angles, alignment, and plumb
- Anchor bolt alignment
- Gravity flow pipe laser setup
- Aligning forms, walls

LT8-300
UNIVERSAL LEVEL-TRANSIT

The Dave White LT8-300 is rugged and dependable, making this five minute instrument the first choice for practically every horizontal and vertical sighting application in construction.

- Powerful 26X optics
- Accuracy: ±3/16-in at 150-ft (4.75mm at 45m)
- Range up to 400-ft (120m)
- Vertical arc and horizontal circle with locks and tangents
- 1:100 stadia with glass reticle

sku	what's included?
LT8-300P /Optical Plummet 46-D8871	LT8-300P level-transit, plumb bob, rain hood, objective lens, case, manual
LT8-300LP /Laser Plummet 46-D8872 	LT8-300LP level-transit, plumb bob, rain hood, objective lens, case, manual



APPLICATIONS

- Turning horizontal angles, establishing 90° reference lines
- Medium range leveling
- Checking angles, alignment
- Determine difference in elevation
- Leveling forms and footers
- Measuring cut-and-fill

AL8-SERIES
AUTOMATIC LEVELS

Make every leveling job faster and easier with Dave White designed automatic levels. Superior design sighting scope and bubble vial are built into the housing for greater durability.

- Lock-out device protects compensator during transport
- Larger aperture allows more light for a sharper image
- Soft control knobs for easier to grip
- Infinite tangent screw
- Horizontal circle with white on black graduations
- Wire-hung magnetically damped compensator holds the level line of sight within ±15 arc minutes of level

sku	what's included?	Magnification	Leveling Accuracy	Working Range
AL8-26 /Standard Kit 45-D8926	AL8-26 automatic level, adjustment tools, lens cap, plumb bob, case, manual	26X	±1/16-in @ 100 ft (±1.5mm @ 30m)	300-ft (90m)
AL8-26 /Complete Kit 45-D8926K-1¹	AL8-26 automatic level, adjustment tools, lens cap, plumb bob, case, manual, tripod, leveling rod	26X	±1/16-in @ 100 ft (±1.5mm @ 30m)	300-ft (90m)
AL8-32 /Standard Kit 45-D8932	AL8-32 automatic level, adjustment tools, lens cap, plumb bob, case, manual	32x	±1/32-in @ 100 ft (±1.0mm @ 30m)	400-ft (120 m)
AL8-32 /Complete Kit 45-D8932K-1¹	AL8-32 automatic level, adjustment tools, lens cap, plumb bob, case, manual, tripod, leveling rod	32x	±1/32-in @ 100 ft (±1.0mm @ 30m)	400-ft (120 m)



David White instruments are guaranteed with a two (2) year limited warranty. Unless otherwise specified, hand level and accessory items include a 90-day limited warranty.

¹ Complete kits available: include aluminum tripod and aluminum rod. Specify leveling rod graduations when ordering, add **C** for 6ths, **T** for 10ths. Example: 44-D8834-1T would include the 10ths leveling rod.

43-D620
2X SIGHTING HAND LEVEL

- Ideal for preliminary survey and simple distance estimation
- Sturdy impact resistant aluminum body and easy-to-read protected vial
- 2-power fixed magnification
- Pocket clip





APPLICATIONS

- Short range leveling
- Turning angles, establishing 90° reference lines
- Checking points in same horizontal plane
- Check elevations

L6-20
22X MERIDIAN LEVEL

Designed for light construction work - leveling and turning angles.

- ±1/4-in at 100-ft (6mm at 30m) leveling accuracy
- Up to 200-ft (60m) range
- Horizontal circle- graduated to 1°, reads by vernier direct to 15-minutes
- Top mount leveling vial
- Horizontal lock and tangent screw provides precise movement control
- Built-in sunshade for clearer sightings

sku	what's included?
L6-20 /BASIC KIT 44-D8824	L6-20 level, plumb bob, case, manual
L6-20 /COMPLETE KIT 44-D8824K-1¹	L6-20 level, plumb bob, case, tripod, leveling rod , manual



APPLICATIONS

- Short range leveling
- Turning angles, establishing 90° reference lines
- Determine vertical angles, basic grade work
- Checking angles, alignment, and plumb

LT6-900
22X MERIDIAN LEVEL-TRANSIT

Ideal for light construction work- leveling, turning angles, and determining vertical angles.

- ±1/4-in at 100-ft (6mm at 30m) leveling accuracy
- Up to 200-ft (60m) range
- Horizontal circle- graduated to 1°, reads by vernier direct to 15-minutes
- Vertical arc read to degrees (0-45°)
- Horizontal lock and tangent screw provides precise movement control
- Built-in sunshade
- Top mount leveling vial

sku	what's included?
LT6-900 /BASIC KIT 44-D8834	LT6-900 transit-level, plumb bob, case, manual
LT6-900 /COMPLETE KIT 44-D8834K-1¹	LT6-900 transit-level, plumb bob, case, tripod, leveling rod , manual



¹ Complete kits available: include aluminum tripod and aluminum rod, and typically shipped in two (2) packages. Specify leveling rod graduations when ordering, add **C** for 8ths, **T** for 10ths. Example: 44-D8834-1T would include the 10ths leveling rod.



APPLICATIONS

- Measure angles, establishing 90-degree reference lines
- Determine difference in elevation
- Check angles, alignment, and plumb
- Basic grade work
- Short range leveling
- Anchor bolt alignment
- Setting out curves
- Gravity flow pipe laser setup
- Aligning forms, walls

DT8-05
DIGITAL TRANSIT THEODOLITE

The David White DT8-Series digital transit theodolites give you accurate measurements for a wide range of construction and survey applications.

- Simple, push button functions gives the user precise LCD digital readouts
- Incremental encoding detection system
- Front and back digital displays
- Coaxial tangent and clamp screws for sighting and alignment
- Automatic power shut-off
- Built-in easy access battery pack
- Water resistant, sealed construction

sku	what's included?
DT8-05P /OPTICAL PLUMMET 46-D8895	DT8-05P Theodolites, sunshade, tool kit, rain cover, plumb bob, carrying case, rechargeable battery kit, alkaline battery tray, user guide
DT8-05LP /LASER PLUMMET 46-D8896 	DT8-05LP Theodolites, sunshade, tool kit, rain cover, plumb bob, carrying case, rechargeable battery kit, alkaline battery tray, user guide
DT8-05LS /LASER SIGHT 46-D8897 	DT8-05LS Theodolites, sunshade, tool kit, rain cover, plumb bob, carrying case, rechargeable battery kit, alkaline battery tray, user guide

	DT8-05P	DT8-05LP	DT8-05LS
Magnification	30x	30x	30x
Field of View	1° 30'	1° 30'	1° 30'
Centering Plummet	3x optical	635nm laser, 2M	3x optical
Reading System	Advanced absolute encoder		
Angular Precision	5" (1 mgon)	5" (1 mgon)	5" (1 mgon)
Minimum Reading	1" / 5" switchable		
Units	deg / mil / gon / V %		
Tilt Sensor	Automatic compensation, ± 3' range		



46-DT8EP
DIAGONAL EYEPIECE

- Easily mounts to DT8- to measure angles and points in any direction
- Provides an erect image, and 1° 30' angle of view
- Measure any target with a distance of at least 4-1/4' (1.3m) from the instrument





APPLICATIONS

- Turning horizontal angles, establishing 90° reference lines
- Medium range leveling
- Checking angles, alignment
- Determine difference in elevation
- Leveling forms and footers
- Measuring cut-and-fill



**SK SERIES
PRO AUTOMATIC LEVEL**

This SitePro SK-Series professional automatic level features superior optics and excellent magnification with large aperture that allows more light for a sharper image.

- Magnetically dampened compensator quickly levels and stabilizes line of sight
- 360° graduated horizontal circle in 1-degree increments
- Cross hairs with 1:100 stadia lines
- Circular bubble vial can be easily viewed with 90-degree mirror
- Fine motion horizontal tangent knobs on left and right sides
- Includes lens cover, plumb bob, adjustment tools, case, user guide
- Solid leveling base with three leveling screws
- Weather resistant- IP54



sku	magnification	accuracy	range	field of view	compensator range	wgt
STANDARD KIT 25-SK32X¹	32X	±1/16" @ 250 ft (±1.5mm @ 76m)	400-ft (120m)	1° 20'	±0.3", +/-15'	3.65 lb (1.6 kg)
STANDARD KIT 25-SK28X¹	28X	±1/16" @ 200 ft (±1.5mm @ 60m)	350-ft (105m)	1° 20'	±0.4", +/-15'	3.65 lb (1.6 kg)
STANDARD KIT 25-SK24X¹	24X	±1/16" @ 150 ft (±1.5mm @ 46m)	300-ft (90m)	1° 25'	±0.5", +/-15'	3.65 lb (1.6 kg)

APPLICATIONS

- Short range leveling
- Turning angles, establishing 90° reference lines
- Determine vertical angles, basic grade work
- Checking angles, alignment, and plumb



**TL 20X
22-POWER TRANSIT LEVEL**

The TL20X transit level is ideal for leveling and vertical applications.

- Fast set-up, simple to use
- Built-in sunshade with rubber eyepiece
- Clamps and tangents bring your instrument quickly on target
- Includes plumb bob, adjustment tools, case, user guide
- 3-screw leveling base with 5/8-11 thread for tripod
- 15 minute horizontal circle



sku	magnification	accuracy	range	field of view	wgt
25-TL20X¹	22X	±1/4-in at 100 ft (6mm @ 30m)	200-ft (60m)	±2'/100 ft (±0.6m/30m)	2.95 lb (1.3kg)

APPLICATIONS

- Wide range of construction and survey applications
- Measure angles
- Determine difference in elevation
- Anchor bolt alignment
- Setting out curves
- Gravity flow pipe laser setup
- Aligning forms, walls



**DT 05
5-SEC DIGITAL TRANSIT THEODOLITE**

The SitePro DT 05 electronic digital theodolites give you accurate measurements in an affordable, easy-to-use platform.

- Photoelectric incremental encoding detection system
- Coaxial tangent and clamp screws provide ease of use in sighting and alignment
- Front and back keypad with large backlit digital displays- units: deg / mil / gon / V %
- Built-in battery pack can be attached and detached by a single action
- 5" (1mgon) angular accuracy; 30x
- Water resistant, sealed construction (IP54)
- Automatic power shut-off
- Includes Plumb Bob, Rechargeable Battery Pack/Charger, Alkaline Battery Tray, Case, User Guide
- 3-power optical plummet for centering on point

sku	magnification	angular accuracy	field of view	compensator	wgt
OPTICAL PLUMMET 26-DT05	30X	5" (1 mgon)	1° 30'	automatic, ± 3' range	9.3 lb (4.2 kg)



**26-DTEP
DIAGONAL EYEPIECE FOR DT 05**

The DTEP diagonal eyepiece is ideal in areas where large buildings or obstacles prevent an ideal working distance between the DT 05 theodolite and target object.

- Easily mounts- work in tight spots with little space behind the instrument
- Angles & points can be measured by telescope in any direction with eyepiece
- Measure distance of at least 4-1/4' (1.3m) from the instrument
- Provides an erect image, and 1° 30' angle of view



Dave White's SitePro instruments are guaranteed with a two (2) year limited warranty. Unless otherwise specified, accessory items include a 90-day limited warranty.

¹ Complete kits available: include aluminum tripod and aluminum rod, and typically shipped in two (2) packages. Specify leveling rod graduations when ordering, add **C** for 8ths, **T** for 10ths. Example: 44-D8834-1T would include the 10ths leveling rod.



	KS ROTARY		LR SERIES ROTARY LASERS			
	KS 100H	KS 100HV	LR 410H	LR 430HDV	LR 420HV-G	LR 422GR
Leveling Accuracy	±1/8" (±3 mm)	±1/8" (±3 mm)	±1/16" (±1.8 mm)	±1/16" (±1.8 mm)	±3/32" (±2.25mm)	±3/32" (±2.25mm)
Leveling Type	Electronic, ±4°	Electronic, ±4°	Electronic, ±4°	Electronic, ±4°		Electronic, ±4°
Working Range (dia.)						
without Detector	---	---	---	65 ft (20m)	265 ft (80m)	65 ft (20m)
with Detector	1,000 ft (300m)	1,000 ft (300m)	2,950 ft (900m)	2,950 ft (900m)	1,350 ft (400m)	1,350-ft (400m)
Functions						
Slope/Grade	Dual Slope, ± 8.0%	Dual Slope, ± 8.0%	Single Slope, ± 7.0%	Single Slope, ± 7.0%	Single Slope, ± 7.0%	Dual Grade: +7%, -7%
Scanning	---	Preset: 0°, 15°, 45°, 90°	Preset: 0°, 15°, 45°, 90°	Preset: 0°, 15°, 45°, 90°	Preset: 0°, 15°, 45°, 90°	Preset: 0°, 15°, 45°, 90°
Height Alert	Yes	Yes	Yes	Yes	Yes	Yes
Rotation speed(s)	600 rpm	150, 300, 600 rpm	400, 800, 2000 rpm	400, 800, 2000 rpm	400, 800, 2000 rpm	400, 1000, 2000 rpm
Power Supply	4-C Alkaline	4-C Alkaline	4-C Alkaline	4-C Alkaline & Lithium Battery Pack	4-C Alkaline & Lithium Battery Pack	4-C Alkaline & Lithium Battery Pack
Environment	IP 54, Water/Dust Resistant	IP 54, Water/Dust Resistant	IP 55, Water/Dust Resistant	IP 55, Water/Dust Resistant	IP 55, Water/Dust Resistant	IP 55, Water/Dust Resistant

 Laser products are manufactured to Class 2M or 3R laser classification. Please refer to product warning labels for actual laser output and classification.

APPLICATIONS

- Leveling, checking elevations, concrete forms
- Installation of decks, pools, drop ceilings, floors
- Excavating, digging footings, septic systems



*Detector may be different than shown.

KS 100H
BASIC HORIZONTAL ROTARY LASER

Keep it simple with the KS 100H horizontal electronic self-leveling rotary laser for precise leveling applications, ideal for outdoor use.

- Simple button operation, easy to use
- ±1/8-in at 100-ft (3.0mm at 30m) leveling accuracy
- Up to 1000-ft (300m) working range
- Electronic self-leveling
- Dual axis slope (±8%) for simple slope applications
- Anti-Drift System alerts user when laser has been disturbed or drifts
- Enclosed Rotor Housing keeps laser safe from tough jobsite conditions



sku	what's included?
STANDARD KIT 27-KS100H	KS 100H rotary laser, detector with bracket, alkaline battery compartment and batteries, case, user guide
COMPLETE KIT 27-KS100H-4 ¹	KS 100H rotary laser, detector with bracket, tripod, leveling rod , alkaline battery compartment and batteries, case, user guide

APPLICATIONS

- Leveling, checking elevations, concrete forms, footings, foundations
- Estimating cut and fill
- Manual slope
- Installation of decks, pools, drop ceilings, floors
- Excavating, digging footings, septic systems



*Detector may be different than shown.

KS 100HV
HORIZONTAL/VERTICAL ROTARY LASER

- Horizontal and vertical electronic self-leveling
- Ideal for outdoor use
- Simple button operation, easy to use
- ±1/8-in at 100-ft (3.0mm at 30m) leveling accuracy
- Up to 1000-ft (300m) working range
- Dual axis slope (±8%) for simple slope applications
- Anti-Drift System alerts user when laser has been disturbed or drifts
- Enclosed Rotor Housing keeps laser safe from tough jobsite conditions



sku	what's included?
KS 102HV /STANDARD KIT 27-KS100HV	KS 100HV rotary laser, laser detector with bracket, universal mount, magnetic target, glasses, 4-C alkaline batteries, carrying case, user guide
KS 102HV /COMPLETE KIT 27-KS100HV-4 ¹	KS 100HV rotary laser, laser detector with bracket, universal mount, magnetic target, glasses, 4-C alkaline batteries, carrying case, tripod, leveling rod , user guide



LR-Series rotary lasers are guaranteed with a two (2) year limited warranty. KS-Series rotary laser are guaranteed with a one (1) year limited warranty. Unless otherwise specified, accessory items include a 90-day limited warranty.

¹ Complete kits include aluminum tripod and aluminum rod, and typically shipped in two (2) packages. Specify leveling rod graduations when ordering, add **C** for 8ths, **T** for 10ths. Example: 27-LR410H-4T would include the 10ths leveling rod.



Laser products are manufactured to Class 2M or 3R laser classification. Please refer to product warning labels for actual laser output and classification.

APPLICATIONS

- Leveling, checking elevations, concrete forms, footings, foundations
- Estimating cut and fill
- Manual slope
- Installation of decks, pools, drop ceilings, floors
- Excavating, digging footings, septic systems



*Detector may be different than shown.

LR 410H HORIZONTAL ROTARY LASER

- ±1/16-in at 100 feet (±1.8mm at 30m) leveling accuracy
- 2,950 ft (900m) diameter working range with detector
- Compact, ergonomic design with single button operation
- Extremely high rotation speed of up to 2,000 rpm-adjustable
- Electronic self-leveling
- Single axis ±7.0% slope

sku	what's included?
LR 410H /STANDARD KIT 27-LR410H	LR 410H rotary laser, detector with bracket, alkaline batteries, case, user guide
LR 410H /COMPLETE KIT 27-LR410H-4¹	LR 410H rotary laser, detector with bracket, tripod, leveling rod , alkaline batteries, case, user guide



Class 2M

APPLICATIONS

- Interior & exterior, light to medium commercial, residential construction
- Leveling, alignment and squaring
- Checking elevations, footings, foundations
- Square and align walls, partitions, and corners
- Installing ceilings & floors



*Detector may be different than shown.

LR 430HDV 3-D ROTARY LASER

- Leveling accuracy: 1/16-in at 100 feet (1.8mm at 30m)
- Working Range up to 2,950 ft (900m)
- Extremely high rotation speed
- Three integrated rotary heads
- Compact, ergonomic design with single button operation
- Multiple scan angles, beam positioning, and variable rotation speeds
- Single axis ±4° slope

sku	what's included?
LR 430HDV /STANDARD KIT 27-LR430HDV	LR 430HDV rotary laser, laser detector, remote, universal mount, magnetic target, glasses, rechargeable battery/charger kit, 4-'C' alkaline batteries, carrying case, user guide
LR 430HDV /COMPLETE KIT 27-LR430HDV-4¹	LR 430HDV rotary laser, laser detector, remote, universal mount, magnetic target, glasses, rechargeable battery/charger kit, 4-'C' alkaline batteries, carrying case, tripod, leveling rod , user guide



Class 2M

APPLICATIONS

- Interior & exterior, light to medium commercial, residential construction
- Leveling, checking elevations, concrete forms, footings, foundations
- Basic slope work, driveways, ramps
- Installing ceilings & floors



*Detector may be different than shown.

LR 420HVG DUAL GREEN BEAM ROTARY LASER

- Leveling accuracy: 3/32-in at 100 feet (2.4mm at 30m)
- Working Range up to 1,350 ft (400m)
- Extremely high rotation speed up to 2,000 rpm projects visible lines
- Single axis ±4° slope
- Two integrated rotary head with built-in 520nm diodes
- Compact, ergonomic design with single button operation
- Multiple scan angles, beam positioning, variable rotation speeds

sku	what's included?
LR 420HVG /INTERIOR-EXTERIOR KIT 27-LR420HVG	LR 420HV-G rotary laser, laser detector, remote, universal mount, magnetic target, glasses, rechargeable battery/charger kit, 4-'C' alkaline batteries, carrying case, user guide
LR 420HVG /COMPLETE KIT 27-LR420HVG¹	LR 420HV-G rotary laser, laser detector, remote, universal mount, magnetic target, glasses, rechargeable battery/charger kit, 4-'C' alkaline batteries, carrying case, tripod, leveling rod , user guide



Class 2M

APPLICATIONS

- Exterior, light to medium commercial, residential construction
- Leveling, checking elevations, concrete forms, footings, foundations
- Slope/grade work, driveways, ramps



*Detector may be different than shown.

LR 422GR DUAL DIAL-IN GRADE ROTARY LASER

- Dual dial-in grade (±7%) in both axes
- Leveling accuracy: 3/32-in at 100 feet (2.4mm at 30m)
- Working Range up to 1,350 ft (400m)
- Extremely high rotation speed up to 2,000 rpm projects visible lines
- Easy to use operation via instrument controls or radio remote control
- Smart H.I. Alert System alerts user when laser has been disturbed or drifts (ADS)

sku	what's included?
LR 422GR /STANDARD KIT 27-LR422GR	LR 422GR rotary laser, laser detector, remote, magnetic target, glasses, rechargeable battery/charger kit, 4-'C' alkaline batteries, carrying case, user guide
LR 422GR /COMPLETE KIT 27-LR422GR¹	LR 422GR rotary laser, laser detector, remote, magnetic target, glasses, rechargeable battery/charger kit, 4-'C' alkaline batteries, carrying case, tripod, leveling rod , user guide



Class 2M

¹ Complete kits include aluminum tripod and aluminum rod, and typically shipped in two (2) packages. Specify leveling rod graduations when ordering, add C for 8ths, T for 10ths. Example: 27-LR430HDV-4C would include the 8ths graduated leveling rod.



LR-Series rotary lasers are guaranteed with a two (2) year limited warranty. Unless otherwise specified, accessory items include a 90-day limited warranty.

KEEP IT **SIMPLE.**

USE FOR

- Level, horiz. & vert. layout
- Alignment of interior walls
- Drop ceiling or acoustical ceiling installation
- Installation of recessed lighting, ductwork, plumbing
- Cabinet & trim installation, finish carpentry



KS 2L
CROSS LINE LAYOUT LASER

The KS 2L projects a vertical and horizontal laser line, ideal for one person leveling, plumb, and layout applications.

- ±1/16-in at 30-ft (1mm at 10m) leveling accuracy
- Up to 100-ft (30m) working range
- Small, compact design
- Detector mode allows laser to be used with optional line laser detector
- Adapter and support base with strong magnets, 1/4-20 and 5/8-11 thread, slots for screws or nails, raceways for optional straps
- Three modes of operation
- Easy access battery compartment
- Self-Leveling up to ± 3°

sku	what's included?
28-KS2L	KS 2L laser, versatile mount, target, batteries, hard case, user manual



USE FOR

- Level, horizontal & vertical layout,
- square, & plumb
- Layout, alignment, and squaring of interior walls
- Drop ceiling or acoustical ceiling installation
- Installation of recessed lighting, ductwork, plumbing
- Cabinet & trim installation, finish carpentry



KS 2LG
CROSS LINE LAYOUT GREEN BEAM LASER

The KS 2L G projects a hi-vis green vertical and horizontal laser line, ideal for one person leveling, plumb, and layout applications.

- ±1/16-in at 30-ft (1mm at 10m) leveling accuracy
- 4 times brighter than red beam lasers for better visibility in illuminated work areas
- Up to 100-ft (30m) working range
- Small, compact design
- Easy access battery compartment
- Detector mode allows laser to be used with optional green beam line laser detector
- Adapter and support base with strong magnets, 1/4-20 and 5/8-11 thread, slots for screws or nails, raceways for optional straps
- Self-Leveling up to ± 3°

sku	what's included?
28-KS2LG	KS 2LG laser, versatile mount, target, batteries, hard case, user manual



USE FOR

- Level, 90° layout, square, and plumb
- Layout and squaring interior walls and drywall track
- Point transfer
- Drop ceiling or acoustical ceiling installation
- Cabinet installation and finish carpentry



KS 5P
5-POINT LASER

The simple to use KS 5P is a versatile laser tool ideal for one person leveling, plumb, layout and squaring. Projects five 90° points for a wide range of applications.

- ±1/4-in at 100-ft (3mm at 30m) accuracy
- Up to 100-ft (30m) working range
- Small, compact design
- Bright, highly focused laser points
- Self-leveling spot beams up to ± 6°
- Easy access battery compartment
- Includes UM1P multi-mounting device for quick positioning of the laser beams

sku	what's included?
28-KS5P	KS 5P laser, UM1P mount, target, batteries, hard case, user manual



USE FOR

- Level, 90° layout, square, and plumb
- Layout and squaring interior walls and drywall track
- Point transfer
- Drop ceiling or acoustical ceiling installation
- Cabinet installation and finish carpentry



KS 5PG
5-POINT GREEN BEAM LASER

The simple to use KS 5PG is a green beam laser tool ideal for one person leveling, plumb, layout and squaring. Projects five 90° points for a wide range of applications.

- ±1/4-in at 100-ft (3mm at 30m) accuracy
- Up to 100-ft (30m) working range
- Small, compact design
- Bright, highly focused green laser points
- Self-leveling spot beams up to ± 6°
- Easy access battery compartment
- Includes UM1P multi-mounting device for quick positioning of the laser beams

sku	what's included?
28-KS5PG	KS 5P laser, UM1P mount, target, batteries, hard case, user manual



SitePro KS layout laser are guaranteed with a one (1) year limited warranty. Accessory items include a 90-day limited warranty.



KEEP IT **SIMPLE.**

USE FOR

- Interior level and vertical layout
- Layout and alignment of walls, partitions
- Installing cabinets, trim
- Finish carpentry



KS 3P
3-POINT LASER

The KS 3P is ideal for one person leveling, plumb, and simple layout. Projects plumb up and down laser points and a horizontal laser point.

- ±1/4-in at 100-ft (3mm at 30m) leveling accuracy
- Up to 100-ft (30m) working range
- Small, compact design
- Bright, highly focused laser points
- Self-leveling spot beams up to ± 6°
- Easy access battery compartment
- Includes UM1P multi-mounting device for quick positioning of the laser beams



sku	what's included?
28-KS3P	KS 3P laser, UM1P mount, target, batteries, hard case, user manual

DIGITAL LEVELS

KEEP IT **SIMPLE.**

DL 48
48" DIGITAL LEVEL

The SitePro **DL48** digital level is a four (4) foot level that provides measurement of level, plumb, or slope. Precision-machined aluminum construction is lightweight and durable. Precise digital readout ensures complete accuracy over the centered bubble vial.

- Precise digital measurements display in degrees, percent, or inches/feet
- Absolute and relative angle measurement
- Range on angle measurement 4 x 90°
- Horizontal and vertical measuring accuracy of ±0.1°
- High visibility LCD with back-lit display with audible level and plumb indicator
- Digital measurement readout flips when upside down for ease of use
- Light weight, rugged aluminum construction
- Quick horizontal and vertical calibration
- Hold function locks measurement readout
- Reference function sets any slope to 0.0°
- Includes: DL48 digital level, AAA batteries, nylon padded case with carry strap, user guide



DL 24
24" DIGITAL LEVEL

The SitePro **DL24** digital level is a two (2) foot level that provides measurement of level, plumb, or slope. Precision-machined aluminum construction is lightweight and durable. Precise digital readout ensures complete accuracy over the centered bubble vial.

- The DL24 has all the same features as the DL48 digital level
- Includes: DL24 digital level, AAA batteries, nylon padded case with carry strap, user guide



	DIGITAL LEVELS	
	29-DL24	29-DL48
Length (Approx.)	24" (62 cm)	48" (120 cm)
Measuring Range	0-360° (4 x 90°)	
Measuring Accuracy	0° and 90°, ±0.1°; -1° to 89°, ±0.2°"	
Weight	1.34 lb (610 g)	2.65 lb (1200 g)
Dimensions	23.7 x 2.6 x 1.2" (62 x 6.6 x 3 cm)	47.3 x 2.6 x 1.2" (120 x 6.6 x 3 cm)



LCD BACK-LIT DISPLAY
with audible sound. Display readout rotates when measuring overhead



DL-Series Digital Levels are guaranteed with a one (1) year limited warranty.



RD100 BASIC LASER DETECTOR

- Front and rear LCD displays allows easy, fast visual detection of laser beam for exterior applications
- Built-in leveling bubble vial on rod clamp
- Automatic shut-off
- Fine and coarse on-grade sensitivity settings for easy grade detection
- Strong built-in magnets on side and top
- Rugged housing and gasket seal -IP55
- Includes rod clamp (#27-RB100), 9v battery

sku	what's included?	Use with:
27-RD100	RD 100, rod clamp (#27-RB100), 9v battery	Most Red Beam Rotary Lasers



Back View

RD105 COMPACT PRO LASER DETECTOR

- Front and rear LCD displays allows easy, fast visual detection of laser beam for exterior applications
- Automatic shut-off
- Fine and coarse on-grade sensitivity settings for easy grade detection
- Strong built-in magnets on side and top
- Rugged housing and gasket seal -IP55

sku	what's included?	Use with:
27-RD105	RD 105, rod clamp, battery	Most Red Beam Rotary Lasers



RD202 SERIES LASER DETECTOR WITH LARGE CAPTURE WINDOW

- Large 4.9" (125mm) capture height allows quick detection
- Fine and coarse on-grade sensitivity settings for easy grade detection
- Front and rear LCD displays allows easy, fast visual detection
- Rugged housing with gasket seal -IP55
- Strong built-in magnets on side and top
- Automatic shut-off preserves battery life
- Simultaneous elevation LED indicators on front for fast, easy visual

sku	what's included?	Use with:
27-RD202	RD 202, rod clamp (#27-RB202), 9v battery	Most Red Beam Rotary Lasers
27-RD202-G	RD 202, rod clamp (#27-RB202), 9v battery	Most Green Beam Rotary Lasers



Back View

LLD20 LINE LASER DETECTOR

- Front and rear LED lights allows easy, fast visual detection of laser beam for luminated or exterior applications
- Fine and coarse on-grade sensitivity settings for easy grade detection
- On-grade is 1-1/4" (32mm) from top
- Two built-in leveling bubble vials
- Speaker on/off
- Includes rod clamp, 9v battery

sku	what's included?	Use with:
28-LLD20	RD 100, rod clamp (#27-RB100), 9v battery	Most Red Beam Rotary Lasers



MAGNETIC LASER TARGETS

- Enhances laser visibility
- Magnetic base for attachment to drop ceilings or metal studs
- Graduations - inch/cm



sku	designed for
27-TARGET-R	red beam lasers
27-TARGET-G	green beam lasers

28-RSLT10 FOLDABLE LASER TARGET

- Designed for the fast and exact alignment of a line laser on axis with range up to 100-ft (30m), depending on laser
- Folds to be easily stored inside your laser carrying case
- Target size: 5.5" x 4.75" (140mm x 120mm)
- Waterproof, suitable for indoor and outdoor use



Laser detectors are guaranteed with a one (1) year limited warranty. Unless otherwise specified, accessory items include a 90-day limited warranty.



27-4852-16

HEAVY-DUTY COLUMN CLAMP

- 12" (30.48 cm) adjustable vertical column
- 6" (15cm) flat platform with 5/8-11 thread mounting stud
- Rubber bumper for hand and fingers protection
- 10 ft (3.05 m) strap with load rating of 2,200 lb (1,000 kg)
- Heavy duty ratchet to create a strong connection to round or square columns
- Center line of the 5/8-11 stud to column measures 15-in (38.1 cm)
- Constructed of structural aluminum for industrial applications and stainless steel hardware
- Weighs 13.8lb (6.25 kg)

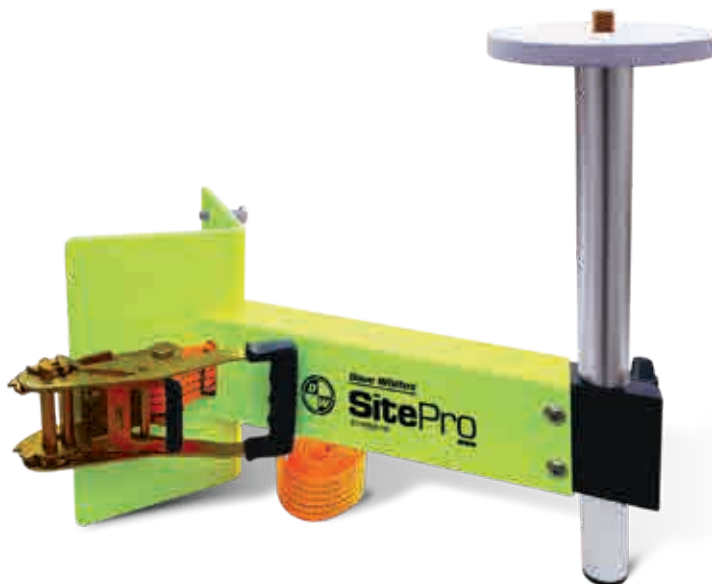

27-MW5

UNIVERSAL MULTI-MOUNT

- Ideal for drop ceilings, remodeling, and masonry
- Quick release push button
- Fine adjustment knob to precisely align laser to intended target
- Graduated scale (± 2 in and ± 50 mm markings) - 1/8" and mm
- Spring lever for quick attachment to drop ceiling grid
- Key slot to quickly mount to a stud or wall using nails or screws
- Weighs 3.0lb (1.4kg)



LASER GLASSES

- Improves visibility of laser beams under bright conditions or over distances
- One size fits all



sku	designed for
27-GLASSES-R	red beam lasers
27-GLASSES-G	green beam lasers

27-LGA

LASER GRADE ADAPTER

- Achieve up to 90° slope in one axis using the manual mode of your instrument
- Attaches onto standard 5/8-11 thread tripod and provides platform with mounting thread for laser and optical instruments
- Built-in 10-minute bubble vial
- Fine adjustment screw with smooth motion adjustment knob to set slope
- Weighs 1.9lb (0.86kg)



BATTERY PACKS AND CHARGERS



sku	designed for
26-NIMHPAK	NiMH Battery Pack for DT 05 Theodolite
27-LR4LIBATPK	LI-ION Battery/Charger Kit for LR-Series Rotary
46-DT805-CHARGER	Battery Charger for DT-8
46-DT8BATTERY	NiMH Battery Pack for DT-8

27-BBMOUNT

BATTER BOARD MOUNT CLAMPING SYSTEM

- Ideal for setting up an instrument for vertical alignment application
- Securely attaches instrument to beam or joist up to 2.17" (55 mm)
- Removable 5/8-11 mounting plate easily fastens to instrument
- Easy-grip locking knobs ensure secure attachment to joist
- Fastener hole to ensure position of a theodolite's axis is precisely over point
- Weighs 2.43lb (1.10kg)



INSTRUMENT CASES

PADDED STORAGE CASES

- For your SitePro and David White precision measuring instrument
- Durable outer shell and heavy duty protective padding



sku	designed for
25-SPCASE-XP	Padded Hard Case for SK AutoLevel
25-TL20X-CASE	Hard Case for TL20X
27-LR4CASE	Padded Hard Case LR4 Series
44-D8834-CASE	Hard Case for D8834
26-DTCASE	Padded Hard Case for DT 05



9300N 0/-30MM TILTING NITROGEN-FILLED PRISM SYSTEM

The advanced SitePro 9300 nitrogen (N₂) sealed 0/-30mm prism system features a single tilting assembly with front lever locking mechanism to secure in position. This hi-performance prism system, precisely positioned in hi-grade aluminum holder ensures accurate measurement and is best for surveying.

- 62mm precision ground glass, up to 2 arc second accuracy
- Nitrogen sealed prism canister
- Height of the prism in the holder is 100 mm
- Front lever locking mechanism to secure prism in position
- 0/-30mm offset constant
- Dual-sided aluminum target 6.9" x 5.5" (17.6 cm x 14 cm)
- 5/8-11 stainless steel bayonet adapter (female thread)
- Includes prism, target and holder assembly, protective cap

sku	what's included?
FLO-ORANGE W/WHITE 03-9300N-0	9300N prism system, prism cap



21-2010
Sold Separately



1010 SERIES 0/-30MM SINGLE TILTING PRISM SYSTEM

The SitePro 1010-series tilting single prism system features a weather-proof sealed 2-1/2" prism, all-metal holder and 5.5 x 7-inch (14 x 17.8cm) target.

- 0/-30mm constant prism system, ≤5 second accuracy
- Weather-proof sealed 62.5 mm precise prism
- Stainless steel tension knob to adjust target
- M20 x 2 mount thread, 5/8-11 bayonet adapter
- Height of the prism in the holder is 100 mm
- Colors available: Orange, Yellow, Florescent Green
- Includes prism, target and holder assembly, protective cap, **21-1010 padded case**

sku	offset	prism type	prism size	target color	accuracy	axis height
03-1010-CC	0 / -30mm	copper coated	62.5 mm	flo-orange w/black 	≤5 sec	100 mm
03-1010-FC	0 / -30mm	copper coated	62.5 mm	flo-lime w/black 	≤5 sec	100 mm
03-1010-0	0 / -30mm	standard	62.5 mm	Flo-orange w/black 	≤5 sec	100 mm
03-1010-Y	0 / -30mm	standard	62.5m	Yellow w/black 	≤5 sec	100 mm



03-1010-CC



21-1010
Sold Separately



2010M SERIES SINGLE TILT PRISM SYSTEM, POLYCARBONATE

The SitePro 2010M series single tilting 0/-30 mm prism system is an affordable high quality prism.

- 62mm precision ground glass, up to 2 arc second accuracy
- Single tilt holder tilts to 360 degrees with built-in peep sight for easy setup
- Can be mounted in either 0 or -30mm offset positions
- Height of the prism in holder is 119.6 mm
- Nickel plated aluminum 5/8-11 bayonet adapter
- Fully compatible with leading manufacturers such as Sokkia, Trimble, Topcon, and other systems
- Prism canister and holder/target molded from durable lightweight polycarbonate, with metal yoke and nylon washer
- Includes: prism, target and holder assembly, protective cap, **21-2010 padded case**

sku	offset	prism type	prism size	target color	accuracy	axis height
03-2010M-0	0 / -30mm	standard	62.5 mm	Flo-orange w/white 	≤5 sec	119.6 mm
03-2010M-Y	0 / -30mm	standard	62.5 mm	Yellow w/Black 	≤5 sec	119.6 mm



03-2010M-0



21-2010
Sold Separately



4011 62MM STROBE PRISM

- Ideal for night time or low-light work conditions
- Red LED strobes every two seconds
- Sealed prism canister with standard M20 thread
- Camera-style battery included, provides approx. 48 hrs of continuous use



sku	description	offset (mm)	accuracy	mount thread
03-4011	62mm strobe prism in flo-orange canister	0/-30	≤ 5"	M20 x 2

PRISM IN CANISTER 0/-30MM PRISMS

- Weather-proof sealed precise prism
- 62mm diameter prism
- M20x2 male mounting thread



sku	dia (mm)	type	color	accuracy	replacement for models
03-2011-0	62mm	std	flo-orange	≤ 5"	1010, 2010M
03-2011-CC	62mm	copper coated	flo-orange	≤ 5"	1010, 2010M
03-2011-FC	62mm	copper coated	flo-green	≤ 5"	1010, 2010M
03-2011-Y	62mm	std	flo-yellow	≤ 5"	1010, 2010M
03-9311N-0	62mm	nitro-filled	flo-orange	≤ 2"	9300

SWISS-STYLE PRISM

3024 62MM SWISS-STYLE PRO PRISM SYSTEM WITH LARGE TARGET

- 62mm circular prism system is designed for high accuracy and maximum range
- High precision with less than 2" beam deviation
- 1.0mm centering accuracy, constant of 0mm
- Range up to 11,500 ft (3,500m)
- Copper coating with special resistant coating to prevent reflectivity caused by small particles or condensation
- Large removable aluminum target
- Includes: 3024 prism system; prism cap; padded case

sku	description	color
03-3024	62mm Swiss-Style Pro Precision Prism System with Large Target	Black/Flo-green



LPR121 SWISS-STYLE PRO PRISM SYSTEM

- Constant of 0mm
- High precision with less than 2" beam deviation, 1.0mm centering accuracy
- Copper coating with special resistant coating to prevent reflectivity caused by small particles
- Range up to 11,500 ft (3,500m)
- Mounted in metal holder with detachable target
- Includes: LPR121 prism system, cap, padded case

sku	description	color
03-LPR121	Swiss-Style Pro Precision Circular Prism System	Black Target with Flo-green one side, Flo-red other with sight alignment



LPR111 SWISS-STYLE BASIC PRISM SYSTEM

- Constant of 0mm
- Entry-level precision prism, 2.0mm centering accuracy
- Copper coated prism
- Range up to 8,000 ft (2,500m)
- Sealed in red polymer holder
- Red target with flo-yellow on side
- Includes: LPR111 prism system, padded case

sku	description	color
03-LPR111	Swiss-Style Basic Circular Prism System	Red/Flo-Yellow

NEW!



TILTING TARGET & HOLDER

These SitePro target and holder assemblies are tilting is ideal for night time or low-light work conditions.



sku	description	color
03-1012-0	Target & holder with rear tension knob	Flo-orange/Black
03-1012-Y	Target & holder with rear tension knob	Flo-yellow w/Black
03-1012-FC	Target & holder with rear tension knob	Flo-green/Black
03-2012M-0	Target & holder with 360 degree tilting	Flo-orange/Black
03-2012M-Y	Target & holder with 360 degree tilting	Flo-yellow/Black
03-9312-0	Target & holder with front locking lever	Flo-orange/Black



03-1517
SWISS-STYLE
+17.5MM MINI
PRISM

- Compact set with high precision centering
- Built-in target plate and circular center-mounted bubble vial
- Constant of +17.5mm
- 1.0mm centering accuracy
- Range up to 6,600 ft (2,000m)
- Built-in circular center-mounted vial
- Includes prism cap, point attachment, case



03-1504-A
BASIC SWISS-STYLE
MINI-PRISM SET

- Ideal for close-range applications
- Fiber reinforced polymer housing for excellent wear and long-term performance
- Four screw-on aluminum rods, 1/4-20 thread
- Prism constant of 0 mm
- 2.0 mm accuracy
- Long range up to 7,000 ft (2,000m)
- Built-in bubble vial located top-center of holder
- Permits five prism heights of 10, 40, 70, 100, and 130cm, with attachable point
- Includes cap, four (4) rods, point, case



03-1518-R
MINI PRISM STAKEOUT POLE SYSTEM

- 25mm precise mini prism with 0/-30mm offset tilting aluminum prism and holder
- Black anodized sealed aluminum can
- Two on-board circular bubble vials
- Four (4) precision machined sectional poles
- Includes prism system, four (4) sectional poles, point, adjustment tools, and padded carrying case
- Weighs 1.7 lb (0.77 kg)



03-1520-OC
STAKEOUT MINI-PRISM

- 25mm copper-coated mini prism
- 0/-30mm offset tilting prism assembly
- Top & bottom adjustable bubble vials
- Includes replaceable point, carrying case
- Weighs 0.9 lb (0.41kg)



03-1558-RC
MINI-PRISM WITH LARGE TARGET

- All anodized aluminum holder, target, and can
- Tilting target with dual 0/30mm offset
- 25.4mm (1-in) copper coated prism
- 5/8-11 mounting thread
- 40-min adjustable circular side-mounted vial
- Includes: plumb bob prism point w/hook (#03-1507), bracket (#03-1516), 5/8-11 height extension, carrying case with belt loop
- Weighs 0.5 lb (0.41kg)



MINI PRISM ACCESSORIES

sku	description	Mount Thread
03-1511	25.4mm Prism w/Canister	M6- male
03-1507	Plumb Bob Holder/Point & S-Hook	5/8-11
03-1516	Prism Mount, 0/-30mm Offset	M6- female



1500/1600
0/-30MM MINI PRISM SYSTEM

- 25mm prism, black anodized sealed aluminum can
- 5/8-11 mounting thread
- 40-min adjustable circular
- Includes: mini prism, prism holder, plumb bob prism point, S-hook, prism mount, 5/8-11 height extension, carrying case with belt loop

sku	prism size	prism type	Vial	color
03-1500-O	25mm	Standard	Side Mounted	Orange
03-1500-CC	25mm	Copper Coated	Side Mounted	Orange
03-1600-O	25mm	Standard	Center Mounted	Orange



03-1700-B
FIXED L-BAR 25MM
MONITORING PRISM

- Ideal for surveying locations where a permanent mounting is needed
- 25mm copper-coated prism which is water and dust proof, 0mm offset
- Assembly made of black anodized aluminum, 10.3mm ID mounting hole



03-1703-07
12.5MM ROAD MONITORING PRISM

- Textured, ribbed surface for easy mount
- 12.5 mm high accuracy coated prism
- Offset is +21.3 mm for use with swiss-style instruments, and -13.1 mm for all other instruments
- Low-profile, non reflective black housing is not distracting to drivers
- Installs easily and quickly with textured and ribbed bottom surface





SMART SURVEY TARGETS
FOR SURVEYORS AND ENGINEERS

03-RSMP290 /03-RSMP290M

17.5 SWIVELING MINI PRISM, 360° ROTATION

- 17.5 mm mini-prism
- Offset -16.9 (Leica +24.4)
- Height of tilting axis: 45 mm
- Range: 300m to 500m (ATR mode ranges)
- 03-RSM290M features magnetic base plate for easy installation on steel structures
- Available in red and grey



03-RSMP390 /03-RSMP390M

25.4 SWIVELING MINI PRISM, 360° ROTATION

- 25.4 mm mini-prism
- Offset -16.9 (Leica +17.5)
- Height of tilting axis: 45 mm
- Range: 500-700m (ATR ranges)
- 03-RSM390M has magnetic base plate for easy installation on steel structures
- Available in red and grey



03-RSMP280

17.5 MM SWIVELING MINI PRISM, 180° ROTATION

- Twistable, extensible mini-prism made with a rugged plastic housing system
- Offset -16.9; height of tilting axis: 30 mm
- Accuracy is 5 arc sec (+/- 2 arc sec)
- Available in red and grey



03-RSMP380

25.4 MM SWIVELING MINI PRISM, 180° ROTATION

- Twistable, extensible mini-prism made with a rugged plastic housing system
- Offset -16.9; height of tilting axis: 30 mm
- Height: 13.125 mm (+/- 0.2 mm)
- Accuracy is 5 arc sec (+/- 2 arc sec)
- Available in red and grey



RSMP10/12/15

MINI-PRISM SYSTEMS



sku	prism	size (mm)	offset
03-RSMP10	12.7 mm	19 x 33.8	10.1 (Leica +24.3)
03-RSMP12	17.5 mm	25 x 64.5	-11.3 (Leica +23.1)
03-RSMP15	12.7 mm	35 x 100 x 30	-10.1 (Leica +24.3)

03-RSFP-X80G

FIXPOINT ADAPTER HOLDER FOR TILTING PRISMS AND TARGETS

- Plastic mounting system for **RS183** reflector targets, as well as **RSMP280** and **RSMP380** mini-prisms
- Provides one single survey point for total stations (with RS183), robotic total station (with RS380), etc.
- Available in red and grey



03-RS183

180° SWIVELING SURVEY MARKER

- When using tachymeter and total stations, the reflective mark can always be aligned precisely with the measuring instrument.
- Reflective target can be rotated 180° making it possible to use the same survey point from different directions
- Offset: 0; Height of tilting axis: 30 mm
- Available in red and grey



03-RSFP-X90

RESTORE POINT FOR MAGNETIC BASE PLATE

- Restore point made of stainless steel, for **RS193M**, **RSMP190M**, **RSMP290M** and **RSMP390M**
- Magnets in the floor plate hold the reflective target or the mini-prism exactly on the desired point



03-RS193 /03-RS193M

30MM REFLECTIVE TARGET W/ 360° ROTATION

- Rotates 360° for unlimited tilting and turning
- Range approx. 80 m
- Offset: 0; Height of tilting axis: 45 mm
- 03-RS193M features magnetic base plate for easy installation on steel structures
- Available in red and grey



07-2072-31

TILT MONUMENT MOUNT FOR 2-IN PIPE

- Adjustable tilt monument mount for 2-inch pipe with MPT 2 x 11-1/2 TPI
- The adapter has 3.20-inch (8.19 cm) diameters and overall heights of 3.036 inches (7.71 cm)
- Includes a removable brass 5/8 x 11 male stud that is adjustable in azimuth and held in location by two set screws
- The adapters are leveled by three screws with a tilt range +/- 7°
- The height above the pivot point to the stud shoulder is 1.37 inches (3.50 cm)
- The height below the brass 5/8 stud to the shoulder is 0.463 inches (1.18 cm)
- The axis height is engraved on the outside of the monuments
- Weighs 6.80 lb (3.08 kg)

NEW!



03-RSFP1

MEASURING POINT

- Aluminium plate with 5/8-11 stainless steel thread for screwing on a prism or instrument
- Fixed point at bottom, allows you to position instrument precisely above the cross
- Includes a plastic or aluminium protective cap for the 5/8" thread
- Size: 100mm x 100mm





SMART SURVEY TARGETS
FOR SURVEYORS AND ENGINEERS



03-RS30

30MM SMART MARKER W/ LEVEL

- For documentation and permanent security of heights and axis
- 30mm target reflector w/ crosshair; range approx. 80m (262 ft)
- Size: 60mm x 90mm
- Available in red and grey



03-RS50

SMART MARKER W/30MM TARGET

- Ideal for bridges, buildings, measuring and monitoring facades
- Range: 10m to 100m
- Size: 60mm x 75mm
- Available in red and grey



03-RS60

40MM SMART MARKER TARGET

- Ideal for bridges, buildings, measuring and monitoring facades
- Range: 10m to 100m
- Size: 60mm x 75mm
- Available in red and grey



03-RS80

40MM ANGLE MARKER TARGETS

- Ideal when difficult positions would make it impossible to sight on the reference points
- Angle of approx. 90 degrees
- Range approx. 100m (328 ft)
- Available in red and grey



03-RSAK80

REFLECTIVE MARKER ADAPTER W/ RS80

- XYZ coordinates ensure 3-D observations
- Range: 100m (328 ft)
- Size: 120mm x 75mm x 50mm
- 40 x 40mm reflective target
- Available in red and grey

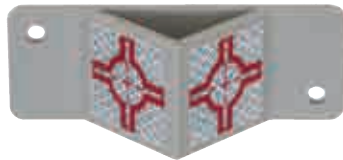

03-RSAK130

30MM REFLECTIVE ANGLE SURVEY MARKER

- Used on rails, bridges, tunnels, dams, buildings, supports
- Size: 100mm x 35mm x 30mm H
- Crosshairs on backing plate
- Target range approx. 80m (262 ft)
- Available in red and grey

BIM CONSTRUCTION TARGETS
TARGETS FOR BUILDING INFORMATION MODELING (BIM)



03-RS11

BENCHMARK TARGET

- Ideal to secure the surveyed points at jobsite without plastering work
- Size: 50mm x 80mm
- Available in red



03-RS21

BENCHMARK TARGET W/ STUBS

- Ideal for building sites with plastering and to securely mark axes
- Elastic stubs ensures stable datum
- Size: 50mm x 80mm
- Available in red

RSZ-SERIES
REFLECTIVE ADHESIVE TARGETS

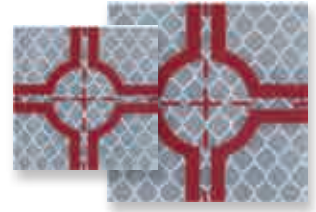

- Recommended for carrying out distance measurements using a tachymeter or total station
- Reflective target with red crosshairs
- Sheet of 10 targets (03-RSZ6-4 has 4 targets per sheet)

sku	contains	qty/sheet	range (approx)	target size
03-RSZ2-10	Sheet of 21mm Targets	10	50 m	21 mm x 21 mm
03-RSZ3-10	Sheet of 30mm Targets	10	80 m	30 mm x 30 mm
03-RSZ4-10	Sheet of 40mm Targets	10	100 m	40 mm x 40 mm
03-RSZ6-4	Sheet of 60mm Targets	4	120 m	60 mm x 60 mm

RT-SERIES
REFLECTIVE RETRO ADHESIVE TARGETS

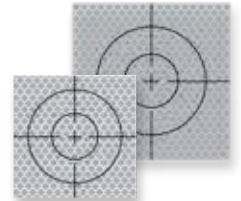

- These self adhesive reflective targets can easily be seen in daylight.
- 0 constant standard deviation at shortest target range 10m is less than 1.0mm
- Available in seven (7) different sizes, **Packaged with 10 targets**

sku	contains:	size
03-RT20MM	RT20MM targets (Bag of 10 targets)	20 mm x 20 mm
03-RT30MM	RT30MM targets (Bag of 10 targets)	30 mm x 30 mm
03-RT40MM	RT40MM targets (Bag of 10 targets)	40 mm x 40 mm
03-RT50MM	RT50MM targets (Bag of 10 targets)	50 mm x 50 mm
03-RT60MM	RT60MM targets (Bag of 10 targets)	60 mm x 60 mm
03-RT70MM	RT70MM targets (Bag of 10 targets)	70 mm x 70 mm
03-RT90MM	RT90MM targets (Bag of 10 targets)	90 mm x 90 mm

03-RS96
STAKEOUT REFLECTIVE TARGET

- Ideal for stake-out work on the batter board and on a floor slab
- Exact measuring of the survey point on the floor slab
- Foldable- fits in shirt pocket
- 20mm target reflector



03-RSL301
LASER SCANNER TARGET

- Suitable for use with scanners from Leica, Geomax and Faro
- Fixed points for connecting several positions
- Self-adhesive for quick and easy attachment
- Size: 200mm x 150mm (7.875" x 5.9")
- Waterproof, suitable for indoor & outdoor use



03-RSL496
LASER SCANNER TARGET, FOLDABLE

NEW!

- Suitable for use with scanners from Leica®, Geomax® and Faro®
- Fixed points for connecting several positions
- Can be used from two sides (offset +2 mm)
- Target size: 120mm x 140mm (4.75" x 5.5")
- Foldable for compact easy stowing and transport



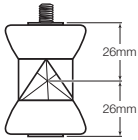

1360
360° MINI REFLECTOR SYSTEMS

- Compatible with Leica instruments and offsets
- +30mm constant
- Precise standards, ≤5 sec. accuracy
- Ideal for 360° surveying applications
- Includes 4-section pole set, mount with bubble vial, point, carrying case

sku	description	constant	wgt
03-1360	360° Mini Reflector System	+30mm	1.7lb (.77kg)

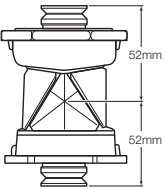

ATP360
BUILDER SERIES 360° ROBOTIC PRISM

- -7mm constant
- Efficient solution compatible with Sokkia and Topcon robotic stations
- ≤5 sec. accuracy
- Six (6) precision-machined cubes mounted in solid metal core housing
- 5/8-11 mounting thread on top and bottom

sku	description	constant	wgt
03-ATP360	Builder Series 360° Robotic Prism	-7mm	0.46 lb (0.2kg)

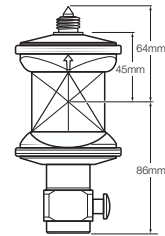

GMAX360
360° ROBOTIC PRISM

- Compatible with Leica
- +23.1 constant
- ≤5 sec. accuracy
- Six prisms are arranged to provide high pointing accuracy
- Working range up to 2000-ft (600m)
- Includes: 360 robotic prism, protective wrap, carrying case

sku	description	constant	wgt
03-GMAX360	360° Robotic Prism	+23.1mm	0.46 lb (0.2kg)



NEW!

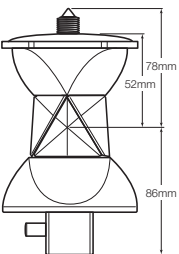

2360
360° PRO REFLECTOR SYSTEM

- Compatible with Leica
- ≤5 sec. accuracy
- Positions directly on a survey mark using the built-in point, height of 78mm
- Six prisms are arranged to provide high pointing accuracy
- 3D pointing accuracy of 2mm can be achieved
- Target tracking range up to 2000-ft (600m)
- Includes: Prism Pole Adapter, Case

sku	description	constant	wgt
03-2360	360° Professional Reflector System	+23.1mm	1.25 lb (0.6kg)

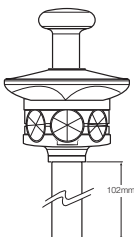

3600
360° ROBOTIC PRISM SYSTEM

- Precision 360° robotic prisms ensure tracking lock
- Compatible with Spectra
- Seven 25.4mm prisms; ≤5 sec. accuracy
- Includes 4" (102mm) height adapter system with 5/8-11 thread, padded carrying case

sku	description	constant	wgt
03-3600	360° Robotic Prism System	+2.0mm	1.11 lb (0.5kg)



05-1200 EURO-STYLE TRIBRACH WITH OPTICAL PLUMMET

- Smooth locking mechanism
- 8-minute circular vial
- Precision aligned support cavity on 5/8-11 threaded base plate assures accurate centering of instrument
- Optical- over point accuracy 0.5 mm - 15 m
- Available colors: Black (-B), Green (-GN), Grey (-GY), or Yellow (-Y)
- Weighs 1.85lb (0.84kg)



05-1201-B EURO-STYLE TRIBRACH

- Smooth locking mechanism
- 8-minute circular vial
- Precision aligned support cavity on 5/8-11 threaded base plate assures accurate centering of instrument
- Optical- over point accuracy 0.5 mm - 15 m
- Weighs 1.85lb (0.84k)



05-1300-B EURO-STYLE TRIBRACH

- High-precision, smooth locking mechanism with secure motion foot screws
- Circular vial with 8-minute sensitivity
- Precise alignment of support cavity to the 5/8-11 threaded base plate assures accurate centering of instrument
- Laser plummet- accuracy 0.5mm - 15m
- Push-button switch located close to body prevents accidental turning on
- CR2 lithium battery (included) provides 10 hrs of continuous operation
- Weighs 2.2lb (0.98kg)



05-1400-GY JAPANESE-STYLE TRIBRACH WITH OPTICAL PLUMMET

- High-precision, smooth locking mechanism with secure motion foot screws
- Access for Sokkia® EDM systems, electronic and optical theodolites
- Precise alignment of support cavity to the 5/8-11 threaded base plate assures accurate centering of instrument
- Circular vial with 10-minute/2 mm sensitivity
- Push-pull slide focus
- Optical- over point accuracy 0.5 mm - 15 m
- Weighs 1.85lb (0.84kg)



21-1200 PADDED TRIBRACH CASE

- Protects tribrach during transport and storage
- Fits all 05-1200 models
- Size: 9" x 8.5" x 5.5"
- Available separately



PROTECT YOUR TRIBRACH

2500 SERIES TRIBRACH ADAPTERS

- Anodized black aluminum
- 5/8-11 brass thread mounting
- Anodized aluminum mounting studs



sku	style
05-2520	Fixed Tribrach Adapter, 5/8-11 female thread
05-2521	Friction Type Rotating Tribrach Adapter
05-2525	Zeiss/Wild Type Rotating Tribrach Adapter, Adjustable

3511K TRAVERSE ADAPTER SYSTEMS

- For precise setups and traversing applications
- 2.5X optical plummet
- 60-second plate vial, adjustable
- Precision-machined axis rotates 360°
- Compatible with all prisms with a 24.9 mm bayonet base
- Adjustable height: 100 mm-to-120 mm
- Traverse tribrach adapter fits all standard three-prong tribrachs
- The over point accuracy is 0.5 mm at 1.5 m



Color of Tribrach/Adapter may vary



21-3500 PROTECTIVE HARD CASE

- Padded to protect instruments during transport and storage
- Carries your traverse kit
- Included with 05-3511K

sku	description
05-3511K	Traverse Kit - Includes 05-3511 Tribrach Adapter, 05-1201-B Tribrach (Page 18), 03-1010-O Prism System (Page 12), 21-3500 Padded Hard Case
05-3511	Traverse Tribrach Adapter with Optical Plummet
21-3500	Padded Hard Case, for Traverse Kit



QuickTip™
Adapter Set Included
(See Below)



QuickTip™ VERSATILITY ON THE JOBSITE

PRISM POLES INCLUDE THE
UNIVERSAL ADAPTER SET
INCLUDED with 2.6m, 3.6m, and 4.65m Prism Poles



Includes QuickTip Adapters to set fixed height of pole for use with **Zeiss 360, CST 1010, SitePro 1010**, and others with target height of 100mm



QuickTip™ Adapter Set



4200-SERIES COMPRESSION LOCK PRISM POLES

- Designed for 5/8-11 QuickTip adapters for prism mounting (includes the adapter set)
- Compression lock system is made of brass/aluminum, providing a quick positive hold on extension pole
- Easily visible precise 20-minute level vial
- Inner aluminum pole with dual graduations: 10ths and metric
- Aluminum pole with red/white outer pole
- Includes 07-2090-50A adapter, 07-2090-135A adapter, carrying case with shoulder strap

sku	length	inner grads	wgt	mounting type	sect.
07-4208-TMA	8.5' (2.6m)	10ths / metric	2.1 lb (0.95kg)	5/8-11	2
07-4212-TMA	11.81' (3.6m)	10ths / metric	2.9 lb (1.32kg)	5/8-11	3
07-4215-TMA	15.25' (4.65m)	10ths / metric	3.8 lb (1.72kg)	5/8-11	4



QuickTip™ Adapter Set



4700 SERIES TWIST LOCK PRISM POLE

- Designed for 5/8-11 QuickTip adapters for prism mounting (includes the adapter set)
- Twist lock system with built-in 20-min. precise level vial
- The soft rubber knob is easy to tighten and loosen
- Inner aluminum pole with dual graduations: 10ths and metric
- Red/White aluminum outer pole
- Includes 07-2090-50A adapter, 07-2090-135A adapter, carrying case with shoulder strap

sku	length	inner grads	wgt	mounting type	sect.
07-4708-TMA	8.5' (2.6m)	10ths / metric	3.1 lb (1.4kg)	5/8-11	2
07-4712-TMA	11.81' (3.6m)	10ths / metric	4.1 lb (1.85kg)	5/8-11	3
07-4715-TMA	15.25' (4.65m)	10ths / metric	6.2 lb (2.79kg)	5/8-11	4



QuickTip™ Adapter Set



4700-FY SERIES HI-VIS TWIST LOCK PRISM POLE

- Designed for 5/8-11 QuickTip adapters for prism mounting (includes the adapter set)
- Twist lock system with built-in 20-minute precise level vial
- The soft rubber knob is easy to tighten and loosen
- Inner aluminum pole with dual graduations: 10ths and metric
- High-visibility flo-yellow outer pole with anodized graduations in 10ths
- Includes 07-2090-50A adapter, 07-2090-135A adapter, carrying case with shoulder strap

sku	length	inner grads	wgt	mounting type	sect.
07-4708-TMA-FY	8.5' (2.6m)	10ths / metric	3.1 lb (1.4kg)	5/8-11	2
07-4712-TMA-FY	11.81' (3.6m)	10ths / metric	4.1 lb (1.85kg)	5/8-11	3
07-4715-TMA-FY	15.25' (4.65m)	10ths / metric	6.2 lb (2.79kg)	5/8-11	4



All SitePro rods and poles include carrying case with shoulder strap

Place your company logo and contact on poles. Ask for details.



QuickTip™ Adapter Set



4700-FY SERIES TWIST LOCK PRISM POLE

- Designed for 5/8-11 QuickTip adapters for prism mounting (includes the adapter set)
- 3-section aluminum pole system
- Twist lock system with built-in 20-minute precise level vial
- Inner aluminum pole with dual graduations: 10ths and metric
- The soft rubber knob is easy to tighten and loosen
- Easily visible precise level vial
- Flo-yellow outer pole with anodized graduations in 10ths
- Includes 07-2090-50A adapter, 07-2090-135A adapter, carrying case with shoulder strap

sku	length	inner grads	wgt	mounting type	sect.
07-4705-TMA-FY	5.10' (1.55m)	10ths / metric	2.8 lb (1.29 kg)	5/8-11	3



4027 0.7M (2.3') MINI PRISM POLE

- Twist locking mechanism with built-in 20-minute vial
- 2-section aluminum pole system
- Replaceable hardened point
- Dual graduation: 10ths and metric
- 5/8-11 adjustable QuickTip™ adapter (#07-2090-135A) included
- Extended: 2.3 ft (70cm), collapsed: 19.5 in (50cm)
- Includes carrying case with shoulder strap

sku	length	material	wgt	mounting type
07-4027-TMA-FY	2.3' (0.7m)	Aluminum	1.23 lb (0.56kg)	5/8-11, Adj.



4001 MINI STAKEOUT POLE, 1.28 FT

The SitePro mini stakeout pole is only 1.28 ft tall with a 5/8-11 thread fixed tip for prism mounting. Mostly used with a mini prism.

- Built-in 20-minute precise level vial
- Point can removed to use as a pole extension, 1-1/4" outside diameter.
- Includes replaceable hardened prism pole point

sku	length	material	wgt	mounting type
07-4001-FY	1.28' (0.39m)	Aluminum	1.5 lb (0.68kg)	5/8-11, Fixed



4047 4.7" MINI HANDHELD ROD

The SitePro mini handheld rod features a 5/8-11 threaded stud with adjustable bubble vial. Use with any prism system that fits the 5/8-11 male thread.

- Height of 4.7" (120 mm)
- Built-in adjustable 20-min circular bubble vial
- Removable tip
- Carrying case not available

sku	length	material	wgt	mounting type
07-4047	4.7" (120mm)	Aluminum	0.4 lb (0.18kg)	5/8-11, Fixed



90 day guarantee on all poles

All SitePro rods and poles include carrying case with carrying strap

Place your company logo and contact on poles. Ask for details.



Includes 50mm Height Adapter

4602-TM 8.6-FT CARBON FIBER ROBOTIC POLE

NEW!

Designed to work with the Topcon®-style 360-degree prism and remote control. An essential accessory for the Topcon-style robotic total stations.

- Carbon fiber outer pole, dual graduation (0.01 ft/ 0.1 cm); black aluminum inner pole, dual graduation (0.01 ft/ 0.1 cm) for direct reading
- Locking pin secures pole to prevent slipping of pole section
- 5/8-11 thread fixed mail tip
- Built-in 20-minute bubble vial
- Soft grip twist-lock knob tightens and loosens easily to secure two sections
- Includes carrying case

sku	grads	lengths	inner pole	locking pin positions	wgt
07-4602-TM	Dual	4.90 to 8.60 ft (1.52 to 2.60m)	Aluminum	5.5-ft, 6.0-ft, 6.5-ft, 7.0-ft, 7.5-ft, 8.0-ft, 8.5-ft	2.5lb (1.2kg)

THE ULTIMATE TOPOGRAPHIC POLE



QuickTip™ Set



4626-TM TOPOGRAPHIC QUICKTIP™ CARBON FIBER PRISM POLE

Lightweight, rugged and weatherproof versatile pole designed for professional surveyors to quickly adapt for GPS, robotic, or total station surveying. Features inner aluminum pole with dual graduations, easy grip twist-lock with locking pin mechanism and QuickTip system.

- Carbon fiber pole with aluminum inner pole, dual graduation (0.01 ft/ 0.1 cm)
- Interchangeable QuickTip adapters to achieve correct target height
- Locking pin secures pole to prevent slipping of pole section
- Built-in 20-minute bubble vial
- Soft grip twist-lock knob tightens and loosens easily to secure two sections
- Compatible with most targets, prisms, or GPS antennas
- Includes carrying case, 2090-135A universal adjustable adapter, and 2090-150 GPS mounting adapter

sku	grads	lengths	inner pole	locking positions	adapter included	wgt
07-4626-TM	Dual	1.52 to 2.60m (4.97 to 8.53 ft)	Aluminum	1.8 m, 2.0 m, 2.2 m, 2.4 m	2090-135A, 2090-150	2.5lb (1.2kg)

4507-TML QUICK-RELEASE PRISM POLE

- Ultra-lite swiss-style prism pole with 1" (25.4mm) pole diameter
- Quick release locking with built-in 20-min bubble vial
- Compatible with swiss-style prisms
- Aluminum pole with hardened aluminum point
- Extended: 7.1 ft (210cm), collapsed: 47.8" (122cm)

sku	length	inner grads	wgt	mounting type	sections
07-4507-TML	7.1 ft (2.1m)	Dual: 10ths, metric	1.3 lb (0.59kg)	Swiss-style, 'snap-in'	2

3812/3912 3.6M RANGE POLE

- Lightweight, 3-section with point
- Available in aluminum or composite with steel point
- 4-ft sections with alternate white & red striping
- 1-1/4" (32mm) dia. tubes with 5/8-11 male and female thread metal inserts
- Model 3812 includes carrying case and rubber boot

sku	length	material	locking	wgt	mounting type	sections
09-3812	Fixed, 3.6m (12 ft)	Aluminum Red/White	5/8-11	3.4 lb (1.54kg)	5/8-11, Adj. H.I.	3
09-3912	Fixed, 3.6m (12 ft)	Composite Red/White	5/18-11	2.0 lb (0.91kg)	5/8-11, Adj. H.I.	3



Model 3812 Shown



90 day guarantee on all poles

All SitePro rods and poles include carrying case with carrying strap

Place your company logo and contact on poles. Ask for details.



2022
2 METER CARBON FIBER SNAP-LOC ROVER ROD

- Snap-loc for non-slip positioning, secures height at 2.0m
- Compression lock mechanism
- On-board 20-minute, adjustable circular vial
- Lightweight telescoping 2-section pole

sku	length	heights	material	grads	wgt
09-2022-M	2.0m	2m, Collapses to 4.5 ft (1.37 m)	Carbon Fiber, Black	n/a	1.8 lb (0.82kg)



2122
2 METER ALUMINUM SNAP-LOC ROVER ROD

- Snap-loc for non-slip positioning, secures height at 2.0m
- Compression lock mechanism
- On-board 20-minute, adjustable circular vial
- Lightweight telescoping 2-section pole

sku	length	heights	material	grads	wgt
09-2122-GT	2.0m	2m, Collapses to 4.5 ft (1.37 m)	Aluminum, Fluorescent	10ths 100ths	2.4 lb (1.09kg)
09-2122-GM	2.0m	2m, Collapses to 4.5 ft (1.37 m)	Aluminum, Fluorescent	metric	2.4 lb (1.09kg)



2222
3-POSITION CARBON FIBER SNAP-LOC GPS ROVER ROD

- Lightweight 2-section telescoping **carbon fiber** rod
- Snap-loc for no slip with compression lock - 3 height positions: 2m, 1.8m or 1.6m and collapses to 4.5 ft (1.37m)
- On-board 20-minute, adjustable circular vial

sku	length	heights	material	grads	wgt
09-2222-M	2.0m	1.6m, 1.8m, 2m; Collapses to 4.5 ft (1.37 m)	Carbon fiber	n/a	1.8 lb (0.82kg)
09-2222-GT	2.0m	1.6m, 1.8m, 2m; Collapses to 4.5 ft (1.37 m)	Carbon fiber	10ths 100ths	1.8 lb (0.82kg)
09-2222-GM	2.0m	1.6m, 1.8m, 2m; Collapses to 4.5 ft (1.37 m)	Carbon fiber	metric	1.8 lb (0.82kg)



2300
3-POSITION ALUMINUM SNAP-LOC GPS ROVER ROD

- **All-aluminum** 2-section telescoping rod
- Snap-loc for no slip with compression lock - 3 height positions: 2m, 1.8m or 1.6m and collapses to 4.5 ft (1.37m)
- On-board 20-minute, adjustable circular vial

sku	length	heights	material	grads	wgt
09-2322-GT	2.0m	1.6m, 1.8m, 2m; Collapses to 4.5 ft (1.37 m)	Aluminum	10ths 100ths	2.2 lb (0.99kg)
09-2322-GM	2.0m	1.6m, 1.8m, 2m; Collapses to 4.5 ft (1.37 m)	Aluminum	Metric	2.2 lb (0.99kg)



90 day guarantee on all poles

All SitePro rods and poles include carrying case with carrying strap

Option to place your company logo and contact info. Ask for details.



3902/3920/3930 BASIC ALUMINUM RANGE POLES

- Lightweight aluminum with steel point
- Alternate 20 cm white and red striping
- 35mm diameter
- Includes carrying case

sku	length	type	sections	grads	wtg
09-3902A	2M, 1.27M (min. height)	Telescoping	2	20cm red/white stripe	1.0 lb (0.45 kg)
09-3920B	2M, 1.03M (min. height)	5/8 thread	2	20cm red/white stripe	1.2lb (0.55 kg)
09-3930B	3M, 1.03M (min. height)	5/8 thread	3	20cm red/white stripe	1.5 lb (0.66 kg)



2002 / 2102 2M TWO-PIECE GNSS ROVER ROD

- Available in lightweight carbon fiber or aluminum model
- Fixed height at two (2) meters
- Built-in on-board 20-minute, adjustable circular vial
- Easy soft-grip

sku	length	inner grads	mounting type	wtg	sections
09-2002-M	Fixed 2.0m (6.56 ft)	Carbon fiber, Black	5/8-11, Fixed	1.76 lb (0.80kg)	2
09-2102-M	Fixed 2.0m (6.56 ft.)	Aluminum, Yellow	5/8-11, Fixed	4.0 lb (1.81kg)	2



100 SERIES GPS ANTENNA TRIPOD

The SitePro 100S GPS antenna tripod, ideal for GPS and machine-control applications, features aluminum construction with extendable tripod legs and 2 meter center staff with twist-lock mechanisms.

- Center staff rotates 360° to check calibration of plumb
- Built-in 8-minute bubble vial
- 3-position center staff with steel locking pin – adjusts to 3 heights: 2.0m, 1.8m, 1.5m
- Lightweight, heavy duty aluminum legs and staff are electrostatically powder-coated in flo-lime paint
- Aluminum hardware is anodized black
- Large attachable soft-turf spurs (included) for more grip to maximize stability in soft-ground applications and prevent twisting, ideal when using angle measuring instruments such as robots
- Built-in compass with 8 minute vial
- Removable 5/8-11 threaded head adapter
- Replaceable points
- Includes **LGSPUR** Soft-Turf Spur Set, **21-81540 heavy bag**



SOFT-TURF
SPURS

Large spur (included) attaches to add grip to maximize stability in soft-ground applications



sku	locking type	center locking	open	collapsed	wtg
09-100S-FY	Twist Lock	2.0m, 1.8m, 1.5m	79" (201cm)	50" (127cm)	15 lb (6.8kg)



Open-Top Clamping System

4250 THUMB-RELEASE TRIPOD WITH TOP ENTRY

- Tripod creates free-standing setup for GNSS antenna poles or prism poles.
- Top mount universal head will accommodate 1 to 1.25 inch diameter
- Feature large, thumb release buttons for quick setup on even or uneven ground.
- Impact resistant materials, replaceable shoes, and quick release telescoping aluminum legs.
- Legs extend independently up to 6-ft (180 cm)
- Fine adjustment knob to fine tuning your setup
- Includes carrying case

sku	type	color	style	open	collapsed	wtg
07-4250	Aluminum	Flo-Yellow	Thumb Release	71" (180 cm)	42-1/2" (108cm)	6.0 lb (2.72kg)





- Open-Side Clamping System
- Anti-Crushing
- Fits 1" to 1.5" Poles

4260 V-SERIES ANTI-CRUSH THUMB-RELEASE BIPOD

ANTI-CRUSH

The SitePro 4260 is designed to provide non-slip grip while preventing user to over-tightening clamp and crushing the prism pole. Used by a surveyor to set up a freestanding GPS antenna pole or prism pole. Easy grip twist-lock for securing pole.

- Side-entry head with open clamp for quick and easy pole setup
- Reinforced feet with replaceable points
- Unique locking system provides non-slip quick clamping
- Easily adjust height of legs independently with thumb release push buttons
- Fits 1" to 1-1/2" (25mm-38mm) diameter poles
- Includes velcro strap to secure legs during transport

sku	type	color	style	Fits (Pole Diameter)	open	closed	wgt
07-4260	Aluminum	Flo-Yellow	Open-Side, Anti-Crush	1" to 1-1/2" (25mm-38mm)	71-1/2" (182cm)	42-1/2" (108cm)	4.3 lb (1.95kg)



- Open-Face Clamping System
- Anti-Crushing
- Fits 1" to 1.5" Poles

4364 ALUMINUM ANTI-CRUSH THUMB-RELEASE BIPOD

ANTI-CRUSH

The SitePro 4364 is designed to provide non-slip grip while preventing user to over-tightening clamp and crushing the prism pole. Used by a surveyor to set up a freestanding GPS antenna pole or prism pole. Fits 1 to 1.25 inch (25.4 to 32 mm) outside diameter poles easily through the open-face head with anti-crush clamp. 1.5-inch (38 mm) poles be attached easily through the top of the open face clamp.

- Open-face head with anti-crush clamp for quick and easy pole setup
- Unique anti-crush locking system provides non-slip quick clamping
- Fits 1" to 1-1/2" (25mm-38mm) diameter poles
- Easily adjust height of legs independently with thumb release push buttons
- Replaceable points
- Includes velcro strap to secure legs during transport

sku	type	color	style	Fits (Pole Diameter)	open	closed	wgt
07-4364-FY	Aluminum	Flo-Yellow	Open-Face, Anti-Crush	1" to 1-1/2" (25mm-38mm)	71" (182cm)	42" (108cm)	4.7 lb (2.13kg)



- Open-Side Clamping System
- Fits 1" to 1.5" Poles

4360 ALUMINUM THUMB-RELEASE BIPOD

Easily set up a freestanding GPS antenna pole or prism pole. Fits 1 to 1.25 inch (25.4 to 32 mm) outside diameter poles easily through the side entry head with open clamp. 1.5-inch (38 mm) poles be attached easily through the top of the open clamp.

- Side-entry head with open clamp for quick and easy pole setup
- Unique locking system provides non-slip quick clamping
- Easily adjust height of legs independently with thumb release push buttons
- Fits 1" to 1-1/2" (25mm-38mm) diameter poles
- Replaceable points
- Includes velcro strap to secure legs during transport

sku	type	color	style	Fits (Pole Diameter)	open	closed	wgt
07-4360-FY	Aluminum	Flo-Yellow	Open-Side	1" to 1-1/2" (25mm-38mm)	71" (182cm)	42" (108cm)	4.7 lb (2.13kg)
07-4360-Y	Aluminum	Yellow	Open-Side	1" to 1-1/2" (25mm-38mm)	71" (182cm)	42" (108cm)	4.7 lb (2.13kg)

Option to place your company logo and contact info. Ask for details.

All SitePro bipods include carrying bag with shoulder strap

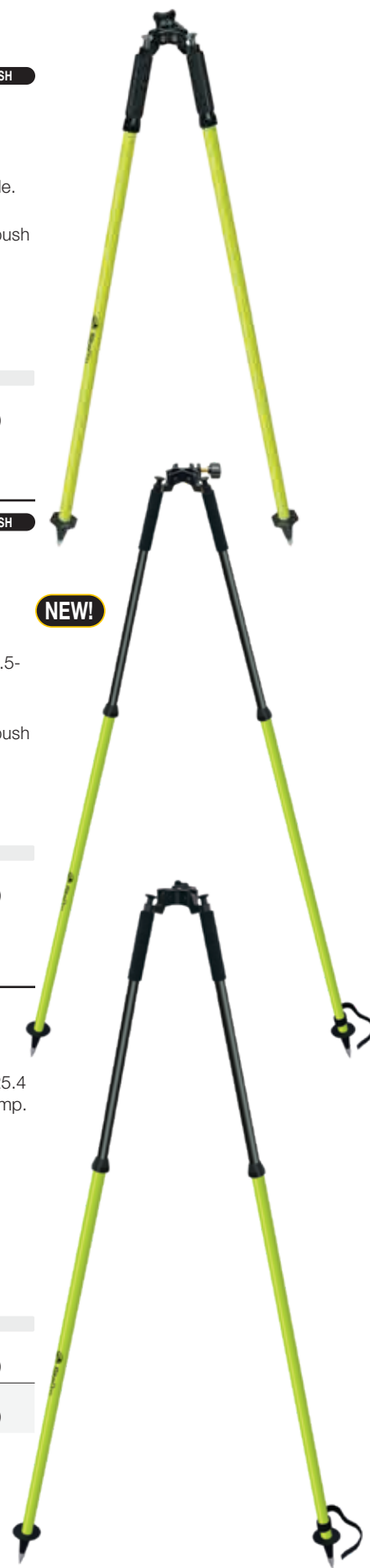



- Open-Face Clamping System
- Anti-Crushing
- Fits 1" to 1.5" Poles

4365

CARBON FIBER ANTI-CRUSH THUMB-RELEASE BIPOD

ANTI-CRUSH

The SitePro 4365 is constructed of carbon fiber and used to quickly set up a freestanding GPS antenna pole or prism pole. Fits 1 to 1.25 inch (25.4 to 32 mm) outside diameter poles easily through the open-face entry head with anti-crush clamp. 1.5-inch (38 mm) poles be attached easily through the top of the open clamp.

- Open-face head with anti-crush clamp for quick and easy pole setup
- Unique locking system provides non-slip quick clamping
- Fits 1" to 1-1/2" (25mm-38mm) diameter poles
- Easily adjust height of legs independently with thumb release push buttons
- Replaceable points
- Includes velcro strap to secure legs during transport

sku	type	color	style	Fits (Pole Diameter)	open	closed	wgt
07-4365	Carbon Fiber	Black	Open-Face, Anti-Crush	1" to 1-1/2" (25mm-38mm)	71-1/2" (182cm)	42-1/2" (108cm)	4.1 lb (1.86 kg)



- Open-Side Clamping System
- Anti-Crushing
- Fits 1" to 1.5" Poles

4361

CARBON FIBER THUMB-RELEASE BIPOD

Constructed of carbon fiber and used to quickly set up a freestanding GPS antenna pole or prism pole. Fits 1 to 1.25 inch (25.4 to 32 mm) outside diameter poles easily through the side entry head with open clamp.

- Side-entry head with open clamp for quick and easy pole setup
- Unique locking system provides non-slip quick clamping
- Easily adjust height of legs independently with thumb release push buttons
- Fits 1" to 1-1/2" (25mm-38mm) diameter poles. 1-1/2" (38 mm) poles attach easily through top of the open clamp
- Replaceable points
- Includes velcro strap to secure legs during transport

sku	type	color	style	Fits (Pole Diameter)	open	closed	wgt
07-4361	Carbon Fiber	Flo-Yellow	Open-Side	1" to 1-1/2" (25mm-38mm)	71-1/2" (182cm)	42-1/2" (108cm)	4.1 lb (1.86 kg)



- Open-Side Clamping System
- Fits 1" to 1.5" Poles

4360-05

THUMB-RELEASE MINI BIPOD

This Mini Bipod utilizes the same style as the 07-4360 series bipod, but shorter. Fits 1 to 1.25 inch (25.4-to-31.8 mm) diameter poles easily through the side entry head.

- 1-to-1.25 inch (25.4-to-31.8 mm) diameter poles attach easily through the open clamp
- 1.5 inch (3.81 cm) outside diameter poles can be loaded through the top
- Collapses to 25 inches (63.5 cm) and extends to 35 inches (88.9 cm)
- Replaceable points

sku	type	color	style	Fits (Pole Diameter)	open	closed	wgt
07-4360-05-FY	Aluminum	Flo-Yellow	Open-Side	1" to 1-1/2" (25mm-38mm)	35" (90cm)	25" (64cm)	3.5 lb (1.6kg)



- Open-Side Clamping System
- Fits 1" to 1.5" Poles

4160

FIXED MINI PRISM POLE BIPOD

A simple mini bipod, ideal for use with poles under 24-in (61 cm) long. The legs are a fixed length of 10-inches (25 cm) each. Fits 1 to 1.25 inch (25.4-to-31.8 mm) diameter poles easily through the side entry head.

- Side-entry head with open clamp for quick and easy pole setup
- Unique locking system provides non-slip quick clamping
- Legs are made of solid aluminum at a fixed height of 10-in (25 cm)

sku	type	color	style	Fits (Pole Diameter)	open	closed	wgt
07-4160	Aluminum	Black	Fixed Height	1" to 1-1/2" (25mm-38mm)	10" (25cm)	n/a	0.8 lb (0.36 kg)



NEW!



2090 SERIES QUICKTIP™ POLE ADAPTERS

- Precision machined aircraft aluminum
- 5/8-11 pole mounting thread
- Compatible with the QuickTip™ series poles and other prism poles with interchangeable design
- Adapters length is designed to achieve 150mm target height

QuickTip™

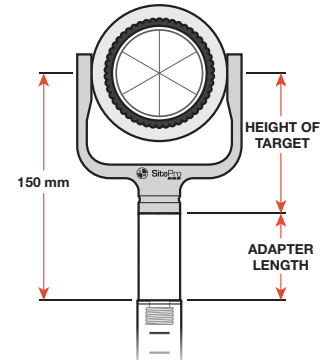

sku	target(s) designed for	target height	adapter 'L'
07-2090-125A	Swiss-Style, Adjustable	86-125 mm	n/a
07-2090-135A	5/8-11 Adj. Adapter	50-135 mm	n/a
07-2090-15	Trimble RMT	135 mm	15 mm
07-2090-150	GPS Antenna	0 mm	150 mm
07-2090-35	SitePro 2010M	115 mm	35 mm

sku	target(s) designed for	target height	adapter 'L'
07-2090-50	GPH1, SitePro 03-3024	86 mm	50 mm
07-2090-50A	Zeiss 360° Prism, CST 1010	100 mm	50 mm
07-2090-73	TopCon 360 Prisms	77 mm	73 mm
07-2090-80	SitePro Mini Prisms	70 mm	80 mm

07-2090-76 GPS QUICK-DISCONNECT 76.2MM ADAPTER

- Anodized aluminum adapter with leica-style connector on the bottom, 5/8-11 thread on the top
- Can be combined with #2090-24 for quick release adapter
- Adds* 76.22 mm to GNSS or prism pole
- Weighs 0.14 lb (0.06 kg)



07-2090-24 GPS QUICK-RELEASE ADAPTER

- Anodized aluminum adapter with female 5/8-11 thread on the bottom, leica-style connector on the top
- Adds* 24 mm to your GNSS or prism pole length
- Weighs 0.05 lb (0.02 kg)



07-2080 SNAP-ON TYPE PRISM ADAPTER

- Adapter for Swiss-style snap-on prisms
- Mounts to 5/8-11 tribrach adapter or prism pole
- Weighs 0.06 lb (0.03 kg)



07-191-A PRISM POLE TOPO SHOE

- Precision machined aluminum body with 1" (25.4 mm) base
- 5/8-11 female thread
- Height: 3.37 in (85.6 mm); Weighs: 0.34 lb (0.16 kg)



07-191-B PRISM POLE TOPO SHOE

- Aluminum body with 2.5" (64 mm) wide base
- 5/8-11 female thread
- Height: 3.37 in (85.6 mm); Weighs 1.26 lb (0.57 kg)



09-114-10 TRIPLE MAGNET MOUNT FOR TRIMBLE R10

- Light-weight magnetic bracket for GNSS antennas on the roof of vehicles
- Spring design for greater flexibility
- Three (3) very strong 4.5" (115mm) diameter magnets to ensure a stable position of the antenna
- 5/8-11 thread connector for mounting GNSS antenna
- 6.375 inches (162 mm) in height
- Includes mount and extra-tall adapter
- Weighs 3.75 lb (1.70 kg)



09-LGSPUR SOFT-TURF™ GPS TRIPOD SPUR

- Large spur attaches to the 100S GPS Tripod for added grip to maximize stability in soft-ground applications
- 5/8-11 thread mount
- Aluminum anodized black



07-1422 FOOT GRIP ATTACHMENT

- Attaches to the base of any 1-1/2" (38mm) diameter bipod or tripod leg
- Made of aluminum with stainless steel set screw
- Provides support to easily and firmly set the points of the bipod or tripod



07-1460 BIPOD LEG CLIP

- Attaches to the lower section of any 1-1/2" (38mm) diameter prism or antenna pole
- Construction with hi-strength poly material
- Bipod legs snap into the clips making the system convenient for storage and transport



*Note: consider heights in your software or when post-processing your data in the office.

SUREGRIP™ CLAMPING **ANTI-CRUSHING QUICK RELEASE CRADLES****5200 SERIES****SUREGRIP QUICK RELEASE CRADLES**

The SureGrip quick release cradles feature a clamping system that easily secures data collector/controller without crushing it.

- Anti-crush quick release design locks cradle securely when tightened
- Plugs directly into quick-release pole clamps
- Easily secures data collector/controller with anti-crush quick release design that locks cradle when tightened
- Durable anodized aluminum design



Item	Designed to fit	Wgt
10-52139	Ranger 7™, TSC 7™	0.55lb (0.25kg)
10-5250	TSC 2™, Ranger™ 300X, 500X	0.42lb (0.19kg)
10-5262	Carlson Surveyor, Surveyor+	0.43lb (0.19kg)
10-5264	Geo 6000 Series	0.55lb (0.25kg)
10-5265	TSC3	0.46lb (0.21kg)

Item	Designed to fit	Wgt
10-5272	Mesa, Tesla	0.76lb (0.34kg)
10-5273	Archer2, FC-500, Mini2	0.49lb (0.23kg)
10-5274	Surveyor 2, Allegro 2	0.49lb (0.23kg)
10-5277	MESA 2, FC-5000, RT3	0.45lb (0.20kg)

Design Your Own Custom Solution for Securing Your Data Collector or Controller.**OCP SERIES****OPEN CLAMP POLE BRACKETS**

- Designed for efficient mounting to poles and rods
- Made of aluminum for durability and performance
- Quick-release button allows a quick-release cradle to rotate in a comfortable position
- Compatible with SureGrip and most competitor's cradles

**QR SERIES****QUICK RELEASE CLAMPS**

- Easily secures to pole with special design to prevent overtightening the pole clamp screw
- Ideal for RTK and GNSS surveys requiring a pole and a data collector
- Made of anodized aluminum for durability and performance
- Compatible with most popular quick-release cradles to hold data controllers

**BAS SERIES****BALL AND SOCKET SYSTEMS**

- Ball and socket link system is designed to allow versatile positioning of the controller position on the pole
- Easily secures data collector/controller with anti-crush quick release design that locks cradle when tightened
- Quick-release pole clamp
- Durable anodized aluminum design

sku	description	fits (dia.)
10-5194	OCP Bracket with Compass	1.25-in (32mm)
10-5198	OCP Bracket with 0.15 x 0.92" Slot for Radio	1.5-in (38mm)
10-5199	OCP Bracket with 0.15 x 0.92" Slot for Radio	1.25-in (32mm)

sku	description	fits (dia.)
10-5215	QR Pole Clamp	1.25-in (32mm)
10-5215X	QR Pole Clamp w/20-min Vial & Compass	1.25-in (32mm)
10-52154	QR Pole Clamp with Compass	32mm (1.25-in)

sku	description	fits (dia.)
10-52160	BAS Pole Clamp	1.25-in (32mm)
10-52201	BAS Link	1-in (25.4mm) Ram Ball
10-52805	BAS Cradle for FC-100, Mobile Mapper CE/CX, ProMark 3	

11-750**ROD LEVEL**

- Fits round or rectangular rods for quick setup of your leveling rod with convenience
- Strong die-cast aluminum housing and adjustable vial
- Strong aluminum housing, quickly level your leveling rod with convenience
- Large, easy to read 30-min bubble vial
- Works with all leveling staffs and prism poles
- Mounting hardware included

**11-751****HEADS UP ROD LEVEL**

- Specially designed for safety while performing routine surveys in traffic areas
- Clamps onto a rod up to 1.25-in (32mm) diameter and allows user to simply look through the side window to check level while keeping partner in sight
- Twist lock knob for clamping to rod or pole
- 20-min bubble vial for accurate and quick setup
- Special mirror allows for direct reading of adjustable circular bubble



ALQR20-ELAZ ELEVATOR ALUMINUM TRIPOD

The **ALQR** is a **medium duty, aluminum elevator tripod** with positive locking quick release clamp style clamps.

- Adjustable center column with height adjustment range of 21" (54cm) and metal gear & rack system for smooth continuous motion
- Special inner column provides additional 22" (56cm) height adjustment
- Aluminum shoe with hardened steel replaceable shoe points
- Powder coated castings for durability and wear-resistance
- Includes: heavy-duty poly-webbing shoulder strap

sku	extend	collapse	clamping	head style	wgt
01-ALQR20ELAZ	116" (2.95m)	48" (1.22m)	Quick Clamp	5/8-11, FLAT	15lb (6.8kg)
01-ALQRHD-ELAZ	116" (2.95m)	48" (1.22m)	Quick Clamp	5/8-11, FLAT	15lb (6.8kg)



01-ALQRHD-ELAZ

FGC20ELAZ ELEVATOR COMPOSITE TRIPOD

The **FGC20** is a **medium duty fiberglass tripod** with positive locking quick clamp style clamps. Adjustable center column with height adjustment range of 20" (51 cm) and metal gear & rack system for smooth continuous motion.

- Double banded extension legs and large positive locking quick clamp for extra stability
- Precision machined aluminum head and leg hinges provides stable mounting base
- Die-cast aluminum shoe with hardened steel replaceable shoe points
- Powder coated castings for durability and wear-resistance
- Includes: heavy-duty poly-webbing shoulder strap

sku	extend	collapse	clamping	head style	wgt
01-FGC20ELAZ-B	93" (2.36m)	48" (1.22m)	Quick Clamp	5/8-11, FLAT	15lb (6.7kg)



01-FGC20ELAZ-B



LARGE QUICK CLAMP LEVER

FGH30ELAZ ELEVATOR COMPOSITE TRIPOD

The **FGHD30** elevator tripod is a **heavy duty with dual clamp** design for add extra stability - both positive locking quick clamp and wing screw. Tall adjustable center column with height adjustment range up to 44" (112cm) and metal gear & rack system for smooth continuous motion.

- Double banded extension legs and large positive locking quick clamp for extra stability
- Precision machined aluminum head and leg hinges provides stable mounting base
- Die-cast aluminum shoe with hardened steel replaceable shoe points
- Powder coated castings for durability and wear-resistance
- Includes: heavy-duty poly-webbing shoulder strap

sku	extend	collapse	clamping	head style	wgt
01-FGH30ELAZ-DCB	12' 8" (3.86m)	72" (1.82m)	Dual Clamp	5/8-11, FLAT	33lb (15kg)



01-FGH30ELAZ-DCB



Option to place your company logo and contact info. Ask for details.

RHIVIZ20-B

SALAMANDER® ROBOTIC COMPOSITE TRIPOD

- Ideal for robotic total stations and laser scanners or construction lasers where accuracy is important.
- **Meets ISO standard (12858-2-H)**
- Tongue-groove strut and legs for stability and accurate performance
- Heavy duty dual clamp design add extra stability - both quick clamp & wing screw
- Double banded extension legs and large positive locking quick clamp add stability
- Ergonomic hand carrying handle
- Large 6-5/8-in (17 cm) precision machined flat head with large 2-3/8-in (6 cm) center hole for easy set-up over a point
- Large foot pad for solid planting and improves stability on any terrain
- Replaceable shoe points
- Built-in retainer support tabs for adding support system to prevent leg kick out
- Includes: heavy-duty poly-webbing shoulder strap, retainer strap, head protective cap, adjustment tool

sku	extended	collapsed	clamping	head style	net wgt	hardware
01-RHIVIZ20-B	70" (180cm)	44.75" (114cm)	Dual Clamp	5/8-11, FLAT	17.8lb (8.1kg)	Black



SHIVIZ20-B

SALAMANDER SURVEYOR COMPOSITE TRIPOD

- Ideal for both land surveying and precision construction instruments.
- Large hand grip, quick clamp lock type
- Durable all composite legs and struts with powder coated wear-resistant metal hardware
- Double banded extension legs and large positive locking quick clamp
- Precision machined flat head with center hole for easy set-up over a point
- Precision machined aluminum head and leg hinges provides stable mounting base
- Die-cast aluminum shoe with hardened steel replaceable shoe points
- Includes: heavy-duty poly-webbing shoulder strap for ease of carrying to the job site

sku	extended	collapsed	clamping	head style	net wgt	hardware
01-SHIVIZ20-B	70" (180cm)	44.75" (114cm)	Quick Clamp	5/8-11, FLAT	16.6lb (7.5kg)	Black



VHIVIZ20-B

SALAMANDER CONTRACTOR COMPOSITE TRIPOD

- Ideal for both optical and laser construction instruments.
- Medium weight fiberglass tripod
- Large hand grip, quick clamp lock type
- Powder coated wear-resistant metal hardware
- Double banded extension legs and large positive locking quick clamp
- Precision machined aluminum head and leg hinges provides stable mounting base
- Die-cast aluminum shoe with hardened steel replaceable shoe points
- Includes: heavy-duty poly-webbing shoulder strap for ease of carrying to the job site

sku	extended	collapsed	clamping	head style	net wgt	hardware
01-VHIVIZ20-B	70" (180cm)	44.75" (114cm)	Quick Clamp	5/8-11, FLAT	16.0lb (7.2kg)	Black

ALHVZ20

SALAMANDER CONTRACTOR ALUMINUM TRIPOD

- Ideal for both optical and laser construction instruments
- Medium weight, heavy gauge aluminum with added stability of double banded legs
- Positive locking quick release clamps
- Powder coated wear-resistant metal hardware
- Die-cast aluminum shoe with hardened steel replaceable shoe points
- Includes: heavy-duty poly-webbing shoulder strap

sku	extended	collapsed	clamping	head style	net wgt	hardware
01-ALHVZ20	64" (163cm)	40" (102cm)	Quick Clamp	5/8-11, FLAT	10lb (4.6kg)	Black

THE FIRST HI-VIZ TRIPOD SERIES DESIGNED FOR ALL-ENVIRONMENTS

HVFG-DC
SITEMAX™ LARGE HEAD COMPOSITE TRIPOD WITH DUAL-CLAMP

The SiteMax HVFG is the best value heavy duty fiberglass tripod on the market. Heavy duty dual clamp design add extra stability - both quick clamp and wing screw. Large round head is precision machined to add even more stability for your instrument.

- Powder coated wear-resistant metal hardware
- Double banded extension legs and large positive locking quick clamp add stability
- Replaceable shoe points
- Ergonomic hand carrying handle
- Includes: heavy-duty poly-webbing shoulder strap, head protective cap, adjustment tool

sku	extended	collapsed	clamping	head style	net wgt	hardware
01-HVFG20-DCB	72" (183cm)	47" (119cm)	Dual Clamp	5/8-11, FLAT	18lb (8.2kg)	Black



WDF20-DC
WOOD/COMPOSITE TRIPOD, DUAL CLAMP

- The best value heavy duty wood/composite tripod on the market
- Heavy duty clamp design add extra stability - quick clamp and dual-clamp with wing screw available
- Combination of hardwood legs with fiberglass dowels provides stability and weather resistance
- Double banded extension legs and large positive locking quick clamp add extra stability
- Powder coated wear-resistant metal hardware
- Replaceable shoe points
- Includes: heavy-duty poly-webbing shoulder strap, head protective cap, adjustment tool

sku	extended	collapsed	clamping	head style	net wgt	hardware
01-WDF20-DCB	72" (183cm)	42" (107cm)	Dual Clamp	5/8-11, Large Flat	16lb (7.2kg)	Black

WDF20
WOOD/COMPOSITE TRIPOD, QUICK CLAMP

- Heavy duty quick clamp design add extra stability
- Combination of hardwood legs with fiberglass dowels provides stability and weather resistance
- Double banded extension legs and large positive locking quick clamp add extra stability
- Powder coated wear-resistant metal hardware
- Replaceable shoe points
- Includes: heavy-duty poly-webbing shoulder strap, head protective cap, adjustment tool

sku	extended	collapsed	clamping	head style	net wgt	hardware
01-WDF20-B	72" (183cm)	42" (107cm)	Quick Clamp	5/8-11, Flat	16lb (7.2kg)	Black
01-WDF20-O	72" (183cm)	42" (107cm)	Quick Clamp	5/8-11, Flat	16lb (7.2kg)	Orange



WDW20
WOOD TRIPOD, WING SCREW

The WDW tripod is made of high quality hardwood with wide-frame extension legs and 1" diameter dowels. Designed to absorb and dampen vibration which adds stability for your instrument.

- Large aluminum head and leg hinges provide stable mounting base
- Wing screw style clamp with die cast aluminum hardware for maximum stability
- Wear-resistant with treated finish and powder coated metal hardware
- Aluminum shoe with hardened steel replaceable shoe points
- Includes: heavy-duty poly-webbing shoulder strap, head protective cap, adjustment tool

sku	extended	collapsed	clamping	head style	net wgt	hardware
01-WDW20HV-O	72" (183cm)	42" (107cm)	Wing Screw	5/8-11, FLAT	16lb (7.2kg)	Orange

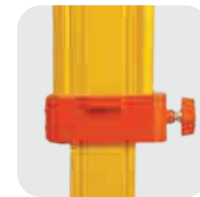

Option to place your company logo and contact info. Ask for details.



ALQR20-DC HEAVY-DUTY ALUMINUM TRIPOD, DUAL CLAMP SYSTEM

The ALQR Series tripods are made of medium weight, heavy gauge aluminum with added stability of double banded legs.

- Positive locking quick release clamps
- Powder coated wear-resistant metal hardware
- Replaceable shoe points
- Includes: heavy-duty poly-webbing shoulder strap

sku	extended	collapsed	clamping	head style	net wgt	hardware
01-ALQR20-DCB	64" (163cm)	40" (102cm)	Dual Clamp	5/8-11, FLAT	10lb (4.6kg)	Black



ALQR20 ALUMINUM TRIPOD WITH QUICK RELEASE

The ALQR Series tripods are made of medium weight, heavy gauge aluminum with added stability of double banded legs.

- Positive locking quick release clamps
- Powder coated wear-resistant metal hardware
- Replaceable shoe points
- Includes: heavy-duty poly-webbing shoulder strap

sku	extended	collapsed	clamping	head style	net wgt	hardware
01-ALQR20-B	64" (163cm)	40" (102cm)	Quick Clamp	5/8-11, FLAT	10lb (4.6kg)	Black
01-ALQR20-O	64" (163cm)	40" (102cm)	Quick Clamp	5/8-11, FLAT	10lb (4.6kg)	Orange



ALQR40 DOMED-HEAD ALUMINUM TRIPOD

The ALQR Series tripods are made of medium weight, heavy gauge aluminum with added stability of double banded legs.

- Circular dome head for fast setup with compensated instruments and lasers
- Positive locking quick release clamps
- Powder coated wear-resistant metal hardware
- Replaceable shoe points
- Includes: heavy-duty poly-webbing shoulder strap

sku	extended	collapsed	clamping	head style	net wgt	hardware
01-ALQR40-B	64" (163cm)	40" (102cm)	Quick Clamp	5/8-11, DOME	10lb (4.6kg)	Black



EASY COLLAPSE & CARRY

Carrying your tripod to and from the jobsite with other gear or tools can be cumbersome. The heavy duty poly-webbed shoulder strap makes it easier.

Strap is **included with all SitePro Tripods** and has built-in webbed belt with locking clip to secure legs of tripod.





ALW20 ALUMINUM TRIPOD WITH WING SCREW

The ALW20 is a heavy duty, aluminum tripod with wing screw clamps.

- Aluminum hinge, clamp and shoe castings
- Powder coated castings for durability and wear-resistance
- Replaceable shoe points
- Includes: heavy-duty poly-webbing shoulder strap

sku	extended	collapsed	clamping	head style	net wgt	hardware
01-ALW20-B	65" (165cm)	42" (107cm)	Wing Screw	5/8-11, FLAT	10lb (4.6kg)	Black



ALW10 ALUMINUM MINI-TRIPOD WITH WING SCREW

The ALW10 tripod has a small footprint, yet heavy duty and sturdy. Features standard head with wing screw clamps.

- Aluminum hinge, clamp and shoe castings
- Powder coated castings for durability and wear-resistance
- Replaceable shoe points
- Includes carrying strap and adjustment tool

sku	extended	collapsed	clamping	head style	net wgt	hardware
01-ALW10-B	28.5" (73cm)	22" (56cm)	Wing Screw	5/8-11, FLAT	6.4lb (2.9kg)	Black

ALC20 ALUMINUM TRIPOD WITH QUICK CLAMP

The ALC is a lightweight, aluminum contractors' tripod with positive locking quick clamp style clamps and individually tightened hinge screws.

- Aluminum hinge, clamp and shoe castings with replaceable shoe points
- Powder coated castings for durability and wear-resistance
- Includes: heavy-duty poly-webbing shoulder strap

sku	extended	collapsed	clamping	head style	net wgt	hardware
01-ALC20-B	65" (165cm)	39" (99cm)	Quick Clamp	5/8-11, FLAT	9.0lb (4.1kg)	Black



01-TLS **NEW!** TRIPOD RETAINER STRAP

- Use with tripods with clamp lock holder on legs
- Fixes the legs in place to maintain stability while you work
- Use with SitePro model RHIVIZ20 and HVFG-DC



01-TFG2

TRIPOD FLOOR GUIDE

- Ideal when setting up tripod on slick surfaces and concrete floors. Makes setting up over a point faster
- Heavy-duty aluminum arms with slots to extend and stabilize tripod legs to 25-375" (65cm) from center; additional slots to extend 14" (35.6 cm) from center
- Tripod mounts to the legs which have slots for points and rubber straps
- Weight: 1.0 lb (0.45kg)

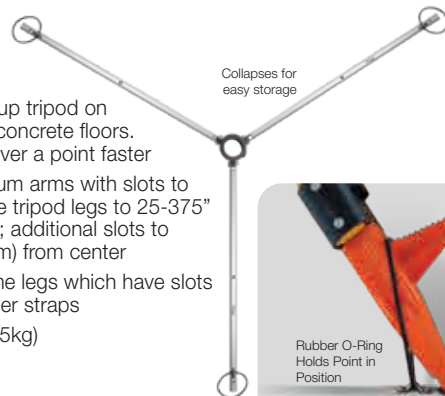



SPR-SERIES SURVEYOR'S FIBERGLASS GRADE ROD

Our most popular rods designed for surveyors, the SitePro SPR-Series leveling rods are constructed of durable, rigid fiberglass with reinforced ribs for strength and stability. Lightweight, telescoping rectangular-oval shaped sections make the SPR-Series leveling rod easier to grip and allows for widened easy-to-read scales. Graduated scales are glare-resistant with formulated coating that protects the scales from wear.

- Reliable, long-lasting spring-loaded round buttons provide tight, secure, locking of the sections, and designed to resist jamming from debris
- Special backside measuring scale allows users to read overall height measurements at eye level
- 1/4-20 female adapter in top section for mounting prism
- Non-conductive fiberglass is water-proof and corrosion-resistant
- Glare resistant, easy-to-read graduations and a special measuring scale on the backside, suitable for many clearance and height measurements
- Sections are removable for easy cleaning
- Includes carrying case

sku	length	graduations	sections	collapsed	wgt
11-SPR17-T	17-ft	10ths/100ths	5	48-in (122cm)	5.00 lb (2.3kg)
11-SPR17-C	17-ft	Inches/8ths	5	48-in (122cm)	5.00 lb (2.3kg)
11-SPR25-T	25-ft	10ths/100ths	6	58.5-in (149cm)	6.00 lb (2.3kg)
11-SPR25-C	25-ft	Inches/8ths	6	58.5-in (149cm)	6.00 lb (2.3kg)
11-SPR07-M	7.6m	Metric "E", mm	6	58.5-in (149cm)	6.00 lb (2.3kg)



MOUNTING TIP FOR MINI PRISM

Section buttons are round to provide tight, secure, locking of the sections, and designed to resist jamming from debris.



RELIABLE, LONG-LASTING SPRING-LOADED BUTTONS

Section buttons are round to provide tight, secure, locking of the sections, and designed to resist jamming from debris.



SPR-Series include carrying case with carrying strap

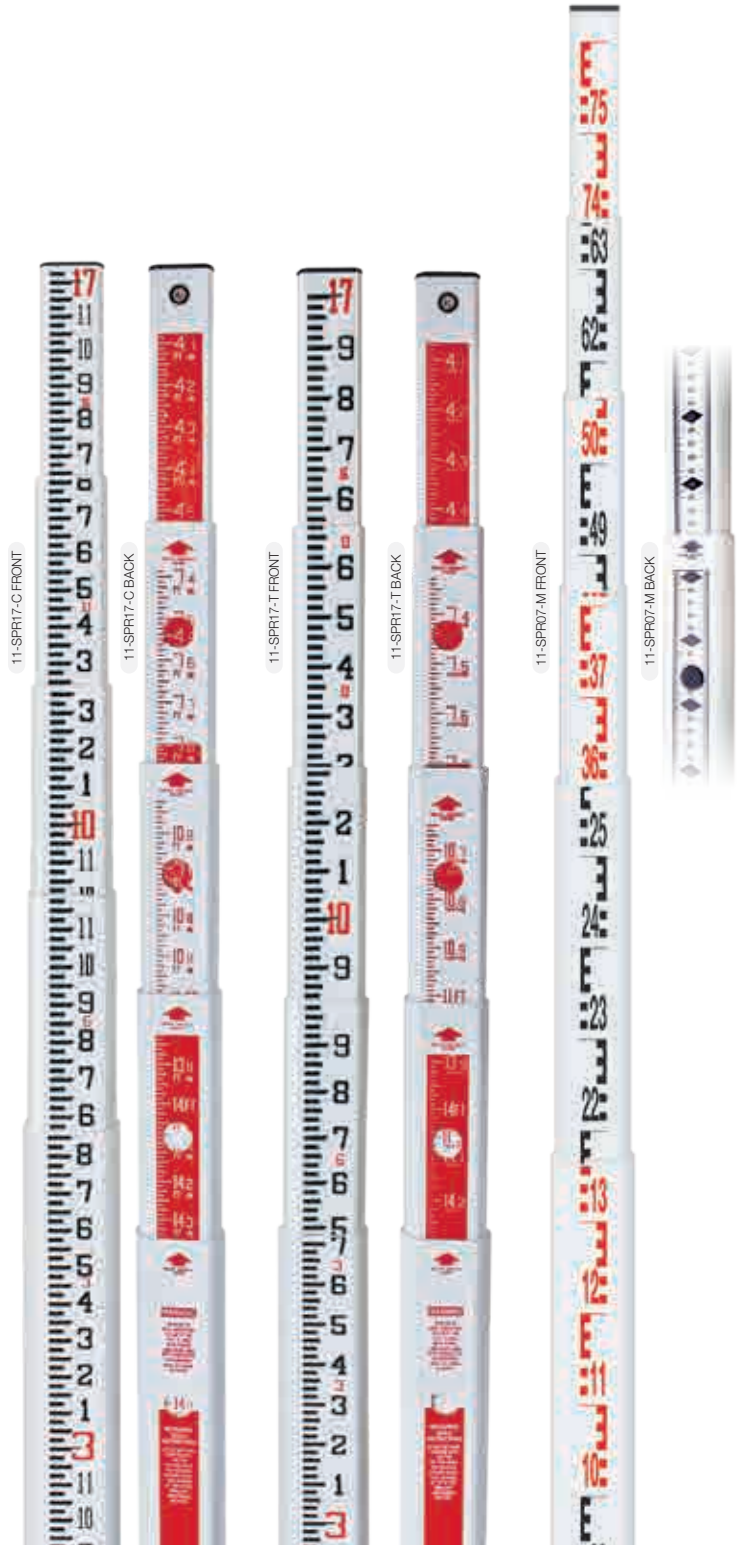



SCR-SERIES CONSTRUCTION FIBERGLASS GRADE ROD

The SitePro SCR-Series leveling rods are constructed of durable corrosion-resistant and non-conductive fiberglass. Lightweight, telescoping rectangular shaped sections with rounded back corners make the SCR-Series leveling rod easier to grip.

Features stand-off ribs on front corners to protect the large, easy-to-read graduated scale from wear. Scales are glare-resistant with formulated coating that protects the scales from wear.

- Reliable, long-lasting spring-loaded Delrin® buttons securely lock sections together, and designed to resist jamming from debris
- Special backside measuring scale allows users to read overall height measurements at eye level
- Rectangular shape allows for laser detector clamp to mount to any section of the leveling rod
- Non-conductive fiberglass is water-proof and corrosion-resistant
- Sections are removable for easy cleaning

sku	length	graduations	sections	collapsed	wgt
11-SCR13-C	13-ft	8ths	3	58-in (148cm)	4.5 lb (2.0kg)
11-SCR13-T	13-ft	100ths	3	58-in (148cm)	4.5 lb (2.0kg)
11-SCR16-C	16-ft	8ths	4	57-in (145cm)	6.2 lb (2.8kg)
11-SCR16-T	16-ft	100ths	4	57-in (145cm)	6.2 lb (2.8kg)
11-SCRO5-M	5 m	Metric 'E'	4	57-in (145cm)	6.2 lb (2.8kg)
11-SCRO5-MC	5m/16-ft	Metric 'E'/8ths	4	57-in (145cm)	6.2 lb (2.8kg)
11-SCR25-C	25-ft	8ths	5	63.5-in (161cm)	10 lb (4.5kg)
11-SCR25-T	25-ft	100ths	5	63.5-in (161cm)	10 lb (4.5kg)

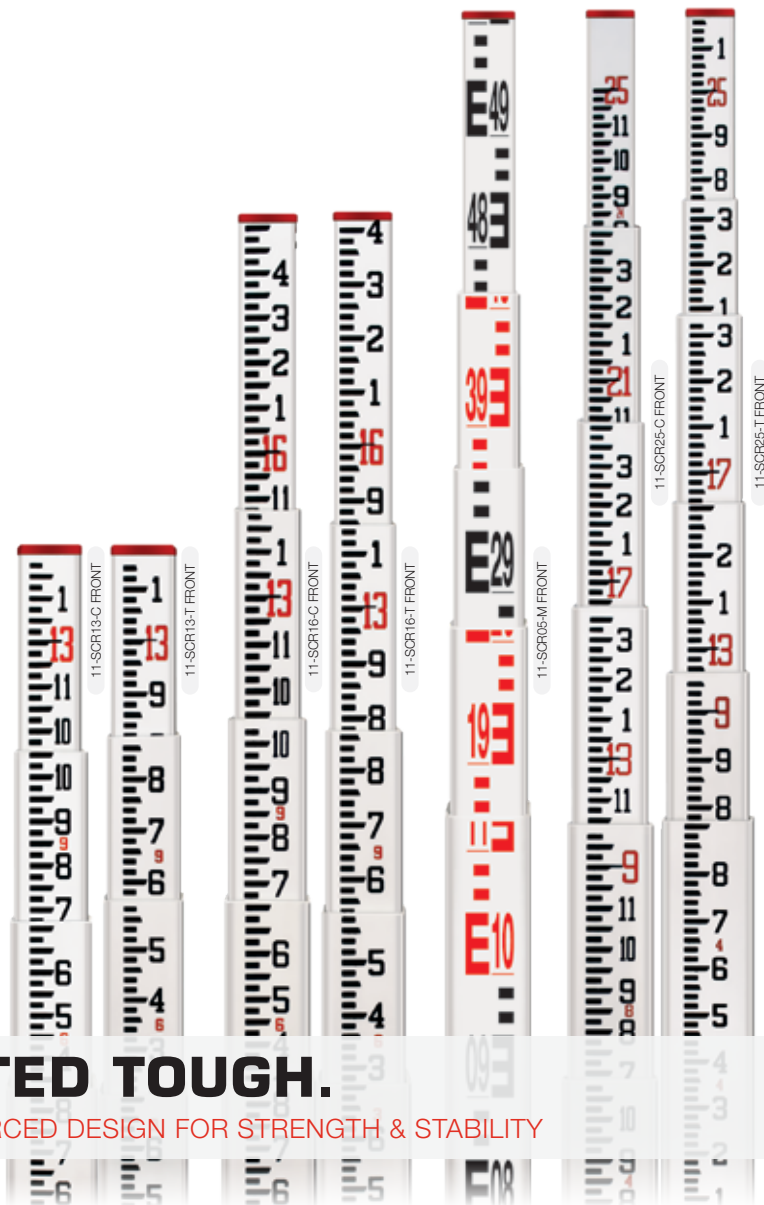

CONSTRUCTED TOUGH.

DURABLE, RIGID FIBERGLASS WITH REINFORCED DESIGN FOR STRENGTH & STABILITY



MOUNTING TIP FOR MINI PRISM

Section buttons are round to provide tight, secure, locking of the sections, and designed to resist jamming from debris.



GRADUATED IMPRINTED BACKSIDE

Special backside measuring scale allows users to read overall height measurements at eye level



SCR-Series include carrying case with carrying strap



11-8 SERIES ALUMINUM LEVELING RODS

The SitePro telescoping aluminum leveling rod are constructed with durable, lightweight aluminum alloy that allows smooth extension and prevents unnecessary clattering.

The 11-8 series are imprinted with weather and corrosion-resistant inks. The telescoping sections are injection molded section joints and capped with secure high strength buttons.

- Lightweight and durable telescoping aluminum leveling rods
- Heavy duty aluminum wall thickness
- Easy-to-read graduations with measuring scale on the backside for direct reading at eye level
- Three different unit of measure are available, see graduations: 8ths, 100ths, and Metric
- Includes leveling bubble vial attachment and carrying case



SNAP-IN PUSH BUTTON

High strength push-buttons with injection molded section joints for secure locking of telescopic sections.



ATTACHABLE ROD LEVEL

Bubble Vial Attachment easily clips into slot for quick leveling of aluminum rods.

INCLUDES CARRYING CASE

All SitePro 11-8 series aluminum rods include carrying case with accessory pouch and shoulder strap.

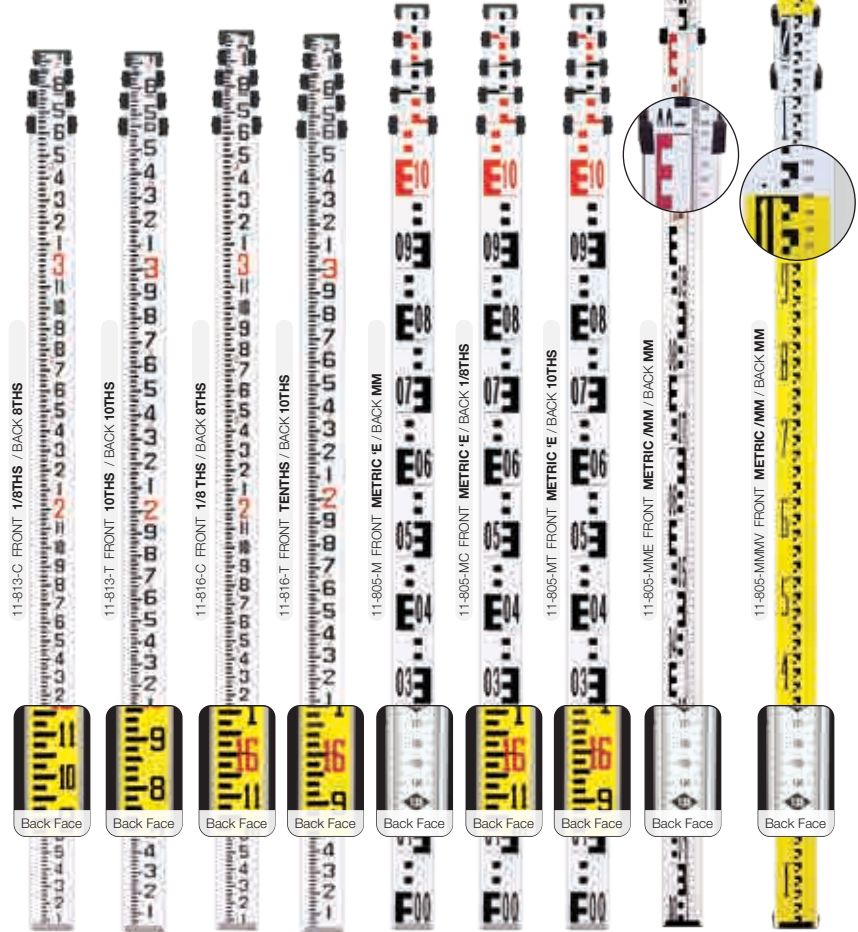

sku	length	graduations- front face	graduations-back face	sections	collapsed	wgt
11-813-C	13-ft	Feet Inches/8ths	Feet Inches/8ths	4	47-in (119cm)	3.0 lb (1.4kg)
11-813-T	13-ft	Feet 10ths/100ths	Feet 10ths/100ths	4	47-in (119cm)	3.0 lb (1.4kg)
11-805-BM	5m	Barcode for 25-SDL32 (Pg 1)	Metric E	5	48-in (122cm)	3.5 lb (1.6kg)
11-805-M	5m	Metric "E"	Metric mm	5	48-in (122cm)	3.5 lb (1.6kg)
11-805-MC	16-ft/5m	Metric 'E'	Feet Inches/8ths	5	48-in (122cm)	3.5 lb (1.6kg)
11-805-MT	16-ft/5m	Metric 'E'	Feet 10ths/100ths	5	48-in (122cm)	3.5 lb (1.6kg)
11-805-MME	5m	Metric 'E' mm	Metric mm	5	122cm (48-in)	1.6kg (3.5 lb)
11-805-MMES	5m	Metric 'E' mm	Metric mm, Surveyor	5	122cm (48-in)	1.6kg (3.5 lb)
11-805-MMMV	5m	Metric, 1/2 cm, mm	Metric mm	5	122cm (48-in)	1.6kg (3.5 lb)
11-816-C	16-ft	Feet Inches/8ths	Feet Inches/8ths	5	48-in (123cm)	3.5 lb (1.6kg)
11-816-T	16-ft	Feet 10ths/100ths	Feet 10ths/100ths	5	48-in (123cm)	3.5 lb (1.6kg)

11-TURLT 5-IN LEVELING ROD TURNING PLATES

NEW!

The SitePro turning plate is used to improve the accuracy of level runs in soft terrain. The leveling plates (or Turtles as they are commonly known) are cast heavy steel and red.

- Heavy cast steel with flo-red powder painted for durability and longevity
- Carrying handle with ground points
- Dome is 1.2-in (3.0cm) half ball
- Diameter: 5-in (12.7cm)
- Height of foot to top of half ball: 2.75-in (7cm)
- 6.6 lb (3.0 kg)
- **Set of Two (2) turning plates**



APPLICATIONS

- Land surveying
- General construction
- Law enforcement
- Road construction
- Utilities
- Real estate appraisals



PS 401M PROFESSIONAL SERIES
1M PROFESSIONAL MEASURING WHEEL, METRIC

All-steel construction with accuracy 1 cm measuring and belt-driven counter. Professionals can count on the durable design and accurate, reliable measuring with a 32 cm (1m circum.) steel-spoked wheel that provides best performance on rough terrain.

- 5-digit belt-driven counter records up to 9,999.9 meter with convenient rest knob
- 1m circumference spoke wheel and wide rubber tire makes it easier to measure accurately on rough terrain & uneven ground
- Wheel brake prevents slipping and allows for easy transport without losing measurement
- Built-in wheel stand keeps wheel upright
- Easy-grip handle folds for compact storage when not in use

sku	wheel dia.	circum.	units	wgt	extended height	collapse height
31-PS401M	0.318 m	1 m	m	4.3 lb (1.95 kg)	45.5" (116 cm)	21.5" (55 cm)



APPLICATIONS

- Land Surveying
- General construction
- Law enforcement
- Road construction
- Utilities
- Landscaping



PS 301 PROFESSIONAL SERIES
SPOKED 3' PROFESSIONAL MEASURING WHEEL

All-steel construction with an 11-1/2" (3-ft circumference) steel-spoked wheel that provides best performance on rough terrain for construction, utilities, land surveying and other measuring applications. Most popular wheel in performance, durability, and value.

- 5-digit ratchet-style mechanical counter records up to 99,999 feet with rest knob
- Steel-spoked wheel, wide rubber tire registers single feet click (3-ft per revolution)
- Built-in wheel stand keeps wheel upright
- Wheel brake prevents wheel from slipping and allows for easy transport without losing existing measurement
- Easy-grip handle quickly collapses for compact storage when not in use

sku	wheel dia.	circum.	units	wgt	extended height	collapse height
31-PS301	11-1/2 in	3 ft.	ft	5.3 lb (2.4 kg)	45.5" (116 cm)	26.5" (67 cm)



APPLICATIONS

- Landscaping
- General construction
- Law enforcement
- Road construction
- Real estate appraisals
- Home remodeling



RS 312/RS 312M CONTRACTOR SERIES
12-1/2" / 0.318M CONTRACTOR MEASURING WHEEL

Aluminum three-spoke wheel with precision molded wide rubber tire. Affordable, easy to use measuring wheel and more accurate on rough terrain than other wheels on the market.

- 5-digit, easy-read counter
- 3-section aluminum telescopic handle with lever locks collapses for easy storage
- Robust, industry-proven meter housing is durable, heavy duty poly cast
- Measures in both directions
- Reset switch to set counter to <00000>
- Comfortable, ergonomic pistol grip handle
- Fold-away kick stand keeps wheel upright when not in use

sku	wheel dia.	circum.	units	wgt	extended height	collapse height
31-RS312	12-1/2 in	3 ft.	ft/in	3.2 lb (1.5 kg)	44.5" (113 cm)	26" (66 cm)
31-RS312M	0.318 m	1 m	m/dm	3.2 lb (1.5 kg)	44.5" (113 cm)	26" (66 cm)



APPLICATIONS

- Home remodeling
- Interior design
- Real estate appraisals
- General construction



RS 104 CONTRACTOR SERIES
COMPACT 4" MEASURING WHEEL, FT/IN

Compact measuring wheel is lightweight and durable. Wide, precision molded tire provides accurate measurements on any smooth, hard surface from interior floors to sidewalks.

- 5-digit, easy-read counter measures 9,999 feet, 11 inches
- Heavy-duty 1-ft circumference poly cast six-spoke plastic wheel with rubber tread
- 3-section aluminum telescopic handle with lever locks collapses for easy storage
- Robust, industry-proven meter housing is durable, heavy duty poly cast
- Measures in both directions
- Reset switch to set counter to <00000>
- Easy grip handle

sku	wheel dia.	circum.	units	wgt	extended height	collapse height
31-RS104	4 in	1 ft.	ft/in	1 lb (0.45 kg)	38.5" (98 cm)	18.3" (46.5 cm)



SitePro PS-Series measuring wheels are guaranteed with a three (3) year limited warranty. Unless otherwise specified, accessory items include a 90-day limited warranty.



SitePro RS-Series measuring wheels are guaranteed with a one (1) year limited warranty. Unless otherwise specified, accessory items include a 90-day limited warranty.



34-SERIES
FIBERGLASS TAPES

- Durable with non-woven pvc-coated fiberglass, waterproof
- Dual-sided graduations
- Easy to rewind with fast reel design (3:1 gear ratio), with folding crank handle
- Tape width is 1/2" with various graduations available.



34-Y3001

sku	length	unit of measure
34-Y1001	100'	10ths/100ths
34-Y2001	200'	10ths/100ths
34-Y3001	300'	10ths/100ths
34-Y1008M	100' /30m	Side 1: Inch /8ths; Side 2: Meter /cm /mm
34-Y1001M	100' /30m	Side 1: 10ths /100ths; Side 2: Meter /cm /mm
34-Y1658M	165' /50m	Side 1: Inch/8ths; Side 2: Meter /cm /mm
34-Y1651M	165' /50m	Side 1: 10ths /100ths; Side 2: Meter /cm /mm

sku	length	unit of measure
34-Y1008	100'	Inch /8ths
34-Y2008	200'	Inch /8ths
34-Y3008	300'	Inch /8ths
34-Y3008M	300' /100m	Side 1: Inch /8ths; Side 2: Meter /cm /mm
34-Y30M	30M	Meter /cm /mm
34-Y50M	50M	Meter /cm /mm
34-Y100M	100M	Meter /cm /mm

32-SERIES
STEEL TAPES

- Accurate and durable high tempered steel tapes with temperature stability for superior performance.
- Nylon coated wear-resistant graduated tape withstands the extreme conditions
- Dual-sided graduations
- Easy to rewind with fast reel design (3:1 gear ratio), with folding crank handle
- Tape width is 1/2" with various graduations available.



32-30080

B End Type

sku	length	end type*	unit of measure
32-10010B	100'	B	10ths/100ths
32-20010B	200'	B	10ths/100ths
32-30010B	300'	B	10ths/100ths
32-10080B	100'	B	Inch/8ths
32-20080B	200'	B	Inch/8ths

sku	length	end type*	unit of measure
32-30080B	300'	B	Inch/8ths
32-30MA	30m	A	Meter/cm/mm
32-50MA	50m	A	Meter/cm/mm
32-100MA	100m	A	Meter/cm/mm

35-SERIES
DEPTH GAUGE TAPES

Lightweight fiberglass tapes are rugged and versatile, ideal for measuring in water, mud, and rough terrain.



sku	length	units
35-2588	25'	Ft/In
35-5088	50'	Ft/In
35-10088	100'	Ft/In
35-20088	200'	Ft/In
35-30MM	30M	Metric
35-50MM	50M	Metric



SmartTRAK

THE SMART CHOICE FOR LOCATING FERROUS METALS



ST101 SMART-TRAK™ MAGNETIC LOCATOR

The Smart-TRAK is the smart choice for locating manholes, steel covers, septic systems, corner survey markers, cast iron pipes, iron valves, and re-bar. The ST100 series feature one-handed operation with pinpoint accuracy and large visual display.

- Precision-crafted superior ergonomics and balanced design for one-handed operation
- Large LCD screen for visual search results 0-99 numeric indicator with signal strength bar graph and battery level indicator
- High-grade waterproof speaker is water resistant and dust proof to ensure years of dependable operation
- Robust co-molded housing is water resistant and dust proof to ensure years of dependable operation
- Waterproof tube (IP67) and tip for locating even in the toughest environments and weather conditions



ST102 SMART-TRAK™ MAGNETIC LOCATOR

The ST102 features patent pending **Smart-Search Technology™** that provides pinpoint accuracy around fences or other large metal objects.

- Precision-crafted superior ergonomics and balanced design for one-handed operation
- Large LCD screen for visual search results 0-99 numeric indicator with signal strength bar graph, North/South polarity indicator, and battery level indicator
- Four (4) modes of operation: Standard, Erase, Smart+, Smart-
- High-grade waterproof speaker is water resistant and dust proof to ensure years of dependable operation
- Robust co-molded housing is water resistant and dust proof to ensure years of dependable operation
- Waterproof tube (IP67) and tip for locating even in the toughest environments and weather conditions



MAG NAILS

1-ft to 2.7-ft
(30cm to 82cm)

REBAR

9-ft (2.7m)

SURVEY MARKERS

10-ft (3m)

MANHOLE COVERS

10-ft (3m)

CAST IRON PIPE (4")

10-ft (3m)

SEPTIC TANK HANDLES

6-ft (1.8m)

	59-ST102	59-ST101
Audio Output:	10Hz frequency tone, increases with magnetic field strength	
Visual Output:	LCD - Numeric 0 - 99, signal strength bar graph	
Gain (Sensitivity):	6 settings	
Smart-Search	Yes	No
Volume:	4 settings	
Modes:	Standard, Erase, Smart +, Smart -	Standard
Power:	Six AA alkaline batteries- 50 hours (intermittent operation)	
Operating Temp:	-13° F to 140° F (-25° C to 60° C)	
Weight:	2.5 lb (1.13kg) with batteries	
Length:	42-3/4 in (108.6 cm)	
Environment:	IP54 – plastic housing; IP67 – sensor tube to below plastic housing	
Includes:	Carrying case, batteries, manual	

★ MADE IN ★
USA
★ OF GLOBAL COMPONENTS ★

SmartTrak is proudly made in U.S.A.

SmartTrak locators are guaranteed with a seven (7) year limited warranty. Unless otherwise specified, accessory items include a 90-day limited warranty.





17-RF48E,17-RF64E

48 OZ / 64 OZ ENGINEER'S HAMMER

- Made from forged steel head which is hardened and tempered
- Dual machine finished faces that are beveled and fully polished
- Designed for striking spikes and hardened nails, cold chisels, brick chisels, punches, star drills
- Textured yellow fiberglass handle which allows for heavier blows in an environment where there is limited swing
- Ribbed grip to help prevent slipping



17-EWB3-4LB

4 LB CLUB/DRILLING HAMMER

Made from forged steel head which is hardened and tempered. Idea for use with chisels, punches, star drills and hardened nails.

- 10-Inch Handle & Shock Reduction Grip
- Permits heavy blows with limited swing
- Head and handle are forged in one piece and have a black UV coating
- Both faces are fully polished



17-BH6006

45 OZ DEAD BLOW HAMMER

- Specialized mallet designed to minimize damage to struck surface with minimal elastic rebound from struck surface
- Vibration dampening head for increased power and control
- 14" (36cm) handle
- Constructed of steel interior with hard Nitrile rubber exterior, filled with steel shot
- Comfortable, durable grip for strong hold in all conditions



17-FP18FY

18" FROST PIN

Ideal for breaking up hardened, dried earth as well as frozen ground.

- Made of 1" diameter high grade tool steel
- Weighs 4.0 lb (1.8 kg)
- 2" button top and a hardened diamond point



17-GAD18

18" GAD

Ideally used to break, chip, chisel and pry rocks apart.

- Size: 3/4" x 1-1/2"
- Made of high-grade tool steel
- Hardened-steel tip
- Weighs 5.3 lb (2.4 kg)



17-MCP32-FH

MANHOLE COVER PICK

Ideal for lifting drain grate and manhole cover safely while protecting your hands from injury as well as back and other injuries.

- Made of 5/8" hex high grade tool steel
- Harden steel flat head tip
- Length: 32"



17-AX8901

4.5 LB WOOD SPLITTING MAUL

- Ideal for splitting wood or driving wedges and stakes
- Fully forged and hardened steel head
- 3-1/2" geometric blade optimizes penetration to blast tough logs apart
- Forged, heat-treated steel is finished with a rust-resistant coating
- Durable straight-grained Hickory handle
- Hawk length: 8"; Overall length: 36"
- Overall weight: 6.5 lb (2.9 kg)



17-AX3902

1.75 LB AXE W/ HICKORY HANDLE

- Compact axe intended for bringing down or cutting up small to medium sized trees
- Fully forged and hardened steel head
- 4-3/8" geometric blade optimizes penetration
- 13.5" curved shaft handle is made of durable straight-grained Hickory
- Hawk length: 6-3/8" (16.2 cm)
- Head weight: 1.75 lb (0.79 kg)
- Overall length: 15.3" (38.9 cm)
- Weighs: 2.4 lb (1.1 kg)



17-RP4001

5 LB RAILROAD PICK

- Combo-head design is ideal for breaking up gravel and hardened, dried earth (pointed end), or use as a hoe when digging in tough soil (flat end)
- 36-inch durable fiberglass handle is shock absorbent
- Rubber easy grip for improved handling and control
- Pick blades cuts through and chews up hard pan soil and rocks



COLO SERIES

HEAVY DUTY MACHETES

The COLO-Series machetes are heavy duty tempered steel blade for strength and longevity and world's best selling machete with lifetime guarantee¹.

- Colombian made
- 5" ergonomic handle is made of **durable engineered wood** for better gripping power and longevity
- 2.5 mm thick, hot roll tempered high carbon steel blade for strength (49 HRC)
- Sharpenable blade extends through the riveted handle for durability
- Blade lengths: 18", 22", 24", and 28"

World's Best Selling Machete with Lifetime Guarantee

COLO22-W Shown in Packaging

NEW!

sku	blade length	Handle Type	thickness	HRC rating	wgt
17-COLO18-W*	18"	Engineered Wood	2.5 mm	49 +/- 1	19oz (580g)
17-COLO22-W*	22"	Engineered Wood	2.5 mm	49 +/- 1	20.5oz (580g)

sku	blade length	Handle Type	thickness	HRC rating	wgt
17-COLO24-W*	24"	Engineered Wood	2.5 mm	49 +/- 1	22.0oz (623g)
17-COLO28-W	28"	Engineered Wood	2.5 mm	49 +/- 1	22.8oz (646g)

*Available in retail packaging, call for details

¹ Guaranteed not to break with normal use. Find more details at dwsitepro.com

CROC SERIES

MARTINDALE® PRO MACHETES

The Croc-Series Machetes are made from British steel that are hand rolled. Each knife is individually made by a hand rolling process from high quality British carbon steel, which makes the blades strong and durable.

- 2.25mm thick carbon steel blade is strong and durable (45-52 HRC)
- 5" handle is available in solid beech wood or durable plastic
- Turn-back grip handle
- Sharpenable blade extends through the riveted handle for durability
- Blade lengths: 18", 22", 24", and 28"

MARTINDALE
REGD. IN ENGLAND

sku	blade length	Handle Type	thickness	HRC rating	wgt
17-CROC18-P	18"	Plastic	2.25 mm	45-52	17oz (485g)
17-CROC18-W	18"	Wood	2.25 mm	45-52	18.4oz (522g)
17-CROC22-P	22"	Plastic	2.25 mm	45-52	18.4oz (522g)
17-CROC22-W	22"	Wood	2.25 mm	45-52	20oz (567g)

sku	blade length	Handle Type	thickness	HRC rating	wgt
17-CROC24-P	24"	Plastic	2.25 mm	45-52	20oz (567g)
17-CROC24-W	24"	Wood	2.25 mm	45-52	21.8oz (618g)
17-CROC28-P	28"	Plastic	2.25 mm	45-52	21.8oz (618g)
17-CROC28-W	28"	Wood	2.25 mm	45-52	22.4oz (635g)



750 SERIES

CLASS 2- ANSI/ISEA 107-2010 SAFETY STANDARDS

PREMIUM SURVEYOR'S VEST

- Made from durable heavy-duty ANSI/ ISEA compliant polyester and polyester mesh
- Padded collar on the inside
- Back pouch for additional storage
- Multiple outside pockets, two inside pockets, and dual mic clips
- Solid polyester front with mesh back for ultra-cool comfort

sku	sizes available	color	reflective striping
23-750-FL	S, M, L, XL, 2X, 3X	Flo-Lime	2" (51mm) thick strip with 4" (102mm) wide flo-orange color
23-750-FO	S, M, L, XL, 2X, 3X	Flo-Orange	2" (51mm) thick strip with 4" (102mm) wide flo-yellow color



NEW!



Back View

700 SERIES

CLASS 2- ANSI/ISEA 107-2010 SAFETY STANDARDS

SURVEYOR'S/UTILITY VEST WITH I-PAD POCKET

- Polyester fabric for maximum protection and durability
- Clear ID pocket; Inside pocket for I-Pad
- Front right chest pockets with velcro top closure (fits smart phones)
- Front left chest two (2) layered pockets with pen divider
- Two (2) bottom pockets with flap cover, mic-tab on both shoulders
- D-Ring pass
- Zippered pouch on back for blue-prints
- Heavy-duty zipper up front closure
- 2" (51mm) grey reflective stripes with 3" contrast color binding

sku	sizes available	color	reflective striping
23-700-FL	S, M, L, XL, 2X, 3X	Flo-Lime	2" (51mm) thick reflective strip with 3" (76mm) wide flo-orange color
23-700-FO	S, M, L, XL, 2X, 3X	Flo-Orange	2" (51mm) thick reflective strip with 3" (76mm) wide flo-yellow color



NEW!



Back View 700

SNC5500 / SNC5600

SAFETY NECK SHADE FOR HARD HATS

- One size fits most hard hats
- Elastic band to secure onto hat
- Two colors available
- 3/4" (19mm) grey reflective stripes with contrast color binding

sku	sizes available	color	reflective striping
23-SNC5500	One Size Fits All	Flo-Lime	3/4" (19mm) reflective strip with orange contrast
23-SNC5600	One Size Fits All	Flo-Orange	3/4" (19mm) reflective strip with yellow contrast



RS-SERIES

EYEWEAR, CUSTOM-FIT

Sleek and contemporary with comfort fit.

- Soft, pliable TPR material on tips and pads
- Adjustable saddle nose pads for a comfort-fit
- Polycarbonate lenses prevent scratching
- Lenses are tapered to eliminate refraction



CN-SERIES

EYEWEAR, 3-POINT FIT

Designed to offer the best eye protection as well as a comfortable, stylish design.

- Soft, pliable TPR material on tips and pads
- Frames are conveniently lightweight with durable, comfortable straight temple design
- Polycarbonate lenses prevent scratching



SZ-SERIES

EYEWEAR, SEMI-RIMLESS

Semi-rimless style that eliminates side shields to allow full use of your peripheral vision.

- TPR material on tips and pads
- Adjustable saddle nose pads for a comfort-fit
- Sporty curve-shaped polycarbonate lenses prevent scratching or fog up from below



sku	lens type	frame color
24-RS21W	Non-polarized	White
24-RS21WP	Polarized	White
24-RS21B	Non-polarized	Black
24-RS21BP	Polarized	Black

sku	lens type	frame color
24-CN21B	Non-polarized,	Black
24-CN21BP	Polarized	Black
24-CN21C	Non-polarized,	Camouflage
24-CN21CP	Polarized	Camouflage

sku	lens type	frame color
24-SZ21B	Non-polarized	Black
24-SZ21BP	Polarized	Black
24-SZ22G	Non-polarized	Grey
24-SZ22GP	Polarized	Grey

ANSI Z87.1+2010 SAFETY STANDARDS

• For impact and projectile protection

NOTE: Polarized lenses create sharper, clearer vision and filter light from above and below to minimize glare and maximize visibility. Non-polarized lenses are better suited for LCD/GPS devices.

MACHETE SHEATHS

Leather sheath keeps your machete safe guarded and handy, protects machete while carrying on your side or during transport. Heavy duty formed leather is side-stitched with durable nylon thread and then riveted at strain points. Built for quality, strength, and longevity.

- Made of heavy duty top grain leather for durability and maximum life
- Side-stitched and riveted at strain points
- Durable, reinforced 1-1/2" wide belt loop fits up to 3-in belt
- Available for: 28", 24", 22", and 18" machete



sku	designed for	actual length	fits blade width	wgt
17-LS18	18" machete	17-1/2"	2-1/2"	0.45 lb (204 g)
17-LS22	22" machete	21-1/2"	2-1/2"	0.52 lb (235 g)

sku	designed for	actual length	fits blade width	wgt
17-LS24	24" machete	23-1/2"	2-1/2"	0.61 lb (276 g)
17-LS28	28" machete	27-1/2"	2-1/2"	0.73 lb (331 g)

17-406

LEATHER QUIVER FOR MARKING PINS

Leather quiver keeps your survey marking pins handy at your side. Heavy duty formed leather is side-stitched with durable nylon thread and then riveted at strain points. Built for quality, strength, and maximum life.

- Holds up to twelve (12) 14" marking pins
- Side-stitched and riveted at strain points, reinforced bottom
- Durable, reinforced 1-1/2" wide belt loop fits up to 3" belt



51-WE26T

SHOT BAG PAPERWEIGHT

Leather paperweight is ideal for anchoring blueprints and plans when working outside. Top grain leather suede bag is filled with steel shot and stitched with heavy duty nylon thread.

- Made of top grain brown leather
- 4" (10.2cm) diameter
- Holds down important documents such as blueprints and plans
- Weighs 1.5 lb (0.68 kg)
- Filled with steel shot



51-10107

7-POCKET SURVEYOR'S TOOL POUCH

Surveyor's tool pouch is made of top grain saddle leather and features seven (7) pockets. Stores field book, plumb bob marking pins, folding rule, scribe, survey tacks and nails, and pencils.

- Riveted and stitched in heavy duty nylon thread for extra strength and durability
- Tunnel loop saddle fits up to 2-1/2 in belt
- Tapered pocket with snap-button strap secures up to 16-oz plumb bob
- Easy access front pocket snap-lid for tacks or nails



1016/2432

PLUMB BOB SHEATHS

- Keeps your plumb bob handy at your side
- Made of top grain leather for durability and maximum life
- Tapered pocket with snap-button strap fits and secures plumb bob
- Riveted and stitched in heavy duty nylon thread for extra durability
- Slits to fit 2-in belt insertion

sku	designed for
15-1016	16 to 18 ounce plumb bob
15-2432	24 to 32 ounce plumb bob



51-10109

PRO CONTRACTOR'S TOOL POUCH

- Made of top grain saddle leather
- Nine (9) pouches stores field book, 16oz. plumb bob, marking pins, folding rule, scribe, survey tacks and nails, and pencils.
- Riveted and stitched in heavy duty nylon thread for extra strength and durability
- Tunnel loop saddle fits up to 2-1/2-in belt
- Tapered pocket with snap-button strap secures plumb bob
- Easy access front pocket snap-lid for tacks or nails



51-10218G

SHEATH FOR GAMMON REEL & PLUMB BOB

Heavy-duty leather scabbard with stitched and riveted pockets provides snug and convenient pockets with cut-out hole on front for easy access.

- Holds 16-18 oz plumb bob and Gammon Reel® or tape
- Riveted and stitched in heavy duty nylon thread for extra strength and durability
- Snap button straps secure plumb bob and Gammon Reel in pockets
- Slits for up to 3-in belt insertion



*Plumb bob and GammonReel not included

Gammon Reel® is a registered trademark of Dave White's SitePro



SITEGEAR®



51-15018-DB

3-POUCH PRO LEATHER TOOL BAG WITH TAPE HOLDER

- Pockets/tool holders: 11, Right Hand Type
- 8-inch deep pouch, tape holster designed to hold up to a 35' tape, and holders for hammer, work knife, lumber crayon, chisel, small level, pencils
- Built for easy access with the left hand and are worn on the left side of the body
- Main pouch: 9 x 8" ;
Two Outer pouches: 5.2 x 5.5"
- Fits belt size up to 3" wide



51-15062

4-POUCH PRO LEATHER FASTENER BAG WITH HOLDERS

- Pockets/tool holders: 10, Left Hand Type
- 8-inch deep pouch and holders for angle square, cat's paw loop, 1" blade square, driver bits, pencils
- Built for easy access with the left hand and are worn on the left side of the body
- Main pouch: 9 x 8"; Middle pouch: 7 x 6";
Outer pouch: 5.6 x 5.6";
Upper pouch: 4.6 x 4.6"
- Fits belt size up to 3" wide



51-15060

3-POUCH PRO LEATHER FASTENER BAG WITH HOLDERS

- Pockets/tool holders: 9, Right Hand Type
- Designed to hold tools and fasteners for framing and carpentry applications
- Holders for angle square, cat's paw loop, 1" blade square, driver bits, pencils, etc
- Fits belt size up to 3" wide
- Main pouch: 9 x 8" ; Outer pouch: 7 x 6";
Upper-pouch: 4.6 x 4.6"



51-10110-TS

10-POCKET TOOL AND NAIL POUCH

- Pockets/tool holders: 12
- Made of top grain oily-tanned leather
- Left, right side steel swinging hammer ring holders
- Double-gusset front pocket
- Contrasting heavy duty suede trim and stitching
- Fits belt size up to 3" wide

NEW!



51-15024

LARGE PRO LEATHER UTILITY BAG

- Pockets: 1
- Large pouch designed to hold fasteners for framing and carpentry applications
- Designed with an extra deep bag
- Fits belt size up to 3" wide
- Main pouch: 10" x 10.5"

NEW!



51-15019

COMPACT PRO LEATHER UTILITY BAG

- Pockets: 1
- Designed to hold fasteners (or use as a tool holder) for framing and carpentry applications
- Compact design is ideal for that third bag in the back
- Fits belt size up to 3" wide
- Main pouch: 7.75" x 8"



SITEGEAR Pro Leather Bags and Pouches are guaranteed with a two (2) year limited warranty. visit our website for more details.

SITEGEAR®

51-15089 7-POUCH PRO FRAMER SET

The 15089 provides the most pouches offered in the SiteGear™ Series. The 15089 set is designed for professional framers.

- Left side fastener has one extra bag for maximum fastener capacity
- Pockets/tool holders: 23
- Available Sizes (belt): M, L, or XL
- Weight: 6.0 lb



Three sizes available: Medium (51-15089-M), Large (51-15089-L), and X-Large (51-15089-XL). See [page 46](#) for information- How To Size Your Work Belt.

SITEGEAR offers combo kits that will fit your needs of the general contractor, carpenter, construction worker. Our tool belts are dependable and packed with features. We are committed to quality, value, and features.

51-10113-TSB 10-POCKET CARPENTER'S NAIL AND TOOL BAG

- Pockets/tool holders: 13
- Made of top grain oily-tanned leather
- Web loop for pry bar
- Snap-lock pouch handle
- Double-gusset front pocket
- Swinging hammer ring holder; steel tape measure clip
- Fits belt size up to 3" wide
- Includes 2" web belt (one-size-fits-all)



51-B2617 PRO FRAMER BALLISTIC COMBO TOOL BELT

- 6-piece carpenter's combo is the perfect belt for any tradesman or professional builder's needs
- 28 convenient pockets
- Designed with rugged, lightweight ballistic poly fabric and double-stitched pockets to survive all wear/tear
- Padded, adjustable suspenders
- Wide padded belt system with steel roller buckle for comfort - fits waist sizes: 29-inches to 46-inches
- Removeable carry handles for easy carrying
- Weighs 4.1 lb (1.86kg)





SITEGEAR®



51-12101 M L XL
2" TOP GRAIN LEATHER BELT

- Leather 2" work belt- rugged and comfortable
- Constructed with thick bridal leather
- Heavy duty steel roller buckle is reinforced with a nickel finish
- Edge stitched for quality, appearance and strength
- Sizes: M (33" to 35"), L (36" to 39"), XL (40" to 44")



51-12035 M L XL
3-IN RANGER WORK BELT

- Leather 3" ranger style work belt with 2" wide tongue
- Constructed with high quality bridle leather with nickel plated steel roller buckle
- Edge stitched for quality, appearance and strength
- Steel rivet reinforcement
- Sizes: M (33" to 35"), L (36" to 39"), XL (40" to 44")



51-12102 M L XL
2" DOUBLE GROMMET BELT

- Double-pronged roller buckle keeps it secure
- 2-in poly web belt is durable and weather resistant
- Edge stitched with heavy duty nylon thread
- Ends are finished top grain oil-black leather for comfort and appearance
- Sizes: M (33" to 35"), L (36" to 39"), XL (40" to 44")

HOW TO SIZE YOUR WORK BELT?

To size your tool belt, place your existing tool belt on an even surface and measure it from the end of the buckle to the most commonly used hole. Select the belt size by the mid point that is closest to your measurement.



If you do not have a current tool belt to measure, you can get an approximate mid range measurement by adding 4-inches to your pant waist size.

51-11220
PRO HAMMER
HOLDER

- Made of heavy duty custom-tanned top grain leather
- Steel hammer ring is wedged between two layers of leather and stitched with heavy duty nylon thread
- Rivets and Edge stitching in contrasting heavy duty nylon thread for durability and maximum life
- Slits to fit up to 3" (76mm) belt



51-15009
LEATHER WORK
SUSPENDERS

- Traditional heavy duty leather suspenders
- Hand crafted from Bridle leather with large shoulder pads
- Heavy duty spring clips snap on and off your work belt
- Direct connection loop attachment hardware
- Fully adjustable



51-11422P
LEATHER KNEE PADS

- Wide adjustable leather buckle strap with steel buckle
- Made of top grain leather
- 1" thick water repellent soft felt lining shaped to fit your knees and add extra comfort
- Stitched with heavy duty nylon thread and riveted for extra strength
- One size fits most



51-11137
HIGH MOUNT
TAPE HOLDER

- Made of heavy duty top grain leather
- Belt worn (up to 3" belt)
- Made to fit up to 35' tape
- Rivets for durability
- Cut-out bottom for easy access to tape



51-11230
TAPE HOLDER

- Made of heavy duty top grain leather
- Belt worn (up to 3" belt)
- Made to fit 25' to 30' tape
- Rivets and edge stitching in contrasting heavy duty nylon thread for durability and maximum life
- Cut-out bottom for easy access to tape



51-B1528
11" ELECT. & MAINT. TOOL CARRIER

- 32 pockets with built-in measuring tape clip
- Flapped external pocket
- Large open-top center cavity
- Water-resistant Ballistic quality material, made of reinforced 600D polyester, reinforced rivets
- Durable molded polypropylene base
- Non-slip, ergonomic carrying handle with key clip
- Inner dimensions: 9.25" L x 10.5" D x 10.25" H

NEW!



51-B1535
18-IN WIDE MOUTH TOOL BAG

- Wide mouth top and large interior compartment with HD zipper
- Durable water-resistant Ballistic quality material, made of reinforced 600D polyester, reinforced rivets
- 19 pockets, slots- includes a zippered pocket
- Durable molded polypropylene base
- Padded adj. shoulder strap with non-slip handle
- Weighs 3.6 lbs (1.63 kg)

NEW!





GAMMON REEL®

#001
PLUMB LINE REEL
FOR SURVEYOR

- Designed for use in the surveying field
- 6-1/2 foot (1.9m) orange string
- Quickly retracts eliminating tangled string



sku	description
15-001	Gammon Reel® Plumb Line Reel for Surveyors (6-1/2 foot)

GAMMON REEL®

#012
PLUMB LINE REEL
FOR CONSTRUCTION

- Designed for use in the construction field
- 12 foot (3.6m) fluorescent red string
- Mylar® protected target also serves as a sight
- Quickly retracts eliminating tangled string



sku	description
15-012	Gammon Reel® Plumb Line Reel for Construction (12-ft)
15-012B	Gammon Reel® Plumb Line Reel for Construction (12-ft), Black

GAMMON REEL®

#015
GAMMAGNET® MAGNETIC
CASE FOR #001

- For use with the #012 GAMMON REEL® plumb line reel in steel frame and beam construction
- Strong neodymium (rare earth) magnet mounts to any steel surface



sku	description
15-015	GAMMAGNET® magnetic case, for use with #012

GAMMON REEL®

#002
REPLACEMENT STRING

- Refill string is made of high-quality nylon
- Innovative bobbin case keeps string wound and safely stowed.
- 24 yd. replacement string
- Strong 72-lb test nylon string
- Choice of six (6) available colors



sku	string color	length
15-002-O	Orange	24 yd (22 m)
15-002-FR	Flo-Red	24 yd (22 m)
15-002-FY	Flo-Yellow	24 yd (22 m)

PLUMB BOBS

SitePro plumb bobs are precision machined for perfect balance and treated for a lasting finish.

- Brass construction
- Steel ASA screw cap allows storage for extra point
- Includes a hardened steel point with ASA thread- stored inside cap



sku	wgt	sku	wgt
15-016	16 oz (454 g)	15-024	24 oz (680 g)
15-018	18 oz (510 g)	15-032	32 oz (907 g)

PLUMB BOB SHEATHS

- Heavy duty and riveted for long life
- Made of top grain saddle leather
- Strong metal snap secures bob in sheath



sku	description	designed for
15-1016	Small Plumb Bob Sheath	16oz - 18oz Plumb Bob
15-2432	Large Plumb Bob Sheath	24oz - 32oz Plumb Bob

CONTRACTOR KITS

GAMMON REEL KIT W/ PLUMB BOB AND SHEATH

The Gammon Reel kits are ideal for the contractor. Leather sheath keeps your plumb bob and Gammon Reel handy at your side.

- Riveted and stitched in heavy duty nylon thread for extra strength and durability
- Snap button straps secure plumb bob and Gammon Reel in pockets
- Slits for up to 3-in belt insertion
- Gammon Reel and plumb bob included



sku	plumb bob	plumb reel
15-1021GR16KIT	16-oz (#15-016)	12-ft (#15-012)
15-1021GR18KIT	18-oz (#15-018)	12-ft (#15-012)

GAMMON REEL® and GAMMAGNET® are trademarks of Dave White's SitePro



SURVEY BOOKS

The SitePro survey books are made of white quality paper with extra-stiff hard cover book. Published on quality paper, cover protected by a water barrier with blind embossing.

- 80 Sheets (160 pages)
- Quality content paper
- Ruled light blue with red vertical lines
- Hardback, orange color
- Size: 4-1/2" x 7-1/4"
- Reference tables/diagrams in back section

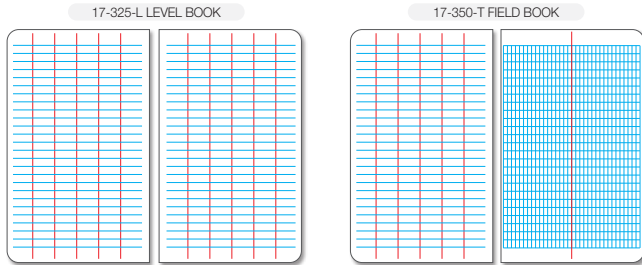

sku	description	left page	right page	#pages
17-325-L	Level Book	Six (6) Vertical Columns	Six (6) Vertical Columns	160
17-350-T	Field Book	Six (6) Vertical Columns	8 x 4 Grid	160

13-642

TOPOGRAPHIC ABNEY LEVEL

- Square sighting tube with internal focusing telescope
- Dual interchangeable arcs: one arc graduated in percentage of grade/degrees (bi-directional, 0° to 60°) and one graduated in percentage of grade/topographic scale
- Length: 6-3/8" (16.1cm)
- Includes belt loop case



651 / 661

TRANSIT COMPASS

- Graduated circle for optimal versatility
- Dampened for superior stability
- Includes velvet lined, belt-loop case for storage and transport



sku	description
17-651	Compass, Transit Pocket 0-360 Degrees
17-661	Compass, Transit Pocket Quadrants

13-632

6" BRASS HAND LEVEL

- 2-power magnification
- 6" (15.2cm) long draw eyepiece extends to 7-1/2" (19.1cm)
- Internally mounted bubble assembly



17-100

4-DIGIT TALLY COUNTER

- Four-digit mechanical counter counts up to 9999, with reset to zero
- Audible click
- Easy reading digits with protective window



13-590

2.5X HAND LEVEL

- 2.5-power magnification
- Convenient pocket-sized tool for establishing a level line of sight
- Ideal for preliminary survey and simple distance estimation
- Stadia and vertical lines
- Length: 5" (12.7cm)
- Includes carrying case



17-401

14-IN MARKING PINS

Used primarily by land surveyors and are also known as chaining pins.

- 14-in (35.5 cm) length
- 3/16" (4.8 mm) spring steel, heat-treated
- Powder-painted red and white, alternating at each 1-inch (25.4mm)
- Eleven (11) marking pins
- Weigh 1.6 lb (.73 kg) per 11 pins

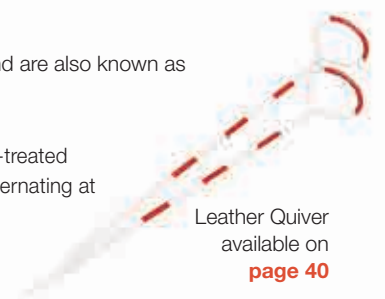

Leather Quiver available on [page 40](#)

17-911

DOUBLE RIGHT ANGLE PRISM

- Large field of view and foresight viewing glass
- Center lens permits foresight viewing
- Step off angles of 90° and 180°
- Includes carrying case



17-411

CARRYING RING FOR MARKING PINS

- 3/16" (4.8 mm) spring steel, heat-treated
- Power-painted white
- Eye with slip hook locks ring to secure pins





700 SERIES SURVEY MARKERS

- Cast from solid brass
- Ideal for boundary or general survey markers
- Shank is ribbed to prevent turning or loosening
- Non-glare finish
- Available in both flat and domed head design



FLAT HEAD



DOMED HEAD

sku	length	head type	sku	length	head type
19-700	1-3/8 in (34.9mm)	Flat	19-705	2 in (50.8mm)	Domed
19-701	2 in (50.8mm)	Flat	19-706	2-1/2 in (63.5mm)	Domed
19-702	2-1/2 in (63.5mm)	Flat	19-707	3 in (76.2mm)	Domed
19-703	3 in (76.2mm)	Flat			

207 GIANT CONCRETE SCRIBE

- Ideal for fine line marking on metal and stone
- Precision ground carbide scribe tip
- Machined aluminum handles with diamond knurling for sure grip
- Pocket clip and protective cap



sku	description	tip
17-207	7-1/2 in Concrete Scribe, with Replaceable Tip	Carbide
17-201-10	Replacement Tip (Pack of 10)	Carbide

DWSITEPRO HI-MAGNETIC MASONRY NAILS

- 3 times easier to locate the other nails on the market
- Most preferred by professionals
- Zinc plated to resist corrosion
- Large targeted center point
- 6 sizes available from 2-1/2 to 3/4 inches in length

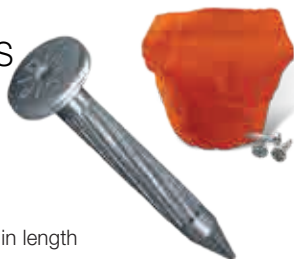

sku	length	diameter	ct per box
20-751	3/4 in (19.05mm)	1/8 in (3.18mm)	100
20-752	1 in (25.4mm)	5/32 in (3.97mm)	100
20-753	1-1/4 in (31.75mm)	3/16 in (4.76mm)	100
20-754	1-1/2 in (38.1mm)	1/4 in (6.35mm)	100
20-755	2 in (50.8mm)	1/4 in (6.35mm)	100
20-756	2-1/2 in (63.5mm)	1/4 in (6.35mm)	100

19-750 3/4" STAKE TACKS, ZINC PLATED

- New and improved zinc plated surveyor tacks
- 3/4-in length
- 1 lb (0.45kg) per box
- Approximately 750 tacks per box



sku	description	wgt
19-750	3/4-in (19mm) Stake Tacks, Zinc-Plated	1 lb (0.45kg)
19-BALL750	3" (76mm) Rubber Sponge Tack Ball with Loop	

STAKE FLAGS STEEL WIRE FLAGS

Ideal to ensure consistent communication and long-lasting visibility for utility construction, line locating, forestry, and landscaping.

- Steel wire constructed of rust-resistant alloy steel
- Flags made of long lasting PVC material with high visibility ink color
- Tear resistant for high performance to -20°F
- Flag is glued to staff for durability
- Sold in Box of 10 bundles (each bundle includes 100 flags)



sku	flag size	length	color	flags in box	box gross wgt
19-F4521-B	4" x 5"	21"	Blue	1000	23 lbs
19-F4521-G	4" x 5"	21"	Green	1000	23 lbs
19-F4521-GL	4" x 5"	21"	Glo-Lime	1000	23 lbs
19-F4521-GO	4" x 5"	21"	Glo-Orange	1000	23 lbs
19-F4521-GP	4" x 5"	21"	Glo-Pink	1000	23 lbs
19-F4521-R	4" x 5"	21"	Red	1000	23 lbs
19-F4521-W	4" x 5"	21"	White	1000	23 lbs
19-F4521-Y	4" x 5"	21"	Yellow	1000	23 lbs
19-F4530-B	4" x 5"	30"	Blue	1000	31 lbs
19-F4530-G	4" x 5"	30"	Green	1000	31 lbs
19-F4530-GL	4" x 5"	30"	Glo-Lime	1000	31 lbs
19-F4530-GO	4" x 5"	30"	Glo-Orange	1000	31 lbs
19-F4530-GP	4" x 5"	30"	Glo-Pink	1000	31 lbs
19-F4530-R	4" x 5"	30"	Red	1000	31 lbs
19-F4530-W	4" x 5"	30"	White	1000	31 lbs
19-F4530-Y	4" x 5"	30"	Yellow	1000	31 lbs

FTX-G GLOW FLAGGING TAPE, 4MIL

- Bright, long-lasting high visibility glo-colors
- -20°F temperature resistance
- Smooth, bright, and reflective appearance
- 4.0 mil thickness
- Environmental protection material
- Six (6) colors available
- Sold in box of 12 rolls



sku	ribbon size	color	ribbon length (approx.)
19-FTX-GL	1-3/16" (30mm)	Glo-Lime/Green	150' (45m)
19-FTX-GO	1-3/16" (30mm)	Glo-Orange	150' (45m)
19-FTX-GOR	1-3/16" (30mm)	Glo-Reddish Orange	150' (45m)
19-FTX-GP	1-3/16" (30mm)	Glo-Pink	150' (45m)
19-FTX-GR	1-3/16" (30mm)	Glo-Red	150' (45m)
19-FTX-GY	1-3/16" (30mm)	Glo-Yellow	150' (45m)



21-200
48" STANDARD
LATH BAG

- Hold and carry 36" or 48" (92cm or 122cm) laths
- Constructed with high strength fiber material with reinforced base
- Three (3) large, pleated outside pockets for markers, paint, and other materials
- Heavy duty adjustable shoulder strap to carry
- Overall inside: 8" x 33.5" (20cm x 84cm)
- Color: Hi-vis orange



21-248
48" REINFORCED
LATH BAG

- Hold and carry 48" (122cm) lath
- High strength fiber material with tough, waterproof and abrasion-resistant material at the bottom and 6" (15cm) up the side
- 8" (20 cm) diameter bucket style bottom
- Three (3) large, pleated outside pockets for markers, paint, and other materials
- Heavy duty adjustable shoulder strap and hand loop to carry
- Overall inside: 8" x 45" (20 cm x 114 cm)
- Color: Hi-vis orange



21-236
36" REINFORCED LATH BAG

- Hold and carry 36" (92cm) lath
- High strength fiber material with tough, waterproof and abrasion-resistant material at the bottom and 6" (15cm) up the side
- 8" (20cm) diameter bucket style bottom
- Three (3) large, pleated outside pockets for markers, paint, and other materials
- Heavy duty adjustable shoulder strap and hand loop to carry
- Overall inside: 8" x 33.5" (20cm x 84cm)
- Color: Hi-vis orange



HEAVY DUTY DESIGNS FOR PURPOSE, DURABILITY, AND WITH STYLE

21-28102
38" LATH BAG, HEAVY-DUTY WITH HANDLES

- Constructed with high strength fiber material and tough with heavy duty stitching and reinforced bottom
- Designed to hold up to 50 lath or rebar
- Carries up to 50 lath or rebar
- Bottom of bag features tough, waterproof and abrasion-resistant composite material
- 7 large pockets and slots: One (1) large pocket, two (2) small pockets, one (1) can holder, 3 small market slots
- Heavy duty adjustable padded shoulder strap and two hand loops to carry
- Overall dimensions: 9" x 38" (23 cm x 97 cm)
- Color: Hi-vis orange



21-758
24" STAKE BAG, HEAVY-DUTY

- Designed to hold 24-inch (60 cm) wood survey stakes or iron rebar
- Five (5) large pockets made of tough nylon fiber material to store flagging tape, nails, or other gear
- Constructed with high strength fiber material and tough with heavy duty stitching and reinforced bottom
- Bottom of bag features tough, waterproof and abrasion-resistant composite material
- Heavy duty adjustable shoulder strap for carrying
- Grommet drain holes are positioned at both end of bag



21-718
18" STAKE BAG, HEAVY-DUTY

- Designed to hold 18" wood survey stakes or iron rebar
- Constructed with high strength fiber material and tough with heavy duty stitching and reinforced bottom
- Bottom of bag features tough, waterproof and abrasion-resistant composite material
- Heavy duty adjustable shoulder strap for carrying
- Five (5) large pockets made of tough nylon fiber material to store flagging tape, nails, or other gear
- Grommet drain holes are positioned at both end of bag





21-81540

56" GPS TRIPOD BAG, HEAVY-DUTY

The SitePro heavy duty GPS tripod bag is designed to protect and carry heavy duty GPS antenna tripod (#09-100).

- Ends of the bag are protected with tough, waterproof and abrasion-resistant composite material
- Heavy duty adjustable shoulder strap is detachable
- Two hand loops with built-in Velcro grip to carry

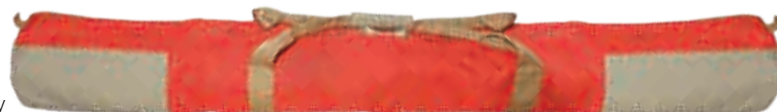

- Constructed with high strength fiber material and tough, waterproof and abrasion-resistant material at bottom
- Heavy duty zipper and stitching for greater durability
- Overall Inside: 8" x 56" (20.3 cm x 142 cm)

21-81520

HEAVY DUTY TRIPOD BAG

- Holds all major brands of aluminum or wood tripods
- Constructed with high strength fiber material and tough with heavy duty stitching and reinforced bottom
- Double pull string ties at the top
- Three (3) large pockets made of tough nylon fiber material to store other gear
- Grommet drain hole at end of bag
- Heavy duty adjustable shoulder strap for carrying
- Weight: 1.85 lb (0.85kg)



21-2547

TOP LOADING FIELD CASE FOR TOTAL STATION, HEAVY-DUTY

This heavy duty padded field case fits most total stations. Designed as a backpack and constructed with water-resistant nylon.

- Constructed with high strength fiber material and tough with heavy duty stitching and reinforced bottom
- Designed to load instrument from the top of case
- 2-in thick foam padding on all inner sides
- Bottom of case is protected with a tough waterproof and abrasion-resistant composite material



- Inside dimensions for total station: 14.0 x 9.0 x 7.0-in (36 x 23 x 18cm)
- Weight: 6.75 lb (3.1kg)

21-PC50

SPRAY CAN HOLDER

- Holds a paint can on hip for easy access; designed to carry a standard size spray-paint can
- Heavy duty nylon construction with nylon webbing belt loop that fits up to a 2-in wide belt
- Color: Hi-vis orange
- Wgt: 0.14lb (0.06kg)



21-PC50P

PAINT CAN HOLDER WITH POCKETS

- Designed with pockets to hold a folding rule which includes a Velcro strap; marker pens; pencils; and other items
- Heavy duty belt loop with reinforced stitching that fits up to a 2-in wide belt
- Paint can pocket lined with reinforcement for easy in and out of can
- Velcro safety strap
- Constructed with high strength fiber material that is tough and abrasion-resistant
- Color: Hi-vis orange



21-2542

LARGE PADDED BAG

- Extra thick padding on all inner sides for protection of your device
- Suitable for use with triple tilting prism
- Strap handles for carrying
- Heavy-duty zipper
- Inside dimensions: 9" x 7" x 2" (22.9cm x 17.8cm x 5.1cm)
- Weighs 0.5 lb (0.34 kg)



OTHER CASES



21-2581

JUMBO PADDED BAG

- Ideal for triple prisms and prism targets or tribrach kits
- Thick padded interior
- Heavy-duty zipper
- Inside dimensions: 10" x 9.5" x 3" (25.4cm x 24.1cm x 7.7cm)
- Outside dimensions: 12" x 12.5" x 8" (30.5cm x 32cm x 20.3cm)
- Outside pocket
- Weighs 1.06 lb (0.48 kg)



sku	description	designed for
21-1200	Padded Bag, Tribrach	05-1200 Series tribrachs
21-2010	Padded Bag, Prism	03-2010M, 03-1010 prisms

OUR BRANDS

GAMMON REEL®

GAMMON REEL®, founded in 1962, provides line reels for both surveying and construction, as well as the GAMMAGNET® magnetic case for steel beam construction. GAMMON REEL is a well-known and respected brand in the surveying and construction industry.

David White®

David White®, founded in 1895 (Milwaukee, Wisconsin), provides productivity tools for leveling, layout and measuring in the construction and surveying industries. The David White brand is offered exclusively by Dave White's SitePro.



The SITEGEAR® brand is focused to provide best-in-class solutions for professionals in the construction and industrial market with work gear that works.



The SALAMANDER® brand is focused to provide professionals in the construction and industrial market with all-environment, high-visibility products.

Dave White's SitePro is a leading supplier of surveying and contractor's tools, accessories, optical and laser instruments, measuring devices, site gear, and field supplies for surveyors, industrial and construction use.

SitePro aims to give its customers the value and quality they seek to increase performance and best in class customer service. We're constantly

looking for better solutions to improve the customer experience. Our customers deserve the best experience every time, and improving upon that is our priority.

SitePro products are sold through a network of dealers and distributors and also as private-labeled products. Please contact us with any questions or suggestions.



Dave White's
SitePro™

Dave White's SitePro

Lafayette, IN

email: info@dwsitepro.com
website: www.dwsitepro.com