



Color Laser Printer

Xpress C1810 series

SL-C1810W

(Ver 1.01)

SERVICE MANUAL

Color Laser Printer

Contents



1. Precautions
2. Product specification and description
3. Disassembly and Reassembly
4. Alignment and Troubleshooting
5. System Diagram
6. Reference Information

Refer to the service manual in the GSPN (see the rear cover) for more information.

Contents

1.	Precautions	1 – 1
1.1.	Safety warning	1 – 1
1.2.	Caution for safety	1 – 2
1.2.1.	Toxic material.....	1 – 2
1.2.2.	Electric shock and fire safety precautions	1 – 2
1.2.3.	Handling precautions	1 – 4
1.2.4.	Assembly and Disassembly precautions	1 – 4
1.2.5.	Disregarding this warning may cause bodily injury	1 – 5
1.3.	ESD precautions.....	1 – 6
2.	Product specification and description.....	2 – 1
2.1.	Product Specification.....	2 – 1
2.1.1.	Product Overview.....	2 – 1
2.1.2.	Specifications	2 – 2
2.1.2.1.	General Print Engine.....	2 – 2
2.1.2.2.	Controller and Software.....	2 – 2
2.1.2.3.	Paper Handling.....	2 – 3
2.1.2.4.	Reliability and Service	2 – 4
2.1.2.5.	Environment	2 – 5
2.1.2.6.	Consumables.....	2 – 5
2.1.2.7.	Maintenance Parts	2 – 6
2.1.3.	Model Comparison Table	2 – 7
2.2.	System Overview.....	2 – 8
2.2.1.	Front View.....	2 – 8
2.2.2.	Rear View.....	2 – 9
2.2.3.	Paper Path.....	2 – 10
2.2.4.	System Layout.....	2 – 11
2.2.4.1.	Feeding Section	2 – 12
2.2.4.2.	Transfer Roller	2 – 13
2.2.4.3.	Drive Unit	2 – 13
2.2.4.4.	Fuser Unit.....	2 – 14
2.2.4.5.	LSU (Laser Scanner Unit).....	2 – 15
2.2.4.6.	Toner Cartridge.....	2 – 16
2.2.5.	Hardware configuration	2 – 17
2.2.5.1.	Main board	2 – 19
2.2.5.2.	OPE Controller.....	2 – 21
2.2.5.3.	Wireless LAN board	2 – 22
2.2.5.4.	SMPS board.....	2 – 23
2.2.5.5.	HVPS board.....	2 – 25

2.2.5.6.	ITB EEPROM PBA.....	2 – 26
2.2.5.7.	NFC Tag Sticker.....	2 – 27
2.2.5.8.	Electrical Parts Location.....	2 – 28
2.2.6.	Engine F/W Control Algorithm.....	2 – 30
2.2.6.1.	Feeding.....	2 – 30
2.2.6.2.	Transfer.....	2 – 30
2.2.6.3.	Fusing.....	2 – 31
2.2.6.4.	LSU.....	2 – 31
2.2.7.	Software Descriptions.....	2 – 32
2.2.7.1.	Software system overview.....	2 – 32
2.2.7.2.	Architecture.....	2 – 32
2.2.7.3.	Data and Control Flow.....	2 – 33
3.	Disassembly and Reassembly.....	3 – 1
3.1.	Precautions when replacing parts.....	3 – 1
3.1.1.	Precautions when assembling and disassembling.....	3 – 1
3.1.2.	Precautions when handling PBA.....	3 – 1
3.1.3.	Releasing Plastic Latches.....	3 – 2
3.2.	Screws used in the printer.....	3 – 3
3.3.	Replacing the maintenance parts.....	3 – 4
3.3.1.	Toner Cartridge.....	3 – 4
3.3.2.	Waste Toner Container.....	3 – 5
3.3.3.	ITB Unit.....	3 – 6
3.3.4.	Fuser Unit.....	3 – 8
3.3.5.	Transfer Roller Assy.....	3 – 9
3.3.6.	Pick up_Forward_Reverse roller.....	3 – 9
3.4.	Replacing the main SVC parts.....	3 – 10
3.4.1.	Cover.....	3 – 10
3.4.2.	HVPS board.....	3 – 12
3.4.3.	Outer Temperature Sensor.....	3 – 12
3.4.4.	Waste toner container sensor.....	3 – 13
3.4.5.	LSU.....	3 – 13
3.4.6.	Main Board.....	3 – 14
3.4.7.	SMPS board.....	3 – 14
3.4.8.	Feed Drive Unit.....	3 – 15
3.4.9.	FRAME-RETARD.....	3 – 16
3.4.10.	Main Drive Unit.....	3 – 17
4.	Alignment and Troubleshooting.....	4 – 1
4.1.	Alignment and Adjustments.....	4 – 1
4.1.1.	Control panel.....	4 – 1
4.1.2.	Understanding the status LED.....	4 – 3

- 4.1.3. Clearing paper jams 4 – 4
- 4.1.4. Useful menu item for service 4 – 8
- 4.1.5. Periodic Defective Image 4 – 10
- 4.1.6. Useful management tools 4 – 11
 - 4.1.6.1. Using Samsung Easy Printer Manager (Windows and Macintosh only)..... 4 – 11
 - 4.1.6.2. Using Samsung Printer Status (Windows only) 4 – 13
 - 4.1.6.3. Using SyncThru Web Service (SWS) 4 – 14
- 4.1.7. Updating Firmware 4 – 16
 - 4.1.7.1. Update the firmware by using the USB port 4 – 16
 - 4.1.7.2. Update the firmware by using the network 4 – 17
- 4.1.8. Tech Mode (Diagnostic Mode) 4 – 19
- 4.2. Troubleshooting 4 – 23
 - 4.2.1. Procedure of checking the symptoms 4 – 23
 - 4.2.1.1. Basic Check List 4 – 24
 - 4.2.2. Error Code and Troubleshooting 4 – 25
 - 4.2.3. Image quality problems 4 – 44
- 5. System Diagram 5 – 1
 - 5.1. Block Diagram 5 – 1
 - 5.2. Connection Diagram 5 – 2
- 6. Reference Information 6 – 1
 - 6.1. Tool for Troubleshooting 6 – 1
 - 6.2. Glossary 6 – 2
 - 6.3. The Sample Pattern for the Test 6 – 8
 - 6.4. Document Revision List 6 – 9

1. Precautions

In order to prevent accidents and damages to the equipment please read the precautions listed below carefully before servicing the product and follow them closely.

1.1. Safety warning

- 1) Only to be serviced by a factory trained service technician.

High voltages and lasers inside this product are dangerous. This product should only be serviced by a factory trained service technician.

- 2) Use only Samsung replacement parts.

There are no user serviceable parts inside the product. Do not make any unauthorized changes or additions to the product as these could cause the product to malfunction and create an electric shocks or fire hazards.

- 3) Laser Safety Statement

The printer is certified in the U.S. to conform to the requirements of DHHS 21 CFR, chapter 1 Subchapter J for Class I(1) laser products, and elsewhere is certified as a Class I laser product conforming to the requirements of IEC/EN 60825-1:2014. Class I laser products are not considered to be hazardous. The laser system and printer are designed so there is never any human access to laser radiation above a Class I level during normal operation, user maintenance or prescribed service condition.

- Wavelength: 788 nm (-13/+12)
- Beam divergence
 - Parallel: 8 degrees (-2/+4)
 - Perpendicular: 31 degrees (-6/+4)
- Maximum power of energy output: 12 mW



WARNING

Never operate or service the product with the protective cover removed from Laser/Scanner assembly. The reflected beam, although invisible, can damage your eyes.

When using this product, these basic safety precautions should always be followed to reduce risk of fire, electric shock, and personal injury.



- 4) Lithium battery not replaceable by user

1.2. Caution for safety

1.2.1. Toxic material

This product contains toxic materials that could cause illness if ingested.

- 1) Please keep imaging unit and toner cartridge away from children. The toner powder contained in the imaging unit and toner cartridge may be harmful, and if swallowed, you should contact a doctor.

1.2.2. Electric shock and fire safety precautions

Failure to follow the following instructions could cause electric shock or potentially cause a fire.

- 1) Use only the correct voltage, failure to do so could damage the product and potentially cause a fire or electric shock.
- 2) Use only the power cable supplied with the product. Use of an incorrectly specified cable could cause the cable to overheat and potentially cause a fire.
- 3) Do not overload the power socket, this could lead to overheating of the cables inside the wall and could lead to a fire.
- 4) Do not allow water or other liquids to spill into the product, this can cause electric shock. Do not allow paper clips, pins or other foreign objects to fall into the product, these could cause a short circuit leading to an electric shock or fire hazard.

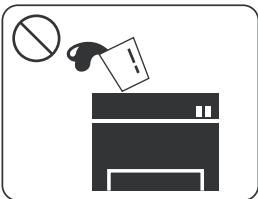

- 5) Never touch the plugs on either end of the power cable with wet hands, this can cause electric shock. When servicing the product, remove the power plug from the wall socket.

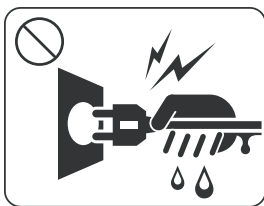

- 6) Use caution when inserting or removing the power cord. When removing the power cord, grip it firmly and pull. The power cord must be inserted completely, otherwise a poor contact could cause overheating leading to a fire.
- 7) Take care of the power cable. Do not allow it to become twisted, bent sharply around corners or power cable may be damaged. Do not place objects on top of the power cable. If the power cable is damaged it could overheat and cause a fire. Exposed cables could cause an electric shock. Replace the damaged power cable immediately, do not reuse or repair the damaged cable. Some chemicals can attack the coating on the power cable, weakening the cover or exposing cables causing fire and shock risks.

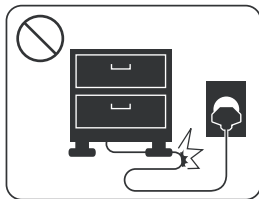

- 8) Ensure that the power sockets and plugs are not cracked or broken in any way. Any such defects should be repaired immediately. Take care not to cut or damage the power cable or plugs when moving the machine.
- 9) Use caution during thunder or lightning storms. Samsung recommends that this machine be disconnected from the power source when such weather conditions are expected. Do not touch the machine or the power cord if it is still connected to the wall socket in these weather conditions.

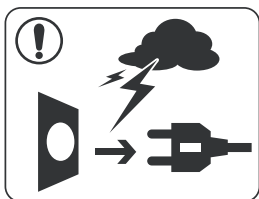

- 10) Avoid damp or dusty areas, install the product in a clean well ventilated location. Do not position the machine near a humidifier or in front of an air conditioner. Moisture and dust built up inside the machine can lead to overheating and cause a fire or cause parts to rust.

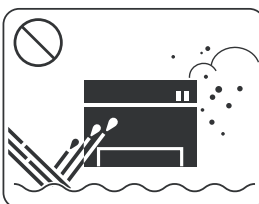

- 11) Do not position the product in direct sunlight. This will cause the temperature inside the product to rise possibly leading to the product failing to work properly and in extreme conditions could lead to a fire.
- 12) Do not insert any metal objects into the machine through the ventilator fan or other part of the casing, it could make contact with a high voltage conductor inside the machine and cause an electric shock.

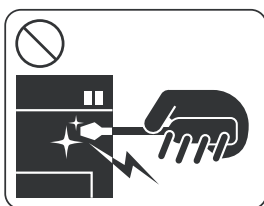

- 13)  When replacing the SMPS board, please wait 5 minutes after unplugging the power cord, then replace it. You can get a shock by the electric discharge.

1.2.3. Handling precautions

The following instructions are for your own personal safety to avoid injury and so as not to damage the product.

- 1) Ensure the product is installed on a level surface, capable of supporting its weight. Failure to do so could cause the product to tip or fall.
- 2) The product contains many rollers, gears and fans. Take great care to ensure that you do not catch your fingers, hair or clothing in any of these rotating devices.
- 3) Do not place any small metal objects, containers of water, chemicals or other liquids close to the product which if spilled could get into the machine and cause damage or a shock or fire hazard.
- 4) Do not install the machine in areas with high dust or moisture levels, beside an open window or close to a humidifier or heater. Damage could be caused to the product in such areas.
- 5) Do not place candles, burning cigarettes, etc on the product, These could cause a fire.
- 6) Ensure that the machine is installed and used in proper area to meet the temperature and humidity specifications.
 - If the machine is stored at below zero Celsius for a long time, do not use the machine instantly after movement. It can malfunction. Take care of the machine storage. If the machine is stored at below zero Celsius for a long time, keep the machine at room temperature and install it.

1.2.4. Assembly and Disassembly precautions

- 1) Replace parts carefully and always use Samsung parts. Take care to note the exact location of parts and also cable routing before dismantling any part of the machine. Ensure all parts and cables are replaced correctly. Please carry out the following procedures before dismantling the product or replacing any parts.
- 2) Ensure that power is disconnected before servicing or replacing any electrical parts.
- 3) Disconnect interface cables and power cables.
- 4) Only use approved spare parts. Ensure that part number, product name, any voltage, current or temperature rating are correct.
- 5) When removing or re-fitting any parts do not use excessive force, especially when fitting screws into plastic.
- 6) Take care not to drop any small parts into the machine.
- 7) Handling of the OPC Drum
 - The OPC Drum can be irreparably damaged if it is exposed to light. Take care not to expose the OPC Drum either to direct sunlight or to fluorescent or incandescent room lighting. Exposure for as little as 5 minutes can damage the surface of the photoconductive properties and will result in print quality degradation. Take extra care when servicing the product. Remove the OPC Drum and store it in a black bag or other lightproof container. Take care when working with the Covers (especially the top cover) open as light is admitted to the OPC area and can damage the OPC Drum.
 - Take care not to scratch the green surface of the OPC Drum Unit. If the green surface of the Drum Cartridge is scratched or touched the print quality will be compromised.

1.2.5. Disregarding this warning may cause bodily injury

- 1) Be careful with the high temperature part.

The fuser unit works at a high temperature. Use caution when working on the printer. Wait for the fuser unit to cool down before disassembly.



- 2) Do not put fingers or hair into the rotating parts.

When operating a printer, do not put hand or hair into the rotating parts (Paper feeding entrance, motor, fan, etc.). If do, you can get harm.



- 3) When you move the printer, use safe lifting and handling techniques.

This printer is heavy. Use the lifting handles located on each side of the machine. Back injury could be caused if you do not lift carefully.

- 4) Ensure the printer is installed safely.

Ensure the printer is installed on a level surface, capable of supporting its weight. Failure to do so could cause the printer to tip or fall possibly causing personal injury or damaging the printer.

- 5) Do not install the printer on a sloping or unstable surface. After installation, double check that the printer is stable.

1.3. ESD precautions

Certain semiconductor devices can be easily damaged by static electricity. Such components are commonly called “Electrostatically Sensitive (ES) Devices” or ESDs. Examples of typical ESDs are: integrated circuits, some field effect transistors, and semiconductor “chip” components. The techniques outlined below should be followed to help reduce the incidence of component damage caused by static electricity.



CAUTION

Be sure no power is applied to the chassis or circuit, and observe all other safety precautions.

- 1) Immediately before handling a semiconductor component or semiconductor-equipped assembly, drain off any electrostatic charge on your body by touching a known earth ground. Alternatively, employ a commercially available wrist strap device, which should be removed for your personal safety reasons prior to applying power to the unit under test.
- 2) After removing an electrical assembly equipped with ESDs, place the assembly on a conductive surface, such as aluminum or copper foil, or conductive foam, to prevent electrostatic charge buildup in the vicinity of the assembly.
- 3) Use only a grounded tip soldering iron to solder or desolder ESDs.
- 4) Use only an “anti-static” solder removal device. Some solder removal devices not classified as “anti-static” can generate electrical charges sufficient to damage ESDs.
- 5) Do not use Freon-propelled chemicals. When sprayed, these can generate electrical charges sufficient to damage ESDs.
- 6) Do not remove a replacement ESD from its protective packaging until immediately before installing it. Most replacement ESDs are packaged with all leads shorted together by conductive foam, aluminum foil, or a comparable conductive material.
- 7) Immediately before removing the protective shorting material from the leads of a replacement ESD, touch the protective material to the chassis or circuit assembly into which the device will be installed.
- 8) Maintain continuous electrical contact between the ESD and the assembly into which it will be installed, until completely plugged or soldered into the circuit.
- 9) Minimize bodily motions when handling unpackaged replacement ESDs. Normal motions, such as the brushing together of clothing fabric and lifting one’s foot from a carpeted floor, can generate static electricity sufficient to damage an ESD.

2. Product specification and description

2.1. Product Specification

2.1.1. Product Overview

	<ol style="list-style-type: none">1) Printing Speed<ul style="list-style-type: none">• 18 (Color)/ 18 (Mono) ppm in A4 (19/19 ppm in Letter)2) Processor<ul style="list-style-type: none">• 533 MHz3) Printer Language<ul style="list-style-type: none">• SPLC, PCL5Ce, PCL6C, PS3, PDF V1.74) Memory<ul style="list-style-type: none">• 256MB (Standard)5) Interface<ul style="list-style-type: none">• High Speed USB 2.0• 10/100/1000 BaseTX network connector• 802.11b/g/n wireless LAN• NFC printing support6) Toner Cartridge Yield<ul style="list-style-type: none">• Initial : 1,000 pages (K)/ 700 pages (CMY)• Sales: 2,500 pages (K)/ 1,800 pages (CMY)
--	---

2.1.2. Specifications



NOTE

Product Specifications are subject to change without notice.

2.1.2.1. General Print Engine

Item		Specification
Engine Speed	Simplex (C/M)	Up to 18/18 ppm in A4 (19/19 ppm in Letter)
	Duplex	N/A
FPOT	From Ready (C/M)	As fast as 16/16 sec
	From Sleep (C/M)	As fast as 32/32 sec
Resolution	Optical	600 x 600 dpi
	Enhanced	Up to 9,600 x 600 effective output

2.1.2.2. Controller and Software

Item		Specification
Processor		Samsung 533MHz
Memory	Std.	256 MB
Printer Languages		SPLC, PCL5Ce, PCL6C, PS3, PDF V1.7
Fonts		<ul style="list-style-type: none"> PCL : 95 Scalable Fonts (include OCR-A, OCR-B), 1 bitmap PS : 136 Scalable Fonts
Driver	Default Driver	SPL
	Supporting OS	[WINDOW] <ul style="list-style-type: none"> Windows 8, 7, Vista, XP, 2008R2, 2008, 2003
		[Linux] <ul style="list-style-type: none"> RedHat Enterprise Linux WS 4 / 5 (32 / 64 bit) Fedora 5 ~ 13 (32 / 64 bit) SuSE Linux 10.1 (32 bit) OpenSuSE 10.2 / 10.3 / 11.0 / 11.1 / 11.2 (32 / 64 bit) Mandriva 2007 / 2008 / 2009 / 2009.1 / 2010 (32 / 64 bit) Ubuntu 6.06 / 6.10 / 7.04 / 7.10 / 8.04 / 8.10 / 9.04 / 9.10 / 10.04 (32 / 64 bit) SuSE Linux Enterprise Desktop 10 / 11 (32 / 64 bit) Debian 4.0 / 5.0 (32 / 64 bit)
		Mac OS X 10.5 ~ 10.9
		[UNIX] <ul style="list-style-type: none"> Sun Solaris 9 / 10 (x86 / SPARC) HP-UNIX 11.0 / 11i v1 / 11i v2 / 11i v3 (PA-RISC / Itanium) IBM AIX 5.1 / 5.2 / 5.3 / 5.4
Network	Protocol	TCP/IPv4, TCP/IPv6, Raw TCP/IP, LPR, IPP, Google Cloud printing, Telnet, WSD, SLP, UPnP, mDNS, SNMPv1/v2/v3, SMTP, HTTP

Item		Specification
Application	Anyweb Print	No
	Easy Printer Manager	Yes
	Easy Color Manager	Yes
	Easy Document Creator	Yes
	Net PC Fax	N/A
	Direct Printing Utility	Yes
	Easy Deployment Manager	Yes
	Easy Eco Driver	Yes
	Universal Printer Driver	Yes
	Universal Scan Driver	N/A
Mobile Printing	GCP (Google Cloud Print)	Yes
	AirPrint	Yes

■ Interface

Item		Specification
Parallel	Option Interface	N/A
USB	High Speed USB 2.0	Device 1 Port
Wired Network		10/100/1000 Base TX
Wireless Network		802.11b/g/n
User Interface	LCD	16 characters x 2 lines
	LED	5 (ECO, POWER, NAVI, STATUS, Wireless)
	Key	Power, ECO, NAVI, OK, Stop, WPS

2.1.2.3. Paper Handling

Item		Specification
Standard Capacity	-	<ul style="list-style-type: none"> 250-sheet Cassette Tray@80g/m² 1-sheet Manual Tray
Max. Capacity	-	251 sheets @80g/m ²
Printing	Max. Size	216 x 356 mm (8.5" x 14")
	Min. Size	76 x 127 mm (3.0" x 5.0")
Standard Cassette Tray	Capacity	<ul style="list-style-type: none"> 250 sheets @80g/m²
	Media sizes	A4 / A5 / A6 / Letter / Legal / Executive / Folio / Oficio / ISO B5 / JIS B5 / Statement / Postcard / Envelope (Monarch, No-10, No-9, DL, C5, C6) / Custom [98 x 127 mm (3.86" x 5") ~ 216 x 356 mm (8.5" x 14")]
	Media types	Plain / Thin / Thick / Thicker / Cardstock / Transparency / Pre-Printed / Recycled / Archive / Bond / Label / Envelope / Cotton / Colored / Hole Punched / LetterHead / Cardstock 3" x 5" / Glossy

2. Product specification and description

Item		Specification
	Media weight	<ul style="list-style-type: none"> Supported Weight : 60 ~ 220gsm Thin Paper : 60~69g/m² Plain Paper : 70~89g/m² Thick Paper : 90~120g/m² Cardstock : 121~163g/m² Thicker Paper : 164~220g/m²
	Sensing	<ul style="list-style-type: none"> H/W Install Detect: No Paper Empty : Yes Paper Type Detect: No Paper Size Detect: No
Multi-purpose tray	Capacity	<ul style="list-style-type: none"> Plain Paper : 1 sheet @80g/m² Transparency : 1 sheet Label : 1 sheet Envelope : 1 sheet
	Media sizes	A4 / A5 / A6 / Letter / Legal / Executive / Folio / Oficio / ISO B5 / JIS B5 / Statement / Postcard / Envelope (Monarch, No-10, No-9, DL, C5, C6) / Custom [98 x 127 mm (3.86" x 5") ~ 216 x 356 mm (8.5" x 14")]
	Media type	Plain / Thin / Thick / Thicker / Cardstock / Transparency / Pre-Printed / Recycled / Archive / Bond / Label / Envelope / Cotton / Colored / Hole Punched / LetterHead / Cardstock 3" x 5" / Glossy
	Media weight	<ul style="list-style-type: none"> Supported Weight : 60 ~ 220g/m² Thin Paper : 60~69g/m² Plain Paper : 70~89g/m² Thick Paper : 90~120g/m² Cardstock : 121~163g/m² Thicker Paper : 164~220g/m² Thick paper : 90~104g/m² Bond Paper: 105~120g/m²
	Sensing	Paper Empty : no
Option Cassette (SCF)		N/A
Output Stacking	Capacity (Face-Down)	100 sheets @80g/m ²
	Output Full sensing	Paper full Sensor
ADF		N/A
Duplex		N/A

2.1.2.4. Reliability and Service

Item	Specification
Printing Volume (SET AMPV)	1,600 sheets / month
Max. Monthly Duty	40,000 sheets

2.1.2.5. Environment

Item		Specification
Temperature	Operation	15 to 30 °C (59 to 86 °F)
	Storage (packed)	-20 to 50 °C (-4 to 122 °F)
Humidity	Operation	20 to 80% RH
	Storage (packed)	10 to 90% RH
Acoustic Noise Level(Sound Power/Pressure)	Printing	Less than 50 dBA(Sound Pressure)
	Standby	Less than 32 dBA(Sound Pressure)
	Sleep	Back Ground Level
Power Consumption	Ready	Less than 50W
	AVG.	Less than 380W
	Max/Peak	1000W
	Power Save	Less than 1.5W
Dimension (W x D x H)	SET	420 x 426 x 264 mm (16.54 x 16.77 x 10.39 inches)
Weight	SET	16.62 Kg (36.7 lbs)



2.1.2.6. Consumables

Item		Specification
Toner Cartridge	Model	<ul style="list-style-type: none"> • CLT-K504S: Black • CLT-Y504S: Yellow • CLT-M504S: Magenta • CLT-C504S: Cyan
	Yield	<ul style="list-style-type: none"> • Average continuous black cartridge yield: Apporx. 2,500 standard pages (Black) • Average continuous color cartridge yield: Apporx. 1,800 standard pages (Yellow/Magenta/Cyan) <div style="background-color: #e0e0e0; padding: 5px;">  NOTE Declared cartridge yield in accordance with ISO/IEC 19798 </div>
Waste Toner Container	Model	CLT-W504
	Yield	Apporx. 14,000 standard pages (Black) Apporx. 3,500 standard pages (Yellow/Magenta/Cyan)

2.1.2.7. Maintenance Parts

Item	Part Code	Life
Transfer roller	JC95-01637A	100,000 pages
Fuser unit	<ul style="list-style-type: none">JC91-01130A (220V)JC91-01131A (110V)	50,000 pages
Pick-Up roller	JC93-00673A	200,000 pages
Retard (Reverse) roller	JC93-00675A	100,000 pages
ITB unit	JC96-06514A	100,000 pages

2.1.3. Model Comparison Table

	Samsung Xpress C1810W	Samsung CLP-680ND	HP CP2025dn
Image			
Mono/Color Speed (A4)	18 / 18 ppm	24/ 24 ppm	20/ 20 ppm
Processor	533 MHz	533 MHz	600 MHz
Memory (Std/ Max)	256 MB / 256 MB	256 MB / 512 MB	128 MB / 384 MB
Print Language	SPLC, PCL5Ce, PCL6C, PS3, PDF V1.7	SPLC, PCL5Ce, PCL6C, PS3, PDF V1.7	HP PCL 6, HP PCL 5c, HP postscript3
Paper Input	250 sheets Cassette	250 sheets Cassette 520 sheets Optional Cassette	250 sheets Cassette 250 sheets Optional Cassette
Duplex	N/A	Standard	Standard
Interface	High Speed USB 2.0 10/100/1000 Base TX NFC printing support	High Speed USB 2.0 10/100/1000 Base TX	High Speed USB 2.0 10/100 Base TX
Size (mm)	420 x 426 x 264 mm (16.54 x 16.77 x 10.39 inches)	453 x 420 x 312 mm (17.83 x 16.54 x 12.28 inches)	405 x 484 x 322 mm
Toner Cartridge Yield (K/CMY)	2,500 / 1,800	<ul style="list-style-type: none"> • 2,500 / 1,500 • 6,000 / 3,500 	3,500 / 2,800

2.2. System Overview

This chapter describes the functions and operating principal of the main component.

2.2.1. Front View

NOTE

- This illustration may differ from your machine depending on your model. There are various types of machine.
- Some features and optional goods may not be available depending on model or country.

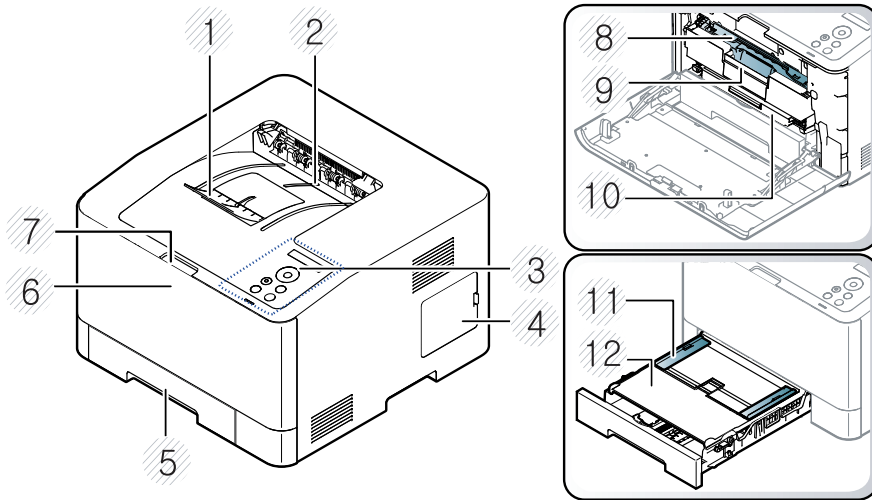

1	Output support
2	Output tray
3	Control panel
4	Control board cover
5	Tray 1
6	Front cover
7	Front cover handle
8	Toner cartridges
9	Toner cartridge handle
10	Intermediate Transfer Belt (ITB)
11	Paper width guides on a manual feeder
12	Manual feeder

2.2.2. Rear View

NOTE

- This illustration may differ from your machine depending on your model. There are various types of machine.
- Some features and optional goods may not be available depending on model or country.

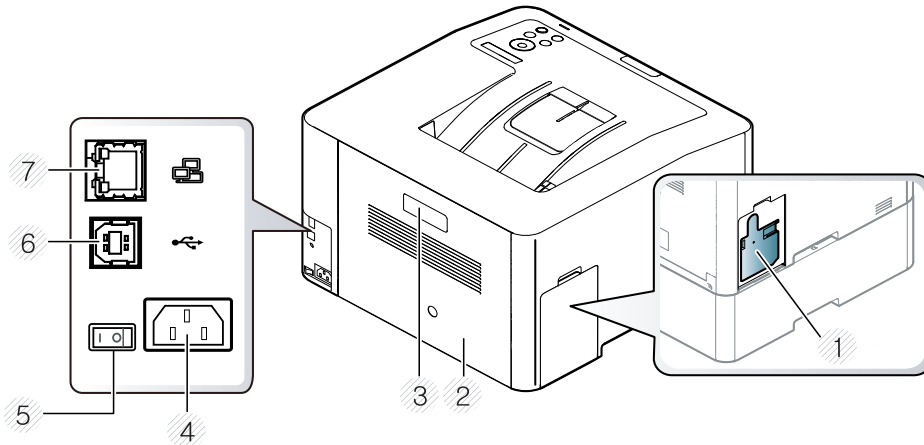

1	Waster toner container
2	Rear cover
3	Rear cover handle
4	Power receptacle
5	Power-switch
6	USB port
7	Network port

2.2.3. Paper Path

The following diagram displays the path the paper follows during the printing process.

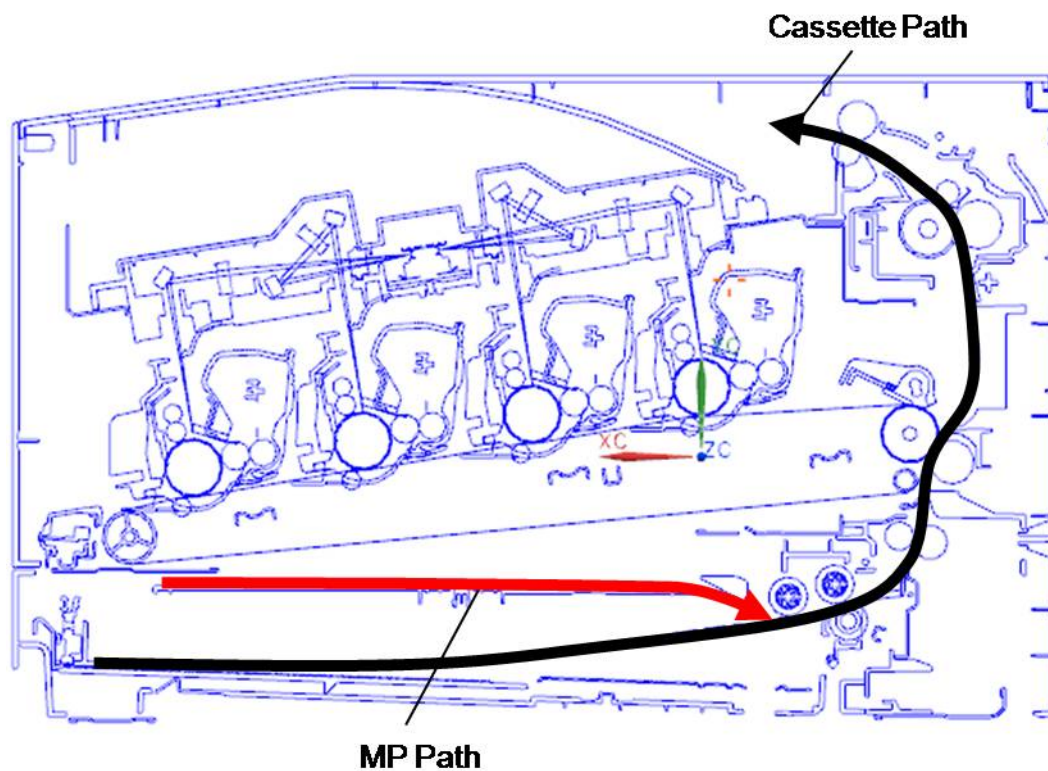

2.2.4. System Layout

This model consists of the engine parts, hardware parts, firmware. The engine parts consists of the mechanical parts comprising Frame, Toner Cartridge, Drive Unit, Transfer roller, Pick up unit, Fuser, Cassette. The hardware parts consists of the main board, SMPS, HVPS board, OPE board, PC interface.



1	Exit Unit
2	Fuser Unit
3	Transfer Roller
4	Registration(Regi.) Roller
5	Pick-Up Roller
6	Retard Roller

7	Cassette
8	LSU
9	Toner Cartridge
10	ITB Unit

2.2.4.1. Feeding Section

It consists of a basic cassette, pick up/forward/retard roller and parts related to paper transferring.

1) Cassette (Tray1)

This model has a cassette type tray that includes the MP tray.

It has a paper existence sensing function, paper arranging function.

The MP(multi-purpose) tray can hold special sizes and types of print material, such as postcards, note cards, and envelopes. It is useful for single page printing on letterhead or colored paper.

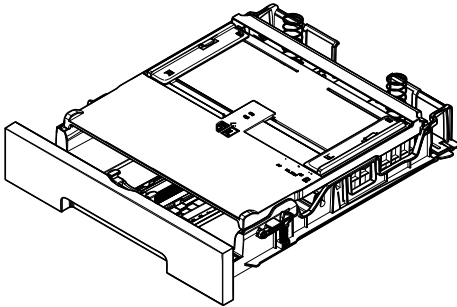

2) Pick up/Forward/Reverse roller

They have functions such as a paper pickup function, driving control function, paper feeding function, and removing electronic static function. Pick up roller is driven by clutch.

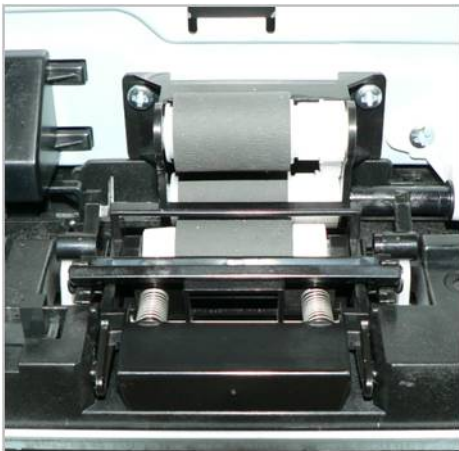

2.2.4.2. Transfer Roller

The transfer roller unit is assembled to the rear cover. The transfer roller delivers the toner of the OPC drum to the paper.

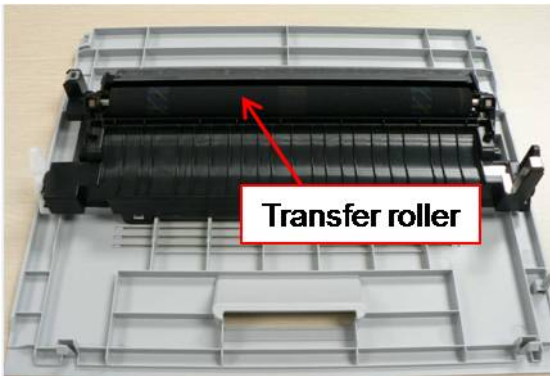

2.2.4.3. Drive Unit

This machine has the Main Drive Unit and Feed Drive Unit. The Main Drive Unit has 2 BLDC motors and Feed Drive Unit has 1 Step motor. These Drive unit is assembled to the right frame.

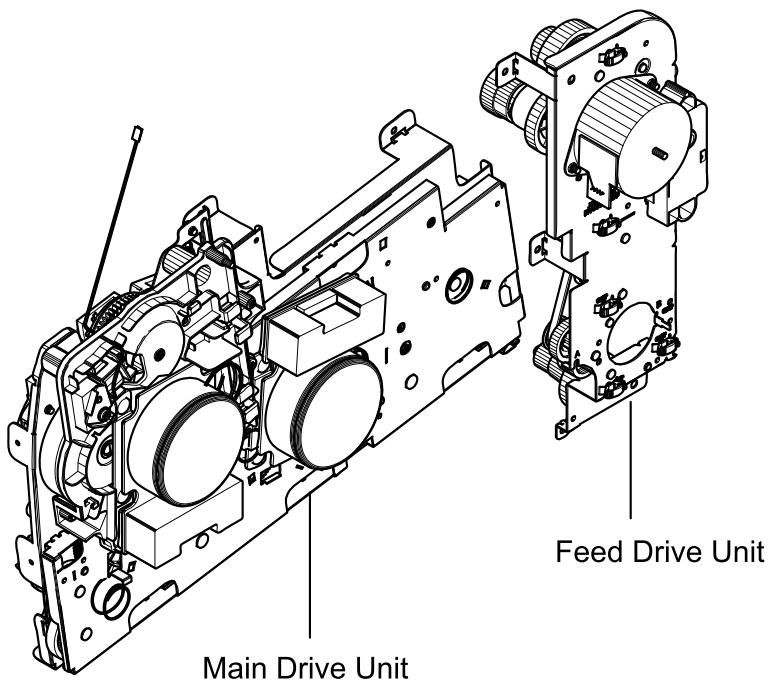

2.2.4.4. Fuser Unit

This unit consists of Heat Roller, a Thermostat, and Thermistor, etc. It fuses the toner that was transferred by the transfer roller onto the paper, by applying heat and pressure to complete fusing process.

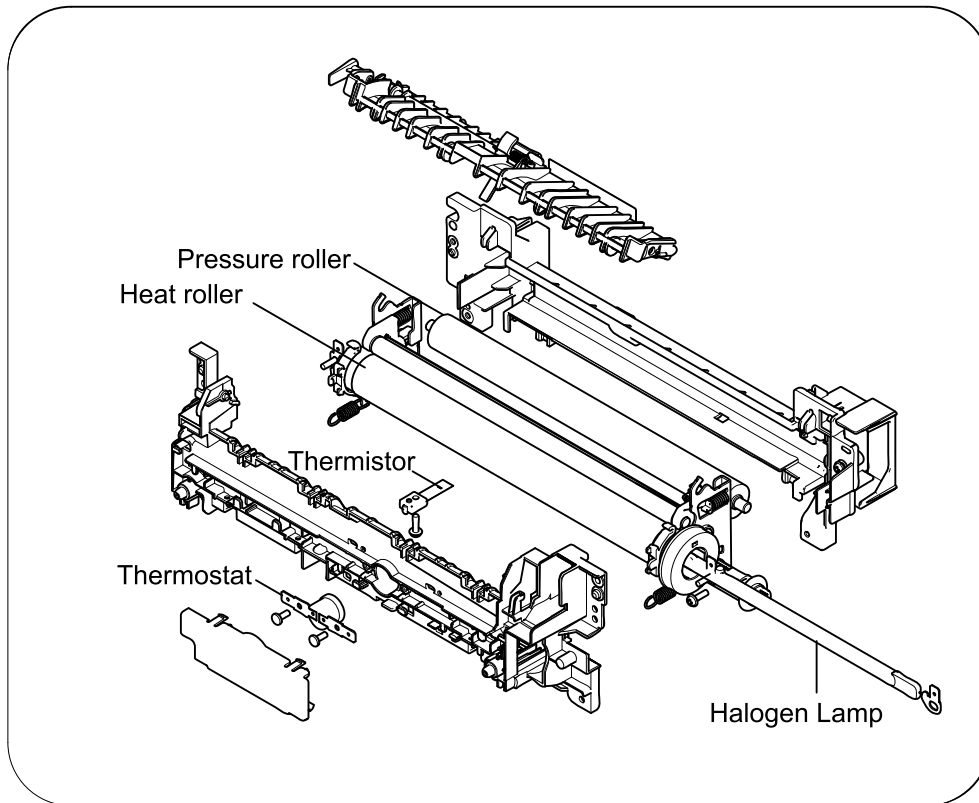

1) **Thermostat**

When a heat lamp is overheated, a Thermostat cuts off the main power to prevent over- heating.

- Thermostat Type : Non- Contact type Thermostat
- Control Temperature : $195^{\circ}\text{C} \pm 5^{\circ}\text{C}$

2) **Thermistor**

It is a temperature detecting sensor.

- Temperature Resistance : $7\text{ k}\Omega(180^{\circ}\text{C})$

3) **Heat roller**

The heat roller transfers the heat from the lamp to apply a heat on the paper.

The surface of a heat roller is coated with Teflon, so toner does not stick to the surface.

4) **Pressure roller**

A pressure roller mounted under a heat roller is made of a silicon resin, and the surface also is coated with Teflon. When a paper passes between a heat roller and a pressure roller, toner adheres to the surface of a paper and is permanently fused.

5) **Halogen Lamp**

- Voltage : $120\text{ V} (115 \pm 5 \%) / 220\text{ V} : 230 \pm 5 \%$
- Capacity : $850\text{ Watt} \pm 25\text{ W}$

2.2.4.5. LSU (Laser Scanner Unit)

It is the core part of the LBP (Laser Beam Printer) which switches from the video data received to the controller to the electrostatic latent image on the OPC drum by controlling laser beam, exposing OPC drum, and turning principle of polygon mirror. The OPC drum is turned with the paper feeding speed. The HSYNC signal is created when the laser beam from LSU reaches the end of the polygon mirror, and the signal is sent to the controller. The controller detects the HSYNC signal to adjust the vertical line of the image on paper. In other words, after the HSYNC signal is detected, the image data is sent to the LSU to adjust the left margin on paper. The one side of the polygon mirror is one line for scanning.

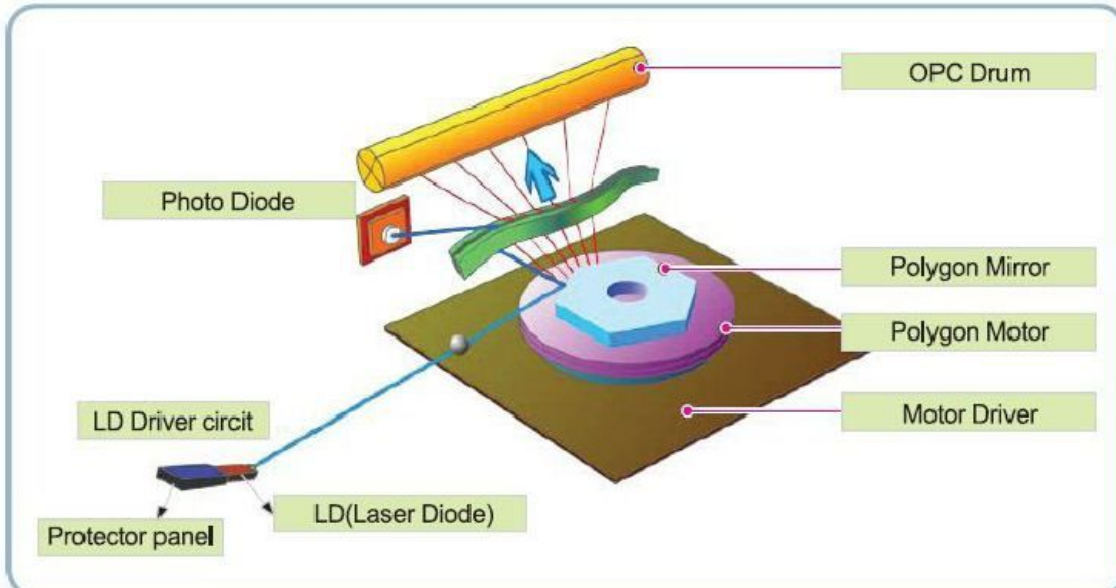

2.2.4.6. Toner Cartridge

By using the electronic photo process, it creates a visual image. In the toner cartridge, the OPC unit and the developing unit are in a body. The OPC unit has OPC drum and charging roller, and the developing unit has toner, supply roller, developing roller, and blade.

- Developing Method : Non magnetic single component non-contacting method
- Toner : Non magnetic single component pulverized type toner
- The life span of toner (ISO 19798 pattern / A4 standard)
 - Initial toner : 1,000 (K) / 700 (CMY)
 - Sales toner : 2,500 (K) / 1,800 (CMY)
- OPC Cleaning : Collect the toner by using cleaning blade
- Handling of wasted toner : Collect the wasted toner in the cleaning frame by using cleaning blade
- Classifying device for toner cartridge: ID is classified by CRUM

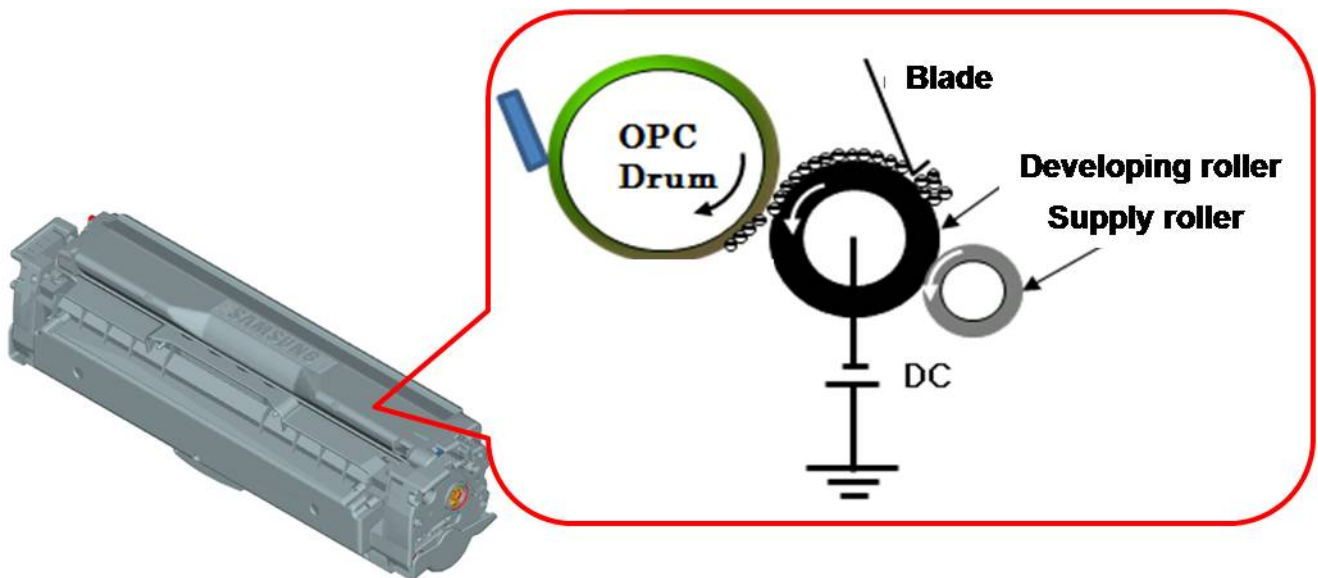

2.2.5. Hardware configuration

Xpress C1810 series Electrical Circuit System consists of the following:

- Main board (System board)
- OPE board
- SMPS board
- HVPS board

Diagram of Xpress C1810 series Electrical Circuit

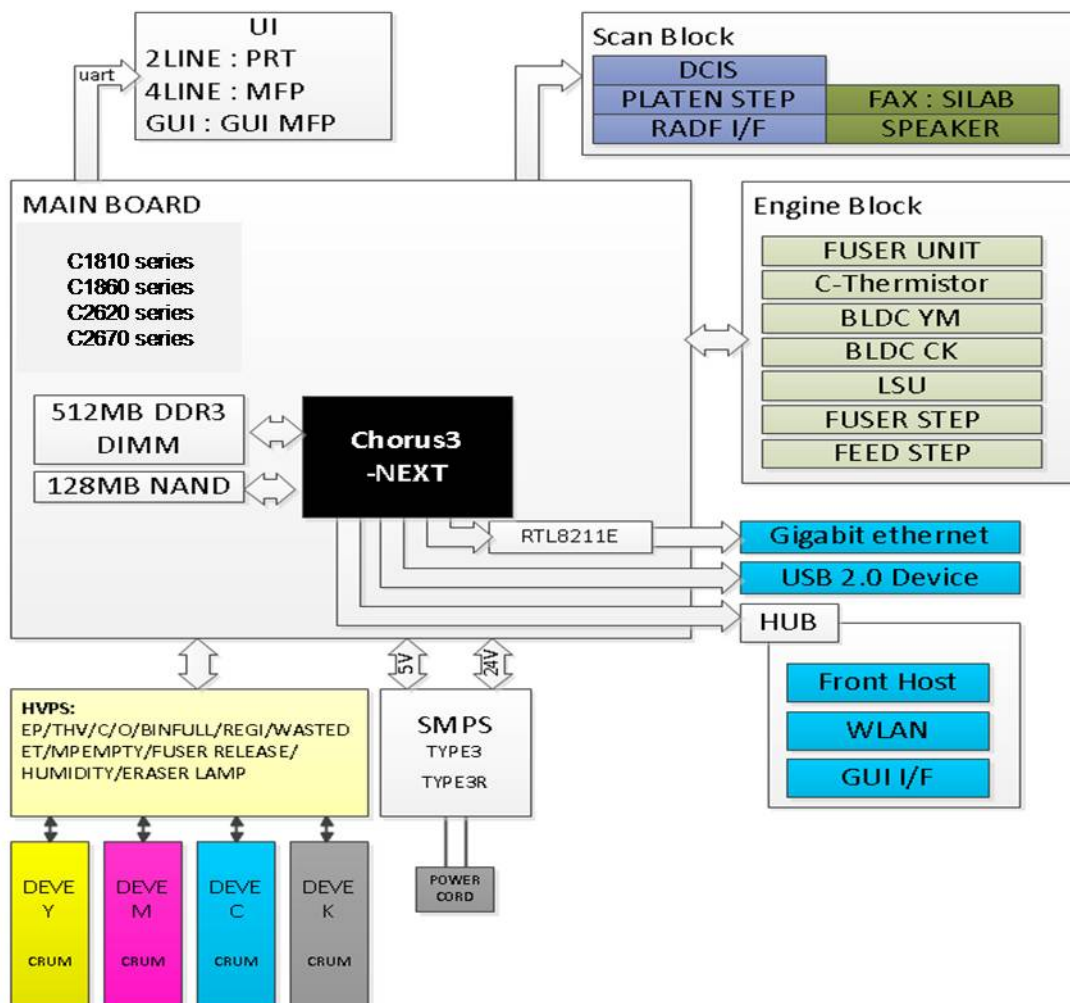

Xpress C1810 series has a system board of integrated engine controller and video controller.

The engine controller controls all modules required to print, that is, LSU, HVPS/SMPS, Fuser, Motor etc. It communicates with the video control block inside CPU for printing. And it has the interface for all video sync signal to print out the video data.

The video controller receives print data from the host through network or USB Port and receives copy data from the scan controller. It takes this information and generates printable video bitmap data.

The main board is adopted 533 MHz C3N CPU that is integrated with engine/ video/ scan controller. It uses DDR3 256MByte.

Circuit board locations

The following diagrams show the locations of the printer circuit boards:

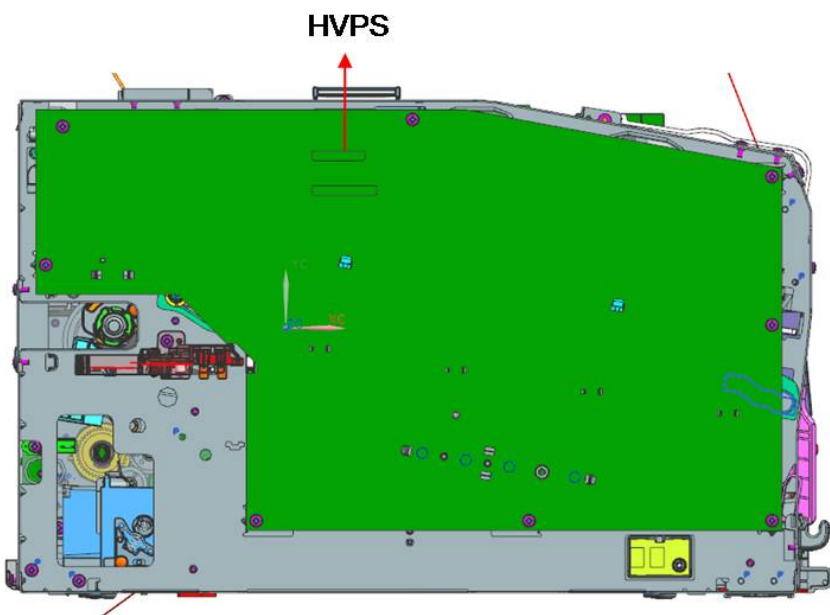
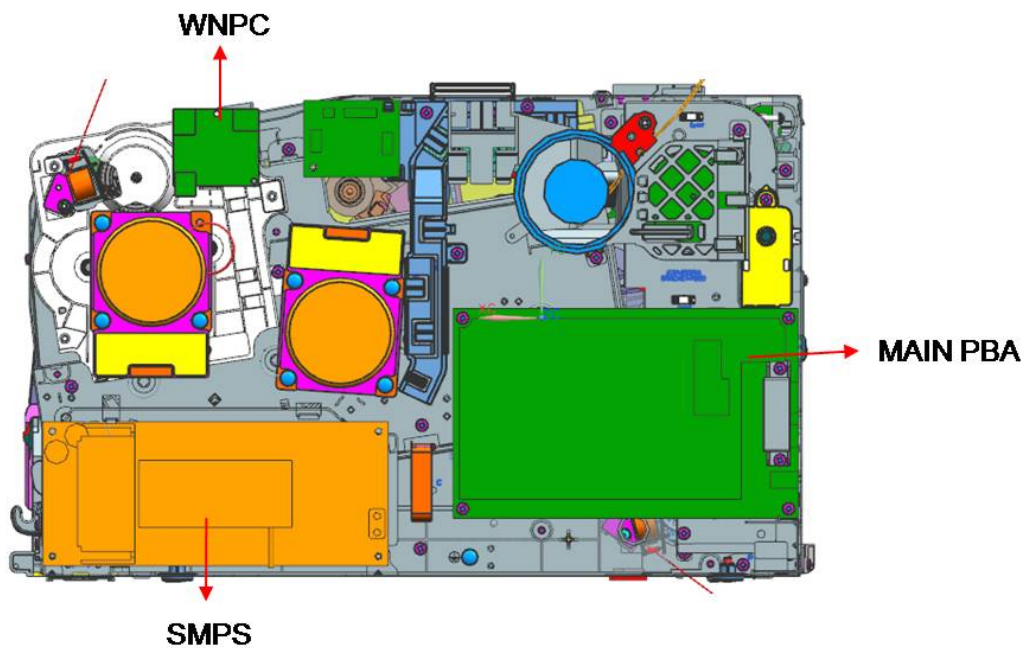

2.2.5.1. Main board

Chorus3-Next(C3N) chip is adopted as the main processor. Its process speed is 533 MHz. It is integrated engine controller, video controller, scan controller.

DDR3 256MB is adopted for high speed data processing. Boot adopted the 128MB NAND Flash.

USB is the embedded type and wired network supports 1000M full duplex.

[Main board diagram]

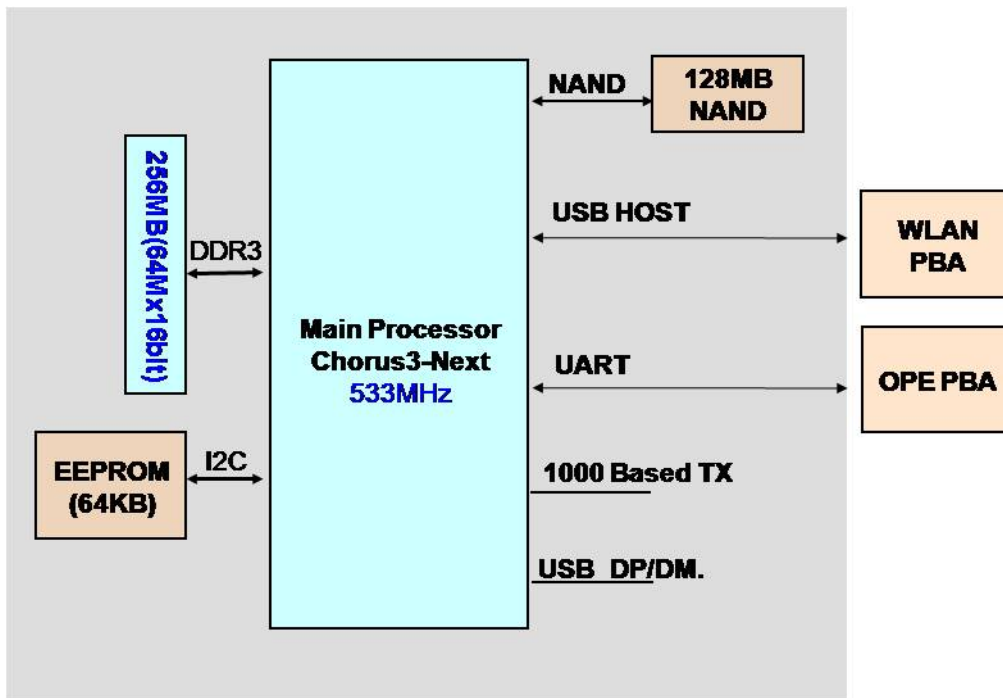

[Main board image]

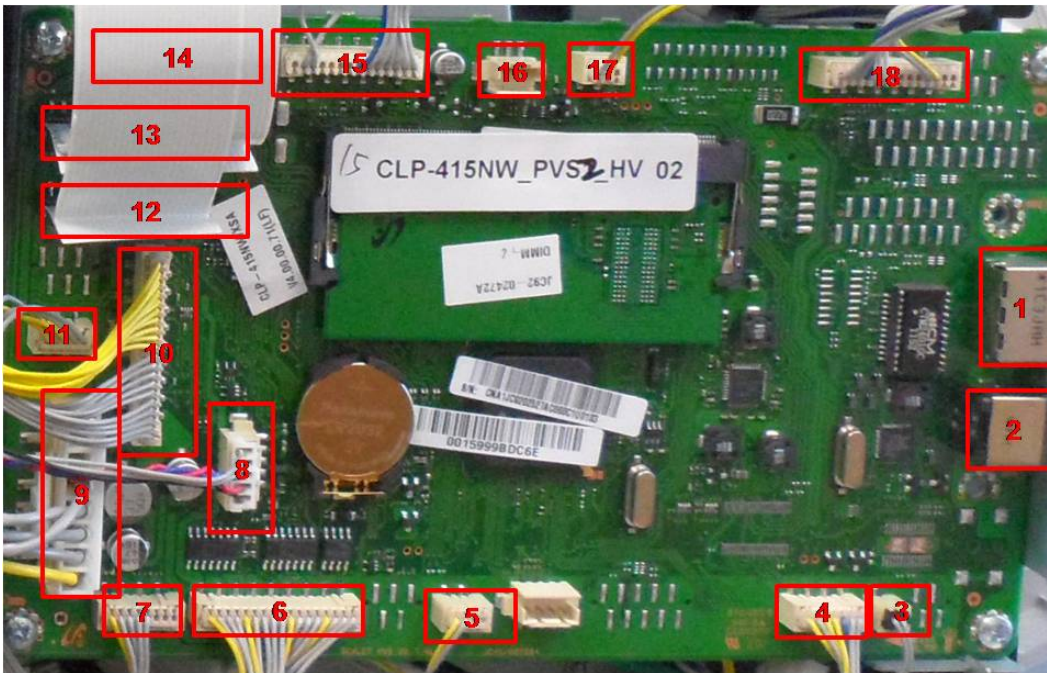

• Connection

1	NETWORK connector
2	USB Device connector
3	Regi. Clutch connector
4	Pick Up Clutch connector
5	SMPS Fan T1 DC motor connector
6	ITB Joint connector
7	Fuser CONT. connector
8	HUB I/F connector
9	SMPS connector
10	BLDC Motor connector
11	DEVE Home sensor/solenoid connector
12	HVPS2 connector
13	HVPS1 connector
14	LSU connector
15	OPE connector
16	Fuser Fan connector
17	Thermistor connector
18	Exit Motor connector

• Information

- Part Code : JC92-02794A
- Part Name : PBA-MAIN

2.2.5.2. OPE Controller

The OPE controller is composed of an OPE MICOM(STM8SP103K3MAZTR), Status LED, Eco LED, Power LED, Navigation LED, WPS LED, 2-Line LCD, Key.

The OPE controller communicates with main controller via UART. The power LED is controlled by the main board.

[OPE controller diagram]

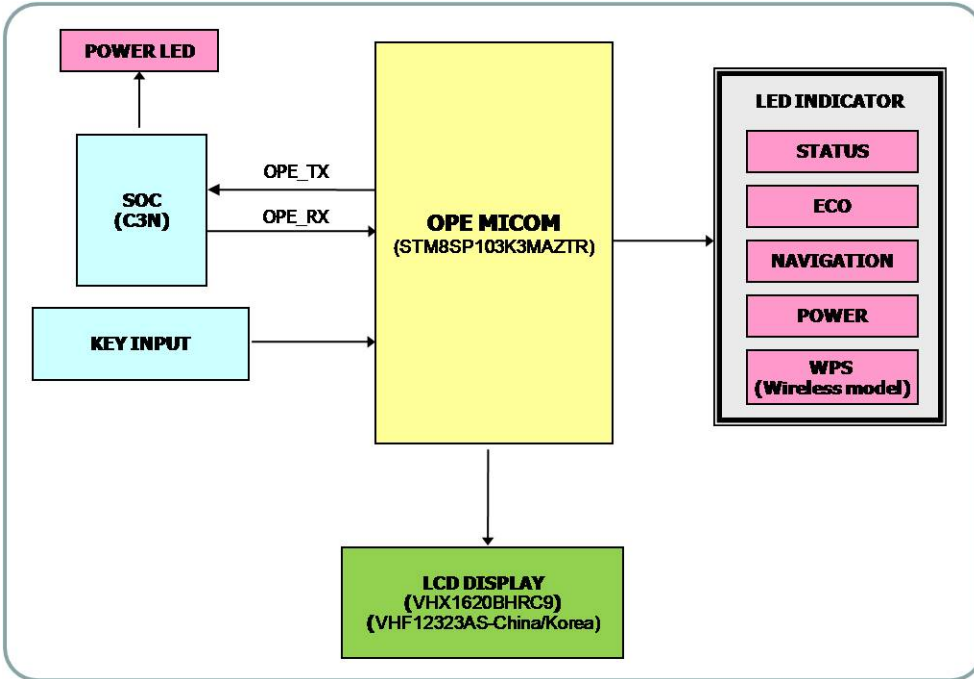

[OPE controller image]

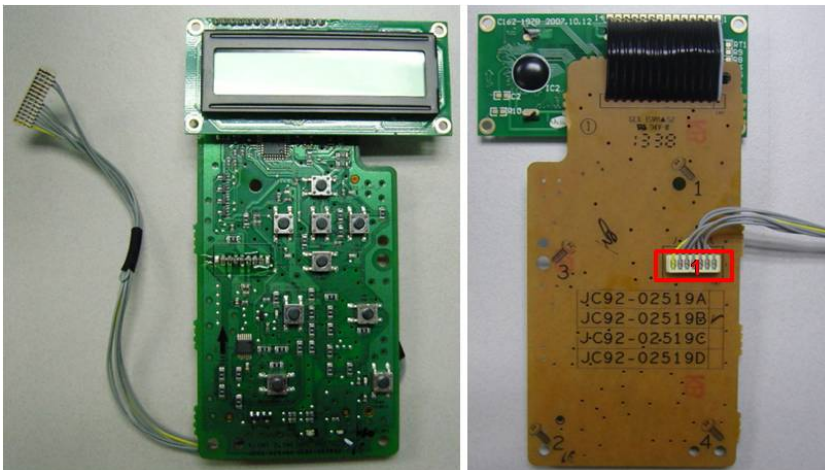

- Information
 - Part Code : JC92-02519A/ JC92-02519B/ JC92-02519C/ JC92-02519D
 - PBA Name : OPE-PBA

• Connection

1	Interface connector to main controller
---	--

2.2.5.3. Wireless LAN board

The Wireless LAN Module supports 802.11b/g/n. It communicates with video controller via USB.



- **Information**

- Part Code : JC92-02510A
- PBA Name : PBA-WNPC

- **Connection**

1	Interface Connector to System board (JC39-01858A , HARNESS-WLAN)
---	---

2.2.5.4. SMPS board

The SMPS (Switching Mode Power Supply) Board supplies electric power to the Main Board and other boards through a Main Controller. The voltage provided includes +24V from a 110V/220V power input.

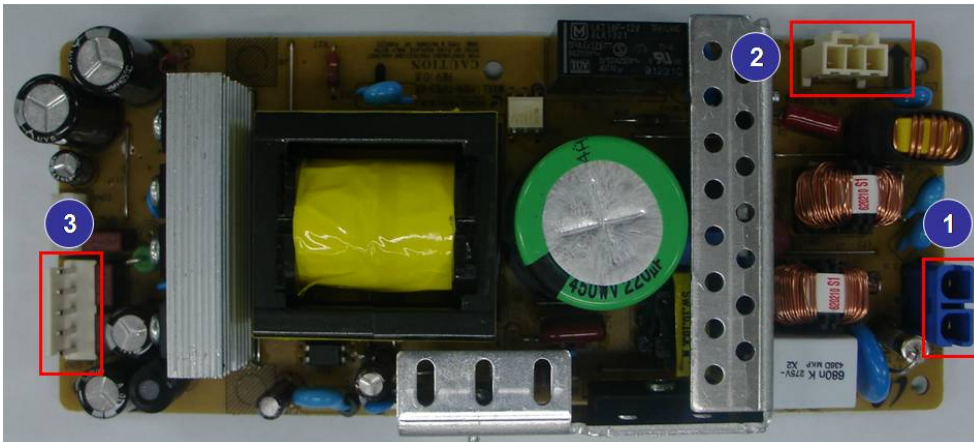

- **Specification**

- 1) AC 110V (90V ~ 135V)
- 2) AC 220V (180V ~ 270V)
- 3) Input Current: 10.0A (110V) / 8.0A (220V)
- 4) Output Power: 111W
 - DC 5V : 15W
 - DC 24V : 96W

- **Information**

	110V	220V
Part Code	JC44-00097E	JC44-00090E
PBA Name	SMPS V1	SMPS V2

- **Connection**

1	AC_Inlet
2	FUSER_AC Output
3	OUTPUT_DC

- **Input / Output connector**

- AC Input Connector(CON1)

PIN ASSIGN	PIN NO	Description
1	AC_L	AC Input
2	AC_N	

- AC Input Connector(CON2)

PIN ASSIGN	PIN NO	Description
1	AC_L	AC Output

2. Product specification and description

PIN ASSIGN	PIN NO	Description
2	AC_N	for Heater Controller

- DC Output Connector (CON3)

PIN ASSIGN	PIN NO	Description
1	5V	+5V Power
2	GND	Ground
3	24V1	+24V Power
4	GND	Ground
5	24V2	+24V Power

- Signal Connector (CON4)

PIN ASSIGN	PIN NO	Description
1	GND	Ground
2	24V_ON_OFF	24V_ON_OFF
3	Relay on	Fuser Relay
4	24VS	Photo Triac Bias
5	Fuser On	Fuser On

2.2.5.5. HVPS board

The HVPS board generates high-voltage channels which includes MHV, DEV, Blade, SUP, THV1, THV2.

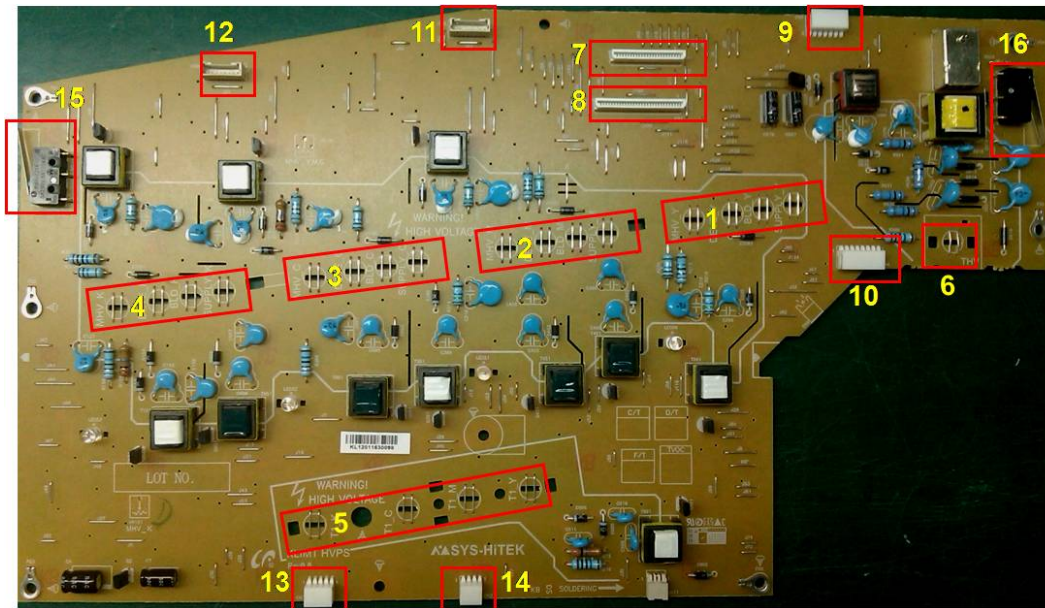

- **Connection**

1	MHV/DEV/BLD/SUP Y
2	MHV/DEV/BLD/SUP M
3	MHV/DEV/BLD/SUP C
4	MHV/DEV/BLD/SUP K
5	THV1 YMCK
6	THV2
7	Main-HVPS I/F #1
8	Main-HVPS I/F #2
9	Paper Exit. Outbin Full
10	WTB interface
11	Crum Y,M
12	Crum C,K
13	Ambient, Humidity
14	Paper Regi.
15	Front Cover Open Switch
16	Rear Cover Open Switch

- **Information**

- Part Code : JC44-00217A
- PBA Name : HVPS

2.2.5.6. ITB EEPROM PBA

The ITB EEPROM PBA stored the ITB serial number and adjustment information like a S-Gain, ITB life.

It consists of the 4-pin connector, EEPROM, resistor, cap and is connected to the main board. It communicates with main board.

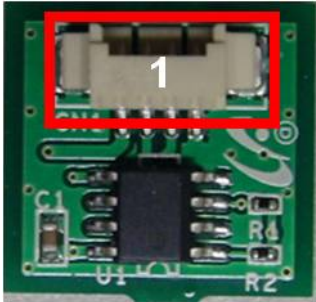

- **Information**

- Part Code : JC92-02531A
- PBA Name : PBA-ITB EEPROM

- **Connection**

1	Interface Connector to System Board (JC39-01814A, HARNESS-ITB)
---	---

2.2.5.7. NFC Tag Sticker

Near field communication (NFC) is a set of standards for smartphones and similar devices to establish radio communication with each other by touching them together or bringing them into close proximity, usually no more than a few centimeters. Present and anticipated applications include contactless transactions, data exchange, and simplified setup of more complex communications such as Wi-Fi. Communication is also possible between an NFC device and an unpowered NFC chip, called a "tag". NFC tag sticker stores Mac, PIN, Mobile Print App URL of Printer/MFP.



Front - label



Rear – Inlay & NFC chip

- **Information**

- Part Code : JC68-03012A
- Part Name : LABEL ETC-NFC TECTILE STICKER (25x25mm)

2.2.5.8. Electrical Parts Location

1) Sensors

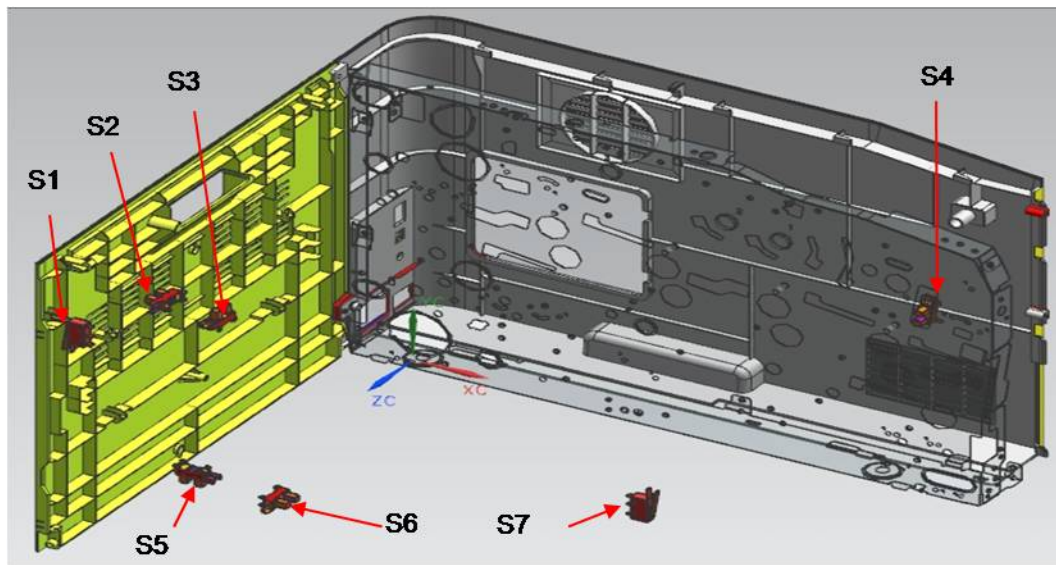

No.	Description	Controller	Function
S1	Switch Rear Cover (Cover Rear Open sensor)	HVPS	Cover Open detection
S2	Photo interrupter (Fuser Exit sensor)	Main Board	Fuser Exit detection
S3	Photo interrupter (Binfull sensor)	Main Board	Binfull detection
S4	Photo interrupter (Deve Nip sensor)	Main Board	Deve Nip detection
S5	Photo interrupter (WTB Open sensor)	Main Board	WTB Open detection
S6	Photo interrupter (Empty sensor)	Main Board	Empty detection
S7	Switch Front Cover (Cover Front Open sensor)	HVPS	Cover Open detection

2) Motor, Clutch, Solenoid, etc

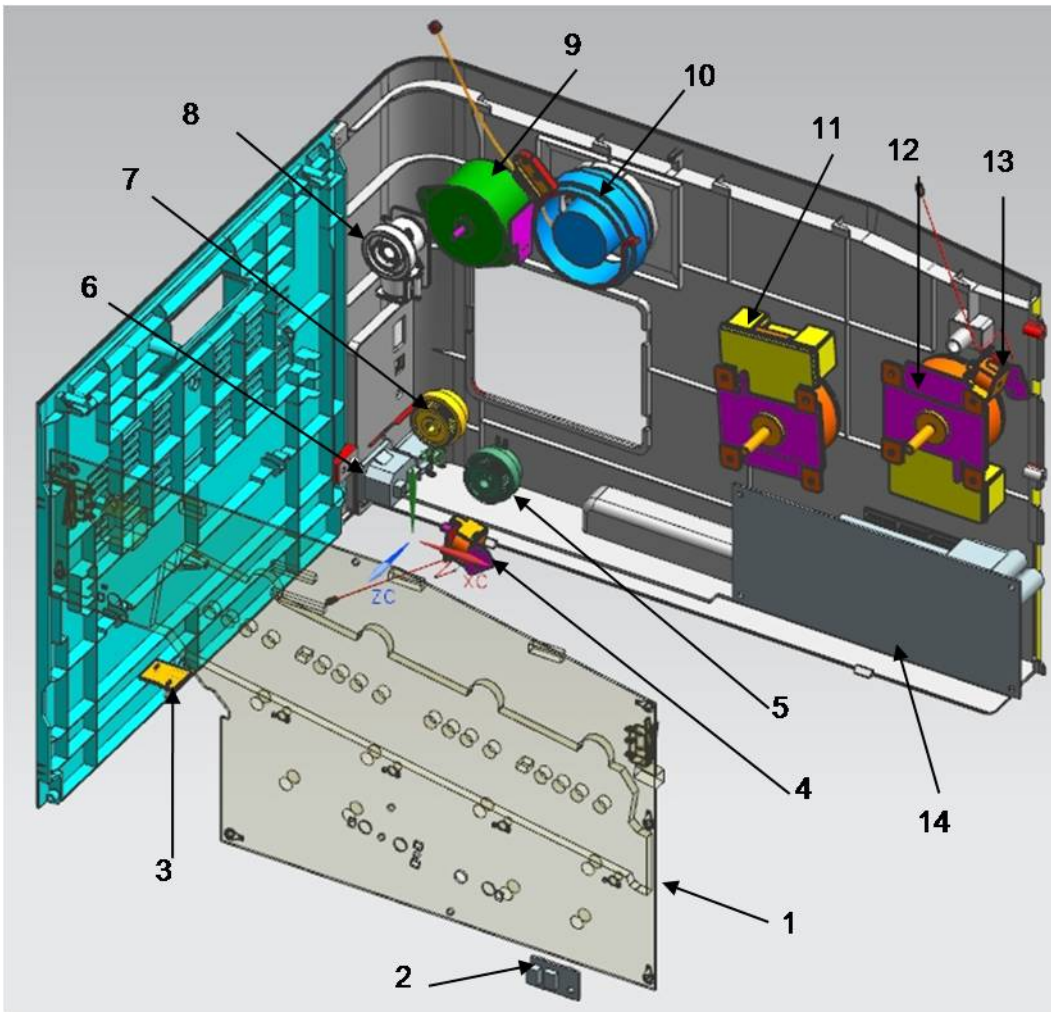

No.	Description
1	HVPS
2	Humidi.-Temp Sensor
3	PBA Waste Sensor
4	Solenoid MP
5	Clutch-Electric Z41
6	Power Inlet
7	Clutch-Electric
8	Clutch-Fuser Cam

No.	Description
9	Motor-Step
10	Fan Type-5 (Not Used)
11	Motor BLDC-BT6
12	Motor BLDC-BT6
13	Solenoid
14	SMPS

2.2.6. Engine F/W Control Algorithm

2.2.6.1. Feeding

If feeding from a cassette, the drive of the pickup roller is controlled by controlling the solenoid. The on/off of the solenoid is controlled by controlling the general output port or the external output port. While paper moves, occurrence of Jam is judged as below.

Item	Description
Jam in Tray 1	<ul style="list-style-type: none">• After picking up, paper entered but it cannot reach to the feed sensor in predetermined period of time. due to slip, etc.• After picking up, if the feed sensor is not on, re-pick up. After re-picking up, if the feed sensor is not on after certain time, it is JAM 0.• Even though the paper reaches to the feed sensor, the feed sensor doesn't be ON.
Jam inside machine	<ul style="list-style-type: none">• After the leading edge of the paper passes the feed sensor, the trailing edge of the paper cannot pass the feed sensor after predetermined period of time.• After the leading edge of the paper passes the feed sensor, the paper cannot reach the exit sensor after predetermined period of time. <p>* The paper exists between the feed sensor and the exit sensor.</p>
Jam in Exit area	After the trailing edge of the paper passes the feed sensor, the paper cannot pass the exit sensor predetermined period of time.

2.2.6.2. Transfer

The charging voltage, developing voltage and the transfer voltage are controlled by PWM (Pulse Width Modulation). The each output voltage is changeable due to the PWM duty. The transfer voltage admitted when the paper passes the transfer roller is decided by environment conditions. The resistance value of the transfer roller is changed due to the surrounding environment or the environment of the set, and the voltage value, which changes due to the environments, is changed through AD converter. The voltage value for impressing to the transfer roller is decided by the changed value.

2.2.6.3. Fusing

The temperature change of the heat roller's surface is changed to the resistance value through the use of a thermistor. The Main Board uses the resistance value of the Thermistor and converts it to a voltage value through the use of an AD converter, the temperature is decided based on the voltage value read. The AC power is controlled by comparing the target temperature to the value from the thermistor. If the value from the thermistor is out of controlling range while controlling the fusing, the error stated in the below table occurs.

- Open Heat Error

When the engine operates the warm-up process, if the temperature of the fixing unit is not higher than a specified temperature, the engine defines Open Heat Error. When this error is detected, the engine stops all functions and keeps the error state. Also, the engine informs the error status of the main system, so it can take appropriate action; and then the error message is displayed at LCD window or LED informing the error status of the user.

- Low Heat Error

When the engine is at stand-by, printing or warm-up mode, if the temperature of the fixing unit is lower than the specified temperature at each state and the lower temperature state is maintained during the specified time, the engine defines Low Heat Error. When this error is detected, the engine stops all functions and keeps it at the error state. Also, the engine informs the error status of the main system, so it can take appropriate action; and then the error message is displayed at LCD window or LED informing the error status of the user.

- Over Heat Error

For overall engine state, if the temperature of the fixing unit is higher than the specified temperature and the temperature state is detected for a specific duration, then the engine defines Over Heat Error. When this error is detected, the engine stops all functions and keeps it at the error state. Also, the engine informs the error status of the main system, so it can take appropriate action; and then the error message is displayed at LCD window or LED informing the error status of the user.

2.2.6.4. LSU

LSU receives the image data from PVC or HPVC and make the latent image on OPC surface. It uses the single beam, LD. The errors related to LSU are as follows:

- By Lready

When the printing is started, the engine drives the polygon motor of LSU. After the specified time is elapsed, if the motor is not in a ready status, the engine detects the error that the polygon motor is not in a ready status. If this error happens, the engine stops all functions and keeps it at the error state. Also, the engine informs the error status of the main system and the error message is displayed at LCD window to inform the error status of the user.

- By Hsync

When the polygon motor is ready, the LSU sends out the signal called Hsync and used to synchronize with each image line. So, if the engine does not detect consecutively the signal for a fixed time, it defines the Hsync Error. If this error happens, the engine stops all functions and keeps it at the error state. Also, the engine informs the error status of the main system and then the error message is displayed at LCD window to inform the error status of the user. LSU Error Recovery: If the LReady or Hsync error happens, the paper is exited before the error code is initiated. The engine mode is changed to recovery mode and the engine informs the main system of the engine mode. And the engine checks the LSU error. If the error doesn't happen, the printing job.

2.2.7. Software Descriptions

2.2.7.1. Software system overview

The software system of this model is constructed with

- Host Software part that the application software operated in Window and Web Environment
- Firmware parts that is a Embedded software controls printing job.

2.2.7.2. Architecture

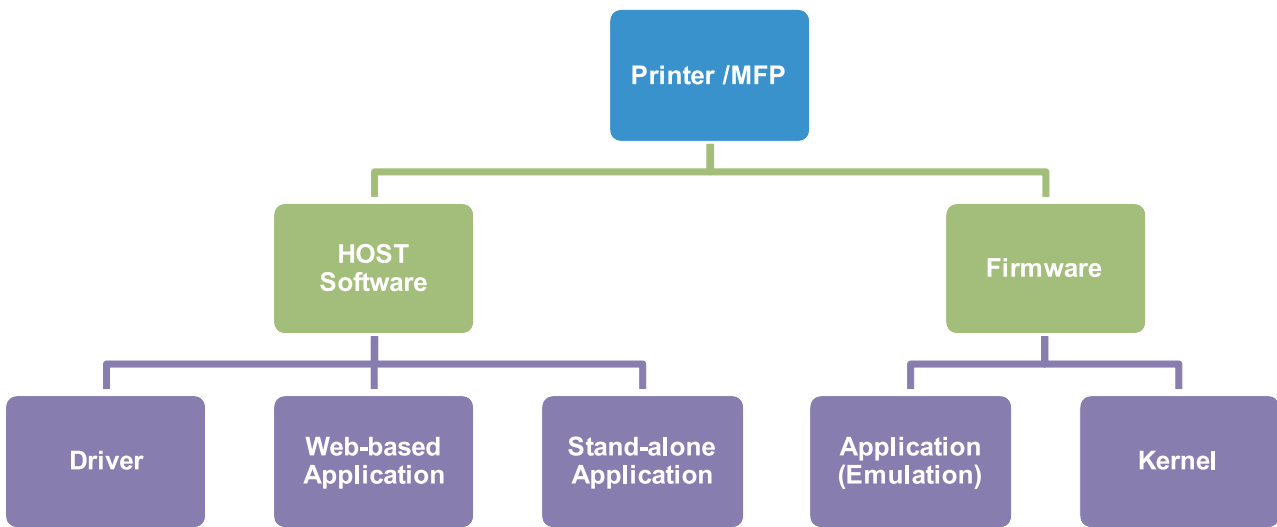

Host Software is made up of

- 1) Graphic User Interface offers the various editing functions to user in Host.
- 2) Driver translates the received document to a Printing Command language which printer can understand and transfers data to spooler.
- 3) Stand-alone Application offers the various printing application such as Easy Printer Manager, Printer Status in Window system.
- 4) Web-based-Application offers the same functions as Stand-alone Application in Web environment.

Firmware is made up of

- 1) Application (Emulation) that is a interpreter translates data received from Host to a printing language (PCL, PS, GDI, etc.) to be able to make the user to take same output as originally one what composed in Host.
- 2) Kernel controls and manage the whole procedure including Control flow and Printing Job before transferring to Engine system.

2.2.7.3. Data and Control Flow

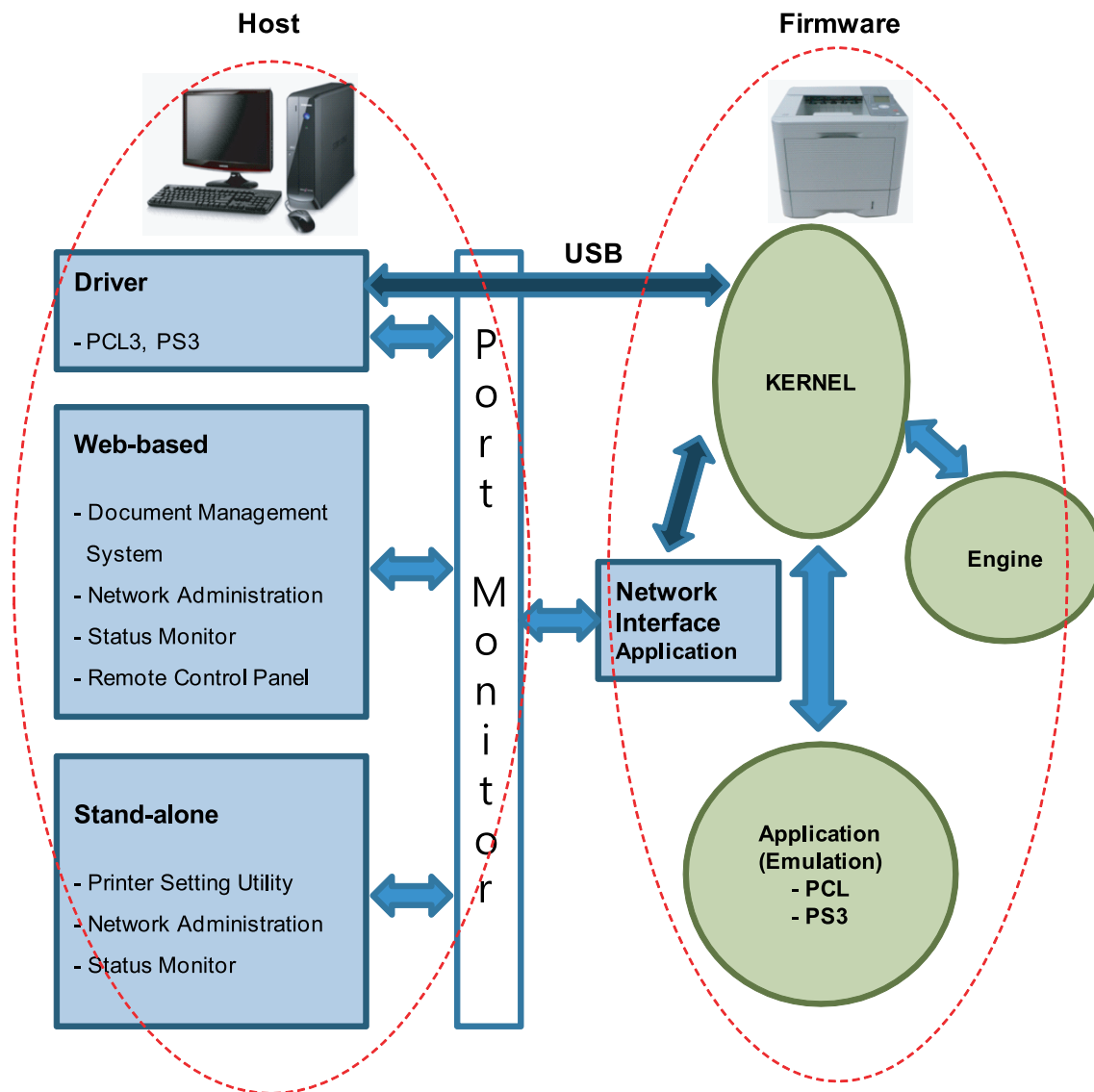

The above Block Diagram is explained that:

Host Side is made up of

- 1) Driver that is Windows application software translate printed data to one of printer language and create spooler file.
- 2) Web-based Application that offer a various printer additional functions, management of printing job, printer administration, Status monitor to monitoring the printer status by real time in Web, independent environment on OS.
- 3) Stand-alone Application that is a similar Window software as same as above 2.
- 4) Port Monitor that manages the network communication between spooler and Network Interface Card, or various additional application and Network Interface Card,(this is, at first, make communication logical port, manage the data, transfer them from spooler to network port, and offer the result of printing).

Firmware Side is made up of

- 1) Network Interface Card is that relay the communication between Host and kernel using various network protocol.
- 2) Kernel is that manages the flow control of emulation procedure, receiving data from Host or Network card and printing with engine & rendering job.

- 3) Emulation is that interprets the various output data from selected emulation.
- 4) Engine is that prints rendered bit-map data to paper with required size and type by Kernel.

And then, for Job Spooling function for Multi-User, Multi-Printing that is occurred in Network printing and various additional printing functions, this Kernel use max. 10 Queuing systems in a memory.

In Printing, the two procedures are

1) Case of using USB Port

- After user start to print the wanted document to PCL string or compressed GDI bit-map data, the Driver translates the all graphic data of the client PC and send data to host spooler. And then the spooler sends the data stream to the printer via USB port.
- Kernel receives this data from Host, and then select emulation fit to data and start selected one. After emulation job end, Kernel sends the output bit-map data to Engine using Printer Video Controller (by clock type for LSU).
- Engine print the received data to required paper with the sequential developing process.

2) Case of using Network Interface Card

- After user start to print the wanted document to PCL string or compressed GDI bit-map data, Driver translate the all graphic data of it and send data to host spooler.
- If so, Port monitor managing network port receives data from spooler and sends a data stream to the Network Interface Card.
- Network interface card receives it and send to Kernel part.
- Kernel receives this data from Host, and then select emulation fit to data and start selected one. After emulation job end, Kernel sends the output bit-map data to Engine using Printer Video Controller (by clock type for LSU).
- Engine print the received data to required paper with the sequential developing process.

3. Disassembly and Reassembly

3.1. Precautions when replacing parts

3.1.1. Precautions when assembling and disassembling

- Use only approved Samsung spare parts. Ensure that part number, product name, any voltage, current or temperature rating are correct. Failure to do so could result in damage to the machine, circuit overload, fire or electric shock.
- Do not make any unauthorized changes or additions to the printer, these could cause the printer to malfunction and create electric shock or fire hazards.
- Take care when dismantling the unit to note where each screw goes. There are 19 different screws. Use of the wrong screw could lead to system failure, short circuit or electric shock.
- Do not disassemble the LSU unit. Once it is disassembled dust is admitted to the mirror chamber and will seriously degrade print quality. There are no serviceable parts inside.
- Regularly check the condition of the power cord, plug and socket. Bad contacts could lead to overheating and fire. Damaged cables could lead to electric shock or unit malfunction.

3.1.2. Precautions when handling PBA

Static electricity can damage a PBA, always use approved anti-static precautions when handling or storing a PBA.

- **Precautions when moving and storing PBA**
 - 1) Please keep PBA in a conductive case, anti-static bag, or wrapped in aluminum foil.
 - 2) Do not store a PBA where it is exposed to direct sunlight.
- **Precautions when replacing PBA**
 - 1) Disconnect power connectors first, before disconnecting other cables.
 - 2) Do not touch any soldered connections, connector terminals or other electronic parts when handling insulated parts.
- **Precautions when checking PBA**
 - 1) Before touching a PBA, please touch other grounded areas of the chassis to discharge any static electrical charge on the body.
 - 2) Take care not to touch the PBA with your bare hands or metal objects as you could create a short circuit or get an electric shock. Take extra care when handling PBAs with moving parts fitted such as sensors, motors or lamps as they may get hot.
 - 3) Take care when fitting, or removing, screws. Look out for hidden screws. Always ensure that the correct screw is used and always ensure that when toothed washers are removed they are refitted in their original positions.

3.1.3. Releasing Plastic Latches

Many of the parts are held in place with plastic latches. The latches break easily; release them carefully.

To remove such parts, press the hook end of the latch away from the part to which it is latched.

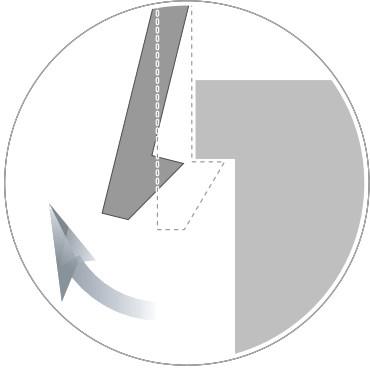

3.2. Screws used in the printer

The screws listed in the table below are used in this printer. Please ensure that, when you disassemble the printer, you keep a note of which screw is used for which part and that, when reassembling the printer, the correct screws are used in the appropriate places.

Parts Code	Location	Description	Qty
6003-000196	FUSER	SCREW-TAPTYPE;PWH,+,B,M3,L10,NI PLT,SWRCH18A	7
6003-000282	FUSER	SCREW-TAPTYPE;BH,+,-,B,M3,L8,ZPC(BLK),SWRCH18A,-	2
6003-000269	FRAME	SCREW-TAPTYPE;BH,+,-,S,M3,L6,ZPC(WHT),SWRCH18A,-	4
6003-000269	FRAME BASE	SCREW-TAPTYPE;BH,+,-,S,M3,L6,ZPC(WHT),SWRCH18A,-	31
6002-000440	FRAME-LEFT	SCREW-TAPPING;PWH,+,2,M3,L8,ZPC(BLK),SWRCH18A	7
6003-000269	FRAME-LEFT	SCREW-TAPTYPE;BH,+,-,S,M3,L6,ZPC(WHT),SWRCH18A,-	11
6002-000440	FRAME-CRUM HOLDER	SCREW-TAPPING;PWH,+,2,M3,L8,ZPC(BLK),SWRCH18A	8
6002-000440	FRAME-RIGHT	SCREW-TAPPING;PWH,+,2,M3,L8,ZPC(BLK),SWRCH18A	3
6003-000269	FRAME-RIGHT	SCREW-TAPTYPE;BH,+,-,S,M3,L6,ZPC(WHT),SWRCH18A,-	20
6002-000440	FRAME-GUIDE RAIL CST R	SCREW-TAPPING;PWH,+,2,M3,L8,ZPC(BLK),SWRCH18A	1
6003-000269	FRAME-PICK UP BRACKET	SCREW-TAPTYPE;BH,+,-,S,M3,L6,ZPC(WHT),SWRCH18A,-	8
6003-000196	FRAME MAIN	SCREW-TAPTYPE;PWH,+,B,M3,L10,NI PLT,SWRCH18A	6
6003-000269	FRAME MAIN	SCREW-TAPTYPE;BH,+,-,S,M3,L6,ZPC(WHT),SWRCH18A,-	41
6003-000301	FRAME MAIN	SCREW-TAPTYPE;BH,+,S,M4,L6,ZPC(WHT),SWRCH18A	1
6003-000196	FRAME-FAN	SCREW-TAPTYPE;PWH,+,B,M3,L10,NI PLT,SWRCH18A	1
6003-000196	DRIVE-MAIN	SCREW-TAPTYPE;PWH,+,B,M3,L10,NI PLT,SWRCH18A	5
6003-000269	DRIVE-MAIN	SCREW-TAPTYPE;BH,+,-,S,M3,L6,ZPC(WHT),SWRCH18A,-	14
6003-000301	DRIVE-MAIN	SCREW-TAPTYPE;BH,+,S,M4,L6,ZPC(WHT),SWRCH18A	7
6009-001697	DRIVE-MAIN	SCREW-SPECIAL;PH,+,M3,L4.4(3),NI PLT,SWRCH18A,MACH,2 BODY	1
6003-000269	DRIVE-FEED	SCREW-TAPTYPE;BH,+,-,S,M3,L6,ZPC(WHT),SWRCH18A,-	4
6003-000282	FRAME-RETARD	SCREW-TAPTYPE;BH,+,-,B,M3,L8,ZPC(BLK),SWRCH18A,-	4
6003-000196	COVER-FRONT	SCREW-TAPTYPE;PWH,+,B,M3,L10,NI PLT,SWRCH18A	7
6003-000196	COVER-TOP	SCREW-TAPTYPE;PWH,+,B,M3,L10,NI PLT,SWRCH18A	13
6003-000269	COVER-TOP	SCREW-TAPTYPE;BH,+,-,S,M3,L6,ZPC(WHT),SWRCH18A,-	2
6003-000196	MAINLINE	SCREW-TAPTYPE;PWH,+,B,M3,L10,NI PLT,SWRCH18A	8
6003-000269	MAINLINE	SCREW-TAPTYPE;BH,+,-,S,M3,L6,ZPC(WHT),SWRCH18A,-	35
6003-000261	FRAME-DRAWER	SCREW-TAPTYPE;BH,+,-,B,M3,L6,ZPC(WHT),SWRCH18A,-	4

3.3. Replacing the maintenance parts

3.3.1. Toner Cartridge

1. Open the front cover.



2. Hold the green handle and pull the guide-cartridge.

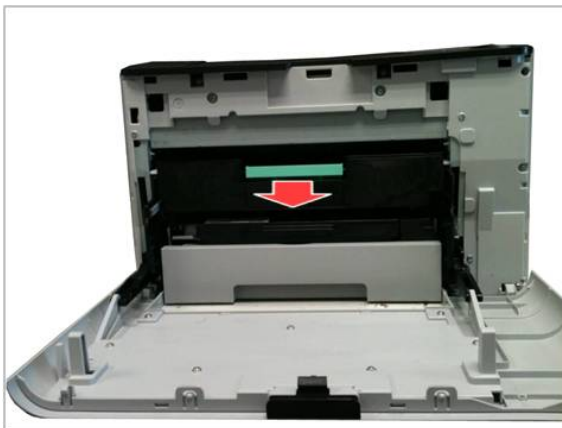

3. Remove the toner cartridge.



3.3.2. Waste Toner Container

1. Open the Waste Toner Container cover. Remove the Waste Toner Container while pulling the hook.

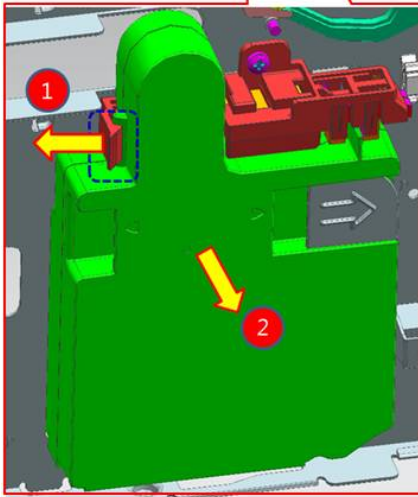
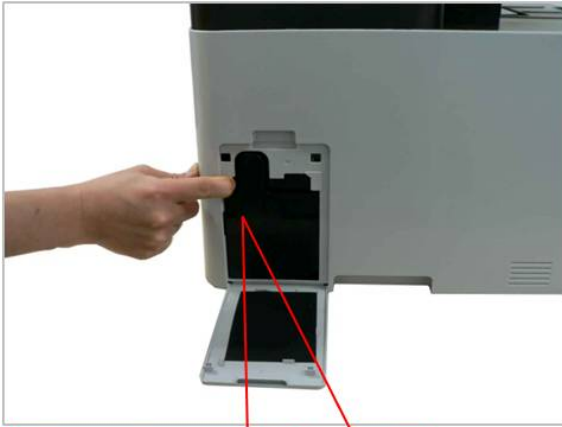

3.3.3. ITB Unit

1. Remove all toner cartridges.
2. Remove the guide-cartridge by releasing the right hook.



3. Remove the cassette.



4. Remove the harness cover after removing 1 screw.



5. Unplug the connector.



6. Lift up the both sides of the ITB Unit slightly.



7. Remove 2 screws securing the left cover.



8. Open the rear cover. Remove 2 screws securing the left cover.



9. Remove the waste toner container. Release the left cover by pulling it to the direction of arrow.



10. Remove the bracket[A] after removing 2 screws.

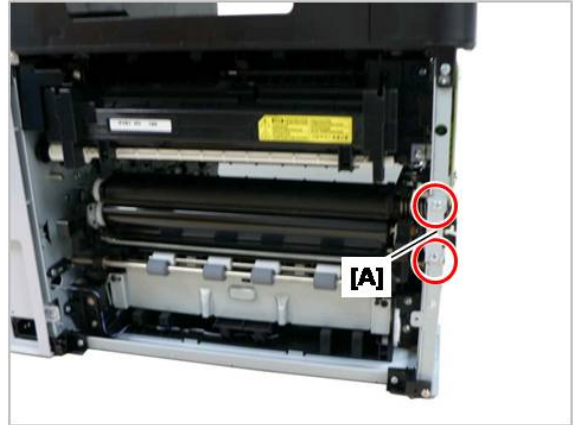

11. Remove the ITB Unit from the rear.



3.3.4. Fuser Unit

1. Open the rear cover.



2. Remove the part as shown in below.

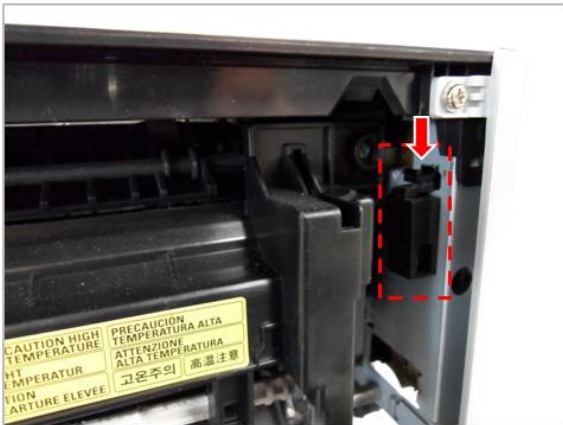

3. Remove 4 screws. Remove the harness cover[A].



4. Unplug the AC connector.

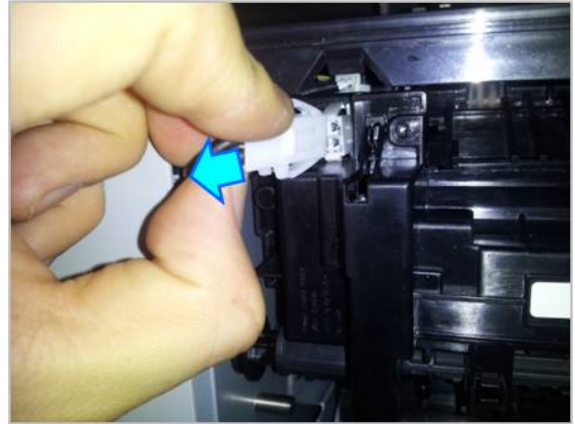

5. Remove 1 screw. Take off the fuser unit while pulling the shaft-cam to the right.



6. Unplug the thermistor connector. Remove the fuser unit perfectly.



3.3.5. Transfer Roller Assy

1. Open and remove the rear cover.



2. Remove the Transfer Roller Assy by releasing 4 hooks.

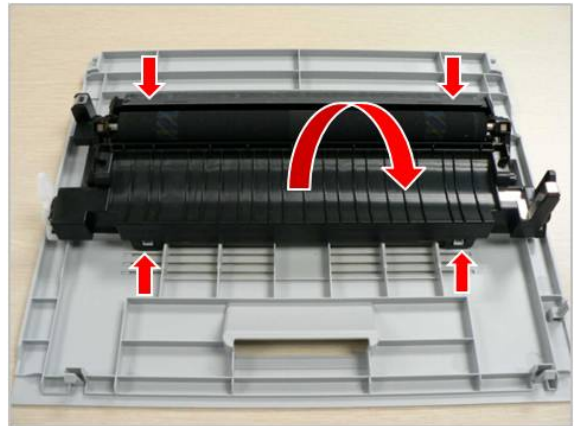

3.3.6. Pick up_Forward_Reverse roller

1. Remove the cassette. Stand the machine to see the bottom.
2. Release the Reverse roller Assy by pushing both hooks.

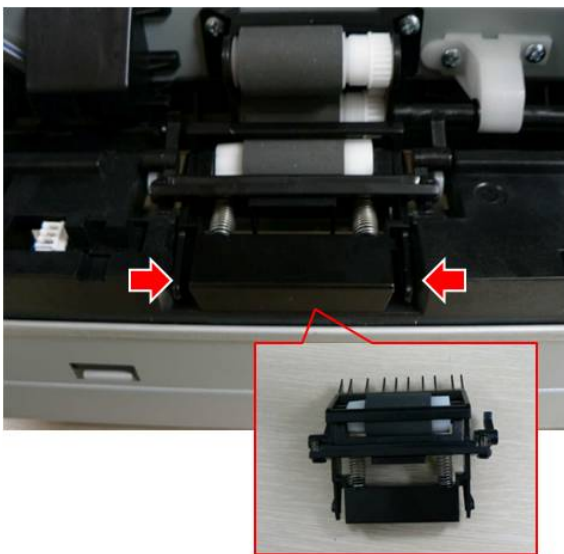

3. Remove 2 screws. Pull and release the Pick-up/Forward roller Assy.

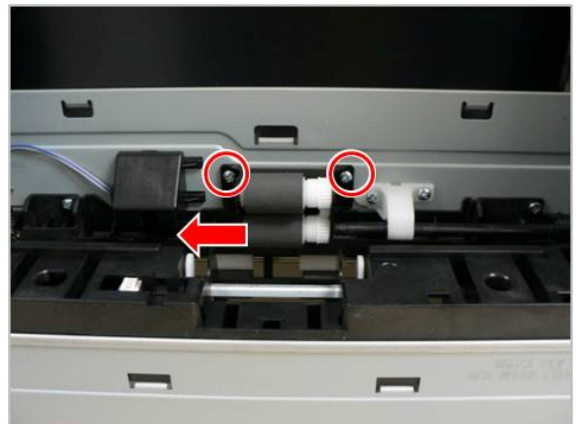

3.4. Replacing the main SVC parts

NOTE

Before service, remove all toner cartridges and guide-cartridge.

3.4.1. Cover

1. Open the front cover. Remove 4 screws.



2. Open the rear cover. Remove 4 screws.

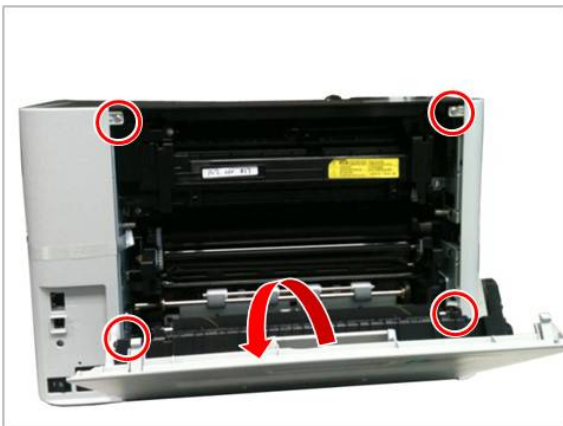

3. Release the left cover by pushing it to the direction of arrow.



4. Release the right cover.



5. Open the front cover. Remove 2 screws.

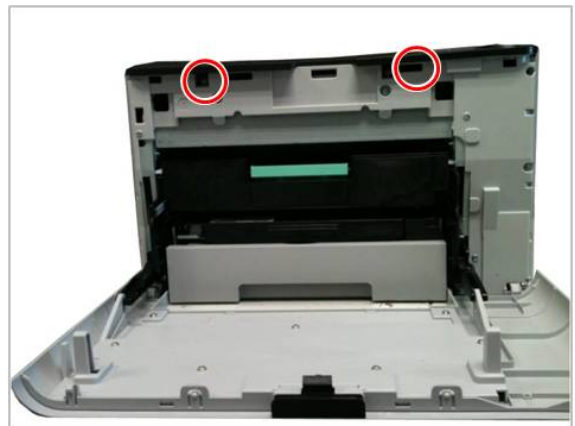

6. Remove 2 screws from the rear. Lift up and release the top cover.

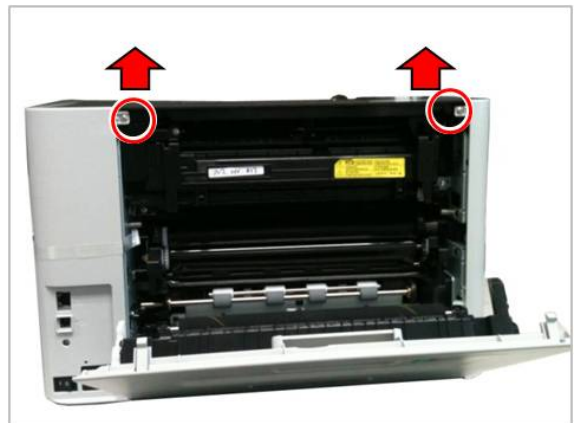

7. Release the hook of the linker. And remove the front cover.

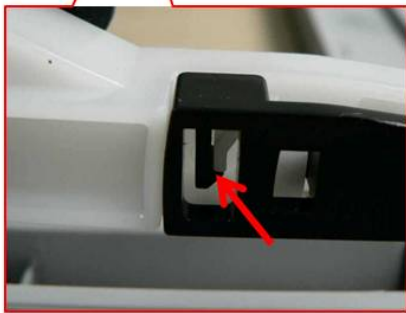
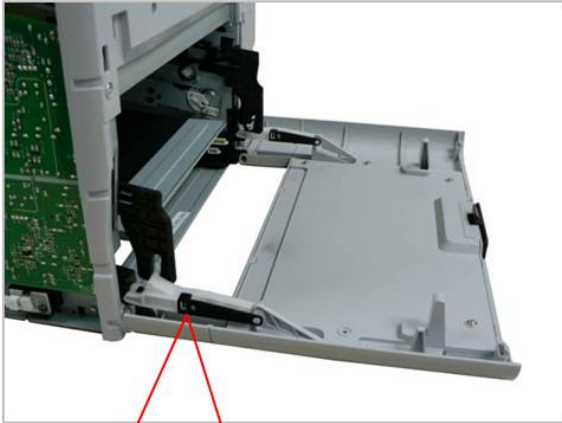

3.4.2. HVPS board

1. Remove the left cover. (Refer to 3.4.1)
2. Remove 9 screws. Unplug the connector. And release the HVPS board.

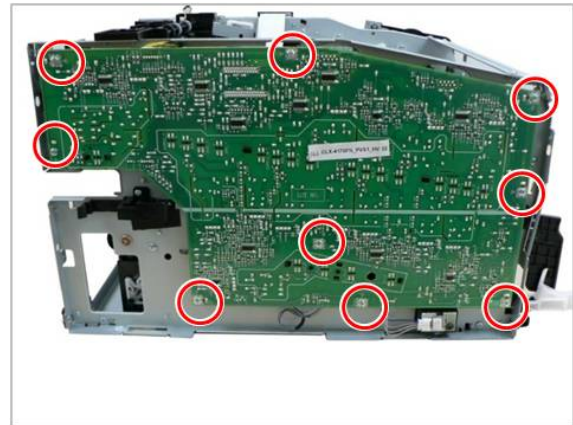

3.4.3. Outer Temperature Sensor

1. Remove the left cover. (Refer to 3.4.1)
2. Remove 1 screw. Unplug the connector. And remove the sensor.

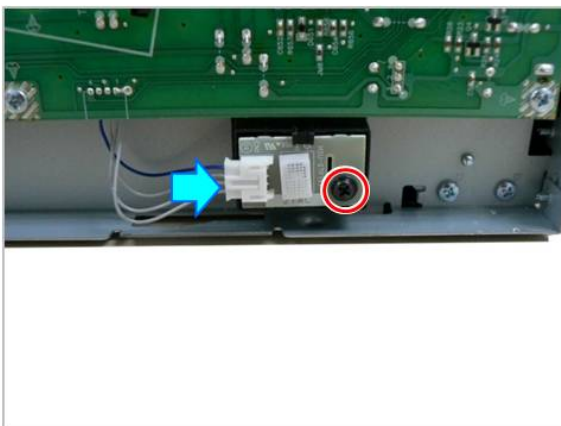

3.4.4. Waste toner container sensor

1. Remove the left cover. (Refer to 3.4.1)
2. Release the sensor holder after removing 1 screw.



3.4.5. LSU

1. Remove the top cover. (Refer to 3.4.1)
2. Remove the Bracket Top Front after removing 6 screws.
4. Unplug the flat cable. Remove the LSU.

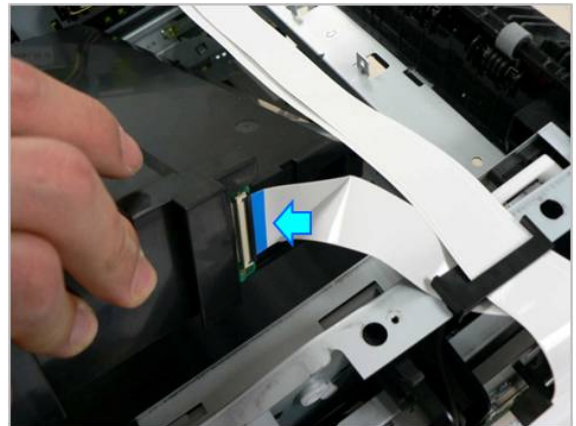
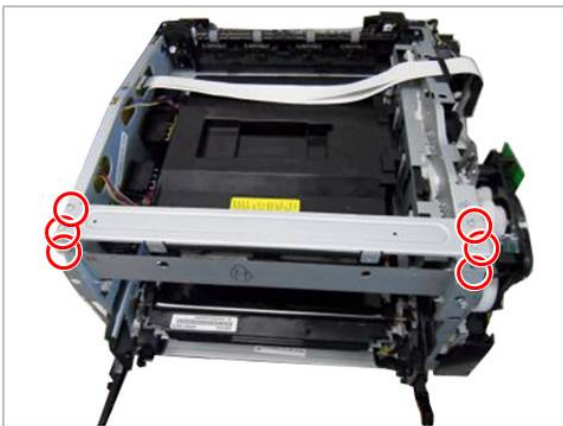

3. Remove 4 screws.

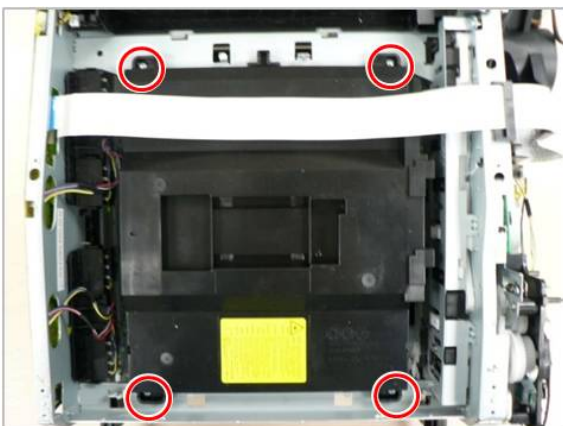

3.4.6. Main Board

1. Remove the right cover. (Refer to 3.4.1)
2. Unplug all connector. Remove 4 screws. And remove the main board.

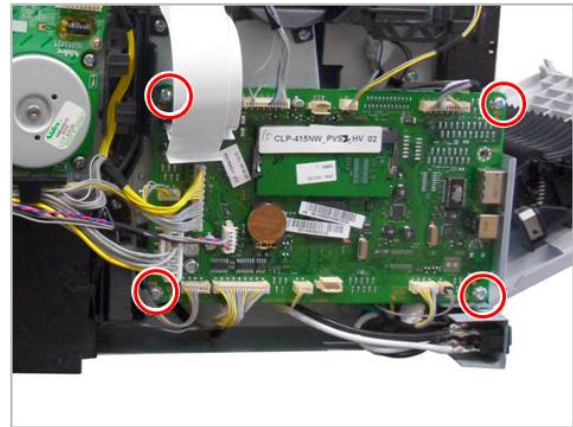

3.4.7. SMPS board

1. Remove the right cover. (Refer to 3.4.1)
2. Remove the SMPS board cover after removing 3 screws.
3. Unplug all connectors on SMPS board. Remove 3 screws. And remove the SMPS board.

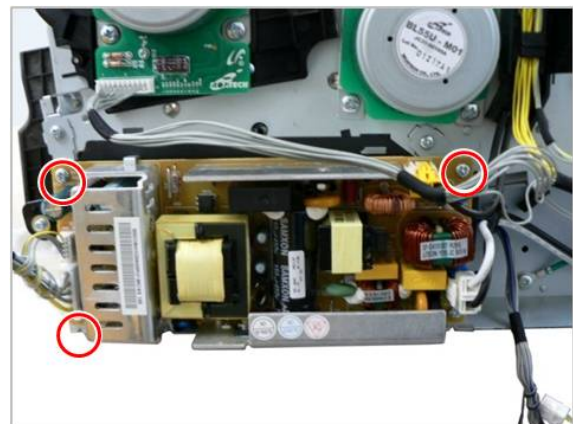
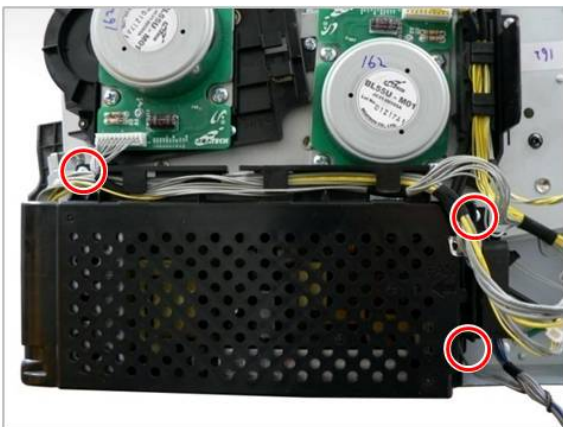

3.4.8. Feed Drive Unit

1. Remove the right cover.
2. Unplug all connectors on the main board.
3. Remove the main board bracket after removing 4 screws.

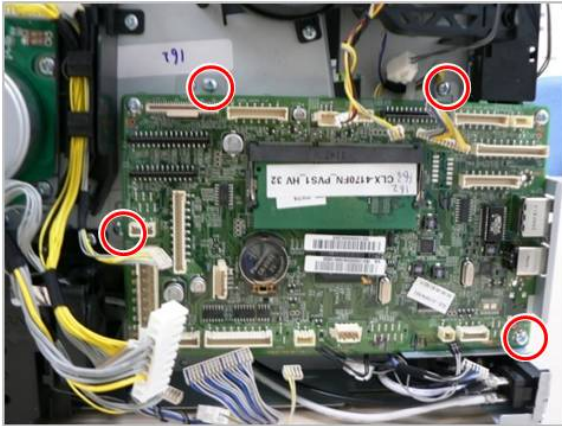

4. Remove the FRAME-FAN after removing 2 screws.

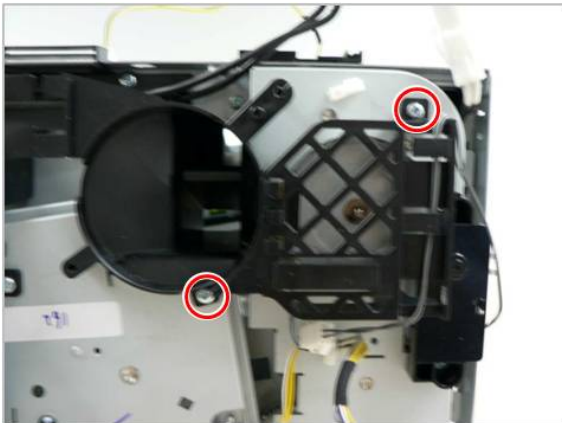

5. Remove the FRAME-INLET after removing 2 screws.

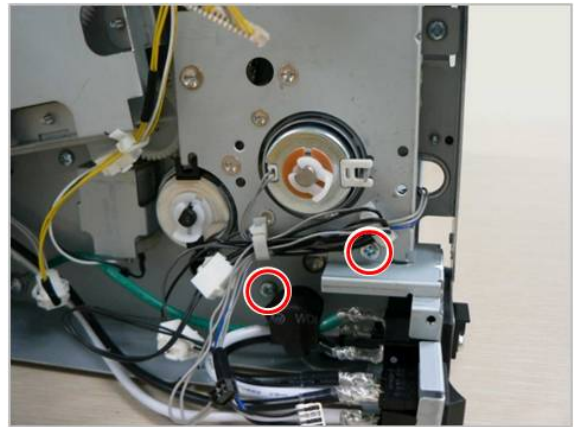

6. Remove 2 clutches after removing each fixer.
7. Remove the Feed Drive Unit after removing 6 screws.

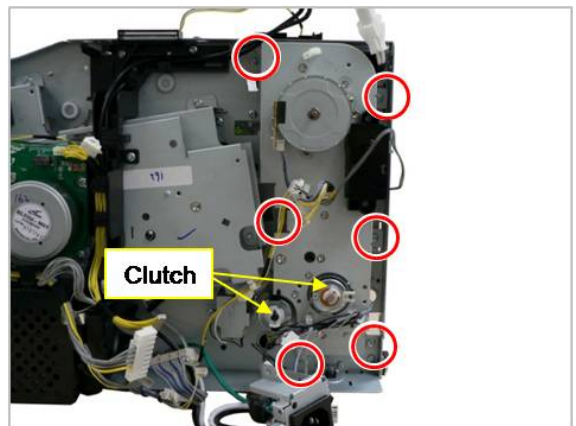

3.4.9. FRAME-RETARD

1. Remove the right cover. (Refer to 3.4.1)
2. Remove the main board bracket and FRAME-INLET.
(Refer to 3.4.8)
3. Remove the bracket after removing 2 screws.

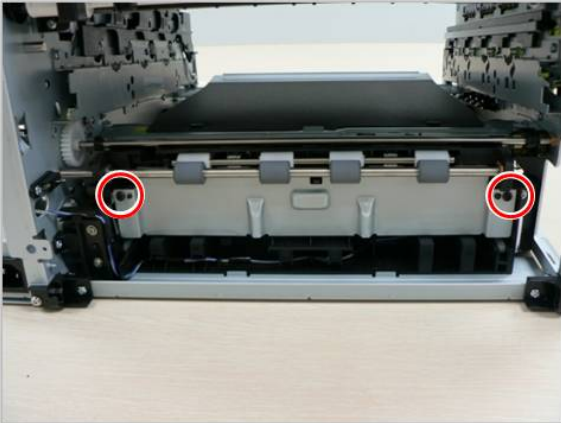

4. Remove 8 screws. Remove the Rear Hinge R,L and Bottom-Bracket.

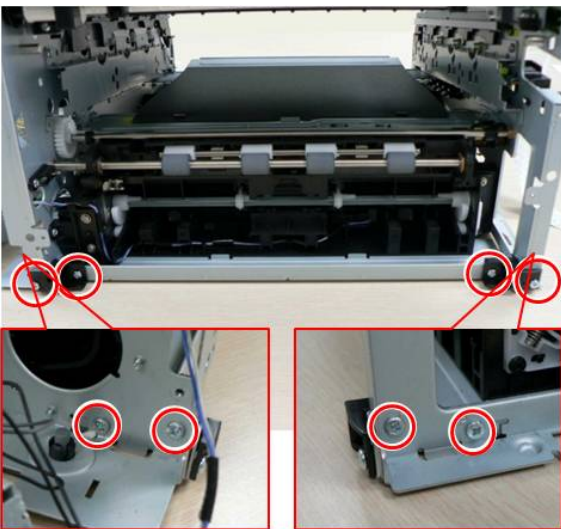

5. Remove the FRAME-RETARD after removing 4 screws.

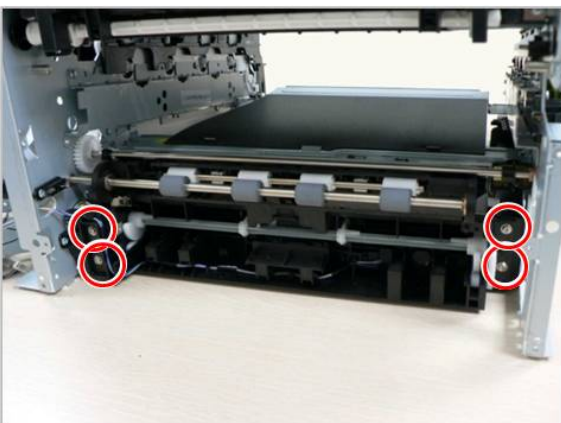

3.4.10. Main Drive Unit

1. Remove the right cover. (Refer 3.4.1)
2. Remove the SMPS board (Refer to 3.4.7)
3. Remove the main drive unit after removing 6 screws.

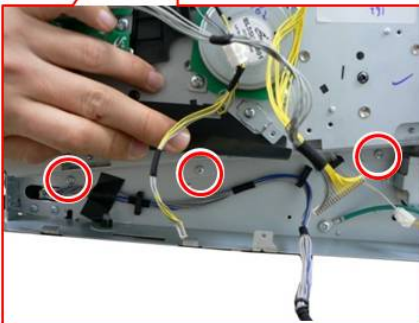
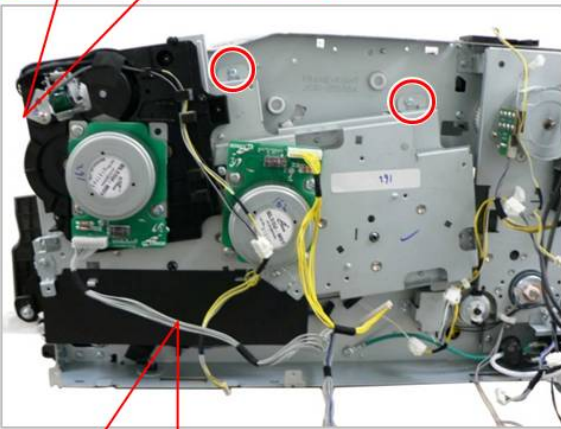
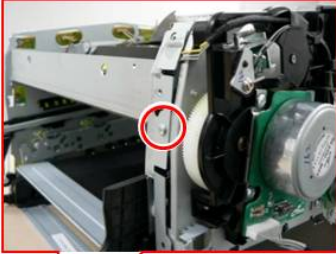

4. Alignment and Troubleshooting

4.1. Alignment and Adjustments

This chapter describes the main functions for service, such as the product maintenance method, the test output related to maintenance and repair, Jam removing method, and so on. It includes the contents of user guide.

4.1.1. Control panel

NOTE

- This control panel may differ from your machine depending on its model. There are various types of control panels.
- Some features and optional goods may not be available depending on model or country.

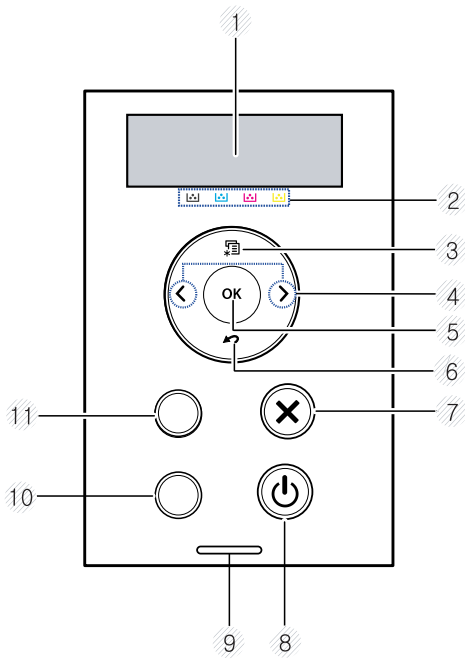

1	Display screen	Shows the current status and prompts during an operation.
2	Toner colors	Show the status of each toner cartridge. If the toner cartridge is low or needs to be replaced, the Status LED turns red and the display shows the message. However the arrow mark shows which color toner is of concern or may be installed with a new cartridge.
3	Menu	Enters menu mode and scrolls through the available menus.
4	Arrow	Navigates available values by moving to the next or previous options.
5	OK	Confirms the selection on the screen.
6	Back	Sends you back to the upper menu level.
7	Cancel	Stops current operation.
8	Power / Wake up	You can turn the power on and off with this button. Or wake up from the power save mode.

9	LED	Status	Indicates the status of your machine.
		Wireless*	Indicates the wireless status of your machine.
10	WPS		Configures the wireless network connection easily without a computer.
11	Eco		Enters eco mode to reduce toner consumption and paper usage.

4.1.2. Understanding the status LED

The color of the LED indicates the machine's current status.



NOTE

- Some LEDs may not be available depending on model or country.
- To resolve the error, look at the error message and its instructions from the troubleshooting part.
- You also can resolve the error with the guideline from the computers's Samsung Printing Status window.

LED	Status	Description	
Status	Off	The machine is off-line.	
	Green	Blinking	When the backlight blinks, the machine is receiving or printing data.
		On	<ul style="list-style-type: none"> • The machine is on-line and can be used.
	Red	Blinking	<ul style="list-style-type: none"> • A minor error has occurred and the machine is waiting for the error to be cleared. Check the display message. When the problem is cleared, the machine resumes. • Small amount of toner is left in the cartridge. The estimated cartridge life* of toner is close. Prepare a new cartridge for replacement. You may temporarily increase the printing quality by redistributing the toner.
		On	<ul style="list-style-type: none"> • A toner cartridge has almost reached its estimated cartridge life*. It is recommended to replace the toner cartridge. • The cover is opened. Close the cover. • There is no paper in the tray. Load paper in the tray. • The machine has stopped due to a major error. • A paper jam has occurred.
	WPS** Wireless**	Blue	Blinking
On			The machine is connected to a wireless network.
Off			The machine is disconnected from a wireless network.
Power/Wake up	Blue	On	The machine is in power save mode.
		Off	The machine is in ready mode or machine's power is off.
Eco	Green	On	Eco mode is on.
		Off	Eco mode is off.

* Estimated cartridge life means the expected or estimated toner cartridge life, which indicates the average capacity of print-outs and is designed pursuant to ISO/IEC 19798. The number of pages may be affected by operating environment, percentage of image area, printing interval, graphics, media and media size. Some amount of toner may remain in the cartridge even when red LED is on and the printer stops printing.

** Some LEDs may not be available depending on model or country.

4.1.3. Clearing paper jams

 **NOTE**

To avoid tearing the paper, pull the jammed paper out slowly and gently.

 **NOTE**

Illustrations on this user's guide may differ from your machine depending on its options or models.

In tray 1

1) Take off the cassette.

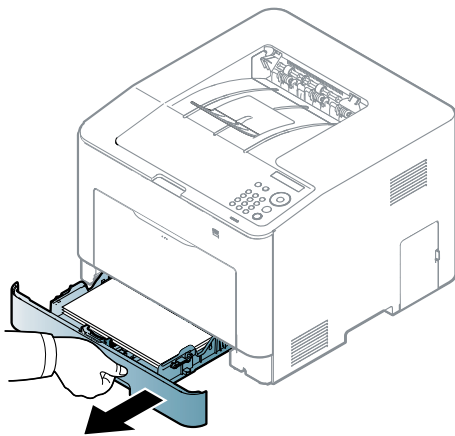

3) Reinstall the cassette.

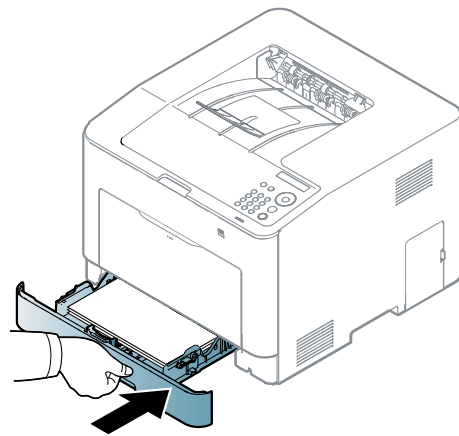

2) Remove the jammed paper by gently pulling it straight out.

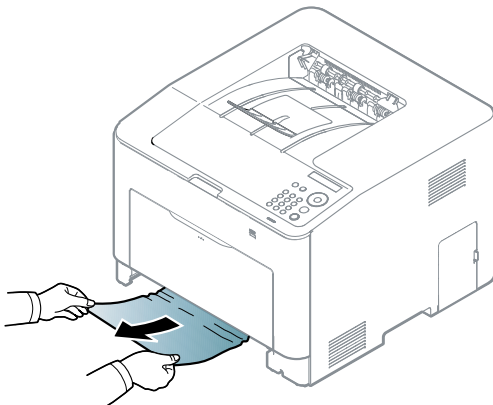



NOTE

Illustrations on this user's guide may differ from your machine depending on its options or models.

In the multi-purpose tray

1) Take off the cassette.

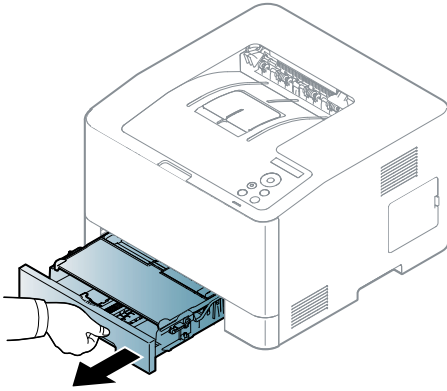

3) Reinstall the cassette.

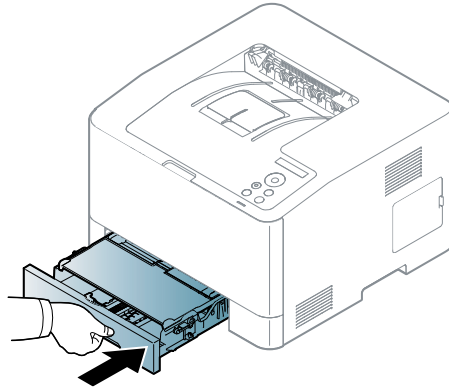

2) Remove the jammed paper by gently pulling it straight out.

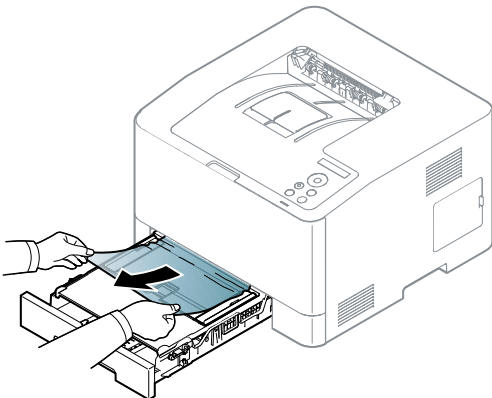

Inside the machine



CAUTION

The fuser area is hot. Take care when removing paper from the machine.

- 1) Open the rear cover.

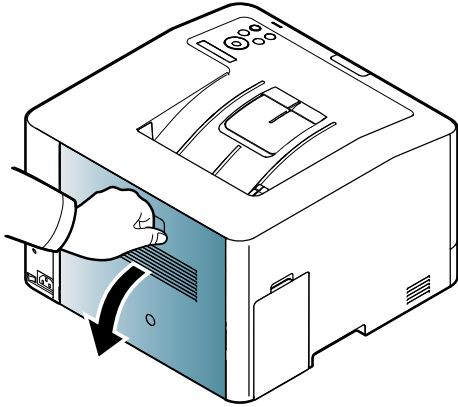

- 2) Remove the jammed paper by gently pulling it straight out.

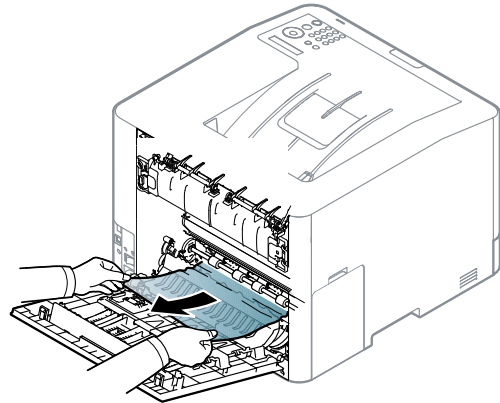

- 3) Close the rear cover.

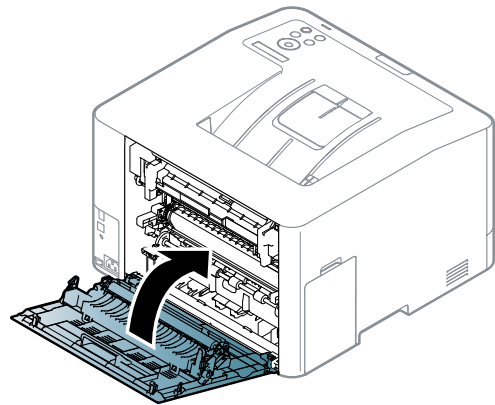

In exit area

- 1) Remove the jammed paper by gently pulling it straight out.

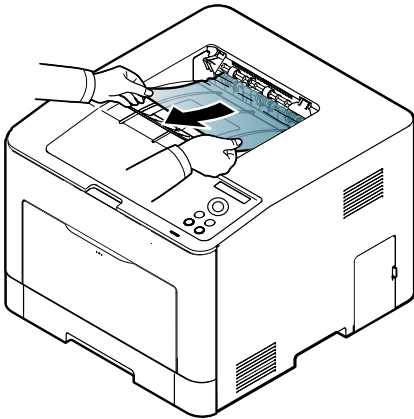

- 4) Remove the jammed paper by gently pulling it straight out.

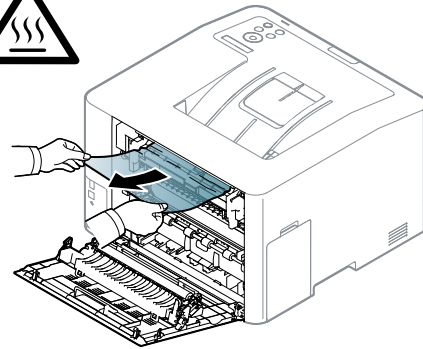

If you do not see the paper in this area, stop and go to next step:

- 2) Open the rear cover.

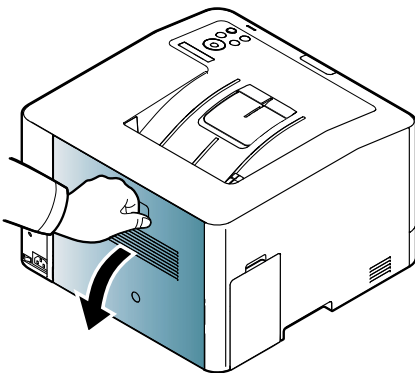

- 5) Close the fuser jam cover.

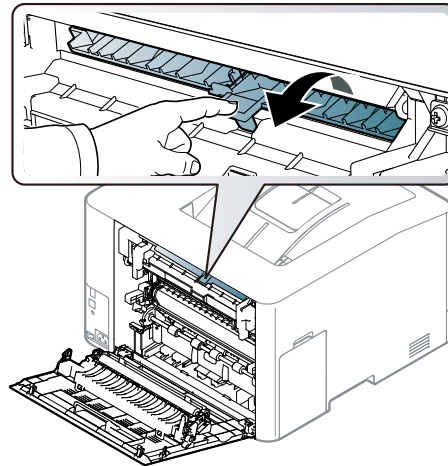

- 3) Open the fuser jam cover.

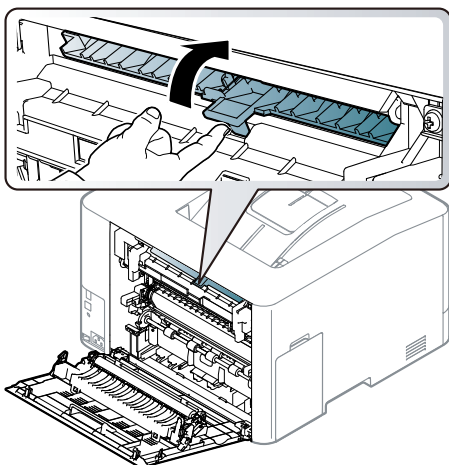

- 6) Close the rear cover.

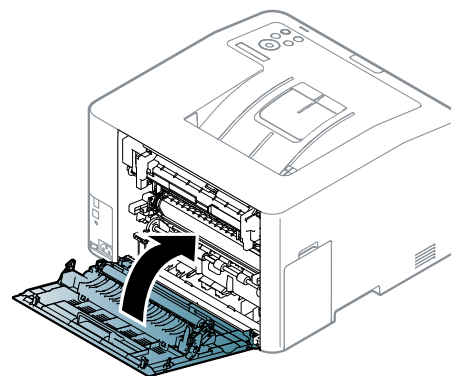

4.1.4. Useful menu item for service

1) Monitoring the supplies life

If you experience frequent paper jams or printing problems, check the number of pages the machine has printed or scanned. Replace the corresponding parts, if necessary.

NOTE

- It may be necessary to press OK to navigate to lower-level menus for some models.

- 1) Select “**Menu > System Setup > Maintenance > Supplies Life**” on the control panel.
- 2) Select the option you want and press OK.
- 3) Press “**Stop/Clear**” button to return to ready mode.

2) Altitude adjustment

Print quality is affected by atmospheric pressure, which is determined by the height of the machine above sea level. The following information will guide you on how to set your machine for the best print quality.

Before you set the altitude value, determine the altitude where you are.

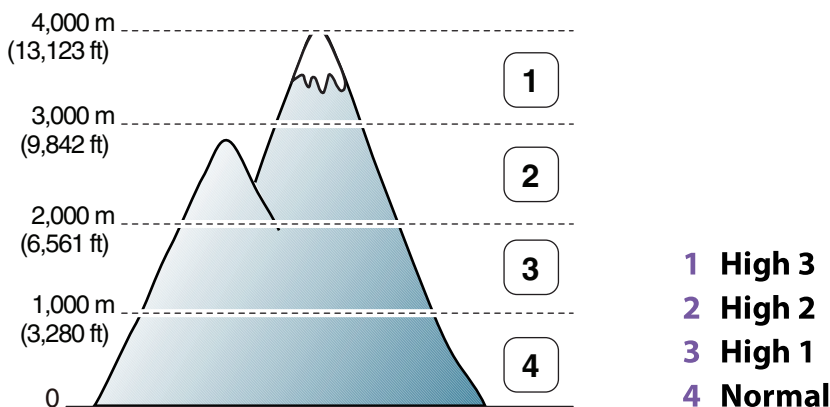

You can set the altitude value from Device Settings in Samsung Easy Printer Manager program.

- For Windows and Macintosh users, you set from **Samsung Easy Printer Manager > Switch to advanced mode > Device Settings**.

NOTE

- If your machine is connected to the network, you can set the altitude via SyncThru™ Web Service.
- You can also set the altitude in System Setup option on the machine’s display.
 - **Menu > System Setup > Altitude Adj**

3) Auto Color Reg.

The machine virtually prints certain patterned image to calibrate the color printing position. This feature enhances the colored image sharper and clearer, which means the machine prints the colored image on the paper more like the one in the monitor.



NOTE

If you have moved the machine, it is strongly recommended to operate this menu manually.

Select the menu item.

- Select “**Menu > Image Mgr > Auto Color Reg.**” on the OP Panel

4.1.5. Periodic Defective Image

If an image defects appears at regular intervals on the printed-paper, it is due to a faulty or damaged roller. Refer to the table below and check the condition of the appropriate roller.



	Roller	Diameter	Period	Phenomenon	Defective part
1	Pressure Roller	20 mm	62.8 mm	Background	Fuser Unit
2	Heat Roller	24.3 mm	76.3 mm	Black spot and image ghost	
3	Charging Roller	8.5 mm	26.7 mm	Black Spot and line and periodic band	Toner Cartridge
4	OPC Drum	24 mm	75.4 mm	White and Black Spots	
5	Developing Roller	12 mm	37.7 mm	White spot, Horizontal black band	
6	Supply Roller	11.3 mm	35.5 mm	Periodic Band by little difference of density	
7	Transfer Roller	8 mm	25.1 mm	Ghost, Damaged image by abnormal transfer	Transfer roller

4.1.6. Useful management tools

4.1.6.1. Using Samsung Easy Printer Manager (Windows and Macintosh only)

NOTE

- This feature may not be available depending on model or optional goods.
- Available for Windows or Macintosh OS users only.
- For Windows, Internet Explorer 6.0 or higher is the minimum requirement for Samsung Easy Printer Manager.

Samsung Easy Printer Manager is an application that combines Samsung machine settings into one location. Samsung Easy Printer Manager combines device settings as well as printing environments, settings/actions and launching. All of these features provide a gateway to conveniently use your Samsung machine. Samsung Easy Printer Manager provides two different user interfaces for the user to choose from: the basic user interface and the advanced user interface. Switching between the two interfaces is easy: just click a button.

Understanding Samsung Easy Printer Manager

To open the program:

- For Windows, Select Start > Programs or All Programs > Samsung Printers > Samsung Easy Printer Manager > Samsung Easy Printer Manager.
- For Macintosh, Open the Applications folder > Samsung folder > Samsung Easy Printer Manager.

The Samsung Easy Printer Manager interface is comprised of various basic sections as described in the table that follows:

NOTE

The screenshot may differ depending on operating system you are using.

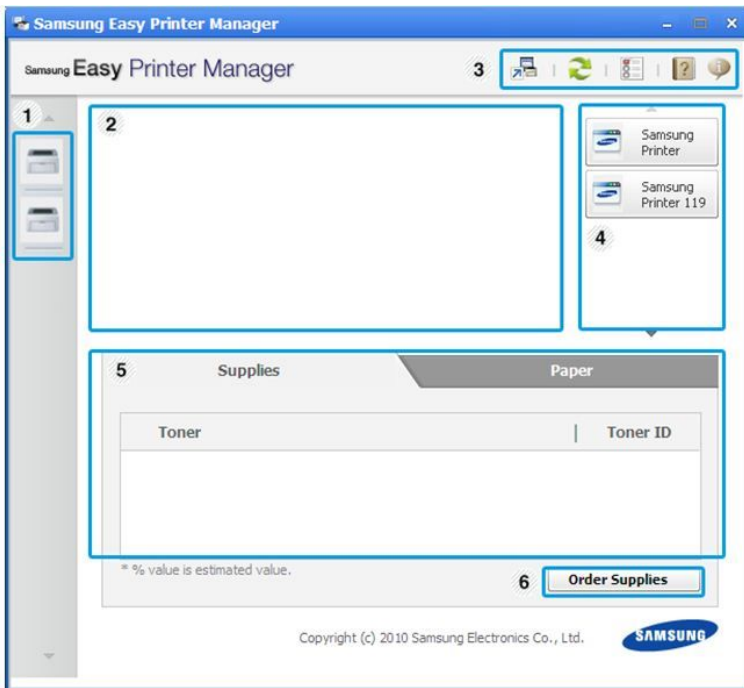

No	Area	Description
1	Printer List	The printer list displays the installed printer icons on your computer.
2	Printer Information	<p>This area gives you general information about your machine. You can check information, such as the machine's model name, IP address (or Port name), and machine status.</p> <div style="background-color: #e0e0e0; padding: 5px;">  NOTE Troubleshooting button: This button opens Troubleshooting Guide when an error occurs. You can directly open the necessary section in the user's guide. </div>
3	Application Information	Includes links for changing to the advanced settings, preference, help, and about.
4	Quick links	Displays Quick links to machine specific functions. This section also includes links to applications in the advanced settings.
5	Contents Area	Displays information about the selected machine, remaining toner level, and paper. The information will vary based on the machine selected. Some machines do not have this feature.
6	Order Supplies	Click on the Order button from the supply ordering window. You can order replacement toner cartridge(s) from online.

Advanced settings user interface overview

The advanced user interface is intended to be used by the person responsible for managing the network and machines.

- **Device Settings**

You can configure various machine settings such as machine setup, paper, layout, emulation, network, and print information.

- **Scan to PC Settings**

This menu includes settings to create or delete scan to PC profiles.

- **Scan Activation** : Determines whether or not scanning is enabled on the device.
- **Profile** : Displays the scanning profiles saved on the selected device.
- **Basic tab** : Contains settings related general scan and device settings.
- **Image tab** : Contains settings related to image altering.

- **Fax to PC settings**

This menu includes settings related to the basic fax functionality of the selected device.

- **Disable** : If Disable is On, incoming faxes will not be received on this device.
- **Enable Fax Receiving from Device** : Enables faxing on the device and allow more options to be set.

- **Alert Settings**

This is menu includes settings related to error alerting.

- **Printer Alert** : Provides settings related to when alerts will be received.
- **Email Alert** : Provides options relating to receiving alerts via email.
- **History Alert** : Provides a history of device and toner related alerts.

- **Job Accounting**

Provides querying of quota information of the specified job accounting user. This quota information can be created and applied to devices by job accounting software such as SyncThru™ or CounThru™ admin software.

4.1.6.2. Using Samsung Printer Status (Windows only)

The Samsung Printer Status is a program that monitors and informs you of the machine status.

NOTE



- The Samsung Printer Status window and its contents shown in this user’s guide may differ depending on the machine or operating system in use.
- Check the operating system(s) that are compatible with your machine.

Samsung Printer Status overview

If an error occurs while operating, you can check the error from the Samsung Printer Status. Samsung Printer Status is installed automatically when you install the machine software.

You can also launch Samsung Printer Status manually. Go to the **Printing Preferences** , click the **Basic** tab > **Printer Status** button.

These icons appear on the Windows task bar:

Icon	Mean	Description
	Normal	The machine is in ready mode and experiencing no errors or warnings.
	Warning	The machine is in a state where a soft error has occurred. For example, a toner low status, which may lead to toner empty status.
	Error	The machine has at least one hard error, such as out of paper, fuser error, etc. Machine does not have ability to come to ready without customer intervention.

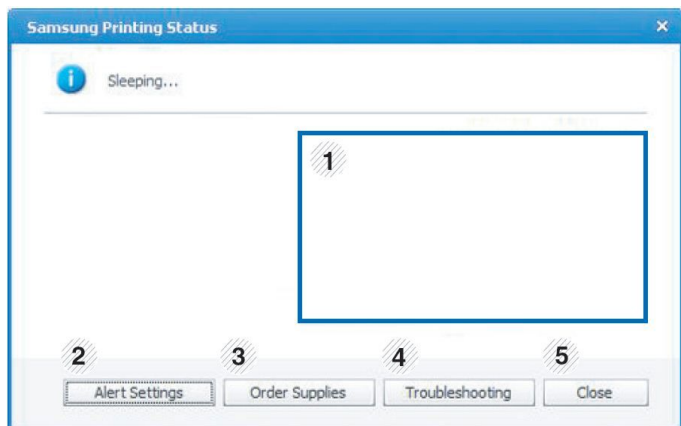

1	Toner Level	You can view the level of toner remaining in each toner cartridge. The machine and the number of toner cartridge(s) shown in the above window may differ depending on the machine in use. Some machines do not have this feature.
2	Alert Settings	Select the settings you want from the options window.
3	Order Supplies	You can order replacement toner cartridge(s) from online.
4	Troubleshooting	You can directly open the troubleshooting section in the user’s guide.
5	Close	Close the window.

4.1.6.3. Using SyncThru Web Service (SWS)

SWS is an embedded web server in the machine. This web server informs you of machine configuration, version, status and allows you to customize the machine's settings. You can contact this server via wired and wireless network using your web browser in the remote place.

Connecting preparations

- Wired or Wireless Network connection is established.
- Browser (Ex> Internet Explorer) Program on your PC network connected

SWS overview

SyncThru Web Service (SWS)

- accepts HTTP request via port 80 as normal web servers.
- provides interface to users information of networked printers and allow to configure the setting of printers.
- is able to provide more complicated options than Local UI for printer configuration.

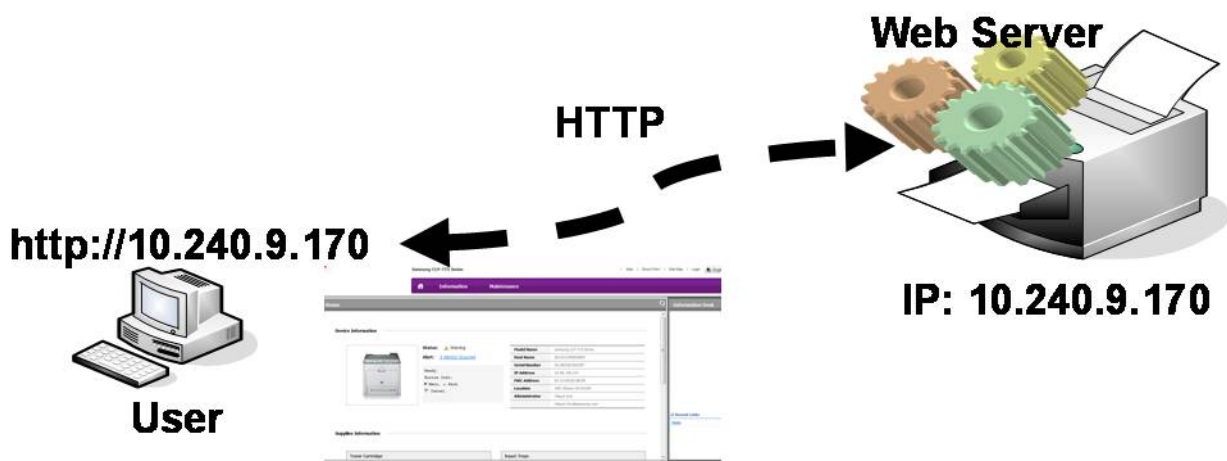

Connection Procedure

- 1) Open the Web-browser and input IP address of machine. Click "Login".
- 2) Log-in Admin Mode. (ID: admin, PW: sec00000)
- 3) Select pages to check the configuration and customize the settings.



CAUTION

Please, change SWS Default ID and Password for system security in case of your first connection.

 **NOTE**

If the machine supports 'Direct Print', you can enable this function using the SWS menu. The default configuration is 'Disabled' for your security.

Firstly, you have to login to SWS.

- 1) Click 'Direct Print Configuration' in the pop up windows when clicking 'Direct Print'.
- 2) In the 'Services' Menu, check 'Direct Print'.

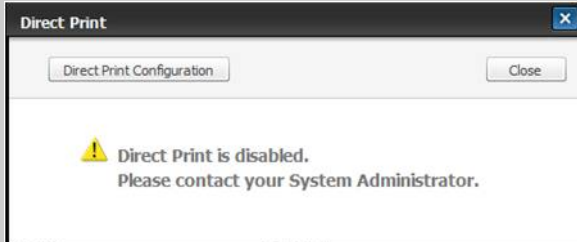

Or,

- 1) Click 'System Security' in the 'Security' menu.
- 2) Select 'Feature Management' in the left frame.
- 3) In the 'Services' Menu, check 'Direct Print'.

4.1.7. Updating Firmware

This chapter includes instructions for updating the printer firmware. You can update the printer firmware by using one of the following methods :

- Update the firmware by using the USB port.
- Update the firmware by using the Network.

4.1.7.1. Update the firmware by using the USB port

Upgrading preparations

- usblast2.exe : Tool which sends firmware data to printer.
- Firmware file to update , SWUPGRADE_ON.prn file

Upgrade Procedure

- 1) Turn the machine off.
- 2) Connect USB cable to printer.
- 3) Turn the machine on. Check if the printer is the ready status.
- 4) Drag the SWUPGRADE_ON.prn file and drop down on the usblast2.exe.
- 5) Drag the firmware file and Drop down on the usblast2.exe.

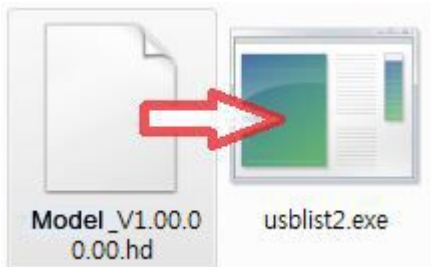

And then firmware update will be started automatically.

- 6) When upgrading is completed, machine is automatically re-booting.

4.1.7.2. Update the firmware by using the network

Upgrading preparations

- Wired or Wireless Network connection is established.
- Firmware file to update

Upgrade Procedure

1) Open the Web-browser and input IP address of machine. Click “Login”.

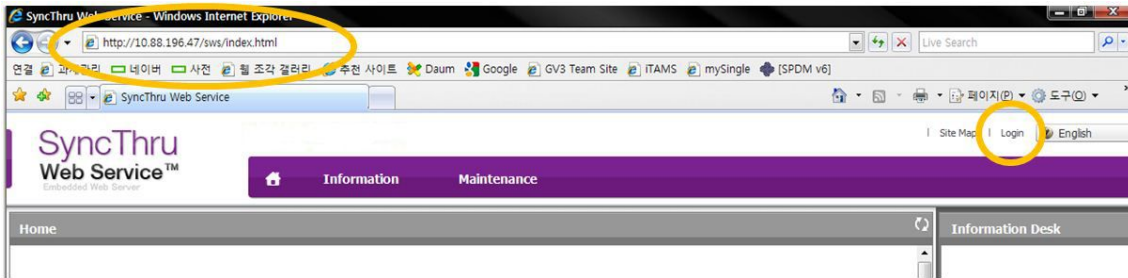

2) Log-in Admin Mode. (ID: admin, PW: sec00000)

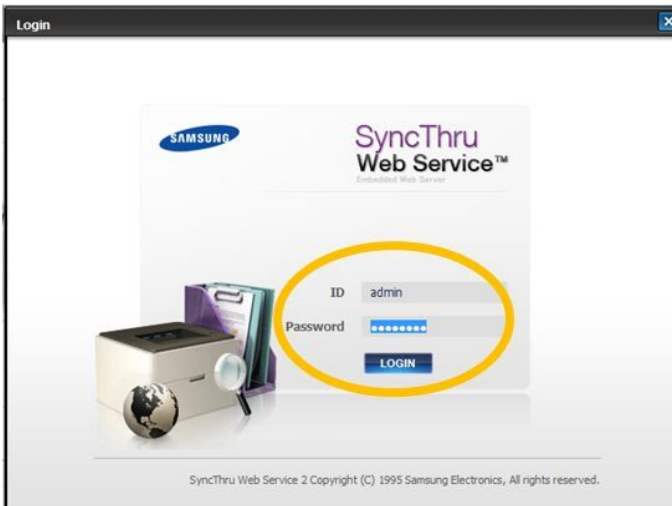

3) Select Maintenance menu and click “upgrade wizard”

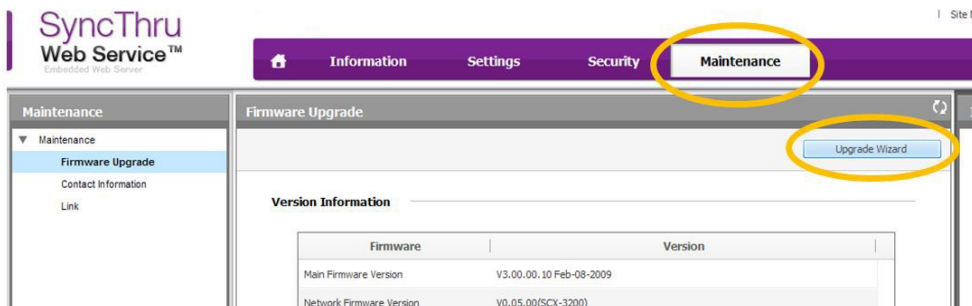

- 4) Select firmware file using “browser” button and press next button.

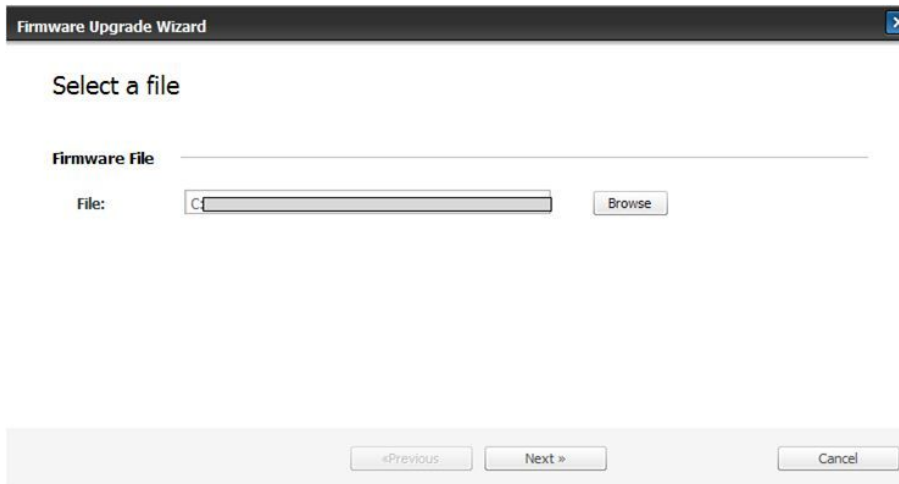

- 5) SyncThru will check verify firmware file and compare version and press next button.

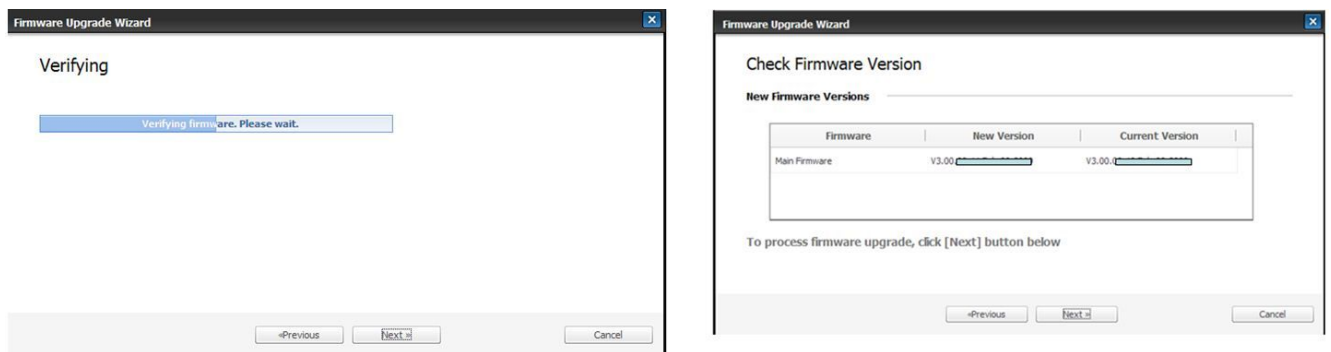

- 6) Machine starts upgrading. SyncThru will return home page after upgrading is completed.

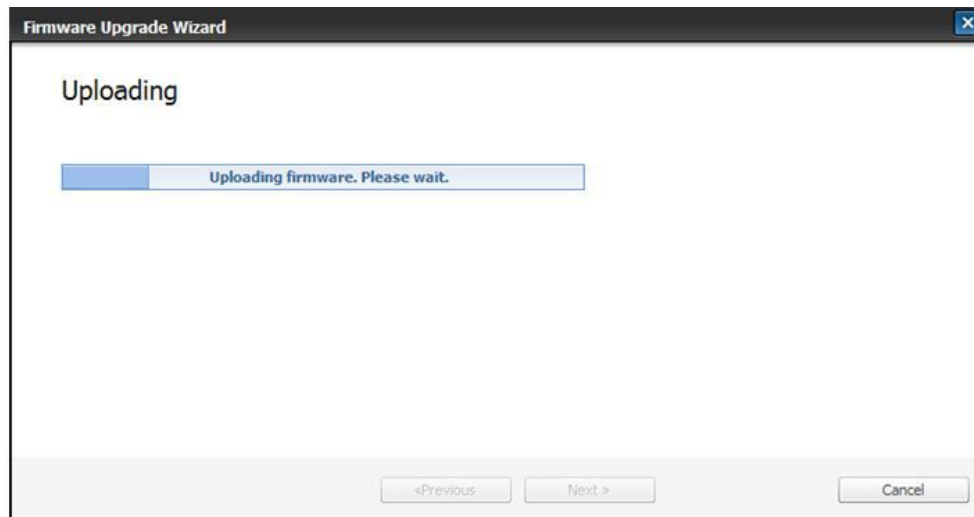

4.1.8. Tech Mode (Diagnostic Mode)

In service (tech) mode, the technician can check the machine and perform various test to isolate the cause of a malfunction. While in Tech mode, the machine still performs all normal operations.

1) Entering Tech Mode

- Press “Menu > Back > Left > Right > OK > Stop” on the control panel continuously.

2) Tech Mode Menu



NOTE

Some menu items may not appear on the display depending on the options or models.

Depth 1	Depth 2	Depth 3	Depth 4	Depth 5
Tech Mode	Data Setup	Counter Reset	Fuser	
			Pickup Roller	Tray1
				Tray2
		MP Tray		
		Clear All Mem.	[Country list]	
		B2B Mode	0-99	
		Toner Low Level	[1~30]: 10 %*	
	Report	Supplies Info	Printing...	
		Configuration	Printing...	
		Usage Counter	Printing...	
		Job Duty	Printing...	
		Error Info	Printing...	
		Auto Color Reg	Printing...	
Auto Toning	Printing...			
EDC Mode	NVM Read Write			
	NVM Initialize	Initialize Now		
	Test Routines			

3) Data Setup

- **Counter Reset**

This function resets the count value you select.

- **Clear All Memory**

The function resets the system to factory default settings. This function is used to reset the system to the initial value when the product is functioning abnormally . All the values are returned to the default values, and all the information, which was set by the user, will be erased.



NOTE

Always perform a memory clear after replacing the main board. Otherwise, the system may not operate properly.

- **Toner Low Level**

The function is to set up the time to inform toner low status. This function can provide user convenience for replacing the toner cartridge.

4) Report

- **Supplies Info**

Supplies Information Report shows toner cartridge information such as toner remaining, toner capacity, toner product date etc.

- **Configuration**

Configuration report shows the status of the user-selectable options. You may print this list to confirm your changes after changing settings. This page provides useful information for service.

- **Error Info**

Error Information Report shows error records.

5) EDC mode

- **NVM Read/Write** : This menu changes a configuration value for engine firmware.

Depth 1	Depth 2
105-Charger	0030-MHV DC K
	0031-MHV DC Co
106-Developer	0000-Deve DC Y
	0010-Deve DC M
	0020-Deve DC C
	0030-Deve DC K
	0121-Y Blade DC
	0122-M Blade DC
	0123-C Blade DC
	0124-K Blade DC
107-Transfer	0030-THV
	0080-THV2
109-Fixing	0010-Print Temp
110-LSU	0040-LD Power Y
	0050-LD Power M
	0060-LD Power C
	0070-LD Power K

- **NVM Initialize** : This menu resets all NVM value to the factory setting.
- **Test Routines** : This menu performs test routines for the engine.

Depth 1	Depth 2
100-Motor	0051-YMCK OPC
	0052-YMCK OPC Rdy
	0072-YMCK Dev
	0073-YMCK Dev Rdy
	0260-SMPS Fan
	0340-Feed Mot
	0360-ITB TR Mot
101-Clutch	0010-Tray1 Pickup
	0030-Tray3 Pickup
	0050-Registration
	0171-Front Cover Open
	0190-OutBin Full
	0230-T2 Nip Release
	0240-DR Nip Release
	0250-Knock Up Plate
	0251-Fuser Gap Enable
102-Sensor	0010-Tray1 Empty
	0360-Regi Sens
	0370-Exit Sens
	0680-ITB Tension Home Sensor
105-Charger	0030-K MHV Bias
	0031-Color MHV Bias
106-Developer	0000-Y Dev Bias
	0010-M Dev Bias
	0020-C Dev Bias
	0030-K Dev Bias
	0040-Black OPC Home Sensor
	0050-Color OPC Home Sensor
	0060-DR Nip Home Sensor
	0070-Y Blade DC
	0080-M Blade DC
	0090-C Blade DC
	0100-K Blade DC
107-Transfer	0071-YMCK THV Bias
	0072-YMCK THV Bias R
	0073-YMCK THV- Bias
	0080-THV +
	0090-THV + R
	0160-Erase Lamp

Depth 1	Depth 2
109-Fixing	0000-Temp A
	0011-LSU Temperature
	0012-Inner Temperature
	0013-Outer Temperature
	0014-Humidity
	0020-Fuser Fan Rdy
	0040-Fuser Fan Run
110-LSU	0000-LSU Motor 1 Rdy
	0060-LSU Motor1 Run
	0080-LD Power1
	0090-LD Power2
	0100-LD Power3
	0110-LD Power4
111-Toner	0080-ID Sensor
	0090-ID Sensor Chk

4.2. Troubleshooting

4.2.1. Procedure of checking the symptoms

Before attempting to repair the printer first obtain a detailed description of the problem from the customer.

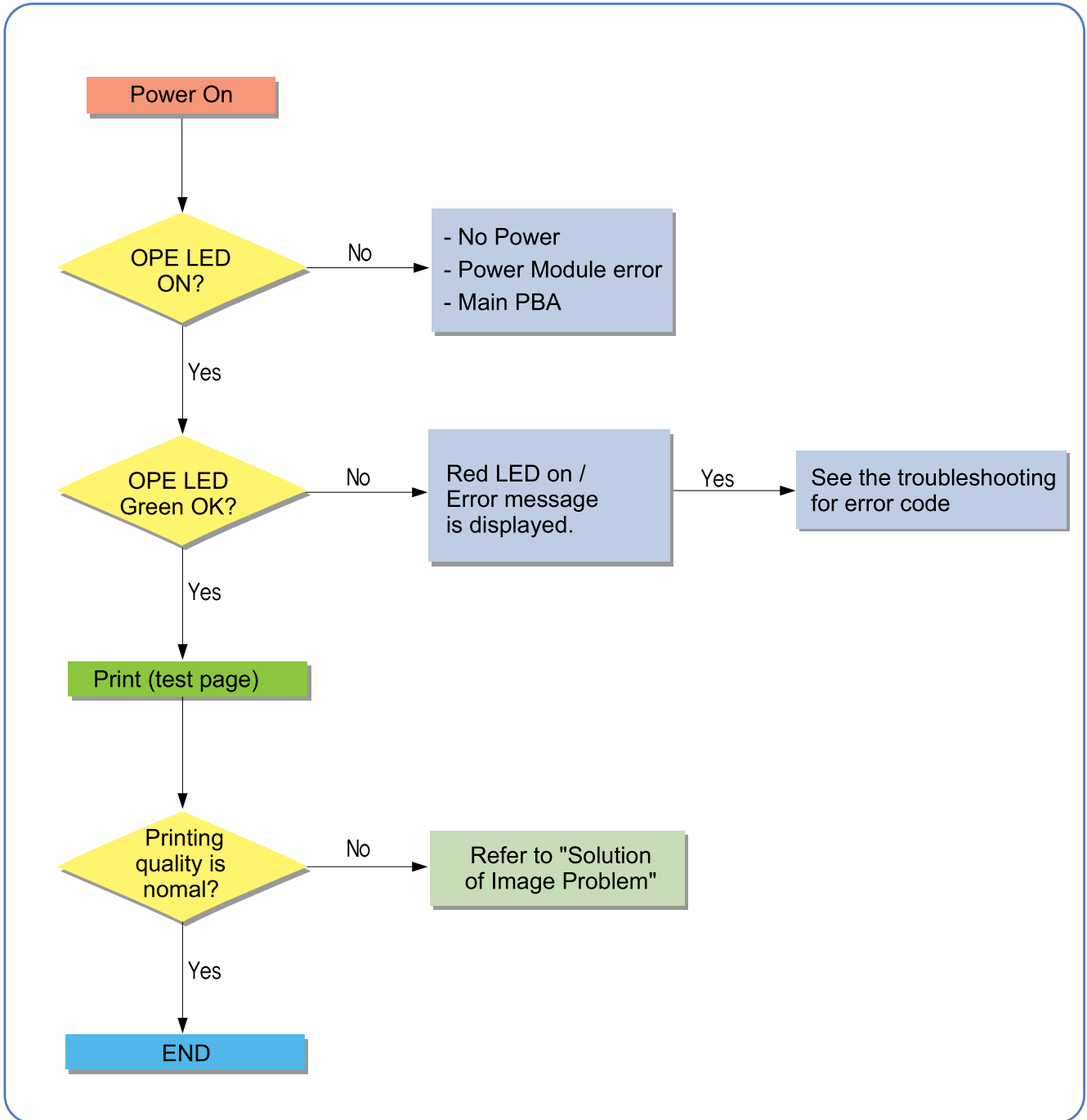

4.2.1.1. Basic Check List

1) Check the Power.

- Check that the power switch is turned on.
- Check that the power cable is plugged into the outlet and the printer.
- Check the voltage of the power outlet.

2) Check the LED of Panel.

- Is there OPE LED ON?
 - › If not check power cable, switch SMPS or Main board.
- Is the abnormal Lamp?
 - › Check the Main board and cable harness.

3) Check the Paper Path

- Is there a Paper Jam?
 - › Remove any paper fragments caught in the paper path.
- Paper Jam occurs repeatedly at a specific point in the Paper Path
 - › Open the fuser cover, Jam clear.
 - › Dismantle the machine and carefully inspect the region where the jam occurs.
(Especially, check if paper fragments are caught in the Fuser)

4) Print the Information Page (Configuration).

- Try printing a test page from a computer.
 - › If there is an error check cables and driver installation.

5) Check the Print Quality.

- Is there are a Print Quality Problem?
 - › Refer to image quality problem section.

6) Check consumables (toner etc.).

- Using the keys print the Test Pattern.
 - › Expected life of various consumable parts, compare this with the figures printed and replace as required

4.2.2. Error Code and Troubleshooting

Messages appear on the control panel display to indicate the machine's status or errors. Refer to the tables below to understand the messages' and their meaning, and correct the problem, if necessary.



NOTE

Some messages may not appear on the display depending on the options or models.

Error Code	Error Message	Troubleshooting Page
A1-1210	Error #A1-1210 Call for service	Page 4-27
A1-2112	Error #A1-2112 Call for service	Page 4-28
A1-3612	Error #A1-3612 Call for service	Page 4-28
A1-4111	Error #A1-4111 Call for service	Page 4-29
A1-4112	Error #A1-4112 Call for service	Page 4-29
A1-4310	Error #A1-4310 Call for service	Page 4-29
A2-1210	Error #A2-1210 Call for service	Page 4-30
A2-2110	Error #A2-2110 Call for service	Page 4-30
A3-3211	Error #A3-3211 Call for service	Page 4-30
A3-3212	Error #A3-3212 Call for service	Page 4-30
A3-3311	Error #A3-3311 Call for service	Page 4-31
A3-3312	Error #A3-3312 Call for service	Page 4-31
A3-3320	Not proper room temp. Move set	Page 4-31
C2-2110	Prepare Toner	Page 4-32
C2-2120	Replace Toner	Page 4-32
C2-2150	Replace Toner	Page 4-32
C2-2320	Error #C2-2320 Install Y toner	Page 4-33
C2-2410	Install yellow toner cartridge	Page 4-33
C2-2512	Not Compatible Y toner cart.	Page 4-34
C2-3110	Prepare Toner	Page 4-32
C2-3120	Replace Toner	Page 4-32
C2-3150	Replace Toner	Page 4-32
C2-3320	Error #C2-3320 Install M toner	Page 4-33
C2-3410	Install magenta toner cartridge	Page 4-33
C2-3512	Not Compatible M toner cart.	Page 4-34
C2-4110	Prepare Toner	Page 4-32
C2-4120	Replace Toner	Page 4-32
C2-4150	Replace Toner	Page 4-32
C2-4320	Error #C2-4320 Install C toner	Page 4-33
C2-4410	Install Cyan toner cartridge	Page 4-33
C2-4512	Not Compatible C toner cart.	Page 4-34
C2-5110	Prepare Toner	Page 4-32
C2-5120	Replace Toner	Page 4-32
C2-5150	Replace Toner	Page 4-32

Error Code	Error Message	Troubleshooting Page
C2-5320	Error #C2-5320 Install K toner	Page 4-33
C2-5410	Install black toner cartridge	Page 4-33
C2-5512	Not Compatible K toner cart.	Page 4-34
C5-1110	Prepare new Transfer belt	Page 4-34
C5-1120	Replace new Transfer belt	Page 4-34
C5-1310	Install TR. belt unit.	Page 4-34
C5-1410	Not compatible transfer belt	Page 4-35
C5-1710	Transfer Belt Error	Page 4-35
C6-1110	Replace Fuser Soon	Page 4-35
C6-1120	Replace new Fuser unit	Page 4-35
C7-1110	Waste toner Full Replace new one	Page 4-35
C7-1311	Not Installed Waste tank	Page 4-36
C9-1112	Replace new Tray1 roller	Page 4-36
C9-1116	Replace new Tray1 roller	Page 4-36
M1-1110	Paper Jam in Tray 1	Page 4-37
M1-5112	Paper Empty in Tray1	Page 4-37
M2-1110	Paper Jam inside machine	Page 4-38
M2-1116	Paper jam or empty	Page 4-38
M3-1110	Paper Jam in exit area	Page 4-39
M3-2130	Output bin full Remove paper	Page 4-40
S2-4120	Door open Close it	Page 4-41
S5-3110	Error #S5-3110 Call for service	Page 4-41
S6-3123	Network Problem: IP Conflict	Page 4-42
S6-3128	802.1x Network Error	Page 4-42
U1-2132	Error #U1-2132 Turn off then on	Page 4-42
U1-2315	Error #U1-2315 Turn off then on	Page 4-42
U1-2320	Error #U1-2320 Turn off then on	Page 4-42
U1-2330	Error #U1-2330 Turn off then on	Page 4-42
U1-2334	Error #U1-2334 Turn off then on	Page 4-42
U1-2340	Error #U1-2340 Turn off then on	Page 4-42
U1-234H	Error #U1-234H Turn off then on	Page 4-42
U2-6122	Error #U2-6122 Turn off then on	Page 4-43
U2-6142	Error #U2-6142 Turn off then on	Page 4-43

▶ **Error Code**

A1-1210

▶ **Error message**

Error #A1-1210 Call for service

▶ **Symptom**

The fuser motor does not operate. / The fuser motor is operating but is recognized as stop status.

▶ **Troubleshooting method**

- 1) Turn the machine off then on. If the error persists, turn the machine off again.
- 2) Remove the rear and right cover.
- 3) Check if there are any obstacles or paper around the fuser unit.
- 4) Check if the connection between main board and fuser motor are correct.
- 5) If the connection is OK, replace the fuser motor.

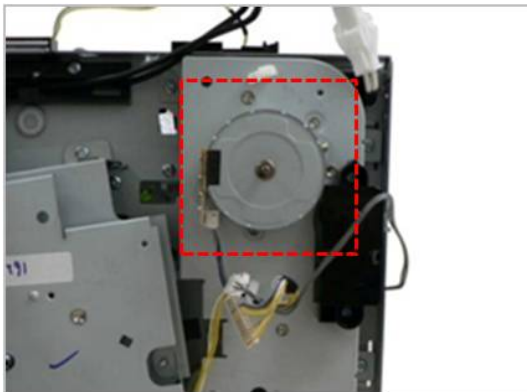

- 6) If the problem persists, replace the main board.

▶ Error Code

A1-2112

A1-3612

▶ Error message

Error #A1-2112 Call for service

Error #A1-3612 Call for service

▶ Symptom

The OPC/Deve motor does not operate. / The OPC/Deve motor is operating but is recognized as stop status.

▶ Troubleshooting method

- 1) Turn the machine off then on. If the error persists, turn the machine off again.
- 2) Remove the right cover.
- 3) Check if the connection between main board and OPC/Deve motor are correct.
- 4) If the connection is OK, replace the OPC/Deve motor.

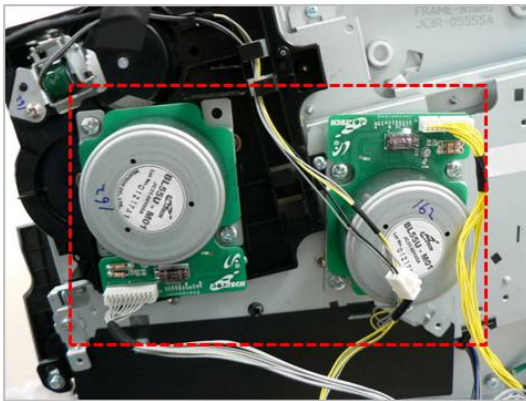

- 5) If the problem persists, replace the main board.

▶ **Error Code**

A1-4111

A1-4112

▶ **Error message**

Error #A1-4111 Call for service

Error #A1-4112 Call for service

▶ **Symptom**

The transfer roller can't move the engage/disengage position.

▶ **Troubleshooting method**

- 1) Turn the machine off then on. If the error persists, turn the machine off again.
- 2) Remove the right cover.
- 3) Check if the connection between main board and Feed drive unit are correct.
- 4) If the connection is OK, replace the step motor of the Feed drive unit.
- 5) If the problem persists, replace the main board.

▶ **Error Code**

A1-4310

▶ **Error message**

Error #A1-4310 Call for service

▶ **Symptom**

The motor for ITB unit does not operate normally.

▶ **Troubleshooting method**

- 1) Turn the machine off then on. If the error persists, turn the machine off again.
- 2) Remove the right cover.
- 3) Check if the connection between main board and the main drive unit are correct.
- 4) If the connection is OK, replace the main drive unit.

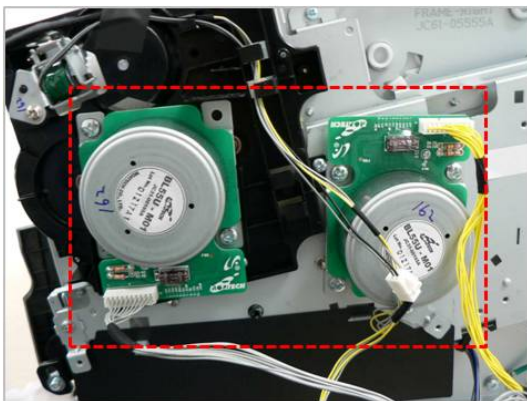

- 5) If the problem persists, replace the main board.

▶ Error Code

A2-1210

A2-2110

▶ Error message

Error #A2-1210 Call for service

Error #A2-2110 Call for service

▶ Symptom

The SMPS fan or Fuser fan does not operate normally.

▶ Troubleshooting method

- 1) Turn the machine off then on. If the error persists, turn the machine off again.
- 2) Remove the right cover.
- 3) Check if the connection between main board and the related fan is correct.
- 4) If the connection is OK, replace the defective fan.

▶ Error Code

A3-3211

A3-3212

▶ Error message

Error #A3-3211 Call for service

Error #A3-3212 Call for service

▶ Symptom

The inner temperature sensor is defective.

▶ Troubleshooting method

- 1) Turn the machine off then on. If the error persists, turn the machine off again.
- 2) Enter the tech mode. Check the temperature sensor output.
- 3) If the sensor is defective, replace it.
- 4) If the temperature sensor is OK, replace the main board.

▶ **Error Code**

A3-3311

A3-3312

▶ **Error message**

Error #A3-3311 Call for service

Error #A3-3312 Call for service

▶ **Symptom**

The outer temperature sensor is defective.

▶ **Troubleshooting method**

- 1) Turn the machine off then on. If the error persists, turn the machine off again.
- 2) Enter the tech mode. Check the temperature sensor output.
- 3) If the sensor is defective, replace it.

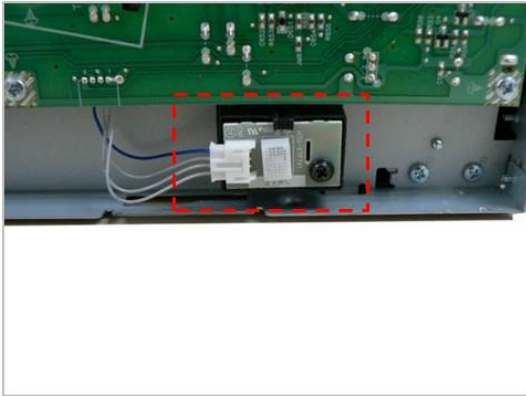

- 4) If the temperature sensor is OK, replace the main board.

▶ **Error Code**

A3-3320

▶ **Error message**

Not proper room temp. Move set

▶ **Symptom**

The value of the outer temperature sensor is out of normal area.

▶ **Troubleshooting method**

- 1) Check if the machine is installed in the proper area.
- 2) If the temperature sensor is defective, replace it.

▶ Error Code

C2-2110

C2-3110

C2-4110

C2-5110

▶ Error message

Prepare Toner

▶ Symptom

The remaining toner cartridge is less than 10%

▶ Troubleshooting method

- 1) Print the supply information report. Check the life remaining of the toner cartridge.
- 2) If its life is at the end, turn the machine off and replace the toner cartridge with new one.

▶ Error Code

C2-2120

C2-2150

C2-3120

C2-3150

C2-4120

C2-4150

C2-5120

C2-5150

▶ Error message

Replace Toner

▶ Symptom

The toner cartridge is at the end of its life.

▶ Troubleshooting method

- 1) If its life is at the end, turn the machine off and replace the toner cartridge with new one.

▶ Error Code

C2-2320

C2-2410

C2-3320

C2-3410

C2-4320

C2-4410

C2-5320

C2-5410

▶ Error message

Error #C2-2320 Install Y toner

Install yellow toner cartridge

Error #C2-3320 Install M toner

Install magenta toner cartridge

Error #C2-4320 Install C toner

Install cyan toner cartridge

Error #C2-5320 Install K toner

Install black toner cartridge

▶ Symptom

The toner cartridge is not installed or the CRUM has some problem.

▶ Troubleshooting method

- 1) Check if the toner cartridge is installed properly. Turn the machine off then on.
- 2) If the error message is not disappear, remove the toner cartridge. Thoroughly roll the cartridge five or six times to distribute the toner evenly inside the cartridge. And reinstall the toner cartridge.
- 3) If the problem persists, check that the CRUM contact area is contaminated. Clean it.
- 4) If the problem persists, replace the toner cartridge with new one.

▶ Error Code

C2-2512

C2-3512

C2-4512

C2-5512

▶ Error message

Not Compatible Y toner cart.

Not Compatible M toner cart.

Not Compatible C toner cart.

Not Compatible K toner cart.

▶ Symptom

Toner cartridge is not compatible.

▶ Troubleshooting method

- 1) Print the supply information report. Check information of the toner cartridge.
- 2) If the toner cartridge is not a Samsung genuine toner cartridge, replace with new one.

▶ Error Code

C5-1110

C5-1120

▶ Error message

Prepare new Transfer belt

Replace new Transfer belt

▶ Symptom

The ITB Unit is at the end of its life.

▶ Troubleshooting method

- 1) Print the supply information report. Check the life remaining of the ITB unit.
- 2) If its life is at the end, turn the machine off and replace the ITB unit with new one.

▶ Error Code

C5-1310

▶ Error message

Install TR belt unit.

▶ Symptom

The ITB Unit is not installed properly.

▶ Troubleshooting method

- 1) Turn the machine off. Remove and reinstall the ITB unit.
- 2) Turn the machine on. If the problem persists, replace the ITB unit.

▶ **Error Code**

C5-1410

▶ **Error message**

Not compatible transfer belt.

▶ **Symptom**

The ITB unit is not compatible.

▶ **Troubleshooting method**

- 1) If the toner cartridge is not a Samsung genuine ITB Unit, replace with new one.

▶ **Error Code**

C5-1710

▶ **Error message**

Transfer Belt Error

▶ **Symptom**

The ITB home position sensor has the problem.

▶ **Troubleshooting method**

- 1) Turn the machine off. Replace the ITB Unit.

▶ **Error Code**

C6-1110

C6-1120

▶ **Error message**

Replace Fuser Soon

Replace new Fuser unit

▶ **Symptom**

The fuser unit is at the end of its life.

▶ **Troubleshooting method**

- 1) If its life is at the end, turn the machine off and replace the fuser unit with new one.

▶ **Error Code**

C7-1110

▶ **Error message**

Waste toner Full Replace new one

▶ **Symptom**

The waste toner container is at the end of its life.

▶ **Troubleshooting method**

- 1) If its life is at the end, turn the machine off and replace the waste toner container with new one.

▶ **Error Code**

C7-1311

▶ **Error message**

Not Installed Waste tank

▶ **Symptom**

The waste toner container is not installed

▶ **Troubleshooting method**

- 1) Check if the waste toner container is installed properly.
- 2) Remove and reinstall the waste toner container.

▶ **Error Code**

C9-1112

C9-1116

▶ **Error message**

Replace new Tray1 roller

Replace new Tray1 roller

▶ **Symptom**

The pick up roller or reverse roller is at the end of its life.

▶ **Troubleshooting method**

- 1) Turn the machine off.
- 2) Replace the pick up roller Assy and reverse roller Assy.

▶ **Error Code**

M1-1110

▶ **Error message**

Paper Jam in Tray 1

▶ **Symptom**

The jammed paper has occurred in the tray1.

▶ **Troubleshooting method**

- 1) Remove the jammed paper.
- 2) If the jammed paper occurs continually, check the followings.
 - a) Check if the pick up/forward/reverse roller are worn out or contaminated. Clean the contaminated part or replace it.

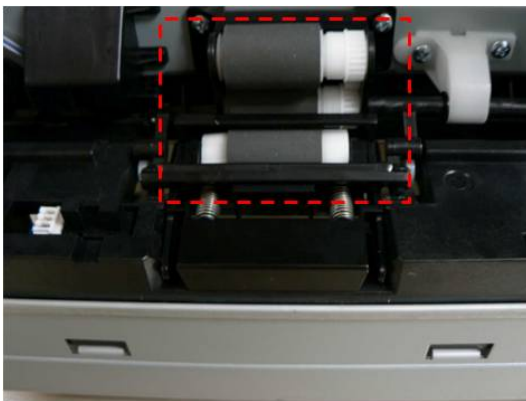

- b) Check if the actuator is assembled correctly.
- 3) Check the pick up clutch and regi clutch operation. If they are defective, replace them.

▶ **Error Code**

M1-5112

▶ **Error message**

Paper Empty in Tray1

▶ **Symptom**

Paper is empty in Tray1

▶ **Troubleshooting method**

- 1) Take off the cassette. If there is no paper on the tray, load the paper.
- 2) If the problem persists, check the following.
 - a) Check if the paper empty sensor is contaminated or defective. Replace it.

► Error Code

M2-1110

M2-1116

► Error message

Paper Jam inside machine

Paper jam or empty

► Symptom

The jammed paper has occurred inside machine.

► Troubleshooting method

- 1) Remove the jammed paper.
- 2) If the problem persists, check the following.
 - a) Check if there is any obstacles or paper on the paper path. Remove it.
 - b) Check if the FRAME-RETARD unit is assembled properly.

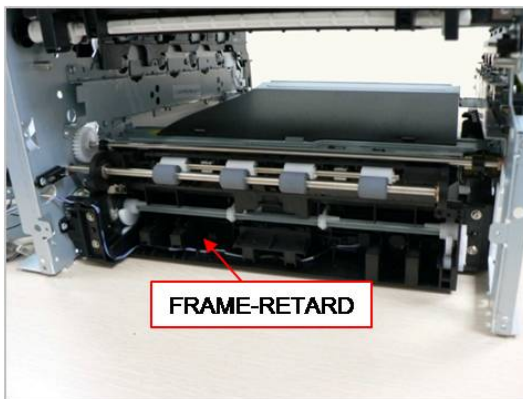

-
-
- c) Check if the pick up clutch, regi clutch, feed drive unit are working normally. If there is a defective part, replace it.

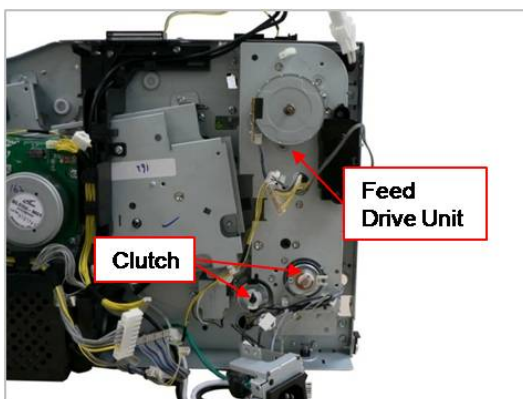

▶ **Error Code**

M3-1110

▶ **Error message**

Paper Jam in exit area

▶ **Symptom**

The jammed paper has occurred in the exit area.

▶ **Troubleshooting method**

- 1) Remove the jammed paper.
- 2) If the problem persists, check the following.
 - a) Check if there is any obstacles or paper on the paper path. Remove it.
 - b) Check if the fuser unit is assembled properly. If the fuser unit is defective, replace it.
 - c) Check if the FRAME-EXIT unit has any defective parts. Replace the FRAME-EXIT.

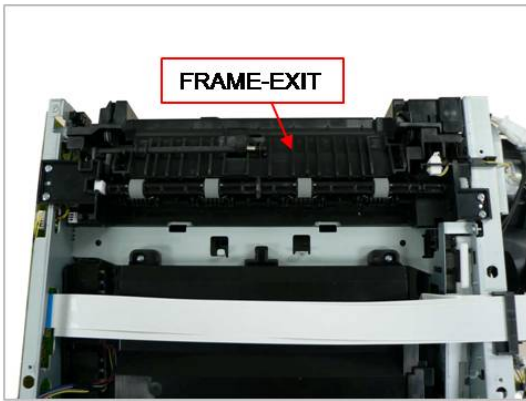

▶ **Error Code**

M3-2130

▶ **Error message**

Output bin full Remove paper

▶ **Symptom**

The machine detected that the output tray has got full or the bin-full sensor is defective.

▶ **Troubleshooting method**

- 1) Remove the paper on the output tray.
- 2) Check if the Bin-full Sensor connector is connected properly. Reconnect it.
- 3) If the sensor is defective, replace it.

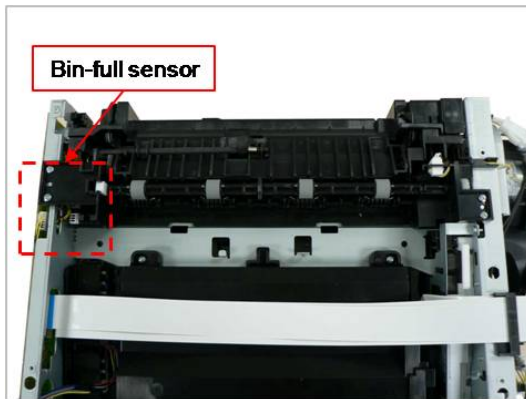

▶ **Error Code**

S2-4120

▶ **Error message**

Door open Close it

▶ **Symptom**

Door is open or the cover open switch is defective.

▶ **Troubleshooting method**

- 1) Check if the front cover is closed perfectly.
- 2) If the error persists, check that the cover-open sensor is working normally. If it is defective, replace the HVPS board.

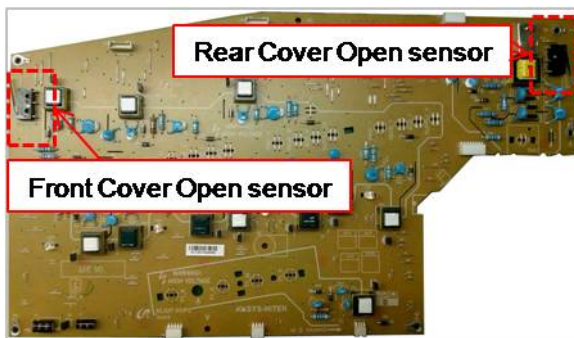

▶ **Error Code**

S5-3110

▶ **Error message**

Error #S5-3110 Call for service

▶ **Symptom**

The communication error between main board and OPE board has occurred.

▶ **Troubleshooting method**

- 1) Turn the machine off then on.
- 2) If the problem persists, check the followings.
 - a) Check the connection between main board and OPE board. Reconnect the harness.
 - b) If the connection is OK, replace the main board or OPE board.

▶ **Error Code**

S6-3123

S6-3128

▶ **Error message**

Network Problem: IP Conflict

802.1x Network Error

▶ **Symptom**

IP address conflicts with that of other system.

▶ **Troubleshooting method**

- 1) Change the machine's IP address.
- 2) Check the setting-up for 802.1x confirmation server.

▶ **Error Code**

U1-2132

U1-2315

U1-2320

U1-2330

U1-2334

U1-2340

U1-234H

▶ **Error message**

Error #U1-2132 Turn off then on

Error #U1-2315 Turn off then on

Error #U1-2320 Turn off then on

Error #U1-2330 Turn off then on

Error #U1-2334 Turn off then on

Error #U1-2340 Turn off then on

Error #U1-234H Turn off then on

▶ **Symptom**

The temperature control of fuser unit is abnormal.

▶ **Troubleshooting method**

- 1) Check if the input voltage is normal.
- 2) Turn the machine off. Remove and reinstall the fuser unit. Be careful when connecting the AC-connector and Thermistor connector.
- 3) Turn the machine on. Is the error message is disappeared?
- 4) Check the followings. If the fuser unit has any problem, replace it.
 - a) Check if the fuser connector is connected properly.
 - b) Check if the halogen lamp voltage is normal.
 - c) Check if the thermistor is contaminated or twisted.
- 5) If the problem persists, replace the main board or SMPS board.

▶ **Error Code**

U2-6122

U2-6142

▶ **Error message**

Error #U2-6122 Turn off then on

Error #U2-6142 Turn off then on

▶ **Symptom**

LSU Motor does not work normally. / LSU Hsync signal is abnormal.

▶ **Troubleshooting method**

- 1) Check if the LSU harness on the main board is connected properly.
- 2) If it is OK, check that the LSU harness on LSU board is connected properly.
- 3) Check if the LSU harness is defective.

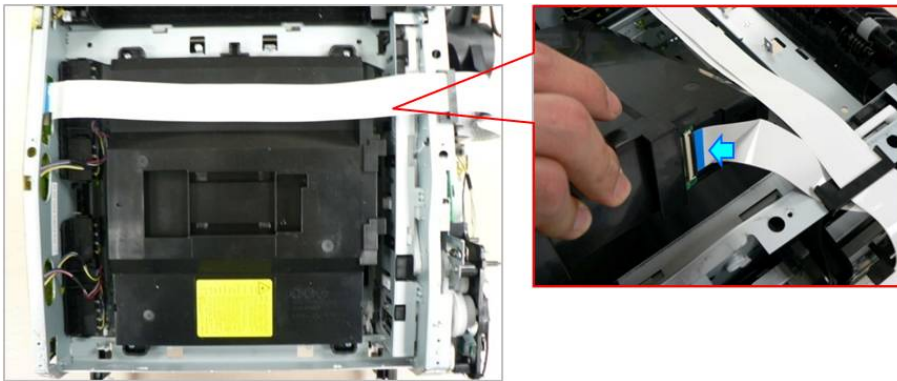

- 4) If the problem persists, replace the LSU.
- 5) If the problem persists after replacing LSU, replace the main board.

4.2.3. Image quality problems

1) Vertical Black Line and Band

- Description : Straight thin black vertical line occurs in the printed image.



Cause and Check Point	Solution
Check if the surface of the charge roller is scratched or contaminated.	Replace the toner cartridge and test again.
Check if there are grooves on the circumference of the OPC drum.	Replace the toner cartridge and test again.
Check if the cleaning blade is damaged	Replace the toner cartridge and test again.
Check if paper transfer belt is damaged or contaminated.	Replace the ITB unit and test again.

2) Vertical White Line

- Description : White vertical voids in the image.



Cause and Check Point	Solution
Check if the LSU window or internal lenses of LSU is contaminated.	Clean the LSU window with recommended cleaner(IPA). Clean the window with a clean cotton swab. If dirt is inside the LSU, replace the LSU.
Check if there are scratches on the circumference of the OPC drum.	Replace the toner cartridge and test again.
Check if there are scratches on the circumference of the developing roller.	Replace the toner cartridge and test again.
Check if paper transfer belt is damaged or contaminated.	Replace the ITB unit and test again.

3) Contamination on back of page

- Description : The back of the page is contaminated.

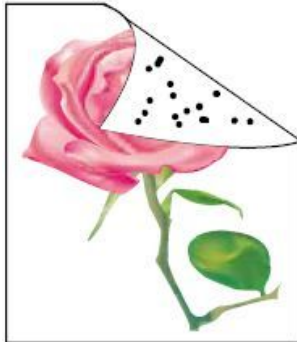

Cause and Check Point	Solution
Dirty registration roller, pressure roller, feed roller, etc. Any dirty rollers through the path of the paper.	Identify the roller which may cause the problem by comparing the period of the contamination on images with the size of rollers. Clean any dirt from the roller or replace the dirty roller.
Check if the transfer roller is damaged or contaminated.	Replace the transfer roller and test again.
Check if paper transfer belt is damaged or contaminated.	Replace the ITB unit and test again.

4) Dark or Black image

- Description : The black page is printed out.



Cause and Check Point	Solution
No charging voltage in the HVPS.	Check the connecting state between the Main PBA and HVPS. Reconnect the harness.
Poor contact between toner cartridge and set contacts.	Clean the contacts as necessary. Replace any deformed or damaged contacts.
HVPS is defective.	Replace the HVPS.

5) Blank Page

- Description : Blank page is printed.

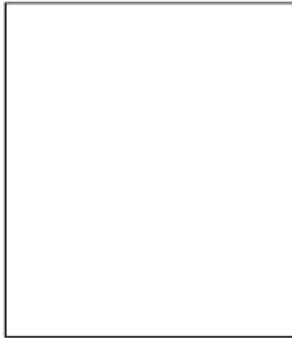

Cause and Check Point	Solution
Bad contacts from OPC drum and/or toner cartridge to ground.	Check the terminal of Ground-OPC.
Not working the LSU.	Check the connector of LSU.
Not working the developing bias voltage on HVPS.	Replace the HVPS.

6) Uneven Density

- Description : Print Density is uneven between left and right.



Cause and Check Point	Solution
The life of the Toner Cartridge has expired.	Replace the toner cartridge.
The pressure force in the left and right springs of the ITB unit is not even.	Replace the ITB Unit

7) Horizontal Bands

- Description : Dark or white horizontal stripes appear in the page. (These may occur at regular intervals down the page.)



Cause and Check Point	Solution
The developing roller, OPC drum or other rollers in the toner cartridge may be contaminated or deformed.	Replace the toner cartridge.
Bad contacts of HV terminals of the toner cartridge with high voltage terminals from printer set.	Clean all HV terminals in the cartridge and on the set frame. Ensure all toner or paper dust, particles are removed.

8) Poor Fusing

- Description : Toner is not properly fixed on paper.

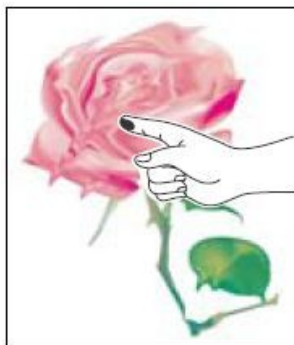

Cause and Check Point	Solution
The media doesn't meet specification	Use the proper media in specifications.
Fuser is defective	Replace the fuser unit.

5. System Diagram

5.1. Block Diagram

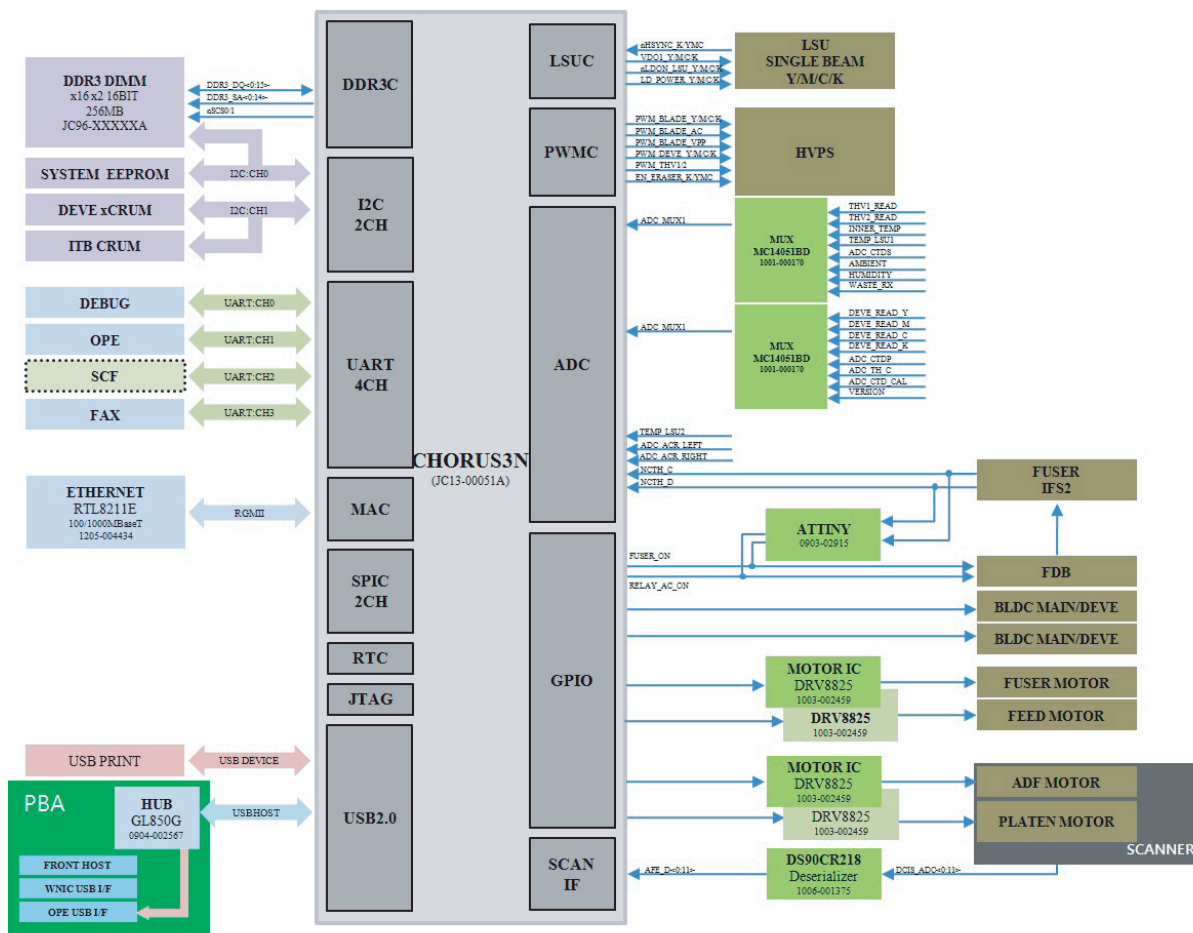

5.2. Connection Diagram

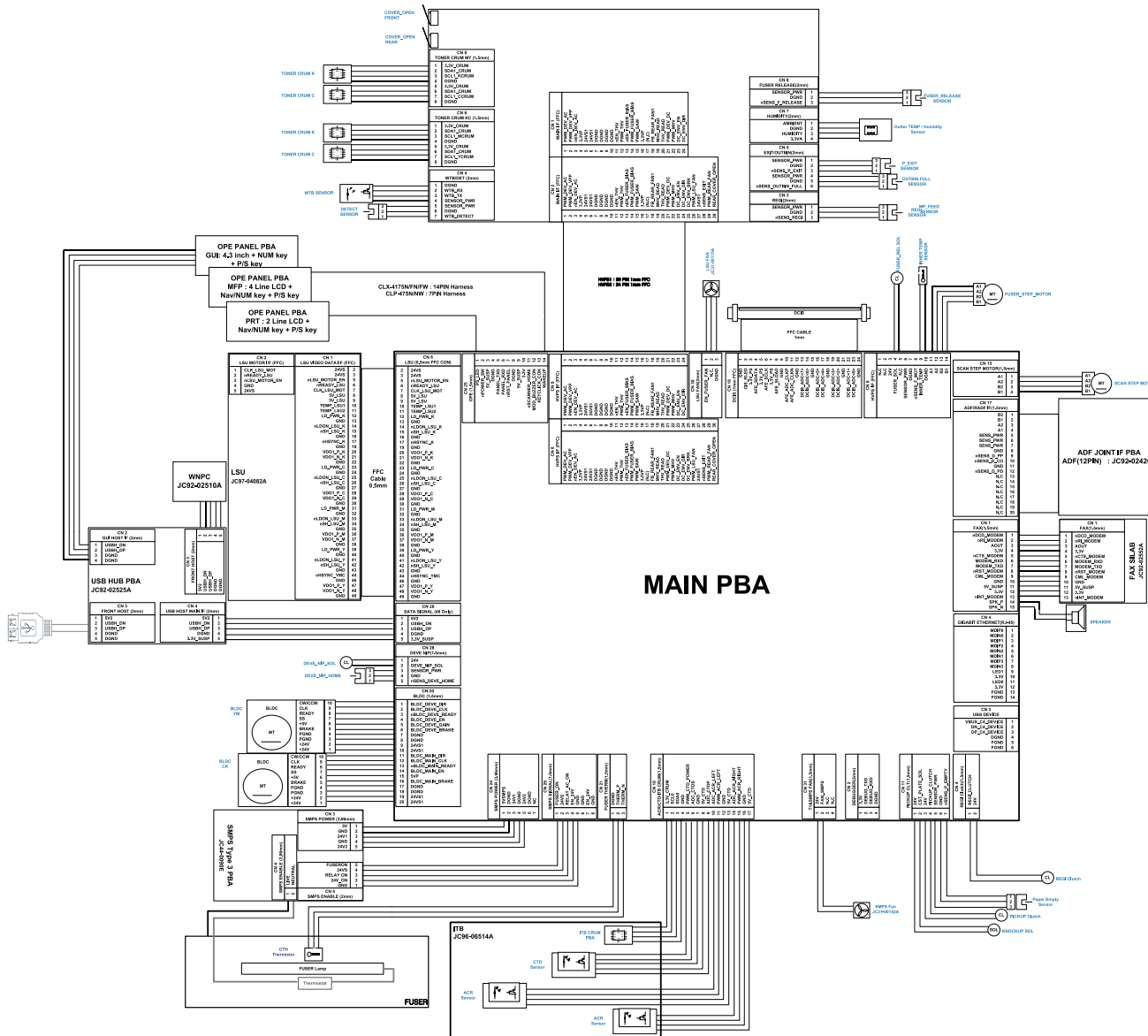





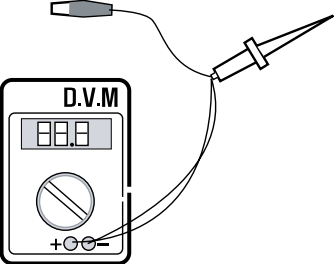

6. Reference Information

This chapter contains the tools list, list of abbreviations used in this manual, and a guide to the location space required when installing the printer. A definition of test pages and Wireless Network information definition is also included.

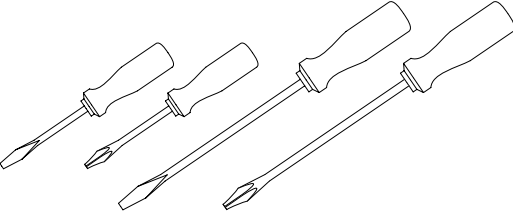
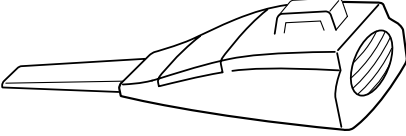
6.1. Tool for Troubleshooting

The following tools are recommended safe and easy troubleshooting as described in this service manual.

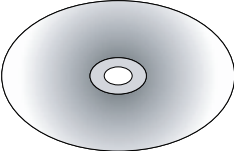
<p>DVM (Digital Volt Meter) Standard : Indicates more than 3 digits.</p> 	<p>Cleaning Equipments Standard : An IPA (Isopropyl Alcohol) dry wipe tissue or a gentle neutral detergent and lint-free cloth.</p> 
<p>Driver Standard : “-” type, “+” type (M3 long, M3 short, M2 long, M2 short).</p> 	<p>Vacuum Cleaner</p> 
<p>Tweezers Standard : For general home use, small type.</p> 	<p>Spring Hook Standard : For general use</p> 
<p>Cotton Swab Standard : For general home use, for medical service.</p> 	<p>Software (Driver) installation CD ROM</p> 

6.2. Glossary

The following glossary helps you get familiar with the product by understanding the terminologies commonly used with printing as well as mentioned in this user's guide and service manual.

802.11	802.11 is a set of standards for wireless local area network (WLAN) communication, developed by the IEEE LAN/MAN Standards Committee (IEEE 802).
802.11b/g/n	802.11b/g/n can share same hardware and use the 2.4 GHz band. 802.11b supports bandwidth up to 11 Mbps, 802.11n supports bandwidth up to 150 Mbps. 802.11b/g/n devices may occasionally suffer interference from microwave ovens, cordless telephones, and Bluetooth devices.
Access point	Access Point or Wireless Access Point (AP or WAP) is a device that connects wireless communication devices together on wireless local area networks (WLAN), and acts as a central transmitter and receiver of WLAN radio signals.
ADF	An Automatic Document Feeder (ADF) is a scanning unit that will automatically feed an original sheet of paper so that the machine can scan some amount of the paper at once.
AppleTalk	AppleTalk is a proprietary suite of protocols developed by Apple, Inc for computer networking. It was included in the original Macintosh (1984) and is now deprecated by Apple in favor of TCP/IP networking.
BIT Depth	A computer graphics term describing the number of bits used to represent the color of a single pixel in a bitmapped image. Higher color depth gives a broader range of distinct colors. As the number of bits increases, the number of possible colors becomes impractically large for a color map. 1-bit color is commonly called as monochrome or black and white.
BMP	A bitmapped graphics format used internally by the Microsoft Windows graphics subsystem (GDI), and used commonly as a simple graphics file format on that platform.
BOOTP	Bootstrap Protocol. A network protocol used by a network client to obtain its IP address automatically. This is usually done in the bootstrap process of computers or operating systems running on them. The BOOTP servers assign the IP address from a pool of addresses to each client. BOOTP enables 'diskless workstation' computers to obtain an IP address prior to loading any advanced operating system.
CCD	Charge Coupled Device (CCD) is a hardware which enables the scan job. CCD Locking mechanism is also used to hold the CCD module to prevent any damage when you move the machine.
Collation	Collation is a process of printing a multiple-copy job in sets. When collation is selected, the device prints an entire set before printing additional copies.
Control Panel	A control panel is a flat, typically vertical, area where control or monitoring instruments are displayed. They are typically found in front of the machine.
Coverage	It is the printing term used for a toner usage measurement on printing. For example, 5% coverage means that an A4 sided paper has about 5% image or text on it. So, if the paper or original has complicated images or lots of text on it, the coverage will be higher and at the same time, a toner usage will be as much as the coverage.
CSV	Comma Separated Values (CSV). A type of file format, CSV is used to exchange data between disparate applications. The file format, as it is used in Microsoft Excel, has become a de facto standard throughout the industry, even among non-Microsoft platforms.
DADF	A Duplex Automatic Document Feeder (DADF) is a scanning unit that will automatically feed and turn over an original sheet of paper so that the machine can scan on both sides of the paper.
Default	The value or setting that is in effect when taking a printer out of its box state, reset, or initialized.
DHCP	A Dynamic Host Configuration Protocol (DHCP) is a client-server networking protocol. A DHCP server provides configuration parameters specific to the DHCP client host requesting, generally, information required by the client host to participate on an IP network. DHCP also provides a mechanism for allocation of IP addresses to client hosts.
DIMM	Dual Inline Memory Module (DIMM), a small circuit board that holds memory. DIMM stores all the data within the machine like printing data, received fax data.

DLNA	The Digital Living Network Alliance (DLNA) is a standard that allows devices on a home network to share information with each other across the network.
DNS	The Domain Name Server (DNS) is a system that stores information associated with domain names in a distributed database on networks, such as the Internet.
Dot Matrix Printer	A dot matrix printer refers to a type of computer printer with a print head that runs back and forth on the page and prints by impact, striking an ink-soaked cloth ribbon against the paper, much like a typewriter.
DPI	Dots Per Inch (DPI) is a measurement of resolution that is used for scanning and printing. Generally, higher DPI results in a higher resolution, more visible detail in the image, and a larger file size.
DRPD	Distinctive Ring Pattern Detection. Distinctive Ring is a telephone company service which enables a user to use a single telephone line to answer several different telephone numbers.
Duplex	A mechanism that will automatically turn over a sheet of paper so that the machine can print (or scan) on both sides of the paper. A printer equipped with a Duplex Unit can print on both sides of paper during one print cycle.
Duty Cycle	Duty cycle is the page quantity which does not affect printer performance for a month. Generally the printer has the lifespan limitation such as pages per year. The lifespan means the average capacity of print-outs, usually within the warranty period. For example, if the duty cycle is 48,000 pages per month assuming 20 working days, a printer limits 2,400 pages a day.
ECM	Error Correction Mode (ECM) is an optional transmission mode built into Class 1 fax machines or fax modems. It automatically detects and corrects errors in the fax transmission process that are sometimes caused by telephone line noise.
Emulation	Emulation is a technique of one machine obtaining the same results as another. An emulator duplicates the functions of one system with a different system, so that the second system behaves like the first system. Emulation focuses on exact reproduction of external behavior, which is in contrast to simulation, which concerns an abstract model of the system being simulated, often considering its internal state.
Ethernet	Ethernet is a frame-based computer networking technology for local area networks (LANs). It defines wiring and signaling for the physical layer, and frame formats and protocols for the media access control (MAC)/data link layer of the OSI model. Ethernet is mostly standardized as IEEE 802.3. It has become the most widespread LAN technology in use during the 1990s to the present.
EtherTalk	A suite of protocols developed by Apple Computer for computer networking. It was included in the original Macintosh (1984) and is now deprecated by Apple in favor of TCP/IP networking.
FDI	Foreign Device Interface (FDI) is a card installed inside the machine to allow a third party device such as a coin operated device or a card reader. Those devices allow the pay-for-print service on your machine.
FTP	A File Transfer Protocol (FTP) is a commonly used protocol for exchanging files over any network that supports the TCP/IP protocol (such as the Internet or an intranet).
Fuser Unit	The part of a laser printer that fuses the toner onto the print media. It consists of a heat roller and a pressure roller. After toner is transferred onto the paper, the fuser unit applies heat and pressure to ensure that the toner stays on the paper permanently, which is why paper is warm when it comes out of a laser printer.
Gateway	A connection between computer networks, or between a computer network and a telephone line. It is very popular, as it is a computer or a network that allows access to another computer or network.
Grayscale	A shades of gray that represent light and dark portions of an image when color images are converted to grayscale; colors are represented by various shades of gray.
Halftone	An image type that simulates grayscale by varying the number of dots. Highly colored areas consist of a large number of dots, while lighter areas consist of a smaller number of dots.
HDD	Hard Disk Drive (HDD), commonly referred to as a hard drive or hard disk, is a non-volatile storage device which stores digitally-encoded data on rapidly rotating platters with magnetic surfaces.

IEEE	The Institute of Electrical and Electronics Engineers (IEEE) is an international non-profit, professional organization for the advancement of technology related to electricity.
IEEE 1284	The 1284 parallel port standard was developed by the Institute of Electrical and Electronics Engineers (IEEE). The term "1284-B" refers to a specific connector type on the end of the parallel cable that attaches to the peripheral (for example, a printer).
Intranet	A private network that uses Internet Protocols, network connectivity, and possibly the public telecommunication system to securely share part of an organization's information or operations with its employees. Sometimes the term refers only to the most visible service, the internal website.
IP address	An Internet Protocol (IP) address is a unique number that devices use in order to identify and communicate with each other on a network utilizing the Internet Protocol standard.
IPM	The Images Per Minute (IPM) is a way of measuring the speed of a printer. An IPM rate indicates the number of single-sided sheets a printer can complete within one minute.
IPP	The Internet Printing Protocol (IPP) defines a standard protocol for printing as well as managing print jobs, media size, resolution, and so forth. IPP can be used locally or over the Internet to hundreds of printers, and also supports access control, authentication, and encryption, making it a much more capable and secure printing solution than older ones.
IPX/SPX	IPX/SPX stands for Internet Packet Exchange/Sequenced Packet Exchange. It is a networking protocol used by the Novell NetWare operating systems. IPX and SPX both provide connection services similar to TCP/IP, with the IPX protocol having similarities to IP, and SPX having similarities to TCP. IPX/SPX was primarily designed for local area networks (LANs), and is a very efficient protocol for this purpose (typically its performance exceeds that of TCP/IP on a LAN).
ISO	The International Organization for Standardization (ISO) is an international standard-setting body composed of representatives from national standards bodies. It produces world-wide industrial and commercial standards.
ITU-T	The International Telecommunication Union is an international organization established to standardize and regulate international radio and telecommunications. Its main tasks include standardization, allocation of the radio spectrum, and organizing interconnection arrangements between different countries to allow international phone calls. A -T out of ITU-T indicates telecommunication.
ITU-T No. 1 chart	Standardized test chart published by ITU-T for document facsimile transmissions.
JBIG	Joint Bi-level Image Experts Group (JBIG) is an image compression standard with no loss of accuracy or quality, which was designed for compression of binary images, particularly for faxes, but can also be used on other images.
JPEG	Joint Photographic Experts Group (JPEG) is a most commonly used standard method of lossy compression for photographic images. It is the format used for storing and transmitting photographs on the World Wide Web.
LDAP	The Lightweight Directory Access Protocol (LDAP) is a networking protocol for querying and modifying directory services running over TCP/IP.
LED	A Light-Emitting Diode (LED) is a semiconductor device that indicates the status of a machine.
MAC address	Media Access Control (MAC) address is a unique identifier associated with a network adapter. MAC address is a unique 48-bit identifier usually written as 12 hexadecimal characters grouped in pairs (e. g., 00-00-0c-34-11-4e). This address is usually hard-coded into a Network Interface Card (NIC) by its manufacturer, and used as an aid for routers trying to locate machines on large networks.
MFP	Multi Function Peripheral (MFP) is an office machine that includes the following functionality in one physical body, so as to have a printer, a copier, a fax, a scanner and etc.
MH	Modified Huffman (MH) is a compression method for decreasing the amount of data that needs to be transmitted between the fax machines to transfer the image recommended by ITU-T T.4. MH is a codebook-based run-length encoding scheme optimized to efficiently compress white space. As most faxes consist mostly of white space, this minimizes the transmission time of most faxes.
MMR	Modified Modified READ (MMR) is a compression method recommended by ITU-T T.6.

Modem	A device that modulates a carrier signal to encode digital information, and also demodulates such a carrier signal to decode transmitted information.
MR	Modified Read (MR) is a compression method recommended by ITUT T.4. MR encodes the first scanned line using MH. The next line is compared to the first, the differences determined, and then the differences are encoded and transmitted.
NetWare	A network operating system developed by Novell, Inc. It initially used cooperative multitasking to run various services on a PC, and the network protocols were based on the archetypal Xerox XNS stack. Today NetWare supports TCP/IP as well as IPX/SPX.
OPC	Organic Photo Conductor (OPC) is a mechanism that makes a virtual image for print using a laser beam emitted from a laser printer, and it is usually green or rust colored and has a cylinder shape. An imaging unit containing a drum slowly wears the drum surface by its usage in the printer, and it should be replaced appropriately since it gets worn from contact with the cartridge development brush, cleaning mechanism, and paper.
Originals	The first example of something, such as a document, photograph or text, etc, which is copied, reproduced or translated to produce others, but which is not itself copied or derived from something else.
OSI	Open Systems Interconnection (OSI) is a model developed by the International Organization for Standardization (ISO) for communications. OSI offers a standard, modular approach to network design that divides the required set of complex functions into manageable, self-contained, functional layers. The layers are, from top to bottom, Application, Presentation, Session, Transport, Network, Data Link and Physical.
PABX	A private automatic branch exchange (PABX) is an automatic telephone switching system within a private enterprise.
PCL	Printer Command Language (PCL) is a Page Description Language (PDL) developed by HP as a printer protocol and has become an industry standard. Originally developed for early inkjet printers, PCL has been released in varying levels for thermal, dot matrix printer, and laser printers.
PDF	Portable Document Format (PDF) is a proprietary file format developed by Adobe Systems for representing two dimensional documents in a device independent and resolution independent format.
PostScript(PS)	PostScript (PS) is a page description language and programming language used primarily in the electronic and desktop publishing areas. - that is run in an interpreter to generate an image.
Printer Driver	A program used to send commands and transfer data from the computer to the printer.
Print Media	The media like paper, envelopes, labels, and transparencies which can be used in a printer, a scanner, a fax or, a copier.
PPM	Pages Per Minute (PPM) is a method of measurement for determining how fast a printer works, meaning the number of pages a printer can produce in one minute.
PRN file	An interface for a device driver, this allows software to interact with the device driver using standard input/output system calls, which simplifies many tasks.
Protocol	A convention or standard that controls or enables the connection, communication, and data transfer between two computing endpoints.
PSTN	The Public-Switched Telephone Network (PSTN) is the network of the world's public circuit-switched telephone networks which, on industrial premises, is usually routed through the switchboard.
RADIUS	Remote Authentication Dial In User Service (RADIUS) is a protocol for remote user authentication and accounting. RADIUS enables centralized management of authentication data such as usernames and passwords using an AAA (authentication, authorization, and accounting) concept to manage network access.
Resolution	The sharpness of an image, measured in Dots Per Inch (DPI). The higher the dpi, the greater the resolution.
SMB	Server Message Block (SMB) is a network protocol mainly applied to share files, printers, serial ports, and miscellaneous communications between nodes on a network. It also provides an authenticated Interprocess communication mechanism.

SMTP	Simple Mail Transfer Protocol (SMTP) is the standard for e-mail transmissions across the Internet. SMTP is a relatively simple, text based protocol, where one or more recipients of a message are specified, and then the message text is transferred. It is a client server protocol, where the client transmits an email message to the server.
SSID	Service Set Identifier (SSID) is a name of a wireless local area network (WLAN). All wireless devices in a WLAN use the same SSID in order to communicate with each other. The SSIDs are case-sensitive and have a maximum length of 32 characters.
Subnet Mask	The subnet mask is used in conjunction with the network address to determine which part of the address is the network address and which part is the host address.
TCP/IP	The Transmission Control Protocol (TCP) and the Internet Protocol (IP); the set of communications protocols that implement the protocol stack on which the Internet and most commercial networks run.
TCR	Transmission Confirmation Report (TCR) provides details of each transmission such as job status, transmission result and number of pages sent. This report can be set to print after each job or only after failed transmissions.
TIFF	Tagged Image File Format (TIFF) is a variable-resolution bitmapped image format. TIFF describes image data that typically come from scanners. TIFF images make use of tags, keywords defining the characteristics of the image that is included in the file. This flexible and platform-independent format can be used for pictures that have been made by various image processing applications.
Toner Cartridge	A kind of bottle or container used in a machine like a printer which contains toner. Toner is a powder used in laser printers and photocopiers, which forms the text and images on the printed paper. Toner can be fused by a combination of heat/pressure from the fuser, causing it to bind to the fibers in the paper.
TWAIN	An industry standard for scanners and software. By using a TWAIN-compliant scanner with a TWAIN-compliant program, a scan can be initiated from within the program. It is an image capture API for Microsoft Windows and Apple Macintosh operating systems.
UNC Path	Uniform Naming Convention (UNC) is a standard way to access network shares in Window NT and other Microsoft products. The format of a UNC path is: \\<servername>\<sharename>\<Additional directory>
URL	Uniform Resource Locator (URL) is the global address of documents and resources on the Internet. The first part of the address indicates what protocol to use, the second part specifies the IP address or the domain name where the resource is located.
USB	Universal Serial Bus (USB) is a standard that was developed by the USB Implementers Forum, Inc., to connect computers and peripherals. Unlike the parallel port, USB is designed to concurrently connect a single computer USB port to multiple peripherals.
Watermark	A watermark is a recognizable image or pattern in paper that appears lighter when viewed by transmitted light. Watermarks were first introduced in Bologna, Italy in 1282; they have been used by papermakers to identify their product, and also on postage stamps, currency, and other government documents to discourage counterfeiting.
WEP	Wired Equivalent Privacy (WEP) is a security protocol specified in IEEE 802.11 to provide the same level of security as that of a wired LAN. WEP provides security by encrypting data over radio so that it is protected as it is transmitted from one end point to another.
WIA	Windows Imaging Architecture (WIA) is an imaging architecture that is originally introduced in Windows Me and Windows XP. A scan can be initiated from within these operating systems by using a WIA-compliant scanner.
WPA	Wi-Fi Protected Access (WPA) is a class of systems to secure wireless (Wi-Fi) computer networks, which was created to improve upon the security features of WEP.
WPA-PSK	WPA-PSK (WPA Pre-Shared Key) is special mode of WPA for small business or home users. A shared key, or password, is configured in the wireless access point (WAP) and any wireless laptop or desktop devices. WPA-PSK generates a unique key for each session between a wireless client and the associated WAP for more advanced security.

WPS	The Wi-Fi Protected Setup (WPS) is a standard for establishing a wireless home network. If your wireless access point supports WPS, you can configure the wireless network connection easily without a computer.
XPS	XML Paper Specification (XPS) is a specification for a Page Description Language (PDL) and a new document format, which has benefits for portable document and electronic document, developed by Microsoft. It is an XML-based specification, based on a new print path and a vector-based device-independent document format.

6.3. The Sample Pattern for the Test

The life of the toner cartridge and the printing speed are measured using the pattern shown below.

Sample page 1 content includes a header with 'Stephen J. Singel', a bar chart with 5 bars, a table with 4 columns, and a small photo of a child.

Sample page 2 content includes a header with 'Ve Emerire Et Tum Ober', multiple columns of text, and a small photo of a child.

Color calibration chart showing a grid of colored squares (yellow, cyan, magenta, blue, red, black) and a grayscale ramp.

Sample page 3 content includes a header with 'Sempter Fdud Aploriosis', a table with 5 columns, a 3D bar chart, and a pie chart.

Sample page 4 content includes a header with 'Suscipt Lobortis', a pie chart, and a list of bullet points.



GSPN (GLOBAL SERVICE PARTNER NETWORK)

Area	Web Site
Europe, MENA, CIS, Africa	https://gspn1.samsungcsportal.com
E.Asia, W.Asia, China, Japan	https://gspn2.samsungcsportal.com
N.America, S.America	https://gspn3.samsungcsportal.com

This Service Manual is a property of Samsung Electronics Co.,Ltd.
Any unauthorized use of Manual can be punished under applicable International and/or domestic law.

© 2017 Samsung Electronics Co.,Ltd.
All rights reserved.
Printed in Korea