

MAKING YOUR SECURITY MORE CONVENIENT FOR OVER 60 YEARS.

2009 CATALOG

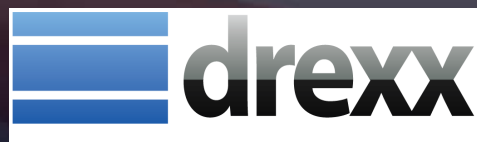

KEY-BAK®



www.keybak.com

West Coast Chain Mfg. Co.

An Employee Owned Company Ontario, California, U.S.A.

Proud U.S.A. Manufacturer



Making Your Security More Convenient...Since 1948

A famous American industrialist of the 1940's when asked for the secret of his success, declared "Find a need and fill it." Among those who heeded Henry J. Kaiser's advice was a California railroad man, Russ Lummis, founder of our company. He saw a need for brakemen and switchmen to have a better, safer, more convenient way to handle their keys. Dangling key chains they wore sometimes caught on moving trains. Lummis filled that need by inventing the KEY-BAK®. It was an instant success, first in the railroad industry and then in other industries, wherever "keys" were part of the job.

Today we continue to fill the need that Lummis found. Our focus is on combining security with convenience, and that's a need we find everywhere. So in addition to several models of self-retracting key reels for different applications, we also manufacture self retracting reels for photo identification badges (the new "key"), light industrial retractors to keep quality control gauges at their proper work station, and retractors for sport and outdoor use to keep your gear secure and convenient to use.

Offer security and convenience to your customers; buy the original KEY-BAK® brand self-retracting reels, key and identification badge accessories. You will be assured of top quality products and service from our team of employee owners!

Boake Paugh, President,
West Coast Chain Mfg. Co.

West Coast Chain Mfg. Co. is located in Ontario, California,
only 50 miles (80 kilometers) East of Los Angeles

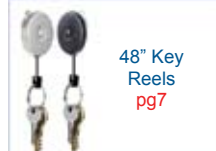

THE SUPER 48™ - The Standard of Excellence for Key Reels

Now available in both Heavy Duty and Super Duty retraction force.

- Heavy Duty has 8-10oz. retraction force, 48" of reach
- Super Duty has 13-15oz retraction force, 36" of reach

Tough Kevlar® cord extends smoothly. Exclusive quick-draw extension makes this KEY-BAK® faster, easier to use, and holds more keys. Back attachment is both belt clip and Belt Loop. Robust case fabricated of durable polycarbonate material. American origin, engineering, and quality manufactured under U.S. and foreign patents.

Available in law enforcement model, #S48-LEK, fits 2 1/4" wide duty belt. Available with custom logo, inquire. Backed by a Lifetime Service Policy.



S48K Standard Belt Clip

S48-LEK 2 1/2" Leather Loop



Item #	Model #	Description	Package	Inner Pack	Case Pack	Wt. Lbs.	Case Dimensions
0S48-802	S48K	Super 48™ with Standard Clip	Bulk	N/A	144	25	14 1/4 x 13 x 7
0S48-803	S48K	Super 48™ with Standard Clip	PAC	12	144	39	18 1/2 x 19 x 17 1/2
0S48-804	S48K	Merchandising Strip of 12 ea.	PAC	12	72	17	24 x 8 x 30
0S48-702	S48-SDK	Super 48™ Super Duty with standard Clip	Bulk	N/A	144	26	14 1/4 x 13 x 7
0S48-714	S48-SDLEK	Super 48™ Super Duty fits 2 1/4 Duty Belt	Bulk	N/A	144	26	14 1/4 x 13 x 7
0S48-814	S48-LEK	Super 48™ fits 2 1/4 Duty Belt	Bulk	N/A	144	26	14 1/4 x 13 x 7
0S48-813	S48-LEK	Super 48™ Super fits 2 1/4 Duty Belt	PAC	12	144	39	18 1/2 x 19 x 17 1/2

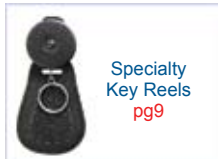

Specialty Key Reels pg9



Industrial & Theft Deterrent Tool Retractors pgs10-11



MINI-BAK® Retractors pg12



USA Made Key Accessories pg14



Key Accessories pg15



Custom Imprinted Products pgs16-17

THE #6 - MID-SIZE RETRACTOR



New from the makers of the Original KEY-BAK® Key Reel...
 ...A mid size self retracting reel smaller and more discreet than the Original Model #5 and with more carrying capacity than our popular line of MINI-BAK® reels. We've combined the most valuable features of both items in a size that's appealing to many different markets. Produced to the same high quality standards that characterize all KEY-BAK® products we're proud to introduce the New KEY-BAK® Model #6!



#6



This new self retracting reel is less than 1 3/4" (44 mm) in diameter, features a strong 36" (90 cm) nylon cord and offers 6 oz. (170 gm) retraction force; perfect for about 6 keys or to carry multiple identification cards. The KEY-BAK® Model #6 is made from a tough polycarbonate material and features a 360° rotating steel clip. Small and discreet, yet tough and versatile!

#6ID



Back Attachment
 360° Rotating Belt Clip



GREAT FOR AT WORK OR AT PLAY!



- Keep your keys convenient and secure
- Carry multiple identification cards
- Hold a flashlight, pocket knife, multi purpose tool, bottle opener or any other small item you need to keep secure and ready for use.

Item #	Model #	Description	Package	Inner Pack	Case Pack	Wt. Lbs.	Case Dimensions
0006-001	6	36" Cord Swivel Clip w/Split Ring	PAC	12	144	23	19 x 13½ x 14¼
0006-002	6	36" Cord Swivel Clip w/Split Ring	Bulk	N/A	144	11	12½ x 12½ x 4
0006-005	6 ID	36" Cord Swivel Clip w/Vinyl ID Strap	PAC	12	144	23	19 x 13½ x 14¼
0006-006	6 ID	36" Cord Swivel Clip w/Vinyl ID Strap	Bulk	N/A	144	11	12½ x 12½ x 4

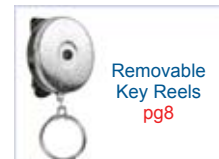
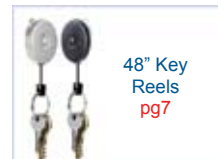

THE ORIGINAL KEY-BAK® - SELF RETRACTING REEL

Stainless Steel Chain extends 24". Available in chrome texture or black vinyl front. Pocket watch size, light weight 2 1/2 oz. Precision made for years of trouble free use. 8 -10oz. retraction force. Available with custom logo, inquire. Backed by a Lifetime Service Policy.

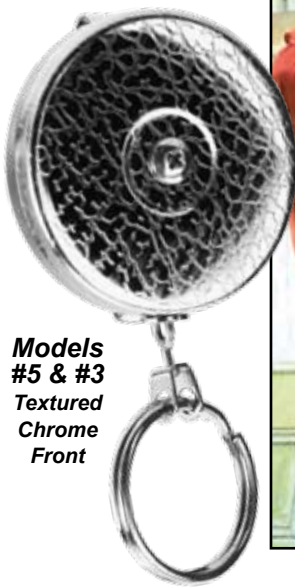

Models #5 & #3
Textured Chrome Front



Models #5B & #3B
Black Vinyl Front



Belt Clip Models #5 or #5B



Belt Loop Models #3 or #3B

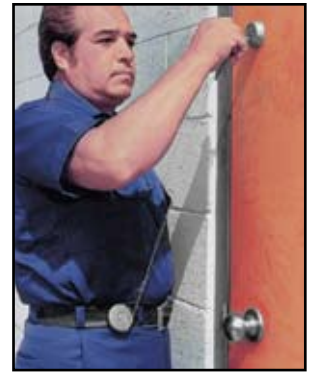

Item #	Model #	Description	Package	Inner Pack	Case Pack	Wt. Lbs.	Case Dimensions
0005-002	5	Standard Clip, Textured Chrome Front	Bulk	N/A	144	19	12½ x 12½ x 4
0005-011	5	Standard Clip, Textured Chrome Front	PAC	12	144	34	18½ x 19 x 17½
0005-012	5	Merchandising Strip of 12 ea.	PAC	12	72	15	24 x 8 x 30
0005-004	5B	Standard Clip, Black Vinyl Front	Bulk	N/A	144	19	12½ x 12½ x 4
0005-013	5B	Standard Clip, Black Vinyl Front	PAC	12	144	34	18½ x 19 x 17½
0005-014	5B	Merchandising Strip of 12 ea.	PAC	12	72	15	24 x 8 x 30
0003-002	3	Belt Loop, Textured Chrome Front	Bulk	N/A	144	19	12½ x 12½ x 4
0003-011	3	Belt Loop, Textured Chrome Front	PAC	12	144	34	18½ x 19 x 17½
0003-004	3B	Belt Loop, Black Vinyl Front Bulk	N/A	144	19	12	24 x 8 x 30
0003-013	3B	Belt Loop, Black Vinyl Front	PAC	121	144	34	18½ x 19 x 17½

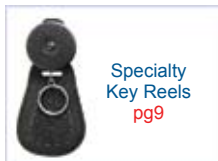

Specialty Key Reels
pg9



Industrial & Theft Deterrent Tool Retractors
pgs10-11



MINI-BAK® Retractors
pg12



USA Made Key Accessories
pg14



Key Accessories
pg15



Custom Imprinted Products
pgs16-17

SECURIT™ - The All Purpose Carabineer Retractor

Securit™ THE ALL WEATHER, ALL PURPOSE CARABINEER RETRACTOR

The all weather, all purpose retractor for the person who demands the best quality and reliability available. Securit™ is designed to keep everything from keys, flashlights, GPS, and small hand tools secure and handy. The rugged carabineer makes securing the unit to almost anything easy. Available with a Tough 48" Kevlar® Cord or Rugged 24" Stainless Steel Chain. Now available in both Heavy Duty and Super Duty retraction force.

- Heavy Duty has 8-10oz. retraction force, 48" of reach
- Super Duty has 13-15oz retraction force, 36" of reach

Robust case fabricated from durable Polycarbonate material. Backed by a Lifetime Service Policy.

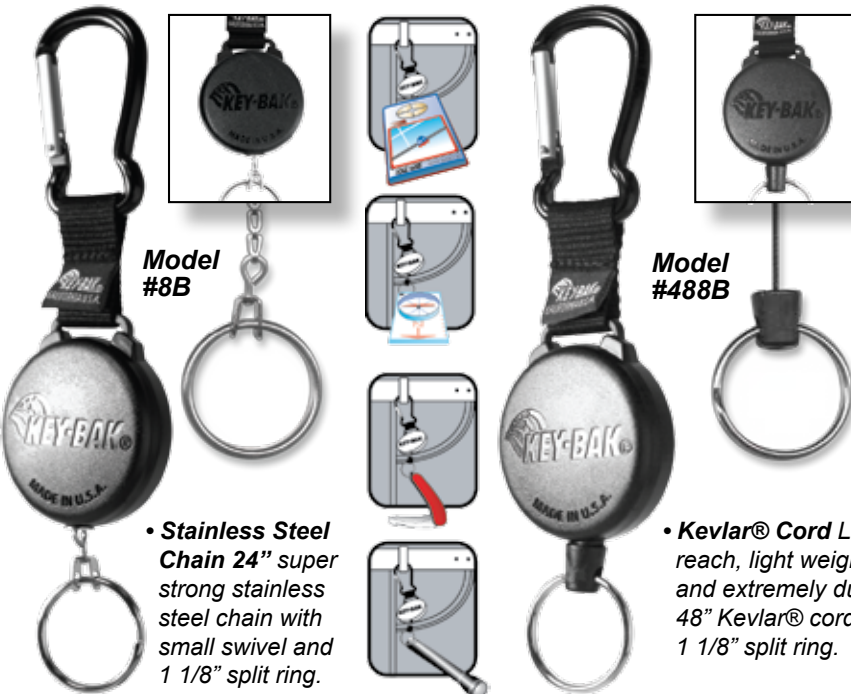

Model #8B

Model #488B

• **Stainless Steel Chain 24"** super strong stainless steel chain with small swivel and 1 1/8" split ring.

• **Kevlar® Cord Long reach,** light weight and extremely durable 48" Kevlar® cord with 1 1/8" split ring.



Item #	Model #	Description	Package	Inner Pack	Case Pack	Wt. Lbs.	Case Dimensions
0008-003	8B	24" Stainless Steel Chain	PAC	N/A	144	39	18½ x 19x 17½
0008-004	8B	24" Stainless Steel Chain	Bulk	N/A	144	33	18½ x 19x 17½
0488-803	488B	48" Kevlar® Cord	PAC	N/A	144	39	18½ x 19x 17½
0488-804	488B	48" Kevlar® Cord	Bulk	N/A	144	29	18½ x 19x 17½
0488-704	488BSD	36" Super Duty, Kevlar Cord	Bulk	N/A	144	33	18½ x 19x 17½

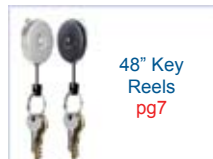

48" KEY REELS - KEVLAR® CORD EXTENDS 48"

TOUGH KEVLAR® CORD EXTENDS 48" FOR SMOOTH ACTION AND EXTRA REACH

KEY-BAK® 48" Key Reel Tough Kevlar® Cord extends 48". Available in belt clip or belt loop models. Available in chrome texture or black vinyl front. Pocket watch size, light weight 2 1/2 oz. Precision made for years of trouble free use. Available with custom logo, Inquire. Backed by a Lifetime Service Policy



**Models
#485-HDK
#483-HDK**

**Models
#485B-HDK
#483B-HDK**

Now available in both Heavy Duty and Super Duty retraction force.

•Heavy Duty has 8-10oz. retraction force, 48" of reach

•Super Duty has 13-15oz retraction force, 36" of reach



**Belt Clip back attachment
#485-HDK, #485B-HDK**

**Belt Loop back attachment
#483-HDK, #483B-HDK**

Item #	Model #	Description	Package	Inner Pack	Case Pack	Wt. Lbs.	Case Dimensions
0485-802	485-HDK	Standard Clip, Textured Chrome Front	Bulk	N/A	144	22	12½ x 12½ x 4
0485-821	485-HDK	Standard Clip, Textured Chrome Front	PAC	12	144	37	18½ x 19 x 17½
0485-822	485-HDK	Merchandising Strip of 12 ea.	PAC	12	72	15	8½ x 19 x 17½
0485-702	485-SHDK	Super Duty, Standard Clip, Textured Chrome Front	Bulk	N/A	144	22	12½ x 12½ x 4
0485-804	485B-HDK	Standard Clip, Black Vinyl Front	Bulk	N/A	144	22	12½ x 12½ x 4
0485-823	485B-HDK	Standard Clip, Black Vinyl Front	PAC	12	144	37	18½ x 19 x 17½
0485-824	485B-HDK	Merchandising Strip of 12 ea.	PAC	12	72	15	8½ x 19 x 17½
0485-704	485B-SDK	Super Duty, Standard Clip, Black Vinyl Front	Bulk	N/A	144	22	12½ x 12½ x 4
0483-802	483-HDK	Belt Loop, Textured Chrome Front	Bulk	N/A	144	22	12½ x 12½ x 4
0483-821	483-HDK	Belt Loop, Textured Chrome Front	PAC	12	144	37	18½ x 19 x 17½
0483-702	483-SDK	Super Duty, Standard Clip, Textured Chrome Front	Bulk	N/A	144	22	12½ x 12½ x 4
0483-804	483B-HDK	Belt Loop, Black Vinyl Front	Bulk	N/A	144	22	12½ x 12½ x 4
0483-823	483B-HDK	Belt Loop, Black Vinyl Front	PAC	12	144	37	18½ x 19 x 17½
0483-704	483B-SDK	Super Duty, Standard Loop, Black Vinyl Front	Bulk	N/A	144	22	12½ x 12½ x 4

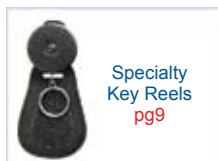

Specialty Key Reels
pg9



Industrial & Theft Deterrent Tool Retractors
pgs10-11



MINI-BAK® Retractors
pg12



USA Made Key Accessories
pg14



Key Accessories
pg15



Custom Imprinted Products
pgs16-17

REMOVABLE KEY REELS - ROTATING CLIP KEY REELS

- Removable, rotating clip
 - Rotation reduces abrasion
 - Keeps attachment handy where you need it
 - A key retractor and multipurpose retriever
- 8-10oz. retraction force
Backed by a Lifetime Service Policy

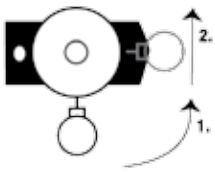

360 Degree Rotation

1. Twist 90 Degrees
2. Remove Retractor from clip



Model: #4

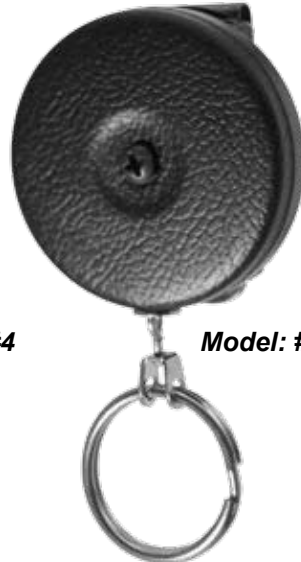

Model: #4B



Model: #484-HDK

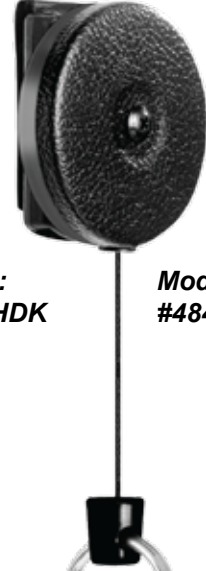

Model: #484B-HDK



24" Extension
Stainless
Steel Chain

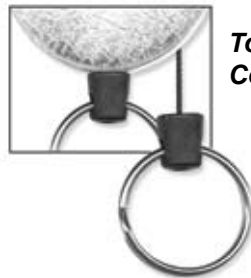

Tough Kevlar®
Cord Extends 48"

Item #	Model #	Description	Package	Inner Pack	Case Pack	Wt. Lbs.	Case Dimensions
0004-002	4	24" Chain, Textured Chrome Front	Bulk	N/A	144	21	14¼ x 13 x 7
0004-011	4	24" Chain, Textured Chrome Front	PAC	12	144	37	18½ x 19 x 17½
0004-012	4	Merchandising Strip of 12 ea.	PAC	12	72	15	24 x 8 x 30
0004-004	4B	24" Chain, Black Vinyl Front	Bulk	N/A	144	21	14¼ x 13 x 7
0004-013	4B	24" Chain, Black Vinyl Front	PAC	12	144	37	18½ x 19 x 17½
0004-014	4B	Merchandising Strip of 12 ea.	PAC	12	72	15	24 x 8 x 30
0484-802	484-HDK	48" Kevlar, Textured Chrome Front	Bulk	N/A	144	23	14¼ x 13 x 7
0484-821	484-HDK	48" Kevlar, Textured Chrome Front	PAC	12	144	37	18½ x 19 x 17½
0484-822	484-HDK	Merchandising Strip of 12 ea.	PAC	12	72	15	24 x 8 x 30
0484-804	484B-HDK	48" Kevlar, Black Vinyl Front	Bulk	N/A	144	23	14¼ x 13 x 7
0484-823	484B-HDK	48" Kevlar, Black Vinyl Front	PAC	12	144	37	18½ x 19 x 17½
0484-824	484B-HDK	Merchandising Strip of 12 ea.	PAC	12	72	15	24 x 8 x 30



Super 48™
pg3



The #6
pg4



The
Original
KEY-BAK®
pg5



SecurIt™
pg6

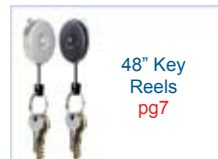

48" Key
Reels
pg7



Removable
Key Reels
pg8

SPECIALTY - KEY REELS & RETRACTORS

OTHER KEY-BAK® KEY REELS & SPECIALTY RETRACTORS



- **#5S & #5BS** Have an extra 12" of chain to allow keys to be kept in a pocket, extends an additional 24" and keeps keys secure.
- **#1BSC-F & #481BSC-FK** Incorporate uniform protection tab to keep swinging keys from damaging expensive uniforms.
- **#9, & #9B, #489-HDK, #489B-HDK** Incorporate a tool pouch and are specially designed for maintenance workers.
- **#1B-L, #481B-LK, #1BSC-F, #481BSC-FK** Fit standard Sam Browne 2 1/4" wide belts.
- **#5H & #5BH** Feature KEY-BAK's exclusive HUS-KEY™, allowing the use of more keys.
- **#1B-L & 1BSC-F** Meet "anti-snatch" requirements of penal institutions.



Item #	Model #	Description	Package	Inner Pack	Case Pack	Wt. Lbs.	Case Dimensions
0001-114	1B-L	24" Chain, 2¼ Loop, Black Front	Bulk	N/A	144	18	14¼ x 13 x 7
0481-817	481B-LK	48" Kevlar, 2¼ Loop, Black Front	Bulk	N/A	144	21	14¼ x 13 x 7
0001-104	1BSC-F	24" Chain, Loop & Flap, Black Front	Bulk	N/A	144	27	13 x 13 x 10
0001-105	1BSC-FH	24" Chain, Loop & Flap, Black Front, HUS-KEY™	Bulk	N/A	144	21	12½ x 12½ x 4
0481-805	481BSC-FK	48" Kevlar, Loop & Flap, Black Front	Bulk	N/A	144	28	13 x 13 x 10
0005-005	5SK	Striker/Tool Reel	PAC	12	144	30	19 x 13½ x 14¼
0005-101	5H	24" Chain, Chrome Front, HUS-KEY™	PAC	12	144	28	18½ x 19 x 17½
0005-102	5H	24" Chain, Chrome Front, HUS-KEY™	Bulk	N/A	144	21	12½ x 12½ x 4
0005-103	5BH	24" Chain, Black Front, HUS-KEY™	PAC	12	144	28	18½ x 19 x 17½
0005-104	5BH	24" Chain, Black Front, HUS-KEY™	Bulk	N/A	144	21	12½ x 12½ x 4
0005-900	5S	24" Chain, & 12" ext., Standard Clip, Chrome	Bulk	N/A	144	18	12½ x 12½ x 4
0005-905	5BS	24" Chain, & 12" ext., Standard Clip, Black	Bulk	N/A	144	18	12½ x 12½ x 4
0005-906	5BS	24" Chain, & 12" ext., Standard Clip, Black	PAC	12	144	34	18½ x 19 x 17½
0009-002	9	24" Chain, Tool Pouch, Textured Chrome	Bulk	N/A	144	31	16 x 10 5/8 x 11 5/8
0009-004	9B	24" Chain, Tool Pouch, Textured Black	Bulk	N/A	144	31	16 x 10 5/8 x 11 5/8
0009-102	9H	24" Chain, Tool Pouch, Textured Chrome, HUS-KEY™	Bulk	N/A	144	31	16 x 10 5/8 x 11 5/8
0489-802	489-HDK	48" Kevlar, Tool Pouch, Textured Chrome	Bulk	N/A	144	36	16 x 10 5/8 x 11 5/8
0489-804	489B-HDK	48" Kevlar, Tool Pouch, Textured Black	Bulk	N/A	144	36	16 x 10 5/8 x 11 5/8

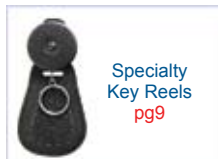



Super 48™
pg3



The #6
pg4



The Original
KEY-BAK®
pg5



SecurIt™
pg6

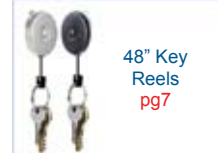

48" Key
Reels
pg7



Removable
Key Reels
pg8

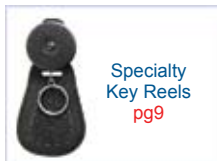
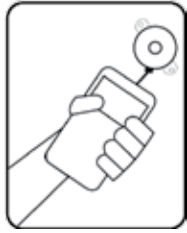
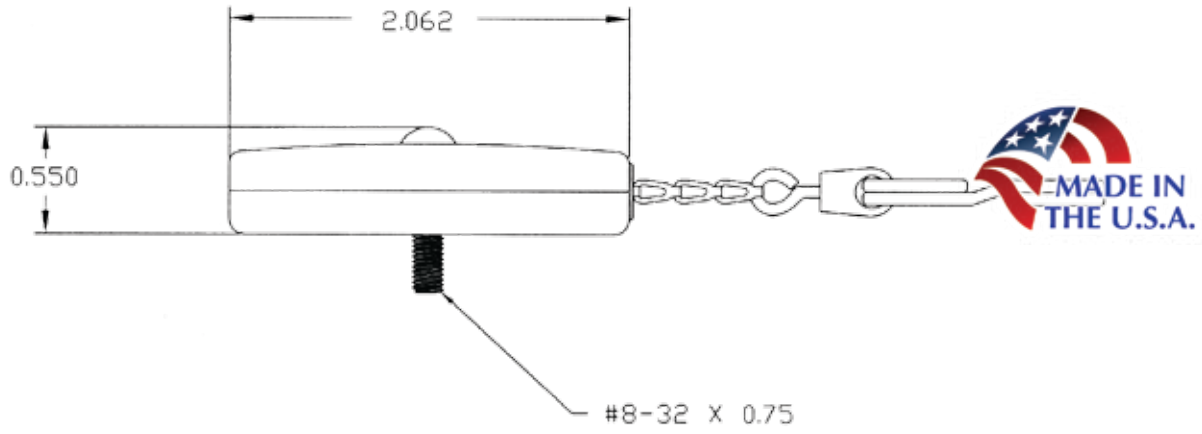

Specialty Key Reels
pg9



Industrial & Theft Deterrent Tool Retractors
pgs10-11



MINI-BAK® Retractors
pg12



USA Made Key Accessories
pg14



Key Accessories
pg15



Custom Imprinted Products
pgs16-17

MINI-BAK® - RETRACTORS

MINI-BAK® is designed for anybody that needs to keep a few keys, an ID badge, or a small tool (up to 2 oz.) handy and ready for use. Inside every MINI-BAK® is a precision spring-loaded reel attached to a three foot long, three strand nylon cord. The wearer can effortlessly extend the cord out to arms length, yet never lose control of the item being used. MINI-BAK® is made in the U.S.A. with rugged, high strength, and corrosion resistant materials. It has been tested in excess of 180,000 pulls; KEY-BAK® products are still the best!

MINI-BAK® with Split Ring (MB)

- 3/4" split ring for 3-4 keys or small tools.
- Available with 4 different back attachments: standard clip, swivel clip, pin back, and magnetic back
- Available in HD model-will support 4 oz (24" extension)



MINI-BAK® ID CLASSIC (MBID)

- Vinyl Strap with snap for ID cards
- Available with 4 different back attachments: standard clip, swivel clip, pin back, and magnetic back
- Available in HD model-will support 4 oz (24" extension)

MINI-BAK® CLICK'N'BAK™



- Ratchet mechanism keeps tension off cord until button releases. Perfect for cards that remain in a machine or in one position during a transaction.
- Available in 5 colors: black, white, blue, red, and grey
- Available with 4 different back attachments: standard clip, swivel clip, pin back, and magnetic back
- Available end fittings: split ring, vinyl strap, twist-free, and flexhook
- Inquire for part numbers

MINI-BAK® SKI-BAK



- Compact for active sportsmen
- Specially designed for skiers
- Bottom attachment slips through small holes
- Available in 4 colors: black, white, and neon yellow and green
- Top attachment connects to any small opening including zippers and D-rings

MINI-BAK® PENCIL PULL®



- MINI-BAK with a pencil holder
- Available in 11 colors: opaque black, white, blue, red, grey and translucent red, orange, yellow, purple, blue and green.
- Available with 4 different back attachments: standard clip, swivel clip, pin back, and magnetic back
- Never lose your pencil, again! Holds pencils, carpenter pencils, pens, highlighters, crayons, markers, etc.

MINI-BAK® TWIST-FREE ID



- Exclusive Twist-Free design keeps ID badge facing forward
- Available in 5 colors: black, white, blue, red, and grey
- Available with 4 different back attachments: standard clip, swivel clip, pin back, and magnetic back
- Available in HD model-will support 4 oz (24" extension)

MINI-BAK® Flex-HOOK ID



- Available in black and white
- Designed for round hole ID badges
- Available with 4 different back attachments: standard clip, swivel clip, pin back, and magnetic back

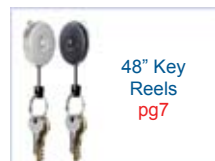

MINI-BAK® RETRACTORS - PRODUCTS CHART

Shipping Information	Package	Inner Pack	Case Pack	Wt. Lbs.	Case Dimensions inches
MINI-BAK®, MINI-BAK® ID	PAC	12	144	14	19 x 13 x 14¾
TWIST FREE ID, FLEX HOOK	PAC	12	144	14	19 x 13 x 14¾
MINI-BAK®, MINI-BAK® ID	Bulk	N/A	1000	31	11 x 8 x 12
TWIST FREE ID, FLEX HOOK, SKI-BAK	Bulk	N/A	1000	31	11 x 8 x 12
MINI-BAK®, MINI-BAK® ID	Twin-PAC	12	144	16	19 x 13 x 14¾
PENCIL PULL®	Bulk	N/A	1000	35	14¼ x 13 x 7

Color	Style	Clip Bulk	PAC	Swivel Clip Bulk	Swivel Clip PAC	Pin Bulk	Pin PAC	Magnet Bulk	SKI-BAK Bulk
GREY	MB	0051-006	0051-005	0024-006	0024-005	0031-006	0031-007	0041-006	---
	MBID	0054-006	0054-005	0064-006	0064-005	0034-006	0034-005	0044-006	---
	Twist Free	0054-016	0054-015	0064-016	0064-015	0034-016	0034-015	0044-016	---
	MB-HD	0051-056	0051-055	0024-056	0024-055	---	---	---	---
	MBID-HD	0054-065	0054-068	0064-065	0064-068	---	---	---	---
	Twist Free-HD	0054-076	0054-078	0064-076	0064-077	---	---	---	---
	Pencil Pull	0054-081	0054-082	0064-083	0064-084	---	---	---	---
BLUE	MB	0052-006	0052-005	0025-006	0025-005	0032-006	0032-005	0042-006	---
	MBID	0055-006	0055-005	0065-006	0065-005	0035-006	0035-005	0045-006	---
	Twist Free	0055-016	0055-015	0065-016	0065-015	0035-016	0035-015	0045-016	---
	Pencil Pull	0055-041	0055-042	0065-43	0065-44	---	---	---	---
WHITE	MB	0053-006	0053-005	0026-006	0026-005	0033-006	0033-005	0043-006	---
	MBID	0056-006	0056-005	0066-006	0066-005	0036-006	0036-005	0046-006	---
	Twist Free	0056-016	0056-015	0066-016	0066-015	0036-016	0036-015	0046-016	---
	Flex Hook	0056-016	0056-105	0066-103	0066-104	0036-103	0036-104	0046-103	---
	SKI-BAK	---	---	---	---	---	---	---	0116-302
	Pencil Pull	0056-201	0056-202	0066-203	0066-204	---	---	---	---
BLACK	MB	0050-006	0050-005	0027-006	0027-005	0030-006	0030-005	0040-006	---
	MBID	0057-006	0057-005	0067-006	0067-005	0037-006	0037-005	0047-006	---
	Twist Free	0057-016	0057-015	0067-016	0067-013	0037-016	0037-015	0047-016	---
	Flex Hook	0057-106	0057-104	0067-103	0067-104	0037-103	0037-104	0046-102	---
	SKI-BAK	---	---	---	---	---	---	---	0117-302
	Pencil Pull	0057-201	0057-202	0067-203	0067-204	---	---	---	---
RED	MB	0081-006	0081-005	0029-006	0029-005	0071-006	0071-005	0091-006	---
	MBID	0059-006	0059-005	0069-006	0069-005	0039-006	0039-005	0049-006	---
	Twist Free	0059-016	0059-015	0069-016	0069-015	0039-016	0039-015	0049-016	---
	Pencil Pull	0059-021	0059-022	0069-023	0069-024	---	---	---	---
TRANSLUCENT BLUE	MB	0214-002	0214-001	0214-006	0214-005	0214-004	0214-003	0214-008	---
	MBID	0214-012	0214-011	0214-016	0214-015	0214-014	0214-013	0214-018	---
	Pencil Pull	0214-031	0214-032	0214-033	0214-034	---	---	---	---
TRANSLUCENT GREEN	MB	0215-002	0215-001	0215-006	0215-005	0215-004	0215-003	0215-008	---
	MBID	0215-012	0215-011	0215-016	0215-015	0215-014	0215-013	0215-018	---
	Pencil Pull	0215-031	0215-032	0215-033	0215-034	---	---	---	---
TRANSLUCENT PURPLE	MB	0217-002	0217-001	0217-006	0217-005	0217-004	0217-003	0217-008	---
	MBID	0217-012	0217-011	0217-016	0217-015	0217-014	0217-013	0217-018	---
	Pencil Pull	0217-031	0217-032	0217-033	0217-034	---	---	---	---
TRANSLUCENT RED	MB	0219-002	0219-001	0219-006	0219-005	0219-004	0219-003	0219-008	---
	MBID	0219-012	0219-011	0219-016	0219-015	0219-014	0219-013	0219-018	---
	Pencil Pull	0219-031	0219-32	0219-033	0219-034	---	---	---	---
NEON YELLOW NEON GREEN	SKI-BAK	---	---	---	---	---	---	---	0117-322
		---	---	---	---	---	---	---	0117-332

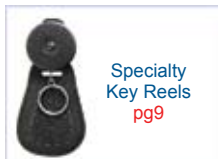

Model #KK2 Belt Carrier For Keys, Cell Phone, and Pagers



FRONT

BACK

- Belt Carrier clips onto belt
- Comes with a 1 1/4" key ring and two double sided adhesive clips to hold a cellphone or a pager...
- Key ring and clip lock into place twist 90 degrees to remove split rings

#600 Secure-A-Key®

- Eliminates wear on pockets
- Keeps keys handy
- Clips easily to belt
- Made of stainless steel; won't rust or discolor
- 1 1/8" I.D. split ring



#650 HUS-KEY™

- Allows the belt clip KEY-BAK® to carry five times the weight
- Snaps into place on the KEY-BAK® case.
- Can only be used with model #5 or #485



#8200 Carabineer Split Ring

- 1 1/4" ID Split Ring
- Snaps easily to belt loop, purse strap, tote bag

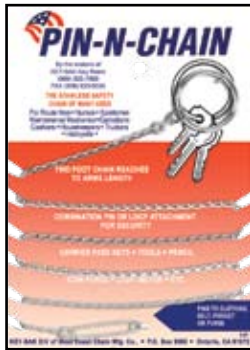

#PC-12 PIN-N-CHAIN



#MM-24 MITY-MITE® STAINLESS STEEL KEY CHAIN



#SS-12 STAINLESS STEEL CHAIN 100 ft, Spool

BULK SPLIT RINGS



5/16" Zinc Split Ring



1 1/8" Chrome Split Ring



3/4" Chrome Split Ring



1 1/4" Black Split Ring

Item #	Model #	Description	Package	Inner Pack	Case Pack	Wt. Lbs.	Case Dimensions
0308-704	KK2	KK2 Belt Carrier	Card	12	144	16	19 x 13 1/2 x 14 3/4
0600-001	600	Secure-A-Key®	Card	12	144	12	15 x 12 x 12
0650-001	650	HUS-KEY™	Card	10	120	12	16 x 11 x 12
0308-200	8200	Carabineer With Split Ring	Card	12	144	15	15 x 12 1/2 x 12
0700-001	700	Split Ring 5/16", Zinc plated, 100/bag	N/A	N/A	100 pc.	0.5	6 3/4 x 4 1/8 x 3 3/4
0800-001	800	Chrome Split Ring 3/4" 100/bag	N/A	N/A	100 pc.	0.5	6 3/4 x 4 1/8 x 3 3/4
0850-001	850	Black Split Ring 1 1/4" 100/bag	N/A	N/A	100 pc.	2	7 1/8 x 4 1/8 x 3 1/8
0900-001	900	Chrome Split Ring 1 1/8" 100/bag	N/A	N/A	100 pc.	1.5	7 1/8 x 4 1/8 x 3 1/8
0901-001	MM-24	Mity-Mite® Key Chain, 24/Card	Card	N/A	36	6.5	11 1/4 x 8 3/4 x 12
0902-001	PC-12	Pin-N-Chain Key Chain	Card	N/A	144	11	20 x 2 x 12
0903-001	SS-12	Stainless Steel Chain 100 ft. Spool	N/A	N/A	1	1.5	7 1/8 x 4 1/8 x 3 1/8



Super 48™ pg3



The #6 pg4



The Original KEY-BAK® pg5



SecurIt™ pg6

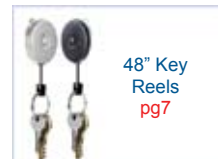

48" Key Reels pg7



Removable Key Reels pg8

KEY ACCESSORIES



- ◀#8802 Chrome Key Spider**
- Beautiful chrome finish
 - Keeps keys organized on separate rings which can be removed individually
 - Slide keys to notched opening and press button to release
 - Five removable nickel plated tempered steel key rings



▶#8803 Key Spider with Trigger Attachment

- Attractive chrome finish
- Trigger snap secures unit to belt loop
- Keys stay organized on separate rings
- Keys can be removed individually
- Four removable nickel plated tempered steel split rings

▶#3131 Single Ring Belt Key Holder

- Slips easily over belt and holds firmly
- Made of nickel plated steel
- 1" I.D. split ring
- Nickel plated tempered steel split ring
- Split rings slides into position



Quick Releases

- Pull apart key holder allows keys to be separated
- Tough nickel plated brass chrome, or gold finish
- Nickel plated tempered steel, gold electroplated tempered steel, or chrome plated split rings, return to original shape after expansion



FOR QUICK RELEASES PACKAGING INFORMATION, GO TO WWW.KEYBAK.COM

▼#9903 Small Trigger Snap 1" I.D. Split Ring

- Nickel plated zinc trigger snap keeps keys accessible
- Clips to belt loop or purse/tote
- Nickel plated tempered steel split ring
- Opens wide for easy attachment
- Bottom loop rotates so keys lie flat

◀#9904 Large Trigger Snap 1 1/8" I.D. Split Ring

◀#7402 Pocket Chain with Trigger Snap

- Trigger snap secures chain onto belt loop, or purse strap
- Nickel plated tempered steel split ring holds keys, or can attach to wallet for security
- 19" in length
- Tough nickel finish link chain

▶#7403 Pocket Chain with Belt Hook

- Keeps keys safely inside pocket
- Nickel plated tempered steel split key ring
- 19-1/2" in length
- Tough nickel finish link chain

◀#6139 Leather Bolt Hook

- Features bolt snap for easy removal of keys
- Leather strap attaches to belt
- Snaps on and off easily
- Nickel plated tempered steel split ring
- 1 1/8" I.D. split ring

▶#5905a Bolt Snap with Leather Key Ring Holder

- Key ring snaps off for easy key removal.
- Genuine leather ring holder.
- Nickel plated zinc
- 1 1/8" I.D. split ring

▶#5906 Double Ended Bolt Snap

- Easy removal of keys
- Medium sized bolt snap with clips at each end
- Made of nickel plated zinc
- 1 1/8" I.D. split ring

▼#5902 Small Bolt Snap 3/8" ID Split Ring

- Strong nickel plated zinc bolt snap
- Snaps easily to belt loop
- Bottom loop rotates so keys lie flat

◀#5905 Large Bolt Snap 1 1/8" ID Split Ring

Item #	Model #	Description	Package	Inner Pack	Case Pack	Wt. Lbs.	Case Dimensions
0303-131	3131	Single Ring Belt Key Holder	Card	6	144	14	15 x 11 x 14
0301-121	1121C	Economy Quick release Chrome Cylinder	Card	6	144	13	17 1/2 x 15 3/4 x 16 1/4
0301-123	1123C	Economy Quick release Chrome Flat	Card	6	144	13	15 x 9 1/2 x 14 1/4
0500-001	500	Quick release Chrome Cylinder	Card	6	144	13	17 1/2 x 15 3/4 x 16 1/4
0305-902	5902	Small Bolt Snap	Card	6	144	13	15 x 9 1/2 x 14
0305-905	5905	Large Bolt Snap	Card	6	144	20	15 x 11 x 14
0305-906	5906	Double-ended Bolt Snap	Card	6	144	31	16 1/2 x 10 x 14
0305-907	5905A	Bolt Snap with Leather & Key Ring	Card	6	144	26	16 1/2 x 11 x 14
0306-139	6139	Leather Bolt Hook	Card	6	144	22	16 1/2 x 14 x 14
0307-402	7402	Pocket Chain with Trigger Snap	Card	6	144	20	16 1/2 x 9 1/2 x 11
0307-403	7403	Pocket Chain with Belt Hook	Card	6	144	18	16 1/2 x 9 1/2 x 11
0308-802	8802	Chrome 5 ring Key Spider	Card	6	144	17	15 x 10 x 11
0308-803	8803	Chrome Key Spider with Trigger Snap	Card	6	144	19.5	15 x 12 x 14
0309-903	9903	Small Trigger Snap	Card	6	144	14	15 x 9 1/2 x 14
0309-904	9904	Large Trigger Snap	Card	6	144	32	15 x 12 1/2 x 14

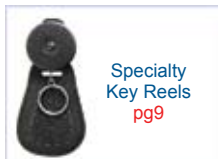

Specialty Key Reels pg9



Industrial & Theft Deterrent Tool Retractors pgs10-11



MINI-BAK® Retractors pg12



USA Made Key Accessories pg14



Key Accessories pg15



Custom Imprinted Products pgs16-17

CUSTOM - IMPRINTED PRODUCTS



◀ #15C



◀ The Super 48™



Securit™ ▶

Travel-SecureID™



IDEEZ™



USL100 ▶
Compatriot™
Lanyard



USL200 ▶
Compatriot™
Lanyard



MINI-BAK® ID
◀ (solid)
(translucent) ▶



USL200 ▶
Compatriot™
Lanyard



Retractable-A-Badge™ RAB-S (square)
▲ (solid) ▲ (chrome) ▲ (translucent)

Retractable-A-Badge™ RAB-H (heart)
▲ (solid) ▲ (translucent)

Retractable-A-Badge™ RAB-BC (bottlecap)
▲ (chrome) ▲ (solid)

Retractable-A-Badge™ RAB-LB (lightbulb)
▲ (solid) (translucent)▲



Super 48™
pg3



NEW!
The #6
pg4



The Original
KEY-BAK®
pg5



Securit™
pg6

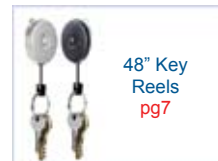

48" Key
Reels
pg7



Removable
Key Reels
pg8

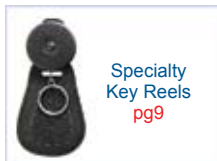

Specialty
Key Reels
pg9



Industrial &
Theft Deterrent
Tool Retractors
pgs10-11



MINI-BAK®
Retractors
pg12



USA Made Key
Accessories
pg14



Key Accessories
pg15



Custom
Imprinted
Products
pgs16-17



NEW! #6



Page 4

#481-HD
#487-HD



Page 11



Page 9



#9
#9H

Page 9

MINI-BAK®



Page 12

SECURIT™



Page 6



THE ORIGINAL KEY-BAK®



Page 5

THE SUPER 48™



Page 3



Super 48™
pg3



NEW!
The #6
pg4



The
Original
KEY-BAK®
pg5



SecurIt™
pg6

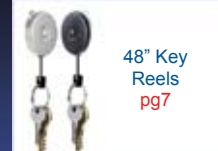

48" Key
Reels
pg7



Removable
Key Reels
pg8

KEY-BAK® AND MINI-BAK® Clam Shell Display Cards ▶

- High security with access to product
- New visual information on multiple uses printed on front
- Multi language to increase sales
- Additional sale information enclosed inside
- KEY-BAK® clam shell measure 7.625" high by 4.75" wide
- MINI-BAK® clam shell measure 6.5" high by 3.75" wide
- UPC and bar code printed on back



◀ MERCHANDISING STRIPS

KEY-BAK® introduces Merchandising Strips for our best selling items. Win additional sales in high traffic retail areas. Each Merchandising Strip is loaded with 12 units ready for display with included "S" hook for hanging. No counter space required. Merchandising Strips are individually bagged and come six strips to a carton.



◀ COUNTER DISPLAY

KEY-BAK®'s new Counter Display features 7 of our best selling items. Each fully stocked Counter Display comes with 6 items each and includes a handsome header card. KEY-BAK®'s Counter Display is fabricated of sturdy white powder coated, heavy gauge wire. Measurements: 20 in. high, 16 inches wide, 9 in. deep. Weight: 9 lbs (Fully Stocked).



DREXX s.r.o.

Líský 72
273 76 Pozdeň

Tel.: +420 313 574 808

info@drex.cz



LOG ONTO
www.keybak.com
FOR MORE INFO

STANDARD IMPRINT COLORS

BLACK	ROYAL or REFLEX
WHITE	BLUE 293
COOL GREY	BLUE 281
YELLOW 116	GREEN 368
ORANGE 165	BROWN 464
RED 485	GOLD 871
PURPLE 2592	SILVER 877

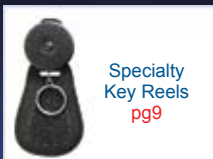

Specialty
Key Reels
pg9



Industrial &
Theft Deterrent
Tool Retractors
pgs10-11



MINI-BAK®
Retractors
pg12



USA Made Key
Accessories
pg14

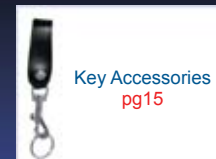

Key Accessories
pg15



Custom
Imprinted
Products
pgs16-17

MAKING YOUR SECURITY MORE CONVENIENT FOR OVER 60 YEARS.

2009 CATALOG



www.keybak.com

West Coast Chain Mfg. Co.

An Employee Owned Company Ontario, California, U.S.A.

Printed in The U.S.A.