



Powered by **Eaton Technology**

VSD Series Drives

User Manual

November 2009
Supersedes September 2006



November 2009

IMPORTANT NOTICE – PLEASE READ

The product discussed in this literature is subject to terms and conditions outlined in Johnson Controls Inc. selling policies. The sole source governing the rights and remedies of any purchaser of this equipment is the relevant Johnson Controls Inc. selling policy.

NO WARRANTIES, EXPRESS OR IMPLIED, INCLUDING WARRANTIES OF FITNESS FOR A PARTICULAR PURPOSE OR MERCHANTABILITY, OR WARRANTIES ARISING FROM COURSE OF DEALING OR USAGE OF TRADE, ARE MADE REGARDING THE INFORMATION, RECOMMENDATIONS AND DESCRIPTIONS CONTAINED HEREIN. In no event will Johnson Controls Inc. or Eaton Electrical Inc. be responsible to the purchaser or user in contract, in tort (including negligence), strict liability or otherwise for any special, indirect, incidental or consequential damage or loss whatsoever, including but not limited to damage or loss of use of equipment, plant or power system, cost of capital, loss of power, additional expenses in the use of existing power facilities, or claims against the purchaser or user by its customers resulting from the use of the information, recommendations and descriptions contained herein.

The information contained in this manual is subject to change without notice.

Cover Photo: Johnson Controls VSD Series Drive.

November 2009

Table of Contents

LIST OF FIGURES	v
LIST OF TABLES	vii
SAFETY ISSUES	
Definitions and Symbols.....	x
Hazardous High Voltage	x
Warnings, Cautions and Notices	xi
CHAPTER 1 — OVERVIEW	
How to Use This Manual.....	1-1
Receiving and Inspection	1-1
Catalog Numbering System.....	1-2
CHAPTER 2 — MOUNTING OPEN TYPE 1, TYPE 12 DRIVES	
Space Requirements.....	2-1
Environmental Requirements.....	2-2
Standard Mounting Instructions	2-2
CHAPTER 3 — POWER WIRING	
Guidelines	3-1
UL Compatible Cable Selection and Installation	3-2
Installation Instructions.....	3-4
Standard Wiring Diagrams and Terminal Locations	3-6
Checking the Cable and Motor Insulation.....	3-9
CHAPTER 4 — CONTROL WIRING	
General Information	4-1
CHAPTER 5 — INTELLIPASS BYPASS OPTION	
Product Description.....	5-1
Catalog Number Selection	5-2
IntelliPass Control Wiring Instructions	5-16
CHAPTER 6 — MENU INFORMATION	
Keypad Operation	6-1
Main Menu Navigation.....	6-4
CHAPTER 7 — START-UP	
Safety Precautions.....	7-1
Sequence of Operation.....	7-2
CHAPTER 8 — N2, XT, AND SA BUS COMMUNICATION	
CHAPTER 9 — REMOTE INPUT APPLICATION (SVCHS200)	
Introduction	9-1
Control Input/Output.....	9-2
Parameter Lists	9-3
CHAPTER 10 — GENERIC PI APPLICATION (SVCHS201)	
Introduction	10-1
Control Input/Output.....	10-2
Parameter Lists	10-3
CHAPTER 11 — DUCT STATIC APPLICATION (SVCHS202)	
Introduction	11-1
Control Input/Output.....	11-2
Parameter Lists	11-3

Table of Contents, continued

CHAPTER 12 — BUILDING STATIC APPLICATION (SVCHS203)	
Introduction	12-1
Control Input/Output	12-2
Parameter Lists.....	12-3
CHAPTER 13 — PRESSURE CONTROL APPLICATION (SVCHS204)	
Introduction	13-1
Control Input/Output	13-2
Parameter Lists.....	13-3
CHAPTER 14 — TEMPERATURE CONTROL APPLICATION (SVCHS205)	
Introduction	14-1
Control Input/Output	14-2
Parameter Lists.....	14-3
CHAPTER 15 — DESCRIPTION OF PARAMETERS	
Parameters by ID Number.....	15-1
Keypad Control Parameters	15-28
APPENDIX A — TECHNICAL DATA	
Specifications	A-1
Power Ratings.....	A-3
Power Loss and Switching Frequency	A-4
Dimensions	A-8
EMC Capability.....	A-15
Declaration of Conformity.....	A-15
Warranty and Liability Information.....	A-16
APPENDIX B — FAULT AND WARNING CODES	
APPENDIX C — ACCESSORIES	
RS-232 Cables Used with VS Drives.....	C-1
APPENDIX D — WIRING DIAGRAMS	

November 2009

List of Figures

Figure 2-1: Mounting Space Requirements	2-1
Figure 3-1: Input Power and Motor Cable Stripping and Wire Lengths	3-4
Figure 3-2:	3-5
Figure 3-3: Principle Wiring Diagram of VSD Series Power Unit, FR4, FR5 and FR6	3-6
Figure 3-4:	3-8
Figure 3-5: Option Board A9 Location and Settings	3-8
Figure 4-1: Option Board Slots	4-1
Figure 4-2: Option Board A2 Terminal Locations	4-2
Figure 4-3: Positive/Negative Logic	4-2
Figure 5-1: Identification of NEMA Type 1 Components	5-4
Figure 5-2: VSD Series IntelliPass/IntelliDisconnect Drive Dimensions	5-4
Figure 5-3: VSD Series IntelliPass with Three Contactors	5-7
Figure 5-4: Identification of NEMA Type 12 and NEMA Type 3R Components	5-9
Figure 5-5: VSD Series Enclosed Drive Dimensions	5-9
Figure 5-6:	5-12
Figure 5-7: Schematic for Static Checks (Sample for Frames 4 and 5)	5-15
Figure 5-8: Option Board B5 Wiring Diagram	5-16
Figure 5-9: Option Board B5 Terminal Location	5-17
Figure 5-10: Enable Bypass	5-17
Figure 6-1: Keypad and Display	6-1
Figure 6-2: Operate Menu Navigation	6-1
Figure 6-3: Main Menu Navigation	6-5
Figure 6-4: Parameter Menu Structure Example	6-6
Figure 6-5: Keypad Control Menu	6-7
Figure 6-6: Active Fault Display Example	6-8
Figure 6-7: Sample Fault History Display	6-10
Figure 6-8: System Menu Keypad Structure	6-11
Figure 6-9: Expander Board Menu Structure	6-19
Figure 6-10: Digital Inputs — DI-1, DI-2, DI-3 Status	6-20
Figure 6-11: Digital Inputs — DI-4, DI-5, DI-6 Status	6-21
Figure 6-12: Digital and Relay Outputs — DO-1, RO-1, RO-2 Status	6-21
Figure 7-1: Start-Up Wizard Navigation (1 of 3)	7-4
Figure 7-2: Start-Up Wizard Navigation (2 of 3)	7-5
Figure 7-3: Start-Up Wizard Navigation (3 of 3)	7-6
Figure 7-4: Remote Input Start-Up Wizard	7-7
Figure 15-1: AI-1 No Signal Inversion	15-4
Figure 15-2: AI-1 Signal Inversion	15-4
Figure 15-3: AI-1 No Signal Filtering	15-5
Figure 15-4: Analog Input AI-2 Scaling	15-5
Figure 15-5: Setpoint Scaling	15-6
Figure 15-6: Sensor Scaling	15-6
Figure 15-7: Analog Output Filtering	15-7
Figure 15-8: Analog Output Invert	15-8
Figure 15-9: Analog Output Scaling	15-9
Figure 15-10: Output Frequency Supervision	15-11
Figure 15-11: Acceleration/Deceleration (S-shaped)	15-13
Figure 15-12: Example of Prohibit Frequency Area Setting	15-14
Figure 15-13: Ramp Speed Scaling between Prohibit Frequencies	15-15
Figure 15-14: Linear and Squared V/Hz Ratio	15-17
Figure 15-15: Programmable V/Hz Curve	15-17
Figure 15-16: Motor Thermal Current IT Curve	15-21

List of Figures, continued

Figure 15-17: Motor Temperature Calculation	15-22
Figure 15-18: Stall Characteristics Settings	15-23
Figure 15-19: Stall Time Count	15-23
Figure 15-20: Setting of Minimum Load	15-24
Figure 15-21: Underload Time Counter Function	15-25
Figure 15-22: Auto Acceleration/Deceleration (S-shaped)	15-27
Figure A-1: Power Loss as Function of Switching Frequency: 1 – 3 hp 230V, 1-1/2 – 7-1/2 hp 480V	A-5
Figure A-2: Power Loss as Function of Switching Frequency: 5 – 10 hp 230V, 10 – 20 hp 480V	A-5
Figure A-3: Power Loss as Function of Switching Frequency: 15 – 20 hp 230V, 25 – 40 hp 480V	A-6
Figure A-4: Power Loss as Function of Switching Frequency: 25 – 40 hp 230V, 50 – 75 hp 480V	A-6
Figure A-5: Power Loss as Function of Switching Frequency: 50 – 75 hp 230V, 100 – 150 hp 480V	A-7
Figure A-6: Power Loss as Function of Switching Frequency: 200 – 250 hp 480V	A-7
Figure A-7: TYPE 1 and TYPE 12 VSD Series Open Drive Dimensions, FR4, FR5 and FR6	A-8
Figure A-8: VSD Series Open Drive Dimensions, TYPE 1 and TYPE 12 with Flange Kit, FR4, FR5 and FR6	A-9
Figure A-9: VSD Series Open Drive Dimensions, TYPE 1 and TYPE 12, FR7	A-10
Figure A-10: VSD Series Open Drive Dimensions, TYPE 1 and TYPE 12, FR8	A-11
Figure A-11: VSD Series Open Drive Dimensions, TYPE 1 and TYPE 12, with Flange Kit, FR7 and FR8	A-12
Figure A-12: VSD Series Open Drive Dimensions, OPEN 1 and OPEN 12 FR9	A-13
Figure A-13: VSD Series Open Drive Dimensions, TYPE 1 and TYPE 12 FR9 with Flange Kit	A-14
Figure C-1: RS-232 Cable for Parameter Setting or Software Downloading by Using PC	C-1
Figure C-2: Connection of Cable Used with Keypad	C-1
Figure C-3: RS-232 Cable	C-2
Figure D-1: VSD Series IntelliPass with Three Contactors	D-1
Figure D-2: VSD Series IntelliPass Disconnect	D-2

November 2009

List of Tables

Table 1-1: VSD Series Open Drives Selection Chart	1-2
Table 2-1: Space Requirements for Mounting a VSD Series Drive	2-1
Table 2-2: Cooling Airflow Requirements	2-2
Table 3-1: Cable Spacings	3-1
Table 3-2: Cable and Fuse Sizes — 208 – 240V Ratings ®	3-2
Table 3-3: Cable and Fuse Sizes — 380 – 500V Ratings ®	3-2
Table 3-4: Cable and Fuse Sizes — 525 – 690V Ratings ®	3-3
Table 3-5: Maximum Symmetrical Supply Current	3-3
Table 3-6: Power Connection Tightening Torque	3-3
Table 3-7: Power and Motor Cable Stripping Lengths	3-4
Table 3-8: Control Wiring Instructions — NEMA Type 1/12 Open Drives	3-5
Table 4-1: Option Board A2 Terminal Descriptions	4-2
Table 5-1: VSD Series IntelliPass/IntelliDisconnect Drives Selection Chart	5-2
Table 5-2: VSD Series Enclosed Drives Selection Chart	5-3
Table 5-3: Options List	5-3
Table 5-4: Option Notes	5-3
Table 5-5: VSD Series NEMA Type 1 IntelliPass/IntelliDisconnect Drive Dimensions	5-4
Table 5-6: Bypass Power Wiring Instructions — NEMA Type 1 IntelliPass/IntelliDisconnect Drive	5-5
Table 5-7: VSD Series NEMA Type 12 Enclosed IntelliPass Drive Dimensions	5-9
Table 5-8: VSD Series NEMA Type 3R Enclosed IntelliPass Drive Dimensions	5-9
Table 5-9: Bypass Power Wiring Instructions — Enclosed NEMA Type 12/3R	5-10
Table 5-10: Static Checks of Converter	5-14
Table 5-11: Static Checks of Inverter	5-14
Table 5-12: Static Checks of DC Bus	5-15
Table 5-13: Option Board B5 Terminal Descriptions	5-16
Table 6-1: LCD Status Indicators	6-2
Table 6-2: LED Status Indicators	6-2
Table 6-3: Navigation Buttons	6-3
Table 6-4: Fault Types	6-9
Table 6-5: Fault Time Data	6-9
Table 6-6: Total Counters	6-16
Table 6-7: Trip Counters	6-17
Table 6-8: Software Information	6-17
Table 6-9: Application Information	6-17
Table 6-10: Hardware Information	6-18
Table 6-11: Expander Board Information	6-18
Table 6-12: Drive Output Phase Current Measurement	6-18
Table 6-13: Monitoring Menu Items — Generic PI Application Example	6-20
Table 6-14: Operate Menu Items — Generic PI Application Example	6-21
Table 9-1: Remote Input Application Default I/O Configuration	9-2
Table 9-2: Quick Setup Parameters — M1 → G1.1	9-3
Table 9-3: Input Signals — M1 → G1.2	9-5
Table 9-4: Output Signals — M1 → G1.3	9-8
Table 9-5: Drive Control Parameters — M1 → G1.4	9-10
Table 9-6: Prohibit Frequencies — M1 → G1.5	9-11
Table 9-7: Motor Control Parameters — M1 → G1.6	9-12
Table 9-8: Protections — M1 → G1.7	9-13

List of Tables, continued

Table 9-9: Fieldbus Parameters — M1 → G1.8	9-14
Table 9-10: Preset Speeds — M1 → G1.10	9-15
Table 9-11: Keypad Control Parameters — M2	9-16
Table 9-12: Monitoring Menu	9-16
Table 10-1: Generic PI Application Default I/O Configuration	10-2
Table 10-2: Quick Setup Parameters — M1 → G1.1	10-3
Table 10-3: Input Signals — M1 → G1.2	10-5
Table 10-4: Output Signals — M1 → G1.3	10-8
Table 10-5: Drive Control Parameters — M1 → G1.4	10-10
Table 10-6: Prohibit Frequencies — M1 → G1.5	10-11
Table 10-7: Motor Control Parameters — M1 → G1.6	10-12
Table 10-8: Protections — M1 → G1.7	10-13
Table 10-9: Fieldbus Parameters — M1 → G1.8	10-14
Table 10-10: PI-Control Parameters — M1 → G1.9	10-16
Table 10-11: Preset Speeds — M1 → G1.10	10-16
Table 10-12: Keypad Control Parameters — M2	10-17
Table 10-13: Monitoring Menu	10-17
Table 11-1: Duct Static Application Default I/O Configuration	11-2
Table 11-2: Quick Setup Parameters — M1 → G1.1	11-3
Table 11-3: Input Signals — M1 → G1.2	11-5
Table 11-4: Output Signals — M1 → G1.3	11-8
Table 11-5: Drive Control Parameters — M1 → G1.4	11-10
Table 11-6: Prohibit Frequencies — M1 → G1.5	11-11
Table 11-7: Motor Control Parameters — M1 → G1.6	11-12
Table 11-8: Protections — M1 → G1.7	11-13
Table 11-9: Fieldbus Parameters — M1 → G1.8	11-14
Table 11-10: PI-Control Parameters — M1 → G1.9	11-16
Table 11-11: Preset Speeds — M1 → G1.10	11-16
Table 11-12: Keypad Control Parameters — M2	11-17
Table 11-13: Monitoring Menu	11-18
Table 12-1: Building Static Application Default I/O Configuration	12-2
Table 12-2: Quick Setup Parameters — M1 → G1.1	12-3
Table 12-3: Input Signals — M1 → G1.2	12-5
Table 12-4: Output Signals — M1 → G1.3	12-8
Table 12-5: Drive Control Parameters — M1 → G1.4	12-10
Table 12-6: Prohibit Frequencies — M1 → G1.5	12-11
Table 12-7: Motor Control Parameters — M1 → G1.6	12-12
Table 12-8: Protections — M1 → G1.7	12-13
Table 12-9: Fieldbus Parameters — M1 → G1.8	12-14
Table 12-10: PI-Control Parameters — M1 → G1.9	12-16
Table 12-11: Preset Speeds — M1 → G1.10	12-16
Table 12-12: Keypad Control Parameters — M2	12-17
Table 12-13: Monitoring Menu	12-18
Table 13-1: Pressure Control Application Default I/O Configuration	13-2
Table 13-2: Quick Setup Parameters — M1 → G1.1	13-3
Table 13-3: Input Signals — M1 → G1.2	13-5
Table 13-4: Output Signals — M1 → G1.3	13-8
Table 13-5: Drive Control Parameters — M1 → G1.4	13-10
Table 13-6: Prohibit Frequencies — M1 → G1.5	13-11
Table 13-7: Motor Control Parameters — M1 → G1.6	13-12

November 2009

List of Tables, continued

Table 13-8: Protections — M1 → G1.7	13-13
Table 13-9: Fieldbus Parameters — M1 → G1.8	13-14
Table 13-10: PI-Control Parameters — M1 → G1.9	13-16
Table 13-11: Preset Speeds — M1 → G1.10	13-16
Table 13-12: Keypad Control Parameters — M2	13-17
Table 13-13: Monitoring Menu	13-18
Table 14-1: Temperature Control Application Default I/O Configuration	14-2
Table 14-2: Quick Setup Parameters — M1 → G1.1	14-3
Table 14-3: Input Signals — M1 → G1.2	14-5
Table 14-4: Output Signals — M1 → G1.3	14-8
Table 14-5: Drive Control Parameters — M1 → G1.4	14-10
Table 14-6: Prohibit Frequencies — M1 → G1.5	14-11
Table 14-7: Motor Control Parameters — M1 → G1.6	14-12
Table 14-8: Protections — M1 → G1.7	14-13
Table 14-9: Fieldbus Parameters — M1 → G1.8	14-14
Table 14-10: PI-Control Parameters — M1 → G1.9	14-16
Table 14-11: Preset Speeds — M1 → G1.10	14-16
Table 14-12: Keypad Control Parameters — M2	14-17
Table 14-13: Monitoring Menu	14-18
Table 15-1: Selections for IDs 112, 113, 114 and 115	15-2
Table 15-2: Analog Output Scaling	15-8
Table 15-3: Output Signals Via DO-1 and Output Relays RO-1 and RO-2	15-9
Table 15-4: Size-Dependent Switching Frequencies	15-18
Table 15-5: Fieldbus Parameters	15-26
Table 15-6: Preset Speeds	15-28
Table A-1: VSD Series Drive Specifications	A-1
Table A-2: 230V VT Output Power Ratings	A-3
Table A-3: 480V VT Output Power Ratings	A-3
Table A-4: 575V VT Output Power Ratings	A-4
Table A-5: VSD Series Open Drive Dimensions	A-8
Table A-6: Dimensions for VSD Series Open Drive, FR4, FR5 and FR6 with Flange Kit	A-9
Table A-7: Dimensions for the Flange Opening, FR4 to FR6	A-9
Table A-8: VSD Series Open Drive Dimensions, FR7	A-10
Table A-9: VSD Series Open Drive Dimensions, FR8	A-11
Table A-10: Dimensions for VSD Series Open Drive, FR7 and FR8 with Flange Kit	A-12
Table A-11: Dimensions for the Flange Opening, FR7/FR8	A-12
Table A-12: Dimensions for VSD Series Open Drive, FR9	A-13
Table A-12: Dimensions for VSD Series Open Drive, FR9, continued	A-13
Table A-13: Dimensions for VSD Series Open Drive, FR9 with Flange Kit	A-14
Table B-1: Fault Codes	B-1

Safety Issues

Definitions and Symbols

 **WARNING**

This symbol indicates high voltage. It calls your attention to items or operations that could be dangerous to you and other persons operating this equipment. Read the message and follow the instructions carefully.



This symbol is the "Safety Alert Symbol." It occurs with either of two signal words: WARNING or CAUTION as described below.

 **WARNING**

Indicates a potentially hazardous situation which, if not avoided, can result in serious injury or death.

 **CAUTION**

Indicates a potentially hazardous situation which, if not avoided, can result in minor to moderate injury, or serious damage to the equipment. The situation described in the CAUTION may, if not avoided, lead to serious results. Important safety measures are described in CAUTION (as well as WARNING).

Hazardous High Voltage

 **WARNING**

Motor control equipment and electronic controllers are connected to hazardous line voltages. When servicing drives and electronic controllers, there may be exposed components with housings or protrusions at or above line potential. Extreme care should be taken to protect against shock.

- Stand on an insulating pad and make it a habit to use only one hand when checking components.
- Always work with another person in case an emergency occurs.
- Disconnect power before checking controllers or performing maintenance.
- Be sure equipment is properly grounded.
- Wear safety glasses whenever working on electronic controllers or rotating machinery.

November 2009

Warnings, Cautions and Notices

Read this manual thoroughly and make sure you understand the procedures before you attempt to install, set up or operate this Johnson Controls VSD Series Variable Speed Drive powered by Cutler-Hammer® technology from Eaton's electrical business.

Warnings

 WARNING

Be sure to ground the unit following the instructions in this manual. Ungrounded units may cause electric shock and/or fire.

 WARNING

This equipment should be installed, adjusted, and serviced by qualified electrical maintenance personnel familiar with the construction and operation of this type of equipment and the hazards involved. Failure to observe this precaution could result in death or severe injury.

 WARNING

Components within the VSD Series power unit are live when the drive is connected to power. Contact with this voltage is extremely dangerous and may cause death or severe injury.

 WARNING

Line terminals (L1, L2, L3), motor terminals (U, V, W) and the DC-link/brake resistor terminals (-/+) are live when the drive is connected to power, even if the motor is not running. Contact with this voltage is extremely dangerous and may cause death or severe injury.

 WARNING

Even though the control I/O-terminals are isolated from line voltage, the relay outputs and other I/O-terminals may have dangerous voltage present even when the drive is disconnected from power. Contact with this voltage is extremely dangerous and may cause death or severe injury.

 WARNING

The VSD Series drive has a large capacitive leakage current during operation, which can cause enclosure parts to be above ground potential. Proper grounding, as described in this manual, is required. Failure to observe this precaution could result in death or severe injury.

 WARNING

Before applying power to the VSD Series drive, make sure that the front and cable covers are closed and fastened to prevent exposure to potential electrical fault conditions. Failure to observe this precaution could result in death or severe injury.

 WARNING

An upstream disconnect/protective device must be provided as required by the National Electric Code (NEC). Failure to follow this precaution may result in death or severe injury.

 WARNING

Before opening the VSD Series drive covers:

- Disconnect all power to the VSD Series drive.
- Wait a minimum of 5 (five) minutes after all the lights on the keypad are off. This allows time for the DC bus capacitors to discharge.
- A hazardous voltage may still remain in the DC bus capacitors even if the power has been turned off. Confirm that the capacitors have fully discharged by measuring their voltage using a multimeter set to measure DC voltage.

Failure to follow the above precautions may cause death or severe injury.

 WARNING

The VSD Series output terminals U, V and W correspond to a phase rotation of ABC. If the input terminals L1, L2 and L3 have not been wired for ABC, the motor rotation will be different when powered from the bypass instead of the VSD Series drive which can result in personal injury and equipment damage. In this situation the input line wiring must be changed to correspond to ABC rotation.

Cautions

 CAUTION

Do not perform any Megger or voltage withstand tests on any part of the VSD Series drive or its components. Improper testing may result in damage.

 CAUTION

Prior to any tests or measurements of the motor or the motor cable, disconnect the motor cable at the VSD Series output terminals (U, V, W) to avoid damaging the VSD Series drive during the motor or cable testing.

 CAUTION

Do not touch any components on the circuit boards. Static voltage discharge may damage the components.

 CAUTION

Any electrical or mechanical modification to this equipment without prior written consent of Johnson Controls will void all warranties and may result in a safety hazard in addition and voiding of the UL listing.

November 2009

⚠ CAUTION

Install the VSD Series drive on flame-resistant material such as a steel plate to reduce the risk of fire.

⚠ CAUTION

Install the VSD Series drive on a perpendicular surface that is able to support the weight of the drive and is not subject to vibration, to lessen the risk of the drive falling and being damaged and/or causing personal injury.

⚠ CAUTION

Prevent foreign material such as wire clippings or metal shavings from entering the drive enclosure, as this may cause arcing damage and fire.

⚠ CAUTION

Install the VSD Series drive in a well-ventilated room that is not subject to temperature extremes, high humidity, or condensation, and avoid locations that are directly exposed to sunlight, or have high concentrations of dust, corrosive gas, explosive gas, inflammable gas, grinding fluid mist, etc. Improper installation may result in a fire hazard.

Motor and Equipment Safety

⚠ CAUTION

Before starting the motor, check that the motor is mounted properly and aligned with the driven equipment. Ensure that starting the motor will not cause personal injury or damage equipment connected to the motor.

⚠ CAUTION

Set the maximum motor speed (frequency) in the VSD Series drive according to the requirements of the motor and the equipment connected to it. Incorrect maximum frequency settings can cause motor or equipment damage and the potential for personal injury.

⚠ CAUTION

Before reversing the motor rotation, ensure that this will not cause personal injury or equipment damage.

⚠ CAUTION

Make sure that no power factor correction capacitors are connected to the VSD Series output or the motor terminals to prevent VSD Series drive malfunction and potential damage.

⚠ CAUTION

Make sure that the VSD Series output terminals (U, V, W) are not connected to the utility line power as severe damage to the VSD Series drive and personal injury may occur.

November 2009

Chapter 1 — Overview

This chapter describes the purpose and contents of this manual, the receiving inspection recommendations and the Johnson Controls VSD Series Open Drive catalog numbering system.

How to Use This Manual

The purpose of this manual is to provide you with information necessary to install, set and customize parameters, start up, troubleshoot and maintain the Johnson Controls VSD Series drive powered by Cutler-Hammer® technology from Eaton's electrical business. To provide for safe installation and operation of the equipment, read the safety guidelines at the beginning of this manual and follow the procedures outlined in the following chapters before connecting power to the VSD Series drive. Keep this operating manual handy and distribute to all users, technicians and maintenance personnel for reference.

Chapter 1 – Overview

Chapter 2 – Mounting

Chapter 3 – Power Wiring

Chapter 4 – Control Wiring

Chapter 5 – IntelliPass Bypass Option

Chapter 6 – Menu Information

Chapter 7 – Start-Up

Chapter 8 – Johnson Controls Metasys N2 Protocol

Chapter 9 to 14 – Applications

Chapter 15 – Description of Parameters

Appendix A – Technical Data

Appendix B – Fault and Warning Codes

Appendix C – Accessories

Receiving and Inspection

The VSD Series AC drive has met a stringent series of factory quality requirements before shipment. It is possible that packaging or equipment damage may have occurred during shipment. After receiving your VSD Series drive, please check for the following:

- Check to make sure that the package(s) includes the VSD Series drive, the User Manual, rubber conduit covers, screws, conduit plate and ground straps.
- Inspect the unit to ensure it was not damaged during shipment.
- Make sure that the part number indicated on the nameplate corresponds with the Catalog Number on your order.

If shipping damage has occurred, please contact and file a claim with the carrier involved immediately.

If the delivery does not correspond to your order, please contact your Johnson Controls representative.

Note: Do not destroy the packing. The template printed on the protective cardboard can be used for marking the mounting points of the VSD Series on the wall or cabinet.

Catalog Numbering System

Table 1-1: VSD Series Open Drives Selection Chart

	Code Number	V	S					0	A	-	N	0	0	0	0
Base Product	VS = Variable Speed Drive Prefix														
Horsepower (VT) ①	001 = 1.0 hp to 250 = 250 hp ②														
Voltage ③	2 = 230V (or 208V) 4 = 480V 5 = 575V														
Enclosure Rating	1 = TYPE 1 2 = TYPE 12														
Enclosure Style	0 = None (Open Drive)														
Revision #	A = Rev 1 (Americas) C = Rev 1 (Canada)														
Separator (-)															
Communications ④	0 = None N = N2/XT/SA ^⑤ Bus Comm (N2 by default) L = LONWORKS [®] Network														
Option 1	00 = None														
Option 2	00 = None														

- ① All horsepower ratings are Variable Torque (VT).
- ② 3 to 200 @ 575V; 1-1/2 to 250 hp @ 480V; 1 to 100 hp @ 230V.
- ③ Voltage Ratings: 230V = 208 – 240V; 480V = 380 – 500V; 575V = 525 – 690V.
- ④ N2/XT Communications selectable on drive keypad.
- ⑤ SA = Sensor Actuator Bus for FEC Interface.



**Johnson Controls Open Drive
TYPE 1 & TYPE 12, 208 – 240V, 380 – 500V, 525 – 690V**

November 2009

Chapter 2 — Mounting Open TYPE 1, TYPE 12 Drives

VSD Series open drives may be mounted side-by-side or stacked vertically, as outlined in the following section.

Note: See **Chapter 5** for mounting TYPE 1, TYPE 12 and TYPE 3R IntelliPass drives.

Space Requirements

To ensure proper air circulation and cooling, follow the guidelines below.

Table 2-1: Space Requirements for Mounting a VSD Series Drive

Drive Type Variable Torque Rating	Approximate Dimensions in Inches (mm) ^①				
	A	A ₂	B	C	D
230V, 1 – 3 hp 480V, 1-1/2 – 7-1/2 hp	0.8 (20)		0.8 (20)	3.9 (100)	2.0 (50)
230V, 5 – 10 hp 480V, 10 – 20 hp	0.8 (20)		0.8 (20)	4.7 (120)	2.4 (60)
230V, 15 – 20 hp 480V, 25 – 40 hp 575V, 3 – 30 hp	1.2 (30)		1.2 (30)	6.3 (160)	3.1 (80)
230V, 25 – 40 hp 480V, 50 – 75 hp 575V, 40 – 50 hp	3.1 (80)		3.1 (80)	11.8 (300)	3.9 (100)
230, 50 – 75 hp 480V, 100 – 150 hp 575V, 60 – 100 hp	3.1 (80)	5.9 (150)	3.1 (80)	11.8 (300)	7.9 (200)
230V, 100 hp 480V, 200 – 250 hp 575V, 125 – 200 hp	2.0 (50)		3.1 (80)	15.7 (400)	9.8 (250) 13.8 ^② (350)

^① Dimensions represent the minimum clearance needed when mounting a drive. See **Figure 2-1** below.

A = clearance around the VSD Series drive.

A₂ = clearance needed to change the fan without disconnecting the motor cables.

B = distance between adjacent VSD Series drives or between the VSD Series drive and an enclosure wall.

C = clearance above the VSD Series drive.

D = clearance below the VSD Series drive.

^② Minimum clearance below the VSD Series drive needed to change the fan.

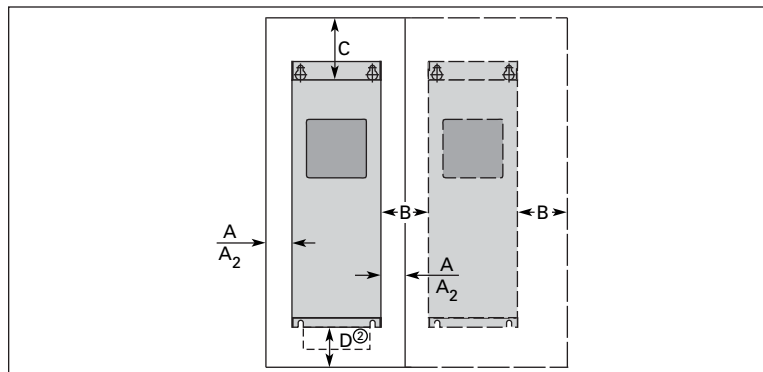


Figure 2-1: Mounting Space Requirements

If several units are mounted above each other, the clearance between the drives should equal C + D (see **Table 2-1** and **Figure 2-1** above). In addition, the outlet air used for cooling the lower unit must be directed away from the inlet air used by the upper unit.

Environmental Requirements

Ensure that the environment meets the requirements listed in **Table A-1** of **Appendix A** for any storage or operating situation.

The following table specifies the minimum airflow required in the area where the drive will be mounted.

Table 2-2: Cooling Airflow Requirements

Drive Type Variable Torque Ratings	Cooling Air Required
230V, 1 – 3 hp 480V, 1-1/2 – 7-1/2 hp	41 cfm (70 m ³ /h)
230V, 5 – 10 hp 480V, 10 – 20 hp	112 cfm (190 m ³ /h)
230V, 15 – 20 hp 480V, 25 – 40 hp 575V, 3 – 30 hp	250 cfm (425 m ³ /h)
230V, 25 – 40 hp 480V, 50 – 75 hp 575V, 40 – 50 hp	250 cfm (425 m ³ /h)
230V, 50 – 75 hp 480V, 100 – 150 hp 575V, 60 – 100 hp	383 cfm (650 m ³ /h)
230V, 100 hp 480V, 200 – 250 hp 575V, 125 – 200 hp	765 cfm (1300 m ³ /h)

Standard Mounting Instructions

1. Measure the mounting space to ensure that it allows for the minimum space surrounding the VSD Series drive. Drive dimensions are in **Appendix A**.
2. Make sure the mounting surface is flat and strong enough to support the drive, is not flammable, and is not subject to excessive motion or vibration.
3. Ensure that the minimum airflow requirements for your drive are met at the mounting location.
4. Mark the location of the mounting holes on the mounting surface, using the template provided on the cover of the cardboard shipping package.
5. Using fasteners appropriate to your drive and mounting surface, securely attach the drive to the mounting surface using all 4 screws or bolts.

November 2009

Chapter 3 — Power Wiring

Guidelines

To ensure proper wiring, use the following guidelines:

- Use heat-resistant copper cables only, +75°C or higher.
- The input line cable and line fuses must be sized in accordance with the rated input current of the unit. See **Tables 3-2** and **3-5**.
- Consistent with UL listing requirements, for maximum protection of the VSD Series drive, UL recognized fuses type RK should be used.
- If motor temperature sensing is used for overload protection, the output wire size may be selected based on the motor specifications.
- If three or more shielded cables are used in parallel for the output on the larger units, every cable must have its own overload protection.
- Avoid placing the motor cables in long parallel lines with other cables.
- If the motor cables run in parallel with other cables, note the minimum distances between the motor cables and other cables given in **Table 3-1** below:

Table 3-1: Cable Spacings

Minimum Distance Between Cables in Feet (m)	Shielded Cable Length in Feet (m)
1 (0.3)	≤164 (50)
3.3 (1.0)	≤656 (200)

- The spacings of **Table 3-1** also apply between the motor cables and signal cables of other systems.
- Maximum length of the motor cables is as follows:
 - 1 – 2 hp 230V units, 328 ft. (100m); filters required **on lead length ≥175 ft.**
 - All other hp units, 984 ft. (300m); filters required **on lead length ≥200 ft.**

Note: Lead lengths ≥500 ft. require sine wave filter for all voltages.
- The motor cables should cross other cables at an angle of 90 degrees.
- If conduit is being used for wiring, use separate conduits for the input power wiring, the output power wiring, the signal wiring, and the control wiring.
- For Frame 4 installations, refer to conduit mounting requirements in **Chapter 4**.

UL Compatible Cable Selection and Installation

Use only copper wire with temperature rating of at least 167°F (75°C).

Table 3-2: Cable and Fuse Sizes — 208 – 240V Ratings ^②

hp	Frame Size	NEC I _l (A)	I _l (A)	Fuse (A) ^③	Wire Size		Terminal Size	
					Power	Ground	Power	Ground
1	FR4	4.2	4.8	10	14	14	16 – 12	16 – 14
1-1/2	FR4	6	6.6	10	14	14	16 – 12	16 – 14
2	FR4	6.8	7.8	10	14	14	16 – 12	16 – 14
3	FR4	9.6	11	15	14	14	16 – 12	16 – 14
5	FR5	15.2	17.5	20	12	12	16 – 8	16 – 8
7-1/2	FR5	22	25	30	10	10	16 – 8	16 – 8
10	FR5	28	31	40	8	8	16 – 8	16 – 8
15	FR6	42	48	60	4	8	14 – 0	10 – 2
20	FR6	54	61	80	2	6	14 – 0	10 – 2
25	FR7	68	75	100	2	6	14 – 0	10 – 00
30	FR7	80	88	110	1	6	14 – 0	10 – 00
40	FR7	104	114	125	1/0	4	14 – 0	10 – 00
50	FR8	130	140	175	3/0	2	4-3/0	4-000
60	FR8	154	170	200	4/0	0	000-350 MCM	4-000
75	FR8	192	205	250	300	2/0	000-350 MCM	4-000
100	FR9	248	261	300	2 x 4/0	3/0	2*000-350 MCM	4-000

^① If power cubes are used, a UL recognized RK fuse is recommended.

^② Based on maximum environment of 104°F (40°C).

^③ If bypass is used, a UL recognized RK5 fuse is recommended.

Table 3-3: Cable and Fuse Sizes — 380 – 500V Ratings ^⑤

hp	Frame Size	NEC I _l (A)	I _l (A)	Fuse (A) ^④	Wire Size		Terminal Size	
					Power	Ground	Power	Ground
1-1/2	FR4	3	3.3	10	14	14	16 – 12	16 – 14
2	FR4	3.4	4.3	10	14	14	16 – 12	16 – 14
3	FR4	4.8	5.6	10	14	14	16 – 12	16 – 14
5	FR4	7.6	7.6	10	14	14	16 – 12	16 – 14
7-1/2	FR4	11	12	15	12	14	16 – 12	16 – 14
10	FR5	14	16	20	10	12	16 – 8	16 – 8
15	FR5	21	23	30	10	10	16 – 8	16 – 8
20	FR5	27	31	35	8	8	16 – 8	16 – 8
25	FR6	34	38	50	6	8	14 – 0	10 – 2
30	FR6	40	46	60	4	8	14 – 0	10 – 2
40	FR6	52	61	80	2	6	14 – 0	10 – 2
50	FR7	65	72	100	2	6	14 – 0	10 – 00
60	FR7	77	87	110	1	6	14 – 0	10 – 00
75	FR7	96	105	125	1/0	4	14 – 0	10 – 00
100	FR8	124	140	175	3/0	2	4 – 3/0	4 – 000
125	FR8	156	170	200	4/0	0	000 – 350 MCM	4 – 000
150	FR8	180	205	250	300	2/0	000 – 350 MCM	4 – 000
200	FR9	240	261	350	350	3/0	2*000 – 350 MCM	4 – 000
250	FR9	302	300	400	2 X 250	300	2*000 – 350 MCM	4 – 000

^④ If power cubes are used, a UL recognized RK fuse is recommended.

^⑤ Based on maximum environment of 104°F (40°C).

^⑥ If bypass is used, a UL recognized RK5 fuse is recommended.

November 2009

Table 3-4: Cable and Fuse Sizes — 525 – 690V Ratings ^②

hp	Frame Size	I _L (A)	Fuse (A) ^③	Wire Size		Terminal Size	
				Power	Ground	Power	Ground
3	FR6	4.5	10	14	14	14 – 0	14 – 2
5	FR6	7.5	10	14	14	14 – 0	14 – 2
7-1/2	FR6	10	10	14	14	14 – 0	14 – 2
10	FR6	13.5	15	12	14	14 – 0	14 – 2
15	FR6	18	20	10	12	14 – 0	14 – 2
20	FR6	22	30	10	10	14 – 0	14 – 2
25	FR6	27	35	8	8	14 – 0	14 – 2
30	FR6	34	40	8	8	14 – 0	14 – 2
45	FR7	41	50	6	8	14 – 0	10 – 0
50	FR7	52	60	4	6	14 – 0	10 – 0
60	FR8	62	80	2	6	4 – 3/0	4 – 3/0
75	FR8	80	100	1	6	4 – 3/0	4 – 3/0
100	FR8	100	125	1/0	6	4 – 3/0	4 – 3/0
125	FR9	125	175	3/0	6	4 – 3/0	4 – 3/0
150	FR9	144	200	4/0	2	2x3/0 – 350 MCM	4 – 3/0
200	FR9	208	250	350	1/0	2x3/0 – 350 MCM	4 – 3/0

^① If power cubes are used, a UL recognized RK fuse is recommended.

^② Based on maximum environment of 104°F (40°C).

^③ If bypass is used, a UL recognized RK5 fuse is recommended.

Table 3-5: Maximum Symmetrical Supply Current

Product	Voltage	Maximum RMS Symmetrical Amperes on Supply Circuit
1 – 75 hp	230	100,000A
1-1/2 – 250 hp	480	100,000A
3 – 200 hp	575	100,000A

Table 3-6: Power Connection Tightening Torque

Rating	Frame Size	Tightening Torque (in-lbs)	Tightening Torque (Nm)
230V, 1 – 3 hp 480V, 1-1/2 – 7-1/2 hp	FR4	5	0.6
230V, 5 – 10 hp 480V, 10 – 20 hp	FR5	13	1.5
230V, 15 – 20 hp 480V, 25 – 40 hp 575V, 3 – 30 hp	FR6	35	4
230V, 25 – 40 hp 480V, 50 – 75 hp 575V, 40 – 50 hp	FR7	88	10
230, 50 – 75 hp 480V, 100 hp	FR8	170/80 ^④	20/9 ^④
480V, 125 – 150 hp 575V, 60 – 100 hp	FR8	354/195 ^④	40/22 ^④
230V, 100 hp 480V, 200 – 250 hp 575V, 125 – 200 hp	FR9	354/195 ^④	40/22 ^④

^④ The isolation standoff of the bus bar will not withstand the listed tightening torque. Use a wrench to apply a counter torque when tightening.

Installation Instructions

Strip the motor and power cables as shown in **Figure 3-1** and **Table 3-7**.

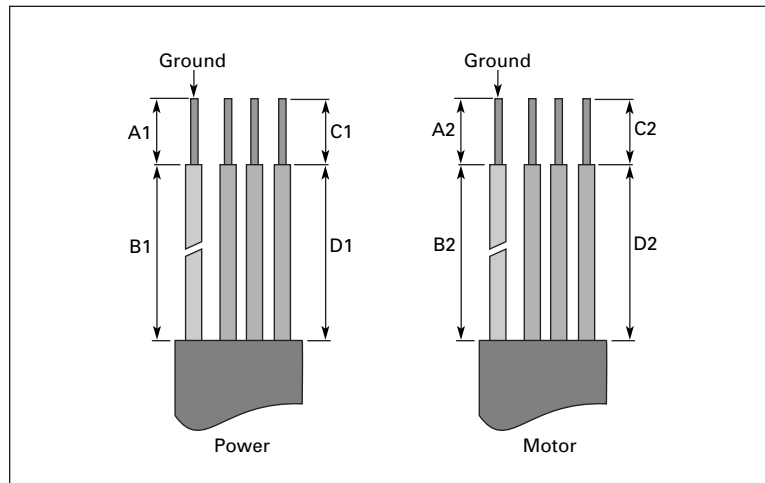


Figure 3-1: Input Power and Motor Cable Stripping and Wire Lengths

Table 3-7: Power and Motor Cable Stripping Lengths

Product		Frame Size	Power Wiring in Inches (mm)				Motor Wiring in Inches (mm)			
Horsepower	Voltage		A1	B1	C1	D1	A2	B2	C2	D2
1 – 3 1-1/2 – 7-1/2	230 480	FR4	0.59 (15)	1.38 (35)	0.39 (10)	0.79 (20)	0.28 (7)	1.97 (50)	0.28 (7)	1.38 (35)
5 – 10 10 – 20	230 480	FR5	0.79 (20)	1.57 (40)	0.39 (10)	1.18 (30)	0.79 (20)	2.36 (60)	0.39 (10)	1.57 (40)
15 and 20 25 – 40 3 – 30	230 480 575	FR6	0.79 (20)	3.54 (90)	0.59 (15)	2.36 (60)	0.79 (20)	3.54 (90)	0.59 (15)	2.36 (60)
25 – 40 50 – 75 40 – 50	230 480 575	FR7	0.98 (25)	4.72 (120)	0.98 (25)	4.72 (120)	0.98 (25)	4.72 (120)	0.98 (25)	4.72 (120)
50 – 75 100 – 150 60 – 100	230 480 575	FR8	1.1 (28)	9.45 (240)	1.1 (28)	9.45 (240)	1.1 (28)	9.45 (240)	1.1 (28)	9.45 (240)
100 200 – 250 125 – 200	230 480 575	FR9	1.1 (28)	11.61 (295)	1.1 (28)	11.61 (295)	1.1 (28)	11.61 (295)	1.1 (28)	11.61 (295)

November 2009

NEMA Type 1/12 Open Drives (1 – 250 HP)

Table 3-8: Control Wiring Instructions — NEMA Type 1/12 Open Drives

Mounting Drive

1. Mount Drive
(See Table below for dimensions.)

Figure 3-2:

VSD Series Open Drive Dimensions													
Frame Size	Voltage	hp (VT)	Approximate Dimensions in Inches (mm)										Weight Lbs. (kg)
			H1	H2	H3	D1	D2	D3	W1	W2	R1 dia.	R2 dia.	
FR4	230V	3/4 – 3	12.9 (327)	12.3 (313)	11.5 (292)	7.5 (190)	2.5 (64)	5.0 (126)	5.0 (128)	3.9 (100)	.5 (13)	.3 (7)	11 (5)
	480V	1 – 5											
FR5	230V	5 – 7-1/2	16.5 (419)	16.0 (406)	15.4 (391)	8.4 (214)	2.7 (68)	5.8 (148)	5.7 (144)	3.9 (100)	.5 (13)	.3 (7)	17.9 (8.1)
	480V	7-1/2 – 15											
FR6	230V	10 – 15	22.0 (558)	21.3 (541)	20.4 (519)	9.3 (237)	2.7 (68)	6.7 (171)	7.7 (195)	5.8 (148)	.7 (18)	.4 (9)	40.8 (18.5)
	480V	20 – 30											
	575V	2 – 25											
FR7	230V	20 – 30	24.8 (630)	24.2 (614)	23.3 (591)	10.1 (257)	2.7 (68)	7.5 (189)	9.3 (237)	7.5 (190)	.7 (18)	.4 (9)	77.2 (35)
	480V	40 – 60											
	575V	30 – 40											
FR8	480V	75 – 125	29.7 (755)	28.8 (732)	28.4 (721)	11.3 (288)	1.3 (34)	11.0 (279)	11.2 (285)	10.0 (255)	.7 (18)	.4 (9)	127.8 (58)
	575V	50 – 75											
FR9	480V	150 – 200	45.3 (1150)	44.1 (1120)	—	14.3 (362)	5.4 (137)	8.8 (224)	18.9 (480)	15.7 (400)	.7 (18)	.4 (9)	321.9 (146)
	575V	100 – 150											
FR10	480V	250 – 350	44 (1120)	33.5 (850)	—	23.6 (600)	NA	NA	23.6 (600)	16.7 (425)	.9 (23)	.47 (12)	550.7 (250)
	575V	200 – 300											

Power Wiring

Notice

Do not discard the plastic bag containing the wiring plate.

2. Remove the bottom cover by rotating the cover toward you on the base hinges, then lifting the cover away from the base.

Power Wiring

3. Locate the plastic bag shipped with the drive containing the wiring plate, and remove the wiring plate.

Standard Wiring Diagrams and Terminal Locations

Power and Motor Wiring Terminal Schematics for VSD Series Drives

The following wiring diagrams show the line and motor connections of the drive.

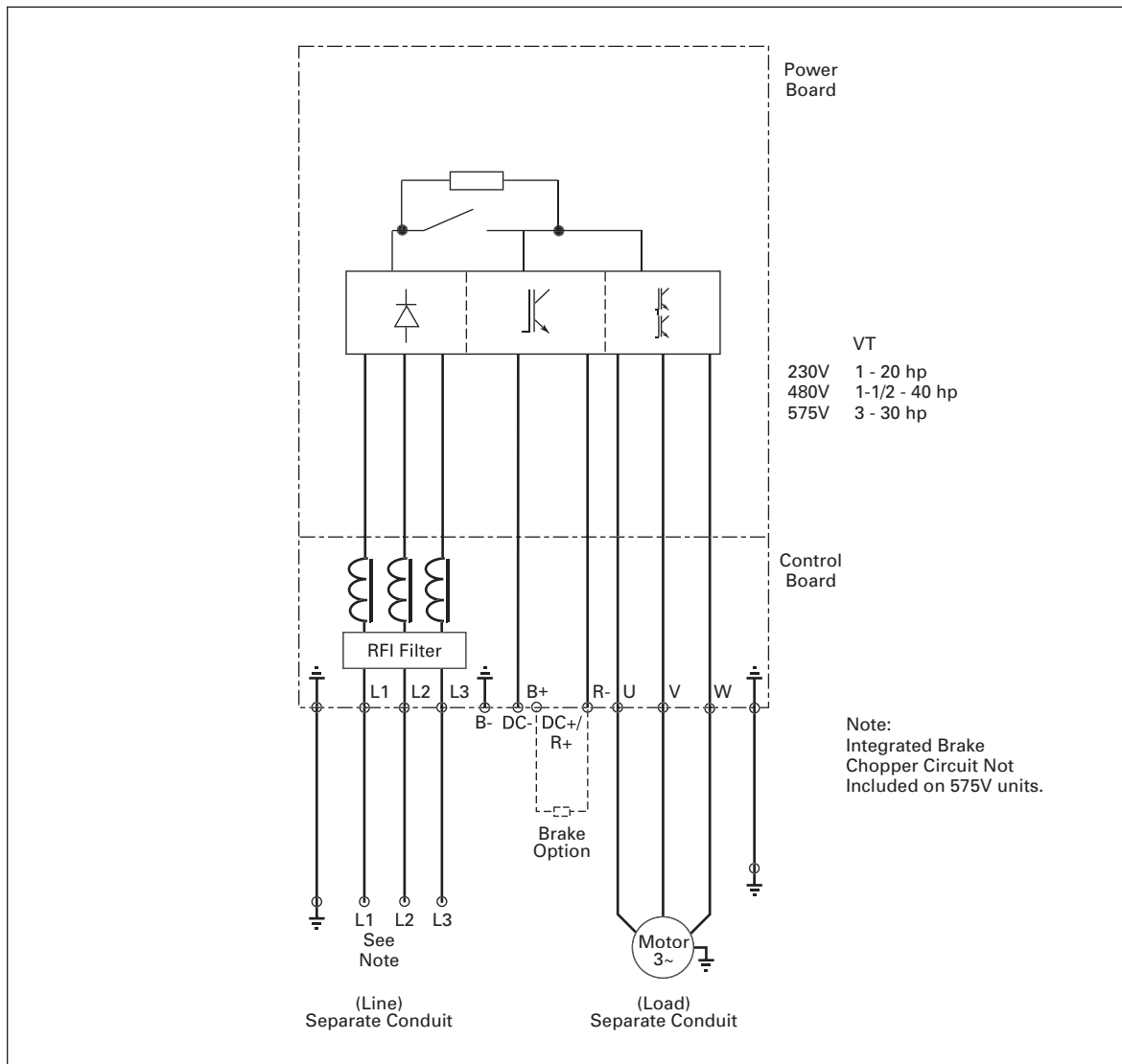


Figure 3-3: Principle Wiring Diagram of VSD Series Power Unit, FR4, FR5 and FR6

Note: When using a 1-phase supply, for units rated for such, connect the input power to terminals L1 and L2. Refer to **Tables A-2 and A-3** in **Appendix A**.

November 2009

Table 3-8: Control Wiring Instructions — NEMA Type 1/12 Open Drives (Continued)


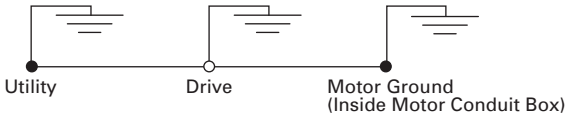
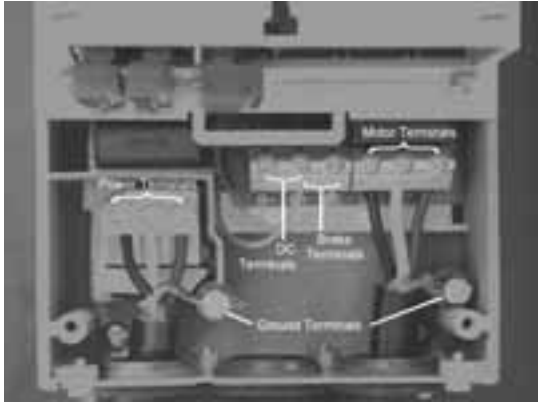

<p>Power Wiring</p> <ol style="list-style-type: none"> If conduit is being used, attach the wiring plate to it. Pass the motor and input power wires/cables through the holes of the wiring plate. If shielded cable is used, connect the shields of the input line power cable and the motor cable to the motor and power ground terminals of the VSD Series drive. 	
<p>Power Wiring/Grounding</p> <ol style="list-style-type: none"> Wire power terminals, motor terminals, and grounding terminals per diagram. Power and Motor leads must be in separate conduit. <p>Note: Do not wire motor loads to B- B+ R-. This will cause damage.</p> <hr/> <p style="text-align: center;">GROUND WIRING</p> <hr/> <ul style="list-style-type: none"> Run motor cables in separate conduit. DO NOT RUN CONTROL WIRES in same conduit Cables sized per NEC. Provide low impedance ground between drive and motor.  <div style="border: 1px solid black; padding: 5px; margin-top: 10px;"> <p>IMPORTANT: Improper grounding could result in damage to the motor and/or drive and could void warranty</p> </div>	
<p>Control Wiring</p> <ol style="list-style-type: none"> Wire the control terminals following the details for the specific option boards shown on the following pages. <p>Note: For ease of access, the option board terminal blocks can be unplugged for wiring.</p> <p>Note: If using conduit or Seal Tite for control wiring for Frame 4, you must order NEMA Type 12 kit.</p>	

Table 3-8: Control Wiring Instructions — NEMA Type 1/12 Open Drives (Continued)

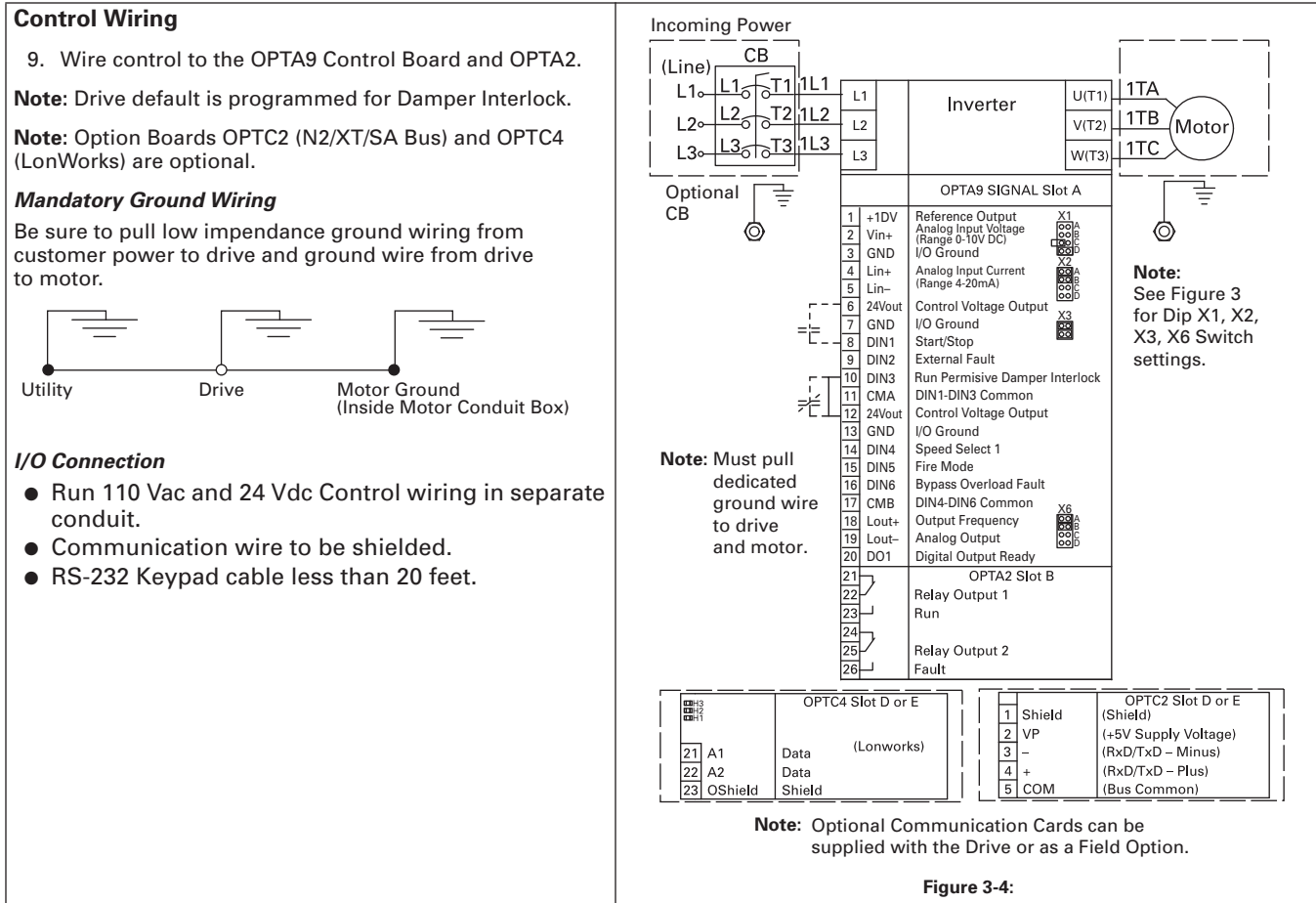


Figure 3-4:

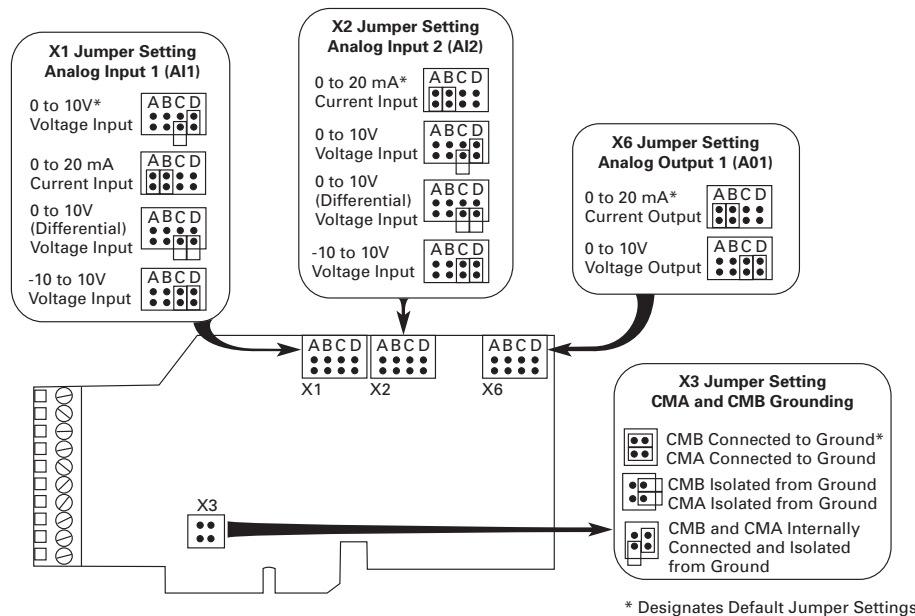


Figure 3-5: Option Board A9 Location and Settings

Start-Up Wizard

See Page 7-4, Start-Up Wizard

November 2009

Checking the Cable and Motor Insulation

1. Check the motor cable insulation as follows:
 - Disconnect the motor cable from terminals U, V and W of the VSD Series drive and from the motor.
 - Measure the insulation resistance of the motor cable between each phase conductor as well as between each phase conductor and the protective ground conductor.
 - The insulation resistance must be $>1\text{M}\Omega$.
2. Check the input power cable insulation as follows:
 - Disconnect the input power cable from terminals L1, L2 and L3 of the VSD Series drive and from the utility line feeder.
 - Measure the insulation resistance of the input power cable between each phase conductor as well as between each phase conductor and the protective ground conductor.
 - The insulation resistance must be $>1\text{M}\Omega$.
3. Check the motor insulation as follows:
 - Disconnect the motor cable from the motor and open any bridging connections in the motor connection box.
 - Measure the insulation resistance of each motor winding. The measurement voltage must equal at least the motor nominal voltage but not exceed 1000V.
 - The insulation resistance must be $>1\text{M}\Omega$.

November 2009

Chapter 4 — Control Wiring

General Information

The control unit of the VSD Series drive consists of the control board and various option boards that plug into the five slot connectors (A to E) of the control board.

Galvanic isolation of the control terminals is provided as follows:

- Control connections are isolated from power, and the GND terminals are permanently connected to ground.
- Digital inputs are galvanically isolated from the I/O ground.
- Relay outputs are double-isolated from each other at 300V AC.

Option Board General Information

The VSD Series drives can accommodate a wide selection of *expander* and *adapter boards* to customize the drive for your application needs.

The drive's control unit is designed to accept a total of five option boards. Option boards are available for normal analog and digital inputs and outputs, for communication and for additional application-specific hardware.

The VSD Series factory installed standard option board configuration includes an A9 I/O board and an A2 relay output board, which are installed in slots A and B. For information on additional option boards, see the VSD Series drives option board manuals.

Note: If your VSD Series drive has been shipped with a factory installed IntelliPass bypass, the B5 option board is installed in slot C.

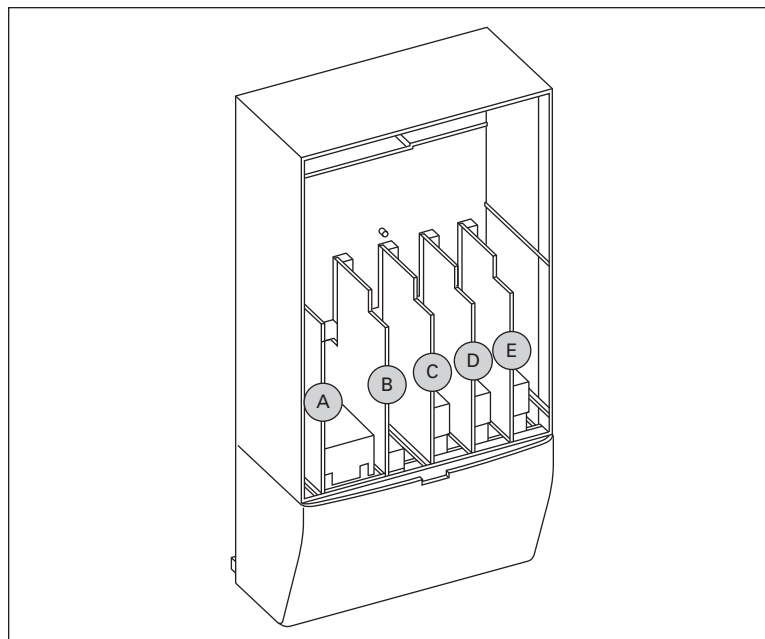


Figure 4-1: Option Board Slots

Table 4-1: Option Board A2 Terminal Descriptions

Terminal	Signal	Description and Parameter Reference	
21	RO-1/1	Normally Closed (NC) Run Switching Capacity: 24V DC / 8A 250V AC / 8A 125V DC / 0.4Az Min switching load: 5V/10 mA Continuous Capacity: <2 Arms	
22	RO-1/2		Common
23	RO-1/3		Normally Open (NO)
24	RO-2/1	Normally Closed (NC) Fault Switching Capacity: 24V DC / 8A 250V AC / 8A 125V DC / 0.4A Min switching load: 5V/10 mA Continuous Capacity: <2 Arms	
25	RO-2/2		Common
26	RO-2/3		Normally Open (NO)

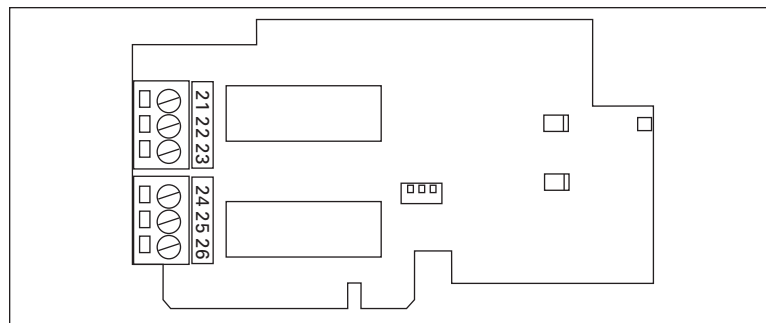


Figure 4-2: Option Board A2 Terminal Locations

Inverting the Digital Input Signal

The active signal level depends on which potential the common inputs CMA and CMB (terminals 11 and 17) are connected to. The alternatives are either 24V DC or ground (0V). See **Figure 4-3**.

The 24V DC control voltage and the ground for the digital inputs and the common inputs (CMA, CMB) can be either the internal 24V DC supply or an external supply.

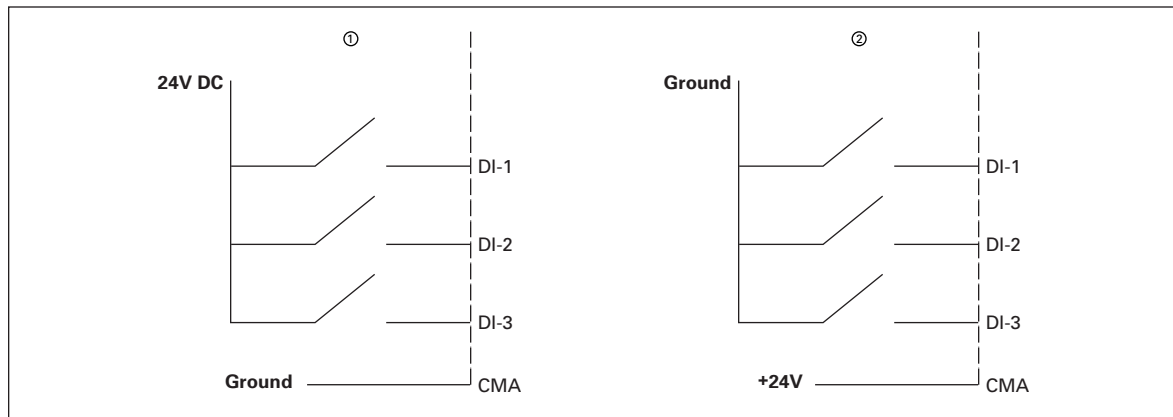


Figure 4-3: Positive/Negative Logic

- ① Positive logic (24V DC is the active signal) = the input is active when the switch is closed.
- ② Negative logic (0V is the active signal) = the input is active when the switch is closed.

November 2009

Chapter 5 — IntelliPass Bypass Option

Product Description

The Johnson Controls VSD Series IntelliPass Drive is powered by the Cutler-Hammer® tradition of providing a premier intelligent drive integrated with a reliable bypass configuration, by taking advantage of the enclosed control and circuit breaker expertise of Eaton's electrical business.

The IntelliPass bypass is a two- or three-contactor design utilizing the Cutler-Hammer 24V DC series of contactors and power supplies. The features, function and form allow the drive and bypass to become an integrated design, enabling Johnson Controls to introduce the world's smallest drive and bypass package. The IntelliPass drive comes standard with a Cutler-Hammer protective disconnect integrated into the drive and bypass design.

IntelliPass 2 & 3 Contactor Bypass Drive

208V, 1 – 30 hp
230V, 1 – 30 hp
480V, 1 – 75 hp



IntelliPass TYPE 12, 2 & 3 Contactor Bypass Drive

208V, 1-1/2 – 60 hp
230V, 1 – 75 hp
480V, 1 – 150 hp
575V, 3 – 100 hp



IntelliPass TYPE 3R, 2 & 3 Contactor Bypass Drive

208V, 1-1/2 – 60 hp
230V, 1 – 75 hp
480V, 1 – 150 hp
575V, 3 – 100 hp



DX-9100 TYPE 1, 2 & 3 Contactor Bypass Drive

208V, 1-1/2 – 60 hp
230V, 1 – 75 hp
480V, 1 – 150 hp
575V, 3 – 100 hp



Catalog Number Selection

Table 5-1: VSD Series IntelliPass/IntelliDisconnect Drives Selection Chart

	Code Number	V	S					1	1	A	-	N					
Base Product	VS = Variable Speed Drive Prefix																
Horsepower (VT) ^①	001 = 1.0 hp to 075 = 75 hp ^②																
Voltage	1 = 208V 2 = 230V 4 = 480V																
Enclosure Rating	1 = TYPE 1																
Enclosure Style	1 = IntelliPass 4 = IntelliDisconnect																
Revision #	A = Rev 1 (Americas)																
Separator (-)																	
Communications ^③	0 = None N = N2/XT/SA ^④ Bus Comm (N2 by default) L = LONWORKS® Network																
Option 1	See Options List ^⑤																
Option 2	See Options List ^⑤																

- ① All horsepower ratings are Variable Torque (VT).
 - ② 1 – 30 hp 208/230V AC; 1 – 75 hp 480V AC
 - ③ N2/XT Communications selectable on drive keypad.
 - ④ SA = Sensor Actuator Bus for FEC Interface.
 - ⑤ Options List: 00 = None
P6 = 3rd Contactor Drive Isolation (IntelliPass only)
- Note: All VSD Series IntelliPass Drives incorporate two factory installed Auxiliary Contacts (formerly the “K9” option).

November 2009

Table 5-2: VSD Series Enclosed Drives Selection Chart

	Code Number	V	S																	
Base Product	VS = Variable Speed Drive Prefix																			
Horsepower (VT) ^①	001 = 1.0 hp to 150 = 150 hp ^②																			
Voltage	1 = 208V 2 = 230V 4 = 480V 5 = 575V																			
Enclosure Rating	1 = TYPE 1 2 = TYPE 12 3 = TYPE 3R																			
Enclosure Style	2 = Enclosed IntelliPass 3 = Enclosed Drive w/Disconnect (IntelliDisconnect)																			
Revision Number	A = Rev 1 (Americas)																			
Separator (-)																				
Communications ^③	0 = None N = N2/XT/SA ^④ Bus Comm (N2 by default) L = LONWORKS [®] Network																			
Option 1	See Options List																			
Option 2	See Options List																			

- ① All horsepower ratings are Variable Torque (VT).
- ② 1 to 60 hp @ 208V; 1 to 75 hp @ 230V; 1 to 150 hp @ 480V; 3 to 100 hp @ 575V
- ③ N2/XT/SA Communications selectable on drive keypad.
- ④ SA = Sensor Actuator Bus for FEC Interface.

Table 5-3: Options List

Option	Description
00	None
P3	Line Fuses (formerly Drive Isolation Fusing) — Provides high-level fault protection of the input power circuit from the load side of the fuses to the input side of the power transistors. The option consists of three 200 kA fuses, which are factory mounted in the enclosure.
P6 ^⑤	Third Contactor Drive Isolation — Provides load side isolation to the drive in the event of an SCR or DC Bus failure, allowing the drive to go into bypass without tripping the circuit breaker. Typically used in critical applications or when required in a specification.
P9 ^⑤	Line Fuses & Third Contactor
SA	Space Heater w/Transformer — Prevents condensation from forming in the enclosure when the drive is inactive or in storage. Includes a thermostat for variable temperature control.

^⑤ IntelliPass only.

Table 5-4: Option Notes

All VSD Series IntelliPass Drives incorporate two factory-installed Auxiliary Contacts (formerly the K9 option).		
P3	Line Fuses	Line Fuses, on load side of breaker in both drive and bypass modes Always included in the part number for 575V Enclosed IntelliPass Drives
P9	Line Fuses & Third Contactor	Mutually exclusive from Option P3 (Line Fuses) in 575V Enclosed IntelliPass Drives
SA	Space Heater w/Transformer	Only available for TYPE 3R (Enclosure Rating 3).

NEMA Type 1 IntelliPass/IntelliDisconnect Drive

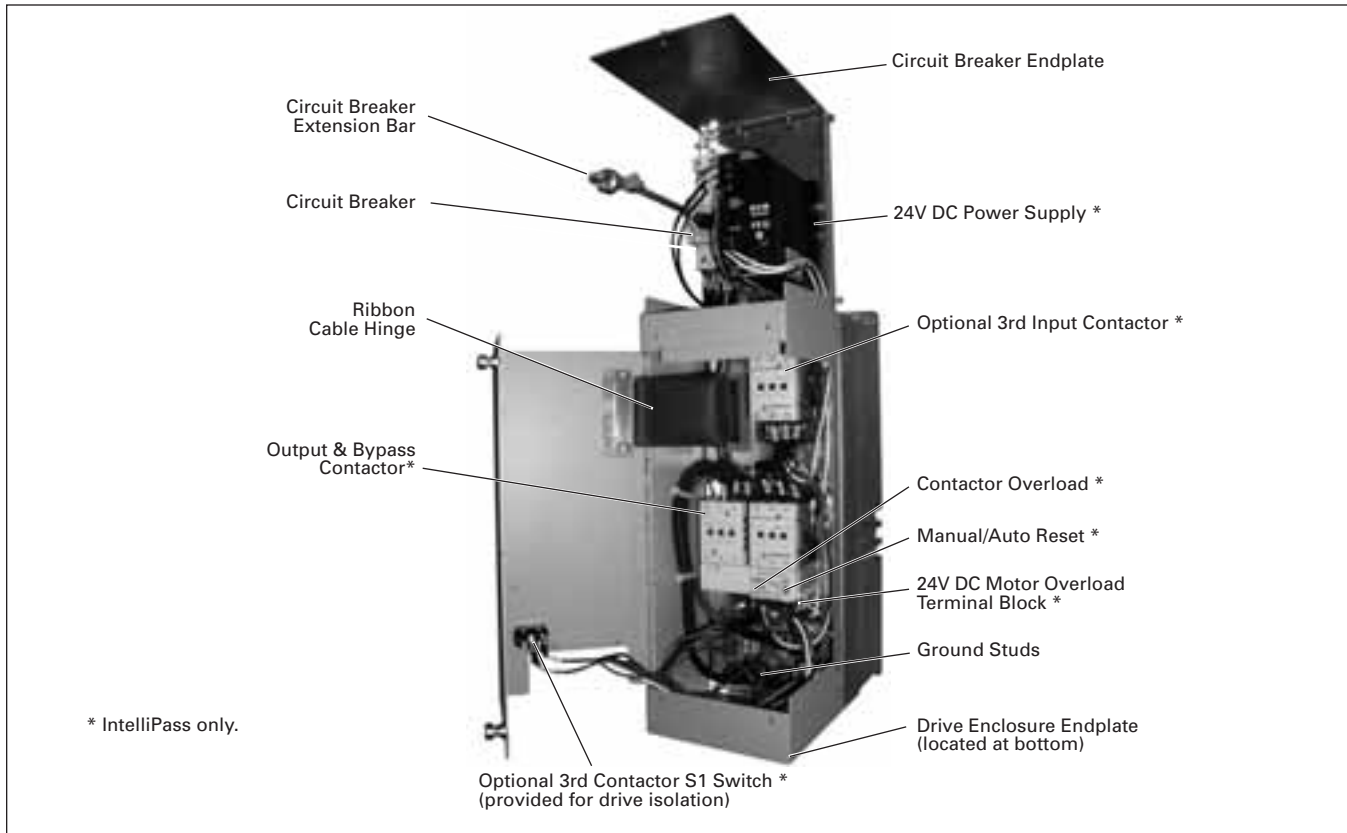


Figure 5-1: Identification of NEMA Type 1 Components

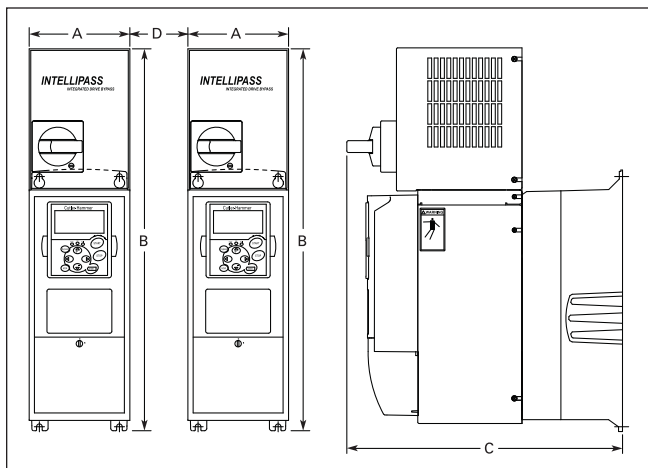


Figure 5-2: VSD Series IntelliPass/IntelliDisconnect Drive Dimensions

Table 5-5: VSD Series NEMA Type 1 IntelliPass/IntelliDisconnect Drive Dimensions

Drive Horsepower (VT)	Frame Size	Approximate Dimensions in Inches (mm)			Approx. Weight in lbs. (kg)	Distance Between Drives in Inches (mm) ^①
		A	B	C		
208V, 1 – 3 hp 230V, 1 – 3 hp 480V, 1 – 7-1/2 hp	FR4	5.04 (128)	18.25 (464)	13.24 (336)	21 (9.5)	5.3 (134.6)
208V, 5 – 7-1/2 hp 230V, 5 – 10 hp 480V, 10 – 20 hp	FR5	5.50 (140)	23.25 (591)	13.24 (336)	35 (15.9)	5.7 (144.8)
208V, 10 – 20 hp 230V, 15 and 20 hp 480V, 25 – 40 hp	FR6	7.50 (191)	29.38 (746)	15.25 (387)	67 (30.4)	7.5 (190.5)
208V, 25 and 30 hp 230V, 25 and 30 hp 480V, 50 – 75 hp	FR7	9.10 (231)	37.53 (953)	15.25 (387)	108 (49.0)	9.0 (228.6)

^① If mounting two or more IntelliPass Drives next to each other, make sure to use the proper spacing between the drives for hinged door operation.

November 2009

Table 5-6: Bypass Power Wiring Instructions — NEMA Type 1 IntelliPass/IntelliDisconnect Drive


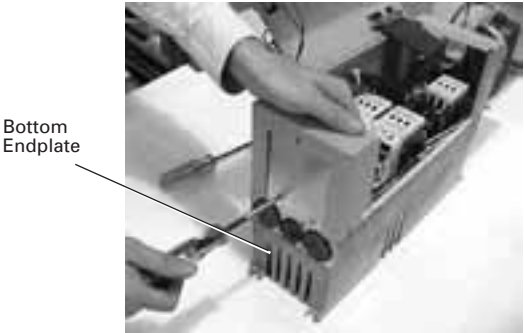
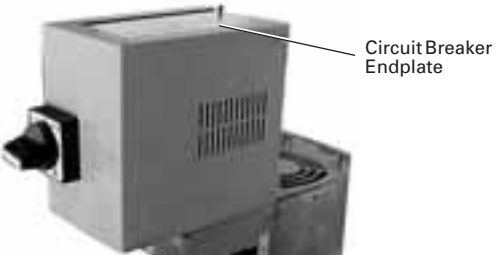
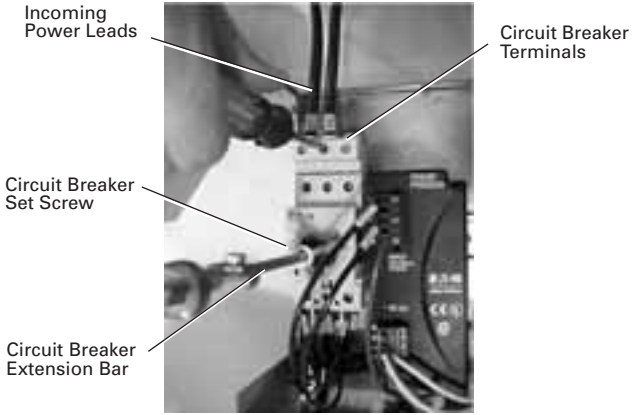
<p>Mounting Drive</p> <ol style="list-style-type: none"> 1. Mount drive per dimensions. (See Page 5-4) 2. Verify that the main power source is removed upstream. 3. Using a flat-blade screwdriver, remove the four screws securing the outer cover of the drive and remove the cover. 4. Using the same screwdriver, remove the two center screws securing the side cover. 5. Make sure there is adequate room, and open the hinged side cover. 	
<p>Power Wiring</p> <ol style="list-style-type: none"> 6. Using a flat-blade screwdriver, remove the screws securing the endplate at the bottom of the drive enclosure, and remove the endplate. 7. Using a Greenlee conduit cutter (recommended), cut one or more holes in the endplate, located at the bottom of the drive's enclosure, for the motor and power leads. <p>Note: If bringing the power leads in through the top of the drive's enclosure, go to step 8. If not, proceed to step 10.</p>	
<p>Power Wiring</p> <ol style="list-style-type: none"> 8. Using a flat-blade screwdriver, remove the screws securing the endplate for the circuit breaker enclosure, and remove the endplate. 9. Using a Greenlee conduit cutter (recommended), cut one hole in the circuit breaker endplate for the power leads. 	
<p>Power Wiring</p> <ol style="list-style-type: none"> 10. Calibrate the circuit breaker amperage, so it is 1.25 times the amperage on the motor nameplate, by turning the red set screw located below the circuit breaker extension bar. See the circuit breaker user's manual supplied with the drive. 11. Connect the incoming power leads to circuit breaker terminals labeled L1, L2 and L3. Cables sized per NEC. 12. Using the torque wrench, tighten each terminal to the torque value found in the appropriate user's manual supplied with the drive. <hr/> <p style="text-align: center;">POWER WIRING</p> <hr/> <ul style="list-style-type: none"> ● Run cabling in separate metal conduit or wiring tray. ● DO NOT RUN CONTROL WIRING with incoming power wiring. ● Provide low impedance ground connection to drive chassis. ● DO NOT CONNECT to B+, B-, R terminals. 	

Table 5-6: Bypass Power Wiring Instructions — NEMA Type 1 IntelliPass/IntelliDisconnect Drive (Continued)

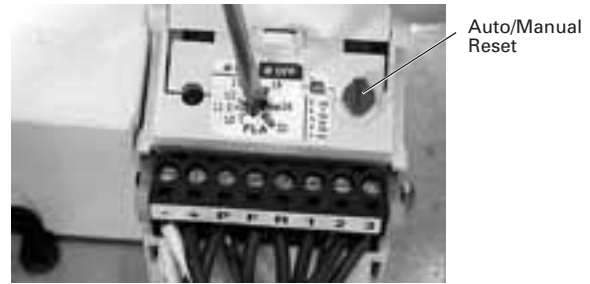
<p>Motor Wiring</p> <ol style="list-style-type: none"> Use your first and second fingers and simultaneously push down to release the two orange retaining clips (one on each side of the 24V DC motor overload terminal block). If necessary, use a flat-blade screwdriver to carefully remove the terminal block in a straight plane to avoid damaging it. 	
<p>Motor Wiring</p> <ol style="list-style-type: none"> Connect the motor leads to the motor overload terminals labeled 1TA, 1TB and 1TC. Using the appropriate metric Allen wrench (2.5 mm, 3 mm or 4 mm), tighten each overload terminal per the specifications in the contactor user's manual. <hr/> <p style="text-align: center;">MOTOR WIRING</p> <hr/> <p>An SAE allen wrench will damage the terminals, and the motor overload will need to be replaced (not covered by warranty).</p> <ol style="list-style-type: none"> Using the torque wrench, tighten each terminal to the torque value found in the appropriate user's manual supplied with the drive. Reinsert the motor overload terminal block. 	
<p>Grounding</p> <ol style="list-style-type: none"> Use a flat-blade screwdriver to connect the motor ground wire to the ground stud (located at either the top or bottom of the drive's enclosure). (Mandatory) Ground connection main power ground must be connected to other ground screws. <hr/> <p style="text-align: center;">GROUND WIRING</p> <hr/> <ul style="list-style-type: none"> Run motor cables in separate conduit. DO NOT RUN CONTROL WIRES in same conduit Cables sized per NEC. Provide low impedance ground between drive and motor. <div style="border: 1px solid black; padding: 5px; margin-top: 10px;"> <p>IMPORTANT: Improper grounding could result in damage to the motor and/or drive and could void warranty</p> </div>	

November 2009

Table 5-6: Bypass Power Wiring Instructions — NEMA Type 1 IntelliPass/IntelliDisconnect Drive (Continued)

Setting Overload

20. Lift to open the cover on the motor overload, and use a 1/8" flat-blade screwdriver to set the overload amperage to match the value on the motor nameplate.
21. Turn the auto/manual reset (factory default is manual) on the motor overload 90° to the auto position.



Control Wiring

22. Use a flat-blade screwdriver to carefully remove the low-voltage I/O terminal block.
23. Insert the incoming control leads into the terminal block. Refer to the electrical schematic supplied with the drive.
24. Reinsert the I/O terminal block into the control board.
25. Verify that all other wires to the terminal block are connected.
26. Terminate control wiring to the OPTA9 and OPTA2 board (Terminals 1 – 26).



CONTROL WIRING

- Run 110 Vac and 24 Vdc control wiring in separate conduit.
- Communication wire must be shielded.
- RS-232 keypad cable must be less than 25 feet.

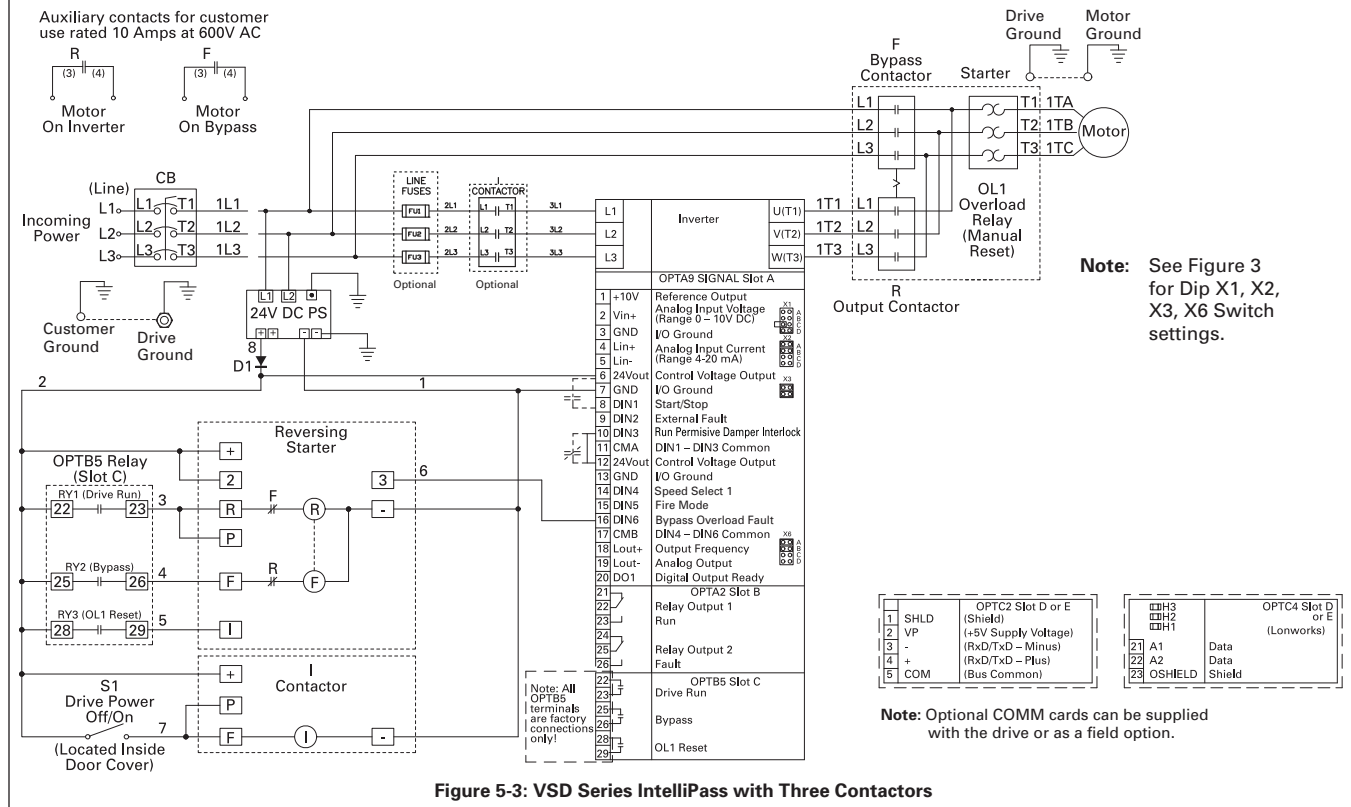


Figure 5-3: VSD Series IntelliPass with Three Contactors

Table 5-6: Bypass Power Wiring Instructions — NEMA Type 1 IntelliPass/IntelliDisconnect Drive (Continued)

<p>Static Check</p> <p>27. Make sure power is off, and perform static checks as described in Table 5-10 (for the converter), Table 5-11 (for the inverter) and Table 5-12 (for the DC bus). Refer to Page 5-14, Static Check.</p> <p>Note: Static check shown is for L3 and B+ terminals.</p> <p>28. Once the pre-power static checks are completed, reinstall the drive's outer and side covers, tightening all the screws.</p> <hr/> <p style="text-align: center;">⚠ WARNING</p> <hr/> <p>High Voltage is present on L1, L2, L3, B-, B+, BT, T1, T2, T3.</p>	
<p>Starting Drive</p> <p>29. Make sure that the drive's 3rd contactor S1 switch, if present, is in the ON position (shown in OFF position).</p> <p>Note: The bypass mode operates with the switch in the OFF position, however the drive will not run. Yet the keypad will operate.</p>	
<p>Starting Drive</p> <p>30. Turn the circuit breaker handle in a clockwise direction.</p> <hr/> <p style="text-align: center;">⚠ WARNING</p> <hr/> <p>High Voltage</p> <ul style="list-style-type: none"> ● Always work with another person. ● Be sure equipment is properly grounded. ● Wear safety glasses. 	
<p>Start-Up Wizard</p>	<p>See Page 7-4, Start-Up Wizard</p>

November 2009

Enclosed NEMA Type 12/3R

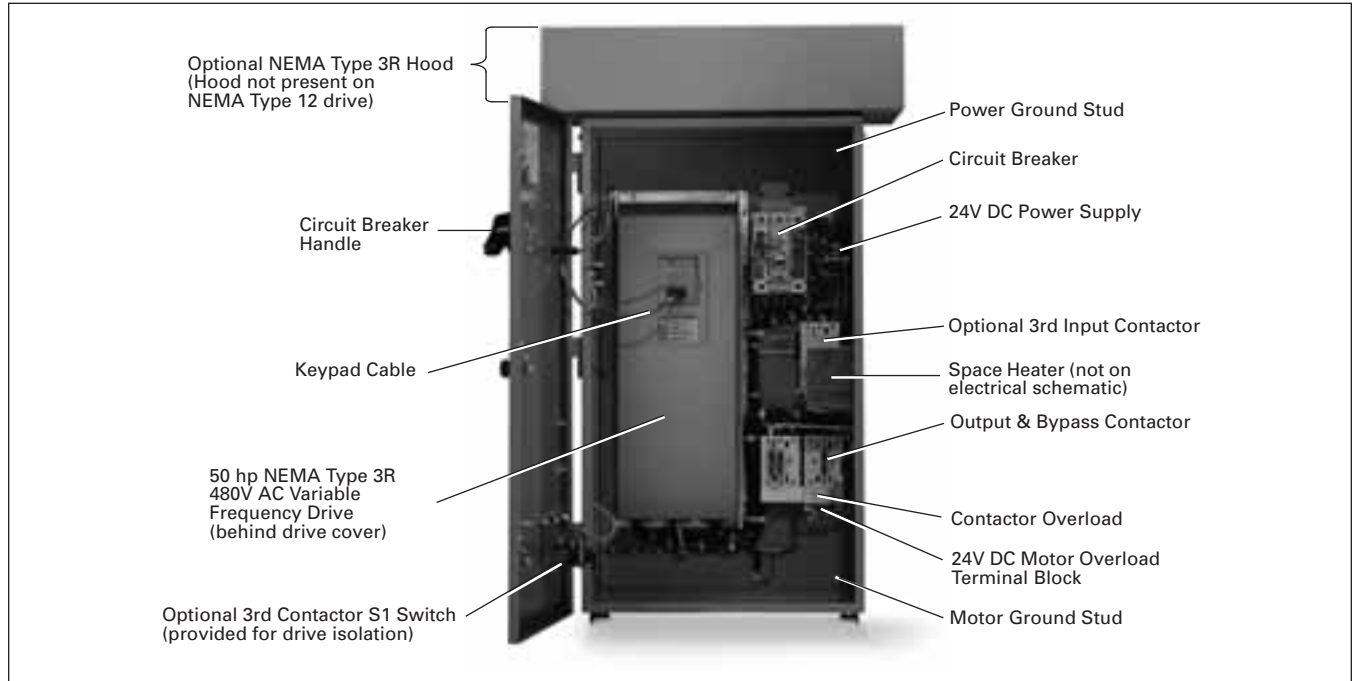


Figure 5-4: Identification of NEMA Type 12 and NEMA Type 3R Components

Note: You will need to consult the electrical schematic supplied with the drive and the appropriate wiring diagram in Appendix D.

Table 5-7: VSD Series NEMA Type 12 Enclosed IntelliPass Drive Dimensions

Drive Horsepower (VT)	Frame Size	Enclosure Box	Approximate Dimensions in Inches (mm)		
			A	B	C
208V, 1 – 15 hp 230V, 1 – 15 hp 480V, 1 – 30 hp 575V, 3 – 30 hp	FR4 – FR6 FR4 – FR6 FR4 – FR6 FR6	A	16.92 (429.8)	29.00 (736.6)	18.60 (472.4)
208V, 20 – 30 hp 230V, 20 – 30 hp 480V, 40 – 75 hp 575V, 40 – 50 hp	FR6 – FR7	B	20.92 (531.3)	40.00 (1016.0)	19.10 (485.1)
208V, 40 – 60 hp 230V, 40 – 60 hp 480V, 100 – 150 hp	FR8	C	30.92 (785.3)	52.00 (1320.8)	19.10 (485.1)

① Floor Stands available on Box C only and can be purchased and shipped separately as kit.

Table 5-8: VSD Series NEMA Type 3R Enclosed IntelliPass Drive Dimensions

Drive Horsepower (VT)	Frame Size	Enclosure Box	Approximate Dimensions in Inches (mm)		
			A	B	C
208V, 1 – 15 hp 230V, 1 – 15 hp 480V, 1 – 30 hp 575V, 3 – 30 hp	FR4 – FR6	A	21.05 (534.7)	33.00 (838.2)	19.57 (497.0)
208V, 20 – 30 hp 230V, 20 – 30 hp 480V, 40 – 75 hp 575V, 40 – 50 hp	FR6 – FR7	B	26.31 (668.3)	46.09 (1170.7)	20.07 (509.9)
208V, 40 – 60 hp 230V, 40 – 60 hp 480V, 100 – 150 hp	FR8	C	37.73 (958.3)	58.09 (1475.5)	20.08 (510.0)

② Floor Stands available on Box C only and can be purchased and shipped separately as kit.

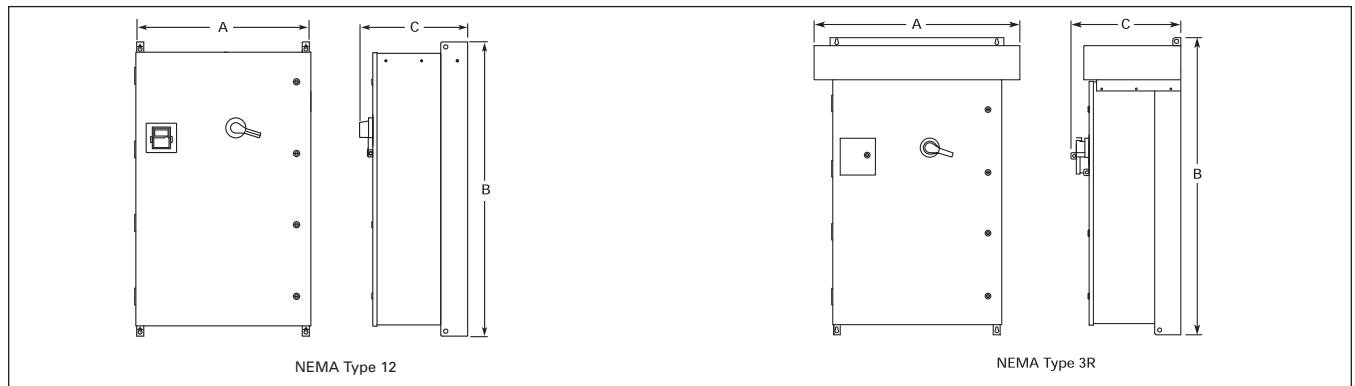
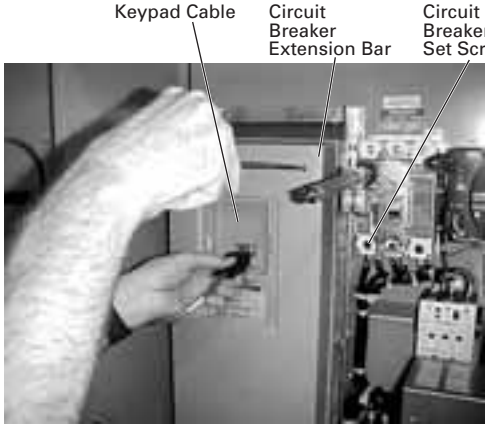




Figure 5-5: VSD Series Enclosed Drive Dimensions

Table 5-9: Bypass Power Wiring Instructions — Enclosed NEMA Type 12/3R

<p>Mounting Drive</p> <ol style="list-style-type: none"> 1. Mount drive per dimensions. (See Page 5-9.) 2. Verify that the main power source is removed upstream. 3. Remove the keypad cable from the drive. 4. Remove the screws from the drive cover, and remove the cover. <hr/> <p style="text-align: center;">CAUTION</p> <hr/> <p>The circuit breaker extension bar is sharp and can cause injury.</p> <ol style="list-style-type: none"> 5. Calibrate the circuit breaker amperage, so it is 1.25 times the value on the motor nameplate, by turning the red set screw located below the circuit breaker extension bar. See the circuit breaker user's manual supplied with the drive. 	 <p>Keypad Cable Circuit Breaker Extension Bar Circuit Breaker Set Screw</p>
<p>Power and Ground Wiring</p> <ol style="list-style-type: none"> 6. Using a Greenlee conduit cutter (recommended), cut three holes in the drive's enclosure for the incoming power, motor and low-voltage control leads. <hr/> <p style="text-align: center;">POWER WIRING</p> <hr/> <p>Note: Power, motor and control leads must each be located in separate conduit.</p> <ul style="list-style-type: none"> ● DO NOT RUN CONTROL WIRING in same conduit with power wiring. ● Provide low impedance ground connection to drive chassis. ● DO NOT CONNECT B+, B-, R terminal. (Reserved for Braking Resistor only.) <ol style="list-style-type: none"> 7. Connect the incoming power leads to circuit breaker terminals labeled L1, L2 and L3. 8. Using the torque wrench, tighten each terminal to the torque value found in the appropriate user's manual supplied with the drive. 9. Connect the power ground wire to the ground stud. Connect motor ground to ground stud. 	 <p>Incoming Power Leads Power Ground Wire</p>
<p>Setting Space Heater</p> <ol style="list-style-type: none"> 10. If applicable, set the space heater. See the space heater user's manual supplied with the drive. <p>Note: The space heater is used to prevent condensation from damaging the equipment when the drive is not operating (OFF).</p>	 <p>Space Heater Temperature Setting</p>

November 2009

Table 5-9: Bypass Power Wiring Instructions — Enclosed NEMA Type 12/3R (Continued)

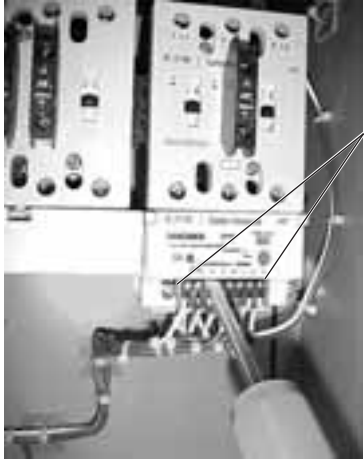

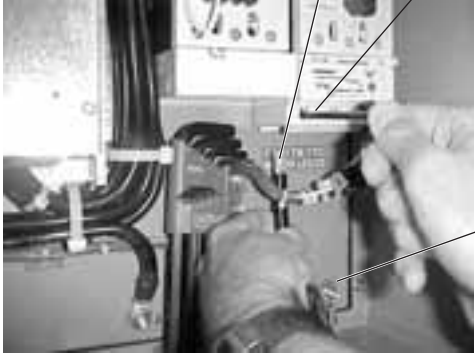
<p>Motor Wiring</p> <ol style="list-style-type: none"> Use your first and second fingers and simultaneously push down to release the two orange retaining clips (one on each side of the 24V DC motor overload terminal block). If necessary, use a flat-blade screwdriver to carefully remove the terminal block in a straight plane to avoid damaging it. 	 <p>Bypass Contactor Assembly</p> <p>Orange Retaining Clips</p>
<p>Setting Motor Overload</p> <ol style="list-style-type: none"> Lift to open the cover on the motor overload, and use a 1/8" flat-blade screwdriver to set the overload amperage to match the value on the motor nameplate. Turn the auto/manual reset (factory default is manual) on the motor overload 90° to the auto position. 	 <p>Auto/Manual Reset</p> <p>Bypass Contactor Assembly</p>
<p>Motor Wiring</p> <ol style="list-style-type: none"> Connect the motor leads to the motor overload terminals labeled 1TA, 1TB and 1TC. Using the appropriate metric Allen wrench (2.5 mm, 3 mm or 4 mm), tighten each overload terminal per the specifications in the contactor user's manual. <hr/> <p style="text-align: center;">MOTOR WIRING</p> <hr/> <p>An SAE allen wrench will damage the terminals, and the motor overload will need to be replaced (not covered by warranty).</p> <ol style="list-style-type: none"> Using the torque wrench, tighten each terminal to the torque value found in the appropriate user's manual supplied with the drive. Reinsert the motor overload terminal block. Connect the motor ground wire to the ground stud. <p>Note:</p> <ul style="list-style-type: none"> ● Run motor cables in separate conduit. ● Do not run control wires in same conduit. ● Size motor leads per NEC. ● Provide low impedance ground. 	 <p>Motor Leads</p> <p>Motor Overload Terminals</p> <p>Motor Ground Stud</p>

Table 5-9: Bypass Power Wiring Instructions — Enclosed NEMA Type 12/3R (Continued)

Control Wiring

20. Use a flat-blade screwdriver to carefully remove the low-voltage I/O terminal block.
21. Reinsert the I/O terminal block into the control board.
22. Terminate control wiring to the OPTA9 and OPTA2 board (Terminals 1 – 26).

Note: Use 1/8" flat-blade.

CAUTION

- Run 110 Vac and 24 Vdc control wiring in separate conduit.
- Communication wire to be shielded.
- RS-232 keypad cable must be less than 25 feet (to prevent nuisance trips).

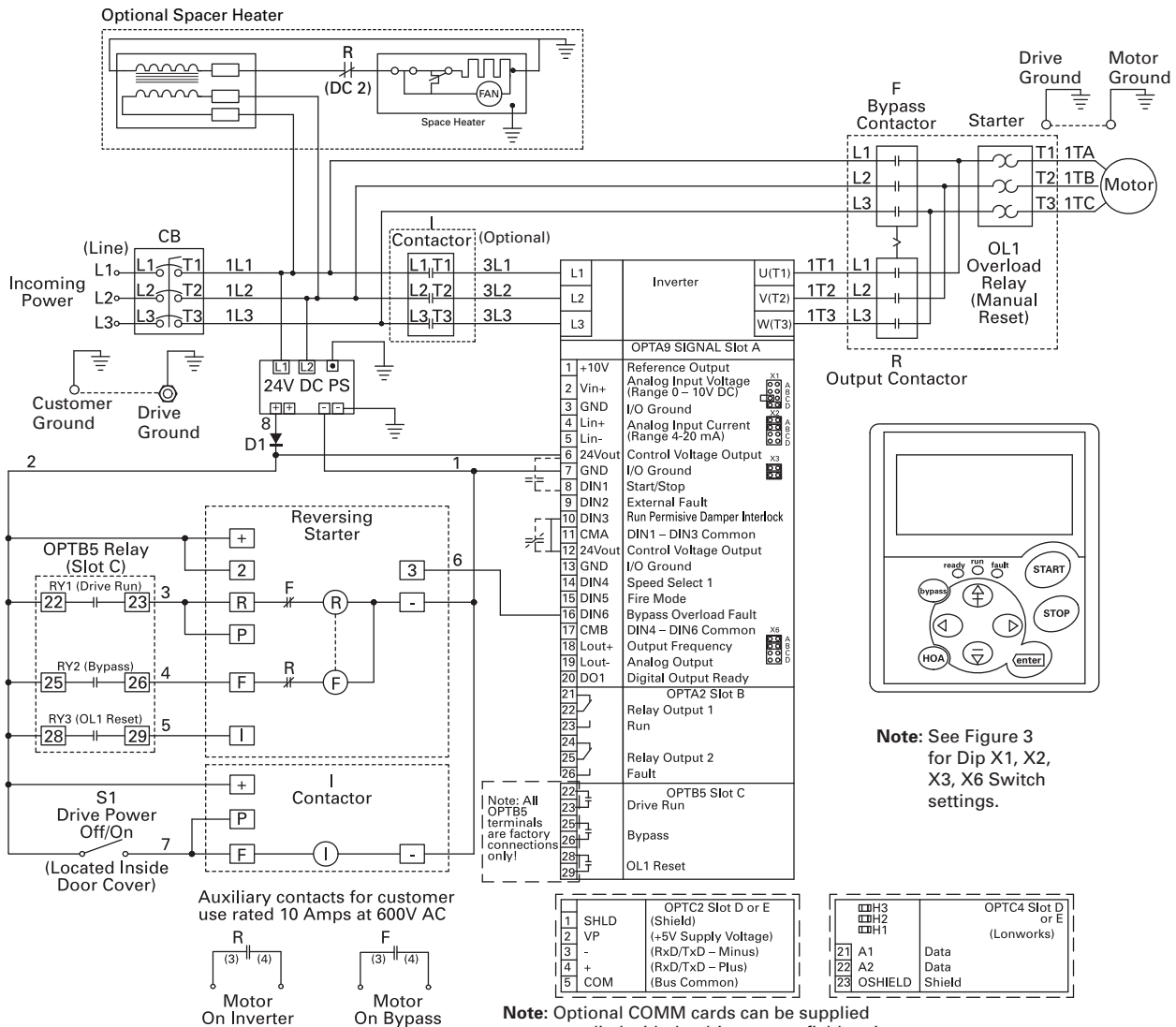
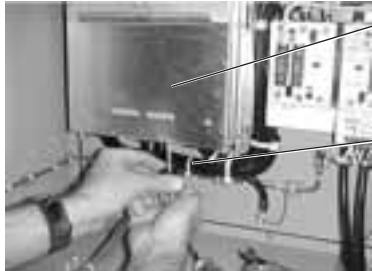





Figure 5-6:

November 2009

Table 5-9: Bypass Power Wiring Instructions — Enclosed NEMA Type 12/3R (Continued)

<p>Static Check</p> <p>23. Use a Phillips screwdriver to remove all the faceplate screws on the high-voltage faceplate, and remove the faceplate.</p> <p>Note: Location of the screws may vary from the drive illustrated. There may be screws securing a bottom faceplate, which also need to be removed.</p>	
<p>Static Check</p> <p>24. Make sure power is off, and perform static checks as described in Table 5-10 (for the converter), Table 5-11 (for the inverter) and Table 5-12 (for the DC bus). Refer to Page 5-14.</p> <p>Note: Static check shown is for L3 and B+ terminals.</p> <p>25. Once the pre-power static checks are completed, reinstall the drive's outer and side covers, tightening all the screws.</p> <hr/> <p style="text-align: center;">⚠ WARNING</p> <hr/> <p>High Voltage is present on L1, L2, L3, B-, B+, BT, T1, T2, T3.</p>	
<p>Starting Drive</p> <p>26. Make sure that the drive's 3rd contactor S1 switch, if present, is in the ON position (shown in OFF position).</p> <p>Note: The bypass mode operates with the switch in the OFF position, however the drive will not run. Yet the keypad will operate.</p> <p>27. Reinsert the keypad cable and control board on small drives.</p>	
<p>Starting Drive</p> <p>28. Close the drive door, and turn the circuit breaker handle in a clockwise direction.</p> <p>29. Go to Appendix E for keypad operation.</p> <p>Note: If the circuit breaker latch is locked, use a flat-blade screwdriver to turn the screw to release the handle.</p> <hr/> <p style="text-align: center;">⚠ WARNING</p> <hr/> <p>High Voltage</p> <ul style="list-style-type: none"> ● Always work with another person. ● Be sure equipment is properly grounded. ● Wear safety glasses. 	
<p>Start-Up Wizard</p>	<p>See Page 7-4, Start-Up Wizard</p>

Static Checking

Static checking tests the integrity of the power-carrying components (diodes, capacitors and IGBTs) within the drive assembly. Performing these static checks ensures that no damage occurred during shipping or installation that could cause a failure when the drive is powered.

Make sure there is no power to the drive before proceeding with any of the static checks.

After checking each set of terminals, zero out the multimeter by touching the metal tips of the red (positive) and black (negative) leads to each other.

Note: Set the multimeter to the diode function, and check each power terminal consecutively with each DC bus terminal as indicated in **Table 5-10**.

Table 5-10: Static Checks of Converter

DC Bus Terminal	Power Terminal			Multimeter Reading
	L1	L2	L3	
B+ (1st Overload Check) Insert red (+) multimeter lead.	Insert black (-) multimeter lead.	Insert black (-) multimeter lead.	Insert black (-) multimeter lead.	.OL
B- (2nd Overload Check) Insert black (-) multimeter lead.	Insert red (+) multimeter lead.	Insert red (+) multimeter lead.	Insert red (+) multimeter lead.	.OL
B- (1st Voltage Check) Insert red (+) multimeter lead.	Insert black (-) multimeter lead.	Insert black (-) multimeter lead.	Insert black (-) multimeter lead.	.25 – .55V DC (±10%)
B+ (2nd Voltage Check) Insert black (-) multimeter lead.	Insert red (+) multimeter lead.	Insert red (+) multimeter lead.	Insert red (+) multimeter lead.	.25 – .55V DC (±10%)

Note: Set the multimeter to the diode function, and check each motor terminal consecutively with each DC bus terminal as indicated in **Table 5-11**.

Table 5-11: Static Checks of Inverter

DC Bus Terminal	Motor Terminal on Contactor if Bypass or Output Contactor			Multimeter Reading
	T1	T2	T3	
B+ (1st Overload Check) Insert red (+) multimeter lead.	Insert black (-) multimeter lead.	Insert black (-) multimeter lead.	Insert black (-) multimeter lead.	.OL
B- (2nd Overload Check) Insert black (-) multimeter lead.	Insert red (+) multimeter lead.	Insert red (+) multimeter lead.	Insert red (+) multimeter lead.	.OL
B- (1st Voltage Check) Insert red (+) multimeter lead.	Insert black (-) multimeter lead.	Insert black (-) multimeter lead.	Insert black (-) multimeter lead.	.25 – .40V DC (±10%)
B+ (2nd Voltage Check) Insert black (-) multimeter lead.	Insert red (+) multimeter lead.	Insert red (+) multimeter lead.	Insert red (+) multimeter lead.	.25 – .40V DC (±10%)

November 2009

Note: Set the multimeter to the ohm function, and check the power ground terminal and DC bus terminals as indicated in **Table 5-12**.

Note: Frame 6 and larger use a "Hybrid" rectifier section. "Shown in Service Manual." Readings will be different when taking measurements from (B+) DC.

Table 5-12: Static Checks of DC Bus

DC Bus Terminal	DC Bus Terminal (B-)	Ground Terminal (Power)	Multimeter Reading
B+ (Overload Check) Insert red (+) multimeter lead.	Insert black (-) multimeter lead.	Not used.	.OL
B+ (1st Ohm Check) Insert black (-) multimeter lead.	Not used.	Insert red (+) multimeter lead.	O.L
B- (2nd Ohm Check) Insert black (-) multimeter lead.	Not used.	Insert red (+) multimeter lead.	O.L

Figure 5-7 is a detailed schematic to aid in performing the static checks.

Continuity Test to Ground

Test L1, L2, L3 to ground.
T1, T2, T3 to ground.

This should read .OL ohms.

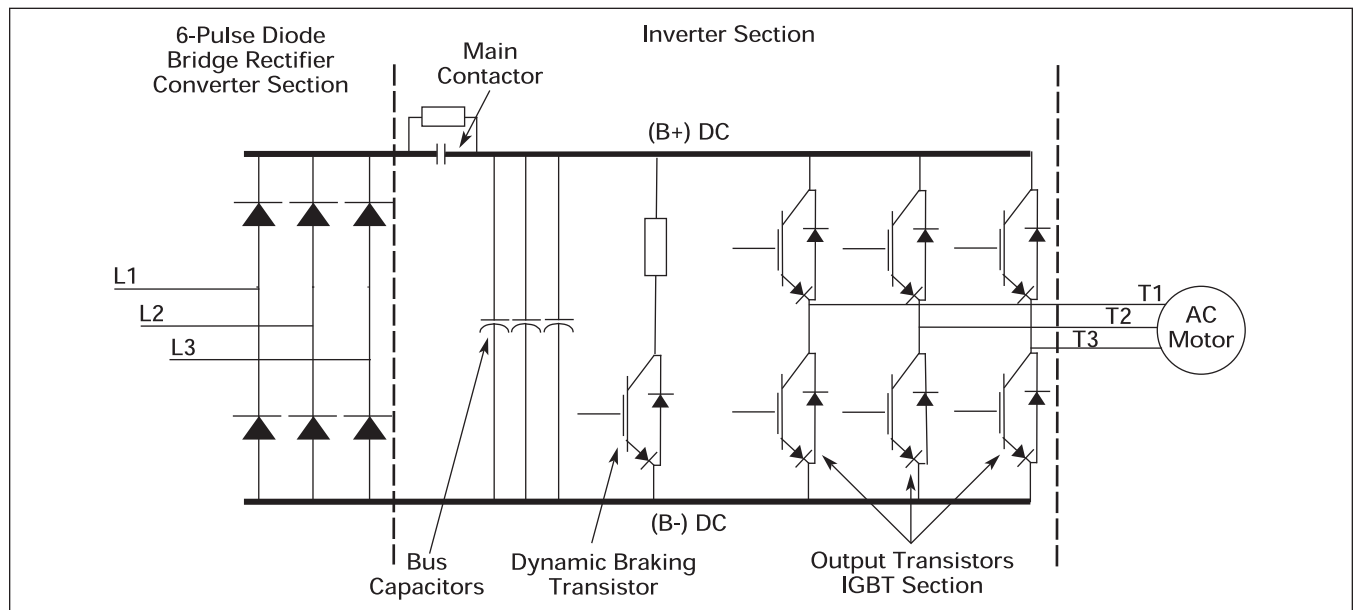


Figure 5-7: Schematic for Static Checks (Sample for Frames 4 and 5)

IntelliPass Control Wiring Instructions

Use the instructions and diagrams in Chapter 4 “Control Wiring” for wiring standard option boards A9 and A2.

In addition to these two boards, the IntelliPass Bypass includes option board B5, which is described in the following section.

Wiring Option Board B5

- This board is to be mounted in slot C.

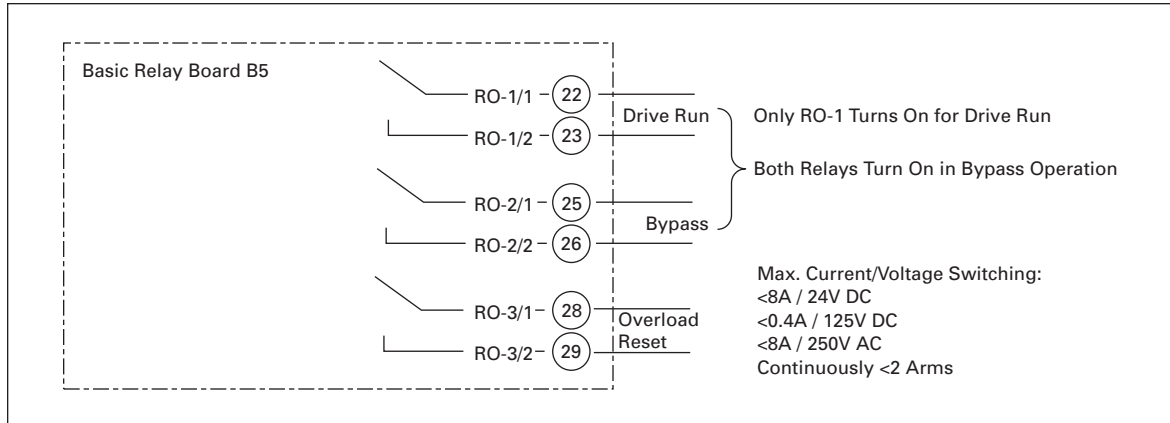


Figure 5-8: Option Board B5 Wiring Diagram

Table 5-13: Option Board B5 Terminal Descriptions

Terminal	Signal		Description and Parameter Reference
22	RO-1/1	Common	Drive Run Switching Capacity: 24V DC / 8A 250V AC / 8A 125V DC / 0.4A Min Switching Load: 5V/10 mA Continuously: <2 Arms
23	RO-1/2	Normally Open	
25	RO-2/1	Common	Bypass Switching Capacity: 24V DC / 8A 250V AC / 8A 125V DC / 0.4A
26	RO-2/2	Normally Open	
28	RO-3/1	Common	Overload Reset Switching Capacity: 24V DC / 8A 250V AC / 8A 125V DC / 0.4A
29	RO-3/2	Normally Open	

November 2009

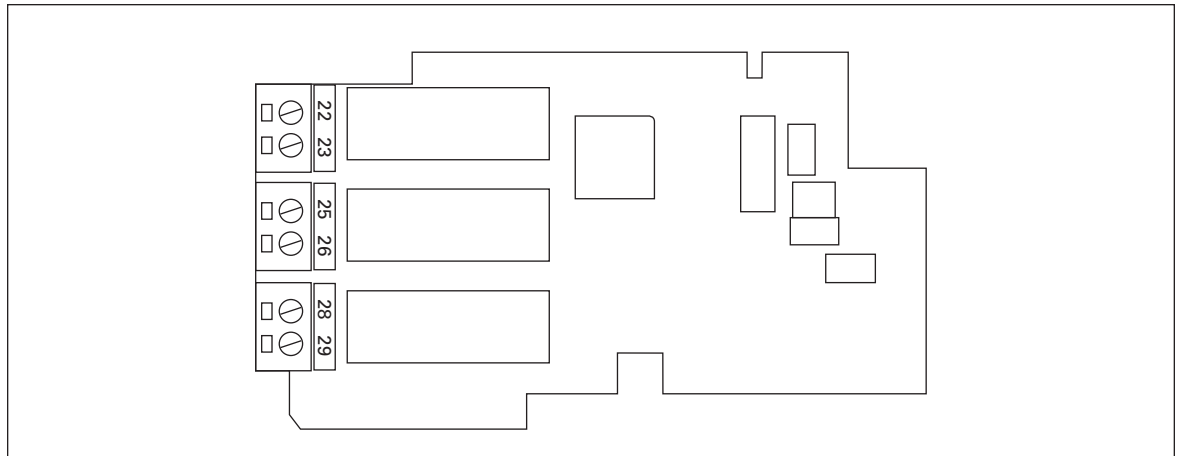


Figure 5-9: Option Board B5 Terminal Location

Note: Once selected, bypass operation will be controlled through keypad, I/O terminal or fieldbus. Bypass option is automatically available when B5 option board is installed in Slot C.

Enabling Bypass in Hand Mode

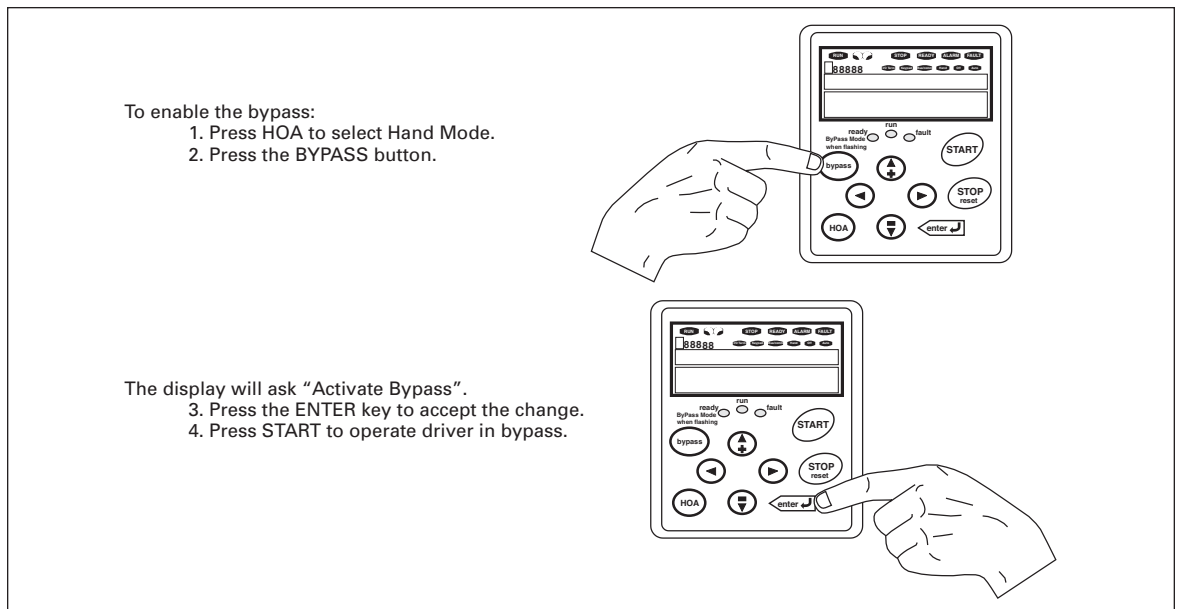


Figure 5-10: Enable Bypass

Additional Instructions for Keypad Operation

Procedure to run in bypass operation from keypad.

1. Press the BYPASS button: "Activate Bypass? Press ENTER" will appear on keypad display.
2. Press the HOA button to select desired control location, e.g. HAND. Bypass mode LED will start flashing.
3. Press the START button: "Motor Running in BYPASS!" will appear on the keypad display.
 - Motor is running in bypass.
 - Run LED is lit solid.

Procedure to return to drive operation from keypad.

1. Press the STOP button.
2. Press the BYPASS button: "Return to Drive? Press Enter!" will appear on keypad display.
3. Press the ENTER button to return to drive operation.
 - Bypass is disabled.
 - Ready LED is lit solid.

BYPASS will be disabled in all control sources only when B5 option board is removed from Slot C.

November 2009

Chapter 6 — Menu Information

Keypad Operation

The menu is navigated by using the left and right arrow buttons. If a reference level is available for setting, the up and down arrow buttons adjust the value. To exit the Operate Menu to access the other menus, depress the ENTER button for 2 seconds. While in the other menus, if there is no keypad activity, the display will return to the Operate Menu after one minute. **Figure 6-2** illustrates the Operate Menu button function.

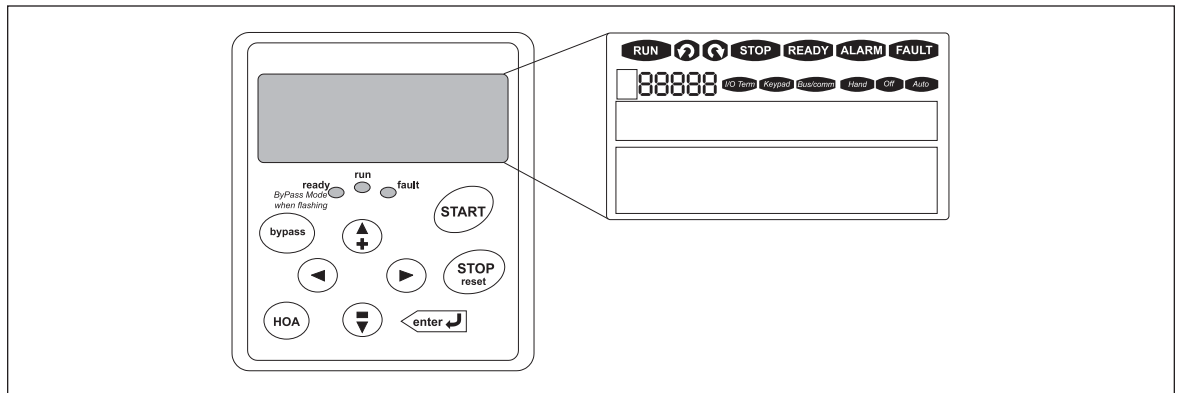


Figure 6-1: Keypad and Display

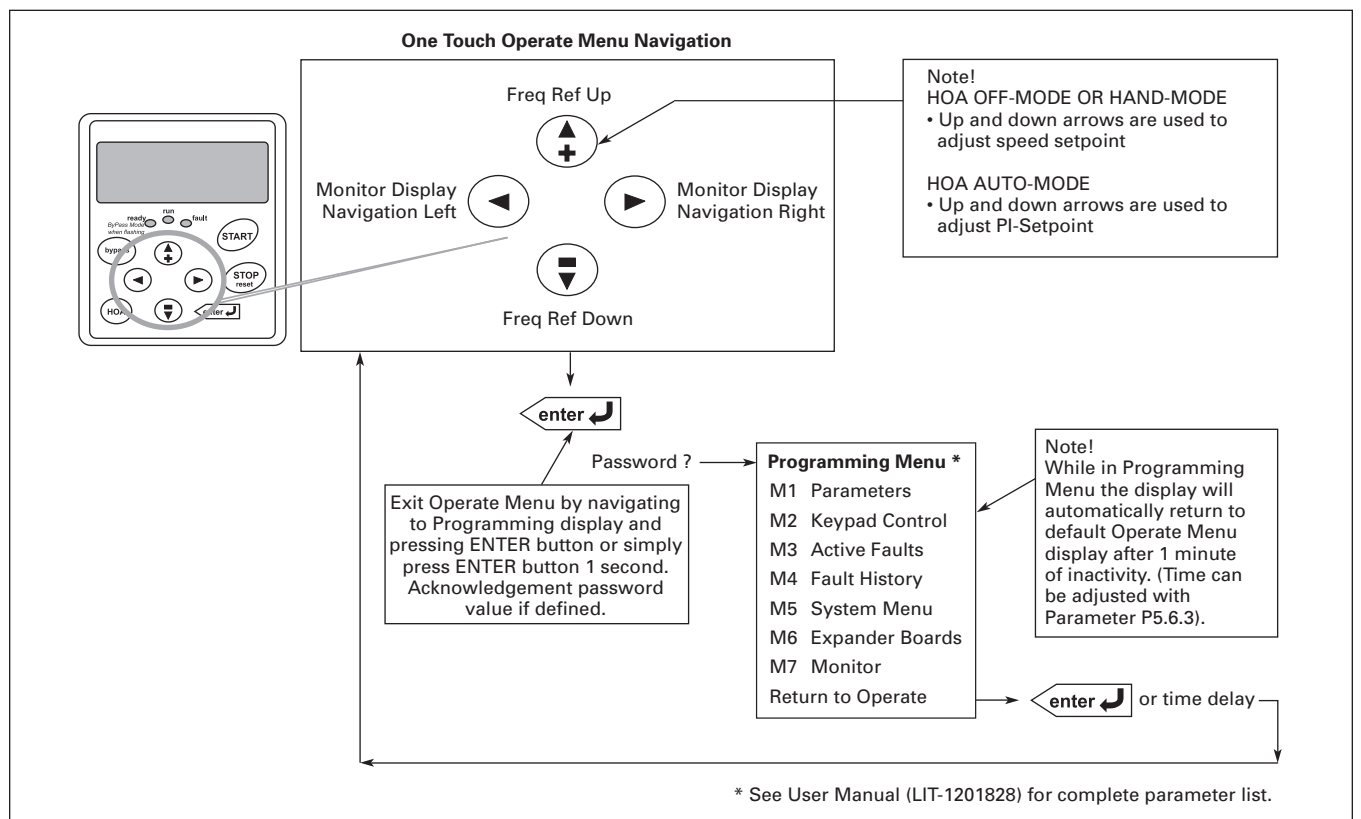


Figure 6-2: Operate Menu Navigation

Table 6-1: LCD Status Indicators























Indicator	Description
	Run Indicates that the VSD Series drive is running and controlling the load in Drive or Bypass.
	Counterclockwise Operation The output phase rotation is BAC , corresponding to counterclockwise rotation of most motors.
	Clockwise Operation The output phase rotation is ABC , corresponding to clockwise rotation of most motors.
	Stop Indicates that the VSD Series drive is stopped and not controlling the load.
	Ready Indicates that the VSD Series drive is ready to be started.
	Alarm Indicates that there is one or more active drive alarm(s).
	Fault Indicates that there is one or more active drive fault(s).
	I/O Terminal Indicates that the I/O terminal has been chosen for control of start/stop – signals.
	Keypad Indicates that the keypad has been chosen for control of start/stop – signals.
	Bus/Communications Indicates that the communications bus has been chosen for control of start/stop – signals.
	Hand Indicates that HAND has been chosen in the HOA control mode.
	Off Indicates that the VSD Series drive is not ready to operate. (Ready-indicator is OFF).
	Auto Indicates that AUTO has been chosen in the HOA control mode.

Table 6-2: LED Status Indicators

Indicator	Description
ready	Ready — Steady Illumination Indicates that the VSD Series drive is ready to be started. Ready — Flashing Indicates that the VSD Series drive is in Bypass Mode.
run	Run — Steady Illumination Indicates that the VSD Series drive or bypass is operating and controlling the load. Run — Flashing Indicates that the VSD Series drive or bypass is going to start. (Waiting for the Interlock signal or delay time expiration.)
fault	Fault Indicates that there is one or more active drive fault(s).

November 2009

Table 6-3: Navigation Buttons

Button	Description
	<p>Start This button operates as START button for normal operation when the "Keypad" is selected as the active control.</p>
	<p>Enter</p> <ul style="list-style-type: none"> • confirmation of selections • leave the operating mode, if pressed ≥ 2 seconds (leaving the operating menu can be password protected) • reset the "Fault History" menu, if pressed 2 – 3 seconds while in the "Fault History" menu
	<p>Stop/Reset This button has four integrated functions.</p> <ul style="list-style-type: none"> • motor STOP from the keypad • used to reset the active fault • reactivates "Start-Up Wizard" if pressed ≥ 5 seconds (Text "Start-Up Wizard Activated!" will appear on keypad display. • cancel "Start-Up Wizard" setup
	<p>Bypass Switches between the drive and bypass modes only when IntelliPass bypass is installed.</p>
	<p>HOA Steps through Hand, Off and Auto control modes. Press "Enter" to select mode. If "Enter" is not pressed within 5 seconds, control mode will remain in previous control mode.</p>
	<p>Left Arrow</p> <ul style="list-style-type: none"> • navigation button, movement to left • in programming mode, exit parameter group mode • in parameter edit mode, exits mode, backs up one step • cancels edited parameter (exit from a parameter edit mode)
	<p>Right Arrow</p> <ul style="list-style-type: none"> • navigation button, movement to right • enter parameter group mode • enter parameter mode from group mode • set parameter to edit mode (= parameter value is blinking)
 	<p>Up and Down Arrows</p> <ul style="list-style-type: none"> • move either up or down the parameter group list in order to select the desired group • move either up or down the parameter list in order to select the desired parameter in the group • increase/decrease the reference value of the selected parameter

Main Menu Navigation

The data on the control keypad are arranged in menus and submenus.

The first menu level consists of menus M1 to M8 and is called the Main menu. These menus and their submenus are illustrated in **Figure 6-2**.

Navigation Tips

- To navigate within one level of menu, use the up and down arrows.
- To move deeper into the menu structure and back out, use the right and left arrows.
- To edit a parameter, navigate to show that parameter's value, and press the right arrow button to enter the edit mode. In edit mode, the parameter value will flash.
- When in edit mode, the parameter value can be changed by pressing the up or down arrow keys.
- When in edit mode, pressing the right arrow a second time will allow you to edit the parameter value digit by digit.
- To confirm the parameter change you must press the ENTER key. *The value will not change unless the ENTER button is pushed.*

Note: For special navigation tips for M8, see **Page 6-21**.

November 2009

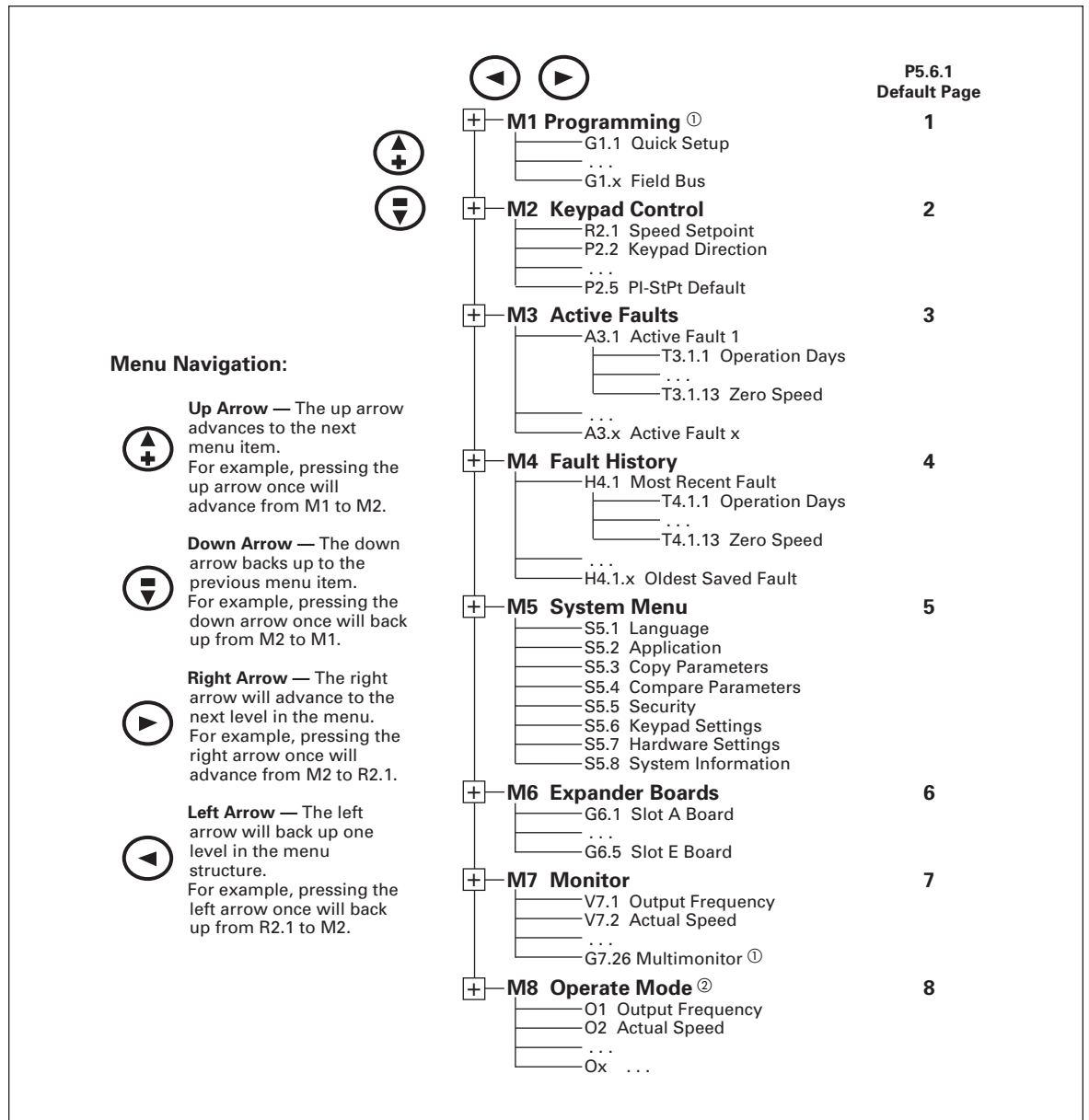


Figure 6-3: Main Menu Navigation

① Menu application dependent.

② For navigation of Operate Menu (M8), see Figure 6-2 on Page 6-1.

Parameter Menu (M1)

The Parameter Menu is a single or multi-level menu dependent upon the application in use, arranged by the parameter group items. **Figure 6-4** illustrates this for the Generic PI application. Parameters and parameter groups are explained in further detail in **Chapters 9 – 15**.

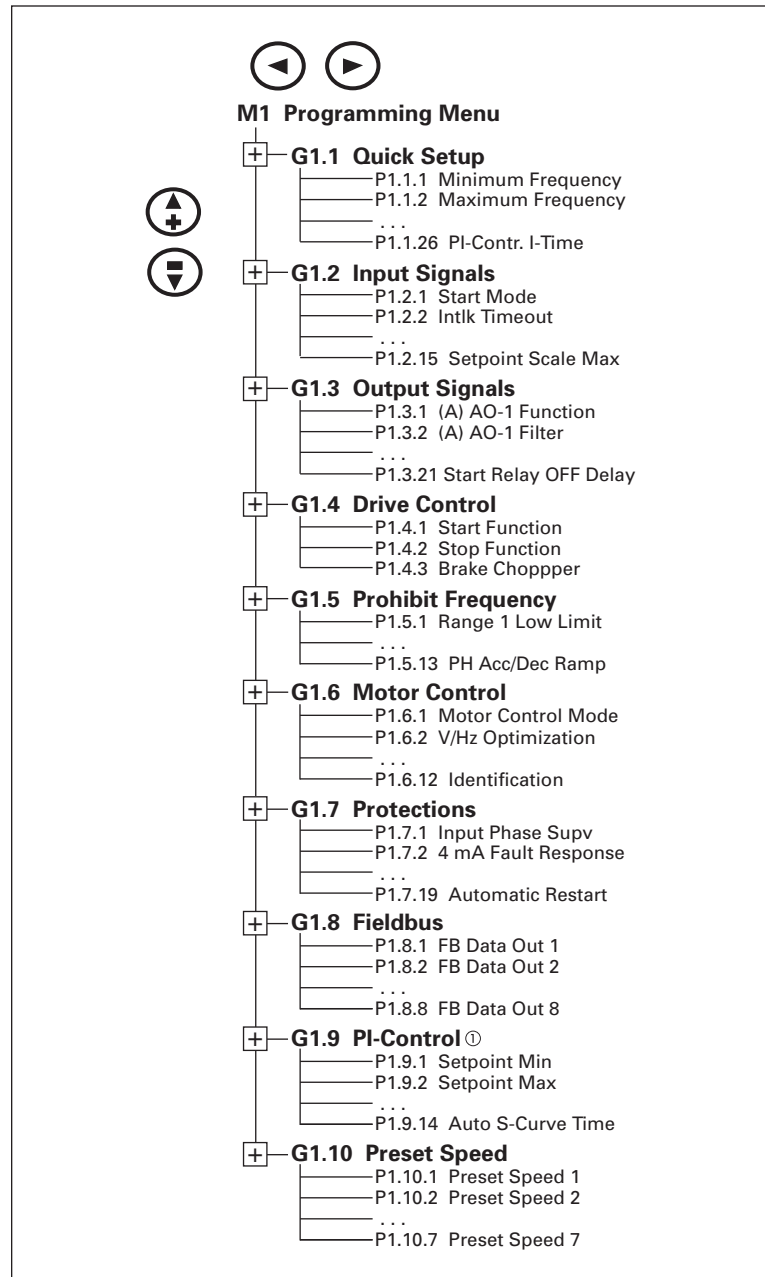


Figure 6-4: Parameter Menu Structure Example

^① Not available in Remote Input Application.

November 2009

Keypad Control Menu (M2)

In the Keypad Control Menu, you can set the frequency reference, choose the motor direction for keypad operation, and determine if the STOP button will be active at all times. See **Figure 6-5**.

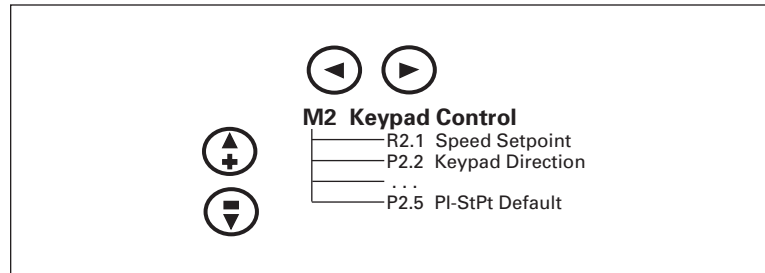


Figure 6-5: Keypad Control Menu

R2.1 Speed Setpoint	<p>Range: 0 — Max. Frequency Units: % <i>SPEED SETPOINT</i></p> <p>This displays and allows the operator to edit the keypad speed setpoint. A change takes place immediately. This reference value will not influence the output frequency unless the keypad has been selected as the active control place.</p>	
P2.2 Keypad Direction	<p>Range: Forward, Reverse <i>KEYPAD DIRECTION</i></p> <p>This allows the operator to change the rotation direction of the motor. This setting will not influence the rotation direction of the motor unless the keypad has been selected as the active control place.</p>	Default: Forward
P2.3 Stop Button Active	<p>Range: Yes, No <i>STOPBUTTONACTIVE</i></p> <p>By default, pushing the STOP button will always stop the motor regardless of the selected control place. If this parameter is set to No, the STOP button will stop the motor only when the keypad has been selected as the active control place. The Start Command must be toggled or re-issued to restart the drive.</p>	Default: Yes
R2.4 PI Setpoint	<p>Range: Application Dependent <i>PI SETPOINT</i></p> <p>PI regulators setpoint. Parameter not available in Remote Input Application.</p>	Default: Application Dependent
P2.5 PI Setpoint Default	<p>Range: Application Dependent <i>PI STPT DEFAULT</i></p> <p>PI regulators default setpoint. This parameter is set in Start-Up Wizard. Parameter not available in Remote Input Application.</p>	Default: Application Dependent

Active Faults Menu (M3)

When a fault occurs, the drive stops. The sequence indication F1, the fault code, a short description of the fault and the fault type symbol will appear on the display. In addition, the indication FAULT or ALARM is displayed and, in case of a FAULT, the red LED on the keypad starts to blink. If several faults occur simultaneously, the sequence of active faults can be browsed with the Browser buttons. See **Figure 6-6**.

The active faults memory can store the **maximum of 10** faults in the sequential order of appearance. The fault remains active until it is cleared with the STOP/RESET button or with a reset signal from the I/O terminal. Upon fault reset the display will be cleared and will return to the same state it was before the fault trip.

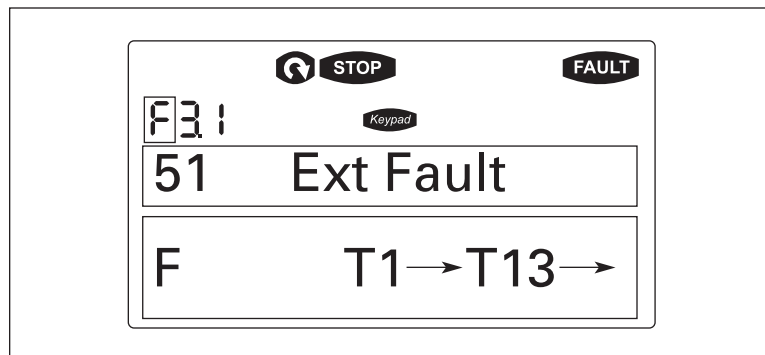


Figure 6-6: Active Fault Display Example

CAUTION

Remove any External Start signals or permissives before resetting the fault to prevent an unintentional restart of the drive, which could result in personal injury or equipment damage.

November 2009

Fault Type Range: A, F, AR, FT

FAULT TYPE

There are four different types of faults. These faults and their definitions are given in **Table 6-4**.

Table 6-4: Fault Types

Fault Type	Fault Name	Description
A	Alarm	This type of fault is a sign of an unusual operating condition. It does not cause the drive to stop, nor does it require any special actions. The "A fault" remains in the display for about 30 seconds.
F	Fault	An "F fault" is a kind of fault that makes the drive stop. Actions need to be taken in order to restart the drive.
AR	Auto-Restart Fault	If an "AR fault" occurs the drive will also stop immediately. The fault is reset automatically and the drive tries to restart the motor. If the restart is not successful, a fault trip (FT) occurs.
FT	Fault Trip	If the drive is unable to restart the motor after an AR fault, an FT fault occurs. The effect of the "FT fault" is the same as that of the F fault — the drive is stopped.

Fault Code Range: 1 – 81

Fault codes indicate the cause of the fault. A list of fault codes, their descriptions, and possible solutions can be found in **Appendix B — Fault and Warning Codes**.

Fault Time Data Record Range: T.1 – T.13

In this menu, important data recorded at the time the fault is available. This feature is intended to help the user or the service person to determine the cause of fault. **Table 6-5** indicates the information that is recorded.

Table 6-5: Fault Time Data

Data	Units	Description
T.1 ^①	D	Counted operation days (Fault 43: Additional code)
T.2 ^①	hh:mm:ss (d)	Counted operation hours (Fault 43: Counted operation days)
T.3	Hz hh:mm:ss	Output frequency (Fault 43: Counted operation hours)
T.4	A	Motor current
T.5	V	Motor voltage
T.6	%	Motor power
T.7	%	Motor torque
T.8	V	DC bus voltage
T.9	°C	Unit temperature
T.10	—	Run status
T.11	—	Direction
T.12	—	Warnings
T.13	—	Zero speed

^① Real time record.

If real time is set, T.1 and T.2 will appear as follows:

T.1	yyyy-mm-dd	Counted operation days (Fault 43: Additional code)
T.2	hh:mm:ss.sss	Counted operation hours (Fault 43: Counted operation days)

Fault History Menu (M4)

All faults are stored in the Fault History Menu, which can be viewed by using the Browser buttons. Additionally, the Fault time data record pages are accessible for each fault as in the Active Faults Menu described above. See **Figure 6-7**.

The drive's memory can store a **maximum of 30 faults**, in the order of appearance. If there are 30 uncleared faults in the memory, the next occurring fault will erase the oldest fault from the memory.

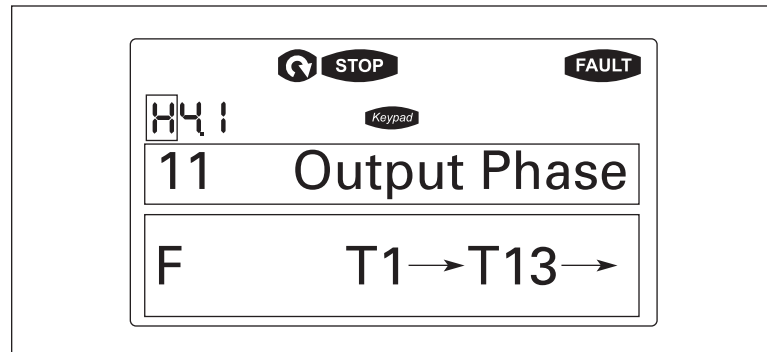


Figure 6-7: Sample Fault History Display

Note: Pressing the ENTER button for 3 seconds will clear the entire fault history.

November 2009

System Menu (M5)

The controls associated with the general use of the drive, such as application selection, customized parameter sets or information about the hardware and software are located in the System Menu. Password protection can be activated by parameter **S5.5.1**.

Descriptions of the system menu parameters are illustrated in **Figure 6-8**.

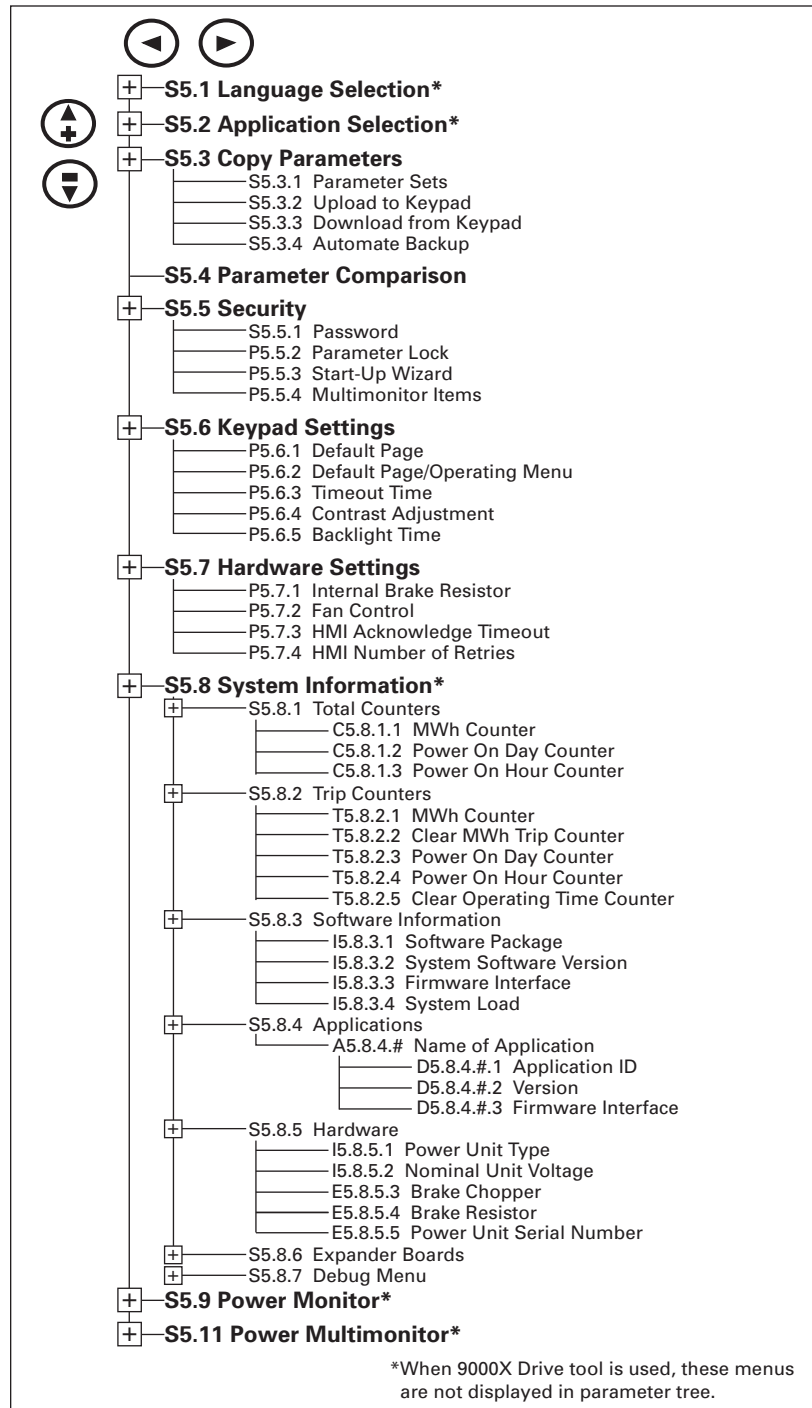


Figure 6-8: System Menu Keypad Structure

System Menu Parameters

S5.1 Language Selection Range: English (Spanish^①, French^①, Portuguese^①) Default: English
LANGUAGE
 This parameter offers the ability to control the drive through the keypad in the language of your choice. Currently available language: English.
^① Available in the future.

S5.2 Application Selection Default: Remote Input
APPLICATION
 This parameter sets the active application.
 When changing applications, you will be asked if you want the parameters of the new application to be uploaded to the keypad. If you wish to load the new application parameters, push the ENTER button. Pushing any other button saves the parameters of the previously used application in the keypad.

System Menu Copy Parameter Options (S5.3)

The parameter copy function is used when the operator wants to copy one or all parameter groups from one drive to another. All the parameter groups are first uploaded to the keypad, then the keypad is connected to another drive and then the parameter groups are downloaded to it (or possibly back to the same drive).

Note: Before any parameters can successfully be copied from one drive to another, the drive must be stopped when the parameters are downloaded to it.

S5.3.1 Parameter Sets Range: 0 – 4
PARAMETER SETS
 This parameter allows you to reload the factory default parameter values, and to store and load two customized parameter sets.

- 0 Load Factory defaults
- 1 Store Set 1
- 2 Load Set 1
- 3 Store Set 2
- 4 Load Set 2

S5.3.2 Upload to Keypad
UP TO KEYPAD
 This function uploads all existing parameter groups to the keypad.

S5.3.3 Download from Keypad Range: 0 – 3 Default: 0 (All parameters)
DOWN FROM KEYPAD
 This function downloads one or all parameter groups from the keypad to the drive.

- 0 All parameters
- 1 All, no motor
- 2 Application parameters

November 2009

S5.3.4 Automatic Backup Range: Yes, No Default: Yes
AUTO.BACKUP

This parameter activates and deactivates the parameter backup function. When the Parameter backup function is activated, the keypad makes a copy of the parameters and settings in the currently active application. When applications are changed, you will be asked if you wish the parameters of the **new** application to be uploaded to the keypad. For this to happen, push the ENTER button. If you wish to keep the copy of the parameters of the **previously used** application saved in the keypad push any other button.

Note: Parameters saved in the parameter settings of S5.3.1 will be deleted when applications are changed. If you want to transfer the parameters from one application to another you have to upload them to the keypad first.

System Menu Parameter Comparison Options (S5.4)

S5.4 Parameter Comparison
PARAMETER COMPARISON

With the Parameter Comparison function, you can compare the actual parameter values to the values of your customized parameter sets and those loaded to the control keypad.

The actual parameter values are first compared to those of the customized parameter Set1. If no differences are detected, a "0" is displayed on the lowermost line of the keypad.

If any of the parameter values differ from those of the Set1 parameters, the number of the deviations is displayed together with symbol P (e.g. P1 ➡ P5 = five deviating values).

By pressing the right arrow button once again you will see both the actual value and the value it was compared to. In this display, the value on the Description line (in the middle) is the default value, and the one on the value line (lowermost line) is the edited value. You can also edit the actual value by pushing the Right Arrow button.

Actual values can also be compared to Set2, Factory Settings and the Keypad Set values.

Security Menu Parameter Options (S5.5)

Note: The Security submenu is protected with a password. Store the password in a safe place.

S5.5.1 Password Range: 0 – 65535 Default: 0 = Not in use
PASSWORD

The application selection can be protected against unauthorized changes with the Password function. When the password function is enabled, the user will be prompted to enter a password before application changes, parameter value changes, or password changes. Password can also be used to prevent user from exiting the operating menu.

By default, the password function is not in use. If you want to activate the password, change the value of this parameter to any number between 1 and 65535. The password will be activated after the Timeout time (**Timeout Time**) has expired.

To deactivate the password, reset the parameter value to 0. Back door password is 2277.

P5.5.2 Parameter Lock Range: ChangeEnable, ChangeDisabl Default: ChangeDisabl
PARAMETER LOCK

This function allows the user to prohibit changes to the parameters. If the parameter lock is activated the text **LOCKED** will appear on the display if you try to edit a parameter value.

Note: This function does not prevent unauthorized editing of parameter values.

P5.5.3 Start-Up Wizard Range: Yes, No Default: No
START-UP WIZARD
 The Start-Up Wizard facilitates commissioning the drive. If selected active, the Start-Up Wizard prompts the operator for the language and application desired and then advances through the start-up parameter list. After completion it allows the user to repeat the Start-Up Wizard or return to the default page, the Operate Menu. The Start-Up Wizard is always active for the initial power up of the drive.
 This feature can also be selected by pressing the STOP/RESET button for 5 seconds. Display will then show "Start-Up Wizard Activated". Unit must then be powered down and "SUW" will be displayed on powerup.
 Yes = Startup Wizard turns on every time power turns on.

P5.5.4 Multimonitor Items Range: ChangeEnable, ChangeDisabl Default: ChangeEnable
MULTIMON.ITEMS
 The keypad display can display three actual monitored values at the same time. This parameter determines if the operator is allowed to replace the values being monitored with other values.

Keypad Settings (S5.6)

There are five parameters (**Default Page** to **Backlight Time**) associated with the keypad operation:

P5.6.1 Default Page Range: 0 – 8 Default: 0
DEFAULT PAGE
 This parameter sets the view the display shows when entering the Programming Mode. See **Figure 6-3** on **Page 6-5**.

- 0,1 M1 Programming
- 2 M2 Keypad Control
- 3 M3 Active Faults
- 4 M4 Fault History
- 5 M5 System Menu
- 6 M6 Expander Boards
- 7 M7 Monitor
- 8 M8 Operate Mode

P5.6.2 Default Page in the Operating Menu Range: 0 – 16 Default: 0
DEFAULT PAGE/OP
 Here you can set the location in the Operating menu to which the display automatically moves as the set **Timeout Time** expires, or when the keypad power is switched on. See **Table 6-14** on **Page 6-21**.

- 0,1 O1 Output Frequency
- 2 O2 Actual Speed
- 3 O3 Speed Setpoint
- ...
- 16 O16 Multimonitor

P5.6.3 Timeout Time Range: 0 – 65,535 Default: 60
 Units: Seconds
TIMEOUT TIME
 The **Timeout Time** setting defines the time after which the keypad display returns to the **Default Page**.
Note: If the **Default Page** value is 0 the **Timeout Time** setting has no effect.

November 2009

P5.6.4 Contrast Adjustment *CONTRAST ADJUSTMENT* Default: 18
 If the display is not clear, you can adjust the keypad contrast with this parameter.

P5.6.5 Backlight Time *BACKLIGHT TIME* Default: 10
 Range: 1 – 65,535 or Forever
 Units: Minutes
 This parameter determines how long the backlight stays on before going out. You can select any time between 1 and 65,535 minutes or “Forever”. 0 minutes = Forever.

Hardware Settings (S5.7)

The Hardware Settings submenu (S5.7) provides parameters for setting information on Internal brake resistor connection, Fan control, Keypad acknowledge timeout and Keypad retries.

P5.7.1 Internal Brake Resistor Connection *INTERNBRAKES* Default: Connected
 Range: Connected – Not Connected
 With this function you tell the drive whether the internal brake resistor is connected or not.

If your drive has an internal brake resistor, the default value of this parameter is “Connected”. However, if it is necessary to increase braking capacity by installing an external brake resistor, or if the internal brake resistor is disconnected, it is advisable to change the value of this function to “Not Connected” in order to avoid unnecessary fault trips.

Note: The brake resistor is available as an option for all drives. It can be installed internally in frame sizes FR4 to FR6.

P5.7.2 Fan Control *FAN CONTROL* Default: Continuous
 Range: Continuous, Temperature

This function sets the control method of the drive’s cooling fan. You can set the fan to run continuously when the power is switched on or to run based on the temperature of the unit. If the latter function has been selected, the fan is switched on automatically when the heatsink temperature reaches 60°C. The fan receives a stop command when the heatsink temperature falls to 55°C. The fan runs for about a minute after receiving the stop command or switching on the power, as well as after changing the value from “Continuous” to “Temperature”.

Note: The fan runs continuously, regardless of this setting, when the drive is in RUN state.

- P5.7.3 HMI Acknowledge Timeout** Range: 200 – 5,000 Units: mseconds Default: 200
HMI ACK TIMEOUT
- This function allows the user to change the timeout of the Keypad acknowledgement time.
- Note:** If the drive has been connected to a PC with a serial cable, the default values of **Keypad Acknowledge Timeout** and **Number of Retries to Receive Keypad Acknowledgement** must not be changed.
- If the drive has been connected to a PC via a modem and there is delay in transferring messages, the value of **Keypad Acknowledge Timeout** must be set according to the delay as follows:
- Example:*
- Transfer delay between the drive and the PC is found to be = 600 ms
 - The value of Keypad Acknowledge Timeout is set to 1200 ms (2 x 600, sending delay + receiving delay)
 - The corresponding setting is then entered in the [Misc] section of the file NCDrive.ini:
Retries = 5
AckTimeOut = 1200
TimeOut = 5000
- It must also be considered that intervals shorter than the **Keypad Acknowledge Timeout** time cannot be used in drive monitoring.
- P5.7.4 Number of Retries to Receive Keypad Acknowledgement** Range: 1 – 10 Default: 5
KEYPAD RETRY
- With this parameter you can set the number of times the drive will try to receive an acknowledgement when it has not been received within the acknowledgement time (**Keypad Acknowledge Timeout**) or if the received acknowledgement is faulty.

System Information (S5.8)

This section contains hardware and software information as well as operation information.

S5.8.1 Total Counters

TOTAL COUNTERS

In the **Total Counters** page you will find information related to the drive operating times, i.e. the total numbers of MWh, operating days and operating hours. See **Table 6-6**.

Unlike the counters for the **Trip Counters**, these counters cannot be reset.

Note: The Power On time counters, days and hours, operate whenever power is applied to the drive.

Table 6-6: Total Counters

Number	Name	Description
C5.8.1.1	MWh counter	Megawatt hours total operation time counter
C5.8.1.2	Power On day counter	Number of days the drive has been supplied with power
C5.8.1.3	Power On hour counter	Number of hours the drive has been supplied with power

November 2009

**S5.8.2
Trip Counters**

TRIP COUNTERS

The **Trip Counters** are counters whose values can be reset to zero. The resettable counters are shown in **Table 6-7**.

Table 6-7: Trip Counters

Number	Name	Description
T5.8.2.1	MWh counter	Megawatts hours since last reset
P5.8.2.2	Clear MWh counter	Resets megawatts hours counter
T5.8.2.3	Power On day counter	Number of days the drive has been run since the last reset
T5.8.2.4	Power On hour counter	Number of hours the drive has been run since the last reset
P5.8.2.5	Clr Optime cntr	Resets the operating day and hour counters

Note: The **Trip Counters** operate only when the motor is running.

**S5.8.3
Software Information**

SOFTWARE

The Software information page includes information on the following software related topics:

Table 6-8: Software Information

Number	Name	Description
I5.8.3.1	Software package	SVX00031V010 or later
I5.8.3.2	System software version	11.62.7486 or later
I5.8.3.3	Firmware interface	4.45 or later
I5.8.3.4	System load	XX % (actual value)

**S5.8.4
Application Information**

APPLICATIONS

The Application information page includes information on not only the application currently in use but also all other applications loaded into the drive. The information available is shown in **Table 6-9**. Note that the "x" in the table refers to the sequential number of the application in the list.

Table 6-9: Application Information

Name	Content
A5.8.4.x	Application name
D5.8.4.x.1	Application ID
D5.8.4.x.2	Version
D5.8.4.x.3	Firmware interface

S5.8.5 Hardware Information

HARDWARE

The Hardware information page provides information on the following hardware-related topics:

Table 6-10: Hardware Information

Number	Content
I5.8.5.1	Nominal power of the unit
I5.8.5.2	Nominal voltage of the unit
E5.8.5.3	Brake chopper
E5.8.5.4	Brake resistor
E5.8.5.5	Power unit serial number

S5.8.6 Expander Board Information

EXPANDER BOARDS

This parameter and its sub-items provide information about the basic and option boards plugged into the control board as shown in **Table 6-11**. Note that the "x" in the table refers to the sequential number of the slot, with slot A being "1" and slot E being "5".

Table 6-11: Expander Board Information

Number	Content
E5.8.6.x	Slot "x" board identification
E5.8.6.x.1	Operating state
E5.8.6.x.2	Software version

See option board manual for additional information data.

S5.8.7 Debug Menu

DEBUG

This menu is meant for advanced users and application designers. Contact the factory for any assistance needed.

S5.9 Power Monitor

POWER MONITOR

Table 6-12: Drive Output Phase Current Measurement

Number	Content
V5.9.1	IU filtered, Phase 1
V5.9.2	IV filtered, Phase 2
V5.9.3	IW filtered, Phase 3

S5.10 Reserved

Parameter not displayed, reserved for future use.

S5.11 Power Multi- monitoring

POWER MULTIMON

Displays all three output phase currents simultaneously.

November 2009

Expander Board Menu (M6)

The Expander Board Menu makes it possible for the user to:

- to see what expander boards are connected to the control board and
- to access and edit the parameters associated with the expander board.

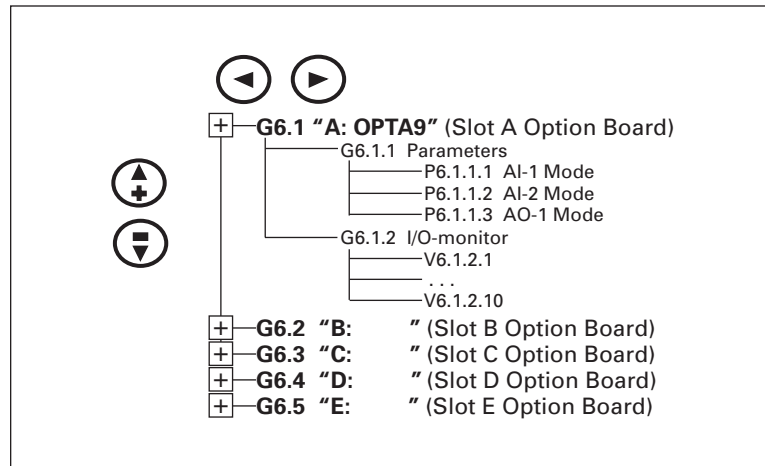


Figure 6-9: Expander Board Menu Structure

Example of Expander Board Parameters for Option Board A9

P6.1.1.1 AI-1 Mode	Range: 1 – 5 <i>AI-1 MODE</i> Analog Input 1 input options: 1 0 – 20 mA 2 4 – 20 mA 3 0 – 10V DC 4 2 – 10V DC 5 -10 – +10VP	Default: 3
P6.1.1.2 AI-2 Mode	Range: 1 – 5 <i>AI-2 MODE</i> Analog Input 2 input options: 1 0 – 20 mA 2 4 – 20 mA ① 3 0 – 10V DC ① 4 2 – 10V DC ① 5 -10 – +10VP ①	Default: 1
① Values 2 – 5 require changing pins. See Figure [?] on Page [?]. (THIS WAS DELETED)		
P6.1.1.3 AO-1 Mode	Range: 1 – 4 <i>AO-1 MODE</i> Analog Output 1 output options: 1 0 – 20 mA 2 4 – 20 mA 3 0 – 10V DC 4 2 – 10V DC	Default: 1

Monitoring Menu (M7)

The Monitoring Menu items are meant for viewing parameter values during operation. Monitored values are updated every 0.3 sec. Monitored items are identified by item numbers V7.1 to V1.xx, where “xx” varies by application. **Table 6-13** provides an example of the monitored values for the **Generic PI** application.

Monitored parameters are not editable from this menu (See Parameter Menu [M1] to change parameter values).

Table 6-13: Monitoring Menu Items — Generic PI Application Example

Code	Signal Name	Unit	ID	Description
V7.1	Actual speed	%	1	Actual motor speed between min and max frequency
V7.2	Output frequency	Hz	2	Output frequency to motor
V7.3	Speed Setpoint	%	3	Speed Setpoint
V7.4	Motor speed	rpm	4	Calculated motor speed in rpm
V7.5	Motor current	A	5	Motor current
V7.6	Motor torque	%	6	Calculated torque as a percentage of nominal torque
V7.7	Motor power	%	7	Calculated motor shaft power
V7.8	Motor voltage	V	8	Calculated motor voltage
V7.9	DC-Bus voltage	V	9	DC-Bus voltage
V7.10	Unit temperature	°F	10	Heatsink temperature
V7.11	Motor temperature	%	11	Calculated motor temperature
V7.12	Analog input 1	V	12	Analog input AI-1
V7.13	Analog input 2	mA	13	Analog input AI-2
V7.14	DI-1, DI-2, DI-3	—	14	Digital input status (Figure 6-10)
V7.15	DI-4, DI-5, DI-6	—	15	Digital input status (Figure 6-11)
V7.16	DO-1, RO-1, RO-2	—	16	Digital and relay output status (Figure 6-12)
V7.17	Analog lout	mA	17	Analog output AO-1
V7.18	Active Fault Code		18	Active Fault Code for fieldbus use
V7.19	Active Warning Code		19	Active Warning Code for fieldbus use
V7.20	Status Word		20	Status Word for fieldbus use
V7.21 ^②	PI Setpoint	% ^①	21	PI Setpoint
V7.22 ^②	PI Input	% ^①	22	PI Input
V7.23 ^②	PI error	% ^①	23	Calculated error between PI actual and reference values
V7.24 ^②	PI output	%	24	PI output (speed reference when PI active)
G7.25	Multimonitor		—	Displays three selectable monitoring values

^① Units will vary depending on active application.

^② Not available in Remote Input application.

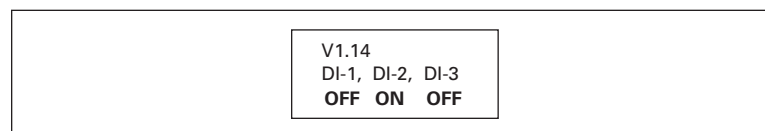


Figure 6-10: Digital Inputs — DI-1, DI-2, DI-3 Status

November 2009

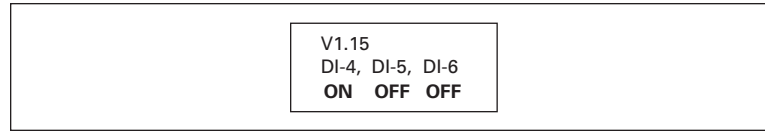


Figure 6-11: Digital Inputs — DI-4, DI-5, DI-6 Status

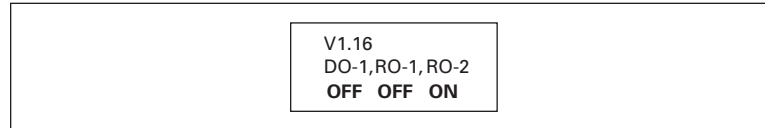


Figure 6-12: Digital and Relay Outputs — DO-1, RO-1, RO-2 Status

Multimonitor (G7.25)

This parameter allows the viewing and selection (if allowed by System menu item, P5.5.4) of three simultaneously monitored items from the Monitored Menu Items shown in **Table 6-13**. Use the right arrow key to select the item to be modified and then the up or down arrow keys to select the new item. Press the ENTER key to accept the change.

Operate Menu (M8)

The Operate Menu provides a easy to use method of viewing key numerical Monitoring Menu items. Some applications also support the setting of reference values in this menu. The items displayed vary by application. **Table 6-14** is an example for the Generic PI application.

Table 6-14: Operate Menu Items — Generic PI Application Example

Index	Signal Name	Unit	Description
O1	Output Frequency	Hz	Actual motor frequency
O2	Actual Speed	%	Actual motor speed between min and max frequency
O3	Speed Setpoint	%	Speed Setpoint (Can be Keypad on AI-1/AI-2)
O4	Motor Speed	rpm	Actual motor speed
O5	Motor Current	A	Measured Motor Current
O6	Motor Torque	%	Calculated Motor Torque
O7	Motor Power	%	Calculated Motor Power
O8	Motor Voltage	V	Measured Motor Voltage
O9	DC-Bus Voltage	V	Measured DC-Bus Voltage
O10	Unit Temperature	°F	Heatsink temperature
O11	Motor Temperature	%	Calculated motor temperature based on the motor nameplate information and actual motor load
O12 ②	PI-Setpoint	% ①	PI Setpoint
O13 ②	PI-Input	% ①	PI Input (measured) value
O14 ②	PI-Error Value	% ①	Calculated error between PI actual and reference values
O15 ②	PI-Output	%	PI output (speed reference when PI active)
O16	Multimonitor	①	Displays three values simultaneously

① Units will vary depending on active application.

② Not available in Remote Input application.

November 2009

Chapter 7 — Start-Up

Safety Precautions

Before start-up, observe the following warnings and safety instructions.

 WARNING

- 1** Internal components and circuit boards (except the isolated I/O terminals) are at utility potential when the VSD Series drive is connected to the line. This voltage is extremely dangerous and may cause death or severe injury if you come in contact with it.
- 2** When the VSD Series drive is connected to the utility, the motor connections U (T1), V (T2), W (T3) and DC-link/brake resistor connections B-, B+ and R- are live even if the motor is not running.
- 3** Do not make any connections when the VSD Series drive is connected to the utility line.
- 4** Do not open the cover of the VSD Series drive immediately after disconnecting power to the unit, because components within the drive remain at a dangerous voltage potential for some time. Wait until at least five minutes after the cooling fan has stopped and the keypad or cover indicators are dark before opening the VSD Series drive cover.
- 5** The control I/O terminals are isolated from the utility potential, but relay outputs and other I/Os may have dangerous external voltages connected even if power is disconnected from the VSD Series drive.
- 6** Before connecting to the utility make sure that the cover of the VSD Series drive is closed.

Sequence of Operation

1. Read and follow all safety precautions.
2. At installation ensure:
 - a. That the VSD Series drive and motor are connected to ground.
 - b. That the utility and motor cables are in accordance with the installation and connection instructions as detailed in **Chapter 3**.
 - c. That the control cables are located as far as possible from the power cables as detailed in **Chapter 4** and **Table 3-1**. That control cable shields are connected to protective ground. That no wires make contact with any electrical components in the VSD Series drive.
 - d. That the common input of digital input groups is connected to 24V DC or ground of the I/O terminal supply or an external supply as detailed in **Chapter 4** and **Figure 4-3**.
3. Check the quality of the cooling air as detailed in **Chapter 2**.
4. Check that moisture has not condensed inside the VSD Series drive.
5. Check that all START/STOP switches connected to the I/O terminals are in the STOP state.
6. Connect the VSD Series drive to the utility and switch the power on.
7. Use start-up wizard. It is active by default, if not keep STOP/RESET button pressed 5 seconds to activate it. Start-up wizard will guide you through correct application-specific parameter settings, like motor nameplate values etc.

November 2009

8. Perform either Test A or Test B without the motor connected to the VSD Series drive.

As a default, these tests should be done with the Remote Input application.

Test A — Control from the Control Panel.

- Apply input power to the VSD Series drive.
- Press HOA button until HAND LCD is flashing, then press ENTER.
- Press the START button.
- Press up arrow (+) or down arrow (-) to get speed setpoint.
- Check that the actual speed follows the setpoint (operate menu display 01).
- Press the STOP/RESET button.

Test B — Control from the I/O Terminals.

- Apply input supply power to the VSD Series drive.
- Change control from the keypad to the I/O terminals. Press HOA button until AUTO LCD is flashing, then press ENTER. Start drive by closing DI-1.
- Change the speed setpoint, from where "Setpoint Source Auto" (P1.1.15) has been selected.
- Check that the actual speed follows the setpoint (operate menu display 01).
- Stop the drive by opening the start contact at DI-1.

Disconnect all power to the VSD Series drive. Wait until the cooling fan on the unit stops and the indicators on the panel are not lit. If no keypad is present, check the indicators in the cover. Wait at least five more minutes for the DC bus to discharge. Ensure bus voltage has discharged by measuring B+ and B- with DC voltage. Connect the motor to the VSD Series drive and check for correct motor rotation. If possible, perform a start-up test with the motor connected to the VSD Series drive but not connected to the process. If the VSD Series drive must be tested with the motor connected to the process, perform it under no-load or light load conditions.

Start-Up Wizard — Duct Static, Building Static, Pressure Control, Temperature Control, Generic PI

Upon initial power up, the **Start-Up Wizard** guides the commissioner through the basic VSD Series setup. The **Start-Up Wizard** may be set to function upon power up by setting parameter P5.5.3, or by pressing the STOP/RESET button for 5 seconds while in the "Operate Menu". The display will read "Start-Up Wizard Activate!" after 5 seconds.

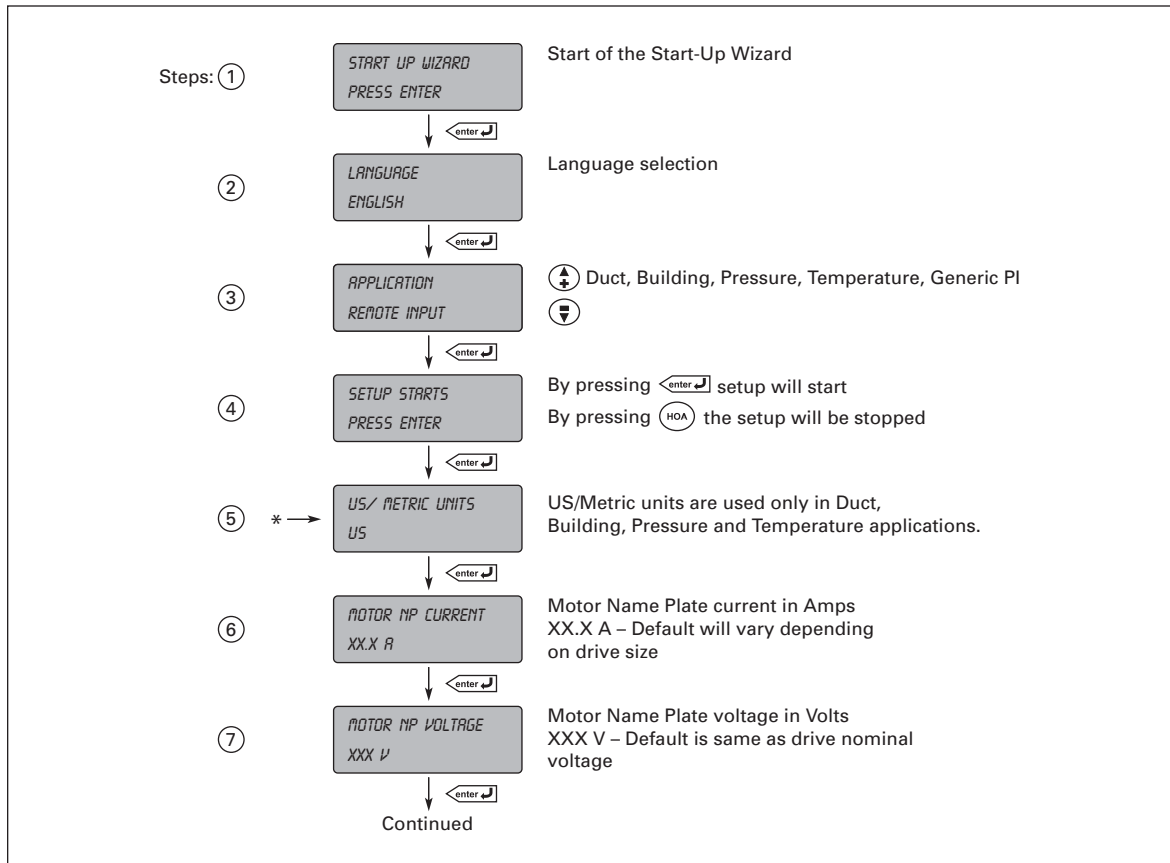


Figure 7-1: Start-Up Wizard Navigation (1 of 3)

Note: Use \uparrow / \downarrow for changing parameter. Then press ENTER to save and move forward.

November 2009

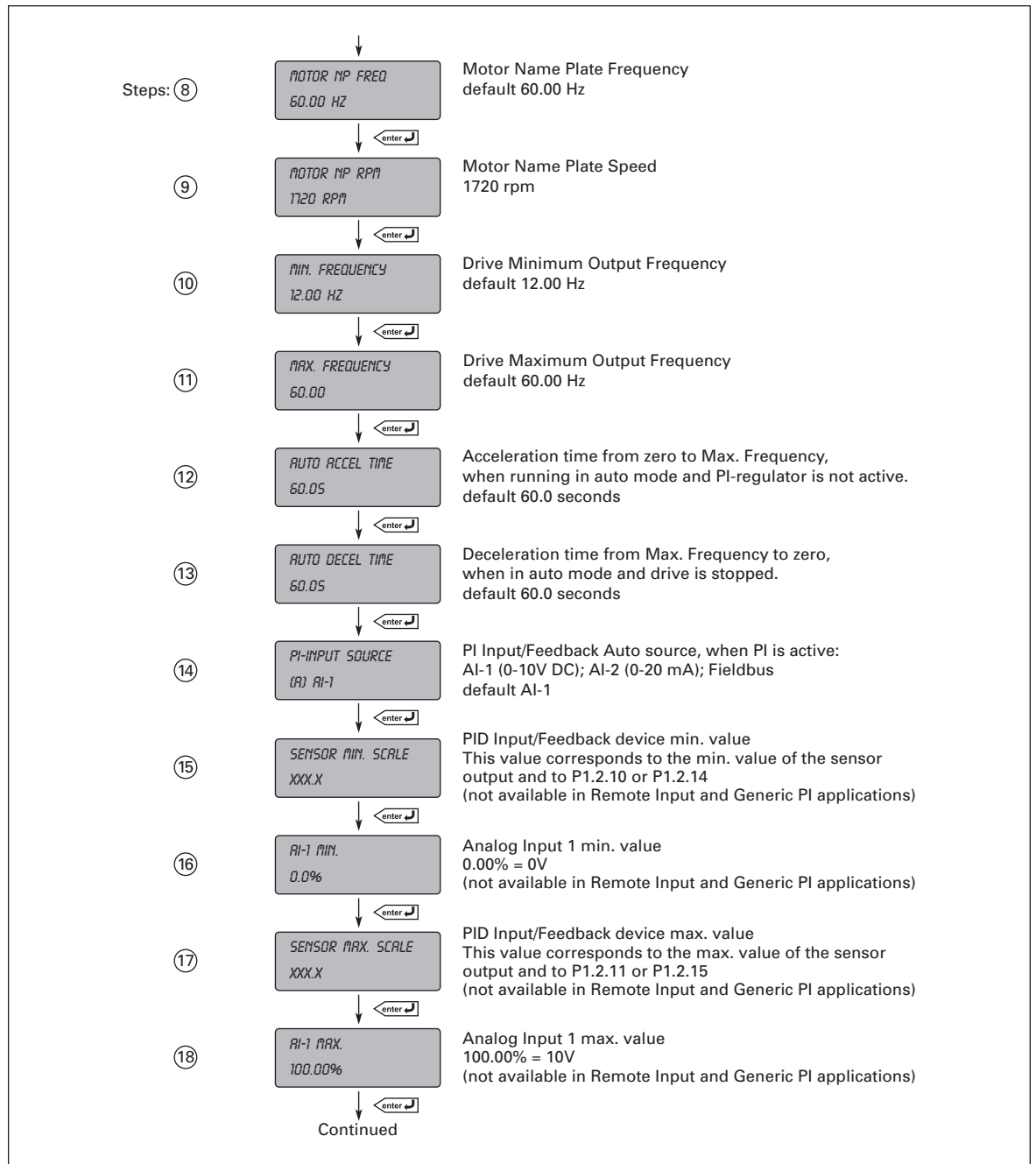


Figure 7-2: Start-Up Wizard Navigation (2 of 3)

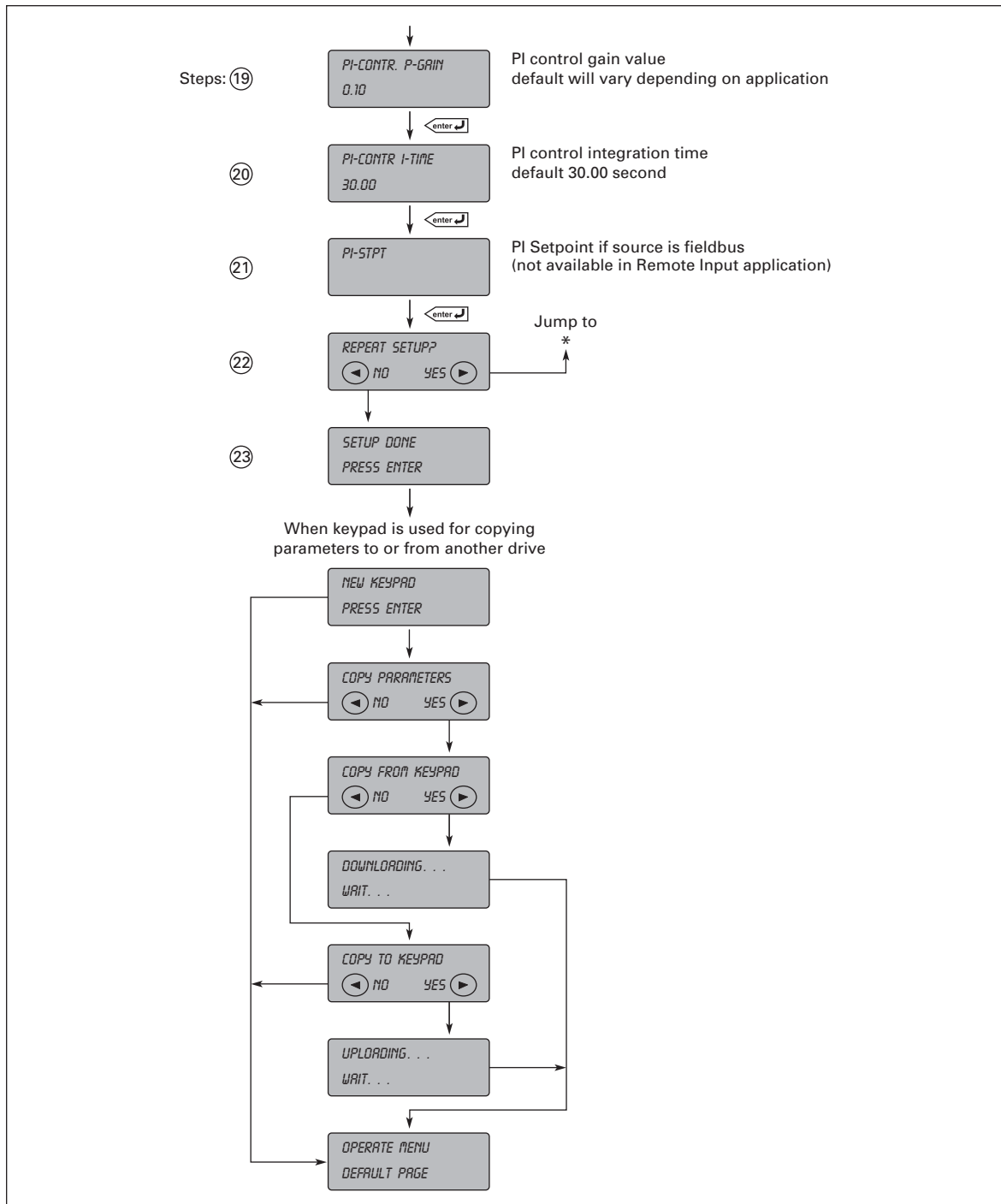


Figure 7-3: Start-Up Wizard Navigation (3 of 3)

Note: Start-Up Wizard can be cancelled with the STOP/RESET button. If pressed, the text "EXIT?" is shown on the display along with "No" and "Yes".

Note: In Pressure Control application, inverse selection is an option.

November 2009

Start-Up Wizard — Remote Input Application

The Remote Input application uses a slightly different Start-Up Wizard:

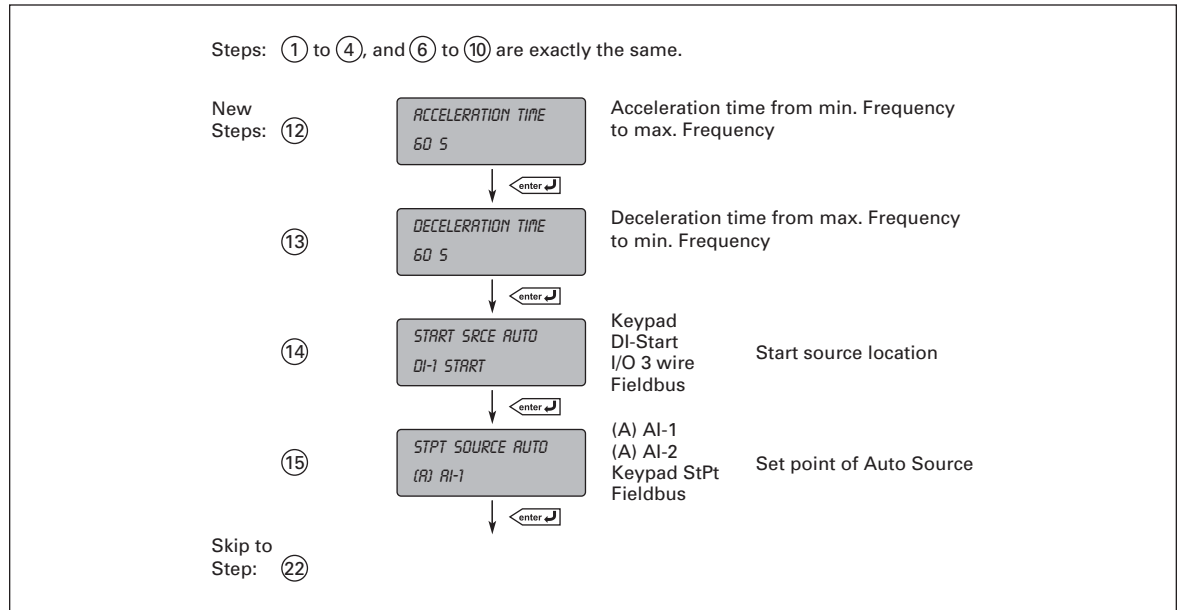


Figure 7-4: Remote Input Start-Up Wizard

November 2009

Chapter 8 — N2, XT, and SA BUS Communication

The Johnson Controls VSD Series Drives powered by Cutler-Hammer® technology from Eaton's electrical business can be controlled, monitored and programmed from a host system via Johnson Controls N2, XT, or SA BUS communication protocols with the addition of the VS-OPTNX RS-485 Communication Option Board.

If you purchase your Communication Board separate from the drive, please note that it must be installed in slot D or E on the control board of the VSD Series drive.



November 2009

Chapter 9 — Remote Input Application (SVCHS200)

Introduction

The Remote Input Application is typically used for direct frequency control without the PI. In these applications, the Remote Input Application provides a smooth control and an integrated measurement and control package where no additional components are needed.

The direct frequency reference is used for the control without the PI controller and is selected from the analog inputs, fieldbus or keypad.

- Digital inputs DI-2, DI-3, DI-4, DI-5 and DI-6 and all outputs are freely programmable.

Additional functions:

- Analog input signal range selection
- Fire Mode
- Torque limit supervision
- Reference limit supervision
- Two sets of ramp times and S-shape ramp programming
- Programmable start and stop functions
- DC Brake Chopper
- Six skip frequency areas
- Programmable V/Hz curve and switching frequency
- Auto restart
- Motor thermal and stall protection: Programmable action; off, warning, fault
- Motor underload protection
- Input phase supervision

Details of the parameters shown in this section are available in **Chapter 15** of this Manual, listed by parameter ID number.

Control Input/Output

Table 9-1: Remote Input Application Default I/O Configuration

Terminal	Signal	Description
OPTA9		
1	+10V DC _{ref}	Reference output Voltage for potentiometer, etc.
2	AI-1+	Analog input, voltage range 0 – 10V DC Voltage input frequency setpoint
3	AI-1-	I/O Ground Ground for reference and controls
4	AI-2+	Analog input, current range 0 – 20 mA Current input frequency setpoint
5	AI-2-	
6	24V DC	Control voltage output Voltage for switches, etc. max 0.1A
7	GND	I/O ground Ground for reference and controls
8	DI-1	Start/Stop Control Contact closed = start
9	DI-2	External fault input (programmable) Contact closed = fault Contact open = no fault
10	DI-3	External Interlock (programmable) Contact closed = OK Open = Interlocked
11	CMA	Common for DI-1 – DI-3 Connect to GND or 24V DC
12	24V DC	Control voltage output Voltage for switches (see terminal 6)
13	GND	I/O ground Ground for reference and controls
14	DI-4	Speed Select 1 (programmable) Contact closed = Speed Select 1
15	DI-5	Fire Mode (programmable) Contact closed = Fire Mode active
16	DI-6	Overload relay (IntelliPass) (programmable) Contact open = no fault Contact closed = fault
17	CMB	Common for DI-4 – DI-6 Connect to GND or 24V DC
18	AO-1+	Output frequency Analog output Programmable Range 0 – 20 mA, R _L max. 500 Ω
19	AO-1	
20	DO-1	Digital output READY Programmable Open collector, I ≤ 50 mA, V ≤ 48V DC
OPTA2		
21	RO-1	Relay output 1 Programmable Drive RUN is default.
22	RO-1	
23	RO-1	
24	RO-2	Relay output 2 Programmable Drive FAULT is default.
25	RO-2	
26	RO-2	

Note: For more information on jumper selections, see **Chapter 4**.

X3 Jumper Setting — CMA and CMB Grounding

- CMB Connected to Ground
CMA Connected to Ground
- CMB Isolated from Ground
CMA Isolated from Ground
- CMB and CMA Internally Connected
and Isolated from Ground

CAUTION

Unattended start will occur if power is supplied with Start Command activated.

November 2009

Parameter Lists

On the next pages you will find the lists of parameters within the respective parameter groups. The parameter descriptions are given by ID number in **Chapter 15**.

Column explanations:

- Code = Location indication on the keypad; Shows the operator the present parameter number
- Parameter = Name of parameter
- Min. = Minimum value of parameter
- Max. = Maximum value of parameter
- Unit = Unit of parameter value; Given if available
- Default = Value preset by factory
- ID = ID number of the parameter for reference to **Chapter 15**

Quick Setup Parameters — M1 → G1.1

Table 9-2: Quick Setup Parameters — M1 → G1.1

Code	Parameter	Min.	Max.	Unit	Default	ID Number	Description
P1.1.1	Min Frequency	0.00	Max_Frequency	Hz	12.00	101	Minimum output frequency, f[Hz].
P1.1.2	Max Frequency	FreqMin	320.00	Hz	60.00	102	Maximum output frequency, f[Hz].
P1.1.3	Acceleration Time	0.1	3000.0	s	60.0	103	Time from minimum frequency to maximum frequency.
P1.1.4	Deceleration Time	0.1	3000.0	s	60.0	104	Time from maximum frequency to minimum frequency.
P1.1.5	Motor NP Voltg	180	Motor VoltageMax	V	400	105	Motor nameplate voltage in Volts.
P1.1.6	Motor NP Freq	8.00	320.00	Hz	60.00	106	Motor nameplate frequency in Hertz.
P1.1.7	Motor Nom Speed	24	20000	rpm	1720	111	Motor nameplate speed in Rpm.
P1.1.8	Motor Nom Currnt	Motor CurrentMin	Motor CurrentMax	A	5.40	108	Motor nameplate current, I[A]
P1.1.9	Power Factor	0.30	1.00		0.85	109	Motor power factor. (Cos Phii)
P1.1.10	Service Factor	0.10	2.00		1.00	110	Motor service factor. This will calculate the motor current limit. (MotorNomCurrent x Service Factor)
P1.1.11	Current Limit	Motor CurrentMin	Motor CurrentMax	A	7.00	107	Output current limit of the unit in Amps.

Table 9-2: Quick Setup Parameters — M1 → G1.1, continued

Code	Parameter	Min.	Max.	Unit	Default	ID Number	Description
P1.1.12	Start Srce Hand	1	3		1	112	Parameter for Local Start/Stop/Reverse control location. Default = Keypad 1 = Keypad 2 = DI-1 Start 3 = I/O Three Wire
P1.1.13	StPt Source Hand	0	3		2	113	Local speed setpoint selection: 0 = analog input AI-1 1 = analog input AI-2 2 = Speed Setpoint from Keypad 3 = Motor Potentiometer
P1.1.14	Start Srce Auto	1	4		2	114	Parameter for Remote Start/Stop/Reverse control location. Default = DI-1 Start 1 = Keypad 2 = DI-1 Start 3 = I/O Three Wire 4 = Fieldbus
P1.1.15	StPt Source Auto	0	4		0	115	Remote speed setpoint selection: 0 = analog input AI-1 1 = analog input AI-2 2 = Speed Setpoint from Keypad 3 = Motor Potentiometer 4 = Speed Setpoint from Fieldbus

November 2009

Input Signals — M1 → G1.2

Table 9-3: Input Signals — M1 → G1.2

Code	Parameter	Min.	Max.	Unit	Default	ID Number	Description
P1.2.1	Start Mode (A) DI-1 Funct.	0	3		1	201	Start Function: 0 = Normal start without interlockings. 1 = Interlocked start. One of the digital inputs must be programmed to Intlk/RunEna. DI-3 is defaulted for this feature. 2 = Mode 1 + timeout supervision. If the interlock is not OK within the interlock timeout time, start request is ignored and must be given again. 3 = Delayed start. Start request is given after delay time has expired.
P1.2.2	Intlk Stop Mode	0	1		1	216	0 = Coasting 1 = Ramp
P1.2.3	Intlk Timeout	0.00	300.00	s	5.00	202	Interlock timeout time for Start Function #2. Default = 5s.
P1.2.4	Start Delay Time	0.00	300.00	s	5.00	203	Start delay time for Start Function #3. Default = 5s.
P1.2.5	(A) DI-2 Funct.	0	17		1	204	Default #1 External Fault Close 0 = Stop pulse, when 3-wire start/stop logic is selected. (False=Stop, True=Ready to Run) 1 = Ext. fault, closing contact 2 = External fault, opening contact 3 = Fault reset 4 = Run enable-Closed Contact 5 = Force ctrl. place to Hand 6 = Force ctrl. place to Auto 7 = Reverse 8 = Speed Select 1 9 = Fire Mode-Closed Contact 10 = Speed Select 2 11 = Speed Select 3 12 = Force Bypass 13 = External interlock closed 14 = External interlock open 15 = Mot. Pot. UP 16 = Mot. Pot. DOWN 17 = Fire Mode-Open Contact

⚠ CAUTION

Unattended start will occur if power is supplied with Start Command activated.

Table 9-3: Input Signals — M1 → G1.2, continued

Code	Parameter	Min.	Max.	Unit	Default	ID Number	Description
P1.2.6	(A) DI-3 Funct.	0	17		13	205	Default #13 Interlock/Run Enable 0 = Not Used 1 = Ext. fault, closing contact 2 = External fault, opening contact 3 = Fault reset 4 = Run enable-Closed Contact 5 = Force ctrl. place to Hand 6 = Force ctrl. place to Auto 7 = Reverse 8 = Speed Select 1 9 = Fire Mode-Closed Contact 10 = Speed Select 2 11 = Speed Select 3 12 = Force Bypass 13 = External interlock closed 14 = External interlock open 15 = Mot. Pot. UP 16 = Mot. Pot. DOWN 17 = Fire Mode-Open Contact
P1.2.7	(A) DI-4 Funct.	0	17		8	206	Default #8 Speed Select 1 0 = Not Used 1 = Ext. fault, closing contact 2 = External fault, opening contact 3 = Fault reset 4 = Run enable-Closed Contact 5 = Force ctrl. place to Hand 6 = Force ctrl. place to Auto 7 = Reverse 8 = Speed Select 1 9 = Fire Mode-Closed Contact 10 = Speed Select 2 11 = Speed Select 3 12 = Force Bypass 13 = External interlock closed 14 = External interlock open 15 = Mot. Pot. UP 16 = Mot. Pot. DOWN 17 = Fire Mode-Open Contact

November 2009

Table 9-3: Input Signals — M1 → G1.2, continued

Code	Parameter	Min.	Max.	Unit	Default	ID Number	Description
P1.2.8	(A) DI-5 Funct.	0	17		9	207	Default #9 Fire-Mode 0 = Not Used 1 = Ext. fault, closing contact 2 = External fault, opening contact 3 = Fault reset 4 = Run enable-Closed Contact 5 = Force ctrl. place to Hand 6 = Force ctrl. place to Auto 7 = Reverse 8 = Speed Select 1 9 = Fire Mode-Closed Contact 10 = Speed Select 2 11 = Speed Select 3 12 = Force Bypass 13 = External interlock closed 14 = External interlock open 15 = Mot. Pot. UP 16 = Mot. Pot. DOWN 17 = Fire Mode-Open Contact
P1.2.9	(A) DI-6 Funct.	0	17		0	208	Default #0 Overload Fault Relay-input 0 = Overload Fault Relay input. (Used in Intellipass) 1 = Ext. fault, closing contact 2 = External fault, opening contact 3 = Fault reset 4 = Run enable-Closed Contact 5 = Force ctrl. place to Hand 6 = Force ctrl. place to Auto 7 = Reverse 8 = Speed Select 1 9 = Fire Mode-Closed Contact 10 = Speed Select 2 11 = Speed Select 3 12 = Force Bypass 13 = External interlock closed 14 = External interlock open 15 = Mot. Pot. UP 16 = Mot. Pot. DOWN 17 = Fire Mode-Open Contact
P1.2.10	(A) AI-1 Invert	0	1		0	209	0 = Not inverted 1 = Inverted
P1.2.11	(A) AI-1 Filter	0.00	10.00	s	0.10	210	0 = No filtering
P1.2.12	(A) AI-2 Range	0	1		1	211	Default =1 (4-20mA) (0 – 100%) 0 = 0 - 20 mA 1 = 4 - 20 mA
P1.2.13	(A) AI-2 Invert	0	1		0	212	0 = Not inverted 1 = Inverted
P1.2.14	(A) AI-2 Filter	0.00	10.00	s	0.10	213	0 = No filtering
P1.2.15	StPt. Scale Min	0.0	100.0	%	0.0	214	Speed that corresponds to the minimum setpoint signal.

Table 9-3: Input Signals — M1 → G1.2, continued

Code	Parameter	Min.	Max.	Unit	Default	ID Number	Description
P1.2.16	StPt. Scale Max	0.0	100.0	%	0.0	215	Speed that corresponds to the maximum setpoint signal. 0.0%=NOT IN USE!
P1.2.17	MotPotStPt Memory	0	1		0	221	Parameter to select reset function for motor potentiometer speed setpoint. Default: No reset.

Output Signals — M1 → G1.3**Table 9-4: Output Signals — M1 → G1.3**

Code	Parameter	Min.	Max.	Unit	Default	ID Number	Description
P1.3.1	(A) AO-1 Funct.	0	8		1	301	Analog output function: 0 = Fieldbus controlled 1 = O/P frequency (0 - f max) 2 = Reference frequency (0 - f max) 3 = Motor speed (0 - 100% x Motor nom. speed) 4 = O/P current (0 - 100% x I nMot) 5 = Motor torque (0 - 100% x T nMot) 6 = Motor power (0 - 100% x P nMot) 7 = Motor voltage (0 - 100% x U nMot) 8 = DC-Bus Voltage (0 - 100% x U nMot)
P1.3.2	(A) AO-1 Filter	0.00	10.00	s	1.00	302	
P1.3.3	(A) AO-1 Invert	0	1		0	303	0 = Not inverted 1 = Inverted
P1.3.4	(A) AO-1 Min.	0	1		0	304	0 = 0 mA 1 = 4 mA
P1.3.5	(A) AO-1 Scale	10	1000	%	100	305	

November 2009

Table 9-4: Output Signals — M1 → G1.3, continued

Code	Parameter	Min.	Max.	Unit	Default	ID Number	Description
P1.3.6	(A) DO-1 Funct.	0	26		1	306	Default=Drive Ready 0 = Not used 1 = Drive Ready 2 = Drive Running 3 = General Fault 4 = General Fault inverted 5 = Drive overheat warning 6 = External fault or warning 7 = Reference (4mA) fault or warning 8 = General Warning 9 = Drive Reversing 10 = Preset Speed Active 11 = Speed setpoint=Actual Speed (=At speed) 12 = Motor regulator activated 13 = Actual Speed limit supervision 14 = Speed Setpoint limit supervision 15 = Torque limit supervision 16 = Timer On/Timer Off output control (Trigger is run request) 17 = Selections #16 inverted 18 = Frequency converter temperature limit supervision 19 = Unrequested rotation direction 20 = Thermistor fault / warning 21 = Hand Control Active 22 = Auto Control Active 23 = DI-Fire Mode Active 24 = Relay to energize an external element before starting the drive. 25 = Fieldbus Passthrough 26 = Bypass Run
P1.3.7	(B) RO-1 Funct.	0	25		2	307	Same as parameter 1.3.6.
P1.3.8	(B) RO-2 Funct.	0	25		3	308	Same as parameter 1.3.6
P1.3.9	(D) RO-1 Funct.	0	25		0	309	Same as parameter 1.3.6
P1.3.10	(D) RO-2 Funct.	0	25		0	310	Same as parameter 1.3.6
P1.3.11	(D) RO-3 Funct.	0	25		0	311	Same as parameter 1.3.6
P1.3.12	Sp.StPt Supv Fct	0	2		0	312	Speed Setpoint Supervision Function: 0 = Not used 1 = Low limit 2 = High limit
P1.3.13	Sp.StPt Supv Lim	0.0	100.0	%	0.0	313	Speed Setpoint Supervision Value.

Table 9-4: Output Signals — M1 → G1.3, continued

Code	Parameter	Min.	Max.	Unit	Default	ID Number	Description
P1.3.14	Act.Sp. Supv Fct	0	2		0	314	Actual Speed Supervision Function: 0 = Not used 1 = Low limit 2 = High limit
P1.3.15	Act.Sp. Supv Lim	0.0	100.0	%	0.0	315	Actual Speed Supervision Value. (±1.0% hysteresis)
P1.3.16	Torque Supv Fct	0	2		0	316	Torque Limit Supervision Function: 0 = Not used 1 = Low limit 2 = High limit
P1.3.17	Torque Supv Lim	0.0	300.0	%	0.0	317	Torque Limit Supervision Value
P1.3.18	TempLim Supv Fct	0	2		0	318	Temperature Limit Supervision Function: 0 = Not used 1 = Low limit 2 = High limit
P1.3.19	TempLim Supv Lim	-50	170	°F	104	319	Temperature Limit Supervision value
P1.3.20	StartRlyON-Del.	0.0	100.0	s	0.0	320	Relay/Digital output ON-delay time after start-command is given.
P1.3.21	StartRlyOFF-Del.	0.0	100.0	s	0.0	321	Relay/Digital output OFF-delay time after stop-command is given.

Drive Control Parameters — M1 → G1.4**Table 9-5: Drive Control Parameters — M1 → G1.4**

Code	Parameter	Min.	Max.	Unit	Default	ID Number	Description
P1.4.1	Start Mode	0	1		0	401	0 = Ramp 1 = Flying start
P1.4.2	Stop Mode	0	1		1	402	0 = Coasting 1 = Ramp
P1.4.3	Brake Chopper	0	4		0	403	Brake Chopper Mode Selection. 0 = Brake NO, Test NO 1 = Brake YES(Run), Test YES (Ready+run) 2 = Brake chopper EXTERNAL, Test NO 3 = Brake YES(Ready+run), Test YES (Ready+run) 4 = Brake YES(Run), Test NO
P1.4.4	S-curve Time	0.0	10.0	s	0.0	404	Smooth ratio for S-curve

November 2009

Prohibit Frequencies— M1 → G1.5

Table 9-6: Prohibit Frequencies — M1 → G1.5

Code	Parameter	Min.	Max.	Unit	Default	ID Number	Description
P1.5.1	SkipF1 Low Lim	0.0	100.0	%	0.0	501	Prohibit speed range 1 low limit.
P1.5.2	SkipF1 High Lim	Range_1_Low_Lim	100.0	%	0.0	502	Prohibit speed range 1 high limit: 0 = No prohibit frequency range
P1.5.3	SkipF2 Low Lim	0.0	100.0	%	0.0	503	Prohibit speed range 2 low limit
P1.5.4	SkipF2 High Lim	Range_2_Low_Lim	100.0	%	0.0	504	Prohibit speed range 2 high limit: 0 = No prohibit frequency range
P1.5.5	SkipF3 Low Lim	0.0	100.0	%	0.0	505	Prohibit speed range 3 low limit
P1.5.6	SkipF3 High Lim	Range_3_Low_Lim	100.0	%	0.0	506	Prohibit speed range 3 high limit: 0 = No prohibit frequency range
P1.5.7	SkipF4 Low Lim	0.0	100.0	%	0.0	507	Prohibit speed range 4 low limit
P1.5.8	SkipF4 High Lim	Range_4_Low_Lim	100.0	%	0.0	508	Prohibit speed range 4 high limit: 0 = No prohibit frequency range
P1.5.9	SkipF5 Low Lim	0.0	100.0	%	0.0	509	Prohibit speed range 5 low limit
P1.5.10	SkipF5 High Lim	Range_5_Low_Lim	100.0	%	0.0	510	Prohibit speed range 5 high limit: 0 = No prohibit frequency range
P1.5.11	SkipF6 Low Lim	0.0	100.0	%	0.0	511	Prohibit speed range 6 low limit
P1.5.12	SkipF6 High Lim	Range_6_Low_Lim	100.0	%	0.0	512	Prohibit speed range 6 high limit: 0 = No prohibit frequency range
P1.5.13	PH Acc/Dec Ramp	0.1	10.0	x	1.0	513	Acceleration/Deceleration time factor to pass prohibit speed window.

Motor Control Parameters — M1 → G1.6**Table 9-7: Motor Control Parameters — M1 → G1.6**

Code	Parameter	Min.	Max.	Unit	Default	ID Number	Description
P1.6.1	Motor Ctrl Mode	0	1		0	601	Motor control mode: 0 = frequency control 1 = speed control
P1.6.2	V/Hz Optim.	0	1		0	602	V/F optimization selection: 0 = none 1 = automatic torque boost
P1.6.3	V/Hz Ratio	0	3		0	603	V/F ratio selection: 0 = linear 1 = squared 2 = programmable 3 = Linear with flux optim.
P1.6.4	Field WeakngPnt	8.00	320.00	Hz	60.00	604	Field weakening point.
P1.6.5	Voltage at FWP	10.00	200.00	%	100.00	605	Motor voltage (%*MotorNPVoltage) at field weakening point.
P1.6.6	V/Hz Mid Freq	0.00	Field Weakening Point	Hz	60.00	606	Programmable V/Hz curve middle point frequency.
P1.6.7	V/Hz Mid Voltg	0.00	100.00	%	100.00	607	Motor voltage (%*MotorNPVoltage) at programmable V/Hz curve middle point.
P1.6.8	Zero Freq Voltg	0.00	40.00	%	0.00	608	Motor voltage (%*MotorNPVoltage) at zero speed.
P1.6.9	Switching Freq	1.0	Switching FreqMax	kHz	3.6	609	Switching frequency in kHz. See Appendix A, Table A-1 .
P1.6.10	Overvolt Contr	0	2		1	610	0 = Off 1 = On with no ramping 2 = On with ramping
P1.6.11	Undervolt Contr	0	1		1	611	0 = Off 1 = On
P1.6.12	Identification	0	2		0	612	Identification run. When this parameter is set greater than zero, then start command must be given within 20 seconds.

November 2009

Protections — M1 → G1.7
Table 9-8: Protections — M1 → G1.7

Code	Parameter	Min.	Max.	Unit	Default	ID Number	Description
P1.7.1	Input Phase Supv	0	2		2	701	Response to input phase supervision. 0 = No Action 1 = Warning 2 = Fault
P1.7.2	4mA Fault Resp	0	2		0	702	Response to 4 mA signal supervision. 0 = No Action 1 = Warning 2 = Fault
P1.7.3	Ext. Fault Resp	0	2		2	703	Response to external fault digital input signal supervision. 0 = No Action 1 = Warning 2 = Fault
P1.7.4	FBComm. FaultResp	0	2		0	704	Response to fieldbus communication supervision. 0 = No Action 1 = Warning 2 = Fault
P1.7.5	SlotComFault Resp	0	2		0	705	Response to slot communication supervision. 0 = No Action 1 = Warning 2 = Fault
P1.7.6	Motor Therm Prot	0	3		0	707	0 = No response 1 = Warning 2 = Fault, stop mode after fault according to ID402 3 = Fault, stop mode after fault always by coasting
P1.7.7	MotAmbTemp Factor	-100.0	100.0	%	0.0	708	Percent of ambient temperature.
P1.7.8	MTP f0 Current	0.0	150.00	%	40.0	709	Percent of motor nameplate current.
P1.7.9	MTP Motor T	1	200	min	45	710	Time to reach 63% of final value.
P1.7.10	Motor Duty Cycle	0	100	%	100	711	Percent of nominal motor load.
P1.7.11	Stall Protection	0	3		0	712	0 = No response 1 = Warning 2 = Fault, stop mode after fault according to ID402 3 = Fault, stop mode after fault always by coasting
P1.7.12	Stall Current	0.00	Motor CurrentMax	A	1.00	713	
P1.7.13	Stall Time Lim	1.00	120.00	s	15.00	714	
P1.7.14	Stall Freq Lim	1.00	Max_Freq	Hz	25.00	715	

Tables 9-8: Protections — M1 → G1.7, continued

Code	Parameter	Min.	Max.	Unit	Default	ID Number	Description
P1.7.15	Underload Protection	0	3		0	716	0 = No response 1 = Warning 2 = Fault, stop mode after fault according to ID402 3 = Fault, stop mode after fault always by coasting
P1.7.16	UP f _{nom} Torque	10.0	150.00	%	50.0	717	Minimum torque allowed when above FWP.
P1.7.17	UP f ₀ Torque	5.0	150.00	%	10.0	718	Minimum torque allowed with zero frequency.
P1.7.18	UP Time Limit	2.00	600.00	s	20.00	719	
P1.7.19	Autom. Restart	0	3		0	706	Resets faults. See Page 15-20 . 0 = Disabled 1 = Automatically transferred to Bypass 2 = Reset drive only 3 = Reset drive, if fails, transferred to Bypass
P1.7.20	Fire Mode Speed	0	100.0	%	100	804	When fire mode input is triggered, drive will run at fire mode speed.

Fieldbus Parameters — M1 → G1.8**Table 9-9: Fieldbus Parameters — M1 → G1.8**

Code	Parameter	Min.	Max.	Unit	Default	ID Number	Description
P1.8.1	FB Data Out1 Sel	0	10000		1 ^①	1001	Fieldbus process data output 1 selection. Default = Actual Speed
P1.8.2	FB Data Out2 Sel	0	10000		5 ^①	1002	Fieldbus process data output 2 selection. Default = Motor Current
P1.8.3	FB Data Out3 Sel	0	10000		8 ^①	1003	Fieldbus process data output 3 selection. Default = Motor Voltage
P1.8.4	FB Data Out4 Sel	0	10000		7 ^①	1004	Fieldbus process data output 4 selection. Default = Motor Power
P1.8.5	FB Data Out5 Sel	0	10000		9 ^①	1005	Fieldbus process data output 5 selection. Default = DC-Link Voltage

^① ID number of parameter or variable to be sent over fieldbus. ID 1 – 20 are Monitoring values, Menu 7 (M7). See **Table 9-12**.

November 2009

Table 9-9: Fieldbus Parameters — M1 → G1.8, continued

Code	Parameter	Min.	Max.	Unit	Default	ID Number	Description
P1.8.6	FB Data Out6 Sel	0	10000		20 ^①	1006	Fieldbus process data output 6 selection. Default = Application Status Word (Variable:AppIStatusWord) b0 = Drive Ready b1 = Run Enable b2 = Drive Running b3 = Drive Reversing b4 = General Fault b5 = General Warning b6 = Preset Speed Active b7 = Motor Regulator active b8 = Output speed supervision indication b9 = Setpoint speed supervision indication b10 = HAND Control indication b11 = AUTO Control indication b12 = D-IN Firemode b13 = Damper control signal b14 = Bypass mode status indication b15 = Bypass running
P1.8.7	FB Data Out7 Sel	0	10000		18 ^①	1007	Fieldbus process data output 7 selection. Default = Active Fault Code
P1.8.8	FB Data Out8 Sel	0	10000		19 ^①	1008	Fieldbus process data output 8 selection. Default = Active Warning Code

^① ID number of parameter or variable to be sent over fieldbus. ID 1 – 20 are Monitoring values, Menu 7 (M7). See Table 9-12.

Preset Speeds — M1 → G1.10

Table 9-10: Preset Speeds — M1 → G1.10

Code	Parameter	Min.	Max.	Unit	Step	Default	ID Number	Description
P1.10.1	Preset Speed 1	0	100.0	%	0.1	30.0	1701	Preset speeds when Digital Inputs are programmed
P1.10.2	Preset Speed 2	0	100.0	%	0.1	40.0	1702	
P1.10.3	Preset Speed 3	0	100.0	%	0.1	50.0	1703	
P1.10.4	Preset Speed 4	0	100.0	%	0.1	60.0	1704	
P1.10.5	Preset Speed 5	0	100.0	%	0.1	70.0	1705	
P1.10.6	Preset Speed 6	0	100.0	%	0.1	80.0	1706	
P1.10.7	Preset Speed 7	0	100.0	%	0.1	90.0	1707	

Keypad Control Parameters — M2

This menu provides the parameters for the setting of the keypad speed setpoint, the selection of motor direction when in keypad operation, and when the STOP button is active.

Table 9-11: Keypad Control Parameters — M2

Code	Parameter	Min.	Max.	Unit	Default	ID Number ①	Description
R2.1	Speed Setpoint	0.0	100.0	%	0.0		Keypad Speed Setpoint.
P2.2	Keypad Direction	0	1		0	1009	Reverse request active from the panel 0 = Forward 1 = Reverse
P2.3	StopButton Active	0	1		1	1110	Stop button (Keypad) always active (Yes/No)

① Keypad Control Parameter ID Numbers are listed separately on **Page 15-28**.

Menus — M3 to M6

Menus M3 to M6 provide information on the Active Faults, Fault History, System Menu settings and the Expander Board setup. These menu items are explained in detail in **Chapter 6**.

Monitoring Menu — M7

The monitored items are the actual values of parameters and signals as well as the status and measurements of other elements. Monitored items cannot be edited.

See **Chapter 6** — Menu information item M7, for more information.

Table 9-12: Monitoring Menu

Code	Parameter	Min.	Max.	Unit	Default	ID Number	Description
V7.1	Output Frequency	-320.00	320.00	Hz	0.00	2	Output frequency to the motor
V7.2	Actual Speed	-320.0	320.0	%	0.0	1	Output speed to the motor
V7.3	Speed Setpoint	-320.0	320.0	%	0.0	3	Monitored speed setpoint. This will show also the speed setpoint below the minimum frequency.
V7.4	Motor Speed	-10000	10000	rpm	0	4	Calculated motor speed in rpm
V7.5	Motor Current	0.0	Motor CurrentMax	A	0.0	5	
V7.6	Motor Torque	-300.0	300.0	%	0.0	6	[R] Motor torque as % value, +1000 equals +100.0 % pos = clockwise, neg = counterclockwise
V7.7	Motor Power	-300.0	300.0	%	0.0	7	
V7.8	Motor Voltage	0.0	1000.0	V	0.0	8	Measured motor voltage
V7.9	DC-Bus Voltage	0	1000	V	0	9	[R] DC voltage in Volts Tfilt = 32ms.
V7.10	Unit Temperature	-120	570	°F	0	10	Temperature of the heat sink

November 2009

Table 9-12: Monitoring Menu, continued

Code	Parameter	Min.	Max.	Unit	Default	ID Number	Description
V7.11	Motor Temperature	0.0	1000.0	%	0.0	11	
V7.12	(A) AI-1	-10.00	20.00	V	0.00	12	Voltage Input value [V]
V7.13	(A) AI-2	-10.00	20.00	mA	0.00	13	Current Input value [mA]
V7.14	DI-1 DI-2 DI-3	0	7		0	14	DIA-1, DIA-2 and DIA-3 status
V7.15	DI-4 DI-5 DI-6	0	7		0	15	DIB-4, DIB-5 and DIB-6 status
V7.16	DO-1 RO-1 RO-2	0	7		0	16	DO-1, RO-1 and RO-2 status
V7.17	(A) AO-1	0.00	20.00	mA	0.00	17	
V7.18	ActFaultCode	0	200		0	18	Active Fault code.
V7.19	ActWarnCode	0	200		0	19	Active Warning code.
V7.20	Status Word	-32768	32767		0	20	b0 = Drive Ready b1 = Run Enable b2 = Drive Running b3 = Drive Reversing b4 = General Fault b5 = General Warning b6 = Preset Speed Active b7 = Motor Regulator active b8 = Output speed supervision indication b9 = Setpoint speed supervision indication b10 = HAND Control indication b11 = AUTO Control indication b12 = D-IN Firemode b13 = Damper control signal b14 = Bypass mode status indication b15 = Bypass running
G7.21	RO-1 RO-2 RO-3	0	7		0	21	Monitoring the OPTB5 relay outputs.
G7.22	Multimonitor	—	—		—	—	Displays three monitor values simultaneously

Operate Menu — M8

The Operate Menu provides an easy to use method of viewing key numerical Monitoring Menu items. It also allows the setting of the keypad frequency reference. See **Chapter 6** for more information.



November 2009

Chapter 10 — Generic PI Application (SVCHS201)

Introduction

The Generic PI Application is typically used to control levels of pumps and fans with a pressure transducer.

The direct frequency reference can be used for the control without the PI controller and is selected from the analog inputs, fieldbus, motor potentiometer or keypad.

The Generic PI Application is typically used to control levels or pumps and fans. In these applications, the Generic PI Application provides a smooth control and an integrated measurement and control package where no additional components are needed.

- Digital inputs DI-2, DI-3 and DI-5 and all outputs are freely programmable.

Additional functions:

- Analog input signal range selection
- One frequency limit supervision
- Torque limit supervision
- Speed setpoint limit supervision
- Programmable start and stop functions
- DC Brake Chopper
- Six skip frequency areas
- Programmable V/Hz curve and switching frequency
- Auto restart
- Motor thermal and stall protection: Programmable action; off, warning, fault
- Motor underload protection
- Input and output phase supervision

Details of the parameters shown in this section are available in **Chapter 15** of this Manual, listed by parameter ID number.

Control Input/Output

Table 10-1: Generic PI Application Default I/O Configuration

Terminal	Signal	Description
OPTA9		
1	+10V DC _{ref}	Reference output Voltage for potentiometer, etc.
2	AI-1+	Analog input, voltage range 0 – 10V DC Voltage input for PI setpoint or feedback (Programmable)
3	AI-1-	I/O Ground Ground for reference and controls
4	AI-2+	Analog input, current range 0 – 20 mA Current input for PI setpoint or feedback (Programmable)
5	AI-2-	I/O Ground Ground for reference and controls
6	24V DC	Control voltage output Voltage for switches, etc. max 0.1A
7	GND	I/O ground Ground for reference and controls
8	DI-1	Start/Stop Control Contact closed = start
9	DI-2	External fault input (programmable) Contact closed = fault Contact open = no fault
10	DI-3	External Interlock (programmable) Contact closed = OK Open = Interlocked
11	CMA	Common for DI-1 – DI-3 Connect to GND or 24V DC
12	24V DC	Control voltage output Voltage for switches (see terminal 6)
13	GND	I/O ground Ground for reference and controls
14	DI-4	Speed Select 1 (programmable) Contact closed = Speed Select 1
15	DI-5	Fire Mode (programmable) Contact closed = Fire Mode active
16	DI-6	Overload relay (IntelliPass) (programmable) Contact open = no fault Contact closed = fault
17	CMB	Common for DI-4 – DI-6 Connect to GND or 24V DC
18	AO-1+	Output frequency Analog output Programmable Range 0 – 20 mA, R _L max. 500Ω
19	AO-1	I/O Ground Ground for reference and controls
20	DO-1	Digital output READY Programmable Open collector, I ≤ 50 mA, V ≤ 48V DC
OPTA2		
21-22 Opens on RUN	21 RO-1	Relay output 1 Programmable Drive RUN is default.
22-23 Closes on RUN	22 RO-1	
	23 RO-1	
24-25 Opens on FAULT	24 RO-2	Relay output 2 Programmable Drive FAULT is default.
25-26 Closes on FAULT	25 RO-2	
	26 RO-2	

Note: For more information on jumper selections, see **Chapter 4**.

X3 Jumper Setting — CMA and CMB Grounding

- CMB Connected to Ground
CMA Connected to Ground
- CMB Isolated from Ground
CMA Isolated from Ground
- CMA and CMB Internally Connected
and Isolated from Ground

CAUTION

Unattended start will occur if power is supplied with Start Command activated.

November 2009

Parameter Lists

On the next pages you will find the lists of parameters within the respective parameter groups. The parameter descriptions are given by ID number in **Chapter 15**.

Column explanations:

- Code = Location indication on the keypad; Shows the operator the present parameter number
- Parameter = Name of parameter
- Min. = Minimum value of parameter
- Max. = Maximum value of parameter
- Unit = Unit of parameter value; Given if available
- Default = Value preset by factory
- ID = ID number of the parameter for reference to **Chapter 15**

Quick Setup Parameters — M1 → G1.1

Table 10-2: Quick Setup Parameters — M1 → G1.1

Code	Parameter	Min.	Max.	Unit	Default	ID Number	Description
P1.1.1	Min Frequency	0.00	Max_Frequency	Hz	12.00	101	Minimum output frequency, f[Hz].
P1.1.2	Max Frequency	FreqMin	320.00	Hz	60.00	102	Maximum output frequency, f[Hz].
P1.1.3	Acceleration Time	0.1	3000.0	s	60.0	103	Time from 0 Hz to maximum Hz.
P1.1.4	Deceleration Time	0.1	3000.0	s	60.0	104	Time from maximum Hz to 0 Hz.
P1.1.5	Motor NP Voltg	180	Motor VoltageMax	V	400	105	Motor nameplate voltage in Volts.
P1.1.6	Motor NP Freq	8.00	320.00	Hz	60.00	106	Motor nameplate frequency in Hertz.
P1.1.7	Motor Nom Speed	24	20000	rpm	1720	111	Motor nameplate speed in Rpm.
P1.1.8	Motor Nom Currnt	Motor CurrentMin	Motor CurrentMax	A	5.40	108	Motor nameplate current, I[A]
P1.1.9	Power Factor	0.30	1.00		0.85	109	Motor power factor. (Cos Phi)
P1.1.10	Service Factor	0.10	2.00		1.00	110	Motor service factor. This will calculate the motor current limit. (MotorNomCurrent x Service Factor)
P1.1.11	Current Limit	Motor CurrentMin	Motor CurrentMax	A	7.00	107	Output current limit of the unit in Amps.
P1.1.12	Start Srce Hand	1	3		1	112	Parameter for Local Start/Stop/Reverse control location. Default = Keypad 1 = Keypad 2 = DI-1 Start 3 = I/O Three Wire

Table 10-2: Quick Setup Parameters — M1 → G1.1, continued

Code	Parameter	Min.	Max.	Unit	Default	ID Number	Description
P1.1.13	StPt Source Hand	0	3		2	113	Local speed setpoint selection: 0 = analog input AI-1 1 = analog input AI-2 2 = Speed Setpoint from Keypad 3 = Motor Potentiometer
P1.1.14	Start Srce Auto	1	4		2	114	Parameter for Remote Start/Stop/Reverse control location. Default = DI-1 Start 1 = Keypad 2 = DI-1 Start 3 = I/O Three Wire 4 = Fieldbus
P1.1.15	StPt Source Auto	0	4		0	115	PI-setpoint selection: 0 = analog input AI-1 1 = analog input AI-2 2 = PI Setpoint from Keypad 3 = Motor Potentiometer 4 = PI Setpoint from Fieldbus
P1.1.16	PI-Input Source	0	2		0	1106	PI-Controller Input Source Selection: Default #0 = (A) AI-1 0 = (A) AI-1 1 = (A) AI-2 2 = Fieldbus, Process Data 1 3 = Min. Both 4 = Max. Both 5 = Ave. Both
P1.1.17	PI-Contr. P-Gain	0.00	10.00		0.10	1109	P-Term (Gain) for the PI-Controller
P1.1.18	PI-Contr. I-Time	0.00	320.00	s	30.00	1110	I-Term (Integral Time) for the PI-controller
P1.1.19	PI-Deadband	0.0	100.0	%	0.0	1111	Deadband for the PI-controller
P1.1.20	PI-Mode	0	1		0	1112	PI-controller acting mode
P1.1.21	AutoAccelTime	0.1	3000.0	s	60.0	1113	Acceleration time, when in AUTO mode
P1.1.22	AutoDecelTime	0.1	3000.0	s	60.0	1114	Deceleratin time, when in AUTO mode

November 2009

Input Signals — M1 → G1.2

Table 10-3: Input Signals — M1 → G1.2

Code	Parameter	Min.	Max.	Unit	Default	ID Number	Description
P1.2.1	Start Mode	0	3		1	201	Start Function: 0 = Normal start without interlockings. 1 = Interlocked start. One of the digital inputs must be programmed to Intlk/RunEna. DI-3 is defaulted for this feature. 2 = Mode 1 + timeout supervision. If the interlock is not OK within the interlock timeout time, start request is ignored and must be given again. 3 = Delayed start. Start request is given after delay time has expired.
P1.2.2	Intlk Stop Mode	0	1		1	216	0 = Coasting 1 = Ramp
P1.2.3	Intlk Timeout	0.00	300.00	s	5.00	202	Interlock timeout time for Start Function #2. Default = 5s.
P1.2.4	Start Delay Time	0.00	300.00	s	5.00	203	Start delay time for Start Function #3. Default = 5s.
P1.2.5	(A) DI-2 Funct.	0	17		1	204	Default #1 External Fault Close 0 = Stop pulse, when 3-wire start/stop logic is selected. (False=Stop, True=Ready to Run) 1 = Ext. fault, closing contact 2 = External fault, opening contact 3 = Fault reset 4 = Run enable-Closed Contact 5 = Force ctrl. place to Hand 6 = Force ctrl. place to Auto 7 = Reverse 8 = Speed Select 1 9 = Fire Mode-Closed Contact 10 = Speed Select 2 11 = Speed Select 3 12 = Force Bypass 13 = External interlock closed 14 = External interlock open 15 = Mot. Pot. UP 16 = Mot. Pot. DOWN 17 = Fire Mode-Open Contact

CAUTION

Unattended start will occur if power is supplied with Start Command activated.

Table 10-3: Input Signals — M1 → G1.2, continued

Code	Parameter	Min.	Max.	Unit	Default	ID Number	Description
P1.2.6	(A) DI-3 Funct.	0	17		13	205	Default #13 Interlock/Run Enable 0 = Not Used 1 = Ext. fault, closing contact 2 = External fault, opening contact 3 = Fault reset 4 = Run enable-Closed Contact 5 = Force ctrl. place to Hand 6 = Force ctrl. place to Auto 7 = Reverse 8 = Speed Select 1 9 = Fire Mode-Closed Contact 10 = Speed Select 2 11 = Speed Select 3 12 = Force Bypass 13 = External interlock closed 14 = External interlock open 15 = Mot. Pot. UP 16 = Mot. Pot. DOWN 17 = Fire Mode-Open Contact
P1.2.7	(A) DI-4 Funct.	0	17		8	206	Default #8 Speed Select 1 0 = Not Used 1 = Ext. fault, closing contact 2 = External fault, opening contact 3 = Fault reset 4 = Run enable-Closed Contact 5 = Force ctrl. place to Hand 6 = Force ctrl. place to Auto 7 = Reverse 8 = Speed Select 1 9 = Fire Mode-Closed Contact 10 = Speed Select 2 11 = Speed Select 3 12 = Force Bypass 13 = External interlock closed 14 = External interlock open 15 = Mot. Pot. UP 16 = Mot. Pot. DOWN 17 = Fire Mode-Open Contact

November 2009

Table 10-3: Input Signals — M1 → G1.2, continued

Code	Parameter	Min.	Max.	Unit	Default	ID Number	Description
P1.2.8	(A) DI-5 Funct.	0	17		9	207	Default #9 Fire-Mode 0 = Not Used 1 = Ext. fault, closing contact 2 = External fault, opening contact 3 = Fault reset 4 = Run enable-Closed Contact 5 = Force ctrl. place to Hand 6 = Force ctrl. place to Auto 7 = Reverse 8 = Speed Select 1 9 = Fire Mode-Closed Contact 10 = Speed Select 2 11 = Speed Select 3 12 = Force Bypass 13 = External interlock closed 14 = External interlock open 15 = Mot. Pot. UP 16 = Mot. Pot. DOWN 17 = Fire Mode-Open Contact
P1.2.9	(A) DI-6 Funct.	0	17		0	208	Default #0 Overload Fault Relay-input 0 = Overload fault relay (Used in Intellipass) 1 = Ext. fault, closing contact 2 = External fault, opening contact 3 = Fault reset 4 = Run enable-Closed Contact 5 = Force ctrl. place to Hand 6 = Force ctrl. place to Auto 7 = Reverse 8 = Speed Select 1 9 = Fire Mode-Closed Contact 10 = Speed Select 2 11 = Speed Select 3 12 = Force Bypass 13 = External interlock closed 14 = External interlock open 15 = Mot. Pot. UP 16 = Mot. Pot. DOWN 17 = Fire Mode-Open Contact
P1.2.10	(A) AI-1 Minimum	0.00	Max.	%	0.00	217	Default applies for 0V or 0 mA
P1.2.11	(A) AI-1 Maximum	Min.	100.0	%	100.00	218	Default applies for 10V or 20 mA
P1.2.12	(A) AI-1 Invert	0	1		0	209	0 = Not inverted 1 = Inverted
P1.2.13	(A) AI-1 Filter	0.00	10.00	s	0.10	210	0 = No filtering
P1.2.14	(A) AI-2 Minimum	0.00	Max.	%	20.00	219	Default applies for 2V or 4 mA

Table 10-3: Input Signals — M1 → G1.2, continued

Code	Parameter	Min.	Max.	Unit	Default	ID Number	Description
P1.2.15	(A) AI-2 Maximum	Min.	100.0	%	100.00	220	Default applies for 10V or 20 mA
P1.2.16	(A) AI-2 Invert	0	1		0	212	0 = Not inverted 1 = Inverted
P1.2.17	(A) AI-2 Filter	0.00	10.00	s	0.10	213	0 = No filtering
P1.2.18	StPt. Scale Min	0.0	100.0	%	0.0	214	Speed that corresponds to the minimum setpoint signal.
P1.2.19	StPt. Scale Max	0.0	100.0	%	0.0	215	Speed that corresponds to the maximum setpoint signal. 0.0%=NOT IN USE!
P1.2.20	MotPotStPt Memory	0	1		0	221	Parameter to select reset function for motor potentiometer speed setpoint. Default: No reset.

Output Signals — M1 → G1.3**Table 10-4: Output Signals — M1 → G1.3**

Code	Parameter	Min.	Max.	Unit	Default	ID Number	Description
P1.3.1	(A) AO-1 Funct.	0	8		1	301	Analog output function: 0 = FB-Control (Fieldbus Passthrough, ProcessDataIN3) 1 = O/P frequency (0 - f max) 2 = Reference frequency (0 - f max) 3 = Motor speed (0 - 100% x Motor nom. speed) 4 = O/P current (0 - 100% x I nMot) 5 = Motor torque (0 - 100% x T nMot) 6 = Motor power (0 - 100% x P nMot) 7 = Motor voltage (0 - 100% x U nMot) 8 = DC-Bus Voltage (0 - 100% x U nMot)
P1.3.2	(A) AO-1 Filter	0.00	10.00	s	1.00	302	
P1.3.3	(A) AO-1 Invert	0	1		0	303	0 = Not inverted 1 = Inverted
P1.3.4	(A) AO-1 Min.	0	1		0	304	0 = 0 mA 1 = 4 mA
P1.3.5	(A) AO-1 Scale	10	1000	%	100	305	

November 2009

Table 10-4: Output Signals — M1 → G1.3, continued

Code	Parameter	Min.	Max.	Unit	Default	ID Number	Description
P1.3.6	(A) DO-1 Funct.	0	26		1	306	Default=Drive Ready 0 = Not used 1 = Drive Ready 2 = Drive Running 3 = General Fault 4 = General Fault inverted 5 = Drive overheat warning 6 = External fault or warning 7 = Reference (4mA) fault or warning 8 = General Warning 9 = Drive Reversing 10 = Preset Speed Active 11 = Speed setpoint=Actual Speed (=At speed) 12 = Motor regulator activated 13 = Actual Speed limit supervision 14 = Speed Setpoint limit supervision 15 = Torque limit supervision 16 = Timer On/Timer Off output control (Trigger is run request) 17 = Selections #16 inverted 18 = Frequency converter temperature limit supervision 19 = Unrequested rotation direction 20 = Thermistor fault / warning 21 = Hand Control Active 22 = Auto Control Active 23 = DI-Fire Mode Active 24 = Relay to energize an external element before starting the drive. 25 = FB-Control 26 = Bypass Run
P1.3.7	(B) RO-1 Funct.	0	25		2	307	Same as parameter 1.3.6.
P1.3.8	(B) RO-2 Funct.	0	25		3	308	Same as parameter 1.3.6
P1.3.9	(D) RO-1 Funct.	0	25		0	309	Same as parameter 1.3.6
P1.3.10	(D) RO-2 Funct.	0	25		0	310	Same as parameter 1.3.6
P1.3.11	(D) RO-3 Funct.	0	25		0	311	Same as parameter 1.3.6
P1.3.12	Sp.StPt Supv Fct	0	2		0	312	Speed Setpoint Supervision Function: 0 = Not used 1 = Low limit 2 = High limit
P1.3.13	Sp.StPt Supv Lim	0.0	100.0	%	0.0	313	Speed Setpoint Supervision Value.

Table 10-4: Output Signals — M1 → G1.3, continued

Code	Parameter	Min.	Max.	Unit	Default	ID Number	Description
P1.3.14	Act.Sp. Supv Fct	0	2		0	314	Actual Speed Supervision Function: 0 = Not used 1 = Low limit 2 = High limit
P1.3.15	Act.Sp. Supv Lim	0.0	100.0	%	0.0	315	Actual Speed Supervision Value. (±1.0% hysteresis)
P1.3.16	Torque Supv Fct	0	2		0	316	Torque Limit Supervision Function: 0 = Not used 1 = Low limit 2 = High limit
P1.3.17	Torque Supv Lim	0.0	300.0	%	0.0	317	Torque Limit Supervision Value
P1.3.18	TempLim Supv Fct	0	2		0	318	Temperature Limit Supervision Function: 0 = Not used 1 = Low limit 2 = High limit
P1.3.19	TempLim Supv Lim	-50	170	°F	104	319	Temperature Limit Supervision value
P1.3.20	StartRlyON-Del.	0.0	100.0	s	0.0	320	Relay/Digital output ON-delay time after start-command is given.
P1.3.21	StartRlyOFF-Del.	0.0	100.0	s	0.0	321	Relay/Digital output OFF-delay time after stop-command is given.

Drive Control Parameters — M1 → G1.4**Table 10-5: Drive Control Parameters — M1 → G1.4**

Code	Parameter	Min.	Max.	Unit	Default	ID Number	Description
P1.4.1	Start Mode	0	1		0	401	0 = Ramp 1 = Flying start
P1.4.2	Stop Mode	0	1		1	402	0 = Coasting 1 = Ramp
P1.4.3	Brake Chopper	0	4		0	403	Brake Chopper Mode Selection. 0 = Brake NO, Test NO 1 = Brake YES(Run), Test YES (Ready+run) 2 = Brake chopper EXTERNAL, Test NO 3 = Brake YES(Ready+run), Test YES (Ready+run) 4 = Brake YES(Run), Test NO
P1.4.4	S-curve Time	0.0	10.0	s	0.0	404	Smooth ratio for S-curve

November 2009

Prohibit Frequencies— M1 → G1.5

Table 10-6: Prohibit Frequencies — M1 → G1.5

Code	Parameter	Min.	Max.	Unit	Default	ID Number	Description
P1.5.1	SkipF1 Low Lim	0.0	100.0	%	0.0	501	Prohibit speed range 1 low limit.
P1.5.2	SkipF1 High Lim	Range_1_Low_Lim	100.0	%	0.0	502	Prohibit speed range 1 high limit: 0 = No prohibit frequency range
P1.5.3	SkipF2 Low Lim	0.0	100.0	%	0.0	503	Prohibit speed range 2 low limit
P1.5.4	SkipF2 High Lim	Range_2_Low_Lim	100.0	%	0.0	504	Prohibit speed range 2 high limit: 0 = No prohibit frequency range
P1.5.5	SkipF3 Low Lim	0.0	100.0	%	0.0	505	Prohibit speed range 3 low limit
P1.5.6	SkipF3 High Lim	Range_3_Low_Lim	100.0	%	0.0	506	Prohibit speed range 3 high limit: 0 = No prohibit frequency range
P1.5.7	SkipF4 Low Lim	0.0	100.0	%	0.0	507	Prohibit speed range 4 low limit
P1.5.8	SkipF4 High Lim	Range_4_Low_Lim	100.0	%	0.0	508	Prohibit speed range 4 high limit: 0 = No prohibit frequency range
P1.5.9	SkipF5 Low Lim	0.0	100.0	%	0.0	509	Prohibit speed range 5 low limit
P1.5.10	SkipF5 High Lim	Range_5_Low_Lim	100.0	%	0.0	510	Prohibit speed range 5 high limit: 0 = No prohibit frequency range
P1.5.11	SkipF6 Low Lim	0.0	100.0	%	0.0	511	Prohibit speed range 6 low limit
P1.5.12	SkipF6 High Lim	Range_6_Low_Lim	100.0	%	0.0	512	Prohibit speed range 6 high limit: 0 = No prohibit frequency range
P1.5.13	PH Acc/Dec Ramp	0.1	10.0	x	1.0	513	Acceleration/Deceleration time factor to pass prohibit speed window.

Motor Control Parameters — M1 → G1.6**Table 10-7: Motor Control Parameters — M1 → G1.6**

Code	Parameter	Min.	Max.	Unit	Default	ID Number	Description
P1.6.1	Motor Ctrl Mode	0	1		0	601	Motor control mode: 0 = frequency control 1 = speed control
P1.6.2	V/Hz Optim.	0	1		0	602	V/F optimization selection: 0 = none 1 = automatic torque boost
P1.6.3	V/Hz Ratio	0	3		0	603	V/F ratio selection: 0 = linear 1 = squared 2 = programmable 3 = Linear with flux optim.
P1.6.4	Field WeakngPnt	8.00	320.00	Hz	60.00	604	Field weakening point.
P1.6.5	Voltage at FWP	10.00	200.00	%	100.00	605	Motor voltage (%*MotorNPVoltage) at field weakening point.
P1.6.6	V/Hz Mid Freq	0.00	Field Weakening Point	Hz	60.00	606	Programmable V/Hz curve middle point frequency.
P1.6.7	V/Hz Mid Voltg	0.00	100.00	%	100.00	607	Motor voltage (%*MotorNPVoltage) at programmable V/Hz curve middle point.
P1.6.8	Zero Freq Voltg	0.00	40.00	%	0.00	608	Motor voltage (%*MotorNPVoltage) at zero speed.
P1.6.9	Switching Freq	1.0	Switching FreqMax	kHz	3.6	609	Switching frequency in kHz. See Appendix A, Table A-1 .
P1.6.10	Overvolt Contr	0	2		1	610	0 = Off 1 = On with no ramping 2 = On with ramping
P1.6.11	Undervolt Contr	0	1		1	611	0 = Off 1 = On
P1.6.12	Identification	0	2		0	612	Identification run. When this parameter is set greater than zero, then start command must be given within 20 seconds.

November 2009

Protections — M1 → G1.7
Table 10-8: Protections — M1 → G1.7

Code	Parameter	Min.	Max.	Unit	Default	ID Number	Description
P1.7.1	Input Phase Supv	0	2		2	701	Response to input phase supervision. 0 = No Action 1 = Warning 2 = Fault
P1.7.2	4mA Fault Resp	0	2		0	702	Response to 4 mA signal supervision. 0 = No Action 1 = Warning 2 = Fault
P1.7.3	Ext. Fault Resp	0	2		2	703	Response to external fault digital input signal supervision. 0 = No Action 1 = Warning 2 = Fault
P1.7.4	FBComm. FaultResp	0	2		0	704	Response to fieldbus communication supervision. 0 = No Action 1 = Warning 2 = Fault
P1.7.5	SlotComFault Resp	0	2		0	705	Response to slot communication supervision. 0 = No Action 1 = Warning 2 = Fault
P1.7.6	Motor Therm Prot	0	3		0	707	0 = No response 1 = Warning 2 = Fault, stop mode after fault according to ID402 3 = Fault, stop mode after fault always by coasting
P1.7.7	MotAmbTemp Factor	-100.0	100.0	%	0.0	708	Percent of ambient temperature.
P1.7.8	MTP f0 Current	0.0	150.00	%	40.0	709	Percent of motor nameplate current.
P1.7.9	MTP Motor T	1	200	min	45	710	Time to reach 63% of final value.
P1.7.10	Motor Duty Cycle	0	100	%	100	711	Percent of nominal motor load
P1.7.11	Stall Protection	0	2		0	712	0 = No response 1 = Warning 2 = Fault, stop mode after fault according to ID402 3 = Fault, stop mode after fault always by coasting
P1.7.12	Stall Current	0.00	Motor CurrentMax	A	1.00	713	
P1.7.13	Stall Time Lim	1.00	120.00	s	15.00	714	
P1.7.14	Stall Freq Lim	1.00	Max_Freq	Hz	25.00	715	

Tables 10-8: Protections — M1 → G1.7, continued

Code	Parameter	Min.	Max.	Unit	Default	ID Number	Description
P1.7.15	Underload Protection	0	3		0	716	0 = No response 1 = Warning 2 = Fault, stop mode after fault according to ID402 3 = Fault, stop mode after fault always by coasting
P1.7.16	UP f _{nom} Torque	10.0	150.00	%	50.0	717	Minimum torque allowed when above FWP.
P1.7.17	UP f ₀ Torque	5.0	150.00	%	10.0	718	Minimum torque allowed with zero frequency.
P1.7.18	UP Time Limit	2.00	600.00	s	20.00	719	
P1.7.19	Autom. Restart	0	3		0	706	Resets faults. See Page 15-20 . 0 = Disabled 1 = Automatically transferred to Bypass 2 = Reset drive only 3 = Reset drive, if fails, transferred to Bypass
P1.7.20	Fire Mode Speed	0	100.0	%	100	804	When fire mode input is triggered, drive will run at fire mode speed.

Fieldbus Parameters — M1 → G1.8**Table 10-9: Fieldbus Parameters — M1 → G1.8**

Code	Parameter	Min.	Max.	Unit	Default	ID Number	Description
P1.8.1	FB Data Out1 Sel	0	10000		1 ^①	1001	Fieldbus process data output 1 selection. Default = Actual Speed
P1.8.2	FB Data Out2 Sel	0	10000		5 ^①	1002	Fieldbus process data output 2 selection. Default = Motor Current
P1.8.3	FB Data Out3 Sel	0	10000		8 ^①	1003	Fieldbus process data output 3 selection. Default = Motor Voltage
P1.8.4	FB Data Out4 Sel	0	10000		7 ^①	1004	Fieldbus process data output 4 selection. Default = Motor Power
P1.8.5	FB Data Out5 Sel	0	10000		9 ^①	1005	Fieldbus process data output 5 selection. Default = DC-Link Voltage

^① ID number of parameter or variable to be sent over fieldbus. ID 1 – 20 are Monitoring values, Menu 7 (M7). See **Table 10-13**.

November 2009

Table 10-9: Fieldbus Parameters — M1 → G1.8, continued

Code	Parameter	Min.	Max.	Unit	Default	ID Number	Description
P1.8.6	FB Data Out6 Sel	0	10000		20 ^①	1006	Fieldbus process data output 6 selection. Default = Application Status Word (Variable:AppIStatusWord) b0 = Drive Ready b1 = Run Enable b2 = Drive Running b3 = Drive Reversing b4 = General Fault b5 = General Warning b6 = Preset Speed Active b7 = Motor Regulator active b8 = Output speed supervision indication b9 = Setpoint speed supervision indication b10 = HAND Control indication b11 = AUTO Control indication b12 = D-IN Firemode b13 = Damper control signal b14 = Bypass mode status indication b15 = Bypass running
P1.8.7	FB Data Out7 Sel	0	10000		18 ^①	1007	Fieldbus process data output 7 selection. Default = Active Fault Code
P1.8.8	FB Data Out8 Sel	0	10000		19 ^①	1008	Fieldbus process data output 8 selection. Default = Active Warning Code

^① ID number of parameter or variable to be sent over fieldbus. ID 1 – 20 are Monitoring values, Menu 7 (M7). See Table 10-13.

PI-Control Parameters — M1 → G1.9**Table 10-10: PI-Control Parameters — M1 → G1.9**

Code	Parameter	Min.	Max.	Unit	Default	ID Number	Description
P1.9.1	Setpoint Min.	Sensor_Min	PI_Setpoint_Max	%	0.0	1102	Minimum limit for the PI-Controller setpoint.
P1.9.2	Setpoint Max.	PI_Setpoint_Min	Sensor_Max	%	100.0	1103	Maximum limit for the PI-Controller setpoint.
P1.9.3	PI-Input Source	0	5		0	1106	PI-Controller Input Source Selection: Default #0 = (A) AI-1 0 = (A) AI-1 1 = (A) AI-2 2 = Fieldbus, ProcessData1 3 = Min. Both 4 = Max. Both 5 = Ave. Both
P1.9.4	PI-StPt Ramp Time	0.00	20.00	s	1.00	1104	Parameter for the PI-Setpoint ramp time.
P1.9.5	PI-Contr. P-Gain	0.00	10.00		0.10	1109	P-Term (Gain) for the PI-controller.
P1.9.6	PI-Contr. I-Time	0.00	320.00		30.00	1110	I-Term (Integral Time) for the PI-controller.
P1.9.7	Deadband	0.0	100.0	%	0.0	1111	Deadband for the PI-controller
P1.9.8	PI Acting Mode	0	1		1	1112	PI-controller acting mode. 0 = Reverse acting 1 = Forward acting
P1.9.9	Auto Accel. Time	0.1	3000.0	s	60.0	1113	Auto Mode Accel. Time
P1.9.10	Auto Decel. Time	0.1	3000.0	s	60.0	1114	Auto Mode Decel. Time
P1.9.11	Auto S-Curve Time	0.0	10.0	s	0.0	1115	Auto Mode and PI-control is NOT active

Preset Speeds — M1 → G1.10**Table 10-11: Preset Speeds — M1 → G1.10**

Code	Parameter	Min.	Max.	Unit	Step	Default	ID Number	Description
P1.10.1	Preset Speed 1	0	100.0	%	0.1	30.0	1701	Preset speeds when Digital Inputs are programmed
P1.10.2	Preset Speed 2	0	100.0	%	0.1	40.0	1702	
P1.10.3	Preset Speed 3	0	100.0	%	0.1	50.0	1703	
P1.10.4	Preset Speed 4	0	100.0	%	0.1	60.0	1704	
P1.10.5	Preset Speed 5	0	100.0	%	0.1	70.0	1705	
P1.10.6	Preset Speed 6	0	100.0	%	0.1	80.0	1706	
P1.10.7	Preset Speed 7	0	100.0	%	0.1	90.0	1707	

November 2009

Keypad Control Parameters — M2

This menu provides the parameters for the setting of the keypad speed setpoint, the selection of motor direction when in keypad operation, and when the STOP button is active.

Table 10-12: Keypad Control Parameters — M2

Code	Parameter	Min.	Max.	Unit	Default	ID Number ^①	Description
R2.1	Speed Setpoint	0.0	100.0	%	0.0		Keypad Speed Setpoint.
P2.2	Keypad Direction	0	1		0	1009	Reverse request active from the panel 0 = Forward 1 = Reverse
P2.3	StopButton Active	0	1		1	1110	Stop button (Keypad) always active (Yes/No)
R2.4	PI-Setpoint	PI_Setpoint_Min	PI_Setpoint_Max	%	0.0		
P2.5	PI-Setpoint Default	PI_Setpoint_Min	PI_Setpoint_Max			1011	PI-regulators default setpoint

^① Keypad Control Parameter ID Numbers are listed separately on Page 15-28.

Menus — M3 to M6

Menus M3 to M6 provide information on the Active Faults, Fault History, System Menu settings and the Expander Board setup. These menu items are explained in detail in Chapter 6.

Monitoring Menu — M7

The monitored items are the actual values of parameters and signals as well as the status and measurements of other elements. Monitored items cannot be edited.

See Chapter 6 — Menu information item M7, for more information.

Table 10-13: Monitoring Menu

Code	Parameter	Min.	Max.	Unit	Default	ID Number	Description
V7.1	Output Frequency	-320.00	320.00	Hz	0.00	2	Output frequency to the motor
V7.2	Actual Speed	-320.0	320.0	%	0.0	1	Output speed to the motor
V7.3	Speed Setpoint	-320.0	320.0	%	0.0	3	Monitored speed setpoint. This will show also the speed setpoint below the minimum frequency.
V7.4	Motor Speed	-10000	10000	rpm	0	4	Calculated motor speed in rpm
V7.5	Motor Current	0.0	Motor CurrentMax	A	0.0	5	
V7.6	Motor Torque	-300.0	300.0	%	0.0	6	[R] Motor torque as % value, +1000 equals +100.0 % pos = clockwise, neg = counterclockwise
V7.7	Motor Power	-300.0	300.0	%	0.0	7	
V7.8	Motor Voltage	0.0	1000.0	V	0.0	8	Measured motor voltage

Table 10-13: Monitoring Menu, continued

Code	Parameter	Min.	Max.	Unit	Default	ID Number	Description
V7.9	DC-Bus Voltage	0	1000	V	0	9	[R] DC voltage in Volts Tfilt = 32ms.
V7.10	Unit Temperature	-1000	1000	°F	0	10	Temperature of the heat sink
V7.11	Motor Temperature	0.0	1000.0	%	0.0	11	
V7.12	(A) AI-1	-10.00	20.00	V	0.00	12	Voltage Input value [V]
V7.13	(A) AI-2	-10.00	20.00	mA	0.00	13	Current Input value [mA]
V7.14	DI-1 DI-2 DI-3	0	7		0	14	DIA-1, DIA-2 and DIA-3 status
V7.15	DI-4 DI-5 DI-6	0	7		0	15	DIB-4, DIB-5 and DIB-6 status
V7.16	DO-1 RO-1 RO-2	0	7		0	16	DO-1, RO-1 and RO-2 status
V7.17	(A) AO-1	0.00	20.00	mA	0.00	17	
V7.18	ActFaultCode	0	200		0	18	Active Fault code.
V7.19	ActWarnCode	0	200		0	19	Active Warning code.
V7.20	Status Word	-32768	32767		0	20	b0 = Drive Ready b1 = Run Enable b2 = Drive Running b3 = Drive Reversing b4 = General Fault b5 = General Warning b6 = Preset Speed Active b7 = Motor Regulator Active b8 = Output speed supervision indication b9 = Setpoint speed supervision indication b10 = HAND Control indication b11 = AUTO Control indication b12 = D-IN Firemode b13 = Damper control signal b14 = Bypass mode status indication b15 = Bypass running
V7.21	PI-Setpoint	0.0	100.0	%	0.0	21	
V7.22	PI-Input	0.0	100.0	%	0.0	22	Actual Sensor Value
V7.23	PI-Error	0.0	100.0	%	0.0	23	
V7.24	PI-Output	0.0	100.0	%	0.0	24	
V7.25 ^①	RO-1 RO-2 RO-3	0	7		0	25	Monitoring the OPTB5 relay outputs.
G7.26	Multimonitor	—	—		—	—	Displays three monitor values simultaneously

^① When OPTB5 is not installed in option slot C, this in not displayed.

Operate Menu — M8

The Operate Menu provides an easy to use method of viewing key numerical Monitoring Menu items. It also allows the setting of the keypad frequency reference. See **Chapter 6** for more information.

November 2009

Chapter 11 — Duct Static Application (SVCHS202)

Introduction

The Duct Static Application is typically used to control fans with a pressure transducer and provide WC/PA units to a keypad.

The direct frequency reference can be used for the control without the PI controller and is selected from the analog inputs, fieldbus, motor potentiometer or keypad.

The Duct Static Application is typically used to control Duct pressure. In these applications, the Duct Static Application provides a smooth control and an integrated measurement and control package where no additional components are needed.

- Digital inputs DI-2, DI-3 and DI-5 and all outputs are freely programmable.

Additional functions:

- Analog input signal range selection
- One frequency limit supervision
- Torque limit supervision
- Speed setpoint limit supervision
- Programmable start and stop functions
- DC Brake Chopper
- Six skip frequency areas
- Programmable V/Hz curve and switching frequency
- Auto restart
- Motor thermal and stall protection: Programmable action; off, warning, fault
- Motor underload protection
- Input and output phase supervision

Details of the parameters shown in this section are available in **Chapter 15** of this Manual, listed by parameter ID number.

Control Input/Output

Table 11-1: Duct Static Application Default I/O Configuration

Terminal	Signal	Description
OPTA9		
1	+10V DC _{ref}	Reference output Voltage for potentiometer, etc.
2	AI-1+	Analog input, voltage range 0 – 10V DC Voltage input for PI setpoint or feedback (Programmable)
3	AI-1-	I/O Ground Ground for reference and controls
4	AI-2+	Analog input, current range 0 – 20 mA Current input for PI setpoint or feedback (Programmable)
5	AI-2-	I/O Ground Ground for reference and controls
6	24V DC	Control voltage output Voltage for switches, etc. max 0.1A
7	GND	I/O ground Ground for reference and controls
8	DI-1	Start/Stop Control Contact closed = start
9	DI-2	External fault input (programmable) Contact closed = fault Contact open = no fault
10	DI-3	External Interlock (programmable) Contact closed = OK Open = Interlocked
11	CMA	Common for DI-1 – DI-3 Connect to GND or 24V DC
12	24V DC	Control voltage output Voltage for switches (see terminal 6)
13	GND	I/O ground Ground for reference and controls
14	DI-4	Speed Select 1 (programmable) Contact closed = Speed Select 1
15	DI-5	Fire Mode (programmable) Contact closed = Fire Mode active
16	DI-6	Overload relay (IntelliPass) (programmable) Contact open = no fault Contact closed = fault
17	CMB	Common for DI-4 – DI-6 Connect to GND or 24V DC
18	AO-1+	Output frequency Analog output Programmable Range 0 – 20 mA, R _L max. 500w
19	AO-1	I/O Ground Ground for reference and controls
20	DO-1	Digital output READY Programmable Open collector, I ≤ 50 mA, V ≤ 48V DC
OPTA2		
21-22 Opens on RUN	21 RO-1	Relay output 1 Programmable Drive RUN is default.
22-23 Closes on RUN	22 RO-1	
	23 RO-1	
24-25 Opens on FAULT	24 RO-2	Relay output 2 Programmable Drive FAULT is default.
25-26 Closes on FAULT	25 RO-2	
	26 RO-2	

Note: For more information on jumper selections, see **Chapter 4**.

X3 Jumper Setting — CMA and CMB Grounding

- CMB Connected to Ground
CMA Connected to Ground
- CMB Isolated from Ground
CMA Isolated from Ground
- CMB and CMA Internally Connected
and Isolated from Ground

CAUTION

Unattended start will occur if power is supplied with Start Command activated.

November 2009

Parameter Lists

On the next pages you will find the lists of parameters within the respective parameter groups. The parameter descriptions are given by ID number in **Chapter 15**.

Column explanations:

- Code = Location indication on the keypad; Shows the operator the present parameter number
- Parameter = Name of parameter
- Min. = Minimum value of parameter
- Max. = Maximum value of parameter
- Unit = Unit of parameter value; Given if available
- Default = Value preset by factory
- ID = ID number of the parameter for reference to **Chapter 15**

Quick Setup Parameters — M1 → G1.1

Table 11-2: Quick Setup Parameters — M1 → G1.1

Code	Parameter	Min.	Max.	Unit	Default	ID Number	Description
P1.1.1	Min Frequency	0.00	Max_Frequency	Hz	12.00	101	Minimum output frequency, f[Hz].
P1.1.2	Max Frequency	FreqMin	320.00	Hz	60.00	102	Maximum output frequency, f[Hz].
P1.1.3	Acceleration Time	0.1	3000.0	s	60.0	103	Time from 0 Hz to maximum Hz.
P1.1.4	Deceleration Time	0.1	3000.0	s	60.0	104	Time from maximum Hz to 0 Hz.
P1.1.5	Motor NP Voltg	180	Motor VoltageMax	V	400	105	Motor nameplate voltage in Volts.
P1.1.6	Motor NP Freq	8.00	320.00	Hz	60.00	106	Motor nameplate frequency in Hertz.
P1.1.7	Motor Nom Speed	24	20000	rpm	1720	111	Motor nameplate speed in Rpm.
P1.1.8	Motor Nom Currnt	Motor CurrentMin	Motor CurrentMax	A	5.40	108	Motor nameplate current, I[A]
P1.1.9	Power Factor	0.30	1.00		0.85	109	Motor power factor. (Cos Phi)
P1.1.10	Service Factor	0.10	2.00		1.00	110	Motor service factor. This will calculate the motor current limit. (MotorNomCurrent x Service Factor)
P1.1.11	Current Limit	Motor CurrentMin	Motor CurrentMax	A	7.00	107	Output current limit of the unit in Amps.
P1.1.12	Start Srce Hand	1	3		1	112	Parameter for Local Start/Stop/Reverse control location. Default = Keypad 1 = Keypad 2 = DI-1 Start 3 = I/O Three Wire

Table 11-2: Quick Setup Parameters — M1 → G1.1, continued

Code	Parameter	Min.	Max.	Unit	Default	ID Number	Description
P1.1.13	StPt Source Hand	0	3		2	113	Local speed setpoint selection: 0 = analog input AI-1 1 = analog input AI-2 2 = Speed Setpoint from Keypad 3 = Motor Potentiometer
P1.1.14	Start Srce Auto	1	4		2	114	Parameter for Remote Start/Stop/Reverse control location. Default = DI-1 Start 1 = Keypad 2 = DI-1 Start 3 = I/O Three Wire 4 = Fieldbus
P1.1.15	StPt Source Auto	0	4		0	115	PI-setpoint selection: 0 = analog input AI-1 1 = analog input AI-2 2 = PI Setpoint from Keypad 3 = Motor Potentiometer 4 = PI Setpoint from Fieldbus
P1.1.16	PI-Input Source	0	2		0	1106	PI-Controller Input Source Selection: Default #0 = (A) AI-1 0 = (A) AI-1 1 = (A) AI-2 2 = Fieldbus, Process Data 1 3 = Min. Both 4 = Max. Both 5 = Ave. Both
P1.1.17	Sensor Min.	(-10000)	Sensor_Max		(0)	1107	Actual Sensor minimum value at 0/4 mA.
P1.1.18	Sensor Max.	Sensor_Min	(10000)		(2500)	1108	Actual Sensor maximum value at 20 mA.
P1.1.19	PI-Contr. P-Gain	0.00	10.00		0.10	1109	P-Term (Gain) for the PI-Controller
P1.1.20	PI-Contr. I-Time	0.00	320.00	s	30.00	1110	I-Term (Integral Time) for the PI-controller
P1.1.21	PI-Deadband	(0)	(20000)		(0)	1111	Deadband area in units. (Hysteresis to PI-Setpoint)
P1.1.22	AutoAccelTime	0.1	3000.0	s	60.0	1113	Acceleration time, when in AUTO mode
P1.1.23	AutoDecelTime	0.1	3000.0	s	60.0	1114	Deceleratin time, when in AUTO mode
P1.1.24	US/Metric Units	0	1		0	1101	

November 2009

Input Signals — M1 → G1.2

Table 11-3: Input Signals — M1 → G1.2

Code	Parameter	Min.	Max.	Unit	Default	ID Number	Description
P1.2.1	Start Mode	0	3		1	201	Start Function: 0 = Normal start without interlockings. 1 = Interlocked start. One of the digital inputs must be programmed to Intlk/RunEna. DI-3 is defaulted for this feature. 2 = Mode 1 + timeout supervision. If the interlock is not OK within the interlock timeout time, start request is ignored and must be given again. 3 = Delayed start. Start request is given after delay time has expired.
P1.2.2	Intlk Stop Mode	0	1		1	216	0 = Coasting 1 = Ramp
P1.2.3	Intlk Timeout	0.00	300.00	s	5.00	202	Interlock timeout time for Start Function #2. Default = 5s.
P1.2.4	Start Delay Time	0.00	300.00	s	5.00	203	Start delay time for Start Function #3. Default = 5s.
P1.2.5	(A) DI-2 Funct.	0	17		1	204	Default #1 External Fault Close 0 = Stop pulse, when 3-wire start/stop logic is selected. (False=Stop, True=Ready to Run) 1 = Ext. fault, closing contact 2 = External fault, opening contact 3 = Fault reset 4 = Run enable-Closed Contact 5 = Force ctrl. place to Hand 6 = Force ctrl. place to Auto 7 = Reverse 8 = Speed Select 1 9 = Fire Mode-Closed Contact 10 = Speed Select 2 11 = Speed Select 3 12 = Force Bypass 13 = External interlock closed 14 = External interlock open 15 = Mot. Pot. UP 16 = Mot. Pot. DOWN 17 = Fire Mode-Open Contact

 **CAUTION**

Unattended start will occur if power is supplied with Start Command activated.

Table 11-3: Input Signals — M1 → G1.2, continued

Code	Parameter	Min.	Max.	Unit	Default	ID Number	Description
P1.2.6	(A) DI-3 Funct.	0	17		13	205	Default #13 Interlock/Run Enable 0 = Not Used 1 = Ext. fault, closing contact 2 = External fault, opening contact 3 = Fault reset 4 = Run enable-Closed Contact 5 = Force ctrl. place to Hand 6 = Force ctrl. place to Auto 7 = Reverse 8 = Speed Select 1 9 = Fire Mode-Closed Contact 10 = Speed Select 2 11 = Speed Select 3 12 = Force Bypass 13 = External interlock closed 14 = External interlock open 15 = Mot. Pot. UP 16 = Mot. Pot. DOWN 17 = Fire Mode-Open Contact
P1.2.7	(A) DI-4 Funct.	0	17		8	206	Default #8 Speed Select 1 0 = Not Used 1 = Ext. fault, closing contact 2 = External fault, opening contact 3 = Fault reset 4 = Run enable-Closed Contact 5 = Force ctrl. place to Hand 6 = Force ctrl. place to Auto 7 = Reverse 8 = Speed Select 1 9 = Fire Mode-Closed Contact 10 = Speed Select 2 11 = Speed Select 3 12 = Force Bypass 13 = External interlock closed 14 = External interlock open 15 = Mot. Pot. UP 16 = Mot. Pot. DOWN 17 = Fire Mode-Open Contact

November 2009

Table 11-3: Input Signals — M1 → G1.2, continued

Code	Parameter	Min.	Max.	Unit	Default	ID Number	Description
P1.2.8	(A) DI-5 Funct.	0	17		9	207	Default #9 Fire-Mode 0 = Not Used 1 = Ext. fault, closing contact 2 = External fault, opening contact 3 = Fault reset 4 = Run enable-Closed Contact 5 = Force ctrl. place to Hand 6 = Force ctrl. place to Auto 7 = Reverse 8 = Speed Select 1 9 = Fire Mode-Closed Contact 10 = Speed Select 2 11 = Speed Select 3 12 = Force Bypass 13 = External interlock closed 14 = External interlock open 15 = Mot. Pot. UP 16 = Mot. Pot. DOWN 17 = Fire Mode-Open Contact
P1.2.9	(A) DI-6 Funct.	0	17		0	208	Default #0 Overload Fault Relay-input 0 = Overload fault relay (Used in Intellipass) 1 = Ext. fault, closing contact 2 = External fault, opening contact 3 = Fault reset 4 = Run enable-Closed Contact 5 = Force ctrl. place to Hand 6 = Force ctrl. place to Auto 7 = Reverse 8 = Speed Select 1 9 = Fire Mode-Closed Contact 10 = Speed Select 2 11 = Speed Select 3 12 = Force Bypass 13 = External interlock closed 14 = External interlock open 15 = Mot. Pot. UP 16 = Mot. Pot. DOWN 17 = Fire Mode-Open Contact
P1.2.10	(A) AI-1 Minimum	0.00	Max.	%	0.00	217	Default applies for 0V or 0 mA
P1.2.11	(A) AI-1 Maximum	Min.	100.0	%	100.00	218	Default applies for 10V or 20 mA
P1.2.12	(A) AI-1 Invert	0	1		0	209	0 = Not inverted 1 = Inverted
P1.2.13	(A) AI-1 Filter	0.00	10.00	s	0.10	210	0 = No filtering
P1.2.14	(A) AI-2 Minimum	0.00	Max.	%	20.00	219	Default applies for 2V or 4 mA
P1.2.15	(A) AI-2 Maximum	Min.	100.0	%	100.00	220	Default applies for 10V or 20 mA

Table 11-3: Input Signals — M1 → G1.2, continued

Code	Parameter	Min.	Max.	Unit	Default	ID Number	Description
P1.2.16	(A) AI-2 Invert	0	1		0	212	0 = Not inverted 1 = Inverted
P1.2.17	(A) AI-2 Filter	0.00	10.00	s	0.10	213	0 = No filtering
P1.2.18	StPt. Scale Min	0.0	100.0	%	0.0	214	Speed that corresponds to the minimum setpoint signal.
P1.2.19	StPt. Scale Max	0.0	100.0	%	0.0	215	Speed that corresponds to the maximum setpoint signal. 0.0%=NOT IN USE!
P1.2.20	MotPotStPt Memory	0	1		0	221	Parameter to select reset function for motor potentiometer speed setpoint. Default: No reset.

Output Signals — M1 → G1.3**Table 11-4: Output Signals — M1 → G1.3**

Code	Parameter	Min.	Max.	Unit	Default	ID Number	Description
P1.3.1	(A) AO-1 Funct.	0	8		1	301	Analog output function: 0 = FB-Control (Fieldbus Passthrough, ProcessDataIN3) 1 = O/P frequency (0 - f max) 2 = Reference frequency (0 - f max) 3 = Motor speed (0 - 100% x Motor nom. speed) 4 = O/P current (0 - 100% x I nMot) 5 = Motor torque (0 - 100% x T nMot) 6 = Motor power (0 - 100% x P nMot) 7 = Motor voltage (0 - 100% x U nMot) 8 = DC-Bus Voltage (0 - 100% x U nMot)
P1.3.2	(A) AO-1 Filter	0.00	10.00	s	1.00	302	
P1.3.3	(A) AO-1 Invert	0	1		0	303	0 = Not inverted 1 = Inverted
P1.3.4	(A) AO-1 Min.	0	1		0	304	0 = 0 mA 1 = 4 mA
P1.3.5	(A) AO-1 Scale	10	1000	%	100	305	

November 2009

Table 11-4: Output Signals — M1 → G1.3, continued

Code	Parameter	Min.	Max.	Unit	Default	ID Number	Description
P1.3.6	(A) DO-1 Funct.	0	26		1	306	Default=Drive Ready 0 = Not used 1 = Drive Ready 2 = Drive Running 3 = General Fault 4 = General Fault inverted 5 = Drive overheat warning 6 = External fault or warning 7 = Reference (4mA) fault or warning 8 = General Warning 9 = Drive Reversing 10 = Preset Speed Active 11 = Speed setpoint=Actual Speed (=At speed) 12 = Motor regulator activated 13 = Actual Speed limit supervision 14 = Speed Setpoint limit supervision 15 = Torque limit supervision 16 = Timer On/Timer Off output control (Trigger is run request) 17 = Selections #16 inverted 18 = Frequency converter temperature limit supervision 19 = Unrequested rotation direction 20 = Thermistor fault / warning 21 = Hand Control Active 22 = Auto Control Active 23 = DI-Fire Mode Active 24 = Relay to energize an external element before starting the drive. 25 = FB-Control 26 = Bypass Run
P1.3.7	(B) RO-1 Funct.	0	25		2	307	Same as parameter 1.3.6.
P1.3.8	(B) RO-2 Funct.	0	25		3	308	Same as parameter 1.3.6
P1.3.9	(D) RO-1 Funct.	0	25		0	309	Same as parameter 1.3.6
P1.3.10	(D) RO-2 Funct.	0	25		0	310	Same as parameter 1.3.6
P1.3.11	(D) RO-3 Funct.	0	25		0	311	Same as parameter 1.3.6
P1.3.12	Sp.StPt Supv Fct	0	2		0	312	Speed Setpoint Supervision Function: 0 = Not used 1 = Low limit 2 = High limit
P1.3.13	Sp.StPt Supv Lim	0.0	100.0	%	0.0	313	Speed Setpoint Supervision Value.

Table 11-4: Output Signals — M1 → G1.3, continued

Code	Parameter	Min.	Max.	Unit	Default	ID Number	Description
P1.3.14	Act.Sp. Supv Fct	0	2		0	314	Actual Speed Supervision Function: 0 = Not used 1 = Low limit 2 = High limit
P1.3.15	Act.Sp. Supv Lim	0.0	100.0	%	0.0	315	Actual Speed Supervision Value. (±1.0% hysteresis)
P1.3.16	Torque Supv Fct	0	2		0	316	Torque Limit Supervision Function: 0 = Not used 1 = Low limit 2 = High limit
P1.3.17	Torque Supv Lim	0.0	300.0	%	0.0	317	Torque Limit Supervision Value
P1.3.18	TempLim Supv Fct	0	2		0	318	Temperature Limit Supervision Function: 0 = Not used 1 = Low limit 2 = High limit
P1.3.19	TempLim Supv Lim	-50	170	°F	104	319	Temperature Limit Supervision value
P1.3.20	StartRlyON-Del.	0.0	100.0	s	0.0	320	Relay/Digital output ON-delay time after start-command is given.
P1.3.21	StartRlyOFF-Del.	0.0	100.0	s	0.0	321	Relay/Digital output OFF-delay time after stop-command is given.

Drive Control Parameters — M1 → G1.4**Table 11-5: Drive Control Parameters — M1 → G1.4**

Code	Parameter	Min.	Max.	Unit	Default	ID Number	Description
P1.4.1	Start Mode	0	1		0	401	0 = Ramp 1 = Flying start
P1.4.2	Stop Mode	0	1		1	402	0 = Coasting 1 = Ramp
P1.4.3	Brake Chopper	0	4		0	403	Brake Chopper Mode Selection. 0 = Brake NO, Test NO 1 = Brake YES(Run), Test YES (Ready+run) 2 = Brake chopper EXTERNAL, Test NO 3 = Brake YES(Ready+run), Test YES (Ready+run) 4 = Brake YES(Run), Test NO
P1.4.4	S-curve Time	0.0	10.0	s	0.0	404	Smooth ratio for S-curve

November 2009

Prohibit Frequencies— M1 → G1.5

Table 11-6: Prohibit Frequencies — M1 → G1.5

Code	Parameter	Min.	Max.	Unit	Default	ID Number	Description
P1.5.1	SkipF1 Low Lim	0.0	100.0	%	0.0	501	Prohibit speed range 1 low limit.
P1.5.2	SkipF1 High Lim	Range_1_Low_Lim	100.0	%	0.0	502	Prohibit speed range 1 high limit: 0 = No prohibit frequency range
P1.5.3	SkipF2 Low Lim	0.0	100.0	%	0.0	503	Prohibit speed range 2 low limit
P1.5.4	SkipF2 High Lim	Range_2_Low_Lim	100.0	%	0.0	504	Prohibit speed range 2 high limit: 0 = No prohibit frequency range
P1.5.5	SkipF3 Low Lim	0.0	100.0	%	0.0	505	Prohibit speed range 3 low limit
P1.5.6	SkipF3 High Lim	Range_3_Low_Lim	100.0	%	0.0	506	Prohibit speed range 3 high limit: 0 = No prohibit frequency range
P1.5.7	SkipF4 Low Lim	0.0	100.0	%	0.0	507	Prohibit speed range 4 low limit
P1.5.8	SkipF4 High Lim	Range_4_Low_Lim	100.0	%	0.0	508	Prohibit speed range 4 high limit: 0 = No prohibit frequency range
P1.5.9	SkipF5 Low Lim	0.0	100.0	%	0.0	509	Prohibit speed range 5 low limit
P1.5.10	SkipF5 High Lim	Range_5_Low_Lim	100.0	%	0.0	510	Prohibit speed range 5 high limit: 0 = No prohibit frequency range
P1.5.11	SkipF6 Low Lim	0.0	100.0	%	0.0	511	Prohibit speed range 6 low limit
P1.5.12	SkipF6 High Lim	Range_6_Low_Lim	100.0	%	0.0	512	Prohibit speed range 6 high limit: 0 = No prohibit frequency range
P1.5.13	PH Acc/Dec Ramp	0.1	10.0	x	1.0	513	Acceleration/Deceleration time factor to pass prohibit speed window.

Motor Control Parameters — M1 → G1.6**Table 11-7: Motor Control Parameters — M1 → G1.6**

Code	Parameter	Min.	Max.	Unit	Default	ID Number	Description
P1.6.1	Motor Ctrl Mode	0	1		0	601	Motor control mode: 0 = frequency control 1 = speed control
P1.6.2	V/Hz Optim.	0	1		0	602	V/F optimization selection: 0 = none 1 = automatic torque boost
P1.6.3	V/Hz Ratio	0	3		0	603	V/F ratio selection: 0 = linear 1 = squared 2 = programmable 3 = Linear with flux optim.
P1.6.4	Field WeakngPnt	8.00	320.00	Hz	60.00	604	Field weakening point.
P1.6.5	Voltage at FWP	10.00	200.00	%	100.00	605	Motor voltage (%*MotorNPVoltage) at field weakening point.
P1.6.6	V/Hz Mid Freq	0.00	Field Weakening Point	Hz	60.00	606	Programmable V/Hz curve middle point frequency.
P1.6.7	V/Hz Mid Voltg	0.00	100.00	%	100.00	607	Motor voltage (%*MotorNPVoltage) at programmable V/Hz curve middle point.
P1.6.8	Zero Freq Voltg	0.00	40.00	%	0.00	608	Motor voltage (%*MotorNPVoltage) at zero speed.
P1.6.9	Switching Freq	1.0	Switching FreqMax	kHz	3.6	609	Switching frequency in kHz. See Appendix A, Table A-1 .
P1.6.10	Overvolt Contr	0	2		1	610	0 = Off 1 = On with no ramping 2 = On with ramping
P1.6.11	Undervolt Contr	0	1		1	611	0 = Off 1 = On
P1.6.12	Identification	0	2		0	612	Identification run. When this parameter is set greater than zero, then start command must be given within 20 seconds.

November 2009

Protections — M1 → G1.7
Table 11-8: Protections — M1 → G1.7

Code	Parameter	Min.	Max.	Unit	Default	ID Number	Description
P1.7.1	Input Phase Supv	0	2		2	701	Response to input phase supervision. 0 = No Action 1 = Warning 2 = Fault
P1.7.2	4mA Fault Resp	0	2		0	702	Response to 4 mA signal supervision. 0 = No Action 1 = Warning 2 = Fault
P1.7.3	Ext. Fault Resp	0	2		2	703	Response to external fault digital input signal supervision. 0 = No Action 1 = Warning 2 = Fault
P1.7.4	FBComm. FaultResp	0	2		0	704	Response to fieldbus communication supervision. 0 = No Action 1 = Warning 2 = Fault
P1.7.5	SlotComFault Resp	0	2		0	705	Response to slot communication supervision. 0 = No Action 1 = Warning 2 = Fault
P1.7.6	Motor Therm Prot	0	3		0	707	0 = No response 1 = Warning 2 = Fault, stop mode after fault according to ID402 3 = Fault, stop mode after fault always by coasting
P1.7.7	MotAmbTemp Factor	-100.0	100.0	%	0.0	708	Percent of ambient temperature.
P1.7.8	MTP f0 Current	0.0	150.00	%	40.0	709	Percent of motor nameplate current.
P1.7.9	MTP Motor T	1	200	min	45	710	Time to reach 63% of final value.
P1.7.10	Motor Duty Cycle	0	100	%	100	711	Percent of nominal motor load
P1.7.11	Stall Protection	0	3		0	712	0 = No response 1 = Warning 2 = Fault, stop mode after fault according to ID402 3 = Fault, stop mode after fault always by coasting
P1.7.12	Stall Current	0.00	Motor CurrentMax	A	1.00	713	
P1.7.13	Stall Time Lim	1.00	120.00	s	15.00	714	
P1.7.14	Stall Freq Lim	1.00	Max_Freq	Hz	25.00	715	

Tables 11-8: Protections — M1 → G1.7, continued

Code	Parameter	Min.	Max.	Unit	Default	ID Number	Description
P1.7.15	Underload Protection	0	3		0	716	0 = No response 1 = Warning 2 = Fault, stop mode after fault according to ID402 3 = Fault, stop mode after fault always by coasting
P1.7.16	UP f _{nom} Torque	10.0	150.00	%	50.0	717	Minimum torque allowed when above FWP.
P1.7.17	UP f ₀ Torque	5.0	150.00	%	10.0	718	Minimum torque allowed with zero frequency.
P1.7.18	UP Time Limit	2.00	600.00	s	20.00	719	
P1.7.19	Autom. Restart	0	3		0	706	Resets faults. See Page 15-20 . 0 = Disabled 1 = Automatically transferred to Bypass 2 = Reset drive only 3 = Reset drive, if fails, transferred to Bypass
P1.7.20	Fire Mode Speed	0	100.0	%	100	804	When fire mode input is triggered, drive will run at fire mode speed.

Fieldbus Parameters — M1 → G1.8**Table 11-9: Fieldbus Parameters — M1 → G1.8**

Code	Parameter	Min.	Max.	Unit	Default	ID Number	Description
P1.8.1	FB Data Out1 Sel	0	10000		1 ^①	1001	Fieldbus process data output 1 selection. Default = Actual Speed
P1.8.2	FB Data Out2 Sel	0	10000		5 ^①	1002	Fieldbus process data output 2 selection. Default = Motor Current
P1.8.3	FB Data Out3 Sel	0	10000		8 ^①	1003	Fieldbus process data output 3 selection. Default = Motor Voltage
P1.8.4	FB Data Out4 Sel	0	10000		7 ^①	1004	Fieldbus process data output 4 selection. Default = Motor Power
P1.8.5	FB Data Out5 Sel	0	10000		9 ^①	1005	Fieldbus process data output 5 selection. Default = DC-Link Voltage

^① ID number of parameter or variable to be sent over fieldbus. ID 1 – 20 are Monitoring values, Menu 7 (M7). See **Table 11-13**.

November 2009

Table 11-9: Fieldbus Parameters — M1 → G1.8, continued

Code	Parameter	Min.	Max.	Unit	Default	ID Number	Description
P1.8.6	FB Data Out6 Sel	0	10000		20	1006	Fieldbus process data output 6 selection. Default = Application Status Word (Variable:AppIStatusWord) b0 = Drive Ready b1 = Run Enable b2 = Drive Running b3 = Drive Reversing b4 = General Fault b5 = General Warning b6 = Preset Speed Active b7 = Motor Regulator active b8 = Output speed supervision indication b9 = Setpoint speed supervision indication b10 = HAND Control indication b11 = AUTO Control indication b12 = D-IN Firemode b13 = Damper control signal b14 = Bypass mode status indication b15 = Bypass running
P1.8.7	FB Data Out7 Sel	0	10000		18 ^①	1007	Fieldbus process data output 7 selection. Default = Active Fault Code
P1.8.8	FB Data Out8 Sel	0	10000		19 ^①	1008	Fieldbus process data output 8 selection. Default = Active Warning Code

^① ID number of parameter or variable to be sent over fieldbus. ID 1 – 20 are Monitoring values, Menu 7 (M7). See Table 11-13.

PI-Control Parameters — M1 → G1.9**Table 11-10: PI-Control Parameters — M1 → G1.9**

Code	Parameter	Min.	Max.	Unit	Default	ID Number	Description
P1.9.1	US/Metric Units	0	1		0	1101	
P1.9.2	Setpoint Min.	Sensor_Min	PI_Setpoint_Max		(0)	1102	Minimum limit for the PI-Controller setpoint.
P1.9.3	Setpoint Max.	PI_Setpoint_Min	Sensor_Max		(2500)	1103	Maximum limit for the PI-Controller setpoint.
P1.9.4	PI-StPt Ramp Time	0.00	20.00	s	1.00	1104	Parameter for the PI-Setpoint ramp time. Default: 1.00s
P1.9.5	PI-Input Source	0	5		0	1106	PI-Controller Input Source Selection: Default #0 = (A) AI-1 0 = (A) AI-1 1 = (A) AI-2 2 = Fieldbus, ProcessData1 3 = Min. Both 4 = Max. Both 5 = Ave. Both
P1.9.6	Sensor Min.	(-10000)	Sensor_Max		(0)	1107	Actual Sensor minimum value at 0/4 mA.
P1.9.7	Sensor Max.	Sensor_Min	(10000)		(2500)	1108	Actual Sensor maximum value at 20 mA.
P1.9.8	PI-Contr. P-Gain	0.00	10.00		0.10	1109	P-Term (Gain) for the PI-controller.
P1.9.9	PI-Contr. I-Time	0.00	320.00	s	30.00	1110	I-Term (Integral Time) for the PI-controller.
P1.9.10	Deadband	(0)	(20000)		(0)	1111	Deadband area in units (Hysteresis to PI Setpoint)
P1.9.11	PI Acting Mode	0	1		1	1112	PI-controller acting mode. 0 = Reverse acting 1 = Forward acting
P1.9.12	Auto Accel. Time	0.1	3000.0	s	60.0	1113	Auto Mode Accel. Time
P1.9.13	Auto Decel. Time	0.1	3000.0	s	60.0	1114	Auto Mode Decel. Time
P1.9.14	Auto S-curve Time	0.0	10.0	s	0.0	1115	Auto Mode and PI-control is NOT active

Preset Speeds — M1 → G1.10**Table 11-11: Preset Speeds — M1 → G1.10**

Code	Parameter	Min.	Max.	Unit	Step	Default	ID Number	Description
P1.10.1	Preset Speed 1	0	100.0	%	0.1	30.0	1701	Preset speeds when Digital Inputs are programmed
P1.10.2	Preset Speed 2	0	100.0	%	0.1	40.0	1702	
P1.10.3	Preset Speed 3	0	100.0	%	0.1	50.0	1703	
P1.10.4	Preset Speed 4	0	100.0	%	0.1	60.0	1704	
P1.10.5	Preset Speed 5	0	100.0	%	0.1	70.0	1705	
P1.10.6	Preset Speed 6	0	100.0	%	0.1	80.0	1706	
P1.10.7	Preset Speed 7	0	100.0	%	0.1	90.0	1707	

November 2009

Keypad Control Parameters — M2

This menu provides the parameters for the setting of the keypad speed setpoint, the selection of motor direction when in keypad operation, and when the STOP button is active.

Table 11-12: Keypad Control Parameters — M2

Code	Parameter	Min.	Max.	Unit	Default	ID Number ^①	Description
R2.1	Speed Setpoint	0.0	100.0	%	0.0		Keypad Speed Setpoint.
P2.2	Keypad Direction	0	1		0	1009	Reverse request active from the panel 0 = Forward 1 = Reverse
P2.3	StopButton Active	0	1		1	1010	Stop button (Keypad) always active (Yes/No)
R2.4	PI-Setpoint	(-10000)	(10000)		(1500)		Active PI reference if ID115 = 2.
P2.5	PI-Setpoint Default	(-10000)	(10000)			1011	PI-regulators default setpoint

^① Keypad Control Parameter ID Numbers are listed separately on **Page 15-28**.

Menus — M3 to M6

Menus M3 to M6 provide information on the Active Faults, Fault History, System Menu settings and the Expander Board setup. These menu items are explained in detail in **Chapter 6**.

Monitoring Menu — M7

The monitored items are the actual values of parameters and signals as well as the status and measurements of other elements. Monitored items cannot be edited.

See **Chapter 6** — Menu information item M7, for more information.

Table 11-13: Monitoring Menu

Code	Parameter	Min.	Max.	Unit	Default	ID Number	Description
V7.1	Output Frequency	-320.00	320.00	Hz	0.00	2	Output frequency to the motor
V7.2	Actual Speed	-320.0	320.0	%	0.0	1	Output speed to the motor
V7.3	Speed Setpoint	-320.0	320.0	%	0.0	3	Monitored speed setpoint. This will show also the speed setpoint below the minimum frequency.
V7.4	Motor Speed	-10000	10000	rpm	0	4	Calculated motor speed in rpm
V7.5	Motor Current	0.0	Motor CurrentMax	A	0.0	5	
V7.6	Motor Torque	-300.0	300.0	%	0.0	6	[R] Motor torque as % value, +1000 equals +100.0 % pos = clockwise, neg = counterclockwise
V7.7	Motor Power	-300.0	300.0	%	0.0	7	
V7.8	Motor Voltage	0.0	1000.0	V	0.0	8	Measured motor voltage
V7.9	DC-Bus Voltage	0	1000	V	0	9	[R] DC voltage in Volts Tfilt = 32ms.
V7.10	Unit Temperature	-1000	1000	°F	0	10	Temperature of the heat sink
V7.11	Motor Temperature	0.0	1000.0	%	0.0	11	
V7.12	(A) AI-1	-10.00	20.00	V	0.00	12	Voltage Input value [V]
V7.13	(A) AI-2	-10.00	20.00	mA	0.00	13	Current Input value [mA]
V7.14	DI-1 DI-2 DI-3	0	7		0	14	DIA-1, DIA-2 and DIA-3 status
V7.15	DI-4 DI-5 DI-6	0	7		0	15	DIB-4, DIB-5 and DIB-6 status
V7.16	DO-1 RO-1 RO-2	0	7		0	16	DO-1, RO-1 and RO-2 status
V7.17	(A) AO-1	0.00	20.00	mA	0.00	17	
V7.18	ActFaultCode	0	200		0	18	Active Fault code.
V7.19	ActWarnCode	0	200		0	19	Active Warning code.

November 2009

Table 11-13: Monitoring Menu, continued

Code	Parameter	Min.	Max.	Unit	Default	ID Number	Description
V7.20	Status Word	-32768	32767		0	20	b0 = Drive Ready b1 = Run Enable b2 = Drive Running b3 = Drive Reversing b4 = General Fault b5 = General Warning b6 = Preset Speed Active b7 = Motor Regulator active b8 = Output speed supervision indication b9 = Setpoint speed supervision indication b10 = HAND Control indication b11 = AUTO Control indication b12 = D-IN Firemode b13 = Damper control signal b14 = Bypass mode status indication b15 = Bypass running
V7.21	PI-Setpoint	(-10000)	(10000)	WC/PA	(0)	21	
V7.22	PI-Input	(-10000)	(10000)		(0)	22	Actual Sensor Value
V7.23	PI-Error	(-10000)	(10000)		(0)	23	
V7.24	PI-Output	0.0	100.0	%	0.0	24	
V7.25 ^①	RO-1 RO-2 RO-3	0	7		0	25	Monitoring the OPTB5 relay outputs.
G7.26	Multimonitor	—	—		—	—	Displays three monitor values simultaneously

^① When OPTB5 is not installed in option slot C, this is not displayed.

Operate Menu — M8

The Operate Menu provides an easy to use method of viewing key numerical Monitoring Menu items. It also allows the setting of the keypad frequency reference. See **Chapter 6** for more information.

November 2009

Chapter 12 — Building Static Application (SVCHS203)

Introduction

The Building Static Application is typically used to control fans with a pressure transducer and provide WC/PA units to a keypad.

The direct frequency reference can be used for the control without the PI controller and is selected from the analog inputs, fieldbus, motor potentiometer or keypad.

The Building Static Application is typically used to control Building pressure. In these applications, the Building Static Application provides a smooth control and an integrated measurement and control package where no additional components are needed.

- Digital inputs DI-2, DI-3 and DI-5 and all outputs are freely programmable.

Additional functions:

- Analog input signal range selection
- One frequency limit supervision
- Torque limit supervision
- Speed setpoint limit supervision
- Programmable start and stop functions
- DC Brake Chopper
- Six skip frequency areas
- Programmable V/Hz curve and switching frequency
- Auto restart
- Motor thermal and stall protection: Programmable action; off, warning, fault
- Motor underload protection
- Input and output phase supervision

Details of the parameters shown in this section are available in **Chapter 15** of this Manual, listed by parameter ID number.

Control Input/Output

Table 12-1: Building Static Application Default I/O Configuration

Terminal	Signal	Description
OPTA9		
1	+10V DC _{ref}	Reference output Voltage for potentiometer, etc.
2	AI-1+	Analog input, voltage range 0 – 10V DC Voltage input for PI setpoint or feedback (Programmable)
3	AI-1-	I/O Ground Ground for reference and controls
4	AI-2+	Analog input, current range 0 – 20 mA Current input for PI setpoint or feedback (Programmable)
5	AI-2-	I/O Ground Ground for reference and controls
6	24V DC	Control voltage output Voltage for switches, etc. max 0.1A
7	GND	I/O ground Ground for reference and controls
8	DI-1	Start/Stop Control Contact closed = start
9	DI-2	External fault input (programmable) Contact closed = fault Contact open = no fault
10	DI-3	External Interlock (programmable) Contact closed = OK Open = Interlocked
11	CMA	Common for DI-1 – DI-3 Connect to GND or 24V DC
12	24V DC	Control voltage output Voltage for switches (see terminal 6)
13	GND	I/O ground Ground for reference and controls
14	DI-4	Speed Select 1 (programmable) Contact closed = Speed Select 1
15	DI-5	Fire Mode (programmable) Contact closed = Fire Mode active
16	DI-6	Overload relay (IntelliPass) (programmable) Contact open = no fault Contact closed = fault
17	CMB	Common for DI-4 – DI-6 Connect to GND or 24V DC
18	AO-1+	Output frequency Analog output Programmable Range 0 – 20 mA, R _L max. 500w
19	AO-1	I/O Ground Ground for reference and controls
20	DO-1	Digital output READY Programmable Open collector, I ≤ 50 mA, V ≤ 48V DC
OPTA2		
21-22 Opens on RUN	21 RO-1	Relay output 1 Programmable Drive RUN is default.
22-23 Closes on RUN	22 RO-1	
	23 RO-1	
24-25 Opens on FAULT	24 RO-2	Relay output 2 Programmable Drive FAULT is default.
25-26 Closes on FAULT	25 RO-2	
	26 RO-2	

Note: For more information on jumper selections, see **Chapter 4**.

X3 Jumper Setting — CMA and CMB Grounding

- CMB Connected to Ground
CMA Connected to Ground
- CMB Isolated from Ground
CMA Isolated from Ground
- CMB and CMA Internally Connected
and Isolated from Ground

CAUTION

Unattended start will occur if power is supplied with Start Command activated.

November 2009

Parameter Lists

On the next pages you will find the lists of parameters within the respective parameter groups. The parameter descriptions are given by ID number in **Chapter 15**.

Column explanations:

- Code = Location indication on the keypad; Shows the operator the present parameter number
- Parameter = Name of parameter
- Min. = Minimum value of parameter
- Max. = Maximum value of parameter
- Unit = Unit of parameter value; Given if available
- Default = Value preset by factory
- ID = ID number of the parameter for reference to **Chapter 15**

Quick Setup Parameters — M1 → G1.1

Table 12-2: Quick Setup Parameters — M1 → G1.1

Code	Parameter	Min.	Max.	Unit	Default	ID Number	Description
P1.1.1	Min Frequency	0.00	Max_Frequency	Hz	12.00	101	Minimum output frequency, f[Hz].
P1.1.2	Max Frequency	FreqMin	320.00	Hz	60.00	102	Maximum output frequency, f[Hz].
P1.1.3	Acceleration Time	0.1	3000.0	s	60.0	103	Time from 0 Hz to maximum Hz.
P1.1.4	Deceleration Time	0.1	3000.0	s	60.0	104	Time from maximum Hz to 0 Hz.
P1.1.5	Motor NP Voltg	180	Motor VoltageMax	V	400	105	Motor nameplate voltage in Volts.
P1.1.6	Motor NP Freq	8.00	320.00	Hz	60.00	106	Motor nameplate frequency in Hertz.
P1.1.7	Motor Nom Speed	24	20000	rpm	1720	111	Motor nameplate speed in Rpm.
P1.1.8	Motor Nom Currnt	Motor CurrentMin	Motor CurrentMax	A	5.40	108	Motor nameplate current, I[A]
P1.1.9	Power Factor	0.30	1.00		0.85	109	Motor power factor. (Cos Phi)
P1.1.10	Service Factor	0.10	2.00		1.00	110	Motor service factor. This will calculate the motor current limit. (MotorNomCurrent x Service Factor)
P1.1.11	Current Limit	Motor CurrentMin	Motor CurrentMax	A	7.00	107	Output current limit of the unit in Amps.
P1.1.12	Start Srce Hand	1	3		1	112	Parameter for Local Start/Stop/Reverse control location. Default = Keypad 1 = Keypad 2 = DI-1 Start 3 = I/O Three Wire

Table 12-2: Quick Setup Parameters — M1 → G1.1, continued

Code	Parameter	Min.	Max.	Unit	Default	ID Number	Description
P1.1.13	StPt Source Hand	0	3		2	113	Local speed setpoint selection: 0 = analog input AI-1 1 = analog input AI-2 2 = Speed Setpoint from Keypad 3 = Motor Potentiometer
P1.1.14	Start Srce Auto	1	4		2	114	Parameter for Remote Start/Stop/Reverse control location. Default = DI-1 Start 1 = Keypad 2 = DI-1 Start 3 = I/O Three Wire 4 = Fieldbus
P1.1.15	StPt Source Auto	0	4		0	115	PI-setpoint selection: 0 = analog input AI-1 1 = analog input AI-2 2 = PI Setpoint from Keypad 3 = Motor Potentiometer 4 = PI Setpoint from Fieldbus
P1.1.16	PI-Input Source	0	2		0	1106	PI-Controller Input Source Selection: Default #0 = (A) AI-1 0 = (A) AI-1 1 = (A) AI-2 2 = Fieldbus, Process Data 1 3 = Min. Both 4 = Max. Both 5 = Ave. Both
P1.1.17	Sensor Min.	(-10000)	Sensor_Max		(-100)	1107	Actual Sensor minimum value at 0/4 mA.
P1.1.18	Sensor Max.	Sensor_Min	(10000)		(100)	1108	Actual Sensor maximum value at 20 mA.
P1.1.19	PI-Contr. P-Gain	0.00	10.00		0.10	1109	P-Term (Gain) for the PI-Controller
P1.1.20	PI-Contr. I-Time	0.00	320.00	s	30.00	1110	I-Term (Integral Time) for the PI-controller
P1.1.21	PI-Deadband	(0)	(20000)		(0)	1111	Deadband area in units. (Hysteresis to PI-Setpoint)
P1.1.22	AutoAccelTime	0.1	3000.0	s	60.0	1113	Acceleration time, when in AUTO mode
P1.1.23	AutoDecelTime	0.1	3000.0	s	60.0	1114	Deceleratin time, when in AUTO mode
P1.1.24	US/Metric Units	0	1		0	1101	

November 2009

Input Signals — M1 → G1.2

Table 12-3: Input Signals — M1 → G1.2

Code	Parameter	Min.	Max.	Unit	Default	ID Number	Description
P1.2.1	Start Mode	0	3		1	201	Start Function: 0 = Normal start without interlockings. 1 = Interlocked start. One of the digital inputs must be programmed to Intlk/RunEna. DI-3 is defaulted for this feature. 2 = Mode 1 + timeout supervision. If the interlock is not OK within the interlock timeout time, start request is ignored and must be given again. 3 = Delayed start. Start request is given after delay time has expired.
P1.2.2	Intlk Stop Mode	0	1		1	216	0 = Coasting 1 = Ramp
P1.2.3	Intlk Timeout	0.00	300.00	s	5.00	202	Interlock timeout time for Start Function #2. Default = 5s.
P1.2.4	Start Delay Time	0.00	300.00	s	5.00	203	Start delay time for Start Function #3. Default = 5s.
P1.2.5	(A) DI-2 Funct.	0	17		1	204	Default #1 External Fault Close 0 = Stop pulse, when 3-wire start/stop logic is selected. (False=Stop, True=Ready to Run) 1 = Ext. fault, closing contact 2 = External fault, opening contact 3 = Fault reset 4 = Run enable-Closed Contact 5 = Force ctrl. place to Hand 6 = Force ctrl. place to Auto 7 = Reverse 8 = Speed Select 1 9 = Fire Mode-Closed Contact 10 = Speed Select 2 11 = Speed Select 3 12 = Force Bypass 13 = External interlock closed 14 = External interlock open 15 = Mot. Pot. UP 16 = Mot. Pot. DOWN 17 = Fire Mode-Open Contact

 **CAUTION**

Unattended start will occur if power is supplied with Start Command activated.

Table 12-3: Input Signals — M1 → G1.2, continued

Code	Parameter	Min.	Max.	Unit	Default	ID Number	Description
P1.2.6	(A) DI-3 Funct.	0	17		13	205	Default #13 Interlock/Run Enable 0 = Not Used 1 = Ext. fault, closing contact 2 = External fault, opening contact 3 = Fault reset 4 = Run enable-Closed Contact 5 = Force ctrl. place to Hand 6 = Force ctrl. place to Auto 7 = Reverse 8 = Speed Select 1 9 = Fire Mode-Closed Contact 10 = Speed Select 2 11 = Speed Select 3 12 = Force Bypass 13 = External interlock closed 14 = External interlock open 15 = Mot. Pot. UP 16 = Mot. Pot. DOWN 17 = Fire Mode-Open Contact
P1.2.7	(A) DI-4 Funct.	0	17		8	206	Default #8 Speed Select 1 0 = Not Used 1 = Ext. fault, closing contact 2 = External fault, opening contact 3 = Fault reset 4 = Run enable-Closed Contact 5 = Force ctrl. place to Hand 6 = Force ctrl. place to Auto 7 = Reverse 8 = Speed Select 1 9 = Fire Mode-Closed Contact 10 = Speed Select 2 11 = Speed Select 3 12 = Force Bypass 13 = External interlock closed 14 = External interlock open 15 = Mot. Pot. UP 16 = Mot. Pot. DOWN 17 = Fire Mode-Open Contact

November 2009

Table 12-3: Input Signals — M1 → G1.2, continued

Code	Parameter	Min.	Max.	Unit	Default	ID Number	Description
P1.2.8	(A) DI-5 Funct.	0	17		9	207	Default #9 Fire-Mode 0 = Not Used 1 = Ext. fault, closing contact 2 = External fault, opening contact 3 = Fault reset 4 = Run enable-Closed Contact 5 = Force ctrl. place to Hand 6 = Force ctrl. place to Auto 7 = Reverse 8 = Speed Select 1 9 = Fire Mode-Closed Contact 10 = Speed Select 2 11 = Speed Select 3 12 = Force Bypass 13 = External interlock closed 14 = External interlock open 15 = Mot. Pot. UP 16 = Mot. Pot. DOWN 17 = Fire Mode-Open Contact
P1.2.9	(A) DI-6 Funct.	0	17		0	208	Default #0 Overload Fault Relay-input 0 = Overload fault relay (Used in Intellipass) 1 = Ext. fault, closing contact 2 = External fault, opening contact 3 = Fault reset 4 = Run enable-Closed Contact 5 = Force ctrl. place to Hand 6 = Force ctrl. place to Auto 7 = Reverse 8 = Speed Select 1 9 = Fire Mode-Closed Contact 10 = Speed Select 2 11 = Speed Select 3 12 = Force Bypass 13 = External interlock closed 14 = External interlock open 15 = Mot. Pot. UP 16 = Mot. Pot. DOWN 17 = Fire Mode-Open Contact
P1.2.10	(A) AI-1 Minimum	0.00	Max.	%	0.00	217	Default applies for 0V or 0 mA
P1.2.11	(A) AI-1 Maximum	Min.	100.0	%	100.00	218	Default applies for 10V or 20 mA
P1.2.12	(A) AI-1 Invert	0	1		0	209	0 = Not inverted 1 = Inverted
P1.2.13	(A) AI-1 Filter	0.00	10.00	s	0.10	210	0 = No filtering
P1.2.14	(A) AI-2 Minimum	0.00	Max.	%	20.00	219	Default applies for 2V or 4 mA
P1.2.15	(A) AI-2 Maximum	Min.	100.0	%	100.00	220	Default applies for 10V or 20 mA
P1.2.16	(A) AI-2 Invert	0	1		0	212	0 = Not inverted 1 = Inverted
P1.2.17	(A) AI-2 Filter	0.00	10.00	s	0.10	213	0 = No filtering
P1.2.18	StPt. Scale Min	0.0	100.0	%	0.0	214	Speed that corresponds to the minimum setpoint signal.

Table 12-3: Input Signals — M1 → G1.2, continued

Code	Parameter	Min.	Max.	Unit	Default	ID Number	Description
P1.2.19	StPt. Scale Max	0.0	100.0	%	0.0	215	Speed that corresponds to the maximum setpoint signal. 0.0%=NOT IN USE!
P1.2.20	MotPotStPt Memory	0	1		0	221	Parameter to select reset function for motor potentiometer speed setpoint. Default: No reset.

Output Signals — M1 → G1.3**Table 12-4: Output Signals — M1 → G1.3**

Code	Parameter	Min.	Max.	Unit	Default	ID Number	Description
P1.3.1	(A) AO-1 Funct.	0	8		1	301	Analog output function: 0 = FB-Control (Fieldbus Passthrough, ProcessDataIN3) 1 = O/P frequency (0 - f max) 2 = Reference frequency (0 - f max) 3 = Motor speed (0 - 100% x Motor nom. speed) 4 = O/P current (0 - 100% x I nMot) 5 = Motor torque (0 - 100% x T nMot) 6 = Motor power (0 - 100% x P nMot) 7 = Motor voltage (0 - 100% x U nMot) 8 = DC-Bus Voltage (0 - 100% x U nMot)
P1.3.2	(A) AO-1 Filter	0.00	10.00	s	1.00	302	
P1.3.3	(A) AO-1 Invert	0	1		0	303	0 = Not inverted 1 = Inverted
P1.3.4	(A) AO-1 Min.	0	1		0	304	0 = 0 mA 1 = 4 mA
P1.3.5	(A) AO-1 Scale	10	1000	%	100	305	

November 2009

Table 12-4: Output Signals — M1 → G1.3, continued

Code	Parameter	Min.	Max.	Unit	Default	ID Number	Description
P1.3.6	(A) DO-1 Funct.	0	26		1	306	Default=Drive Ready 0 = Not used 1 = Drive Ready 2 = Drive Running 3 = General Fault 4 = General Fault inverted 5 = Drive overheat warning 6 = External fault or warning 7 = Reference (4mA) fault or warning 8 = General Warning 9 = Drive Reversing 10 = Preset Speed Active 11 = Speed setpoint=Actual Speed (=At speed) 12 = Motor regulator activated 13 = Actual Speed limit supervision 14 = Speed Setpoint limit supervision 15 = Torque limit supervision 16 = Timer On/Timer Off output control (Trigger is run request) 17 = Selections #16 inverted 18 = Frequency converter temperature limit supervision 19 = Unrequested rotation direction 20 = Thermistor fault / warning 21 = Hand Control Active 22 = Auto Control Active 23 = DI-Fire Mode Active 24 = Relay to energize an external element before starting the drive. 25 = FB-Control 26 = Bypass Run
P1.3.7	(B) RO-1 Funct.	0	25		2	307	Same as parameter 1.3.6.
P1.3.8	(B) RO-2 Funct.	0	25		3	308	Same as parameter 1.3.6
P1.3.9	(D) RO-1 Funct.	0	25		0	309	Same as parameter 1.3.6
P1.3.10	(D) RO-2 Funct.	0	25		0	310	Same as parameter 1.3.6
P1.3.11	(D) RO-3 Funct.	0	25		0	311	Same as parameter 1.3.6
P1.3.12	Sp.StPt Supv Fct	0	2		0	312	Speed Setpoint Supervision Function: 0 = Not used 1 = Low limit 2 = High limit
P1.3.13	Sp.StPt Supv Lim	0.0	100.0	%	0.0	313	Speed Setpoint Supervision Value.

Table 12-4: Output Signals — M1 → G1.3, continued

Code	Parameter	Min.	Max.	Unit	Default	ID Number	Description
P1.3.14	Act.Sp. Supv Fct	0	2		0	314	Actual Speed Supervision Function: 0 = Not used 1 = Low limit 2 = High limit
P1.3.15	Act.Sp. Supv Lim	0.0	100.0	%	0.0	315	Actual Speed Supervision Value. (±1.0% hysteresis)
P1.3.16	Torque Supv Fct	0	2		0	316	Torque Limit Supervision Function: 0 = Not used 1 = Low limit 2 = High limit
P1.3.17	Torque Supv Lim	0.0	300.0	%	0.0	317	Torque Limit Supervision Value
P1.3.18	TempLim Supv Fct	0	2		0	318	Temperature Limit Supervision Function: 0 = Not used 1 = Low limit 2 = High limit
P1.3.19	TempLim Supv Lim	-50	170	°F	104	319	Temperature Limit Supervision value
P1.3.20	StartRlyON-Del.	0.0	100.0	s	0.0	320	Relay/Digital output ON-delay time after start-command is given.
P1.3.21	StartRlyOFF-Del.	0.0	100.0	s	0.0	321	Relay/Digital output OFF-delay time after stop-command is given.

Drive Control Parameters — M1 → G1.4**Table 12-5: Drive Control Parameters — M1 → G1.4**

Code	Parameter	Min.	Max.	Unit	Default	ID Number	Description
P1.4.1	Start Mode	0	1		0	401	0 = Ramp 1 = Flying start
P1.4.2	Stop Mode	0	1		1	402	0 = Coasting 1 = Ramp
P1.4.3	Brake Chopper	0	4		0	403	Brake Chopper Mode Selection. 0 = Brake NO, Test NO 1 = Brake YES(Run), Test YES (Ready+run) 2 = Brake chopper EXTERNAL, Test NO 3 = Brake YES(Ready+run), Test YES (Ready+run) 4 = Brake YES(Run), Test NO
P1.4.4	S-curve Time	0.0	10.0	s	0.0	404	Smooth ratio for S-curve

November 2009

Prohibit Frequencies— M1 → G1.5

Table 12-6: Prohibit Frequencies — M1 → G1.5

Code	Parameter	Min.	Max.	Unit	Default	ID Number	Description
P1.5.1	SkipF1 Low Lim	0.0	100.0	%	0.0	501	Prohibit speed range 1 low limit.
P1.5.2	SkipF1 High Lim	Range_1_Low_Lim	100.0	%	0.0	502	Prohibit speed range 1 high limit: 0 = No prohibit frequency range
P1.5.3	SkipF2 Low Lim	0.0	100.0	%	0.0	503	Prohibit speed range 2 low limit
P1.5.4	SkipF2 High Lim	Range_2_Low_Lim	100.0	%	0.0	504	Prohibit speed range 2 high limit: 0 = No prohibit frequency range
P1.5.5	SkipF3 Low Lim	0.0	100.0	%	0.0	505	Prohibit speed range 3 low limit
P1.5.6	SkipF3 High Lim	Range_3_Low_Lim	100.0	%	0.0	506	Prohibit speed range 3 high limit: 0 = No prohibit frequency range
P1.5.7	SkipF4 Low Lim	0.0	100.0	%	0.0	507	Prohibit speed range 4 low limit
P1.5.8	SkipF4 High Lim	Range_4_Low_Lim	100.0	%	0.0	508	Prohibit speed range 4 high limit: 0 = No prohibit frequency range
P1.5.9	SkipF5 Low Lim	0.0	100.0	%	0.0	509	Prohibit speed range 5 low limit
P1.5.10	SkipF5 High Lim	Range_5_Low_Lim	100.0	%	0.0	510	Prohibit speed range 5 high limit: 0 = No prohibit frequency range
P1.5.11	SkipF6 Low Lim	0.0	100.0	%	0.0	511	Prohibit speed range 6 low limit
P1.5.12	SkipF6 High Lim	Range_6_Low_Lim	100.0	%	0.0	512	Prohibit speed range 6 high limit: 0 = No prohibit frequency range
P1.5.13	PH Acc/Dec Ramp	0.1	10.0	x	1.0	513	Acceleration/Deceleration time factor to pass prohibit speed window.

Motor Control Parameters — M1 → G1.6**Table 12-7: Motor Control Parameters — M1 → G1.6**

Code	Parameter	Min.	Max.	Unit	Default	ID Number	Description
P1.6.1	Motor Ctrl Mode	0	1		0	601	Motor control mode: 0 = frequency control 1 = speed control
P1.6.2	V/Hz Optim.	0	1		0	602	V/F optimization selection: 0 = none 1 = automatic torque boost
P1.6.3	V/Hz Ratio	0	3		0	603	V/F ratio selection: 0 = linear 1 = squared 2 = programmable 3 = Linear with flux optim.
P1.6.4	Field WeakngPnt	8.00	320.00	Hz	60.00	604	Field weakening point.
P1.6.5	Voltage at FWP	10.00	200.00	%	100.00	605	Motor voltage (%*MotorNPVoltage) at field weakening point.
P1.6.6	V/Hz Mid Freq	0.00	Field Weakening Point	Hz	60.00	606	Programmable V/Hz curve middle point frequency.
P1.6.7	V/Hz Mid Voltg	0.00	100.00	%	100.00	607	Motor voltage (%*MotorNPVoltage) at programmable V/Hz curve middle point.
P1.6.8	Zero Freq Voltg	0.00	40.00	%	0.00	608	Motor voltage (%*MotorNPVoltage) at zero speed.
P1.6.9	Switching Freq	1.0	Switching FreqMax	kHz	3.6	609	Switching frequency in kHz. See Appendix A, Table A-1 .
P1.6.10	Overvolt Contr	0	2		1	610	0 = Off 1 = On with no ramping 2 = On with ramping
P1.6.11	Undervolt Contr	0	1		1	611	0 = Off 1 = On
P1.6.12	Identification	0	2		0	612	Identification run. When this parameter is set greater than zero, then start command must be given within 20 seconds.

November 2009

Protections — M1 → G1.7

Table 12-8: Protections — M1 → G1.7

Code	Parameter	Min.	Max.	Unit	Default	ID Number	Description
P1.7.1	Input Phase Supv	0	2		2	701	Response to input phase supervision. 0 = No Action 1 = Warning 2 = Fault
P1.7.2	4mA Fault Resp	0	2		0	702	Response to 4 mA signal supervision. 0 = No Action 1 = Warning 2 = Fault
P1.7.3	Ext. Fault Resp	0	2		2	703	Response to external fault digital input signal supervision. 0 = No Action 1 = Warning 2 = Fault
P1.7.4	FBComm. FaultResp	0	2		0	704	Response to fieldbus communication supervision. 0 = No Action 1 = Warning 2 = Fault
P1.7.5	SlotComFault Resp	0	2		0	705	Response to slot communication supervision. 0 = No Action 1 = Warning 2 = Fault
P1.7.6	Motor Therm Prot	0	3		0	707	0 = No response 1 = Warning 2 = Fault, stop mode after fault according to ID402 3 = Fault, stop mode after fault always by coasting
P1.7.7	MotAmbTemp Factor	-100.0	100.0	%	0.0	708	Percent of ambient temperature.
P1.7.8	MTP f0 Current	0.0	150.00	%	40.0	709	Percent of motor nameplate current.
P1.7.9	MTP Motor T	1	200	min	45	710	Time to reach 63% of final value.
P1.7.10	Motor Duty Cycle	0	100	%	100	711	Percent of nominal motor load
P1.7.11	Stall Protection	0	3		0	712	0 = No response 1 = Warning 2 = Fault, stop mode after fault according to ID402 3 = Fault, stop mode after fault always by coasting
P1.7.12	Stall Current	0.00	Motor CurrentMax	A	1.00	713	
P1.7.13	Stall Time Lim	1.00	120.00	s	15.00	714	
P1.7.14	Stall Freq Lim	1.00	Max_Freq	Hz	25.00	715	

Tables 12-8: Protections — M1 → G1.7, continued

Code	Parameter	Min.	Max.	Unit	Default	ID Number	Description
P1.7.15	Underload Protection	0	3		0	716	0 = No response 1 = Warning 2 = Fault, stop mode after fault according to ID402 3 = Fault, stop mode after fault always by coasting
P1.7.16	UP f _{nom} Torque	10.0	150.00	%	50.0	717	Minimum torque allowed when above FWP.
P1.7.17	UP f ₀ Torque	5.0	150.00	%	10.0	718	Minimum torque allowed with zero frequency.
P1.7.18	UP Time Limit	2.00	600.00	s	20.00	719	
P1.7.19	Autom. Restart	0	3		0	706	Resets faults. See Page 15-20 . 0 = Disabled 1 = Automatically transferred to Bypass 2 = Reset drive only 3 = Reset drive, if fails, transferred to Bypass
P1.7.20	Fire Mode Speed	0	100.0	%	100	804	When fire mode input is triggered, drive will run at fire mode speed.

Fieldbus Parameters — M1 → G1.8**Table 12-9: Fieldbus Parameters — M1 → G1.8**

Code	Parameter	Min.	Max.	Unit	Default	ID Number	Description
P1.8.1	FB Data Out1 Sel	0	10000		1 ^①	1001	Fieldbus process data output 1 selection. Default = Actual Speed
P1.8.2	FB Data Out2 Sel	0	10000		5 ^①	1002	Fieldbus process data output 2 selection. Default = Motor Current
P1.8.3	FB Data Out3 Sel	0	10000		8 ^①	1003	Fieldbus process data output 3 selection. Default = Motor Voltage
P1.8.4	FB Data Out4 Sel	0	10000		7 ^①	1004	Fieldbus process data output 4 selection. Default = Motor Power
P1.8.5	FB Data Out5 Sel	0	10000		9 ^①	1005	Fieldbus process data output 5 selection. Default = DC-Link Voltage

^① ID number of parameter or variable to be sent over fieldbus. ID 1 – 20 are Monitoring values, Menu 7 (M7). See **Table 12-13**.

November 2009

Table 12-9: Fieldbus Parameters — M1 → G1.8, continued

Code	Parameter	Min.	Max.	Unit	Default	ID Number	Description
P1.8.6	FB Data Out6 Sel	0	10000		20 ^①	1006	Fieldbus process data output 6 selection. Default = Application Status Word (Variable:AppIStatusWord) b0 = Drive Ready b1 = Run Enable b2 = Drive Running b3 = Drive Reversing b4 = General Fault b5 = General Warning b6 = Preset Speed Active b7 = Motor Regulator active b8 = Output speed supervision indication b9 = Setpoint speed supervision indication b10 = HAND Control indication b11 = AUTO Control indication b12 = D-IN Firemode b13 = Damper control signal b14 = Bypass mode status indication b15 = Bypass running
P1.8.7	FB Data Out7 Sel	0	10000		18 ^①	1007	Fieldbus process data output 7 selection. Default = Active Fault Code
P1.8.8	FB Data Out8 Sel	0	10000		19 ^①	1008	Fieldbus process data output 8 selection. Default = Active Warning Code

^① ID number of parameter or variable to be sent over fieldbus. ID 1 – 20 are Monitoring values, Menu 7 (M7). See Table 12-13.

PI-Control Parameters — M1 → G1.9**Table 12-10: PI-Control Parameters — M1 → G1.9**

Code	Parameter	Min.	Max.	Unit	Default	ID Number	Description
P1.9.1	US/Metric Units	0	1		0	1101	
P1.9.2	Setpoint Min.	Sensor_Min	PI_Setpoint_Max		(-100)	1102	Minimum limit for the PI-Controller setpoint.
P1.9.3	Setpoint Max.	PI_Setpoint_Min	Sensor_Max		(100)	1103	Maximum limit for the PI-Controller setpoint.
P1.9.4	PI-StPt Ramp Time	0.00	20.00	s	1.00	1104	Parameter for the PI-Setpoint ramp time. Default: 1.00s
P1.9.5	PI-Input Source	0	5		0	1106	PI-Controller Input Source Selection: Default #0 = (A) AI-1 0 = (A) AI-1 1 = (A) AI-2 2 = Fieldbus, ProcessData1 3 = Min. Both 4 = Max. Both 5 = Ave. Both
P1.9.6	Sensor Min.	(-10000)	Sensor_Max		(-100)	1107	Actual Sensor minimum value at 0/4 mA.
P1.9.7	Sensor Max.	Sensor_Min	(10000)		(100)	1108	Actual Sensor maximum value at 20 mA.
P1.9.8	PI-Contr. P-Gain	0.00	10.00		0.10	1109	P-Term (Gain) for the PI-controller.
P1.9.9	PI-Contr. I-Time	0.00	320.00	s	30.00	1110	I-Term (Integral Time) for the PI-controller.
P1.9.10	PI Deadband	(0)	(20000)		(0)	1111	Deadband area in units. (Hysteresis to PI Setpoint)
P1.9.11	PI Acting Mode	0	1		1	1112	PI-controller acting mode. 0 = Reverse acting 1 = Forward acting
P1.9.12	Auto Accel. Time	0.1	3000.0	s	60.0	1113	Auto Mode Accel. Time
P1.9.13	Auto Decel. Time	0.1	3000.0	s	60.0	1114	Auto Mode Decel. Time
P1.9.14	Auto S-curve Time	0.0	10.0	s	0.0	1115	Auto Mode and PI-control is NOT active

Preset Speeds — M1 → G1.10**Table 12-11: Preset Speeds — M1 → G1.10**

Code	Parameter	Min.	Max.	Unit	Step	Default	ID Number	Description
P1.10.1	Preset Speed 1	0	100.0	%	0.1	30.0	1701	Preset speeds when Digital Inputs are programmed
P1.10.2	Preset Speed 2	0	100.0	%	0.1	40.0	1702	
P1.10.3	Preset Speed 3	0	100.0	%	0.1	50.0	1703	
P1.10.4	Preset Speed 4	0	100.0	%	0.1	60.0	1704	
P1.10.5	Preset Speed 5	0	100.0	%	0.1	70.0	1705	
P1.10.6	Preset Speed 6	0	100.0	%	0.1	80.0	1706	
P1.10.7	Preset Speed 7	0	100.0	%	0.1	90.0	1707	

November 2009

Keypad Control Parameters — M2

This menu provides the parameters for the setting of the keypad speed setpoint, the selection of motor direction when in keypad operation, and when the STOP button is active.

Table 12-12: Keypad Control Parameters — M2

Code	Parameter	Min.	Max.	Unit	Default	ID Number ①	Description
R2.1	Speed Setpoint	0.0	100.0	%	0.0		Keypad Speed Setpoint.
P2.2	Keypad Direction	0	1		0	1009	Reverse request active from the panel 0 = Forward 1 = Reverse
P2.3	StopButton Active	0	1		1	1010	Stop button (Keypad) always active (Yes/No)
R2.4	PI-Setpoint	(-10000)	(10000)		(30)		
P2.5	PI-Setpoint Default	(-10000)	(10000)			1011	PI-regulators default setpoint

① Keypad Control Parameter ID Numbers are listed separately on **Page 15-28**.

Menus — M3 to M6

Menus M3 to M6 provide information on the Active Faults, Fault History, System Menu settings and the Expander Board setup. These menu items are explained in detail in **Chapter 6**.

Monitoring Menu — M7

The monitored items are the actual values of parameters and signals as well as the status and measurements of other elements. Monitored items cannot be edited.

See **Chapter 6** — Menu information item M7, for more information.

Table 12-13: Monitoring Menu

Code	Parameter	Min.	Max.	Unit	Default	ID Number	Description
V7.1	Output Frequency	-320.00	320.00	Hz	0.00	2	Output frequency to the motor
V7.2	Actual Speed	-320.0	320.0	%	0.0	1	Output speed to the motor
V7.3	Speed Setpoint	-320.0	320.0	%	0.0	3	Monitored speed setpoint. This will show also the speed setpoint below the minimum frequency.
V7.4	Motor Speed	-10000	10000	rpm	0	4	Calculated motor speed in rpm
V7.5	Motor Current	0.0	Motor CurrentMax	A	0.0	5	
V7.6	Motor Torque	-300.0	300.0	%	0.0	6	[R] Motor torque as % value, +1000 equals +100.0 % pos = clockwise, neg = counterclockwise
V7.7	Motor Power	-300.0	300.0	%	0.0	7	
V7.8	Motor Voltage	0.0	1000.0	V	0.0	8	Measured motor voltage
V7.9	DC-Bus Voltage	0	1000	V	0	9	[R] DC voltage in Volts Tfilt = 32ms.
V7.10	Unit Temperature	-1000	1000	°F	0	10	Temperature of the heat sink
V7.11	Motor Temperature	0.0	1000.0	%	0.0	11	
V7.12	(A) AI-1	-10.00	20.00	V	0.00	12	Voltage Input value [V]
V7.13	(A) AI-2	-10.00	20.00	mA	0.00	13	Current Input value [mA]
V7.14	DI-1 DI-2 DI-3	0	7		0	14	DIA-1, DIA-2 and DIA-3 status
V7.15	DI-4 DI-5 DI-6	0	7		0	15	DIB-4, DIB-5 and DIB-6 status
V7.16	DO-1 RO-1 RO-2	0	7		0	16	DO-1, RO-1 and RO-2 status
V7.17	(A) AO-1	0.00	20.00	mA	0.00	17	
V7.18	ActFaultCode	0	200		0	18	Active Fault code.
V7.19	ActWarnCode	0	200		0	19	Active Warning code.

November 2009

Table 12-13: Monitoring Menu, continued

Code	Parameter	Min.	Max.	Unit	Default	ID Number	Description
V7.20	Status Word	-32768	32767		0	20	b0 = Drive Ready b1 = Run Enable b2 = Drive Running b3 = Drive Reversing b4 = General Fault b5 = General Warning b6 = Preset Speed Active b7 = Motor Regulator active b8 = Output speed supervision indication b9 = Setpoint speed supervision indication b10 = HAND Control indication b11 = AUTO Control indication b12 = D-IN Firemode b13 = Damper control signal b14 = Bypass mode status indication b15 = Bypass running
V7.21	PI-Setpoint	(-10000)	(10000)	WC/PA	(0)	21	
V7.22	PI-Input	(-10000)	(10000)		(0)	22	Actual Sensor Value
V7.23	PI-Error	(-10000)	(10000)		(0)	23	
V7.24	PI-Output	0.0	100.0	%	0.0	24	
V7.25	RO-1 RO-2 RO-3	0	7		0	25	Monitoring the OPTB5 relay outputs.
G7.26	Multimonitor	—	—		—	—	Displays three monitor values simultaneously

Operate Menu — M8

The Operate Menu provides an easy to use method of viewing key numerical Monitoring Menu items. It also allows the setting of the keypad frequency reference. See **Chapter 6** for more information.



November 2009

Chapter 13 — Pressure Control Application (SVCHS204)

Introduction

The Pressure Control Application is typically used to control levels of pumps in fans with a pressure transducer and provide PSI/kPa units to a keypad.

The direct frequency reference can be used for the control without the PI controller and is selected from the analog inputs, fieldbus, motor potentiometer or keypad.

The Pressure Control Application is typically used to control Pressure pumps. In these applications, the Pressure Control Application provides a smooth control and an integrated measurement and control package where no additional components are needed.

- Digital inputs DI-2, DI-3 and DI-5 and all outputs are freely programmable.

Additional functions:

- Analog input signal range selection
- One frequency limit supervision
- Torque limit supervision
- Speed setpoint limit supervision
- Programmable start and stop functions
- DC Brake Chopper
- Six skip frequency areas
- Programmable V/Hz curve and switching frequency
- Auto restart
- Motor thermal and stall protection: Programmable action; off, warning, fault
- Motor underload protection
- Input and output phase supervision

Details of the parameters shown in this section are available in **Chapter 15** of this Manual, listed by parameter ID number.

Control Input/Output

Table 13-1: Pressure Control Application Default I/O Configuration

Terminal	Signal	Description
OPTA9		
1	+10V DC _{ref}	Reference output Voltage for potentiometer, etc.
2	AI-1+	Analog input, voltage range 0 – 10V DC Voltage input for PI setpoint or feedback (Programmable)
3	AI-1-	I/O Ground Ground for reference and controls
4	AI-2+	Analog input, current range 0 – 20 mA Current input for PI setpoint or feedback (Programmable)
5	AI-2-	I/O Ground Ground for reference and controls
6	24V DC	Control voltage output Voltage for switches, etc. max 0.1A
7	GND	I/O ground Ground for reference and controls
8	DI-1	Start/Stop Control Contact closed = start
9	DI-2	External fault input (programmable) Contact closed = fault Contact open = no fault
10	DI-3	External Interlock (programmable) Contact closed = OK Open = Interlocked
11	CMA	Common for DI-1 – DI-3 Connect to GND or 24V DC
12	24V DC	Control voltage output Voltage for switches (see terminal 6)
13	GND	I/O ground Ground for reference and controls
14	DI-4	Speed Select 1 (programmable) Contact closed = Speed Select 1
15	DI-5	Fire Mode (programmable) Contact closed = Fire Mode active
16	DI-6	Overload relay (IntelliPass) (programmable) Contact open = no fault Contact closed = fault
17	CMB	Common for DI-4 – DI-6 Connect to GND or 24V DC
18	AO-1+	Output frequency Analog output Programmable Range 0 – 20 mA, R _L max. 500Ω
19	AO-1	I/O Ground Ground for reference and controls
20	DO-1	Digital output READY Programmable Open collector, I ≤ 50 mA, V ≤ 48V DC
OPTA2		
21-22 Opens on RUN	21 RO-1	Relay output 1 Programmable Drive RUN is default.
22-23 Closes on RUN	22 RO-1	
	23 RO-1	
24-25 Opens on FAULT	24 RO-2	Relay output 2 Programmable Drive FAULT is default.
25-26 Closes on FAULT	25 RO-2	
	26 RO-2	

Note: For more information on jumper selections, see **Chapter 4**.

X3 Jumper Setting — CMA and CMB Grounding

- CMB Connected to Ground
CMA Connected to Ground
- CMB Isolated from Ground
CMA Isolated from Ground
- CMB and CMA Internally Connected
and Isolated from Ground

CAUTION

Unattended start will occur if power is supplied with Start Command activated.

November 2009

Parameter Lists

On the next pages you will find the lists of parameters within the respective parameter groups. The parameter descriptions are given by ID number in **Chapter 15**.

Column explanations:

- Code = Location indication on the keypad; Shows the operator the present parameter number
- Parameter = Name of parameter
- Min. = Minimum value of parameter
- Max. = Maximum value of parameter
- Unit = Unit of parameter value; Given if available
- Default = Value preset by factory
- ID = ID number of the parameter for reference to **Chapter 15**

Quick Setup Parameters — M1 → G1.1

Table 13-2: Quick Setup Parameters — M1 → G1.1

Code	Parameter	Min.	Max.	Unit	Default	ID Number	Description
P1.1.1	Min Frequency	0.00	Max_Frequency	Hz	12.00	101	Minimum output frequency, f[Hz].
P1.1.2	Max Frequency	FreqMin	320.00	Hz	60.00	102	Maximum output frequency, f[Hz].
P1.1.3	Acceleration Time	0.1	3000.0	s	60.0	103	Time from 0 Hz to maximum Hz.
P1.1.4	Deceleration Time	0.1	3000.0	s	60.0	104	Time from maximum Hz to 0 Hz.
P1.1.5	Motor NP Voltg	180	Motor VoltageMax	V	400	105	Motor nameplate voltage in Volts.
P1.1.6	Motor NP Freq	8.00	320.00	Hz	60.00	106	Motor nameplate frequency in Hertz.
P1.1.7	Motor Nom Speed	24	20000	rpm	1720	111	Motor nameplate speed in Rpm.
P1.1.8	Motor Nom Currnt	Motor CurrentMin	Motor CurrentMax	A	5.40	108	Motor nameplate current, I[A]
P1.1.9	Power Factor	0.30	1.00		0.85	109	Motor power factor. (Cos Phi)
P1.1.10	Service Factor	0.10	2.00		1.00	110	Motor service factor. This will calculate the motor current limit. (MotorNomCurrent x Service Factor)
P1.1.11	Current Limit	Motor CurrentMin	Motor CurrentMax	A	7.00	107	Output current limit of the unit in Amps.
P1.1.12	Start Srce Hand	1	3		1	112	Parameter for Local Start/Stop/Reverse control location. Default = Keypad 1 = Keypad 2 = DI-1 Start 3 = I/O Three Wire

Table 13-2: Quick Setup Parameters — M1 → G1.1, continued

Code	Parameter	Min.	Max.	Unit	Default	ID Number	Description
P1.1.13	StPt Source Hand	0	3		2	113	Local speed setpoint selection: 0 = analog input AI-1 1 = analog input AI-2 2 = Speed Setpoint from Keypad 3 = Motor Potentiometer
P1.1.14	Start Srce Auto	1	4		2	114	Parameter for Remote Start/Stop/Reverse control location. Default = DI-1 Start 1 = Keypad 2 = DI-1 Start 3 = I/O Three Wire 4 = Fieldbus
P1.1.15	StPt Source Auto	0	4		0	115	PI-setpoint selection: 0 = analog input AI-1 1 = analog input AI-2 2 = PI Setpoint from Keypad 3 = Motor Potentiometer 4 = PI Setpoint from Fieldbus
P1.1.16	PI-Input Source	0	2		0	1106	PI-Controller Input Source Selection: Default #0 = (A) AI-1 0 = (A) AI-1 1 = (A) AI-2 2 = Fieldbus, Process Data 1 3 = Min. Both 4 = Max. Both 5 = Ave. Both
P1.1.17	Sensor Min.	(-10000)	Sensor_Max		(0)	1107	Actual Sensor minimum value at 0/4 mA.
P1.1.18	Sensor Max.	Sensor_Min	(10000)		(500)	1108	Actual Sensor maximum value at 20 mA.
P1.1.19	PI-Contr. P-Gain	0.00	10.00		0.10	1109	P-Term (Gain) for the PI-Controller
P1.1.20	PI-Contr. I-Time	0.00	320.00	s	30.00	1110	I-Term (Integral Time) for the PI-controller
P1.1.21	PI-Deadband	(0)	(20000)		(0)	1111	Deadband area in units. (Hysteresis to PI-Setpoint)
P1.1.22	AutoAccelTime	0.1	3000.0	s	60.0	1113	Acceleration time, when in AUTO mode
P1.1.23	AutoDecelTime	0.1	3000.0	s	60.0	1114	Deceleratin time, when in AUTO mode
P1.1.24	US/Metric Units	0	1		0	1101	

November 2009

Input Signals — M1 → G1.2

Table 13-3: Input Signals — M1 → G1.2

Code	Parameter	Min.	Max.	Unit	Default	ID Number	Description
P1.2.1	Start Mode	0	3		1	201	Start Function: 0 = Normal start without interlockings. 1 = Interlocked start. One of the digital inputs must be programmed to Intlk/RunEna. DI-3 is defaulted for this feature. 2 = Mode 1 + timeout supervision. If the interlock is not OK within the interlock timeout time, start request is ignored and must be given again. 3 = Delayed start. Start request is given after delay time has expired.
P1.2.2	Intlk Stop Mode	0	1		1	216	0 = Coasting 1 = Ramp
P1.2.3	Intlk Timeout	0.00	300.00	s	5.00	202	Interlock timeout time for Start Function #2. Default = 5s.
P1.2.4	Start Delay Time	0.00	300.00	s	5.00	203	Start delay time for Start Function #3. Default = 5s.
P1.2.5	(A) DI-2 Funct.	0	17		1	204	Default #1 External Fault Close 0 = Stop pulse, when 3-wire start/stop logic is selected. (False=Stop, True=Ready to Run) 1 = Ext. fault, closing contact 2 = External fault, opening contact 3 = Fault reset 4 = Run enable-Closed Contact 5 = Force ctrl. place to Hand 6 = Force ctrl. place to Auto 7 = Reverse 8 = Speed Select 1 9 = Fire Mode-Closed Contact 10 = Speed Select 2 11 = Speed Select 3 12 = Force Bypass 13 = External interlock closed 14 = External interlock open 15 = Mot. Pot. UP 16 = Mot. Pot. DOWN 17 = Fire Mode-Open Contact

 CAUTION

Unattended start will occur if power is supplied with Start Command activated.

Table 13-3: Input Signals — M1 → G1.2, continued

Code	Parameter	Min.	Max.	Unit	Default	ID Number	Description
P1.2.6	(A) DI-3 Funct.	0	17		13	205	Default #13 Interlock/Run Enable 0 = Not Used 1 = Ext. fault, closing contact 2 = External fault, opening contact 3 = Fault reset 4 = Run enable-Closed Contact 5 = Force ctrl. place to Hand 6 = Force ctrl. place to Auto 7 = Reverse 8 = Speed Select 1 9 = Fire Mode-Closed Contact 10 = Speed Select 2 11 = Speed Select 3 12 = Force Bypass 13 = External interlock closed 14 = External interlock open 15 = Mot. Pot. UP 16 = Mot. Pot. DOWN 17 = Fire Mode-Open Contact
P1.2.7	(A) DI-4 Funct.	0	17		8	206	Default #8 Speed Select 1 0 = Not Used 1 = Ext. fault, closing contact 2 = External fault, opening contact 3 = Fault reset 4 = Run enable-Closed Contact 5 = Force ctrl. place to Hand 6 = Force ctrl. place to Auto 7 = Reverse 8 = Speed Select 1 9 = Fire Mode-Closed Contact 10 = Speed Select 2 11 = Speed Select 3 12 = Force Bypass 13 = External interlock closed 14 = External interlock open 15 = Mot. Pot. UP 16 = Mot. Pot. DOWN 17 = Fire Mode-Open Contact

November 2009

Table 13-3: Input Signals — M1 → G1.2, continued

Code	Parameter	Min.	Max.	Unit	Default	ID Number	Description
P1.2.8	(A) DI-5 Funct.	0	17		9	207	Default #9 Fire-Mode 0 = Not Used 1 = Ext. fault, closing contact 2 = External fault, opening contact 3 = Fault reset 4 = Run enable-Closed Contact 5 = Force ctrl. place to Hand 6 = Force ctrl. place to Auto 7 = Reverse 8 = Speed Select 1 9 = Fire Mode-Closed Contact 10 = Speed Select 2 11 = Speed Select 3 12 = Force Bypass 13 = External interlock closed 14 = External interlock open 15 = Mot. Pot. UP 16 = Mot. Pot. DOWN 17 = Fire Mode-Open Contact
P1.2.9	(A) DI-6 Funct.	0	17		0	208	Default #0 Overload Fault Relay-input 0 = Overload fault relay (Used in Intellipass) 1 = Ext. fault, closing contact 2 = External fault, opening contact 3 = Fault reset 4 = Run enable-Closed Contact 5 = Force ctrl. place to Hand 6 = Force ctrl. place to Auto 7 = Reverse 8 = Speed Select 1 9 = Fire Mode-Closed Contact 10 = Speed Select 2 11 = Speed Select 3 12 = Force Bypass 13 = External interlock closed 14 = External interlock open 15 = Mot. Pot. UP 16 = Mot. Pot. DOWN 17 = Fire Mode-Open Contact
P1.2.10	(A) AI-1 Minimum	0.00	Max.	%	0.00	217	Default applies for 0V or 0 mA
P1.2.11	(A) AI-1 Maximum	Min.	100.0	%	100.00	218	Default applies for 10V or 20 mA
P1.2.12	(A) AI-1 Invert	0	1		0	209	0 = Not inverted 1 = Inverted
P1.2.13	(A) AI-1 Filter	0.00	10.00	s	0.10	210	0 = No filtering
P1.2.14	(A) AI-2 Minimum	0.00	Max.	%	20.00	219	Default applies for 2V or 4 mA
P1.2.15	(A) AI-2 Maximum	Min.	100.0	%	100.00	220	Default applies for 10V or 20 mA
P1.2.16	(A) AI-2 Invert	0	1		0	212	0 = Not inverted 1 = Inverted
P1.2.17	(A) AI-2 Filter	0.00	10.00	s	0.10	213	0 = No filtering
P1.2.18	StPt. Scale Min	0.0	100.0	%	0.0	214	Speed that corresponds to the minimum setpoint signal.

Table 13-3: Input Signals — M1 → G1.2, continued

Code	Parameter	Min.	Max.	Unit	Default	ID Number	Description
P1.2.19	StPt. Scale Max	0.0	100.0	%	0.0	215	Speed that corresponds to the maximum setpoint signal. 0.0%=NOT IN USE!
P1.2.20	MotPotStPt Memory	0	1		0	221	Parameter to select reset function for motor potentiometer speed setpoint. Default: No reset.

Output Signals — M1 → G1.3**Table 13-4: Output Signals — M1 → G1.3**

Code	Parameter	Min.	Max.	Unit	Default	ID Number	Description
P1.3.1	(A) AO-1 Funct.	0	8		1	301	Analog output function: 0 = FB-Control (Fieldbus Passthrough, ProcessDataIN3) 1 = O/P frequency (0 - f max) 2 = Reference frequency (0 - f max) 3 = Motor speed (0 - 100% x Motor nom. speed) 4 = O/P current (0 - 100% x I nMot) 5 = Motor torque (0 - 100% x T nMot) 6 = Motor power (0 - 100% x P nMot) 7 = Motor voltage (0 - 100% x U nMot) 8 = DC-Bus Voltage (0 - 100% x U nMot)
P1.3.2	(A) AO-1 Filter	0.00	10.00	s	1.00	302	
P1.3.3	(A) AO-1 Invert	0	1		0	303	0 = Not inverted 1 = Inverted
P1.3.4	(A) AO-1 Min.	0	1		0	304	0 = 0 mA 1 = 4 mA
P1.3.5	(A) AO-1 Scale	10	1000	%	100	305	

November 2009

Table 13-4: Output Signals — M1 → G1.3, continued

Code	Parameter	Min.	Max.	Unit	Default	ID Number	Description
P1.3.6	(A) DO-1 Funct.	0	26		1	306	Default=Drive Ready 0 = Not used 1 = Drive Ready 2 = Drive Running 3 = General Fault 4 = General Fault inverted 5 = Drive overheat warning 6 = External fault or warning 7 = Reference (4mA) fault or warning 8 = General Warning 9 = Drive Reversing 10 = Preset Speed Active 11 = Speed setpoint=Actual Speed (=At speed) 12 = Motor regulator activated 13 = Actual Speed limit supervision 14 = Speed Setpoint limit supervision 15 = Torque limit supervision 16 = Timer On/Timer Off output control (Trigger is run request) 17 = Selections #16 inverted 18 = Frequency converter temperature limit supervision 19 = Unrequested rotation direction 20 = Thermistor fault / warning 21 = Hand Control Active 22 = Auto Control Active 23 = DI-Fire Mode Active 24 = Relay to energize an external element before starting the drive. 25 = FB-Control 26 = Bypass Run
P1.3.7	(B) RO-1 Funct.	0	24		2	307	Same as parameter 1.3.6.
P1.3.8	(B) RO-2 Funct.	0	24		3	308	Same as parameter 1.3.6
P1.3.9	(D) RO-1 Funct.	0	24		0	309	Same as parameter 1.3.6
P1.3.10	(D) RO-2 Funct.	0	24		0	310	Same as parameter 1.3.6
P1.3.11	(D) RO-3 Funct.	0	24		0	311	Same as parameter 1.3.6
P1.3.12	Sp.StPt Supv Fct	0	2		0	312	Speed Setpoint Supervision Function: 0 = Not used 1 = Low limit 2 = High limit
P1.3.13	Sp.StPt Supv Lim	0.0	100.0	%	0.0	313	Speed Setpoint Supervision Value.

Table 13-4: Output Signals — M1 → G1.3, continued

Code	Parameter	Min.	Max.	Unit	Default	ID Number	Description
P1.3.14	Act.Sp. Supv Fct	0	2		0	314	Actual Speed Supervision Function: 0 = Not used 1 = Low limit 2 = High limit
P1.3.15	Act.Sp. Supv Lim	0.0	100.0	%	0.0	315	Actual Speed Supervision Value. (±1.0% hysteresis)
P1.3.16	Torque Supv Fct	0	2		0	316	Torque Limit Supervision Function: 0 = Not used 1 = Low limit 2 = High limit
P1.3.17	Torque Supv Lim	0.0	300.0	%	0.0	317	Torque Limit Supervision Value
P1.3.18	TempLim Supv Fct	0	2		0	318	Temperature Limit Supervision Function: 0 = Not used 1 = Low limit 2 = High limit
P1.3.19	TempLim Supv Lim	-50	170	°F	104	319	Temperature Limit Supervision value
P1.3.20	StartRlyON-Del.	0.0	100.0	s	0.0	320	Relay/Digital output ON-delay time after start-command is given.
P1.3.21	StartRlyOFF-Del.	0.0	100.0	s	0.0	321	Relay/Digital output OFF-delay time after stop-command is given.

Drive Control Parameters — M1 → G1.4**Table 13-5: Drive Control Parameters — M1 → G1.4**

Code	Parameter	Min.	Max.	Unit	Default	ID Number	Description
P1.4.1	Start Mode	0	1		0	401	0 = Ramp 1 = Flying start
P1.4.2	Stop Mode	0	1		1	402	0 = Coasting 1 = Ramp
P1.4.3	Brake Chopper	0	4		0	403	Brake Chopper Mode Selection. 0 = Brake NO, Test NO 1 = Brake YES(Run), Test YES (Ready+run) 2 = Brake chopper EXTERNAL, Test NO 3 = Brake YES(Ready+run), Test YES (Ready+run) 4 = Brake YES(Run), Test NO
P1.4.4	S-curve Time	0.0	10.0	s	0.0	404	Smooth ratio for S-curve

November 2009

Prohibit Frequencies— M1 → G1.5

Table 13-6: Prohibit Frequencies — M1 → G1.5

Code	Parameter	Min.	Max.	Unit	Default	ID Number	Description
P1.5.1	SkipF1 Low Lim	0.0	100.0	%	0.0	501	Prohibit speed range 1 low limit.
P1.5.2	SkipF1 High Lim	Range_1_Low_Lim	100.0	%	0.0	502	Prohibit speed range 1 high limit: 0 = No prohibit frequency range
P1.5.3	SkipF2 Low Lim	0.0	100.0	%	0.0	503	Prohibit speed range 2 low limit
P1.5.4	SkipF2 High Lim	Range_2_Low_Lim	100.0	%	0.0	504	Prohibit speed range 2 high limit: 0 = No prohibit frequency range
P1.5.5	SkipF3 Low Lim	0.0	100.0	%	0.0	505	Prohibit speed range 3 low limit
P1.5.6	SkipF3 High Lim	Range_3_Low_Lim	100.0	%	0.0	506	Prohibit speed range 3 high limit: 0 = No prohibit frequency range
P1.5.7	SkipF4 Low Lim	0.0	100.0	%	0.0	507	Prohibit speed range 4 low limit
P1.5.8	SkipF4 High Lim	Range_4_Low_Lim	100.0	%	0.0	508	Prohibit speed range 4 high limit: 0 = No prohibit frequency range
P1.5.9	SkipF5 Low Lim	0.0	100.0	%	0.0	509	Prohibit speed range 5 low limit
P1.5.10	SkipF5 High Lim	Range_5_Low_Lim	100.0	%	0.0	510	Prohibit speed range 5 high limit: 0 = No prohibit frequency range
P1.5.11	SkipF6 Low Lim	0.0	100.0	%	0.0	511	Prohibit speed range 6 low limit
P1.5.12	SkipF6 High Lim	Range_6_Low_Lim	100.0	%	0.0	512	Prohibit speed range 6 high limit: 0 = No prohibit frequency range
P1.5.13	PH Acc/Dec Ramp	0.1	10.0	x	1.0	513	Acceleration/Deceleration time factor to pass prohibit speed window.

Motor Control Parameters — M1 → G1.6**Table 13-7: Motor Control Parameters — M1 → G1.6**

Code	Parameter	Min.	Max.	Unit	Default	ID Number	Description
P1.6.1	Motor Ctrl Mode	0	1		0	601	Motor control mode: 0 = frequency control 1 = speed control
P1.6.2	V/Hz Optim.	0	1		0	602	V/F optimization selection: 0 = none 1 = automatic torque boost
P1.6.3	V/Hz Ratio	0	3		0	603	V/F ratio selection: 0 = linear 1 = squared 2 = programmable 3 = Linear with flux optim.
P1.6.4	Field WeakngPnt	8.00	320.00	Hz	60.00	604	Field weakening point.
P1.6.5	Voltage at FWP	10.00	200.00	%	100.00	605	Motor voltage (%*MotorNPVoltage) at field weakening point.
P1.6.6	V/Hz Mid Freq	0.00	Field Weakening Point	Hz	60.00	606	Programmable V/Hz curve middle point frequency.
P1.6.7	V/Hz Mid Voltg	0.00	100.00	%	100.00	607	Motor voltage (%*MotorNPVoltage) at programmable V/Hz curve middle point.
P1.6.8	Zero Freq Voltg	0.00	40.00	%	0.00	608	Motor voltage (%*MotorNPVoltage) at zero speed.
P1.6.9	Switching Freq	1.0	Switching FreqMax	kHz	3.6	609	Switching frequency in kHz. See Appendix A, Table A-1 .
P1.6.10	Overvolt Contr	0	2		1	610	0 = Off 1 = On with no ramping 2 = On with ramping
P1.6.11	Undervolt Contr	0	1		1	611	0 = Off 1 = On
P1.6.12	Identification	0	2		0	612	Identification run. When this parameter is set greater than zero, then start command must be given within 20 seconds.

November 2009

Protections — M1 → G1.7
Table 13-8: Protections — M1 → G1.7

Code	Parameter	Min.	Max.	Unit	Default	ID Number	Description
P1.7.1	Input Phase Supv	0	2		2	701	Response to input phase supervision. 0 = No Action 1 = Warning 2 = Fault
P1.7.2	4mA Fault Resp	0	2		0	702	Response to 4 mA signal supervision. 0 = No Action 1 = Warning 2 = Fault
P1.7.3	Ext. Fault Resp	0	2		2	703	Response to external fault digital input signal supervision. 0 = No Action 1 = Warning 2 = Fault
P1.7.4	FBComm. FaultResp	0	2		0	704	Response to fieldbus communication supervision. 0 = No Action 1 = Warning 2 = Fault
P1.7.5	SlotComFault Resp	0	2		0	705	Response to slot communication supervision. 0 = No Action 1 = Warning 2 = Fault
P1.7.6	Motor Therm Prot	0	3		0	707	0 = No response 1 = Warning 2 = Fault, stop mode after fault according to ID402 3 = Fault, stop mode after fault always by coasting
P1.7.7	MotAmbTemp Factor	-100.0	100.0	%	0.0	708	Percent of ambient temperature.
P1.7.8	MTP f0 Current	0.0	150.00	%	40.0	709	Percent of motor nameplate current.
P1.7.9	MTP Motor T	1	200	min	45	710	Time to reach 63% of final value.
P1.7.10	Motor Duty Cycle	0	100	%	100	711	Percent of nominal motor load
P1.7.11	Stall Protection	0	3		0	712	0 = No response 1 = Warning 2 = Fault, stop mode after fault according to ID402 3 = Fault, stop mode after fault always by coasting
P1.7.12	Stall Current	0.00	Motor CurrentMax	A	1.00	713	
P1.7.13	Stall Time Lim	1.00	120.00	s	15.00	714	
P1.7.14	Stall Freq Lim	1.00	Max_Freq	Hz	25.00	715	

Tables 13-8: Protections — M1 → G1.7, continued

Code	Parameter	Min.	Max.	Unit	Default	ID Number	Description
P1.7.15	Underload Protection	0	3		0	716	0 = No response 1 = Warning 2 = Fault, stop mode after fault according to ID402 3 = Fault, stop mode after fault always by coasting
P1.7.16	UP f _{nom} Torque	10.0	150.00	%	50.0	717	Minimum torque allowed when above FWP.
P1.7.17	UP f ₀ Torque	5.0	150.00	%	10.0	718	Minimum torque allowed with zero frequency.
P1.7.18	UP Time Limit	2.00	600.00	s	20.00	719	
P1.7.19	Autom. Restart	0	3		0	706	Resets faults. See Page 15-20 . 0 = Disabled 1 = Automatically transferred to Bypass 2 = Reset drive only 3 = Reset drive, if fails, transferred to Bypass
P1.7.20	Fire Mode Speed	0	100.0	%	100	804	When fire mode input is triggered, drive will run at fire mode speed.

Fieldbus Parameters — M1 → G1.8**Table 13-9: Fieldbus Parameters — M1 → G1.8**

Code	Parameter	Min.	Max.	Unit	Default	ID Number	Description
P1.8.1	FB Data Out1 Sel	0	10000		1 ^①	1001	Fieldbus process data output 1 selection. Default = Actual Speed
P1.8.2	FB Data Out2 Sel	0	10000		5 ^①	1002	Fieldbus process data output 2 selection. Default = Motor Current
P1.8.3	FB Data Out3 Sel	0	10000		8 ^①	1003	Fieldbus process data output 3 selection. Default = Motor Voltage
P1.8.4	FB Data Out4 Sel	0	10000		7 ^①	1004	Fieldbus process data output 4 selection. Default = Motor Power
P1.8.5	FB Data Out5 Sel	0	10000		9 ^①	1005	Fieldbus process data output 5 selection. Default = DC-Link Voltage

^① ID number of parameter or variable to be sent over fieldbus. ID 1 – 20 are Monitoring values, Menu 7 (M7). See **Table 13-13**.

November 2009

Table 13-9: Fieldbus Parameters — M1 → G1.8, continued

Code	Parameter	Min.	Max.	Unit	Default	ID Number	Description
P1.8.6	FB Data Out6 Sel	0	10000		20 ^①	1006	Fieldbus process data output 6 selection. Default = Application Status Word (Variable:AppIStatusWord) b0 = Drive Ready b1 = Run Enable b2 = Drive Running b3 = Drive Reversing b4 = General Fault b5 = General Warning b6 = Preset Speed Active b7 = Motor Regulator active b8 = Output speed supervision indication b9 = Setpoint speed supervision indication b10 = HAND Control indication b11 = AUTO Control indication b12 = D-IN Firemode b13 = Damper control signal b14 = Bypass mode status indication b15 = Bypass running
P1.8.7	FB Data Out7 Sel	0	10000		18 ^①	1007	Fieldbus process data output 7 selection. Default = Active Fault Code
P1.8.8	FB Data Out8 Sel	0	10000		19 ^①	1008	Fieldbus process data output 8 selection. Default = Active Warning Code

^① ID number of parameter or variable to be sent over fieldbus. ID 1 – 20 are Monitoring values, Menu 7 (M7). See Table 13-13.

PI-Control Parameters — M1 → G1.9**Table 13-10: PI-Control Parameters — M1 → G1.9**

Code	Parameter	Min.	Max.	Unit	Default	ID Number	Description
P1.9.1	US/Metric Units	0	1		0	1101	
P1.9.2	Setpoint Min.	Sensor_Min	PI_Setpoint_Max		(0)	1102	Minimum limit for the PI-Controller setpoint.
P1.9.3	Setpoint Max.	PI_Setpoint_Min	Sensor_Max		(500)	1103	Maximum limit for the PI-Controller setpoint.
P1.9.4	PI-StPt Ramp Time	0.00	20.00	s	1.00	1104	PI-Setpoint ramp time. (Ramp-Up Time)
P1.9.5	PI-Input Source	0	5		0	1106	PI-Controller Input Source Selection: Default #0 = (A) AI-1 0 = (A) AI-1 1 = (A) AI-2 2 = Fieldbus, ProcessData1 3 = Min. Both 4 = Max. Both 5 = Ave. Both
P1.9.6	Sensor Min.	(-10000)	Sensor_Max		(0)	1107	Actual Sensor minimum value at 0/4 mA.
P1.9.7	Sensor Max.	Sensor_Min	(10000)		(500)	1108	Actual Sensor maximum value at 20 mA.
P1.9.8	PI-Contr. P-Gain	0.00	10.00		0.10	1109	P-Term (Gain) for the PI-controller.
P1.9.9	PI-Contr. I-Time	0.00	320.00	s	30.00	1110	I-Term (Integral Time) for the PI-controller.
P1.9.10	PI-Deadband	(0)	(20000)		(0)	1111	Deadband area in units. (Hysteresis to PI Setpoint)
P1.9.11	PI Acting Mode	0	1		1	1112	PI-controller acting mode. 0 = Reverse acting 1 = Forward acting
P1.9.12	Auto Accel. Time	0.1	3000.0	s	60.0	1113	Auto Mode Accel. Time
P1.9.13	Auto Decel. Time	0.1	3000.0	s	60.0	1114	Auto Mode Decel. Time
P1.9.14	Auto S-curve Time	0.0	10.0	s	0.0	1115	Auto Mode and PI-control is NOT active

Preset Speeds — M1 → G1.10**Table 13-11: Preset Speeds — M1 → G1.10**

Code	Parameter	Min.	Max.	Unit	Step	Default	ID Number	Description
P1.10.1	Preset Speed 1	0	100.0	%	0.1	30.0	1701	Preset speeds when Digital Inputs are programmed
P1.10.2	Preset Speed 2	0	100.0	%	0.1	40.0	1702	
P1.10.3	Preset Speed 3	0	100.0	%	0.1	50.0	1703	
P1.10.4	Preset Speed 4	0	100.0	%	0.1	60.0	1704	
P1.10.5	Preset Speed 5	0	100.0	%	0.1	70.0	1705	
P1.10.6	Preset Speed 6	0	100.0	%	0.1	80.0	1706	
P1.10.7	Preset Speed 7	0	100.0	%	0.1	90.0	1707	

November 2009

Keypad Control Parameters — M2

This menu provides the parameters for the setting of the keypad speed setpoint, the selection of motor direction when in keypad operation, and when the STOP button is active.

Table 13-12: Keypad Control Parameters — M2

Code	Parameter	Min.	Max.	Unit	Default	ID Number ①	Description
R2.1	Speed Setpoint	0.0	100.0	%	0.0		Keypad Speed Setpoint.
P2.2	Keypad Direction	0	1		0	1009	Reverse request active from the panel 0 = Forward 1 = Reverse
P2.3	StopButton Active	0	1		1	1110	Stop button (Keypad) always active (Yes/No)
R2.4	PI-Setpoint	(-10000)	(10000)		(50)		
P2.5	PI-Setpoint Default	(-10000)	(10000)			1011	PI-regulators default setpoint

① Keypad Control Parameter ID Numbers are listed separately on **Page 15-28**.

Menus — M3 to M6

Menus M3 to M6 provide information on the Active Faults, Fault History, System Menu settings and the Expander Board setup. These menu items are explained in detail in **Chapter 6**.

Monitoring Menu — M7

The monitored items are the actual values of parameters and signals as well as the status and measurements of other elements. Monitored items cannot be edited.

See **Chapter 6** — Menu information item M7, for more information.

Table 13-13: Monitoring Menu

Code	Parameter	Min.	Max.	Unit	Default	ID Number	Description
V7.1	Output Frequency	-320.00	320.00	Hz	0.00	2	Output frequency to the motor
V7.2	Actual Speed	-320.0	320.0	%	0.0	1	Output speed to the motor
V7.3	Speed Setpoint	-320.0	320.0	%	0.0	3	Monitored speed setpoint. This will show also the speed setpoint below the minimum frequency.
V7.4	Motor Speed	-10000	10000	rpm	0	4	Calculated motor speed in rpm
V7.5	Motor Current	0.0	Motor CurrentMax	A	0.0	5	
V7.6	Motor Torque	-300.0	300.0	%	0.0	6	[R] Motor torque as % value, +1000 equals +100.0 % pos = clockwise, neg = counterclockwise
V7.7	Motor Power	-300.0	300.0	%	0.0	7	
V7.8	Motor Voltage	0.0	1000.0	V	0.0	8	Measured motor voltage
V7.9	DC-Bus Voltage	0	1000	V	0	9	[R] DC voltage in Volts Tfilt = 32ms.
V7.10	Unit Temperature	-1000	1000	°F	0	10	Temperature of the heat sink
V7.11	Motor Temperature	0.0	1000.0	%	0.0	11	
V7.12	(A) AI-1	-10.00	20.00	V	0.00	12	Voltage Input value [V]
V7.13	(A) AI-2	-10.00	20.00	mA	0.00	13	Current Input value [mA]
V7.14	DI-1 DI-2 DI-3	0	7		0	14	DIA-1, DIA-2 and DIA-3 status
V7.15	DI-4 DI-5 DI-6	0	7		0	15	DIB-4, DIB-5 and DIB-6 status
V7.16	DO-1 RO-1 RO-2	0	7		0	16	DO-1, RO-1 and RO-2 status
V7.17	(A) AO-1	0.00	20.00	mA	0.00	17	
V7.18	ActFaultCode	0	200		0	18	Active Fault code.
V7.19	ActWarnCode	0	200		0	19	Active Warning code.

November 2009

Table 13-13: Monitoring Menu, continued

Code	Parameter	Min.	Max.	Unit	Default	ID Number	Description
V7.20	Status Word	-32768	32767		0	20	b0 = Drive Ready b1 = Run Enable b2 = Drive Running b3 = Drive Reversing b4 = General Fault b5 = General Warning b6 = Preset Speed Active b7 = Motor Regulator active b8 = Output speed supervision indication b9 = Setpoint speed supervision indication b10 = HAND Control indication b11 = AUTO Control indication b12 = D-IN Firemode b13 = Damper control signal b14 = Bypass mode status indication b15 = Bypass running
V7.21	PI-Setpoint	(-10000)	(10000)	PSI or kPa	(0)	21	
V7.22	PI-Input	(-10000)	(10000)		(0)	22	Actual Sensor Value
V7.23	PI-Error	(-10000)	(10000)		(0)	23	
V7.24	PI-Output	0.0	100.0	%	0.0	24	
V7.25	RO-1 RO-2 RO-3	0	7		0	21	Monitoring the OPTB5 relay outputs.
G7.26	Multimonitor	—	—		—	—	Displays three monitor values simultaneously

Operate Menu — M8

The Operate Menu provides an easy to use method of viewing key numerical Monitoring Menu items. It also allows the setting of the keypad frequency reference. See **Chapter 6** for more information.



November 2009

Chapter 14 — Temperature Control Application (SVCHS205)

Introduction

The Temperature Control Application is typically used to control levels of pumps in fans with a pressure transducer and provide °F/°C units to a keypad.

The direct frequency reference can be used for the control without the PI controller and is selected from the analog inputs, fieldbus, motor potentiometer or keypad.

The Temperature Control Application is typically used to control Building temperature. In these applications, the Temperature Control Application provides a smooth control and an integrated measurement and control package where no additional components are needed.

- Digital inputs DI-2, DI-3 and DI-5 and all outputs are freely programmable.

Additional functions:

- Analog input signal range selection
- One frequency limit supervision
- Torque limit supervision
- Speed setpoint limit supervision
- Programmable start and stop functions
- DC Brake Chopper
- Six skip frequency areas
- Programmable V/Hz curve and switching frequency
- Auto restart
- Motor thermal and stall protection: Programmable action; off, warning, fault
- Motor underload protection
- Input and output phase supervision

Details of the parameters shown in this section are available in **Chapter 15** of this Manual, listed by parameter ID number.

Control Input/Output

Table 14-1: Temperature Control Application Default I/O Configuration

Terminal	Signal	Description
OPTA9		
1	+10V DC _{ref}	Reference output Voltage for potentiometer, etc.
2	AI-1+	Analog input, voltage range 0 – 10V DC Voltage input for PI setpoint or feedback (Programmable)
3	AI-1-	I/O Ground Ground for reference and controls
4	AI-2+	Analog input, current range 0 – 20 mA Current input for PI setpoint or feedback (Programmable)
5	AI-2-	I/O Ground Ground for reference and controls
6	24V DC	Control voltage output Voltage for switches, etc. max 0.1A
7	GND	I/O ground Ground for reference and controls
8	DI-1	Start/Stop Control Contact closed = start
9	DI-2	External fault input (programmable) Contact closed = fault Contact open = no fault
10	DI-3	External Interlock (programmable) Contact closed = OK Open = Interlocked
11	CMA	Common for DI-1 – DI-3 Connect to GND or 24V DC
12	24V DC	Control voltage output Voltage for switches (see terminal 6)
13	GND	I/O ground Ground for reference and controls
14	DI-4	Speed Select 1 (programmable) Contact closed = Speed Select 1
15	DI-5	Fire Mode (programmable) Contact closed = Fire Mode active
16	DI-6	Overload relay (IntelliPass) (programmable) Contact open = no fault Contact closed = fault
17	CMB	Common for DI-4 – DI-6 Connect to GND or 24V DC
18	AO-1+	Output frequency Analog output Programmable Range 0 – 20 mA, R _L max. 500 Ω
19	AO-1	I/O Ground Ground for reference and controls
20	DO-1	Digital output READY Programmable Open collector, I ≤ 50 mA, V ≤ 48V DC
OPTA2		
21-22 Opens on RUN	21 RO-1	Relay output 1 Programmable Drive RUN is default.
22-23 Closes on RUN	22 RO-1	
	23 RO-1	
24-25 Opens on FAULT	24 RO-2	Relay output 2 Programmable Drive FAULT is default.
25-26 Closes on FAULT	25 RO-2	
	26 RO-2	

Note: For more information on jumper selections, see **Chapter 4**.

X3 Jumper Setting — CMA and CMB Grounding

- CMB Connected to Ground
CMA Connected to Ground
- CMB Isolated from Ground
CMA Isolated from Ground
- CMB and CMA Internally Connected
and Isolated from Ground

CAUTION

Unattended start will occur if power is supplied with Start Command activated.

November 2009

Parameter Lists

On the next pages you will find the lists of parameters within the respective parameter groups. The parameter descriptions are given by ID number in **Chapter 15**.

Column explanations:

- Code = Location indication on the keypad; Shows the operator the present parameter number
- Parameter = Name of parameter
- Min. = Minimum value of parameter
- Max. = Maximum value of parameter
- Unit = Unit of parameter value; Given if available
- Default = Value preset by factory
- ID = ID number of the parameter for reference to **Chapter 15**

Quick Setup Parameters — M1 → G1.1

Table 14-2: Quick Setup Parameters — M1 → G1.1

Code	Parameter	Min.	Max.	Unit	Default	ID Number	Description
P1.1.1	Min Frequency	0.00	Max_Frequency	Hz	12.00	101	Minimum output frequency, f[Hz].
P1.1.2	Max Frequency	FreqMin	320.00	Hz	60.00	102	Maximum output frequency, f[Hz].
P1.1.3	Acceleration Time	0.1	3000.0	s	60.0	103	Time from 0 Hz to maximum Hz.
P1.1.4	Deceleration Time	0.1	3000.0	s	60.0	104	Time from maximum Hz to 0 Hz.
P1.1.5	Motor NP Voltg	180	Motor VoltageMax	V	400	105	Motor nameplate voltage in Volts.
P1.1.6	Motor NP Freq	8.00	320.00	Hz	60.00	106	Motor nameplate frequency in Hertz.
P1.1.7	Motor Nom Speed	24	20000	rpm	1720	111	Motor nameplate speed in Rpm.
P1.1.8	Motor Nom Currnt	Motor CurrentMin	Motor CurrentMax	A	5.40	108	Motor nameplate current, I[A]
P1.1.9	Power Factor	0.30	1.00		0.85	109	Motor power factor. (Cos Phi)
P1.1.10	Service Factor	0.10	2.00		1.00	110	Motor service factor. This will calculate the motor current limit. (MotorNomCurrent x Service Factor)
P1.1.11	Current Limit	Motor CurrentMin	Motor CurrentMax	A	7.00	107	Output current limit of the unit in Amps.
P1.1.12	Start Srce Hand	1	3		1	112	Parameter for Local Start/Stop/Reverse control location. Default = Keypad 1 = Keypad 2 = DI-1 Start 3 = I/O Three Wire

Table 14-2: Quick Setup Parameters — M1 → G1.1, continued

Code	Parameter	Min.	Max.	Unit	Default	ID Number	Description
P1.1.13	StPt Source Hand	0	3		2	113	Local speed setpoint selection: 0 = analog input AI-1 1 = analog input AI-2 2 = Speed Setpoint from Keypad 3 = Motor Potentiometer
P1.1.14	Start Srce Auto	1	4		2	114	Parameter for Remote Start/Stop/Reverse control location. Default = DI-1 Start 1 = Keypad 2 = DI-1 Start 3 = I/O Three Wire 4 = Fieldbus
P1.1.15	StPt Source Auto	0	4		0	115	PI-setpoint selection: 0 = analog input AI-1 1 = analog input AI-2 2 = PI Setpoint from Keypad 3 = Motor Potentiometer 4 = PI Setpoint from Fieldbus
P1.1.16	PI-Input Source	0	2		0	1106	PI-Controller Input Source Selection: Default #0 = (A) AI-1 0 = (A) AI-1 1 = (A) AI-2 2 = Fieldbus, Process Data 1 3 = Min. Both 4 = Max. Both 5 = Ave. Both
P1.1.17	Sensor Min.	(-10000)	Sensor_Max		(200)	1107	Actual Sensor minimum value at 0/4 mA.
P1.1.18	Sensor Max.	Sensor_Min	(10000)		(1200)	1108	Actual Sensor maximum value at 20 mA.
P1.1.19	PI-Contr. P-Gain	0.00	10.00		0.10	1109	P-Term (Gain) for the PI-Controller
P1.1.20	PI-Contr. I-Time	0.00	320.00	s	30.00	1110	I-Term (Integral Time) for the PI-controller
P1.1.21	PI-Deadband	(0)	(20000)		(0)	1111	Deadband area in units. (Hysteresis to PI-Setpoint)
P1.1.22	AutoAccelTime	0.1	3000.0	s	60.0	1113	Acceleration time, when in AUTO mode
P1.1.23	AutoDecelTime	0.1	3000.0	s	60.0	1114	Deceleratin time, when in AUTO mode
P1.1.24	US/Metric Units	0	1		0	1101	

November 2009

Input Signals — M1 → G1.2

Table 14-3: Input Signals — M1 → G1.2

Code	Parameter	Min.	Max.	Unit	Default	ID Number	Description
P1.2.1	Start Mode	0	3		1	201	Start Function: 0 = Normal start without interlockings. 1 = Interlocked start. One of the digital inputs must be programmed to Intlk/RunEna. DI-3 is defaulted for this feature. 2 = Mode 1 + timeout supervision. If the interlock is not OK within the interlock timeout time, start request is ignored and must be given again. 3 = Delayed start. Start request is given after delay time has expired.
P1.2.2	Intlk Stop Mode	0	1		1	216	0 = Coasting 1 = Ramp
P1.2.3	Intlk Timeout	0.00	300.00	s	5.00	202	Interlock timeout time for Start Function #2. Default = 5s.
P1.2.4	Start Delay Time	0.00	300.00	s	5.00	203	Start delay time for Start Function #3. Default = 5s.
P1.2.5	(A) DI-2 Funct.	0	17		1	204	Default #1 External Fault Close 0 = Stop pulse, when 3-wire start/stop logic is selected. (False=Stop, True=Ready to Run) 1 = Ext. fault, closing contact 2 = External fault, opening contact 3 = Fault reset 4 = Run enable-Closed Contact 5 = Force ctrl. place to Hand 6 = Force ctrl. place to Auto 7 = Reverse 8 = Speed Select 1 9 = Fire Mode-Closed Contact 10 = Speed Select 2 11 = Speed Select 3 12 = Force Bypass 13 = External interlock closed 14 = External interlock open 15 = Mot. Pot. UP 16 = Mot. Pot. DOWN 17 = Fire Mode-Open Contact



CAUTION

Unattended start will occur if power is supplied with Start Command activated.

Table 14-3: Input Signals — M1 → G1.2, continued

Code	Parameter	Min.	Max.	Unit	Default	ID Number	Description
P1.2.6	(A) DI-3 Funct.	0	17		13	205	Default #13 Interlock/Run Enable 0 = Not Used 1 = Ext. fault, closing contact 2 = External fault, opening contact 3 = Fault reset 4 = Run enable-Closed Contact 5 = Force ctrl. place to Hand 6 = Force ctrl. place to Auto 7 = Reverse 8 = Speed Select 1 9 = Fire Mode-Closed Contact 10 = Speed Select 2 11 = Speed Select 3 12 = Force Bypass 13 = External interlock closed 14 = External interlock open 15 = Mot. Pot. UP 16 = Mot. Pot. DOWN 17 = Fire Mode-Open Contact
P1.2.7	(A) DI-4 Funct.	0	17		8	206	Default #8 Speed Select 1 0 = Not Used 1 = Ext. fault, closing contact 2 = External fault, opening contact 3 = Fault reset 4 = Run enable-Closed Contact 5 = Force ctrl. place to Hand 6 = Force ctrl. place to Auto 7 = Reverse 8 = Speed Select 1 9 = Fire Mode-Closed Contact 10 = Speed Select 2 11 = Speed Select 3 12 = Force Bypass 13 = External interlock closed 14 = External interlock open 15 = Mot. Pot. UP 16 = Mot. Pot. DOWN 17 = Fire Mode-Open Contact

November 2009

Table 14-3: Input Signals — M1 → G1.2, continued

Code	Parameter	Min.	Max.	Unit	Default	ID Number	Description
P1.2.8	(A) DI-5 Funct.	0	17		9	207	Default #9 Fire-Mode 0 = Not Used 1 = Ext. fault, closing contact 2 = External fault, opening contact 3 = Fault reset 4 = Run enable-Closed Contact 5 = Force ctrl. place to Hand 6 = Force ctrl. place to Auto 7 = Reverse 8 = Speed Select 1 9 = Fire Mode-Closed Contact 10 = Speed Select 2 11 = Speed Select 3 12 = Force Bypass 13 = External interlock closed 14 = External interlock open 15 = Mot. Pot. UP 16 = Mot. Pot. DOWN 17 = Fire Mode-Open Contact
P1.2.9	(A) DI-6 Funct.	0	17		0	208	Default #0 Overload Fault Relay-input 0 = Overload fault relay (Used in Intellipass) 1 = Ext. fault, closing contact 2 = External fault, opening contact 3 = Fault reset 4 = Run enable-Closed Contact 5 = Force ctrl. place to Hand 6 = Force ctrl. place to Auto 7 = Reverse 8 = Speed Select 1 9 = Fire Mode-Closed Contact 10 = Speed Select 2 11 = Speed Select 3 12 = Force Bypass 13 = External interlock closed 14 = External interlock open 15 = Mot. Pot. UP 16 = Mot. Pot. DOWN 17 = Fire Mode-Open Contact
P1.2.10	(A) AI-1 Minimum	0.00	Max.	%	0.00	217	Default applies for 0V or 0 mA
P1.2.11	(A) AI-1 Maximum	Min.	100.0	%	100.00	218	Default applies for 10V or 20 mA
P1.2.12	(A) AI-1 Invert	0	1		0	209	0 = Not inverted 1 = Inverted
P1.2.13	(A) AI-1 Filter	0.00	10.00	s	0.10	210	0 = No filtering
P1.2.14	(A) AI-2 Minimum	0.00	Max.	%	20.00	219	Default applies for 2V or 4 mA
P1.2.15	(A) AI-2 Maximum	Min.	100.0	%	100.00	220	Default applies for 10V or 20 mA
P1.2.16	(A) AI-2 Invert	0	1		0	212	0 = Not inverted 1 = Inverted
P1.2.17	(A) AI-2 Filter	0.00	10.00	s	0.10	213	0 = No filtering
P1.2.18	StPt. Scale Min	0.0	100.0	%	0.0	214	Speed that corresponds to the minimum setpoint signal.

Table 14-3: Input Signals — M1 → G1.2, continued

Code	Parameter	Min.	Max.	Unit	Default	ID Number	Description
P1.2.19	StPt. Scale Max	0.0	100.0	%	0.0	215	Speed that corresponds to the maximum setpoint signal. 0.0%=NOT IN USE!
P1.2.20	MotPotStPt Memory	0	1		0	221	Parameter to select reset function for motor potentiometer speed setpoint. Default: No reset.

Output Signals — M1 → G1.3**Table 14-4: Output Signals — M1 → G1.3**

Code	Parameter	Min.	Max.	Unit	Default	ID Number	Description
P1.3.1	(A) AO-1 Funct.	0	8		1	301	Analog output function: 0 = FB-Control (Fieldbus Passthrough, ProcessDataIN3) 1 = O/P frequency (0 - f max) 2 = Reference frequency (0 - f max) 3 = Motor speed (0 - 100% x Motor nom. speed) 4 = O/P current (0 - 100% x I nMot) 5 = Motor torque (0 - 100% x T nMot) 6 = Motor power (0 - 100% x P nMot) 7 = Motor voltage (0 - 100% x U nMot) 8 = DC-Bus Voltage (0 - 100% x U nMot)
P1.3.2	(A) AO-1 Filter	0.00	10.00	s	1.00	302	
P1.3.3	(A) AO-1 Invert	0	1		0	303	0 = Not inverted 1 = Inverted
P1.3.4	(A) AO-1 Min.	0	1		0	304	0 = 0 mA 1 = 4 mA
P1.3.5	(A) AO-1 Scale	10	1000	%	100	305	

November 2009

Table 14-4: Output Signals — M1 → G1.3, continued

Code	Parameter	Min.	Max.	Unit	Default	ID Number	Description
P1.3.6	(A) DO-1 Funct.	0	26		1	306	Default=Drive Ready 0 = Not used 1 = Drive Ready 2 = Drive Running 3 = General Fault 4 = General Fault inverted 5 = Drive overheat warning 6 = External fault or warning 7 = Reference (4mA) fault or warning 8 = General Warning 9 = Drive Reversing 10 =Preset Speed Active 11 = Speed setpoint=Actual Speed (=At speed) 12 = Motor regulator activated 13 = Actual Speed limit supervision 14 = Speed Setpoint limit supervision 15 = Torque limit supervision 16 = Timer On/Timer Off output control (Trigger is run request) 17 = Selections #16 inverted 18 = Frequency converter temperature limit supervision 19 = Unrequested rotation direction 20 = Thermistor fault / warning 21 = Hand Control Active 22 = Auto Control Active 23 = DI-Fire Mode Active 24 = Relay to energize an external element before starting the drive. 25 = FB-Control 26 = Bypass Run
P1.3.7	(B) RO-1 Funct.	0	24		2	307	Same as parameter 1.3.6.
P1.3.8	(B) RO-2 Funct.	0	24		3	308	Same as parameter 1.3.6
P1.3.9	(D) RO-1 Funct.	0	24		0	309	Same as parameter 1.3.6
P1.3.10	(D) RO-2 Funct.	0	24		0	310	Same as parameter 1.3.6
P1.3.11	(D) RO-3 Funct.	0	24		0	311	Same as parameter 1.3.6
P1.3.12	Sp.StPt Supv Fct	0	2		0	312	Speed Setpoint Supervision Function: 0 = Not used 1 = Low limit 2 = High limit
P1.3.13	Sp.StPt Supv Lim	0.0	100.0	%	0.0	313	Speed Setpoint Supervision Value.

Table 14-4: Output Signals — M1 → G1.3, continued

Code	Parameter	Min.	Max.	Unit	Default	ID Number	Description
P1.3.14	Act.Sp. Supv Fct	0	2		0	314	Actual Speed Supervision Function: 0 = Not used 1 = Low limit 2 = High limit
P1.3.15	Act.Sp. Supv Lim	0.0	100.0	%	0.0	315	Actual Speed Supervision Value. (±1.0% hysteresis)
P1.3.16	Torque Supv Fct	0	2		0	316	Torque Limit Supervision Function: 0 = Not used 1 = Low limit 2 = High limit
P1.3.17	Torque Supv Lim	0.0	300.0	%	0.0	317	Torque Limit Supervision Value
P1.3.18	TempLim Supv Fct	0	2		0	318	Temperature Limit Supervision Function: 0 = Not used 1 = Low limit 2 = High limit
P1.3.19	TempLim Supv Lim	-50	170	°F	104	319	Temperature Limit Supervision value
P1.3.20	StartRlyON-Del.	0.0	100.0	s	0.0	320	Relay/Digital output ON-delay time after start-command is given.
P1.3.21	StartRlyOFF-Del.	0.0	100.0	s	0.0	321	Relay/Digital output OFF-delay time after stop-command is given.

Drive Control Parameters — M1 → G1.4**Table 14-5: Drive Control Parameters — M1 → G1.4**

Code	Parameter	Min.	Max.	Unit	Default	ID Number	Description
P1.4.1	Start Mode	0	1		0	401	0 = Ramp 1 = Flying start
P1.4.2	Stop Mode	0	1		1	402	0 = Coasting 1 = Ramp
P1.4.3	Brake Chopper	0	4		0	403	Brake Chopper Mode Selection. 0 = Brake NO, Test NO 1 = Brake YES(Run), Test YES (Ready+run) 2 = Brake chopper EXTERNAL, Test NO 3 = Brake YES(Ready+run), Test YES (Ready+run) 4 = Brake YES(Run), Test NO
P1.4.4	S-curve Time	0.0	10.0	s	0.0	404	Smooth ratio for S-curve

November 2009

Prohibit Frequencies— M1 → G1.5

Table 14-6: Prohibit Frequencies — M1 → G1.5

Code	Parameter	Min.	Max.	Unit	Default	ID Number	Description
P1.5.1	SkipF1 Low Lim	0.0	100.0	%	0.0	501	Prohibit speed range 1 low limit.
P1.5.2	SkipF1 High Lim	Range_1_Low_Lim	100.0	%	0.0	502	Prohibit speed range 1 high limit: 0 = No prohibit frequency range
P1.5.3	SkipF2 Low Lim	0.0	100.0	%	0.0	503	Prohibit speed range 2 low limit
P1.5.4	SkipF2 High Lim	Range_2_Low_Lim	100.0	%	0.0	504	Prohibit speed range 2 high limit: 0 = No prohibit frequency range
P1.5.5	SkipF3 Low Lim	0.0	100.0	%	0.0	505	Prohibit speed range 3 low limit
P1.5.6	SkipF3 High Lim	Range_3_Low_Lim	100.0	%	0.0	506	Prohibit speed range 3 high limit: 0 = No prohibit frequency range
P1.5.7	SkipF4 Low Lim	0.0	100.0	%	0.0	507	Prohibit speed range 4 low limit
P1.5.8	SkipF4 High Lim	Range_4_Low_Lim	100.0	%	0.0	508	Prohibit speed range 4 high limit: 0 = No prohibit frequency range
P1.5.9	SkipF5 Low Lim	0.0	100.0	%	0.0	509	Prohibit speed range 5 low limit
P1.5.10	SkipF5 High Lim	Range_5_Low_Lim	100.0	%	0.0	510	Prohibit speed range 5 high limit: 0 = No prohibit frequency range
P1.5.11	SkipF6 Low Lim	0.0	100.0	%	0.0	511	Prohibit speed range 6 low limit
P1.5.12	SkipF6 High Lim	Range_6_Low_Lim	100.0	%	0.0	512	Prohibit speed range 6 high limit: 0 = No prohibit frequency range
P1.5.13	PH Acc/Dec Ramp	0.1	10.0	x	1.0	513	Acceleration/Deceleration time factor to pass prohibit speed window.

Motor Control Parameters — M1 → G1.6**Table 14-7: Motor Control Parameters — M1 → G1.6**

Code	Parameter	Min.	Max.	Unit	Default	ID Number	Description
P1.6.1	Motor Ctrl Mode	0	1		0	601	Motor control mode: 0 = frequency control 1 = speed control
P1.6.2	V/Hz Optim.	0	1		0	602	V/F optimization selection: 0 = none 1 = automatic torque boost
P1.6.3	V/Hz Ratio	0	3		0	603	V/F ratio selection: 0 = linear 1 = squared 2 = programmable 3 = Linear with flux optim.
P1.6.4	Field WeakngPnt	8.00	320.00	Hz	60.00	604	Field weakening point.
P1.6.5	Voltage at FWP	10.00	200.00	%	100.00	605	Motor voltage (%*MotorNPVoltage) at field weakening point.
P1.6.6	V/Hz Mid Freq	0.00	Field Weakening Point	Hz	60.00	606	Programmable V/Hz curve middle point frequency.
P1.6.7	V/Hz Mid Voltg	0.00	100.00	%	100.00	607	Motor voltage (%*MotorNPVoltage) at programmable V/Hz curve middle point.
P1.6.8	Zero Freq Voltg	0.00	40.00	%	0.00	608	Motor voltage (%*MotorNPVoltage) at zero speed.
P1.6.9	Switching Freq	1.0	Switching FreqMax	kHz	3.6	609	Switching frequency in kHz. See Appendix A, Table A-1 .
P1.6.10	Overvolt Contr	0	2		1	610	0 = Off 1 = On with no ramping 2 = On with ramping
P1.6.11	Undervolt Contr	0	1		1	611	0 = Off 1 = On
P1.6.12	Identification	0	2		0	612	Identification run. When this parameter is set greater than zero, then start command must be given within 20 seconds.

November 2009

Protections — M1 → G1.7
Table 14-8: Protections — M1 → G1.7

Code	Parameter	Min.	Max.	Unit	Default	ID Number	Description
P1.7.1	Input Phase Supv	0	2		2	701	Response to input phase supervision. 0 = No Action 1 = Warning 2 = Fault
P1.7.2	4mA Fault Resp	0	2		0	702	Response to 4 mA signal supervision. 0 = No Action 1 = Warning 2 = Fault
P1.7.3	Ext. Fault Resp	0	2		2	703	Response to external fault digital input signal supervision. 0 = No Action 1 = Warning 2 = Fault
P1.7.4	FBComm. FaultResp	0	2		0	704	Response to fieldbus communication supervision. 0 = No Action 1 = Warning 2 = Fault
P1.7.5	SlotComFault Resp	0	2		0	705	Response to slot communication supervision. 0 = No Action 1 = Warning 2 = Fault
P1.7.6	Motor Therm Prot	0	3		0	707	0 = No response 1 = Warning 2 = Fault, stop mode after fault according to ID402 3 = Fault, stop mode after fault always by coasting
P1.7.7	MotAmbTemp Factor	-100.0	100.0	%	0.0	708	Percent of ambient temperature.
P1.7.8	MTP f0 Current	0.0	150.00	%	40.0	709	Percent of motor nameplate current.
P1.7.9	MTP Motor T	1	200	min	45	710	Time to reach 63% of final value.
P1.7.10	Motor Duty Cycle	0	100	%	100	711	Percent of nominal motor load
P1.7.11	Stall Protection	0	3		0	712	0 = No response 1 = Warning 2 = Fault, stop mode after fault according to ID402 3 = Fault, stop mode after fault always by coasting
P1.7.12	Stall Current	0.00	Motor CurrentMax	A	1.00	713	
P1.7.13	Stall Time Lim	1.00	120.00	s	15.00	714	
P1.7.14	Stall Freq Lim	1.00	Max_Freq	Hz	25.00	715	

Tables 14-8: Protections — M1 → G1.7, continued

Code	Parameter	Min.	Max.	Unit	Default	ID Number	Description
P1.7.15	Underload Protection	0	3		0	716	0 = No response 1 = Warning 2 = Fault, stop mode after fault according to ID402 3 = Fault, stop mode after fault always by coasting
P1.7.16	UP f _{nom} Torque	10.0	150.00	%	50.0	717	Minimum torque allowed when above FWP.
P1.7.17	UP f ₀ Torque	5.0	150.00	%	10.0	718	Minimum torque allowed with zero frequency.
P1.7.18	UP Time Limit	2.00	600.00	s	20.00	719	
P1.7.19	Autom. Restart	0	3		0	706	Resets faults. See Page 15-20 . 0 = Disabled 1 = Automatically transferred to Bypass 2 = Reset drive only 3 = Reset drive, if fails, transferred to Bypass
P1.7.20	Fire Mode Speed	0	100.0	%	100	804	When fire mode input is triggered, drive will run at fire mode speed.

Fieldbus Parameters — M1 → G1.8**Table 14-9: Fieldbus Parameters — M1 → G1.8**

Code	Parameter	Min.	Max.	Unit	Default	ID Number	Description
P1.8.1	FB Data Out1 Sel	0	10000		1 ^①	1001	Fieldbus process data output 1 selection. Default = Actual Speed
P1.8.2	FB Data Out2 Sel	0	10000		5 ^①	1002	Fieldbus process data output 2 selection. Default = Motor Current
P1.8.3	FB Data Out3 Sel	0	10000		8 ^①	1003	Fieldbus process data output 3 selection. Default = Motor Voltage
P1.8.4	FB Data Out4 Sel	0	10000		7 ^①	1004	Fieldbus process data output 4 selection. Default = Motor Power
P1.8.5	FB Data Out5 Sel	0	10000		9 ^①	1005	Fieldbus process data output 5 selection. Default = DC-Link Voltage

^① ID number of parameter or variable to be sent over fieldbus. ID 1 – 20 are Monitoring values, Menu 7 (M7). See **Table 14-13**.

November 2009

Table 14-9: Fieldbus Parameters — M1 → G1.8, continued

Code	Parameter	Min.	Max.	Unit	Default	ID Number	Description
P1.8.6	FB Data Out6 Sel	0	10000		20 ^①	1006	Fieldbus process data output 6 selection. Default = Application Status Word (Variable:AppIStatusWord) b0 = Drive Ready b1 = Run Enable b2 = Drive Running b3 = Drive Reversing b4 = General Fault b5 = General Warning b6 = Preset Speed Active b7 = Motor Regulator active b8 = Output speed supervision indication b9 = Setpoint speed supervision indication b10 = HAND Control indication b11 = AUTO Control indication b12 = D-IN Firemode b13 = Damper control signal b14 = Bypass mode status indication b15 = Bypass running
P1.8.7	FB Data Out7 Sel	0	10000		18 ^①	1007	Fieldbus process data output 7 selection. Default = Active Fault Code
P1.8.8	FB Data Out8 Sel	0	10000		19 ^①	1008	Fieldbus process data output 8 selection. Default = Active Warning Code

^① ID number of parameter or variable to be sent over fieldbus. ID 1 – 20 are Monitoring values, Menu 7 (M7). See Table 14-13.

PI-Control Parameters — M1 → G1.9**Table 14-10: PI-Control Parameters — M1 → G1.9**

Code	Parameter	Min.	Max.	Unit	Default	ID Number	Description
P1.9.1	US/Metric Units	0	1		0	1101	
P1.9.2	Setpoint Min.	Sensor_Min	PI_Setpoint_Max		(200)	1102	Minimum limit for the PI-Controller setpoint.
P1.9.3	Setpoint Max.	PI_Setpoint_Min	Sensor_Max		(1200)	1103	Maximum limit for the PI-Controller setpoint.
P1.9.4	StPt Ramp Time	0.00	20.00	s	1.00	1104	PI-Setpoint ramp time. (Ramp-Up Time)
P1.9.5	PI-Input Source	0	5		0	1106	PI-Controller Input Source Selection: Default #0 = (A) AI-1 0 = (A) AI-1 1 = (A) AI-2 2 = Fieldbus, ProcessData1 3 = Min. Both 4 = Max. Both 5 = Ave. Both
P1.9.6	Sensor Min.	(-10000)	Sensor_Max		(200)	1107	Actual Sensor minimum value at 0/4 mA.
P1.9.7	Sensor Max.	Sensor_Min	(10000)		(1200)	1108	Actual Sensor maximum value at 20 mA.
P1.9.8	PI-Contr. P-Gain	0.00	10.00		0.10	1109	P-Term (Gain) for the PI-controller.
P1.9.9	PI-Contr. I-Time	0.00	320.00	s	30.00	1110	I-Term (Integral Time) for the PI-controller.
P1.9.10	PI-Deadband	(0)	(20000)		(0)	1111	Deadband area in units. (Hysteresis to PI Setpoint)
P1.9.11	PI Acting Mode	0	1		1	1112	PI-controller acting mode. 0 = Reverse acting 1 = Forward acting
P1.9.12	Auto Accel. Time	0.1	3000.0	s	60.0	1113	Auto Mode Accel. Time
P1.9.13	Auto Decel. Time	0.1	3000.0	s	60.0	1114	Auto Mode Decel. Time
P1.9.14	Auto S-curve Time	0.0	10.0	s	0.0	1115	Auto Mode and PI-control is NOT active

Preset Speeds — M1 → G1.10**Table 14-11: Preset Speeds — M1 → G1.10**

Code	Parameter	Min.	Max.	Unit	Step	Default	ID Number	Description
P1.10.1	Preset Speed 1	0	100.0	%	0.1	30.0	1701	Preset speeds when Digital Inputs are programmed
P1.10.2	Preset Speed 2	0	100.0	%	0.1	40.0	1702	
P1.10.3	Preset Speed 3	0	100.0	%	0.1	50.0	1703	
P1.10.4	Preset Speed 4	0	100.0	%	0.1	60.0	1704	
P1.10.5	Preset Speed 5	0	100.0	%	0.1	70.0	1705	
P1.10.6	Preset Speed 6	0	100.0	%	0.1	80.0	1706	
P1.10.7	Preset Speed 7	0	100.0	%	0.1	90.0	1707	

November 2009

Keypad Control Parameters — M2

This menu provides the parameters for the setting of the keypad speed setpoint, the selection of motor direction when in keypad operation, and when the STOP button is active.

Table 14-12: Keypad Control Parameters — M2

Code	Parameter	Min.	Max.	Unit	Default	ID Number ①	Description
R2.1	Speed Setpoint	0.0	100.0	%	0.0		Keypad Speed Setpoint.
P2.2	Keypad Direction	0	1		0	1009	Reverse request active from the panel 0 = Forward 1 = Reverse
P2.3	StopButton Active	0	1		1	1110	Stop button (Keypad) always active (Yes/No)
R2.4	PI-Setpoint	(-10000)	(10000)		(800)		
P2.5	PI-Setpoint Default	(-10000)	(10000)			1011	PI-regulators default setpoint

① Keypad Control Parameter ID Numbers are listed separately on **Page 15-28**.

Menus — M3 to M6

Menus M3 to M6 provide information on the Active Faults, Fault History, System Menu settings and the Expander Board setup. These menu items are explained in detail in **Chapter 6**.

Monitoring Menu — M7

The monitored items are the actual values of parameters and signals as well as the status and measurements of other elements. Monitored items cannot be edited.

See **Chapter 6** — Menu information item M7, for more information.

Table 14-13: Monitoring Menu

Code	Parameter	Min.	Max.	Unit	Default	ID Number	Description
V7.1	Output Frequency	-320.00	320.00	Hz	0.00	2	Output frequency to the motor
V7.2	Actual Speed	-320.0	320.0	%	0.0	1	Output speed to the motor
V7.3	Speed Setpoint	-320.0	320.0	%	0.0	3	Monitored speed setpoint. This will show also the speed setpoint below the minimum frequency.
V7.4	Motor Speed	-10000	10000	rpm	0	4	Calculated motor speed in rpm
V7.5	Motor Current	0.0	Motor CurrentMax	A	0.0	5	
V7.6	Motor Torque	-300.0	300.0	%	0.0	6	[R] Motor torque as % value, +1000 equals +100.0 % pos = clockwise, neg = counterclockwise
V7.7	Motor Power	-300.0	300.0	%	0.0	7	
V7.8	Motor Voltage	0.0	1000.0	V	0.0	8	Measured motor voltage
V7.9	DC-Bus Voltage	0	1000	V	0	9	[R] DC voltage in Volts Tfilt = 32ms.
V7.10	Unit Temperature	-1000	1000	°F	0	10	Temperature of the heat sink
V7.11	Motor Temperature	0.0	1000.0	%	0.0	11	
V7.12	(A) AI-1	-10.00	20.00	V	0.00	12	Voltage Input value [V]
V7.13	(A) AI-2	-10.00	20.00	mA	0.00	13	Current Input value [mA]
V7.14	DI-1 DI-2 DI-3	0	7		0	14	DIA-1, DIA-2 and DIA-3 status
V7.15	DI-4 DI-5 DI-6	0	7		0	15	DIB-4, DIB-5 and DIB-6 status
V7.16	DO-1 RO-1 RO-2	0	7		0	16	DO-1, RO-1 and RO-2 status
V7.17	(A) AO-1	0.00	20.00	mA	0.00	17	
V7.18	ActFaultCode	0	200		0	18	Active Fault code.
V7.19	ActWarnCode	0	200		0	19	Active Warning code.

November 2009

Table 14-13: Monitoring Menu, continued

Code	Parameter	Min.	Max.	Unit	Default	ID Number	Description
V7.20	Status Word	-32768	32767		0	20	b0 = Drive Ready b1 = Run Enable b2 = Drive Running b3 = Drive Reversing b4 = General Fault b5 = General Warning b6 = Preset Speed Active b7 = Motor Regulator active b8 = Output speed supervision indication b9 = Setpoint speed supervision indication b10 = HAND Control indication b11 = AUTO Control indication b12 = D-IN Firemode b13 = Damper control signal b14 = Bypass mode status indication b15 = Bypass running
V7.21	PI-Setpoint	(-10000)	(10000)	F or C	(0)	21	
V7.22	PI-Input	(-10000)	(10000)		(0)	22	Actual Sensor Value
V7.23	PI-Error	(-10000)	(10000)		(0)	23	
V7.24	PI-Output	0.0	100.0	%	0.0	24	
V7.25	RO-1 RO-2 RO-3	0	7		0	25	Monitoring the OPTB5 relay outputs.
G7.26	Multimonitor	—	—		—	—	Displays three monitor values simultaneously

Operate Menu — M8

The Operate Menu provides an easy to use method of viewing key numerical Monitoring Menu items. It also allows the setting of the keypad frequency reference. See **Chapter 6** for more information.



November 2009

Chapter 15 — Description of Parameters

Parameters by ID Number

On the following pages you will find the parameter descriptions arranged according to the individual ID number of the parameter.

101 Minimum frequency

102 Maximum frequency

Defines the frequency limits of the drive. The maximum value for these parameters is 320 Hz. The software will automatically check the value of parameter ID314.

103 Acceleration time 1

104 Deceleration time 1

These limits correspond to the time required for the output frequency to accelerate from the zero frequency to the set maximum frequency (parameter ID102).

105 Nominal voltage of the motor

Find this value V_n on the motor nameplate. This parameter sets the voltage at the field weakening point (ID604) to $100\% * V_{nMotor}$.

106 Nominal frequency of the motor

Find this value f_n on the motor nameplate. This parameter sets the field weakening point (ID604) to the same value.

107 Current limit

This parameter determines the maximum motor current from the drive. The parameter value range differs for each power rating.

108 Nominal current of the motor

Find this value I_n on the motor nameplate.

109 Motor Power Factor

Find this value "Power Factor" on the motor nameplate.

110 Service Factor

This will calculate motor current limit current limit.
Current Limit = Service Factor (SF) x Motor nominal current ID108.

111 Nominal speed of the motor

Find this value n_n on the motor nameplate.

112 Start Source Hand

Start/Stop/Reverse control location in Hand mode:

- 1 Keypad
- 2 DI-1
- 3 I/O Three-Wire start

Note: When Three-Wire mode selected, DI-2 is automatically selected as stop command.

113 Setpoint Source Hand

Speed setpoint source selection in Hand Mode.

- 0 analog input AI-1
- 1 analog input AI-2
- 2 Keypad
- 3 Motor potentiometer

114 Start Source Auto (PI-Control)

Start/Stop/Reverse control location in Auto mode:

- 1 Keypad
- 2 DI-1
- 3 I/O Three-Wire
- 4 Fieldbus




Note: When Three-Wire mode selected, DI-2 is automatically selected as stop command.

115 Setpoint Source Auto (PI-Control)

PI Setpoint Source selection:

- 0 Analog input AI-1
- 1 Analog input AI-2
- 2 Keypad
- 3 Motor potentiometer
- 4 Fieldbus

Table 15-1: Selections for IDs 112, 113, 114 and 115

Indicator	Description
	Hand Indicates that HAND has been chosen in the HOA control mode.
	Off Indicates that the VSD Series drive is not ready to operate. (Ready-indicator is OFF).
	Auto Indicates that AUTO has been chosen in the HOA control mode.

116 Preset Speed

This parameter determines the frequency reference for Preset Speed 1 operation when either DI-2, DI-4, DI-5 or DI-6 are set to control Speed Select 1 and closed.
100% = Max. Frequency (ID102)

November 2009

201 Start Mode

This parameter determines the start function.

- 0** Start – normal start without interlockings
- 1** Interlocked Start – One of the inputs DI-2 to DI-6 must be programmed for selection 13 or 14 “Interlock.” After start command, when the interlock is removed the drive will stop and message “Interlock Missing” will be displayed. When the interlock contact is closed the drive will start automatically. **NOTE:** To do automatic start with interlock signal, the start command must remain “ON”. Blinking “run” LED on the keypad will indicate that “start” command is still on and the drive will start as soon as the interlock contact is closed.
- 2** Interlock Time Start – This functions the same as the Interlocked Start, except that if the interlock contact is not received within the **Interlock Timeout**, an “IntlkTime Out” message is displayed and the start sequence will need to be restarted.
- 3** Delay Start – This start is similar to the Interlocked Start, except that a return contact is not used. After the “Delay Time” the Drive starts.

202 Interlock Timeout

The timeout time used for an Interlocked Time Start, after which the start sequence must be restarted if no acknowledgement contact is received. See Start Mode (ID201).

203 Delay Time

The delay time following a Delay Start, after which the drive will be started. See Start Mode (ID201).

204 DI-2 – DI6 function

This parameter has 17 selections.

- 0** Stop pulse, when 3-wire start/stop selected
- 1** External fault closed
- 2** External fault open
- 3** Fault reset
- 4** Run enable —
Contact open: Drive start disabled
Contact closed: Drive start enabled
- 5** Force ctrl. place to Hand
- 6** Force ctrl. place to Auto
- 7** Reverse
- 8** Speed Select 1
- 9** Fire Mode-Closed Contact
- 10** Speed Select 2
- 11** Speed Select 3
- 12** Force Bypass
- 13** Interlock – See parameter Start Mode ID201 for details, closed contact
- 14** Interlock – See parameter Start Mode ID201 for details, open contact
- 15** Motor potentiometer UP
- 16** Motor potentiometer DOWN
- 17** Fire Mode-Open Contact

208 DI-6 Function

Same as DI-2 (ID204) except selection 0 = Overload fault relay input for Intellipass use.

209 AI-1 signal inversion

If this parameter = 0 no inversion of analog V_{in} signal takes place.

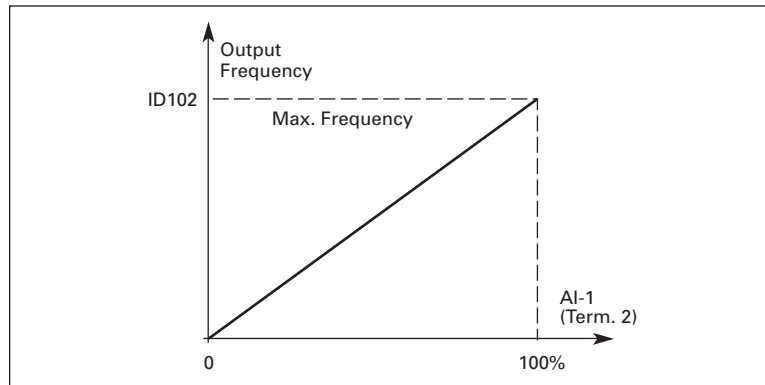


Figure 15-1: AI-1 No Signal Inversion

If this parameter = 1 inversion of analog signal takes place.

max. AI-1 signal = zero speed

min. AI-1 signal = maximum set speed

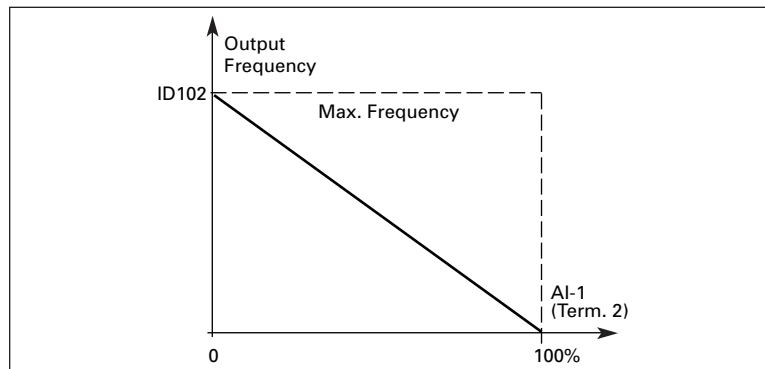


Figure 15-2: AI-1 Signal Inversion

November 2009

210 AI-1 signal filter time

When this parameter is given a value greater than 0 the function that filters out disturbances from the incoming analog signal is activated.

A long filtering time makes the regulation response slower. See **Figure 15-3**.

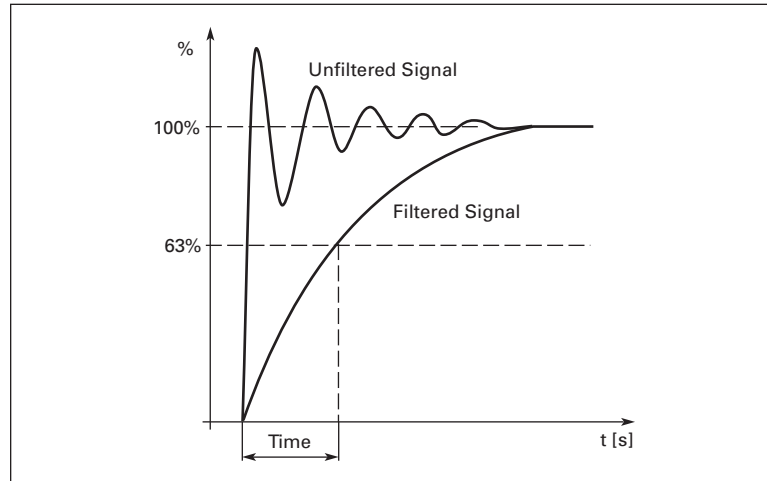


Figure 15-3: AI-1 No Signal Filtering

211 Analog input AI-2 signal range

- 0** 0 – 20 mA
- 1** 4 – 20 mA

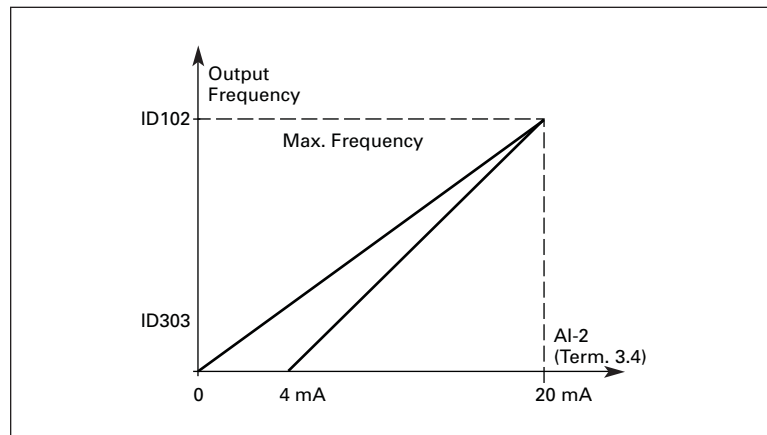


Figure 15-4: Analog Input AI-2 Scaling

212 Analog input AI-2 inversion

See ID209.

213 Analog input AI-2 (lin) filter time

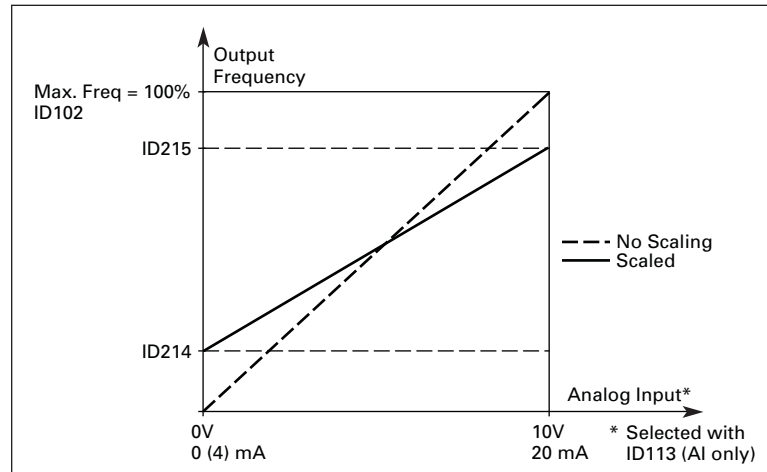
See ID210.

214 Setpoint Scale Minimum

Setpoint scaling minimum

215 Setpoint Scale Maximum

Setpoint scaling maximum

Setting value limits $0 \leq ID214 \leq ID215 \leq ID102$. If $ID215 = 0$, scaling is set OFF.**Figure 15-5: Setpoint Scaling****216 Intlk Stop Mode**

Coasting:

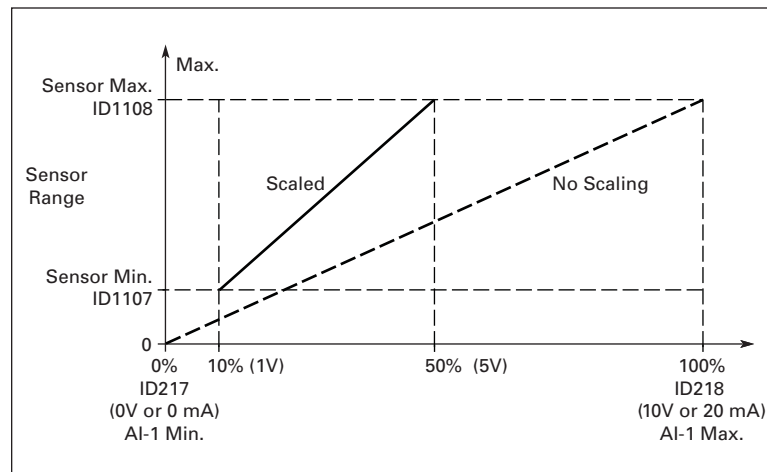
0

The motor coasts to a halt without any control from the drive, after the Stop command.

Ramp:

1

After the Stop command, the speed of the motor is decelerated according to the set deceleration parameters. If the regenerated energy is high it may be necessary to use an external braking resistor for faster deceleration.

**Figure 15-6: Sensor Scaling**

November 2009

217 AI-1 Minimum Value

Minimum scaling value for Analog input 1.

218 AI-1 Maximum Value

Maximum scaling value for Analog input 1.

221 Motor potentiometer memory reset (PID reference)

- 0** No reset
- 1** Memory reset in stop and powerdown
- 2** Memory reset in powerdown

301 Analog output function

This parameter selects the desired function for the analog output signal. See the specific parameters for the values available in each respective application.

302 Analog output filter time

Defines the filtering time for the analog output signal. Setting this parameter value to **0.00** will deactivate filtering.

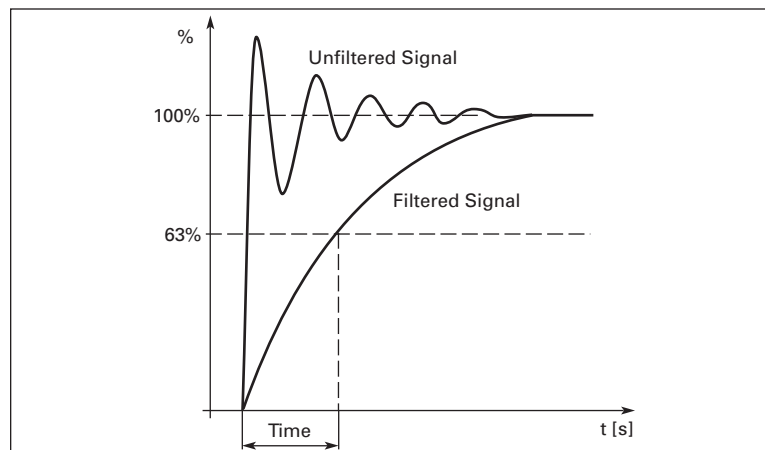


Figure 15-7: Analog Output Filtering

303 Analog output inversion

Inverts the analog output signal:

Maximum output signal = Minimum set value

Minimum output signal = maximum set value

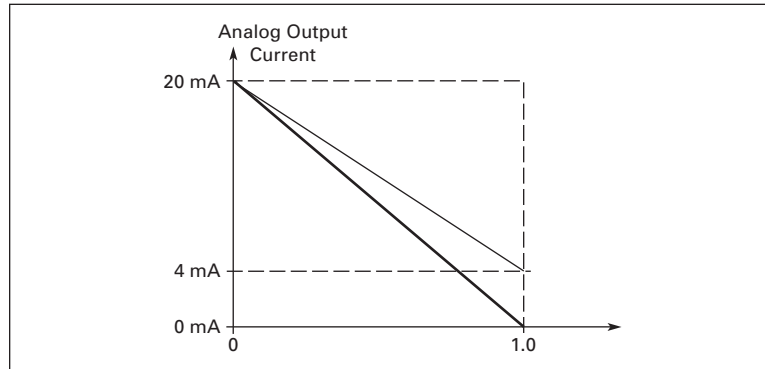


Figure 15-8: Analog Output Invert

304 Analog output minimum

Defines the signal minimum to be either 0 mA or 4 mA (“living zero”). Note the difference in analog output scaling in parameter ID305 (**Figure 15-9**).

0 Set minimum value to 0 mA

1 Set minimum value to 4 mA

305 Analog output scale

Scaling factor for analog output.

Table 15-2: Analog Output Scaling

Signal	Max. value of the signal
Output frequency	Max frequency (ID102)
Freq. Reference	Max frequency (ID102)
Motor speed	Motor nom. speed $1 \times n_{mMotor}$
Output current	Motor nom. current $1 \times I_{nMotor}$
Motor torque	Motor nom. torque $1 \times T_{nMotor}$
Motor power	Motor nom. power $1 \times P_{nMotor}$
Motor voltage	$100\% \times V_{nMotor}$
DC-link voltage	1000 V

November 2009

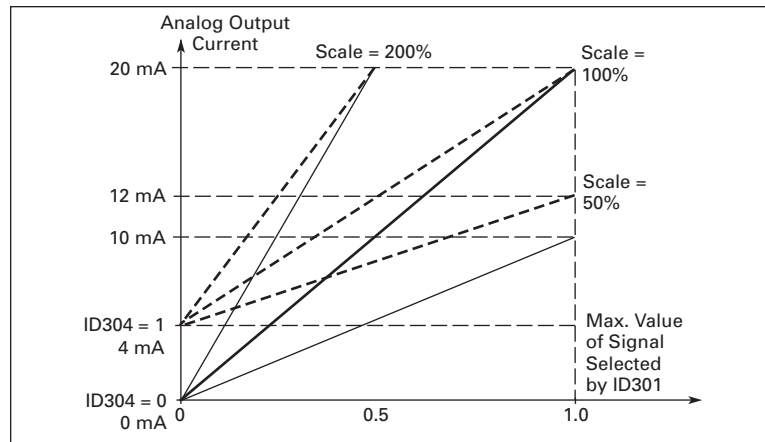


Figure 15-9: Analog Output Scaling

- 306 Digital output function
- 307 Relay output 1 function (B)
- 308 Relay output 2 function (B)
- 309 Relay output 1 function (D)
- 310 Relay output 2 function (D)
- 311 Relay output 3 function (D)

Table 15-3: Output Signals Via DO-1 and Output Relays RO-1 and RO-2

Setting value	Signal content
0 = Not used	Out of operation
1 = Ready	The drive is ready to operate
2 = Run	The drive is operating (motor is running)
3 = Fault	A fault trip has occurred
4 = Fault inverted	A fault trip <u>not</u> occurred
5 = Overheat warning	The heat-sink temperature exceeds +70°C/+158°F
6 = External fault or warning	Fault or warning depending on ID703
7 = Reference fault or warning	Fault or warning depending on par. ID702 • if analog reference is 4 – 20 mA and signal is <4 mA
8 = Warning	Always if a warning exists
9 = Reversed	The reverse command has been selected
10 = Preset Speed Active	Preset Speed Active digital input
11 = At speed	The output frequency has reached the set reference
12 = Motor regulator activated	Overvoltage or overcurrent regulator was activated
13 = Output frequency limit supervision	The output frequency is outside the set supervision low limit/high limit (ID314 and ID315)
14 = Speed setpoint limit supervision	The output frequency goes outside the set supervision low limit/high limit (ID312 and ID313)
15 = Torque limit supervision	The motor torque is beyond the set supervision low limit/high limit (ID316 and ID317).

Table 15-3: Output Signals Via DO-1 and Output Relays RO-1 and RO-2 (Continued)

Setting value	Signal content
16 = Start ON relay	Start command delay timer ID320
17 = Start OFF Delay	Start command delay timer ID321
18 = Frequency converter temperature limit supervision	Frequency converter heatsink temperature goes beyond the set supervision limits (ID318 and ID319).
19 = Unrequested rotation direction	Rotation direction is different from the requested one.
20 = Thermistor fault or warning	The thermistor input of option board indicates overtemperature.
21 = HAND control active	HAND control active
22 = AUTO control active	AUTO control active
23 = Fire Mode	Fire mode active
24 = Start delay relay	Start delay relay. Used e.g. with Damper control. See param. 1.2.1 (ID201) for more details.
25 = FB-Control	Fieldbus Control
26 = Bypass Run	Unit running in bypass

312 Speed Setpoint limit, supervision function

- 0 No supervision
- 1 Low limit supervision
- 2 High limit supervision

If the reference value falls below or exceeds the set limit (ID313), this function generates a warning message via the digital output DO-1 or via a relay output RO-1 or RO-2 depending on the settings of ID306 to ID311.

313 Speed Setpoint, supervision value

The frequency value to be supervised by ID312.

314 Actual Speed supervision function

- 0 No supervision
- 1 Low limit supervision
- 2 High limit supervision

If the output frequency goes under/over the set limit (ID315) this function generates a warning message via the digital output DO-1 or via the relay outputs RO-1 or RO-2 depending on the settings of parameters ID306 to ID311.

November 2009

315 Actual Speed supervision value

Selects the frequency value supervised by parameter ID314. See **Figure 15-10**.

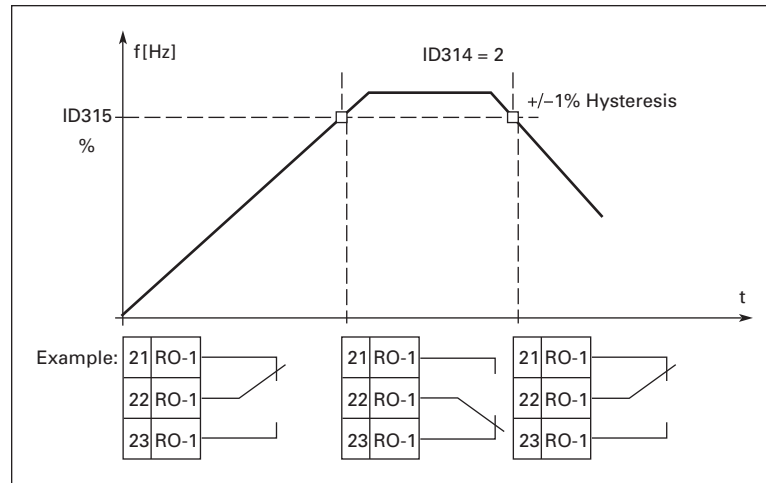


Figure 15-10: Output Frequency Supervision

316 Torque limit, supervision function

- 0 No supervision
- 1 Low limit supervision
- 2 High limit supervision

If the calculated torque value falls below or exceeds the set limit (ID317) this function generates a warning message via the digital output DO-1 or via a relay output RO-1 or RO-2 depending on the settings of ID306 to ID311.

317 Torque limit, supervision value

Set here the torque value to be supervised by ID316.

318 Frequency converter temperature limit supervision

- 0 No supervision
- 1 Low limit supervision
- 2 High limit supervision

If the temperature of the drive falls below or exceeds the set limit (ID319), this function generates a warning message via digital output DO-1 or relay outputs RO-1 or RO-2 depending on the settings of ID306 to ID311.

319 Frequency converter temperature limit value

This temperature value is supervised by ID318.

320 Start ON Delay

Relay or Digital output ON-delay time after start command is given.

321 Start OFF Delay

Relay or Digital output OFF-delay time after start command is given.

401 Start Function

Ramp:

0 The drive starts from 0 Hz and accelerates to the set reference frequency within the set acceleration time. (Load inertia or starting friction may cause prolonged acceleration times.)

Flying start:

1 The drive is able to start into a running motor by applying a small torque to motor and searching for the frequency corresponding to the speed the motor is running at. Searching starts from the maximum frequency towards the actual frequency until the correct value is detected. Thereafter, the output frequency will be increased/decreased to the set reference value according to the set acceleration/deceleration parameters.
Use this mode if the motor is coasting when the start command is given. With the flying start it is possible to ride through short utility voltage interruptions.

402 Stop Function

Coasting:

0 The motor coasts to a halt without any control from the drive, after the Stop command.

Ramp:

1 After the Stop command, the speed of the motor is decelerated according to the set deceleration parameters. If the regenerated energy is high it may be necessary to use an external braking resistor for faster deceleration.

403 Brake chopper

- 0** No brake chopper used
- 1** Brake chopper in use and tested when running. Can be tested also in READY state
- 2** External brake chopper (no testing)
- 3** Used and tested in READY state and when running
- 4** Used when running (no testing)

When the drive is decelerating the motor, the energy stored in the inertia of the motor and the load is fed into an external brake resistor. This enables the drive to decelerate the load with a torque equal to that of acceleration (provided that the correct brake resistor has been selected). See the separate Brake resistor installation manual.

November 2009

404 Acceleration/Deceleration ramp shape

Used when not in Auto Mode

The start and end of the acceleration and deceleration ramps can be smoothed with these parameters. Setting a value of 0.0 gives a linear ramp shape which causes acceleration and deceleration to react immediately to the changes in the reference signal.

Setting a value from 0.1 – 10 seconds for this parameter produces S-shaped acceleration/deceleration. The acceleration time is determined with ID103 and ID104.

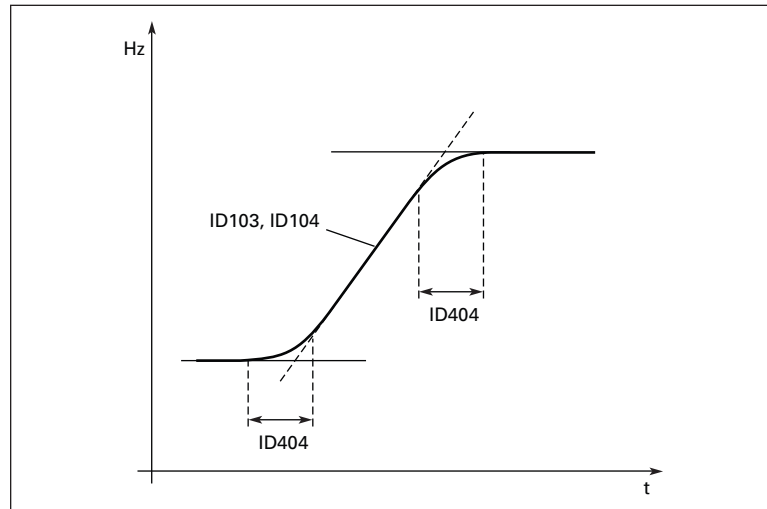


Figure 15-11: Acceleration/Deceleration (S-shaped)

501 Prohibit frequency area 1; Low limit

502 Prohibit frequency area 1; High limit

In some systems it may be necessary to avoid certain frequencies because of mechanical resonance problems. With these parameters limits are set for the “skip frequency” regions. See **Figure 15-12**.

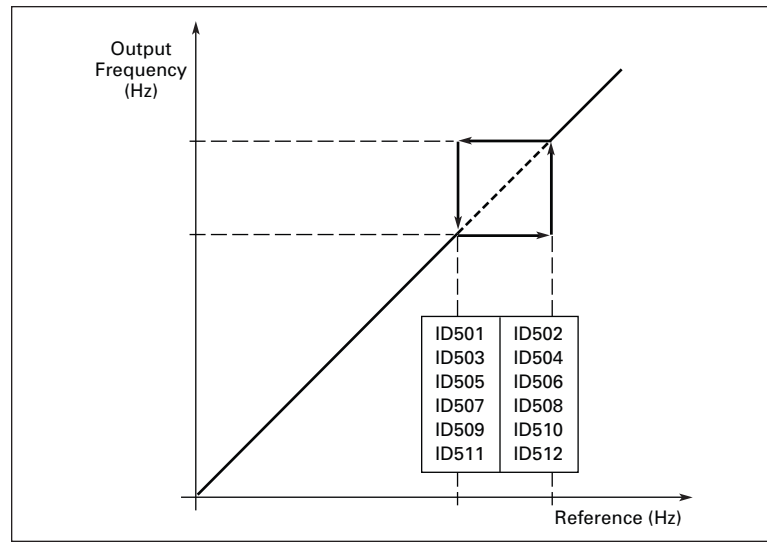


Figure 15-12: Example of Prohibit Frequency Area Setting

- 503 Prohibit frequency area 2;
Low limit**
- 504 Prohibit frequency area 2;
High limit**
- 505 Prohibit frequency area 3;
Low limit**
- 506 Prohibit frequency area 3;
High limit**
- 507 Prohibit frequency area 4;
Low limit**
- 508 Prohibit frequency area 4;
High limit**
- 509 Prohibit frequency area 5;
Low limit**
- 510 Prohibit frequency area 5;
High limit**
- 511 Prohibit frequency area 6;
Low limit**
- 512 Prohibit frequency area 6;
High limit**

November 2009

513 Acceleration/deceleration ramp speed scaling ratio between prohibit frequency limits

Defines the acceleration/deceleration time when the output frequency is between the selected prohibit frequency range limits (ID501 and ID502). The ramping speed (selected acceleration/deceleration time 1 or 2) is multiplied with this factor. E.g. value 0.1 makes the acceleration time 10 times shorter than outside the prohibit frequency range limits.

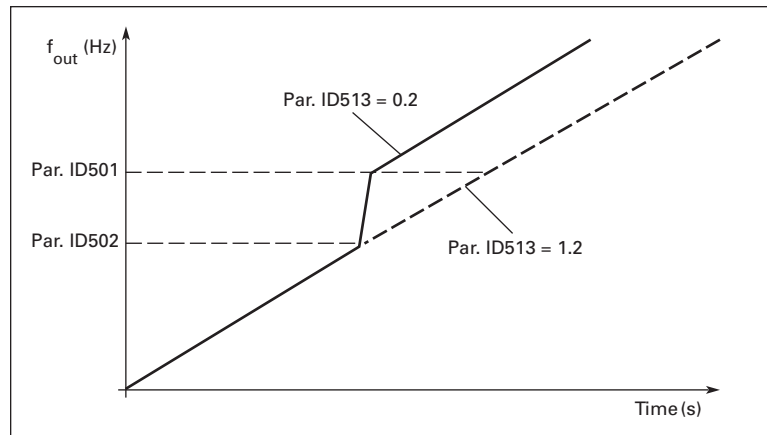


Figure 15-13: Ramp Speed Scaling between Prohibit Frequencies

601 Motor control mode

- 0** Frequency control: The I/O terminal and keypad references are frequency references and the drive controls the output frequency (output frequency resolution = 0.01 Hz)
- 1** Speed control: The I/O terminal and keypad references are speed references and the drive controls the motor speed compensating for motor slip (accuracy ± 0.5%).

602 V/Hz optimization

Automatic torque boost The voltage to the motor changes automatically which makes the motor produce sufficient torque to start and run at low frequencies. The voltage increase depends on the motor type and rating. Automatic torque boost can be used in applications where starting torque due to starting friction is high, e.g. in conveyors.

Example 1:

What changes are required to start the load from 0 Hz?

- First set the motor nominal values (Parameter group 1.1).

Option 1: Activate the Automatic torque boost.

Option 2: Programmable V/Hz curve

To obtain the required torque, the zero point voltage and midpoint voltage/frequency (in parameter group 1.6) need to be set, so that the motor can draw enough current at the low frequencies. First set parameter ID603 to *Programmable V/Hz curve* (value 2). Increase the zero point voltage (ID608) to get enough current at zero speed. Then set the midpoint voltage (ID607) to $1.4142 \cdot ID608$ and the midpoint frequency (ID606) to $ID606/100\% \cdot ID111$.

Note: In high torque — low speed applications — it is likely that the motor will overheat. If the motor has to run a prolonged time under these conditions, special attention must be paid to cooling the motor. Use external cooling for the motor if the temperature tends to rise too high.

603 V/Hz ratio selection

Linear:

0 The voltage of the motor changes linearly with the frequency in the constant flux area from 0 Hz to the field weakening point where the nominal voltage is supplied to the motor. A linear V/Hz ratio should be used in constant torque applications. **This default setting should be used if there is no special need for another setting.**

Squared:

1 The voltage of the motor changes following a squared curve form with the frequency in the area from 0 Hz to the field weakening point where the nominal voltage is supplied to the motor. The motor runs under magnetized below the field weakening point and produces less torque and electromechanical noise. A squared V/Hz ratio can be used in applications where the torque demand of the load is proportional to the square of the speed, e.g. in centrifugal fans and pumps.

November 2009

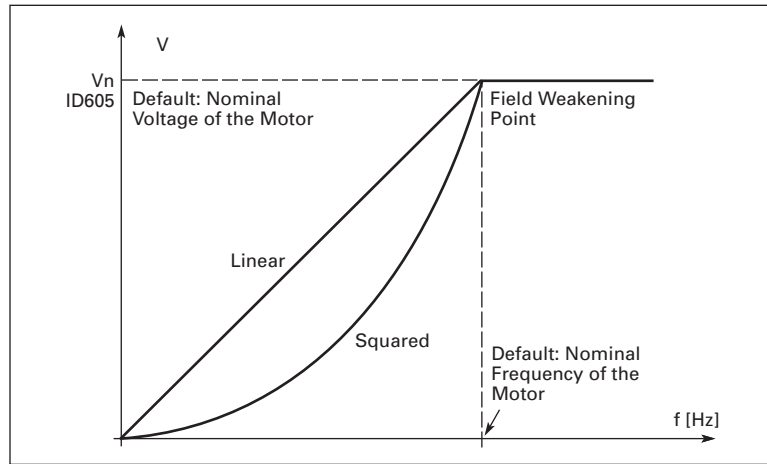


Figure 15-14: Linear and Squared V/Hz Ratio

Programmable V/Hz curve:

- 2 The V/Hz curve can be programmed with three different points. A programmable V/Hz curve can be used if the other settings do not satisfy the needs of the application.

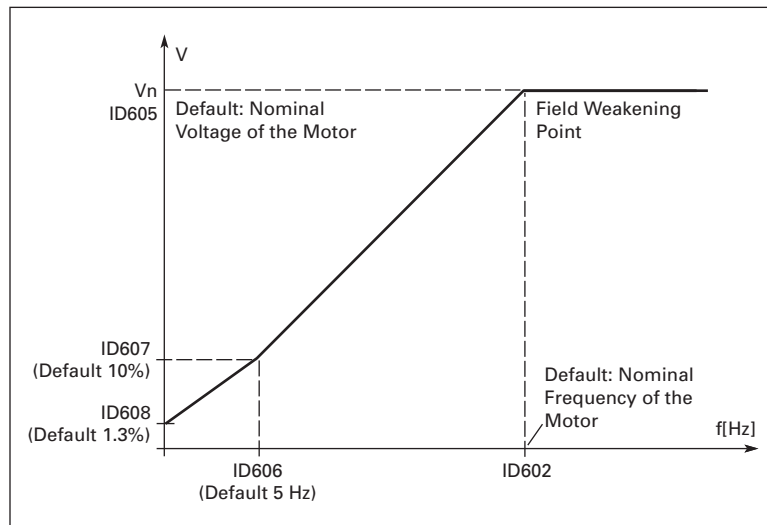


Figure 15-15: Programmable V/Hz Curve

Linear with flux optimization:

- 3 The drive starts to search for the minimum motor current in order to save energy, lower the disturbance level and the noise. This function can be used in applications with constant motor load, such as fans, pumps etc.

604 Field weakening point

The field weakening point is the output frequency at which the output voltage reaches the set (ID605) maximum value.

605 Voltage at field weakening point

Above the frequency at the field weakening point, the output voltage remains at the set maximum value. Below the frequency at the field weakening point, the output voltage depends on the setting of the V/Hz curve parameters. See ID109, ID108, ID606 and ID607.

When ID105 and ID106 (nominal voltage and nominal frequency of the motor) are set, ID604 and ID605 are automatically set to the corresponding values. If you need different values for the field weakening point and the maximum output voltage, change these parameters **after** setting ID105 and ID106.

606 V/Hz curve, middle point frequency

If the programmable V/Hz curve has been selected with ID108, this parameter defines the middle point frequency of the curve. See **Figure 15-15**.

607 V/Hz curve, middle point voltage

If the programmable V/Hz curve has been selected with the ID108, this parameter defines the middle point voltage of the curve. See **Figure 15-15**.

608 Output voltage at zero speed

If the programmable V/Hz curve has been selected with the ID108, this parameter defines the zero frequency voltage of the curve. See **Figure 15-15**.

609 Switching frequency

Motor noise can be minimized using a high switching frequency. Increasing the switching frequency reduces the rating of the drive. The range of switching frequencies is dependent upon the horsepower size of the drive:

Table 15-4: Size-Dependent Switching Frequencies

Type	Min. [kHz]	Max. [kHz]	Default [kHz]
230V: 1 – 20 hp 480V: 1-1/2 – 40 hp	1.0	16.0	3.6
230V: 25 – 40 hp 480V: 50 – 250 hp	1.0	10.0	3.6

November 2009

610 Overvoltage controller

This parameter (and ID611) allows the overvoltage (undervoltage) controller to be switched out of operation. This may be useful, for example, if the utility supply voltage varies more than -15% to +10% and the application will not tolerate the overvoltage (undervoltage). When on, this controller adjusts the output frequency based on the supply voltage fluctuations.

Note: An overvoltage trip may occur if the controller is switched off.

- 0 Controller switched off
- 1 Controller switched on (no ramping) = Minor adjustments of OP frequency are made
- 2 Controller switched on (with ramping) = Controller adjusts OP freq. up to max. freq.

611 Undervoltage controller

See ID610.

Note: An undervoltage trip may occur if the controller is switched off.

- 0 Controller switched off
- 1 Controller switched on

612 Identification

Identification run is a part of tuning the motor and the drive specific parameters. It is a tool for commissioning and service of the drive with the aim to find the best parameter values possible for most drives. The automatic motor identification calculates or measures the motor parameters that are needed for optimum motor and speed control.

- 0 No action — No identification requested
- 1 Identification without motor run — The drive is run without speed to identify the motor parameters. The motor is supplied with current and voltage but with zero frequency.
- 2 Identification with motor run — The drive is run with speed to identify the motor parameters.

Note: It is recommended that the identification test is done with no load on the motor for best results.

701 Input phase supervision

- 0 No response
- 1 Warning
- 2 Fault, stop mode after fault according to ID402

The input phase supervision ensures that the input phases of the drive have approximately equal currents.

702 Response to the 4 mA reference fault

0	No response
1	Warning
2	Fault, stop mode after fault according to ID402

A warning or a fault action and message is generated if the 4 – 20 mA reference signal is used and the signal falls below 3.5 mA for 5 seconds or below 0.5 mA for 0.5 seconds. The information can also be programmed into digital output DO-1 or relay outputs RO-1 and RO-2.

703 Response to external fault

0	No response
1	Warning
2	Fault, stop mode after fault according to ID402

A warning or a fault action and message is generated from the external fault signal applied to programmable digital input DI-3. The information can also be programmed into digital output DO-1 or relay outputs RO-1 and RO-2.

704 Response to fieldbus fault

This sets the response mode for the fieldbus fault when a fieldbus board is used. For more information, see the respective Fieldbus Board Manual.

705 Response to slot fault

This sets the response mode for a board slot fault caused by a missing or failed board.

706 Automatic restart

The Automatic restart is used when this parameter is enabled.

0	Disabled
1	Automatically transferred to Bypass
2	Reset drive only
3	Reset drive, if fails, then transferred to Bypass

The function resets the following faults (max. three times every 5 seconds) (see **Appendix B**):

- Overcurrent (F1)
- Overvoltage (F2)
- Undervoltage (F9)
- Drive overtemperature (F14)
- Motor overtemperature (F16)
- Reference fault (F50)
- Saturation trip (F7)
- Motor underload (F17)
- IGBT temperature hardware (F31)
- IGBT temperature software (F41)

November 2009

707 Motor Thermal Protection

- 0** No response
- 1** Warning
- 2** Fault, stop mode after fault according to ID402
- 3** Fault, stop mode after fault always by coasting

If tripping is selected the drive will stop and activate the fault stage. Deactivating the protection, ie. setting parameter to 0, will reset the thermal stage of the motor to 0%.

708 Motor Thermal Protection: Motor Ambient Temperature Factor

The factor can be set between -100.0% – 100.0%.

709 Motor Thermal Protection: Motor Cooling Factor at Zero Speed

The current can be set between 0 – 150.0% x $I_{n\text{motor}}$. This parameter sets the value for thermal current at zero frequency. See **Figure 15-16**.

The default value is set assuming that there is no external fan cooling the motor. If an external fan is used, this parameter can be set to 90% (or even higher).

Note: The value is set as a percentage of the motor nameplate data, ID108 (Nominal current of motor), not the drive’s nominal output current. The motor’s nominal current is the current that the motor can withstand in direct on-line use without being overheated.

If nominal current of motor (ID108) is changed, this parameter is automatically restored to the default value. Setting this parameter does not affect the maximum output current of the drive, which is determined by ID107 alone.

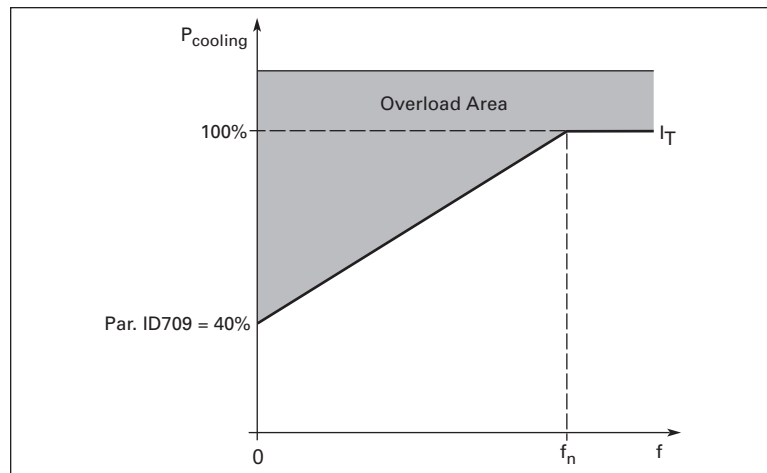


Figure 15-16: Motor Thermal Current I_T Curve

710 Motor Thermal Protection: Time Constant

This time can be set between 1 and 200 minutes.

This is the thermal time constant of the motor. The bigger the motor, the bigger the time constant. The time constant is the time within which the calculated thermal stage has reached 63% of its final value.

If the motor's t6-time (t6 is the time in seconds the motor can safely operate at six times the rated current) is known (given by the motor manufacturer) the time constant in minutes is equal to 2xt6. If the drive is in stop stage, the time constant is internally increased to three times the set parameter value. Cooling in the stop stage is based on convection and the time constant is increased. See **Figure 15-17**.

711 Motor Thermal Protection: Motor Duty Cycle

Define how much of the nominal motor load is applied. The value can be set to 0% – 100%.

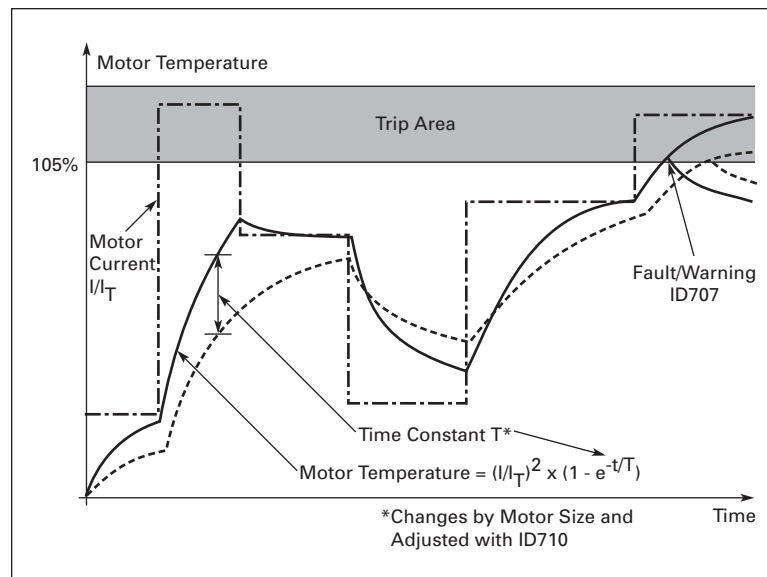


Figure 15-17: Motor Temperature Calculation

712 Stall Protection

- | | |
|----------|---|
| 0 | No response |
| 1 | Warning |
| 2 | Fault, stop mode after fault according to ID402 |
| 3 | Fault, stop mode after fault always by coasting |

Setting the parameter to 0 will deactivate the protection and reset the stall time counter.

November 2009

713 Stall Current Limit

The current can be set to $0.0 - 2 \cdot I_H$. For a stall stage to occur, the current must have exceeded this limit. See **Figure 15-18**. The software does not allow entering a greater value than $2 \cdot I_H$. If ID107 (nominal current limit of motor) is changed, this parameter is automatically calculated to 90% of the current limit.

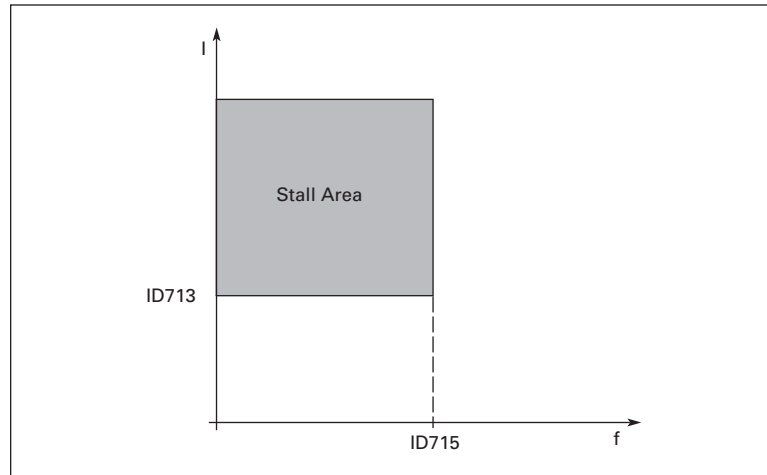


Figure 15-18: Stall Characteristics Settings

714 Stall Time

This time can be set between 1.0 and 120.

This is the maximum time allowed for a stall stage. The stall time is counted by an internal up/down counter. If the stall time counter value goes above this limit, the protection will cause a trip (see ID712).

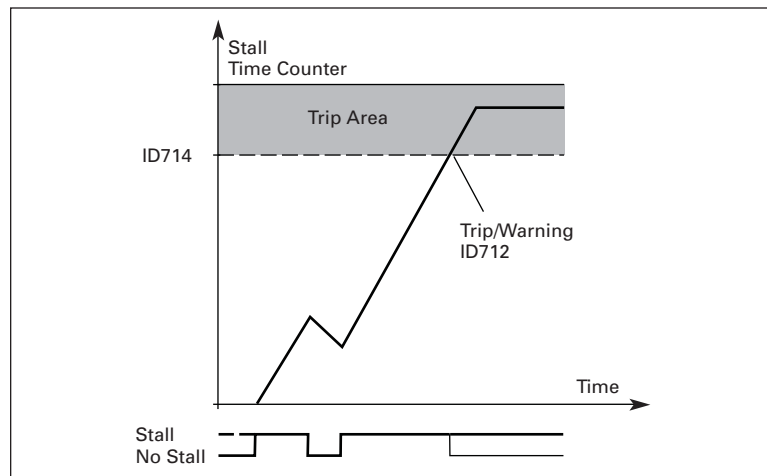


Figure 15-19: Stall Time Count

715 Stall Frequency Limit

The frequency can be set between $1 - f_{max}$ (ID102). For a stall state to occur, the output frequency must remain below this limit.

716 Underload Protection

- 0** No response
- 1** Warning
- 2** Fault, stop mode after fault according to ID402
- 3** Fault, stop mode after fault always by coasting

If tripping is set active the drive will stop and activate the fault stage. Deactivating the protection by setting the parameter to 0 will reset the underload time counter to zero.

717 Underload Protection, Field Weakening Area Load

The torque limit can be set between 10.0 – 150.0% $\times T_{nMotor}$.

This parameter gives the value for the minimum torque allowed when the output frequency is above the field weakening point. See **Figure 15-20**.

If you change ID108 (motor nominal current), this parameter is automatically restored to the default value.

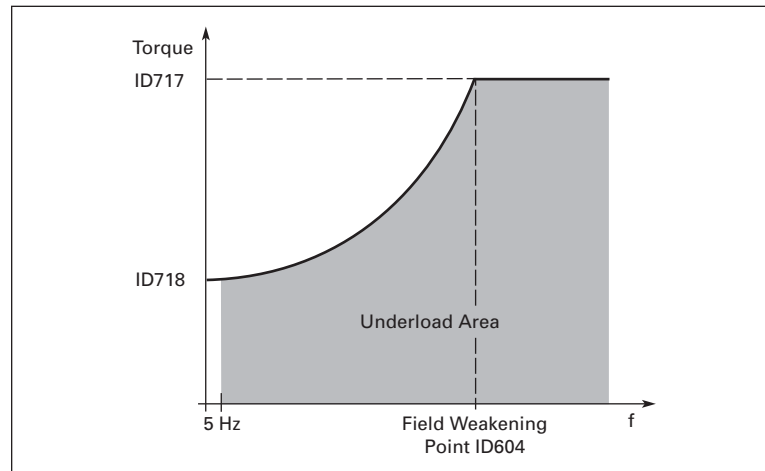


Figure 15-20: Setting of Minimum Load

718 Underload Protection, Zero Frequency Load

The torque limit can be set between 5.0 – 150.0% $\times T_{nMotor}$.

This parameter gives the value for the minimum torque allowed with zero frequency. See **Figure 15-20**.

If you change ID108 (motor nominal current), this parameter is automatically restored to the default value.

November 2009

719 Underload Time

This time can be set between 2.0 and 600.0 sec.

This is the maximum time allowed for an underload state to exist. An internal up/down counter counts the accumulated underload time. If the underload counter value goes above this limit, the protection will cause a trip according to ID716. If the drive is stopped, the underload counter is reset to zero. See **Figure 15-21**.

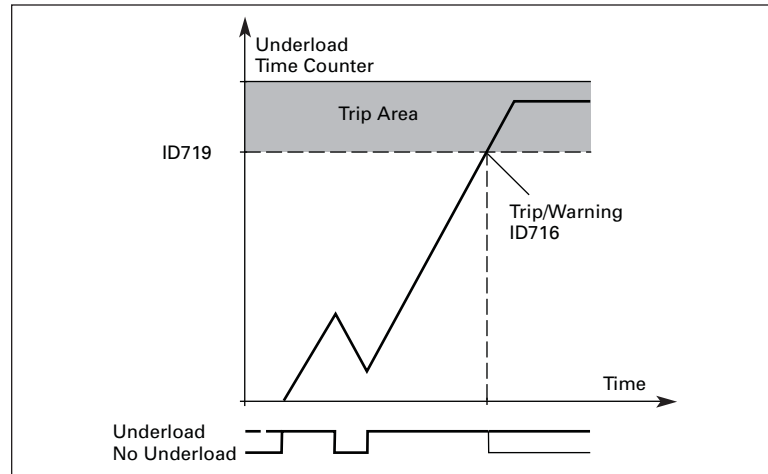


Figure 15-21: Underload Time Counter Function

804 Fire Mode Function

Fire Mode is used to start motor and continue to operate due to emergency conditions. Faults will be changed to warnings to prevent shutdown. The overload should be selected to AUTO to prevent overload trip during "Fire Mode" operation. This is only required if unit is an IntelliPass bypass which uses an electronic overload with contactor to run motor. If set to AUTO on the overload, the overload fault will be ignored and motor will continue to run.



IMPORTANT

The electronic overload on the contactor must be set to AUTO, otherwise the overload will function normally.

- Note:** (1) Fire Mode has no effect on Bypass operation.
 (2) Removing the "Fire Mode" digital input will return the drive to normal operation.

This parameter determines whether the fire mode function is determined by a contact closure or contact opening on digital input.

- Closing contact initiates fire mode function. Option 9 in digital input parameter.
- Opening contact initiates fire mode function. Option 14 in digital input parameter.

Fire Mode Speed Reference

Parameter P1.7.20 sets the drive's fire mode speed.

1001 Fieldbus Data Out to 1008

These parameters can be used to send parameter or monitoring values to fieldbus. The values can be selected by using ID numbers.

Table 15-5: Fieldbus Parameters

ID	Data	Default	Description	Unit
1001	FB Data Out 1 Select	1	Actual Speed	rpm
1002	FB Data Out 2 Select	5	Motor Current	A
1003	FB Data Out 3 Select	8	Motor Voltage	V
1004	FB Data Out 4 Select	7	Motor Power	%
1005	FB Data Out 5 Select	9	DC Bus Voltage	V
1006	FB Data Out 6 Select	20	Status Word	—
1007	FB Data Out 7 Select	18	Active Fault Code	—
1008	FB Data Out 8 Select	19	Active Warning Code	—

1011 PI Setpoint Default

PI-regulators default setpoint. This parameter is set with Start-Up Wizard. Parameter not available in Remote Input application.

1101 US/Metric Units

(Duct, building, pressure and temperature applications only.)

- 0 US units
- 1 Metric units

1102 PI Setpoint Min. Limit

Default: Same value as ID1107.

PI Setpoint limitation minimum value.

1103 PI Setpoint Max. Limit

Default: Same value as ID1108.

PI Setpoint limitation maximum value.

1104 PI Setpoint Ramp Time

Defines the time during which the PI controller reference rises from 0% to 100% or falls from 100% to 0%.

1106 PI-Controller Input Source

- 0 AI-1 (control board)
- 1 AI-2 (control board)
- 2 Fieldbus (*Actual value 1: FBProcessDataIN1*)
- 3 Min. Both
- 4 Max. Both
- 5 Ave. Both

1107 Sensor Minimum Scale

Feedback sensor minimum output value. See **Figure 15-6**.

1108 Sensor Maximum Scale

Feedback sensor maximum output value. See **Figure 15-6**.

November 2009

1109 PI controller gain

This parameter defines the gain of the PI controller. If the value of the parameter is set to 1.00 a change of 0.01 in the error value causes the controller output to change by 10%.

1110 PI controller I-time

This parameter defines the integration time of the PI controller. If this parameter is set to 1.00 second, a change of 10% in the error value causes the controller output to change by 10.00%/s. If the parameter value is set to 0.00 s the PI controller will operate as PD controller.

1111 Deadband

Parameter will set \pm deadband area for PI controllers error value (Setpoint – Feedback). When inside the deadband area the PI regulation is stopped and the output is frozen to current value.

1112 PI controller acting mode

This parameter allows you to invert the error value of the PI controller (and thus the operation of the PI controller).

- 0 Forward Acting
- 1 Reverse Acting

1113 Acceleration time auto mode

Output frequency acceleration time in auto mode.

1114 Deceleration time auto mode

Output frequency deceleration time in auto mode.

1115 Auto Acceleration/Deceleration ramp shape

Used in Auto Mode and PI control is NOT active

The start and end of the acceleration and deceleration ramps can be smoothed with these parameters. Setting a value of 0.0 gives a linear ramp shape which causes acceleration and deceleration to react immediately to the changes in the reference signal.

Setting a value from 0.1 – 10 seconds for this parameter produces S-shaped acceleration/ deceleration. The acceleration time is determined with ID1113 and ID1114.

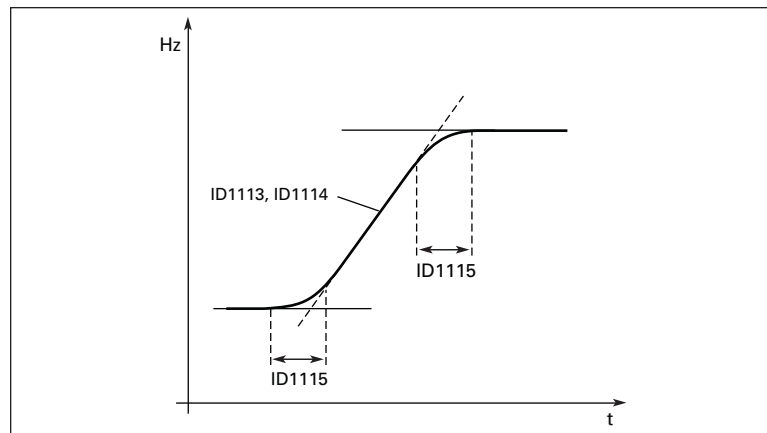


Figure 15-22: Auto Acceleration/Deceleration (S-shaped)

Keypad Control Parameters

Unlike the parameters listed above, these parameters are located in the **M2** menu of the control keypad. The keypad reference and PI setpoint parameters do not have ID numbers.

1009 Keypad direction

- 0** Forward: The rotation of the motor is forward, when the keypad is the active control place.
- 1** Reverse: The rotation of the motor is reverse, when the keypad is the active control place.

For more information, see **Chapter 6**, Keypad Control Menu (M2).

1010 STOP button activated

To make the STOP button a “hotspot” which always stops the drive regardless of the selected control place, set the value of this parameter to **1**.

R2.1 Keypad reference

The frequency reference can be adjusted from the keypad with this parameter. The output frequency can be copied as the keypad reference by pushing the STOP button for 3 seconds when you are on any of the pages of menu **M2**. For more information, see **Chapter 6**, Keypad Control Menu (M2).

R2.4 PI Setpoint

The PI controller keypad reference can be set between 0% and 100%. This reference value is the active PI reference if ID115 = 2. Units are application dependent.

1701 Preset Speed to 1707

Digital Input(s) for ...			Status
Preset Speed 1	Preset Speed 2	Preset Speed 3	
0	0	0	OFF
1	0	0	Preset Speed 1
0	1	0	Preset Speed 2
1	1	0	Preset Speed 3
0	0	1	Preset Speed 4
1	0	1	Preset Speed 5
1	1	0	Preset Speed 6
1	1	1	Preset Speed 7

Table 15-6: Preset Speeds

Code	Parameter	Min.	Max.	Unit	Step	Default	ID Number	Description
P1.10.1	Preset Speed 1	0	100.0	%	0.1	30.0	1701	Preset speeds when Digital Inputs are programmed
P1.10.2	Preset Speed 2	0	100.0	%	0.1	40.0	1702	
P1.10.3	Preset Speed 3	0	100.0	%	0.1	50.0	1703	
P1.10.4	Preset Speed 4	0	100.0	%	0.1	60.0	1704	
P1.10.5	Preset Speed 5	0	100.0	%	0.1	70.0	1705	
P1.10.6	Preset Speed 6	0	100.0	%	0.1	80.0	1706	
P1.10.7	Preset Speed 7	0	100.0	%	0.1	90.0	1707	

November 2009

Appendix A — Technical Data

Specifications

Table A-1: VSD Series Drive Specifications

Description	Specification
Power Connections	
Input Voltage (V_{in})	230V +10%/-15% 480V +10%/-15% 575V +10%/-15%
Input Frequency (f_{in})	50/60 Hz (variation up to 45 – 66 Hz)
Connection to Utility Power	Once per minute or less (typical operation)
High Interrupt Rating	The current withstand rating of the drive is 100,000 Amperes When Freedom Starters and an HMCP, the current interrupting rating is 100,000 Amperes When used with <i>IT</i> . style starters, the current interrupting rating is 36,000 Amperes
Motor Connections	
Output Voltage	0 to V_{in}
Continuous Output Current	Ambient temperature max. +104°F (+40°C), overload 1.1 x I_L (1 min./10 min.)
Starting Torque	110%
Output Frequency	0 to 320 Hz
Frequency Resolution	0.01 Hz
Control Characteristics	
Control Method	Frequency Control (V/f) Open Loop Sensorless Vector Control
Switching Frequency	Adjustable with Switching Frequency 230V: 1 – 20 hp: 1 to 16 kHz; default 3.6 kHz 25 – 40 hp: 1 to 10 kHz; default 3.6 kHz 480V: 1 – 40 hp: 1 to 16 kHz; default 3.6 kHz 50 – 250 hp: 1 to 10 kHz; default 3.6 kHz 575V: All hp: 1 to 6 kHz; default 1.5 kHz
Frequency Reference	Analog Input: Resolution 0.1% (10-bit), accuracy $\pm 1\%$ Panel Reference: Resolution 0.01 Hz
Field Weakening Point	30 to 320 Hz
Acceleration Time	0.1 to 3000 sec.
Deceleration Time	0.1 to 3000 sec.
Braking Torque	DC brake: 15% to 150% x T_n (without brake option)
Environment	
Ambient Operating Temperature	14°F (-10°C), no frost to 104°F (+40°C)
Storage Temperature	-40°F (-40°C) to 158°F (70°C)
Relative Humidity	0 to 95% RH, noncondensing, non-corrosive, no dripping water
Air Quality	Chemical vapors: IEC 60721-3-3, unit in operation, class 3C2 Mechanical particles: IEC 60721-3-3, unit in operation, class 3S2
Altitude	100% load capacity (no derating) up to 3300 ft. (1000m); 1% derating for each 330 ft. (100m) above 3300 ft. (1000m); max. 10000 ft. (3000m)

Table A-1: VSD Series Drive Specifications (Continued)

Description	Specification
Environment, continued	
Vibration	EN 50178, EN 60068-2-6 5 to 50 Hz, displacement amplitude 1 mm (peak) at 3 to 15.8 Hz, Max. acceleration amplitude 1 G at 15.8 to 150 Hz
Shock	EN 50178, EN 60068-2-27 UPS Drop test (for applicable UPS weights) Storage and shipping: max. 15 G, 11 ms (in package)
Enclosure Class	TYPE 1/IP21 standard 250 hp and below Open chassis standard 300 hp and above
Standards	
EMC (at default settings)	Immunity: Fulfills all EMC immunity requirements Emissions: EN 61800-3
Safety	UL 508C
Product	IEC 61800-2
Control Connections	
Analog Input Voltage	0 to 10V, R - 200W differential (-10 to 10V joystick control) Resolution 0.1%; accuracy $\pm 1\%$
Analog Input Current	0(4) to 20 mA; R_i - 250W differential
Digital Inputs (6)	Positive or negative logic; 18 to 24V DC
Auxiliary Voltage	24V DC $\pm 15\%$, max. 250 mA
Output Reference Voltage	+10V +3%, max. load 10 mA
Analog Output	0(4) to 20 mA; R_L max. 500W ; Resolution 10 bit; Accuracy $\pm 2\%$ or 0 to 10V, R_L 1 kW , select with jumper
Digital Outputs	Open collector output, 50 mA/48V
Relay Outputs	2 programmable Form C relay outputs Switching capacity: 24V DC / 8A, 250V AC / 8A, 125V DC / 0.4A Minimum switching load: 5V/10 mA Continuous capacity: $< 2 A_{rms}$
Protections	
Overcurrent Protection	Yes
Overvoltage Protection	Yes
Undervoltage Protection	Yes
Ground (Earth) Fault	In case of a ground fault in motor or motor cables, only the VSD Series is protected
Input Phase Supervision	Trips if any of the input phases are missing
Motor Phase Supervision	Trips if any of the output phases are missing
Overtemperature Protection	Yes
Motor Overload Protection	Yes
Motor Stall Protection	Yes
Motor Underload Protection	Yes
Short Circuit Protection of the 24V DC and +10V DC Reference Voltages	Yes
Programmable Automatic Restart Options	Yes — Disable; Automatically transferred to Bypass; Reset drive only; Reset drive, if fails, then transferred to Bypass

November 2009

Power Ratings

Table A-2: 230V VT Output Power Ratings

Catalog Number ^①	Frame Size	Three-Phase Input	
		Horsepower	Current
VS0012x0A_ VSF152x0A_ VS0022x0A_ VS0032x0A_	FR4	1	4.8
		1-1/2	6.6
		2	7.8
		3	11
VS0052x0A_ VS0072x0A_ VS0102x0A_	FR5	5	17.5
		7-1/2	25
		10	31
VS0152x0A_ VS0202x0A_	FR6	15	48
		20	61
VS0252x0A_ VS0302x0A_ VS0402x0A_	FR7	25	75
		30	88
		40	114
VS0502x0A_ VS0602x0A_ VS0752x0A_	FR8	50	140
		60	170
		75	205
VS1002x0A_	FR9	100	261

^① Insert a "1" for TYPE 1 or a "2" for TYPE 12 in place of the "x" in the Catalog Number.

Table A-3: 480V VT Output Power Ratings

Catalog Number ^①	Frame Size	Three-Phase Input	
		Horsepower	Current
VSF154x0A_ VS0024x0A_ VS0034x0A_ VS0054x0A_ VS0074x0A_	FR4	1-1/2	3.3
		2	4.3
		3	5.6
		4	7.6
		7-1/2	12
VS0104x0A_ VS0154x0A_ VS0204x0A_	FR5	10	16
		15	23
		20	31
VS0254x0A_ VS0304x0A_ VS0404x0A_	FR6	25	38
		30	46
		40	61
VS0504x0A_ VS0604x0A_ VS0754x0A_	FR7	50	72
		60	87
		75	105
VS1004x0A_ VS1254x0A_ VS1504x0A_	FR8	100	140
		125	170
		150	205
VS2004x0A_ VS2504x0A_	FR9	200	261
		250	300

^① Insert a "1" for TYPE 1 or a "2" for TYPE 12 in place of the "x" in the Catalog Number.

Table A-4: 575V VT Output Power Ratings

Catalog Number ^①	Frame Size	Three-Phase Input	
		Horsepower	Current
VS0035x0A_ VS0055x0A_ VS0075x0A_ VS0105x0A_	FR6	3	4.5
		5	7.5
		7-1/2	10
		10	13.5
VS0155x0A_ VS0205x0A_ VS0255x0A_ VS0305x0A_		15	18
		20	22
		25	27
		30	34
VS0405x0A_ VS0505x0A_	FR7	40	41
		50	52
VS0605x0A_ VS0755x0A_ VS1005x0A_	FR8	60	62
		75	80
		100	100
VS1255x0A_ VS1505x0A_ VS2005x0A_	FR9	125	125
		150	144
		200	208

^① Insert a "1" for TYPE 1 or a "2" for TYPE 12 in place of the "x" in the Catalog Number.

Power Loss and Switching Frequency

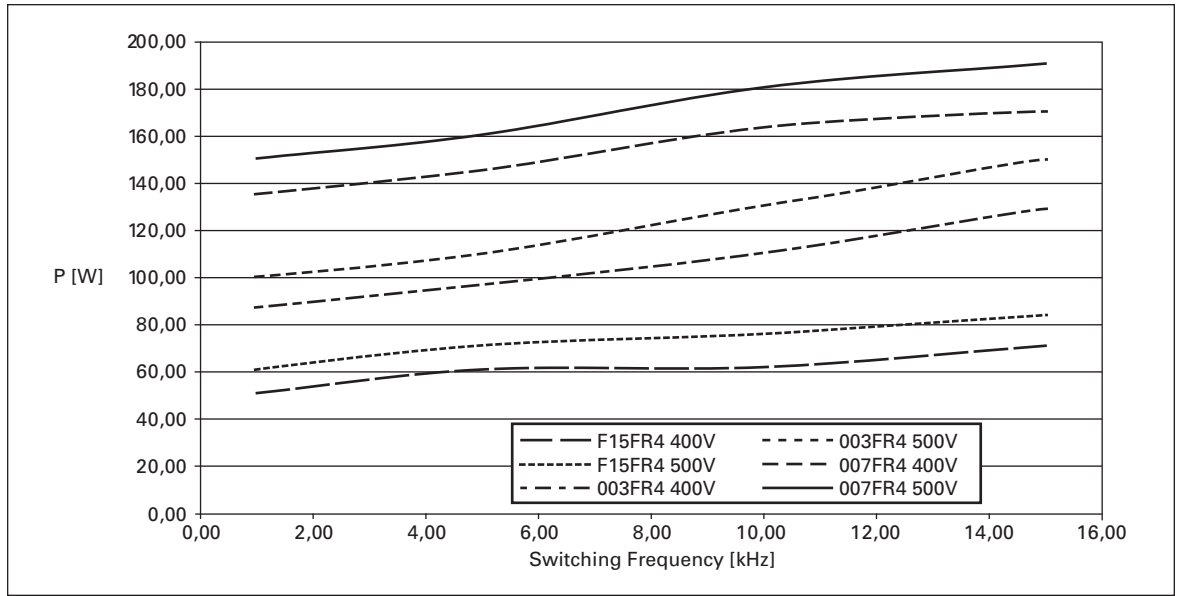
In some situations it may be desirable to change the switching frequency of the VSD Series drive for some reason (typically e.g. to reduce the motor noise). Raising the switching frequency above the factory default level increases the drive power loss and increases the cooling requirements. **Figures A-1** through **A-6** illustrate the power loss increase for the different VSD Series models. When operating above the default switching frequency, the VSD Series output current rating should be derated by the ratio of the increased power loss to the nominal power loss.

Example: The user of a 40 hp, 61A, 480V VSD Series drive wishes to increase the switching frequency from the factory default value of 10 kHz to 15 kHz to reduce motor noise. From **Figure A-3** the loss at the factory default switching frequency of 10 kHz is 1240 watts. The loss at 15 kHz from **Figure A-3** is 1340 watts.

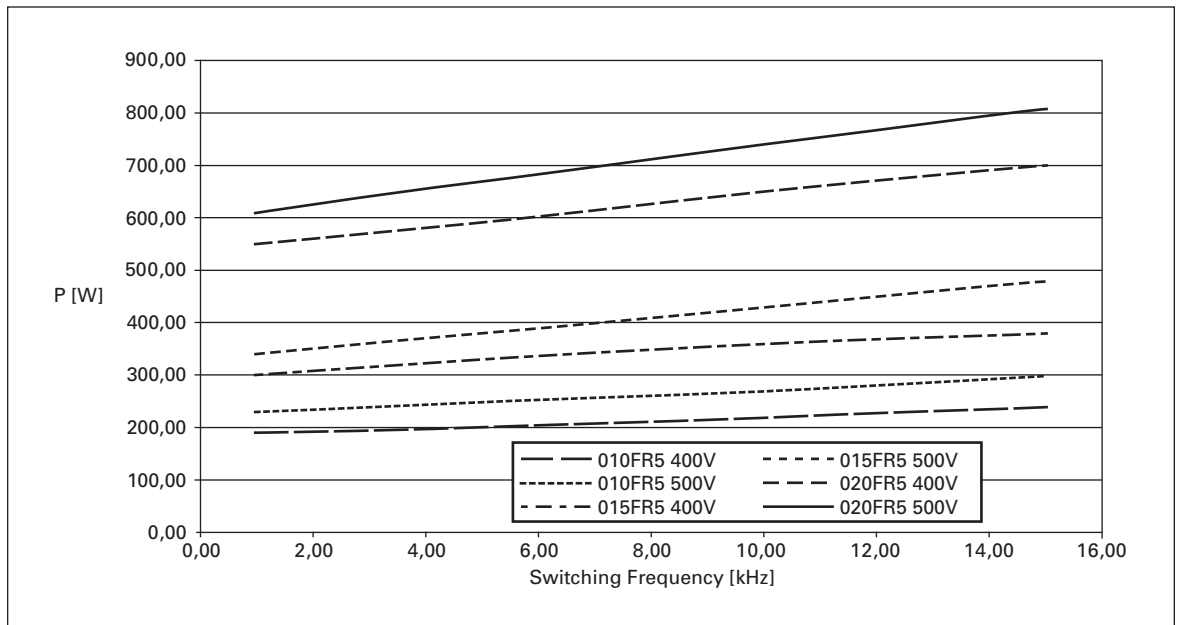
$$\text{Re rate} = 61 \times \frac{1240}{1340} = 56\text{A}$$

Thus at the increased switching frequency, the maximum load allowed is 56A to avoid overheating the VSD Series drive.

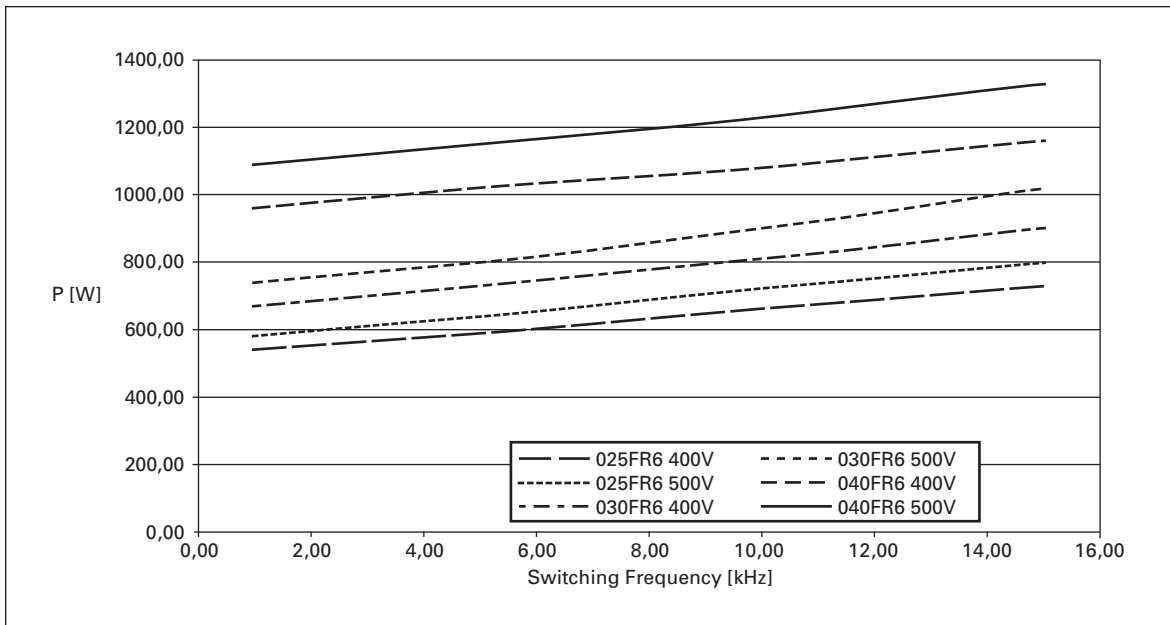
November 2009



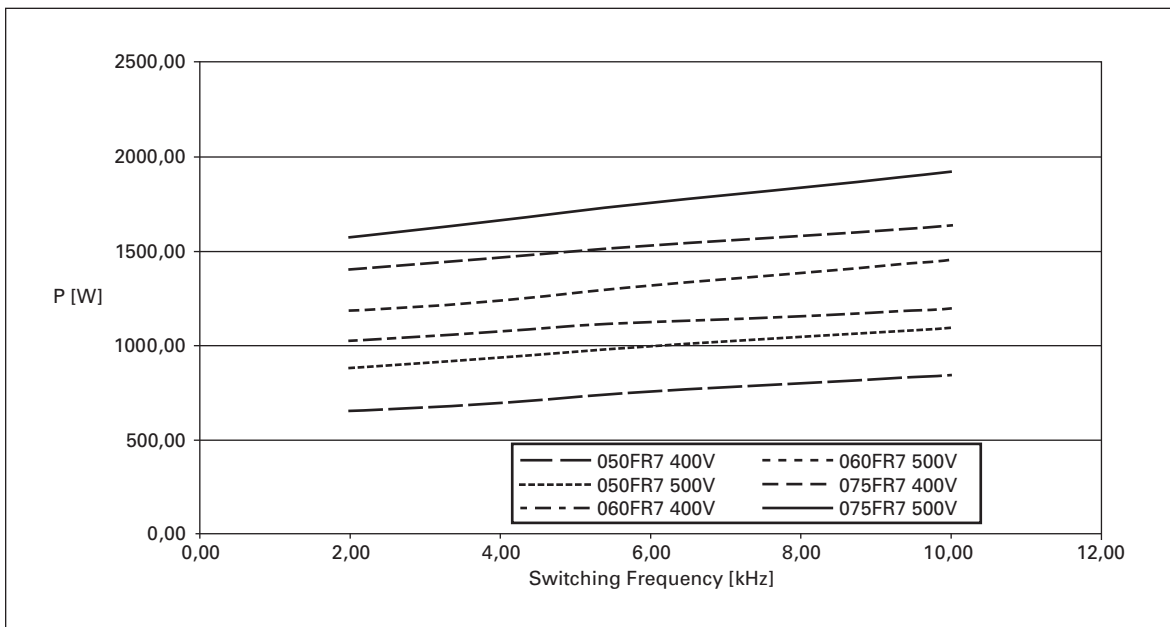
**Figure A-1: Power Loss as Function of Switching Frequency:
1 – 3 hp 230V, 1-1/2 – 7-1/2 hp 480V**



**Figure A-2: Power Loss as Function of Switching Frequency:
5 – 10 hp 230V, 10 – 20 hp 480V**

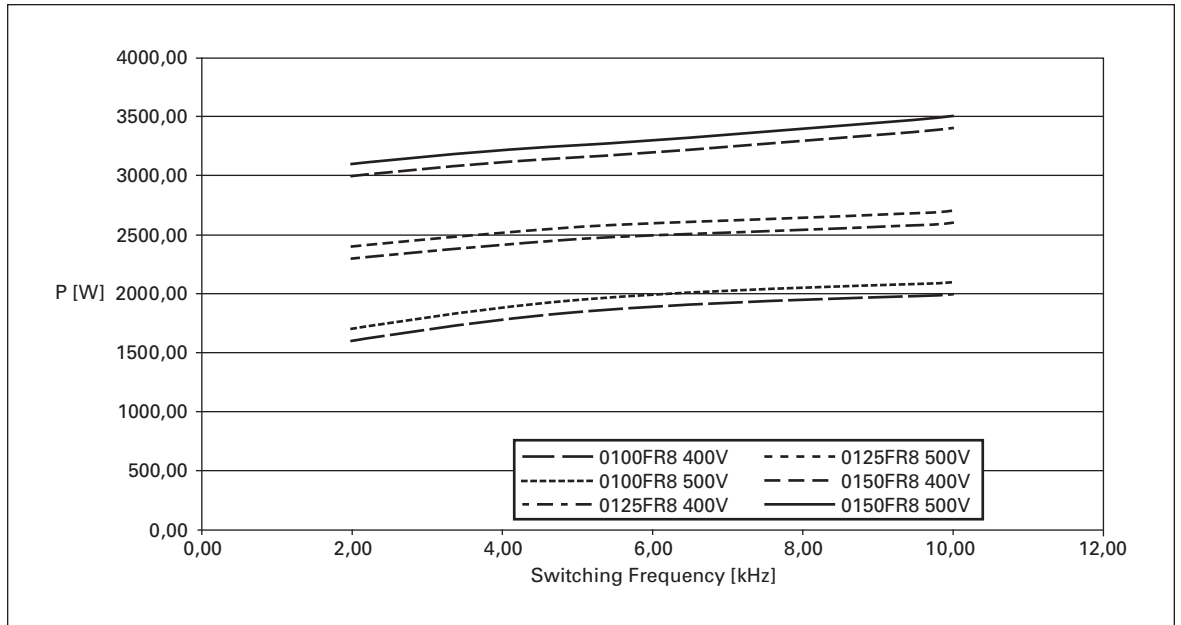


**Figure A-3: Power Loss as Function of Switching Frequency:
15 – 20 hp 230V, 25 – 40 hp 480V**

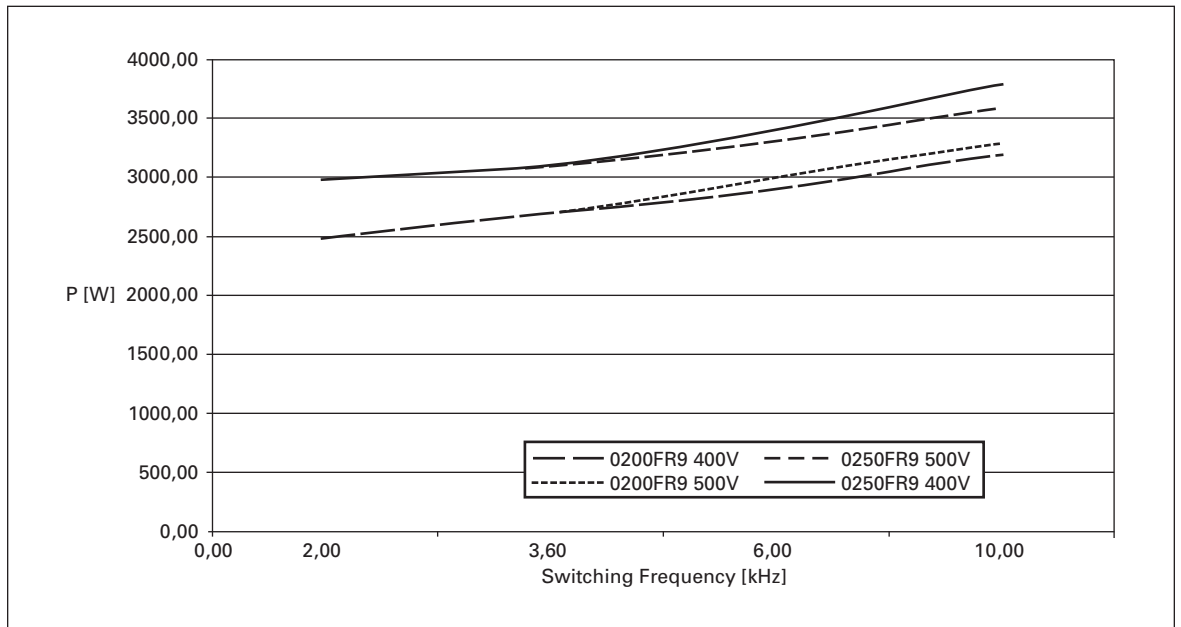


**Figure A-4: Power Loss as Function of Switching Frequency:
25 – 40 hp 230V, 50 – 75 hp 480V**

November 2009



**Figure A-5: Power Loss as Function of Switching Frequency:
50 – 75 hp 230V, 100 – 150 hp 480V**



**Figure A-6: Power Loss as Function of Switching Frequency:
200 – 250 hp 480V**

Dimensions

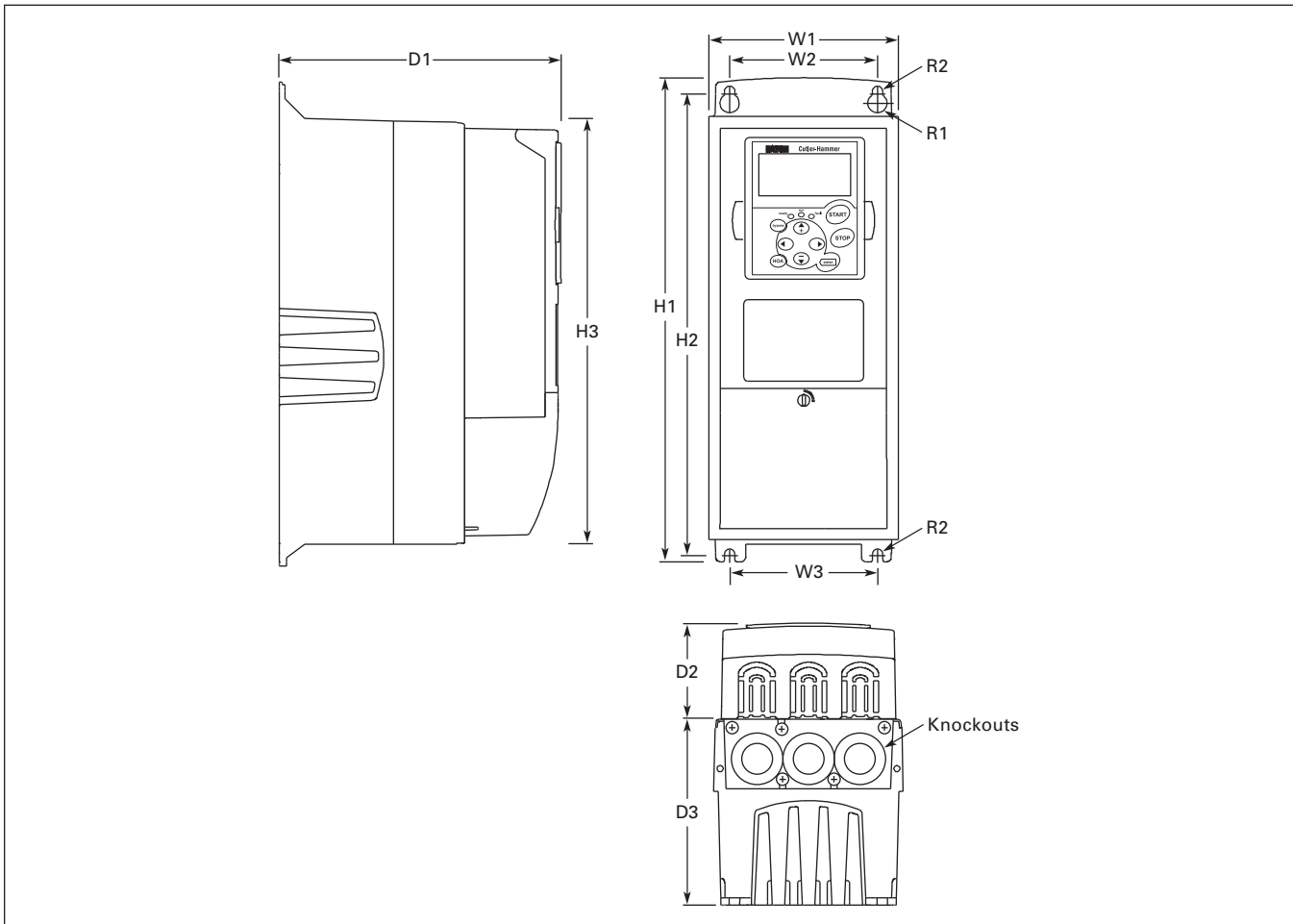


Figure A-7: TYPE 1 and TYPE 12 VSD Series Open Drive Dimensions, FR4, FR5 and FR6

Table A-5: VSD Series Open Drive Dimensions

Frame Size	Voltage	hp (VT)	Approximate Dimensions in Inches (mm)											Weight Lbs. (kg)	Knockouts @ Inches (mm) N1 (O.D.)
			H1	H2	H3	D1	D2	D3	W1	W2	W3	R1 dia.	R2 dia.		
FR4	230V	1 – 3	12.9	12.3	11.5	7.5	2.5	5.0	5.0	3.9	—	.5	.3	11.0	3 @ 1.1
	480V	1-1/2 – 7-1/2	(327)	(313)	(292)	(190)	(64)	(126)	(128)	(100)		(13)	(7)	(5)	(28)
FR5	230V	5 – 10	16.5	16.0	15.4	8.4	2.7	5.7	5.7	3.9	—	.5	.3	17.9	2 @ 1.5
	480V	10 – 20	(419)	(406)	(391)	(214)	(68)	(148)	(144)	(100)		(13)	(7)	(8)	1 @ 1.1 (28)
FR6	230V	15 – 20	22.0	21.3	20.4	9.3	2.7	6.7	7.6	5.8	—	.7	.4	40.8	3 @ 1.5
	480V	25 – 40	(558)	(541)	(519)	(237)	(68)	(171)	(195)	(148)		(18)	(9)	(19)	(37)
	575V	3 – 30													

November 2009

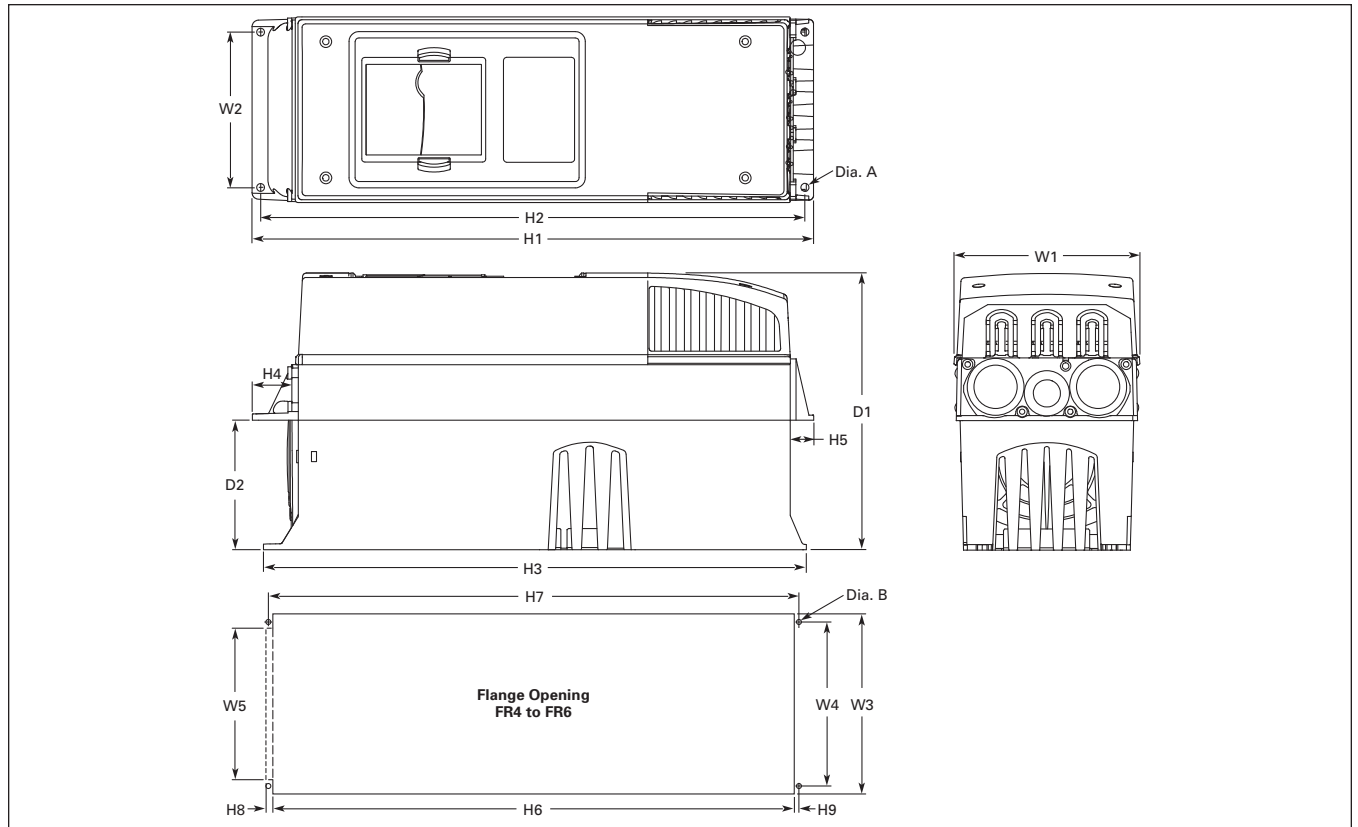


Figure A-8: VSD Series Open Drive Dimensions, TYPE 1 and TYPE 12 with Flange Kit, FR4, FR5 and FR6

Table A-6: Dimensions for VSD Series Open Drive, FR4, FR5 and FR6 with Flange Kit

Frame Size	Voltage	hp (VT)	Approximate Dimensions in Inches (mm)									
			W1	W2	H1	H2	H3	H4	H5	D1	D2	Dia. A
FR4	230V	1 – 3	5.0 (128)	4.5 (113)	13.3 (337)	12.8 (325)	12.9 (327)	1.2 (30)	.9 (22)	7.5 (190)	3.0 (77)	.3 (7)
	480V	1-1/2 – 7-1/2										
FR5	230V	5 – 10	5.7 (144)	4.7 (120)	17.0 (434)	16.5 (420)	16.5 (419)	1.4 (36)	.7 (18)	8.4 (214)	3.9 (100)	.3 (7)
	480V	10 – 20										
FR6	230V	15 – 20	7.7 (195)	6.7 (170)	22.0 (560)	21.6 (549)	22.0 (558)	1.2 (30)	.8 (20)	9.3 (237)	4.2 (106)	.3 (7)
	480V	25 – 40										
	575V	3 – 30										

Table A-7: Dimensions for the Flange Opening, FR4 to FR6

Frame Size	Voltage	hp (VT)	Approximate Dimensions in Inches (mm)							
			W3	W4	W5	H6	H7	H8	H9	Dia. B
FR4	230V	1 – 3	4.8 (123)	4.5 (113)	—	12.4 (315)	12.8 (325)	—	.2 (5)	.3 (7)
	480V	1-1/2 – 7-1/2								
FR5	230V	5 – 10	5.3 (135)	4.7 (120)	—	16.2 (410)	16.5 (420)	—	.2 (5)	.3 (7)
	480V	10 – 20								
FR6	230V	15 – 20	7.3 (185)	6.7 (170)	6.2 (157)	21.2 (539)	21.6 (549)	.3 (7)	.2 (5)	.3 (7)
	480V	25 – 40								
	575V	3 – 30								

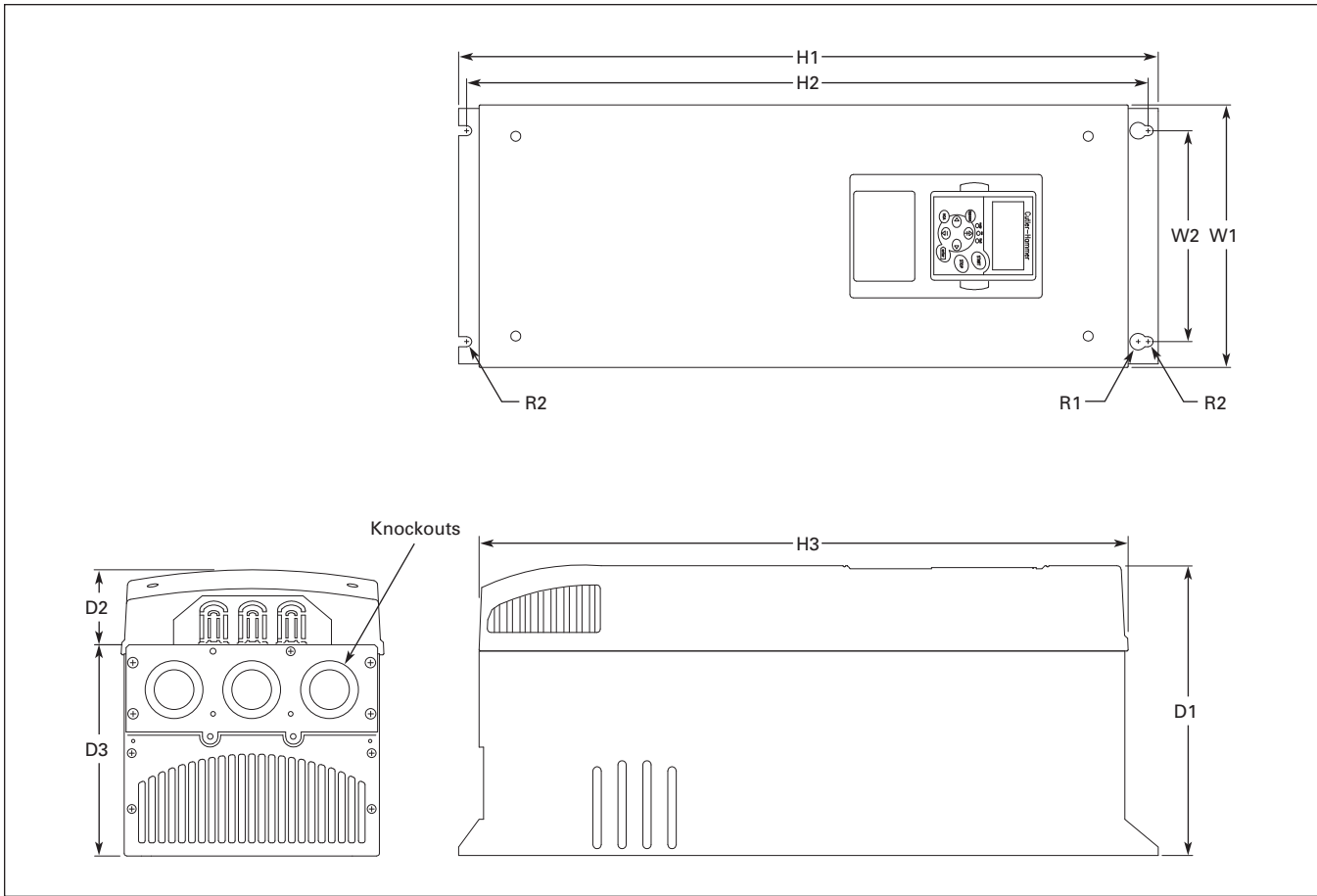


Figure A-9: VSD Series Open Drive Dimensions, TYPE 1 and TYPE 12, FR7

Table A-8: VSD Series Open Drive Dimensions, FR7

Frame Size	Voltage	hp (VT)	Approximate Dimensions in Inches (mm)										Weight Lbs. (kg)	Knockouts @ Inches (mm)
			H1	H2	H3	D1	D2	D3	W1	W2	R1 dia.	R2 dia.		N1 (O.D.)
FR7	230V	25 – 40	24.8 (630)	24.2 (614)	23.3 (591)	10.1 (257)	2.7 (68)	7.5 (190)	9.3 (237)	7.5 (190)	.7 (18)	.4 (9)	77.2 (35)	3 @ 1.85 (47)
	480V	50 – 75												
	575V	40 – 50												

November 2009

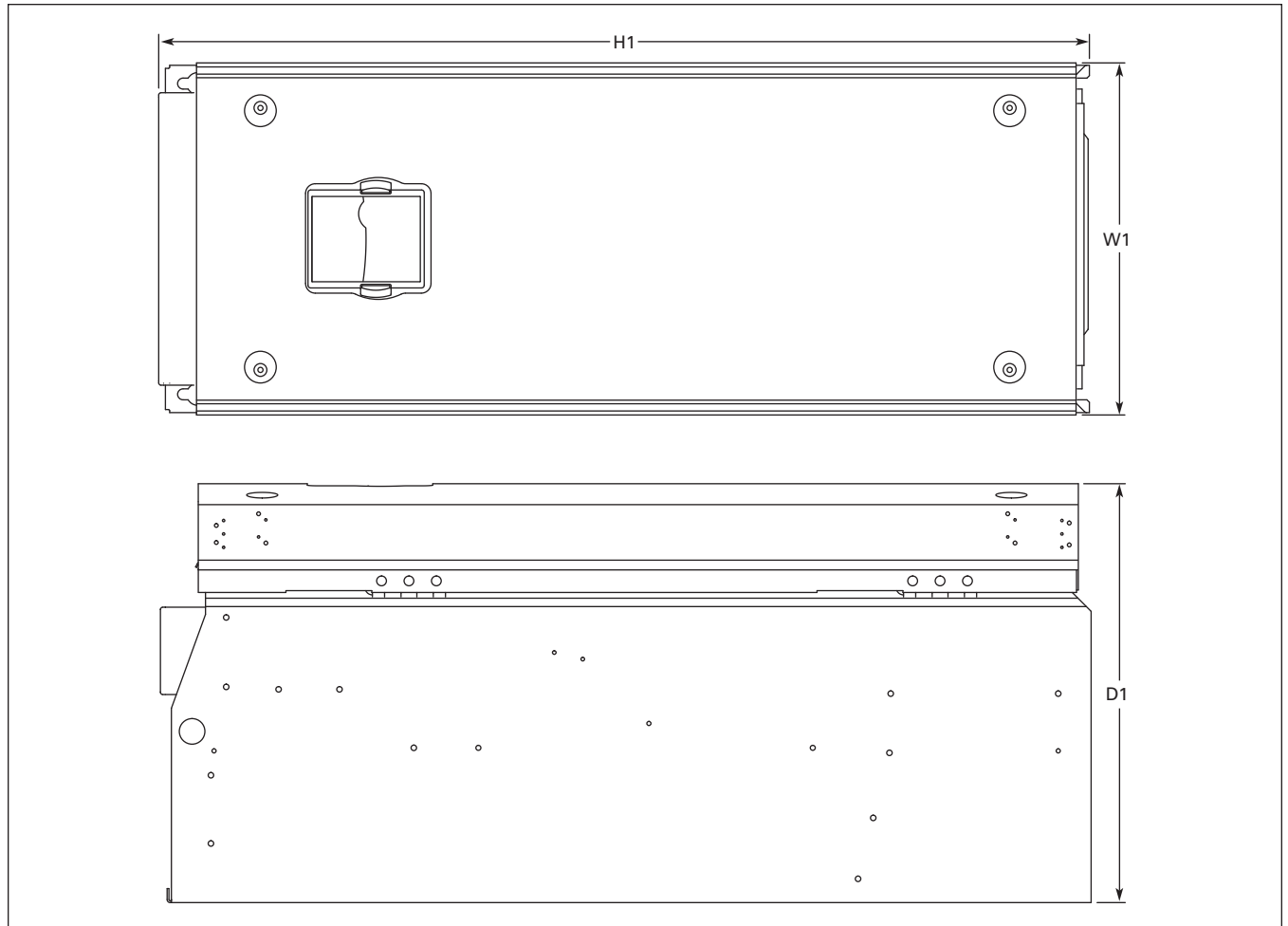


Figure A-10: VSD Series Open Drive Dimensions, TYPE 1 and TYPE 12, FR8

Table A-9: VSD Series Open Drive Dimensions, FR8

Frame Size	Voltage	hp (VT)	Approximate Dimensions in Inches (mm)			Knockout @ Inches (mm)
			D1	H1	W1	
FR8	230V	50 – 75	13.5 (344)	30.1 (764)	11.4 (289)	3 @ 1.1 (28)
	480V	100 – 150				
	575V	60 – 100				2 @ 2.32 (59)

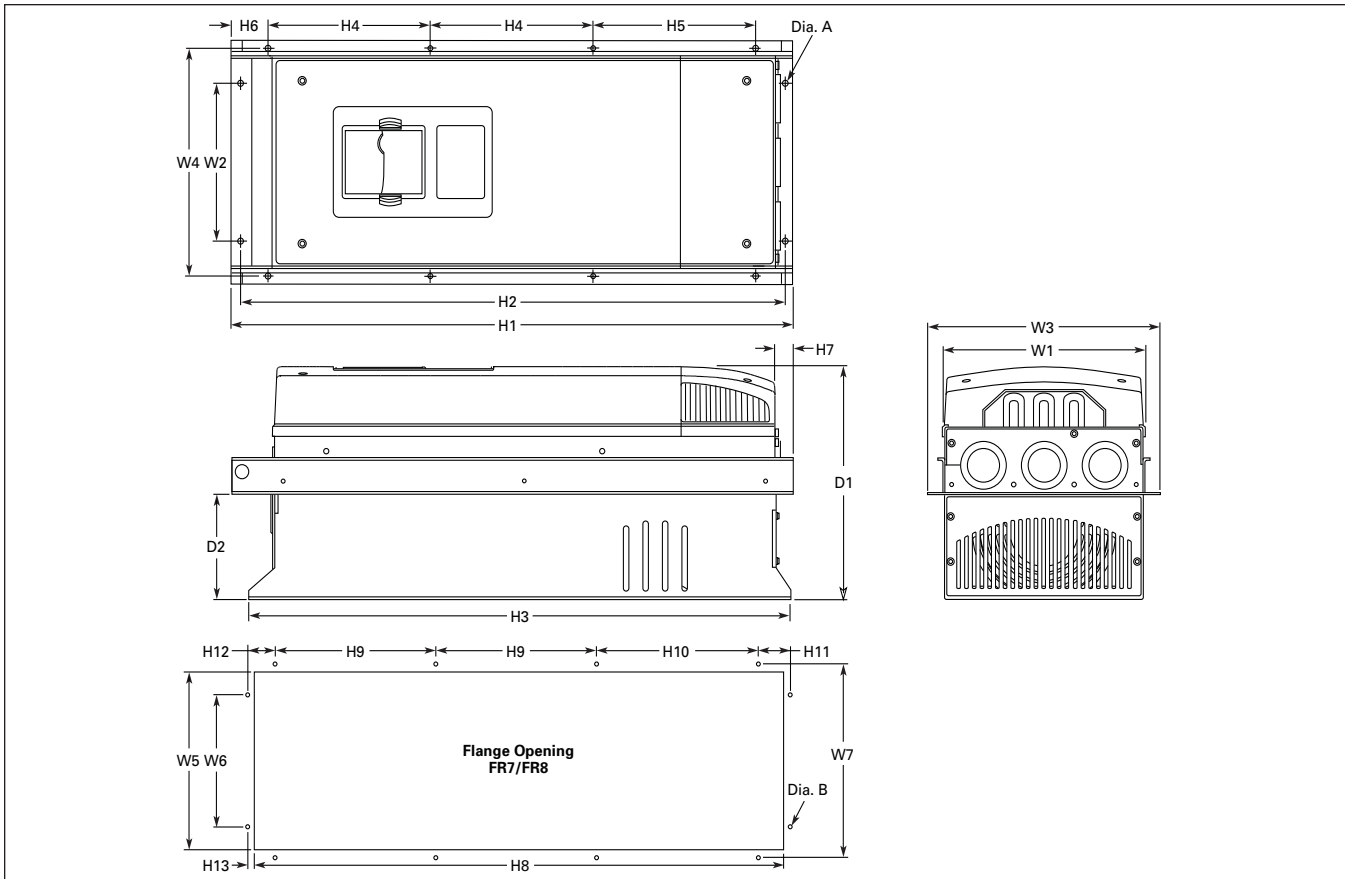


Figure A-11: VSD Series Open Drive Dimensions, TYPE 1 and TYPE 12, with Flange Kit, FR7 and FR8

Table A-10: Dimensions for VSD Series Open Drive, FR7 and FR8 with Flange Kit

Frame Size	Voltage	hp (VT)	Approximate Dimensions in Inches (mm)													
			W1	W2	W3	W4	H1	H2	H3	H4	H5	H6	H7	D1	D2	Dia. A
FR7	230V	25 – 40	9.3 (237)	6.8 (175)	10.6 (270)	10.0 (253)	25.6 (652)	24.8 (632)	24.8 (630)	7.4 (189)	7.4 (189)	.9 (23)	.8 (20)	10.1 (257)	4.6 (117)	.3 (6)
	480V	50 – 75														
	575V	40 – 50														
FR8	230V	50 – 75	11.2 (285)	—	14.0 (355)	13.0 (330)	32.8 (832)	—	29.3 (745)	10.2 (258)	10.4 (265)	1.7 (43)	2.2 (57)	13.5 (344)	4.3 (110)	.4 (9)
	480V	100 – 150														
	575V	60 – 100														

Table A-11: Dimensions for the Flange Opening, FR7/FR8

Frame Size	Voltage	hp (VT)	Approximate Dimensions in Inches (mm)										
			W5	W6	W7	H8	H9	H10	H11	H12	H13	Dia. B	
FR7	230V	25 – 40	9.2 (233)	6.9 (175)	10.0 (253)	24.4 (619)	7.4 (189)	7.4 (189)	1.4 (35)	1.3 (32)	.3 (7)	.3 (6)	
	480V	50 – 75											
	575V	40 – 50											
FR8	230V	50 – 75	11.9 (301)	—	13.0 (330)	31.9 (810)	10.2 (258)	10.4 (265)	—	—	—	.4 (9)	
	480V	100 – 150											
	575V	60 – 100											

November 2009

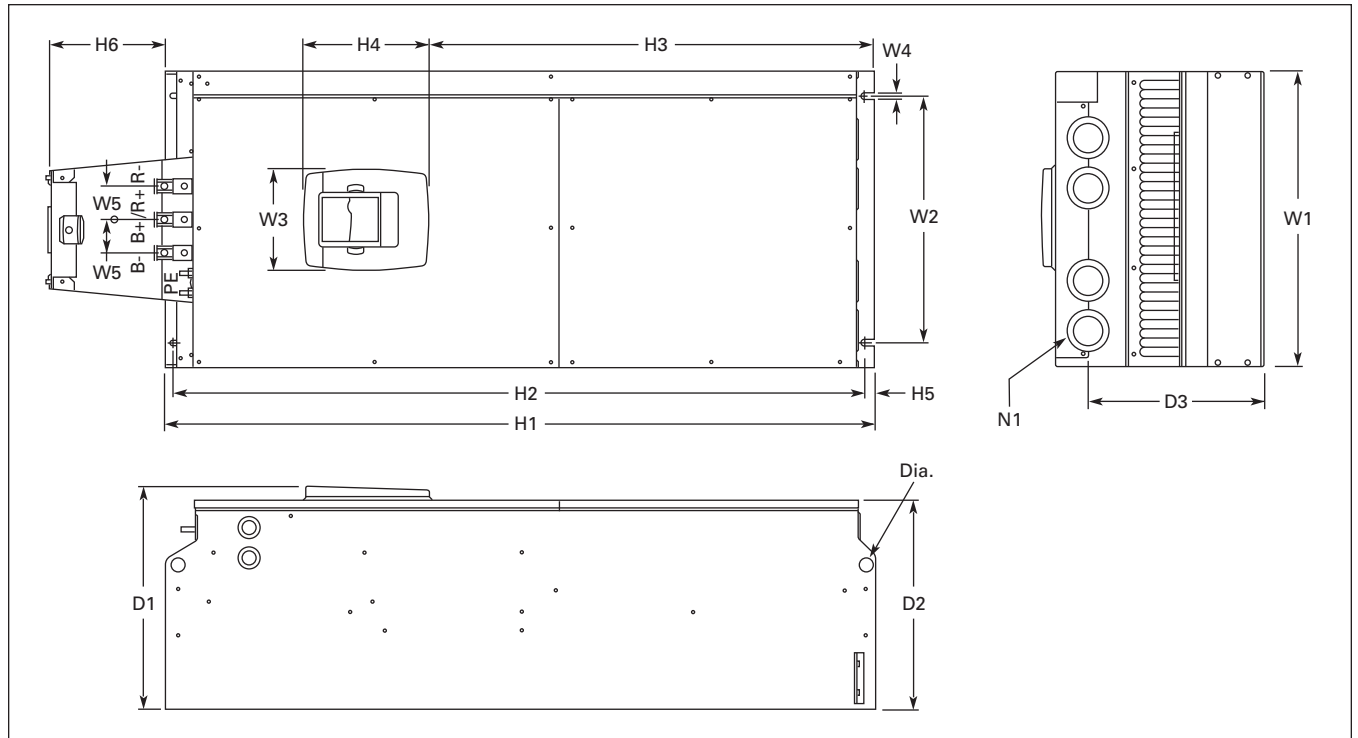


Figure A-12: VSD Series Open Drive Dimensions, OPEN 1 and OPEN 12 FR9

Table A-12: Dimensions for VSD Series Open Drive, FR9

Frame Size	Voltage	hp (VT)	Approximate Dimensions in Inches (mm)								
			W1	W2	W3	W4	W5	H1	H2	H3	H4
FR9	230V	100	18.9 (480)	15.7 (400)	6.5 (165)	.4 (9)	2.1 (54)	45.3 (1152)	44.2 (1122)	28.3 (721)	8.0 (205)
	480V	200 – 250									
	575V	125 – 200									

Table A-12: Dimensions for VSD Series Open Drive, FR9, continued

Frame Size	Voltage	hp (VT)	Approximate Dimensions in Inches (mm)						Knockouts @ Inches (mm)
			H5	H6 ①	D1	D2	D3	Dia.	N1 (O.D.)
FR9	230V	100	.6 (16)	7.4 (188)	14.3 (362)	12.9 (327)	11.2 (285)	.8 (21)	4 @ 2.32 (59)
	480V	200 – 250							
	575V	125 – 200							

① Brake resistor terminal box (H6) included when brake chopper ordered.

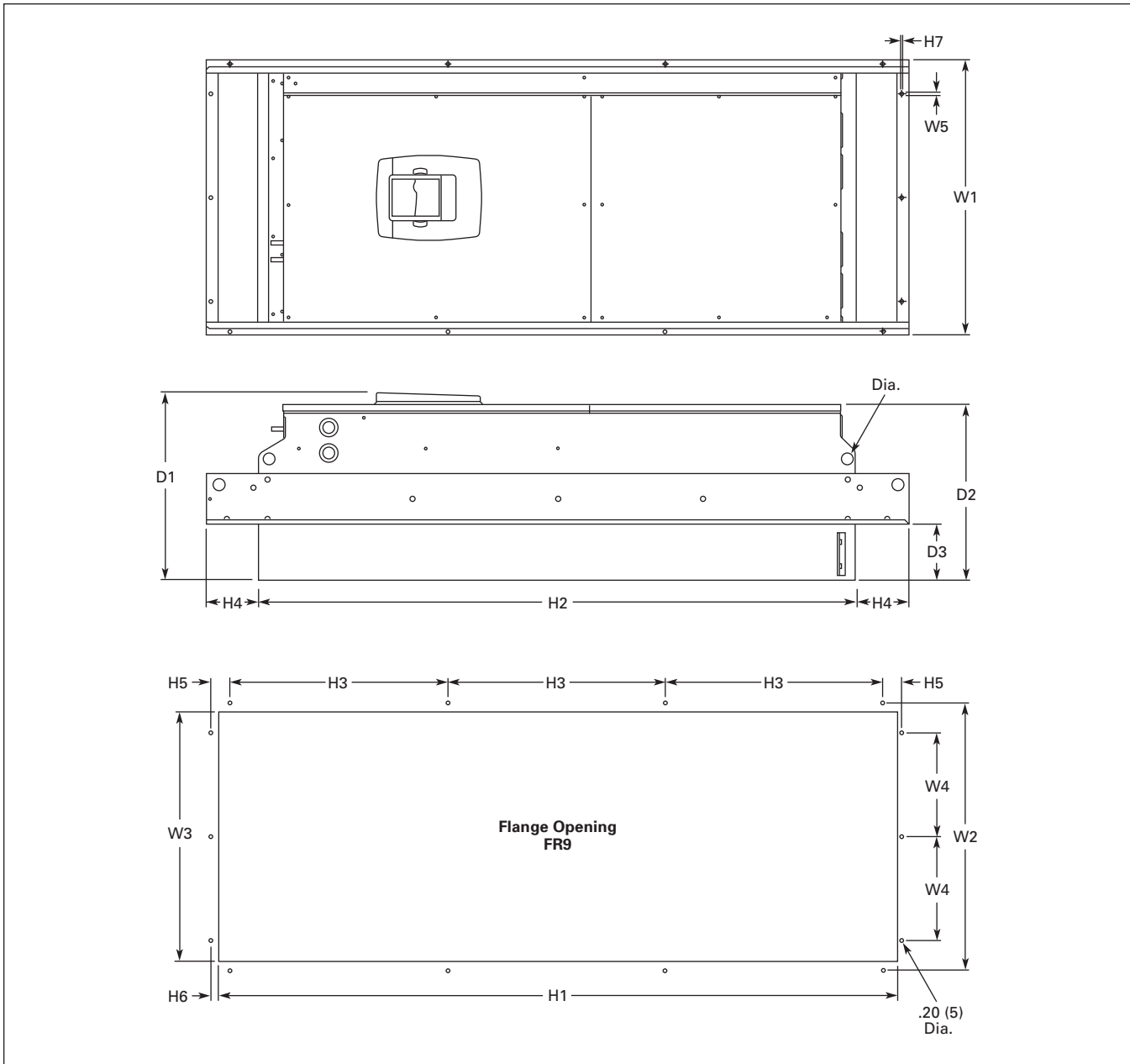


Figure A-13: VSD Series Open Drive Dimensions, TYPE 1 and TYPE 12 FR9 with Flange Kit

Table A-13: Dimensions for VSD Series Open Drive, FR9 with Flange Kit

Frame Size	Voltage	hp (VT)	Approximate Dimensions in Inches (mm)															
			W1	W2	W3	W4	W5	H1	H2	H3	H4	H5	H6	H7	D1	D2	D3	Dia.
FR9	230V	100	20.9 (530)	20.0 (510)	19.1 (485)	7.9 (200)	.2 (6)	51.7 (1312)	45.3 (1150)	16.5 (420)	3.9 (100)	1.4 (35)	.4 (9)	.1 (2)	24.9 (362)	13.4 (340)	4.3 (109)	.8 (21)
	480V	200 – 250																
	575V	125 – 200																

November 2009

EMC Capability

General

For products used within the European Community (EC), the Electro Magnetic Compatibility (EMC) directive states that the electrical equipment must not disturb the environment and must be immune to other Electro Magnetic Disturbances in the environment.

The design intent was to develop a family of drives, which is user friendly and cost effective, while fulfilling the user's needs. EMC compliance was a major consideration from the outset of the design.

The VSD Series drives are targeted at the world market. To ensure maximum flexibility, yet meet the EMC needs of different regions, all drives meet the highest immunity levels, while emission levels meet the requirements noted in the following section.

EMC Classification

the VSD Series drives are EMC classification H capable.

Class H:

VSD Series drives have been designed to fulfill the requirements of the product standard EN 61800-3_A11 for the 1st environment restricted distribution and the 2nd environment.

The emission levels correspond to the requirements of EN 61000-6-4.

VSD Series drives fulfill all applicable EMC immunity requirements (standards EN 61000-6-1, EN 61000-6-2 and EN 61800-3+A11).

Declaration of Conformity

The Manufacturer's Declarations of Conformity assuring the compliance of the VSD Series drives with the European Community (EC) EMC-directives is available upon request.

Warranty and Liability Information

Johnson Controls Inc. warrants the product delivered in the Johnson Controls shipping package to be free from defects in material and workmanship, under normal use and service, for twenty four (24) months from date of manufacturing. Products that fail during this period will be repaired or replaced at Johnson Controls discretion, with the same or a functionally equivalent product, provided the original purchaser (A) returns the failed product, and (B) provides proof of original date of purchase. This warranty does not apply, in the judgment of Johnson Controls, to damage caused during shipment, handling, storage, or accidental misuse. The original purchaser of the product must obtain a Johnson Controls Return Material Authorization (RMA) number prior to returning any defective product. (When purchased through an Authorized Distributor, the Distributor should supply an RMA number to their customer.)

The maximum liability of this warranty is limited to the purchase price of the product. In no event, regardless of cause, shall Johnson Controls Inc. or Eaton Electrical Inc. be liable (a) for penalties or penalty clauses of any description, or (b) for certification not otherwise specifically provided herein and/or indemnification of purchaser or others for costs, damages or expenses, each arising out of or related to the product or services of any order or (c) for any damages resulting from loss of profits, use of products or for any incidental indirect or consequential damages, even if advised of the possibility of such damages.

November 2009

Appendix B — Fault and Warning Codes

Table B-1: Fault Codes

Fault Code	Fault	Possible Cause	Solution
1	Overcurrent	VSD Series drive has detected a high current ($>4xI_n$) in its output due to: <ul style="list-style-type: none"> • sudden heavy load increase • short in the motor • short in the cables to the motor • unsuitable motor 	Check loading. Check motor. Check cables.
2	Overvoltage	The DC-link voltage has exceeded its high limit due to: <ul style="list-style-type: none"> • too short a deceleration time • high voltage levels or surges in the utility supply 	Make the deceleration time longer. Use brake chopper and brake resistor (standard on some models, available as options on others). Correct utility supply voltage (level is too high). Add input impedance to limit surges.
3	Ground (Earth) Fault	Current sensing indicates that the sum of motor phase currents is not zero. <ul style="list-style-type: none"> • insulation failure in motor or motor cables 	Check motor and motor cables.
5	Charging Switch	The charging switch was open, when the START command was given due to: <ul style="list-style-type: none"> • faulty operation • component failure 	Reset the fault and restart. Should the fault re-occur, contact your Johnson Controls distributor.
6	Emergency stop	An Emergency stop signal was received from one of the digital inputs	Determine reason for the Emergency stop and remedy it.
7	Saturation trip	<ul style="list-style-type: none"> • defective component • motor or motor cable short 	Cannot be reset from the keypad. Switch off power. IF THE PROBLEM IS NOT IN THE MOTOR OR ITS CABLES, DO NOT RE-CONNECT POWER! Contact your Johnson Controls distributor. If this fault appears simultaneously with Fault 1, check the motor and motor cables.
8	System fault	<ul style="list-style-type: none"> • component failure • faulty operation Note: exceptional fault data record, see Active Fault Menu for more information	Reset the fault and restart. Should the fault re-occur, contact your Johnson Controls distributor.

Table B-1: Fault Codes, continued

Fault Code	Fault	Possible Cause	Solution
9	Undervoltage	DC-link voltage is less than the minimum safe operating voltage limit <ul style="list-style-type: none"> • most probable cause: too low a utility supply voltage • VSD Series internal fault 	If there was a supply voltage loss or dip, reset the fault and restart the VSD Series drive. Check the supply voltage. If it was within specification at the time of the fault, an internal failure has occurred. Contact your Johnson Controls distributor.
10	Input line supervision	Input line phase is low or missing.	Check the utility supply voltage, cables and connections.
11	Output phase supervision	Current sensing indicates that there is no current in one motor phase	Check the motor cables, connections and motor.
12	Brake chopper supervision	<ul style="list-style-type: none"> • no brake resistor installed • brake resistor is broken • brake chopper failure 	Check the brake resistor. If the resistor is ok, the chopper is faulty. Contact your Johnson Controls distributor.
13	VSD Series undertemperature	Heatsink temperature is under -10°C	Provide supplemental heating or relocate the VSD Series drive to a warmer location.
14	VSD Series overtemperature	Heatsink temperature is over 90°C.	An overtemperature warning is issued when the heatsink temperature exceeds 85°C, a fault occurs at 90°C. Check for the correct amount and unrestricted flow of cooling air. Check the heatsink for dust or dirt buildup. Check the highest ambient temperature level. Make sure that the switching frequency is not set too high in relation to the ambient temperature and motor load.
15	Motor stalled	<ul style="list-style-type: none"> • motor or load mechanical failure • load too high • stall parameter settings incorrect 	Check the motor, mechanical system and load level. Confirm the stall parameter settings.
16	Motor overtemperature	<ul style="list-style-type: none"> • motor is overloaded • motor overheating has been detected by VSD Series motor temperature model 	Decrease the motor load. If no motor overload exists, check the temperature model parameters.
17	Motor underload	<ul style="list-style-type: none"> • mechanical or load problem • underload parameter settings incorrect 	Check the motor, check for a loose belt, broken coupling or load problems. Confirm underload parameter settings.

November 2009

Table B-1: Fault Codes, continued

Fault Code	Fault	Possible Cause	Solution
22 23	EEPROM checksum fault	Parameter save fault <ul style="list-style-type: none"> • faulty operation • component failure 	Upon reset of this fault, the VSD Series drive will automatically reload the parameter default settings. Check all parameter settings after reset. If the fault reoccurs, contact your Johnson Controls distributor.
25	Microprocessor watchdog fault	<ul style="list-style-type: none"> • faulty operation • component failure 	Reset the fault and restart. If the fault reoccurs, contact your Johnson Controls distributor.
26	Start-up prevented	Start-up of the drive has been prevented.	Check Start Enable/Interlock settings.
29	Thermistor fault	The thermistor input of an option board has detected a high motor temperature	Check the motor cooling and the motor loading. Check the thermistor connection. (If the thermistor input of an option board is not being used, it must be short-circuited.)
31	IGBT temperature hardware	IGBT Inverter Bridge overtemperature protection has detected high short term overload current	Check loading. Check motor size.
32	Fan cooling	The VSD Series cooling fan did not start when commanded	Contact your Johnson Controls distributor.
34	CAN bus communication	Sent message not acknowledged	Ensure that there is another device on the bus with the appropriate configuration.
36	Control unit	Control unit cannot control the power unit and vice-versa	Change control unit.
37	Device change	<ul style="list-style-type: none"> • option board changed • different power rating of drive 	Reset. Note: No fault time data record!
38	Device added	<ul style="list-style-type: none"> • option board added • drive of different power rating added 	Reset. Note: No fault time data record!
39	Device removed	<ul style="list-style-type: none"> • option board removed • drive removed 	Reset. Note: No fault time data record!
40	Device unknown	Unknown option board or drive	Contact your Johnson Controls distributor.
41	IGBT temperature software	IGBT Inverter Bridge overtemperature protection has detected high short term overload current	Check loading. Check motor size.
42	Brake resistor overtemperature	Brake resistor overtemperature protection has detected excessive braking	Set the deceleration time longer. Use an external brake resistor.

Table B-1: Fault Codes, continued

Fault Code	Fault	Possible Cause	Solution
43	Encoder fault	<p>Note: the exceptional Fault data record. See Active Fault Menu for more information. Additional codes:</p> <ol style="list-style-type: none"> 1 Encoder 1 channel A is missing 2 Encoder 1 channel B is missing 3 Both encoder 1 channels are missing 4 Encoder reversed 	<p>Check encoder channel connections.</p> <p>Check the encoder board.</p>
50	Analog input $I_{in} < 4$ mA (for signal range 4 to 20 mA)	<p>Current at the analog input is < 4 mA</p> <ul style="list-style-type: none"> • control cable is broken or loose • signal source has failed 	Check the current loop, signal source and wiring.
51	External fault	Digital input set as an external fault input has been triggered.	Check source of trigger.
52	Keypad communication fault	The connection between the control keypad and the VSD Series drive has been lost.	Check keypad connection and keypad cable.
53	Communication bus fault	The data connection between the communication bus master and the communication bus board has failed	<p>Check installation.</p> <p>If installation is correct, contact your Johnson Controls distributor.</p>
54	Slot fault	Defective option board or slot	Check that the board is properly installed and seated in slot. If installation is correct, contact your Johnson Controls distributor.
82	BypassOverLoad	The motor has been overloaded while connected to the bypass	<p>Decrease the motor load.</p> <p>Disable the Current Imbalance feature – see the <i>IT</i> manual.</p>

November 2009

Appendix C — Accessories

RS-232 Cables Used with VS Drives

Communication with PC

When communicating using 9000X software tools 9000XDrive or 9000XLoad, a cable with three wires and 9-pin D-connectors is used. See **Figure C-1**.

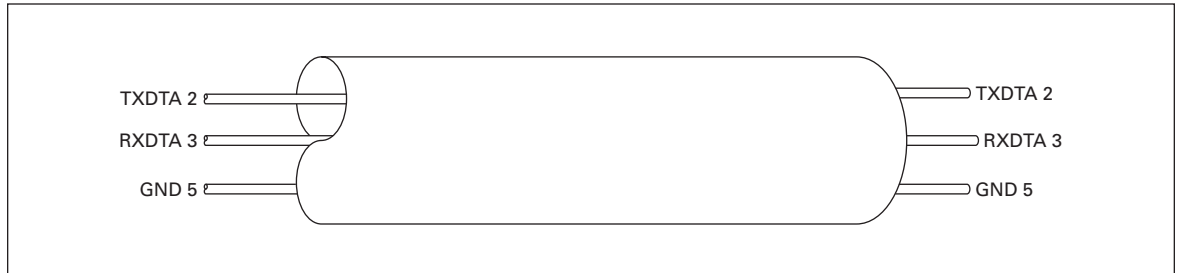


Figure C-1: RS-232 Cable for Parameter Setting or Software Downloading by Using PC

Remote Assembly of the Control Panel

When units are installed inside the cabinet, the keypad is often preferred mounted on the door of the cabinet to make programming and monitoring possible without opening the door. The keypad remote installation can be done with a similar pin-to-pin connected RS-232 cable as the PC-connection, with two additional wires (+12V, -12V) connected to the pins #6 and #9, feeding power to the keypad.

Note: When using these cables for PC-connection you have to check first whether the +12V / -12V lines can cause problems/damages in RS-232 output of PC/laptop. In some PC outputs, $\pm 12V$ can generate extra current loops which might cause overheating of the components.

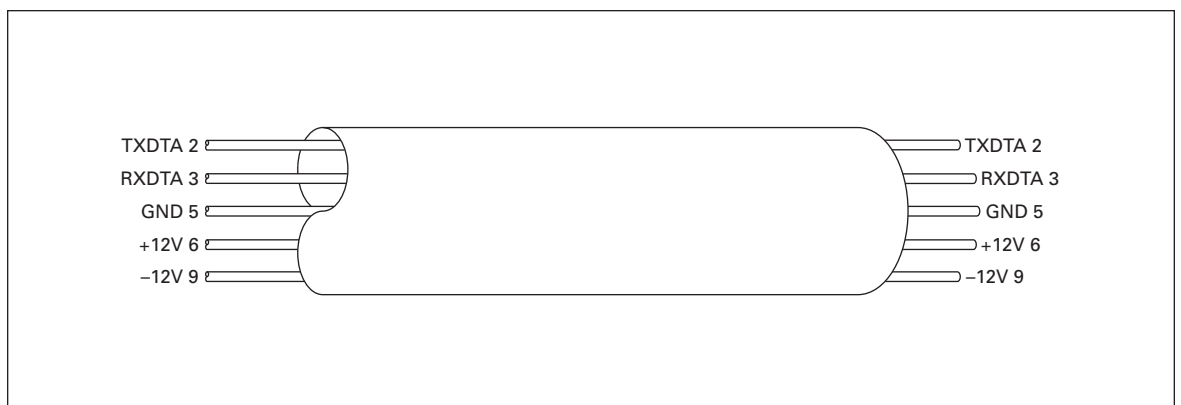


Figure C-2: Connection of Cable Used with Keypad

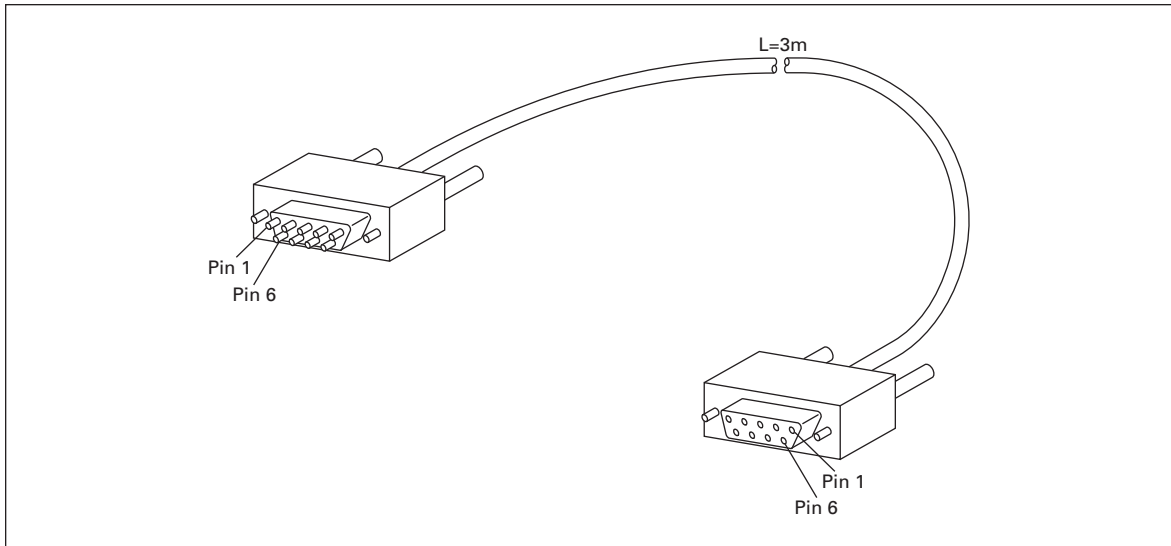


Figure C-3: RS-232 Cable

November 2009

Appendix D — Wiring Diagrams

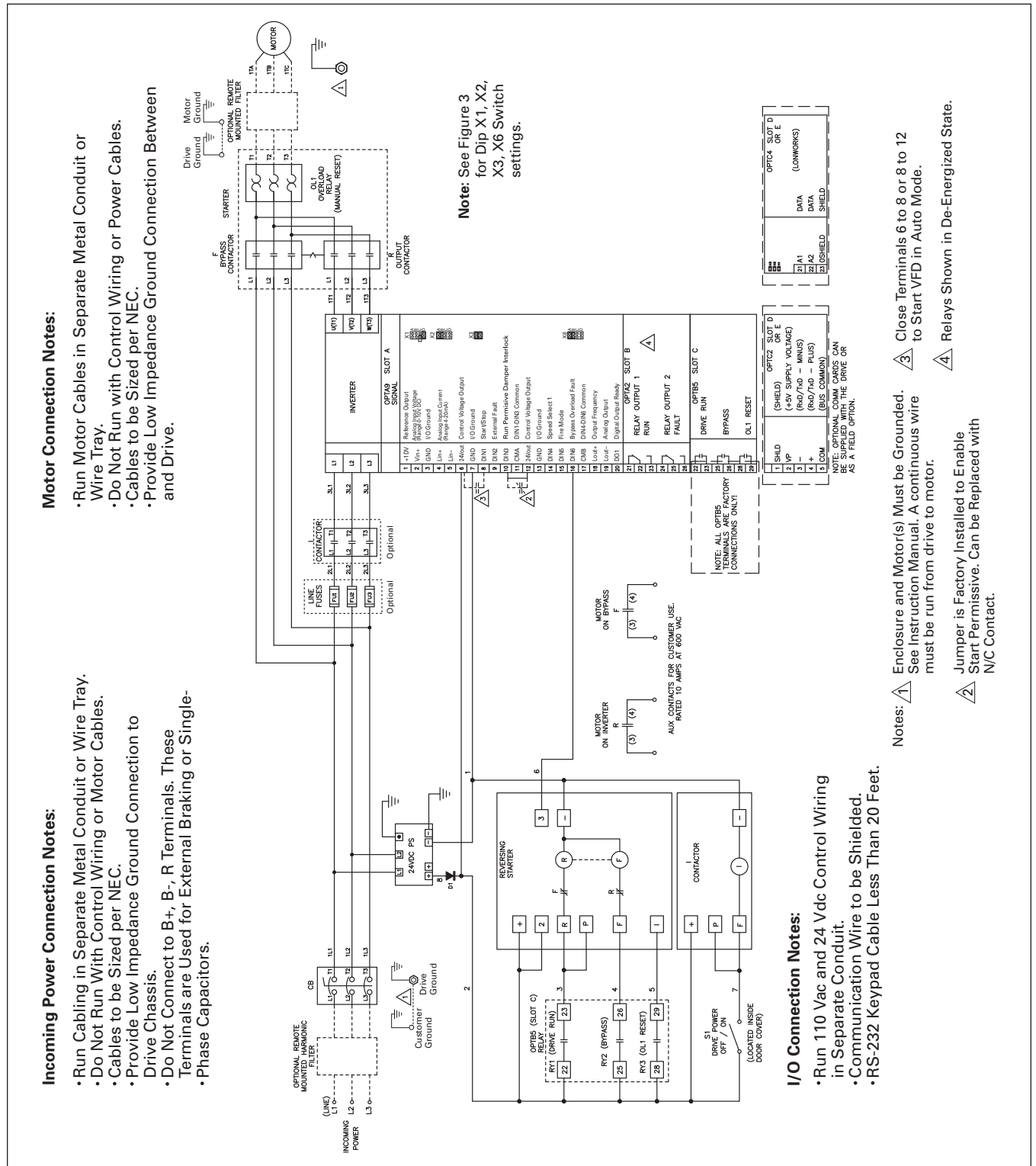
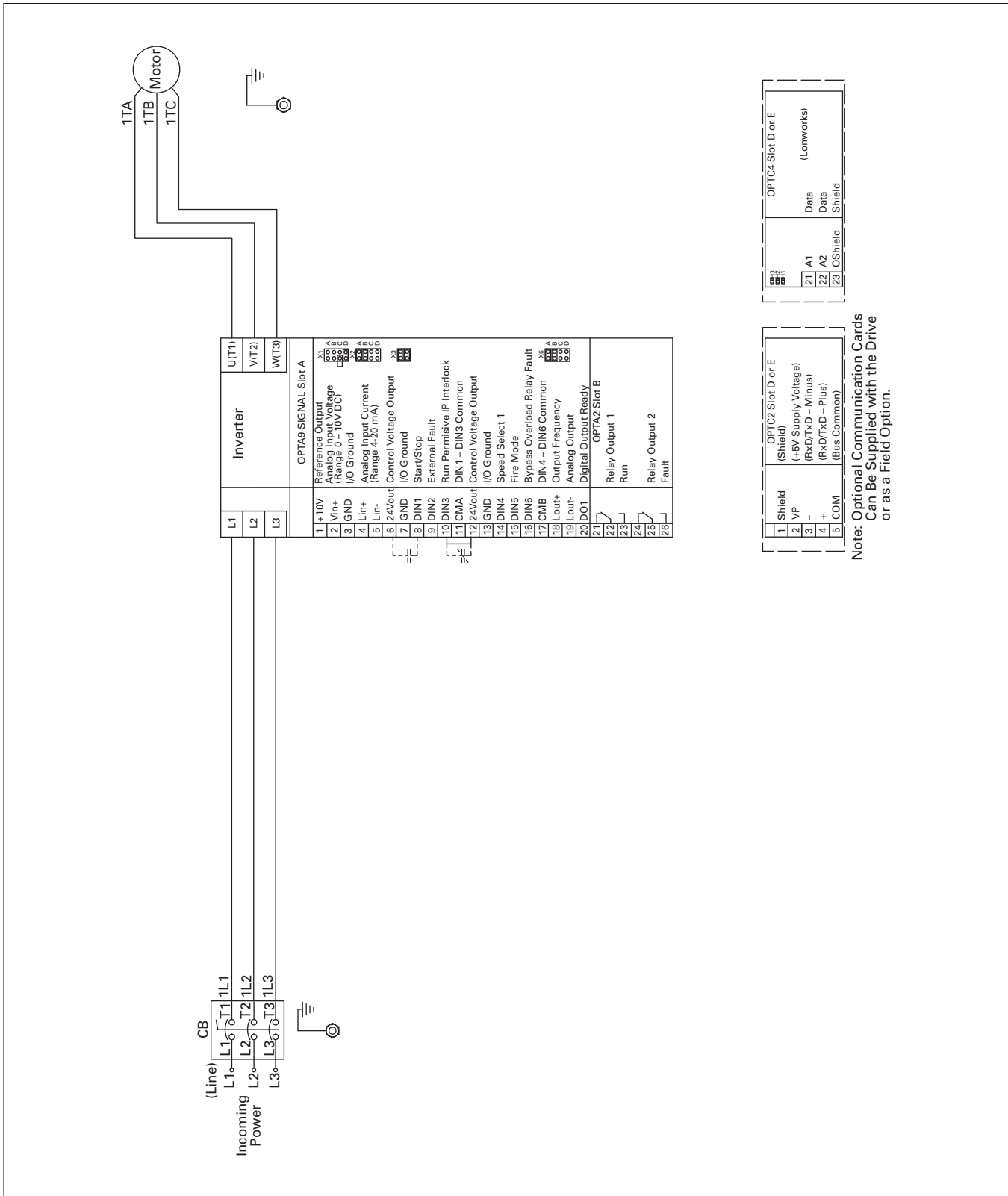


Figure D-1: VSD Series IntelliPass with Three Contactors



Note: Optional Communication Cards Can Be Supplied with the Drive or as a Field Option.

Figure D-2: VSD Series IntelliPass Disconnect



Controls Group
507 E. Michigan Street
P.O. Box 423
Milwaukee, WI 53201

Powered by **Eaton Technology**

© 2009 Johnson Controls
All Rights Reserved
Printed in USA
Publication No. LIT-1201828 / Z8520
www.johnsoncontrols.com
November 2009