



VICI Jour[®]

Chromatography Fluid/Gas Transfer

CATALOG 15 INT



2 Products for UHPLC



4 Tubing



16 Fittings introduction



18 High pressure polymeric fittings



30 High pressure stainless fittings



36 Nanovolume® HPLC fittings

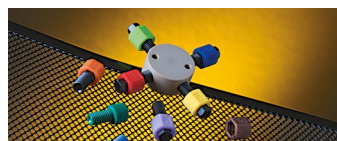

40 Low pressure fittings

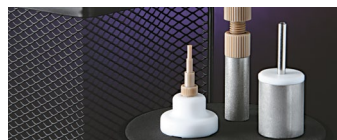

50 Filters and mobile phase filters



58 Safety products



72 Frits



76 Columns and guard columns

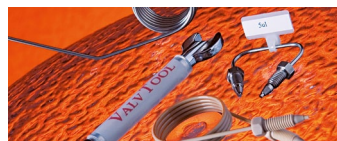

80 Sample loops

84 Accessories

92 General reference

108 Index by product number

110 Index by name of product

112 Order information

Europe, Middle East, Asia, Africa, Australia, New Zealand, and other countries

VICI AG International

Sales

Phone: Int + 41· 41· 925-6200
 Fax: Int + 41· 41· 925-6201
 Email: order@vici.ch

Technical/Service

Phone: Int + 41· 41· 925-6200
 Fax: Int + 41· 41· 925-6201
 Email: support@vici.ch

Parkstrasse 2
 CH-6214 Schenkon / Switzerland
 info@vici.ch

North America, South America, and Central America (except Canada)

VICI Precision Sampling

Sales

Toll-free: 800-828-1653
 Phone: 225-927-1128
 Fax: 225-923-1331
 Email: precision@vici.com

Technical/Service

Phone: 225-927-1128
 Fax: 225-923-1331
 Email: precision@vici.com

P.O. Box 15886
 Baton Rouge, Louisiana / USA
 precision@vici.com

Canada

VICI Valco Instruments Canada

Sales

Toll-free: 866-297-2626
 Phone: 613-342-2600
 Fax: 613-342-0111
 Email: canada@vici.com

Technical/Service

Phone: 613-342-2600
 Fax: 613-342-0111
 Email: canada@vici.com

26 Water Street East
 Brockville, Ontario / Canada K6V 1A1
 canada@vici.com

VICI AG International

VICI Jour has been a part of VICI AG International in Switzerland since 2004. The complete Jour line of accessories and consumables for fluid transfer in GC and LC is available from VICI AG International, VICI Valco Canada, VICI Precision Sampling, and through our international distributor network.

VICI AG International, in Schenkon, Switzerland, is an independent site for the manufacturing of Valco and Cheminert valves and the handling of all VICI product lines in Europe, Africa, the Middle East, and the Far East.

VICI AG International has obtained the ISO certificate to the standard of 9001:2008 and 14001:2004, and is the first ISO-certified manufacturer of high pressure and low pressure valves for scientific equipment.

VICI Jour product line

Jour products include a complete line of tubing and capillaries in a wide variety of diameters and materials, high and low pressure fingertight fittings and connection accessories, column hardware, high and low pressure filters, cutters and other tools, backpressure regulators, and much more.

We offer accessories and consumables for fluid transfer in GC and LC, including:

- Fittings - high pressure polymeric and stainless, Nanovolume® PEEK and stainless, and low pressure
- Tubing and sample loops
- Safety products and mobile phase handling systems
- Filters and frits
- PEEK columns and guard columns

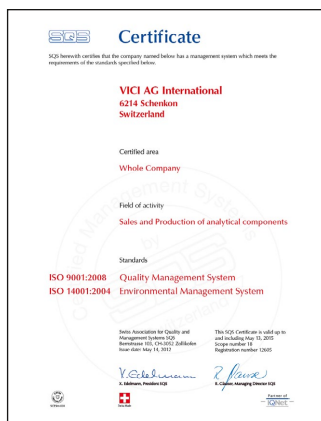

VICI Jour now offers high quality, high pressure fittings, filters, and tubing for use in Ultra-High Performance Liquid Chromatography (UHPLC).

Page 15 **Stainless steel tubing – premium grade** **UHPLC**

- Seamless Type 316 stainless steel
- Variety of sizes for UHPLC, HPLC, and GC applications
- Smooth internal surface
- Soft annealed OD for easy ferrule connections
- Available in 3 m and 10 m lengths

Page 19 **PEEK one-piece hex-head fittings** **NEW** **UHPLC**

- Made of special PEEK HT™ for better pressure resistance
- One-piece – no ferrule required
- Biocompatible



Page 22 **PEEK ferrules** **NEW** **UHPLC**

- Biocompatible 1/16" ferrule for ultra-high pressures
- Alternative to titanium ferrules in applications with titanium valves
- Excellent in combination with stainless nuts



Pages 38-39 **Nanovolume® 360 micron fittings** **UHPLC**

- For direct connection of 360 µm tubing
- Work with metal, fused silica, or PEEK
- Up to 20,000 psi with metal tubing
- Snap-in rotating ferrule for “one-piece” fitting with no tubing twist

Our high pressure fittings permit direct connection of 360 micron OD fused silica, PEEK, stainless, or electroformed nickel tubing without the use of liners.



Pages 31, 32 **Valco® stainless steel nuts and ferrules** **UHPLC**

- Excellent fit to Valco fitting details
- Different lengths available

These fittings are for use with all standard Valco internal fittings and most valves. They may be used with fittings from other manufacturers as well. Valco metal ferrules cut a ring near the end of the tube, preventing tube release at high pressures without significantly deforming and restricting the tube interior.



Page 32 **Stainless steel plugs and caps** **UHPLC**

- For 1/32", 1/16", and 1/8" OD tubing

Plugs close off an unused port in a valve, manifold, or HPLC column. Caps close off a tube with a ferrule and internal nut already made up.





Page 34 **Stainless steel unions** **UHPLC**

- Choice of four bores: 0.15 mm, 0.25 mm, 0.50 mm, or 0.75 mm
- For 1/16" OD tubing



Page 34 **Stainless steel reducing unions, imperial** **UHPLC**

These reducing unions join 1/16" OD to 1/8" OD tubing.



Page 35 **Stainless steel reducing unions, imperial to metric** **NEW UHPLC**

- For 1 mm, 2 mm, and 3 mm OD tubing
- With these new reducing unions, metric tubing can be connected to imperial fittings, valves, and chromatographic systems.



Page 33 **Stainless steel tees and crosses** **UHPLC**

- For 1/16" OD tubing
- 0.25 mm, 0.50 mm, and 0.75 mm bores



Page 56 **Stainless steel precolumn filter** **NEW UHPLC**

- Fewer connections compared to in-line filters
- Works with 1/16" column connections from all manufacturers
- Three porosity options: 0.5 μ m, 2 μ m, and 5 μ m

The design of this precolumn filter reduces the number of connections compared to a standard in-line filter, increasing the stability and reducing the potential of leakage.



Page 57 **Stainless steel in-line filter** **UHPLC**

- Minimized hold-up volume
- Two bores for analytical and semi-prep flow rates
- Three porosity options: 0.5 μ m, 2 μ m, and 5 μ m

The stainless steel in-line filter has virtually no hold-up volume and can be used in various applications without significant band broadening or loss of efficiency.



Page 90 **Stainless steel starter kit** **UHPLC**

The kit consists of stainless fittings, ferrules, tubing, and solvent filters, as well as a union, our cutting-wheel type metal tubing cutter, and other useful items like our ValvTool. All boxed together for a very competitive price.

Tubing

METAL AND POLYMERIC

We offer chromatography grade tubing in a variety of polymers as well as stainless steel. Outside diameters are 360 µm, 1/32", 1/16", 1/8", and 1/4".

Tubing index

PEEK tubing

Natural PEEK.....page 5

Available in ODs from 360 micron to 1/4", in custom lengths (priced per meter) and packages of 3 and 10 meters.

Striped color-coded PEEK 6

A stripe is added to the outside of the tubing, so dye never contacts the fluid stream.

Dual-layer PEEK..... 7

With an inner layer of natural PEEK and an outer layer of color-coded PEEK, there is no possibility of stream contents coming in contact with coloring agents.

Solid color-coded PEEK..... 8

Color coding identifies the ID or your PEEK tubing. Each ID is coded with a different color.

Other polymeric tubing

ETFE..... 9

FEP

Solid color-coded 10

Natural 11

PFA 9

PTFE

Solid color-coded 12

Natural 12

Thermo-formed polymeric tubing 13

Impermeable tubing 13

FEP coated with PVDF combines the chemical resistance of FEP with the tight, impermeable structure of PVDF.

Stainless steel tubing

Pre-cut SS tubing

Pre-cut tubing 14

Flexible pre-cut tubing 14

1/32" tubing with 1/16" ends.

Bulk SS tubing

Premium grade, seamless 15

Standard grade, welded seam 15

DISCLAIMER

The maximum holding pressure for any type of connections involving tubing and a ferrule varies considerably with the tubing material, the ferrule material, the clearance between tubing OD and ferrule ID, and the shape of the fitting detail.

RELATED PRODUCTS

SolviFlex

coiled tubing 70

Tubing tools and accessories

Easy-Flange kit 85

Easy-Flange combi kit . 85

PEEK tubing elbows . . 86

Tubing cutters for

polymeric tubing

Clean-cut..... 86

Guillotine..... 86

Tubing cutters for

stainless tubing

Cutting wheel type . 87

Plier type 87

Tubing clip – the LC

tubing organizer..... 86

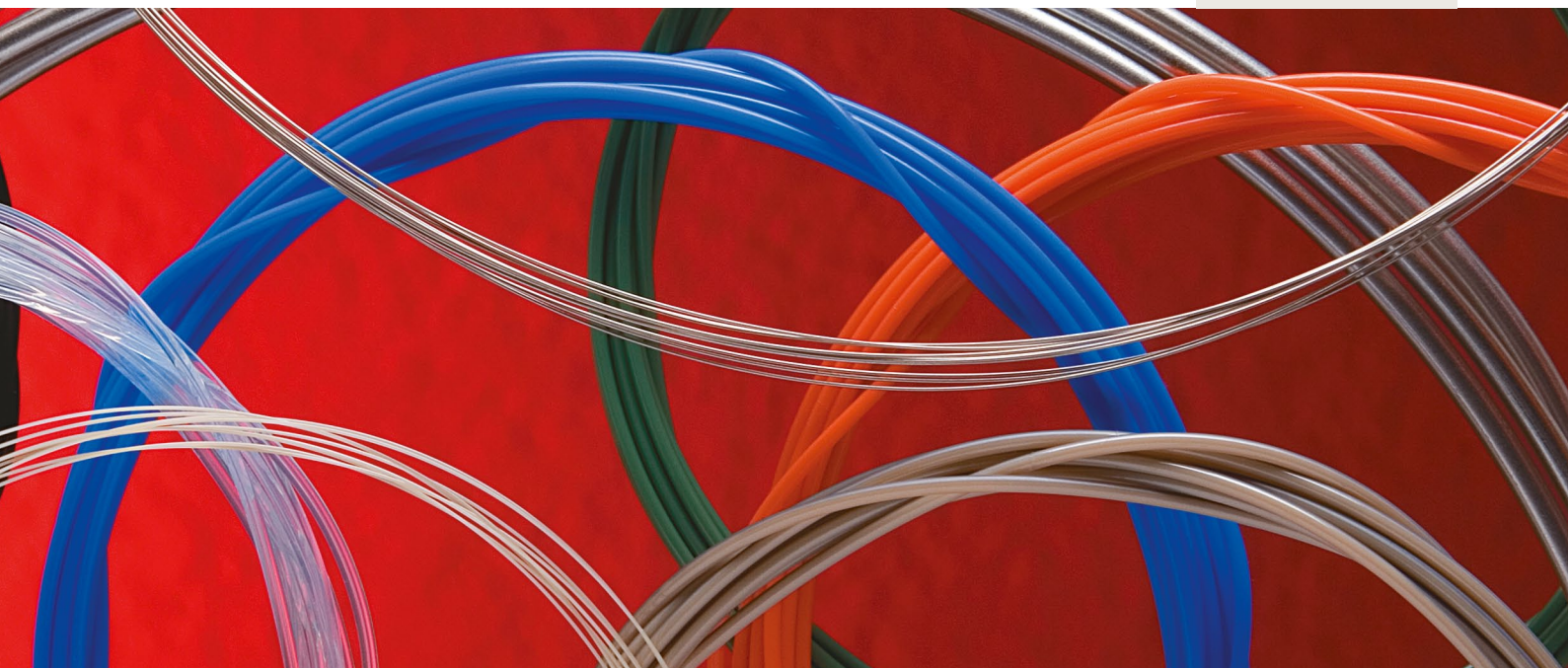

PEEK TUBING TOLERANCES

Due to tighter tolerances, VICI Jour PEEK tubing is the best choice for chromatography applications in which exact flow rates or tube volume are of importance. The tighter tolerance ensures a more consistent internal volume of transfer lines.

Tubing OD	OD (±) (mm)	ID (±) (mm)
360 µm	0.025	0.013
1/32"	0.025	0.013
1/16" *	0.025	0.013
1/16" **	0.025	0.025
1/8"	0.05	0.05

* For ID up to 0.25 mm
** For ID over 0.25 mm

OPTIONS

Contact your distributor for more information about:

- Longer bulk tubing lengths
- Customized ODs and IDs (30 m minimum quantity)

TECH TIP

- A clean burr-free perpendicular cut can be achieved with our Clean-Cut tubing cutter..... 86
- To bend PEEK tubing at the optimal radius, use our tubing elbows..... 86

MORE INFORMATION

- About PEEK® 99
- Chemical resistance PEEK 96-98
- PEEK at higher temperatures 96
- Maximum working pressure 94
- Tubing ID chart: volume per length... 93
- Tubing tolerances 95

RELATED PRODUCTS

- Clean-cut tubing cutter 86
- Easy-Flange kit 85
- PEEK fittings
 - High pressure . . . 19-29
 - Low pressure . 42,44-47
- PEEK tubing elbows . . . 86

VICI offers natural and color-coded PEEK® tubing. PEEK tubing has the strength required to withstand continuous use at HPLC pressure without swelling or bursting, and is not affected by halide salts, high strength buffers, or other aggressive mobile phases that corrode stainless steel. The polymer surface will not leach metal ions into the eluent or extract metal-sensitive components from the sample. Note however that dichloromethane, THF, and DMSO may cause swelling in PEEK, and concentrated nitric and sulphuric acid will attack PEEK.

PEEK tubing – natural

Qty/pkg:	3 m	10 m	per meter	SPECS
OD	ID	Product No.	Product No.	Product No.
360 µm	75 µm	JR-T-6060-M3	JR-T-6060-M10	—
1/32"	0.13 mm	JR-T-5993-M3	JR-T-5993-M10	—
1/16"	0.064 mm	JR-T-5998-M3	JR-T-5998-M10	—
1/8"	0.75 mm	JR-T-60041-M3	JR-T-60041-M10	—
	1.59 mm	JR-T-6004-M3	JR-T-6004-M10	—
	2.00 mm	JR-T-60042-M3	JR-T-60042-M10	—
1/4"	3.17 mm	—	—	JR-T-6006

- Maximum recommended working temp: 100°C (continuous) for 1/16" OD tubing with ID up to 0.75 mm
- Max working pressures: see page 94
- Tubing tolerances: see page 95

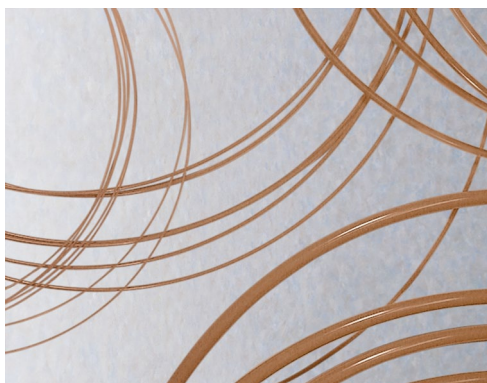

Natural PEEK tubing shown with ODs of 1/8", 1/16", 1/32", and 360 µm

WHICH PEEK TUBING FOR WHICH APPLICATION?

Application	Tubing
Standard HPLC*	1/16" OD x 0.25 mm ID
High pressure semi-prep LC*	1/8" OD
Agilent 1100 LC systems**	1/32"
Most capillary systems	360 µm

* Smaller ID for low flow rates/higher ID for high flow rates. Note that a low linear flow rate (cm/min) causes peak broadening.

** For some 1100 LC systems with high pressure flow paths

TECH TIP: STRAIGHTENING PEEK TUBING

1. Start with stainless steel tubing: ID slightly larger than OD of PEEK Length = 2 cm shorter than PEEK
2. Slide PEEK tubing into stainless tubing, extending 1 cm out each end of the stainless
3. Place sleeved PEEK tubing into oven: 220°C for 30 minutes, or 180°C for 60 minutes
4. Allow sleeved tubing to cool in oven to ambient temperature
5. Once tubing is cooled, remove PEEK tubing from the SS sleeve
6. Check for straightness
7. Repeat if necessary

Striped color-coded PEEK tubing

SPECS

- Maximum recommended working temp: 100°C (continuous) for 1/16" OD tubing with ID up to 0.75 mm
- Max working pressures: see page 94
- Tubing tolerances: see page 95

We recommend striped PEEK tubing for easy color-coded identification of tubing ID, with maximum chemical resistance and biocompatibility. The stripe is added to the outside, so dye never contacts the fluid stream.

All colorants used in the manufacture of this tubing are RoHS-compliant. (Restriction of Hazardous Substances)

Qty/pkg:		1 m		3 m	
<i>Tubing OD</i>	<i>Color</i>	<i>ID (µm)</i>	<i>Product No.</i>	<i>Product No.</i>	
360 µm	Orange	50	JR-T-3650-M1	JR-T-3650-M3	
	Green	75	JR-T-3675-M1	JR-T-3675-M3	
	Grey	100	JR-T-36100-M1	JR-T-36100-M3	
	Red	125	JR-T-36125-M1	JR-T-36125-M3	
	Black	150	JR-T-36150-M1	JR-T-36150-M3	

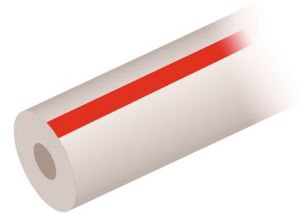

	<i>Color</i>	<i>ID (mm)</i>	1 m <i>Product No.</i>	3 m <i>Product No.</i>
1/32"	Orange	0.050	JR-T-5702-M1	JR-T-5702-M3
	Pink	0.064	JR-T-5764-M1	JR-T-5764-M3
	Green	0.075	JR-T-5703-M1	JR-T-5703-M3
	Black	0.100	JR-T-5704-M1	JR-T-5704-M3
	Red	0.13	JR-T-5705-M1	JR-T-5705-M3
	Yellow	0.18	JR-T-5707-M1	JR-T-5707-M3
	Orange	0.20	JR-T-5708-M1	JR-T-5708-M3
1/16"	Blue	0.25	JR-T-5710-M1	JR-T-5710-M3
	Orange	0.50	JR-T-5720-M1	JR-T-5720-M3

	<i>Color</i>	<i>ID (mm)</i>	3 m <i>Product No.</i>	5m <i>Product No.</i>
1/16"	Orange	0.050	JR-T-5802-M3	JR-T-5802-M5
	Pink	0.064	JR-T-5998C-M3	JR-T-5998C-M5
	Green	0.075	JR-T-5803-M3	JR-T-5803-M5
	Black	0.10	JR-T-5804-M3	JR-T-5804-M5
	Red	0.13	JR-T-5999-M3	JR-T-5999-M5
	Yellow	0.18	JR-T-6000-M3	JR-T-6000-M5
	Blue	0.25	JR-T-6001-M3	JR-T-6001-M5
	Orange	0.50	JR-T-6002-M3	JR-T-6002-M5
	Green	0.75	JR-T-6003-M3	JR-T-6003-M5
	Grey	1.00	JR-T-60031-M3	JR-T-60031-M5
Black	1.40	JR-T-60032-M3	JR-T-60032-M5	

	<i>Color</i>	<i>ID (mm)</i>	10 m <i>Product No.</i>	25m <i>Product No.</i>
1/16"	Orange	0.050	JR-T-5802-M10	JR-T-5802-M25
	Pink	0.064	JR-T-5998C-M10	JR-T-5998C-M25
	Green	0.075	JR-T-5803-M10	JR-T-5803-M25
	Black	0.100	JR-T-5804-M10	JR-T-5804-M25
	Red	0.13	JR-T-5999-M10	JR-T-5999-M25
	Yellow	0.18	JR-T-6000-M10	JR-T-6000-M25
	Blue	0.25	JR-T-6001-M10	JR-T-6001-M25
	Orange	0.50	JR-T-6002-M10	JR-T-6002-M25
	Green	0.75	JR-T-6003-M10	JR-T-6003-M25
	Grey	1.00	JR-T-60031-M10	JR-T-60031-M25
Black	1.40	JR-T-60032-M10	JR-T-60032-M25	

TECH TIP

VICI Jour sample loops for analytical applications are made of PEEK striped color-coded tubing.
PEEK loops 81

OPTIONS

Contact your distributor or VICI about:
 ■ Longer bulk tubing lengths
 ■ Customized ODs and IDs (30 m minimum quantity)

MORE INFORMATION

About PEEK® 99
 Chemical resistance
 PEEK 96-98
 PEEK at higher temperatures 96
 Maximum working pressure 94
 Tubing ID chart: volume per length ... 93
 Tubing tolerances 95

RELATED PRODUCTS

Clean-cut tubing cutter 86
 Easy-Flange kit 85
 PEEK fittings
 High pressure ... 19-29
 Low pressure . 42, 44-47
 PEEK tubing elbows ... 86

Dual layer color-coded PEEK tubing

- Inner layer of natural PEEK, outer layer of color-coded PEEK
- No possibility of stream coming in contact with coloring agents
- Pressure performance equivalent to single layer tubing
- 1/16" OD, IDs from 0.10 to 0.75 mm

Our dual layer PEEK tubing eliminates any concern that a critical sample stream could be contaminated by pigments used to color code the tubing. It looks like any other color-coded tubing at first glance, but a closer look reveals that the pigmented layer* surrounds a separate but integrally-bonded inner layer of natural PEEK. Only natural PEEK is in contact with the fluid stream.

The ID tolerance of ±0.025 mm (.001") is equivalent to or better than that of tubing typically sold as premium grade.

*All colorants used in the manufacture of this tubing are RoHS-compliant. (Restriction of Hazardous Substances)

SPECS

- Maximum recommended working temp: 100°C (continuous)
- Max working pressures: see page 94
- Tubing tolerances: see page 95

Qty/pkg:					3 m	10 m	25 m
Tubing OD	Color	ID (mm)	bar	psi	Product No.	Product No.	Product No.
1/16"	Black	0.10	460	6700	JR-TD-5804-M3	JR-TD-5804-M10	JR-TD-5804-M25
	Red	0.13	420	6100	JR-TD-6007-M3	JR-TD-6007-M10	JR-TD-6007-M25
	Yellow	0.18	400	5800	JR-TD-6008-M3	JR-TD-6008-M10	JR-TD-6008-M25
	Blue	0.25	386	5600	JR-TD-6009-M3	JR-TD-6009-M10	JR-TD-6009-M25
	Orange	0.50	350	4500	JR-TD-6010-M3	JR-TD-6010-M10	JR-TD-6010-M25
	Green	0.75	240	3500	JR-TD-6011-M3	JR-TD-6011-M10	JR-TD-6011-M25

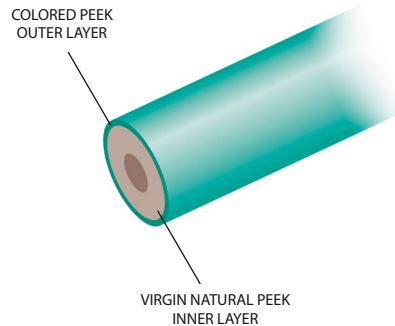

OPTIONS AND MORE INFORMATION

See facing page.

RELATED PRODUCTS

Solid color-coded PEEK tubing 8

Solid color-coded PEEK tubing

SPECS

- Maximum recommended working temp: 100°C (continuous) for 1/16" OD tubing with ID up to 0.75 mm
- Max working pressures: see page 94
- Tubing tolerances: see page 95

Color-coding identifies the ID of your PEEK tubing – each ID is coded with a different color. Solid colored tubing is made of pre-dyed raw material.

All colorants used in the manufacture of this tubing are RoHS-compliant. (Restriction of Hazardous Substances)

Qty/pkg:			1 m	3 m	10 m
Tubing OD	Color	ID (µm)	Product No.	Product No.	Product No.
360 µm	Orange	50	JR-T-3750-M1	JR-T-3750-M3	—
	Natural	75	—	JR-T-6060-M3	JR-T-6060-M10
	Green	75	JR-T-3775-M1	JR-T-3775-M3	—
	Grey	100	JR-T-37100-M1	JR-T-37100-M3	—
	Red	125	JR-T-37125-M1	JR-T-37125-M3	—
	Black	150	JR-T-37150-M1	JR-T-37150-M3	—

			1 m	3 m	10 m
	Color	ID (mm)	Product No.	Product No.	Product No.
1/32"	Orange	0.050	JR-T-5602-M1	JR-T-5602-M3	—
	Pink	0.064	JR-T-5664-M1	JR-T-5664-M3	—
	Green	0.075	JR-T-5603-M1	JR-T-5603-M3	—
	Black	0.100	JR-T-5604-M1	JR-T-5604-M3	—
	Natural	0.13	—	JR-T-5993-M3	JR-T-5993-M10
	Red	0.13	JR-T-5605-M1	JR-T-5605-M3	—
	Purple	0.15	JR-T-5606-M1	JR-T-5606-M3	—
	Natural	0.18	—	JR-T-5994-M3	JR-T-5994-M10
	Yellow	0.18	JR-T-5607-M1	JR-T-5607-M3	—
	Orange	0.20	JR-T-5608-M1	JR-T-5608-M3	—
	Natural	0.25	—	JR-T-5995-M3	JR-T-5995-M10
	Blue	0.25	JR-T-5610-M1	JR-T-5610-M3	—
	Natural	0.38	—	JR-T-5715-M3	JR-T-5715-M10
	Orange	0.50	JR-T-5620-M1	JR-T-5620-M3	—

			3 m	10 m	25 m
	Color	ID (mm)	Product No.	Product No.	Product No.
1/16"	Natural	0.064	JR-T-5998-M3	JR-T-5998-M10	JR-T-5998-M25
	Black	0.10	JR-T-6020-M3	JR-T-6020-M10	JR-T-6020-M25
	Red	0.13	JR-T-6007-M3	JR-T-6007-M10	JR-T-6007-M25
	Purple	0.15	JR-T-6030-M3	JR-T-6030-M10	JR-T-6030-M25
	Yellow	0.18	JR-T-6008-M3	JR-T-6008-M10	JR-T-6008-M25
	Blue	0.25	JR-T-6009-M3	JR-T-6009-M10	JR-T-6009-M25
	Grey	0.38	JR-T-6040-M3	JR-T-6040-M10	JR-T-6040-M25
	Orange	0.50	JR-T-6010-M3	JR-T-6010-M10	JR-T-6010-M25
	Green	0.75	JR-T-6011-M3	JR-T-6011-M10	JR-T-6011-M25

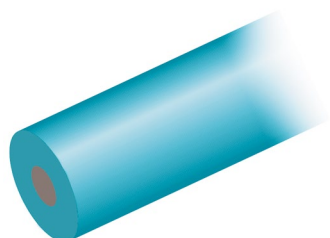

TECH TIP

See our dual layer PEEK tubing for solid colored PEEK tubing with no possibility of stream coming into contact with coloring agents. 7

OPTIONS

Contact your distributor or VICI about:

- Longer bulk tubing lengths
- Customized ODs and IDs (30 m minimum quantity)

MORE INFORMATION

About PEEK® 99
 Chemical resistance
 PEEK 96-98
 PEEK at higher temperatures 96
 Maximum working pressure 94
 Tubing ID chart:
 volume per length 93
 Tubing tolerances 95

RELATED PRODUCTS

Clean-cut tubing cutter 86
 Easy-Flange kit 85
 PEEK fittings
 High pressure 19-29
 Low pressure 42, 44-47
 PEEK tubing elbows 86



ETFE tubing

ETFE (ethyltrifluoroethylene) tubing is particularly suitable for HPLC, since it has a higher burst pressure as compared to PTFE. 1/16" OD x 0.25 mm ID tubing will withstand up to 186 bar (2700 psi) with water as mobile phase. However, it is important to note that when used with organic solvents, ETFE tubing may swell, reducing that maximum pressure to 70 bar (1000 psi).

SPECS

- Max working pressures: see page 94
- Tubing tolerances: see page 95

This is the ideal polymer for applications with chloride salts, which typically corrode stainless steel.

Qty/pkg:		3 m	10 m	25 m
Tubing OD	ID (mm)	Product No.	Product No.	Product No.
1/32"	0.25	JR-T-084-M3	JR-T-084-M10	JR-T-084-M25
1/16"	0.18	JR-T-078-M3	JR-T-078-M10	JR-T-078-M25
	0.25	JR-T-080-M3	JR-T-080-M10	JR-T-080-M25
	0.50	JR-T-082-M3	JR-T-082-M10	JR-T-082-M25
	0.75	JR-T-083-M3	JR-T-083-M10	JR-T-083-M25
1/8"	1.00	JR-T-085-M3	JR-T-085-M10	JR-T-085-M25
	1.59	JR-T-086-M3	JR-T-086-M10	JR-T-086-M25
		1 m	3 m	
	ID (mm)	Product No.	Product No.	
3.0 mm	1.0	JR-T-087-M1	JR-T-087-M3	
6.0 mm	4.0	JR-T-088-M1	JR-T-088-M3	

TECH TIP

- When selecting tubing for low pressure applications, give careful consideration to gas permeability characteristics.
- Use PFA instead of PTFE if gas permeability is an issue.

OPTIONS

Contact your distributor or VICI about:

- Longer tubing lengths at competitive bulk prices
- Customized ODs and IDs (30 m minimum quantity)

MORE INFORMATION

- About ETFE..... 99
- Chemical resistance 96-98
- Maximum working pressure 94
- Tubing ID chart: volume per length... 93
- Tubing tolerances 95

RELATED PRODUCTS

- Clean-cut tubing cutter 86
- Easy-Flange kit 85
- Low pressure fittings 40-47
- SolviFlex coiled PFA tubing 70

PFA tubing

PFA (perfluoroalkoxy) tubing from VICI Jour has excellent chemical stability and mechanical strength. 1/16" OD high purity tubing has a maximum pressure rating of up to 100 bar (1450 psi), while 1/8" OD tubing can be used at up to 72 bar (1050 psi).

SPECS

- Max working pressures: see page 94
- Tubing tolerances: see page 95

Always use PFA instead of PTFE if gas permeability is an issue.

Qty/pkg:		1 m	3 m	10 m	25 m
Tubing OD	ID (mm)	Product No.	Product No.	Product No.	Product No.
360 µm	50 µm	JR-T-43650-M1	JR-T-43650-M3		
	75 µm	JR-T-43675-M1	JR-T-43675-M3		
	100 µm	JR-T-436100-M1	JR-T-436100-M3		
		3 m	10 m	25 m	
	ID (mm)	Product No.	Product No.	Product No.	
1/16"	0.50 mm	JR-T-4001-M3	JR-T-4001-M10	JR-T-4001-M25	
	0.75 mm	JR-T-4002-M3	JR-T-4002-M10	JR-T-4002-M25	
	1.00 mm	JR-T-4007-M3	JR-T-4007-M10	JR-T-4007-M25	
1/8"	1.59 mm	JR-T-4003-M3	JR-T-4003-M10	JR-T-4003-M25	
		per meter			
	ID (mm)	Product No.			
1/8"	1.70 mm	JR-T-4005			
3/16"	3.20 mm	JR-T-4009			
1/4"	4.35 mm	JR-T-4004			



FEP tubing, solid color-coded

SPECS

- Maximum recommended working temp: 80°C (continuous)
- Max working pressures: see page 94
- Tubing tolerances: see page 95

FEP (FluorinatedEthylenePropylene) tubing is chemically inert to most HPLC solvents, and is recommended for low pressure applications. Typically 1/16" OD tubing holds up to 117 bar (1700 psi), and 1/8" OD holds up to 70 bar (1000 psi).

Solid colors identify the tubing ID.

We recommend FEP for ion chromatography applications.

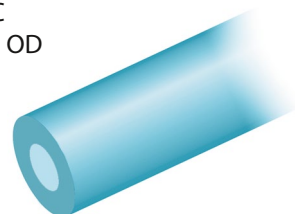

Qty/pkg:				3 m	10 m	25 m
Tubing OD	Color	ID (mm)	Product No.	Product No.	Product No.	
1/32"	Black	0.10	JR-T-6604C-M3	JR-T-6604C-M10	JR-T-6604C-M25	
	Red	0.13	JR-T-6605C-M3	JR-T-6605C-M10	JR-T-6605C-M25	
	Purple	0.15	JR-T-6606C-M3	JR-T-6606C-M10	JR-T-6606C-M25	
	Yellow	0.18	JR-T-6607C-M3	JR-T-6607C-M10	JR-T-6607C-M25	
	Blue	0.25	JR-T-6610C-M3	JR-T-6610C-M10	JR-T-6610C-M25	
	Orange	0.50	JR-T-6620C-M3	JR-T-6620C-M10	JR-T-6620C-M25	
			3 m	10 m	25 m	
		Color	ID (mm)	Product No.	Product No.	Product No.
1/16"	Black	0.10	JR-T-6704C-M3	JR-T-6704C-M10	JR-T-6704C-M25	
	Red	0.13	JR-T-6705C-M3	JR-T-6705C-M10	JR-T-6705C-M25	
	Purple	0.15	JR-T-6706C-M3	JR-T-6706C-M10	JR-T-6706C-M25	
	Yellow	0.18	JR-T-6707C-M3	JR-T-6707C-M10	JR-T-6707C-M25	
	Blue	0.25	JR-T-6812C-M3	JR-T-6812C-M10	JR-T-6812C-M25	
	Orange	0.50	JR-T-6802C-M3	JR-T-6802C-M10	JR-T-6802C-M25	
	Green	0.75	JR-T-6803C-M3	JR-T-6803C-M10	JR-T-6803C-M25	
	Black	1.00	JR-T-6806C-M3	JR-T-6806C-M10	JR-T-6806C-M25	

TECH TIP

When selecting tubing for low pressure applications, give careful consideration to gas permeability characteristics.

OPTIONS

- Contact your distributor or VICI about:
- Longer tubing lengths at competitive bulk prices
 - Customized ODs and IDs (30 m minimum quantity)

MORE INFORMATION

About FEP 99
 Chemical resistance 96-98
 Maximum working pressure 94
 Tubing ID chart: volume per length . . . 93
 Tubing tolerances 95

RELATED PRODUCTS

Clean-cut tubing cutter 86
 Easy-Flange kit 85
 Low pressure fittings 40-47

FEP tubing, natural color

FEP (FluorinatedEthylenePropylene) tubing is chemically inert to most HPLC solvents, and is recommended for low pressure applications. Typically 1/16" OD tubing holds up to 117 bar (1700 psi), and 1/8" OD holds up to 70 bar (1000 psi).

We recommend FEP for ion chromatography applications.

Qty/pkg:		1 m		3 m		10 m		
<i>Tubing OD</i>	<i>ID (mm)</i>	<i>Product No.</i>	<i>Product No.</i>	<i>Product No.</i>	<i>Product No.</i>	<i>Product No.</i>	<i>Product No.</i>	
1/32"	0.10	JR-T-6794-M1	JR-T-6794-M3	JR-T-6794-M10				
	0.13	JR-T-6605-M1	JR-T-6605-M3	JR-T-6605-M10				
	0.15	JR-T-6606-M1	JR-T-6606-M3	JR-T-6606-M10				
	0.18	JR-T-6607-M1	JR-T-6607-M3	JR-T-6607-M10				
	0.25	JR-T-6610-M1	JR-T-6610-M3	JR-T-6610-M10				
	0.38	JR-T-6615-M1	JR-T-6615-M3	JR-T-6615-M10				
	0.50	JR-T-6620-M1	JR-T-6620-M3	JR-T-6620-M10				
		3 m		10 m		25 m		
	<i>ID (mm)</i>	<i>Product No.</i>	<i>Product No.</i>	<i>Product No.</i>	<i>Product No.</i>	<i>Product No.</i>	<i>Product No.</i>	
1/16"	0.10	JR-T-6704-M3	JR-T-6704-M10	JR-T-6704-M25				
	0.13	JR-T-6705-M3	JR-T-6705-M10	JR-T-6705-M25				
	0.15	JR-T-6706-M3	JR-T-6706-M10	JR-T-6706-M25				
	0.18	JR-T-6707-M3	JR-T-6707-M10	JR-T-6707-M25				
	0.20	JR-T-6708-M3	JR-T-6708-M10	JR-T-6708-M25				
	0.25	JR-T-6812-M3	JR-T-6812-M10	JR-T-6812-M25				
	0.30	JR-T-6702-M3	JR-T-6702-M10	JR-T-6702-M25				
	0.50	JR-T-6802-M3	JR-T-6802-M10	JR-T-6802-M25				
1/8"	0.75	JR-T-6803-M3	JR-T-6803-M10	JR-T-6803-M25				
	1.00	JR-T-6806-M3	JR-T-6806-M10	JR-T-6806-M25				
1/8"	1.59	JR-T-6804-M3	JR-T-6804-M10	JR-T-6804-M25				
	2.10	JR-T-6813-M3	JR-T-6813-M10	JR-T-6813-M25				
3/16"	3.18	JR-T-6835-M3	JR-T-6835-M10	JR-T-6835-M25				
1 mm	0.50	JR-T-6105-M3	JR-T-6105-M10	JR-T-6105-M25				
2 mm	1.00	JR-T-6210-M3	JR-T-6210-M10	JR-T-6210-M25				
3 mm	1.00	JR-T-6310-M3	JR-T-6310-M10	JR-T-6310-M25				
	2.00	JR-T-6320-M3	JR-T-6320-M10	JR-T-6320-M25				
Qty/pkg:		per meter						
<i>Tubing OD</i>	<i>ID (mm)</i>	<i>Product No.</i>						
1/4"	4.35	JR-T-6809						

SPECS

- Maximum recommended working temp: 80°C (continuous)
- Max working pressures: see page 94
- Tubing tolerances: see page 95

**OPTIONS AND MORE INFORMATION**

See facing page.

TUBING

PTFE tubing, solid color-coded

SPECS

- Maximum recommended working temp: 100°C (continuous)
- Maximum working pressures: see page 94
- Tubing tolerances: see page 95

PTFE (polytetrafluoroethylene) tubing is chemically inert and suitable for lower pressure applications. Typically 1/16" OD tubing holds up to 62 bar (900 psi) and 1/8" up to 35 bar (500 psi). Maximum continuous operating temperature is 100°C.

Black PTFE, available in two IDs, is recommended for light sensitive applications such as enzymatic reactions, luminescent reactions, connecting to a flow cell, and radioactive HPLC.

Solid colors identify the tubing ID.

Qty/pkg:			3 m	10 m	25 m
OD	Color	ID (mm)	Product No.	Product No.	Product No.
1/16"	Blue	0.25	JR-T-4011C-M3	JR-T-4011C-M10	JR-T-4011C-M25
	Black	0.25	JR-T-6808-M3	JR-T-6808-M10	JR-T-6808-M25
		0.50	JR-T-6811-M3	JR-T-6811-M10	JR-T-6811-M25
Orange	Green	0.50	JR-T-4183C-M3	JR-T-4183C-M10	JR-T-4183C-M25
		0.75	JR-T-4136C-M3	JR-T-4136C-M10	JR-T-4136C-M25

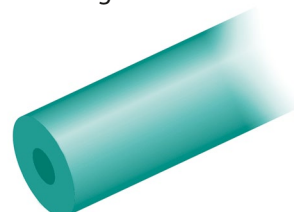

PTFE tubing, natural color

SPECS

- Maximum recommended working temp: 100°C (continuous)
- Max working pressures: see page 94
- Tubing tolerances: see page 95

PTFE tubing is chemically inert and suitable for lower pressure applications. Typically 1/16" OD tubing holds up to 62 bar (900 psi) and 1/8" up to 35 bar (500 psi). Maximum continuous operating temperature is 100°C.

Qty/pkg:			3 m	5 m	10 m	25 m
Tubing OD	ID (mm)	Product No.	Product No.	Product No.	Product No.	Product No.
1/16"	0.18	JR-T-6805-M3	JR-T-6805-M5	JR-T-6805-M10	JR-T-6805-M25	
	0.25	JR-T-4011-M3	JR-T-4011-M5	JR-T-4011-M10	JR-T-4011-M25	
		0.50	JR-T-4183-M3	JR-T-4183-M5	JR-T-4183-M10	JR-T-4183-M25
	0.75	JR-T-4036-M3	JR-T-4036-M5	JR-T-4036-M10	JR-T-4036-M25	
	1.00	JR-T-6807-M3	JR-T-6807-M5	JR-T-6807-M10	JR-T-6807-M25	
1/8"	1.59	JR-T-6800-M3	JR-T-6800-M5	JR-T-6800-M10	JR-T-6800-M25	
	2.40	JR-T-4037-M3	JR-T-4037-M5	JR-T-4037-M10	JR-T-4037-M25	
		3 m	10 m	25 m		
	ID (mm)	Product No.	Product No.	Product No.		
2 mm	1.70	JR-T-6801-M3	JR-T-6801-M10	JR-T-6801-M25		
4 mm	3.00	JR-T-4039-M3	JR-T-4039-M10	—		
Qty/pkg:		per meter				
Tubing OD	ID (mm)	Product No.				
in.	mm					
3/16"	4.76	3.76	JR-T-4041			
1/4"	6.35	4.35	JR-T-6810			



TECH TIP

Use PFA instead of PTFE if gas permeability is an issue.

TECH TIP

Use black PTFE for light sensitive applications such as enzymatic reactions, luminescent reactions, connectioning to a flow cell, and radioactive HPLC.

OPTIONS

Contact your distributor or VICI about:

- Longer tubing lengths at competitive bulk prices
- Customized ODs and IDs (30 m minimum quantity)

MORE INFORMATION

About PTFE 99
 Chemical resistance 96-98
 Maximum working pressure 94
 Tubing ID chart: volume per length . . . 91
 Tubing tolerances 95

RELATED PRODUCTS

Clean-cut tubing-cut 86
 Easy-Flange kit 85
 Flanged fittings 40, 43
 Flangeless fittings . . 41-42

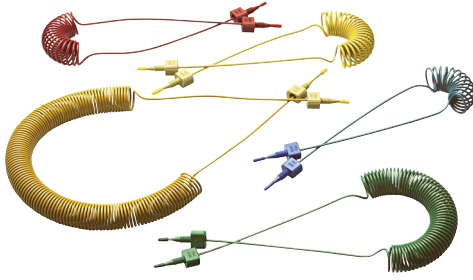

Thermo-formed polymeric tubing

- Available in a variety of polymers
- Provides axial flexibility
- Telephone cables or customer-specified shapes

VICI Jour offers thermo-formed tubing in various geometric shapes and polymers. The form will maintain its shape so long as the temperature does not exceed 100°C.

Straight tubing, spirals, or even more complex forms – just define your form and material on a drawing for us.

FOR PRICING

Contact VICI or your local distributor for more information or a quotation.



Impermeable polymeric tubing

- FEP coated with PVDF
- Prevents “re-gassing”
- Excellent chemical resistance

PTFE and FEP have very good chemical resistance, but are too permeable to be suitable for mobile phase transfer lines. PVDF, on the other hand, lacks chemical resistance but is a very tight polymer with no observable micropores. Our impermeable tubing is produced by co-extruding PVDF over FEP to combine the best features of both polymers, ensuring that degassed solvent will stay degassed until it reaches the HPLC pump.

The PVDF layer can easily be stripped away with our Clean-Cut tubing cutter or a razor blade, leaving a length of exposed FEP to extend into the solvent reservoir.

When making connections, a special PCTFE tubing insert fits into the ID of the tubing and seals against the bottom of the port, preventing the solvent from contacting the PVDF layer at the end of the tube.

SPECS

- Low pressure only
- 1/8" OD, 1.65 mm ID
- OD and ID tolerances: ±0.05 mm (.002")
- Materials
 Tubing: FEP coated with PVDF
 Insert: PCTFE
 Ferrule: ETFE
 Fitting: PPS

TECH TIP

Use FEP or PFA tubing inside the solvent reservoir, since PVDF has limited chemical resistance.

TECH TIP

Always use the specially-designed tubing insert to prevent solvent contact with the PVDF layer.

OPTIONS

Contact us for more info about longer tubing lengths at competitive bulk prices.

MORE INFORMATION

- About FEP 99
- About PVDF 100
- Chemical resistance 96-98
- Tubing ID chart: volume per length . . . 93
- Tubing tolerances 95

RELATED PRODUCTS

- Clean-cut tubing cutter 86
- Color-sleeve fingertight adapters . 17

Qty/pkg:	3 m		10 m	
	Product No.	Product No.	Product No.	Product No.
Impermeable tubing, 1/8" OD x 1.65 mm ID	JR-T-6130-M3	JR-T-6130-M10		
Additional spare parts	Qty/pkg	Product No.		
PCTFE tubing inserts	10	JR-6141-10		
1/8" PPS nuts	10	JR-55071-10		
1/8" ETFE ferrules	10	JR-051-10		
Fitting kit		JR-6140		
contains:				
PCTFE tubing inserts	2			
1/8" PPS nuts	2			
1/8" ETFE ferrules	2			

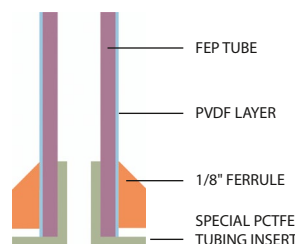

TUBING

Pre-cut stainless steel tubing

UHPLC

SPECS

- Pressure rating varies with ID; minimum is 365 bar (5300 psi) (see page 93)
- Tolerances
 - OD ±0.05mm (.002")
 - ID ±0.025mm (.001")

- For zero dead volume connections
- Steam-cleaned and ready to use
- Soft annealed OD for easy ferrule connections
- Color bands for quick identification of tubing ID

VICI Jour offers pre-cut 1/16" stainless steel tubing in lengths most commonly required in UHPLC and HPLC systems. The tubes are cut to square, burr-free ends for zero dead volume connections. Colored bands allow quick ID identification.

VICI pre-cut tubing is specially cleaned with steam from micro-filtered deionized water, which removes both organic and inorganic contaminants. Longer tubes are cleaned with liquid hexane. Softener-free polyethylene caps are used to prevent any contamination during shipment and storage.

Length:		50 mm		100 mm	200 mm	300 mm
OD	Color	ID (mm)	Product No.	Product No.	Product No.	Product No.
1/16"	Red	0.13	JR-T-97005	JR-T-97010	JR-T-97015	JR-T-97020
	Yellow	0.18	JR-T-97025	JR-T-97030	JR-T-97035	JR-T-97040
	Blue	0.25	JR-T-97045	JR-T-97055	JR-T-97060	JR-T-97065
	Orange	0.50	JR-T-97075	JR-T-97080	JR-T-97085	JR-T-97090
	Green	0.75	JR-T-97095	JR-T-97100	JR-T-97105	JR-T-97110



Pre-cut flexible stainless steel tubing

UHPLC

SPECS

- Pressure rating varies with ID; minimum is 365 bar (5300 psi) (see page 93)
- Tolerances
 - OD ±0.05mm (.002")
 - ID ±0.025mm (.001")

- Seamless 1/32" tubing with 1/16" laser-welded ends
- For zero dead volume connections
- Steam-cleaned and ready to use
- Soft annealed OD for easy ferrule connections
- Color bands for quick identification

Our flexible pre-cut stainless steel tubing is made of 1/32" premium grade 316 stainless steel tubing with ends laser-welded into 1/16" tubing of the same premium grade. Available in lengths most commonly required in UHPLC and HPLC systems.



The tubes are cut to square, burr-free ends for zero dead volume connections. Colored bands allow quick ID identification.

VICI pre-cut tubing is specially cleaned with steam from micro-filtered deionized water, which removes both organic and inorganic contaminants. Longer tubes that cannot be steam-cleaned are cleaned with liquid hexane. Softener-free polyethylene caps are used to prevent any contamination during shipment and storage.

Length:		105 mm		150 mm	200 mm	280 mm	400 mm
OD	Color	ID (mm)	Product No.	Product No.	Product No.	Product No.	Product No.
1/16"	Red	0.13	JR-T-96005	JR-T-96010	JR-T-96015	JR-T-96020	JR-T-96025
	Yellow	0.18	JR-T-96105	JR-T-96110	JR-T-96115	JR-T-96120	JR-T-96125
	Blue	0.25	JR-T-96205	JR-T-96210	JR-T-96215	JR-T-96220	JR-T-96225
	Orange	0.50	JR-T-96305	JR-T-96310	JR-T-96315	JR-T-96320	JR-T-96325
		600 mm		700 mm	800 mm	900 mm	
			Product No.	Product No.	Product No.	Product No.	
	Red	0.13	JR-T-96030	JR-T-96035	JR-T-96040	—	
	Yellow	0.18	JR-T-96130	JR-T-96135	JR-T-96140	JR-T-96145	
	Blue	0.25	JR-T-96230	JR-T-96235	JR-T-96240	—	
	Orange	0.50	JR-T-96330	JR-T-96335	JR-T-96340	—	

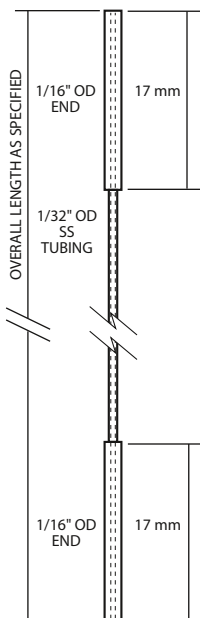

TECH TIP

Contact your local distributor or VICI for custom lengths.



Stainless steel tubing – premium grade

UHPLC

- Seamless Type 316 stainless steel
- Variety of sizes for UHPLC, HPLC, and GC applications
- Smooth internal surface
- Soft annealed OD for easy ferrule connections

Our premium grade seamless stainless steel tubing is the base for all high pressure and ultra-high pressure lines in your equipment.

Note that this tubing is roughly cut with tubing pliers so the ends must be properly cut before use.

Qty/pkg:		3 m		10 m	
Tubing OD	ID (mm)	Product No.	Product No.	Product No.	Product No.
1/32"	0.13	JR-TSS.505-M3	JR-TSS.505-M10		
	0.18	JR-TSS.507-M3	JR-TSS.507-M10		
	0.25	JR-TSS.510-M3	JR-TSS.510-M10		
	0.50	JR-TSS.520-M3	JR-TSS.520-M10		
1/16"	0.13	JR-TSS105-M3	JR-TSS105-M10		
	0.25	JR-TSS110-M3	JR-TSS110-M10		
	0.38	JR-TSS115-M3	JR-TSS115-M10		
	0.50	JR-TSS120-M3	JR-TSS120-M10		
	0.75	JR-TSS130-M3	JR-TSS130-M10		
	1.00	JR-TSS140-M3	JR-TSS140-M10		
	1.70	JR-TSS267-M3	JR-TSS267-M10		
1/8"	0.75	JR-TSS230-M3	JR-TSS230-M10		
	1.00	JR-TSS240-M3	JR-TSS240-M10		
	1.52	JR-TSS260-M3	JR-TSS260-M10		
	1.70	JR-TSS267-M3	JR-TSS267-M10		
	2.16	JR-TSS285-M3	JR-TSS285-M10		

SPECS

- Pressure rating (values shown are minimum; rating varies with ID; (see page 93))

OD	bar	psi
1/32"	400	5800
1/16"	365	5300
1/8"	315	4600
- Tolerances

OD	±0.05mm (.002")
ID	±0.025mm (.001")

TECH TIP

For zero dead volume connections, we strongly recommend pre-cut stainless steel tubing . . . 14

NOTE

ID dimensions in mm are converted from nominal inch dimensions.

OPTIONS

Contact us for more info about longer tubing lengths at competitive bulk prices.

MORE INFORMATION

About Type 316 stainless steel 100
 Maximum working pressure 93
 Tubing ID chart: volume per length . . . 93

RELATED PRODUCTS

Stainless steel tubing cutter 87
 Stainless fittings 30-35

Stainless steel tubing – standard grade

UHPLC

- Type 316 stainless steel, welded under inert gas
- Variety of sizes for HPLC and GC applications
- Smooth internal surface
- Soft annealed OD for easy ferrule connections

Qty/pkg:		3 m		10 m	
Tubing OD	ID (mm)	Product No.	Product No.	Product No.	Product No.
1/16"	0.13	JR-T-625-04-M3	JR-T-625-04-M10		
	0.18	JR-T-625-05-M3	JR-T-625-05-M10		
	0.25	JR-T-625-10-M3	JR-T-625-10-M10		
	0.50	JR-T-625-20-M3	JR-T-625-20-M10		
	0.75	JR-T-625-30-M3	JR-T-625-30-M10		
	1.00	JR-T-625-40-M3	JR-T-625-40-M10		
1/8"	2.1	JR-T-626-00-M3	JR-T-626-00-M10		
Qty/pkg:		per meter			
Tubing OD	ID (mm)	Product No.	Product No.	Product No.	Product No.
1/4"	4.65	JR-T-628-00			

SPECS

- Pressure rating (values shown are minimum; rating varies with ID; (see page 93))

OD	bar	psi
1/16"	315	4600
1/8"	315	4600
- Tolerances

OD	±0.05mm (.002")
ID	±0.05mm (.002")

Fittings

HIGH AND LOW PRESSURE



High pressure polymeric fittings... page 18

High pressure polymeric fittings are useful in applications involving proteins, peptides, and other samples of biological origin where metal systems may interact with samples.



High pressure stainless fittings.... page 30

Our stainless steel fittings are typically compression fittings, in which a ferrule is compressed onto the tube as a nut is tightened. They offer the best reliability in high pressure situations.



Nanovolume® HPLC fittings page 36

With bore sizes of 100 and 150 microns, (.004" -.006"), the minimal transfer volume contributed by Nanovolume® components makes them especially beneficial in applications with flow rates in the $\mu\text{l}/\text{min}$ range, when the transfer volume can be critical.



Low pressure fittings..... page 40

Low pressure fittings are ideally suited for flow injection analysis, low pressure liquid chromatography, and stream sampling devices. They may be safely used at pressures up to 500 psi and temperatures to 50°C.

MORE INFORMATION

Tools for fittings

Ferrule removal kit.....	89
Tweezer.....	89
ValvTool.....	88
Wrench.....	89





Color-It fingertight adapters

- For high and low pressure
- Fit all hex-head PEEK and SS fittings for 1/16" tubing
- Available in six colors for easy solvent line identification

SPECS

- For 1/4" hex-head nuts
- Material: Polypropylene

Color-It snap-on fingertight adapters are used with for our 1/4" PEEK and stainless hex-head nuts, converting them into color-coded fingertight fittings in an instant. Available in six colors.

Color	Qty/pkg	Product No.
Blue	5	JR-55010-5
Yellow	5	JR-55011-5
Green	5	JR-55012-5
Black	5	JR-55013-5
White	5	JR-55014-5
Red	5	JR-55015-5
Assorted	2 each	JR-55016-12

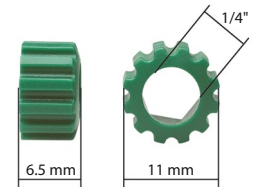

Color-Sleeve fingertight adapters

- For high and low pressure
- Designed for our PPS fittings for 1/16" tubing
- Available in twelve colors for easy solvent line identification

SPECS

- For 1/4" hex-head nuts
- Material: Polypropylene

This adapter is useful for color coding different solvent lines, and turns VICI Jour PPS nuts into fingertight fittings in an instant.



Color	Qty/pkg	Product No.	Color	Qty/pkg	Product No.
Natural	5	JR-55080-5	Brown	5	JR-55088-5
	10	JR-55080-10		10	JR-55088-10
White	5	JR-55081-5	Green	5	JR-55089-5
	10	JR-55081-10		10	JR-55089-10
Dark grey	5	JR-55082-5	Blue	5	JR-55090-5
	10	JR-55082-10		10	JR-55090-10
Black	5	JR-55083-5	Purple	5	JR-55091-5
	10	JR-55083-10		10	JR-55091-10
Lavender	5	JR-55084-5	Assorted	2 each	JR-5508X-24
	10	JR-55084-10			
Red	5	JR-55085-5	All 12 colors	2 each	JR-5508X-12
	10	JR-55085-10			
Yellow	5	JR-55086-5	Blue, red, green, yellow, black, white	2 each	JR-5508X-12
	10	JR-55086-10			
Orange	5	JR-55087-5			
	10	JR-55087-10			

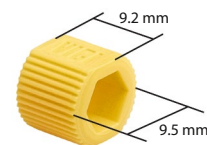

MORE INFORMATION

Hex head nuts
 PEEK 19-23
 Stainless..... 31
 PPS
 High pressure... 19,25
 Low pressure 41

High pressure fittings

POLYMERIC

Our high pressure fittings are rated up to 350 bar (5000 psi) with fingertight nuts, well beyond the burst strength of most PEEK tubing. These fittings are manufactured from high quality inert polymers to exacting tolerances.

High pressure polymeric fittings index

One-piece fittings

PEEK hex-head	
Over 5,000 psi	NEW ... page 19
5,000 psi	19
PEEK fingertight	
Color-coded	20
Natural	20
PPS hex-head	19
PEEK no-twist one piece fittings	21

Nuts and ferrules

PEEK ferrules, over 5,000 psi	NEW ... 22
Single ferrule connections	22
Double ferrule connections	23
1/4-28 connections	25

Plugs and caps

PEEK plugs	24
PEEK caps	24

PEEK unions

Unions	26
Bulkhead unions	26
Reducing unions	27

PEEK tees and crosses

Standard tees and crosses	28
Biocompatible mixing tee	28

PEEK adapters

PEEK port and Luer adapters	29
-----------------------------	----

DISCLAIMER

The maximum holding pressure for any type of connections involving tubing and a ferrule varies considerably with the tubing material, the ferrule material, the clearance between tubing OD and ferrule ID, and the shape of the fitting detail.

RELATED PRODUCTS

ChromBox kit	91
HPLC parts kit with PEEK and stainless fittings and tubing	
Fingertight adapters	
Color-It	17
Color-Sleeve	17
Nanovolume® high pressure fittings	36-39
PEEK starter kits	90
Tools for fittings	88-89





PEEK one-piece hex-head fittings

NEW

UHPLC

- Made of special PEEK™ HT for better pressure resistance
- One-piece – no ferrule required
- Biocompatible
- Handy tightening tool included

These fittings are machined from special PEEK material to reach a higher pressure rating than standard PEEK fittings.

Sold in packages of 10.

Includes a tightening tool (*page 89*) for easy installation.

Tubing ID	Thread	Product No.
1/32"	6-40	JR-5525-10
1/16"	10-32	JR-5520-10

SPECS

- Material: PEEK, special black
- Threads: 1/32" 6-40, 1/16" 10-32
- Pressure ratings, fingertight, on SS tubing: 1/32" 625 bar (9,000 psi), 1/16" 700 bar (10,000 psi)



PEEK one-piece hex-head fittings

10-32

- Fingertight up to 350 bar (5000 psi)
- Excellent chemical and mechanical properties
- One-piece – no ferrule required
- Biocompatible
- For any 10-32 high pressure fitting

PEEK one-piece hex-head fittings are easy to use with the ValvTool or with the Color-It color-coded fingertight adapters. The 10-32 thread will fit virtually all standard high pressure female connections, and will withstand pressures of up to 350 bar (5000 psi). Available in short and long versions.

Sold in packages of 5.

Description	Product No.
Short	JR-55100-5
Long	JR-55110-5

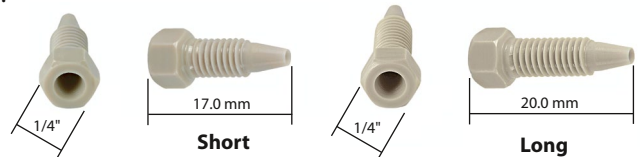

SPECS

- For 1/16" OD tubing
- Material: PEEK
- 10-32 threads
- Tolerance: ±0.05 mm (.002")
- Pressure rating: <350 bar (5000 psi) (Varies with tubing material and ID)

TECH TIP

Coloration pigments are carefully chosen so as to contain no heavy metals or hazardous chemicals.

MORE INFORMATION

About PEEK 99
 About PPS..... 99
 Chemical resistance 96-98

RELATED PRODUCTS

1/16" OD tubing for high pressure applications 5-8
 PEEK starter kit 90
 Color-Sleeve adapters . 17



1/32" and 1/16" tightening tools for PEEK fittings. 89



PPS one-piece hex-head fittings

10-32

- Economically-priced alternative to PEEK
- Excellent chemical and mechanical properties
- One-piece – no ferrule required
- Slim design – finger-tight with Color-Sleeve adapter

The VICI Jour PPS one-piece hex-head (fingertight with adapter) fitting offers excellent chemical and pressure resistance.

Sold in packages of 5.

Product No.
JR-58000-5

Shown with Color-Sleeve adapter, sold separately

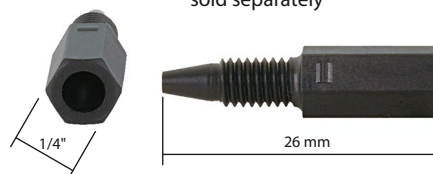

SPECS

- For 1/16" OD tubing
- Material: Black PPS (Polyphenylene sulfide)
- 10-32 threads
- Tolerance: ±0.05 mm (.002")
- Pressure rating: <350 bar (5000 psi) (Varies with tubing material and ID)

PEEK one-piece fingertight fittings – color-coded

10-32

SPECS

- For 1/16" OD tubing
- Material: PEEK
- 10-32 threads
- Tolerance: ±0.05 mm (.002")
- Pressure rating: <350 bar (5000 psi) (Varies with tubing material and ID)

- Fingertight up to 350 bar (5000 psi)
- Excellent chemical and mechanical properties
- One-piece – no ferrule required
- Biocompatible

Our PEEK fingertight fittings are available in six colors, for easy identification of tubing lines. They are rated to 350 bar (5000 psi) and can be used in virtually any type of 10-32 thread HPLC fitting detail on the market.

Sold in packages of 5.

Color	Product No.
Natural	JR-55020-5
Black	JR-55021-5
Red	JR-55022-5
Yellow	JR-55023-5
Blue	JR-55024-5
Green	JR-55025-5

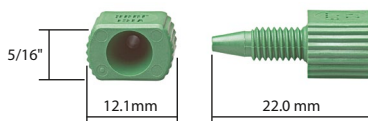

PEEK one-piece fingertight fittings

10-32

SPECS

- For 1/16" OD tubing
- Material: PEEK
- 10-32 threads
- Tolerance: ±0.05 mm (.002")
- Pressure rating: <350 bar (5000 psi) (Varies with tubing material and ID)

- Natural PEEK versions fingertight up to 350 bar (5000 psi)
- One-piece – no ferrule required
- Biocompatible
- Four styles, machined for extra precision

Sold in packages of 5.

Description	Product No.
Standard	JR-5502-5
Short	JR-5504-5
Long	JR-5507-5
Narrow hex-head/fingertight	JR-5508-5

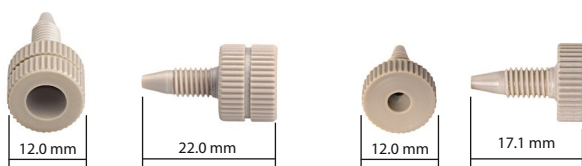

Standard

Short

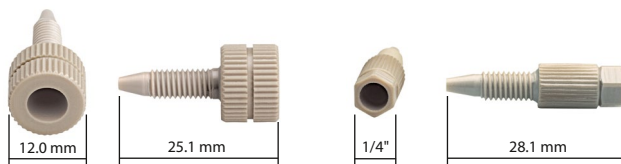

Long

Narrow hex-head/fingertight

TECH TIP

Coloration pigments are carefully chosen so as to contain no heavy metals or hazardous chemicals.

MORE INFORMATION

- About PEEK 99
- About CTFE 99
- Chemical resistance 96-98

PEEK no-twist "one-piece" fittings

10-32

- Snap-in ferrule rotates freely
- Choice of ferrule materials
- Choice of fitting lengths

No-twist fittings offer the convenience of a one-piece fitting while solving a problem inherent to such designs. In other one-piece designs, the ferrule rotates against the fitting detail, creating particulates. The no twist design has a separate ferrule that snaps into the nut, so it's attached but still free to avoid rotation during tightening.



Since the ferrule is not machined onto the nut, it can be made from a different material. We offer several PEEK nuts, with ferrules of PEEK, CTFE, or glass-filled PEEK.

Sold in packages of 5.

Ferrule material:	PEEK	Glass-filled PEEK	CTFE
<i>Description</i>	<i>Product No.</i>	<i>Product No.</i>	<i>Product No.</i>
Fingertight	JR-ZNF1FPK-5	JR-ZNF1FPKG-5	JR-ZNF1FKF-5
Hex, short	JR-ZNF1PK-5	JR-ZNF1PKG-5	JR-ZNF1KF-5
Hex, medium	JR-MZNF1PK-5	JR-MZNF1PKG-5	JR-MZNF1KF-5
Hex, long	JR-LZNF1PK-5	JR-LZNF1PKG-5	JR-LZNF1KF-5
Replacement ferrules	JR-ZNF1PK-F-5	JR-ZNF1PKG-F-5	JR-ZNF1KF-F-5

SPECS

- For 1/16" OD tubing
- Materials:
Nut: PEEK
Ferrule: PEEK, glass-filled PEEK, or CTFE
- 10-32 threads
- Pressure rating:
<350 bar (5000 psi)
(Varies with tubing material and ID)

OPTIONS

- Optional ferrule materials available: FEP, PFA, PTFE, and glass-filled PTFE. Contact us for availability.
- Some 1/32" versions are available. Call for details.

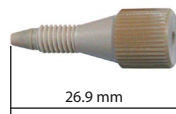

Fingertight

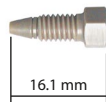

Hex, short

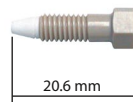

Hex, medium



Hex, long

RELATED PRODUCTS

- 1/16" OD tubing for high pressure applications 5-8
- PEEK starter kit 90
- ValvTool for tightening hex-head fittings 88
- Color-It fingertight adapters. 17



HIGH PRESSURE FITTINGS - POLYMERIC

PEEK ferrules

NEW

UHPLC

SPECS

- For 1/16" OD tubing
- Material: PEEK, special black
- Pressure rating on SS tubing and with SS nut: (preliminary) 1170 bar (17,000 psi)

- Biocompatible 1/16" ferrule for ultra-high pressures
- Alternative to titanium ferrules in applications with titanium valves
- Excellent in combination with stainless nuts

Sold in packages of 5.

Product No.
JR-5010-5



PEEK nuts with single ferrules

10-32

SPECS



- Material: PEEK
- Pressure rating: <280 bar (4000 psi) (Varies with tubing material and ID)

- Reuseable nut, replaceable ferrule
- For 1/32", 1/16", and 1/8" tubing
- Suitable for pressures to 280 bar (4000 psi)

Fingertight nuts have a knurled surface designed to allow sufficient sealing force to be applied to the ferrule without wrenches. Hex style nuts allow wrench tightening; however, since they are polymeric, they can break, and are recommended for use only when space is limited and fingers will not fit.

Sold in packages of 5.



	Tubing OD	Description	Thread	Product No.
Nuts	1/32"	Fingertight	6-40	JR-ZN.5FPK-5
	1/16"	Fingertight	10-32	JR-5570-5
	1/8"	Hex-head	5/16-24	JR-ZN2PK-5
Single ferrules	1/32"			JR-ZF.5PK-5
	1/16"			JR-5003-5
	1/8"			JR-ZF2PK-5

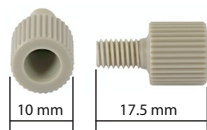

1/16" fingertight

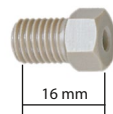

1/8" hex-head

MORE INFORMATION

About PEEK 99
Chemical resistance 96-98

RELATED PRODUCTS

1/16" OD tubing for high pressure applications 5-8
PEEK starter kit 90
PEEK tubing 5-8
Stainless steel nuts 31
ValvTool for tightening hex-head fittings 88
Color-It fingertight adapters. 17

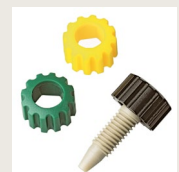

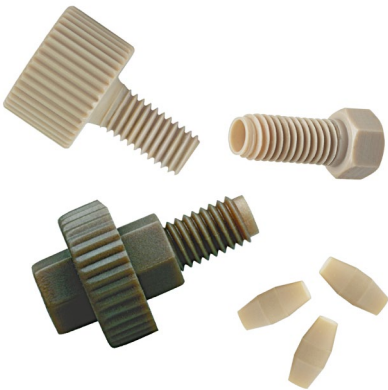

PEEK nuts with double ferrules

10-32

- High pressure rating - up to 420 bar (6000 psi)
- Ideal for 1/16" PEEK tubing
- Fit any 10-32 fitting

These nuts are for use with VICI Jour double ferrules, which grip the tubing twice for added stability. The fingertight version may be hand-tightened for operation at up to 420 bar (6000 psi). The hex-head version can be used for connections that are difficult to reach, or are closely spaced. The fittings work in virtually any female 1/16" fitting.

SPECS

- For 1/16" OD tubing
- Material: PEEK
- 10-32 threads
- Pressure rating: <420 bar (6000 psi) (Varies with tubing material and ID)

Sold in packages of 5.

Description		Product No.
1/16" nuts	Hex-head, short	JR-5511-5
	Hex-head, long	JR-5510-5
	Fingertight	JR-5580-5
	Universal fingertight*	JR-5503-5*
1/16" ferrule	Double	JR-5004-5

*Limited to existing stock.

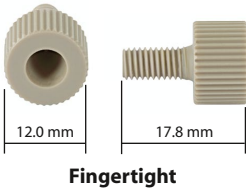
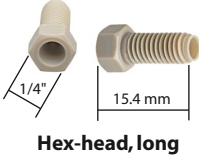
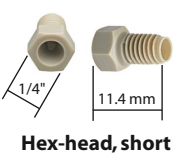

PEEK plugs and caps

SPECS

- Material: PEEK
- Pressure rating: <350 bar (5000 psi) (Varies with tubing material and ID)

- For plugging ports and capping solvent lines
- Available in all common thread sizes

Sold individually.

	Threads	Product No.	
Plugs	6-40	JR-ZP5FPK	
	10-32	fingertight	JR-408
		hex	JR-ZP1FPK
		long hex	JR-MZP1PK
	1/4-28	JR-409	
	M6	JR-410	
Caps	6-40	JR-ZC.5FPK	
	10-32	JR-ZC1PK	
	1/4-28	JR-CCPK-1	

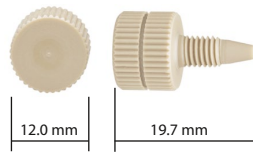
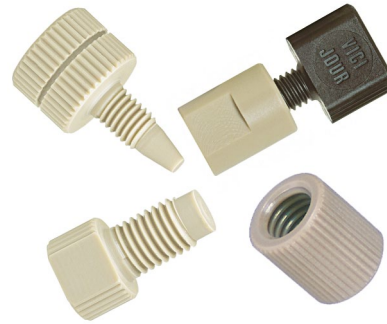

10-32 plug
(JR-408)

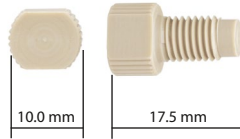

1/4-28 plug

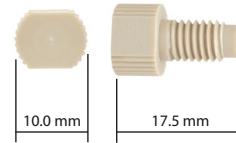

M6 plug

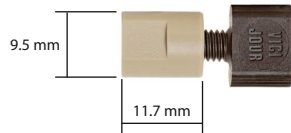

10-32 cap

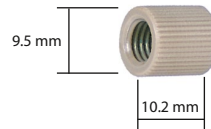

1/4-28 cap

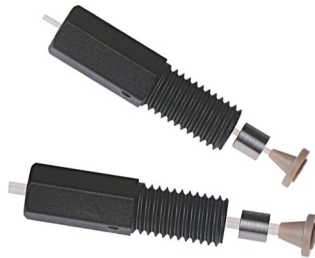

Nut, ferrule, and bushing

1/4-28

- High pressure rating – up to 480 bar (7000 psi) with 1/16" tubing
- For 1/4-28 connections
- Available for 1/32" and 1/16" tubing

This combination of PPS nut, PEEK ferrule, and stainless steel bushing allows a high pressure connection in a 1/4-28 flat-bottomed fitting detail.

Sold in packages of 10.

Order nuts and bushing/ferrules separately.

Description	Tubing OD	Product No.
PPS hex-head nut	1/32" or 1/16"	JR-55050-10

SPECS

- For 1/32" and 1/16" OD tubing
 - Materials
Nut: PPS
Ferrule: PEEK
Bushing: SS
 - 1/4-28 connection
 - Pressure rating
- | OD | bar | psi |
|-------|-----|------|
| 1/32" | 175 | 2500 |
| 1/16" | 480 | 7000 |
- (Varies with tubing material and ID)



Bushing and ferrule	1/32"		JR-FPKBSS.5-10
	1/16"		JR-FPKBSS1-10

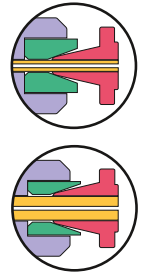

**LOW PRESSURE
1/4-28 NUTS AND
FERRULES**

1/4-28 PPS hex-head nuts are available with three different sealing designs for flangeless and flanged fittings 41

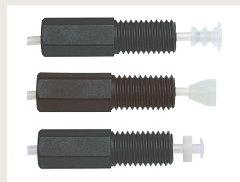

TECH TIP

To make up high pressure connection with nut, ferrule, and bushing, first slide the nut on the tubing, then the bushing, and then the PEEK ferrule as shown in the product photo.

PEEK unions

10-32

SPECS

- For 1/16" OD tubing
- Material: PEEK
- 10-32 threads
- Pressure rating: <350 bar (5000 psi) (Varies with tubing material and ID)

- Easy connection of transfer/solvent lines
- Low dead volume
- Completely inert and biocompatible

VICI Jour PEEK unions are usable with most common organic and inorganic HPLC solvents without risking corrosion, metal contamination, or protein degradation that might occur with stainless steel.

Small diameter bores are used to ensure low dead volume connections. These unions have the standardized Valco fitting details with smooth transition of the taper into the threaded part. Connections to these PEEK unions can be made with any 10-32 fitting that uses polymeric ferrules.

PEEK unions are available in body-only versions as well as complete with our PEEK one-piece fingertight fittings ready to connect to any 1/16" OD tubing.

	Bore (mm)	Qty/pkg	Product No.
Union	0.25	1	JR-1061
with fittings	0.50	1	JR-1066
	0.75	1	JR-1067
Body only	0.25	1	JR-061
	0.50	1	JR-066
	0.75	1	JR-067
Replacement fittings		Qty/pkg	Product No.
PEEK 1/16" one-piece fingertight fittings, 10-32, black		5	JR-55021-5

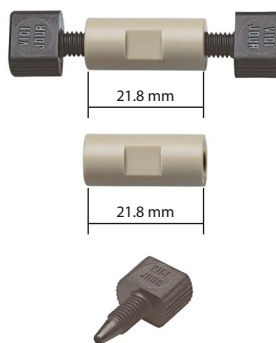

PEEK bulkhead unions

10-32

SPECS

- For 1/16" OD tubing
- Material: PEEK
- 10-32 threads
- Pressure rating: <350 bar (5000 psi) (Varies with tubing material and ID)

- Designed for panel mounting
- Easy connection of transfer/solvent lines
- Low dead volume
- Completely inert and biocompatible

Bulkhead unions are designed to be mounted through an instrument panel or on a bracket. Typically the mounting nut goes inside the instrument, so that the long threaded portion will be out of sight.

Bulkhead unions require a minimum 10 mm panel hole, 9 mm maximum thickness.

Includes fittings.

	Bore (mm)	Qty/pkg	Product No.
	0.25	1	JR-ZBU1CFPK
	0.50	1	JR-ZBU1MFPK
	0.75	1	JR-ZBU1FPK
Replacement fittings		Qty/pkg	Product No.
PEEK 1/16" one-piece fingertight fittings, 10-32, black		5	JR-55021-5
JAM-Nut replacement mounting nut for bulkhead fittings		1	JR-CBN

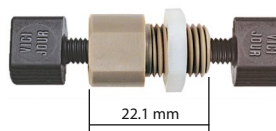

RELATED PRODUCTS

Low pressure PEEK
1/4-28 unions. 44
PEEK one-piece
fingertight fittings 19-21

PEEK reducing unions

- Connects 1/16" to 1/32" tubing, or 1/8" to 1/16" tubing
- Easy connection of transfer/solvent lines
- Completely inert and biocompatible

VICI Jour PEEK reducing unions are usable with most common organic and inorganic HPLC solvents without risking corrosion, metal contamination, or protein degradation that might occur with stainless steel. These reducing unions have the standardized Valco fitting details with smooth transition of the taper into the threaded part.

Includes fittings.

SPECS

- Material: PEEK
- Threads: 1/32": 6-40
1/16": 10-32
1/8": 5/16-24
- Pressure rating: <350 bar (5000 psi) (Varies with tubing material and ID)

Tubing OD	Bore (mm)	Qty/pkg	Product No.
1/16" to 1/32"	0.25	1	JR-ZRU1.5FPK
1/8" to 1/16"	0.75	1	JR-ZRU21FPK

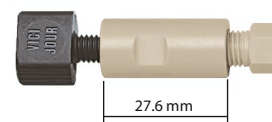

PEEK replacement fittings

For 1/16" to 1/32" reducing unions

	Qty/pkg	Product No.
1/16" One-piece fitting, black	5	JR-55021-5
1/32" Fingertight nut	1	JR-ZN.5FPK
1/32" Ferrule	1	JR-ZF.5PK

For 1/8" to 1/16" reducing unions

	Qty/pkg	Product No.
1/8" Hex-head PEEK nut	5	JR-ZN2PK-5
1/8" PEEK ferrule	5	JR-ZF2PK-5
1/16" One-piece fitting, black	5	JR-55021-5

RELATED PRODUCTS

Low pressure PEEK
1/4-28 reducing
unions 45

PEEK tees and crosses

10-32

SPECS

- For 1/16" OD tubing
- Material: PEEK
- 10-32 threads
- Body size: 25.0 mm OD, 12.0 mm thick
- Pressure rating: <350 bar (5000 psi) *(Varies with tubing material and ID)*

- Easy connection of transfer/solvent lines
- Low dead volume
- Completely inert and biocompatible

The 100% PEEK flowpath makes VICI Jour PEEK tees and crosses usable with most common organic and inorganic HPLC solvents without risking corrosion, metal contamination, or protein degradation that might occur with stainless steel.

Small diameter through-holes are used to ensure low dead volume connections. These unions have the standardized Valco fitting details with smooth transition of the taper into the threaded part. Connections to these PEEK tees and crosses can be made with any 10-32 fitting that uses polymeric ferrules.

PEEK tees and crosses are available in body-only versions as well as complete with our PEEK one-piece fingertight fittings ready to connect to any 1/16" OD tubing.

	Bore (mm)	Qty/pkg	With fittings Product No.	Body only Product No.
Tee	0.25	1	JR-1030	JR-2030
	0.50	1	JR-1032	JR-2032
	0.75	1	JR-1033	JR-2033
Cross	0.25	1	JR-1040	JR-2040
	0.50	1	JR-1042	JR-2042
	0.75	1	JR-1043	JR-2043
Replacement fittings		Qty/pkg	Product No.	
PEEK 1/16" one-piece fingertight fittings, 10-32, black		5	JR-55021-5	



Biocompatible mixing tee

10-32

SPECS

- For 1/16" OD tubing
- Material: PEEK
- 10-32 threads
- Pressure rating: <350 bar (5000 psi) *(Varies with tubing material and ID)*

- High pressure gradient mixing
- Post column reactions
- Completely biocompatible
- Built-in protein-friendly titanium filter, 10 µm

A unique, more thorough mixing results from the turbulence generated by the introduction angle of the solvents as well as by the flow through our titanium filter element. The biocompatible tee can be used for high pressure gradient mixing as well as for post column reactions.



Mixing tee with fittings

Product No.
JR-9000-0670

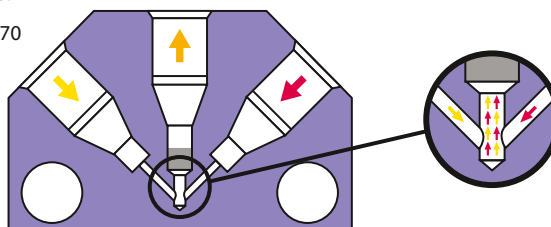

The two solvent streams are well-mixed in the vortex mixing chamber

TECH TIP

Use our color-coded one-piece fingertight fittings for easy solvent line identification. 20



MORE INFORMATION

About PEEK 99
Chemical resistance 96-98

RELATED PRODUCTS

Low pressure 1/4-28 tees and crosses 46
Low pressure 1/4-28 mixing tees 47

PEEK adapters

- Connect various combinations of thread types, male and female
- Includes male and female Luer adapters
- Low dead volume
- For any 10-32 high pressure fitting

We offer male and female Luer adapters as well as adapters to connect standard LC fittings to standard LC ports.

The 100% PEEK flowpath makes VICI Jour PEEK adapters usable with most common organic and inorganic HPLC solvents without risking corrosion, metal contamination, or protein degradation that might occur with stainless steel.

Sold individually.

SPECS

- Material: PEEK
 - Bore: 0.40 mm
 - Pressure ratings:
 - M6, 1/4-28 <70 bar (1000 psi)
 - Luer <35 bar (502 psi)
- (Varies with tubing material and ID)*

Description		Product No.
1/4-28 female to	10-32 male	JR-0612
	10-32 female	JR-062
	M6 male	JR-0622
	Luer female	JR-0625
	Luer male	JR-0626
10-32 female to	1/4-28 male	JR-0617
	M6 female (Pharmacia*)	JR-5595
	Luer female	JR-0623
Waters female to	10-32 male	JR-0611
M6 female to	10-32 male	JR-5505
Female Luer to	1/4-28	JR-CFLAPK
	10-32	JR-ZUFLPK
Male Luer to	1/4-28	JR-CMLAPK

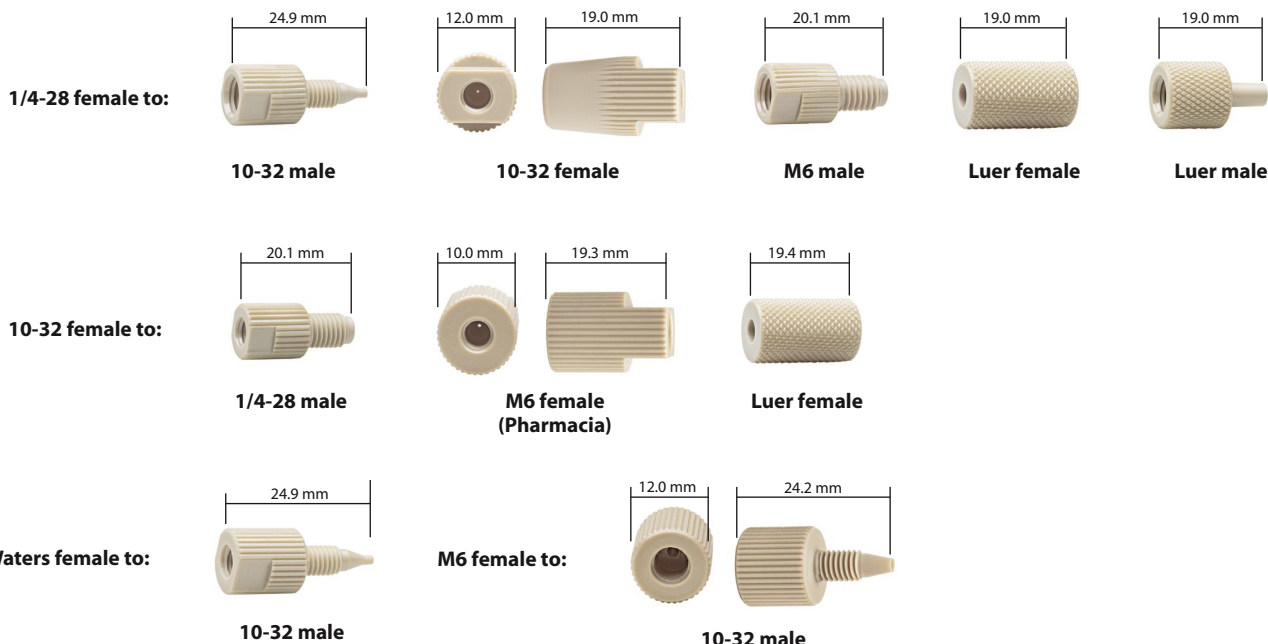

* Pharmacia is a division of GE Healthcare.

High pressure fittings

STAINLESS STEEL

Our stainless steel fittings are typically compression fittings, in which a ferrule is compressed onto the tube as a nut is tightened. They offer the best reliability in high pressure situations.

High pressure stainless fittings index

Nuts

Valco nuts page 31

Valco nuts are available for 1/32", 1/16", and 1/8" tubing, in several lengths.

Rheodyne® compatible nuts31

These nuts are sized for 1/16" tubing, and come in three lengths.

Ferrules

Valco32

Rheodyne compatible.....32

Plugs and caps32

Tees and crosses

Tees33

Crosses33

Unions and reducing unions

Unions.....34

Reducing unions

Imperial34

Imperial to metric **NEW**35

DISCLAIMER

The maximum holding pressure for any type of connections involving tubing and a ferrule varies considerably with the tubing material, the ferrule material, the clearance between tubing OD and ferrule ID, and the shape of the fitting detail.

MORE INFORMATION

ChromBox kit..... 91
HPLC parts kit with PEEK and stainless fittings and tubing
Fingertight adapters
Color-It 17
Color-Sleeve..... 17
Nanovolume® high pressure fittings...36-39
Stainless starter kits ... 90
Tools for fittings ... 88-89





Valco® stainless nuts

UHPLC

- Excellent fit to Valco fitting details
- Different lengths available
- For 1/32", 1/16", and 1/8" OD tubing

These nuts are for use with all standard Valco internal fittings and most valves. They may be used with fittings from other manufacturers as well. The medium and long types are ideal for metal Valco and Cheminert valves with more than 8 ports, or where the fitting head may be otherwise inaccessible.

Sold in packages of 5.

Tubing OD	Length	Product No.
1/32"	Standard	JR-ZN.5-5
1/16"	Standard	JR-ZN1-5
	Medium	JR-MZN1-5
	Long	JR-LZN1-5
1/8"	Standard	JR-ZN2-5

SPECS

- For 1/32", 1/16", and 1/8" OD tubing
- Material: Type 303 SS
- Threads: 1/32": 6-40
1/16": 10-32
1/8": 5/16-24
- Pressure rating with premium SS tubing and ZF1S6 ferrule: 1375 bar (20,000 psi)

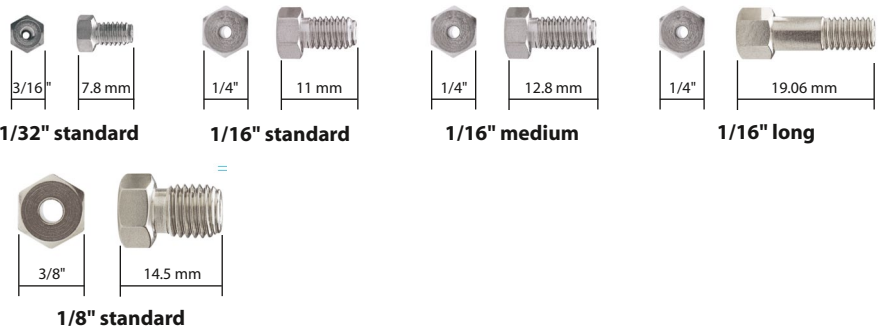

TECH TIP

Using nuts with different lengths will create more space, for better wrench access.

MORE INFORMATION

About stainless steel... 100

RELATED PRODUCTS

- Ferrules
- Rheodyne 32
- Valco 32
- Stainless steel starter kit 90
- Stainless tubing 14-15
- ValvTool for tightening hex-head fittings 88
- Color-It fingertight adapters 17



Rheodyne® compatible stainless nuts

- Excellent fit to Rheodyne fitting details
- Different lengths available
- For 1/16" OD tubing

These nuts are for use with metal Rheodyne valves. Three different length nuts are available, in order to accommodate any possible connecting situation. The standard nut is suitable for easily accessible connections (couplers, detectors, columns, etc.) For very tight and difficult to reach areas, we recommend the long and extra long nut.



Sold in packages of 5.

Tubing OD	Length	Product No.
1/16"	Short	JR-56-5
	Long head	JR-57-5
	Extra long	JR-58-5

SPECS

- For 1/16" OD tubing
- Material: Type 316 SS
- Threads: 10-32
- Pressure rating: <500 bar (7,250 psi) (Varies with tubing material and ID)

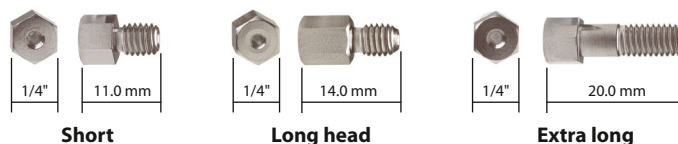

Valco® stainless ferrules

UHPLC

SPECS

- For 1/32", 1/16", and 1/8" OD tubing
- Material: Type 316 SS
- Pressure rating: 1375 bar (20,000 psi) (Varies with tubing material and ID)

- Excellent fit to Valco fitting details
- For 1/32", 1/16", and 1/8" OD tubing

These ferrules are for use with all standard Valco internal fittings and most valves, and with those of most other manufacturers as well. Valco metal ferrules cut a ring near the end of the tube, preventing tube release at high pressures without significantly deforming and restricting the tube interior. (However, if the hardness of the tubing is equal to or greater than that of the ferrule, deformation of the tube rather than a cut ring is likely.)

Sold in packages of 5.

Size		Product No.
1/32"		JR-ZF.5S6-5
1/16"		JR-ZF1S6-5
1/8"		JR-ZF2S6-5

Rheodyne® compatible stainless ferrules



SPECS

- For 1/16" OD tubing
- Material: Type 316 SS
- Pressure rating: <500 bar (7,250 psi) (Varies with tubing material and ID)

- Excellent fit to Rheodyne fitting details
- For 1/16" OD tubing

These ferrules are for use with metal Rheodyne valves.

Sold in packages of 5.

Description		Product No.
Standard ferrule		JR-59-5
2-step Rheodyne-type ferrule		JR-60-5

Stainless steel plugs

UHPLC

SPECS

- For 1/16", and 1/8" OD tubing
- Material: 1/16": SS 316, 1/8": SS 313
- Threads: 1/16": 10-32, 1/8": 5/16-24

Use a plug to close off an unused port in a valve, manifold, or HPLC column. The standard stainless plug consists of a zero volume nut with a ferrule made up on a piece of solid rod.

Sold individually.

Tubing OD	Product No.
1/32"	JR-ZP.5
1/16"	JR-ZP1
1/8"	JR-ZP2

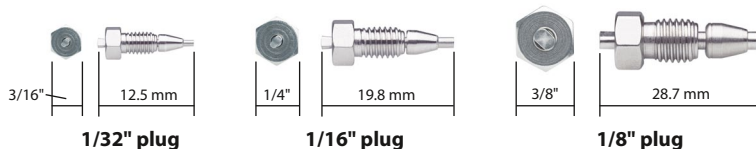

Stainless steel caps

UHPLC

SPECS

- For 1/16", and 1/8" OD tubing
- Material: Type 303 SS
- Threads: 1/16": 10-32, 1/8": 5/16-24

Use a cap to close off a tube with a ferrule and internal nut already made up. A cap is essentially a piece of hex stock with a zero volume fitting detail machined into it, but with no through-hole.

Sold individually.

Tubing OD	Product No.
1/32"	JR-ZC.5
1/16"	JR-ZC1
1/8"	JR-ZC2

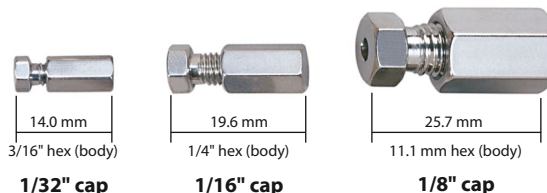

RELATED PRODUCTS
UHPLC PEEK ferrules . . . 22

HIGH PRESSURE FITTINGS - STAINLESS STEEL

- Easy connection of solvent lines
- Low dead volume
- For 1/16" OD tubing

VICI stainless steel tees and crosses are for joining solvent lines. They are precision machined with a focus on the concentricity of the bore as well as on the finish of the surfaces to give an absolute leak-free connection.

These tees and crosses have internal threads, which we recommend for most applications. Internal threads make stronger connections and internal fitting details provide the lowest dead volume for high performance instrumentation.



Stainless tees

UHPLC

VICI stainless steel tees join three solvent lines.

Three nuts and ferrules ship with each tee.

Description	Bore (mm)	Qty/pkg	Product No.
1/16" tee	0.25	1	JR-ZT1C
	0.50	1	JR-ZT1M
	0.75	1	JR-ZT1
Replacement nut		5	JR-ZN1-5
Replacement ferrule		5	JR-ZF1S6-5

SPECS

- For 1/16" OD tubing
- Material:
Body Type 316 SS
Nuts Type 303 SS
Ferrules 316 SS
- Pressure rating:
1375 bar
(20,000 psi)
(Varies with tubing material and ID)



Stainless crosses

UHPLC

VICI stainless steel crosses join four solvent lines.

Four nuts and ferrules ship with each tee.

Description	Bore (mm)	Qty/pkg	Product No.
1/16" cross	0.25	1	JR-ZX1C
	0.50	1	JR-ZX1M
	0.75	1	JR-ZX1
Replacement nut		5	JR-ZN1-5
Replacement ferrule		5	JR-ZF1S6-5

SPECS

- For 1/16" OD tubing
- Material:
Body Type 316 SS
Nuts Type 303 SS
Ferrules 316 SS
- Pressure rating:
1375 bar
(20,000 psi)
(Varies with tubing material and ID)

MORE INFORMATION

About stainless steel... 100

RELATED PRODUCTS

Open end wrench 89

Stainless steel starter kit..... 90

ValvTool for tightening hex-head fittings 88

- Easy connection of solvent lines
- Low dead volume

VICI stainless steel unions and reducing unions are precision machined with a focus on the concentricity of the bore as well as on the finish of the surfaces to give an absolute leak-free connection.

These unions have internal threads, which we recommend for most applications. Internal threads make stronger connections and internal fitting details provide the lowest dead volume for high performance instrumentation.

Stainless unions

UHPLC

SPECS

- For 1/16" OD tubing
- Material:
Body Type 316 SS
Nuts Type 303 SS
Ferrules 316 SS
- Pressure rating:
1375 bar (20,000 psi)
(Varies with tubing material and ID)

- Choice of four bores
- For 1/16" OD tubing

VICI stainless steel unions join two pieces of 1/16" OD metal tubing.

Two nuts and ferrules ship with each union.

Description	Bore (mm)	Qty/pkg	Product No.
1/16" union	0.15	1	JR-ZU1XCS6
	0.25	1	JR-ZU1CS6
	0.50	1	JR-ZU1MS6
	0.75	1	JR-ZU1S6
Replacement nut		5	JR-ZN1-5
Replacement ferrule		5	JR-ZF1S6-5

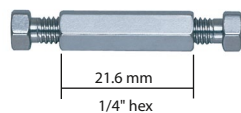
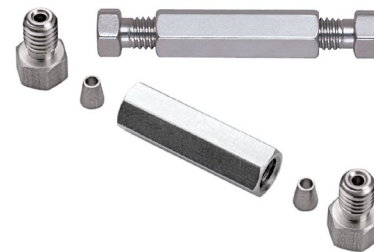

Stainless reducing unions

Imperial

UHPLC

SPECS

- For joining 1/8" to 1/16" OD tubing
- Material:
Body Type 316 SS
Nuts Type 303 SS
Ferrules 316 SS
- Pressure rating:
1375 bar (20,000 psi)
(Varies with tubing material and ID)

These reducing unions join 1/16" OD to 1/8" OD tubing.

Two nuts and ferrules ship with each union.

Description	Size	Qty/pkg	Product No.
Reducing union	1/8" to 1/16"	1	JR-ZRU21
Replacement nut	1/8"	5	JR-ZN2-5
	1/16"	5	JR-ZN1-5
Replacement ferrule	1/8"	5	JR-ZF2S6-5
	1/16"	5	JR-ZF1S6-5

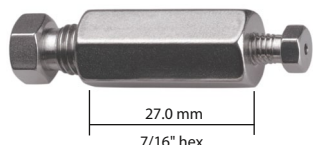

RELATED PRODUCTS
 Nanovolume® high pressure fittings . . . 36-39
 Stainless starter kit . . . 90
 HPLC parts kit with stainless fittings and tubing
 ChromBox kit 91
 HPLC parts kit with PEEK and stainless fittings and tubing



Stainless reducing unions *NEW* Imperial to metric *UHPLC*

- Ultra-high pressure
- For 1 mm, 2 mm, and 3 mm OD tubing

With these new reducing unions, metric tubing can be connected to imperial fittings, valves, and chromatographic systems. The unions are manufactured from Type 303 stainless steel.

For easy identification, the metric end is marked by a groove.

Two nuts and ferrules ship with each reducing union.

SPECS

- Material:
 - Body Type 303 SS
 - Nuts Type 303 SS
 - Ferrules 316 SS
- Tube reducing OD
 - 1/32" to 1.0 mm
 - 1/16" to 2.0 mm
 - 1/8" to 3.0 mm
- Pressure rating:
 - 1375 bar (20,000 psi)
 - (Varies with tubing material and ID)

Description	Bore (mm)	Threads	Qty/pkg	Product No.
Reducing union				
1/32" to 1.0 mm	0.25	6-40 to 10-32	1	JR-096
1/16" to 2.0 mm	0.75	10-32	1	JR-082
1/8" to 3.0 mm	0.75	5/16-24	1	JR-086

Description	Size	Threads	Qty/pkg	Product No.
Replacement nut				
	1/32"	6-40	5	JR-ZN.5-5
	1/16"	10-32	5	JR-ZN1-5
	1/8"	5/16-24	5	JR-ZN2-5
	for 1.0 mm	10-32	5	JR-ZN1-5
	for 2.0 mm	10-32	5	JR-80-5
	for 3.0 mm	5/16-24	5	JR-ZN2-5
Replacement ferrule				
	1/32"		5	JR-ZF.5S6-5
	1/16"		5	JR-ZF1S6-5
	1/8"		5	JR-ZF2S6-5
	1.0 mm	<i>NEW</i>	5	JR-097-5
	2.0 mm	<i>NEW</i>	5	JR-083-5
	3.0 mm	<i>NEW</i>	5	JR-087-5

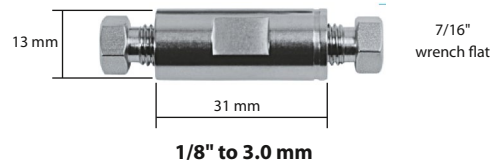
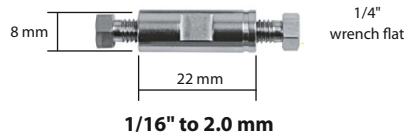

Metric ferrules

WRENCH SIZE FOR BODY FLAT

Wrench size	Reducing union	P/N
1/4"	1/32" to 1.0 mm	JR-096
1/4"	1/16" to 2.0 mm	JR-082
7/16"	1/8" to 3.0 mm	JR-086

High pressure fittings

NANOVOLUME® FITTINGS • FOR 360 MICRON AND 1/32" TUBING

VICI Nanovolume® fittings generally have bore sizes of 100-150 µm (.004" - .006"), with some as small as 50 µm (.002"). The minimal transfer volume contributed by Nanovolume® components makes them especially beneficial in applications with flow rates in the µl/min range, when the transfer volume can be critical.

High pressure Nanovolume® fittings index

1/32" Nanovolume® Fittings

Nuts, ferrules, unions, reducing unions37
1/32" fittings, with 100 µm or 150 µm bore, are ideal for high resolution capillary chromatography. Rated at 5,000 psi with fingertight nuts, they will remain leak-tight well beyond the burst strength of most PEEK tubing. These fittings are machined from high quality inert polymers to the same exacting tolerances as our popular Valco zero dead volume fittings, and the taper angle and detail design conform to the industry standard established by the Valco line.

360 Micron Nanovolume® Fittings

For PEEK or FS tubing, <10K psi38
For fused silica tubing, 10K psi39
For metal tubing, <20K psi39
Our newest high pressure fittings permit direct connection of 360 micron OD fused silica, PEEK, stainless, or electroformed nickel tubing without the use of liners. The ferrule snaps into the nut so that the fitting is "one-piece," but the ferrule remains free to rotate as the nut is tightened so that the tube doesn't twist. Because of the compact size and fine 2-56 threads, a leak-free connection that seals at pressures in excess of 20,000 psi can be easily formed with the available manual tool.

DISCLAIMER

The maximum holding pressure for any type of connections involving tubing and a ferrule varies considerably with the tubing material, the ferrule material, the clearance between tubing OD and ferrule ID, and the shape of the fitting detail.

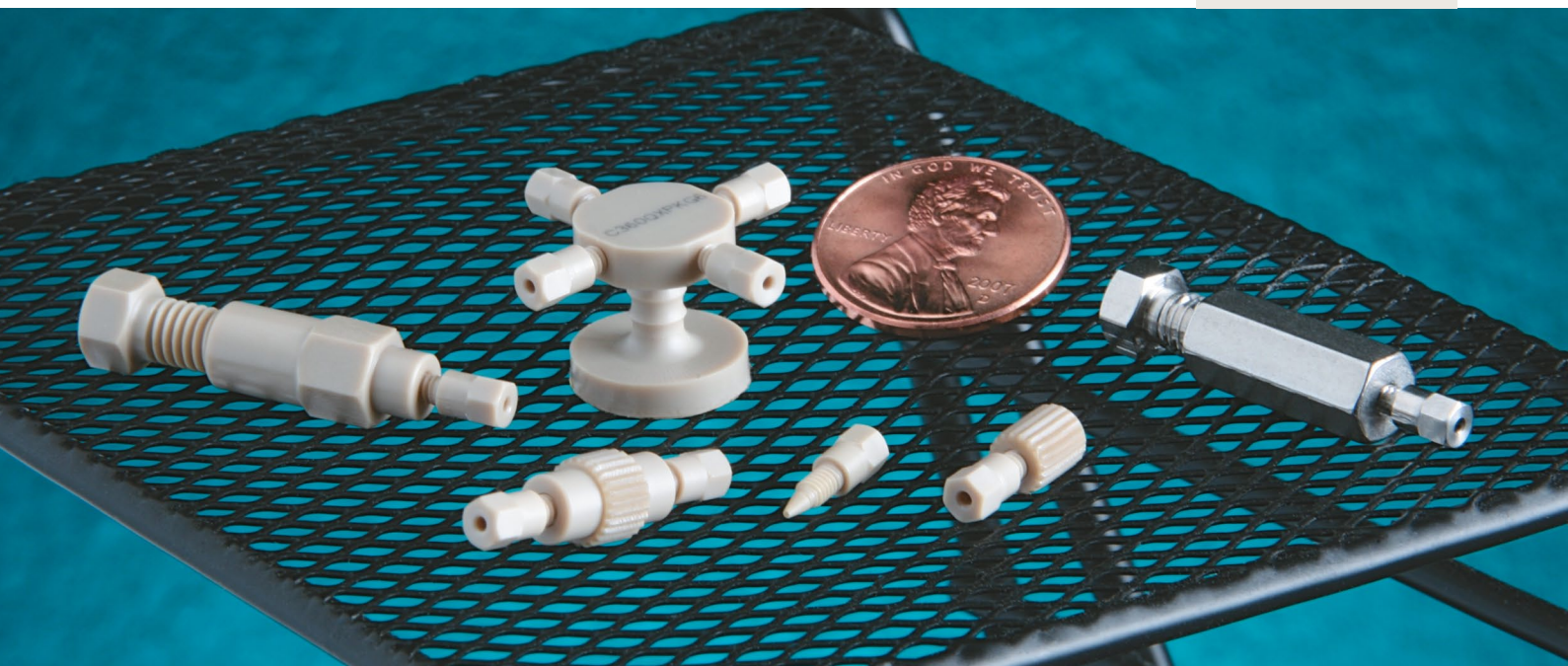

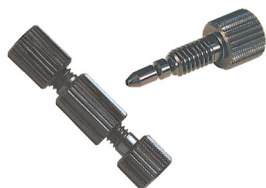

- 100 and 150 µm bores available
- Nuts, ferrules, and unions
- For PEEK tubing

VICI Nanovolume® fittings are designed for capillary LC, used in HTS techniques, proteomics, genomics, and other newer developments in industrial research requiring small sample size for reduction of analysis time.

VICI Nanovolume connectors include our one-piece fingertight fittings for 1/32" OD tubing, featuring our

patented* collapsible ferrule. PEEK ferrules for use with our external nuts also feature the collapsible, grooved design. To avoid potential confusion, all fittings utilizing the Cheminert collapsible ferrule are made of black PEEK; fittings with a standard Valco ZDV fitting detail are natural PEEK.

VICI Nanovolume fittings are as easy to handle as our standard analytical fittings and unions. The only difference is their size.

*U.S. patent no. 6,575,501.

Nanovolume® fittings

1/32"

The internal nut includes a collapsible ferrule as an integral part of the fitting; the external nut must be used with the separate ferrule listed below.

Description	Tubing OD	Product No.	
One-piece nut/ferrule	1/32"	JR-C-NNFFPK	
External nut	1/32"	JR-C-EN.5FPKB	
	1/16"	JR-EN1FPKB	
Ferrule, collapsible	1/32"	JR-ZGF.5PK	
	1/16"	JR-ZGF1PK	
Bore size:			
	Tubing OD	100 micron Product No.	150 micron Product No.
Union (external to internal)	1/32"	JR-C-NEU.5XFPK	JR-C-NEU.5FPK
Reducing union	1/16" to 1/32"	—	JR-C-NERU1FPK

SPECS

- For 1/32" OD PEEK
- Material: PEEK
- Threads:
Nut/ferrule 6-40
External nut 1/32" 8-36
1/16" 10-32
- Pressure rating:
<350 bar (5,000 psi)
(Varies with tubing material and ID)
- Tolerances:
±0.05mm (.002")

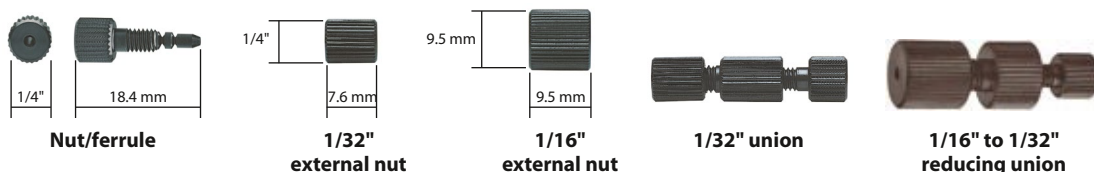

Liners for 1/32" connectors

for use with fused silica tubing

Use these natural PEEK liners to adapt 1/32" connectors to the most common sizes of fused silica tubing. The 27 mm liners are for internal nuts with collapsible ferrules. 10 mm liners are for use with external nuts. Sold in packages of 5.

MORE INFORMATION

360 µm Nanovolume® fittings38-39

CONVERSIONS

- 50 µm = .002"
- 100 µm = .004"
- 150 µm = .006"
- 0.25 mm = .010"
- 0.50 mm = .020"
- 0.75 mm = .030"

27 mm liners

Use with internal nuts JR-C-NNFFPK or JR-C-NNFLFPK

	For tubing OD	Prod No
	125 - 175 µm	JR-C-NL.15L-5
	175 - 225 µm	JR-C-NL.20L-5
	225 - 275 µm	JR-C-NL.25L-5
	275 - 325 µm	JR-C-NL.30L-5
	325 - 375 µm	JR-C-NL.35L-5

10 mm liners

Use with external nut JR-C-EN.5FPKB

	For tubing OD	Prod No
	125 - 175 µm	JR-C-NL.15S-5
	175 - 225 µm	JR-C-NL.20S-5
	225 - 275 µm	JR-C-NL.25S-5
	275 - 325 µm	JR-C-NL.30S-5
	325 - 375 µm	JR-C-NL.35S-5

Nanovolume® fittings - for 360 µm tubing

HIGH PRESSURE FITTINGS - NANO VOLUME®

- For direct connection of 360 µm tubing
- Work with metal, fused silica, or PEEK
- Up to 20,000 psi with metal tubing
- Snap-in rotating ferrule for "one-piece" fitting with no tubing twist
- Eliminate use of troublesome liners

Our high pressure fittings permit direct connection of 360 micron OD fused silica, PEEK, stainless, or electroformed nickel tubing without the use of liners. The ferrule snaps into the nut so that the fitting is "one-piece"; but the ferrule remains free to rotate as the nut is tightened so that the tube doesn't twist. Because of the compact size and fine 2-56 threads, a leak-free connection that seals at pressures in excess of 20,000 psi can be easily formed with the available manual tool.

VICI Nanovolume® 360 µm fittings are dedicated for use with either fused silica, metal, or PEEK tubing; components cannot be mixed or used with a different tubing material.

Tees and crosses offer a choice of three bore sizes, and feature a "quick-mount" base with adhesive backing to make sure that the fitting is stable and fragile tubing doesn't get broken. There is also a quick-mount PEEK union.



For PEEK or fused silica tubing — up to 10,000 psi

360 µm

SPECS

- For PEEK or FS tubing, 360 µm
- Material: PEEK
- Threads: 2-56
- Pressure rating: <689.5 bar (10,000 psi) (Varies with tubing material and ID)

These fittings are constructed from premium grade natural PEEK material. They are intended for use with PEEK or fused silica tubing at pressures up to 10,000 psi, or the maximum pressure for which the tubing is rated, whichever is lower. Quick-mount versions have integral base with double stick tape to secure fittings to a surface.

		Product No.
Nut/ferrule		JR-C360NFPK
Cap		JR-C360CPK
Plug		JR-C360PPK
Tightening tool		JR-C360ET

Bore size:	50 micron	100 micron	150 micron
	Product No.	Product No.	Product No.
Union	JR-C360UPK2	JR-C360UPK4	JR-C360UPK6
Reducing union, 1/16" to 360 µm	—	—	JR-C360RU1PK6
Union, quick mount	JR-C360QUPK2	JR-C360QUPK4	JR-C360QUPK6
Tee, quick mount	JR-C360QTPK2	JR-C360QTPK4	JR-C360QTPK6
Cross, quick mount	JR-C360QXPK2	JR-C360QXPK4	JR-C360QXPK6



360 µm union



1/16" to 360 µm reducing union



Union, quick mount



Tee, quick mount



Cross, quick mount

TECH TIP

360 micron fittings are dedicated for use with either fused silica, metal, or PEEK tubing. Components cannot be mixed or used with a different tubing material.

TECH TIP

Grooves on the fitting body indicate the bore size:



Grooves indicate bore size
 1 groove: 50 µm
 2 grooves: 100 µm
 no grooves: 150 µm



For fused silica tubing — 10,000 psi and above

360 µm

These fittings are constructed from HPLC grade stainless steel, with stainless steel nut and a special ferrule which is precision machined from electroformed nickel. For optimal sealing characteristics, the ferrule is gold plated.

SPECS

- For FS tubing, 360 µm
- Materials
Body and nut: HPLC grade SS
Ferrule: Gold-plated nickel
- Threads: 2-56
- Pressure rating: ≥ 689.5 bar (10,000 psi) (Varies with tubing material and ID)

	<i>Product No.</i>			
Nut/ferrule 		JR-C360NFFS		
Cap 		JR-C360CFS		
Bore size:	50 micron	100 micron	150 micron	
	<i>Product No.</i>	<i>Product No.</i>	<i>Product No.</i>	
Union	JR-C360UFS2	JR-C360UFS4	JR-C360UFS6	
Reducing union, 1/32" to 360 µm	JR-C360RU.5FS2	JR-C360RU.5FS4	JR-C360RU.5FS6	
Reducing union, 1/16" to 360 µm	—	—	JR-C360RU1FS6	





For metal tubing — up to 20,000 psi

360 µm

Our highest pressure Nanovolume® fittings are constructed of HPLC grade stainless steel, including stainless steel nut and ferrule. These fittings are optimized for use with stainless or electroformed nickel tubing.

SPECS

- For metal tubing, 360 µm
- Materials
HPLC grade SS
- Threads: 2-56
- Pressure rating: <1375 bar (20,000 psi) (Varies with tubing material and ID)

	<i>Product No.</i>			
Nut/ferrule 		JR-C360NFS6		
Cap 		JR-C360C		
Bore size:	50 micron	100 micron	150 micron	
	<i>Product No.</i>	<i>Product No.</i>	<i>Product No.</i>	
Union	JR-C360US62	JR-C360US64	JR-C360US66	
Reducing union, 1/32" to 360 µm	JR-C360RU.5S62	JR-C360RU.5S64	JR-C360RU.5S66	
Reducing union, 1/16" to 360 µm	—	—	JR-C360RU1S66	



MORE INFORMATION

1/32" Nanovolume® fittings 37

CONVERSIONS

- 50 µm = .002"
- 100 µm = .004"
- 150 µm = .006"
- 0.25 mm = .010"
- 0.50 mm = .020"
- 0.75 mm = .030"

Low pressure fittings

POLYMERIC

Our low pressure fittings are ideally suited for flow injection analysis, low pressure liquid chromatography, and stream sampling devices. They may be safely used at pressures up to 500 psi and temperatures to 50°C.

Low pressure polymeric fittings index

Nuts, ferrules, and washers

for 1/4-28 flat-bottom fitting details

PPS hex head nuts	
Flangeless	page 41
Flanged	41
Flangeless ferrules	
Collapsible	41
Inverted	41
Flangeless nuts	
PPS hex-head	41
PEEK fingertight nuts	42
Color-coded polyacetal fingertight nuts ...	42
Flanged color-coded polypropylene fingertight nuts	43

Unions and reducing unions

Union body, polyamide	43
PEEK unions	44
PEEK bulkhead unions	44
PEEK reducing unions	45
PEEK reducing unions, imperial to metric NEW	45

Tees, crosses, and manifolds

Tees	46
Biocompatible mixing tee	47
Crosses	46
Manifolds with 5 and 9 ports	46

Plugs

10-32 and 1/4-28 polypropylene plugs	48
--	----

Adapters, polypropylene

48
A wide offering of adapters, including male and female Luer to barbed, 10-32, and 1/4-28 male and female, plus many other combinations.

Micro valves for LC and GC

49
Simplify your liquid or gas handling application. The unique design of the fitting detail allows a leak-free seal with no potential for rotor damage from overtightening.

Peristaltic tubing adapter set

49
Connect soft tubing to PTFE and PTFE-like tubing with this biocompatible adapter set, which works with peristaltic tubing up to 4.50 mm OD.

FITTING DESIGNS

VICI Jour offers two types of low pressure fittings for 1/4-28 flat-bottomed fitting details:

- **Flangeless** connections utilize several ferrule designs. The ferrule grips the tubing as the fitting is tightened, without significantly reducing the tubing ID.
- **Flanged** tube end fittings are retained on polymeric tubing by a flange formed around a polypropylene washer. The washer never comes in contact with the mobile phase.

DISCLAIMER

The maximum holding pressure for any type of connections involving tubing and a ferrule varies considerably with the tubing material the ferrule material, the clearance between tubing OD and ferrule ID, and the shape of the fitting detail.



- Economically priced alternative to PEEK
- Excellent chemical resistance
- For 1/16" or 1/8" OD tubing
- Fingertight when used with Color-Sleeve adapters

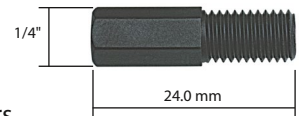

Our PPS 1/4-28 fitting series offers excellent chemical and pressure resistance. Three different sealing options are available.

PPS hex-head nuts and collapsible ferrules (flangeless) 1/4-28

Patented* collapsible ferrules are not included. Order separately.

* Patent No. 6,575,501

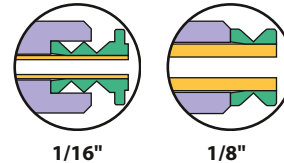

SPECS

- For 1/16" and 1/8" OD tubing
- Threads: 1/4-28
- Pressure rating:

OD	Bar	Psi
1/16"	105	1500
1/8"	35	500

(Varies with tubing material and ID)

- * Patent No. 6,575,501

Description	Material	Tubing OD	Qty/pkg	Product No.
Nut for use with collapsible ferrule	PPS	1/16"	10	JR-55050-10
		1/8"	10	JR-55051-10
Collapsible ferrules	CTFE	1/16"	10	JR-CFL-CB1KF
		1/8"	10	JR-CFL-CB2KF
	PEEK	1/16"	10	JR-CFL-CB1PK

HIGH PRESSURE 1/4-28 NUTS AND FERRULES

A PPS nut, PEEK ferrule, and stainless steel bushing allow a high pressure connection in a 1/4-28 flat-bottomed fitting detail. 25



TECH TIP

Color-Sleeve adapters turn PPS nuts into fingertight fittings and color-code different solvent lines. 17



CHEMICAL RESISTANCE OF PPS

- A = suitable
- B = marginal
- C = not recommended

Chemical class	Resistance
Acids, organic	A
Acids, inorganic	B/C*
Aldehydes	A
Alcohols	A
Bases	B
Esters	A
Halogenated org.	A/B
Hydrocarbons	A
Ketones	A

* Concentrated halogen acids
See detailed chemical resistance chart 96-98

MORE INFORMATION
About polymers . . . 99-100

PPS hex-head nuts and inverted ferrules (flangeless) 1/4-28

Ferrules are not included. Order separately.

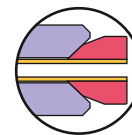

SPECS

- For 1/32"-1/8" OD tubing
- Threads: 1/4-28
- Pressure rating:

OD	Bar	Psi
1/16"	105	1500
1/8"	35	500

(Varies with tubing material and ID)

Description	Material	Tubing OD	Qty/pkg	Product No.
Nut for use with inverted ferrule	PPS	1/32"	10	JR-55073-10
		1/16"	10	JR-55070-10
		1/8"	10	JR-55071-10
		1.0 mm	10	JR-55073-10
		2.0 mm	10	JR-55072-10
Inverted ferrules	ETFE	1/32"	NEW 10	JR-032-10
		1/16"	10	JR-041-10
		1/8"	10	JR-051-10
		1.0 mm	NEW 10	JR-031-10
		2.0 mm	NEW 10	JR-042-10
		3.0 mm	NEW 10	JR-049-10

PPS hex-head nuts and washers (flanged connections) 1/4-28

Washers are not included. Order separately.

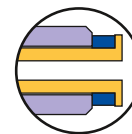

SPECS

- For 1/16" and 1/8" OD tubing
- Threads: 1/4-28
- Pressure rating:

OD	Bar	Psi
1/16"	105	1500
1/8"	35	500

(Varies with tubing material and ID)

Description	Material	Tubing OD	Qty/pkg	Product No.
Nut for flange/washer connection	PPS	1/16"	10	JR-55060-10
		1/8"	10	JR-55061-10
		1/8"	10	JR-201926-10
Washer	PP	1/16"	10	JR-201926-10
		1/8"	10	JR-201928-10
Easy-Flange kit (see page 85)				JR-201540

PEEK fingertight nuts (flangeless)

1/4-28

SPECS

- For 1/16" and 1/8" OD tubing
- Materials
Nut: PPS
Ferrules: ETFE
- 1/4-28 threads
- Pressure rating:

OD	Bar	Psi
1/16"	105	1500
1/8"	35	500

 (Varies with tubing material and ID)

- Compatible with all 1/4-28 flat-bottom ports
- Excellent chemical resistance
- For 1/16" or 1/8" OD tubing
- True fingertight – no tools required

PEEK flangeless nuts in combination with our inverted ferrule do not require a flanging tool. A hand-tightening procedure makes leak-free seals.

With this fitting system, the inert ETFE ferrule is the only part besides the tubing which comes into contact with the fluid stream – the nut is never in contact.

Ferrules are not included. Order separately.



Tubing OD:		1/16"		1/8"	
Description	Material	Qty/pkg	Product No.	Product No.	
Nut for use with inverted ferrule	PEEK	10	JR-20124-10	JR-20116-10	
Inverted ferrules	ETFE	10	JR-041-10	JR-051-10	

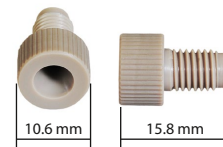
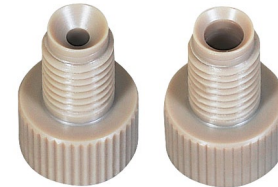
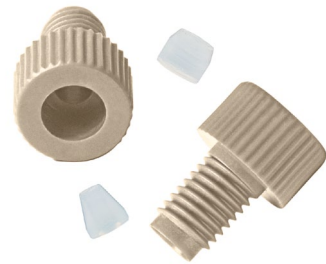

Color-coded fingertight nuts (flangeless)

1/4-28

SPECS

- For 1/16" and 1/8" OD tubing
- Materials
Nut: Polyacetal
Ferrules: ETFE
- 1/4-28 threads
- Pressure rating:

OD	Bar	Psi
1/16"	70	1000
1/8"	35	500

 (Varies with tubing material and ID)

- Polyacetal – economical alternative to PEEK
- Compatible with all 1/4-28 flat-bottom ports
- For 1/16" or 1/8" OD tubing
- True fingertight – no tools required

Polyacetal flangeless nuts in combination with the inverted ferrule do not require a flanging tool. A hand-tightening procedure makes leak-free seals. With this fitting system, the inert ETFE ferrule is the only part besides the tubing which comes into contact with the fluid stream – the nut is never in contact. Six colors are available.



Tubing OD:		1/16"		1/8"	
Description	Color	Qty/pkg	Product No.	Product No.	
Nuts	Green	10	JR-040GR-10	JR-050GR-10	
	Blue	10	JR-040BL-10	JR-050BL-10	
	Yellow	10	JR-040YL-10	JR-050YL-10	
	Red	10	JR-040RE-10	JR-050RE-10	
	White	10	JR-040WH-10	JR-050WH-10	
	Black	10	JR-040BK-10	JR-050BK-10	
1" long nuts	White	10	JR-040WL-10	JR-050WL-10	
Inverted ETFE ferrules		10	JR-041-10	JR-051-10	

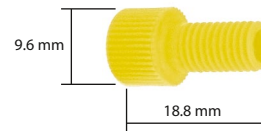

TECH TIP

The inert ETFE ferrule used with these nuts is the only part besides the tubing which is in contact with the fluid stream.



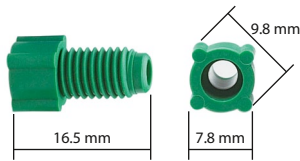

Color-coded fingertight nuts (flanged connections)

1/4-28

- For flanged connections
- Compatible with all 1/4-28 flat-bottom ports
- For 1/16" or 1/8" OD tubing
- Fiberglass-reinforced PP with PP washers

For those systems requiring or preferring flanged connections, use these fiberglass-reinforced fittings with our Easy-Flange flanging tool and polypropylene washers to make a clean connection. The flange on the tubing ensures that the washer never comes in contact with the mobile phase.

Six colors are available.

SPECS

- For 1/16" and 1/8" OD tubing
- Material: Fiberglass-reinforced polypropylene
- 1/4-28 threads
- Pressure rating: <30 bar (435 psi) (Varies with tubing material and ID)

Tubing OD:

Description	Color	Qty/pkg	1/16" Product No.	1/8" Product No.
Nuts	Green	10	JR-202123-10	JR-202143-10
	Blue	10	JR-202122-10	JR-202142-10
	Yellow	10	JR-202124-10	JR-202144-10
	Red	10	JR-202125-10	JR-202145-10
	White	10	JR-201094WH-10	JR-201580WH-10
	Black	10	JR-201094BK-10	JR-201580BK-10
1" long nuts	White	10	JR-202120-10	JR-202119-10
	Black	10	JR-202118-10	JR-202121-10
Polypropylene washer		10	JR-201926-10	JR-201928-10

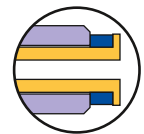

Union body for flanged connections

1/4-28



- Through bore low pressure union
- For flanged 1/4-28 flat-bottom connections
- For 1/16" or 1/8" OD tubing
- Completely inert and biocompatible

Flanged fittings are not included.

Order PPS hex-head flanged nuts or color-coded fingertight flanged nuts separately.

SPECS

- For 1/16" and 1/8" OD tubing
- Material: Polyamide
- 1/4-28 threads

Description	Qty/pkg	Product No.
Union body, polyamide	5	JR-060-5

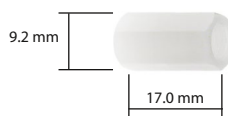
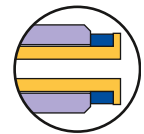

TECH TIP

Use our Easy-Flange kit for forming flanges on tubing 85

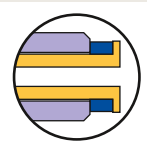

PEEK unions

1/4-28

SPECS

- For 1/16" and 1/8" OD tubing
- Materials
Body: PEEK
Nut: PPS
Ferrules: ETFE
- 1/4-28 threads
- Pressure rating:
OD Bar Psi
1/16" 105 1500
1/8" 35 500
(Varies with tubing material and ID)

- For easy connection of low pressure solvent lines
- Low dead volume
- For 1/16" or 1/8" OD tubing
- Flat-bottomed 1/4-28 fitting details
- Completely inert and biocompatible

These unions facilitate the quick and reliable connection of two pieces of 1/16" or 1/8" OD tubing. Use with color-coded adapters for easy solvent line identification.

These are available as the body only, or complete with fittings.

A union with fittings includes:

- PEEK low pressure union
- 2 PPS flangeless hex-head nuts
- ETFE inverted ferrules
- Color-Sleeve adapters

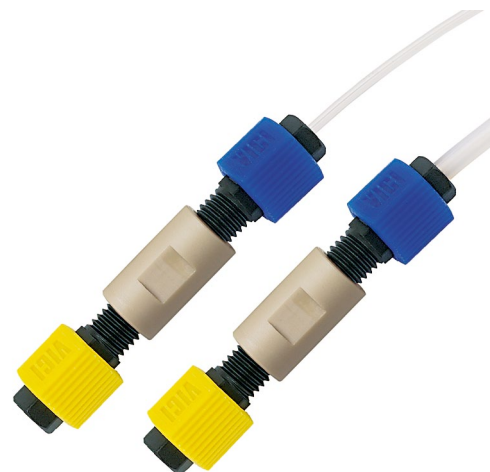

	Bore (mm)	Tubing OD	Qty/pkg	Product No.
Union, with fittings	0.50	1/16"	1	JR-1064
	0.75	1/8"	1	JR-1068
	1.30	1/8"	1	JR-1065
Body only	0.50	1/16"	1	JR-064
	0.75	1/8"	1	JR-068
	1.30	1/8"	1	JR-065

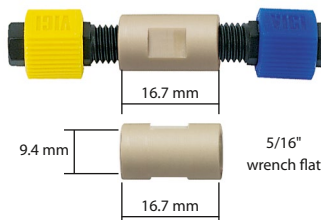

Spare parts	Tubing OD	Qty/pkg	Product No.
PPS flangeless nuts	1/16"	10	JR-55070-10
	1/8"	10	JR-55071-10
Inverted ETFE ferrules	1/16"	10	JR-041-10
	1/8"	10	JR-051-10

TECH TIP

While our PEEK unions are typically used with inverted ferrules, collapsible ferrules or flanged connections can also be used.



Standard: Inverted ferrule



Collapsible ferrule



Flanged ferrule

TECH TIP

Use our impermeable tubing to avoid gas diffusion in the solvent lines 13

RELATED PRODUCTS

- Color-coded fingertight flanged nuts 43
- Color-Sleeve adapters, in 12 colors 17
- High pressure PEEK unions 26
- PPS hex-head flanged nuts 41

PEEK bulkhead unions

1/4-28

SPECS

- For 1/16" and 1/8" OD tubing
- Materials
Body: PEEK
Nut: PPS
Ferrules: ETFE
- 1/4-28 threads
- Pressure rating:
OD Bar Psi
1/16" 105 1500
1/8" 35 500
(Varies with tubing material and ID)

- Panel mounting (10 mm hole required, max 9 mm thick)
- For easy connection of low pressure solvent lines
- Low dead volume
- For 1/16" or 1/8" OD tubing
- Completely inert and biocompatible

Bulkhead unions are designed to be mounted through an instrument panel or on a bracket.

They are sold complete with fittings, and include:

- 2 PPS flangeless hex-head nuts
- 2 ETFE inverted ferrules
- 2 Color-Sleeve adapters

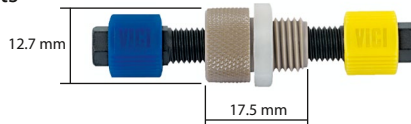

	Bore (mm)	Tubing OD	Qty/pkg	Product No.
Bulkhead union, with fittings	0.75	1/16"	1	JR-CBUMPK
	1.50	1/8"	1	JR-CBULPK

Spare parts	Tubing OD	Qty/pkg	Product No.
PPS flangeless nuts	1/16"	10	JR-55070-10
	1/8"	10	JR-55071-10
Inverted ETFE ferrules	1/16"	10	JR-041-10
	1/8"	10	JR-051-10





PEEK reducing unions

NEW

Imperial to metric, 1/4-28

- Connects 1/16", 1/8", 1 mm, 2 mm, and 3 mm OD polymeric tubing
- Completely inert and biocompatible

With these new reducing unions, metric tubing can be connected to imperial fittings on valves and LC systems.

A reducing union with fittings includes:

- PEEK low pressure reducing union
- 1 PPS flangeless hex-head nut, imperial size noted
- 1 PPS flangeless hex-head nut, metric size noted
- ETFE inverted ferrules
- Color-Sleeve adapters

SPECS

- For 1/32"-1/8" OD tubing, flangeless connections
- Materials
Body: PEEK
Nuts: PPS
Ferrules: ETFE
- 1/4-28 threads
- Pressure rating: ≤48 bar (700 psi) (Varies with tubing material and ID)



Tubing OD	Bore (mm)	Qty/pkg	Product No.
Reducing union, with fittings			
1/32" to 1 mm	0.50	1	JR-0640
1/16" to 2 mm	0.75	1	JR-0680
1/8" to 3 mm	1.30	1	JR-0650

Spare parts	Tubing OD	Qty/pkg	Product No.
PPS flangeless nuts			
	1/16"	10	JR-55070-10
	1/8"	10	JR-55071-10
	1.0 mm/ 1/32"	10	JR-55073-10
	2.0 mm	10	JR-55072-10
Inverted ETFE ferrules			
	1/32"	10	JR-032-10
	1/16"	10	JR-041-10
	1/8"	10	JR-051-10
	1.0 mm	10	JR-031-10
	2.0 mm	10	JR-042-10
	3.0 mm	10	JR-049-10



Metric ferrules

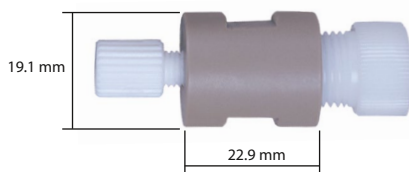

PEEK reducing unions

Imperial, 1/2-20 to 1/4-28

- Connects 1/4" and 1/8" OD tubing
- Low dead volume
- Completely inert and biocompatible

PEEK reducing unions are sold complete with fittings, and include:

- One 1/8" flangeless nut, white polypropylene
- One 1/8" ferrule, CTFE
- One 1/4" flangeless nut, polyacetal
- One 1/4" ferrule, CTFE

SPECS

- For 1/4" to 1/8" OD tubing, flangeless connections
- Materials
Body: PEEK
Nuts: 1/8" PP
1/4" Polyacetal
Ferrules: CTFE
- Threads: 1/2-20 to 1/4-28
- Pressure rating: <35 bar (500 psi) (Varies with tubing material and ID)

	Bore (mm)	Tubing OD	Qty/pkg	Product No.
Reducing union with fittings	1.5	1/4" to 1/8"	1	JR-CU4LPK

Spare parts	Tubing OD	Description	Qty/pkg	Product No.
	1/8"	Flangeless nut, white propylene	1	JR-CFL-2W-S
		Ferrule, CTFE	1	JR-CFL-CB2KF-S
	1/4"	Flangeless nut, polyacetal	1	JR-CFL-4D
		Ferrule, CTFE	1	JR-CFL-CB4KF-S

TECH TIP

While our PEEK bulkhead unions are typically used with inverted ferrules, collapsible ferrules or flanged connections can also be used.

RELATED PRODUCTS

Color-Sleeve adapters, in 12 colors 17



PEEK tees, crosses, and manifolds

1/4-28

SPECS

- For 1/16" and 1/8" OD tubing
- Materials
 Body: PEEK
 Nut: PPS
 Ferrules: ETFE
- 1/4-28 threads
- Body sizes:
 see chart below
- Pressure rating:

OD	Bar	Psi
1/16"	105	1500
1/8"	35	500

 (Varies with tubing material and ID)

- For 1/16" or 1/8" OD tubing
- Flat-bottomed 1/4-28 fitting details
- Completely inert and biocompatible

These VICI Jour connectors for low pressure applications are machined from PEEK. The bodies have 1/4-28 female ports which accept any flanged or flangeless fittings for 1/8" or 1/16" OD tubing.

Choose smaller through-holes for applications where low flowrate or low dead volume is required. Fittings with 1.50 mm through-holes are preferred for high flowrate applications.

These are available as the body only, or complete with fittings.

The appropriate number of the following are included when fittings are ordered:

- PPS flangeless hex-head nuts
- ETFE inverted ferrules
- Color-Sleeve adapters

Sold individually.



	Tubing OD	Bore (mm)	With fittings	Body only
			Product No.	Product No.
Tees	1/16"	0.50	JR-6029	JR-6034
		0.80	JR-6030	JR-6032
	1/8"	1.50	JR-6031	JR-6033
Crosses	1/16"	0.50	JR-6039	JR-6044
		0.80	JR-6040	JR-6042
	1/8"	1.50	JR-6041	JR-6043
Manifolds	5 ports	1/16"	JR-C5M1PK	JR-B-C5M1PK
		1/8"	JR-C5M2PK	JR-B-C5M2PK
	9 ports	1/16"	JR-C9M1PK	JR-B-C9M1PK
		1/8"	JR-C9M2PK	JR-B-C9M2PK
Spare parts	Tubing OD	Qty/pkg	Product No..	
PPS flangeless nuts	1/16"	10	JR-55070-10	
	1/8"	10	JR-55071-10	
Inverted ETFE ferrules	1/16"	10	JR-041-10	
	1/8"	10	JR-051-10	

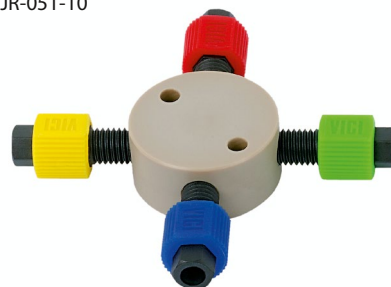

TECH TIP

While our PEEK tees and crosses are typically used with inverted ferrules, collapsible ferrules or flanged connections can also be used.



**Standard:
Inverted ferrule**



**Collapsible
ferrule**



**Flanged
ferrule**

TECH TIP

Use our impermeable tubing to avoid gas diffusion in the solvent lines 13

RELATED PRODUCTS

- Color-Sleeve adapters, in 12 colors 17
- High pressure PEEK tees 28
- PPS hex-head flanged nuts 41

BODY SIZES

	Diameter	Thickness
Tees	25.0 mm	17.1 mm
Crosses	25.0 mm	17.1 mm
Manifolds		
5 ports	25.0 mm	17.1 mm
9 ports	25.0 mm	28.6 mm



PEEK mixing tees

1/4-28

- For 1/16" or 1/8" OD tubing
- Mountable
- Completely inert and biocompatible

A unique mixing results from the the turbulence created by the introduction angle of the solvents. The mixing is much more thorough than with a conventional tee.

Typically our inverted ferrules are used in these fittings, but the 1/4-28 flat-bottomed details will also accept collapsible ferrule or flanged fittings.

These are available as the body only, or complete with fittings. A mixing tee with fittings includes:

- 3 PPS flangeless hex-head nuts
- 3 ETFE inverted ferrules
- 3 Color-Sleeve adapters

Sold individually.

	<i>Tubing OD</i>	<i>Bore (mm)</i>	<i>Product No..</i>
Mixing tee,	1/16"	0.75	JR-CM1XPK
with fittings	1/8"	1.50	JR-CM2XPK
Body only	1/16"	0.75	JR-B-CM1XPK
	1/8"	1.50	JR-B-CM2XPK

Spare parts	<i>Tubing OD</i>	<i>Qty/pkg</i>	<i>Product No..</i>
PPS flangeless nuts	1/16"	10	JR-55070-10
	1/8"	10	JR-55071-10
Inverted ETFE ferrules	1/16"	10	JR-041-10
	1/8"	10	JR-051-10

SPECS

- For 1/16" and 1/8" OD tubing
- Materials
Body: PEEK
Nut: PPS
Ferrules: ETFE
- 1/4-28 threads
- Pressure rating:

OD	Bar	Psi
1/16"	105	1500
1/8"	35	500

(Varies with tubing material and ID)
- Mixing volume

Bore	Volume
0.75 mm	25 µl
1.50 mm	100 µl

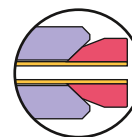

RELATED PRODUCTS

Color-Sleeve adapters, in 12 colors 17





Polypropylene plugs

1/4-28 or 10-32

SPECS

- Material: Polypropylene
- 10-32 or 1/4-28 threads

Sold in packages of 10.

Description	Product No.
10-32 male 	JR-072450-10
1/4-28 male 	JR-072350-10
1/4-28 male, flat bottom 	JR-201999-10

Polypropylene adapters

SPECS

- Material: Polypropylene

Sold in packages of 10.

Inlet		Outlet		Product No.
Male	Luer	Barbed	1/16"	JR-070211-10
			3/32"	JR-070212-10
			1/8"	JR-070213-10
Male	10-32	Male	10-32	JR-070224-10
			1/4-28	JR-070225-10
Male	1/4-28	Barbed	1/16"	JR-071123-10
			1/8"	JR-071323-10
Male	10-32	Barbed	1/16"	JR-071124-10
			1/8"	JR-071324-10
Female	Luer	Barbed	1/16"	JR-070111-10
			3/32"	JR-070112-10
			1/8"	JR-070113-10
Female	Luer	Female	Luer	JR-070101-10
			Male	10-32
Female	Luer	Male	10-32	JR-070124-10
			1/4-28	JR-070123-10

Sold individually.

Flat bottom	1/4-28	Barbed	1/8" ID		JR-075013
-------------	--------	--------	---------	---	-----------

RELATED PRODUCTS
 High pressure PEEK adapters 29
 High pressure plugs . . . 24

Micro valves for GC and LC

1/4-28

- Compact 1" design
- Convenient panel mount, hole diameter 8 mm (0.3125"), 6 mm maximum thickness
- Biocompatible and inert
- Variety of configurations

Simplify your liquid or gas handling application with a VICI Jour sampling micro valve. The unique design of the fitting detail allows a leak-free seal with no potential for rotor damage from overtightening. Internal parts are PEEK and PTFE.



SPECS

- For 1/16" and 1/8" OD tubing
- Materials
Wetted parts: PEEK
Body: POM
Nuts: PPS
Ferrules: CTFE
- 1/4-28 threads
- 1.50 mm bore
- Pressure rating: see notes at left

Includes flangeless PPS fittings and CTFE collapsible ferrules for 1/8" OD tubing. Sold individually.

		Product No.
"T" flow path	3 ports	JR-660100
	4 ports	JR-660110
180° flow path	2 ports	JR-660200
	4 ports	JR-660210
90° flow path	2 ports	JR-660300
	3 ports	JR-660310
	4 ports	JR-660320

"T" flow path



180° flow path

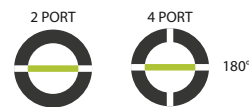

90° flow path



MICRO VALVE PRESSURE RATINGS

- 200 psi gas
Tested with helium using 1/16" OD x 0.84 mm ID PTFE tubing with PEEK collapsible ferrules
- 500 psi liquid
Tested with isopropanol using 1/8" OD x 0.75 mm ID PTFE tubing with CTFE collapsible ferrules

TECH TIP

While micro valves are typically used with collapsible ferrules, inverted ferrules or flanged connections can also be used.



Standard: Collapsible ferrule



Inverted ferrule

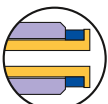

Flanged ferrule

TECH TIP

Use our impermeable tubing to avoid gas diffusion in the solvent lines

RELATED PRODUCTS

Color-Sleeve adapters, in 12 colors



High pressure PEEK tees..... 28
PPS hex-head flanged nuts..... 41

Spare parts	Material	Tubing OD	Qty/pkg	Product No.
Nuts	PPS	1/16"	10	JR-55050-10
		1/8"	10	JR-55051-10
Collapsible ferrules	PEEK	1/16"	10	JR-CFL-CB1PK
	CTFE	1/8"	10	JR-CFL-CB2KF

Peristaltic tubing adapter set

1/4-28

- For connecting soft tubing to PTFE and PTFE-like tubing
- Works with peristaltic tubing up to 4.50 mm OD
- For 1/16" and 1/8" PTFE and PTFE-like tubing
- Biocompatible
- Low dead volume

This "one-fits-all" set consists of everything needed to connect 1/16" or 1/8" OD PTFE and PTFE-like tubing to soft tubing (such as silicone), up to 4.5 mm in OD, minimum 0.5 mm ID.

The adapter includes:

- 3 different bushings (for the different soft tubing ODs)
- 2 PPS nuts (one each for 1/16" and 1/8" OD tubing)
- 2 ETFE inverted ferrules (one each for 1/16" and 1/8" OD tubing)
- 2 Color-Sleeve adapters

Sold individually.

SPECS

- For 1/16" and 1/8" OD tubing
- Materials
Body: PEEK
Bushings: PPS
Nut: PPS
Ferrules: ETFE
- 1/4-28 threads
- 1.50 mm bore
- Body size: 28 mm long 12 mm diameter.



Product No.
JR-PTAS

Filters

AND MOBILE PHASE FILTERS

Filters trap foreign particulates from sample and mobile phase streams before they can damage valuable columns and instruments.

Filters index

Low pressure filters

In-line filters	page 50
Mobile phase filters	
Last Drop	51
Economy Last Drop	51
Last Drop biocompatible glass filter	52
No-Met biocompatible	52
Filter/spargers	
Last Drop	53
Stainless steel	53

High pressure filters

PEEK high pressure filters	
In-line filter kit	54
Precolumn filter kit	55
Sure-Guard	54
Stainless UHPLC filters	56
Stainless inline filter	57

In-line filter cartridges

Low pressure

SPECS

- Materials
 - Cartridge: PTFE/CTFE
 - Filter screen: 316 stainless
- 1/4-28 detail
- Dimensions
 - OD 5.20 mm
 - Thickness 2.03 mm
 - Bore 0.8 mm
 - Filter surface diameter 2 mm
- Tolerances
 - ±0.05 mm (.002")

- Easy to replace
- Compact design
- Fit all 1/4-28 fitting details
- Three porosity options

These convenient-to-use filters can be simply dropped into any 1/4-28 fitting detail, such as in a union. The filters are constructed of PTFE and CTFE, with a Type 316 stainless low-pressure-drop screen. The inner design of the cartridge ensures the equal distribution of the solvent to the screen.

Pore size	Maximum flow rate *	Qty/pkg	Product No.
2 µm	30 ml/min	5	JR-CFE-S2-5
10 µm	30 ml/min	5	JR-CFE-S10-5
75 µm	30 ml/min	5	JR-CFE-S75-5



NOTES

* Flowrate measured with methanol/water (1:1), ultrasonic degassed, helium sparging to prevent regassing.

TECH TIP

We recommend using these in-line filter cartridges in combination with our low pressure fittings:

PEEK unions	44
Tees and crosses	46
Manifolds	46
Micro valves	49

DISCLAIMER

The maximum holding pressure for any type of connections involving tubing and a ferrule varies considerably with the tubing material, the ferrule material, the clearance between tubing OD and ferrule ID, and the shape of the fitting detail.

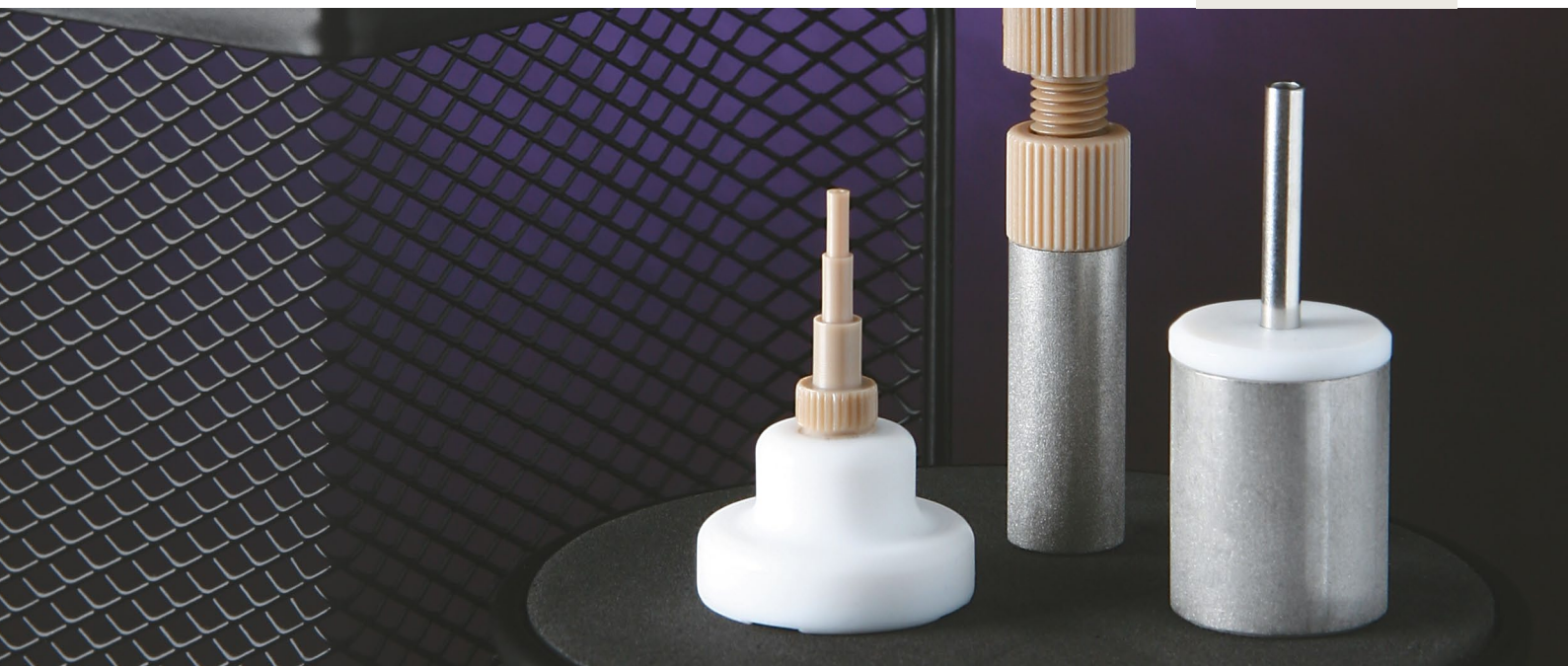

Last Drop mobile phase filters

Low pressure

- No loss of mobile phase
- Biocompatible PTFE frits or stainless steel frits
- Three porosity options
- Two connector types: stepped tubing and 1/4-28 fitting



SPECS

- Materials
 - Body: PTFE
 - Frits: PTFE/ 316 SS/PE
- Stepped tubing version is for 1.5, 2.2, and 3.5 mm ID tubing
- Fitting version (for 1/8" OD tubing) includes PEEK 1/4-28 nut with ETFE ferrule

The Last Drop mobile phase filter allows more analyses per batch of mobile phase and helps reduce hazardous waste. The flat filter element sits parallel to the bottom of the reservoir, allowing the Last Drop to filter all but the last 2% of the mobile phase from the reservoir without drawing air into the system. Compare this with conventional cylindrical filters that can begin to draw air into the system when nearly 10% of the solvent remains in the reservoir.

The Last Drop mobile phase filter consists of a 316 stainless steel, PTFE 2.5 µm, or a hydrophobic PE filter element pressed into an inert PTFE housing. The top of the housing has a 1/4-28 nut and ferrule or a stepped PEEK fitting connector which slips into 1.5, 2.2, or 3.5 mm ID pump inlet lines.

Connector type:			Stepped tubing connector	Fitting connector
Filter material	Pore size	Maximum flow rate *	Product No.	Product No.
PTFE	2.5 µm	1.2 ml/min	JR-9000-0520	JR-9000-0520F
	5 µm	2.6 ml/min	JR-9000-0521	JR-9000-0521F
	10 µm	3.5 ml/min	JR-9000-0522	JR-9000-0522F
Polyethylene	10 µm	11 ml/min	JR-9000-0522H	JR-9000-0522HF
Stainless	2 µm	28 ml/min	JR-9000-0530	JR-9000-0530F
	5 µm	30 ml/min	JR-9000-0531	JR-9000-0531F
	10 µm	30 ml/min	JR-9000-0532	JR-9000-0532F



NOTES

* Flowrate measured with methanol/water (1:1), ultrasonic degassed, helium sparging to prevent regassing.

TECH TIPS

- Economy Last Drop mobile phase filters are easy to replace - easy to clean. Use ultrasound or replace with a new filter.
- Connect the Economy Last Drop filter with 1/8" OD/ 1.59 mm OD tubing:
 - PFA tubing 9
 - PTFE tubing 12
- We recommend metal-free PTFE or glass filters for sensitive biochromatography applications where metal surfaces may corrode or interact with samples.

RELATED PRODUCTS

Last Drop mobile phase filter/spargers 53

Economy Last Drop mobile phase filters

Low pressure

- Very competitively priced
- Biocompatible PTFE frits or stainless steel frits
- Three porosity options
- Two diameters



Economy mobile phase filters come in two body diameters, for various dimensions of bottle necks. The filter body is made of PTFE, which is resistant to virtually all common mobile phases.

Frit material	Body OD	Pore size	Maximum flow rate *	Product No.
PTFE	19 mm	2.5 µm	1.2 ml/min	JR-4676-2.5TF
		5 µm	2.6 ml/min	JR-4676-5TF
		10 µm	3.5 ml/min	JR-4676-10TF
	22 mm	2.5 µm	1.2 ml/min	JR-4677-2.5TF
		5 µm	2.6 ml/min	JR-4677-5TF
		10 µm	3.5 ml/min	JR-4677-10TF
Stainless steel	19 mm	2 µm	30 ml/min	JR-4676-2
		10 µm	30 ml/min	JR-4676-10
	22 mm	2 µm	30 ml/min	JR-4677-2
		10 µm	30 ml/min	JR-4677-10



FILTERS

Last Drop biocompatible glass mobile phase filters *Low pressure*

SPECS

- Materials
 - Body: Glass
 - Frit: Glass
- For use with 1/8" tubing

- The solution for biocompatibility and high flowrates
- Easy-push tubing connection

Because it has a glass frit, the flowrate can be much higher with this filter than with PTFE mobile phase filters. The glass foot allows withdrawal of nearly all of the mobile phase – less than 2% is left in the bottle.

Includes 1/8" tubing connector.

Frit material	Pore size	Maximum flow rate *	Product No.
Glass	1.0 - 1.6 µm	30 ml/min	JR-9000-0520B
	10-16 µm	50 ml/min	JR-9000-0526G
	40-100 µm	200 ml/min	JR-9000-0528G

Replacement connectors

For tubing	Size	Qty/pkg	Product No.
1/8" OD	6.8 mm	1	JR-9000-0525GC



No-Met biocompatible mobile phase filters

Low pressure

SPECS

- Materials
 - Body: PTFE/ Polyethylene
 - Adapter: PEEK
 - Fitting: PEEK
 - Ferrule: ETFE
- For use with 1/8" tubing

- Very competitively priced
- Inert and biocompatible
- Replacement filters
- Also recommended for IC

Stainless steel in the flowpath is not acceptable in a growing number of applications involving the separation of biomolecules. High salt buffers can corrode stainless steel, and the metal ions released from metallic filters may contaminate or otherwise react with the biomolecules of interest.

The No-Met polyethylene filter is designed for these applications, with inert polymeric fittings for 1/8" tubing and a 20 µm filter effectively eliminating metal contamination from the fluid path. Use them for IC and biochromatography applications.

No-Met filters can be used at flow rates up to 500 ml/min, measured with methanol/water (1:1), ultrasonically degassed. Flow rates can vary with solvent and tubing ID.

The economy version can easily be slipped over 1/8" OD tubing, with no fitting required.

Connection	Filter material	Pore size	Maximum flow rate *	Product No.
1/4-28 nut and ferrule	PTFE	5 µm	2.2 ml/min	JR-32171
	Polyethylene	<20 µm	500 ml/min	JR-32178
Economy slip-on connection	Polyethylene	5 µm	300 ml/min	JR-32174

Replacement element

Filter material	Pore size	Maximum flowrate *	Product No.
PTFE	5 µm	2.2 ml/min	JR-32172
Polyethylene	<20 µm	500 ml/min	JR-32179

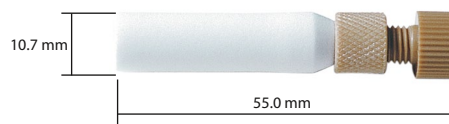

NOTES

* Flowrate measured with methanol/water (1:1), ultrasonic degassed, helium sparging to prevent regassing.

TECH TIPS

- Because they are hydrophobic, No-Met filters may initially require some priming with methanol or acetonitrile.
- Connect the No-Met filter with 1/8" OD/ 1.59 mm OD tubing:
 - PFA tubing 9
 - PTFE tubing 12



Last Drop filter/sparger

Low pressure

The Last Drop filter/sparger combines filtration and sparging in a single unit. The PTFE housing contains a mobile phase filter with a stainless steel, PTFE, or hydrophobic PE filter element.

Spargers have a porosity of 10 microns.

The filter/sparger includes:

- PEEK tripod connector which slips into 1.5, 2.2, or 3.5 mm ID solvent lines
- 1/4-28 nut and ferrule for the sparging line

SPECS

- Materials
 - Body: PTFE
 - Frits: PTFE/316 SS/PE
 - Stepped tubing connector: PEEK
 - Nut: PEEK
 - Ferrule: ETFE
- Stepped tubing connector for 1.5, 2.2, and 3.5 mm ID tubing
- PEEK 1/4-28 nut with ETFE ferrule for 1/8" OD tubing

Filter material	Pore size	Maximum flow rate *	Product No.
PTFE	2.5 µm	1.2 ml/min	JR-9000-0602
	5 µm	2.6 ml/min	JR-9000-0603
	10 µm	3.5 ml/min	JR-9000-0604
Polyethylene	10 µm	11 ml/min	JR-9000-0604H
Stainless	2 µm	28 ml/min	JR-9000-0640
	5 µm	30 ml/min	JR-9000-0641
	10 µm	30 ml/min	JR-9000-0642

Stainless steel mobile phase filter/helium sparger

Low pressure



- Ideal for helium sparging
- Four porosities
- Fitting and pipe connectors

VICI Jour mobile phase filters protect HPLC systems from small particles in the mobile phase. These filters are made from SS316 with PEEK or PTFE connectors and are suitable for most solvents. The complete line has versions for both analytical and preparative applications.

VICI Jour helium spargers (2 µm versions) offer an inexpensive way to prepare and maintain mobile phases free of dissolved gases. Connected to a regulated supply of helium gas (0-400 mL/min.) they effectively remove dissolved oxygen, nitrogen, and other atmospheric gases from the mobile phase.

SPECS

- Materials
 - Body: SS316
 - Pipe: SS316
 - Pipe adapter: PTFE
 - Fitting adapter: PEEK
 - Fittings: PEEK
 - Ferrules: ETFE

Fitting type	Tubing/ pipe size	Pore size	Maximum flow rate *	Product No.
1/4-28 fitting	1/16"	2 µm	35 ml/min	JR-367016-2
		10 µm	35 ml/min	JR-367016-10
		20 µm	35 ml/min	JR-367016-20
	1/8"	2 µm	35 ml/min	JR-367008-2
		10 µm	100 ml/min	JR-367008-10
		20 µm	120 ml/min	JR-367008-20
Pipe	1/8"	2 µm	95 ml/min	JR-3675-2
Pipe	1/8"	2 µm	50 ml/min	JR-3678-2
		25 µm	100 ml/min	JR-3678-25

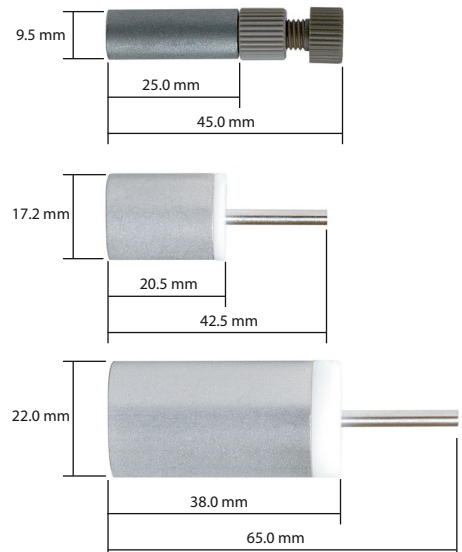

TECH TIPS

- We recommend metal free PTFE filters for sensitive biochromatography applications where metal surfaces may corrode or interact with samples.
- We recommend our impermeable tubing to prevent "regassing" of helium-degassed solvents.

RELATED PRODUCTS

Last Drop mobile phase filters 51

FILTERS

PEEK in-line filter kit

HPLC

SPECS

- For 1/16" OD tubing
- Materials
Body: PEEK
Frit: Titanium, Polyethylene
- 0.25/0.4 mm bore
- 10-32 threads
- Pressurating: <350 bar (< 5000 psi)

- Replaceable metal-free polyethylene frits and biocompatible titanium frits
- 100% biocompatible
- Minimal hold-up volume
- Different porosities

The PEEK in-line filter traps fines and other particles from samples and mobile phases before they damage valuable instruments and columns.

This female-to-female design is made entirely of PEEK, with PEEK-encased titanium or polyethylene filter elements, for biocompatibility and chemical resistance. The design has virtually no hold-up volume and can be used in analytical applications with virtually no band broadening or loss of efficiency.

Sold individually.

Frit material	Pore size	Internal volume (µL) *	Maximum flow rate **	Product No.
Titanium	0.5 µm	9.50	25 ml/min	JR-68247
	2 µm	11.85	30 ml/min	JR-68253
	5 µm	12.7	30 ml/min	JR-68256
	10 µm	13.2	30 ml/min	JR-68257
Polyethylene	10 µm	13.9	30 ml/min	JR-68257PE



Sure-Guard in-line filter kit

HPLC

SPECS

- Materials
Body: PEEK
Frit: Stainless, Titanium
- 0.4 mm bore
- 10-32 female to 10-32 male threads
- Pressurating: <350 bar (< 5000 psi)

- Disposable filter guard
- Minimal hold-up volume
- Titanium (biocompatible) and stainless steel frits, permanently pressed in place
- Two porosity options

The VICI Jour Sure-Guard disposable in-line filter offers an easy and inexpensive way to protect valuable columns against fines and particles. It is easily connected directly to any column, with an inlet for 1/16" OD tubes and 10-32 threads. The VICI Jour Sure-Guard can be changed in seconds without tools.

Sold in packages of three. Waters type filter kits are sold individually.

Frit material	Pore size	Internal volume *	Maximum flow rate **	Product No.	Product No. Waters type
Stainless steel	0.5 µm	0.45 µL	30 ml/min	JR-0611-SS05-3	JR-0641-SS05
	2 µm	0.61 µL	30 ml/min	JR-0611-SS2-3	JR-0641-SS2
Titanium	0.5 µm	0.45 µL	30 ml/min	JR-0611-TI05-3	JR-0641-TI05
	2 µm	0.61 µL	30 ml/min	JR-0611-TI2-3	JR-0641-TI2

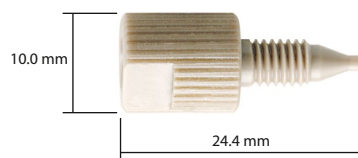

NOTES / TECH TIPS
See facing page.

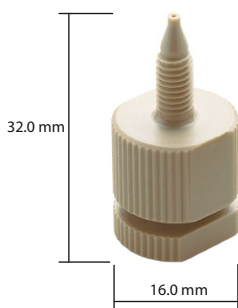

PEEK precolumn filter kit

HPLC

- 100% biocompatible
- Minimal hold-up volume
- Replaceable metal-free polyethylene frits and biocompatible titanium frits encased in PEEK
- Different porosities

SPECS

- Materials
 - Body: PEEK
 - Frit: Titanium, Polyethylene
- 0.25/0.4 mm bore
- 10-32 threads
- Pressurering: <350 bar (< 5000 psi)

The VICI Jour precolumn filter kit has a standard 10-32 fitting and fits direct to most column types without introducing additional dead volume.

The filter kit protects expensive columns against fine particles, which may otherwise accumulate on the column frit and lead to split peaks and high backpressure.

Sold individually.

Frit material	Pore size	Internal volume (µL) *	Maximum flow rate **	Product No.
Titanium	0.5 µm	11.5	30 ml/min	JR-68258
	2 µm	13.85	30 ml/min	JR-68262
	5 µm	14.7	30 ml/min	JR-68263
	10 µm	15.2	30 ml/min	JR-68264
Polyethylene	10 µm	15.9	30 ml/min	JR-68264P

Replacement frits

for PEEK in-line and precolumn filter kits

Replacement frits for PEEK precolumn filter kit and PEEK in-line filter kit (see facing page).

Frit material	Pore size	Internal volume (µL) *	Qty/pkg	Product No.
Titanium	0.5 µm	6.87	5	JR-1125-05P-5
	2 µm	9.24	5	JR-1125-2P-5
	5 µm	10.04	5	JR-1125-5P-5
	10 µm	10.56	5	JR-1125-10P-5
Polyethylene	10 µm	11.31	5	JR-1151-10P-5

NOTES

* The internal volume is the hold-up volume between the end of the connecting tube and the filter 10-32 connector outlet, including the frit volume.

** Flowrate measured with methanol/ water (1:1), ultrasonic degassed, helium sparging to prevent regassing.

TECH TIP

We recommend 2 µm frits for columns with 5 µm or larger particles, and 0.5 µm frits for smaller particles.

NOTE

Polyethylene frits are for single use only.

MORE INFORMATION

Calculation of frit volume 95
 PEEK-encased stainless frits 74

Stainless steel precolumn filter

NEW

UHPLC

SPECS

- Materials
Body: 316 SS
Frit: PEEK-encased SS
- 10-32 threads
 Female for inlet
 Male for outlet
- Pressure rating with ZN1 nut and ZF1S6 ferrule:
 1375 bar (20,000 psi)

- UHPLC
- Mimimized hold-up volume
- Three porosity options
- Fewer connections compared to in-line filters
- Works with 1/16" column connections from all manufacturers



VICI Jour's new stainless steel precolumn filter is based on our well-known in-line filter. The design of this precolumn filter reduces the number of connections compared to a standard in-line filter, increasing the stability and reducing the potential of leakage.

The small bore sizes (0.15 mm in the nut/body and 0.13 mm in the tubing) guarantee a very small (virtually zero) hold-up volume.

With minimal dead-volume and available with three porosities, these filters are the best column protectors.

Bore size	Pore size	Internal volume	Product No.
0.13/0.15 mm	0.5 µm	0.61 µl	JR-69230-05
	2 µm	0.66 µ	JR-69230-2
	5 µm	0.68 µ	JR-69230-5

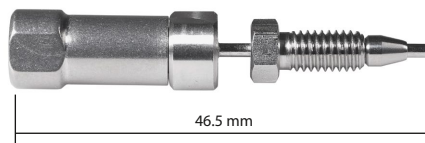

Inlet nuts and ferrules

Includes one 1/16" stainless nut and one 1/16" stainless ferrule.

Pore size	Product No.
0.5 um	JR-69330-05
2 um	JR-69330-2
5 um	JR-69330-5

Replacement PEEK-encased SS frits

Pore size	Frit volume	Qty/pkg	Product No.
0.5 um	0.13 uL	5	JR-1110-05P-5
2 um	0.18 uL	5	JR-1110-2P-5
5 um	0.20 ul	5	JR-1110-5P-5



Stainless steel in-line filter

UHPLC

- UHPLC (up to 1375 bar / 20,000 psi)
- Minimized hold-up volume
- Two bores for analytical and semi-prep flow rates
- Three porosity options



The stainless steel in-line filter has virtually no hold-up volume and can be used in various applications without significant band broadening or loss of efficiency.

The 0.25 mm bore versions are intended for analytical use between autosampler/injection valve and column. The 0.75 mm bore versions are suitable for higher flow rates in semi-prep systems or for solvent supply from pump to autosampler.

With minimal dead volume and available frit porosities of 0.5, 2 or 5 µm, these in-line filters are the ideal column protectors

Sold individually.

Bore size	Pore size	Internal volume *	Product No.
0.25 mm	0.5 µm	0.2 µL	JR-68230-05
	2 µm	0.3 µL	JR-68230-2
	5 µm	0.3 µL	JR-68230-5
0.75 mm	0.5 µm	1.7 µL	JR-68231-05
	2 µm	1.9 µL	JR-68231-2
	5 µm	1.9 µL	JR-68231-5

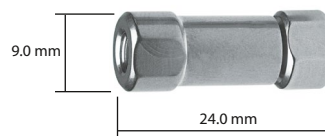

SPECS

- Materials
 - Body: 316 SS
 - Frit: PEEK-encased 316 stainless
- 0.25 or 0.75 mm bore
- 10-32 female to 10-32 male threads
- Pressure rating with ZN1 nut and ZF1S6 ferrule: 1375 bar (20,000 psi)

Nuts and ferrules

Includes one 1/16" stainless nut and one 1/16" stainless ferrule.

Bore size	Pore size	Product No.
0.25 mm	0.5 µm	JR-68330-05
	2 µm	JR-68330-2
	5 µm	JR-68330-5
0.75 mm	0.5 µm	JR-68331-05
	2 µm	JR-68331-2
	5 µm	JR-68331-5

Replacement PEEK-encased SS frits

for filter above

Bore size	Pore size	Frit volume	Qty/pkg	Product No.
0.25 mm	0.5 µm	0.13 µL	5	JR-1110-05P-5
	2 µm	0.18 µL	5	JR-1110-2P-5
	5 µm	0.20 µL	5	JR-1110-5P-5
0.75 mm	0.5 µm	0.55 µL	5	JR-1111-05P-5
	2 µm	0.74 µL	5	JR-1111-2P-5
	5 µm	0.80 µL	5	JR-1111-5P-5
	10 µm	0.87 µL	5	JR-1111-10P-5



NOTES

*The internal volume is the hold-up volume between the end of the connecting tube and the filter 10-32 connector outlet, including the frit volume.

Safety products

AND MOBILE PHASE HANDLING SYSTEMS

- Save cost on solvents
- Avoid hazardous air in the laboratories
- Increase reproducibility of chromatographic analyses

VICI strives to provide customers with the best solutions for their problems, making the work better and/or easier with respect to environment and health.

Safety products index

VICI safety filters

Air inlet valves	page 59
Air outlet valve.....	59
Exhaust filters.....	60-61
Carbon dioxide filter . . . NEW	71
Humidity filter NEW	71

Caps

Safety cap kits	62
Safety caps	
DIN50 threads	63
GL45 threads	63
VICI cap kits.....	64
VICI caps	
GL38 threads	65
DIN50 threads	65
GL45 threads	64
S40 threads..... NEW	65

Waste caps

GL45 threads	NEW66
B53 threads	68
B83 threads	68
GLS80 threads	64
DIN60 threads	67
S51 threads.....	67
S61 threads.....	67
Eco cap	69
Eco cap kit.....	69

Safety-coated glass bottles

Solviflex tubing

Flexible coiled PFA tubing expands and contracts, giving flexibility to move mobile phase bottles on the bench.





Safety air inlet valves

- No evaporation of volatile compounds into lab air
- Better composition stability of the mobile phases
- Less shift of retention times
- No bacterial contamination
- Fit any VICI cap or VICI safety cap

The air inlet valve has a check valve which blocks vapors of the solution in a bottle, preventing the vapors from escaping into the lab. The mobile phase composition remains stable, resulting in constant retention times.

The check valve regulates the pressure when the negative pressure reaches 1.5 psi or 0.1 bar. This small negative pressure prevents evaporation of the liquid (lower vapor pressure) and still guarantees the stability of the flow rate. A negative pressure which is too high can influence the aspiration of a constant flow.

Several tests have indicated that the 0.2 µm cellulose filter will keep mobile phase liquid free of bacteria and dust particles over time. If you use a filter and still have bacteria growth in your liquid, it is likely due to the presence of bacteria in the deionized water used.

Air inlet valves fit on any VICI safety cap or VICI cap.

Description	Product No.
With 4 mm filter	JR-S-20003
With 15 mm filter	JR-S-20009
Without filter	JR-S-20006

Spare parts

Replacement cellulose filter	
0.2 µm x 4 mm	
0.2 µm x 15 mm	



SPECS

- Connections
Valve to cap:
1/4-28
Filter:
Female Luer
- Materials
Housing:
Polypropylene
Filter: Cellulose
O-ring: NBR
(O-ring is not a wetted part)

TECH TIPS

- The air inlet valve is not suitable when helium sparging is used.
- We recommend that safety air inlet valves and safety air outlet valves be replaced every 6-7 months to guarantee correct operation of the check valve. The lifetime of the check valve and the filter depend on the intensity of use and the quality of the ambient air.

RELATED PRODUCTS

Safety caps 62-63
VICI caps 64-65

Safety air outlet filters

The VICI safety air outlet filter regulates the pressure during helium sparging.

Air outlet filters fit on any VICI safety cap or VICI cap.

Description	Product No.
Safety air outlet filter	JR-S-20004



SPECS

- Connections
Valve to cap:
1/4-28
Filter:
Female Luer
- Materials
Housing:
Polypropylene
Filter: Cellulose
O-ring: NBR
(O-ring is not a wetted part)

Safety exhaust filters

SAFETY PRODUCTS

- Prevents pollution of ambient air with volatile compounds
- Large capacity and long lifetime
- Break-through detector available, alerting users to saturation of the filter absorbent
- Universal 1/4-28 connection – fit all VICI safety caps and VICI caps
- Adapter to competitor products available

Our improved exhaust filter is the center of the VICI Jour safety program, ridding ambient air of solvent vapors which could adversely affect the health of lab workers. When placed on the waste bottle of an HPLC system, the specially-treated absorbent filters out nearly all organic solvent vapor evaporating out of the waste solution.

Our new absorbent has an increased capacity over our previous filter and definitely over a competing brand. Excellent capacity leads to longer lifetime of the exhaust filter: up to 10 months* for methanol, and up to 8 months* for acetonitrile. The new design also has improved stability at the connecting threads.

The optional break-through detector recognizes trace amounts of acetone, acetonitrile, ethanol, ethyl acetate, methanol, methylene chloride and THF. When the absorbent is saturated, break-through is indicated by a color change in the detector from orange/pink to dark purple. A small charcoal filter absorbs the vapors after they pass the detector.

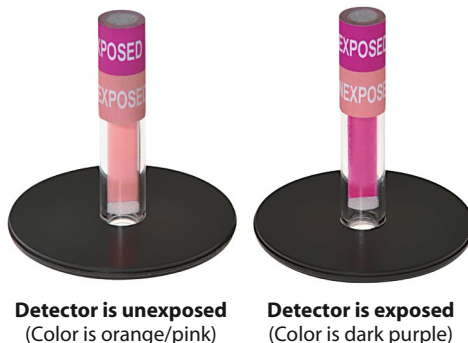

*Based on results of our tests (water/organics = 50/50; flow rate 1.0 ml/min during the day, 0.5 ml/min overnight, 0.1 ml/min during weekends).

Safety exhaust filters

1/4-28

SPECS	Description	Product No.
<ul style="list-style-type: none"> ■ Connections: 1/4-28 ■ Materials: Filter housing: POM; Detector housing: PC; Frits: Polyethylene; O-ring: NBR (O-ring is not a wetted part) 	<p>Exhaust filter</p> <ul style="list-style-type: none"> With detector: JR-S-20i Without detector: JR-S-20i 	
	<p>Adapter</p>  <p>Connects VICI safety exhaust filter to SCAT® waste caps and A.I.T. smart waste caps</p>	JR-S-40004



NOTE
Disposal of the saturated filters must be done according to the local regulations for chemical waste.

TECH TIPS

- Larger capacity = longer lifetime = lower costs
- As a general rule, halving the flow rate doubles the lifetime at constant composition and temperature. Doubling the flow rate halves it.

RELATED PRODUCTS

- Carbon dioxide filter... 71
- Humidity filter... 71
- Safety caps... 62-63
- VICI caps... 64-65

See additional information about VICI safety exhaust filters on the facing page.

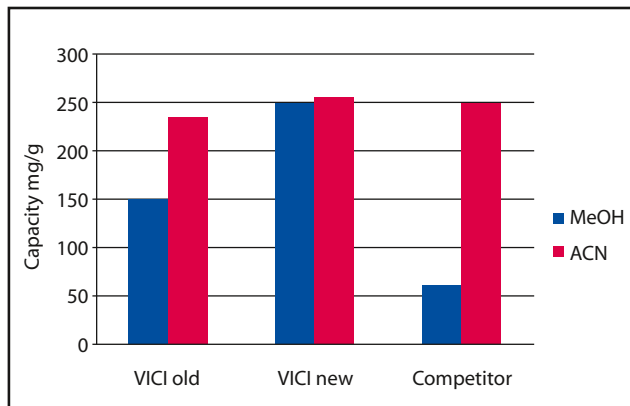

Optimized absorbent of safety exhaust filters

In our continuous work to improve our products, VICI has optimized the absorbent for increased capacity.

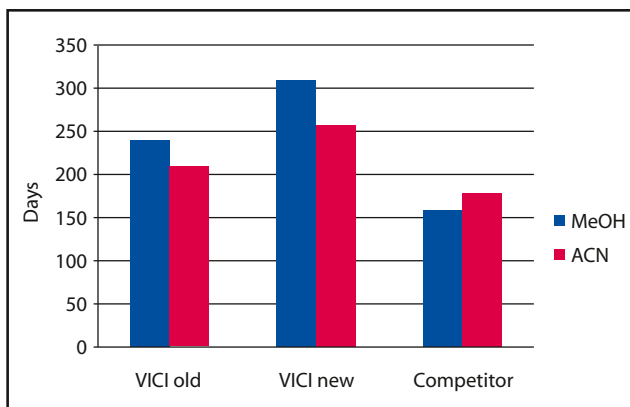

The excellent capacity of our new absorbent leads to longer lifetimes – up to 10 months for methanol and 8 months for acetonitrile.*

*Based on results of our tests (water/organics = 50/50; flow rate 1.0 ml/min during the day, 0.5 ml/min overnight, 0.1 ml/min during weekends).

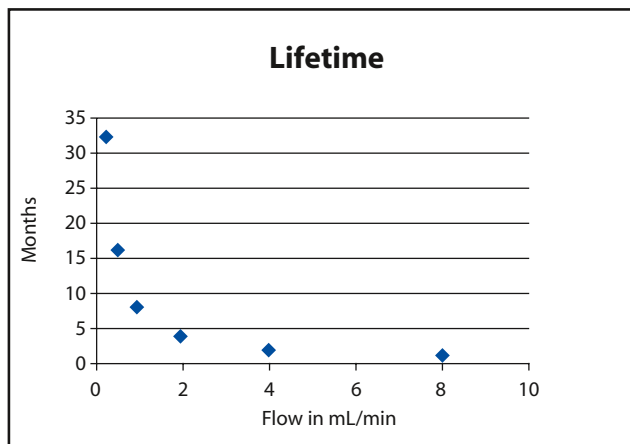

Safety exhaust filter lifetime

The lifetime of the filter depends on:

- Composition of the mobile phase
- Flow rate
- Ambient temperature: a higher temperature leads to an increased vapor pressure of the volatile compound

The theoretical lifetime of an exhaust filter, depending on the flow rate, is shown here.

TECH TIP

Acetonitrile and water form an “azeotropic” mixture at 85% acetonitrile. Due to this physical property, the vapor of an acetonitrile/water mixture always corresponds to the 85/15 mixture. This explains the non-linearity of the lifetime for acetonitrile compared to methanol.

ADDITIONAL APPLICATIONS

Other applications for safety filters are possible, e.g. an exhaust filter for the GC split vent.

Contact Tech Support for more information.

Safety caps have built-in stopcocks to close off unused ports or to provide a convenient cut off of the liquid stream when tubing is removed.

- Stopcocks rated up to 72 psi gas at 25°C
- Prevent evaporation of volatile compounds
- Ideal for delivery of mobile phase or collection of waste LC solutions
- 2, 3, or 4 ports with 1/4-28 threads for 1/8" or 1/16" tubing
- Optional bottom-sealing barbed adapter to connect 1/8" (3.2 mm) ID tubing (shown at right – order separately from "Spare Parts")



Safety cap kit

GL45 threads

SPECS

- Connections: 1/4-28
- Materials: Closure: PP (polypropylene)
- Insert: PTFE
- Stopcock: CTFE
- O-ring: EPDM (alternative: FEP-coated)
- Nuts: PPS
- Ferrules: ETFE
- Sleeves: PP
- Bottle: Borosilicate 3.3, safety coated
- Filter: Polyethylene

In addition to a GL45 safety cap with color-coded fittings, this kit offers a safety bottle (1 or 2 liter), PFA tubing, and a mobile phase filter.

GL45 safety caps seal to the bottle with an O-ring* (EPDM) which is resistant to commonly used HPLC solvents. If improved chemical resistance is required (e.g. for halogenated hydrocarbons), order an FEP-coated O-ring separately.

Bottle size:	No. of ports	1 Liter		2 Liters	
		Product No.	Product No.	Product No.	Product No.
Safety cap kit, GL45	2	JR-S-11111	JR-S-11211		
	3	JR-S-11112	JR-S-11212		
	4	JR-S-11113	JR-S-11213		
		Qty/pkg	Product No.		
O-ring, FEP-coated, GL45		1	JR-S-40008		



INCLUDES

- 1 safety cap, GL45 thread, with fittings
- 1 safety-coated glass bottle (option: 1L or 2L)
- 3 m, PFA tubing
- 1 No-Met mobile phase filter, 5 µm
- Additional nuts and ferrules for the bottom side connections

* GL45 caps produced beginning in 2012 will seal with an O-ring behind a PTFE lip.

Spare parts for safety cap kit

	Tubing OD	Qty/pkg	Product No.
1/4-28 flangeless nuts, PPS	1/16" OD	10	JR-55070-10
	1/8" OD	10	JR-55071-10
Inverted ferrules, ETFE	1/16" OD	10	JR-041-10
	1/8" OD	10	JR-051-10
Safety-coated bottle with solid cap			
1 Liter		1	JR-9000-0005
2 Liters		1	JR-9000-0010
Plug, 1/4-28, PEEK		1	JR-409
Barbed hose adapter for 1/8" ID tubing		1	JR-075013
Color-Sleeve adapters, 12 colors (2 each)		24	JR-5508X-24
No-Met biocompatible mobile phase filter, economy slip-on connection, 5 µm pore		1	JR-32174
PFA tubing, 1/8" x 1.59 mm x 3m		1	JR-T-4003-M3

TECH TIP

PFA tubing provides less re-gassing of the mobile phase.

RELATED PRODUCTS

Color-Sleeve adapters 17



No-Met mobile phase filters 52
 PFA tubing 9
 Safety-coated bottles (for additional sizes) . 70
 Safety air inlet valves . . 59

Safety caps

INCLUDES

- 1 cap, GL45 thread, with stopcocks
- 1 O-ring, EPDM
- 1 set: 1/16" nut/ferrule/ color-sleeve adapter
- 1, 2, or 3 sets: 1/8" nut/ferrule/ color-sleeve adapter
- Additional nuts and ferrules for the bottom side connections



- Fit all bottles or canisters with GL45 thread
- Built-in stopcocks for easy interruption of solvent lines
- 2, 3, or 4 ports with 1/4-28 threads for 1/8" or 1/16" tubing

GL45 safety caps seal to the bottle with an O-ring* (EPDM) which is resistant to commonly used HPLC solvents. If improved chemical resistance is required (e.g. for halogenated hydrocarbons), order an FEP-coated O-ring separately.

	No. of ports	Product No.
Safety cap, GL45	2	JR-S-11011
	3	JR-S-11012
	4	JR-S-11013
O-ring, FEP-coated, GL45		JR-S-40008

GL45 threads

SPECS

- Connections: 1/4-28
- Materials
Closure: PP (Polypropylene)
Insert: PTFE
Stopcock: CTFE
O-ring: EPDM (alternative: FEP-coated)
Nuts: PPS
Ferrules: ETFE
Sleeves: PP

* GL45 caps produced beginning in 2012 will seal with an O-ring behind a PTFE lip.

Safety caps

INCLUDES

- 1 cap, DIN50 thread, with stopcocks
- 1 O-ring,
- 1 set: 1/16" nut/ ferrule/ color-sleeve adapter
- 1, 2, or 3 sets: 1/8" nut/ferrule/ color-sleeve adapter
- Additional nuts and ferrules for the bottom side connections



- Fit all bottles or canisters with DIN50 thread
- Built-in stopcocks for easy interruption of solvent lines
- 2, 3, or 4 ports with 1/4-28 threads for 1/8" or 1/16" tubing

DIN50 safety caps seal to the bottle/canister with an O-ring behind a PTFE lip, so the O-ring is therefore not a wetted part.

	No. of ports	Product No.
Safety cap, DIN50	2	JR-S-15011
	3	JR-S-15012
	4	JR-S-15013

DIN50 threads

SPECS

- Connections: 1/4-28
- Materials
Closure: PP (Polypropylene)
Insert: PTFE
Stopcock: CTFE
O-ring: EPDM/ NBR
Nuts: PPS
Ferrules: ETFE
Sleeves: PP

NOTE

One port must be reserved for the exhaust filter or the air inlet valve.

MORE INFORMATION

Chemical resistance 96-98

RELATED PRODUCTS

Air inlet valves 59
 Exhaust filters 60-61

Spare parts *for safety caps*

	Tubing OD	Qty/pkg	Product No.
1/4-28 flangeless nuts, PPS	1/16"	10	JR-55070-10
	1/8"	10	JR-55071-10
Inverted ferrules, ETFE	1/16"	10	JR-041-10
	1/8"	10	JR-051-10
Barbed hose adapter for 1/8" ID tubing		1	JR-075013
Color-Sleeve adapters, 12 colors (2 each)		24	JR-5508X-24

VICI caps seal to the bottle with an O-ring (EPDM) which is resistant to commonly used HPLC solvents. If improved chemical resistance is required (e.g. for halogenated hydrocarbons), order an FEP-coated O-ring separately. Unused ports should be closed with plugs, available in PEEK or polypropylene. (See "Spare Parts," below)

- Prevent evaporation of volatile compounds
- 2, 3, or 4 ports with 1/4-28 threads for 1/8" or 1/16" tubing
- 6 or 7 ports available in some models
- Optional bottom-sealing barbed adapter to connect 1/8" (3.2 mm) ID tubing (shown at right – order separately from "Spare Parts")



VICI cap kit

GL45 threads

SPECS

- Connections: 1/4-28
- Materials
 - Closure: PP (polypropylene)
 - Insert: PTFE
 - O-ring: EPDM (alternative: FEP-coated)
 - Nuts: PPS
 - Ferrules: ETFE
 - Sleeves: PP
 - Bottle: Borosilicate 3.3, safety coated
 - Filter: Polyethylene

In addition to a GL45 VICI cap with fittings, this kit includes a safety bottle (1 or 2 liter), PFA tubing, and a mobile phase filter.

Bottle size:	No. of ports	1 Liter	2 Liters
		Product No.	Product No.
VICI cap kit, GL45	2	JR-S-11101	JR-S-11201
	3	JR-S-11102	JR-S-11202
	4	JR-S-11103	JR-S-11203
O-ring, FEP-coated, GL45		Qty/pkg	Product No.
		1	JR-S-40008



INCLUDES

- 1 VICI cap, GL45 thread, with fittings
- 1 safety-coated glass bottle (option: 1L or 2L)
- 3 m, PFA tubing
- 1 No-Met mobile phase filter, 5 µm

VICI caps

GL45 threads

SPECS

- Connections: 1/4-28
- Materials
 - Closure: PP (Polypropylene)
 - Insert: PTFE
 - Stopcock: CTFE
 - O-ring: EPDM (alternative: FEP-coated)
 - Nuts: PPS
 - Ferrules: ETFE
 - Sleeves: PP

- Fit all bottles or canisters with GL45 thread
 - 2, 3, 4, 6, and 7 ports with 1/4-28 threads for 1/8" or 1/16" tubing
- GL45 VICI caps seal to the bottle with an O-ring* (EPDM) which is resistant to commonly used HPLC solvents. If improved chemical resistance is required (e.g. for halogenated hydrocarbons), order an FEP-coated O-ring separately.

	No. of ports	Product No.
VICI cap, GL45	2	JR-S-11001
	3	JR-S-11002
	4	JR-S-11003
	6	JR-S-11005
	7	JR-S-11006
O-ring, FEP-coated, GL45		JR-S-40008



INCLUDES

- 1 cap, GL45 thread
- 1 O-ring, EPDM
- 1 set: 1/16" nut/ferrule/ color-sleeve adapter
- 1, 2, 3, 5, or 6 sets: 1/8" nut/ferrule/ color-sleeve adapter



PTFE insert for 6 port cap



PTFE insert for 7 port cap

* GL45 caps produced beginning in 2012 will seal with an O-ring behind a PTFE lip.

Spare parts

for VICI caps

	Tubing OD	Qty/pkg	Product No.
1/4-28 flangeless nuts, PPS	1/16"	10	JR-55070-10
	1/8"	10	JR-55071-10
	1/8"	10	JR-051-10
Inverted ferrules, ETFE	1/16"	10	JR-041-10
	1/8"	10	JR-051-10
Plug, 1/4-28	PEEK	1	JR-409
	Polypropylene	1	JR-201999
Barbed hose adapter for 1/8" ID tubing		1	JR-075013
Color-Sleeve adapters, 12 colors (2 each)		24	JR-5508X-24

Additional spare parts for VICI cap kits	Qty/pkg	Product No.
Safety-coated bottle with solid cap	1 Liter	1 JR-9000-0005
	2 Liters	1 JR-9000-0010
No-Met biocompatible mobile phase filter, economy slip-on connection, 5 µm pore	1	JR-32174
PFA tubing, 1/8" x 1.59 mm x 3m	1	JR-T-4003-M3

VICI caps

NEW

S40 threads

INCLUDES

- 1 cap, S40 thread
- 1 set: 1/16" nut/ ferrule/ color-sleeve adapter
- 2 sets: 1/8" nut/ferrule/ color-sleeve adapter



- Fit all bottles with S40 thread
- 3 ports with 1/4-28 threads for 1/8" or 1/16" tubing

The latest addition to the Jour Safety product line, the S40 VICI cap seals to the bottle with an O-ring (EPDM) which is resistant to commonly used HPLC solvents.

	No. of ports	Product No.
VICI cap, S40	3	JR-S-14002

SPECS

- Connections: 1/4-28
- Materials: Closure: PP* (Polypropylene)
- Insert: PTFE
- O-ring: EPDM
- Nuts: PPS*
- Ferrules: ETFE
- Sleeves: PP*
- *not a wetted part

VICI caps

DIN50 threads

INCLUDES

- 1 cap, DIN50 thread
- 1 O-ring,
- 1 set: 1/16" nut/ ferrule/ color-sleeve adapter
- 1, 2, or 3 sets: 1/8" nut/ferrule/ color-sleeve adapter



- Fit all bottles or canisters with DIN50 thread
- 2, 3, or 4 ports with 1/4-28 threads for 1/8" or 1/16" tubing

DIN50 VICI caps seal to the bottle/canister with an O-ring behind a PTFE lip, so the O-ring is therefore not a wetted part.

	No. of ports	Product No.
VICI cap, DIN50	2	JR-S-15001
	3	JR-S-15002
	4	JR-S-15003



SPECS

- Connections: 1/4-28
- Materials: Closure: PP (Polypropylene)
- Insert: PTFE
- Stopcock: CTFE
- O-ring: EPDM/NBR
- Nuts: PPS
- Ferrules: ETFE
- Sleeves: PP

VICI caps

GL38 threads

INCLUDES

- 1 cap, GL37/430 thread
- 1 O-ring
- 1 set: 1/16" nut/ ferrule/ color-sleeve adapter
- 1, 2, or 3 sets: 1/8" nut/ferrule/ color-sleeve adapter
- 1 adapter ring



- Fit all bottles or canisters with GL38/430 thread (See NOTES, below)
- 2, 3, or 4 ports with 1/4-28 threads for 1/8" or 1/16" tubing

Color-coded PP sleeves fit on all ports on 2 and 3 port caps. With 4 port caps, the use of PP sleeves is limited to two sleeves per cap. (Four colors are included.)

	No. of ports	Product No.
VICI cap, GL38	2	JR-S-13001
	3	JR-S-13002
	4	JR-S-13003
O-ring, FEP-coated, GL38		JR-S-40009

SPECS

- Connections: 1/4-28
- Materials: Closure: PP (Polypropylene)
- Insert: PTFE
- O-ring: EPDM (alternative: FEP-coated)
- Adapter ring: PA/PP
- Nuts: PPS
- Ferrules: ETFE
- Sleeves: PP

TECH TIP

PFA tubing provides less re-gassing of the mobile phase.

MORE INFORMATION

Chemical resistance 96-98

RELATED PRODUCTS

- Color-Sleeve adapters . 17
- No-Met mobile phase filters 52
- PFA tubing 9
- Safety-coated bottles (for additional sizes) . 70
- Safety air inlet valves . . 59

NOTES

- GL38 thread is available in different variations. Please check the inside diameter of the neck:
- For 21-24 mm ID (e.g. Wheaton® bottles), use the GL38 cap as is, without an adapter.
 - For 24-28 mm ID (e.g. Nalgene® bottles), use the adapter ring (JR-S-40006) which is included with this VICI cap.

SAFETY PRODUCTS

Waste caps seal the bottle/canister with an O-ring behind a PTFE lip, so the O-ring is therefore not a wetted part. Unused ports should be closed with plugs, available in PEEK or polypropylene. (See "Spare Parts" on page 66.)

- Prevent evaporation of volatile compounds
- 3 or 4 ports with 1/4-28 threads for 1/8" or 1/16" tubing
- Additional port with 1/2-20 thread for 1/4" OD tubing or M10 x 1 thread for a barbed adapter
- Thread-sealing barbed adapters available in three sizes, to connect 4 mm, 6 mm, or 8 mm ID tubing (shown at right – order separately)



Waste caps NEW

GL45 threads

SPECS

- Connections: 1/4-28, 1/2-20
- Materials
 - Closure: PP (Polypropylene)
 - Insert: PTFE
 - O-ring: NBR
 - Nuts: PPS/POM
 - Ferrules: ETFE/CTFE
 - Plug: PTFE
 - Barbed adapter: PA/PP

- Fits all bottles or canisters with GL45 thread
- 4 ports with with one M10 x 1 port for barbed/angled adapters

This waste cap seals the bottle/cannester with an O-ring behind a PTFE lip, so the O-ring is therefore not a wetted part.



INCLUDES

- 1 cap
- 1 O-ring
- 1 set: 1/16" nut/ ferrule/ color-sleeve adapter
- 2 sets: 1/8" nut/ferrule/ color-sleeve adapter

	No. of ports	Product No.
Waste cap, GL45	4	JR-S-11023

Waste caps

GLS80 threads

SPECS

- Connections: 1/4-28, 1/2-20
- Materials
 - Closure: PP (Polypropylene)
 - Insert: PTFE
 - O-ring: NBR
 - Nuts: PPS/POM
 - Ferrules: ETFE/CTFE
 - Plug: PTFE
 - Barbed adapter: PA/PP

- Fits all bottles or canisters with GLS80 thread
- 4 ports with 1/4-28 thread for 1/8" or 1/16" tubing
- Fifth port with choice of threads

	Product No.
Waste cap, GLS80	
Fifth port:	
1/2-20 thread for 1/4" OD tubing, with 1/4" plug	JR-S-18004
M10 x 1 thread for barbed adapter	JR-S-18014
(Order barbed adapter from "Spare Parts" on page 66)	



INCLUDES

- 1 cap
- 1 O-ring
- 1 set: 1/16" nut/ ferrule/ color-sleeve adapter
- 1 set: 1/4" nut/ferrule
- 3 sets: 1/8" nut/ferrule/ color-sleeve adapter
- 1 plug, 1/4" (1/2-20), where noted in product number chart

NOTES

One port must be reserved for the exhaust filter or the air inlet valve.

MORE INFORMATION

Spare parts for waste caps 68
Chemical resistance 96-98

RELATED PRODUCTS

Waste caps
B53 threads 68
B83 threads 68

Waste caps

DIN60 threads

INCLUDES

- 1 cap
- 1 O-ring
- 1 set: 1/16" nut/ ferrule/ color-sleeve adapter
- 1 set: 1/4" nut/ferrule
- 2 sets:
 - 1/8" nut/ferrule/ color-sleeve adapter
- 1 plug, 1/4" (1/2-20), where noted in product number chart



- Fits all bottles or canisters with DIN60 thread
- 3 ports with 1/4-28 thread for 1/8" or 1/16" tubing
- Fourth port with choice of threads

Waste cap, DIN60

Product No.

Fourth port:

- 1/2-20 thread for 1/4" OD tubing, with 1/4" plug JR-S-16003
 - M10 x 1 thread for barbed adapter JR-S-16013
- (Order barbed adapter from "Spare Parts" on page 64)*

SPECS

- Connections: 1/4-28, 1/2-20
- Materials
 - Closure: PP (Polypropylene)
 - Insert: PTFE
 - O-ring: NBR
 - Nuts: PPS/POM
 - Ferrules: ETFE/CTFE
 - Plug: PTFE
 - Barbed adapter: PA/PP

Waste caps

S51 threads

INCLUDES

- 1 cap
- 1 O-ring
- 1 set: 1/16" nut/ ferrule/ color-sleeve adapter
- 1 set: 1/4" nut/ferrule
- 2 sets:
 - 1/8" nut/ferrule/ color-sleeve adapter
- 1 plug, 1/4" (1/2-20), where noted in product number chart



- Fits all bottles or canisters with S51 thread
- 3 ports with 1/4-28 thread for 1/8" or 1/16" tubing
- Fourth port with choice of threads

Waste cap, S51

Product No.

Fourth port:

- 1/2-20 thread for 1/4" OD tubing, with 1/4" plug JR-S-15103
 - M10 x 1 thread for barbed adapter JR-S-15113
- (Order barbed adapter from "Spare Parts" on page 66)*

SPECS

- Connections: 1/4-28, 1/2-20
- Materials
 - Closure: PP (Polypropylene)
 - Insert: PTFE
 - O-ring: NBR
 - Nuts: PPS/POM
 - Ferrules: ETFE/CTFE
 - Plug: PTFE
 - Barbed adapter: PA/PP

Waste caps

S61 threads

INCLUDES

- 1 cap
- 1 O-ring
- 1 set: 1/16" nut/ ferrule/ color-sleeve adapter
- 1 set: 1/4" nut/ferrule
- 2 sets:
 - 1/8" nut/ferrule/ color-sleeve adapter
- 1 plug, 1/4" (1/2-20), where noted in product number chart



- Fits all bottles or canisters with S61 thread
- 3 ports with 1/4-28 thread for 1/8" or 1/16" tubing
- Fourth port with choice of threads

Waste cap, S61

Product No.

Fourth port:

- 1/2-20 thread for 1/4" OD tubing, with 1/4" plug JR-S-16103
 - M10 x 1 thread for barbed adapter JR-S-16113
- (Order barbed adapter from "Spare Parts" on page 66)*

SPECS

- Connections: 1/4-28, 1/2-20
- Materials
 - Closure: PP (Polypropylene)
 - Insert: PTFE
 - O-ring: NBR
 - Nuts: PPS/POM
 - Ferrules: ETFE/CTFE
 - Plug: PTFE
 - Barbed adapter: PA/PP

RELATED PRODUCTS

- Color-Sleeve adapters..... 17
- Exhaust filters60-61
- Air inlet valves..... 59

Waste caps

B53 threads

SPECS

- Connections: 1/4-28, 1/2-20
- Materials
- Closure: PP (Polypropylene)
- Insert: PTFE
- O-ring: NBR
- Nuts: PPS/POM
- Ferrules: ETFE/CTFE
- Plug: PTFE
- Barbed adapter: PA/PP

- Fits all bottles or canisters with B53 thread
- 3 ports with 1/4-28 thread for 1/8" or 1/16" tubing
- Fourth port with choice of threads

Waste cap, B53
Fourth port:

- 1/2-20 thread for 1/4" OD tubing, with 1/4" plug
- M10 x 1 thread for barbed adapter
- (Order barbed adapter from "Spare Parts" below)

Product No.

- JR-S-15303
- JR-S-15313



INCLUDES

- 1 cap
- 1 O-ring
- 1 set: 1/16" nut/ ferrule/ color-sleeve adapter
- 1 set: 1/4" nut/ferrule
- 2 sets: 1/8" nut/ferrule/ color-sleeve adapter
- 1 plug, 1/4" (1/2-20), where noted in product number chart

Waste caps

B83 threads

SPECS

- Connections: 1/4-28, 1/2-20
- Materials
- Closure: PP (Polypropylene)
- Insert: PTFE
- O-ring: NBR
- Nuts: PPS/POM
- Ferrules: ETFE/CTFE
- Plug: PTFE
- Barbed adapter: PA/PP

- Fits all bottles or canisters with B83 thread
- 4 ports with 1/4-28 thread for 1/8" or 1/16" tubing
- Fifth port with choice of threads

Waste cap, B83
Fifth port:

- 1/2-20 thread for 1/4" OD tubing, with 1/4" plug
- M10 x 1 thread for barbed adapter
- (Order barbed adapter from "Spare Parts" below)

Product No.

- JR-S-18304
- JR-S-18314



INCLUDES

- 1 cap
- 1 O-ring
- 1 set: 1/16" nut/ ferrule/ color-sleeve adapter
- 1 set: 1/4" nut/ferrule
- 3 sets: 1/8" nut/ferrule/ color-sleeve adapter
- 1 plug, 1/4" (1/2-20), where noted in product number chart

Spare parts for waste caps

	Material	Tubing OD	Qty/pkg	Product No.
1/4-28 flangeless nuts	PPS	1/16"	10	JR-55070-10
		1/8"	10	JR-55071-10
Inverted ferrules	ETFE	1/16"	10	JR-041-10
		1/8"	10	JR-051-10
1/2-20 nut	POM	1/4"	1	JR-CFL-4D
Collapsible ferrule	CTFE	1/4"	1	JR-CFL-CB4KF-S
Adapter				
1/2-20 to 1/4-28	POM	NEW	1	JR-S-40200
Barbed adapter, M10 x 1				
For 4 mm ID tubing	PA		1	JR-S-40104
For 6 mm ID tubing	PA		1	JR-S-40106
For 8 mm ID tubing	PA		1	JR-S-40108
Barbed hose adapter				
For 1/8" ID tubing	PA/PP		1	JR-075013
Plug, 1/4-28	PEEK		1	JR-409
	Polypropylene		1	JR-201999
Plug, 1/2-20	PTFE		1	JR-S-40007
Color-Sleeve adapters, 12 colors (2 each)			24	JR-5508X-24

NOTES

One port must be reserved for the exhaust filter or the air inlet valve.

MORE INFORMATION

Chemical resistance 96-98

RELATED PRODUCTS

Waste caps

DIN60 threads	67
GL45 threads	66
GLS80 threads	66
S51 threads	67
S61 threads	67

Color-Sleeve adapters. 17

Exhaust filters 60-61

Air inlet valves. 59

Eco cap kit**INCLUDES**

- 1 cap, GL45 thread, with three ports
- 1 safety-coated glass bottle (option: 1 L or 2 L)
- 1 male Luer plug, polypropylene

In addition to an Eco cap with polypropylene male Luer plug, this kit offers a safety bottle (1 or 2L).

The Eco cap consists of a three-hole ETFE insert with a polyethylene collar, compatible with all standard GL45 thread bottles. The Eco cap has no threading for fittings on the inside of the tubing ports – the tubing is just inserted.

Product No.

Eco cap kit
1 Liter bottle
2 Liter bottle

**GL45 threads****SPECS**

- Materials
- Screw collar: PP (polypropylene)
- Pouring ring: PP
- Insert: ETFE
- O-rings: EPDM
- Luer plug: PP

Eco cap**INCLUDES**

- 1 cap, GL45 thread, with three ports
- 1 male Luer plug, polypropylene

- Competitively priced alternative to sparge and deliver mobile phases
- Also available as bottle kit

The Eco cap consists of a three-hole ETFE insert with a polyethylene collar, compatible with all standard GL45 thread bottles. The Eco cap has no threading for fittings on the inside of the tubing ports – the tubing is just inserted.

Product No.

Eco cap JR-9000-0007

**GL45 threads****SPECS**

- Materials
- Screw collar: PP (polypropylene)
- Pouring ring: PP
- Insert: ETFE
- O-rings: EPDM
- Luer plug: PP

Spare parts**for Eco cap**

Product No.

Male Luer plug, polypropylene 10/pkg JR-070350-10

NOTE

These caps are not usable for building up a helium atmosphere within in the solvent bottle, but only for continuous helium sparging.

TECH TIP

Once the mobile phase is degassed, we recommend our impermeable tubing between bottle cap and pump to prevent regassing of helium degassed solvents.

RELATED PRODUCTS

Impermeable tubing . . . 13
Polymeric tubing . . . 9-13
Waste caps 66-68

SAFETY PRODUCTS

Safety-coated glass bottles

SPECS

- Pressure rating
0.8 bar (11.6 psi)
- Materials
Bottle:
Borosilicate
3.3 glass
Cap: PP
(Polypropylene)
Pouring ring: PP

- Special design for helium sparging of LC mobile phases
- Safety coating to minimize risk of injury
- Available in 0.25, 0.5, 1 and 2 Liter sizes

These glass bottles with GL45 screw threading are made of chemical resistant Borosilicate 3.3 and are coated on the outside with a layer of sturdy polymer, decreasing the chances of breakage if the bottle is dropped. Even if the bottle breaks, glass fragments will be kept within the polymer coating. Solvents will be kept within the coating for a short while. The coating also protects solvents against UV light up to 385 nm.

These safety-coated glass bottles cannot be autoclaved.

Bottles include a solid cap.

	<i>Bottle size</i>	<i>Product No.</i>
Safety-coated bottle	0.25 L	JR-9000-0011
	0.5 L	JR-9000-0012
	1 L	JR-9000-0005
	2 L	JR-9000-0010



SolviFlex

SPECS

- 1/8" OD tubing
- Materials
Tubing: PFA
Nuts: PPS
Ferrules: ETFE
Filter: PE
(Polyethylene)

- Be "mobile" with mobile phase bottles
- Ideal for with VICI safety caps or VICI caps
- Customized version on request

The SolviFlex is made of flexible telephone cable-like PFA tubing which expands and contracts, providing flexibility to move mobile phase bottles up to 1.5 m radius on the bench. Approximately 3 m of tubing is coiled with straight stretches of tubing at each end.

Includes:

- ~3 m coiled 1/8" PFA tubing
- 2 sets: 1/4-28 nut/ferrules for 1/8" OD tubing
- 1 No-Met mobile phase filter with economy slip-on connection (JR-32174)

	<i>Product No.</i>
SolviFlex assembly	JR-6120-50030

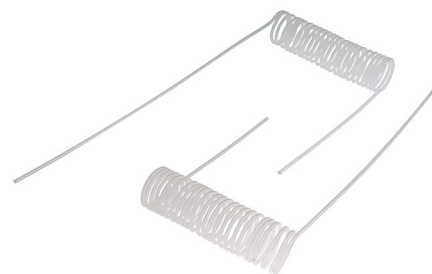

A typical use of SolviFlex
Shown installed on a VICI cap and bottle, along with an exhaust filter

NOTES

- The bottles are not suitable to be stressed with pressures above 0.8 bar (11.6 psi), but only for continuous helium sparging.
- The safety coating on a bottle is not intended to replace safe working conditions and precautions in laboratories.

RELATED PRODUCTS

No-Met biocompatible mobile phase filter... 52
 Safety caps... 63
 Safety cap kit... 62
 Safety exhaust filter 60-61
 VICI caps... 64-65
 VICI cap kit... 64

**Carbon dioxide filter****NEW****CO₂**

In ion chromatography, a basic solution is often used as mobile phase. The buffer capacity of such solutions is small, so the pH of the solution can be affected by the carbon dioxide in the air.

Using a bottle in combination with a VICI cap and a carbon dioxide filter prevents any change in the pH of the mobile phase, thus increasing the stability of the analysis. In this application, the carbon dioxide filter also functions as an air inlet valve.

<i>Description</i>	<i>Product No.</i>
Carbon dioxide filter	JR-S-20100

**Humidity filter****NEW****H₂O**

In applications requiring a non-aqueous organic solvent, the moisture in the ambient air can influence the results. The use of a humidity filter in combination with a VICI cap solves this problem.

<i>Description</i>	<i>Product No.</i>
Humidity filter	JR-S-20200

RELATED PRODUCTS

Safety exhaust filters... 60

Frits

REPRODUCIBILITY AND PRECISION

VICI Jour unidense frits, with uniform flow across the entire frit, offer unexcelled reproducibility and precision. Proprietary manufacturing processes ensure uniformity and precise, repeatable dimensional control.

PEEK-encased frits surround the frit with a ring of PEEK, reducing the actual porous surface to the ID of an HPLC column or filter.

Frits index

Unidense frits

Stainless.....	page 73
Titanium.....	73
Polyethylene.....	72

PEEK-encased frits

Stainless.....	74
Titanium.....	75
Polyethylene.....	75

Polyethylene frits – unidense type

SPECS

- Material: UHMWPE
- Tolerances: ± 0.08 mm (.003")

- Biocompatible
- Metal free

Our completely metal-free polymer frits are made of UHMWPE (Ultra High Molecular Weight PolyEthylene), and offer a competitively priced alternative to titanium.

For single use only. Sold in packages of 5.

OD		Thickness		Porosity	Frit volume	Product No.
inches	mm	inches	mm	μ m	μ L	
.255"	6.50	.079"	2.00	10	26.5	JR-F-255-079-10PE-5



OPTIONS AND MORE INFORMATION

See facing page.

RELATED PRODUCTS

PEEK-encased polyethylene frits . . . 75

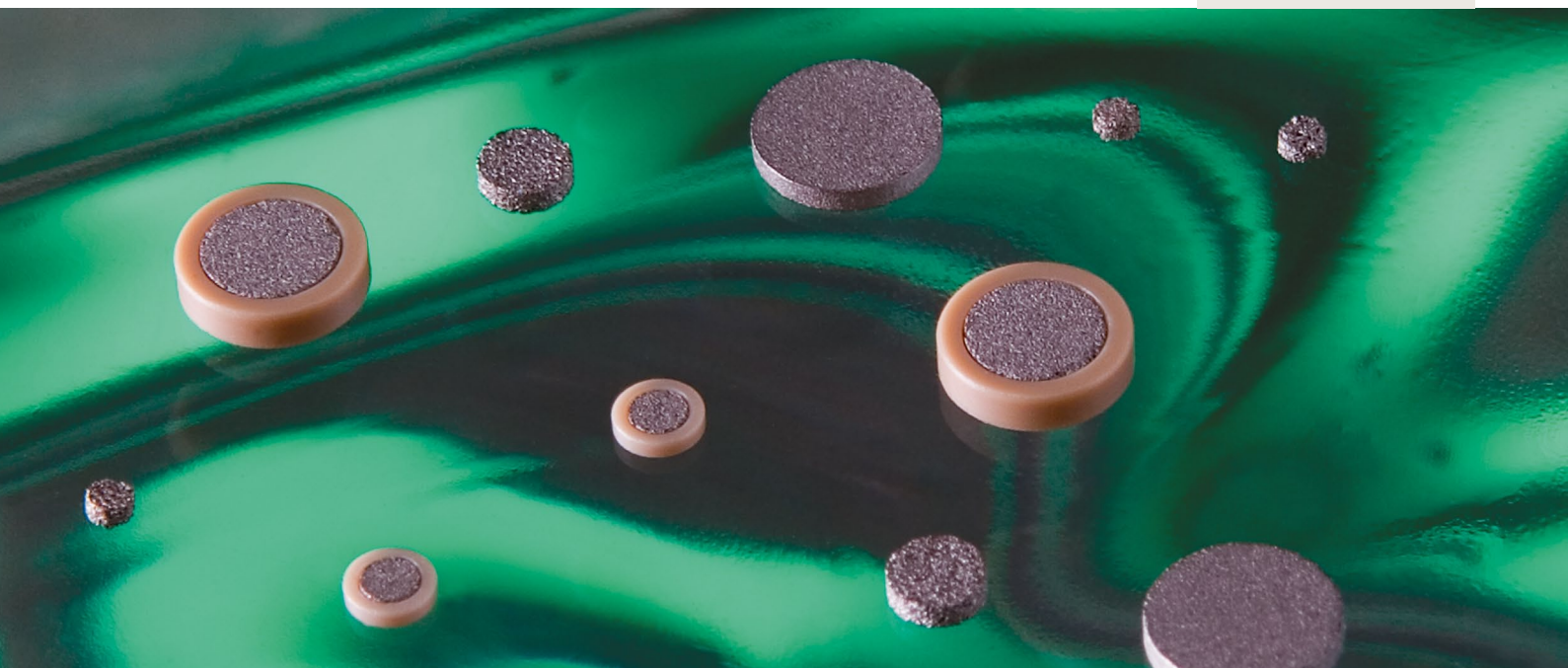

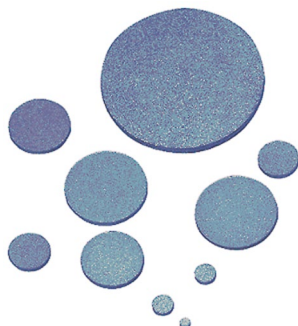

Stainless steel frits – unidense type

For both standard frits and those produced to custom specifications, these frits offer unexcelled reproducibility and precision. Proprietary manufacturing processes ensure uniformity and precise, repeatable dimensional control.

Stainless steel frits are manufactured of SS316L, which has extra-low carbon content. The sintering process used results in a strong bonding of the sinter metal particles. Depending on the grade of powder used, the porosity of the frit can be precisely tuned. Sold in packages of 5.

SPECS

- Material: Stainless steel Type 316L sintered
- Tolerances: See chart below

OD		Thickness		Porosity	Frit volume	Product No.
inches	mm	inches	mm	µm	µL	
1/16"	1.59	.030"	0.76	0.5	0.39	JR-.5FR1-5
				1	0.45	JR-1FR1-5
				2	0.53	JR-2FR1-5
				10	0.60	JR-10FR1-5
1/8"	3.18	.040"	1.02	0.5	2.10	JR-.5FR2-5
				1	2.43	JR-1FR2-5
				2	2.83	JR-2FR2-5
				10	3.24	JR-10FR2-5
1/4"	6.35	.040"	1.02	0.5	8.39	JR-.5FR4-5
				2	11.30	JR-2FR4-5
				10	12.91	JR-10FR4-5
3/8"	9.53	.040"	1.02	0.5	18.91	JR-.5FR6-5
				2	25.45	JR-2FR6-5
				10	29.09	JR-10FR6-5
1/2"	12.70	.040"	1.02	0.5	33.58	JR-.5FR8-5
				2	45.2	JR-2FR8-5
				10	51.66	JR-10FR8-5
1"	25.40	.060"	1.52	2	269.43	JR-2FR1K-5
				10	307.92	JR-10FR1K-5

OPTIONS

- Standard frits do not have chamfers. Chamfered frits are available on request.
- Other dimensions and porosities are available on request. Minimum order quantity: 100 pieces. Please contact your local distributor or VICI directly.

TOLERANCES

OD (mm)	Tolerance
<5	±0.05 mm (.002")
5-12	±0.08 mm (.003")
12.5-25.4	±0.20 mm (.008")

NOTES

- Stated porosities are only nominal and do not reflect the maximum pore size of a frit.
- See frit volume chart for help choosing the right frit and porosity for your application 95
- Frit volumes are theoretical and are calculated by multiplying overall frit volume times the porosity proportion.

RELATED PRODUCTS

- PEEK-encased frits
- Stainless 74
- Titanium 75

Titanium frits – unidense type

- Biocompatible
- Recommended for protein analysis
- High corrosion resistance
- Various pore sizes and diameters

Titanium is preferred over stainless steel for applications related to the analysis of sensitive substances in general and large biomolecules in particular. Evidently proteins have a tendency to adsorb on the stainless steel (iron) frit and consequently reduce recovery or may even decompose. Titanium also offers higher corrosion resistance and can be used with solvents containing halides.

Sold in packages of 5.

OD		Thickness		Porosity	Frit volume	Product No.
inches	mm	inches	mm	µm	µL	
1/16"	1.59	.030"	0.76	0.5	0.82	JR-.5FR1TI-5
				2	0.71	JR-2FR1TI-5
1/8"	3.18	.040"	1.02	2	2.83	JR-2FR2TI-5
1/4"	6.35	.040"	1.02	2	11.30	JR-2FR4TI-5
3/8"	9.53	.040"	1.02	2	25.45	JR-2FR6TI-5
1/2"	12.70	.040"	1.02	2	45.2	JR-2FR8TI-5
				10	51.66	JR-10FR8TI-5
1"	25.40	.060"	1.52	2	180.80	JR-2FR1KTI-5

SPECS

- Material: Titanium, sintered
- Tolerances: See chart at left

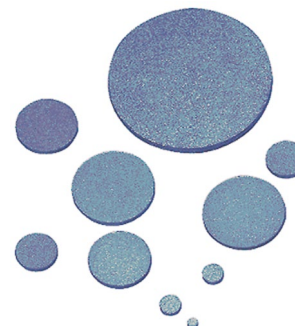

PEEK-encased frits surround the frit with a ring of PEEK, reducing the actual porous surface to the ID of an HPLC column or filter.

The compressed PEEK ring forms a seal between the bottom of the fitting and the column end, preventing the mobile phase and the sample from entering the previously accessible poorly swept areas.

Stainless steel frits – PEEK-encased

SPECS

- Material:
Frit Stainless SS316L
Ring PEEK
- Tolerances:
±0.05 mm (.002")

- For HPLC columns or in-line filters
- Eliminate poorly swept volume and improves peak symmetry
- Various porosities and dimensions available

Our PEEK-encased frits with 0.118" or 1/4" OD ring are intended for HPLC columns with IDs of 3.2, 3.9, and 4.6 mm. With the frit surrounded by a PEEK ring, the actual porous surface is reduced to the column ID.

The compressed PEEK ring forms a seal between the bottom of the fitting and the column end, preventing the mobile phase and the sample from entering the previously accessible poorly swept areas.

Sold in packages of 5.



Ring OD		Frit OD		Thickness		Porosity	Frit volume	Product No.		
inches	mm	inches	mm	inches	mm	µm	µL			
.118"	3.00	.038"	0.97	.028"	0.70	0.5	0.13	JR-1110-05P-5		
						2	0.18	JR-1110-2P-5		
						5	0.20	JR-1110-5P-5		
		.077"	1.96	.028"	0.70	0.5	.055	JR-1111-05P-5		
						2	0.74	JR-1111-2P-5		
						5	0.80	JR-1111-5P-5		
						10	0.87	JR-1111-10P-5		
		.25"	6.35	.078"	2.00	.062"	1.59	0.5	1.30	JR-1104-05P-5
								2	1.74	JR-1104-2P-5
.125"	3.20			.062"	1.59	0.5	3.32	JR-1102-05P-5		
						2	4.47	JR-1102-2P-5		
.153"	3.90			.062"	1.59	0.5	4.94	JR-1101-05P-5		
						2	4.47	JR-1101-2P-5		
.181"	4.60			.062"	1.59	0.5	6.87	JR-1100-05P-5		
						2	9.24	JR-1100-2P-5		
.125"	3.20			.032"	0.80	0.5	1.75	JR-1103-05P-5		
		2	2.25			JR-1103-2P-5				

OPTIONS

- Other dimensions and porosities are available on request. Minimum order quantity: 100 pieces. Please contact your local distributor or VICI directly.

NOTES

- Stated porosities are only nominal and do not reflect the maximum pore size of a frit.
- See frit volume chart for help choosing the right frit and porosity for your application 95
- Frit volumes are theoretical and are calculated by multiplying overall frit volume times the porosity proportion.

RELATED PRODUCTS

- Unidense type frits
- Polyethylene 72
- Stainless 73
- Titanium 73

Titanium frits – PEEK-encased

- For HPLC columns or in-line filters
- Biocompatible – recommended for protein analysis
- Eliminate poorly swept volume and improves peak symmetry
- Higher corrosion resistance
- Various porosities and dimensions available

SPECS

- Material:
Frit Titanium
Ring PEEK
- Tolerances:
±0.05 mm
(.002")

In terms of biocompatibility, the frit is the critical spot for contributing metal ions to the mobile phase and for interaction with protein samples.

VICI Jour PEEK-encased frits with 1/5" or 1/4" OD ring are intended for HPLC columns with IDs of 3.2 and 4.6 mm. With the frit surrounded by a PEEK ring, the actual porous surface is reduced to the column ID.

The compressed PEEK ring forms a seal between the bottom of the fitting and the column end, preventing the mobile phase and the sample from entering the previously accessible poorly swept areas.

Sold in packages of 5.

Ring OD		Frit OD		Thickness		Porosity	Frit volume	Product No.
inches	mm	inches	mm	inches	mm	µm	µL	
1/5"	5.08	.102"	2.60	.062"	1.59	5	3.20	JR-1128-5P-5
.25"	6.35	.125"	3.20	.062"	1.59	0.5	3.32	JR-1127-05P-5
						2	4.47	JR-1127-2P-5
		.181"	4.60	.062"	1.59	0.5	6.87	JR-1125-05P-5
						2	2.94	JR-1125-2P-5
						5	10.04	JR-1125-5P-5
						10	10.56	JR-1125-10P-5



Polyethylene frits – PEEK-encased

- Biocompatible
- Metal free

SPECS

- Material:
Frit UHMWPE
Ring PEEK
- Tolerances:
±0.05 mm
(.002")

Our polymer frits are made of UHMWPE (Ultra High Molecular Weight PolyEthylene). They are a competitively priced alternative to titanium and are completely metal free.

With the frit surrounded by a PEEK ring, the actual porous surface is reduced to the column ID. The compressed PEEK ring forms a seal between the bottom of the fitting and the column end, preventing the mobile phase and the sample from entering the previously accessible poorly swept areas.

Sold in packages of 5.

Ring OD		Frit OD		Thickness		Porosity	Frit volume	Product No.
inches	mm	inches	mm	inches	mm	µm	µL	
1/5"	5.08	.098"	2.50	.059"	1.50	10	2.94	JR-1150-10P-5
.25"	6.35	.181"	4.60	.059"	1.50	10	11.31	JR-1151-10P-5



OPTIONS AND MORE INFORMATION

See facing page.

TECH TIPS

- PEEK-encased titanium frits can also be used as spare parts frits for the PEEK in-line filter kit...54
- PEEK-encased polyethylene frits can be used as spare parts for:
PEEK in-line filter kit.....54
PEEK columns.....77

Columns

PEEK COLUMNS • GUARD COLUMNS

Columns index

PEEK columns

2.1 mm ID page 77

4.0 mm ID77

In-line biocompatible

guard columns78

This PEEK guard column system extends the life of valuable analytical columns by trapping contaminants from the sample and mobile phase. Only PEEK and titanium contact the mobile phase and sample.

Column couplers and plugs

Column coupler,
one-piece fingertight79

Column end plugs79

Column end plugs, logotype79

Packing kits78

VICI Jour column packing kits are ready-to-use tools to pack our PEEK columns and PEEK guard columns. Includes needed slurry reservoir, packing adapter, and packing seals.





2.1 mm ID PEEK columns

- Biocompatible
- High pressure applications
- Packing devices available

We have designed this column for narrow-bore applications, and for those when a limit amount of sample is available for analysis.

Because 2.1 mm ID columns operate at 1/5th of the flow rate of their 4.6 mm counterparts, the same sample mass injected on a 2.1 mm column will produce five times the detector signal. This greater mass sensitivity provides the same analysis as on a 4.6 mm column with only 20% of the sample.

All our columns are delivered without frits. Purchase frits separately.

SPECS

- Material: PEEK, black and natural
- Tolerances: ±0.05 mm (.002")
- Pressure rating maximum: 210 bar (3000 psi)
During packing, using a VICI Jour packing kit: 350 bar (5000 psi)

Length	Product No.
30 mm	JR-65001NF
50 mm	JR-65002NF
100 mm	JR-65003NF
150 mm	JR-65005NF
250 mm	JR-65006NF

Spare parts

Description	Qty/pkg	Product No.
Column end fitting	1	JR-062
PEEK-encased frit		
Titanium, 5 µm	5	JR-1128-5P-5
Polyethylene, 10 µm	5	JR-1150-10P-5

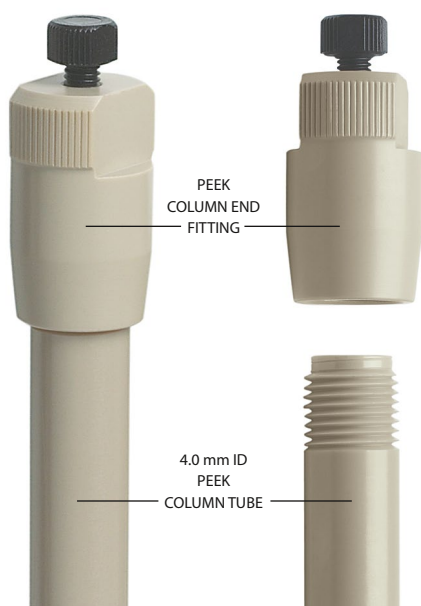

4.0 mm ID PEEK columns

- Biocompatible
- High pressure applications
- Packing devices available

Today's HPLC and IC applications are more demanding than ever. The limitations of traditional stainless steel pose significant problems for a growing number of important biotechnology and ion chromatography applications.

All our columns are delivered without frits. Purchase frits separately.

SPECS

- Material: PEEK, black and natural
- Tolerances: ±0.05 mm (.002")
- Pressure rating maximum: 350 bar (5000 psi)
During packing, using a VICI Jour packing kit: 560 bar (8000 psi)

Length	Product No.
50 mm	JR-68181NF
100 mm	JR-68182NF
125 mm	JR-68183NF
150 mm	JR-68184NF
250 mm	JR-68185NF
300 mm	JR-68186NF

Spare parts

Description	Qty/pkg	Product No.
Column end fitting	1	JR-66140
PEEK-encased frit		
Titanium, 5 µm	5	JR-1125-2P-5
Polyethylene, 10 µm	5	JR-1151-10P-5

RELATED PRODUCTS

- Column packing kit. 78
- PEEK-encased frits
- Titanium 75
- Polyethylene frits 75

In-line biocompatible guard column

SPECS

- Material: PEEK, titanium
- Pressure rating: < 350 bar (< 5000 psi)

- Biocompatible
- Easy to fill
- Packing device for self-packing available

The VICI Jour in-line PEEK guard column system extends the life of valuable analytical columns by trapping contaminants from the sample and mobile phase, thereby preventing loss of retention.

Only PEEK and titanium contact the mobile phase and sample. This system is ideal for use with proteins or other biopolymers that may be contaminated or absorbed by steel surfaces. VICI Jour guard columns can be easily dry packed or slurry packed. Guard columns may be changed in minutes without the use of tools – all connections may be made by hand.

Guard column system includes:

- Guard column cartridge
- 2 Titanium frits
- Housing
- O-ring



Guard column cartridge includes:

- Guard column cartridge
- 2 Titanium frits (2 µm or 5 µm)



Description		Product No.
Guard column system	2 µm	JR-68252TI2
	5 µm	JR-68252TI
Guard cartridge with 2 frits	2 µm	JR-68242TI2
	5 µm	JR-68242TI

Spare parts

Description	Qty/pkg	Product No.
Replacement frit, titanium	2 µm	1 JR-F-197-062-2TINC
	5 µm	1 JR-F-197-062-5TI
Packing seal	1	JR-9

Packing kits

SPECS

- Material: PEEK
 - Pressure ratings during packing, using a VICI Jour packing kit:
- | Column ID | Packing pressure |
|-----------|--------------------|
| 2.1 mm | 350 bar (5000 psi) |
| 4.0 mm | 560 bar (8000 psi) |
- See column pages for operating pressure ratings.

VICI Jour column packing kits are ready-to-use tools to pack our PEEK columns and PEEK guard columns. Every kit consists of the needed slurry reservoir, packing adapter, and packing seals.

Description	Product No.
For 2.1 mm ID columns	
Packing kit	JR-67-250-2A
Replacement PEEK packing adapter	JR-67140-1A
Replacement PEEK packing seal	JR-65011
For 4.0 mm ID columns	
Packing kit	JR-67-250-4
Replacement PEEK packing adapter	JR-67140-2B
Replacement PEEK packing seal	JR-65158
For in-line biocompatible guard columns	
Packing kit	JR-27305
Replacement CTFE packing seal	JR-9

TECH TIP

Our packing kit is a “ready-to-use” tool to pack our PEEK guard cartridges. Every kit consists of the needed slurry reservoir, packing adapter, and packing seals.

RELATED PRODUCTS

PEEK columns	
2.1 mm ID	77
4.0 mm ID	77

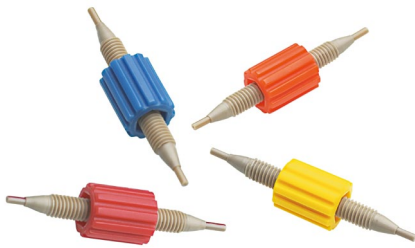

One-piece fingertight column couplers

- Self-adjusting – zero dead volume for all fitting types
- Four bore sizes
- Biocompatible

Choose from a variety of coupler IDs, indicated by the color of the sleeve. A unique feature of this column coupler is that it adapts automatically to fit all pilot lengths – Valco, Waters, Upchurch, Rheodyne, etc. Since the tubing bottoms out in any fitting detail, added void volume is minimal.

Sold individually.

Color	ID	Product No.
Red	0.13 mm	JR-26501
Yellow	0.17 mm	JR-26502
Blue	0.25 mm	JR-26503
Orange	0.50 mm	JR-26504

SPECS

- Material:
 - Tubing PEEK
 - Fittings PEEK
 - Sleeve PP (Polypropylene)
- Threads: 10-32 male to 10-32 male
- Pressure rating: <350 bar (5000 psi)



Coupler shown installed between two columns (columns not included)

Column end plugs – logotype

- Customizable with your logo and color (OEM version)
- Same features as column end plugs below

Ensure safe closure of valuable columns with your own customized column end plugs. Easy handling is guaranteed by the 5/16" wrench flat. Fit all columns with 10-32 thread.

Sold in packages of 10.

Color	Product No.
White	JR-4081-10
Black	JR-4082-10
Red	JR-4083-10
Green	JR-4084-10
Blue	JR-4085-10



SPECS

- Material: Nylon
- Threads: 10-32
- Tolerances: ±0.05 mm (.002")

Column end plugs

- Seal analytical columns
- One size fits all
- Fingertight, with wrench flats as well

Fingertight column end plugs fit all columns with 10-32 threads. Easy handling is guaranteed by an additional 5/16" wrench flat, which allows the plug to be loosened by a wrench if it gets stuck. The long design and threading down to the ferrule ensure safe closing of valuable columns.

Sold in packages of 10.

Color	Product No.
White	JR-4071-10
Black	JR-4072-10
Red	JR-4073-10
Green	JR-4074-10
Blue	JR-4075-10



SPECS

- Material: Nylon
- Threads: 10-32
- Tolerances: ±0.05 mm (.002")

RELATED PRODUCTS

Color-coded PEEK tubing 6-8

Sample loops

VALCO • CHEMINERT® • RHEODYNE®

Sample loops are accurately sized for each valve type. However, with small volume loops, the tolerance on the ID of the tubing (± 0.001 ") can have a significant effect on the volume. Therefore loop volume and loop appearance may differ from batch to batch.

Sample loops index

PEEK loops

PEEK loops for:

Cheminert.....	page 81
Rheodyne	81
Valco	81

Stainless steel loops

Stainless loops for:

Cheminert.....	82
Rheodyne	83
Valco	82

SPECS

- Material:
 - Loops PEEK
 - Nuts PEEK
 - Ferrules PEEK
 - Caps PE (Polyethylene)
- Tolerances:
 - ± 0.025 mm
 - (.001")

PEEK loops

- Wide range of volumes available
- Biocompatible

VICI Jour PEEK sample loops are made from striped color-coded PEEK tubing and PEEK fittings. PEEK is a mechanically strong, chemically inert polymer ideal for HPLC applications. Since our PEEK sample loops contain no metals or other extractable compounds, no foreign materials will be introduced into the system. Softener-free polyethylene caps are used to avoid contamination of the tubing.

PEEK sample loops are particularly well suited for separations involving proteins, peptides, nucleic acids or other samples of biological origin as well as in IC systems where metal traces may interact with ionic samples or release transition metals that may deactivate ion exchange columns.

PEEK hex-head nuts and PEEK ferrules provide reliable connections, and avoid twisting of the tube.

DISCLAIMER

The maximum holding pressure for any type of connections involving tubing and a ferrule varies considerably with the tubing material the ferrule material, the clearance between tubing OD and ferrule ID, and the shape of the fitting detail.

MORE INFORMATION

ValvTool..... 88



PEEK loops

for Cheminert valves



Fit all Cheminert C1, C1CF, C2, C2V, and C3 type valves.

Sample size	Pressure *		Product No.	Sample size	Pressure *		Product No.
	bar	psi			bar	psi	
5 µl	400	5800	JR-SLC-85-5	250 µl	240	3500	JR-SLC-85-250
10 µl	400	5800	JR-SLC-85-10	300 µl	240	3500	JR-SLC-85-300
20 µl	400	5800	JR-SLC-85-20	500 µl	240	3500	JR-SLC-85-500
50 µl	400	5800	JR-SLC-85-50	1 ml	240	3500	JR-SLC-85-1000
100 µl	400	5800	JR-SLC-85-100				
200 µl	240	3500	JR-SLC-85-200				

PEEK loops

for Rheodyne valves



Fit all Rheodyne metal and metal-free valves.

Sample size	Pressure *		Product No.	Sample size	Pressure *		Product No.
	bar	psi			bar	psi	
1 µl	435	6300	JR-SLR-2190	50 µl	350	4500	JR-SLR-2202
2 µl	420	6100	JR-SLR-2191	100 µl	350	4500	JR-SLR-2204
3 µl	420	6100	JR-SLR-2192	200 µl	240	3500	JR-SLR-2206
4 µl	420	6100	JR-SLR-2193	250 µl	240	3500	JR-SLR-2207
5 µl	400	5800	JR-SLR-2194	500 µl	240	3500	JR-SLR-2210
10 µl	400	5800	JR-SLR-2196	1 ml	240	3500	JR-SLR-2222
20 µl	386	5600	JR-SLR-2195				
30 µl	386	5600	JR-SLR-2200				
40 µl	386	5600	JR-SLR-2201				

* Recommended maximum permanent working pressure

TECH TIPS

- See general information about PEEK loops on facing page.
- The tighter ID tolerance of the tubing minimizes the tolerance of the loop volume.
- The ValvTool tightens nuts with tube or loop installed, providing easy access to many hard-to-reach areas..... 88



OPTIONS

Other sample sizes are available on request. Please contact your distributor or VICI Jour directly.

MORE INFORMATION

Chemical resistance 96-98
About PEEK 99

PEEK loops

for Valco valves

Fit all 1/16" Valco W and UW type valves.

Sample size	Pressure *		Product No.
	bar	psi	
5 µl	400	5800	JR-SLV-75-5
10 µl	400	5800	JR-SLV-75-10
20 µl	400	5800	JR-SLV-75-20
50 µl	400	5800	JR-SLV-75-50
100 µl	400	5800	JR-SLV-75-100
250 µl	240	3500	JR-SLV-75-250
500 µl	240	3500	JR-SLV-75-500
1 ml	240	3500	JR-SLV-75-1000



Spart parts

for PEEK Cheminert, Rheodyne, and Valco loops

Sold in packages of 5.

Description	Product No.
PEEK nuts for use with double ferrules, 1/16" hex head long, 10-32	JR-5510-5
PEEK single ferrules, 1/16" (Use 2 per nut, as shown at right.)	JR-5005-5



SAMPLE LOOPS

SPECS

- Material:
 - Loops SS316
 - Nuts SS303
 - Ferrules SS316
 - Caps PE
(Polyethylene)
- Tolerances:
 - ±0.05 mm
(.002")
- Pressure rating:
 - ≤ 1375 bar
(≤ 20,000 psi)

- Wide range of volumes available
- Ultra high pressure resistance

VICI Jour stainless steel sample loops are made of high quality SS316. They are cut using an electrolytic cutting process, cleaned with ultrasound and high pressure steam to remove contaminants, dried, and capped with softener-free caps to avoid recontamination of the tubing.

All loops are supplied with stainless hex-head nuts and stainless ferrules for reliable connections.

Stainless steel loops

for Cheminert valves

Fit all Cheminert C1, C1CF, C2, C2V, and C3 type valves.

Sample size Product No.

5 µl	JR-SLC-86-5
10 µl	JR-SLC-86-10
20 µl	JR-SLC-86-20
50 µl	JR-SLC-86-50
100 µl	JR-SLC-86-100
250 µl	JR-SLC-86-250
500 µl	JR-SLC-86-500
1 ml	JR-SLC-86-1000



Stainless steel loops

for Valco valves

Fit all 1/16" Valco W and UW type valves.

Sample size Product No.

5 µl	JR-SLV-76-5
10 µl	JR-SLV-76-10
20 µl	JR-SLV-76-20
50 µl	JR-SLV-76-50
100 µl	JR-SLV-76-100
250 µl	JR-SLV-76-250
500 µl	JR-SLV-76-500
1 ml	JR-SLV-76-1000



Spart parts *for stainless Cheminert and Valco loops*

Sold in packages of 5.

<i>Description</i>	<i>Product No.</i>
1/16" stainless nuts, 10-32	JR-ZN1-5
1/16" stainless ferrules	JR-ZF1S6-5

**TECH TIPS AND
OPTIONS**
See facing page.

Stainless steel loops*for Rheodyne valves*

- Fit all Rheodyne valves
- Special loops for valve Model 7725

Sample size Product No.

5 µl	JR-SLR-111
10 µl	JR-SLR-112
20 µl	JR-SLR-113
50 µl	JR-SLR-114

100 µl	JR-SLR-115
200 µl	JR-SLR-116
500 µl	JR-SLR-117
1 ml	JR-SLR-118

Loops for Rheodyne valve 7725, 1/16"*Sample size Product No.*

5 µl	JR-SLR-111-77
10 µl	JR-SLR-112-77
20 µl	JR-SLR-113-77
50 µl	JR-SLR-114-77

100 µl	JR-SLR-115-77
200 µl	JR-SLR-116-77
500 µl	JR-SLR-117-77
1 ml	JR-SLR-118-77

**Spart parts** *for stainless Rheodyne loops*

Sold in packages of 5.

<i>Description</i>	<i>Product No.</i>
1/16" Rheodyne type stainless nuts	
For valve 7725, long head	JR-57-5
X-long	JR-58-5
Stainless ferrules	
1/16"	JR-59-5
2-step Rheodyne type, 1/16"	JR-60-5

TECH TIPS

- Not recommended for use with halides.
- We offer nuts in three lengths to facilitate wrench access on valves. For loops that will be replaced frequently, we recommend our longest nut – particularly when space is restricted. See long nuts..... 31
- The ValvTool tightens nuts with tube or loop installed, providing easy access to many hard-to-reach areas..... 88

**OPTIONS**

Other sample sizes are available on request. Please contact your distributor or VICI Jour directly.

MORE INFORMATION

About stainless steel. . 100

Accessories

TOOLS · STARTER KITS · BACK-PRESSURE REGULATOR

Our low pressure fittings are ideally suited for flow injection analysis, low pressure liquid chromatography, and stream sampling devices. They may be safely used at pressures up to 500 psi and temperatures to 50°C.

Accessories index

Accessories for tubing

Easy-Flange kit.....	page 85
Easy-Flange combi kit.....	85
PEEK tubing elbows.....	86
Tubing clip - the LC tubing organizer.....	86
LC tubing organizer.....	86
Tubing cutters for polymeric tubing	
Clean-cut.....	86
Guillotine.....	86
Tubing cutters for stainless tubing	
Cutting wheel type.....	87
Plier type.....	87

Accessories for fittings

Color-It fingertight adapters.....	17
Work great with all our PEEK and stainless hex head nuts for 1/16" tubing.	
Color-Sleeve adapters.....	17
Designed to be used with our black PPS nuts and one-piece fittings.	

Back-pressure regulators.....88

Our back-pressure regulator improves baseline stability by preventing bubble formation in the flow cell.

Tools

Ferrule removal kit.....	89
File.....	87
Hex key set.....	89
Tweezer.....	89
Wrench.....	89
ValvTool.....	88
Tubing cutters	
For polymeric.....	86
For stainless.....	87

Starter kits

Easy flange combi kit.....	85
Flange-rolling tool, PTFE tubing, fittings, and accessories	
PEEK starter kit.....	90
PEEK fittings and tubing	
Stainless starter kit.....	90
Stainless steel fittings and tubing	
ChromBox kit.....	91
PEEK and stainless fittings and tubing	

RELATED PRODUCTS

Color-Sleeve adapters turn PPS nuts into fingertight fittings and color-code different solvent lines. 17



Color-It fingertight adapters work great with all our PEEK and stainless hex head nuts for 1/16" tubing. 17

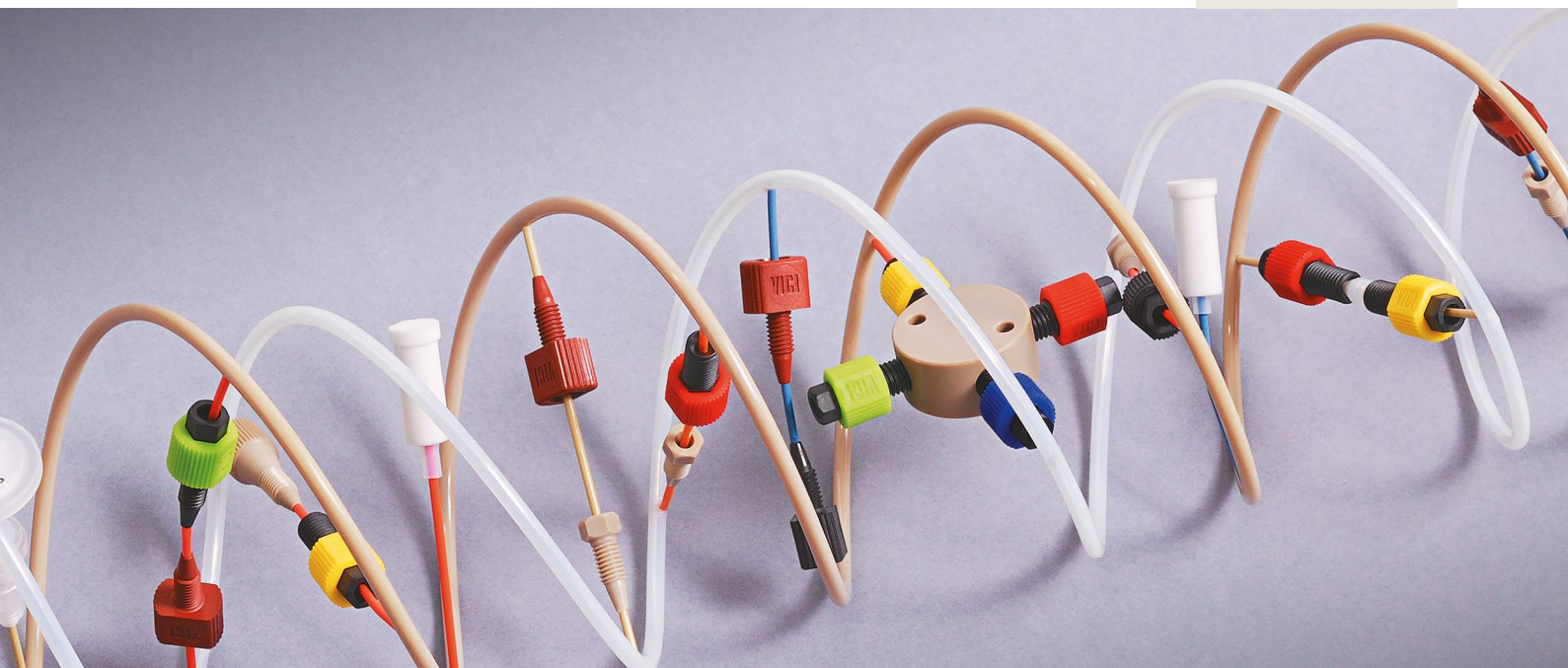



Easy-Flange kit

- Handy tool for perfect flanges
- No heat or electricity required
- No contamination

The Easy-Flange flange-rolling tool for flanged fittings is suitable for PTFE and PTFE-like tubes with OD between 1/16" and 1/8". The tool forms the flange by applying a mechanical force and does not require electrical power.

The quality of the flange is considerably improved over other available methods, since the tubing is not stressed by heat and because the specially-designed negative conical profile of the flange-forming part yields an ideal shape for optimized sealing properties.

Description		Product No.
Easy-Flange kit		JR-201540
Kit includes:	Qty	Product No.
Flanging clamp	1 pair	JR-201531
Flanging discs with:		
0.5 mm SS pin for PEEK tubing	1	JR-202235
0.8 mm polymer pin	1	JR-201541
0.8 mm titanium pin	1	JR-201554
1.3 mm polymer pin	1	JR-201536
1.3 mm titanium pin	1	JR-201537
Clean-Cut tubing cutter	1	JR-797
Tubing, PTFE, 1/16" x 0.75 mm ID	2 m	JR-T-4036
Plastic box	1	JR-201540L
Flanger/distance gauge	1	JR-201532



Easy-Flange combi kit

In addition to the contents of the Easy-Flange kit, the combi kit includes 1/8" PTFE tubing, nuts/rings for tube end fittings, and color-coded adapters.

Description		Product No.
Easy-Flange combi Kit		JR-201539
Includes:	Qty	Product No.
Easy-Flange kit above	1	JR-201540
PPS nuts, 1/4-28, flanged		
White, for 1/16" tubing	10	JR-201094WH-10
Black, for 1/8" tubing	10	JR-201580BK-10
PP washers		
For 1/16" tubing	10	JR-201926-10
For 1/8" tubing	10	JR-201928-10
PTFE tubing		
1/16" x 0.75 mm ID	3m	JR-T-4036-M3
1/8" x 1/16" ID	3m	JR-T-680 0-M3

OPTIONS

Additional sizes of flanging discs are available.

Flanging disc with

1.0 mm

polymer pin JR-201662

1.5 mm

polymer pin JR-201663

MORE INFORMATION

Flanged fittings... 41,43

Polymeric

tubing..... 9-13

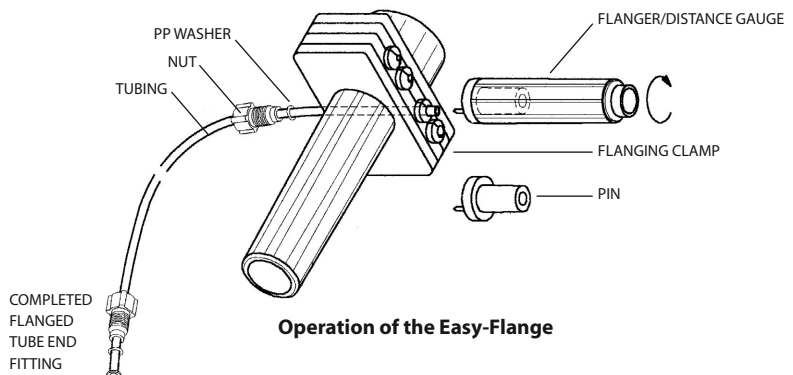

PEEK tubing elbows

Tubing elbows (90° and 180°) are ideal for routing 1/16" PEEK tubing through an LC system. These elbows are proportioned to bend PEEK tubing at the optimum radius for maximum chemical resistance and burst pressure. Installation is simple – just snap the tubing into the elbow.

Sold in packages of 5.

Description	Product No.
90° elbow	JR-357090
180° elbow	JR-357180



Tubing clip – the LC tubing organizer

- Fixes 1/16" and 1/8" tubing to beakers, flasks, or bottles
- Stainless steel spring for long life

This convenient device holds both 1/16" and 1/8" polymer tubes precisely where they should be in your beakers, flasks and bottles etc. up to 4 mm wall thickness. The stainless steel spring will keep your tubing clip working for a long time, and helps keep the solvent line in the solvent.

Description	Product No.
Tubing clip	JR-9001



Clean-Cut tubing cutter

for polymeric tubing

- Cuts PEEK, PTFE, ETFE, and other polymeric tubing
- No distortion to OD or ID
- Ideal for the most demanding LC applications
- Safety lock secures the blade

Right angles and clean cuts are essential in LC to avoid leaks and dead volume. This handy tool makes it easy to get burr-free, perpendicular ends on polymeric tubing without distorting the outside diameter and/or closing the inside diameter of the tubing.

It is designed to cut PTFE, ETFE and polymers in general and PEEK capillary tubing in particular. The compact design and unique safety locking mechanism allow every chromatographer to keep one in their pocket.

Description	Product No.
Clean-Cut tubing cutter	JR-797
Replacement blade	JR-798



Guillotine tubing cutter

for polymeric tubing

- Cuts PEEK, PTFE, ETFE, and other polymeric tubing
- Ideal for less demanding LC applications

Description	Product No.
Guillotine tubing cutter	JR-794
Replacement blade	JR-795

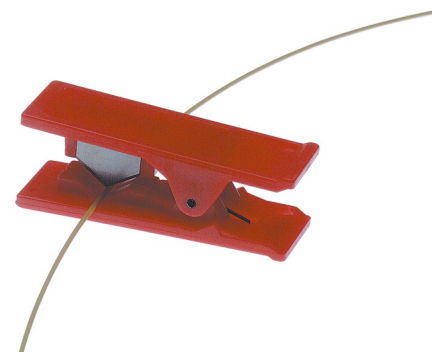



Stainless steel tubing cutter – cutting wheel type

- For 1/16" and 1/8" SS tubing
- Leaves smooth, uniform cuts
- Minimal deburring and/or reaming required
- Easy replacement of the cutting wheel

This is the ideal tool for cutting 1/16" and 1/8" stainless steel tubing, leaving smooth, uniform cuts requiring a minimum of deburring and/or reaming. The easily replaced cutting wheel scores tubing, leaving cuts which allow tube-to-tube and tube-to-frit connections.

<i>Description</i>	<i>Product No.</i>
Tubing cutter for metal tubing	JR-792
Replacement cutting wheel	JR-793

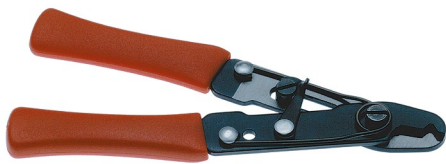

Stainless steel tubing cutter – plier type

- For easy cutting of 1/16" tubing off a coil
- Reach "hard-to-get" places in an HPLC system
- Delivered in a plastic sheath

These pliers can be used for quick cuts for non-critical applications or at "hard to get" places. However, for scientific equipment, we strongly recommend our pre-cut and cleaned stainless tubing.

<i>Description</i>	<i>Product No.</i>
Tubing pliers for metal tubing	JR-796



File

This deburring file is handy tool for cleaning up metal tubing ends.

<i>Description</i>	<i>Product No.</i>
Deburring file	JR-802

TECH TIP

Between the sample injector, column, and detector, use our pre-cut stainless steel tubing, which has been electrolytically cut and steam cleaned. 14

MORE INFORMATION

Pre-cut stainless steel tubing. 14

Backpressure regulator

SPECS

- For 1/16" OD tubing
- Materials
Wetted parts:
Housing: PEEK/
CTFE
Membrane:
Polyimide
- 10-32 threads
- Dead volume:
0.25 µl
(theoretical)

- Improves baseline stability by preventing bubble formation in the flow cell
- Adjust backpressure without disconnecting anything
- Completely biocompatible fluid path, with low dead volume
- Easy mount with 17 mm panel hole, 9 mm maximum thickness

Even properly degassed mobile phases may contain some dissolved gases that can release bubbles in the detector flow cell resulting in baseline noise and drift. The VICI Jour backpressure regulator provides a quick and convenient way to improve the stability of detector baseline by providing a constant back-pressure on the flow cell, which stops the release of dissolved gases from the mobile phase.

Because of the unique design, the backpressure regulator has a very small internal volume. The peak shape is not affected when the regulator is installed between two detectors in a multi-detector system, or between a detector and a fraction collector or fraction collector system. Typically, 90% or more of a given component's efficiency will be retained upon passing through the regulator.

A spring-loaded diaphragm provides the force that generates the back-pressure. Spring tension may be adjusted using the backpressure adjustment screw on the top of the regulator to vary the backpressure without disconnecting any lines.

Backpressure regulators are available in two ranges: 1-20 bar (15-300 psi) and 20-103 bar (300-1500 psi), and two housing types: PEEK and CTFE.

Range		Housing	Product No.
1-20 bar	15-300 psi	PEEK	JR-BPR1
		CTFE	JR-BPR1KF
20-103 bar	300-1500 psi	PEEK	JR-BPR2
		CTFE	JR-BPR2KF



ValvTool

- For making connections in hard-to-reach areas
- Ideal for nuts with 1/4" hex and 5/16" heads

The ValvTool is a time-saving device which provides easy access to many hard-to-reach areas. The unique design with its slotted wrench allows tightening of nuts where a loop or a capillary might otherwise make it difficult. The ValvTool is ideal for Valco and Rheodyne® valves and fittings, as well as most of the HPLC and PEEK fittings on the market with 1/4" and 5/16" heads.

Description	Product No.
ValvTool wrench 1/4" and 5/16"	JR-800



ValvTool shown loosening a nut on a valve
(Valve and loop not included)



Ferrule removal kit
For 360 µm and 1/32" ferrules



Ferrule removal kit
For 1/16" and 1/8" ferrules

Ferrule removal kits

- Remove polymeric ferrules stuck in fitting details
- One version for 1/32" and 360 micron ferrules
- Another version for 1/16" and 1/8" ferrules

Ferrule removal kits are easy-to-handle tools for removing ferrules stuck in a fitting detail. Two versions cover four different ID's of ferrules.

Description	For use with	Product No.
Ferrule removal kits	360 µm and 1/32" ferrules	JR-FRK1
	1/16" and 1/8" ferrules	JR-FRK2

Tightening tools for PEEK fittings

These handy tools make it fast and easy to tighten hex-head fittings. The green tool is for any 1/32" fitting with a 3/16" hex head nut, and the blue version fits the 1/4" hex common in fittings for 1/16" tubing.

Color	For use with	Prod No
Green	1/32" fittings (6-40 threads)	JR-CNFT
Blue	1/16" fittings	JR-ZNFT

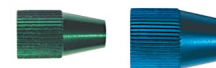

Hex key set

The hex key set has a wrench to fit any socket head screw on any VICI valve or actuator. Includes the following sizes: .050", 1/16", 5/64", 3/32", 7/64", 1/8", 9/64", and 5/32".

Description	Product No.
Hex key set	JR-HKS3

Tweezer

Ideal for picking up small fittings, etc.

Description	Product No.
Tweezer	JR-806



Wrenches

Open end wrenches for nuts with 1/4", 5/16", 3/8", or 7/16" heads.

Description	Product No.
Open end wrench	
1/4" and 5/16"	JR-804
3/8" and 7/16"	JR-805



RELATED PRODUCTS

Deburring file 87
Tools for tubing ... 86-87

PEEK starter kit

- All parts biocompatible
- Ideal kit for all HPLC users

The PEEK starter kit is ideal for anyone working in the field of biochromatography. It consists of fittings, ferrules, tubing, and mobile phase filters, as well as a union, our Clean-Cut tubing cutter, and other useful accessories like our tubing elbows – all boxed together for a very competitive price.

For a number of interesting LC applications involving proteins, peptides, nucleic acids, or other samples of biological origin, metal systems may interact with samples or release transition metals that will deactivate columns. Replacing stainless steel parts (such as tubing fittings, ferrules, filters, etc.) with PEEK creates a biocompatible environment for samples and mobile phase.

<i>Description</i>		<i>Product No.</i>	
PEEK starter kit		JR-35P	
Kit includes:		<i>Qty</i>	<i>Product No.</i>
PEEK fittings	One-piece 10-32 fittings	10	JR-55020-5
	Fingertight 10-32 nuts	5	JR-5580-5
	Hex-head long 10-32 nuts	5	JR-5510-5
	1/16" double ferrules	20	JR-5004-10
	Union body, 0.25 mm bore	1	JR-061
PEEK tubing, 1/16" OD			
	0.25 mm ID x 3 m, blue stripe	1	JR-T-6001-M3
	0.50 mm ID x 3 m, orange stripe	1	JR-T-6002-M3
Filters	PEEK in-line filter kit	1	JR-68256
	Last Drop mobile phase filter, 5 µm, PTFE	1	JR-9000-0521
Accessories	Tubing elbow, 90°	2	JR-357090
	Tubing elbow, 180°	2	JR-357180
Tools	Clean-Cut polymeric tubing cutter	1	JR-797
	Tweezer	1	JR-806

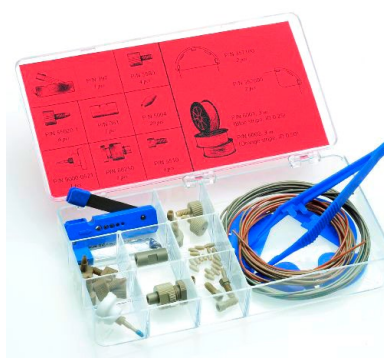

Stainless steel starter kit

UHPLC

The kit consists of stainless fittings, ferrules, tubing, and solvent filters, as well as a union, our cutting-wheel type metal tubing cutter, and other useful items like our ValvTool. All boxed together for a very competitive price.

<i>Description</i>		<i>Product No.</i>	
Stainless steel starter kit		JR-35S	
Kit includes:		<i>Qty</i>	<i>Product No.</i>
Stainless fittings			
	1/16" nuts, 10-32	10	JR-ZN1-5
	1/16" nuts, 10-32, 19 mm long	10	JR-LZN1-5
	1/16" ferrules	20	JR-ZF1S6-5
	1/16" union with nuts/ferrules, 0.25 mm bore	1	JR-ZU1CS6
Stainless tubing			
	1/16" x 0.25 mm x 3 m	1	JR-T-625-10-M3
	1/16" x 0.50 mm ID x 3 m	1	JR-T-625-20-M3
	1/16" x 0.18 mm ID x 100 mm	2	JR-T-97030
	1/16" x 0.25 mm ID x 200 mm	2	JR-T-97060
Filters	Mobile phase, 2 µm, 1/8" pipe OD	1	JR-3675-2
	Stainless in-line, 0.25 mm ID	1	JR-68230-5
	Last Drop, 10 µm	1	JR-9000-0532
Tools	ValvTool 1/4" x 5/16" wrench	1	JR-800
	Open end wrench, 1/4" x 5/16"	1	JR-804
	Tubing cutter	1	JR-792
	Tweezer	1	JR-806



RELATED PRODUCTS

IN THE PEEK KIT

PEEK fittings

- One-piece 10-32 fittings 20
- Nuts for double ferrule
- Fingertight 23
- Hex-head, long 23
- Double ferrules 23
- Union body 26

PEEK tubing

- Color-coded striped .. 6

Filters

- PEEK in-line filter kit . 54
- Last Drop mobile phase filter 51

Accessories

- Tubing elbows..... 86

Tools

- Clean-Cut polymeric tubing cutter 86
- Tweezer 89

IN THE STAINLESS KIT

Stainless fittings

- 1/16" nuts 31
- 1/16" ferrules 32
- 1/16" union 34

Stainless tubing 15

Filters

- Mobile phase 53
- Stainless in-line 57
- Last Drop 51

Tools

- ValvTool 88
- Open end wrench ... 89
- Tubing cutter 87
- Tweezer 89

ChromBox kit

Includes

- PEEK, PTFE, and stainless tubing
- PEEK and stainless nuts, ferrules, and unions
- Tubing cutters and wrenches
- More accessories, all in a convenient carrying case

The ChromBox is an all-purpose analytical spare parts kit for all our customers using HPLC. It contains the most often used spare parts made both of high quality Type 316L stainless steel as well as PEEK and PTFE.

Description		Product No.	
ChromBox kit		JR-34N	
ChromBox kit includes:			
PEEK fittings	One-piece 10-32 fittings	5	JR-55020-5
	Fingertight 10-32 nuts	5	JR-5580-5
	Long hex-head 10-32 nuts	5	JR-5510-5
	1/16" double ferrules	10	JR-5004-10
	Union, 0.25 mm bore, body only	1	JR-061
SS fittings	1/16" nuts, 10-32, 13 mm long	5	JR-MZN1-5
	1/16" nuts, 10-32, 19 mm long	5	JR-LZN1-5
	1/16" ferrules	10	JR-ZF1S6-5
	1/16" union with nuts and ferrules, 0.50 mm bore	1	JR-ZU1MS6
Tubing			
PEEK	1/16" x 0.25 mm ID x 3 m, blue stripe	1	JR-T-6001-M3
	1/16" x 0.50 mm ID x 3 m, orange stripe	1	JR-T-6002-M3
PTFE	1/8" x 1/16" ID x 3 m	1	JR-T-6800-M3
Stainless	1/16" x 0.25 mm x 3 m	1	JR-T-625-10-M3
	1/16" x 0.50 mm ID x 3 m	1	JR-T-625-20-M3
Filters	PEEK in-line filter kit	1	JR-68256
	Stainless Last Drop, 2 µm	1	JR-9000-0530
Accessories	Tubing elbow, 90°	1	JR-357090
	Tubing elbow, 180°	1	JR-357180
	Tubing clip	2	JR-9001
Tools	Clean-Cut polymeric tubing cutter	1	JR-797
	Plier style SS tubing cutter	1	JR-796
	ValvTool 1/4" x 5/16" wrench	1	JR-800
	Open end wrench, 1/4" x 5/16"	1	JR-804
	Deburring file	1	JR-802
	Tweezer	1	JR-806

RELATED PRODUCTS

IN THE CHROMBOX KIT

- PEEK fittings
 - One-piece 10-32 fittings 20
- Nuts for double ferrule
 - Fingertight 23
 - Hex-head, long 23
- Double ferrules 23
- Union body 26
- Stainless fittings
 - 1/16" nuts 31
 - 1/16" ferrules 32
 - 1/16" union 34
- Tubing
 - Color-coded striped PEEK 6
 - PTFE 12
 - Stainless 15
- Filters
 - PEEK in-line filter kit . 54
 - Stainless in-line 57
- Accessories
 - Tubing elbows 86
 - Tubing clip 86
- Tools
 - Clean-Cut polymeric tubing cutter 86
 - Plier style stainless tubing cutter 87
 - ValvTool 88
 - Open end wrench ... 89
 - Deburring file 87
 - Tweezer 89

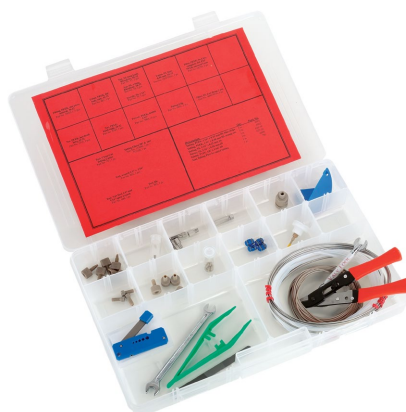

General reference

CHEMICAL RESISTANCE • MATERIALS • GLOSSARY

Reference index

General conversion factorspage 92

Tubing charts

Maximum working pressures

Stainless steel tubing93

PEEK tubing94

Polymeric tubing94

Tubing tolerances.....95

Tubing volume/length conversion.....93

Volume – frits.....95

Standard threads95

Chemical resistance charts

PEEK at high temperature96

PEEK and other polymers.....96

Properties of materials

Metals.....100

Polymers99

Miscellaneous

Glossary102

Safety101

Trademarks101

Conversion tables

Length107

Pressure107

Temperature.....107

Index

By product numbers108

Alphabetical by product name110

Order information112

General conversion factors

inches to mm	inches x 25.4 = mm
feet to meters	feet x 0.3048 = meters
meters to feet	meter x 3.28 = feet

bar to psi	bar x 14.5 = psi
psi to bar	psi x 0.069 = bar
psi to kPa	psi x 6.9 = kPa

RELATED PRODUCTS

Tubing

ETFE..... 9

FEP

Natural 11

Solid-color..... 11

PEEK 5-8

Dual-layer 7

Natural 5

Solid-color..... 8

Striped 6

PFA..... 9

PTFE 12

Natural 12

Solid-color..... 12

Stainless steel

Premium grade 15

Welded..... 15

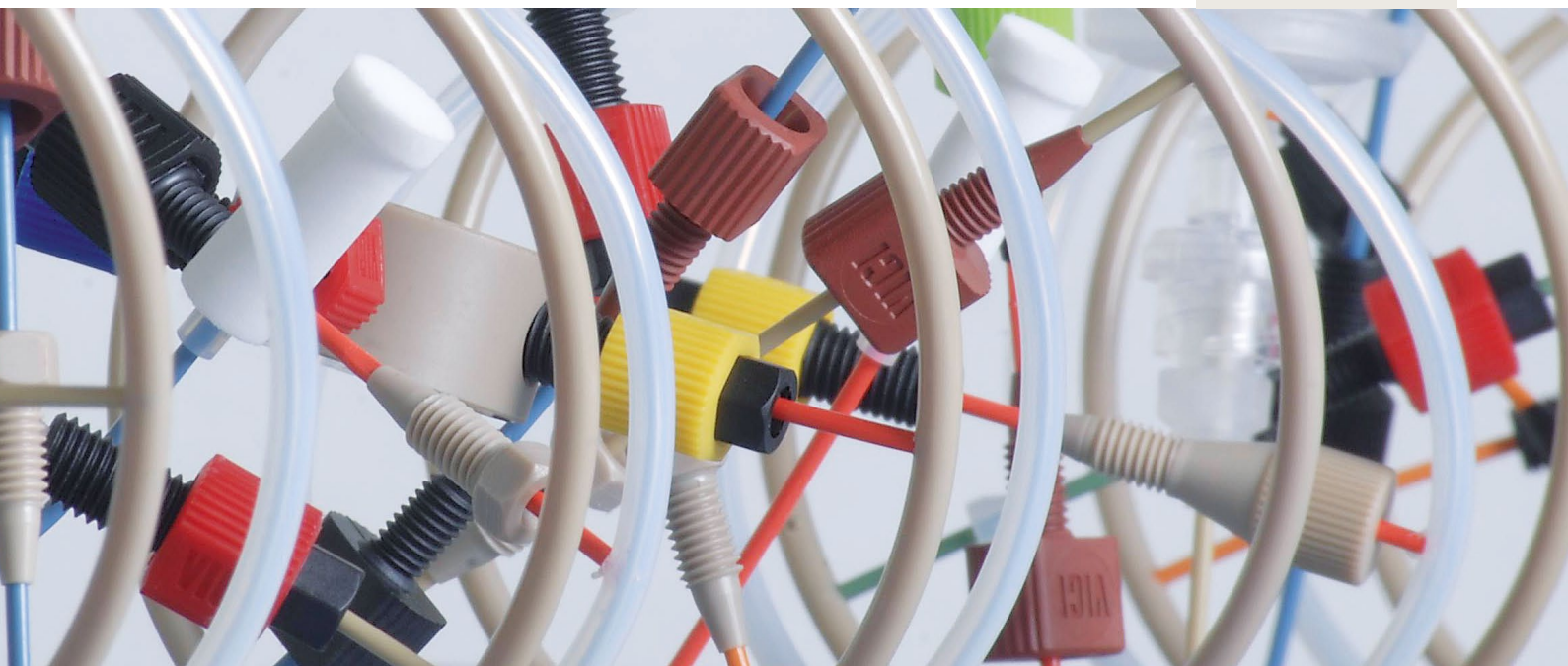

Tubing volume/length conversion chart

1/16" OD tubing sold by VICI typically has an ID tolerance of ±0.025 mm. This is much tighter than normal commercial grades of tubing; however, it is enough to result in noticeable error if exact volumes are not measured, according to the equation

$$V = \Pi (\frac{1}{2} D)^2 L.$$

Tubing ID		Volume/length	
mm	inches	µl/cm	µl/in
0.050	.002"	0.02	0.05
0.064	.0025"	0.03	0.08
0.075	.003"	0.04	0.12
0.10	.004"	0.08	0.21
0.13	.005"	0.13	0.32
0.17	.0067"	0.23	0.58
0.18	.007"	0.25	0.63
0.25	.010"	0.51	1.29
0.38	.015"	1.14	2.90
0.50	.020"	2.03	5.15
0.64	.025"	3.17	8.04
0.75	.030"	4.56	11.58

Tubing ID		Volume/length	
mm	inches	µl/cm	µl/in
1.00	.040"	8.11	20.59
1.40	.055"	15.39	38.93
1.52	.060"	18.24	46.33
1.59	.062"	19.86	49.47
1.65	.065"	21.38	54.38
1.70	.067"	22.70	57.78
1.78	.070"	24.83	63.06
2.00	.079"	31.42	80.32
2.10	.083"	34.64	88.66
2.16	.085"	36.61	92.99
2.40	.094"	45.24	113.72
3.18	.125"	79.4	201
3.76	.148"	111	282
4.35	.171"	149	376

Maximum recommended working pressures for stainless steel tubing

PREMIUM GRADE STAINLESS TUBING			
OD	ID (mm)	bar	psi
1/32"	0.13	1735	25,160
	0.18	1601	23,225
	0.25	1395	20,230
	0.50	734	10,645
1/16"	0.13	1902	27,580
	0.18	1835	26,610
	0.25	1735	25,160
	0.50	1395	20,230
	0.75	1067	15,480
	1.00	734	10,645

OD	ID (mm)	bar	psi
1/8"	0.68	1622	23,520
	0.75	1572	22,800
	1.00	1406	20,400
	1.50	1075	15,600
	1.70	960	13,920
	2.16	662	9,600
	1/4"	4.65	554

WELDED STAINLESS TUBING			
OD	ID (mm)	bar	psi
1/16"	0.13	1871	27,140
	0.18	1794	26,025
	0.25	1717	24,910
	0.50	1384	20,080
	0.75	1076	15,610
	1.00	743	10,780
	1/8"	2.10	680
1/4"	4.65	538	7,800

WORKING PRESSURE FOR STAINLESS STEEL TUBING

The working pressure for stainless tubing is calculated from the burst pressure by dividing by 2.5. The theoretical burst pressure(s) were calculated using Lamé's formula and a safety factor of 2. Additionally, these results assume the tubing is not subject to any other stresses (e.g. temperature different from ambient, bends) that would influence the calculations. The end user must decide the safe maximum working pressure based on this information and the specific application.

GENERAL REFERENCE

Maximum recommended working pressures for PEEK tubing

PEEK TUBING											
OD	ID (µm)	bar	psi	OD	ID (mm)	bar	psi	OD	ID (mm)	bar	psi
360 µm	50	358	5200	1/32"	0.050	455	6600	1/16"	0.050	480	7000
	75	345	5000		0.064	455	6600		0.064	480	7000
	100	300	4400		0.075	455	6600		0.075	470	6800
	125	275	4000		0.100	455	6600		0.100	460	6700
	150	240	3500		0.13	414	6000		0.13	460	6700
			0.15		400	5800	0.18		440	6400	
			0.18		386	5600	0.25		420	6100	
			0.20		369	5350	0.50		345	5000	
			0.25		338	4900	0.75		262	3800	
			0.38		269	3900	1.00		179	2600	
			0.50	207	3000	1.40	55	800			
						1/8"	0.75	379	5500		
							1.59	248	3600		
							2.00	179	2600		
						1/4"	3.17	227	3300		

Maximum recommended working pressures for polymeric tubing

FEP TUBING											
OD	ID (mm)	bar	psi	OD	ID (mm)	bar	psi	OD	ID (mm)	bar	psi
1/32"	0.10	82	1200	1/16"	0.10	124	1800	1/8"	1.59	69	1000
	0.13	78	1100		0.13	124	1800		2.10	41	600
	0.15	78	1100		0.15	117	1700	3/16"	3.18	41	600
	0.18	72	1050		0.18	117	1700	1/4"	4.35	45	650
	0.25	68	980		0.20	117	1700	1.0 mm	0.50	62	900
	0.38	51	750		0.25	117	1700	2.0 mm	1.00	62	900
	0.50	35	500		0.50	96	1400	3.0 mm	1.00	82	1200
			0.75		76	1100		2.00	41	600	
			1.00		52	750					

ETFE TUBING			
OD	ID (mm)	bar	psi
1/32"	0.25	152	2200
1/16"	0.17	200	2900
	0.25	186	2700
	0.50	152	2200
	0.75	117	1700
	1.00	83	1200
1/8"	1.59	110	1600
3.0 mm	1.00	138	2000
6.0 mm	4.00	69	1000

PFA TUBING			
OD	ID (µm)	bar	psi
360 µm	50	103	1500
	75	96	1400
	100	90	1300
	150	75	1100

OD	ID (mm)	bar	psi
1/16"	0.50	100	1450
	0.75	76	1100
	1.00	55	800
1/8"	1.59	72	1050
	1.70	65	940
3/16"	3.20	41	600
1/4"	4.35	45	650

PTFE TUBING			
OD	ID (mm)	bar	psi
1/16"	0.18	62	900
	0.25	55	800
	0.50	48	700
	0.75	37	550
	1.00	25	350
1/8"	1.59	35	500
	2.40	18	250
1/4"	4.75	17	250
2.0 mm	1.70	10	150
4.0 mm	3.00	17	250
4.76 mm	3.76	14	200

WORKING PRESSURE FOR POLYMERIC TUBING

The quoted maximum working pressure(s) were calculated from the burst pressure and the factor 2.5.

Tolerances – PEEK tubing

Due to tighter tolerances, VICI Jour PEEK tubing is the best choice for chromatography applications in which exact flow rates or tube volume are of importance. The tighter tolerance ensures a more consistent internal volume of transfer lines.

PEEK TUBING		
Tubing OD	OD (±) (mm)	ID (±) (mm)
360 µm	0.025	0.013
1/32"	0.025	0.013
1/16" *	0.025	0.013
1/16" **	0.025	0.025
1/8"	0.050	0.050

* For ID up to 0.25 mm
** For ID over 0.25 mm

Tolerances – polymeric tubing

POLYMERIC TUBING		
Tubing OD	OD (±) (mm)	ID (±) (mm)
360 µm	0.025	0.013
1/32"	0.025	0.025
1/16"	0.050	0.025
1/8"	0.10	0.10
3/16"	0.10	0.10
1/4"	0.10	0.10

Frit volume



Stainless, titanium, and polymer frits

Internal frit volumes are theoretical and are calculated by multiplying the total frit volume by the proportion of the pores in the frit (porosity proportion). Stated frit porosities are only nominal and do not reflect the maximum pore size of a frit. The chart below will help you in selecting the right frit for your application.

Porosity in µm	Max pore size in µm	Particles retained in µm	Porosity in %
0.2	1	≥ 1.0	22
0.5	2	≥ 1.5	26
1	3	≥ 3.0	30
2	5	≥ 3.5 - 5.0	35
5	15	≥ 15.0	38
10	30	≥ 30	40

Standard threads

Following are illustrations of standard threads for VICI Jour fittings. Place your fitting on the drawings below to identify the thread size.

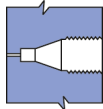
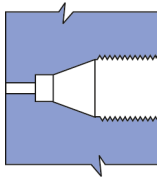
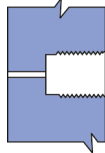
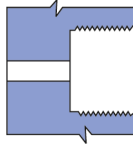
2-56	6-40	10-32	5/16-24	1/4-28	1/2-20
for 360 µm OD tubing	for 1/32" OD tubing	for 1/16" OD tubing	for 1/8" OD tubing	for 1/16" and 1/8" OD tubing	for 1/4" OD tubing
					

GENERAL REFERENCE

Chemical resistance of PEEK at high temperature

Chemical	°C	°F	Rating
Acetic acid	200	420	□
Ammonia gas	200	420	■
Carbon monoxide gas	200	420	■
Ethylene glycol	200	420	□
Ethylene glycol (50%)	140	284	■
Hydrogen sulphide gas	200	420	■
Liquid ammonia	200	420	□
Methane	200	420	■
Methylethylketone	200	420	■
Nitrobenzene	200	420	■
Phosphoric acid (50%)	200	420	■
Sodium hydroxide solution	200	420	■
Sulphuric acid (50%)	200	420	□
Sulphur dioxide gas	200	420	■

Chemical characteristics of PEEK®

PEEK exhibits excellent resistance to a wide range of organic and inorganic chemicals. The compatibility of PEEK with many chemicals at 20°C (68°F) has been investigated and the results for unreinforced grades are given in the table below.

PEEK is compatible with almost any of the solvents used in HPLC. The only solvents which will attack PEEK are concentrated nitric acid and sulphuric acids. However, PEEK tubing can safely withstand 20-30% nitric acid when passivating a system.

Methylene chloride, DMSO, and THF may cause swelling in PEEK. The highest temperature we recommend for PEEK is 100°C. The tubing will maintain the stated pressure rating up to this temperature.

Chemical resistance of PEEK and other polymers

A

Resistance at 20°C	PEEK	PA	PE	PP	PPS	FEP	ETFE	PFA	PTFE	NBR	EPDM
Acetaldehyde	■	■	-	-	-	■	-	■	-	■	■
Acetic acid (20 %)	■	■	■	■	■	■	■	■	■	□	■
Acetic acid (80 %)	■	■	■	■	■	■	-	■	■	-	-
Acetic acid (glacial)	■	■	■	■	■	■	■	■	■	■	■
Acetone	■	■	□	■	■	■	■	■	■	■	■
Acetonitrile	■	■	-	-	■	■	■	■	■	□	■
Acrylic acid	■	-	-	-	■	■	-	■	-	-	-
Ammonia, anhydrous	■	□	-	-	■	■	-	■	-	-	-
Ammonia (10 %)	■	□	□	■	■	■	■	■	■	-	-
Ammonia (Liquid)	□	■	-	-	■	■	-	■	-	-	-
Ammonium hydroxide	■	-	■	■	■	■	■	■	■	-	-
Aqua regia	■	■	-	-	■	■	-	■	-	■	■
Aromatic hydrocarbons	■	-	□	■	■	■	-	■	-	-	-

B

Resistance at 20°C	PEEK	PA	PE	PP	PPS	FEP	ETFE	PFA	PTFE	NBR	EPDM
Benzene	■	■	□	■	■	■	■	■	■	-	-
Benzoic acid	■	-	-	-	■	■	-	■	-	-	-
Benzaldehyde	■	-	-	-	■	■	-	■	-	-	-
Bromine/dibromoethane	■	-	-	-	■	■	-	■	-	-	-
Bromine (dry)	■	-	-	-	■	■	-	■	-	-	-
Bromine (wet)	■	□	-	-	■	■	-	■	-	■	■
Boric acid	■	-	-	-	■	■	-	■	-	-	-
Butanol	■	-	■	■	■	■	■	■	■	-	-

LEGEND

- Suitable
- Marginal; dependent on application
- Not recommended
- No data available

C

Resistance at 20°C	PEEK	PA	PE	PP	PPS	FEP	ETFE	PFA	PTFE	NBR	EPDM
Calcium hydroxide	■	-	-	-	■	■	-	■	-	-	-
Carbon tetrachloride	■	-	-	-	■	■	-	■	-	-	-
Chlorine (gas)	■	■	-	-	■	■	-	■	-	■	■
Chlorine (liquid)	■	■	-	-	■	■	-	■	-	-	-
Chloroacetic acid	■	-	□	□	■	■	■	■	■	-	-
Chlorobenzene	■	■	-	-	■	■	-	■	-	-	-
Chloroform	■	■	□	□	■	■	■	■	■	-	-
Cyclohexane	■	■	□	■	■	■	■	■	■	-	-
Cyclohexanone	■	■	■	■	■	■	■	■	■	■	■

D

Resistance at 20°C	PEEK	PA	PE	PP	PPS	FEP	ETFE	PFA	PTFE	NBR	EPDM
Diethylamine	■	-	■	■	-	■	■	■	■	-	-
Diethylether	■	■	-	-	■	■	-	■	-	-	-
Diethylformamide	■	■	■	■	■	■	■	■	■	■	■
Dioxane	■	■	-	-	■	■	■	■	-	-	-

E

Resistance at 20°C	PEEK	PA	PE	PP	PPS	FEP	ETFE	PFA	PTFE	NBR	EPDM
Ethanol	■	■	□	■	■	■	■	■	■	■	■
Ether	■	■	□	■	■	■	■	■	■	-	-
Ethyl acetate	■	■	□	■	■	■	■	■	■	■	■
Ethylene chloride	-	■	□	□	■	■	■	■	■	-	-
Ethylene glycol	■	■	■	■	■	■	■	■	■	■	■

H

Resistance at 20°C	PEEK	PA	PE	PP	PPS	FEP	ETFE	PFA	PTFE	NBR	EPDM
Heptane	■	□	□	□	■	■	■	■	■	■	■
Hexane	■	■	□	□	■	■	■	■	■	-	-
Hydrobromic acid (100%)	■	-	□	□	■	■	-	■	■	-	-
Hydrobromic acid (20%)	■	-	□	■	-	■	■	■	■	-	-
Hydrochloric acid (100%)	■	-	-	□	■	■	■	■	■	-	-
Hydrochloric acid (20%)	■	-	■	□	■	■	■	■	■	-	-
Hydrofluoric acid (100%)	■	-	-	□	■	■	■	■	■	-	-
Hydrofluoric acid (20%)	-	-	■	■	■	■	■	■	■	-	-
Hydrogen peroxide (100%)	■	-	□	□	■	■	-	■	■	-	-
Hydrogen peroxide (50%)	■	-	□	□	-	■	■	■	■	-	-
Hydrogen peroxide (10%)	■	-	■	■	■	■	■	■	■	-	-

I

Resistance at 20°C	PEEK	PA	PE	PP	PPS	FEP	ETFE	PFA	PTFE	NBR	EPDM
Iso-octane	■	-	-	■	■	■	-	■	■	-	-
Isopropanol	■	□	■	■	■	■	-	■	■	□	■
Isopropyl ether	-	■	■	□	-	■	-	■	■	-	-

K

Resistance at 20°C	PEEK	PA	PE	PP	PPS	FEP	ETFE	PFA	PTFE	NBR	EPDM
Ketones	■	-	□	□	■	■	-	■	■	-	-

GENERAL REFERENCE

M

Resistance at 20°C	PEEK	PA	PE	PP	PPS	FEP	ETFE	PFA	PTFE	NBR	EPDM
Methanol	■	■	■	■	■	■	■	■	■	■	■
Methyl dichloride	-	□	-	■	-	■	-	■	-	-	-
Methyl ethylketone	■	■	□	□	■	■	■	■	■	-	-
Methylene chloride	□	□	□	□	■	■	■	■	■	■	■

N

Resistance at 20°C	PEEK	PA	PE	PP	PPS	FEP	ETFE	PFA	PTFE	NBR	EPDM
Nitric acid (100%)	■	-	□	■	■	■	■	■	■	-	-
Nitric acid (20%)	■	-	□	■	■	■	■	■	■	-	-

P

Resistance at 20°C	PEEK	PA	PE	PP	PPS	FEP	ETFE	PFA	PTFE	NBR	EPDM
Pentane	■	-	■	■	-	■	-	■	■	-	-
Perchloric acid	■	-	□	□	-	□	-	□	■	-	-
Phenol (dilute)	■	-	-	-	■	■	-	■	-	-	-
Phenol (concentrated)	■	-	-	-	■	■	-	■	-	-	-
Phosphoric acid (100%)	■	-	□	■	■	■	■	■	■	-	-
Phosphoric acid (40%)	■	-	■	■	■	■	■	■	■	-	-
Potassium hydroxide (dilute)	■	-	-	-	■	■	-	■	-	-	-
Potassium hydroxide (70%)	■	-	-	-	■	■	-	■	-	-	-
Propanol	■	□	-	-	-	■	-	■	-	■	■
Pyridine	■	-	□	■	■	■	■	■	■	-	-

S

Resistance at 20°C	PEEK	PA	PE	PP	PPS	FEP	ETFE	PFA	PTFE	NBR	EPDM
Sodium hydroxide (80%)	■	□	□	■	■	■	-	■	■	-	-
Sodium hydroxide (20%)	■	□	■	■	■	■	■	■	■	-	-
Sulfuric acid (100%)	■	■	□	□	■	■	■	■	■	-	-
Sulfuric acid (75%)	■	□	■	■	■	■	■	■	■	-	-
Sulfuric acid (40%)	■	■	■	■	■	■	■	■	■	-	-

T

Resistance at 20°C	PEEK	PA	PE	PP	PPS	FEP	ETFE	PFA	PTFE	NBR	EPDM
Tetrahydrofuran	□		□	□	■	■	■	■	■	-	-
Toluene	■		□	□	■	■	■	■	■	-	-
Trichloroacetic acid	■		■	■	■	■	■	■	■	-	-
Trichloroethane	■		-	□	-	■	-	■	■	-	-
Trichloroethylene	■		-	-	■	■	-	■	-	-	-
Triethylamine	-		-	■	-	■	■	■	■	-	-

W

Resistance at 20°C	PEEK	PA	PE	PP	PPS	FEP	ETFE	PFA	PTFE	NBR	EPDM
Water	■	■	■	■	■	■	■	■	■	■	■
Water (distilled)	■	-	■	■	■	■	■	■	■	-	-

X

Resistance at 20°C	PEEK	PA	PE	PP	PPS	FEP	ETFE	PFA	PTFE	NBR	EPDM
Xylene	■	-	-	-	■	■	-	■	-	-	-

LEGEND

- Suitable
- Marginal; dependent on application
- Not recommended
- No data available

Properties of polymers

CTFE

Chlorotrifluoroethylene, is the generic name for the material produced as Kel-F®. It is very resistant to all chemicals except THF and some halogenated solvents, and is resistant to all inorganic corrosive liquids, including oxidizing acids. CTFE can be used at temperatures up to 100°C. Swells in ketones.

EPDM

Ethylene Propylene Diene Monomer. Ethylene-propylene synthetic rubbers offer excellent heat resistance as well as resistance to aging from oxidation, ozone, and weather due to their stable, saturated polymer backbone structure. As non-polar elastomers, they have good electrical resistivity as well as resistance to polar solvents such as water, acids, alkanes, phosphates, esters, and many ketones and alcohols.

ETFE

Ethyltrifluoroethylene is the generic name for the material such as Tefzel®. A fluoropolymer used for sealing surfaces, it is resistant to most chemical attack; however, some chlorinated chemicals will cause a physical swelling of ETFE tubing.

FEP

Fluorinated ethylene propylene is another member of the fluorocarbon family with similar chemical properties. It is generally more rigid than PTFE, with somewhat increased tensile strength. It is typically more transparent than PTFE, slightly less porous, and less permeable to oxygen. FEP is not as subject to compressive creep at room temperature as PTFE, and because of its slightly higher coefficient of friction is easier to retain in a compression fitting.

FFKM

FFKM (perfluorinated rubber) is a perfluoroelastomer, a class of materials such as Kalrez®. It is chemically resistant to polar solvents, organic solvents, inorganic and organic acids and bases, fuels, oils, lubricants, inorganic salts, aldehydes, metal halogen compounds, chlorine, sodium hydroxide, aromatics, alcohols, steam, and strong oxidizing agents. The normal temperature service range is -40°C to 315°C, with up to 343°C in intermittent service.

PEEK™

Considered relatively inert and biocompatible, polyetheretherketone tubing can withstand temperatures up to 100°C. Under the right circumstances, .005" - .020" ID tubing can be used up to 5000 psi for a limited time, and 0.030" to 3000 psi. Larger IDs are typically good to 500 psi. These limits will be substantially reduced at elevated temperatures and in contact with some solvents or acids.

Its mechanical properties allow PEEK to be used instead of stainless in many situations and in some environments where stainless would be too reactive. However, PEEK can be somewhat absorptive of solvents and analytes, notably methylene chloride, DMSO, THF, and high concentrations of sulfuric and nitric acid. This tubing is highly prone to "kinking," or sealing off, if held in a sharp bend over time.

PFA

Perfluoroalkoxy is a fluorocarbon with chemical and mechanical properties similar to FEP. More rigid than either PTFE or FEP. Commonly used for injection molded parts.

PPS

Polyphenylene sulphide is the generic name for the material produced as Fortron®, Ryton®, and Techtron®. It is very resistant to all solvents, acids, and bases.

PTFE

Polytetrafluoroethylene is the generic name for the class of materials such as Teflon®. It offers superior chemical resistance but is limited in pressure and temperature capabilities. Because it's so easy to handle, it is often used in low pressure situations where stainless steel might cause adsorption. PTFE tubing is relatively porous, and compounds of low molecular weight can diffuse through the tubing wall.

Polyacetal

Polyacetal or polyoxymethylene (POM) is the generic name for the material produced as Delrin®. It is an engineering polymer with high mechanical strength and rigidity, excellent dimensional stability and excellent resistance to moisture and solvents. It has a wide useful temperature range in air of -50°C to +90°C. It is not suitable for use with acids, alkalis, or oxidizing agents, and has limited resistance to dichloromethane and methyl ethyl ketone.

Continued, next page.

GENERAL REFERENCE

Polyamide

Polyamide is a thermoplastic polymer also known as nylon. Nylon has very good physical properties, but moisture can have a significant effect. It exhibits very good heat resistance and excellent chemical and wear resistance.

Polyethylene

Polyethylene is a semi-crystalline material with excellent chemical resistance, plus good fatigue and wear resistance. Polyethylenes provide good resistance to organic solvents and staining, and have low moisture absorption rates.

Polypropylene

Widely used polymer for non-wetted parts. Attacked by strong oxidizers as well as aromatic and chlorinated hydrocarbons.

PVDF

PVDF, or polyvinylidene fluoride, has excellent resistance to most mineral and organic acids, aliphatic and aromatic hydrocarbons, and halogenated solvents. Poor resistance to acetone, MEK, THF, and potassium and sodium hydroxide. Often supplied as Kynar®.

Properties of metals

Stainless steel, Type 316

This is the standard tubing material for chromatography, suitable for a wide variety of applications. It is cold drawn seamless, not welded, with close tolerances held on both ID and OD. We neither recommend nor offer Type 304 stainless steel for analytical applications.

Austenitic stainless steels may be used for most chromatographic applications. Type 316 is most commonly used for HPLC because of its superior chloride ion resistance.

Stainless steel, Type 303

Recommended for GC use and general purpose connections, combining excellent machining characteristics with good resistance to corrosion and high temperature oxidation. Susceptible to attack by chlorides, iodides, and bromides.

Titanium

Although it is more difficult to machine than common alloys containing aluminum and vanadium, VICI uses Grade 2 pure titanium in order to avoid possible contamination of the sample stream with these metals. Good for organic and inorganic salts except aluminum and calcium chlorides, and all alkalis except boiling concentrated potassium hydroxide.

Good with dilute, low temperature formic, lactic, sulfuric, hydrochloric, and phosphoric acids, but rapidly attacked by hydrofluoric acid. Good with dilute nitric acid at low temperatures; corrodes at high concentrations and temperatures. Can ignite with fuming nitric acid. Attacked by oxalic acid, concentrated phosphoric acid, hot trichloroacetic acid, and zinc chloride.

Safety

1. Never tighten or loosen a fitting or valve connection while it is pressurized. Provisions should be made within the system to release pressure via suitable valve components.
2. Do not exceed pressure or temperature specifications. Note that in many cases, the system pressure is limited by the tubing used, not the fittings.
3. The use of toxic or hazardous fluids requires extra caution during operation or maintenance. The user is responsible for insuring safe operation and for understanding the nature of the fluids and chemistry involved.
4. The use of thread lubricants or sealants is required only on tapered pipe threads. These sealants and lubricants may have different temperature limits or chemical compatibility than the valves or fittings.

Trademarks

Trademarks of materials and products found in VICI Jour products or referred to in this website. Please contact us regarding errors, omissions, or discrepancies.

Cheminert®	Valco Instruments Co. Inc. and VICI AG International
Delrin®	E.I. duPont de Nemours
Duran®	Schott AG
Fortron®	Fortron Industries LLC
Kalrez®	DuPont Dow Elastomers
Kel-F®	3M Company
Kynar®	Elf Atochem North America Inc.
Nanovolume®	Valco Instruments Co. Inc.
PEEK™	Victrex plc
PEEK HT™	Victrex plc
Rheodyne®	Rheodyne LLC
Ryton®	Chevron Phillips Chemical Company LLC
SCAT®	SCAT-Europe GmbH
Techtron®	Quadrant Engineering Plastic Products
Teflon®	E.I. duPont de Nemours
Valco®	Valco Instruments Co. Inc.
VICI®	Valco Instruments Co. Inc. and VICI AG International
VICI Jour®	Valco Instruments Co. Inc. and VICI AG International

CAUTION

The improper selection or use of components or systems described herein can cause personal injury or property damage.

The system designer and user are solely responsible for the selection of products suitable for the specific requirements of the application, as well as proper installation, operation, and maintenance of these products.

Compatibility with hazardous fluid streams, environmental conditions, and mechanical requirements are the responsibility of the user.

A

Adapter

A type of fitting which provides a method of joining two components of differing thread types or systems.

Analytical column

A long narrow tube packed or coated with one of many available chemically diverse compounds that can separate the components in a sample according to their boiling point, polarity, molecular size, or combination thereof. A column of some kind is used with most chromatographic techniques.

B

Biocompatibility

Defines the materials used in a system (i.e. fittings, tubing, and valves) that do not change the bioactivity of the biological substances that come into contact with the surface of these materials. Note that in chromatographic systems, the tubing and column contribute over 99% of the surface area and the valves and fittings are insignificant.

Bore

The diameter of the minimum orifice through the fitting. See capillary bore, through-type bore, and large bore.

Bulkhead fitting

A type of fitting in which the fitting body is inserted through an instrument panel or mounting bracket, to which it is affixed with a mounting nut. The Valco fitting body is uniquely undercut so that it "bites" into the panel when the mounting nut is tightened, eliminating the need for a lock washer.

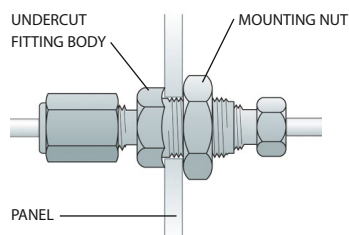
**Butt connection**

A type of connection in which the two tube ends are directly and squarely in contact, usually effected with a through-type union. Typically used with fused silica connections, or small bore metal tubing.

C

Cap

A cap is used to dead-end a piece of tubing with a nut and ferrule attached.

Capillary bore

The smallest available standard orifice in a given fitting design (usually 0.25 mm). Typically denoted by suffix "C" in the product number.

Collapsible ferrule

A one-piece ferrule engineered to collapse as it is tightened. The collapse takes place in two very narrow areas, and results in a very effective seal with virtually no distortion of the tubing ID and no dead volume. Patent No. 6,575,501

Compression fitting

A style of fitting in which a threaded nut compresses a tapered ferrule onto tubing as the nut is tightened. Valco metal ferrules cut a ring into the tubing wall while polymer types rely on surface compression to form a seal.

Connecting volume

The volume between two or more connections. This may be cleanly swept, thus not contributing to peak distortion, or may be "dead volume" such as that found in fittings with larger bores than the connecting tubing.

Cross

A type of distribution fitting which connects four pieces of tubing, arranging them in the pattern of a cross.

D

Dead volume

Any volume which a component introduces to a system that is not cleanly swept and relies on diffusion to clear the space. See connecting volume.

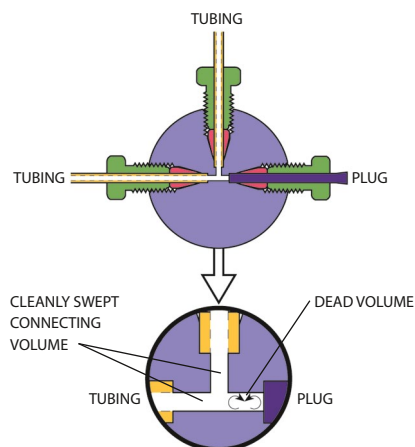

Detail

See *fitting detail*.

Distribution fitting

A generic term for tees, crosses, and manifolds, used to provide multiple access points to “distribute” a gas or liquid through a system. CAUTION! Using a distribution fitting in reverse to coalesce multiple streams may create dead volume. Special manifolds are available for this application.

F**FIA**

Flow Injection Analysis.

A simple and versatile analytical technique for automating wet chemical analyses based on the manipulation of a sample zone formed from the injection of the sample into a continuous stream of fluid used as a carrier.

Female nut

A nut with female threads; also called external nut.

Ferrule

One of the components of a compression fitting; the conical piece of metal or plastic that compresses onto the tube as it is forced into a tapered seat. Valco metal ferrules are unique in that they attach to and seal at the tube by cutting a shallow ring into it, instead of by actually swaging it. This is preferable since it introduces no flow restriction.

Filter

A type of union or reducing union which traps the particulates in a stream. The filtering element is typically a mesh screen or sintered frit.

Fingertight fitting

A fingertight fitting is a knurled or winged nut which is hand tightened to compress the ferrule. Note: Polymeric ferrules rely on surface compression to form a seal and hold the tube by friction.

Fitting detail

A fitting detail includes the thread to accept the nut, a tapered ferrule seat, and the pilot for the tube. The nut, ferrule, and tube go into the fitting detail to make the seal.

Valco fitting details have the perfect shape, with a smooth transition from the ferrule seat into the cylindrical and threaded part. Many other fitting details are poor in design where the ferrule is forced in a too shallow ferrule seat. The result is a “nicked” ferrule which can no longer apply its sealing force to the front of the ferrule.

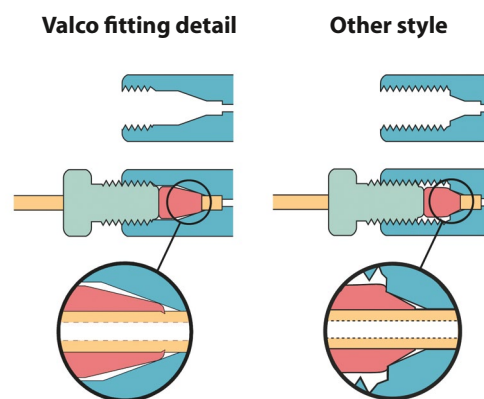
**Flanged fitting**

A type of fitting used with fluoropolymer tubing (PTFE, FEP) in which a flange is made at the tube end. Connections are made at the flange either by compressing the flange into a flat detail (typically 1/4-28 threaded) or by butting two flanges together. A special flanging tool forms the flanges.

Flangeless fitting

Similar in application to the flanged fitting, but the flange is not required. A ferrule system is used which grips/compresses the tube. This fitting type can be used with virtually any polymeric tubing since the tube end does not have to be formed, but simply square cut. Typically used in 1/4-28 threaded fittings, it is usually interchangeable with flanged fittings.

Frit

A filter element typically made of stainless, Hastelloy, Titanium, or polymers, usually 0.75 mm or 1 mm thick. Frits may provide better filtration than screens, but because they are thicker there is greater mixing potential, and they typically result in increased pressure drop.

G**GC**

Gas Chromatography.

An analytical method incorporating an injection system, analytical column, controlled temperature zone, and detector. An inert carrier gas moves the sample through the column, which separates the sample components into discrete bands which are measured as they pass through the detector.

Guard column

A column used in series between the injector and analytical column to prevent certain types of components from entering the analytical column.

H**HPLC**

High Performance Liquid Chromatography.

An analytical system consisting of an injector, pump, analytical column, and detector. Using a liquid mobile phase, the sample is pumped through the column, where it is separated into discrete sample component bands which are detected and measured as the bands elute from the column.

I**ID**

Internal diameter.

Inert

Technically, unreactive with other substances; however, in the instrumentation field, "inert" is a relative term. Often polymers are termed inert but are soluble in some fluids and can react with some compounds.

Internal fitting

A type of compression fitting in which the fitting body has female threads; an internal nut has male threads.

L**LC**

Liquid Chromatography.

Any of a variety of low to medium pressure techniques which use a liquid mobile phase as the carrier to move sample. Similar to HPLC.

Large bore

A bore that is larger than the standard for a given fitting; a fitting ordered with a large bore will have a larger flow orifice than the standard or capillary bore fitting of the same design. Denoted by suffix "L" in the product number.

Luer adapter

An adapter that connects a tapered luer fitting (square nib) of a syringe to a tube or tube fitting.

M**Male nut**

A nut with male threads.

Make up

The point at which a ferrule, nut, and tube are assembled in the fashion which will effect a leak-free seal. In most compression fittings, that is accomplished by compressing the tube with the small end of the ferrule. With Valco metal ferrules, the ferrule usually makes up on the tube by cutting a shallow ring in it.

Manifold

A type of distribution fitting in which a single source is directed to multiple outlets, or vice versa. Caution! Using a common distribution fitting in reverse to merge multiple streams may create dead volume. Special manifolds are available for this application.

Microbore column

A liquid chromatography column of narrow bore (typically 2 mm or less) for improved resolution.

N**NPT**

National Pipe Thread; a standardized tapered pipe fitting. See pipe thread.

Nanobore

Nanobore generally refers to components with bore sizes less than 250 μm (0.010").

Nanovolume®

The trademark registered to Valco Instruments Co. Inc. and VICI AG International, applied to our nanobore components with bore sizes less than 250 μm (0.010").

Nut

The tensioning component of a compression fitting. As the threaded nut is tightened into the fitting detail, it pushes the ferrule forward into the tapered ferrule seat, causing it to make up on the tube.

O**OD**

Outside diameter.

One-piece fingertight

A one-piece fingertight fitting is a knurled or winged nut with integrated ferrule. It is convenient to use since the ferrule is retrieved from the port with the nut. Note: Polymer type ferrules rely on surface compression to form a seal and hold the tube by friction.

P**Pilot**

The tubing which extends beyond the ferrule in a made-up fitting, or the integral portion of a ZRF internal reducing ferrule which extends beyond the ferrule. See also pilot depth, below.

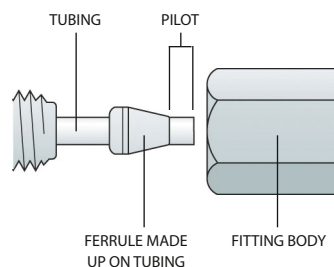
**Pilot depth**

The length of the tubing diameter cavity beyond the tapered ferrule seat within a fitting detail. Valco fitting pilot depths are tightly controlled to facilitate the interchangeability of components without the risk of leaks or dead volume.

Pipe thread

The external or internal threads of a fitting designed to effect a metal-to-metal seal on the conical thread faces. This type of fitting does not “bottom out” in the detail. Typically used with PTFE tape or other compound to lubricate the threads; however, since the diffusion rate of air components through the PTFE tape is considerable, pipe fittings should not be used in systems where leakage rates are critical.

Plug

A plug is used to block a fitting detail in a union, tee, cross, or valve.

R**Reducing ferrule**

A ferrule which allows a smaller tube to be used in a fitting detail designed for a larger tube. Caution should be taken if standard reducing ferrules without integral pilots are used, since dead volume may be created in the fitting pilot depth.

Reducing union

A fitting which joins two tubes of different ODs. The bore of the fitting should typically match the ID of the smaller tube.

S**SFE**

Supercritical Fluid Extraction. An extraction technique using a fluid in its supercritical state as the extraction medium. Some liquids and mixtures maintained above a critical temperature and pressure exhibit properties of both the liquid and gas phases of the element. These are defined as supercritical. CO₂ is a common supercritical fluid. Extreme caution must be used with supercritical CO₂, since uncontrolled expansion (leaks) can be very hazardous due to the substantial stored energy.

SFC

Supercritical Fluid Chromatography. An analytical technique using a supercritical fluid (see SFE) as the mobile phase/carrier.

Standard bore

A bore which was chosen as the standard for a particular fitting, typically based on the most common tubing ID used with that fitting.

T

Tee

A type of distribution fitting which connects three pieces of tubing, arranging them in the pattern of a "T".

Through-type bore

A bore which is slightly larger than the OD of the tubing which is used with the given fitting. A union with a through-type bore allows the tube ends to butt directly together, or for one tube to run completely through the fitting. Denoted by suffix "T" in the product number. In order to assure correct pilot lengths, we recommend that ferrules be made up on the tubing in a standard union.

U

Union

A fitting for connecting two pieces of tubing of the same OD.

See also *reducing union*.

Female union

A type of compression fitting in which the fitting body has female threads. Also referred to as internal union.

Male union

A type of compression fitting in which the fitting body has male threads. Also referred to as external union.

Unswept volume

The volume of any portion of a fitting which is in the flowpath but which is a different diameter than the primary flow orifice through the tubing/fitting assembly, or any area not directly swept by the fluid flow. This can also be known as "dead volume" if it is very poorly swept.

V

VICI

VICI® is an acronym for Valco Instruments Company Inc.

VICI now defines multiple companies which manufacture various products for the analytical industry.

W

Wetted surfaces

The surfaces which are contacted by the sample stream.

Y

Y ("Wye")

A type of distribution fitting which connects three pieces of tubing, arranging them in the pattern of a "Y". Occasionally referred to as a "wye".

Z

ZDV

Zero dead volume. See definition below.

Zero dead volume

Describes a connection which does not add volume to the system beyond what an extension of tubing would in its place.

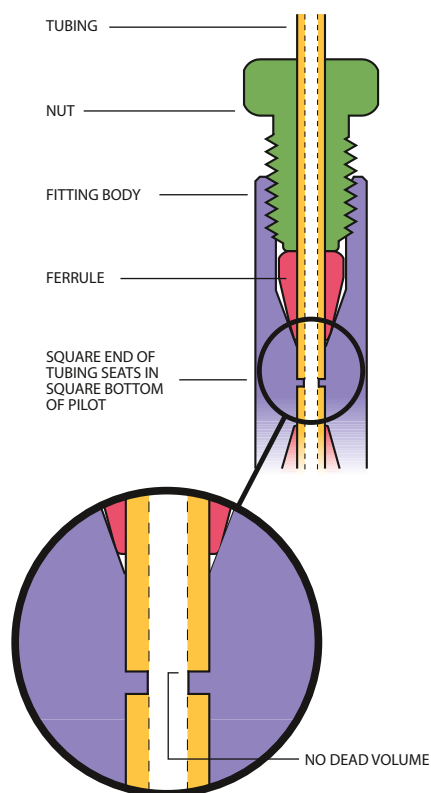
**Zero volume**

While often used interchangeably with zero dead volume, it ideally describes a fitting design in which there is no internal volume, such as a through-type union designed to butt-fit two pieces of tubing.

Temperature conversions

°C	°F	°C	°F	°C	°F	°C	°F	°C	°F
-40	-40	65	149	170	338	275	527	500	932
-35	-31	70	158	175	347	280	536	525	977
-30	-22	75	167	180	356	285	545	550	1022
-25	-13	80	176	185	365	290	554	575	1067
-20	-4	85	185	190	374	295	563	600	1112
-15	5	90	194	195	383	300	572	625	1157
-10	14	95	203	200	392	305	581	650	1202
-5	23	100	212	205	401	310	590	675	1247
0	32	105	221	210	410	315	599	700	1292
5	41	110	230	215	419	320	608	725	1337
10	50	115	239	220	428	325	617	750	1382
15	59	120	248	225	437	330	626	775	1427
20	68	125	257	230	446	335	635	800	1472
25	77	130	266	235	455	340	644	825	1517
30	86	135	275	240	464	345	653	850	1562
35	95	140	284	245	473	350	662	875	1607
40	104	145	293	250	482	375	707	900	1652
45	113	150	302	255	491	400	752	925	1697
50	122	155	311	260	500	425	797	950	1742
55	131	160	320	265	509	450	842	975	1787
60	140	165	329	270	518	475	887	1000	1832

Length

µm	inches
100	.004"
150	.006"

mm	inches
0.050	.002"
0.064	.0025"
0.075	.003"
0.100	.004"
0.13	.005"
0.15	.006"
0.18	.007"
0.20	.008"
0.25	.010"
0.38	.015"
0.40	.016"
0.50	.020"
0.75	.030"
1.00	.039"
1.50	.059"
2.00	.079"
3.00	.118"
4.00	.157"
4.60	.181"
6.00	.236"
6.35	.250"
6.40	.252"
7.00	.276"
10.00	.394"
12.70	.500"

inches	mm
1/32"	0.79
1/16"	1.59
3/32"	2.38
1/8"	3.18
1/4"	6.35
5/16"	7.94
3/8"	9.50
1/2"	12.70
1"	25.40

feet	mm
1 ft	304.8

Pressure conversions

bar	psi	kPa	MPa	bar	psi	kPa	MPa	bar	psi	kPa	MPa
0.1	1.5	10	0.01	6	87.0	600	0.6	100	1,450	10,000	10
0.2	2.9	20	0.02	7	101.5	700	0.7	200	2,900	20,000	20
0.3	4.4	30	0.03	8	116.0	800	0.8	300	4,350	30,000	30
0.4	5.8	40	0.04	9	130.5	900	0.9	400	5,800	40,000	40
0.5	7.3	50	0.05	10	145	1,000	1	500	7,250	50,000	50
0.6	8.7	60	0.06	20	290	2,000	2	600	8,700	60,000	60
0.7	10.2	70	0.07	30	435	3,000	3	700	10,150	70,000	70
0.8	11.6	80	0.08	40	580	4,000	4	800	11,600	80,000	80
0.9	13.1	90	0.09	50	725	5,000	5	900	13,050	90,000	90
1	14.5	100	0.1	60	870	6,000	6	1,000	14,500	100,000	100
2	29.0	200	0.2	70	1,015	7,000	7	1,100	15,950	110,000	110
3	43.5	300	0.3	80	1,160	8,000	8	1,200	17,400	120,000	120
4	58.0	400	0.4	90	1,305	9,000	9	1,300	18,850	130,000	130
5	72.5	500	0.5								

Index by product number

GENERAL REFERENCE

JR-5FR1-5.....73	JR-082.....35	JR-201928-10.....41	JR-4676-10TF.....51	JR-5511-5.....23	JR-68264.....55	JR-BPR1KF.....88
JR-5FR1TI-5.....73	JR-083-5.....35	JR-201999.....64	JR-4676-2.....51	JR-5520-10.....19	JR-68264P.....55	JR-BPR2KF.....88
JR-5FR2-5.....73	JR-086.....35	JR-201999-10.....48	JR-4676-2.5TF.....51	JR-5525-10.....19	JR-68330-05.....57	JR-C360C.....39
JR-5FR4-5.....73	JR-087-5.....35	JR-202118-10.....43	JR-4676-5TF.....51	JR-5570-5.....22	JR-68330-2.....57	JR-C360CFS.....39
JR-5FR6-5.....73	JR-096.....35	JR-202119-10.....43	JR-4677-10.....51	JR-5580-5.....23	JR-68330-5.....57	JR-C360CPK.....38
JR-031-10.....41	JR-097-5.....35	JR-202120-10.....43	JR-4677-10TF.....51	JR-5595.....29	JR-68331-05.....57	JR-C360ET.....38
JR-032-10.....41	JR-1030.....28	JR-202121-10.....43	JR-4677-2.....51	JR-56-5.....31	JR-68331-2.....57	JR-C360NFFS.....39
JR-040 RE-10.....42	JR-1032.....28	JR-202122-10.....43	JR-4677-2.5TF.....51	JR-57-5.....31	JR-68331-5.....57	JR-C360NFPK.....38
JR-040BK-10.....42	JR-1033.....28	JR-202123-10.....43	JR-4677-5TF.....51	JR-58000-5.....19	JR-69230-05.....56	JR-C360NFS6.....39
JR-040BL-10.....42	JR-1040.....28	JR-202124-10.....43	JR-5003-5.....22	JR-58-5.....31	JR-69230-2.....56	JR-C360PPK.....38
JR-040GR-10.....42	JR-1042.....28	JR-202125-10.....43	JR-5004-5.....23	JR-59-5.....32	JR-69230-5.....56	JR-C360QTPK2.....38
JR-040WH-10.....42	JR-1043.....28	JR-202142-10.....43	JR-5010-5.....22	JR-6029.....46	JR-69330-05.....56	JR-C360QTPK4.....38
JR-040WL-10.....42	JR-1061.....26	JR-202143-10.....43	JR-55010-5.....17	JR-6029.....46	JR-69330-2.....56	JR-C360QTPK6.....38
JR-040YL-10.....42	JR-1064.....44	JR-202145-10.....43	JR-55011-5.....17	JR-6030.....46	JR-69330-5.....56	JR-C360QUPK2.....38
JR-041-10.....41	JR-1065.....44	JR-202235.....85	JR-55012-5.....17	JR-6032.....46	JR-792.....87	JR-C360QUPK4.....38
JR-042-10.....41	JR-1066.....26	JR-2030.....28	JR-55013-5.....17	JR-6033.....46	JR-793.....87	JR-C360QUPK6.....38
JR-049-10.....41	JR-1067.....26	JR-2032.....28	JR-55014-5.....17	JR-6034.....46	JR-794.....86	JR-C360QXPk2.....38
JR-050 RE-10.....42	JR-1068.....44	JR-2033.....28	JR-55015-5.....17	JR-6039.....46	JR-795.....86	JR-C360QXPk4.....38
JR-050BK-10.....42	JR-10FR1-5.....73	JR-2040.....28	JR-55016-12.....17	JR-6040.....46	JR-796.....87	JR-C360QXPk6.....38
JR-050BL-10.....42	JR-10FR1K-5.....73	JR-2042.....28	JR-55020-5.....20	JR-6041.....46	JR-797.....86	JR-C360RU.5FS2.....39
JR-050GR-10.....42	JR-10FR2-5.....73	JR-2043.....28	JR-55021-5.....20	JR-6042.....46	JR-798.....86	JR-C360RU.5FS4.....39
JR-050WH-10.....42	JR-10FR4-5.....73	JR-26501.....79	JR-55021-5.....26	JR-6043.....46	JR-800.....88	JR-C360RU.5FS6.....39
JR-050WL-10.....42	JR-10FR6-5.....73	JR-26502.....79	JR-55022-5.....20	JR-6044.....46	JR-802.....87	JR-C360RU.5S62.....39
JR-050YL-10.....42	JR-10FR8TI-5.....73	JR-26503.....79	JR-55023-5.....20	JR-60-5.....32	JR-804.....89	JR-C360RU.5S64.....39
JR-051-10.....41	JR-1100-05P-5.....74	JR-26504.....79	JR-55024-5.....20	JR-6120-50030.....70	JR-805.....89	JR-C360RU.5S66.....39
JR-060-5.....43	JR-1100-2P-5.....74	JR-27305.....78	JR-5502-5.....20	JR-6140.....13	JR-80-5.....35	JR-C360RU1FS6.....39
JR-061.....26	JR-1101-05P-5.....74	JR-2FR1-5.....73	JR-55025-5.....20	JR-6141-10.....13	JR-806.....89	JR-C360RU1PK6.....38
JR-0611.....29	JR-1101-2P-5.....74	JR-2FR1K-5.....73	JR-5503-5.....23	JR-65001NF.....77	JR-9.....78	JR-C360RU1S66.....39
JR-0611 TI05-3.....54	JR-1102-05P-5.....74	JR-2FR1KI-5.....73	JR-5504-5.....20	JR-65002NF.....77	JR-9000-0005.....62	JR-C360UFS2.....39
JR-0611-SS05-3.....54	JR-1102-2P-5.....74	JR-2FR1TI-5.....73	JR-5505.....29	JR-65003NF.....77	JR-9000-0007.....69	JR-C360UFS4.....39
JR-0611-SS2-3.....54	JR-1103-05P-5.....74	JR-2FR2-5.....73	JR-55050-10.....25	JR-65005NF.....77	JR-9000-0010.....62	JR-C360UFS6.....39
JR-0611-TI2-3.....54	JR-1103-2P-5.....74	JR-2FR2TI-5.....73	JR-55050-10.....41	JR-65006NF.....77	JR-9000-0011.....70	JR-C360UPK2.....38
JR-0612.....29	JR-1104-05P-5.....74	JR-2FR4-5.....73	JR-55051-10.....41	JR-65011.....78	JR-9000-0012.....70	JR-C360UPK4.....38
JR-0617.....29	JR-1104-2P-5.....74	JR-2FR4TI-5.....73	JR-55060-10.....41	JR-65158.....78	JR-9000-0013.....69	JR-C360UPK6.....38
JR-062.....29	JR-1110-05P-5.....74	JR-2FR6-5.....73	JR-55061-10.....41	JR-660100.....49	JR-9000-0014.....69	JR-C360US62.....39
JR-0622.....29	JR-1110-2P-5.....74	JR-2FR6TI-5.....73	JR-55070-10.....41	JR-660110.....49	JR-9000-0520.....51	JR-C360US64.....39
JR-0623.....29	JR-1110-5P-5.....74	JR-2FR8TI-5.....73	JR-55071-10.....41	JR-660200.....49	JR-9000-0520B.....52	JR-C360US66.....39
JR-0625.....29	JR-1111-05P-5.....74	JR-32171.....52	JR-55072-10.....41	JR-660210.....49	JR-9000-0520F.....51	JR-C5M1PK.....46
JR-0626.....29	JR-1111-10P-5.....74	JR-32172.....52	JR-55073-10.....41	JR-660300.....49	JR-9000-0521.....51	JR-C5M2PK.....46
JR-064.....44	JR-1111-2P-5.....74	JR-32174.....52	JR-5507-5.....20	JR-660310.....49	JR-9000-0521F.....51	JR-C9M1PK.....46
JR-0640.....45	JR-1111-5P-5.....74	JR-32178.....52	JR-55080-10.....17	JR-660320.....49	JR-9000-0522.....51	JR-C9M2PK.....46
JR-0641-SS05.....54	JR-1125-05P-5.....75	JR-32179.....52	JR-55080-5.....17	JR-66140.....77	JR-9000-0522F.....51	JR-CBN.....26
JR-0641-SS2.....54	JR-1125-10P-5.....75	JR-34N.....91	JR-55081-10.....17	JR-67140-1A.....78	JR-9000-0522H.....51	JR-CBULPK.....44
JR-0641-TI05.....54	JR-1125-2P-5.....75	JR-357090.....86	JR-55081-5.....17	JR-67140-2A.....78	JR-9000-0522HF.....51	JR-CBUMPK.....44
JR-0641-TI2.....54	JR-1125-5P-5.....75	JR-357180.....86	JR-55082-10.....17	JR-67-250-2A.....78	JR-9000-0525GC.....52	JR-CCPK-1.....24
JR-065.....44	JR-1127-05P-5.....75	JR-35P.....90	JR-55082-5.....17	JR-67-250-4.....78	JR-9000-0526G.....52	JR-C-EN.5FPKB.....37
JR-0650.....45	JR-1127-2P-5.....75	JR-35S.....90	JR-55083-10.....17	JR-681812NF.....77	JR-9000-0528G.....52	JR-CFE-S10-5.....50
JR-066.....26	JR-1128-5P-5.....75	JR-367008-10.....53	JR-55083-5.....17	JR-68181NF.....77	JR-9000-0530.....51	JR-CFE-S2-5.....50
JR-067.....26	JR-1150-10P-5.....75	JR-367008-2.....53	JR-55084-10.....17	JR-68183NF.....77	JR-9000-0530F.....51	JR-CFE-S75-5.....50
JR-068.....44	JR-1151-10P-5.....75	JR-367008-20.....53	JR-55084-5.....17	JR-68184NF.....77	JR-9000-0531.....51	JR-CFL-2W-5.....45
JR-0680.....45	JR-1FR1-5.....73	JR-367016-10.....53	JR-55085-5.....17	JR-68185NF.....77	JR-9000-0531F.....51	JR-CFL-4D.....45
JR-070101-10.....48	JR-1FR2-5.....73	JR-367016-2.....53	JR-55085-10.....17	JR-68186NF.....77	JR-9000-0532.....51	JR-CFLAPK.....29
JR-070111-10.....48	JR-201094BK-10.....43	JR-367016-20.....53	JR-55085-5.....17	JR-68230-05.....57	JR-9000-0532F.....51	JR-CFL-CB1KF.....41
JR-070112-10.....48	JR-201094WH-10.....43	JR-3675-2.....53	JR-55086-10.....17	JR-68230-2.....57	JR-9000-0602.....53	JR-CFL-CB1PK.....41
JR-070113-10.....48	JR-201144-10.....43	JR-3678-2.....53	JR-55086-5.....17	JR-68230-5.....57	JR-9000-0603.....53	JR-CFL-CB1PK.....49
JR-070123-10.....48	JR-201116-10.....42	JR-3678-25.....53	JR-55087-10.....17	JR-68231-05.....57	JR-9000-0604.....53	JR-CFL-CB2KF.....41
JR-070124-10.....48	JR-20124-10.....42	JR-4071-10.....79	JR-55087-5.....17	JR-68231-2.....57	JR-9000-0604H.....53	JR-CFL-CB2KF.....49
JR-070211-10.....48	JR-201531.....85	JR-4072-10.....79	JR-55088-10.....17	JR-68231-5.....57	JR-9000-0640.....53	JR-CFL-CB2KF-S.....45
JR-070212-10.....48	JR-201532.....85	JR-4073-10.....79	JR-55088-5.....17	JR-68242TI.....78	JR-9000-0641.....53	JR-CFL-CB4KF-S.....45
JR-070213-10.....48	JR-201536.....85	JR-4074-10.....79	JR-55089-10.....17	JR-68242TI2.....78	JR-9000-0642.....53	JR-CM1XPK.....47
JR-070224-10.....48	JR-201537.....85	JR-4075-10.....79	JR-55089-5.....17	JR-68247.....54	JR-9000-0670.....28	JR-CM2XPK.....47
JR-070225-10.....48	JR-201539.....85	JR-408.....24	JR-5508X-12.....17	JR-68252TI.....78	JR-9001.....86	JR-CMLAPK.....29
JR-070350-10.....69	JR-201540.....41	JR-4081-10.....79	JR-5508X-24.....17	JR-68252TI2.....78	JR-B-C5M1PK.....46	JR-C-NERU1FPK.....37
JR-071123-10.....48	JR-201540.....85	JR-4082-10.....79	JR-55090-10.....17	JR-68253.....54	JR-B-C5M2PK.....46	JR-C-NEU.5FPK.....37
JR-071124-10.....48	JR-201540L.....85	JR-4083-10.....79	JR-55090-5.....17	JR-68256.....54	JR-B-C9M1PK.....46	JR-C-NEU.5XFPK.....37
JR-071323-10.....48	JR-201541.....85	JR-4084-10.....79	JR-55091-10.....17	JR-68257.....54	JR-B-CM2PK.....46	JR-CNFT.....19
JR-071324-10.....48	JR-201554.....85	JR-4085-10.....79	JR-55091-5.....17	JR-68257PE.....54	JR-B-CM1XPK.....47	JR-C-NL.15L-5.....37
JR-072350-10.....48	JR-201580BK-10.....43	JR-409.....24	JR-55100-5.....19	JR-68258.....55	JR-B-CM2XPK.....47	JR-C-NL.15S-5.....37
JR-072450-10.....48	JR-201580WH-10.....43	JR-410.....24	JR-5510-5.....23	JR-68262.....55	JR-BPR1.....88	JR-C-NL.20L-5.....37
JR-075013.....48	JR-201926-10.....41	JR-4676-10.....51	JR-55110-5.....19	JR-68263.....55	JR-BPR1.....88	JR-C-NL.20S-5.....37

JR-C-NL25L-5.....	37	JR-S-18314.....	68	JR-SLV-75-1000....	81	JR-T-5720-***.....	6	JR-T-6801-***.....	12	JR-T-97100.....	14	JR-ZX1.....	33
JR-C-NL25S-5.....	37	JR-S-20002.....	60	JR-SLV-75-20.....	81	JR-T-5764-***.....	6	JR-T-6802-***.....	11	JR-T-97105.....	14	JR-ZX1C.....	33
JR-C-NL30L-5.....	37	JR-S-20003.....	59	JR-SLV-75-250.....	81	JR-T-5802-***.....	6	JR-T-6802C-***.....	10	JR-T-97110.....	14	JR-ZX1M.....	33
JR-C-NL30S-5.....	37	JR-S-20004.....	59	JR-SLV-75-5.....	81	JR-T-5803-***.....	6	JR-T-6803-***.....	11	JR-TD-5804-***.....	7		
JR-C-NL35L-5.....	37	JR-S-20005.....	60	JR-SLV-75-50.....	81	JR-T-5804-***.....	6	JR-T-6803C-***.....	10	JR-TD-6007-***.....	7		
JR-C-NL35S-5.....	37	JR-S-20006.....	59	JR-SLV-75-500.....	81	JR-T-5993-***.....	5	JR-T-6804-***.....	11	JR-TD-6008-***.....	7		
JR-C-NNFFPK.....	37	JR-S-20007.....	59	JR-SLV-76-10.....	82	JR-T-5993-***.....	8	JR-T-6805-***.....	12	JR-TD-6009-***.....	7		
JR-CU4LPK.....	45	JR-S-20008.....	59	JR-SLV-76-100.....	82	JR-T-5994-***.....	8	JR-T-6806-***.....	11	JR-TD-6010-***.....	7		
JR-EN1FPKB.....	37	JR-S-20009.....	59	JR-SLV-76-1000....	82	JR-T-5995-***.....	8	JR-T-6806C-***.....	10	JR-TD-6011-***.....	7		
JR-F-197-062 2TI.....	78	JR-S-20100.....	71	JR-SLV-76-20.....	82	JR-T-5998-***.....	5	JR-T-6807-***.....	12	JR-TSS505-***.....	15		
JR-F-197-062-2TINC... 78		JR-S-20200.....	71	JR-SLV-76-200.....	82	JR-T-5998-***.....	8	JR-T-6808-***.....	12	JR-TSS507-***.....	15		
JR-F-255-079-10PE-5 72		JR-S-40004.....	60	JR-SLV-76-5.....	82	JR-T-5998C-***.....	6	JR-T-6809.....	11	JR-TSS510-***.....	15		
JR-FPKBSS5-10.....	25	JR-S-40006.....	65	JR-SLV-76-50.....	82	JR-T-5999-***.....	6	JR-T-6810.....	12	JR-TSS520-***.....	15		
JR-FPKBSS1-10.....	25	JR-S-40007.....	68	JR-SLV-76-500.....	82	JR-T-6000-***.....	6	JR-T-6811-***.....	12	JR-TSS105-***.....	15		
JR-FRK1.....	89	JR-S-40008.....	62	JR-T-078-***.....	9	JR-T-6001-***.....	6	JR-T-6812-***.....	11	JR-TSS110-***.....	15		
JR-FRK2.....	89	JR-S-40009.....	65	JR-T-080-***.....	9	JR-T-6002-***.....	6	JR-T-6812C-***.....	10	JR-TSS115-***.....	15		
JR-HKS3.....	89	JR-S-40104.....	68	JR-T-082-***.....	9	JR-T-6003-***.....	6	JR-T-6813-***.....	11	JR-TSS120-***.....	15		
JR-LZN1-5.....	31	JR-S-40106.....	68	JR-T-083-***.....	9	JR-T-60031-***.....	6	JR-T-6835-***.....	11	JR-TSS130-***.....	15		
JR-LZNF1KF-5.....	21	JR-S-40108.....	68	JR-T-084-***.....	9	JR-T-60032-***.....	6	JR-T-96005.....	14	JR-TSS140-***.....	15		
JR-LZNF1PK-5.....	21	JR-SLC-85-10.....	81	JR-T-085-***.....	9	JR-T-6004-***.....	5	JR-T-96010.....	14	JR-TSS230-***.....	15		
JR-LZNF1PKG-5.....	21	JR-SLC-85-100.....	81	JR-T-086-***.....	9	JR-T-60041-***.....	5	JR-T-96015.....	14	JR-TSS240-***.....	15		
JR-LZP1PK.....	24	JR-SLC-85-1000....	81	JR-T-087-***.....	9	JR-T-60042-***.....	5	JR-T-96020.....	14	JR-TSS260-***.....	15		
JR-MZN1-5.....	31	JR-SLC-85-20.....	81	JR-T-088-***.....	9	JR-T-6006.....	5	JR-T-96025.....	14	JR-TSS267-***.....	15		
JR-MZNF1KF-5.....	21	JR-SLC-85-200.....	81	JR-T-36100-***.....	6	JR-T-6007-***.....	8	JR-T-96030.....	14	JR-TSS285-***.....	15		
JR-MZNF1PK-5.....	21	JR-SLC-85-250.....	81	JR-T-36125-***.....	6	JR-T-6008-***.....	8	JR-T-96035.....	14	JR-ZBU1CFPK.....	26		
JR-MZNF1PKG-5.....	21	JR-SLC-85-300.....	81	JR-T-36150-***.....	6	JR-T-6009-***.....	8	JR-T-96040.....	14	JR-ZBU1FPK.....	26		
JR-MZP1PK.....	24	JR-SLC-85-5.....	81	JR-T-3650-***.....	6	JR-T-6010-***.....	8	JR-T-96045.....	14	JR-ZBU1MFPK.....	26		
JR-PTAS.....	49	JR-SLC-85-50.....	81	JR-T-3675-***.....	6	JR-T-6011-***.....	8	JR-T-96110.....	14	JR-ZC5.....	32		
JR-S-11001.....	64	JR-SLC-85-500.....	81	JR-T-37100-***.....	8	JR-T-6020-***.....	8	JR-T-96115.....	14	JR-ZC5FPK.....	24		
JR-S-11002.....	64	JR-SLC-86-10.....	82	JR-T-37125-***.....	8	JR-T-6030-***.....	8	JR-T-96120.....	14	JR-ZC1.....	32		
JR-S-11003.....	64	JR-SLC-86-100.....	82	JR-T-37150-***.....	8	JR-T-6040-***.....	8	JR-T-96125.....	14	JR-ZC1PK.....	24		
JR-S-11005.....	64	JR-SLC-86-1000....	82	JR-T-3750-***.....	8	JR-T-6060-***.....	5	JR-T-96130.....	14	JR-ZC2.....	32		
JR-S-11006.....	64	JR-SLC-86-20.....	82	JR-T-3775-***.....	8	JR-T-6060-***.....	8	JR-T-96135.....	14	JR-ZF5PK-5.....	22		
JR-S-11011.....	63	JR-SLC-86-250.....	82	JR-T-4001-***.....	9	JR-T-6105-***.....	11	JR-T-96140.....	14	JR-ZF5S6-5.....	32		
JR-S-11012.....	63	JR-SLC-86-5.....	82	JR-T-4002-***.....	9	JR-T-6130-***.....	13	JR-T-96145.....	14	JR-ZF1S6-5.....	32		
JR-S-11013.....	63	JR-SLC-86-50.....	82	JR-T-4003-***.....	9	JR-T-6210-***.....	11	JR-T-96205.....	14	JR-ZF2PK-5.....	22		
JR-S-11023.....	66	JR-SLC-86-500.....	82	JR-T-4004.....	9	JR-T-625-04-***.....	15	JR-T-96210.....	14	JR-ZF2S6-5.....	32		
JR-S-11101.....	64	JR-SLR-111.....	83	JR-T-4005.....	9	JR-T-625-05-***.....	15	JR-T-96215.....	14	JR-ZGF5PK.....	37		
JR-S-11102.....	64	JR-SLR-111-77.....	83	JR-T-4007-***.....	9	JR-T-625-10-***.....	15	JR-T-96220.....	14	JR-ZGF1PK.....	37		
JR-S-11103.....	64	JR-SLR-112.....	83	JR-T-4009.....	9	JR-T-625-20-***.....	15	JR-T-96225.....	14	JR-ZN5-5.....	31		
JR-S-11111.....	62	JR-SLR-112-77.....	83	JR-T-4011-***.....	12	JR-T-625-30-***.....	15	JR-T-96230.....	14	JR-ZN5FPK-5.....	22		
JR-S-11112.....	62	JR-SLR-113.....	83	JR-T-4011C-***.....	12	JR-T-625-40-***.....	15	JR-T-96235.....	14	JR-ZN1-5.....	31		
JR-S-11113.....	62	JR-SLR-113-77.....	83	JR-T-4036-***.....	12	JR-T-626-00-***.....	15	JR-T-96240.....	14	JR-ZN2-5.....	31		
JR-S-11201.....	64	JR-SLR-114.....	83	JR-T-4037-***.....	12	JR-T-628-00.....	15	JR-T-96305.....	14	JR-ZN2PK-5.....	22		
JR-S-11202.....	64	JR-SLR-114-77.....	83	JR-T-4039-***.....	12	JR-T-6310-***.....	11	JR-T-96310.....	14	JR-ZNF1FKFK-5.....	21		
JR-S-11203.....	64	JR-SLR-115.....	83	JR-T-4041.....	12	JR-T-6320-***.....	11	JR-T-96315.....	14	JR-ZNF1FPK-5.....	21		
JR-S-11211.....	62	JR-SLR-115-77.....	83	JR-T-4136C-***.....	12	JR-T-6604C-***.....	10	JR-T-96320.....	14	JR-ZNF1PKG-5.....	21		
JR-S-11212.....	62	JR-SLR-116.....	83	JR-T-4183-***.....	12	JR-T-6605-***.....	11	JR-T-96325.....	14	JR-ZNF1KF-5.....	21		
JR-S-11213.....	62	JR-SLR-116-77.....	83	JR-T-4183C-***.....	12	JR-T-6605C-***.....	10	JR-T-96330.....	14	JR-ZNF1KF-F-5.....	21		
JR-S-13001.....	65	JR-SLR-117.....	83	JR-T-436100-***.....	9	JR-T-6606-***.....	11	JR-T-96335.....	14	JR-ZNF1PK-5.....	21		
JR-S-13002.....	65	JR-SLR-117-77.....	83	JR-T-43650-***.....	9	JR-T-6606C-***.....	10	JR-T-96340.....	14	JR-ZNF1PK-F-5.....	21		
JR-S-13003.....	65	JR-SLR-118.....	83	JR-T-43675-***.....	9	JR-T-6607-***.....	11	JR-T-97005.....	14	JR-ZNF1PKG-5.....	21		
JR-S-14002.....	65	JR-SLR-118-77.....	83	JR-T-5602-***.....	8	JR-T-6607C-***.....	10	JR-T-97010.....	14	JR-ZNF1PKG-F-5.....	21		
JR-S-15001.....	65	JR-SLR-2190.....	81	JR-T-5603-***.....	8	JR-T-6610-***.....	11	JR-T-97015.....	14	JR-ZNFT.....	19		
JR-S-15002.....	65	JR-SLR-2191.....	81	JR-T-5604-***.....	8	JR-T-6610C-***.....	10	JR-T-97020.....	14	JR-ZP5.....	32		
JR-S-15003.....	65	JR-SLR-2192.....	81	JR-T-5605-***.....	8	JR-T-6615-***.....	11	JR-T-97025.....	14	JR-ZP5FPK.....	24		
JR-S-15011.....	63	JR-SLR-2193.....	81	JR-T-5606-***.....	8	JR-T-6620-***.....	11	JR-T-97030.....	14	JR-ZP1.....	32		
JR-S-15012.....	63	JR-SLR-2194.....	81	JR-T-5607-***.....	8	JR-T-6620C-***.....	10	JR-T-97035.....	14	JR-ZP1FPK.....	24		
JR-S-15013.....	63	JR-SLR-2195.....	81	JR-T-5608-***.....	8	JR-T-6702-***.....	11	JR-T-97040.....	14	JR-ZP2.....	32		
JR-S-15103.....	67	JR-SLR-2196.....	81	JR-T-5610-***.....	8	JR-T-6704-***.....	11	JR-T-97045.....	14	JR-ZRU1.5FPK.....	27		
JR-S-15113.....	67	JR-SLR-2200.....	81	JR-T-5620-***.....	8	JR-T-6704C-***.....	10	JR-T-97050.....	14	JR-ZRU21.....	34		
JR-S-15303.....	68	JR-SLR-2201.....	81	JR-T-5664-***.....	8	JR-T-6705-***.....	11	JR-T-97055.....	14	JR-ZRU21FPK.....	27		
JR-S-15313.....	68	JR-SLR-2202.....	81	JR-T-5702-***.....	6	JR-T-6705C-***.....	10	JR-T-97060.....	14	JR-ZT1.....	33		
JR-S-16003.....	67	JR-SLR-2204.....	81	JR-T-5703-***.....	6	JR-T-6706-***.....	11	JR-T-97065.....	14	JR-ZT1C.....	33		
JR-S-16013.....	67	JR-SLR-2206.....	81	JR-T-5704-***.....	6	JR-T-6706C-***.....	10	JR-T-97070.....	14	JR-ZT1M.....	33		
JR-S-16103.....	67	JR-SLR-2207.....	81	JR-T-5705-***.....	6	JR-T-6707-***.....	11	JR-T-97075.....	14	JR-ZU1CS6.....	34		
JR-S-16113.....	67	JR-SLR-2210.....	81	JR-T-5707-***.....	6	JR-T-6707C-***.....	10	JR-T-97080.....	14	JR-ZU1MS6.....	34		
JR-S-18004.....	66	JR-SLR-2222.....	81	JR-T-5708-***.....	6	JR-T-6708-***.....	11	JR-T-97085.....	14	JR-ZU1S6.....	34		
JR-S-18014.....	66	JR-SLV-75-10.....	81	JR-T-5710-***.....	6	JR-T-6794-***.....	11	JR-T-97090.....	14	JR-ZU1XC.....	34		
JR-S-18304.....	68	JR-SLV-75-100.....	81	JR-T-5715-***.....	8	JR-T-6800-***.....	12	JR-T-97095.....	14	JR-ZUFLPK.....	29		

GENERAL REFERENCE

A

- Adapters
 - High pressure PEEK 29
 - Low pressure polypropylene 48
- Air inlet valve..... 59
- Air outlet filter..... 59

B

- Backpressure regulator 88
- Barbed hose adapter
 - for 1/8" ID tubing..... 63
- Bottles, safety-coated glass 70
- Bulkhead unions, PEEK
 - High pressure 26
 - Low pressure..... 44
- Bushing for high pressure
 - 1/4-28 connection..... 25

C

- Caps
 - Nanovolume® 360 µm ... 38-39
 - PEEK 24
 - Stainless..... 32
- Carbon dioxide filter..... 71
- ChromBox kit..... 91
- Clean-Cut tubing cutter..... 86
- Color-It fingertight adapters 17
- Color-Sleeve
 - fingertight adapters..... 17
- Column couplers 79
- Column end plugs
 - Color-coded 79
 - Logotype 79
- Columns, PEEK
 - 2.1 mm 77
 - 4.0 mm 77
- Crosses
 - Nanovolume®..... 38
 - PEEK
 - High pressure..... 28
 - Low pressure 46
 - Stainless 33
- Cutting wheel SS tubing cutter.. 87

E

- ETFE tubing 9
- Easy-Flange kit 85
- Easy-Flange combi kit 85
- Eco cap 69
- Eco cap kit 69
- Economy Last Drop
 - mobile phase filters 51
- Elbows for PEEK tubing 86
- Exhaust filter 60

F

- FEP tubing
 - Natural color..... 11
 - Solid color-coded 10
- Ferrule removal kits..... 89
- Ferrules
 - High pressure
 - Collapsible 37
 - Nanovolume® 37
 - PEEK
 - Collapsible 37
 - Double-ended..... 23
 - Single 22
 - UHPLC **NEW** .. 22

F, continued

- Ferrules, continued
 - High pressure, cont'd
 - Stainless
 - Metric 35
 - Rheodyne 32
 - Valco 32
 - Low pressure
 - Collapsible..... 41
 - Inverted 41
 - File 87
 - Filters
 - UHPLC stainless
 - In-line filter 57
 - Precolumn filter 56
 - High pressure PEEK
 - In-line filter kit..... 54
 - Precolumn filter kit ... 55
 - Sure-Guard 54
 - Low pressure
 - Economy Last Drop 51
 - In-line 50
 - Last Drop 51
 - Last Drop glass 52
 - Mobile phase filters ... 51-52
 - No-Met biocompatible... 52
 - Safety
 - Air outlet filter 59
 - Carbon dioxide filter 71
 - Humidity filter 71
 - Filter/spargers
 - Last Drop 53
 - Stainless steel 53
 - Fingertight adapters
 - Color-It 17
 - Color-Sleeve 17
 - Fingertight one-piece column
 - couplers 79
 - Flanged nuts
 - Fingertight color-coded 43
 - Hex-head nuts 41
 - Flangeless nuts
 - Fingertight color-coded 42
 - Fingertight PEEK 42
 - Hex-head nuts 41
 - Frits
 - for PEEK filter kits..... 55
 - for stainless in-line filter 57
 - PEEK-encased
 - Stainless..... 74
 - Titanium..... 75
 - Polyethylene..... 75
 - Unidense
 - Stainless..... 73
 - Titanium..... 73
 - Polyethylene..... 72

G

- Guard columns,
 - in-line biocompatible 78
- Guillotine tubing cutter..... 86

H

- Hex key set..... 89
- Humidity filter..... 71

I

- Impermeable
 - polymeric tubing..... 13
- In-line biocompatible
 - guard column 78
- In-line filter cartridges 50
- In-line filter, stainless steel 57
- In-line filter kit
 - PEEK..... 54
 - Sure-guard 54

K

- Kits
 - Chrombox kit 91
 - Easy-Flange kit..... 85
 - Easy-Flange combi kit 85
 - PEEK starter kit..... 90
 - Stainless steel starter kit 90

L

- Last Drop biocompatible glass
 - mobile phase filters 52
- Last Drop filter/sparger 53
- Last Drop mobile phase filters... 51
- Liners for 1/32" Nanovolume®
 - fittings.....37
- Loops
 - PEEK..... 80-81
 - Stainless steel..... 82-83

M

- Manifolds, low pressure PEEK ... 46
- Micro valves for GC and LC..... 49
- Mixing tees
 - Biocompatible high pressure 28
 - Low pressure..... 47
- Mobile phase filters
 - Biocompatible glass 52
 - Economy Last Drop 51
 - Last Drop 51
 - No-Met biocompatible 52

N

- Nanovolume® fittings
 - for 1/32" tubing 37
 - for 360 µm tubing..... 38-39
- No-Met biocompatible
 - mobile phase filters 52
- Nuts
 - High pressure
 - PPS..... 25
 - PEEK
 - for double ferrules.... 23
 - for single ferrules 22
 - Stainless
 - Rheodyne compatible 31
 - Valco..... 31
 - Low pressure
 - Flanged
 - Fingertight
 - color-coded..... 43
 - Hex-head 41
 - Flangeless
 - Fingertight
 - color-coded..... 42
 - Fingertight PEEK..... 42
 - Hex-head 41
- Nanovolume®
 - 1/32" 37
 - 360 micron 38-39

O

- One-piece fittings
 - Column couplers..... 79
 - Nanovolume® nut-ferrule. 38-39
 - No-twist PEEK 21
 - PPS hex-head 19
 - PEEK fingertight
 - Color-coded 20
 - Natural 20
 - PEEK hex-head
 - 5000 psi 19
 - UHPLC..... **NEW** ..19

P

- PEEK columns 77
- PEEK starter kit 89
- PEEK tubing
 - Dual layer color-coded 7
 - Natural 5
 - Solid color-coded 8
 - Striped color-coded 6
- PEEK tubing elbows 86
- PFA tubing 9
- PTFE tubing
 - Natural color 12
 - Solid color-coded 12
- Packing kits
 - for PEEK columns..... 78
 - for guard columns..... 78
- Peristaltic tubing adapter set... 49
- Plier type SS tubing cutter 87
- Plugs
 - High pressure
 - PEEK 24
 - Stainless..... 32
 - Low pressure
 - Polypropylene 48
- Precolumn filter kit, PEEK 55
- Precolumn filter, stainless 56

R

- Reducing unions
 - Nanovolume® 37-39
 - PEEK, high pressure 27
 - PEEK, low pressure
 - Imperial 45
 - Imperial to metric **NEW** .. 45
 - Stainless
 - Imperial 34
 - Imperial to metric **NEW** .. 35

S

- Safety
 - Air inlet valves 59
 - Air outlet filters 59
 - Exhaust filters..... 60-61
 - Caps..... 63
 - Cap kit..... 62
 - Carbon dioxide filter 71
 - Humidity filter 71
- Safety-coated glass bottles 70
- Sample loops
 - PEEK..... 80-81
 - Stainless steel..... 82-83

S, continued

SolviFlex coiled tubing..... 70
 Stainless steel in-line filter 57
 Stainless steel mobile phase filter/
 helium sparger..... 53
 Stainless steel starter kit 90
 Stainless steel tubing
 Pre-cut..... 14
 Pre-cut flexible..... 14
 Premium grade..... 15
 Standard grade..... 15
 Stainless steel tubing cutters
 Cutting wheel type..... 87
 Plier type..... 87
 Starter kits
 Chrombox kit..... 91
 PEEK starter kit..... 90
 Stainless steel starter kit..... 90
 Sure-Guard in-line filter kit54

T

Tees
 Biocompatible mixing..... 28
 Nanovolume®..... 38
 PEEK
 High pressure..... 28
 Low pressure..... 46
 Mixing..... 47
 Stainless..... 33

T, continued

Thermo-formed
 polymeric tubing..... 13
 Tubing
 ETFE..... 9
 FEP
 Natural color..... 11
 Solid color-coded..... 10
 Impermeable
 polymeric tubing..... 13
 PEEK
 Dual layer color-coded..... 7
 Natural..... 5
 Solid color-coded..... 8
 Striped color-coded..... 6
 PFA..... 9
 PTFE
 Natural color..... 12
 Solid color-coded..... 12
 Stainless
 Pre-cut..... 14
 Pre-cut flexible..... 14
 Premium grade..... 15
 Standard grade..... 15
 Thermo-formed
 polymeric tubing..... 13
 Tubing clip..... 86

T, continued

Tubing cutters
 Clean-Cut (for polymers)..... 86
 Cutting wheel type
 (for stainless)..... 87
 Guillotine type (for polymers) 86
 Plier type (for stainless)..... 87
 Tubing elbows..... 86
 Tweezer..... 89

U

UHPLC
 Filters
 Stainless in-line filter..... 57
 Stainless precolumn
 filter..... **NEW** .. 56
 PEEK
 Ferrules..... **NEW** .. 22
 HT™ one-piece hex-head
 fittings..... **NEW** .. 19
 Stainless steel
 Caps..... 32
 Crosses..... 33
 Ferrules..... 32
 Nuts..... 31
 Plugs..... 32
 Reducing unions..... 34,35
 Tees..... 33
 Unions..... 34

U, continued

Unidense frits 72-73
 Unions
 Body only, for
 low-pressure flanged..... 43
 Bulkhead... *see Bulkhead unions*
 Nanovolume®..... 37-39
 PEEK
 High pressure..... 26
 Low pressure..... 44
 Reducing... *see Reducing unions*
 Stainless..... 34

V

VICI caps..... 64-65
 VICI cap kit..... 64
 ValvTool..... 88

W

Washers
 for flanged connections..... 41
 Waste caps..... 66-68
 Wrenches
 Open end..... 89
 ValvTool..... 88



- Valco valves
- Cheminert valves
- Actuators
- Valco fittings
- Cheminert fittings
- Tubing
- Flow, pressure, and on/off devices
- Dynacal® permeation devices
- Instrumentation
- GC columns
- GC purifiers

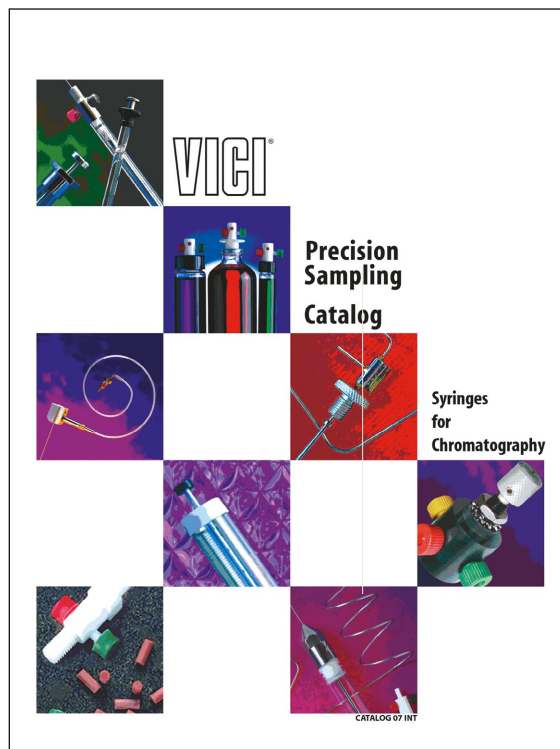

- Gas tight syringes
- HPLC injection syringes
- Magnum syringes up to 500 mL
- Syringes for sampling from gas cylinders
- Mininert™ – Valves for vials
- Customized probes and shaped tubing

TO ORDER

Our sales personnel will work with you by email, phone, or fax to determine the best products for your specifications.

Our Schenkon, Switzerland, Brockville, Ontario, and Baton Rouge, Louisiana offices serve different regions of the world.

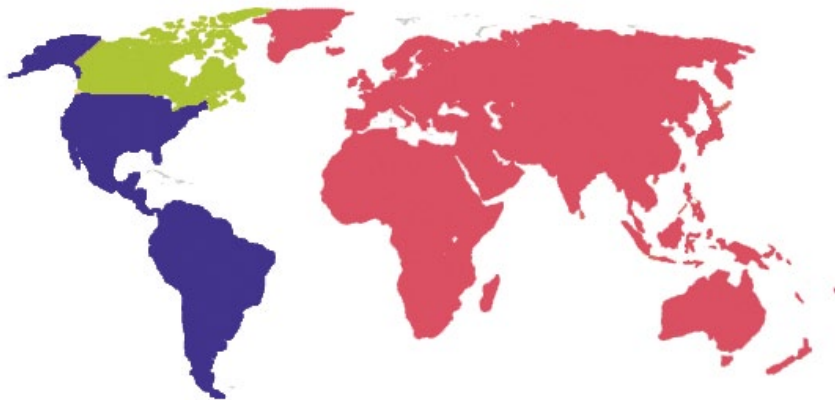

Europe, Middle East, Asia, Africa, Australia, and other countries

VICI AG International

Sales

Phone: Int + 41· 41· 925-6200

Fax: Int + 41· 41· 925-6201

Email: order@vici.ch

Technical/Service

Phone: Int + 41· 41· 925-6200

Fax: Int + 41· 41· 925-6201

Email: support@vici.ch

Parkstrasse 2
CH-6214 Schenkon / Switzerland
info@vici.ch

EXW shipping point, our factory,
Schenkon, Switzerland.

We accept:



North, South, and Central America (except Canada)

VICI Precision Sampling

Sales

Toll-free: 800-828-1653

Phone: 225-927-1128

Fax: 225-923-1331

Email: precision@vici.com

Technical/Service

Phone: 225-927-1128

Fax: 225-923-1331

Email: precision@vici.com

P.O. Box 15886
Baton Rouge, Louisiana / USA
precision@vici.com

F.O.B. shipping point, our factory,
Baton Rouge, Louisiana

We accept:



Canada

VICI Valco Instruments Canada

Sales

Toll-free: 866-297-2626

Phone: 613-342-2600

Fax: 613-342-0111

Email: canada@vici.com

Technical/Service

Phone: 613-342-2600

Fax: 613-342-0111

Email: canada@vici.com

26 Water Street East
Brockville, Ontario / Canada K6V 1A1
canada@vici.com

F.O.B. shipping point, our factory,
Brockville, Canada.

We accept:



Conditions of Sale

There is no minimum order.
Terms are net 30 days.
Prices subject to change without notice.

Notice

VICI reserves the right to correct errors and change prices, designs, or specifications without notice or liability. The information in this catalog is correct to the best of our knowledge but is not guaranteed to be so. VICI assumes no responsibility with respect thereto.

Repairs

For repair return authorization or information about factory refurbishments, contact our Service Department.

Returns

No returns will be accepted more than 90 days after shipment for any reason. Before 90 days, no returns will be accepted without prior authorization. If it is necessary to return material to us, please contact our Sales Department for a return authorization number and forwarding instructions. Inspect shipments upon receipt and report

Technical Service

Our capable staff is waiting to assist you with your technical questions and application needs.

shortages and incorrect or damaged material to us immediately.

Important! Damaged shipments must remain with the original packaging for freight company inspection.

Returned material will be subject to a restocking charge of 20% for catalog items. Special orders cannot be returned unless defective.

CANADA

VICI Valco Instruments Canada Corp
26 Water Street East
CA-Brockville, ON K6V 1A1
Phone: +1 613 342 2600
Toll free: +1 866 297 2626
Fax: +1 613 342 0111
Email: canada@vici.com
Web: www.vici.com

CHINA

J & J Industries
Room 917/918, Prime Tower
22 Chaoyangmen Wai Da Jie
CN-Beijing 100020
Phone: +86 10 65888666
Fax: +86 10 65886577
Email: sales@jjindustries.com.cn
Web: www.jjindustries.com.cn

DENMARK

Mikrolab Aarhus A/S
Axel Kiers Vej 34
DK-8270 Højbjerg
Phone: +45 86 29 61 11
Fax: +45 86 29 61 22
Email: ml@mikrolab.dk
Web: www.mikrolab.dk

FINLAND

Krotek O.Y.
Salmintie 4B
FI-02140 Espoo
Phone: +358 9 412 88 08
Fax: +358 9 412 88 09
Email: krotek@krotek.fi
Web: www.krotek.fi

FRANCE

Interchim SA
211 Bis, Avenue J.F. Kennedy
BP 1140
FR-03103 Montluçon Cedex
Phone: +33 4 700 388 55
Fax: +33 4 700 382 60
Email: interchrom@interchim.com
Web: www.interchim.com

GERMANY

Macherey-Nagel GmbH + Co. KG
Neumann-Neander-Strasse 6-8
DE-52355 Düren
Phone: +49 2421 969 0
Fax: +49 2421 969 122
Email: sales-de@mn-net.com
Web: www.mn-net.com

IRELAND

Carl Stuart Ltd.
Tallaght Business Park
Whitestown
IE-Dublin 24
Phone: +353 1 452 34 32
Fax: +353 1 452 39 67
Email: info@carlstuart.com
Web: www.carlstuart.com

ITALY

C.P.S. Analitica S.r.l.
Via Neera 8/A
IT-20141 Milano
Phone: +39 02 895 4201
Fax: +39 02 895 42022
Email: cps@cps.it
Web: www.cps.it

ITALY

Labservice Analytica S.r.l.
Via Emilia 51/C
IT-40011 Anzola Emilia/Bologna
Phone: +39 051 732351
Fax: +39 051 732759
Email: info@labservice.it
Web: www.labservice.it

JAPAN

GL Sciences Inc.
22-1 Nishishinjuku 6-chome
Shinjuku-Ku
JP-163-1130 Tokyo
Phone: +81 3 5323 6620
Fax: +81 3 5323 6621
Email: world@gls.co.jp
Web: www.gls.co.jp

NETHERLANDS

Da Vinci Europe Laboratory Solutions B.V.
P.O. Box 12.103
NL-3004 GC Rotterdam
Phone: +31 10 258 18 70
Fax: +31 10 258 18 79
Email: solutions@davincieurope.com
Web: www.davincieurope.com

NORWAY

Teknolab AS
Trollasveien 34
NO-1414 Trollasen
Phone: +47 66 81 34 70
Fax: +47 66 81 34 71
Email: mail@teknolab.no
Web: www.teknolab.no

RUSSIA

Fizlabpribor Ltd.
Podolskih Kursantov str. 3/2
RU-117535 Moscow
Phone: +7 495 740 5406
Fax: +7 495 316 9600
Email: info@fizlabpribor.ru
Web: www.fizlabpribor.ru

SINGAPORE

Nareen Technologies PTE Ltd.
196, Pandan Loop, # 07-18
Pantech Industrial Complex
SG-Singapore 128384
Phone: +65 6777 4001
Fax: +65 6779 4401
Email: enquiry@nareen.com.sg
Web: www.nareen.com

SOUTH KOREA

Young-Wha Scientific Co., Ltd.
5th Floor, Gu-Jung B/D
577-7 Shinsa-Dong, Kangnam-Ku
KR-135-891 Seoul, South Korea
Phone: +82 2 2140 5400
Fax: +82 2 2140 5405
Email: ywsc@youngwha.com
Web: www.youngwha.com

SPAIN

Symta, S.A.L.
Calle de San Máximo, 31
ES-28041 Madrid
Phone: +34 915 002 060
Fax: +34 915 000 045
Email: info@symta.com
Web: www.symta.com

SWEDEN

Scantec Lab AB
Box 238
SE-43324 Partille
Phone: +46 31 336 90 00
Fax: +46 31 336 90 36
Email: scantec.info@scanteclab.se
Web: www.scanteclab.se

SWITZERLAND

BGB Analytik AG
Rohrmattstrasse 4
CH-4461 Böckten
Phone: +41 61 991 00 46
Fax: +41 61 991 00 25
Email: sales@bgb-analytik.ch
Web: www.bgb-analytik.ch

THAILAND

Amani Corporation Ltd.
201/220 M6 Pravate, Pravate
TH-10250 Bangkok
Phone: +66 (2) 322 44 22
Fax: +66 (2) 322 67 05
Email: amani@ksc.th.com

UNITED KINGDOM

Thames Restek UK Ltd.
Units 8/16, Ministry Wharf
Wycombe Road, Saunderton
GB-Buckinghamshire HP14 4HW
Phone: +44 1494 563377
Fax: +44 1494 564990
Email: sales@thamesrestek.co.uk
Web: www.thamesrestek.co.uk

USA

VICI Precision Sampling
8275 W. El Cajon Drive
US-70815, Baton Rouge / LA
Phone: +1 225 927 1128
Toll free: +1 800 828 1653
Fax: +1 225 923 1331
Email: precision@vici.com
Web: www.vici.com

NOTE

Our products could also be available from your local distributor. Please contact VICI AG International for other countries.

www.vici-jour.com

VICI Jour®

VICI AG International

Parkstrasse 2
6214 Schenkon
Switzerland

Phone +41 41 925 62 00

Fax +41 41 925 62 01

Email info@vici.ch



printed carbon neutral

Energy efficient and CO₂ compensated print
SG2012030701 - gremp.ch

© 2012 by VICI AG International

Printed in Switzerland