



ITM



2024 CATALOG

"ANYTHING THAT MAKES A HOLE"[®]

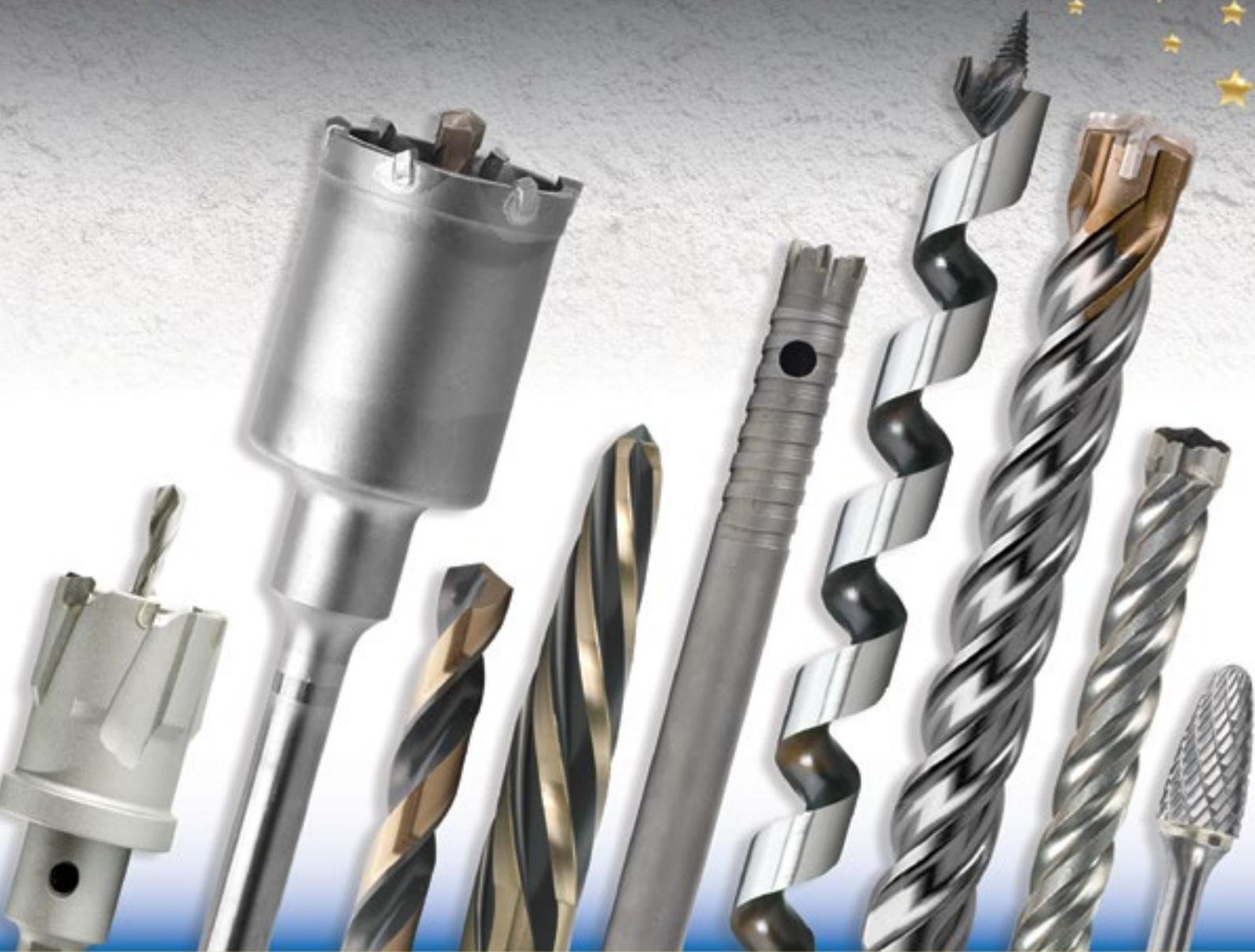

CONSTRUCTION DRILLING AND CUTTING SOLUTIONS

WWW.ITMTOOLS.COM | (800) 247-5696 | SALES@ITMTOOLS.COM



100% LAB TESTED

FAST DELIVERY

4000 items. Orders are shipped the same day if received before 3 P.M. Eastern Time.

EASY ORDERING

Order toll free, by fax, or email, either by part number or description. Our staff will quickly help you decide which product best fits your application. Order what you need, there is never a minimum order.

COMPLETE SATISFACTION

Simple: all of your purchases must satisfy you completely, or we will issue you a refund, exchange, or credit.

ITM catalogs are always made with YOU in mind! You will find our catalog easy to use and our staff a valuable resource for your business.

Thank you for your business and patronage.

Call us. We will make your job a little bit easier.

Sincerely yours,

Berardo Paradiso
President - ITM Corp.

Alberic Paradiso

Bryan Markell

Alex Teitelbaum

Chun Keat

Marilyn Rodriguez

Annette Kempadoo



p.10 Two Tone Jobbers HSS 118° Point



p.10 Bright Finish Jobbers HSS 118° Point



p.11 Black Oxide Jobbers HSS 118° Point



p.11 Black Oxide Wire Gauge HSS 118° Point



p.12 Black Oxide Jobbers HSS 135° Split Point



p.12 Black Oxide Wire Gauge HSS 135° Split Point



p.13 Black Oxide Letter HSS 135° Split Point



p.13 Black Oxide Metric HSS 118° Point



p.14 Black Oxide Stub Length HSS 135° Split Point



p.15 Black Oxide Silver & Deming HSS 118° Point

**BLACK
Oxide**



p.17 Black & Gold Jobbers HSS 135° Split Point



p.17 Black & Gold Wire Gauge HSS 135° Split Point



p.18 Black & Gold Mechanics Length HSS 135° Split Point



p.19 Black & Gold Letter Size HSS 135° Split Point



p.19 Black & Gold Silver & Deming HSS 118° Split Point



p.20 MRO Black & Gold Jobbers 135° Split Point



p.20 MRO Black & Gold Letter Size HSS 135° Split Point



p.21 MRO Black & Gold Wire Gauge 135° Split Point

Black & Gold



p.22 Cobalt Jobbers 135° Split Point



p.22 Cobalt Wire Gauge 135° Split Point



p.23 Cobalt Stub Length 135° Split Point

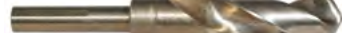

p.23 Cobalt Silver & Deming 118° Split Point

COBALT



p.24 Titanium (TiN) Jobbers HSS 135° Split Point



p.24 1/4" Hex Impact Titanium (TiN) Jobbers
HSS 135° Split Point



p.25 Parabolic Jobbers 135° Split Point



p.25 Cobalt Jobbers 135° Split Point



p.26 Spotweld Double End



p.26 Double End Drills - Sheet Metal Drills



p.26 VIP Step Jobbers HSS - Sheet Metal Drills



p.27 Aircraft HSS 135° Split Point (6", 12" & 18" Long)



p.28 Bullet Case Drill Bit Sets / HUOT Case Drill Bit Sets



p.30 Tap & Drill Sets / 525 Pc. Dispenser



Bar Champ Outer Reamer
 Pipe Taps, NPT
 Hand Tap Wrenches
 Hand Taps, Carbon Steel
 Hand Taps, HSS
 Combo Drill Taps
 Spiral Point (Gun) Taps
 3 in 1 Combo Drill Taps
 Rim Champ Inner Reamer
 Countersinks - Zero Flute Countersinks
 Screw Extractor
 Wire Brushes
 Burs - Solid Carbide / Kit
 Step Drills Fast Spiral - HSS - TiALN
 Reamers
 Annular Twist Drill HSS
 Annular Cutters HSS / Kit
 Step Reamers / Kit
 Magnetic Drill Accessories
 Magnet, Countersinks & Chucks
 T.C.T. Hole Cutters
 Hole Saws - Bi-Metal
 Hole Saws - Carbide Tipped
 Hole Saws - Carbide Grit
 Pilot Drills and Accessories
 Arbors

p.32
 p.35
 p.35
 p.36
 p.37
 p.38
 p.38
 p.39
 p.40
 p.41
 p.41
 p.42
 p.44
 p.46
 p.48
 p.50
 p.51
 p.52
 p.53
 p.54
 p.56
 p.58
 p.59
 p.60
 p.61





p.62 Hack-Saw Blades - Bi-Metal



p.62 Band-Saw Blades - Bi-Metal



p.63 Reciprocating Blades - Bi-Metal - Wood & Metal - Bulk Packs



p.64 Reciprocating Blades - Bi-Metal - Retail Ready Packs
Wood & Metal, Heavy Metal and Carbide



p.66 Reciprocating Blades - Bi-Metal - Heavy Duty - Demolition



p.67 Reciprocating Blades - Bi-Metal - Wood & Metal - REDLINE

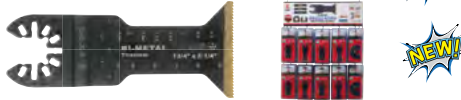

p.68 Oscillating Blades - Bi-Metal



p.70 Bell Hanger Drills (Fish Hole Drills)
HSS & Carbide Tipped



p.71 Electrician's Flex Bit (Stretch Bit)



p.71 Circular Saw Blades - Wood



p.72 Long Boy Drills HSS (12" & 18")



p.72 Brad Point Wood Drills



p.73 Self Feed (Multispur) Wood Drills



p.73 Extensions (For Ship Augers / Multispur)



p.74 Spade Drills



p.74 Drywall Cutter



p.75 Self Feed Twister



p.75 Carbide Tipped Hole Saw - The Butcher



p.76 Power Pole Auger Drills



p.77 Ship Auger Wood Drills (8" & 18" Long)



p.78 V Groove Tile Bit



p.79 V Groove Bathroom Install Kit



p.79 V Screw 101 Pc. Stainless Screws



p.80 White Diamond Tile Bit



Diamond Milling & Countersinks	p.81	
Glass Drills	p.82	
Blu Diamond Tile Bit	p.82	
Multi Purpose Drills	p.83	
Hard Steel Drills - Left & Right Hand	p.83	
Roto Percussion Masonry Drills - Standard	p.84	
Carpet Tack Strip Stub Drills	p.84	
Roto Percussion Masonry Drills - Heavy Duty	p.85	
SPLINE Rotary Hammer Drills	p.87	
SDS-PLUS Redline	p.89	
SDS-PLUS Bohr Hammer	p.90+	
SDS-PLUS X-Cutter	p.94	
SDS-MAX Rotary Hammer Drills	p.96	
Extension Systems / Adapters	p.97	
SDS-MAX Tunnel Bore	p.98	
Core Bits - SDS-MAX Ratio Shank	p.99	
Core Bits - SDS-MAX - Taper Shank	p.100	
Core Bits - SDS-MAX - 1 Piece	p.101	
Core Bits - SDS-Plus	p.102	
SDS-PLUS Diamond Core	p.103	
Dry Diamond Core Stone Countertops	p.104	
Wet Diamond Core	p.105	
Duster Rotary Hammer	p.106	
Dust Pro Cups	p.107	



p.108

SDS-PLUS Stop Bit (For Drop In Anchors)



p.108

SDS-Max to SDS-Plus Adapter



p.109

Concrete Screw Drills



p.109

SDS-Plus HEX for Concrete Screws



p.109

Concrete Screw Sleeve / Concrete Screw Kit



p.110

Rebar Cutters - Impact & Rotary Only

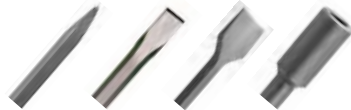

p.112

SDS-MAX - SDS-PLUS - SDS-PLUS MINI Chisels



p.114

PCD Cup Wheel - Diamond Grinding Cup Wheel



p.115+

Diamond Cutting Wheels And Tuck Points



p.119+

Screwdrivers and Insert Bits



p.124

Bit Holders



p.126

Sockets (Magnetic Impact) & Drivers



p.127

Nut Setters - Magnetic / Impact Protection



p.128

Insert Bit Sets & MEGAPRO Screwdriver



p.130

Cable Ties



p.131

Plastic Anchor Kits & Zap In Anchors



p.132

Utility Knives and Accessories



p.133+

Retail Ready Displays / Standard Displays

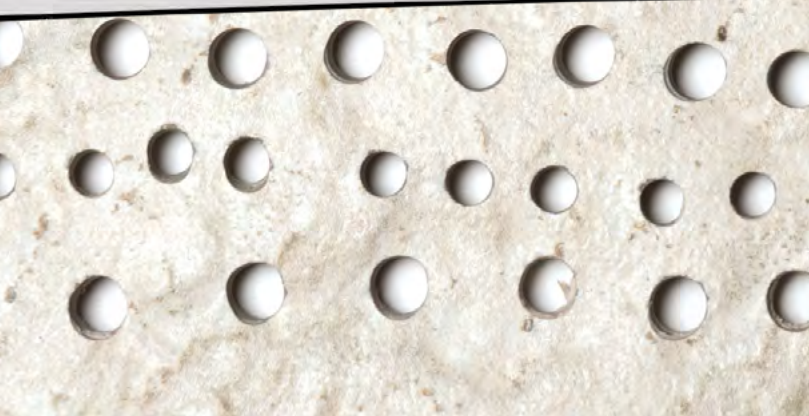

expertise

because drilling solutions



can be out of the ordinary

Terms Of Sale

- Terms:** 2% 10 Days, Net 30 Days. All credit cards welcome.
- Credit:** Open account privileges are extended to any firm that is satisfactorily rated. New accounts should submit at least 3 commercial references including all contact information and their tax resale number.
- Quantities:** Although there is no minimum purchase order, we reserve the right to adjust any order to the minimum packaged quantities indicated in catalog.
- Claims:** Should be made within 15 days of receipts.
- Freight:** Prepaid for NET invoices equaling \$600 or more.



EFFECTIVE JANUARY 2024.



HSS TOOL DATA

Suggested Drill Bits To Be Used For Various Types Of Materials:

MATERIAL	DRILL STYLE	ANGLE POINT	PRESSURE TO APPLY	COOLANT OR LUBRICANT
CARBON STEEL DUCTILE STEEL BRASS BRONZE	GENERAL PURPOSE DRILLS	118° POINT	MEDIUM TO HEAVY	OIL or WATER SOLUTION
CARBON STEEL ALUMINUM AUSTENITIC STAINLESS STEEL	HEAVY DUTY AND TITANIUM	135° SPLIT POINT	MEDIUM TO HEAVY	OIL or ACTIVATED SOLUTION
STAINLESS STEEL SERIES C CAST IRON	COBALT DRILLS	135° SPLIT POINT	MEDIUM TO HEAVY	OIL or ACTIVATED SOLUTION
HARD STEEL HEAT TREATED ALLOYS	HARD BODY CARBIDE TIPPED AND COBALT	130° & 135° SPLIT POINT	HEAVY	OIL or ACTIVATED SOLUTION

Chemical Analysis Of The Three Primary High Speed Steels Used To Manufacture HSS Drill Bits:

TYPE	CHEMICAL COMPOSITION						ROCKWELL C HARDNESS	TERM
	CARBON	TUNGSTEN	MOLYBDENUM	CHROMIUM	VANADIUM	COBALT		
M2	0.85	6.00	5.00	4.00	1.90	-	63-65	HSS
M35	1.10	1.50	9.50	1.15	1.15	5.00	65-67	COBALT
M42	1.10	1.50	9.50	1.15	1.15	8.00	65-67	SUPER COBALT

M2 "HSS" is the standard material used for all **ITM** drill bits. M2 has good red-hardness and retains its cutting edge longer than other general purpose high speed steels because of its increased quantity of tungsten (dull red heat up to 1000° F without loss of hardness or rapid dulling of cutting edge). M2 is generally favored for high production machine work.

M35 M35 is the standard cobalt material used for most **ITM** cobalt drill bits. M35 has excellent resistance to abrasion and very good red-hardness for working difficult materials.

M42 M42 "Super Cobalt" is American made premium cobalt material used for higher performance **ITM** cobalt drill bits. M42 has the best resistance to abrasion and red-hardness.

COBALT DRILLS

Made of the finest Cobalt steel obtainable and furnished with a 135° split point, these drills are designed for use in machining hard, tough materials beyond the normal cutting capabilities of regular high speed steel tools. These include work-hardening grades of stainless steels, titanium, high temperature alloys, and many other heat treated materials. In addition, due to their resistant properties, they can also be used at higher speeds to drill abrasive plastics, cast iron, and other types of difficult to machine work materials.



Always Use Protection When Drilling.

Always Use High RPM For Smaller Diameters and Lower RPM For Larger Diameters.

HSS TOOL DATA

Understanding High Speed Steel Drill Bits:

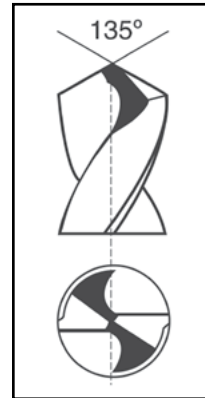
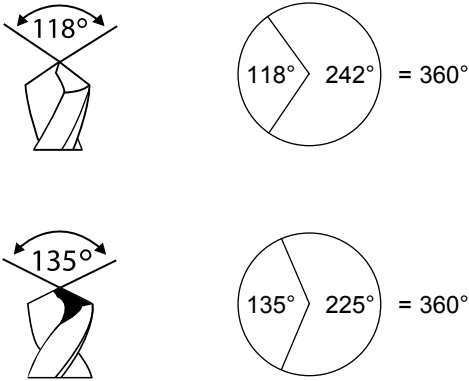

Split Point

An extra cutting angle on the 2 cutting edges of a drill bit.

Split Point is designated here in black.

Split Pointing is almost always reserved for 135° HSS drill bits.

118° drill bits have a sharp point and are common on standard / general purpose drill bits where light duty work is needed. Because of this sharp point, 118° drill bits will tend to “walk” or spin like a top on flat surfaces. This is why a centering drill or center punch is normally used to start off holes. If the operator has very steady hands, then the 118° drill bit can be used without center punching.

135° drill bits have a flatter point which gives the drill bit more cutting surface area. When more surface area cuts the steel, drilling is faster.



Understanding Nomenclature Vis-a-vis Size:

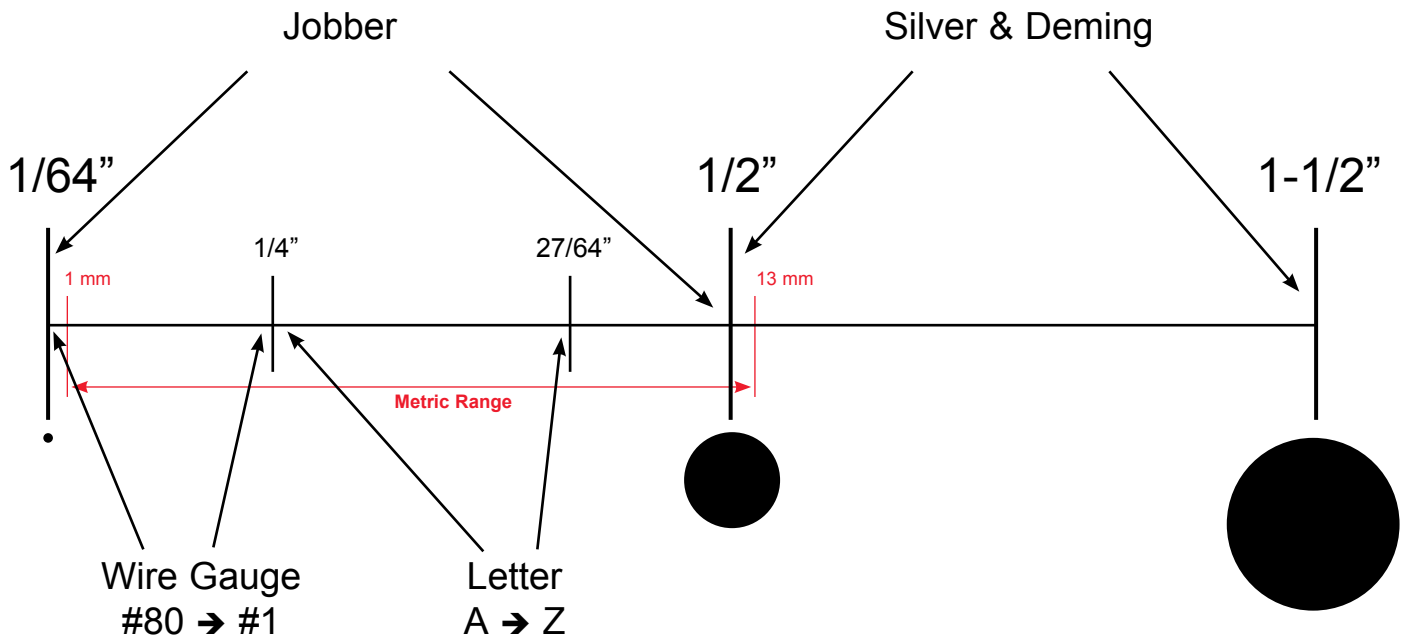

Chart Not To Scale.



Jobber Drills - General Purpose - TWO TONE FINISH - M2 HSS



- ◆ Jobber Length
- ◆ 118° Point
- ◆ General Purpose
- ◆ Roll Forged
- ◆ Straight Shank
- ◆ Two Tone Finish
- ◆ M2 HSS



Part #	Size	Dec.	OAL	Flute	Qty.	List	Part #	Size	Dec.	OAL	Flute	Qty.	List
200HS0464	1/16"	.0625	1-7/8"	7/8"	12	\$1.16	200HS1964	19/64"	.2969	4-3/8"	3-1/16"	12	\$4.17
200HS0564	5/64"	.0781	2"	1"	12	\$1.16	200HS2064	5/16"	.3125	4-1/2"	3-3/16"	12	\$4.30
200HS0664	3/32"	.0938	2-1/4"	1-1/4"	12	\$1.16	200HS2164	21/64"	.3281	4-5/8"	3-5/16"	6	\$4.84
200HS0764	7/64"	.1094	2-5/8"	1-1/2"	12	\$1.16	200HS2264	11/32"	.3438	4-3/4"	3-7/16"	6	\$5.51
200HS0864	1/8"	.1250	2-3/4"	1-5/8"	12	\$1.16	200HS2364	23/64"	.3594	4-7/8"	3-1/2"	6	\$6.30
200HS0964	9/64"	.1406	2-7/8"	1-3/4"	12	\$1.29	200HS2464	3/8"	.3750	5"	3-5/8"	6	\$7.14
200HS1064	5/32"	.1562	3-1/8"	2"	12	\$1.34	200HS2564	25/64"	.3906	5-1/8"	3-3/4"	6	\$7.74
200HS1164	11/64"	.1719	3-1/4"	2-1/8"	12	\$1.47	200HS2664	13/32"	.4062	5-1/4"	3-1/8"	6	\$7.95
200HS1264	3/16"	.1875	3-1/2"	2-5/16"	12	\$1.63	200HS2764	27/64"	.4219	5-3/8"	3-15/16"	6	\$8.80
200HS1364	13/64"	.2031	3-5/8"	2-7/16"	12	\$1.88	200HS2864	7/16"	.4375	5-1/2"	4-1/16"	6	\$9.42
200HS1464	7/32"	.2188	3-3/4"	2-1/2"	12	\$2.10	200HS2964	29/64"	.4531	5-5/8"	4-3/16"	6	\$11.11
200HS1564	15/64"	.2344	3-7/8"	2-5/8"	12	\$2.41	200HS3064	15/32"	.4688	5-3/4"	4-5/16"	6	\$11.30
200HS1664	1/4"	.2500	4"	2-3/4"	12	\$2.72	200HS3164	31/64"	.4844	5-7/8"	4-3/8"	6	\$12.01
200HS1764	17/64"	.2656	4-1/8"	2-7/8"	12	\$3.39	200HS3264	1/2"	.5000	6"	4-1/2"	6	\$13.55
200HS1864	9/32"	.2812	4-1/4"	2-15/16"	12	\$3.87							



Jobber Drills - General Purpose - BRIGHT FINISH - M2 HSS



- ◆ Jobber Length
- ◆ 118° Point
- ◆ General Purpose
- ◆ Ground Flute
- ◆ Straight Shank
- ◆ Bright Finish
- ◆ M2 HSS



Part #	Size	Dec.	OAL	Flute	Qty.	List	Part #	Size	Dec.	OAL	Flute	Qty.	List
250US0164	1/64"	.0156	3/4"	3/16"	12	\$1.66	250US1764	17/64"	.2656	4-1/8"	2-7/8"	12	\$5.15
250US0264	1/32"	.0312	1-3/8"	1/2"	12	\$1.66	250US1864	9/32"	.2812	4-1/4"	2-15/16"	12	\$5.84
250US0364	3/64"	.0469	1-3/4"	3/4"	12	\$1.66	250US1964	19/64"	.2969	4-3/8"	3-1/16"	12	\$6.46
250US0464	1/16"	.0625	1-7/8"	7/8"	12	\$1.12	250US2064	5/16"	.3125	4-1/2"	3-3/16"	12	\$7.23
250US0564	5/64"	.0781	2"	1"	12	\$1.12	250US2164	21/64"	.3281	4-5/8"	3-5/16"	6	\$8.15
250US0664	3/32"	.0938	2-1/4"	1-1/4"	12	\$1.12	250US2264	11/32"	.3438	4-3/4"	3-7/16"	6	\$9.38
250US0764	7/64"	.1094	2-5/8"	1-1/2"	12	\$1.17	250US2364	23/64"	.3594	4-7/8"	3-1/2"	6	\$10.30
250US0864	1/8"	.1250	2-3/4"	1-5/8"	12	\$1.38	250US2464	3/8"	.3750	5"	3-5/8"	6	\$11.30
250US0964	9/64"	.1406	2-7/8"	1-3/4"	12	\$1.45	250US2564	25/64"	.3906	5-1/8"	3-3/4"	6	\$11.69
250US1064	5/32"	.1562	3-1/8"	2"	12	\$1.77	250US2664	13/32"	.4062	5-1/4"	3-1/8"	6	\$12.42
250US1164	11/64"	.1719	3-1/4"	2-1/8"	12	\$2.08	250US2764	27/64"	.4219	5-3/8"	3-15/16"	6	\$13.91
250US1264	3/16"	.1875	3-1/2"	2-5/16"	12	\$2.77	250US2864	7/16"	.4375	5-1/2"	4-1/16"	6	\$15.72
250US1364	13/64"	.2031	3-5/8"	2-7/16"	12	\$3.00	250US2964	29/64"	.4531	5-5/8"	4-3/16"	6	\$16.28
250US1464	7/32"	.2188	3-3/4"	2-1/2"	12	\$3.15	250US3064	15/32"	.4688	5-3/4"	4-5/16"	6	\$17.76
250US1564	15/64"	.2344	3-7/8"	2-5/8"	12	\$3.34	250US3164	31/64"	.4844	5-7/8"	4-3/8"	6	\$18.83
250US1664	1/4"	.2500	4"	2-3/4"	12	\$4.69	250US3264	1/2"	.5000	6"	4-1/2"	6	\$23.91



Jobber Drills - General Purpose - BLACK FINISH - M2 HSS

Part #	Size	Dec.	OAL	Flute	Qty.	List	Part #	Size	Dec.	OAL	Flute	Qty.	List
200BF0464	1/16"	.0625	1-7/8"	7/8"	12	\$0.95	200BF1964	19/64"	.2969	4-3/8"	3-1/16"	12	\$2.98
200BF0564	5/64"	.0781	2"	1"	12	\$0.95	200BF2064	5/16"	.3125	4-1/2"	3-3/16"	12	\$3.05
200BF0664	3/32"	.0938	2-1/4"	1-1/4"	12	\$0.95	200BF2164	21/64"	.3281	4-5/8"	3-5/16"	6	\$3.45
200BF0764	7/64"	.1094	2-5/8"	1-1/2"	12	\$0.95	200BF2264	11/32"	.3438	4-3/4"	3-7/16"	6	\$3.99
200BF0864	1/8"	.1250	2-3/4"	1-5/8"	12	\$0.95	200BF2364	23/64"	.3594	4-7/8"	3-1/2"	6	\$4.50
200BF0964	9/64"	.1406	2-7/8"	1-3/4"	12	\$0.95	200BF2464	3/8"	.3750	5"	3-5/8"	6	\$4.62
200BF1064	5/32"	.1562	3-1/8"	2"	12	\$0.99	200BF2564	25/64"	.3906	5-1/8"	3-3/4"	6	\$5.01
200BF1164	11/64"	.1719	3-1/4"	2-1/8"	12	\$1.05	200BF2664	13/32"	.4062	5-1/4"	3-7/8"	6	\$5.14
200BF1264	3/16"	.1875	3-1/2"	2-5/16"	12	\$1.16	200BF2764	27/64"	.4219	5-3/8"	3-15/16"	6	\$5.70
200BF1364	13/64"	.2031	3-5/8"	2-7/16"	12	\$1.34	200BF2864	7/16"	.4375	5-1/2"	4-1/16"	6	\$6.23
200BF1464	7/32"	.2188	3-3/4"	2-1/2"	12	\$1.48	200BF2964	29/64"	.4531	5-5/8"	4-3/16"	6	\$7.42
200BF1564	15/64"	.2344	3-7/8"	2-5/8"	12	\$1.77	200BF3064	15/32"	.4688	5-3/4"	4-5/16"	6	\$8.13
200BF1664	1/4"	.2500	4"	2-3/4"	12	\$1.93	200BF3164	31/64"	.4844	5-7/8"	4-3/8"	6	\$8.13
200BF1764	17/64"	.2656	4-1/8"	2-7/8"	12	\$2.42	200BF3264	1/2"	.5000	6"	4-1/2"	6	\$8.34
200BF1864	9/32"	.2812	4-1/4"	2-15/16"	12	\$2.76							



- ◆ Jobber Length
- ◆ 118° Point
- ◆ General Purpose
- ◆ Roll Forged
- ◆ Straight Shank
- ◆ Black Oxide Finish
- ◆ M2 HSS



Wire Gauge Drills - General Purpose - BLACK FINISH - M2 HSS

Part #	Size	Dec.	OAL	Flute	Qty.	List	Part #	Size	Dec.	OAL	Flute	Qty.	List
203HS0001	1	.2280	3-7/8"	2-5/8"	12	\$2.07	203HS0031	31	.1200	2-3/4"	1-5/8"	12	\$1.19
203HS0002	2	.2210	3-7/8"	2-5/8"	12	\$2.07	203HS0032	32	.1160	2-3/4"	1-5/8"	12	\$1.19
203HS0003	3	.2130	3-3/4"	2-1/2"	12	\$2.24	203HS0033	33	.1130	2-5/8"	1-1/2"	12	\$1.19
203HS0004	4	.2090	3-3/4"	2-1/2"	12	\$2.24	203HS0034	34	.1110	2-5/8"	1-1/2"	12	\$1.19
203HS0005	5	.2055	3-3/4"	2-1/2"	12	\$2.24	203HS0035	35	.1100	2-5/8"	1-1/2"	12	\$1.19
203HS0006	6	.2040	3-3/4"	2-1/2"	12	\$2.24	203HS0036	36	.1065	2-1/2"	1-7/16"	12	\$1.19
203HS0007	7	.2010	3-5/8"	2-7/16"	12	\$2.24	203HS0037	37	.1040	2-1/2"	1-7/16"	12	\$1.19
203HS0008	8	.1990	3-5/8"	2-7/16"	12	\$2.24	203HS0038	38	.1015	2-1/2"	1-7/16"	12	\$1.19
203HS0009	9	.1960	3-5/8"	2-7/16"	12	\$2.24	203HS0039	39	.0995	2-3/8"	1-3/8"	12	\$1.19
203HS0010	10	.1935	3-5/8"	2-7/16"	12	\$2.24	203HS0040	40	.0980	2-3/8"	1-3/8"	12	\$1.19
203HS0011	11	.1910	3-1/2"	2-5/16"	12	\$2.12	203HS0041	41	.0960	2-3/8"	1-3/8"	12	\$1.19
203HS0012	12	.1890	3-1/2"	2-5/16"	12	\$2.12	203HS0042	42	.0935	2-1/4"	1-1/4"	12	\$1.19
203HS0013	13	.1850	3-1/2"	2-5/16"	12	\$2.12	203HS0043	43	.0890	2-1/4"	1-1/4"	12	\$1.19
203HS0014	14	.1820	3-3/8"	2-3/16"	12	\$2.12	203HS0044	44	.0860	2-1/8"	1-1/8"	12	\$1.19
203HS0015	15	.1800	3-3/8"	2-3/16"	12	\$2.12	203HS0045	45	.0820	2-1/8"	1-1/8"	12	\$1.19
203HS0016	16	.1770	3-3/8"	2-3/16"	12	\$2.12	203HS0046	46	.0810	2-1/8"	1-1/8"	12	\$1.19
203HS0017	17	.1730	3-3/8"	2-3/16"	12	\$2.12	203HS0047	47	.0785	2"	1"	12	\$1.19
203HS0018	18	.1695	3-1/4"	2-1/8"	12	\$2.12	203HS0048	48	.0760	2"	1"	12	\$1.19
203HS0019	19	.1660	3-1/4"	2-1/8"	12	\$2.12	203HS0049	49	.0730	2"	1"	12	\$1.19
203HS0020	20	.1610	3-1/4"	2-1/8"	12	\$1.99	203HS0050	50	.0700	2"	1"	12	\$1.19
203HS0021	21	.1590	3-1/4"	2-1/8"	12	\$1.99	203HS0051	51	.0670	2"	1"	12	\$1.19
203HS0022	22	.1570	3-1/8"	2"	12	\$1.99	203HS0052	52	.0635	1-7/8"	7/8"	12	\$1.19
203HS0023	23	.1540	3-1/8"	2"	12	\$1.99	203HS0053	53	.0595	1-7/8"	7/8"	12	\$1.19
203HS0024	24	.1520	3-1/8"	2"	12	\$1.42	203HS0054	54	.0550	1-7/8"	7/8"	12	\$1.19
203HS0025	25	.1495	3"	1-7/8"	12	\$1.42	203HS0055	55	.0520	1-7/8"	7/8"	12	\$1.19
203HS0026	26	.1470	3"	1-7/8"	12	\$1.42	203HS0056	56	.0465	1-3/4"	3/4"	12	\$1.19
203HS0027	27	.1440	3"	1-7/8"	12	\$1.42	203HS0057	57	.0430	1-3/4"	3/4"	12	\$1.19
203HS0028	28	.1405	2-7/8"	1-3/4"	12	\$1.42	203HS0058	58	.0420	1-5/8"	11/16"	12	\$1.19
203HS0029	29	.1360	2-7/8"	1-3/4"	12	\$1.19	203HS0059	59	.0410	1-5/8"	11/16"	12	\$1.19
203HS0030	30	.1285	2-3/4"	1-5/8"	12	\$1.19	203HS0060	60	.0400	1-5/8"	11/16"	12	\$1.19



- ◆ Wire Gauge
- ◆ 118° Point
- ◆ General Purpose
- ◆ Roll Forged
- ◆ Straight Shank
- ◆ Black Oxide Finish
- ◆ M2 HSS



AVAILABLE:
SIZES 61 → 80
List \$2.28



Jobber Drills - HEAVY DUTY - BLACK OXIDE FINISH - M2 HSS

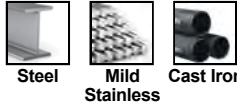

- ◆ Jobber Length
- ◆ 135° Split Point
- ◆ Ground Flute
- ◆ Straight Shank
- ◆ Heavy Duty Web
- ◆ Black Oxide Finish
- ◆ M2 HSS



Part #	Size	Dec.	OAL	Flute	Qty.	List	Part #	Size	Dec.	OAL	Flute	Qty.	List
206SP0464	1/16"	.0625	1-7/8"	7/8"	12	\$1.34	206SP1964	19/64"	.2969	4-3/8"	3-1/16"	12	\$6.03
206SP0564	5/64"	.0781	2"	1"	12	\$1.34	206SP2064	5/16"	.3125	4-1/2"	3-3/16"	12	\$6.17
206SP0664	3/32"	.0938	2-1/4"	1-1/4"	12	\$1.34	206SP2164	21/64"	.3281	4-5/8"	3-5/16"	6	\$6.86
206SP0764	7/64"	.1094	2-5/8"	1-1/2"	12	\$1.34	206SP2264	11/32"	.3438	4-3/4"	3-7/16"	6	\$8.30
206SP0864	1/8"	.1250	2-3/4"	1-5/8"	12	\$1.49	206SP2364	23/64"	.3594	4-7/8"	3-1/2"	6	\$8.57
206SP0964	9/64"	.1406	2-7/8"	1-3/4"	12	\$1.59	206SP2464	3/8"	.3750	5"	3-5/8"	6	\$9.35
206SP1064	5/32"	.1562	3-1/8"	2"	12	\$1.67	206SP2564	25/64"	.3906	5-1/8"	3-3/4"	6	\$10.83
206SP1164	11/64"	.1719	3-1/4"	2-1/8"	12	\$1.89	206SP2664	13/32"	.4062	5-1/4"	3-7/8"	6	\$11.45
206SP1264	3/16"	.1875	3-1/2"	2-5/16"	12	\$2.30	206SP2764	27/64"	.4219	5-3/8"	3-15/16"	6	\$12.82
206SP1364	13/64"	.2031	3-5/8"	2-7/16"	12	\$2.54	206SP2864	7/16"	.4375	5-1/2"	4-1/16"	6	\$14.54
206SP1464	7/32"	.2188	3-3/4"	2-1/2"	12	\$2.74	206SP2964	29/64"	.4531	5-5/8"	4-3/16"	6	\$14.95
206SP1564	15/64"	.2344	3-7/8"	2-5/8"	12	\$3.09	206SP3064	15/32"	.4688	5-3/4"	4-5/16"	6	\$16.52
206SP1664	1/4"	.2500	4"	2-3/4"	12	\$3.91	206SP3164	31/64"	.4844	5-7/8"	4-3/8"	6	\$17.76
206SP1764	17/64"	.2656	4-1/8"	2-7/8"	12	\$4.17	206SP3264	1/2"	.5000	6"	4-1/2"	6	\$19.22
206SP1864	9/32"	.2812	4-1/4"	2-15/16"	12	\$4.59							



Wire Gauge Drills - HEAVY DUTY - BLACK OXIDE FINISH - M2 HSS



- ◆ Wire Gauge
- ◆ 135° Split Point
- ◆ Ground Flute
- ◆ Straight Shank
- ◆ Heavy Duty Web
- ◆ Black Oxide Finish
- ◆ M2 HSS



Part #	Size	Dec.	OAL	Flute	Qty.	List	Part #	Size	Dec.	OAL	Flute	Qty.	List
207SP0001	1	.2280	3-7/8"	2-5/8"	12	\$2.97	207SP0031	31	.1200	2-3/4"	1-5/8"	12	\$1.89
207SP0002	2	.2210	3-7/8"	2-5/8"	12	\$2.97	207SP0032	32	.1160	2-3/4"	1-5/8"	12	\$1.75
207SP0003	3	.2130	3-3/4"	2-1/2"	12	\$2.97	207SP0033	33	.1130	2-5/8"	1-1/2"	12	\$1.75
207SP0004	4	.2090	3-3/4"	2-1/2"	12	\$2.97	207SP0034	34	.1110	2-5/8"	1-1/2"	12	\$1.75
207SP0005	5	.2055	3-3/4"	2-1/2"	12	\$2.97	207SP0035	35	.1100	2-5/8"	1-1/2"	12	\$1.75
207SP0006	6	.2040	3-3/4"	2-1/2"	12	\$2.97	207SP0036	36	.1065	2-1/2"	1-7/16"	12	\$1.75
207SP0007	7	.2010	3-5/8"	2-7/16"	12	\$2.77	207SP0037	37	.1040	2-1/2"	1-7/16"	12	\$1.75
207SP0008	8	.1990	3-5/8"	2-7/16"	12	\$2.77	207SP0038	38	.1015	2-1/2"	1-7/16"	12	\$1.75
207SP0009	9	.1960	3-5/8"	2-7/16"	12	\$2.77	207SP0039	39	.0995	2-3/8"	1-3/8"	12	\$1.75
207SP0010	10	.1935	3-5/8"	2-7/16"	12	\$2.77	207SP0040	40	.0980	2-3/8"	1-3/8"	12	\$1.75
207SP0011	11	.1910	3-1/2"	2-5/16"	12	\$2.77	207SP0041	41	.0960	2-3/8"	1-3/8"	12	\$1.69
207SP0012	12	.1890	3-1/2"	2-5/16"	12	\$2.77	207SP0042	42	.0935	2-1/4"	1-1/4"	12	\$1.69
207SP0013	13	.1850	3-1/2"	2-5/16"	12	\$2.36	207SP0043	43	.0890	2-1/4"	1-1/4"	12	\$1.69
207SP0014	14	.1820	3-3/8"	2-3/16"	12	\$2.36	207SP0044	44	.0860	2-1/8"	1-1/8"	12	\$1.69
207SP0015	15	.1800	3-3/8"	2-3/16"	12	\$2.36	207SP0045	45	.0820	2-1/8"	1-1/8"	12	\$1.69
207SP0016	16	.1770	3-3/8"	2-3/16"	12	\$2.36	207SP0046	46	.0810	2-1/8"	1-1/8"	12	\$1.69
207SP0017	17	.1730	3-3/8"	2-3/16"	12	\$2.36	207SP0047	47	.0785	2"	1"	12	\$1.69
207SP0018	18	.1695	3-1/4"	2-1/8"	12	\$2.36	207SP0048	48	.0760	2"	1"	12	\$1.69
207SP0019	19	.1660	3-1/4"	2-1/8"	12	\$2.36	207SP0049	49	.0730	2"	1"	12	\$1.69
207SP0020	20	.1610	3-1/4"	2-1/8"	12	\$2.36	207SP0050	50	.0700	2"	1"	12	\$1.69
207SP0021	21	.1590	3-1/4"	2-1/8"	12	\$2.36	207SP0051	51	.0670	2"	1"	12	\$1.69
207SP0022	22	.1570	3-1/8"	2"	12	\$2.36	207SP0052	52	.0635	1-7/8"	7/8"	12	\$1.69
207SP0023	23	.1540	3-1/8"	2"	12	\$1.89	207SP0053	53	.0595	1-7/8"	7/8"	12	\$1.69
207SP0024	24	.1520	3-1/8"	2"	12	\$1.89	207SP0054	54	.0550	1-7/8"	7/8"	12	\$1.69
207SP0025	25	.1495	3"	1-7/8"	12	\$1.89	207SP0055	55	.0520	1-7/8"	7/8"	12	\$1.69
207SP0026	26	.1470	3"	1-7/8"	12	\$1.89	207SP0056	56	.0465	1-3/4"	3/4"	12	\$1.69
207SP0027	27	.1440	3"	1-7/8"	12	\$1.89	207SP0057	57	.0430	1-3/4"	3/4"	12	\$1.69
207SP0028	28	.1405	2-7/8"	1-3/4"	12	\$1.89	207SP0058	58	.0420	1-5/8"	11/16"	12	\$1.69
207SP0029	29	.1360	2-7/8"	1-3/4"	12	\$1.89	207SP0059	59	.0410	1-5/8"	11/16"	12	\$1.69
207SP0030	30	.1285	2-3/4"	1-5/8"	12	\$1.89	207SP0060	60	.0400	1-5/8"	11/16"	12	\$1.69

i
 NOTE:
 SIZES 40 → 60
 HAVE NO
 SPLIT POINT.



Jobber Drills - HEAVY DUTY 3/8" Shank - BLACK OXIDE FINISH - M2 HSS

Part #	Size	Dec.	OAL	Flute	Qty.	List	Part #	Size	Dec.	OAL	Flute	Qty.	List
206R82564	25/64"	.3906	5-1/8"	3-3/4"	6	\$17.40	206R82964	29/64"	.4531	5-5/8"	4-3/16"	6	\$22.55
206R82664	13/32"	.4062	5-1/4"	3-1/8"	6	\$17.67	206R83064	15/32"	.4688	5-3/4"	4-5/16"	6	\$23.02
206R82764	27/64"	.4219	5-3/8"	3-15/16"	6	\$19.07	206R83164	31/64"	.4844	5-7/8"	4-3/8"	6	\$23.76
206R82864	7/16"	.4375	5-1/2"	4-1/16"	6	\$20.21	206R83264	1/2"	.5000	6"	4-1/2"	6	\$24.42



◆ Same as 206SP with 3/8" Shank.



Letter Drills - HEAVY DUTY - BLACK OXIDE FINISH - M2 HSS

Part #	Size	Dec.	OAL	Flute	Qty.	List	Part #	Size	Dec.	OAL	Flute	Qty.	List
208SP000A	A	.2340	3-7/8"	2-5/8"	12	\$3.83	208SP000N	N	.3020	4-3/8"	3-1/16"	6	\$6.59
208SP000B	B	.2380	4"	2-3/4"	12	\$4.01	208SP000O	O	.3160	4-1/2"	3-3/16"	6	\$6.76
208SP000C	C	.2420	4"	2-3/4"	12	\$4.01	208SP000P	P	.3230	4-5/8"	3-5/16"	6	\$7.30
208SP000D	D	.2460	4"	2-3/4"	12	\$4.01	208SP000Q	Q	.3320	4-3/4"	3-7/16"	6	\$7.41
208SP000E	E	.2500	4"	2-3/4"	12	\$4.01	208SP000R	R	.3390	4-3/4"	3-7/16"	6	\$7.41
208SP000F	F	.2570	4-1/8"	2-7/8"	12	\$4.92	208SP000S	S	.3480	4-7/8"	3-1/2"	6	\$9.08
208SP000G	G	.2610	4-1/8"	2-7/8"	12	\$4.92	208SP000T	T	.3580	4-7/8"	3-1/2"	6	\$9.08
208SP000H	H	.2660	4-1/8"	2-7/8"	12	\$5.02	208SP000U	U	.3680	5"	3-5/8"	6	\$9.33
208SP000I	I	.2720	4-1/8"	2-7/8"	12	\$5.02	208SP000V	V	.3770	5"	3-5/8"	6	\$10.40
208SP000J	J	.2770	4-1/8"	2-7/8"	12	\$5.59	208SP000W	W	.3860	5-1/8"	3-3/4"	6	\$10.59
208SP000K	K	.2810	4-1/4"	2-15/16"	12	\$5.59	208SP000X	X	.3970	5-1/8"	3-3/4"	6	\$12.09
208SP000L	L	.2900	4-1/4"	2-15/16"	6	\$6.44	208SP000Y	Y	.4040	5-1/4"	3-7/8"	6	\$12.47
208SP000M	M	.2950	4-3/8"	3-1/16"	6	\$6.59	208SP000Z	Z	.4130	5-1/4"	3-7/8"	6	\$14.02



- ◆ Jobber Length
- ◆ 135° Split Point
- ◆ Ground Flute
- ◆ Straight Shank
- ◆ Heavy Duty Web
- ◆ Black Oxide Finish
- ◆ M2 HSS



Metric Drills - General Purpose - BLACK OXIDE FINISH - M2 HSS

Part #	Size	Dec.	OAL	Flute	Qty.	List	Part #	Size	Dec.	OAL	Flute	Qty.	List
205HS0010	1	.0393	41	18	12	\$2.19	205HS0075	7.5	.2953	111	78	12	\$6.99
205HS0015	1.5	.0591	48	22	12	\$2.19	205HS0080	8	.3150	114	81	12	\$8.07
205HS0020	2	.0787	54	29	12	\$2.19	205HS0085	8.5	.3346	121	87	6	\$9.62
205HS0025	2.5	.0984	60	35	12	\$2.19	205HS0090	9	.3543	124	89	6	\$10.78
205HS0030	3	.1181	70	41	12	\$2.19	205HS0095	9.5	.3740	127	92	6	\$11.16
205HS0035	3.5	.1378	73	45	12	\$2.37	205HS0100	10	.3937	130	95	6	\$13.13
205HS0040	4	.1575	83	54	12	\$2.85	205HS0105	10.5	.4134	137	100	6	\$14.37
205HS0045	4.5	.1772	86	56	12	\$3.31	205HS0110	11	.4331	140	103	6	\$14.56
205HS0050	5	.1969	92	62	12	\$3.61	205HS0115	11.5	.4528	143	106	6	\$16.94
205HS0055	5.5	.2165	95	64	12	\$4.16	205HS0120	12	.4724	150	111	6	\$18.89
205HS0060	6	.2362	102	70	12	\$4.94	205HS0125	12.5	.4921	152	114	6	\$18.89
205HS0065	6.5	.2559	105	73	12	\$5.32	205HS0130	13	.5118	168	122	6	\$22.37
205HS0070	7	.2756	105	73	12	\$5.92							



- ◆ Metric Size
- ◆ 118° Point
- ◆ General Purpose
- ◆ Roll Forged
- ◆ Straight Shank
- ◆ Black Oxide Finish
- ◆ M2 HSS





**BLACK
Oxide**

**135°
SPLIT
POINT**



- ◆ Stub Length
- ◆ 135° Split Point
- ◆ Ground Flute
- ◆ Straight Shank
- ◆ Heavy Duty Web
- ◆ Black Oxide Finish
- ◆ M2 HSS



STUB Fractional - M2 HSS

Part #	Size	Dec.	OAL	Flute	Qty.	List
209SM0464	1/16"	.0625	1-5/8"	5/8"	12	\$1.27
209SM0564	5/64"	.0781	1-11/16"	11/16"	12	\$1.27
209SM0664	3/32"	.0938	1-3/4"	3/4"	12	\$1.27
209SM0764	7/64"	.1094	1-13/16"	13/16"	12	\$1.27
209SM0864	1/8"	.1250	1-7/8"	7/8"	12	\$1.27
209SM0964	9/64"	.1406	1-15/16"	15/16"	12	\$1.43
209SM1064	5/32"	.1562	2-1/16"	1"	12	\$1.64
209SM1164	11/64"	.1719	2-1/8"	1-1/16"	12	\$2.00
209SM1264	3/16"	.1875	2-3/16"	1-1/8"	12	\$2.31
209SM1364	13/64"	.2031	2-1/4"	1-3/16"	12	\$2.61
209SM1464	7/32"	.2188	2-3/8"	1-1/4"	12	\$2.85
209SM1564	15/64"	.2344	2-7/16"	1-5/16"	12	\$3.34
209SM1664	1/4"	.2500	2-1/2"	1-3/8"	12	\$3.95
209SM1764	17/64"	.2656	2-5/8"	1-7/16"	12	\$4.55
209SM1864	9/32"	.2812	2-11/16"	1-1/2"	12	\$4.86
209SM1964	19/64"	.2969	2-3/4"	1-9/16"	12	\$5.52
209SM2064	5/16"	.3125	2-13/16"	1-5/8"	12	\$6.19
209SM2164	21/64"	.3281	2-15/16"	1-11/16"	6	\$7.22
209SM2264	11/32"	.3438	3"	1-11/16"	6	\$7.77
209SM2364	23/64"	.3594	3-1/16"	1-3/4"	6	\$8.32
209SM2464	3/8"	.3750	3-1/8"	1-13/16"	6	\$9.35
209SM2564	25/64"	.3906	3-1/4"	1-7/8"	6	\$11.05
209SM2664	13/32"	.4062	3-5/16"	1-15/16"	6	\$11.84
209SM2764	27/64"	.4219	3-3/8"	2"	6	\$12.56
209SM2864	7/16"	.4375	3-7/16"	2-1/16"	6	\$13.17
209SM2964	29/64"	.4531	3-9/16"	2-1/8"	6	\$14.63
209SM3064	15/32"	.4688	3-5/8"	2-1/8"	6	\$16.02
209SM3164	31/64"	.4844	3-11/16"	2-3/16"	6	\$17.60
209SM3264	1/2"	.5000	3-3/4"	2-1/4"	6	\$18.45



STUB Wire Gauge - M2 HSS

Part #	Size	Dec.	OAL	Flute	Qty.	List
210SM0001	1	.2280	2-7/16"	1-15/16"	12	\$3.84
210SM0002	2	.2210	2-7/16"	1-15/16"	12	\$3.84
210SM0003	3	.2130	2-3/8"	1-1/4"	12	\$3.26
210SM0004	4	.2090	2-3/8"	1-1/4"	12	\$3.26
210SM0005	5	.2055	2-3/8"	1-1/4"	12	\$3.26
210SM0006	6	.2040	2-3/8"	1-1/4"	12	\$3.26
210SM0007	7	.2010	2-1/4"	1-3/16"	12	\$2.90
210SM0008	8	.1990	2-1/4"	1-3/16"	12	\$2.90
210SM0009	9	.1960	2-1/4"	1-3/16"	12	\$2.90
210SM0010	10	.1935	2-1/4"	1-3/16"	12	\$2.90
210SM0011	11	.1910	2-1/4"	1-3/16"	12	\$2.90
210SM0012	12	.1890	2-1/4"	1-3/16"	12	\$2.90
210SM0013	13	.1850	2-3/16"	1-1/8"	12	\$2.47
210SM0014	14	.1820	2-3/16"	1-1/8"	12	\$2.47
210SM0015	15	.1800	2-3/16"	1-1/8"	12	\$2.47
210SM0016	16	.1770	2-3/16"	1-1/8"	12	\$2.47
210SM0017	17	.1730	2-3/16"	1-1/8"	12	\$2.47
210SM0018	18	.1695	2-1/8"	1-1/16"	12	\$2.18
210SM0019	19	.1660	2-1/8"	1-1/16"	12	\$2.18
210SM0020	20	.1610	2-1/8"	1-1/16"	12	\$2.18
210SM0021	21	.1590	2-1/8"	1-1/16"	12	\$2.18
210SM0022	22	.1570	2-1/8"	1-1/16"	12	\$2.18
210SM0023	23	.1540	2-1/16"	1"	12	\$1.81
210SM0024	24	.1520	2-1/16"	1"	12	\$1.81
210SM0025	25	.1495	2-1/16"	1"	12	\$1.81
210SM0026	26	.1470	2-1/16"	1"	12	\$1.81
210SM0027	27	.1440	2-1/16"	1"	12	\$1.81
210SM0028	28	.1405	1-15/16"	15/16"	12	\$1.58
210SM0029	29	.1360	1-15/16"	15/16"	12	\$1.58
210SM0030	30	.1285	1-15/16"	15/16"	12	\$1.58
210SM0031	31	.1200	1-7/8"	7/8"	12	\$1.58
210SM0032	32	.1160	1-7/8"	7/8"	12	\$1.58
210SM0033	33	.1130	1-7/8"	7/8"	12	\$1.58
210SM0034	34	.1110	1-7/8"	7/8"	12	\$1.58
210SM0035	35	.1100	1-7/8"	7/8"	12	\$1.58
210SM0036	36	.1065	1-13/16"	13/16"	12	\$1.58
210SM0037	37	.1040	1-13/16"	13/16"	12	\$1.58
210SM0038	38	.1015	1-13/16"	13/16"	12	\$1.58
210SM0039	39	.0995	1-13/16"	13/16"	12	\$1.58
210SM0040	40	.0980	1-13/16"	13/16"	12	\$1.58



**BLACK
Oxide**



Silver & Deming - 1/2" Shank - M2 HSS

Part #	Size	Dec.	OAL	Flute	Qty.	List	Part #	Size	Dec.	OAL	Flute	Qty.	List
201SD3364	33/64"	.5156	6"	2-3/4"	1	\$20.33	201SD5364	53/64"	.8281	6"	2-3/4"	1	\$37.72
201SD3464	17/32"	.5312	6"	2-3/4"	1	\$20.67	201SD5464	27/32"	.8438	6"	2-3/4"	1	\$38.07
201SD3564	35/64"	.5469	6"	2-3/4"	1	\$20.98	201SD5564	55/64"	.8594	6"	2-3/4"	1	\$38.95
201SD3664	9/16"	.5625	6"	2-3/4"	1	\$20.98	201SD5664	7/8"	.8750	6"	2-3/4"	1	\$38.95
201SD3764	37/64"	.5781	6"	2-3/4"	1	\$23.48	201SD5764	57/64"	.8906	6"	2-3/4"	1	\$42.94
201SD3864	19/32"	.5938	6"	2-3/4"	1	\$23.48	201SD5864	29/32"	.9062	6"	2-3/4"	1	\$42.94
201SD3964	39/64"	.6094	6"	2-3/4"	1	\$23.80	201SD5964	59/64"	.9219	6"	2-3/4"	1	\$43.38
201SD4064	5/8"	.6250	6"	2-3/4"	1	\$23.80	201SD6064	15/16"	.9375	6"	2-3/4"	1	\$43.38
201SD4164	41/64"	.6406	6"	2-3/4"	1	\$25.43	201SD6164	61/64"	.9531	6"	2-3/4"	1	\$46.69
201SD4264	21/32"	.6562	6"	2-3/4"	1	\$25.43	201SD6264	31/32"	.9688	6"	2-3/4"	1	\$46.69
201SD4364	43/64"	.6719	6"	2-3/4"	1	\$26.54	201SD6364	63/64"	.9844	6"	2-3/4"	1	\$49.79
201SD4464	11/16"	.6875	6"	2-3/4"	1	\$30.52	201SD6464	1"	1.0000	6"	2-3/4"	1	\$54.77
201SD4564	45/64"	.7031	6"	2-3/4"	1	\$32.12	201SD8664	1-1/16"	1.0625	6"	2-3/4"	1	\$81.38
201SD4664	23/32"	.7188	6"	2-3/4"	1	\$32.12	201SD7264	1-1/8"	1.1250	6"	2-3/4"	1	\$85.35
201SD4764	47/64"	.7344	6"	2-3/4"	1	\$33.10	201SD7664	1-3/16"	1.1875	6"	2-3/4"	1	\$101.80
201SD4864	3/4"	.7500	6"	2-3/4"	1	\$33.10	201SD8064	1-1/4"	1.2500	6"	2-3/4"	1	\$117.89
201SD4964	49/64"	.7656	6"	2-3/4"	1	\$35.51	201SD8464	1-5/16"	1.3125	6"	2-3/4"	1	\$123.80
201SD5064	25/32"	.7812	6"	2-3/4"	1	\$35.51	201SD8864	1-3/8"	1.3750	6"	2-3/4"	1	\$134.51
201SD5164	51/64"	.7969	6"	2-3/4"	1	\$36.12	201SD9664	1-1/2"	1.5000	6"	2-3/4"	1	\$150.07
201SD5264	13/16"	.8125	6"	2-3/4"	1	\$36.12							



- ◆ 6" Length
- ◆ 118° Point
- ◆ Ground Flute
- ◆ 1/2" Shank
- ◆ Black Oxide Finish
- ◆ M2 HSS



**BLACK
Oxide**



Silver & Deming - 3/8" Shank - M2 HSS

Part #	Size	Dec.	OAL	Flute	Qty.	List	Part #	Size	Dec.	OAL	Flute	Qty.	List
201R83364	33/64"	.5156	6"	2-3/4"	1	\$33.05	201R84164	41/64"	.6406	6"	2-3/4"	1	\$40.55
201R83464	17/32"	.5312	6"	2-3/4"	1	\$33.85	201R84264	21/32"	.6562	6"	2-3/4"	1	\$40.55
201R83564	35/64"	.5469	6"	2-3/4"	1	\$35.06	201R84364	43/64"	.6719	6"	2-3/4"	1	\$41.61
201R83664	9/16"	.5625	6"	2-3/4"	1	\$35.06	201R84464	11/16"	.6875	6"	2-3/4"	1	\$42.47
201R83764	37/64"	.5781	6"	2-3/4"	1	\$37.84	201R84564	45/64"	.7031	6"	2-3/4"	1	\$45.27
201R83864	19/32"	.5938	6"	2-3/4"	1	\$37.84	201R84664	23/32"	.7188	6"	2-3/4"	1	\$48.07
201R83964	39/64"	.6094	6"	2-3/4"	1	\$37.84	201R84764	47/64"	.7344	6"	2-3/4"	1	\$51.24
201R84064	5/8"	.6250	6"	2-3/4"	1	\$38.94	201R84864	3/4"	.7500	6"	2-3/4"	1	\$55.55



- ◆ 6" Length
- ◆ 118° Point
- ◆ Ground Flute
- ◆ 3/8" Shank
- ◆ Black Oxide Finish
- ◆ M2 HSS





INTERNATIONAL TOOL MANUFACTURING

150 Express St. Plainview, NY 11803

(516) 738-0388 • (800) 247-5696

Fax (516) 279-1106

ITM

100% LAB TESTED

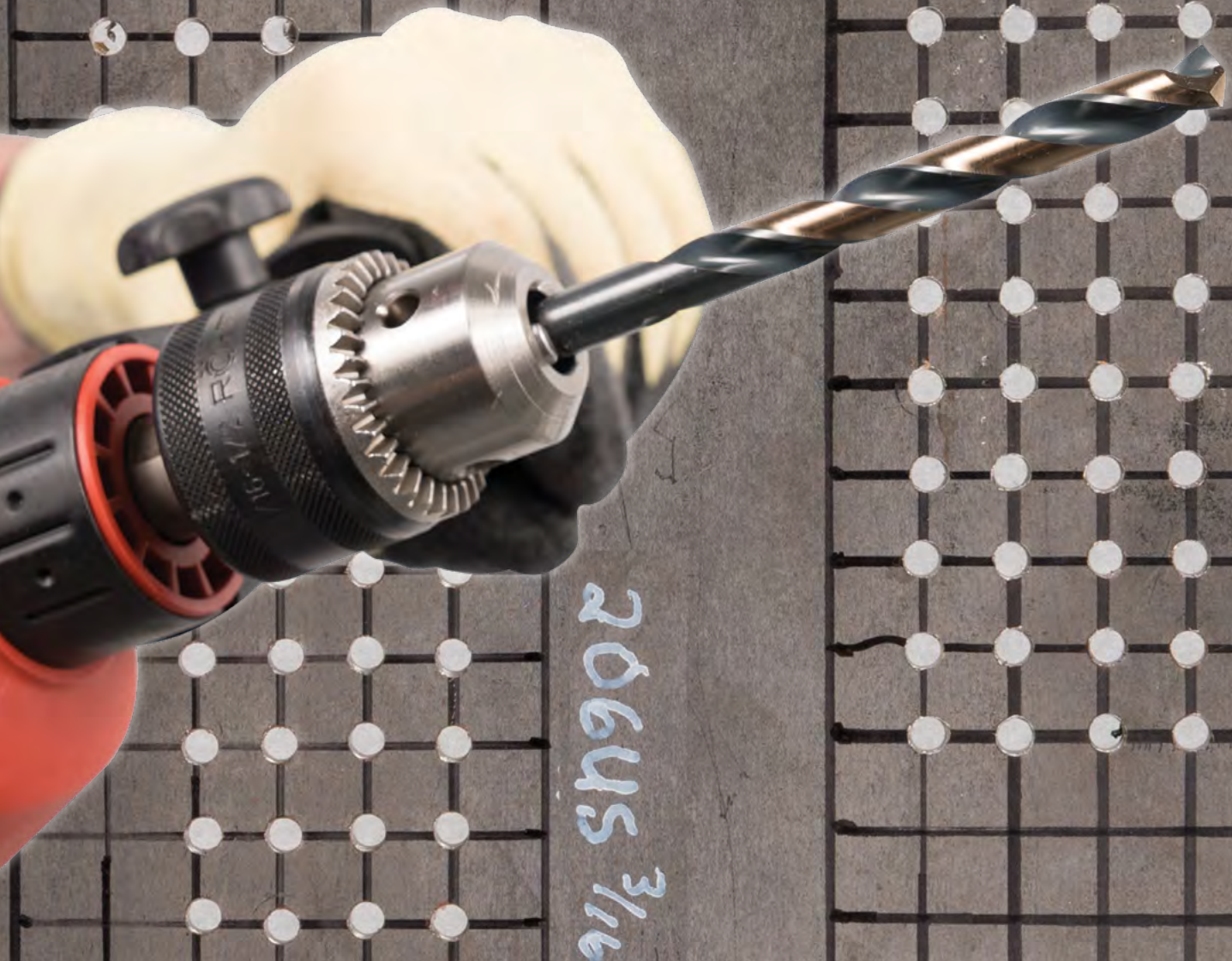

20645 3/16"

Black & Gold

The Most Recognizable Finish Anywhere.



Black & Gold Jobber Drills - HEAVY DUTY - M2 HSS

Part #	Size	Dec.	OAL	Flute	Qty.	List	Part #	Size	Dec.	OAL	Flute	Qty.	List
206US0464	1/16"	.0625	1-7/8"	7/8"	12	\$1.70	206US1964	19/64"	.2969	4-3/8"	3-1/16"	12	\$6.04
206US0564	5/64"	.0781	2"	1"	12	\$1.70	206US2064	5/16"	.3125	4-1/2"	3-3/16"	12	\$6.27
206US0664	3/32"	.0938	2-1/4"	1-1/4"	12	\$1.70	206US2164	21/64"	.3281	4-5/8"	3-5/16"	6	\$7.17
206US0764	7/64"	.1094	2-5/8"	1-1/2"	12	\$1.70	206US2264	11/32"	.3438	4-3/4"	3-7/16"	6	\$8.03
206US0864	1/8"	.1250	2-3/4"	1-5/8"	12	\$1.89	206US2364	23/64"	.3594	4-7/8"	3-1/2"	6	\$9.14
206US0964	9/64"	.1406	2-7/8"	1-3/4"	12	\$2.02	206US2464	3/8"	.3750	5"	3-5/8"	6	\$9.38
206US1064	5/32"	.1562	3-1/8"	2"	12	\$2.12	206US2564	25/64"	.3906	5-1/8"	3-3/4"	6	\$10.75
206US1164	11/64"	.1719	3-1/4"	2-1/8"	12	\$2.40	206US2664	13/32"	.4062	5-1/4"	3-7/8"	6	\$12.18
206US1264	3/16"	.1875	3-1/2"	2-5/16"	12	\$2.61	206US2764	27/64"	.4219	5-3/8"	3-15/16"	6	\$13.69
206US1364	13/64"	.2031	3-5/8"	2-7/16"	12	\$3.08	206US2864	7/16"	.4375	5-1/2"	4-1/16"	6	\$15.36
206US1464	7/32"	.2188	3-3/4"	2-1/2"	12	\$3.14	206US2964	29/64"	.4531	5-5/8"	4-3/16"	6	\$16.16
206US1564	15/64"	.2344	3-7/8"	2-5/8"	12	\$3.59	206US3064	15/32"	.4688	5-3/4"	4-5/16"	6	\$16.69
206US1664	1/4"	.2500	4"	2-3/4"	12	\$4.11	206US3164	31/64"	.4844	5-7/8"	4-3/8"	6	\$19.46
206US1764	17/64"	.2656	4-1/8"	2-7/8"	12	\$4.53	206US3264	1/2"	.5000	6"	4-1/2"	6	\$20.30
206US1864	9/32"	.2812	4-1/4"	2-15/16"	12	\$5.59							

Black & Gold



- ◆ Jobber Length
- ◆ 135° Split Point
- ◆ Ground Flute
- ◆ Straight Shank
- ◆ Heavy Duty Web
- ◆ Black & Gold Finish
- ◆ M2 HSS



Black & Gold Wire Gauge Drills - HEAVY DUTY - M2 HSS

Part #	Size	Dec.	OAL	Flute	Qty.	List	Part #	Size	Dec.	OAL	Flute	Qty.	List
207US-01	1	.2280	3-7/8"	2-5/8"	12	\$3.45	207US-31	31	.1200	2-3/4"	1-5/8"	12	\$1.97
207US-02	2	.2210	3-7/8"	2-5/8"	12	\$3.45	207US-32	32	.1160	2-3/4"	1-5/8"	12	\$1.91
207US-03	3	.2130	3-3/4"	2-1/2"	12	\$3.45	207US-33	33	.1130	2-5/8"	1-1/2"	12	\$1.91
207US-04	4	.2090	3-3/4"	2-1/2"	12	\$3.45	207US-34	34	.1110	2-5/8"	1-1/2"	12	\$1.91
207US-05	5	.2055	3-3/4"	2-1/2"	12	\$3.45	207US-35	35	.1100	2-5/8"	1-1/2"	12	\$1.91
207US-06	6	.2040	3-3/4"	2-1/2"	12	\$3.45	207US-36	36	.1065	2-1/2"	1-7/16"	12	\$1.91
207US-07	7	.2010	3-5/8"	2-7/16"	12	\$3.03	207US-37	37	.1040	2-1/2"	1-7/16"	12	\$1.91
207US-08	8	.1990	3-5/8"	2-7/16"	12	\$3.03	207US-38	38	.1015	2-1/2"	1-7/16"	12	\$1.91
207US-09	9	.1960	3-5/8"	2-7/16"	12	\$3.03	207US-39	39	.0995	2-3/8"	1-3/8"	12	\$1.91
207US-10	10	.1935	3-5/8"	2-7/16"	12	\$3.03	207US-40	40	.0980	2-3/8"	1-3/8"	12	\$1.91
207US-11	11	.1910	3-1/2"	2-5/16"	12	\$2.77	207US-41	41	.0960	2-3/8"	1-3/8"	12	\$1.79
207US-12	12	.1890	3-1/2"	2-5/16"	12	\$2.77	207US-42	42	.0935	2-1/4"	1-1/4"	12	\$1.79
207US-13	13	.1850	3-1/2"	2-5/16"	12	\$2.77	207US-43	43	.0890	2-1/4"	1-1/4"	12	\$1.79
207US-14	14	.1820	3-3/8"	2-3/16"	12	\$2.77	207US-44	44	.0860	2-1/8"	1-1/8"	12	\$1.79
207US-15	15	.1800	3-3/8"	2-3/16"	12	\$2.77	207US-45	45	.0820	2-1/8"	1-1/8"	12	\$1.79
207US-16	16	.1770	3-3/8"	2-3/16"	12	\$2.77	207US-46	46	.0810	2-1/8"	1-1/8"	12	\$1.79
207US-17	17	.1730	3-3/8"	2-3/16"	12	\$2.77	207US-47	47	.0785	2"	1"	12	\$1.79
207US-18	18	.1695	3-1/4"	2-1/8"	12	\$2.44	207US-48	48	.0760	2"	1"	12	\$1.79
207US-19	19	.1660	3-1/4"	2-1/8"	12	\$2.44	207US-49	49	.0730	2"	1"	12	\$1.79
207US-20	20	.1610	3-1/4"	2-1/8"	12	\$2.44	207US-50	50	.0700	2"	1"	12	\$1.79
207US-21	21	.1590	3-1/4"	2-1/8"	12	\$2.44	207US-51	51	.0670	2"	1"	12	\$1.79
207US-22	22	.1570	3-1/8"	2"	12	\$2.44	207US-52	52	.0635	1-7/8"	7/8"	12	\$1.79
207US-23	23	.1540	3-1/8"	2"	12	\$2.07	207US-53	53	.0595	1-7/8"	7/8"	12	\$1.79
207US-24	24	.1520	3-1/8"	2"	12	\$2.07	207US-54	54	.0550	1-7/8"	7/8"	12	\$1.79
207US-25	25	.1495	3"	1-7/8"	12	\$2.07	207US-55	55	.0520	1-7/8"	7/8"	12	\$1.79
207US-26	26	.1470	3"	1-7/8"	12	\$2.07	207US-56	56	.0465	1-3/4"	3/4"	12	\$1.79
207US-27	27	.1440	3"	1-7/8"	12	\$2.07	207US-57	57	.0430	1-3/4"	3/4"	12	\$1.79
207US-28	28	.1405	2-7/8"	1-3/4"	12	\$2.07	207US-58	58	.0420	1-5/8"	11/16"	12	\$1.79
207US-29	29	.1360	2-7/8"	1-3/4"	12	\$2.07	207US-59	59	.0410	1-5/8"	11/16"	12	\$1.79
207US-30	30	.1285	2-3/4"	1-5/8"	12	\$2.07	207US-60	60	.0400	1-5/8"	11/16"	12	\$1.79



Black & Gold



- ◆ Wire Gauge
- ◆ 135° Split Point
- ◆ Ground Flute
- ◆ Straight Shank
- ◆ Heavy Duty Web
- ◆ Black & Gold Finish
- ◆ M2 HSS



NOTE:
SIZES 40 → 60
HAVE NO
SPLIT POINT.



INTERNATIONAL TOOL MANUFACTURING
 150 Express St. Plainview, NY 11803
 (516) 738-0388 • (800) 247-5696
 Fax (516) 279-1106



Black & Gold

Black & Gold Jobber Drills - HEAVY DUTY 3/8" Shank - M2 HSS



Part #	Size	Dec.	OAL	Flute	Qty.	List	Part #	Size	Dec.	OAL	Flute	Qty.	List
206U82564	25/64"	.3906	5-1/8"	3-3/4"	6	\$18.73	206U82964	29/64"	.4531	5-5/8"	4-3/16"	6	\$24.28
206U82664	13/32"	.4062	5-1/4"	3-1/8"	6	\$19.02	206U83064	15/32"	.4688	5-3/4"	4-5/16"	6	\$24.79
206U82764	27/64"	.4219	5-3/8"	3-15/16"	6	\$20.54	206U83164	31/64"	.4844	5-7/8"	4-3/8"	6	\$25.58
206U82864	7/16"	.4375	5-1/2"	4-1/16"	6	\$21.76	206U83264	1/2"	.5000	6"	4-1/2"	6	\$26.30

- ◆ Jobber Length
- ◆ 3/8" Shank
- ◆ 135° Split Point
- ◆ Ground Flute
- ◆ Straight Shank
- ◆ Heavy Duty Web
- ◆ M2 HSS



Black & Gold

Black & Gold Mechanics Length Drills - HEAVY DUTY - M2 HSS



Part #	Size	Dec.	OAL	Flute	Qty.	List	Part #	Size	Dec.	OAL	Flute	Qty.	List
208MC0464	1/16"	.0625	1 7/8"	7/8"	12	\$1.97	208MC1964	19/64"	.2969	3-7/8"	2-3/8"	12	\$7.45
208MC0564	5/64"	.0781	2"	1"	12	\$1.97	208MC2064	5/16"	.3125	4"	2-1/2"	12	\$7.57
208MC0664	3/32"	.0938	2-1/4"	1-1/4"	12	\$2.15	208MC2164	21/64"	.3281	4-1/16"	2-9/16"	6	\$8.52
208MC0764	7/64"	.1094	2-3/8"	1-5/16"	12	\$2.15	208MC2264	11/32"	.3438	4-1/8"	2-5/8"	6	\$9.30
208MC0864	1/8"	.1250	2-1/2"	1-7/16"	12	\$2.26	208MC2364	23/64"	.3594	4-3/16"	2-11/16"	6	\$9.83
208MC0964	9/64"	.1406	2-5/8"	1-9/16"	12	\$2.38	208MC2464	3/8"	.3750	4-1/4"	2-11/16"	6	\$10.19
208MC1064	5/32"	.1562	2-3/4"	1-11/16"	12	\$2.98	208MC2564	25/64"	.3906	4-5/16"	2-3/4"	6	\$11.50
208MC1164	11/64"	.1719	2-7/8"	1-13/16"	12	\$3.10	208MC2664	13/32"	.4062	4-3/8"	2-13/16"	6	\$11.92
208MC1264	3/16"	.1875	3"	1-7/8"	12	\$3.93	208MC2764	27/64"	.4219	4-7/16"	2-7/8"	6	\$12.69
208MC1364	13/64"	.2031	3-1/8"	1-15/16"	12	\$4.17	208MC2864	7/16"	.4375	4-1/2"	2-15/16"	6	\$13.83
208MC1464	7/32"	.2188	3-1/4"	2"	12	\$4.41	208MC2964	29/64"	.4531	4-5/8"	3"	6	\$15.79
208MC1564	15/64"	.2344	3-3/8"	2"	12	\$4.71	208MC3064	15/32"	.4688	4-3/4"	3-1/8"	6	\$16.69
208MC1664	1/4"	.2500	3-1/2"	2"	12	\$4.95	208MC3164	31/64"	.4844	4-7/8"	3-1/4"	6	\$16.75
208MC1764	17/64"	.2656	3-5/8"	2-1/8"	12	\$5.30	208MC3264	1/2"	.5000	5"	3-3/8"	6	\$17.88
208MC1864	9/32"	.2812	3-3/4"	2-1/4"	12	\$6.44							

- ◆ Mechanics Length
- ◆ 135° Split Point
- ◆ 3-Flat Shank (3/16" → 1/2")
- ◆ Black & Gold Finish for Strength & Rigidity
- ◆ M2 HSS





Black & Gold Letter Drills - HEAVY DUTY - M2 HSS

Part #	Size	Dec.	OAL	Flute	Qty.	List	Part #	Size	Dec.	OAL	Flute	Qty.	List
208US-A	A	.234	3-7/8"	2-5/8"	12	\$5.54	208US-N	N	.302	4-3/8"	3-1/16"	6	\$7.26
208US-B	B	.238	4"	2-3/4"	12	\$5.54	208US-O	O	.316	4-1/2"	3-3/16"	6	\$7.84
208US-C	C	.242	4"	2-3/4"	12	\$5.54	208US-P	P	.323	4-5/8"	3-5/16"	6	\$8.57
208US-D	D	.246	4"	2-3/4"	12	\$5.54	208US-Q	Q	.332	4-3/4"	3-7/16"	6	\$8.95
208US-E	E	.250	4"	2-3/4"	12	\$5.54	208US-R	R	.339	4-3/4"	3-7/16"	6	\$8.95
208US-F	F	.257	4-1/8"	2-7/8"	12	\$5.80	208US-S	S	.348	4-7/8"	3-1/2"	6	\$9.81
208US-G	G	.261	4-1/8"	2-7/8"	12	\$5.80	208US-T	T	.358	4-7/8"	3-1/2"	6	\$10.70
208US-H	H	.266	4-1/8"	2-7/8"	12	\$5.80	208US-U	U	.368	5"	3-5/8"	6	\$11.57
208US-I	I	.272	4-1/8"	2-7/8"	12	\$6.33	208US-V	V	.377	5"	3-5/8"	6	\$11.57
208US-J	J	.277	4-1/8"	2-7/8"	12	\$6.33	208US-W	W	.386	5-1/8"	3-3/4"	6	\$11.57
208US-K	K	.281	4-1/4"	2-15/16"	12	\$6.33	208US-X	X	.397	5-1/8"	3-3/4"	6	\$13.86
208US-L	L	.290	4-1/4"	2-15/16"	6	\$7.08	208US-Y	Y	.404	5-1/4"	3-7/8"	6	\$14.15
208US-M	M	.295	4-3/8"	3-1/16"	6	\$7.26	208US-Z	Z	.413	5-1/4"	3-7/8"	6	\$15.26



Black & Gold

- ◆ Jobber Length
- ◆ 135° Split Point
- ◆ Ground Flute
- ◆ Straight Shank
- ◆ Heavy Duty Web
- ◆ Black & Gold Finish
- ◆ M2 HSS



Black & Gold Silver & Deming - 1/2" Shank - M2 HSS

Part #	Size	Dec.	OAL	Flute	Qty.	List	Part #	Size	Dec.	OAL	Flute	Qty.	List
201US3364	33/64"	.5156	6"	2-3/4"	1	\$22.76	201US5164	51/64"	.7969	6"	2-3/4"	1	\$42.30
201US3464	17/32"	.5312	6"	2-3/4"	1	\$22.76	201US5264	13/16"	.8125	6"	2-3/4"	1	\$42.30
201US3564	35/64"	.5469	6"	2-3/4"	1	\$23.66	201US5364	53/64"	.8281	6"	2-3/4"	1	\$43.62
201US3664	9/16"	.5625	6"	2-3/4"	1	\$23.66	201US5464	27/32"	.8438	6"	2-3/4"	1	\$43.62
201US3764	37/64"	.5781	6"	2-3/4"	1	\$24.34	201US5564	55/64"	.8594	6"	2-3/4"	1	\$46.74
201US3864	19/32"	.5938	6"	2-3/4"	1	\$24.34	201US5664	7/8"	.8750	6"	2-3/4"	1	\$46.74
201US3964	39/64"	.6094	6"	2-3/4"	1	\$24.71	201US5764	57/64"	.8906	6"	2-3/4"	1	\$47.40
201US4064	5/8"	.6250	6"	2-3/4"	1	\$25.95	201US5864	29/32"	.9062	6"	2-3/4"	1	\$47.40
201US4164	41/64"	.6406	6"	2-3/4"	1	\$27.23	201US5964	59/64"	.9219	6"	2-3/4"	1	\$49.64
201US4264	21/32"	.6562	6"	2-3/4"	1	\$27.23	201US6064	15/16"	.9375	6"	2-3/4"	1	\$49.64
201US4364	43/64"	.6719	6"	2-3/4"	1	\$29.51	201US6164	61/64"	.9531	6"	2-3/4"	1	\$52.65
201US4464	11/16"	.6875	6"	2-3/4"	1	\$29.51	201US6264	31/32"	.9688	6"	2-3/4"	1	\$52.65
201US4564	45/64"	.7031	6"	2-3/4"	1	\$31.02	201US6364	63/64"	.9844	6"	2-3/4"	1	\$55.20
201US4664	23/32"	.7188	6"	2-3/4"	1	\$31.02	201US6464	1"	1.0000	6"	2-3/4"	1	\$55.20
201US4764	47/64"	.7344	6"	2-3/4"	1	\$40.08	201US6864	1-1/16"	1.0625	6"	2-3/4"	1	\$77.52
201US4864	3/4"	.7500	6"	2-3/4"	1	\$40.08	201US7264	1-1/8"	1.1250	6"	2-3/4"	1	\$82.02
201US4964	49/64"	.7656	6"	2-3/4"	1	\$41.35	201US7664	1-3/16"	1.1875	6"	2-3/4"	1	\$91.03
201US5064	25/32"	.7812	6"	2-3/4"	1	\$41.35	201US8064	1-1/4"	1.2500	6"	2-3/4"	1	\$110.50



Black & Gold

- ◆ 6" Length
- ◆ 118° Split Point
- ◆ Ground Flute
- ◆ 3-Flat Round 1/2" Shank
- ◆ Heavy Duty Web
- ◆ Black & Gold Finish
- ◆ M2 HSS





INTERNATIONAL TOOL MANUFACTURING

150 Express St. Plainview, NY 11803

(516) 738-0388 • (800) 247-5696

Fax (516) 279-1106

ITM

3-Flat, No-Slip Shank

(3/16" → 1/2")

Made in U.S.A.

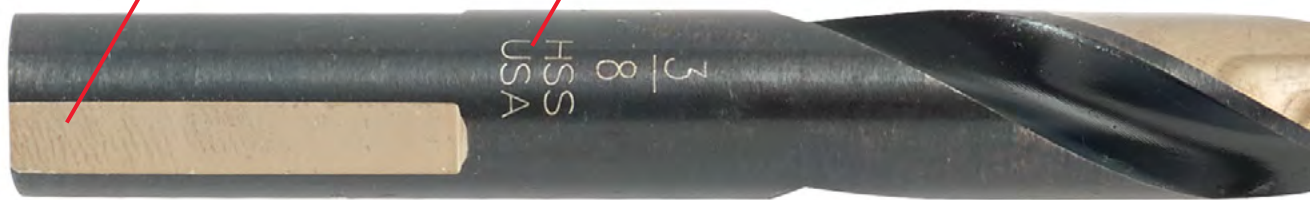

Black & Gold

MRO Black and Gold Jobber Drills - HEAVY DUTY - M2 HSS



- ◆ Jobber Length
- ◆ 135° Split Point
- ◆ Ground Flute
- ◆ 3-Flat Shank (3/16" → 1/2")
- ◆ 3-Flat Shank On All Letter Drills
- ◆ Heavy Duty Web for Strength & Rigidity
- ◆ Black & Gold Finish
- ◆ M2 HSS

Part #	Size	Dec.	OAL	Flute	Qty.	List	Part #	Size	Dec.	OAL	Flute	Qty.	List
MRO-0464	1/16"	.0625	1-7/8"	7/8"	12	\$2.35	MRO-1964	19/64"	.2969	4-3/8"	3-1/16"	12	\$8.72
MRO-0564	5/64"	.0781	2"	1"	12	\$2.35	MRO-2064	5/16"	.3125	4-1/2"	3-3/16"	12	\$8.85
MRO-0664	3/32"	.0938	2-1/4"	1-1/4"	12	\$2.48	MRO-2164	21/64"	.3281	4-5/8"	3-5/16"	6	\$9.91
MRO-0764	7/64"	.1094	2-5/8"	1-1/2"	12	\$2.56	MRO-2264	11/32"	.3438	4-3/4"	3-7/16"	6	\$11.19
MRO-0864	1/8"	.1250	2-3/4"	1-5/8"	12	\$2.70	MRO-2364	23/64"	.3594	4-7/8"	3-1/2"	6	\$12.59
MRO-0964	9/64"	.1406	2-7/8"	1-3/4"	12	\$2.92	MRO-2464	3/8"	.3750	5"	3-5/8"	6	\$12.68
MRO-1064	5/32"	.1562	3-1/8"	2"	12	\$3.20	MRO-2564	25/64"	.3906	5-1/8"	3-3/4"	6	\$15.44
MRO-1164	11/64"	.1719	3-1/4"	2-1/8"	12	\$3.48	MRO-2664	13/32"	.4062	5-1/4"	3-7/8"	6	\$15.79
MRO-1264	3/16"	.1875	3-1/2"	2-5/16"	12	\$4.20	MRO-2764	27/64"	.4219	5-3/8"	3-15/16"	6	\$17.48
MRO-1364	13/64"	.2031	3-5/8"	2-7/16"	12	\$4.81	MRO-2864	7/16"	.4375	5-1/2"	4-1/16"	6	\$18.69
MRO-1464	7/32"	.2188	3-3/4"	2-1/2"	12	\$4.86	MRO-2964	29/64"	.4531	5-5/8"	4-3/16"	6	\$21.81
MRO-1564	15/64"	.2344	3-7/8"	2-5/8"	12	\$5.26	MRO-3064	15/32"	.4688	5-3/4"	4-5/16"	6	\$22.03
MRO-1664	1/4"	.2500	4"	2-3/4"	12	\$5.78	MRO-3164	31/64"	.4844	5-7/8"	4-3/8"	6	\$22.99
MRO-1764	17/64"	.2656	4-1/8"	2-7/8"	12	\$6.94	MRO-3264	1/2"	.5000	6"	4-1/2"	6	\$23.28
MRO-1864	9/32"	.2812	4-1/4"	2-15/16"	12	\$8.07							



Made In



MRO Black & Gold Letter Drills - HEAVY DUTY - M2 HSS

Part #	Size	Dec.	OAL	Flute	Qty.	List	Part #	Size	Dec.	OAL	Flute	Qty.	List
MRO-A	A	.234	3-7/8"	2-5/8"	12	\$7.79	MRO-N	N	.302	4-3/8"	3-1/16"	6	\$12.87
MRO-B	B	.238	4"	2-3/4"	12	\$7.79	MRO-O	O	.316	4-1/2"	3-3/16"	6	\$13.29
MRO-C	C	.242	4"	2-3/4"	12	\$7.82	MRO-P	P	.323	4-5/8"	3-5/16"	6	\$13.40
MRO-D	D	.246	4"	2-3/4"	12	\$7.82	MRO-Q	Q	.332	4-3/4"	3-7/16"	6	\$13.29
MRO-E	E	.250	4"	2-3/4"	12	\$7.91	MRO-R	R	.339	4-3/4"	3-7/16"	6	\$13.40
MRO-F	F	.257	4-1/8"	2-7/8"	12	\$8.22	MRO-S	S	.348	4-7/8"	3-1/2"	6	\$15.66
MRO-G	G	.261	4-1/8"	2-7/8"	12	\$8.56	MRO-T	T	.358	4-7/8"	3-1/2"	6	\$15.66
MRO-H	H	.266	4-1/8"	2-7/8"	12	\$8.96	MRO-U	U	.368	5"	3-5/8"	6	\$16.71
MRO-I	I	.272	4-1/8"	2-7/8"	12	\$9.01	MRO-V	V	.377	5"	3-5/8"	6	\$16.85
MRO-J	J	.277	4-1/8"	2-7/8"	12	\$10.55	MRO-W	W	.386	5-1/8"	3-3/4"	6	\$17.90
MRO-K	K	.281	4-1/4"	2-15/16"	12	\$10.55	MRO-X	X	.397	5-1/8"	3-3/4"	6	\$21.30
MRO-L	L	.290	4-1/4"	2-15/16"	6	\$12.14	MRO-Y	Y	.404	5-1/4"	3-7/8"	6	\$23.43
MRO-M	M	.295	4-3/8"	3-1/16"	6	\$12.87	MRO-Z	Z	.413	5-1/4"	3-7/8"	6	\$24.60



MRO Black & Gold Wire Gauge Drills - HEAVY DUTY - M2 HSS

Part #	Size	Dec.	OAL	Flute	Qty.	List	Part #	Size	Dec.	OAL	Flute	Qty.	List
MRO-01	1	.2280	3-7/8"	2-5/8"	12	\$6.97	MRO-21	21	.1590	3-1/4"	2-1/8"	12	\$4.08
MRO-02	2	.2210	3-7/8"	2-5/8"	12	\$6.59	MRO-22	22	.1570	3-1/8"	2"	12	\$4.19
MRO-03	3	.2130	3-3/4"	2-1/2"	12	\$6.59	MRO-23	23	.1540	3-1/8"	2"	12	\$4.09
MRO-04	4	.2090	3-3/4"	2-1/2"	12	\$6.59	MRO-24	24	.1520	3-1/8"	2"	12	\$4.05
MRO-05	5	.2055	3-3/4"	2-1/2"	12	\$6.59	MRO-25	25	.1495	3"	1-7/8"	12	\$3.80
MRO-06	6	.2040	3-3/4"	2-1/2"	12	\$6.59	MRO-26	26	.1470	3"	1-7/8"	12	\$3.84
MRO-07	7	.2010	3-5/8"	2-7/16"	12	\$5.65	MRO-27	27	.1440	3"	1-7/8"	12	\$3.64
MRO-08	8	.1990	3-5/8"	2-7/16"	12	\$5.76	MRO-28	28	.1405	2-7/8"	1-3/4"	12	\$3.63
MRO-09	9	.1960	3-5/8"	2-7/16"	12	\$5.76	MRO-29	29	.1360	2-7/8"	1-3/4"	12	\$3.58
MRO-10	10	.1935	3-5/8"	2-7/16"	12	\$5.60	MRO-30	30	.1285	2-3/4"	1-5/8"	12	\$3.58
MRO-11	11	.1910	3-1/2"	2-5/16"	12	\$5.49	MRO-31	31	.1200	2-3/4"	1-5/8"	12	\$3.21
MRO-12	12	.1890	3-1/2"	2-5/16"	12	\$5.51	MRO-32	32	.1160	2-3/4"	1-5/8"	12	\$3.21
MRO-13	13	.1850	3-1/2"	2-5/16"	12	\$5.20	MRO-33	33	.1130	2-5/8"	1-1/2"	12	\$3.23
MRO-14	14	.1820	3-3/8"	2-3/16"	12	\$5.23	MRO-34	34	.1110	2-5/8"	1-1/2"	12	\$3.23
MRO-15	15	.1800	3-3/8"	2-3/16"	12	\$5.20	MRO-35	35	.1100	2-5/8"	1-1/2"	12	\$3.21
MRO-16	16	.1770	3-3/8"	2-3/16"	12	\$5.10	MRO-36	36	.1065	2-1/2"	1-7/16"	12	\$3.11
MRO-17	17	.1730	3-3/8"	2-3/16"	12	\$4.82	MRO-37	37	.1040	2-1/2"	1-7/16"	12	\$3.13
MRO-18	18	.1695	3-1/4"	2-1/8"	12	\$4.45	MRO-38	38	.1015	2-1/2"	1-7/16"	12	\$3.12
MRO-19	19	.1660	3-1/4"	2-1/8"	12	\$4.45	MRO-39	39	.0995	2-3/8"	1-3/8"	12	\$3.09
MRO-20	20	.1610	3-1/4"	2-1/8"	12	\$4.43	MRO-40	40	.0980	2-3/8"	1-3/8"	12	\$3.08

Black & Gold



- ◆ 135° Split Point
- ◆ Ground Flute
- ◆ 3-Flat Shank on #1-12
- ◆ Heavy Duty Web for Strength & Rigidity
- ◆ Black & Gold Finish
- ◆ M2 HSS



**Sizes 41-60 are available upon request.



NOTE:
SIZES 40 → 60
HAVE NO
SPLIT POINT.



MRO
MADE IN USA



COBALT

Cobalt Jobber Drills - HEAVY DUTY - M35 COBALT



- ◆ Jobber Length
- ◆ 135° Split Point
- ◆ Ground Flute
- ◆ Straight Shank
- ◆ Heavy Duty Web
- ◆ Gold Finish
- ◆ M35 Cobalt



Part #	Size	Dec.	OAL	Flute	Qty.	List	Part #	Size	Dec.	OAL	Flute	Qty.	List
219CO0464	1/16"	.0625	1-7/8"	7/8"	12	\$1.97	219CO1964	19/64"	.2969	4-3/8"	3-1/16"	12	\$9.00
219CO0564	5/64"	.0781	2"	1"	12	\$2.18	219CO2064	5/16"	.3125	4-1/2"	3-3/16"	12	\$9.65
219CO0664	3/32"	.0938	2-1/4"	1-1/4"	12	\$2.37	219CO2164	21/64"	.3281	4-5/8"	3-5/16"	6	\$10.58
219CO0764	7/64"	.1094	2-5/8"	1-1/2"	12	\$2.51	219CO2264	11/32"	.3438	4-3/4"	3-7/16"	6	\$12.25
219CO0864	1/8"	.1250	2-3/4"	1-5/8"	12	\$2.86	219CO2364	23/64"	.3594	4-7/8"	3-1/2"	6	\$13.92
219CO0964	9/64"	.1406	2-7/8"	1-3/4"	12	\$3.05	219CO2464	3/8"	.3750	5"	3-5/8"	6	\$14.60
219CO1064	5/32"	.1562	3-1/8"	2"	12	\$3.37	219CO2564	25/64"	.3906	5-1/8"	3-3/4"	6	\$16.24
219CO1164	11/64"	.1719	3-1/4"	2-1/8"	12	\$3.57	219CO2664	13/32"	.4062	5-1/4"	3-7/8"	6	\$17.36
219CO1264	3/16"	.1875	3-1/2"	2-5/16"	12	\$3.92	219CO2764	27/64"	.4219	5-3/8"	3-15/16"	6	\$18.34
219CO1364	13/64"	.2031	3-5/8"	2-7/16"	12	\$5.17	219CO2864	7/16"	.4375	5-1/2"	4-1/16"	6	\$19.61
219CO1464	7/32"	.2188	3-3/4"	2-1/2"	12	\$5.53	219CO2964	29/64"	.4531	5-5/8"	4-3/16"	6	\$22.86
219CO1564	15/64"	.2344	3-7/8"	2-5/8"	12	\$6.08	219CO3064	15/32"	.4688	5-3/4"	4-5/16"	6	\$23.29
219CO1664	1/4"	.2500	4"	2-3/4"	12	\$6.62	219CO3164	31/64"	.4844	5-7/8"	4-3/8"	6	\$24.14
219CO1764	17/64"	.2656	4-1/8"	2-7/8"	12	\$7.14	219CO3264	1/2"	.5000	6"	4-1/2"	6	\$25.10
219CO1864	9/32"	.2812	4-1/4"	2-15/16"	12	\$7.80							



COBALT

Cobalt Wire Gauge Drills - HEAVY DUTY - M35 COBALT



- ◆ Wire Gauge
- ◆ 135° Split Point
- ◆ Ground Flute
- ◆ Straight Shank
- ◆ Heavy Duty Web
- ◆ Gold Finish
- ◆ M35 Cobalt



Part #	Size	Dec.	OAL	Flute	Qty.	List	Part #	Size	Dec.	OAL	Flute	Qty.	List
220CO0001	1	.2280	3-7/8"	2-5/8"	12	\$5.99	220CO0031	31	.1200	2-3/4"	1-5/8"	12	\$2.89
220CO0002	2	.2210	3-7/8"	2-5/8"	12	\$5.99	220CO0032	32	.1160	2-3/4"	1-5/8"	12	\$2.89
220CO0003	3	.2130	3-3/4"	2-1/2"	12	\$5.99	220CO0033	33	.1130	2-5/8"	1-1/2"	12	\$2.89
220CO0004	4	.2090	3-3/4"	2-1/2"	12	\$5.99	220CO0034	34	.1110	2-5/8"	1-1/2"	12	\$2.89
220CO0005	5	.2055	3-3/4"	2-1/2"	12	\$5.99	220CO0035	35	.1100	2-5/8"	1-1/2"	12	\$2.89
220CO0006	6	.2040	3-3/4"	2-1/2"	12	\$5.99	220CO0036	36	.1065	2-1/2"	1-7/16"	12	\$2.89
220CO0007	7	.2010	3-5/8"	2-7/16"	12	\$4.55	220CO0037	37	.1040	2-1/2"	1-7/16"	12	\$2.89
220CO0008	8	.1990	3-5/8"	2-7/16"	12	\$4.55	220CO0038	38	.1015	2-1/2"	1-7/16"	12	\$2.89
220CO0009	9	.1960	3-5/8"	2-7/16"	12	\$4.55	220CO0039	39	.0995	2-3/8"	1-3/8"	12	\$2.89
220CO0010	10	.1935	3-5/8"	2-7/16"	12	\$4.55	220CO0040	40	.0980	2-3/8"	1-3/8"	12	\$2.89
220CO0011	11	.1910	3-1/2"	2-5/16"	12	\$4.55	220CO0041	41	.0960	2-3/8"	1-3/8"	12	\$2.89
220CO0012	12	.1890	3-1/2"	2-5/16"	12	\$4.55	220CO0042	42	.0935	2-1/4"	1-1/4"	12	\$2.89
220CO0013	13	.1850	3-1/2"	2-5/16"	12	\$4.55	220CO0043	43	.0890	2-1/4"	1-1/4"	12	\$2.89
220CO0014	14	.1820	3-3/8"	2-3/16"	12	\$4.55	220CO0044	44	.0860	2-1/8"	1-1/8"	12	\$2.89
220CO0015	15	.1800	3-3/8"	2-3/16"	12	\$4.55	220CO0045	45	.0820	2-1/8"	1-1/8"	12	\$2.89
220CO0016	16	.1770	3-3/8"	2-3/16"	12	\$4.55	220CO0046	46	.0810	2-1/8"	1-1/8"	12	\$2.89
220CO0017	17	.1730	3-3/8"	2-3/16"	12	\$4.55	220CO0047	47	.0785	2"	1"	12	\$2.89
220CO0018	18	.1695	3-1/4"	2-1/8"	12	\$4.55	220CO0048	48	.0760	2"	1"	12	\$2.89
220CO0019	19	.1660	3-1/4"	2-1/8"	12	\$3.37	220CO0049	49	.0730	2"	1"	12	\$2.89
220CO0020	20	.1610	3-1/4"	2-1/8"	12	\$3.37	220CO0050	50	.0700	2"	1"	12	\$2.89
220CO0021	21	.1590	3-1/4"	2-1/8"	12	\$3.37	220CO0051	51	.0670	2"	1"	12	\$2.89
220CO0022	22	.1570	3-1/8"	2"	12	\$3.37	220CO0052	52	.0635	1-7/8"	7/8"	12	\$2.89
220CO0023	23	.1540	3-1/8"	2"	12	\$3.37	220CO0053	53	.0595	1-7/8"	7/8"	12	\$2.89
220CO0024	24	.1520	3-1/8"	2"	12	\$3.37	220CO0054	54	.0550	1-7/8"	7/8"	12	\$2.89
220CO0025	25	.1495	3"	1-7/8"	12	\$3.37	220CO0055	55	.0520	1-7/8"	7/8"	12	\$2.89
220CO0026	26	.1470	3"	1-7/8"	12	\$3.37	220CO0056	56	.0465	1-3/4"	3/4"	12	\$2.89
220CO0027	27	.1440	3"	1-7/8"	12	\$3.37	220CO0057	57	.0430	1-3/4"	3/4"	12	\$2.89
220CO0028	28	.1405	2-7/8"	1-3/4"	12	\$3.37	220CO0058	58	.0420	1-5/8"	11/16"	12	\$2.89
220CO0029	29	.1360	2-7/8"	1-3/4"	12	\$3.37	220CO0059	59	.0410	1-5/8"	11/16"	12	\$2.89
220CO0030	30	.1285	2-3/4"	1-5/8"	12	\$2.89	220CO0060	60	.0400	1-5/8"	11/16"	12	\$2.89



NOTE:
 SIZES 40 → 60
 HAVE NO
 SPLIT POINT.



COBALT

Cobalt Jobber Drills - 3/8" Shank - M35 COBALT

Part #	Size	Dec.	OAL	Flute	Qty.	List	Part #	Size	Dec.	OAL	Flute	Qty.	List
219R82564	25/64"	.3906	5-1/8"	3-3/4"	6	\$26.32	219R82964	29/64"	.4531	5-5/8"	4-3/16"	6	\$35.97
219R82664	13/32"	.4062	5-1/4"	3-1/8"	6	\$27.15	219R83064	15/32"	.4688	5-3/4"	4-5/16"	6	\$36.45
219R82764	27/64"	.4219	5-3/8"	3-15/16"	6	\$30.18	219R83164	31/64"	.4844	5-7/8"	4-3/8"	6	\$37.55
219R82864	7/16"	.4375	5-1/2"	4-1/16"	6	\$30.73	219R83264	1/2"	.5000	6"	4-1/2"	6	\$37.76

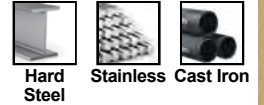

◆ Same as 219CO with 3/8" Shank.



COBALT

Cobalt Stub Fractional - M35 COBALT

Part #	Size	Dec.	OAL	Flute	Qty.	List	Part #	Size	Dec.	OAL	Flute	Qty.	List
CTS-0464	1/16"	.0625	1-5/8"	5/8"	12	\$1.58	CTS-1964	19/64"	.2969	2-3/4"	1-9/16"	12	\$8.78
CTS-0564	5/64"	.0781	1-11/16"	11/16"	12	\$1.58	CTS-2064	5/16"	.3125	2-13/16"	1-5/8"	12	\$10.54
CTS-0664	3/32"	.0938	1-3/4"	3/4"	12	\$1.68	CTS-2164	21/64"	.3281	2-15/16"	1-11/16"	6	\$11.33
CTS-0764	7/64"	.1094	1-13/16"	13/16"	12	\$1.90	CTS-2264	11/32"	.3438	3"	1-11/16"	6	\$12.12
CTS-0864	1/8"	.1250	1-7/8"	7/8"	12	\$2.21	CTS-2364	23/64"	.3594	3-1/16"	1-3/4"	6	\$12.98
CTS-0964	9/64"	.1406	1-15/16"	15/16"	12	\$2.53	CTS-2464	3/8"	.3750	3-1/8"	1-13/16"	6	\$13.61
CTS-1064	5/32"	.1562	2-1/16"	1"	12	\$2.72	CTS-2564	25/64"	.3906	3-1/4"	1-7/8"	6	\$16.08
CTS-1164	11/64"	.1719	2-1/8"	1-1/16"	12	\$2.81	CTS-2664	13/32"	.4062	3-5/16"	1-15/16"	6	\$18.23
CTS-1264	3/16"	.1875	2-3/16"	1-1/8"	12	\$3.16	CTS-2764	27/64"	.4219	3-3/8"	2"	6	\$19.11
CTS-1364	13/64"	.2031	2-1/4"	1-3/16"	12	\$3.69	CTS-2864	7/16"	.4375	3-7/16"	2-1/16"	6	\$20.70
CTS-1464	7/32"	.2188	2-3/8"	1-1/4"	12	\$4.30	CTS-2964	29/64"	.4531	3-9/16"	2-1/8"	6	\$21.48
CTS-1564	15/64"	.2344	2-7/16"	1-5/16"	12	\$5.01	CTS-3064	15/32"	.4688	3-5/8"	2-1/8"	6	\$22.51
CTS-1664	1/4"	.2500	2-1/2"	1-3/8"	12	\$6.15	CTS-3164	31/64"	.4844	3-11/16"	2-3/16"	6	\$23.48
CTS-1764	17/64"	.2656	2-5/8"	1-7/16"	12	\$6.59	CTS-3264	1/2"	.5000	3-3/4"	2-1/4"	6	\$23.52
CTS-1864	9/32"	.2812	2-11/16"	1-1/2"	12	\$7.29							



- ◆ Stub Length
- ◆ 135° Split Point
- ◆ Ground Flute
- ◆ Straight Shank
- ◆ Heavy Duty Web
- ◆ Gold Finish
- ◆ M35 Cobalt



COBALT

Cobalt Silver & Deming - 1/2" Shank - M35 COBALT

Part #	Size	Dec.	OAL	Flute	Qty.	List	Part #	Size	Dec.	OAL	Flute	Qty.	List
201CO3464	17/32"	.5312	6	2-3/4"	1	\$42.87	201CO5864	29/32"	.9062	6	2-3/4"	1	\$85.73
201CO3664	9/16"	.5625	6	2-3/4"	1	\$49.41	201CO6064	15/16"	.9375	6	2-3/4"	1	\$91.54
201CO3864	19/32"	.5938	6	2-3/4"	1	\$52.31	201CO6264	31/32"	.9688	6	2-3/4"	1	\$104.21
201CO4064	5/8"	.6250	6	2-3/4"	1	\$55.22	201CO6464	1"	1.0000	6	2-3/4"	1	\$107.53
201CO4264	21/32"	.6562	6	2-3/4"	1	\$58.86	201CO6864	1-1/16"	1.0625	6	2-3/4"	1	\$134.00
201CO4464	11/16"	.6875	6	2-3/4"	1	\$61.75	201CO7264	1-1/8"	1.1250	6	2-3/4"	1	\$152.50
201CO4664	23/32"	.7188	6	2-3/4"	1	\$64.66	201CO7664	1-3/16"	1.1875	6	2-3/4"	1	\$174.37
201CO4864	3/4"	.7500	6	2-3/4"	1	\$67.57	201CO8064	1-1/4"	1.2500	6	2-3/4"	1	\$202.55
201CO5064	25/32"	.7812	6	2-3/4"	1	\$70.46	201CO8464	1-5/16"	1.3125	6	2-3/4"	1	\$222.89
201CO5264	13/16"	.8125	6	2-3/4"	1	\$75.56	201CO8864	1-3/8"	1.3750	6	2-3/4"	1	\$240.00
201CO5464	27/32"	.8438	6	2-3/4"	1	\$78.46	201CO9664	1-1/2"	1.5000	6	2-3/4"	1	\$275.00
201CO5664	7/8"	.8750	6	2-3/4"	1	\$81.37							



- ◆ 6" Length
- ◆ 118° Split Point
- ◆ Ground Flute
- ◆ 3-Flat Round 1/2" Shank
- ◆ Gold Finish
- ◆ M35 Cobalt





Titanium Jobber Drills - (TiN) Coating - M2 HSS



- ◆ Jobber Length
- ◆ 135° Split Point
- ◆ Ground Flute
- ◆ Straight Shank
- ◆ Heavy Duty Web
- ◆ TiN Coating
- ◆ M2 HSS



Part #	Size	Dec.	OAL	Flute	Qty.	List	Part #	Size	Dec.	OAL	Flute	Qty.	List
255SP0464	1/16"	.0625	1-7/8"	7/8"	12	\$2.84	255SP1964	19/64"	.2969	4-3/8"	3-1/16"	12	\$9.74
255SP0564	5/64"	.0781	2"	1"	12	\$2.84	255SP2064	5/16"	.3125	4-1/2"	3-3/16"	12	\$9.92
255SP0664	3/32"	.0938	2-1/4"	1-1/4"	12	\$2.84	255SP2164	21/64"	.3281	4-5/8"	3-5/16"	6	\$10.33
255SP0764	7/64"	.1094	2-5/8"	1-1/2"	12	\$2.84	255SP2264	11/32"	.3438	4-3/4"	3-7/16"	6	\$10.67
255SP0864	1/8"	.1250	2-3/4"	1-5/8"	12	\$2.84	255SP2364	23/64"	.3594	4-7/8"	3-1/2"	6	\$14.55
255SP0964	9/64"	.1406	2-7/8"	1-3/4"	12	\$2.89	255SP2464	3/8"	.3750	5"	3-5/8"	6	\$15.11
255SP1064	5/32"	.1562	3-1/8"	2"	12	\$2.89	255SP2564	25/64"	.3906	5-1/8"	3-3/4"	6	\$18.38
255SP1164	11/64"	.1719	3-1/4"	2-1/8"	12	\$3.11	255SP2664	13/32"	.4062	5-1/4"	3-7/8"	6	\$18.67
255SP1264	3/16"	.1875	3-1/2"	2-5/16"	12	\$3.17	255SP2764	27/64"	.4219	5-3/8"	3-15/16"	6	\$19.38
255SP1364	13/64"	.2031	3-5/8"	2-7/16"	12	\$5.68	255SP2864	7/16"	.4375	5-1/2"	4-1/16"	6	\$20.13
255SP1464	7/32"	.2188	3-3/4"	2-1/2"	12	\$5.95	255SP2964	29/64"	.4531	5-5/8"	4-3/16"	6	\$20.82
255SP1564	15/64"	.2344	3-7/8"	2-5/8"	12	\$6.01	255SP3064	15/32"	.4688	5-3/4"	4-5/16"	6	\$21.41
255SP1664	1/4"	.2500	4"	2-3/4"	12	\$6.05	255SP3164	31/64"	.4844	5-7/8"	4-3/8"	6	\$21.92
255SP1764	17/64"	.2656	4-1/8"	2-7/8"	12	\$9.06	255SP3264	1/2"	.5000	6"	4-1/2"	6	\$22.17
255SP1864	9/32"	.2812	4-1/4"	2-15/16"	12	\$9.20							



1/4" Hex Titanium Jobber Drills - (TiN) Coating - M2 HSS

- ◆ 1/4" Hex Impact Shank
- ◆ Jobber Length
- ◆ 135° Split Point
- ◆ 1 Pc. Construction >3/16"
- ◆ Ground Flute
- ◆ Heavy Duty Web
- ◆ TiN Coating
- ◆ M2 HSS

Part #	Size	Dec.	OAL	Flute	Qty.	List	Part #	Size	Dec.	OAL	Flute	Qty.	List
255HEX0464	1/16"	.0625	1-7/8"	7/8"	12	\$3.58	255HEX1664	1/4"	.2500	4"	2-3/4"	12	\$10.08
255HEX0664	3/32"	.0938	2-1/4"	1-1/4"	12	\$3.58	255HEX1864	9/32"	.2812	4-1/4"	2-15/16"	12	\$10.75
255HEX0864	1/8"	.1250	2-3/4"	1-5/8"	12	\$3.92	255HEX2064	5/16"	.3125	4-1/2"	3-3/16"	12	\$12.10
255HEX1064	5/32"	.1562	3-1/8"	2"	12	\$4.76	255HEX2464	3/8"	.3750	5"	3-5/8"	6	\$13.44
255HEX1264	3/16"	.1875	3-1/2"	2-5/16"	12	\$6.16	255HEX2864	7/16"	.4375	5-1/2"	4-1/16"	6	\$18.69
255HEX1464	7/32"	.2188	3-3/4"	2-1/2"	12	\$9.52	255HEX3264	1/2"	.5000	6"	4-1/2"	6	\$24.96



1/4" Hex Titanium Jobber Drills - (TiN) Coating - M2 HSS

Part #	Size	Dec.	OAL	Flute	Qty.	List	Part #	Size	Dec.	OAL	Flute	Qty.	List
255H04	1/16"	.0625	1-7/8"	7/8"	1	\$4.03	255H16	1/4"	.2500	4"	2-3/4"	1	\$11.09
255H06	3/32"	.0938	2-1/4"	1-1/4"	1	\$4.03	255H18	9/32"	.2812	4-1/4"	2-15/16"	1	\$11.83
255H08	1/8"	.1250	2-3/4"	1-5/8"	1	\$4.33	255H20	5/16"	.3125	4-1/2"	3-3/16"	1	\$13.31
255H10	5/32"	.1562	3-1/8"	2"	1	\$5.24	255H24	3/8"	.3750	5"	3-5/8"	1	\$14.78
255H12	3/16"	.1875	3-1/2"	2-5/16"	1	\$6.78	255H28	7/16"	.4375	5-1/2"	4-1/16"	1	\$20.56
255H14	7/32"	.2188	3-3/4"	2-1/2"	1	\$10.47	255H32	1/2"	.5000	6"	4-1/2"	1	\$27.45



Rack P. 134



135°
SPLIT POINT

Parabolic Jobber Drills - SUPER HEAVY DUTY - M2 HSS

Part #	Size	Dec.	OAL	Flute	Qty.	List	Part #	Size	Dec.	OAL	Flute	Qty.	List
PB-0464	1/16"	.0625	1-7/8"	7/8"	12	\$2.66	PB-1964	19/64"	.2969	4-3/8"	3-1/16"	12	\$7.97
PB-0564	5/64"	.0781	2"	1"	12	\$2.66	PB-2064	5/16"	.3125	4-1/2"	3-3/16"	12	\$8.31
PB-0664	3/32"	.0938	2-1/4"	1-1/4"	12	\$2.66	PB-2164	21/64"	.3281	4-5/8"	3-5/16"	6	\$9.47
PB-0764	7/64"	.1094	2-5/8"	1-1/2"	12	\$2.93	PB-2264	11/32"	.3438	4-3/4"	3-7/16"	6	\$10.28
PB-0864	1/8"	.1250	2-3/4"	1-5/8"	12	\$2.93	PB-2364	23/64"	.3594	4-7/8"	3-1/2"	6	\$11.71
PB-0964	9/64"	.1406	2-7/8"	1-3/4"	12	\$3.06	PB-2464	3/8"	.3750	5"	3-5/8"	6	\$11.92
PB-1064	5/32"	.1562	3-1/8"	2"	12	\$3.06	PB-2564	25/64"	.3906	5-1/8"	3-3/4"	6	\$14.66
PB-1164	11/64"	.1719	3-1/4"	2-1/8"	12	\$3.27	PB-2664	13/32"	.4062	5-1/4"	3-7/8"	6	\$14.81
PB-1264	3/16"	.1875	3-1/2"	2-5/16"	12	\$3.61	PB-2764	27/64"	.4219	5-3/8"	3-15/16"	6	\$17.04
PB-1364	13/64"	.2031	3-5/8"	2-7/16"	12	\$3.95	PB-2864	7/16"	.4375	5-1/2"	4-1/16"	6	\$17.39
PB-1464	7/32"	.2188	3-3/4"	2-1/2"	12	\$4.70	PB-2964	29/64"	.4531	5-5/8"	4-3/16"	6	\$19.98
PB-1564	15/64"	.2344	3-7/8"	2-5/8"	12	\$5.11	PB-3064	15/32"	.4688	5-3/4"	4-5/16"	6	\$20.63
PB-1664	1/4"	.2500	4"	2-3/4"	12	\$5.24	PB-3164	31/64"	.4844	5-7/8"	4-3/8"	6	\$22.14
PB-1764	17/64"	.2656	4-1/8"	2-7/8"	12	\$6.54	PB-3264	1/2"	.5000	6"	4-1/2"	6	\$22.43
PB-1864	9/32"	.2812	4-1/4"	2-15/16"	12	\$7.42							

Black & Gold



- ◆ Jobber Length
- ◆ 135° Split Point
- ◆ Ground Flute
- ◆ Straight Shank
- ◆ Heavy Duty Web
- ◆ Black & Gold Finish
- ◆ M2 HSS



1/2" DRILL

Extra Heavy Duty Web

30% thicker than even heavy duty webs, resists the extra shear stress found in deep hole drilling.

Parabolic Flute

Fast parabolic spiral allows deep hole drilling without frequent drill removal to clear chips.

Made In



135°
SPLIT POINT

Cobalt Jobber Drills - SUPER HEAVY DUTY - M42 SUPER COBALT

Part #	Size	Dec.	OAL	Flute	Qty.	List	Part #	Size	Dec.	OAL	Flute	Qty.	List
CO-0464	1/16"	.0625	1-7/8"	7/8"	12	\$3.66	CO-1964	19/64"	.2969	4-3/8"	3-1/16"	12	\$13.62
CO-0564	5/64"	.0781	2"	1"	12	\$3.66	CO-2064	5/16"	.3125	4-1/2"	3-3/16"	12	\$13.98
CO-0664	3/32"	.0938	2-1/4"	1-1/4"	12	\$3.66	CO-2164	21/64"	.3281	4-5/8"	3-5/16"	6	\$16.31
CO-0764	7/64"	.1094	2-5/8"	1-1/2"	12	\$3.80	CO-2264	11/32"	.3438	4-3/4"	3-7/16"	6	\$17.83
CO-0864	1/8"	.1250	2-3/4"	1-5/8"	12	\$4.30	CO-2364	23/64"	.3594	4-7/8"	3-1/2"	6	\$17.90
CO-0964	9/64"	.1406	2-7/8"	1-3/4"	12	\$4.84	CO-2464	3/8"	.3750	5"	3-5/8"	6	\$17.97
CO-1064	5/32"	.1562	3-1/8"	2"	12	\$4.98	CO-2564	25/64"	.3906	5-1/8"	3-3/4"	6	\$21.56
CO-1164	11/64"	.1719	3-1/4"	2-1/8"	12	\$5.18	CO-2664	13/32"	.4062	5-1/4"	3-7/8"	6	\$24.26
CO-1264	3/16"	.1875	3-1/2"	2-5/16"	12	\$5.98	CO-2764	27/64"	.4219	5-3/8"	3-15/16"	6	\$27.37
CO-1364	13/64"	.2031	3-5/8"	2-7/16"	12	\$7.53	CO-2864	7/16"	.4375	5-1/2"	4-1/16"	6	\$27.99
CO-1464	7/32"	.2188	3-3/4"	2-1/2"	12	\$7.74	CO-2964	29/64"	.4531	5-5/8"	4-3/16"	6	\$32.07
CO-1564	15/64"	.2344	3-7/8"	2-5/8"	12	\$8.78	CO-3064	15/32"	.4688	5-3/4"	4-5/16"	6	\$32.97
CO-1664	1/4"	.2500	4"	2-3/4"	12	\$8.74	CO-3164	31/64"	.4844	5-7/8"	4-3/8"	6	\$35.04
CO-1764	17/64"	.2656	4-1/8"	2-7/8"	12	\$10.37	CO-3264	1/2"	.5000	6"	4-1/2"	6	\$35.39
CO-1864	9/32"	.2812	4-1/4"	2-15/16"	12	\$11.13							

COBALT



- ◆ Jobber Length
- ◆ 135° Split Point
- ◆ Ground Flute
- ◆ Straight Shank
- ◆ Heavy Duty Web
- ◆ Gold Finish
- ◆ M42 Super Cobalt



1/2" DRILL

Made In





Made In



COBALT

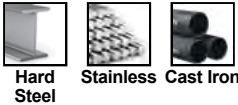

- ◆ Heavy Duty Spur
- ◆ M42 Super Cobalt
- ◆ High Red Hot Hardness
- ◆ Double End
- ◆ Gold Finish



Spotweld - Double End - M42 COBALT

Part #	Size	Frac.	OAL	Qty.	List
219DE0065	6.5 mm	1/4"	3-5/8"	5	\$38.69
219DE0080	8.0 mm	5/16"	3-5/8"	5	\$51.65
219DE0100	10.0 mm	3/8"	3-5/8"	5	\$77.20



Double End - M42 COBALT

Part #	Size	Dec.	OAL	Flute	Qty.	List
211CO0864	1/8"	.1250	2"	1/2"	12	\$5.35
211CO0030	#30	.1285	2"	1/2"	12	\$5.35

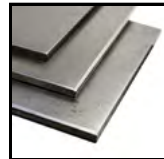

Sheet Metal



Double End - BRIGHT - M2 HSS

Part #	Size	Dec.	OAL	Flute	Qty.	List
211DE0764	7/64"	.1094	1-7/8"	1/2"	12	\$1.34
211DE0864	1/8"	.1250	2"	1/2"	12	\$1.44
211DE0964	9/64"	.1406	2"	1/2"	12	\$1.57
211DE1064	5/32"	.1562	2-1/16"	1/2"	12	\$1.74
211DE1264	3/16"	.1875	2-3/16"	1/2"	12	\$2.39
211DE1464	7/32"	.2188	2-3/8"	1/2"	12	\$3.44
211DE1664	1/4"	.2500	2-1/2"	1/2"	12	\$3.77
211DE0030	#30	.1285	2"	1/2"	12	\$1.51



Double End - BLACK - M2 HSS

Part #	Size	Dec.	OAL	Flute	Qty.	List
211DE0864-B	1/8"	.1250	2"	1/2"	12	\$1.49
211DE0030-B	#30	.1285	2"	1/2"	12	\$1.56

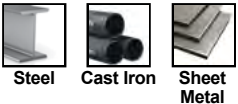

- ◆ Heavy Duty
- ◆ 135° Split Point
- ◆ M2 HSS
- ◆ Bright and Black Finish
- ◆ Automotive



Black & Gold VIP-STEP Jobber Drills - M2 HSS

Part #	Size	Dec.	OAL	Flute	Qty.	List	Part #	Size	Dec.	OAL	Flute	Qty.	List
VIP-1264	3/16"	.1875	3-1/2"	2-5/16"	12	\$7.42	VIP-2064	5/16"	.3125	4-1/2"	3-3/16"	12	\$11.03
VIP-1464	7/32"	.2188	3-3/4"	2-1/2"	12	\$7.89	VIP-2264	11/32"	.3438	4-3/4"	3-7/16"	6	\$13.48
VIP-1664	1/4"	.2500	4"	2-3/4"	12	\$8.67	VIP-2464	3/8"	.3750	5"	3-5/8"	6	\$14.96
VIP-1864	9/32"	.2812	4-1/4"	2-15/16"	12	\$10.05	VIP-2864	7/16"	.4375	5-1/2"	4-1/16"	6	\$18.74
							VIP-3264	1/2"	.5000	6"	4-1/2"	6	\$22.91



- ◆ Jobber Length
- ◆ 135° Step Point
- ◆ Ground Flute
- ◆ 3-Flat Shank
- ◆ Heavy Duty Web
- ◆ M2 HSS

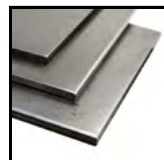
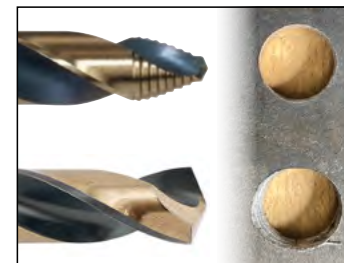
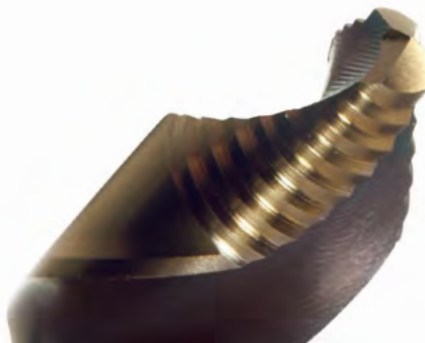

Sheet Metal



6" Cobalt Aircraft - M35 COBALT

Part #	Size	Dec.	OAL	Flute	Qty.	List
212CO0464	1/16"	.0625	6"	7/8"	6	\$7.82
212CO0864	1/8"	.1250	6"	1-5/8"	6	\$7.82
212CO1064	5/32"	.1562	6"	2"	6	\$7.82
212CO1164	11/64"	.1719	6"	2-1/8"	6	\$9.40
212CO1264	3/16"	.1875	6"	2-5/16"	6	\$9.40
212CO1464	7/32"	.2188	6"	2-1/2"	6	\$11.69
212CO1664	1/4"	.2500	6"	2-3/4"	6	\$14.50
212CO2064	5/16"	.3125	6"	3-3/16"	1	\$28.21
212CO2464	3/8"	.3750	6"	3-5/8"	1	\$35.64



COBALT



- ◆ Straight Shank
- ◆ 135° Split Point
- ◆ Ground Flute
- ◆ Extra Flexibility
- ◆ Heavy Duty Web
- ◆ Gold Finish
- ◆ M35 Cobalt



6" Aircraft - M2 HSS

Part #	Size	Dec.	OAL	Flute	Qty.	List
212SP0464	1/16"	.0625	6"	7/8"	6	\$5.17
212SP0864	1/8"	.1250	6"	1-5/8"	6	\$5.17
212SP0964	9/64"	.1406	6"	1-3/4"	6	\$5.17
212SP1064	5/32"	.1562	6"	2"	6	\$5.17
212SP1164	11/64"	.1719	6"	2-1/8"	6	\$5.50
212SP1264	3/16"	.1875	6"	2-5/16"	6	\$5.90
212SP1364	13/64"	.2031	6"	2-7/16"	6	\$6.94
212SP1464	7/32"	.2188	6"	2-1/2"	6	\$7.32
212SP1564	15/64"	.2344	6"	2-5/8"	6	\$7.78
212SP1664	1/4"	.2500	6"	2-3/4"	6	\$9.30
212SP1764	17/64"	.2656	6"	2-7/8"	6	\$11.36
212SP1864	9/32"	.2812	6"	2-15/16"	6	\$11.59
212SP2064	5/16"	.3125	6"	3-3/16"	1	\$12.05
212SP2264	11/32"	.3438	6"	3-7/16"	1	\$15.55
212SP2464	3/8"	.3750	6"	3-5/8"	1	\$17.11
212SP2864	7/16"	.4375	6"	4-1/16"	1	\$21.20
212SP3264	1/2"	.5000	6"	4-1/2"	1	\$25.49

18" Aircraft - M2 HSS

Part #	Size	Dec.	OAL	Flute	Qty.	List
215SP1264	3/16"	.1875	18"	2-5/16"	1	\$18.84
215SP1664	1/4"	.2500	18"	2-3/4"	1	\$23.91
215SP2064	5/16"	.3125	18"	3-3/16"	1	\$36.84
215SP2464	3/8"	.3750	18"	3-5/8"	1	\$43.16
215SP3264	1/2"	.5000	18"	4-1/2"	1	\$65.30

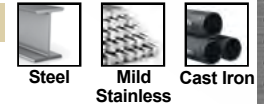

- ◆ Straight Shank
- ◆ 135° Split Point
- ◆ Ground Flute
- ◆ Extra Flexibility
- ◆ Heavy Duty Web
- ◆ Black Oxide Finish
- ◆ M2 HSS

6" Wire Gauge Aircraft - M2 HSS

Part #	Size	Dec.	OAL	Flute	Qty.	List
213SP0001	1	.2280	6"	2-5/8"	6	\$7.56
213SP0002	2	.2210	6"	2-5/8"	6	\$7.56
213SP0007	7	.2010	6"	2-7/16"	6	\$7.56
213SP0009	9	.1960	6"	2-7/16"	6	\$7.56
213SP0010	10	.1935	6"	2-7/16"	6	\$6.50
213SP0011	11	.1910	6"	2-5/16"	6	\$6.50
213SP0016	16	.1770	6"	2-3/16"	6	\$6.50
213SP0017	17	.1730	6"	2-3/16"	6	\$6.50
213SP0021	21	.1590	6"	2-1/8"	6	\$6.30
213SP0026	26	.1470	6"	1-7/8"	6	\$6.30
213SP0029	29	.1360	6"	1-3/4"	6	\$6.30
213SP0030	30	.1285	6"	1-5/8"	6	\$4.70
213SP0031	31	.1200	6"	1-5/8"	6	\$4.70
213SP0040	40	.0980	6"	1-3/8"	6	\$6.75



12" Aircraft - M2 HSS

Part #	Size	Dec.	OAL	Flute	Qty.	List
214SP0864	1/8"	.1250	12"	1-5/8"	1	\$7.28
214SP1064	5/32"	.1562	12"	2"	1	\$8.50
214SP1264	3/16"	.1875	12"	2-5/16"	1	\$13.42
214SP1464	7/32"	.2188	12"	2-1/2"	1	\$17.12
214SP1664	1/4"	.2500	12"	2-3/4"	1	\$18.78
214SP1864	9/32"	.2812	12"	2-15/16"	1	\$25.01
214SP2064	5/16"	.3125	12"	3-3/16"	1	\$26.90
214SP2264	11/32"	.3438	12"	3-7/16"	1	\$28.55
214SP2464	3/8"	.3750	12"	3-5/8"	1	\$30.98
214SP2864*	7/16"	.4375	12"	4-1/16"	1	\$41.20
214SP3264*	1/2"	.5000	12"	4-1/2"	1	\$49.90

* 3/8" Shank

12" Wire Gauge Aircraft - M2 HSS

Part #	Size	Dec.	OAL	Flute	Qty.	List
213SP1201	1	.2280	12"	2-5/8"	1	\$20.64
213SP1207	7	.2010	12"	2-7/16"	1	\$15.85
213SP1210	10	.1935	12"	2-7/16"	1	\$15.85
213SP1221	21	.1590	12"	2-1/8"	1	\$12.06
213SP1229	29	.1360	12"	1-3/4"	1	\$8.60
213SP1230	30	.1285	12"	1-5/8"	1	\$8.60
213SP1231	31	.1200	12"	1-5/8"	1	\$8.60
213SP1240	40	.0980	12"	1-3/8"	1	\$9.25

Long Boy - Full Body Spiral Drills P. 72



13 PC Jobber Sets - Straight Shank

Part #	Set	Sizes	Type	Drills	Point	List
AD-13	13 pc	1/16" → 1/4" x 64ths	Black Oxide	p.11	118°	\$26.39
BT-13	13 pc	1/16" → 1/4" x 64ths	Bright Finish	p.10	118°	\$37.04
SP-13	13 pc	1/16" → 1/4" x 64ths	Black Oxide	p.12	135° S.P.	\$37.34
BG-13	13 pc	1/16" → 1/4" x 64ths	Black & Gold	p.17	135° S.P.	\$38.36
MRO-13F	13 pc	1/16" → 1/4" x 64ths	MRO 3-FLAT*	p.20	135° S.P.	\$55.60
CX-13	13 pc	1/16" → 1/4" x 64ths	Cobalt	p.22	135° S.P.	\$51.68
TI-13	13 pc	1/16" → 1/4" x 64ths	Titanium	p.24	135° S.P.	\$54.08
PB-13	13 pc	1/16" → 1/4" x 64ths	Parabolic*	p.25	135° S.P.	\$51.35
CO-13	13 pc	1/16" → 1/4" x 64ths	Cobalt*	p.25	135° S.P.	\$73.52

◆ Metal Huot Case



* Made in USA

S.P. = Split Point



15 PC Jobber Sets - Straight Shank

Part #	Set	Sizes	Type	Drills	Point	List
SP-15	15 pc	1/16" → 1/2" x 32nds	Black Oxide	p.12	135° S.P.	\$105.94
BG-15	15 pc	1/16" → 1/2" x 32nds	Black & Gold	p.17	135° S.P.	\$110.53
MRO-15F	15 pc	1/16" → 1/2" x 32nds	MRO 3-FLAT*	p.20	135° S.P.	\$146.80
CX-15	15 pc	1/16" → 1/2" x 32nds	Cobalt	p.22	135° S.P.	\$157.24
PB-15	15 pc	1/16" → 1/2" x 32nds	Parabolic*	p.25	135° S.P.	\$116.07
CO-15	15 pc	1/16" → 1/2" x 32nds	Cobalt*	p.25	135° S.P.	\$183.33

◆ Metal Huot Case



* Made in USA

S.P. = Split Point



29 PC Jobber Sets - Straight Shank

Part #	Set	Sizes	Type	Drills	Point	List
AD-29	29 pc	1/16" → 1/2" x 64ths	Black Oxide	p.11	118°	\$89.76
BT-29	29 pc	1/16" → 1/2" x 64ths	Bright Finish	p.10	118°	\$191.77
SP-29	29 pc	1/16" → 1/2" x 64ths	Black Oxide	p.12	135° S.P.	\$192.10
BG-29	29 pc	1/16" → 1/2" x 64ths	Black & Gold	p.17	135° S.P.	\$197.17
MRO-29F	29 pc	1/16" → 1/2" x 64ths	MRO 3-FLAT*	p.20	135° S.P.	\$258.28
CX-29	29 pc	1/16" → 1/2" x 64ths	Cobalt	p.22	135° S.P.	\$283.16
TI-29	29 pc	1/16" → 1/2" x 64ths	Titanium	p.24	135° S.P.	\$280.18
PB-29	29 pc	1/16" → 1/2" x 64ths	Parabolic*	p.25	135° S.P.	\$209.82
CO-29	29 pc	1/16" → 1/2" x 64ths	Cobalt*	p.25	135° S.P.	\$339.80

◆ Metal Huot Case



* Made in USA

S.P. = Split Point

29 PC Jobber Sets - 3/8" Shank

Part #	Set	Sizes	Type	Drills	Point	List
SP-29R	29 pc	1/16" → 1/2" x 64ths	Black Oxide	p.13	135° S.P.	\$191.64
BG-29R	29 pc	1/16" → 1/2" x 64ths	Black & Gold	p.18	135° S.P.	\$211.13
CX-29R	29 pc	1/16" → 1/2" x 64ths	Cobalt	p.23	135° S.P.	\$319.37

1/16" - 3/8" STRAIGHT SHANK, 25/64" - 1/2" WITH 3/8" SHANK

S.P. = Split Point

◆ Metal Huot Case

29 PC Jobber Sets - Bullet Case

Part #	Set	Sizes	Type	Drills	Point	List
BX-1	29 pc	1/16" → 1/2" x 64ths	Black Oxide	p. 12	135° S.P.	\$192.10
BT-1	29 pc	1/16" → 1/2" x 64ths	Bright	p. 10	118°	\$191.77
BG-1	29 pc	1/16" → 1/2" x 64ths	Black & Gold	p. 17	135° S.P.	\$197.17
MC-1	29 pc	1/16" → 1/2" x 64ths	Mechanics 3-FLAT*	p. 18	135° S.P.	\$215.17
MRO-1F	29 pc	1/16" → 1/2" x 64ths	MRO 3-FLAT*	p. 20	135° S.P.	\$244.13
CX-1	29 pc	1/16" → 1/2" x 64ths	Cobalt	p. 22	135° S.P.	\$283.16
TI-1	29 pc	1/16" → 1/2" x 64ths	Titanium	p. 24	135° S.P.	\$280.18
PB-1	29 pc	1/16" → 1/2" x 64ths	Parabolic*	p. 25	135° S.P.	\$209.82
CO-1	29 pc	1/16" → 1/2" x 64ths	Cobalt*	p. 25	135° S.P.	\$339.80

◆ Huot Bullet Case



* Made in USA

S.P. = Split Point



8 PC Silver & Deming Sets

Part #	Set	Sizes	Type	Drills	Point	List
AD-8	8 pc	See Below	Black Oxide	p.15	118°	\$264.43
BG-8	8 pc	See Below	Black & Gold	p.19	118°	\$305.73
CX-8	8 pc	See Below	Cobalt	p.23	135° S.P.	\$589.95

ALL SETS: 9/16", 5/8", 11/16", 3/4", 13/16", 7/8", 15/16", 1"

S.P. = Split Point

◆ Metal Huot Case



60 PC Wire Gauge Sets

Part #	Set	Sizes	Type	Drills	Point	List
SP-60	60 pc	#1 → #60	Black Oxide	p.12	135° S.P.	\$119.39
BG-60	60 pc	#1 → #60	Black & Gold	p.17	135° S.P.	\$127.19
CX-60	60 pc	#1 → #60	Cobalt	p.22	135° S.P.	\$257.82

S.P. = Split Point

◆ Metal Huot Case





LETTER A → Z Sets - Straight Shank

Part #	Set	Sizes	Type	Drills	Point	List
SP-AZ	26 pc	A → Z	Black Oxide	p.13	135° S.P.	\$200.19
BG-AZ	26 pc	A → Z	Black & Gold	p.19	135° S.P.	\$213.90

◆ Metal Huot Case

S.P. = Split Point



115 PC MASTER Sets - Straight Shank

Part #	Set	Sizes	Type	Drills	Point	List
SP-115	115 pc	See Below	Black Oxide	p.12	135° S.P.	\$498.55
BG-115	115 pc	See Below	Black & Gold	p.17	135° S.P.	\$570.81
CX-115	115 pc	See Below	Cobalt	p.22	135° S.P.	\$967.74

JOBBER SIZES: 1/16" → 1/2", WIRE GAUGE DRILL SIZES #1 → #60,
 LETTER SIZES: A → Z. STRAIGHT SHANK.

◆ Metal Huot Case

S.P. = Split Point



METRIC Sets - Straight Shank

Part #	Set	Sizes	Type	Drills	Point	List
MM-11	11 pc	1.00MM → 6.00MM	Black Oxide	p.13	118°	\$32.49
MM-25	25 pc	1.00MM → 13.00MM	Black Oxide	p.13	118°	\$161.54

◆ Metal Huot Case



TAP & DRILL Sets - CARBON / M2 HSS TAPS

Part #	Sizes	Type	Drills	Point	List
CD-SP-019	See Below	Carbon Taps	p.11	118°	\$77.25
TD-SP-019	See Below	M2 HSS Taps	p.12	135° S.P.	\$108.35

HSS DRILL BIT SIZES: #36, #29, #25, #21, #7, F, 5/16", U, 27/64"
 TAP SIZES: 6-32, 8-32, 10-24, 10-32, 1/4"-20, 5/16"-18, 3/8"-16, 7/16"-14, 1/2"-13

◆ Metal Huot Case

525 Pc. Dispenser Contains:

24- 1/16"	24- 5/64"	48- 3/32"	24- 7/64"	72- 1/8"
24- 9/64"	36- 5/32"	24- 11/64"	48- 3/16"	24- 13/64"
24- 7/32"	12- 15/64"	60- 1/4"	3- 17/64"	12- 9/32"
3- 19/64"	12- 5/16"	3- 21/64"	3- 11/32"	3- 23/64"
12- 3/8"	3- 25/64"	3- 13/32"	3- 27/64"	6- 7/16"
3- 29/64"	3- 15/32"	3- 31/64"	6- 1/2"	

This attractive drill bit merchandiser puts all 29 essential jobber sizes at your fingertips. Made of heavy duty steel construction, this deep red cabinet dispenser fits perfectly on any counter top. Comes with lock and key.



DISPLAY - PART# 13125
14" Out X 15"H X 12"W

525 PC Jobber Countertop Dispenser

Part #	Set	Sizes	Type	Drills	Point	List
SP-525	525 pc	1/16" → 1/2" x 64ths	Black Oxide	p.12	135° S.P.	\$1629.16
BG-525	525 pc	1/16" → 1/2" x 64ths	Black & Gold	p.17	135° S.P.	\$1926.34
MC-525	525 pc	1/16" → 1/2" x 64ths	Mechanics*	p.18	135° S.P.	\$2124.08
MRO-525	525 pc	1/16" → 1/2" x 64ths	MRO 3-FLAT*	p.20	135° S.P.	\$2879.42
CX-525	525 pc	1/16" → 1/2" x 64ths	Cobalt	p.22	135° S.P.	\$2845.68

S.P. = Split Point



* Made in USA

◆ Metal Huot Case

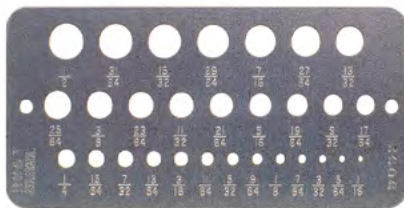

Metal Drill Gauges

Part #	Description	Sizes	List
29GAUGE	29 Hole Gauge	1/16" → 1/2"	\$21.79
60GAUGE	60 Hole Gauge	#1 → #60 Wire	\$30.98



INTERNATIONAL TOOL MANUFACTURING
 150 Express St. Plainview, NY 11803
 (516) 738-0388 • (800) 247-5696
 Fax (516) 279-1106

NEW!



**BUY 7
 BAR CHAMPS**

**GET THE
 FREE DISPLAY**

BAR CHAMP™



IMPACT
 1/4" HEX IMPACT SHANK



Bar Champ - Small - M2 HSS

Part #	Description	Size	Qty.	List
BAR-01	Outer Reamer (HSS)	1/8" - 3/4"	1	\$35.50
DIS-07	Counter Display		1	\$54.75

- ◆ 1/4" Hex Impact Shank
- ◆ Outer Reamer
- ◆ Retail Packaging

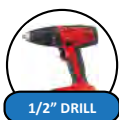



Bar Champ - Small - Carbide Blade

Part #	Description	Size	Qty.	List
BAR-01C	Outer Reamer (Carbide)	1/8" - 3/4"	1	\$60.60



Bar Champ - Medium - Carbide Blade

Part #	Description	Size	Qty.	List
BAR-02C	Outer Reamer (Carbide)	1/2" - 1-3/8"	1	\$118.68



Bar Champ - Large - Carbide Blade

Part #	Description	Size	Qty.	List
BAR-03C	Outer Reamer (Carbide)	1-3/8" - 2-1/8"	1	\$211.44



IMPACT
1/4" HEX IMPACT SHANK



- ◆ 1/4" Hex Impact Shank
- ◆ Outer Reamer
- ◆ Retail Packaging

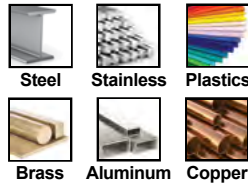

- ◆ 3/8" Hex Shank
- ◆ Outer Reamer
- ◆ Retail Packaging



For Use With:

- Threaded Rod
- Round Stock
- Bar Stock
- Rebar
- Bolts



Works Great For
Damaged Bolts
And Fasteners!



TAP AND DRILL

NC = National Course
 NF = National Fine

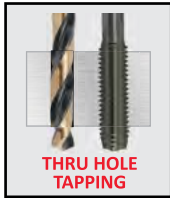

THRU HOLE TAPPING

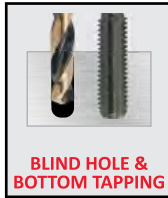

BLIND HOLE & BOTTOM TAPPING





TAPER



8 to 10 threads chamfered for easy thread starting in tough materials.

PLUG

3 to 5 threads chamfered for general use in thru holes or when tapping to bottom of hole is not critical.
MOST POPULAR STYLE TAP.

BOTTOM



1-1/2 threads chamfered for use after threads have been started. Use for blind holes or clean tapping to bottom of holes.

DRILL THIS SIZE HOLE			
DECIMAL INCHES	DRILL SIZE	NEAREST FRACTION	TO TAP FOR THIS BOLT OR SCREW
.0469"	3/64"	3/64"	0-80 NF
.0595"	No. 53	none	1-64 NC
.0595"	No. 53	1/16"	1-72 NF
.0700"	No. 50	none	2-56 NC
.0700"	No. 50	none	2-64 NF
.0785"	No. 47	5/64"	3-48 NC
.0820"	No. 45	none	3-56 NF
.0860"	No. 44	none	4-36 NS
.0890"	No. 43	3/32"	4-40 NC
.0935"	No. 42	3/32"	4-48 NF
.0984"	2.5mm	none	3mm-0.60mm
.1015"	No. 38	none	1/8"-40 NS
.1015"	No. 38	none	5-40 NC
.1040"	No. 37	none	5-44 NF
.1100"	No. 35	7/64"	6-32 NC
.1110"	No. 34	none	6-36 NS
.1130"	No. 33	none	6-40 NF
.1200"	No. 31	none	6-48 NS
.1338"	3.4mm	none	4mm-0.70mm
.1338"	3.4mm	none	4mm-0.75mm
.1360"	No. 29	none	8-32 NC
.1360"	No. 29	9/64"	8-36 NF
.1405"	No. 28	none	8-40 NS
.1470"	No. 26	none	3/16"-24 NS
.1495"	No. 25	5/32"	10-24 NC
.1570"	No. 22	none	3/16"-32 NS
.1590"	No. 21	5/32"	10-32 NF
.1653"	4.2mm	none	5mm-0.90mm
.1693"	4.3mm	none	5mm-0.80mm
.1770"	No. 16	11/64"	12-24 NC
.1820"	No. 14	3/16"	12-28 NF
.1850"	No. 13	none	12-32 NEF
.1935"	No. 10	none	14-20 NS
.2010"	No. 7	13/64"	1/4"-20 NC
.2010"	No. 7	none	14-24 NS
.2047"	5.2mm	none	6mm-1.00mm
.2090"	No. 4	none	1/4"-24 NS
.2130"	No. 3	7/32"	1/4"-28 NF
.2188"	7/32"	7/32"	1/4"-32 NEF
.2280"	No. 1	none	1/4"-40 NS
.2401"	6.1mm	15/64"	7mm-1.00mm
.2570"	Ltr. F	17/64"	5/16"-18 NC
.2716"	6.9mm	17/64"	8mm-1.25mm
.2720"	Ltr. I	none	5/16"-24 NF
.2795"	7.1mm	none	8mm-1.00mm
.2812"	9/32"	9/32"	5/16"-32 NEF
.3110"	7.9mm	none	9mm-1.25mm
.3125"	5/16"	5/16"	3/8"-16 NC

DRILL THIS SIZE HOLE			
DECIMAL INCHES	DRILL SIZE	NEAREST FRACTION	TO TAP FOR THIS BOLT OR SCREW
.3189"	8.1mm	none	9mm-1.00mm
.3268"	8.3mm	none	9mm-0.75mm
.3320"	Ltr. Q	21/64"	3/8"-24 NF
.3425"	8.7mm	none	10mm-1.50mm
.3503"	8.9mm	11/32"	10mm-1.25mm
.3583"	9.1mm	none	*10mm-1.00mm
.3680"	Ltr. U	23/64"	7/16"-14 NC
.3818"	9.7mm	none	11mm-1.50mm
.3906"	25/64"	25/64"	7/16"-20 NF
.4133"	10.5mm	none	12mm-1.75mm
.4212"	10.7mm	27/64"	12mm-1.50mm
.4219"	27/64"	27/64"	1/2"-13 NC
.4291"	10.9mm	27/64"	*12mm-1.25mm
.4531"	29/64"	29/64"	1/2"-20 NF
.4531"	29/64"	29/64"	1/2"-24 NS
.4803"	12.2mm	none	14mm-2.00mm
.4844"	31/64"	31/64"	9/16"-12 NC
.4999"	12.7mm	none	14mm-1.50mm
.5039"	12.8mm	none	*14mm-1.25mm
.5156"	33/64"	33/64"	9/16"-18 NF
.5312"	17/32"	17/32"	5/8"-11 NC
.5590"	14.2mm	35/64"	16mm-2.00mm
.5781"	37/64"	37/64"	5/8"-18 NF
.5787"	14.7mm	none	16mm-1.50mm
.5938"	19/32"	19/32"	11/16"-11 NS
.6220"	15.8mm	39/64"	18mm-2.50mm
.6250"	5/8"	5/8"	11/16"-16 NS
.6562"	21/32"	21/32"	3/4"-10 NC
.6614"	16.8mm	none	*18mm-1.50mm
.6875"	11/16"	11/16"	3/4"-16 NF
.7008"	17.8mm	11/16"	20mm-2.50mm
.7656"	49/64"	49/64"	7/8"-9 NC
.8125"	13/16"	13/16"	7/8"-14 NF
.8228"	20.9mm	none	22mm-1.50mm
.8281"	53/64"	53/64"	*7/8"-18 NS
.8425"	21.4mm	53/64"	24mm-3.00mm
.8750"	7/8"	7/8"	1"-8 NC
.8779"	22.3mm	none	24mm-2.00mm
.9219"	59/64"	59/64"	1"-12 NF
.9375"	15/16"	15/16"	1"-14 NS
.9844"	63/64"	63/64"	1-1/8" - 7 NC
1.0469"	1-3/64"	1-3/64"	1-1/8" - 12 NF
1.1094"	1-7/64"	1-7/64"	1-1/4" - 7 NC
1.1719"	1-11/64"	1-11/64"	1-1/4" - 12 NF
1.2188"	1-7/32"	1-7/32"	1-3/8" - 6 NC
1.2969"	1-19/64"	1-19/64"	1-3/8" - 12 NF
1.3468"	1-11/32"	1-11/32"	1-1/2" - 6 NC
1.4219"	1-27/64"	1-27/64"	1-1/2" - 12 NF

* Spark Plug Taps.

HSS Taps

6 PC. PER PACK FROM
 4 - 40 → 5/8" - 18
 SOLD 1 PC. OVER 5/8" - 18

Carbon Steel Taps

10 PC. PER PACK FROM 4 - 40 → 1/2" - 20
 5 PC. PER PACK FROM
 9/16" - 12 → 7/8" - 14
 SOLD 1 PC. OVER 7/8" - 14

**INTERNAL
PIPE THREADING**

NPT Taper Pipe Taps - M2 HSS

Part #	Size	Threads Per Inch NPT Only	No. Of Flutes	OAL	Thread Length	List
265TP0464	1/16"	27	4	2-1/8"	11/16"	\$16.61
265TP0864	1/8"	27	4	2-1/8"	3/4"	\$16.61
265TP1664	1/4"	18	4	2-7/16"	1-1/16"	\$26.78
265TP2464	3/8"	18	4	2-9/16"	1-1/16"	\$32.05
265TP3264	1/2"	14	4	3-1/8"	1-3/8"	\$57.67
265TP4864	3/4"	14	5	3-1/4"	1-3/8"	\$90.04
265TP6464	1"	11.5	5	3-3/4"	1-3/4"	\$144.50
265TP8064	1-1/4"	11.5	5	4"	1-3/4"	\$182.84
265TP9664	1-1/2"	11.5	7	4-1/4"	1-3/4"	\$282.46
265TP9964	2"	11.5	7	4-1/2"	1-3/4"	\$409.59



- ◆ National Pipe Tap
- ◆ M2 HSS
- ◆ Ground Thread
- ◆ Heavy Duty

SOLD INDIVIDUALLY IN PLASTIC TUBES.

(Carbon Steel) NPT Taper Pipe Taps

Part #	Size	Threads Per Inch NPT Only	No. Of Flutes	OAL	Thread Length	List
NPT0464	1/16"	27	4	2-1/8"	11/16"	\$7.91
NPT0864	1/8"	27	4	2-1/8"	3/4"	\$7.91
NPT1664	1/4"	18	4	2-7/16"	1-1/16"	\$9.39
NPT2464	3/8"	18	4	2-9/16"	1-1/16"	\$12.52
NPT3264	1/2"	14	4	3-1/8"	1-3/8"	\$21.90
NPT4864	3/4"	14	5	3-1/4"	1-3/8"	\$30.59
NPT6464	1"	11.5	5	3-3/4"	1-3/4"	\$52.81
NPT8864	1-1/4"	11.5	5	4"	1-3/4"	\$74.67
NPT9664	1-1/2"	11.5	7	4-1/4"	1-3/4"	\$109.52
NPT9964	2"	11.5	7	4-1/2"	1-3/4"	\$153.34



- ◆ National Pipe Tap
- ◆ Carbon Steel
- ◆ Ground Thread
- ◆ General Purpose

SOLD INDIVIDUALLY IN PLASTIC TUBES.

**NPT
TAP-DRILL CHART**



DRILL THIS SIZE HOLE			TO TAP FOR THIS BOLT OR SCREW
DECIMAL INCHES	DRILL SIZE	NEAREST FRACTION	
.3390"	Ltr. R	none	1/8-27 NPT
.4375"	7/16"	7/16"	1/4-18 NPT
.5781"	37/64"	37/64"	3/8- 18 NPT
.7031"	45/64"	45/64"	1/2-14 NPT
.9219"	59/64"	59/64"	3/4-14 NPT
1.1562"	1-5/32"	1-5/32"	1 - 11-1/2 NPT
1.5000"	1-1/2"	1-1/2"	1-1/4 - 11-1/2 NPT
1.7344"	1-47/64"	1-47/64"	1-1/2 - 11-1/2 NPT
2.2188"	2-3/16"	2-3/16"	2 - 11-1/2 NPT

i Wrenches will accommodate all HSS & Carbon Hand Taps within O.D. size.
O.D. Size = Actual Tap Size (machine screw thread).

T-Handle Tap Wrench

Part #	O.D. Size	List
271TT0001	#0 - 1/4"	\$14.88
271TT0002	#10 - 1/2"	\$20.76



Tap Reamer Wrench

Part #	O.D. Size	Size	List
270TW0000	#0-1/4"	TW0	\$15.54
270TW0004	#0-3/8"	TW4	\$32.72
270TW0005	#7-1/2"	TW5	\$27.62
270TW0006	#7-3/4"	TW6	\$39.76
270TW0007	1/4" → 1-1/8"	TW7	\$69.97





Carbon Steel Hand Taps - MACHINE SCREW

PART #			Machine Screw Thread	No. Of Flutes	Ground Thread Limit	OAL	Use Thread Length	Drill Size	List
TAPER	PLUG	BOTTOM							
C62NC0004	C63NC0004	C64NC0004	4-40 NC	3	H2	1-7/8"	9/16"	43	\$3.14
C62NF0004	C63NF0004	C64NF0004	4-48 NF	3	H2	1-7/8"	9/16"	42	\$3.14
C62NC0005	C63NC0005	C64NC0005	5-40 NC	3	H2	1-15/16"	7/8"	38	\$3.14
C62NF0005	C63NF0005	C64NF0005	5-44 NF	3	H2	1-15/16"	7/8"	37	\$3.14
C62NC0006	C63NC0006	C64NC0006	6-32 NC	3	H2	2"	11/16"	35	\$3.14
C62NF0006	C63NF0006	C64NF0006	6-40 NF	3	H2	2"	11/16"	33	\$3.14
C62NC0008	C63NC0008	C64NC0008	8-32 NC	4	H3	2-1/8"	3/4"	29	\$3.29
C62NF0008	C63NF0008	C64NF0008	8-36 NF	4	H3	2-1/8"	3/4"	29	\$3.29
C62NC0010	C63NC0010	C64NC0010	10-24 NC	4	H3	2-3/8"	7/8"	25	\$3.51
C62NF0010	C63NF0010	C64NF0010	10-32 NF	4	H3	2-3/8"	7/8"	21	\$3.51
C62NC0012	C63NC0012	C64NC0012	12-24 NC	4	H3	2-3/8"	15/16"	16	\$4.81
C62NF0012	C63NF0012	C64NF0012	12-28 NF	4	H3	2-3/8"	15/16"	14	\$4.81

Carbon Steel Hand Taps - FRACTIONAL

PART #			Machine Screw Thread	No. Of Flutes	Ground Thread Limit	OAL	Use Thread Length	Drill Size	List
TAPER	PLUG	BOTTOM							
C65NC0310	C66NC0310	C67NC0310	1/4"-20 NC	4	H3	2-1/2"	1"	7	\$3.17
C65NF0312	C66NF0312	C67NF0312	1/4"-28 NF	4	H3	2-1/2"	1"	3	\$3.17
C65NC0315	C66NC0315	C67NC0315	5/16"-18 NC	4	H3	2-23/32"	1-1/8"	F	\$4.40
C65NF0316	C66NF0316	C67NF0316	5/16"-24 NF	4	H3	2-23/32"	1-1/8"	I	\$4.40
C65NC0318	C66NC0318	C67NC0318	3/8"-16 NC	4	H3	2-15/16"	1-1/4"	5/16"	\$5.04
C65NF0319	C66NF0319	C67NF0319	3/8"-24 NF	4	H3	2-15/16"	1-1/4"	Q	\$5.04
C65NC0320	C66NC0320	C67NC0320	7/16"-14 NC	4	H3	3-5/32"	1-7/16"	U	\$6.05
C65NF0321	C66NF0321	C67NF0321	7/16"-20 NF	4	H3	3-5/32"	1-7/16"	25/64"	\$6.05
C65NC0322	C66NC0322	C67NC0322	1/2"-13 NC	4	H3	3-3/8"	1-21/32"	27/64"	\$8.08
C65NF0323	C66NF0323	C67NF0323	1/2"-20 NF	4	H3	3-3/8"	1-21/32"	29/64"	\$8.08
C65NC0325	C66NC0325	C67NC0325	9/16"-12 NC	4	H3	3-19/32"	1-21/32"	31/64"	\$10.20
C65NF0326	C66NF0326	C67NF0326	9/16"-18 NF	4	H3	3-19/32"	1-21/32"	33/64"	\$10.20
C65NC0327	C66NC0327	C67NC0327	5/8"-11 NC	4	H3	3-13/16"	1-13/16"	17/32"	\$12.52
C65NF0328	C66NF0328	C67NF0328	5/8"-18 NF	4	H3	3-13/16"	1-13/16"	37/64"	\$12.52
C65NC0331	C66NC0331	C67NC0331	3/4"-10 NC	4	H3	4-1/4"	2"	21/32"	\$14.47
C65NF0332	C66NF0332	C67NF0332	3/4"-16 NF	4	H3	4-1/4"	2"	11/16"	\$14.47
C65NC0333	C66NC0333	C67NC0333	7/8"-9 NC	4	H4	4-11/16"	2-7/32"	49/64"	\$22.08
C65NF0334	C66NF0334	C67NF0334	7/8"-14 NF	4	H4	4-11/16"	2-7/32"	13/16"	\$22.08
C65NC0335	C66NC0335	C67NC0335	1"-8 NC	4	H4	5-1/8"	2-1/2"	7/8"	\$27.88
C65NF0336	C66NF0336	C67NF0336	1"-12 NF	4	H4	5-1/8"	2-1/2"	59/64"	\$27.88
C65NS0337	C66NS0337	C67NS0337	1"-14 NS	4	H4	5-1/8"	2-1/2"	15/16"	\$27.88
C65NC0338	C66NC0338	C67NC0338	1-1/8"- 7 NC	4	H4	5-7/16"	2-9/16"	63/64"	\$49.46

Carbon Steel Taps



- ◆ Mild Steel
- ◆ Cast Iron
- ◆ Aluminum
- ◆ Carbon Steel
- ◆ Ground Thread
- ◆ General Purpose

10 PC. PER PACK FROM
 4 - 40 → 1/2" - 20
 5 PC. PER PACK FROM
 9/16" - 12 → 7/8" - 14
 SOLD 1 PC. OVER 7/8" - 14



High Speed Steel Hand Taps - MACHINE SCREW GROUND THREAD - *M2 HSS*

PART #			Machine Screw Thread	No. Of Flutes	Ground Thread Limit	OAL	Use Thread Length	Drill Size	List
TAPER	PLUG	BOTTOM							
262NC0004	263NC0004	264NC0004	4-40 NC	3	H2	1-7/8"	9/16"	43	\$6.64
262NF0004	263NF0004	264NF0004	4-48 NF	3	H2	1-7/8"	9/16"	42	\$6.64
262NC0005	263NC0005	264NC0005	5-40 NC	3	H2	1-15/16"	7/8"	38	\$6.64
262NF0005	263NF0005	264NF0005	5-44 NF	3	H2	1-15/16"	7/8"	37	\$6.64
262NC0006	263NC0006	264NC0006	6-32 NC	3	H2	2"	11/16"	35	\$6.64
262NF0006	263NF0006	264NF0006	6-40 NF	3	H2	2"	11/16"	33	\$6.64
262NC0008	263NC0008	264NC0008	8-32 NC	4	H3	2-1/8"	3/4"	29	\$6.85
262NF0008	263NF0008	264NF0008	8-36 NF	4	H3	2-1/8"	3/4"	29	\$6.85
262NC0010	263NC0010	264NC0010	10-24 NC	4	H3	2-3/8"	7/8"	25	\$6.95
262NF0010	263NF0010	264NF0010	10-32 NF	4	H3	2-3/8"	7/8"	21	\$6.95
262NC0012	263NC0012	264NC0012	12-24 NC	4	H3	2-3/8"	15/16"	16	\$7.11
262NF0012	263NF0012	264NF0012	12-28 NF	4	H3	2-3/8"	15/16"	14	\$7.11

High Speed Steel Hand Taps - FRACTIONAL GROUND THREAD - *M2 HSS*

PART #			Machine Screw Thread	No. Of Flutes	Ground Thread Limit	OAL	Use Thread Length	Drill Size	List
TAPER	PLUG	BOTTOM							
265NC0310	266NC0310	267NC0310	1/4"-20 NC	4	H3	2-1/2"	1"	7	\$6.86
265NF0312	266NF0312	267NF0312	1/4"-28 NF	4	H3	2-1/2"	1"	3	\$6.86
265NC0315	266NC0315	267NC0315	5/16"-18 NC	4	H3	2-23/32"	1-1/8"	F	\$9.60
265NF0316	266NF0316	267NF0316	5/16"-24 NF	4	H3	2-23/32"	1-1/8"	I	\$9.68
265NC0318	266NC0318	267NC0318	3/8"-16 NC	4	H3	2-15/16"	1-1/4"	5/16"	\$11.40
265NF0319	266NF0319	267NF0319	3/8"-24 NF	4	H3	2-15/16"	1-1/4"	Q	\$11.40
265NC0320	266NC0320	267NC0320	7/16"-14 NC	4	H3	3-5/32"	1-7/16"	U	\$14.67
265NF0321	266NF0321	267NF0321	7/16"-20 NF	4	H3	3-5/32"	1-7/16"	25/64"	\$14.67
265NC0322	266NC0322	267NC0322	1/2"-13 NC	4	H3	3-3/8"	1-21/32"	27/64"	\$17.42
265NF0323	266NF0323	267NF0323	1/2"-20 NF	4	H3	3-3/8"	1-21/32"	29/64"	\$17.42
265NC0325	266NC0325	267NC0325	9/16"-12 NC	4	H3	3-19/32"	1-21/32"	31/64"	\$24.15
265NF0326	266NF0326	267NF0326	9/16"-18 NF	4	H3	3-19/32"	1-21/32"	33/64"	\$24.15
265NC0327	266NC0327	267NC0327	5/8"-11 NC	4	H3	3-13/16"	1-13/16"	17/32"	\$24.75
265NF0328	266NF0328	267NF0328	5/8"-18 NF	4	H3	3-13/16"	1-13/16"	37/64"	\$24.75
265NS0329	266NS0329	267NS0329	11/16"-11 NS	4	H3	4-1/32"	1-13/16"	19/32"	\$54.74
265NS0330	266NS0330	267NS0330	11/16"-16 NS	4	H3	4-1/32"	1-13/16"	5/8"	\$54.74
265NC0331	266NC0331	267NC0331	3/4"-10 NC	4	H3	4-1/4"	2"	21/32"	\$38.76
265NF0332	266NF0332	267NF0332	3/4"-16 NF	4	H3	4-1/4"	2"	11/16"	\$38.76
265NC0333	266NC0333	267NC0333	7/8"-9 NC	4	H4	4-11/16"	2-7/32"	49/64"	\$54.07
265NF0334	266NF0334	267NF0334	7/8"-14 NF	4	H4	4-11/16"	2-7/32"	13/16"	\$62.18
265NC0335	266NC0335	267NC0335	1"-8 NC	4	H4	5-1/8"	2-1/2"	7/8"	\$85.20
265NF0336	266NF0336	267NF0336	1"-12 NF	4	H4	5-1/8"	2-1/2"	59/64"	\$85.20
265NS0337	266NS0337	267NS0337	1"-14 NS	4	H4	5-1/8"	2-1/2"	15/16"	\$85.20

HSS Taps
 6 PC. PER PACK FROM
 4 - 40 → 5/8" - 18
 SOLD 1 PC. OVER 5/8" - 18

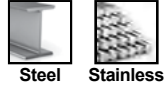

- ◆ Steel
- ◆ Stainless
- ◆ M2 HSS
- ◆ Ground Thread
- ◆ Heavy Duty



- ◆ M2 HSS
- ◆ Ground Thread
- ◆ Heavy Duty

Spiral Point Taps are ideal for machine tapping through holes or blind holes with adequate bottom clearance.

SOLD IN PACKS OF 6.



Spiral Point (Gun) Taps - *M2 HSS*

Part #	Size	No. Of Flutes	OAL	Thread Length	Drill Size	List
265SP0632	6-32	2	2"	11/16"	35	\$6.97
265SP0832	8-32	2	2-1/8"	3/4"	29	\$6.97
265SP1024	10-24	2	2-3/8"	7/8"	25	\$6.97
265SP1032	10-32	2	2-3/8"	7/8"	25	\$6.97
265SP1224	12-24	2	2-3/8"	15/16"	16	\$7.50
265SP1420	1/4"-20	2	2-1/2"	1"	7	\$7.82
265SP1428	1/4"-28	2	2-1/2"	1"	7	\$7.82
265SP5618	5/16"-18	2	2-23/32"	1-1/8"	F	\$9.08
265SP3816	3/8"-16	3	2-15/16"	1-1/4"	5/16"	\$10.88
265SP1312	1/2"-13	3	3-3/8"	1-21/32"	27/64"	\$17.28



- ◆ M2 HSS
- ◆ Ground Thread
- ◆ Heavy Duty



Spiral Point Taps are ideal for machine tapping through holes or blind holes with adequate bottom clearance.

SOLD IN PACKS OF 5.



Spiral Point (Gun) Taps - *M2 HSS*

Part #	Size	No. Of Flutes	OAL	Thread Length	Drill Size	List
GUN-0632	6-32	2	2"	11/16"	35	\$11.16
GUN-0832	8-32	2	2-1/8"	3/4"	29	\$11.66
GUN-1024	10-24	2	2-3/8"	7/8"	25	\$12.23
GUN-1032	10-32	2	2-3/8"	7/8"	25	\$12.23
GUN-1224	12-24	2	2-3/8"	15/16"	16	\$14.91
GUN-1420	1/4"-20	2	2-1/2"	1"	7	\$12.76
GUN-1428	1/4"-28	2	2-1/2"	1"	7	\$13.86
GUN-5618	5/16"-18	2	2-23/32"	1-1/8"	F	\$16.85
GUN-3816	3/8"-16	3	2-15/16"	1-1/4"	5/16"	\$18.53
GUN-1312	1/2"-13	3	3-3/8"	1-21/32"	27/64"	\$35.07
GUN-3410	3/4"-10	3	3-3/8"	1-21/32"	27/64"	\$95.50



- ◆ M2 HSS
- ◆ Ground Thread
- ◆ Heavy Duty

Drill and Tap holes in one operation, saving a complete setup!

SOLD IN PACKS OF 5.



Combo Drill Taps - *M2 HSS*

Part #	Thread Size	Drill Size	Thread Length	OAL	List
266TD0632	6-32	0.1095	11/16"	2"	\$22.13
266TD0832	8-32	0.1360	3/4"	2-1/8"	\$22.70
266TD0836	8-36	0.1360	3/4"	2-1/8"	\$22.71
266TD1024	10-24	0.1520	7/8"	2-3/8"	\$23.46
266TD1032	10-32	0.1520	7/8"	2-3/8"	\$23.46
266TD1224	12-24	0.1770	15/16"	2-3/8"	\$24.66
267TD1420	1/4"-20	0.2010	15/16"	2-1/2"	\$27.41
267TD1428	1/4"-28	0.2010	15/16"	2-1/2"	\$27.41
267TD5618	5/16"-18	0.2570	1-1/8"	3"	\$32.91
267TD3816	3/8"-16	0.3125	1-1/4"	3-1/2"	\$38.31
267TD3824	3/8"-24	0.3125	1-1/4"	3-1/2"	\$46.20
267TD7614	7/16"-14	0.3680	1-7/16"	3-7/8"	\$48.22
267TD1213	1/2"-13	0.4250	1-21/32"	4-1/4"	\$57.00



3 in 1 Combo Drill Taps - M2 HSS

Part #	Thread Size	Drill Size	Thread Length	OAL	List
HDT-0632	6-32	0.0787	9/64"	2-1/4"	\$21.08
HDT-0832	8-32	0.0984	5/32"	2-1/4"	\$21.62
HDT-1024	10-24	0.1181	13/64"	2-1/4"	\$22.34
HDT-1032	10-32	0.1181	5/32"	2-23/64"	\$22.34
HDT-1224	12-24	0.1181	13/64"	2-23/64"	\$23.48
HDT-1420	1/4"-20	0.1574	1/4"	2-37/64"	\$26.10
HDT-5618	5/16"-18	0.1574	29/64"	3"	\$36.49
HDT-3816	3/8"-16	0.1968	15/32"	3-3/16"	\$36.49
HDT-1213	1/2"-13	0.3419	27/64"	3-13/32"	\$51.22

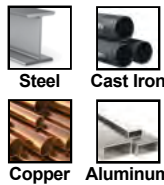

- ◆ 1/4" Hex Impact Shank
- ◆ M2 HSS
- ◆ Ground Thread
- ◆ Fast Spiral Flute
- ◆ Tri-Point Tip
- ◆ Retail Packaging
- ◆ Sold Individually



1. DRILLING

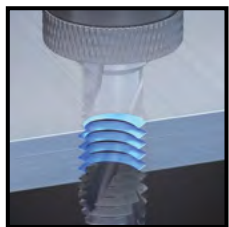

2. TAPPING



3. CHAMFER



IMPACT
1/4" HEX IMPACT SHANK



FAST SPIRAL FLUTE



IMPACT
1/4" HEX IMPACT SHANK



RETAIL PACKAGING

3 in 1 Combo Drill Taps - 8 Pc. Kit

Part #	Description	Sizes	List
HDT-SET8	8 Pc. 3 in 1 Drill Tap Kit	6-32 - 1/2"-13	\$238.82



6-32



12-24



8-32



1/4"-20



10-24



3/8"-16



10-32



1/2"-13



Tri-Point Tip



- ◆ M2 HSS
- ◆ Milled Body
- ◆ Ground Flute
- ◆ Sold Individually



Single (1) Flute Countersinks - *M2 HSS*

60° Part #	82° Part #	90° Part #	100° Part #	Size	Shank Diameter	Shank Length	OAL	List
CI-60-1264	CI-82-1264	CI-90-1264	CI-100-1264	3/16"	3/16"	3/4"	1-1/2"	\$11.50
CI-60-1664	CI-82-1664	CI-90-1664	CI-100-1664	1/4"	1/4"	3/4"	2"	\$11.74
CI-60-2064	CI-82-2064	CI-90-2064	CI-100-2064	5/16"	1/4"	1"	2"	\$13.74
CI-60-2464	CI-82-2464	CI-90-2464	CI-100-2464	3/8"	1/4"	1"	2"	\$16.29
CI-60-3264	CI-82-3264	CI-90-3264	CI-100-3264	1/2"	1/4"	1"	2"	\$20.28
CI-60-4064	CI-82-4064	CI-90-4064	CI-100-4064	5/8"	3/8"	1-1/8"	2-3/4"	\$31.15
CI-60-4864	CI-82-4864	CI-90-4864	CI-100-4864	3/4"	3/8"	1-5/16"	2-3/4"	\$34.90
CI-60-5064	CI-82-5064	CI-90-5064	CI-100-5064	7/8"	1/2"	1-5/16"	2-3/4"	\$55.50
CI-60-6464	CI-82-6464	CI-90-6464	CI-100-6464	1"	1/2"	1-5/16"	2-3/4"	\$61.65



Three (3) Flute Countersinks - *M2 HSS*

60° Part #	82° Part #	90° Part #	100° Part #	Size	Shank Diameter	Shank Length	OAL	List
R3-60-1664	R3-82-1664	R3-90-1664	R3-100-1664	1/4"	3/16"	3/4"	1-1/2"	\$11.74
R3-60-2464	R3-82-2464	R3-90-2464	R3-100-2464	3/8"	1/4"	7/8"	2-3/4"	\$16.29
R3-60-3264	R3-82-3264	R3-90-3264	R3-100-3264	1/2"	3/8"	1"	2"	\$20.28
R3-60-4064	R3-82-4064	R3-90-4064	R3-100-4064	5/8"	3/8"	1"	2-1/4"	\$31.15
R3-60-4864	R3-82-4864	R3-90-4864	R3-100-4864	3/4"	1/2"	1-1/4"	2-5/8"	\$34.90
R3-60-6464	R3-82-6464	R3-90-6464	R3-100-6464	1"	1/2"	1-1/4"	2-3/4"	\$61.65



IMPACT
 1/4" HEX IMPACT SHANK

- ◆ 1/4" Hex Impact Shank
- ◆ Inner Reamer
- ◆ Retail Packaging



Rim Champ - 90° - *M2 HSS*

Part #	Description	Size	Qty.	List
RIM-01	Inner Reamer (HSS)	1/8" - 3/4"	1	\$29.33
RIM-02	Inner Reamer (HSS)	3/16" - 7/8"	1	\$41.74



**TiALN
COATED**

Three (3) Flute Countersinks - M35 COBALT - 82°

Part #	Degree	Size	Shank	OAL	List
SK-82-2	82°	1/4"	1/4" HEX	1-1/2"	\$14.81
SK-82-4	82°	3/8"	1/4" HEX	1-1/2"	\$20.31
SK-82-5	82°	1/2"	1/4" HEX	1-1/2"	\$28.67
SK-82-7	82°	5/8"	1/4" HEX	1-1/2"	\$39.67
SK-82-8	82°	3/4"	1/4" HEX	1-1/2"	\$51.30



- ◆ 1/4" Hex Impact Shank
- ◆ M35 Cobalt
- ◆ Titanium Aluminum Nitride Coating
- ◆ Window & Door Installs
- ◆ Chatterless
- ◆ Sold Individually

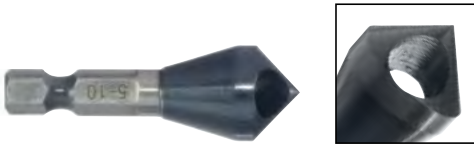

**TiALN
COATED**

Zero Flute Countersinks - M35 COBALT - 82°

Part #	Degree	Screw Size	Body Dia.	Shank	OAL	List
SX-1	82°	No. 2, 3, 4	1/4"	1/4" HEX	1-1/4"	\$17.77
SX-2	82°	No. 5, 6, 8	11/32"	1/4" HEX	1-1/2"	\$24.10
SX-3	82°	No. 10, 12, 14	9/16"	1/4" HEX	1-3/4"	\$35.45



- ◆ 1/4" Hex Impact Shank
- ◆ M2 HSS
- ◆ Window & Door Installs
- ◆ Chatterless
- ◆ Sold Individually



Zero Flute Countersinks - 82° - M2 HSS

Part #	Degree	Screw Size	Body Dia.	Shank	OAL	List
ZF-1	82°	No. 2, 3, 4	1/4"	1/4" HEX	1-27/32"	\$15.83
ZF-2	82°	No. 5, 6, 8	11/32"	1/4" HEX	2"	\$21.53
ZF-3	82°	No. 10, 12, 14	9/16"	1/4" HEX	2-5/16"	\$31.65



Screw Extractor - LEFT HAND SPIRAL FLUTE

Part #	Size	Shank Diameter	Removes Screws or Pipe	List
SE0001	1	5/64"	3/32" to 5/32"	\$4.72
SE0002	2	7/64"	5/32" to 7/32"	\$4.86
SE0003	3	5/32"	7/32" to 9/32"	\$5.83
SE0004	4	1/4"	9/32" to 3/8" 1/8" Pipe	\$6.81
SE0005	5	19/64"	3/8" to 5/8" 1/4" Pipe	\$8.75
SE0006	6	13/32"	5/8" to 7/8" 3/8" Pipe	\$13.24
SE0007	7	17/32"	7/8" to 1-1/8" 1/2" Pipe	\$16.23
SE0008	8	13/16"	1-1/8" to 1-3/8" 3/4" Pipe	\$27.52
SE0009	9	1-1/16"	1-3/8" to 2" 1" Pipe	\$40.08



Part # SE-006-16
6 Pc. Screw Extractor Set
 #1, #2, #3, #4, #5, #6
List \$40.55

6 Pc. Set



NEW
PACKAGING



- ◆ Individually Blister Packaged
- ◆ Industrial Quality
- ◆ 5/8" - 11 SPINDLE



USE RED - NUT WIRE CUP
 ADAPTER IN CLOCKWISE
 ROTATION ONLY.

KC



CC



Industrial Wire Cups

Part #	Size	Description	Wire Type	Max RPM	List
KCC075	2-3/4"	Knotted Cup	.020 Carbon Steel	12,500	\$15.81
KCS075	2-3/4"	Knotted Cup	.020 Stainless Steel	12,500	\$22.77
KCC100	4"	Knotted Cup	.020 Carbon Steel	8,500	\$22.84
KCC150	6"	Knotted Cup	.020 Carbon Steel	6,500	\$47.09
CCC075	3"	Crimped Cup	.014 Carbon Steel	12,500	\$14.93
CCC100	4"	Crimped Cup	.014 Carbon Steel	8,500	\$21.79

NEW!



The Red-Nut Wire Cup Adapter

Part #	Description	List
REDNUT	5/8"-11 Bolt and Nut Adapter	\$35.00

- ◆ 3-Flat Shank
- ◆ For Use in 1/2" Handheld Drills
- ◆ Light Grinding





Stringer Bead Wheel

NEW PACKAGING



Industrial Wire Wheels

Part #	Size	Description	Wire Type	Max RPM	List
TKW100	4"	Twist Knot Wheel	.020 Carbon Steel	12,500	\$18.27
SBW100	4"	Stringer Bead Wheel	.020 Carbon Steel	12,500	\$26.93
SBS100	4"	Stringer Bead Wheel	.020 Stainless Steel	12,500	\$40.06
SBW150	5"	Stringer Bead Wheel	.020 Carbon Steel	12,500	\$35.10
SBW175	7"	Stringer Bead Wheel	.020 Carbon Steel	9,000	\$54.03
WBB120	12"	Walk Behind Wire Brush	.035 Carbon Steel (1" Spindle)	3,600	\$143.55



- ◆ Individually Blister Packaged
- ◆ Industrial Quality
- ◆ 5/8" - 11 SPINDLE

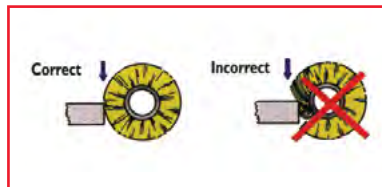

APPLICATION	KNOTTED CUP WIRE BRUSH	CRIMPED CUP WIRE BRUSH	TWIST KNOT WIRE BRUSH	STRINGER BEAD WIRE BRUSH
DEBURRING (FINE)	⊕	⊕		
DEBURRING (COURSE)			⊕	⊕
EDGE BLENDING	⊕	⊕		
WELD, SCALE REMOVAL			⊕	⊕
WELD PREP				⊕
SURFACE FINISHING	⊕	⊕		
RUST OXIDE (FINE)	⊕	⊕		
RUST OXIDE (COARSE)			⊕	⊕
PAINT REMOVAL	⊕	⊕		
ROUGHENING	⊕	⊕	⊕	⊕
CLEANING	⊕	⊕		⊕
FLASH REMOVAL		⊕	⊕	
TOOL MARK REMOVAL		⊕	⊕	
EXPANSION JOINT		⊕	⊕	





Cylinder

Part #	Dia.	Cut	Qty.	List
CBA-1	1/4"	5/8"	1	\$17.12
CBA-3	3/8"	3/4"	1	\$24.07
CBA-5	1/2"	1"	1	\$37.76
CBA-7	3/4"	1"	1	\$81.55



Tree w/ Radius

Part #	Dia.	Cut	Qty.	List
CBF-1	1/4"	5/8"	1	\$25.98
CBF-3	3/8"	3/4"	1	\$32.78
CBF-5	1/2"	1"	1	\$47.20
CBF-6	5/8"	1"	1	\$67.09



14° Taper w/ Radius

Part #	Dia.	Cut	Qty.	List
CBL-1	1/4"	5/8"	1	\$26.65
CBL-3	3/8"	1-1/16"	1	\$40.25
CBL-4	1/2"	1-1/8"	1	\$51.35
CBL-5	5/8"	1-3/16"	1	\$90.16
CBL-7	3/4"	1-1/2"	1	\$129.42

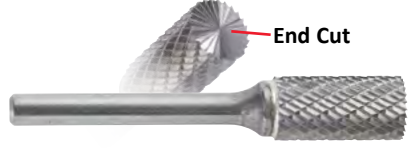

Cylinder w/ End Cut

Part #	Dia.	Cut	Qty.	List
CBB-1	1/4"	5/8"	1	\$23.18
CBB-3	3/8"	3/4"	1	\$33.27
CBB-5	1/2"	1"	1	\$51.75
CBB-7	3/4"	1"	1	\$92.53



Tree w/ Point

Part #	Dia.	Cut	Qty.	List
CBG-1	1/4"	5/8"	1	\$25.96
CBG-3	3/8"	3/4"	1	\$33.32
CBG-5	1/2"	1"	1	\$47.20



Pointed Cone

Part #	Dia.	Cut	Qty.	List
CBM-2	1/4"	3/4"	1	\$27.76
CBM-4	3/8"	5/8"	1	\$39.72
CBM-5	1/2"	7/8"	1	\$50.84



Cylinder w/ Radius

Part #	Dia.	Cut	Qty.	List
CBC-1	1/4"	5/8"	1	\$24.46
CBC-3	3/8"	3/4"	1	\$32.38
CBC-5	1/2"	1"	1	\$50.84
CBC-6	5/8"	1"	1	\$56.73



Flame

Part #	Dia.	Cut	Qty.	List
CBH-1	1/4"	1/2"	1	\$29.21
CBH-5	1/2"	1-1/4"	1	\$65.06



Inverted Cone

Part #	Dia.	Cut	Qty.	List
CBN-1	1/4"	5/16"	1	\$23.76
CBN-2	3/8"	3/8"	1	\$44.21
CBN-4	1/2"	1/2"	1	\$45.28

Made In



- ◆ Solid Carbide
- ◆ Bright Finish
- ◆ Sold Individually



DIE GRINDER



Ball

Part #	Dia.	Cut	Qty.	List
CBD-1	1/4"	1/4"	1	\$22.21
CBD-3	3/8"	3/8"	1	\$25.97
CBD-5	1/2"	1/2"	1	\$35.17



Cone 60°

Part #	Dia.	Cut	Qty.	List
CBJ-1	1/4"	3/16"	1	\$24.07
CBJ-3	3/8"	1/4"	1	\$29.61
CBJ-5	1/2"	7/16"	1	\$36.54



Oval

Part #	Dia.	Cut	Qty.	List
CBE-1	1/4"	3/8"	1	\$26.83
CBE-3	3/8"	5/8"	1	\$29.27
CBE-5	1/2"	7/8"	1	\$51.75
CBE-6	5/8"	1"	1	\$67.47



Cone 90°

Part #	Dia.	Cut	Qty.	List
CBK-1	1/4"	1/4"	1	\$24.64
CBK-3	3/8"	3/8"	1	\$30.36
CBK-5	1/2"	1/2"	1	\$36.54



Cylinder

Part #	Dia.	Cut	Qty.	List
SA-1NF	1/4"	3/4"	1	\$20.02
SA-3NF	3/8"	3/4"	1	\$29.08
SA-5NF	1/2"	1"	1	\$43.85
SA-6NF	5/8"	1"	1	\$52.10
SA-7NF	3/4"	1"	1	\$72.36



Ball

Part #	Dia.	Cut	Qty.	List
SD-1NF	1/4"	1/4"	1	\$19.21
SD-3NF	3/8"	3/8"	1	\$26.31
SD-5NF	1/2"	1/2"	1	\$37.28
SD-6NF	5/8"	5/8"	1	\$47.14
SD-7NF	3/4"	3/4"	1	\$63.06



Tree w/ Radius

Part #	Dia.	Cut	Qty.	List
SF-1NF	1/4"	3/4"	1	\$20.02
SF-3NF	3/8"	3/4"	1	\$29.36
SF-5NF	1/2"	1"	1	\$43.62
SF-6NF	5/8"	1"	1	\$52.62
SF-14NF	3/4"	1-1/4"	1	\$97.86



Cylinder w/ Radius

Part #	Dia.	Cut	Qty.	List
SC-1NF	1/4"	3/4"	1	\$20.31
SC-3NF	3/8"	3/4"	1	\$23.10
SC-5NF	1/2"	1"	1	\$43.85
SC-6NF	5/8"	1"	1	\$52.91
SC-7NF	3/4"	1"	1	\$73.45



Oval

Part #	Dia.	Cut	Qty.	List
SE-3NF	3/8"	5/8"	1	\$29.60
SE-5NF	1/2"	7/8"	1	\$43.85
SE-6NF	5/8"	1"	1	\$54.29
SE-7NF	3/4"	1"	1	\$73.74



14° Taper w/ Radius

Part #	Dia.	Cut	Qty.	List
SL-3NF	3/8"	1-1/16"	1	\$35.37
SL-4NF	1/2"	1-1/8"	1	\$45.52
SL-6NF	5/8"	1-5/16"	1	\$81.99
SL-7NF	3/4"	1-1/2"	1	\$112.40



METAL HUOT CASE

8 Pc. Carbide Burr Set

Part #	Description	Qty.	List
CB-8	8 Pc Ferrous Metal Set	1	\$214.37



Part#	Dia.	Cut
CBA-1	1/4"	5/8"
CBA-5	1/2"	1"



Part#	Dia.	Cut
CBC-3	3/8"	3/4"
CBC-5	1/2"	1"



Part#	Dia.	Cut
CBD-1	1/4"	1/4"
CBD-5	1/2"	1/2"



Part#	Dia.	Cut
CBF-3	3/8"	3/4"
CBF-5	1/2"	1"



Made In



- ◆ Solid Carbide
- ◆ Deep Flute
- ◆ Bright Finish
- ◆ Sold Individually



Non-Ferrous (Soft) Metals



Brass

Aluminum



Copper

Plastics



DIE GRINDER



- ◆ Solid Carbide
- ◆ Bright Finish

Made In



SOLID CARBIDE BURS



M2 HSS FAST SPIRAL



274MC0001
13 Steps 1/8" - 1/2"
List \$48.40

1/8"
5/32"
3/16"
7/32"
1/4"
9/32"
5/16"
11/32"
3/8"
13/32"
7/16"
15/32"
1/2"



274MC0002
6 Steps 3/16" - 1/2"
List \$47.13

3/16"
1/4"
5/16"
3/8"
7/16"
1/2"



274MC0003
10 Steps 3/16" - 3/4"
List \$58.60

3/16"
1/4"
5/16"
3/8"
7/16"
1/2"
9/16"
5/8"
11/16"
3/4"

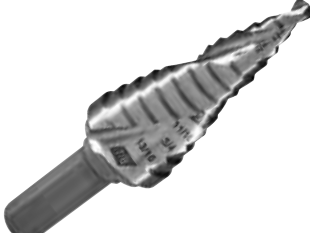

274MC0004
12 Steps 3/16" - 7/8"
List \$72.09

3/16"
1/4"
5/16"
3/8"
7/16"
1/2"
9/16"
5/8"
11/16"
3/4"
13/16"
7/8"



274MC0005
12 Steps 7/16" - 1-1/8"
List \$109.74

7/16"
1/2"
9/16"
5/8"
11/16"
3/4"
13/16"
7/8"
15/16"
1"
1-1/16"
1-1/8"

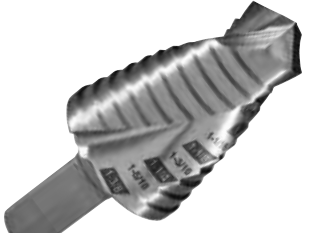

274MC0006
11 Steps 3/4" - 1-3/8"
List \$130.16

3/4"
13/16"
7/8"
15/16"
1"
1-1/16"
1-1/8"
1-3/16"
1-1/4"
1-5/16"
1-3/8"



274MC0007
3 Steps 3/8" - 3/4"
List \$76.36

3/8"
7/16"
3/4"

For drilling 3 standard size holes to accommodate drive screws for knockout punches.



274MC0008
2 Steps 7/8" - 1-1/8"
List \$108.21

3/16" STARTER POINT

7/8"
1-1/8"

7/8" hole for 1/2" conduit.
1-1/8" hole for 3/4" conduit.



274MC0009
5 Steps 7/8" - 1-3/8"
List \$121.99

3/16" STARTER POINT

7/8"
1-1/8"
1-7/32"
1-1/4"
1-3/8"

1-7/32" hole for oil tight switches.



274MC0010
1 Cone 7/8"
List \$65.53

7/8"



274MC0011
11 Steps 3/16" - 1-3/8"
List \$135.06

ENHANCED FAST SPIRAL

NEW!

3/8" HEX Shank

3/16" Drilling Depth

ENHANCED THE BIG 11
One Size Fits All

3/16"
1/4"
3/8"
1/2"
5/8"
3/4"
7/8"
1"
1-1/8"
1-1/4"
1-3/8"

- Steel
- Aluminum
- Copper
- Sheet Metal
- Mild Stainless
- Plastics

- ◆ M2 HSS
- ◆ 3/8" & 1/2" HEX Non-Slip Shank
- ◆ Drill 1/8" Thick
- ◆ 2-Fast Spiral Flutes
- ◆ Bright Finish

1/2" DRILL

STEP DRILLS ARE SOLD INDIVIDUALLY.

M2 HSS FAST SPIRAL



274HEX01
13 Steps 1/8" - 1/2"
List \$48.04

1/8"
5/32"
3/16"
7/32"
1/4"
9/32"
5/16"
11/32"
3/8"
13/32"
7/16"
15/32"
1/2"



274HEX02
6 Steps 3/16" - 1/2"
List \$46.78

3/16"
1/4"
5/16"
3/8"
7/16"
1/2"



274HEX03
10 Steps 3/16" - 3/4"
List \$58.16

3/16"
1/4"
5/16"
3/8"
7/16"
1/2"
9/16"
5/8"
11/16"
3/4"



274HEX04
12 Steps 3/16" - 7/8"
List \$74.80

3/16"
1/4"
5/16"
3/8"
7/16"
1/2"
9/16"
5/8"
11/16"
3/4"
13/16"
7/8"



274HEX05
12 Steps 7/16" - 1-1/8"
List \$117.16

7/16"
1/2"
9/16"
5/8"
11/16"
1/2"
3/4"
13/16"
7/8"
15/16"
1"
1-1/16"
1-1/8"



3/16" STARTER POINT
274HEX08
2 Steps 7/8" - 1-1/8"
List \$114.37

7/8"
1-1/8"

7/8" hole for 1/2" conduit.
1-1/8" hole for 3/4" conduit.



- ◆ 1/4" Hex Impact Shank
- ◆ M2 HSS
- ◆ 2-Fast Spiral Flutes
- ◆ Jam Free Performance
- ◆ Self Starting Split Point
- ◆ Bright Finish
- ◆ Sold Individually



IMPACT
1/4" HEX IMPACT SHANK

REDLINE

TiAlN COATED

M2 HSS



FXT-01
13 Steps 1/8" - 1/2"
List \$50.44

1/8"
5/32"
3/16"
7/32"
1/4"
9/32"
5/16"
11/32"
3/8"
13/32"
7/16"
15/32"
1/2"



FXT-02
6 Steps 3/16" - 1/2"
List \$49.12

3/16"
1/4"
5/16"
3/8"
7/16"
1/2"



FXT-03
10 Steps 3/16" - 3/4"
List \$61.07

3/16"
1/4"
5/16"
3/8"
7/16"
1/2"
9/16"
5/8"
11/16"
3/4"



FXT-04
12 Steps 3/16" - 7/8"
List \$78.54

3/16"
1/4"
5/16"
3/8"
7/16"
1/2"
9/16"
5/8"
11/16"
3/4"
13/16"
7/8"



FXT-05
12 Steps 7/16" - 1-1/8"
List \$111.84

7/16"
1/2"
9/16"
5/8"
11/16"
1/2"
3/4"
13/16"
7/8"
15/16"
1"
1-1/16"
1-1/8"



FXT-08
2 Steps 7/8" - 1-1/8"
List \$109.18

7/8"
1-1/8"

7/8" hole for 1/2" conduit.
1-1/8" hole for 3/4" conduit.

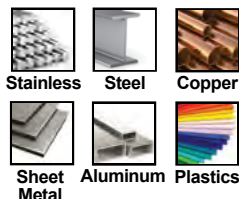

- ◆ 1/4" Hex Impact Shank
- ◆ M2 HSS
- ◆ 2-Fast Spiral Flutes
- ◆ Jam Free Performance
- ◆ Self Starting Split Point
- ◆ Titanium Aluminum Nitride Coating
- ◆ Sold Individually



XFLUTE M35 CO-TiAlN COATING FAST SPIRAL STEP DRILL

TiAlN COATED



XSTP-01
13 Steps 1/8" - 1/2"
List \$55.49

1/8"
5/32"
3/16"
7/32"
1/4"
9/32"
5/16"
11/32"
3/8"
13/32"
7/16"
15/32"
1/2"



XSTP-03
10 Steps 3/16" - 3/4"
List \$67.18

3/16"
1/4"
5/16"
3/8"
7/16"
1/2"
9/16"
5/8"
11/16"
3/4"



XSTP-04
12 Steps 3/16" - 7/8"
List \$86.39

3/16"
1/4"
5/16"
3/8"
7/16"
1/2"
9/16"
5/8"
11/16"
3/4"
13/16"
7/8"

- ◆ 1/4" Hex Impact Shank
- ◆ Cobalt
- ◆ 4-Fast Spiral Flutes
- ◆ Great for Stainless
- ◆ Self Starting Split Point
- ◆ Titanium Aluminum Nitride Coating
- ◆ Sold Individually





3-FLAT SHANK

Reamer - CAR / Construction - Spiral Flute - **M2 HSS**

Part #	Size	Point Diameter	OAL	Flute	Shank	Type	List
CRF-2464	3/8"	0.250	5"	4"	3/8"	3-Flat Car / Constr.	\$48.81
CRF-2864	7/16"	0.281	5-1/4"	4"	7/16"	3-Flat Car / Constr.	\$55.19
CRF-3264	1/2"	0.343	6"	4-1/2"	1/2"	3-Flat Car / Constr.	\$62.64
CRF-3664	9/16"	0.343	6-1/4"	4-1/2"	1/2"	3-Flat Car / Constr.	\$66.31
CRF-4064	5/8"	0.343	6-1/2"	4-1/2"	1/2"	3-Flat Car / Constr.	\$73.17
CRF-4464	11/16"	0.375	7"	4-1/2"	1/2"	3-Flat Car / Constr.	\$84.65
CRF-4864	3/4"	0.406	7-1/4"	5"	1/2"	3-Flat Car / Constr.	\$97.63
CRF-5264	13/16"	0.468	7-1/4"	5"	1/2"	3-Flat Car / Constr.	\$103.52
CRF-5664	7/8"	0.500	7-1/4"	5"	1/2"	3-Flat Car / Constr.	\$116.05
CRF-6064	15/16"	0.585	7-1/4"	5"	1/2"	3-Flat Car / Constr.	\$129.64
CRF-6464	1"	0.594	7-1/4"	5"	1/2"	3-Flat Car / Constr.	\$137.42
CRF-6864	1-1/16"	0.807	7-1/4"	5"	1/2"	3-Flat Car / Constr.	\$159.10



- ◆ M2 HSS
- ◆ Tapered Point
- ◆ Left-Hand Spiral
- ◆ Right-Hand Cut
- ◆ 3-Flat Shank
- ◆ Made in Europe
- ◆ Sold Individually



Reaming Steel For Aligning Existing Holes & Bolt / Rivet Installation



Reamer - CAR/Construction - Spiral Flute - **HEX - M2 HSS**

Part #	Size	Point Diameter	OAL	Flute	Shank	Type	List
CHX-4464	11/16"	0.375	6-3/8"	4-1/2"	1-1/16"	HEX Car	\$91.71
CHX-5264	13/16"	0.468	7"	5"	1-1/4"	HEX Car	\$98.81
CHX-6064	15/16"	0.585	7"	5"	1-7/16"	HEX Car	\$117.46
CHX-6864	1-1/16"	0.807	7"	5"	1-5/8"	HEX Car	\$152.51



- ◆ M2 HSS
- ◆ Tapered Point
- ◆ Left-Hand Spiral
- ◆ Right-Hand Cut
- ◆ HEX Nut Shank
- ◆ Made in Europe
- ◆ Sold Individually



Reaming Steel For Aligning Existing Holes & Bolt / Rivet Installation



Reamer - BRIDGE - Spiral Flute - **HEX - M2 HSS**

Part #	Size	Point Diameter	OAL	Flute	Shank	Type	List
CBB-4464	11/16"	0.375	9-1/4"	7-1/8"	1-1/16"	HEX Bridge	\$110.64
CBB-5264	13/16"	0.468	9-3/8"	7-3/8"	1-1/4"	HEX Bridge	\$139.79
CBB-6064	15/16"	0.585	9-3/8"	7-3/8"	1-7/16"	HEX Bridge	\$166.16
CBB-6864	1-1/16"	0.807	9-3/8"	7-3/8"	1-5/8"	HEX Bridge	\$226.14



3-FLAT SHANK

Reamer - CAR / Construction - Spiral Flute - M2 HSS

Part #	Size	Point Diameter	OAL	Flute	Shank	Type	List
ASF-2464	3/8"	0.250	5"	4"	3/8"	3-Flat Car / Constr.	\$102.59
ASF-3264	1/2"	0.281	6"	4-1/2"	1/2"	3-Flat Car / Constr.	\$122.18
ASF-3664	9/16"	0.343	6-1/4"	4-1/2"	1/2"	3-Flat Car / Constr.	\$130.02
ASF-4064	5/8"	0.343	6-1/2"	4-1/2"	1/2"	3-Flat Car / Constr.	\$141.90
ASF-4464	11/16"	0.375	7"	4-1/2"	1/2"	3-Flat Car / Constr.	\$157.73
ASF-4864	3/4"	0.406	7-1/4"	5"	1/2"	3-Flat Car / Constr.	\$189.25
ASF-5264	13/16"	0.468	7-1/4"	5"	1/2"	3-Flat Car / Constr.	\$193.93
ASF-5664	7/8"	0.500	7-1/4"	5"	1/2"	3-Flat Car / Constr.	\$213.75
ASF-6064	15/16"	0.585	7-1/4"	5"	1/2"	3-Flat Car / Constr.	\$213.75
ASF-6464	1"	0.594	7-1/4"	5"	1/2"	3-Flat Car / Constr.	\$250.78
ASF-8064	1-1/4"	0.719	7-1/4"	5"	1/2"	3-Flat Car / Constr.	\$391.81



3-FLAT SHANK

Reamer - CAR/Construction - Fast Spiral - M2 HSS

Part #	Size	Point Diameter	OAL	Flute	Shank	Type	List
AFC-2464	3/8"	0.250	5"	4"	3/8"	3-Flat Car / Constr.	\$113.14
AFC-3264	1/2"	0.281	6"	4-1/2"	1/2"	3-Flat Car / Constr.	\$134.70
AFC-3664	9/16"	0.343	6-1/4"	4-1/2"	1/2"	3-Flat Car / Constr.	\$143.05
AFC-4064	5/8"	0.343	6-1/2"	4-1/2"	1/2"	3-Flat Car / Constr.	\$156.72
AFC-4464	11/16"	0.375	7"	4-1/2"	1/2"	3-Flat Car / Constr.	\$174.39
AFC-4864	3/4"	0.406	7-1/4"	5"	1/2"	3-Flat Car / Constr.	\$208.25
AFC-5264	13/16"	0.468	7-1/4"	5"	1/2"	3-Flat Car / Constr.	\$213.52
AFC-5664	7/8"	0.500	7-1/4"	5"	1/2"	3-Flat Car / Constr.	\$236.05
AFC-6064	15/16"	0.585	7-1/4"	5"	1/2"	3-Flat Car / Constr.	\$236.05
AFC-6464	1"	0.594	7-1/4"	5"	1/2"	3-Flat Car / Constr.	\$276.24
AFC-8064	1-1/4"	0.719	7-1/4"	5"	1/2"	3-Flat Car / Constr.	\$430.99



Reamer - CAR - Spiral Flute - HEX - M2 HSS

Part #	Size	Point Diameter	OAL	Flute	Shank	Type	List
ACX-4464	11/16"	0.375	6-3/8"	4-1/2"	1-1/16"	HEX Car	\$185.12
ACX-5264	13/16"	0.468	7"	5"	1-1/4"	HEX Car	\$221.87
ACX-6064	15/16"	0.585	7"	5"	1-7/16"	HEX Car	\$251.05
ACX-6864	1-1/16"	0.807	7"	5"	1-5/8"	HEX Car	\$328.72

Reaming Steel For Aligning Existing Holes & Bolt / Rivet Installation

Black & Gold



- ◆ M2 HSS
- ◆ Tapered Point
- ◆ Left-Hand Spiral
- ◆ Right-Hand Cut
- ◆ 3-Flat Shank
- ◆ Sold Individually



Black & Gold



- ◆ M2 HSS
- ◆ Tapered Point
- ◆ Left-Hand Spiral
- ◆ Right-Hand Cut
- ◆ 3-Flat Shank
- ◆ Sold Individually



Black & Gold



- ◆ M2 HSS
- ◆ Tapered Point
- ◆ Left-Hand Spiral
- ◆ Right-Hand Cut
- ◆ HEX Nut Shank
- ◆ Sold Individually





1" Cutting Depth

1" Annular Twist Drill-M2 HSS

Part #	Size	Depth	List
100DR1664	1/4"	1"	\$53.47
100DR2064	5/16"	1"	\$53.47
100DR2464	3/8"	1"	\$53.47
100DR2864	7/16"	1"	\$53.47
100DR3264	1/2"	1"	\$59.72



2" Cutting Depth

2" Annular Twist Drill-M2 HSS

Part #	Size	Depth	List
200DR1664	1/4"	2"	\$63.19
200DR2064	5/16"	2"	\$63.19
200DR2464	3/8"	2"	\$63.19
200DR2864	7/16"	2"	\$63.19
200DR3264	1/2"	2"	\$75.00



- ◆ M2 HSS
- ◆ 3/4" Weldon Shanks
- ◆ For Small Diameters
- ◆ Aggressive Cutting Edges
- ◆ No Center Punch Required
- ◆ Cut up to 2"
- ◆ For All Magnetic Drills
- ◆ Sold Individually

ANNULAR TWIST DRILL M2 HSS



3/4" Weldon Shank

Use Cutting Oil



Annular Cutter Kit - 6 Pc.

Part #	Description	List
100MC-SET1	1" Cutting Depth	\$395.70
200MC-SET1	2" Cutting Depth	\$563.68

**Each Set Include the Diameters:
 1/2" • 9/16" • 5/8" • 3/4" • 13/16" • 7/8"**

- ◆ M2 HSS
- ◆ 3/4" Weldon Shanks
- ◆ Aggressive Cutting Edges
- ◆ No Center Punch Required
- ◆ Cut up to 2"
- ◆ For All Magnetic Drills
- ◆ Sold Individually

ANNULAR CUTTER M2 HSS



3/4" Weldon Shank

Use Cutting Oil



6 H.S.S. Annular Cutters + 2 Pilot Pins



1" Cutting Depth



2" Cutting Depth



1" Annular Cutter - *M2 HSS*

Part #	Size	Depth	Pin	List
100MC2864	7/16"	1"	SS-1	\$53.24
100MC3264	1/2"	1"	SS-2	\$53.24
100MC3664	9/16"	1"	SS-3	\$55.66
100MC4064	5/8"	1"	SS-3	\$60.04
100MC4464	11/16"	1"	SS-3	\$64.57
100MC4864	3/4"	1"	SS-3	\$66.01
100MC5264	13/16"	1"	SS-3	\$73.52
100MC5664	7/8"	1"	SS-3	\$79.80
100MC6064	15/16"	1"	SS-3	\$82.63
100MC6464	1"	1"	SS-3	\$92.46
100MC6864	1-1/16"	1"	SS-3	\$107.22
100MC7264	1-1/8"	1"	SS-3	\$117.25
100MC7664	1-3/16"	1"	SS-3	\$119.67
100MC8064	1-1/4"	1"	SS-3	\$121.94
100MC8464	1-5/16"	1"	SS-3	\$140.50
100MC8864	1-3/8"	1"	SS-3	\$160.73
100MC9264	1-7/16"	1"	SS-3	\$179.25
100MC9664	1-1/2"	1"	SS-3	\$211.05
100MC1916	1-9/16"	1"	SS-3	\$215.89
100MC1058	1-5/8"	1"	SS-3	\$218.57
100MC1116	1-11/16"	1"	SS-3	\$220.57
100MC1034	1-3/4"	1"	SS-3	\$224.89
100MC1316	1-13/16"	1"	SS-3	\$232.55
100MC1078	1-7/8"	1"	SS-3	\$242.27
100MC1516	1-15/16"	1"	SS-3	\$251.23
100MC2002	2"	1"	SS-3	\$294.50
100MC2116	2-1/16"	1"	SS-3	\$475.35

2" Annular Cutter - *M2 HSS*

Part #	Size	Depth	Pin	List
200MC2864	7/16"	2"	LL-1	\$72.08
200MC3264	1/2"	2"	LL-2	\$72.08
200MC3664	9/16"	2"	LL-3	\$74.50
200MC4064	5/8"	2"	LL-3	\$82.73
200MC4464	11/16"	2"	LL-3	\$92.01
200MC4864	3/4"	2"	LL-3	\$97.70
200MC5264	13/16"	2"	LL-3	\$107.22
200MC5664	7/8"	2"	LL-3	\$124.55
200MC6064	15/16"	2"	LL-3	\$126.57
200MC6464	1"	2"	LL-3	\$130.76
200MC6864	1-1/16"	2"	LL-3	\$135.63
200MC7264	1-1/8"	2"	LL-3	\$165.05
200MC7664	1-3/16"	2"	LL-3	\$171.74
200MC8064	1-1/4"	2"	LL-3	\$188.56
200MC8464	1-5/16"	2"	LL-3	\$204.05
200MC8864	1-3/8"	2"	LL-3	\$221.49
200MC9264	1-7/16"	2"	LL-3	\$236.46
200MC9664	1-1/2"	2"	LL-3	\$244.13
200MC1916	1-9/16"	2"	LL-3	\$280.76
200MC1058	1-5/8"	2"	LL-3	\$290.80
200MC1116	1-11/16"	2"	LL-3	\$303.09
200MC1034	1-3/4"	2"	LL-3	\$315.08
200MC1316	1-13/16"	2"	LL-3	\$328.39
200MC1078	1-7/8"	2"	LL-3	\$341.30
200MC1516	1-15/16"	2"	LL-3	\$386.18
200MC2002	2"	2"	LL-3	\$405.84
200MC2116	2-1/16"	2"	LL-3	\$581.80

TCT - Carbide Tipped Annular Cutters Available. Please call.



Pilot Pins - 1" Cutter

Part #	Description	List
SS-1	1" Pilot Pin (for 7/16" x 1")	\$15.00
SS-2	1" Pilot Pin (for 1/2" x 1")	\$15.00
SS-3	1" Pilot Pin (for 9/16" x 1" +)	\$15.00



Pilot Pins - 2" Cutter

Part #	Description	List
LL-1	2" Pilot Pin (for 7/16" x 2")	\$19.00
LL-2	2" Pilot Pin (for 1/2" x 2")	\$19.00
LL-3	2" Pilot Pin (for 9/16" x 2" +)	\$19.00



Steel



Stainless Cast Iron

- ◆ M2 HSS
- ◆ 3/4" Weldon Shanks
- ◆ Aggressive Cutting Edges
- ◆ No Center Punch Required
- ◆ Cut up to 2"
- ◆ For All Magnetic Drills
- ◆ Sold Individually



MAGNETIC DRILL



3/4" Weldon Shank

Use Cutting Oil



Allows overlap cut on existing holes

ANNULAR CUTTER
M2 HSS



5/16", 3/8", 7/16", 1/2", 9/16"

9/16", 5/8", 11/16", 3/4", 13/16"

13/16", 7/8", 15/16", 1", 1-1/16"

Step Reamer - Individual - *M2 HSS*

Part #	Description	Depth	Qty.	List
STR-1	5 Step - 5/16" to 9/16"	1/2"	1	\$81.81
STR-2	5 Step - 9/16" to 13/16"	1/2"	1	\$87.50
STR-3	5 Step - 13/16" to 1-1/16"	1/2"	1	\$100.00

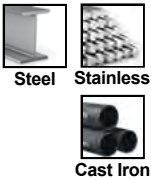

- ◆ M2 HSS
- ◆ 1/2" Cutting Depth
- ◆ Double Flute
- ◆ Black Oxide Coating
- ◆ 3/8" - 3-Flat Shank
- ◆ Sold Individually



Step Reamer - 3 Pc. Kit - *M2 HSS*

Part #	Description	Depth	Qty.	List
STR-SET3	3 Pc. Kit with Case	1/2"	1	\$258.33

For Enlarging Holes in Steel Plate up to 1/2" Thick!



FEIN Adapter
Part # WFE-1



2" Extension
Part # MXT-2



6" Extension
Part # MXT-6



NITTO Adapter
Part # WNT-1

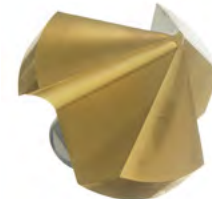

Mag Drill - Extensions & Adapters

Part #	Description	List
MXT-2	2" Weldon Mag Drill Extension	\$67.05
MXT-3	3" Weldon Mag Drill Extension	\$79.25
MXT-4	4" Weldon Mag Drill Extension	\$91.44
MXT-6	6" Weldon Mag Drill Extension	\$109.73
MXT-8	8" Weldon Mag Drill Extension	\$144.08
MXT-10	10" Weldon Mag Drill Extension	\$176.78
WFE-1	FEIN to Weldon Adapter	\$45.00
WNT-1	NITTO to Weldon Adapter	\$45.00

MAG DRILL ACCESSORIES
ARE SOLD INDIVIDUALLY.

Titanium Countersink - 3 FLUTE

Part #	Degree	Range	Qty.	List
SCS-82	82°	5/16" - 2-1/8"	1	\$378.19
SCS-90	90°	5/16" - 2-1/8"	1	\$378.19



**TITANIUM-M2 HSS
COUNTERSINK**

- ◆ Titanium Coating
- ◆ 3/4" Weldon Shanks
- ◆ Aggressive Cutting Edges
- ◆ For All Magnetic Drills
- ◆ Sold Individually





MAGNETIC

MAGNETIC CHIP COLLECTOR

EASY CLEAN UP OF METAL CHIPS & SHAVINGS

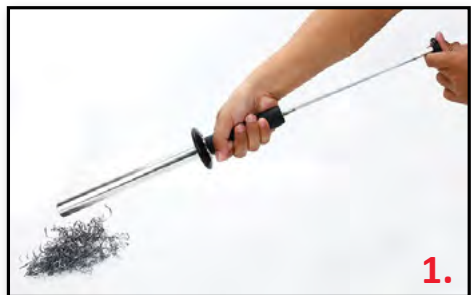

1.



2.



3.



Magnetic Chip Collector

Part #	Description	List
MAG-BAT	Magnetic Chip Collector	\$94.44

MAG DRILL ACCESSORIES ARE SOLD INDIVIDUALLY.



Mag Drill 1/2" Chuck Adapter

Part #	Description	List
MAG-CHUCK	1/2" Chuck with Key	\$98.99

- ◆ Fits Any 3/4" Weldon Shank Mag Drill
- ◆ Use With 1/2" Shank Drill Accessories
- ◆ Sold Individually

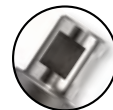

Use Cutting Oil

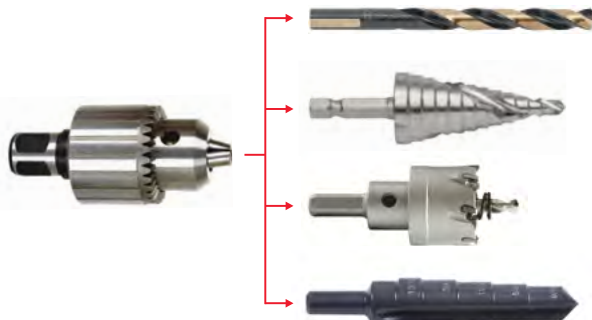



IMPACT
 1/4" HEX IMPACT SHANK



Steel



Stainless



Sheet Metal



Copper

- ◆ Excellent Wear and Heat Resistance
- ◆ Tungsten Carbide Teeth
- ◆ Cuts Stainless Steel and Tough Alloys
- ◆ Ejects the Slug Saving Time
- ◆ Works in 3/8" & 1/2" Chucks
- ◆ Made In Taiwan



1/2" DRILL

T.C.T. HOLE CUTTERS
 ARE SOLD
 INDIVIDUALLY.



3/16" Cutting Depth

T.C.T. Hole Cutter

Part #	Size	Depth	Shank	List
XF0012	5/8"	3/16"	1/4" HEX	\$35.00
XF0014	3/4"	3/16"	1/4" HEX	\$39.08
XF0016	7/8"	3/16"	1/4" HEX	\$39.08
XF0018	1"	3/16"	1/4" HEX	\$39.08
XF0019	1-1/8"	3/16"	1/4" HEX	\$44.92
XF0021	1-1/4"	3/16"	1/4" HEX	\$52.50
XF0023	1-3/8"	3/16"	1/4" HEX	\$52.50



3/16" Cutting Depth

T.C.T. Hole Cutter

Part #	Size	Depth	Shank	List
HF0012	5/8"	3/16"	3/8"	\$33.39
HF0013	11/16"	3/16"	3/8"	\$33.39
HF0014	3/4"	3/16"	3/8"	\$37.12
HF0015	13/16"	3/16"	3/8"	\$37.12
HF0016	7/8"	3/16"	3/8"	\$37.12
HF0017	15/16"	3/16"	3/8"	\$37.12
HF0018	1"	3/16"	3/8"	\$37.12
HF0119	1-1/16"	3/16"	3/8"	\$41.22
HF0019	1-1/8"	3/16"	3/8"	\$41.22
HF0021	1-1/4"	3/16"	3/8"	\$47.70
HF0023	1-3/8"	3/16"	3/8"	\$47.70
HF0024	1-1/2"	3/16"	3/8"	\$55.36
HF0025	1-5/8"	3/16"	3/8"	\$64.93
HF0026	1-3/4"	3/16"	3/8"	\$64.93
HF0027	1-7/8"	3/16"	3/8"	\$72.45
HF0028	2"	3/16"	3/8"	\$80.85
HF0029	2-1/8"	3/16"	3/8"	\$80.85
HF0030	2-1/4"	3/16"	3/8"	\$93.04
HF0032	2-3/8"	3/16"	3/8"	\$93.04
HF0033	2-1/2"	3/16"	1/2"	\$110.12
HF0135	2-3/4"	3/16"	1/2"	\$118.37
HF0035	3"	3/16"	1/2"	\$130.91
HF0138	3-1/4"	3/16"	1/2"	\$147.13
HF0036	3-1/2"	3/16"	1/2"	\$157.76
HF0140	3-5/8"	3/16"	1/2"	\$178.22
HF0037	4"	3/16"	1/2"	\$211.58

POW!

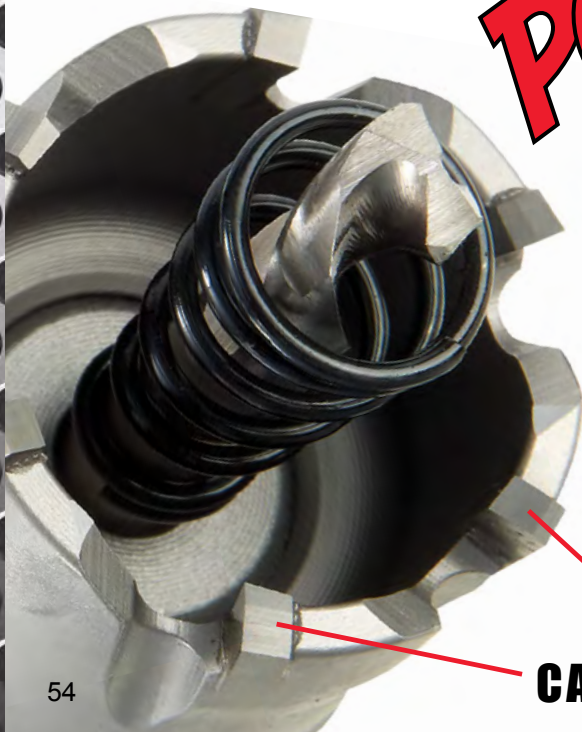

- Cut Faster
- Cut Cleaner
- Lasts Longer

**TUNGSTEN
 CARBIDE TEETH**



7/8" - 1-1/8" - 1-3/8"
 1-3/4" - 2" - 2-1/2"

T.C.T. Hole Cutter Kits

Part #	Set	Depth	Shank	List
XF-KIT3	3 Pc.	3/16"	1/4" HEX	\$136.00
HF-KIT3	3 Pc.	3/16"	3/8"	\$136.00
HF-KIT6	6 Pc.	3/16"	3/8"	\$375.00

Size	Steel (rpm)	Stainless Steel (rpm)
9/16" to 13/16"	700-1000	300-700
7/8" to 1-3/16"	500-800	200-450
1-1/4" to 1-9/16"	300-600	175-315
1-5/8" to 2"	200-500	120-225
2-1/16" to 2-3/8"	200-400	95-195
2-7/16" to 3"	150-300	80-150
3-1/16" to 5"	100-200	60-120



1/2" Cutting Depth

T.C.T. Hole Cutter

Part #	Size	Depth	Shank	List
HG0011	9/16"	1/2"	3/8"	\$44.17
HG0012	5/8"	1/2"	3/8"	\$44.17
HG0013	11/16"	1/2"	3/8"	\$44.17
HG0014	3/4"	1/2"	3/8"	\$49.56
HG0015	13/16"	1/2"	3/8"	\$49.56
HG0016	7/8"	1/2"	3/8"	\$49.56
HG0017	15/16"	1/2"	3/8"	\$49.56
HG0018	1"	1/2"	3/8"	\$49.56
HG0119	1-1/16"	1/2"	3/8"	\$57.42
HG0019	1-1/8"	1/2"	3/8"	\$57.42
HG0020	1-3/16"	1/2"	3/8"	\$57.42
HG0021	1-1/4"	1/2"	3/8"	\$66.98
HG0023	1-3/8"	1/2"	3/8"	\$66.99
HG0024	1-1/2"	1/2"	3/8"	\$77.30
HG0025	1-5/8"	1/2"	3/8"	\$89.80
HG0026	1-3/4"	1/2"	3/8"	\$89.81
HG0027	1-7/8"	1/2"	3/8"	\$90.04
HG0028	2"	1/2"	3/8"	\$100.40
HG0029	2-1/8"	1/2"	3/8"	\$100.41
HG0030	2-1/4"	1/2"	3/8"	\$114.66
HG0032	2-3/8"	1/2"	3/8"	\$114.66
HG0033	2-1/2"	1/2"	1/2"	\$134.74
HG0135	2-3/4"	1/2"	1/2"	\$145.75
HG0035	3"	1/2"	1/2"	\$169.07
HG0138	3-1/4"	1/2"	1/2"	\$172.54
HG0036	3-1/2"	1/2"	1/2"	\$184.91
HG0037*	4"	1/2"	1/2"	\$228.02
HG0040*	4-1/2"	1/2"	1/2"	\$264.19
HG0050*	5"	1/2"	1/2"	\$281.17

* Use Pilot Part# HG-PILOT2



Replacement Parts

Part #	Description	List
HF-PILOT	CENTER DRILL φ6mm x 50L	\$8.75
HF-S	SPRING 1.2MM X 16L	\$0.80
HG-PILOT	CENTER DRILL φ6mm x 60L	\$10.02
HG-PILOT2	CENTER DRILL φ8mm x 60L	\$10.02
HG-S	SPRING 1.2MM X 23L	\$0.80
HM-PILOT	CENTER DRILL φ6mm x 75L	\$11.78
HM-S	SPRING 1.2MM X 50L	\$2.23
HP-PILOT	CENTER DRILL φ6mm x 90L	\$13.25
HP-S	SPRING 1.2MM X 60L	\$0.80



1-3/8" Cutting Depth

T.C.T. Hole Cutter

Part #	Size	Depth	Shank	List
HM0011	9/16"	1-3/8"	1/2"	\$88.99
HM0012	5/8"	1-3/8"	1/2"	\$88.99
HM0013	11/16"	1-3/8"	1/2"	\$88.99
HM0014	3/4"	1-3/8"	1/2"	\$88.99
HM0015	13/16"	1-3/8"	1/2"	\$88.99
HM0016	7/8"	1-3/8"	1/2"	\$88.99
HM0017	15/16"	1-3/8"	1/2"	\$88.99
HM0018	1"	1-3/8"	1/2"	\$88.99
HM0119	1-1/16"	1-3/8"	1/2"	\$103.01
HM0019	1-1/8"	1-3/8"	1/2"	\$103.01
HM0020	1-3/16"	1-3/8"	1/2"	\$103.01
HM0021	1-1/4"	1-3/8"	1/2"	\$120.68
HM0023	1-3/8"	1-3/8"	1/2"	\$120.68
HM0024	1-1/2"	1-3/8"	1/2"	\$140.19
HM0025	1-5/8"	1-3/8"	1/2"	\$162.74
HM0026	1-3/4"	1-3/8"	1/2"	\$162.74
HM0027	1-7/8"	1-3/8"	1/2"	\$184.68
HM0028	2"	1-3/8"	1/2"	\$206.62
HM0029	2-1/8"	1-3/8"	1/2"	\$206.62
HM0030	2-1/4"	1-3/8"	1/2"	\$234.66
HM0032	2-3/8"	1-3/8"	1/2"	\$234.66
HM0033	2-1/2"	1-3/8"	1/2"	\$276.71



- ◆ Excellent Wear and Heat Resistance
- ◆ Tungsten Carbide Teeth
- ◆ Cuts Stainless Steel and Tough Alloys
- ◆ Works in 1/2" Chucks
- ◆ Made In Taiwan



T.C.T. HOLE CUTTERS ARE SOLD INDIVIDUALLY.



2" Cutting Depth

T.C.T. Steel Door Hole Cutter

Part #	Size	Cut	Shank	List
HP0014	3/4"	2"	1/2"	\$79.50
HP0018	1"	2"	1/2"	\$79.50
HP0021	1-1/4"	2"	1/2"	\$107.47
HP0029	2-1/8"	2"	1/2"	\$183.29

- ◆ Made for Door Knob and Lock Installation
- ◆ Tungsten Carbide Teeth
- ◆ Works in 1/2" Chucks
- ◆ Made In Taiwan

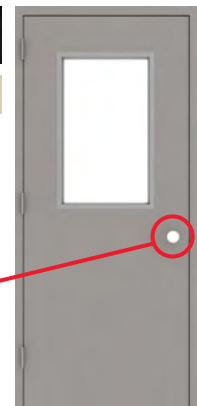



BI-METAL

**PART # 275AV02E
 ELECTRICIAN'S HOLE SAW KIT**

8 Pc. Set contains:
 1 each 7/8" - 1-1/8" - 1-3/8" - 1-3/4" - 2" - 2-1/2"
 2 Arbors - ARB-2 - ARB-5

List \$182.70



BI-METAL

**PART # 275AV100
 MAINTENANCE HOLE SAW KIT**

11 Pc. Set contains:
 1 each 3/4" - 7/8" - 1-1/8" - 1-3/8" - 1-1/2"
 1-3/4" - 2" - 2-1/4" - 2-1/2"
 2 Arbors - ARB-2 - ARB-5

List \$251.17



CARBIDE TIPPED

**PART # 275AT100
 CARBIDE TIPPED
 MAINTENANCE HOLE SAW KIT**

11 Pc. Set contains:
 1 each 3/4" - 7/8" - 1-1/8" - 1-3/8" - 1-1/2"
 1-3/4" - 2" - 2-1/4" - 2-1/2"
 2 Arbors - ARB-2 - ARB-5

List \$379.95



BI-METAL

**PART # 275AV08E
 MASTER ELECTRICIAN'S HOLE
 SAW KIT**

12 Pc. Set contains:
 1 each 7/8" - 1-1/8" - 1-3/8" - 1-3/4" - 2" - 2-1/2"
 3" - 3-5/8" - 4-1/8" - 4-1/2"
 2 Arbors - ARB-2 - ARB-5

List \$305.49



**RECOMMENDED
 Bi-Metal HOLE SAW
 CUTTING SPEEDS IN RPM'S**



- ① **LUBRICANTS** - Use a good cutting oil for faster, more efficient cutting in ferrous metals. Cutting oil should not be used when cutting cast iron. Beeswax or paraffin is often used when cutting aluminum.
- ② **CUTTING POSITION** - Do not cut materials at an angle. All the hole saw teeth should be in contact with the material to avoid tooth damage.
- ③ **FEEDS** - For effective cutting, apply level and even pressure. Excessive pressure results in premature wear, dulling of the teeth, and breakage. When cutting material over 1" thick, the saw should be pulled back at intervals to allow chip clearance.

Made In



SIZE	MILD STEEL	CAST IRON	TOOL & STAINLESS	BRASS	ALUMINUM
9/16"	580	400	300	790	900
5/8"	550	365	275	730	825
11/16"	500	330	250	665	750
3/4"	460	300	230	600	690
13/16"	425	280	210	560	635
7/8"	390	260	195	520	585
15/16"	370	245	185	495	555
1"	350	235	175	470	525
1 - 1/16"	325	215	160	435	480
1 - 1/8"	300	200	150	400	450
1 - 3/16"	285	190	145	380	425
1 - 1/4"	275	180	140	360	410
1 - 5/16"	260	175	135	345	390
1 - 3/8"	250	165	125	330	375
1 - 7/16"	240	160	120	315	360
1 - 1/2"	230	150	115	300	345
1 - 9/16"	220	145	110	290	330
1 - 5/8"	210	140	105	280	315
1 - 11/16"	205	135	100	270	305
1 - 3/4"	195	130	95	260	295
1 - 13/16"	190	125	95	250	285
1 - 7/8"	180	120	90	240	270
2"	170	115	85	230	255
2 - 1/16"	165	110	80	220	245
2 - 1/8"	160	105	80	210	240
2 - 1/4"	150	100	75	200	225
2 - 5/16"	145	100	75	195	225
2 - 3/8"	140	95	70	190	220
2 - 1/2"	135	90	65	180	205
2 - 9/16"	130	85	65	175	200
2 - 5/8"	130	85	65	170	195
2 - 3/4"	125	80	60	160	185
2 - 7/8"	120	80	60	160	180
3"	115	75	55	150	170
3 - 1/8"	110	70	55	140	165
3 - 1/4"	105	70	50	140	155
3 - 3/8"	100	65	50	130	150
3 - 1/2"	95	65	45	130	145
3 - 5/8"	95	60	45	120	140
3 - 3/4"	90	60	45	120	135
3 - 7/8"	90	60	45	120	135
4"	85	55	40	110	130
4 - 1/8"	80	55	40	110	120
4 - 1/4"	80	55	40	110	120
4 - 1/2"	75	50	35	100	105
4 - 3/4"	75	50	35	95	95
5"	65	45	30	90	90
5 - 1/2"	60	40	25	85	85
5 - 3/4"	55	35	25	75	75
6"	55	35	25	75	75



BI-METAL

**PART # 275AV04P
 PLUMBER'S HOLE SAW KIT**

8 Pc. Set contains:
 1 each 3/4" - 7/8" - 1-1/8" - 1-1/2" - 1-3/4" -
 2-1/4"
 2 Arbors - ARB-2 - ARB-5

List \$146.35

Bi-Metal Hole Saws - Variable Pitch

Part #	Dia. Inches	Dia. MM	PIPE TAP SIZE		PIPE ENT. SIZE		Use Arbor	List
			Inches	MM	Inches	MM		
275HW0011	9/16"	14.3	3/8"				*	\$16.38
275HW0012	5/8"	15.5					*	\$12.43
275HW0013	11/16"	17.5					*	\$12.43
275HW0014	3/4"	19.0	1/2"	13 mm	3/8"	10 mm	*	\$12.43
275HW0114	20mm	20.0					*	\$15.72
275HW0015	13/16"	20.6					*	\$12.43
275HW0016	7/8"	22.2	3/4"	19 mm	1/2"	13 mm	*	\$12.43
275HW0017	15/16"	23.8					*	\$12.43
275HW0018	1"	25.4					*	\$13.19
275HW0185	1-1/16"	27.0					*	\$13.19
275HW0019	1-1/8"	28.8	1"	25 mm	3/4"	19 mm	*	\$13.19
275HW0020	1-3/16"	30.2					*	\$13.19
275HW0021	1-1/4"	31.8					**	\$13.19
275HW0022	1-5/16"	33.3					**	\$13.19
275HW0023	1-3/8"	34.9			1"	25 mm	**	\$13.99
275HW0123	1-7/16"	36.5					**	\$13.99
275HW0024	1-1/2"	38.1	1-1/4"	32 mm			**	\$14.26
275HW0124	1-9/16"	39.7					**	\$14.26
275HW0025	1-5/8"	41.2					**	\$14.42
275HW0125	1-11/16"	42.9					**	\$14.42
275HW0026	1-3/4"	44.5	1-1/2"	38 mm	1-1/4"	32 mm	**	\$17.47
275HW0226	45mm	45.0					**	\$23.86
275HW0126	1-13/16"	46.0					**	\$17.47
275HW0027	1-7/8"	47.6					**	\$17.73
275HW0127	50mm	50.0					**	\$24.57
275HW0028	2"	50.8			1-1/2"	38 mm	**	\$19.16
275HW0128	2-1/16"	52.4					**	\$21.49
275HW0029	2-1/8"	53.9					**	\$21.49
275HW0129	55mm	55.0					**	\$29.36
275HW0030	2-1/4"	57.2	2"	51 mm			**	\$21.65
275HW0031	2-5/16"	58.7					**	\$21.84
275HW0032	2-3/8"	60.3			2"	51 mm	**	\$21.96
275HW0033	2-1/2"	63.5					**	\$23.16
275HW0034	2-9/16"	65.1					**	\$23.29
275HW0134	2-5/8"	66.7	2-1/2"	64 mm			**	\$23.83
275HW0234	68mm	68.0					**	\$32.56
275HW0334	68.5mm	68.5					**	\$32.56
275HW0135	2-3/4"	69.9					**	\$23.83
275HW0136	2-7/8"	73.0					**	\$23.83
275HW0236	75mm	75.0					**	\$32.56
275HW0035	3"	76.2			2-1/2"	64 mm	**	\$23.83
275HW0137	3-1/8"	79.4					**	\$24.08
275HW0138	3-1/4"	82.6	3"	76 mm			**	\$24.08
275HW0139	3-3/8"	85.7					**	\$24.08
275HW0036	3-1/2"	88.9					**	\$24.08
275HW0140	3-5/8"	92.1			3"	76 mm	**	\$28.28
275HW0141	3-3/4"	95.3	3-1/2"	89 mm			**	\$33.21
275HW0142	3-7/8"	98.4					**	\$34.93
275HW0100	100mm	100.0					**	\$43.57
275HW0037	4"	101.6					**	\$36.44
275HW0143	4-1/8"	104.8			3-1/2"	89 mm	**	\$40.82
275HW0144	4-1/4"	108.0	4"	102 mm			**	\$53.13
275HW0038	4-1/2"	114.3			4"	102 mm	**	\$73.49
275HW0145	4-3/4"	120.7	4-1/2"				**	\$85.14
275HW0039	5"	127.0					**	\$90.54
275HW0040	5-1/2"	139.7					**	\$108.03
275HW0146	5-3/4"	146.0					**	\$117.31
275HW0041	6"	152.4					**	\$126.56



1 HOLE SAW PER BOX.
ARBOR NOT INCLUDED.

Made In



- ◆ Made In USA
- ◆ Bi-Metal Construction
- ◆ M3 Cutting Edge
- ◆ 5 Variable Pitch. Rc. 63-65
- ◆ Positive Rake
- ◆ 1-15/16" Cutting Depth
- ◆ Premium Quality
- ◆ Cuts Through a 2" x 4"
- ◆ Red Finish



- * ARB-0, ARB-1 or ARB-2 with (1/2"-20 Thread).
- ** ARB-3, ARB-4 or ARB-5 with (5/8"-18 Thread).

These High Quality Bi-Metal Hole Saws are made by a very special process. The cutting edge is electron beam welded to a tough alloy steel back. These hole saws are ideal for work where high performance & accuracy are needed. Saws have knock-out holes for easy core removal.



1 HOLE SAW PER BOX.
 ARBOR NOT INCLUDED.

Made In



- ◆ **Made In USA**
- ◆ Tungsten Carbide Teeth
- ◆ Ground & Welded Set Teeth
- ◆ 3 Teeth Per Inch
- ◆ High Wear Resistance
- ◆ 1-15/16" Cutting Depth
- ◆ Premium Quality
- ◆ Black Finish



* ARB-0, ARB-1 or ARB-2 with (1/2"-20 Thread).
 ** ARB-3, ARB-4 or ARB-5 with (5/8"-18 Thread).

Carbide Tipped Hole Saws

Part #	Dia.		PIPE TAP SIZE		PIPE ENT. SIZE		Use	
	Inches	MM	Inches	MM	Inches	MM	Arbor	List
AT120034	3/4"	19.0	1/2"	13 mm	3/8"	10 mm	*	\$22.47
AT131316	13/16"	20.6					*	\$22.88
AT140078	7/8"	22.2	3/4"	19 mm	1/2"	13 mm	*	\$23.18
AT151516	15/16"	23.8					*	\$23.99
AT160001	1"	25.4					*	\$24.69
AT171116	1-1/16"	27.0					*	\$25.57
AT180118	1-1/8"	28.8	1"	25 mm	3/4"	19 mm	*	\$26.16
AT191316	1-3/16"	30.2					*	\$27.10
AT200114	1-1/4"	31.8					**	\$27.87
AT211516	1-5/16"	33.3					**	\$27.88
AT220138	1-3/8"	34.9			1"	25 mm	**	\$28.34
AT231716	1-7/16"	36.5					**	\$28.41
AT240112	1-1/2"	38.1	1-1/4"	32 mm			**	\$29.02
AT251916	1-9/16"	39.7					**	\$30.10
AT260158	1-5/8"	41.2					**	\$30.77
AT271116	1-11/16"	42.9					**	\$32.22
AT280134	1-3/4"	44.5	1-1/2"	38 mm	1-1/4"	32 mm	**	\$32.23
AT291316	1-13/16"	46.0					**	\$32.90
AT300178	1-7/8"	47.6					**	\$33.57
AT320002	2"	50.8			1-1/2"	38 mm	**	\$34.59
AT332116	2-1/16"	52.4					**	\$40.02
AT340218	2-1/8"	53.9					**	\$40.71
AT360214	2-1/4"	57.2	2"	51 mm			**	\$42.10
AT372516	2-5/16"	58.7					**	\$42.91
AT380238	2-3/8"	60.3					**	\$43.52
AT400212	2-1/2"	63.5			2"	51 mm	**	\$45.47
AT412916	2-9/16"	65.1					**	\$45.82
AT420258	2-5/8"	66.7	2-1/2"	64 mm			**	\$46.97
AT440234	2-3/4"	69.9					**	\$48.37
AT460278	2-7/8"	73.0					**	\$49.85
AT480003	3"	76.2			2-1/2"	64 mm	**	\$51.97
AT500318	3-1/8"	79.4					**	\$62.64
AT520314	3-1/4"	82.6	3"	76 mm			**	\$63.73
AT540338	3-3/8"	85.7					**	\$67.73
AT560312	3-1/2"	88.9					**	\$69.15
AT580358	3-5/8"	92.1			3"	76 mm	**	\$70.58
AT600334	3-3/4"	95.3	3-1/2"	89 mm			**	\$72.56
AT620378	3-7/8"	98.4					**	\$73.46
AT640004	4"	101.6					**	\$77.14
AT660418	4-1/8"	104.8			3-1/2"	89 mm	**	\$107.08
AT680414	4-1/4"	108.0	4"	102 mm			**	\$110.94
AT700438	4-3/8"	111.0					**	\$112.34
AT720412	4-1/2"	114.3			4"	102 mm	**	\$112.95
AT760434	4-3/4"	120.7					**	\$122.98
AT800005	5"	127.0					**	\$126.60
AT880512	5-1/2"	139.7					**	\$133.33
AT920534	5-3/4"	146.0					**	\$136.61
AT960006	6"	152.4					**	\$140.24

CARBIDE TIPPED & CARBIDE GRIT RPM CHART

SIZE	ALUMINUM	PLASTIC	FIBER-GLASS	CERAMIC TILE	PARTICLE BOARD	CAST IRON	FORMICA
3/4"	1700	3430	250	500	3430	410	210
7/8"	1500	2940	210	430	2940	350	180
1"	1300	2570	190	370	2570	310	150
1-1/8"	1100	2290	170	330	2290	270	140
1-3/8"	900	1870	140	270	1870	220	110
1-1/2"	900	1710	120	250	1710	210	100
1-3/4"	700	1470	110	210	1470	180	90
2"	600	1290	90	190	1290	150	80
2-1/4"	600	1140	80	170	1140	140	70
2-1/2"	500	1030	70	150	1030	120	60
3"	400	860	60	120	860	100	50
3-1/4"	400	790	60	110	790	90	50
3-5/8"	400	710	50	100	710	90	40
3-3/4"	300	690	50	100	690	80	40
4-1/8"	300	620	50	90	620	70	40
4-3/4"	300	540	40	80	540	60	30
5"	200	480	40	80	500	60	30
5-1/2"	200	420	40	70	460	50	30
6"	100	360	30	60	420	40	30

These High Quality Carbide Tipped Hole Saws have the highest wear resistance for abrasive materials. They are ideal for work where high performance & accuracy are needed. Saws have knock-out holes for easy core removal.

Carbide Grit Hole Saws

Part #	Dia.		PIPE TAP SIZE		PIPE ENT. SIZE		Use	
	Inches	MM	Inches	MM	Inches	MM	Arbor	List
CG0012	3/4"	19.0	1/2"	13 mm	3/8"	10 mm	*	\$49.67
CG0013	13/16"	20.6					*	\$49.67
CG0014	7/8"	22.2	3/4"	19 mm	1/2"	13 mm	*	\$49.67
CG0015	15/16"	23.8					*	\$49.67
CG0016	1"	25.4					*	\$54.24
CG0017	1-1/16"	27.0					*	\$54.24
CG0018	1-1/8"	28.8	1"	25 mm	3/4"	19 mm	*	\$54.24
CG0019	1-3/16"	30.2					*	\$54.24
CG0020	1-1/4"	31.8					**	\$55.66
CG0021	1-5/16"	33.3					**	\$55.66
CG0022	1-3/8"	34.9			1"	25 mm	**	\$56.11
CG0023	1-7/16"	36.5					**	\$56.11
CG0024	1-1/2"	38.1	1-1/4"	32 mm			**	\$56.11
CG0025	1-9/16"	39.7					**	\$56.11
CG0026	1-5/8"	41.2					**	\$56.11
CG0027	1-11/16"	42.9					**	\$56.11
CG0028	1-3/4"	44.5	1-1/2"	38 mm	1-1/4"	32 mm	**	\$68.83
CG0029	1-13/16"	46.0					**	\$68.83
CG0030	1-7/8"	47.6					**	\$68.83
CG0032	2"	50.8			1-1/2"	38 mm	**	\$68.83
CG0033	2-1/16"	52.4					**	\$68.83
CG0034	2-1/8"	53.9					**	\$81.45
CG0036	2-1/4"	57.2	2"	51 mm			**	\$81.45
CG0037	2-5/16"	58.7					**	\$81.45
CG0038	2-3/8"	60.3					**	\$81.45
CG0040	2-1/2"	63.5			2"	51 mm	**	\$91.81
CG0041	2-9/16"	65.1					**	\$91.81
CG0042	2-5/8"	66.7	2-1/2"	64 mm			**	\$91.81
CG0044	2-3/4"	69.9					**	\$91.81
CG0046	2-7/8"	73.0					**	\$91.81
CG0048	3"	76.2			2-1/2"	64 mm	**	\$111.24
CG0050	3-1/8"	79.4					**	\$111.24
CG0052	3-1/4"	82.6	3"	76 mm			**	\$111.24
CG0054	3-3/8"	85.7					**	\$111.24
CG0056	3-1/2"	88.9					**	\$118.13
CG0058	3-5/8"	92.1			3"	76 mm	**	\$127.16
CG0060	3-3/4"	95.3	3-1/2"	89 mm			**	\$136.95
CG0062	3-7/8"	98.4					**	\$141.44
CG0064	4"	101.6					**	\$146.67
CG0066	4-1/8"	104.8			3-1/2"	89 mm	**	\$156.98
CG0068	4-1/4"	108.0	4"	102 mm			**	\$164.87
CG0070	4-3/8"	111.0					**	\$173.05
CG0072	4-1/2"	114.3			4"	102 mm	**	\$180.76
CG0076	4-3/4"	120.7					**	\$193.46
CG0080	5"	127.0					**	\$206.98
CG0088	5-1/2"	139.7					**	\$221.46
CG0092	5-3/4"	146.0					**	\$221.46
CG0096	6"	152.4					**	\$221.46



1 HOLE SAW PER BOX.
ARBOR NOT INCLUDED.

Made In



ARBORS

			Use ARB-0, ARB-1, ARB-2, ARB-3, ARB-4 and ARB-5. With 1/4" HSS Pilot For These Materials.
			Use ARB-8 or ARB-9. With 1/4" Carbide Pilot For These Materials.

- ◆ Made In USA
- ◆ Tungsten Carbide Grit
- ◆ Bonded to Alloy Back
- ◆ Gulletted Edge
- ◆ Super Wear Resistance
- ◆ 1-15/16" Cutting Depth
- ◆ Premium Quality
- ◆ Black Finish



* ARB-0, ARB-1, ARB-2 or ARB-8 with (1/2"-20 Thread).
** ARB-3, ARB-4, ARB-5 or ARB-9 with (5/8"-18 Thread).



CARBIDE GRIT

RECESSED LIGHTING HOLE SAWS

Part#	Size	List
CG0104	6-3/8"	\$233.86
CG0110	6-7/8"	\$233.86

These High Quality Carbide Grit Hole Saws are designed for use in hard or abrasive materials such as ceramics, fiberglass, hard woods, cast iron, & composites. They are best suited for thin materials that would strip bi-metal or carbide teeth. Saws have knock-out holes for easy core removal. Use a carbide tipped pilot arbor when drilling ceramics.



- ◆ Industrial Quality
- ◆ High Speed Steel
- ◆ Designed For Arbors
- ◆ Sold Packs of 10

1/4" Pilot Drills - M2 HSS



PART #
277PD0014
 1/4" HSS PILOT DRILL
 3 STEPS
 List \$2.71



PART #
277PD0016
 1/4" HSS PILOT DRILL
 3 FLATS
 List \$2.71



PART #
277PD0018
 1/4" HSS PILOT DRILL
 1 FLAT
 List \$2.97

1/4" Pilot Drills - Carbide



- ◆ Industrial Quality
- ◆ Carbide Head
- ◆ Designed For Arbors
- ◆ Sold Individually



PART #
277PD0020
 1/4" CARBIDE PILOT DRILL
 3-3/32" LONG 1 FLAT
 List \$10.50

Arbor Adapter Nut

PART #
NUT001
Adapter Nut



Turns
 1/2"-20
 Thread
 To 5/8"-18
 Thread

List
 \$8.26

Adapter nut allows smaller arbors without pins to fit larger hole saws. Not recommended for use with hole saws larger than 2-1/2".

Will work with any of the following 1/2"-20 threaded arbors:

- ARB-0
- ARB-1
- ARB-2
- ARB-8

Extension

PART #
EXT001
 12" Arbor Extension
 For 7/16" Hex Shank Arbors Only!!!
 List \$25.00

PART #
EXT002
 12" Arbor Extension
 For 3/8" Hex Shank Arbors Only!!!
 List \$29.58



3/8" Hex Shank



- ◆ Industrial Quality
- ◆ Individually Boxed & Sold in a 5 Pack
- ◆ Includes (1) 1-Flat 1/4" HSS Pilot Drill



Individually Boxed and Sold in a 5 Pack.

FOR USE WITH:

- Bi-Metal Hole Saws
- Carbide Tipped Hole Saws
- Carbide Grit Hole Saws

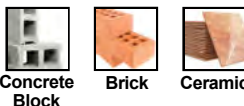

- ◆ Use With Carbide Grit Hole Saws
- ◆ Carbide Head
- ◆ Includes (1) 1/4" Carbide Pilot Drill
- ◆ Sold Individually



Arbors - With 1/4" Pilot Drill - M2 HSS

* **PART #**
ARB-0
1/4" 3-FLAT SHANK ARBOR FOR HOLE SAWS
9/16" - 1-3/16"
List/ea. \$12.75



1/2"-20 Thread HSS PILOT 277PD0016

* **PART #**
ARB-1
1/4" HEX POWER SHANK ARBOR FOR HOLE SAWS
9/16" - 1-3/16"
List/ea. \$14.50



1/2"-20 Thread HSS PILOT 277PD0018

* **PART #**
ARB-2
3/8" HEX POWER SHANK ARBOR FOR HOLE SAWS
9/16" - 1-3/16"
List/ea. \$17.86



1/2"-20 Thread HSS PILOT 277PD0018

** **PART #**
ARB-3
1/4" HEX POWER SHANK FOR HOLE SAWS
1-1/4" - 6"
List/ea. \$17.86



5/8"-18 Thread HSS PILOT 277PD0018

** **PART #**
ARB-4
3/8" HEX POWER SHANK ARBOR FOR HOLE SAWS
1-1/4" - 6"
List/ea. \$27.44



5/8"-18 Thread HSS PILOT 277PD0018

** **PART #**
ARB-5
7/16" HEX POWER SHANK FOR HOLE SAWS
1-1/4" - 6"
List/ea. \$27.44



5/8"-18 Thread HSS PILOT 277PD0018

Arbors - With 1/4" Carbide Pilot Drill

* **PART #**
ARB-8
3/8" HEX POWER SHANK FOR HOLE SAWS
3/4" - 1-3/16"
List/ea. \$31.96



1/2"-20 Thread CARBIDE PILOT 277PD0020

** **PART #**
ARB-9
7/16" HEX POWER SHANK FOR HOLE SAWS
1-1/4" - 6"
List/ea. \$40.30



5/8"-18 Thread CARBIDE PILOT 277PD0020



- ◆ RED Cast Aluminum
- ◆ Light Weight
- ◆ Extremely Rigid
- ◆ Versatile
- ◆ 25,000 lbs Per Square Inch
- ◆ Includes 1 12" x 24T Bi-Metal Blade
- ◆ Sold Individually

This High Tension Hack Saw Frame features a **NEW Cushin' Grip** handle and end pieces made of die cast aluminum. It is light weight yet extremely rigid and high tensioned; which provides cleaner, surer cuts. The blade can be set at a 55° angle for special flush cutting jobs (see figure A). The blade can also be inserted into the front end of the hack saw frame, and used as a versatile compass saw (see figure B). This frame fits most standard tool boxes.

High Tension Hack Saw Frame

Part #	Description	List
278HX0002	High Tension Hack Saw Frame	\$40.00

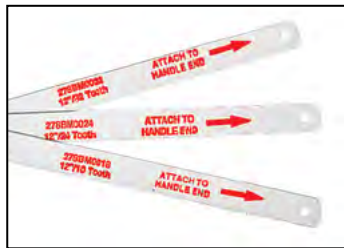

- ◆ **Made In USA**
- ◆ Bi-Metal
- ◆ 8% Cobalt
- ◆ Premium Quality
- ◆ White Finish

Hack Saw Blades - Bi-Metal

Part #	OAL	Teeth Per Inch	Wide	Thick	QTY.	List/ea.
278BM0018	12"	18T	1/2"	.025"	10	\$3.00
278BM0024	12"	24T	1/2"	.025"	10	\$3.00
278BM0032	12"	32T	1/2"	.025"	10	\$3.00



- ◆ **Made In USA**
- ◆ Bi-Metal
- ◆ 8% Cobalt
- ◆ Premium Quality
- ◆ Standard or Variable Pitch
- ◆ Use In All Hand Held Band Saws

Band Saw Blades - Bi-Metal

Part #	OAL	Teeth Per Inch	Wide	Thick	QTY.	List/ea.
B320018 *	32-7/8"	18T	1/2"	.020"	3	\$11.95
B321418 *	32-7/8"	14/18T	1/2"	.020"	3	\$11.95
B350018 **	35-3/8"	18T	1/2"	.020"	3	\$11.95
B351418 **	35-3/8"	14/18T	1/2"	.020"	3	\$11.95
279SB0014	44-7/8"	14T	1/2"	.020"	3	\$13.10
279SB0018	44-7/8"	18T	1/2"	.020"	3	\$13.10
279SB0024	44-7/8"	24T	1/2"	.020"	3	\$13.10
279VP1014	44-7/8"	10/14	1/2"	.020"	3	\$13.10
279VP1418	44-7/8"	14/18	1/2"	.020"	3	\$13.10

* DEWALT® - DCS370L, B, K
 ** MILWAUKEE® - M18 (2629-20), 6242-6, 2629-22





All Purpose Reciprocating Blades - Wood Cutting - Bi-Metal

Part #	Blade Length	Teeth Per Inch	Description	Width / Length	Pack QTY.	List/ea.	Bulk (50 Pcs.) Part #	List/ea.
RB636W	6"	6T	Wood & Nail Slope	3/4" x 6" x .050"	5	\$4.37	BU-RB636W	\$4.25
RB656WS	6"	6T	Wood & Nail Scroll	3/4" x 6" x .050"	5	\$4.64	BU-RB656WS	\$4.50
RB956W	9"	6T	Wood & Nail	3/4" x 9" x .050"	5	\$7.02	BU-RB956W	\$6.81
RB125W	12"	6T	Wood & Nail	3/4" x 12" x .050"	5	\$8.76	BU-RB125W	\$8.50
RB636DW	6"	6T	Drywall - V Tooth	3/4" x 6" x .050"	5	\$5.00	BU-RB636DW	\$4.85



- ◆ Made In USA
- ◆ 1/2" Universal Shank
- ◆ Bi-Metal
- ◆ 8% Cobalt
- ◆ Tooth Hardness Rc 65-67



All Purpose Reciprocating Blades - Metal Cutting - Bi-Metal

Part #	Blade Length	Teeth Per Inch	Description	Width / Length	Pack QTY.	List/ea.	Bulk (50 Pcs.) Part #	List/ea.
RB414M	4"	14T	Metal	3/4" x 4" x .035"	5	\$2.75	BU-RB414M	\$2.65
RB418M	4"	18T	Metal	3/4" x 4" x .035"	5	\$2.75	BU-RB418M	\$2.65
RB424M	4"	24T	Metal	3/4" x 4" x .035"	5	\$2.75	BU-RB424M	\$2.65
RB610HDM	6"	10T	Metal	3/4" x 6" x .035"	5	\$3.15	BU-RB610HDM	\$3.05
RB614HDM	6"	14T	Metal	3/4" x 6" x .035"	5	\$3.15	BU-RB614HDM	\$3.05
RB618HDM	6"	18T	Metal	3/4" x 6" x .035"	5	\$3.15	BU-RB618HDM	\$3.05
RB624HDM	6"	24T	Metal	3/4" x 6" x .035"	5	\$3.15	BU-RB624HDM	\$3.05
RB810HDM	8"	10T	Metal 10/14 V.P.	3/4" x 8" x .035"	5	\$4.89	BU-RB810HDM	\$4.75
RB814HDM	8"	14T	Metal	3/4" x 8" x .035"	5	\$4.89	BU-RB814HDM	\$4.75
RB818HDM	8"	18T	Metal	3/4" x 8" x .035"	5	\$4.89	BU-RB818HDM	\$4.75
RB1010HDM	10"	10T	Metal	3/4" x 10" x .035"	5	\$6.95	BU-RB1010HDM	\$6.75
RB1018HDM	10"	18T	Metal	3/4" x 10" x .035"	5	\$6.95	BU-RB1018HDM	\$6.75
RB1218HDM	12"	18T	Metal	3/4" x 12" x .035"	5	\$7.75	BU-RB1218HDM	\$7.50
R8CCRF	8"	CARBIDE GRIT	Cast Iron Ceramics	3/4" x 8" x .050"	1	\$12.95	BU-R8CCRF	\$12.25



Wood - Metal Sleeve of 5. Box of 50.



INTERNATIONAL TOOL MANUFACTURING
 150 Express St. Plainview, NY 11803
 (516) 738-0388 • (800) 247-5696
 Fax (516) 279-1106



Wood/Nail Wood Fiberboard

- ◆ 1/2" Universal Shank
- ◆ Bi-Metal
- ◆ 8% Cobalt
- ◆ Tooth Hardness Rc 65-67



All Purpose Reciprocating Blades - Wood Cutting - Bi-Metal

Part #	Blade Length	Teeth Per Inch	Description	Width / Length	Pack QTY.	List/Pack	Part # QTY. 50 Pcs.	List/Pack
W636	6"	6T	Wood & Nail Slope	3/4" x 6" x .050"	5	\$24.06	W636-B	\$215.00
W656S	6"	6T	Wood & Nail Scroll	3/4" x 6" x .050"	5	\$25.49	W656-B	\$230.00
W956	9"	6T	Wood & Nail	3/4" x 9" x .050"	5	\$38.60	W956-B	\$345.00
W125	12"	6T	Wood & Nail	3/4" x 12" x .050"	5	\$48.15	W125-B	\$425.00
DW636	6"	6T	Drywall - V Tooth	3/4" x 6" x .050"	5	\$27.48	DW636-B	\$215.00



All Purpose Reciprocating Blades - Metal Cutting - Bi-Metal

Part #	Blade Length	Teeth Per Inch	Description	Width / Length	Pack QTY.	List/Pack	Part # QTY. 50 Pcs.	List/Pack
M414	4"	14T	Metal	3/4" x 4" x .035"	5	\$15.13	M414-B	\$137.80
M418	4"	18T	Metal	3/4" x 4" x .035"	5	\$15.13	M418-B	\$137.80
M424	4"	24T	Metal	3/4" x 4" x .035"	5	\$15.13	M424-B	\$137.80
M610	6"	10T	Metal	3/4" x 6" x .035"	5	\$17.33	M610-B	\$158.60
M614	6"	14T	Metal	3/4" x 6" x .035"	5	\$17.33	M614-B	\$158.60
M618	6"	18T	Metal	3/4" x 6" x .035"	5	\$17.33	M618-B	\$158.60
M624	6"	24T	Metal	3/4" x 6" x .035"	5	\$17.33	M624-B	\$158.60
M810	8"	10T	Metal 10/14 V.P.	3/4" x 8" x .035"	5	\$26.91	M810-B	\$247.00
M814	8"	14T	Metal	3/4" x 8" x .035"	5	\$26.91	M814-B	\$247.00
M818	8"	18T	Metal	3/4" x 8" x .035"	5	\$26.91	M818-B	\$247.00
M1010	10"	10T	Metal	3/4" x 10" x .035"	5	\$38.24	M1010-B	\$351.00
M1018	10"	18T	Metal	3/4" x 10" x .035"	5	\$38.24	M1018-B	\$351.00
M1218	12"	18T	Metal	3/4" x 12" x .035"	5	\$42.63	M1218-B	\$390.00



- ◆ Made In USA
- ◆ 1/2" Universal Shank
- ◆ Bi-Metal
- ◆ 8% Cobalt
- ◆ Tooth Hardness Rc 65-67



Made In



HEAVY METAL Reciprocating Blades - Bi-Metal

Part #	Blade Length	Teeth Per Inch	Description	Width / Length	Pack QTY.	List/Pack	Part # QTY. 50 Pcs.	List/Pack
HM610	6"	10T	Heavy Metal	1" x 6" x .042"	5	\$32.50	HM610-B	\$300.00
HM614	6"	14T	Heavy Metal	1" x 6" x .042"	5	\$32.50	HM614-B	\$300.00
HM618	6"	18T	Heavy Metal	1" x 6" x .042"	5	\$32.50	HM618-B	\$300.00
HM910	9"	10T	Heavy Metal	1" x 9" x .042"	5	\$43.50	HM910-B	\$412.00
HM914	9"	14T	Heavy Metal	1" x 9" x .042"	5	\$43.50	HM914-B	\$412.00
HM918	9"	18T	Heavy Metal	1" x 9" x .042"	5	\$43.50	HM918-B	\$412.00
HM1214	12"	14T	Heavy Metal	1" x 12" x .042"	5	\$52.00	HM1214-B	\$495.00
HM1218	12"	18T	Heavy Metal	1" x 12" x .042"	5	\$52.00	HM1218-B	\$495.00

- ◆ Made In USA
- ◆ 1/2" Universal Shank
- ◆ Bi-Metal
- ◆ 8% Cobalt
- ◆ Tooth Hardness Rc 65-67



Made In



MAX METAL Carbide Tipped Reciprocating Blades

Part #	Blade Length	Teeth Per Inch	Description	Width / Length	Pack QTY.	List/Pack	Part # QTY. 25 Pcs.	List/Pack
CT6	6"	8T	Carbide Teeth	1" x 6" x .050"	5	\$115.00	CT6-B	\$550.00
CT9	9"	8T	Carbide Teeth	1" x 9" x .050"	5	\$171.00	CT9-B	\$810.00



CUT FASTER.

CUT LONGER.





INTERNATIONAL TOOL MANUFACTURING
 150 Express St. Plainview, NY 11803
 (516) 738-0388 • (800) 247-5696
 Fax (516) 279-1106

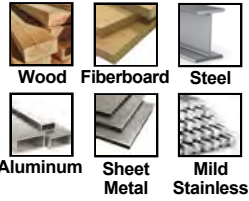

VIGOR™ Heavy Duty Reciprocating Blades - Bi-Metal

Part #	Blade Length	Teeth Per Inch	Description	Width / Length	Pack QTY.	List/Pack	Part # QTY. 50 Pcs.	List/Pack
HD610	6"	10/14 VP	Heavy Duty	3/4" x 6" x .050"	5	\$28.00	HD610-B	\$260.00
HD810	8"	10/14 VP	Heavy Duty	3/4" x 8" x .050"	5	\$38.00	HD810-B	\$355.00
HD120	12"	10/14 VP	Heavy Duty	3/4" x 12" x .050"	5	\$48.00	HD120-B	\$450.00

VP = Variable Pitch Teeth



VIGOR™ Demolition Reciprocating Blades - Bi-Metal

Part #	Blade Length	Teeth Per Inch	Description	Width / Length	Pack QTY.	List/Pack	Part # QTY. 25 Pcs.	List/Pack
DM606	6"	6T	Demolition	7/8" x 6" x .062"	3	\$26.70	DM606-B	\$209.64
DM610	6"	10T	Demolition	7/8" x 6" x .062"	3	\$26.70	DM610-B	\$209.64
DM906	9"	6T	Demolition	7/8" x 9" x .062"	3	\$33.49	DM906-B	\$266.27
DM910	9"	10T	Demolition	7/8" x 9" x .062"	3	\$33.49	DM910-B	\$266.27
DM1206	12"	6T	Demolition	7/8" x 12" x .062"	3	\$43.90	DM1206-B	\$353.04
DM1210	12"	10T	Demolition	7/8" x 12" x .062"	3	\$43.90	DM1210-B	\$353.04

- ◆ Made In USA
- ◆ 1/2" Universal Shank
- ◆ Bi-Metal
- ◆ 8% Cobalt
- ◆ Tooth Hardness Rc 65-67
- ◆ 45% Thicker Than All Purpose Blades
- ◆ Stay Rigid
- ◆ No Vibration





Wood/Nail Wood Fiberboard

All Purpose Reciprocating Blades - **Wood Cutting** - Bi-Metal

Part #	Blade Length	Teeth Per Inch	Description	Width / Length	Pack QTY.	List/Pack	Part # QTY. 50 Pcs.	List/Pack
C636W	6"	6T	Wood & Nail Slope	3/4" x 6" x .050"	5	\$18.00	C636W-B	\$173.60
C956W	9"	6T	Wood & Nail	3/4" x 9" x .050"	5	\$27.50	C956W-B	\$259.75
C125W	12"	6T	Wood & Nail	3/4" x 12" x .050"	5	\$37.60	C125W-B	\$350.00

- ◆ 1/2" Universal Shank
- ◆ Bi-Metal
- ◆ 8% Cobalt
- ◆ Tooth Hardness Rc 65-67



Singles
INDIVIDUALLY WRAPPED



Steel Aluminum Sheet Metal

All Purpose Reciprocating Blades - **Metal Cutting** - Bi-Metal

Part #	Blade Length	Teeth Per Inch	Description	Width / Length	Pack QTY.	List/Pack	Part # QTY. 50 Pcs.	List/Pack
C614M	6"	14T	Metal	3/4" x 6" x .035"	5	\$13.50	C614M-B	\$128.25
C618M	6"	18T	Metal	3/4" x 6" x .035"	5	\$13.50	C618M-B	\$128.25
C814M	8"	14T	Metal	3/4" x 8" x .035"	5	\$20.20	C814M-B	\$187.00
C818M	8"	18T	Metal	3/4" x 8" x .035"	5	\$20.20	C818M-B	\$187.00
C1218M	12"	18T	Metal	3/4" x 12" x .035"	5	\$32.00	C1218M-B	\$299.50

- ◆ 1/2" Universal Shank
- ◆ Bi-Metal
- ◆ 8% Cobalt
- ◆ Tooth Hardness Rc 65-67



RECIPROCATING SAW



REDLINE

BI-METAL RECIPROCATING BLADES



- ◆ Bi-Metal
- ◆ 8% Cobalt
- ◆ Deep Plunge Depth
- ◆ Premium Quality



Retail (1)







Bulk (5)







Bulk (10)







Oscillating Blades - Wood / Plastic

	Part #	Teeth	Width	Plunge	Qty.	List/ea.
   	OW-2	BIM-Japanese	1-3/8"	1-1/2"	1	\$13.44
	OW-2A	BIM-Japanese	1-3/8"	1-1/2"	5	\$11.61
	OW-2B	BIM-Japanese	1-3/8"	1-1/2"	10	\$11.00
	OW-3	BIM-Japanese	1-3/4"	2-1/4"	1	\$14.69
	OW-3A	BIM-Japanese	1-3/4"	2-1/4"	5	\$13.01
	OW-3B	BIM-Japanese	1-3/4"	2-1/4"	10	\$12.33







Oscillating Blades - Metal / Wood & Nail

	Part #	Teeth	Width	Plunge	Qty.	List/ea.
   	OM-2	BIM-Titanium	1-3/8"	1-1/2"	1	\$19.38
	OM-2A	BIM-Titanium	1-3/8"	1-1/2"	5	\$18.29
	OM-2B	BIM-Titanium	1-3/8"	1-1/2"	10	\$17.33
	OM-3	BIM-Titanium	1-3/4"	2-1/4"	1	\$21.98
	OM-3A	BIM-Titanium	1-3/4"	2-1/4"	5	\$21.22
	OM-3B	BIM-Titanium	1-3/4"	2-1/4"	10	\$20.11





Oscillating Blades - Max Metal Carbide Tipped - Stainless / Hard Metal

	Part #	Teeth	Width	Plunge	Qty.	List/ea.
   	OCS-2	Carbide	1-3/8"	1-1/2"	1	\$30.00
	OCS-2A	Carbide	1-3/8"	1-1/2"	5	\$29.31
	OCS-2B	Carbide	1-3/8"	1-1/2"	10	\$27.78

Oscillating Blades - Scrapers - Linoleum / Adhesive / Paint

	Part #	Teeth	Width	Plunge	Qty.	List/ea.
  	ORB-1	Stainless/Rigid	2"	1-1/2"	1	\$7.76
	ORB-1A	Stainless/Rigid	2"	1-1/2"	5	\$6.38
	ORB-1B	Stainless/Rigid	2"	1-1/2"	10	\$6.04
  	OFB-1	Stainless/Flex	2"	1-1/2"	1	\$7.76
	OFB-1A	Stainless/Flex	2"	1-1/2"	5	\$6.38
	OFB-1B	Stainless/Flex	2"	1-1/2"	10	\$6.04

Oscillating Blades - Drywall / Grout

	Part #	Teeth	Width	Plunge	Qty.	List/ea.
   	WDR-3	BIM-Drywall	3-1/2"	3/4"	1	\$11.81
	OCG-2	Carbide-Grout	3-1/2"	3/4"	1	\$20.15



OSCILLATING BLADES



Wood
Bi-Metal



Stainless
Carbide Titanium Coated



Metal
Bi-Metal Titanium Coated



- ◆ Open Fit / Quick Release
- ◆ Bi-Metal
- ◆ Deep Plunge Depth
- ◆ Premium Quality



Open Fit / Quick Release



Flexible



Rigid

Scrapers



Drywall
Bi-Metal



Grout
Carbide Grit

Part #	Size	Qty.
--------	------	------

OM-2	1-3/8" X 1-1/2" (METAL)	10
OM-3	1-3/4" X 2-1/4" (METAL)	10
OW-2	1-3/8" X 1-1/2" (WOOD)	10
OW-3	1-3/4" X 2-1/4" (WOOD)	10
OCS-2	1-3/8" X 1-1/2" (CARBIDE)	10
ORB-1	2" X 1" (RIGID SCRAPER)	10
OFB-1	2" X 1" (FLEX SCRAPER)	10
WDR-3	3-1/2" CIRCLE (DRYWALL)	10
OCG-2	3-1/2" CIRCLE (GROUT)	10

RACK20

7"Out X 17"H X 20"W

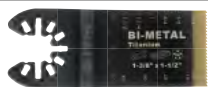

OSCILLATING BLADES

Oscillating Blades

Part #	Contents	List
RACK20	Black Header - 10 Prong	Free
H-9	Oscillating Blade Header	Free
DIS-OSC	Oscillating Blades	\$1,469.58



HSS Bell Hanger - Feeler Bits With Fish Hole (Electrical / Wire)

- ◆ Fish Hole In Flute For Pulling Wire
- ◆ Special Point For Fast Drilling In Wood & Metal
- ◆ Tapering For Quick Chip Clearance
- Telephone Installation
- Burglar Alarms
- Wire & Cable Applications

Part #	Size	OAL	Shank	Qty.	List	Part #	Size	OAL	Shank	Qty.	List
308BH1200	3/16"	12"	3/16"	1	\$12.42	308BH2403	3/8"	24"	3/8"	1	\$24.34
308BH1800	3/16"	18"	3/16"	1	\$13.23	308BH3003	3/8"	30"	3/8"	1	\$26.97
308BH1201	1/4"	12"	1/4"	1	\$13.04	308BH4203	3/8"	42"	3/8"	1	\$55.90
308BH1801	1/4"	18"	1/4"	1	\$14.38	308BH4803	3/8"	48"	3/8"	1	\$65.21
308BH2401	1/4"	24"	1/4"	1	\$17.94	308BH1806	7/16"	18"	3/8"	1	\$31.88
308BH3001	1/4"	30"	1/4"	1	\$23.95	308BH1204	1/2"	12"	3/8"	1	\$19.25
308BH4201	1/4"	42"	1/4"	1	\$49.16	308BH1804	1/2"	18"	3/8"	1	\$22.47
308BH1202	5/16"	12"	5/16"	1	\$14.43	308BH2404	1/2"	24"	3/8"	1	\$31.78
308BH1802	5/16"	18"	5/16"	1	\$16.16	308BH3004	1/2"	30"	3/8"	1	\$59.59
308BH2402	5/16"	24"	5/16"	1	\$23.63	308BH4204	1/2"	42"	3/8"	1	\$70.49
308BH1203	3/8"	12"	3/8"	1	\$15.43	308BH4804	1/2"	48"	3/8"	1	\$106.40
308BH1803	3/8"	18"	3/8"	1	\$17.61	308BH1858	5/8"	18"	1/2"	1	\$31.42
						308BH1805	3/4"	18"	1/2"	1	\$34.24
						308BH1810	1"	18"	1/2"	1	\$42.97



CARBON STEEL Bell Hanger - Feeler Bits With Fish Hole

ALL BELL HANGER DRILL BITS ARE SOLD INDIVIDUALLY

Part #	Size	OAL	Shank	Qty.	List	Part #	Size	OAL	Shank	Qty.	List
308CS1412	1/4"	12"	1/4"	1	\$7.02	308CS3818	3/8"	18"	3/8"	1	\$10.15
308CS1418	1/4"	18"	1/4"	1	\$8.27	308CS3824	3/8"	24"	3/8"	1	\$14.58
308CS1424	1/4"	24"	1/4"	1	\$11.66	308CS1804	1/2"	18"	3/8"	1	\$18.81

Less expensive than High Speed Steel (HSS) - Carbon Steel drills all wood, studs, aluminum, insulation, and drywall. Will not perform as well as HSS in steel.



Carbide Tip Bell Hanger - Feeler Bits With Fish Hole (Electrical / Wire)

- ◆ Fish Hole In Flute For Pulling Wire
- ◆ Special Point For Fast Drilling In Masonry & Wood
- Telephone Installation
- Burglar Alarms
- Wire & Cable Applications

Part #	Size	OAL	Shank	Qty.	List	Part #	Size	OAL	Shank	Qty.	List
308CT1301	1/4"	13"	1/4"	1	\$14.83	308CT1304	1/2"	13"	3/8"	1	\$17.46
308CT1801	1/4"	18"	1/4"	1	\$16.16	308CT1804	1/2"	18"	3/8"	1	\$22.13
308CT2401	1/4"	24"	1/4"	1	\$19.02	308CT2404	1/2"	24"	3/8"	1	\$23.42
308CT1302	5/16"	13"	5/16"	1	\$15.98	308CT3004	1/2"	30"	3/8"	1	\$27.50
308CT1802	5/16"	18"	5/16"	1	\$17.77	308CT1305	3/4"	13"	1/2"	1	\$33.47
308CT2402	5/16"	24"	5/16"	1	\$19.02	308CT1805	3/4"	18"	1/2"	1	\$47.95
308CT1303	3/8"	13"	3/8"	1	\$16.56						
308CT1803	3/8"	18"	3/8"	1	\$18.64						
308CT2403	3/8"	24"	3/8"	1	\$20.11						
308CT3003	3/8"	30"	3/8"	1	\$22.91						
308CT3638	3/8"	36"	3/8"	1	\$27.80						





Electrician's Flex Bit With Screw Point - Stretch Bit

Part #	Size	X	OAL	Shank	Application	List
308FB2438	3/8"	X	24"	3/16"	Popular with alarm & communication installers for pulling light wire.	\$44.42
308FB3638	3/8"	X	36"	3/16"		\$46.76
308FB5438	3/8"	X	54"	3/16"		\$51.96
308FB7238	3/8"	X	72"	3/16"		\$57.87
308FB2412	1/2"	X	24"	3/16"	Popular with alarm & communication installers for pulling light wire.	\$56.29
308FB3612	1/2"	X	36"	3/16"		\$57.90
308FB5412	1/2"	X	54"	3/16"		\$58.79
308FB7212	1/2"	X	72"	3/16"		\$64.32
308FB5496	9/16"	X	54"	3/16"	Popular with alarm & communication installers for pulling light wire.	\$67.61
308FB7296	9/16"	X	72"	3/16"		\$73.97
308FB5434	3/4"	X	54"	3/16"	Popular with alarm & communication installers for pulling light wire.	\$75.73
308FB7234	3/4"	X	72"	3/16"		\$81.37



- ◆ Screw Point
- ◆ Self Drilling
- ◆ Fish Hole On Each End
- ◆ Flexible Shaft
- ◆ Sold Individually



FISH HOLE ON SHANK



Stretch Bits are constructed of a high carbon steel self-feed auger bit, permanently brazed to a flexible shaft. This tool can be inserted through small wall openings enabling the operator to bore holes through studs within the wall cavities without damaging finished walls or ceilings.

Eye Holes are provided at each end of the Stretch Bits which allow easy retrieval of wires from either direction after drilling.

Steering Guide

Part #	Description	Application	List
308FBG	Steering Guide	Helps manipulate bits while within the wall cavity.	\$58.00



Circular Saw Blades

Part #	Size	Box Qty.	List
DS-58-724	7-1/4" X 24T	25	\$16.00
CS-58-824	8-1/4" X 24T	25	\$28.00
CS-58-840	8-1/4" X 40T	25	\$42.00



- ◆ Tungsten Carbide Tipped
- ◆ 5/8" Arbor With Diamond Knock Out
- ◆ 7000 RPM Maximum
- ◆ Hard Body 38-42 Rc.
- ◆ K20 Tungsten Carbide Grade
- ◆ Individually Protected
- ◆ Individually Barcoded
- ◆ Imported

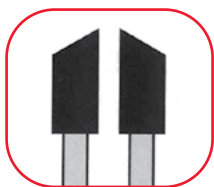

ALTERNATE TOP BEVELED TEETH





- ◆ M2 HSS
- ◆ Straight Shank To 1/2", Then Reduced
- ◆ Sharp Cutting Edge To Drill In Many Different Materials



- ⊙ Precision point angle for effective penetration through steel and wood.
- ⊙ Extra length flute with continuous cutting edges for drilling deep holes and fast chip removal.
- ⊙ Reduced shank fits all drill motors with 1/2" chucks.
- ⊙ Non-slip grips prevent the bit from spinning in the chuck.



12" Long Boy - M2 HSS

Part #	Size	Dec.	OAL	Flute	Qty.	List
216HS0864	1/8"	.1250	12"	9"	1	\$14.23
216HS1264	3/16"	.1875	12"	9"	1	\$14.63
216HS1464	7/32"	.2188	12"	9"	1	\$18.63
216HS1664	1/4"	.2500	12"	9"	1	\$17.22
216HS1864	9/32"	.2812	12"	9"	1	\$19.93
216HS2064	5/16"	.3125	12"	9"	1	\$24.69
216HS2464	3/8"	.3750	12"	9"	1	\$33.40
216HS2864	7/16"	.4375	12"	9"	1	\$53.43
216HS3264	1/2"	.5000	12"	9"	1	\$53.90
216HS3664	9/16"	.5625	12"	9"	1	\$97.86
216HS4064	5/8"	.6250	12"	9"	1	\$113.79
216HS4464	11/16"	.6875	12"	9"	1	\$146.72
216HS4864	3/4"	.7500	12"	9"	1	\$162.63
216HS5264	13/16"	.8125	12"	9"	1	\$184.83
216HS5664	7/8"	.8750	12"	9"	1	\$211.07
216HS6064	15/16"	.9375	12"	9"	1	\$236.06
216HS6464	1"	1.000	12"	9"	1	\$254.00
216HS7264	1-1/8"	1.1250	12"	9"	1	\$347.32

18" Long Boy - M2 HSS

Part #	Size	Dec.	OAL	Flute	Qty.	List
217HS1664	1/4"	.2500	18"	14"	1	\$31.39
217HS2064	5/16"	.3125	18"	14"	1	\$45.35
217HS2464	3/8"	.3750	18"	14"	1	\$62.67
217HS3064	15/32"	.4688	18"	14"	1	\$89.50
217HS3264	1/2"	.5000	18"	14"	1	\$105.08
217HS4064	5/8"	.6250	18"	14"	1	\$139.57
217HS4864	3/4"	.7500	18"	14"	1	\$187.50



Brad Point Wood Drill

Part #	Size	OAL	Shank	Qty.	List
309BP0864	1/8"	2-1/2"	1/8"	1	\$2.81
309BP1064	5/32"	3-1/8"	5/32"	1	\$3.36
309BP1264	3/16"	3-3/8"	3/16"	1	\$3.83
309BP1664	1/4"	4"	1/4"	1	\$4.38
309BP2064	5/16"	4-5/8"	5/16"	1	\$4.69
309BP2464	3/8"	4-7/8"	3/8"	1	\$5.24
309BP2864	7/16"	5-1/2"	3/8"	1	\$7.35
309BP3264	1/2"	6"	3/8"	1	\$8.91
309BP4064	5/8"	7"	3/8"	1	\$13.03
309BP4864	3/4"	7-3/4"	3/8"	1	\$34.01
309BP5664	7/8"	8-1/8"	3/8"	1	\$44.83
309BP6464	1"	8-1/2"	3/8"	1	\$58.25



Great For Acrylics!



- ◆ Precision Ground Flute
- ◆ Center Spur
- ◆ Two Shoulder Cutting Spurs
- ◆ Industrial Quality



Part # 309BP007
7 Pc. Set Woodworking
 1/8" - 3/16" - 1/4" - 5/16" - 3/8" -
 7/16" - 1/2"
List \$51.10

Self Feed (Multispur) Wood Drill

Part #	Size	MM	Pipe Entrance	Tubing Entrance	Cutting Flute	Shank	List
306ST-1	1"	25.4	1/2"	7/8"	1"	7/16"	\$46.29
306ST-2	1-1/8"	28.6	1/2"	1"	1"	7/16"	\$46.29
306ST-3	1-1/4"	31.8	3/4"	1-1/8"	1"	7/16"	\$46.29
306ST-4	1-3/8"	34.9	1"	1-1/4"	1"	7/16"	\$46.29
306ST-5	1-1/2"	38.1	1"	1-3/8"	1"	7/16"	\$46.29
306ST-6	1-3/4"	44.5	1-1/4"	1-1/2"	1"	7/16"	\$49.67
306ST-7	2"	50.8	1-1/2"	1-7/8"	1"	7/16"	\$53.06
306ST-8	2-1/8"	54.0	1-1/2"	2"	1"	7/16"	\$54.27
306ST-9	2-1/4"	57.2	1-1/2"	2-1/8"	1"	7/16"	\$58.87
306ST-10	2-9/16"	65.1	2"	2-1/2"	1"	7/16"	\$59.32
306ST-11	3"	76.2	2-1/2"	2-7/8"	2"	7/16"	\$152.89
306ST-12	3-5/8"	92.1	3"	3-1/2"	2"	7/16"	\$207.89
306ST-13	4-5/8"	117.5	4"	4-1/2"	2"	7/16"	\$244.66



Wood Plywood

Replacement Screw Points

Part #	Size	Fits	List
SP0001	1/4"	1-1/4" to 2-9/16"	\$7.76
SP0002	1/4"	3" to 4-5/8"	\$11.65

Screw Points come with replacement set screw and wrench.

- ◆ 7/16" Hex Impact Shank
- ◆ Fast Continuous and Self Feeding
- ◆ Deep Holes
- ◆ Double End Screw
- ◆ Extra Screw & Wrench
- ◆ Industrial Quality
- ◆ Plumbing
- ◆ Rough In Work



1/2" DRILL

IMPACT DRIVER

SOLD INDIVIDUALLY
1 PER TUBE.



Extensions for Ship Auger & Multispur

POWER BIT EXTENSIONS

Part #	Size	For Shank	Ø	List	Part #	Size	For Shank	Ø	List
307BT5618	5/16" x 18"	5/16"	11/16"	\$28.51	307HEX-1	7/16" x 9-1/2"	7/16"	7/8"	\$32.50
					307HEX-2	7/16" x 12"	7/16"	7/8"	\$36.70
					307HEX-3	7/16" x 18"	7/16"	7/8"	\$40.86
					307HEX-4	7/16" x 24"	7/16"	7/8"	\$45.58

5/16" Extensions - Drill Diameter Must Be Larger Than 11/16".
7/16" Extensions - Drill Diameter Must Be Larger Than 7/8".

- ◆ 7/16" Hex Impact Shank
- ◆ HEX Wrench Included
- ◆ 2 Set Screws
- ◆ Sold Individually



1/2" DRILL

IMPACT DRIVER



IMPACT
 1/4" HEX IMPACT SHANK



- ◆ 1/4" Hex Impact Shank
- ◆ Cold Forged
- ◆ Full Length Treated
- ◆ Machine Finish Cutting Groove
- ◆ Rust Protection
- ◆ Wing Tip Design
- ◆ Individually Stamped With Size
- ◆ Industrial Quality



Part # 300-ST-06

6 Pc. Spade Bit Set
 3/8" - 1/2" - 5/8"
 3/4" - 7/8" - 1"

List \$32.50



6" Long Spade Wood Drill

Part #	Size	OAL	Qty.	List
300SB1664	1/4"	6"	1	\$4.48
300SB2064	5/16"	6"	1	\$4.48
300SB2464	3/8"	6"	1	\$4.48
300SB2864	7/16"	6"	1	\$4.48
300SB3264	1/2"	6"	1	\$4.48
300SB3664	9/16"	6"	1	\$5.33
300SB4064	5/8"	6"	1	\$5.33
300SB4464	11/16"	6"	1	\$5.33
300SB4864	3/4"	6"	1	\$5.33
300SB5264	13/16"	6"	1	\$5.33
300SB5664	7/8"	6"	1	\$5.53
300SB6064	15/16"	6"	1	\$5.53
300SB6464	1"	6"	1	\$5.53
300SB7264	1-1/8"	6"	1	\$8.03
300SB8064	1-1/4"	6"	1	\$8.03
300SB8864	1-3/8"	6"	1	\$8.03
300SB9664	1-1/2"	6"	1	\$8.03

16" Long Spade Wood Drill

Part #	Size	OAL	Qty.	List
301SB1664	1/4"	16"	1	\$11.09
301SB2464	3/8"	16"	1	\$11.09
301SB3264	1/2"	16"	1	\$11.09
301SB4064	5/8"	16"	1	\$11.54
301SB4864	3/4"	16"	1	\$11.54
301SB5664	7/8"	16"	1	\$13.30
301SB6464	1"	16"	1	\$14.61
301SB8864	1-3/8"	16"	1	\$16.57

SOLD INDIVIDUALLY
 1 PER POUCH.



5/8"



Quick Insert / Quick Spring
 Out Chuck Extensions.
 SOLD INDIVIDUALLY.



IMPACT
 1/4" HEX IMPACT SHANK

- ◆ 1/4" Hex Impact Shank
- ◆ Quick-Change
- ◆ 1 PC. Construction
- ◆ Industrial Quality
- ◆ Sold Individually

Extension - For Spade Bit

Part #	Size	For Shank	Ø	List
EXT-300	1/4" x 12"	1/4"	5/8"	\$17.12
EXT-500	1/4" x 18"	1/4"	5/8"	\$19.65

1/4" Extensions - Drill Diameter Must Be Larger Than 5/8".



Drywall Cutter - M2 HSS

Part #	Size	OAL	Qty.	List
DW-018	1/8"	2-3/4"	1	\$8.25
DW-018A	1/8"	2-3/4"	10	\$82.50
DW-018B	1/8"	2-3/4"	25	\$206.25
DW-316	3/16"	3-1/4"	1	\$15.25
DW-316A	3/16"	3-1/4"	10	\$152.50
DW-316B	3/16"	3-1/4"	25	\$381.25



- ◆ 1/8" & 1/4" Shank
- ◆ Electrical Boxes
- ◆ Air Ducts

SOLD INDIVIDUALLY OR
 IN BULK PACKS





REDLINE

Self Feed Twister Wood Drill



Part #	Size	OAL	Qty.	List
THX-2464	3/8"	6"	1	\$11.91
THX-3264	1/2"	6"	1	\$16.59
THX-3664	9/16"	6"	1	\$19.03
THX-4064	5/8"	6"	1	\$21.89
THX-4864	3/4"	6"	1	\$23.72
THX-5664	7/8"	6"	1	\$26.06
THX-6464	1"	6"	1	\$37.13
THX-7264	1-1/8"	6"	1	\$41.53
THX-8064	1-1/4"	6"	1	\$45.10

- ◆ 1/4" Hex Impact Shank
- ◆ Self Feeding
- ◆ 4-Cutting Edges
- ◆ Rust Protection
- ◆ Individually Stamped With Size
- ◆ Industrial Quality



Carbide Tipped Wood Hole Saw - The Butcher

Part #	Size	Teeth	Use Arbor	List
BCHR-35	1-3/8"	2	ARB-5	\$33.34
BCHR-44	1-3/4"	2	ARB-5	\$42.03
BCHR-54	2-1/8"	3	ARB-5	\$45.52
BCHR-57	2-1/4"	3	ARB-5	\$45.52
BCHR-65	2-9/16"	3	ARB-5	\$49.11
BCHR-70	2-3/4"	3	ARB-5	\$50.81
BCHR-76	3"	3	ARB-5	\$50.81
BCHR-92	3-5/8"	3	ARB-5	\$77.07
BCHR-102	4"	3	ARB-5	\$84.06
BCHR-108	4-1/4"	3	ARB-5	\$87.55
BCHR-118	4-5/8"	3	ARB-5	\$105.02
BCHR-133	5-1/4"	3	ARB-5	\$140.06
BCHR-159	6-1/4"	3	ARB-5	\$175.01



PART #
ARB-5
7/16" HEX POWER SHANK
WORKS ON ALL SIZES OF BUTCHER HOLE SAWS
List/ea. **\$27.44**

5/8"-18 Thread M2 HSS PILOT INCLUDED
REPLACEMENT PILOT PART # 277PD0018

2-1/8" Cutting Depth
1 HOLE SAW PER BLISTER PACK.
ARBOR NOT INCLUDED.



PART #
BC-8P
CARBIDE PILOT DRILL
List/ea. **\$5.86**

4-1/2" OAL

- ◆ Tungsten Carbide Teeth
- ◆ 3 Carbide Teeth
- ◆ High Wear Resistance
- ◆ 2-1/8" Cutting Depth
- ◆ Premium Quality
- ◆ Red Finish

PART #
BC-6S
WOOD SPADE PILOT DRILL
List/ea. **\$5.86**

6" OAL





Cuts

Nails



- ◆ 7/16" Hex Impact Shank
- ◆ Carbide Tipped
- ◆ Hex Shank
- ◆ Heat Treated
- ◆ Machine Ground Hollows
- ◆ Deep Throat
- ◆ Single Twist
- ◆ Single Cutter
- ◆ Side Lip
- ◆ Power Groove
- ◆ Self-Feeding Screw Point



SOLD INDIVIDUALLY
 1 PER POUCH.

Carbide Tipped Auger Wood Drills

Part #	Size	OAL	Drilling	Shank	List
CPP-11121	1/2"	18"	15"	7/16"	\$143.75
CPP-12122	1/2"	24"	21"	7/16"	\$199.54
CPP-13123	1/2"	36"	33"	7/16"	\$205.85
CPP-14911	9/16"	18"	15"	7/16"	\$183.33
CPP-15912	9/16"	24"	21"	7/16"	\$214.34
CPP-16913	9/16"	36"	33"	7/16"	\$246.62
CPP-17581	5/8"	18"	15"	7/16"	\$176.47
CPP-18582	5/8"	24"	21"	7/16"	\$235.46
CPP-19583	5/8"	36"	33"	7/16"	\$249.85
CPP-20161	11/16"	18"	15"	7/16"	\$179.17
CPP-21162	11/16"	24"	21"	7/16"	\$241.00
CPP-22163	11/16"	36"	33"	7/16"	\$251.28
CPP-23241	3/4"	18"	15"	7/16"	\$185.44
CPP-24342	3/4"	24"	21"	7/16"	\$249.44
CPP-25343	3/4"	36"	33"	7/16"	\$260.07
CPP-26131	13/16"	18"	15"	7/16"	\$191.93
CPP-27132	13/16"	24"	21"	7/16"	\$258.17
CPP-28133	13/16"	36"	33"	7/16"	\$269.17
CPP-28648	13/16"	48"	45"	7/16"	\$302.73
CPP-29781	7/8"	18"	15"	7/16"	\$267.20
CPP-30782	7/8"	24"	21"	7/16"	\$278.59
CPP-31783	7/8"	36"	33"	7/16"	\$313.33
CPP-32561	15/16"	18"	15"	7/16"	\$276.55
CPP-33562	15/16"	24"	21"	7/16"	\$288.34
CPP-34563	15/16"	36"	33"	7/16"	\$324.29
CPP-34648	15/16"	48"	45"	7/16"	\$348.76
CPP-35115	1"	18"	15"	7/16"	\$282.08
CPP-36121	1"	24"	21"	7/16"	\$294.11
CPP-37133	1"	36"	33"	7/16"	\$330.78
CPP-38135	1-1/16"	24"	21"	7/16"	\$284.90
CPP-39136	1-1/16"	36"	33"	7/16"	\$297.05
CPP-40137	1-1/16"	48"	45"	7/16"	\$334.09



CHECK STOCK BEFORE ORDERING!

POWER POLE DRILLS ARE SUBJECT TO AVAILABILITY.

Use with 1/2" Drills or Impact Drivers:

- Stanley ID-04 "Yellow Jacket"
- Racine HIW-716
- Fairmount H8508

Also works well in heavy duty electric, pneumatic, and gas powered drills.

Power Pole Auger Drill Bits are carbide tipped wood drill bits that have a carbide-tipped cutting tip combined with a hardened steel cutting edge. These unique carbide tipped wood drill bits bore holes in all types of wood quickly, leaving little or no residue. A truly clean, smooth hole is produced. Power Pole carbide tipped wood auger drill bits require less torque to operate and can be used with electric, air, or gasoline powered drill motors and impact wrenches.

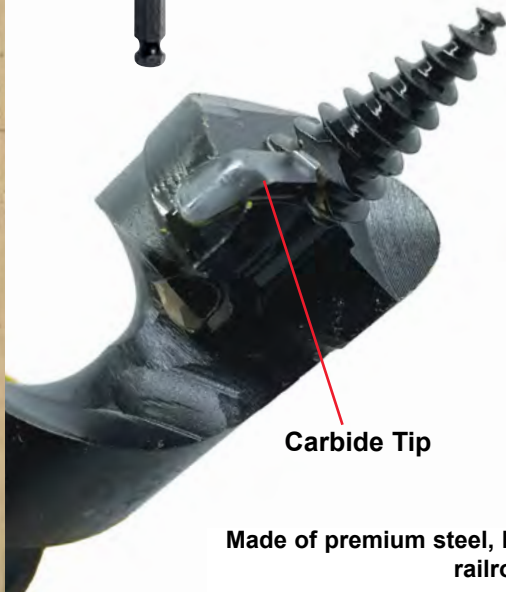

Carbide Tip

Made of premium steel, Power Pole Auger Bits are for boring CCA and Creosoted poles, railroad ties, bulkheads, and other heavy timber.



8" Long Ship Auger Wood Drill

Part #	Size	Size In 16ths	OAL	Hex Shank	List
302SL3264	1/2"	8	8"	7/16"	\$32.13
302SL3664	9/16"	9	8"	7/16"	\$36.21
302SL4064	5/8"	10	8"	7/16"	\$36.21
302SL4464	11/16"	11	8"	7/16"	\$37.63
302SL4864	3/4"	12	8"	7/16"	\$37.63
302SL5264	13/16"	13	8"	7/16"	\$39.74
302SL5664	7/8"	14	8"	7/16"	\$41.06
302SL6064	15/16"	15	8"	7/16"	\$49.73
302SL6464	1"	16	8"	7/16"	\$50.76
302SL7264	1-1/8"	18	8"	7/16"	\$56.48
302SL8064	1-1/4"	20	8"	7/16"	\$65.43
302SL8864	1-3/8"	22	8"	7/16"	\$82.28
302SL9664	1-1/2"	24	8"	7/16"	\$85.35

Cuts
Nails



- ◆ 7/16" Hex Impact Shank
- ◆ 6" Twist Length
- ◆ Heat Treated
- ◆ Deep Throat
- ◆ Single Twist
- ◆ Single Cutter
- ◆ Side Lip
- ◆ Self-Feeding Screw Point



18" Long Ship Auger Wood Drill

Part #	Size	Size In 16ths	OAL	Hex Shank	List
303SL2464	3/8"	6	18"	7/16"	\$39.50
303SL2864	7/16"	7	18"	7/16"	\$39.50
303SL3264	1/2"	8	18"	7/16"	\$39.50
303SL3664	9/16"	9	18"	7/16"	\$39.50
303SL4064	5/8"	10	18"	7/16"	\$39.50
303SL4464	11/16"	11	18"	7/16"	\$43.39
303SL4864	3/4"	12	18"	7/16"	\$43.42
303SL5264	13/16"	13	18"	7/16"	\$48.23
303SL5664	7/8"	14	18"	7/16"	\$50.50
303SL6064	15/16"	15	18"	7/16"	\$55.22
303SL6464	1"	16	18"	7/16"	\$56.11
303SL7264	1-1/8"	18	18"	7/16"	\$79.30
303SL8064	1-1/4"	20	18"	7/16"	\$86.00
303SL8864	1-3/8"	22	18"	7/16"	\$112.06
303SL9664	1-1/2"	24	18"	7/16"	\$115.00

Cuts
Nails



- ◆ 7/16" Hex Impact Shank
- ◆ 15" Twist Length
- ◆ Heat Treated
- ◆ Deep Throat
- ◆ Single Twist
- ◆ Single Cutter
- ◆ Side Lip
- ◆ Self-Feeding Screw Point



7" Sharpening File - Ship Augers

Part #	Description	List
303SL-F1	7" Sharpening File	\$23.65

Made Of Premium Steel, Ship Auger Drills Are For Boring Bulkheads And General Timber.



SOLD INDIVIDUALLY
1 PER TUBE.



INTERNATIONAL TOOL MANUFACTURING
 150 Express St. Plainview, NY 11803
 (516) 738-0388 • (800) 247-5696
 Fax (516) 279-1106



- ◆ 20 Holes Drilled In Grade 5 Porcelain Tile
- ◆ Precision Design
- ◆ Unique Carbide Head
- ◆ Carbide Serrations



Rotation Only!



IMPACT DRIVER



USE WATER



IMPACT
 1/4" HEX IMPACT SHANK



V GROOVE Tile Bit - Impact - Skin Card

Part #	Size	X	OAL	Drilling	Shank	Qty.	List
VH-3002	3/16"	X	3"	2"	HEX	1	\$9.75
VH-4003	1/4"	X	4"	3"	HEX	1	\$10.80



V GROOVE Tile Bit - Impact - Bulk Pack

Part #	Size	X	OAL	Drilling	Shank	Qty.	List
VH-3002B	3/16"	X	3"	2"	HEX	25	\$243.75
VH-4003B	1/4"	X	4"	3"	HEX	25	\$270.00



V GROOVE Tile Bit - Skin Card

Part #	Size	X	OAL	Drilling	Shank	Qty.	List
VG-4001	1/8"	X	3"	2"	1/8"	1	\$7.53
VG-3002	3/16"	X	3"	2"	3/16"	1	\$7.53
VG-4002	3/16"	X	4"	2-3/4"	3/16"	1	\$8.85
VG-6001	3/16"	X	6"	4-1/4"	3/16"	1	\$9.24
VG-4003	1/4"	X	4"	2-3/4"	1/4"	1	\$8.90
VG-6002	1/4"	X	6"	4-1/4"	1/4"	1	\$11.33
VG-6003	5/16"	X	6"	4-1/4"	5/16"	1	\$14.49
VG-6004	3/8"	X	6"	4-1/4"	3/8"	1	\$18.91
VG-6716	7/16"	X	6"	4-1/4"	3/8"	1	\$21.86
VG-6005	1/2"	X	6"	4-1/4"	3/8"	1	\$22.70



V GROOVE Tile Bit - Bulk Pack

Part #	Size	X	OAL	Drilling	Shank	Qty.	List
VG-4001B	1/8"	X	3"	2"	1/8"	25	\$188.25
VG-3002B	3/16"	X	3"	2"	3/16"	25	\$188.25
VG-4002B	3/16"	X	4"	2-3/4"	3/16"	25	\$221.25
VG-6001B	3/16"	X	6"	4-1/4"	3/16"	25	\$231.00
VG-4003B	1/4"	X	4"	2-3/4"	1/4"	25	\$222.50
VG-6002B	1/4"	X	6"	4-1/4"	1/4"	25	\$283.25
VG-6003B	5/16"	X	6"	4-1/4"	5/16"	25	\$362.25
VG-6716B	7/16"	X	6"	4-1/4"	7/16"	25	\$565.00



PULSE & PUSH™ Method of Drilling



1. Pulse the drill and apply pressure.
2. Repeat this step 3 times.
3. Dip carbide tip in water. Repeat PULSE & PUSH™ until hole is drilled.



20 Holes Drilled In Porcelain Tile Video

Take a Picture of QR Code

Unique Carbide Head Design

Carbide Serrations To Evacuate Fine Dust.

No Walk Carbide Point.





V GROOVE™

BATHROOM FIXTURE INSTALL KIT

V GROOVE Kit - Stainless Pan Head Screws

Part #	Description	Drill Bit	Anchor	Screw	List
VGK-1	3/16" Install Kit	3/16" x 4"	3/16" x 7/8"	#8 x 1"	\$55.50
VGK-2	3/16" Install Kit	3/16" x 4"	3/16" x 7/8"	#8 x 1-1/2"	\$55.50
VGK-3	1/4" Install Kit	1/4" x 4"	1/4" x 1"	#10 x 1"	\$55.50
VGK-4	1/4" Install Kit	1/4" x 4"	1/4" x 1"	#10 x 1-1/2"	\$55.50



V GROOVE Tile Bits (5)



#2 x 2" Phillips® Insert Bit (1)



Conical Anchors (50)



Phillips® Pan Head Stainless Screws (50)



BATH
•
SHOWER
•
KITCHEN

V GROOVE Kit - Stainless Flat Head Screws

Part #	Description	Drill Bit	Anchor	Screw	List
VGK-1F	3/16" Install Kit	3/16" x 4"	3/16" x 7/8"	#8 x 1"	\$55.50
VGK-2F	3/16" Install Kit	3/16" x 4"	3/16" x 7/8"	#8 x 1-1/2"	\$55.50
VGK-3F	1/4" Install Kit	1/4" x 4"	1/4" x 1"	#10 x 1"	\$55.50
VGK-4F	1/4" Install Kit	1/4" x 4"	1/4" x 1"	#10 x 1-1/2"	\$55.50



V GROOVE Tile Bits (5)



#2 x 2" Phillips® Insert Bit (1)



Conical Anchors (50)



Phillips® Flat Head Stainless Screws (50)



V SCREW - 101 Pcs. Stainless Pan Head Screws

Part #	Description	Anchor	Qty.	Screw	List
VS-1	#8 x 1" Pan Head	3/16"	101	Phillips®	\$14.21
VS-2	#8 x 1-1/2" Pan Head	3/16"	101	Phillips®	\$17.13
VS-3	#10 x 1" Pan Head	1/4"	101	Phillips®	\$16.09
VS-4	#10 x 1-1/2" Pan Head	1/4"	101	Phillips®	\$20.77

V SCREW™

101 Pcs. STAINLESS STEEL SCREWS



V SCREW - 101 Pcs. Stainless Flat Head Screws

Part #	Description	Anchor	Qty.	Screw	List
VS-1F	#8 x 1" Flat Head	3/16"	101	Phillips®	\$14.21
VS-2F	#8 x 1-1/2" Flat Head	3/16"	101	Phillips®	\$17.13
VS-3F	#10 x 1" Flat Head	1/4"	101	Phillips®	\$16.09
VS-4F	#10 x 1-1/2" Flat Head	1/4"	101	Phillips®	\$20.77



V SCREW - 101 Pcs. Conical Anchors

Part #	Description	Anchor	Qty.	Screw	List
VAC-1	Conical Anchor	3/16" x 7/8"	101	#8	\$11.50
VAC-3	Conical Anchor	1/4" x 1"	101	#10	\$13.50

BLUE SHOCK



#2 X 2" PHILLIPS INCLUDED IN EVERY V SCREW TUBE.

EXTRAS ON P.122



WHITE DIAMOND



IMPACT 1/4" HEX IMPACT SHANK



- ◆ 1/4" Hex Impact Shank
- ◆ Dry Cutting
- ◆ Vacuum Brazed Diamond
- ◆ Wax Filled For Lubrication up To 1/2" Diameter



White Diamond Tile Bit - 1/4" Hex Shank

Part #	Size	X	OAL	Drilling	Qty.	List
HEX-12	3/16"	X	2-5/8"	1-1/4"	1	\$22.05
HEX-14	1/4"	X	2-5/8"	1-1/4"	1	\$22.05
HEX-16	5/16"	X	3-1/8"	1-1/4"	1	\$22.68
HEX-18	3/8"	X	3-1/8"	1-1/4"	1	\$22.68
HEX-20	1/2"	X	3-1/8"	1-1/4"	1	\$24.60
HEX-22	5/8"	X	2-3/4"	1-1/4"	1	\$25.08
HEX-24	3/4"	X	2-3/4"	1-1/4"	1	\$26.40
HEX-26	7/8"	X	2-3/4"	1-1/4"	1	\$26.85
HEX-28	1"	X	2-3/4"	1-1/4"	1	\$29.70



- ◆ Dry Cutting
- ◆ Vacuum Brazed Diamond
- ◆ 5/8"-11 Thread



White Diamond Tile Bit - 5/8"-11 Thread

Part #	Size	X	OAL	Drilling	Qty.	List
ANG-26	7/8"	X	2-3/8"	1-1/4"	1	\$27.30
ANG-28	1"	X	2-3/8"	1-1/4"	1	\$30.38
ANG-30	1-1/8"	X	2-3/8"	1-1/4"	1	\$34.02
ANG-32	1-1/4"	X	2-3/8"	1-1/4"	1	\$38.88
ANG-34	1-3/8"	X	2-3/8"	1-1/4"	1	\$42.53
ANG-36	1-1/2"	X	2-3/8"	1-1/4"	1	\$46.17
ANG-38	2"	X	2-3/8"	1-1/4"	1	\$60.75
ANG-40	2-1/2"	X	2-3/8"	1-1/4"	1	\$76.55



Point Adapter

Part #	Size	Qty.	List
PAD-5811	Point Adapter (5/8"-11)	1	\$17.78

- ◆ Fits Diamond Milling / Countersink / Holesaw
- ◆ 5/8"-11 Thread
- ◆ 3/8" Shank





V Tip Tile Countersink

Part #	Size	Qty.	List
VT-1	For 3/16" & 1/4" Holes	1	\$17.78



1. Drill



2. Countersink



3. Set Anchor



IMPACT 1/4" HEX IMPACT SHANK



- ◆ 1/4" Hex Impact Shank
- ◆ For 3/16" & 1/4"
- ◆ Vacuum Brazed Diamond
- ◆ Set Flush Anchors in Tile



1/2" DRILL



IMPACT DRIVER



SET A FLUSH TILE ANCHOR!



POINT-1



POINT-2



POINT-3

Diamond Countersink

Part #	Size	Qty.	List
POINT-1	Hole Sizes - 3/16" - 1-3/8"	1	\$65.46
POINT-2	Hole Sizes - 1" - 1-7/8"	1	\$87.30
POINT-3	Hole Sizes - 1-7/8" - 3"	1	\$145.80



- ◆ Vacuum Brazed Diamond
- ◆ 5/8"-11 Thread
- ◆ Wet or Dry Cutting
- ◆ #45/50 Diamond Grit
- ◆ Cleaning Rough Edges On Drilled Circle Holes



1.



2.



3. Nice Smooth Edge.



Diamond Milling Cutter

Part #	Size	OAL	Qty.	List
DMC-6	1/4"	2-7/8"	1	\$36.60
DMC-8	5/16"	2-7/8"	1	\$41.82
DMC-10	3/8"	2-7/8"	1	\$47.04
DMC-16	5/8"	2-7/8"	1	\$57.48
DMC-20	3/4"	2-7/8"	1	\$62.70
DMC-25	1"	2-7/8"	1	\$67.98
DMC-50	2"	2-7/8"	1	\$94.08
DMC-75	3"	2-7/8"	1	\$125.46

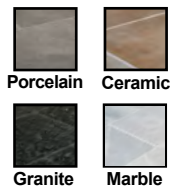

- ◆ Vacuum Brazed Diamond
- ◆ 5/8"-11 Thread
- ◆ Wet or Dry Cutting
- ◆ #45/50 Diamond Grit
- ◆ Milling Inside Circle Or Half Circle For Pipe



1.



2.



3.



GLASS DRILL

ROTATION ONLY
 Fast drilling speeds and lubricant are recommended when using these drills.

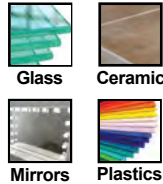

Glass Drills - STANDARD TIP

Part #	Size	OAL	Shank	List
GL-0864	1/8"	2-1/4"	1/8"	\$7.41
GL-1264	3/16"	2-3/4"	3/16"	\$8.54
GL-1664	1/4"	3"	1/4"	\$9.05
GL-2064	5/16"	3-1/4"	1/4"	\$10.05
GL-2464	3/8"	3-1/2"	3/8"	\$14.13
GL-3264	1/2"	4"	3/8"	\$20.10

ANSI ♦ Tungsten Carbide Tip



Glass Drills - Bulk 25 Pack

Part #	Size	OAL	Shank	List
GL-1264B	3/16"	2-3/4"	3/16"	\$192.25
GL-1664B	1/4"	3"	1/4"	\$203.75



USE WATER



Glass Drills - QUAD-CUTTER

Part #	Size	OAL	Shank	List
QG-0012	3/16"	2-3/4"	3/16"	\$9.03
QG-0014	1/4"	3"	1/4"	\$11.00
QG-0016	5/16"	3-1/4"	1/4"	\$13.26
QG-0018	3/8"	3-1/2"	3/8"	\$16.58
QG-0020	1/2"	4"	3/8"	\$23.87

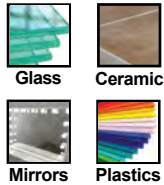

♦ Tungsten Carbide Tip
 ♦ Sold Individually



Glass Drills - RAZOR CUTTER

Part #	Size	OAL	Shank	List
RAZ-4001	1/8"	3"	1/8"	\$8.58
RAZ-4002	3/16"	3"	3/16"	\$9.33
RAZ-4003	1/4"	4"	1/4"	\$10.11
RAZ-4004	5/16"	4"	1/4"	\$12.29
RAZ-4005	3/8"	4"	5/16"	\$17.36
RAZ-4006	1/2"	4"	3/8"	\$22.36



♦ Diamond Segments
 ♦ Wet Drilling
 ♦ Core Extraction
 ♦ Rotation Only
 ♦ Sold Individually



Blu Diamond Tile Bit

Part #	Size	OAL	Shank	List
BLU-1	1/4"	2"	3/8"	\$36.18
BLU-3	5/16"	2"	3/8"	\$39.09
BLU-4	3/8"	2-1/2"	3/8"	\$39.96
BLU-5	1/2"	2-1/2"	3/8"	\$50.08
BLU-6	3/4"	2-3/4"	3/8"	\$52.63
BLU-8	1"	2-3/4"	3/8"	\$56.07

Glass Drills - Bulk 25 Pack

Part #	Size	OAL	Shank	List
RAZ-4002B	3/16"	3"	3/16"	\$221.58
RAZ-4003B	1/4"	4"	1/4"	\$240.11



Part # RAZ-SET5

5 Pc. RAZOR Glass Drill Set
 1/8", 3/16", 1/4", 3/8", 1/2"

List \$67.75





ROTATION ONLY
Moderate drilling speeds and lubricant are recommended when using these drills.

Multi Purpose Drills - CARBIDE TIP

Part #	Size	OAL	Drilling	Shank	List
BLU-0864	1/8"	2-1/2"	1-1/2"	1/8"	\$8.26
BLU-1064	5/32"	3"	2"	5/32"	\$8.70
BLU-1264	3/16"	3-1/2"	2-1/2"	3/16"	\$9.25
BLU-1264-L	3/16"	6"	5"	3/16"	\$13.13
BLU-1664	1/4"	4"	3"	1/4"	\$9.86
BLU-1664-L	1/4"	6"	5"	1/4"	\$14.19
BLU-1664-XL	1/4"	10"	9"	1/4"	\$22.55
BLU-2064	5/16"	4"	3"	5/16"	\$11.03
BLU-2064-XL	5/16"	10"	9"	5/16"	\$28.82
BLU-2464	3/8"	4-1/2"	3-1/2"	3/8"	\$12.08
BLU-2464-XL	3/8"	12"	11"	3/8"	\$31.42
BLU-3264-L	1/2"	6"	5"	1/2"	\$16.51
BLU-3264-XL	1/2"	12"	11"	1/2"	\$35.19
BLU-4064-L	5/8"	6"	5"	1/2"	\$22.17



- ◆ Positive Carbide Tip with Centering Point
- ◆ Tungsten Carbide
- ◆ Angle Tip 118°
- ◆ 4-Sided Sharpening
- ◆ ANSI Specification
- ◆ Sold Individually

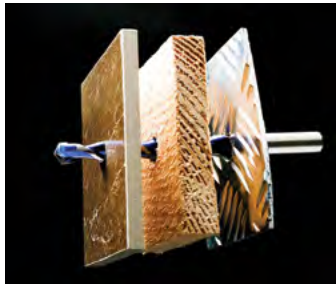

Part # BLU-SET5
5 Pc. Multi Purpose Drill Set
1/8", 3/16", 1/4", 5/16", 3/8"
List \$45.94



Hard Steel Drill - Left Hand

Part #	Size	X	OAL	Shank	List
LHB-18	1/8"	X	3"	1/8"	\$11.71
LHB-20	3/16"	X	3"	3/16"	\$13.80
LHB-22	1/4"	X	4"	1/4"	\$15.31
LHB-26	5/16"	X	4"	1/4"	\$16.59
LHB-32	3/8"	X	6"	3/8"	\$19.71
LHB-50	1/2"	X	6"	1/2"	\$34.79



Hard Steel Drill - Right Hand

Part #	Size	X	OAL	Shank	List
RHB-18	1/8"	X	3"	1/8"	\$10.13
RHB-20	3/16"	X	3"	3/16"	\$11.32
RHB-22	1/4"	X	4"	1/4"	\$12.84
RHB-26	5/16"	X	4"	1/4"	\$13.98
RHB-32	3/8"	X	6"	3/8"	\$15.49
RHB-50	1/2"	X	6"	1/2"	\$30.20



- ◆ Safes
- ◆ Broken Bolts
- ◆ Carbide Tip
- ◆ Tempered Body
- ◆ ANSI B212.15-1994
- ◆ Sold Individually



Part # LHB-SET5
5 Pc. Left Hand Hard Steel Drill Set
1/8", 3/16", 1/4", 5/16", 3/8"
List \$77.11



Part # RHB-SET5
5 Pc. Right Hand Hard Steel Drill Set
1/8", 3/16", 1/4", 5/16", 3/8"
List \$63.76

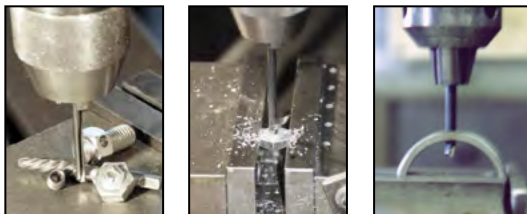

Left Hand Carbide Cut

Right Hand Carbide Cut

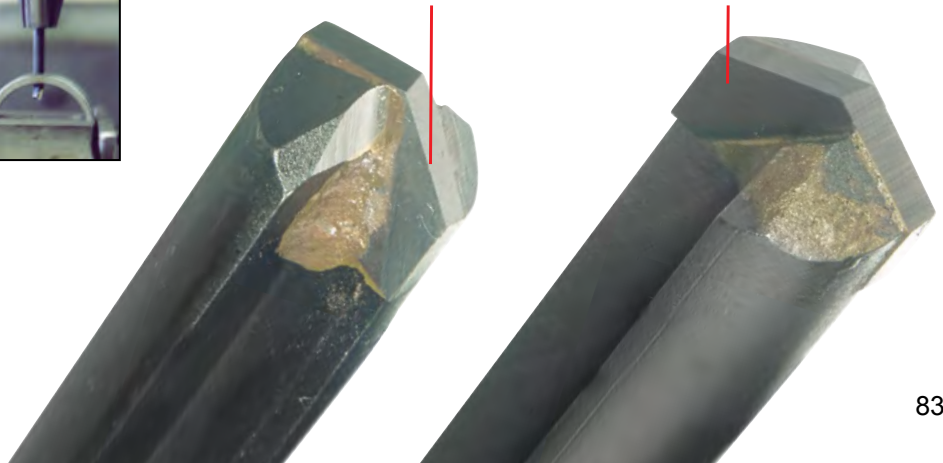



STRAIGHT SHANK



Roto Percussion Drills - Standard

Part #	Size	X	OAL	Drilling	Shank	Qty.	List
502SP4001	1/8"	X	3"	1-1/2"	1/8"	1	\$1.63
502SP4001-B	1/8"	X	3"	1-1/2"	1/8"	25	\$36.68
502SP4002	3/16"	X	4"	2-1/2"	3/16"	1	\$1.79
502SP4002-B	3/16"	X	4"	2-1/2"	3/16"	25	\$40.21
502SP6001	3/16"	X	6"	4"	3/16"	1	\$3.21
502SP6001-B	3/16"	X	6"	4"	3/16"	25	\$72.27
502SP4732	7/32"	X	4"	2-1/2"	7/32"	1	\$1.91
502SP4003	1/4"	X	4"	2-1/2"	1/4"	1	\$1.94
502SP4003-B	1/4"	X	4"	2-1/2"	1/4"	25	\$43.74
502SP6002	1/4"	X	6"	4"	1/4"	1	\$3.43
502SP6002-B	1/4"	X	6"	4"	1/4"	25	\$77.16
502SP1201	1/4"	X	12"	10"	1/4"	1	\$7.56
502SP1814	1/4"	X	18"	16"	1/4"	1	\$10.06
502SP4004	5/16"	X	4"	2-1/2"	1/4"	1	\$2.39
502SP4004-B	5/16"	X	4"	2-1/2"	1/4"	25	\$53.79
502SP6003	5/16"	X	6"	4"	1/4"	1	\$4.09
502SP6003-B	5/16"	X	6"	4"	1/4"	25	\$92.10
502SP4005	3/8"	X	4"	2-1/2"	1/4"	1	\$3.20
502SP6004	3/8"	X	6"	4"	3/8"	1	\$4.62
502SP6004-B	3/8"	X	6"	4"	3/8"	25	\$104.06
502SP1203	3/8"	X	12"	10"	3/8"	1	\$10.16
502SP1838	3/8"	X	18"	16"	3/8"	1	\$13.22
502SP6005	7/16"	X	6"	4"	1/4"	1	\$4.77
502SP4006	1/2"	X	4"	2-1/2"	1/4"	1	\$4.77
502SP6007	1/2"	X	6"	4"	3/8"	1	\$4.93
502SP6007-B	1/2"	X	6"	4"	3/8"	25	\$110.85
502SP1204	1/2"	X	12"	10"	3/8"	1	\$11.39
502SP1812	1/2"	X	18"	16"	3/8"	1	\$14.74
502SP6008	9/16"	X	6"	4"	3/8"	1	\$7.91
502SP6009	5/8"	X	6"	4"	3/8"	1	\$8.68
502SP1205	5/8"	X	12"	10"	3/8"	1	\$16.10
502SP1858	5/8"	X	18"	16"	3/8"	1	\$20.52
502SP6010	3/4"	X	6"	4"	1/2"	1	\$11.28
502SP1206	3/4"	X	12"	10"	1/2"	1	\$20.35
502SP1834	3/4"	X	18"	16"	1/2"	1	\$26.21
502SP6011	7/8"	X	6"	4"	1/2"	1	\$13.19
502SP1207	7/8"	X	12"	10"	1/2"	1	\$22.87
502SP1878	7/8"	X	18"	16"	1/2"	1	\$28.82
502SP6012	1"	X	6"	4"	1/2"	1	\$17.47
502SP1208	1"	X	12"	10"	1/2"	1	\$25.78
502SP1801	1"	X	18"	16"	1/2"	1	\$34.64

Use with Percussion

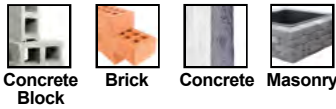

- ◆ General Purpose
- ◆ Tungsten Carbide
- ◆ Slow Spiral Flute
- ◆ Tempered Body
- ◆ Black Oxide Finish
- ◆ Gold Head
- ◆ Straight Shank
- ◆ ANSI Specification



SOLD INDIVIDUALLY
OR IN BULK PACKS.

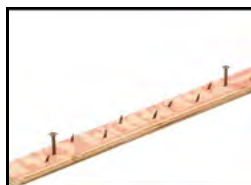

- ◆ Carbide Tip
- ◆ Bright Finish
- ◆ For Tack Strip



Carpet Stub Drills

Part #	Size	OAL	Qty.	List
CD-18	1/8"	1-7/8"	1	\$2.35
CD-18L	1/8"	2-3/4"	1	\$2.55



Roto Percussion Drills - Heavy Duty

Part #	Size	X	OAL	Drilling	Shank	Qty.	List
700040864	1/8"	X	3"	2"	1/8"	1	\$4.30
700040864-B	1/8"	X	3"	2"	1/8"	25	\$96.65
700061064	5/32"	X	6"	5"	5/32"	1	\$5.47
700061064-B	5/32"	X	6"	5"	5/32"	25	\$123.01
700041264	3/16"	X	4"	3"	3/16"	1	\$4.56
700041264-B	3/16"	X	4"	3"	3/16"	25	\$102.51
700061264	3/16"	X	6"	5"	3/16"	1	\$4.79
700061264-B	3/16"	X	6"	5"	3/16"	25	\$107.83
700061464	7/32"	X	6"	5"	7/32"	1	\$6.31
700041664	1/4"	X	4"	3"	1/4"	1	\$4.56
700041664-B	1/4"	X	4"	3"	1/4"	25	\$102.51
700061664	1/4"	X	6"	5"	1/4"	1	\$5.50
700061664-B	1/4"	X	6"	5"	1/4"	25	\$123.81
700081664	1/4"	X	12"	11"	1/4"	1	\$12.50
700024166	1/4"	X	24"	23"	1/4"	1	\$24.80
700062064	5/16"	X	6"	5"	5/16"	1	\$7.81
700062064-B	5/16"	X	6"	5"	5/16"	25	\$175.73
700062464	3/8"	X	6"	5"	3/8"	1	\$7.10
700062464-B	3/8"	X	6"	5"	3/8"	25	\$159.75
700082464	3/8"	X	12"	11"	3/8"	1	\$14.45
700020246	3/8"	X	18"	17"	3/8"	1	\$22.65
700024246	3/8"	X	24"	20"	3/8"	1	\$28.12
700063264	1/2"	X	6"	4"	3/8"	1	\$11.26
700063264-B	1/2"	X	6"	4"	3/8"	25	\$253.34
700083264	1/2"	X	12"	10"	3/8"	1	\$21.02
700020326	1/2"	X	18"	17"	3/8"	1	\$27.07
700024326	1/2"	X	24"	23"	3/8"	1	\$32.41
700064064	5/8"	X	6"	5"	Hex 3/8"	1	\$16.99
700084064	5/8"	X	12"	11"	Hex 3/8"	1	\$26.81
700024406	5/8"	X	24"	23"	Hex 1/2"	1	\$46.85
700064864	3/4"	X	6"	5"	Hex 1/2"	1	\$21.67
700084864	3/4"	X	12"	11"	Hex 1/2"	1	\$30.85
700024034	3/4"	X	24"	23"	Hex 1/2"	1	\$58.68
700065664	7/8"	X	6"	5"	Hex 1/2"	1	\$25.77
700066464	1"	X	6"	5"	Hex 1/2"	1	\$30.46



Use with Percussion



- ◆ Heavy Duty
- ◆ Percussion Grade Tungsten Carbide
- ◆ Unique Spiral Flute for Fast Dust Removal
- ◆ Heat Treated Body
- ◆ Polished Finish
- ◆ Hex Shank on Larger Diameters to Prevent Slipping
- ◆ ANSI Specification



SOLD INDIVIDUALLY OR IN BULK PACKS.

i These Drill Bits are made for machines with percussion. They will not perform with rotation only.

Made For Hammer Drills!



SDS-PLUS ROTARY HAMMER DRILL MACHINES



BOSCH	DEWALT	HILTI	HITACHI	MAKITA	MILWAUKEE	METABO
11207	D25012K	TE 1	DH18DL	BHR202	0756-22	6010
11210	D25023K	TE 2	DH22PG	BHR241	2412-20	6011
11211	D25111K	TE 2-A	DH24	HR160	2416-20XC	6015
11212	D25123K	TE 2-A18	DH24PF3	HR1821	2605-20	6018
11215	D25133K	TE 2-M	DH25	HR1830	2612-22	6020
11524	D25211K	TE 2-S	DH28	HR1830F	2712-22	6021
11213RK	D25213K	TE 4-A18	DH28PC	HR2000	2715-22	6024
11221DVS	D25223K	TE 4-A22	DH28PD	HR2010	5262	6026
11222EVS/G	D25211K	TE 6-A36-AVR	DH30	HR2400	5262-21	6028
11224VSR	D25213K	TE 6-S	H30PV	HR2410	5263	BHA18
11225VSR/H	D25223K	TE 7	VR16	HR2420	5263-21	BHE22
11228VSR	D25260K	TE 7-A	VRT22	HR2431	5268-21	BHE2243
11234VSR	D25262K	TE 7-C		HR2432	5302	BHE24
11236VS	D25263K	TE 30		HR2450	5303	BHE2444
11239VS	D25313K	TE 30-A36		HR2455	5312	BHE2644
11250VSR	D25323K	TE 30-C-AVR		HR2470F	5320	BHE6015
11250VSRD	D25324K	TE 30-M-AVR		HR2475	5324	KHE24
11253VSR	D25404K	TE 40		HR2511	5342	KHE2444
11255VSR	D25413K	TE 40-AVR		HR2611F	5359	KHE2640
11536C-1(2)	D25416K	TE A-36AVR		HR2621	5359-21	KHE2644
11536VSR		TE/GP 22		HR2811F	5360	KHE3650
RH228VC				HR3000C	5362	KHE28
RH328VC(Q)				HR3210C	5363	KHE2851
RH432VC(Q)					5363-21	KHE32
RHH181-01					5365	KHE3250
RHH181BL					5366	KHE3251
RHS181B					5368	UHE22
RHS181K					5369	UHE2250
					5383	UHE2450
					V28	UHE2650
						UHE28
						UHE2850

SDS-MAX ROTARY HAMMER DRILL MACHINES



BOSCH	DEWALT	HILTI	HITACHI	MAKITA	MILWAUKEE	METABO
11214EVS	25600K	TE-F 52	DH38MS	HR4000C	5308	6045
1223	2570K	TE-F 60	DH40MA	HR4001C	5313	KHE 5-40
1227	541K	TE-F 72	DH40MB	HR4002	5314	KHE56
1230	545K	TE-F 92	DH40MR	HR4002C	5315	KHE76
11216	D25501K	TE-Y 54	DH45MR	HR4010C	5317	KHE96
11231	D25601K	TE-Y 55	DH50MR	HR4013C	5317-21	
11235	D25602K	TE-Y 56	H60HR	HR4500C	5342	
11240	D25603K	TE-Y 70		HR4510C	5342-21	
11241	D25712K	TE-Y 74		HR5001C	5346	
11245	D25721K	TE-Y 75		HR5210C	5426	
11245EVS	D25723K	TE-Y 76		HR5212C	5426-1	
11263	D25761K	TE50			5446	
11263EVS	D25762K	TE60				
11264	D25763K	TE60-ATC/AVR				
11264EVS		TE70				
RH540M		TE70-ATC/AVR				
RH745		TE80-ATC/AVR				
RH850VC						

SPLINE DRIVE ROTARY HAMMER DRILL MACHINES



BOSCH	DEWALT	HILTI	HITACHI	MAKITA	MILWAUKEE	METABO
11202	D25651K	N/A	DH38YE2	HR3851	5309	N/A
11203	D25553K		DH40FR	HR4040C	5311	
11204	530K		DS50SBK	HR4041C	5316	
11205	531K			HR5000	5316-21	
11209	532K				5317	
11214	533K				5318	
11219					5319	
11220					5321	
11232					5340-21	
11233					5341	
11247					5343	
11248					5344	
11244E					5347	
11265EVS					5348	
RH540S					5352	
					5345	



6-CUTTER *DRILLS REINFORCED CONCRETE!*

Spline Drive Rotary Hammer Drills

Part #	Size	X	OAL	Drilling	Head	List
717SP1312	1/2"	X	13"	8"	6-CUTTER	\$80.58
717SP2412	1/2"	X	24"	19"	6-CUTTER	\$112.79
717SP1658	5/8"	X	16"	11"	6-CUTTER	\$95.64
717SP2458	5/8"	X	24"	19"	6-CUTTER	\$116.83
717SP1234	3/4"	X	12"	7"	6-CUTTER	\$99.00
717SP2134	3/4"	X	21"	16"	6-CUTTER	\$156.66
717SP3634	3/4"	X	36"	31"	6-CUTTER	\$210.28
717SP1678	7/8"	X	16"	11"	6-CUTTER	\$115.62
717SP2478	7/8"	X	24"	19"	6-CUTTER	\$171.11
717SP1601	1"	X	16"	11"	6-CUTTER	\$121.18
717SP2101	1"	X	21"	16"	6-CUTTER	\$149.78
717SP1618	1-1/8"	X	16"	11"	6-CUTTER	\$172.10
717SP2118	1-1/8"	X	21"	16"	6-CUTTER	\$196.78
717SP1614	1-1/4"	X	16"	11"	6-CUTTER	\$198.61
717SP2414	1-1/4"	X	24"	19"	6-CUTTER	\$221.02
717SP2438	1-3/8"	X	16"	19"	6-CUTTER	\$205.64
717SP2438	1-3/8"	X	24"	19"	6-CUTTER	\$250.37
717SP4112	1-1/2"	X	24"	19"	6-CUTTER	\$287.69



- ◆ Rotary Hammer Drill
- ◆ Industrial Quality
- ◆ 6 Carbide Cutting Edges
- ◆ Heat Resistant
- ◆ Fastest Dust Removal
- ◆ Fastest Drilling Speeds
- ◆ Heat Treated Body
- ◆ Clean Round Holes
- ◆ Less Vibration
- ◆ Polished Finish
- ◆ ANSI Specification



SPLINE SHANK

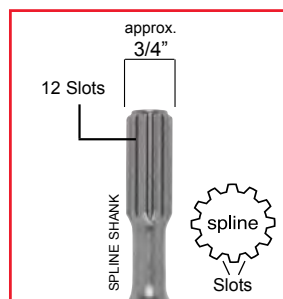

SOLD INDIVIDUALLY
1 PER TUBE.



INTERNATIONAL TOOL MANUFACTURING
 150 Express St. Plainview, NY 11803
 (516) 738-0388 • (800) 247-5696
 Fax (516) 279-1106

NEW PACKAGING ON ALL ROTARY HAMMER DRILLS



Chisel Shaped Head Geometry - Fast Penetration
High Volume Flute - Fast Dust Removal



P. 89



◆ ANSI Specification



Optimized Carbide Head Geometry - Easy Spot Drilling
Web Shaped Head - Improved Dust Release to Flute
High Volume Flute - Faster Debris Removal
Flute Core Reinforcement - Reduces Vibrations
Rebar Chamfers - Prevents Carbide From Cracking When in Contact with Rebar



BOHR HAMMER P. 90-93



◆ ANSI Specification
 ◆ Made in Germany



4 x 90° X-Cutter Carbide Head - Crushes Through and Prevents Sticking in Rebar
Wear Mark Indicator - Ensures Dimensional Hole Accuracy
Rebar Chamfers - Prevents Carbide From Cracking When in Contact With Rebar
More Carbide Mass - Extra Carbide Compared to Bohr Hammer
Flute Core Reinforcement - Reduces Vibrations



XCUTTER P.94



◆ ANSI Specification
 ◆ Made in Germany

REDLINE

2 - CUTTER

SDS-PLUS Rotary Hammer Drills

Part #	Size	X	OAL	Drilling	Qty.	List
RL-41064	5/32"	X	4-1/4"	2"	1	\$3.99
RL-61064	5/32"	X	6-1/4"	4"	1	\$4.64
RL-61064-B	5/32"	X	6-1/4"	4"	25	\$108.10
RL-41264	3/16"	X	4-1/4"	2"	1	\$3.41
RL-61264	3/16"	X	6-1/4"	4"	1	\$4.52
RL-61264-B	3/16"	X	6-1/4"	4"	25	\$105.23
RL-81264	3/16"	X	8-1/4"	6"	1	\$6.29
RL-81264-B	3/16"	X	8-1/4"	6"	25	\$148.47
RL-10316	3/16"	X	10-1/4"	8"	1	\$8.50
RL-10316-B	3/16"	X	10-1/4"	8"	25	\$201.88
RL-61464	7/32"	X	6-1/4"	4"	1	\$5.11
RL-61464-B	7/32"	X	6-1/4"	4"	25	\$121.48
RL-81464	7/32"	X	8-1/4"	6"	1	\$6.72
RL-81464-B	7/32"	X	8-1/4"	6"	25	\$159.60
RL-10732	7/32"	X	10-1/4"	8"	1	\$9.56
RL-10732-B	7/32"	X	10-1/4"	8"	25	\$226.93
RL-41664	1/4"	X	4-1/4"	2"	1	\$3.34
RL-41664-B	1/4"	X	4-1/4"	2"	25	\$76.48
RL-61664	1/4"	X	6-1/4"	4"	1	\$3.99
RL-61664-B	1/4"	X	6-1/4"	4"	25	\$91.81
RL-81664	1/4"	X	8-1/4"	6"	1	\$5.52
RL-81664-B	1/4"	X	8-1/4"	6"	25	\$129.57
RL-12014	1/4"	X	12-1/4"	10"	1	\$10.29
RL-12014-B	1/4"	X	12-1/4"	10"	25	\$231.58
RL-62064	5/16"	X	6-1/4"	4"	1	\$4.37
RL-62064-B	5/16"	X	6-1/4"	4"	25	\$102.35
RL-62464	3/8"	X	6-1/4"	4"	1	\$4.79
RL-62464-B	3/8"	X	6-1/4"	4"	25	\$111.94
RL-12038	3/8"	X	12-1/4"	10"	1	\$9.58
RL-12038-B	3/8"	X	12-1/4"	10"	20	\$187.46
RL-18038	3/8"	X	18"	16"	1	\$19.51
RL-18038-B	3/8"	X	18"	16"	20	\$370.74
RL-24038	3/8"	X	24"	22"	1	\$32.11
RL-24038-B	3/8"	X	24"	22"	20	\$610.14
RL-63264	1/2"	X	6-1/4"	4"	1	\$6.25
RL-63264-B	1/2"	X	6-1/4"	4"	25	\$149.12
RL-12012	1/2"	X	12-1/4"	10"	1	\$11.00
RL-12012-B	1/2"	X	12-1/4"	10"	10	\$107.53
RL-63664	9/16"	X	6-1/4"	4"	1	\$10.54
RL-64064	5/8"	X	6-1/4"	6"	1	\$12.25
RL-64064-B	5/8"	X	6-1/4"	6"	10	\$114.19
RL-84064	5/8"	X	8-1/4"	6"	1	\$14.63
RL-84064-B	5/8"	X	8-1/4"	6"	10	\$142.10
RL-12058	5/8"	X	12"	10"	1	\$19.69
RL-84864	3/4"	X	8"	6"	1	\$20.96
RL-84864-B	3/4"	X	8"	6"	10	\$207.46
RL-12034	3/4"	X	12"	10"	1	\$26.91
RL-12034-B	3/4"	X	12"	10"	5	\$134.09
RL-85664	7/8"	X	8"	6"	1	\$31.08
RL-85664-B	7/8"	X	8"	6"	5	\$154.75
RL-12078	7/8"	X	12"	10"	1	\$35.33
RL-12078-B	7/8"	X	12"	10"	5	\$176.68
RL-10001	1"	X	10"	8"	1	\$39.85
RL-10001-B	1"	X	10"	8"	5	\$199.24



**For General Purpose.
Rotary Hammer Drilling.**



Mild Concrete



Stone



Brick



Masonry

- ◆ Rotary Hammer Drill
- ◆ 2-Cutter Carbide Head
- ◆ ANSI Specification





- ◆ Rotary Hammer Drill
- ◆ Optimized Carbide Head Geometry
- ◆ Self Centering Chisel Point
- ◆ ANSI Specification
- ◆ Special Tungsten Carbide Tip
- ◆ Copper / Silver Brazing
- ◆ Fastest Dust Removal
- ◆ Fastest Drilling Speeds
- ◆ Clean Round Holes
- ◆ Less Vibration
- ◆ Polished Finish
- ◆ Industrial Quality



BOHR HAMMER

SDS-PLUS Rotary Hammer Drills

Part #	Size	X	OAL	Drilling	Head	Qty.	List
715S41064	5/32"	X	4-1/4"	2"	4-PLUS	1	\$6.39
715S61064	5/32"	X	6-1/4"	4"	4-PLUS	1	\$7.29
715S61064-B	5/32"	X	6-1/4"	4"	4-PLUS	25	\$173.06
715S41264	3/16"	X	4-1/4"	2"	4-PLUS	1	\$6.39
715S41264-B	3/16"	X	4-1/4"	2"	4-PLUS	25	\$151.71
715S61264	3/16"	X	6-1/4"	4"	4-PLUS	1	\$7.29
715S61264-B	3/16"	X	6-1/4"	4"	4-PLUS	25	\$173.06
715S81264	3/16"	X	8-1/4"	6"	4-PLUS	1	\$10.08
715S81264-B	3/16"	X	8-1/4"	6"	4-PLUS	25	\$239.39
715S10316	3/16"	X	10-1/4"	8"	4-PLUS	1	\$13.38
715S12316	3/16"	X	12-1/4"	10"	4-PLUS	1	\$16.59
715S14316	3/16"	X	14"	12"	4-PLUS	1	\$24.17
715S16316	3/16"	X	16"	14"	4-PLUS	1	\$31.74
715S20316	3/16"	X	20"	18"	4-PLUS	1	\$58.00
715S24316	3/16"	X	24"	22"	4-PLUS	1	\$64.71
715S41464	7/32"	X	4-1/4"	2"	4-PLUS	1	\$7.48
715S61464	7/32"	X	6-1/4"	4"	4-PLUS	1	\$7.73
715S81464	7/32"	X	8-1/4"	6"	4-PLUS	1	\$9.60
715S10732	7/32"	X	10-1/4"	8"	4-PLUS	1	\$17.34
715S14732	7/32"	X	14"	12"	4-PLUS	1	\$24.21
715S16732	7/32"	X	16"	14"	4-PLUS	1	\$30.18
715S20732	7/32"	X	20"	18"	4-PLUS	1	\$59.20
715S24732	7/32"	X	24"	22"	4-PLUS	1	\$78.00
715S41664	1/4"	X	4-1/4"	2"	4-PLUS	1	\$6.39
715S41664-B	1/4"	X	4-1/4"	2"	4-PLUS	25	\$151.71
715S61664	1/4"	X	6-1/4"	4"	4-PLUS	1	\$6.69
715S61664-B	1/4"	X	6-1/4"	4"	4-PLUS	25	\$158.83
715S81664	1/4"	X	8-1/4"	6"	4-PLUS	1	\$9.60
715S81664-B	1/4"	X	8-1/4"	6"	4-PLUS	25	\$227.95
715S10014	1/4"	X	10-1/4"	8"	4-PLUS	1	\$12.25
715S14014	1/4"	X	14"	12"	4-PLUS	1	\$24.02
715S16014	1/4"	X	16"	14"	4-PLUS	1	\$28.06
715S20014	1/4"	X	20"	18"	4-PLUS	1	\$39.59
715S24014	1/4"	X	24"	22"	4-PLUS	1	\$54.62
715S62064	5/16"	X	6-1/4"	4"	4-PLUS	1	\$8.89
715S62064-B	5/16"	X	6-1/4"	4"	4-PLUS	25	\$211.18
715S82064	5/16"	X	8-1/4"	6"	4-PLUS	1	\$11.79
715S12516	5/16"	X	12-1/4"	10"	4-PLUS	1	\$22.20
715S62464	3/8"	X	6-1/4"	4"	4-PLUS	1	\$9.66
715S62464-B	3/8"	X	6-1/4"	4"	4-PLUS	25	\$229.47
715S82464	3/8"	X	8-1/4"	6"	4-PLUS	1	\$12.50
715S10038	3/8"	X	10-1/4"	8"	4-PLUS	1	\$15.63
715S12038	3/8"	X	12-1/4"	10"	4-PLUS	1	\$19.83
715S12038-B	3/8"	X	12-1/4"	10"	4-PLUS	10	\$188.36
715S18038	3/8"	X	18"	16"	4-PLUS	1	\$32.27
715S24038	3/8"	X	24"	22"	4-PLUS	1	\$40.88
715S62864	7/16"	X	6-1/4"	4"	4-PLUS	1	\$14.11
715S10716	7/16"	X	10-1/4"	8"	4-PLUS	1	\$19.92
715S12716	7/16"	X	12-1/4"	10"	4-PLUS	1	\$23.32
715S18716	7/16"	X	18"	16"	4-PLUS	1	\$35.53



BOHR HAMMER

SDS-PLUS Rotary Hammer Drills

Part #	Size	X	OAL	Drilling	Head	Qty.	List
715S63264	1/2"	X	6-1/4"	4"	4-PLUS	1	\$11.12
715S63264-B	1/2"	X	6-1/4"	4"	4-PLUS	25	\$264.04
715S10012	1/2"	X	10-1/4"	8"	4-PLUS	1	\$19.19
715S12012	1/2"	X	12-1/4"	10"	4-PLUS	1	\$23.07
715S12012-B	1/2"	X	12-1/4"	10"	4-PLUS	10	\$198.83
715S12018	1/2"	X	18"	16"	4-PLUS	1	\$33.73
715S12024	1/2"	X	24"	22"	4-PLUS	1	\$52.92
715S63664	9/16"	X	6-1/4"	4"	4-PLUS	1	\$17.23
715S10916	9/16"	X	10-1/4"	8"	4-PLUS	1	\$23.32
715S12916	9/16"	X	12-1/4"	10"	4-PLUS	1	\$26.90
715S18916	9/16"	X	18"	16"	4-PLUS	1	\$34.88
715S64064	5/8"	X	6-1/4"	4"	4-PLUS	1	\$16.09
715S84064	5/8"	X	8-1/4"	6"	4-PLUS	1	\$21.69
715S84064-B	5/8"	X	8-1/4"	6"	4-PLUS	10	\$206.08
715S12058	5/8"	X	12-1/4"	10"	4-PLUS	1	\$31.45
715S18058	5/8"	X	18"	16"	4-PLUS	1	\$47.20
715S24058	5/8"	X	24"	22"	4-PLUS	1	\$58.34
715S14464	11/16"	X	12"	10"	4-PLUS	1	\$46.79
715S84864	3/4"	X	8"	6"	4-PLUS	1	\$27.98
715S84864-B	3/4"	X	8"	6"	4-PLUS	10	\$251.82
715S10034	3/4"	X	10"	8"	4-PLUS	1	\$33.10
715S12034	3/4"	X	12"	10"	4-PLUS	1	\$38.88
715S12034-B	3/4"	X	12"	10"	4-PLUS	5	\$184.70
715S18034	3/4"	X	18"	16"	4-PLUS	1	\$49.59
715S24034	3/4"	X	24"	22"	4-PLUS	1	\$64.92
715S85664	7/8"	X	8"	6"	4-PLUS	1	\$44.50
715S85664-B	7/8"	X	8"	6"	4-PLUS	5	\$211.38
715S10078	7/8"	X	10"	8"	4-PLUS	1	\$47.59
715S12078	7/8"	X	12"	10"	4-PLUS	1	\$58.82
715S12078-B	7/8"	X	12"	10"	4-PLUS	5	\$264.69
715S18078	7/8"	X	18"	16"	4-PLUS	1	\$67.42
715S86464	1"	X	8"	6"	4-PLUS	1	\$54.13
715S10001	1"	X	10"	8"	4-PLUS	1	\$61.08
715S10001-B	1"	X	10"	8"	4-PLUS	5	\$274.86
715S12001	1"	X	12"	10"	4-PLUS	1	\$71.87
715S18001	1"	X	18"	16"	4-PLUS	1	\$82.39



4-PLUS = 4 ANGLES
 A new, fast and tough serrated carbide tip provides long life, easy centering, and fast drilling through all aggregates, concrete, masonry, brick and natural stone.

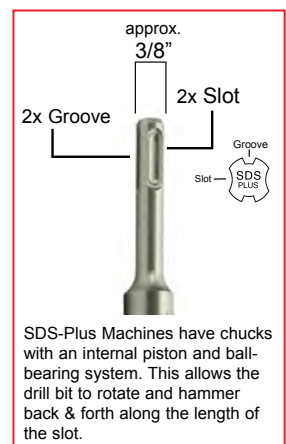

SDS-Plus Machines have chucks with an internal piston and ball-bearing system. This allows the drill bit to rotate and hammer back & forth along the length of the slot.



SDS-PLUS Rotary Hammer - Extra Long

Part #	Size	X	OAL	Drilling	Head	Qty.	List
715FL3614	1/4"	X	36"	34"	4-PLUS	1	\$68.00
715FL3638	3/8"	X	36"	34"	4-PLUS	1	\$75.00
715FL3632	1/2"	X	36"	34"	4-PLUS	1	\$82.50
715FL3658	5/8"	X	36"	34"	4-PLUS	1	\$96.25
715FL3634	3/4"	X	36"	34"	4-PLUS	1	\$126.56





INTERNATIONAL TOOL MANUFACTURING

150 Express St. Plainview, NY 11803

(516) 738-0388 • (800) 247-5696

Fax (516) 279-1106

BOHR HAMMER - BULK DRILLS

SDS-PLUS Rotary Hammer Drills



Concrete



Stone



Brick



Masonry



- ◆ Rotary Hammer Drill
- ◆ Optimized Carbide Head Geometry
- ◆ Self Centering Chisel Point
- ◆ ANSI Specification
- ◆ Special Tungsten Carbide Tip
- ◆ Copper / Silver Brazing
- ◆ Fastest Dust Removal
- ◆ Fastest Drilling Speeds
- ◆ Clean Round Holes
- ◆ Less Vibration
- ◆ Polished Finish
- ◆ Industrial Quality



Part #	Size	X	OAL	Drilling	Pack	Min.Qty.	List/ea.
715B41064	5/32"	X	4-1/4"	2"	BULK	50	\$6.33
715B61064	5/32"	X	6-1/4"	4"	BULK	50	\$7.22
715B41264	3/16"	X	4-1/4"	2"	BULK	50	\$6.33
715B61264	3/16"	X	6-1/4"	4"	BULK	100	\$7.22
715B81264	3/16"	X	8-1/4"	6"	BULK	50	\$9.99
715B10316	3/16"	X	10-1/4"	8"	BULK	25	\$13.25
715B12316	3/16"	X	12-1/4"	10"	BULK	25	\$16.43
715B14316	3/16"	X	14"	12"	BULK	25	\$23.95
715B16316	3/16"	X	16"	14"	BULK	25	\$31.44
715B20316	3/16"	X	20"	18"	BULK	25	\$56.46
715B24316	3/16"	X	24"	22"	BULK	25	\$63.95
715B41464	7/32"	X	4-1/4"	2"	BULK	50	\$7.41
715B61464	7/32"	X	6-1/4"	4"	BULK	50	\$7.65
715B81464	7/32"	X	8-1/4"	6"	BULK	50	\$9.51
715B10732	7/32"	X	10-1/4"	8"	BULK	25	\$17.18
715B14732	7/32"	X	14"	12"	BULK	25	\$24.12
715B16732	7/32"	X	16"	14"	BULK	25	\$30.18
715B20732	7/32"	X	20"	18"	BULK	25	\$53.76
715B24732	7/32"	X	24"	22"	BULK	25	\$73.56



BOHR HAMMER - BULK DRILLS

SDS-PLUS Rotary Hammer Drills

Part #	Size	X	OAL	Drilling	Pack	Min.Qty.	List/ea.
715B41664	1/4"	X	4-1/4"	2"	BULK	50	\$6.33
715B61664	1/4"	X	6-1/4"	4"	BULK	100	\$6.63
715B81664	1/4"	X	8-1/4"	6"	BULK	50	\$9.51
715B10014	1/4"	X	10-1/4"	8"	BULK	50	\$12.14
715B14014	1/4"	X	14"	12"	BULK	25	\$23.80
715B16014	1/4"	X	16"	14"	BULK	25	\$27.79
715B20014	1/4"	X	20"	18"	BULK	25	\$38.85
715B24014	1/4"	X	24"	22"	BULK	25	\$52.38
715B62064	5/16"	X	6-1/4"	4"	BULK	50	\$8.81
715B82064	5/16"	X	8-1/4"	6"	BULK	25	\$11.68
715B12516	5/16"	X	12-1/4"	10"	BULK	25	\$22.00
715B62464	3/8"	X	6-1/4"	4"	BULK	100	\$9.57
715B82464	3/8"	X	8-1/4"	6"	BULK	50	\$12.10
715B10038	3/8"	X	10-1/4"	8"	BULK	25	\$15.49
715B12038	3/8"	X	12-1/4"	10"	BULK	25	\$19.64
715B18038	3/8"	X	18"	16"	BULK	25	\$31.66
715B24038	3/8"	X	24"	22"	BULK	25	\$40.12
715B63264	1/2"	X	6-1/4"	4"	BULK	100	\$11.01
715B10012	1/2"	X	10-1/4"	8"	BULK	25	\$19.01
715B12012	1/2"	X	12-1/4"	10"	BULK	25	\$22.85
715B12018	1/2"	X	18"	16"	BULK	25	\$33.09
715B12024	1/2"	X	24"	22"	BULK	25	\$51.92



4-PLUS = 4 ANGLES

A new, fast and tough serrated carbide tip provides long life, easy centering, and fast drilling through all aggregates, concrete, masonry, brick and natural stone.

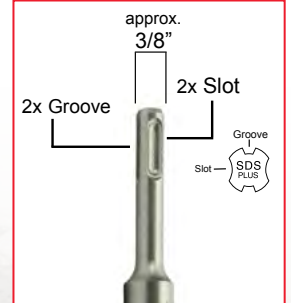

SDS-Plus Machines have chucks with an internal piston and ball-bearing system. This allows the drill bit to rotate and hammer back & forth along the length of the slot.





X-CUTTER *DRILLS REINFORCED CONCRETE!*

SDS-PLUS Rotary Hammer Drills

Part #	Size	X	OAL	Drilling	Head	Qty.	List
EVL41264	3/16"	X	4-1/2"	2"	X-CUTTER	1	\$10.92
EVL41264-B	3/16"	X	4-1/2"	2"	X-CUTTER	25	\$272.95
EVL61264	3/16"	X	6-1/2"	4"	X-CUTTER	1	\$11.87
EVL61264-B	3/16"	X	6-1/2"	4"	X-CUTTER	25	\$296.80
EVL81264	3/16"	X	8-1/2"	6"	X-CUTTER	1	\$15.58
EVL81264-B	3/16"	X	8-1/2"	6"	X-CUTTER	25	\$389.55
EVL10316	3/16"	X	10-1/2"	8"	X-CUTTER	1	\$22.18
EVL12316	3/16"	X	12-1/2"	10"	X-CUTTER	1	\$27.33
EVL41664	1/4"	X	4-1/2"	2"	X-CUTTER	1	\$10.43
EVL41664-B	1/4"	X	4-1/2"	2"	X-CUTTER	25	\$260.76
EVL61664	1/4"	X	6-1/2"	4"	X-CUTTER	1	\$11.46
EVL61664-B	1/4"	X	6-1/2"	4"	X-CUTTER	25	\$286.47
EVL81664	1/4"	X	8-1/2"	6"	X-CUTTER	1	\$14.76
EVL81664-B	1/4"	X	8-1/2"	6"	X-CUTTER	25	\$368.88
EVL10014	1/4"	X	10-1/2"	8"	X-CUTTER	1	\$22.59
EVL12014	1/4"	X	12-1/2"	10"	X-CUTTER	1	\$31.45
EVL62064	5/16"	X	6-1/2"	4"	X-CUTTER	1	\$13.31
EVL62064-B	5/16"	X	6-1/2"	4"	X-CUTTER	25	\$332.84
EVL12516	5/16"	X	12-1/2"	10"	X-CUTTER	1	\$25.06
EVL18516	5/16"	X	18"	16"	X-CUTTER	1	\$37.02
EVL62464	3/8"	X	6-1/4"	4"	X-CUTTER	1	\$14.76
EVL62464-B	3/8"	X	6-1/4"	4"	X-CUTTER	25	\$368.88
EVL12038	3/8"	X	12-1/4"	10"	X-CUTTER	1	\$25.06
EVL18038	3/8"	X	18"	16"	X-CUTTER	1	\$40.11
EVL62864	7/16"	X	6-1/4"	4"	X-CUTTER	1	\$19.91
EVL12716	7/16"	X	12-1/4"	10"	X-CUTTER	1	\$32.80
EVL18716	7/16"	X	18"	16"	X-CUTTER	1	\$51.69
EVL63264	1/2"	X	6-1/4"	4"	X-CUTTER	1	\$19.38
EVL63264-B	1/2"	X	6-1/4"	4"	X-CUTTER	25	\$484.42
EVL12012	1/2"	X	12-1/4"	10"	X-CUTTER	1	\$30.84
EVL18012	1/2"	X	18"	16"	X-CUTTER	1	\$41.75



- ◆ Rotary Hammer Drill
- ◆ One Pc. Solid Carbide Head up to 1/2"
- ◆ ANSI Specification
- ◆ Drills Reinforced Concrete
- ◆ Rebar Chamfers
- ◆ Centering Tip
- ◆ 50% More Holes
- ◆ Optimized Core Ensures Impact Durability and Rotational Stability
- ◆ High Break Resistance
- ◆ Less Vibration



X-CUTTER *DRILLS REINFORCED CONCRETE!*

- ◆ 1 Pc. Monoblock Solid Carbide X CUTTER Head - 3/16" - 1/2"
- ◆ 1 Pc. Solid Carbide X CUTTER Head - 9/16" - 1"
- ◆ 3 Pc. Carbide X CUTTER Head - 1-1/16" - 2"



X-CUTTER *DRILLS REINFORCED CONCRETE!*



SDS-PLUS Rotary Hammer Drills

Part #	Size	X	OAL	Drilling	Head	List
EVL63664	9/16"	X	6-1/4"	4"	X-CUTTER	\$26.17
EVL12916	9/16"	X	12-1/4"	10"	X-CUTTER	\$38.26
EVL18916	9/16"	X	18"	16"	X-CUTTER	\$52.48
EVL84064	5/8"	X	8-1/4"	6"	X-CUTTER	\$36.94
EVL10058	5/8"	X	10-1/4"	8"	X-CUTTER	\$41.21
EVL12058	5/8"	X	12-1/4"	10"	X-CUTTER	\$44.07
EVL18058	5/8"	X	18"	16"	X-CUTTER	\$53.89
EVL84864	3/4"	X	8"	6"	X-CUTTER	\$48.37
EVL10034	3/4"	X	10"	8"	X-CUTTER	\$51.42
EVL12034	3/4"	X	12"	10"	X-CUTTER	\$57.95
EVL18034	3/4"	X	18"	16"	X-CUTTER	\$67.20
EVL85664	7/8"	X	8"	6"	X-CUTTER	\$78.75
EVL10078	7/8"	X	10"	8"	X-CUTTER	\$81.15
EVL12078	7/8"	X	12"	10"	X-CUTTER	\$85.30
EVL18078	7/8"	X	18"	16"	X-CUTTER	\$93.57
EVL10001	1"	X	10"	8"	X-CUTTER	\$81.68
EVL12001	1"	X	12"	10"	X-CUTTER	\$89.18
EVL18001	1"	X	18"	16"	X-CUTTER	\$108.08
EVL10118	1-1/8"	X	10"	8"	X-CUTTER	\$109.70
EVL18118	1-1/8"	X	18"	16"	X-CUTTER	\$121.31
EVL18114	1-1/4"	X	18"	16"	X-CUTTER	\$152.09

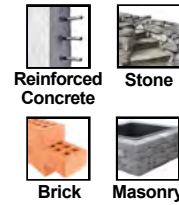

- ◆ Rotary Hammer Drill
- ◆ 4 x 90° Carbide Head
- ◆ Self Centering Chisel Point
- ◆ ANSI Specification
- ◆ Drills Reinforced Concrete
- ◆ Special Tungsten Carbide Tip
- ◆ Copper / Silver Brazing
- ◆ Fast Dust Removal
- ◆ Fast Drilling Speeds
- ◆ Clean Round Holes
- ◆ Less Vibration



SDS-PLUS Rotary Hammer - Extra Long

Part #	Size	X	OAL	Drilling	Head	List
EVL37038	3/8"	X	37-1/2"	35"	X-CUTTER	\$86.91
EVL37012	1/2"	X	37-1/2"	35"	X-CUTTER	\$113.48
EVL37058	5/8"	X	37-1/2"	35"	X-CUTTER	\$145.18
EVL37034	3/4"	X	37-1/2"	35"	X-CUTTER	\$158.58



SOLD INDIVIDUALLY
1 PER TUBE.





X-CUTTER *DRILLS REINFORCED CONCRETE!*

SDS-MAX® Rotary Hammer Drills



- ◆ Rotary Hammer Drill
- ◆ Industrial Quality
- ◆ Special Tungsten Carbide Tip
- ◆ Copper / Silver Brazing
- ◆ Fastest Dust Removal
- ◆ Fastest Drilling Speeds
- ◆ Heat Treated Body
- ◆ Clean Round Holes
- ◆ Less Vibration
- ◆ Polished Finish
- ◆ ANSI Specification



SOLD INDIVIDUALLY
1 PER TUBE.

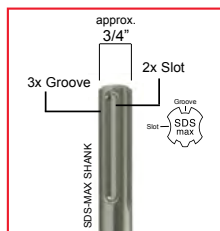

Bosch® License

Part #	Size	X	OAL	Drilling	Head	List
SMTE1338	3/8"	X	13"	8"	X-CUTTER	\$53.90
SMTE1312	1/2"	X	13"	8"	X-CUTTER	\$54.12
SMTE1712	1/2"	X	17"	12"	X-CUTTER	\$65.25
SMTE2212	1/2"	X	21"	16"	X-CUTTER	\$68.85
SMTE1391	9/16"	X	13"	8"	X-CUTTER	\$73.53
SMTE2192	9/16"	X	21"	16"	X-CUTTER	\$95.99
SMTE1358	5/8"	X	13"	8"	X-CUTTER	\$62.89
SMTE1758	5/8"	X	17"	12"	X-CUTTER	\$71.56
SMTE2258	5/8"	X	21"	16"	X-CUTTER	\$76.05
SMTE3658	5/8"	X	36"	31"	X-CUTTER	\$149.58
SMTE2111	11/16"	X	21"	16"	X-CUTTER	\$104.96
SMTE1334	3/4"	X	13"	8"	X-CUTTER	\$65.21
SMTE1734	3/4"	X	17"	12"	X-CUTTER	\$77.25
SMTE2234	3/4"	X	21"	16"	X-CUTTER	\$85.03
SMTE3634	3/4"	X	36"	31"	X-CUTTER	\$163.30
SMTE2113	13/16"	X	21"	16"	X-CUTTER	\$111.55
SMTE1378	7/8"	X	13"	8"	X-CUTTER	\$76.78
SMTE1778	7/8"	X	17"	12"	X-CUTTER	\$88.00
SMTE2278	7/8"	X	21"	16"	X-CUTTER	\$92.80
SMTE3678	7/8"	X	36"	31"	X-CUTTER	\$226.45
SMTE1301	1"	X	13"	8"	X-CUTTER	\$84.00
SMTE1701	1"	X	17"	12"	X-CUTTER	\$97.03
SMTE2201	1"	X	21"	16"	X-CUTTER	\$101.99
SMTE3601	1"	X	36"	31"	X-CUTTER	\$229.17
SMTE2311	1-1/16"	X	23"	18"	X-CUTTER	\$144.80
SMTE1718	1-1/8"	X	17"	12"	X-CUTTER	\$122.10
SMTE2218	1-1/8"	X	21"	16"	X-CUTTER	\$131.74
SMTE3618	1-1/8"	X	36"	31"	X-CUTTER	\$259.69
SMTE1714	1-1/4"	X	15"	10"	X-CUTTER	\$136.73
SMTE2214	1-1/4"	X	23"	18"	X-CUTTER	\$154.53
SMTE3614	1-1/4"	X	36"	31"	X-CUTTER	\$274.57
SMTE1738	1-3/8"	X	17"	12"	X-CUTTER	\$177.10
SMTE2238	1-3/8"	X	23"	18"	X-CUTTER	\$186.68
SMTE3638	1-3/8"	X	36"	31"	X-CUTTER	\$310.11
SMTE1721	1-1/2"	X	17"	12"	X-CUTTER	\$199.42
SMTE2221	1-1/2"	X	23"	18"	X-CUTTER	\$230.03
SMTE3621	1-1/2"	X	36"	31"	X-CUTTER	\$410.13
SMTE2334	1-3/4"	X	23"	18"	X-CUTTER	\$341.72
SMTE3613	1-3/4"	X	36"	31"	X-CUTTER	\$507.94
SMTE2202	2"	X	23"	18"	X-CUTTER	\$378.92



SDS-MAX® Rotary Hammer - Extra Long

Part #	Size	X	OAL	Drilling	Head	List
SMTE5258	5/8"	X	52"	47"	CROSS HEAD	\$218.07
SMTE5234	3/4"	X	52"	47"	CROSS HEAD	\$231.78
SMTE5201	1"	X	52"	47"	CROSS HEAD	\$295.04
SMTE5214	1-1/4"	X	52"	47"	CROSS HEAD	\$312.44
SMTE5212	1-1/2"	X	52"	47"	CROSS HEAD	\$629.70

X-Tend Your Drilling Depths!



X-Tendr™ - MAX to MAX SHANK ADAPTER

Part #	Description	List
XT6700	Adapter (1-3/16" x 7-1/2")	\$395.78
XT6750	Adapter Grease (Tube)	\$7.67

Drill Bit Diameter Must Be 1-1/4" Or Larger if X-Tendr™ is to Pass Through Hole Being Drilled.

Drill bit extension system for all SDS-MAX machines.

- ◆ X-Tend Any SDS-MAX® Tool
- ◆ Quick & Safe Connection
- ◆ Simple To Use
- ◆ No Energy Loss
- ◆ No Weak Points
- ◆ Saves Time & Money
- ◆ Reduces Tool Requirements
- ◆ Sold Individually

How it works:

- X-Tendr™ Adapter has double locking SDS-MAX inputs.
- All EXTENSION SHAFTS have 1 SDS-MAX® end which locks into X-Tendr™ Adapter. Other end can be inserted into an SDS-MAX® machine.
- X-Tend any SDS-MAX® drill bit, core bit, tunnel bore drill.
- Reach of X-Tendr™ system limited to 1 adapter and 1 extension.



X-Tendr™ Extension Shafts

Part #	OAL	Shank	List
XT6701	12-1/2"	SDS-MAX	\$64.91
XT6702	30"	SDS-MAX	\$79.80
XT6703	44"	SDS-MAX	\$108.92
XT6704	82-1/2"	SDS-MAX	\$231.03



1. Choose SDS-MAX® desired length Extension.



2. Attach X-Tendr™ Adaptor to SDS-MAX® end of Extension.



3. Attach desired SDS-MAX® Rotary Hammer Drill Bit, Core Bit, Tunnel Bore Drill.

Drill Bit Diameter Must Be 1-1/4" Or Larger if X-Tendr™ is to Pass Through Hole Being Drilled.

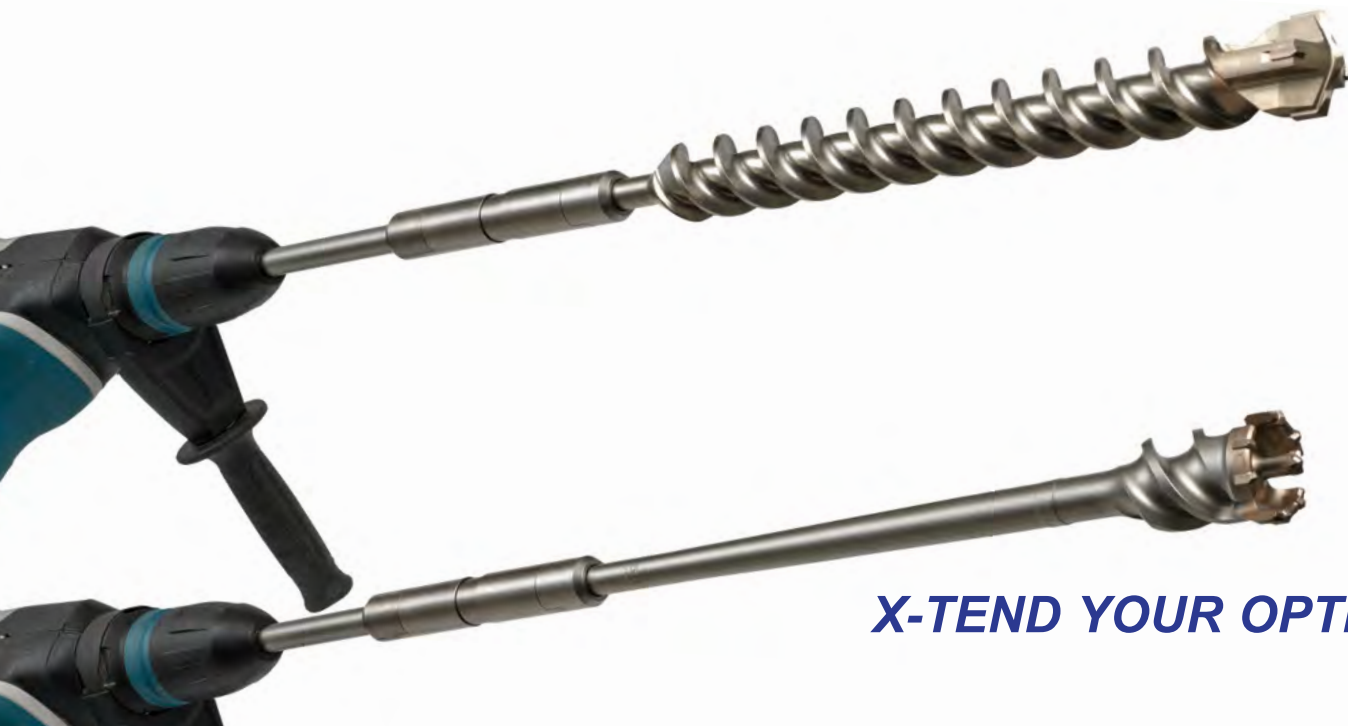

X-TEND YOUR OPTIONS...



INTERNATIONAL TOOL MANUFACTURING

150 Express St. Plainview, NY 11803

(516) 738-0388 • (800) 247-5696

Fax (516) 279-1106



- ◆ Industrial Quality
- ◆ 1 Piece Construction
- ◆ Special Tungsten Carbide Tip
- ◆ Copper / Silver Brazing
- ◆ Fast Drilling Speed
- ◆ Clean Round Holes
- ◆ Less Vibration
- ◆ Polished Finish



SDS-MAX® Tunnel Bore Drills

Part #	Size	X	OAL	Shank	List
950CC7331	1-1/2"	X	22"	SDS-MAX	\$362.20
950CC7333	1-3/4"	X	22"	SDS-MAX	\$371.79
950CC7342	1-3/4"	X	39"	SDS-MAX	\$448.00
950CC7337	2-1/8"	X	22"	SDS-MAX	\$381.14
950CC7343	2-1/8"	X	39"	SDS-MAX	\$502.75
950CC7339	2-1/2"	X	22"	SDS-MAX	\$441.85
950CC7344	2-1/2"	X	39"	SDS-MAX	\$542.57
950CC7341	3-1/8"	X	22"	SDS-MAX	\$498.06
950CC7345	3-1/8"	X	39"	SDS-MAX	\$622.22



Extensions on Page 97.



SOLD INDIVIDUALLY
1 PER TUBE.





Ratio Pilot Drills

Part #	Description	List
800RP124	5/8" X 4-3/4" PILOT (DRILL HEAD)	\$44.94
800RP255	1/2" X 6" PILOT (CORE BIT)	\$36.35



RATIO
SYSTEM



- ◆ Modular System
- ◆ Up to 6" Diameter
- ◆ Adapters Accommodate Any Combination
- ◆ Unmatched Flexibility
- ◆ Sold Individually



Ratio Drill Heads

Part #	Description	OAL	List
800RC040	1-1/2" DRILL HEAD	1-1/2"	\$217.61
800RC045	1-3/4" DRILL HEAD	1-1/2"	\$250.63
800RC052	2" DRILL HEAD	1-1/2"	\$285.52
800RC065	2-5/8" DRILL HEAD	1-1/2"	\$386.40
800RC080	3-1/8" DRILL HEAD	1-1/2"	\$435.80
800RC090	3-1/2" DRILL HEAD	1-1/2"	\$508.55
800RC100	4" DRILL HEAD	1-1/2"	\$544.86
800RC110	4-1/2" DRILL HEAD	1-1/2"	\$680.97
800RC125	5" DRILL HEAD	1-1/2"	\$779.72



Ratio Core Bits - INTERNAL THREAD

Part #	Description	OAL	List
800RK150	1-1/2" CORE BIT	3"	\$167.92
800RK175	1-3/4" CORE BIT	3"	\$170.78
800RK200	2" CORE BIT	3"	\$175.55
800RK250	2-3/4" CORE BIT	3"	\$209.90
800RK300	3" CORE BIT	3"	\$268.63
800RK350	3-1/2" CORE BIT	3"	\$288.89
800RK400	4" CORE BIT	3"	\$354.14
800RK500	5" CORE BIT	3"	\$479.57
800RK600	6" CORE BIT	3"	\$720.00



Extensions

Part #	Description	List
800RE300	11" LONG EXTENSION	\$145.31



SDS-MAX® Adapter

Part #	Description	OAL	List
800RA020	SDS-MAX ADAPTER	7"	\$85.95

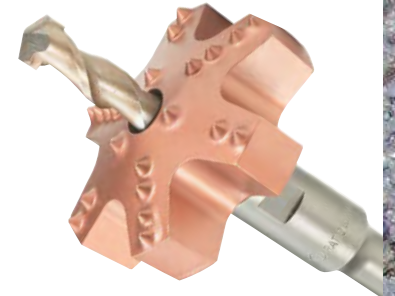

SOLD INDIVIDUALLY
1 PER TUBE.



TAPER SYSTEM



- ◆ Industrial Quality
- ◆ Taper System
- ◆ Special Tungsten Carbide Tip
- ◆ Copper / Silver Brazing
- ◆ Clean Round Holes
- ◆ Less Vibration
- ◆ Polished Finish
- ◆ 3" Cutting Depth Before Core Removal



SOLD INDIVIDUALLY
1 PER TUBE.

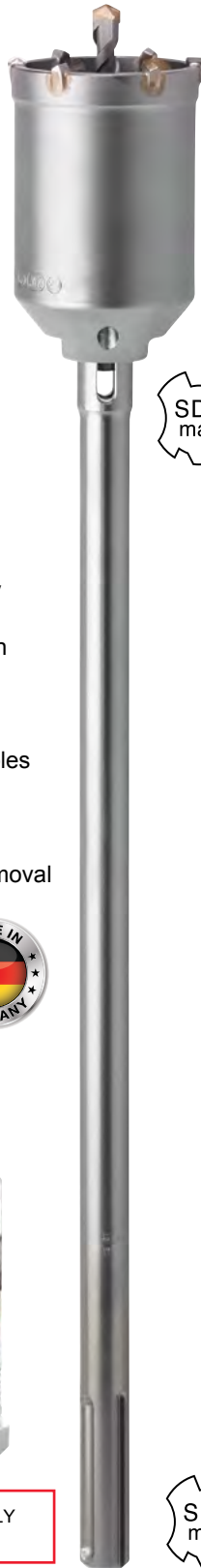

TAPER



Pilot Drill - A-TAPER FOR EXTENSION

Part #	Size	List
721PD0385	3/8" X 5" PILOT DRILL	\$16.46



Ejector Key

Part #	Description	List
722EJ0001	EJECTOR KEY	\$12.00



Carbide Core Bit - 4" OAL / TAPER

Part #	Size	# Teeth	List
719CB0040	1-1/2"	6	\$141.73
719CB0050	2"	6	\$168.52
719CB0065	2-3/4"	6	\$182.69
719CB0080	3" (3-1/8")	8	\$238.99
719CB0090	3-1/2" (3-9/16")	8	\$269.59
719CB0100	4"	10	\$347.35
719CB0125	5"	12	\$463.26



SDS-MAX® Taper Shanks

Part #	Size	Shank	List
720MAX008	8"	SDS-MAX	\$98.89
720MAX018	18"	SDS-MAX	\$132.93

INSTRUCTIONS

- 1 Wipe off oil or lubricant from the taper of the extension and the inner taper of the core bit.
- 2 Insert the pilot drill into the drive extension first.
- 3 Insert the drive extension into the core bit.
- 4 Start drilling hole until the core bit is 3/8" deep.
- 5 Use the ejector key to push out the pilot drill.
- 6 Continue drilling the hole until the material being drilled fills the core bit interior. Approximately 3" deep.
- 7 Break the drilled material inside the core bit with a chisel (if necessary.)
- 8 Return to Step 6 until desired hole depth is achieved.

These Heavy Duty Rotary Hammer Core Bits are used with SDS-MAX electric rotary hammer machines. The special alloy steel body and Tungsten Carbide withstand continuous hammering. A pilot drill bit and extension are required.



Notice: Core Bit drilling without the use of a pilot drill bit causes excessive pressure on the taper shank system. This can result in breakage to the extension at the tapered end, especially between the two slots. Such jagged breaks are not considered defective and may not be covered under warranty.



Each Core Bit Includes Pilot Drill

Pilot Drill - THREADED

Part #	Size	List
880PD1143	1/2" X 5" PILOT DRILL (Threaded)	\$32.50

1-Pc SDS-MAX® Core Bits

Part #	Size	X	OAL	# Teeth	Shank	List
880SL1035	2"	X	12"	6	SDS-MAX	\$304.85
880SL1045	2"	X	22"	6	SDS-MAX	\$357.60
880SL1055	2-3/4"	X	12"	6	SDS-MAX	\$346.29
880SL1065	2-3/4"	X	22"	6	SDS-MAX	\$398.55
880SL1075	3-1/4"	X	12"	8	SDS-MAX	\$433.57
880SL1085	3-1/4"	X	22"	8	SDS-MAX	\$481.42
880SL1095	3-1/2"	X	12"	8	SDS-MAX	\$460.00
880SL1105	3-1/2"	X	22"	8	SDS-MAX	\$503.09
880SL1115	4"	X	12"	10	SDS-MAX	\$508.98
880SL1125	4"	X	22"	10	SDS-MAX	\$543.24
880SL1135	5"	X	22"	12	SDS-MAX	\$614.03
880SL1145	6"	X	22"	14	SDS-MAX	\$804.52



- ◆ Industrial Quality
- ◆ 1 Piece Construction
- ◆ Special Tungsten Carbide Tip
- ◆ Copper / Silver Brazing
- ◆ Clean Round Holes
- ◆ Less Vibration
- ◆ Polished Finish
- ◆ 3" Cutting Depth Before Core Removal



SOLD INDIVIDUALLY
1 PER TUBE.



INTERNATIONAL TOOL MANUFACTURING
 150 Express St. Plainview, NY 11803
 (516) 738-0388 • (800) 247-5696
 Fax (516) 279-1106



Each Extension Comes With One Pilot Bit

SDS-PLUS Extension and Pilot Bit

Part #	Size	List
LCB-PILOT	Carbide Pilot Bit (5/16" x 4-3/4")	\$12.37
LCB-12EX	12" SDS-Plus Extension with Pilot Bit	\$72.42
LCB-18EX	18" SDS-Plus Extension with Pilot Bit	\$95.94



- ◆ Industrial Quality
- ◆ Tungsten Carbide Teeth
- ◆ M16 Thread
- ◆ 2" Cutting Depth
- ◆ Use Rotary Hammer Action
- ◆ Clean Round Holes
- ◆ Each Piece Sold Individually



Carbide Lightweight Core Bits

Part #	Size	Depth	Teeth	Shank	List
LCB-1	1-3/16"	2"	6	SDS-PLUS	\$106.96
LCB-2	1-3/8"	2"	6	SDS-PLUS	\$113.94
LCB-3	1-1/2"	2"	6	SDS-PLUS	\$118.89
LCB-4	1-3/4"	2"	6	SDS-PLUS	\$120.10
LCB-5	2"	2"	6	SDS-PLUS	\$127.82
LCB-6	2-1/2"	2"	6	SDS-PLUS	\$154.63
LCB-7	3-1/8"	2"	6	SDS-PLUS	\$189.17
LCB-8	3-1/2"	2"	6	SDS-PLUS	\$216.10
LCB-9	4"	2"	8	SDS-PLUS	\$241.07



SOLD INDIVIDUALLY
 1 PER TUBE.





Superdry™ Center Pin

Part #	Description	List
DRY-CP1	CENTER PIN - FOR SUPERDRY DIAMOND	\$96.00

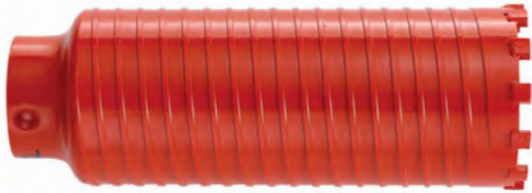

**WON'T
BLOW THE
BACK OUT**

Superdry™ Diamond Core Bit

Part #	Size	# Teeth	Drilling	Shank	List
DRY-25C	1"	6	6"	#1	\$379.63
DRY-29C	1-1/8"	7	6"	#1	\$379.63
DRY-32C	1-1/4"	8	6"	#1	\$379.63
DRY-35C	1-3/8"	8	6"	#1	\$379.63
DRY-38C	1-1/2"	9	6"	#1	\$379.63
DRY-45C	1-3/4"	9	6"	#1	\$379.63
DRY-50C	2"	10	6"	#2	\$397.06
DRY-55C	2-1/8"	11	6"	#2	\$397.06
DRY-60C	2-3/8"	12	6"	#2	\$414.57
DRY-65C	2-9/16"	12	6"	#2	\$436.37
DRY-70C	2-3/4"	13	6"	#2	\$462.57
DRY-75C	2-7/8"	15	6"	#2	\$510.57
DRY-80C	3-1/8"	16	6"	#2	\$558.57
DRY-90C	3-1/2"	16	6"	#2	\$632.74
DRY-95C	3-3/4"	16	6"	#2	\$698.20
DRY-100C	3-7/8"	17	6"	#2	\$741.80
DRY-105C	4-1/8"	17	6"	#2	\$785.43
DRY-120C	4-3/4"	17	6"	#2	\$916.37
DRY-130C	5-1/8"	18	6"	#2	\$938.20
DRY-155C	6"	22	6"	#2	\$1156.37
DRY-165C	6-1/2"	24	6"	#2	\$1200.00
DRY-180C	7"	25	6"	#2	\$1289.86
DRY-210C	8-1/4"	30	6"	#2	\$1549.06



Superdry™ SDS-Plus Extension

Part #	Size	Shank	List
DRY-S1-8	5" EXTENSION (FOR 1" THRU 1-3/4")	#1	\$79.40
DRY-S1-12	8" EXTENSION (FOR 1" THRU 1-3/4")	#1	\$96.00
DRY-S2-8	5" EXTENSION (FOR 2" THRU 8-1/4")	#2	\$142.77
DRY-S2-12	8" EXTENSION (FOR 2" THRU 8-1/4")	#2	\$171.03



Rotation Only!

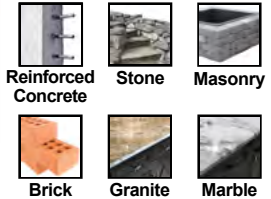

- ◆ CLIC System
- ◆ Diamond Teeth
- ◆ Capable of Dry Drilling in Reinforced Concrete
- ◆ Carbide Tipped Center Pin
- ◆ Clean Round Holes
- ◆ Made in Japan
- ◆ Each Piece Sold Individually



JAPAN



**Replacement
Guide Plates
Available.**



Diamond Core Bits - Stone Countertops

Part #	Size	X	OAL	# Teeth	Thread	List
GRA-09	1"	X	4"	3	5/8" - 11	\$84.54
GRA-10	1-1/4"	X	4"	3	5/8" - 11	\$97.42
GRA-11	1-3/8"	X	4"	4	5/8" - 11	\$104.54
GRA-12	1-1/2"	X	4"	4	5/8" - 11	\$114.05
GRA-13	2"	X	4"	4	5/8" - 11	\$151.20
GRA-15	3"	X	4"	5	5/8" - 11	\$193.14
GRA-18	4"	X	4"	6	5/8" - 11	\$233.10

- ◆ Stone Countertops
- ◆ Quality Premium Diamond Teeth
- ◆ 2-1/2" Cutting Depth
- ◆ Vacuum Brazed Side Diamond
- ◆ 10mm Segments
- ◆ Sold Individually



SDS-Plus to 5/8"-11 Adapter
P. 105



Diamond Core Bits - Dry Drilling

Part #	Size	X	OAL	# Teeth	Thread	List
DRX-02	1-1/4"	X	10-3/4"	3	5/8" - 11	\$100.83
DRX-03	1-1/2"	X	10-3/4"	3	5/8" - 11	\$108.33
DRX-04	2"	X	10-3/4"	4	5/8" - 11	\$152.78
DRX-05	2-1/2"	X	10-3/4"	4	5/8" - 11	\$188.89
DRX-07	3"	X	10-3/4"	4	5/8" - 11	\$241.67

- ◆ Industrial Quality
- ◆ Quality Premium Diamond Teeth
- ◆ 9" Cutting Depth
- ◆ Dry Drilling
- ◆ 10mm Segments
- ◆ Sold Individually



FOR USE WITH
A 7" ANGLE
GRINDER



FOR DRILLING
LARGER DIAMETER
HOLES IN CONCRETE



Diamond Core Bits - Premium

Part #	Size	X	OAL	# Teeth	Thread	List
KDX-01	1"	X	15-3/4"	3	5/8" - 11	\$105.83
KDX-02	1-1/4"	X	15-3/4"	4	1-1/4" - 7	\$120.83
KDX-25	1-1/2"	X	15-3/4"	4	1-1/4" - 7	\$125.00
KDX-03	1-3/4"	X	15-3/4"	4	1-1/4" - 7	\$129.17
KDX-04	2"	X	15-3/4"	5	1-1/4" - 7	\$140.00
KDX-05	2-1/2"	X	15-3/4"	6	1-1/4" - 7	\$151.67
KDX-06	2-3/4"	X	15-3/4"	6	1-1/4" - 7	\$175.00
KDX-07	3"	X	15-3/4"	6	1-1/4" - 7	\$186.67
KDX-75	3-1/2"	X	15-3/4"	6	1-1/4" - 7	\$231.11
KDX-08	4"	X	15-3/4"	8	1-1/4" - 7	\$244.44
KDX-95	4-1/2"	X	15-3/4"	9	1-1/4" - 7	\$306.67
KDX-11	5"	X	15-3/4"	10	1-1/4" - 7	\$330.67
KDX-12	6"	X	15-3/4"	12	1-1/4" - 7	\$380.44
KDX-65	6-1/2"	X	15-3/4"	12	1-1/4" - 7	\$425.00
KDX-20	8"	X	15-3/4"	16	1-1/4" - 7	\$610.50
KDX-30	10"	X	15-3/4"	18	1-1/4" - 7	\$669.39
KDX-40	12"	X	15-3/4"	20	1-1/4" - 7	\$858.39

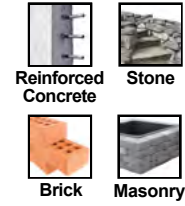

- ◆ Industrial Quality
- ◆ Quality Premium Diamond Teeth
- ◆ 14" Cutting Depth
- ◆ Use With Water



SOLD INDIVIDUALLY
1 PER BOX.

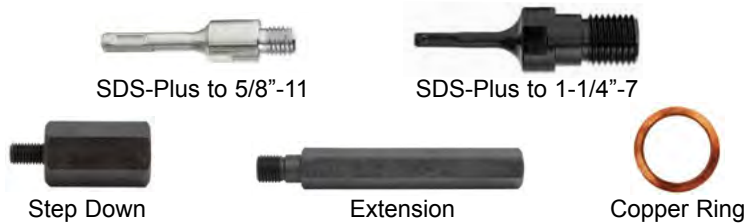
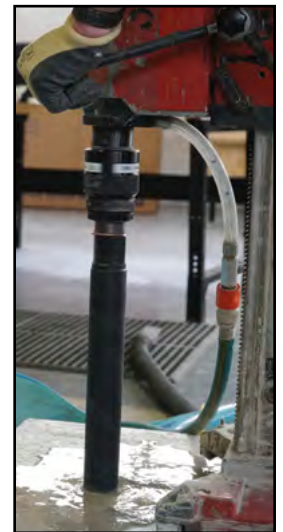

Diamond Core Adapters / Extensions

Part #	Description	List
ADA001	ADAPTER STEP DOWN (1-1/4"-7 TO 5/8"-11)	\$76.40
ADA002	SDS-PLUS TO 5/8"-11 ADAPTER	\$34.50
ADA003	SDS-PLUS TO 1-1/4"-7 ADAPTER	\$48.50
DCEXT01	6" DIAMOND CORE BIT EXTENSION (5/8"-11)	\$130.61
DCEXT02	12" DIAMOND CORE BIT EXTENSION (5/8"-11)	\$180.19
DCEXT03	6" DIAMOND CORE BIT EXTENSION (1-1/4"-7)	\$178.58
DCEXT04	12" DIAMOND CORE BIT EXTENSION (1-1/4"-7)	\$194.03
CR01	COPPER RING (FOR EASY CORE BIT REMOVAL)	\$5.00



Diamond Core Machine Adapters

Part #	Description	List
HILA001	HILTI BI+ TO 5/8"-11 ADAPTER - 100/110/120/130/150/160	\$67.32
HILA002	HILTI BI+ TO 1-1/4"-7 ADAPTER - 100/110/120/130/150/160	\$84.58
HILA003	HILTI BL TO 1-1/4"-7 ADAPTER - DD 200/250/350/500	\$452.78
HILA004	HILTI BU (SPLINE) TO 1-1/4"-7 ADAPTER - DD 400/750	\$187.22

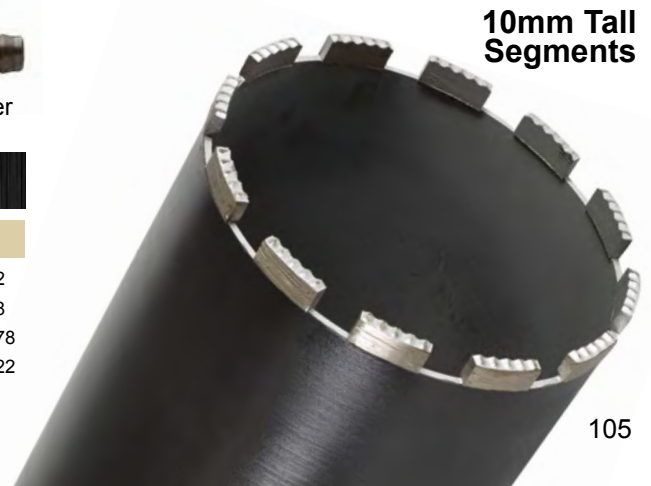



SDS-Plus Duster Drill Bit

Part #	Size	X	OAL	Drilling	Head	List
EXS-038	3/8"	X	10-1/2"	6"	DUSTER	\$100.45
EXS-716	7/16"	X	13"	8"	DUSTER	\$152.64
EXS-012	1/2"	X	13"	8"	DUSTER	\$157.28
EXS-916	9/16"	X	14"	9"	DUSTER	\$160.24
EXS-058	5/8"	X	14"	9"	DUSTER	\$168.65
EXS-034	3/4"	X	14"	9"	DUSTER	\$180.40
EXS-078	7/8"	X	14"	9"	DUSTER	\$284.37
EXS-1S	PLASTIC ADAPTER SDS-PLUS REPLACEMENT					\$40.02



- ◆ Rotary Hammer Drill
- ◆ Industrial Quality
- ◆ 4-Cutter Head
- ◆ Two Large Suction Holes
- ◆ Cleaner and Faster
- ◆ Copper / Silver Brazing
- ◆ Heat Treated Body
- ◆ Clean Round Holes
- ◆ Less Vibration
- ◆ Polished Finish
- ◆ ANSI Specification



SDS-MAX® Duster Drill Bit

Part #	Size	X	OAL	Drilling	Head	List
EXM-120	1/2"	X	24"	15-1/2"	DUSTER	\$306.56
EXM-580	5/8"	X	24"	15-1/2"	DUSTER	\$328.14
EXM-340	3/4"	X	24"	15-1/2"	DUSTER	\$342.53
EXM-780	7/8"	X	24"	15-1/2"	DUSTER	\$355.58
EXM-100	1"	X	25"	17-1/2"	DUSTER	\$380.10
EXM-118	1-1/8"	X	35"	28"	DUSTER	\$576.14
EXM-138	1-3/8"	X	35"	28"	DUSTER	\$641.25
EXM-1M	PLASTIC ADAPTER SDS-MAX REPLACEMENT					\$41.65

SOLD INDIVIDUALLY.

Suction Holes



Attach to Any HEPA Rated Vacuum to Meet OSHA Silica Dust Containment Standards.

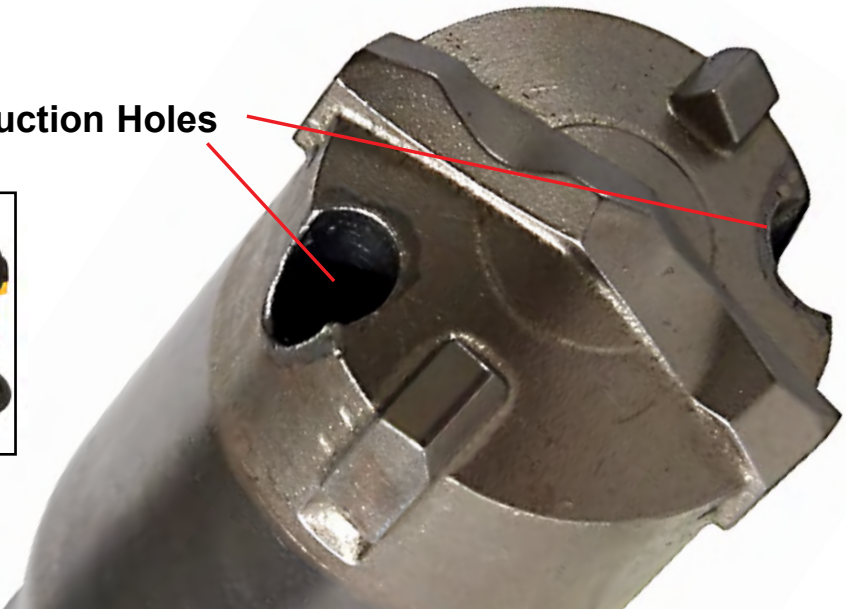



Economy Dust Pro (Up to 1")

Part #	Description	Qty.	List
DP-1	ECONOMY DUST PRO (PLASTIC)	1	\$7.63

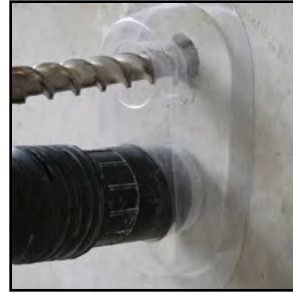

- ◆ Attach to HEPA Vacuum and Stick to Drilling Surface
- ◆ No Drilling Dust
- ◆ No Need to Clean Holes Before Anchoring



SOLD INDIVIDUALLY.



Sold With One Metal Insert.



Small Dust Pro (Up to 1")

Part #	Description	Qty.	List
DP-2	SMALL DUST PRO	1	\$96.83

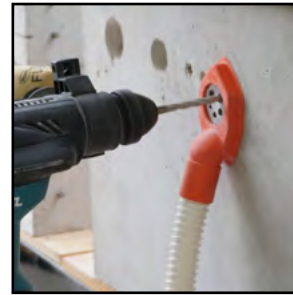

Sold With One Rubber Insert.



Large Dust Pro (Up to 3")

Part #	Description	Qty.	List
DP-3	LARGE DUST PRO	1	\$116.28



Metal Plate for DP-2



Rubber Plate for DP-3



Replacement Inserts

Part #	Description	Qty.	List
DP-2-PL	METAL PLATE REPLACEMENT	1	\$17.67
DP-3-PL	RUBBER CUT OUT REPLACEMENT	1	\$21.75

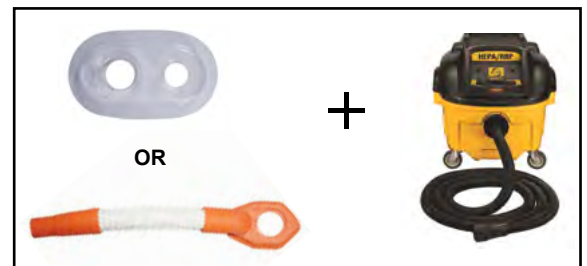

Attach to Any HEPA Rated Vacuum to Meet OSHA Silica Dust Containment Standards.



For Drop-in Anchors



Concrete



Stone



Brick



Masonry

- ◆ Rotary Hammer Drill
- ◆ STOP - Lip Prevents Over-Drilling
- ◆ Drill Exact Depth For Drop-In Anchor
- ◆ Less Likely to Hit Rebar
- ◆ ANSI Specification
- ◆ Sold Individually



SDS-PLUS + STOP Rotary Hammer Bit

Part #	Size	Drill Depth	Anchor Size	Qty.	List
STP-413	1/4"	11/16"	3/16"	1	\$24.10
STP-617	3/8"	1-1/16"	1/4"	1	\$26.24
STP-813	1/2"	13/16"	3/8" Short	1	\$29.15
STP-827	1/2"	1-11/16"	3/8"	1	\$30.61
STP-1019	5/8"	1-3/16"	1/2" Short	1	\$32.77
STP-1033	5/8"	2-1/16"	1/2"	1	\$37.23
STP-418	7/8"	2-5/8"	5/8"	1	\$47.10
STP-419	1"	3-1/4"	3/4"	1	\$55.58



SDS-Max[®] to SDS-Plus Adapter

Use Your SDS-Plus Drill Bits In Larger SDS-MAX[®] Machines.



Adapter

SDS-MAX[®] to SDS-PLUS

Part #	Description	List
725MAX001	SDS-MAX To SDS-Plus Adapter	\$119.86



Half Flat Shank



Concrete Bits - FOR CONCRETE SCREWS

Part #	Size	x	OAL	Screw	Qty.	List
602TC0503	5/32"	X	3-1/2"	3/16"	50	\$3.17
602TC0500	5/32"	X	4-1/2"	3/16"	50	\$3.31
602TC0505	5/32"	X	5-1/2"	3/16"	50	\$3.60
602TC0603	3/16"	X	3-1/2"	1/4"	50	\$3.60
602TC0604	3/16"	X	4-1/2"	1/4"	50	\$3.73
602TC0605	3/16"	X	5-1/2"	1/4"	50	\$4.01
602TC0606	3/16"	X	6-3/4"	1/4"	50	\$4.72
602TC0607	3/16"	X	7-5/8"	1/4"	50	\$5.67



- ◆ Industrial Quality
- ◆ Tungsten Carbide Tip
- ◆ ANSI Specification
- ◆ Sold Individually



Each concrete screw carbide drill bit is precisely ground to match a certain tolerance to assure proper hole diameter and to achieve maximum thread holding power. The flat on the shank fits all drill adapters. The drill bit is specially heat treated to make it very durable.

5/16" HEX SHOULDER



SDS-HEX Bits - FOR CONCRETE SCREWS

Part #	Size	x	OAL	Drilling	Screw	Qty.	List
HEX5325	5/32"	X	5"	2-1/2"	3/16"	1	\$10.92
HEX5327	5/32"	X	7"	4-1/2"	3/16"	1	\$12.17
HEX3165	3/16"	X	5"	2-1/2"	1/4"	1	\$10.92
HEX3167	3/16"	X	7"	4-1/2"	1/4"	1	\$12.17
HEX2345	.234"	X	5"	2-1/2"	Crete-Flex®	1	\$12.56
HEX2347	.234"	X	7"	4-1/2"	Crete-Flex®	1	\$15.40

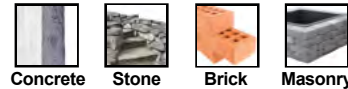

- ◆ Industrial Quality
- ◆ Special Tungsten Carbide Tip
- ◆ ANSI Specification
- ◆ Copper / Silver Brazing
- ◆ Polished Finish
- ◆ Sold Individually



SDS-HEX Rotary Hammer drill bits are specifically designed to be used in concrete screw installation. These SDS bits have a special 5/16" HEX shoulder for use with standard concrete screw installation sleeves, which eliminate the need for drill adapters. The benefits of using an SDS machine rather than a standard rotation drill means a decrease in operation time of nearly 50%. **SEE BELOW FOR INSTALLATION KIT**



Concrete Screw Installation Sleeve

Part #	Description	Qty.	List
TPCDSL	6-1/2" Concrete Screw Sleeve	1	\$23.09



These Installation Kits are Suitable for both Standard Concrete Bits & SDS-HEX Rotary Hammer Bits.

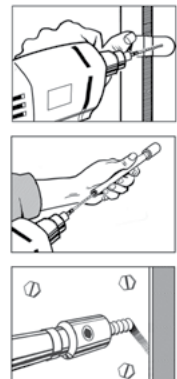

Deluxe Installation Kit

Part #	Description	List
602TC1000	Installation Kit	\$88.55

INCLUDES:

- 5/32" x 7" SDS-PLUS Hex Bit
- 3/16" x 7" SDS-PLUS Hex Bit
- 1/4" Magnetic Driver
- 5/16" Magnetic Driver
- Phillips Bit Adapter
- Masonry Drill Adapter
- 6-1/2" Sleeve
- 1/8" Hex Key
- Phillips #2 x 1" Insert
- Phillips #3 x 1" Insert

Basic Installation Kit

Part #	Description	List
602TC2000	Installation Kit	\$76.25

INCLUDES:

- 1/4" Magnetic Driver
- 5/16" Magnetic Driver
- Phillips Bit Adapter
- Masonry Drill Adapter
- 6-1/2" Sleeve
- 1/8" Hex Key
- Phillips #2 x 1" Insert
- Phillips #3 x 1" Insert

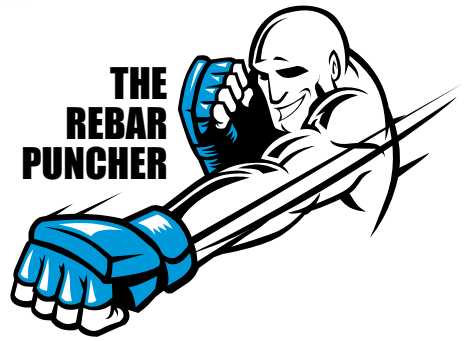

NEW!



USE IN ROTARY
HAMMER MODE

2X SPEED



Rebar

- ◆ Use in Rotary Hammer Action
- ◆ Industrial Quality
- ◆ Tungsten Carbide Teeth
- ◆ Twice the Speed
- ◆ Ratio System
- ◆ Sold Individually



SOLD INDIVIDUALLY
1 PER TUBE.



Rebar Puncher - ROTARY HAMMER ACTION

Part #	Size	OAL	RPM	List
RT-6	3/8"	12"	HAMMER ACTION	\$73.27
RT-8	1/2"	12"	HAMMER ACTION	\$113.26
RT-10	5/8"	12"	HAMMER ACTION	\$126.40
RT-12	3/4"	12"	HAMMER ACTION	\$140.14
RT-14	7/8"	12"	HAMMER ACTION	\$142.86
RT-16	1"	12"	HAMMER ACTION	\$147.02

BEST ON #5 (5/8") REBAR
SIZE AND UNDER.

REBAR PUNCHER IS NOW A 1-PC. DESIGN.
SDS-PLUS SHANK ONLY.



Rebar

NEW!

- ◆ Micro SDS-Plus System
- ◆ Tungsten Carbide Teeth
- ◆ Fast Cutting
- ◆ Made in France
- ◆ Sold Individually



**Rotation
Only!**



Rebar Cutter - ONE PIECE SYSTEM

Part #	Size	OAL	SHANK	List
MCX-1	3/8"	8"	SDS-PLUS	\$78.11
MCX-2	1/2"	12"	SDS-PLUS	\$84.39
MCX-3	9/16"	12"	SDS-PLUS	\$92.42
MCX-4	5/8"	12"	SDS-PLUS	\$98.11
MCX-1F	3/8"	8"	3-FLAT	\$78.11
MCX-2F	1/2"	12"	3-FLAT	\$84.39
MCX-3F	9/16"	12"	3-FLAT	\$92.42
MCX-4F	5/8"	12"	3-FLAT	\$98.11



1/2"-13
Thread



**Rotation
Only!**



Rebar Cutter - TWO PIECE SYSTEM

MCX-5	3/4"	4"	HEAD ONLY	\$85.82
MCX-6	7/8"	4"	HEAD ONLY	\$105.54
MCX-7	1"	4"	HEAD ONLY	\$116.80
MCX-8	1-1/8"	4"	HEAD ONLY	\$132.71
MCX-9	1-1/4"	4"	HEAD ONLY	\$153.17
MCX-10	1-3/8"	4"	HEAD ONLY	\$166.81
MCX-11	1-1/2"	4"	HEAD ONLY	\$178.75
MCX-SDS	EXTENSION	9"	SDS-PLUS	\$32.53
MCX-FLAT	EXTENSION	9"	3-FLAT	\$32.53

MCX-5 → MCX-11 ARE HEAD ONLY AND
YOU WILL NEED TO BUY AN SDS-PLUS OR
3-FLAT THREADED ADAPTER.

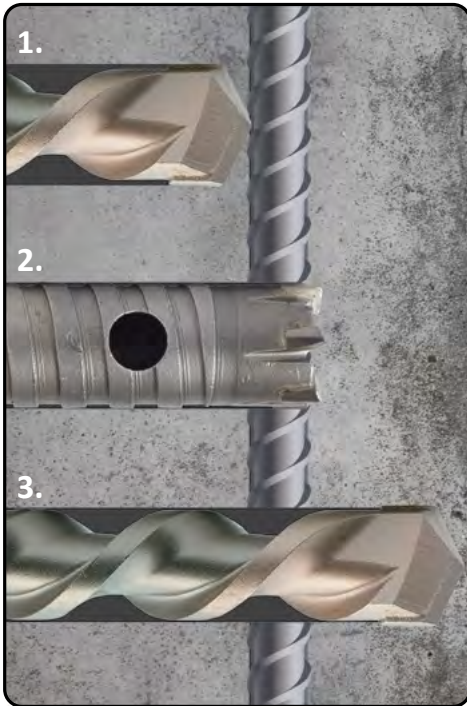

3 SIMPLE STEPS TO DRILLING REBAR

1. When rebar is encountered while drilling, immediately stop the hammer drill and remove the bit from the hole. (failure to do this will severely damage a carbide hammer bit.)
2. With a rotary rebar cutter mounted in a drill motor with the selector in the **rotary only position**, insert the rotary rebar cutter into the hole and drill through the embedded rebar.
3. Remove the rotary rebar cutter after the rebar has been drilled completely through and finish drilling the hole with the hammer bit.

HEAD SIZES	THREAD
3/8" → 1-1/2"	1 pc.
1-3/4" → 2-1/2"	3/4"-10

⚠ REMINDER:

Rebar Cutters are problem solvers only. A 1/2" Rebar Cutter drilling through #6 (3/4") rebar dead center may result in 5 to 10 holes being drilled provided correct speed and pressure are utilized. It is not uncommon for only one piece of rebar to be cut per Rebar Cutter. Rebar Cutters *should* not be used for drilling concrete.

Rebar Cutters are not warranted for replacement or repair.



Rebar Cutter - SDS-PLUS SHANK

Part #	Size	OAL	RPM	List
RBS-6	3/8"	8"	850-1200	\$60.43
RBS-8	1/2"	12"	850-1200	\$63.25
RBS-9	9/16"	12"	850-1200	\$66.08
RBS-10	5/8"	12"	750-1000	\$80.20
RBS-11	11/16"	12"	750-1000	\$85.85
RBS-12	3/4"	12"	600-850	\$88.67
RBS-13	13/16"	12"	600-850	\$108.45
RBS-14	7/8"	12"	600-850	\$125.58
RBS-16	1"	12"	500-750	\$133.86
RBS-18	1-1/8"	12"	500-750	\$142.32
RBS-20	1-1/4"	12"	450-600	\$150.79
RBS-22	1-3/8"	12"	450-600	\$164.92
RBS-24	1-1/2"	12"	350-500	\$173.39

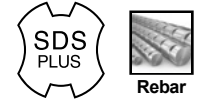

SOLD INDIVIDUALLY
1 PER TUBE.

Rotation Only!



Rebar Cutter - STRAIGHT SHANK

Part #	Size	OAL	RPM	List
RBC0838	3/8"	8"	850-1200	\$51.59
RBC1212	1/2"	12"	850-1200	\$61.28
RBC1916	9/16"	12"	850-1200	\$63.45
RBC1258	5/8"	12"	750-1000	\$72.84
RBC1116	11/16"	12"	750-1000	\$78.07
RBC1234	3/4"	12"	600-850	\$82.75
RBC1834	3/4"	18"	600-850	\$106.03
RBC1316	13/16"	12"	600-850	\$97.43
RBC1278	7/8"	12"	600-850	\$114.62
RBC1201	1"	12"	500-750	\$123.22
RBC1218	1-1/8"	12"	500-750	\$131.82
RBC1214	1-1/4"	12"	450-600	\$140.43
RBC1238	1-3/8"	12"	450-600	\$154.76
RBC1112	1-1/2"	12"	350-500	\$165.07
RBC1134	1-3/4"	12"	350-500	\$213.05
RBC1202	2"	12"	350-500	\$320.95
RBC1222	2-1/2"	12"	350-500	\$378.27



SOLD INDIVIDUALLY
1 PER TUBE.





**MINI CHISELS
 FOR THOSE
 TIGHT SPOTS**

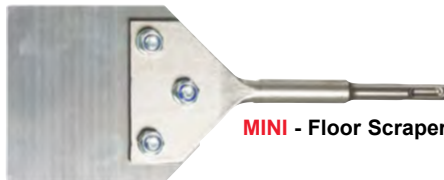

SDS-PLUS Chisels - **MINI**

Part #	Size	Description	List
2100BP	5-1/2"	MINI - Bull Point	\$21.00
2110FC	3/4" x 5-1/2"	MINI - Flat Chisel	\$23.30
2115SC	1-1/4" x 5-1/2"	MINI - Scaling Chisel	\$29.20
2244FS	4" x 10"	MINI - Floor Scraper	\$119.65
FS-4B		MINI - Replacement Blade (Floor Scraper)	\$22.92
FS-4NUT		MINI - Replacement Nuts & Bolts (Floor Scraper)	\$22.88



SDS-PLUS Chisels

Part #	Size	Description	List
3100BP	10"	Bull Point	\$23.07
3110FC	3/4" x 10"	Flat Chisel	\$23.07
3115SC	1-1/2" x 10"	Scaling Chisel	\$42.88
3120GC	7/8" x 10"	Gouge Chisel	\$41.10
3150GR	5/8" x 10"	Ground Rod Driver	\$70.46
3175TC	3" x 6-1/2"	Tile Chisel	\$43.53



SOLD INDIVIDUALLY
 1 PER CLIP.

SDS-MAX® Chisels

Part #	Size	Description	List
7000BP	12"	Bull Point	\$22.48
7005BP	18"	Bull Point	\$28.02
7024BP	24"	Bull Point	\$52.00
7010FC	1" x 12"	Flat Chisel	\$22.48
7015FC	1" x 18"	Flat Chisel	\$28.02
7024FC	1" x 24"	Flat Chisel	\$52.00
7020SC	1-1/2" x 12"	Scaling Chisel	\$34.89
7025SC	2" x 12"	Scaling Chisel	\$36.47
7028SC	2" x 18"	Scaling Chisel	\$47.78
7029SC	2" x 24"	Scaling Chisel	\$54.00
7030SC	3" x 12"	Scaling Chisel	\$45.69
7035AC	2" x 12"	Angled Chisel	\$58.64
7045BT	1-7/8" x 9-7/8"	Bushing Tool	\$144.86
7050GR	7/8" x 10-1/4"	Ground Rod Driver	\$131.48
7055PH	3-1/2" x 16"	Asphalt Cutter	\$175.99
7060SM	1-1/8" x 12"	Seam Tool	\$48.92
7065CS	5-3/8" x 16"	Clay Spade	\$180.04
7075GC	1" x 12"	Gouge Chisel	\$74.82
520MAX	12"	SDS-Max Tamping Shank	\$62.05
520STP	5" SQUARE	Tamping Plate	\$130.31
7070FS	6" x 25"	Floor Scraper	\$509.91
FS-6B		Replacement Blade (Floor Scraper)	\$23.31
FS-6NUT		Replacement Nuts & Bolts (Floor Scraper)	\$39.89



Bull Point



Flat Chisel



Scaling Chisel



Angled Chisel



Bushing Tool



Ground Rod Driver



Asphalt Cutter



Seam Tool



Clay Spade



Gouge Chisel



Tamping



Floor Scraper



SOLD INDIVIDUALLY
1 PER CLIP.

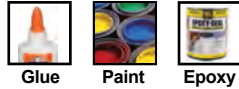

- ◆ For Removal Of Surface Coatings / Porous Ceramic Glue
- ◆ Wet or Dry
- ◆ Will Not Smear Like Diamond Cup Wheel
- ◆ Sold Individually



PCD Cup Wheel

Part #	Size	Arbor	Segments	Qty.	List
PCD-50	5"	7/8" Open	6	1	\$117.36
PCD-50T	5"	5/8"-11	6	1	\$117.36
PCD-70	7"	7/8" Open	9	1	\$162.98
PCD-70T	7"	5/8"-11	9	1	\$162.98



- ◆ High Diamond Concentration
- ◆ Wet Or Dry
- ◆ 5/8"-11 Thread or 7/8" Open Hole
- ◆ Sold Individually



Diamond Grinding Cup Wheel

Part #	Size	Arbor	Segments	Qty.	List
GCW-50	5"	7/8" Open	16	1	\$119.21
GCW-50T	5"	5/8"-11	16	1	\$122.38
GCW-70	7"	7/8" Open	18	1	\$158.52
GCW-70T	7"	5/8"-11	18	1	\$158.52

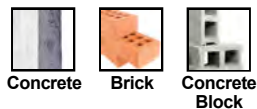

- ◆ High Diamond Concentration
- ◆ Wet Or Dry
- ◆ Fast Aggressive Grinding
- ◆ Smooth Finish
- ◆ 7/8" Open Hole
- ◆ Sold Individually



Diamond Turbo Grinding Cup Wheel

Part #	Size	Arbor	Segments	Qty.	List
TTT-50	5"	7/8" Open	12	1	\$182.11
TTT-70	7"	7/8" Open	18	1	\$228.36



SOLD INDIVIDUALLY
1 PER BOX.





Part # 2DD2216
5/8" Brass Ring for
7/8" Open Arbor Grinding Wheels
List \$3.51

Diamond Cutting Wheels



- ◆ Industrial Quality
- ◆ For Dry & Wet Use
- ◆ Individually Blister Carded



3" SANDWICH TUCK POINT DIAMOND CUTTING WHEEL

Part # **DSB-30**

List \$40.00

- DRY TYPE
- DIAMETER: 3" ± 0.70MM
- TEETH THICKNESS: 0.25" (-0.00/+0.20MM)
- 28 CRMO Body / LASER WELDED BLADE
- 20MM ROUND ARBOR W/ 5/8" BUSHING ADAPTER (SOLID BRASS)
- 20-25% CONCENTRATION OF DIAMOND GRAIN
- 13,700 RPM MAXIMUM



5" SANDWICH TUCK POINT DIAMOND CUTTING WHEEL

Part # **DSB-50**

List \$45.50

- DRY TYPE
- DIAMETER: 5" ± 0.70MM
- TEETH THICKNESS: 0.25" (-0.00/+0.20MM)
- 28 CRMO Body / LASER WELDED BLADE
- 20MM ROUND ARBOR W/ 5/8" BUSHING ADAPTER (SOLID BRASS)
- 20-25% CONCENTRATION OF DIAMOND GRAIN
- 13,700 RPM MAXIMUM

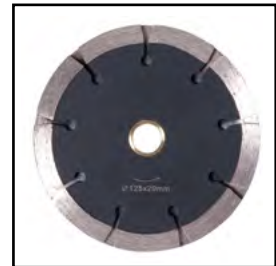

4" TUCK POINT DIAMOND CUTTING WHEEL

Part # **TPS40**

List \$76.64

- DRY TYPE
- DIAMETER: 4" ± 0.70MM
- TEETH THICKNESS: 0.25" (-0.00/+0.20MM)
- 28 CRMO Body / LASER WELDED BLADE
- 20MM ROUND ARBOR W/ 5/8" BUSHING ADAPTER (SOLID BRASS)
- 20-25% CONCENTRATION OF DIAMOND GRAIN
- 13,700 RPM MAXIMUM



4-1/2" TUCK POINT DIAMOND CUTTING WHEEL

Part # **TPS45**

List \$93.88

- DRY TYPE
- DIAMETER: 4-1/2" ± 0.70MM
- TEETH THICKNESS: 0.25" (-0.00/+0.20MM)
- 28 CRMO Body / LASER WELDED BLADE
- 20MM ROUND ARBOR W/ 5/8" BUSHING ADAPTER (SOLID BRASS)
- 20-25% CONCENTRATION OF DIAMOND GRAIN
- 13,700 RPM MAXIMUM

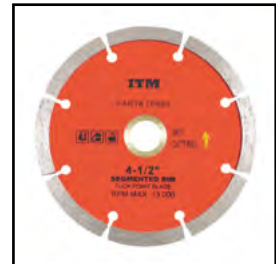

4" CONTINUOUS RIM DIAMOND CUTTING WHEEL

Part # **DCR40**

List \$17.61

- DRY & WET TYPE
- DIAMETER: 4" ± 0.70MM
- TEETH THICKNESS: 0.08" (-0.00/+0.20MM)
- 65MN BODY
- 7/8" ROUND ARBOR W/ 20MM & 5/8" BUSHING ADAPTER (SOLID BRASS)
- 20-25% CONCENTRATION OF DIAMOND GRAIN
- 13,700 RPM MAXIMUM





4-1/2" CONTINUOUS RIM DIAMOND CUTTING WHEEL

Part # DCR45

List \$20.96

- DRY & WET TYPE
- DIAMETER: 4-1/2" ± 0.70MM
- TEETH THICKNESS: 0.08" (-0.00/+0.20MM)
- 65MN BODY
- 7/8" ROUND ARBOR W/ 20MM & 5/8" BUSHING ADAPTER (SOLID BRASS)
- 20-25% CONCENTRATION OF DIAMOND GRAIN
- 13,300 RPM MAXIMUM



7" CONTINUOUS RIM DIAMOND CUTTING WHEEL

Part # DCR70

List \$47.79

- DRY & WET TYPE
- DIAMETER: 7" ± 0.70MM
- TEETH THICKNESS: 0.08" (-0.00/+0.20MM)
- 65MN BODY
- 7/8" ROUND ARBOR W/ 20MM & 5/8" BUSHING ADAPTER (SOLID BRASS)
- 20-25% CONCENTRATION OF DIAMOND GRAIN
- 8,400 RPM MAXIMUM

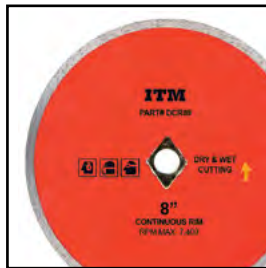

8" CONTINUOUS RIM DIAMOND CUTTING WHEEL

Part # DCR80

List \$51.62

- DRY & WET TYPE
- DIAMETER: 8" ± 0.70MM
- TEETH THICKNESS: 0.1" (-0.00/+0.20MM)
- 65MN BODY
- 7/8" ROUND ARBOR W/ 20MM & 5/8" RHOMBIC BUSHING ADAPTER (SOLID BRASS)
- 20-25% CONCENTRATION OF DIAMOND GRAIN
- 7,400 RPM MAXIMUM



4" TURBO DIAMOND CUTTING WHEEL

Part # DTU40

List \$19.39

- DRY & WET TYPE
- DIAMETER: 4" ± 0.70MM
- TEETH THICKNESS: 0.08" (-0.00/+0.20MM)
- 65MN BODY
- 7/8" ROUND ARBOR W/ 20MM & 5/8" BUSHING ADAPTER (SOLID BRASS)
- 20-25% CONCENTRATION OF DIAMOND GRAIN
- 13,700 RPM MAXIMUM



4-1/2" TURBO DIAMOND CUTTING WHEEL

Part # DTU45

List \$24.37

- DRY & WET TYPE
- DIAMETER: 4-1/2" ± 0.70MM
- TEETH THICKNESS: 0.08" (-0.00/+0.20MM)
- 65MN BODY
- 7/8" ROUND ARBOR W/ 20MM & 5/8" BUSHING ADAPTER (SOLID BRASS)
- 20-25% CONCENTRATION OF DIAMOND GRAIN
- 13,300 RPM MAXIMUM



7" TURBO DIAMOND CUTTING WHEEL

Part # DTU70

List \$56.46

- DRY & WET TYPE
- DIAMETER: 7" ± 0.70MM
- TEETH THICKNESS: 0.08" (-0.00/+0.20MM)
- 65MN BODY
- 7/8" ROUND ARBOR W/ 20MM & 5/8" BUSHING ADAPTER (SOLID BRASS)
- 20-25% CONCENTRATION OF DIAMOND GRAIN
- 8,400 RPM MAXIMUM

8" TURBO DIAMOND CUTTING WHEEL	
Part # DTU80 List \$60.98	<ul style="list-style-type: none"> • DRY & WET TYPE • DIAMETER: 8" ± 0.70MM • TEETH THICKNESS: 0.1" (-0.00/+0.20MM) • 65MN BODY • 7/8" ROUND ARBOR W/ 20MM & 5/8" RHOMBIC BUSHING ADAPTER (SOLID BRASS) • 20-25% CONCENTRATION OF DIAMOND GRAIN • 7,400 RPM MAXIMUM

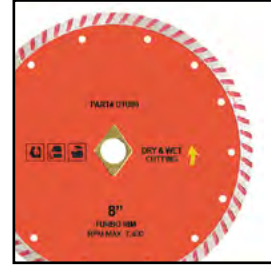

4" SEGMENTED DIAMOND CUTTING WHEEL	
Part # DCS40 List \$17.61	<ul style="list-style-type: none"> • DRY TYPE • DIAMETER: 4" ± 0.70MM • TEETH THICKNESS: 0.08" (-0.00/+0.20MM) • 65MN BODY • 7/8" ROUND ARBOR W/ 20MM & 5/8" BUSHING ADAPTER (SOLID BRASS) • 20-25% CONCENTRATION OF DIAMOND GRAIN • 13,700 RPM MAXIMUM

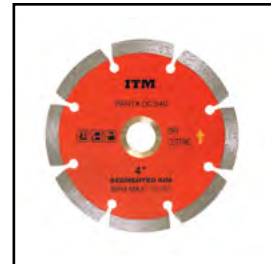

4-1/2" SEGMENTED DIAMOND CUTTING WHEEL	
Part # DCS45 List \$20.96	<ul style="list-style-type: none"> • DRY TYPE • DIAMETER: 4-1/2" ± 0.70MM • TEETH THICKNESS: 0.08" (-0.00/+0.20MM) • 65MN BODY • 7/8" ROUND ARBOR W/ 20MM & 5/8" BUSHING ADAPTER (SOLID BRASS) • 20-25% CONCENTRATION OF DIAMOND GRAIN • 13,300 RPM MAXIMUM



7" SEGMENTED DIAMOND CUTTING WHEEL	
Part # DCS70 List \$47.79	<ul style="list-style-type: none"> • DRY TYPE • DIAMETER: 7" ± 0.70MM • TEETH THICKNESS: 0.08" (-0.00/+0.20MM) • 65MN BODY • 7/8" ROUND ARBOR W/ 20MM & 5/8" BUSHING ADAPTER (SOLID BRASS) • 20-25% CONCENTRATION OF DIAMOND GRAIN • 8,400 RPM MAXIMUM



12" SEGMENTED DIAMOND CUTTING WHEEL	
Part # DCS120 List \$92.25	<ul style="list-style-type: none"> • DRY TYPE • DIAMETER: 12" • TEETH THICKNESS: 0.1" (-0.05/+0.20MM) • TEETH (HIGH): 0.256" (-0.20/+0.70mm) • 65MN BODY • 1" ROUND ARBOR W/ 20MM & 7/8" BUSHING ADAPTER (SOLID BRASS) • 20-25% CONCENTRATION OF DIAMOND GRAIN • 5,000 RPM MAXIMUM
 Part # 2DD191S 14MM Brass Ring for 1" Arbor Diamond Wheels List \$3.68	



14" SEGMENTED DIAMOND CUTTING WHEEL	
Part # DCS140 List \$124.76	<ul style="list-style-type: none"> • DRY TYPE • DIAMETER: 14" • TEETH THICKNESS: 0.12" (-0.05/+0.20MM) • TEETH (HIGH): 0.315" (-0.20/+0.70mm) • 65MN BODY • 1" ROUND ARBOR W/ 20MM & 7/8" BUSHING ADAPTER (SOLID BRASS) • 20-25% CONCENTRATION OF DIAMOND GRAIN • 4,300 RPM MAXIMUM
 Part # 2DD191S 14MM Brass Ring for 1" Arbor Diamond Wheels List \$3.68	

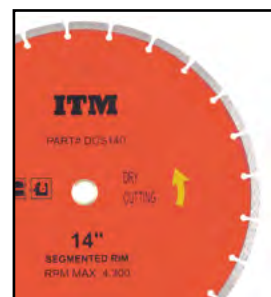



Phillips

PHILLIPS POINT #	SHEET METAL SCREWS	WOOD SCREWS		MACHINE SCREWS		
	FLAT, ROUND, OVAL STOVE BINDING	FLAT, OVAL	ROUND	FLAT, OVAL BINDING	ROUND, FILLISTER	TRUSS, BRAZIER BUTTON
0	0, 1	0, 1	0, 1	0, 1	0, 1	0, 1
1	2, 3, 4	2, 3, 4	2, 3, 4	2, 3, 4	2, 3, 4	2, 3, 4, 5
2	5, 6, 7, 8, 10	5, 6, 7, 8, 9	5, 6, 7, 8, 9, 10	5, 6, 8, 10	5, 6, 8, 10	6, 8, 10
3	12, 14	10, 12, 14, 16	12, 14, 16	12, 1/4"	12, 1/4", 5/16"	12, 1/4"

Slotted

SLOTTED POINT #	SCREW SIZE	SLOT SCREW WIDTH		THREAD DIA.	MAXIMUM HEAD DIAMETER					
		MIN.	MAX.		FLAT or OVAL HEAD	ROUND HEAD	FILLISTER HEAD	BINDING HEAD	PAN HEAD	TRUSS HEAD
4-5	3	.027	.035	.099	.199	.187	.161	.208	.193	.226
4-5	4	.031	.039	.112	.225	.211	.183	.235	.219	.257
6-8	5	.035	.043	.125	.252	.236	.205	.263	.245	.289
8-10	6	.039	.048	.138	.279	.260	.226	.290	.270	.321
10-12	8	.045	.054	.164	.332	.309	.270	.344	.322	.384

Square

SQUARE POINT #	TAPPING SCREWS	WOOD SCREWS	MACHINE SCREWS
0	3, 4	3, 4	3, 4
1	5, 6, 7	5, 6, 7	5, 6
2	8, 10	8, 9, 10	8, 10
3	12, 14	12, 14	12, 14

Star **FOR TORX® SCREWS.**

SCREW SIZE	THREAD DIA.	INTERNAL TORX WASHER HEAD	PAN HEAD	FLAT HEAD	HEX HEAD	TRUSS HEAD	FILLISTER HEAD	OVAL HEAD	SOCKET HEAD CAP	SOCKET SET SCREW
2	.086	T7	T7	T6						
3	.099	T8	T8	T7						
4	.112	T9	T9	T8	T9		T9		T10	T6
5	.125	T10	T10	T9	T10		T10	T10	T10	T7
6	.138	T15	T15	T10	T15	T10	T15	T15	T15	T7
8	.164	T20	T20	T15	T20	T15	T20	T20	T25	T8
10	.190	T25	T25	T20	T25	T20	T25	T25	T27	T10
12	.216	T27	T27	T25	T27	T25	T27	T27	T27	T10
1/4"	.250	T30	T30	T27	T30	T27	T30	T30	T30	T20
5/16"	.312			T40	T40	T40	T340	T40	T45	T27
3/8"	.375		T45	T40	T45	T45	T45	T45	T50	T30
7/16"	.437		T50	T50		T45	T50	T50	T55	T40
1/2"	.500		T55	T50		T50	T55	T50	T55	T45



STAINLESS STEEL
SHAFT

1/4" Drive Magnetic Screwdriver
With Insert Bit Storage Handle. *BITS NOT INCLUDED.*

Part #	Drive	Description	List
HH-08-001	1/4"	8" MAGNETIC STORAGE HANDLE	\$25.00



1/4" Drive Magnetic Flexible Screwdriver

Part #	Drive	Description	List
HAN-1	1/4"	10" Magnetic Flexible Screwdriver (1/4" Bits)	\$32.00



1/4" Drive Quick Change Screwdriver

Part #	Drive	Description	List
HAN-2	1/4"	1/4" Quick Change Screwdriver (1/4" Bits)	\$33.00



Insert Bit Countertop Dispenser

Part #	Type	Qty.	List
BITDIS	EMPTY DISPLAY	1	\$760.00

KEEP YOUR INSERT BITS AND NUT SETTERS SAFE AND ORGANIZED.



- ◆ Sold Empty
- ◆ Make Your Own Assortment
- ◆ Display Made In Canada





Phillips® Insert Bits - 1/4" Hex Shank

Part #	Size	OAL	Type	Qty.	List
T3-025-00	#0 X 1"		PHILLIPS INSERT	25	\$0.75
T3-025-01	#1 X 1"		PHILLIPS INSERT	25	\$0.50
T3-025-02	#2 X 1"		PHILLIPS INSERT	25	\$0.45
T3-025-03	#3 X 1"		PHILLIPS INSERT	25	\$0.45
T3-025-04	#4 X 1"		PHILLIPS INSERT	25	\$4.00



Reduced Body

Phillips® Drywall Bits - 1/4" Hex Shank

Part #	Size	OAL	Type	Qty.	List
T3-025-1W	#1 X 1"		PHILLIPS DRYWALL	25	\$0.50
T3-025-2W	#2 X 1"		PHILLIPS DRYWALL	25	\$0.50



Phillips® Insert Bits - 5/16" Hex Shank

Part #	Size	OAL	Type	Qty.	List
T3-032-01	#1 X 1-1/4"		PHILLIPS INSERT	25	\$1.15
T3-032-02	#2 X 1-1/4"		PHILLIPS INSERT	25	\$1.15
T3-032-03	#3 X 1-1/4"		PHILLIPS INSERT	25	\$1.15



Phillips® Stopper - 1/4" Hex Shank

Part #	Size	OAL	Type	Qty.	List
SP-025-2P	#2 X 1"		PHILLIPS STOPPER	25	\$4.00



Phillips® ACR® Insert Bits - 1/4" Hex

Part #	Size	OAL	Type	Qty.	List
ACR-025-01	#1 X 1"		PHILLIPS ACR INSERT	25	\$0.80
ACR-025-02	#2 X 1"		PHILLIPS ACR INSERT	25	\$0.80
ACR-025-03	#3 X 1"		PHILLIPS ACR INSERT	25	\$0.80



Phillips® Power Bits - 1/4" Hex Shank

Part #	Size	OAL	Type	Qty.	List
T3-050-01	#1 X 2"		PHILLIPS POWER	25	\$0.80
T3-070-01	#1 X 2-3/4"		PHILLIPS POWER	25	\$1.33
T3-075-01	#1 X 3"		PHILLIPS POWER	25	\$1.43
T3-090-01	#1 X 3-1/2"		PHILLIPS POWER	25	\$1.64
T3-100-01	#1 X 4"		PHILLIPS POWER	25	\$1.96
T3-125-01	#1 X 5"		PHILLIPS POWER	25	\$2.70
T3-150-01	#1 X 6"		PHILLIPS POWER	25	\$3.45
T3-050-02	#2 X 2"		PHILLIPS POWER	25	\$0.80
T3-070-02	#2 X 2-3/4"		PHILLIPS POWER	25	\$1.33
T3-075-02	#2 X 3"		PHILLIPS POWER	25	\$1.43
T3-090-02	#2 X 3-1/2"		PHILLIPS POWER	25	\$1.64
T3-100-02	#2 X 4"		PHILLIPS POWER	25	\$1.96
T3-125-02	#2 X 5"		PHILLIPS POWER	25	\$2.70
T3-150-02	#2 X 6"		PHILLIPS POWER	25	\$3.45
T3-050-03	#3 X 2"		PHILLIPS POWER	25	\$0.80
T3-070-03	#3 X 2-3/4"		PHILLIPS POWER	25	\$1.33
T3-075-03	#3 X 3"		PHILLIPS POWER	25	\$1.43
T3-090-03	#3 X 3-1/2"		PHILLIPS POWER	25	\$1.64
T3-100-03	#3 X 4"		PHILLIPS POWER	25	\$1.96
T3-125-03	#3 X 5"		PHILLIPS POWER	25	\$2.70
T3-150-03	#3 X 6"		PHILLIPS POWER	25	\$3.45



Reduced Body

Phillips® Drywall Bits

Part #	Size	OAL	Type	Qty.	List
T3-050-2W	#2 X 2"		PHILLIPS DRYWALL	25	\$0.90
T3-070-2W	#2 X 2-3/4"		PHILLIPS DRYWALL	25	\$1.43
T3-090-2W	#2 X 3-1/2"		PHILLIPS DRYWALL	25	\$2.28

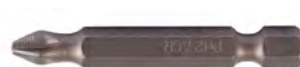

Phillips® ACR® Power Bits - 1/4" Hex

Part #	Size	OAL	Type	Qty.	List
ACR-050-01	#1 X 2"		PHILLIPS ACR POWER	25	\$1.15
ACR-050-02	#2 X 2"		PHILLIPS ACR POWER	25	\$1.15
ACR-050-03	#3 X 2"		PHILLIPS ACR POWER	25	\$1.15



For Torx® Screws

Star Insert Bits - 1/4" Hex Shank

Part #	Size	OAL	Type	Qty.	List
TX-025-04	T4	X 1"	STAR INSERT	25	\$0.75
TX-025-06	T6	X 1"	STAR INSERT	25	\$0.75
TX-025-07	T7	X 1"	STAR INSERT	25	\$0.75
TX-025-08	T8	X 1"	STAR INSERT	25	\$0.75
TX-025-09	T9	X 1"	STAR INSERT	25	\$0.75
TX-025-10	T10	X 1"	STAR INSERT	25	\$0.75
TX-025-15	T15	X 1"	STAR INSERT	25	\$0.75
TX-025-20	T20	X 1"	STAR INSERT	25	\$0.75
TX-025-25	T25	X 1"	STAR INSERT	25	\$0.75
TX-025-27	T27	X 1"	STAR INSERT	25	\$0.75
TX-025-30	T30	X 1"	STAR INSERT	25	\$0.75
TX-025-40	T40	X 1"	STAR INSERT	25	\$0.75



Square Insert Bits - 1/4" Hex Shank

Part #	Size	OAL	Type	Qty.	List
T3-R25-00	#0	X 1"	SQUARE INSERT	25	\$1.00
T3-R25-01	#1	X 1"	SQUARE INSERT	25	\$0.70
T3-R25-02	#2	X 1"	SQUARE INSERT	25	\$0.70
T3-R25-03	#3	X 1"	SQUARE INSERT	25	\$0.70



For Torx® Screws

Star Insert Bits - 5/16" Hex Shank

Part #	Size	OAL	Type	Qty.	List
TX-032-30	T30	X 1-1/4"	STAR INSERT	25	\$2.00
TX-032-40	T40	X 1-1/4"	STAR INSERT	25	\$2.00
TX-032-45	T45	X 1-1/4"	STAR INSERT	25	\$2.00
TX-032-50	T50	X 1-1/4"	STAR INSERT	25	\$2.00
TX-032-55	T55	X 1-1/4"	STAR INSERT	25	\$2.00



Square Power Bits - 1/4" Hex Shank

Part #	Size	OAL	Type	Qty.	List
T3-R50-01	#1	X 2"	SQUARE POWER	25	\$1.60
T3-R70-01	#1	X 2-3/4"	SQUARE POWER	25	\$1.76
T3-R75-01	#1	X 3"	SQUARE POWER	25	\$2.04
T3-R90-01	#1	X 3-1/2"	SQUARE POWER	25	\$2.36
T3-R10-01	#1	X 4"	SQUARE POWER	25	\$2.47
T3-R12-01	#1	X 5"	SQUARE POWER	25	\$3.16
T3-R15-01	#1	X 6"	SQUARE POWER	25	\$4.31
T3-R50-02	#2	X 2"	SQUARE POWER	25	\$1.60
T3-R70-02	#2	X 2-3/4"	SQUARE POWER	25	\$1.76
T3-R75-02	#2	X 3"	SQUARE POWER	25	\$2.04
T3-R90-02	#2	X 3-1/2"	SQUARE POWER	25	\$2.36
T3-R10-02	#2	X 4"	SQUARE POWER	25	\$2.47
T3-R12-02	#2	X 5"	SQUARE POWER	25	\$3.16
T3-R15-02	#2	X 6"	SQUARE POWER	25	\$4.31
T3-R50-03	#3	X 2"	SQUARE POWER	25	\$1.60
T3-R70-03	#3	X 2-3/4"	SQUARE POWER	25	\$1.76
T3-R75-03	#3	X 3"	SQUARE POWER	25	\$2.04
T3-R90-03	#3	X 3-1/2"	SQUARE POWER	25	\$2.36
T3-R10-03	#3	X 4"	SQUARE POWER	25	\$2.47
T3-R12-03	#3	X 5"	SQUARE POWER	25	\$3.16
T3-R15-03	#3	X 6"	SQUARE POWER	25	\$4.31



For Torx® Screws

Star Power Bits - 1/4" Hex Shank

Part #	Size	OAL	Type	Qty.	List
TX-050-10	T10	X 2"	STAR POWER	25	\$1.25
TX-150-10	T10	X 6"	STAR POWER	25	\$8.20
TX-050-15	T15	X 2"	STAR POWER	25	\$1.25
TX-150-15	T15	X 6"	STAR POWER	25	\$8.20
TX-050-20	T20	X 2"	STAR POWER	25	\$1.25
TX-150-20	T20	X 6"	STAR POWER	25	\$8.20
TX-050-25	T25	X 2"	STAR POWER	25	\$1.25
TX-150-25	T25	X 6"	STAR POWER	25	\$8.20
TX-050-27	T27	X 2"	STAR POWER	25	\$1.25
TX-150-27	T27	X 6"	STAR POWER	25	\$8.20
TX-050-30	T30	X 2"	STAR POWER	25	\$1.25
TX-150-30	T30	X 6"	STAR POWER	25	\$8.20
TX-050-40	T40	X 2"	STAR POWER	25	\$1.25
TX-150-40	T40	X 6"	STAR POWER	25	\$8.20



Quick Change Extensions
P. 74

- ◆ S2 Modified Steel
- ◆ Rc. 58-62 Heat Treated
- ◆ German Grade Steel





Poizidriv® Insert Bits - 1/4" Hex Shank

Part #	Size	OAL	Type	Qty.	List
PZ-025-01	#1 X 1"		POZIDRIV INSERT	25	\$1.00
PZ-025-02	#2 X 1"		POZIDRIV INSERT	25	\$1.00
PZ-025-03	#3 X 1"		POZIDRIV INSERT	25	\$1.00



Poizidriv® Power Bits - 1/4" Hex Shank

Part #	Size	OAL	Type	Qty.	List
PZ-050-01	#1 X 2"		POZIDRIV POWER	25	\$1.54
PZ-050-02	#2 X 2"		POZIDRIV POWER	25	\$1.54
PZ-075-02	#2 X 3"		POZIDRIV POWER	25	\$2.09
PZ-050-03	#3 X 2"		POZIDRIV POWER	25	\$1.54



Slotted Insert Bits - 1/4" Hex Shank

Part #	Size	OAL	Type	Qty.	List
ST-025-04	#4-5 X 1"		SLOTTED INSERT	25	\$0.75
ST-025-08	#6-8 X 1"		SLOTTED INSERT	25	\$0.75
ST-025-10	#8-10 X 1"		SLOTTED INSERT	25	\$0.75
ST-025-12	#10-12 X 1"		SLOTTED INSERT	25	\$0.75



Slotted Power Bits - 1/4" Hex Shank

Part #	Size	OAL	Type	Qty.	List
ST-050-04	#4-5 X 2"		SLOTTED POWER	25	\$1.30
ST-050-08	#6-8 X 2"		SLOTTED POWER	25	\$1.30
ST-050-10	#8-10 X 2"		SLOTTED POWER	25	\$1.30
ST-070-10	#8-10 X 3"		SLOTTED POWER	25	\$1.96
ST-090-10	#8-10 X 3-1/2"		SLOTTED POWER	25	\$2.18
ST-050-12	#10-12 X 2"		SLOTTED POWER	25	\$1.30

- ◆ S2 Modified Steel
- ◆ Rc. 58-62 Heat Treated
- ◆ German Grade Steel



Hex Insert Bits - 1/4" Hex Shank

Part #	Size	OAL	Type	Qty.	List
HE-25-564	5/64" X 1"		HEX INSERT	25	\$0.98
HE-25-332	3/32" X 1"		HEX INSERT	25	\$0.98
HE-25-764	7/64" X 1"		HEX INSERT	25	\$0.98
HE-25-864	1/8" X 1"		HEX INSERT	25	\$0.98
HE-25-532	5/32" X 1"		HEX INSERT	25	\$0.98
HE-25-316	3/16" X 1"		HEX INSERT	25	\$0.98



Hex Insert Bits - 5/16" Hex Shank

Part #	Size	OAL	Type	Qty.	List
HE-32-316	3/16" X 1-1/4"		HEX INSERT	25	\$2.01
HE-32-732	7/32" X 1-1/4"		HEX INSERT	25	\$2.01
HE-32-014	1/4" X 1-1/4"		HEX INSERT	25	\$2.01



Double End Bits - 1/4" Hex Shank

Part #	Size	Qty.	List
DW-050-22	#2 PHILLIPS / #2 PHILLIPS	25	\$2.01
DW-050-26	#2 PHILLIPS / #6-8 SLOTTED	25	\$2.01
DW-050-28	#2 PHILLIPS / #8-10 SLOTTED	25	\$2.01



Phillips® Impact Bits - 1/4" Hex Shank

Part #	Size	OAL	Type	Qty.	List
BLU-025-02	#2 X 1-3/16"		PHILLIPS IMPACT	25	\$3.45
BLU-050-02	#2 X 2"		PHILLIPS IMPACT	25	\$5.08
BLU-025-03	#3 X 1-3/16"		PHILLIPS IMPACT	25	\$3.45
BLU-050-03	#3 X 2"		PHILLIPS IMPACT	25	\$5.08





Spanner Insert Bits - 1/4" Hex Shank

Part #	Size	OAL	Type	Qty.	List
SP-025-04	#4 X 1"		SPANNER	25	\$1.80
SP-025-06	#6 X 1"		SPANNER	25	\$1.80
SP-025-08	#8 X 1"		SPANNER	25	\$1.80
SP-025-10	#10 X 1"		SPANNER	25	\$1.80
SP-025-12	#12 X 1"		SPANNER	25	\$1.80
SP-025-14	#14 X 1"		SPANNER	25	\$1.80



Hex Tamper Insert Bits - 1/4" Hex

Part #	Size	OAL	Type	Qty.	List
TH-25-332	3/32" X 1"		HEX TAMPER	25	\$1.75
TH-25-018	1/8" X 1"		HEX TAMPER	25	\$1.75
TH-25-964	9/64" X 1"		HEX TAMPER	25	\$1.75
TH-25-532	5/32" X 1"		HEX TAMPER	25	\$1.75
TH-25-316	3/16" X 1"		HEX TAMPER	25	\$1.75
TH-25-732	7/32" X 1"		HEX TAMPER	25	\$1.75
TH-25-014	1/4" X 1"		HEX TAMPER	25	\$1.75
TH-25-516	5/16" X 1"		HEX TAMPER	25	\$1.75



For TAMPER RESISTANT Torx® Screws

Star Tamper Insert Bits - 1/4" Hex

Part #	Size	OAL	Type	Qty.	List
TT-025-08	T8 X 1"		STAR TAMPER	25	\$1.54
TT-025-09	T9 X 1"		STAR TAMPER	25	\$1.54
TT-025-10	T10 X 1"		STAR TAMPER	25	\$1.54
TT-025-15	T15 X 1"		STAR TAMPER	25	\$1.54
TT-025-20	T20 X 1"		STAR TAMPER	25	\$1.54
TT-025-25	T25 X 1"		STAR TAMPER	25	\$1.54
TT-025-27	T27 X 1"		STAR TAMPER	25	\$1.54
TT-025-30	T30 X 1"		STAR TAMPER	25	\$1.54
TT-025-40	T40 X 1"		STAR TAMPER	25	\$1.54



Tri-Wing® Tamper Insert Bits - 1/4" Hex

Part #	Size	OAL	Type	Qty.	List
TRI-25-01	#1 X 1"		TRI-WING	25	\$2.00
TRI-25-02	#2 X 1"		TRI-WING	25	\$2.00
TRI-25-03	#3 X 1"		TRI-WING	25	\$2.00



For TAMPER RESISTANT Torx® Screws

Star Tamper Insert Bits - 5/16" Hex

Part #	Size	OAL	Type	Qty.	List
TT-032-45	T45 X 1-1/4"		STAR TAMPER	25	\$3.20
TT-032-50	T50 X 1-1/4"		STAR TAMPER	25	\$3.20
TT-032-55	T55 X 1-1/4"		STAR TAMPER	25	\$3.20



Phillips® Tamper Insert Bits - 1/4" Hex

Part #	Size	OAL	Type	Qty.	List
TP-025-02	#2 X 1"		PHILLIPS TAMPER	25	\$3.35
TP-025-03	#3 X 1"		PHILLIPS TAMPER	25	\$3.35

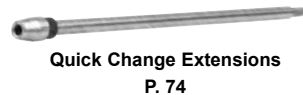
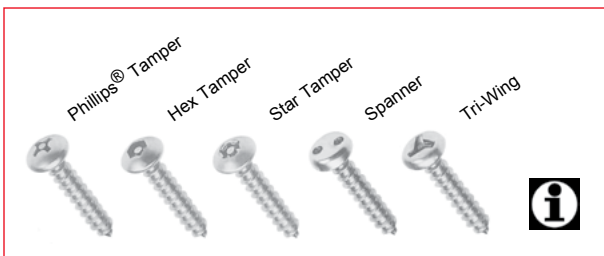

- ◆ S2 Modified Steel
- ◆ Rc. 58-62 Heat Treated
- ◆ German Grade Steel





SOLD INDIVIDUALLY.

Bit Holders - Stainless Steel - Magnetic

Part #	OAL	Body Dia.	Retaining Ring	Description	List
BH-020-RC	1-3/4"	7/16"	NO	2PC. CONSTRUCTION	\$5.76

Part #	OAL	Body Dia.	Retaining Ring	Description	List
BH-040-RC	1-13/16"	7/16"	YES	1PC. CONSTRUCTION	\$6.10



Made in Germany

Part #	OAL	Body Dia.	Retaining Ring	Description	List
BH-060-BLU	2-1/2"	7/16"	YES	2PC. CONSTRUCTION	\$8.75

Part #	OAL	Body Dia.	Retaining Ring	Description	List
BH-060-RC	2-5/8"	7/16"	YES	1PC. CONSTRUCTION	\$5.13

BH-060-40 made of Chrome Vanadium.

Part #	OAL	Body Dia.	Retaining Ring	Description	List
BH-060-40	2-5/8"	3/8"	NO	2PC. CONSTRUCTION	\$3.47



Part #	OAL	Body Dia.	Retaining Ring	Description	List
BH-075-14	3"	7/16"	NO	2PC. CONSTRUCTION	\$5.15



Part #	OAL	Body Dia.	Retaining Ring	Description	List
BH-075-14R	3"	7/16"	YES	2PC. CONSTRUCTION	\$5.40



Part #	OAL	Body Dia.	Retaining Ring	Description	List
BH-075-RC	3"	7/16"	YES	1PC. CONSTRUCTION	\$5.78



Part #	OAL	Body Dia.	Retaining Ring	Description	List
BH-100-TR	3"	7/16"	THREADED	1PC. CONSTRUCTION	\$11.66



Part #	OAL	Body Dia.	Retaining Ring	Description	List
BH-100-RC	4"	7/16"	YES	1PC. CONSTRUCTION	\$9.54



Part #	OAL	Body Dia.	Retaining Ring	Description	List
BH-150-RC	6"	7/16"	YES	1PC. CONSTRUCTION	\$18.28

SOLD INDIVIDUALLY.



5/16" Bit Holders - Stainless Steel - Magnetic

Part #	OAL	Body Dia.	Retaining Ring	Description	List
LBH-1	3-1/2"	1/2"	YES	2PC. CONSTRUCTION	\$15.45
LBH-2	3"	1/2"	YES	1PC. CONSTRUCTION	\$16.00



Bit Holders - Special Application - Magnetic

Part #	OAL	Body Dia.	Retaining Ring	Description	List
BH-050-LK	2"	9/16"	YES / LOCK	SNAP LOCK HOLDER	\$7.75
BH-075-LK	3"	9/16"	YES / LOCK	SNAP LOCK HOLDER	\$10.40



Pull back system locks in bits.

Part #	OAL	Body Dia.	Retaining Ring	Description	List
BH-075-SL	3"	7/16"	NO	SLEEVE GUIDE HOLDER	\$6.18
BH-125-SL	5"	7/16"	NO	SLEEVE GUIDE HOLDER	\$6.53



Sleeve extends up to 8" (on 5" length sleeve guide) to hold screw while fastening.

Part #	OAL	Body Dia.	Retaining Ring	Description	List
FX-075-01	7-1/4"	1/2"	YES / BALL	FLEXIBLE BIT HOLDER	\$14.85



Flexible shaft can bend up to 45° for those hard to reach areas.

Part #	OAL	Body Dia.	Retaining Ring	Description	List
QUI0001	1-3/4"	13/16"	LOCK	METAL/SPRING OUT	\$6.75



Chucks have a quick insert / quick spring out system for easy bit changing. Locks in bits. Use with 2"+ POWER bits only!!!

Lag Driver / Ceiling Tile Hanger Driver

Part #	OAL	Body Dia.	Driver Size	Description	List
CE-075-14SL	2-1/2"	5/8"	7/16"	LAG DRIVER WITH SLEEVE	\$6.25



For eye lag screws to install suspended drop down ceilings.



SOLD INDIVIDUALLY.



1/4"
DRIVE

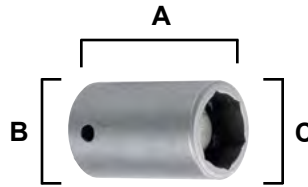

1/4" Square Drive Extension

Part #	OAL	List
AD-025-14	1"	\$3.05
AD-032-14	1-1/4"	\$4.47
AD-050-14	2"	\$4.51
AD-075-14	3"	\$4.94
AD-100-14	4"	\$7.50
AD-150-14	5"	\$9.44
AD-200-14	6"	\$11.57

1/4" Square Drive Impact Sockets

Part #	Hex Size	Length (A)	Body (B)	Nose (C)	List
250ST1264	3/16"	15/16"	1/2"	3/8"	\$4.62
250ST1664	1/4"	15/16"	1/2"	7/16"	\$4.82
250ST2064	5/16"	15/16"	1/2"	1/2"	\$5.36
250ST2464	3/8"	1"	5/8"	9/16"	\$5.52
250ST3264	1/2"	1"	3/4"	3/4"	\$6.71



3/8"
DRIVE

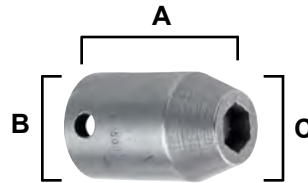

3/8" Square Drive Extension

Part #	OAL	List
AD-050-38	2"	\$6.37
AD-075-38	3"	\$6.84
AD-100-38	4"	\$11.38
AD-150-38	6"	\$13.99
AD-200-38	8"	\$20.67

3/8" Square Drive Impact Sockets

Part #	Hex Size	Length (A)	Body (B)	Nose (C)	List
375ST1664	1/4"	1-1/4"	3/4"	7/16"	\$5.42
375ST2064	5/16"	1-1/4"	3/4"	1/2"	\$5.42
375ST2464	3/8"	1-1/4"	3/4"	9/16"	\$6.06
375ST3264	1/2"	1-1/2"	15/16"	3/4"	\$8.21



1/2"
DRIVE

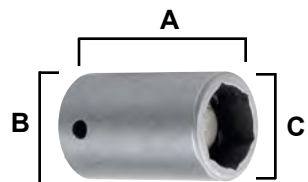

1/2" Square Drive Extension

Part #	OAL	List
AD-055-12	2-1/8"	\$7.56
AD-075-12	3"	\$9.21
AD-150-12	6"	\$15.76
AD-200-12	8"	\$20.97

1/2" Square Drive Impact Sockets

Part #	Hex Size	Length (A)	Body (B)	Nose (C)	List
500ST1664	1/4"	1-1/2"	15/16"	7/16"	\$6.10
500ST2064	5/16"	1-1/2"	15/16"	1/2"	\$6.32
500ST2464	3/8"	1-1/2"	15/16"	9/16"	\$6.47
500ST3264	1/2"	1-1/2"	15/16"	3/4"	\$9.10



1000+ SCREW GUARANTEE

Nut Setters - Magnetic Impact Protection

Part #	Hex Head Size	X	OAL	Type	Qty.	List
IMP-042-16	1/4"	X	1-3/4"	MAG. IMPACT	10	\$3.93
IMP-065-16	1/4"	X	2-9/16"	MAG. IMPACT	10	\$4.70
IMP-075-16	1/4"	X	4"	MAG. IMPACT	5	\$10.93
IMP-085-16	1/4"	X	6"	MAG. IMPACT	5	\$14.86
IMP-042-20	5/16"	X	1-3/4"	MAG. IMPACT	10	\$4.40
IMP-065-20	5/16"	X	2-9/16"	MAG. IMPACT	10	\$6.22
IMP-075-20	5/16"	X	4"	MAG. IMPACT	5	\$13.11
IMP-085-20	5/16"	X	6"	MAG. IMPACT	5	\$19.83
IMP-042-24	3/8"	X	1-3/4"	MAG. IMPACT	10	\$5.01
IMP-065-24	3/8"	X	2-9/16"	MAG. IMPACT	10	\$7.43
IMP-075-24	3/8"	X	4"	MAG. IMPACT	5	\$15.03
IMP-085-24	3/8"	X	6"	MAG. IMPACT	5	\$25.09
IMP-085-40	9/16"	X	6"	MAG. IMPACT	5	\$27.59

Nut Setters - Magnetic (Standard)

Part #	Hex Head Size	X	OAL	Type	Qty.	List
NS-042-16	1/4"	X	1-3/4"	MAG. NUT SETTER	10	\$2.62
NS-053-16	1/4"	X	2-1/8"	MAG. NUT SETTER	10	\$3.00
NS-065-16	1/4"	X	2-9/16"	MAG. NUT SETTER	10	\$3.16
NS-075-16	1/4"	X	4"	MAG. NUT SETTER	5	\$9.50
NS-085-16	1/4"	X	6"	MAG. NUT SETTER	5	\$12.92
NS-042-20	5/16"	X	1-3/4"	MAG. NUT SETTER	10	\$2.78
NS-053-20	5/16"	X	2-1/8"	MAG. NUT SETTER	10	\$3.33
NS-065-20	5/16"	X	2-9/16"	MAG. NUT SETTER	10	\$3.55
NS-075-20	5/16"	X	4"	MAG. NUT SETTER	5	\$11.40
NS-085-20	5/16"	X	6"	MAG. NUT SETTER	5	\$17.24
NS-042-24	3/8"	X	1-3/4"	MAG. NUT SETTER	10	\$3.55
NS-053-24	3/8"	X	2-1/8"	MAG. NUT SETTER	10	\$4.64
NS-065-24	3/8"	X	2-9/16"	MAG. NUT SETTER	10	\$5.08
NS-075-24	3/8"	X	4"	MAG. NUT SETTER	5	\$13.07
NS-085-24	3/8"	X	6"	MAG. NUT SETTER	5	\$21.82
NS-042-28	7/16"	X	1-3/4"	MAG. NUT SETTER	5	\$7.37
NS-053-28	7/16"	X	2-1/8"	MAG. NUT SETTER	5	\$8.26
NS-065-28	7/16"	X	2-9/16"	MAG. NUT SETTER	5	\$8.73
NS-042-32	1/2"	X	1-3/4"	MAG. NUT SETTER	5	\$8.14
NS-065-32	1/2"	X	2-9/16"	MAG. NUT SETTER	5	\$9.45

- ◆ 1/4" Hex Impact Shank
- ◆ Made for Powerful Impact Drivers / Wrenches
- ◆ 1pc Construction
- ◆ Industrial Grade Magnet



1-3/4" Long



2-9/16" Long



4" Long



- ◆ 1/4" Hex Impact Shank
- ◆ 1pc Construction
- ◆ Industrial Grade Magnet



1-3/4" Long



2-1/8" Long



2-9/16" Long



4" Long

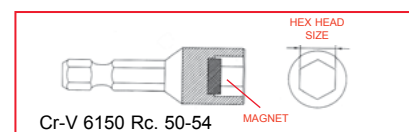



COMES WITH CASE AND HANDLE!



30 Pc. Screwdriver Insert Set - STANDARD

Part #	Description	List
ST-100-30	<ul style="list-style-type: none"> ⊕ Phillips: #1, #2, #3 ⊖ Slotted: 3-4, 4-5, 6-8, 8-10 ⊕ Posidriv: #1, #2, #3 ⊖ Square: #0, #1, #2, #3 ⊖ Hex: 5/64", 3/32", 7/64", 1/8", 9/64" ⊖ Star: T10, T15, T20, T25, T27, T30, T40 ● 1" Long Socket Adaptor ● 3" Long Bit Holder 	\$46.79

COMES WITH CASE AND HANDLE!



30 Pc. Screwdriver Insert Set - TAMPER PROOF

Part #	Description	List
TR-100-30	<ul style="list-style-type: none"> ⊕ Spanner: #6, #8, #10 ⊕ Posidriv: #1, #2, #3 ⊖ Tri-Wing: #1, #2, #3 ⊖ Hex Tamper: 3/32", 1/8", 9/64", 5/32", 3/16", 7/32", 1/4", 5/16" ⊖ Star Tamper: T8, T9, T10, T15, T20, T25, T27, T30, T40 ● 1" Long Socket Adaptor ● 3" Long Bit Holder 	\$58.71



32 Pc. Screwdriver Insert Set - STANDARD

Part #	Description	List
TECH-32	<ul style="list-style-type: none"> ⊕ Phillips: #0, #1, #2 (2), #3, #2DW (2) ⊖ Slotted: 6-8, 8-10, 10-12 ⊖ Square: #0, #1, #2 (3), #3 ⊖ Hex: 5/64", 3/32", 7/64", 1/8", 5/32", 3/16" ⊖ Star: T8, T10, T15, T20, T25, T27, T30, T40 ● 1/4" Impact Driver Adaptor ● 1/4" Auto Locking Magnetic Bit Holder 	\$45.83



← Belt Clip



32 Pc. Screwdriver Insert Set - TAMPER PROOF

Part #	Description	List
TECH-32TR	<ul style="list-style-type: none"> ⊕ Spanner: #6, #8, #10, #12, #14 ⊖ Star Tamper: T8, T9, T10, T15, T20, T25, T27, T30, T40 ⊖ Hex Tamper: 3/32", 1/8", 9/64", 5/32", 3/16", 7/32", 1/4", 5/16" ⊖ Tri-Wing: #1, #2, #3 ⊖ Square: #1, #2, #3 ⊕ Phillips: #2, #3 ● 1/4" Impact Driver Adaptor ● 1/4" Auto Locking Magnetic Bit Holder 	\$54.07

US PATENT 5265504

Made In

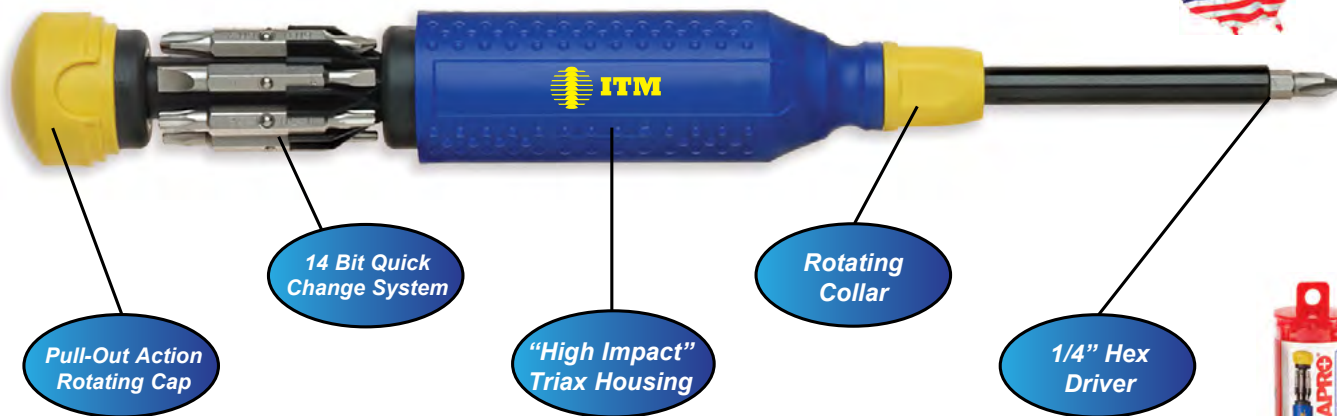

Part #	Description	List
MEGAPRO151	15-IN-1 MEGAPRO SCREWDRIVER #0 - #3 PHILLIPS #10 - #15 STAR #1 - #2 PHILLIPS #20 - #25 STAR #0 - #3 SQUARE #4 - #6 SLOTTED #1 - #2 SQUARE	\$54.60



MEGAPRO®



Part #	Description	List
MEGATAM151	15-IN-1 TAMPERPROOF SCREWDRIVER #6 - #8 SPANNER #10 - #15 STAR PIN #10 - #12 SPANNER #20 - #25 STAR PIN 1/8" - 9/64" HEX PIN #27 - #30 STAR PIN 5/32" - 3/16" HEX PIN	\$62.00



Tamper Proof Tamper Proof Driver sold Individually Tubed.

Part #	Description	List
470001	#0 - #3 PHILLIPS®	\$3.48
470002	#1 - #2 PHILLIPS®	\$3.48
470003	#0 - #3 SQUARE	\$3.48
470004	#1 - #2 SQUARE	\$3.48
470005	#10 - #15 STAR	\$3.48
470006	#20 - #25 STAR	\$3.48
470009	#27 - #30 STAR (SPECIAL SIZE)	\$3.48
470007	#4 - #6 SLOTTED	\$3.48
690001	#6 - #8 SPANNER	\$3.48
690002	#10 - #12 SPANNER	\$3.48
690003	1/8" - 9/64" HEX PIN	\$3.48
690004	5/32" - 3/16" HEX PIN	\$3.48
690005	#10 - #15 STAR PIN	\$3.48
690006	#20 - #25 STAR PIN	\$3.48
690007	#27 - #30 STAR PIN	\$3.48

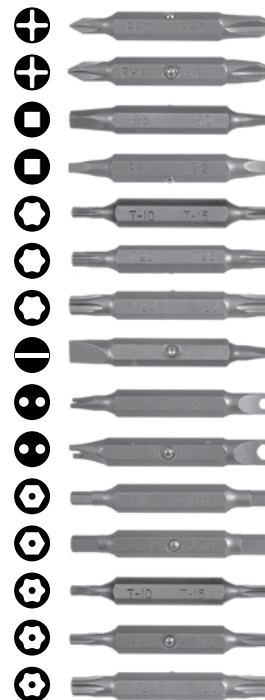

Replacement bits for the Megapro & Megapro Tamper Proof are sold individually.



NATURAL NYLON 6.6 CABLE TIES

- ◆ Manufactured of 100% Nylon
- ◆ Non-Corrosive
- ◆ Specification: Type 6.6 Nylon
- ◆ Self-Extinguishing
- ◆ Natural & Weather Resistant Black
- ◆ Operating Temperatures From 40° F (-40° C) to 185° F (85° C).
- ◆ Recognized Under the Components Program of Underwriter Laboratories, Inc.

Part #	Length	Tensile Strength	Width	Bundle Diameter	Military Specification	Pack Qty.	List / 100
MS0016-C	4"	18 lbs.	3/32"	1/16" → 5/8"	MS-3367-4-9	100	\$7.22
MS0032-C	5.5"	40 lbs.	1/8"	1/16" → 1-1/4"	MS-3367-5-9	100	\$9.00
MS0050-C	8"	50 lbs.	3/16"	1/16" → 2-1/8"	MS-3367-1-9	100	\$10.91
MS0070-C	11"	50 lbs.	3/16"	1/16" → 3"	MS-3367-7-9	100	\$24.02
MS0108-C	15"	50 lbs.	3/16"	1/16" → 4"	MS-3367-2-9	100	\$33.02

NATURAL NYLON 6.6 CABLE TIES - EXTRA HEAVY DUTY

Part #	Length	Tensile Strength	Width	Bundle Diameter	Military Specification	Pack Qty.	List / 100
XMS0050	8"	120 lbs.	5/16"	3/16" → 2"	-	100	\$30.51
XMS0070	11"	120 lbs.	5/16"	3/16" → 3"	-	100	\$33.93
XMS0108	15"	120 lbs.	5/16"	3/16" → 4"	-	100	\$39.23
XMS0152	24"	175 lbs.	3/8"	3/16" → 7"	-	100	\$71.51
XMS0225	36"	175 lbs.	3/8"	3/16" → 10"	-	100	\$82.83
XMS0300	48"	175 lbs.	3/8"	3/16" → 12"	-	100	\$124.10

File # E 57800.



BLACK WEATHER RESISTANT NYLON CABLE TIES



Part #	Length	Tensile Strength	Width	Bundle Diameter	Military Specification	Pack Qty.	List / 100
BWR0016-C	4"	18 lbs.	3/32"	1/16" → 5/8"	MS-3367-4-0	100	\$8.66
BWR0032-C	5.5"	40 lbs.	1/8"	1/16" → 1-1/4"	MS-3367-5-0	100	\$10.80
BWR0050-C	8"	50 lbs.	3/16"	1/16" → 2-1/8"	MS-3367-1-0	100	\$13.08
BWR0070-C	11"	50 lbs.	3/16"	1/16" → 3"	MS-3367-7-0	100	\$25.86
BWR0108-C	15"	50 lbs.	3/16"	1/16" → 4"	MS-3367-2-0	100	\$35.69

BLACK WEATHER RESISTANT NYLON CABLE TIES - EXTRA H.D.

Part #	Length	Tensile Strength	Width	Bundle Diameter	Military Specification	Pack Qty.	List / 100
XBWR050	8"	120 lbs.	5/16"	3/16" → 2"	-	100	\$31.04
XBWR070	11"	120 lbs.	5/16"	3/16" → 3"	-	100	\$34.97
XBWR108	15"	120 lbs.	5/16"	3/16" → 4"	-	100	\$44.37
XBWR152	24"	175 lbs.	3/8"	3/16" → 7"	-	100	\$77.88
XBWR225	36"	175 lbs.	3/8"	3/16" → 10"	-	100	\$97.64
XBWR300	48"	175 lbs.	3/8"	3/16" → 12"	-	100	\$146.96



CABLE TIE WITH SCREW MOUNT HOLE

Part #	Length	Tensile Strength	Width	Bundle Diameter	Military Specification	Pack Qty.	List / 100
NATURAL							
WCM0050	8"	50 lbs.	3/16"	1/16" → 2-1/8"	-	100	\$15.33
WCM0070	11"	50 lbs.	3/16"	1/16" → 3"	-	100	\$29.16
WCM0108	14"	50 lbs.	3/16"	1/16" → 4"	-	100	\$30.71
BLACK							
BCM0050	8"	50 lbs.	3/16"	1/16" → 2-1/8"	-	100	\$15.33
BCM0070	11"	50 lbs.	3/16"	1/16" → 3"	-	100	\$29.16
BCM0108	14"	50 lbs.	3/16"	1/16" → 4"	-	100	\$30.71



CONICAL ANCHOR - BLUE

PART# 807AK0010	
100 pcs.	- 3/16" Conical Anchors
100 pcs.	- #8 Combo Screws
1 pc.	- 3/16" Slow Spiral Masonry
List	\$12.00



SUPER ANCHOR - YELLOW

PART# SUPRAK006	
100 pcs.	- 3/16" SUPER Anchors
100 pcs.	- #8 Combo Screws
1 pc.	- 3/16" Slow Spiral Masonry
List	\$12.50



ZAP-IN ANCHOR (ZINC)

PART# EZZ-PACK	
50 pcs.	- Zinc Zap-In
50 pcs.	- #8 x 1" Combo Screws
1 pc.	- #2 X 2" Phillips Bit
List	\$35.00



ZAP-IN ANCHOR (NYLON)

PART# EZN-PACK	
50 pcs.	- Plastic Zap-In
50 pcs.	- #8 x 1" Combo Screws
1 pc.	- #2 X 2" Phillips Bit
List	\$24.00

PART# 807AK0011	
100 pcs.	- 1/4" Conical Anchors
100 pcs.	- #10 Combo Screws
1 pc.	- 1/4" Slow Spiral Masonry
List	\$13.50

PART# SUPRAK008	
100 pcs.	- 1/4" SUPER Anchors
100 pcs.	- #10 x 1/4" Combo Screws
1 pc.	- 1/4" Slow Spiral Masonry
List	\$15.40

PART# 807AK0013	
50 pcs.	- 5/16" Conical Anchors
50 pcs.	- #12 Combo Screws
1 pc.	- 5/16" Slow Spiral Masonry
List	\$16.00

PART# SUPRAK009	
50 pcs.	- 5/16" SUPER Anchors
50 pcs.	- #12 x 1/2" Combo Screws
1 pc.	- 5/16" Slow Spiral Masonry
List	\$18.00



COMBO SCREW

Anchor Kits



ZAP-IN Anchors

Part #	OAL	Description	Box Qty.	Packaged	List / C
EZZ1212	1-5/16"	ZAP IN ZINC ALLOY	100	BOX	\$54.35
EZZ1212B	1-5/16"	ZAP IN ZINC ALLOY	2,000	BULK	\$46.83
EZN1212	1-3/4"	ZAP IN NYLON	100	BOX	\$39.76
EZN1212B	1-3/4"	ZAP IN NYLON	2,000	BULK	\$35.28

- ◆ Industrial Quality
- ◆ Ideal for Fastening to Drywall and Other Low Density Substrates
- ◆ Easily Removable by Simply Backing Out Screw



- ◆ Retractable 3 Blade Positions
- ◆ Extra Blade Inside Compartment
- ◆ Carded and Sold Individually



Carded Utility Knife - 1 Pack

Part #	Description	List
UTK0001	UTILITY KNIFE	\$8.79

- ◆ Retractable 3 Blade Positions
- ◆ 3 Blades In Each Knife
- ◆ Heavy Duty Die Cast Aluminum
- ◆ Pull Out Mechanism For Quick Blade Change

FREE COUNTER DISPLAY WITH EVERY ORDER.



Quick Release Utility Knife - 12 Pack

Part #	Description	List
UTK0002	UTILITY KNIFE (12 PK)	\$15.81/ea

- ◆ Double Sided Tooth Geometry
- ◆ Narrow Blade Ideal For Awkward Cuts
- ◆ Carded And Sold Individually



6" Wallboard Saw - 1 Pack

Part #	Description	List
WS-6	6" WALLBOARD SAW	\$8.10

- ◆ 6 in 1 Quick Change
- ◆ Industrial Quality

SOLD IN 12 PIECE DISPLAY BOX ONLY.



6-IN-1 Combination Screwdriver

Part #	Description	List
ST-100-20	6-IN-1 SCREWDRIVER #1, #2, PHILLIPS 1/4" NUT SETTER #5, #8-10, SLOTTED 5/16" NUT SETTER	\$9.25/ea

- ◆ Heavy Duty
- ◆ Fits All Standard Knives
- ◆ Made in Taiwan



Heavy Duty Utility Blades

Part #	Description	Qty.	List
HDB9005	INDIVIDUAL PACK	5	\$2.47
HDB9100	100 PACK (20 X 5 PACKS)	100	\$31.93
HDB9100-HOOK	100 PACK - DOUBLE HOOK	100	\$52.56



Safety Goggles

Part #	Description	Qty.	List
GOG0001	SAFETY GOGGLES	1	\$6.00



RETAIL READY DISPLAYS

Part #	Size	Qty.
VG-4001B	1/8" X 3" - 25 PC.	2
VG-4002B	3/16" X 4" - 25 PC.	2
VG-4003B	1/4" X 4" - 25 PC.	2
VG-6001B	3/16" X 6" - 25 PC.	2
VG-6002B	1/4" X 6" - 25 PC.	2
VG-4002	3/16" X 4"	25
VG-4003	1/4" X 4"	25
VG-6001	3/16" X 6"	25
VG-6002	1/4" X 6"	25
VG-6003	5/16" X 6"	10
VG-6004	3/8" X 6"	5
VG-6005	1/2" X 6"	5



V GROOVE Tile Bit

Part #	Contents	List
RACK12	Black Header - 12 Prong	Free
H-2	V GROOVE Header	Free
DIS-VG	V GROOVE Tile Bits	\$3,603.45



RACK12
7"Out X 8"H X 23"W

HEX-12	3/16" X 2-5/8"	10
HEX-14	1/4" X 2-5/8"	10
HEX-16	5/16" X 3-1/8"	6
HEX-18	3/8" X 3-1/8"	6
HEX-20	1/2" X 3-1/8"	6
HEX-22	5/8" X 2-3/4"	5
HEX-24	3/4" X 2-3/4"	5
HEX-26	7/8" X 2-3/4"	5
HEX-28	1" X 2-3/4"	5



White Diamond Tile - Hex

Part #	Contents	List
RACK30	Black Header - 9 Prong	Free
H-8	White Diamond Header	Free
DIS-WD9	White Diamond - HEX	\$1,297.14



RACK30
7"Out X 8"H X 23"W

HEX-12	3/16" X 2-5/8"	10
HEX-14	1/4" X 2-5/8"	10
HEX-16	5/16" X 3-1/8"	6
HEX-18	3/8" X 3-1/8"	6
HEX-20	1/2" X 3-1/8"	6
HEX-22	5/8" X 2-3/4"	5
HEX-24	3/4" X 2-3/4"	5
HEX-26	7/8" X 2-3/4"	5
HEX-28	1" X 2-3/4"	5
ANG-26	7/8" X 2-3/8"	5
ANG-28	1" X 2-3/8"	5
ANG-30	1-1/8" X 2-3/8"	3
ANG-32	1-1/4" X 2-3/8"	3
ANG-34	1-3/8" X 2-3/8"	3
ANG-36	1-1/2" X 2-3/8"	3
ANG-38	2" X 2-3/8"	3
ANG-40	2-1/2" X 2-3/8"	3
PAD-5811	ADAPTER 5/8"-11	6

White Diamond Tile - Full

Part #	Contents	List
RACK35	Black Header - 19 Prong	Free
H-8	White Diamond Header	Free
DIS-WD19	White Diamond - HEX & Angle	\$2,501.08



RACK35
7"Out X 23"H X 23"W



INTERNATIONAL TOOL MANUFACTURING
 150 Express St. Plainview, NY 11803
 (516) 738-0388 • (800) 247-5696
 Fax (516) 279-1106



Part #	Size	Qty.
255H04	1/16" X 1-7/8"	12
255H06	3/32" X 2-1/4"	12
255H08	1/8" X 2-3/4"	12
255H10	5/32" X 3-1/8"	12
255H12	3/16" X 3-1/2"	12
255H14	7/32" X 3-3/4"	12
255H16	1/4" X 4"	12
255H18	9/32" X 4-1/4"	12
255H20	5/16" X 4-1/2"	12
255H24	3/8" X 5"	12
255H28	7/16" X 5-1/2"	6
255H32	1/2" X 6"	6



1/4" Hex Titanium Jobbers

Part #	Contents	List
RACK12	Black Header - 12 Prong	Free
H-3	HEX Titanium Header	Free
DIS-THEX	HEX Titanium Jobber Drills	\$1062.30

TITANIUM NITRIDE P. 24



HF0016	7/8" (3/16" Depth)	2
HF0019	1-1/8" (3/16" Depth)	2
HF0023	1-3/8" (3/16" Depth)	2
HG0016	7/8" (1/2" Depth)	2
HG0019	1-1/8" (1/2" Depth)	2
HG0023	1-3/8" (1/2" Depth)	2
HM0016	7/8" (1-3/8" Depth)	2
HM0019	1-1/8" (1-3/8" Depth)	2
HM0023	1-3/8" (1-3/8" Depth)	2



T.C.T. Hole Cutter

Part #	Contents	List
RACK12	Black Header - 12 Prong	Free
H-7	TCT Hole Cutter Header	Free
DIS-TCT	TCT Hole Cutters	\$1136.40

TUNGSTEN CARBIDE P. 54-55



W636	6" X 6T	3
W956	9" X 6T	3
W125	12" X 6T	3
M1218	12" X 18T	3
M810	8" X 10T	3
M814	8" X 14T	3
M818	8" X 18T	3
M614	6" X 14T	3
M618	6" X 18T	3
M624	6" X 24T	3



Reciprocating Blades

Part #	Contents	List
RACK10	Red Header - 10 Prong	Free
H-10	Reciprocating Blade Header	Free
DIS-RECP	Reciprocating Blades	\$718.20

RACK10
 3"Out X 8"H X 12"W

BI-METAL 8% COBALT P. 64



RACK12
 7"Out X 8"H X 24"W
 1/4" Metal Wire



RACK18
 15"Out X 8"H X 24"W
 1/4" Metal Wire



◆ Heavy Duty
 ◆ Black Oxide Finish

All individually packed **ITM** drill bits have barcode and can be hung on this display. Simple and hassle free.



ITM Displays - Empty

Part #	Rack	List
RACK10	Reciprocating Blade	\$58.18
RACK12	Top Header	\$87.99
RACK18	Bottom Extra	\$82.47
RACK20	Oscillating Blade	\$81.60
RACK30	White Diamond - Hex Only	\$78.99
RACK35	White Diamond - Hex & Grinder	\$103.13
H-1	Anything That Makes a Hole Header	Free



SDS-Plus - Redline

Part #	Contents	List
RACK12	Black Header - 12 Prong	Free
H-4	SDS Redline Header	Free
DIS-REDL	SDS Redline Bits - Starter	\$1,074.55



STARTER - P. 89

RL-41264	3/16" X 4-1/4"	10
RL-61264	3/16" X 6-1/4"	10
RL-41664	1/4" X 4-1/4"	10
RL-61664	1/4" X 6-1/4"	10
RL-62464	3/8" X 6-1/4"	10
RL-12038	3/8" X 12-1/4"	10
RL-63264	1/2" X 6-1/4"	10
RL-12012	1/2" X 12-1/4"	10
RL-84064	5/8" X 8-1/4"	10
RL-84864	3/4" X 8"	5
RL-85664	7/8" X 8"	5
RL-10001	1" X 10"	5



SDS-Plus - Bohr Hammer

Part #	Contents	List
RACK12	Black Header - 12 Prong	Free
H-5	SDS Bohr Hammer Header	Free
DIS-BOHR	SDS Bohr Hammer Bits - Starter	\$1,449.20

BOHR HAMMER STARTER - P. 90-91

715S41264	3/16" X 4-1/2"	10
715S61264	3/16" X 6-1/2"	10
715S41664	1/4" X 4-1/2"	10
715S61664	1/4" X 6-1/2"	10
715S62464	3/8" X 6-1/2"	10
715S82464	3/8" X 8-1/2"	10
715S63264	1/2" X 6-1/2"	10
715S12012	1/2" X 12-1/2"	10
715S84064	5/8" X 8-1/4"	5
715S84864	3/4" X 8"	5
715S85664	7/8" X 8"	5
715S10001	1" X 10"	5



SDS-Plus - Bohr Hammer

Part #	Contents	List
RACK12	Black Header - 12 Prong	Free
H-5	SDS Bohr Hammer Header	Free
DIS-B12S	SDS Bohr Hammer Bits - Short	\$977.25

BOHR HAMMER SHORT - P. 90-91

715S61064	5/32" X 6-1/4"	10
715S61264	3/16" X 6-1/2"	10
715S81264	3/16" X 8-1/2"	10
715S41664	1/4" X 4-1/2"	10
715S61664	1/4" X 6-1/2"	10
715S81664	1/4" X 8-1/2"	10
715S62064	5/16" X 6-1/2"	10
715S62464	3/8" X 6-1/2"	10
715S63264	1/2" X 6-1/2"	5
715S10012	1/2" X 10-1/2"	5
715S84064	5/8" X 8"	5
715S84864	3/4" X 8"	5



SDS-Plus - Bohr Hammer

Part #	Contents	List
RACK12	Black Header - 12 Prong	Free
H-5	SDS Bohr Hammer Header	Free
DIS-B12L	SDS Bohr Hammer Bits - Long	\$1,399.57

BOHR HAMMER LONG - P. 90-91

715S10316	3/16" X 10-1/2"	6
715S12316	3/16" X 12-1/2"	6
715S10014	1/4" X 10-1/2"	6
715S14014	1/4" X 14"	6
715S82464	3/8" X 8-1/2"	6
715S12038	3/8" X 12-1/2"	6
715S18038	3/8" X 18"	6
715S12012	1/2" X 12-1/2"	6
715S12058	5/8" X 12-1/4"	3
715S12034	3/4" X 12"	3
715S12078	7/8" X 12"	3
715S18001	1" X 18"	3



SDS-Plus - X Cutter

Part #	Contents	List
RACK12	Black Header - 12 Prong	Free
H-6	SDS X Cutter Header	Free
DIS-EVO	SDS X Cutter Bits - Starter	\$1,590.20

XCUTTER STARTER - P. 94-95

EVL41264	3/16" X 4-1/2"	10
EVL61264	3/16" X 6-1/2"	10
EVL81264	3/16" X 8-1/2"	10
EVL41664	1/4" X 4-1/2"	10
EVL61664	1/4" X 6-1/2"	10
EVL81664	1/4" X 8-1/2"	10
EVL62064	5/16" X 6-1/2"	10
EVL62464	3/8" X 6-1/4"	10
EVL12038	3/8" X 12-1/4"	10
EVL63264	1/2" X 6-1/4"	10
EVL12012	1/2" X 12-1/4"	5





PRIVATE LABELING ON ALL ROTARY HAMMER DRILLS



LET US BRING YOUR BRAND TO THE CONSUMER.

