

# **Intel<sup>®</sup> Server System R1000GZ/GL Family Service Guide**

---

**A Guide for Technically Qualified Assemblers of Intel<sup>®</sup> identified Subassemblies/Products**

Order Number: G24884-003

## Disclaimer

### Disclaimer

Information in this document is provided in connection with Intel<sup>®</sup> products. No license, express or implied, by estoppel or otherwise, to any intellectual property rights is granted by this document. Except as provided in Intel's Terms and Conditions of Sale for such products, Intel assumes no liability whatsoever, and Intel disclaims any express or implied warranty, relating to sale and/or use of Intel products including liability or warranties relating to fitness for a particular purpose, merchantability, or infringement of any patent, copyright or other intellectual property right. Intel products are not designed, intended or authorized for use in any medical, life saving, or life sustaining applications or for any other application in which the failure of the Intel product could create a situation where personal injury or death may occur. Intel may make changes to specifications and product descriptions at any time, without notice.

Intel<sup>®</sup> server boards contain a number of high-density VLSI and power delivery components that need adequate airflow for cooling. Intel's own chassis are designed and tested to meet the intended thermal requirements of these components when the fully integrated system is used together. It is the responsibility of the system integrator that chooses not to use Intel developed server building blocks to consult vendor datasheets and operating parameters to determine the amount of airflow required for their specific application and environmental conditions. Intel Corporation can not be held responsible if components fail or the server board does not operate correctly when used outside any of their published operating or non-operating limits.

Intel, Intel Pentium, and Intel Xeon are trademarks or registered trademarks of Intel Corporation or its subsidiaries in the United States and other countries.

\* Other names and brands may be claimed as the property of others.

Copyright © 2011 Intel Corporation. All Rights Reserved.

# Safety Information

---

## Important Safety Instructions

Read all caution and safety statements in this document before performing any of the instructions. See also Intel® Server Boards and Server Chassis Safety Information on the Intel® Server Deployment Toolkit 3.0 CD and/or at <http://www.intel.com/support/motherboards/server/sb/cs-010770.htm>.

## Wichtige Sicherheitshinweise

Lesen Sie zunächst sämtliche Warnund Sicherheitshinweise in diesem Dokument, bevor Sie eine der Anweisungen ausführen. Beachten Sie hierzu auch die Sicherheitshinweise zu Intel® - Serverplatinen und Servergehäusen auf der Intel® Server Deployment Toolkit 3.0 CD oder unter <http://www.intel.com/support/motherboards/server/sb/cs-010770.htm>.

## Consignes de sécurité

Lisez attention toutes les consignes de sécurité et les mises en garde indiquées dans ce document avant de suivre toute instruction. Consultez Intel Server Boards and Server Chassis Safety Information sur le Intel® Server Deployment Toolkit 3.0 CD ou bien rendez-vous sur le site <http://www.intel.com/support/motherboards/server/sb/cs-010770.htm>.

## Instrucciones de seguridad importantes

Lea todas las declaraciones de seguridad y precaución de este documento antes de realizar cualquiera de las instrucciones. Vea Intel® Server Boards and Server Chassis Safety Information en el Intel® Server Deployment Toolkit 3.0 CD y/o en <http://www.intel.com/support/motherboards/server/sb/cs-010770.htm>.

## 重要安全指导

在执行任何指令之前，请阅读本文档中的所有注意事项及安全声明。和/或 <http://www.intel.com/support/motherboards/server/sb/cs-010770.htm> 上的 *Intel® Server Boards and Server Chassis Safety Information*（《Intel® 服务器主板与服务器机箱安全信息》）。

### Warnings

**Heed safety instructions:** Before working with your server product, whether you are using this guide or any other resource as a reference, pay close attention to the safety instructions. You must adhere to the assembly instructions in this guide to ensure and maintain compliance with existing product certifications and approvals. Use only the described, regulated components specified in this guide. Use of other products/components will void the UL listing and other regulatory approvals of the product and will most likely result in noncompliance with product regulations in the region(s) in which the product is sold.

**System power on/off:** The power button DOES NOT turn off the system AC power. To remove power from the system, you must unplug the AC power cord from the wall outlet. Make sure the AC power cord is unplugged before you open the chassis, add, or remove any components.

**Hazardous conditions, devices and cables:** Hazardous electrical conditions may be present on power, telephone, and communication cables. Turn off the server and disconnect the power cord, telecommunications systems, networks, and modems attached to the server before opening it. Otherwise, personal injury or equipment damage can result.

**Electrostatic discharge (ESD) and ESD protection:** ESD can damage disk drives, boards, and other parts. We recommend that you perform all procedures in this chapter only at an ESD workstation. If one is not available, provide some ESD protection by wearing an antistatic wrist strap attached to chassis ground—any unpainted metal surface—on your server when handling parts.

**ESD and handling boards:** Always handle boards carefully. They can be extremely sensitive to ESD. Hold boards only by their edges. After removing a board from its protective wrapper or from the server, place the board component side up on a grounded, static free surface. Use a conductive foam pad if available but not the board wrapper. Do not slide board over any surface.

**Installing or removing jumpers:** A jumper is a small plastic encased conductor that slips over two jumper pins. Some jumpers have a small tab on top that you can grip with your fingertips or with a pair of fine needle nosed pliers. If your jumpers do not have such a tab, take care when using needle nosed pliers to remove or install a jumper; grip the narrow sides of the jumper with the pliers, never the wide sides. Gripping the wide sides can damage the contacts inside the jumper, causing intermittent problems with the function controlled by that jumper. Take care to grip with, but not squeeze, the pliers or other tool you use to remove a jumper, or you may bend or break the pins on the board.

# Preface

---

## About this Manual

This manual is written for system technicians who are responsible for troubleshooting, upgrading, and repairing this server system. This document provides a brief overview of the features of the server board/chassis, a list of accessories or other components you may need, troubleshooting information, and instructions on how to add and replace components on the Intel® Server System R1000GZ/GL family products. For the latest revision of this manual, go to <http://www.intel.com/support>.

## Manual Organization

Chapter 1 provides a brief overview of the Intel® Server System R1000GZ/GL family. In this chapter, you will find a list of the server system features, and figures of the system and components to help you identify your system components and their locations.

Chapter 2 provides instructions on adding and replacing components. Use this chapter for step-by-step instructions and diagrams for installing or replacing components such as the fan, power supply, and front panel board, among other components.

Chapter 3 provides instructions on using the utilities that are shipped with the board or that may be required to update the system. This includes information for navigating through the BIOS Setup screens, performing a BIOS update, and resetting the password or BIOS defaults.

The back of this manual provides technical specifications, regulatory information, LED Decoder, "getting help" information, and Intel® Server Issue Report Form.

## Additional Information and Software

For additional information about this family of products or any of their supported accessories, refer to the following resources available at <http://www.intel.com/support>.

**Table 1. Server System References**

For this information or software	Use this Document or Software
For in-depth technical information about this product.	<i>Intel® Server System R1000GZ/GL Product Family Technical Product Specification</i> <i>Intel® Server Board S2600GZ/GL Technical Product Specification</i>
For a quick guide of how to assemble the server system and install components	<i>Intel® Server System R1000GZ/GL Product Family Quick Installation User's Guide</i>
For product list and supported Intel spares and accessories	<i>Spares and Accessories List and Configuration Guide</i>
For server configuration guidance and compatibility	Intel® Server Configurator tool <a href="http://serverconfigurator.intel.com">http://serverconfigurator.intel.com</a>
For system power budget guidance	Power Budget Tool
For system firmware updates and onboard device drivers and software to manage your Intel® Server System.	Intel® Server Deployment & Management DVD
Product Safety and Regulatory document	<i>Intel Server Products - Product Safety and Regulatory Compliance Document</i>

# Table of Contents

---

<b>Safety Information</b> .....	<b>iii</b>
<b>Preface</b> .....	<b>v</b>
<b>1 Server System Features</b> .....	<b>1</b>
Server System Feature Overview .....	1
Server System Components .....	3
Hot Swap Hard Drive Bay and Front Panel Options .....	3
Front Panel .....	4
Back Panel .....	4
Server Board Components .....	5
Intel® Light-Guided Diagnostics .....	6
System Recovery Jumpers .....	8
Peripheral Devices .....	9
<b>2 Hardware Installations and Upgrades</b> .....	<b>12</b>
Before You Begin .....	12
Tools and Supplies Needed .....	12
System Reference .....	12
Cable Routing .....	13
For system with 4 x 3.5" hard drive bay: .....	14
For system with 8 x 2.5" hard drive bay: .....	15
Fan Connections .....	16
Removing and Installing the Front Bezel .....	16
Removing the Front Bezel .....	16
Installing the Front Bezel .....	17
Removing and Installing the System Cover .....	18
Removing the System Cover .....	18
Installing the System Cover .....	18
Removing and Installing the Air Duct .....	19
Removing the Air Duct .....	19
Installing the Air Duct .....	19
Removing and Installing Processor .....	20
Removing Processor Heatsink(s) .....	20
Installing the Processor .....	20
Installing Processor Heatsink(s) .....	22
Removing the Processor .....	23
Installing and Removing Memory .....	23
Installing Memory .....	23
Removing Memory .....	24
Installing and Removing Hot-swap Hard Drive .....	24
Installing a Hard Disk Drive into 3.5" Hard Drive Carrier .....	24
Installing a Hard Disk Drive into 2.5" Hard Drive Carrier .....	26
Removing and Installing the PCI Riser Assembly .....	27
Removing the PCI Riser Assembly .....	27
Installing the PCI Riser Assembly .....	28
Installing and Removing a PCI Add-in Card .....	28

Installing a PCI Add-in Card .....	28
Removing a PCI Add-in Card.....	29
Replacing a PCI Riser Card.....	29
Removing a PCI Riser Card .....	30
Installing a PCI Riser Card.....	30
Installing and Removing a Slimline Optical Drive .....	30
Installing a Slimline Optical Drive.....	31
Removing a Slimline Optical Drive .....	31
Installing and Removing Intel® I/O Expansion Module .....	32
Installing Intel® I/O Expansion Module.....	32
Removing Intel® I/O Expansion Module .....	33
Installing and Removing the Intel® RAID C600 Upgrade Key .....	33
Installing the Intel® RAID C600 Upgrade Key.....	33
Removing the Intel® RAID C600 Upgrade Key .....	33
Installing and Removing the Intel® Remote Management Module 4 .....	34
Installing the Intel® RMM4 Lite .....	34
Install the Intel® RMM4 NIC.....	34
Removing the Intel® RMM4 Lite.....	34
Removing the Intel® RMM4 NIC .....	35
Installing and Removing the Intel® RAID Smart Battery .....	35
Installing the Intel® RAID Smart Battery.....	35
Removing the Intel® RAID Smart Battery .....	36
Replacing the Power Supply.....	36
Installing and Removing the Server Board .....	37
Removing the Server Board .....	37
Installing the Server Board.....	38
Replacing the Backup Battery .....	39
Replacing a System Fan .....	41
Replacing the Backplane .....	41
Removing the Backplane .....	41
Installing the Backplane.....	42
Installing and Removing the Rack Handles .....	43
Installing the Rack Handles.....	43
Removing the Rack Handles .....	43
<b>3 Server Utilities .....</b>	<b>44</b>
Using the BIOS Setup Utility .....	44
Entering BIOS Setup .....	44
If You Cannot Access Setup.....	44
Setup Menus .....	44
Upgrading the BIOS .....	46
Clearing the Password.....	46
Restoring the BIOS Defaults .....	46
<b>Appendix A: Technical Reference.....</b>	<b>47</b>
Power Supply Input Voltages .....	47
Power Supply Output Voltages.....	47
System Environmental Specifications .....	47

**Table of Contents**

<b>Appendix B: Regulatory and Compliance Information.....</b>	<b>49</b>
<b>Appendix C: Getting Help.....</b>	<b>50</b>
Warranty Information .....	50
<b>Appendix D: Intel® Server Issue Report Form .....</b>	<b>51</b>



## List of Figures

---

Figure 1. Intel® Server System R1000GZ/GL .....	1
Figure 2. Intel® Server System R1000GZ/GL Components .....	3
Figure 3. 3.5" Hard Drive Bay - 4 Drive Configuration .....	3
Figure 4. 2.5" Hard Drive Bay - 8 Drive Configuration .....	3
Figure 5. Front Panel Options .....	4
Figure 6. Back Panel Feature Identification.....	4
Figure 7. Server Board Connector and Component Locations .....	5
Figure 8. Intel® Light-Guided Diagnostic LEDs - Server Board .....	6
Figure 9. Configuration Jumpers .....	8
Figure 10. Optional Peripherals (8x2.5-inch hard drive bays as shown) .....	9
Figure 11. Front view of Front Bezel.....	10
Figure 12. 4 x 3.5-inch Hard Drive Backplane Components (Front View) .....	10
Figure 13. 4 x 3.5-inch Hard Drive Backplane Components (Rear View) .....	11
Figure 14. 8 x 2.5-inch Hard Drive Backplane Components (Front View) .....	11
Figure 15. 8 x 2.5-inch Hard Drive Backplane Components (Rear View) .....	11
Figure 16. Cable Routing – 4 x 3.5" HDD.....	14
Figure 17. Cable Routing – 8 x 2.5" HDD.....	15
Figure 18. System Fan Order .....	16
Figure 20. Removing the Front Bezel.....	17
Figure 21. Installing the Front Bezel .....	17
Figure 22. Removing the System Cover .....	18
Figure 23. Installing the System Cover.....	18
Figure 24. Removing the Air Duct.....	19
Figure 25. Installing the Air Duct .....	19
Figure 26. Removing Processor Heatsink.....	20
Figure 27. Installing Processor – Open the Socket Lever .....	21
Figure 28. Installing Processor – Open the Load Plate.....	21
Figure 29. Installing Processor – Install the Processor .....	21
Figure 30. Installing Processor – Remove the Cover.....	22
Figure 31. Installing Processor – Close the Load Plate .....	22
Figure 32. Installing Processor – Latch the Locking Lever .....	22
Figure 33. Installing Processor Heatsink .....	23
Figure 34. Installing Memory .....	24
Figure 35. Installing Hard Disk Drive – Removing 3.5" HDD carrier .....	24
Figure 36. Installing Hard Disk Drive – Removing 3.5" HDD interface bracket.....	25
Figure 37. Installing Hard Disk Drive – Installing 3.5" HDD .....	25
Figure 38. Installing Hard Disk Drive – Installing 2.5" HDD .....	25
Figure 39. Installing Hard Disk Drive – Inserting 3.5" HDD assembly .....	26
Figure 40. Installing Hard Disk Drive – Removing 2.5" HDD carrier .....	26
Figure 41. Installing Hard Disk Drive – Removing plastic drive blank .....	26
Figure 42. Installing Hard Disk Drive – Installing 2.5" HDD .....	27
Figure 43. Installing Hard Disk Drive – Inserting 2.5" HDD assembly .....	27
Figure 44. Removing PCI Riser Assembly .....	27
Figure 45. Installing PCI Riser Assembly .....	28
Figure 46. Installing a PCI Add-In Card.....	29
Figure 47. Removing a PCI Add-In Card .....	29
Figure 48. Removing the PCI Riser Card .....	30

## List of Figures

Figure 49. Installing the PCI Riser Card.....	30
Figure 50. Installing the Plastic Guide to the Optical Drive.....	31
Figure 51. Installing an Optical Drive.....	31
Figure 52. Removing the Slimline Optical Drive.....	32
Figure 53. Installing Intel® I/O Expansion Module.....	32
Figure 54. Removing an I/O Expansion Module.....	33
Figure 55. Installing the Intel® RAID C600 Upgrade Key.....	33
Figure 56. Installing the Intel® RMM4 Lite.....	34
Figure 57. Installing the Intel® RMM4 NIC.....	34
Figure 58. Removing the Intel® RMM4 NIC.....	35
Figure 59. Installing the Intel® RAID Smart Battery.....	35
Figure 60. Removing the Intel® RAID Smart Battery.....	36
Figure 61. Removing the filler panel.....	36
Figure 62. Removing the power supply module.....	37
Figure 63. Installing the power supply module.....	37
Figure 64. Installing the filler panel.....	37
Figure 65. Removing the Air Duct Side Wall.....	38
Figure 66. Removing the Server Board.....	38
Figure 67. Installing the Server Board.....	39
Figure 68. Installing the Air Duct Side Wall.....	39
Figure 69. Replacing the Backup Battery.....	40
Figure 70. Replacing a system fan.....	41
Figure 71. Removing the backplane.....	42
Figure 72. Installing the backplane.....	42
Figure 73. Installing the Rack Handle.....	43
Figure 74. Removing the Rack Handle.....	43

## List of Tables

---

Table 1. Server System References.....	v
Table 2. Intel® Server System R1000GZ/GL Feature Summary .....	1
Table 3. Hard Disk Drive Options .....	9
Table 4. BIOS Setup: Keyboard Command Bar .....	45
Table 5. Power Supply Output Capability .....	47
Table 6. System Environmental Limits Summary .....	47



# 1 Server System Features

This chapter briefly describes the main features of the Intel® Server System R1000GZ/GL family. This includes illustrations of the products, a list of the server system features, and diagrams showing the location of important components and connections on the server systems.

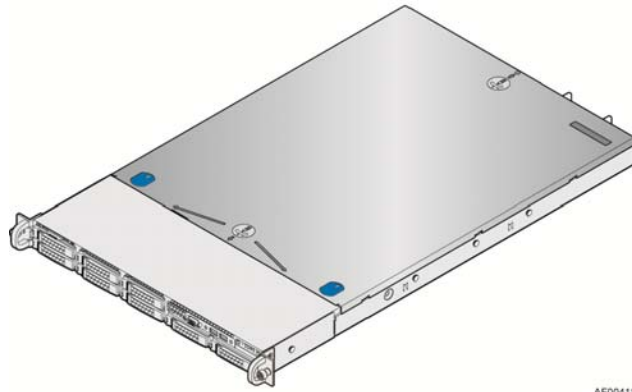

Figure 1. Intel® Server System R1000GZ/GL

## Server System Feature Overview

Table below summarizes the features of the the server systems.

Table 2. Intel® Server System R1000GZ/GL Feature Summary

Server System	Integrated Server Board
Intel® Server System R1000GZ product family	Intel® Server Board S2600GZ
Intel® Server System R1000GL product family	Intel® Server Board S2600GL

Feature	Description
Processor Support	<ul style="list-style-type: none"> <li>Support for one or two Intel® Xeon® processors E5-2600 product family with a Thermal Design Power (TDP) of up to 130 W.</li> </ul>
Memory	<ul style="list-style-type: none"> <li><b>S2600GL</b> - 16 DIMM slots – 2 DIMMs / Channel – 4 memory channels per processor</li> <li><b>S2600GZ</b> - 24 DIMM slots – 3 DIMMs / Channel – 4 memory channels per processor</li> <li>Unbuffered DDR3 (UDIMM), registered DDR3 (RDIMM), Load Reduced DDR3 (LRDIMM)</li> <li>Memory DDR3 data transfer rates of 800, 1066, 1333 MT/s, and 1600 MT/s</li> <li>DDR3 standard I/O voltage of 1.5V and DDR3 Low Voltage of 1.35V</li> </ul>
Chipset	Intel® C600-A chipset with support for optional Storage Option Select keys
External I/O connections	<ul style="list-style-type: none"> <li>Video (back and front video connectors)</li> <li>RJ-45 Serial- A Port</li> <li>Four RJ-45 Network Interface Connectors supporting 10/100/1000Mb</li> <li>USB 2.0 connectors - 3 on back panel + 2 on front panel</li> </ul>
Internal I/O	<ul style="list-style-type: none"> <li>One Type-A USB 2.0 connector</li> </ul>

## Server System Features

Feature	Description
connectors/headers	<ul style="list-style-type: none"> <li>One DH-10 Serial-B port connector</li> </ul>
Optional I/O Module support	<p>The following I/O modules utilize a single proprietary on-board connector. An installed I/O module can be supported in addition to standard on-board features and any add-in expansion cards.</p> <ul style="list-style-type: none"> <li>Quad port 1 GbE based on Intel® Ethernet Controller I350 – RMS25CB0080</li> <li>Dual port 10GBase-T Ethernet module based on Intel® Ethernet Controller I350 – AXX10GBTWLIOM</li> <li>Dual SFP+ port 10GbE module based on Intel® 82500 10 GbE controller – AXX10GBNIAIOM</li> <li>Single Port FDR speed InfiniBand module with QSFP connector – AXX1FDRIBIOM</li> <li>Intel® Quick Assist Accelerator Card - AXXQAAIOMOD</li> </ul>
System Fans	<ul style="list-style-type: none"> <li>Six dual rotor managed system fans</li> <li>One power supply fan for each installed power supply module</li> </ul>
Riser Cards	<p>Concurrent support for two PCIe riser cards. Each riser card slot has support for the following riser card options:</p> <ul style="list-style-type: none"> <li>Single add-in card slot – PCIe x16, x16 mechanical</li> </ul>
Video	<ul style="list-style-type: none"> <li>Integrated 2D Video Controller</li> <li>16 MB DDR3 Memory</li> </ul>
On-board storage controllers and options	<ul style="list-style-type: none"> <li>One eUSB 2x5 pin connector to support 2mm low-profile eUSB solid state devices</li> <li>Two 7-pin single port AHCI SATA connectors capable of supporting up to 6 GB/sec</li> <li>Two SCU 4-port mini-SAS connectors capable of supporting up to 3 GB/sec SAS/SATA</li> <li>Intel® Integrated RAID module support (Optional)</li> <li>Intel® RAID C600 Upgrade Key support providing optional expanded SATA / SAS RAID capabilities</li> </ul>
Security	Intel® Trusted Platform Module (TPM) - AXXTPE5 (Accessory Option)
Server Management	<ul style="list-style-type: none"> <li>Integrated Baseboard Management Controller, IPMI 2.0 compliant</li> <li>Support for Intel® Server Management Software</li> <li>Intel® Remote Management Module 4 Lite – Accessory Option</li> <li>Intel® Remote Management Module 4 Management NIC – Accessory Option</li> </ul>
Power Supply Options	<ul style="list-style-type: none"> <li>The server system can have up to two power supply modules installed, providing support for the following power configurations: 1+0, 1+1 Redundant Power, and 2+0 Combined Power</li> <li>Three power supply options: <ul style="list-style-type: none"> <li>AC 460W Gold</li> <li>AC 750W Platinum</li> <li>DC 750W</li> </ul> </li> </ul>
Storage Bay Options	<ul style="list-style-type: none"> <li>4x – 3.5” SATA/SAS Hot Swap Hard Drive Bays + Optical Drive support</li> <li>8x – 2.5” SATA/SAS Hot Swap Hard Drive Bays + Optical Drive support (capable)</li> </ul>
Supported Rack Mount Kit Accessory Options	<ul style="list-style-type: none"> <li>Tool-less rack mount rail kit – Intel Product Code – AXXPRAIL</li> <li>Value rack mount rail kit – Intel Product Code – AXXVRAIL</li> <li>Cable Management Arm – Intel Product Code – AXX1U2UCMA (*supported with AXXPRAIL only)</li> <li>2-post fixed mount bracket kit – Intel Product Code – AXX2POSTBRCKT</li> </ul>

## Server System Components

This section helps you identify the components of your server system. If you are near the system, you can also use the *Quick Reference Label* provided on the inside of the chassis cover to assist in identifying components.

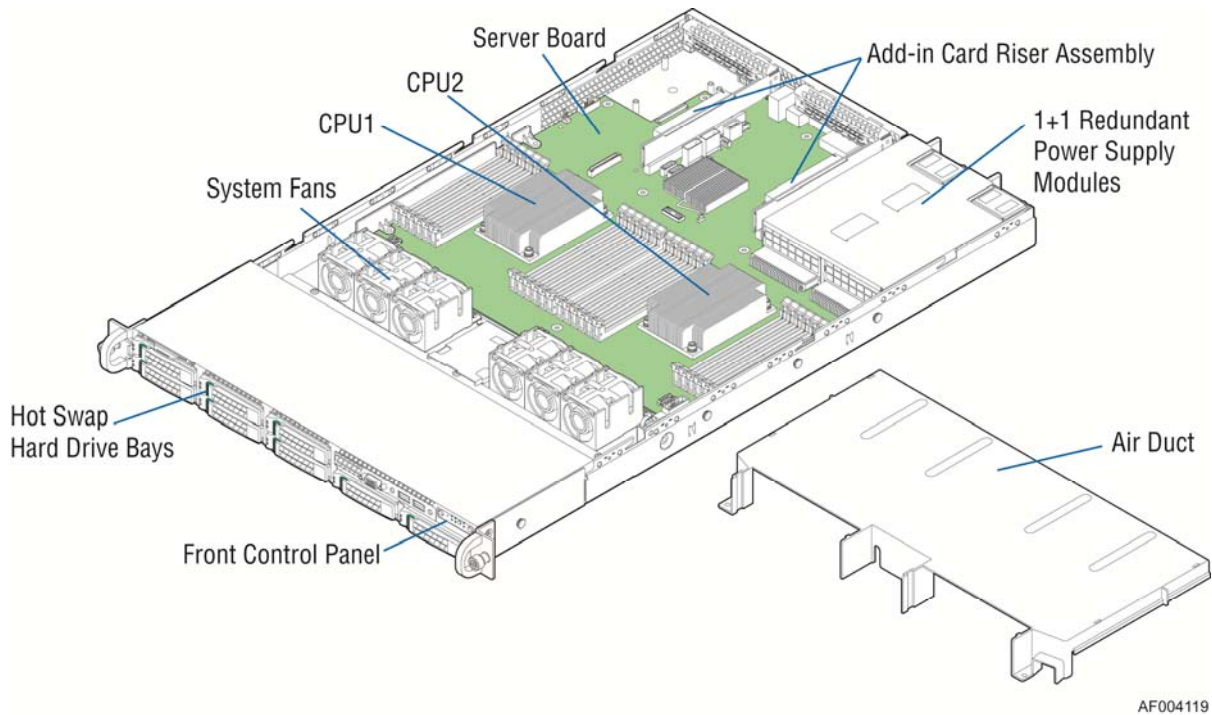

Figure 2. Intel® Server System R1000GZ/GL Components

## Hot Swap Hard Drive Bay and Front Panel Options

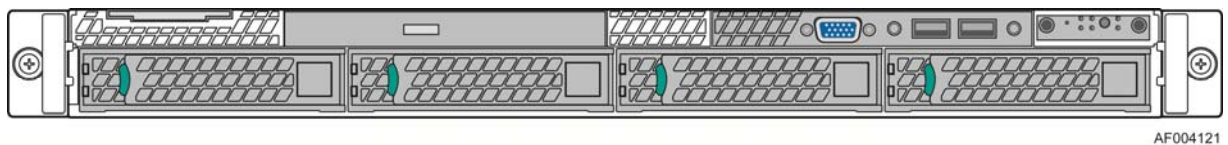

Figure 3. 3.5" Hard Drive Bay - 4 Drive Configuration

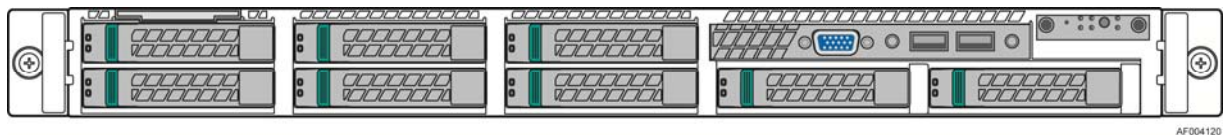
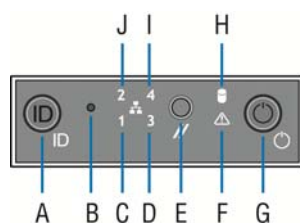

Figure 4. 2.5" Hard Drive Bay - 8 Drive Configuration

## Front Panel



Label	Description	Label	Description
A	System ID Button w/Integrated LED	F	System Status LED
B	NMI Button (recessed, tool required for use)	G	Power Button w/Integrated LED
C	NIC-1 Activity LED	H	Hard Drive Activity LED
D	NIC-3 Activity LED	I	NIC-4 Activity LED
E	System Cold Reset Button	J	NIC-2 Activity LED

Figure 5. Front Panel Options

## Back Panel

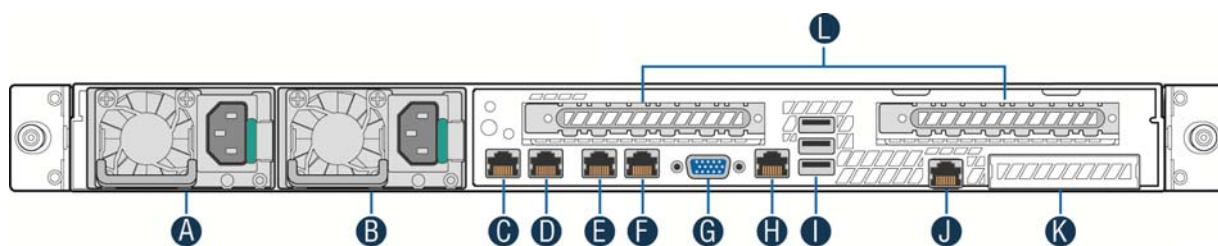

A	Power Supply Module #1	G	Video Connector
B	Power Supply Module #2	H	RJ45 Serial-A Port
C	NIC - 1	I	USB Ports
D	NIC - 2	J	RMM4 NIC Port
E	NIC - 3	K	I/O Module Ports/Connectors (Optional)
F	NIC - 4	L	Add-in adapter slots via Riser Card 1 and Riser Card 2

Figure 6. Back Panel Feature Identification



## Server Board Components

This section helps you identify the components and connectors on the server board.

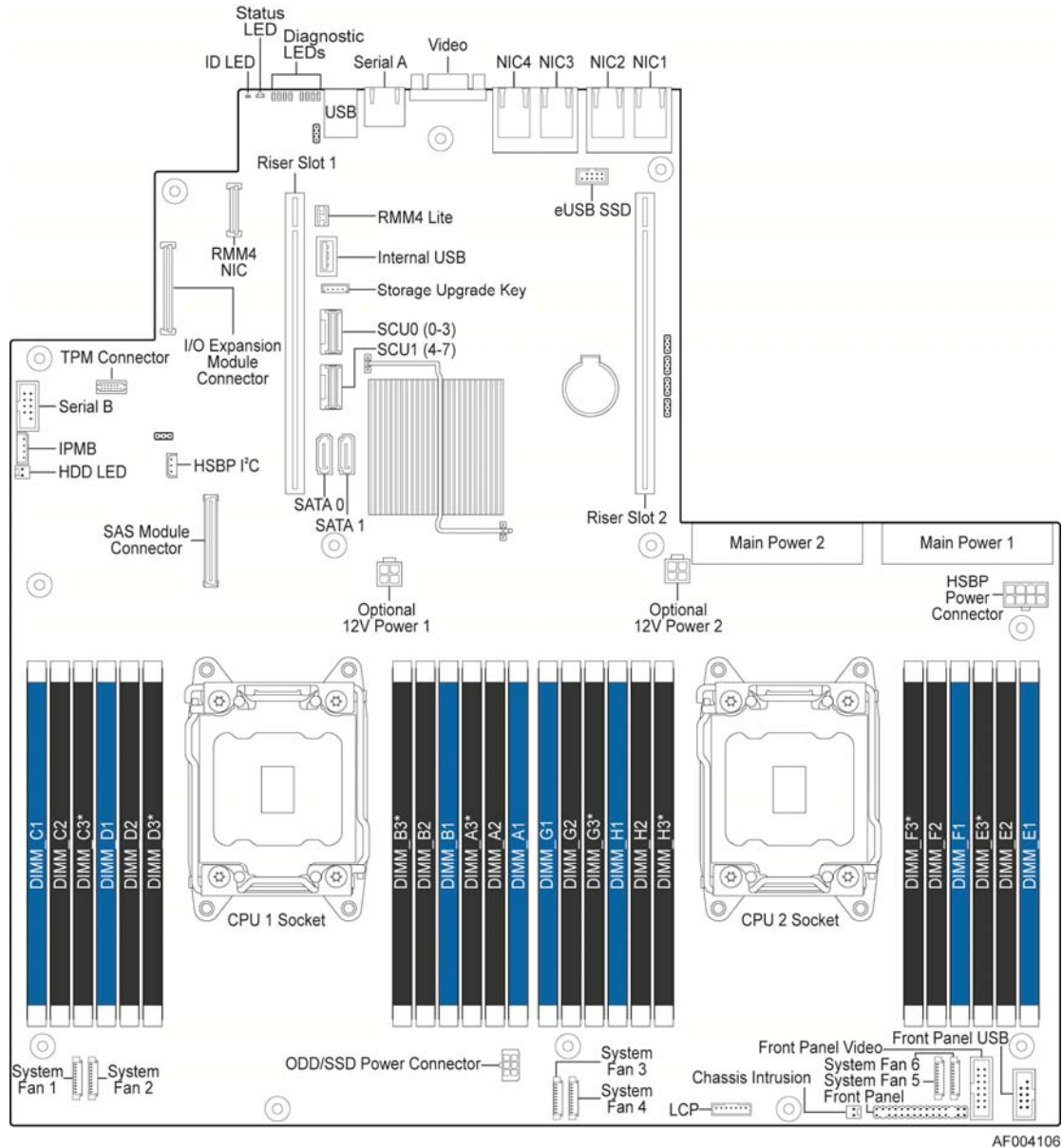

**Figure 7. Server Board Connector and Component Locations**

\* For server systems integrated with Intel® Server Board S2600GZ only.

## Intel® Light-Guided Diagnostics

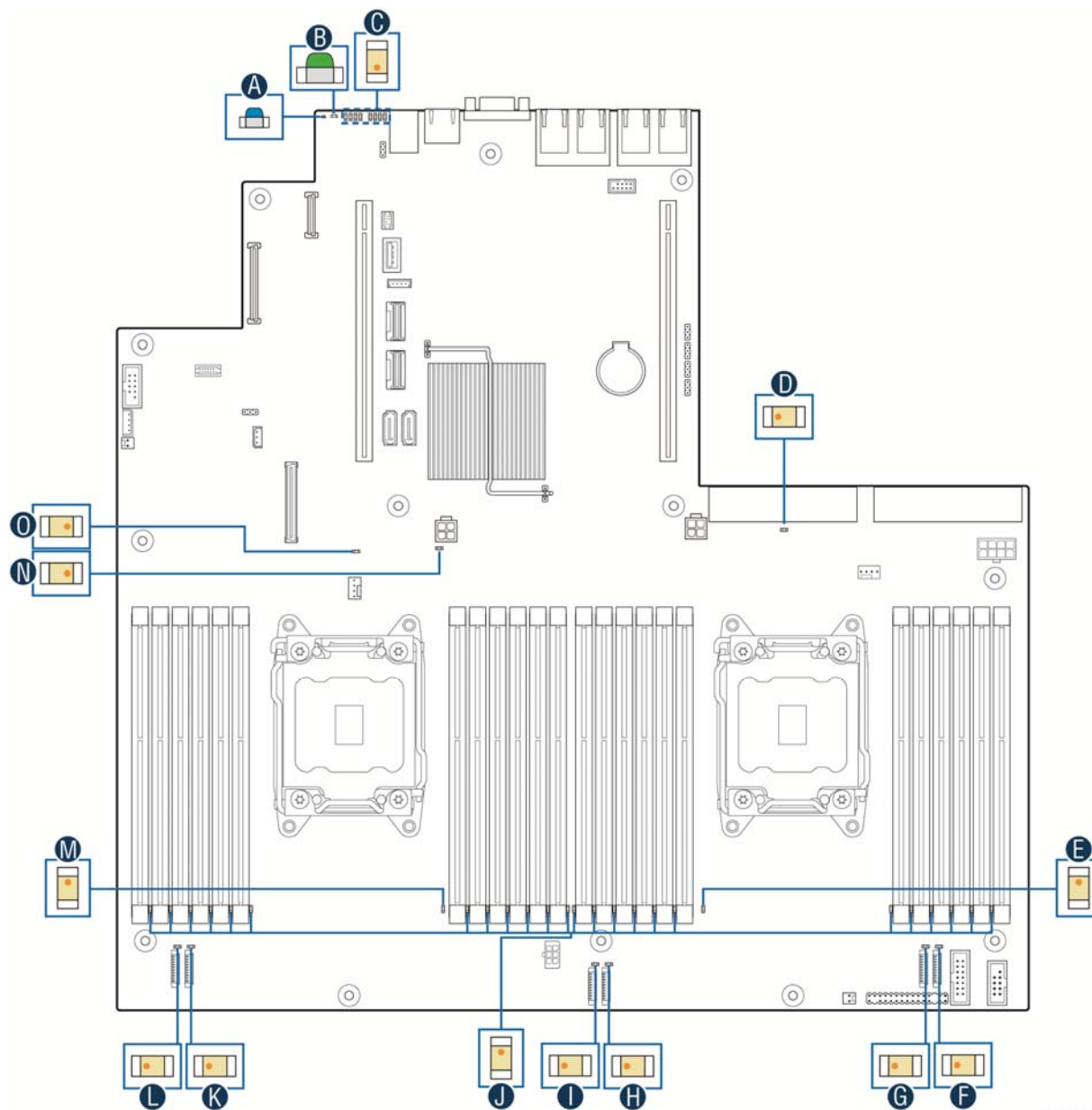

AF003994

A	System ID LED	I	System Fan – 3 Fault LED
B	System Status LED	J	DIMM Fault LEDs
C	POST Code Diagnostic LEDs	K	System Fan – 2 Fault LED
D	12V Stand By LED	L	System Fan – 1 Fault LED
E	CPU-2 Fault LED	M	CPU-1 Fault LED
F	System Fan – 6 Fault LED	N	CATERR LED
G	System Fan – 5 Fault LED	O	System Power Good LED
H	System Fan – 4 Fault LED		

**Figure 8. Intel® Light-Guided Diagnostic LEDs - Server Board**

## Server System Features

The server system contains the following diagnostic LEDs, each providing the following functions:

A - The System Identification LED on the front and back panel helps identify the server from among several servers. The ID LED is off by default, and blue when activated by button or software.

B - The System Status LED on the front and back panels shows the overall health of the system (green, blinking green, blinking amber, amber, off).

C - POST Code Diagnostic LEDs on the server board change color or state (off, green, red, and amber) according to the POST sequence.

D - The 12V-STBY LED on the server board is illuminated (green) when power is applied.

F, G, H, I, K and L - Fan Fault LEDs help identify failed and failing fans. The fan fault LEDs turn on (amber) if there is a fan fault.

E and M – CPU fault LEDs help identify the failure of CPU. The CPU fault LEDs turn on (amber) if there is a CPU fault.

J - DIMM Fault LEDs on the server board help identify failed and failing DIMM slots. The DIMM fault LEDs turn on (amber) if there is a DIMM fault.

## System Recovery Jumpers

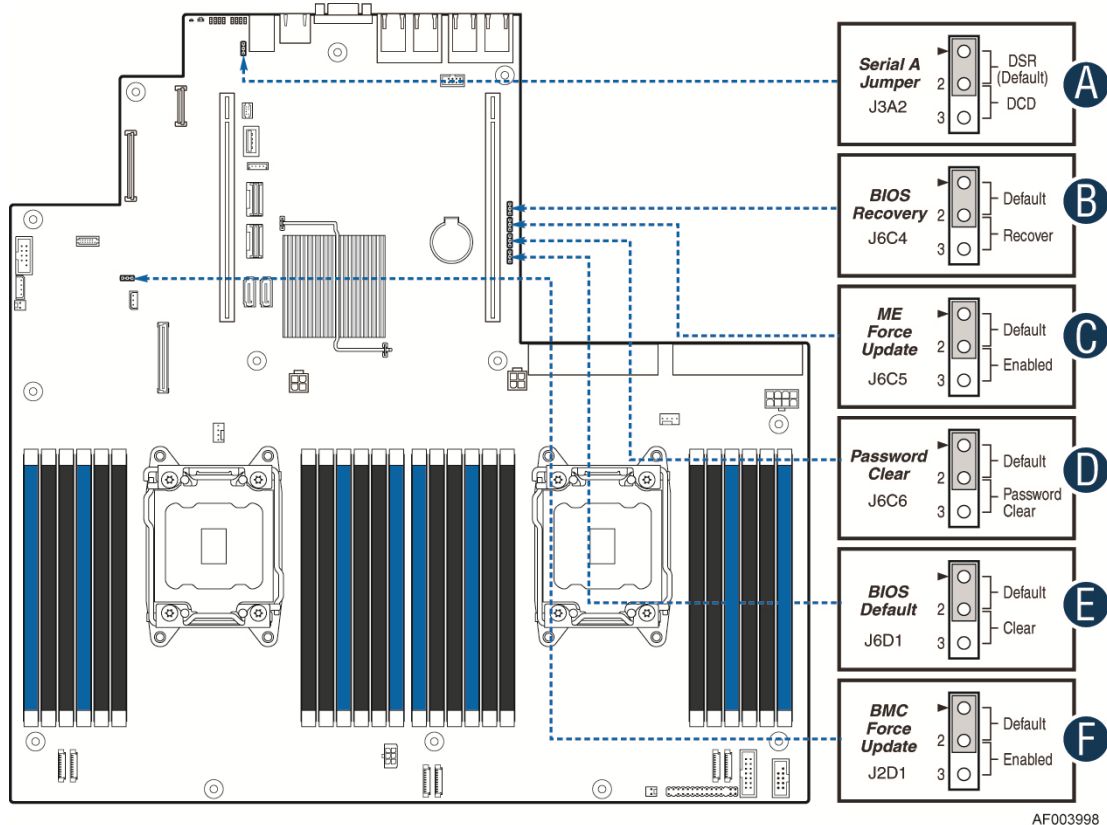

	Jumper Name	Jumper Purpose
A	Serial A Jumper (J3A2)	If pins 2-3 are selected, the serial-A configuration is in Data Carrier Detect (DCD) mode. These pins should be selected on 1-2 for normal system operation.
B	BIOS Recover (J6C4)	If pins 2-3 are selected, the system can only boot from EFI-bootable recovery media with the recovery BIOS image. The main system BIOS will not boot. These pins should be selected on 1-2 for normal system operation.
C	ME Force Update (J6C5)	If pins 2-3 are selected, the ME Force Update Mode is enabled. These pins should be selected on 1-2 for normal system operation.
D	Password Clear (J6C6)	If pins 2-3 are selected, administrator and user passwords are cleared within five to ten seconds after the system is powered on. These pins should be selected on 1-2 for normal system operation.
E	BIOS Default (J6D1)	If pins 2-3 are selected, the BIOS settings are cleared on the next reset. These pins should be selected on 1-2 for normal system operation.
F	BMC Force Update (J2D1)	If pins 2-3 are selected, the Integrated BMC Force Update Mode is enabled. These pins should be selected on 1-2 for normal system operation.

**Figure 9. Configuration Jumpers**

## Peripheral Devices

The Intel® Server System R1000GZ/GL provides locations and hardware for installing hard drives, CD-ROM drive, or DVD-ROM drive. The following figure shows the available options.

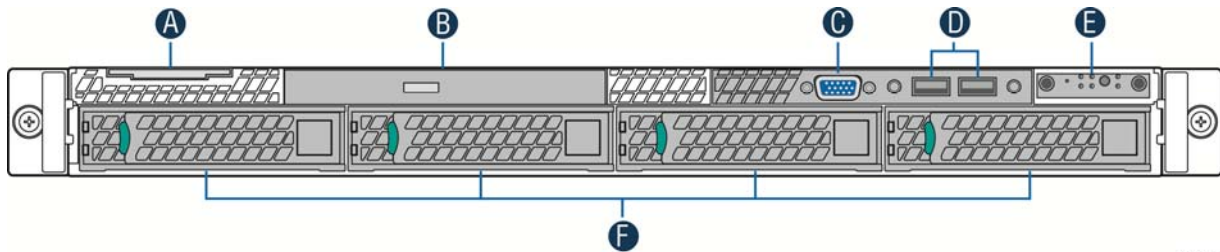

AF004581

A	System Label Pull-out
B	Slimline Optical Drive Bay
C	Video Port
D	USB Ports
E	Front Control Panel
F	Hard Disk Drive Bays

**Figure 10. Optional Peripherals (8x2.5-inch hard drive bays as shown)**

## Hard Disk Drive Carriers

The Intel® Server System R1000GZ/GL ships with either 3.5-inch or 2.5 inch hard disk drive carrier, and with different maximum number of hard disk drives, see Table 4 for details :

**Table 3. Hard Disk Drive Options**

Intel® Server System	Supported Hard Drive Type	Maximum Hard Drive Number
R1304GZ/GL	3.5-inch or 2.5-inch	4
R1208GZ/GL	2.5-inch	8

**Note:** SAS drives are only supported when proper Intel® RAID C600 Upgrade Key or Intel® Integrated RAID Module is installed.

For instructions on installing hard drives, see [“Installing a Hot-swap Hard Disk Drive”](#).

**Note:** Drives can consume up to 17 watts of power each. Drives must be specified to run at a maximum ambient temperature of 45°C.

**Note:** The Intel® Server System R1000GZ/GL does not support all SAS or Serial ATA (SATA) hard drives. For a web link to a list of supported hard drives, see [“Additional Information and Software”](#).

## Slimline Optical Drive Support

The system has support for a single optical drive. The optical drive is NOT hot-swappable. The system power must be turned off to insert or remove the slimline optical drive. For instructions on installing an optical drive, see “Installing or Removing a Slimline Optical Drive”.

Intel® makes the following optical drive accessory kits available for this server system:

- Slimline DVD-ROM Drive: AXXSATADVROM
- Slimline DVD-RW Drive: AXXSATADVDRWROM

**Note:** For a complete list of supported peripherals, go to <http://serverconfigurator.intel.com>.

## Bezel

The front bezel is available as optional accessory for the server system:

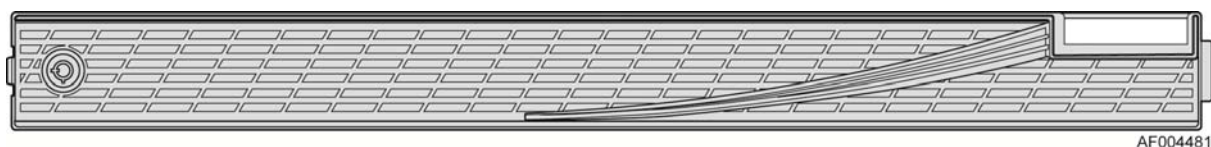

AF004481

Figure 11. Front view of Front Bezel

## Hot-Swap SAS/SATA Backplane

The Hot-Swap SAS/SATA backplane serves as an interface between the mother board and the system drives. The following diagrams show the location for each connector found on the backplane.

### 4 x 3.5-inch Hard Drive Backplane

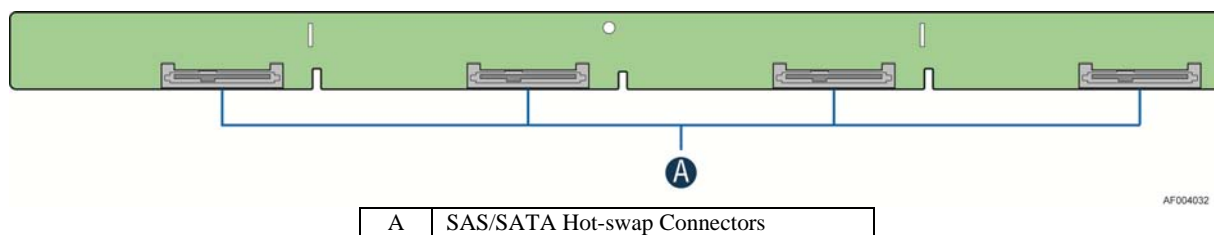

AF004032

Figure 12. 4 x 3.5-inch Hard Drive Backplane Components (Front View)

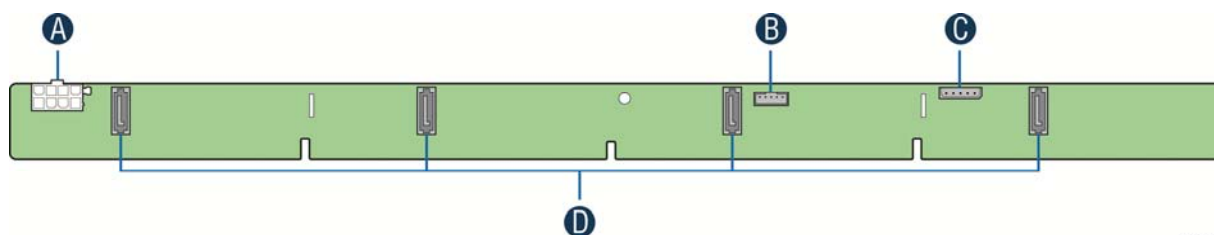

AF004033

A	Power Connector
B	SGPIO Connector
C	I <sup>2</sup> C Connector
D	SATA Connectors

Figure 13. 4 x 3.5-inch Hard Drive Backplane Components (Rear View)

### 8 x 2.5-inch Hard Drive Backplane

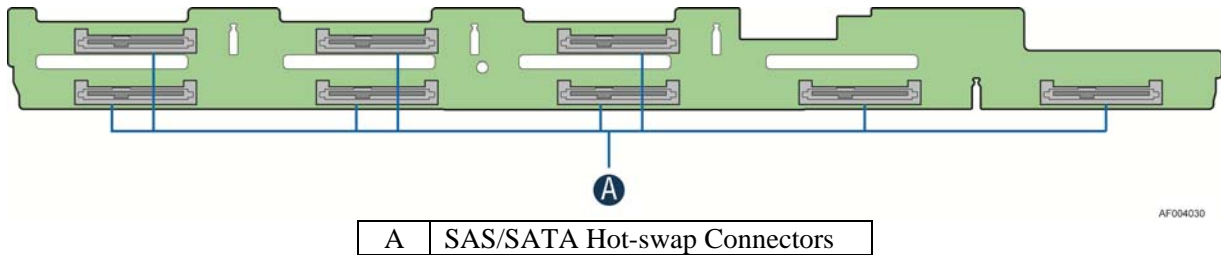

Figure 14. 8 x 2.5-inch Hard Drive Backplane Components (Front View)

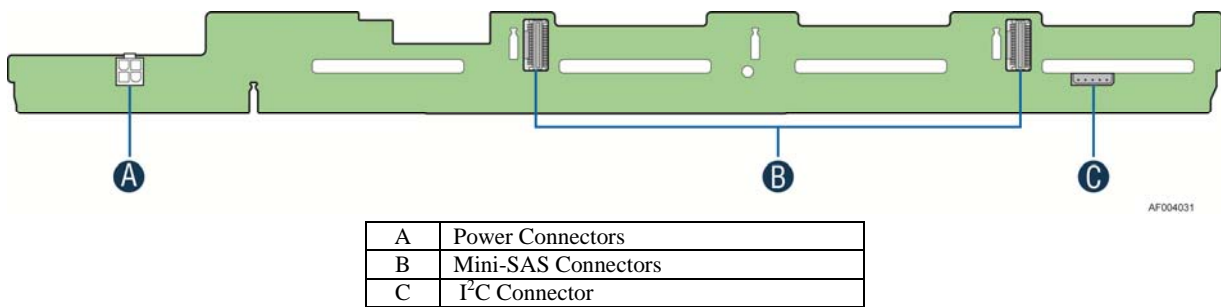

Figure 15. 8 x 2.5-inch Hard Drive Backplane Components (Rear View)

## Advanced Management Options

### Intel® Remote Management Module 4

The Intel® Remote Management Module 4 plugs into a dedicated connector on the server board and provides additional server management functionality to the server board. This module provides a dedicated web server for viewing server information and remote control of the system. It also provides Remote KVM Redirection and USB Media Redirection allowing USB devices attached to the remote system to be used on the managed server. For instructions on installing the Intel® Remote Management Module 4, see [“Installing and Removing the Intel® Remote Management Module 4”](#).

## 2 Hardware Installations and Upgrades

---

### Before You Begin

Before working with your server product, pay close attention to the “[Safety Information](#)” at the beginning of this manual.

***Note:** Whenever you service the system, you must first power down the server and unplug all peripheral devices and the power cord.*

### Tools and Supplies Needed

- Phillips\* (cross head) screwdriver (#2 bit)
- Needle nosed pliers
- Anti-static wrist strap and conductive foam pad (recommended)

### System Reference

All references to left, right, front, top, and bottom assume the reader is facing the front of the chassis as it would be positioned for normal operation.

***Note:** The Intel® Server System R1208GZ is shown for illustration purposes. Server components with the product family are identical.*



## Cable Routing

When you add or remove components from your server system, make sure your cables are routed correctly before reinstalling the server system cover. Use caution to make sure no cables or wires are pinched and that the airflow from the fans is not blocked. Use the figures below to determine the correct cable routing.

*Note: Red lines are for power connection, dot lines are for optional device connection.*

For system with 4 x 3.5" hard drive bay:

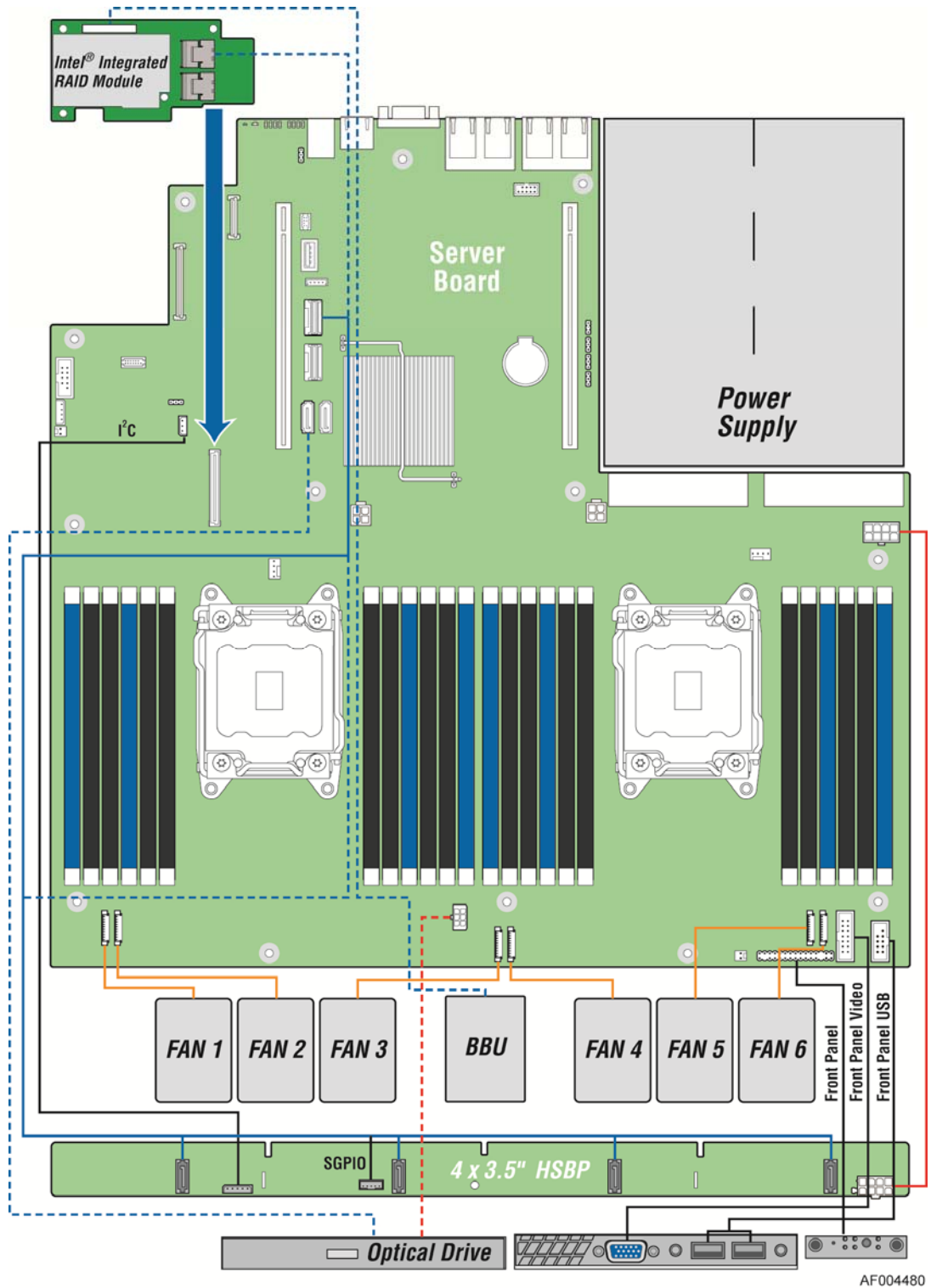
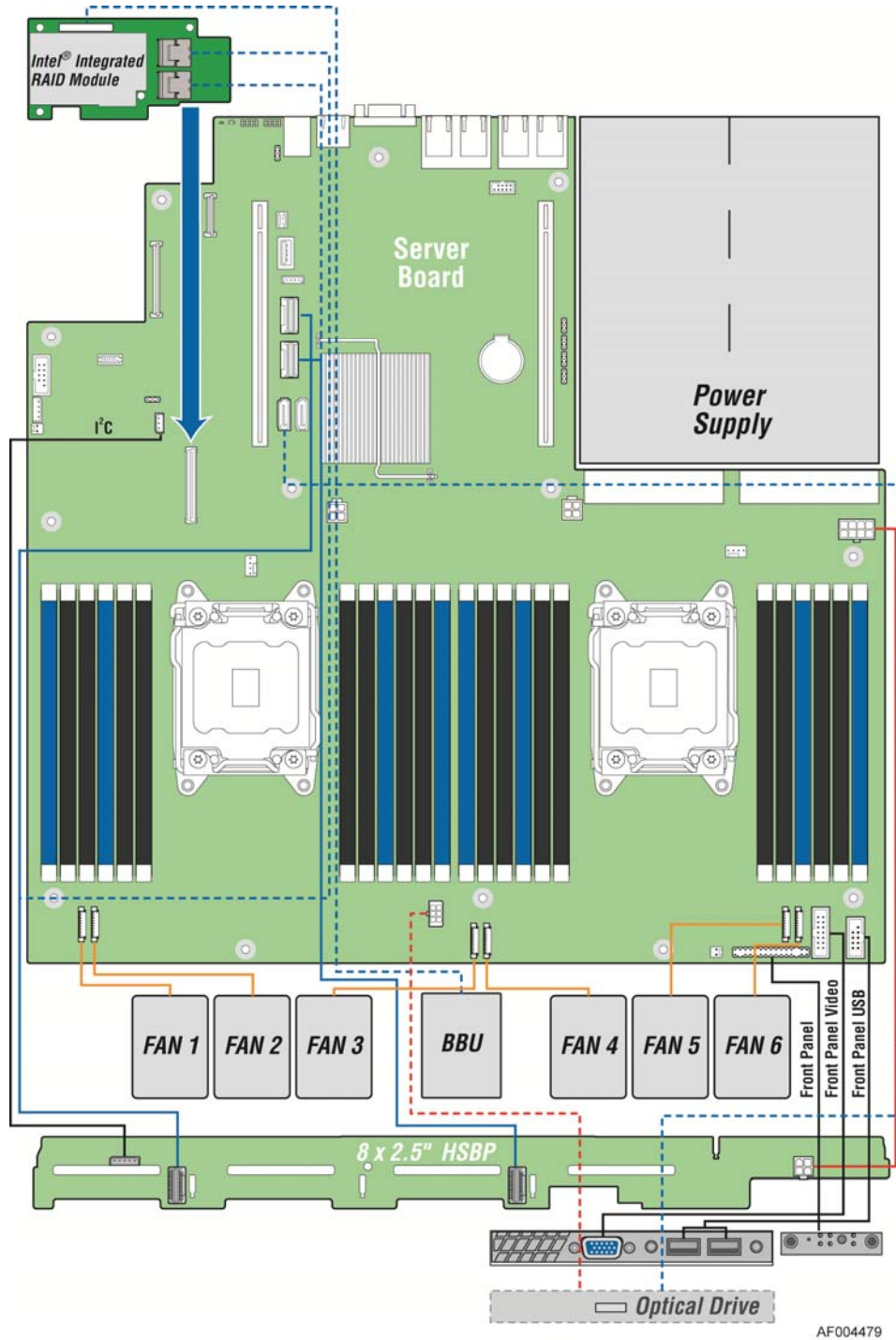

Figure 16. Cable Routing – 4 x 3.5" HDD

**For system with 8 x 2.5" hard drive bay:**

*Note: To activate the port SCU1 (4-7) on the server board, a proper Intel® RAID C600 Upgrade Key must be installed. For instructions, see Intel® RAID C600 Upgrade Key Installation Guide.*

*Note: An optical drive can be installed to replace the Front Panel I/O.*



**Figure 17. Cable Routing – 8 x 2.5" HDD**

## Fan Connections

Use the figures below to determine the proper fan connections.

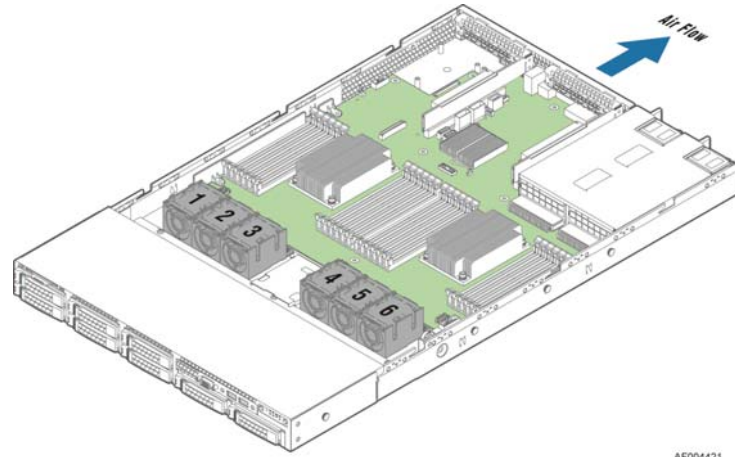

AF004421

Figure 18. System Fan Order

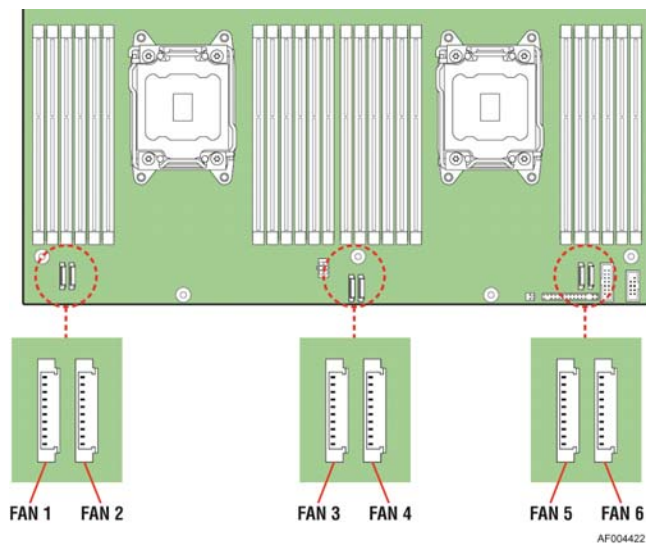

AF004422

Figure 19. Connecting the Fan Power Cables to the Mother Board

## Removing and Installing the Front Bezel

### Removing the Front Bezel

If your system includes a front bezel, follow these steps to remove the front bezel:

1. Unlock the bezel if it is locked.
2. Remove the left end of front bezel from rack handle (see letter “A”).

3. Rotate the front bezel anticlockwise to release the latches on the right end from the rack handle (see letter “B”).

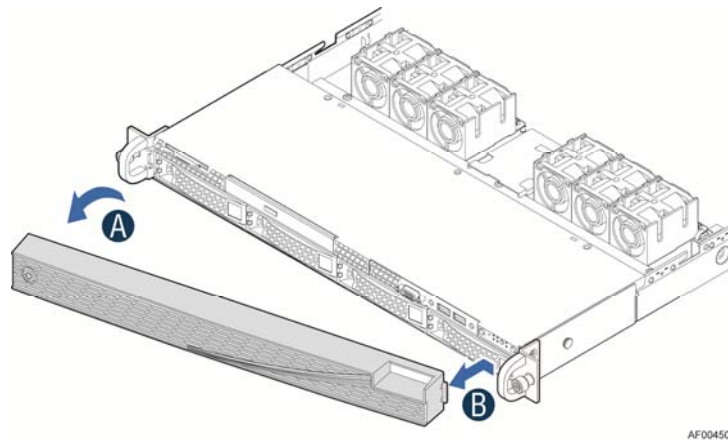
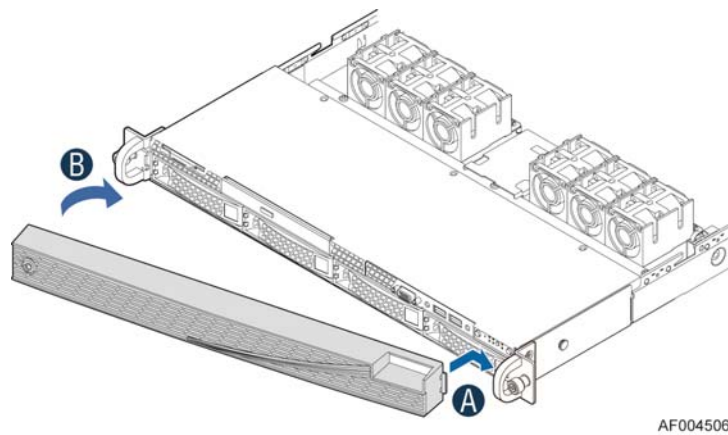

**Figure 20. Removing the Front Bezel**

## Installing the Front Bezel

*Note: Before installing the bezel, you must install the rack handles.*

1. Lock the right end of the front bezel to the rack handle (see letter “A”).
2. Rotate the front bezel clockwise till the left end clicks into place (see letter “B”).
3. Lock the bezel if needed.



**Figure 21. Installing the Front Bezel**

## Removing and Installing the System Cover

### Removing the System Cover

The server system must be operated with the system cover in place to ensure proper cooling. You will need to remove the top cover to add or replace components inside of the server. Before removing the top cover, power down the server and unplug all peripheral devices and the power cable(s).

**Note:** A non-skid surface or a stop behind the server system may be needed to prevent the server system from sliding on your work surface.

1. Observe the safety and ESD precautions at the beginning of this book.
2. Turn off all peripheral devices connected to the server. Turn off the server.
3. Disconnect the power cord.
4. Remove the four screws (see letter "A").
5. Slide cover back and lift upward (see letter "B").

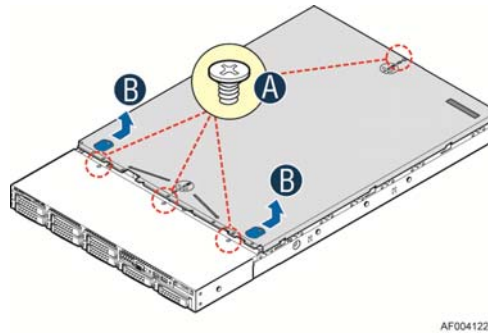

Figure 22. Removing the System Cover

### Installing the System Cover

1. Place system cover onto the chassis and slide forward to engage recessed edge at front of cover (see letter "A").
2. Tighten the four screws (see letter "B").

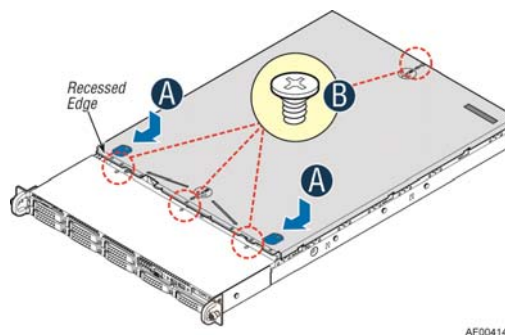

Figure 23. Installing the System Cover

## Removing and Installing the Air Duct

Always operate your server system with the air duct in place. The air duct is required for proper airflow within the server system.

### Removing the Air Duct

Remove the air duct by lifting straight up.

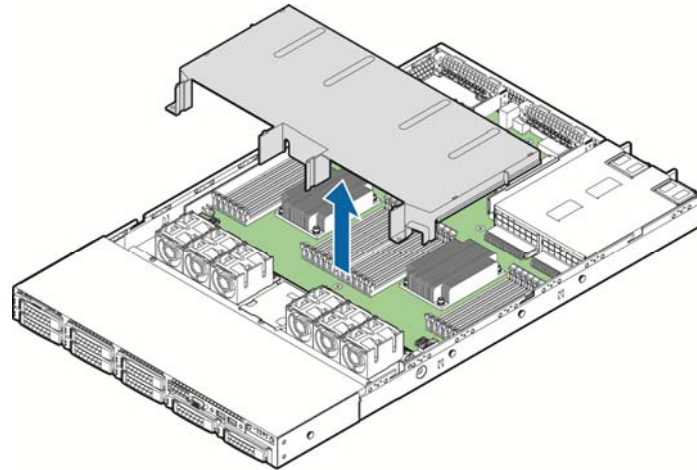

AF004123

Figure 24. Removing the Air Duct

### Installing the Air Duct

Align the two holes on the air duct with the alignment pins on the chassis and install the air duct into place.

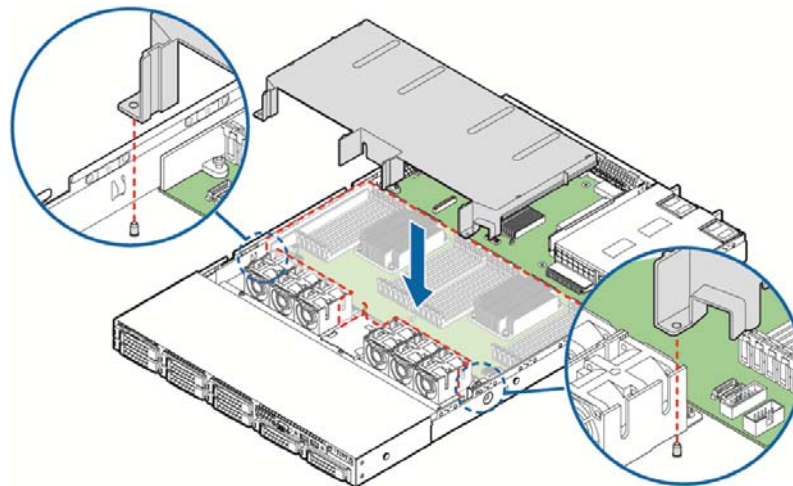

AF004131

Figure 25. Installing the Air Duct

## Removing and Installing Processor

The heatsink has thermal interface material (TIM) on the underside of it. Use caution so that you do not damage the thermal interface material. Use gloves to avoid sharp edges.

### Removing Processor Heatsink(s)

The heatsink is attached to the server board/processor socket with captive fasteners. Using a #2 Phillips\* screwdriver, loosen the four screws located on the heatsink corners in a diagonal manner using the following procedure:

1. Using a #2 Phillips\* screwdriver, start with screw 1 and loosen it by giving it two rotations and stop (see letter “A”). (IMPORTANT: Do not fully loosen.)
2. Proceed to screw 2 and loosen it by giving it two rotations and stop (see letter “B”). Similarly, loosen screws 3 and 4. Repeat steps A and B by giving each screw two rotations each time until all screws are loosened.
3. Lift the heatsink straight up (see letter “C”).

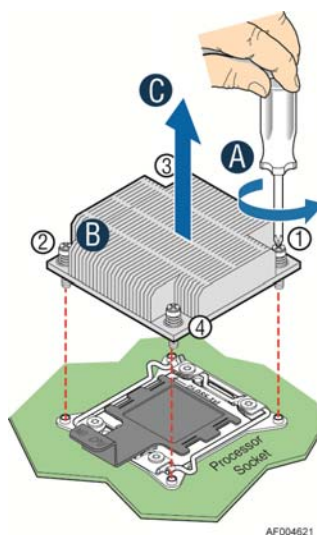

Figure 26. Removing Processor Heatsink

### Installing the Processor

**Caution:** Processor must be appropriate: You may damage the server board if you install a processor that is inappropriate for your server. For a web link to the list of compatible processor(s), see “Additional Information and Software” on page 4.

**Caution:** ESD and handling processors: Reduce the risk of electrostatic discharge (ESD) damage to the processor by doing the following: (1) Touch the metal chassis before touching the processor or server board. Keep part of your body in contact with the metal chassis to dissipate the static charge while handling the processor. (2) Avoid moving around unnecessarily.

**Caution:** Protective socket cover needs to be removed for proper cooling of the processor; failure to remove the cover could result in damage to the system.



1. Open the Socket Lever. Push down the lever handle on the **OPEN 1st** side and away from the socket to release it. (see letter “A”). Repeat the steps to release the lever on the other side (see letter “B”).

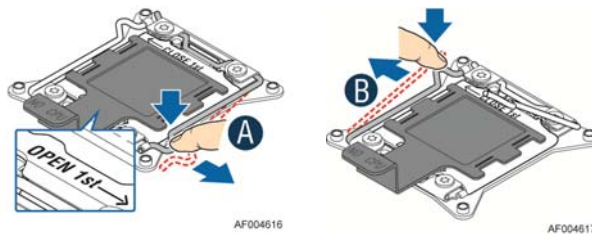

**Figure 27. Installing Processor – Open the Socket Lever**

2. Open the Load Plate. Press the locking lever slightly to raise the load plate (see letter “A”). Open the load plate all the way (see letter “B”).

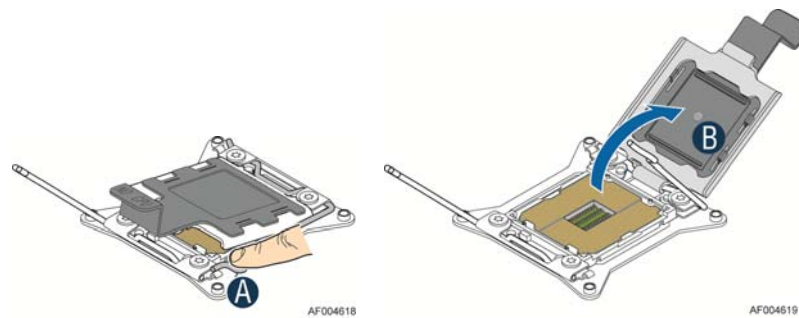

**Figure 28. Installing Processor – Open the Load Plate**

3. Install the Processor. Take the processor out of the box and remove the protective shipping cover (see letter “A”). Orient the processor with the socket so that the processor cutouts match the four orientation posts on the socket (see letter “B”). Note location of gold key at corner of processor (see letter “C”).

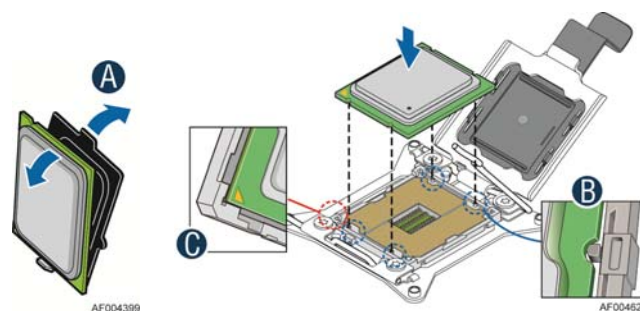

**Figure 29. Installing Processor – Install the Processor**

*Note: The underside of the processor has components that may damage the socket pins if installed improperly. Processor must align correctly with the socket opening before installation. DO NOT DROP processor into socket!*

4. Remove the Cover. Press the cover to remove it. Save the protective cover.

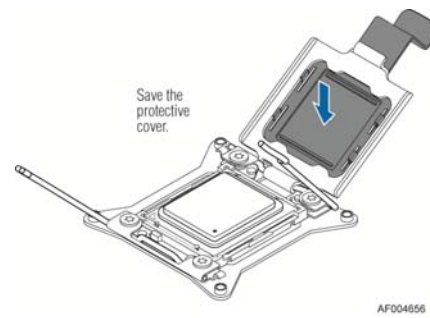

Figure 30. Installing Processor – Remove the Cover

5. Close the Load Plate. Carefully lower the load plate over the processor.

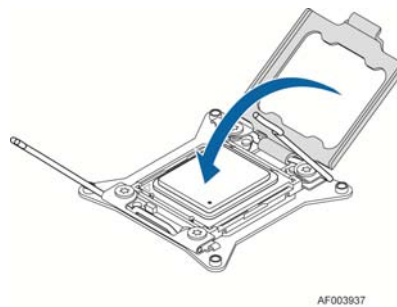

Figure 31. Installing Processor – Close the Load Plate

6. Latch the Locking Lever. Push down on the locking lever on the CLOSE 1st side (see letter “A”). Slide the tip of the lever under the notch in the load plate (see letter “B”). Make sure the load plate tab engages under the socket lever when fully closed. Repeat the steps to latch the locking lever on the other side (see letter “C”). Latch the levers in the order as shown.

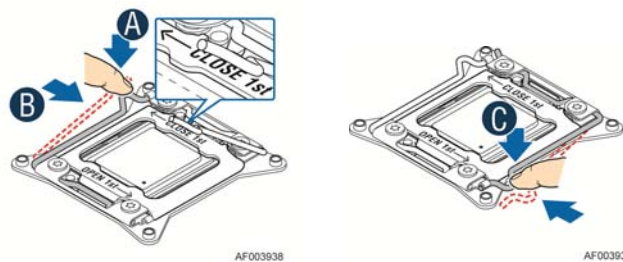

Figure 32. Installing Processor – Latch the Locking Lever

## Installing Processor Heatsink(s)

1. Remove the protective film on the TIM if present (see letter “A”).
2. Align heatsink fins to the front and back of the chassis for correct airflow. Airflow goes from front-to-back of chassis (see letter “B”).

Each heatsink has four captive fasteners and should be tightened in a diagonal manner using the following procedure:

3. Using a #2 Phillips\* screwdriver, start with screw 1 and engage screw threads by giving it two rotations and stop (see letter “C”). (Do not fully tighten.)
4. Proceed to screw 2 and engage screw threads by giving it two rotations and stop (see letter “D”). Similarly, engage screws 3 and 4.
5. Repeat steps C and D by giving each screw two rotations each time until each screw is lightly tightened up to a maximum of 8 inch-lbs torque (see letter “E”).

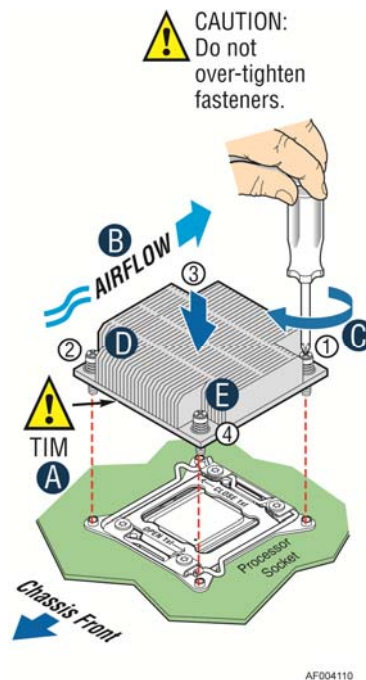

Figure 33. Installing Processor Heatsink

## Removing the Processor

1. Remove the processor heatsink, see Figure 26.
2. Open the socket lever, see Figure 27.
3. Open the load plate, see Figure 28.
4. Remove the processor.

## Installing and Removing Memory

### Installing Memory

1. Locate the DIMM sockets. Make sure the clips at either end of the DIMM socket(s) are pushed outward to the open position (see letter “A”).

## Hardware Installations and Upgrades

2. Holding the DIMM by the edges, remove it from its anti-static package. Position the DIMM above the socket. Align the notch on the bottom edge of the DIMM with the key in the DIMM socket (see letter “B”).
3. Insert the bottom edge of the DIMM into the socket (see letter “C”). When the DIMM is inserted, push down on the top edge of the DIMM until the retaining clips snap into place (see letter “D”). Make sure the clips are firmly in place (see letter “E”).

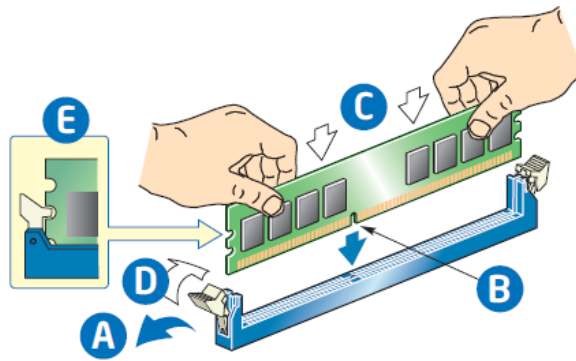

Figure 34. Installing Memory

## Removing Memory

1. Locate the DIMM sockets. Gently spread the retaining clips at each end of the socket. The DIMM lifts from the socket.
2. Holding the DIMM by the edges, lift it from the socket, and store it in an anti-static package.

## Installing and Removing Hot-swap Hard Drive

**Caution:** If you don't install all drives, empty drive bays must be occupied by carriers with plastic drive blank provided to maintain proper system cooling.

### Installing a Hard Disk Drive into 3.5" Hard Drive Carrier

1. Remove the drive carrier by pressing the green button and opening the lever (see letter “A”). Slide the carrier out (see letter “B”).

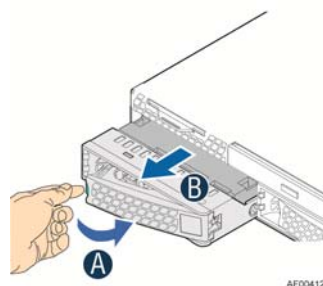
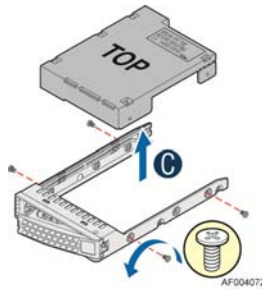

Figure 35. Installing Hard Disk Drive – Removing 3.5" HDD carrier

- Remove the four screws securing the HDD interface bracket and remove the HDD interface bracket (see letter “C”).



**Figure 36. Installing Hard Disk Drive – Removing 3.5” HDD interface bracket**

- Install the hard disk drive using the same four screws as shown. Make sure the connector end of the drive matches the backplane connector (see letter “D”).

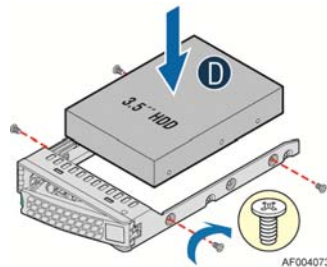

**Figure 37. Installing Hard Disk Drive – Installing 3.5” HDD**

For installing 2.5” Hard Disk Drive as option:

Break off the tab on the HDD interface bracket (see letter “d1”). Install the HDD interface bracket from top. Secure the bracket with three screws as shown (see letter “d2”). Slide the 2.5” HDD into the bracket to align the screw holes with the right and left rail (see letter “d3”). Secure the hard disk drive using the four screws for 2.5” HDD (see letter “d4”).

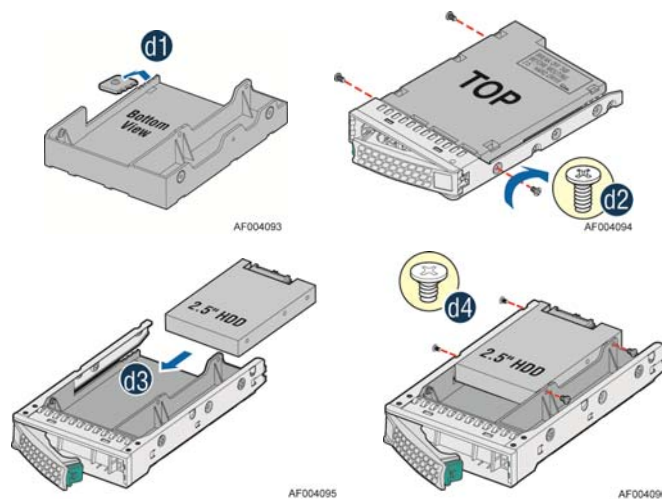

**Figure 38. Installing Hard Disk Drive – Installing 2.5” HDD**

## Hardware Installations and Upgrades

4. With the lever open, insert the hard disk drive assembly into the chassis (see letter “E”). Push in the lever to lock it into place (see letter “F”).

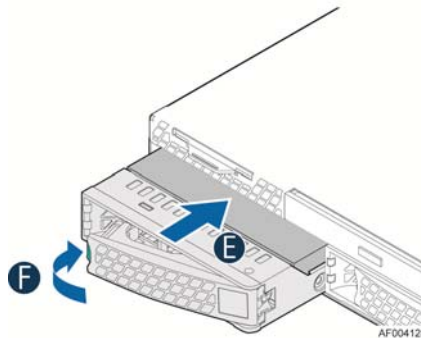

**Figure 39. Installing Hard Disk Drive – Inserting 3.5” HDD assembly**

## Installing a Hard Disk Drive into 2.5” Hard Drive Carrier

1. Remove the drive carrier by pressing the green latch to unlock (see letter “A”). Pull out the black lever and slide the carrier out (see letter “B”).

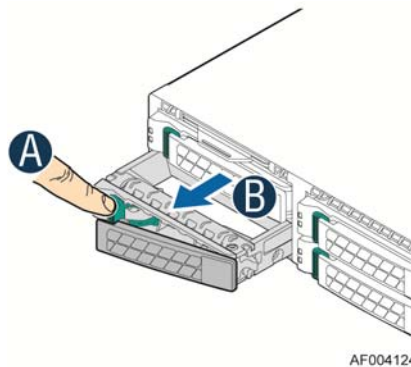

**Figure 40. Installing Hard Disk Drive – Removing 2.5” HDD carrier**

2. Remove the four screws securing the plastic drive blank from the 2.5" HDD carrier (see letter “C”). Disengage the plastic drive blank from the HDD carrier. Remove the plastic drive blank from the 2.5" HDD carrier (see letter “D”).

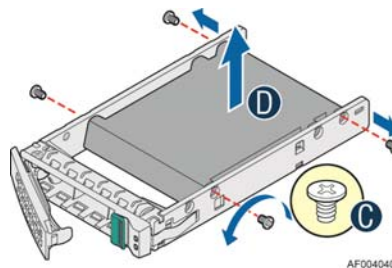

**Figure 41. Installing Hard Disk Drive – Removing plastic drive blank**

3. Install the hard disk drive using the four screws as shown. Make sure the connector end of the drive matches the backplane connector (see letter “E”).

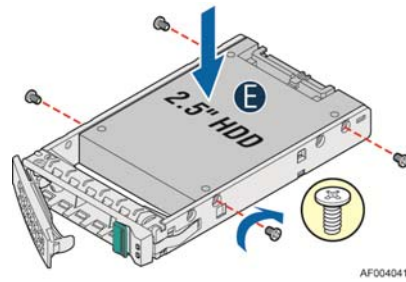

**Figure 42. Installing Hard Disk Drive – Installing 2.5” HDD**

4. With the lever open, insert the hard disk drive assembly into the chassis, then push in the lever to lock it into place (see letter “F”).

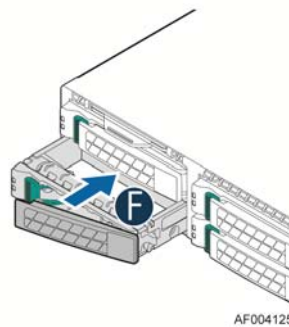
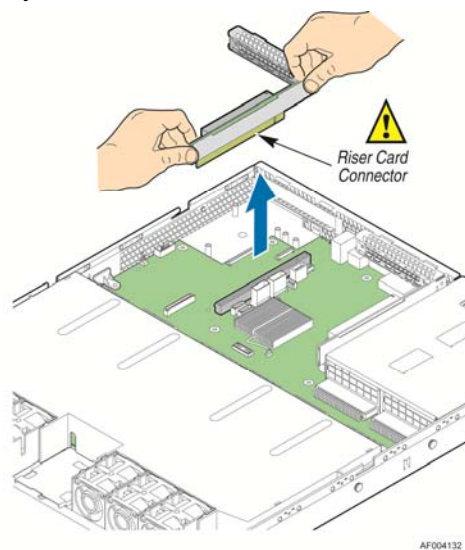

**Figure 43. Installing Hard Disk Drive – Inserting 2.5” HDD assembly**

## Removing and Installing the PCI Riser Assembly

### Removing the PCI Riser Assembly

Disconnect any cables attached to any add-in cards. Grasp the riser assembly with both hands and pull up to remove from system.



**Figure 44. Removing PCI Riser Assembly**

## Hardware Installations and Upgrades

Do one of the following:

- If you need to add or replace a PCI add-in card, see “[Installing and Removing a PCI Add-in Card](#)”.
- If you need to add or replace a PCI riser card, see “[Replacing a PCI Riser Card](#)”.
- If you removed the PCI riser assembly for another procedure, continue with that procedure.

### Installing the PCI Riser Assembly

1. Position the riser card edge connector over the server board riser socket and align the two hooks on the back edge of the riser assembly with the slots on the back of the chassis, then press straight down into riser socket.

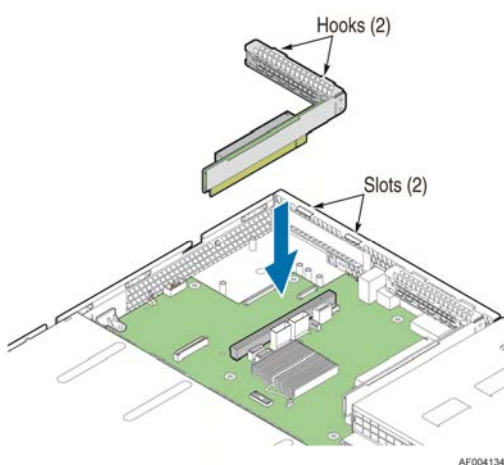

**Figure 45. Installing PCI Riser Assembly**

2. Connect any cables to add-in cards that require them. See your add-in card documentation for information and add-in card requirements.

## Installing and Removing a PCI Add-in Card

### Installing a PCI Add-in Card

1. Remove the PCI riser assembly. For instructions, see “[Removing the PCI Riser Assembly](#)”.
2. Remove the filler panel from the add-in card slot and remove the screw as shown (see letter “A”).
3. Insert add-in card until it seats in the riser connector (see letter “B”).
4. Secure add-in card with screw as shown (see letter “C”).



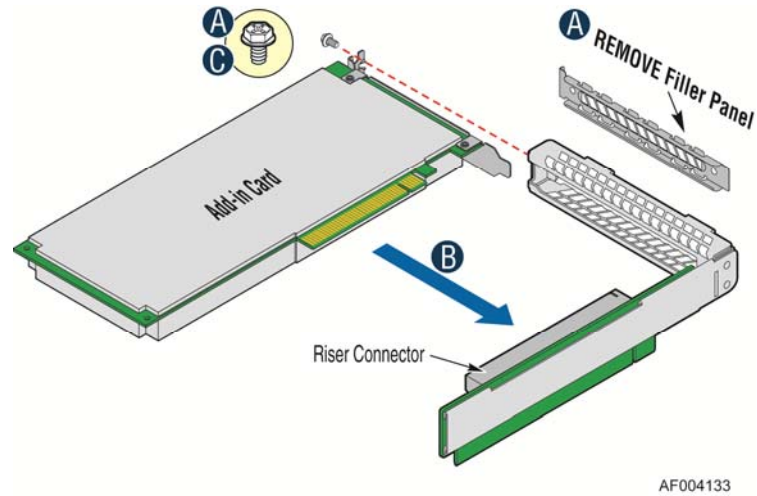

Figure 46. Installing a PCI Add-In Card

## Removing a PCI Add-in Card

1. Remove the PCI riser assembly. For instructions, see “[Removing the PCI Riser Assembly](#)”.
2. Remove the screw as shown (see letter “A”).
3. Remove the PCI add-in card from the riser card connector (see letter “B”).

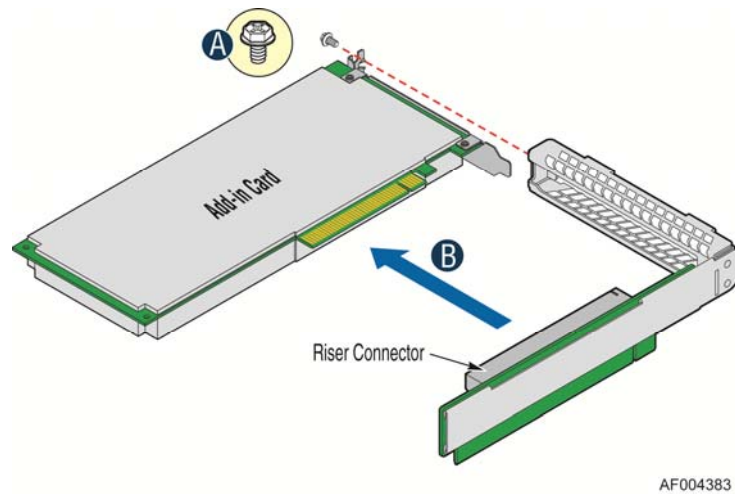

Figure 47. Removing a PCI Add-In Card

*Note: Make sure that all empty add-in card slots have filler panels installed.*

## Replacing a PCI Riser Card

**Caution:** PCI riser cards are NOT hot-swappable. Before removing or replacing the riser card, you must first take the server out of service, turn off all peripheral devices connected to the system,

turn off the system by pressing the power button, and unplug the power cord from the system or wall outlet.

**Note:** To eliminate the possibility of installing the replacement connector on the wrong side of the PCI riser assembly, replace one connector at a time.

### Removing a PCI Riser Card

1. Disconnect any cables attached to any add-in cards.
2. Remove the PCI riser assembly. For instructions, see “[Removing the PCI Riser Assembly](#)”.
3. Remove any add-in cards from the PCI riser card. For instructions, see “[Removing a PCI Add-in Card](#)”.
4. Remove the two screws securing the PCI Riser Card (see letter “A”).
5. Remove from the riser card from riser assembly (see letter “B”).

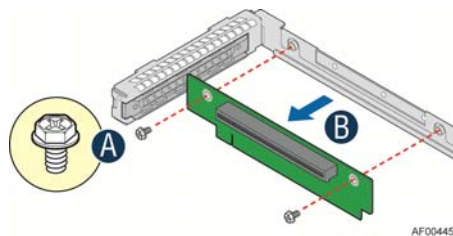

Figure 48. Removing the PCI Riser Card

### Installing a PCI Riser Card

1. Place the riser card onto the riser assembly (see letter “A”).
2. Secure the riser card using the two screws (see letter “B”).

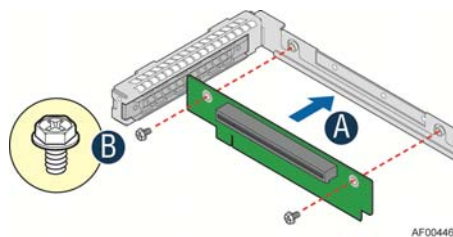

Figure 49. Installing the PCI Riser Card

## Installing and Removing a Slimline Optical Drive

**Caution:** The slimline optical drive is NOT hot-swappable. Before removing or replacing the drive, you must first take the server out of service, turn off all peripheral devices connected to the system, turn off the system by pressing the power button, and unplug the power cord from the system or wall outlet.

To maintain proper system cooling, a filler panel must be installed if you do not install a device at this location.

## Installing a Slimline Optical Drive

1. Install the plastic guide onto the back of the drive and attach with two screws as shown (see letter “A”).

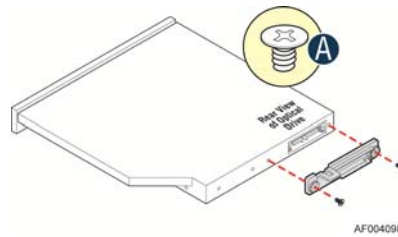

Figure 50. Installing the Plastic Guide to the Optical Drive

2. Insert the optical drive into chassis opening and push all the way until it stops (see letter “B”).
3. Connect the cables as shown (see letter “C”).

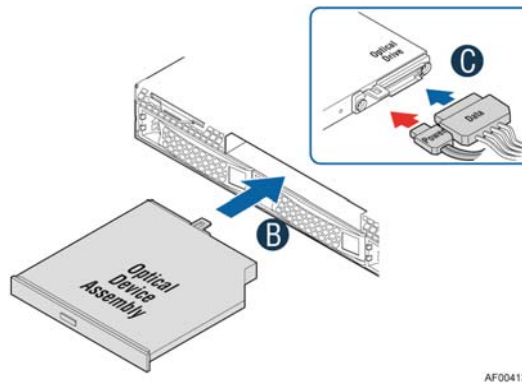

Figure 51. Installing an Optical Drive

## Removing a Slimline Optical Drive

1. Remove the cables (see letter “A”).
2. Lift up the blue tab to release the optical drive (see letter “B”).
3. Slide the optical drive out (see letter “C”).

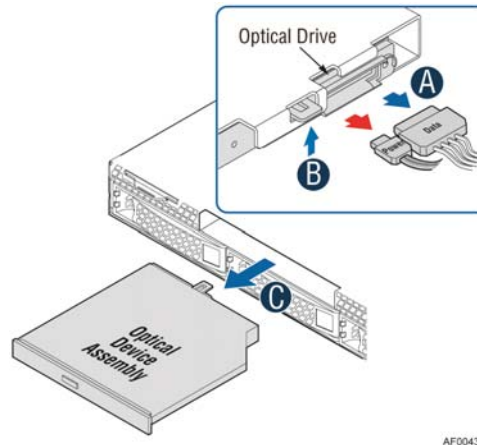

Figure 52. Removing the Slimline Optical Drive

4. If no device will be installed in this location, install a filler panel in this location.

## Installing and Removing Intel® I/O Expansion Module

### Installing Intel® I/O Expansion Module

1. Squeeze the sides of the filler panel to disengage it from the server system back panel and remove it (see letter “A”).
2. Position the module over the server board, fit the front of the module into the back panel slot (see letter “B”).
3. Attach the module to the server board connector (see letter “C”).
4. Secure the module with the three screws as shown (see letter “D”).

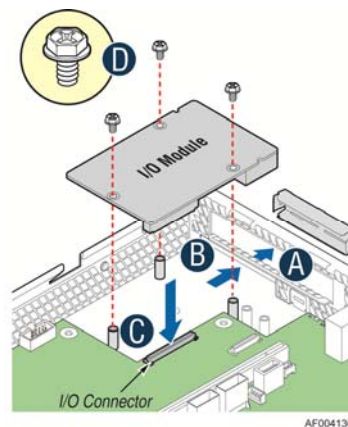

Figure 53. Installing Intel® I/O Expansion Module

## Removing Intel® I/O Expansion Module

1. Remove the three screws as shown (see letter “A”).
2. Remove the module out of the server system (see letter “B”).

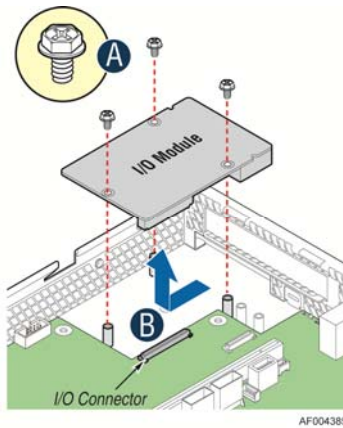

Figure 54. Removing an I/O Expansion Module

3. Install the I/O expansion module filler panel into the system back panel.

## Installing and Removing the Intel® RAID C600 Upgrade Key

### Installing the Intel® RAID C600 Upgrade Key

Locate the white 4-pin key header next to Riser Slot 1. Carefully pick up the Intel® RAID C600 Upgrade Key. Match the Key and connector orientation and press down to install.

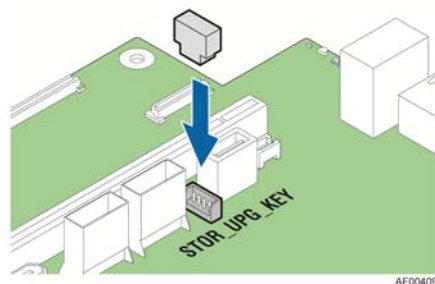

Figure 55. Installing the Intel® RAID C600 Upgrade Key

### Removing the Intel® RAID C600 Upgrade Key

Pull up the key to remove it from the mother board.

## Installing and Removing the Intel® Remote Management Module 4

### Installing the Intel® RMM4 Lite

Locate the RMM4 Lite connector next to Riser Slot 1, carefully pick up the Intel® RMM4 Lite module, match the alignment pin of the module and the connector on server board, then press to install.

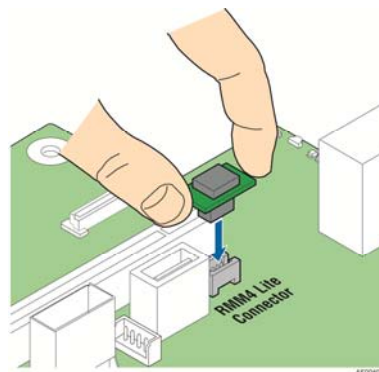

Figure 56. Installing the Intel® RMM4 Lite

### Install the Intel® RMM4 NIC

1. Push out and remove the metal cover on the chassis where the NIC RJ-45 receptacle will align (see letter “A”).
2. Position the module over the server board, fit the front of the module into the back panel slot, then attach the module to the server board connector (see letter “B”).
3. Secure the module with the two screws as shown (see letter “C”).

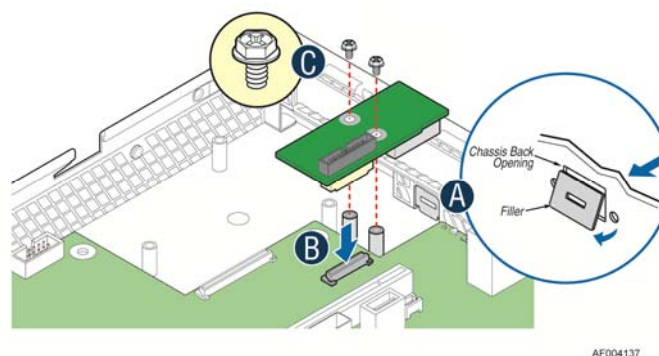

Figure 57. Installing the Intel® RMM4 NIC

### Removing the Intel® RMM4 Lite

Pull up the RMM4 Lite module to remove it from the mother board.

## Removing the Intel® RMM4 NIC

1. Remove the two screws as shown (see letter “A”).
2. Remove the module out of the server system (see letter “B”).

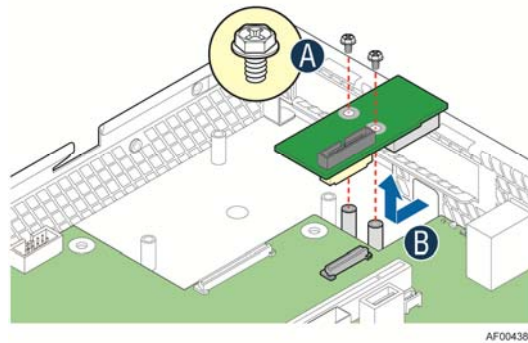

Figure 58. Removing the Intel® RMM4 NIC

## Installing and Removing the Intel® RAID Smart Battery

### Installing the Intel® RAID Smart Battery

1. Connect the cable between the BBU and the RAID card. For details, see *Intel® RAID Smart Battery User's Guide*.
2. Locate the BBU bracket inside the chassis. Align the tabs on the plastic battery holder with mounting holes on the BBU bracket (see letter “A”).
3. Slide the plastic battery holder toward the rear of the system until the tabs engage with the mounting holes in the BBU bracket (see letter “B”).

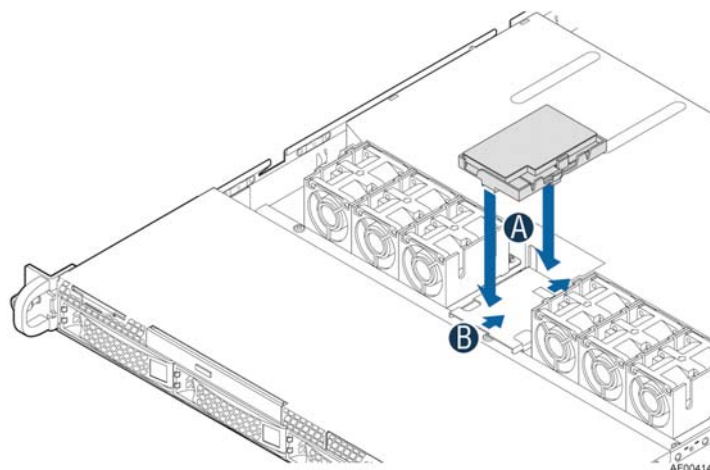

Figure 59. Installing the Intel® RAID Smart Battery

## Removing the Intel® RAID Smart Battery

1. Slide the plastic battery holder toward the front of the system to disengage it from the BBU bracket (see letter “A”).
2. Lift the battery up to remove it from the server chassis (see letter “B”).

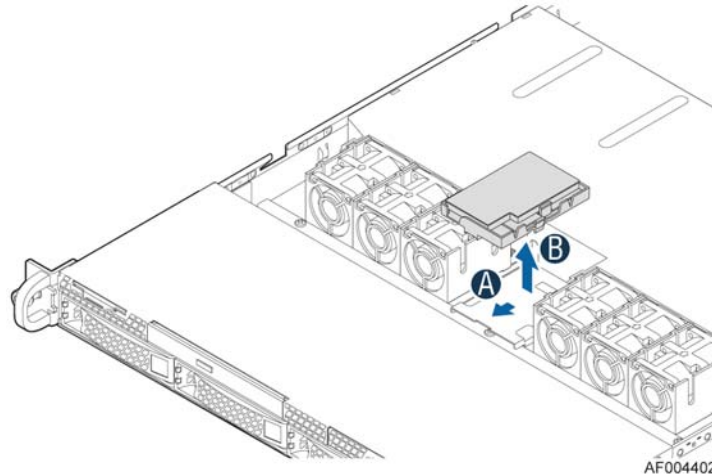

Figure 60. Removing the Intel® RAID Smart Battery

## Replacing the Power Supply

**Caution:** The power supply is only hot-swappable if you have a redundant system with two power supplies installed. If you only have one power supply installed, before removing or replacing the power supply, you must first take the server out of service, turn off all peripheral devices connected to the system, turn off the system by pressing the power button, and unplug the AC power cord from the system or wall outlet.

The power supply can be replaced if it fails. To replace the power supply, follow these steps:

1. Do one of the following:
  - If a filler panel is installed, use the 'finger hole' to remove the filler panel (see letter “A”).

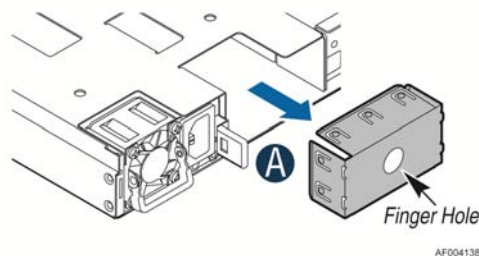
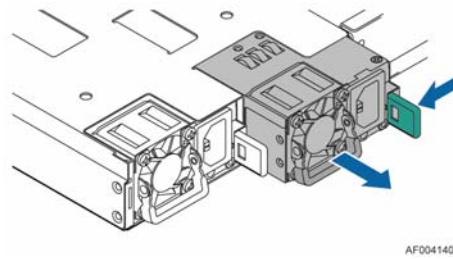

Figure 61. Removing the filler panel

- If a power supply is installed, push the green latch in the direction shown while pulling out of the system by the handle.

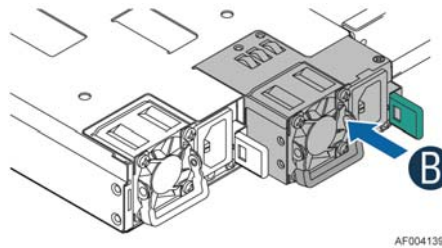



**Figure 62. Removing the power supply module**

2. Do one of the following:

- Insert the power supply module into the power supply cage and push all the way until it clicks into place (see letter “B”).



**Figure 63. Installing the power supply module**

- If no power supply is to be installed, install the filler panel into the power supply cage.

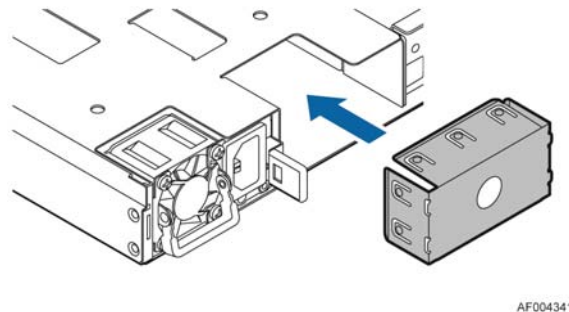
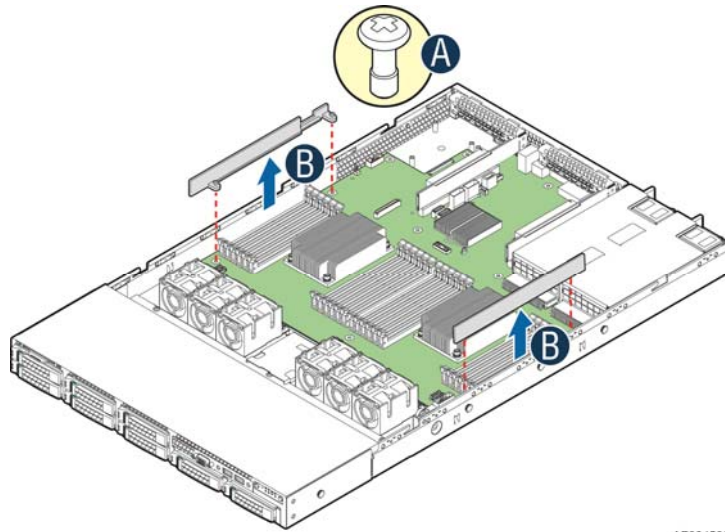

**Figure 64. Installing the filler panel**

## Installing and Removing the Server Board

### Removing the Server Board

1. Disconnect all cables from the server board.
2. Remove the four screws to release the air duct side wall (see letter “A”).
3. Lift the air duct side wall straight up to remove from the server board (see letter “B”).



AF004583

**Figure 65. Removing the Air Duct Side Wall**

4. Remove the nine screws from the server board (see letter “C”).
5. Lift the server board from the server system (see letter “D”).

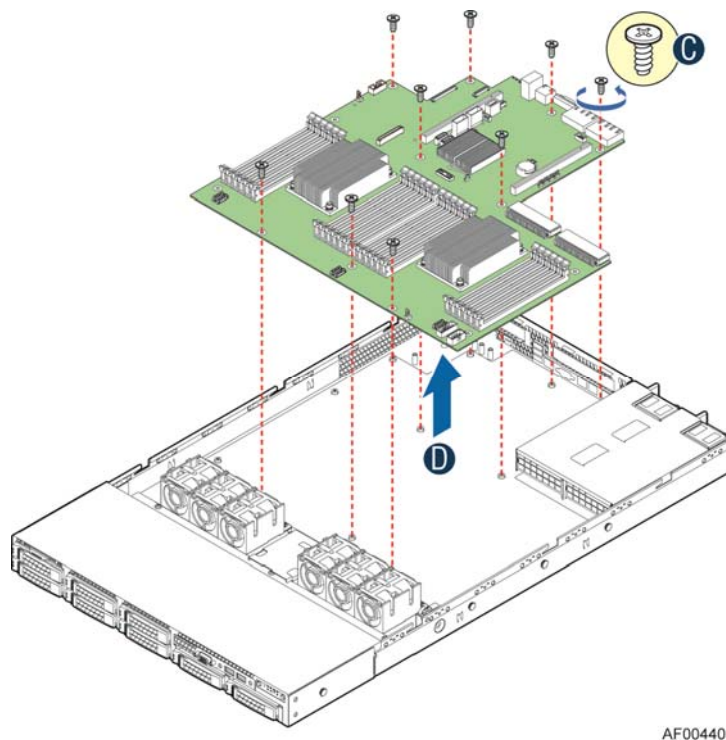

AF004403

**Figure 66. Removing the Server Board**

## Installing the Server Board

1. Place the server board into the server system (see letter “A”).

- Secure the server board with nine screws (see letter “B”).

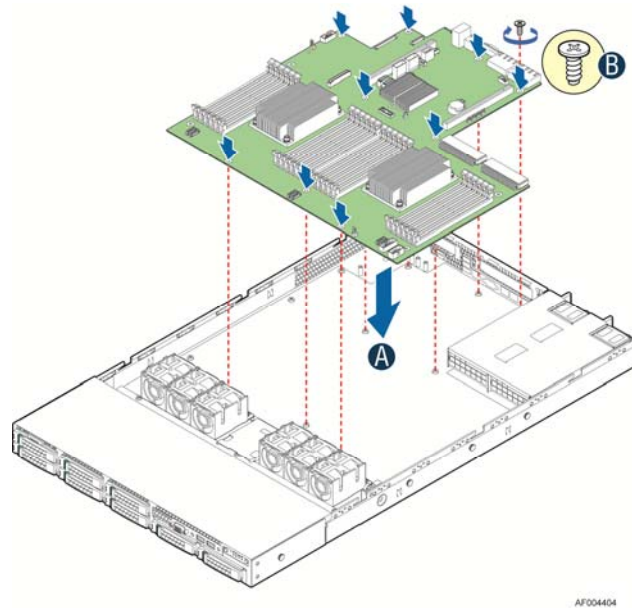

**Figure 67. Installing the Server Board**

- Place air duct side wall onto the server board (see letter “C”).
- Secure the air duct side wall with the four screws (see letter “D”).

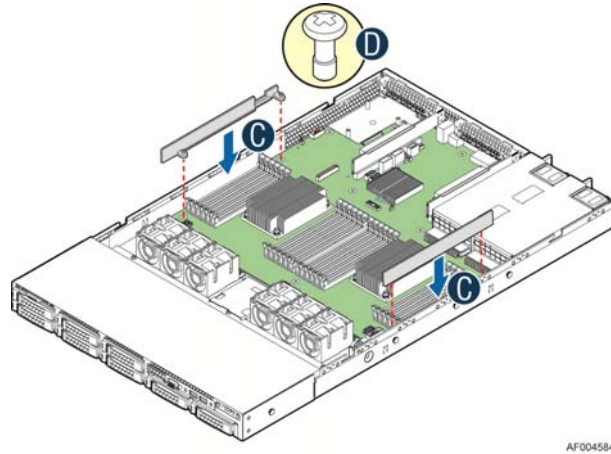

**Figure 68. Installing the Air Duct Side Wall**

- Connect all power cables to the server board.

## Replacing the Backup Battery

The lithium battery on the server board powers the RTC for up to 10 years in the absence of power. When the battery starts to weaken, it loses voltage, and the server settings stored in CMOS RAM in the RTC (for example, the date and time) may be wrong. Contact your customer service representative or dealer for a list of approved devices.

**Warning:** *Danger of explosion if battery is incorrectly replaced. Replace only with the same or equivalent type recommended by the equipment manufacturer. Discard used batteries according to manufacturer's instructions.*

**Advarsel:** Lithiumbatteri - Eksplosjonsfare ved feilagtig håndtering. Utskiftning må kun ske med batteri af samme fabrikat og type. Levér det brugte batteri tilbage til leverandøren.

**Advarsel:** Lithiumbatteri - Eksplosjonsfare. Ved utskifting benyttes kun batteri som anbefalt av apparatfabrikanten. Brukt batteri returneres apparatleverandøren.

**Warning:** Explosionsfara vid felaktigt batteribyte. Använd samma batterityp eller en ekvivalent typ som rekommenderas av apparattillverkaren. Kassera använt batteri enligt fabrikantens instruktion.

**Varoitus:** Paristo voi räjähtää, jos se on virheellisesti asennettu. Vaihda paristo ainoastaan laitevalmistajan suosittelemaan tyyppiin. Hävitä käytetty paristo valmistajan ohjeiden mukaisesti.

1. Locate the battery on the server board.
2. Gently press the metal clip as shown to release the battery (see letter “A”).
3. Remove the battery from the plastic socket (see letter “B”).

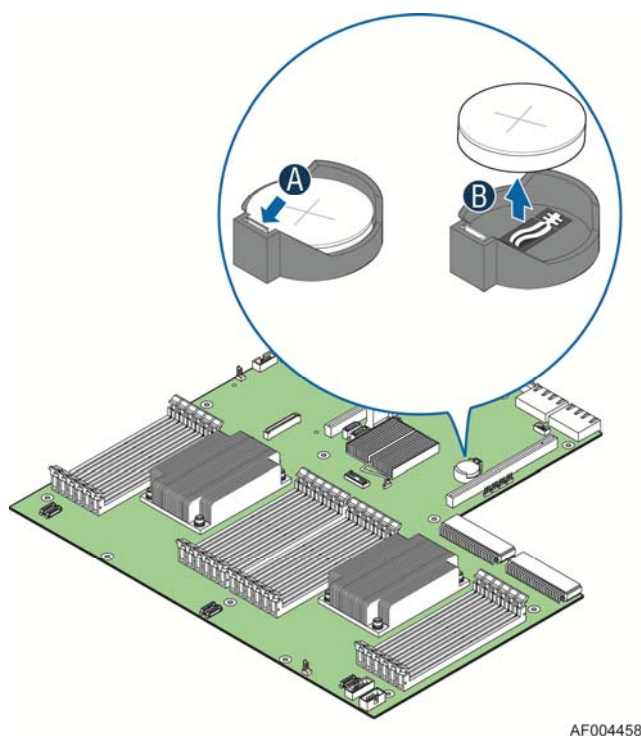

AF004458

**Figure 69. Replacing the Backup Battery**

4. Dispose of the battery according to local ordinance.
5. Remove the new lithium battery from its package, and, being careful to observe the correct polarity, insert it in the battery socket.

**Note:** *You will need to run the BIOS Setup to restore the configuration settings to the RTC.*

## Replacing a System Fan

1. Disconnect the fan cable (see letter “A”).
2. Pull system fan straight up to remove it from the fan holder.

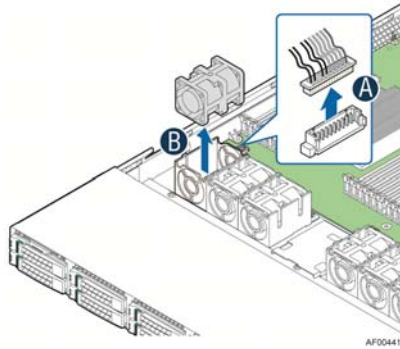

Figure 70. Replacing a system fan

3. Replace the system fan.

## Replacing the Backplane

### Removing the Backplane

1. Remove all hot-swap drive carriers, regardless of whether or not a drive is installed in the carrier.
2. Disconnect all cables from the backplane.
3. Remove the screw (see letter “A”).
4. Pull up the backplane (see letter “B”).
5. Remove the backplane from the server chassis (see letter “C”).

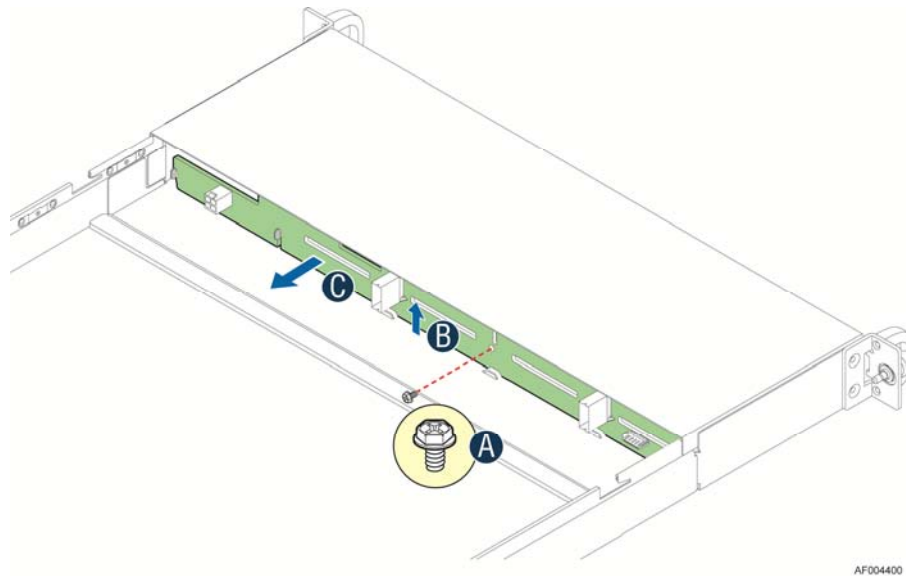

Figure 71. Removing the backplane

## Installing the Backplane

1. Remove all hot-swap drive carriers, regardless of whether or not a drive is installed in the carrier.
2. Hold the backplane only by the edges. Do not push or pull on any components on the backplane. Position the backplane in place at the front of the server system (see letter “A”).
3. Slide the backplane into the server system guides (see letter “B”).
4. Secure the backplane with the screw as shown (see letter “C”).

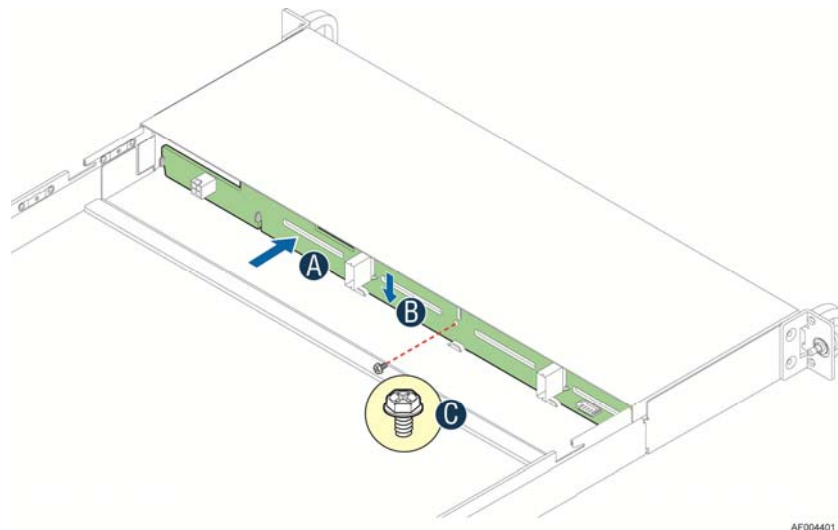

Figure 72. Installing the backplane

5. Connect cables to backplane, please refer to “[Cable Routing](#)”

## Installing and Removing the Rack Handles

### Installing the Rack Handles

Align the rack handle with the two holes on the side of the server system and attach the rack handle to the server system with two screws as shown.

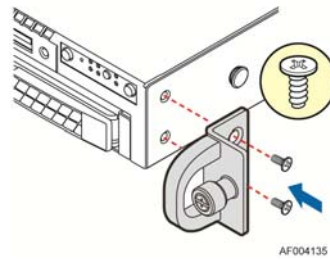

Figure 73. Installing the Rack Handle

### Removing the Rack Handles

Remove the two screws holding the rack handle in place, and remove the rack handle from the server system as shown.

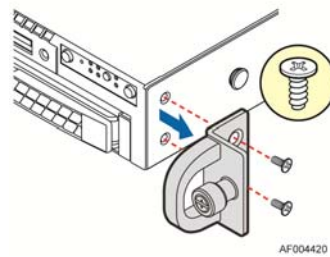

Figure 74. Removing the Rack Handle

## 3 Server Utilities

---

### Using the BIOS Setup Utility

This section describes the BIOS Setup utility options, which is used to change server configuration defaults. You can run the BIOS Setup with or without an operating system being present. For information about specific BIOS setup screens, see the *Intel® Server Board S2600GZ/GL Technical Product Specification*. For a web link to this document, see [“Additional Information and Software”](#).

#### Entering BIOS Setup

To enter the BIOS Setup using a keyboard (or emulated keyboard), press the <F2> function key during boot time when the OEM or Intel Logo Screen or the POST Diagnostic Screen is displayed.

The following instructional message is displayed on the Diagnostic Screen or under the Quiet Boot Logo Screen:

Press <F2> to enter setup, <F6> Boot Menu, <F12> Network Boot

*Note: With a USB keyboard, it is important to wait until the BIOS “discovers” the keyboard and beeps – until the USB Controller has been initialized and the USB keyboard activated, key presses will not be read by the system.*

When the Setup Utility is entered, the Main screen is displayed initially. However, serious errors cause the system to display the Error Manager screen instead of the Main screen.

It is also possible to cause a boot directly to Setup using an IPMI 2.0 command “Get/Set System Boot Options”. For details on that capability, see the explanation in the IPMI description.

#### If You Cannot Access Setup

If you are not able to access the BIOS Setup, you might need to restore the BIOS default settings. For instructions, see [“Restoring the BIOS Defaults”](#).

#### Setup Menus

The bottom right portion of the Setup screen provides a list of commands that are used to navigate through the Setup utility. These commands are displayed at all times.

Each Setup menu page contains a number of features. Each feature is associated with a value field, except those used for informative purposes. Each value field contains configurable parameters. Depending on the security option chosen and in effect by the password, a menu feature’s value may or may not be changed. If a value cannot be changed, its field is made inaccessible and appears grayed out.



Table 4. BIOS Setup: Keyboard Command Bar

Key	Option	Description
<Enter>	Execute Command	The <Enter> key is used to activate submenus when the selected feature is a submenu, or to display a pick list if a selected option has a value field, or to select a subfield for multi-valued features like time and date. If a pick list is displayed, the <Enter> key selects the currently highlighted item, undoes the pick list, and returns the focus to the parent menu.
<Esc>	Exit	The <Esc> key provides a mechanism for backing out of any field. When the <Esc> key is pressed while editing any field or selecting features of a menu, the parent menu is re-entered.  When the <Esc> key is pressed in any submenu, the parent menu is re-entered. When the <Esc> key is pressed in any major menu, the exit confirmation window is displayed and the user is asked whether changes can be discarded. If “No” is selected and the <Enter> key is pressed, or if the <Esc> key is pressed, the user is returned to where they were before <Esc> was pressed, without affecting any existing settings. If “Yes” is selected and the <Enter> key is pressed, the setup is exited and the BIOS returns to the main System Options Menu screen.
↑	Select Item	The up arrow is used to select the previous value in a pick list, or the previous option in a menu item's option list. The selected item must then be activated by pressing the <Enter> key.
	Select Item	The down arrow is used to select the next value in a menu item's option list, or a value field's pick list. The selected item must then be activated by pressing the <Enter> key.
	Select Menu	The left and right arrow keys are used to move between the major menu pages. The keys have no effect if a sub-menu or pick list is displayed.
<Tab>	Select Field	The <Tab> key is used to move between fields. For example, <Tab> can be used to move from hours to minutes in the time item in the main menu.
-	Change Value	The minus key on the keypad is used to change the value of the current item to the previous value. This key scrolls through the values in the associated pick list without displaying the full list.
+	Change Value	The plus key on the keypad is used to change the value of the current menu item to the next value. This key scrolls through the values in the associated pick list without displaying the full list. On 106-key Japanese keyboards, the plus key has a different scan code than the plus key on the other keyboards, but will have the same effect.
<F9>	Setup Defaults	Pressing the <F9> key causes the following to display:  <div style="border: 1px solid black; padding: 5px; text-align: center;">           Load Optimized Defaults?            Yes No         </div> If “Yes” is highlighted and <Enter> is pressed, all Setup fields are set to their default values. If “No” is highlighted and <Enter> is pressed, or if the <Esc> key is pressed, the user is returned to where they were before <F9> was pressed without affecting any existing field values.
<F10>	Save and Exit	Pressing the <F10> key causes the following message to display:  <div style="border: 1px solid black; padding: 5px; text-align: center;">           Save configuration and reset?            Yes No         </div> If “Yes” is highlighted and <Enter> is pressed, all changes are saved and the Setup is exited. If “No” is highlighted and <Enter> is pressed, or the <Esc> key is pressed, the user is returned to where they were before <F10> was pressed without affecting any existing values.

## Upgrading the BIOS

Follow the instructions in the readme file that came with the BIOS upgrade. When the update completes, remove the bootable media from which you performed the upgrade.

**Caution:** Do not power down the system during the BIOS update process! The system will reset automatically when the BIOS update process is completed.

**Note:** You may encounter a CMOS Checksum error or other problem after reboot. If this happens, shut down the system and boot it again. CMOS checksum errors require that you enter Setup, load BIOS defaults, check your settings, save your settings, and exit Setup.

## Clearing the Password

If the user or administrator password(s) is lost or forgotten, moving the password clear jumper into the "clear" position clears both passwords. The password clear jumper must be restored to its original position before a new password(s) can be set.

1. Power down the system. Do not unplug the power cord.
2. Open the server system. For instructions on removing the system cover, see [“Removing the System Cover”](#).
3. Locate the Password Clear jumper block at board.
4. Move the jumper from the normal operation position, that is, Password Clear Protect position (covering pins 1 and 2) to the Password Clear Erase position (covering pins 2 and 3). See [“System Recovery Jumpers”](#).
5. Wait ten seconds.
6. Move the Password Clear jumper back to the Password Clear Protect position (covering pins 1 and 2).
7. Close the server system.
8. Power up the server.

The password is now cleared and can be reset by going into the BIOS setup.

## Restoring the BIOS Defaults

If you need to restore the BIOS default settings, the BIOS Default jumper will need to be used.

1. Power down the system; do not disconnect the AC power.
2. Open the server system. For instructions on removing the system cover, see [“Removing the System Cover”](#).
3. Locate the BIOS Default jumper block at board.
4. Move the jumper from the normal operation position (covering pins 1 and 2) to the Set Default position (covering pins 2 and 3). See [“System Recovery Jumpers”](#).
5. Wait five seconds.
6. Return the BIOS Default jumper to the normal position (covering pins 1 and 2).
7. Close the server system.
8. Power up the system.

The BIOS defaults settings are now restored and can be reset by going into the BIOS setup.

## Appendix A: Technical Reference

---

### Power Supply Input Voltages

460W power supply module

- 100 - 127 V at 50/60 Hz 5.8 A
- 200 - 240 V at 50/60 Hz 2.9 A

750W power supply module

- 100 - 127 V at 50/60 Hz 8.2 A
- 200 - 240 V at 50/60 Hz 4.4 A

### Power Supply Output Voltages

The following table lists the total wattage available from the power subsystem for each voltage. For information about calculating the power usage for your configuration, please use the Power Budget Tool.

**Table 5. Power Supply Output Capability**

Voltage	Maximum Current
12V	62.0A
12VSB	2.1A

### System Environmental Specifications

The following table defines the system level operating and non-operating environmental limits.

**Table 6. System Environmental Limits Summary**

Parameter	Limits
Operating Temperature	+10°C to +35°C with the maximum rate of change not to exceed 10°C per hour
Non-Operating Temperature	-40°C to +70°C
Non-Operating Humidity	90%, non-condensing at 35°C
Acoustic noise	Sound power: 7.0 BA in operating conditions at typical office ambient temperature. (23 +/- 2 degrees C)
Shock, operating	Half sine, 2 g peak, 11 milliseconds

## Appendix A: Technical Reference

Parameter	Limits
Shock, unpackaged	Trapezoidal, 25 g, velocity change 136 inches/second ( $\cong$ 40 lbs to < 80 lbs)
Shock, packaged	Non-palletized free fall in height 24 inches ( $\cong$ 40 lbs to < 80 lbs)
Vibration, unpackaged	5 Hz to 500 Hz, 2.20 g RMS random
ESD	+/-12 KV except I/O port +/- 8 KV per Intel® Environmental test specification
System Cooling Requirement in BTU/Hr	460 Watt Max – 1570 BTU/hour 750 Watt Max – 2560 BTU/hour

## Appendix B: Regulatory and Compliance Information

---

Please refer to the Server Products Regulatory and Safety document for the product regulatory compliance reference. The document can be downloaded from <http://www.intel.com/support/server>.

## Appendix C: Getting Help

---

If you encounter an issue with your server system, follow these steps to obtain support:

1. Visit the following Intel support web page:  
<http://www.intel.com/support/>  
This web page provides 24x7 support when you need it to get the latest and most complete technical support information on all Intel Enterprise Server and Storage Platforms. Information available at the support site includes:
  - Latest BIOS, firmware, drivers and utilities
  - Product documentation, installation and quick start guides
  - Full product specifications, technical advisories and errata
  - Compatibility documentation for memory, hardware add-in cards, chassis support matrix and operating systems
  - Server and chassis accessory parts list for ordering upgrades or spare parts
  - A searchable knowledgebase to search for product information throughout the support site
2. If you are still unable to obtain a solution to your issue, send an email to Intel's technical support center using the online form available at <http://www.intel.com/support/feedback.htm?group=server>.
3. Lastly, you can contact an Intel support representative using one of the support phone numbers available at <http://www.intel.com/support/feedback.htm?group=server> (charges may apply). Intel customer support suggests filling out the issue report form available at “[Intel® Server Issue Report Form](#)” to better service the issue.

Intel also offers Channel Program members around-the-clock 24x7 technical phone support on Intel® server boards, server chassis, server RAID controller cards, and Intel® Server Management at <http://www.intel.com/reseller/>.

*Note: You will need to log in to the Reseller site to obtain the 24x7 number.*

### Warranty Information

To obtain warranty information, visit the following Intel web site:

<http://www.intel.com/support/warranty>

## Appendix D: Intel® Server Issue Report Form

---

### Issue Report Form (Rev 3.6)

*Note: Filling out this form completely is required for any escalation.*

---

---

**Customer Contact Information:**

Customer Support Case#:

---

---

**Intel® Server Board or System:**

(Example: S2600GZ, R1000GZ)

---

---

**Server Chassis:**

(Example P4000M. If third-party chassis used, indicate make and model.)

---

---

**Base Board Information: (some information maybe found by accessing BIOS & going through the Server Management menu -> System Information)**

Baseboard PBA/TA/AA # (Example: 123456-789):

- can be found on the white sticker label on the baseboard.

System BIOS Version:

Intel® Remote Management Module Firmware Version (if applicable):

Intel® Management Module BMC Revision (if applicable):

BMC Version:

FRU/SDR Version:

Has the latest BIOS been tried? (Yes/No):

Has the latest BMC been tried? (Yes/No):

Has the latest RMM Firmware been tried? (Yes/No):

Has the latest FRU/SDR been tried? (Yes/No):

---

---

**Processor information:**

**Appendix D: Intel® Server Issue Report Form**

	Type	Speed	sSpec	Thermal Solution
Processor 1				
Processor 2				

Thermal solution (Heat sink) examples:

(1U, Passive w/air ducting, Active w/fan, and so on)

**Memory:**

Manufacturer	Part Number	DRAM Part Number	On Intel tested list?

**Add-in adapters (Example: NICs, Management Adapters, Serial Expansion Cards, PCI-Express\* Adapters, RAID Controllers, SCSI Controllers, and so on):**

Type	Slot	Manufacturer	Model	Firmware

**Other third part hardware (Example: Example: KVM, Chassis, and so on):**

Description/Use	Manufacturer	Model	Firmware



**Storage Devices (Example: SCSI, SATA, SAS, USB, Tape, and so on):**

Manufacturer	Model	Type	Size	Firmware	In Hot Swap Bay?

---

**Operating System Information (Example: RedHat\* Enterprise Linux, Microsoft\* Windows\* Server 2003, Service pack 1, OEM CD):**

Manufacturer:

Version:

Language version (English, Arabic, Chinese (Simplified)):

Service Pack Level or Kernel Revision:

Distribution (OEM/Retail):

---

**Intel® RAID Controller: (Example SRCU42E)**

RAID controller part number (PBA number):

RAID controller firmware version:

Has the latest RAID firmware been tried? (Yes/No):

RAID driver version:

Has the latest RAID driver been tried? (Yes/No):

RAID volumes configuration (disks & RAID level):

RAID volume use (Boot device/Data Volume):

Is BBU (Battery Backup Unit) installed? (Yes/No):

BBU part number:

---

**Detailed description of issue:**

**Appendix D: Intel® Server Issue Report Form**

**Troubleshooting tried:**

**Steps to replicate the issue:**

**Issue impact statements:**

**Do you have any potential Intel system, or component purchases that this issue is holding up? If yes, please provide a brief description below.**

**Do you have systems already purchased that are not being delivered to your customers because of this issue? If yes, please provide a brief description below.**

**Have you returned systems or components to your place of purchase because of this issue? If yes, please provide a brief description below.**

\*All other brands and names are property of their respective owners.