

TravelMate C110

Service Guide

Service guide files and updates are available on the CSD web; for more information, please refer to <http://csd.acer.com.tw>

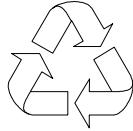

100% Recycled Paper

Revision History

Please refer to the table below for the updates made on Travelmate C110 service guide.

Date	Chapter	Updates

Copyright

Copyright © 2003 by Acer Incorporated. All rights reserved. No part of this publication may be reproduced, transmitted, transcribed, stored in a retrieval system, or translated into any language or computer language, in any form or by any means, electronic, mechanical, magnetic, optical, chemical, manual or otherwise, without the prior written permission of Acer Incorporated.

Disclaimer

The information in this guide is subject to change without notice.

Acer Incorporated makes no representations or warranties, either expressed or implied, with respect to the contents hereof and specifically disclaims any warranties of merchantability or fitness for any particular purpose. Any Acer Incorporated software described in this manual is sold or licensed "as is". Should the programs prove defective following their purchase, the buyer (and not Acer Incorporated, its distributor, or its dealer) assumes the entire cost of all necessary servicing, repair, and any incidental or consequential damages resulting from any defect in the software.

Acer is a registered trademark of Acer Corporation.

Intel is a registered trademark of Intel Corporation.

Pentium and Pentium II/III are trademarks of Intel Corporation.

Other brand and product names are trademarks and/or registered trademarks of their respective holders.

Conventions

The following conventions are used in this manual:

Screen messages	Denotes actual messages that appear on screen.
NOTE	Gives bits and pieces of additional information related to the current topic.
WARNING	Alerts you to any damage that might result from doing or not doing specific actions.
CAUTION	Gives precautionary measures to avoid possible hardware or software problems.
IMPORTANT	Reminds you to do specific actions relevant to the accomplishment of procedures.

Preface

Before using this information and the product it supports, please read the following general information.

1. This Service Guide provides you with all technical information relating to the BASIC CONFIGURATION decided for Acer's "global" product offering. To better fit local market requirements and enhance product competitiveness, your regional office MAY have decided to extend the functionality of a machine (e.g. add-on card, modem, or extra memory capability). These LOCALIZED FEATURES will NOT be covered in this generic service guide. In such cases, please contact your regional offices or the responsible personnel/channel to provide you with further technical details.
2. Please note WHEN ORDERING FRU PARTS, that you should check the most up-to-date information available on your regional web or channel. If, for whatever reason, a part number change is made, it will not be noted in the printed Service Guide. For ACER-AUTHORIZED SERVICE PROVIDERS, your Acer office may have a DIFFERENT part number code to those given in the FRU list of this printed Service Guide. You MUST use the list provided by your regional Acer office to order FRU parts for repair and service of customer machines.

Chapter 1	System Specifications	1
	Features	1
	System Block Diagram	3
	Board Layout	4
	Top View	4
	Bottom View	5
	Outlook View	6
	Front View	6
	Left Panel	8
	Right Panel	9
	Rear Panel	10
	Bottom Panel	11
	Indicators	12
	Launch Keys	13
	Lock Keys	14
	Embedded Numeric Keypad	15
	Windows Keys	16
	Hot Keys	17
	Hardware Specifications and Configurations	19
Chapter 2	System Utilities	31
	BIOS Setup Utility	31
	Navigating the BIOS Utility	31
	System Information	32
	Main System Settings	33
	Advanced System Settings	35
	IDE Primary Master	36
	I/O Device Configuration	37
	System Security	39
	Boot Options	41
	Exit Setup	42
	Multi-Boot Menu	43
	Load Default Settings	45
	BIOS Flash Utility	46
	System Utility Diskette	46
	System Diagnostic Diskette	46
	Running PQA Diagnostics Program	47
Chapter 3	Machine Disassembly and Replacement	49
	General Information	50
	Before You Begin	50
	Disassembly Procedure Flowchart	51
	Removing the Battery Pack	53
	Removing the Wireless LAN Module	54
	Removing the Hard Disk Drive Module	55
	Disassembling the Main Unit	56
	Removing the Middle Covers	56
	Removing the Keyboard	56
	Removing the DIMM Upper Plate	57
	Removing the Internal Memory Module	57
	Removing the Modem Board	57
	Removing the LCD Module	58
	Separating the Upper Case from the Lower Case	60
	Removing the RTC Battery	61

Table of Contents

Removing the Speaker	61
Removing the Touch Pad Module	62
Removing the Touch Pad FPC	62
Removing the LCD Support Knobs	63
Removing the Main Board	64
Removing the Thermal Plate	64
Removing the PCMCIA Socket	65
Removing the Modem Cable	65
Disassembling the LCD Module	66
Removing the LCD Bezel	66
Removing the LCD Hinges with the Center Hinge	67
Removing the Button Board & Inverter Board	67
Removing the Main and Auxiliary Antenna	68
Removing the LCD	68
Removing the Coaxial Cable	68
Removing the Sensor Board	69
Chapter 4 Troubleshooting	71
System Check Procedures	72
External Diskette Drive Check	72
External CD-ROM Drive Check	72
Keyboard or Auxiliary Input Device Check	73
Memory Check	73
Power System Check	73
Touchpad Check	75
Power-On Self-Test (POST) Error Message	76
Index of Error Messages	77
Index of Symptom-to-FRU Error Message	80
Intermittent Problems	83
Undetermined Problems	84
Index of AFlash BIOS Error Message	85
Index of PQA Diagnostic Error Code, Message	86
Chapter 5 Jumper and Connector Locations	87
Top View	87
SW1 Settings	88
Bottom View	89
Chapter 6 FRU (Field Replaceable Unit) List	91
Exploded Diagram	92
Appendix A Model Definition and Configuration	101
Appendix B Test Compatible Components	103
Microsoft Windows XP Environment Test	104
Appendix C Online Support Information	107
Index	109

System Specifications

Features

This computer was designed with the user in mind. Here are just a few of its many features:

Performance

- Intel® ultra low-voltage Pentium® M processor up to 900MHz CPU with on-die 1MB cache. CPU is lower power, fully static and with SMI feature.
- Intel® Centrino™ Mobile Technology
- 64-bit memory bus
- High-capacity, Enhanced-IDE hard disk
- Li-Ion main battery pack
- Power management system with ACPI (Advanced Configuration Power Interface)

Display

- 10.4" Thin-Film Transistor (TFT) eXtended Graphics Array (XGA) liquid crystal-display (LCD)
- 16M colors at 1024x768 eXtended Graphics Array (XGA) resolution
- 3D capabilities
- Integrated VGA with DVMT (Dynamic Video Memory Technology) support
- Simultaneous LCD and CRT display support
- Supports other output display devices such as LCD projection panels for large-audience presentations
- "Automatic LCD dim" feature that automatically decides the best settings for your display and conserves power
- Tablet mode for LCD panel (Rotatable display)

Multimedia

- Built-in AC link audio subsystem which complies with the Microsoft PC 97/PC 98/ PC 99/PC2001 specifications and meets WHQL audio requirements.
- Built-in one speaker and microphone
- High-speed optical drive
- 16-bit high-fidelity AC'97 PCI stereo audio with wavetable synthesizer

Connectivity

- High-speed fax/data modem port
- Fast infrared wireless communication
- USB 2.0 (Universal Serial Bus) ports
- Ethernet/Fast Ethernet port
- IEEE1394 port
- Optional Wireless LAN
- Optional Bluetooth

Expansion

- One type II CardBus PC Card slot
- Upgradeable memory
- DockMate V

Keyboard and Pointing Device

- 84-/85-/88-key international language keyboards
- Ergonomically-centered touchpad pointing device with scroll function

I/O Ports

- One type II CardBus PC Card slot
- Acer 100 pins standard docking connector
- One RJ-45 jack for 10/100BaseT LAN
- One RJ-11 data/fax modem jack
- One DC-in jack (AC adapter)
- One external monitor port
- One audio line-in/microphone-in jack
- One line-out/headphone-out jack
- One FIR port
- Two USB ports
- One IEEE 1394 port

System Block Diagram

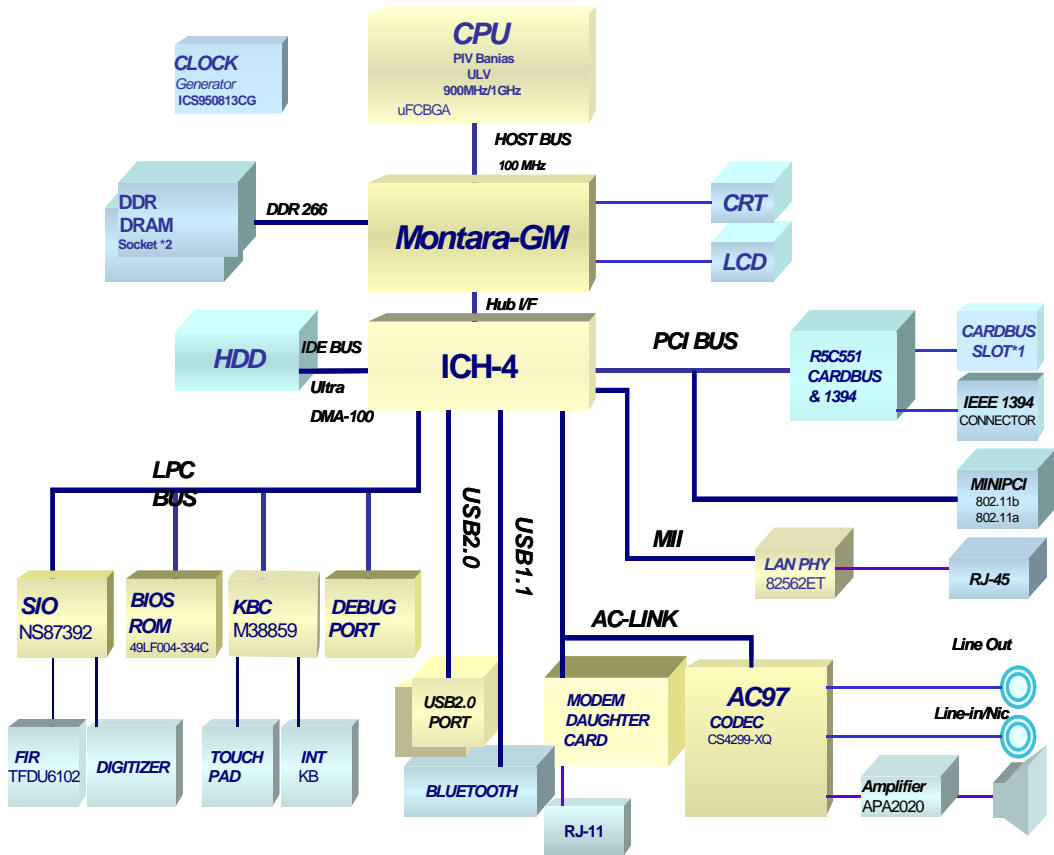

Board Layout

Top View

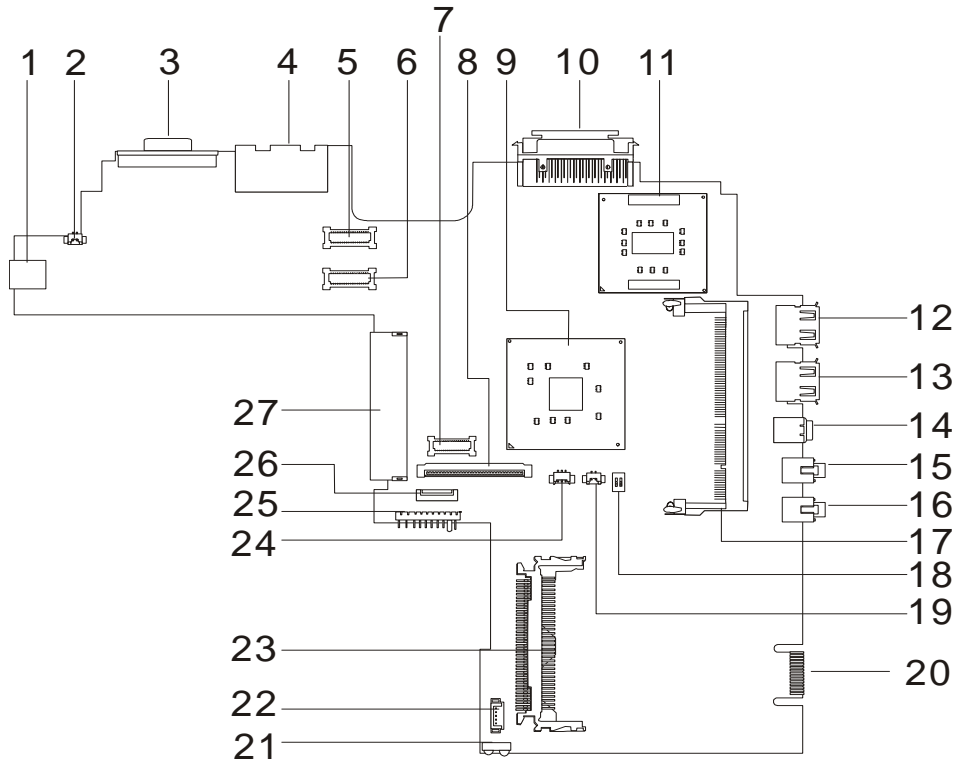

1	AC adapter connector	15	Line-in port
2	LCD cover switch connector	16	Line-out port
3	VGA port	17	Memory slot 1
4	RJ11 and RJ45 connectors	18	Please refer to below for SW settings
5	LCD coaxial cable connector	19	RTC battery connector
6	LED/Inverter board connector	20	Debug purpose only
7	Fax/Modem board connector	21	FIR connector
8	Keyboard cable connector	22	Internal microphone and tablet PC lid connector
9	855-GM chip (North bridge)	23	PCMCIA card connector
10	Docking connector	24	Speaker cable connector
11	CPU	25	Battery connector
12	USB port 1	26	Touchpad connector
13	USB port 2	27	Hard disk drive connector
14	1394 port		

Bottom View

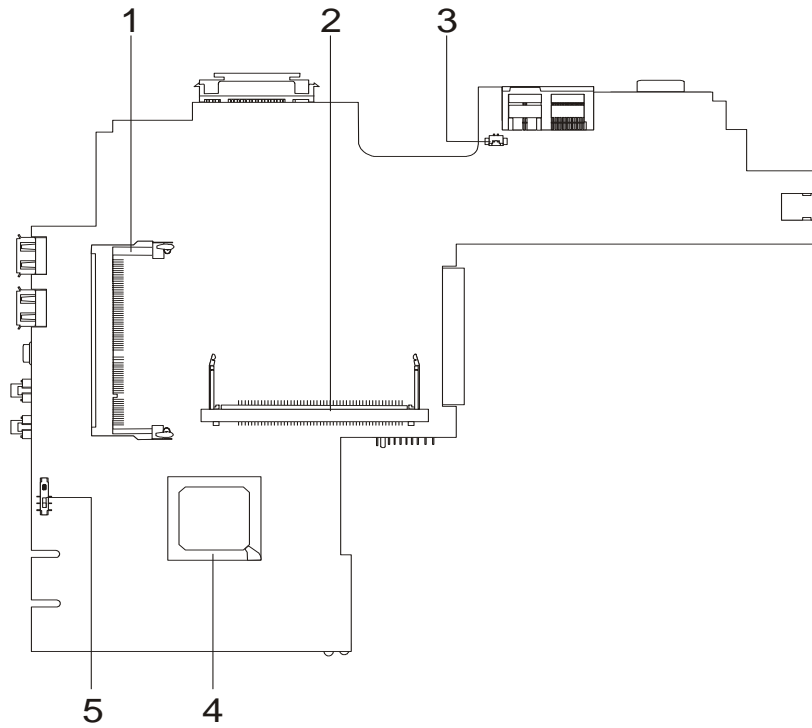

- | | | | |
|---|-----------------------------------|---|----------------------|
| 1 | Memory slot (DM2) | 4 | ICH-4 (South Bridge) |
| 2 | MiniPCI wireless module connector | 5 | Power switch |
| 3 | Modem cable connector | | |



Outlook View

A general introduction of ports allow you to connect peripheral devices, as you would with a desktop PC.

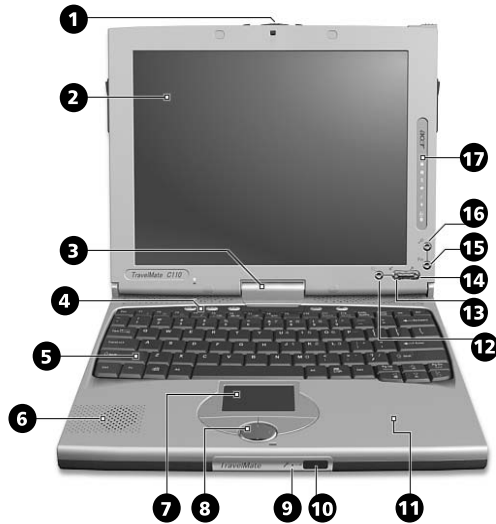
Front View



#	Item	Description
1	Two-way latch	Use to latch the LCD screen in both normal mode and tablet mode.
2	Display screen	Also called LCD (liquid-crystal display), displays computer output. Input-capable with the aid of the EMR stylus.
3	Convertible hinge	Hinges the LCD screen in place when switching from PC mode to tablet mode and vice versa.
4	Launch keys	Buttons for launching frequently used programs.
5	Keyboard	Inputs data into your computer.
6	Speaker	Outputs sound from your computer.
7	Touchpad	Touch-sensitive pointing device which functions like a computer mouse.
8	Click buttons (left, center and right)	The left and right buttons function like the left and right mouse buttons; the center button is a 4-direction scroll button.
9	Microphone	Captures sounds and voices into your computer.
10	Infrared port	Interfaces with infrared devices (e.g., infrared printer, IR-aware computer).
11	Palmrest	Comfortable support area for your hands when you use the computer.
12	Enter button	Use to confirm selection in tablet mode. This button can also be used to emulate the ^ button by first pressing the Fn button and then this button. This button can be configured by the user.

#	Item	Description
13	Page down buttons 	Use to scroll one page down in tablet mode. This button can also be used to emulate the Tab button by first pressing the Fn button and then this button. This button can be configured by the user.
14	Page up buttons 	Use to scroll one page up in tablet mode. This button is used to rotate the display by first pressing the Fn button and then this button. This button can be configured by the user.
15	Function key button Fn	This button is used together with other buttons to invoke the tablet applications. This button is set and cannot be configured by the user.
16	Windows Security button 	This button is used to emulate the b+ a+ ckey combination which launches the Windows Security dialog box. This button is set and cannot be configured by the user.
17	Status indicators	LEDs (light-emitting diode) that turn on and off to show the status of the computer, its functions and components.





Left Panel

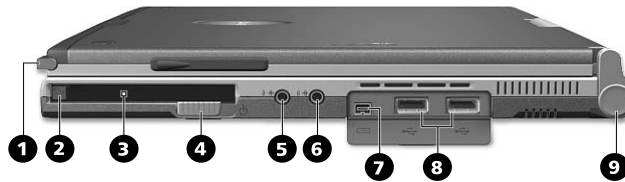

#	Item	Description
1	Screen Support	Supports the LCD screen, press and release before switching from PC mode to tablet mode and vice versa.
2	Power jack 	Connects to an AC adapter
3	Hard disk bay	Houses the computer's hard disk (secured by a screw).





Right Panel



#	Item	Description
1	EMR Stylus	Electromagnetic resonance (EMR) stylus that is used to input data in tablet mode. Use only an EMR-compatible stylus to input data on the screen.
2	PC Card eject button	Ejects the PC Card from the slot.
3	PC Card slot 	Accepts one Type II 16-bit PC Card or 32-bit CardBus PC Card.
4	Power switch	Turns on the computer power.
5	Speaker/Headphone-out jack 	Connects to audio line-out devices (e.g., speakers, headphones).
6	Line-in jack 	Accepts audio line-in devices (e.g., audio CD player, stereo walkman).
7	IEEE 1394 port 	Connects to IEEE 1394 devices.
8	USB ports (two) 	Connects to any Universal Serial Bus devices (e.g., USB mouse, USB camera).
9	Screen Support	Supports the LCD screen, press and release before switching from PC mode to tablet mode and vice versa.

Rear Panel



#	Item	Description
1	Security keylock	Connects to a Kensington-compatible computer security lock.
2	Port replicator 	Connects to the EasyPort port replicator for one-step connection and disconnection of external devices.
3	Modem jack 	Connects to a phone line.
4	Network jack 	Connects to an Ethernet 10/100-based network
5	External display port 	Connects to a display device (e.g., external monitor, LCD projector) and displays up to 16M colors at 1024x768 resolution.

Bottom Panel

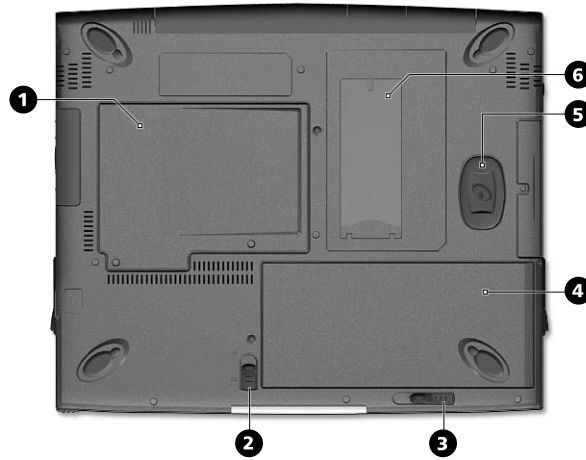







#	Item	Description
1	Memory compartment	Houses the computer's main memory.
2	Battery lock/unlock latch	Locks and unlocks the battery bay.
3	Battery release latch	Unlatches the battery to remove the battery pack.
4	Battery bay	Houses the computer's battery pack.
5	Hard disk anti-shock protection	Protects your hard disk against accidental shock and vibration.
6	Personal identification slot	Insert an identification card to personalize your computer.

Indicators

The computer has seven easy-to-read status icons on the right of the display screen.



The Power and Standby status icons are visible even when you close the display cover so you can see the status of the computer while the cover is closed.

Icon	Function	Description
	Num Lock	Lights when Num Lock is activated.
	Caps Lock	Lights when Caps Lock is activated.
	Battery Charge	Lights when the battery is being charged.
	Media Activity	Lights when the floppy drive, hard disk or optical drive is active.
	Sleep	Lights when the computer enters Sleep mode.
	Power	Lights when the computer is on.
	Wireless Communication	Lights when the Wireless LAN and/or Bluetooth feature is enabled.

Launch Keys

Located at the top of the keyboard are four launch keys used to launch frequently used applications

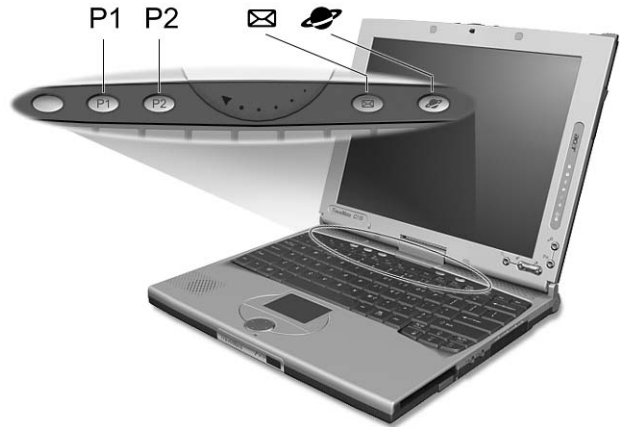

The Power and Standby status icons are visible even when you close the display cover so you can see the status of the computer while the cover is closed.

Function	Description
P1	This button is user-programmable.
P2	This button is user-programmable.
E-Mail	The mail button is used to launch the email application.
Web browser	By default, is used to launch your Internet browser.

Lock Keys

The keyboard has three lock keys which you can toggle on and off.



Lock Key	Description
Caps Lock	When Caps Lock is on, all alphabetic characters typed are in uppercase.
Num Lock (Fn-F11)	When Num Lock is on, the embedded keypad is in numeric mode. The keys function as a calculator (complete with the arithmetic operators +, -, *, and /). Use this mode when you need to do a lot of numeric data entry. A better solution would be to connect an external keypad.
Scroll Lock (Fn-F12)	When Scroll Lock is on, the screen moves one line up or down when you press the up or down arrow keys respectively. Scroll Lock does not work with some applications.

NOTE: To access the Num Lock and Scroll Lock functions, hold the Fn key down while pressing the F11 and F12 keys respectively.

Embedded Numeric Keypad

The embedded numeric keypad functions like a desktop numeric keypad. It is indicated by small characters located on the upper right corner of the keycaps. To simplify the keyboard legend, cursor-control key symbols are not printed on the keys.











Desired Access	Num Lock On	Num Lock Off
Number keys on embedded keypad	Type numbers in a normal manner.	
Cursor-control keys on embedded keypad	Hold SHIFT while using cursor-control keys.	Hold Fn while using cursor-control keys.
Main keyboard keys	Hold Fn while typing letters on embedded keypad.	Type the letters in a normal manner.

NOTE: If an external keyboard or keypad is connected to the computer, the Num Lock feature automatically shifts from the internal keyboard to the external keyboard or keypad.

Windows Keys

The keyboard has two keys that perform Windows-specific functions.



Key	Description
Windows logo key 	Start button. Combinations with this key perform shortcut functions. Below are a few examples:  + Tab (Activates next taskbar button)  + E (Explores My Computer)  + F (Finds Document)  + M (Minimizes All)  +  + M (Undoes Minimize All)  + R (Displays the Run...dialog box)
Application key 	Opens a context menu (same as a right-click).



Hot Keys

The computer employs hot keys or key combinations to access most of the computer's controls like screen contrast and brightness, volume output and the BIOS Utility.

To activate hot keys, press and hold the **Fn** key before pressing the other key in the hot key combination.



Hot Key	Icon	Function	Description
Fn-F1	?	Hot key help	Displays help on hot keys.
Fn-F2	⚙️	Setup	Accesses the notebook's configuration utility.
Fn-F3	🔋	Power Management Scheme Toggle	Switches the power management scheme used by the computer (function available if supported by operating system).
Fn-F4	Zz	Sleep	Puts the computer in Sleep mode.
Fn-F5	🖥️	Display toggle	Switches display output between the display screen, external monitor (if connected) and both the display screen and external monitor.
Fn-F6	🌑	Screen blank	Turns the display screen backlight off to save power. Press any key to return.
Fn-F7	🖱️	Touchpad toggle	Turns the internal touchpad on and off.
Fn-F8	🔊	Speaker toggle	Turns the speakers on and off.
Fn-⏮️	🔊	Volume up	Increases the speaker volume.
Fn-⏭️	🔊	Volume down	Decreases the speaker volume.
Fn-☀️	☀️	Brightness up	Increases the screen brightness.

Hot Key	Icon	Function	Description
Fn- 		Brightness down	Decreases the screen brightness.

Hardware Specifications and Configurations

Processor

Item	Specification
CPU type	Intel® ultra low voltage Pentium® M processor up to 900MHz CPU with on-die 1MB L2 cache
CPU package	uFC-BGA package
CPU core voltage	1.004V/0.844V
CPU I/O voltage	1.05V

BIOS

Item	Specification
BIOS vendor	Acer
BIOS Version	R01-A0x
BIOS ROM type	Flash ROM
BIOS ROM size	512KB
BIOS package	32-pin TSOP
Supported protocols	ACPI 1.0b/2.0, SMBIOS 2.3.1, IEEE 1394 1.0, IrDA V1.0, PCI 2.2, PnP BIOS 1.0a, Intel AC 97 CNR specification, USB specification 1.1/2.0, PC card standard 1995 (PCMCIA V3.0 compliant device), System/HDD password security, INT 13h extensions, USB/1394 CD-ROM Boot Up support, BIOS boot specification (Compal, Phoenix, Intel), Simple Boot Flag 1.0, Boot Block, PCI Bus Power Management interface specification, Preboot execution environment (PXE) 2.1, Boot Integrity Service Application Program interface (BIS) 1.0, PC99a and Mobile PC2001 compliant, Intel SpeedStep Technology
BIOS password control	Set by switch, see SW1 setting

Second Level Cache

Item	Specification
Cache controller	Built-in CPU
Cache size	1MB for Pentium-M
1st level cache control	Always enabled
2st level cache control	Always enabled
Cache scheme control	Fixed in write-back

System Memory

Item	Specification
Memory controller	Built-in Intel 885GM
Onboard memory size	0MB
DIMM socket number	2 sockets (2 banks)
Supports memory size per socket	128/256/512MB
Supports maximum memory size	512MB
Supports DIMM type	DDR SDRAM
Supports DIMM Speed	266 MHz
Supports DIMM voltage	2.5V
Supports DIMM package	200-pin soDIMM
Memory module combinations	You can install memory modules in any combinations as long as they match the above specifications.

Memory Combinations

Slot 1	Slot 2	Total Memory
64 MB	0 MB	64 MB
0 MB	64MB	64 MB
64 MB	64 MB	128 MB
128 MB	0 MB	128 MB
0 MB	128 MB	128 MB
128 MB	128 MB	256 MB
256 MB	0 MB	256 MB
0 MB	256 MB	256MB
256 MB	128 MB	384 MB
128 MB	256 MB	384 MB
256 MB	256 MB	512 MB
512 MB	0 MB	512 MB
0 MB	512 MB	512 MB
512 MB	128 MB	640 MB
128 MB	512 MB	640 MB
512 MB	256 MB	768 MB
256 MB	512 MB	768 MB
512 MB	512 MB	1 GB

Above table lists some system memory configurations. You may combine DIMMs with various capacities to form other combinations.

NOTE: The shipping specification for DIMM combination is 256/512MB in slot 1.

LAN Interface

Item	Specification
Chipset	Intel ICH4+PHY (Intel 82562)
Supports LAN protocol	10/100 Mbps
LAN connector type	RJ45
LAN connector location	Rear side

Wireless LAN Interface

Item	Specification	
Module	Ambit	Intel 2100
LAN interface	Mini PCI interface IEEE 802.11a/b LAN module	Mini PCI interface IEEE 802.11b LAN module
Channel support and default channel protocol	IEEE 802.11ba/b	IEEE 802.11b
Enable/disable radio	Support FAA requirement	

Modem Interface

Item	Specification	
Module	Ambit T60M283.10 MDC	Ambit T60M665.00
Fax modem data baud rate (bps)	14.4K	14.4K
Data modem data baud rate (bps)	56K	56K
Supports modem protocol	V.92 MDC	BLUETOOTH/MODEM COMBO MODULE MDC
Modem connector type	RJ11	RJ11
Modem connector location	Rear side	Rear side

Hard Disk Drive Interface

Item	Specification		
Vendor & Model Name	IBM Travelstar DJSA-210	IBM Travelstar DJSA-220	IBM Travelstar DJSA-230
Capacity	10G	20G	30G
Bytes per sector	512	512	512
Data heads	2	4	6
Recording zone	16	16	16
Drive Format			
Disks	1	2	3
Spindle speed (RPM)	4200 RPM	4200 RPM	4200 RPM
Performance Specifications			
Buffer size	384KB	1874KB	1874KB
Interface	ATA-5	ATA-5	ATA-5
Data transfer rate (buffer to/ from media, Mbytes/s)	109 ~ 203	109 ~ 203	109 ~ 203
Interface transfer rate (host~buffer, Mbytes/s)	66 MB/Sec. Ultra DMA mode 66	66 MB/Sec. Ultra DMA mode 66	66 MB/Sec. Ultra DMA mode 66
DC Power Requirements			
Voltage tolerance	5V(DC) +/- 5%	5V(DC) +/- 5%	5V(DC) +/- 5%

CD-ROM (6X) Interface

Item	Specification
Vendor & model Name	AOpen SC-924U
Performance specification	With CD Diskette
Transfer rate (KB/sec)	Sustained: Max 900KBytes/sec
Disc data capacity	12cm Disc: 540MBytes (Mode 1), 630MBytes (Mode 2) 8cm Disc: 180MBytes (Mode 1), 210MBytes (Mode 2)
Interface	USB1.1
Applicable disc format	CD-DA, CD-ROM (Mode 1 and Mode 2), CD-ROM/XA (Mode 2, Form 1 and Form 2), CD-Extra, CD-I, Video CD, Photo CD (Single and Multiple Sessions), I-Trax, CD-R, CD-RW
Operating system	Windows 98SE, Windows NT, Windows ME, Windows 2000, Windows XP
Power requirement	
Input voltage	5V(DC) +/- 5%

NOTE: The hardware specification of the external CD-ROM drive is 24X. However the actual performance is only 6X under USB 1.1.

Audio Interface

Item	Specification
Audio Controller	CS4299-XQ
Audio onboard or optional	Built-in
Mono or Stereo	Stereo
Resolution	20 bit stereo Digital to analog converter 18 bit stereo Analog to Ditial converter
Compatibility	Microsoft AC97 2.1
Mixed sound source	Line-out, Line-in/Microphone, CD, Video, AUX, Speaker
Voice channel	8/16-bit, mono/stereo
Sampling rate	44.1 KHz
Internal microphone	Yes
Internal speaker / Quantity	Yes

Video Interface

Item	Specification
Chip vendor	Intel
Chip name	855GM
Chip voltage	Core/2.5V Memory/2.5V
Supports ZV (Zoomed Video) port	No
Graph interface	PCI
Maximum resolution (LCD)	1600x1200 (32 bit colors)
Maximum resolution (CRT)	2048x1536 (16 bit colors)

Video Memory

Item	Specification
Fixed or upgradeable	Fixed
Video memory size	8 MB

Video Resolutions Mode (for both LCD and CRT)

Resolution	8 bits (256 colors)	16 bits (High color)	24 bits (True color)
640x480	Yes	Yes	Yes
720x480	Yes	Yes	Yes
800x600	Yes	Yes	Yes
848x480	Yes	Yes	Yes
1024x768	Yes	Yes	Yes
1280x1024 (CRT only)	Yes	Yes	Yes
2048x768 (CRT only)	Yes	Yes	No

USB Port

Item	Specification
USB Compliancy Level	1.1/2.0
UHCI	USB 1.1
OHCI	USB 2.0
Number of USB port	2
Location	Right side
Serial port function control	Not available

IrDA Port

Item	Specification
IrDA FIR port controller	NS 87392 (SIO)
Number of IrDA FIR port	1
Location	Front side
IrDA FIR port function control	Not Available
IrDA FIR port	2F8
IrDA FIR port IRQ	IRQ3
ECP DMA channel	DMA channel 3
Optional IrDA FIR port DRQ	Not available

PCMCIA Port

Item	Specification
PCMCIA controller	RICOH R5C551
Supports card type	Type-II
Number of slots	One type-II
Access location	Right side
Supports ZV (Zoomed Video) port	ZV support
Supports 32 bit CardBus	Yes (IRQ10)

System Board Major Chips

Item	Controller
System core logic	855-GM
Super I/O controller	ICH4-M
Audio controller	CS4299-XQ
Video controller	855-GM
Hard disk drive controller	ICH4-M
Keyboard controller	Mitsubishi M38857
RTC	ICH4-M

Keyboard

Item	Specification
Keyboard controller	Mitsubishi M38857
Keyboard vendor & model name	Darfon A5001 (84) / A500G (85) / A500J (88)
Total number of keypads	84/85/88-key
Windows 98 keys	Yes
Internal & external keyboard work simultaneously	Yes

Battery

Item	Specification
Vendor & model name	Sanyo 4UF103450P
Battery Type	Lithium Ion
Pack capacity	1800 mAh
Cell voltage	Over charge protection: Charge FET turns off if any cell voltage is 4.27V +/- 0.05V or over Over discharge protection: Discharge FET turns off when any cell voltage is less than 2.5V
Number of battery cell	4
Package configuration	1 row with 4 cells
Package voltage	14.8 V

DC-AC LCD Inverter

Item	Specification
Vendor & model name	Ambit T62I227.00
Input supply voltage (V)	LCDBATOUT 8.5V ~ 21V
Input signal voltage	Front Panel Back: 2.0 ~ 3.6V=ON, -0.3 ~ 0.8=OFF#
Output current (mA)	Min.: 0.6 +/- 0.6 (mA) Max.: 5.3 +/- 0.3 (mA)
Environmental Specifications	
Ambient operating temperature	0 ~ 50 degree C
Ambient operating humidity	10% ~ 90%
Storage temperature	-20 ~ 60 degree C
Storage humidity	10% ~ 90%

NOTE: DC-AC inverter is used to generate very high AC voltage, then support to LCD CCFT backlight user, and is also responsible for the control of LCD brightness. Avoid touching the DC-AC inverter area while the system unit is turned on.

NOTE: There is an EEPROM in the inverter, which stores its supported LCD type and ID code. If you replace a new inverter or replace the LCD with a different brand, use Inverter ID utility to update the ID information.

LCD

Item	Specification
Vendor & model name	Toshiba LTM10C321K
Mechanical Specifications	
LCD display area (diagonal, inch)	10.4
Display technology	TFT
Resolution	XGA (1024x768)
Supports colors	256K
Optical Specification	
Brightness control	keyboard hotkey
Contrast control	No
Recommended Operating Conditions	
Supply voltage for LCD display (V)	3.0 ~ 3.6 V
Fluorescent lamp driving voltage (Vrms)	540 ~ 640 V(rms)

Electronic Stylus

Item	Specification
Vendor	WACOM
Model number	MP-200-00
Maximum pressure	Tip switch: 1Kg or less Side switch: 300g or less
Weight	Approximately 8g
Environmental Specification	
Operating temperature	+5 ~ +40
Storage temperature	-10 ~ +60

Electronic Stylus

Item	Specification
Operating humidity	+20 ~ +80% (no condensation)
Storage humidity	+20 ~ +80% (no condensation)

Digitizer Unit

Item	Specification
Vendor	WACOM
Model number	SU-001-01
Supply voltage	-0.3 ~ +4.0 V
Input voltage of signals	-0.3 ~ Supply voltage +0.3 V
High level output current	-5 mA
Low level output current	-10 mA
Weight	Approximately 47.5g
Environmental Specification	
Operating ambient temperature	0 ~ +60
Storage temperature	-10 ~ +70
Operating ambient humidity	+20 ~ +80% (no condensation)
Storage humidity	+20 ~ +90% (no condensation)

AC/DC Adapter

Item	Specification
Vendor & model name	LITE-ON PA-1500-02
Input Requirements	
Maximum input current (A, @90Vac, full load)	The maximum input current shall be less than 1.5 Ampere at full (50W) load and 90Vac input voltage.
Nominal input frequency	50 ~ 60 Hz
Input frequency variation range	47 ~ 63 Hz
Nominal input voltages	100 ~ 240 Vac
Input voltage variation range	90 ~ 270 Vac
Inrush current	Input Voltage: 100Vac, Inrush Current: 50A maximum Input Voltage: 240Vac, Inrush Current: 100A maximum
Efficiency	The adapter efficiency shall be capable to meet the case temperature rising requirement, above 85% is needed.
Output Ratings (CV mode)	
DC output voltage	+20V ± 1.0V
Noise + Ripple	200mvp-pmax (20mHZ bandwidth)
Load	0 A (min.) 2.5 A (max.)
Output Ratings (CC mode)	
Constant output	3.0 ± 0.3 A
Dynamic Output Characteristics	
Turn-on delay time	3 sec.
Hold up time	8 ms
Over Voltage Protection (OVP)	Trip point 24V (max.)
Short circuit protection	Shall be capable of withstanding a continuous short-circuit to DC output without damage or overstress to the component, PCB traces and connector under the AC input conditions specified above.

AC/DC Adapter

Item	Specification
Electrostatic discharge (ESD)	+/-4KV (at air discharge, no allowed errors.) +/-8KV (at air discharge, restart & damage errors are not allowed) +/-15KV (at air discharge, restart & damage errors are not allowed) +/-4KV (at contact discharge, no allowed errors.) +/-6KV (at contact discharge, restart & damage errors are not allowed) +/-8KV (at contact discharge, restart & damage errors are not allowed)
Dielectric Withstand Voltage	
Primary to secondary	The adapter shall withstand for 1 minute without breakdown the application of a 60Hz 3000Vac supply voltage applied between both input line and output (10mA DC cut-off current).
Leakage current	0.25 mA max. (@ 254 Vac, 60Hz)
Regulatory requirements	Shall meet: 1. FCC CFR47 Part 15 class B requirements. (USA) 2. VFG 243 class B requirements. (Germany) 3. CISPR 22 Class B requirements. (Scandinavia) 4. VCCI class II requirements. (Japan)

Power Management

Power Saving Mode	Phenomenon
Standby Mode Waiting time specified by the System Standby value or the operating system elapses without any system activity. Or When the computer is about to enter Hibernation mode (e.g., during a battery-low condition), but the Hibernation file is invalid or not present.	<input type="checkbox"/> The Sleep indicator lights up
Hibernation Mode When customized functions for power management are set to Hibernation and the corresponding action is taken.	<input type="checkbox"/> All power shuts off
Display Standby Mode Keyboard, built-in touchpad, and an external PS/2 pointing device are idle for a specified period.	<input type="checkbox"/> The display shuts off
Hard Disk Standby Mode Hard disk is idle within a specified period of time.	<input type="checkbox"/> Hard disk drive is in standby mode. (spindle turned-off)

Environmental Requirements

Item	Specification
Temperature	
Operating	+5 ~ +35 °C
Non-operating	-10 ~ +60 °C
Non-operating	-20 ~ +60 °C (storage package)
Humidity	
Operating	20% to 80% RH, non-condensing
Non-operating	20% to 90% RH, non-condensing (unpacked)

Environmental Requirements

Item	Specification
Non-operating	20% to 90% RH, non-condensing (storage package)
Vibration	
Operating (unpacked)	5 ~ 25.6Hz: 0.38mm (peak to peak) 25.6 ~ 250Hz: 0.5G
Non-operating (unpacked)	5 ~ 27.1Hz: 0.6G 27.1Hz ~ 50Hz: 0.4mm (peak to peak) 50 ~ 500Hz: 2.0G
Non-operating (packed)	5 ~ 62.6Hz: 0.51mm (peak to peak) 62.6 ~ 500Hz: 4G

Mechanical Specification

Item	Specification
Dimensions	257 (W) x 216 (D) x 29.7 (H)
Weight	3.2 lbs with 10.4" XGA LCD
I/O Ports	1 type II CardBus socket, 1 RJ-11 modem port, 1 RJ-45 LAN port, 1 DC-in jack (AC adapter), 1 FIR port, 1 external monitor port, 2 USB ports, 1 audio line-out/headphone-out jack, 1 audio line-in/microphone-in jack
Drive Bays	None
Material	Housing: MCS-050 Panel : Plastic
Indicators	Num Lock, Caps Lock, Battery Charge, Media Activity, Sleep LED, Power LED, Wireless Communication
Switch	Power

Memory Address Map

Memory Address	Size	Function
00100000h-000F0000h	64 KB	System BIOS
000F0000h-000E0000h	64 KB	UMB Area
000E0000h-000C0000h	128 KB	VGA BIOS
000C0000h-000A0000h	128 KB	Video memory (VRAM)
000A0000h-00000000h	640 KB	Conventional memory

I/O Address Map

I/O Address	Function
0000-000F	Direct memory access controller
0000-0CF7	PCI bus
0020-0021	Programmable interrupt controller
0040-0043	System timer
0060-0060	Standard 101/102-key or Microsoft natural PS/2 keyboard
0061-0061	System speaker
0062-0062	Microsoft ACPI-compliant embedded controller
0064-0064	Standard 101/102-key or Microsoft natural PS/2 keyboard
0066-0066	Microsoft ACPI-compliant embedded controller
0070-0073	System CMOS/real time clock
0080-0080	Motherboard resources
0081-008F	Direct memory access controller

I/O Address Map

I/O Address	Function
0092-0092	Motherboard resources
00A0-00A1	Programmable interrupt controller
00B0-00B3	Motherboard resources
00C0-00DF	Direct memory access controller
00F0-00FF	Numeric data processor
01F0-01F7	Primary IDE channel
0274-0277	ISAPNP Read Data Port
0279-0279	ISAPNP Read Data Port
02C8-02CF	Motherboard resources
02F8-02FF	Acer Laptop Fast Infrared port
03B0-03BB	Silicon Motion Lynx3DM
03C0-03DF	Silicon Motion Lynx3DM
03F6-03F6	Primary IDE channel
03F8-03FF	Wacom Serial Pen HID Tablet
0460-0463	Tablet PC Buttons
04D0-04D1	Motherboard resources
0A79-0A79	ISAPNP Read Data Port
0D00-FFFF	PCI bus
7000-70FF	Avance AC'97 Audio for Intel (R) Audio Controller
7400-743F	Avance AC'97 Audio for Intel (R) Audio Controller
7800-78FF	Lucent Technologies Soft Modem AMR
7C00-7C7F	Lucent Technologies Soft Modem AMR
8000-80FF	Realtek RTL 8139 Family PCI Fast Ethernet NIC
8400-841F	Intel (R) 82440MX USB Universal Host Controller
8440-844F	Intel (R) 82440MX Bus Master IDE Controller
F000-F03F	Motherboard resources
F100-F10F	Motherboard resources
FB00-FBFE	O2 Micro Smart Card Bus Reader
FC00-FCFF	O2 Micro Card Bus Controller
FD00-FDFF	O2 Micro Card Bus Controller
FE00-FEFF	O2 Micro Card Bus Controller
FF00-FFFF	O2 Micro Card Bus Controller

IRQ Assignment Map

Interrupt Channel	Function
IRQ0	System timer
IRQ1	Keyboard
IRQ2	Cascade
IRQ3	FIR (Serial port)
IRQ4	Reserved for Serial port 2
IRQ5	Reserved for PCMCIA R2 card
IRQ6	COM1 (Serial port) for Digitizer
IRQ7	LPT (Parallel port)
IRQ8	CMOS/RTC
IRQ9	SCI IRQ used by ACPI bus
IRQ10	SMBus (PIRQB#), Audio (PIRQB#), Modem (PIRQB#), LAN (PIRQE#), CardBus (PIRQE#), IEEE1394 (PIRQF#),
IRQ11	USB1.1 (PIRQA#, PIRQC#, PIRQD#), VGA (PIRQA#), USB2.0 (PIRQH#), MiniPCI (PIRQG#)
IRQ12	PS/2 device
IRQ13	Math processor
IRQ14	IDE primary channel
IRQ15	None

DMA Channel Assignment

DMA Channel	Function
DRQ0	Reserved
DRQ1	Reserved
DRQ2	Reserved
DRQ3	IrDA FIR controller (DMA:1,3)
DRQ4	DMA controller
DRQ5	Reserved
DRQ6	Reserved
DRQ7	Reserved

System Utilities

BIOS Setup Utility

The BIOS Setup Utility is a hardware configuration program built into your computer's BIOS (Basic Input/Output System).

Your computer is already properly configured and optimized, and you do not need to run this utility. However, if you encounter configuration problems, you may need to run Setup. Please also refer to Chapter 4 Troubleshooting when problem arises.

To activate the BIOS Utility, press **F2** during POST (while the TravelMate logo is being displayed).

PhoenixBIOS Setup Utility	
Information	Main Advanced Security Boot Exit
CPU Type	Intel(R) Pentium(R) M processor 900MHz
System Memory	640 KB
Extended Memory	XXXXXX KB
HDD1 Serial Number	XXXXXX
System BIOS Version	R01-XXX
VGA BIOS Version	XXXX
KBC Version:	02.13.29
Serial Number	12345678901234567
Asset Tag Number	
Product Name	TravelMate C110
Manufacture Name	Acer
UUID Number	c9862ee0-11df-11d6-b30b-dbbbf201d3f
F1 Help ↑ / ↓ Select Item F5/F6 Change Values F9 Setup Defaults Esc Exit ← / → Select Menu Enter Select >Sub Menu F10 Save and Exit	

Navigating the BIOS Utility

There are six menu options: System Information, Basic System Settings, Startup Configuration, System Security and Loading Default Settings.

To enter a menu, highlight the item using the **↑** / **↓** keys, then press **ENTER**.

Within a menu, navigate through the BIOS Utility by following these instructions:

- Press the **↑** / **↓** keys to move between the parameters.
- Press the **←** / **→** keys to change the value of a parameter.
- Press the **Esc** key while you are in any of the menu options to return to the main menu.

NOTE: You can change the value of a parameter if it is enclosed in square brackets. Navigation keys are shown at the bottom of the screen.

System Information

The System Information screen displays a summary of your computer hardware information.

PhoenixBIOS Setup Utility	
Information	Main Advanced Security Boot Exit
CPU Type	Intel(R) Pentium(R) M processor 900MHz
System Memory	640 KB
Extended Memory	XXXXXX KB
HDD1 Serial Number	XXXXXX
System BIOS Version	R01-XXX
VGA BIOS Version	XXXX
KBC Version:	02.13.29
Serial Number	12345678901234567
Asset Tag Number	
Product Name	TravelMate C110
Manufacture Name	Acer
UUID Number	c9862ee0-11df-11d6-b30b-dbbbf201d3f
F1 Help ↑↓ Select Item F5/F6 Change Values F9 Setup Defaults Esc Exit ←→ Select Menu Enter Select >Sub Menu F10 Save and Exit	

NOTE: The screen above is a sample and may not reflect the actual data on your computer.

The following table describes the information in this screen.

Parameter	Description
CPU Type	Display the type and speed of CPU .
System Memory	Display the current system memory.
Extended Memory	Display the current extended memory
HDD1 Serial Number	Display the primary master HDD serial number. If no primary master HDD, show 'None'.
System BIOS Version	The current system BIOS version
VGA BIOS Version	The current VGA BIOS version. It is got from VGA BIOS AX=5F01.
KBC Version	The current KBC version.
Serial Number	Display the serial number of the computer. (30 characters)
Asset Tag Number	Display the asset tag number of the computer. (32 characters)
Product Name	Display the Product Name. (15 characters)
Manufacturer Name	Display the manufacturer Name (15 characters)
UUID	Display the universally unique identifier of your computer. (16 Byte Hex digital)

The items in this screen are important and vital information about your computer. If you experience computer problems and need to contact technical support, this data helps our service personnel know more about your computer.

Main System Settings

The Main System Settings screen allows you to set the system date and time.

PhoenixBIOS Setup Utility			
Information	Main	Advanced Security Power Boot Exit	
System Time:	[12:00:00]	Item Specific Help	
System Date:	[01/01/2002]		
Boot Display	[Auto]	<Tab>, <Shift-Tab>, or <Enter>selects field	
Screen Expansion	[Enabled]		
QuickBoot Mode	[Enabled]		
Startup Screen	[Enabled]		
Boot on LAN	[Disabled]		
Hotkey Beep	[Enabled]		
Auto Dim	[Enabled]		
F12 Multi-Boot	[Enabled]		
F1 Help ↑↓ Select Item F5/F6 Change Values F9 Setup Defaults Esc Exit ←→ Select Menu Enter Select > Sub Menu F10 Save and Exit			

The following table describes the parameters in this screen

Parameter	Description
System Time	Sets the system time Format: HH:MM:SS (Hour : Minute : Second) <i>Help:</i> <Tab>, <Shft-Tab>, or <Enter> selects field.
System Date	Sets the system date. Format: MM/DD/YYYY (Month/Day/Year) <i>Help:</i> <Tab>, <Shift>, or <Enter> selects field.
Boot Display	Set the display output device on boot up. <i>Help:</i> Set the display output device on boot up. When set to Auto, the computer automatically determines the display device. If an external display device (e.g., monitor) is connected, it becomes the boot display. When set to Both, the computer outputs to both the LCD and the external display if one is connected. Option: Both or Auto
Screen Expansion	Options: Enable or Disable. <i>Help:</i> Options: Enable or Disable.
QuickBoot Mode	Options: Enable or Disable <i>Help:</i> Allow the system to skip certain tests while booting. This will decrease the time needed to boot the system.

Parameter	Description
Startup Screen	Display OEM logo picture screen during boot up. Options: Enable or Disable <i>Help:</i> Enable to show the graphic picture screen on boot up.
Boot on LAN	Options: Enable or Disable . <i>Help:</i> When set to enabled, system will boot on LAN. Notice: Need to restart system for enabling Boot-on-LAN function.
Hotkey Beep	Options: Enable or Disable <i>Help:</i> Enable or Disable Hotkey Beep.
Auto Dim	Options: Enable or Disable <i>Help:</i> The system will support an automatic dimming of the LCD backlight when the AC power source is NOT available (running on battery power).
F12 Multi-Boot	Options: Enable or Disable <i>Help:</i> Users could choose if to display "Fn-F12 for multi-boot" message during post.

Advanced System Settings

The Startup Configuration screen contains parameter values that define how your computer behaves on system startup.

PhoenixBIOS Setup Utility	
Information Main Advanced Security Power Boot Exit	
>IDE Primary Master [HITACHI_DK23EA-60]	Item Specific Help
>I/O Device Configuration	IDE Primary Master Drive.
Legacy USB Support [Enabled]	
Boot From Hard disk Recovery [Disabled]	
Default Wireless Device [Disabled]	
F1 Help ↑↓ Select Item F5/F6 Change Values F9 Setup Defaults Esc Exit ←→ Select Menu Enter Select >Sub Menu F10 Save and Exit	

The following table describes the parameters in this screen. Settings in **boldface** are the default and suggested parameter settings.

Parameter	Description	Options
IDE Primary Master	Show IDE Primary Master drive. User can enter submenu to set some detail functions	Auto
I/O Device Configuration	Enter submenu to set onboard device configuration <i>Help: Pheripheral Configuration.</i>	
Legacy USB Support	Set Enabled or Disabled support for Legacy USB Keyboards and Mice. <i>Help: Enable support for Legacy USB.</i>	Enabled or Disabled
Boot From Hard Disk Recovery	<i>Help: Enable support for D2D Recovery in Boot Sequence.</i>	Disabled or Enabled
Default Wireless Device	Select default wireless device when system boots up. User may select preferred device as default wireless device, or disable all wireless device to prevent unnecessary RF signals. For the model without Wireless LAN or Bluetooth, the corresponding item should be invisible. If both wireless devices are not equipped, the option should be invisible. <i>Help: Select default wireless device when system boots up.</i>	Disabled Wireless LAN Bluetooth Both

IDE Primary Master

The IDE Primary Master sub-menu contains parameters related to the primary hard disk.

CAUTION: The parameters in this screen are for the advanced users only. Typically, you do not need to change the values in this screen. The default setting of **Auto** optimizes all the settings for your hard disk.

PhoenixBIOS Setup Utility	
Advanced	
Primary Master [HITACHI_DK23EA-60-(PM)]	Item Specific Help
Type: [Auto] LBA Format	User = you enter parameters of hard-disk drive installed at this connection. Auto = Autotype Hard-Disk Drive installed here.
Total Sectors: 117210240 Maximum Capacity: 60012MB	
Multi-Sector Transfers: [16 Sectors]	
LBA Mode Control: [Enabled]	
32 Bit I/O: [Disabled]	
Transfer Mode: [FPIO 4 / DMA 2]	
Ultra DMA Mode: [Mode 5]	
F1 Help ↑↓ Select Item F5/F6 Change Values F9 Setup Defaults Esc Exit ←→ Select Menu Enter Select >Sub Menu F10 Save and Exit	

I/O Device Configuration

The parameters in this screen are for advanced users only. You do not need to change the values in this screen because these values are already optimized.

The I/O Device Configuration screen assigns resources to basic computer communication hardware.

PhoenixBIOS Setup Utility		
Advanced		
I/O Device Configuration		Item Specific Help
Serial port:	[Enabled]	Configure serial port using options:
Mode:	[FIR]	[Disabled]
Base I/O Address:	[2F8]	No configuration
Interrupt:	[IRQ4]	[Enabled]
DMA channel:	[DMA3]	User Configuration
Parallel port:	[Enabled]	[Auto]
Mode:	[Bi-directional]	BIOS or OS chooses configuration
Base I/O address:	[378]	(OS Controlled)
Interrupt:	[IRQ7]	Displayed when Controlled by OS
F1 Help ↑↓ Select Item F5/F6 Change Values F9 Setup Defaults Esc Exit ←→ Select Menu Enter Select > Sub Menu F10 Save and Exit		

NOTE: When the device is disabled, all the sub-items will be showed as [--].

The following table describes the parameters in this screen. Settings in boldface are the default and suggested parameter settings.

Parameter	Description	Options
Serial Port A	Enables or disables the serial port. The serial port is a PnP device. Enabled/Disabled setting won't affect the setting of the serial port in device manager of Windows. When enabled, you can set the base I/O address and interrupt request (IRQ) of the serial port. <i>Help:</i> [Enabled] : User configuration [Disabled] : No configuration [Auto] : BIOS or OS chooses configuration	Enabled , Disabled or Auto
Mode	Sets operation mode of the serial port. Only set the serial port operation mode in BIOS Setup. <i>Help:</i> Set the mode for the serial port using	FIR or COM Port
Base I/O Address	Sets the I/O address of the com operation. <i>Help:</i> Set the base I/O address for serial port.	3F8, 2F8 , 3E8 or 2E8

Parameter	Description	Options
Interrupt	Sets the IRQ of the Com operation. <i>Help:</i> Set the base I/O address for serial port A.	IRQ3 , IRQ4
DMA Channel	Sets a DMA channel for the printer to operate in ECP mode. This parameter is enabled only if operation mode is set to ECP. <i>Help:</i> Set the DMA channel for the parallel port.	DMA1 or DMA3
Parallel Port	Enables or disable the parallel port. The parallel port is a PnP device. Enabled/Disabled setting won't affect the Windows Device Manager setting of the parallel port. Sets operation mode of the parallel port. Only set the parallel post operation mode in BIOS setup. If set to be ECP mode, the Windows will assume the parallel port as the ECP port. If operation mode is set to Base I/O address, sets the base I/O address, of the parallel port. If operation mode is set to interrupt, sets the interrupt request of the parallel port. If operation mode is set to ECP DMA Channel, sets the direct memory access (DMA) channel for the printer to operate in ECP mode. This parameter is enabled only if operation mode is set to ECP. <i>Help:</i> Set the mode for the parallel port using	Enabled , Disabled or Auto
Mode	Sets speration mode of the parallel port. Only set the parallel post operation mode in BIOS Setup. If set to be ECP mode, the Windows will assume the parallel port as the ECP port. <i>Help:</i> Set the mode for the parallel port using	Bi-directional , EPP, ECP
Base I/O address	Sets the base I/O address of the parallel port. <i>Help:</i> Set the base I/O address for the parallel port.	378 , 278, or 3BC
Interrupt	Sets the interrupt request of the parallel port. <i>Help:</i> Set the interrupt request for the parallel port.	IRQ5 or IRQ7

System Security

The System Security screen contains parameters that help safeguard and protect your computer from unauthorized use.



PhoenixBIOS Setup Utility	
Information	Main Advanced Security Boot Exit
Set Supervisor Password [Enter]	Item Specific Help Supervisor password controls the access to the whole setup utility. It can be used to boot up when Password on boot is enabled.
Set User Password [Enter]	
Password on boot [Enter]	
Set Primary Hard Disk Password [Enter]	
F1 Help ↑↓ Select Item F5/F6 Change Values F9 Setup Defaults Esc Exit ←→ Select Menu Enter Select >Sub Menu F10 Save and Exit	

The following table describes the parameters in this screen. Settings in **boldface** are the default and suggested parameter settings.



Parameter	Description	Options
Set Supervisor Password	While entering SETUP, BIOS need to request user to enter supervisor password if set. This password protects the BIOS SETUP menu from unauthorized modification. <i>Help:</i> Supervisor Password controls the access of the whole setup utility. It can be used to boot up when Password on boot is enabled.	Enter or Present
Set User Password	During POST, BIOS need to check user password if set. This password protects the system from unallowable user entry before OS boots up. <i>Help:</i> User Password controls the access of the whole setup utility. It can be used to boot up when Password on boot is enabled.	Enter or Present
Password on boot	During POST, BIOS need to check power on password if set. This password protects the computer from unauthorized entry during boot-up. <i>Help:</i> Enable password entry on boot up.	Enabled or Disabled
Set Primary Hard Disk Password	During POST, BIOS need to check power on password if set. This password protects the interanl hard disk to prevent from any unauthorized access. When there is no hard disk existence, this item should be hidden. If S/W Jumper: Hide HDD Password is Enabled, this item should be hidden. <i>Help:</i> Input HDD Password to prevent from any unauthorized access.	Enter or Present

Setting a Password

Follow these steps:



1. Use the cursor / keys to highlight a Password parameter (Setup, Power-on or Hard Disk) and press the  key. The password box appears:
2. Type a password. The password may consist of up to eight characters (A-Z, a-z, 0-9).

IMPORTANT: Be very careful when typing your password because the characters do not appear on the screen.

3. Press . Retype the password to verify your first entry and press .
4. After setting the password, the computer automatically sets the chosen password parameter to Present.

Removing a Password

Should you want to remove a password, do the following:

1. Use the cursor up/ down keys to highlight a password parameter (Setup, Power-on or Hard Disk) and press the  key. The password box appears.
2. Enter the current password and press .
3. Press Enter twice without entering anything in the new field and confirm password fields to remove the existing password.

NOTE: When you want to remove the Hard Disk (or 2nd Hard Disk) password, you are prompted for the current Hard Disk password before it is removed.

Changing a Password

To change a password, follow these steps:

- Remove the current password. See "Removing a Password" on page 40.
- Set a new password. See "Setting a Password" on page 44.

Boot Options

Users can press F12 during POST to enter the Boot Options Menu. In this menu users can change boot device without entering BIOS SETUP utility.

PhoenixBIOS Setup Utility	
Information Main Advanced Security Boot Exit	
Removable Devices	Item Specific Help
+Hard Drive	Keys used to view or configure devices: <Enter> expands or collapses devices with a + or -. <F6> and <F5> moves the device up or down.
CD-ROM Drive	
!D2D Recovery	
F1 Help ↑↓ Select Item F5/F6 Change Values F9 Setup Defaults Esc Exit ←→ Select Menu Enter Select >Sub Menu F10 Save and Exit	

NOTE: There are four priorities that can let the user to specify the boot device sequence.

The priority of options from top to down is 1st, 2nd, 3rd, 4th.

If the Removable Device or Hard Drive option has multi devices, show '+' in front of option and show each device information.

If secondary Hard Disk exists, user can also choose it to Boot. If secondary hard Disk is nonexistence, hide the secondary Hard Disk option.

Exit Setup

This menu contains exit options.

PhoenixBIOS Setup Utility	
Information Main Advanced Security Boot Exit	
Exit Saving Changes Exit Discarding Changes Load Setup Defaults Discard Changes Save Changes	Item Specific Help
	Exit System Setup and save your changes to CMOS.
F1 Help ↑↓ Select Item F5/F6 Change Values F9 Setup Defaults Esc Exit ←→ Select Menu Enter Select >Sub Menu F10 Save and Exit	

The following table describes the parameters in this screen. Setting in **boldface** are the defaults and suggested parameter settings.

Parameter	Description
Exit Saving Changes	Save any changes, and exit BIOS setup. <i>Help:</i> Exit System Setup and save your changes to CMOS.
Exit Discarding Changes	Discard any changes, and exit BIOS setup. <i>Help:</i> Exit utility without saving Setup data to CMOS.
Load Setup Defaults	Load Setup Defaults. <i>Help:</i> Load default values for all SETUP items.
Discard Changes	Discard any changes. <i>Help:</i> Load previous value from CMOS for all SETUP items.
Save Changes	Save changes. <i>Help:</i> Save Setup data to CMOS.

Multi-Boot Menu

Users can press F12 during POST to enter the Multi Boot Selection Menu. In this menu users can change boot device without entering BIOS SETUP utility.

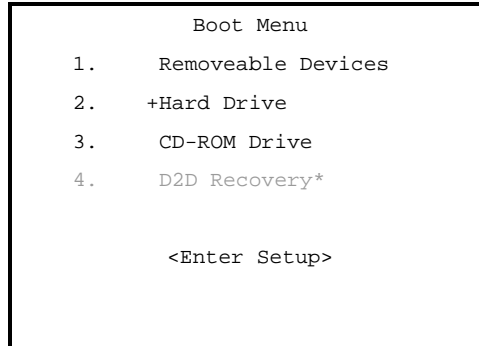



NOTE: * If D2D Recovery function is not available, then this item will be disappeared

NOTE: ** If users disable the “Boot from LAN” option in BIOS SETUP utility, then this item will be disappeared.

Setting a Password



Follow these steps:

1. Use the cursor up/down keys to highlight a Password parameter (Setup, Power-on, Hard Disk, or Resume) and press the  /  key. The password box appears:



2. Type a password. The password may consist of up to eight characters (A-Z, a-z, 0-9).

IMPORTANT: Be very careful when typing your password because the characters do not appear on the screen.

3. Press . Retype the password to verify your first entry and press .
4. After setting the password, the computer automatically sets the chosen password parameter to Present.

Four password types protect your computer from unauthorized access. Setting these passwords creates several different levels of protection for your computer and data:

- Setup Password prevents unauthorized entry to the BIOS Utility. Once set, you must key-in this password to gain access to the BIOS Utility.
- Power-On Password secures your computer against unauthorized use. Combine the use of this password with password checkpoints on boot-up and resume from hibernation for maximum security.
- Hard Disk Password protects your data by preventing unauthorized access to your hard disk. Even if the hard disk is removed from the computer and moved to another computer, it cannot be accessed without the Hard Disk Password.

When a password is set, a password prompt appears on the left-hand corner of the display screen.



1. When the Setup Password is set, the following prompt appears when you press  to enter the BIOS Utility at boot-up.

Setup Password

Type the Setup Password and press  to access the BIOS Utility.



2. When the Power On Password is set, the following prompt appears at boot-up.



Type the Power On Password (a symbol appears for each character you type) and press  to use the computer. If you enter the password incorrectly, an **x** symbol appears. Try again and press .

3. When the Hard Disk Password is set, the following prompt appears at boot-up.



Type the Hard Disk Password (a symbol appears for each character you type) and press  to use the computer. If you enter the password incorrectly, an **x** symbol appears. Try again and press .

You have three chances to enter a password. If you successfully entered the password, the system starts Windows.

If you fail to enter the password correctly after three tries, the system hangs.

To change a password, follow the same steps used to set a password.

To remove a password, follow the same steps used to set a password, except type nothing in the password boxes.

Load Default Settings

If you want to restore all parameter settings to their default values, select this menu item and press **ENTER**. The following dialog box displays.

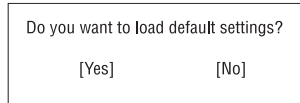

Do you want to load default settings?

[Yes] [No]

If you would like to load default settings for all parameters, use the cursor **←** / **→** keys to select **Yes**; then press **ENTER**. Choose **No** if otherwise.

BIOS Flash Utility

The BIOS flash memory update is required for the following conditions:

- New versions of system programs
- New features or options

Use the IFlash utility to update the system BIOS flash ROM.

NOTE: Do not install memory-related drivers (XMS, EMS, DPMI) when you use IFlash.

NOTE: This program contains a readme.txt file. This readme.txt file will introduce on how to use IFlash utility.

System Utility Diskette

This utility diskette is for the Acer TravelMate C110 notebook machine. You can find the utility in Service CD kit. It provides the following functions :

1. Panel ID Utility
2. Thermal Utility
3. Mother Board Data Utility

To use this diskette, first boot from this diskette, then a "Microsoft Windows ME Startup Menu" prompt you to choose the testing item. Follow the instructions on screen to proceed.

NOTE: This program contains a readme.txt file. This readme.txt file will introduce each test utility and its functions.

System Diagnostic Diskette

IMPORTANT: ¹The diagnostics program here that we used is called PQA (Product Quality Assurance) and is provided by Acer Headquarters. You can utilize it as a basic diagnostic tool. To get this program, either download it from <http://csd.acer.com.tw> or find it in the TravelMate C110 service CD kit. To better fit local service requirements, your regional office MAY have other diagnostic program. Please contact your regional offices or the responsible personnel/channel to provide you with further technical details.

NOTE: This program contains a readme.txt file. This readme.txt file will introduce each test and its functions.

¹ New added description. Please pay attention to it.

Running PQA Diagnostics Program

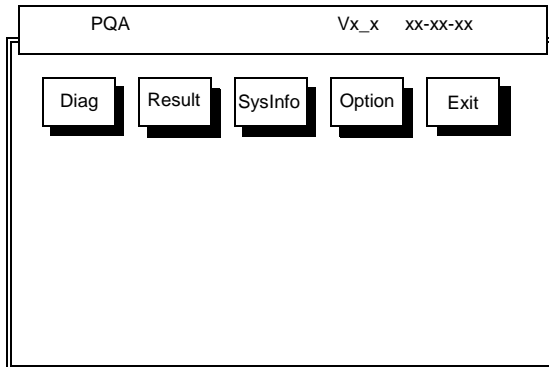

Press **←** / **→** to move around the main menu. Press **ENTER** to enable the selected option. The main options are Diag, Result, SysInfo, Option and Exit.

The Diag option lets you select testing items and times.

The following screen appears when you select Diag from the main menu.

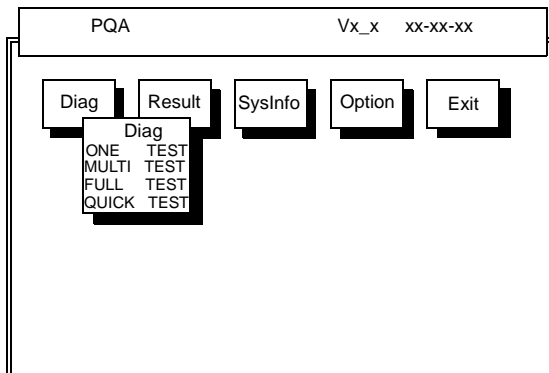

One Test performs a single test and Manual checks the selected test items in sequence.

Multi Test performs multiple tests of the selected items and check the selected test items in sequence.

Full Test performs all test items in detail for your system.

Quick Test performs all test items quickly for your system.

The screen below appears if you select Multi Test.

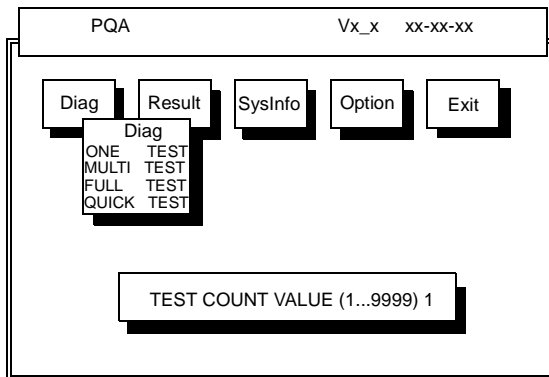

Specify the desired number of tests and press **ENTER**.

After you specify the number of tests to perform, the screen shows a list of test items (see below).

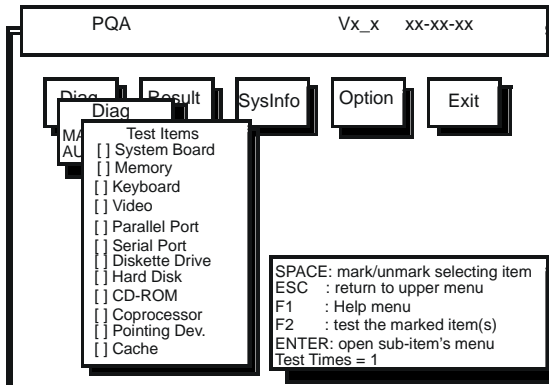

Move the highlight bar from one item to another. Press Space to enable or disable the item. Press **ENTER** to view the available options of each selected item. Press **ESC** to close the submenu.

The right corner screen information gives you the available function keys and the specified test number.

- Space: Enables/disables the item
- ESC: Exits the program
- F1: Help
- F2: Tests the selected item(s)
- Enter: Opens the available options
- Test Times: Indicates the number of tests to perform.

NOTE: The F1 and F2 keys function only after you finish configuring the Test option.

NOTE: When any errors are detected by diagnostic program, refer to "Index of PQA Diagnostic Error Code" for troubleshooting.

Machine Disassembly and Replacement

This chapter contains step-by-step procedures on how to disassemble the notebook computer for maintenance and troubleshooting.

To disassemble the computer, you need the following tools:

- Wrist grounding strap and conductive mat for preventing electrostatic discharge
- Flat-bladed screw driver
- Phillips screw driver
- Tweezers
- Flat-bladed screw driver or plastic stick

NOTE: The screws for the different components vary in size. During the disassembly process, group the screws with the corresponding components to avoid mismatch when putting back the components.

General Information

Before You Begin

Before proceeding with the disassembly procedure, make sure that you do the following:

1. Turn off the power to the system and all peripherals.
2. Unplug the AC adapter and all power and signal cables from the system.
3. Remove the battery pack.

Disassembly Procedure Flowchart

The flowchart on the succeeding page gives you a graphic representation on the entire disassembly sequence and instructs you on the components that need to be removed during servicing. For example, if you want to remove the system board, you must first remove the keyboard, then disassemble the inside assembly frame in that order.

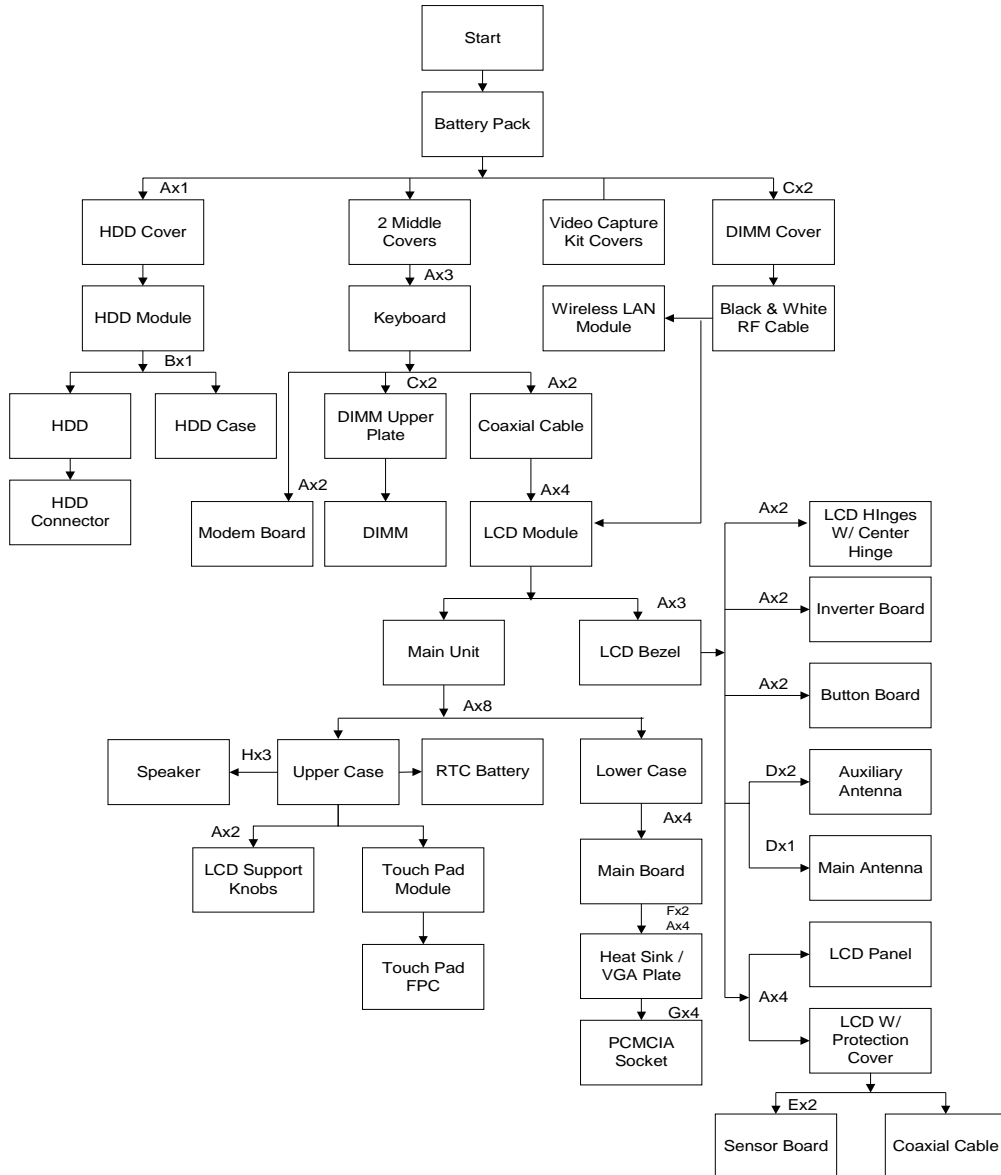

Screw List

Item	Description
A	Screw M2.5 X L6 (Black)
B	Screw M3 X L4 (Silver)
C	Screw M2 X L4 ((Black)
D	Screw M2 X L4 (Silver)
E	Screw M2 X L4.5 (Golden)
F	Hex Screw (Silver)
G	Screw M2 X L4 (Black)
H	Screw M2 X L2 (Silver)

Removing the Battery Pack

1. Push the battery lock latch forward to unlock the battery.
2. Push the battery release latch to release the battery.
3. Remove the battery.



Removing the Wireless LAN Module

1. See "Removing the Battery Pack" on page 53
2. First remove the two screws as shown here, and then lift the DIMM cover up.



3. Detach the gray and black RF cables from the wireless LAN module.



4. Push the two latches on both sides of the socket to release the wireless LAN module. Remove the wireless LAN module..



Removing the Hard Disk Drive Module

1. See “Removing the Battery Pack” on page 53
2. Remove the screw of the HDD cover, then remove the HDD cover.
3. Pull and slide out the HDD module from its bay.



Disassembling the Hard Disk Drive Module

1. See “Removing the Battery Pack” on page 53
2. See “Removing the Hard Disk Drive Module” on page 55
3. Remove the one silver screw, and then detach the HDD module out from the HDD case. Detach the HDD connector from the HDD.



Disassembling the Main Unit

Removing the Middle Covers

1. See “Removing the Battery Pack” on page 53
2. First, push outward the middle cover as shown here, and then detach the other middle cover on the rear of the unit.

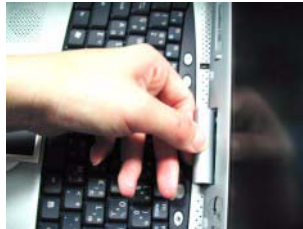

Removing the Keyboard

1. See “Removing the Battery Pack” on page 53
2. See “Removing the Middle Covers” on page 56
3. Remove the three screws, lift the keyboard upward, and then put it on the upper case as shown here.



4. Disconnect the keyboard cable from the main board by using a plastic flat screwdriver and remove the keyboard.

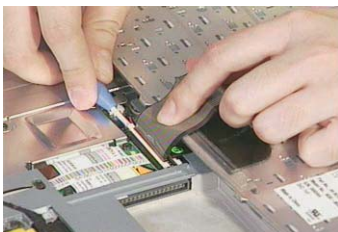

Removing the DIMM Upper Plate

1. See “Removing the Battery Pack” on page 53
2. See “Removing the Middle Covers” on page 56
3. See “” on page 56
4. Remove the two screws, and then detach the DIMM upper plate from the heat sink plate.

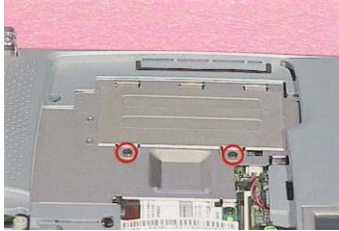

Removing the Internal Memory Module

1. See “Removing the Battery Pack” on page 53
2. See “Removing the Middle Covers” on page 56
3. See “” on page 56
4. See “Separating the Upper Case from the Lower Case” on page 60
5. Push the latches on both sides of the socket to release the DIMM, and then remove the DIMM from the main unit.



Removing the Modem Board

1. See “Removing the Battery Pack” on page 53
2. See “Removing the Middle Covers” on page 56
3. See “” on page 56
4. Remove the two screws, and then detach the modem board from the main board. Turn the modem board over.

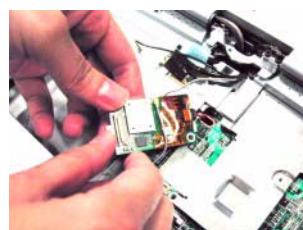

5. Disconnect the modem cable and the bluetooth cable from the modem board, and then

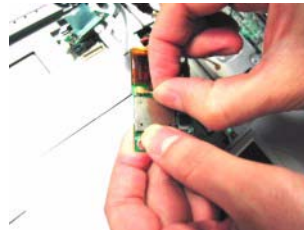

Removing the LCD Module

1. See "Removing the Battery Pack" on page 53
2. See "Removing the Middle Covers" on page 56
3. See "" on page 56
4. Remove the two screws as shown here, and then disconnect the LCD coaxial cable from the main board. Disconnect the inverter cable from the main board



5. Pull up the two RF cables with the tweezers gently. Remove the two screws and the other two on the center hinge.

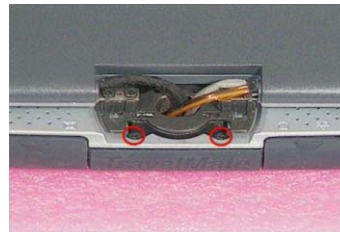
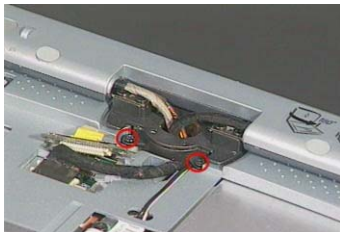

6. Press the two LCD support knobs inward and then remove the LCD module from the main unit.



NOTE: We would like to highlight the correct way to rotate the LCD module here. Please note that the LCD module can only be rotated at 180 degrees. Rotating the LCD module in the wrong direction may cause the damage to the cables.

1. Pressing the two LCD support knobs inward, rotate the LCD module clockwise at 180 degrees.

|



2. To rotate the LCD module back to its original position, rotate the LCD module counterclockwise at 180 degrees. Press the two LCD support knobs to secure the LCD module well.



Separating the Upper Case from the Lower Case

1. See “Removing the Battery Pack” on page 53
2. See “Removing the Middle Covers” on page 56
3. See “” on page 56
4. See “. ” on page 58
5. Disconnect the RTC battery cable and the speaker cable from the main board.



6. Disconnect the touch pad cable and the cover switch cable from the main board with a plastic flat screwdriver.



7. Turn over the machine, please note that the machine should be put on a sponge with the two LCD support knobs against the edge of the sponge. Remove the eight screws at the back side of the main unit.

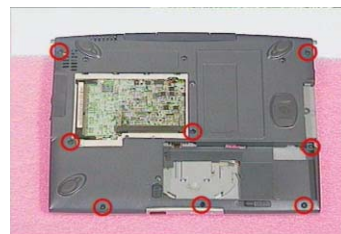

8. Release the I/O port rubber doors, and the docking rubber door on the rear side of the unit . Release USB & 1934 ports on the right side of the unit. (Please do not remove the rubber doors from the main unit.).



9. Separate the upper case from the lower case.



Removing the RTC Battery

1. See “Removing the Battery Pack” on page 53
2. See “Removing the Middle Covers” on page 56
3. See “” on page 56
4. See “. ” on page 58
5. See “Separating the Upper Case from the Lower Case” on page 60
6. Remove the tape and then detach the RTC battery from the upper case carefully.

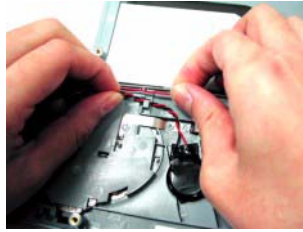

Removing the Speaker

1. See “Removing the Battery Pack” on page 53
2. See “Removing the Middle Covers” on page 56
3. See “” on page 56
4. See “. ” on page 58
5. See “Separating the Upper Case from the Lower Case” on page 60
6. Remove the three screws, and then detach the speaker from the upper case carefully.

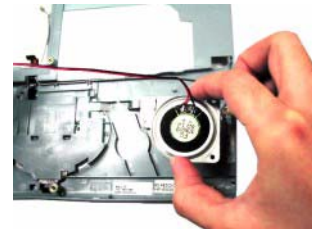

Removing the Touch Pad Module

1. See “Removing the Battery Pack” on page 53
2. See “Removing the Middle Covers” on page 56
3. See “” on page 56
4. See “. ” on page 58
5. See “Separating the Upper Case from the Lower Case” on page 60
6. First release the latches in the way as shown here. Snap off the touch pad module from the upper case carefully.

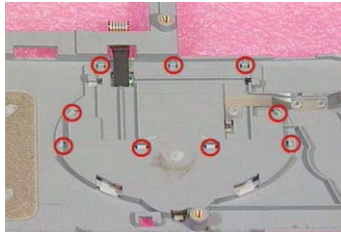

7. Turn the touch pad board over, put it on the upper case, and then disconnect the touch pad cable from the touch pad board. Remove the touch pad board from the upper case



Removing the Touch Pad FPC

1. See “Removing the Battery Pack” on page 53
2. See “Removing the Middle Covers” on page 56
3. See “” on page 56
4. See “. ” on page 58
5. See “Separating the Upper Case from the Lower Case” on page 60
6. See “Removing the Speaker” on page 61
7. Remove the touch pad FPC from the upper case as shown below.



Removing the LCD Support Knobs

1. See “Removing the Battery Pack” on page 53
2. See “Removing the Middle Covers” on page 56
3. See “” on page 56
4. See “.” on page 58
5. See “Separating the Upper Case from the Lower Case” on page 60
6. Remove the two screws as shown, and then use a plastic flat screwdriver to help remove the left and right LCD support knobs consecutively

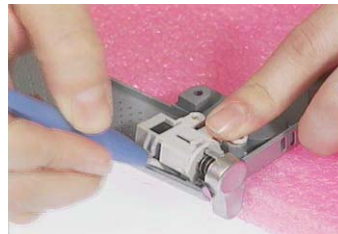
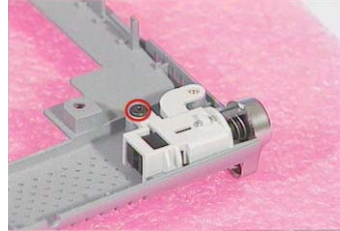

Removing the Main Board

1. See “Removing the Battery Pack” on page 53
2. See “Removing the Middle Covers” on page 56
3. See “” on page 56
4. See “. ” on page 58
5. See “Separating the Upper Case from the Lower Case” on page 60
6. Remove the four screws as shown below, and then remove the main board from the lower case with caution..



Removing the Thermal Plate

1. See “Removing the Battery Pack” on page 53
2. See “Removing the Middle Covers” on page 56
3. See “” on page 56
4. See “. ” on page 58
5. See “Separating the Upper Case from the Lower Case” on page 60
6. See “Removing the Main Board” on page 64
7. Remove the four screws and two hex screws as shown below, and then remove the thermal plate from the main board with caution.

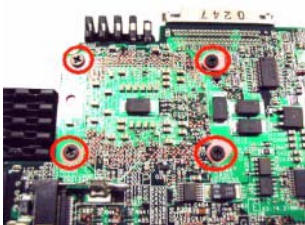

Removing the PCMCIA Socket

1. See “Removing the Battery Pack” on page 53
2. See “Removing the Middle Covers” on page 56
3. See “” on page 56
4. See “. ” on page 58
5. See “Separating the Upper Case from the Lower Case” on page 60
6. See “Removing the Main Board” on page 64
7. See “Removing the Thermal Plate” on page 64
8. Remove the four screws, and then detach the PCMCIA socket from the main board.

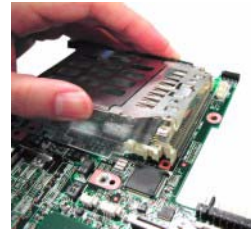
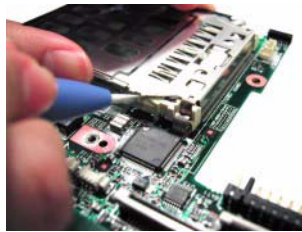

Removing the Modem Cable

1. See “Removing the Battery Pack” on page 53
2. See “Removing the Middle Covers” on page 56
3. See “” on page 56
4. See “. ” on page 58
5. See “Removing the Modem Board” on page 57
6. See “Separating the Upper Case from the Lower Case” on page 60
7. See “Removing the Main Board” on page 64
8. See “Removing the Thermal Plate” on page 64
9. Detach the tape, and then disconnect the modem cable from the main board.
10. Remove the modem cable

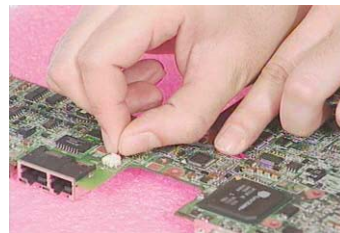
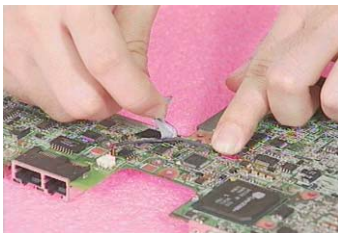

Disassembling the LCD Module

Removing the LCD Bezel

1. See “Removing the Battery Pack” on page 53
2. See “Removing the Middle Covers” on page 56
3. See “” on page 56
4. See “. ” on page 58
5. Remove the stylus and the two video capture kit covers.



6. Remove the three LCD screw cushions and then the three screws on the LCD bezel..



7. Snap off the LCD bezel carefully, and then detach the LCD bezel from the LCD module



Removing the LCD Hinges with the Center Hinge

1. See “Removing the Battery Pack” on page 53
2. See “Removing the Middle Covers” on page 56
3. See “” on page 56
4. See “. ” on page 58
5. See “Removing the LCD Bezel” on page 66
6. Pull the cables out from the center hinge, remove the two screws, push the cables out through the center hinge and then remove the LCD hinges together with the center hinge from the LCD panel.

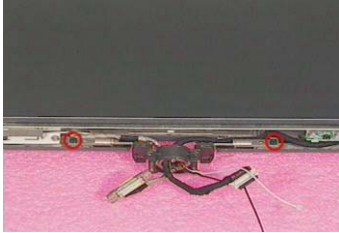

Removing the Button Board & Inverter Board

1. See “Removing the Battery Pack” on page 53
2. See “Removing the Middle Covers” on page 56
3. See “” on page 56
4. See “. ” on page 58
5. See “Removing the LCD Bezel” on page 66
6. Remove the two screws on the button board, and the other two screws on the inverter board respectively.

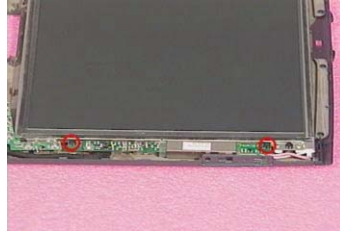

7. Disconnect the LCD power cable from the inverter board and then detach the button board together with inverter board from the LCD panel carefully.. Disconnect inverter cable from the inverter board.

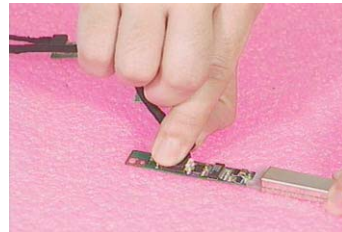

Removing the Main and Auxiliary Antenna

1. See “Removing the Battery Pack” on page 53
2. See “Removing the Middle Covers” on page 56
3. See “” on page 56
4. See “. ” on page 58
5. See “Removing the LCD Bezel” on page 66
6. Remove the one silver screw and the other two silver screws as shown below. Detach the main antenna at the top and auxiliary antenna at the bottom from the LCD module.

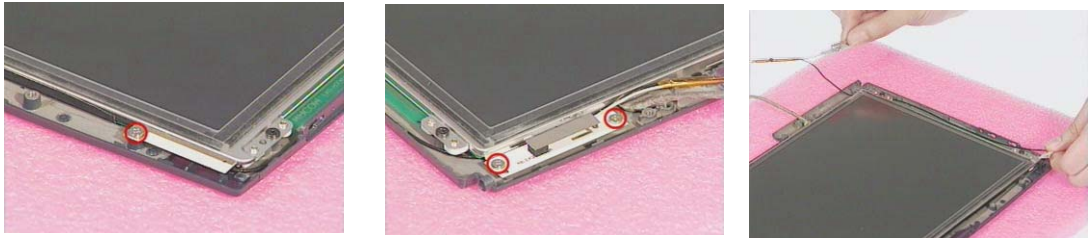

NOTE: When you reassemble the machine, please remember to put the two antennas back with the small latches installed well and the two RF cables arranged well.

Removing the LCD

1. See “Removing the Battery Pack” on page 53
2. See “Removing the Middle Covers” on page 56
3. See “” on page 56
4. See “. ” on page 58
5. See “Removing the LCD Bezel” on page 66
6. Remove the four screws and then detach the LCD together with the protection cover from the LCD panel carefully.

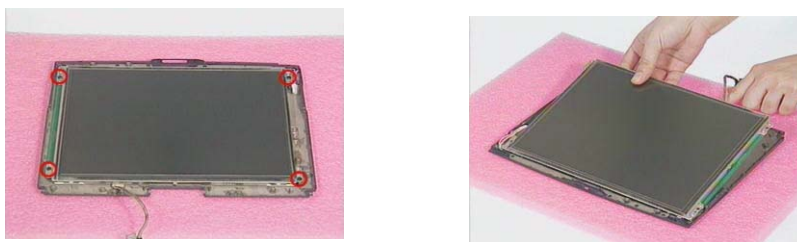

NOTE: Please do not detach the protection cover from the LCD. The intention to do so will cause the damage to the protection cover and the LCD.

Removing the Coaxial Cable

1. See “Removing the Battery Pack” on page 53
2. See “Removing the Middle Covers” on page 56
3. See “” on page 56
4. See “. ” on page 58
5. See “Removing the LCD Bezel” on page 66
6. See “Removing the LCD” on page 68

7. Remove the tape, disconnect the coaxial cable, and then remove the coaxial cable from the LCD carefully.

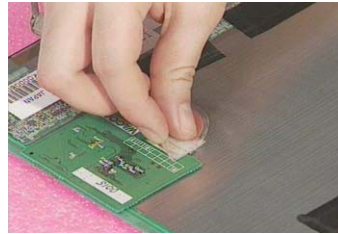

Removing the Sensor Board

1. See “Removing the Battery Pack” on page 53
2. See “Removing the Middle Covers” on page 56
3. See “” on page 56
4. See “. ” on page 58
5. See “Removing the LCD Bezel” on page 66
6. See “Removing the LCD” on page 68
7. Remove the two golden screws, remove the tapes and then detach the sensor board from the LCD carefully.

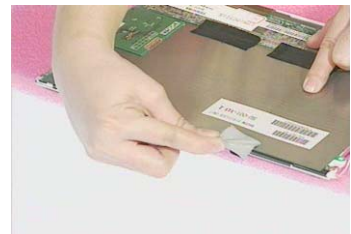

Troubleshooting

Use the following procedure as a guide for computer problems.

NOTE: The diagnostic tests are intended to test only Acer products. Non-Acer products, prototype cards, or modified options can give false errors and invalid system responses.

1. Obtain the failing symptoms in as much detail as possible.
2. Verify the symptoms by attempting to re-create the failure by running the diagnostic test or by repeating the same operation.
3. Use the following table with the verified symptom to determine which page to go to.

Symptoms (Verified)	Go To
Power failure. (The power indicator does not go on or stay on.)	"Power System Check" on page 73.
POST does not complete. No beep or error codes are indicated.	"Power-On Self-Test (POST) Error Message" on page 76 "Undetermined Problems" on page 84
POST detects an error and displayed messages on screen.	"Error Message List" on page 77
The diagnostic test detected an error and displayed a FRU code.	"System Diagnostic Diskette" on page 46
Other symptoms (i.e. LCD display problems or others).	"Power-On Self-Test (POST) Error Message" on page 76
Symptoms cannot be re-created (intermittent problems).	Use the customer-reported symptoms and go to "Power-On Self-Test (POST) Error Message" on page 76 "Intermittent Problems" on page 83 "Undetermined Problems" on page 84

System Check Procedures

External Diskette Drive Check

Do the following to isolate the problem to a controller, driver, or diskette. A write-enabled, diagnostic diskette is required.

NOTE: Make sure that the diskette does not have more than one label attached to it. Multiple labels can cause damage to the drive or cause the drive to fail.

Do the following to select the test device. See "System Diagnostic Diskette" on page 46 for details.

1. Boot from the diagnostics diskette and start the PQA program (see "System Diagnostic Diskette" on page 46).
2. Go to the diagnostic Diskette Drive in the test items.
3. Press  in the test items.
4. Follow the instructions in the message window.

If an error occurs with the internal diskette drive, reconnect the diskette connector on the system board.

If the error still remains:

1. Reconnect the external diskette drive/CD-ROM module.
2. Replace the external diskette drive/CD-ROM module.
3. Replace the system board.

External CD-ROM Drive Check

Do the following to isolate the problem to a controller, drive, or CD-ROM. Make sure that the CD-ROM does not have any label attached to it. The label can cause damage to the drive or can cause the drive to fail.

Do the following to select the test device:

1. Boot from the diagnostics diskette and start the PQA program (refer to "System Diagnostic Diskette" on page 46).
2. Go to the diagnostic CD-ROM in the test items.
3. Press  in the test items.
4. Follow the instructions in the message window.

If an error occurs, reconnect the connector on the System board. If the error still remains:

1. Reconnect the external diskette drive/CD-ROM module.
2. Replace the external diskette drive/CD-ROM module.
3. Replace the system board.

Keyboard or Auxiliary Input Device Check

Remove the external keyboard if the internal keyboard is to be tested.

If the internal keyboard does not work or an unexpected character appears, make sure that the flexible cable extending from the keyboard is correctly seated in the connector on the system board.

If the keyboard cable connection is correct, run the Keyboard Test. See “System Diagnostic Diskette” on page 46 for details.

If the tests detect a keyboard problem, do the following one at a time to correct the problem. Do not replace a non-defective FRU:

1. Reconnect the keyboard cables.
2. Replace the keyboard.
3. Replace the system board.

The following auxiliary input devices are supported by this computer:

- Numeric keypad
- External keyboard

If any of these devices do not work, reconnect the cable connector and repeat the failing operation.

Memory Check

Memory errors might stop system operations, show error messages on the screen, or hang the system.

1. Boot from the diagnostics diskette and start the PQA program (please refer to “System Diagnostic Diskette” on page 46).
2. Go to the diagnostic memory in the test items.
3. Press **F2** in the test items.
4. Follow the instructions in the message window.

NOTE: Make sure that the DIMM is fully installed into the connector. A loose connection can cause an error.

Power System Check

To verify the symptom of the problem, power on the computer using each of the following power sources:

1. Remove the battery pack.
2. Connect the power adapter and check that power is supplied.
3. Disconnect the power adapter and install the charged battery pack; then check that power is supplied by the battery pack.

If you suspect a power problem, see the appropriate power supply check in the following list:

- “Check the Power Adapter” on page 74
- “Check the Battery Pack” on page 75

Check the Power Adapter

Unplug the power adapter cable from the computer and measure the output voltage at the plug of the power adapter cable. See the following figure

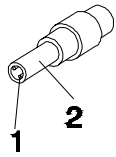

Pin 1: +19 to +20.5V
Pin 2: 0V, Ground

1. If the voltage is not correct, replace the power adapter.
2. If the voltage is within the range, do the following:
 - Replace the System board.
 - If the problem is not corrected, see “Undetermined Problems” on page 84.
 - If the voltage is not correct, go to the next step.

NOTE: An audible noise from the power adapter does not always indicate a defect.

3. If the power-on indicator does not light up, check the power cord of the power adapter for correct continuity and installation.
4. If the operational charge does not work, see “Check the Battery Pack” on page 75.

Check the Battery Pack

To check the battery pack, do the following:

From Software:

1. Check out the Power Management in control Panel
2. In Power Meter, confirm that if the parameters shown in the screen for Current Power Source and Total Battery Power Remaining are correct.
3. Repeat the steps 1 and 2, for both battery and adapter.
4. This helps you identify first the problem is on recharging or discharging.

From Hardware:

1. Power off the computer.
2. Remove the battery pack and measure the voltage between battery terminals 1(+) and 7(ground). See the following figure.

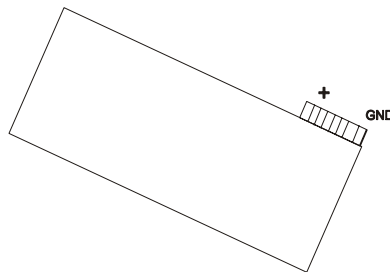

3. If the voltage is still less than 2.7 Vdc after recharging, replace the battery.

To check the battery charge operation, use a discharged battery pack or a battery pack that has less than 50% of the total power remaining when installed in the computer.

If the battery status indicator does not light up, remove the battery pack and let it return to room temperature. Re-install the battery pack.

If the charge indicator still does not light up, replace the battery pack. If the charge indicator still does not light up, replace the DC/DC charger board.

Touchpad Check

If the touchpad doesn't work, do the following actions one at a time to correct the problem. Do not replace a non-defective FRU:

1. Reconnect the touchpad cables.
2. Replace the touchpad.
3. Replace the system board.

After you use the touchpad, the pointer drifts on the screen for a short time. This self-acting pointer movement can occur when a slight, steady pressure is applied to the touchpad pointer. This symptom is not a hardware problem. No service actions are necessary if the pointer movement stops in a short period of time.

Power-On Self-Test (POST) Error Message

The POST error message index lists the error message and their possible causes. The most likely cause is listed first.

NOTE: Perform the FRU replacement or actions in the sequence shown in FRU/Action column, if the FRU replacement does not solve the problem, put the original part back in the computer. Do not replace a non-defective FRU.

This index can also help you determine the next possible FRU to be replaced when servicing a computer.

If the symptom is not listed, see “Undetermined Problems” on page 84.

The following lists the error messages that the BIOS displays on the screen and the error symptoms classified by function.

NOTE: Most of the error messages occur during POST. Some of them display information about a hardware device, e.g., the amount of memory installed. Others may indicate a problem with a device, such as the way it has been configured.

NOTE: If the system fails after you make changes in the BIOS Setup Utility menus, reset the computer, enter Setup and install Setup defaults or correct the error.

Index of Error Messages

Error Code List

Error Codes	Error Messages
006	Equipment Configuration Error Causes: 1. CPU BIOS Update Code Mismatch 2. IDE Primary Channel Master Drive Error 3. IDE Secondary Channel Master Drive Error
010	Memory Error at XXXX:XXXX:XXXXh (R:XXXXh, W:XXXXh)
070	Real Time Clock Error
071	CMOS Battery Bad
072	CMOS Checksum Error
110	Incorrect password specified, system disabled. (Text mode only)
<No Error Code>	Battery critical low In this situation, BIOS will issue 4 short beeps that shut down the system. No message will be shown.
<No Error Code>	Thermal critical high In this situation, BIOS will issue 3 long beeps then shut down the system.

Error Message List

Error Messages	FRU/Action in Sequence
Failure Fixed Disk	Reconnect hard disk drive connector. "Load Default Settings" in BIOS Setup Utility. Hard disk drive System board
Stuck Key	see "Keyboard or Auxiliary Input Device Check" on page 73 .
Keyboard error	see "Keyboard or Auxiliary Input Device Check" on page 73.
Keyboard Controller Failed	see "Keyboard or Auxiliary Input Device Check" on page 73.
Keyboard locked - Unlock key switch	Unlock external keyboard
Monitor type does not match CMOS - Run Setup	Run "Load Default Settings" in BIOS Setup Utility.
Shadow RAM Failed at offset: nnnn	BIOS ROM System board
System RAM Failed at offset: nnnn	DIMM System board
Extended RAM Failed at offset: nnnn	DIMM System board
System battery is dead - Replace and run Setup	Replace RTC battery and Run BIOS Setup Utility to reconfigure system time, then reboot system.
System CMOS checksum bad - Default configuration used	RTC battery Run BIOS Setup Utility to reconfigure system time, then reboot system.
System timer error	RTC battery Run BIOS Setup Utility to reconfigure system time, then reboot system. System board

Error Message List

Error Messages	FRU/Action in Sequence
Real time clock error	RTC battery Run BIOS Setup Utility to reconfigure system time, then reboot system. System board
Previous boot incomplete - Default configuration used	Run "Load Default Settings" in BIOS Setup Utility. RTC battery System board
Memory size found by POST differed from CMOS	Run "Load Default Settings" in BIOS Setup Utility. DIMM System board
Diskette drive A error	Check the drive is defined with the proper diskette type in BIOS Setup Utility See "External Diskette Drive Check" on page 72.
Incorrect Drive A type - run SETUP	Check the drive is defined with the proper diskette type in BIOS Setup Utility See "External Diskette Drive Check" on page 72.
System cache error - Cache disabled	System board
CPU ID:	System board
DMA Test Failed	DIMM System board
Software NMI Failed	DIMM System board
Fail-Safe Timer NMI Failed	DIMM System board
Device Address Conflict	Run "Load Default Settings" in BIOS Setup Utility. RTC battery System board
Allocation Error for device	Run "Load Default Settings" in BIOS Setup Utility. RTC battery System board
Failing Bits: nnnn	DIMM BIOS ROM System board
Fixed Disk n	None
Invalid System Configuration Data	BIOS ROM System board
I/O device IRQ conflict	Run "Load Default Settings" in BIOS Setup Utility. RTC battery System board
Operating system not found	Enter Setup and see if fixed disk and drive A: are properly identified. Diskette drive Hard disk drive System board

Error Message List

No beep Error Messages	FRU/Action in Sequence
No beep, power-on indicator turns off and LCD is blank.	Power source (battery pack and power adapter). See "Power System Check" on page 73. Ensure every connector is connected tightly and correctly. Reconnect the DIMM. LED board. System board.
No beep, power-on indicator turns on and LCD is blank.	Power source (battery pack and power adapter). See "Power System Check" on page 73. Reconnect the LCD connector Hard disk drive LCD inverter ID LCD cable LCD Inverter LCD System board
No beep, power-on indicator turns on and LCD is blank. But you can see POST on an external CRT.	Reconnect the LCD connectors. LCD inverter ID LCD cable LCD inverter LCD System board
No beep, power-on indicator turns on and a blinking cursor shown on LCD during POST.	Ensure every connector is connected tightly and correctly. System board
No beep during POST but system runs correctly.	Speaker System board

Error Beep List

Code	Beeps	Description
00h	Two long beeps, one short beep, and then one long beep	Success
F1h	One long, One short beeps	BIOS file size mismatch
F2h	One long, two short beeps	BIOS file reading error
D1h	Two short beeps	Floppy drive not installed

Index of Symptom-to-FRU Error Message

LCD-Related Symptoms

Symptom / Error	Action in Sequence
LCD backlight doesn't work LCD is too dark LCD brightness cannot be adjusted LCD contrast cannot be adjusted	Enter BIOS Utility to execute "Load Setup Default Settings", then reboot system. Reconnect the LCD connectors. Keyboard (if contrast and brightness function key doesn't work). LCD inverter ID LCD cable LCD inverter LCD System board
Unreadable LCD screen Missing pels in characters Abnormal screen Wrong color displayed	Reconnect the LCD connector LCD inverter ID LCD cable LCD inverter LCD System board
LCD has extra horizontal or vertical lines displayed.	LCD inverter ID LCD inverter LCD cable LCD System board

Indicator-Related Symptoms

Symptom / Error	Action in Sequence
Indicator incorrectly remains off or on, but system runs correctly	Reconnect the inverter board Inverter board System board

Power-Related Symptoms

Symptom / Error	Action in Sequence
Power shuts down during operation	Power source (battery pack and power adapter). See "Power System Check" on page 73. Battery pack Power adapter Hard drive & battery connection board System board
The system doesn't power-on.	Power source (battery pack and power adapter). See "Power System Check" on page 73. Battery pack Power adapter Hard drive & battery connection board System board
The system doesn't power-off.	Power source (battery pack and power adapter). See "Power System Check" on page 73. Hold and press the power switch for more than 4 seconds. System board
Battery can't be charged	See "Check the Battery Pack" on page 75. Battery pack System board

PCMCIA-Related Symptoms

Symptom / Error	Action in Sequence
System cannot detect the PC Card (PCMCIA)	PCMCIA slot assembly System board
PCMCIA slot pin is damaged.	PCMCIA slot assembly

Memory-Related Symptoms

Symptom / Error	Action in Sequence
Memory count (size) appears different from actual size.	Enter BIOS Setup Utility to execute "Load Default Settings, then reboot system. DIMM System board

Speaker-Related Symptoms

Symptom / Error	Action in Sequence
In Windows, multimedia programs, no sound comes from the computer.	Audio driver Speaker System board
Internal speakers make noise or emit no sound.	Speaker System board

Power Management-Related Symptoms

Symptom / Error	Action in Sequence
The system will not enter hibernation	Keyboard (if control is from the keyboard) Hard disk drive System board
The system doesn't enter hibernation mode and four short beeps every minute.	See "Hibernation Mode" on page 27. Press Fn+F4 and see if the computer enters hibernation mode. Touchpad Keyboard Hard disk connection board Hard disk drive System board
The system doesn't enter standby mode after closing the LCD	See "Hibernation Mode" on page 27. LCD cover switch System board
The system doesn't resume from hibernation mode.	See "Hibernation Mode" on page 27. Hard disk connection board Hard disk drive System board
The system doesn't resume from standby mode after opening the LCD.	See "Standby Mode" on page 27. LCD cover switch System board
Battery fuel gauge in Windows doesn't go higher than 90%.	Remove battery pack and let it cool for 2 hours. Refresh battery (continue use battery until power off, then charge battery). Battery pack System board

Power Management-Related Symptoms

Symptom / Error	Action in Sequence
System hangs intermittently.	See "Thermal Utility" on page 46. Reconnect hard disk/CD-ROM drives. Hard disk connection board System board

Peripheral-Related Symptoms

Symptom / Error	Action in Sequence
System configuration does not match the installed devices.	Enter BIOS Setup Utility to execute "Load Default Settings", then reboot system. Reconnect hard disk/CD-ROM/diskette drives.
External display does not work correctly.	Press Fn+F5, LCD/CRT/Both display switching See "System Diagnostic Diskette" on page 46. System board
USB does not work correctly	See "System Diagnostic Diskette" on page 46 System board
Print problems.	Ensure the "Parallel Port" in the "Onboard Devices Configuration" of BIOS Setup Utility is set to Enabled. Onboard Devices Configuration Run printer self-test. Printer driver Printer cable Printer System Board
Serial or parallel port device problems.	Ensure the "Serial Port" in the Devices Configuration" of BIOS Setup Utility is set to Enabled. Device driver Device cable Device System board

Keyboard/Touchpad-Related Symptoms

Symptom / Error	Action in Sequence
Keyboard (one or more keys) does not work.	Reconnect the keyboard cable. Keyboard System board
Touchpad does not work.	Reconnect touchpad cable. Touchpad board System board

Modem-Related Symptoms

Symptom / Error	Action in Sequence
Internal modem does not work correctly.	See "System Diagnostic Diskette" on page 46. Modem phone port modem combo board System board

NOTE: If you cannot find a symptom or an error in this list and the problem remains, see "Undetermined Problems" on page 84.

Intermittent Problems

Intermittent system hang problems can be caused by a variety of reasons that have nothing to do with a hardware defect, such as: cosmic radiation, electrostatic discharge, or software errors. FRU replacement should be considered only when a recurring problem exists.

When analyzing an intermittent problem, do the following:

1. Run the advanced diagnostic test for the system board in loop mode at least 10 times.
2. If no error is detected, do not replace any FRU.
3. If any error is detected, replace the FRU. Rerun the test to verify that there are no more errors.

Undetermined Problems

The diagnostic problems does not identify which adapter or device failed, which installed devices are incorrect, whether a short circuit is suspected, or whether the system is inoperative.

Follow these procedures to isolate the failing FRU (do not isolate non-defective FRU).

NOTE: Verify that all attached devices are supported by the computer.

NOTE: Verify that the power supply being used at the time of the failure is operating correctly. (See "Power System Check" on page 73):

1. Power-off the computer.
2. Visually check them for damage. If any problems are found, replace the FRU.
3. Remove or disconnect all of the following devices:
 - Non-Acer devices
 - Printer, mouse, and other external devices
 - Battery pack
 - Hard disk drive
 - DIMM
 - CD-ROM/Diskette drive Module
 - PC Cards
4. Power-on the computer.
5. Determine if the problem has changed.
6. If the problem does not recur, reconnect the removed devices one at a time until you find the failing FRU.
7. If the problem remains, replace the following FRU one at a time. Do not replace a non-defective FRU:
 - System board
 - LCD assembly

Index of AFlash BIOS Error Message

Error Message	Action in Sequence
Hardware Error	See "System Diagnostic Diskette" on page 46
VPD Checksum Error	Reboot the system and then retest with this diskette.
BIOS Update Program Error	Turn off the power and restart the system.
System Error	Make sure this AFlash BIOS diskette for this model.
Without AC adapter	make sure to connect AC adapter
Battery Low	make sure to install a highly charged battery, and reboot system.

Index of PQA Diagnostic Error Code, Message

Error Code	Message	Action in Sequence
16XXX	Backup battery error	Backup battery
01XXX	CPU or main board error	Reload BIOS default setting. System board
02XXX	Memory error	DIMM System board
03XXX	Keyboard error	Reset Keyboard Keyboard System board
04XXX	Video error	System board
05XXX	Parallel Port error	System board
06XXX	Serial port or main board error	System board
07XXX	Diskette drive error	Diskette drive System board
08XXX	Hard disk error	Reload BIOS default setting Hard disk System board
09XXX	CD-ROM error	Reset CD-ROM cable CD-ROM drive System board
10XXX	Co-processor error	System board
11XXX	Pointing device error	Reset Keyboard Keyboard System board
12XXX	Cache test error	System board

Jumper and Connector Locations

Top View

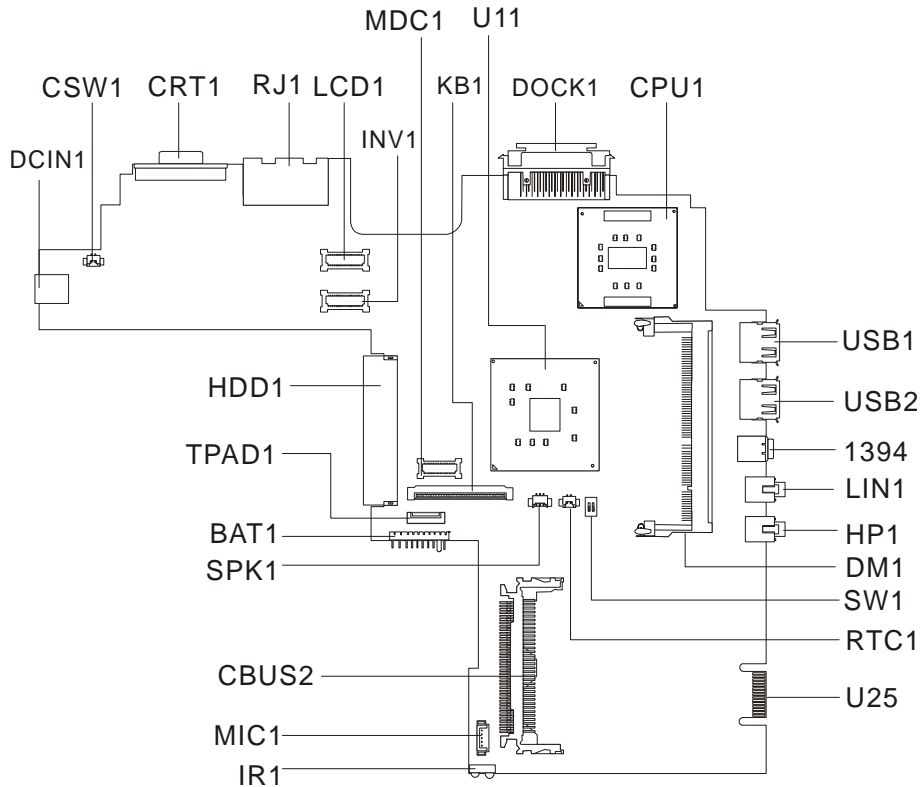

PCB 02225-SB

DCIN1	AC adapter connector	LIN1	Line-in port
CSW1	LCD cover switch connector	HP1	Line-out port
CRT1	VGA port	DM1	Memory slot 1
RJ1	RJ11 and RJ45 connectors	SW1	Please refer to below for SW1 settings
LCD1	LCD coaxial cable connector	RTC1	RTC battery connector
INV1	LED/Inverter board connector	U25	Debug purpose only
MDC1	Fax/Modem board connector	IR1	FIR connector
KB1	Keyboard cable connector	MIC1	Internal microphone and tablet PC lid connector
U11	855-GM chip (North bridge)	CBUS2	PCMCIA card connector
DOCK1	Docking connector	SPK1	Speaker cable connector
CPU1	CPU	BAT1	Battery connector
USB1	USB port 1	TPAD1	Touchpad connector
USB2	USB port 2	HDD1	Hard disk drive connector
1394	1394 port		

SW1 Settings

SW4	Setting
Switch 1	ON: Disable password check OFF*: Enable password check
Switch 2	ON: Enable BootBlock Erasable OFF*: Disable BootBlock Erasable

NOTE: *: Default setting

Bottom View

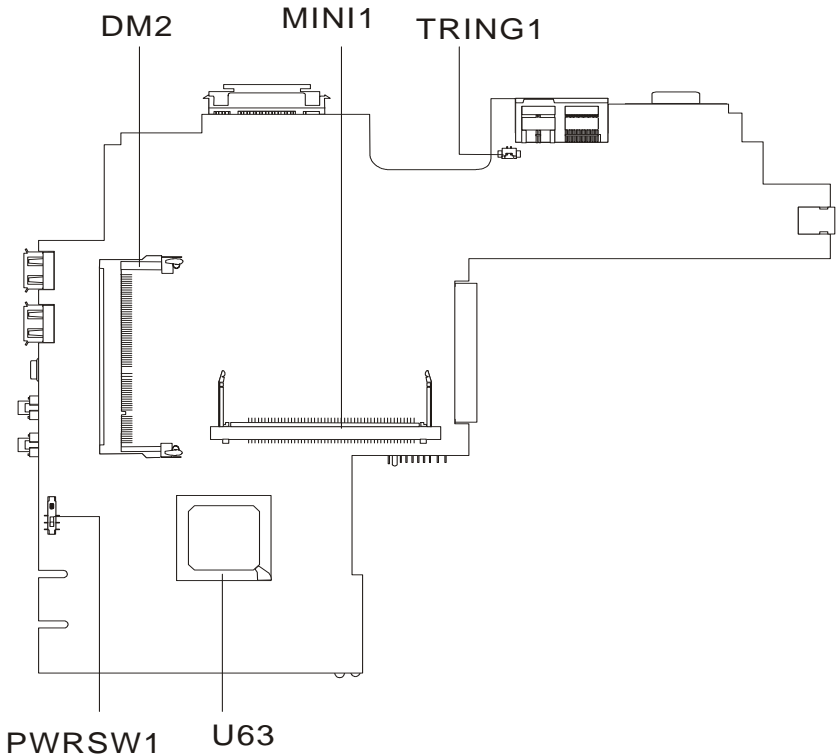

DM2	Memory slot	U63	ICH-4 (I/O controller)
MINI1	MiniPCI wireless module connector	PWRSW1	Power switch
TRING1	Modem cable connector		

FRU (Field Replaceable Unit) List





This chapter gives you the FRU (Field Replaceable Unit) listing in global configurations of TravelMate C110. Refer to this chapter whenever ordering for parts to repair or for RMA (Return Merchandise Authorization).







Please note that WHEN ORDERING FRU PARTS, you should check the most up-to-date information available on your regional web or channel. For whatever reasons a part number change is made, it will not be noted on the printed Service Guide. For ACER AUTHORIZED SERVICE PROVIDERS, your Acer office may have a DIFFERENT part number code from those given in the FRU list of this printed Service Guide. You MUST use the local FRU list provided by your regional Acer office to order FRU parts for repair and service of customer machines.







NOTE: To scrap or to return the defective parts, you should follow the local government ordinance or regulations on how to dispose it properly, or follow the rules set by your regional Acer office on how to return it.

NOTE: The Exploded Diagram is not yet available at this moment. Once the file is ready, this chapter will be revised accordingly.







Exploded Diagram

Picture	No.	Partname	Description
Memory			
	NS	MEMORY SODIMM 128MB PC133	SODIMM 128M W17128A4NC8602A
STYLUS			
		STYLUS	ASSY SLIM PEN MP-200-00B WACOM
		STYLUS	STYLUS PEN UP-714E-36A WACOM
LCD			
		LCD MODULE 10.4" TOSHIBA	ASSY HYDIS LCD W/ANTENNA P=1
		LCD 10.4" XGA TOSHIBA LTM10C321K V01 W/PROTECT	ASSY PROTECT LCD MODULE BARBET
Cables			
	NS	POWER CORD 125V 3PIN	CORD 125V UL 3P K01081B1183WP
	NS	TOUCH PAD CABLE	CABLE TOUCHPAD FPC A1+





Picture	No.	Partname	Description
	NS	INVERTER CABLE	CABLE INVERTER A1+
	NS	LCD COAXIAL CABLE	CABLE LCD COAXIAL
		MODEM CABLE	CABLE RJ11
		COVER SWITCH CABLE	CABLE COVER SWITCH
Microphone			
		MICROPHONE / SWITCH SENSOR CABLE	CABLE LATCH SENSOR SWITCH
Case/Cover/Bracket Assembly			
	11	DIMM COVER W/SCREW	ASSEMBLY DIMM COVER LOW
	9	LOWER CASE W/IO RUBBER COVER & FRONT COVER & RUBBER FOOT & SENSOR CABLE & USB RUBBER COVER	ASSY LOWER CASE A1 PLUS



Picture	No.	Partname	Description
	5	REAR MIDDLE COVER SMALL	COVER MIDDLE SMALL
	6	FRONT MIDDLE COVER BIG	COVER MIDDLE BIG
	8	UPPER CASE W/COVER SWITCH CABLE & RTC BATTERY & SPEAKER & SUPPORT KNOB LEFT & RIGHT W/O TOUCHPAD MODULE	ASSEMBLY UPPER CASE A1 PLUS
	NS	TOUCH PAD COVER	ASSEMBLY TOUCH PAD COVER
		HDD COVER	ASSEMBLY HDD BEZEL TMC100
	NS	HDD CONNECTOR	HEAD FML 2R40P ST 1277257-1
		HDD BRACKET	ASSY BRACKET HDD

Picture	No.	Partname	Description
	NS	LCD PANEL W/CAMERA RUBBER & HINGE ASSY & LOGO & RUBBER FOOT	ASSEMBLY PANEL A1+
	1	HINGE ASSEMBLY	ASSEMBLY HINGE TM 100
	NS	LCD BEZEL W/ICON LABEL & LATCH & NAME PLATE & WARNING LABEL	ASSY BEZEL A1 PLUS
		LCD LATCH	ASSEMBLY LCD LATCH
		FRONT COVER	ASSEMBLY FRONT COVER
		I/O RUBBER COVER	
		USB PORT RUBBER COVER	RUBBER USB DOOR
		LCD SUPPORT KNOB LEFT	ASSEMBLY LCD SUPP KNOB LEFT
		LCD SUPPORT KNOB RIGHT	ASSEMBLY LCD SUPP KNOB RIGHT
Boards			
	NS	MODEM BOARD AMBIT/T60M283.10	MODEM MDC AMBIT/T60M283.10
		MODEM / BLUETOOTH COMBO BOARD	

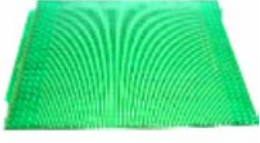
Picture	No.	Partname	Description
		WIRELESS LAN BOARD 802.11B INTEL 2100 (MINI PCI)	LAN WIRELESS INTEL 2100 802.11B
		WIRELESS LAN BOARD 802.11A/B INTEL 2100 (MINI PCI)	
		TOUCHPAD BOARD SYNAPTIC	TOUCHPAD SYNAPTICS/TM41P- 356
	NS	BUTTON BOARD	BARBET (TM C100) BUTTON BOARD
	NS	INVERTER BOARD & BUTTON BOARD CABLE ASSY 10.4" AMBIT	INVERTER 10.4" XGA T62I227.00
Battery			
	NS	BATTERY ASSY 1800MA SANYO W/ FOOT	ASSY BATTERY A1+
		BATTERY 1800MA SANYO BTP-42C1	BATTERY PACK BTP-42C1 1800MA
		RTC BATTERY 3V 65MAH	BTY LI 3V ML2032T6 65MAH 170MM
Adapter			
	NS	ADAPTER 50W 19V 3PIN LITEON PA-1500-02	ADT 50W 3P 19V PA-1500-02
		ADAPTER USB AOPEN W/ MULTI - REGION POWER CORD	ADAPTER USB CD-ROM AOPEN

Picture	No.	Partname	Description
Keyboard			
	16	KEYBOARD 84KEY DARFON NSK-A5002 TAIWAN	KB DF/NSK-A5002 TAIWAN(84)
		KEYBOARD DARFON NSK-A5201 US	KB DARFON NSK-A5201 US
SPEAKER			
	NS	SPEAKER	SPEAKER W/CABLE A1+
Heatsink			
	NS	CPU HEATSINK	ASSY CPU HEAT PLATE A1+
	12	DIMM PLATE UPPER W/SCREW	ASSEMBLY DIMM UPPER PLATE
HDD/Hard Disk Drive			
	13	HDD 60G HITACHI DK23EA-60	HDD 60G/HITACHI DK23EA-60
		HDD 40G FUJITSU MHS2040AT	HDD 40G/FUJ MHS2040AT A1(8004)
FDD/Floppy Disk Drive			
		FDD 1.44M YEDATA YD-8U10 M861P USB	FDD MDL SLIM USB YD-8U10 M861P

Picture	No.	Partname	Description
COMBO Drive			
		COMBO 24X 1394 AOPEN ESV-189I W/LOGO	COMBO 1394 24X ESV-189I W/ LOGO
Communication Module			
	NS	BLUETOOTH ANTENNA	ANTENNA BLUETOOTH FOR A1 PLUS
		WIRELESS ANTENNA ASSEMBLY 802.11A/B	ASSY 802.11A/B ANTENNA A1 PLUS
		WIRELESS ANTENNA PACK B	
Digitizer			
	NS	DIGITIZER WACOM SU-001-A01	ASSY DIGITIZER SU-001-A01TM100
Main board			
	7	MAINBOARD TM110 A1+ W/CPU 900MHZ (CPU ON BOARD) W/ MODEM CABLE & PCMCIA SLOT	A1+ TM110 MB W/CPU 02225-SC
PCMCIA SLOT/PC CARD SLOT			
		PCMCIA SLOT/PC CARD SLOT	CONN CARDBUS 4P 54922-22LOC
Miscellaneous			
		RUBBER FOOT	RUBBER FOOT A1+
		ICON LABEL	LBL ICON PLATE 83.2*7.7MM A1+
		NAME PLATE	PLATE NAME 45.8x5.7MM A1+
		WARNING LABEL	LABEL STICKER TM100
		PANEL RUBBER UPPER	CUSHION LCD PANEL
		LOGO	

Picture	No.	Partname	Description
	NS	CARDBUS DUMMY CARD TM C100	CARDBUS DUMMY CARD TM C100
	NS	CAMERA RUBBER	RUBBER CAMERA A1
Screws			
	NS	SCREW	SCRW HEX NUT WWASHER #4 NI BT
	NS	SCREW	SCREW DIMM COVER STEEL NAGANO-1
	NS	SCREW	SCREW M2X4(BLACK)
	NS	SCREW	SCREW M2.5*X4L (NYLOCK) BLACK ZN
	NS	SCREW	SCREW M2.5X6
	NS	SCREW	SCREW M2.5*4 (BLACK)
	NS	SCREW	SCREW MACH WAFER M2*L4.5 ZN
	NS	SCREW	SCREW M3X4 (86.9A524.4R0)
	NS	SCREW	SCREW M2X2.0
	NS	SCREW	SCREW NI M2*6L

Model Definition and Configuration

Model Number Definitions

Model Number	LCD	CPU	Memory	HDD	CD/DVD	Battery
110T	10.4" XGA	PM 900	256MB	30GB	24x CD-ROM	1x Li-Ion
110T	10.4" XGA	PM 900	6256MB	30GB	24x CD-ROM	1x Li-Ion
110T	10.4" XGA	PM 900	256MB	30GB	24x CD-ROM	1x Li-Ion
110T	10.4" XGA	PM 900	256MB	40GB	24x CD-ROM	Li-Ion
110T	10.4" XGA	PM 900	256MB	40GB	24x CD-ROM	Li-Ion
110T	10.4" XGA	PM 900	256MB	40GB	24x CD-ROM	Li-Ion
110T	10.4" XGA	PM 900	256MB	40GB	24x CD-ROM	Li-Ion
110Ti	10.4" XGA	PM 900	256MB	30GB	N	1x Li-Ion
110Ti	10.4" XGA	PM 900	256MB	30GB	N	1x Li-Ion
110Ti	10.4" XGA	PM 900	256MB	30GB	N	1x Li-Ion
110Ti	10.4" XGA	PM 900	2X128MB	30GB	N	Li-Ion
110Ti	10.4" XGA	PM 900	2X128MB	40GB	N	Li-Ion
110TCi	10.4" XGA	PM 900	256MB	40GB	24X DVD+CD-RW	2x Li-Ion
110TCi	10.4" XGA	PM 900	256MB	40GB	24X DVD+CD-RW	2x Li-Ion
110TCi	10.4" XGA	PM 900	256MB	40GB	24X DVD+CD-RW	2x Li-Ion
110TCi	10.4" XGA	PM 900	2X128MB	40GB	24X DVD+CD-RW	Li-Ion
110TCi	10.4" XGA	PM 900	2X128MB	40GB	24X DVD+CD-RW	Li-Ion
110TCi	10.4" XGA	PM 900	512MB	40GB	24X DVD+CD-RW	2x Li-Ion
110TCi	10.4" XGA	PM 900	512MB	40GB	24X DVD+CD-RW	2x Li-Ion
110TCi	10.4" XGA	PM 900	512MB	40GB	24X DVD+CD-RW	2x Li-Ion
110TCi	10.4" XGA	PM 900	512MB	40GB	24X DVD+CD-RW	2x Li-Ion

Test Compatible Components

This computer's compatibility is tested and verified by Acer's internal testing department. All of its system functions are tested under Windows XP environment.

Refer to the following list of components, adapter cards and peripherals which have passed this test. Regarding configuration, combination and test procedures please refer to the TravelMate C110 Compatibility Test Report released by Acer Mobile System Testing Department.

Microsoft Windows XP Environment Test

Item	Specifications
Processor	Banias 900MHz Banias 800MHz
LCD	10.4" Toshiba
Har Disk Drive	Hitachi 60GB Fujitsu 40GB
Memory	Infineon 512MB DDR Nanya 256MB DDR
Keyboard	US(84)
Battery	Sanyo(Li)
Adapter	ADT 3P 50W PA 1600-06AC
Inverter	Ambit
Touchpad	Synaptics
Modem	Ambit Modem
Ambit 802.11a/b	Ambit 802.11a/b
Intel 802.11b	Intel 802.11b
BT/MDC Module	Ambit BT/Modem MDC
PC Card List	
LAN Card	3Com EtherLink III 3C589D IBM EtherJet CardBus Adapter 10/100 Intel EtherExpress Pro/100 Mobile Adapter MBLA3200 Xircom CardBus Ethernet 10/100 32Bit CBE-10/100BTX D-Link DE-660
Modem Card	3Com Megahertz 56K Modem PC Card Xircom CreditCard Modem 56 IBM 56K Double Jack Modem 02K4197
Combo Card	IBM 10/100 EtherJet CardBus Real Port w/ 56K modem 34L1301 3Com Megahertz 10/100 LAN + 56K Modem PC Card KB-04-002 Xircom RealPort CardBus Ethernet 10/100 + Modem 56 RBEM5G-100
ATA Card	IBM Microdrive 340MB IBM Microdrive 1G Iomega Click! 40MB
USB 2.0 Card	Apricorn EZ-USB2.0 Cardbus PC Card IOGEAR USB2.0 PC Card
1394 Card	Buffalo 1394 Interface Cardbus IFC-ILCB/DV I-O Data 1394 Interface Cardbus CB1394/DVC Pixela 1394 Cardbus PC Card PIX-PCMC/FW1
Wireless Lan Card	IBM Wireless Lan Card Bus Adapter Intel Pro/Wireless Lan PC Card 2011B Proxim Skyline 802.11a Cardbus Card
Bluetooth Card	IBM Community Bluetooth PC Card Toshiba Bluetooth PC Card PABTC001
ISDN Card	US Robotics Megahertz 128K ISDN Card 405R17T7117M IBM OBI International ISDN PC Card IBM ISDN Card D5K3320

Item	Specifications
Token Ring Card	IBM Token Ring 16/4 Adapter II IBM Turbo 16/4 Token Ring 85H3677 Olicom Token Ring GoCard OC-3221
I/O Peripherals	
I/O Display ⁴	Acer 211c 21" ViewSonic PF790 19" Acer FP751 17" TFT LCD IBM Color TFT LCD 14" 9514-B03 Compaq Color Monitor V70 NET Color Monitor 20" Mozo 17" TFT LCD (DVI)
I/O - Projector	NEC MultiSync MT-1040
I/O - Legacy (Parallel) Printer / Scanner	Canon BJC-600J Epson Stylus Color 740 Parallel Interface HP Deskjet 890C HP DeskJet 880C Parallel Interface HP LaserJet 6MP HP LaserJet 2200 Acer AcerScan Prisa 620P 6696-0PC
I/O - USB Keyboard / Mouse	Chicony USB Keyboard KU-8933 IBM USB Numeric Keypad Microsoft Natural Keyboard Pro Acer Aspire USB Mouse M-UB48 Logicoool USB Mouse IOWCM-USB Logitech Coreless MouseMan Wheel USB Interface Logitech USB Wheel Mouse M-BB48 Microsoft IntelliMouse Optical USB Interface Acer USB mini mouse
I/O - USB Printer / Scanner	Epson Stylus Color 740 USB interface HP DeskJet 880C USB interface Canon CanonSCan D1250 (usb 2.0)(JP OS only) HP ScanJet 3300C Color Scanner MY97712194
I/O - USB Speaker / Joystick	JS USB Digital Panasonic USB Speaker EAB-MPC57USB Aiwa Multimedia Digital Speaker SC-UC78 Microsoft SideWinder Precision Pro Joystick 326-00069 Logitech WingMan Warrior Joystick Logitech WingMan RumblePad G-UA3
I/O - USB Camera	Intel Easy PC Camera A20953-001 Logitech QuickCam Express Internet Logitech QuickCam Home PC Video Camera VCAM-U1 Nikon Superhigh-Performance 3X Zoom COOLPIX990

Item	Specifications
I/O - USB Storage Drive	Logitech CDRW + DVDROM combo USB interface Iomega USB Zip 250MB Argosy Ultra slim CDRW (usb 2.0) Plextor Burn-Proof CDRW (usb 2.0) PX-S88TU Fujitsu MO-1300 1.3G (usb 2.0) Fujitsu 20G HDD (usb 2.0) t4988618913874 Sony DVDROM (usb 2.0) IO-Data DVDROM (usb 2.0) IBM 32MB USB Memory Key Trek 32MB USB Memory Key Y-E Data USB Floppy Apacer USB Handy drive 256MB Apacer USB Handy drive 512MB
I/O - USB Hub	Belkin 4 Port USB Hub F5u001 Eizo I Station USB Hub DH-1401 Elecom USB Hub 4 Port UH-4S Sanwa USB Hub 4 Port Elecom 4 Port Hub (usb 2.0) UH-204
I/O - USB Bluetooth Module	Dongle USB Bluetooth Module
I/O - USB Card Reader	Sandisk Imagemate USB2.0 6 in 1 Card Reader
I/O - 1394 Storage Drive	Logitech Fireware CDRW + DVDROM Combo Yamaha Fireware 8824 CDRW CRW8824IX-VK Buffalo Fireware HD I.Link 20GB DIL-20G I-O Data Fireware HD I.Link 30GB HAD-130G Lacie Fireware HD 20G 7200RPM EXT-K525 DPTA-372050 VST Fireware HD FW1260
I/O - 1394 Scanner	UMAX Fireware PowerLook 110
I/O - 1394 Camera	Sony DV DCR-TRV10
I/O - Access Point 802.11b	Hitachi DC-CN3300 Lucent RG-1000 Lucent WavePoint-II Cisco Aironet 350 Orinoco AP-500
I/O - Access Point 802.11a/b	Intel Dual Pro/Wireless 5000
I/O - Access Point 802.11a	Intel Pro/wireless 5000
I/o - Bluetooth Printer	HP 995c Bluetooth Printer

Online Support Information

This section describes online technical support services available to help you repair your Acer Systems.

If you are a distributor, dealer, ASP or TPM, please refer your technical queries to your local Acer branch office. Acer Branch Offices and Regional Business Units may access our website. However some information sources will require a user i.d. and password. These can be obtained directly from Acer CSD Taiwan.

Acer's Website offers you convenient and valuable support resources whenever you need them.

In the Technical Information section you can download information on all of Acer's Notebook, Desktop and Server models including:

- Service guides
- User's manuals
- Training materials
- Main manuals
- Bios updates
- Software utilities
- Spare parts lists
- Chips
- TABs (Technical Announcement Bulletin)

For these purposes, we have included an Acrobat File to facilitate the problem-free downloading of our technical material.

Also contained on this website are:

- Detailed information on Acer's International Traveller's Warranty (ITW)
- Returned material authorization procedures
- An overview of all the support services we offer, accompanied by a list of telephone, fax and email contacts for all your technical queries.

We are always looking for ways to optimize and improve our services, so if you have any suggestions or comments, please do not hesitate to communicate these to us.

A

- AC Adapter 26
- ACPI 1.0a 19
- AFLASH Utility 46
- APM 1.2 19
- Audio 22, 24

B

- Battery 24
- Battery Pack 53
- battery pack
 - charging indicator 12
- BIOS 19
 - package 19
 - password control 19
 - ROM size 19
 - ROM type 19
 - vendor 19
 - Version 19
- BIOS Setup Utility 31
- BIOS Supports protocol 19
- BIOS Utility 31–45
 - Basic System Settings 33
 - Load Default Settings 45
 - Navigating 31
 - System Information 32
- Board Layout 4
 - Bottom View 5
 - Top View 4
- brightness
 - hotkeys 17

C

- Cache
 - controller 19
 - size 19
- caps lock
 - on indicator 12
- CardBus 23
- computer
 - on indicator 12
- Core logic 24
- CPU
 - core voltage 19

- I/O voltage 19
- package 19
- type 19

D

- DIMM 19
 - Combinations 20
 - package 19
 - Speed 19
 - voltage 19
- Disassembly
 - Battery Pack 53
 - LCD Module 58
 - Machine 49
 - Procedure Flowchart 51
- Display 3
- display
 - hotkeys 17
- Display Standby Mode 27
- DMA Channel Assignment 30
- DVD-ROM Interface 22

E

- Environmental Requirements 27
- Error Symptom-to-Spare Part Index 76
- External CD-ROM Drive Check 72
- External Diskette Drive Check 72

F

- Features 1
- FIR 23
- Flash Utility 46
- FRU (Field Replaceable Unit) List 91

H

- Hard disk 21, 24
- Hard Disk Standby Mode 27
- Hardware Specifications and Configurations 19
- HDD 21, 24
- Hibernation Mode 27
- Hibernation mode
 - hotkey 17

I

I/O Address Map 28
Indicators 12
Intermittent Problems 83
IrDA 23
IRQ Assignment Map 30

J

Jumper and Connector Locations 87
 Top View 87

K

Keyboard 24
 Removing 56
Keyboard or Auxiliary Input Device Check 73

L

L2 cache 19
LAN/Modem Combo 20
LCD 25
 DC-AC LCD Inverter 25
LCD Bezel
 Removing 66

M

Machine Disassembly 49
Mechanical Specification 28
media access
 on indicator 12
Memory
 Address Map 28
Memory Address Map 28
Memory Check 73
Microsoft Windows XP Environment Test 104
Model Number Definitions 101
Modem 21
Modem Power Cable
 Removing 65

N

Notebook Manager
 hotkey 17
num lock
 on indicator 12

O

Online Support Information 107

P

Panel 6
 Bottom 11
 left 6
 Rear 9
 right 9
parallel port
 setting in BIOS Utility 37, 38
Password Setting
 Hard Disk Password 44
 Power-On Password 44
 Setup Password 44
PC Card 12, 23
PCMCIA 23
Power Management 27
Power System Check 73
 Battery Pack 75
 Power Adapter 74
PQA 46
Processor 19

R

Removing the Main Board 64
Removing the Speaker 61
Removing the Thermal Plate 64
RMA 91
Rotating the display in tablet mode 7
RTC 24

S

Screw List 52
Second Level Cache 19
speakers
 hotkey 17
Standby Mode 27
Super I/O 24
System
 Block Diagram 3
 Layout 4
System Check Procedures 72
System Diagnostic Diskette 46
System Memory 19
System Utilities 31
System Utility Diskette 46

T

Temperature 27
Test Compatible Components 103

touchpad
 hotkey 17
Touchpad Check 75
TouchPad Module
 Removing 62
Troubleshooting 71

U

Undetermined Problems 84

USB 23
utility
 BIOS 31–45

V

Video 22, 23
 Resolutions 23
Video controller 24

