

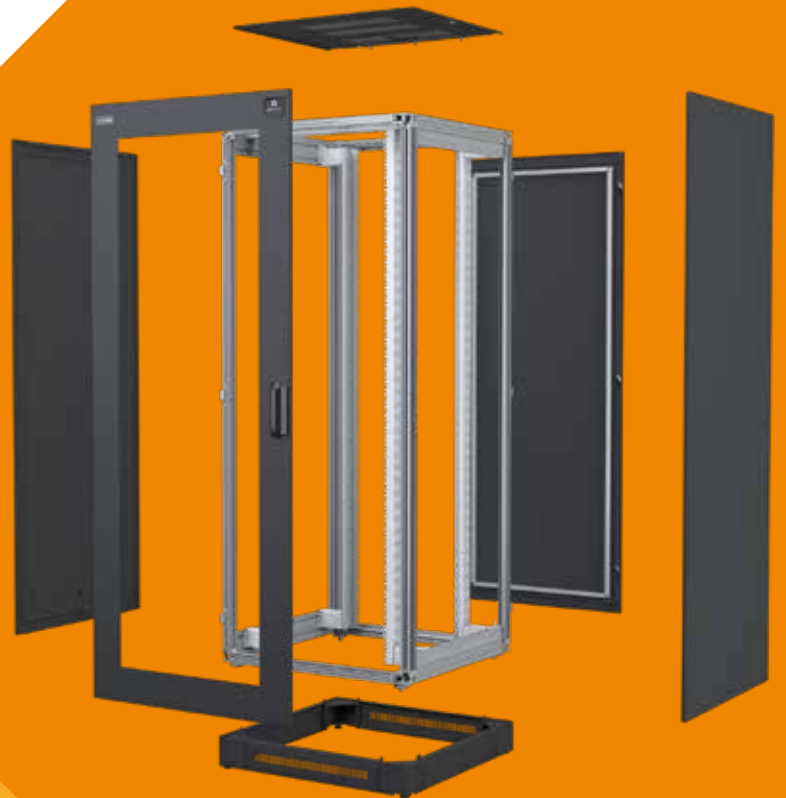

VERTIV™

VERTIV™ KNÜRR®
PRIORITY RANGE



Vertiv™

Vertiv designs, produces and maintains mission-critical technologies for data centers, communication networks and commercial and industrial environments. Our portfolio includes solutions for electricity supply, thermal and infrastructure management as well as software, and is supplemented by our global service network which enables us to meet all the requirements of the growing mobile and cloud computing markets. The Vertiv team of experts unites global range with local knowledge, and continues the decades-long heritage of brands such as ASCO®, Chloride®, Liebert®, NetSure™ and Trellis™. We would be delighted to assist you in meeting even the most complex of challenges and can develop solutions to keep your systems running and move your business forward. Let's work together for a future in which mission-critical technologies always work.

YOUR VISION, OUR PASSION.

VertivCo.de



Table of Contents

Racks



Page	4	Vertiv™ Knürr® MIR2
Page	6	Vertiv Knürr MIR2 - Server cabinet
Page	7	Vertiv Knürr MIR2 - Network cabinet
Page	8	Vertiv Knürr DCM Heavy-duty cabinet

Components and accessories



Page	11	Vertiv Knürr cabinet-specific accessories
Page	12	Vertiv Knürr system accessories
Page	16	Vertiv Knürr cable management
Page	20	Vertiv Knürr fan units

Electricity distribution



Page	24	Vertiv MPX™
Page	28	Vertiv MPH2™
Page	31	Vertiv MPE
Page	32	Vertiv Knürr DIS Rack PDU

Priority Range

Additional configuration options are available in our Knürr IT Special Catalog

Vertiv™ Knürr® MIR2 All-in-One server and network cabinets

- Material**
 - Extruded aluminum profile.
 - Die-cast aluminum corner connectors.
 - Galvanized sheet steel cladding panels.
 - Sheet steel doors.
- Installation dimensions in accordance with IEC 60297-1 and IEC 60297-2**
 - Height: 42 U / 47 U.
- Capacity**
 - Front stowing space 80 mm to 215 mm.
 - Internal hinge: 130° as a cabinet row, 160° as a single cabinet.
- Installation types**
 - Stationary, or mobile.
- Surface/color**
 - Polished base frame
 - Visible panel surfaces.
 - Powder-coated black-gray RAL 7021 and light gray RAL 7035.
- Static load**
 - 8000 N (stationary version).
 - 4000 N (mobile version).
- Tests depending on version**
 - Grounding and protective conductor testing, in accordance with DIN EN 60950.

Configuration table	Dimensions			Doors		19" extrusions		Coverings			Packaging		Color		
	2	3	4	5	6	7	8	9	10	11	12	13	14	15	
	Cabinet Height	Cabinet Width	Cabinet Depth	Cabinet door Front	Cabinet door Rear	19" Vertical extrusion Front	19" Vertical extrusion Rear	Cabinet cover	Cabinet base	Side panels	Packaging	Stowing depth 19" extrusion / insertion depth	Free	Color	
Vertiv™ Knürr® MIR2 Rack	N= P	B= P	8= P	C= P	A= P	A= P	A= P	H= P	B= P	F= P	B= P	X= P	A= P	X= P	1= P
	42 U	800 mm	800 mm	Single-leaf glass door, right	Single-leaf glass door, right	19" vertical server extrusions with air partition and 1U covers	19" hole pattern extrusions	Cover with cable inlet to rear and Coolblast fan option	no base, with adjustable feet	Left and right side panels	Standard packaging	80/740mm*		RAL 7035	
	D= P		E= P	B= P	B= P	C= P	S= P	C= P	G= P	L= P		C= P		8= P	
	47 U		1000 mm	Single-leaf sheet steel door, right	Sheet steel door single-leaf, right	19" server extrusions inc. cable management*	19" 19" server extrusions	Cover with cable inlet to rear	Stationary base, 100 mm, perforated front/rear	Left side panel		115/740mm*		RAL 7021	
			G= P	C= P	C= P	H= P	T= P	E= P	R= P	R= P		D= P		X= P	
			1200 mm	Perforated sheet steel door, single-leaf, right	Sheet steel door perforated, single-leaf, right	19" hole pattern extrusions	19" vertical extrusion with T-groove	Cover with side cable inlet	mobile using rollers	Right side panel		123/740mm*		no color **	
				E= P	E= P	S= P	X= P	X= P		X= P		E= P			
				Double-leaf glass doors	Double-leaf glass doors	19" server extrusions	without extrusions	without cover		open to left and right		200/740mm*			
				F= P	F= P	T= P						F= P			
				Double-leaf sheet steel door	Double-leaf sheet steel door	19" vertical extrusion with T-groove						215/740mm*			
			G= P	G= P	X= P						G= P				
			Perforated sheet steel door, double-leaf	Sheet steel door perforated, double-leaf	without extrusions						150/740mm*				
			X= P	X= P							Q= P				
			without door	without door							80/565mm*				
											T= P				
											123/565mm*				
											U= P				
											150/565mm*				
											V= P				
											200/565mm*				

P - Priority item (dispatched from our factory within 5 working days) Attention: Delivery times may be longer for large orders.

Note:

* This option is not available for all cabinet widths, cabinet depths, installation depths and insertion depths.

** Please use "X" if no cladding panels are selected.

SELECT YOUR OPTIONS

Vertiv™ Knürr® MIR2 Server and Network Cabinet Configurator

Vertiv Knürr MIR2 – put together by you.

Vertiv Knürr MIR2 is one of our configurable rack platforms.

Using the configuration table, you can put together your own individual rack.



Overview of all mountable components

Dimensions				Doors		19" extrusions		Coverings				Color		
Product	Height	Width	Depth	Front door	Rear door	19" vertical extrusion front	19" vertical extrusion rear	Cover	Base	Side panel	Packaging	Stowing depth	Free	Color
N	W	8	E	A	W	S	S	W	F	W	X	Q	X	8



Vertiv Knürr MIR2 Server Rack

Vertiv™ Knürr® MIR2 – Server Cabinet Features

- With fixed 19" installation from front and rear for installations in accordance with IEC 297-3.
- Perforated single-leaf front and rear doors.
- Special 19" server extrusions to accommodate all standard 19" servers.
- Installations in accordance with IEC 297-3.
- Cable inlet via floor and via cover.
- Cable inlet at cover rear completely removable, making cover assembly/disassembly possible after cabling.

■ Stowing space

- To front 80 mm.

■ Load-bearing capacity

- 8000 N static.

■ Protection class

- IP 20.

■ Tests

- Grounding in accordance with VDE 0100 T 540.
- Grounding in accordance with DIN EN 60950.
- IP test in accordance with EN 60529.

■ Material/ Surface

- Extruded aluminum profile base frame
- Plain die-cast aluminum corner connectors
- Galvanized sheet steel panels, powder-coated structure.
- Sheet steel doors, powder-coated structure.
- 19" extrusions, 2.0 mm sheet steel, galvanized.

■ Color

- x = .1 visible surfaces and cladding panels RAL 7035 light gray.
- x = .8 visible surfaces and cladding panels RAL 7021 black-gray.

■ Scope of supply

- 1 x base frame.
- 4 x 19" sheet steel server extrusions incl. U marking.
- 2 x side panels with quick locks.
- 1 x cover with rear cable inlet (sliding panels in three parts, may also be opened complete).
- 1 x front door, single-leaf with handle and receptacle for locking cylinder.
- 1 x rear door, single-leaf with handle and receptacle for locking cylinder.
- 1 x grounding set, complete (VDE 0100).
- 4 x leveling feet

■ How supplied

- Assembled.

■ Note

For drawers, pull-out shelves and chassis rails please also order extrusion adapter 01.147.640.9.

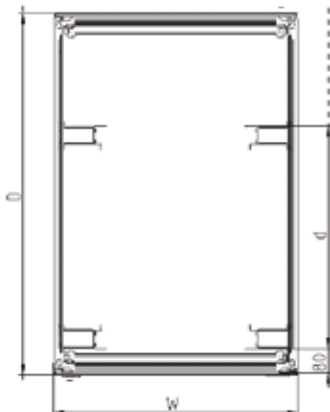
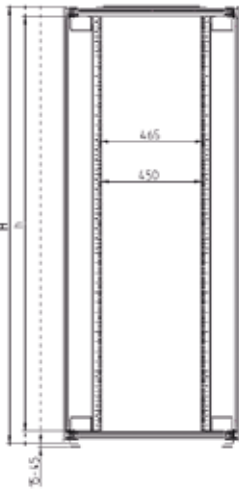

W	H	D	U	H	D	Kg	Part No.	PU
800	1969	1000	42	1873	740	107	01.157.011.x-026	1 pc
800	2191	1000	47	2095	740	116	01.157.011.x-036	1 pc
800	1969	1200	42	1873	740	111	01.157.011.x-028	1 pc
800	2191	1200	47	2095	740	123	01.157.011.x-038	1 pc

Priority Item (dispatched from our factory within 5 working days)
Attention: Delivery times may be longer for large orders.



Vertiv Knürr MIR2 Network Cabinet

Priority storage rack

Vertiv™ Knürr® MIR2 – Network Cabinet

- With fixed 19" installation to front and rear for installations in accordance with IEC 297-3.
- Installation of chassis rails, drawers, pull-out shelves and cable management.
- Cable inlet via base and via cover.
- Cable inlet at cover, to rear; cover assembly or disassembly possible after cabling.
- Heat loss discharge via raised roof.
- Door opening angle 160° with internal hinge.

■ Stowing space

- To front 123 mm.

■ Load capacity

- 8000 N static.

■ Protection class

- IP 20.

■ Tests

- Grounding in accordance with VDE 0100 T 540.
- IP test in accordance with EN 60529.

■ Material / Surface

- Extruded aluminum profile base frame
- Plain die-cast aluminum corner connectors
- Galvanized sheet steel panels, powder-coated structure.
- Sheet steel doors, powder-coated structure, glass filling to front with 4 mm single-pane safety glass.
- 19" extrusions, 1.5 mm sheet steel, galvanized.

■ Color

- x = 1 visible surfaces and panels
RAL 7035 light gray.
- x = .8 visible surfaces and panels
RAL 7021 black-gray.

■ Scope of supply

- 1 x base frame.
- 4 x 19" hole pattern sheet steel extrusions incl. U marking. For cabinet depth 600mm, only 2 x 19" extrusions to front..
- 2 x side panels with quick locks.
- 1 x raised cover with cable inlet (sliding panels in three parts, may also be opened complete) to rear.
- 1 x front door, single-leaf, single-pane safety glass, with handle and receptacle for locking cylinder.
- 1 x rear door, single-leaf, sheet steel, with handle and receptacle for locking cylinder.
- 1 x base with ventilation slits to front and rear, closed to sides, filter mat may be retrofitted.
- 1 x grounding set, complete (VDE 0100).
- 4 x leveling feet.

■ How supplied

- Assembled.

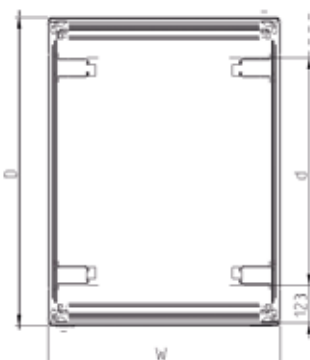
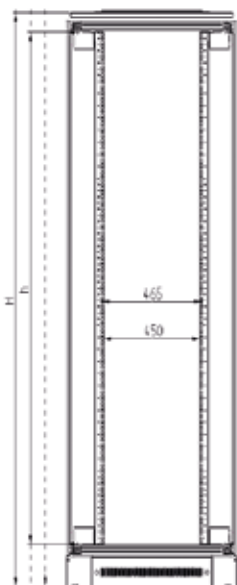

W	H	D	U	H	D	Kg	Order no.	PU	
800	2120	800	42	1873	565	115	01.157.005.1-024	1 pc	P

P - Priority item (dispatched from our factory within 5 working days)
Attention: Delivery times may be longer for large orders.

Dimensions in mm:				Conversion:	
W = Width	H = Installation height	U = standardized height unit	Kg = Weight	1 mm	= 0.03937 inch
H = Height	D = Insertion depth	1 U = 44,45 mm		1 kg	= 2.2046 pounds
D = Depth	L = Length	PU = Packaging unit			

Priority Range

Additional configuration options are available in our Knürr IT Special Catalog

Vertiv™ Knürr® DCM Heavy Duty Cabinet

Material

- Extruded aluminum profile.
- Die-cast aluminum corner connectors.
- Galvanized sheet steel cladding panels.
- Sheet steel doors.

Installation dimensions in accordance with IEC 60297-1 and IEC 60297-2

- Height: 42 U / 47 U

Capacity

- Front stowing space 80 mm.
- Internal hinge: 130° as a cabinet row, 160° as a single cabinet.

Installation types

- Stationary, or mobile.

Surface/color

- Plain base frame
- Visible panel surfaces powder-coated black-gray RAL 7021.

Static load

- 15000 N (stationary version).
- 10000 N (mobile version).

Tests depending on version

- IP test in accordance with IEC 60529.
- Grounding and protective conductor test in accordance with DIN EN 60950.

Product line

Vertiv Knürr DCM Heavy Duty Cabinet

	Dimensions			Doors		19" extrusions		Coverings			Color				
	2	3	4	5	6	7	8	9	10	11	12	13	14	15	
	Cabinet Height	Cabinet Width	Cabinet Depth	Cabinet door Front side	Cabinet door Rear side	19" Vertical extrusion Front	19" Vertical extrusion Rear	Cover	Base	Side panels	Packaging	Stowing depth 19" extrusions /Insertion depth	Free	Color	
1	D= Vertiv Knürr DCM Rack	B= 42 U	6= 600 mm	G= 1200 mm	C= Perforated single door	C= Perforated single door	A= 19" server vertical extrusion with air partitioning und 3x1U breakouts*	S= 19" server vertical extrusion	C= Cover with cable inlet	A= Base stationary 100mm	B= To both sides	X= Standard packaging	A= 80/740mm	X= Free	1= RAL 7035
	D= 47 U	8= 800 mm		G= Perforated double door	G= Perforated double door	C= 19" server extrusion with vertical cable manager	X= Without 19" extrusions	E= Cover with side cable routing*	R= With rollers	L= Left		B= 85/740 mm		8= RAL 7021	
				X= Without door	X= Without door	S= 19" server vertical extrusion		X= Without cover	F= Stationary without base. Only adjustable feet are height-adjustable	R= Right		C= 115/740 mm		X= no color **	
										X= Without		D= 123/740 mm			
												E= 200/740 mm			
												F= 215/740 mm			
												G= 150/740 mm			
Example configuration:															
	D	W	8	G	C	X	A	X	C	A	L	X	X	X	8

Example article number

P - Priority Item (dispatched from our factory within 5 working days)
Attention: Delivery times may be longer for large orders.

Note:

* This option is not available for all cabinet widths, cabinet depths, installation depths and insertion depths.

** Please use "X" if no cladding panels are selected.

Vertiv™ Knürr® DCM Heavy Duty Cabinet Configurator

1

- Up to 2.5 million possible configurations





DCM20003 stationary DCM20022 mobile

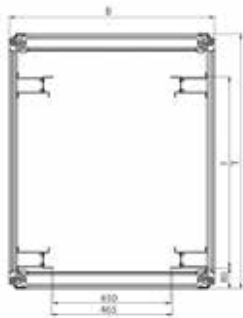

DCM20063 Cut width 800 mm, stationary



DCM20062 Cut width 600 mm, stationary

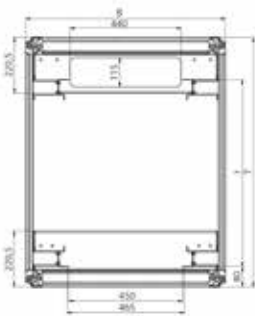

DCM20065 Cut width 800 mm, mobile

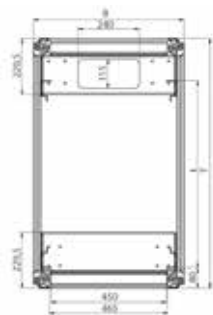

DCM20064 Cut width 600 mm, mobile

Vertiv™ Knürr® DCM Heavy Duty Cabinet 19" Server Cabinet Width 600 and 800, stationary and mobile

- Perforated front door.
- Perforated door leaf to rear.
- Special 19" server extrusions to accommodate all standard 19" servers.
- Installations in accordance with IEC 297-3.
- Cable inlet via floor and via cover.
- Cable inlet at cover rear completely removable, making making cover assembly/disassembly possible after cabling.
- In mobile version with heavyweight rollers with excellent ground clearance.

Stowing space

- To front 80 mm.

Load capacity

- 15,000 N static.
- 10,000 N mobile in RZ with load.

Protection class

- IP 20.

Tests

- Grounding in accordance with DIN EN 60950.
- Mobile version: Grounding in accordance with VDE 0100 T 540.
- IP test in accordance with DIN 40 050 / IEC 529.

Flow cross-section

- Perforation 83%.

Material / Surface

- Extruded aluminum profile base frame, polished.
- Die-cast aluminum corner connectors, polished.
- Sheet steel doors, powder-coated structure.
- Galvanized sheet steel panels, powder-coated structure.
- 19" extrusions, 2.0 mm sheet steel, galvanized.

Color

- Visible panel surfaces.
- RAL 7021 black-gray.

Scope of supply

- 1 base frame.
- 4 19" server extrusions, sheet steel incl. U marking.
- 2 side panels with quick locks.
- 1 Cover with cable inlet (sliding panels in three parts, may also be opened complete).
- 1 Front door, single leaf, perforated with handle and receptacle for locking cylinder.
- 1 Rear door, double leaf, perforated, sheet steel, with handle and receptacle for locking cylinder.
- 4 leveling feet.
- 1 grounding set, complete (VDE 0100).
- Mobile version: also includes 2 roller mountings with heavyweight rollers with integrated cable inlets.

How supplied

- Assembled.

Note

For assembling Vertiv Knürr accessories, please also order fixing adapter for 19" server extrusion.

W	H	D	U	d	kg	Version	Part No.	PU	P
600	2000	1200	42	740	117	stationary, with side panels	DB6GCGSSCFBXXX8	1 pc	P
600	2200	1200	47	740	121	stationary, with side panels	DD6GCGSSCFBXXX8	1 pc	P
800	2000	1200	42	740	132	stationary, with side panels	DB8GCGSSCFBXXX8	1 pc	P
800	2200	1200	47	740	136	stationary, with side panels	DD8GCGSSCFBXXX8	1 pc	P
600	2000	1200	42	740	75	stationary, without side panels	DB6GCGSSCFXXX8	1 pc	P
600	2200	1200	47	740	81	stationary, without side panels	DD6GCGSSCFXXX8	1 pc	P
800	2000	1200	42	740	92	stationary, without side panels	DB8GCGSSCFXXX8	1 pc	P
800	2200	1200	47	740	94	stationary, without side panels	DD8GCGSSCFXXX8	1 pc	P
600	2000	1200	42	740	127	mobile, with side panels	DB6GCGSSCRBXXX8	1 pc	P
800	2200	1200	47	740	146	mobile, with side panels	DD8GCGSSCRBXXX8	1 pc	P
600	2000	1200	42	740	85	mobile, without side panels	DB6GCGSSCRXXX8	1 pc	P
800	2200	1200	47	740	104	mobile, without side panels	DD8GCGSSCRXXX8	1 pc	P

P - Priority item (dispatched from our factory within 5 working days)
Attention: Delivery times may be longer for large orders.

Our Priority System Accessories

For the full range, see our new Knürr IT Special Catalog

Base plates

- For cladding the cabinet underside.
- Flexible cable insertion to front and rear with foam rubber seal or brush strips.
- For racks with and without roller beam.

Material / Surface

- Sheet steel, 1.5 mm, galvanized.
- With foam rubber seal (foam rubber 50 x 30 mm).

Scope of supply

- Base plates.
- 2 securing brackets.
- Assembly material.

How supplied

- As a set.

Image	Description	Dimensions		
	Base plate for cable insertion with foam rubber seal	W 600 mm	D 1000 mm	D 1200 mm
		01157.0410-001	01147.846.0	01147.852.0
	Base plate for cable insertion with foam rubber seal	W 800 mm	D 1000 mm	D 1200 mm
		01157.0410-003	01147.850.0	01147.856.0



MEC20179

19" Quick-Fix blind panel. tool-free assembly.

- For covering open 19" surfaces (cold-warm separation)
- Quick and easy assembly and disassembly without tools (one click) (quarter-turn).
- Fits 9.5 x 9.5 square perforations.

Material

- Sheet steel 1.0 mm.

Surface

- Last figure in order number .1: Power-coated RAL 7035, light gray structure.
- Last figure in order number .8: Powder-coated RAL 7021, black-gray structure.

Scope of supply

- X (for volume, see order no.) 19" Quick-Fix blind panel.
- Assembly material.

How supplied

- As a set (for volume, see order no.); securing clips pre-installed.



MEC20180



MEC20178

W	H	U	Part No.	PU	
482.6	43.6	1	01103.301.X	6 pc	
482.6	88.1	2	01103.302.X	3 pc	
482.6	132.5	3	01103.303.X	2 pc	
482.6	265.9	6	01103.306.X	1 pc	

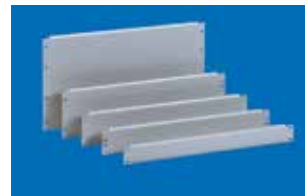

CUD00005

19" blind panel Screw-fastened

- For covering open 19" surfaces (cold-warm separation)

Material

- Sheet steel 1.0 mm.

Surface

- Last figure in order number .1: Power-coated RAL 7035, light gray structure.

Scope of supply

- X (for volume, see order no.) 19" blind panel.

How supplied

- As a set (for volume, see order no.).

Note

- Please also order matching front panel securing material!



CUD00004

W	H	RU	Part No.	PU	
482.6	88.1	2	01103.202.1	3 pc	

- Priority item (dispatched from our factory within 5 working days)
Attention: For large orders, delivery times may be longer.

Dimensions in mm:				Conversion:
W = Width	H = Installation height	U = standardized height unit	Kg = Weight	1 mm = 0.03937 inch
H = Height	d = Insertion depth	1 U = 44.45 mm		1 kg = 2.2046 pounds
D = Depth	L = Length	PU = Packaging unit		



MEC20162

Insertion rail may be hooked or screw-fastened

- For installation in 19" cabinet and 19" housing.
- May be hooked for quick and easy assembly.
- May also be screw-fastened for higher loads.
- May be screw-fastened from the interior (cabinet row application).
- Height may be adjusted for different corpus heights.



MEC20167

- Material/surface**
 - Sheet steel 2.0 mm.
 - Galvanized, blue chromated.
- Load capacity**
 - 1000 N maximum, with even distribution.
- Scope of supply**
 - 2 chassis rails.
 - Assembly material.



MEC20167

- How supplied**
 - As a pair.
- Note**

When selecting a chassis rail, please bear in mind the insertion depth of the cabinet or housing. 4 x 19" extrusions are required for assembly.

T _{Rack}	d	L	for cabinet type	Part No.	PU
900 and above	740	711	MIR2 / DCM / Smaract / CoolTherm	01.103.056.0	1 pair

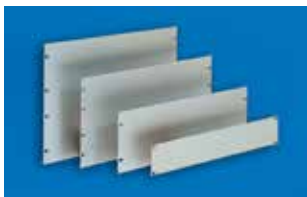

FR000005

19" front panel 3 mm aluminum

- Material/surface**
 - Last figure in order number 0: AlMg3 - F23 polished with protective film.
 - Last figure in order number 1: AlMg3 - F23, powder-coated RAL 7035, light gray.
 - Last figure in order number 6: AlMg3 - F23 EB (suitable for anodizing), anodized E6/EV1.
 - Last figure in order number 8: AlMg3 - F23, powder-coated RAL 7021, black-gray.

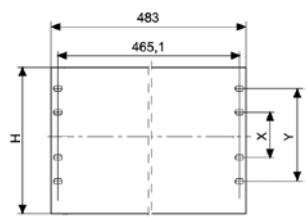
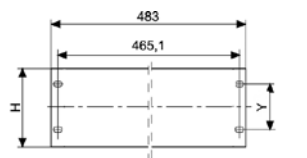

MEC20109

- Scope of supply**
 - 1 19" front panel.
- How supplied**
 - Individually.
- Note**

Please also order matching front panel securing material.

H	X	Y	U	Version	Part No.	PU
436		317	1	powder-coated, RAL 7035	02.008.021.1	1 pc



MEC20189

Aluminum chassis rails Screw-fastened

- For installation in 19" cabinet and 19" housing.
- May be screw-fastened from the interior (cabinet row application).
- Height adjustment possible for different corpus heights.

- Material/surface**
 - Extruded aluminum profile, polished.
- Load capacity**
 - 700 N maximum, with even distribution.
- Scope of supply**
 - 2 chassis rails.
 - Assembly material.
- How supplied**
 - As a pair.
- Note**

When selecting chassis rails, please bear in mind the insertion depth of the cabinet or housing. 4 x 19" extrusions are required for assembly. Adapter set when using 19" server extrusions: 1 set 01.147640.9.

T _{Rack}	d	L	for cabinet type	Part No.	PU
800	565	536	MIR2 / DCM / Smaract	01.103.103.0	1 pair
800	640	611	MIR2 / DCM / Smaract	01.103.104.0	1 pair
900 and above	740	711	MIR2 / DCM / Smaract / CoolTherm	01.103.106.0	1 pair



MEC20154

Articulated cable girder

- May be swung out to rear, allowing free access to rear side (only 3-part)
- For easy assembly within the cabinet/to an intermediate base; quick securing and removal from intermediate base or cabinet via a spring bracket.
- Guarantees defined and kink-free cable routing.
- Minimum space requirement behind the inserted intermediate base 40 mm.



MEC88005

- Material/surface**
 - steel sheet 1.5 mm, galvanized.
- Scope of supply**
 - 1 articulated cable girder.
 - Assembly material.
- How supplied**
 - As a set.

Type	Part No.	PU
2-part	05.040.096.0	1 pc



MEC20163

Depth-adjustable chassis rail Screw-fastened

- For installation in 19" cabinet and 19" housing.
- Depth-adjustable.
- May be screw-fastened from the interior (cabinet row application).
- Height may be adjusted for different corpus heights.

Material/surface

- Sheet steel 1.25 mm.
- Galvanized, blue chromated.

Load capacity

- 200 N maximum, with even distribution.

Scope of supply

- 2 basic rails.
- 2 extension rails.
- Assembly material.

How supplied

- As a pair.

Note

When selecting the chassis rail, please bear in mind the insertion depth of the cabinet or housing. 4 x 19" extrusions are required for assembly. Adapter set when using 19" server extrusions: 1 set 01.147.640.9.



MEC20166

T _{Rack}	d	for cabinet type	Part No.	PU
800-1200	565-740	MIR2 / DCM / Smaract	01.103.092.0	1 pair
900-1200	740	CoolTherm	01.103.092.0	1 pair
600-800	560-660	DoubleProRack	01.103.092.0	1 pair



MIR00114

Assembly aid for cage nut

- For assistance with clipping the cage nut into the extrusion.

Material

- Spring steel.

Scope of supply

- 1 assembly aid.

Part No.	PU
01.130.985.9	1 pc

- **Priority item** (dispatched from our factory within 5 working days)
Attention: Delivery times may be longer for large orders.

Dimensions in mm:				Conversion:
W = Width	h = Installation height	U = standardized height unit	kg = Weight	1 mm = 0.03937 inch
H = Height	d = Insertion depth	1 U = 44.45 mm		1 kg = 2.2046 pounds
D = Depth	L = Length	PU = Packaging unit		



MEC20126

Hole pattern securing set server extrusion M5/Sheet 2.5 mm for MIR2/DCM®/Smaract®

- For securing 19" front panels and 19" installations.

Scope of supply

- 100 cage nuts M5 / Sheet 2.5 mm.
- 100 oval-head screws FormZ M5 x 16.
- 20 spring nuts M5 wide.
- 20 cylinder screws M5 x 8.

How supplied

- As a set.

Part No.	PU
05.041.325.9	1 set



MEC20129

Type 1

Front panel securing set T-groove M5 wide for MIR2/Smaract®

- For securing 19" front panels and 19" installations.

Scope of supply

- Type 1: 50 spring nuts M5 wide, 50 oval-head screws FormZ M5 x 10.
- Type 2: 50 spring nuts M5 wide, 50 countersunk screws M5 x 12, 50 rosettes.

How supplied

- As a set.



MEC20130

Type 2

Version	Part No.	PU
Type 1: Screw FormZ	05.041.335.9	1 set



MEC20098

Type 1

Front panel securing set hole pattern Hole pattern M5/Sheet 2.5 mm for MIR2/DCM®/Smaract®/DoubleProRack®

- For securing 19" front panels and 19" installations.

Scope of supply

- Type 1: 50 cage nuts M5 / Sheet 2.5 mm, 50 oval-head screws FormZ M5 x 16.
- Type 2: 50 cage nuts M5 / Sheet 2.5 mm, 50 countersunk screws M5 x 16, 50 rosettes.

How supplied

- As a set.



MEC20097

Type 2

Version	Part No.	PU
Type 1: Screw FormZ	05.041.337.9	1 set



MEC00060

Spring nut

- For clipping into T-groove wherever required.
- **Type 1:** M5 wide. for MIR2/Smaract. Slot nut size: 10 x 13 mm.
- **Type 2:** M5 narrow. for DoubleProRack. Slot nut size: 8 x 13 mm.
- **Type 3:** M6. for MIR2/Smaract. Slot nut size: 10 x 13 mm.

- **Scope of supply**
 - 50 spring nuts.

- **How supplied**
 - As a set.

Version	Part No.	PU
Type 1: M5 wide	01.350.431.9	1 set
Type 2: M5 narrow	05.041.503.9	1 set
Type 3: M6	01.350.405.9	1 set



MEC20139

Cage nuts

- For clipping into extrusions with hole pattern.
- **Type 1:** Sheet 1.5 mm. for MIR2/Smaract/ConAct.
- **Type 2:** Sheet 2.5 mm for MIR2 Server/Smaract Server/ DoubleProRack with 19° hole pattern.

- **Scope of supply**
 - 50 cage nuts.

- **How supplied**
 - As as set

Version	Part No.	PU
M6: Type 2: sheet metal, 2.5 mm	05.041.519.7	1 set



MEC20140

Fillister head screw

- IEC DIN 967.

- **Scope of supply**
 - 50 oval-head screws FormZ.

- **How supplied**
 - As a set.

Version	Part No.	PU
M5 x 10	05.041.330.9	1 set



MEC20141

Countersunk screw and Rosette

- IEC DIN EN ISO 7047.

- **Scope of supply**
 - 50 countersunk screws.
 - 50 rosettes.

- **How supplied**
 - As a set.

Version	Part No.	PU
M5 x 12	05.041.203.9	1 set



ELM00068

Grounding rail

- For safe grounding or equipotential bonding of devices and installation components.

- **Material**
 - Electrolytic copper 9 x 9.

- **Scope of supply**
 - 1 grounding rail.
 - 2 brackets
 - Assembly material.

U	Version	Part No.	PU
41	for MIR2 / DCM	01.110.708.9	1 pc



DOP20016

Contact clamp

- For the safe connection of devices and installation components with the grounding rail.
- For cables up to 25 mm².

- **Scope of supply**
 - 20 contact clamps.

Version	Part No.	PU
	01.110.715.9	20 pc

Priority item (dispatched from our factory within 5 working days)
Attention: Delivery times may be longer for large orders.

Dimensions in mm:				Conversion:	
W = Width	h = Installation height	U = standardized height unit	kg = Weight	1 mm	= 0.03937 inch
H = Height	d = Insertion depth	1 U = 44.45 mm		1 kg	= 2.2046 pounds
D = Depth	L = Length	PU = Packaging unit			

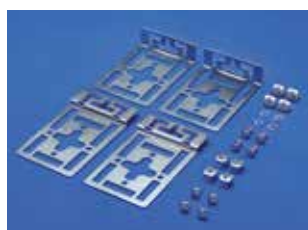

MEC20222 Type 1

PDU assembly kit

- For securing different rack PDUs.
- Fits MIR2 and DCM cabinets.
- For assembling 1 or 2 PDUs.
- Assembly possibilities available in the manual "Assembly instructions for PDUs".

Material/surface

- steel sheet 2 mm, galvanized.

Scope of supply

- 2 L-Form securing brackets.
- 2 elbowed securing brackets.
- Assembly material.

How supplied

- As a set.



MEC20223 Type 2

Version	for cabinet type	Part No.	PU
Type 1: short	MIR2 / DCM	01.147.813.9	1 set



MIR00069

Locking set, complete

Scope of supply

- 2 extrusion cylinders, each with 2 keys.
- 2 lockable sash locks for side panel, each with 2 keys.

Version	Part No.	PU
MIR2 / DCM	01.130.940.9	1 set

A matching securing set for every type of cabinet.

DCM	MIR2 T-groove	MIR2 Hole pattern	MIR2 Server	MIR2 Swivel frame	Smaract T-groove	Smaract Hole pattern	Smaract Server	Double- ProRack T-groove	Double- ProRack Hole pattern	ConAct	Designation	Part No.	PU
											Securing set - Hole pattern M5/BI 2.5	05.041.325.9	1 set

The matching securing set for front panels Version: Screw FormZ

DCM	MIR2 T-groove	MIR2 Hole pattern	MIR2 Server	MIR2 Swivel frame	Smaract T-groove	Smaract Hole pattern	Smaract Server	Double- ProRack T-groove	Double- ProRack Hole pattern	ConAct	Designation	Part No.	PU
											FP securing set T-groove M5 wide	05.041.335.9	1 set
											FP securing set Hole pattern M5/BI 2.5	05.041.337.9	1 set

Matching accessories for every type of cabinet

DCM	MIR2 T-groove	MIR2 Hole pattern	MIR2 Server	MIR2 Swivel frame	Smaract T-groove	Smaract Hole pattern	Smaract Server	Double- ProRack T-groove	Double- ProRack Hole pattern	ConAct	Designation	Part No.	PU
											Spring nut M5 wide	01.350.431.9	1 set
											Spring nut M5 narrow	05.041.503.9	1 set
											Spring nut M6	01.350.405.9	1 set
											Oval-head screw FormZ M5 x 10	05.041.330.9	1 set
											Countersunk screw M5 x 12 + rosette	05.041.203.9	1 set



MEC20038

Universal cable routing bracket

- May be used for extrusion clearances (from front) of 123 mm and 73 mm.
- For orderly cable routing.
- Open design, no threading.
- Secured to the exterior sides of the 19" extrusion.
- Installation position may be freely selected.

- **Material**
 - Round steel, d = 6 mm.

- **Surface**
 - Galvanized.

- **Scope of supply**
 - 4 cable routing brackets.
 - Assembly material.

- **How supplied**
 - As a set.



MEC20072

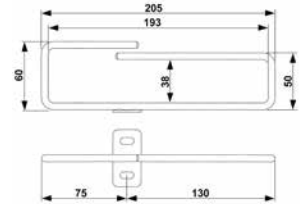

MEC20106

W _{rack}	For cabinet type	Part No.	PU
800 and above	MIR2 / DCM	05.040.220.9	4 pc



MEC20039

Rectangular cable routing bracket

- For orderly cable routing.
- Open design, no threading.
- Secured to the exterior side of the 19" extrusion.
- Installation position may be freely selected.
- For large cable volumes.

- **Material**
 - Round steel, d = 6 mm.

- **Surface**
 - Galvanized.

- **Scope of supply**
 - 4 rectangular cable routing brackets.
 - Assembly material.

- **How supplied**
 - As a set.

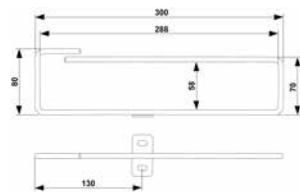

MEC20107

Type 1

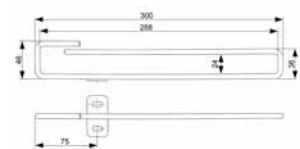

MEC20116

Type 2

W _{rack}	Type	For cabinet type	Part No.	PU
800 and above	Type 1	MIR2 / DCM	05.040.221.9	4 pc

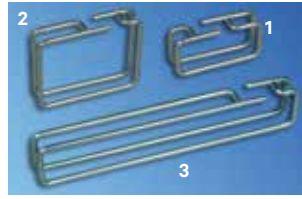

MEC20035

Flexible cable routing bracket

- For flexible and orderly cable routing.
- Installation position and installation location may be freely chosen.
- Open design, no threading.

- **Material**
 - Round steel, d = 5 mm.

- **Surface**
 - Galvanized.

- **Scope of supply**
 - 10 cable routing brackets.
 - Assembly material.

- **How supplied**
 - As a set.



MEC20065

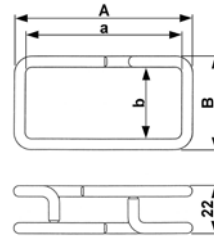

MEC20108

A	A	W	W	Version	Part No.	PU
102	92	82	72	Figure 2	05.040.233.9	10 pc



ELM00028

Marshaling rungs

- Ideal for vertical cable routing and support.
- Open design, no threading.
- Secured to the exterior side T-groove of the 19" extrusion.
- Installation position may be freely selected.
- From cabinet width 600 mm.

Material/surface
- Round steel, d = 5 mm, galvanized.

Scope of supply
- 2 marshaling rungs.

How supplied
- As a set.

Note
Please also order matching securing material.

Z56-1/FH

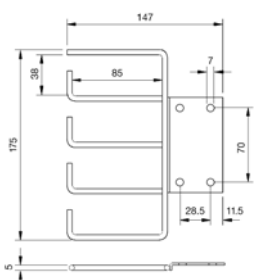

ELM00029

Part No.	PU
01.117.033.7	2 pc



MIR00183

Square cable routing bracket

- For orderly cable routing.
- Open design, no threading.
- Secured to the exterior side T-groove of the 19" extrusion.
- Installation position may be freely selected.
- From cabinet width 800 mm.

Surface
- Galvanized Zn 10c white.

Scope of supply
- 4 vertical cable routing brackets.
- Assembly material.

How supplied
- As a set.

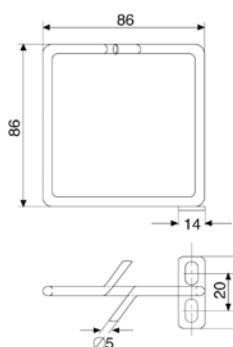

ELM00057

W _{rack}	Version	Part No.	PU
800 and above	86 x 86	05.040.224.9	4 pc



ELM20008

Cable router ring

- For orderly cable routing.
- Open design, no threading.
- Secured to the vertical extrusion T-grooves.
- Installation position may be freely selected.

Material/surface
- PA 6, GF 15, black, UL 94-HB.

Scope of supply
- 5 cable routing rings.
- Assembly material.

How supplied
- As a set.



ELM20007

Version	Part No.	PU
54 x 118 mm	01.312.207.9	5 pc



MEC20187

Plastic Quick-Clamp cable routing bracket for T-groove – tool-free assembly

- Quick securing without tools.
- For orderly cable routing.
- Open design, no threading.
- Secured at any desired point on the T-grooves.

Material
- Nylon.
- F.R.T., UL-94 HB.

Color
- Black.

Scope of supply
- 10 plastic cable routing brackets.

How supplied
- As a set.



MEC20188

For cabinet type	Part No.	PU
DCM, Miracel	00.218.505.0	1 set

Priority item (dispatched from our factory within 5 working days)
Attention: Delivery times may be longer for large orders.

Dimensions in mm:				Conversion:	
W = Width	h = Installation height	U = standardized height unit	kg = Weight	1 mm	= 0.03937 inch
H = Height	d = Insertion depth	1 U = 44.45 mm		1 kg	= 2.2046 pounds
D = Depth	L = Length	PU = Packaging unit			



MEC20041

19" cable routing panel Flexible, 1 U

- For orderly cable routing.
- For safe routing of copper cables and fiber-optic cables.

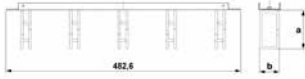

MEC20102

Material/surface

- Front panel sheet steel 1.5 mm powder-coated.
- Cable routing bracket, round steel, d = 5 mm galvanized.

Color

- Last figure in order number .1: RAL 7035 light gray.
- Last figure in order number .8: RAL 7021 black-gray.

Outer dimensions

- Cable routings (a x b):
- 1 U: 82 x 43 mm.
 - 2 U: 102 x 82 mm.

Scope of supply

- 1 front panel.
- 5 cable routing panels.

How supplied

- Pre-assembled.

Note

Please also order matching front panel securing material.



MEC20076

W	U	Mount depth	Version	Part No.	PU
483	1	from 100 mm	Type 1	05.040.100.X	1 pc



MEC20224

Cable trough

- For orderly cable routing in MIR2 and DCM cabinets.
- Cable secured using Velcro strips or cable ties.
- Slot width 9 mm for securing various parts to cage nut.

Material/surface

- Sheet steel 1.5mm, galvanized, powder-coated.

Color

- Last figure in order number .1: RAL 7035 Light gray
- Last figure in order number .8: RAL 7021 black-gray.

Scope of supply

- 1 cable trough.
- Assembly material.

How supplied

- As a set.

Note

Please also order Velcro strip if desired.



MEC20067

H	W	Version	Part No.	PU
2000	150	for cabinet types MIR2 and DCM	05.040.254.X	1 set



MEC00110 Type 1



MEC20014 Type 2

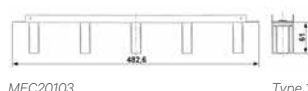

MEC20103 Type 1

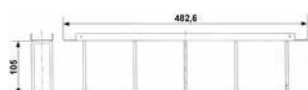

MEC20104 Type 2

19" cable routing panel, 1 U

- For orderly cable routing.
- For safe routing of copper cables and fiber-optic cables.

Material/surface

- Type 1: Front panel sheet steel 1.5 mm powder-coated.
- Type 2: Front panel sheet steel 1.0 mm powder-coated.

Color

- Last figure in order number .1: RAL 7035 light gray.
- Last figure in order number .8: RAL 7021 black-gray.

Outer dimensions

- Cable routing:
- Type 1: 55 x 22 mm, plastic.
 - Type 2: 95 x 32 mm, steel.

Scope of supply

- 1 19" front panel.
- 5 cable routings.

How supplied

- Pre-assembled.

Note

Please also order matching front panel securing material.

W	U	Mount depth	Version	Part No.	PU
483	1	from 80 mm	Type 1	05.040.111.1	1 pc
483	1	from 123 mm	Type 2	01.117.144.X	1 pc



MEC20081

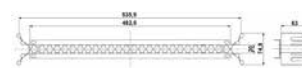

MEC20105



MEC20058

FO cable routing panel 1 U

- For orderly cable routing.
- For safe cable routing of fiber-optic cables.
- Optionally supplied with covering panels for cable protection and labeling.

Material/Surface

- FO cable routing panel: Sheet steel 1.5 mm, powder-coated.
- Covering accessory: Aluminum 2.5 mm, powder-coated.
- Covering accessory: Aluminum 2.5 mm, powder-coated.

Color

- Last figure in order number .1: RAL 7035 Light gray

Scope of supply

- 1 19" cable routing panel.

How supplied

- Individually.

Note

Please also order matching front panelsecuring material and covering.
Not suitable for cabinet widths 600 mm and 700 mm (asymmetrical)!

W	U	Version	Part No.	PU
483	1	Cable routing panel	05.040.050.1	1 pc

- **Priority item** (dispatched from our factory within 5 working days)
Attention: Delivery times may be longer for large orders.

Dimensions in mm:				Conversion:	
W = Width	h = Installation height	U = standardized height unit	kg = Weight	1 mm = 0.03937 inch	
H = Height	d = Insertion depth	1 U = 44.45 mm		1 kg = 2.2046 pounds	
D = Depth	L = Length	PU = Packaging unit			



LUF20203



LUF20205



LUF20124

Vertiv™ Knürr® CoolBlast® Fan Unit for Roof Installation unregulated and thermostatically controlled

- For forced cooling of the cabinet.
- Suitable for retrofitting in MIR2/DCM® roof.
- DC versions and 115 VAC versions on request (see CoolBlast® fan inserts).
- In thermostatically-controlled version:
Thermostatically-controlled fan function (ON/OFF), adjustable from 0° to +60° C.

Material

- Housing: Sheet steel, stainless steel mesh.

Surface

- Galvanized.

Approvals

- CE marking in accordance with Low Voltage Directive 73/23/EEC, EMC Directive 89/366/EEC.

Scope of supply

- 1 CoolBlast fan unit.
- 13 m network cable with safety plug (230 VAC).
- Assembly material.
- Operating manual.

How supplied

- Assembled, wired and tested.

Note

- Please additionally order specific network cable!

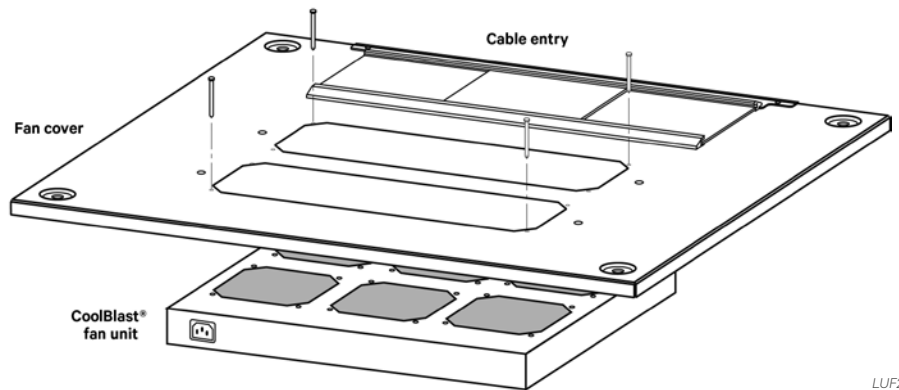

LUF20175

Designation	Version	Electrical Connection	P(W)	V̇ (m³/h)	ΔP(Pa)	p (dB(A))	Part No.	PU
CoolBlastT 230V triple	Thermostat	207..253 VAC; 50/60 Hz	45	495	74	45.2	03.027.311.1	1 pc

P - Priority item (dispatched from our factory within 5 working days)
Attention: Delivery times may be longer for large orders.

Dimensions in mm:		Conversion:	
W = Width	H = Installation height	U = standardized height unit	Kg = Weight
H = Height	D = Usable depth	1 U = 44.45 mm	1 mm = 0.03937 inch
D = Depth	L = Length	PU = Packaging unit	1 kg = 2.2046 pounds
SP = Standard Performance	V̇ = Air volume flow (m³/h)		
HP = High Performance	ΔV̇ = Loss of air volume flow (%)		
UP = Ultra High Performance	ΔP = Pressure increase (Pa)		
n = Number of fans	I nom. = nominal current (A)		
W = Power consumption	I max. = Starting current (A)		
V = Voltage (400V = 3-phase)	p = Acoustic pressure (dB(A)) at 1 meter distance from cabinet (600 mm x 600 mm; raised cover)		



LUF20128



LUF20140



LUF20054

19" Vertiv™ Knürr® CoolBlast® Fan Unit Speed-regulated

- Fan unit for vertical ventilation of assemblies in 19" racks.
- Adjustable required temperature (20°C to 55°C).
- Speed regulation 30% to 100% of the nominal speed, in the case of sensor failure 100% of speed.
- Individual fan monitoring.
- Potential-free collective alarm output for exceeded temperature alarm and fan failure.
- Optical status display for OK, exceeded temperature and fan failure.
- Acoustic warning can be switched off via button.
- Insertion rails recommended for assembly. Chassis rails are required with 6-piece CoolBlast (use depth-adjustable chassis runners).

Material

- Sheet steel, stainless steel mesh.

Surface/Color

- Galvanized housing.
- Front screen smooth powder-coated RAL 7035 light gray.

Approvals

- CE designation in accordance with Low Voltage Directive 73/23/EEC, EMC Directive 89/366/EEC.

Scope of supply

- 1 CoolBlast fan unit, packaged with operating manual.
- 1 sensor cable 2 m (pluggable).
- 1 signal cable 2 m (pluggable).

For DC devices only:

- 1 connection cable 2 meters with connecting plug- and free ends.

For AC devices only:

- 1 connection cable 2 metres, Schuko cold devices.

How supplied

- Assembled, wired, tested.

Note

In the case of projects, additional close-to-standard characteristics are possible.

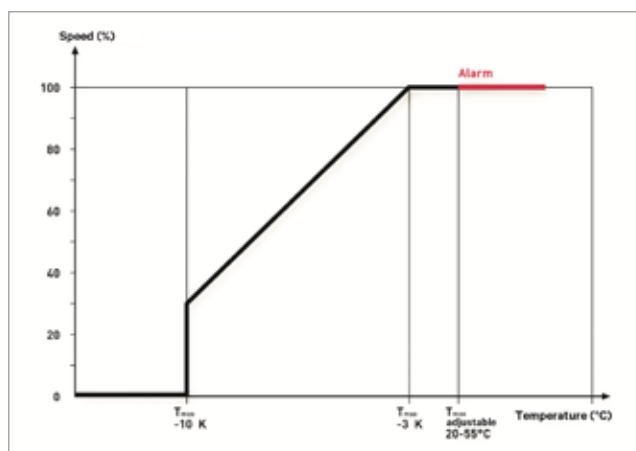

LUF20179

Designation	W	H	D	kg	n	Electrical Connection	P(W)	\dot{V} (m ³ /h)	ΔP (Pa)	p (dB(A))	Part No.
CoolBlast 115/230V, triple regulated HP	440	436	230	3.2	3	100 to 253VAC; 50/60Hz	32	711	173	55.8	03.027.024.1



LUF20160



LUF20161



LUF20124

Vertiv™ Knürr® CoolBlast® Fan Unit for RoofR Installation Speed-regulated

- For forced cooling of the cabinet.
- suitable for retrofitting in MIR2/DCM® roof.
- DC version on request (see Cool-Blast® fan inserts).
- Adjustable required temperature (20° to 55° C).
- Speed regulation 30 to 100 %, in the case of sensor failure 100 % of speed.
- Individual fan monitoring.
- Potential-free collective alarm output for over temperature and fan failure.
- Optical status display for OK, exceeded temperature and fan failure.
- Acoustic warning inc. reset button.

Material

- Housing: Sheet steel, stainless steel mesh.

Surface

- Galvanized, smooth powder-coated front blind RAL 7035 light gray

Approvals

- CE marking in accordance with Low Voltage Directive 73/23/EEC, EMC Directive 89/366/EEC.

Scope of supply

- 1 CoolBlast fan unit.
- 1 sensor cable 2 meters (pluggable).
- 1 signal cable 2 meters (pluggable).
- 1 network cable 3 meters with safety plug (230 VAC).
- Assembly material.
- Operating manual.

How supplied

- Assembled, wired and tested.

Note



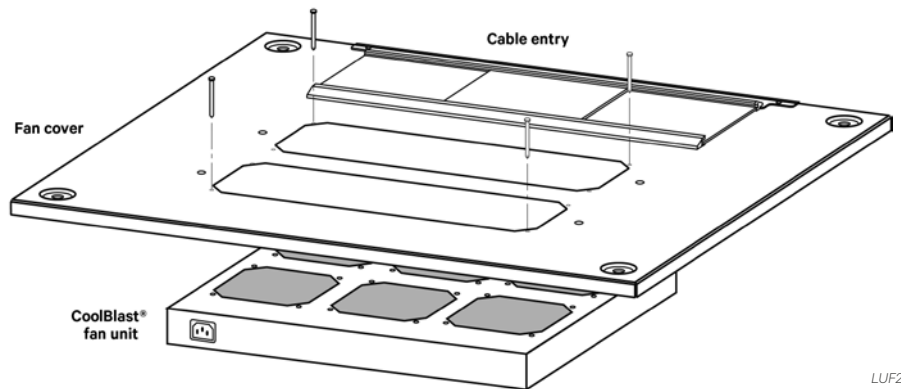

- Please additionally order specific network cable!



LUF20175

Designation	Version	Electrical Connection	P(W)	V̇ (m³/h)	ΔP(Pa)	p (dB(A))	Part No.	PU
CoolBlastT 230V triple	regulated HP	100..253 VAC; 50/60 Hz	32	711	173	55.8	03.027.324.1	1 pc
CoolBlastT 230V 6**	regulated HP	100..253 VAC; 50/60 Hz	62	1422	173	59.1	03.027.325.1	1 pc

Technical Data for Axial Single Fans

	Vertiv Knürr CoolBlast	Vertiv Knürr CoolBlast
Article number	01.914.075.9	01.914.051.9
Dimensions L x W x H	119 x 119 x 38	119 x 119 x 38
Max. volume flow, free-blowing	237 m ³ /h	165 m ³ /h
Voltage	24 VDC	230 VAC
Frequency		50 Hz
Power consumption	11 W	15 W
Noise level free-blowing	59 dB(A)	38 dB(A)
Bearing system	Ball bearing	Ball bearing
Nominal speed	4400 min-1	2600 min-1
Permitted environmental temperature	-30 °C to +55 °C	-40 °C to +60 °C
Lifespan L10 at 40°C	70,000 h	43,500 h
Standards	CE, VDE	CE, VDE
Deployed in fan unit:	03.027.024.1  03.027.324.1  03.027.325.1 	03.027.311.1 

 **Priority item** (dispatched from our factory within 5 working days)
Attention: Delivery times may be longer for large orders.

Dimensions in mm:		Conversion:	
W = Width	H = Installation height	U = standardized height unit	Kg = Weight
H = Height	D = Usable depth	1 U = 44.45 mm	1 mm = 0.03937 inch
D = Depth	L = Length	PU = Packaging unit	1 kg = 2.2046 pounds
SP = Standard Performance	\dot{V} = Air volume flow (m ³ /h)		
HP = High Performance	$\Delta\dot{V}$ = Loss of air volume flow (%)		
UP = Ultra High Performance	ΔP = Pressure increase (Pa)		
N = Number of fans	I nom. = nominal current (A)		
W = Power consumption	I max. = Starting current (A)		
V = Voltage (400V = 3-phase)	P = Acoustic pressure (dB(A)) at 1 meter distance from cabinet (600 mm x 600 mm; raised cover)		

Vertiv™ MPX™ – Adaptive Rack PDU

React to changes and work profitably

Our Priority PDU Range View the entire range in our new IT Special Catalog or find your dream PDU at <https://findyourpdu.com/de>

Vertiv™ MPX™ – Configuration models in Europe

		Four models				
		Order number	MPX Elementary	MPX Elementary Phase-monitored	MPX Branch-monitored	MPX Receptacle-managed
Busbar	Length 1035	MPXPRC-V1035XXX	P	■	■	■
	Length 1880	MPXPRC-V1880XXX	P	■	■	■
Input module	3ph 16A fixed	MPXPEM-EHABXT30	P	■	■	■
	3ph 32A fixed	MPXPEM-EHABXR30	P	■	■	■
Output module Elementary	IEC-C13 L1 (7)	MPXBRM-EEBC7N1N	P	■	■	
	IEC-C13 L2 (7)	MPXBRM-EEBC7N2N	P	■	■	
	IEC-C13 L3 (7)	MPXBRM-EEBC7N3N	P	■	■	
	IEC-C19 L1 (4)	MPXBRM-EEBC4O1N	P	■	■	
	IEC-C19 L2 (4)	MPXBRM-EEBC4O2N	P	■	■	
	IEC-C19 L3 (4)	MPXBRM-EEBC4O3N	P	■	■	
	Schuko L1 (3)	MPXBRM-EEBC3P1N	P	■	■	
	Schuko L2 (3)	MPXBRM-EEBC3P2N	P	■	■	
	Schuko L3 (3)	MPXBRM-EEBC3P3N	P	■	■	
	Output module Branch-monitored	IEC-C13 L1 (6)	MPXBRM-EBBC6N1N	P		■
IEC-C13 L2 (6)		MPXBRM-EBBC6N2N	P		■	
IEC-C13 L3 (6)		MPXBRM-EBBC6N3N	P		■	
IEC-C19 L1 (4)		MPXBRM-EBBC4O1N	P		■	
IEC-C19 L2 (4)		MPXBRM-EBBC4O2N	P		■	
IEC-C19 L3 (4)		MPXBRM-EBBC4O3N	P		■	

↑ Upgrades possible ↓

← Different combinations are possible →

*Attention:

Input module (Vertiv MPX PEM):

Conducts the input electricity to the busbar system. Elementary version (without RPC2™) and version with input measurement (with pre-installed RPC2™) are available.

Output modules (Vertiv MPX BRM):

With overload protection, distribute the electricity to the individual servers. Available in the functions Elementary, Branch measurement and Output measurement with switch function.

Communication module (RPC2):

Installed in the electricity input module and offers an extensible interface for network communication, sensors and the local display.

The busbar (Vertiv™ MPX™ PRC):

serves for electricity and communication distribution to all supported modules. Available in two heights, making differing rack heights possible.



DOS20153

Vertiv™ MPX™ – Input Module/Power Supply

Elementary and Monitored types

- The Vertiv MPX PEM is secured to the Vertiv MPX PRC and establishes the connection to the power supply.
- Securely connected supply line, cable length 3 meters.
- With IEC60309 plug 1Ph/N/PE 6h blue, 3ph/N/PE 6h red.

Monitored type

- The Vertiv MPX PEM establishes the connection to the data bus for data communication.
- Integrated communication card, RPC2, facilitates remote monitoring and maintenance of the Vertiv MPX units.
- Provides the following values for the phase inputs: Voltage, current, active power, consumption and frequency.
- Also supports current alarm functions for individual phases and their operating status.
- Further key characteristics: Three displays update users on the current state of each individual input. An acoustic alarm is activated in specific overload conditions.
- The communication card centralizes the local and remote administration of the Vertiv MPX.
- Also serves as a connection point for varied support options and devices, such as e.g. the display module (RPC BDM), various sensors and connection to other Vertiv MPX or Vertiv MPH2™ systems.
- Possesses RJ-45 connectors for all connections (except USB port) and requires no special cabling.

Technical data

Interfaces:

- RJ-45 LAN port (10/100/1000 Mbit) – for connection to the local area network (LAN) via Ethernet cable.
- Extension/Administration port for local configuration using a computer/laptop, for creating a series of multiple PDUs (Vertiv MPX or Vertiv MPH2).

- Serial interface RS232.
- Display port for connection of the RPC BDM (display module).
- External sensor port for connection of the optional sensors.
- Remote Management: Onboard Web Interface, CLI, SNMPv1,2,3, SSH, Telnet Syslog, can be integrated in Avocent ACS, UMG & MPU, SiteScan, DSView, Rack Power Manager, Vertiv Nform & Vertiv *Trellis* as well as in Nagios or other management software programs.
- Authentication: Local, Remote: Active Directory, LDAP, TACACS, Radius, Kerberos.
- Encryption: MD5, AES, DES.

Material/Surface

- Housing: Aluminum.
- Covering: Sheet steel.
- Electrical contacts: Silver-plated.
- Data bus contacts: Gold-plated (Monitored type only).

Dimensions

- Width: 75 mm.
- Height: 65 mm.
- Supply line: 3 meters.

Color

- Housing: Aluminum/RAL 7021 black-gray.

Approvals

- CE designation in accordance with:
 - Low Voltage Directive 2014/35/EU
 - EMC Directive 2014/30/EU
 - RoHS-Directive 2011/65/EC.
- Bureau-Veritas BG Certificate (Factory inspection).
- Bureau-Veritas CB Certificate.

Scope of supply

- 1 Vertiv MPX PEM power input module.
- Incl. connection cable.
- Inc. RPC2 communication card (Monitored type only).

L	W	H	Feed	Load capacity	Type	Part No.	PU
220	75	65	Fixed	230/400VAC, max. 16 A	Monitored	MPXPEM-EHABXT30	1 pc
220	75	65	Fixed	230/400VAC, max. 32 A	Monitored	MPXPEM-EHABXR30	1 pc

Dimensions in mm:

W = Width	N = Number of sockets	U = standardized height unit
H = Height	F1 = Standard side panel	1 U = 44.45 mm
L = Length	F2 = Designer side panel	PU = Packaging unit
S = Switch	19" = suitable for 19" installation	Safe = childproofing

Conversion:

1 mm	= 0.03937 inch
1 kg	= 2.2046 pounds

Substitute **x** with the number of the desired color combination: **1** = RAL 7035, **6** = RAL 7035/RAL 2003

- **Priority item** (dispatched from our factory within 5 working days)
Attention: Delivery times may be longer for large orders.



DOS20153

Vertiv™ MPX™ BRM – Output Module

- The Vertiv MPX BRM effects the distribution of capacity to the individual consumers.
- Each module deals with one phase; this is indicated on the module in color.
- All modules are protected against overloading with a 20 A circuit breaker.
- Module exchange during operation facilitates a user-defined installation, without needing to shut down the Vertiv MPX.

Material/Surface

- Housing: Aluminum.
- Covering: Sheet steel.
- Electricity contacts: silver-plated.
- Data bus contacts: gold-plated (Types B and R only).

Dimensions

- Width: 75 mm / Height: 65 mm.

Color

- Housing: Aluminum/RAL 7021 black-gray.

Approvals

- CE designation in accordance with:
 - Low Voltage Directive 2014/35/EU
 - EMC Directive 2014/30/EU
 - RoHS-Directive 2011/65/EC.
- Bureau-Veritas BG Certificate (Factory inspection).
- Bureau-Veritas CB certificate.

Scope of supply

- 1 output module.
- 1 operating manual.

Type E – Elementary

- Module for electricity distribution via corresponding outputs.

Type B – Branch-monitored

- Module for electricity distribution via corresponding outputs with measurement function at module level.
- The Vertiv MPX BRMs have an LED ID indicator, which clearly identifies each module with a numerical value.
- The modules are managed in the software.
- Provide following readings: Voltage, current, capacity, rail capacity, kWh and power factor.
- Current alarm functions and operating status are supported.

Type R – Receptacle Managed:

- Module for electricity distribution via corresponding outputs with measurement function at module level and output level.
- The Vertiv MPX BRMs have an LED ID indicator, which clearly identifies each module with a numerical value.
- The modules are managed in the software.
- Provide following readings: Voltage, current, capacity, rail capacity, kWh, Frequency, power factor and crest factor.
- Current alarm functions and operating status are supported.
- The individual outputs can be switched on and off remotely.

L	n	Outputs	Load capacity per output	Phase pickup	Type	Part No.	PU
266	7	IEC320 C 13	10 A	L1	E	MPXBRM-EEBC7N1N	1 pc
266	7	IEC320 C 13	10 A	L2	E	MPXBRM-EEBC7N2N	1 pc
266	7	IEC320 C 13	10 A	L3	E	MPXBRM-EEBC7N3N	1 pc
266	4	IEC320 C 19	16 A	L1	E	MPXBRM-EEBC4O1N	1 pc
266	4	IEC320 C 19	16 A	L2	E	MPXBRM-EEBC4O2N	1 pc
266	4	IEC320 C 19	16 A	L3	E	MPXBRM-EEBC4O3N	1 pc
266	3	Schuko CEE 7/4	16 A	L1	E	MPXBRM-EEBC3P1N	1 pc
266	3	Schuko CEE 7/4	16 A	L2	E	MPXBRM-EEBC3P2N	1 pc
266	3	Schuko CEE 7/4	16 A	L3	E	MPXBRM-EEBC3P3N	1 pc
266	6	IEC320 C 13	10 A	L1	R	MPXBRM-ERBC6N1N	1 pc
266	6	IEC320 C 13	10 A	L2	R	MPXBRM-ERBC6N2N	1 pc
266	6	IEC320 C 13	10 A	L3	R	MPXBRM-ERBC6N3N	1 pc
266	4	IEC320 C 19	16 A	L1	R	MPXBRM-ERBC4O1N	1 pc
266	4	IEC320 C 19	16 A	L2	R	MPXBRM-ERBC4O2N	1 pc
266	4	IEC320 C 19	16 A	L3	R	MPXBRM-ERBC4O3N	1 pc



DOS20153

Vertiv™ MPX™ PRC – Power Distribution Rail/Communication Bus

- The Vertiv MPX PRC represents the foundation stone of the Vertiv MPX energy distribution unit.
 - Power and data transfer buses are securely integrated along the full length of the Vertiv MPX PRC.
 - The Vertiv MPX BRMs (output modules) and the Vertiv MPX PEM (power input module) are secured on the Vertiv MPX PRC and, depending on module type, effect the electricity feed, power output, monitoring and management.
- **Material/surface**
 - Busbar housing: Aluminum.
 - Busbars: Copper.
 - Data bus: gold-plated.
 - **Dimensions**
 - Width: 68 mm.
 - Height: 24 mm.
 - **Color**
 - Housing: Aluminum.
 - **Standards**
 - CE designation in accordance with:
 - Low Voltage Directive 2014/35/EU
 - EMC Directive 2014/30/EU
 - RoHS-Directive 2011/65/EC.
 - Bureau-Veritas BG Certificate (Factory inspection).
 - Bureau-Veritas CB certificate.
 - **Load capacity**
 - Max. current strength: 3 x 63 A.
 - Nominal voltage (L-N / L-L): 230 / 400 VAC.
 - **Scope of supply**
 - 1 Vertiv MPX PRC - power distribution rail/communication bus.
 - 1 securing set.

L	W	H	U	Version	Order no.	PU
1035	68	24	23	1 PEM (220 mm) + 3 BRM	MPXPRC-V1035XXX	1 pc
1880	68	24	42	1 PEM (220/266 mm) + 6 BRM	MPXPRC-V1880XXX	1 pc



DOS20153

Vertiv MPX/Vertiv MPH™/Vertiv MPH2™/IMS™ – Sensors

- The sensors have been designed for tool-free installation in a Vertiv Knürr MIR / DCM cabinet, but can also be installed in any other rack.
 - "Fixed" type sensors are secured to a cable.
 - "Modular" type sensors can be connected using the cable supplied.
 - Are plugged into the RPC-1000 or RPC2 communication card.
 - Several sensors can be plugged together in series.
 - Are automatically displayed in the Vertiv MPX/Vertiv MPH/Vertiv MPH2/IMS software.
 - Temperature measurement range: 5–60° C.
 - Precision: +/- 0.5° C.
 - Air humidity measurement range: 10–95 %.
 - Precision: +/- 3.5 %.
- **Note**

The sensors are not required for the operation of the Vertiv MPX or Vertiv MPH, Vertiv MPH2, IMS, but require a communication card themselves.
 - **Scope of supply**
 - 1 sensor with connection cable.
 - 1 operating manual.

Cable length	Type	Version	Part No.	PU
5180	fixed	Triple temperature probe + single air humidity	SN-Z03	1 pc
2000	modular	Single temperature probe	SN-T	1 pc
2000	modular	Single temperature probe + single air humidity	SN-TH	1 pc
2000	modular	2 x door contacts - input module*	SN-2D	1 pc

* Matching door contact switch: Order no.: 06.108.115.9

Dimensions in mm:			Conversion:	
W = Width	n = Number of sockets	U = standardized height unit	1 mm = 0.03937 inch	
H = Height	F1 = Standard side panel	1 U = 44.45 mm	1 kg = 2.2046 pounds	
L = Length	F2 = Designer side panel	PU = Packaging unit		
S = Switch	19" = suitable for 19" installation	safe = childproofing		

- **Priority item** (dispatched from our factory within 5 working days)
Attention: Delivery times may be longer for large orders.

Vertiv™ MPH2™ – Managed Rack PDU

Systems monitoring and control

Our Priority PDU Range View the entire range in our new IT Special Catalog or find your dream PDU at <https://findyourpdu.com/de>

Vertiv™ MPH2™

- The Vertiv MPH2 is a power distribution unit for IT cabinets with the option to measure electrical readings. Additionally and depending on model, individual outputs can be controlled via remote.
- The integrated RPC2 communications card facilitates the interconnection of up to 4 Vertiv MPH2 / Vertiv MPX units as well as the remote monitoring and maintenance of all connected unit. Up to 10 sensors (temperature, air humidity, door contacts as well as potential-free input contacts) can be connected.
- The Vertiv MPH2 unit has an integrated display, and in addition the RPCBDM-1000 external display module can be optionally connected and flexibly secured to the cabinet.
- Special locking cables can be connected to the outputs.
- Depending on model type, the Vertiv MPH2 connection cable is securely attached to the housing

■ Vertiv MPH2™ Models

- **Vertiv MPH2 B** – Measurement per phase as well as per group (only versions >16 A input current).
- **Vertiv MPH2 C** – Measurement per phase as well as per group (only versions >16 A input current). In addition, the outputs may be switched on and off individually via remote.
- **Vertiv MPH2 M** – Measurement per phase, per group (only versions >16 A input current) as well as per output.
- **Vertiv MPH2 R** – Measurement per phase, per group (only versions >16 A input current) as well as per output. In addition, the outputs may be switched on and off individually via remote.

■ Material/surface/color

- Closed housing, aluminum extrusion, upper section powdered in RAL 7021 fine structure, plastic parts recyclable vampamide 6 0024 V0 (UL94), colored fine structure RAL 9005.

(Cable length 3 m) or a connection cable can be directly connected on site (models with connection block).

- Remote Management: Onboard Web Interface, CLI, SNMPv1,2,3, SSH, Telnet, may be integrated in Avocent ACS, UMG & MPU, DSView, Rack Power Manager, Vertiv Nform & Vertiv *Trellis* as well as in Nagios and other management software programs.
- Authentication: Local, Remote: Active Directory, LDAP, TACACS, Radius, Kerberos. Encryption: MD5, AES, DES.
- Measurement parameters: Current (A), voltage (V), active power (W), apparent power (VA), consumption (kWh), power factor, frequency and crest factor (Types M and R only); accuracy of measurement: +/-1% (V,A).

■ Mechanical dimensions

- Vertical models:
Width x depth x length (mm): 56 x 50 x (see table).
- Horizontal models:
1 U: Width x depth x height (mm): 482.6 (440) x 250 x 44.
2 U: Width x depth x height (mm): 482.6 (440) x 250 x 88.

■ Standards

- CE designation in accordance with:
 - Low Voltage Directive 2014/35/EU
 - EMC Directive 2014/30/EU
 - RoHS-Directive 2011/65/EC.
- Bureau-Veritas BG-Certificate (factory inspection)
- Bureau-Veritas CB certificate.

■ Scope of supply

- Vertiv MPH2 Rack PDU.
- Standard securing bracket.
- Safety information.
- Quickstart Guide.



SN sensors:

Consolidate the environmental monitoring of temperature, air humidity and potential-free input contacts with the power supply at rack level.

Flexible network cable insertion:

Simplifies the installation of the Rack PDU.

Integrated display:

For easy access to important information at the rack.

Extra-flat overload switch:

For compact construction, minimises the space requirement within the rack.

Communication module (RPC2™):

Offers extensible interfaces for network communication sensors and local display.

Special Vertiv Knürr DCM-Rack attachment without tools:

Reduced installation costs, together with even more space in the rack for cables and other components.

Dimensions in mm:

W = Width		n = Number of sockets		U = standardized height unit		Conversion:	
H = Height	F1 = Standard side panel			1 U = 44.45 mm		1 mm	= 0.03937 inch
L = Length	F2 = Designer side panel			PU = Packaging unit		1 kg	= 2.2046 pounds
S = Switch	19" = suitable for 19" installation	safe = childproofing					

P - Priority item (dispatched from our factory within 5 working days)
Attention: Delivery times may be longer for large orders.

Vertiv™ MPH2™ Types for Europe

Vertical models

Model / Functions	Vertiv MPHR	Vertiv MPHM	Vertiv MPH2C	Vertiv MPH2B
Input / Group measurement	■	■	■	■
Output measurement	■	■		
Output switching	■		■	

Type	Input values		Input plug	Outputs		Lengths (mm)	Order number
	Voltage	Current		C13	C19		
W	230V	16A	C20 inlet	17	2	916.5	MPHB3241
W	230V	16A	C20 inlet	30	6	1736.5	MPHB1241
W	230V	16A	IEC 60309 16A 1P+N+G	17	2	916.5	MPHB3242
W	230V	16A	IEC 60309 16A 1P+N+G	30	6	1736.5	MPHB1242
W	230V	32A	IEC 60309 32 A 1P+N+G	30	6	1736.5	MPHB1243
W	230/400V	3 x 16A	IEC 60309 16A 3P+N+G	30	6	1736.5	MPHB1244
W	230/400 V	3 x 32A	IEC 60309 32A 3P+N+G	18	12	1826.5	MPHB1345
W	230/400V	3 x 32A	IEC 60309 32A 3P+N+G	30	6	1826.5	MPHB1245
C	230V	16A	C20 inlet	16		1004	MPHC3141
C	230V	16A	C20 inlet	18	6	1736.5	MPHC1141
C	230V	16A	C20 inlet	24		1736.5	MPHC1241
C	230V	16A	IEC 60309 16A 1P+N+G	18	6	1736.5	MPHC1142
C	230V	32A	IEC 60309 32A 1P+N+G	18	6	1736.5	MPHC1143
C	230V	32 A	IEC 60309 32 A 1P+N+G	24		1736.5	MPHC1243
C	230/400 V	3 x 16 A	IEC 60309 16 A 3P+N+G	18	6	1736.5	MPHC1144
C	230/400 V	3 x 16 A	IEC 60309 16 A 3P+N+G	24		1736.5	MPHC1244
C	230/400 V	3 x 32 A	IEC 60309 32 A 3P+N+G	18	6	1736.5	MPHC1145
C	230/400V	3 x 32 A	IEC 60309 32 A 3P+N+G	6	12	1736.5	MPHC1345
M	230V	16 A	IEC 60309 16 A 1P+N+G	18	6	1736.5	MPHM1142
M	230V	32 A	IEC 60309 32 A 1P+N+G	18	6	1736.5	MPHM1143
M	230/400 V	3 x 16 A	IEC 60309 16 A 3P+N+G	24		1736.5	MPHM1244
M	230/400 V	3 x 32 A	IEC 60309 32 A 3P+N+G	18	6	1736.5	MPHM1145
R	230V	16 A	C20 inlet	24		1736.5	MPHR1241
R	230V	16 A	IEC 60309 16 A 1P+N+G	18	6	1736.5	MPHR1142
R	230V	16 A	IEC 60309 16 A 1P+N+G	24		1736.5	MPHR1242
R	230V	16 A	IEC 60309 16 A 1P+N+G	16		1004	MPHR3142
R	230V	32 A	IEC 60309 32 A 1P+N+G	18	6	1736.5	MPHR1143
R	230V	32 A	IEC 60309 32 A 1P+N+G	24		1736.5	MPHR1243
R	230/400 V	3 x 16 A	IEC 60309 16 A 3P+N+G	18	6	1736.5	MPHR1144
R	230/400 V	3 x 32 A	IEC 60309 32 A 3P+N+G	18	6	1736.5	MPHR1145
R	230/400 V	3 x 32 A	IEC 60309 32 A 3P+N+G	6	12	1736.5	MPHR1345

Vertiv™ MPH2™ Types for Europe

Horizontal models

Model / Functions	Vertiv MPHR	Vertiv MPH2M	Vertiv MPH2C	Vertiv MPH2B
Input / Group measurement	■	■	■	■
Output measurement	■	■		
Output switching	■		■	

Type	Input values		Input plug	Outputs		Order number
	Voltage	Current		C13	C19	
W	230V	16 A	C20 inlet	12		MPHB2141
W	230V	32 A	IEC 60309 32 A 1P+N+G	12		MPHB2143
W	230/400 V	3 x 32 A	IEC 60309 32A 3P+N+G	2	6	MPHB2245
M	230V	16 A	C20 inlet	9		MPHM2141
M	230V	32 A	IEC 60309 32A 1P+N+G	9		MPHM2143
M	230/400V	3 x 32 A	IEC 60309 32A 3P+N+G	2	6	MPHM2345
R	230V	16 A	C20 inlet	9		MPHR2141
R	230V	32 A	IEC 60309 32 A 1P+N+G	9		MPHR2143



DOS20153

Vertiv™ MPX™/Vertiv MPH™/Vertiv MPH2™/IMS™ – Sensors

- The sensors have been designed for tool-free installation in a Vertiv Knürr MIR / DCM cabinet, but can also be installed in any other rack.
- "Fixed" type sensors are secured to a cable.
- "Modular" type sensors can be connected using the cable supplied.
- Are plugged into the RPC-1000 or RPC2 communication card.
- Several sensors can be plugged together in series.
- Are automatically displayed in the Vertiv MPX/Vertiv MPH/Vertiv MPH2/IMS software.
- Temperature measurement range: 5-55° C.
- Precision: +/- 0.5° C.
- Air humidity measurement range: 10-95 %.
- Precision: +/- 3.5 %.

Note

The sensors are not required for the operation of the Vertiv MPX or Vertiv MPH, Vertiv MPH2, IMS, but require a communication card themselves.

Scope of supply

- 1 sensor with connection cable.
- 1 operating manual.

Cable length	Type	Version	Part No.	PU	
5180	fixed	Triple temperature probe + single air humidity	SN-Z03	1 pc	P
2000	modular	Single temperature probe	SN-T	1 pc	P
2000	modular	Single temperature probe + single air humidity	SN-TH	1 pc	P
2000	modular	2 x door contacts - input module*	SN-2D	1 pc	P

* Matching door contact switch: Order no: 06.108.115.9

P = **Priority item** (dispatched from our factory within 5 working days)
Attention: Delivery times may be longer for large orders.

Dimensions in mm:		Conversion:	
W = Width	n = Number of sockets	U = standardized height unit	1 mm = 0.03937 inch
H = Height	F1 = Standard side panel	1 U = 44.45 mm	1 kg = 2.2046 pounds
L = Length	F2 = Designer side panel	PU = Packaging unit	
S = Switch	19" = suitable for 19" installation	safe = childproofing	

Vertiv™ MPE – Rack PDU

Reliable power distribution for your data center

Our Priority PDU Range View the entire range in our new IT Special Catalog or find your dream PDU at <https://findyourpdu.com/de>



Vertiv MPE1345

Vertiv™ MPE – Rack PDU

- The Vertiv MPE Rack PDU is an electricity distribution unit for data center applications. It offers all necessary functions of a rack-based electricity distribution unit and guarantees reliable power distribution. A broad range of IT devices and other sensitive electrical loads can be connected to it.
- Special cables with a locking function can be connected to the outputs.
- Depending on model type, the Vertiv PH2 connection cable is securely attached to the housing (supply line length 3 meters), or a connection cable can be directly connected on site (models with terminal block).
- The PDU can be installed without tools in ENP Vertiv Knürr Racks or other housing systems with appropriate spaces.
- In the case of 32A models, the individual groups are protected with a 20A circuit breaker (hydraulic, magnetic).
- Max. operating temperature is 60°C (does not apply to Vertiv MPE-3345-002; this type has 6 x 16A circuit breaker).

Material / Surface / Color

- Closed housing, aluminum extrusion, upper section powdered in RAL 7021 fine structure, plastic parts recyclable vampamide 60024 V0 (UL94), colored fine structure RAL 9005.

Mechanical dimensions

- Width x depth x length (mm)
56 x 50 x (see table)

Standards

- CE designation in accordance with:
 - Low Voltage Directive 2014/35/EU
 - RoHS Directive 2011/65/EC.
- Bureau-Veritas BG Certificate (Factory inspection).
- Bureau-Veritas CB certificate.

Input values		Input plug	Outputs			Lengths (mm)	Part No.	
Voltage	Current		C13	C19	Schuko			
100-240V	16A	C20 inlet	18	3		826.5	MPE-3141	
100-240V	16A	C20 inlet	24			826.5	MPE-3241	
230V	16A	IEC 60309 16A 1P+N+G	18	3		826.5	MPE-3142	
230V	16A	IEC 60309 16A 1P+N+G	24			826.5	MPE-3242	
230V	32A	IEC 60309 32 A 1P+N+G	36	6		1736.5	MPE-1243	
230V	32A	IEC 60309 32 A 1P+N+G	24	6	3	1736.5	MPE-1543	
230/400 V	3 x 16A	IEC 60309 16 A 3P+N+G	36	12		1736.5	MPE-1144	
230/400 V	3 x 16A	IEC 60309 16 A 3P+N+G	36	6	3	1736.5	MPE-1444	
230/400 V	3 x 32A	IEC 60309 32A 3P+N+G	36	6		1736.5	MPE-1245	
230/400 V	3 x 32A	IEC 60309 32A 3P+N+G	24	12		1736.5	MPE-1345	
230/400 V	3 x 32A	IEC 60309 32A 3P+N+G	24	6	3	1736.5	MPE-1545	

Vertiv™ Knürr® DIS Rack PDU® – Basic Rack PDU

Robust PDUs with useful features

Our Priority PDU Range View the entire range in our new IT Special Catalog or find your dream PDU at <https://findyourpdu.com/de>



DOS20062



DOS00458



DOS00460



DOS20102

Vertiv™ Knürr® DIS Rack PDU® Cold Device Plug System IEC 320

- Optionally with illuminated switch, bi-polar switching.
- 19" installation possible.
- With cold device combinations from IEC 320 sockets C13 and C19.
- Supply line:
 - H05VV-F 3 G 1.5 mm² (16 A types)
 - H05VV-F 3 G 4 mm² (32 A types).
- Supply line: 2.5 m / 5 m.

Material/Surface

- Housing: closed sheet steel extrusion, galvanized, powder-coated structure.
- Plastic parts: vampamide 6 0024 VO (UL94), recyclable.

Dimensions

- Height: 45.5 mm.
- Housing width: 44.4 mm (= 1 U).

Approvals/certificates

- CE designation in accordance with:
 - Low Voltage Directive 2014/35/EU
 - EMC Directive 2014/30/EU
 - RoHS-Directive 2011/65/EC.
- Bureau-Veritas BG Certificate (Factory inspection).
- Bureau-Veritas CB Certificate.
- CSA (only types with IEC60320 input).

Color

- Housing: RAL 7035 light gray.
- Plastic parts: RAL 7021 black-gray.

Scope of supply

- 1 socket strip.
- 2 securing brackets.

VERTIV KNÜRR DIS Rack PDU Model	Input values		Input plug	Outputs						L	S	F1	F2	19"	safe	Part No.
	Voltage	Current		C13	C19	Schuko	UTE	Type 13	Type 23							

Cold device plug IEC320 system																	
with supply line	230V	10 A	IEC60320 C13	12						483						03600.3121	
Cold device input in plug field	230V	10 A	IEC60320 C14 inlet	6						383						03622.0061	
	230V	10 A	IEC60320 C14 inlet	9						483						03622.0091	
Cold device input in side panel	230V	10 A	IEC60320 C14 inlet	6						383						03624.7061	
	230V	10 A	IEC60320 C14 inlet	9						483						03624.7091	

= **Priority item** (dispatched from our factory within 5 working days)
Attention: Delivery times may be longer for large orders.

Dimensions in mm:			Conversion:		
W = Width	n = Number of sockets	U = standardized height unit	1 mm = 0.03937 inch		
H = Height	F1 = Standard side panel	1 U = 44.45 mm	1 kg = 2.2046 pounds		
L = Length	F2 = Designer side panel	PU = Packaging unit			
S = Switch	19" = suitable for 19" installation	safe = childproofing			



DOS20126

Vertiv Knürr DIS Rack PDU TriplePower® Cold Device Plug System IEC 320 with supply line

- Supply line:
 - H05VV-F 5 G 2.5 mm² (3 x 16 A types)
 - H05VV-F 5 G 4 mm² (3 x 32 A types).
- Supply line: 2.5 m (optionally with IEC60309 plug 3Ph/N/PE 6h).
- Easy assembly on cabinet extrusion.
- 3 x 16 A feed-in as standard.
- Ideal for realizing redundancies (e.g. 96 A with redundant feed-in).
- Color labeling of phase allocation.
- Optimum distribution over the total cabinet height (23 U or 41 U).
- Alternative to 3-phase GST18 system.

■ Material/Surface

- Housing: closed sheet steel extrusion, galvanized, powder-coated structure.
- Plastic parts: vampamide 6 0024 VO (UL94), recyclable.

■ Dimensions

- Height: 45.5 mm.
- Housing width: 44.4 mm (= 1 U).

■ Approvals/certificates

- CE designation in accordance with:
 - Low Voltage Directive 2014/35/EU
 - EMC Directive 2014/30/EU
 - RoHS-Directive 2011/65/EC.
- Bureau-Veritas BG Certificate (Factory inspection).
- Bureau-Veritas CB certificate.

■ Color

- Housing: RAL 7035 light gray.
- Plastic parts: RAL 7021 black-gray.

■ Load capacity

- 100-240/173-415 Vac.
- Input: 3 x 16 A.
- Output: 10 A (C13).
- Output: 16 A (C19 / Schuko).

■ Scope of supply

- 1 socket strip.
- 2 securing brackets.

VERTIV KNÜRR DIS Rack PDU Model	Input values		Input plug	Outputs						L	S	F1	F2	19"	safe	Part No.
	Voltage	Current		C13	C19	Schuko	UTE	Type 13	Type 23							

TriplePower																	
	230/400 V	3 x 16 A	without	24							1033	■				03.600.024.1	



DOS00401

with switch

Vertiv Knürr DIS Rack PDU Compact

- Optionally with illuminated switch, Bi-polar switching.
 - 19" installation possible (for length 483 mm).
 - 2 versions: Standard side panel or Designer side panel.
 - Socket rotation: 45°.
 - Supply line: H05VV-F 3G 1.5 mm².
 - Molded angle plug.
 - Optionally with cold device plug IEC320 for UPS applications.
- **Approvals/Certificates**
 - CE designation in accordance with:
 - Low Voltage Directive 2014/35/EU
 - EMC Directive 2014/30/EU
 - RoHS-Directive 2011/65/EC.
 - Bureau-Veritas BG Certificate (Factory inspection).
 - Bureau-Veritas CB Certificate.
 - VDE GS Certificate.
- **Material/Surface**
 - Housing: closed sheet steel extrusion, galvanized, powder-coated structure.
 - Plastic parts: vampfamide 6 0024 VO (UL94), recyclable.
 - Inner conductor: continuous busbars, brass.
- **Dimensions**
 - Distance between sockets: 50 mm.
 - Height: 45.5 mm.
 - Housing width: 44.4 mm (= 1 U).
 - Supply line 2.5 meters.
- **Color combination**
 - Order number end figure .1: RAL 7035 Light gray
 - Order number end figure .6: Housing RAL 2003 pastel orange. Plastic parts: RAL 7035 Light gray
- **Load-bearing capacity**
 - 100–240 Vac/16 A (Schuko and UTE outputs).
 - 100–240 Vac/10 A (Swiss outputs).
- **Scope of supply**
 - 1 plug strip.
 - 2 securing brackets.

VERTIV KNÜRR DIS Rack PDU Model	Input values		Input plug	Outputs						L	S	F1	F2	19"	safe	Part No.
	Voltage	Current		C13	C19	Schuko	UTE	Type 13	Type 23							

Compact																	
UPS application	230V	16 A	Schuko CEE7/7				11				683	■				03.300.011.1	P
	230V	16 A	Schuko CEE7/7				7				483	■		■		03.300.007.X	P
	230V	16 A	Schuko CEE7/7				8				483	■		■		03.300.008.1	P
	230V	16 A	Schuko CEE7/7				4				333	■				03.300.004.1	P
	230V	16 A	Schuko CEE7/7				6				483	■	■		■	03.302.006.X	P
	230V	16 A	Schuko CEE7/7				7				483	■			■	03.400.007.1	P

P = Priority item (dispatched from our factory within 5 working days)
Attention: Delivery times may be longer for large orders.

Dimensions in mm:			Conversion:
W = Width	n = Number of sockets	U = standardized height unit	1 mm = 0.03937 inch
H = Height	F1 = Standard side panel	1 U = 44.45 mm	1 kg = 2.2046 pounds
L = Length	F2 = Designer side panel	PU = Packaging unit	
S = Switch	19" = suitable for 19" installation	safe = childproofing	



DOS20068

with overvoltage protection.

Vertiv™ Knürr® DIS Rack PDU® Safety Basic

- For protection against transient overvoltages from the network caused e.g. by machines being switched on and off.
- In the case of critical overvoltages, a disconnection from the network takes place.
- After the safety arrester has been triggered, the green function display goes out. The socket strip is then no longer ready for usage. For replacement of safety arrester, please send plug strip to manufacturer! The protective effect of test category type 3 or requirement class D is a device protection, i.e. fine protection. For optimum protection, protective installations of test category or requirement class 1 and 2 or B and C should be provided upstream in the building installation.
- 19" installation possible (for length 483 mm).
- Socket rotation: 45°.
- Supply line: H05VV-F 3G 1.5 mm².
- Molded angle plug.

Material/Surface

- Housing: closed sheet steel extrusion, galvanized, powder-coated structure.
- Plastic parts: vampamide 6 0024 VO (UL94), recyclable.
- Internal conductor: continuous busbars, brass.

Dimensions

- Distance between sockets: 50 mm.
- Height: 45.5 mm.
- Housing width: 44.4 mm (= 1 U).

Approvals/Certificates

- CE designation in accordance with:
 - Low Voltage Directive 2014/35/EU
 - EMC Directive 2014/30/EU
 - RoHS-Directive 2011/65/EC.
- Bureau-Veritas BG Certificate (Factory inspection).
- Bureau-Veritas CB Certificate.

Color combination

- Order number end figure 1: RAL 7035 Light gray
- Order number end figure 6:
 - Housing RAL 2003 pastel orange.
 - Plastic parts: RAL 7035 Light gray

Technical data

- Test class: Type 3 – in accordance with DIN EN 61643-11.
- Requirement class: D – in accordance with VDE 0675-6.
- Network voltage: 230 VAC.
- Nominal current: max. 16 A.
- Limit discharge current (8/20 μs): 10 kA.
- Response time: < 25 ns.
- Protective level (at 100 A varistor peak current):
 - L against N: < 800 V / L/N against PE: < 1500 V.

Scope of supply

- 1 socket strip.
- 2 securing brackets.

VERTIV KNÜRR DIS Rack PDU Model	Input values		Input plug	Outputs						L	S	F1	F2	19"	safe	Part No.
	Voltage	Current		C13	C19	Schuko	UTE	Type 13	Type 23							

Safety Basic

230V	16 A	Schuko CEE7/7		6		483	■	■						03.316.0061	
------	------	---------------	--	---	--	-----	---	---	--	--	--	--	--	-------------	--



VertivCo.de | **Vertiv GmbH**, Lehrer-Wirth-Str. 4, 81829, München, Germany Id.-Nr. De 131181345, WEEE DE90254228

© 2016 Vertiv Co. All rights reserved. Vertiv™, Vertiv logo are trade marks or registered trademarks of Vertiv Co. All other names and logos referred to are trading names, trademarks or registered trademarks of the respective owners. Although every precaution has been taken to ensure accuracy and completeness, Vertiv Co. accepts no responsibility and is not liable for any errors or omissions, or any damage resulting from this information. Specifications are subject to change without prior notice.