



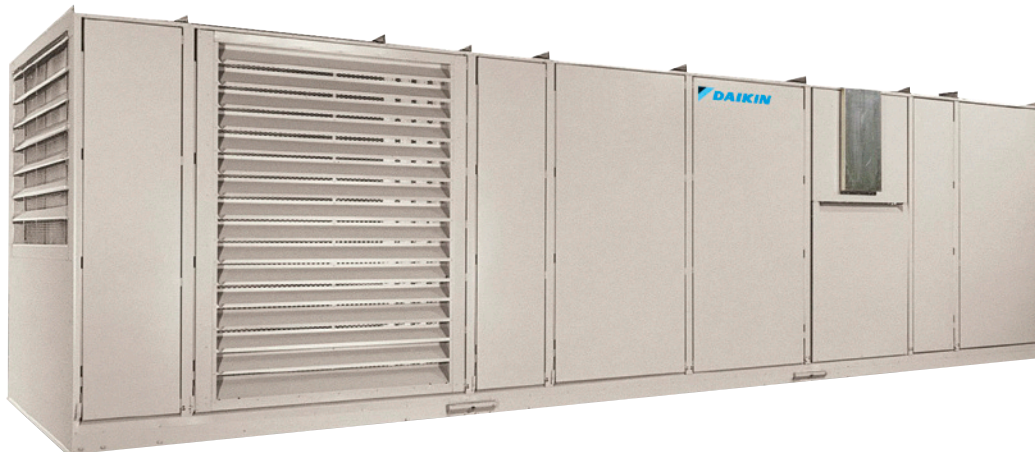
Catalog 218-3

RoofPak™

Applied Rooftop System Air Handler

Type RAH 047C and 077C 12,000 to 50,00 cfm

Type RDS 708B, 800C and 802C 2,000 to 20,00 cfm



People and ideas you can trust.™

Introduction	3	Unit Selection	38
A New Standard in Rooftop Air Handling Systems	3	Selecting Unit Size and Arrangement	38
Blow-through Heating and/or Cooling Features	6	Selecting Cooling Coils	38
Draw-through Heating and/or Cooling Features	7	Selecting Heating Coils and Equipment	39
Features and Options	8	Selecting Fans and Motors	40
Unit Construction	8	Selecting Unit Size and Arrangement	41
Supply and Return Fan Section	8	Selecting Heating Equipment at 50Hz	41
Supply and Return Air Plenum	9	Selecting Motors at 50 Hz	42
Variable Air Volume Control	9	Selecting RAH 077CL Chilled Water Coils	42
Gas Heat	10	Physical Data	43
Electric Heat	11	Cooling Capacity Data	48
Steam Heat	11	RDS 800C and 802C	48
Hot Water Heat	11	RAH 047C and 077C	49
Outside/Return Air Section	12	Heating Capacity Data	51
Filter Section	14	Gas Heat	51
Static Air Mixers	14	Electric Heat	53
Sound Attenuators	14	Component Pressure Drops	57
Humidifiers	14	RDS 708B, 800C, and 802C	57
Roof Curbs	14	Fan Performance	62
Heating and Cooling Coils	15	DWDI Supply Fans	62
Cooling Coils	16	SWSI Supply Fans	71
Options	17	Propeller Exhaust Fans	73
Intelligent Equipment™	18	Return Fans	75
Unit Controls	20	Dimensional Data	79
MicroTech III Controls	22	Section Options and Locations—RDS 708B	79
Application Considerations	29	Application Considerations—RDS 800C and 802C	83
General	29	Section Options and Locations—RDS 800C	84
Unit Location	29	Section options and locations—RDS 802C	85
Split Units	29	Section Options and Locations—RAH 047C	88
Curb Installation	29	Unit Considerations—RAH 077C	90
Acoustical Considerations	29	Section Options and Locations—RAH 077C	91
Ductwork	30	Recommended Clearances	96
Filters	32	Service Clearance	96
Variable Air Volume Application	32	Gas Piping	98
Multiple Air Handler Control	32	Gas Piping Schematic	98
Fan Operating Range	33	Electrical Data	99
Fan Isolation	33	Unit Weights	102
Indoor Fan and Motor Heat, Blow-through vs. Draw-through Cooling	33	Roof Curb Weights—RDS 800C and 802C	104
Altitude Adjustments	34	Engineering Guide Specification—RDS 708	110
System Operating Limits	35	Engineering Guide Specification —RDS 800, 802, RAH 047 to 077	115
Coil Freeze Protection	35		
Piping and Condensate Drainage	36		
Zone Sensor Placement	36		
Unit Wiring	36		
Winter Shipment	36		
Field-Installed Actuators	37		
Face and Bypass Damper Option	37		

A New Standard in Rooftop Air Handling Systems

- Flexibility to provide up to 50,000 cfm of conditioned air
- Multiple fan, coil, filter and heat options to fit your application needs
- Durable, double wall construction to improve indoor air quality
- Walk-in access doors with easy-to-use latches on both sides of every section for better serviceability
- Both Blow-through and Draw-through configuration available
- Patented DesignFlow™ ventilation control maintains proper amounts of outdoor air
- SuperMod™ furnace provides superior turndown and comfort control
- Return fans allow superior building pressure control
- Final filters for hospitals, labs or clean rooms
- 100% make-up air, VAV or CV operation
- DX or chilled water coil cooling flexibility
- Factory integrated and commissioned MicroTech® III advanced DDC control system
- Modular construction and customized application flexibility
- Daikin's innovative Open Choices™ feature provides building automation system interoperability with BACnet® and LonWorks® communications capability
- Unit controllers are LONMARK® 3.4 certified with an optional LonWorks communication module
- Fully factory operation tested

Agency Listed



All US standard and Canadian units.



MEA Numbers
Type RAH 047C & RAH 077C



Type RDS 708B, 800C & 902C



Agency Certification

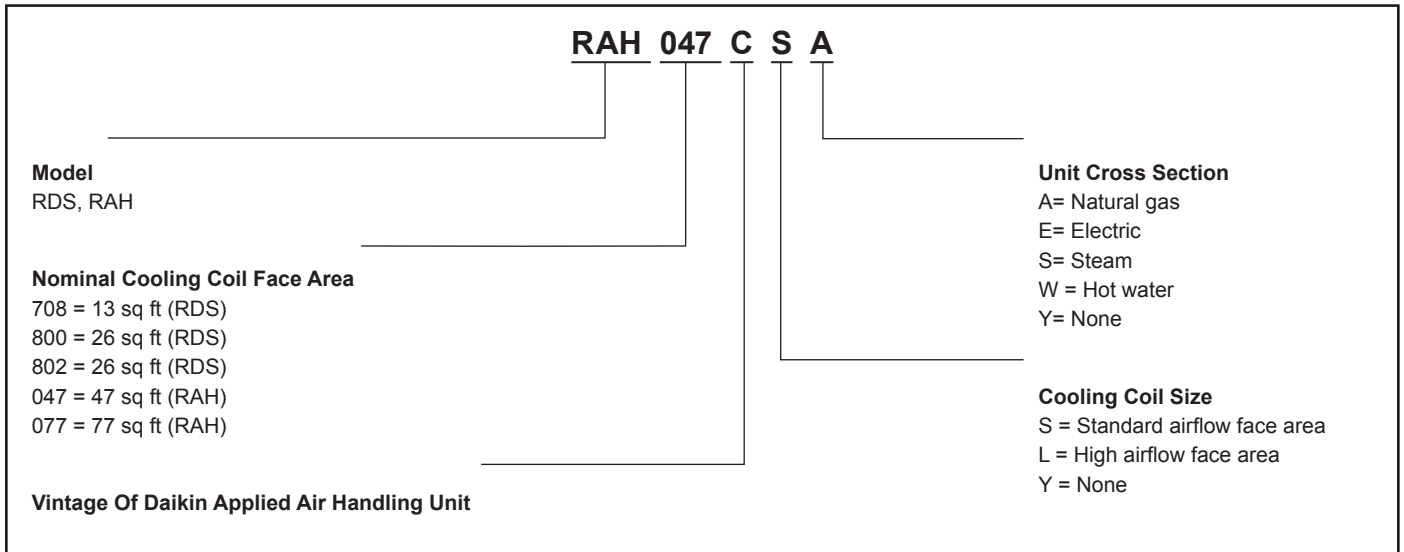


Certification in accordance with the forced circulation air cooling and air heating coils certification program, which is based on AHRI Standard 410.



Certified in accordance with the central station air handling units certification program, which is based on AHRI standard 430. (Plenum SAF performance is not within the scope of the certification program.)

Nomenclature



Daikin RAH & RDS air handling equipment trace their history to the late 1970s. With decades of innovation, design flexibility, durable construction, low capital and operating cost, make RAH and RDS the preferred HVAC solution for thousand of most prominent building projects. RAH & RDS are ideal options for a job where energy efficiency, reliability, indoor air quality and acoustic are top priorities. Along with providing high quality and state-of-the-art technology, RAH & RDS offer the following valuable features and benefits to satisfy a wide range of diverse applications.

Daikin RoofPak air handlers are applicable to schools, offices, shopping centers, manufacturing facilities, etc.

Economical First Cost

Daikin RoofPak air handling units are single-piece construction that reduces field labor, installation time and expense. Units up to 52 feet long are a standard single piece. Units may be split at the Supply Air Fan section bulkhead for convenience in job site handling. Split units are provided with a connection kit for a water-tight joint at the job site.

Individually extensive factory testing and checkout procedures reduce startup and installation expense. An optional valve package† and power package provide complete factory piping and wiring for quick connections. The prefabricated roof curb with integral duct support fits inside the unit base for a leak-tight installation that eliminates the need for field-provided duct supports. Lifting brackets in the base channel permit quick, inexpensive rigging.

The high CFM capacity eliminates the need to install two units when one can do the job

Energy Efficient System

The large cross-sectional area of the unit holds static pressure drops to a minimum, reducing fan horsepower requirements. In addition, the entire cabinet is fully insulated to minimize heat loss or gain for overall energy conservation.

To complement the efficient cabinet design, Daikin's patented UltraSeal™ low leak dampers are provided as standard feature. UltraSeal dampers significantly reduce infiltration losses with the lowest leakage rate in the industry (less than 1.5 cfm/ft² at 1" SP). The hollow core airfoil type damper provides 12 times the insulating factor over flat blade dampers. Operating economy is maximized with available comparative enthalpy control on the economizer cycle† to take full advantage of outside air for cooling.

Airfoil fans provided with a factory-mounted variable frequency drive, with MicroTech® III controls, significantly reducing fan power when applied to variable air volume (VAV) systems.

Our industry leading Protocol Selectability™ feature provides effective BAS selection flexibility. Factory integrated and commissioned MicroTech III DDC unit control systems,† eliminate the need for additional cost and time field installation of controls.

Economizers reduce compressor operating hours and energy costs for year-round "free cooling" capability.

Improving Indoor Air Quality

For flexibility in selecting filtration filter, Daikin includes: MERV 8, 11, 13, or 14 options with & without pre-filters. Microbial-resistant filters are also an available option. Double-wall panel construction that eliminates fibers in the supply air stream and is easy to clean. Units are provided with double-sloped, galvanized or stainless steel drain pans to eliminate stagnant water and minimize bacterial growth.

Quiet System Operation

Low decibel output is provided by structural quality and specialized design. Units can be equipped with SWSI airfoil plenum fans for excellent acoustics and better efficiency. Supply and return fans are equipped with 200,000 hour greaseable ball bearings for reliable operation.

Lower Maintenance Costs

Service and maintenance are performed out of the occupied space eliminating any inconvenience to the occupants. Control and product reliability functions is designed for single source responsibility and improved reliability.

Units are constructed of pre-painted galvanized steel. Hinged access doors are provided on both sides of each section. This design eliminates the need for stepladders to remove multiple screws common to the access panels used on most competitive rooftop units. Hinges are stainless steel. A single lever roller latching mechanism is located at the unit base to provide easy access. All wiring is in accordance with the National Electrical Code (NEC). All components are UL listed where applicable. For easy identification, all electrical components are labeled and all wiring is color and number coded. Large, conveniently located control panels with full access doors offer easy servicing of units with the power package. Units also are equipped with a 115-volt outlet located in the main control panel for added convenience. Operating and safety controls are centrally located behind a hinged, deadfront safety panel.

Three-phase factory fusing available for fan motors provides positive protection against damage from short circuits and locked rotor conditions. In addition, phase failure and ground fault protection can be provided. The MicroTech III unit controller provides complete temperature control and, if required, static pressure control for VAV systems.

The MicroTech III control system is provided with a keypad display module mounted in the main control panel for entering set points and unit monitoring.

† Not available on size 708.

Unit Flexibility

The Daikin rooftop air handler is designed to meet the degree of emphasis has been put on providing increased requirements of the present and the future. Along with flexibility. Units are a semi-custom air handler with the providing high quality and state-of-the-art innovation, a large flexibility to satisfy a wide range of application specifications.

Table 1: Availability of options per unit size

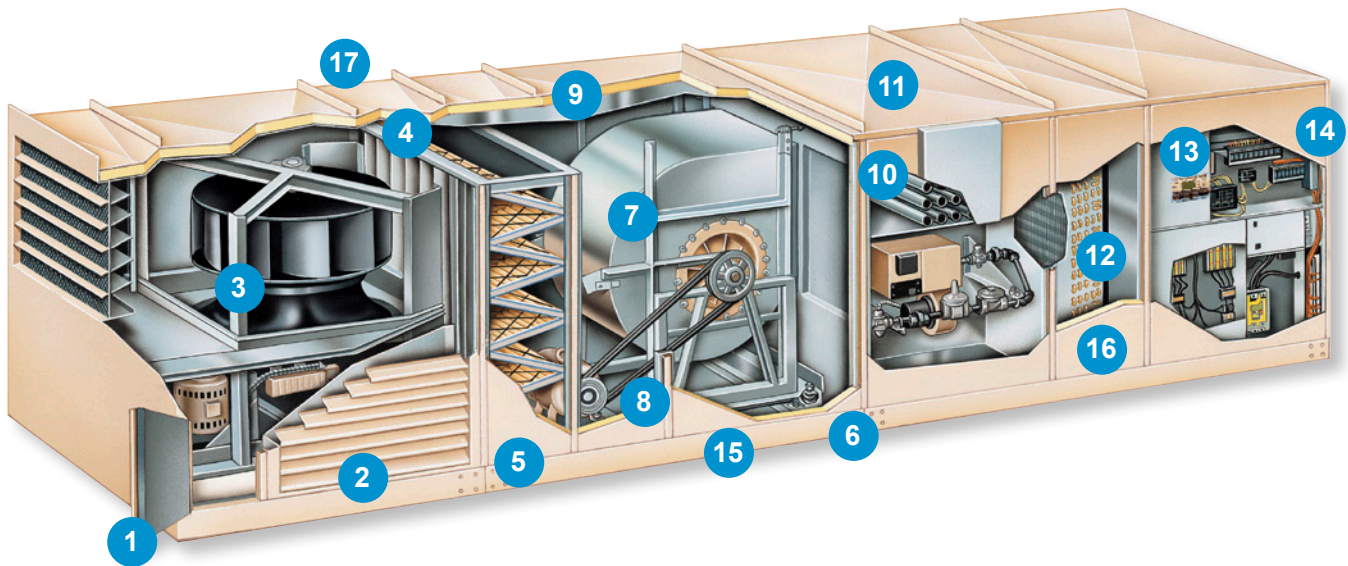
Factory Installed Options		Unit Size				
		708	800/802	047-077		
Electrical	Factory wired electrical	Available	Available	Available		
	Starters and outlet					
	VFDs	Limited availability				
	Disconnect	Available				
	Lights with receptacle					
Ground fault or phase protection						
Mixing	100% outdoor air hood	Available			Limited availability	Available
	100% return air plenum					
	0-30% outdoor air					
	0-100% outdoor air less exhaust					
	0-100% outdoor air with exhaust					
	DesignFlow outdoor air measurement	Limited availability				
Blender	Available					
Return/exhaust fans [3]	DWDI FC	Available	Limited availability	Available		
	SWSI AF	Limited availability				
	Propeller exhaust					
Controls	Temperature controls		Available			
	Static pressure controls					
	Valve packages					
	Smoke detectors					
Freezestats	Available					
Damper actuators						
Filters	2" angular	Available	Limited availability		Available	
	Cartridge filters	Limited availability				
	Two cartridge filter face areas					
Coils	Draw-through and blow-through filters [2]	Available	Available			
	DX, water, and steam					
	Two coil face areas					
	Galvanized or stainless drain pan					
Supply fans [and return fans*]	Draw-through and blow-through coils	Limited availability	Limited availability	Available		
	DWDI FC or AF	Available				
	SWSI AF	Limited availability				
	Multiple fan diameters	Available	Limited availability			
	Belt guards*					
	TEFC or premium efficiency motors*					
	150% drives*					
Down blast fan						
Duct connections	Bottom and back return	Available	[1]			
	Bottom and end discharge					
	Discharge plenum					
Special Sections	Extra access in air stream	Limited availability	Available	Available		
	Out of air stream, blank section					
	Staged or modulating furnaces					
	Electric Heat					
Construction	Face + Bypass	Available	Available			
	Double wall with R6.5 insulation					
	Burglar bars or isolation dampers	Limited availability				
	Split Unit					
	Sheet metal underliner	Available				

[1] Available with SWSI plenum fan

[2] Blow-through filters are only available with draw-through cooling

[3] Only available with 0-100% outdoor air with exhaust

† Not available on size 708.



1 Standard insulation

- 1½ lb fully insulated unit with galvanized steel floor and door liners. All exposed insulation is pinned and retained leaving no exposed edges to delaminate.

2 Outdoor air louvers

- Designed with low inlet velocities to minimize moisture entrainment. Outdoor louvers on both sides of the unit minimize air stratification within the unit.

3 Efficient return fan

- Airfoil design is available with or without spring isolation and seismic restraints. Optional MicroTech III VaneTrol™ control logic on VAV applications provides proper building pressurization.

4 UltraSeal low leak dampers

- Standard on both outside and return air dampers to minimize air leakage and reduce energy costs. UltraSeal dampers have a low leakage rate.

5 Dual side access filter section

- With multiple filter options that have up to 95% efficiency.

6 Exclusive door latch

- Pinioned single point door latch. Unique vinyl door gasket provides positive seal in all sections. Hinged access doors on both sides of each section. Stainless steel hinges. Safety tie back rods on all doors.

7 Efficient supply fan

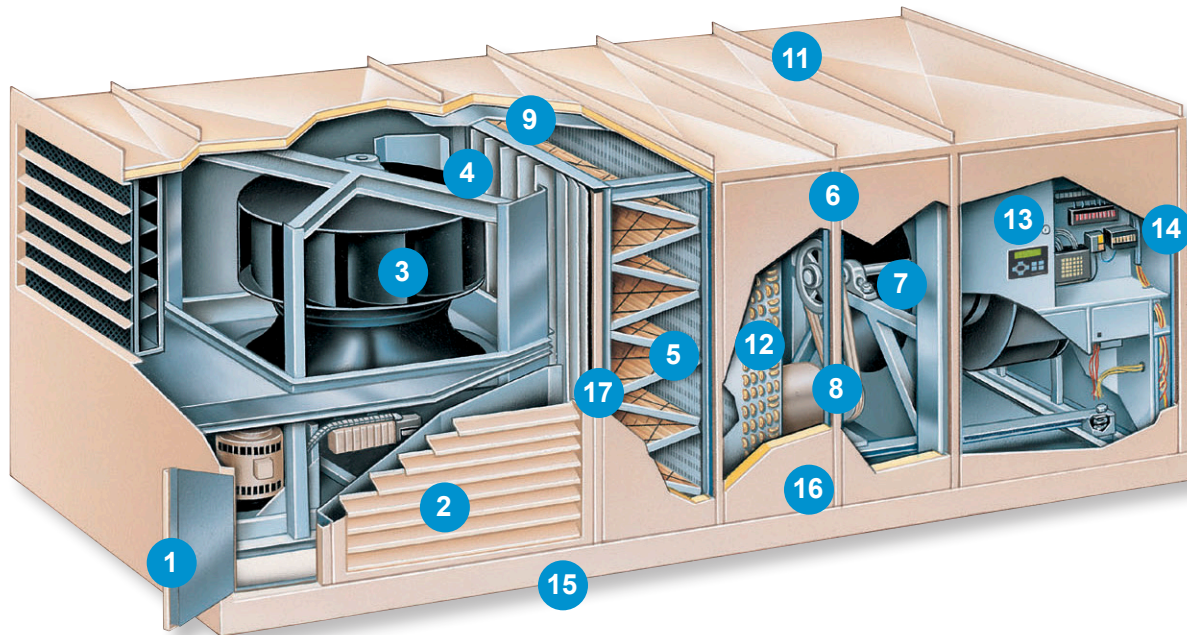
- Multiple forward curved and airfoil fan selections allow efficient selection for blow-through and draw-through applications. Fans are DWDI or SWSI and are available with spring isolation and seismic restraints.

8 Drive selection

- Up to 150% service factor available for both fixed and adjustable pitch drives.

9 Insulated double wall construction

- Complete double wall unit construction is available with R6.5 insulation. Double wall construction eliminates damage to insulation, minimizes heat loss, prevents glass fibers from entering airstream, and provides a cleanable surface.



10 Industrial furnace

- Long life stainless steel drum with stainless steel secondary tubes. 200 to 2000 MBh outputs. All burners are forced draft type and are ETL and ETL-Canada listed.*

11 Leak resistant construction

- Prepainted baked enamel finish with standing top seam and cross broken top panels for positive drainage.

12 Cooling coil flexibility

- Select coils from a wide variety of row, fins per inch and face area combinations to optimize performance and efficiency.

13 Optional MicroTech III controls

- State-of-the-art keypad interface allows easy adjustment of Direct Digital Control functions, bidirectional communications, stand-alone or network operation.*
- Option: add the Intelligent Equipment™ control solution, which provides real-time data streams for benchmarking performance, monitoring system operations and implementing remote diagnostics and control.



14 Large control panel

- Single or multiple power connections, integral door disconnect, deadfront panels, 115V convenience outlet, color coded and numbered wiring are all offered with available power package.

15 Full unit base rail

- Heavy, full perimeter base rail with integral accessible wire chase. Heavy-duty lifting lugs provided for single piece rigging of units up to 52 feet in length.

16 Stainless steel sloped drain pan

- Available with all cooling coils for superior corrosion resistance and cleanability. Sloped drain pan is mounted at a minimum 1/8" per foot incline to provide positive condensate drainage.

17 Blank sections

- Provide flexibility for factory or field-installed specialty equipment.

* MicroTech III and furnace options are not available on size 708

Daikin RoofPak systems are built to perform, with features and options that provide for lower installed costs, high energy efficiency, good indoor air quality, quiet operation, low cost maintenance and service, and longevity. Completed systems are factory tested and shipped with an ETL or ETL Canada Safety Listing.

Unit Construction

- Nominal unit cooling capacities from 15 to 135 tons. Units up to 52-feet long can be shipped completely assembled.
- Weather resistant cabinet design with standing top seams and cross-broken top panels to provide positive drainage.
- Pre-painted exterior surfaces that withstand a minimum 750 hour salt spray test per ASTM B117.
- Full size, double-wall hinged access doors on both sides of each section. All positive pressure door latches have a safety catch designed to prevent the door from opening rapidly when the cabinet is under positive pressure.
- Single lever latch mechanism and door holders on each access door.
- Heavy-gauge galvanized steel unit base with formed recess to seat on roof curb gasket and provide positive weathertight seal.
- Heavy duty lifting brackets strategically placed for balanced cable or chain hook lifting.
- Full double-wall construction is available throughout the unit to protect R-6.5 insulation, enhance performance and satisfy IAQ requirements.
- Perforated liners are available in the plenum areas to enhance sound performance.
- Available auxiliary blank sections provide the flexibility for factory-installed or field-installed specialty equipment.
- Factory-mounted and factory-wired service lights with switch and outlet are available in each fan section.

Figure 1: Standing top seam



Figure 2: Full double-wall construction



Supply and Return Fan Section

- Multiple double width, double inlet (DWDI) forward curved and airfoil supply air fan selections provide efficient, quiet operation at wide ranging static pressure and cfm requirements. SWSI airfoil plenum supply fans are available on sizes 047 to 077.
- Each fan assembly is dynamically trim balanced at the factory before shipment.
- Neoprene gasket isolates the fan housing and eliminates vibration transmission to the fan bulkhead.
- Solid steel fan shafts rotate in 200,000 hour, greaseable ball bearings.
- All fan assemblies are isolated from the main unit on RIS or 2-in deflection spring mounts.
- Open drip-proof or totally enclosed motors comply with EPACT efficiency requirements. Premium efficiency motor upgrades available.
- All fan drives are factory sized according to job specific airflow, static pressure, and power requirements.
- Single width, single inlet (SWSI) airfoil return fans effectively handle high return duct static pressures and provide superior building static pressure control in VAV systems.
- For seismic sensitive regions, spring fan isolators are available with seismic restraints.
- 150% service factor drives extend service life of the fan belts.
- Fan motor power factor correction to a minimum of 0.90.
- Fan motor and drive assembly belt guards.

† Not available on size 708.

Figure 3: Airfoil fans



Figure 4: SWSI airfoil plenum fans



Variable Air Volume Control†

- Energy saving, advanced technology, variable frequency drive (VFD), fan speed control is available with the convenience and cost savings of factory mounting and testing.
- All VFD selections are plenum rated and are conveniently mounted within the filtered air stream for extended service life and easy accessibility to maintenance and service personnel.
- To manage building static pressure, dedicated VFDs are used for the supply and return fans.
- MicroTech III controls provide advanced duct and building static pressure control and equipment diagnostics capability.†

Figure 5: Factory-installed variable frequency drive



Supply and Return Air Plenum

- Bottom, side, top and front (RFS only) discharge locations and bottom and back return locations provide application flexibility to match complex system configuration requirements.
- Available with burglar bars or isolation dampers in both the discharge and return openings for additional building security.

† Not available on size 708.

Gas Heat†

- Extensive selection flexibility from 200 to 2,000 MBh output can satisfy wide ranging needs.
- Two-stage, 3:1 and patented SuperMod 20:1 modulating control provides the flexibility to solve diverse needs.
- All gas burners exceed ASHRAE Standard 90.1 efficiency requirement of 78% for low fire and 80% for high fire with efficiencies as high as 88% and 85%, respectively.
- The complete furnace assembly is ETL or ETL-Canada listed.
- Special order capability with FM or IRI/FIA gas trains.
- All burner assemblies are factory tested and adjusted prior to shipment.
- Heat exchangers are a two-pass, drum-and-tube design with stainless steel primary and secondary surfaces.
- Air temperature rise capability of up to 100°F on most models.
- Burners are forced draft type with all controls and valves housed in the burner vestibule.
- Designed for ease of inspection, cleaning and maintenance.
- Patented design of integral flue improves combustion gas distribution, resulting in lower surface temperatures, reduced stresses and higher efficiencies.
- High-pressure regulators (2 psi to 10 psi) also available.
- 321 stainless steel heat exchangers provide long life.
- Fuel lines may be conveniently routed through the curb or the burner vestibule door.
- Heating control fully integrated into the unit's MicroTech III control system.

SuperMod High Turndown Gas Burner†

- Full 20:1 turndown with continuous modulation between 5% and 100% of rated capacity provides precise temperature control for a comfortable tenant environment, even in demanding applications such as dehumidification, 100% make-up air and VAV systems.
- Solves the mixed air tempering requirements of VAV systems when meeting ASHRAE 62.1-2001 ventilation requirements at cold ambient, light load conditions.
- Operates at normal inlet gas pressures, throughout the entire modulation range.
- 14-burner sizes ranging from 200 to 2,000 MBh output capacity.
- Patent pending design featuring four unique design innovations and 37 patent claims.

Figure 6: SuperMod 20:1 burner versus 3:1 burner

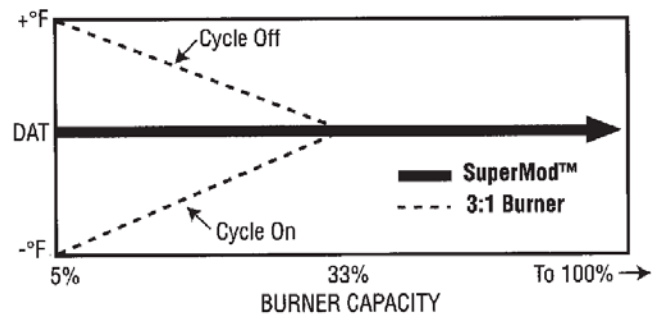
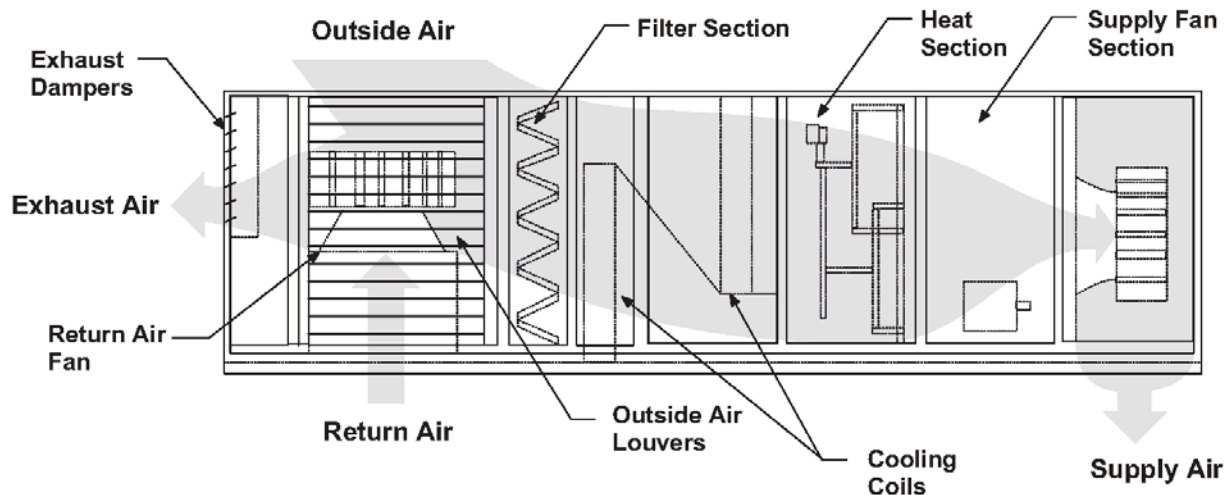


Figure 7: Draw-through airflow configuration



† Not available on size 708.

Electric Heat†

- 40 to 320 kW selections factory assembled, installed and tested.
- Single-stage or multi-stage capability for application flexibility.
- Durable, low watt density, nickel chromium elements for longer life.
- Entire heat bank protected by a linear high limit control with each heater element protected by an automatic reset high limit control
- Fuses provided in each branch circuit.
- MicroTech III controls sequence circuits for operating economy and reduced cycling wear.

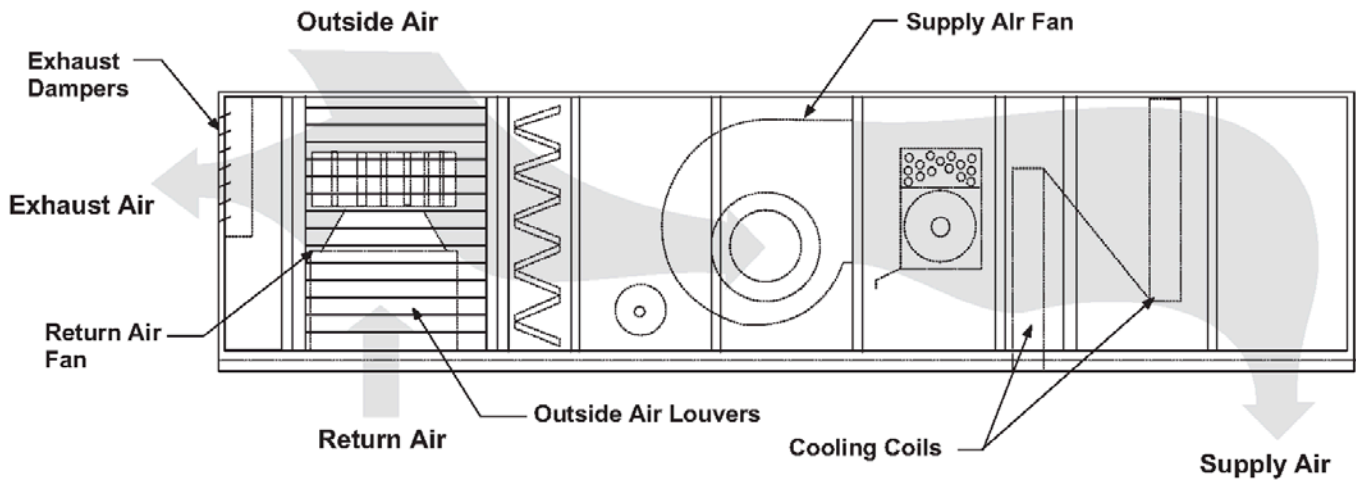
Hot Water Heat

- Hot water coils are 1-row or 2-row, 5/8-in O.D. copper tube/aluminum fin design with patented HI-F5 fins.
- Rated in accordance with ARI Standard 430.
- Multiple coil selections offered to size heating output to application needs.
- Factory-installed, three-way modulating control valve, piping and modulating spring return actuator provide system control and full flow through the coil in the event of a power failure. Not available on size 708.
- Available with factory-mounted freeze stat.†

Steam Heat

- Steam heating coils are 1-row or 2-row, 5/8-in O.D. copper tube/aluminum fin jet distributing type with patented HI-F5 fin design.
- Rated in accordance with ARI Standard 430.
- Four different steam coil selections offered to size heating output to application needs.
- Factory-installed, two-way modulating control valve, piping and modulating spring return actuator provide system control and full flow through the coil in the event of a power failure.*
- Available with factory-mounted freeze stat.†

Figure 8: Blow-through airflow configuration



† Not available on size 708.

Outside/Return Air Section

100% Return Air Option

- Includes a return air plenum with a bottom, back or top return air opening.

0% to 30% Outside Air Option†

Includes return air plenum and 0% to 30% outside air intake hood with patented UltraSeal™ low leak dampers to minimize leakage during off cycles. Damper is field adjusted to a fixed open position that is easily set using the MicroTech III keypad. Compatible with two-position or modulating control.

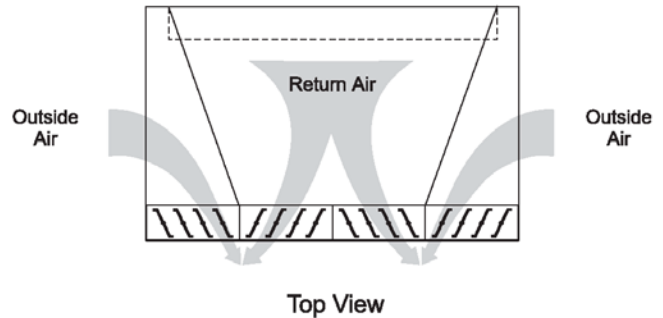
100% Outside Air Option

- Includes a weather hood factory mounted to the filter section, bird screen to help prevent infiltration of foreign objects, and UltraSeal low leak dampers to minimize leakage during off cycles.
- Dampers arranged vertically and compatible with a two-position control to sequence open when the supply fan is running and to close when the supply fan is off.

0% to 100% Economizer Option

- Includes return air plenum with back or bottom opening, exhaust air dampers and UltraSeal low leak economizer intake dampers to minimize leakage during off cycles.
- Available with or without return or exhaust air fans.
- Outside air is introduced from both sides of the unit through outside and return air dampers that are arranged vertically to converge the multiple air streams in circular mixing patterns, minimizing temperature stratification and improving system performance. (Size 708 has two outdoor air hoods on one side opposite the exhaust.)
- 0% to 100% economizer sections use horizontal louvered intakes, eliminating unsightly hood assemblies.
- DesignFlow outdoor air control system measures outside air intake volume and automatically adjusts damper position to maintain minimum volume requirements.*
- Outside air enthalpy, comparative enthalpy or dry-bulb temperature changeover provides control flexibility to bring in the most economical amount of outside air for “free” cooling.†
- Exhaust dampers exhaust air out the back of the unit.

Figure 9: Economizer airflow for 800, 802, 047C, and 077C



Mixing Box (not available on sizes 800 to 802)

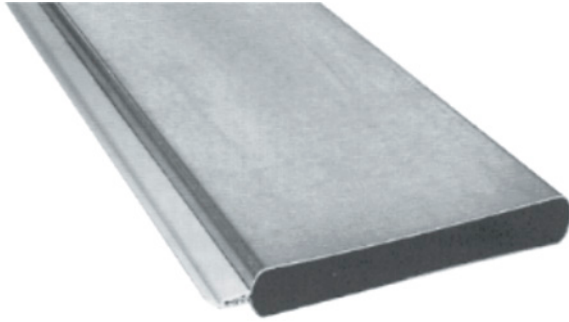
The mixing box option consists of a return air plenum, outside air hood, and UltraSeal low leak mixing dampers. The return air and outside air damper blades are positioned vertically for optimum mixing capability. A factory-mounted modulating spring return type actuator can be installed to operate the interconnected dampers.

The patented UltraSeal low leak dampers are standard equipment on both outdoor and return air dampers. This damper drastically reduces energy losses due to conduction and infiltration. The hollow core airfoil type damper provides 12 times the insulating factor over flat blade dampers. Air leakage is maintained below 1.5 cfm/ft² at 1" SP, as tested and confirmed in accordance with AMCA Standard 500. This is accomplished with the following design features:

- Heavy-duty, tubular airfoil blades that eliminate twisting and warping while minimizing air pressure drop.
- Heavy-duty construction allows the use of larger 7" wide blades running the full height of the cabinet. Fewer blades reduces the potential for leakage.
- All blade edges are provided with a unique gasketing design for low pressure differentials experienced on economizer applications.
- Flexible stainless steel side seals between the blade ends and the damper frame provide UltraSeal with one of the lowest leakage rates in the industry.

† Not available on size 708.

Figure 10: UltraSeal damper cross section



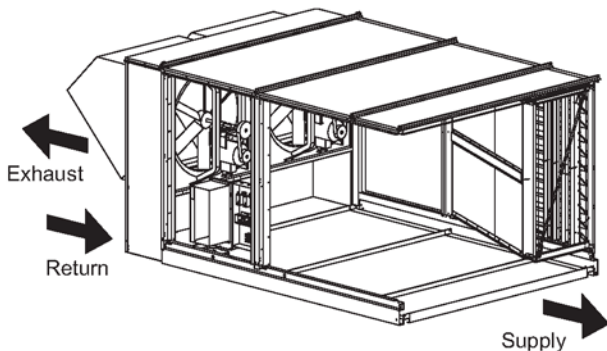
0% to 100% Economizer with Centrifugal Return Fan

Figure 11 shows return fan air flow configuration.

- All 0% to 100% economizer components are included
- Includes a DWDI forward curved, air foil or an SWSI air foil, centrifugal return fan
- Return fans are in series with the supply fan and operate simultaneously with the supply fan to control building pressure and handle the return duct ESP at all times.

NOTE: Return fans and exhaust fans have different performance characteristics and are not interchangeable. See page 29 for application recommendations.

Figure 11: Airflow configuration—exhaust fan



0% to 100% Economizer with Propeller Exhaust Fans (sizes 047 to 077 only)

Figure 11 shows exhaust fan air flow configuration.

- All 0% to 100% economizer components are included.
- Includes one to three propeller fans, depending on required capacity, all controlled from one VFD.
- Exhaust fans are in parallel with the supply fan and may only operate during the economizer mode to control building pressure. They do not handle the return duct at ESP design conditions.

NOTE: Return fans and exhaust fans have different performance characteristics and are not interchangeable. See page 26 for application recommendations.

DesignFlow Precision Ventilation Air Control System†

- Patented precision mass flow sensor assemblies directly measure the total mass volume of air flowing through the outdoor air intakes with accuracy exceeding 95% at the values indicated in Table 2.
- Repeatable accuracy helps provide adequate ventilation air for good indoor air quality (IAQ), energy efficiency, and compliance with ASHRAE Standard 62.1-2001. See Table 2 for ventilation airflow measurement ranges verified by Intertek Testing Services, Inc.
- Pre-engineered, factory-installed, and calibrated system requires no additional field-installed devices.
- MicroTech III controls automatically respond to mass flow sensor signals and adjusts outdoor air damper position to maintain ventilation rate set point.

Table 2: Ventilation airflow measurement range

Unit size	Ventilation airflow measurement range
800C	540 to 9,400 cfm
802C	808 to 13,120 cfm
047C	1080 to 18,000 cfm
077C	1594 to 37,126 cfm

† Not available on size 708.

Filter Section

- Selection flexibility includes large face, area angular filter racks with 2-inch, 30% panel filters, or high efficiency cartridge filter assemblies with pre-filters.
- Multiple access doors allow easy filter changes from either side of the unit.
- 65% and 95% efficient filter selections feature permanent gaskets to seal against the cartridge filters and include a 2-inch, MERV 8, 30% pre-filter.
- Extended filter face area arrangements meet a wide range of airflow requirements.
- Double wall, 95% efficient final filter selections are available as the last section before the discharge plenum.

Figure 12: Multiple filter options



Static Air Mixers

- Factory installed between the outside/return air section and the filter section.
- Provides blended air temperatures to minimize the potential for freeze/ice trips when using a hydronic heating source.
- Blended outside/return air streams improve system control and avoid uneven temperature distribution at the duct take-offs.

Sound Attenuators†

- Factory-installed downstream of the supply fan to dampen fan noise in sound sensitive applications.
- Can reduce sound levels by as much as half in the lower octave bands and more than half in the higher octave bands.
- Tedlar™ coating available for added protection of the acoustic insulation.

Figure 13: Factory-installed sound attenuators



Humidifiers

- Factory installed steam humidifier distribution grids downstream of the supply air fan.

Roof Curbs

- Constructed in accordance with NRCA guidelines with 12-gauge galvanized steel.
- Fits inside the unit base around the perimeter of air handling section.
- Duct frames are provided as part of each curb assembly to allow duct connections to be completed before the unit is placed.†
- Gasket seals between the curb duct frame and the unit.

† Not available on size 708.

Heating and Cooling Coils

Daikin's ARI certified coils are designed to maximize face area and minimize face velocity, thereby reducing static pressure losses. The Daikin HI-F fin design of RDS/RAH coils provides a substantial improvement to fin efficiency. Design of the HI-F fin produces a state of continuous turbulence that effectively reduces boundary layer formation. As a result, heat transfer efficiency sharply improves, making the HI-F surface an industry leader.

In addition, coil performance is enhanced by the design of staggered tubing. This arrangement exposes the tubes to more moving air than the in-line design, yielding greater heat transfer. The geometry of the staggered tube design also allows the rows to be spaced closer together for a more compact coil.

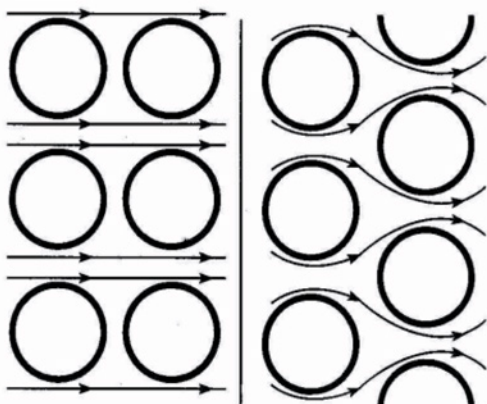
Daikin offers a broad variety of coil types, fin spacings, row and circuiting combinations, which permits using standard coils to accurately meet load and comfort requirements. Multiple face areas are offered in each cabinet size to allow more selection flexibility.

A standard coil can be selected manually or through the Daikin SelectTools for Contractor Coils selection program to deliver the specified leaving air dry and wet bulb temperatures for virtually any condition. SelectTools offers designers easy and accurate coil selection for optimal performance.

Figure 14: Daikin HI-F5 fin



Figure 15: In-line vs. Daikin staggered tube design

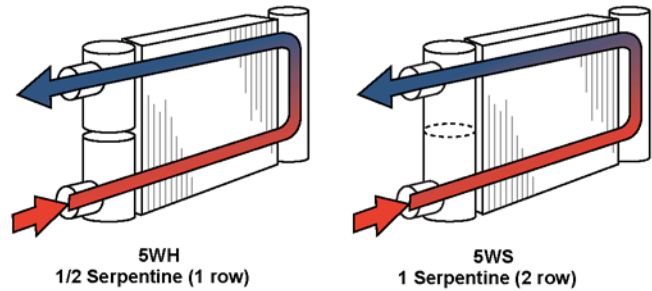


Heating Coils

Hot Water Coils

Water heating coils are offered in two counterflow arrangements to satisfy a variety of design needs. The one-row, half serpentine circuit allows increased water velocity for low heat applications. For water coils operating under normal supply and pressure drop conditions, the two-row, full serpentine circuit offers exceptional capacity for high heating demands.

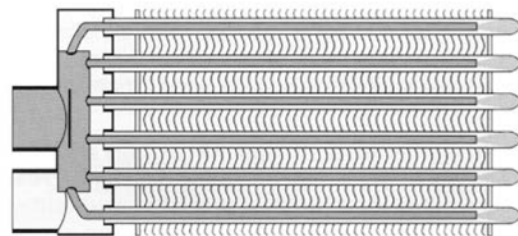
Figure 16: Hot water coil circuitings



Steam Coils

Steam coils are available with two-row and two-fin spacing options for sizing flexibility. Steam coils are tube-in-tube design with directionally orificed inner tubes for jet distribution. A specially designed coil casing automatically provides the proper pitch for positive condensate removal.

Figure 17: Steam coils circuitings



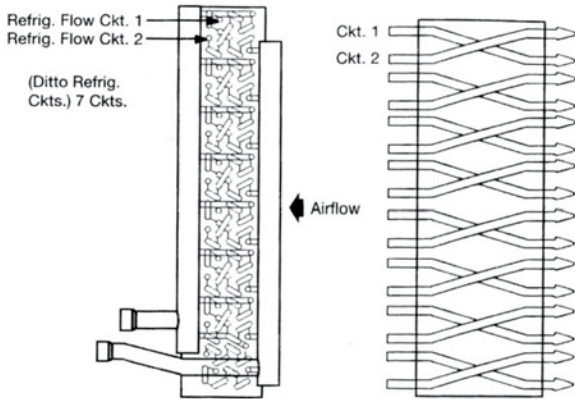
† Not available on size 708.

Cooling Coils

Evaporator Coils

Evaporator coils are available with four-row and three-fin spacing options to match a wide variety of design loads. All evaporator coils are completely interlaced with the full face of the coil active, eliminating air stratification problems.

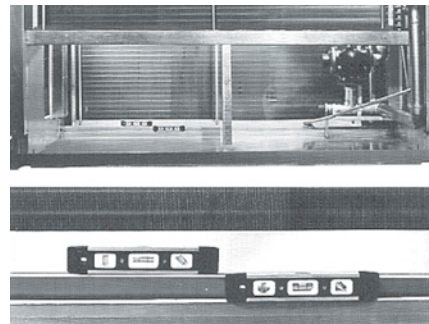
Figure 18: Evaporator coil circuiting



Sloped Drain Pan

Galvanized steel sloped drain pans finished with baked-on enamel paint are standard with all cooling coils for superior corrosion resistance and cleanability. Optional stainless-steel sloped drain pans are available to meet the needs of the most demanding applications. The drain pan is mounted at a minimum of 1/8" per foot incline to provide positive condensate drainage. In addition, an intermediate drain pan is provided in the coil bank to provide condensate removal without carryover. A threaded drain connection on one side of the unit allows for convenient attachment of trap and drain line.

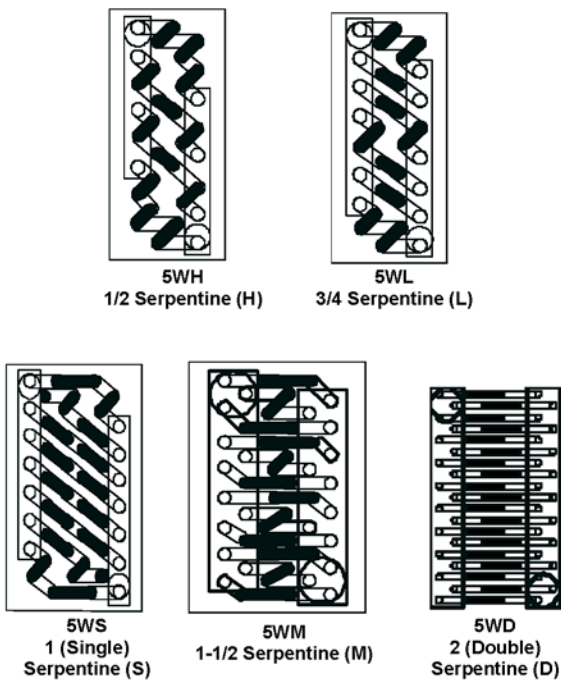
Figure 20: Sloped drain pan



Chilled Water Coils

Available water cooling coils provide flow-controlled circuiting in five standard counterflow arrangements for optimum selection at any given water velocity. With the multitude of rows and fin spacings available, the ideal chilled water coil can be applied.

Figure 19: Chilled water coil circuitings



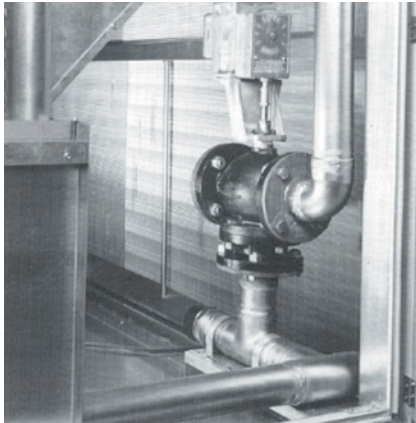
Options

Coil Section Options

A factory-mounted valve package is offered for heating coils located in the heat section of the unit and for all chilled water coils. The valve package consists of a modulating control valve, piping, and a spring return type valve actuator. During a power failure, these valves open to provide full flow through the coil. Complete control of the valves can be provided by the available MicroTech III controller.†

A field-installed coil vestibule is available and is recommended when piping must enter the side of the unit. It is required on many coil arrangements to facilitate piping through the curb. Face and bypass dampers may also be provided for coil capacity control and freeze protection. Dampers are available for all chilled water, hot water, and steam coils positioned in the heat/cool sections of the unit.

Figure 21: Valve package



Electrical Options

- Units are completely wired and tested at the factory, with control wiring routed in an accessible, protective wire raceway at the base of the unit.
- Wiring complies with NEC requirements and all applicable UL standards.
- For ease of use, wiring and electrical components are number coded and labeled according to the electrical diagram.
- Units have a 115 V convenience receptacle. (unit powered or field powered)
- Supply and return air fan motors, compressor motors, and condenser fan motor branch circuits have individual short circuit protection.
- A single point power connection with power block or disconnect switch is standard.
- A unit-mounted disconnect includes a service handle on the exterior of the control panel door.
- Electrical power feeds inside the perimeter roof curb through factory provided knockouts in the bottom of the main control panel.
- Phase-failure/under-voltage protection is available to protect three phase motors. Not available on size 708.

Power Package Options

An optional power package is available to provide full unit power wiring from a factory-installed power block or disconnect switch to fan motors and other electrical components. Also included is short circuit protection, motor contactors, external motor overload protection, a 115-volt transformer, system switch, and a 115-volt convenience outlet. All circuits are fused and centrally located in the main control panel for easy access.

Main power lines enter the unit inside the roof curb through power knockouts in the bottom of the main control panel. With a power package, all power wiring is factory installed in an accessible wire raceway at the base of the unit for added protection and convenience.

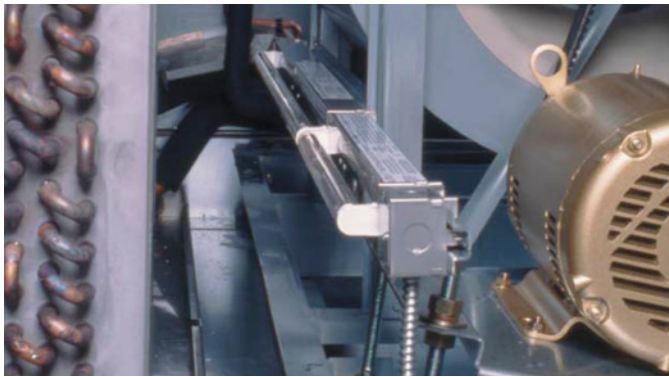
The power package allows for a single field power connection. A dual power connection that separates the electric heat from the fan motors and multiple power connections that allow for connection of an on-site emergency power source are also available for operation flexibility.

Ultraviolet Lights

Factory-installed ultraviolet lights are available on the downstream side of all cooling coils and above the unit drain pan.

All ultraviolet lights are pre-engineered and factory installed for ease of use and proper placement for maximum effectiveness. The ultraviolet lamps irradiate the coil and drain pan surfaces with light in the 245 nanometer wavelength of the light spectrum (UV-C). UV-C light has proven effective in killing most bacteria, molds, and viruses in both laboratory and practical application. This complete package of equipment and ultraviolet lights includes Intertek Services Inc. (ETL) safety agency certification.

Figure 22: Ultraviolet light



Features

- High-output, hot cathode lamps produce Ultraviolet Germicidal Irradiation (UVGI) for 254 nm that constantly irradiates the coil and drain pan surfaces.
- Fixture design and stainless steel construction make the ultraviolet light device suitable for saturated air conditions.
- Automatic disconnects are standard on all doors (or panels) with line-of-sight access to the lamps to help prevent eye contact with the UV-C ultraviolet light.
- Special ultraviolet filtering glass windows block ultraviolet light, allowing the coil, drain pan, and lights to be inspected while in use from outside the unit.

Benefits

- For pennies a day, UVGI can improve IAQ by destroying mold, fungi, and bacteria on coil and drain pan surfaces.
- Clean coil surfaces maintain peak heat transfer for “near new” performance and lower energy costs.
- Reduced coil and drain pan maintenance requirements and costs.
- Satisfies GSA federal facilities standard requirements for UVGI lights to be incorporated downstream of all cooling coils and above all drain pans to control airborne and surface microbial growth and transfer.

Intelligent Equipment™

Intelligent Equipment (IE) from Daikin Applied is a secure, cloud-based controls solution that enables delivery of equipment and/or system information to customers via web or mobile devices.



A power measurement module and communications gateway installed on Daikin equipment enables the unit to be directly connected to the Internet via wireless (cellular, WI-FI) or local area network (LAN), providing management, monitoring control analysis and decision-making functionality for Daikin rooftop systems and the facility.

Features

- Remote monitoring and control of Daikin rooftop units
- Remote servicing capabilities
- Integration to the Energy Star® Portfolio Manager®
- Advanced data analytics including equipment performance, financial performance and building Comfort Index matrix based on ASHRAE Standard 55-2010
- Dynamic user dashboards with photo-realistic graphics and responsive-design interface optimized for users' mobile devices, tablets or PCs
- Secure, role-based user access

Benefits

- Informed decision-making
- Increased equipment efficiency
- 24/7 monitoring capability
- Real-time equipment information
- Accelerated equipment payback
- Historical performance data
- Can be used with, or without, an existing building automation system (BAS)

Figure 23: Intelligent Equipment Dashboards

Customer Dashboard

DAIKIN
John Doe
Demo Customer Administrator

[Sites List / Daikin Corporate Office Dashboard](#)

Building

Building Status

My Usage Comparison

- Energy ↓ 4.6% Lower than last year
- Water ↓ 6.6% Lower than last year
- Fuel ↓ 3.6% Lower than last year

Energy Star Score 100
Target Score: 75

[View Details](#) [Setup Meters](#)

HVAC Summary

Unit Status

No Alarm

[View Details](#)

Maintenance

Not Needed

[View Details](#)

Live Power Usage

0.45%

From last week 360 (kW)

[View Details](#)

95% Comfort Index

1.0 Performance Index

Building Info

Site Name: Daikin Corporate Office
Unit: RTU-2
Site Address: 13500 Industrial Park Blvd, Plymouth, MN 55441, United States

As of the Last 30 Days

RTU-2

Economy Winter | Fixed Comfort | Economy Summer

95% Comfort Index

Complies with ASHRAE Standard 55-2010

Relative Humidity (%) vs Space Temperature (°F)

Weather

Plymouth, MN
07/15/2014 4:39:13 PM Today

High 72°F 70°F
Low 54°F 66°F

Partly Cloudy
Current OA Temp 72°F
Wind 12 mph
Humidity 50%
Precipitation 8%

Thursday 61...75°F | Friday 63...81°F | Saturday 66...81°F | Sunday 66...82°F

Financial Summary

All Units

Monthly Savings (USD) vs Cumulative Savings

Energy Saving Recommendations

Outside Air Temp: 70°F | Outside Humidity: 59%

Wind Speed: 7 mph | Conditions: Sunny

Air Temp: 73.9°F | Humidity: 50%

Auto | Manual | Apply

Mean Radiant Temp: 71.7°F | Air Speed: 10 mph

Clothing Level: 0.65 clo | Metabolic Rate: 1.2 met

Technician Dashboard

Unit Tag - RTU-4

Schedule (CST): No schedule selected

[Change Schedule](#) | [Change Time Zone](#) | [C](#)

Alarm Cleared / No Active Alarms

[Alarm Log](#)

Technician Read and Write Subscription expiration date 09/19/2015

Unit attributes data received at: Mar 10, 2015 09:58 AM

Overview

1. ERW, Economizer & Filter Access
2. Coil Access Panel
3. Supply Fan & Gas Heat Access
4. Gas Connection
5. Condensate
6. Control Panel
7. Inverter Panel

Upcoming Maintenance

RTU-4 is scheduled to undergo Weekly, Bi-Monthly, Monthly, Four Times a Year, Annual maintenance.

Overview Live Data

Unit Overview	
Discharge Air Temperature:	72.7 °F
Occupancy Mode:	Auto
Occupancy Status:	Occ
Return Air Temperature:	69.9 °F
Heating	
Economizer	
Cooling	
Power Usage	

www.DaikinApplied.com

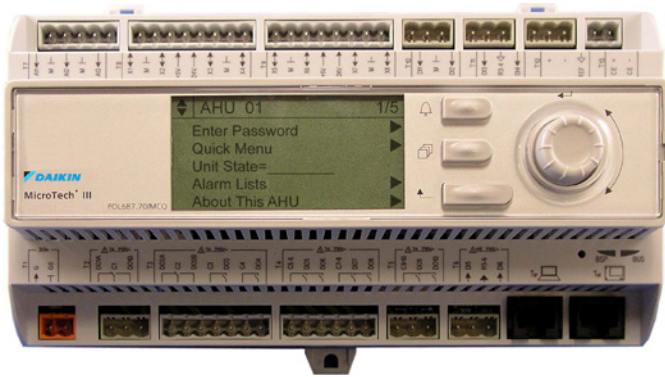
19

CAT 218-3 • ROOFPACK APPLIED AIR HANDLERS

Unit Controls†

- Integrated MicroTech III DDC controls with unitmounted user interface featuring a 5-line, 22 character English display for fast equipment diagnostics and adjustments.
- Factory-installed and commissioned prior to shipment.
- 100% make-up air, dehumidification, VAV, or CV control capabilities.
- Factory integrated minimum ventilation airflow measurement and control capability.
- Open Choices feature allows interoperability with any BAS that uses BACnet and LonWorks protocols.

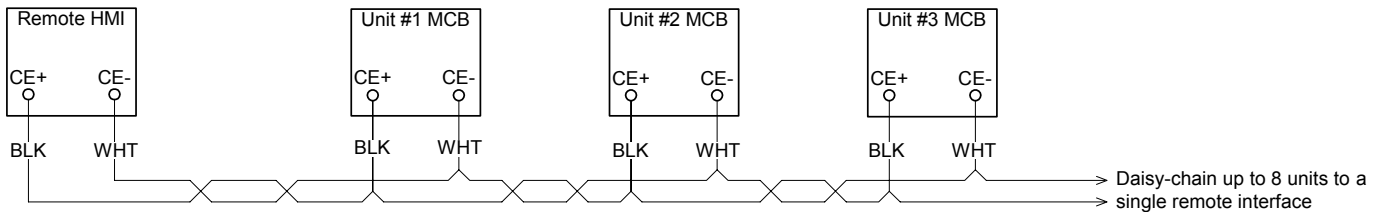
Figure 24: MicroTech III Keypad/Display



MicroTech III Remote User Interface

In addition to the unit-mounted user interface provided with MicroTech III controls, Daikin applied rooftop systems and indoor vertical self-contained systems can be equipped with a remote user interface that handles up to eight units per interface. The remote user interface provides convenient access to unit diagnostics and control adjustments, without having to access your roof or mechanical rooms located on each floor.

Figure 26: Process Bus Wiring Connections



Each remote user interface offers similar functionality as its unit-mounted counterpart, including:

- Push-and-roll navigation wheel with an 8-line by 30-character display format.
- Digital display of messages in English language.
- All operating conditions, system alarms, control parameters and schedules are monitored.

Features

- Can be wired up to 700 meters from units for flexibility in placing each remote user interface within your building.
- Unit and remote user interfaces are both active.

Benefits

- Allows you to access the user interface for each unit from one location, inside the building.
- Users need to learn one format because the remote user interface is nearly identical to the unit-mounted version.
- No additional field commissioning is required for the remote user interface.

Figure 25: Remote User Interface



† Not available on size 708.

Variable Air Volume

Daikin RoofPak variable air volume systems (VAV) employ the concept of varying the air quantity to a space at a constant temperature thereby balancing the heat gains or losses and maintaining the desired room temperature. This true variable volume system is commonly referred to as a “squeeze-off” or “pinch-off” system. Unlike a “bypass” or “dump” system, supply air is diverted from areas where it is not required to areas that need cooling and, at system part load conditions, reduces the total fan volume. This ability to reduce supply air quantities not only provides substantial fan energy savings at partial load conditions, but it also minimizes equipment sizing.

Variable volume systems offer the following advantages:

- Lowers system first cost by using system diversity to reduce equipment and duct sizes.
- Lowers operating costs by reducing fan energy demands, especially at part load conditions.
- Lowers first cost by reducing space requirements for duct trunks and mechanical equipment.
- Provides system flexibility to match changing occupancy demands.

Variable Frequency Drives†

Variable frequency drives offer reliable operation over a wide range of airflow, with advantages in sound and energy performance.

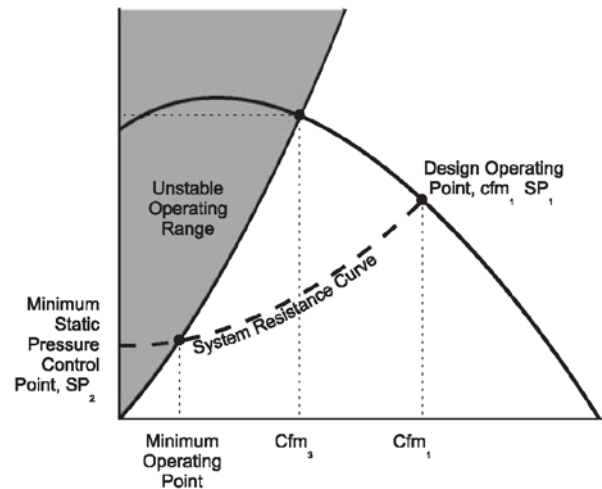
Variable frequency drives provide the most efficient means of variable volume control by taking advantage of the fan law relation between fan speed (rpm) and fan brake horsepower (bhp). Also, since airflow is reduced by changing fan speed, the noise penalties often associated with mechanical control devices, e.g. inlet vanes, are not introduced. The following equation illustrates how fan bhp varies as the cube of the change in fan speed:

$$hp_2 = hp_1 \left(\frac{\text{density}_2}{\text{density}_1} \right) \left(\frac{\text{rpm}_2}{\text{rpm}_1} \right)^3$$

In an ideal system, at 50% fan speed, brake horsepower would be reduced to 12.5% of that at full speed.

Variable frequency control varies the speed of the fan by adjusting the frequency and voltage to the motor. Keeping a constant volts/frequency ratio (constant magnetic flux) to the motor allows the motor to run at its peak efficiency over a wide range of speeds and resulting fan airflow volumes. illustrates on a fan curve the effect of varying air volume with a variable frequency drive.

Figure 27: Variable frequency drive control



Airfoil Fans

To further enhance VAV system performance, Daikin RoofPak VAV systems use efficient airfoil fan selections.

Daikin airfoil fan selections feature:

- Higher operating efficiencies than with commonly used, forward curved fans, reducing system energy demands and electrical requirements.
- A non-overloading brake horsepower curve.
- A single wheel design, eliminating potential problems with fan paralleling at light loads.

MicroTech III VAV Fan Tracking Control†

A key element in successful VAV application is the ability to track supply and return air fan volumes so that proper building static pressure is maintained. Daikin, a pioneer in the development of rooftop VAV systems, developed its exclusive VaneTrol fan tracking control logic to solve this issue. Incorporating over 35 years of rooftop VAV system experience, the latest generation MicroTech III controls with VaneTrol logic provide advanced and accurate duct static pressure control plus supply and return fan tracking control that effectively and efficiently manages building static pressure.

The MicroTech III controller provides complete control of your variable frequency drive applications.

Static Pressure Sensing Locations

In placing a duct static pressure sensor, locate a pressure tap near the end of the main duct trunk. Adjust the static pressure control so that at minimum airflow all the terminals receive the minimum static pressure required plus any downstream resistance. Locate a pressure tap in the ductwork free from turbulent effect, at least ten duct diameters downstream and several duct diameters upstream from any major interference including branch takeoffs. Do not sense the static in a branch duct. On installations having multiple duct trunks, multiple floors, or widely varying zones (e.g. east/west), use optional second sensor.

† Not available on size 708.

MicroTech III Controls

MicroTech III unit control systems are preengineered, preprogrammed, and factory tested prior to shipment. These components include:

- Unit controller with user interface display and navigation wheel
- Optional expansion modules
- Communication module (optional)
- Pressure transducers
- Unit-mounted temperature sensors
- Zone temperature sensor packages
- Humidity sensor

Open Choices Benefits for Easy Integration

- Easy, low cost integration into most building automation systems without costly gateway panels.
- Flexibility to select either BACnet or LonWorks communication. Units are LonMark 3.4 certified with the appropriate communications module for LonWorks networks.
- Comprehensive unit control and status information is available at the BAS regardless of communication protocol.
- Long-term choices for equipment adds or replacements, and for service support.
- Flexible alarm notification and prioritization with Intrinsic Alarm Management (BACnet).
- Simplified BAS integration with the ability to set network parameters at the unit controller, reducing installation time and costs.
- Easy monitoring and troubleshooting of communication status from the unit controller to the BAS.

MicroTech III Unit Controller

The unit controller is preprogrammed with the software necessary to control the unit. Use the unit controller keypad display to keep schedules, set points and parameters from being lost, even during a long-term power outage. The unit controller processes system input data and then determines and controls output responses. An optional field- or factory-mounted BACnet or LonWorks communication module provides a network interface to the BAS.

Expansion Modules

These boards are used to expand the input and output capability of the unit controller. Each board communicates via serial data communications. These microprocessor based boards provide independent operation and alarm response even if communication is lost with the unit controller.

Communication Module

An optional communication module provides the means to factory or field configure MicroTech III unit controls for interoperability with an independent BAS. Communication modules are available to support industry recognized communication protocols including BACnet MS/TP, BACnet/IP and LonWorks.

Keypad/Display

All MicroTech III unit controllers include a push/pull navigation wheel and display. The display is a supertwist nematic type with highly visible black characters on a yellow background. The 5-line by 22-character format allows for easy to understand plain English display messages. All operating conditions, system alarms, control parameters and schedules can be monitored from the keypad/display. If the correct password has been entered, any adjustable parameter or schedule can be modified from the keypad.

Figure 28: Open Choices Integration

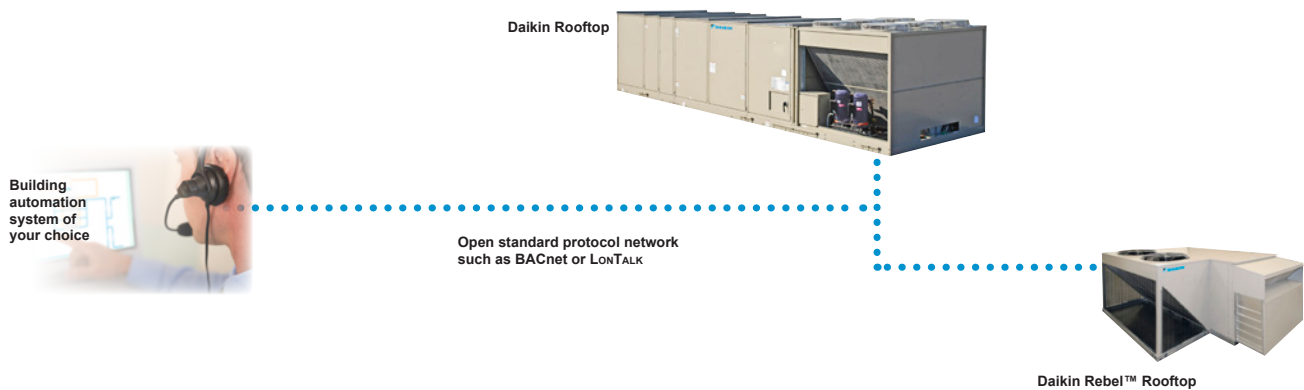


Figure 29: MicroTech III Keypad/Display



Temperature and Humidity Sensors

With the exception of the zone sensor, all temperature sensors are factory installed and tested. Zone sensor packages are available to suit any application. When required for dehumidification applications, a humidity sensor is available for field installation.

Static Pressure Transducers

All pressure transducers are factory installed and tested. Connection and routing of field-supplied sampling tubes is done at time of unit installation.

Zone Temperature Sensors

Two optional zone temperature sensors are available:

- Zone sensor with tenant override switch.
- Zone sensor with tenant override switch and remote set point adjustment.

Timed tenant override is a standard MicroTech III control feature.

Zone sensors are required for the controller’s purge cycle, space reset of supply air set point, and night setback or setup features. All zone sensors are field installed with field wiring terminated at a separate, clearly marked terminal strip.

Stand-alone Controller Features

MicroTech III applied rooftop unit controls include all of the essential features required to make them capable of completely independent, stand-alone operation.

Internal Time Clock

An internal, battery-backed time clock is included in the MicroTech III unit controller. Current date and time can be quickly and easily set at the user interface keypad.

Internal Schedule

Seven daily schedules and one holiday schedule can be entered at the keypad of all unit controllers. For each of these eight schedules, one start and one stop time can be entered. Up to 10 holiday periods, of any duration, can be designated. The unit will automatically run according to the holiday schedule on the holiday dates. To handle special occasions, an additional ‘one event’ schedule can also be used.

In lieu of its internal schedule, the unit can be operated according to a network schedule from a BAS.

External Time Clock or Tenant Override Input

An input is supplied that can be used to accept a field wired start/stop signal from a remote source. An external time clock, a tenant override switch, or both may be connected. Whenever the external circuit is closed, the controller overrides the internal schedule (if activated) and places the unit into the occupied mode.

If the internal schedule or a BAS network schedule is used, field wiring is not required.

Timed Tenant Override

Off-hour operation flexibility is a must in today’s office environments and even stand-alone MicroTech III controls handle it with ease. When unit operation is desired during unoccupied hours, initiate timed tenant override by pressing the tenant override button on either of the optional zone sensor packages. The unit then starts and runs in the occupied mode for a keypad-adjustable length of time (up to five hours). If the button is pressed again while the unit is operating, the timer resets to the full time allowance without interrupting unit operation. Tenant override operation also can be initiated by a BAS.

Three Remote Set Point Adjustment Options

1. Remote user interface option (RUI). See [Variable Air Volume on page 21](#).
2. Building automation system (BAS). See [Open Choices Benefits for Easy Integration on page 22](#).
3. All constant air volume-zone temperature control (CAV-ZTC) unit controllers include an input that can be used to remotely adjust the zone cooling and heating set points. To use this feature, wire the optional zone sensor package with set point adjustment to the controller. The remote set point adjustment feature can be enabled or disabled from the keypad at any time. When enabled, remote set point adjustment is available even if the return temperature is selected to be the Control Temperature.

Auto/Manual Operation Selection

Automatic or manual operation can be controlled either remotely or at the keypad.

All controllers include three inputs that can be used to enable or disable cooling, heating, and fan operation from remote switches. With the “heat enable” and “cool enable” terminals, the operator can enable cooling, heating, or both as desired. Using the system “off” terminals, the operator can disable the fans, and thus the entire unit.

From the keypad, there are a variety of occupancy and auto/manual control mode selections available to the operator:

- Occupancy modes
 - Auto
 - Occupied
 - Unoccupied
 - Bypass (tenant override)
- Control modes
 - Off manual
 - Auto
 - Heat/cool
 - Cool only
 - Heat only
 - Fan only

Economizer Changeover Selection

On units equipped with an economizer, there are three methods of determining whether the outdoor air is suitable for free cooling: two methods sense enthalpy (dry bulb temperature and humidity) and one senses outdoor air dry bulb temperature.

The two enthalpy changeover methods use external, factory installed controls. One compares the outdoor ambient enthalpy to a set point; the other is a solid state device that compares the outdoor ambient enthalpy to the return air enthalpy. This comparative enthalpy control can improve total economizer performance.

All unit controls include an internal dry bulb changeover strategy that can be selected at the keypad. When this method is selected, the controller compares the outdoor air dry-bulb temperature to a keypad programmable set point. The external enthalpy control input is then ignored.

Cooling and Heating Lockout Control

All unit controls include separate keypad programmable set points for locking out mechanical cooling and heating. Mechanical cooling is locked out when the outdoor temperature is below the cooling lockout set point; heating is locked out when the outdoor temperature is above the heating lockout set point. This feature can save energy cost by eliminating unnecessary heating and cooling during warm-up or cool-down periods or when the outdoor air temperature is mild.

Night Setback and Setup Control

When one of the zone temperature sensors is connected to the unit controller, night setback heating and night setup cooling control are available. Separate, keypad programmable night heating and cooling set points are used to start the unit when necessary. After the unit starts, night setback and setup control is similar to normal occupied control except that the minimum outside air damper position is set to zero. If the outside air is suitable for free cooling, it is used during night setup operation.

Except for 100% outside air applications, night setback control is available even if the unit is not equipped with any heating equipment. When the space temperature falls to the night setback set point, the fans simply start and run until the temperature rises above the differential. This feature might be useful for applications that use, for example, duct-mounted reheat coils.

Morning Warm-up Control

If the Control Temperature (space or return) is below set point when the unit enters the occupied mode, the morning warm-up control function will keep the outside air dampers closed while heat is supplied to satisfy set point. The outside air damper will remain closed until either the space temperature rises to the heating set point or the keypad adjustable morning warm-up timer expires (default is 90 minutes). The morning warm-up timer supplies the minimum required amount of outdoor air after a certain time regardless of the space temperature.

Morning warm-up control is automatically included on all except 100% outside air units. It is available even if the unit is not equipped with any heating equipment, for applications that utilize, for example, duct-mounted reheat coils.

Proportional Integral (PI) Control

The Proportional Integral (PI) control algorithm controls modulating actuators to maintain a measured variable (temperature or pressure) at or near its set point. For example, it controls economizer dampers to maintain the discharge cooling set point and it controls the supply fan variable frequency drives to maintain the duct static pressure set point. The integral control feature effectively eliminates “proportional droop” (load dependent offset) resulting in the tightest possible control.

For each PI loop, four keypad adjustable parameters allow the control loop to be properly tuned for any application:

- Period
- Dead band
- Proportional band
- Integral time

Appropriate default values for these parameters are loaded into each controller. These default values will provide proper control for most applications; therefore, field tuning is usually not required and thus start-up time is reduced.

Change Algorithm

The PI function is also used to adjust set points instead of controlling variable speed drives or actuators directly. For example, in zone control applications, the PI loop automatically “changes” the discharge temperature set point (cooling or heating) as the Control Temperature deviates from the zone set point. Another PI loop then controls the economizer actuator or heating valve actuator using the current discharge temperature set point. Unlike a typical “master-submaster” reset strategy, this “cascade control” continuously adjusts the discharge set point, even if the Control Temperature’s deviation from set point remains constant. This means that the unit’s cooling or heating output is set according to the actual load, not just the current zone temperature. The tightest possible zone temperature control results because “proportional droop” (load dependent offset) is eliminated.

Calibrate

When initiated at the keypad by an operator, the Calibrate function automatically calibrates all actuator position feedback inputs and all pressure transducer inputs. It does this by shutting the unit down and then driving all actuators to the full closed and full open positions. The controller records the input voltage values that correspond to these positions. The pressure transducer input voltages, which are assumed for 0.00-in. W.C., are also recorded. When Calibrate is finished, enter an operator command at the keypad to start the unit.

Field Output Signals

All MicroTech III RoofPak controls include two solid-state relay outputs that are available for field connection to any suitable device: the remote alarm output and the occupied output. These two outputs are used to signal field equipment of unit status.

Remote Alarm Output:

The remote alarm output can be used to operate a 24 volt relay to provide a remote alarm signal to a light, audible alarm, or other device when an alarm condition exists at the unit.

Fan Operation Output:

The fan operation output is used to operate a 24 volt relay to control field equipment that depends on fan operation; for instance, to open field installed isolation dampers or VAV boxes. To allow actuators enough time to stroke, the fan operation output is energized three minutes before the fans start. It then remains energized until thirty seconds after the unit airflow switch senses no airflow. The fan operation output is on whenever the unit airflow switch senses airflow.

Standard Control Options

Applied rooftop systems are available for most any constant or variable air volume application. MicroTech III controls offer three basic control configurations: variable air volume with discharge temperature control (VAV-DTC), constant air volume with zone temperature control (CAV-ZTC), and constant air volume with discharge temperature control (CAV-DTC), that use sophisticated state change control logic to provide stable, reliable and efficient control. When combined with MicroTech III’s many available control capabilities, both factory installed and keypad programmable, these three basic configurations can be customized to meet the requirements of the most demanding applications.

Variable Air Volume with Discharge Temperature Control (VAV)

All VAV units provide true discharge temperature control in addition to duct static pressure control. Cooling only, cooling with single-stage “morning warm-up” heat, and cooling with modulating heat configurations are available. On units with a return fan, two building static pressure control options are available: VaneTrol™ logic tracking or direct building pressure control. Because proper ventilation rates have been identified as critical to maintaining good indoor air quality, all RoofPak VAV controllers include software algorithms designed to maintain minimum outside air volume at all times when the unit is in the Occupied mode.

Constant Air Volume with Zone Temperature Control (CAV-ZTC)

CAV-ZTC units are available in either cooling only or cooling with modulating heat configurations. Either of these configurations is available for 100% recirculated, mixed, or 100% outdoor air applications. On units that have a return fan, a direct building static pressure control option is also available.

Constant Air Volume with Discharge Temperature Control (CAV-DTC)

CAV-DTC units are available in cooling only, cooling with single-stage “morning warm-up” heat, or cooling with modulating heat configurations. This unit configuration can be used for applications that have zone controlled terminal reheat coils or for constant volume, 100% outdoor air applications. The discharge temperature control strategies used with the hybrid CAV-DTC unit are identical to those used with the VAVDTC unit. On units that have a return fan, a direct building static pressure control option is available (constant supply air volume applications only).

Discharge Temperature Control

MicroTech III VAV-DTC and CAV-DTC controls provide sophisticated and flexible discharge air temperature control that is only possible with DDC systems. Separate discharge air temperature set points are used for cooling and modulating heating control. At the keypad, the operator can either enter the desired set points or select separate reset methods and parameters for each set point (see [Supply Air Reset on page 27](#)).

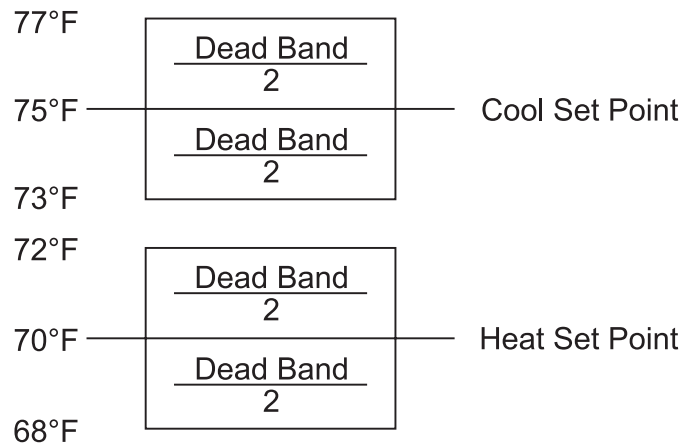
Control Temperature

The Control Temperature makes the heat/cool changeover decision. It determines whether cooling or heating is enabled; the discharge temperature then determines whether cooling or heating is actually supplied. At the keypad, the operator can choose the source of the Control Temperature from among the following selections.

- Space temperature sensor
- Return temperature sensor
- Outside air temperature sensor (modulating heat only)
- Network communication

The operator enters separate cool and heat enable set points and deadbands that the Control Temperature is compared with (see [Figure 30](#)). When the Control Temperature is greater than or equal to the cooling set point plus DB/2, cooling is enabled. When the Control Temperature is less than or equal to the heat set point minus DB/2, heating is enabled. If desired, these set points and differentials can be set so that there is a dead band in which both cooling and heating are disabled. The controller’s software prevents simultaneous cooling and heating.

Figure 30: Control Temperature Logic



Supply Air Reset

By automatically varying the discharge air temperature to suit a building's cooling or heating needs, supply air temperature reset can increase the energy efficiency of VAV and CAV-DTC systems. MicroTech III controllers offer a variety of different reset strategies that can be selected at the keypad. Because they are keypad programmable, reset strategies can be changed or eliminated as desired. Separate strategies can be selected for both cooling and modulating heat. If reset is not desired, a fixed discharge cooling or heating set point can be entered.

The following reset methods are available:

- Space temperature
- Return temperature
- Outdoor air temperature
- Supply airflow (VAV, cooling set point only)
- External 0–10 VDC or 0–20 mA signal
- Network communication

For all temperature reset methods, the minimum and maximum cooling and heating set points are keypad programmable along with the corresponding minimum and maximum space, return or outdoor air temperature parameters. For the supply airflow method, the discharge set point will be reset as the supply fan modulates between 30% adjustable and 100% adjustable. For the external method, the discharge set point will be reset as the voltage or current signal varies over its entire range. For units in a BAS network, the discharge set points are reset via the communication signal.

Zone Temperature Control

MicroTech III CAV-ZTC controls provide the sophisticated and flexible zone temperature control that is only possible with DDC systems. Zone temperature sensors are available with or without a remote set point adjustment. With the remote adjustment model, the space set point can be set at the keypad or at the zone sensor package. Even if a zone sensor is connected, remote set point adjustment can be enabled or disabled as desired at the keypad.

Control Temperature

The Control Temperature is the representative zone temperature. When compared with the zone set points, the Control Temperature determines whether the unit supplies heating, cooling, or neither. It also determines the amount of cooling or heating required to satisfy the load. Its source can be selected at the keypad from among the following selections:

- Zone temperature sensor
- Return temperature sensor

Because it is the representative zone temperature, the Control Temperature is the primary input to the MicroTech III zone temperature control algorithms. Control Temperature parameters are described below. The controller's software will prevent cooling and heating from being inadvertently enabled at the same time.

Project Ahead Algorithm

Because the inherent lag effect in zone temperature control applications can cause overshoot during warm-up or cooldown periods, MicroTech III features a "Project Ahead" control algorithm. Project Ahead calculates the rate at which the Control Temperature is changing and reduces the unit's cooling or heating output as the zone temperature nears its set point, essentially eliminating overshoot.

Duct Static Pressure Control

On all VAV-DTC units, duct static pressure control is maintained by the PI algorithm, which provides precise control of the supply fan variable speed drive. The keypad programmable set point can be set between 0.20-in. W.C. and 4.00-in. W.C.

On larger buildings with multiple floors, multiple trunk runs or large shifts in load due to solar effects (east/west building orientation), an optional second duct static sensor is offered. The MicroTech III controller automatically selects and uses the lower of the two sensed pressures to control fan volume to provide adequate static pressure to the most demanding space at all times.

Building Static Pressure Control

VaneTrol™ Fan Tracking Control (does not apply to exhaust fans)

VaneTrol fan tracking control logic offers close and reliable building static pressure control for VAV units equipped with a return air fan. With the VaneTrol logic method, the return fan's variable speed drive assembly tracks the supply fan volume as the supply fan maintains the required duct static pressure using the additional parameter of maintaining a field programmable offset between supply fan and return fan volume. The result is that building pressure is maintained, regardless of the building cooling load, because the proper relationship between supply and return fan volume is maintained. Because the return fan/supply fan tracking relationship is established once during controlled test-and-balance conditions, ongoing building pressure control is not affected by a fluctuating ambient pressure reference signal or the temporary effects of opening and closing doors on a pressure sensor in the lobby.

VaneTrol control logic uses four keypad programmable parameters to maintain the required relationship between return fan and supply fan volumes. These are the supply and corresponding return fan volumes as measured by variable speed drive position, at both maximum and minimum airflow conditions.

Table 3 shows an example of how supply and return air fan modulation must vary to maintain the correct balance of supply and return air volumes based on the building's parameters and therefore maintain building pressure. Determining the building's correct VaneTrol parameters is easy with MicroTech III's Balance feature. With Balance, start-up time is reduced because final adjustments are made at the keypad.

Table 3: VaneTrol Logic Air Balancing

SAF cfm	RAF cfm	Building exhaust
16000 (100%)	14000 (100%)	2000
14000 (88%)	12000 (80%)	2000
12000 (75%)	10000 (71%)	2000
10000 (63%)	8000 (57%)	2000
8000 (50%)	6000 (43%)	2000

Direct Space Pressure Control (for return or exhaust fans)

Any constant or variable air volume unit equipped with a variable volume return or exhaust fan can be provided with direct building static pressure control capability. With the direct method, building static pressure is measured and processed by the PI algorithm. This algorithm provides precise control of the return fan variable speed drive or inlet vanes to maintain the space pressure set point. The range of the keypad programmable set point is between minus 0.25-in. W.C. and 0.25-in. W.C.

This type of control can be used for either whole building or lab pressurization (positive or negative) applications, or exhaust fan control where VaneTrol control logic does not apply.

Minimum Ventilation Air Volume Control

Consistently maintaining the minimum outdoor air requirements of ASHRAE Standard 62 has been a long standing control challenge for VAV systems. As supply air fan volumes were reduced, the volume of air introduced through a fixed position, minimum outdoor air damper was also reduced, compromising indoor air quality. To meet this challenge, MicroTech III controls feature four user-selected control methods for maintaining outdoor air volume.

- The MicroTech III controller can accept a signal from a DesignFlow Precision Ventilation Air Control System, which is continuously measuring outdoor air volume, and adjust outdoor air damper position to maintain the minimum volume set point.
- MicroTech III controls have a keypad selected control function that automatically adjusts outdoor air damper position in response to changes in supply air fan volume. Regardless of supply air volume, this strategy maintains a nearly constant outdoor air volume at all times. The MicroTech III controller can accept an external 0–10 VDC signal from a CO₂ sensor or other control device and adjust outdoor air damper position.
- If desired, a fixed minimum damper position can be keypad programmed. This selection may be acceptable when ventilation requirements are met through other sources.

During cold ambient conditions where outdoor/return mixed air conditions can become too low, MicroTech III controls maintain the cooling discharge temperature set point by controlling the unit heating system. For applications where ambient temperatures and minimum outdoor air requirements can generate this condition, order the RoofPak unit with modulating heating equipment, such as the SuperMod gas burner.

Table 4 illustrates the effect of minimum ventilation control and cold ambient conditions on unit discharge air temperature and how it dictates the need for mixed air tempering capability at the light load/low ambient conditions. It assumes a VAV unit with a 20% outdoor air requirement at design conditions and a 40% minimum airflow requirement.

Table 4: Effect of Minimum Ventilation Control on Discharge Temperature

Supply fan volume (cfm)	Outdoor air volume (cfm)	Outdoor air volume (%)	Outdoor air temp. (°F)	Mixed air temp. (°F)
10,000	2,000	20	95	79
8,000	2,000	25	70	73.8
6,000	2,000	33.3	40	63.3
4,000	2,000	50	0	37.5

The following section contains basic application and installation guidelines that must be considered as part of the detailed analysis of any specific project.

General

Units are intended for use in normal heating, ventilating and air conditioning applications. Consult your local Daikin Applied sales representative for applications involving operation at high ambient temperatures, high altitudes, non-cataloged voltages and for applications requiring modified or special control sequences. Consult your local Daikin Applied sales representative for job specific unit selections that fall outside of the range of the catalog tables, such as 100% outside air applications.

For proper operation, units should be rigged in accordance with instructions stated in [IM 485](#). Fire dampers, if required, must be installed in the ductwork according to local or state codes. No space is allowed for these dampers in the unit. Follow factory check, test and start procedures explicitly to achieve satisfactory start-up and operation (see [IM 485](#)).

Unit Location

The structural engineer must verify that the roof has adequate strength and ability to minimize deflection. Take extreme caution when using a wooden roof structure.

Locate the unit fresh air intakes away from building flue stacks or exhaust ventilators to reduce possible reintroduction of contaminated air to the system. Unit condenser coils should be located to avoid contact with any heated exhaust air.

Allow sufficient space around the unit for maintenance/service clearance as well as to allow for full outside air intake and removal of exhaust air. Refer to [Recommended Clearances on page 96](#) for recommended clearances. Consult your Daikin Applied sales representative if available clearances do not meet minimum recommendations. Where code considerations, such as the NEC, require extended clearances, they take precedence.

Split Units

Units may sometimes have to be split into multiple pieces to accommodate shipping limitations or jobsite lifting limitations. Units exceeding 52 feet in length may need to be split for shipping purposes. Units exceeding the rating of an available crane or helicopter may also need to be split for rigging purposes. Unit can be split between the supply fan and heat section. Contact your local Daikin sales representative for more details.

Curb Installation

The roof curb is field assembled and must be installed level (within 1/16 in per foot side to side). A sub-base has to be constructed by the contractor in applications involving pitched roofs. Gaskets are furnished and must be installed between the unit and curb. For proper installation, follow NRCA guidelines. Typical curb installation is illustrated in [Section Options and Locations—RDS 708B on page 79](#). In applications requiring post and rail installation, an I-beam securely mounted on multiple posts should support the unit on each side.

Applications in geographic areas that are subjected to seismic or hurricane conditions must meet code requirements for fastening the unit to the curb and the curb to the building structure.

When curbs are installed on a built-up roof with metal decking, provide an inverted 6-in channel on both sides of the unit. Install acoustical material over the decking, inside the roof curb. Only the supply and return air ducts should penetrate the acoustical material and decking. Apply appropriate acoustical and vibration design practices during the early stages of design to provide noise compatibility with the intended use of the space. Consult your Daikin sales representative for unit sound power data.

Acoustical Considerations

Good acoustical design is a critical part of any installation and should start at the earliest stages in the design process. Each of the four common sound paths for rooftop equipment must be addressed. These are:

- Radiated sound through the bottom of the unit and into the space
- Structure-borne vibration from the unit to the building
- Airborne sound through the supply air duct
- Airborne sound through the return air duct

Locating rooftop equipment away from sound sensitive areas is critical and the most cost-effective means of avoiding sound problems. If possible, always locate rooftop equipment over less sensitive areas such as corridors, toilet facilities or auxiliary spaces and away from office areas, conference rooms and classrooms.

† Not available on size 708.

Some basic guidelines for good acoustical performance are:

- Always provide proper structural support under all areas of the unit.
- Always locate the unit's center of gravity close to a main support to minimize roof deflection. Maintaining a roof deflection under 1/3 in minimizes vibration-induced noise.
- Use a concrete deck or pad when a unit has to be located over an occupied space where good acoustics are essential.
- Only the supply and return air ducts should penetrate the acoustical material and decking within the curb perimeter; seal the openings once the duct is installed.
- Don't overlook the return air path. Never leave a clear "line of sight" into a return or exhaust fan; always include some duct work (acoustically lined tee) at the return inlet.
- Minimize system static pressure losses to reduce fan sound generation.
- Select the appropriate fan for the application. Select fans as close as possible to their peak static efficiency. Peak static efficiency is identified by the first system curve to the right of the shaded "Do not select" region, as illustrated in Figure 31.
- Design duct systems to minimize turbulence.
- Account for low frequency duct breakout in system design. Route the first 20 ft of rectangular duct over non-sensitive areas and avoid large duct aspect ratios. Consider round or oval duct to reduce breakout.
- When an added measure of airborne fan sound control is required, sound attenuators can be supplied, factory installed in a unit discharge air section, to treat the supply fan. On the return side, additional attenuation can often be achieved by routing the return duct within the curb area beneath the unit.

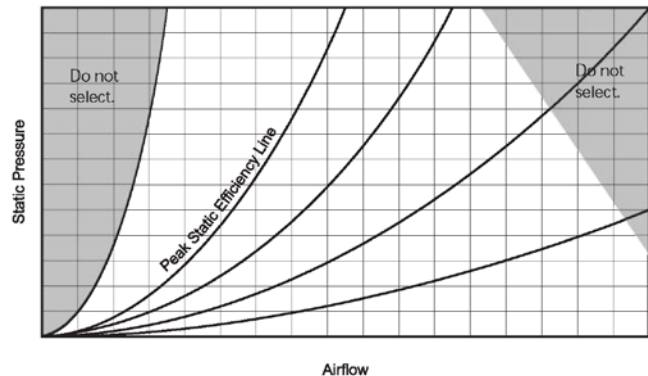
There are many sound sources in rooftop systems. Fans, duct take-offs, etc. all generate sound. For guidelines on reducing sound generation in the duct system, refer to the [2003 ASHRAE Applications Handbook, Chapter 47](#).

Contact your local Daikin sales representative for equipment supply, return and radiated sound power data specific to your application.

Ductwork

A well-designed duct system is required to allow the rooftop equipment to provide rated performance and to minimize system resistance and sound generation. Duct connections to and from units should allow straight, smooth airflow transitions. Avoid any abrupt change in duct size and sharp turns in the fan discharge. Avoid turns opposed to wheel rotation since they generate air turbulence and result in unwanted sound. If 90° turns are necessary, use turning vanes. Refer to the [2003 ASHRAE Applications Handbook, Chapter 47](#) for specific guidelines relevant to rooftop equipment.

Figure 31: Optimal fan selection line



Return Duct

The return path is the most often overlooked. A section of return duct is required to avoid a "line of sight" to the return air opening and to provide attenuation of return air sound. Install an insulated tee with a maximum duct velocity of 1000 to 1200 feet per minute. Extend the duct 15 feet to provide adequate attenuation.

Supply Duct

Insulate supply air ductwork for at least the first 20 feet from the unit. Consider using round or oval ductwork since it significantly reduces low frequency breakout noise near the equipment. If rectangular duct is used, keep the aspect ratio of the duct as low as possible. The large flat surfaces associated with high aspect ratios increase low frequency breakout to the space and can generate noise, such as "oil canning." The maximum recommended supply duct velocity is 1800 to 2000 feet per minute.

Duct High Limit

All Daikin RoofPak systems with VAV control include an adjustable duct high limit switch as a standard feature. This is of particular importance when fast acting, normally closed boxes are used. The switch is field adjustable and must be set to meet the specific rating of the system ductwork.

Vibration Isolation

Make duct attachments to the unit with a flexible connection.

Economizer, Return Fan, and Exhaust Fan Application

(Exhaust fan not available on size 708)

Rooftop economizer applications usually require return or exhaust fans to properly control building pressure and maintain minimum ventilation. Daikin offers both exhaust and return fan capability. They usually are not interchangeable for a given design. In general:

- Use return air fans (RAF) on ducted return systems (return ESP exceeds 0.4" to 0.5").
- Properly selected propeller exhaust air fans (EAF) can operate successfully and save energy on open return systems (return ESP is less than 0.4" to 0.5").
- Supply air fan (SAF) selection depends on whether a return or exhaust fan is used.
 - RAF system-SAF handles only the supply ESP at design.
 - EAF system-SAF handles both the supply and return ESP at design (EAF is off).

Figure 32 illustrates why supply fan only units can have problems, especially as return ESP increases.

- No exhaust occurs from the rooftop because the economizer section must be at a negative pressure.
- The air balancer must adjust the outdoor air damper to generate large pressure drops at minimum ventilation settings (about 0.9" in Figure 32).

Figure 32: Supply air fan only system static pressures with 1" return duct ESP

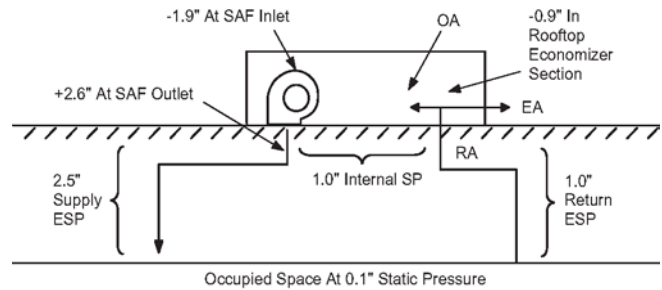
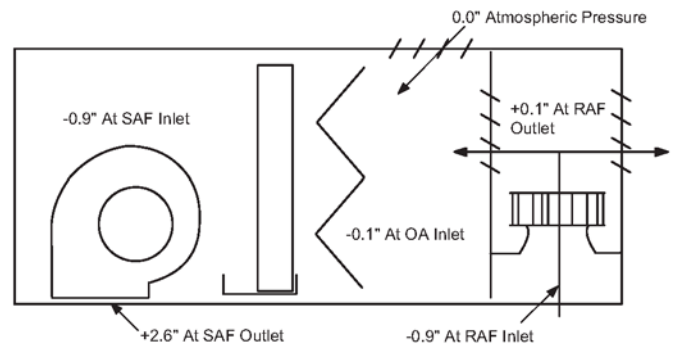


Figure 33 illustrates how adding a return fan corrects these problems. The return fan is responsible for return system ESP and maintains a slightly positive pressure in the economizer section (about +0.1" in Figure 33) to allow for exhaust air control and a more suitable outside air intake pressure.

Figure 33: RAF system allows proper exhaust and outdoor air control



Exhaust fans are very different than return fans and cannot maintain proper building pressure and ventilation control as return ESP increases.

- The EAF is normally off during non-economizer operation. During these minimum outdoor air conditions, the system essentially acts like a supply fan only system.
- When the exhaust fan cycles off, there is no device available to maintain a positive pressure for relief, the mixed air plenum pressure dramatically changes, and minimum ventilation air control and space pressure are lost.

An exhaust fan's performance weaknesses diminish as return ESP decreases. Properly selected and controlled propeller exhaust fans can successfully operate and save energy at reduced return ESP designs.

- At system operating conditions where a single fan can be used successfully, it generally is more efficient than operating series fans under the same total load. When the exhaust fan turns off, the supply fan handles both the supply and return duct loads more efficiently.
- At the relatively high cfm, low static pressure conditions of exhaust/return application, exhaust fans can be selected closer to their peak design efficiency than can full return fans. This allows them to run more efficiently throughout their operating range.

Therefore, when return duct losses don't dictate using a return air fan, exhaust fans are an efficient alternative.

Smoke and Fire Protection

Daikin optionally offers factory-installed outdoor air, return air, and exhaust air dampers as well as smoke detectors in the supply and return air opening, complete with wiring and control. These components often are used in the building's smoke, fume, and fire protection systems. However, due to the wide variation in building design and ambient operating conditions into which our units are applied, we do not represent or warrant that our products are fit and sufficient for smoke, fume, and fire control purposes. The owner and a fully qualified building designer are responsible for meeting all local and NFPA building code requirements with respect to smoke, fume, and fire control. Daikin offers the flexibility to offer these various components and control sequences, as directed by the customer, to help meet code requirements.

Filters

General

Routinely replace filters to minimize filter loading. As filters get dirty, the filter pressure drop increases, causing a decrease in airflow. Depending on fan type, forward curved or airfoil, this airflow change can be significant. The effect of filter loading is the most critical when using 65% and 95% efficient filters.

When making a fan selection, include a pressure drop component in the system total static pressure for filters since they get dirty. Generally, select a value midway between clean and dirty filter ratings. If a minimum airflow is critical, the fan selection should be made using the higher, dirty filter pressure drop value. Following these recommendations should limit airflow fluctuation as the filters load.

Final Filters

The application of final filters (filters downstream of the fan) places special requirements on unit selection. When final filters are employed, cooling coils must be located in the draw-through position so that the filters will not be in a saturated air stream. Also, final filters applications for a unit with gas heat requires the filters to be rated for 500°F. Instruct maintenance personnel to use properly rated replacement filters.

Variable Air Volume Application

RoofPak units are available with variable speed drives to provide variable air volume (VAV) control. Refer to [Variable Air Volume on page 21](#) for further information on VAV systems.

In placing a duct static pressure sensor, locate a pressure tap near the end of the main duct trunk. Adjust the static pressure set point so that at minimum airflow all of the terminals receive the minimum static pressure required plus any downstream resistance. Locate the static pressure sensor tap in the ductwork in an area free from turbulence effects and at least ten duct diameters downstream and several duct diameters upstream from any major interference, including branch takeoffs. A second sensor is available and should be used on installations having multiple duct trunks, multiple floors, or significantly varying zones (e.g., east/west). The MicroTech III controller will control the variable speed drive to satisfy the supply duct requiring the most static pressure.

Multiple Air Handler Control

For applications in which multiple units are connected in a common duct system, it is important to control all units from a common duct static pressure sensor and to control all operating units in unison. Centralized duct static pressure control can be accomplished through communication with the BAS network or the Daikin MicroTech Integrated Control System (see brochure [ASP 31-260](#)).

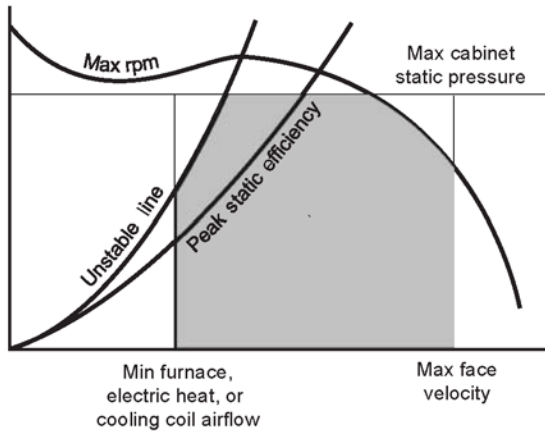
Fan Operating Range

The acceptable system operating range of the Daikin rooftop is determined by all of the following characteristics. Each of these limiting factors must be considered for proper performance and component design life.

- Unstable fan operation
- Maximum fan rpm
- Maximum cabinet static pressure
- Maximum face velocity (cooling coil is most important)
- Minimum furnace or electric heater velocity
- Turndown capability on VAV applications

Figure 34 illustrates these limiting factors with exception of the last two items. The shaded area indicates the design operating range of the fan. For optimal efficiency, select fans as close to the fan's peak static efficiency line as possible. This line is the first system curve to the right of the unstable line illustrated.

Figure 34: Fan selection boundary



Fan Isolation

All Daikin RoofPak systems feature internally isolated fans. All supply and return air fans are statically and dynamically balanced in the factory and mounted on rubber-in-shear (RIS) or 2-in deflection spring isolators. Flexible isolation is provided as standard between the fan outlet and the discharge bulkhead to prevent hard contact and vibration transmission. Spring isolated fan assemblies also are available with seismic restraints.

The choice of 2-in deflection spring isolation or RIS isolation depends on an analysis of the roof structure and whether or not an isolation curb is being provided. When using an isolation curb, consult with the curb manufacturer before selecting spring isolation in the rooftop unit. Doubling or “stacking” spring isolation can generate a resonant vibration.

Indoor Fan and Motor Heat, Blow-through vs. Draw-through Cooling

Daikin offers blow-through and draw-through cooling coils so the unit can be best selected to match job requirements. (Blow-through coils not available on size 708.)

Indoor fan and motor heat.

- The indoor fan and motor electrical consumption is a sensible cooling load approximately equal to 2.8 MBh per BHP (depending slightly on motor efficiency). This occurs at the fan. See Figure 35 and Figure 36. The fan and motor preheat the mixed air before it enters a blow-through cooling coil. The fan and motor reheat the air leaving a draw-through cooling coil. Refer also to 2001 ASHRAE Fundamentals Handbook, Chapter 31.
- Fan and motor temperature rise is equal to $Btu/h / (1.08 \times cfm)$ and is typically about 3°F.
- Due to fan and motor heat placement (Figure 35), blow-through coils provide a high sensible heat ratio while draw-through coils provide more latent cooling per total ton. Blow-through coils achieve a higher sensible heat ratio because they operate with a higher coil approach temperature and a lower entering relative humidity. Conversely, draw-through coils cool air at a lower approach temperature and a higher relative humidity, increasing latent cooling.
- Blow-through coils effectively provide colder supply air temperatures per ton of air conditioning and greater sensible heat ratio. This potentially allows a significant reduction in design cfm for buildings with high sensible heat ratios and a resulting reduction in building energy use.

Figure 35: Blow-through vs. draw-through concept

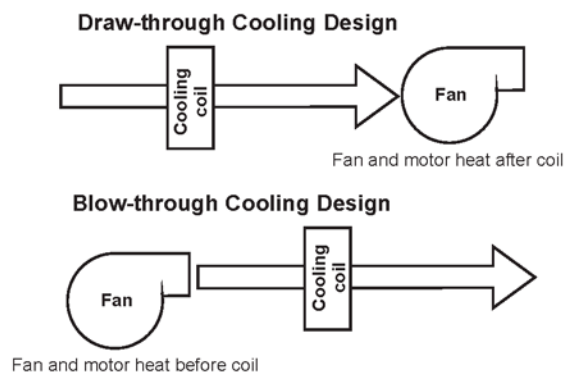
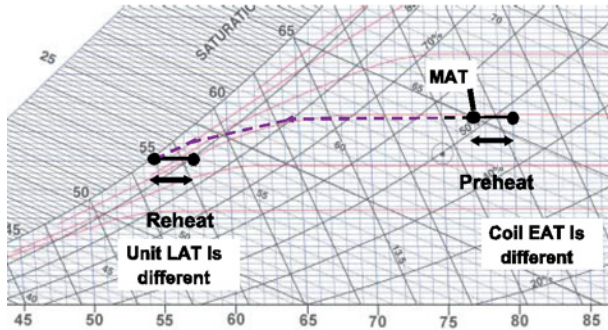


Figure 36: Blow-through vs. draw-through performance



Draw-through (available on all units)

In a draw-through unit, the fan is located after the cooling coil. In this arrangement, fan heat is applied as reheat to the cold, conditioned air coming off of the coil. This arrangement has a lower sensible heat ratio and higher dehumidification capability than a blow-through coil arrangement. Draw-through arrangements are well suited for 100% outside air applications and applications needing more dehumidification. A draw-through arrangement is mandatory for all applications requiring final filters. The discharge temperature available to the supply duct is always the sum of the coil leaving air temperature plus the fan temperature rise. This must be considered when selecting the supply air volume required to satisfy space requirements.

Example:

55°F leaving coil temperature + 3°F fan temp. rise = 58°F discharge air temperature

Blow-through (not available on size 708)

In a blow-through unit, the fan is located before the DX cooling coil. In this arrangement, fan heat is applied as preheat to the coil. Preheating the air lowers its relative humidity, giving this arrangement a high sensible heat ratio. Blow-through arrangements are well suited for comfort conditioning applications where space heat gains are primarily sensible and the primary latent load is from ventilation air. The discharge temperature available to the supply duct is the coil leaving air temperature.

Altitude Adjustments

Fan curve performance is based on 70°F air temperature and sea level elevation. Selections at any other conditions require the following adjustment for air densities listed in Table 6. Higher elevations generally require more rpm to provide a given static pressure but less bhp due to the decrease in air density.

1. Assume 32,000 cfm is required at 3.11" TSP. The elevation is 5000 ft and 70°F average air temperature is selected. A 40" DWDI airfoil fan is selected.
2. The density adjustment factor for 5000 ft and 70°F is 0.83.
3. TSP must be adjusted as follows: 3.11" / 0.83 = 3.75".
4. Locate 32,000 cfm and 3.75 on the fan curve. Rpm = 900 and bhp = 27.5. The required fan speed is 900 rpm.
5. The consumed fan power at design = 27.5 bhp × 0.83 = 22.8 bhp.

Table 5: Temperature and altitude conversion factors

Air temp (°F)	Altitude (feet)								
	0	1000	2000	3000	4000	5000	6000	7000	8000
-20	1.20	1.16	1.12	1.08	1.04	1.00	0.97	0.93	0.89
0	1.15	1.10	1.08	1.02	0.99	0.95	0.92	0.88	0.85
20	1.11	1.06	1.02	0.98	0.95	0.92	0.88	0.85	0.82
40	1.06	1.02	0.98	0.94	0.91	0.88	0.84	0.81	0.78
60	1.02	0.98	0.94	0.91	0.88	0.85	0.81	0.79	0.76
70	1.00	0.96	0.93	0.89	0.86	0.83	0.80	0.77	0.74
80	0.98	0.94	0.91	0.88	0.84	0.81	0.78	0.75	0.72
100	0.94	0.91	0.88	0.84	0.81	0.78	0.75	0.72	0.70
120	0.92	0.88	0.85	0.81	0.78	0.76	0.72	0.70	0.67
140	0.89	0.85	0.82	0.79	0.76	0.73	0.70	0.78	0.65

Furnace Performance

Gas heat performance data is based on standard 70°F air temperature and zero feet altitude (sea level). For altitudes of 2000 feet and higher, the gas burner may be derated 4% for every 1000 feet of altitude. However, if the design ambient is cold enough then the effect of colder temperatures and higher altitudes may be offset.

Example:

A 1000 MBh furnace at an altitude of 3000 feet and 70°F ambient is derated (0.04 × 3 = 0.12). At 1000 MBh input (1000 × 0.12 MBh), the actual input is 1000 – 120 = 880 MBh at 3000 feet. If ambient is 10°F then no derate is required.

NOTE: Above 6000 feet, consult factory

System Operating Limits

Daikin RoofPak systems are designed to operate over an extensive operating range. However, for proper system operation some limits do apply.

To help prevent moisture blow-off, design guidelines have been established for cooling coil selection.

Based on laboratory testing, average coil face velocities should not exceed the following limits:

- 650 ft/min for 8 and 10 fpi selections
- 600 ft/min for 12 fpi selections
- For applications outside of these limits, consult your Daikin Applied sales representative. Velocities exceeding these limits not only present the potential for moisture carry-over, but also high face velocities generate high air pressure drops, resulting in poor fan energy performance.

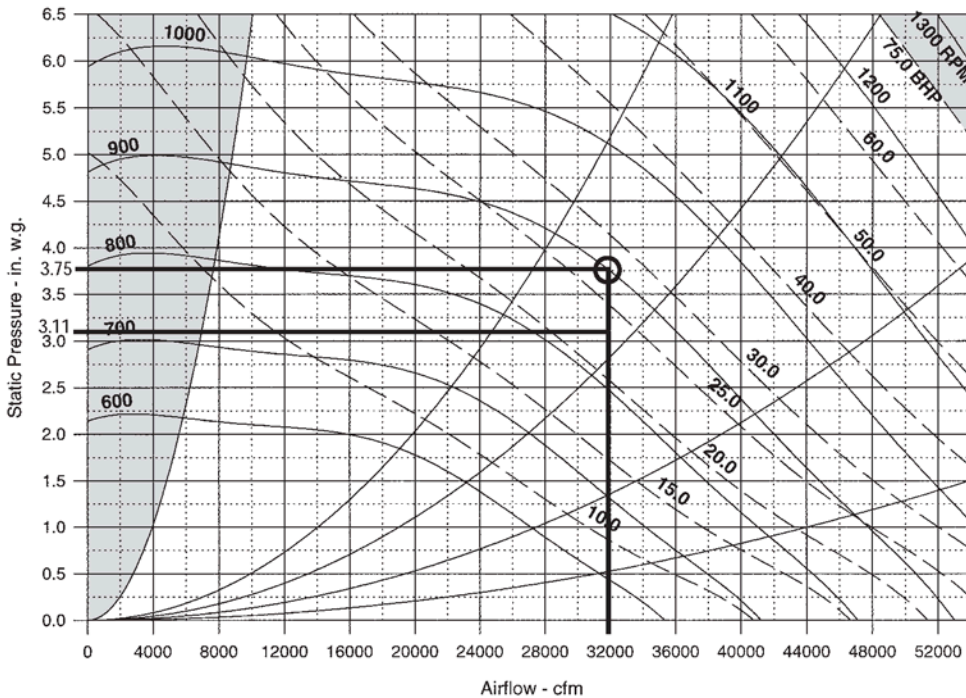
In addition to maximum face velocity limitations, minimum velocity guidelines are 200 ft/min. When selecting a variable air volume unit, it is necessary to design the system such that the 200 ft/min limit is maintained at light load conditions.

Coil Freeze Protection

When applying roof-mounted equipment in areas that experience subfreezing conditions, coil freeze protection measures must be provided. Subfreezing temperatures can adversely affect water and steam coils during controlled or uncontrolled unit shutdowns and even during unit operation. Daikin RoofPak economizer dampers are arranged to direct the outside and return air streams in multiple mixing patterns, minimizing air stratification. Even though this is one of the most effective mixing arrangements available, there may not always be a uniform unit temperature profile under all load and ambient temperatures. Some temperature stratification will occur, particularly at low ambient temperatures and the associated reduced airflow inherent with VAV systems. When required, static air mixers/blenders are available that can significantly improve mixing and reduce stratification. This can result in improved protection against freeze-up.

Glycol is strongly recommended as a positive means of freeze protection for water coils. No control sequence can prevent coil freezing in the event of a power failure or equipment malfunction. During those periods, glycol is the only positive means of freeze protection. When selecting water coils, specify glycol to account for performance differences.

Figure 37: RAH 0 77C 40" DWDI airfoil



An optional non-averaging freeze-stat equipment protection control can be provided, located downstream of the heating coil. If a potential freezing condition is sensed, a sequence is initiated by the unit control system, closing outdoor air dampers, opening the heating valve and de-energizing the fan. The freeze-stat setting should be some increment higher than freezing to provide an added margin of protection. The use of a freeze-stat control may cause nuisance trips. It cannot prevent freeze-up in the event of power failure or equipment malfunction.

Freeze protection control strategies must be designed to keep unit cabinet temperatures from exceeding 150°F during a unit shutdown. Temperatures in excess of 150°F may exceed the design limits of motors, electrical components, gaskets, etc. potentially leading to premature failure of components.

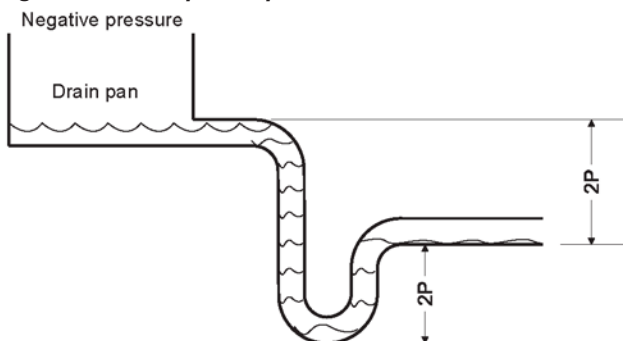
Piping and Condensate Drainage

Always follow good industry practice in the design of the water piping system. Do not apply undue stress at the connection to coil headers. In addition, support piping independently from the coils with adequate piping flexibility for thermal expansion.

Provide all drain pans with a properly sized p-trap to allow free drainage of coil condensate. Provide traps to prevent cabinet static pressure from leaking air at the drain line in blow-through coil applications. For draw-through coil applications, a properly sized and installed trap is essential to allow for proper condensate drainage. An improper trap could cause condensate to build up in the drain pan and overflow into the unit. For trap sizing, follow instruction given in [IM 240](#) and [IM 487](#). Run all traps and drain lines full size from the threaded unit connection to the roof drain.

Units providing steam heat must be installed level to provide proper drainage and adequate steam pressure at the steam valve and coil. Condensate must be properly trapped with vacuum breakers installed on the coil (See [Figure 38](#)). For steam piping recommendations, see [Daikin Steam Coil Catalog 413](#).

Figure 38: Drain pan traps



Zone Sensor Placement

Placement of the zone temperature sensor is critical for proper and economical operation of the heating and cooling system. It is generally recommended that the space sensor be located on an inside wall (3 to 5 feet from an outside wall) in a space having a floor area of at least 400 square feet. Do not locate the sensor below the outlet of a supply diffuser, in the direct rays of the sun, on a wall adjacent to an unheated or abnormally warm room (boiler or incinerator room), or near any heat producing equipment. Where zone sensor placement is a problem, all zone control systems, as standard, have the capability to use a return air sensor for heating and cooling.

Unit Wiring

All units require three phase, 60 Hz, 208, 230, 460 or 575 volt power or three phase, 50 Hz, 400 volt power. Units do not operate satisfactorily at $\pm 10\%$ of rated voltage, at the power connections to the units. All units include branch circuit, short circuit protection and are available with one or multiple power blocks or non-fused disconnect switches. Each unit is provided with a 115-volt convenience outlet circuit. Per the NEC, this circuit must be fed independent of the main unit power supply.

All wiring must be installed in accordance with the National Electric Code (NEC) and local codes.

Winter Shipment

Flat bed shipment in winter can expose units to harsh road chemicals. Since equipment size and configuration precludes covering during transit, wash units free of these chemicals as soon as possible to help prevent corrosion.

Field-Installed Actuators

Install an actuator to meet the design torque requirement. For vane actuators, this requirement is based on the effective wheel diameter and design rpm of the fan. Use the following equation and table to size actuators:

$$\text{Torque (ft-lb)} = (D) \times (\text{design rpm} / 1000)^2$$

Table 6: Effective wheel diameters

Fan description	"D" value
15" x 15", DWDI	7.5
20", DWDI	3.8
24", DWDI	8.3
27", DWDI	13.3
30", SWSI	9.8
30", DWDI	20.3
33", DWDI	29.8
36", DWDI	42.2
40", SWSI	31.0
40", DWDI	64.3
44", SWSI	45.4
49", SWSI	70.0

Size damper actuators in relation to the damper area. For RDS 708B, 800C and 802C units, a 50 in-lb electric actuator is recommended for proper operation. Typically, a 160° stroke rotary electric actuator can handle up to 40 sq ft of damper. For pneumatic actuators, allow 5 in-lb per square foot of damper area.

Areas of unit openings and dampers are tabulated in the following table. To minimize pressure drop and help prevent moisture intake, keep air velocity through the 100% outside air hood to a maximum of 1000 feet per minute. Air velocity through the 0–30% outside air hood or through the 0–100% economizer intake louvers/ hoods should not exceed 740 feet per minute.

Discharge or return opening, VAV or isolation dampers have the same face area as the opening (see dimensional drawings).

Face and bypass damper face areas are shown in the [Physical Data](#) on page 43.

Table 7: Outside/return air damper and opening areas

Area (sq ft)	Unit size				
	708B	800C	802C	047C	077C
100% O.A. hood	10	22	22	34	48
100% O.A. dampers	9	19	19	33	45
0–30% O.A. hood	4	9	9	19	27
0–30% O.A. dampers	4	10	10	19	27
Mixing box O.A. dampers	7	—	—	33	45
Mixing box R.A. dampers	7	—	—	20	34
Econ. O.A. louvers	10	22*	22	48	67
Econ. O.A. & R.A. dampers	19	22	22	33	41

* The RDS 800 with 15" ft FC return fan has an 19 sq ft outside air louver opening.

Face and Bypass Damper Option

Face and bypass dampers are offered for coil capacity control when control valves are not suitable. This option is especially beneficial for heating applications requiring a large percent of outside air. Face and bypass dampers also can provide some amount of coil freeze protection. However, additional freeze protection should be provided. Design air velocity through bypass dampers should not exceed 2500 feet per minute. Reference the [Physical Data](#) section for face and bypass areas when determining airflow rates.

Achieving the optimal performance of a rooftop system requires both accurate system design and proper equipment selection. Factors that control the unit selection include applicable codes, ventilation and air filtration requirements, heating and cooling loads, acceptable temperature differentials, and installation limitations. Daikin RoofPak units offer a wide selection of component options providing the capability to meet diverse application requirements.

The Daikin SelectTools software selection program allows your local Daikin Applied sales representative to provide you with fast, accurate and complete selection of Daikin RoofPak units. You also can select your unit through reference to physical, performance, dimensional, and unit weight data included in this catalog. Due to the variety of cooling coil options available, only a sample of cooling capacity data is presented in the catalog.

To properly select unit equipment:

1. Select unit size and cooling coil
2. Select heating coils and equipment
3. Select fans and motors

Below are examples that illustrate the equations and catalog references used in the unit selection process.

Example 1

A constant volume system with chilled water, gas heat, economizer with return fan, and 65% efficient filtration is required to meet the following criteria:

Supply air capacity = 26,000 cfm
 Return air capacity = 20,800 cfm
 Maximum face velocity = 600 fpm
 Supply duct = 2.00-in wg
 Return duct = 0.50-in wg
 Altitude = Sea level

Summer design:

Ambient air temperature = 95°F
 Mixed air temperature = 80°F/67°F
 Entering water temperature = 45°F
 Leaving water temperature = 55°F
 Total cooling load = 640,000 Btu/hr
 Sensible cooling load = 510,000 Btu/hr

Winter design:

Entering air temperature = 60°F
 Total heating load = 700,000 Btu/hr
 Air temperature rise = 20°F

Electrical design: 460 V/60 Hz/3 phase

Selecting Unit Size and Arrangement

Unit size is based on coil face area and cooling capacity requirements. Supply air capacity and maximum face velocity constraints should serve as a guide for selecting coil dimensions and cabinet size. Many model sizes are available with a standard and a high airflow coil selection. This flexibility prevents the need to increase cabinet size to accommodate high airflow per ton applications. Face and bypass dampers (if required) should be requested from the start to provide proper unit sizing.

Based on the given data, the appropriate coil face area may be determined as follows:

$$\begin{aligned} \text{Minimum face area} &= \text{supply air cfm}/\text{max. face velocity} \\ &= 26,000 \text{ cfm}/600 \text{ fpm} \\ &= 43.3 \text{ square feet} \end{aligned}$$

NOTE: Unit data is based on standard air conditions of 70°F at sea level. Refer to [Table 5 on page 34](#) for temperature/ altitude conversion factors for nonstandard conditions.

Face and bypass is not specified for this example. Therefore, referring to [Physical Data on page 43](#), the correct unit size is 047 CL. This unit has a total coil face area of 45 square feet, which is greater than the minimum required.

Determine system arrangement initially to clarify component selection. [Indoor Fan and Motor Heat, Blow-through vs. Draw-through Cooling on page 33](#) discusses draw-through/ blow-through decision criteria. For the given example, a blow-through arrangement should be provided to offer greater sensible heat capacity.

Selecting Cooling Coils

Use the Daikin SelectTools for Contractor Coils selection program to select unit coils. See [Physical Data on page 43](#) to specify coils. See [Cooling Capacity Data on page 48](#) for valve and piping pressure drops for chilled water coils. In addition, see [Application Considerations on page 29](#) for information on face velocity guidelines, fan motor heat gain, and other unit coil considerations. For the given blow-through coil, add fan and motor heat gain to the entering air conditions.

Selecting Heating Coils and Equipment

Electric heat and furnaces can be completely selected from the [Heating Capacity Data on page 51](#). To select hot water and steam heating coil selections:

1. To identify coil fin height, fin length, available fins per inch, and available row, see [Physical Data on page 43 — 56](#).
2. Use the Coil SelectTools selection program to select the coil with acceptable capacity and pressure drops.
3. Add optional hot water valve and piping pressure drop, provided in the [Heating Capacity Data on page 51](#), to the hot water coil pressure drop obtained from the Coil SelectTools program.

Gas Heat

When selecting a gas furnace, the system heating load, minimum airflow and maximum temperature rise constraints are needed. See [Figure 43 on page 51](#) for furnace model size selection. Enter the graph at 206,000 cfm and move up vertically to the intersection of 700 MBh output. In this example, the intersection of Minimum cfm and MBh Output occurs between model lines. Therefore, the larger model size, Model 790, should be selected for adequate heating. For all heat exchangers, there exists a maximum temperature rise. This limitation is determined by the heat exchanger surface area to airflow ratio. See [Table 21 on page 52](#) for verification of the temperature rise capability of the furnace selected. Also, use this table when specifying baffle position based on minimum airflow design. Refer to [Altitude Adjustments on page 34](#).

NOTE: In VAV applications, consider range of airflow modulation when selecting furnace model and baffle position. The maximum temperature rise cannot be exceeded at either maximum or minimum airflows.

Hot Water Heat

Hot water design:

Entering water temperature = 180°F
Leaving water temperature = 165°F

The water temperature drop (Δt) is as follows:

$$\begin{aligned} \Delta t &= \text{Ent. water temp.} - \text{Lvg. water temp.} \\ &= 180 - 165 = 15^\circ\text{F} \end{aligned}$$

The Coil SelectTools program indicates that the Standard Capacity hot water coil provides 748 MBh at design conditions and provides sufficient capacity. Water pressure drop is 6.0 feet of water column.

At a water temperature drop of 15°F, the water flow rate required is 102 gpm. Enter the value at 102 gpm and select a valve size that has a pressure drop greater than 11.5 feet of water. The valve pressure drop should be as large as possible to maintain proper valve modulation. The valve pressure drop should be at least 50% of the total water pressure drop. If more than one valve selection meets the requirement, make the valve size decision based on first cost versus pumping head.

The total water pressure drop of the unit water coil is the sum of the coil, valve, and valve piping. Valve and valve piping pressure drops are illustrated in [Figure 39](#) and [Figure 40 on page 48](#). For the given example, the total water pressure drop is as follows:

Unit water coil pressure drops:

Standard capacity coil, 045C to 75C = 6.0 ft of water
1-1/2-in valve = 22.0 ft of water
1-1/2-in valve piping = 11.5 ft of water
Total water pressure drop = 39.5 ft wc of water

The pressure drop of the 1-1/2-in valve is 56% of the total pressure drop and is acceptable.

If a glycol solution is used in the water coil, use the Daikin SelectTools selection program for accurate coil and valve sizing or contact your Daikin Applied sales representative.

Steam Heat

Steam design:

Steam supply pressure = 10 psig

With an 80% pressure drop across the valve, determine the steam coil pressure as follows:

$$\text{Steam coil pressure} = 10 - (10 \times 0.80) = 2 \text{ psig}$$

The Coil SelectTools program indicates that the Standard Capacity steam coil provides 823 MBh at design conditions and provides sufficient capacity. This heating capacity meets design; therefore, the standard face area steam coil for the unit is acceptable.

Valve size can be determined from the condensation rate of steam for a given coil pressure. Use Table 9 and Table 10 below to select manual steam valve selection for systems with atmospheric return mains and supply main pressure not exceeding 25 psig at stated conditions. For the given example, find the appropriate valve size as follows:

$$\begin{aligned} \text{Condensation Rate} &= \text{Capacity} / \text{latent heat of steam} \\ &= 823,000 / 966.1 \\ &= 852 \text{ lb/hr} \end{aligned}$$

Enter [Table 8](#), at 10 psig and 852 lb/hr. The correct valve size is 1-1/2 in. For other operating conditions, use the Selection program for accurate selection or contact your Daikin Applied sales representative.

Steam traps are field furnished and mounted. Refer to [Application Considerations on page 29](#) of this catalog or Daikin Steam Coil Catalog 413 for piping recommendations.

Table 8: Steam valve selection chart

Valve size (in.)	Condensate rate, lbs/hr			
	Steam supply pressure			
	5 psig	10 psig	15 psig	25 psig
1	196–260	301–380	391–480	571–650
1¼	261–380	381–560	481–700	651–940
1½	381–600	561–870	701–1090	940–1470
2	601–950	871–1390	1091–1750	1471–2350
2½	951–1330	1391–1940	1751–2450	2351–3290
3	1331–2020	1941–2950	2451–3716	—

* Based on valve pressure drop of 80% of saturated steam supply pressure

Table 9: Saturated steam properties

PSIG	Temperature (°F)	Latent heat
2	218.5	966.1
5	227.1	960.6
10	239.4	952.6
15	249.7	945.7
25	266.8	934.0

Selecting Fans and Motors

Fan and motor selections are based on total static pressure drop and design airflow. Total static pressure includes internal air pressure drops of unit components and external air pressure drops in supply and return ducts.

In the [Component Pressure Drops on page 57](#) section, see [Table 29 on page 57](#) and [Table 32 on page 59](#) for internal pressure drops of unit components. When selecting unit fans and motors, use the fan curves provided in [Fan Performance on page 62](#), [SWSI Supply Fans on page 71](#), [Propeller Exhaust Fans on page 73](#), and [Return Fans on page 75](#). To optimize fan performance, select the fan size having design airflow and static pressure intersecting as close to the first system curve as possible after the shaded Do Not Select region. See [Application Considerations on page 29](#).

Select the motor size as close below the horsepower curve as possible to prevent motor oversizing. An oversized motor (large horsepower to load ratio) can greatly increase electric consumption due to the reduction in motor performance.

Return Fan and Motor

Select an economizer with a return fan for the given system. A return (or exhaust fan) system is often necessary for maintaining proper pressure in a building. See [Application Considerations on page 29](#) for more information on the economizer and return fan application. Use the external air pressure drop of the return duct along with the design return airflow to select a return fan. Based on [Figure 79 on page 78](#), the return fan size is 44 inches and the bhp = 4.6. The required fan motor size is 5.0 hp.

Supply Fan and Motor

Since this system includes a return fan, the return duct static pressure drop is not added to the supply fan pressure drop. Therefore, total static pressure for the supply fan in the example is:

Internal pressure drops:

- 0–100% economizer, with RAF = 0.54-in wg
- 65% cartridge filter, med. flow = 0.63-in wg
- Gas furnace = 0.50-in wg
- Chilled water coil (5WH 3-row, 8 fpi) = 0.35-in wg
- Total internal pressure drop = 2.02-in wg

External pressure drops:

- Supply duct = 2.00-in wg
- Total external pressure drop = 2.00-in wg

$$\begin{aligned} \text{Total static pressure} &= \text{internal drops} + \text{external drops} \\ &= 2.02 + 2.00 \\ &= 4.02 \text{ in wg} \end{aligned}$$

NOTE: When gas or electric heat is provided, do not add the cooling coil diffuser pressure drop. In VAV applications with gas heat, consult your Daikin Applied sales representative for design pressure drop determinations.

For the constant volume, blow-through unit in Example 1, a DWDI, forward curve or airfoil type fan can be selected. See [Application Considerations on page 29](#) for fan configuration considerations. A fan type selection comparison for Example 1 is conducted as follows:

The optimal fan size for an airfoil fan without vanes is 30" (from [Figure 59 on page 68](#)). Corresponding fan motor characteristics are: Fan rpm = 1450 Brake horsepower = 27

Make the final selection by comparing energy savings to first cost as follows:

$$\text{Payback} = \text{savings} / \text{cost}$$

where:

$$\text{Savings} = (\text{bhp}_2 - \text{bhp}_1) \times (0.75 \text{ kW/hp} / \text{motor eff.}) \times \$/\text{kwh} \times \text{hr/yr, and cost} = (\text{fan and motor cost})_1 - (\text{fan and motor cost})_2$$

Supply Power Wiring for Units Without Electric Heat

Sizing supply power wire for a unit is based on the circuit with the largest amperage draw. With the power package option, all electrical equipment is wired to a central panel for single or optional dual connections. For Example 1, inclusion of a power package with a single power connection is assumed. Refer to [Electrical Data on page 99](#) for FLA and RLA ratings of equipment. Determining wire sizing amperes for Example 1 is as follows.

Fans Only:

Wire sizing amperes = 1.25 × FLA of largest motor + 1.00 × FLA of other loads

- Supply fan motor, 30 hp 37.5
- Return fan motor, 5 hp 7.0

$$\text{Therefore, wire sizing amperes} = 1.25 \times 37.5 + 1.00 \times 7.0 = 53.9 \text{ amperes}$$

Example 2

A constant air volume system with electric heat at 50 Hz. Applicable design constraints in Example 1 are used in Example 2 with the following parameters.

Winter design:

- Total heating load 480,000 Btu/h
- Electrical Design: 380 V/50 Hz/3 phase

Selecting Unit Size and Arrangement

For units providing no cooling, base model size on design supply air capacity. Refer to the [Physical Data on page 43](#) for approximate operating airflow ranges of each unit. The minimum volume of air may be lower than the specified range. Check the unit fan curve for stable operation of fan at desired operating conditions. Based on air capacity constraints in Example 2, select a RAH 047CY unit.

Selecting Heating Equipment at 50Hz

Electric heat

Select electric heat based on design heating load, minimum supply air capacity, and air temperature rise requirements. A maximum air temperature rise and minimum airflow limit exist with all electric heaters. For the electric heating elements available, the minimum airflow requirements are as follows:

- RAH 047C 14,200 cfm minimum
- RAH 077C 21,000 cfm minimum

Also, the supply fan static pressure is limited to 5.0 inches wg in electric heat applications. Limitations are based on testing performed under ETL-Canada guidelines.

When selecting electric heat for Example 2, correct heater capacity to account for derated voltage supply. First convert the given heating load to kW as follows:

$$\text{kW} = \text{MBh} / 3.413 = 480 / 3.413 = 140.6 \text{ kW}$$

Since electrical data is not tabulated for a 380/50/3 supply, use data provided for a voltage rating greater than design. For Example 2, 480/60/3 data is used to determine the appropriate model size of the heater. Follow the steps below when derating electric heat:

1. Choose model size from tabulated kW greater than design.
2. Derate tabulated kW.
3. If derated kW is greater than design, select electric heater.

Example 2—Model 240

$$\begin{aligned} \text{kW2} &= \text{KW1} \times \text{V2} / \text{V1}^2 \\ &= 238.8 \times (380 / 480)^2 \\ &= 149.7 \text{ kW} \end{aligned}$$

Based on heating load capacity, Model 240 is adequate. Reference [Table 27](#) and [Table 28 on page 55](#) for air temperature rise data for heater. The air temperature rise capability of this model at design conditions is 26.4°F. Comparing this value with design for a 20°F temperature rise confirms the acceptability of Model 240.

When electrical data is not tabulated, calculate the FLA rating of the heater as follows:

$$\begin{aligned} \text{FLA} &= (\text{kW} \times 1000) / (1.732 \times \text{V}) \\ &= (149.7 \times 1000) / (1.732 \times 380) \\ &= 227.5 \text{ amps} \end{aligned}$$

Selecting Motors at 50 Hz

When operating at 50 Hz, available fan motors operate at approximately 5/6 the rated capacity. Fans and motors may be selected as in Example 1. However, selected motors must be derated and design verified. The table below provides motor correction factors for derating horsepower at 50 Hz.

Table 10: Motor correction factors

Volts	380	400	415
O.D.P.	0.85	0.80	0.75
T.E.F.C.	0.80	0.75	0.70

Supply power wiring for fans and electric heat

For Example 2, supply power wiring can be sized based on the following wire sizing amperes formula.

Electric heat plus fans:

- Electric heat less than or equal to 50 kW:
MCA = 1.25 (largest motor load plus heater FLA) + (the rest of the loads)
- Electric heat greater than or equal to 50 kW:
MCA = 1.25 (largest motor load) + heater FLA + (the rest of the loads)

Example 3

Selecting RAH O77CL Chilled Water Coils

Supply airflow = 40,000 cfm

The RAH O77CL unit contains two staggered chilled water coils with a fin height of 63 inches each (see the [Physical Data on page 43](#)). Divide coils greater than 54" in height and individually run them on the coil selection program. For the given configuration, split the coil into one 30 × 83 coil and one 33 × 83 coil and specify accordingly.

Ratio the airflow to each coil as follows:

$$\begin{aligned} \text{Ind. airflow} &= \text{airflow} \times (\text{in FH} / \text{total FH}) \\ &= 40,000 \times (30/126) = 9,523 \text{ cfm} \\ &= 40,000 \times (33/126) = 10,476 \text{ cfm} \end{aligned}$$

Read the coil selection output as follows:

1. Add capacities together and multiply by two for staggered configuration.
2. Take air pressure drop directly from individual run.
3. Add water flow rates together.
4. Use the lowest water pressure drop value without addition. The most economical chilled water unit coil is a 5WL with 4 rows and 12 fpi. This coil assembly has a cooling capacity of 1126 MBh sensible and 1615 MBh total. Air pressure drop is 0.92 inches of water across the coil. The required water flow rate is 160 gpm with a water pressure drop of 12.5 feet of water through the coil.

For the RAH O77CL without F&BP and the RAH O77CS with F&BP, [Table 16 on page 49](#) provides additional header pressure drops. These values are added to the water pressure drop provided by the coil selection program to account for the presence of a continuous header. In the given example, an additional 6.5 feet of water is added resulting in a water pressure drop of 19 feet of water through the coil.

Example:

RAH O77CL chilled water valve and piping selection

$$\begin{aligned} \text{Coil type} &= 5 \text{ WL} \\ \text{Water flow rate} &= 160 \text{ gpm} \end{aligned}$$

Determine valve size selection for the given chilled water coil by entering [Figure 41 on page 49](#) at 160 gpm and moving vertically up past the minimum pressure drop line to the nearest curve. Select a 2" valve with a pressure drop of 19.5 feet of water under design conditions. For proper temperature control, maintain adequate pressure drop through the valve.

To determine the pressure drop through the valve piping, first reference [Table 15 on page 47](#) for the assigned index number of the given valve. Then enter [Figure 41 on page 49](#) at the designated index number and water flow rate. Following vertically down from the gpm curve, locate the corresponding pressure drop. For this example, the chilled water valve piping pressure drop is 8.0 feet of water. Therefore, the total valve and piping pressure drop for the given chilled water coil is 27.5 feet of water.

Table 11: RDS 708B, 800C, and 802C—component data

Data	Unit size		
	708B	800C	802C
Cabinet Dimensions			
Length (in)	114–279	62–538	84–566
Height (in)	51.0	55.5	55.5
Width (in)	67.5	94.0	94.0
Supply Fans			
Type: Forward curved			
Qty—diameter (in)	1—15 × 6	2—15 × 6	1—24
Qty—diameter (in)	1—15 × 9	2—15 × 15	—
Qty—diameter (in)	1—15 × 15	—	—
Airflow range (cfm)	2,000–8,000	4,000–16,000	8,000–20,000
Motor hp range	1–7.5	1–20	1–25
Type: Backward curved			
Qty—diameter (in)	—	—	1—24
Airflow range (cfm)	—	—	8,000–20,000
Motor hp range	—	—	1–25
Type: Airfoil			
Qty—diameter (in)	1—16	1—20	—
Airflow range (cfm)	2,000–8,000	4,000–16,000	—
Motor hp range	1–10	1–25	—
Return Fans			
Type: Forward curved			
Qty—diameter (in)	1—15 × 15 ¹	2—15 × 15	—
Airflow range (cfm)	2,000–7,200	3,000–14,400	—
Motor hp range	1–5	1–10	—
Type: Airfoil			
Qty—diameter (in)	1—16	1—30	1—30
Qty—diameter (in)	—	—	1—40
Airflow range (cfm)	2,000–7,200	3,000–14,400	6,000–18,000
Motor hp range	1–5	1–10	1–10
Throwaway 30% Pleated, Cleanable filters			
Area (sq ft)	13.9 ¹	50.0	50.0
Qty—size (in)	4—20 × 25 × 2	10—16 × 20 × 2 10—16 × 25 × 2	10—16 × 20 × 2 10—16 × 25 × 2
Area (sq ft)	20.8 ²	—	—
Qty—size (in)	6—20 × 25 × 2	—	—
65% Cartridge Filters with 2" Pre-Filters			
Area (sq ft)	6.0 ¹	24.0	24.0
Qty—size (in)	1—24 × 24 × 12 1—12 × 24 × 12	4—24 × 24 × 12 4—12 × 24 × 12	4—24 × 24 × 12 4—12 × 24 × 12
Area (sq ft)	12.0 ²	—	—
Qty—size (in)	2—24 × 24 × 12 2—12 × 24 × 12	—	—
95% Cartridge Filters with 2" Pre-Filters			
Area (sq ft)	8.0 ¹	24.0	24.0
Qty—size (in)	2—24 × 24 × 12	4—24 × 24 × 12 4—12 × 24 × 12	4—24 × 24 × 12 4—12 × 24 × 12
Area (sq ft)	14.0 ²	—	—
Qty—size (in)	2—24 × 24 × 12 3—12 × 24 × 12	—	—
Gas, oil furnace³			
Input (MBh)	—	250, 312, 400, 500, 625, 800, 812, 988, 1000, 1250	
Nominal output (MBh)	—	200, 250, 320, 400, 500, 640, 650, 790, 800, 1000	
Electric³			
Nominal Output (kW)	—	20, 40, 60, 80, 100, 120, 140, 160, 180, 200, 220, 240	

1. Filter area for RDS 708B units with a 15" × 6" supply fan.

2. Filter area for RDS 708B units with a 15" × 9", 15" × 15" or 16" supply fan.

3. Gas, oil and electric heat selection is limited by the minimum airflow requirements.

Table 12: RDS 708B, 800C, and 802C—contractor coil¹ data

Data	Unit size							
	708BS		708BL		800CY		802CY	
	Without	With	Without	With	Without	With	Without	With
Face & Bypass								
Physical								
Fin height (in) ²	12-39	12-30	12-39	12-30	12-36	12-30	12-36	12-30
Fin length (in)	36	36	48	48	79	79	79	79
Max. coil depth (in) ³	25.0	20.0	25.0	20.0	19.5	19.5	19.5	19.5
Max. face area (sq ft)	9.8	7.5	13.0	10.0	19.8	16.5	19.8	16.5
Bypass Area (sq ft)	—	1.9	—	2.5	—	3.3	—	3.3
Max bypass cfm	—	4,750	—	6,250	—	8,225	—	8,225
Chilled Water Coil								
Diameter (in.)	5/8				5/8			
Type—rows	5MH—2				5MH—2			
	5WH—3, 4, 5, 6, 8, 10				5WH—3, 4, 5, 6, 8, 10			
	5WL—3, 4, 5, 6, 8, 10				5WL—3, 4, 5, 6, 8, 10			
	5MS—2				5MS—2			
	5WS—4, 6, 8, 10				5WS—4, 6, 8, 10			
	5WM—5, 6, 8, 10				5WM—5, 6, 8, 10			
	5WD—8				5WD—8			
Evaporator coils								
Diameter (in) Type—rows	5/8				5/8			
	SEN—2, 3, 4, 5, 6, 8				SEN—2, 3, 4, 5, 6, 8			
	SER—6				SER—6			
	SEF—2, 3, 4, 5, 6, 8				SEF—2, 3, 4, 5, 6, 8			
	SEJ—3, 4, 6, 8				SEJ—3, 4, 6, 8			
	SEK—4, 8				SEK—4, 8			
Hot water coils								
Diameter (in.)	5/8				5/8			
Type—rows	SWB—1, 2				5WB—1			
	5WQ—1				5WQ—1			
	5WH—1, 2				5WH—1			
	SWS—2				5MH—2 ⁴			
	—				5MS—2 ⁴			
	—				—			
Steam coils								
Diameter (in)	5/8				5/8			
Type—rows	5—JA1, 2				5—JA1, 2			
	5GA—1, 2				5GA—1, 2			
	1				1			
	8JA—1				8JA—1			
	8GA—1				8GA—1			

1. Contractor coils have opposite drive end connections
2. On the RDS 708B, 800C and 802C, contractor coils available with fin heights between given range of 3" increments.
3. On the RDS 708B, the maximum coil depth does not include the 6" spacer provided between the last two coils.
4. If cooling coil is in the same section, the cooling coil is limited to 8 rows.

Table 13: RDS 708B, 800C, and 802C—unit coil data

Data	Unit size	
	800CL	802CL
Chilled water coils		
Type—rows—fin geometry	5WH—3, 4, 5, 6—C	5WH—3, 4, 5, 6—C
	5WL—3, 4, 5, 6—C	5WL—3, 4, 5, 6—C
	5WS—4, 6—C	5WS—4, 6—C
Fins per inch	8, 10, 12	8, 10, 12
FH × FL (in.)	48 × 78	48 × 78
Face area (ft ²)	26.0	26.0
Maximum Airflow (cfm)	16,900	16,900
Valve Package (in.)	1, 1-1/4, 1-1/2, 2	1, 1-1/4, 1-1/2, 2
Supply & return conn. (in.)	2.62 copper sweat	2.62 copper sweat
Evaporator coils		
Type—rows—fin geometry	5EN—3, 4, 5—C	5EJ—3, 4, 5—C
Fins per inch	8, 10, 12	8, 10, 12
FH × FL (in.)	48 × 82	48 × 82
Face area (ft ²)	27.3	27.3
Maximum airflow (cfm)	17,750	17,750
Compressor circuits/split	1/100	2/50-50
Liquid connection (in.)	1-3/8 ODM copper	1-1/8 ODM copper
Suction connection (in.)	2-1/8 ODS copper	1-5/8 ODS copper
Hot water coils		
Type—rows—fin geometry	5WH—1—H	5WH—1—H
	5WS—2—C	5WS—2—C
Fins per inch	9	9
FH × FL (in.)—heat only	39 × 75	39×75
Face area (ft ²) — heat only	20.3	20.3
FH × FL (in.)—heat/cool	39 × 78	39 × 78
Face area (ft ²)—heat/cool	21.1	21.1
Valve package (in.)	1, 1-1/4, 1-1/2, 2	1, 1-1/4, 1-1/2, 2
Supply & return conn. (in.)	1-5/8 ODM copper	1-5/8 ODM copper
Steam coils		
Type—rows—fin geometry	5JA—1—H	5JA—1—H
Fins per inch	6, 12	6, 12
FH × FL (in.)—heat only	39 × 75	39 × 75
Face area (ft ²)—heat only	20.3	20.3
FH × FL (in.)—heat/cool	39 × 78	39 × 78
Face area (ft ²)—heat/cool	21.1	21.1
Valve package (in.)	1, 1-1/4, 1-1/2, 2	1, 1-1/4, 1-1/2, 2
Supply & return conn. (in.)	2-1/2 MPT iron	2-1/2 MPT iron

1. Unit coils are HI-F5 fin design and have opposite drive end connections except to the heat only section.
2. Valve package available in cooling only and heating only sections.
3. For coils with factory valve package, supply and return connections are the size of the valve with female threading.

Table 14: RAH 047C and 077C—component data

Data		Unit size						
		047CS	047CL	047CY	077CS	077CL	077CY	
Cabinet	Length (in.)	96-552	96-576	96-504	96-624	96-696	96-600	
	Height (in.)	73.0			97.0			
	Width (in.)	99.0			99.0			
Throwaway								
Throwaway filters (standard)	Area (ft ²)	73.9			116.1			
	Qty—size (in.)	7—16 × 20 × 2 21—16 × 25 × 2			11—16 × 20 × 2 33—16 × 25 × 2			
30% pleated								
Throwaway filters (optional)	Area (ft ²)	73.9			116.1			
	Qty—size (in.)	7—16 × 20 × 2 21—16 × 25 × 2			11—16 × 20 × 2 33—16 × 25 × 2			
	Pre-filter, standard flow							
	Area (ft ²)	40.0			56.0			
	Qty—size (in.)	4—12 × 24 × 2 8—24 × 24 × 2			4—12 × 24 × 2 12—24 × 24 × 2			
	Pre-filter, medium flow							
	Area (ft ²)	48.0			64.0			
	Qty—size (in.)	8—12 × 24 × 2 8—24 × 24 × 2			— 16—24 × 24 × 2			
	Pre-filter, high flow							
	Area (ft ²)	—			80.0			
Qty—size (in.)	—			8—12 × 24 × 2 16—24 × 24 × 2				
65% or 95%, standard flow								
Cartridge filters (optional)	Area (ft ²)	40.0			56.0			
	Qty—size (in.)	4—12 × 24 × 12 8—24 × 24 × 12			4—12 × 24 × 12 12—24 × 24 × 12			
	65% or 95%, medium flow							
	Area (ft ²)	48.0			64.0			
	Qty—size (in.)	8—12 × 24 × 12 8—24 × 24 × 12			— 16—24 × 24 × 12			
	65% or 95%, high flow							
Area (ft ²)	—			80.0				
Qty—size (in.)	—			8—12 × 24 × 12 16—24 × 24 × 12				
Airfoil (27" FC also offered on 047)								
DWDI supply fans	Diameter (inch)	27, 30, 33			33, 36, 40			
	Max. airflow (cfm)	30,000			50,000			
	Motor hp range	3-50			5-75			
Airfoil								
SWSI supply fans	Diameter (inch)	40, 44			44, 49			
	Max. airflow (cfm)	30,000			50,000			
	Motor hp range	3-50			5-75			
Airfoil								
Return fans	Diameter (inch)	40			44			
	Max. airflow (cfm)	27,000			45,000			
	Motor hp range	2-30			5-60			
Propeller								
Exhaust fans	Diameter (inch)	36 Inch			36 Inch			
	Quantity	1-2 Per Unit			2-3 Per Unit			
	Motor hp	5 HP Each			5 HP Each			
	Airflow range(cfm)	11,000-30,000			22,000-50,000			
Electric	Nom. output (kW)	40, 60, 80, 100, 120, 160, 200, 240			80, 100, 120, 160, 200, 240, 280, 320			
Gas furnace	Input (MBh)	250 312 400 500 625 800 812 988 100 1250*			625 800 812 988 1000 1250 1375 1750 2500*			
	Nom. output (MBh)	200 250 320 400 500 640 650 790 800 1000			500 640 650 650 790 800 1000 1100 1400 1500 2000*			

* Furnace size availability is limited by the minimum airflow per Table 23 on page 46.

Table 15: RAH 047C and 077C—coil data

Data		Unit size							
		047CS		047CL		077CS		077CL	
		wo/ F&BP	w/ F&BP2	wo/ F&BP	w/ F&BP2	wo/ F&BP	w/ F&BP2	wo/ F&BP	w/ F&BP2
Evaporator coils	Rows	3, 4, 5, 6							
	Fins per inch	8, 10, 12,							
	Fin material	Aluminum, copper							
	FH × FW (in.)	66 × 87.5	—	(2) 39 × 87.5	—	90 × 87.5	—	(2) 63 × 87.5	—
	Face area (sq ft)	40.1	—	47.4	—	54.7	—	76.6	—
	Max. cfm	26,000	—	30,800	—	35,500	—	49,800	—
Chilled water coils	Type—rows Valve package (in.)	5WH—3, 4, 5, 6, 8							
		1½, 2, 2½	—	1½, 2, 2½	—	1¼, 1½, 2½, 3	—	2, 2½, 3	—
		5WL—3, 4, 5, 6, 8							
		1½, 2, 2½	—	1½, 2, 2½, 3	—	1½, 2, 2½, 3	—	2, 2½, 3	—
		5WS—4, 6, 8							
		2, 2½, 3	—	1½, 2, 2½, 3	—	1½, 2, 2½, 3	—	2, 2½, 3	—
		5WM—4, 5, 6, 8							
		2, 2½, 3	—	1½, 2, 2½, 3	—	2, 2½, 3	—	2, 2½, 3	—
	5WD—4, 8								
	2, 2½, 3	—	2, 2½, 3	—	2, 2½, 3	—	2, 2½, 3	—	
	Fins per inch	8, 10, 12							
	Fin material	Aluminum, copper							
	FH × FW (in.)	66 × 83	48 × 83	(2) 39 × 83	(2) 39 × 83	90 × 83	63 × 83	(2) 63 × 83	(2) 54 × 83
	Face area (sq ft)	38.0	27.7	45.0	45.01	51.9	36.3	72.6	62.3
	Max face cfm	24,700	18,000	29,200	29,200	33,700	23,600	47,200	40,500
Bypass Area (sq ft)	—	9.2	—	10.4	—	14.4	—	18.4	
Max. bypass cfm	—	23,000	—	25,900	—	36,000	—	46,100	
Hot water coils	Type—rows Valve package (in.)	5WH—1							
		1¼, 1½, 2, 2½, 3	—	1¼, 1½, 2, 2½, 3	—	1½, 2, 2½, 3	—	1½, 2, 2½, 3	—
		5WS—2							
	1¼, 1½, 2, 2½, 3	—	1¼, 1½, 2, 2½, 3	—	1½, 2, 2½, 3	—	1½, 2, 2½, 3	—	
	Fins per inch	9							
	Fin material	Aluminum, copper							
	FH × FW (in.)	57 × 75	39 × 75	57 × 75	—	81 × 75	54 × 75	81 × 75	—
	Face area (sq ft)	29.7	20.3	29.7	—	42.2	28.1	42.2	—
Bypass area (sq ft)	—	9.2	—	—	—	14.4	—	—	
Max. bypass cfm	—	23,000	—	—	—	36,000	—	—	
Steam coils	Rows	1, 2							
	Valve package (in.)	1¼, 1½, 2, 2½, 3	—	1¼, 1½, 2, 2½, 3	—	1½, 2, 2½, 3	—	1½, 2, 2½, 3	—
	Fins per inch	6, 12							
	Fin material	Aluminum, copper							
	FH × FW (in.)	57 × 75	39 × 75	57 × 75	—	81 × 75	54 × 75	81 × 75	—
	Face area (sq ft)	29.7	20.3	29.7	—	42.2	28.1	42.2	—
	Bypass area (sq ft)	—	9.2	—	—	—	14.4	—	—
	Max. bypass cfm	—	23,000	—	—	—	36,000	—	—

1. Unit coils are HI-F5 fin design.
 2. Face and bypass dampers are available only in heating only or cooling only sections.
 3. The valve package for hot water and steam heat is available only in the heating only section.

RDS 800C and 802C

Figure 39: Unit chilled water valve and piping pressure drop

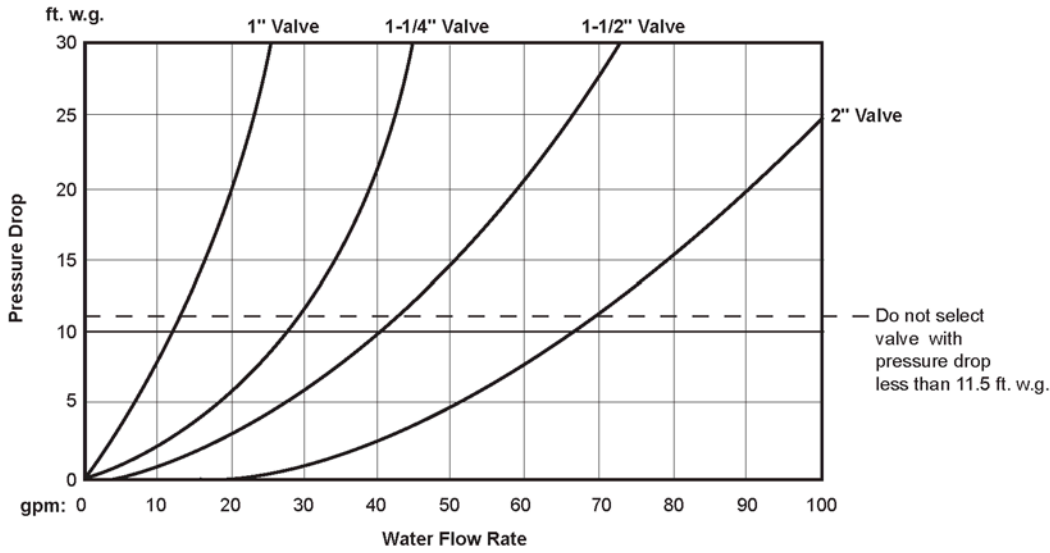
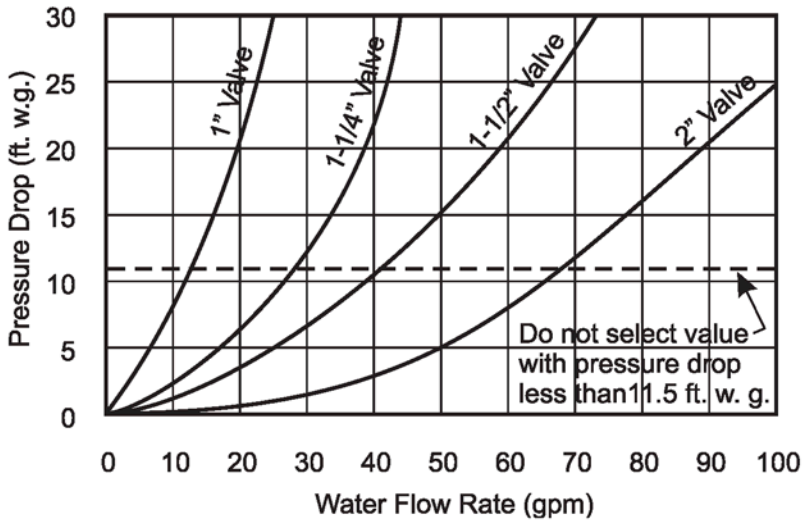


Figure 40: Unit hot water valve and piping pressure drop



RAH 047C and 077C

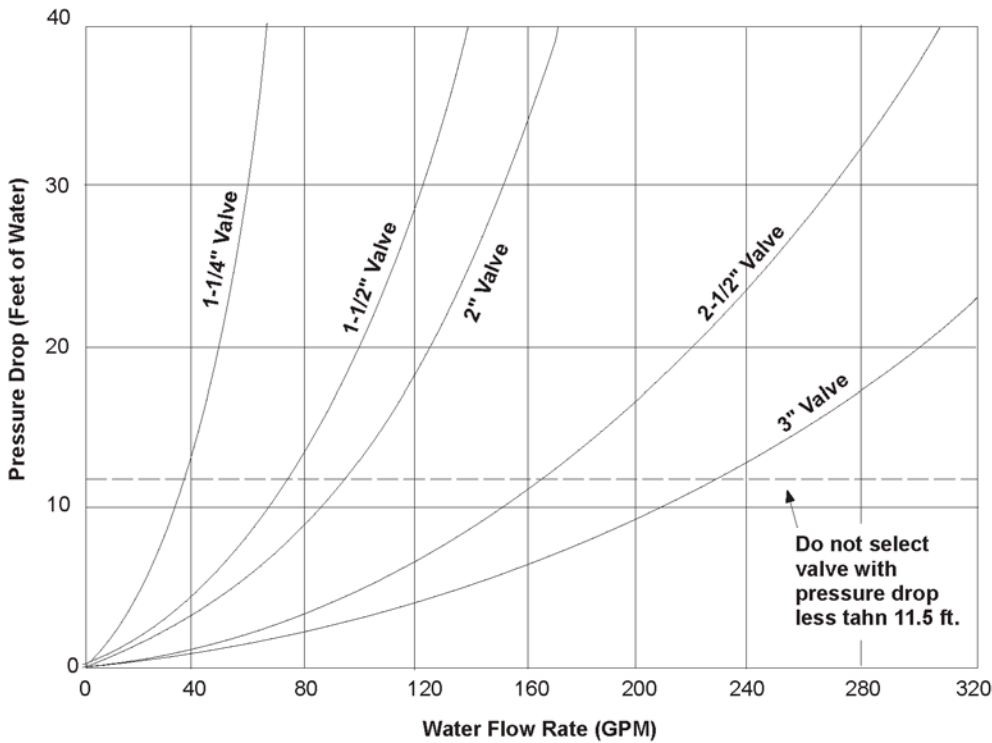
Chilled Water Header and Valve Pressure Drop

NOTE: The RAH 077C chilled water coils have 63" tall headers. Therefore, this pressure drop must be added to the coil pressure drop in the coil selection program.

Table 16: Additional chilled water header pressure drop (feet of water)

Unit size	Header height (in.)	Coil type									
		5WH		5WL		5WS		5WM		5WD	
		GPM	PD	GPM	PD	GPM	PD	GPM	PD	GPM	PD
077CS with F&BP	63	21	0.10	31	0.22	41	0.40	62	0.70	83	1.00
		41	0.39	62	0.89	83	1.61	124	2.83	165	4.05
		83	1.57	124	3.62	165	6.50	248	11.43	331	16.36
077CL without F&BP	(2) 63	21	0.10	31	0.22	41	0.40	62	0.70	83	1.00
		41	0.39	62	0.89	83	1.61	124	2.83	165	4.05
		83	1.57	124	3.62	165	6.50	248	11.43	331	16.36

Figure 41: Chilled water valve pressure drop

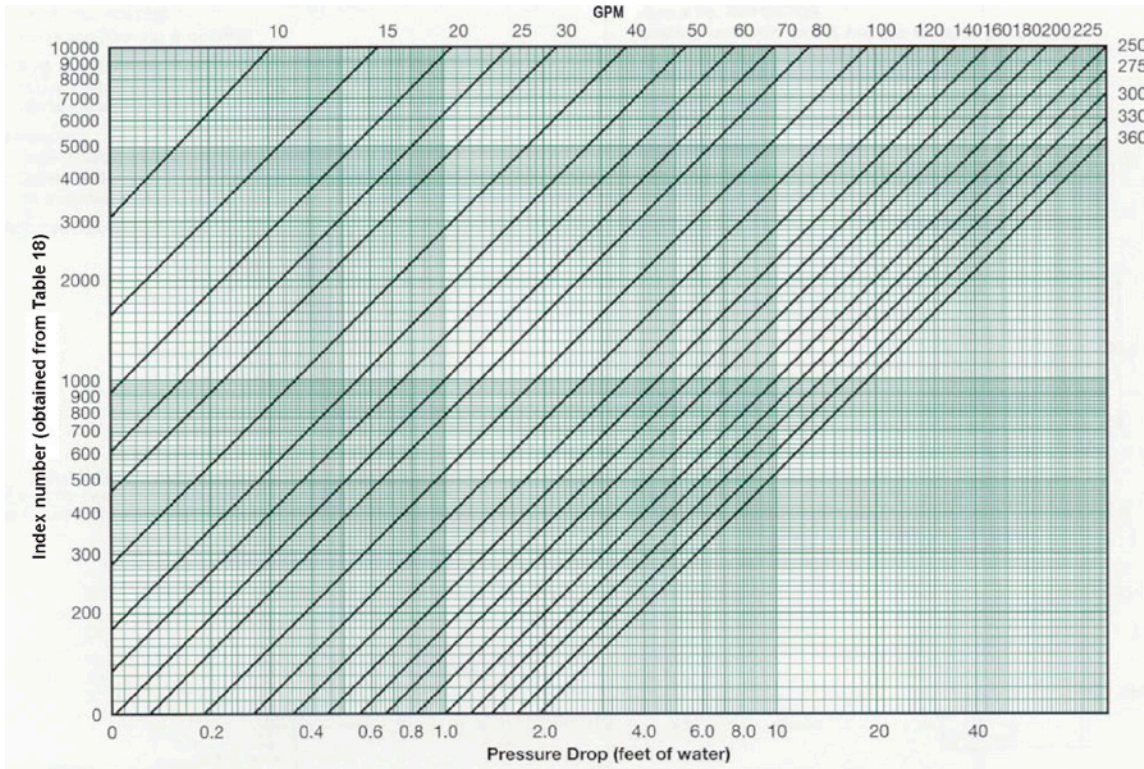


Chilled Water Valve Piping Pressure Drop

Table 17: Chilled water piping index numbers used in Figure 42 to find piping pressure drop

Coil type	Valve size (in.)	Unit size							
		047CS		047CL		077CS		077CL	
		w/o F&BP	w/ F&BP	w/o F&BP	w/ F&BP	w/o F&BP	w/ F&BP	w/o F&BP	w/ F&BP
5WH	1.25	3820	—	—	—	—	—	—	—
	1.50	3510	2230	8810	7250	3760	1820	—	6070
	2.00	2380	1430	4130	3320	2020	760	1910	2280
	2.50	2140	—	3070	2610	1680	540	1350	1820
	3.00	—	—	—	—	1580	—	1190	1640
5WL	1.25	—	4510	—	—	—	—	—	—
	1.50	3750	1860	8460	—	3490	—	—	5740
	2.00	2620	780	3150	2420	1750	830	1810	2220
	2.50	2380	550	1980	1640	1260	500	1250	1490
	3.00	—	—	1670	1370	1310	420	1090	1300
5WS	1.50	—	2420	8460	—	3410	—	—	—
	2.00	1540	710	3150	2420	1670	830	1810	2130
	2.50	1190	370	1980	1640	1330	500	1250	1400
	3.00	1100	290	1670	1370	1230	420	1090	1210
5WM	1.50	—	2420	8460	—	3410	—	—	—
	2.00	1540	710	3150	2420	1670	830	1810	2130
	2.50	1190	370	1980	1640	1330	500	1250	1400
	3.00	1100	290	1670	1370	1230	420	1090	1210
5WD	1.50	—	2420	—	—	3410	—	—	—
	2.00	1460	710	3100	2560	1670	830	1810	2130
	2.50	1110	370	1950	1560	1330	500	1250	1400
	3.00	1030	290	1620	1290	1230	420	1090	1210

Figure 42: Chilled water valve piping pressure drop Index number (obtained from Table 17)



Gas Heat

RDS 800C and 802C, RAH 047C and 077C

Figure 43: Gas heat capacity

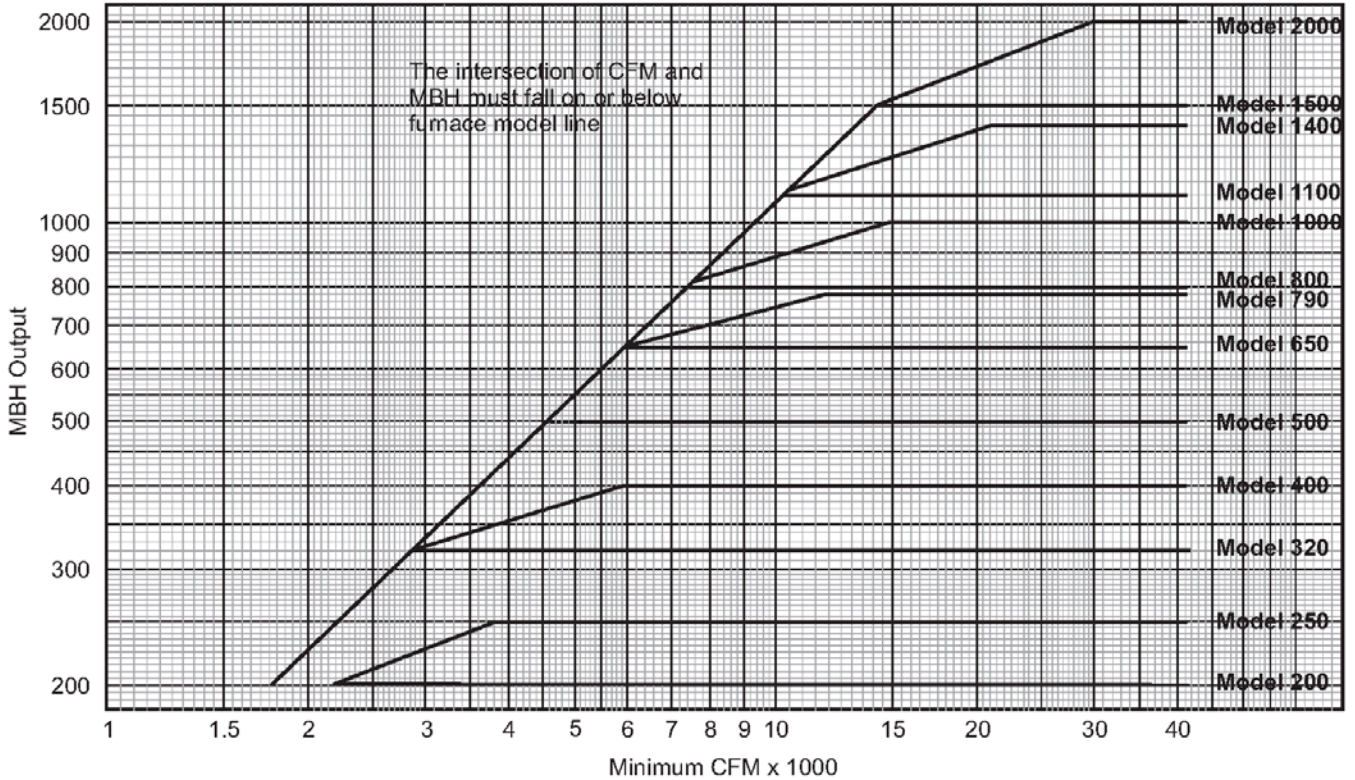


Table 18: Gas furnace inlet pressure range in psig

Regulator	Furnace model number												
	200	250	320	400	500	650	790	800	1000	1100	1400	1500	2000
Minimum pressure	See Table 20.												
Maximum pressure	0.50 psig												
High pressure	2.0-10.0	2.0-10.0	2.0-10.0	2.0-10.0	2.0-10.0	2.0-10.0	2.0-10.0	2.0-10.0	2.0-10.0	2.0-10.0	2.0-10.0	2.0-10.0	2.0-10.0

Note: If furnace application is out of listed pressure range, consult factory.

Table 19: Gas burner connection size (inches)

Description	Furnace size (MBh output)												
	200	250	320	400	500	650	790	800	1000	1100	1400	1500	2000
Natural gas (CFH)	250	312	400	500	625	812	1000	1000	1250	1375	1750	1875	2500
Minimum gas inlet Pressure (in wc)	Standard burner	6.00	6.00	7.00	7.00	7.00	7.00	7.50	7.50	9.00	7.00	8.00	8.00
	20:1 burner	4.50	5.50	6.00	5.00	5.50	7.00	6.50	6.50	6.50	5.00	5.00	6.00
Gas pipe Connection size (N.P.T.)	Through 0.5 psi	0.75	0.75	0.75	1.00	1.00	1.25	1.25	1.25	1.25	1.50	1.50	2.00
	2-3 psi	0.75	0.75	0.75	1.00	1.00	1.25	1.25	1.25	1.25	1.25	1.25	1.50
	5-10 psi	0.75	0.75	0.75	1.00	1.00	1.25	1.25	1.25	1.25	1.25	1.25	1.25

Table 20: Gas furnace air temperature rise (°F)

Unit size	Nominal airflow (cfm)	Furnace size (MBh output) ^a												
		200	250	320	400	500	650	790	800	1000	1100	1400	1500	2000
015C	7000	26.3	32.9	42.1	52.7	65.8	85.6	—	—	—	—	—	—	—
020C	8000	23.0	28.8	36.9	46.1	57.6	74.9	—	92.2	—	—	—	—	—
025C	10000	18.4	23.0	29.5	36.9	46.1	59.9	—	73.7	—	—	—	—	—
030C	12000	15.4	19.2	24.6	30.7	38.4	49.9	60.7	61.4	—	—	—	—	—
036C	14000	13.2	16.5	21.1	26.3	32.9	42.8	52.0	52.7	—	—	—	—	—
040C	16000	11.5	14.4	18.4	23.0	28.8	37.4	45.5	46.1	57.6	—	—	—	—
045C	16000	11.5	14.4	18.4	23.0	28.8	37.4	45.5	46.1	57.6	—	—	—	—
050C	20000	9.2	11.5	14.7	18.4	23.0	30.0	36.4	36.9	46.1	—	—	—	—
060C	24000	7.7	9.6	12.3	15.4	19.2	25.0	30.3	30.7	38.4	—	—	—	—
070C	28000	6.6	8.2	10.5	13.2	16.5	21.4	26.0	26.3	32.9	—	—	—	—
075C	30000	6.1	7.7	9.8	12.3	15.4	20.0	24.3	24.6	30.7	—	—	—	—
080C	32000	—	—	—	—	14.4	18.7	22.8	23.0	28.8	31.7	40.3	43.2	57.6
090C	36000	—	—	—	—	12.8	16.6	20.2	20.5	25.6	28.2	35.8	38.4	51.2
105C	40000	—	—	—	—	11.5	15.0	18.2	18.4	23.0	25.3	32.3	34.6	46.1
115C	46000	—	—	—	—	10.0	13.0	15.8	16.0	20.0	22.0	28.1	30.1	40.1
125C	48000	—	—	—	—	9.6	12.5	15.2	15.4	19.2	21.1	26.9	28.8	38.4
135C	50000	—	—	—	—	9.2	12.0	14.6	14.7	18.4	20.3	25.8	27.6	36.9

a. Output is 80% of input.

RDS 800C and 802C

Table 21: Gas furnace design maximum air temperature rise (°F) and minimum airflow (cfm)

Baffle position	Maximum temperature rise (°F) Minimum airflow (cfm) Furnace model number								
	200	250	320	400	500	650	790	800	1000
A	80	61	100	61	100	100	61	100	61
	2300	3800	2950	6000	4600	5970	12000	7340	15000
B	62	42	78	35	63	73	52	76	50
	3000	5500	3800	10500	7400	82000	14000	9800	18500

Note: When selecting baffle position, consider the minimum reduced airflow on VAV units.

RAH 047C and 077C

Table 22: Gas furnace design maximum air temperature rise (°F) and minimum airflow (cfm)

Baffle position	Maximum temperature rise (°F) Minimum airflow (cfm) Furnace model number												
	200	250	320	400	500	650	790	800	1000	1100	1400	1500	2000
A	46	57	73	61	100	100	61	100	61	100	61	100	61
	4,000	4,000	4,000	6,000	4,600	5,970	12,000	7,340	15,000	10,100	21,000	13,770	30,000
B	13	16	21	26	29	33	41	41	42	46	46	—	51
	14,000	14,000	14,000	14,000	16,000	18,000	18,000	18,000	22,000	22,000	28,000	—	36,000
C	8	10	13	17	19	27	33	33	33	—	38	49	44
	22,000	22,000	22,000	22,000	24,000	22,000	22,000	22,000	28,000	—	34,000	28,000	42,000
D	—	—	—	—	—	23	24	28	25	34	32	—	—
	—	—	—	—	—	26,000	30,000	26,000	36,000	30,000	40,000	—	—

Note: When selecting baffle position, consider the minimum reduced airflow on variable air volume units.

Electric Heat

RDS 800C and 802C

Table 23: 208 V electric heat air temperature rise (°F)*

Airflow (cfm)	Electric heater model number					
	20	40	60	80	100	120
	Electric heater capacity					
	51	102	154	204	255	306
6,000	7.8	15.6	23.5	31.2	39.0	46.8
7,000	6.7	13.4	20.2	26.7	33.4	40.1
8,000	5.9	11.7	17.6	23.4	29.2	35.1
9,000	5.2	10.4	15.7	20.8	26.0	31.2
10,000	4.7	9.4	14.1	18.7	23.4	28.1
11,000	4.3	8.5	12.8	17.0	21.3	25.5
12,000	3.9	7.8	11.8	15.6	19.5	23.4
13,000	3.6	7.2	10.9	14.4	18.0	21.6
14,000	3.4	6.7	10.1	13.4	16.7	20.1
15,000	3.1	6.2	9.4	12.5	15.6	18.7
16,000	2.9	5.8	8.8	11.7	14.6	17.5

Table 24: 230 V, 460 V, 575 V electric heat air temperature rise (°F)*

Airflow (cfm)	Electric heater model number											
	20	40	60	80	100	120	140	160	180	200**	220**	240**
	Electric heater capacity											
	63	125	188	249	312	374	439	499	564	624	689	748
6,000	9.6	19.1	28.7	38.1	47.7	57.2	—	—	—	—	—	—
7,000	8.2	16.3	24.6	32.7	40.9	49.0	57.5	—	—	—	—	—
8,000	7.2	14.3	21.6	28.6	35.8	42.9	50.3	57.2	—	—	—	—
9,000	6.4	12.7	19.2	25.4	31.8	38.1	44.7	50.9	57.5	—	—	—
10,000	5.7	11.4	17.2	22.9	28.6	34.3	40.2	45.8	51.7	57.2	—	—
11,000	5.2	10.4	15.7	20.8	26.0	31.2	36.6	41.6	47.0	52.0	57.5	—
12,000	4.8	9.5	14.4	19.1	23.8	28.6	33.5	38.1	43.1	47.7	52.7	57.2
13,000	4.4	8.8	13.3	17.6	22.0	26.4	31.0	35.2	39.8	44.0	48.7	52.8
14,000	4.1	8.2	12.3	16.3	20.4	24.5	28.7	32.7	37.0	40.9	45.2	49.0
15,000	3.8	7.6	11.5	15.3	19.1	22.9	26.8	30.5	34.5	38.1	42.2	45.8
16,000	3.6	7.2	10.8	14.3	17.9	21.5	25.2	28.6	32.3	35.8	39.5	42.9

* Maximum temperature rise allowed is 60°F with temperature not exceeding 140°F

** Electric heater temperature available at 460 or 575 volts only.

RDS 047C and 077C

Table 25: RAH 047, 208 V electric heat air temperature rise (°F)

Airflow (cfm)*	Electric heater model number					
	40	60	80	100	120	160
	Electric heater capacity (MBh)					
	102.0	153.9	204.1	255.0	306.1	408.2
14,000	6.7	10.1	13.4	16.7	20.0	26.1
15,000	6.3	9.4	12.5	15.7	18.8	25.0
16,000	5.8	8.8	11.7	14.6	17.6	23.4
17,000	5.5	8.3	11.0	13.7	16.6	22.1
18,000	5.2	7.8	10.4	13.0	15.6	20.8
19,000	4.9	7.4	9.9	12.3	14.8	19.8
20,000	4.7	7.0	9.4	11.7	14.0	18.7
21,000	4.5	6.7	8.9	11.1	13.4	17.8
22,000	4.3	6.4	8.5	10.6	12.8	17.0
23,000	4.1	6.1	8.1	10.1	12.2	16.3
24,000	3.9	5.9	7.8	9.7	11.7	15.6
25,000	3.7	5.6	7.5	9.3	11.2	15.0
26,000	3.6	5.4	7.2	9.0	10.8	14.4
27,000	3.4	5.2	6.9	8.7	10.4	13.9
28,000	3.3	5.0	6.7	8.4	10.0	13.5
29,000	3.2	4.8	6.5	8.1	9.7	13.0
30,000	3.1	4.7	6.3	7.8	9.4	12.5

Table 26: RAH 077, 208 V electric heat air temperature rise (°F)

Airflow (cfm)*	Electric heater model number		
	80	100	120
	Electric heater capacity (MBh)		
	204.1	255.0	306.1
22,000	8.5	10.6	12.8
24,000	7.8	9.7	11.7
26,000	7.2	9.0	10.8
28,000	6.7	8.4	10.0
30,000	6.3	7.8	9.4
32,000	5.8	7.3	8.8
34,000	5.5	6.9	8.3
36,000	5.2	6.5	7.8
38,000	4.9	6.1	7.4
40,000	4.7	5.8	7.0
42,000	4.5	5.5	6.7
44,000	4.3	5.3	6.4
46,000	4.1	5.1	6.1
48,000	3.9	4.9	5.8
50,000	3.7	4.7	5.6

*22,000 cfm is the minimum airflow required for unit size 077C with electric heat.

*14,000 cfm is the minimum airflow required for unit size 047C with electric heat

Table 27: RAH 047C, 230, 460, 575 V—electric heat air temperature rise (°F)

Airflow (cfm)*	Electric heater model number							
	40	60	80	100	120	160	200	240
	Electric heater capacity (MBh)							
	124.7	188.1	249.5	311.9	374.3	499.0	623.8	748.5
14,000	8.2	12.3	16.3	20.4	24.5	32.7	40.8	49.0
15,000	7.7	11.5	15.3	19.1	23.0	30.6	38.2	46.0
16,000	7.2	10.8	14.3	17.9	21.5	28.6	35.8	42.9
17,000	6.8	10.2	13.6	16.9	20.4	27.5	33.7	40.8
18,000	6.4	9.6	12.7	15.9	19.2	25.4	31.8	38.4
19,000	6.0	9.1	12.0	15.1	18.1	24.0	30.2	36.2
20,000	5.7	8.6	11.4	14.3	17.2	22.8	28.6	34.3
21,000	5.4	8.2	10.7	13.6	16.4	21.4	27.2	32.8
22,000	5.2	7.8	10.4	13.0	15.6	20.8	26.0	31.2
23,000	5.0	7.5	10.0	12.4	15.0	19.9	24.8	30.0
24,000	4.8	7.2	9.5	11.9	14.4	19.0	23.8	28.8
25,000	4.6	6.9	9.2	11.4	13.8	18.4	22.9	27.6
26,000	4.4	6.6	8.8	11.0	13.2	17.6	22.0	26.4
27,000	4.2	6.4	8.5	10.6	12.8	17.0	21.2	25.6
28,000	4.0	6.2	8.2	10.2	12.4	16.4	20.4	24.8
29,000	3.9	6.0	7.8	9.9	12.0	15.8	19.7	24.0
30,000	3.8	5.8	7.6	9.5	11.6	15.2	19.0	23.2

* 14,000 cfm is the minimum airflow required for unit size 047C with electric heat.

Table 28: RAH 077C, 230,460,575 V—electric heat air temperature rise (°F)

Airflow (cfm)*	Electric heater model number							
	80	100	120	160	200	240	280	320
	Electric heater capacity (MBh)							
	249.5	311.9	374.3	499.0	623.8	748.5	873.3	998.0
22,000	10.4	13.0	15.6	20.8	26.0	31.2	36.4	41.6
24,000	9.5	11.9	14.4	19.0	23.8	28.8	33.4	38.1
26,000	8.8	11.0	13.2	17.6	22.0	26.4	30.8	35.2
28,000	8.2	10.2	12.4	16.4	20.4	24.8	28.6	32.7
30,000	7.6	9.5	11.6	15.2	19.0	23.2	26.7	30.5
32,000	7.2	8.9	10.7	14.3	17.9	21.5	25.0	28.6
34,000	6.7	8.4	10.1	13.5	16.8	20.2	23.6	26.9
36,000	6.3	7.9	9.5	12.6	15.9	19.1	22.2	25.2
38,000	6.0	7.5	9.0	12.0	15.0	18.0	21.1	24.0
40,000	5.7	7.1	8.6	11.4	14.2	17.2	20.0	22.8
42,000	5.4	6.8	8.2	10.9	13.6	16.3	19.1	21.8
44,000	5.2	6.5	7.8	10.4	13.0	15.6	18.2	20.8
46,000	5.0	6.2	7.5	10.0	12.4	15.0	17.4	20.0
48,000	4.8	5.9	7.2	9.6	11.8	14.4	16.7	19.2
50,000	4.6	5.7	6.9	9.2	11.4	13.7	16.0	18.3

*22,000 cfm is the minimum airflow required for unit size 077C with electric heat.

Figure 44: Hot water valve pressure drop

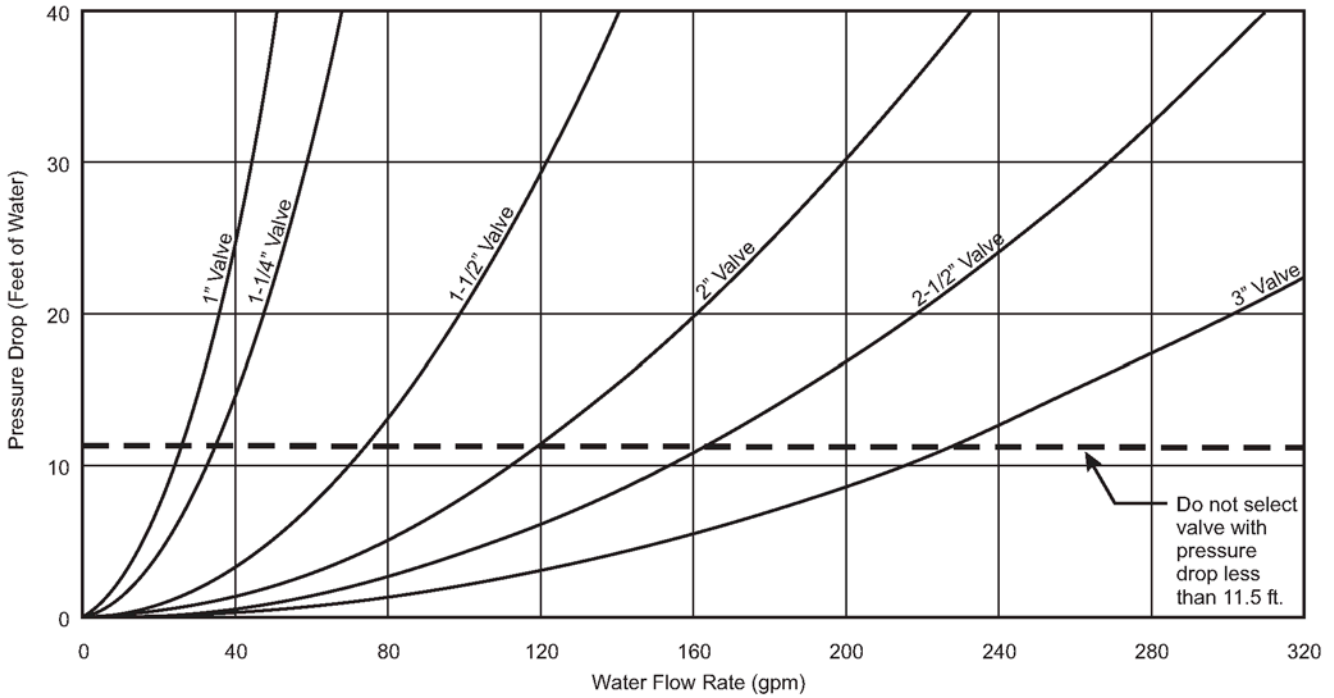
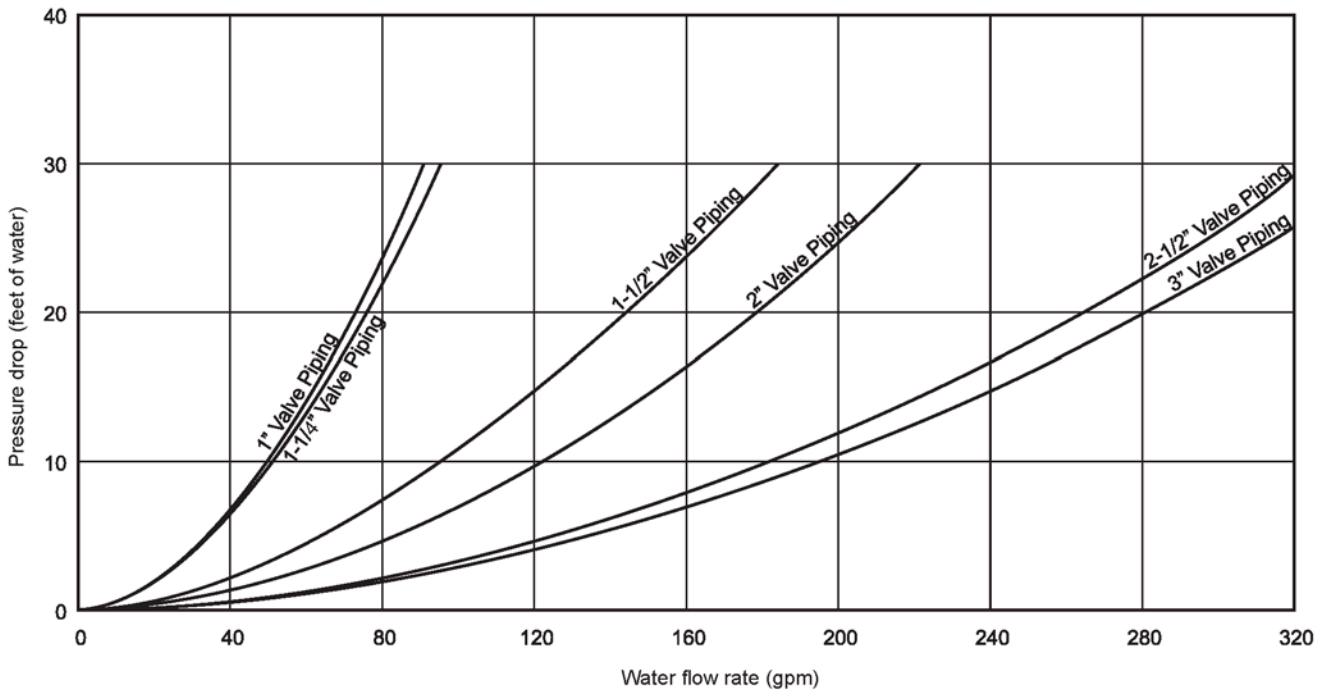


Figure 45: Hot water valve piping pressure drop



Steam valve selection is on [page 40](#), [Table 8](#) and [Table 9](#).

RDS 708B, 800C, and 802C

Table 29: Component air pressure drops—RDS 708B (in wg)

Component		Airflow (cfm)						
		2,000	3,000	4,000	5,000	6,000	7,000	8,000
Outdoor/ return air	0–30% outside air hood w/ damper	0.01	0.01	0.02	0.02	0.03	0.05	0.06
	100% outside air hood w/ damper	0.01	0.03	0.06	0.09	0.13	0.17	0.22
	0–100% economizer	0.01	0.01	0.02	0.04	0.05	0.07	0.10
	Mixing box w/ hood	0.01	0.02	0.03	0.05	0.07	0.09	0.12
Filters 15" × 6" supply fan	Throwaway	0.05	0.07	0.10	—	—	—	—
	30% Pleated	0.05	0.08	0.11	—	—	—	—
	Cleanable	0.02	0.03	0.05	—	—	—	—
	Prefilter, 65% cartridge	0.12	0.21	0.34	—	—	—	—
	Prefilter, 95% cartridge	0.09	0.14	0.21	—	—	—	—
	65% cartridge	0.18	0.39	0.66	—	—	—	—
	95% cartridge	0.21	0.40	0.64	—	—	—	—
Filters 15" × 9" / 15" × 15" supply fans	Throwaway	—	—	0.06	0.08	0.10	0.12	0.15
	30% pleated	—	—	0.07	0.09	0.11	0.14	0.16
	Cleanable	—	—	0.03	0.04	0.05	0.06	0.08
	Prefilter, 65% cartridge	—	—	0.12	0.16	0.21	0.27	0.34
	Prefilter, 95% cartridge	—	—	0.10	0.13	0.17	0.21	0.26
	65% cartridge	—	—	0.19	0.27	0.39	0.52	0.66
	95% cartridge	—	—	0.26	0.37	0.50	0.64	0.79
Face and bypass dampers	Face, 36" long coil	0.01	0.02	0.03	—	—	—	—
	Face, 48" long coil	—	—	0.01	0.02	0.02	—	—
	Bypass, 36" long coil	0.07	0.17	0.29	—	—	—	—
	Bypass, 48" long coil	—	—	0.16	0.26	0.37	—	—
Discharge or return dampers	15" × 6" supply fan	0.13	0.29	0.51	—	—	—	—
	15" × 9" supply fan	0.07	0.15	0.26	0.41	0.58	—	—
	15" × 15" supply fan	0.03	0.07	0.12	0.19	0.28	0.38	0.49
Discharge plenum	15" × 6" supply fan	0.14	0.34	0.59	—	—	—	—
	15" × 9" supply fan	0.11	0.24	0.43	0.67	0.97	—	—
	15" × 15" supply fan	0.07	0.15	0.26	0.41	0.59	0.80	1.05
	16" supply fan	0.03	0.06	0.11	0.18	0.25	0.34	0.45

Note: Pressure drop through coils can be found in the SelectTools for Contractor Coils selection program.

Table 30: RDS 800C and 802C (in wg)

Component		Airflow (cfm)							
		4,000	6,000	8,000	10,000	12,000	14,000	16,000	18,000
Outdoor/return air	0–30% outside air hood w/ damper	0.02	0.03	0.06	0.09	0.13	0.18	0.23	0.28
	100% outside air hood w/ damper	0.01	0.01	0.02	0.03	0.05	0.06	0.08	0.10
	0–100% economizer	0.01	0.03	0.05	0.08	0.12	0.17	0.23	0.29
Filters	Throwaway	0.02	0.03	0.05	0.07	0.09	0.12	0.14	0.17
	30% pleated	0.02	0.04	0.07	0.09	0.12	0.14	0.18	0.21
	Prefilter	0.06	0.10	0.16	0.22	0.28	0.35	0.42	0.50
	65% cartridge	0.05	0.11	0.19	0.27	0.39	0.52	0.66	0.83
	95% cartridge	0.11	0.21	0.33	0.48	0.64	0.83	1.03	1.25
Damper options	Face and bypass	0.01	0.02	0.04	—	—	—	—	—
	Discharge ¹	0.02	0.05	0.08	0.13	0.18	0.25	0.33	0.37
	Return ¹	0.01	0.02	0.04	0.06	0.08	0.11	0.14	0.16
Discharge plenum (deduct) ²	(2) 15" × 6" FC supply fan	0.06	0.13	0.22	—	—	—	—	—
	(2) 15" × 6" FC supply fan	0.02	0.04	0.07	0.12	0.17	0.21	0.28	—
	20" AF supply fan	0.03	0.07	0.11	0.18	0.26	0.35	0.46	—
	24" FC supply fan	—	0.08	0.11	0.17	0.25	0.34	0.45	0.58
	24" BC supply fan	—	0.01	0.02	0.04	0.05	0.07	0.09	0.11

1. Discharge and return air dampers available on the RDS 800C only.
2. Discharge plenum pressure drop incorporated into supply fan curves; deduct pressure drop from total when not provided.
3. Pressure drop through coils are found in the SelectTools for Contractor Coils selection program.

Table 31: RDS 800C and 802C—furnace pressure drops (in wg)

Airflow (cfm)	Furnace model number											
	200, 250, 320, 400		500		650		790		800		1000	
	PD	*	PD	*	PD	*	PD	*	PD	*	PD	*
4,000	0.06	A	—	—	—	—	—	—	—	—	—	—
5,000	0.09	A	0.07	A	—	—	—	—	—	—	—	—
6,000	0.13	A	0.10	A	0.08	A	—	—	—	—	—	—
7,000	0.18	A	0.14	A	0.11	A	—	—	—	—	—	—
8,000	0.24	A	0.17	A	0.14	A	—	—	0.14	A	—	—
9,000	0.30	A	0.22	A	0.18	A	—	—	0.18	A	—	—
10,000	0.37	A	0.27	A	0.22	A	—	—	0.22	A	—	—
12,000	0.53	A	0.39	A	0.32	A	0.32	A	0.32	A	—	—
14,000	0.25	B	0.54	A	0.44	A	0.44	A	0.44	A	—	—
16,000	0.31	B	0.28	B	0.57	A	0.57	A	0.57	A	0.57	A
18,000	0.39	B	0.35	B	—	—	—	—	—	—	0.72	A
20,000	0.48	B	0.43	B	—	—	—	—	—	—	0.89	A
22,000	—	—	0.52	B	—	—	—	—	—	—	—	—
24,000	—	—	—	—	—	—	—	—	—	—	—	—

*Baffle position—factory set

RAH 047C and 077C

Table 32: Component air pressure drops (in wg)—RAH 047C

Component		Airflow (cfm)								
		14,000	16,000	18,000	20,000	22,000	24,000	26,000	28,000	30,000
Outdoor/ return air option ^{1, 2}	0–30% outside air hood w/ damper	0.06	0.08	0.10	0.12	0.15	0.18	0.21	0.24	0.28
	100% outside air hood w/ damper	0.01	0.02	0.02	0.03	0.03	0.04	0.05	0.05	0.06
	0–100% economizer, w/o RAF	0.08	0.10	0.13	0.16	0.19	0.23	0.27	0.31	0.36
	0–100% economizer, w/ RAF	0.21	0.25	0.29	0.33	0.38	0.43	0.48	0.54	0.59
	Mixing box w/ hood	0.05	0.05	0.06	0.07	0.08	0.09	0.10	0.11	0.12
Filter options	2" throwaway	0.07	0.08	0.10	0.11	0.13	—	—	—	—
	30% pleated	0.08	0.10	0.12	0.14	0.16	0.18	0.20	0.25	0.27
	Prefilter, std. flow	0.17	0.20	0.21	0.28	0.32	0.37	0.41	—	—
	Prefilter, med. flow	0.13	0.15	0.18	0.21	0.25	0.28	0.32	0.35	0.39
	65% cartridge, std. flow	0.27	0.34	0.41	0.49	0.57	0.66	0.76	—	—
	65% cartridge, med. flow	0.20	0.25	0.31	0.36	0.43	0.49	0.56	0.63	0.71
	95% cartridge, std. flow	0.38	0.46	0.55	0.64	0.74	0.84	0.95	—	—
95% cartridge, med. flow	0.29	0.35	0.42	0.49	0.56	0.64	0.72	0.81	0.89	
Plenum (deduct) ³	Discharge, 27" DWDI supply fan	(0.17)	(0.22)	(0.28)	(0.34)	(0.42)	(0.50)	(0.58)	(0.67)	(0.77)
	Discharge, 30" DWDI supply fan	(0.14)	(0.19)	(0.24)	(0.30)	(0.36)	(0.43)	(0.50)	(0.58)	(0.66)
	Discharge, 33" DWDI supply fan	(0.13)	(0.17)	(0.21)	(0.26)	(0.32)	(0.38)	(0.44)	(0.51)	(0.59)
Plenum options	Return, isolation damper	0.02	0.03	0.03	0.03	0.03	0.03	0.03	0.03	0.03
	Discharge, isolation damper	0.03	0.03	0.03	0.03	0.03	0.03	0.03	0.03	0.03
Heating options	Hot water, 1 row	0.12	0.15	0.19	0.22	0.26	0.30	0.35	0.39	0.44
	Hot water, 2 row	0.24	0.30	0.37	0.44	0.52	0.60	0.69	0.78	0.88
	Steam heat, 1 row 6 FPI	0.10	0.12	0.18	0.18	0.21	0.24	0.27	0.31	0.35
	Steam heat, 1 row 12 FPI	0.18	0.20	1.24	0.73	0.33	0.38	0.43	0.48	0.54
	Steam heat, 2 row 6 FPI	0.19	0.24	0.30	0.35	0.41	0.48	0.55	0.62	0.70
	Electric heat	0.07	0.10	0.12	0.15	0.18	0.22	0.25	0.29	0.34
	Gas heat	See Table 34: Furnace pressure drops (in wg)—RAH 047C and 077C on page 61.								
Cooling ⁴	Cooling diffuser ⁵	0.04	0.05	0.06	0.08	0.10	0.11	0.13	0.15	0.18
Face and bypass ⁶	Face damper, std. flow	0.04	0.05	0.07	0.08	0.10	0.11	0.14	0.16	0.18
	Face damper, med. flow	0.02	0.02	0.03	0.03	0.04	0.04	0.05	0.06	0.07
	Bypass damper, std. flow	0.25	0.32	0.41	0.50	0.61	0.72	0.85	0.98	1.12
	Bypass damper, med. flow	0.29	0.37	0.47	0.56	0.69	0.82	0.97	1.11	1.27

Notes:

1. Pressure drop through hood and damper is based on 30% of listed airflow.
2. Pressure drop through the economizer assumes that all of the air will be passing through the return air dampers.
3. If a discharge plenum is not used with a DWDI supply fan, subtract this static pressure factor from the total static pressure drop.
4. Pressure drop through cooling coils can be found in the Daikin MS-85 selection program output or Coil Catalog 411.
5. A cooling diffuser is provided on blow-through units with cooling, hot water or steam heating.
6. Base design pressure drop across face and bypass dampers on the position creating the greatest resistance.

Table 33: Component air pressure drops (in wg)—RAH 077C

Component		Airflow (cfm)								
		18,000	22,000	26,000	30,000	34,000	38,000	42,000	46,000	50,000
Outdoor/return air options ^{1, 2}	0–30% outside air hood w/ damper	0.05	0.08	0.11	0.14	0.18	0.23	0.28	0.34	0.40
	100% outside air hood w/ damper	0.01	0.02	0.03	0.03	0.04	0.06	0.07	0.08	0.09
	0–100% economizer, w/o RAF	0.06	0.10	0.15	0.20	0.26	0.32	0.39	0.46	0.54
	0–100% economizer, w/ RAF	0.16	0.22	0.29	0.36	0.44	0.52	0.61	0.70	0.80
	Mixing box w/ hood	0.03	0.05	0.05	0.06	0.07	0.09	0.10	0.11	0.12
Filter options	2" Throwaway	0.15	0.07	0.09	0.11	0.13	—	—	—	—
	30% Pleated	0.06	0.08	0.11	0.13	0.15	0.18	0.21	0.24	0.27
	Prefilter, std. flow	0.15	0.20	0.24	0.31	0.37	—	—	—	—
	Prefilter, med. flow	0.12	0.16	0.21	0.25	0.31	0.36	—	—	—
	Prefilter, high flow	0.09	0.12	0.15	0.18	0.22	0.26	0.30	0.34	0.39
	65% cartridge, std. flow	0.24	0.33	0.43	0.55	0.68	—	—	—	—
	65% cartridge, med. flow	0.19	0.27	0.35	0.44	0.54	0.65	—	—	—
	65% cartridge, med. flow	0.13	0.18	0.24	0.31	0.38	0.45	0.53	0.62	0.71
	95% cartridge, std. flow	0.33	0.45	0.57	0.71	0.85	—	—	—	—
	95% cartridge, med. flow	0.27	0.37	0.47	0.58	0.70	0.83	—	—	—
Plenum (deduct) ³	Discharge, 27" DWDI supply fan	(0.12)	(0.19)	(0.26)	(0.35)	(0.44)	(0.56)	(0.68)	(0.81)	(0.96)
	Discharge, 30" DWDI supply fan	(0.11)	(0.16)	(0.22)	(0.30)	(0.38)	(0.47)	(0.58)	(0.69)	(0.82)
	Discharge, 33" DWDI supply fan	(0.09)	(0.14)	(0.20)	(0.26)	(0.33)	(0.42)	(0.51)	(0.61)	(0.72)
Plenum options	Return, isolation damper	0.02	0.02	0.03	0.03	0.03	0.03	0.03	0.03	0.03
	Discharge, isolation damper	0.03	0.03	0.03	0.03	0.03	0.03	0.03	0.03	0.03
Heating options	Hot water, 1 row	0.10	0.14	0.19	0.24	0.30	0.36	0.43	0.50	0.57
	Hot water, 2 row	0.20	0.28	0.38	0.48	0.59	0.72	0.85	1.00	1.15
	Steam heat, 1 row 6 fpi	0.07	0.11	0.14	0.18	0.23	0.28	0.33	0.39	0.46
	Steam heat, 1 row 12 fpi	0.15	0.21	0.29	0.37	0.46	0.56	0.67	0.79	0.91
	Steam heat, 2 row 6 fpi	0.12	0.17	0.23	0.29	0.36	0.43	0.51	0.60	0.69
	Electric heat	0.07	0.10	0.14	0.19	0.24	0.30	0.37	0.45	0.53
Cooling ⁴	Gas heat	See Table 34: Furnace pressure drops (in wg)—RAH 047C and 077C on page 61.								
	Cooling diffuser ⁵	0.04	0.05	0.07	0.10	0.13	0.16	0.19	0.23	0.28
Face and bypass ⁶	Face damper, std. flow	0.04	0.06	0.08	0.10	0.13	0.17	0.20	0.24	0.29
	Face damper, med. flow	0.01	0.02	0.03	0.04	0.05	0.06	0.08	0.09	0.10
	Bypass damper, std. flow	0.15	0.25	0.35	0.46	0.59	0.74	0.90	1.08	1.28
	Bypass damper, med. flow	0.18	0.29	0.40	0.53	0.67	0.82	1.09	1.17	1.28

Notes:

1. Pressure drop through hood and damper is based on 30% of listed airflow.
2. Pressure drop through the economizer assumes that all of the air will be passing through the return air dampers.
3. If a discharge plenum is not used with a DWDI supply fan, subtract this static pressure factor from the total static pressure drop.
4. Pressure drop through cooling coils can be found in the Daikin MS-85 selection program output or Coil Catalog 411.
5. A cooling diffuser is provided on blow-through units with cooling, hot water or steam heating.
6. Base design pressure drop across face and bypass dampers on the position creating the greatest resistance.

Table 34: Furnace pressure drops (in wg)—RAH 047C and 077C

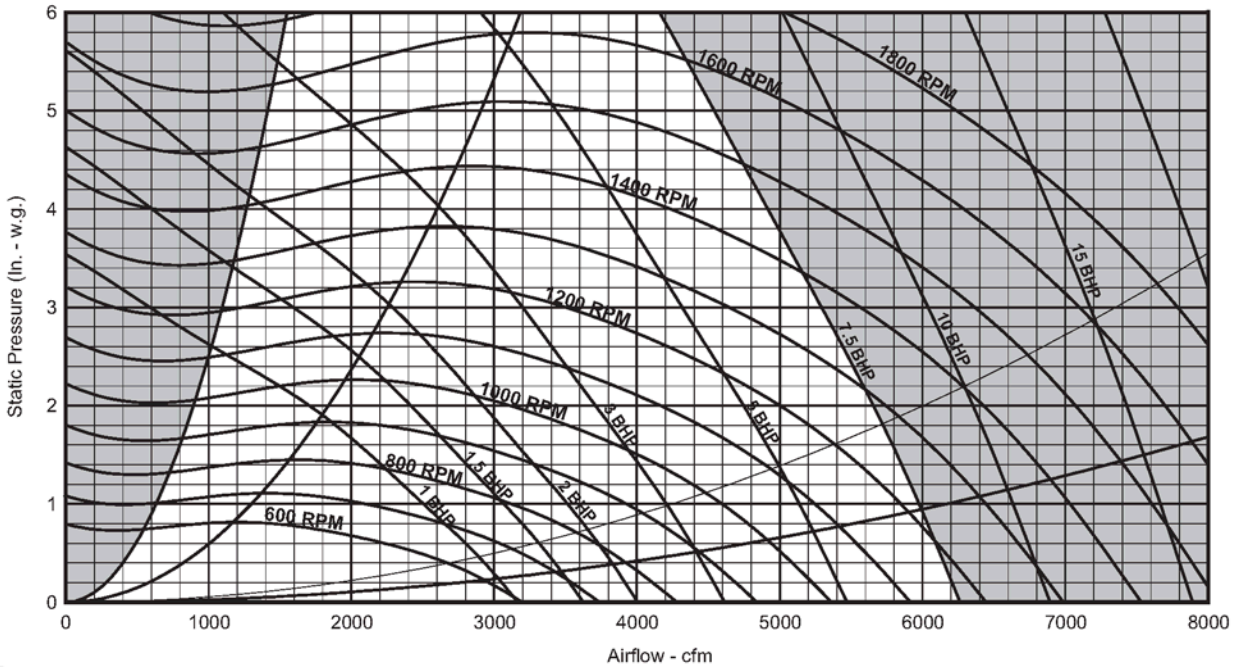
Airflow (cfm)	Furnace model number																						
	200,250,320		400		500		650		790		800		1000		1100		1400		1500		2000		
	PD	*	PD	*	PD	*	PD	*	PD	*	PD	*	PD	*	PD	*	PD	*	PD	*	PD	*	PD
4,000	0.06	A	—	—	—	—	—	—	—	—	—	—	—	—	—	—	—	—	—	—	—	—	—
6,000	0.13	A	0.13	A	0.10	A	0.08	A	—	—	—	—	—	—	—	—	—	—	—	—	—	—	—
8,000	0.24	A	0.24	A	0.18	A	0.14	A	—	—	0.14	A	—	—	—	—	—	—	—	—	—	—	—
10,000	0.37	A	0.37	A	0.28	A	0.22	A	—	—	0.22	A	—	—	0.13	A	—	—	—	—	—	—	—
12,000	0.53	A	0.53	A	0.40	A	0.32	A	0.32	A	0.32	A	—	—	0.19	A	—	—	—	—	—	—	—
14,000	0.25	B	0.25	B	0.54	A	0.44	A	0.44	A	0.44	A	—	—	0.26	A	—	—	0.16	A	—	—	—
16,000	0.33	B	0.33	B	0.27	B	0.57	A	0.57	A	0.57	A	0.57	A	0.34	A	—	—	0.20	A	—	—	—
18,000	0.41	B	0.41	B	0.35	B	0.39	B	0.39	B	0.39	B	0.72	A	0.43	A	—	—	0.26	A	—	—	—
20,000	0.51	B	0.51	B	0.43	B	0.48	B	0.48	B	0.48	B	0.89	A	0.53	A	—	—	0.32	A	—	—	—
22,000	0.25	C	0.25	C	0.52	B	0.36	C	0.36	C	0.36	C	0.58	B	0.44	B	0.64	A	0.39	A	—	—	—
24,000	0.30	C	0.30	C	0.25	C	0.43	C	0.43	C	0.43	C	0.69	B	0.53	B	0.76	A	0.46	A	—	—	—
26,000	0.35	C	0.35	C	0.30	C	0.31	D	0.50	C	0.31	D	0.81	B	0.62	B	0.89	A	0.54	A	—	—	—
28,000	0.41	C	0.41	C	0.35	C	0.36	D	0.59	C	0.36	0	0.59	C	0.72	B	0.72	B	0.38	C	—	—	—
30,000	0.47	C	0.47	C	0.40	C	0.41	D	0.41	D	0.41	D	0.67	C	0.40	D	0.83	B	0.44	C	—	—	—
32,000	—	—	—	—	0.45	C	0.46	D	0.46	D	0.46	D	0.76	C	0.46	0	0.94	B	0.50	C	0.72	A	—
34,000	—	—	—	—	0.51	C	0.52	D	0.52	D	0.52	D	0.86	C	0.52	D	0.72	C	0.56	C	0.82	A	—
36,000	—	—	—	—	0.57	C	0.59	D	0.59	D	0.59	D	0.59	D	0.58	0	0.81	C	0.63	C	0.93	A	—
38,000	—	—	—	—	0.64	C	0.65	D	0.65	D	0.65	D	0.65	D	0.65	0	0.90	C	0.70	C	0.85	B	—
40,000	—	—	—	—	0.71	C	0.73	D	0.73	D	0.73	D	0.73	D	0.72	D	0.72	D	0.78	C	0.95	B	—
42,000	—	—	—	—	0.78	C	0.80	D	0.80	D	0.80	D	0.80	D	0.79	D	0.79	D	0.86	C	1.05	B	—
46,000	—	—	—	—	0.94	C	0.96	D	0.96	D	0.96	D	0.96	D	0.95	D	0.95	D	1.03	C	0.86	C	—
50,000	—	—	—	—	1.11	C	1.13	D	1.13	D	1.13	D	1.13	D	1.12	D	1.12	D	1.22	C	1.03	C	—

* Baffle position—factory set

NOTE: Maximum allowable static pressure at fan bulkhead is 5.0 in (i.e., ESP plus blow-through component pressure drops cannot exceed 5.0 in).

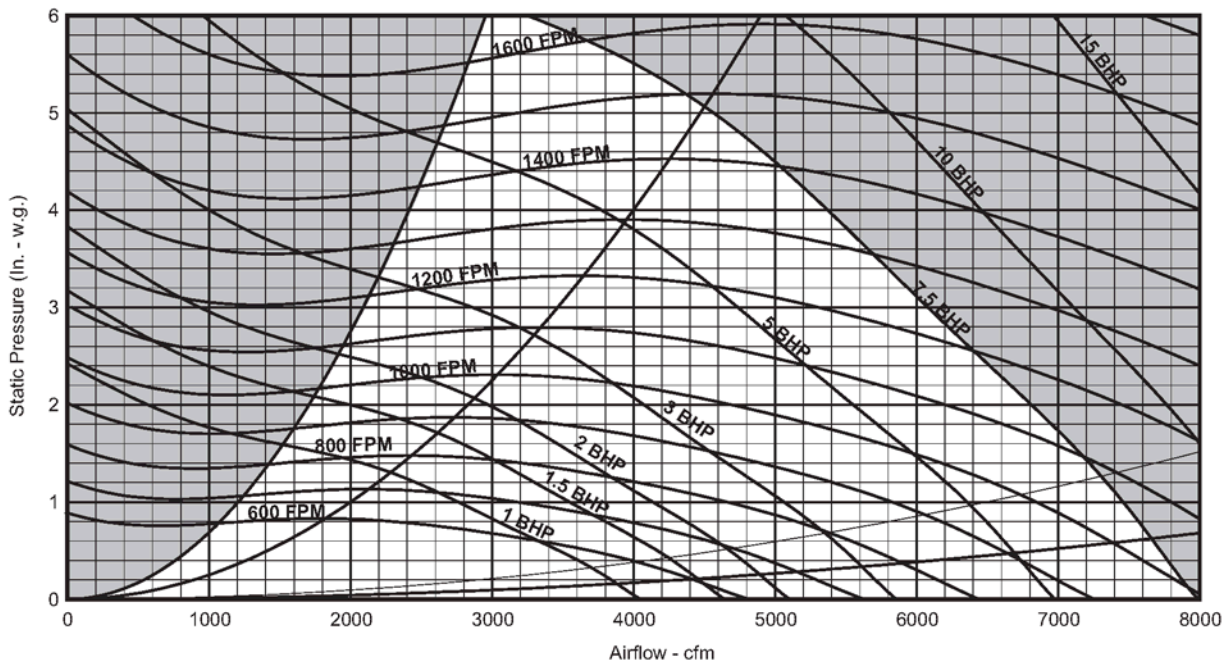
DWDI Supply Fans

Figure 46: RDS 708B supply fan, 15"x6" forward curved fan



■ Do not select

Figure 47: RDS 708B supply fan, 15"x9" forward curved fan



■ Do not select

Figure 48: RDS 708B supply fan, 15"×15" forward curved fan without vanes

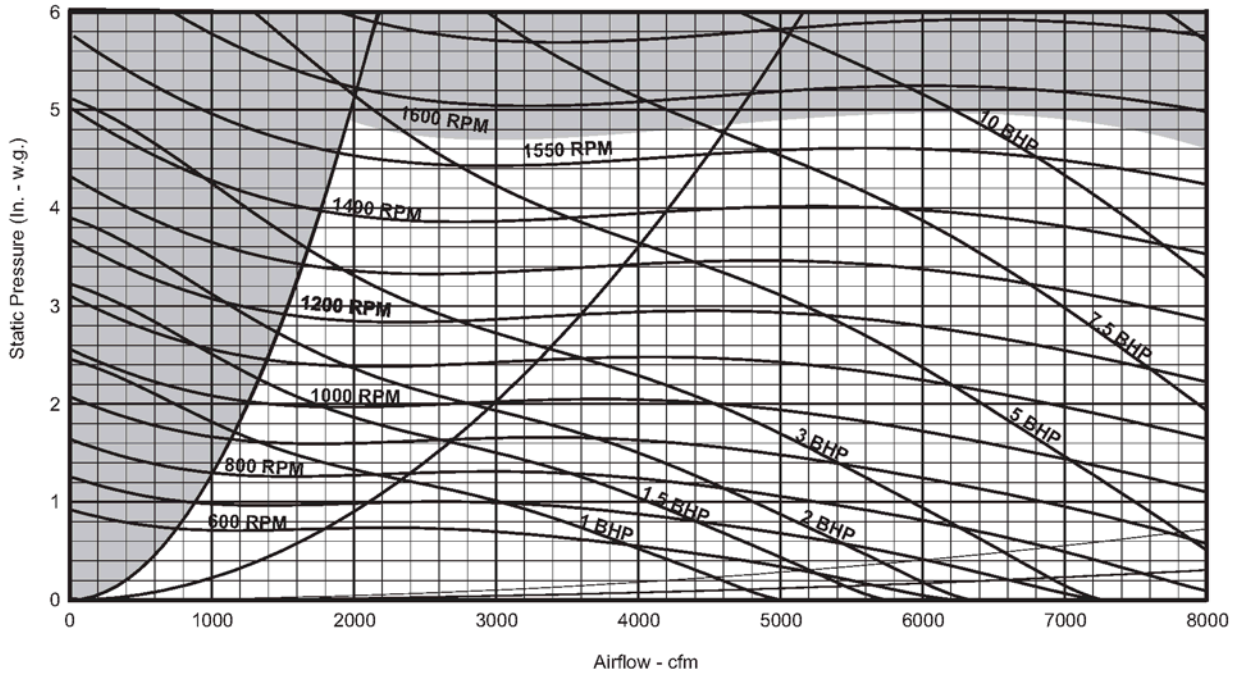


Figure 49: RDS 708B supply fan, 15"×15" forward curved fan with vanes

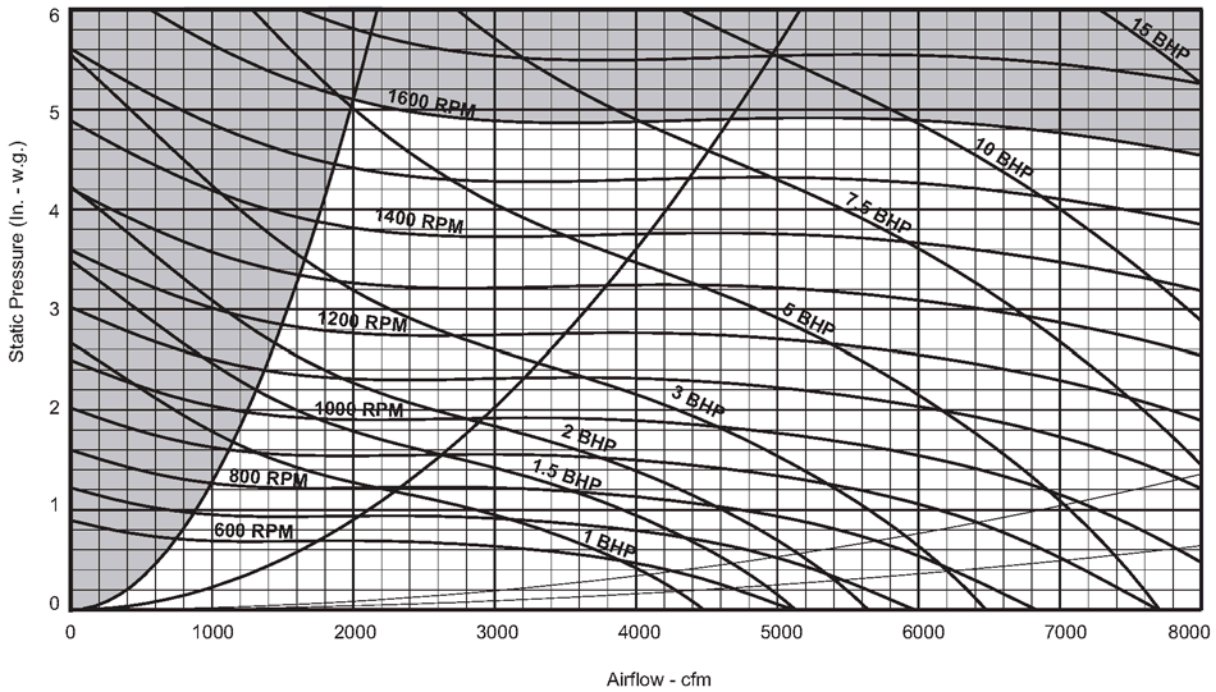


Figure 50: RDS 708B supply fan, 16" airfoil fan without vanes

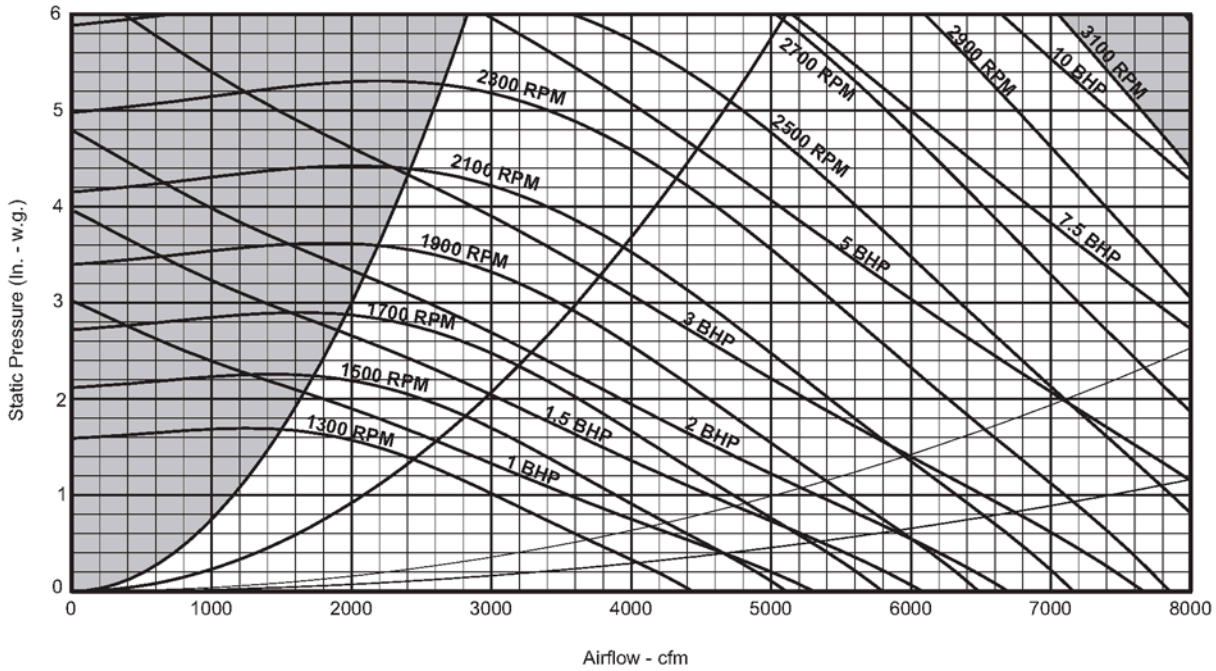


Figure 51: RDS 708B supply fan, 16" airfoil fan with vanes

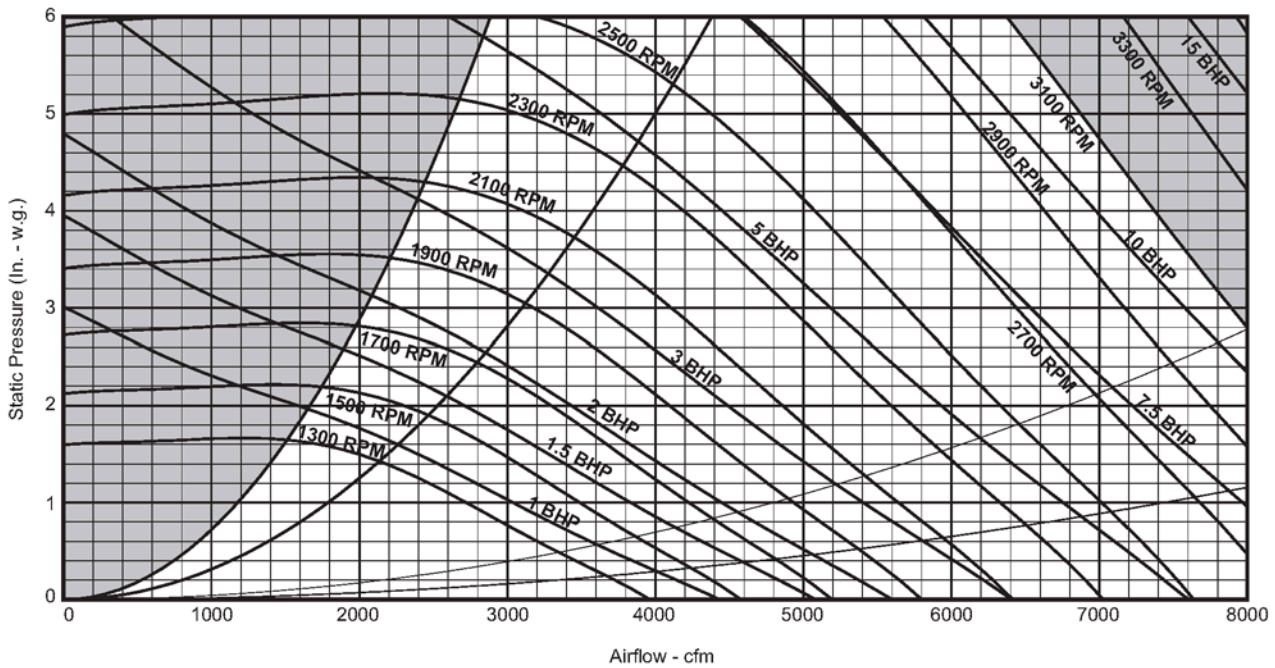


Figure 52: RDS 800C supply fan, (2) 15"×6" forward curved

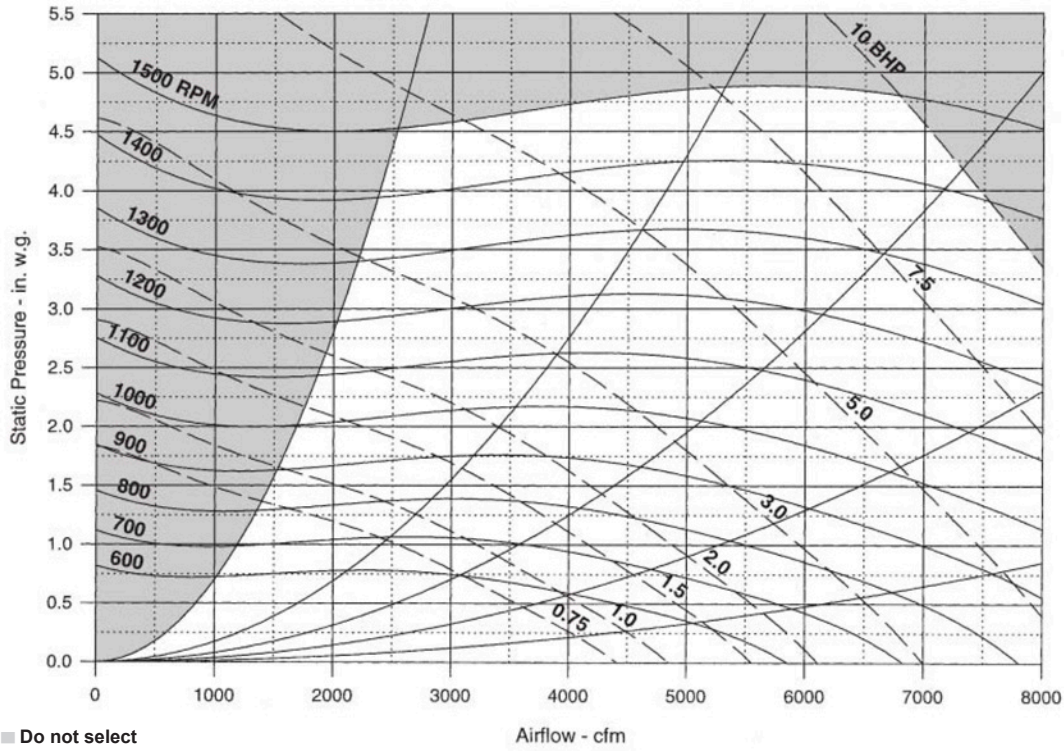


Figure 53: RDS 800C supply fan, (2) 15"×15" forward curved

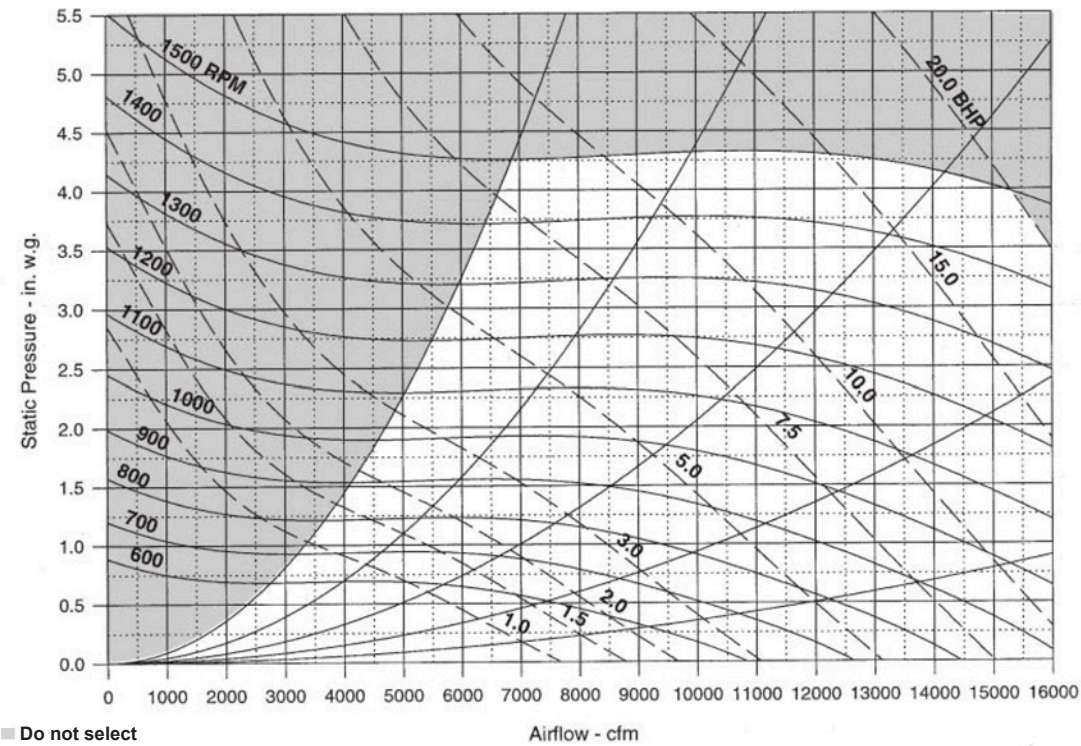
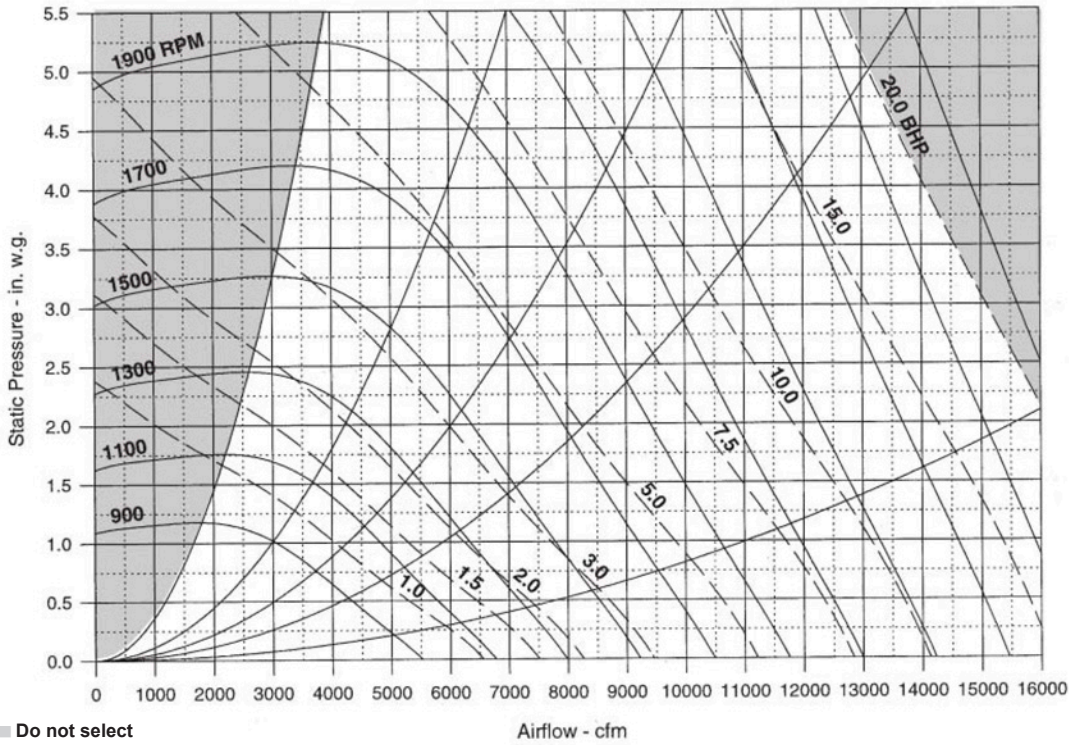
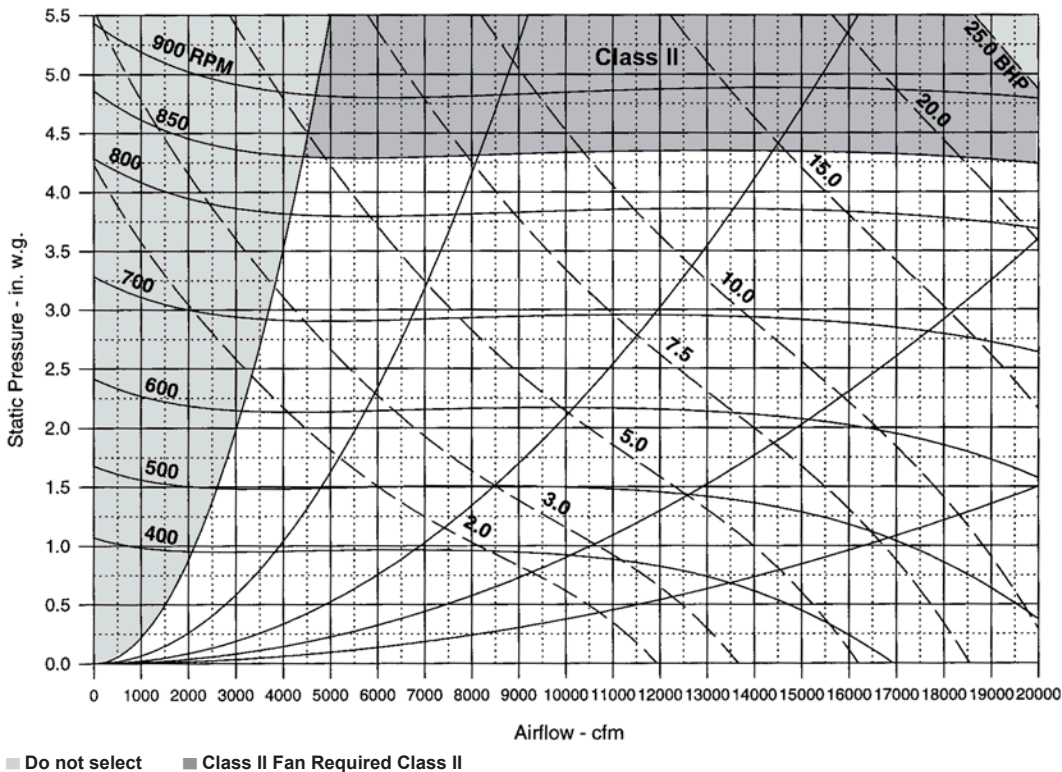


Figure 54: RDS 800C supply fan, 20" airfoil



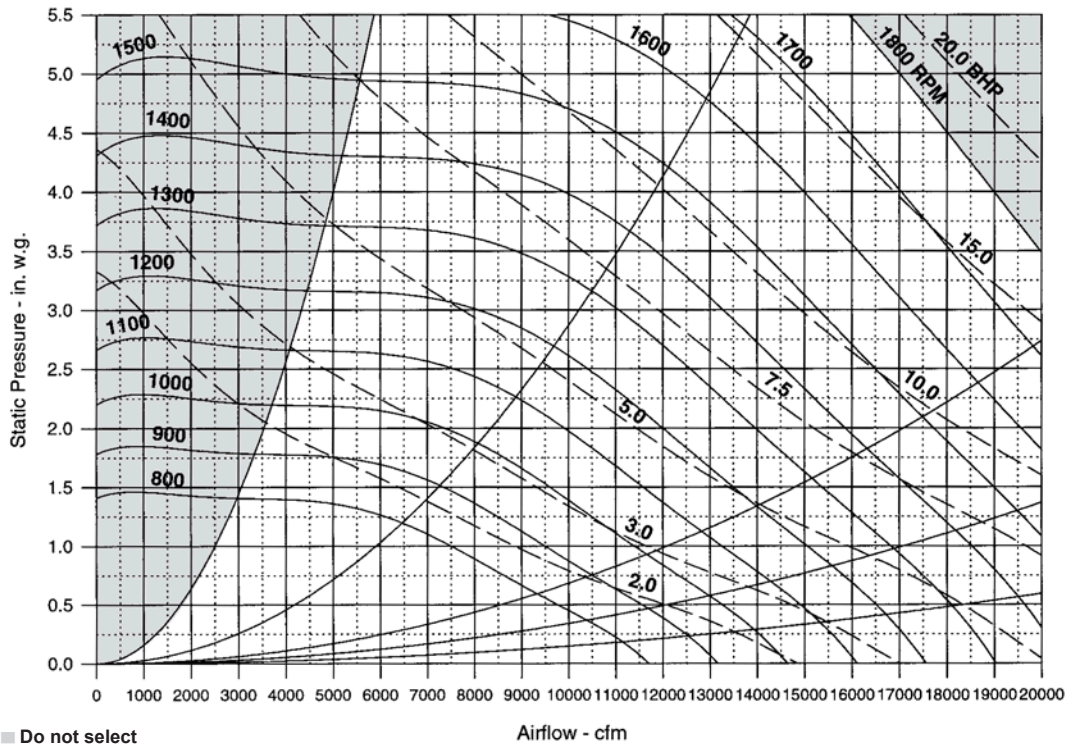
NOTE: Maximum allowable static pressure at fan bulkhead is 5.0 in (i.e., ESP plus blow-through component pressure drops cannot exceed 5.0 in).

Figure 55: RDS 802C supply fan, 24" forward curved fan



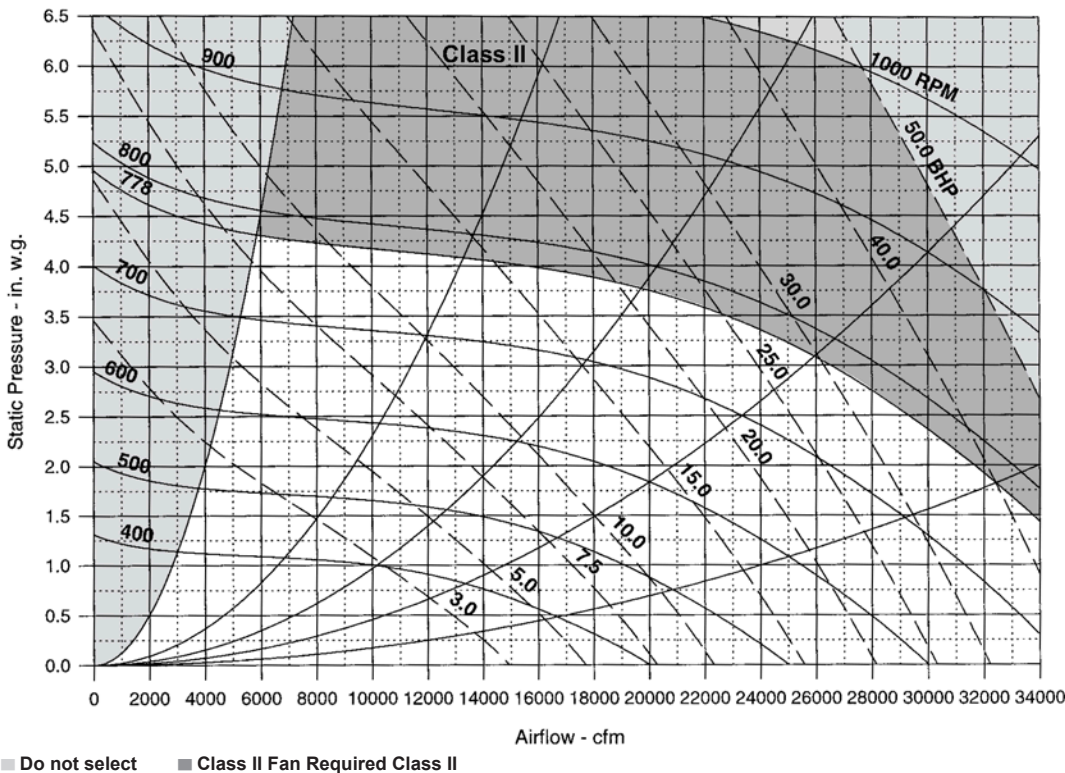
NOTE: Maximum allowable static pressure at fan bulkhead is 5.0 in (i.e., ESP plus blow-through component pressure drops cannot exceed 5.0 in).

Figure 56: RDS 802C supply fan, 24" backward curved fan



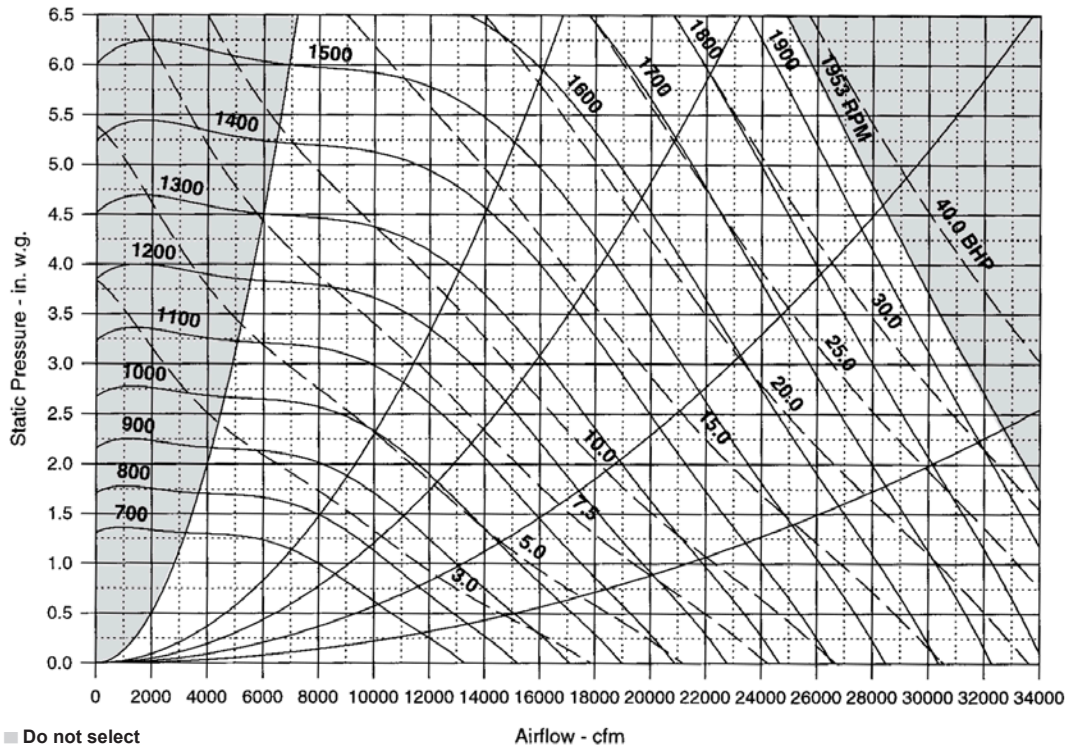
NOTE: Maximum allowable static pressure at fan bulkhead is 5.0 in (i.e., ESP plus blow-through component pressure drops cannot exceed 5.0 in).

Figure 57: RAH 047C, DWDI fan, 27" forward curved Class II



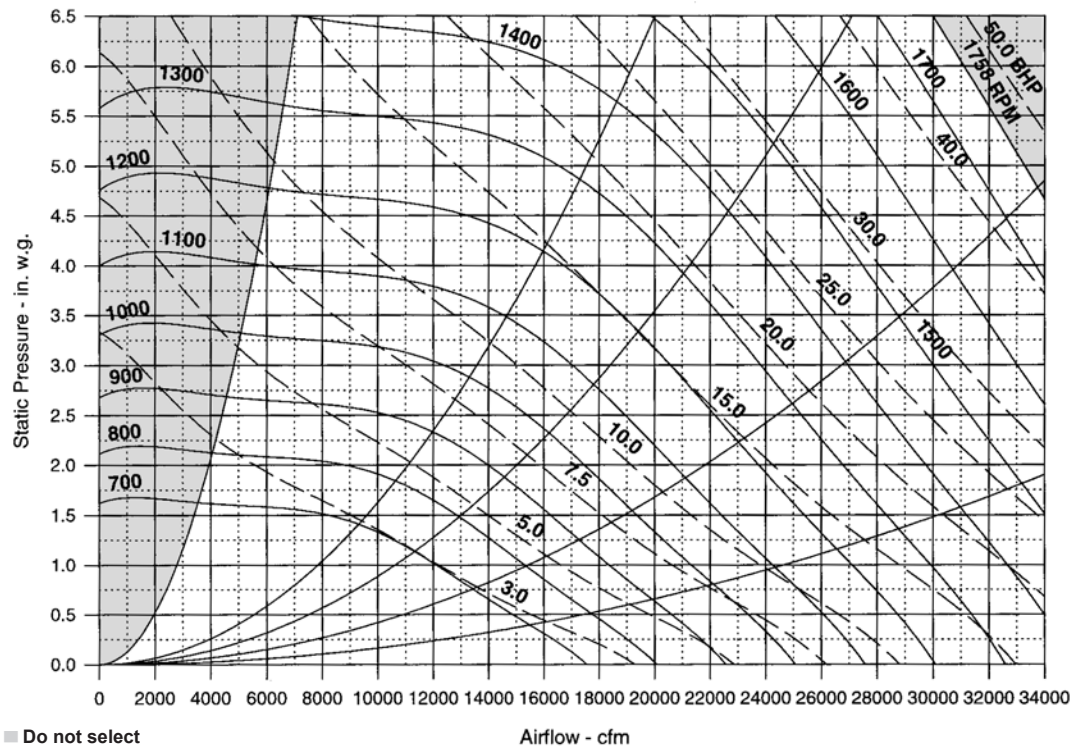
NOTE: Maximum allowable static pressure at fan bulkhead is 5.0 in (i.e., ESP plus blow-through component pressure drops cannot exceed 5.0 in).

Figure 58: RAH 047C, DWDI fan, 27" airfoil



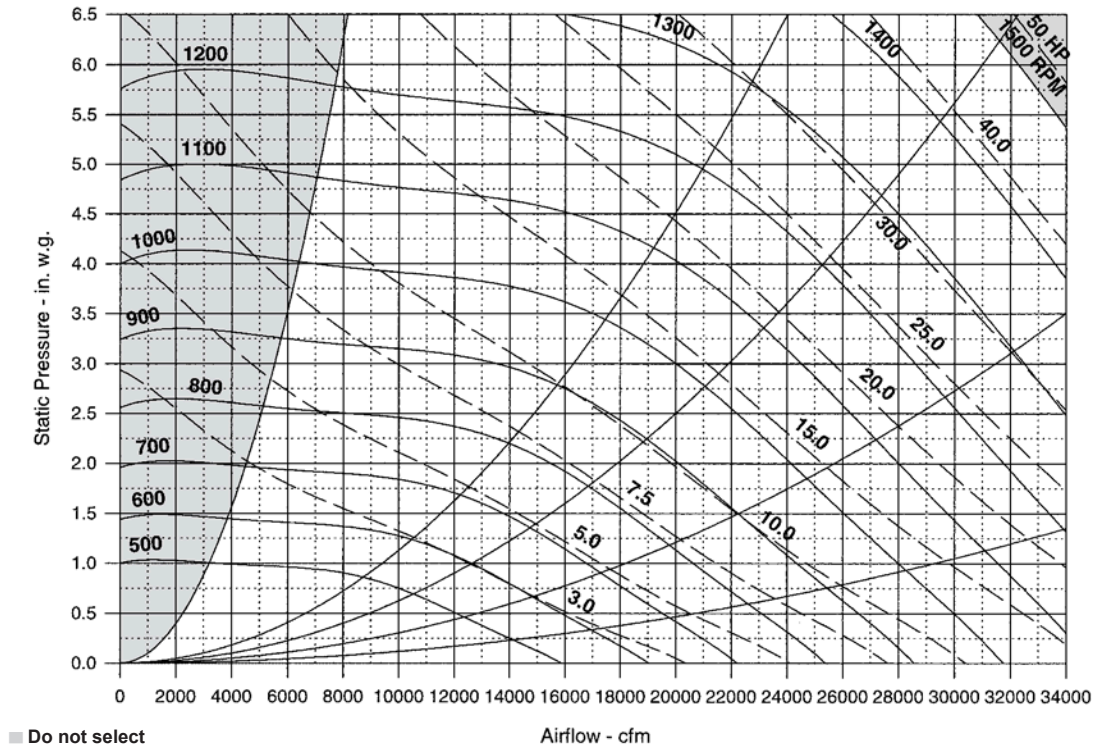
NOTE: Maximum allowable static pressure at fan bulkhead is 5.0 in (i.e., ESP plus blow-through component pressure drops cannot exceed 5.0 in).

Figure 59: RAH 047C, DWDI fan, 30" airfoil



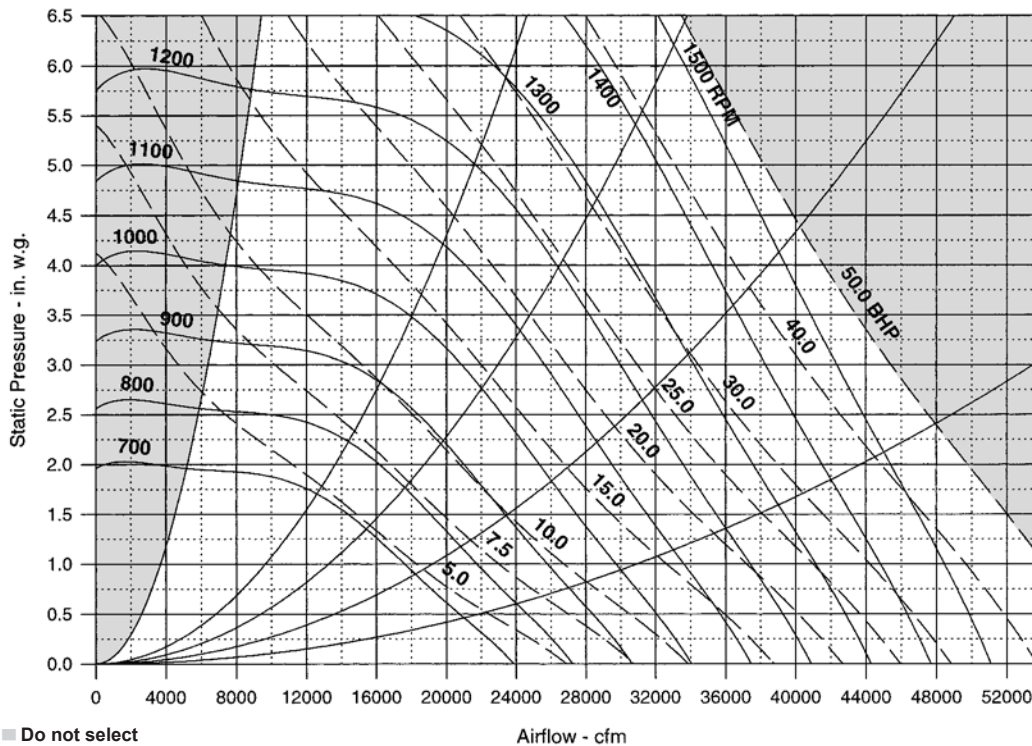
NOTE: Maximum allowable static pressure at fan bulkhead is 5.0 in (i.e., ESP plus blow-through component pressure drops cannot exceed 5.0 in).

Figure 60: RAH 047C, DWDI fan, 33" airfoil



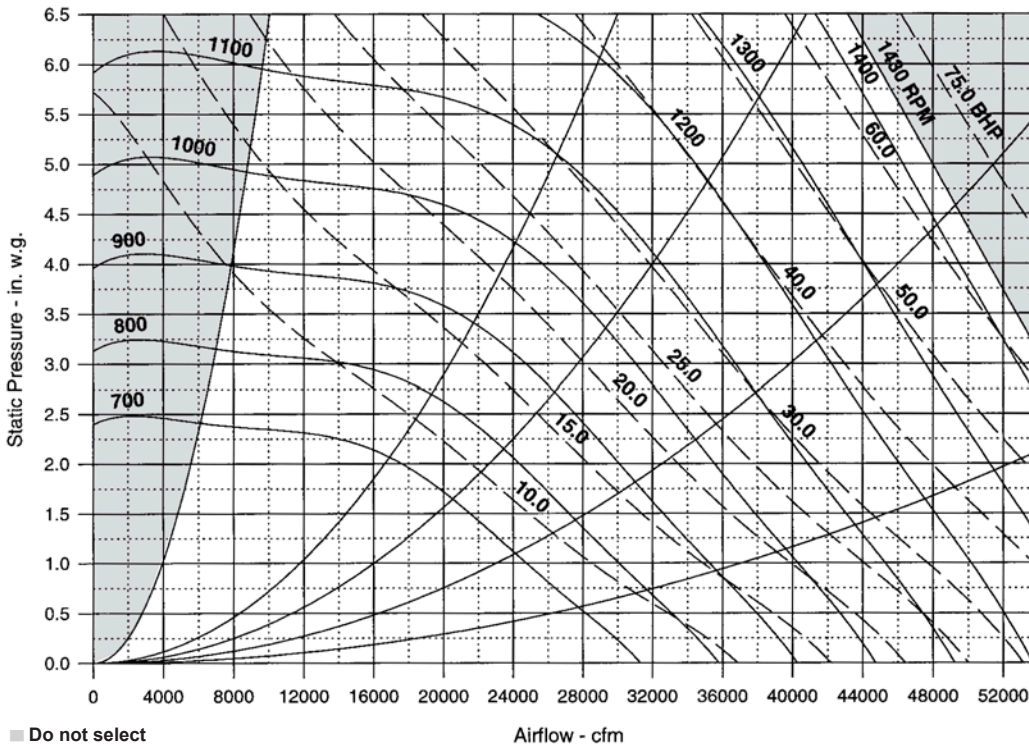
NOTE: Maximum allowable static pressure at fan bulkhead is 5.0 in (i.e., ESP plus blow-through component pressure drops cannot exceed 5.0 in).

Figure 61: RAH 077C DWDI fan, 33" airfoil



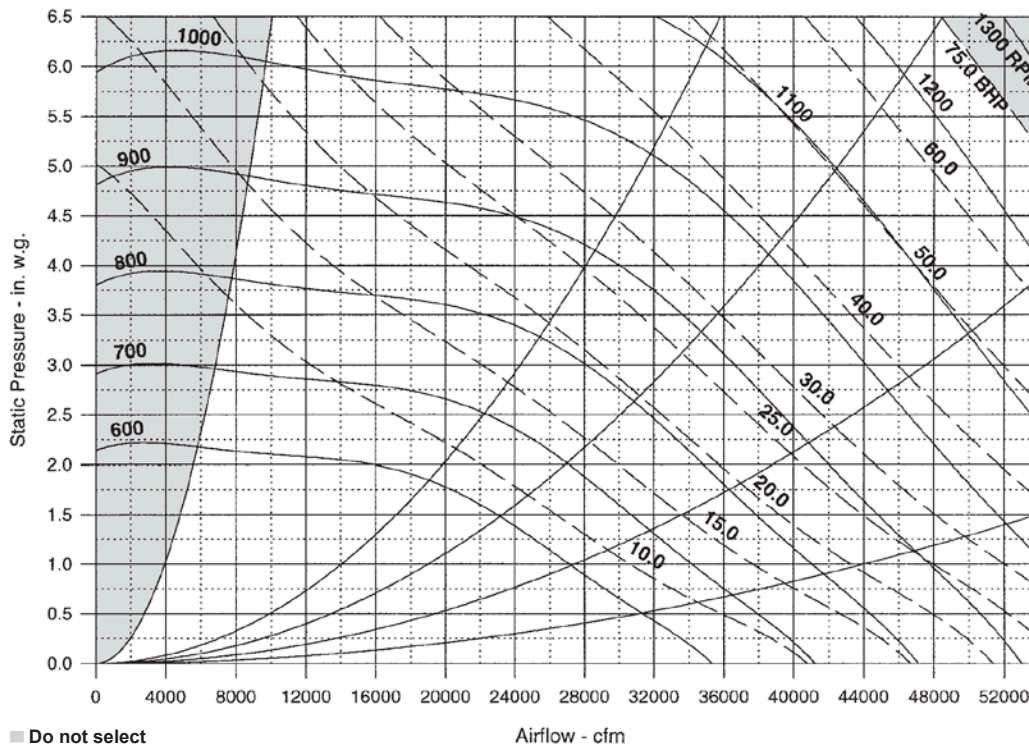
NOTE: Maximum allowable static pressure at fan bulkhead is 5.0 in (i.e., ESP plus blow-through component pressure drops cannot exceed 5.0 in).

Figure 62: RAH 077C, DWDI fan, 36" airfoil



NOTE: Maximum allowable static pressure at fan bulkhead is 5.0 in (i.e., ESP plus blow-through component pressure drops cannot exceed 5.0 in).

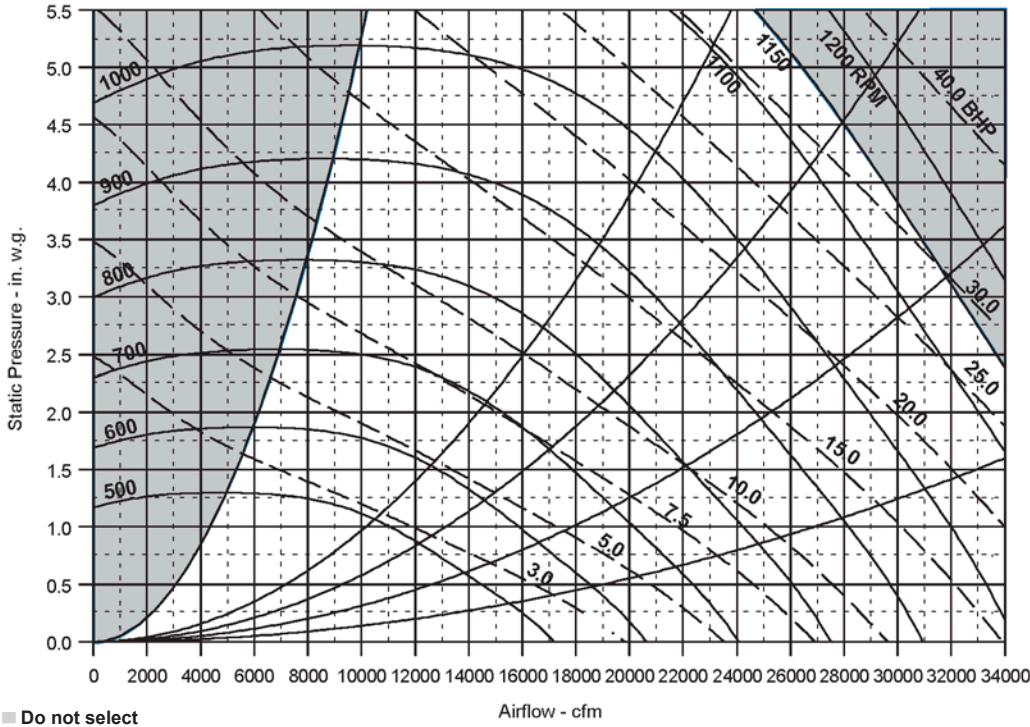
Figure 63: RAH 077C, DWDI fan, 40" airfoil



NOTE: Maximum allowable static pressure at fan bulkhead is 5.0 in (i.e., ESP plus blow-through component pressure drops cannot exceed 5.0 in).

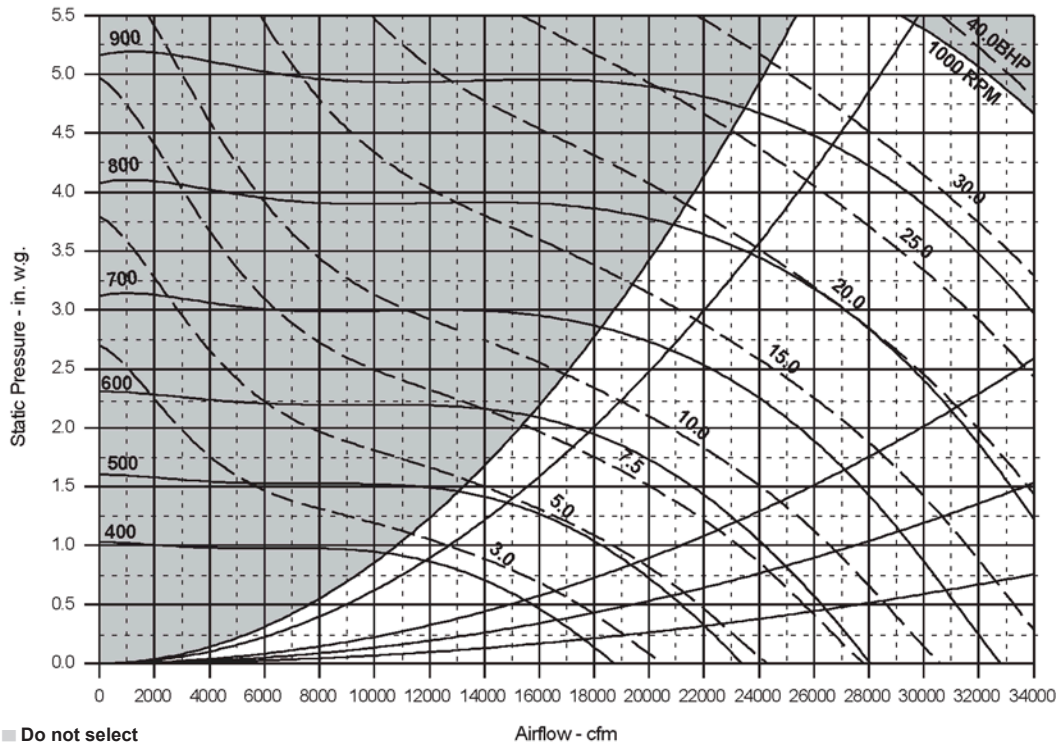
SWSI Supply Fans

Figure 64: RAH 047C, SWSI fan, 40" airfoil



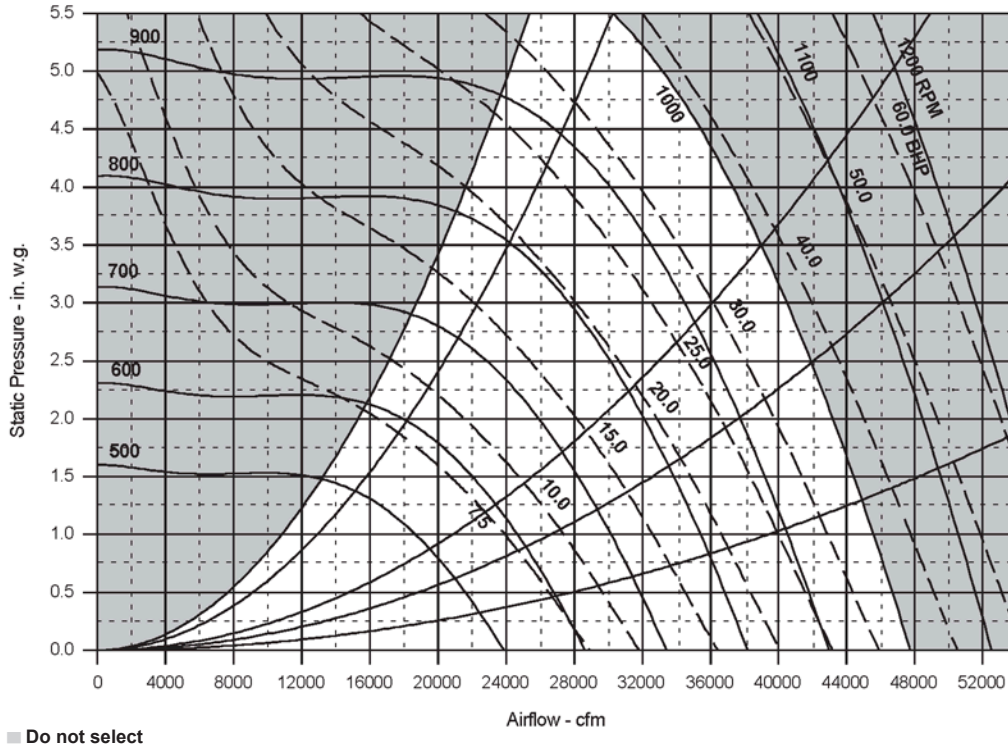
NOTE: Maximum allowable static pressure at fan bulkhead is 5.0 in (i.e., ESP plus blow-through component pressure drops cannot exceed 5.0 in).

Figure 65: RAH 047C, SWSI fan, 44" airfoil



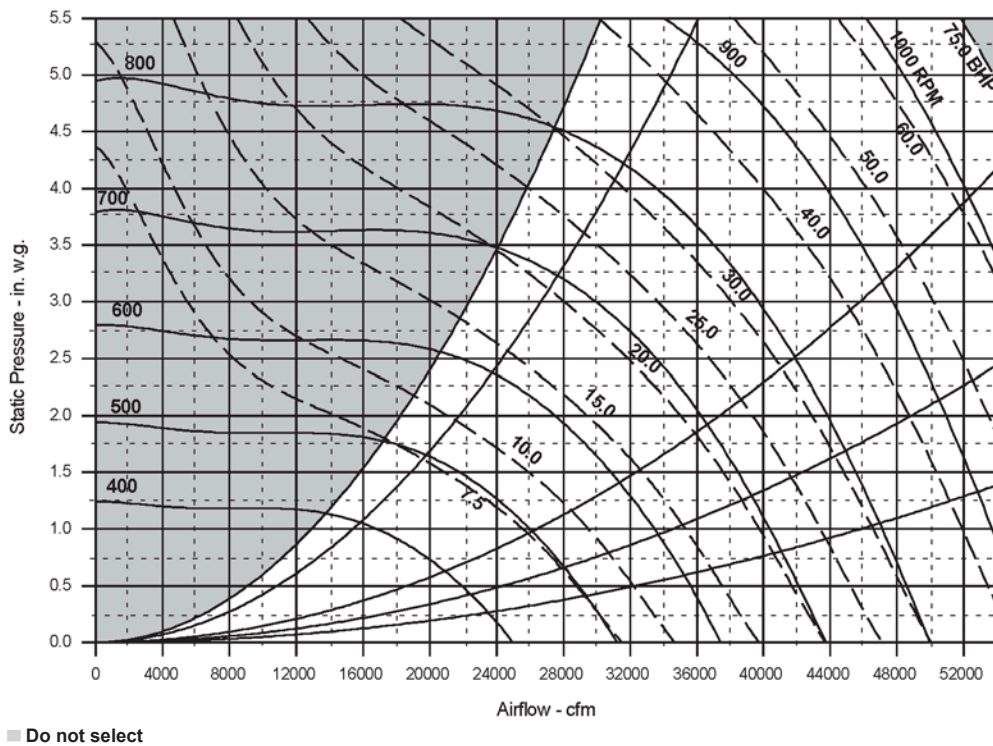
NOTE: Maximum allowable static pressure at fan bulkhead is 5.0 in (i.e., ESP plus blow-through component pressure drops cannot exceed 5.0 in).

Figure 66: RAH 077C, SWSI fan, 44" airfoil



NOTE: Maximum allowable static pressure at fan bulkhead is 5.0 in (i.e., ESP plus blow-through component pressure drops cannot exceed 5.0 in).

Figure 67: RAH 077C, SWSI fan, 49" airfoil



NOTE: Maximum allowable static pressure at fan bulkhead is 5.0 in (i.e., ESP plus blow-through component pressure drops cannot exceed 5.0 in).

Propeller Exhaust Fans

Figure 68: RAH 047C (1) 36" propeller exhaust fan

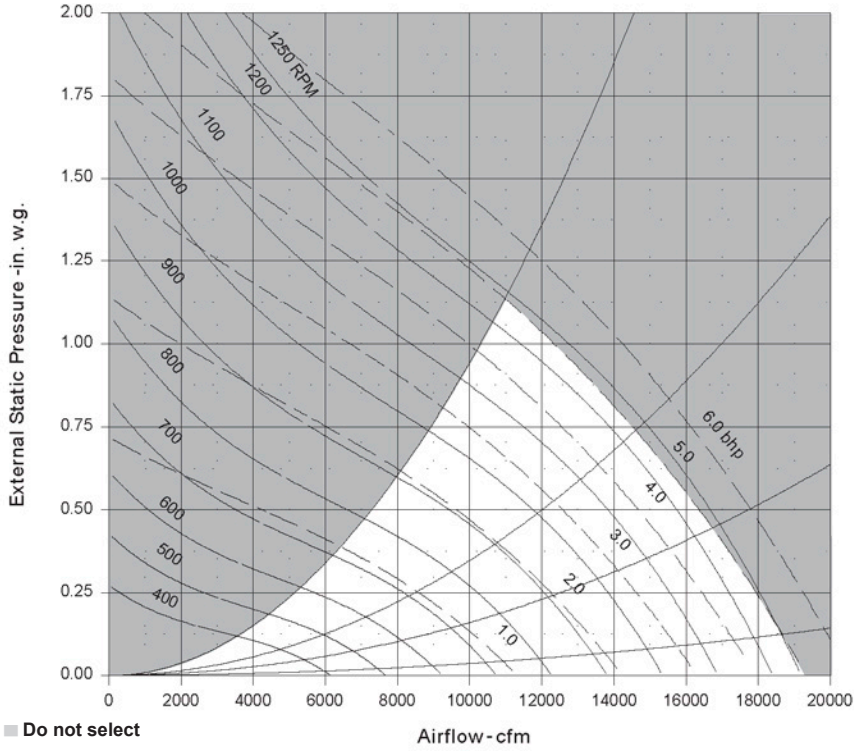


Figure 69: RAH 047C and 077C (2) 36" propeller exhaust fan

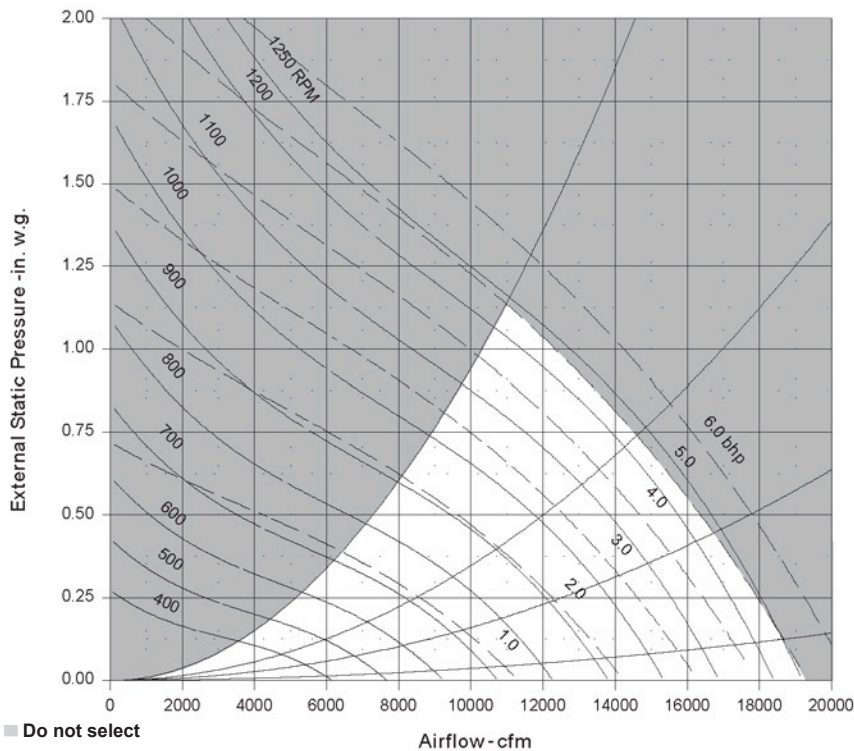
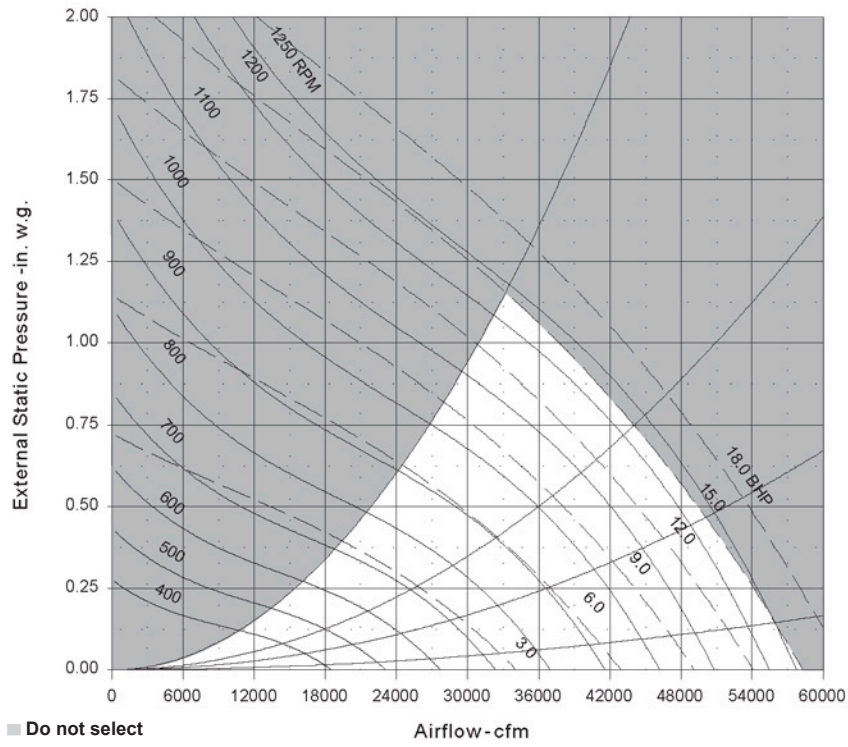


Figure 70: RAH 077C (3) 36" propeller exhaust fan



Return Fans

Figure 71: RDS 708B 15"×15" forward curved return fan without vanes

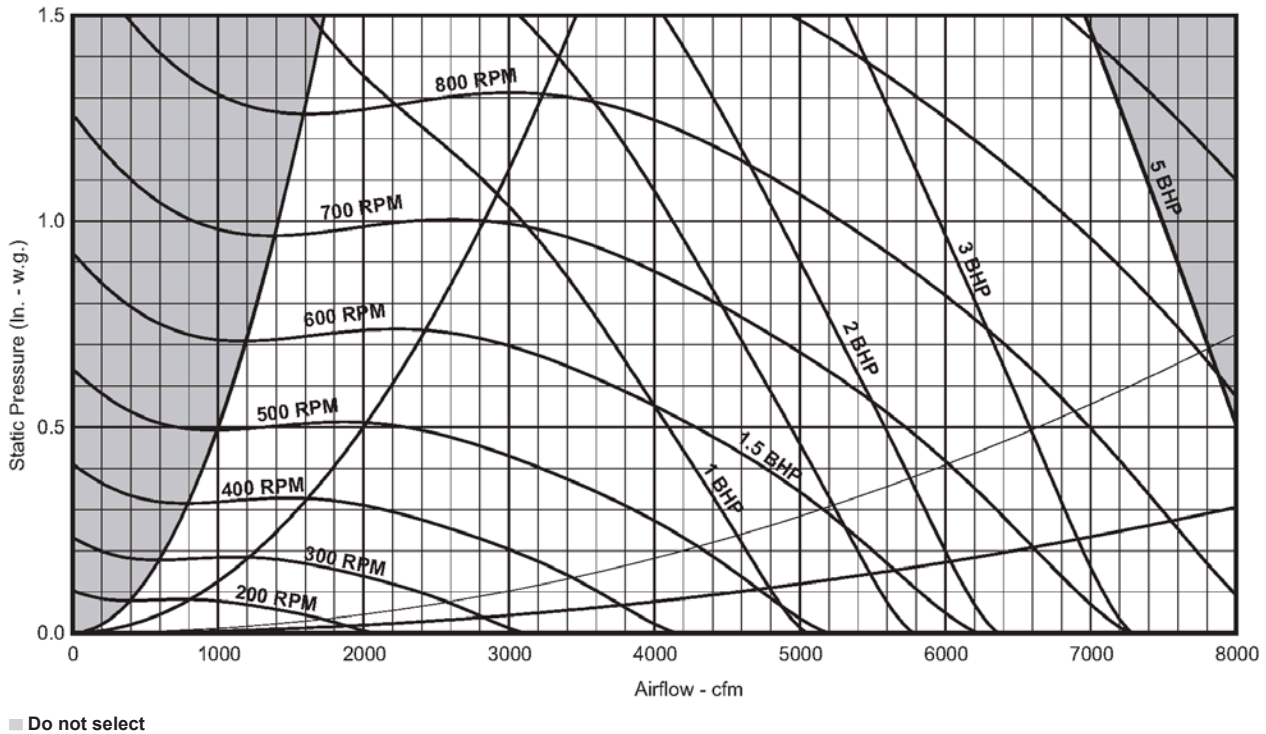


Figure 72: RDS 708B 15"×15" forward curved return fan with vanes

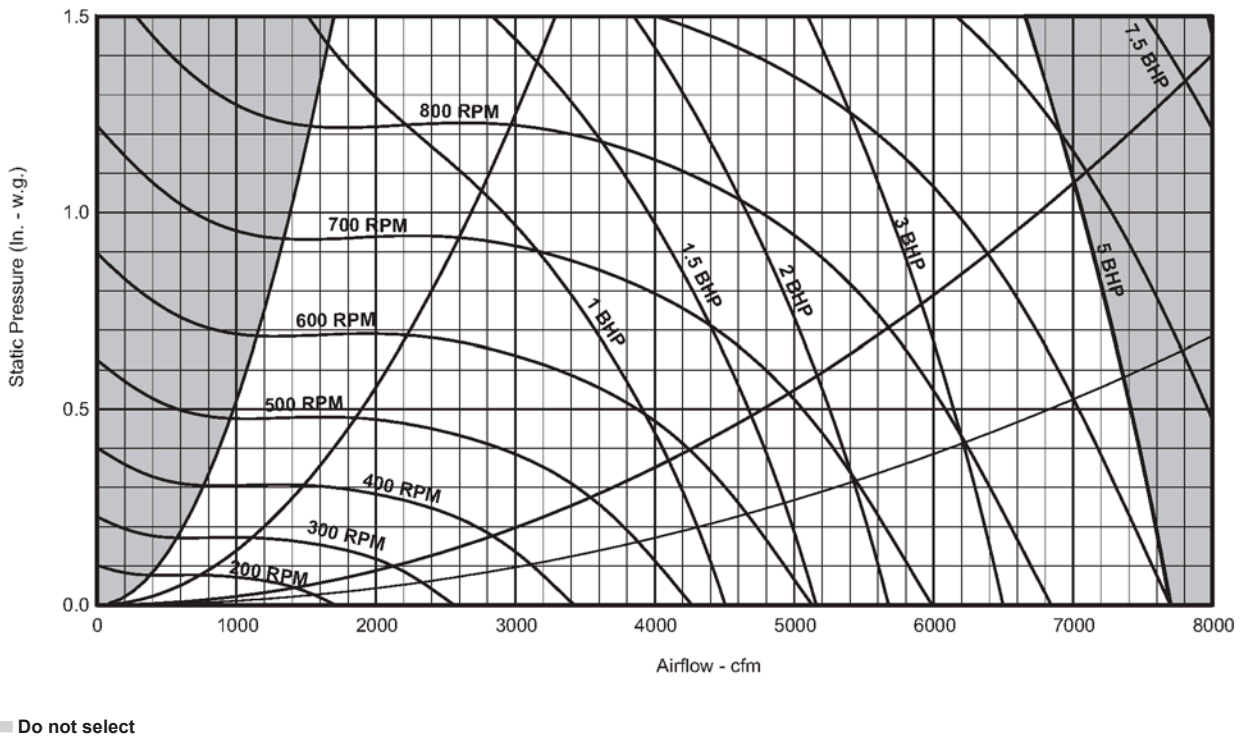


Figure 73: RDS 708B 16" airfoil fan without vanes

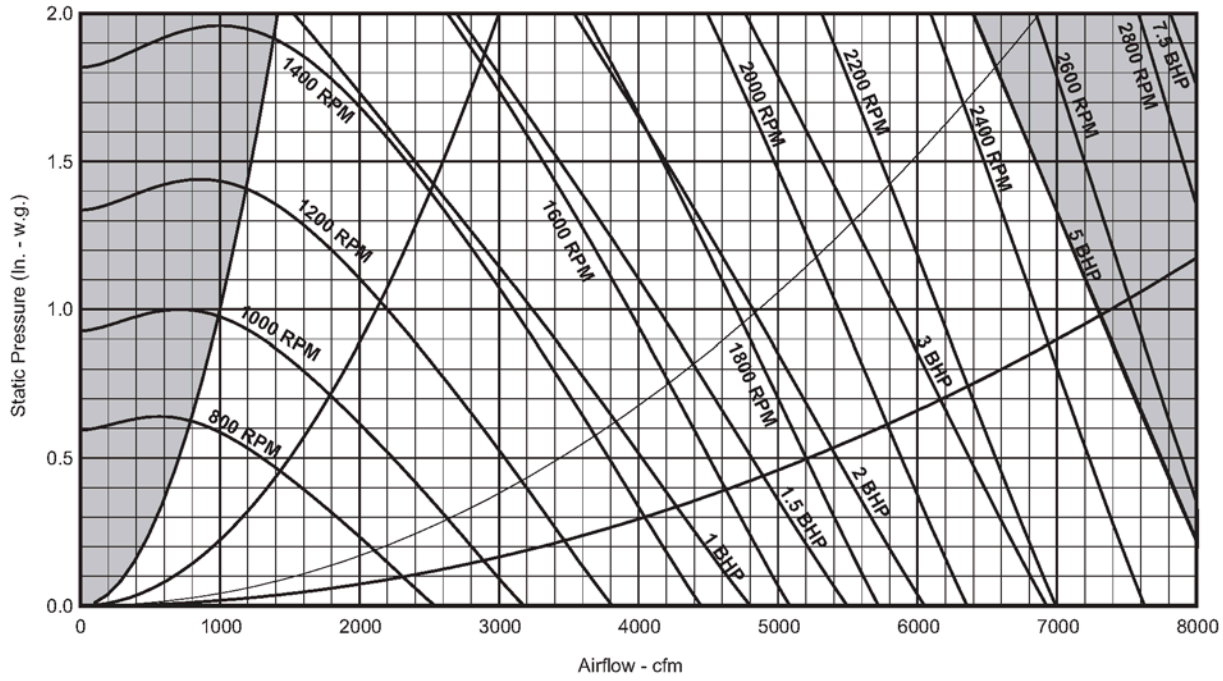


Figure 74: RDS 708B 16" airfoil fan with vanes

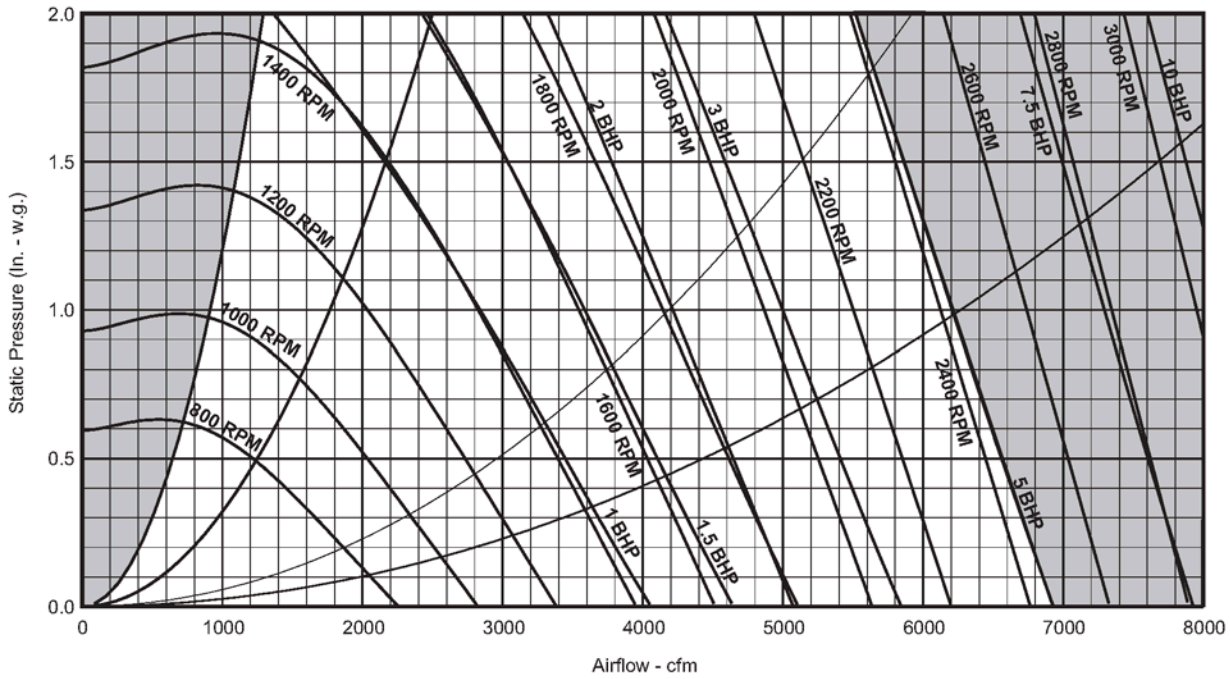
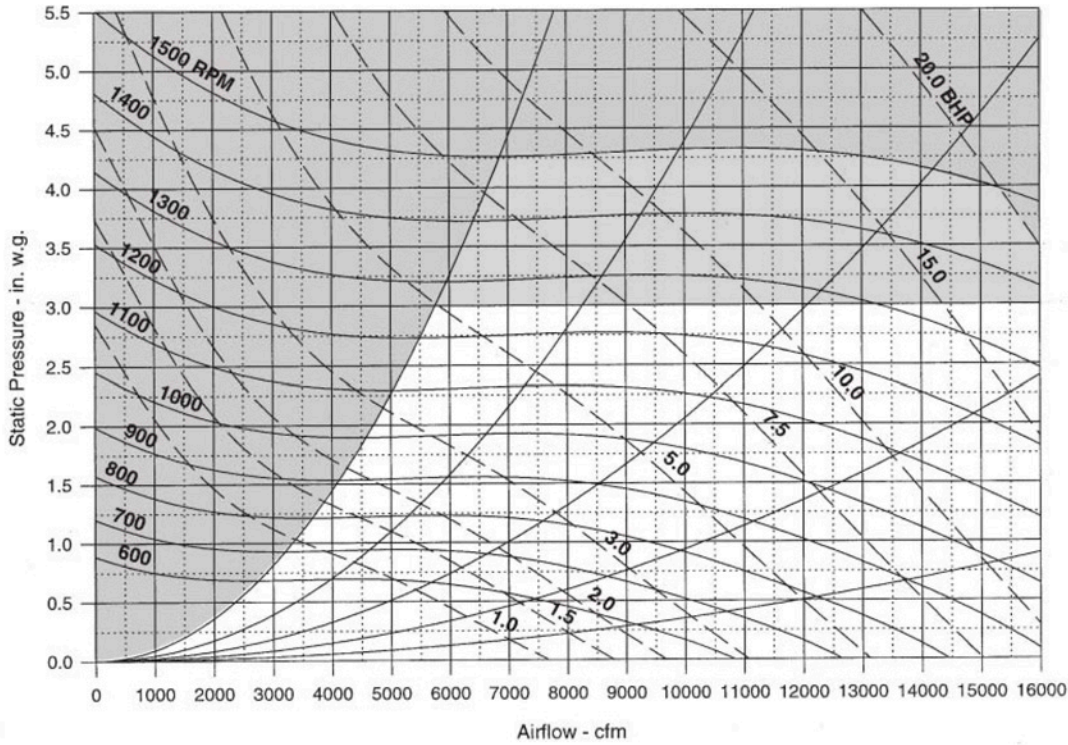


Figure 75: RDS 800C (2) 15" x 15" forward curved return fan



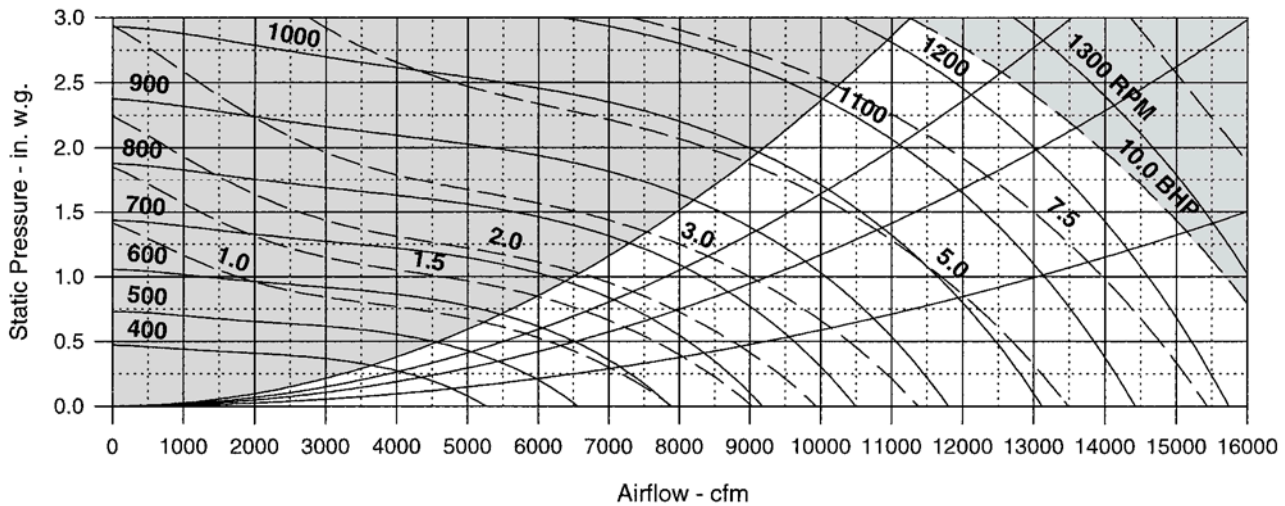
Do not select Class II Fan Required Class II
 *Fan curve applicable for bottom return. Back return corrections are listed below.

Back return performance correction. For 30" airfoil fan Table 35 Additional back return static pressure, 30" with back return, add the following static pressure drop to the airfoil return fan design return duct static pressure drop. Enter Figure 75 at this greater static pressure and the design airflow to determine actual back return performance.

Table 35: Additional back return static pressure, 30" airfoil return fan

Airflow (cfm)	4,000	6,000	8,000	10,000	12,000	14,000
Back return SP (in wg)	0.05	0.12	0.21	0.33	0.48	0.65

Figure 76: RDS 800C and 802C, 30" airfoil return fan (bottom return*)



Do not select

Figure 77: RDS 802C, 40" airfoil return fan

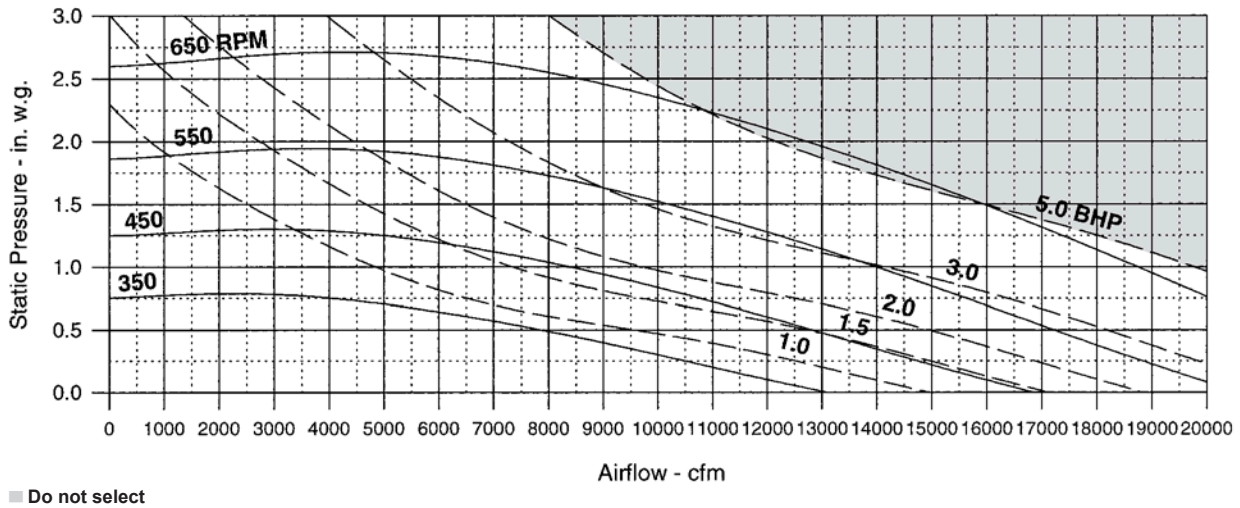


Figure 78: RAH 047C, SWSI fan, 40" airfoil

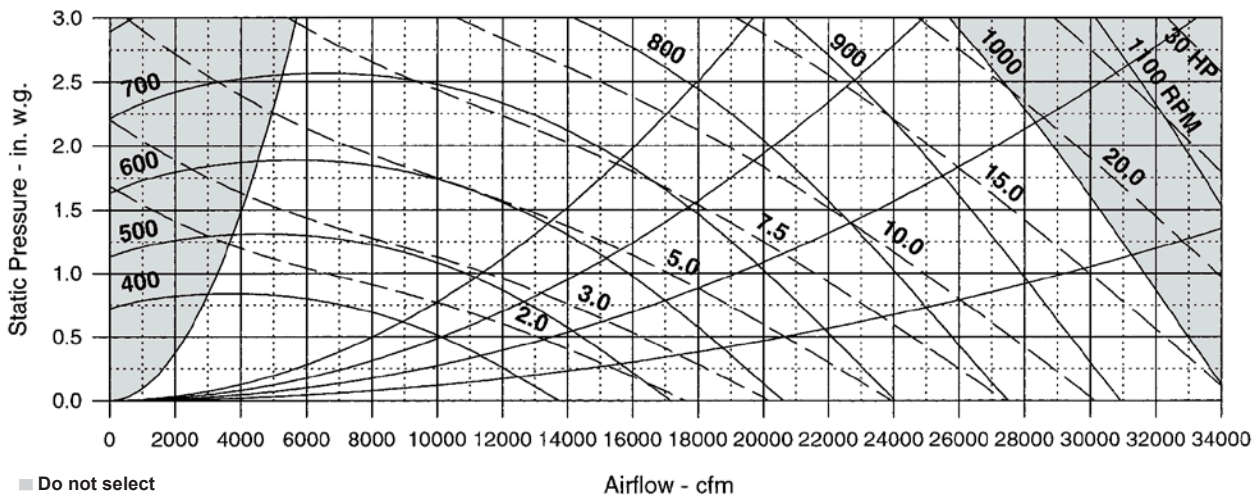
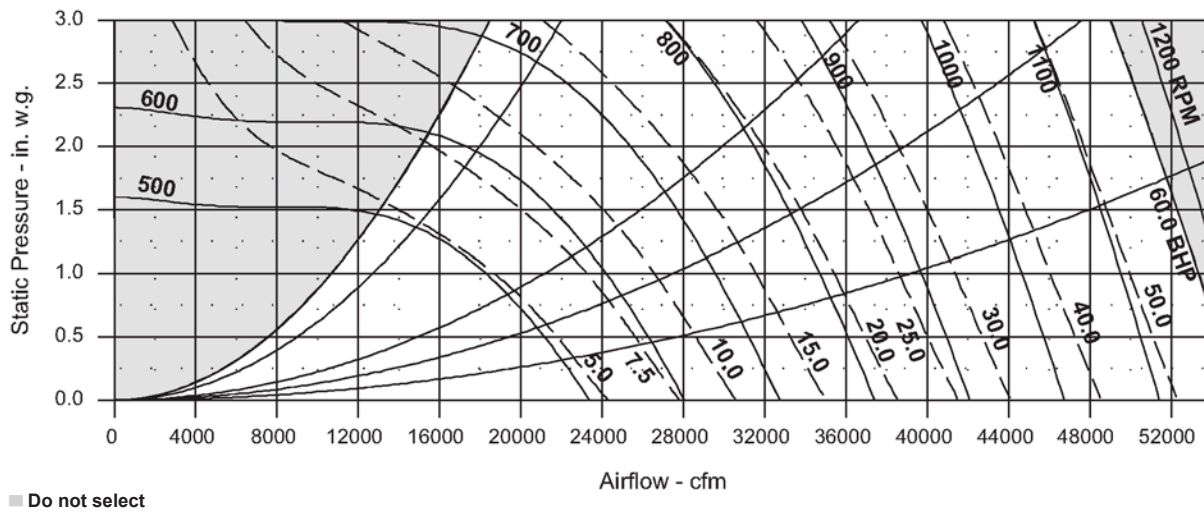


Figure 79: RAH 077C SWSI fan, 44" airfoil



Section Options and Locations—RDS 708B

The figures below show section options, curb lengths, and relative positions. Curb lengths (in inches) are shown below each icon.

Figure 80: RDS 708B


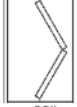

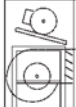






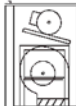

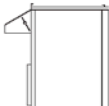
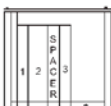
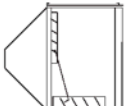


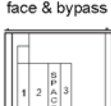

Position A Outdoor Return Air	Position B Filter	Position C Heat/Cool	Position D Supply Air Fan	Position E Blank	Position F Final Filter*	Position G Discharge Plenum
Outdoor air hood  0"	Angular  33"	Drain pan only  48"	Front discharge  33"	Blank access  33"	Cartridge  33"	Discharge plenum  33"
Return plenum  33"	Cartridge  33"	Short coil  48"	Down discharge  33"		Blank access  33"	
30% outside air  33"		Long coil  48"				
Mixing box  33"		Short coil with face & bypass  48"				
Economizer  66"		Long coil with face & bypass  48"		*When Final Filter section is provided, a Blank section (Position E) and a Discharge Plenum (Position G) are required.		
Economizer with return air fan  66"						

Figure 81: Section diagram

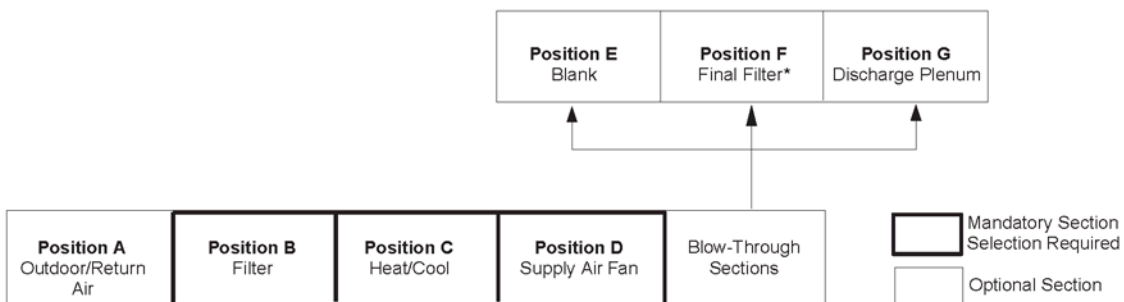


Figure 82: Typical basic unit

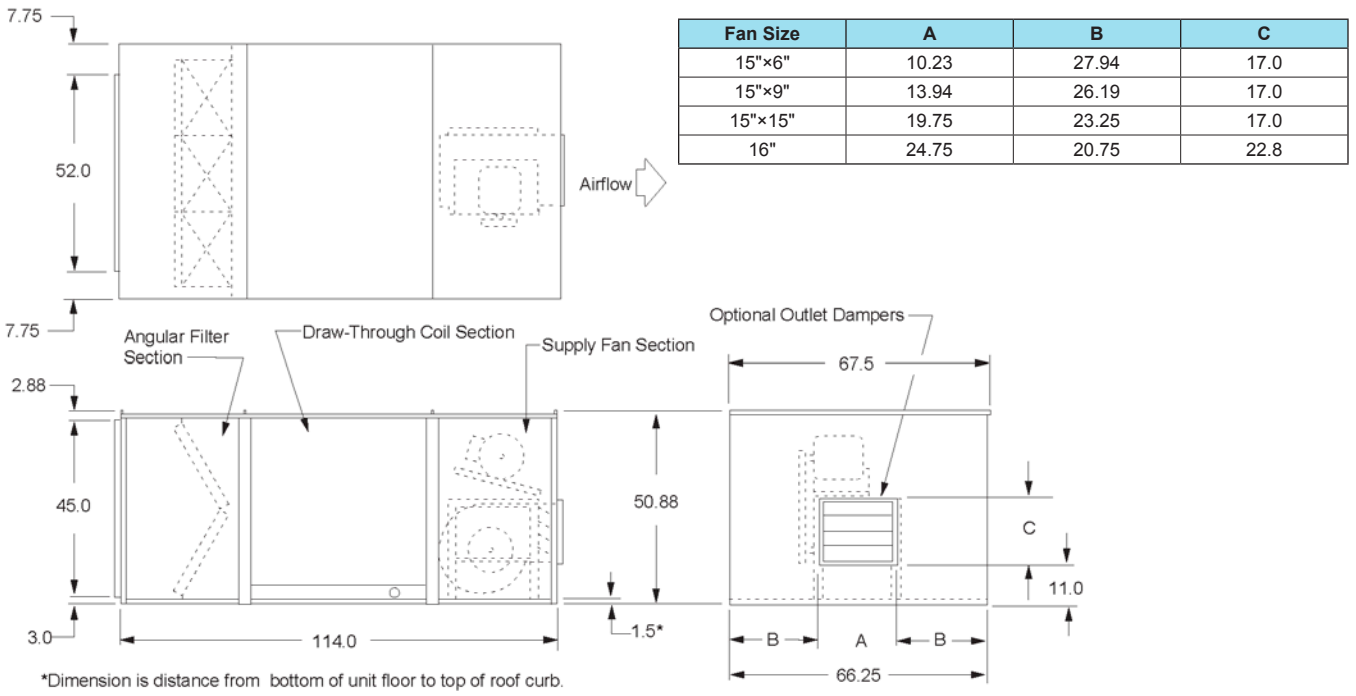
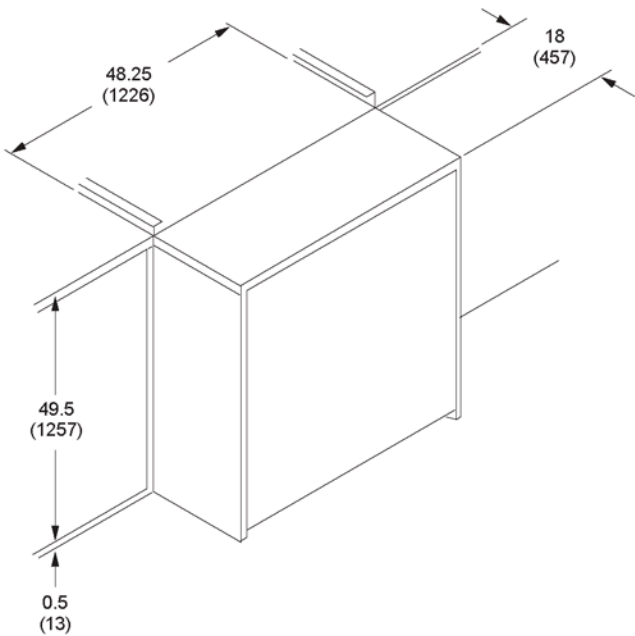


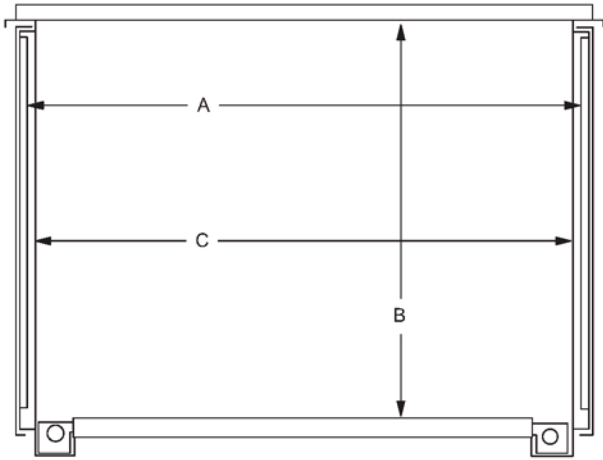
Figure 83: Field-installed coil piping vestibule detail



Note: Vestibule required for 48" long coil with piping entering within the curb and recommended for piping entering the side of the unit.

Blank Access and Drain Pan Only Section Detail—RDS 708B

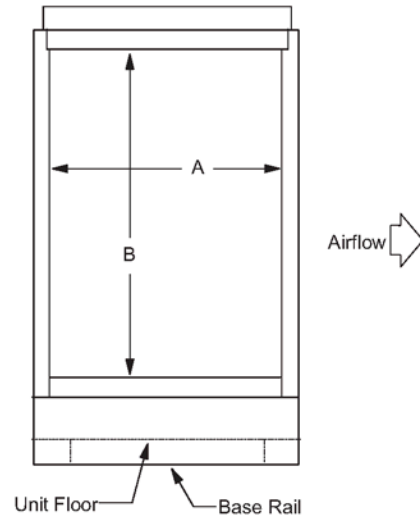
Figure 84: Cross section detail



A	B	C
63.5	45.0	62.0

- A = Door-to-door (with liners)
- B = Ceiling-to-floor (with liners)
- C = Upright-to-upright, located between sections

Figure 85: Access door detail

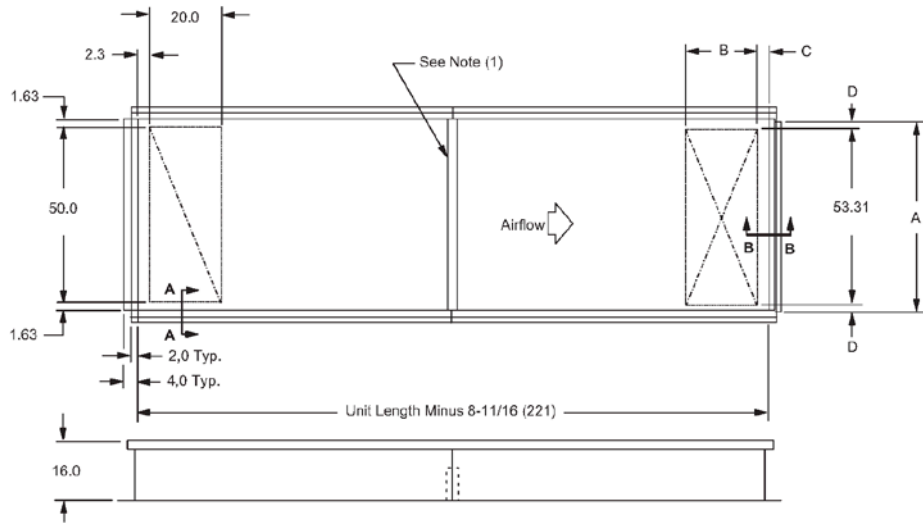


Cabinet Height	Door Opening	
	A	B
50.88	42.0	45.0

Note: Heat/Coil section access opposite to drain connection.

Roof Curbs—RDS 708B

Figure 86: Roof curb knockouts



Discharge air opening	A	B	C	D
Discharge plenum	50.0	20.0	2.13	1.63
Down discharge fan 15" × 6"	10.38	17.0	0.75	21.44
Down discharge fan 15" × 9"	13.94	17.0	0.75	19.69
Down discharge fan 15" × 15"	19.75	17.0	0.75	16.75
Down discharge fan 16"	24.75	22.8	5.62	14.28

Note: 1. Support provided on units 180" (4572 mm) in length or greater.
 2. Curb must be installed level.

Figure 87: Curb cross section A-A

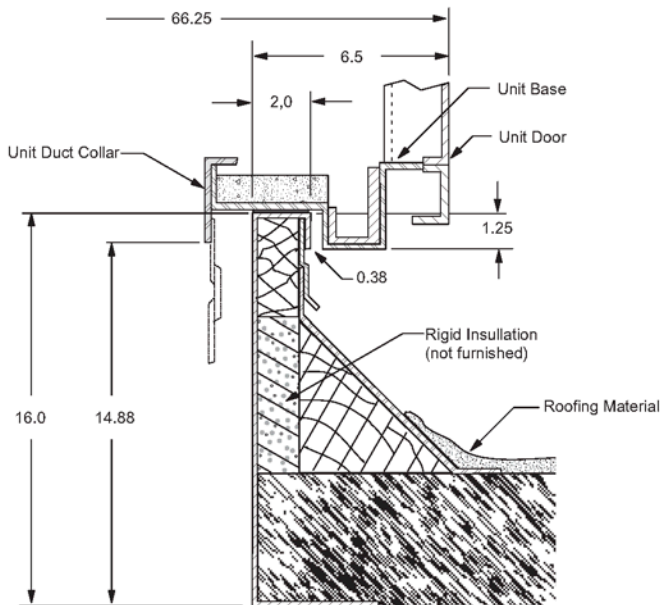
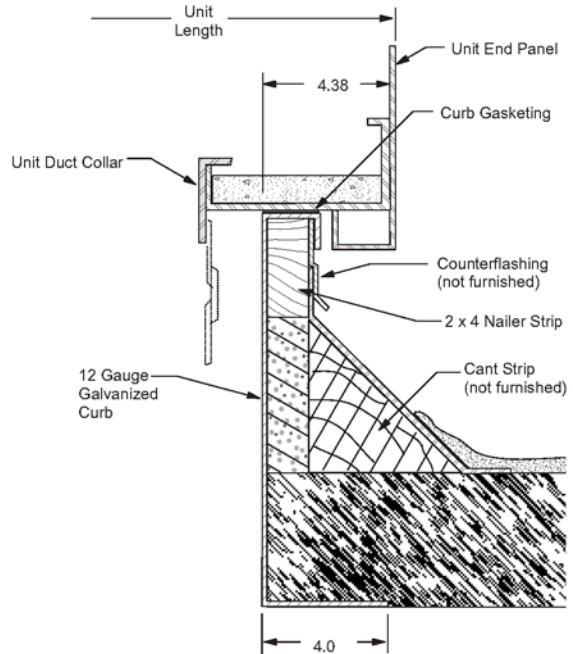


Figure 88: Curb cross section B-B



Application Considerations—RDS 800C and 802C

Unit Coils

- Unit cooling coils are available in either direct expansion or chilled water type and can be located in the Heat/ Cool sections, position D and I (and in the Draw-through Cooling/ Supply Air Fan section, position F on the RDS 800).
- Unit chilled water coils are available with or without a factory-installed control valve when provided without a combination heating coil.
- Unit heating coils are available in either steam or hot water type and can be located in the Heat/Cool sections, positions D and I or the Heat sections, positions E and G.
- Unit heating coils are available with or without a factory-installed control valve in the Heat sections, positions E and G.

Contractor Coils

- Contractor coils are available in direct expansion, chilled water, steam and hot water type and are located in the Heat/ Cool sections, positions D and I.
- Contractor coils are available with or without factory-installed face and bypass dampers less actuator.

Electric Heat

- Electric heating coils are located in the Blow-through Heat section, position G only.

Gas Heat

- A gas heating furnace is located in the Blow-through Heat section, position G only.

Final Filters

- Final filters are not available with a drain pan only or any option with a cooling coil located in the Blow-through Heat/ Cool section, position I.

Blank Access Compartment

- The blank access compartment is available on units with a discharge plenum in position K with bottom or side discharge only.

General

- When any section is located in position H (Blank Access section), I (Blow-through Heat/Cool section) or J (Final Filter section), a heating or blank section must be placed in position G to provide proper airflow diffusion for the sections that follow the supply air fan.

Section Options and Locations—RDS 800C

The figures show section options, curb lengths, and relative positions. Curb lengths (in inches) are shown below each icon.

Figure 89: RDS 800C






































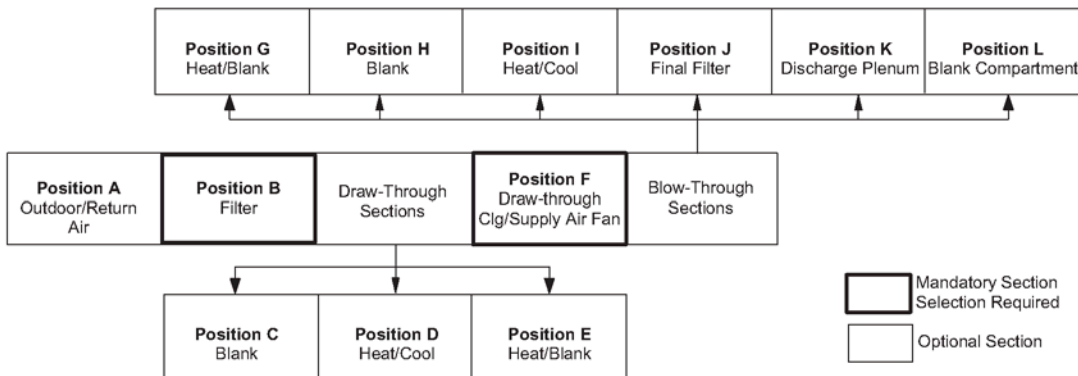
Position A	Position B	Position C	Position D	Position E	Position F	Position G	Position H	Position I	Position J	Position K	Position L
OA/RA	Filter	Blank	Draw-thru Heat/Cool	Heat/Blank	Supply Air Fan	Heat/Blank	Blank	Blow-thru Heat/Cool	Final Filter	Discharge Plenum	Blank Comp.
 0"	 22"	 40"	 40"	 40"	 40"	 40"	 40"	 40"	 28"	 40"	 40"
 40"	 28"	 52"	 40"	 40"	 40"	 40"	 52"	 40"	 52"		
 40"	 22"		 40"		 52"	 40"		 40"	 28"		
 40"	 28"				 52"	 40"		 40"	 52"		
 52"											
 62"											

Figure 90: Section diagram—RDS 800C

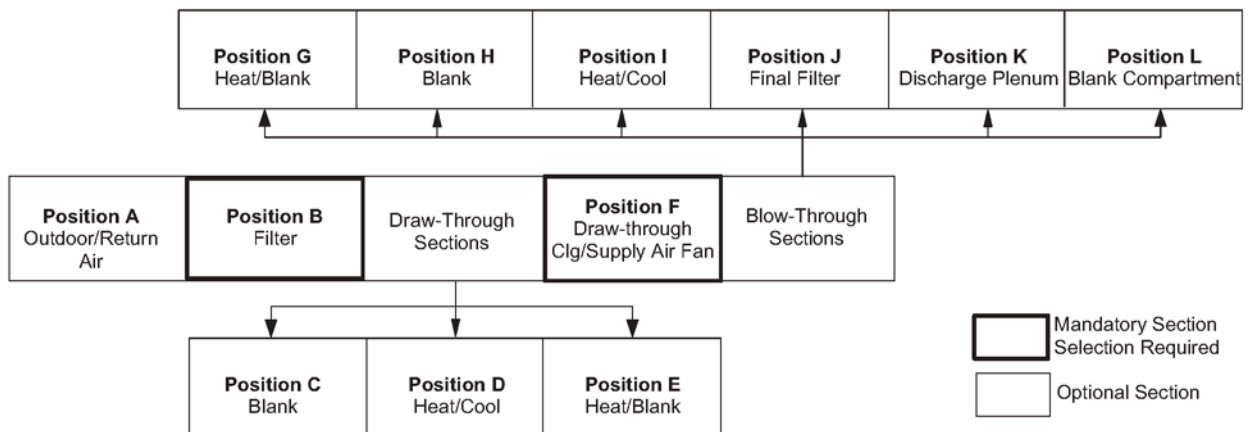


Section options and locations—RDS 802C

Figure 91: Section options and locations—RDS 802C

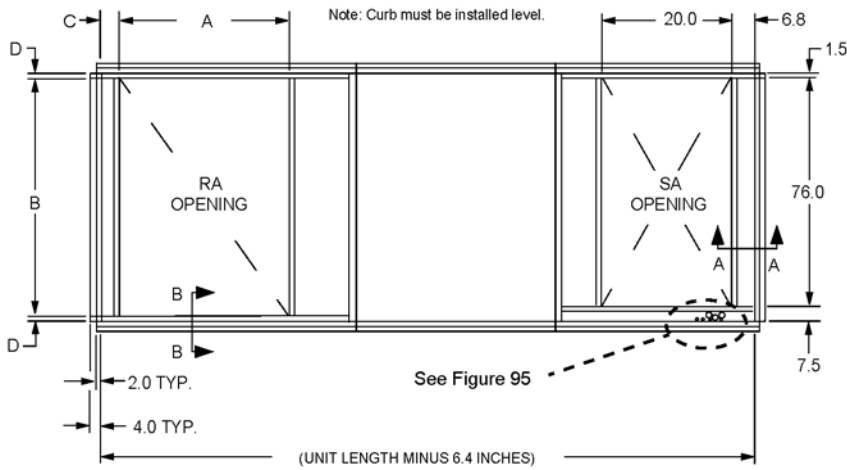
Position A	Position B	Position C	Position D	Position E	Position F	Position G	Position H	Position I	Position J	Position K	Position L
OA/RA	Filter	Blank	Draw-thru Heat/Cool	Heat/Blank	Supply Air Fan	Heat/Blank	Blank	Blow-thru Heat/Cool	Final Filter	Discharge Plenum	Blank Comp.
 0"	 22"	 40"	 40"	 20.3 sq ft 40"	 24" diameter. 62"	 20.3 sq ft 40"	 40"	 40"	 With clg only steam or hot water heat 24.0 sq ft 28"	 40"	 Blank compartment (out of airstream) 40"
 52"	 24 sq ft 28"	 52"	 26.0 sq ft CW 27.3 sq ft DX 40"	 40"		 40"	 52"	 26.0 sq ft CW 27.3 sq ft DX 40"	 24.0 sq ft 52"		
 52"	 22"		 21.1 sq ft HT 26.0 sq ft CW 27.3 sq ft DX 40"			 200-1000 MBh 40"		 21.1 sq ft HT 26.0 sq ft CW 27.3 sq ft DX 40"	 28"		
 52"	 28"		 40"			 40"		 40"	 52"		
 52"											
 80"											

Figure 92: Section diagram—RDS 802C



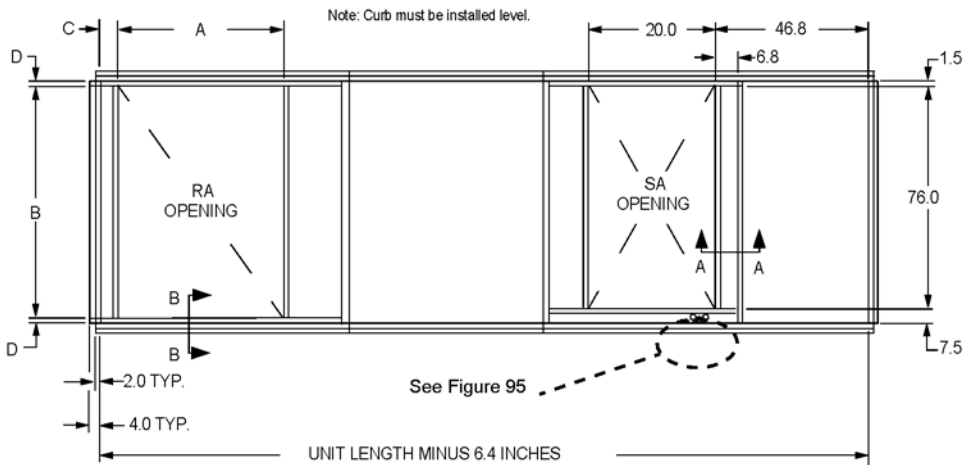
Roof Curbs—RDS 800C and 802C

Figure 93: Roof curb without blank compartment (out of airstream)



Return Fan	A	B	C	D
None	24	82	6.8	1.5
(2) 15" FC	24	82	6.8	1.5
30" AF	30	76	6.8	4.5
40" AF	36	78	14.8	3.5

Figure 94: Roof curb with blank compartment (out of airstream)



Return Fan	A	B	C	D
None	24	82	6.8	1.5
(2) 15" FC	24	82	6.8	1.5
30" AF	30	76	6.8	4.5
40" AF	36	78	14.8	3.5

Figure 95: Curb cross section A-A

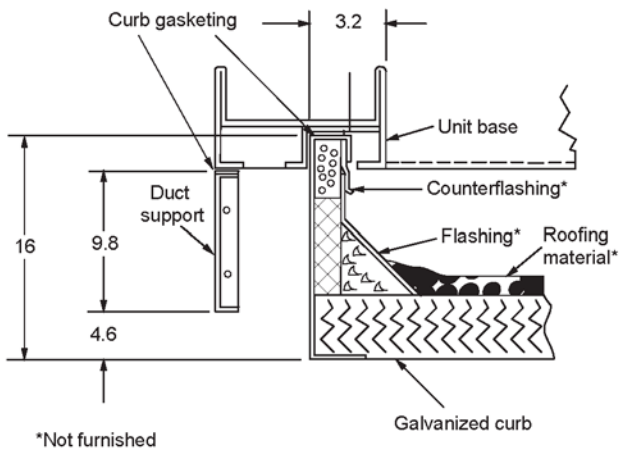
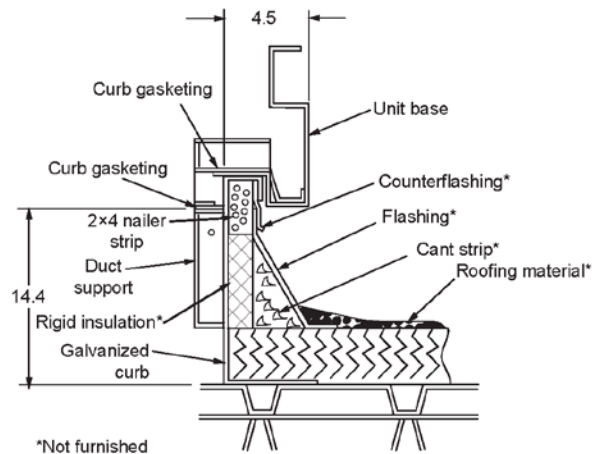


Figure 96: Curb cross section B-B



Blank Access and Drain Pan Only Section Detail—RDS 800C and 802C

Figure 97: Cross section detail and access door detail—RDS 800C and RDS 802C

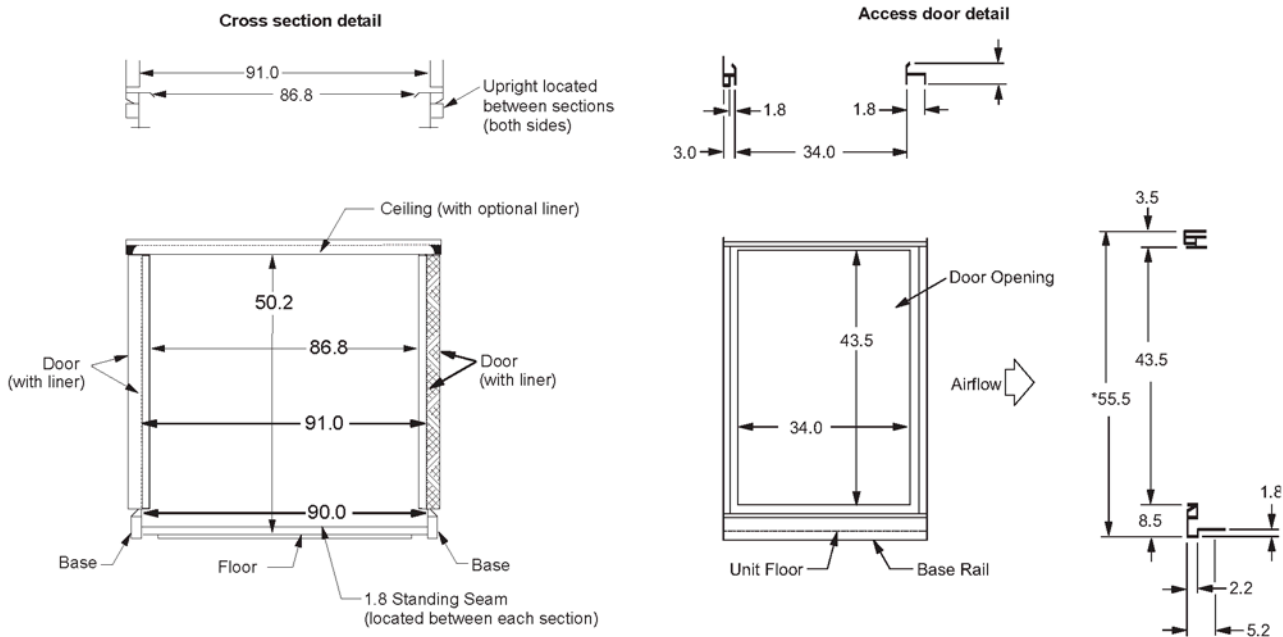
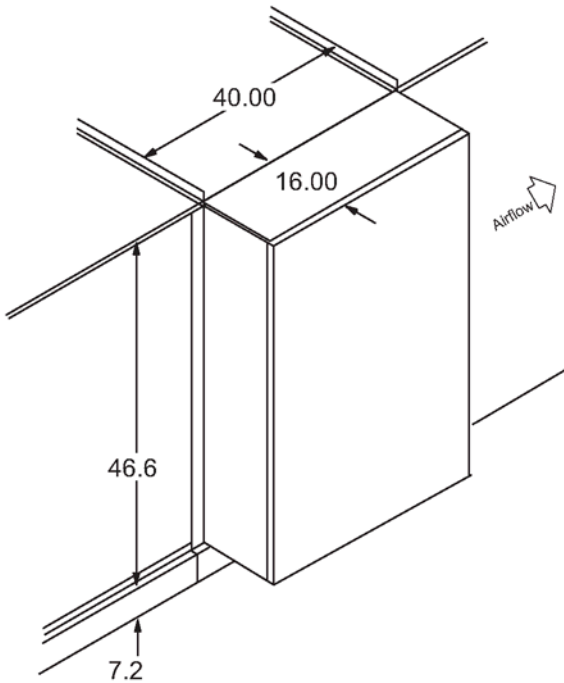
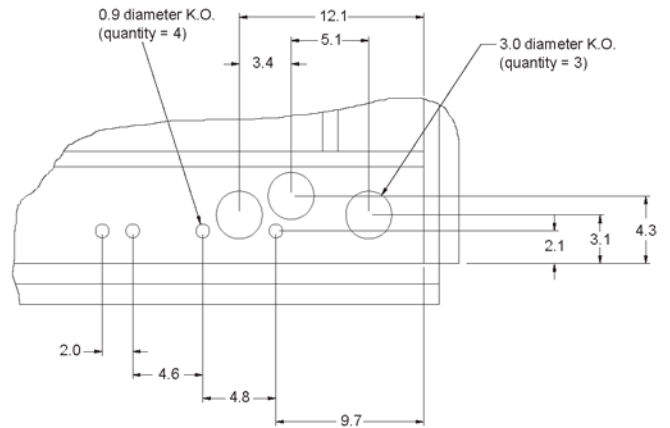


Figure 98: Field-installed coil piping vestibule detail—RDS 800C and RDS 802C



Note:
Vestibule required for coil piping entering within the curb and recommended for piping entering the side of the unit. Unit cooling coil alone does not require a piping vestibule.

Figure 99: Electrical knockouts—RDS 800C and RDS 802C

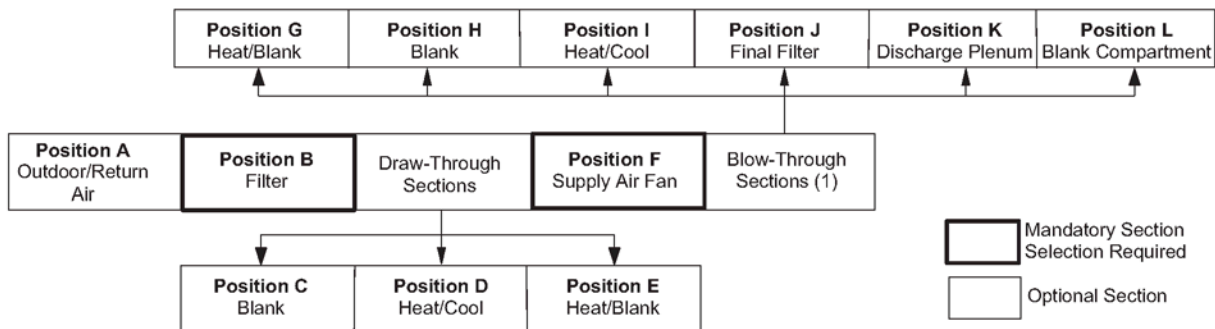


Section Options and Locations—RAH 047C

Figure 100: Standard face area coils—RAH 047C

Position A Outdoor/ Return Air	Position B Filter	Position C Blank	Position D Heat/Cool	Position E Heat/ Blank	Position F Supply Air Fan	Position G Heat/ Blank	Position H Blank	Position I Heat/Cool	Position J Final Filter	Position K Disch. Plenum	Position L Blank Comp.
Outside air hood 0"	Angular 24"	Blank access 48"	Drain pan only 48"	Steam/hot water 29.7 sq ft 48"	DWDI 27" diameter 72"	Steam/hot water 29.7 sq ft 48"	Blank access 48"	Drain pan only 48"	Cartridge 40 sq ft 48"	Discharge plenum 48"	Blank compartment (out of airstream) 72"
Plenum 48"	Cartridge 40 sq ft 24"		Cooling 38.0 sq ft CW 40.1 sq ft DX 48"	Blank Access 48"	30" diameter 72"	Electric 48"		Cooling 38.0 sq ft CW 40.1 sq ft DX 48"	Cartridge 48 sq ft 72"		
30% outside air 48"	Cartridge 48 sq ft 48"		Cooling with face & bypass 27.7 sq ft CW 48"		33" diameter 96"	Gas 200-1000 mbh 48"		Cooling with face & bypass 27.7 sq ft CW 48"	Blank access 48"		
Mixing box 48"	Blank access 24"		Htg/clg 29.7 sq ft HT 38.0 sq ft CW 40.1 sq ft DX 48"		SWSI 40" diameter 72"	Blank access 48"		Htg/clg 29.7 sq ft HT 38.0 sq ft CW 40.1 sq ft DX 48"	Blank access 72"		
Economizer 72"	Blank access 48"		Heating with face & bypass 20.3sq ft HT 48"		44" diameter 72"			Heating with face & bypass 20.3sq ft HT 48"			
Econ. with RA fan 72"	Econ w/prop exh fans, bottom or back ret 72"	Econ w/prop exh and side ret 120"									
									DX = Direct expansion cooling CW = Chilled water cooling HT = Hot water or steam heating		

Figure 101: Section diagram—RAH 047C

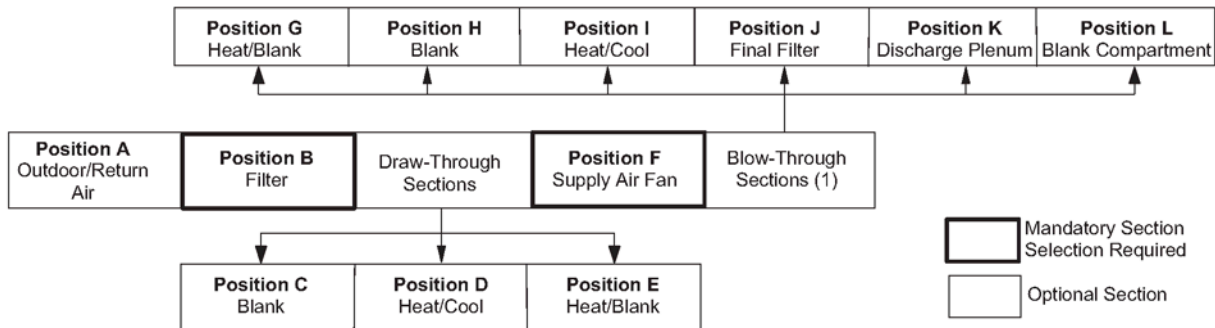


(1) Blow-through sections not available on units with a SWSI supply fan.

Figure 102: Large face area coils—RAH 047C

Position A Outdoor/ Return Air	Position B Filter	Position C Blank	Position D Heat/Cool	Position E Heat/ Blank	Position F Supply Air Fan	Position G Heat/ Blank	Position H Blank	Position I Heat/Cool	Position J Final Filter	Position K Disch. Plenum	Position L Blank Comp.
OA hood 0"	Angular 24"	Blank access 48"	Cooling 47.4 sq ft DX 45.0 sq ft CW 48"	Steam/hot water 29.7 sq ft 48"	DWDI 27" Diameter 72"	Steam/hot water 29.7 sq ft 48"	Blank access 48"	Cooling 47.4 sq ft DX 45.0 sq ft CW 48"	Cartridge 40 sq ft 48"	Discharge plenum 48"	Blank compartment (out of airstream) 72"
Plenum 48"	Cartridge 40 sq ft 24"		Cooling with face & bypass 45.0 sq ft CW 48"	Blank access 48"	30" diameter 72"	Electric 48"		Cooling with face & bypass 45.0 sq ft CW 48"	Cartridge 48 sq ft 72"		
30% OA 48"	Cartridge 48 sq ft 48"		Htg/Clg 29.7 sq ft HT 47.4 sq ft DX 45.0 sq ft CW 48"		33" diameter 96"	Gas 200–1000 MBh 48"		Htg/Clg 29.7 sq ft HT 47.4 sq ft DX 45.0 sq ft CW 48"	Blank access 48"		
Economizer 72"	Blank access 24"		Drain pan only 48"		SWSI 40" diameter 72"	Blank access 48"		Drain pan only 48"	Blank access 72"		
Econ. with 30" FC RA fan 72"	Blank access 48"		Heating with face & bypass 20.3 sq ft HT 48"		44" diameter 72"			Heating with face & bypass 20.3 sq ft HT 48"			
Econ. with (2) 15x15 FC RA fan 48"	Econ w/prop exh fans, bottom or back ret 72"	Econ w/prop exh and side ret 120"									
										DX = Direct expansion cooling CW = Chilled water cooling HT = Hot Water or steam heating	

Figure 103: Section diagram—RAH 047C



Unit Considerations—RAH 077C

Splitting Units

- All units with DWDI supply fans may be split at the Supply Air Fan section outlet.
- Units exceeding 52 feet in length may need to be split at the Supply Air Fan section outlet for shipping purposes.

Cooling Coils

- Cooling Coils are available in either direct expansion or chilled water type and can be located in the Heat/Cool sections.
- Chilled water cooling coils are available with or without factory-installed, three-way modulating control valves as well as face and bypass dampers and actuator.
- Factory-wired control of cooling coils is limited to one cooling coil section per unit.

Heating Media—Steam/Hot Water

- Heating coils are available in either steam or hot water type and can be located in either the Heat/Cool sections or the Heat sections.
- Heating coils are available with or without factory-installed face and bypass dampers and actuator in the Heat/Cool sections. Factory-installed control valves are not available on heating coils in the Heat/Cool sections.
- Heating coils are available with or without a factory-installed control valve in the Heat sections. Factory-installed face and bypass dampers are not available on heating coils in the Heat sections.

Electric Heat

- Electric heating coils can be located in the Blow-through Heat section, position G only on units with a DWDI supply fan.

Gas Heat

- A gas heating furnace can be located in the Blow-through Heat section, position G only on units with a DWDI supply fan. Factory-wired control of cooling coils is limited to one heating section per unit.

Final Filters

- If final filters are installed, a Discharge Plenum section is required in position K.
- Final filters are not available on units with a SWSI supply fan.
- Final filters are not available on units with a blow-through cooling coil in the Heat/Cool section, position I.

Blank Access Compartment

- The blank access compartment is available on units with a discharge plenum in position K with bottom or side discharge only.
- The blank access compartment is not available on units with a SWSI supply fan.

General

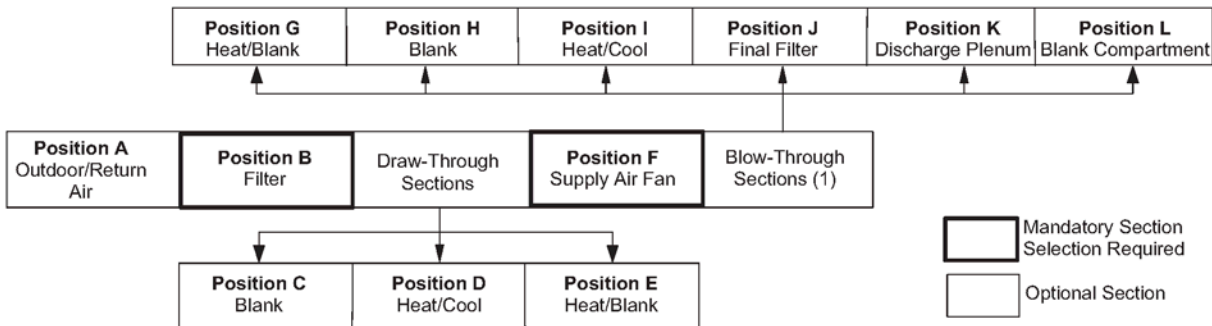
- When any selection is located in position H (Blank access section), I (Blow-through Heat/Cool Section), or J (Final Filter Section), a heating or blank section must be placed in position G to provide proper airflow diffusion for the sections that follow the supply fan.

Section Options and Locations—RAH 077C

Figure 104: Standard face area coils—RAH 077C

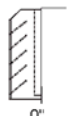


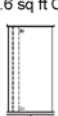
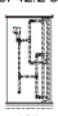
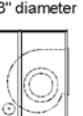



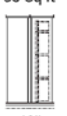
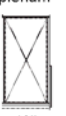




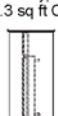



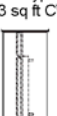




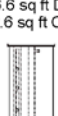
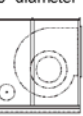

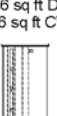








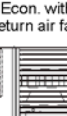


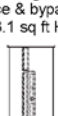
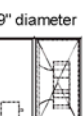

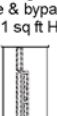



Position A Outdoor/ Return Air	Position B Filter	Position C Blank	Position D Heat/Cool	Position E Heat/ Blank	Position F Supply Air Fan	Position G Heat/Blank	Position H Blank	Position I Heat/Cool	Position J Final Filter	Position K Disch. Plenum	Position L Blank Comp.
OA hood 0"	Angular 24"	Blank access 48"	Drain pan only 48"	Steam/hot water 42.2 sq ft 48"	DWDI 33" diameter 72"	Steam/hot water 42.2 sq ft 48"	Blank access 48"	Drain pan only 48"	Cartridge 56 sq ft 48"	Discharge plenum 48"	Blank compartment (out of airstream) 72"
Plenum 72"	Cartridge 56 sq ft 24"	Cartridge 64 sq ft 48"	Cooling 51.9 sq ft CW 54.7 sq ft DX 48"	Blank access 48"	36" diameter 96"	Electric 48"		Cooling 51.9 sq ft CW 54.7 sq ft DX 48"	Cartridge 64 sq ft 72"		
30% OA 72"	Cartridge 80 sq ft 72"	Blank access 24"	Cooling with face & bypass 36.3 sq ft CW 48"		40" diameter 96"	Gas 500–1400 MBh 48"		Cooling with face & bypass 36.3 sq ft CW 48"	Cartridge 80 sq ft 96"		
Economizer 96"	Blank Access 48"		Htg/clg 42.2 sq ft HT 51.9 sq ft CW 54.7 sq ft DX 48"		SWSI 44" diameter 72"	Gas 1500–2000 MBh 48"		Htg/clg 42.2 sq ft HT 51.9 sq ft CW 54.7 sq ft DX 48"	Blank access 48"		
Econ. with return air fan 96"	Econ w/prop exh, back ret 72"	Econ w/prop exh, side ret 120"	Heating with face & bypass 28.1sq ft HT 48"		49" diameter 96"	Blank access 48"		Heating with face & bypass 28.1sq ft HT 48"	Blank access 72"		
Mixing box 72"	Econ w/prop exh, bottom return 96"										

Figure 105: Section diagram—RAH 077C



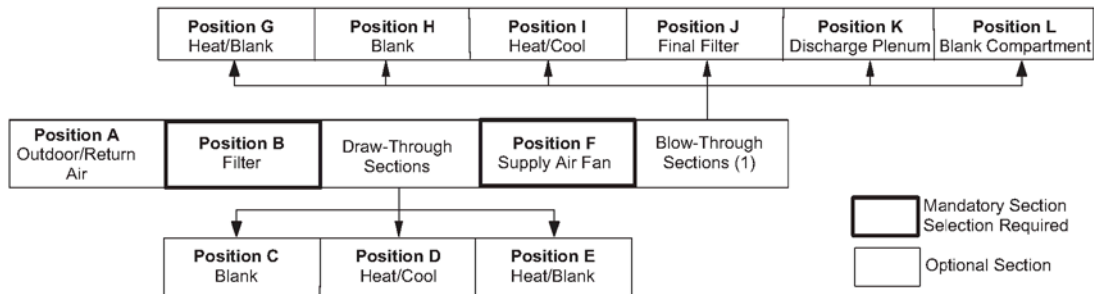
(1) Blow-through sections not available on units with a SWSI supply fan.
 (2) Burglar bars and isolation dampers not available when there are no sections between the supply fan and the discharge plenum for units with bottom discharge.

Figure 106: Large face area coils—RAH 077C

Position A Outdoor/Return Air	Position B Filter	Position C Blank	Position D Heat/Cool	Position E Heat/Blank	Position F Supply Air Fan	Position G Heat/Blank	Position H Blank	Position I Heat/Cool	Position J Final Filter	Position K Disch. Plenum	Position L Blank Comp.
OA hood  0"	Angular  24"	Blank access  48"	Cooling 76.6 sq ft DX 72.6 sq ft CW  72"	Steam/hot water 42.2 sq ft  48"	DWDI 33" diameter  72"	Steam/hot water 42.2 sq ft  48"	Blank access  48"	Cooling 76.6 sq ft DX 72.6 sq ft CW  72"	Cartridge 56 sq ft  48"	Discharge plenum  48"	Blank compartment (out of airstream)  72"
Plenum  72"	Cartridge 56 sq ft  24"	Cartridge 64 sq ft  48"	Cooling with face & bypass 62.3 sq ft CW  96"	Blank access  48"	36" diameter  96"	Electric  48"		Cooling with face & bypass 62.3 sq ft CW  96"	Cartridge 84 sq ft  72"		
30% OA  72"	Cartridge 80 sq ft  72"	Blank access  24"	Htg/clg 42.2 sq ft HT 76.6 sq ft DX 72.6 sq ft CW  96"		40" diameter  96"	Gas 500-1400 mbh  48"		Htg/clg 42.2 sq ft HT 76.6 sq ft DX 72.6 sq ft CW  96"	Cartridge 80 sq ft  96"		
Economizer  96"	Blank access  48"		Drain pan only  48"		SWSI 44" diameter  72"	Gas 1500-2000 MBh  48"		Drain pan only  48"	Blank access  48"		
Econ. with return air fan  96"	Econ w/prop exh fans, back return  72"	Econ w/prop exh fans, side return  120"	Heating with face & bypass 28.1 sq ft HT  48"		49" diameter  96"	Blank access  48"		Heating with face & bypass 28.1 sq ft HT  48"	Blank access  72"		
Mixing box  72"	Econ w/prop exh fans, bottom return  96"										

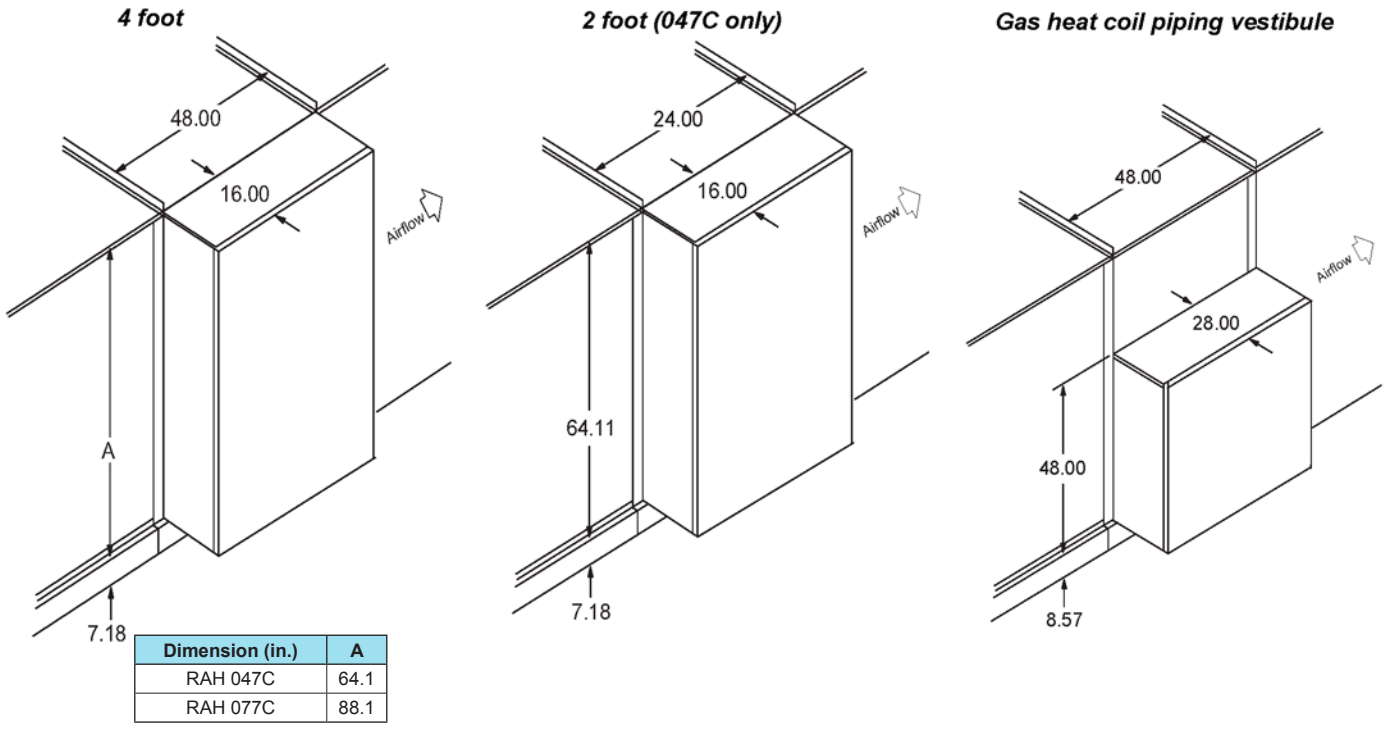
DX = Direct expansion cooling
CW = Chilled water cooling
HT = Hot Water or steam heating

Figure 107: Section diagram—RAH 077C



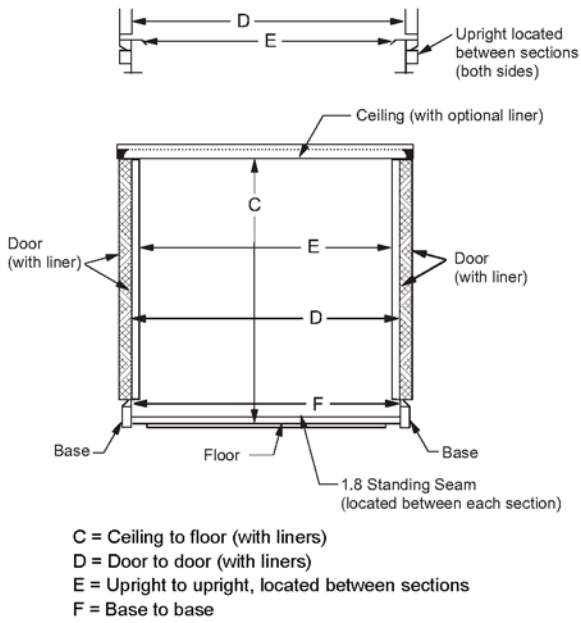
(1) Blow-through sections not available on units with a SWSI supply fan.
 (2) Burglar bars and isolation dampers not available when there are no sections between the supply fan and the discharge plenum for units with bottom discharge.

Figure 108: Heat coil piping vestibule detail—RAH 047C and 077C



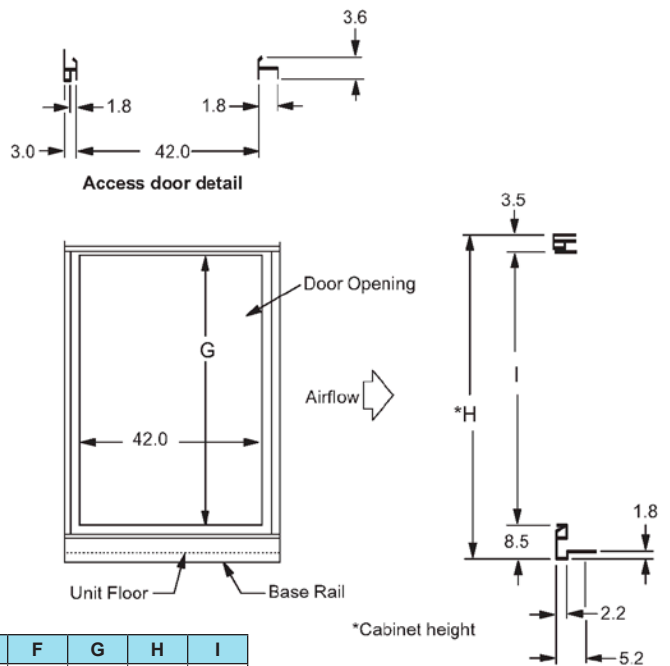
Blank Access and Drain Pan Only Section Details—RAH 047C and RAH 077C

Figure 109: Cross section detail—RAH 047C and 077C



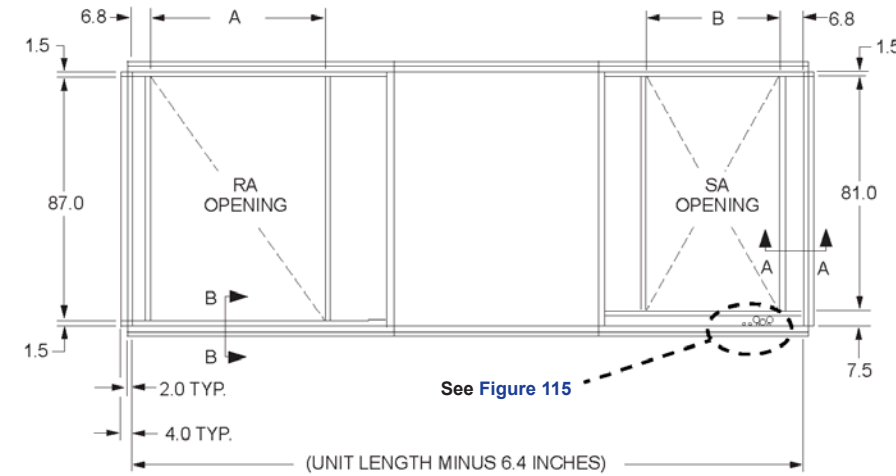
Dimension (in.)	C	D	E	F	G	H	I
RAH 047C	67.7	96.0	91.8	95.0	61.0	73.0	61.0
RAH 077C	91.7	96.0	91.8	95.0	85.0	97.0	85.0

Figure 110: Access door detail—RAH 047C and 077C



Roof Curbs—RAH 047C and RAH 077C

Figure 111: Roof curb without blank compartment



Dimensions (in.)	A	B
RAH 047C	38	28
RAH 077C	62	See tables

SWSI Plenum Supply Fan—
Discharge Opening Dimensions “B” (in.)

Model	SWSI Wheel Diameter	Supply Air Opening “B”
077C	44	38
	49	46

DWDI Plenum Supply Fan—
Discharge Opening Dimensions “B” (in.)

Model	Cooling Coil Type*	Cooling Coil Size (sq ft)	Supply Air Opening “B”
077 CS	Chilled Water (CW) Direct Expansion (DX)	36.3	38
		51.9	
077 CL	Chilled Water (CW) Direct Expansion (DX)	62.3	46
		72.6	
077 CY	None	—	46

* Coil located in draw-through or blow-through position

Figure 112: Roof curb with blank compartment

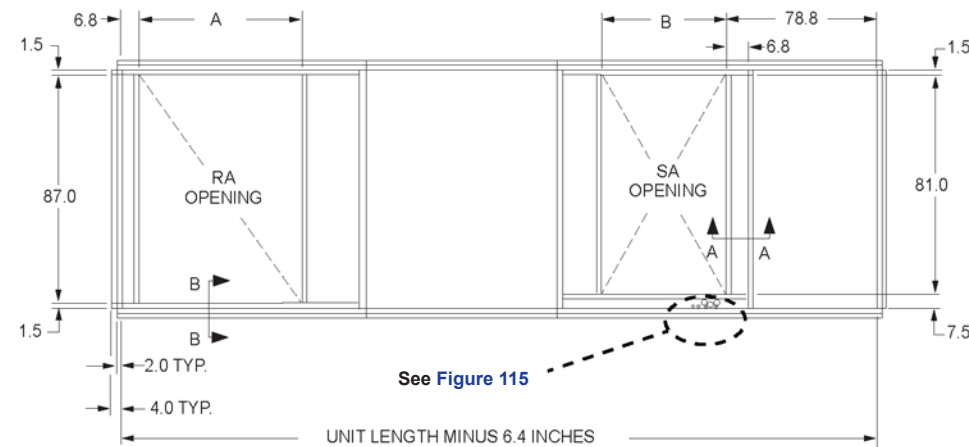


Figure 113: Curb cross section A-A

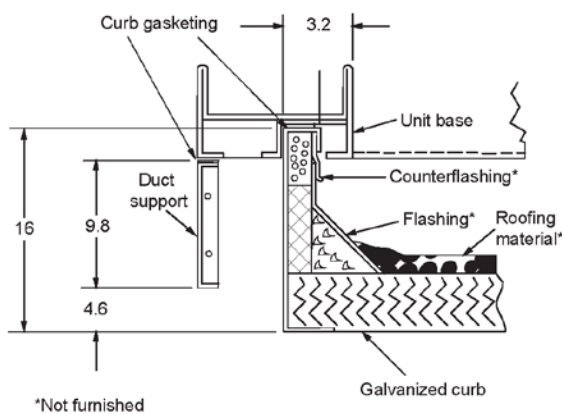
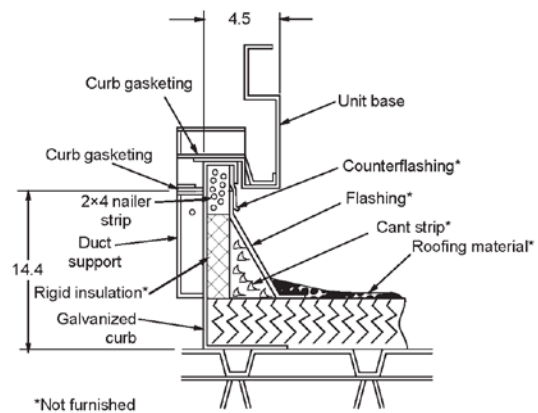
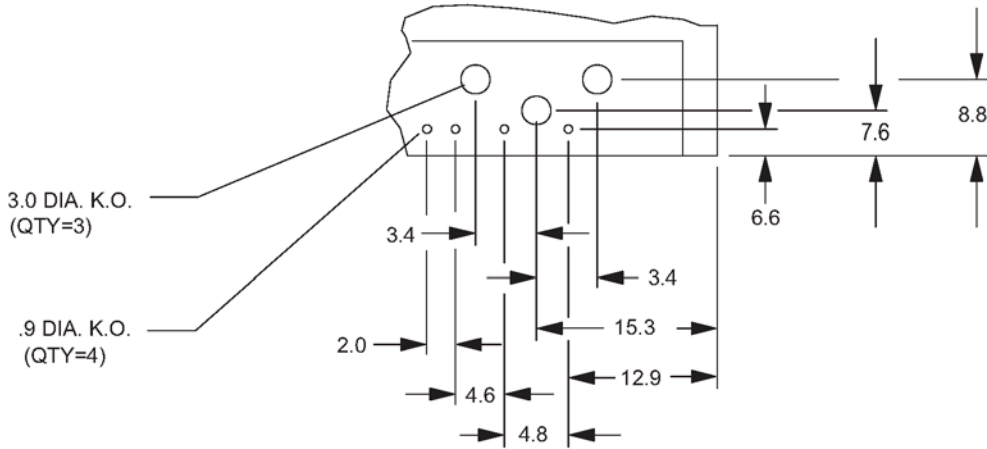


Figure 114: Curb cross section B-B



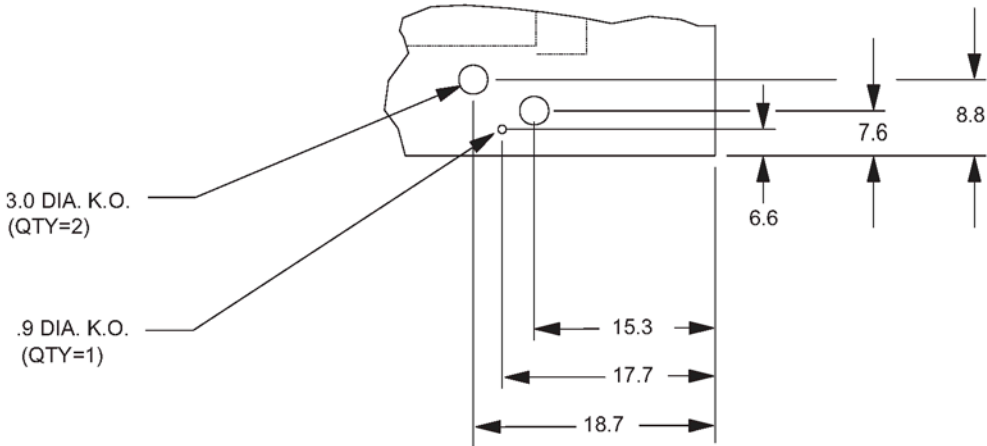
Electrical Knockouts—RAH 047C and 077C

Figure 115: Discharge plenum power and control wiring entrance detail



Note: 0.9 diameter and 3.0 diameter knockouts are electrical entrance locations on the unit only.

Figure 116: Electric heat power and control entrance detail



Note: 0.9 diameter and 3.0 diameter knockouts are electrical entrance locations on the unit only.

Service Clearance

Allow recommended service clearances shown in Figure 117, Figure 118, Figure 119, and Figure 120. Provide a roof walkway along two sides of the unit for service and access to most controls. Contact your Daikin sales representative for service requirements less than those recommended.

Figure 117: Service clearances—RDS 708B

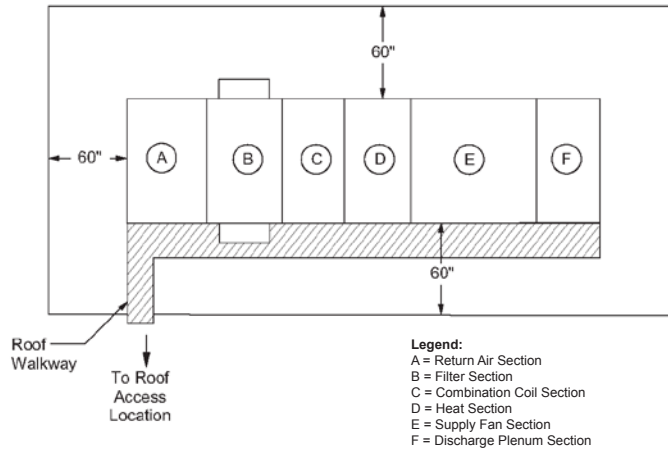


Figure 119: Service clearances—RAH unit with SWSI plenum supply fan

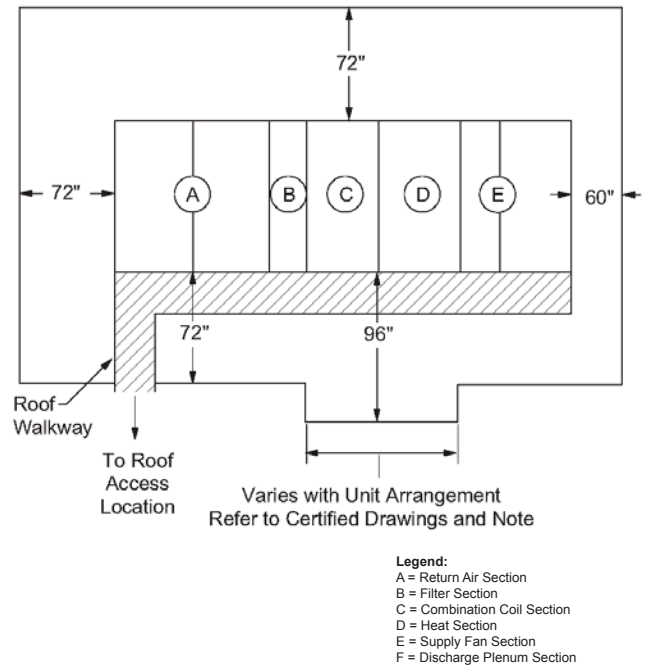


Figure 118: Service clearances—RDS 800C and 802C

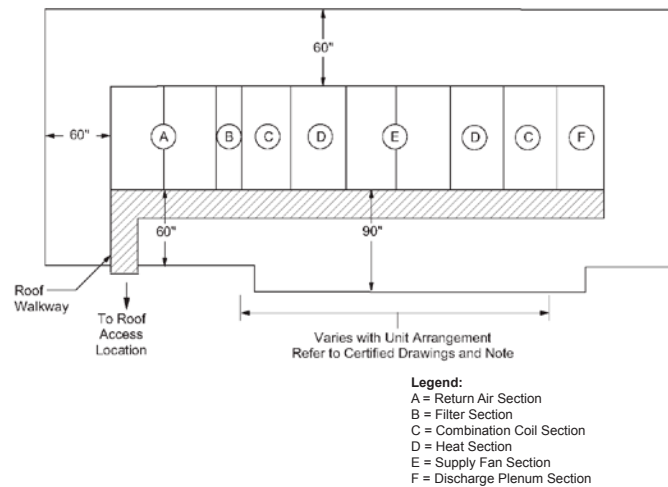
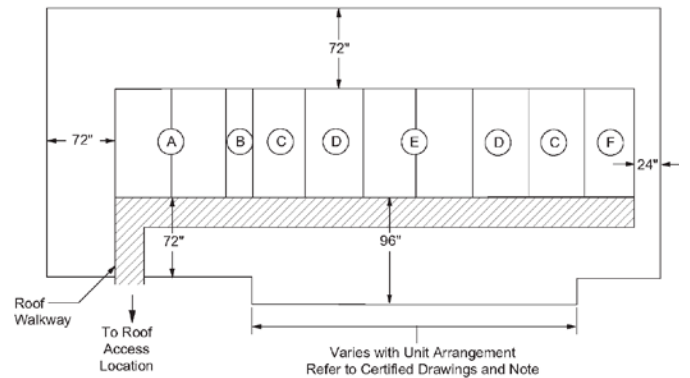


Figure 120: Service clearances—RAH unit with housed DWDI supply fan



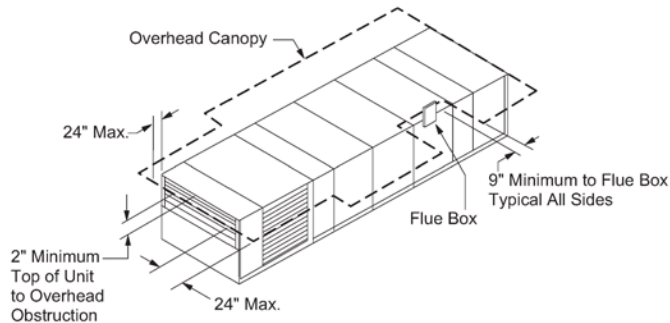
Note:
 Sections with heating and/or cooling coils or DWDI supply fan must have 96" service clearance on control box side.

Legend:
 A = Return Air Section
 B = Filter Section
 C = Combination Coil Section
 D = Heat Section
 E = Supply Fan Section
 F = Discharge Plenum Section

Overhead Clearance

- Unit(s) surrounded by screens or solid walls must have no overhead obstructions over any part of the unit.
- Area above condenser must be unobstructed in all installations to allow vertical air discharge.
- The following restrictions must be observed for overhead obstructions above the air handler section:
 - There must be no overhead obstructions above the furnace flue, or within 9 inches of the flue box.
 - Any overhead obstruction must not be within 2 inches of the top of the unit.
 - A service canopy must not protrude more than 24 inches beyond the unit in the area of the outside air and exhaust dampers.

Figure 121: Overhead clearances



Ventilation Clearance

Unit(s) surrounded by a screen or a fence:

- The bottom of the screen should be a minimum of 1 ft above the roof surface.
- Minimum distance, unit to screen: same service clearance.
- Minimum distance, unit to unit: 120 in

Unit(s) surrounded by solid walls:

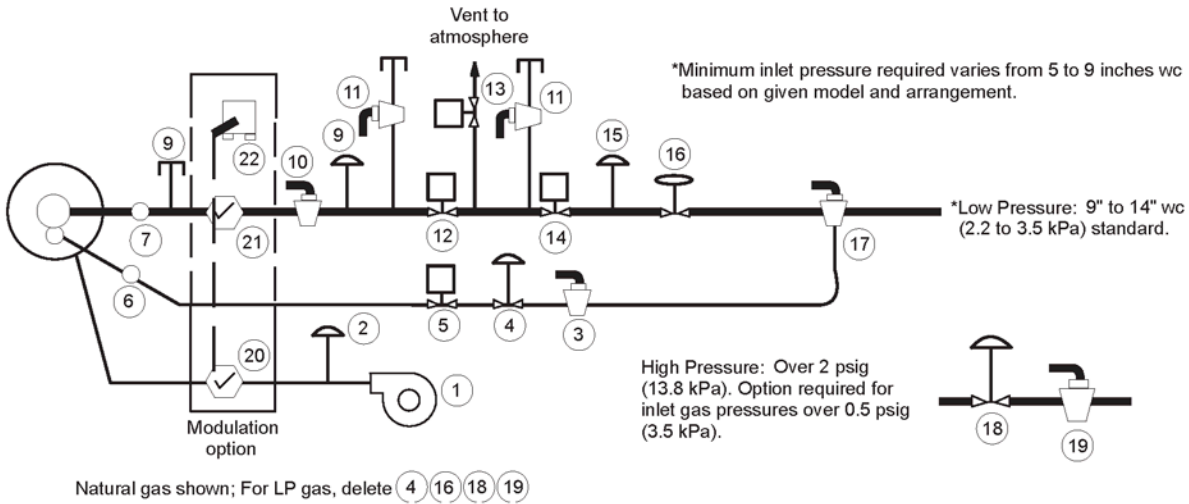
- Minimum distance, unit to wall: 96 in, all sizes
- Minimum distance, unit to unit: 120 in
- Wall height restrictions:
 - Wall on one side only or on two adjacent sides: no restrictions.
 - Walls on more than two adjacent sides: wall height not to exceed unit height.

Do not locate outside air intakes near exhaust vents or other sources of contaminated air.

If the unit is installed where windy conditions are common, install wind screens around the unit, maintaining the clearances specified above. This is particularly important to prevent blowing snow from entering outside air intakes, and to maintain adequate head pressure control when mechanical cooling is required at low outdoor air temperatures. SpeedTrol, which is required for compressor operation below 45° F, will maintain proper head pressure in calm wind conditions.

Gas Piping Schematic†

Figure 122: Gas piping schematic



Item	Description	FM/ETL/UL		FM/ETL-C		IRI
		Thru 400 MBh	Over 400 MBh	Thru 400 MBh	Over 400 MBh	400–2000 MBh
1	Forced draft blower	Standard	Standard	Standard	Standard	Standard
2	Combination air switch	Standard	Standard	Standard	Standard	Standard
3	Pilot cock	Standard	Standard	Standard	Standard	Standard
4	Pilot pressure regulator	Standard	Standard	Standard	Standard	Standard
5	Pilot gas valve	Standard	Standard	Standard	Standard	Standard
6	Pilot orifice	Standard	Standard	Standard	Standard	Standard
7	Main gas orifice	Standard	Standard	Standard	Standard	Standard
8	Manifold pressure tap	Standard	Standard	Standard	Standard	Standard
9	High pressure switch	—	—	—	Standard	—
10	Test cock	Standard	Standard	Standard	Standard	Standard
11	Leak test tap cock	—	—	—	—	Standard
12	Safety shutoff valve	Combination redundant valve and pressure regulator	Standard	Combination redundant valve and pressure regulator	—	Standard
13	Vent to atmosphere valve, N/O	—	—	—	—	Standard
14	Safety shutoff valve	Combination redundant valve and pressure regulator	Standard	Combination redundant valve and pressure regulator	Safety shut off valve	Safety shut off valve with proof of closure switch
15	Low pressure switch	—	—	—	—	Standard
16	Main pressure regulator	Combination redundant valve and pressure regulator	Standard	Combination redundant valve and pressure regulator	Standard	Standard
17	Main gas shutoff cock	Standard	Standard	Standard	Standard	Standard
18	High pressure regulator	Optional	Optional	Optional	Optional	Optional
19	Lubricated shutoff cock	Optional	Optional	Optional	Optional	Optional
20	Combustion air butterfly valve	Standard	Standard	Standard	Standard	Standard
21	Main gas butterfly valve	Standard	Standard	Standard	Standard	Standard
22	Modulating operator	Standard	Standard	Standard	Standard	Standard

† Not available on size 708.

Table 36: Supply, exhaust and return fan motors, RPS 015C to 135C

Fan Motor		208/60/3		230/60/3		460/60/3 ¹		575/60/3	
HP	Efficiency	FLA	LRA	FLA	LRA	FLA	LRA	FLA	LRA
1	High ODP	3.9	26	2.8	20	1.4	10.5	1.15	9
	High TEFC	4	27	2.8	21	1.4	10.5	1.2	9
	Premium ODP	—	—	3	19.2	1.5	15	1.1	7.7
	Premium TEFC	3.3	27	3	28	1.5	14	1.3	10
1.5	High ODP	4.5	39	4.2	32	2.1	16	1.7	12.8
	High TEFC	6.2	39	4.2	32	2.1	16	1.7	12.8
	Premium ODP	4.8	40.3	4.2	25	2.1	14	1.7	14
	Premium TEFC	—	—	4.2	40	2.1	20	1.7	16
2	High ODP	7.1	47	5.6	42	2.8	21	2.2	16.8
	High TEFC	7	50.6	5.6	48	2.8	24	2.2	17
	Premium ODP	6.1	43.2	5.8	37.6	2.9	26.5	2.1	15
	Premium TEFC	—	—	5.6	44	2.8	22	2.2	17
3	High ODP	9.9	79	9	64.6	4.5	32.3	3.4	26.1
	High TEFC	9.6	81	8.2	77.2	4.1	38.6	3.4	30.9
	Premium ODP	9.3	74	8.2	64	4.1	32	3.1	25.6
	Premium TEFC	9.4	80	8.2	71	4.1	35.5	3.3	29
5	High ODP	16.1	106	14	94	7	47	5.3	38
	High TEFC	15.2	126	13.4	102.4	6.7	51.2	5.4	39
	Premium ODP	15.7	110	13.6	96	6.8	48	5.2	38.4
	Premium TEFC	15	124	13	96	6.5	48	5.2	38
7.5	High ODP	25	137	21.6	148.4	10.8	74.2	8.2	49
	High TEFC	24.8	175.3	20.4	145.2	10.2	72.6	8.2	58
	Premium ODP	22.3	185	20	122	10	80	7.4	52
	Premium TEFC	22	177	20	141	10	70.5	8	56
10	High ODP	33	290	28	180	14	94	11	72
	High TEFC	29.5	228	28.4	200	14.2	100	11.4	80
	Premium ODP	29	247	25.8	192	12.9	106	10.3	76.6
	Premium TEFC	28.5	209	25	182	12.5	91	10	67
15	High ODP	44.8	368	40.6	301	20.3	150.5	16.2	120
	High TEFC	43.7	310	38.8	272	19.4	136	15.5	109
	Premium ODP	43.4	271	37.8	233.6	18.9	117	14.1	94
	Premium TEFC	42.4	282	37	246	18.5	123	14	89
20	High ODP	61	342	50	350	25	175	20	135
	High TEFC	60	465	48	320	24	160	19.1	123
	Premium ODP	57	373	49	322	24.5	160.8	18.9	130
	Premium TEFC	56	403	48	350	24	175	18.8	138
25	High ODP	74	427	62	382	31	191	24.3	151
	High TEFC	73	416	60	380	30	190	24.2	152
	Premium ODP	70	438	61	380	30.5	190	24.2	125
	Premium TEFC	68.4	431	61	376	30.5	188	22.8	148
30	High ODP	86.5	560	75	460	37.5	230	30	177
	High TEFC	87	448	72	460	36	230	28.6	184
	Premium ODP	83.3	514	72.4	448	36.2	224	29.8	179
	Premium TEFC	84	566	69	428	34.5	214	27.6	178
40	High ODP	117	660	102	630	51	315	40	251
	High TEFC	114	590	95	544	47.5	272	38	214
	Premium ODP	110	730	96	630	48	315	38	245
	Premium TEFC	106	734	94	650	47	325	37	213
50	High ODP	140	832	124	770	62	385	49.2	303
	High TEFC	136	840	118	744	59	372	48	266
	Premium ODP	137	877	120	752	60	376	47.5	332
	Premium TEFC	131	897	118	778	59	389	46	237
60	High ODP	154	991	144	872	72	442	57.4	355
	High TEFC	—	—	140	1022	70	511	56	409
	Premium ODP	160	1125	140	912	70	456	56	345
	Premium TEFC	—	—	140	1200	70	600	54	403
75	High ODP	189	1240	176	1108	88	553	71	505
	High TEFC	—	—	172	1132	86	566	68	447
	Premium ODP	195	1240	170	1044	85	553	65.5	444
	Premium TEFC	—	—	168	1186	84	593	66	504

1. 380/50/3 applications, 460/60/3 motors are used. Derate nameplate by 0.85 to obtain actual horsepower.

† Not available on size 708.

Table 37: Electric heat, RDS 800C and 802C

Model	208/60/3				240/60/3				480/60/3				600/60/3			
	kW	FLA	Steps ¹	Stages ²	kW	FLA	Steps ¹	Stages ²	kW	FLA	Steps ¹	Stages ²	kW	FLA	Steps ¹	Stages ²
20	14.4	41.4	2	2	19.8	47.6	2	2	19.8	23.8	2	2	19.8	19.0	2	2
40	29.9	83.0	2	2	39.8	95.7	2	2	39.8	47.8	2	2	39.8	38.3	2	2
60	45.1	124.9	4	3	60.0	144.3	4	3	60.0	72.2	2	2	60.0	57.7	2	2
80	59.8	166.0	4	3	79.6	191.5	4	3	79.6	94.7	2	2	79.6	76.6	2	2
100	74.7	207.4	6	3	99.5	239.3	6	3	99.5	19.7	4	3	99.5	95.7	4	3
120	89.7	249.3	6	3	119.4	287.2	6	3	119.4	143.6	4	3	119.4	114.9	4	3
140	—	—	—	—	—	—	—	—	139.1	167.3	4	3	139.1	133.8	4	3
160	—	—	—	—	—	—	—	—	159.2	191.5	4	3	159.2	153.2	4	3
180	—	—	—	—	—	—	—	—	179.1	215.4	6	3	179.1	172.3	6	3
200	—	—	—	—	—	—	—	—	199.0	239.4	6	3	199.0	191.5	6	3
220	—	—	—	—	—	—	—	—	218.7	263.0	6	3	218.7	210.4	6	3
240	—	—	—	—	—	—	—	—	238.6	287.2	6	3	238.8	229.6	6	3

1. Number of fused circuits.

2. Number of controlled heat stages from MicroTech III control system; additional fused circuits controlled by time delay relays.

Table 38: Electric heat, RAH 047C

Model	208/60/3			240/60/3			480/60/3			600/60/3		
	kW	FLA	Stages	kW	FLA	Stages	kW	FLA	Stages	kW	FLA	Stages
40	29.9	83.0	2	39.8	95.7	2	39.8	47.9	2	39.8	38.3	2
60	45.1	124.9	2	60.0	144.3	2	60.0	72.2	2	60.0	57.7	2
80	59.8	166.0	4	79.6	191.5	4	79.6	95.7	4	79.6	76.6	4
100	74.7	207.4	4	99.5	239.4	4	99.5	119.7	4	99.5	95.7	4
120	89.7	249.3	4	119.4	287.2	4	119.4	143.6	4	119.4	114.9	4
160	119.7	332.0	4	159.2	383.0	4	159.2	191.5	4	159.2	153.2	4
200	—	—	—	—	—	4	199.0	239.4	4	199.0	191.5	4
240	—	—	—	—	—	6	238.8	287.2	6	238.8	229.8	6

Table 39: Electric heat, RAH 077C

Model	208/60/3			240/60/3			480/60/3			600/60/3		
	kW	FLA	Stages	kW	FLA	Stages	kW	FLA	Stages	kW	FLA	Stages
80	59.8	166.0	4	79.6	191.5	4	79.6	95.7	4	79.6	76.6	4
100	74.7	207.4	4	99.5	239.4	4	99.5	119.7	4	99.5	95.7	4
120	89.7	249.3	4	119.4	287.2	4	119.4	143.6	4	119.4	114.9	4
160	—	—	—	—	—	—	159.2	191.5	4	159.2	153.2	4
200	—	—	—	—	—	—	199.0	239.4	4	199.0	191.5	4
240	—	—	—	—	—	—	238.8	287.2	6	238.8	229.8	6
280	—	—	—	—	—	—	278.6	335.1	4	278.6	268.1	4
320	—	—	—	—	—	—	318.4	383.0	4	318.4	306.4	4

Supply Power Wiring

Table 40: Recommended power wiring

Ampacity	No. of power wires per phase	No. of conduits	Wire gauge	Insulation rating (0°C)
30	1	1	10	60
40	1	1	8	60
55	1	1	6	60
70	1	1	4	60
85	1	1	3	60
95	1	1	2	60
130	1	1	1	75
150	1	1	1/0	75
175	1	1	2/0	75
200	1	1	3/0	75
230	1	1	4/0	75
255	1	1	250	75
285	1	1	300	75
310	1	1	350	75
335	1	1	400	75
380	1	1	500	75
400	2	2	3/0	75
460	2	2	4/0	75
510	2	2	250	75
570	2	2	300	75
620	2	2	350	75
670	2	2	400	75
760	2	2	500	75
765	3	3	250	75
855	3	3	300	75
930	3	3	350	75

1. Units require three-phase power supply.
2. Allowable voltage tolerances:
 - a. 60 Hertz
 - Nameplate 208 V: Min 187 V, Max. 229 V
 - Nameplate 230 V: Min 207 V, Max. 253 V
 - Nameplate 460 V: Min 414 V, Max. 506 V
 - Nameplate 575 V: Min 518 V, Max. 633 V
 - b. 50 Hertz
 - Nameplate 380V: Min 360V, Max. 418V

3. Minimum Circuit Ampacity (MCA) Calculation:

NOTE: If a unit is provided with multiple power connections, each must be considered alone in selecting power wiring components.

4. The MCA is calculated based on the following formula:

- a. Fan(s) only:

$$\text{MCA} = 1.25 \times \text{largest load} + \text{sum of all other loads}$$

- b. Electric heat plus fan(s):

$$\text{Heater is} = 50 \text{ kW}$$

$$\text{MCA} = 1.25 \times (\text{heater FLA} + \text{largest motor load}) + (\text{the rest of the loads})$$

$$\text{Heater is} > 50 \text{ kW}$$

$$\text{MCA} = 1.25 \times (\text{largest motor load}) + (\text{the rest of the loads}) + \text{heater FLA}$$

NOTE: Control circuit ampacity does not need to be considered in the calculation for wire sizing ampacity. If the unit is provided with one or more fan section lights, they are powered from the separate 15 amp (minimum), 120V supply required by the NEC for the unit convenience outlet.

5. Size wires in accordance with [Table 310-16](#) or [310-19](#) of the [National Electrical Code](#).
6. Size the wires for a maximum of 3% voltage drop.

Table 41: Component unit weights (lbs.)—RDS 708B, 800C, 802C

Components		Unit size		
		708B	800C	802C
Unit configuration	RDS basic unit ¹	881	893	1180
Outdoor/return Air Options	Return air plenum	265	488	599
	0–30% O.A. hood with damper	309	633	744
	100% O.A. Hood	155	—	—
	100% O.A. hood with damper	220	286	286
	0–100% economizer, 40" section	—	1003	1121
	0–100% economizer, 52" section	—	1125	1125
	0–100% economizer, 62" section	—	1180	—
	0–100% economizer, 66" section	767	—	—
	0–100% economizer, 80" section	—	—	1444
	0–100% economizer, 188" section	—	—	—
Filter options—draw-through section	Mixing box with hood	395	—	—
	2" throwaway/30% pleated	63	9	9
	Cleanable	112	19	19
	65% cartridge with prefilter	85	146	146
	95% cartridge with prefilter	113	154	154
Blenders	Blenders (low cfm)	—	540	540
	Blenders (high cfm)	—	548	548
Filter options—blow-through section (final filters, 95% cartridge) ²	With cooling only, steam, or hot water heat	378	625	625
	With gas or electric heat	—	794	794
Supply air fan assembly	15" × 6" dia. forward curved	155	—	—
	15" × 9" dia. forward curved	165	—	—
	15" × 15" dia. forward curved	193	—	—
	15" × 15" dia. forward curved with vanes	212	—	—
	16" dia. airfoil	311	—	—
	16" dia. airfoil with vanes	339	—	—
	(2) 15" × 6" dia. forward curved	—	345	—
	(2) 15" × 15" dia. forward curved	—	375	—
	20" dia. airfoil	—	556	—
	24" dia. forward curved—LP	—	—	539
24" dia. forward curved—MP	—	—	569	
Return air fan assembly	15" × 15" dia. forward curved	211	350	—
	15" × 15" dia. forward curved with vanes	253	—	—
	16" dia. airfoil	311	—	—
	16" dia. airfoil with vanes	339	—	—
	30" dia. airfoil	—	385	385
Supply and return fan motors	40" dia. airfoil	—	—	512
	1–2 hp open drip-proof	48	48	48
	3–5 hp open drip-proof	82	82	82
	7 1/2 hp open drip-proof	124	124	124
	10 hp open drip-proof	144	144	144
	15 hp open drip-proof	—	185	185
	20 hp open drip-proof	—	214	214
	25 hp open drip-proof	—	266	266
30 hp open drip-proof	—	—	—	
Heat/cool section ¹	Single coil section with drain pan	—	540	540
	Staggered coil section with drain pan	—	—	—
	Face and bypass dampers—single coil	135	144	144
	Face and bypass dampers—staggered coil	—	—	—
Coil piping vestibule	Valve package	—	45	45
	22" vestibule, lined	—	102	102
	28" vestibule, lined	—	111	111
	40" vestibule, lined	—	126	126
	48" vestibule, lined	90	—	—
Heat only section	52" vestibule, lined	—	143	143
	Steam/hot water heat section	—	—	—
Electric heat	20 kW	—	565	565
	40 kW	—	664	664
	60 kW	—	668	668
	80 kW	—	696	696
	100 kW	—	769	769
	120 kW	—	777	777
	140 kW	—	811	811
	160 kW	—	819	819
	180 kW	—	841	841
200 kW	—	849	849	

Table 41 continued: Component unit weights (lbs.)—RDS 708B, 800C, 802C

Components		Unit size		
		708B	800C	802C
Gas or oil furnace	200, 250, 320, 400 MBh	—	964	964
	500, 640 MBh	—	1041	1041
	650, 790 MBh	—	1155	1155
	800, 1000 MBh	—	1237	1237
Plenum options	Discharge plenum	265	515	515
	Discharge air damper	23	49	—
	Return air damper	23	58	—
Power package/MicroTech control	Main control panel	150	300	300
Blank section	22" section, unlined	—	262	262
	28" section, unlined	—	309	309
	33" section, unlined	265	—	—
	40" section, unlined	—	405	405
	52" section, unlined	—	512	512
Insulation liners	Weight per foot of unit length	30	24	24
Roof curbs	114" curb	270	See page 99	
	141" curb	—		
	147" curb	320		
	180" curb	400		
	188" curb	—		
	213" curb	450		

1. A basic RDS 708B unit consists of filter section without media, coil section without coil, and supply fan section without fan or motor. A basic RDS 800C and 802C unit consists of angular filter section with 2" throwaway filters and a supply fan section without fan or motor.
2. Final filter option includes liners in final filter and discharge plenum sections.

Roof Curb Weights—RDS 800C and 802C

Calculate the weight of the unit curb using one of the following equations and adding additional weights accordingly.

Weight Formula

$$\text{Base curb wt. (lb)} = 0.74 [170 + 2 \times \text{curb length (in)}]$$

Additional Weights:

1. For return plenum with bottom opening, add 91 lb
2. For discharge plenum with bottom opening, add 78 lb
3. For blank compartment out of airstream, add 30 lb
4. Cross supports:
 - a. For curb length greater than 144 in, add 30 lb
 - b. For curb length greater than 288 in, add 60 lb
 - c. For curb length greater than 432 in, add 90 lb
 - d. For curb length greater than 576 in, add 120 lb

Fin Correction Factors

5/8" Coils

- 6 fpi . . . Deduct 0.28 lb/sq ft of face area/row
- 8 fpi . . . None
- 10 fpi . . . Add 0.28 lb/sq ft of face area/row
- 12 fpi . . . Add 0.56 lb/sq ft of face area/row
- 14 fpi . . . Add 0.84 lb/sq ft of face area/row

1" Coils

- 6 fpi . . . Deduct 0.62 lb/sq ft of face area/row
- 8 fpi . . . None
- 10 fpi . . . Add 0.62 lb/sq ft of face area/row
- 12 fpi . . . Add 1.24 lb/sq ft of face area/row
- 14 fpi . . . Add 1.86 lb/sq ft of face area/row

Table 42: RDS 708B coil weights (lbs)

Fin length	Fin height	Face area	5/8" water and evaporator								5/8" steam		1" steam
			1 row	2 row	3 row	4 row	5 row	6 row	8 row	10 row	1 row	2 row	1 row
36	12	3.0	16	23	32	39	46	54	70	84	21	33	48
	18	4.5	21	32	42	53	64	75	96	116	28	44	61
	24	6.0	26	40	53	68	81	95	124	148	37	57	74
	30	7.5	32	49	66	83	99	116	150	179	44	69	86
	36	9.0	—	—	—	—	—	—	—	—	—	54	84
48	12	4.0	22	31	39	51	61	71	90	109	27	42	59
	18	6.0	26	41	54	69	82	96	124	149	36	56	74
	24	8.0	32	50	68	85	103	122	158	189	45	72	90
	30	10.0	39	61	82	104	126	148	191	229	54	87	104
	36	12.0	43	70	96	122	148	174	226	269	65	104	120

Note: Coil weight based on 8 fpi.

Table 43: RDS 800C and 802C coil weights (lbs)

Fin length	Fin height	Face area	5/8" water and evaporator								5/8" steam		1" steam
			1 row	2 row	3 row	4 row	5 row	6 row	8 row	10 row	1 row	2 row	1 row
36	12	6.6	44	58	72	86	99	113	141	167	46	62	87
	18	9.9	55	76	96	117	138	158	199	240	58	81	108
	24	13.2	66	93	120	148	175	202	258	312	70	102	130
	30	16.5	77	111	146	179	214	248	316	385	81	123	152
	36	19.8	88	128	160	211	251	293	374	458	93	142	173
	42	23.0	99	146	174	242	290	338	433	530	105	161	195

Note:

1. Coil weight based on 8 fpi.
2. Correcting for actual weight of 75", 78" or 82" unit code is not significant

Table 44: Component unit weights (lbs.)—RAH 047C to 077C

Components		Unit size					
		047CS	047CL	047CY	077CS	077CL	077CY
Unit configuration	RAH basic unit ¹	1475	1475	1475	1732	1732	1732
Outdoor/return air options	Return air plenum	524	524	524	973	973	973
	0–30% O.A. hood with damper	746	746	746	1235	1235	1235
	100% O.A. hood with damper	435	435	435	967	967	967
	0–100% economizer—40" section	1589	1589	1589	2239	2239	2239
	Mixing box with hood	1144	1144	1144	2161	2161	2161
Blenders	Blender (low cfm)	628	628	628	727	727	727
	Blender (high cfm)	632	632	632	731	731	731
Exhaust air fan assembly	1 fan, bottom or back return	525	525	525	—	—	—
	2 fans, bottom or back return	785	785	785	891	891	891
	3 fans, bottom or back return	—	—	—	1151	1151	1151
	1 fan, side return	1125	1125	1125	—	—	—
	2 fans, side return	1385	1385	1385	1581	1581	1581
	3 fans, side return	—	—	—	1841	1841	1841
Filter options—draw-through section	2" throwaway	Included in basic unit weight					
	30% pleated	4	4	4	6	6	6
	65% cartridge—standard flow	57	57	57	69	69	69
	65% cartridge—medium flow	538	538	538	589	589	589
	65% cartridge—high flow	—	—	—	1100	1100	1100
	95% cartridge—standard flow	67	67	67	83	83	83
	95% cartridge—medium flow	550	550	550	605	605	605
Filter options—final filters, 95% cartridge ²	95% cartridge—high flow	—	—	—	1120	1120	1120
	95% cartridge—standard flow	1083	1083	1083	1296	1296	1296
	95% cartridge—medium flow	1509	1509	1509	1760	1760	1760
DWDI supply air fan assembly	95% cartridge—high flow	—	—	—	2275	2275	2275
	27" dia. forward curved—LP	919	919	919	—	—	—
	27" dia. forward curved—MP	942	942	942	—	—	—
	27" dia. airfoil	868	868	868	—	—	—
	30" dia. airfoil	965	965	965	—	—	—
	33" dia. airfoil	1452	1452	1452	989	989	989
	36" dia. airfoil	—	—	—	1719	1719	1719
SWSI supply air fan assembly	40" dia. airfoil	—	—	—	1760	1760	1760
	40" dia. airfoil	1068	1068	1068	—	—	—
	44" dia. airfoil	1367	1367	1367	1484	1484	1484
Return air fan assembly	49" dia. airfoil	—	—	—	2540	2540	2540
	40" dia. airfoil	629	629	629	—	—	—
Supply and return fan motors	44" dia. airfoil	—	—	—	1143	1143	1143
	2 hp open drip-proof	44	44	44	—	—	—
	3 hp open drip-proof	71	71	71	—	—	—
	5 hp open drip-proof	82	82	82	82	82	82
	7-1/2 hp open drip-proof	124	124	124	124	124	124
	10 hp open drip-proof	144	144	144	144	144	144
	15 hp open drip-proof	185	185	185	185	185	185
	20 hp open drip-proof	214	214	214	214	214	214
	25 hp open drip-proof	266	266	266	266	266	266
	30 hp open drip-proof	310	310	310	310	310	310
	40 hp open drip-proof	404	404	404	404	404	404
	50 hp open drip-proof	452	452	452	452	452	452
	60 hp open drip-proof	—	—	—	620	620	620
	75 hp open drip-proof	—	—	—	680	680	680
	2 hp totally enclosed	49	49	49	—	—	—
	3 hp totally enclosed	72	72	72	—	—	—
	5 hp totally enclosed	85	85	85	85	85	85
	7-1/2 hp totally enclosed	140	140	140	140	140	140
	10 hp totally enclosed	170	170	170	170	170	170
	15 hp totally enclosed	235	235	235	235	235	235
	20 hp totally enclosed	300	300	300	300	300	300
	25 hp totally enclosed	330	330	330	330	330	330
	30 hp totally enclosed	390	390	390	390	390	390
	40 hp totally enclosed	510	510	510	510	510	510
	50 hp totally enclosed	570	570	570	570	570	570
	60 hp totally enclosed	—	—	—	850	850	850
	75 hp totally enclosed	—	—	—	910	910	910

Table 44 continued: Component unit weights (lbs.)—RAH 047C to 077C

Components		Unit size					
		047CS	047CL	047CY	077CS	077CL	077CY
Electric heat	40 kW	852	852	852	—	—	—
	60 kW	860	860	860	—	—	—
	80 kW	863	863	863	1035	1035	1035
	100 kW	869	869	869	1041	1041	1041
	120 kW	875	875	875	1046	1046	1046
	160 kW	886	886	886	1058	1058	1058
	200 kW	910	910	910	1087	1087	1087
	240 kW	922	922	922	1099	1099	1099
	280 kW	—	—	—	1111	1111	1111
	320 kW	—	—	—	1123	1123	1123
Gas furnace	200 MBh	893	893	893	—	—	—
	250 MBh	893	893	893	—	—	—
	320 MBh	941	941	941	—	—	—
	400 MBh	946	946	946	—	—	—
	500 MBh	1002	1002	1002	1132	1132	1132
	640 MBh	1002	1002	1002	1132	1132	1132
	650 MBh	1086	1086	1086	1230	1230	1230
	790 MBh	1086	1086	1086	1230	1230	1230
	800 MBh	1151	1151	1151	1301	1301	1301
	1000 MBh	1151	1151	1151	1301	1301	1301
	1100 MBh	—	—	—	1496	1496	1496
	1400 MBh	—	—	—	1496	1496	1496
	1500 MBh	—	—	—	1718	1718	1718
	2000 MBh	—	—	—	1733	1733	1733
Gas heating piping vestibule	4 ft lined	—	—	—	233	233	233
Plenum options	Discharge plenum—4 ft	536	536	536	600	600	600
	Discharge plenum—6 ft	—	—	—	—	987	987
	Burglar bars—discharge	53	53	53	69	81	81
	Burglar bars—return	73	73	73	114	114	114
	Isolation dampers—discharge	85	85	85	106	125	125
	Isolation dampers—return	112	112	112	172	172	172
Power package—MicroTech control	Main control panel	410	410	410	470	470	470
Blank section	24" section, unlined	341	341	341	387	387	387
	48" section, unlined	574	574	574	651	651	651
	72" section, unlined	915	915	915	1038	1038	1038
Insulation liners	2", 1.5 lb insulation with liners—weight per ft of unit length, excluding blank compartment.	25	25	25	30	30	30
Roof curbs—without blank compartment (out of airstream)	8 feet	435	435	435	455	455	455
	10 feet	469	469	469	489	489	489
	12 feet	550	550	550	523	523	523
	14 feet	584	584	584	604	604	604
	16 feet	618	618	618	638	638	638
	18 feet	652	652	652	672	672	672
	20 feet	686	686	686	706	706	706
	22 feet	720	720	720	740	740	740
	24 feet	801	801	801	774	774	774
	26 feet	835	835	835	808	808	808
	28 feet	870	870	870	889	889	889
	30 feet	903	903	903	924	924	924
	32 feet	937	937	937	958	958	958
	34 feet	971	971	971	992	992	992
	36 feet	1053	1053	1053	1026	1026	1026
	38 feet	1087	1087	1087	1060	1060	1060
	40 feet	1121	1121	1121	1141	1141	1141
	42 feet	1155	1155	1155	1175	1175	1175
	44 feet	1189	1189	1189	1209	1209	1209
	46 feet	1223	1223	1223	1243	1243	1243
	48 feet	1304	1304	1304	1277	1277	1277
50 feet	1338	1338	1338	1311	1311	1311	
52 feet	—	—	—	1392	1392	1392	
54 feet	—	—	—	1427	1427	1427	

Table 44 continued: Component unit weights (lbs.)—RAH 047C to 077C

Components		Unit size					
		047CS	047CL	047CY	077CS	077CL	077CY
Roof curbs— with blank compartment (out of airstream)	14 feet	584	584	584	604	604	604
	16 feet	618	618	618	638	638	638
	18 feet	699	699	699	672	672	672
	20 feet	733	733	733	706	706	706
	22 feet	767	767	767	787	787	787
	24 feet	801	801	801	821	821	821
	26 feet	835	835	835	855	855	855
	28 feet	869	869	869	889	889	889
	30 feet	950	950	950	923	923	923
	32 feet	985	985	985	957	957	957
	34 feet	1019	1019	1019	1039	1039	1039
	36 feet	1053	1053	1053	1073	1073	1073
	38 feet	1087	1087	1087	1107	1107	1107
	40 feet	1121	1121	1121	1141	1141	1141
	42 feet	1203	1203	1203	1175	1175	1175
	44 feet	1237	1237	1237	1209	1209	1209
	46 feet	1271	1271	1271	1291	1291	1291
	48 feet	1305	1305	1305	1325	1325	1325
	50 feet	1339	1339	1339	1358	1358	1358
	52 feet	1373	1373	1373	1392	1392	1392
54 feet	1454	1454	1454	1426	1426	1426	
56 feet	1488	1488	1488	1460	1460	1460	
58 feet	—	—	—	1541	1541	1541	
60 feet	—	—	—	1575	1575	1575	

1. RAH basic unit includes fan section less fan and motor plus an angular filter section.
2. Final filter option includes liners in final filter and discharge plenum sections.

Table 45: Coil section unit weight (lbs.)—RAH 047C to 077C

Components		Unit size							
		047CS		047CL		077CS		077CL	
		w/o F&BP	w/ F&BP	w/o F&BP	w/ F&BP	w/o F&BP	w/ F&BP	w/o F&BP	w/ F&BP
Heat/cool section	4 ft—unlined w/ drain pan	628	628	—	705	705	—	—	—
	6 ft—unlined w/ drain pan	—	—	969	969	—	—	1092	—
	8 ft—unlined w/ drain pan	—	—	—	—	—	—	1356	1356
Heat section	4 ft—unlined	574	—	574	—	574	—	574	—
Evaporator coils— aluminum fins	3 row—8 FPI	370	—	1001	—	487	—	1374	—
	3 row—10 FPI	395	—	1030	—	520	—	1411	—
	3 row—12 FPI	419	—	1059	—	553	—	1448	—
	4 row—8 FPI	445	—	1135	—	588	—	1495	—
	4 row—10 FPI	478	—	1151	—	632	—	1558	—
	4 row—12 FPI	510	—	1166	—	676	—	1621	—
	5 row—8 FPI	518	—	1176	—	689	—	1637	—
	5 row—10 FPI	559	—	1224	—	744	—	1715	—
	5 row—12 FPI	600	—	1272	—	799	—	1793	—
	6 row—8 FPI	595	—	1269	—	793	—	1786	—
	6 row—10 FPI	644	—	1327	—	859	—	1880	—
	6 row—12 FPI	693	—	1385	—	925	—	1974	—
Evaporator coils— copper fins	3 row—8 FPI	591	—	1262	—	788	—	1776	—
	3 row—10 FPI	671	—	1356	—	897	—	1928	—
	3 row—12 FPI	750	—	1450	—	1005	—	2080	—
	4 row—8 FPI	739	—	1437	—	989	—	2058	—
	4 row—10 FPI	845	—	1562	—	1134	—	2261	—
	4 row—12 FPI	951	—	1687	—	1278	—	2463	—
	5 row—8 FPI	886	—	1611	—	1191	—	2340	—
	5 row—10 FPI	1019	—	1768	—	1372	—	2594	—
	5 row—12 FPI	1151	—	1924	—	1553	—	2847	—
	6 row—8 FPI	1036	—	1791	—	1395	—	2630	—
	6 row—10 FPI	1196	—	1979	—	1612	—	2934	—
	6 row—12 FPI	1355	—	2167	—	1829	—	3238	—
Chiller water coils— aluminum fins	3 row—8 FPI	351	423	950	1117	462	576	1302	1370
	3 row—10 FPI	374	440	978	1145	493	598	1337	1401
	3 row—12 FPI	397	456	1005	1172	525	620	1372	1431
	4 row—8 FPI	422	474	1078	1245	558	643	1417	1469
	4 row—10 FPI	453	497	1093	1260	600	672	1477	1520
	4 row—12 FPI	483	519	1107	1274	641	702	1536	1571
	5 row—8 FPI	491	525	1116	1283	654	710	1552	1584
	5 row—10 FPI	530	553	1162	1329	706	747	1625	1648
	5 row—12 FPI	569	581	1208	1375	758	783	1699	1711
	6 row—8 FPI	564	578	1205	1372	752	779	1693	1706
	6 row—10 FPI	610	612	1260	1427	815	823	1782	1782
	6 row—12 FPI	657	646	1315	1482	878	867	1871	1858
	8 row—8 FPI	722	693	1542	1709	963	927	2167	2112
	8 row—10 FPI	781	736	1613	1780	1043	983	2281	2210
8 row—12 FPI	841	780	1683	1850	1123	1039	2395	2308	

Table 45 continued: Coil section unit weight (lbs.)—RAH 047C to 077C

Components		Unit size							
		047CS		047CL		077CS		077CL	
		w/o F&BP	w/ F&BP	w/o F&BP	w/ F&BP	w/o F&BP	w/ F&BP	w/o F&BP	w/ F&BP
Chiller water coils— copper fins	3 row—8 FPI	560	575	1198	1365	748	776	1683	1697
	3 row—10 FPI	636	631	1287	1454	851	848	1827	1821
	3 row—12 FPI	711	685	1377	1544	954	920	1971	1945
	4 row—8 FPI	700	677	1364	1631	938	909	1951	1927
	4 row—10 FPI	801	751	1483	1650	1076	1006	2143	2092
	4 row—12 FPI	901	824	1602	1769	1213	1101	2334	2256
	5 row—8 FPI	840	779	1529	1696	1130	1043	2218	2156
	5 row—10 FPI	966	871	1678	1845	1302	1163	2459	2363
	5 row—12 FPI	1091	962	1827	1994	1474	1284	2698	2569
	6 row—8 FPI	982	883	1700	1867	1324	1179	2493	2392
	6 row—10 FPI	1133	993	1879	2046	1529	1323	2781	2639
	6 row—12 FPI	1284	1103	2057	2224	1735	1467	3069	2887
	8 row—8 FPI	1257	1083	2176	2343	1694	1438	3191	2991
	8 row—10 FPI	1451	1224	2405	2572	1958	1622	3559	3307
8 row—12 FPI	1644	1365	2633	2800	2221	1807	3928	3624	
Hot water coil— aluminum fins	1 row	235	328	235	—	386	443	286	—
	2 row	311	380	311	—	393	515	393	—
Hot water coil— copper fins	1 row	306	398	306	—	387	544	387	—
	2 row	453	521	453	—	594	716	594	—
Steam coil— aluminum fins	1 row—6 FPI	228	323	228	—	276	437	276	—
	1 row—12 FPI	251	339	251	—	309	459	309	—
	2 row—6 FPI	302	373	302	—	382	507	382	—
Steam coils— copper fins	1 row—6 FPI	252	347	252	—	311	471	311	—
	1 row—12 FPI	368	456	368	—	476	625	476	—
	2 row—6 FPI	351	422	651	—	451	577	451	—
Valve package	Chilled water	126	126	126	126	126	126	126	126
	Hot water	138	—	138	—	138	—	138	—
	Steam	103	—	103	—	103	—	103	—
Heat coil piping vestibule	2 ft—lined	120	120	120	120	—	—	—	—
	4 ft—lined	183	183	183	183	183	183	183	183

Example: RAH 047CL

Components	Weight (lbs)	*Liner weight	Section	Length (ft)	Weight (lbs)
Basic unit	1475				
Economizer	1589				
2" throw-away filter 95% final filters, std. flow	1083		Economizer	6	150
DWDI supply fan, 33" airfoil	1452		Filter	2	50
Return fan, 40" airfoil	629		Supply Fan	8	200
SAF motor—20 hp open drip proof	214		Heat	4	100
RAF motor—10 hp open drip proof	144		Heat/Cool	6	150
Discharge plenum	536				
Burglar bars, discharge	53				
Heat section	574				
Hot water coil, Al fins—2 row	311				
Hot water valve package	138				
Heat/Cool section	969				
Chilled water coil, Al fins, F&BP—5 row, 10 fpi	1329				
Chilled water valve package	126				
MicroTech control	410				
Liners (section length × 25 lb/ft)*	650				
Roof curb—34 feet	971				
Total weight	12,653		Total liner length × 25 lb/ft	26	650

General

- A. Furnish and install, as shown on plans, Daikin RoofPak® Applied Rooftop Air Handling Unit(s) model RDS 708. Unit performance and electrical characteristics shall be per the job schedule.
 - B. Each unit shall be specifically designed for outdoor rooftop application and include a weatherproof cabinet. Units shall be of a modular design to provide maximum design flexibility. Each unit shall be completely factory assembled and shipped in one piece.
 - C. All units shall have decals and tags to indicate caution areas and aid unit service. Unit nameplates shall be fixed to the main control panel door. Electrical wiring diagrams shall be attached to the control panels. Installation, operating and maintenance bulletins and start-up forms shall be supplied with each unit.
 - D. The unit shall undergo a complete factory run test prior to shipment and factory test sheets shall be available upon request. The factory test shall include final balancing of the supply [and return] fan assemblies, [a unit electrical system operations checkout,] and a final unit inspection.
 - E. The complete unit(s) shall be ETL and ETL-Canada listed by Intertek Testing Services, Inc. Units shall conform to bi-national standard ANSI/UL Standard 1995/CSA Standard C22.2 No. 236. Unit(s) shall be accepted for use in the City of New York by the Department of Building, MEA #368-93-E Vol. II.
 - F. Unit supply fan and coil performance shall be AHRI certified.
- C. Exterior surfaces shall be constructed of pre-painted galvanized steel for aesthetics and long term durability. Paint finish to include a base primer with a high quality, polyester resin topcoat of a neutral beige color. Finished surface to withstand a minimum 750-hour salt spray test in accordance with ASTM B117 standard for salt spray resistance.
 - D. Service doors shall be provided on both sides of each section in order to provide user access to all unit components. Service doors shall be constructed of 19 gauge galvanized steel. All service doors shall be mounted on multiple, stainless steel hinges and shall be secured by a latch system that is operated by a single, flush mounted handle. Removable panels, or doors secured by multiple, mechanical fasteners are not acceptable.
 - E. The unit base frame shall be constructed of 8 & 18-gauge galvanized steel. The unit base shall overhang the roof curb for positive water runoff and shall have a formed recess that seats on the roof curb gasket to provide a positive, weather tight seal. Lifting brackets shall be provided on the unit base with lifting holes to accept cable or chain hooks.

Fan Sections

- A. All fan assemblies shall be statically and dynamically balanced at the factory, including a final trim balance, prior to shipment.
- B. All fan assemblies shall employ solid steel fan shafts. Heavy-duty pillow block type, self-aligning, grease-lubricated ball bearings shall be used. Bearings shall be sized to provide an L-50 life at 200,000 hours.
- C. The entire fan assembly shall be isolated from the fan bulkhead and mounted on [rubber-in-shear isolators] [spring isolators] [spring isolators with seismic restraints].
- D. [Fixed] [Adjustable] pitch V-belt drives with matching belts shall be provided. V-belt drives shall be selected at [the manufacturer's standard service factor] [1.5 times fan brake horsepower].
- E. Fan motors shall be heavy-duty 1800 rpm [open drip-proof (ODP)] [totally enclosed TEFC] type with grease-lubricated ball bearings. [Motors shall be premium efficiency.] Motors shall be mounted on an adjustable base that provides for proper alignment and belt tension adjustment.

Cabinet, Casing and Frame

- A. Unit cabinet shall be completely insulated with a minimum of 1" thick, 3/4 lb. density neoprene coated glass fiber secured to all unlined panels with adhesive and mechanical fasteners.
- B. All access doors shall include solid galvanized steel liners to protect insulation during service and maintenance. [Solid galvanized steel liners shall be provided throughout, allowing no exposed insulation within the air stream. All cabinet insulation shall be a nominal 2" thick, 1½ lb. density, R6.5, glass fiber.]

F. Airfoil supply fans

Supply fans shall be double width, double inlet (DWDI) airfoil centrifugal fan. All fans shall be mounted using shafts and hubs with mating keyways. Fans shall be Class II type and fabricated from heavy-gauge aluminum. Fan blades shall be continuously welded to the back plate and end rim.

G. Forward curved supply fans

Supply fan shall be double width, double inlet (DWDI) forward curved centrifugal fan. All fans shall be mounted using shafts and hubs with mating keyways. The forward curved fan wheel and housing shall be fabricated from galvanized steel and shall be [Class I] [Class II] construction to satisfy the specified application.

H. Airfoil return fans

Double width, double inlet (DWDI) airfoil centrifugal return air fan shall be provided. The fan wheel shall be Class II construction and fabricated from heavy-gauge aluminum with fan blades continuously welded to the back plate and end rim. The fan shall be mounted using shafts and hubs with mating keyways. Exhaust fans are not acceptable.

I. Forward curved return fans

Double width, double inlet (DWDI) forward curved centrifugal return air fans shall be provided. Fans shall be mounted using shafts and hubs with mating keyways. The fan wheels and housings shall be fabricated from painted steel and shall be Class I construction to satisfy the specified application. Exhaust fans are not acceptable.

- J. [The supply air fan and return air fan sections shall be provided with an expanded metal belt guard.]

Electrical

- A. [The air handler shall have no power control wiring. All unit wiring shall be the responsibility of the control contractor.]
- B. [Each unit shall come complete with an integral, weatherproof control panel. Wiring shall comply with NEC requirements and with all applicable UL standards. All electrical components shall be UL recognized, where applicable.]
 1. To provide for easy identification, all wiring and electrical components provided with unit shall be numbered, color-coded and labeled according to the electrical diagram provided with the unit.
 2. The main unit control panel shall be completely factory wired and contained in a weatherproof enclosure. The main unit control panel shall be provided with dead front covers over all line voltage components. A terminal board shall be provided for low voltage control wiring.
 3. Branch circuit fusing, 115V control circuit transformer with fuse, system switches, high temperature sensor and 115V service receptacle shall also be provided. The 115V service receptacle shall require a separate power source.
 4. Knockouts shall be provided in the bottom of the main control panels for field wiring entrance.
 5. Supply [and return] fan motors shall have individual fuses, contactors and external, line break overload protection.
 6. [A factory installed and wired marine light, with switch and receptacle, shall be provided in the supply [and return] fan section.]
 7. All receptacles will have ground fault protection.
 8. A single point power connection shall power the entire unit except the receptacle and light circuit. [Separate 115-volt power is required for the lights and receptacle to allow power to these components while the main power is disconnected for service.]
 - a. [A terminal block shall be provided for the 3 phase power connection.]
 - b. A single non-fused disconnect switch shall be provided for disconnecting electrical power at the unit. Disconnect switch shall be mounted internal to the control panel and operated by an externally mounted handle. Externally mounted handle to prohibit opening of the control panel door without the use of a service tool.

Combination Cooling Coil/ Heating Coil Section

- A. The coil section shall be installed in a draw through configuration, upstream of the supply air fan. The coil section shall be complete with [cooling coil] [cooling and heating coils] and sloped drain pan.
 - 1. A [painted galvanized] [stainless] steel, positively sloped drain pan shall be provided. The drain pan shall have a minimum slope of 1/8" per foot to provide positive draining.
 - 2. The drain pan shall extend beyond the leaving side of the coil and underneath the cooling coil connections.
 - 3. The drain pan shall be connected to a threaded drain connection extending through the unit base.
- B. Hinged access doors on both sides of the section shall provide convenient access to the cooling coil and drain pan for inspection and cleaning.
- C. ARI Certified coils shall be provided as follows.
 - 1. [All water coils shall have copper headers complete with threaded steel, supply and return connections plus threaded vent connections.] [Chilled water coils shall also include threaded drain connections.]
 - 2. [Ethylene] [Propylene] glycol shall be added to the water circuit to protect against coil freeze-up.]
 - 3. [DX coils shall have factory installed distributors and suction headers with brazed connections. The installing contractor shall provide Refrigerant specialties.]
 - 4. [Steam coils shall include supply and return headers, threaded supply and return connections, [non-freeze, jet distributing, tube in tube construction] and tubes shall be sloped towards the return connection.]
- D. All coils are fabricated of seamless 5/8" diameter copper tubing that is mechanically expanded into high efficiency [aluminum] [copper] plate fins. Coils shall be multi-row, staggered tube design per the job schedule.
- E. All coils shall be factory leak tested with high pressure air under water.
- F. [Factory installed face and bypass dampers shall be provided.]
- G. Field piping must be able to enter through the floor of the unit, immediately downstream of the drain pan. [If full fin length coils are used then an 18" deep piping vestibule shall be field installed on the heat/cool section to allow space for coil piping connections. The vestibule shall be constructed of the same materials as the unit casing.]

Filter Sections

Draw-through Filters

- A. Unit shall be provided with a draw-through filter section. The filter section shall be supplied complete with the filter rack as an integral part of the unit. The draw-through filter section shall be provided with [panel] [cartridge] filters.
- B. 2" thick AmericanAirFilter® [30% efficient, MERV 8] [85% efficient, MERV 13] pleated panel filters shall be provided. Filters shall be frame mounted and shall slide into galvanized steel racks contained within the unit. Filters shall be installed in an angular arrangement to maximize filter area and minimize filter face velocity. Filters shall be accessible from both sides of the filter section.
- C. [12" deep [60-65%] [90-95%] efficient, UL Std. 900, Class 1, AmericanAirFilter cartridge filters shall be provided. 2" panel, 30% efficient pre-filters shall be included. Cartridge filters shall consist of filter media permanently attached to a metal frame and shall slide into a gasketed, extruded aluminum rack contained within the unit. The filter rack shall have secondary gasketed, hinged end panels to insure proper sealing. Filters shall be accessible from both sides of the filter section.]
- D. [[30% efficient pleated] [60-65% efficient cartridge] [90-95% efficient cartridge] filters shall be provided with INTERSEPT® antimicrobial treatment.]

Final Filters Option

- E. Final Filters—Unit shall be provided with a final filter section downstream of the supply fan. Unit to have at least 40" of unit length between the fan discharge and the final filters to allow for proper air distribution. The final filter section shall be supplied complete with the filter rack as an integral part of the unit. The final filter section shall be provided with cartridge filters.
- F. 12" deep 90-95% efficient, UL Std. 900, Class 1, AmericanAirFilter cartridge filters shall be provided. Cartridge filters shall consist of filter media permanently attached to a metal frame and shall slide into a gasketed, extruded aluminum rack contained within the unit. The filter rack shall have secondary gasketed, hinged end panels to insure proper sealing. Filters shall be accessible from both sides of the filter section.
- G. [Filters shall be provided with INTERSEPT antimicrobial treatment.]

Outdoor/Return Air Section Options

- A. [Unit shall be provided with a return air plenum for handling 100% re-circulated air. The 100% return air plenum shall allow return air to enter from the [bottom] [back] of the unit.]
- B. [A return air plenum shall be provided with a 0 to 30% outdoor air hood. The return air plenum shall allow return air to enter from the [bottom] [back] of the unit.]
 - 1. The hood shall allow outdoor air to enter at the back of the return air plenum.
 - 2. The outdoor air hood shall be factory installed and constructed from galvanized steel finished with the same durable paint finish as the main unit.
 - 3. The hood shall include a bird screen to prevent infiltration of foreign materials and a rain lip to drain water away from the entering air stream.

- 4. Daikin UltraSeal® low leak dampers shall be provided.
 - a. Damper blades shall be fully gasketed and side sealed and arranged horizontally in the hood.
 - b. Damper leakage shall be 1.5 cfm/ft² at 1" SP static pressure differential. Leakage rate to be tested in accordance with AMCA Standard 500.
 - c. Damper blades shall be operated from multiple sets of linkages mounted on the leaving face of the dampers. Control of the dampers shall be from a single lever accessible from outside the hood.
- C. [Unit shall be provided with a 100% outdoor air hood. The 100% outdoor air hood shall allow outdoor air to enter from the back of the unit, at the draw-through filter section.]
 - 1. The outdoor air hood shall be factory installed and constructed from galvanized steel finished with the same durable paint finish as the main unit.
 - 2. The hood shall include a bird screen to prevent infiltration of foreign materials and a rain lip to drain water away from the entering air stream.
 - 3. Daikin UltraSeal low leak dampers shall be provided.
 - a. Damper blades shall be fully gasketed and side sealed and arranged vertically in the hood.
 - b. Damper leakage shall be 1.5 cfm/ft² at 1" SP static pressure differential. Leakage rate to be tested in accordance with AMCA Standard 500.
 - c. Damper blades shall be operated from multiple sets of linkages mounted on the leaving face of the dampers. Control of the dampers shall be from a single lever accessible from outside the hood.
- D. [Unit shall be provided with an outdoor air economizer section. The 0 to 100% outside air economizer section shall include outdoor, return, and exhaust air dampers.]
 - 1. Outdoor air shall enter from one side of the economizer section through factory installed intake hoods complete with rain lip and bird screen. The floor of the outdoor air intakes shall provide for water drainage.

2. The economizer section shall allow return air to enter from the [bottom] [back] of the unit.
3. A barometric exhaust damper shall be provided to exhaust air out of the side opposite the outdoor air intake. Exhaust hoods and a bird screen shall be provided to prevent infiltration of rain and foreign materials. Exhaust damper blades shall be lined with urethane gasket on contact edges.
4. The outside and return air dampers shall be sized to handle 100% of the supply air volume. The dampers shall be opposed sets of parallel blades, arranged vertically to converge the return air and outdoor air streams in circular mixing patterns.
 - a. Daikin UltraSeal low leak dampers shall be provided. Damper blades shall be fully gasketed and side sealed.
 - b. Damper leakage shall be 1.5 cfm/ft² at 1" SP static pressure differential. Leakage rate to be tested in accordance with AMCA Standard 500.
 - c. Damper blades shall be operated from multiple sets of linkages mounted on the leaving face of the dampers.
- E. [Unit shall be provided with a mixing box. The mixing box shall include integral outside and return air dampers and an outdoor air hood.]
 1. Return air shall enter at the bottom of the mixing box. Outside air shall enter at the rear of the mixing box through the outside air hood.
 2. The outside air hood shall come complete with rain lip and bird screen.
 3. Outside and return air dampers shall be linked together and sized to handle 100% of the supply air volume. Low leak dampers shall be provided.

Additional Sections

- A. [No additional sections are required.]
- B. [A blank heat section shall be installed [downstream] [upstream] [and upstream] of the supply air fan.]
- C. [The unit shall be provided with factory installed access sections located [upstream] [downstream] [upstream and downstream] of the supply air fan. Access sections shall have hinged access doors on both sides of the section and shall have the same construction features as the rest of the unit.]
- D. [A supply air discharge plenum shall be provided. The plenum section shall have a [bottom] [side] [front] discharge opening.]

Roof Curb

- A. [No roof curb is required.]
- B. [The installing contractor shall provide the roof curb.]
- C. [The manufacturer shall provide a prefabricated 12-gauge galvanized steel, mounting curb, designed and manufactured by the unit manufacturer, shall be provided for field assembly on the roof decking prior to unit shipment.]
 1. The roof curb shall be a full perimeter type with complete perimeter support of the air handling unit. The curb shall be a minimum of 16" high and include a nominal 2" x 4" wood nailing strip.
 2. Gasket shall be provided for field mounting between the unit base and roof curb.

General

- A. Furnish and install, as shown on plans, Daikin RoofPak Applied Rooftop Air Handling Unit(s) model RDS 800C, 802C, 047C or 077C. Unit performance and electrical characteristics shall be per the job schedule.
- B. Each unit shall be specifically designed for outdoor rooftop application and include a weatherproof cabinet. Units shall be of a modular design to provide maximum design flexibility. Each unit shall be [completely factory assembled and shipped in one piece.] [shipped in multiple sections to facilitate job site rigging] and configured as shown on the drawings.
- C. All units shall have decals and tags to indicate caution areas and aid unit service. Unit nameplates shall be fixed to the main control panel door. Electrical wiring diagrams shall be attached to the control panels. Installation, operating and maintenance bulletins and start-up forms shall be supplied with each unit.
- D. The unit shall undergo a complete factory run test prior to shipment. The factory test shall include final balancing of the supply [and return] fan assemblies, and a final unit inspection. [The following is also required.]
 1. [a unit electrical [and control] system operations checkout]
 2. [test and adjustment of the gas furnace]
- E. The complete unit(s) shall be ETL and ETL-Canada listed by Intertek Testing Services, Inc. Units shall conform to International standard ANSI/UL Standard 1995/CSA Standard C22.2 No. 236. Unit(s) shall be accepted for use in the City of New York by the Department of Building, MEA #368-93-E Vol. II.
- F. The furnace shall be ETL Canada/ [FM [IRI] approved.
- G. Unit supply fan and coil performance shall be ARI certified.

Cabinet, Casing and Frame

- A. Unit cabinet shall be completely insulated with [a minimum of 1 in thick, ¾ psf density neoprene coated glass fiber secured to all unlined panels with adhesive and mechanical fasteners.] [a nominal 2 in thick, 1.5 density, R6.5, glass fiber that is sandwiched between the exterior sheet metal cabinet and internal sheet metal liners. No insulation shall be exposed to the air stream.]
 1. [A combination of solid and perforated galvanized steel liners shall be provided throughout. Perforated liners to be used in the supply and return air plenums to provide improved sound attenuation.]
 2. All access doors shall be provided with solid galvanized steel liners to protect insulation during service and maintenance.
 3. The floor shall be constructed as follows.
 - a. [The walking side of the floor shall be galvanized steel, with no exposed insulation, and insulation attached on the bottom of the floor.]
 - b. [All floor panels shall be double wall construction and include a nominal 2 in thick, 1.5 psf density, R6.5 glass fiber insulation.]
- B. Exterior surfaces shall be constructed of pre-painted galvanized steel for aesthetics and long term durability. Paint finish to include a base primer with a high quality, polyester resin top coat of a neutral beige color. Finished surface to withstand a minimum 750-hour salt spray test in accordance with ASTM B117 standard for salt spray resistance.
- C. Service doors shall be provided on both sides of each section in order to provide user access to all unit components. Service doors shall be constructed of heavy gauge galvanized steel with a galvanized steel interior liner. All service doors shall be mounted on multiple, stainless steel hinges and shall be secured by a latch system that is operated by a single, flush mounted handle. The latch system shall feature a staggered engagement for ease of operation and a second catch to protect the user from injury when opening positive pressure doors. Removable panels, or doors secured by multiple, mechanical fasteners are not acceptable.

- D. D The unit base frame shall be constructed of [15-gauge, RDS 800–802] [13-gauge, RAH 047–077] pre-painted galvanized steel. The unit base shall overhang the roof curb for positive water runoff and shall have a formed recess that seats on the roof curb gasket to provide a positive, weathertight seal. Lifting brackets shall be provided on the unit base with lifting holes to accept cable or chain hooks.
- E. E The cabinet shall be rated to handle up to [5.5", RDS 800 and 802] [6.5", RAH 047–077] of total fan static pressure.

Fan Sections

- A. All fan assemblies shall be statically and dynamically balanced at the factory, including a final trim balance prior to shipment.
 - B. All fan assemblies shall employ solid steel fan shafts. Heavy-duty pillow block type, self-aligning, grease lubricated ball bearings shall be used. Bearings shall be sized to provide an L-50 life at 200,000 hours.
 - C. The entire fan assembly shall be isolated from the fan bulkhead and mounted on [rubber-in-shear isolators] [spring isolators] [spring isolators with seismic restraints].
 - D. [Fixed] [Adjustable] pitch V-belt drives with matching belts shall be provided. V-belt drives shall be selected at [the manufacturer's standard service factor] [1.5 times fan brake horsepower].
 - E. Fan motors shall be heavy-duty 1800 rpm [open drip-proof (ODP)] [totally enclosed TEFC] type with grease-lubricated ball bearings. [Motors shall be high efficiency and meet applicable EPACT requirements.] [Motors shall be premium efficiency.] Motors shall be mounted on an adjustable base that provides for proper alignment and belt tension adjustment.
- F. **Airfoil supply fans**
 1. RDT supply fan shall be single width, single inlet (SWSI) airfoil centrifugal fan. The fan wheel shall be Class II construction with aluminum fan blades continuously welded to the back plate and end rim. Fan blades shall be mounted using shafts and hubs with mating keyways.
 2. Supply fans shall be double width, double inlet (DWDI) airfoil centrifugal fan. All fans shall be mounted using shafts and hubs with mating keyways. Fans shall be Class II type and fabricated from heavy-gauge aluminum. Fan blades shall be continuously welded to the back plate and end rim.
 - G. **Forward curved supply fans.** Supply fan shall be double width, double inlet forward curved centrifugal fan. All fans shall be mounted using shafts and hubs with mating keyways. The forward curved fan wheel and housing shall be fabricated from galvanized steel and shall be [Class I] [Class II] construction to satisfy the specified application.
 - H. **Airfoil return fans.** A single width, single inlet (SWSI) airfoil centrifugal return air fan shall be provided. The fan wheel shall be Class II construction and fabricated from heavy-gauge aluminum with fan blades continuously welded to the back plate and end rim. The fan shall be mounted using shafts and hubs with mating keyways. Exhaust fans are not acceptable.
 - I. **Forward curved return fans.** Double width, double inlet (DWDI) forward curved centrifugal return air fans shall be provided. Fans shall be mounted using shafts and hubs with mating keyways. The fan wheels and housings shall be fabricated from painted steel and shall be Class I construction to satisfy the specified application. Exhaust fans are not acceptable.
 - J. [The supply air fan and return air fan sections shall be provided with an expanded metal belt guard.]

Propeller Exhaust Fans (RAH only)

- A. Belt drive propeller exhaust fans shall be provided. Propellers shall be constructed with fabricated steel, and shall be securely attached to fan shafts. All propellers shall be statically and dynamically balanced. Motors shall be permanently lubricated, heavy-duty type, carefully matched to the fan load. Ground and polished steel fan shafts shall be mounted in permanently lubricated, sealed ball bearing pillow blocks. Bearings shall be selected for a minimum (L10) life in excess of 100,000 hours at maximum cataloged operating speeds. Drives shall be sized for a minimum of 105 percent of driven horsepower. Pulleys shall be of the fully machined cast iron type, keyed and securely attached to wheel and motor shafts. Motor sheaves shall be adjustable for system balancing. Drive frame and panel assemblies shall be galvanized steel. Drive frames shall be formed channels and panels shall be welded construction. The axial exhaust or supply fans shall bear the AMCA Certified Ratings Seals for both sound and air performance. Return fans are not acceptable.
- B. The exhaust fans shall be controlled by a variable frequency drive.
- C. [The exhaust air fan sections shall be provided with an expanded metal belt guard.]

Variable Air Volume Control

- A. [No VAV is required.]
- B. [Factory-installed VFDs]
 - 1. An electronic variable frequency drive shall be provided for the [supply air fan.] [supply and return air fans. Two independent drives, one per fan, shall be provided.] Drives are to be accessible through a hinged door assembly complete with a single handle latch mechanism. Mounting arrangements that expose drives to high temperature and/or unfiltered ambient air are not acceptable. The unit manufacturer shall install all power and control wiring.
 - 2. [The following options must be factory installed.]
 - a. [A manual bypass contactor arrangement shall be provided. The bypass arrangement will allow fan operation at full design cfm, even if the drive has been removed for service.]
 - b. [Line reactors shall be provided factory installed for each variable frequency drive.]
 - 3. Each drive shall be factory installed [in a designated access section, downstream of the filters and upstream of the cooling coil, such that each drive is directly cooled by filtered mixed air.] [in the supply fan section such that it is cooled by filtered air.]

- 4. Variable frequency drives shall be the latest generation pulse width modulation type utilizing IGBT technology. Drives shall meet UL Standard 95-5V and the variable frequency drive manufacturer shall have specifically approved them for plenum duty application. The completed unit assembly shall be listed by a recognized safety agency, such as ETL.
- 5. [The supply air fan drive output shall be controlled by the factory-installed main unit control system and drive status and operating speed shall be monitored and displayed at the main unit control panel.] [The supply and return fan drive outputs shall be independently controlled in order to provide the control needed to maintain both supply duct and building pressure control. Supply and return air fan drives that are slaved off of a common control output are not acceptable.]
- 6. All drives shall be factory run tested prior to unit shipment.

Electrical

- A. Unit wiring shall comply with NEC requirements and with all applicable UL standards. All electrical components shall be UL recognized where applicable. All wiring and electrical components provided with unit shall be number and color coded and labeled according to the electrical diagram provided for easy identification.
 - 1. The unit shall be provided with a factory wired weatherproof control panel. Unit shall have a [single] [dual] point power terminal block for main power connection. A terminal board shall be provided for low voltage control wiring.
 - 2. Branch short circuit protection, 115-volt control circuit transformer and fuse, system switches, high temperature sensor, [and a 115-volt receptacle with a separate electrical connection shall also be provided with unit]. [A factory installed and wired 115 volt power supply shall be provided for the GFI receptacle. The power supply shall be wired to the line side of the disconnect so the receptacle is powered when the main unit disconnect is off. This option shall include a weather proof transformer and disconnect for the 115 volt GFI. The 115 volt GFI electrical circuit shall complete with primary fused short circuit protection.]
 - 3. Supply and return fan motors shall have contactors and external overload protection. Knockouts shall be provided in the bottom of the main control panels for field wiring entrance. All 115–600 voltage wire shall be protected from damage by raceways or conduit.

- B. [A factory-installed and wired marine service light, with switch and receptacle, shall be provided in the supply air and return/exhaust fan section. [The separate, main unit service receptacle electrical circuit shall also power the light circuit.]]
- C. [Phase failure and under voltage protection on three-phase motors shall be provided to prevent damage from single phasing, phase reversal, and low voltage conditions.]
- D. [Ground fault protection shall be provided to protect against arcing ground faults.]

E. Further options

1. Factory-mounted smoke detectors shall be factory installed in the [supply air opening] [supply and return air openings]. Smoke detectors to be ionization type, which responds to invisible products of combustion without requiring the sensing of heat, flame or visible smoke. Upon sensing smoke, the unit shall provide a control output for use by building management system.
2. Unit to have factory-mounted UV lights located on the leaving air side of the cooling coil. Unit to have view port to allow for visual indication of operation through UV resistant glass. Unit to have door interlocks on each door accessing UV light. Interlock to kill power to UV light when door is opened.

Lamp and fixture to consist of a housing, power source, lamp sockets, and lamp. All components are to be constructed to withstand typical HVAC environments and are UL/C-UL listed. Housings are to be constructed of type 304 stainless steel and are to be equipped with both male and female power plugs with one type at each end to facilitate simple fixture-to-fixture plug-in for AC power.

Power source shall be an electric, rapid-type with overload protections and is to be designed to maximize radiance and reliability at UL/C-UL listed temperatures of 55°F–135°F. Power source will include RF and EMI suppression.

Sockets shall be medium bi-pin, single click safety, twist lock type and are to be constructed of a UVC-resistant polycarbonate.

Lamp shall be a high output, hot cathode, T8 diameter, medium bi-pin that produces UVGI of 254 nm. Each tube produces the specified output at 500 fpm and air temperatures of 55°F–135°F.

3. A [single] [dual] non-fused disconnect switch[es] shall be provided for disconnecting electrical power at the unit. [The second switch will service the electric heat.] Disconnect switches shall be mounted internally to the control panel and operated by an externally-mounted handle. Externally-mounted handle is designed to prohibit opening of the control panel door without the use of a service tool.

Coil Sections

- A. [No coil sections are required.]
- B. The coil section shall include hinged access doors on both sides of the section. The doors also provide access for [field installed control valves] [factory-installed control valves].
- C. Cooling coil sections shall include [painted galvanized] [stainless] steel, positively sloped drain pan shall be provided.
 1. The drain pan shall have a minimum slope of 1/8" per foot to provide positive draining.
 2. The drain pan shall extend beyond the leaving side of the coil and underneath the cooling coil connections.
 3. The drain pan shall be connected to a threaded drain connection extending through the unit base.
- D. The coil section shall be located as follows.
 1. [draw-through configuration]
 2. [blow-through configuration including a diffuser and sufficient space between the fan and coil to allow even air flow across the coil.]
 3. [Cooling coils shall be mounted in the blow-through position to minimize leaving air temperature from the unit, and maximize sensible heat ratio, after motor heat is considered. A draw-through alternative must meet the required unit leaving air temperature after fan and fan motor heat is added to the scheduled, cooling coil, leaving air temperature. The submittal must clearly show cooling coil leaving air temperature, fan and fan motor heat temperature rise, and unit leaving air temperature.]
- E. Field piping must be able to enter through the floor of the unit. [A field assembled, piping vestibule shall be provided.]
 1. [Coils can be removed through the access doors, RDS 800–802 only.]
 2. Any coil piping vestibule shall be 16" deep and include sufficient space to allow piping access to the heating coil and be shipped loose and knocked down for field assembly. The vestibule shall be constructed of the same materials as the unit casing.

- F. [Factory installed face and bypass dampers shall be provided.]
- G. ARI Certified coils shall be provided. All coils shall be factory leak tested with high-pressure air under water. All coils are fabricated of seamless 5/8" diameter copper tubing that is mechanically expanded into high efficiency [aluminum] [copper] plate fins. Coils shall be multi-row, staggered tube design per the job schedule.
 - 1. [All water coils shall have copper headers complete with supply, return and threaded vent connections.]
 - a. [Chilled water coils shall also include threaded drain connections.]
 - b. [The factory-installed and wired, three-way modulating control valve shall include piping, single supply connection, single return connection, bypass, and spring return valve actuator. The valve actuator [and factory-installed, microprocessor control] shall modulate the valve to maintain set point.]
 - 3. [Ethylene] [propylene] glycol shall be added to the water circuit to protect against coil freeze-up.]
 - 4. [DX coils shall have factory installed distributors and suction headers with brazed connections. The installing contractor shall provide Refrigerant specialties.]
 - 5. [Steam coils shall include supply and return headers, supply and return connections, and tubes shall be sloped towards the return connection.]
 - a. [non-freeze, jet distributing, tube in tube construction]
 - b. [The factory-installed and wired, two-way modulating, steam control valve shall include single supply connection, single return connection, and spring return valve actuator. The valve actuator [and factory-installed, microprocessor control] shall modulate the valve to maintain set point.]

Heat Sections

- A. [No heat is required.]
- B. [Steam or hot water heat is specified above.]
- C. [Electric heat is required.]
 - 1. Staged electric heating coils shall be factory installed in the unit heat section. Heating coils shall be constructed of a low watt density, high nickel-chromium alloy resistance wire, mechanically stacked and heli-arc welded to corrosion resistant terminals.
 - 2. A corrosion resistant heavy gauge rack shall support the elements.
 - 3. Safety controls shall include automatic reset high limit control for each heater element with manual reset backup line break protection in each heater element branch circuit (Note: Manual reset not provided when ETL-Canada label is provided).
 - 4. Heating element branch circuits shall be individually fused to maximum of 48 Amps per NEC requirements. The electric heat section shall be positioned downstream of the supply air fan.
 - 5. [The electric heat elements shall be controlled by the factory-installed main unit control system]

- D. [A natural gas fired furnace shall be installed immediately down stream of the supply fan.]
1. The heat exchanger shall include a type 321 stainless steel cylindrical primary combustion chamber, a type 321 stainless steel header, type 321 stainless steel secondary tubes and type 321 stainless steel turbulators. Carbon and aluminized steel heat exchanger surfaces are not acceptable.
 2. The heat exchanger shall have a condensate drain. Clean out of the primary heat exchanger and secondary tubes shall be accomplished without removing casing panels or passing soot through the supply air passages.
 3. The furnace shall include the following capacity control.
 - a. [The furnace shall be supplied with a single step forced draft burner.]
 - b. [The furnace will be supplied with a modulating forced draft burner. The burner shall be controlled for low fire start. The burner shall be capable of continuous modulation as follows and shall operate efficiently at all firing rates.]
 - i. [33% to 100% of rated capacity.]
 - ii. [The furnace shall be supplied with a Daikin SuperMod forced draft burner capable of continuous modulation between 5% and 100% of rated capacity, without steps.]
 4. The burner shall have proven open damper low-highlow pre-purge cycle, and proven low fire start. The combustion air control damper shall be in the closed position during the off cycle to reduce losses. The burner shall be rated for operation and full modulation capability at inlet gas pressures down to [7.0", 200–650 MBh] [8.0", 790–800, 1100–1500 MBh] [9.0", 1000 and 2000 MBh]
 5. The shutoff cock and test cock shall be fully ported ball valves.
 6. The burner shall be specifically designed to burn natural gas and shall include a microprocessor based flame safeguard control, combustion air proving switch, pre-purge timer and spark ignition.
 7. The gas train shall include redundant gas valves, [maximum 0.5 psi pressure regulator] [2–3psi high pressure regulator] [5–10 psi high pressure regulator], shutoff cock, pilot gas valve, pilot pressure regulator, and pilot cock.
 8. [The gas burner shall be controlled by the factory-installed main unit control system]
 9. The burner shall be fired, tested and adjusted at the factory. Final adjustments shall be made in the field at initial start-up by a qualified service technician to verify that installation and operation of the burner is according to specifications.

Filter Sections

Draw-through Filters

- A. Unit shall be provided with a draw-through filter section. The filter section shall be supplied complete with the filter rack as an integral part of the unit. The draw-through filter section shall be provided with [panel] [cartridge] filters.
- B. 2" thick AmericanAirFilter [30% efficient, MERV 8] [85% efficient, MERV 13] pleated panel filters shall be provided. Filters shall be frame mounted and shall slide into galvanized steel racks contained within the unit. Filters shall be installed in an angular arrangement to maximize filter area and minimize filter face velocity. Filters shall be accessible from both sides of the filter section.
- C. [12" deep [60-65%] [90-95%] efficient, UL Std. 900, Class 1, AmericanAirFilter cartridge filters shall be provided. 2" panel, 30% MERV 8 efficient pre-filters shall be included. Cartridge filters shall consist of filter media permanently attached to a metal frame and shall slide into a gasketed, extruded aluminum rack contained within the unit. The filter rack shall have secondary gasketed, hinged end panels to insure proper sealing. Filters shall be accessible from both sides of the filter section.]
- D. [[30% efficient pleated] [60-65% efficient cartridge] [90-95% efficient cartridge] filters shall be provided with INTERSEPT antimicrobial treatment.]

Final Filters Option

- E. Final Filters—Unit shall be provided with a final filter section downstream of the supply fan. Unit to have at least 40" of unit length between the fan discharge and the final filters to allow for proper air distribution. The final filter section shall be supplied complete with the filter rack as an integral part of the unit. The final filter section shall be provided with cartridge filters.
- F. 12" deep 90-95% efficient, UL Std. 900, Class 1, AmericanAirFilter cartridge filters shall be provided. [For units with gas or electric heat, AmericanAirFilter High Temperature cartridge filters rated for 500°F shall be used.] Cartridge filters shall consist of filter media permanently attached to a metal frame and shall slide into a gasketed, extruded aluminum rack contained within the unit. The filter rack shall have secondary gasketed, hinged end panels to insure proper sealing. Filters shall be accessible from both sides of the filter section.
- G. [Filters shall be provided with INTERSEPT antimicrobial treatment.]

Outdoor/Return Air Section Options

- A. [Unit shall be provided with a return air plenum for handling 100% re-circulated air. The 100% return air plenum shall allow return air to enter from the [bottom] [back] of the unit.]
- B. [A return air plenum shall be provided with a 0 to 30% outdoor air hood.]
 - 1. The hood shall allow outdoor air to enter at the back of the return air plenum.
 - a. The outdoor air hood shall be factory installed and constructed from galvanized steel finished with the same durable paint finish as the main unit.
 - b. The hood shall include a bird screen to prevent infiltration of foreign materials and a rain lip to drain water away from the entering air stream.
 - 2. The return air plenum shall allow return air to enter from the [bottom] [back] of the unit.
 - 3. Daikin UltraSeal low leak dampers shall be provided.
 - a. Damper blades shall be fully gasketed and side sealed and arranged horizontally in the hood.
 - b. Damper leakage shall be 1.5 cfm/ft² at 1" SP static pressure differential. Leakage rate to be tested in accordance with AMCA Standard 500.
 - c. Damper blades shall be operated from multiple sets of linkages mounted on the leaving face of the dampers. Control of the dampers shall be from a single lever accessible from outside the hood.
 - d. [Control of the dampers shall be from a factory-installed, two-position actuator.]
- C. [The unit shall be provided with a 100% outdoor air hood.]
 - 1. The 100% outdoor air hood shall allow outdoor air to enter from the back of the unit, at the draw-through filter section.
 - 2. The outdoor air hood shall be factory installed and constructed from galvanized steel finished with the same durable paint finish as the main unit.
 - 3. The hood shall include a bird screen to prevent infiltration of foreign materials and a rain lip to drain water away from the entering air stream.
 - 4. Daikin UltraSeal low leak dampers shall be provided.
 - a. Damper blades shall be fully gasketed and side sealed and arranged vertically in the hood.
 - b. Damper leakage shall be 1.5 cfm/ft² at 1" SP static pressure differential. Leakage rate to be tested in accordance with AMCA Standard 500.
 - c. Damper blades shall be operated from multiple sets of linkages mounted on the leaving face of the dampers. Control of the dampers shall be from a single lever accessible from outside the hood.
 - d. [Control of the dampers shall be from a factory-installed, two-position actuator.]
- D. [Unit shall be provided with a mixing box, RAH 047–077 only. The mixing box shall include integral outside and return air dampers and an outdoor air hood.]
 - 1. Return air shall enter at the bottom of the mixing box. Outside air shall enter at the rear of the mixing box through the outside air hood.
 - 2. The outside air hood shall come complete with rain lip and bird screen.
 - 3. Outside and return air dampers shall be linked together and sized to handle 100% of the supply air volume. Low leak dampers shall be provided.

- E. Unit shall be provided with an outdoor air economizer section.
1. The 0 to 100% outside air economizer section shall include outdoor, return, and exhaust air dampers. Outdoor air shall enter from both sides of the economizer section through horizontal, louvered intake panels complete with rain lip and bird screen. The floor of the outdoor air intakes shall provide for water drainage.
 2. The economizer section shall allow return air to enter from the [bottom] [back] of the unit.
 3. A barometric exhaust damper shall be provided to exhaust air out of the back of the unit. Exhaust louvers and a bird screen shall be provided to prevent infiltration of rain and foreign materials. Exhaust damper blades shall be lined with urethane gasket on contact edges.
 4. The outside and return air dampers shall be sized to handle 100% of the supply air volume. The dampers shall be opposed sets of parallel blades, arranged vertically to converge the return air and outdoor air streams in multiple, circular mixing patterns.
 - a. Daikin UltraSeal low leak dampers shall be provided. Damper blades shall be fully gasketed and side sealed.
 - b. Damper leakage shall be 1.5 cfm/ft² at 1" SP static pressure differential. Leakage rate to be tested in accordance with AMCA Standard 500.
 - c. Damper blades shall be operated from multiple sets of linkages mounted on the leaving face of the dampers.
 5. [Control of the dampers shall be by a factory-installed actuator. Damper actuator shall be of the modulating, spring return type.]
 6. [An adjustable enthalpy control shall be provided to sense the dry-bulb temperature and relative humidity of the outdoor air stream to determine if outdoor air is suitable for "free" cooling. If outdoor air is suitable for "free" cooling, the outdoor air dampers shall modulate in response to the unit's temperature control system.]
- F. [The Daikin DesignFlow™ Precision Outdoor Air Control System shall be provided as an integral part of the 0 to 100% outdoor air economizer system.]
1. The outdoor air control system shall directly measure the total mass volume of air flowing through the outdoor air intakes.
 2. The unit's MicroTech III control system shall automatically adjust outdoor damper position to maintain minimum outdoor air cfm.
 3. The airflow station shall measure outdoor air volume to satisfy the requirements of ASHRAE Standard 62.1-1999. Measurement accuracy shall be demonstrated and verified through laboratory testing by a nationally recognized independent testing agency, such as Intertek Testing Services, Inc., (ETL).
 4. Multiple test points shall be taken to verify ventilation performance over the critical operating range of the system. Demonstrated test accuracy shall be no worse than ±5% at any test point. A statement of performance verification shall be available upon request.
- G. [A static air mixing device shall be factory installed between the outside/return air section and the filter section.]
1. The static air mixer shall be installed with proper upstream and downstream distances.
 2. The mixing device shall perform at face velocities from 500 fpm through 2500 fpm with no loss in mixing performance.
 3. The mixing device shall provide mixing and distribution of the outside and return air streams to minimize the threat of coil freeze-up during operation and to improve temperature control.

Additional Sections

- A. [No additional sections are required.]
- B. [A blank heat section shall be installed [downstream] [upstream] [upstream and downstream] of the supply air fan.]
- C. [The unit shall be provided with factory-installed access sections located [upstream] [downstream] [upstream and downstream] of the supply air fan. Access sections shall have hinged access doors on both sides of the section and shall have the same construction features as the rest of the unit.]
- D. [Factory installed sound attenuators shall be provided down stream of the supply fan.

- 1. The insulated section shall be double wall and include perforated insulation liners.
- 2. Hinged access doors shall be provided on both sides of the section with the same, previously specified construction.
- 3. Attenuator insulation combustion ratings shall not exceed:

UL flame spread of 15, UL Fuel Contribution of 0, UL smoke Development of 0, all based on UL Test Procedure 723

Attenuator ratings shall be determined using the duct- to-reverberant room test method which provides for air flow in both directions through the attenuator in accordance with the most current version of ASTM E 477. Insertion loss shall be:

RDS 800 to 802 only								
Octave band	63	125	250	500	1000	2000	4000	8000
ILR w/o mylar	7dB	9dB	23dB	29dB	31dB	31dB	20dB	13dB
ILR w/ mylar	6dB	10dB	21dB	16dB	15dB	19dB	15dB	13dB

RAH 047 to 077 only								
Octave band	63	125	250	500	1000	2000	4000	8000
ILR w/o mylar	7dB	9dB	22dB	28dB	29dB	29dB	18dB	12dB
ILR w/ mylar	6dB	10dB	20dB	16dB	14dB	18dB	13dB	12dB

- 4. [Sound attenuator acoustical insulation shall be tedlar lined.]

- E. [A supply air discharge plenum shall be provided.]
 - 1. The plenum section shall have a [bottom] [side] [front] discharge opening.
 - 2. 2 [The plenum section shall be lined with a perforated acoustic liner to enhance sound attenuation.
 - 3. 3 [Factory mounted and wired smoke detectors shall be factory installed in the supply [and return] air openings. Smoke detectors to be ionization type, which responds to invisible products of combustion without requiring the sensing of heat, flame or visible smoke. The smoke detector contacts shall be wired back to control panel, field terminal strips.]
 - 4. 4 [A combination burglar bar/safety grate shall be provided in the [bottom return air opening] [bottom supply air opening] [bottom return and supply air openings]. Burglar bar/safety grate shall be made of 3/4" diameter ground and polished steel shaft welded to a galvanized steel frame.]
 - 5. 5 [Isolation dampers shall be provided in the [bottom return air opening] [bottom supply air opening] [bottom return and supply air openings]. [A two-position actuator shall be provided to close the dampers when the fans are not running.

Roof Curb

- A. [No roof curb is required.]
- B. [Roof curb is to be supplied by the installing contractor.]
- C. [The rooftop manufacturer shall supply a prefabricated 12-gauge galvanized steel, mounting curb, designed and manufactured by the unit manufacturer, shall be provided for field assembly on the roof decking prior to unit shipment.]
 - 1. The roof curb shall be a full perimeter type with complete perimeter support of the air handling unit. The curb shall be a minimum of 16" high and include a nominal 2" x 4" wood nailing strip.
 - 2. Gasket shall be provided for field mounting between the unit base and roof curb.

Controls

- A. Each unit shall be equipped with a complete MicroTech III microprocessor based control system. The unit control system shall include all required temperature and pressure sensors, input/output boards, main microprocessor and operator interface. The unit control system shall perform all unit control functions including scheduling, unit diagnostics and safeties. Control sequences shall include [constant air volume, zone temperature control (CAV-ZTC)] [constant air volume, discharge temperature control (CAV-DTC)] [variable air volume, cooling only discharge temperature control (VAV-DTC)] [variable air volume, cooling/modulating heating discharge temperature control (VAV-DTC)] [duct static pressure control], [supply/return air fan tracking control] and [building static pressure control. All boards shall be individually replaceable for ease of service. All microprocessors, boards, and sensors shall be factory mounted, wired and tested.
- B. The microprocessor shall be a stand-alone DDC controller not dependent on communications with any on-site or remote PC or master control panel. The microprocessor shall maintain existing set points and operate stand alone if the unit loses either direct connect or network communications. The microprocessor memory shall be protected from voltage fluctuations as well as any extended power failures. All factory and user set schedules and control points shall be maintained in nonvolatile memory. No settings shall be lost, even during extended power shutdowns.
- C. An optional [BACnet IP] [BACnet MS/TP] [LonWorks] communication module shall be provided for direct interface to the BAS network.
- D. All digital inputs and outputs shall be protected against damage from transients or wrong voltages. The status of each input and output can be read on the display. All field wiring shall be terminated at a separate, clearly marked terminal strip.
- E. The microprocessor memory shall be protected from all voltage fluctuations as well as any extended power failures. The microprocessor shall maintain existing set points and operate stand alone if the rooftop loses either direct connect or network communications.
- F. The microprocessor shall have a built-in time schedule. The schedule shall be programmable from the unit keypad interface. The schedule shall be maintained in nonvolatile memory to insure that it is not lost during a power failure. There shall be one start/stop per day and a separate holiday schedule. The controller shall accept up to ten holidays each with up to a 5-day duration. Each unit shall also have the ability to accept a time schedule via BAS network communications.
- G. If the unit is to be programmed with a night setback or setup function, an optional space sensor shall be provided. Space sensors shall be available to support field selectable features. Sensor options shall include:
 1. Zone sensor with tenant override switch.
 2. #1 above plus a heating and cooling set point adjustment. (CAV-ZTC only)
- H. The display character format shall be 22 characters × 5 lines. The character font shall be a 5 × 8 dot matrix. The display shall be a supertwist liquid crystal display (LCD) with black characters on yellow background providing high visibility. The display form shall be in plain English coded formats. Lookup tables are not acceptable
- I. Adjustments and readings shall be made through a push/pull navigational wheel. All control settings shall be password protected from changes by unauthorized personnel.
- J. [Both a unit-mounted and remote-mounted UI shall be provided. Up to eight units can be connected to a remote UI. Both the unit-mounted and remotemounted UI are always operable. The control contractor is responsible for wiring between the unit and the remote UI. The maximum wiring distance to the remote UI is 700 meters. Optical isolation shall protect the main unit controller from remote UI wiring problems. The remote UI shall be provided with the same navigational wheel and keypad/display and have comparable functionality to the unit-mounted UI.]
- K. The display shall provide the following information as required by selected unit options:
 1. Unit status showing number of stages or percent capacity for heating, cooling, and economizer
 2. Supply, return, outdoor, and space air temperature
 3. Duct and building static pressure; the control contractor is responsible for providing and installing sensing tubes
 4. Supply fan and return fan status and airflow verification
 5. Supply and return VFD speed
 6. Outside air damper position and economizer mode
 7. Cooling and heating changeover status
 8. Occupied, unoccupied, and dirty filter status
 9. Date and time schedules
 10. Up to ten current alarms and 25 previous alarms with time and date

- L. The push/pull navigation wheel shall allow the following set points as a minimum as required by selected unit options:
1. Six control modes including off manual, auto, heat/cool, cool only, heat only, and fan only
 2. Four occupancy modes including auto, occupied, unoccupied and bypass (tenant override with adjustable duration)
 3. Control changeover based on return air temperature, outdoor air temperature, or space temperature
 4. Primary cooling and heating set point temperature based on supply or space temperature
 5. Night setback and setup space temperature
 6. Cooling and heating control differential (or dead band)
 7. Cooling and heating supply temperature reset options based on one of the following: Return air temperature, outdoor air temperature, space temperature, airflow, or external (1–5 VDC) signal
 8. Reset schedule temperature
 9. High supply, low supply, and high return air temperature alarm limits
 10. Ambient cooling and heat lockout temperatures
 11. Duct and building static pressure
 12. Return fan tracking (VaneTrol) settings that include minimum/maximum VFD speed
 13. Minimum outdoor airflow reset based on external reset (1–5 VFD) percent of cfm capacity, and fixed outdoor damper position
 14. Economizer changeover based on enthalpy, dry bulb or network signal
 15. Current time and date
 16. Occupied/unoccupied time schedules with allowances for holiday/event dates and duration
 17. Three types of service modes including timers normal (all time delays), timers fast (all time delays 20 seconds), and normal
 18. Tenant override time
- M. Open Communication Protocol—The unit control system shall have the ability to communicate to an independent Building Management System (BMS) through a direct [BACnet IP] [BACnet MS/TP] [LonWorks] communication connection. The independent BMS system shall have access to [quantity from specification] “read only” variables and [quantity from specification] “read & and write” variables. Communications shall not require field mounting of any additional sensors or devices at the unit. [The communications protocol shall be LonMark 3.4 certified under the [Discharge Air] [Space Comfort] functional profiles.]
- The BMS system shall be capable of interacting with the individual rooftop controllers in the following ways:
1. Monitor controller inputs, outputs, set points, parameters and alarms
 2. Set controller set points and parameters
 3. Clear alarms
 4. Reset the cooling and heating discharge air temperature set point (VAV and CAV-DTC units)
 5. Reset the duct static pressure set point (VAV units)
 6. Set the heat/cool changeover temperature (VAV and CAV-DTC units)
 7. Set the representative zone temperature (CAVZTC units)
- N. It will be the responsibility of the Systems Integrating Contractor to integrate the rooftop data into the BMS control logic and interface stations.

Part 3: Execution

3.01 Installation

- A. Install in accordance with manufacturer's instructions.



People and ideas you can trust.™

Daikin Applied Training and Development

Now that you have made an investment in modern, efficient Daikin equipment, its care should be a high priority. For training information on all Daikin HVAC products, please visit us at www.DaikinApplied.com and click on Training, or call 540-248-9646 and ask for the Training Department.

Warranty

All Daikin equipment is sold pursuant to its standard terms and conditions of sale, including Limited Product Warranty. Consult your local Daikin Applied representative for warranty details. To find your local Daikin Applied representative, go to www.DaikinApplied.com.

Aftermarket Services

To find your local parts office, visit www.DaikinApplied.com or call 800-37PARTS (800-377-2787). To find your local service office, visit www.DaikinApplied.com or call 800-432-1342.

This document contains the most current product information as of this printing. For the most up-to-date product information, please go to www.DaikinApplied.com.

Products manufactured in an ISO Certified Facility.