

HP Designjet T610 Printer series Using your printer

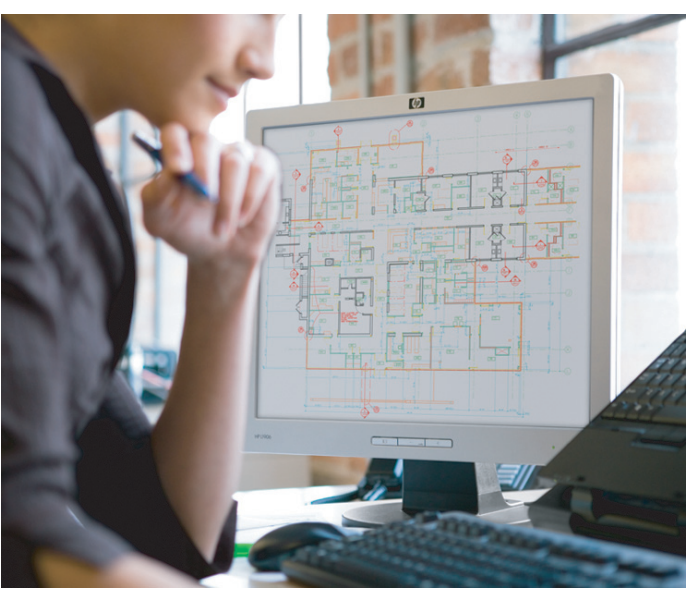

HP Designjet T610 Printer series

Using your printer



Legal notices

© 2007 Hewlett-Packard Development Company, L.P.

The information contained herein is subject to change without notice.

The only warranties for HP Products and services are set forth in the express warranty statement accompanying such products and services. Nothing herein should be construed as constituting an additional warranty. HP shall not be liable for technical or editorial errors or omissions contained herein.

Trademarks

Adobe®, Acrobat®, and Adobe Photoshop® are trademarks of Adobe Systems Incorporated.

Corel® is a trademark or registered trademark of Corel Corporation or Corel Corporation Limited.

ENERGY STAR and the ENERGY STAR mark are registered U.S. trademarks.

Microsoft® and Windows® are U.S. registered trademarks of Microsoft Corporation.



USB 2.0 high-speed certified.

Table of contents

1 Introduction

Safety precautions	2
HP Start-Up Kit	2
Using this guide	2
Introduction	2
Use and maintenance	3
Troubleshooting	3
Accessories, support, and specifications	3
Glossary	3
Index	3
Warnings and Cautions	3
The printer's main features	4
The printer's main components	4
Front view	5
Rear view	6
The front panel	6
Printer software	8
The printer's internal prints	8

2 Installing the software

Choose which connection method to use	10
Connect directly to a computer (Windows)	10
Printer sharing considerations	11
Connect to a network (Windows)	11
Uninstall the printer software (Windows)	12
Connect directly to a computer (Mac OS)	12
Sharing the printer	13
Connect to a network (Mac OS)	13
TCP/IP connection	14
Uninstall the printer software (Mac OS)	14

3 Setting up the printer

Introduction	18
Turn alerts on and off	18
Set Windows driver preferences	18

4 Personalizing the printer

Turn the printer on and off	20
Change the language of the front-panel display	21
Access HP Easy Printer Care (Windows) or HP Printer Utility (Mac OS)	21
Access the Embedded Web Server	22
Change the language of HP Easy Printer Care (Windows) or HP Printer Utility (Mac OS)	22

Change the language of the Embedded Web Server	22
Change the sleep mode setting	23
Turn the buzzer on and off	23
Change the front-panel display contrast	23
Change the units of measurement	23
Configure network settings	23
Change the graphic language setting	24

5 Paper handling

General advice	26
Load a roll onto the 24-inch spindle	26
Load a roll onto the 44-inch spindle	28
Load a roll into the 24-inch printer	30
Easy loading procedure	31
Paper menu procedure	33
Load a roll into the 44-inch printer	34
Easy loading procedure	35
Paper menu procedure	37
Unload a roll	38
Unload paper key procedure with paper on the roll	38
Paper menu procedure with paper on the roll	39
Roll out of paper procedure	39
Load a single sheet	39
Easy loading procedure	40
Paper menu procedure	41
Unload a single sheet	42
Unload paper key procedure	42
Paper menu procedure	42
View information about the paper	43
Paper profiles	43
Print on loaded paper	44
Maintain paper	44
Change the drying time	44
Turn the automatic cutter on and off	45
Feed and cut the paper	45

6 Printing

Select print quality	48
Select paper size	48
Custom paper sizes	49
Select margins options	49
Print with shortcuts	49
Rescale a print	50
Change the treatment of overlapping lines	51
Print a draft	51
High-quality printing	52
If you have a high-resolution image	52
Print in gray shades	53
Print with no margins	53
Reprint last printed job	53
Use paper economically	54
Use ink economically	54

7 Color management

Introduction	56
How colors are represented	56
A summary of the color management process	56
Color calibration	56
Color management from printer drivers	57
Color management options	57
Printer emulation	58
Color adjustment options	58
Printing in color	59
Printing in grayscale	59
Color management from the front panel	60

8 Practical printing examples

Print a draft for revision with the correct scale	62
Using Adobe Acrobat	62
Print a project	64
Using Autodesk Design Review	64
Enabling HP Instant Printing from Autodesk Design Review	65
Enabling HP Instant Printing from the Batch Print Wizard	66
Using HP Instant Printing	68
Using AutoCAD	69
Print a presentation	72
Using AutoCAD	73
Using Adobe Photoshop	76
Print and scale from Microsoft Office	79
Using PowerPoint	80
Using Project	81
Using Excel	83

9 Handling ink cartridges and printheads

About the ink cartridges	86
Check the ink cartridges status	86
Ink menu procedure	86
HP Easy Printer Care (Windows) or HP Printer Utility (Mac OS) procedures	86
Remove an ink cartridge	87
Insert an ink cartridge	88
About the printheads	89
Check the printhead status	90
Remove a printhead	90
Insert a printhead	93

10 Maintaining the printer

Check printer status	98
Clean the exterior of the printer	98
Replace the cutter	98
Maintain the ink cartridges	103
Move or store the printer	103
Update the firmware	104
Update the software	104
Printer maintenance kits	104
Secure Disk Erase	105

11 Accessories

How to order supplies and accessories	108
Order ink supplies	108
Order paper	108
Order accessories	111
Introduction to the accessories	112
Stand	112
Spindle	112
Jetdirect print server	112

12 Troubleshooting paper issues

The paper cannot be loaded successfully	114
General unsuccessful roll load issues	114
Unsuccessful roll load with 24-inch printer	114
Unsuccessful roll load with 44-inch printer	115
Unsuccessful sheet load	115
Paper loading error messages	115
The paper type is not in the driver	116
Transparent or translucent paper	116
Glossy paper	116
Matte Paper	116
General purpose paper	116
Photographic paper	117
HP Banners with Tyvek®	117
Black ink is easily removed when touched	117
After printing, the paper has wrinkles or there is too much ink	117
The paper has jammed	117
The printer displays out of paper when paper is available	120
Prints do not fall nicely into the basket	120
The sheet stays in the printer when the print has been completed	120
The paper is cut when the print has been completed	120
The cutter does not cut well	120
The roll is loose on the spindle	121
A strip stays on the output tray and generates jams	121
Recalibrate the paper advance	121
Recalibrating the paper advance procedure	122
Return to default calibration	122

13 Troubleshooting print-quality issues

General advice	124
Print quality troubleshooting wizard	124
Horizontal lines across the image (banding)	125
Lines are too thick, too thin, or missing	126
Lines appear stepped or jagged	126
Lines print double or in the wrong colors	127
Lines are discontinuous	128
Lines are blurred	129
Line lengths are inaccurate	129
The whole image is blurry or grainy	130
The paper is not flat	130
The print is scuffed or scratched	131
Ink marks on the paper	131
Horizontal smears on the front of coated paper	131

Ink marks on the back of the paper	132
Black ink comes off when you touch the print	132
Edges of objects are stepped or not sharp	132
Edges of objects are darker than expected	133
Horizontal lines at the end of a cut sheet print	133
Vertical lines of different colors	133
White spots on the print	133
Colors are inaccurate	134
Color accuracy using EPS or PDF images in page layout applications	134
Colors are fading	135
The image is incomplete (clipped at the bottom)	135
The image is clipped	135
Some objects are missing from the printed image	136
A PDF file is clipped or objects are missing	136
The Image Diagnostics Print	136
Corrective action	138
If you still have a problem	139

14 Troubleshooting ink cartridge and printhead issues

Cannot insert an ink cartridge	142
Ink cartridge status messages	142
Cannot insert a printhead	142
The front-panel display recommends reseating or replacing a printhead	143
Clean the printheads	143
Clean the printhead drop detector	144
Align the printheads	146
Reinsert printheads procedure	147
Image Quality Maintenance menu procedure	147
Scanning errors during alignment	148
Printhead status messages	148

15 Troubleshooting general printer issues

The printer does not print	150
The printer seems slow	150
Communication failures between computer and printer	150
Cannot access HP Easy Printer Care (Windows) or HP Printer Utility (Mac OS)	151
Cannot access the Embedded Web Server	151
Automatic file system check	152
An AutoCAD 2000 memory allocation error	152
No output when printing from Microsoft Visio 2003	152
Unavailable driver features when printing from QuarkXpress	153
Printer alerts	153

16 Front-panel error messages

17 HP Customer Care

Introduction	158
HP Professional Services	158
Knowledge Center	158
HP Start-Up Kit	158
HP Care Packs and Warranty Extensions	158
HP Installation	159
HP Instant Support	159

HP Proactive Support	159
Contact HP Support	160
Telephone numbers	160

18 Printer specifications

Functional specifications	164
Physical specifications	165
Memory specifications	165
Power specifications	165
Ecological specifications	165
Environmental specifications	166
Acoustic specifications	166

Glossary	167
-----------------------	------------

Index	169
--------------------	------------

1 Introduction

- [Safety precautions](#)
- [HP Start-Up Kit](#)
- [Using this guide](#)
- [The printer's main features](#)
- [The printer's main components](#)
- [The front panel](#)
- [Printer software](#)
- [The printer's internal prints](#)

Safety precautions

The following precautions ensure the proper use of the printer and prevent the printer from being damaged. Follow these precautions at all times.

- Use the power supply voltage specified on the nameplate. Avoid overloading the printer's electrical outlet with multiple devices.
- Ensure the printer is well-grounded. Failure to ground the printer may result in electrical shock, fire, and susceptibility to electromagnetic interference.
- Do not disassemble or repair the printer yourself. Contact your local HP Service Representative for service, see [Contact HP Support on page 160](#).
- Use only the electrical cord supplied by HP with the printer. Do not damage, cut, or repair the power cord. A damaged power cord has risk of fire and electric shock. Replace a damaged power cord with an HP-approved power cord.
- Do not allow metal or liquids (except those used in HP Cleaning Kits) to touch the internal parts of the printer. Doing so may cause fire, electric shock, or other serious hazards.
- Power OFF the printer and unplug the power cable from the power outlet in any of the following cases:
 - When placing your hands inside the printer
 - If there is smoke or an unusual smell coming from the printer
 - If the printer is making an unusual noise not heard during normal operation
 - A piece of metal or a liquid (not part of cleaning and maintenance routines) touches internal parts of the printer
 - During an electrical (thunder/lightning) storm
 - During a power failure.

HP Start-Up Kit

The HP Start-Up Kit is the CD or DVD that comes with your printer; it contains the printer's software and documentation, including introductory multimedia tutorials to help you to get a good first print.

 **NOTE:** The HP Start-Up Kit is provided on CD in Japan, and on DVD elsewhere in the world. The rest of this guide will refer to the DVD version only.

Using this guide

Using your printer (on DVD) and the *Quick Reference Guide* (on paper) are organized into the following chapters. The most complete source of information is *Using your printer*.

Introduction

This chapter provides a brief introduction to the printer and its documentation for new users.

Use and maintenance

These chapters help you carry out normal printer procedures and include the following topics.

- [Installing the software on page 9](#)
- [Setting up the printer on page 17](#)
- [Personalizing the printer on page 19](#)
- [Paper handling on page 25](#)
- [Printing on page 47](#)
- [Color management on page 55](#)
- [Practical printing examples on page 61](#)
- [Handling ink cartridges and printheads on page 85](#)
- [Maintaining the printer on page 97](#)

Troubleshooting

These chapters help you solve problems that may occur while printing and include the following topics.

- [Troubleshooting paper issues on page 113](#)
- [Troubleshooting print-quality issues on page 123](#)
- [Troubleshooting ink cartridge and printhead issues on page 141](#)
- [Troubleshooting general printer issues on page 149](#)
- [Front-panel error messages on page 155](#)

Accessories, support, and specifications

These chapters, [Accessories on page 107](#), [HP Customer Care on page 157](#), and [Printer specifications on page 163](#), contain reference information, including customer care, the printer specifications, and part numbers for paper types, ink supplies, and accessories.

Glossary

The [Glossary on page 167](#) contains definitions of printing and HP terms used in this documentation.

Index

In addition to the table of contents, there is an alphabetical index to help you to find topics quickly.

Warnings and Cautions

The following symbols are used in this manual to ensure the proper use of the printer and to prevent the printer from being damaged. Follow the instructions marked with these symbols.

- △ **WARNING!** Failure to follow the guidelines marked with this symbol could result in serious personal injury or death.
- △ **CAUTION:** Failure to follow the guidelines marked with this symbol could result in minor personal injury or damage to the product.

The printer's main features

Your printer is a color inkjet printer designed for printing high-quality images on paper up to 24 inches (61 cm) or 44 inches (1.12 m) wide depending on your printer's width. Some major features of the printer are shown below:

- Print resolution of up to 2400 × 1200 optimized dpi, from a 1200 × 1200 dpi input, using the **Best** print-quality option, the **Maximum Detail** option, and photo paper
- HP Easy Printer Care (Windows) and HP Printer Utility (Mac OS), see [Access HP Easy Printer Care \(Windows\) or HP Printer Utility \(Mac OS\) on page 21](#), provide an easy-to-use interface including:
 - Calibration of printer
 - Access to the online HP Knowledge Center
- Accurate and consistent color reproduction with automatic color calibration
- Economode for printing economically
- Six-ink system
- Color emulations, see [Printer emulation on page 58](#)
- Paper flexibility and automatic easy load, see [Paper handling on page 25](#), with information and profiles accessible from the front panel, HP Easy Printer Care (Windows), and HP Printer Utility (Mac OS)

The printer's main components

The following front and rear views of the printer illustrate the main components.

Front view

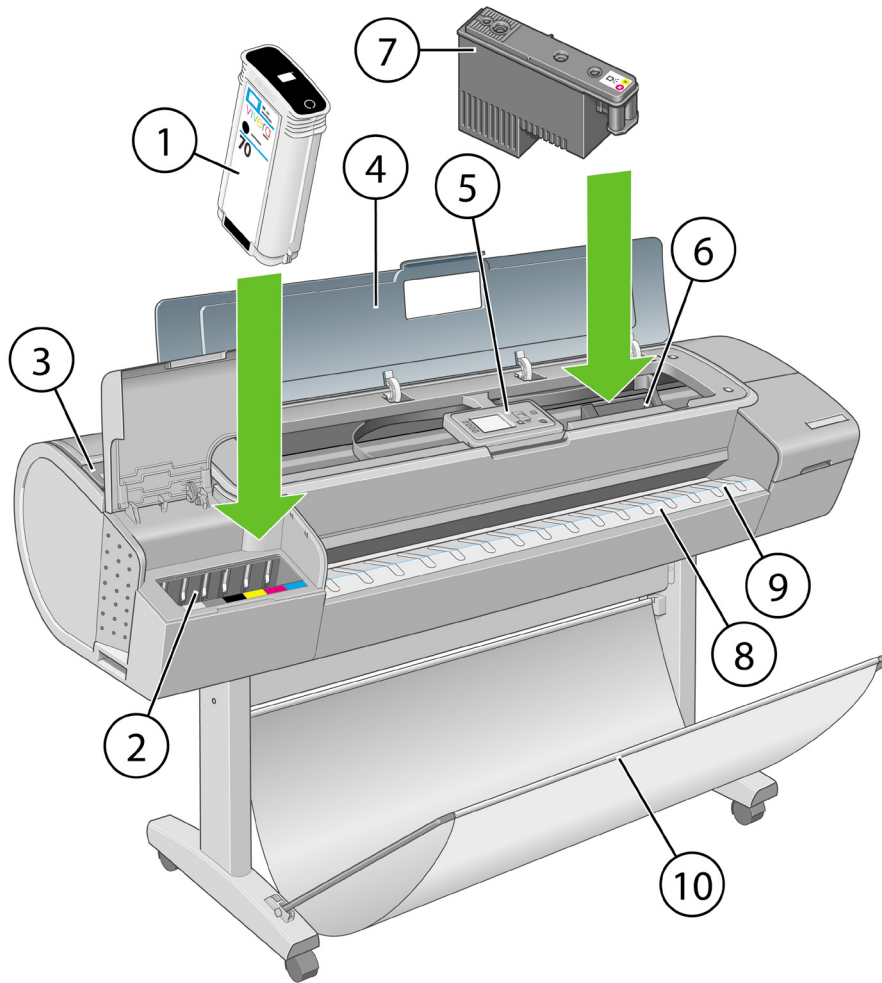

1. Ink cartridge
2. Ink cartridge slots
3. Blue lever
4. Window
5. Front panel
6. Printhead carriage
7. Printhead
8. Output tray
9. Paper alignment lines
10. Basket

Rear view

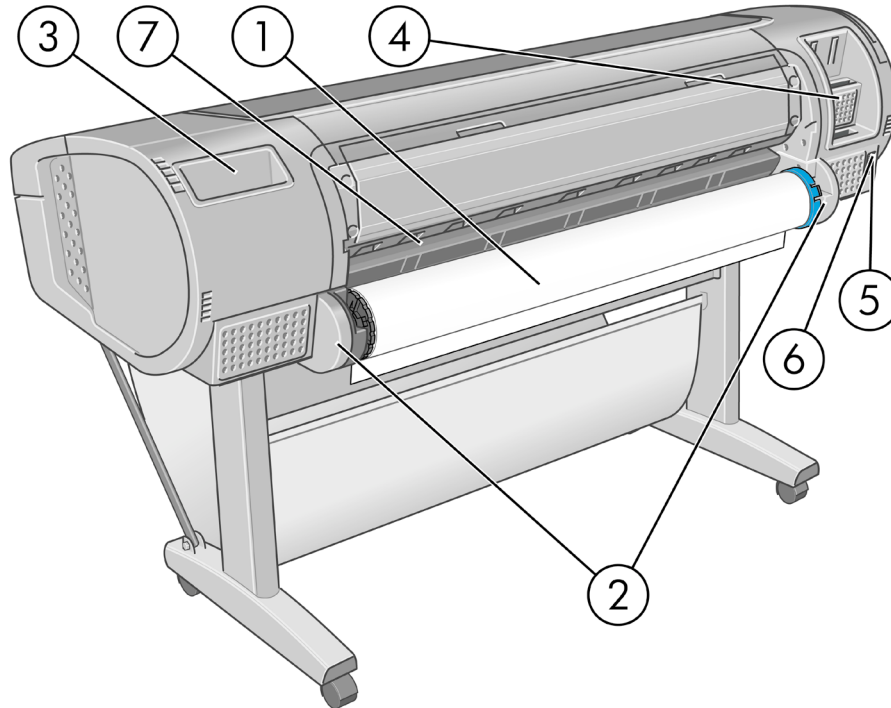

1. Spindle
2. Spindle holders
3. Quick Reference Guide holder
4. Sockets for communication cables and optional accessories
5. Hard power switch
6. Power cord plug in
7. Paper feeder

The front panel



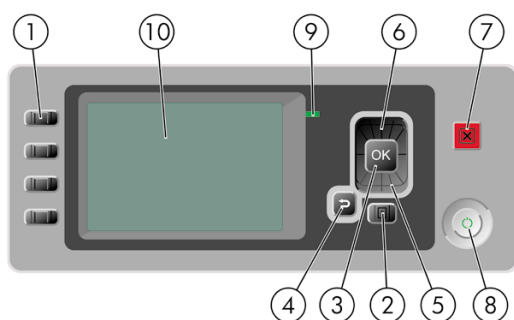

Your printer's front panel is located on the front of the printer, in the center. It has the following important functions:

- Assists you in troubleshooting issues
- Is used to perform certain procedures, such as cutting and unloading paper
- Displays helpful animations to guide you through procedures
- Displays up-to-date information about the status of the printer such as, the ink cartridges, the printheads, the paper, and the print jobs
- Displays warning and error messages, when appropriate, along with audio alerts to call attention to a warning or message
- Can be used to change the values of printer settings and thus change the operation of the printer. However, settings in the front panel are overridden by settings in the printer drivers, see [Installing the software on page 9](#)



The front panel has the following components:

1. **Direct access** keys:

- First key : View ink levels, see [Check the ink cartridges status on page 86](#)
- Second key : View loaded paper, see [View information about the paper on page 43](#)
- Third key : Unload paper, see [Unload a roll on page 38](#) and [Unload a single sheet on page 42](#)
- Fourth key : Form feed and cut, see [Feed and cut the paper on page 45](#)

2. **Menu** key - Press to return to the main menu of the front-panel display. If you are already on the main menu it will display the status screen.
3. **OK** key - To confirm an action while in a procedure or interaction. To enter in a submenu in the menu. To select a value when given an option.
4. **Back** key - To go to the previous step in a procedure or interaction. To go to the upper level, or leave the option in the menu, or when given an option.
5. **Down** key - To go down in a menu or option, or to decrease a value, for example when configuring the front-panel display contrast or the IP address.
6. **Up** key - To go up in a menu or option, or to increase a value, for example when configuring the front-panel display contrast or the IP address.
7. **Cancel** key - To abort a procedure or interaction.
8. **Power** key - To turn the printer off or on, it also has a light to indicate the printer's status. If the power key light is off the printer is off. If the power key light is blinking green, the printer is starting up. If the power key light is green on, the printer is on. If the power key light is amber on, the printer is in standby. If the power key light is blinking amber, the printer needs attention.
9. **LED** light - Indicates the printer's status. If the LED light is solid green, the printer is ready. If it is flashing green, the printer is busy. If it is solid amber, there is a system error. If it is flashing amber, the printer needs attention.
10. **Front-panel display** - Displays errors, warnings, and information on using your printer.

To **highlight** an item in the front-panel display, press the **Up** or **Down** key until the item is highlighted.

To **select** an item in the front-panel display, first highlight it and then press the **OK** key.

When this guide shows a series of front-panel display items like this: **Item1 > Item2 > Item3**, it means that you should select **Item1**, then select **Item2**, then select **Item3**.

Information about specific uses of the front panel can be found throughout this guide.

Printer software

The following software is provided with your printer:

- The RTL and HP-GL/2 driver for Windows
- The PCL3 raster driver
- The HP Easy Printer Care (Windows) or HP Printer Utility (Mac OS), see [Access HP Easy Printer Care \(Windows\) or HP Printer Utility \(Mac OS\) on page 21](#), allows you to:
 - Manage the printer including color with the HP Color Center
 - Access the HP Knowledge Center
 - Update the printer's firmware, see [Update the firmware on page 104](#)
 - Perform calibrations and troubleshooting
- The Embedded Web Server, runs in the printer and enables you to use a Web browser on any computer, see [Access the Embedded Web Server on page 22](#).
- Autodesk Design Review

The printer's internal prints

The internal prints give various kinds of information about your printer. They can be requested from the front panel without using a computer.

-
- △ **CAUTION:** Before requesting any internal print, make sure that paper is loaded (roll or sheet), and that the front panel displays the **Ready** message. The loaded paper should be at least A3 landscape (16.53 in or 42 cm wide); otherwise the print may be clipped.
-

To print any internal print, press the **Menu** key to return to the main menu, select the Internal Prints

menu icon , then select the internal print you want. The following internal prints are available.

- Demo prints: show some of the capabilities of the printer
 - Print drawing demo
 - Print rendering demo
 - Print GIS demo

 **NOTE:** Demo prints are printed the same size as the loaded paper .

- Menu map: shows details of all the front-panel display menus
- Configuration: shows all the current front-panel display settings
- HP-GL/2 palette: shows the color or grayscale definitions in the currently selected color palette
- Service information: provides information needed by service engineers

2 Installing the software

- [Choose which connection method to use](#)
- [Connect directly to a computer \(Windows\)](#)
- [Connect to a network \(Windows\)](#)
- [Uninstall the printer software \(Windows\)](#)
- [Connect directly to a computer \(Mac OS\)](#)
- [Connect to a network \(Mac OS\)](#)
- [Uninstall the printer software \(Mac OS\)](#)

Choose which connection method to use

The following methods can be used to connect your printer.

Connection type	Speed	Cable length	Other factors
USB 2.0	Very fast	Short (5 m = 16 ft)	A certified USB 2.0 cable (as provided with the printer) is necessary for reliable communication.
Jetdirect print server (optional accessory)	Moderate; varies according to network traffic	Long (100 m = 328 ft)	Requires extra equipment (switches) Provides additional features See http://www.hp.com/go/jetdirect/ for more details

 **NOTE:** The speed of any network connection depends on all components used in the network, which can include network interface cards, hubs, routers, switches, and cables. If any one of these components cannot operate at high speed, you will have a low-speed connection. The speed of your network connection can also be affected by the total amount of traffic from other devices on the network.

Connect directly to a computer (Windows)

You can connect your printer directly to a computer by using the printer's built-in USB 2.0 socket (supported under Windows 2000, Windows XP, and later versions of Windows).

1. **Do not connect the computer to the printer yet.** You must first install the printer driver software on the computer, as follows.
2. Insert the *HP Start-Up Kit* DVD into your DVD drive. If the DVD does not start automatically, run the `START.EXE` program in the root folder of the DVD.
3. Click **Install**. The printer drivers, HP Easy Printer Care, and HP Color Center are installed.
4. Follow the instructions on your screen to set up the printer. The following notes help you to understand the screens and make appropriate choices.
 - When asked how the printer is connected, select **Connected directly to this computer**.
 - If you would like to share the printer with other people connected to your network, press the **Printer Properties** button in the **Ready to Install** window, then select the **Sharing** tab and enter the name under which the printer will be shared.
 - When prompted to do so, connect your computer to the printer with a certified USB cable (provided with the printer). Ensure that the printer is turned on.

 **NOTE:** You may complete the installation without connecting your printer if you prefer. To do so, check the box marked **I want to connect my printer after completing the setup wizard**.

NOTE: The use of non-certified USB cables can lead to connectivity problems. Only cables certified by the USB Implementor's Forum (<http://www.usb.org/>) should be used with this printer.

Printer sharing considerations

- HP Easy Printer Care must be installed on a computer before it can be used from that computer.
- Any other users sharing your directly connected printer will be able to send print jobs, but will not be able to receive information from the printer—which affects printer alerts, printer status reports, paper management, printer administration and troubleshooting.

 **TIP:** The best way to share the printer over a network is to connect the printer not to any computer, but to the network. See [Connect to a network \(Windows\) on page 11](#).

Connect to a network (Windows)

You can connect your printer to a local area network by using an HP Jetdirect print server, which is an optional accessory. See [Order accessories on page 111](#).

 **TIP:** A network connection may be slower than a USB connection, but it is easier to share the printer and you can use a longer cable.

Before you begin, check your equipment:

- The printer should be set up and on.
- The Ethernet hub or router should be on and functioning correctly.
- All computers on the network should be on and connected to the network.
- The printer should be connected to the network.

Now you can proceed to install the printer software and connect your printer:

1. Make a note of the IP address from the status screen on the printer's front panel (192.168.1.1 in this example):

Ready for paper

http://XXXX11
http://192.168.1.1

Press  to enter
menu



2. Insert the *HP Start-Up Kit* DVD into your computer. If the DVD does not start automatically, run the START.EXE program in the root folder of the DVD.
3. Click **Install**. The printer drivers, HP Easy Printer Care, and HP Color Center are installed.

 **NOTE:** HP Easy Printer Care and HP Color Center cannot be used with a printer connected through an HP Jetdirect print server.

4. Follow the instructions on your screen to set up the printer. The following notes help you to understand the screens and make appropriate choices.
 - When asked how the printer is connected, select **Wired Networking**.
 - The configuration program looks for printers connected to your network. When the search is complete, a list of printers appears. Identify your printer by its IP address and select it from the list.
 - The configuration program analyzes the network and the printer. The program detects the network settings and suggests the settings to use when configuring the printer. It is not normally necessary to change any of these settings, but you can do so if you wish.

If your computer fails to find any printers on the network, the **Printer Not Found** window is displayed, which helps you to try to find your printer. If you have a firewall in operation; you may have to disable it temporarily in order to find the printer. You also have the options of searching for the printer by its URL, IP address, or MAC address.

Uninstall the printer software (Windows)

1. Insert the *HP Start-Up Kit* DVD into your DVD drive. If the DVD does not start automatically, run the START.EXE program in the root folder of the DVD.
2. Select **Install**, and follow the instructions on your screen to uninstall the printer software.

Connect directly to a computer (Mac OS)

You can connect your printer directly to a computer by using the printer's built-in USB 2.0 socket.

1. Make sure the printer is either turned off, or disconnected from the computer.
2. Insert the *HP Start-Up Kit* DVD into your DVD drive.
3. Open the DVD icon on your desktop.
4. Open the **Mac OS X HP Designjet Installer** icon.
5. Follow the instructions on your screen. You are recommended to use the **Easy Install** option.
6. The printer software is installed, including the printer driver, HP Printer Utility, and HP Color Center.
7. When the software has been installed, the HP Printer Setup Assistant starts automatically, to set up a connection to your printer.
8. Make sure that the printer is turned on and connected to the computer with a certified USB cable (provided with the printer).

 **NOTE:** The use of non-certified USB cables can lead to connectivity problems. Only cables certified by the USB Implementor's Forum (<http://www.usb.org/>) should be used with this printer.

9. In the HP Printer Setup Assistant, click **Continue**.
10. In the list of printers that appears, select the entry that uses the connection type USB, and click **Continue**.
11. The following screen displays information about your printer's installation, where the name of the printer can be modified. Make any changes you wish to make, and click **Continue**.

12. Your printer is now connected. In the Printer Queue Created screen, click **Quit** to exit, or **Create New Queue** if you want to connect another printer.

13. When the HP Printer Setup Assistant has finished, you can remove the DVD from the DVD drive.

If the printer driver is already installed, the HP Printer Setup Assistant can be run at any time from the DVD.

Sharing the printer

 **NOTE:** Printer sharing between users is supported under Mac OS X 10.2 and later.

If your computer is connected to a network, you can make your directly connected printer available to other computers on the same network.

1. Double-click the System Preferences icon on the Dock menu bar on your desktop.
2. Enable printer sharing by going to **Sharing > Services > Printer Sharing**.
3. Your printer now automatically appears in the list of shared printers displayed by any other computer running Mac OS and connected to your local network.

Please bear in mind the following considerations.

- Any other users wishing to share your printer must install the printer software on their own computers.
- Any other users sharing your directly connected printer will be able to send print jobs, but will not be able to receive information from the printer—which affects printer alerts, printer status reports, paper management, printer administration and troubleshooting.
- Mac OS 10.2 users need to enable the **Show printers connected to other computers** option in the Print Center Preferences window in order to see shared printers. To open the Print Center Preferences window, select **Preferences** from the **Print Center** menu.
- You may find that sharing your directly connected printer with other users will slow down your computer unacceptably.

 **TIP:** The best way to share the printer over a network is to connect the printer not to any computer, but to the network. See [Connect to a network \(Mac OS\) on page 13](#).

Connect to a network (Mac OS)

You can connect your printer to a local area network by using an HP Jetdirect print server, which is an optional accessory. See [Order accessories on page 111](#).

 **NOTE:** The printer does not support AppleTalk. You should use a TCP/IP connection.

 **TIP:** A network connection may be slower than a USB connection, but it is easier to share the printer and you can use a longer cable.

Before you begin, check your equipment:

- The printer should be set up and on.
- The Ethernet hub or router should be on and functioning correctly.
- All computers on the network should be on and connected to the network.
- The printer should be connected to the network.

Now you can proceed to install the printer software and connect your printer.

TCP/IP connection

1. Go to your printer's front panel and press the **Menu** key until you see the status screen.

Ready for paper

http://XXXX11
http://192.168.1.1

Press  to enter menu



Note the URL of your printer (http://XXXX11 in this example).

2. Insert the *HP Start-Up Kit DVD* into your DVD drive.
3. Open the DVD icon on your desktop.
4. Open the **Mac OS X HP Designjet Installer** icon.
5. Follow the instructions on your screen. You are recommended to use the **Easy Install** option.
6. The printer software is installed, including the printer driver, HP Printer Utility, and HP Color Center.

 **NOTE:** HP Printer Utility and HP Color Center cannot be used with a printer connected through an HP Jetdirect print server.

7. When the software has been installed, the HP Printer Setup Assistant starts automatically, to set up a connection to your printer. Follow the instructions on your screen.
8. When you reach the Select Printer screen, look for your printer's URL (which you noted in step 1) in the Printer Name column.
 - If you find the right printer name, scroll sideways if necessary to see the Connection Type column, and check that it shows **IP Printing**. Then highlight that line. Otherwise, continue searching further down the list.
 - If you cannot find your printer name with an **IP Printing** connection type, check the box **My printer is not in the list**.

Click **Continue**.

9. Continue following the instructions on the screen. When you reach the Printer Queue Created screen, click **Quit** to exit, or **Create New Queue** if you want to connect another printer to the network.
10. When the HP Printer Setup Assistant has finished, you can remove the DVD from the DVD drive.

If the printer driver is already installed, the HP Printer Setup Assistant can be run at any time from the DVD.

Uninstall the printer software (Mac OS)

1. Insert the *HP Start-Up Kit DVD* into your DVD drive.
2. Open the DVD icon on your desktop.

3. Open the **Mac OS X HP Designjet Installer** icon.
4. Select **Uninstall**, and follow the instructions on your screen to uninstall the printer software.

3 Setting up the printer

- [Introduction](#)
- [Turn alerts on and off](#)
- [Set Windows driver preferences](#)

Introduction

This chapter describes various printer settings that the printer administrator may wish to control as soon as a new printer is assembled and ready for use.

Turn alerts on and off

Printer alerts warn you when there is a printer problem that you can correct by taking action. The alerts are displayed by the printer's front panel, by HP Easy Printer Care under Windows or HP Printer Utility under Mac OS, and by the printer driver.

You can tell the printer which kinds of alerts you would like to see (if any). To access the alert settings:

- Select **Alert Settings** in the Device List page of HP Easy Printer Care or HP Printer Utility.
- Select **Alert Settings** in any alert page displayed by HP Easy Printer Care.
- Right-click the HP Easy Printer Care system tray icon, and select **Alert Settings**.

You can change the settings in the following ways:

- Turn all alerts on or off.
- Turn on or off printer alerts for problems that stop the printer from printing.
- Turn on or off printer alerts for problems that do not stop the printer from printing.
- Turn on printer alerts in all circumstances, or only when you are trying to print to the printer affected by the problem.

Set Windows driver preferences

You can change some default settings in your printer driver according to your own preferences, for instance to set color emulation or paper-saving options. To do this, press the **Start** button on your computer's screen, then select **Printers and Faxes**. In the Printers and Faxes window, right-click on your printer's icon, and select **Printing Preferences**. Any settings you change in the Printing Preferences window will be saved as default values.

4 Personalizing the printer

- [Turn the printer on and off](#)
- [Change the language of the front-panel display](#)
- [Access HP Easy Printer Care \(Windows\) or HP Printer Utility \(Mac OS\)](#)
- [Access the Embedded Web Server](#)
- [Change the language of HP Easy Printer Care \(Windows\) or HP Printer Utility \(Mac OS\)](#)
- [Change the language of the Embedded Web Server](#)
- [Change the sleep mode setting](#)
- [Turn the buzzer on and off](#)
- [Change the front-panel display contrast](#)
- [Change the units of measurement](#)
- [Configure network settings](#)
- [Change the graphic language setting](#)

Turn the printer on and off

 **TIP:** The printer can be left powered on without wasting energy. Leaving it on improves response time and overall system reliability. When the printer has not been used for a certain period of time, it saves power by going into sleep mode. However, any interaction with the printer's front-panel display returns it to active mode, and it can resume printing immediately. To change the sleep mode time, see [Change the sleep mode setting on page 23](#).

 **NOTE:** In sleep mode, the printer performs maintenance service to the printheads from time-to-time. This avoids long preparation times after long idle periods. Therefore, it is strongly recommended to leave the printer powered on or in sleep mode to avoid wasting ink and time.

The printer has three levels of power consumption.

- Plugged in: the power cord is plugged into the back of the printer
- Switched on: the switch at the back of the printer is in the on position
- Powered on: the **Power** key on the front panel shows a green light

If you wish to turn the printer on or off or reset the printer, the normal and recommended method is to use the **Power** key on the front panel.



However, if you plan to store the printer indefinitely or the **Power** key does not seem to work, you are recommended to power it off using the **Power** key, and then also switch off the power switch at the rear.

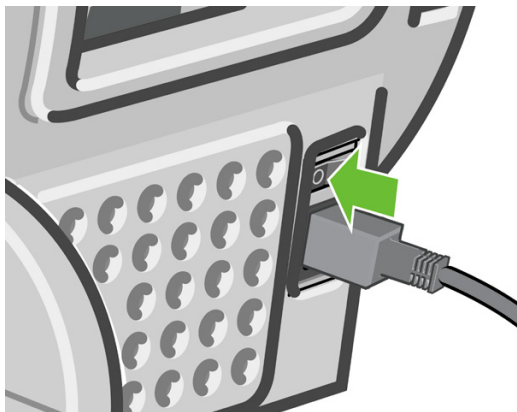

To turn it back on, use the power switch at the rear.

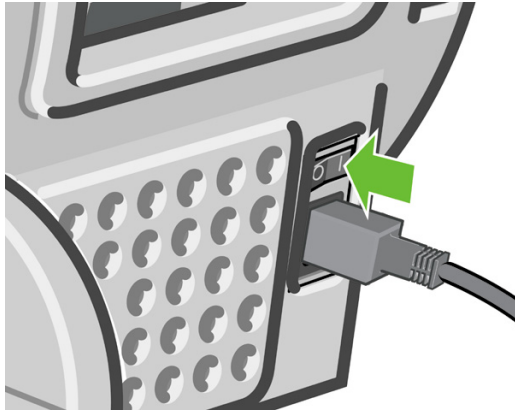

When the printer is powered back on, it takes about three minutes to initialize and check and prepare the printheads. Preparing the printheads takes about one minute and 15 seconds. However, if the printer has been off for six weeks or more, preparing the printheads could take up to 45 minutes.

Change the language of the front-panel display

There are two possible ways to change the language of the front-panel menus and messages.

- If you can understand the current front-panel display language, press the **Menu** key to return to the main menu and select the Setup menu icon , then **Front panel options > Select language**.
- If you cannot understand the current front-panel display language, start with the printer powered off. At the front panel, press the **OK** key and hold it down. While holding the **OK** key down, press the **Power** key and hold it down. Continue to hold down both keys until the green light on the right side of the front-panel display starts flashing, and then release both keys. You can expect a delay of about one second. If the green light starts flashing without any delay, you may need to start again.

Whichever method you used, the language selection menu should now appear on the front-panel display. Highlight your preferred language with the **Up** and **Down** keys, then press the **OK** key.

Access HP Easy Printer Care (Windows) or HP Printer Utility (Mac OS)

HP Easy Printer Care (Windows) or HP Printer Utility (Mac OS) enables you to manage your printer from a computer with a USB connection or TCP/IP.

- Under Windows, start HP Easy Printer Care from your desktop shortcut or from **Start > All Programs > Hewlett-Packard > HP Easy Printer Care > Start HP Easy Printer Care**. This launches HP Easy Printer Care showing the printers installed.
- Under Mac OS, launch the Mac Printer Utility by selecting **STARTUP_DISK > Library > Printers > hp > Utilities > HP Printer Utility**. This launches the HP Printer Selector where you need to add your printer by clicking **More Printers**.

Select your printer and click **Launch Utility**. This launches the HP Printer Utility.

 **NOTE:** To use HP Printer Utility, you must have a USB connection to your printer.

If you have followed these instructions but failed to get through to HP Easy Printer Care (Windows) or HP Printer Utility (Mac OS), see [Cannot access HP Easy Printer Care \(Windows\) or HP Printer Utility \(Mac OS\) on page 151](#).

Access the Embedded Web Server

The Embedded Web Server enables you to manage your printer remotely using an ordinary Web browser running on any computer.

To access the Embedded Web Server directly, you must have a TCP/IP connection to your printer. However, you can access the Embedded Web Server indirectly, through HP Easy Printer Care (Windows) or HP Printer Utility (Mac OS) if you connect to your printer with a USB connection.

The following browsers are known to be compatible with the Embedded Web Server:

- Internet Explorer 6 or later, for Windows
- Internet Explorer 5.2, for Mac OS 10.3
- Safari, for Mac OS 10.4

To access the Embedded Web Server on any computer, open your Web browser and give the address of your printer. You can find out the address of your printer (starting with **http:**) from the front-panel display, by looking at the status screen.

Ready for paper

http://XXXX11
http://192.168.1.1

Press  to enter
menu



If you have followed these instructions but failed to get through to the Embedded Web Server, see [Cannot access the Embedded Web Server on page 151](#).

Change the language of HP Easy Printer Care (Windows) or HP Printer Utility (Mac OS)

HP Easy Printer Care (Windows) or HP Printer Utility (Mac OS) can work in the following languages: English, Portuguese, Spanish, Catalan, French, Italian, German, Russian, Simplified Chinese, Traditional Chinese, Korean, and Japanese.

- Under Windows, select **Tools > Set Language** and select a language from the list.
- Under Mac OS, the language is changed as for any other application. In **System Preferences** select **International** and re-launch the application.

Change the language of the Embedded Web Server

The Embedded Web Server can work in the following languages: English, Portuguese, Spanish, Catalan, French, Italian, German, Russian, Simplified Chinese, Traditional Chinese, Korean, and Japanese. It uses whichever language you have specified in your Web browser's options. If you have specified a language that it cannot support, it works in English.

To change the language, you must change your Web browser's language setting. For example, in Internet Explorer version 6, go to the **Tools** menu and select **Internet Options, Languages**. Then ensure that the language you want is at the top of the list in the dialog box.

To complete the change, you must close and reopen your Web browser.

Change the sleep mode setting

If the printer is left switched on but unused for a certain period of time, it goes automatically into sleep mode to save power. To change the time the printer waits before it goes into sleep mode, press the

Menu key to return to the main menu and select the Setup menu icon , then **Front panel options** > **Sleep mode wait time**. Highlight the wait time you want and then press the **OK** key. You can set the time to 30, 60, 120, 150, 180, 210, or 240 minutes.

Turn the buzzer on and off

To turn the printer's buzzer on or off, press the **Menu** key to return to the main menu and select the

Setup menu icon , then **Front panel options** > **Enable buzzer**, and highlight on or off and press the **OK** key. By default, the buzzer is set to on.

Change the front-panel display contrast

To change the contrast of the front-panel display, select the Setup menu icon , then **Front panel options** > **Select display contrast**, and enter a value using the **Up** or **Down** key. Press the **OK** key to set the value. The default contrast is set to 50.

Change the units of measurement

To change the units of measurement in the front-panel display, select the Setup menu icon , then **Front panel options** > **Select units**, and select **English** or **Metric**. By default the units are set to metric.

Configure network settings

To configure the same network settings from the front panel, press the **Menu** key to go to the main menu and select the Connectivity menu icon . You can view and configure the following network settings.

- **USB**: view information about the USB connection
- **JetDirect EIO**: view information, configure, and reset the JetDirect connection
- **Advanced** > **Select I/O timeout**: specify the number of seconds that an idle connection is allowed to remain open, 270 is the default value, if set to zero, the timeout is disabled
- **Advanced** > **Allow SNMP**: specify whether SNMP is permitted
- **Advanced** > **Embedded Web Server** > **Allow EWS**: specify whether the Embedded Web Server is enabled
- **Advanced** > **Web Services** > **Printer Utility software**: view the Printer Utility software settings
- **Advanced** > **Web Services** > **Color and paper management**: view the color and paper management settings

Change the graphic language setting

 **NOTE:** You should not need to change the default graphic language setting (**Automatic**), and you are not recommended to do so.

You can change the graphic language setting from the front panel. Press the **Menu** key to return to the

main menu then select the Setup menu icon , then **Printer preferences > Select graphic language**. Select one of the following options and press the **OK** key to set the value.

- Select **Automatic** to let the printer determine which type of file it is receiving. This setting works for most software applications.
- Select **HP-GL/2** only if you are sending a file of that type directly to the printer, without going through a printer driver.

5 Paper handling

- [General advice](#)
- [Load a roll onto the 24-inch spindle](#)
- [Load a roll onto the 44-inch spindle](#)
- [Load a roll into the 24-inch printer](#)
- [Load a roll into the 44-inch printer](#)
- [Unload a roll](#)
- [Load a single sheet](#)
- [Unload a single sheet](#)
- [View information about the paper](#)
- [Paper profiles](#)
- [Print on loaded paper](#)
- [Maintain paper](#)
- [Change the drying time](#)
- [Turn the automatic cutter on and off](#)
- [Feed and cut the paper](#)

General advice

- △ **CAUTION:** Before starting a paper loading process, ensure you have enough room around the printer, both in front and behind.

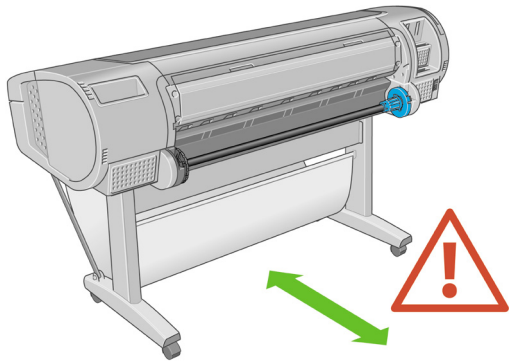

- △ **CAUTION:** Make sure the printer wheels are locked (the brake lever is pressed down) to prevent the printer from moving.

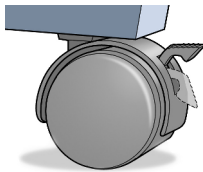

- △ **CAUTION:** All paper must be 11 inches (28 cm) or longer. A4 and letter paper cannot be loaded landscape.

- 💡 **TIP:** For photo paper wear cotton gloves to avoid transferring oils onto the paper.

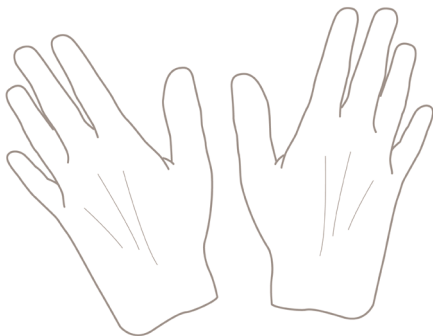

- △ **CAUTION:** Keep the basket closed throughout the loading process.

Load a roll onto the 24-inch spindle

- △ **CAUTION:** Ensure the sheet tray is closed.

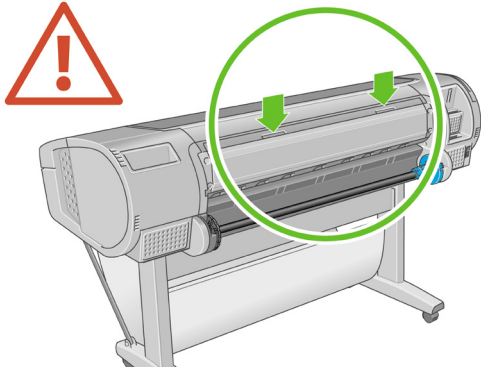

1. Remove the spindle from the printer one end at a time.

⚠ WARNING! Do not insert your fingers into the spindle supports during the removal process.

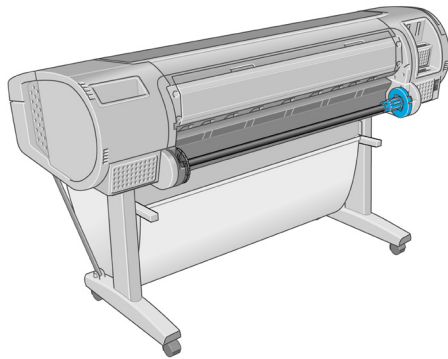

2. The spindle has a stop at each end to keep the roll in position. The blue stop can be removed to mount a new roll; it slides along the spindle to hold rolls of different widths. Remove the blue paper stop from the end of the spindle.

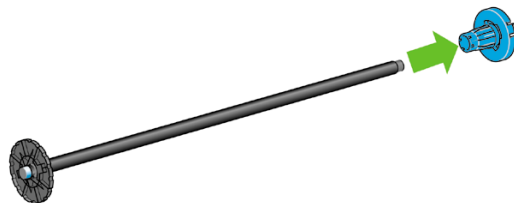

3. If your roll has a three-inch cardboard core, ensure that the core adaptors supplied with the printer have been installed.

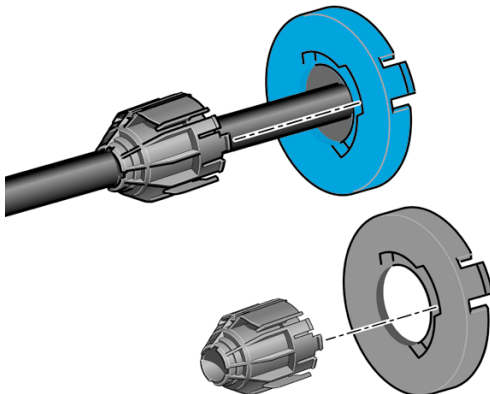

4. If the roll is long; rest the spindle horizontally on a table and load the roll on the table.

TIP: You may need two people to handle a large roll.

- Slide the new roll onto the spindle. Make sure the paper type is oriented as shown. If it is not, remove the roll, turn it 180 degrees and slide it back on to the spindle. There are labels on the spindle showing the correct orientation.

NOTE: From the back of the printer, the blue stopper is inserted into the right-side holder.

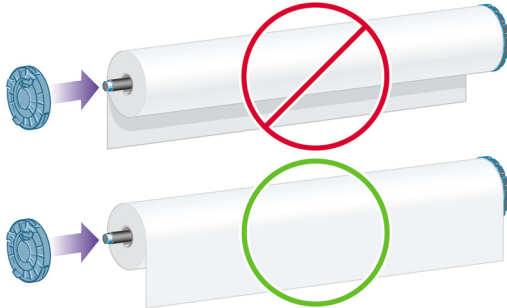

Ensure both ends of the roll are as close to the spindle stops as possible.

- Put the blue paper stop on to the open end of the spindle, and push it towards the end of the roll.

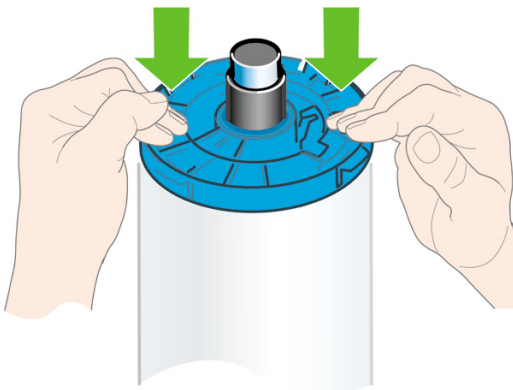

- Ensure the blue paper stop is pushed in as far as it goes; until both ends are against the stoppers.

If you are a regular user of different paper types, you can change rolls more quickly if you preload rolls of different paper types on different spindles. Extra spindles are available for purchase, see [Accessories on page 107](#).

Load a roll onto the 44-inch spindle

CAUTION: Ensure the sheet tray is closed.

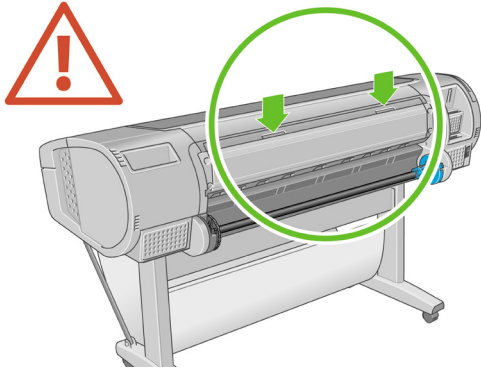

1. Remove the black end of the spindle from the printer, then the blue end.

△ **CAUTION:** Be sure to remove the black end first. Removing the blue end first could damage the black end.

△ **WARNING!** Do not insert your fingers into the spindle supports during the removal process.

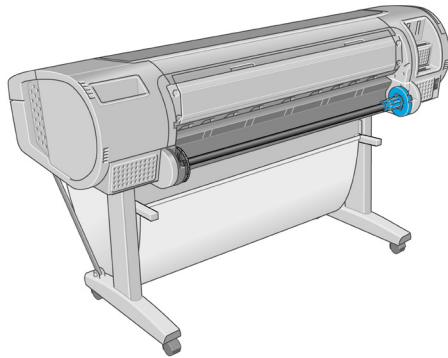

2. The spindle has a stop at each end to keep the roll in position. The blue stop can be removed to mount a new roll; it slides along the spindle to hold rolls of different widths. Remove the blue paper stop from the end of the spindle.

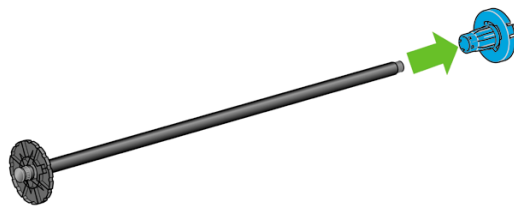

3. If your roll has a three-inch cardboard core, ensure that the core adaptors supplied with the printer have been installed.

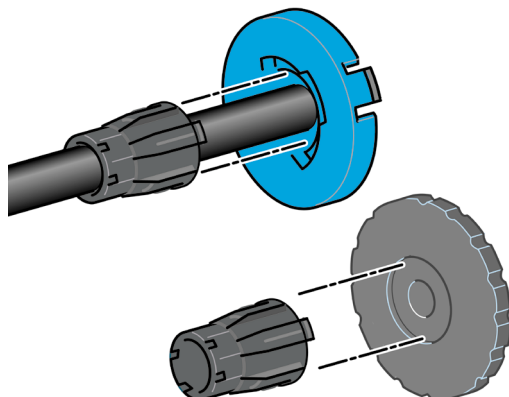

4. If the roll is long; rest the spindle horizontally on a table and load the roll on the table.

 **TIP:** You may need two people to handle a large roll.

5. Slide the new roll onto the spindle. Make sure the paper type is oriented as shown. If it is not, remove the roll, turn it 180 degrees and slide it back on to the spindle. There are labels on the spindle showing the correct orientation.

 **NOTE:** From the back of the printer, the blue stopper is inserted into the right-side holder.

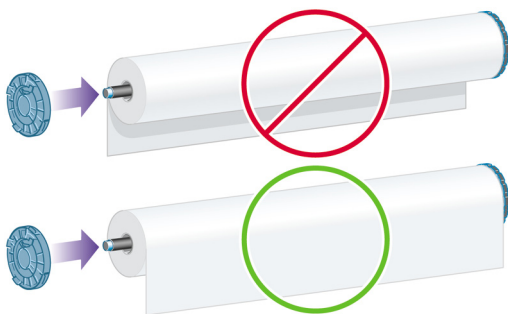

Ensure both ends of the roll are as close to the spindle stops as possible.

6. Put the blue paper stop on to the open end of the spindle, and push it towards the end of the roll.

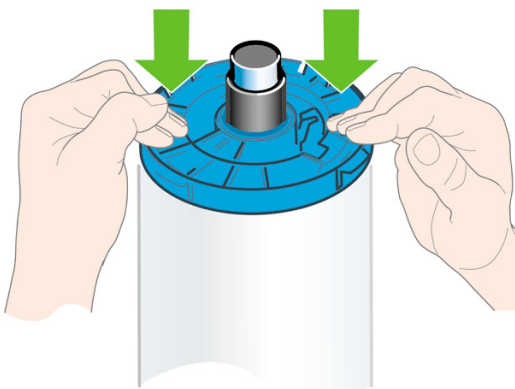

7. Ensure the blue paper stop is pushed in as far as it goes; until both ends are against the stoppers.

If you are a regular user of different paper types, you can change rolls more quickly if you preload rolls of different paper types on different spindles. Extra spindles are available for purchase, see [Accessories on page 107](#).

Load a roll into the 24-inch printer

There are two ways to load a roll. The easy loading procedure is recommended.

-  **CAUTION:** To start these procedures you must have a roll loaded on the spindle. See [Load a roll onto the 24-inch spindle on page 26](#).

Easy loading procedure

1. Standing behind the printer, rest the spindle's black end on the left side roll holder. Do not put the end completely into the roll holder.

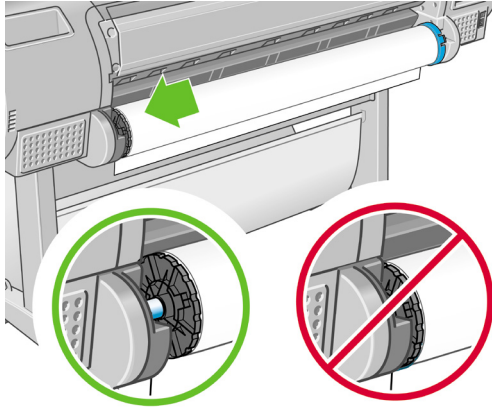

2. Rest the blue end of the spindle on the right side roll holder.

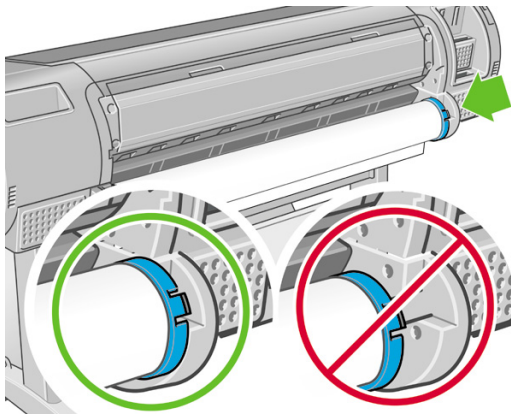

3. With both hands, push the spindle into both roll holders at the same time. The spindle snaps into place.

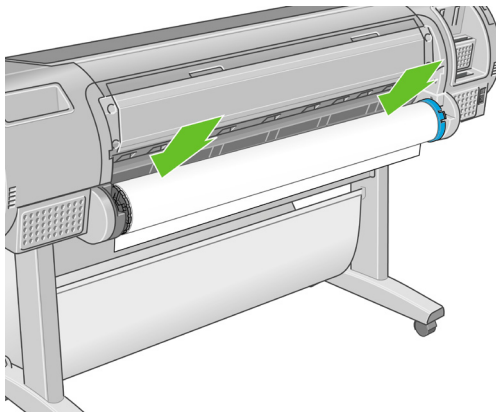

4. If the edge of the roll is not straight or torn (sometimes due to tape used to hold end of the roll), pull paper slightly beyond the cutting groove and use a cutter to cut a straight edge.

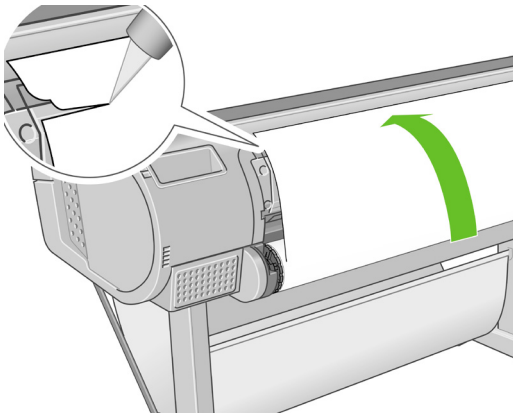

 **TIP:** Cut the paper as straight as possible, as uneven paper does not load correctly.

5. Insert the edge of the paper into the feeder.

 **WARNING!** Do not push your fingers inside the printer's paper path.

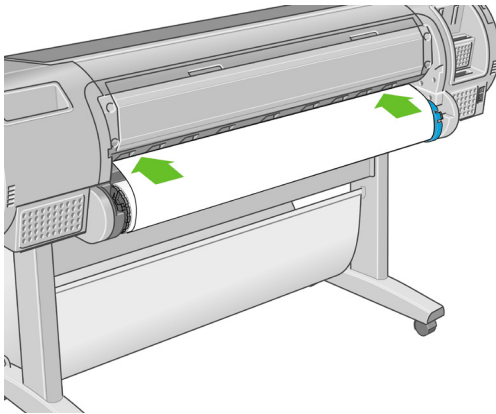

6. Roll the spindle into the feeder until you feel resistance. The printer detects the paper and feeds it automatically into the printer.

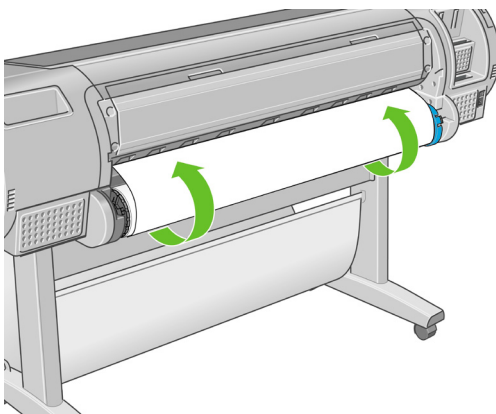

7. Once the paper is fed into the printer, the front-panel display asks if you are loading a roll or a sheet. Select **Roll** with the **Up** and **Down** keys and press **OK**.

8. Select your paper category and type.

Select paper category



- ▶ Bond and Coated Paper
- ▶ Photo Paper
- ▶ Film
- ▶ Technical Paper
- ▶ Backlit material
- ▶ Self-Adhesive material

 **TIP:** If you have loaded a paper type whose name does not appear in the paper list, see [The paper type is not in the driver on page 116](#).

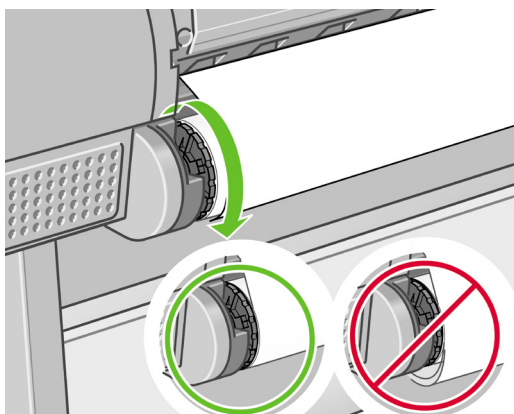
9. The printer checks the alignment and measures the width.
10. Look at the front panel; you may find some instructions there.
11. When the roll is aligned, the front panel displays the **Ready** message and the printer is ready to print. If the roll is not aligned, follow the instructions on the front-panel display.
12. If the paper is loose on the roll, lightly rewind from the end of the spindle until tight.



 **NOTE:** If you have an unexpected issue at any stage of the paper loading process, see [The paper cannot be loaded successfully on page 114](#).

 **TIP:** When prints fall into the basket, they can be torn or get ink marks from other prints. To avoid this, catch your prints as they are cut from the roll and do not stack prints in the basket. You can also turn off the automatic cutter, see [Turn the automatic cutter on and off on page 45](#), and release your print using the [Form feed and cut key](#) .

Paper menu procedure

As an alternative you can use the paper menu to start the paper loading process.

1. Follow steps one through four of the [Easy loading procedure on page 31](#).
2. Press the **Menu** key to return to the main menu, select the Paper menu icon .

3. Select **Paper load**.

Paper

- Paper load
- Unload paper
- View loaded paper
- Change loaded paper type
- Paper types list

4. Select **Load roll**.

Paper load

- Load roll
- Load sheet

5. Select your paper category and type.

Select paper category

- ▶ Bond and Coated Paper
- Photo Paper
- ▶ Film
- ▶ Technical Paper
- ▶ Backlit material
- ▶ Self-Adhesive material

 **TIP:** If you have loaded a paper type whose name does not appear in the paper list, see [The paper type is not in the driver on page 116](#).

6. Continue with step five of the easy loading process, skipping steps eight and nine.

 **TIP:** When prints fall into the basket, they can be torn or get ink marks from other prints. To avoid this, catch your prints as they are cut from the roll and do not stack prints in the basket. You can also turn off the automatic cutter, see [Turn the automatic cutter on and off on page 45](#), and release your print

using the **Form feed and cut** key .

Load a roll into the 44-inch printer

There are two ways to load a roll. The easy loading procedure is recommended.

 **CAUTION:** To start these procedures you must have a roll loaded on the spindle. See [Load a roll onto the 44-inch spindle on page 28](#).

Easy loading procedure

1. Standing behind the printer, rest the spindle's black end on the left side roll holder. Do not put the end completely into the roll holder.

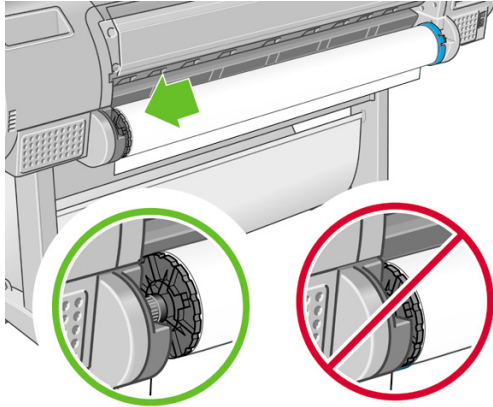

2. Rest the blue end of the spindle on the right side roll holder.

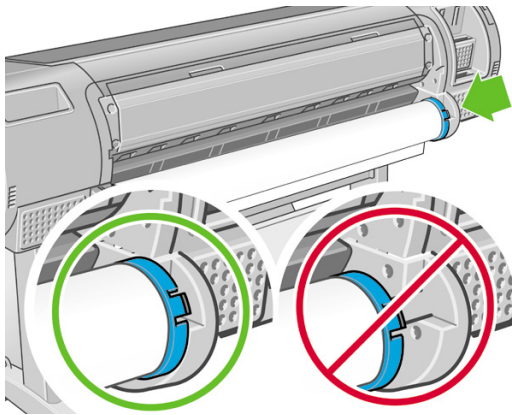

3. With both hands, push the spindle into both roll holders at the same time. The spindle snaps into place.

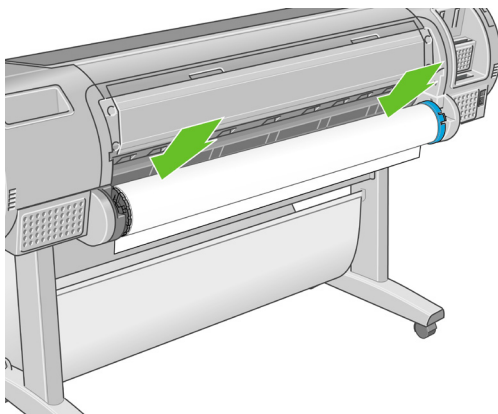

4. If the edge of the roll is not straight or torn (sometimes due to tape used to hold end of the roll), pull paper slightly beyond the cutting groove and use a cutter to cut a straight edge.

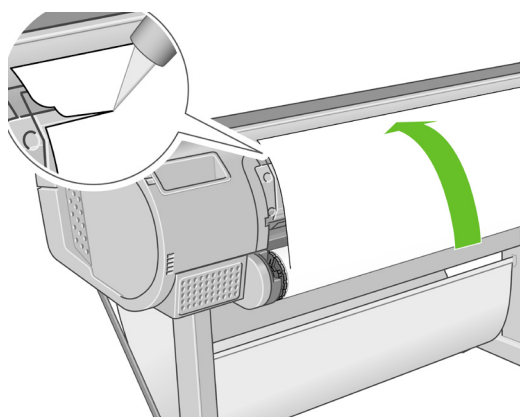

 **TIP:** Cut the paper as straight as possible, as uneven paper does not load correctly.

5. Insert the edge of the paper into the feeder.

 **WARNING!** Do not push your fingers inside the printer's paper path.

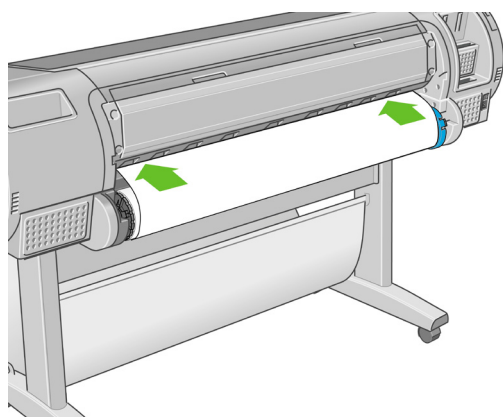

6. Roll the spindle into the feeder until you feel resistance. The printer detects the paper and feeds it automatically into the printer.

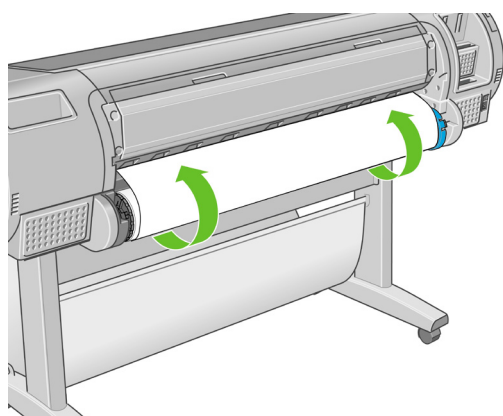

7. Once the paper is fed into the printer, the front-panel display asks if you are loading a roll or a sheet. Select **Roll** with the **Up** and **Down** keys and press **OK**.

8. Select your paper category and type.

Select paper category

- ▶ Bond and Coated Paper
- ▶ Photo Paper
- ▶ Film
- ▶ Technical Paper
- ▶ Backlit material
- ▶ Self-Adhesive material

 **TIP:** If you have loaded a paper type whose name does not appear in the paper list, see [The paper type is not in the driver on page 116](#).

9. The printer checks the alignment and measures the width.
10. Look at the front panel; you may find some instructions there.
11. When the roll is aligned, the front panel displays the **Ready** message and the printer is ready to print. If the roll is not aligned, follow the instructions on the front-panel display.

 **NOTE:** If you have an unexpected issue at any stage of the paper loading process, see [The paper cannot be loaded successfully on page 114](#).

 **TIP:** When prints fall into the basket, they can be torn or get ink marks from other prints. To avoid this, catch your prints as they are cut from the roll and do not stack prints in the basket. You can also turn off the automatic cutter, see [Turn the automatic cutter on and off on page 45](#), and release your print

using the [Form feed and cut key](#) .

Paper menu procedure

As an alternative you can use the paper menu to start the paper loading process.

1. Follow steps one through four of the [Easy loading procedure on page 35](#).
2. Press the **Menu** key to return to the main menu, select the Paper menu icon .
3. Select **Paper load**.

Paper

- ⊕ Paper load
- Unload paper
- View loaded paper
- Change loaded paper type
- ⊕ Paper types list

4. Select **Load roll**.

Paper load

🔒 Load roll

🔒 Load sheet

5. Select your paper category and type.

Select paper category

▶ Bond and Coated Paper

▶ Photo Paper

▶ Film

▶ Technical Paper

▶ Backlit material

▶ Self-Adhesive material

💡 **TIP:** If you have loaded a paper type whose name does not appear in the paper list, see [The paper type is not in the driver on page 116](#).

6. Continue with step five of the easy loading process, skipping steps eight and nine.

💡 **TIP:** When prints fall into the basket, they can be torn or get ink marks from other prints. To avoid this, catch your prints as they are cut from the roll and do not stack prints in the basket. You can also turn off the automatic cutter, see [Turn the automatic cutter on and off on page 45](#), and release your print

using the **Form feed and cut** key .

Unload a roll

Before unloading a roll, check whether there is paper on the roll or if the roll is out of paper, and follow the appropriate procedure as described below.

Unload paper key procedure with paper on the roll

If there is paper on the roll, use the following procedure.

1. Press the **Unload paper** key  on the front panel.
2. When prompted by the front-panel display, lift the blue lever on the left.
3. When prompted by the front-panel display, lightly rewind the paper from the end of the spindle until removed from the printer.
4. When prompted by the front-panel display, lower the blue lever.

Paper menu procedure with paper on the roll

If there is paper on the roll, you can also start the process from the paper menu in the front panel's main menu.

1. Press the **Menu** key to return to the main menu, select the Paper menu icon .

2. Select **Unload paper**.

```
Paper
-----
▣ Paper load
▶ Unload paper
▶ View loaded paper
▣ Change loaded paper type
▣ Paper types list
```

3. Continue from step two of the **Unload paper** key process.

Roll out of paper procedure

If the end of the paper is no longer attached to the roll use the following procedure.

1. If you have already started the unload process, press the **Cancel** key on the front panel to cancel that procedure.
2. Lift the blue lever on the left. If the front panel displays a warning about the lever, ignore it.
3. Pull out the paper from the printer. Pull from wherever the paper is accessible; the back of the printer is recommended.
4. Lower the blue lever.
5. If the front panel displays a warning message, press the **OK** key to clear it.

Load a single sheet

There are two ways to load a sheet. The easy loading procedure is recommended.

△ **CAUTION:** Any loaded roll or sheet must be unloaded before loading a sheet, see [Unload a roll on page 38](#), and [Unload a single sheet on page 42](#).

CAUTION: For sheets thicker than 0.5mm, you must have space behind the printer equal to the length of the sheet.

Easy loading procedure

1. Standing in front of the printer, open the sheet tray.

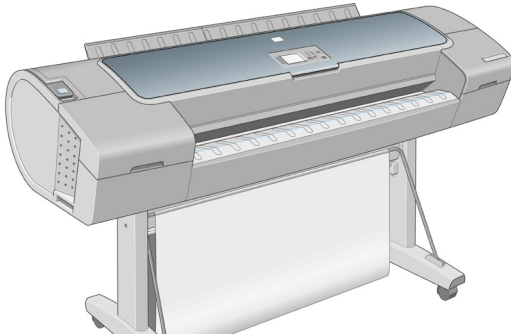

2. Insert the sheet into the feeder. Load your sheet aligned with the load line and insert until the paper will not continue, with thicker sheets you feel resistance. The printer detects the sheet in three seconds. A countdown begins on the front-panel display.

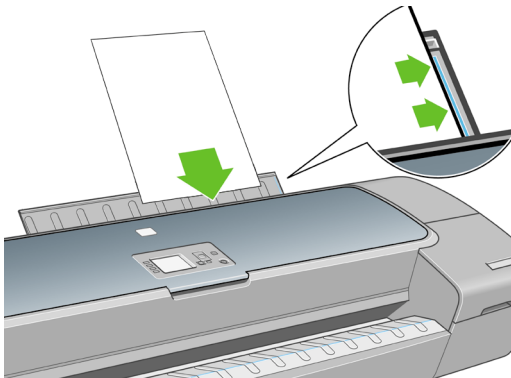

WARNING! Do not push your fingers inside the printer's paper path.

3. After the countdown, the paper feeds into the printer. Guide the sheet into the printer; this is especially important with thicker papers.
4. The front-panel display asks if you are loading a roll or a sheet. Select **Sheet** with the **Up** and **Down** keys.

NOTE: If you select roll, the sheet will not load.

5. Enter your paper category and type.

```
Select paper category
┌───────────────────┴───────────────────┐
▶ Bond and Coated Paper
▶ Photo Paper
▶ Film
▶ Technical Paper
▶ Backlit material
▶ Self-Adhesive material
```

TIP: If you have loaded a paper type whose name does not appear in the paper list, see [The paper type is not in the driver on page 116](#).

6. The printer checks the alignment and measures the sheet.

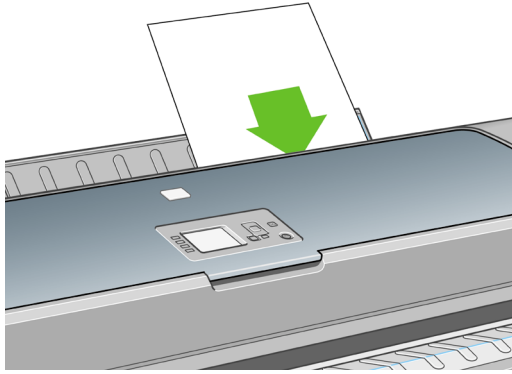

 **NOTE:** Depending on the length of the sheet, it feeds out the front of the printer.

7. If the paper has been loaded successfully, the front panel displays the **Ready** message and the printer ready to print. If the paper is not straight, follow the instructions on the front-panel display.

 **NOTE:** When correctly loaded, the sheet is in the back of the printer.

NOTE: If you have an unexpected problem at any stage of the paper loading process, see [The paper cannot be loaded successfully on page 114](#).

Paper menu procedure

As an alternative you can use the paper menu to start the paper loading process

1. Perform step one of the easy loading procedure.
2. Press the **Menu** key to return to the main menu and select the Paper menu icon .
3. Select **Paper load**.

```
Paper
┆ Paper load
┆ Unload paper
┆ View loaded paper
┆ Change loaded paper type
┆ Paper types list
```

4. Select **Load sheet**.

```
Paper load
-----
Load roll
Load sheet
```

△ **CAUTION:** If you select roll, the sheet will not load.

5. Select your paper category and type.

```
Select paper category
-----
▶ Bond and Coated Paper
▶ Photo Paper
▶ Film
▶ Technical Paper
▶ Backlit material
▶ Self-Adhesive material
```

💡 **TIP:** If you have loaded a paper type whose name does not appear in the paper list, see [The paper type is not in the driver on page 116](#).

6. Continue with step two of the easy loading procedure, skipping steps four and five.

Unload a single sheet

To unload a single sheet after printing, you can simply pull the sheet free from the front of the printer.

To unload a sheet without printing, use the **Unload paper** key  or the paper menu procedure.

Unload paper key procedure

1. Press the **Unload paper** key  on the front panel.
2. The sheet unloads out the front of the printer, either catch it manually or allow it to fall in the basket.

Paper menu procedure

You can also unload a sheet from the paper menu.

1. Press the **Menu** key to return to the main menu and select the Paper menu icon .

2. Select **Unload paper**. The sheet unloads out of the front of the printer, either catch it manually or allow it to fall in the basket.

```
Paper
-----
⊞ Paper load
▶ Unload paper
▶ View loaded paper
⊞ Change loaded paper type
⊞ Paper types list
```

View information about the paper

To view the loaded paper information, press the **View loaded paper** key  on the front panel.

You can also select the Paper menu icon  and then **View loaded paper**.

The following information is displayed on the front panel:

- Roll or sheet status
- Paper type you have selected
- Width of the paper in millimeters (estimated)
- Length of the sheet in millimeters (estimated)
- Color calibration status
- Paper advance calibration status

If no paper is loaded, the message **Out of paper** is displayed.

The same information is displayed in HP Easy Printer Care on the Supplies page.

 **NOTE:** Photo and coated paper requires careful handling, see [The print is scuffed or scratched on page 131](#).

Paper profiles

Each supported paper type has its own characteristics. For optimum print-quality, the printer changes the way it prints on each different paper type. For example, some may need more ink and some may require a longer drying time. So the printer must be given a description of the requirements of each paper type. This description is called the “media” or “paper” profile. The paper profile contains the ICC profile, which describes the color characteristics of the paper; it also contains information on other characteristics and requirements of the paper that are not directly related to color. Existing paper profiles for your printer are already installed in the printer’s software.

However, as it is inconvenient to scroll through a list of all paper types available, your printer only contains paper profiles for the most commonly used paper types. If you have a paper type for which your printer has no profile, you cannot select that paper type in the front-panel display.

There are two ways to assign a profile for a new paper type.

- Use a HP factory paper profile by selecting the closest category and type in the front panel, HP Easy Printer Care (Windows), or HP Printer Utility (Mac OS), see [The paper type is not in the driver on page 116](#).

 **NOTE:** Colors may not be accurate. This method is not recommended for high-quality prints.

- Download the correct paper profile from: <http://www.hp.com/go/designjet/downloads>

 **NOTE:** HP only provides profiles for HP paper types. If you do not find the paper profile you want on the Web, you may find that it has been added to the latest firmware for your printer. You can check the firmware release notes for information, see [Update the firmware on page 104](#).

Print on loaded paper

To print a job on whichever paper is loaded in the printer, select **Any** in the Paper Type option of your Windows driver. Select the **Paper/Quality** tab, then select **Any** in the Paper Type drop-down list.

 **NOTE:** **Any** is the driver default.

Maintain paper

To maintain paper quality, follow the recommendations below.

- Store rolls covered by another piece of paper or cloth
- Store cut sheets covered and clean or brush them before loading them in the printer
- Clean input and output platens and cut sheet tray
- Always keep the window of your printer closed

 **NOTE:** Photo and coated paper requires careful handling, see [The print is scuffed or scratched on page 131](#).



Change the drying time

You may wish to change the drying time setting to suit special printing conditions such as multiple prints where time is of higher importance or when you need to be sure ink is dry before handling.

Select the Setup menu icon , then **Print retrieval > Select drying time**. You can select:

- Extended, to set a longer than recommended time to ensure ink is completely dry
- Optimal, to set the default and recommended time for your selected paper
- Reduced, to set a shorter than recommended time when quality is of lower importance
- None, to disable the drying time and remove your print as soon as it finishes printing

 **CAUTION:** If the ink is not dry when the print is removed it could leave ink in the output tray and marks on the print.

 **NOTE:** If you cancel the drying time during a print, the printer may not feed and cut the paper right away due to the printhead maintenance, which runs in parallel. If the dry time is zero, the printer cuts the paper and then performs the printhead maintenance. However, if the dry time is greater than zero, the printer does not cut the paper until after the printhead maintenance has completed, even if you press the **Form feed and cut** key .

Turn the automatic cutter on and off

To turn the printer's paper cutter on or off:



- From the front panel, press the **Menu** key to return to the main menu, select the Setup menu icon , then **Print retrieval > Enable cutter** and change the cutter option.

 **NOTE:** When cutting between jobs is disabled the paper can still be cut while it is loaded. To completely disable the cutter, use the color center, under HP Easy Printer Care (Windows) or HP Printer Utility (Mac OS), and customize your paper to make it uncuttable.

NOTE: To cut rolled paper while the automatic cutter is disabled, see [Feed and cut the paper on page 45](#).

Feed and cut the paper

To feed and cut the paper when the automatic cutter has been disabled, press the **Form feed and cut** key  on the front panel. The paper advances and the printer makes a straight cut on the front edge.

 **NOTE:** The printer may not cut the paper directly after pressing the **Form feed and cut** key , as each time a print is printed the printheads are serviced and the paper cannot be cut until the process completes.

Remove the cut piece from the output tray.

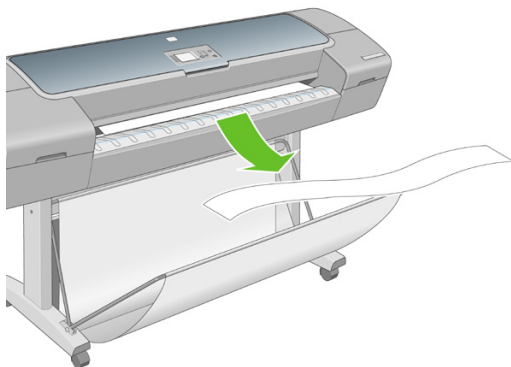

 **CAUTION:** If strips or short prints are left in the output tray the printer could jam.

 **NOTE:** Photo and coated paper requires careful handling, see [The print is scuffed or scratched on page 131](#).

6 Printing

- [Select print quality](#)
- [Select paper size](#)
- [Select margins options](#)
- [Print with shortcuts](#)
- [Rescale a print](#)
- [Change the treatment of overlapping lines](#)
- [Print a draft](#)
- [High-quality printing](#)
- [Print in gray shades](#)
- [Print with no margins](#)
- [Reprint last printed job](#)
- [Use paper economically](#)
- [Use ink economically](#)

Select print quality

The printer has various print-quality options because best-quality printing requires some loss of speed, while fast printing implies some reduction in print quality.

Therefore, the standard print-quality selector is a slider that allows you to choose between quality and speed. With some paper types, you can choose a compromise position between the two.

Alternatively, you can select from the custom options: **Best**, **Normal**, and **Fast**. If you select **Fast**, you can also select **Economode**, which uses a lower rendering resolution and consumes less ink. It therefore increases printing speed even further, but reduces print quality. **Economode** can be selected only from the custom options (not from the slider).

There is also a supplementary custom option that may have an effect on print quality: **Maximum detail**. See [High-quality printing on page 52](#).

 **NOTE:** In the Windows driver dialog, the rendering resolution for your job is displayed in the Custom Print Quality Options dialog box. In the Mac OS Print dialog, it is displayed in the **Summary** panel.

You can select print-quality options in the following ways:

- **In the Windows driver dialog:** go to the **Paper/Quality** tab and look at the Print Quality section. If you select **Standard Options**, you will see a simple slider with which you can select speed or quality. If you select **Custom Options**, you will see the more specific options described above.
- **In the Mac OS Print dialog:** go to the **Paper Type/Quality** panel and select **Paper**. If you select **Standard** quality options, you will see a simple slider with which you can select speed or quality. If you select **Custom** quality options, you will see the more specific options described above.
- **Using the front panel:** select the Setup menu icon , then **Printing preferences > Print quality**.

 **NOTE:** If the print quality is set from your computer, it overrides the print-quality setting in the front panel.

 **NOTE:** You cannot change the print quality of pages that the printer is already receiving or has already received (even if they have not started to print yet).

Select paper size

The paper size can be specified in the following ways.

 **NOTE:** The paper size specified here should be the paper size in which the document was created. It is possible to rescale the document to a different size for printing. See [Rescale a print on page 50](#).

- **In the Windows driver dialog:** select the **Paper/Quality** tab, then **Document Size**.
- **In the Mac OS Page Setup dialog:** select your printer from the **Format for** list, then select your paper size from the **Paper Size** list.
- **Using the front panel:** select the Setup menu icon , then **Printing preferences > Paper > Select paper size**.

 **NOTE:** If the paper size is set from your computer, it overrides the paper size setting in the front panel.

Custom paper sizes

To choose a non-standard paper size not shown in the list of paper sizes:

- **Under Windows**, there are two different ways:
 - In the driver dialog, select **Custom** from the paper size list in the **Paper/Quality** tab, then specify the paper dimensions, then click **Save** to save your new paper size. To see your new custom size in the list of custom sizes, you need to exit the printer properties, then reenter them (and use the **More** button if necessary).
 - From the **Start** menu, select **Printers and Faxes**, then from the **File** menu select **Server Properties**. In the **Forms** tab, check the **Create a new form** box, specify the name and dimensions of the new form, then click **Save Form**.
- **Under Mac OS X 10.4:** select **Paper Size > Manage Custom Sizes** in the **Page Setup** dialog.
- **Under Mac OS X 10.2 or 10.3:** select **Settings > Custom Paper Size** from the **Page Setup** dialog.

Select margins options

By default, the printer leaves a 5 mm margin between the edges of your image and the edges of the paper (increased to 17 mm at the foot of cut-sheet paper). However, you can change this behavior in several ways.

- **In the Windows driver dialog:** select the **Paper/Quality** tab and then the **Margins/Layout** button.
- **In the Mac OS Print dialog:** select the **Paper Type/Quality** panel and then **Layout**.

You will then see at least some of the following options.

 **NOTE:** Under Mac OS, the available margins options depend on the paper size selected in the **Page Setup** dialog. For borderless printing you must select a paper size name that includes the words “no margins”.

- **Standard.** Your image will be printed on a page of the size you have selected, with a narrow margin between the edges of the image and the edges of the paper. The image should be small enough to fit between the margins.
- **Oversize.** Your image will be printed on a page slightly larger than the size you have selected. If you cut off the margins, you will be left with a page of the size you selected, with no margins remaining between your image and the edges of the paper.
- **Clip Contents By Margins.** Your image will be printed on a page of the size you have selected, with a narrow margin between the edges of the image and the edges of the paper. In this case, if the image is the same size as the page, the printer assumes that the extreme edges of the image are either white or unimportant, and do not need to be printed. This may be useful when your image already contains a border.
- **Borderless.** Your image will be printed on a page of the size you have selected, with no margins. The image is slightly enlarged to ensure that no margin is left between the edges of the image and the edges of the paper. If you select **Automatically by Printer**, this enlargement is done automatically. If you select **Manually in Application**, you must select a custom page size slightly larger than the page on which you intend to print. See also [Print with no margins on page 53](#).

Print with shortcuts

The printer driver provides many options that can be set to different values when printing a particular job. A printing shortcut stores the values of all these options that are appropriate for a particular kind of

job, so that you can set them all with a single click. Some settings (such as paper size, paper source, and orientation) may be overridden by the values provided by your application.

To use a shortcut, select the **Printing Shortcuts** tab in the Windows driver dialog.

 **NOTE:** Shortcuts are available only under Windows.

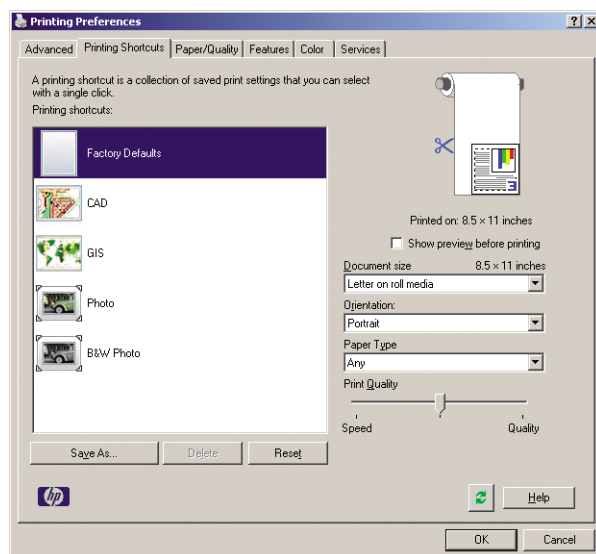

You can see a list of available shortcuts; select the one that matches the kind of job you want to print.

The driver options are now adjusted to suit your job. You can either print immediately, or examine the settings to check that you agree with them. If you like, you can select a shortcut and then change some of its settings manually.

 **TIP:** Check at least the settings that you can see in the **Printing Shortcuts** tab: the document size, orientation, etc.

The Factory Defaults shortcut contains the printer's default settings. When you click on it, it sets all options to their default values.

Printing shortcuts can be customized to your particular needs. To create your own shortcut:

1. Select the shortcut that comes closest to satisfying your requirements.
2. Change any value in the **Printing Shortcuts** tab and/or other tabs.
3. Save the new printing shortcut.

If you decide later that you no longer want a shortcut, you can delete it.

Rescale a print

You can send an image to the printer at a certain size but tell the printer to rescale it to a different size (normally larger). This may be useful:

- If your software does not support large formats
- If your file is too large for the printer's memory—in this case, you can reduce the paper size in your software and then scale it up again using the front-panel option

You can rescale an image in the following ways:

- **In the Windows driver dialog:** select the **Effects** tab, then **Resizing options**.
 - The **Print document on** option adjusts the image size to the paper size you have selected. For example, if you have selected ISO A2 as the paper size and you print an A3-sized image, it is enlarged to fit the A2 paper. If the ISO A4 paper size is selected, the printer reduces a larger image to fit the A4 size.
 - The **% of normal size** option enlarges the printable area of the original paper size (the page minus the margins) by the percentage indicated, then adds the margins to create the output paper size.
- **In the Mac OS Print dialog:** select the **Paper Handling** panel, then **Scale to fit paper size**, and select the paper size to which you want to scale the image. If you want to increase the size of the image, make sure that the **Scale down only** box is unchecked.
- **Using the front panel:** select the Setup menu icon , then **Printing preferences > Paper > Resize**.

If you are printing to a single sheet, you must ensure that the image can actually fit onto the sheet, otherwise the image will be clipped.

Change the treatment of overlapping lines

 **NOTE:** This topic applies only when printing an HP-GL/2 job.

The merge option controls the overlapping lines in an image. There are two settings:

- **Off:** where the lines cross, only the color of the top line is printed.
- **On:** where the lines cross, the colors of the two lines merge.

To turn merge on, go to the front panel and select the Setup menu icon , then **Printing preferences > HP-GL/2 > Enable merge**. You can set the merge option from your software in some applications. Settings in your software override the front-panel settings.

Print a draft

You can specify fast draft-quality printing in the following ways:

- **In the Windows driver dialog:** go to the **Paper/Quality** tab and look at the Print Quality section. Move the print-quality slider to the extreme left ('Speed').
- **In the Mac OS Print dialog:** go to the **Paper Type/Quality** panel and select **Paper**, then move the print-quality slider to the extreme left ('Speed').
- **Using the front panel:** select the Setup menu icon , then **Printing preferences > Print quality > Select quality level > Fast**.

You can specify even faster draft-quality printing by using Economode, as follows. This is intended mainly for documents containing only text and line drawings.

- **In the Windows driver dialog:** go to the **Paper/Quality** tab and look at the Print Quality section. Select **Custom Options**, then set the quality level to **Fast** and check the **Economode** box.
- **In the Mac OS Print dialog:** go to the **Paper Type/Quality** panel and select **Paper**, then set the quality options to **Custom**, set quality to **Fast**, and check the **Economode** box.
- **Using the front panel:** select the Setup menu icon , then **Printing preferences > Print quality > Enable economode**.

 **NOTE:** If the print quality is set from your computer, it overrides the print-quality setting in the front panel.

High-quality printing

You can specify high-quality printing in the following ways:

- **In the Windows driver dialog:** go to the **Paper/Quality** tab and look at the Print Quality section. Move the print-quality slider to the extreme right ('Quality').
- **In the Mac OS Print dialog:** go to the **Paper Type/Quality** panel and select **Paper**, then move the print-quality slider to the extreme right ('Quality').
- **Using the front panel:** select the Setup menu icon , then **Printing preferences > Print quality > Select quality level > Best**.

 **NOTE:** If the print quality is set from your computer, it overrides the print-quality setting in the front panel.

If you have a high-resolution image

If your image has a resolution greater than the rendering resolution (which you can see in the Custom Print Quality Options box under Windows), print sharpness may be improved by selecting the Maximum Detail option. This option is available only if you are printing on glossy paper and you have selected **Best** print quality.

- **In the driver dialog (Mac OS Print dialog):** select Custom instead of Standard print-quality options, then check the **Maximum Detail** box.
- **Using the front panel:** select the Setup menu icon , then **Printing preferences > Print quality > Enable maximum detail**.

 **NOTE:** The Maximum Detail option results in slower printing with photo papers, but it does not increase the amount of ink used.

Print in gray shades

You can convert all colors in your image to shades of gray in the following ways:

- **In your application program:** many programs provide this option.
- **In the Windows driver dialog:** go to the **Color** tab and look at the Color Options section. Select **Print In Grayscale**. You can also select **Print in Pure black and white** if you want only black and white, without gray shades.
- **In the Mac OS Print dialog:** go to the **Paper Type/Quality** panel and select **Color**, then select **Print In Grayscale**. You can also select **Pure Black and White** if you want only black and white, without gray shades.

Print with no margins

Printing with no margins (to the edges of the paper) is known as borderless printing. This can be done only on rolls of glossy paper.

In order to be sure of leaving no margins, the printer prints slightly past the edges of the paper. Any ink deposited outside the paper is absorbed by the sponge situated in the platen.

You can request printing with no margins in the following ways:

- **In the Windows driver dialog:** select the **Paper/Quality** tab and press the **Margins/Layout** button. Then select **Borderless**.
- **In the Mac OS Page Setup dialog:** select a paper size name that includes the words “no margins”. Then, in the **Print** dialog, select **Paper Type/Quality > Layout > Borderless**.

When you select **Borderless**, you must also select one of the following Image Enlargement options:

- **Automatically by printer** means that the printer automatically enlarges your image slightly (normally by a few millimeters in each direction) in order to print over the edges of the paper.
- **Manually in application** means that you must enlarge the image yourself in your application, and select a custom paper size that is slightly larger than the actual paper size.

 **NOTE:** If the first print job after loading paper is a borderless job, the printer may trim the leading edge of the paper before printing.

At the end of a borderless print, the printer normally cuts the print slightly inside the image area to ensure that the print is borderless. It then cuts the paper again so that no residual part of the image is included in the next print. However, if the job is cancelled, or if there is white space at the bottom of the image, only a single cut is made.

Reprint last printed job

You can reprint the last job printed from the front panel. Select the Job management menu icon , then **Reprint last job**.

 **NOTE:** You cannot use this method for PCL3 jobs. To reprint old jobs that are PCL3, you may be able to use your operating system's printer spooler, if you have already set the spooler to save old jobs. This facility depends on your operating system.

Use paper economically

You may be able to save some roll paper by using the following options:

- **In the Windows driver dialog:** select the **Features** tab and then **Remove top/bottom blank areas** and/or **Rotate by 90 degrees**.
- **In the Mac OS Print dialog:** select the **Paper Type/Quality** panel, then **Paper**, then **Remove Top/Bottom Blank Areas**.

Use ink economically

Here are some recommendations for making economical use of ink.

- For draft prints, use plain paper and move the print-quality slider to the left end of the scale ('Speed'). For further economy, select custom print quality options, then select **Fast** and **Economode**.
- Clean the printheads only when needed, and clean only those printheads that need cleaning. Cleaning the printheads can be useful, but it uses a small amount of ink.
- Leave the printer permanently turned on so that it can maintain the printheads in good condition automatically. This regular printhead maintenance uses a small amount of ink. However, if it is not done, the printer may need to use much more ink later to restore the health of the printheads.
- Wide prints make more efficient use of ink than narrow prints, because printhead maintenance uses some ink, and its frequency is related to the number of passes made by the printheads.

7 Color management

- [Introduction](#)
- [How colors are represented](#)
- [A summary of the color management process](#)
- [Color calibration](#)
- [Color management from printer drivers](#)
- [Color management from the front panel](#)

Introduction

HP Designjet T610 printers have been engineered with advanced hardware and software features to ensure predictable and dependable results.

- Color calibration for consistent colors.
- One gray and two black inks provide neutral grays on all paper types.
- The Photo Black ink provides pure blacks when printing on photo papers.
- Color emulation of other HP Designjet printers.

How colors are represented

All devices that display color use a color model to represent color in numerical terms. Most monitors use the RGB (Red-Green-Blue) color model, while most printers use the CMYK (Cyan-Magenta-Yellow-black) color model.

An image can be converted from one color model to another, but in general the conversion is not perfect. Your printer uses the RGB color model: the same color model that is used by your monitor.

This simplifies but does not completely solve the problem of matching colors. Each device represents colors a little differently from another device, even if they use the same color model. However, software can adjust the colors in an image according to the characteristics of the particular device, using a color profile of the device, in order to achieve correct colors.

A summary of the color management process

To get the accurate and consistent colors that you want, you should follow these steps for each paper type that you use.

1. Color-calibrate the paper type, for consistent colors. Calibration should be repeated every now and then (see [Color calibration on page 56](#)). In addition, you may wish to calibrate immediately before a particularly important print job for which color consistency is vital.
2. When printing, select the correct color profile for the paper type you are using.

Color calibration

Color calibration enables your printer to produce consistent colors with the particular printheads, inks, and paper type that you are using, and under your particular environmental conditions. After color calibration, you can expect to get similar prints from any two different printers situated in different geographical locations.

Some paper types cannot be calibrated. For all other paper types, calibration should be done in any of the following circumstances:

- Whenever a printhead is replaced
- Whenever a new paper type is introduced that has not yet been calibrated with the current set of printheads
- Whenever the environmental conditions (temperature and humidity) change significantly

You can check the color calibration status of the currently loaded paper at any time by pressing the **View loaded paper** key on the front panel. The status may be one of the following:

- **PENDING:** the paper has not been calibrated.

 **NOTE:** Whenever you update the printer's firmware, the color calibration status of all papers is reset to **PENDING**.

- **OBSOLETE:** the paper has been calibrated, but the calibration is now out of date because a printhead has been replaced, and should be repeated.
- **DONE:** the paper has been calibrated, and the calibration is up to date.
- **DISABLED:** this paper cannot be calibrated.

 **NOTE:** Color calibration cannot be performed on plain paper, nor on any kind of transparent material.

You can also check the color calibration status by using HP Easy Printer Care (Windows) or HP Printer Utility (Mac OS).

You can start color calibration in the following ways:

- From the printer alert that recommends calibration.
- From the HP Color Center: select **Calibrate Your Printer**.
- From the front panel: select the Image Quality Maintenance menu icon , then **Calibrate color**.

The calibration process is fully automatic and can be performed unattended after you have loaded paper of the type you wish to calibrate—which should be A3 or any larger size.

The process takes about 3–5 minutes and consists of the following steps.

1. A calibration chart is printed, which contains patches of each ink used in your printer.

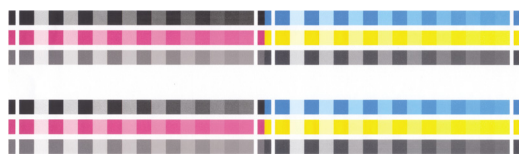

2. The chart is allowed to dry for a period of time that depends on the paper type, so that the colors have time to stabilize.
3. The chart is scanned and measured.
4. From the measurements, the printer calculates the necessary correction factors to apply for consistent color printing on that paper type. It also calculates the maximum amount of each ink that can be applied to the paper.

Color management from printer drivers

Color management options

The aim of color management is to reproduce colors as accurately as possible on all devices: so that, when you print an image, you see very similar colors as when you view the same image on your monitor.

There are two basic approaches to color management for your printer:

- **Application-Managed Colors:** in this case your application program must convert the colors of your image to the color space of your printer and paper type, using the ICC profile embedded in the image and the ICC profile of your printer and paper type.
- **Printer-Managed Colors:** in this case your application program sends your image to the printer without any color conversion, and the printer converts the colors to its own color space. Color management is done using a set of stored color tables; ICC profiles are not used. This method is somewhat less versatile than the previous methods, but is a little simpler and faster, and can produce good results with standard HP paper types.

 **NOTE:** There are only two color spaces that the printer can convert to its own color space using the stored color tables: Adobe RGB and sRGB if you are using Windows, Adobe RGB and ColorSync if you are using Mac OS.

ColorSync is the Mac OS built-in Color Management System; so, in fact, when selecting ColorSync it is the built-in color management part of Mac OS that is performing the color management, and it is done based on the ICC profiles of specified paper type. ColorSync is available with the PCL driver only.

You are recommended to consult the Knowledge Center at http://www.hp.com/go/knowledge_center/djt610/ to see how to use the color management options of your particular application.

To choose between **Application-Managed Colors** and **Printer-Managed Colors**:

- **In the Windows driver dialog:** select the **Color** tab.
- **In the Mac OS Print dialog:** select the **Paper Type/Quality** panel, then **Color**.
- **In some applications:** you can make this choice in the application.

Printer emulation

If you want to print a particular job and to see approximately the same colors that you would get from printing the same job on a different HP Designjet printer, you can use the emulation mode provided by your printer.

 **NOTE:** This option is available only when printing an HP-GL/2 job. It will work correctly only when printing on plain, coated, or heavyweight coated paper.

- **In the Windows HP-GL/2 driver dialog:** select the **Color** tab, then **Printer Managed Colors**, then select **Printer Emulation** from the Source Profile list. You can then select from the Emulated Printer list.
- **In the Mac OS Print dialog:** select the **Paper Type/Quality** panel, then **Color > Printer Managed Colors > Emulated Printer**.

Color adjustment options

The aim of color management is to print accurate colors. If you perform color management correctly, then you should be able to print accurate colors with no need of any manual color adjustments.

However, manual adjustments may be useful in the following situations:

- If your color management is not working correctly for some reason
- If you want colors that are subjectively pleasing rather than accurate

The printer driver provides different adjustment facilities depending on whether you are printing in color or in grayscale. If you are printing in pure black and white, there are no color adjustment options.

Printing in color

You can adjust the colors of your print in similar ways under Windows and Mac OS:

- **In the Windows driver dialog:** select the **Color** tab, ensure that the **Advanced Color Adjustments** box is checked, then press the **Settings** button beside it.
- **In the Mac OS Print dialog:** select the **Paper Type/Quality** panel, then **Lightness and Hue**.

Under either operating system, you will then be able to make adjustments using a lightness slider and three color sliders.

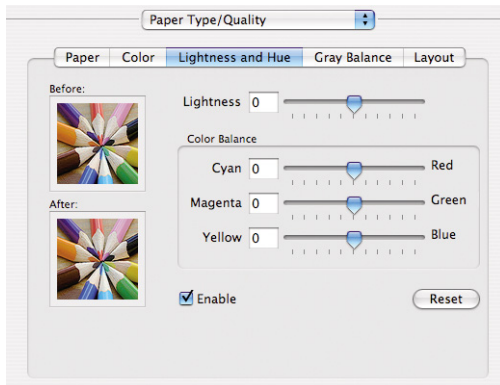

- The lightness slider simply makes the whole print lighter or darker.
- The color sliders can be used to fade or emphasize each of the primary colors in the print. The primary colors may be red, green, and blue; or cyan, magenta, and yellow; depending on the color model used in the image.

The **Reset** button restores each slider to its default central position.

Printing in grayscale

You can adjust the gray balance of your print in similar ways under Windows and Mac OS:

- **In the Windows driver dialog:** select the **Color** tab, ensure that the **Advanced Color Adjustments** box is checked, then press the **Settings** button beside it.
- **In the Mac OS Print dialog:** select the **Paper Type/Quality** panel, then **Gray balance**.

Under either operating system, you will then be able to make adjustments using separate controls for highlights, midtones, and shadows.

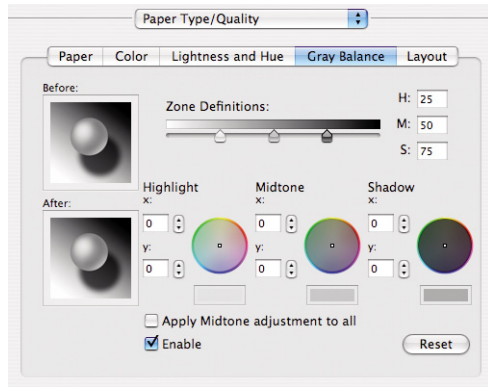



- The lightness slider simply makes the whole print lighter or darker. This slider is available under Windows in the same window as the other grayscale controls; it is available under Mac OS by selecting **Lightness and Hue**.
- The zone definition sliders can be used to define what you mean by highlight, midtone, and shadow.
- The other controls for highlight, midtone, and shadow can be used to adjust the gray balance of highlights, midtones, and shadows respectively.

The **Reset** button restores each control to its default setting.

Color management from the front panel

You can color-calibrate the loaded paper type from the front panel by selecting the Image Quality Maintenance menu icon , then **Calibrate color**. See [Color calibration on page 56](#).

The other color options in the front panel can all be found by selecting the Setup menu icon , then **Printing preferences > Color**.

 **NOTE:** These front panel settings can all be overridden by the printer driver.

- **Color/Grayscale:** you can choose to print in color or in shades of gray. Default: **Print in color**.
- **Select RGB source profile:** you can choose from a selection of RGB source profiles recognized by the printer. Default: **sRGB (HP)**.
- **Emulate printer:** you can choose to emulate a different HP Designjet printer. Default: **None** (no printer emulation).

 **TIP:** If you have old HP-GL/2 files made for a different HP Designjet printer, you can send them to the printer and use the front panel to turn on the appropriate emulation mode.

8 Practical printing examples

- [Print a draft for revision with the correct scale](#)
- [Print a project](#)
- [Print a presentation](#)
- [Print and scale from Microsoft Office](#)

Print a draft for revision with the correct scale

This section demonstrates how to print a draft for revision with the correct scale from Adobe Acrobat.

Using Adobe Acrobat

1. In the Acrobat window, bring the mouse cursor to the bottom left corner of the screen to check the plot size.

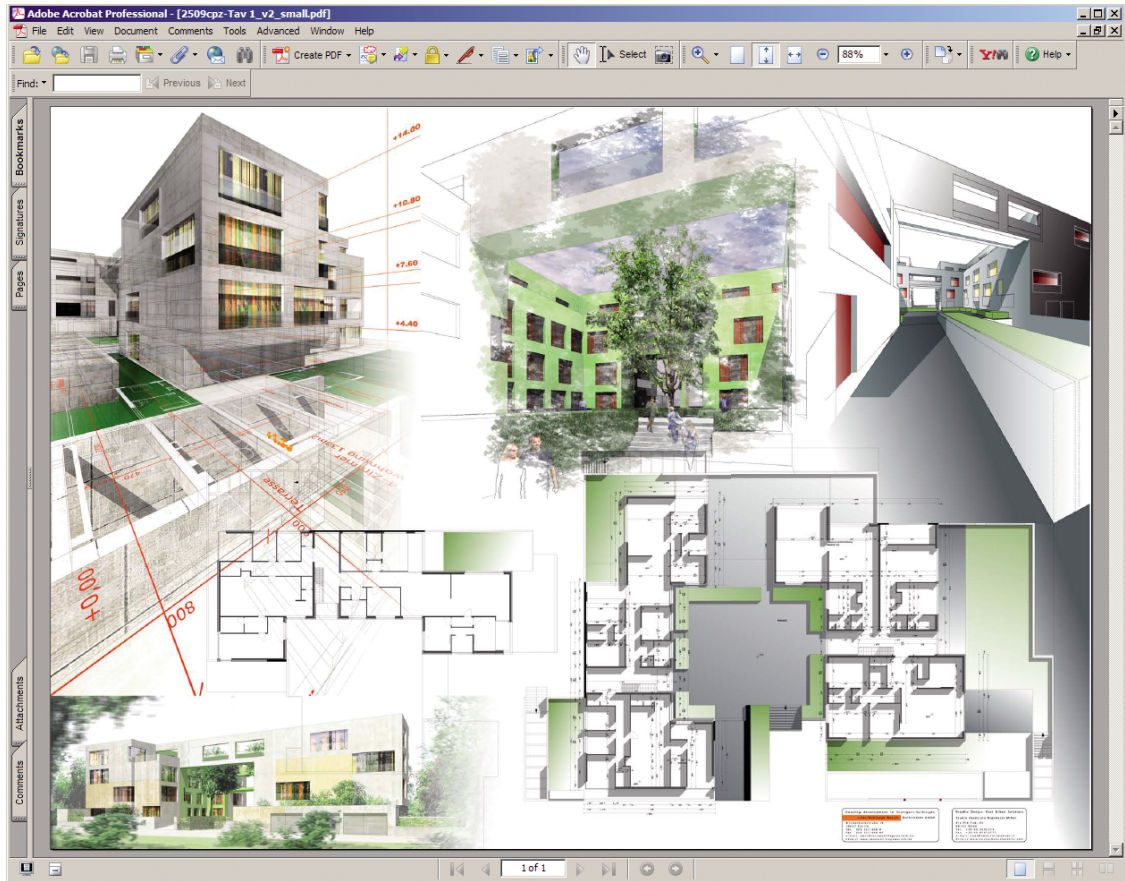

2. Select **File > Print**.

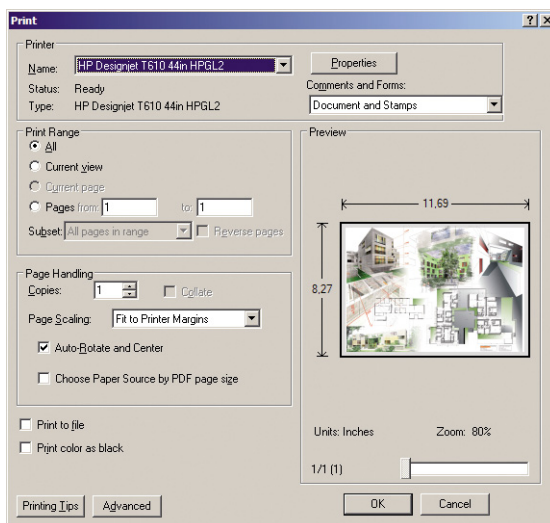

NOTE: The page size will **not** be automatically selected according to the drawing size.

- In order to keep the scale, set **Page Scaling** to **None** (which is not the default setting).

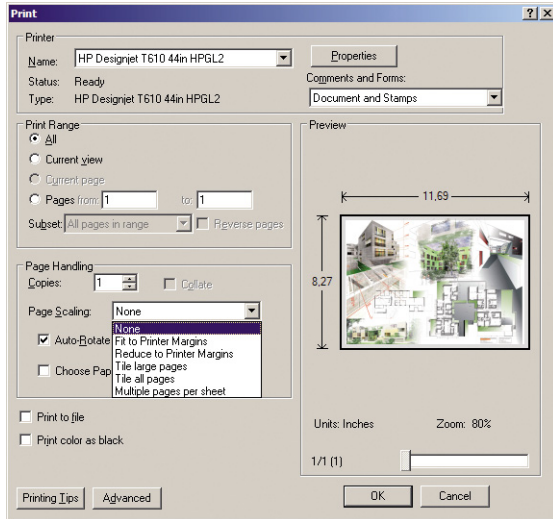

- Press the **Properties** button and then select the **Paper/Quality** tab.

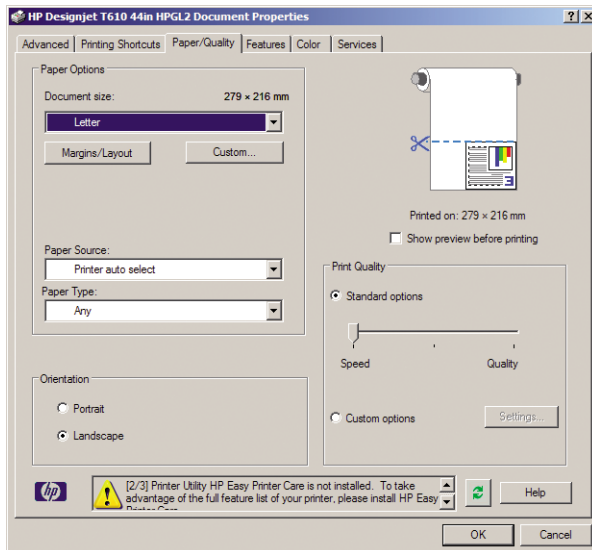

- Choose whatever **Document Size** and **Print Quality** you want to use. If you want to define a new custom paper size, press the **Custom** button.

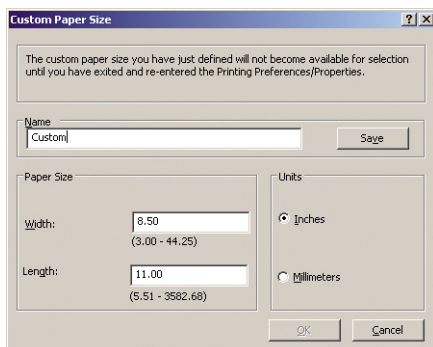

6. Select the **Features** tab, and then **Autorotate**.

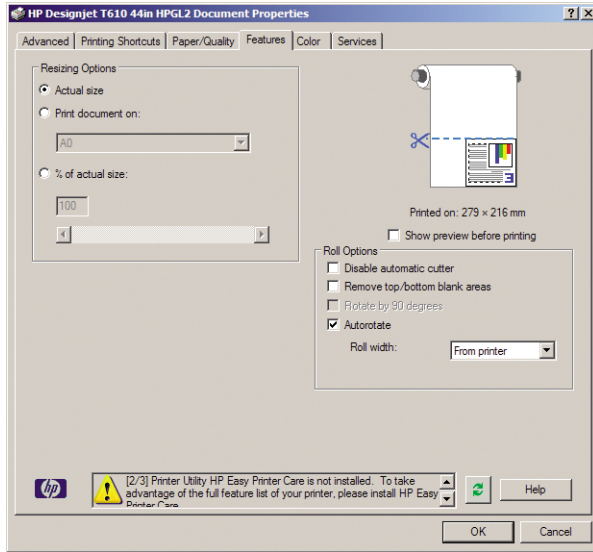

7. Click **OK**, and check that the print preview in the Print dialog box seems correct.

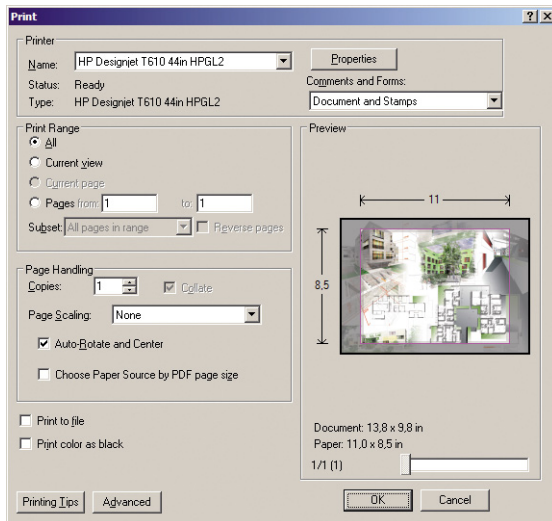

Print a project

This section demonstrates how to print a project from Autodesk Design Review and AutoCAD.

Using Autodesk Design Review

Autodesk Design Review offers the **Use HP Instant Printing** option. This needs to be enabled once, after which it is taken as the default printing option until it is disabled.

Enabling HP Instant Printing from Autodesk Design Review

1. Start Autodesk Design Review and select **File > Print**.

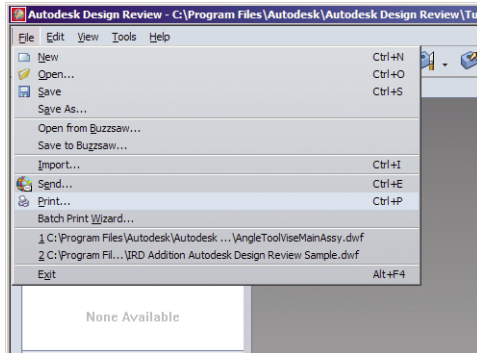

Alternatively, click the Print icon on the toolbar.

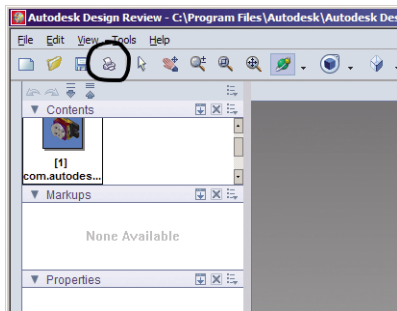

2. In the **Print** dialog box, check the **Use HP Instant Printing** box. You can select your printer and paper size here, or in the next window.

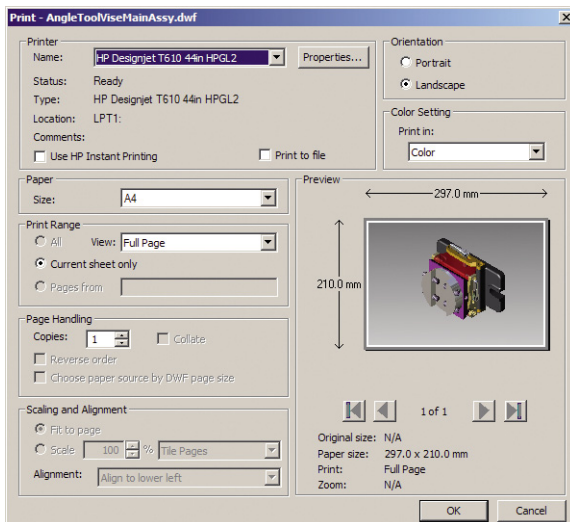

3. Ensure that the printer and paper size are correct, then click **OK** to start printing.

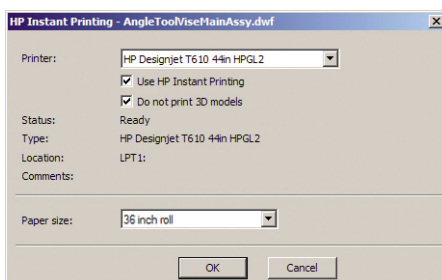

Enabling HP Instant Printing from the Batch Print Wizard

1. Make sure you have installed the Batch Print Wizard. Start Autodesk Design Review and select **File > Batch Print Wizard**.

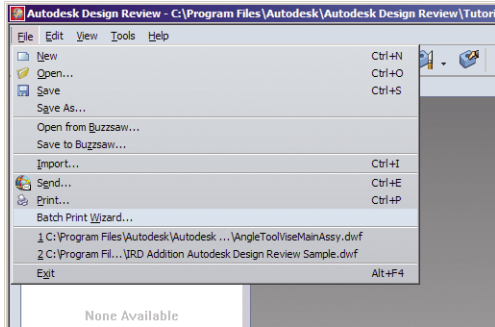

2. In the **Welcome** box, click **Next**.

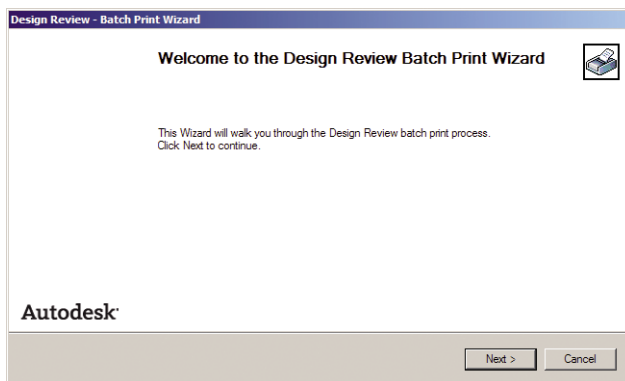

3. Select the DWF files to print, then click **Next**.

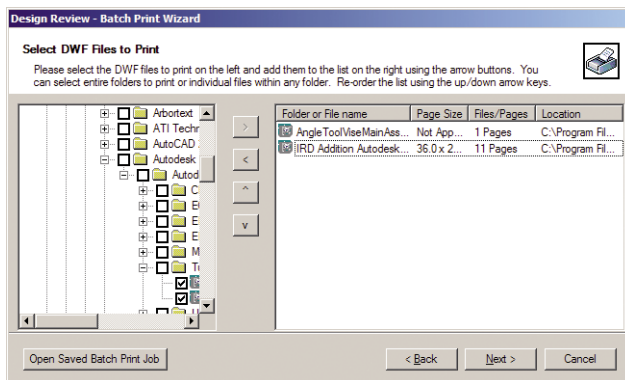

- Use the **Shift** key if you want to select multiple files to configure. Then click **Print Setup**, and the printing configuration will be applied to all the files you have selected..

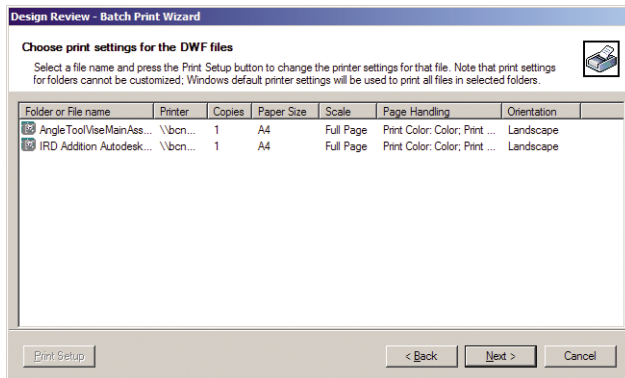

- In the **Print** dialog box, check the **Use HP Instant Printing** box. You can select your printer and paper size here, or in the next window.

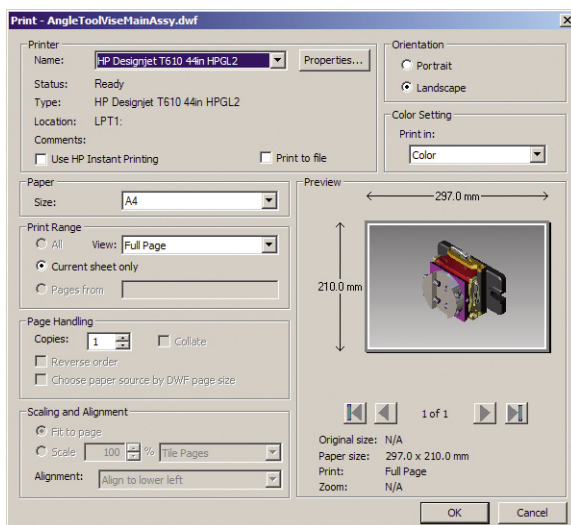

- Ensure that the printer and paper size are correct, then click **OK**. The paper size is automatically preselected.

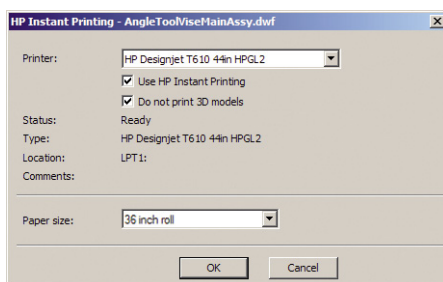

- Back in the **Choose print settings** box, click **Next**.

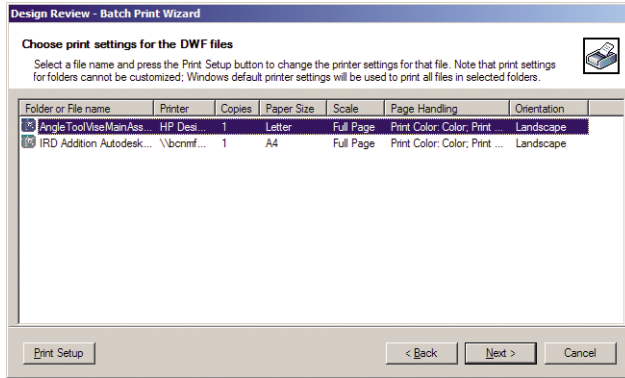

- Save or start the batch print job.

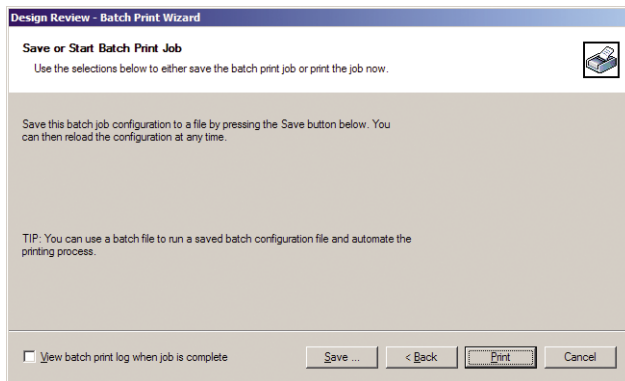

Using HP Instant Printing

- Make sure **Use HP Instant Printing** has been selected. To print, click the Print icon in the toolbar or select **File > Print**. Choose your preferred printing settings and click **OK**.

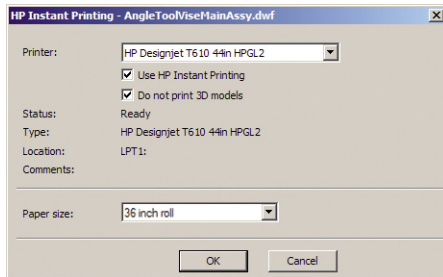

- Alternatively, Use HP Instant Printing can be launched directly from its own toolbar icon. In this case, it starts immediately, using the settings you defined previously.

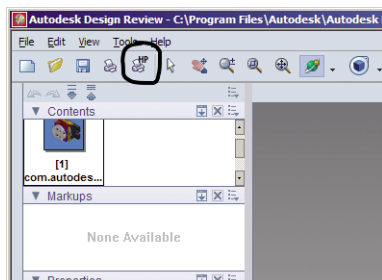

Using AutoCAD

1. The AutoCAD window shows the **Model** tab followed by a tab for each layout. Normally one of the layouts is printed rather than the model.

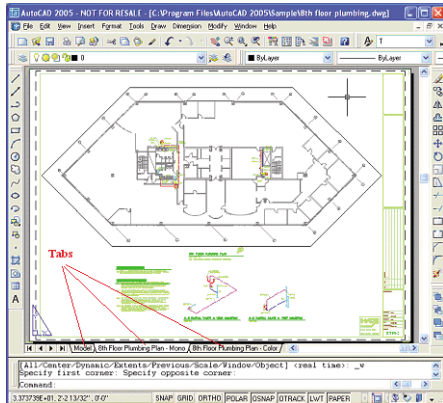

2. Select **File > Plot**.

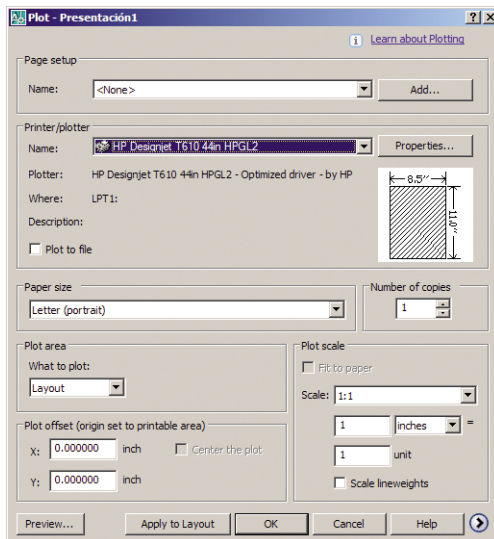

3. You can see further options by pressing the circular button in the lower right corner of the window.

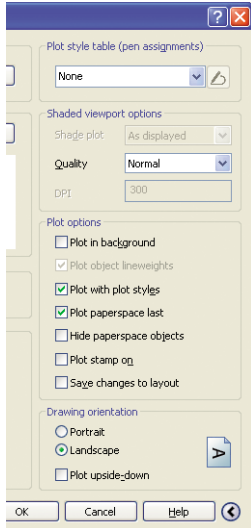

 **NOTE:** The Quality option here does not refer to the final print quality but to the quality of AutoCAD viewport objects that are sent for printing.

4. Press the **Properties** button.

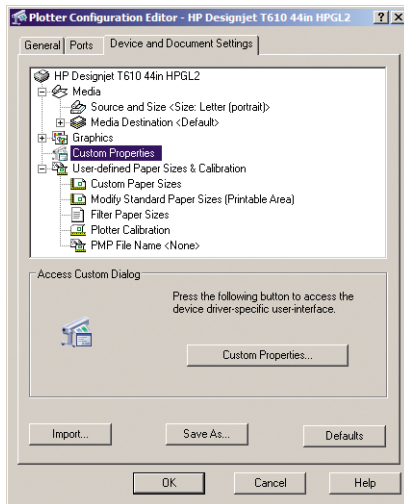

5. Select the **Device and Document Settings** tab, and press the **Custom Properties** button.

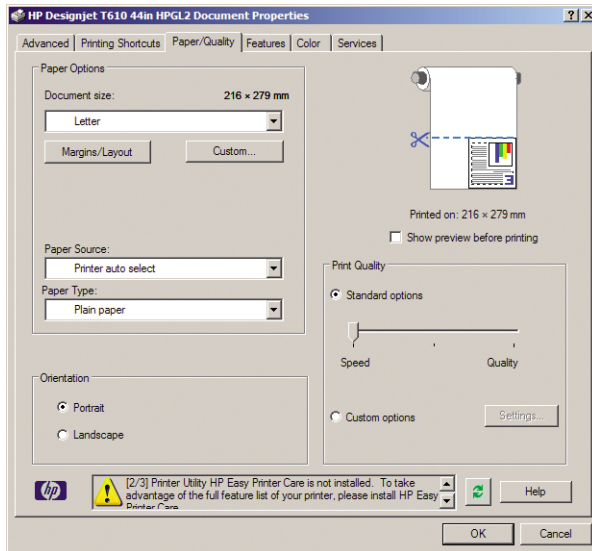

6. Select the **Paper/Quality** tab, then select the paper type that you intend to use.

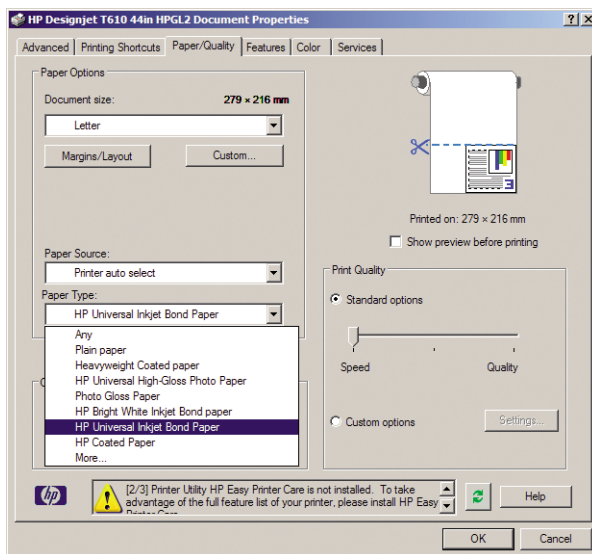

7. Select the print quality (your own choice between speed and quality of printing).
8. If you intend to print on roll paper, you must decide where the printer should cut the paper. Press the **Margins/Layout** button.

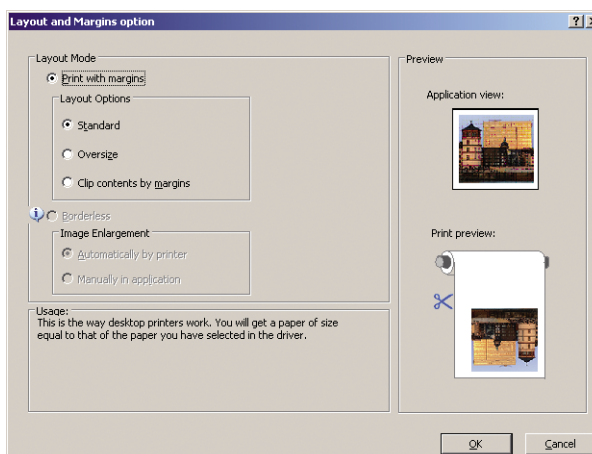

9. Select **Clip contents by margins**.

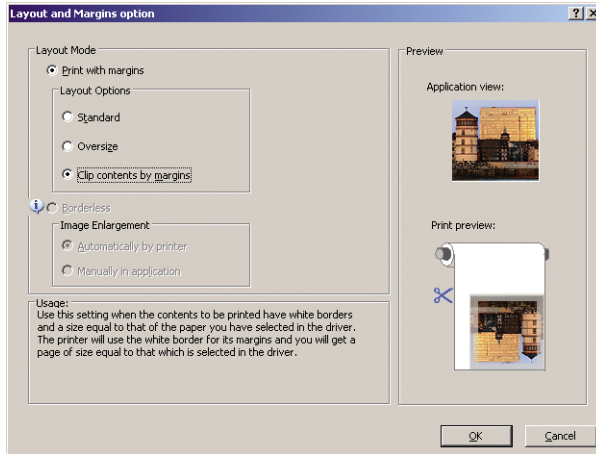

10. Select the **Features** tab, then select **Autorotate**. Autorotation can help to avoid wasting paper.

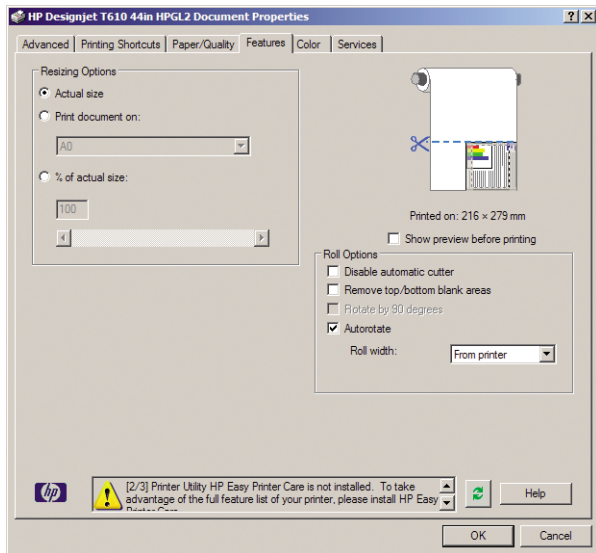

11. Press the **OK** button and save your configuration changes to a PC3 file.

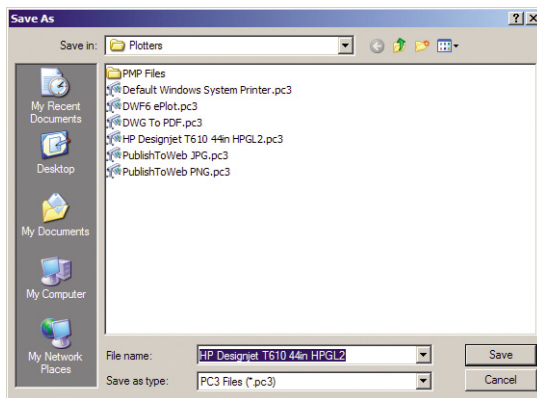

Print a presentation

This section demonstrates how to print a presentation from AutoCAD and from Photoshop.

Using AutoCAD

1. Open the AutoCAD file.
2. Select **Print from Layout**.
3. Select **File > Plot**.

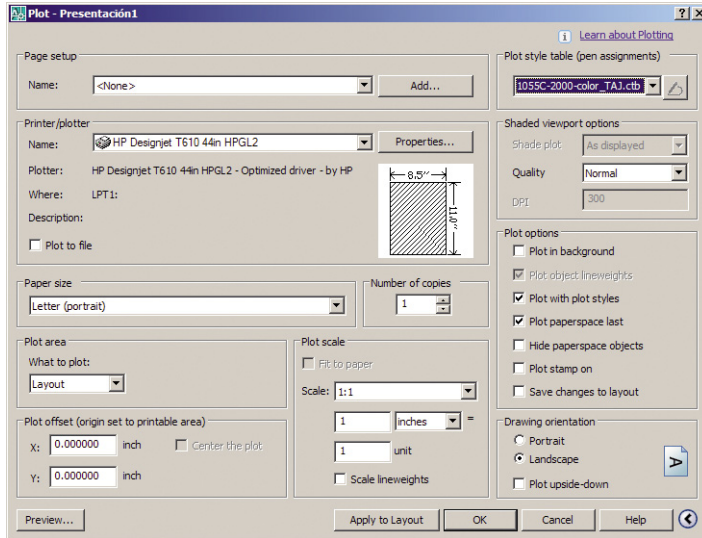

4. Ensure that the correct printer is selected, then press the **Properties** button.

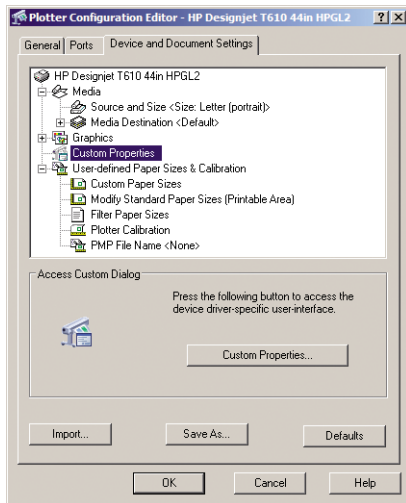

5. Select the **Device and Document Settings** tab, and press the **Custom Properties** button.

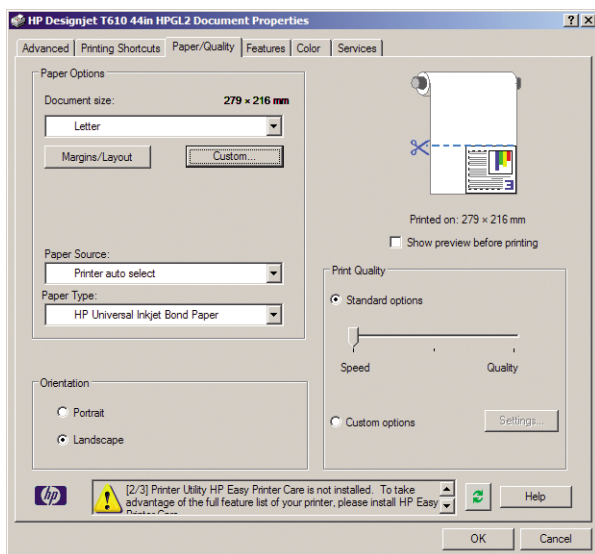

6. Select the **Paper/Quality** tab, then select the paper type that you intend to use.

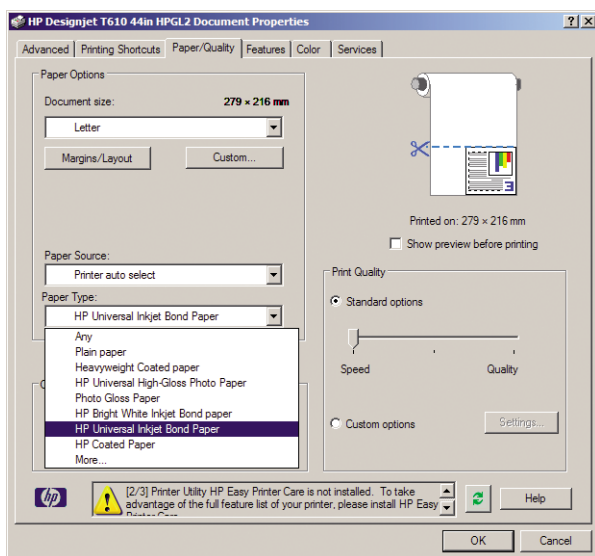

7. Select the print quality (your own choice between speed and quality of printing).
8. If you intend to print on roll paper, you must decide where the printer should cut the paper. Press the **Margins/Layout** button.

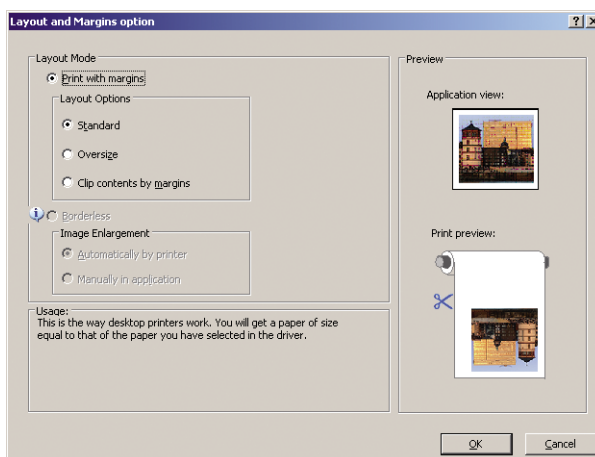

9. Select **Clip contents by margins**.

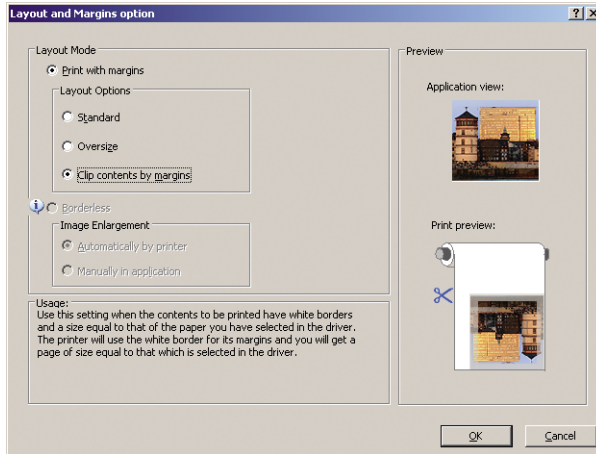

10. If you are using photo or glossy paper, you can select **Borderless** printing.

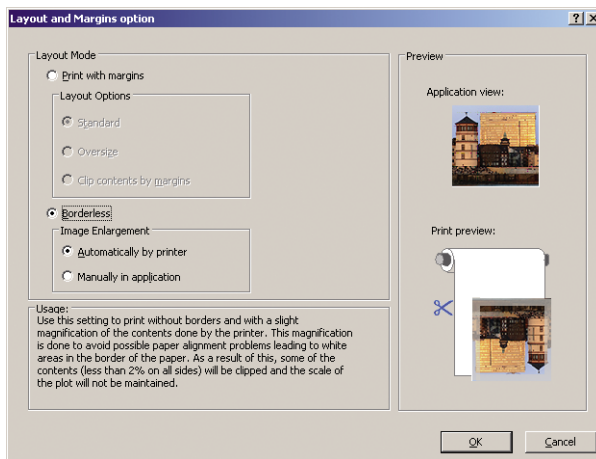

11. Select the **Features** tab, then select **Autorotate**. Autorotation can help to avoid wasting paper.

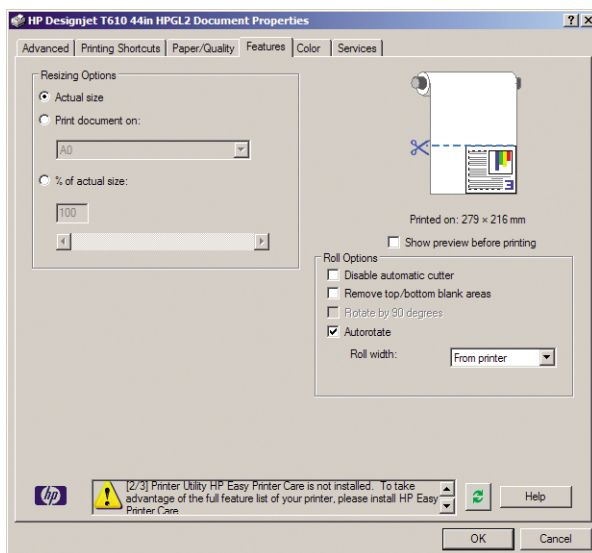

12. Press the **OK** button and save your configuration changes to a PC3 file.

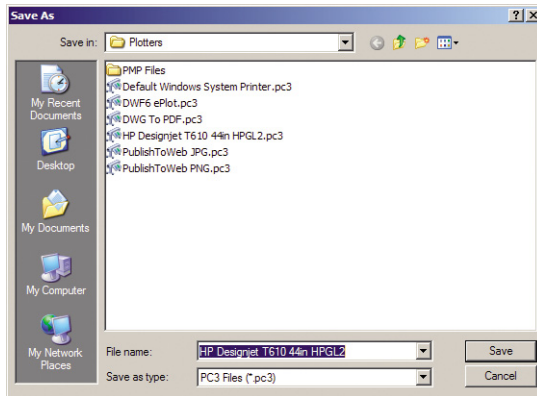

Using Adobe Photoshop

1. Select **File > Page Setup > Printer**, select your printer, and click **OK**.

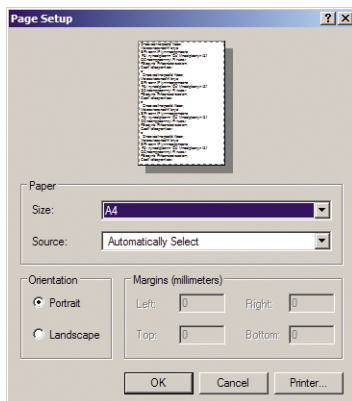

2. Choose from the available paper sizes.

If you do not find the paper size that you intend to use, select **Printer > Properties > Paper/Quality > Custom > Paper Size**. Enter the width, the length, and the name of your custom paper size. Press the **Save** and **OK** buttons.

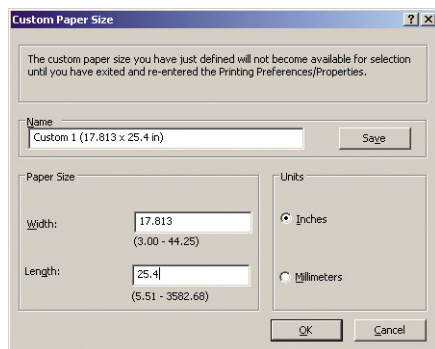
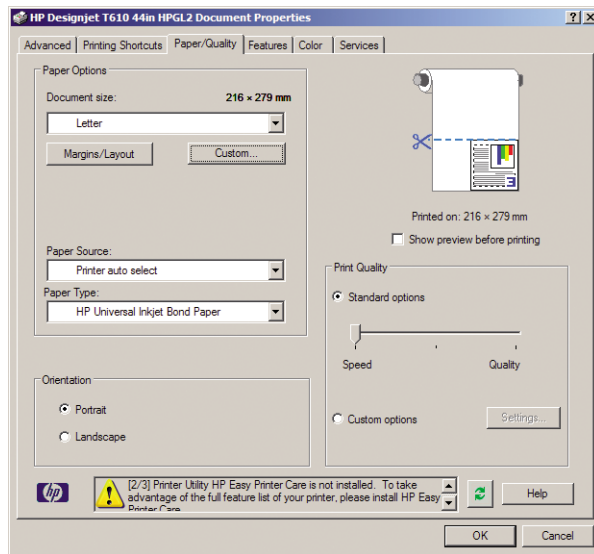

3. Select **File > Print with Preview**.

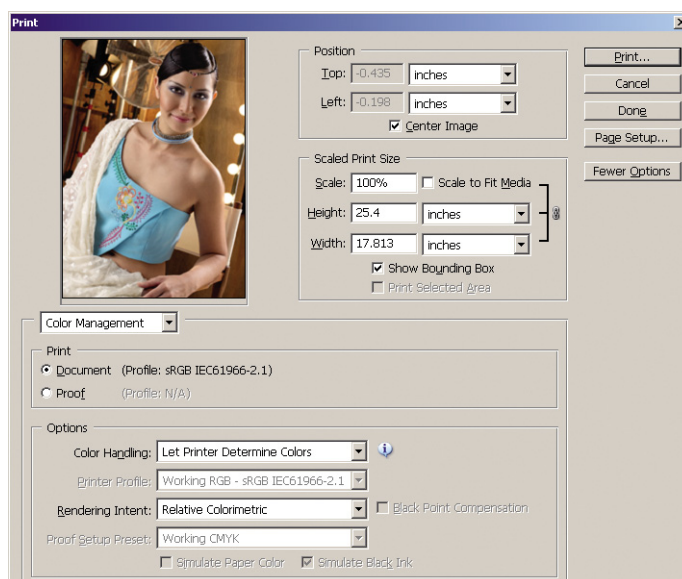

4. Select **Print > Properties**.

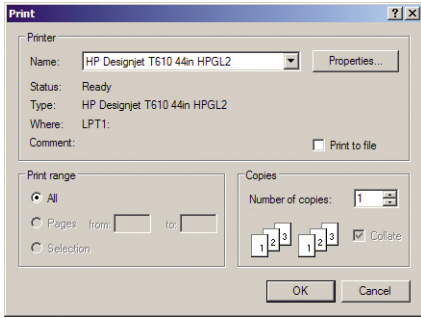

5. Select **Paper Source, Paper Type, and Print Quality**.

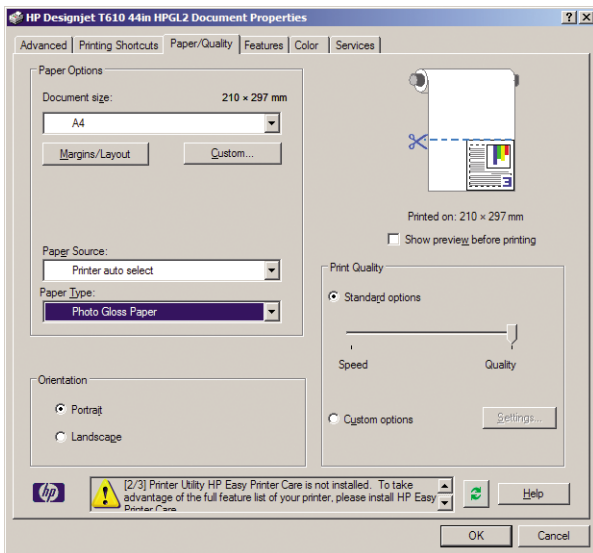
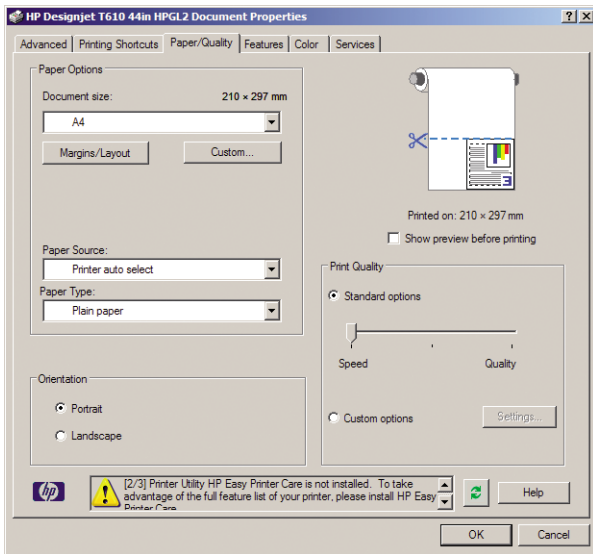

- Press the **Margins/Layout** button. In this example you can select **Borderless** because you have already selected a photo paper (this option is only enabled with photo and glossy papers). The default image enlargement method is **Automatically by printer**. The option **Manually in application** can be used when you want to control the amount of enlargement precisely.

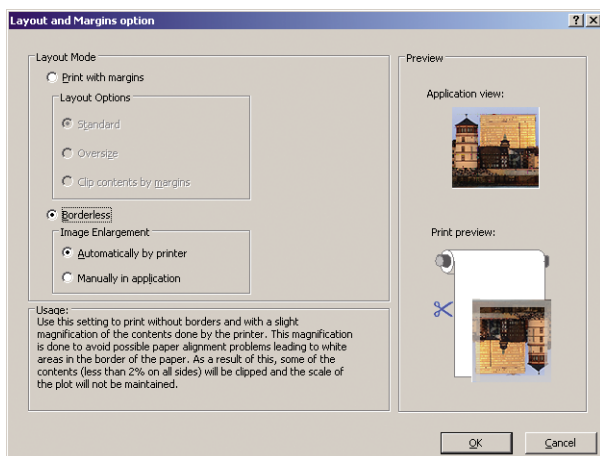

- In the **Color** tab, the default color management option is **Printer Managed Colors**, and this is the correct option because you have already selected **Let Printer Determine Colors** in Photoshop.

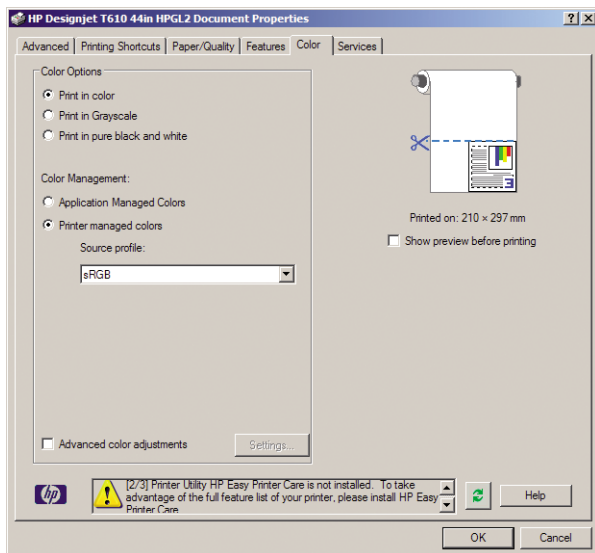

Print and scale from Microsoft Office

This section demonstrates how to print and scale from Microsoft Office.

Using PowerPoint

1. Select **File > Print**, then select the **Name** of your printer.

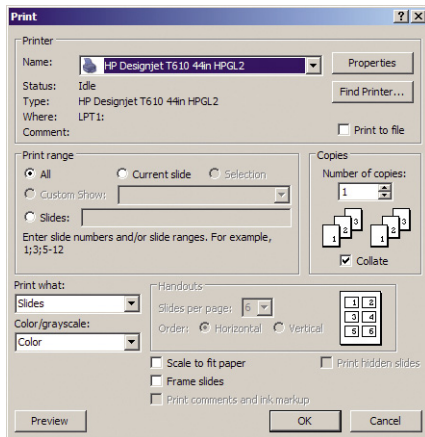

2. Select **Properties > Features > Print document on** to scale the document to a particular size.

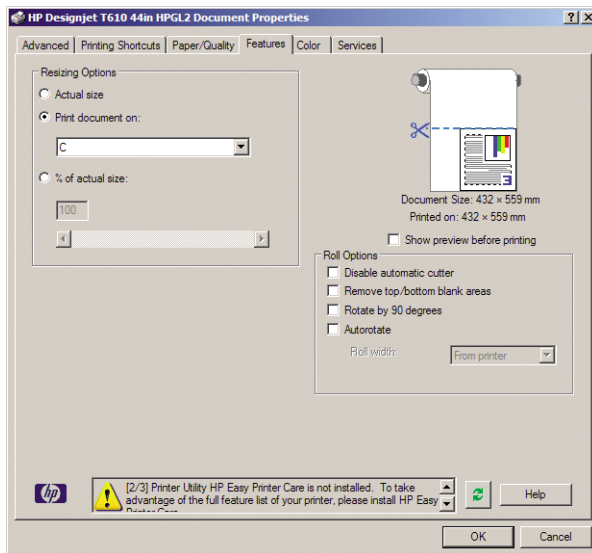

3. Select the **Paper/Quality** tab, then select **Paper Source** and **Paper Type**.

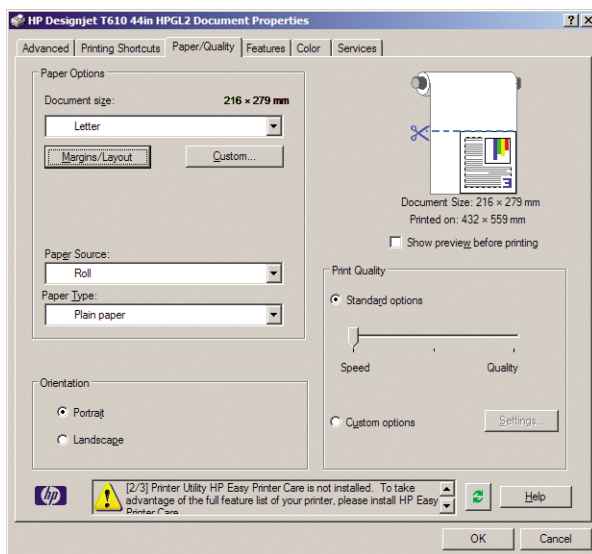

4. Select **Margins/Layout**, then select **Clip contents by margins** to keep the size.

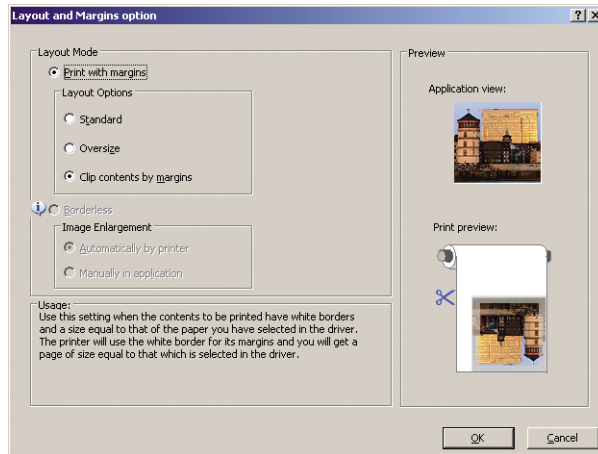

Using Project

1. Select **File > Page Setup > Print**.

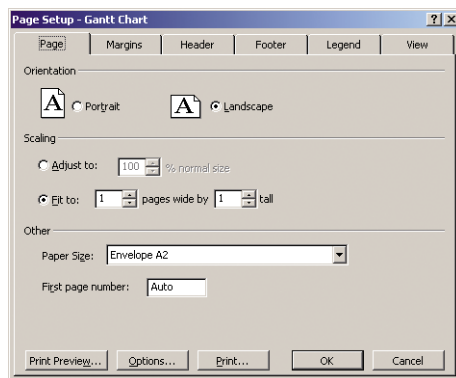

2. Select your printer's name, then **Close**.

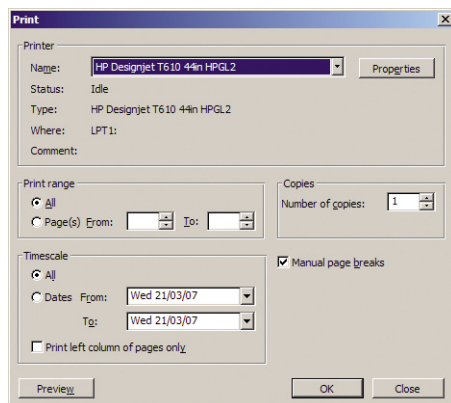

3. Select **Page Setup**, and choose the **Paper Size** you want.

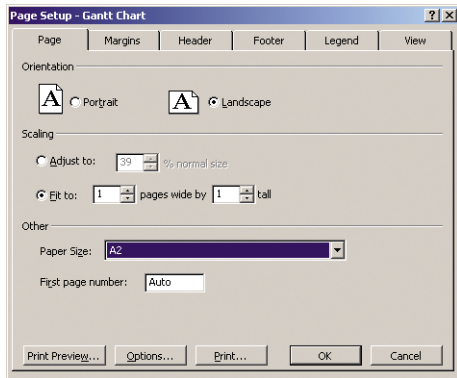

4. Select **Options** to go to the printer driver. The default options in the **Paper/Quality** tab are probably suitable: **Paper Source: Automatically Selected** and **Paper Type: Any**.

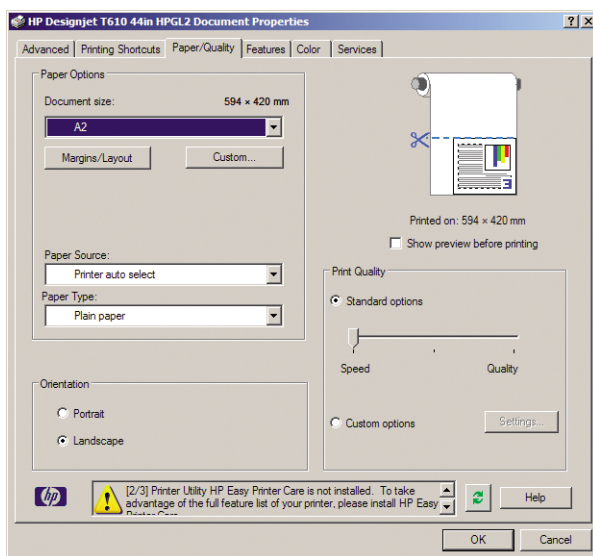

5. Select **Features > Print document on** to scale the document to a particular size. Alternatively, you can scale the document in Project.

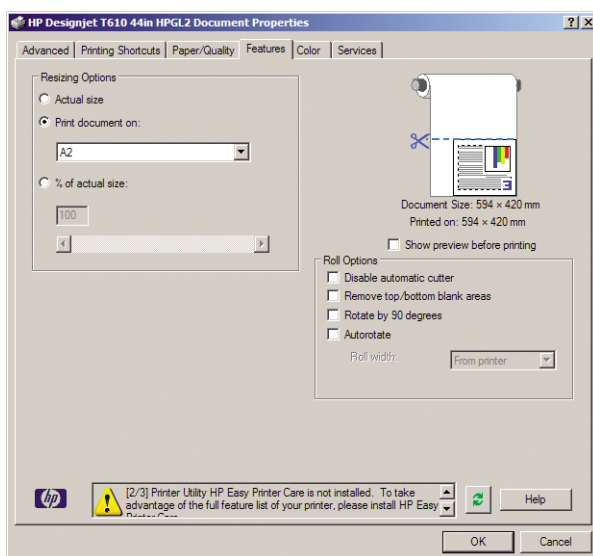

Using Excel

1. Select **File > Page Setup > Print**. Select your printer's name, then click **Close**.

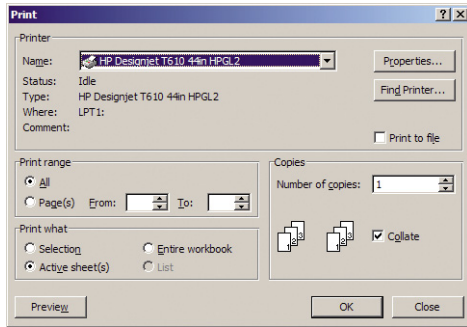

2. Select **File > Page Setup**, and choose the **Paper Size** you want.

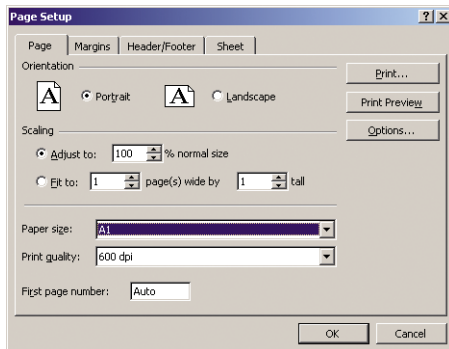

3. Select **Options** to go to the printer driver.

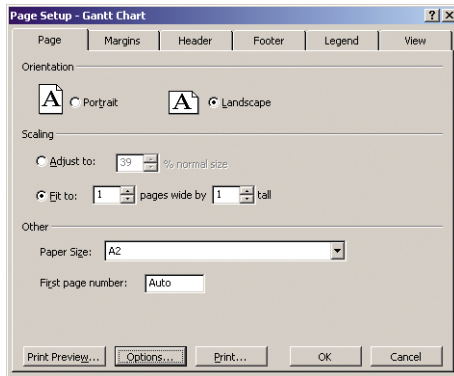

4. Select the **Paper/Quality** tab, where you can select **Paper Type**, **Paper Source**, and **Print Quality**.

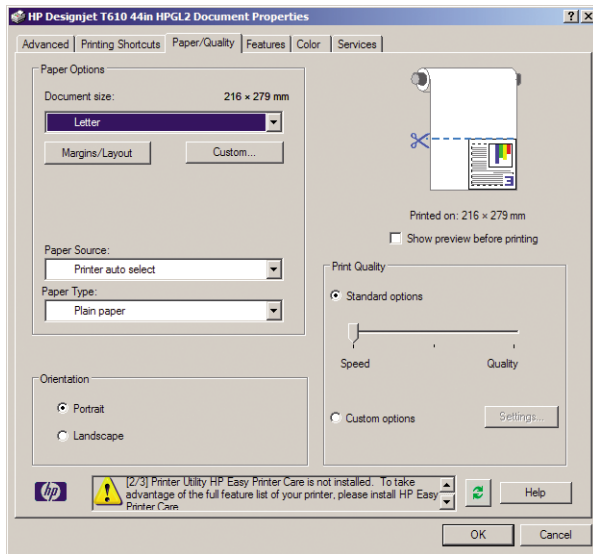

5. Select **Features > Print document on** to scale the document to a particular size. Alternatively, you can scale the document in Excel.

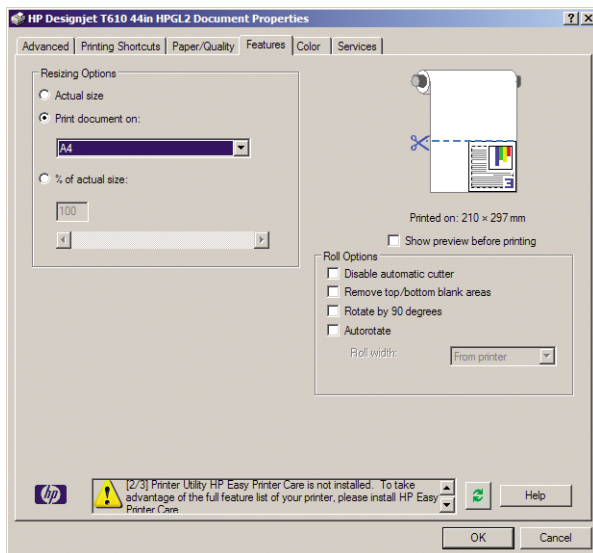

9 Handling ink cartridges and printheads

- [About the ink cartridges](#)
- [Check the ink cartridges status](#)
- [Remove an ink cartridge](#)
- [Insert an ink cartridge](#)
- [About the printheads](#)
- [Check the printhead status](#)
- [Remove a printhead](#)
- [Insert a printhead](#)

About the ink cartridges

Ink cartridges store the ink and are connected to the printheads, which distribute the ink on the paper. Your 24-inch printer comes with one 130 ml matte black ink cartridge and five 69 ml ink cartridges. Your 44-inch printer comes with six 130 ml ink cartridges. To purchase additional cartridges, see [Accessories on page 107](#).

- △ **CAUTION:** Observe precautions when handling ink cartridges because they are ESD-sensitive devices (see the [Glossary on page 167](#)). Avoid touching pins, leads, and circuitry.

Check the ink cartridges status

To view the ink levels of your ink cartridges, press the **View ink level** key on the front panel.

To get more information on your ink cartridges, you can use the front panel ink menu, HP Easy Printer Care (Windows), or HP Printer Utility (Mac OS).

For an explanation of the ink cartridge status messages, see [Ink cartridge status messages on page 142](#).

Ink menu procedure

1. Press the **Menu** key to return to the main menu and select the Ink menu icon , then **Ink cartridge information**.
2. Select the cartridge on which you want information.
3. The front panel displays:
 - Color
 - Product name
 - Product number
 - Serial number
 - Status
 - Ink level, if known
 - Total ink capacity in milliliters
 - Expiration date
 - Warranty status
 - Manufacturer

HP Easy Printer Care (Windows) or HP Printer Utility (Mac OS) procedures

- In HP Easy Printer Care (Windows), go to the **Overview** tab, each cartridge's status is under **Supply Status > Cartridges**.
- In HP Printer Utility (Mac OS), select **Information > Printer Status**.

Remove an ink cartridge

There are two occasions when you need to remove an ink cartridge.

- The ink cartridge is very low and you want to replace it with a full cartridge for unattended printing (you can use up the remaining ink in the first cartridge at a more convenient time).
- The ink cartridge is empty or faulty, and you must replace it to continue printing.

△ **CAUTION:** Do not try to remove an ink cartridge while printing.

CAUTION: Remove an ink cartridge only if you are ready to insert another one.

CAUTION: Make sure the printer wheels are locked (the brake lever is pressed down) to prevent the printer from moving.

1. Press the **Menu** key to return to the main menu and select the Ink menu icon , then **Replace ink cartridges**.

Ink

- ▶ View ink levels
- ▶ **Replace ink cartridges**
- ▶ Replace printheads
- ⊕ Ink cartridge information
- ⊕ Printhead information

2. Open the ink cartridge cover on the left-hand side of the printer. All six inks, gray, photo black, matte black, yellow, magenta, and cyan, are on the left-hand side.

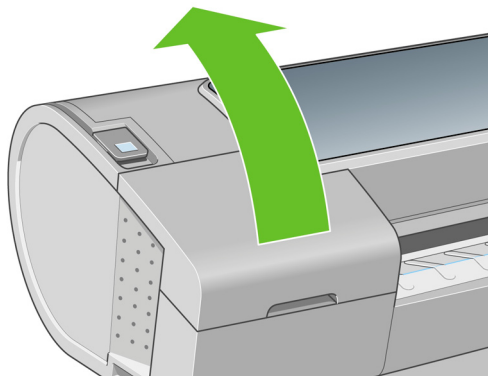

3. Grip the cartridge you wish to remove.

4. Pull the cartridge straight up.

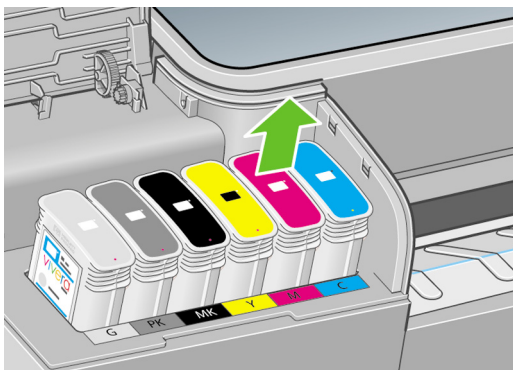

 **NOTE:** Avoid touching the end of the cartridge that is inserted into the printer, as there may be ink on the connection.

NOTE: Avoid storing partially used ink cartridges.

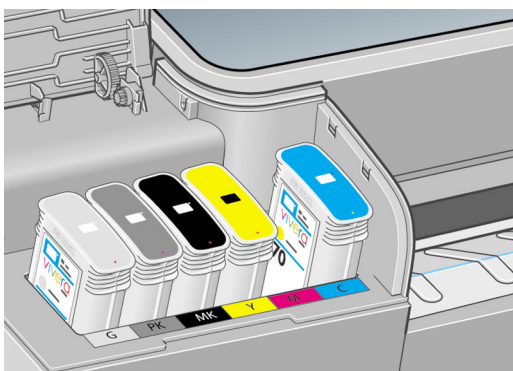

5. The front-panel display identifies the missing ink cartridge.

Insert an ink cartridge

1. Before removing the cartridge from its wrapping, shake it vigorously.
2. Unwrap the new ink cartridge, find the label identifying the ink color. Check that the letter or letters (in these illustrations, M for magenta) marking the empty slot, matches the letter or letters on the cartridge label.
3. Insert the ink cartridge into its slot.

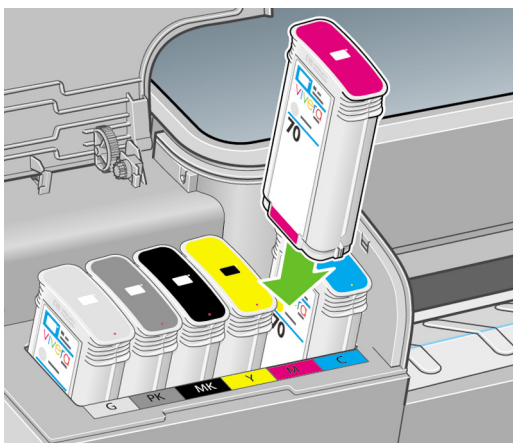

4. Push the cartridge into the slot until it snaps into position. You should hear a beep and see confirmation that the cartridge has been inserted.

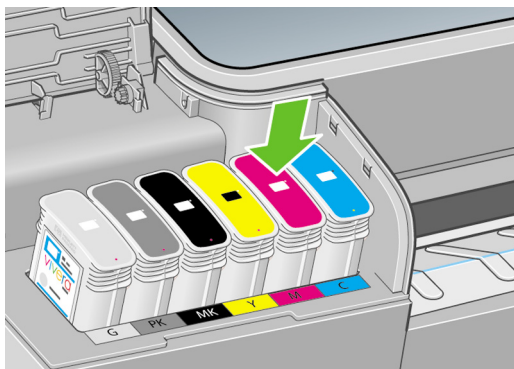

If you have difficulty, see [Cannot insert an ink cartridge on page 142](#).

5. When all cartridges have been inserted, close the cover.

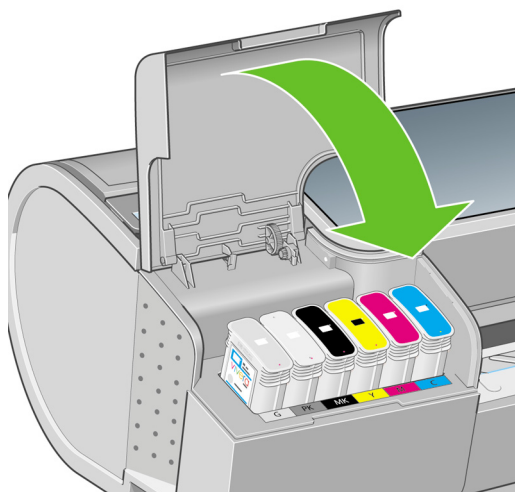

6. The front-panel display confirms that all cartridges have been correctly inserted, press the **OK** key on the front panel.

About the printheads

The printheads are connected to the ink cartridges and jet ink onto the paper.

- △ **CAUTION:** Observe precautions when handling printheads because they are ESD-sensitive devices (see the [Glossary on page 167](#)). Avoid touching pins, leads, and circuitry.

Check the printhead status

The printer automatically checks and services the printheads after each print. Follow the steps below to get more information on your printheads.

1. Press the **Menu** key to return to the main menu and select the Ink menu icon , then **Printhead information**.
2. Select the printhead on which you want information.
3. The front panel displays:
 - Colors
 - Product name
 - Product number
 - Serial number
 - Status, see [Front-panel error messages on page 155](#)
 - Volume of ink it has used
 - Warranty status

You can also get most of this information without leaving your computer by using HP Easy Printer Care (Windows) or HP Printer Utility (Mac OS).

For an explanation of the printhead status messages, see [Printhead status messages on page 148](#).

If the warranty status is **See warranty note**, this indicates that non-HP ink is being used. See the HP Legal Information document provided with your printer for details of the warranty implications.

Remove a printhead

- △ **CAUTION:** Make sure the printer wheels are locked (the brake lever is pressed down) to prevent the printer from moving.

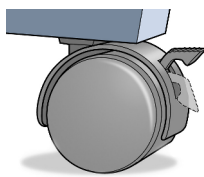

△ **CAUTION:** Printhead replacement must be performed with the printer powered on.

1. Press the **Menu** key to return to the main menu and select the Ink menu icon , then **Replace printheads**.

Ink

- ▶ View ink levels
- ▶ Replace ink cartridges
- ▶ **Replace printheads**
- ⊕ Ink cartridge information
- ⊕ Printhead information

2. The printer moves the carriage into the correct position.

△ **CAUTION:** If the carriage is left in the removal position for more than three minutes without inserting or removing any printheads, it tries to move back to its normal position in the right-hand end.

3. When the carriage has stopped moving, the front-panel display asks you to open the window.

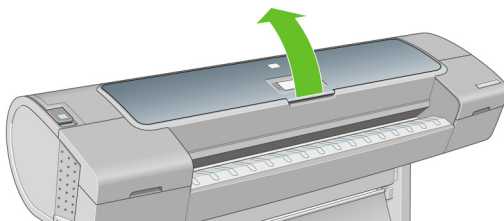

4. Locate the carriage on the right side of the printer.
5. Pull the handle up and toward you to release the wire loop.

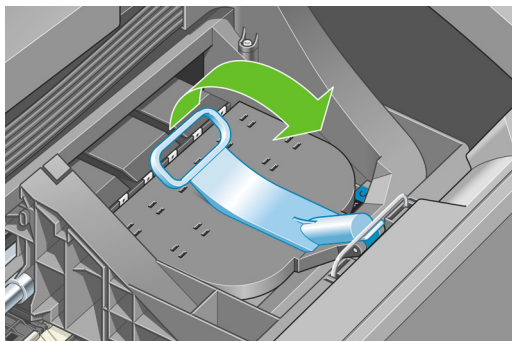

6. Push the handle back to raise the lid.

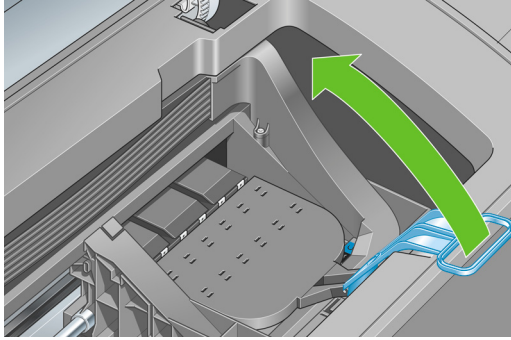

7. This gives you access to the printheads.

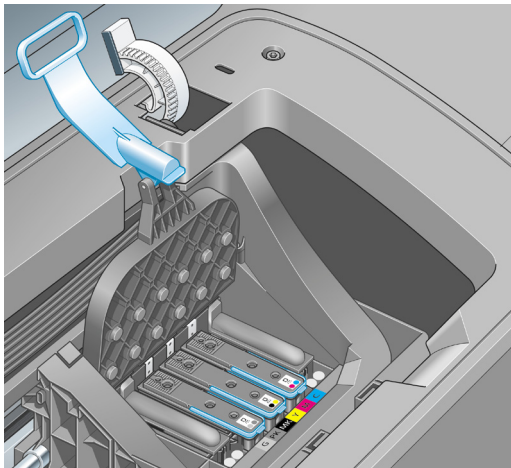

8. To remove a printhead, lift up the blue handle.

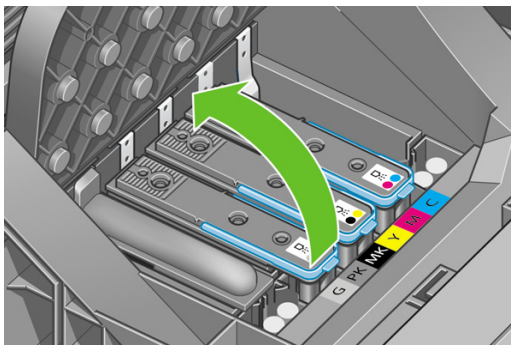

9. Using the blue handle, use steady force to disengage the printhead.

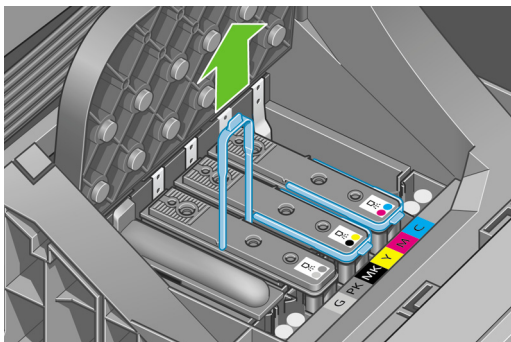

10. Pull the blue handle upward until the printhead is released from the carriage.

△ **CAUTION:** Do not pull abruptly because this can damage the printhead.

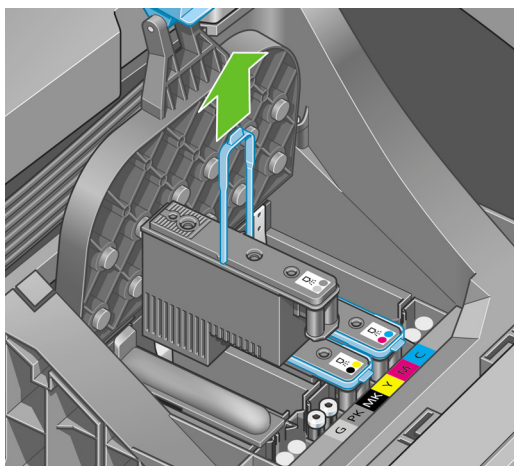

11. The front-panel display identifies the missing printhead.

Insert a printhead

1. Remove the orange protective caps by pulling them down.

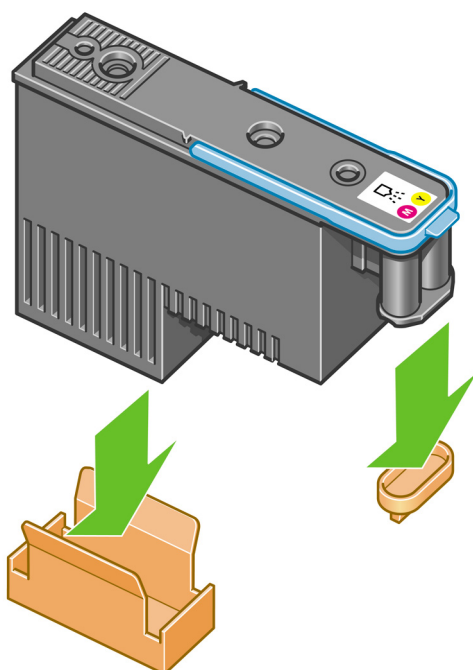

2. The printhead is designed to prevent you from accidentally inserting it into the wrong slot. Check that the colored label on the printhead matches the colored label of the carriage slot into which the printhead is to be inserted.

3. Insert the new printhead into its correct slot in the carriage.

△ **CAUTION:** Insert the printhead slowly and vertically, straight down. It may be damaged if you insert it too fast, or at an angle, or if you rotate it as you insert it.

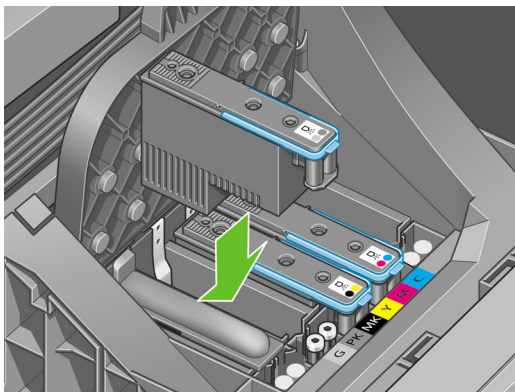

4. Push down as indicated by the arrow shown below.

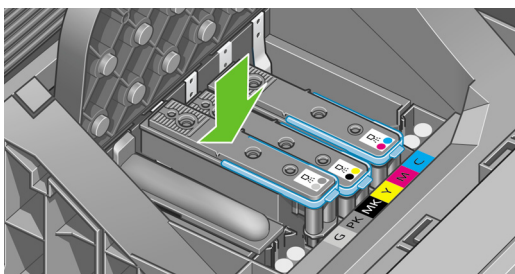

△ **CAUTION:** When installing the new printhead there may be some resistance, so you need to press it down firmly but smoothly. You should hear a beep and see confirmation on the front-panel display that the printhead has been inserted. If you have difficulty, see [Cannot insert a printhead on page 142](#).

5. Insert all other printheads that need to be installed, and close the carriage lid.

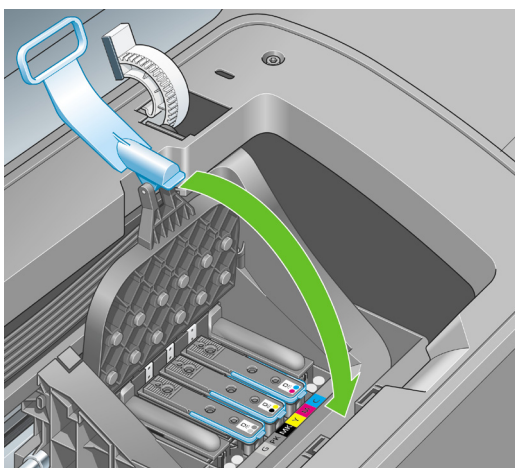

6. Ensure the end of the blue handle catches the wire loop on the near side of the carriage.

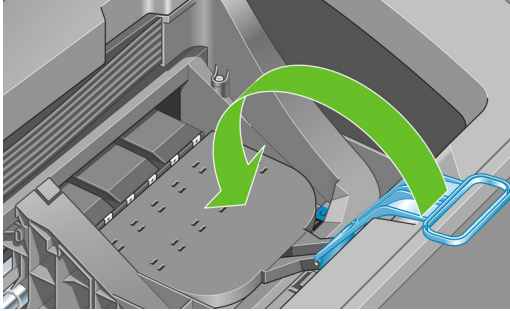

7. Lower the handle to rest on the carriage cover.

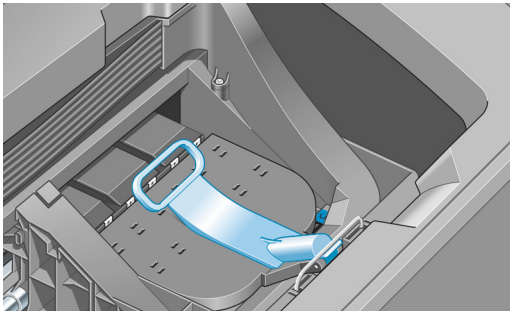

When all the printheads have been inserted correctly and are accepted by the printer, the printer beeps.

 **NOTE:** If the printer does not beep when you insert the printhead and the **Replace** message appears on the front-panel display, the printhead may need to be reinserted.

8. Close the window.

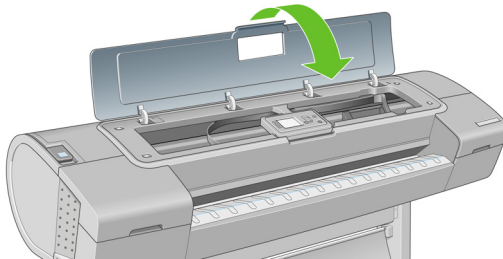





9. The front-panel display confirms that all printheads are correctly inserted. The printer starts checking and preparing the printheads. The default routine process, when all printheads are changed, takes 10 minutes. If the printer finds problems in preparing the printheads, it takes longer, up to 45 minutes. For a single printhead insertion, the times vary between 2 and 40 minutes. After all printheads are checked and prepared, the printhead realignment procedure runs automatically if paper is loaded, see [Align the printheads on page 146](#).

10 Maintaining the printer

- [Check printer status](#)
- [Clean the exterior of the printer](#)
- [Replace the cutter](#)
- [Maintain the ink cartridges](#)
- [Move or store the printer](#)
- [Update the firmware](#)
- [Update the software](#)
- [Printer maintenance kits](#)
- [Secure Disk Erase](#)

Check printer status

You can check the current status of the printer in various ways:

- If you start HP Easy Printer Care under Windows or HP Printer Utility under Mac OS, and select your printer, you see a page of information describing the status of the printer and its paper and ink supplies.
- If you access the Embedded Web Server, you see information about the general status of the printer.
- The status screen of the printer's front panel notifies you of any current problems affecting the printer as a whole. You can also request information about:
 - The currently loaded paper, with the **View loaded paper** key 
 - The ink levels, with the **View ink levels** key 
 - The ink cartridges, by selecting the Ink menu icon  and then **Ink cartridge information**
 - The printheads, by selecting the Ink menu icon  and then **Printhead information**

Clean the exterior of the printer

Clean the outside of the printer and all other parts of the printer that you regularly touch as part of normal operation with a damp sponge or a soft cloth and a mild household cleaner such as non-abrasive liquid soap.

- ⚠ **WARNING!** To avoid an electric shock, make sure that the printer is turned off and unplugged before you clean it. Do not let water get inside the printer.
- ⚠ **CAUTION:** Do not use abrasive cleaners on the printer.

Replace the cutter

The cutter may need to be replaced once or twice during the life of the printer, depending on the total amount and thickness of paper used. The front panel advises when replacement is due. If you do not replace the cutter immediately, the printer continues working normally, but the front panel continues to remind you about the cutter.

To replace the cutter:

1. If there is paper loaded in the printer, unload it.
2. At the front panel, select the Setup menu icon , then **Resets > Reset cutter life counters**.
3. After a brief pause, the printer turns itself off. The printhead carriage is parked on the right-hand side of the printer, and the cutter on the left-hand side.

- ⚠ **WARNING!** There is a risk of electric shock if you attempt to replace the cutter with the printer turned on.

4. Lift the ink cartridge cover on the left-hand side of the printer.

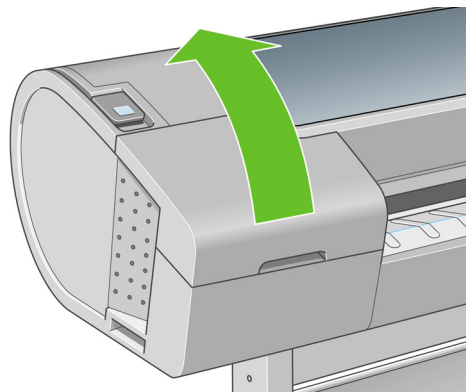

5. Press the button behind the ink cartridges to release the cover of the left-hand end of the printer.

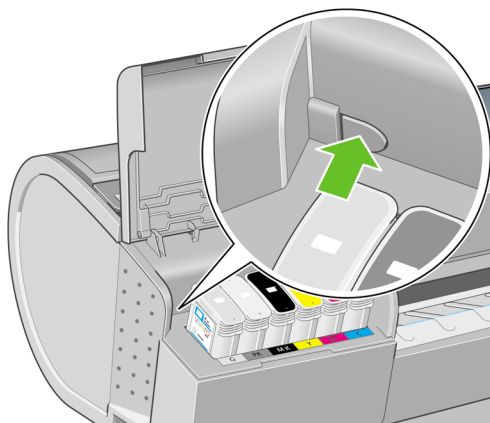

6. Remove the left end cover.

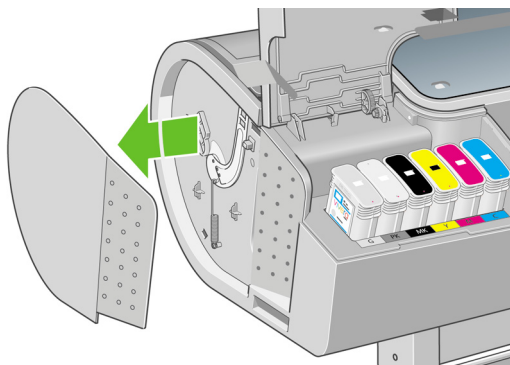

7. Unscrew and remove the cutter stop using the TORX PLUS screwdriver provided with the new cutter. The screw is captive and will not fall out.

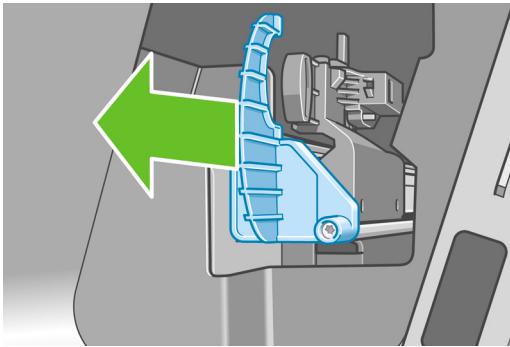
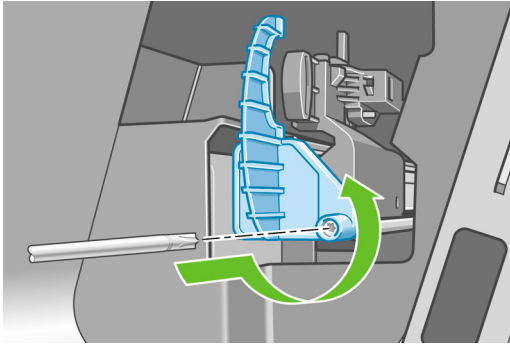

8. Remove the old cutter.

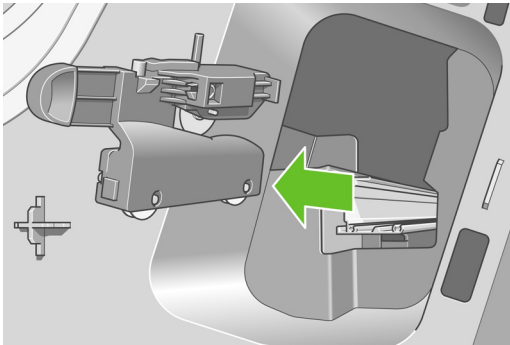

9. Take the new cutter from the maintenance kit and move the plunger at the top slowly back and forth within its housing to check that it moves freely.

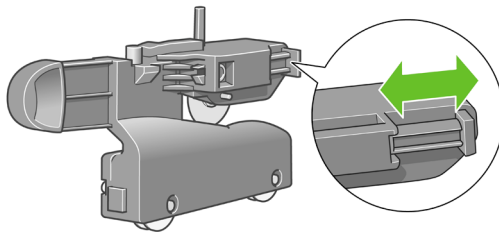

10. Slide the new cutter into position on the cutter rail.

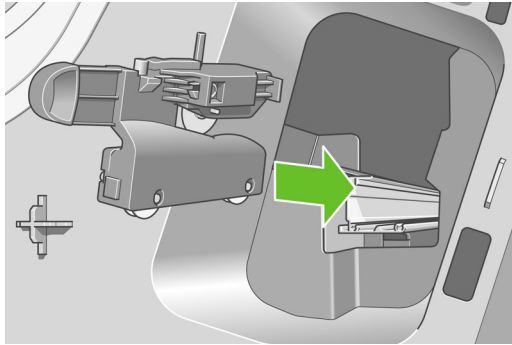

The two wheels on the bottom of the cutter should engage the central ridge on the cutter rail, and the two bushing guides should fit into the groove in the upper part of the cutter rail.

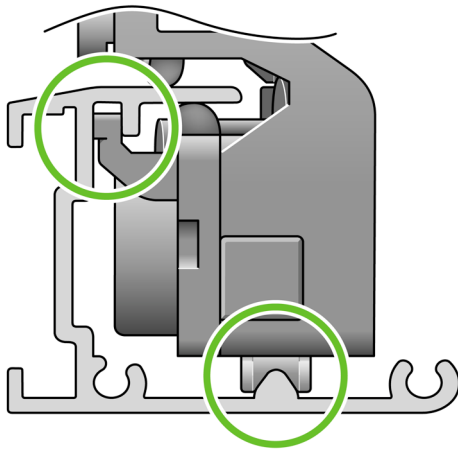

Check that the cutter runs smoothly up and down the rail. You can leave it anywhere on the rail; the printer will park it correctly later.

11. Fit the cutter stop onto the end of the cutter rail, holding it there with one hand while you tighten the screw with the screwdriver in your other hand.

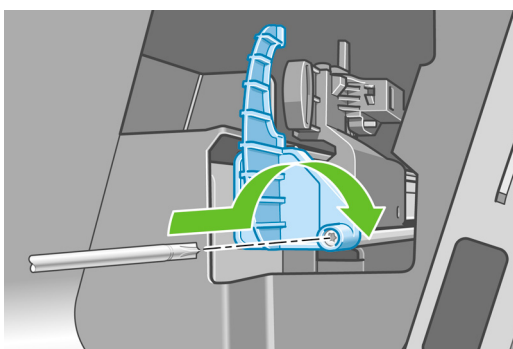
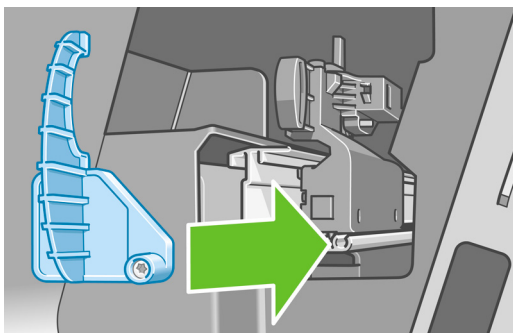

12. Put the left end cover back on the printer, aligning the protrusions with the holes in the printer.

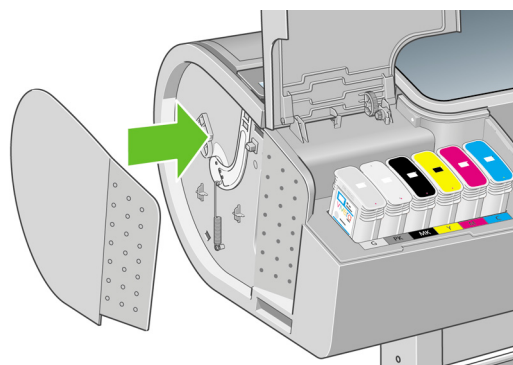

13. Close the ink cartridge cover.



14. At the front panel, turn the printer back on. The printer checks that the cutter has been correctly installed. Look at the front panel and follow its instructions if there is any problem.

Maintain the ink cartridges

During the normal lifetime of a cartridge, no specific maintenance is required. However, in order to maintain the best print quality, replace a cartridge when it reaches its expiration date. The printer's front panel notifies you when any cartridge reaches its expiration date.

You can also check a cartridge's expiration date at any time: see [Check printer status on page 98](#).

See also [Handling ink cartridges and printheads on page 85](#).

Move or store the printer

If you need to move or store the printer, prepare it correctly to avoid possible damage to it. To prepare the printer, follow the instructions below.

1. Do not remove the ink cartridges or printheads.
2. Make sure that no paper is loaded.
3. Make sure that the printer is idle.
4. Disconnect any cables connecting the printer to a network or a computer.

If you need to leave the printer turned off for a long time, follow the additional steps below.

1. Turn off the power using the **Power** key on the front panel.
2. Also turn off the power switch at the rear of the printer.
3. Disconnect the printer's power cable.
4. Before transporting the printer, secure the rear tray in the closed position with tape. Otherwise, the tray could open and perhaps break and fall out of the printer.

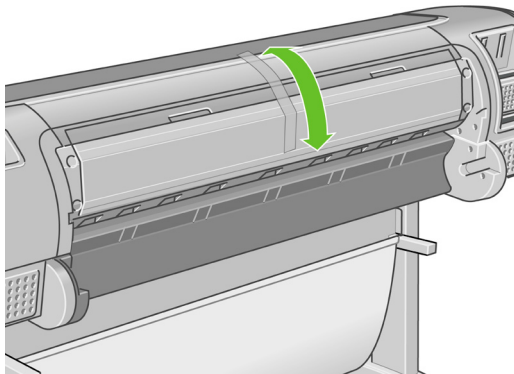

△ **CAUTION:** If you turn the printer upside down, ink could escape into the printer and cause serious damage.

When the printer is turned back on, it takes about three minutes to initialize itself and to check and prepare the printheads. Preparing the printheads normally takes just over a minute. However, if the printer has been off for a six weeks or more, preparing the printheads could take up to 45 minutes.

△ **CAUTION:** If the printer remains off for a long period of time, the printheads may become unusable. In this case, you need to replace the printheads with new ones.

💡 **TIP:** Because preparing and purging the printheads uses both time and ink, you are strongly recommended to leave the printer always on or in sleep mode, whenever possible, to maintain the health of the printheads. In both cases, the printer wakes up from time to time to maintain the printheads. Thus you can avoid going through lengthy preparation processes before using your printer.

Update the firmware

The printer's various functions are controlled by software that resides in the printer, otherwise known as firmware.

From time to time firmware updates will be available from Hewlett-Packard. These updates increase the printer's functionality and enhance its features.

Firmware updates can be downloaded from the Internet and installed in your printer in the following ways; you can choose whichever you find most convenient.

- Using HP Easy Printer Care under Windows, select your printer, the **Support** tab, and then **Firmware Update**.
- Using HP Printer Utility under Mac OS, select **Support** and then **Firmware Update**.
- Using your printer's Embedded Web Server, select the **Main** tab and then **Firmware update**.

 **NOTE:** If you are using an HP Jetdirect print server to connect to a network, the HP Easy Printer Care and HP Printer Utility options will not be available, so you will need to use the Embedded Web Server.

In each case, follow the instructions on your screen to download the firmware file and store it on your hard disk. Then select the downloaded file and click **Update**.

If you experience very slow progress while uploading the firmware file to the printer, the reason could be that you are using a proxy server. In that case, try bypassing the proxy server and accessing the Embedded Web Server directly.

- In Internet Explorer 6 for Windows, go to **Tools > Internet Options > Connections > LAN Settings**, and check the **Bypass proxy server for local addresses** box. Alternatively, for more precise control, click the **Advanced** button and add the printer's IP address to the list of exceptions, for which the proxy server is not used.
- In Safari for Mac OS, go to **Safari > Preferences > Advanced** and click the **Proxies: Change Settings** button. Add the printer's IP address or its domain name to the list of exceptions, for which the proxy server is not used.

The firmware includes a set of the most commonly used paper profiles. Extra paper profiles can be downloaded separately; see [Paper profiles on page 43](#).

Update the software

To update the printer driver and other software for any HP Designjet printer, go to <http://www.hp.com/go/designjet/> and select **Downloads**, then **Drivers**. Then select your printer, your preferred language, and your operating system.

If your operating system is Windows, HP Software Update regularly offers to update your software automatically.

Printer maintenance kits

Four maintenance kits are available for your printer, containing components that may need to be replaced after long use. When one of them is needed, a message is displayed on the front panel and by HP Easy Printer Care under Windows or HP Printer Utility under Mac OS.

When you see the message, you should contact HP Support (see [Contact HP Support on page 160](#)) and request the maintenance kit. Three of the kits are installed by service engineers only; the fourth consists of a replacement cutter, which you can install yourself (see [Replace the cutter on page 98](#)).

Secure Disk Erase

The printer's hard disk is used as a temporary storage area for print jobs. The Secure Disk Erase facility can completely erase your information from the hard disk to protect it from unauthorized access. You can choose to erase particular files, or the whole hard disk.

Secure Disk Erase provides three different levels of security:

- **Non-Secure Fast Erase:** all pointers to the information are erased. The information itself remains on the hard disk until the disk space it occupies is needed for other purposes, and it is then overwritten. While it remains on the disk, it is difficult for most people to access, but may be accessed using software designed for the purpose. This is the normal method in which files are erased on most computer systems; it is the fastest method but the least secure.
- **Secure Fast Erase:** all pointers to the information are erased, and the information itself is also overwritten with a fixed character pattern. This method is slower than Non-Secure Fast Erase, but more secure. It may still be possible to access fragments of the erased information by using special tools to detect residual magnetic traces.



- **Secure Sanitizing Erase:** all pointers to the information are erased, and the information itself is repetitively overwritten using an algorithm designed to eliminate any residual traces. This is the slowest method, but the most secure. Secure Sanitizing Erase meets the US Department of Defense 5220-22.m requirements for clearing and sanitization of disk media. This is the default security level when using Secure Disk Erase.



Secure Disk Erase is one of the facilities provided by Web JetAdmin, which is HP's free Web-based print management software: see <http://www.hp.com/go/webjetadmin/>.

If you have difficulty in using Secure Disk Erase from Web JetAdmin, please contact HP Support: see [Contact HP Support on page 160](#).

 **NOTE:** If you choose to erase the whole hard disk, you may be asked to restart the printer several times during the process, which will take about 6 hours with Secure Disk Erase or 24 hours with Secure Sanitizing Erase.

11 Accessories

- [How to order supplies and accessories](#)
- [Introduction to the accessories](#)

How to order supplies and accessories

There are two alternative ways to order supplies or accessories for your printer:

- Visit http://www.hp.com/go/designjett610_order/ on the Web.
- Contact HP Support (see [Contact HP Support on page 160](#)).

The rest of this chapter lists the available supplies and accessories, and their part numbers.

Order ink supplies

The following ink supplies can be ordered for your printer.

Table 11-1 Ink cartridges

Cartridge	Part number
HP 72 69 ml Photo Black Ink Cartridge	C9397A
HP 72 69 ml Cyan Ink Cartridge	C9398A
HP 72 69 ml Magenta Ink Cartridge	C9399A
HP 72 69 ml Yellow Ink Cartridge	C9400A
HP 72 69 ml Gray Ink Cartridge	C9401A
HP 72 130 ml Matte Black Ink Cartridge	C9403A
HP 72 130 ml Photo Black Ink Cartridge	C9370A
HP 72 130 ml Cyan Ink Cartridge	C9371A
HP 72 130 ml Magenta Ink Cartridge	C9372A
HP 72 130 ml Yellow Ink Cartridge	C9373A
HP 72 130 ml Gray Ink Cartridge	C9374A

Table 11-2 Printheads

Printhead	Part number
HP 72 Gray & Photo Black Printhead	C9380A
HP 72 Magenta & Cyan Printhead	C9383A
HP 72 Matte Black & Yellow Printhead	C9384A

Order paper

The following paper types are currently provided for use with your printer.

 **NOTE:** This list is likely to change over the course of time. For the latest information, see <http://www.hp.com/go/designjet/supplies/>.

NOTE: Paper types that HP does not support may nevertheless be compatible with your printer.

Key to availability:

- (A) indicates papers available in Asia (excluding Japan)
- (C) indicates papers available in China

- (E) indicates papers available in Europe, the Middle East, and Africa
- (J) indicates papers available in Japan
- (L) indicates papers available in Latin America
- (N) indicates papers available in North America

If the part number is not followed by parentheses, the paper is available in all regions.

Table 11-3 Roll paper

Paper type	g/m ²	Length	Width	Part numbers
HP Bond and Coated Paper				
HP Universal Inkjet Bond Paper	80	150 ft = 45.7 m	23.39 in = 594 mm (A1)	Q8003A (AJ)
			24 in = 610 mm	Q1396A
			36 in = 914 mm	Q1397A
			42 in = 1067 mm	Q1398A
		300 ft = 91.4 m	23.39 in = 594 mm (A1)	Q8004A (EAJ)
			33.11 in = 841 mm (A0)	Q8005A (EAJ)
HP Bright White Inkjet Bond Paper	90	150 ft = 45.7 m	16.54 in = 420 mm (A2)	Q1446A (J)
			23.39 in = 594 mm (A1)	Q1445A (EJ)
			24 in = 610 mm	C1860A (LN), C6035A (AEJ)
			33.11 in = 841 mm (A0)	Q1444A (EJ)
			36 in = 914 mm	C1861A (LN), C6036A (AEJ)
			300 ft = 91.4 m	36 in = 914 mm
HP Universal Coated Paper	95	150 ft = 45.7 m	24 in = 610 mm	Q1404A (AEJN)
			36 in = 914 mm	Q1405A (AEJN)
			42 in = 1067 mm	Q1406A
HP Coated Paper	90	150 ft = 45.7 m	16.54 in = 420 mm (A2)	Q1443A (J)
			18 in = 458 mm	Q7897A (EJN)
			23.39 in = 594 mm (A1)	Q1442A (EJ)
			24 in = 610 mm	C6019B
			33.11 in = 841 mm (A0)	Q1441A (EJ)
			36 in = 914 mm	C6020B
			42 in = 1067 mm	C6567B
300 ft = 91.4 m	36 in = 914 mm	C6980A		
HP Universal Heavyweight Coated Paper	120	100 ft = 30.5 m	24 in = 610 mm	Q1412A (AEJN)
			36 in = 914 mm	Q1413A
			42 in = 1067 mm	Q1414A (AEJN)

Table 11-3 Roll paper (continued)

Paper type	g/m ²	Length	Width	Part numbers
HP Heavyweight Coated Paper	131	100 ft = 30.5 m	24 in = 610 mm	C6029C (AEJN)
			36 in = 914 mm	C6030C
			42 in = 1067 mm	C6569C
			225 ft = 67.5 m	42 in = 1067 mm
HP Super Heavyweight Plus Matte Paper	210	100 ft = 30.5 m	24 in = 610 mm	Q6626A (AEJN)
			36 in = 914 mm	Q6627A (AEJN)
			42 in = 1067 mm	Q6628A (AEJN)
HP Colored Paper Fluorescent Yellow	100	150 ft = 45.7 m	36 in = 914 mm	Q1757A (E)
HP Colored Paper Yellow	92	150 ft = 45.7 m	36 in = 914 mm	Q1760A (EN)
		295.3 ft = 90 m	23.39 in = 594 mm (A1)	Q6596A (E)
HP Technical Paper				
HP Natural Tracing Paper	90	150 ft = 45.7 m	16.54 in = 420 mm (A2)	Q1440A (J)
			23.39 in = 594 mm (A1)	Q1439A (J)
			24 in = 610 mm	C3869A
			33.11 in = 841 mm (A0)	Q1438A (J)
			36 in = 914 mm	C3868A
HP Translucent Bond	67	150 ft = 45.7 m	24 in = 610 mm	C3860A (AJN)
			36 in = 914 mm	C3859A (LN)
HP Vellum	75	150 ft = 45.7 m	24 in = 610 mm	C3862A (N)
			36 in = 914 mm	C3861A (LN)
HP Film (Technical and Graphic)				
HP Clear Film	174	75 ft = 22.9 m	24 in = 610 mm	C3876A (AEJN)
			36 in = 914 mm	C3875A
HP Matte Film	160	125 ft = 38.1 m	24 in = 610 mm	51642A (AEJN)
			36 in = 914 mm	51642B
HP Polyester Film White Matte	167	50 ft = 15.2 m	36 in = 914 mm	Q1736A (AEN)
HP Photographic Paper				
HP Universal Instant-Dry Photo Gloss	190	100 ft = 30.5 m	24 in = 610 mm	Q6574A
			36 in = 914 mm	Q6575A
			42 in = 1067 mm	Q6576A
HP Universal Instant-Dry Photo Semi-Gloss	190	100 ft = 30.5 m	24 in = 610 mm	Q6579A
			36 in = 914 mm	Q6580A
			42 in = 1067 mm	Q6581A
TIP: The dye inks used by your printer will fade very quickly on instant-dry photo papers. If you plan to display the prints for more than two weeks, you should laminate them to achieve longer life.				
HP Premium Plus Photo Gloss	286	50 ft = 15.2 m	24 in = 610 mm	Q5488A

Table 11-3 Roll paper (continued)

Paper type	g/m ²	Length	Width	Part numbers
HP Premium Plus Photo Satin	286	50 ft = 15.2 m	18 in = 458 mm	Q7920A
			24 in = 610 mm	Q5491A
HP Universal High-Gloss Photo Paper	190	100 ft = 30.5 m	24 in = 610 mm	Q1426A (AEJN)
			36 in = 914 mm	Q1427A (AEJN)
			42 in = 1067 mm	Q1428A (AEJN)
HP Universal Semi-Gloss Photo Paper	190	100 ft = 30.5 m	24 in = 610 mm	Q1420A (AEJN)
			36 in = 914 mm	Q1421A (AEJN)
			42 in = 1067 mm	Q1422A (AEJN)
HP Photo Paper RC Matte	200	100 ft = 30.5 m	36 in = 914 mm	C7946A (AEN)
HP Backlit Material				
HP Backlit Film Reverse Print Matte	160	75 ft = 22.9 m	36 in = 914 mm	C7960A (AEJN)
HP Self-Adhesive Material and Laminate				
HP Two-View Cling	240	75 ft = 22.9 m	36 in = 914 mm	Q1914A (AEN)
			42 in = 1067 mm	Q1915A (AEN)
HP Indoor Paper Self-Adhesive	170	75 ft = 22.9 m	36 in = 914 mm	Q1733A (EJN)
HP Polypropylene, Matte — Adhesive Backed	225	70 ft = 21.3 m	36 in = 914 mm	Q1908A (AEN)
HP Self-Adhesive Satin/Gloss Polypropylene		75 ft = 22.9 m	36 in = 914 mm	Q8834A
			42 in = 1067 mm	Q8835A
HP Adhesive-backed Polypropylene	128	164 ft = 50 m	36 in = 914 mm	Q8044A (C)

Table 11-4 Sheet paper

Paper type	g/m ²	Length	Width	Part numbers
HP Bond and Coated Paper				
HP Coated Paper	90	24 in = 610 mm	18 in = 457 mm	Q1961A (AEJN)
		36 in = 914 mm	24 in = 610 mm	Q1962A (AEN)
HP Photographic Paper				
HP Premium Plus Photo Gloss	286	19 in = 483 mm	13 in = 330 mm	Q5486A
		24 in = 610 mm	18 in = 457 mm	Q5487A
HP Premium Plus Photo Satin	286	19 in = 483 mm	13 in = 330 mm	Q5489A
		24 in = 610 mm	18 in = 457 mm	Q5490A

Order accessories

The following accessories can be ordered for your printer.

Name	Product number
HP Designjet T610 24in Stand	Q6663A

Name	Product number
HP Designjet T610 24in Spindle	Q6700A
HP Designjet T610 44in Spindle	Q6709A
HP Jetdirect 620n Fast Ethernet Print Server	J7934A
HP Jetdirect 625n Gigabit Ethernet Print Server	J7960G
HP Jetdirect 635n IPv6/IPsec Print Server	J7961A

Introduction to the accessories

Stand

The printer stand is used to support the printer and the basket, which collects prints as they emerge from the printer. The main alternative to the stand is to put the printer on a desk.

The height of the stand is 668 mm.

The weight of the stand is 10.12 kg (24 inch).

Spindle

With extra spindles, you can change rapidly from one paper type to another.

Jetdirect print server

Jetdirect print servers provide the ability to connect your printer to a local area network.

 **TIP:** If you use a Jetdirect print server, you will not be able to use HP Easy Printer Care for Windows or HP Printer Utility for Mac OS.

12 Troubleshooting paper issues

- The paper cannot be loaded successfully
- The paper type is not in the driver
- The paper has jammed
- The printer displays out of paper when paper is available
- Prints do not fall nicely into the basket
- The sheet stays in the printer when the print has been completed
- The paper is cut when the print has been completed
- The cutter does not cut well
- The roll is loose on the spindle
- A strip stays on the output tray and generates jams
- Recalibrate the paper advance

The paper cannot be loaded successfully

- Ensure no paper is loaded.
- Ensure the paper is far enough inside the printer, you should feel the printer grab the paper.
- Do not attempt to straighten the paper during the aligning process, unless instructed to do so by the front-panel display. The printer automatically attempts to straighten the paper.
- The paper may be crumpled, or warped, or may have irregular edges.

General unsuccessful roll load issues

- If the paper does not load, the leading edge of the paper may not be straight or clean and needs to be trimmed. Remove the initial 2 cm (1 in) from the roll and try again. This may be necessary even with a new roll of paper.
- Ensure the roll ends are tight against the spindle ends.
- Check that the spindle is correctly inserted.
- Check that the paper is correctly loaded on the spindle, and that it loads over the roll towards you.
- Check that all roll end plugs have been removed.
- Check that the paper is wound tightly on the roll.
- Do not touch the roll or paper at during the alignment process.

Unsuccessful roll load with 24-inch printer

On a 24-inch printer, if the paper has not been inserted straight, the front panel displays the following instructions.

1. When prompted by the front-panel display, lift the blue lever on the left. The printer attempts to straighten the roll.
2. When prompted by the front-panel display, lower the blue lever. The printer checks the alignment. If the roll is aligned, the printer measures the width and you are now ready to print.

If the roll is still not aligned, the front panel displays an error and instructions.

3. When prompted by the front-panel display, lift the blue lever on the left.
4. Rewind the roll from the end of the spindle until the edge is on the blue line.
5. Press **OK**, on the front panel.
6. When prompted by the front-panel display, lower the lever. The printer checks the alignment. If the roll is aligned, the printer measures the width and you are now ready to print.

If the roll is still not aligned, the front panel displays an error and instructions to start again at step three.

If you would like to start the load process again, cancel the process on the front panel and rewind the roll from the end of the spindle until the edge is removed from the printer.

Unsuccessful roll load with 44-inch printer

On a 44-inch printer, if the paper has not been inserted straight, the front panel displays the following instructions.

1. When prompted by the front-panel display, lift the blue lever on the left. The printer attempts to straighten the roll.
2. When prompted by the front-panel display, lower the blue lever. The printer checks the alignment. If the roll is aligned, the printer measures the width and you are now ready to print.

If the roll is still not aligned, the front panel displays an error and instructions to start again.

If you would like to start the load process again, cancel the process on the front panel and rewind the roll from the end of the spindle until the edge is removed from the printer.

 **NOTE:** If the roll has become loose around the core, the printer cannot load the paper.

Unsuccessful sheet load

- Guide the sheet, especially thick papers, when the printer initially feeds the sheet.
- Do not attempt to straighten the sheet during the loading process, unless instructed to by the front-panel display. The printer automatically attempts to straighten the sheet.
- Do not use hand-cut sheets, which may be of irregular shapes. Use only purchased sheets.

If the sheet is not caught by the printer, the front-panel display asks you to push paper further into the printer, and tries to feed the paper again.

If the sheet is caught by the printer but is not inserted straight, the front panel displays the following instructions.

1. When prompted by the front-panel display, lift the blue lever on the left.
2. Adjust the sheet to align with the front and right side blue lines.
3. Once the sheet is aligned, press **OK** on the front panel.
4. When prompted by the front-panel display, lower the blue lever. The printer checks the alignment. If the sheet is aligned, the printer measures the sheet and feed it out the back into the roll feed. You are now ready to print.

If the sheet is still not aligned, the front panel displays an error and instructions to start again.

If you would like to start the load process again, cancel the process on the front panel and the printer ejects the sheet out the front.

Paper loading error messages

Here is a list of front-panel display messages related to paper loading, with the suggested corrective action.

front-panel display message	Suggested action
Paper incorrectly loaded	The paper has not been loaded correctly; the edge was not aligned with the load guide. Lift the blue lever, remove paper, and lower lever.
Paper not found	During the paper load process the printer did not detect any paper. Ensure the paper is inserted fully and is not transparent.
Paper loaded with too much skew	During the paper load process the printer detected that the paper had too much skew. Follow the instructions on the front-panel display.

front-panel display message	Suggested action
Paper too small	During the load process the printer detected that the paper is too narrow or too short to be loaded in the printer. Press the Cancel key to stop the load process. See Functional specifications on page 164 .
Paper too big	During the load process the printer has detected that the paper is either too wide or too long (sheet only) to be loaded correctly. Press the Cancel key to stop the load process. See Functional specifications on page 164 .
Paper loose around core	The end of the roll has become loose around the core. Tighten the paper to the core or insert a new roll.
Lever lifted	During the load process the blue lever was lifted. This prevents the printer from loading the paper. Follow the instructions on the front-panel display.

The paper type is not in the driver

To work with a paper not in the driver, you can use your paper as one of the profiles already in the driver, however, you must identify whether your paper is transparent or translucent, glossy, matte, or HP Banners with Tyvek®.

 **NOTE:** For glossy paper, it is important to use a glossy paper type, as matte black ink does not print well on glossy paper.

Transparent or translucent paper

If your paper is a transparent film (for example, a transparency) select paper type **Film > Transparent/Clear film**.

If your paper is a translucent paper (for example, technical paper) select paper type **Technical paper > Natural Tracing Paper, Vellum, or Translucent bond**.

Glossy paper

If your paper is glossy, identify whether it is a photo paper or a proofing paper. If you are not sure consider it photo paper.

If your paper is a photo paper, use the **Photo Paper** category. For glossy or high-gloss paper select paper type **Photo Gloss Paper**. For Semi-gloss, Satin, Pearl, or Luster finishes, select paper type **Semi-gloss/Satin Paper**.

To increase gamut on photo paper select paper type **HP Universal High-Gloss Photo Paper** or **HP Universal Semi-Gloss Photo Paper**, depending on the finish.

If you are printing on a glossy banner (for example, HP Instant-Dry Indoor Banner, Gloss) select paper type **Photo Gloss Paper**.

Matte Paper

Your paper type selection for matte paper depends on the paper's ink absorption capacity. To select a paper category and type, first identify if your paper is general purpose or photographic. Then select the recommended paper types.

General purpose paper

- For thin papers (< 90 g/m²) uncoated papers (for example plain paper or bright white paper) select paper type **Bond and Coated > Plain Paper**.
- For light coated papers (<110 g/m²), select paper type **Bond and Coated > Coated Paper**.

- For heavyweight coated papers (<math><200\text{ g/m}^2</math>), select paper type **Bond and Coated > Heavyweight Coated Paper**.
- For cockle-free very thick coated papers (> 200 g/m²), select paper type **Bond and Coated > Super Heavyweight Coated Paper**.

△ **CAUTION:** Only use this option if you are sure your paper does not wrinkle when printed.

Photographic paper

For photographic paper, select paper type **Photo Paper > Photo Matte Paper**.

HP Banners with Tyvek®

For HP Banners with Tyvek®, select paper type **Photo Paper > Photo Gloss Paper**.

Black ink is easily removed when touched

This happens when your paper is incompatible with matte black ink. To use non-matte black ink, select paper type **Photo Paper > Photo Gloss Paper**.

After printing, the paper has wrinkles or there is too much ink

This happens when too much ink is used. To use less ink, select a thinner category. Matte paper categories from thinnest to thickest are:

- Plain Paper
- Coated Paper
- Heavyweight Coated Paper
- Super Heavyweight Coated Paper

For other image quality problems, see [Troubleshooting print-quality issues on page 123](#).

The paper has jammed

When a paper jam occurs, you normally see the **Possible paper jam** message in the front-panel display.

1. Power off the printer at the front panel and also switch it off at the rear.

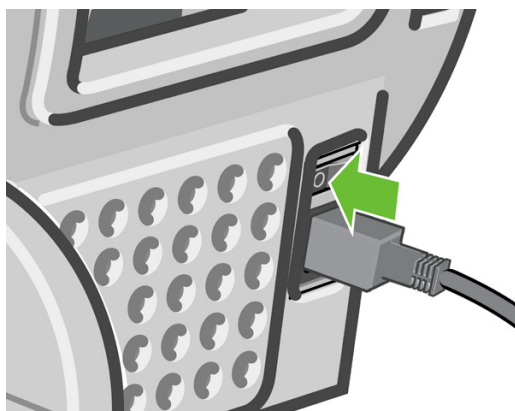

2. Open the window.

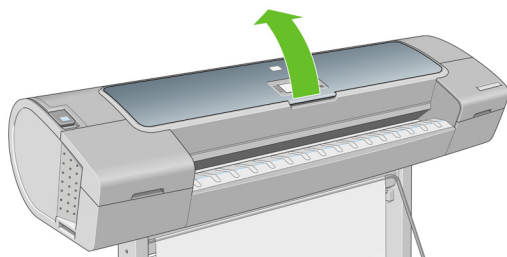

3. Try to move the printhead carriage out of the way.

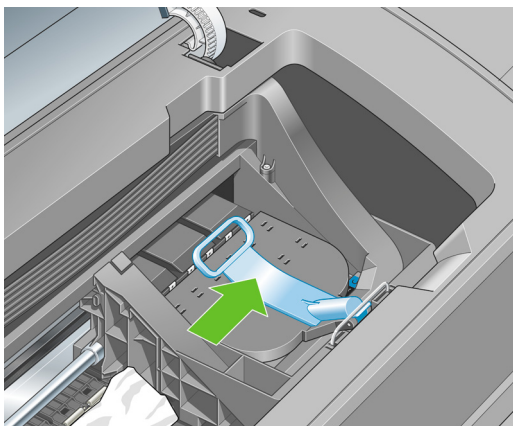

4. Lift the blue lever as far up as it will go.

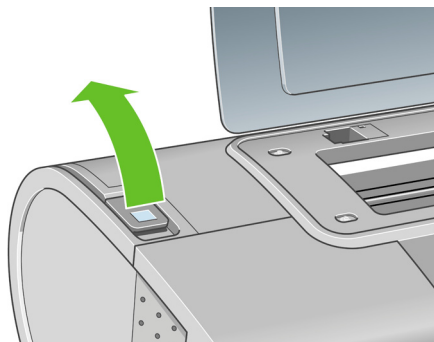

5. Carefully remove any of the jammed paper that you can lift up and out from the top of the printer.

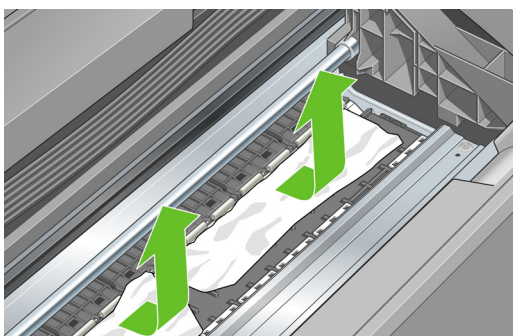

6. Standing behind the printer, rewind the roll or pull the cut sheet from the printer. If you cannot see the paper, return to the front of the printer and remove it from the output tray.

△ **CAUTION:** Do not move the paper sideways, as it could damage the printer.

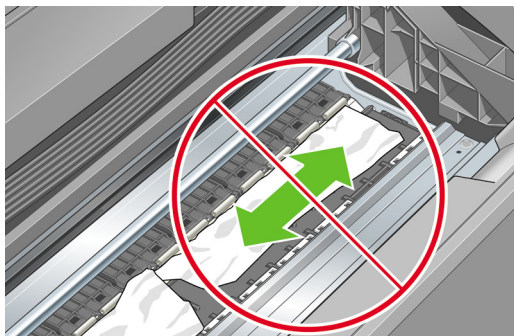

7. Carefully remove all small pieces of paper.

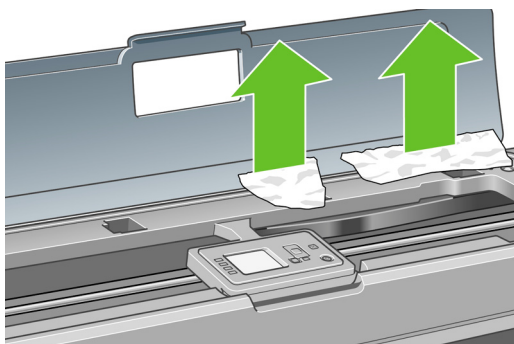

8. Lower the blue lever.

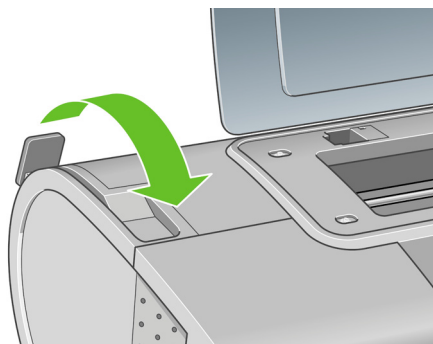

9. Close window.

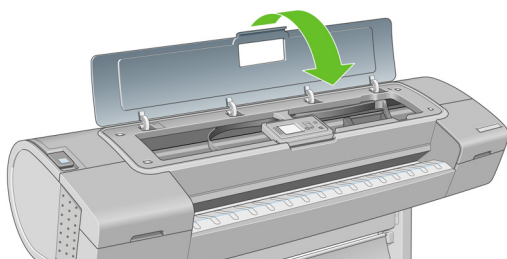

10. Switch on the printer.

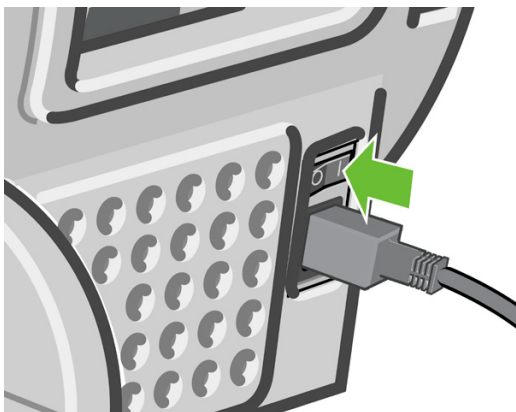

11. Reload the roll, or load a new sheet see [Paper handling on page 25](#).

 **NOTE:** If you find that there is still some paper causing an obstruction within the printer, restart the procedure and carefully remove all pieces of paper.

The printer displays out of paper when paper is available

If the roll has become loose from its core, it will not feed correctly and the printer will not load the paper. If possible, tighten the paper to its core or load a new roll.

Prints do not fall nicely into the basket

- Ensure the basket is correctly installed.
- Ensure the basket is open.
- Ensure the basket not full.
- Paper often tends to curl near the end of a roll, which can cause output problems. Load a new roll, or remove prints manually as they are completed.

The sheet stays in the printer when the print has been completed

The printer holds the paper to allow the print to dry after printing, see [Change the drying time on page 44](#). If the paper is only partially ejected after the drying time, gently pull the sheet out of the printer. If the automatic cutter is disabled, use the **Form feed and cut** key  on the front panel, see [Feed and cut the paper on page 45](#).

The paper is cut when the print has been completed

By default the printer cuts the paper after the drying time has been completed, see [Change the drying time on page 44](#). You can disable the cutter, see [Turn the automatic cutter on and off on page 45](#).

The cutter does not cut well

By default the printer is set to automatically cut the paper after the drying time has been completed.

If the cutter is turned on but not cutting correctly, check that the cutter rail is clean and clear of any obstacles.

If the cutter is turned off, the **Form feed and cut** key  only advances the paper. Use this key to move the print far enough out of the front of the printer, until it is convenient to manually cut with a straight edge or scissors.

The roll is loose on the spindle

The roll may need to be replaced or reloaded. If your roll has a three-inch cardboard core, ensure the core adaptors supplied with the printer have been installed, see [Load a roll onto the 24-inch spindle on page 26](#).

A strip stays on the output tray and generates jams

If a small piece of paper (200 mm or smaller) has been cut, such as before (if new roll) and after a full-bleed print or after the **Form feed and cut** key  has been pressed, the cut strip remains in the output tray. Only when the printer is not working, reach in the tray and remove the strip.

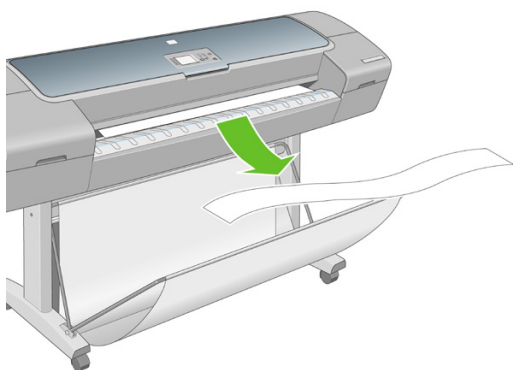

Recalibrate the paper advance

Accurate paper advance is important to image quality because it is part of controlling the proper placement of dots on the paper. If the paper is not advanced the proper distance between printhead passes, light or dark bands appear in the print and image grain may increase.

The printer is calibrated to advance correctly with all the papers appearing in the front panel. When you select the type of loaded paper, the printer adjusts the rate at which to advance the paper while printing. However, if you are not satisfied with the default calibration of your paper, you may need to recalibrate the rate at which the paper advances. See [Troubleshooting print-quality issues on page 123](#) for steps to determine if paper advance calibration will solve your issue.

You can check the paper advance calibration status of the currently loaded paper at any time by pressing the **View loaded paper** key  on the front panel. The status may be one of the following.

- **DEFAULT:** This status appears when loading any paper that has not been calibrated. HP papers in the Front Panel have been optimized by default and unless you experience image quality problems in your printed image such as banding or graininess it is not recommended to recalibrate the paper advance.
- **OK:** This status indicates that the loaded paper has been calibrated before. However you may need to repeat the calibration if you experience image quality problems such as banding or graininess in your printed image.

 **NOTE:** Whenever you update the printer's firmware, the paper advance calibration values are reset to factory default, see [Update the firmware on page 104](#).

△ **CAUTION:** Transparent papers and films must be calibrated using Image Quality Maintenance menu icon , then **Paper advance calibration > Adjust paper advance**, from step four in the Recalibrating the paper advance procedure.

Recalibrating the paper advance procedure

1. Press the **Menu** key to return to the main menu and select the Image Quality Maintenance menu icon , then **Paper advance calibration > Calibrate paper advance**. The printer automatically recalibrates the paper advance and prints a paper advance calibration image.

2. Wait until the front panel displays the status screen and re-print your print.

 **NOTE:** The recalibration procedure takes approximately three minutes. Do not worry about the paper advance calibration image. The front-panel display shows any errors in the process.

If you are satisfied with your print continue using this calibration for your paper type. If you see improvement in your print, continue with step three. If you are dissatisfied with the recalibration, return to the default calibration, see [Return to default calibration on page 122](#).

3. If you would like to fine-tune the calibration or are using a transparent paper, press the **Menu** key to return to the main menu and select the Image Quality Maintenance menu icon , then **Paper advance calibration > Adjust paper advance**.

4. Select the percentage of change from -100% to 100%. To correct light banding, decrease the percentage. To correct dark banding, increase the percentage.

5. Press the **OK** key on the front panel, to save the value.

6. Wait until the front panel displays the status screen and re-print your print.

Return to default calibration

Returning to the default calibration sets all the corrections made by the paper advance calibration to zero. To return to the default paper advance calibration value, you must reset the calibration.

1. Press the **Menu** key to return to the main menu and select the Image Quality Maintenance menu icon , then **Paper advance calibration > Reset paper advance**

2. Wait until the front panel displays the operation has completed successfully before pressing the back key to return to the main menu.

13 Troubleshooting print-quality issues

- [General advice](#)
- [Print quality troubleshooting wizard](#)
- [Horizontal lines across the image \(banding\)](#)
- [Lines are too thick, too thin, or missing](#)
- [Lines appear stepped or jagged](#)
- [Lines print double or in the wrong colors](#)
- [Lines are discontinuous](#)
- [Lines are blurred](#)
- [Line lengths are inaccurate](#)
- [The whole image is blurry or grainy](#)
- [The paper is not flat](#)
- [The print is scuffed or scratched](#)
- [Ink marks on the paper](#)
- [Black ink comes off when you touch the print](#)
- [Edges of objects are stepped or not sharp](#)
- [Edges of objects are darker than expected](#)
- [Horizontal lines at the end of a cut sheet print](#)
- [Vertical lines of different colors](#)
- [White spots on the print](#)
- [Colors are inaccurate](#)
- [Colors are fading](#)
- [The image is incomplete \(clipped at the bottom\)](#)
- [The image is clipped](#)
- [Some objects are missing from the printed image](#)
- [A PDF file is clipped or objects are missing](#)
- [The Image Diagnostics Print](#)
- [If you still have a problem](#)

General advice

When you have any print-quality problem:

- To achieve the best performance from your printer, use only genuine manufacturer's supplies and accessories, whose reliability and performance have been thoroughly tested to give trouble-free performance and best-quality prints. For details of recommended papers, see [Order paper on page 108](#).
 - Make sure that the paper type selected in the front panel is the same as the paper type loaded into the printer. To check this, use the **View loaded paper** key  on the front panel. At the same time, check that the paper type has been calibrated. Also make sure that the paper type selected in your software is the same as the paper type loaded into the printer.
-
- △ **CAUTION:** If you have the wrong paper type selected, you could experience poor print quality and incorrect colors, and perhaps even damage to the printheads.
-
- Check that you are using the most appropriate print-quality settings for your purposes (see [Printing on page 47](#)). You are likely to see lower print quality if you have moved the print-quality slider to the 'Speed' end of the scale, or set the custom quality level to **Fast**.
 - Check that your environmental conditions (temperature, humidity) are in the recommended range. See [Environmental specifications on page 166](#).
 - Check that your ink cartridges and printheads have not passed their expiration dates: see [Maintain the ink cartridges on page 103](#).

Print quality troubleshooting wizard

The Print Quality Troubleshooting Wizard can help with the following problems:

- Horizontal lines across the image (banding)
- The whole image is blurry or grainy
- Lines are too thick, too thin, or missing
- Colors are inaccurate

To start the wizard:

- **From HP Easy Printer Care under Windows:** go to the **Support** tab, and select **Print quality troubleshooting**.
- **From HP Printer Utility under Mac OS:** select **Support**, then **Print quality troubleshooting**.
- **From the Mac OS Print dialog:** go to the **Services** panel, select **Device Maintenance**, then select **Print quality troubleshooting** from the list of maintenance tasks.
- **From the Embedded Web Server:** select **Troubleshooting**, then select **Print quality troubleshooting**.

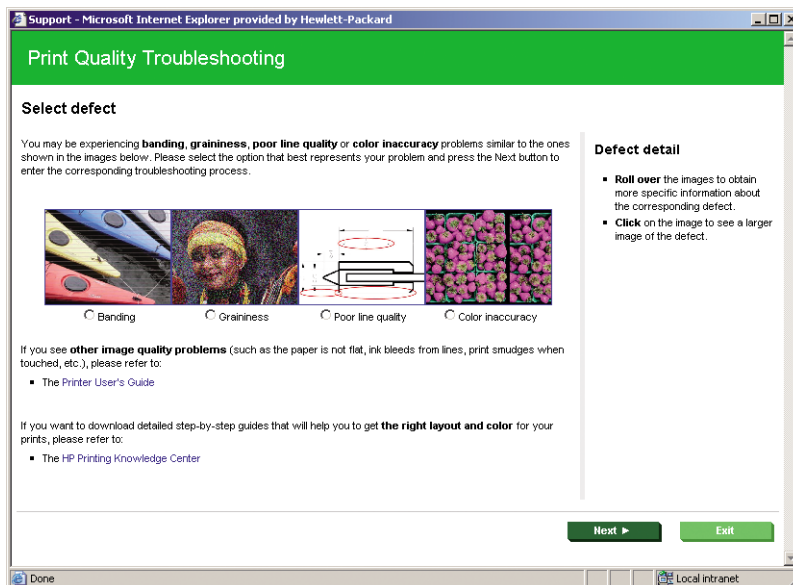



Alternatively, or if you have other print quality problems, you can continue reading this chapter.

Horizontal lines across the image (banding)

If your printed image suffers from added horizontal lines as shown (the color may vary):





1. Check that the paper type you have loaded corresponds to the paper type selected in the front panel and in your software. To check on the front panel, use the **View loaded paper** key .
2. Check that you are using appropriate print-quality settings for your purposes (see [Printing on page 47](#)). In some cases, you can overcome a print-quality problem merely by selecting a higher print-quality level. For instance, if you have set the Print Quality slider to **Speed**, try setting it to **Quality**. If you change the print-quality settings, you may wish to reprint your job at this point in case the problem has been solved.
3. Print the Image Diagnostics Print. See [The Image Diagnostics Print on page 136](#).
4. If the printheads are working correctly, go to the front panel and press the **View loaded paper** key  to see the paper advance calibration status. If the status is DEFAULT, try performing paper advance calibration: see [Recalibrate the paper advance on page 121](#).

If the problem persists despite all the above actions, contact your customer service representative for further support.

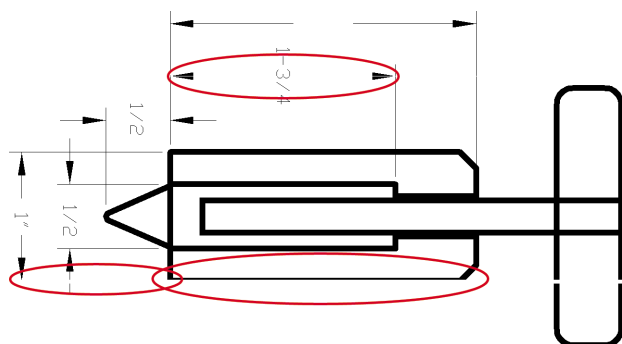
Lines are too thick, too thin, or missing



1. Check that the paper type you have loaded corresponds to the paper type selected in the front panel and in your software. To check on the front panel, use the **View loaded paper** key .
2. Check that you are using appropriate print-quality settings for your purposes (see [Printing on page 47](#)). Select the custom print-quality options in the driver dialog (Mac OS Print dialog), and try turning on the **Maximum detail** option (if available). You may wish to reprint your job at this point in case the problem has been solved.
3. If the resolution of your image is greater than the printing resolution, you may notice a loss of line quality. If you are using the PCL or HP-GL/2 driver for Windows, you can find the **Max. Application Resolution** option in the driver dialog's **Advanced** tab, under **Document Options > Printer Features**. If you change this option, you may wish to reprint your job at this point in case the problem has been solved.
4. If lines are too thin or missing, print the Image Diagnostics Print. See [The Image Diagnostics Print on page 136](#).
5. If the problem remains, go to the front panel and select the Ink menu icon , then **Printhead information** to see the printhead alignment status. If the status is PENDING, you should align the printheads. See [Align the printheads on page 146](#). After alignment, you may wish to reprint your job in case the problem has been solved.
6. Go to the front panel and press the **View loaded paper** key  to see the paper advance calibration status. If the status is DEFAULT, you should perform paper advance calibration: see [Recalibrate the paper advance on page 121](#).

If the problem persists despite all the above actions, contact your customer service representative for further support.

Lines appear stepped or jagged

If lines in your image appear stepped or jagged when printed:

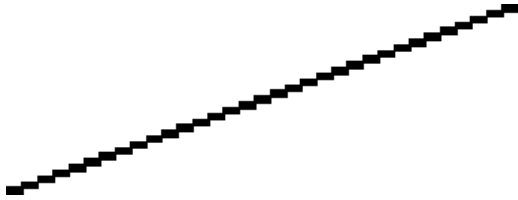

1. The problem may be inherent in the image. Try to improve the image with the application you are using to edit it.
2. Check that you are using appropriate print-quality settings. See [Printing on page 47](#).
3. Select the custom print-quality options in the driver dialog (Mac OS Print dialog), and turn on the **Maximum detail** option (if available).
4. If you are using the PCL or HP-GL/2 driver for Windows, you can change your image rendering resolution to 300 dpi or 600 dpi depending on your printing needs. You can find the **Max. Application Resolution** option in the driver dialog's **Advanced** tab, under **Document Options > Printer Features**.

Lines print double or in the wrong colors

This problem can have various visible symptoms:

- Colored lines are printed double, in different colors.

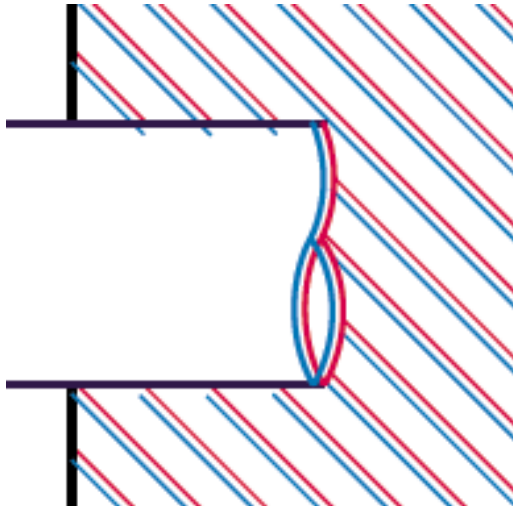

- The borders of colored blocks are wrongly colored.

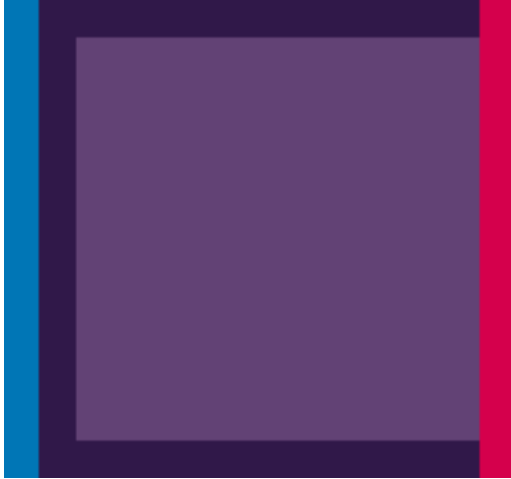

To correct this kind of problem:

1. Reseat the printheads by removing them and then reinserting them. See [Remove a printhead on page 90](#) and [Insert a printhead on page 93](#).
2. Align the printheads. See [Align the printheads on page 146](#).

Lines are discontinuous

If your lines are broken in the following way:



1. Check that you are using appropriate print-quality settings. See [Printing on page 47](#).
2. Reseat the printheads by removing them and then reinserting them. See [Remove a printhead on page 90](#) and [Insert a printhead on page 93](#).
3. Align the printheads. See [Align the printheads on page 146](#).

Lines are blurred



Humidity can cause ink to soak into the paper, making the lines blurred and fuzzy. Try the following:

1. Check that your environmental conditions (temperature, humidity) are suitable for high-quality printing. See [Environmental specifications on page 166](#).
2. Check that the paper type selected in the front panel is the same as the paper type you are using.
To check on the front panel, use the **View loaded paper** key .
3. Try changing to a heavier paper type, such as HP Heavyweight Coated Paper or HP Super Heavyweight Plus Matte Paper.
4. Select a paper type that is slightly thinner than the paper you have loaded; this will persuade the printer to use less ink. Here are some example paper types in ascending order of thickness: Plain Paper, Coated Paper, Heavyweight Coated Paper, Super Heavyweight Plus Matte Paper.
5. If you are using glossy paper, try changing to a different type of glossy paper.
6. Align the printheads. See [Align the printheads on page 146](#).



Line lengths are inaccurate

If you have measured your printed lines and find that the lengths are not sufficiently accurate for your purposes, you can try to improve line length accuracy in the following ways.

1. Print on HP Matte Film, for which your printer's line length accuracy is specified. See [Functional specifications on page 164](#).
Polyester film is about ten times more dimensionally stable than paper. However, using film that is thinner or thicker than HP Matte Film will reduce line length accuracy.
2. Set the Print Quality slider to **Quality**.
3. Maintain the room at a steady temperature between 10 and 30°C (50 and 86°F).
4. Load the roll of film and let it rest for five minutes before printing.
5. If you are still not satisfied, try recalibrating the paper advance. See [Recalibrate the paper advance on page 121](#).

The whole image is blurry or grainy



1. Check that the paper type you have loaded corresponds to the paper type selected in the front panel and in your software. To check on the front panel, use the **View loaded paper** key .
2. Check that you are printing on the correct side of the paper.
3. Check that you are using appropriate print-quality settings (see [Printing on page 47](#)). In some cases, you can overcome a print-quality problem merely by selecting a higher print-quality level. For instance, if you have set the Print Quality slider to **Speed**, try setting it to **Quality**. If you change the print-quality settings, you may wish to reprint your job at this point in case the problem has been solved.
4. Go to the front panel and select the Ink menu icon , then **Printhead information** to see the printhead alignment status. If the status is PENDING, you should align the printheads. See [Align the printheads on page 146](#). After alignment, you may wish to reprint your job in case the problem has been solved.
5. Go to the front panel and press the **View loaded paper** key  to see the paper advance calibration status. If the status is DEFAULT, you should perform paper advance calibration: see [Recalibrate the paper advance on page 121](#).

If the problem persists despite all the above actions, contact your customer service representative for further support.

The paper is not flat

If the paper does not lie flat when it comes out of the printer, but has shallow waves in it, you are likely to see defects in the printed image, such as vertical stripes. This can happen when you use thin paper that becomes saturated with ink.



1. Check that the paper type you have loaded corresponds to the paper type selected in the front panel and in your software. To check on the front panel, use the **View loaded paper** key .
2. Try changing to a thicker paper type, such as HP Heavyweight Coated Paper or HP Super Heavyweight Plus Matte Paper.
3. Select a paper type that is slightly thinner than the paper you have loaded; this will persuade the printer to use less ink. Here are some example paper types in ascending order of thickness: Plain Paper, Coated Paper, Heavyweight Coated Paper, Super Heavyweight Plus Matte Paper.

The print is scuffed or scratched

The black ink pigment can be scuffed or scratched when touched by a finger, a pen, or some other object. This is particularly noticeable on coated paper and matte proofing paper.

Glossy paper may be extremely sensitive to the basket or to anything else that it contacts soon after printing, depending on the amount of ink used and the environmental conditions at the time of printing.

To reduce the risk of scuffs and scratches:

- Handle prints carefully.
- Avoid stacking prints on top of each other.
- Disable the automatic cutter before printing, so that the print will not fall into the basket. See [Turn the automatic cutter on and off on page 45](#). Alternatively, leave a sheet of paper in the basket so that freshly printed sheets do not make direct contact with the basket.

Ink marks on the paper

This problem can occur for several different reasons.

Horizontal smears on the front of coated paper

If a lot of ink is used on plain or coated paper, the paper absorbs the ink quickly and expands. As the printheads move over the paper, the printheads may come into contact with the paper and smear the printed image. This problem is normally seen only on cut sheets of paper (not on roll paper).

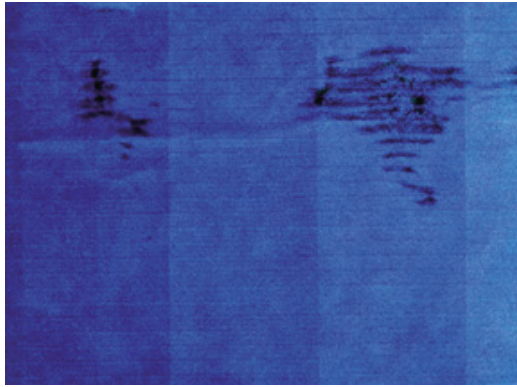

Whenever you notice this problem, cancel the printing job immediately. Press the **Cancel** key and also cancel the job from your computer application. Soaked paper can damage the printheads.

Try the following suggestions to avoid this problem:

1. Check that the paper type you have loaded corresponds to the paper type selected in the front panel and in your software. To check on the front panel, use the **View loaded paper** key .
2. Use a recommended paper type (see [Order paper on page 108](#)) and the correct print settings.
3. If using sheet paper, try rotating the sheet 90 degrees. The orientation of the paper fibers may affect performance.
4. Try changing to a thicker paper type, such as HP Heavyweight Coated Paper and HP Super Heavyweight Plus Matte Paper.
5. Select a paper type that is slightly thinner than the paper you have loaded; this will persuade the printer to use less ink. Here are some example paper types in ascending order of thickness: Plain Paper, Coated Paper, Heavyweight Coated Paper, Super Heavyweight Plus Matte Paper.
6. Try to increase the margins by relocating the image to the center of the page using your software application.

Ink marks on the back of the paper

This can happen after a lot of borderless printing, especially with non-standard paper sizes. Ink residues on the platen are likely to mark the back of the paper.

Clean the platen with a soft cloth. Clean each rib separately without touching the foam between the ribs.

Black ink comes off when you touch the print

This problem may be caused by printing with matte black ink on glossy paper. The printer will not use matte black ink if it knows that the paper will not retain it. To be sure of avoiding matte black ink, you can select Photo Glossy Paper as the paper type (in the Photo Paper category).

Edges of objects are stepped or not sharp

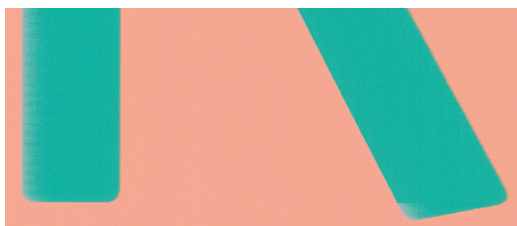

If edges of objects or lines appear to be poorly defined or lighter in density, and you have already set the print-quality slider to **Quality** in the driver dialog (Mac OS Print dialog), select the custom print-quality options, and try setting the quality level to **Normal**. See [Printing on page 47](#).

Edges of objects are darker than expected

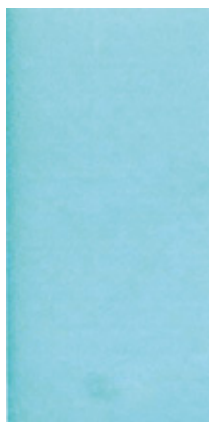

If edges of objects seem darker than expected, and you have already set the print-quality slider to **Quality** in the driver dialog (Mac OS Print dialog), select the custom print-quality options, and try setting the quality level to **Normal**. See [Printing on page 47](#).

Horizontal lines at the end of a cut sheet print

This type of defect affects only the end of a print, within approximately 30 mm of the trailing edge of the paper. You may see some very thin horizontal lines across the print.

To avoid this problem:

1. Print the Image Diagnostics Print. See [The Image Diagnostics Print on page 136](#).
2. Consider printing with roll paper.
3. Consider using larger margins around your image.

Vertical lines of different colors

If your print has vertical bands of different colors along it:

1. Try using thicker paper, choosing from the recommended paper types such as HP Heavyweight Coated Paper and HP Super Heavyweight Paper. See [Order paper on page 108](#).
2. Try using higher print-quality settings (see [Printing on page 47](#)). For instance, if you have set the Print Quality slider to **Speed**, try setting it to **Quality**.

White spots on the print

You may notice white spots on the print. This is probably due to paper fibers, dust, or loose coating material. To avoid this problem:

1. Try cleaning the paper manually with a brush before printing, to remove any loose fibers or particles.
2. Always keep the cover of your printer closed.
3. Protect your paper rolls and sheets by storing them in bags or boxes.

Colors are inaccurate



If the colors of your print do not match your expectations, try the following:

1. Check that the paper type you have loaded corresponds to the paper type selected in the front panel and in your software. To check on the front panel, use the [View loaded paper](#) key . At the same time, check the color calibration status. If the status is PENDING or OBSOLETE, you should perform color calibration: see [Color calibration on page 56](#). If you have made any changes, you may wish to reprint your job in case the problem has been solved.
2. Check that you are printing on the correct side of the paper.
3. Check that you are using appropriate print-quality settings (see [Printing on page 47](#)). If you have selected the **Speed** or **Fast** options, you may not get the most accurate colors. If you change the print-quality settings, you may wish to reprint your job at this point in case the problem has been solved.
4. If you are using Application Color Management, check that the color profile you are using corresponds to the selected paper type and print-quality settings. If you have doubts about which color settings to use, see [Color management on page 55](#).
5. If the problem consists of color differences between your print and your monitor, please follow the instructions in the “How to calibrate your monitor” section of the HP Color Center. At this point, you may wish to reprint your job in case the problem has been solved.
6. Print the Image Diagnostics Print. See [The Image Diagnostics Print on page 136](#).
7. Try using the color adjustment options to produce the colors you want. See [Color adjustment options on page 58](#).

If the problem persists despite all the above actions, contact your customer service representative for further support.

Color accuracy using EPS or PDF images in page layout applications

Page layout applications such as Adobe InDesign and QuarkXPress do not support color management of EPS, PDF, or grayscale files.

If you have to use such files, try to ensure that the EPS, PDF, or grayscale images are already in the same color space that you intend to use later on in Adobe InDesign or QuarkXPress. For instance, if your final goal is to print the job in a press that follows the SWOP standard, convert the image into SWOP when you create it.

Colors are fading

If you print on instant-dry photo paper, your prints will fade rapidly. If you plan to display the prints for more than two weeks, you should laminate them to achieve longer life.

Prints on swellable coated papers will fade much less rapidly. However, lamination will increase the life of prints (depending on the type of lamination) with all paper types. For more information, consult your laminate provider.

The image is incomplete (clipped at the bottom)

- Did you press **Cancel** before all the data were received by the printer? If so, you have ended the data transmission and will have to print the page again.
- The **I/O timeout** setting may be too short. This setting determines how long the printer waits for the computer to send more data, before deciding that the job is finished. From the front panel, increase the **I/O timeout** setting to a longer period and then send the print again. From the Connectivity menu , select **Advanced** > **Select I/O timeout**.
- There may be a communications problem between your computer and the printer. Check your USB or network cable.
- Check to make sure that your software settings are correct for your current page size (for example, long-axis prints).
- If you are using network software, make sure it has not timed out.

The image is clipped

Clipping normally indicates a discrepancy between the actual printable area on the loaded paper and the printable area as understood by your software.

- Check the actual printable area for the paper size you have loaded.
printable area = paper size – margins
- Check what your software understands to be the printable area (which it may call "printing area" or "imageable area"). For example, some software applications assume standard printable areas that are larger than those used in this printer.
- If you have defined a custom page size with very narrow margins, the printer may impose its own minimal margins, clipping your image slightly. You may want to consider using a larger paper size, or borderless printing (see [Select margins options on page 49](#)).
- If your image contains its own margins, you may be able to print it successfully by using the **Clip Contents by Margins** option (see [Select margins options on page 49](#)).
- If you are trying to print a very long image on a roll, check that your software is capable of printing an image of that size.
- You may have asked to rotate the page from portrait to landscape on a paper size that is not wide enough.
- If necessary, reduce the size of the image or document in your software application, so it fits between the margins.

There is another possible explanation for a clipped image. Some applications, such as Adobe Photoshop, Adobe Illustrator, and CorelDRAW, use an internal 16-bit coordinate system which means that they cannot handle an image of more than 32,768 pixels. If you try to print an image larger than this

from these applications, the bottom of the image will be clipped. In this case, the only way to print the whole image is to reduce the resolution so that the whole image requires fewer than 32,768 pixels. The PCL and HP-GL/2 drivers for Windows include an option called **16-bit App. Compatibility**, which can be used to reduce the resolution of such images automatically. You can find this option in the **Advanced** tab, under **Document Options > Printer Features**.

Some objects are missing from the printed image

Large quantities of data may be necessary to print a high-quality large-format print job, and in some specific workflows there may be issues that can lead to some objects missing from the output. Here are some recommendations for the use of the PCL or HP-GL/2 drivers for Windows in these cases.

- In the **Advanced** tab, select **Document options, Printer features**, and set **Send job as bitmap** to **Enabled** (HP-GL/2 driver only).
- In the **Advanced** tab, select **Document options, Printer features**, and set **16-bit App. Compatibility** to **Enabled**.
- In the **Advanced** tab, select **Document options, Printer features**, and set **Max. Application resolution** to 300.

The above settings are mentioned for troubleshooting purposes and may adversely affect the final output quality or the time necessary to generate the print job. Therefore, they should be restored to their default values if they do not help to solve the problem.

If you are working under Mac OS, the above settings are not available. Instead, you could try reducing the resolution of bitmap images in your application software.



A PDF file is clipped or objects are missing

In older versions of Adobe Acrobat or Adobe Reader, large PDF files could be clipped or lose some objects when printing with the HP-GL/2 driver at high resolution. In order to avoid such problems, upgrade your Adobe Acrobat or Adobe Reader software to the latest version. From version 7 onwards, these problems should be solved.

The Image Diagnostics Print

The Image Diagnostics Print consists of patterns designed to highlight printhead reliability problems. It helps you to check the performance of the printheads that are currently installed in your printer, and whether any printhead suffers from clogging or other problems.

To print the Image Diagnostics Print:

1. Use the same paper type that you were using when you detected a problem.
2. Use the **View loaded paper** key  on the front panel to check that the selected paper type is the same as the paper type loaded into the printer.
3. At the printer's front panel, select the Image Quality Maintenance menu icon , then **Print diagnostic image**.

It takes about two minutes to print the Image Diagnostics Print.

The print is divided into two parts, both of which test printhead performance.

- Part 1 (top) consists of rectangles of pure colors, one for each printhead. This part represents the print quality that you will get from each color.
- Part 2 (bottom) consists of small dashes, one for each nozzle on each printhead. This part complements the first, and aims more specifically to detect how many faulty nozzles each printhead has.

Please look carefully at the print. The names of the colors are shown above the rectangles and in the center of the patterns of dashes.

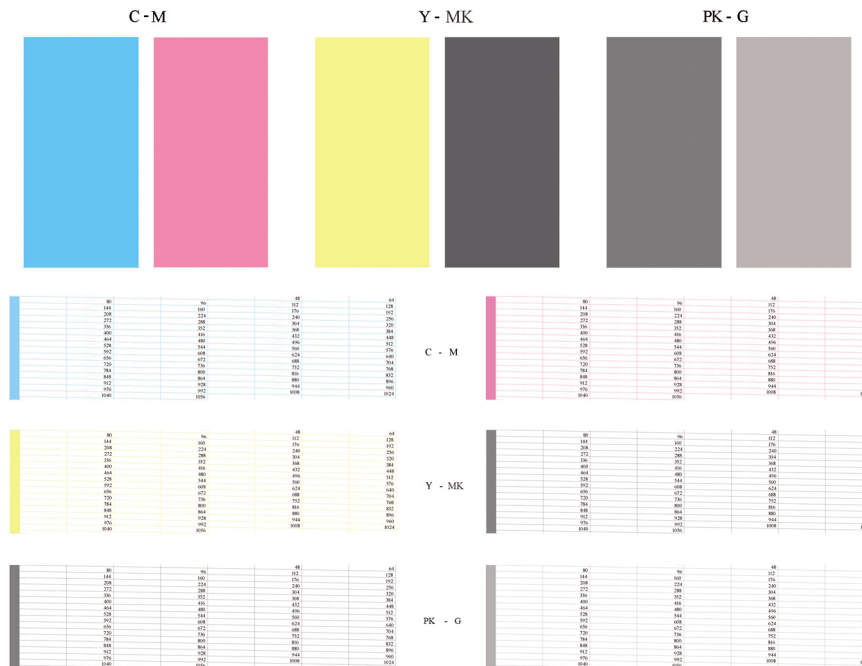

First look at the upper part of the print (part 1). Each colored rectangle should be a uniform color without any horizontal lines across it.

Then look at the bottom part of the print (part 2). For each individual colored pattern, check that most of the dashes are present.

If you see horizontal lines in part 1 and also missing dashes in part 2 for the same color, the printhead responsible needs cleaning. However, if the rectangles look solid, do not worry about just a few missing dashes in part 2; these are acceptable because the printer can compensate for a few clogged nozzles.

Here is an example of a gray printhead in a good state:

G

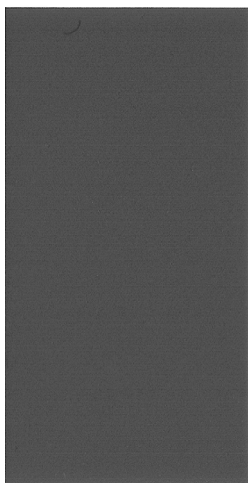

And here is an example of the same printhead in a bad state:

G

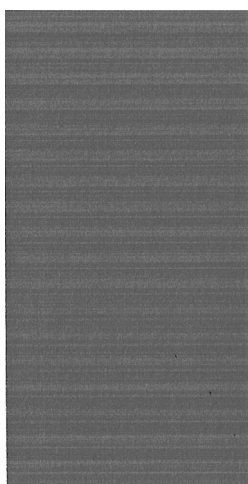

Corrective action

1. Clean any faulty printheads (see [Clean the printheads on page 143](#)). Then reprint the Image Diagnostics Print to see whether the problem has been solved.
2. If the problem remains, clean the printheads again, and reprint the Image Diagnostics Print to see whether the problem has been solved.
3. If the problem remains, consider cleaning your printheads manually (see [Clean the printheads on page 143](#)). You could also try reprinting your current print job, in case it now prints satisfactorily.
4. If the problem remains, try cleaning the printhead drop detector. The printer normally notifies you when this is necessary, but it may be worth trying even if the printer has not suggested it. See [Clean the printhead drop detector on page 144](#).
5. If the problem still remains, replace any persistently faulty printheads (see [Handling ink cartridges and printheads on page 85](#)), or contact HP Support (see [Contact HP Support on page 160](#)).

If you still have a problem

If you still experience print-quality problems after applying the advice in this chapter, here are some further things that you can do:

- Try using a higher print-quality option. See [Printing on page 47](#).
- Check the driver you are using to print with. If it is a non-HP driver, consult the driver vendor about the problem. You could also try using the correct HP driver, if feasible. The latest HP drivers can be downloaded from <http://www.hp.com/go/designjet/>.
- If you are using a non-HP RIP, its settings may be incorrect. See the documentation that came with the RIP.
- Check that your printer's firmware is up to date. See [Update the firmware on page 104](#).
- Check that you have the right settings in your software application.

14 Troubleshooting ink cartridge and printhead issues

- [Cannot insert an ink cartridge](#)
- [Ink cartridge status messages](#)
- [Cannot insert a printhead](#)
- [The front-panel display recommends reseating or replacing a printhead](#)
- [Clean the printheads](#)
- [Clean the printhead drop detector](#)
- [Align the printheads](#)
- [Printhead status messages](#)

Cannot insert an ink cartridge

1. Check that you have the correct type of cartridge (model number).
2. Check that the colored label on the cartridge is the same color as the label on the slot.
3. Check that the cartridge is correctly oriented, with the letter or letters marking the cartridge label right-side up and readable.

△ **CAUTION:** Never clean inside the ink cartridge slots.

Ink cartridge status messages

These are the possible ink cartridge status messages:

- **OK:** the cartridge is working normally, with no known problems.
- **Missing:** there is no cartridge present, or it is not correctly connected to the printer.
- **Low:** the ink level is low.
- **Very low:** the ink level is very low.
- **Empty:** the cartridge is empty.
- **Reseat:** you are recommended to remove the cartridge and then reinsert it.
- **Replace:** you are recommended to replace the cartridge with a new cartridge.
- **Altered:** there is something unexpected about the cartridge's status.
- **Expired:** it is past the cartridge's expiration date.

Cannot insert a printhead

1. Check that you have the correct type of printhead (model number).
2. Check that you have removed the two orange protective caps from the printhead.
3. Check that the colored label on the printhead is the same color as the label on the slot.
4. Check that the printhead is correctly oriented (compare with the others).

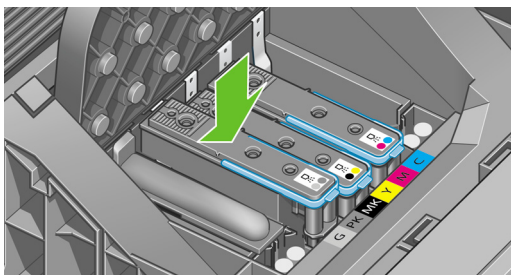

5. Check that you have correctly closed and latched the printhead cover, see [Insert a printhead on page 93](#).

The front-panel display recommends reseating or replacing a printhead

1. From the front panel, turn the power off then on.
2. Check the front-panel display message, if it shows the ready message, the printer is ready to print. If the problem remains continue with the next step.
3. Remove the printhead, see [Remove a printhead on page 90](#).
4. Clean the electrical connections on the backside of the printhead with a lint free cloth. You can carefully use a mild rubbing alcohol if moisture is needed to remove residue. Do not use water.

△ **CAUTION:** This is a delicate process and may damage the printhead. Do not touch the nozzles on the bottom side of the printhead, especially not with any alcohol.

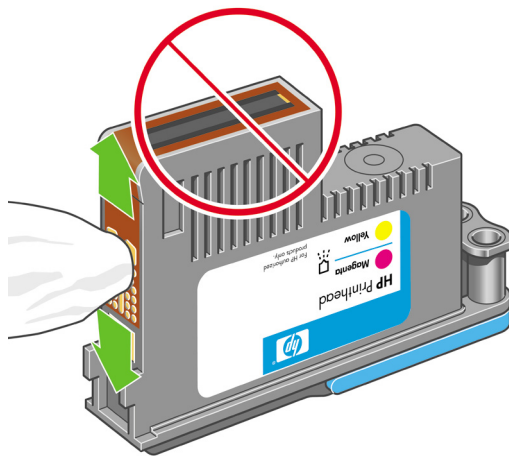

5. Reinsert the printhead, see [Insert a printhead on page 93](#).
6. Check the front-panel display message. If the problem remains, try a new printhead.

Clean the printheads

As long as the printer is kept turned on, an automatic cleaning is performed periodically. This ensures there is fresh ink in the nozzles and prevents nozzle clogs, which ensures color accuracy. If you have not already done so, please see [The Image Diagnostics Print on page 136](#) before proceeding.

To clean the printheads, press the **Menu** key to return to the main menu and select the Image Quality

Maintenance menu icon , then **Clean printheads**. If you have gone through the Image Quality Diagnostic print process, you know which colors are failing. Select the pair of printheads which contain the failing colors. If you are not sure which colors to clean, you can also select to clean all printheads. Cleaning all printheads takes about nine minutes. Cleaning a single pair of printheads takes about six minutes.

 **NOTE:** Cleaning all printheads uses more ink than cleaning a single pair.

If you have cleaned the printheads using the Clean printheads procedure from the front panel and are still experiencing image quality problems, you can try cleaning the printhead nozzles manually using the following procedure.

△ **CAUTION:** This is a delicate process and may damage the printhead. Do not touch the electrical connections on the backside of the printhead.

You must remove the printhead, see [Remove a printhead on page 90](#), and using a lint free cloth, clean the bottom of the printhead until the residue is removed.

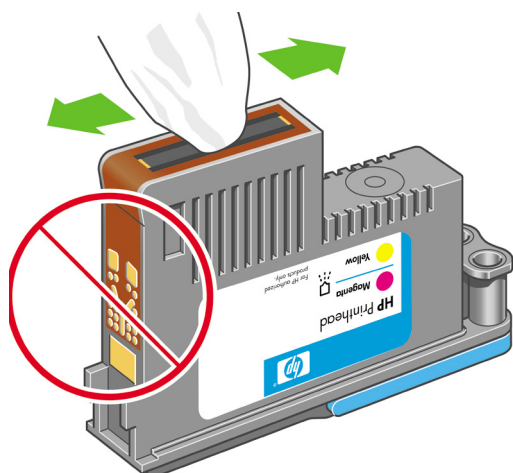

Clean the printhead drop detector

The printhead drop detector is a sensor that detects which nozzles on the printheads are not printing in order to substitute them for good printing nozzles. If particles, such as fibers, hair, or paper pieces, block the sensor print-quality is affected.

When the front panel displays a warning message that the clean process is needed, you are recommended to clean the printhead drop detector. If you do not clean the printhead drop detector immediately, the printer continues working normally, however, the front panel display continues to show the warning.

△ **CAUTION:** Wear gloves to avoid getting ink on your hands.

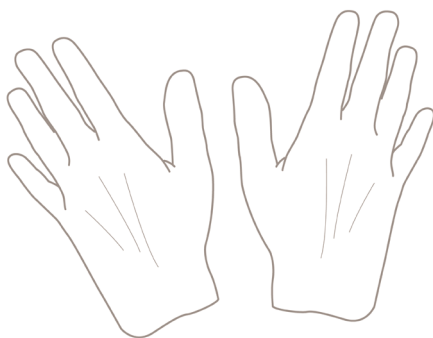

1. Turn off the printer at the front panel.



2. To avoid an electric shock, switch the printer off and unplug it.

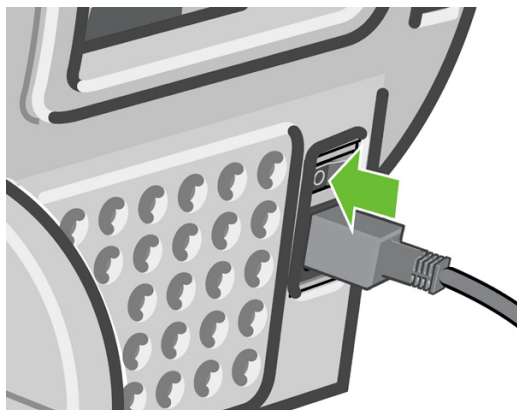

3. Open the window.

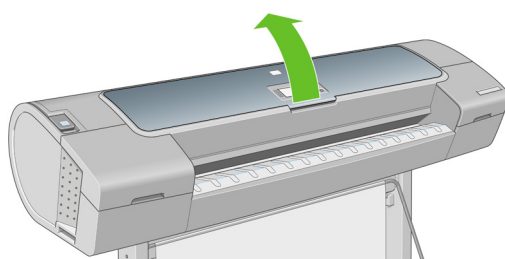

4. Find the printhead drop detector beside the stored printhead carriage.

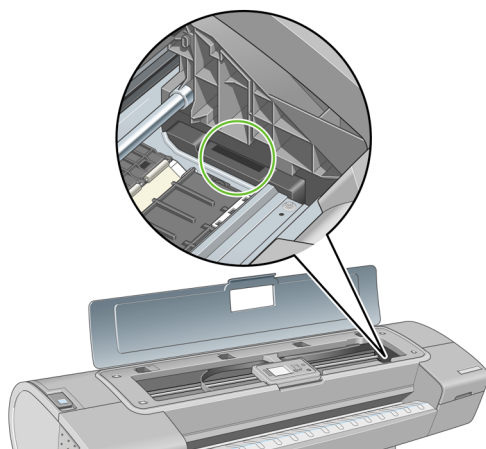

5. Remove any debris blocking the printhead drop detector.

6. With a dry lint free cloth, wipe the surface of the drop detector to remove any non-visible debris.

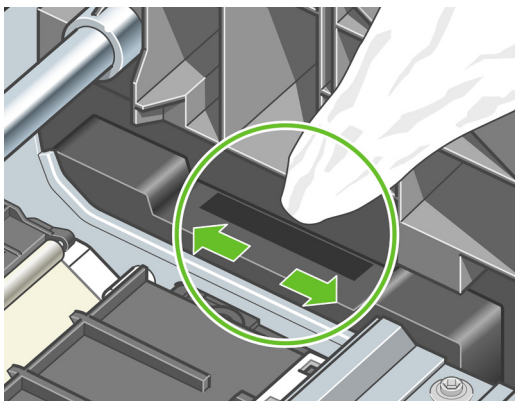

7. Close the window.

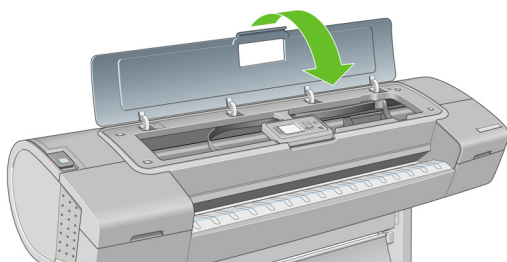

8. Plug in and switch on the printer.

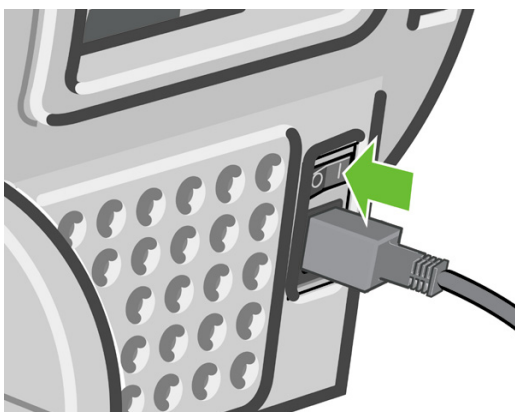



9. Power the printer on at the front panel.



Align the printheads

Precise alignment between printheads is essential for accurate colors, smooth color transitions, and sharp edges in graphical elements. Your printer has an automatic printhead alignment process which runs whenever a printhead has been accessed or replaced.

In cases where the paper has jammed or you are experiencing problems with color accuracy, see [Color management on page 55](#); you may need to align the printheads.

 **NOTE:** If the paper has jammed, it is recommended that you reinsert the printheads and initiate the realignment procedure with the Image Quality Maintenance menu .

△ **CAUTION:** Do not use transparent or semi-transparent paper to align the printheads.

Reinsert printheads procedure

1. If the realignment process is running and the wrong paper is loaded, press the **Cancel** key on the front panel.

△ **CAUTION:** Do not print if the realignment process has been canceled. You can restart the alignment with the Image Quality Maintenance menu procedure.

2. Load the paper you wish to use, see [Paper handling on page 25](#). You can use a roll or cut sheet, however, it must be A3 landscape or larger.

△ **CAUTION:** Do not use transparent or semi-transparent paper to align the printheads.

3. Remove and re-insert all the printheads, see [Remove a printhead on page 90](#) and [Insert a printhead on page 93](#). This starts the printhead alignment procedure.

4. Ensure the window is closed, as a strong light source near the printer during printhead realignment can affect alignment.

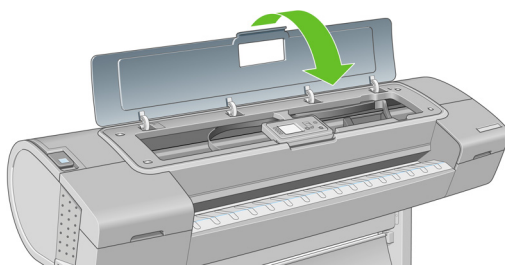

5. The process takes about six minutes. Wait until the front-panel display shows the process complete before using the printer.



 **NOTE:** The printer prints a calibration image. Do not worry about the image. The front-panel display shows any errors in the process.

Image Quality Maintenance menu procedure

1. Load the paper you wish to use, see [Paper handling on page 25](#). You can use a roll or cut sheet, however, it must be A3 landscape or larger (420 by 297 mm).

△ **CAUTION:** Do not use transparent or semi-transparent paper to align the printheads.

2. Press the **Menu** key to return to the main menu and select the Image Quality Maintenance menu icon , then **Align printheads**. The printer checks to see if it has enough paper to run the realignment.

3. If the loaded paper is satisfactory, the printer runs the realignment and prints a realignment pattern. Ensure the window is closed, as a strong light source near the printer during printhead realignment can affect alignment.

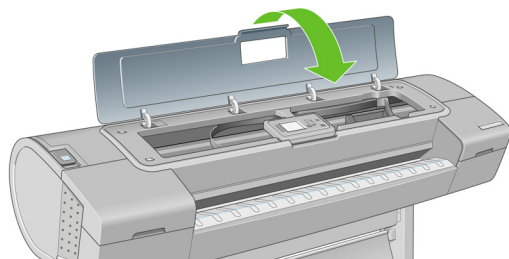

4. The process takes about five minutes. Wait until the front-panel display shows the process complete before using the printer.

Scanning errors during alignment

If the alignment process fails, a Scanning problems message appears on the front panel. This means that the alignment has not completed successfully. Therefore the printer is not aligned and the alignment should be repeated before printing with good image quality. The problem may be due to:

- The paper used was not valid, repeat the alignment with valid paper
- Printhead health problems, clean printheads, see [Clean the printheads on page 143](#)
- The alignment was done with the window open, repeat the alignment with the window closed

If the problem persists after using valid paper, cleaning the printheads, and keeping the window closed, there may be a failure in the scanning system needing reparation or the printheads, although clean, may not work and need to be replaced.

Printhead status messages

These are the possible printhead status messages:

- **OK:** the printhead is working normally, with no known problems
- **Missing:** there is no printhead present, or it is not correctly installed in the printer.
- **Test printhead separately:** you are recommended to test the printheads individually to find the failing printhead. Remove all the printheads and insert them alone one by one, closing the latch and the carriage cover after every insertion. The front-panel display indicates the failing one showing the reset or replace message.
- **Reseat:** you are recommended to remove the printhead and then reinsert it. If that fails, clean the electrical connections, see [The front-panel display recommends reseating or replacing a printhead on page 143](#). If that fails, replace the printhead with a new printhead, see [Remove a printhead on page 90](#) and [Insert a printhead on page 93](#).
- **Replace:** the printhead is failing. Replace the printhead with a working printhead, see [Remove a printhead on page 90](#) and [Insert a printhead on page 93](#).
- **Replacement incomplete:** a printhead replacement process has not completed successfully, re-launch the replacement process and let it finish completely (it is not needed to change the printheads).
- **Remove:** the printhead is not a suitable type for use in printing.

15 Troubleshooting general printer issues

- [The printer does not print](#)
- [The printer seems slow](#)
- [Communication failures between computer and printer](#)
- [Cannot access HP Easy Printer Care \(Windows\) or HP Printer Utility \(Mac OS\)](#)
- [Cannot access the Embedded Web Server](#)
- [Automatic file system check](#)
- [An AutoCAD 2000 memory allocation error](#)
- [No output when printing from Microsoft Visio 2003](#)
- [Unavailable driver features when printing from QuarkXpress](#)
- [Printer alerts](#)

The printer does not print

If all is in order (paper loaded, all ink components installed, and no file errors), there are still reasons why a file you have sent from your computer may not start printing when expected:

- You may have an electrical power problem. If there is no activity at all from the printer, and the front panel does not respond, check that the power cable is connected correctly and that there is power available at the socket.
- You may be experiencing unusual electromagnetic phenomena, such as strong electromagnetic fields or severe electrical disturbances, which can cause the printer to behave strangely or even stop working. In this case, turn off the printer using the **Power** key on the front panel and unplug the power cord, wait until the electromagnetic environment has returned to normal, then turn it on again. If you still experience problems, please contact your customer service representative.
- You may have the wrong graphic language setting, see [Change the graphic language setting on page 24](#).
- You may not have installed in your computer the correct driver for your printer, see the *Assembly instructions*.
- If you are printing on a sheet, you must specify sheet as the paper source in your printer driver.
- The printer may be holding the job for paper.
- You may have requested a print preview from your printer driver. This is a function you can use to check that the image is the one you want. In this case, the preview is displayed on your screen, and you must click the **Print** button to start printing.

The printer seems slow

Here are some possible explanations.

- Did you set the print-quality to **Best** or **Max Detail**? Best-quality and maximum detail prints take longer.
- Did you specify the correct paper type when loading the paper? Some paper types require more time for printing, for example, photo and coated papers require more drying time between passes. To find out the printer's current paper type setting, see [View information about the paper on page 43](#).
- Do you have a network connection to your printer? Check that all components used in the network (network interface cards, hubs, routers, switches, cables) are capable of high-speed operation. Is there a lot of traffic from other devices on the network?
- Did you specify **Extended** drying time in the front panel? Try changing the drying time to **Optimal**.

Communication failures between computer and printer

Some symptoms are:



- The front-panel display does not show the **Receiving** message when you have sent an image to the printer.
- Your computer displays an error message when you are trying to print.
- Your computer or printer hangs (stays idle), while communication is taking place.
- Your printed output shows random or inexplicable errors (misplaced lines, partial graphics etc.)

To solve a communication problem:

- Ensure that you have selected the correct printer in your application, see [Printing on page 47](#).
- Ensure that the printer works correctly when printing from other applications.
- Remember that very large prints may take some time to receive, process, and print.
- If the printer is connected to a network, try using it when connected directly to your computer through a USB cable.
- If your printer is connected to your computer through any other intermediate devices, such as switch boxes, buffer boxes, cable adapters, cable converters, etc., try using it when connected directly to your computer.
- Try another interface cable.
- Ensure that the graphic language setting is correct, see [Change the graphic language setting on page 24](#).
- If the printer is connected with a USB, try to disconnect and reconnect the USB cable with the computer.

Cannot access HP Easy Printer Care (Windows) or HP Printer Utility (Mac OS)

If you have not done so already, please read [Access HP Easy Printer Care \(Windows\) or HP Printer Utility \(Mac OS\) on page 21](#).



1. To use HP Printer Utility (Mac OS), you must have a USB connection to your printer.
2. Press the **Menu** key to return to the main menu and select the Connectivity menu icon .
3. Select **Advanced > Web Services > Printer Utility Software > Enable**.
4. If you have a TCP/IP connection to your printer, press the **Menu** key to return to the main menu and select the Connectivity menu icon  again.
5. Select the type of connection you are using.
6. Select **View Information**.

If you still cannot connect, switch the printer off and back on with the **Power** key on the front panel.

Cannot access the Embedded Web Server

If you have not done so already, please read [Access the Embedded Web Server on page 22](#).

 **NOTE:** If you connect directly to your printer with a USB cable, use HP Easy Printer Care (Windows) or HP Printer Utility (Mac OS).

1. Press the **Menu** key to return to the main menu and select the Connectivity menu icon .
2. Select **Advanced > Embedded Web Server > Allow EWS > On**.
3. If you have a TCP/IP connection to your printer, press the **Menu** key to return to the main menu and select the Connectivity menu icon  again.

4. Select the type of connection you are using.
5. Select **View Information**.
6. Ensure that you see IP enabled. If not, you may need to use a different connection.

If you still cannot connect, switch the printer off and back on with the **Power** key on the front panel.

Automatic file system check

When you turn on the printer, you will occasionally see a front panel display similar to the one shown below.

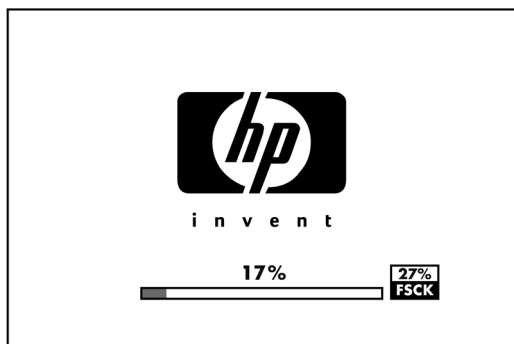

A file system check is taking place; it can take up to 40 minutes. Please wait until it finishes.

- △ **CAUTION:** If you turn the printer off before the file system check has finished, the file system could be seriously damaged, making the printer's hard disk unusable. In any case, the file system check will restart from the beginning whenever you turn the printer on again.

A file system check is scheduled every 90 days, in order to maintain the hard disk's file system integrity.

- 📝 **NOTE:** When the printer is powered back on, it takes about three minutes to initialize and check and prepare the printheads. However, it can take up to 40 under some conditions, for example, when the printer has not been used for a long period of time and requires more time to prepare the printheads.

An AutoCAD 2000 memory allocation error

After installing the printer driver, when you try to print for the first time from AutoCAD 2000, you may see a message saying **Memory allocation error**, after which your image is not printed.

This is due to a problem in AutoCAD 2000, and it can be fixed by downloading the Plotting Update Patch (**plotupdate.exe**) from the Autodesk Web site, <http://www.autodesk.com/>.

This patch is also worth trying if you have any other strange problems when printing from AutoCAD 2000.

No output when printing from Microsoft Visio 2003

For more information about problems when printing large images (more than 129 inches long) from Microsoft Visio 2003, see Microsoft's online knowledge base: <http://support.microsoft.com/search/>.

To avoid these problems, it is possible to scale the image down in Visio to a size shorter than 129 inches and then to scale the drawing up in the driver by using the **Scale to** options in the Effects tab of the Windows driver. If the down-scaling in the application and the up-scaling in the driver match, the result is as originally intended.

Unavailable driver features when printing from QuarkXpress

When you print from QuarkXPress, the following driver features are not available.

- Print Preview
- Rotation
- Scaling
- Microsoft Office features or paper saving options
- Back to front printing

If you are using the HP-GL/2 driver, the following features are not available.

- Print Preview
- Back to front printing

To get the same results, use the equivalent features available in QuarkXPress.

Printer alerts

Your printer can communicate two types of alerts:

- **Errors:** Mainly alerting you to the fact that the printer is unable to print. However, in the driver, errors can also alert you to conditions that could ruin the print, such as clipping, even if the printer is able to print.
- **Warnings:** Alert you when the printer needs attention either for an adjustment, such as calibration or for a possible unprintable situation, such as preventive maintenance or low ink.

There are four different alerts communicators within your printer's system.

- **Front-panel display:** The front panel only shows the most relevant alert at a time. It generally requires the user to press the **OK** key for confirmation, but in the case of a warning, it disappears after a timeout. There are permanent alerts, such as "ink cartridge low on ink", that reappear when the printer becomes idle and there is not another more severe alert.
- **Driver:** The driver shows alerts. The driver warns about job configuration settings that may produce a problem in the final output. If the printer is not ready to print, it displays a warning.
- **HP Easy Printer Care (Windows) or HP Printer Utility (Mac OS):** To see alerts in these applications, go to the **Overview** tab and review the **Items needing attention** list on the right-hand side.

By default, alerts are only displayed when you are printing and there are printing problems, for example: cartridge low or out of ink or printer out of paper. If alerts are enabled and there is a problem that prevents printing, you see a pop-up window, which explains why the printer is not going to print. Follow the instructions to achieve your required result.

 **NOTE:** There are environments that do not support bidirectional communication, for example: a Windows computer connected to the printer with USB. In those cases, alerts do not reach the job owner.

16 Front-panel error messages

Occasionally you may see one of the following messages appear on the front-panel display. If so, please follow the advice in the Recommendation column.

If you see an error message that does not appear here, and you feel in doubt about the correct response, contact HP Support. See [Contact HP Support on page 160](#).

Table 16-1 Text messages

Message	Recommendation
[Color] cartridge has expired	Replace the cartridge. See Handling ink cartridges and printheads on page 85 .
[Color] cartridge is missing	Insert a cartridge of the correct color. See Handling ink cartridges and printheads on page 85 .
[Color] cartridge is out of ink	Replace the cartridge. See Handling ink cartridges and printheads on page 85 .
[Color] printhead #[n] error: not present	Insert the correct printhead. See Handling ink cartridges and printheads on page 85 .
[Color] printhead #[n] error: please remove	Remove the incorrect printhead and insert a new printhead of the correct type (color and number). See Handling ink cartridges and printheads on page 85 .
[Color] printhead #[n] error: replace	Remove the non-functional printhead and insert a new printhead. See Handling ink cartridges and printheads on page 85 .
[Color] printhead #[n] error: reseal	Remove and reinsert the same printhead, or try cleaning the electrical connections. If necessary, insert a new printhead. See The front-panel display recommends resealing or replacing a printhead on page 143 .
[Color] printhead #[n] out of warranty	The printhead's warranty has expired, because of the length of time it has been in operation or because of the volume of ink used.
[Color] printhead #[n] warranty warning	The printhead's warranty may be invalidated by the use of the wrong kind of ink.
IO error	Restart the printer. If the problem persists, contact HP Support. See Contact HP Support on page 160 .
IO warning	Try again; if the problem persists, contact HP Support. See Contact HP Support on page 160 .
Paper advance calibration pending	Perform paper advance calibration. See Recalibrate the paper advance on page 121 .
Paper too small to print paper advance calibration	Unload paper and load larger paper.
Paper too small to scan paper advance calibration	Unload paper and load larger paper.
PDL Error: Ink system not ready	Clean the printheads. See Clean the printheads on page 143 .

Table 16-1 Text messages (continued)

Message	Recommendation
PDL Error: Job clipped	The image is too large for the paper or for the printer. Load larger paper if possible, or reduce the image size.
PDL Error: memory full	Restart the printer and try resending the job; if necessary, reduce the complexity of the job.
PDL Error: out of paper	Load more paper.
PDL Error: parsing error	The print job is unintelligible to the printer. Try to recreate and resend it. Check your cable connections.
PDL Error: print mode error	The paper type or print quality specified for the job are incorrect. Change the loaded paper type or the print settings.
PDL Error: printing error	Try sending the job again.
PDL Error: virtual memory full	Restart the printer and try resending the job; if necessary, reduce the complexity of the job.
Printhead alignment error: paper too small	Unload paper and load larger paper.
Replace [color] cartridge	Replace the cartridge. See Handling ink cartridges and printheads on page 85 .
Reseat [color] cartridge	Remove and reinsert the same cartridge. See Handling ink cartridges and printheads on page 85 .
Update: failed. Invalid file	Make sure that you have selected the correct firmware update file. Then try again to perform the update.

Table 16-2 Numerical error codes

Error code	Recommendation
01.0, 01.1, 01.2	Restart the printer. If the problem persists, contact HP Support. See Contact HP Support on page 160 .
21, 21.1, 22.0, 22.1, 22.2, 22.3, 24	Restart the printer. If the problem persists, contact HP Support. See Contact HP Support on page 160 .
52:01	The printer needs internal cleaning. See Clean the printhead drop detector on page 144 . If the problem persists, contact HP Support. See Contact HP Support on page 160 .
61:01	The file format is wrong and the printer cannot process the job. Check the graphic language setting of your printer (see Change the graphic language setting on page 24). Check for the latest firmware and driver releases.
62, 63, 64, 65, 67	Update your printer's firmware. See Update the firmware on page 104 .
74.1	Try the firmware update again. Do not try to use your computer while the update is in progress. If the problem persists, contact HP Support. See Contact HP Support on page 160 .
79	Restart the printer. If the problem persists, contact HP Support. See Contact HP Support on page 160 .
94, 94.1	Restart color calibration. See Color calibration on page 56 .

17 HP Customer Care

- [Introduction](#)
- [HP Professional Services](#)
- [HP Instant Support](#)
- [HP Proactive Support](#)
- [Contact HP Support](#)

Introduction

HP Customer Care offers award-winning support to ensure you get the most from your HP Designjet, providing comprehensive, proven support expertise and new technologies to give you unique end-to-end support. Services include setup and installation, troubleshooting tools, warranty upgrades, repair and exchange services, phone and Web support, software updates, and self-maintenance services. To find out more about HP Customer Care, please visit us at:

<http://www.hp.com/go/designjet/>

or call us on the telephone (see [Contact HP Support on page 160](#)).

HP Professional Services

Knowledge Center

Enjoy a world of dedicated services and resources to ensure you always get the best performance from your HP Designjet products and solutions.

Join the HP community at the Knowledge Center, your large-format printing community at http://www.hp.com/go/knowledge_center/djt610/ for 24×7 access to:

- Multimedia tutorials
- Step-by-step how-to guides
- Downloads — the latest printer firmware, drivers, software, paper profiles, etc.
- Technical support — online troubleshooting, customer care contacts, and more
- Workflows and detailed advice for completing various printing tasks from particular software applications
- Forums for direct contact with the experts, both HP and your colleagues
- Warranty tracking online, for your peace of mind
- Latest product information — printers, supplies, accessories, software, etc.
- Supplies Center for all you need to know about ink and paper

By customizing your registration for the products you have purchased and your type of business, and by setting your communication preferences, you decide the information you need.

HP Start-Up Kit

The HP Start-Up Kit is the DVD that comes with your printer; it contains the printer's software and documentation, including introductory multimedia tutorials to help you to get a good first print.

HP Care Packs and Warranty Extensions

HP Care Packs and Warranty Extensions allow you to extend your printer's warranty beyond the standard period.

They include remote support. On-site service is also provided if necessary, with two alternative response-time options.

- Next business day
- Same business day, within four hours (may not be available in all countries)

For more information on HP Care Packs, please visit <http://www.hp.com/go/lookuptool/>.

HP Installation

The HP Installation service unpacks, sets up, and connects the printer for you.

This is one of the HP Care Pack services; for more information, please visit <http://www.hp.com/go/lookuptool/>.

HP Instant Support

HP Instant Support Professional Edition is HP's suite of troubleshooting tools that collect diagnostic information from your printer and match it with intelligent solutions from HP's knowledge bases, allowing you to resolve problems as quickly as possible.

You can start an HP Instant Support session by clicking on the link provided on the Troubleshooting page of your printer's Embedded Web Server. See [Access the Embedded Web Server on page 22](#).

To be able to use HP Instant Support:

- You must have a TCP/IP connection to your printer, because HP Instant Support is accessible only through the Embedded Web Server.
- You must have access to the World Wide Web, because HP Instant Support is a Web-based service.

HP Instant Support is currently available in English, Korean, Simplified Chinese, and Traditional Chinese.

You can find more information about HP Instant Support at <http://www.hp.com/go/ispe/>.

HP Proactive Support

HP Proactive Support helps reduce costly printer downtime by preemptively identifying, diagnosing, and resolving printer issues before they become problems for you. HP's Proactive Support tool is designed to help businesses of all sizes reduce support costs and maximize productivity—all with the click of a mouse.

A component of the HP Imaging and Printing suite of services, Proactive Support helps you gain control of your printing environment—with a clear focus on maximizing the value of your investment, increasing printer uptime, and reducing printer management costs.

HP recommends that you enable Proactive Support right away to save you time and prevent problems before they occur, reducing costly downtime. Proactive Support runs diagnostics and checks for software and firmware updates.

You can enable Proactive Support in HP Easy Printer Care for Windows or HP Printer Monitor for Mac OS, where you can specify the frequency of connections between your computer and HP's Web server, and the frequency of diagnostic checks. You can also choose to run the diagnostic checks at any time. To change these settings:

- In HP Easy Printer Care for Windows, select the **Tools** menu, then **HP Proactive Support**.
- In HP Printer Monitor for Mac OS, select **Preferences**, then **HP Proactive Support**.

If Proactive Support finds any potential problem, it notifies you with an alert, which will explain the problem and recommend a solution. In some cases, the solution may be applied automatically; in other cases, you may be asked to perform some procedure to solve the problem.

Contact HP Support

HP Support is available to you by telephone. What to do before you call:

- Review the troubleshooting suggestions in this guide.
- Review the relevant driver documentation.
- If you have installed third-party software drivers and RIPs, see their documentation.
- If you call one of the Hewlett-Packard offices, please have the following information available to help us answer your questions more quickly:
 - The printer you are using (the product number and the serial number, found on the label at the back of the printer)
 - If there is an error code on the front panel, note it down; see [Front-panel error messages on page 155](#)
 - The printer's Service ID: at the front panel, select the Information menu icon , then **View printer information**
 - The computer you are using
 - Any special equipment or software you are using (for example, spoolers, networks, switch-boxes, modems, or special software drivers)
 - The cable you are using (by part number) and where you purchased it
 - The type of interface used on your printer (USB or network)
 - The software name and version you are currently using
 - If possible, print out the following reports; you may be asked to fax them to the support center helping you: Configuration, and "all pages above" from Service Information (see [The printer's internal prints on page 8](#))

Telephone numbers

An up-to-date list of HP Support telephone numbers is available on the Web: please visit http://welcome.hp.com/country/us/en/wwcontact_us.html. If you have no access to the Web, try one of the numbers below.

- Algeria: 213 17 63 80
- Argentina: 0 800 777 HP INVENT, local 5411 4778 8380
- Australia: 13 10 47
- Austria: 0810 00 10 00
- Bahrain: 800 171
- Belgium: (0) 78 600 600
- Bolivia: 0 800 1110, local 54 11 4708 1600
- Brazil: 0800 157 751, local 55 11 3747 7799
- Canada: 1 800 HP INVENT
- Caribbean: 1 800 711 2884

- Central America: 1 800 711 2884
- Chile: 800 HP INVENT, 123 800 360 999
- China: 800 810 59 59, 10 6564 59 59
- Colombia: 01 8000 51 HP INVENT, local 571 606 9191
- Czech Republic: 420 261 307 310
- Denmark: 70 11 77 00
- Ecuador: 999 119, 1 800 225 528
- Egypt: 202 532 5222
- Finland: 0203 53232
- France: 08 26 10 49 49
- Germany: 0180 52 58 143
- Greece: 210 6073603, 801 11 22 55 47
- Guadeloupe: 0800 99 00 11, 877 219 8791
- Guatemala: 1 800 999 5105, 1 800 711 2884
- Hong Kong: 852 3002 8555
- Hungary: 06 1 382 1111
- India: 1 600 112 267
- Indonesia: 350 3408
- Ireland: 1 890 946500
- Israel: 09 830 4848
- Italy: 02 3859 1212
- Jamaica: 0 800 711 2884
- Japan: software 0120 014121, hardware 0120 742594
- Korea: 82 1588 3003
- Luxembourg: 27 303 303
- Malaysia: 1 800 80 5405
- Martinique: 0 800 99 00, 877 219 8671
- Mexico: 01 800 472 6684, local 5258 9922
- Middle East: 4 366 2020
- Morocco: 2240 4747
- Netherlands: 0900 1170 000
- New Zealand: 09 365 9805
- Norway: 800 62 800
- Paraguay: 00 811 800, 800 711 2884

- Panama: 001 800 711 2884
- Peru: 0 800 10111
- Philippines: 632 888 6100
- Poland: 22 566 6000
- Portugal: 213 164 164
- Puerto Rico: 1 800 652 6672
- RSA: 27 11 258 9301, local 086 000 1030
- Romania: 40 21 315 4442
- Russia: 095 797 3520, 812 3467 997
- Saudi Arabia: 6272 5300
- Slovakia: 2 50222444
- South Africa: 0800 001 030
- Spain: 902 010 333
- Sweden: 077 130 30 00
- Switzerland: 0848 80 20 20
- Taiwan: 886 2 872 28000
- Thailand: 0 2353 9000
- Tunisia: 71 89 12 22
- Turkey: 216 444 71 71
- UAE: 800 4520, 04 366 2020
- Ukraine: 44 4903520
- United Kingdom: 0870 842 2339
- United States: 1 800 HP INVENT
- Uruguay: 54 11 4708 1600
- Venezuela: 0 800 HP INVENT, local 58 212 278 8000
- Vietnam: 84 8 823 45 30
- West Africa (French): 351 213 17 63 80

18 Printer specifications

- [Functional specifications](#)
- [Physical specifications](#)
- [Memory specifications](#)
- [Power specifications](#)
- [Ecological specifications](#)
- [Environmental specifications](#)
- [Acoustic specifications](#)

Functional specifications

Table 18-1 HP 72 ink supplies

Printheads	Two inks in each printhead: gray and photo black, matte black and yellow, and magenta and cyan
Ink cartridges	Cartridges containing 69 ml of ink: gray, photo black, yellow, magenta, and cyan Cartridges containing 130 ml of ink: gray, photo black, matte black, yellow, magenta, and cyan

Table 18-2 Paper sizes

	Minimum	Maximum
Roll Width	18 inches (460 mm)	24-inch printer: 24 inches (609 mm) 44-inch printer: 44 inches (1118 mm)
Roll Length		300 feet (91.4 m)
Sheet Width	8.3 inches (210 mm)	24-inch printer: 24 inches (609 mm) 44-inch printer: 44 inches (1118 mm)
Sheet Length	11 inches (279 mm)	24-inch printer: 36 inches (915 mm) 44-inch printer: 66 inches (1676.4 mm)

Table 18-3 Printing resolutions

Print-quality	Maximum detail	Rendering Resolution (dpi)	Printing Resolution (dpi)
Best	On	1200 × 1200	2400 × 1200 (glossy paper only)*
	On	1200 × 1200	1200 × 1200
	Off	600 × 600	600 × 600
	Off	600 × 600	600 × 600
Normal	On	600 × 600	600 × 600
	Off	600 × 600	600 × 600
	Off	300 × 300	300 × 300
Fast	On	600 × 600	600 × 600
	Off	600 × 600	600 × 600
	Off	300 × 300	300 × 300

*For a list of supported glossy paper, see [Order paper on page 108](#).

Table 18-4 Margins

Top right and left margins	5 mm = 0.2 inches
Bottom margin (trailing edge)	5 mm = 0.2 inches (roll) 17 mm = 0.67 inches (sheet)

Table 18-5 Mechanical accuracy

±0.1% of the specified vector length or ±0.2mm (whichever is greater) at 23°C (73°F), 50-60% relative humidity, on E/A0 printing material in Best or Normal mode with HP Matte Film roll feed.

Table 18-6 Graphic languages supported

HP PCL3 GUI, HP GL/2 RTL

Physical specifications

Table 18-7 Printer physical specifications

	24-inch printer	24-inch printer (without stand)	44-inch printer
Weight	143 lb (65 kg)	103.6 lb (47 kg)	189 lb (86 kg)
Width	49.7 inches (1262 mm)	49.7 inches (1262 mm)	69.7 inches (1770 mm)
Depth	Minimum: 26 inches (661 mm) Maximum: 28.8 inches (732 mm)	Minimum: 26 inches (661 mm) Maximum: 28.8 inches (732 mm)	Minimum: 26 inches (661 mm) Maximum: 28.8 inches (732 mm)
Height	41.2 inches (1047 mm)	15.4 inches (391 mm)	41.2 inches (1047 mm)

Memory specifications

Table 18-8 Memory specifications

Memory (DRAM) supplied	256 MB
Hard disk	40 GB

Power specifications

Table 18-9 Printer power specifications

Source	100–240 V ac ±10%, auto-ranging
Frequency	50–60 Hz
Current	< 2 A
Consumption	< 200 W

Ecological specifications

This product complies with European Union WEEE and RoHS Directives. To determine the ENERGY STAR qualification status of these product models, please go to <http://www.hp.com/go/energystar>.

For the up-to-date ecological specifications of your printer, please go to <http://www.hp.com/> and search for “ecological specifications”.

Environmental specifications

Table 18-10 Printer environmental specifications

	Temperature range	Humidity range
Operating for optimal print-quality	22°C to 26°C (72°F to 79°F)	30% to 60%
Operating for standard printing	15°C to 35°C (59°F to 95°F)	20% to 80%
Printer without consumables	5°C to 40°C (41°F to 104°F)	
Non-operating packed consumables and printer:	-40°C to 60°C (-40°F to 140°F)	

Acoustic specifications

Printer acoustic specifications (declared according to ISO 9296).

Table 18-11 Printer acoustic specifications

Idle sound power level	4.4 B (A)
Operating sound power level	6.9 B (A)
Idle sound pressure at bystander	29 dB (A)
Operating sound pressure at bystander	57 dB (A)

Glossary

AppleTalk A suite of protocols that Apple Computer developed in 1984 for computer networking. Apple now recommends TCP/IP networking instead.

Bonjour Apple Computer's trade name for its implementation of the IETF Zeroconf specification framework, a computer network technology used in Apple's Mac OS X from version 10.2 onwards. It is used to discover services available on a local area network. It was originally known as Rendezvous.

Color accuracy The ability to print colors that match the original image as closely as possible, bearing in mind that all devices have a limited color gamut and may not be physically capable of matching certain colors precisely.

Color consistency The ability to print the same colors from a particular print job from print to print and from printer to printer.

Color model A system of representing colors by numbers, such as RGB or CMYK.

Color space A color model in which each color is represented by a specific set of numbers. Many different color spaces can use the same color model: for instance, monitors generally use the RGB color model, but they have different color spaces, because a particular set of RGB numbers results in different colors on different monitors.

Cutter A printer component that slides back and forth across the platen to cut the paper.

ESD ElectroStatic Discharge. Static electricity is common in daily life. It is the spark when touching the car door, or the cling of clothing. Although controlled static electricity has some useful applications, uncontrolled electrostatic discharges are one of the main hazards to the electronics products. Therefore, to prevent damage some precautions are needed when setting up the product, or handling ESD sensitive devices. This type of damage may reduce the life expectancy of the device. One way to minimize uncontrolled ESDs, and therefore reduce this type of damage is by touching any exposed grounded part of the product (mainly metal parts) before handling ESD sensitive devices (such as the printheads or ink cartridges). Additionally, to reduce the generation of electrostatic charge in your body try to avoid working in a carpeted area, and keep your body movements to a minimum when handling ESD sensitive devices. Also, avoid working in low humidity environments.

Ethernet A popular computer networking technology for local area networks.

Firmware Software that controls your printer's functionality and is stored semi-permanently in the printer (it can be updated).

Gamut The range of colors and density values reproducible on an output device, such as a printer or monitor.

HP-GL/2 Hewlett-Packard Graphics Language 2: a language defined by HP to describe vector graphics.

I/O Input/Output: this term describes the passing of data between one device and another.

ICC The International Color Consortium, a group of companies that have agreed on a common standard for color profiles.

Ink cartridge A removable printer component that stores ink of a particular color and provides it to the printhead.

IP address A unique identifier that identifies a particular node on a TCP/IP network. It consists of four integers separated by dots.

Jetdirect HP's brand name for its series of print servers that allow a printer to be connected directly to a local area network.

LED Light-Emitting Diode: a semiconductor device that emits light when electrically stimulated.

MAC address Media Access Control address: a unique identifier used to identify a particular device on a network. It is a lower-level identifier than the IP address. Thus, a device may have both a MAC address and an IP address.

Nozzle One of many tiny holes in a printhead through which ink is deposited onto the paper.

Paper A thin, flat material made to be written or printed on; most commonly made from fibers of some kind which are pulped, dried, and pressed.

Platen The flat surface within the printer over which the paper passes while it is being printed on.

Printer driver Software that converts a print job in a generalized format into data suitable for a particular printer.

Printhead A removable printer component that takes ink of one or more colors from the corresponding ink cartridge(s) and deposits it on the paper, through a cluster of nozzles. In the HP Designjet T610 series, each printhead prints two different colors.

Rendezvous Apple Computer's original name for its networking software later known as Bonjour.

Spindle A rod that supports a roll of paper while it is being used for printing.

TCP/IP Transmission Control Protocol/Internet Protocol: the communications protocols on which the Internet is based.

USB Universal Serial Bus: a standard serial bus designed to connect devices to computers.

Index

A

- accessories
 - order 111
- acoustic specifications 166
- alerts
 - errors 153
 - turn on and off 18
 - warnings 153
- Autodesk Design Review
 - print from 64

B

- banding problems 121
- basket
 - output problems 120
- black and white 53
- blurred lines 129
- buzzer on/off 23

C

- calibration
 - color 56
- cannot load paper 114
- clean the platen 132
- clean the printer 98
- clipped at bottom 135
- clipped image 135
- color
 - adjustment options 58
 - advantages 56
 - calibration 56
 - CMYK 56
 - fading 135
 - inaccurate 134
 - printer emulation 58
 - profile 56
 - RGB 56
- color management
 - from drivers 57
 - from front panel 60
 - options 57
 - process 56
- components of printer 4

- computer communication
 - printer/computer
 - communications issues 150
- configure 23
- connect the printer
 - choose a method 10
 - Mac OS direct 12
 - Mac OS network 13
 - Windows direct 10
 - Windows network 11
- contrast in front panel 23
- core adaptors 27, 29
- Customer Care 158
- cutter
 - on/off 45
- cutter, replace 98

D

- disk erase, secure 105
- draft for revision, print 62
- draft printing 51
- driver features
 - QuarkXpress 153
- driver preferences 18
- drying time
 - change 44

E

- Easy Printer Care
 - access 21
 - cannot access 151
 - language 22
- ecological specifications 165
- economize
 - on ink 54
 - on paper 54
- Embedded Web Server
 - access 22
 - cannot access 151
 - language 22
- environmental specifications 166
- erase hard disk securely 105
- error messages, front panel 155

F

- fading colors 135
- features of printer 4
- file system check 152
- firmware update 104
- front panel
 - contrast 23
 - language 21
 - units 23
- front panel option
 - adjust paper advance 122
 - align printheads 147
 - allow EWS 151
 - calibrate color 57
 - calibrate paper advance 122
 - clean printheads 143
 - color/grayscale 60
 - emulate printer 60
 - enable buzzer 23
 - enable cutter 45
 - enable economode 52
 - enable maximum detail 52
 - enable merge 51
 - form feed and cut 7, 33, 34, 37, 38, 45, 120, 121
 - ink cartridge information 86
 - internal prints 8
 - load roll 33, 37
 - load sheet 41
 - modify configuration 23
 - print diagnostic image 136
 - print quality 48
 - Printer Utility software 151
 - printhead information 90, 126, 130
 - replace ink cartridges 87
 - replace printheads 91
 - reprint last job 53
 - reset cutter life counters 98
 - reset paper advance 122
 - resize 51
 - RGB source profile 60
 - select display contrast 23

- select drying time 44
- select graphics language 24
- select I/O timeout 135
- select language 21
- select paper size 48
- select paper type 116, 117
- select units 23
- sleep mode wait time 23
- unload paper 7, 38, 39, 42
- view connectivity
 - information 151, 152
- view ink levels 7, 98
- view loaded paper 7, 43, 98, 121, 124, 125, 126, 129, 130, 131, 132, 134, 136
- view printer information 160
- functional specifications 164

G

- graininess 130
- graphic languages 165
- gray shades 53

H

- hard disk specification 165
- HP Care Packs 158
- HP Customer Care 158
- HP Installation 159
- HP Instant Support 159
- HP Proactive Support 159
- HP Start-Up Kit 158
- HP Start-Up Kit CD/DVD 2
- HP Support 160
- HP-GL/2 24

I

- image diagnostics print 136
- image problems
 - clipped at bottom 135
 - clipped image 135
 - missing objects 136
 - PDF problems 136
 - Visio 2003 152

ink

- economical use of 54

ink cartridge

- about 86
- cannot insert 142
- insert 88
- maintenance 103
- order 108
- remove 87
- specification 164
- status 86

- Instant Support 159
- internal prints 8

J

- Jetdirect print server 112

K

- Knowledge Center 158

L

- language 21
- line length accuracy 129
- line thickness 126
- load paper
 - cannot load 114
 - general advice 26
 - paper not in driver 116
 - roll cannot load 114
 - roll cannot load 24-inch 114
 - roll cannot load 44-inch 115
 - roll into 24-inch printer 30
 - roll into 24-inch printer easy load 31
 - roll into 24-inch printer with paper menu 33
 - roll into 44-inch printer 34
 - roll into 44-inch printer easy load 35
 - roll into 44-inch printer with paper menu 37
 - roll onto 24-inch spindle 26
 - roll onto 44-inch spindle 28
 - sheet 39
 - sheet cannot load 115
 - sheet easy load 40
 - sheet paper menu load 41
- loading paper problems 114

M

- maintenance kits 104
- margins
 - none 53
 - specification 164
- mechanical accuracy 165
- memory error (AutoCAD) 152
- memory specifications 165
- Microsoft Office
 - print from 79
- misaligned colors 127
- move the printer 103

N

- Network settings 23

O

- order
 - accessories 111
 - ink cartridges 108
 - paper 108
 - printheads 108
- overlapping lines 51

P

- page size 48
- paper
 - advance 45
 - calibrate the paper
 - advance 121
 - cannot load 114
 - download profiles 43
 - economical use of 54
 - feed and cut 45
 - jammed 117
 - loading error messages 115
 - maintenance 44
 - not flat 130
 - output problems in basket 120
 - paper not in driver 116
 - print on loaded paper 44
 - profiles 43
 - select type 44
 - size 48
 - sizes (max and min 164
 - view information 43
- paper not in driver 116
- paper types 108
- PDF clipped 136
- PDF missing objects 136
- physical specifications 165
- platen cleaning 132
- power
 - on/off 20
- power specifications 165
- preferences, Windows driver 18
- presentation, print 72
- print quality
 - select 48
- print with shortcuts 49
- print-quality problems
 - banding 125
 - black ink comes off 132
 - blurred lines 129
 - bottom of print 133
 - discontinuous lines 128
 - edges darker than expected 133
 - edges stepped or not sharp 132

- general 124
- graininess 130
- horizontal lines 125
- inaccurate line lengths 129
- ink marks 131
- line thickness 126
- misaligned colors 127
- paper not flat 130
- scratching 131
- scuffing 131
- stepped lines 126
- vertical lines of different colors 133
- white spots 133
- wizard 124
- printer does not print 150
- printer software
 - Mac OS uninstall 14
 - Windows uninstall 12
- printer stand 112
- printer status 98
- Printer Utility
 - access 21
 - cannot access 151
 - language 22
- printer's main components 4
- printer's main features 4
- printhead
 - about 89
 - align 146
 - cannot insert 142
 - clean; purge 143
 - insert 93
 - order 108
 - remove 90
 - replace, reseal 143
 - specification 164
 - status 90
- printhead cleaner
 - specification 164
- printhead drop detector
 - clean 144
- printing resolutions 164
- Proactive Support 159
- project, print 64

Q

- quality, high 52
- QuarkXpress, unavailable driver features 153

R

- reprint last printed job 53
- rescale a print 50

- roll paper
 - 24-inch load 30
 - 24-inch spindle load 26
 - 44-inch load 34
 - 44-inch spindle load 28
 - unload 38

S

- safety precautions 2
- scale a print 50
- scratched prints 131
- scuffed prints 131
- secure disk erase 105
- sheet paper
 - load 39
 - unload 42
- shortcuts 49
- sleep mode wait time 23
- slow printing 150
- software 8
- software update 104
- specifications
 - acoustic 166
 - ecological 165
 - environmental 166
 - functional 164
 - graphic languages 165
 - hard disk 165
 - ink supplies 164
 - margins 164
 - mechanical accuracy 165
 - memory 165
 - paper size 164
 - physical 165
 - power 165
 - printing resolutions 164
- spindle
 - 24-inch roll load 26
 - 44-inch roll load 28
- stand 112
- statistics
 - ink cartridge 86
- stepped lines 126
- store the printer 103
- support services
 - HP Care Packs 158
 - HP Customer Care 158
 - HP Instant Support 159
 - HP Proactive Support 159
 - HP Start-Up Kit 158
 - HP Support 160
 - Knowledge Center 158
 - printer installation 159
 - warranty extensions 158

T

- telephone numbers 160

U

- unload paper
 - roll 38
 - roll out of paper 39
 - roll with paper 38, 39
 - sheet 42
 - sheet with paper menu 42
 - sheet with Unload paper key 42
- using this guide 2

V

- Visio 2003, no output 152

W

- warranty extensions 158