



H BUMPER

All Makes Catalog
Popular Part Numbers

WELCOME

TO THE HENDRICKSON ALL MAKES BUMPER PROGRAM

Hendrickson is a leading tier-one OEM supplier of heavy-duty truck bumpers for the North American commercial vehicle industry. Our commitment to quality and product innovation drives this industry leadership position, thus promoting the development of products that help enhance vehicle styling and durability. Key capabilities, which include proprietary bumper forming technology and advanced metal materials, enable Hendrickson to manufacture aerodynamically contoured bumper designs that are durable yet lightweight.

Hendrickson has an extensive field sales, parts and service organization to support our customers around the globe — truck owners, dealers, fleets and OEMs. Our investment in new technologies will continue as we strive to deliver value to our customers.

TABLE OF CONTENTS

Bumper Materials and Technology	1
Understanding the Hendrickson All Makes Bumper Program	2
Ford®	3
Freightliner®	4
International®	14
Kenworth®	23
Mack®	29
Peterbilt®	33
Volvo®	38
Western Star®	42
AERO CLAD® Rock Screens	43
Genuine Hendrickson - All Makes Program	46

BUMPER

PRODUCTS AND TECHNOLOGY



AERO CLAD® Stainless Steel Clad Aluminum

- Durable, bright mirrored finish
- Finish up to 10 times thicker than typical chrome finish
- Resists corrosion, cracking, pitting, peeling and fading
- Up to 50 percent lighter than steel options
- Lightweight design
- Minor abrasions can be buffed
- Full 5-year limited warranty*



Steel Chrome

- 1-year limited warranty*
- Available in 7-gauge or 10-gauge steel
- Bright mirrored finish
- Many shapes available
- Customize your bumper with cutouts to accommodate road lights
- Also available in corrosion-resistant E-coat finish, ready for topcoat

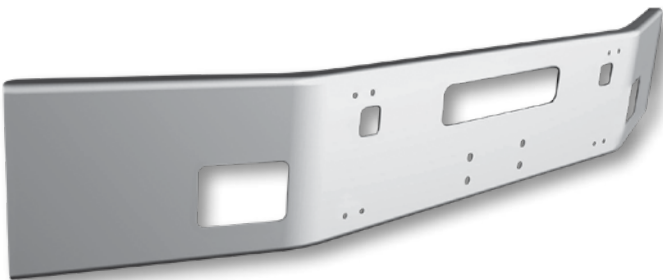

Solid Stainless Steel

- Full 5-year limited warranty*
- Bright mirrored finish
- Resists corrosion, cracking, pitting, peeling and fading
- As durable as a steel bumper
- Minor abrasions can be buffed

* Visit our website at www.hendricksonbumper.com or call 815.727.4031 for complete warranty terms, conditions and limitations.



OVERVIEW

HENDRICKSON ALL MAKES BUMPER PROGRAM

PART NUMBERING ABBREVIATIONS

Part Prefixes:

Alpha characters designate exclusive bumpers available only through the OEM Truck Dealer.

AM - International®

FF - Freightliner®

MM - Mack® / Volvo®

Additional Abbreviations:

AD = Air Dam

K = Kit

NL = No Lights

NS = No Tire Shields

SSC = Stainless Steel Clad Aluminum

SSCSQ = Stainless Steel Clad Aluminum Texas Square

STQ = Solid Stainless Steel Texas Square

SQ = Texas Square

TF = Top Fillers

ORDER / REORDER REQUIREMENTS

Direct Questions to Hendrickson Customer Service at **1-815-727-4031**, or OEM Customer Service Department.

FREIGHT POLICY

Direct Questions to Hendrickson Customer Service at **1-815-727-4031**, or OEM Customer Service Department.

INQUIRIES

Questions regarding literature, order status, warranty, returns and product information may be directed to Hendrickson Customer Service at **1-815-727-4031**, or OEM Customer Service Department.

WARRANTY AND RETURN POLICY*

AERO CLAD®: 5 years or 500,000 miles from date of sale.

Steel Chrome: 1 year or 100,000 miles from date of sale.

Solid Stainless Steel: 5 years or 500,000 miles from date of sale.

* Visit our website at www.hendricksonbumper.com or call 815.727.4031 for complete warranty terms, conditions and limitations.

LN / LT / LTN / L8000 / 9000

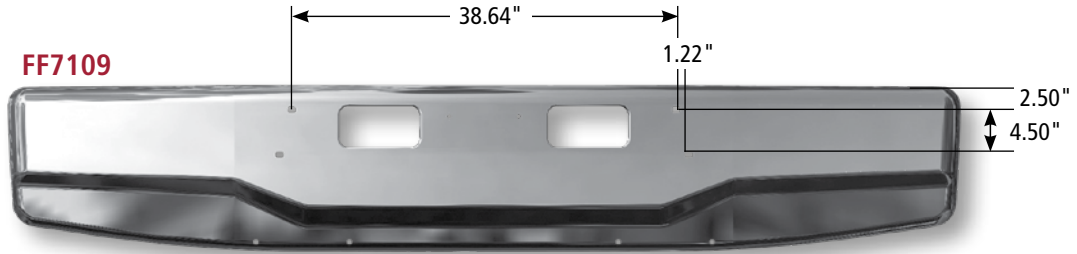

Ford® OEM L-Series 8000 and 9000

PART NO.	MATERIAL / FINISH	GAUGE / THICKNESS	STYLE	LIGHT CUTOUT	CENTER STEP CUTOUT	VENT CUTOUT	TOW COMPATIBLE	RADAR COMPATIBLE	EXCLUSIVE THROUGH OEM	YEAR	MOUNT / BRACKET
FF7109	Chrome	7Ga	16" Taper	N	N	N	Y	N	Y	'88 - '96	N

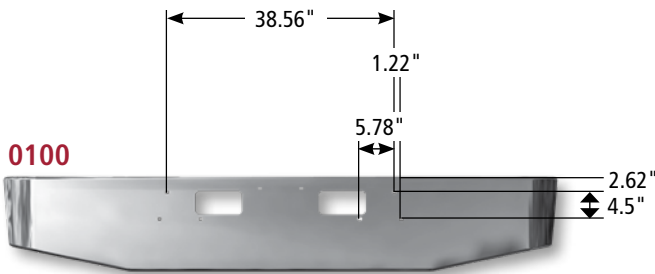

Ford L-Series conventional fits LN-LT-LTN 800, 900, 8000 and 9000 (Tow holes only). Fits trucks with 6V92 Detroit engine or 300 Cummins engine 1988 or newer (Axle forward only).

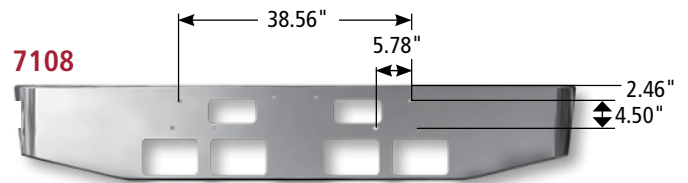

Ford Conventional LTL 9000 — Tow holes and four square light holes.

PART NO.	MATERIAL / FINISH	GAUGE / THICKNESS	STYLE	LIGHT CUTOUT	CENTER STEP CUTOUT	VENT CUTOUT	TOW COMPATIBLE	RADAR COMPATIBLE	EXCLUSIVE THROUGH OEM	YEAR	MOUNT / BRACKET
0100	Chrome	10Ga	16" Taper	N	N	N	Y	N	N	'88 - '96	N
7100	Chrome	8Ga	16" Taper	N	N	N	Y	N	N	'88 - '96	N
7108	Chrome	8Ga	16" Taper	4 Rectangle	N	N	Y	N	N	'88 - '96	N

FLC 112

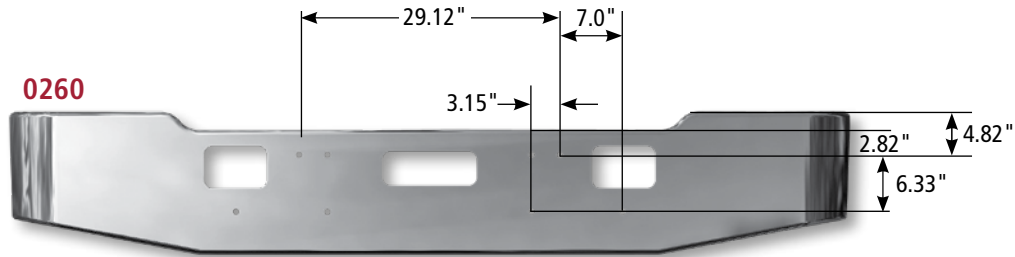

Freightliner® FLC-112

PART NO.	MATERIAL / FINISH	GAUGE / THICKNESS	STYLE	LIGHT CUTOUT	CENTER STEP CUTOUT	VENT CUTOUT	TOW COMPATIBLE	RADAR COMPATIBLE	EXCLUSIVE THROUGH OEM	YEAR	MOUNT / BRACKET
0260	Chrome	10Ga	16" Gullwing	N	Y	Y	Y	N	N	'86 - Newer	N
0261	Chrome	10Ga	16" Gullwing	2 Rectangle	Y	Y	Y	N	N	'86 - Newer	N

FLD 112 / FLD 120 / FLD 120 SEVERE DUTY

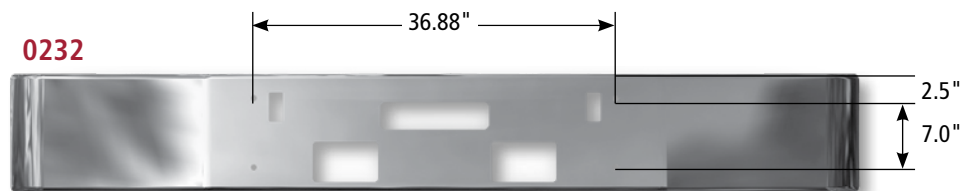

Freightliner FLD 112 (SD)

PART NO.	MATERIAL / FINISH	GAUGE / THICKNESS	STYLE	LIGHT CUTOUT	CENTER STEP CUTOUT	VENT CUTOUT	TOW COMPATIBLE	RADAR COMPATIBLE	EXCLUSIVE THROUGH OEM	YEAR	MOUNT / BRACKET
0232	Chrome	10Ga	12" 17" Set Back	2 Rectangle	Y	N	Y	N	N	'92 - '07	N
7233	Chrome	7Ga	6" 12" Break Back	2 Rectangle	Y	N	Y	N	N	'92 - '07	N

FLD 112 / FLD 120 / FLD 120 SEVERE DUTY cont.

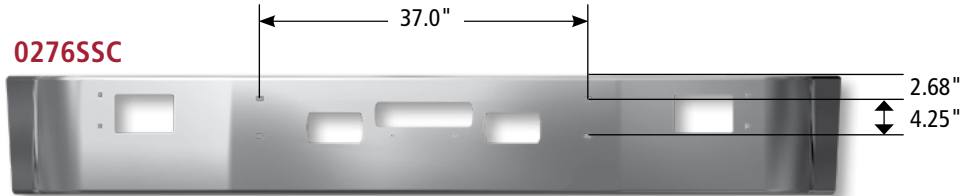

Freightliner® FLD 120

PART NO.	MATERIAL / FINISH	GAUGE / THICKNESS	STYLE	LIGHT CUTOUT	CENTER STEP CUTOUT	VENT CUTOUT	TOW COMPATIBLE	RADAR COMPATIBLE	EXCLUSIVE THROUGH OEM	YEAR	MOUNT / BRACKET
0275SSC¹	AERO CLAD®	0.125"	13.5" Set Back	N	Y	N	Y	N	N	'89 - '04	Y
0276BX¹	Steel Primed	10Ga	13.5" Set Back	2 Rectangle	Y	N	Y	N	N	'89 - '04	Y
0276SSC¹	AERO CLAD	0.125"	13.5" Set Back	2 Rectangle	Y	N	Y	N	N	'89 - '04	Y
0277SSC¹	AERO CLAD	0.125"	13.5" Set Back	N	Y	N	Y	N	N	'89 - '04	Y
0278SSC¹	AERO CLAD	0.125"	13.5" Set Back	2 Rectangle	Y	N	Y	N	N	'89 - '04	Y
0279SSC¹	AERO CLAD	0.125"	13.5" Set Back	N	Y	N	N	N	N	'89 - '04	Y

1. Braces and spacers included with bumper.

For models fitted with Per-Lux drive lights, use Freightliner back-up bar P/N A21-20133-003.

For models fitted with Marchal drive lights, use Freightliner back-up bar P/N A21-20133-000.

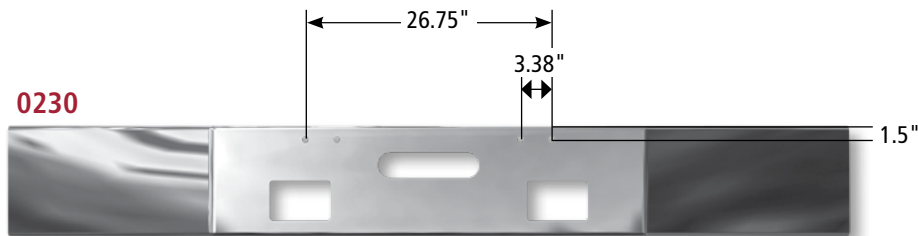

Fits FLD 120 Severe Duty

PART NO.	MATERIAL / FINISH	GAUGE / THICKNESS	STYLE	LIGHT CUTOUT	CENTER STEP CUTOUT	VENT CUTOUT	TOW COMPATIBLE	RADAR COMPATIBLE	EXCLUSIVE THROUGH OEM	YEAR	MOUNT / BRACKET
0230	Chrome	10Ga	12" 17" Set Back	2 Rectangle	Y	N	N	N	N	'86 - '08	N
7230	Chrome	7Ga	12" 17" Set Back	2 Rectangle	Y	N	N	N	N	'86 - '08	N
7240	Chrome	7Ga	12" 6" Break Back	2 Rectangle	Y	N	N	N	N	'86 - '09	N

FLD-CLASSIC

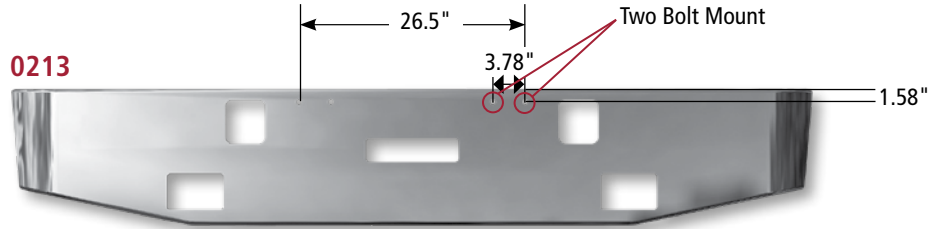

PART NO.	MATERIAL / FINISH	GAUGE / THICKNESS	STYLE	LIGHT CUTOUT	CENTER STEP CUTOUT	VENT CUTOUT	TOW COMPATIBLE	RADAR COMPATIBLE	EXCLUSIVE THROUGH OEM	YEAR	MOUNT / BRACKET
0213	Chrome	10Ga	16" Taper	2 Rectangle	N	N	Y	N	N	'02 - '10	N
0213SQ	Chrome	10Ga	18" Texas Square	2 Rectangle	N	N	Y	N	N	'02 - '10	N
0213SSCSQ	AERO CLAD®	0.125"	18" Texas Square	2 Rectangle	N	N	Y	N	N	'02 - '10	N
7213SQ	Chrome	7Ga	18" Texas Square	2 Rectangle	N	N	Y	N	N	'02 - '10	N
7213SQ12	Chrome	7Ga	12" Texas Square	2 Rectangle	N	N	Y	N	N	'02 - '10	N
7213SSC	AERO CLAD	0.160"	16" Taper	2 Rectangle	N	N	Y	N	N	'02 - '10	N
0216	Chrome	10Ga	16" Taper	N	N	N	Y	N	N	'02 - '10	N
0216SSCSQ	AERO CLAD	0.125"	18" Texas Square	N	N	N	Y	N	N	'02 - '10	N
7216	Chrome	7Ga	16" Taper	N	N	N	Y	N	N	'02 - '10	N
7216SQ	Chrome	7Ga	18" Texas Square	N	N	N	Y	N	N	'02 - '10	N
7216SSC	AERO CLAD	0.160"	16" Taper	N	N	N	Y	N	N	'02 - '10	N

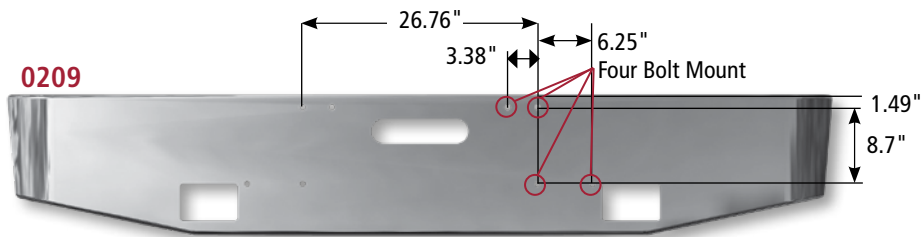

SEVERE DUTY

FLD-CLASSIC cont.

PART NO.	MATERIAL / FINISH	GAUGE / THICKNESS	STYLE	LIGHT CUTOUT	CENTER STEP CUTOUT	VENT CUTOUT	TOW COMPATIBLE	RADAR COMPATIBLE	EXCLUSIVE THROUGH OEM	YEAR	MOUNT / BRACKET
0207	Chrome	10Ga	16" Taper	N	Y	N	Y	N	N	'84 - '02	N
0207SQ	Chrome	10Ga	18" Texas Square	N	Y	N	Y	N	N	'84 - '02	N
0209	Chrome	10Ga	16" Taper	2 Rectangle	N	N	Y	N	N	'84 - '02	N
0209NL	Chrome	10Ga	16" Taper	N	N	N	Y	N	N	'84 - '02	N
0209NLSQ	Chrome	10Ga	18" Texas Square	N	N	N	Y	N	N	'84 - '02	N
0223SQ	Chrome	10Ga	18" Texas Square	N	N	N	N	N	N	'84 - '02	N
0267SQ12	Chrome	10Ga	12" Texas Square	N	N	N	Y	N	N	'84 - '02	N
7209	Chrome	7Ga	16" Taper	2 Rectangle	N	N	Y	N	N	'84 - '02	N
7209NLSQ	Chrome	7Ga	18" Texas Square	N	N	N	Y	N	N	'84 - '02	N
7250SSC	AERO CLAD	0.160"	16" Taper	2 Rectangle	N	N	Y	N	N	'84 - '02	N

122SD

PART NO.	MATERIAL / FINISH	GAUGE / THICKNESS	STYLE	LIGHT CUTOUT	CENTER STEP CUTOUT	VENT CUTOUT	TOW COMPATIBLE	RADAR COMPATIBLE	EXCLUSIVE THROUGH OEM	YEAR	MOUNT / BRACKET
7299SSC	AERO CLAD	0.160"	12" Set Forward	4 Rectangle	N	N	Y	N	N	'13 - Newer	N
7299NLSSC	AERO CLAD	0.160"	12" Set Forward	N	N	N	Y	N	N	'13 - Newer	N



BUSINESS CLASS

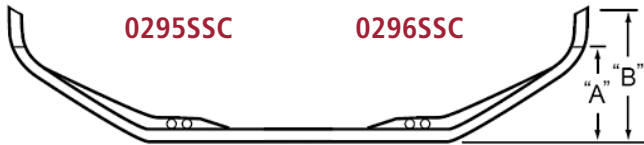

PART NO.	MODEL	LEG	DIMENSION
0296SSC	FL50, 60, 70, 80, 106	A	14.2"
0295SSC	FL50, 60, 70, 80, 106	B	19.9"



Freightliner® stainless steel clad aluminum fits Business Class

PART NO.	MATERIAL / FINISH	GAUGE / THICKNESS	STYLE	LIGHT CUTOUT	CENTER STEP CUTOUT	VENT CUTOUT	TOW COMPATIBLE	RADAR COMPATIBLE	EXCLUSIVE THROUGH OEM	YEAR	MOUNT / BRACKET
0295SSC	AERO CLAD®	0.125"	11" Set Back	2 Rectangle	Y	N	N	N	N	'97 - '04	N
0296SSC	AERO CLAD	0.125"	11" Set Back	2 Rectangle	Y	N	N	N	N	'97 - '04	N

CENTURY CLASS



Freightliner Century Class stainless steel clad aluminum — Includes brackets (Installed)¹

PART NO.	MATERIAL / FINISH	GAUGE / THICKNESS	STYLE	LIGHT CUTOUT	CENTER STEP CUTOUT	VENT CUTOUT	TOW COMPATIBLE	RADAR COMPATIBLE	EXCLUSIVE THROUGH OEM	YEAR	MOUNT / BRACKET
0290SSC ¹	AERO CLAD	0.125"	14.5" Set Back	N	Y	N	Y	N	N	'96 - '03	Y
0291SSC	AERO CLAD	0.125"	14.5" Set Back	N	Y	N	Y	N	N	'04 - '07	Y

1. Additional OEM hardware will be required for installation on '96-'03 truck model:
 Mounting bracket (P/N: A21-25693-000 LH & A21-25693-001 RH) and spacer (2 required, P/N: 23-11427-038)
 available from your Freightliner dealer. Drill 14mm hole in top mounting bracket for pre-1997 Century Class.

COLUMBIA



Freightliner® Columbia stainless steel clad aluminum

PART NO.	LEG	DIMENSION
0292SSC¹	A	25.15"
0293SSC²	B	28.34"

1. When replacing factory bumper you must refer to Freightliner Bill of Material T80133.
2. When replacing factory bumper you must refer to Freightliner Bill of Material T80132.

PART NO.	MATERIAL / FINISH	GAUGE / THICKNESS	STYLE	LIGHT CUTOUT	CENTER STEP CUTOUT	VENT CUTOUT	TOW COMPATIBLE	RADAR COMPATIBLE	EXCLUSIVE THROUGH OEM	YEAR	MOUNT / BRACKET
0292SSC	AERO CLAD®	0.125"	14.5" Set Back	N	Y	N	Y	N	N	'04 -'07	N
0293SSC	AERO CLAD	0.125"	14.5" Set Back	N	Y	N	Y	N	N	Prior to '04	N

New CASCADIA®

H AERO CLAD® Stainless Steel Clad Aluminum Bumper

Features and Benefits

- Lightweight design
- Easy installation to factory mounts
- Durable, bright mirrored finish
- Up to 10 times thicker finish than typical chrome finish
- Resists corrosion, cracking, pitting, peeling and fading
- Quality, American made product
- Ground clearance – 5.5 inches higher relative to OE Aero Package
- Minor abrasions can be buffed
- Full 5-year limited warranty*



*Contact your local Hendrickson representative for complete warranty terms, conditions and limitations.

PART NO.	MATERIAL / FINISH	GAUGE / THICKNESS	STYLE	LIGHT CUTOUT	CENTER STEP CUTOUT	VENT CUTOUT	TOW COMPATIBLE	RADAR COMPATIBLE ¹	EXCLUSIVE THROUGH OEM	YEAR	MOUNT / BRACKET ²	LICENSE PLATE HOLES
FF2200NLSSC	AERO CLAD®	0.125"	Closed End	N	N	Y	Y	Y	Y	2018 - Newer	N	Y
FF2200SSC	AERO CLAD	0.125"	Closed End	Y	N	Y	Y	Y	Y	2018 - Newer	N	Y

1. Contact local dealer to discuss radar options.

2. Mounting brackets, associated hardware and installation instructions are available from your Freightliner dealer.

OEM Bracket Numbers - Sold through OEM

DESCRIPTION	DAIMLER P/N	REQUIREMENTS FOR DAIMLER BUMPER			
		21-28840-004	21-28840-005	21-28840-006	21-28840-007
Mounting Bracket LH / RH	21-28841-006 / -007	X	X	X	X
Back Reinforcement Bracket LH / RH	21-29016-002 / -003	X	X	X	X
Bracket Frame LH / RH	A21-29018-000 / -001	X	X	X	X
Fog Lamp Bracket LH / RH	66-05687-000 / -001		X		X
Fog Lamp Bracket LH / RH	66-05812-000		X		X
WABCO® OnGuard Radar Mounting Bracket	66-06125-000	*	*	*	*
Detroit Assurance Radar Mounting Bracket	66-06125-001	*	*	*	*
Non Radar Screen	21-28972-000	*	*	*	*
Radar Compatible Screens LH / RH	21-28972-001 / -002	*	*	*	*
Radar Cover for AERO CLAD Bumper	66-06345-000	*	*	*	*
Screen Mounting Brackets	21-29203-000	X	X	X	X

* Conversion from an OEM plastic bumper to AERO CLAD requires the corresponding screens, four screen mounting brackets and radar system mount bracket, if equipped. Mounting brackets, screens, associated hardware and installation instructions are available from your Freightliner dealer.

Painted Aluminum CASCADIA®

Features and Benefits

- Lightweight design
- Easy installation
- Ground Clearance – 5.5 inches higher relative to OE AERO Package
- 7lbs lighter than the standard OE plastic bumper
- Integrated look to match OE composite trim package
- Dark grey matte painted finish offers a durable solution that will not fade compared to OE plastic bumpers
- Minor abrasions can be painted



PART NO.	GAUGE / THICKNESS	STYLE	LIGHT CUTOUT ¹	CENTER STEP CUTOUT	VENT CUTOUT	TOW COMPATIBLE	RADAR COMPATIBLE ²	EXCLUSIVE THROUGH OEM	YEAR	MOUNT / BRACKET ³	LICENSE PLATE HOLE	ADAPTER PLATE ⁴
FF4201	0.125"	Closed End	Y	N	Y	Y	Y	Y	2018 - Newer	Y	Y	N
FF4201NL	0.125"	Closed End	N	N	Y	Y	Y	Y	2018 - Newer	Y	Y	N
FF4202	0.125"	Closed End	Y	N	Y	Y	Y	Y	2018 - Newer	Y	Y	Y
FF4202NL	0.125"	Closed End	N	N	Y	Y	Y	Y	2018 - Newer	Y	Y	Y

1. Part numbers that have light cutouts to accommodate lights will require Fog Lamp Brackets listed in the chart below. Available through your local Freightliner dealer.
2. Contact local dealer to discuss radar options.
3. Bumpers above include mounting brackets (and associated hardware) that eliminate the need for OE bracket parts 21-28841-006/007 and 21-29016-002/00.
4. Bumpers noted above include adapter plates when replacing an OE plastic bumper with a Hendrickson painted aluminum bumper, eliminating the need for OE part numbers A21-29018-000/001.

OEM Bracket and Screen Numbers - Sold Through Freightliner Dealer

REQUIREMENTS FOR ALL MAKES BUMPERS			
DESCRIPTION	HENDRICKSON PART NUMBER	FF4201NL / FF4202NL	FF4201 / FF4202
	DAIMLER PART NUMBER	21-28840-004 / 006	21-28840-005 / 007
Fog Lamp Bracket LH / RH	66-05687-000 / -001		X
Fog Lamp Bracket LH / RH	66-05812-000		X
WABCO® OnGuard Radar Mounting Bracket	66-06125-000	*	*
Detroit Assurance Radar Mounting Bracket	66-06125-0001	*	*
Non Radar Screen	21-28972-000	*	*
Radar Compatible Screen LH/ RH	21-28972-001 / -002	*	*
Radar Cover for AERO CLAD® Bumper	66-06345-000	*	*
Screen Mounting Brackets	21-29203-000	X	X

Items listed in this chart are not included with Hendrickson Painted Aluminum Bumpers. Conversion from an OEM plastic bumper requires items marked with an "X". Items marked with an "" are also required per your truck configuration. Contact your local Freightliner Dealer for pricing and availability.



Classic CASCADIA®

H AERO CLAD®

Stainless Steel Clad Aluminum Bumper

Features and Benefits

- Durable, bright mirrored finish
- Up to 10 times thicker finish than typical chrome finish
- Resists corrosion, cracking, pitting, peeling and fading
- Increased ground clearance
- Lightweight design to help enhance fuel efficiency
- Minor abrasions can be buffed
- Full 5-year limited warranty*

*Contact your local Hendrickson representative for complete warranty terms, conditions and limitations.



PART NO.	MATERIAL / FINISH	GAUGE / THICKNESS	STYLE	LIGHT CUTOUT	CENTER STEP CUTOUT	VENT CUTOUT	TOW COMPATIBLE	RADAR COMPATIBLE ³	EXCLUSIVE THROUGH OEM	YEAR	MOUNT / BRACKET ⁴	LICENSE PLATE HOLES
0256NLSSC¹	AERO CLAD®	0.125"	15" Closed End	N	Y	Y	Y	Y	N	'08 - '19	Y	Y
0256SSC¹	AERO CLAD	0.125"	15" Closed End	2 Oval	Y	Y	Y	Y	N	'08 - '19	Y	Y
0257NLSSC²	AERO CLAD	0.125"	15" Closed End	N	Y	Y	Y	Y	N	'08 - '19	Y	Y
0257SSC²	AERO CLAD	0.125"	15" Closed End	2 Oval	Y	Y	Y	Y	N	'08 - '19	Y	Y
FF02C1SSC¹	AERO CLAD	0.125"	15" Closed End	2 Oval	Y	Y	Y	Y	Y	'08 - '19	Y	N
FF02C1NLSSC¹	AERO CLAD	0.125"	15" Closed End	N	Y	Y	Y	Y	Y	'08 - '19	Y	N
FF02C2SSC²	AERO CLAD	0.125"	15" Closed End	2 Oval	Y	Y	Y	Y	Y	'08 - '19	Y	N
FF02C2NLSSC²	AERO CLAD	0.125"	15" Closed End	N	Y	Y	Y	Y	Y	'08 - '19	Y	N

1. Kit includes hardware needed to replace OEM plastic bumper and includes top fillers.

2. Assembly when replacing existing AERO CLAD® bumper. Top fillers sold separately.

3. Contact your local dealer to discuss radar options.

4. Classic Cascadia trucks configured with a large capacity radiator, require mounting brackets A21-28537-000 and A21-28537-001. Available from your Freightliner dealer.

CASCADIA Trim Options

Top Filler Replacements

PART NO.	MATERIAL / FINISH	GAUGE / THICKNESS	STYLE	LIGHT CUTOUT	CENTER STEP CUTOUT	VENT CUTOUT	TOW COMPATIBLE	RADAR COMPATIBLE	EXCLUSIVE THROUGH OEM	YEAR	MOUNT / BRACKET
0256TFLK	TPO	–	Top Fillers	–	–	–	–	–	N	'08 - '19	–
0256TFRK	TPO	–	Top Fillers	–	–	–	–	–	N	'08 - '19	–



M2

H AERO CLAD®

Stainless Steel Clad Aluminum Bumper

Features and Benefits

- Lightweight design
- Easy installation to factory mounts
- Durable, bright mirrored finish
- Up to 10 times thicker finish than typical chrome finish
- Resists corrosion, cracking, pitting, peeling and fading
- Quality, American made product
- Minor abrasions can be buffed
- Full 5-year limited warranty*



**Contact your local Hendrickson representative for complete warranty terms, conditions and limitations.*

PART NO.	MATERIAL / FINISH	GAUGE / THICKNESS	STYLE	LIGHT CUTOUT	CENTER STEP CUTOUT	VENT COMPATIBLE	TOW COMPATIBLE	EXCLUSIVE THROUGH OEM	YEAR	MOUNT / BRACKET	LICENSE PLATE HOLES
FF5212SSC	AERO CLAD®	0.160"	14" Set Back	N	N	Y	Y	Y	'12 - Newer	Y	Y



INTERNATIONAL®

HX™

H AERO CLAD® Stainless Steel Clad Aluminum Bumper

Features and Benefits

- Durable, bright mirrored finish
- Up to 10 times thicker finish than typical chrome finish
- Resists corrosion, cracking, pitting, peeling and fading
- High ground clearance
- Lightweight design
- Minor abrasions can be buffed
- Full 5-year limited warranty*

** Contact your local Hendrickson representative for complete warranty terms, conditions and limitations.*



PART NO.	MATERIAL / FINISH	GAUGE / THICKNESS	STYLE	LIGHT CUTOUT	CENTER TOW CUTOUT*	TOW COMPATIBLE	RADAR COMPATIBLE*	EXCLUSIVE THROUGH OEM	YEAR	TIRE SHIELDS
AM5433SSC	AERO CLAD®	0.160"	12" Set Back	Y	N	Y	N	Y	All	N
AM54C3NLSSC	AERO CLAD	0.160"	12" Set Back	N	N	Y	N	Y	All	N
AM54C4SSC	AERO CLAD	0.160"	12" Set Back	Y	Y	Y	Y	Y	All	N
AM54C4NLSSC	AERO CLAD	0.160"	12" Set Back	N	Y	Y	Y	Y	All	N
24C1SSC	AERO CLAD	0.125"	Set Forward 18" Texas Square	Y	N	Y	N	Y	All	Y
24C1NLSSC	AERO CLAD	0.125"	Set Forward 18" Texas Square	N	N	Y	N	Y	All	Y
24C2SSC	AERO CLAD	0.125"	Set Forward 18" Texas Square	Y	Y	Y	Y	Y	All	Y
24C2NLSSC	AERO CLAD	0.125"	Set Forward 18" Texas Square	N	Y	Y	Y	Y	All	Y
54C5SSC	AERO CLAD	0.160"	Set Forward 16" Taper	Y	N	Y	N	N	All	N
54C5NLSSC	AERO CLAD	0.160"	Set Forward 16" Taper	N	N	Y	N	N	All	N
54C6SSC	AERO CLAD	0.160"	Set Forward 16" Taper	Y	Y	Y	Y	N	All	N
54C6NLSSC	AERO CLAD	0.160"	Set Forward 16" Taper	N	Y	Y	Y	N	All	N

* Bumper is compatible with either a center tow or radar.



INTERNATIONAL®

LT®

H AERO CLAD® Stainless Steel Clad Aluminum Bumper

Features and Benefits

- Durable, bright mirrored finish
- Up to 10 times thicker finish than typical chrome finish
- Resists corrosion, cracking, pitting, peeling and fading
- High ground clearance
- Lightweight design
- Minor abrasions can be buffed
- Includes rock screens
- Includes plastic top fillers
- Full 5-year limited warranty*

*Contact your local Hendrickson representative for complete warranty terms, conditions and limitations.



PART NO.	MATERIAL / FINISH	GAUGE / THICKNESS	LIGHT CUTOUT	CENTER STEP CUTOUT	VENT CUTOUT	TOW COMPATIBLE	RADAR COMPATIBLE	EXCLUSIVE THROUGH OEM	YEAR	MOUNT	BRACKET
AM0453SSC	AERO CLAD®	0.125"	Y	N	Y	Y	N	Y	'17 - Newer	Fixed Mount	None
AM0454VSSC	AERO CLAD	0.125"	Y	N	Y	Y	Y	Y	'17 - Newer	Fixed Mount	None
AM0460BKTK	Bracket Mounting Kit							Y	Feb. '14 - Newer	Fixed Mount	Brackets Only

NOTE: Converting OEM Composite Bumper to AM0453SSC requires bracket kit AM0460BKTK and fog lights 3815291C91 (clear) or 3803013C91 (Halogen).

Top Filler Replacements

PART NO.	MATERIAL / FINISH	GAUGE / THICKNESS	STYLE	LIGHT CUTOUT	CENTER STEP CUTOUT	VENT CUTOUT	TOW COMPATIBLE	RADAR COMPATIBLE	EXCLUSIVE THROUGH OEM	YEAR
AM0453TFK	TPO	-	Top Fillers	-	-	-	-	-	Y	'17 - Newer

NOTE: Top filler kit includes both driver and passenger side replacements.



INTERNATIONAL®

PROSTAR® / RH®

H AERO CLAD® Stainless Steel Clad Aluminum Bumper

Features and Benefits

- Durable, bright mirrored finish
- Up to 10 times thicker finish than typical chrome finish
- Resists corrosion, cracking, pitting, peeling and fading
- High ground clearance
- Lightweight design
- Minor abrasions can be buffed
- Includes rock screens
- Includes plastic top fillers
- Full 5-year limited warranty*

* Contact your local Hendrickson representative for complete warranty terms, conditions and limitations.



PART NO.	MATERIAL / FINISH	GAUGE / THICKNESS	LIGHT CUTOUT	CENTER STEP CUTOUT	VENT CUTOUT	TOW COMPATIBLE	RADAR COMPATIBLE	EXCLUSIVE THROUGH OEM	YEAR	MOUNT	MOUNT / BRACKET
AM0449SSC	AERO CLAD®	0.125"	Y	N	Y	Y	N	Y	'09 - Older	Tilt Mount	Brackets Included*
AM0450SSC	AERO CLAD	0.125"	Y	N	Y	Y	N	Y	'10 - Newer	Fixed Mount	None
AM0455VSSC	AERO CLAD	0.125"	Y	N	Y	Y	Y	Y	'10 - Newer	Fixed Mount	None
AM0451SSC	AERO CLAD	0.125"	Y	N	Y	Y	N	Y	All	Tilt Mount	Brackets Included
AM0460SSCAK	AERO CLAD	0.125"	Y	N	Y	Y	N	Y	'14 - Newer	Fixed Mount	Brackets Included
AM0460BKTK	Bracket Mounting Kit							-	'14 - Newer	Fixed Mount	Brackets Only

NOTE: Converting OEM Fixed Mount Bumper with AM0451SSC will require two additional brackets through OEM.

* Does not include tilt and latch brackets

Top Filler Replacements

PART NO.	MATERIAL / FINISH	GAUGE / THICKNESS	STYLE	LIGHT CUTOUT	CENTER STEP CUTOUT	VENT CUTOUT	TOW COMPATIBLE	RADAR COMPATIBLE	EXCLUSIVE THROUGH OEM	YEAR
AM0449TFK	TPO	-	Top Fillers	-	-	-	-	-	Y	All

NOTE: Top filler kit includes both driver and passenger side replacements.



INTERNATIONAL®

LONESTAR®

AERO CLAD® Stainless Steel Clad Aluminum Bumper

Features and Benefits

- Durable, bright mirrored finish
- Up to 10 times thicker finish than typical chrome finish
- Resists corrosion, cracking, pitting, peeling and fading
- Lightweight design
- Minor abrasions can be buffed
- Full 5-year limited warranty*

*Contact your local Hendrickson representative for complete warranty terms, conditions and limitations.



PART NO.	MATERIAL / FINISH	GAUGE / THICKNESS	LIGHT CUTOUT	CENTER STEP CUTOUT	VENT CUTOUT	TOW COMPATIBLE	RADAR COMPATIBLE	EXCLUSIVE THROUGH OEM	YEAR	MOUNT / BRACKET
AM2461SSC	AERO CLAD®	0.125"	Y	N	Y	Y	Y	Y	'08 - Newer	Y
AM2460SSC	AERO CLAD	0.125"	Y	N	Y	Y	N	Y	'08 - Newer	Y

NOTE: Includes primer coated top trim pieces, lights, wiring harness, rock screen and hardware.

2008 to 2016 models requires mounting braces 4057544C3 and 4057545C3. Not retrofittable to the special edition Harley Davidson® model.

Rock Guard

PART NO.	MATERIAL / FINISH	GAUGE / THICKNESS	LIGHT CUTOUT	CENTER STEP CUTOUT	VENT CUTOUT	TOW COMPATIBLE	RADAR COMPATIBLE	EXCLUSIVE THROUGH OEM	YEAR
602300S	Stainless Steel	0.06"	N/A	N/A	Y	N/A	Y	Y	'17 - Newer
602256S	Stainless Steel	0.06"	N/A	N/A	Y	N/A	N	Y	'17 - Newer

Top Filler Replacements

PART NO.	MATERIAL / FINISH	GAUGE / THICKNESS	STYLE	LIGHT CUTOUT	CENTER STEP CUTOUT	VENT CUTOUT	TOW COMPATIBLE	RADAR COMPATIBLE	MODEL	EXCLUSIVE THROUGH OEM	YEAR	MOUNT / BRACKET
602209KXS	TPO	—	Top Fillers	—	—	—	—	—	LoneStar®	Y	All	—

NOTE: Top filler kits include both driver and passenger side replacements and associated mounting hardware.



INTERNATIONAL®

MV™

H AERO CLAD®

Stainless Steel Clad Aluminum Bumper

Features and Benefits

- Lightweight design
- Easy installation to factory mounts
- Durable, bright mirrored finish
- Resists corrosion, cracking, pitting, peeling and fading
- Quality, American made product
- Minor abrasions can be buffed
- Full 5-year limited warranty*

**Contact your local Hendrickson representative for complete warranty terms, conditions and limitations.*



PART NO.	MATERIAL	GAUGE / THICKNESS	STYLE	LIGHT CUTOUT	CENTER STEP CUTOUT	VENT CUTOUT	TOW COMPATIBLE	RADAR COMPATIBLE	EXCLUSIVE THROUGH OEM	YEAR	MOUNT / BRACKETS	LICENSE PLATE HOLES
24D7SSCA	AERO CLAD	.125"	13.5" Open End	N	N	Y	Y	Y	N	15' - Newer	Y	Y



INTERNATIONAL®

VISION 98 - 9200i / 9400i

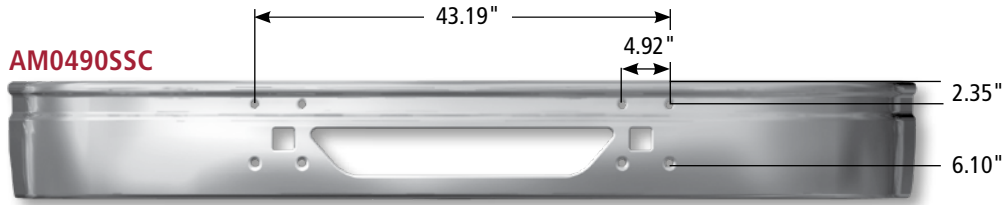

PART NO.	MATERIAL / FINISH	GAUGE / THICKNESS	STYLE	LIGHT CUTOUT	CENTER STEP CUTOUT	VENT CUTOUT	TOW COMPATIBLE	RADAR COMPATIBLE	EXCLUSIVE THROUGH OEM	YEAR	MOUNT / BRACKET
AM0442SSC	AERO CLAD®	0.125"	12" Set Back	N	N	Y	Y	Y	N	'97 - Newer	N
AM0490SSC	AERO CLAD	0.125"	12" Set Back	N	N	Y	Y	N	N	'97 - Newer	N
AM0490X	Aluminum Primed	0.179"	12" Set Back	N	N	Y	Y	N	N	'97 - Newer	N

5000

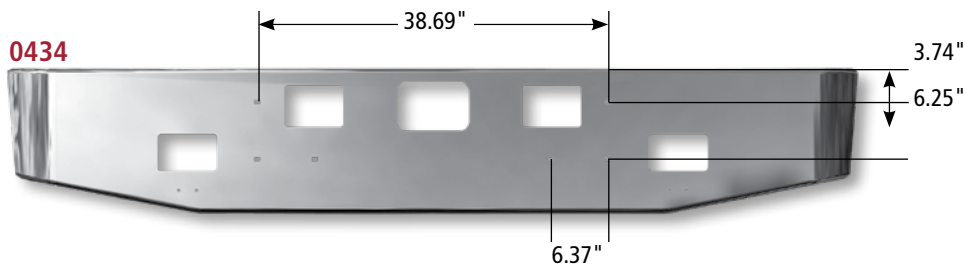

5900 Conventional Series

PART NO.	MATERIAL / FINISH	GAUGE / THICKNESS	STYLE	LIGHT CUTOUT	CENTER STEP CUTOUT	VENT CUTOUT	TOW COMPATIBLE	RADAR COMPATIBLE	EXCLUSIVE THROUGH OEM	YEAR	MOUNT / BRACKET
0434	Chrome	10Ga	16" Taper	2 Rectangle	Y	N	Y	N	N	—	N
0434SQ	Chrome	0.122"	18" Texas Square	2 Rectangle	Y	N	Y	N	N	—	N





9000, 9670 COE and 9370

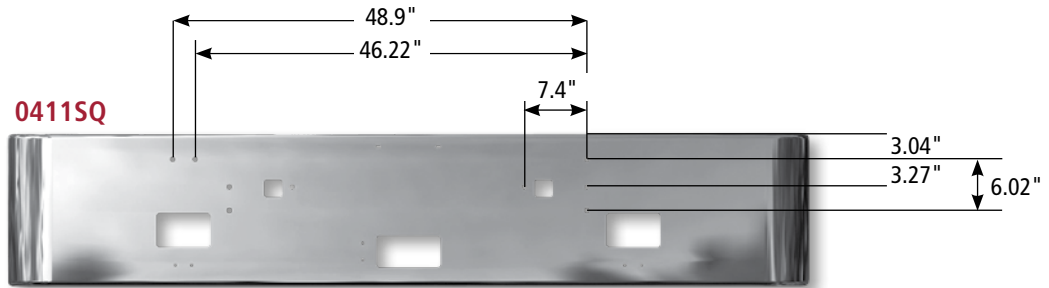

9370 Conventional Series

PART NO.	MATERIAL / FINISH	GAUGE / THICKNESS	STYLE	LIGHT CUTOUT	CENTER STEP CUTOUT	VENT CUTOUT	TOW COMPATIBLE	RADAR COMPATIBLE	EXCLUSIVE THROUGH OEM	YEAR	MOUNT / BRACKET
0410	Chrome	10Ga	16" Taper	N	Y	N	Y	N	N	—	N
0410SQ	Chrome	0.125"	18" Texas Square	N	Y	N	Y	N	N	—	N
0411	Chrome	10Ga	16" Taper	2 Rectangle	Y	N	Y	N	N	—	N
0411SQ	Chrome	0.125"	18" Texas Square	2 Rectangle	Y	N	Y	N	N	—	N
0416SQ	Chrome	0.125"	18" Texas Square	N	N	N	Y	N	N	—	N
0417SQ	Chrome	10Ga	18" Texas Square	9 Oval	N	N	Y	N	N	—	N

9900i CONVENTIONAL

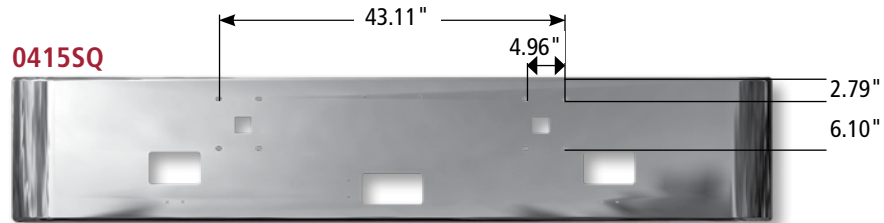

PART NO.	MATERIAL / FINISH	GAUGE / THICKNESS	STYLE	LIGHT CUTOUT	CENTER STEP CUTOUT	VENT CUTOUT	TOW COMPATIBLE	RADAR COMPATIBLE	EXCLUSIVE THROUGH OEM	YEAR	MOUNT / BRACKET
0415	Chrome	10Ga	16" Taper	2 Rectangle	Y	N	Y	N	N	'96 - Newer	N
0415NL	Chrome	10Ga	16" Taper	N	Y	N	Y	N	N	'96 - Newer	N
0415NLSQ	Chrome	0.125"	18" Texas Square	N	Y	N	Y	N	N	'96 - Newer	N
0415SQ	Chrome	0.125"	18" Texas Square	2 Rectangle	Y	N	Y	N	N	'96 - Newer	N
0415SSCSQ*	AERO CLAD®	0.125"	18" Texas Square	2 Rectangle	Y	N	Y	N	N	'96 - Newer	N
0425SQ	Chrome	0.125"	18" Texas Square	N	N	N	Y	N	N	'96 - Newer	N

NOTE: AERO CLAD® Texas Square (0415SSCSQ) requires separate purchase of stiffener brackets P/N 3523291C1 LH and 3523292C1 RH.

*Fits 1996 year and newer.

9200 / 9400

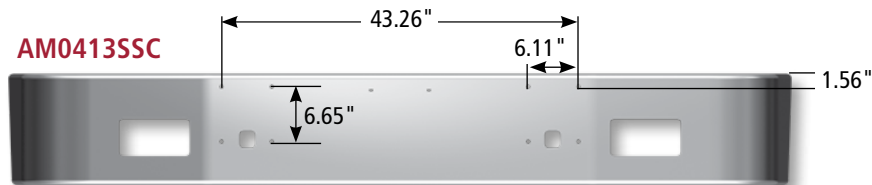

PART NO.	MATERIAL / FINISH	GAUGE / THICKNESS	STYLE	LIGHT CUTOUT	CENTER STEP CUTOUT	VENT CUTOUT	TOW COMPATIBLE	RADAR COMPATIBLE	EXCLUSIVE THROUGH OEM	YEAR	MOUNT / BRACKET
AM0413SSC	AERO CLAD®	0.125"	13.5" Set Back 9200 Series	2 Rectangle	N	N	Y	N	N	'96 - Newer	N
AM0414SSC	AERO CLAD	0.125"	13.5" Set Back 9400 Series	2 Rectangle	N	N	Y	N	N	'96 - Newer	N



7000 / WORKSTAR

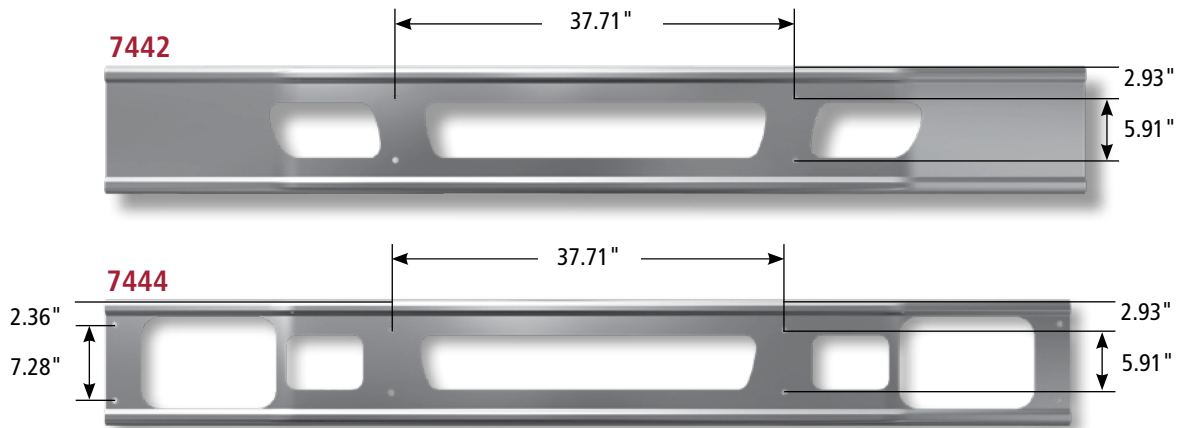

PART NO.	MATERIAL / FINISH	GAUGE / THICKNESS	STYLE	LIGHT CUTOUT	CENTER STEP CUTOUT	VENT CUTOUT	TOW COMPATIBLE	RADAR COMPATIBLE	EXCLUSIVE THROUGH OEM	YEAR	MOUNT / BRACKET
7442BX	Steel Primed	7Ga	12" Set Forward	2 Rectangle	N	Y	Y	N	N	A	N
7442	Chrome	7Ga	12" Set Forward	2 Rectangle	N	Y	Y	N	N	A	N
7442SSC	AERO CLAD®	0.160"	12" Set Forward	2 Rectangle	N	Y	Y	N	N	A	N
7444BX	Steel Primed	7Ga	12" Set Forward	2 Rectangle	N	Y	Y	N	N	A	N
7444	Chrome	7Ga	12" Set Forward	2 Rectangle	N	Y	Y	N	N	A	N
7444SSC	AERO CLAD	0.160"	12" Set Forward	2 Rectangle	N	Y	Y	N	N	A	N
7445BX	Steel Primed	7Ga	12" Set Back	2 Rectangle	N	Y	Y	N	N	A	N
7445	Chrome	7Ga	12" Set Back	2 Rectangle	N	Y	Y	N	N	A	N
7445SSC	AERO CLAD	0.160"	12" Set Back	2 Rectangle	N	Y	Y	N	N	A	N
7467BX	Steel Primed	7Ga	12" Set Forward	2 Rectangle	N	Y	Y	N	Y	A	N
7467	Chrome	7Ga	12" Set Forward	2 Rectangle	N	Y	Y	N	Y	A	N
7468BX	Steel Primed	7Ga	12" Set Back	2 Rectangle	N	Y	Y	N	Y	B	N
7468	Chrome	7Ga	12" Set Back	2 Rectangle	N	Y	Y	N	Y	B	N
7469SSC	AERO CLAD	0.160"	12" Set Back	2 Rectangle	N	Y	Y	N	Y	C	N

APPLICATION GUIDELINES		
A	B	C
7300 – Oct. 2001 and Newer	7300 – Oct. 2001 and Newer	7400 – July 2001 and Newer
7400 – July 2001 and Newer	7400 – July 2001 and Newer	7500 – July 2001 and Newer
7500 – July 2001 and Newer	7500 – July 2001 and Newer	7600 – April 2002 and Newer
7600 – April 2002 and Newer	7600 – April 2002 and Newer	
	7700 – Dec. 2003 and Newer	

T300



PART NO.	MATERIAL / FINISH	GAUGE / THICKNESS	STYLE	LIGHT CUTOUT	CENTER STEP CUTOUT	VENT CUTOUT	TOW COMPATIBLE	RADAR COMPATIBLE	EXCLUSIVE THROUGH OEM	YEAR	MOUNT / BRACKET
0588SSC	AERO CLAD®	0.125"	12" Set Back	N	Y	N	Y	N	N	All	N
0589SSC	AERO CLAD	0.125"	12" Set Back	N	N	N	Y	N	N	All	N
7588BX	Steel Primed	7Ga	12" Set Back	N	Y	N	Y	N	N	All	N
7589BX	Steel Primed	7Ga	12" Set Back	N	N	N	Y	N	N	All	N

T600



PART NO.	MATERIAL / FINISH	GAUGE / THICKNESS	STYLE	LIGHT CUTOUT	CENTER STEP CUTOUT	VENT CUTOUT	TOW COMPATIBLE	RADAR COMPATIBLE	EXCLUSIVE THROUGH OEM	YEAR	MOUNT / BRACKET
0561BX	Steel Primed	10Ga	14" Set Back	N	Y	Y	Y	Y	N	'85 - '07	N
0562SSC	AERO CLAD	0.125"	14" Set Back	N	Y	Y	Y	Y	N	'85 - '07	N





T680

H AERO CLAD®

Stainless Steel Clad Aluminum Bumper

Features and Benefits

- Lightweight design
- Easy installation to factory mounts
- Durable, bright mirrored finish
- Up to 10 times thicker finish than typical chrome finish
- Resists corrosion, cracking, pitting, peeling and fading
- 65 pounds lighter than OEM bumper
- Quality American made product
- Improved ground clearance – up to 3.75 inches
- Minor abrasions can be buffed
- Full 5-year limited warranty*

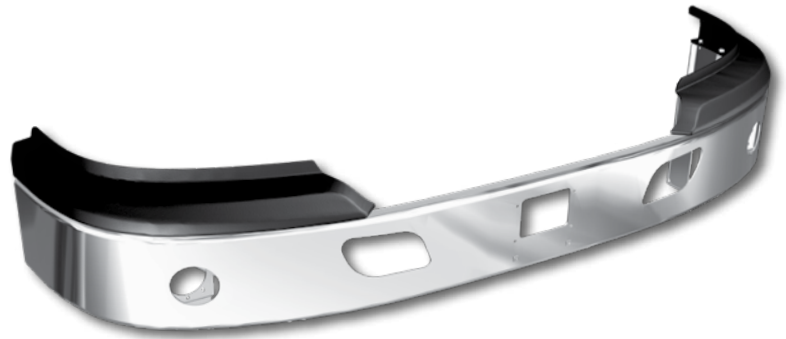

* Contact your local Hendrickson representative for complete warranty terms, conditions and limitations.

PART NO.	MATERIAL / FINISH	GAUGE / THICKNESS	STYLE	LIGHT CUTOUT	CENTER STEP CUTOUT	VENT CUTOUT	TOW COMPATIBLE	RADAR COMPATIBLE	EXCLUSIVE THROUGH OEM	YEAR	MOUNT / BRACKET
2550NLSSCA	AERO CLAD®	0.125"	10" Set Back	N	N	N	Y	N	N	ALL	Y
2550NLVSSCA	AERO CLAD	0.125"	10" Set Back	N	N	N	Y	Y	N	ALL	Y
2550SSCA	AERO CLAD	0.125"	10" Set Back	Y	N	N	Y	N	N	ALL	Y
2550VSSCA	AERO CLAD	0.125"	10" Set Back	Y	N	N	Y	Y	N	ALL	Y

Note: All part numbers include plastic fillers

Note: Fog lights, H4070-83235LI and H4070-83235RI, are available through your Kenworth dealer

Ground clearance: OEM bumper compared to AERO CLAD



Note: Hendrickson AERO CLAD bumper improves ground clearance by 3.75 inches when compared to the OEM bumper

**2550NLVSSCA shown above

T800 / T880

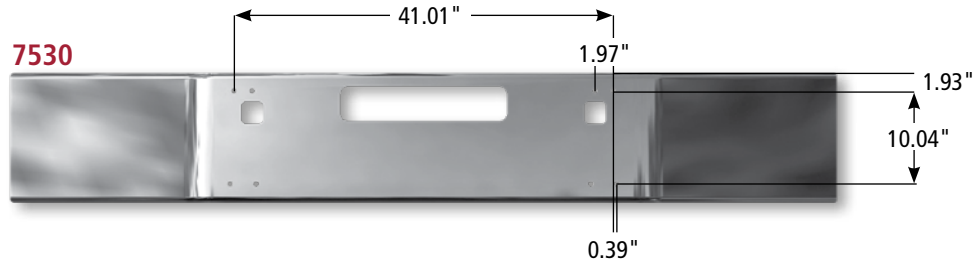

PART NO.	MATERIAL / FINISH	GAUGE / THICKNESS	STYLE	LIGHT CUTOUT	CENTER STEP CUTOUT	VENT CUTOUT	TOW COMPATIBLE	RADAR COMPATIBLE	EXCLUSIVE THROUGH OEM	YEAR	MOUNT / BRACKET
0530NT	Chrome	10Ga	14" Open End	N	N	Y	N	N	N	'86 - '04	N
0530	Chrome	10Ga	14" Open End	N	N	Y	Y	N	N	'86 - '04	N
7530	Chrome	7Ga	14" Open End	N	N	Y	Y	N	N	'86 - '04	N
7530BX	Steel Primed	7Ga	14" Open End	N	N	Y	Y	N	N	'86 - '04	N
5530SSC	AERO CLAD®	0.160"	14" Open End	N	N	Y	Y	N	N	'86 - '04	N
7531	Chrome	7Ga	14" Open End	2 Rectangle	N	Y	Y	N	N	'86 - '04	N
5531SSC	AERO CLAD	0.160"	14" Open End	2 Rectangle	N	Y	Y	N	N	'86 - '04	N
7540	Chrome	7Ga	14" Taper	N	N	Y	Y	N	N	'86 - '04	N
7542'	Chrome	7Ga	14" Taper	N	N	Y	Y	N	N	'86 - '04	N
7543	Chrome	7Ga	14" Taper	2 Rectangle	N	Y	Y	N	N	'86 - '04	N
0544'	Chrome	10Ga	14" Taper	2 Rectangle	N	Y	Y	N	N	'86 - '04	N

Conventional with 7-inch break-back

1. Surface Mount Hitch



KENWORTH®

T800 / T880 cont.

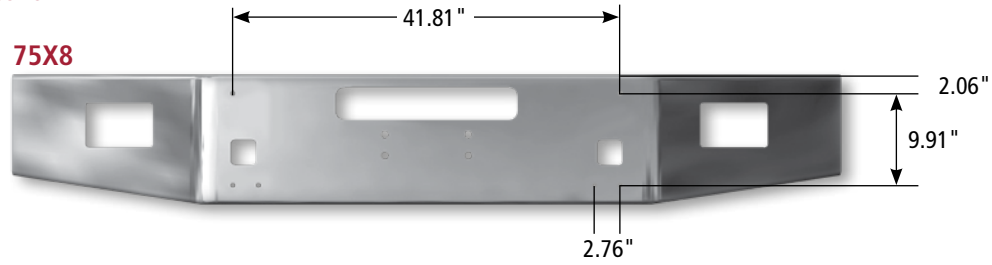

PART NO.	MATERIAL / FINISH	GAUGE / THICKNESS	STYLE	LIGHT CUTOUT	CENTER STEP CUTOUT	VENT CUTOUT	TOW COMPATIBLE	RADAR COMPATIBLE	EXCLUSIVE THROUGH OEM	YEAR	MOUNT / BRACKET
55X0NLSSC	AERO CLAD®	0.160"	14" Open End	N	N	Y	Y	N	Y	'04 - Newer	N
55X0SSC	AERO CLAD	0.160"	14" Open End	2 Rectangle	N	Y	Y	N	Y	'04 - Newer	N
75X0	Chrome	7Ga	14" Open End	2 Rectangle	N	Y	Y	N	Y	'04 - Newer	N
75X0R	Chrome	7Ga	14" Open End	2 Round	N	Y	Y	N	N	'04 - Newer	N
75X0NL	Chrome	7Ga	14" Open End	N	N	Y	Y	N	Y	'04 - Newer	N
75X2NLPOL	Polished Aluminum	0.25"	14" Taper	N	N	Y	Y	N	N	'04 - Newer	N
75X2POL	Polished Aluminum	0.25"	14" Taper	2 Rectangle	N	Y	Y	N	N	'04 - Newer	N
75X2	Chrome	7Ga	14" Taper	2 Rectangle	N	Y	Y	N	Y	'04 - Newer	N
75X2NL	Chrome	7Ga	14" Taper	N	N	Y	Y	N	Y	'04 - Newer	N
75X2RS	Chrome	7Ga	14" Taper	2 Rectangle	N	Y	Y	N	Y	'04 - Newer	N
75X6 ¹	Chrome	7Ga	14" Taper	2 Rectangle	N	Y	Y	N	Y	'04 - Newer	N
75X8 ²	Chrome	7Ga	14" Taper	2 Rectangle	N	Y	Y	N	N	'04 - Newer	N
75X6NL ¹	Chrome	7Ga	14" Taper	N	N	Y	Y	N	Y	'04 - Newer	N
05X8 ²	Chrome	10Ga	14" Taper	2 Rectangle	N	Y	Y	N	N	'04 - Newer	N
05X8NL ²	Chrome	10Ga	14" Taper	N	N	Y	Y	N	N	'04 - Newer	N
05X2	Chrome	10Ga	14" Taper	2 Rectangle	N	Y	Y	N	Y	'04 - Newer	N

1. Recessed Hitch
2. Surface Mount Hitch

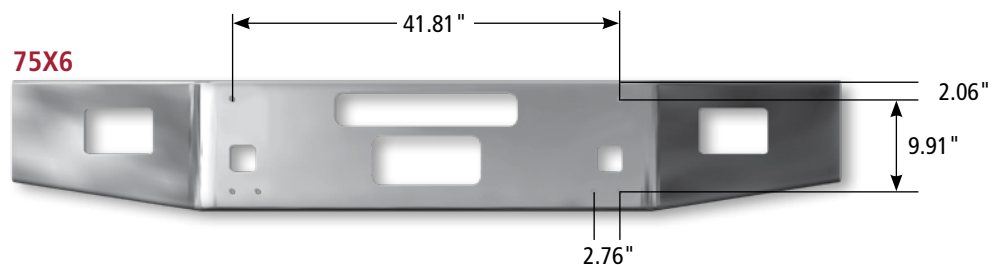

KENWORTH®

W900B / W900L

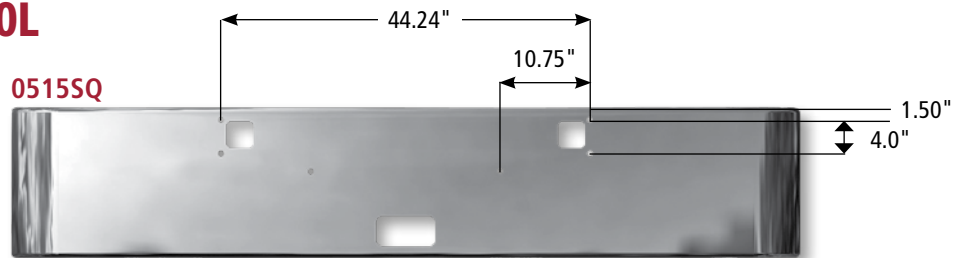

PART NO.	MATERIAL / FINISH	GAUGE / THICKNESS	STYLE	LIGHT CUTOUT	CENTER STEP CUTOUT	VENT CUTOUT	TOW COMPATIBLE	RADAR COMPATIBLE	EXCLUSIVE THROUGH OEM	YEAR	MOUNT / BRACKET	TIRE SHIELDS
7512SQ	Chrome	7Ga	18" Texas Square	N	N	N	Y	N	N	'82 - Newer	N	Y
0574SQ	Chrome	10Ga	18" Texas Square	9 Oval	N	N	Y	N	N	'82 - Newer	N	Y
0514SQ	Chrome	10Ga	18" Texas Square	2 Rectangle	Y	N	Y	N	N	'82 - Newer	N	Y
7514	Chrome	7Ga	16" Taper	2 Rectangle	Y	N	Y	N	N	'82 - Newer	N	Y
7514SQ	Chrome	7Ga	18" Texas Square	2 Rectangle	Y	N	Y	N	N	'82 - Newer	N	Y
0515IN18	Chrome	10Ga	18" Taper	N	Y	N	Y	N	N	'82 - Newer	N	N
0515SSCSQ	AERO CLAD®	0.125"	18" Texas Square	N	Y	N	Y	N	Y	'82 - Newer	Y	Y
0515NSSQ	Chrome	10Ga	18" Texas Square	N	Y	N	Y	N	N	'82 - Newer	N	N
0515SQ	Chrome	10Ga	18" Texas Square	N	Y	N	Y	N	N	'82 - Newer	N	Y
0515STQ	Polished Stainless	11Ga	18" Texas Square	N	Y	N	Y	N	N	'82 - Newer	N	Y
7514NS	Chrome	7Ga	16" Taper	2 Rectangle	Y	N	Y	N	N	'82 - Newer	N	N
7515NS	Chrome	7Ga	16" Taper	N	Y	N	Y	N	N	'82 - Newer	N	N
7515	Chrome	7Ga	16" Taper	N	Y	N	Y	N	N	'82 - Newer	N	Y
7515SQ	Chrome	7Ga	18" Texas Square	N	Y	N	Y	N	N	'82 - Newer	N	Y
0521SQ	Chrome	10Ga	20" Box	N	N	N	Y	N	N	'82 - Newer	N	Y
0522SQ	Chrome	10Ga	18" Texas Square	N	N	N	Y	N	N	'82 - Newer	N	Y

W990

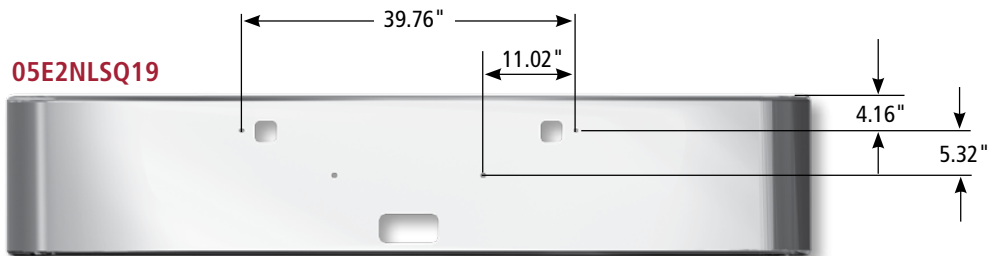

PART NO.	MATERIAL / FINISH	GAUGE / THICKNESS	STYLE	LIGHT CUTOUT	CENTER STEP CUTOUT	VENT CUTOUT	TOW COMPATIBLE	RADAR COMPATIBLE	EXCLUSIVE THROUGH OEM	YEAR	MOUNT / BRACKET	TIRE SHIELDS
05E2NLSQ19	Chrome	10Ga	19" Texas Square	N	Y	N	Y	N	N	'18 - Newer	N	Y



T660

H AERO CLAD®

Stainless Steel Clad
Aluminum Bumper

AERO CLAD® Features and Benefits

- Durable, bright mirrored finish
- Up to 10 times thicker finish than typical chrome finish
- Resists corrosion, cracking, pitting, peeling and fading
- Lightweight design
- High ground clearance
- Minor abrasions can be buffed
- Full 5-year limited warranty*

* Contact your local Hendrickson representative for complete warranty terms, conditions and limitations.



PART NO.	MATERIAL / FINISH	GAUGE / THICKNESS	STYLE	LIGHT CUTOUT	CENTER STEP CUTOUT	VENT CUTOUT	TOW COMPATIBLE	RADAR COMPATIBLE	EXCLUSIVE THROUGH OEM	YEAR	MOUNT / BRACKET
05R1NLSSC	AERO CLAD®	0.125"	14" Set Back	N	N	Y	Y	N	N	'08 - '17	Y
05R1NLVSSC	AERO CLAD	0.125"	14" Set Back	N	N	Y	Y	Y	N	'08 - '17	Y
05R1SSC¹	AERO CLAD	0.125"	14" Set Back	Y	N	Y	Y	N	N	'08 - '17	Y
05R1VSSC¹	AERO CLAD	0.125"	14" Set Back	Y	N	Y	Y	Y	N	'08 - '17	Y
05R1NLBAX	Steel Primed	10Ga	14" Set Back	N	N	Y	Y	N	N	'08 - '17	Y
05R1NLVBAX	Steel Primed	10Ga	14" Set Back	N	N	Y	Y	Y	N	'08 - '17	Y
05R1VBAX¹	Steel Primed	10Ga	14" Set Back	Y	N	Y	Y	Y	N	'08 - '17	Y

1. Includes light bezel trim

CH600 / CH

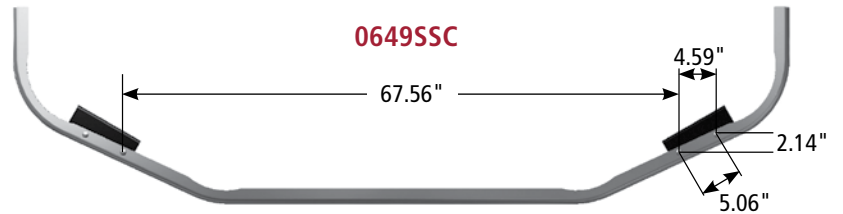

PART NO.	MATERIAL / FINISH	GAUGE / THICKNESS	STYLE	LIGHT CUTOUT	CENTER STEP CUTOUT	VENT CUTOUT	TOW COMPATIBLE	RADAR COMPATIBLE	EXCLUSIVE THROUGH OEM	YEAR	MOUNT / BRACKET
0636B	Steel Primed	10Ga	13.5" Set Forward	N	Y	N	Y	N	N	'96 - Newer	Y
0636SSC	AERO CLAD®	0.125"	13.5" Set Forward	N	Y	N	Y	N	N	'96 - Newer	Y
0637SSC	AERO CLAD	0.125"	13.5" Set Forward	Y	Y	N	Y	N	N	'96 - Newer	Y
0648B	Steel Primed	10Ga	13.5" Set Back	N	Y	N	Y	N	N	'96 - Newer	Y
0648SSC	AERO CLAD	0.125"	13.5" Set Back	N	Y	N	Y	N	N	'96 - Newer	Y
0649B	Steel Primed	10Ga	17.65" Set Back	Y	Y	N	Y	N	N	'96 - Newer	Y
0649SSC	AERO CLAD	0.125"	13.5" Set Back	Y	Y	N	Y	N	N	'96 - Newer	Y
0653SSC	AERO CLAD	0.125"	13.5" Set Back	N	Y	N	Y	N	N	'96 - Newer	Y





CL

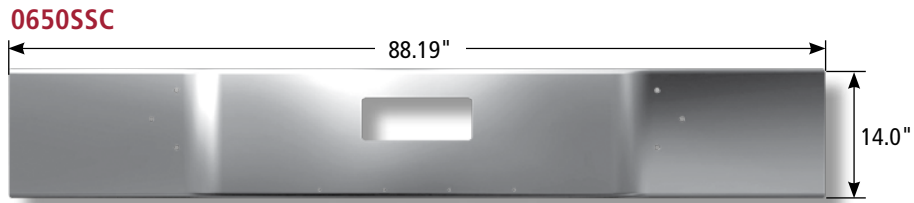

PART NO.	MATERIAL / FINISH	GAUGE / THICKNESS	STYLE	LIGHT CUTOUT	CENTER STEP CUTOUT	VENT CUTOUT	TOW COMPATIBLE	RADAR COMPATIBLE	EXCLUSIVE THROUGH OEM	YEAR	MOUNT / BRACKET
0650SSC	AERO CLAD®	0.125"	14" Set Back	N	Y	N	N	N	N	—	N
0651SSC	AERO CLAD	0.125"	14" Set Back	N	N	N	Y	N	N	—	N

DM

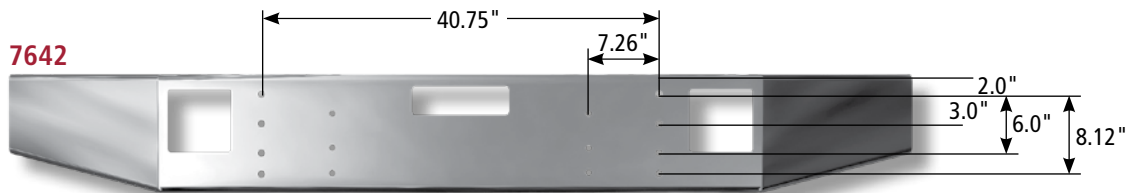

PART NO.	MATERIAL / FINISH	GAUGE / THICKNESS	STYLE	LIGHT CUTOUT	CENTER STEP CUTOUT	VENT CUTOUT	TOW COMPATIBLE	RADAR COMPATIBLE	EXCLUSIVE THROUGH OEM	YEAR	MOUNT / BRACKET
7642	Chrome	8Ga	12" Taper	N	N	Y	Y	N	N	'86 - '97	N

GRANITE



PART NO.	MATERIAL / FINISH	GAUGE / THICKNESS	STYLE	LIGHT CUTOUT	CENTER STEP CUTOUT	VENT CUTOUT	TOW COMPATIBLE	RADAR COMPATIBLE	EXCLUSIVE THROUGH OEM	YEAR	MOUNT / BRACKET
7645SSC	AERO CLAD	0.160"	Set Forward 16" Taper	N	Y	N	Y	N	N	'03 - '04	N

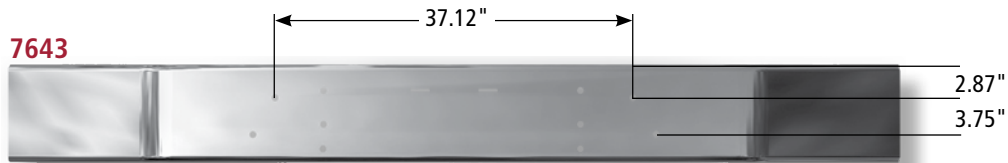

RD / R

PART NO.	MATERIAL / FINISH	GAUGE / THICKNESS	STYLE	LIGHT CUTOUT	CENTER STEP CUTOUT	VENT CUTOUT	TOW COMPATIBLE	RADAR COMPATIBLE	EXCLUSIVE THROUGH OEM	YEAR	MOUNT / BRACKET
7643*	Chrome	8Ga	10" Set Back	N	N	N	N	N	Y	'89 - '98	N

*Includes cow catcher holes

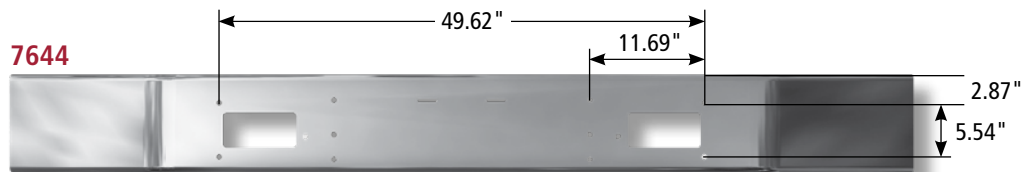

Set back axle with tow holes and cow catcher holes

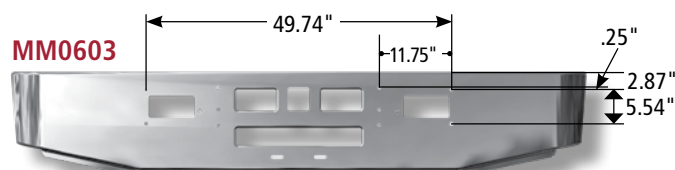

R

PART NO.	MATERIAL / FINISH	GAUGE / THICKNESS	STYLE	LIGHT CUTOUT	CENTER STEP CUTOUT	VENT CUTOUT	TOW COMPATIBLE	RADAR COMPATIBLE	EXCLUSIVE THROUGH OEM	YEAR	MOUNT / BRACKET
MM0603	Chrome	10Ga	16" Taper Set Forward	N	N	Y	Y	N	Y	'97 - Newer	N
7644*	Chrome	8Ga	10" Set Back	N	N	N	Y	N	Y	—	N

*Includes cow catcher holes

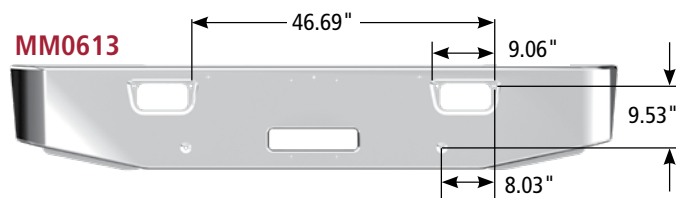

SUPERLINER II

PART NO.	MATERIAL / FINISH	GAUGE / THICKNESS	STYLE	LIGHT CUTOUT	CENTER STEP CUTOUT	VENT CUTOUT	TOW COMPATIBLE	RADAR COMPATIBLE	EXCLUSIVE THROUGH OEM	YEAR	MOUNT / BRACKET
MM0613	Chrome	10Ga	15" Taper	N	Y	N	Y	N	Y	—	N

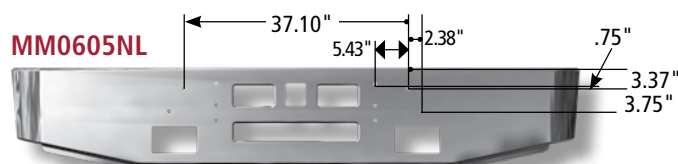

U

PART NO.	MATERIAL / FINISH	GAUGE / THICKNESS	STYLE	LIGHT CUTOUT	CENTER STEP CUTOUT	VENT CUTOUT	TOW COMPATIBLE	RADAR COMPATIBLE	EXCLUSIVE THROUGH OEM	YEAR	MOUNT / BRACKET
MM0605NL	Chrome	10Ga	16" Taper	N	N	Y	Y	N	Y	—	N



MACK ANTHEM® / PINNACLE CXU / VISION CX

H AERO CLAD®

Stainless Steel Clad
Aluminum Bumper

AERO CLAD® Features and Benefits

- Durable, bright mirrored finish
- Up to 10 times thicker finish than typical chrome finish
- Resists corrosion, cracking, pitting, peeling and fading
- Lightweight design
- Minor abrasions can be buffed
- Full 5-year limited warranty*

* Contact your local Hendrickson representative for complete warranty terms, conditions and limitations.



PART NO.	MATERIAL / FINISH	GAUGE / THICKNESS	STYLE	LIGHT CUTOUT	CENTER STEP CUTOUT	VENT CUTOUT	TOW COMPATIBLE	RADAR COMPATIBLE	EXCLUSIVE THROUGH OEM	YEAR	MOUNT / BRACKET*
7665SSC	AERO CLAD®	0.160"	16.5" Set Back	N	Y	N	Y	N	Y	'02 - '05 Vision CX	N
7664SSC	AERO CLAD	0.160"	16.5" Set Back	2 Square	Y	N	Y	N	Y	'02 - '05 Vision CX	N
MM5620NLSSC	AERO CLAD	0.160"	16.5" Set Back	N	Y	Y	Y	Y	Y	'06 - '17 Pinnacle CXU '18 - Newer Anthem®	N
MM5620SSC	AERO CLAD	0.160"	16.5" Set Back	2 Round	Y	Y	Y	Y	Y	'06 - '17 Pinnacle CXU '18 - Newer Anthem	N

* Converting an OEM Vision CX or Pinnacle CXU flush mount bumper to AERO CLAD requires mounting brackets 84741418 and 84741419. Extended mount bumpers require brackets 84741412 and 84741413.

Converting an OEM Anthem composite bumper to AERO CLAD requires one 84750643 LH bracket, one 84750644 RH bracket and two 84753681 brackets.

Mounting brackets and associated hardware are available through your Mack dealer.



330

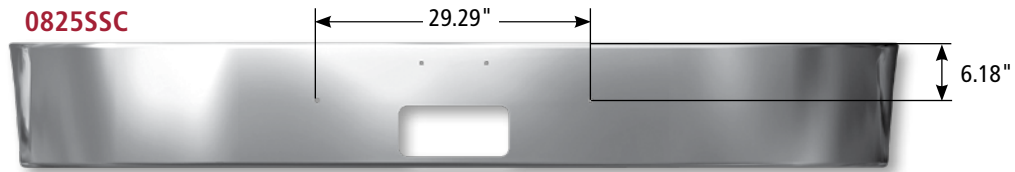

PART NO.	MATERIAL / FINISH	GAUGE / THICKNESS	STYLE	LIGHT CUTOUT	CENTER STEP CUTOUT	VENT CUTOUT	TOW COMPATIBLE	RADAR COMPATIBLE	EXCLUSIVE THROUGH OEM	YEAR	MOUNT / BRACKET
0825SSC	AERO CLAD®	0.125"	13.5" Set Back, 12K	N	N	N	Y	N	Y	'02 - '08	N
0826SSC	AERO CLAD	0.125"	16" Set Back, 16K/20K	N	N	N	Y	N	Y	'97 - Newer	N

359 CONVENTIONAL '67-'86 / 352 COE '67-'80

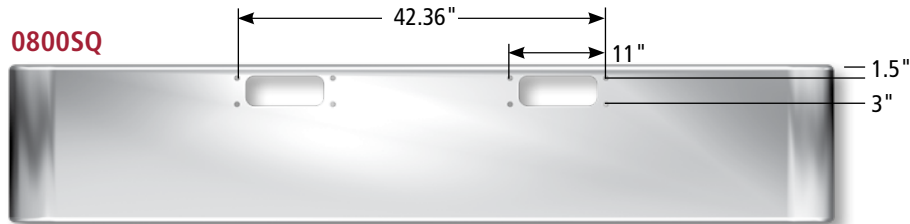

PART NO.	MATERIAL / FINISH	GAUGE / THICKNESS	STYLE	LIGHT CUTOUT	CENTER STEP CUTOUT	VENT CUTOUT	TOW COMPATIBLE	RADAR COMPATIBLE	EXCLUSIVE THROUGH OEM	YEAR	MOUNT / BRACKET
0800SQ	Chrome	10Ga	18" TSQ	N	N	N	Y	N	N	'67 - '86	N

367 / 567 SBFA

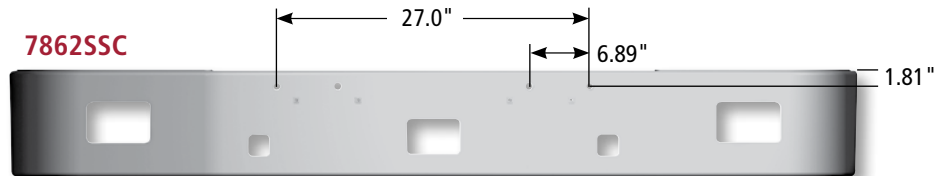

PART NO.	MATERIAL / FINISH	GAUGE / THICKNESS	STYLE	LIGHT CUTOUT	CENTER STEP CUTOUT	VENT CUTOUT	TOW COMPATIBLE	RADAR COMPATIBLE	EXCLUSIVE THROUGH OEM	YEAR	MOUNT / BRACKET
7862SSC*	AERO CLAD	0.160"	12" Set Back	2 Rectangle	Y	N	Y	N	N	'07 - Newer	Y
7862NLSSC*	AERO CLAD	0.160"	12" Set Back	N	Y	N	Y	N	N	'07 - Newer	Y

*Includes treadplates

365 SFFA, 388, 389, 367 / 567 SFFA

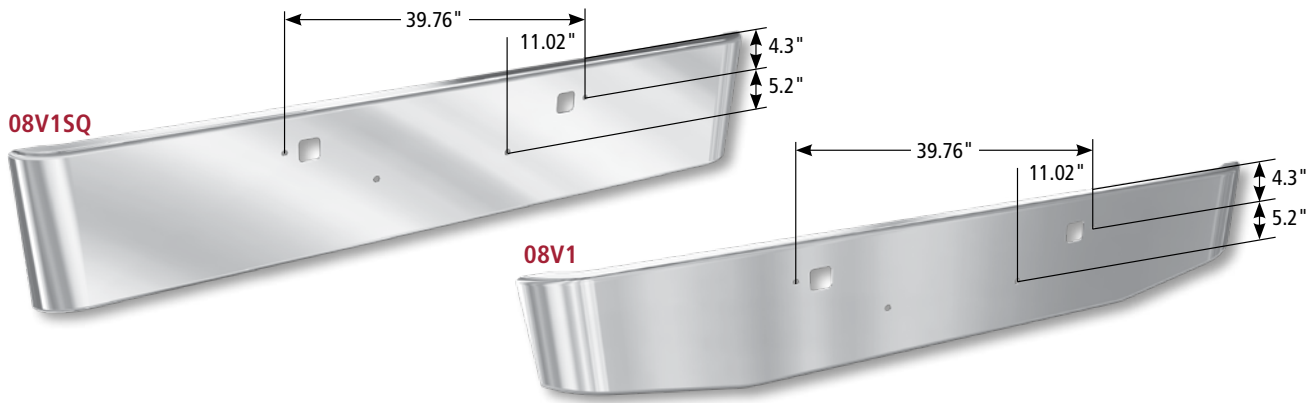

PART NO.	MATERIAL / FINISH	GAUGE / THICKNESS	STYLE	LIGHT CUTOUT	CENTER STEP CUTOUT	VENT CUTOUT	TOW COMPATIBLE	RADAR COMPATIBLE	EXCLUSIVE THROUGH OEM	YEAR	LICENSE PLATE HOLES	TIRE SHIELDS
08V1	Chrome	10Ga	16" Taper	N	N	N	Y	N	N	'06 - Newer	N	N
08V11NSSQ	Chrome	10Ga	18" Texas Square	N	N	N	Y	N	N	'06 - Newer	N	N
08V1SQ	Chrome	10Ga	18" Texas Square	N	N	N	Y	N	N	'06 - Newer	N	Y
08V2SQ	Chrome	10Ga	18" Texas Square	N	Y	N	Y	N	N	'06 - Newer	N	Y
08V3*	Chrome	10Ga	16" Taper	N	N	N	Y	N	N	'06 - Newer	N	N
08V4	Chrome	10Ga	16" Taper	N	N	N	Y	N	N	'06 - Newer	Single	N
08V5	Chrome	10Ga	16" Taper	N	N	N	Y	N	N	'06 - Newer	Dual	N
78V1SQ	Chrome	7Ga	18" Texas Square	N	N	N	Y	N	N	'06 - Newer	N	Y
08V1IN12	Chrome	10Ga	12" Taper	N	N	N	Y	N	N	'06 - Newer	N	N
78V1SQ18	Chrome	7Ga	18" Boxed End	N	N	N	Y	N	N	'06 - Newer	N	Y
78V1SQ20	Chrome	7Ga	20" Boxed End	N	N	N	Y	N	N	'06 - Newer	N	Y
08V11NS	Chrome	10Ga	16" Taper	2 Rectangle	N	N	Y	N	N	'06 - Newer	N	N
08V11NSSQ	Chrome	10Ga	18" Texas Square	N	N	N	Y	N	N	'06 - Newer	N	N
08V12SQ	Chrome	10Ga	18" Texas Square	2 Rectangle	N	N	Y	N	N	'06 - Newer	N	Y
08V13SQ	Chrome	10Ga	18" Boxed End	N	N	N	Y	N	N	'06 - Newer	Single	Y
08V8NLSQ	Chrome	10Ga	18" Texas Square	N	N	N	Y	N	N	'06 - Newer	Dual	Y
08V8SQ	Chrome	10Ga	18" Texas Square	2 Rectangle	N	N	Y	N	N	'06 - Newer	Dual	Y
08V1NTSQ	Chrome	10Ga	18" Texas Square	N	N	N	N	N	N	'06 - Newer	N	Y

*Surface mount hitch



357 / 378 / 379

PART NO.	MATERIAL / FINISH	GAUGE / THICKNESS	STYLE	LIGHT CUTOUT	CENTER STEP CUTOUT	VENT CUTOUT	TOW COMPATIBLE	RADAR COMPATIBLE	EXCLUSIVE THROUGH OEM	YEAR	MOUNT / BRACKET	TIRE SHIELDS
0804	Chrome	10Ga	16" Taper	N	N	N	Y	N	N	'87 - '06	N	Y
0804NS	Chrome	10Ga	16" Taper	N	N	N	Y	N	N	'87 - '06	N	N
0805	Chrome	10Ga	16" Taper	2 Rectangle	N	N	Y	N	N	'87 - '06	N	Y
0813	Chrome	10Ga	16" Taper	N	N	N	Y	N	N	'87 - '06	N	Y
0894	Chrome	10Ga	16" Taper	N	N	N	Y	N	N	'87 - '06	N	Y
7804	Chrome	7Ga	16" Taper	N	N	N	Y	N	N	'87 - '06	N	Y
0804IN12	Chrome	10Ga	12" Taper	N	N	N	Y	N	N	'87 - '06	N	N
0804NSSQ	Chrome	10Ga	18" Texas Square	N	N	N	Y	N	N	'87 - '06	N	N
0804NTSQ	Chrome	10Ga	18" Texas Square	N	N	N	N	N	N	'87 - '06	N	Y
0804SQ	Chrome	10Ga	18" Texas Square	N	N	N	Y	N	N	'87 - '06	N	Y
0804SSC	AERO CLAD®	0.160"	16" Taper	N	N	N	Y	N	N	'87 - '06	N	N
0804STQ	Polished Stainless	11Ga	18" Texas Square	N	N	N	Y	N	N	'87 - '06	N	Y
0805NSSQ	Chrome	10Ga	18" Texas Square	2 Rectangle	N	N	Y	N	N	'87 - '06	N	N
0805SQ	Chrome	10Ga	18" Texas Square	2 Rectangle	N	N	Y	N	N	'87 - '06	N	Y
0805NS	Chrome	10Ga	16" Taper	2 Rectangle	N	N	Y	N	N	'87 - '06	N	N
0807NSSQ	Chrome	10Ga	18" Boxed End	N	N	N	Y	N	N	'87 - '06	N	N
0807SQ	Chrome	10Ga	18" Boxed End	N	N	N	Y	N	N	'87 - '06	N	Y
0809NSSQ20	Chrome	10Ga	20" Boxed End	N	N	N	Y	N	N	'87 - '06	N	N
0809SQ20	Chrome	10Ga	20" Boxed End	N	N	N	Y	N	N	'87 - '06	N	Y
0844SQ	Chrome	10Ga	18" Texas Square	4 Oval	N	N	Y	N	N	'87 - '06	N	Y
0864SQ	Chrome	10Ga	18" Texas Square	6 Oval	N	N	Y	N	N	'87 - '06	N	Y
0874SQ	Chrome	10Ga	18" Texas Square	9 Oval	N	N	Y	N	N	'87 - '06	N	Y
0884SQ	Chrome	10Ga	18" Texas Square	15 Round	N	N	Y	N	N	'87 - '06	N	Y
7804NS	Chrome	7Ga	16" Taper	N	N	N	Y	N	N	'87 - '06	N	N
7804SQ	Chrome	7Ga	18" Texas Square	N	N	N	Y	N	N	'87 - '06	N	Y
7807NSSQ	Chrome	7Ga	18" Boxed End	N	N	N	Y	N	N	'87 - '06	N	N
7807SQ	Chrome	7Ga	18" Boxed End	N	N	N	Y	N	N	'87 - '06	N	Y
7809NSSQ20	Chrome	7Ga	20" Boxed End	N	N	N	Y	N	N	'87 - '06	N	N
7809SQ20	Chrome	7Ga	20" Boxed End	N	N	N	Y	N	N	'87 - '06	N	Y
0894IN12	Chrome	10Ga	12" Taper	N	N	N	Y	N	N	'87 - '06	N	N



385

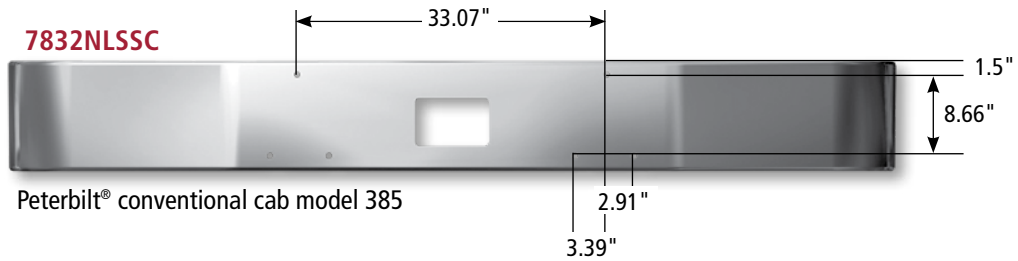

PART NO.	MATERIAL / FINISH	GAUGE / THICKNESS	STYLE	LIGHT CUTOUT	CENTER STEP CUTOUT	VENT CUTOUT	TOW COMPATIBLE	RADAR COMPATIBLE	EXCLUSIVE THROUGH OEM	YEAR	MOUNT / BRACKET
7832NLSSC	AERO CLAD®	0.160"	12" Set Back	N	N	N	Y	N	N	'96 - '07	Y
7832SSC	AERO CLAD	0.160"	12" Set Back	2 Rectangle	N	N	Y	N	N	'96 - '07	Y

387

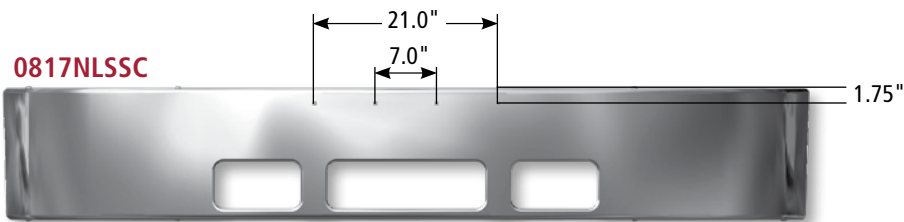

PART NO.	MATERIAL / FINISH	GAUGE / THICKNESS	STYLE	LIGHT CUTOUT	CENTER STEP CUTOUT	VENT CUTOUT	TOW COMPATIBLE	RADAR COMPATIBLE	EXCLUSIVE THROUGH OEM	YEAR	MOUNT / BRACKET
0817NLSSC	AERO CLAD	0.125"	15" Set Back	N	Y	N	Y	N	Y	'02 - '10	Y
0817SSC	AERO CLAD	0.125"	15" Set Back	2 Rectangle	Y	N	Y	N	Y	'02 - '10	Y
0818NLSSC	AERO CLAD	0.125"	15" Set Back	N	Y	N	Y	Y	Y	'02 - '10	Y
0818SSC	AERO CLAD	0.125"	15" Set Back	2 Rectangle	Y	N	Y	Y	Y	'02 - '10	Y

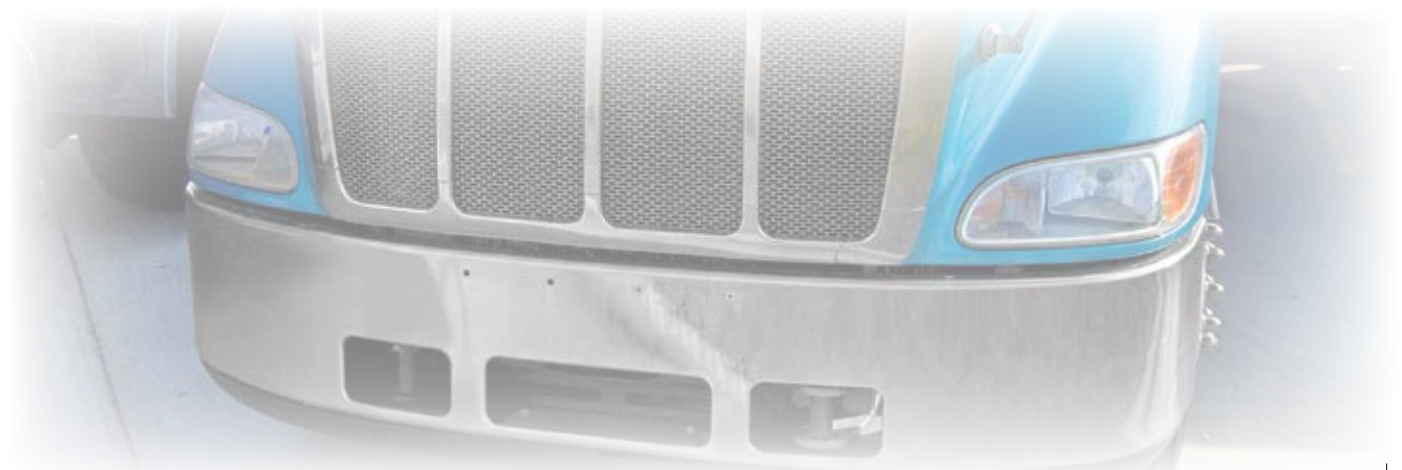

PETERBILT®

384 / 386

H AERO CLAD®

Stainless Steel Clad
Aluminum Bumper

Features and Benefits

- Durable, bright mirrored finish
- 1Up to 10 times thicker finish than typical chrome finish
- Resists corrosion, cracking, pitting, peeling and fading
- Minor abrasions can be buffed
- Full 5-year limited warranty*

* Contact your local Hendrickson representative for complete warranty terms, conditions and limitations.



PART NO.	MATERIAL / FINISH	GAUGE / THICKNESS	STYLE	LIGHT CUTOUT	CENTER STEP CUTOUT	VENT CUTOUT	TOW COMPATIBLE	RADAR COMPATIBLE	EXCLUSIVE THROUGH OEM	YEAR	MOUNT / BRACKET
0889NLSSC	AERO CLAD®	0.125"	13.5" Set Back	N	Y	N	Y	N	Y	'06 - '15	Y
0889SSC	AERO CLAD	0.125"	13.5" Set Back	2 Rectangle	Y	N	Y	N	Y	'06 - '15	Y

When replacing an OE composite molded bumper, spacers N80 - 6006 & N80 - 6006R are required.
No spacers required when replacing OE metal bumper.

587

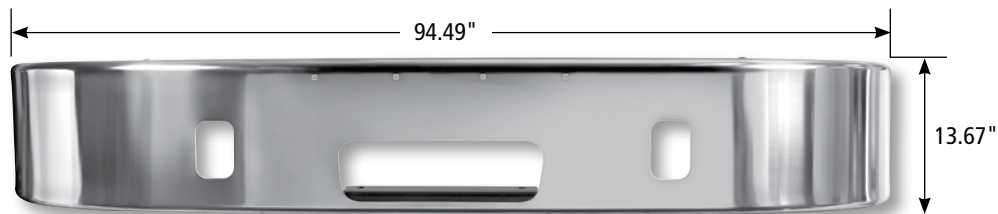

PART NO.	MATERIAL / FINISH	GAUGE / THICKNESS	STYLE	LIGHT CUTOUT	CENTER STEP CUTOUT	VENT CUTOUT	TOW COMPATIBLE	RADAR COMPATIBLE	EXCLUSIVE THROUGH OEM	YEAR	MOUNT / BRACKET
08E0NLSSC	AERO CLAD	0.125"	13.5" Set Back	N	Y	N	Y	N	Y	ALL	Y





VNM

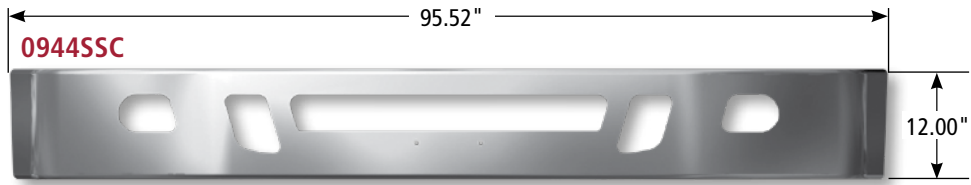

PART NO.	MATERIAL / FINISH	GAUGE / THICKNESS	STYLE	LIGHT CUTOUT	CENTER STEP CUTOUT	VENT CUTOUT	TOW COMPATIBLE	RADAR COMPATIBLE	EXCLUSIVE THROUGH OEM	YEAR	MOUNT / BRACKET
0944SSC	AERO CLAD®	0.125"	12" Set Back	2 Oval	N	Y	Y	N	N	'04 - '17	Y

WG

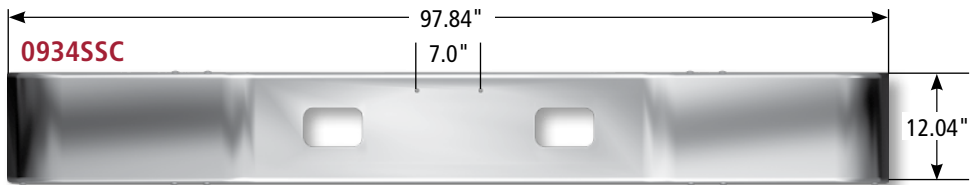

PART NO.	MATERIAL / FINISH	GAUGE / THICKNESS	STYLE	LIGHT CUTOUT	CENTER STEP CUTOUT	VENT CUTOUT	TOW COMPATIBLE	RADAR COMPATIBLE	EXCLUSIVE THROUGH OEM	YEAR	MOUNT / BRACKET
0934SSC	AERO CLAD	0.125"	12" Set Back	N	N	N	Y	N	N	—	Y





New VNL

H AERO CLAD® Stainless Steel Clad Aluminum Bumper

Features and Benefits

- Lightweight design
- Easy installation to factory mounts
- Durable, bright mirrored finish
- Up to 10 times thicker finish than typical chrome finish
- Resists corrosion, cracking, pitting, peeling and fading
- Quality, American made product
- Minor abrasions can be buffed
- Full 5-year limited warranty*



MM29644LSSC shown with optional air dam, MM602243K

* Contact your local Hendrickson representative for complete warranty terms, conditions and limitations.

PART NO.	MATERIAL / FINISH	GAUGE / THICKNESS	STYLE ¹	LIGHT CUTOUT ²	CENTER STEP CUTOUT	VENT CUTOUT	TOW COMPATIBLE	RADAR COMPATIBLE ²	EXCLUSIVE THROUGH OEM	YEAR	MOUNT / BRACKET ³	LICENSE PLATE HOLES
MM2964SSC	AERO CLAD®	0.125"	LWO Closed End	2 lights	N	Y	Y	Y	Y	2018 - Newer	Y	Y
MM29644LSSC	AERO CLAD	0.125"	LWO Closed End	4 lights	N	Y	Y	Y	Y	2018 - Newer	Y	Y
MM2964NLSSC	AERO CLAD	0.125"	LWO Closed End	N	N	Y	Y	Y	Y	2018 - Newer	Y	Y
MM2965SSC	AERO CLAD	0.125"	SWO Closed End	2 lights	N	Y	Y	Y	Y	2018 - Newer	Y	Y
MM29654LSSC	AERO CLAD	0.125"	SWO Closed End	4 lights	N	Y	Y	Y	Y	2018 - Newer	Y	Y
MM2965NLSSC	AERO CLAD	0.125"	SWO Closed End	N	N	Y	Y	Y	Y	2018 - Newer	Y	Y
MM602243K⁴	TPO	-	Air Dam Kit	-	-	-	-	-	-	-	-	-

1. Standard Wheel Opening (SWO) for use with 22.5" diameter tire / Large Wheel Opening (LWO) for use with 24.5" diameter tire

2. Radar compatible unit is mounted off the cross member behind the bumper

3. Supplied with mounting brackets installed on bumper

4. Air dam sold separately

5. Foglight 82744708 available through your Volvo dealer





VNL

AERO CLAD®

Stainless Steel Clad
Aluminum Bumper

AERO CLAD® Features and Benefits

- Lightweight design to help enhance fuel efficiency
- Easy installation to factory mounts
- Mounting brackets included
- Durable, bright mirrored finish
- Up to 10 times thicker finish than typical chrome finish
- Resists corrosion, cracking, pitting, peeling and fading
- Minor abrasions can be buffed
- Full 5-year limited warranty*



MM0960SSC
(0961ADA-Optional)



STEEL 10-GAUGE BUMPER

Features and Benefits

- Easy installation to factory mounts
- Mounting brackets included
- Corrosion-resistant e-coat finish, ready for topcoat
- Manufactured with high-impact corrosion resistant steel
- Optional air dam that bolts up to factory installed belly pan can be attached to this bumper
- 1-year limited warranty*



* Contact your local Hendrickson representative for complete warranty terms, conditions and limitations.



MM0961BAX



VNL cont.

PART NO.	MATERIAL / FINISH	GAUGE / THICKNESS	STYLE	LIGHT CUTOUT	CENTER STEP CUTOUT	VENT CUTOUT	TOW COMPATIBLE	RADAR COMPATIBLE	EXCLUSIVE THROUGH OEM	YEAR	MOUNT / BRACKET
0940SSC	AERO CLAD®	0.125"	—	N	N	Y	Y	N	Y	'98 - '03	Y
MM0960NLSSC¹	AERO CLAD	0.125"	—	N	N	Y	Y	N	N	'03 - '17	Y
MM0960SSC¹	AERO CLAD	0.125"	—	2 Rectangle	N	Y	Y	N	N	'03 - '17	Y
MM0961BAX²	Steel Prime	10Ga	—	2 Rectangle	N	Y	Y	N	N	'03 - '17	Y
MM0961NLBAX²	Steel Prime	10Ga	—	N	N	Y	Y	N	N	'03 - '17	Y
MM0961NLSSC²	AERO CLAD	0.125"	—	N	N	Y	Y	N	N	'03 - '17	Y
MM0961SSC²	AERO CLAD	0.125"	—	2 Rectangle	N	Y	Y	N	N	'03 - '17	Y
MM0963BAX²	Steel Prime	10Ga	—	2 Rectangle	N	Y	Y	Y	N	'03 - '17	Y
0961ADA	ABS	0.187"	VNL AIR DAM KIT	—	—	—	—	—	—	—	—

1. Basic - to be used with small wheel trim 22.5" diameter tire.
2. Extended - to be used with large wheel trim 24.5" diameter tire.





CONVENTIONAL / 4964 CONSTELLATION & HERITAGE

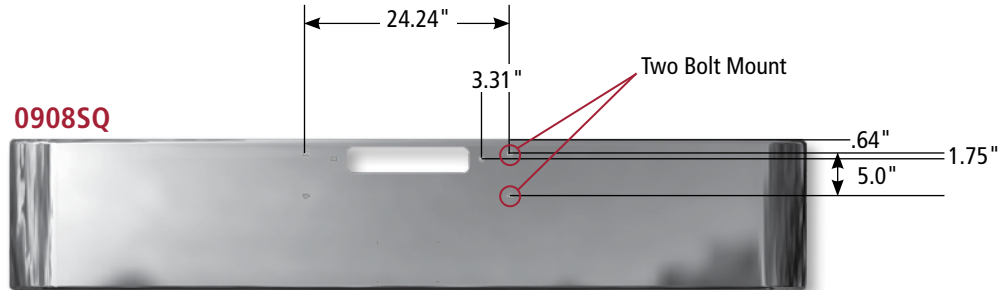

PART NO.	MATERIAL / FINISH	GAUGE / THICKNESS	STYLE	LIGHT CUTOUT	CENTER STEP CUTOUT	VENT CUTOUT	TOW COMPATIBLE	RADAR COMPATIBLE	EXCLUSIVE THROUGH OEM	YEAR	MOUNT / BRACKET	TIRE SHIELDS
0907¹	Chrome	10Ga	16" Taper	2 Rectangle	N	N	Y	N	N	'89 - '07	N/A	Y
0907SQ¹	Chrome	10Ga	18" Texas Square	2 Rectangle	N	N	Y	N	N	'89 - '07	N/A	Y
0908¹	Chrome	10Ga	16" Taper	N	N	N	Y	N	N	'89 - '07	N/A	Y
0908SQ¹	Chrome	0.125"	18" Texas Square	N	N	N	Y	N	N	'89 - '07	N/A	Y
0909SQ¹	Chrome	0.125"	18" Texas Square	N	N	N	N	N	N	'89 - '07	N/A	Y
0910²	Chrome	10Ga	16" Taper	N	N	N	N	N	N	'89 - '07	N/A	Y
0911SQ²	Chrome	10Ga	18" Texas Square	2 Rectangle	N	N	N	N	N	'89 - '07	N/A	Y
0913SQ¹	Chrome	0.125"	18" Texas Square	8 Oval	N	N	Y	N	N	'89 - '07	N/A	Y
7907¹	Chrome	8Ga	16" Taper	2 Rectangle	N	N	Y	N	N	'89 - '07	N/A	Y
7908¹	Chrome	8Ga	16" Taper	N	N	N	Y	N	N	'89 - '07	N/A	Y

- 1. Three bolt mount
- 2. Two bolt mount

NOTE: Brackets are not included



AERO CLAD® ROCK SCREENS

Features and Benefits

- Lightweight
- Easy installation
- Durable, bright mirrored finish
- Resists corrosion, cracking, pitting, peeling and fading
- Quality, American made product
- Protects radiator from gravel / rocks and other road debris
- Airflow into the cooling module
- Integrated appearance

Part Numbers

PART NO.	MATERIAL	CUT OUT STYLE	MODEL	RADAR	NUMBER OF PIECES	EXCLUSIVE
402631KS	.125 AERO CLAD®	Freightliner® Logo Silhouette	New Cascadia®	Y	2	Y
402632KS	.125 AERO CLAD	Freightliner Logo Silhouette	New Cascadia	N	1	Y
402627KS	.125 AERO CLAD	Hexagon Shaped	New Cascadia	Y	2	N
402626KS	.125 AERO CLAD	Hexagon Shaped	New Cascadia	N	1	N

Freightliner® Logo Silhouette Cutouts

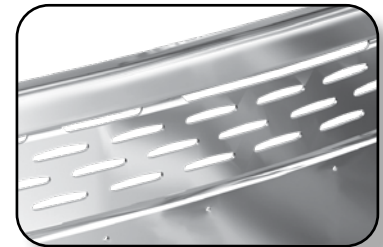

Hexagon Cutouts

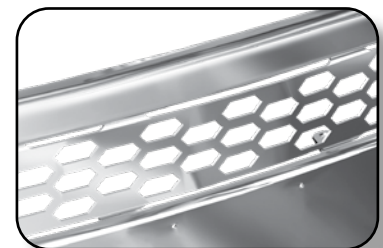

Finding the right bumper is as easy as 1-2-3.

Step 1.

Visit www.hendrickson-intl.com/bumper to utilize the bumper selector tool.

Step 2.

Configure your bumper using easy to navigate menu of options to obtain the Hendrickson ALL Makes part number.

Step 3.

Email, print or send your bumper configuration with a simple click.

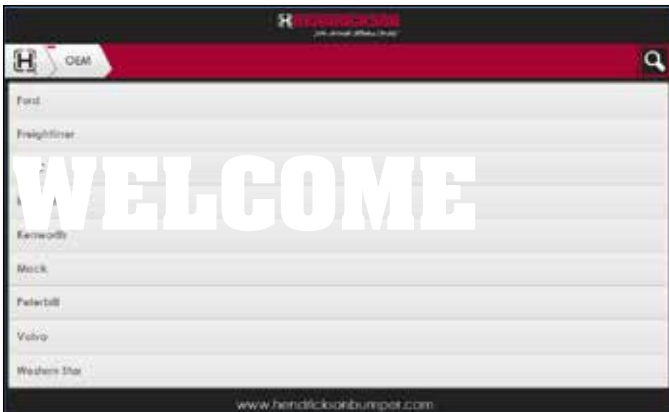
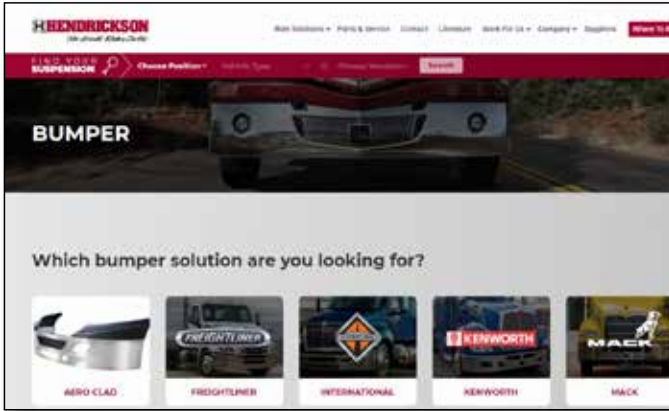

Additional product listings and useful information are only a click away!

Check out our selection and browse our current literature.

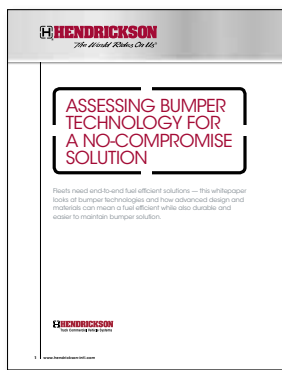

Aerodynamics Study

Fuel consumption testing compares AERO CLAD® bumper technology with alternative plastic bumpers.



Bumper Mobile APP

The Innovative "Truck Bumper Selector Tool" mobile app is available for Apple® and Android® mobile phone and tablet devices.



Bumper Selector Tool

Use our new interactive tool to configure your bumper and cross reference OEM and all makes numbers.

Visit us at www.hendricksonbumper.com

If you can't find what you need, please call Customer Service at 815.727.4031.



GENUINE HENDRICKSON

ALL MAKES PROGRAM

Hendrickson's All Makes Bumper Program offers aftermarket replacement bumpers designed to be a less expensive alternative to the original equipment. The All Makes Program provides parts personnel a wider variety of bumpers than those available through an OEM.

- Comprehensive line of materials and finishes
- New catalog with photos and features / benefits
- Build a bumper configurator available on Hendrickson website
- Premium-grade materials for high quality and finishing
- Free mobile app for more popular bumper selections
- Hundreds of bumper options
- Metal and non-metal bumpers



Hendrickson has a comprehensive product offering of heavy-duty truck bumpers for OEM and aftermarket needs. Hendrickson products feature advanced materials specifically designed for bumpers and flexible manufacturing technology to help provide customers value through durability, weight reduction and fuel economy.

Actual product performance may vary depending upon vehicle configuration, operation, service and other factors. All applications must comply with applicable Hendrickson specifications and must be approved by the respective vehicle manufacturer with the vehicle in its original, as-built configuration. Contact Hendrickson for additional details regarding specifications, applications, capacities, and operation, service and maintenance instructions.

Call Hendrickson at 815.727.4031 for additional information.



www.hendrickson-intl.com

HENDRICKSON BUMPER

501 Caton Farm Road
Lockport, IL 60441 USA
815.727.4031 | fax 815.727.9697
hbatcustservice@hendrickson-intl.com

C154 Rev S 01-22

© 2011 - 2022 Hendrickson USA, LLC. All Rights Reserved. All trademarks shown are owned by Hendrickson USA, LLC., or one of its affiliates, in one or more countries, except for those trademarks owned by the respective vehicle manufacturer. Information contained in this literature was accurate at the time of publication. Product changes may have been made after the copyright date that are not reflected.

Printed in United States of America 