

HENCO TECHNICAL MANUAL 2022

HENCO TECHNICAL MANUAL 2022



English

SANITARY

HEATING

UNDERFLOOR HEATING

GAS

SPRINKLER



		Page
1	PIPES	4
	1.1 STANDARD and RIXc MULTILAYER PIPES	5
	1.2 SYNTHETIC PIPES	40
2	HENCO PRESS	42
	2.1 STANDARD	43
	2.2 GAS	47
	2.3 SUPER SIZES	48
	2.4 ECOLINE	53
3	HENCO VISION	60
	3.1 FITTINGS	61
	3.2 MANIFOLDS	66
4	BRASS PRESS FITTINGS	69
	4.1 STANDARD	70
	4.2 GAS	73
5	BRASS SCREW/COMPRESSION FITTINGS	74
6	BRASS MANIFOLDS AND ACCESSORIES	77
7	ASSEMBLY INSTRUCTIONS	79
8	SPECIFICATIONS	115
9	DELIVERY PROGRAMME	126
10	INSURANCE AND GUARANTEE	175
11	CERTIFICATES	177



FLOOR HEATING: see technical manual Floor Heating



Introduction

Quality

Quality comes as standard. Henco Industries produces and distributes a complete and coordinated range of top-quality products that are distinguished by their constant technological innovation. All system components display the reliability that is the Henco hallmark.

Multilayer pipe

At the heart of our comprehensive range is without doubt the patented multilayer pipe. The Henco multilayer pipe was conceived under the motto “only the best is good enough” and it has been designed to ensure that it meets the most demanding and diverse usage requirements. This has resulted in the most innovative, multifunctional and reliable pipe available on the international market.

Extensive range

Henco also provides a wide range of top-quality products such as press and push fittings, manifolds, screw and compression fittings, sleeve fittings, controllers and tools. In short, we provide everything that allows us to offer you a complete range. All of these products are guaranteed to offer the best quality and work together perfectly.

Test certificates

The high level of quality and the reliability of the Henco range is confirmed internationally by our numerous inspection certificates.

Henco Floor Underfloor Heating

There is a separate Technical Handbook available for Henco Underfloor heating systems - ‘Henco Floor’.

Range overview

Product descriptions are available for our ranges of both synthetic piping systems and the underfloor heating systems. For more details, please consult our product overview or visit the Henco website at www.henco.be.

Recommendations and comments

We have tried to create the most complete and practical Technical Handbook for you. We always appreciate any recommendations or remarks you may have which can make the book even better.

The management and employees of Henco Industries NV



1.1 STANDARD and RIXc multilayer pipe

HENCO STANDARD and RIXc multilayer pipe	5
HENCO PRE-INSULATED	24
HENCO PROTECTION HOSE	26
HENCO COMBI	27
HENCO GAS	28









1.2 SYNTHETIC PIPES

HENCO 5L PE-Xc	40
HENCO 5L PE-Xc with PROTECTION HOSE	40

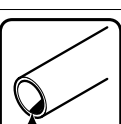

1.1 HENCO STANDARD and RIXc multilayer pipe

The HENCO STANDARD and RIXc multilayer pipe is a multi-purpose pipe

	Drinking water	As drinking water pipes for both hot and cold water and for all possible types of drinking water quality (In accordance with European standard 98/83/EC).
	Heating	As a heating pipe.
	Underfloor heating	For heating and cooling floors, walls and ceilings.
	Cooled water	Suitable for cooling applications and ice water applications.
	Rainwater	As a rainwater pipe for reusing water inside buildings within the specified load values.
	Gas	As a gas pipe in countries where the the system has been tested and where a certificate is available.
	Compressed air	As compressed air piping in oil-free installations (with activated oil filter).
	Heating oil	As heating oil piping within the specified load values.
	Other applications	On request and subject to written consent from Henco.





1 PIPES

1

Composition of the HENCO STANDARD and RIXc multilayer pipe (PE-Xc/AL/PE-Xc)

2

The Henco multilayer pipe consists of a continuous butt-welded aluminium pipe with an inner and outer 4 layer made from polyethylene that has been cross-linked using electron beams. The different layers are bonded to each other by a high quality connecting layer.

3

This results in the Henco multilayer pipe: a pipe that combines all of the advantages of synthetic materials and metal pipes.

4

The inner and outer pipe are made from polyethylene (HDPE) granulates which have been cross-linked using electron beams. Cross-linking multiplies the natural qualities of the polyethylene many times over. This improves the pressure and temperature resistance of the pipe. The pipe meets the most stringent requirements for drinking water installations, and is even resistant to aggressive substances.

5

The aluminium pipe guarantees that the pipe stays oxygen-tight and retains its shape. The butt welds along the length of the aluminium pipe ensure that the aluminium retains a consistent thickness. Consequently, the cross-linked outer layer that is applied with the connecting layer to the aluminium pipe by means of the bond layer will also have the same thickness. This also offers advantages when pressing, as it means that the press loads are perfectly distributed. Depending on the diameter of the pipe, the thickness of the aluminium layer is calculated in such a way that the pipe always retains the greatest flexibility and resistance to pressure.

6

7

8

9

10

11

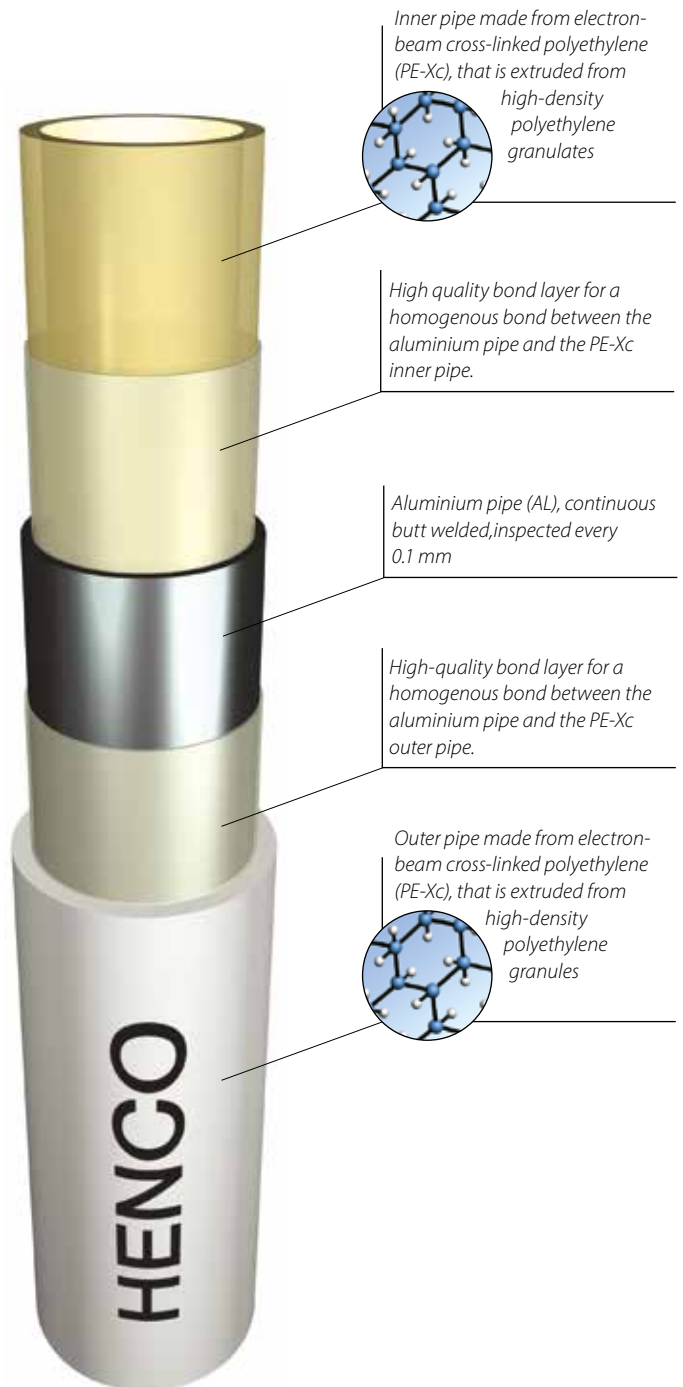



Inner and outer pipes made from PE-Xc with guaranteed quality

Henco produces multilayer pipes which have both an inner and outer pipe consisting of PE-Xc, electron-beam cross-linked polyethylene.

PE = stands for polyethylene

X = stands for cross-linking

c = stands for cross-linking by means of electron beams, in other words the process in which the polyethylene is cross-linked

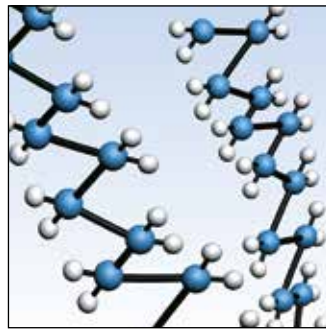

Structure of high-density polyethylene

Polyethylene is a plastic that consists of various chains of molecules. These chains are not directly connected to each other. The basic structure is kept together by weak mutual forces between the molecules. When heated, the chains move further away from each other. This makes the material become softer, more elastic and less pressure-resistant. In other words, polyethylene is less suited to sanitary applications or heating.

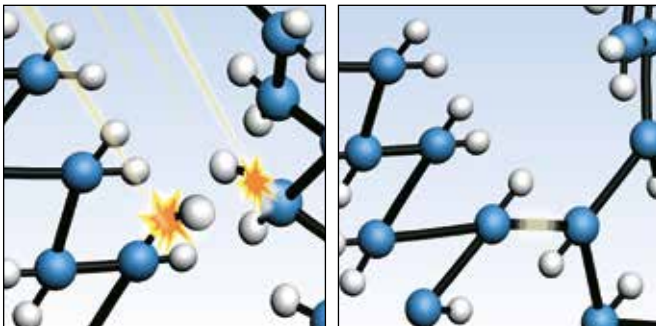

Cross-linking process by means of electron beams

Exposing the multilayer pipe to intense electron beams creates **cross connections** between the different molecular chains in the plastic. The electrons cause the hydrogen atoms to split from the various polyethylene chains. This enables carbon atoms to bond to each other and form a strong cross-linked structure.

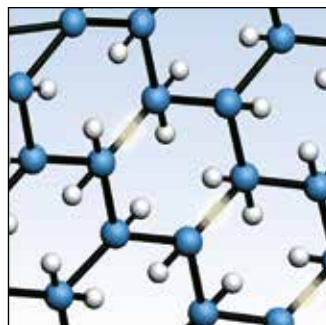

Structure of PE-Xc

The cross connections mean the movement of the chains with respect to each other is kept to a minimum. Applying heat or another form of energy will not distort the strong structure of the pipe. Cross-linked polyethylene displays optimal behaviour under continuous loads due to pressure or temperature loads. Cross-linking gives **enormous durability**.



1 PIPES

1

The best and most accurate way of cross-linking polyethylene is through the use of electron beams.

2

3

4

Polyethylene can be cross-linked in the following ways:

5

6

7

8

9

10

11

The German standard DIN 16892 determines the minimum degree of cross-linking for each of the methods.

b. **PE-Xb:** cross-linking is achieved by adding silane to the polyethylene, followed by a water treatment. This is a chemical method.

c. **PE-Xc:** in contrast to the two previous methods, cross-linking takes place during a second process when the pipe is exposed to intense electron beams. The beams excite the polyethylene molecules so much that they cross-link. This is a physical method.

Cross-linking methods		Procedure	
Description	Minimum cross-linking levels according to DIN 16892 standard	Physical	Chemical
PE-Xa	70 %		Peroxide
PE-Xb	65 %		Silane
PE-Xc	60 %	Electron beams	

So you can see that in order to meet the standard, a PE-Xa pipe needs 70% cross-linking, a PE-Xb pipe needs 65% cross-linking and a PE-Xc pipe needs only 60% cross-linking. Furthermore, the PE-Xc is a physical method which means that no chemical additives are used, so by definition the pipe does not have to be rinsed for sanitary use.



All benefits at a glance



Resistant to temperature and pressure

The working temperature can be up to 95°C, and the maximum working pressure 10 bar.

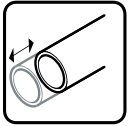

Minimum linear expansion

The aluminium layer in the Henco pipe means that it has a coefficient of expansion comparable to that of copper and 8 times less than an ordinary plastic pipe. Its coefficient of expansion is 0.025 mm/mK.

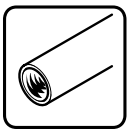

Resistant to corrosion

The smooth inner and outer surfaces of the pipe prevents the build-up of scale or other debris. This avoids sedimentation and corrosion are avoided. The smoothness of the inner pipe also ensures for minimum pressure loss.

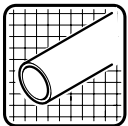

Retains its shape

The pipe retains the required shape after bending. Unlike other synthetic pipes it does not have a thermal memory. This simplifies and speeds up the installation of the pipe and the assembly of any fittings.



Resistant to wear

The outer and inner pipe are made from polyethylene that has been cross-linked using electron beams. This means that the pipe does not suffer wear, even at high temperatures and flow rates.

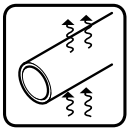

Fully sealed against oxygen and water vapour (diffusion)

The integrated aluminium layer prevents the penetration of oxygen into the pipe. This avoids corrosion problems with any metal components in the installation.



Lightweight (which means fast and simple assembly)

Fast and simple installation saves you time and money. The Henco pipe is flexible and extremely light. A coil of 200 m HENCO STANDARD 16X2 weighs a mere 25 kg.



Long life

If the pipe is used according to the specified working pressure and temperature, it will have a guaranteed working life of at least 50 years.



No noise problems

In contrast to metal pipes, water shock or flow noises do not cause noise problems in these pipes if the correct diameter is chosen. You can avoid contact noises through correct assembly.



From drinking water (in accordance with 98/83/EC) to chemical liquids

The pipe meets the most stringent toxicological and hygienic requirements. It is totally suitable for transporting drinking water. The pipe is also resistant to various liquid chemicals.

1

2

3

4

5

6

7

8

9

10

11



1 PIPES

1

Technical properties of the HENCO STANDARD and RIXc multilayer pipe

2

Technical profile of the HENCO STANDARD and RIXc multilayer pipe

Outer diameter (mm)	12	14	16	16	18	18	20	20	26	26	32	40	50	63	75	90
				RIXC		RIXC		RIXC		RIXC						
Inner diameter (mm)	8.8	10	12	12	14	14	16	16	20	20	26	33	42	54	63	76
Wall thickness (mm)	1.6	2	2	2	2	2	2	2	3	3	3	3.5	4	4.5	6	7
Max. working temperature (°C) **	60	95	95	95	95	95	95	95	95	95	95	95	95	95	95	95
Max. working pressure (bar)	6	10	16	10	10	10	16	10	16	10	16	10	10	10	10	10
Application class (EN ISO21003-1)	4	2-4-5	2-4-5	2-4-5	2-4-5	2-4-5	2-4-5	2-4-5	2-4-5	2-4-5	2-4-5	2-4-5	2-4-5	2-4-5	2-4-5	2-4-5
Coefficient of thermal conductivity (W/mK)	0.43	0.43	0.43	0.43	0.43	0.43	0.43	0.43	0.43	0.43	0.43	0.43	0.43	0.43	0.43	0.43
Coefficient of linear expansion (mm/mK)	0.025	0.025	0.025	0.025	0.025	0.025	0.025	0.025	0.025	0.025	0.025	0.025	0.025	0.025	0.025	0.025
Minimum tensile strength of adhesive layer (N/10 mm)	30	30	30	30	30	30	30	30	30	30	30	30	30	30	30	30
Surface roughness of inner pipe (μ)	7	7	7	7	7	7	7	7	7	7	7	7	7	7	7	7
Oxygen diffusion (mg/L)	0	0	0	0	0	0	0	0	0	0	0	0	0	0	0	0
Min. bending radius, manual/external spiral spring (mm)	5XDU	5XDU	5XDU	5XDU	5XDU	5XDU	5XDU	5XDU	5XDU	5XDU	5XDU	*	*	*	*	*
Min. bending radius, manual/internal spiral spring (mm)	3XDU	3XDU	3XDU*	3XDU*	3XDU	3XDU	3XDU	3XDU	3XDU	3XDU	3XDU	*	*	*	*	*
Degree of cross-linking (%)	60	60	60	60	60	60	60	60	60	60	60	60	60	60	60	60
Weight (kg/m)	0,084	0,108	0,125	0,101	0,132	0,125	0,147	0,129	0,285	0,261	0,390	0,528	0,766	1,155	1,516	2,155
Content (l/m)	0,061	0,079	0,113	0,113	0,154	0,154	0,201	0,201	0,314	0,314	0,531	0,855	1,385	2,29	3,117	4,536

* Elbow fittings should be used here

** Application class table (EN ISO 21003-1)

+ 2XDU when using a BM-16 bending tool

Application class table (EN ISO 21003-1 / ISO 10508)

Application class table (EN ISO 21003-1)							
Application class	T_D		T_{max}		T_{mal}		Typical application
	°C	Time ^a years	°C	Time years	°C	Time h	
1 ^a	60	49	80	1	95	100	Hot water supply (60°C)
2 ^a	70	49	80	1	95	100	Hot water supply (70°C)
4 ^b	20 + cumulative 40 + cumulative 60	2.5 20 25	70	2.5	100	100	Underfloor heating and low-temperature radiators
5 ^b	20 + cumulative 60 + cumulative 80	14 25 10	90	1	100	100	High-temperature radiators

NOTE This international standard does not apply for T_D , T_{max} and T_{mal} greater than those shown in the table above.

a Countries can choose either class 1 or class 2 according to with their national legislation.

b Where there is more than 1 design temperature for a class, the times should be added together. "Plus cumulative" in the table implies a temperature profile for the aforementioned temperature over a certain period. (e.g. for class 5, the design temperature profile over 50 years is 20°C over 14 years. This becomes 60 °C over 25 years, 80 °C over 10 years, 90 °C over 1 year and 100 °C over 100 hours respectively.



- 1
- 2
- 3
- 4
- 5
- 6
- 7
- 8
- 9
- 10
- 11

Pressure loss tables for the HENCO multilayer pipe

Liquids lose energy when they flow through a pipe as a result of friction between the liquid and the walls of the pipe. The diagram and tables below show the pressure loss for a given volumetric flow rate in relation to the pipe diameter and the flow speed.

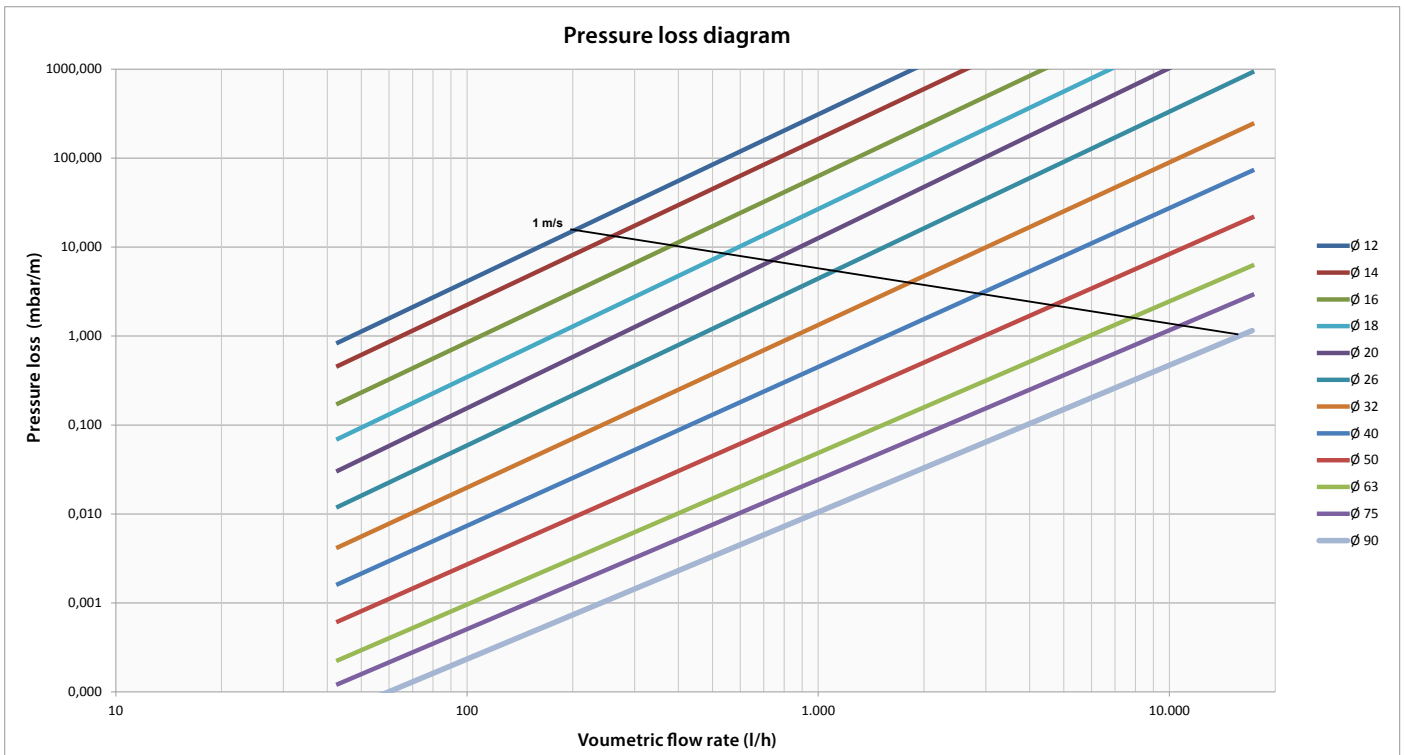



Energy (kW/h)	Flow (l/h)	Diameter 12		Diameter 14		Diameter 16		Diameter 18		Diameter 20		Diameter 26		Diameter 32		Diameter 40		Diameter 50		Diameter 63		Diameter 75		Diameter 90	
		Speed (m/s)	Pressure loss (mbar/m)	Speed (m/s)	Pressure loss (mbar/m)	Speed (m/s)	Pressure loss (mbar/m)	Speed (m/s)	Pressure loss (mbar/m)	Speed (m/s)	Pressure loss (mbar/m)	Speed (m/s)	Pressure loss (mbar/m)	Speed (m/s)	Pressure loss (mbar/m)	Speed (m/s)	Pressure loss (mbar/m)	Speed (m/s)	Pressure loss (mbar/m)	Speed (m/s)	Pressure loss (mbar/m)	Speed (m/s)	Pressure loss (mbar/m)	Speed (m/s)	Pressure loss (mbar/m)
376	16168	73,91	57150,33	57,23	29370,20	39,75	11390,80	29,20	5126,48	22,36	2572,65	14,31	817,02	8,47	214,20	5,26	64,15	3,24	19,17	1,96	5,51	1,44	2,58	0,99	1,03
377	16211	74,11	57452,82	57,39	29525,41	39,85	11450,83	29,28	5153,41	22,42	2586,12	14,35	821,27	8,49	215,31	5,27	64,48	3,25	19,26	1,97	5,54	1,45	2,59	0,99	1,03
378	16254	74,30	57756,11	57,54	29681,04	39,96	11511,01	29,36	5180,42	22,48	2599,63	14,38	825,53	8,51	216,41	5,28	64,81	3,26	19,36	1,97	5,57	1,45	2,61	1,00	1,04
379	16297	74,50	58060,20	57,69	29837,07	40,06	11571,36	29,43	5207,49	22,54	2613,17	14,42	829,80	8,53	217,52	5,30	65,14	3,27	19,46	1,98	5,59	1,45	2,62	1,00	1,05
380	16340	74,69	58365,08	57,84	29993,51	40,17	11631,86	29,51	5234,64	22,60	2626,75	14,46	834,09	8,56	218,63	5,31	65,47	3,28	19,56	1,98	5,62	1,46	2,63	1,00	1,05
381	16383	74,89	58670,76	58,00	30150,35	40,27	11692,52	29,59	5261,85	22,65	2640,36	14,50	838,38	8,58	219,75	5,33	65,80	3,29	19,65	1,99	5,65	1,46	2,64	1,00	1,06
382	16426	75,09	58977,24	58,15	30307,61	40,38	11753,33	29,67	5289,14	22,71	2654,01	14,54	842,69	8,60	220,86	5,34	66,13	3,30	19,75	1,99	5,68	1,47	2,66	1,01	1,06
383	16469	75,28	59284,52	58,30	30465,28	40,49	11814,30	29,75	5316,49	22,77	2667,69	14,58	847,00	8,62	221,98	5,35	66,46	3,31	19,85	2,00	5,70	1,47	2,67	1,01	1,07
384	16512	75,48	59592,59	58,45	30623,35	40,59	11875,44	29,82	5343,92	22,83	2681,41	14,61	851,33	8,65	223,11	5,37	66,79	3,31	19,95	2,00	5,73	1,47	2,68	1,01	1,07
385	16555	75,68	59901,46	58,60	30781,83	40,70	11936,72	29,90	5371,42	22,89	2695,17	14,65	855,67	8,67	224,23	5,38	67,12	3,32	20,04	2,01	5,76	1,48	2,70	1,01	1,08
386	16598	75,87	60211,13	58,76	30940,72	40,80	11998,17	29,98	5398,98	22,95	2708,95	14,69	860,01	8,69	225,36	5,40	67,46	3,33	20,14	2,01	5,79	1,48	2,71	1,02	1,08
387	16641	76,07	60521,60	58,91	31100,02	40,91	12059,77	30,06	5426,62	23,01	2722,78	14,73	864,37	8,71	226,49	5,41	67,79	3,34	20,24	2,02	5,82	1,48	2,72	1,02	1,09
388	16684	76,27	60832,87	59,06	31259,73	41,01	12121,53	30,13	5454,33	23,07	2736,64	14,77	868,74	8,74	227,62	5,42	68,13	3,35	20,34	2,03	5,84	1,49	2,73	1,02	1,09
389	16727	76,46	61144,93	59,21	31419,85	41,12	12183,45	30,21	5482,11	23,13	2750,53	14,80	873,13	8,76	228,76	5,44	68,46	3,36	20,44	2,03	5,87	1,49	2,75	1,03	1,10
390	16770	76,66	61457,79	59,37	31580,38	41,23	12245,53	30,29	5509,96	23,19	2764,46	14,84	877,52	8,78	229,90	5,45	68,80	3,37	20,54	2,04	5,90	1,50	2,76	1,03	1,10
391	16813	76,86	61771,45	59,52	31741,31	41,33	12307,76	30,37	5537,88	23,25	2778,42	14,88	881,92	8,80	231,04	5,47	69,14	3,37	20,64	2,04	5,93	1,50	2,77	1,03	1,11
392	16856	77,05	62085,91	59,67	31902,65	41,44	12370,15	30,44	5565,87	23,31	2792,42	14,92	886,34	8,83	232,19	5,48	69,48	3,38	20,74	2,05	5,96	1,50	2,79	1,03	1,11
393	16899	77,25	62401,17	59,82	32064,41	41,54	12432,70	30,52	5593,93	23,37	2806,46	14,96	890,76	8,85	233,33	5,49	69,82	3,39	20,84	2,05	5,98	1,51	2,80	1,04	1,12
394	16942	77,45	62717,22	59,97	32226,57	41,65	12495,41	30,60	5622,06	23,43	2820,52	14,99	895,20	8,87	234,48	5,51	70,16	3,40	20,94	2,06	6,01	1,51	2,81	1,04	1,12
395	16985	77,64	63034,07	60,13	32389,14	41,75	12558,27	30,68	5650,26	23,49	2834,63	15,03	899,64	8,89	235,64	5,52	70,50	3,41	21,04	2,06	6,04	1,51	2,83	1,04	1,13
396	17028	77,84	63351,72	60,28	32552,11	41,86	12621,29	30,75	5678,53	23,55	2848,77	15,07	904,10	8,92	236,79	5,54	70,84	3,42	21,14	2,07	6,07	1,52	2,84	1,04	1,13
397	17071	78,04	63670,16	60,43	32715,50	41,97	12684,47	30,83	5706,87	23,61	2862,94	15,11	908,57	8,94	237,95	5,55	71,19	3,43	21,24	2,07	6,10	1,52	2,85	1,05	1,14
398	17114	78,23	63989,41	60,58	32879,30	42,07	12747,81	30,91	5735,28	23,67	2877,15	15,15	913,05	8,96	239,11	5,56	71,53	3,43	21,34	2,08	6,13	1,53	2,87	1,05	1,14
399	17157	78,43	64309,45	60,74	33043,50	42,18	12811,30	30,99	5763,77	23,72	2891,39	15,18	917,54	8,98	240,28	5,58	71,87	3,44	21,45	2,08	6,16	1,53	2,88	1,05	1,15
400	17200	78,63	64630,29	60,89	33208,11	42,28	12874,95	31,07	5792,32	23,78	2905,67	15,22	922,04	9,01	241,45	5,59	72,22	3,45	21,55	2,09	6,19	1,53	2,89	1,05	1,15

Medium: water at 70°C

$$P = Q \times \Delta T \times 1.163$$

= power in watts

1 mbar/m = 100 Pa/m

AT = 20°C

Water velocity
Central heating: max. 1m/s
Sanitary: max. 3m/s

- 1
- 2
- 3
- 4
- 5
- 6
- 7
- 8
- 9
- 10
- 11



1 PIPES

1

2

3

4

5

6

7

8

9



10

11

Overview of flow loss coefficients (Zeta values)

Liquids do not only lose energy when they flow through a pipe. They also lose energy when they change direction. This is because liquids have to overcome extra resistance.

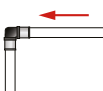
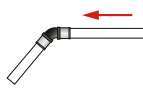
The table below provides an overview of the flow loss coefficients for the various fittings and the corresponding number of meters of piping.

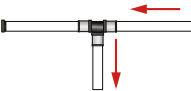
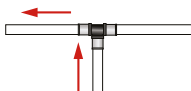
Zeta values (Medium: water at 15°C Flow speed: 2 m/s)										
		Ø14	Ø16	Ø18	Ø20	Ø26	Ø32	Ø40	Ø50	Ø63
Curved bend		zeta	1.50	1.25	1.10	1.85	0.70	-	-	-
	m	0.74	0.65	0.61	0.50	0.49	-	-	-	-
90° bend		zeta	3.071	2.021	2.839	1.87	1.974	1.981	1.865	1.753
	m	1.16	0.96	1.63	1.27	1.76	2.44	3.08	3.88	5.01
45° bend		zeta	-	-	-	-	-	0.761	0.69	0.614
	m	-	-	-	-	-	-	1.26	1.53	1.84
Straight coupling		zeta	0.918	0.689	0.61	0.559	0.504	0.472	0.388	0.342
	m	0.35	0.33	0.35	0.38	0.45	0.58	0.64	0.76	0.98
T-piece		zeta	1.026	0.829	0.739	0.639	0.629	0.562	0.472	0.407
	m	0.39	0.39	0.42	0.43	0.56	0.69	0.78	0.90	1.04
		zeta	2.772	2.329	2.126	1.89	1.974	1.844	1.716	2.001
	m	1.05	1.10	1.22	1.28	1.76	2.27	2.83	4.43	5.66
		zeta	2.851	2.372	2.268	2.010	2.104	1.898	1.716	1.902
	m	1.08	1.12	1.30	1.36	1.88	2.34	2.83	4.21	5.36



- 1
- 2
- 3
- 4
- 5
- 6
- 7
- 8
- 9
- 10
- 11

Zeta values (Medium: water at 15°C Flow speed: 2 m/s)

		Ø16- Ø14-Ø16	Ø18- Ø14-Ø18	Ø18- Ø16-Ø18	Ø20- Ø14-Ø20	Ø20- Ø16-Ø20	Ø20- Ø18-Ø20	Ø26- Ø16-Ø26	Ø26- Ø18-Ø26	Ø26- Ø20-Ø26	Ø32- Ø16-Ø32	Ø32- Ø18-Ø32	Ø32- Ø20-Ø32	Ø32- Ø26-Ø32													
T-piece reduction		zeta	0.79	0.702	0.734	0.606	0.588	0.648	0.578	0.563	0.592	0.544	0.539	0.544	0.549												
	m	0.37	0.40	0.42	0.41	0.40	0.44	0.52	0.50	0.53	0.67	0.66	0.67	0.68													
		zeta	1.864	1.726	1.711	1.486	1.516	1.575	1.256	1.359	1.358	1.32	1.289	1.257	1.296												
	m	0.88	0.99	0.98	1.01	1.03	1.07	1.12	1.21	1.21	1.63	1.59	1.55	1.60													
		zeta	1.697	1.578	1.654	1.408	1.408	1.497	1.181	1.033	1.119	1.464	1.245	1.074	1.129												
	m	0.80	0.91	0.95	0.95	0.95	1.01	1.05	0.92	1.00	1.80	1.53	1.32	1.39													
		<table border="1"> <thead> <tr> <th>Ø40- Ø16-Ø40</th> <th>Ø40- Ø20-Ø40</th> <th>Ø40- Ø26-Ø40</th> <th>Ø40- Ø32-Ø40</th> <th>Ø50- Ø20-Ø50</th> <th>Ø50- Ø26-Ø50</th> <th>Ø50- Ø32-Ø50</th> <th>Ø50- Ø40-Ø50</th> <th>Ø63- Ø26-Ø63</th> <th>Ø63- Ø32-Ø63</th> <th>Ø63- Ø40-Ø63</th> <th>Ø63- Ø50-Ø63</th> </tr> </thead> </table>														Ø40- Ø16-Ø40	Ø40- Ø20-Ø40	Ø40- Ø26-Ø40	Ø40- Ø32-Ø40	Ø50- Ø20-Ø50	Ø50- Ø26-Ø50	Ø50- Ø32-Ø50	Ø50- Ø40-Ø50	Ø63- Ø26-Ø63	Ø63- Ø32-Ø63	Ø63- Ø40-Ø63	Ø63- Ø50-Ø63
Ø40- Ø16-Ø40	Ø40- Ø20-Ø40	Ø40- Ø26-Ø40	Ø40- Ø32-Ø40	Ø50- Ø20-Ø50	Ø50- Ø26-Ø50	Ø50- Ø32-Ø50	Ø50- Ø40-Ø50	Ø63- Ø26-Ø63	Ø63- Ø32-Ø63	Ø63- Ø40-Ø63	Ø63- Ø50-Ø63																
		zeta	0.427	0.378	0.477	0.447	0.362	0.357	0.377	0.397	0.312	0.317	0.327	0.337													
	m	0.70	0.62	0.74	0.74	0.80	0.79	0.83	0.88	0.94	0.95	0.98	1.01														
		zeta	1.315	1.155	1.123	1.599	1.056	1.022	1.183	1.243	1.014	1.262	1.119	1.326													
	m	2.17	1.91	1.85	2.64	2.34	2.26	2.62	2.75	3.05	3.79	3.36	3.98														
		zeta	1.412	1.101	0.999	1.49	1.101	1.027	0.861	0.855	0.92	1.04	0.696	0.988													
	m	2.33	1.82	1.65	2.46	2.44	2.27	1.91	1.89	5.77	3.12	2.09	2.97														



1 PIPES

- 1
- 2
- 3
- 4
- 5
- 6
- 7
- 8
- 9
- 10
- 11

Zeta values (Medium: water at 15°C Flow speed: 2 m/s)		Ø16- Ø14-Ø14	Ø18- Ø16-Ø16	Ø20- Ø16-Ø16	Ø20- Ø18-Ø18	Ø20- Ø20-Ø16	Ø26- Ø20-Ø20	Ø26- Ø26-Ø16	Ø26- Ø26-Ø20	Ø32- Ø26-Ø26	Ø40- Ø32-Ø32	Ø40- Ø40-Ø26	
T-piece 2X reduction		zeta	0.907	0.732	0.699	0.759	0.80	0.694	0.859	0.674	0.671	0.673	0.704
		m	0.43	0.42	0.47	0.51	0.54	0.62	0.77	0.60	0.83	1.11	1.16
		zeta	1.902	1.667	1.759	1.657	1.90	1.413	1.983	2.441	1.254	1.441	1.721
		m	0.90	0.96	1.19	1.12	1.29	1.26	1.77	2.18	1.54	2.38	2.84
		zeta	1.879	1.885	1.34	1.924	1.11	1.731	0.978	1.104	1.398	1.609	0.748
		m	0.89	1.08	0.91	1.30	0.75	1.54	0.87	0.98	1.72	2.65	1.23
			Ø40- Ø40-Ø32	Ø50- Ø40-Ø40	Ø26- Ø16-Ø20	Ø26- Ø20-Ø16	Ø32- Ø20-Ø26	Ø40- Ø20-Ø32	Ø40- Ø26-Ø32	Ø50- Ø20-Ø40	Ø50- Ø26-Ø40	Ø50- Ø32-Ø40	
		zeta	0.633	0.597	0.694	0.832	0.619	0.633	0.673	0.616	0.587	0.621	
		m	1.04	1.32	0.62	0.74	0.76	1.04	1.11	1.36	1.30	1.37	
		zeta	1.701	1.308	1.445	2.526	1.236	1.142	1.123	1.061	1.088	1.307	
		m	2.81	2.89	1.29	2.25	1.52	1.88	1.85	2.35	2.41	2.89	
		zeta	1.02	1.328	1.393	1.337	1.231	1.102	1.143	1.056	1.054	1.223	
		m	1.68	2.94	1.24	1.19	1.52	1.82	1.89	2.34	2.33	2.71	

Zeta values (Medium: water at 15°C Flow speed: 2 m/s)		Ø16- Ø18-Ø16	Ø16- Ø20-Ø16	Ø20- Ø26-Ø20	Ø26- Ø32-Ø26	Ø32- Ø40-Ø32	Ø40- Ø50-Ø40	
T-piece enlarged		zeta	0.841	0.896	0.671	0.629	0.678	0.452
		m	0.48	0.61	0.60	0.77	1.12	1.00
		zeta	1.483	1.255	1.14	1.029	1.233	2.209
		m	0.85	0.85	1.02	1.27	2.03	4.80
		zeta	1.749	1.598	1.507	1.395	1.629	2.298
		m	1.00	1.08	1.34	1.72	2.69	5.08



Zeta values (Medium: water at 15°C Flow speed: 2 m/s)

		Ø14-1/2"	Ø16-3/8"	Ø16-1/2"	Ø18-1/2"	Ø20-1/2"	Ø20-3/4"	Ø26-3/4"				
Backplate		zeta	1.697	1.417	1.441	1.513	1.587	1.264	1.385			
		m	0.64	0.67	0.68	0.87	1.07	0.86	1.24			
		Ø16-1/2"-Ø16		Ø20-1/2"-Ø20								
Double backplate		zeta	4.157	4.315								
		m	1.97	2.92								
Reduction				Ø16-Ø14	Ø18-Ø14	Ø18-Ø16	Ø20-Ø14	Ø20-Ø16	Ø20-Ø18	Ø26-Ø16	Ø26-Ø18	Ø26-Ø20
		zeta	0.953	0.913	0.722	0.838	0.765	0.669	0.746	0.813	0.684	
		m	0.45	0.52	0.41	0.57	0.52	0.45	0.67	0.73	0.61	
				Ø32-Ø16	Ø32-Ø20	Ø32-Ø26	Ø40-Ø26	Ø40-Ø32	Ø50-Ø32	Ø50-Ø40	Ø63-Ø40	Ø63-Ø50
zeta	0.807	0.689	0.598	0.622	0.599	0.671	0.592	0.661	0.531			
m	0.99	0.85	0.74	1.03	0.99	1.46	1.31	1.99	1.60			

- 1
- 2
- 3
- 4
- 5
- 6
- 7
- 8
- 9
- 10
- 11



1 PIPES

1

Expansion table

All materials used in manufacturing the pipe expand when they are warmed and shrink when they cool down.

That is why you always have to take length differences into account as a result of variations in temperature. The temperature difference and the length of the pipe are the

two parameters that will determine the change in length. You can use the expansion table below to see the change in length that can be expected with a certain pipe length and a certain temperature difference. The coefficient of expansion is the same for all diameters.

Expansion (mm/m)	Temperature difference (ΔT)							
	10°C	20°C	30°C	40°C	50°C	60°C	70°C	80°C
Pipe length (m)								
1	0.25	0.50	0.75	1.00	1.25	1.50	1.75	2.00
2	0.50	1.00	1.50	2.00	2.50	3.00	3.50	4.00
3	0.75	1.50	2.25	3.00	3.75	4.50	5.25	6.00
4	1.00	2.00	3.00	4.00	5.00	6.00	7.00	8.00
5	1.25	2.50	3.75	5.00	6.25	7.50	8.75	10.00
6	1.50	3.00	4.50	6.00	7.50	9.00	10.50	12.00
7	1.75	3.50	5.25	7.00	8.75	10.50	12.25	14.00
8	2.00	4.00	6.00	8.00	10.00	12.00	14.00	16.00
9	2.25	4.50	6.75	9.00	11.25	13.50	15.75	18.00
10	2.50	5.00	7.50	10.00	12.50	15.00	17.50	20.00

The expansion table (expressed in mm) was created using the following formula:

$$\Delta L = L \times a \times \Delta T$$

Where:

- ΔL = change in length
- L = length of pipe
- a = coefficient of expansion
- ΔT = temperature difference

and where the coefficient of expansion is 0.025 mm/mK irrespective of the diameter of the pipe.

Example:

Given that:

- $L = 8 \text{ m}$
- $a = 0.025 \text{ mm/mK}$
- $\Delta T = 50^\circ\text{C}$ (where $T_{\text{min}}=20^\circ\text{C}$ and $T_{\text{max}}=70^\circ\text{C}$)

Required: ΔL

Solution: Consult the expansion table or apply the formula.

From the table: $\Delta L = 10.0 \text{ mm}$

Using the formula: $\Delta L = L \times a \times \Delta T$
 $\Delta L = 8 \times 0.025 \times 50$
 $\Delta L = 10.0 \text{ mm}$

This change in length should be considered when a professional installs the piping system.



- 1
- 2
- 3
- 4
- 5
- 6
- 7
- 8
- 9
- 10
- 11

Regression curve (working life) of the Henco STANDARD and RIXc multilayer pipes

The working life of the multilayer pipe depends on the temperature and pressure in the pipe. The straight lines in the diagram below show the pressure that the pipe is capable of withstanding at a certain age and a constant water temperature. Clearly the pipe can withstand less pressure as it becomes older. To obtain German DVGW certification, a pipe must be able to withstand a pressure of 1.5 its working pressure after 50 years and at a constant water temperature of 70°C.

The regression curves for the different diameters of the Henco multilayer pipe show that for all pipe diameters, after 50 years with a water temperature of 70°C, the pipes are able to resist a much greater pressure than that required for DVGW certification. The Henco pipe has a working life of at least 50 years.

Please see the example below of the regression curve for diameter 16, as drawn up by the test laboratory of the SKZ in Germany.

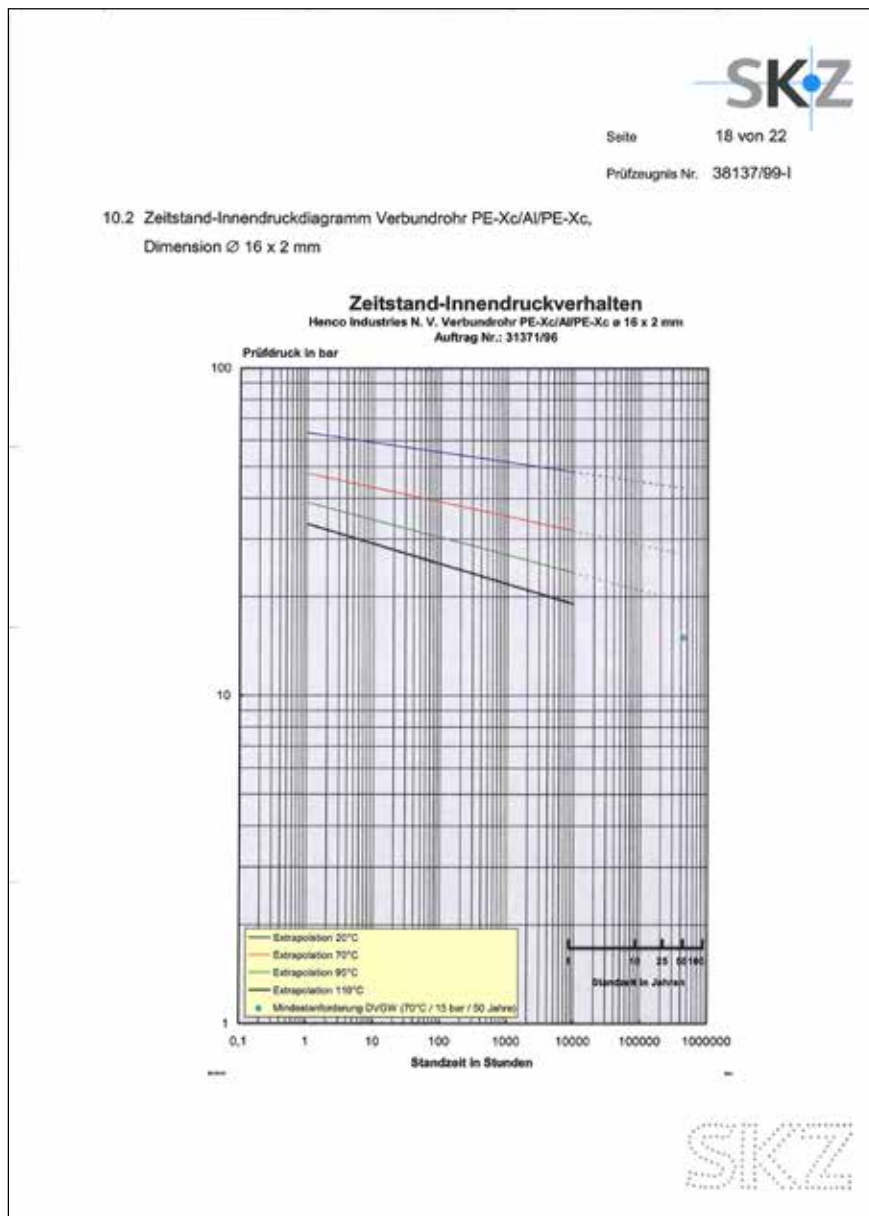



1 PIPES

1 HENCO PRE-INSULATED

2 **Version: STANDARD and RIXc**

3 **General**

4 The PE-Xc/Al/PE-Xc pipes come with a round or eccentric thermal insulating material. This material is made from
5 extruded PE foam with a closed cell structure and protects
6 the pipe against:

- 7 ▶ Heat loss/heat transmission
- 8 ▶ Condensation
- 9 ▶ Expansion
- 10 ▶ Noise transmission

The PE foam has a sturdy outer layer made from PE with a
red or blue meshed vapour tight structure. This protects the
foam against damage, so that the insulating properties of
the product are not lost even during rough building work.
The technical characteristics of the thermal insulation are as
follows:

Insulation value (DIN 52613 / ISO 8497)	0.040 W/mK at +40°C 0.036 W/mK at +10°C
Fire classification	C _L -s1-d0 (EN 13501)
Temperature resistance	-40°C to + 100°C
Usage temperature	+5°C to +100°C (EN 14707)
Sound damping	Up to 23 dB(A) (DIN 52218)
Thickness (round)	6, 10 or 13 mm
Water vapour diffusion resistance	6315 mu





- 1
- 2
- 3
- 4
- 5
- 6
- 7
- 8
- 9
- 10
- 11

Transmission table															
AT	Ø14		Ø16			Ø18		Ø20			Ø26			Ø32	
	6 mm	10 mm	6 mm	10 mm	13 mm	6 mm	10 mm	6 mm	10 mm	13 mm	6 mm	10 mm	13 mm	6 mm	10 mm
0.0	0.0	0.0	0.0	0.0	0.0	0.0	0.0	0.0	0.0	0.0	0.0	0.0	0.0	0.0	0.0
-1.0	-0.4	-0.4	-0.4	-0.4	-0.3	-0.4	-0.3	-0.3	-0.3	-0.3	-0.3	-0.2	-0.2	-0.2	-0.2
-2.0	-0.9	-0.8	-0.8	-0.7	-0.7	-0.7	-0.7	-0.7	-0.6	-0.6	-0.5	-0.5	-0.5	-0.4	-0.4
-3.0	-1.3	-1.2	-1.2	-1.1	-1.0	-1.1	-1.0	-1.0	-0.9	-0.9	-0.8	-0.7	-0.7	-0.6	-0.6
-4.0	-1.8	-1.6	-1.6	-1.4	-1.3	-1.4	-1.3	-1.3	-1.2	-1.1	-0.1	-0.1	-0.9	-0.9	-0.8
-5.0	-2.2	-2.0	-2.0	-1.8	-1.7	-1.8	-1.6	-1.6	-1.5	-1.4	-1.3	-1.2	-1.2	-1.1	-1.0
-6.0	-2.7	-2.4	-2.4	-2.2	-2.0	-2.1	-2.0	-2.0	-1.8	-1.7	-1.6	-1.5	-1.4	-1.3	-1.2
-7.0	-3.1	-2.8	-2.8	-2.5	-2.4	-2.5	-2.3	-2.3	-2.1	-2.0	-1.8	-1.7	-1.6	-1.5	-1.4
-8.0	-3.5	-3.2	-3.2	-2.9	-2.7	-2.9	-2.6	-2.6	-2.4	-2.3	-2.1	-1.9	-1.9	-1.7	-1.6
-9.0	-4.0	-3.6	-3.6	-3.2	-3.0	-3.2	-2.9	-2.9	-2.7	-2.6	-2.3	-2.2	-2.1	-1.9	-1.8
-10.0	-4.4	-4.0	-4.0	-3.6	-3.4	-3.6	-3.3	-3.3	-3.0	-2.8	-2.6	-2.4	-2.3	-2.2	-2.0
-11.0	-4.9	-4.4	-4.4	-3.9	-3.7	-3.9	-3.6	-3.6	-3.3	-3.1	-2.9	-2.7	-2.5	-2.4	-2.2
-12.0	-5.3	-4.8	-4.8	-4.3	-4.0	-4.3	-3.9	-3.9	-3.6	-3.4	-3.1	-2.9	-2.8	-2.6	-2.4
-13.0	-5.8	-5.2	-5.1	-4.7	-4.4	-4.7	-4.3	-4.3	-3.9	-3.7	-3.4	-3.2	-3.0	-2.8	-2.6
-14.0	-6.2	-5.6	-5.5	-5.0	-4.7	-5.0	-4.6	-4.6	-4.2	-4.0	-3.6	-3.4	-3.2	-3.0	-2.8
-15.0	-6.6	-6.0	-5.9	-5.4	-5.0	-5.4	-4.9	-4.9	-4.5	-4.3	-3.9	-3.6	-3.5	-3.2	-3.1
-16.0	-7.1	-6.4	-6.3	-5.7	-5.4	-5.7	-5.2	-5.2	-4.8	-4.6	-4.2	-3.9	-3.7	-3.4	-3.3
-17.0	-7.5	-6.8	-6.7	-6.1	-5.7	-6.1	-5.6	-5.6	-5.1	-4.8	-4.4	-4.1	-3.9	-3.7	-3.5
-18.0	-8.0	-7.1	-7.1	-6.5	-6.0	-6.4	-5.9	-5.9	-5.4	-5.1	-4.7	-4.4	-4.2	-3.9	-3.7
-19.0	-8.4	-7.5	-7.5	-6.8	-6.4	-6.8	-6.2	-6.2	-5.7	-5.4	-4.9	-4.6	-4.4	-4.1	-3.9
-20.0	-8.8	-7.9	-7.9	-7.2	-6.7	-7.2	-6.5	-6.5	-6.0	-5.7	-5.2	-4.9	-4.6	-4.3	-4.1
-21.0	-9.3	-8.3	-8.3	-7.5	-7.1	-7.5	-6.9	-6.9	-6.3	-6.0	-5.5	-5.1	-4.9	-4.5	-4.3
-22.0	-9.7	-8.7	-8.7	-7.9	-7.4	-7.9	-7.2	-7.2	-6.6	-6.3	-5.7	-5.3	-5.1	-4.7	-4.5

The table shows the surface temperature of the insulation at a certain temperature difference.

Example: - ambient temperature: 24°C
 - cold water temperature: 6°C
 - temperature difference: 6°C - 24°C = -18°C

This means that the surface temperature is then 20,2°C (24°C - 3,8°C).

For a 16 mm pipe provided with 10 mm insulation that has a temperature difference of -18°C the correction value is of -3,8°C.

To avoid condensation, the surface temperature of the insulation must always be higher than the dew point temperature.



1 PIPES

1 HENCO PROTECTION HOSE

2 **Version: STANDARD, RIXc and 5L PE-Xc**

3 **General**

4 The Henco STANDARD and RIXc multilayer pipes and the
5 5L PE-Xc synthetic pipes are also supplied with a ribbed
6 protection hose.

7 **Material and characteristics**

8 **Extra protection**

9 The protective sleeves are made from Polyethylene. This
10 offers extra protection to pipes carrying water and gas during
11 building works.

Low insulating capacity

This prevents laid pipes from transmitting too much heat to
the floor above when the pipes are used with central heating
systems.

The layer of air in the protective sleeve provides an insulating
effect.

Henco always recommends to use a protective sleeve for
additional mechanical protection. An additional benefit of
using a protective sleeve is that supply and return pipes can
be colour coded which prevents mistakes with incorrectly
connected pipes.

Gas installations

In gas installations, you are only allowed to combine the
yellow protective sleeves with the Henco STANDARD
multilayer pipe for gas. See page 29 for the gas specifications
concerning protective sleeves.

Range

Pipe sleeves can be supplied in red, blue, yellow or black in
diameters ranging from 14 to 32 mm.





HENCO COMBI®

Versions: STANDARD and RIXc

General

The Henco COMBI® consists of two PE-Xc/AL/PE-Xc pipes which are provided with a double polyethylene protective sleeves. The double protective sleeve is made from two individual sleeves which are connected to each other at various points. This means that you can fit floor fastenings between the two sleeves. As the pipes are only connected at various points, it requires little effort to separate the pipes.

Advantages

The Henco COMBI pipe combines the benefits of having a single protective sleeve with the following advantages

- ▶ Fast installation (supply and return pipes can be fitted in one job)
- ▶ Less fastenings required on the floor below
- ▶ Neat (parallel) installation

Red marking

It is important that the fitter is able to tell which is the supply and which is the return pipe. That is why one of the protective sleeves carries a red marking.

Henco recommends that you always use a protective sleeve for additional mechanical protection.

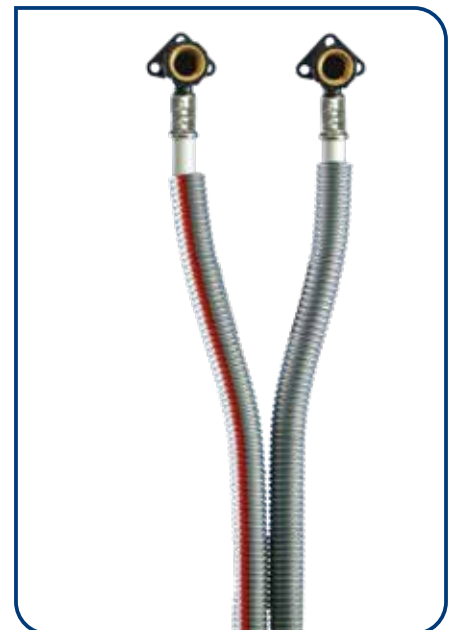
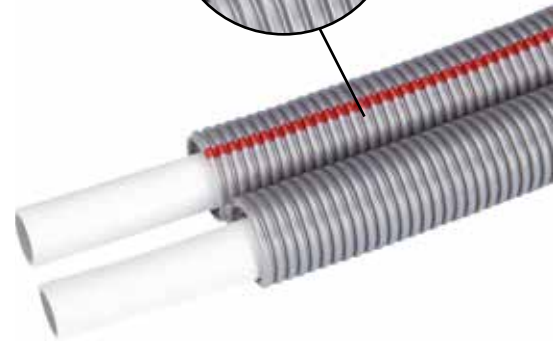

1

2

3

4

5

6

7

8

9

10

11



1 PIPES

1

HENCO GAS

2

Version: STANDARD and with protective sleeve

3

General

4

The Henco STANDARD multilayer pipe PE-Xc/Al/PE-Xc and the PE protective sleeve can also be used with gas, provided that you use yellow pipes and sleeves.

5

6

7

The Henco system for gas is only permitted in countries where a gas quality mark has been granted. Always consult the applicable regulations for gas piping systems which apply in the country.

8

9

10

The Henco synthetic gas system carries the KIWA-GASTEC gas quality mark 39581/01 and is intended for domestic gas installations and for transporting gas according to NPR-3378-5 and NPR-3378-6 of December 2012 and the amendments 3378-5/A1 and 3378-6/A1.

11

In addition, the Henco gas system with brass press fittings possesses the UNI/TS 11344 quality mark.

▶ KIWA-GASTEC

▶ UNI/TS 11344



Synthetic gas pipes don't have to be protected against corrosion in humid areas. This is in contrast to metal gas piping which must be protected against corrosion. Using synthetic piping gives significant savings during purchase and installation.

System

The Henco gas system comprises the Henco PE-Xc/Al/PE-Xc multilayer pipes for gas which can be provided with or without protective sleeves and the Henco PVDF and brass press fittings for gas.





1

2

3

4

5

6

7

8

9

10

11

12

Colour indication

The pipes and sleeves are yellow and are printed with the Henco brand name and the KIWA-GASTEC name. The sleeves of the fitting are required to have a yellow stamp.

Solely for use with gas installations

The yellow pipe (protection hose) and the specially marked gas fittings can only be used in gas installations. The gas fittings are provided with special O-ring seals (HNBR) that have been specially designed for gas and do not work in water installations. Therefore regular water fittings cannot be used in gas installations and conversely, gas fittings cannot be used with water!

Protection hoses

Instructions for the installation of gas piping

- ▶ You should choose the piping route so that that likelihood of damage to pipes from drilling or inserting nails for example is as low as possible.
- ▶ When pipes are bent, the minimum bending radius specified by Henco should be respected. You should remove any cracked pipes.
- ▶ Protection hoses have been adopted and are obligatory in certain circumstances. Protective sleeves give extra protection to pipes carrying gas when building works are being carried out. Henco always recommends to use a protective sleeve as it provides additional mechanical protection. The pipe sleeves are made from polyethylene and can also be supplied separately.
- ▶ When carrying out building work you should block off the end of the gas pipe to prevent debris from entering the pipe. If dirt does enter the pipe, you should remove this using inert gas or compressed air.
- ▶ Pipes and fittings which show signs of surface damage should not be used.

Installation specifications for gas piping and gas fittings

Basic criteria

- ▶ NPR-3378-5 of December 2012 and the amendment 3378-5/A1
- ▶ NPR-3378-6 of December 2012 and the amendment 3378-6/A1



1 PIPES

1

2

3

4

5

6

7

8

9

10

11

Positioning pipes

Pipes can be positioned in the following ways:

- ▶ A In view
- ▶ B Concealed
- ▶ C In the ground

The Henco gas system can be used subject to the following requirements:

- ▶ Pipes use press connections (cannot be detached)
- ▶ Positioning pipes A-B-C

Explanations (the sub-numbers refer to NEN 3378-6):

A Pipes in view (NPR 3378-6, 4.2)

(4.2.1) Examples/definitions of pipes in view:

- ▶ a pipe in a well-accessible crawl space. Well-accessible implies a door or access hatch measuring 1 m x 0.60 m and a clearance height of at least 0.80 m
- ▶ a gas meter installed in a meter box, closed off with a door
- ▶ a burner, closed off with a door

(4.2.2) A crawl space is accessible if it can be accessed for inspection, maintenance and replacement:

- ▶ via a crawl hatch measuring at least 1 m x 0.60 m
- ▶ a clearance height of at least 0.80 m
- ▶ without obstacles impeding free passage

Two types of accessible crawl spaces can be distinguished:

(4.2.2.2) A crawl space with watertight damp-proofing on the bottom (e.g. concrete with contiguous watertight rising walls): It is allowed to install the pipe with a pipe sleeve in this situation, provided that the area is permanently dry and ventilated by means of opposing ventilation openings. The pipe sleeve can be interrupted at the fittings. The Henco gas fittings and multilayer pipes do not require additional protection against corrosion.

(4.2.2.3) A crawl space without watertight damp-proofing on the bottom (e.g. sand): In crawl spaces without watertight damp-proofing, gas pipes should be installed with an uninterrupted pipe sleeve. This pipe sleeve must be:

- ▶ made of a synthetic
- ▶ uninterrupted, i.e. no fittings under the floor
- ▶ able to dispose of any leak gas above the floor. Henco gas pipes and pipe sleeves do not require protection against corrosion.

(4.2.3.2) Space where a gas meter is installed (meter area)

If a Henco multilayer pipe is installed in the area where a gas meter is installed, it needs to be protected against mechanical and heat loads by means of a flexible pipe sleeve made of PE. The fittings do not require protection by means of a pipe sleeve.

(4.2.3.3) Space where a burner is installed

If a multilayer pipe is installed in the area where a burner is installed, it needs to be protected against mechanical and heat loads by means of a flexible pipe sleeve made of PE. The fittings do not require protection by means of a pipe sleeve.

(4.2.3.4) Pipe shafts

If a multilayer pipe is installed in an accessible pipe shaft, it needs to be protected against mechanical and heat loads by means of a flexible pipe sleeve made of PE. The fittings do not require protection by means of a pipe sleeve.

(4.2.4) Pipes above a lowered removable ceiling

If a multilayer pipe is installed in the space above a lowered removable ceiling (system ceiling), it should be protected against mechanical and heat loads by means of a flexible pipe sleeve made of PE. The fittings do not require protection by means of a pipe sleeve.



- 1
- 2
- 3
- 4
- 5
- 6
- 7
- 8
- 9
- 10
- 11

B Concealed pipes (NPR 3378-6, 4.3)

With regard to pipes in inaccessible or out-of-reach spaces, a distinction is made between the following three circumstances:

- ▶ pipes in potentially humid and corrosive spaces
- ▶ pipes in dry, non-corrosive spaces
- ▶ embedded pipes in floors and walls

(4.3.2.2) E.g. in humid crawl spaces without watertight damp-proofing on the bottom, multilayer pipes are allowed, provided that they are installed in an uninterrupted pipe sleeve. In this case, the use of fittings for additional connections is not allowed. Both ends of the pipe sleeve must protrude at least 20 mm above the finished floor. If any additional connection is required, a connection by means of a T-piece above the floor could be a solution. A second pipe with a pipe sleeve can then be connected similarly (as a bypass) to the T-piece. It is important that the brackets around the pipe sleeve are sufficiently wide, to allow any leaked gas to flow freely between the inner pipe and the pipe sleeve.

(4.3.2.3) Pipes in dry, non-corrosive spaces (e.g. fixed ceilings, back panelling, joisting, storey floors, ...): The use of pipe sleeves in these cases is not obligatory. The pipe trajectory must be chosen in such a manner that any risk of damage e.g. by drilling or nailing is avoided.

Press fittings are tensile proof and therefore allowed.

(4.3.3) Embedded pipes

Multilayer pipes and press fittings can be embedded in floors and walls. If the situation permits, we recommend fitting the pipe with a flexible pipe sleeve, but this is not obligatory. Before or during the work, the pipe sleeve will provide more mechanical protection for the inner pipe.

The material of the architectural construction should not be allowed to damage the piping and the fitting. Where the pipe protrudes from the floors and walls, we recommend using a piece of pipe sleeve as protection. At the transition of the finished floor or wall it will protect the inner pipe against notch effects.

(4.3.4) Pipes in a closed pipe trench, tunnel or masonry ducts

Henco multilayer pipes and press fittings can be used in this case. If the situation permits, we recommend fitting the pipe with a flexible pipe sleeve, but this is not obligatory. Before or during the work, the pipe sleeve will provide more mechanical protection for the inner pipe. If the duct has a watertight damp-proofing at the bottom, it must be ventilated upwards.

C Pipes in the ground (NPR 3378-7)

The use of multilayer pipes and fittings for gas transport in the ground is allowed, from a diameter of 16 mm up to and including a diameter of 40 mm, in combination with the press fittings, within the plot lines.

- ▶ Gas inlet bends should be used for façade feed-throughs.
- ▶ The press fittings need to be protected with DENSO grease tape.
- ▶ The multilayer pipes need to be fitted with a pipe sleeve.
- ▶ An underground warning tape must be applied approximately 30 cm above the pipe.
- ▶ If the ground is covered with 0.80 m of clean sand, mechanical protection measures must be taken, when technical objections arise.

It is recommended to feed the gas pipe through with a pipe sleeve in a solid PVC/PE/PP pipe sleeve.

Gas pipes should not be installed under buildings, in polluted soil, in rubble soil and where root growth and significant subsidence may occur.



1 PIPES

1

2

3

4

5

6

7

8

9

10

11

Summary

Places where gas pipes are NOT allowed (NPR 3378-6, 5.0):

- ▶ cavities, except in case of perpendicular feed-through with a pipe sleeve
- ▶ chimneys, drainage or ventilation ducts
- ▶ waste or fuel ducts or elevator shafts

Application/installation WITHOUT a pipe sleeve (NPR 3378-6):

- ▶ (4.3.3) Embedded or plastered-over pipes in floors and walls: Henco PVDF press fittings are allowed without protective measures.
- ▶ (4.3.2.3) Pipes between joisting/storey floors/fixed ceilings/walls/ back panelling /behind kitchen units/ in closed pipe trenches/closed ducts: Henco PVDF press fittings are allowed without protective measures.

Application/installation WITH a pipe sleeve (NPR 3378-6):

- ▶ (4.2.3.2) In meter boxes from the gas meter until the pipe disappears from view (not visible with the naked eye): Henco PVDF press fittings are allowed, pipe sleeve up to the fitting.
- ▶ (4.2.3.3) Connecting pipes to burners until the pipe disappears from view (not visible with the naked eye): Henco a PVDF press fittings are allowed, pipe sleeve up to the fitting.
- ▶ (4.2.4)(4.2.3.4.) Lowered ceilings (system ceilings) /accessible pipe shafts: Henco PVDF press fittings are allowed, pipe sleeve up to the fitting.
- ▶ (4.2.2.2) Crawl space with watertight damp-proofing on the bottom: Henco PVDF press fittings are allowed, pipe sleeve up to the fitting.
- ▶ (4.2.2.3) Crawl space (basement) without watertight damp-proofing on the bottom, uninterrupted pipe sleeve, approx. 20 mm protruding from the finished floor: Henco PVDF press fittings are not allowed.

Application/installation WITH a pipe sleeve in the ground (NPR 3378-7, 5.0):

- ▶ Apply a pipe sleeve up to the Henco PVDF press fittings.
- ▶ Wrap Henco PVDF press fittings in DENSO grease tape (commercially available with QA gas quality label).
- ▶ Apply a yellow underground warning tape (GAS) approx. 30 cm above the gas pipe (also commercially available).
- ▶ It is recommended to install the gas pipe in a pipe sleeve made of PVC/PE/PP. However, this is not obligatory.



- 1
- 2
- 3
- 4
- 5
- 6
- 7
- 8
- 9
- 10
- 11

Protection hose

Henco always recommends to use a protective sleeve as it provides additional mechanical protection.

The Henco pipe sleeve meets the following requirements:

- ▶ Synthetic
- ▶ Internal & external diameter
- ▶ Gas tight

Mechanical damage

We recommend that you do not expose piping in gas installations to the risk of mechanical damage and/or external mechanical stresses.

Earthing

Synthetic piping should not be earthed using a metal barrier coating.

Disconnection from the gas supply

It merits attention that you should be able to disconnect installations from the gas supply as follows:

- ▶ After each point of entry in a home that does not have its own stopcock.
- ▶ After the point of entry to every physical building if the gas supply serves several separate buildings.
- ▶ Outside a heating room
- ▶ Immediately after the point of entry to a practical room or laboratory
- ▶ Immediately before a gas pressure regulator and metering equipment.
- ▶ Where gas appliances are located (in the case of decorative devices this can also be inside the meter cupboard)

Protection in event of a gas leak (Detailed info: NPR-3378-5 of December 2012)

When there is a drop in gas pressure or the gas supply is reconnected there should not be an unlimited discharge of unburned gas from the piping or gas appliance. This is not a problem for gas appliances fitted with a cutoff valve.

The following apply to gas appliances that are not fitted with a cutoff valve:

- ▶ Premises: a gas cutoff valve should be fitted behind every stopcock in sections of piping between the gas meter and the appliance.
- ▶ In homes, a gas shutoff valve should be used in the section of pipe that is immediately behind the tap at the gas meter.





1 PIPES

1

2

3

4

5

6

7

8

9

10

11

Type of gas

Henco gas pipes and press fittings are suitable for:

- ▶ Natural gas
- ▶ Propane
- ▶ Butane

For more information, refer to NEN 1078.



Pressure test

The piping is first thoroughly tested using a blast of air at a pressure of 1 bar (1000 mbar). The pressure should then be reduced to a test pressure that is 100 mb above the working pressure. The piping is considered to be gas-tight when there is no visible drop in pressure over a period of 5 minutes. A U-tube manometer or digital manometer is used to measure the pressure drop.

Note: these guidelines are only a small part of the actual standard. For further details about these guidelines, please consult NPR 3378-5 and NPR 3378-6.

Pressure loss diagram and pressure loss table for gas pipes

Just like water, gas also loses energy due to frictional forces against the wall of the pipe. You can make correct pipe calculations by using the pressure loss diagrams for gas. Under the NEN 1078 standard, piping systems should be planned so that the pressure loss is not greater than the

difference between the working pressure and the minimum required supply pressure that is set by the manufacturer of the appliance. This means for a household gas installation that the total pressure loss from the outlet of the gas meter to the appliance may be 250 Pa (2.5 mbar).

Pressure loss for natural gas 12°C

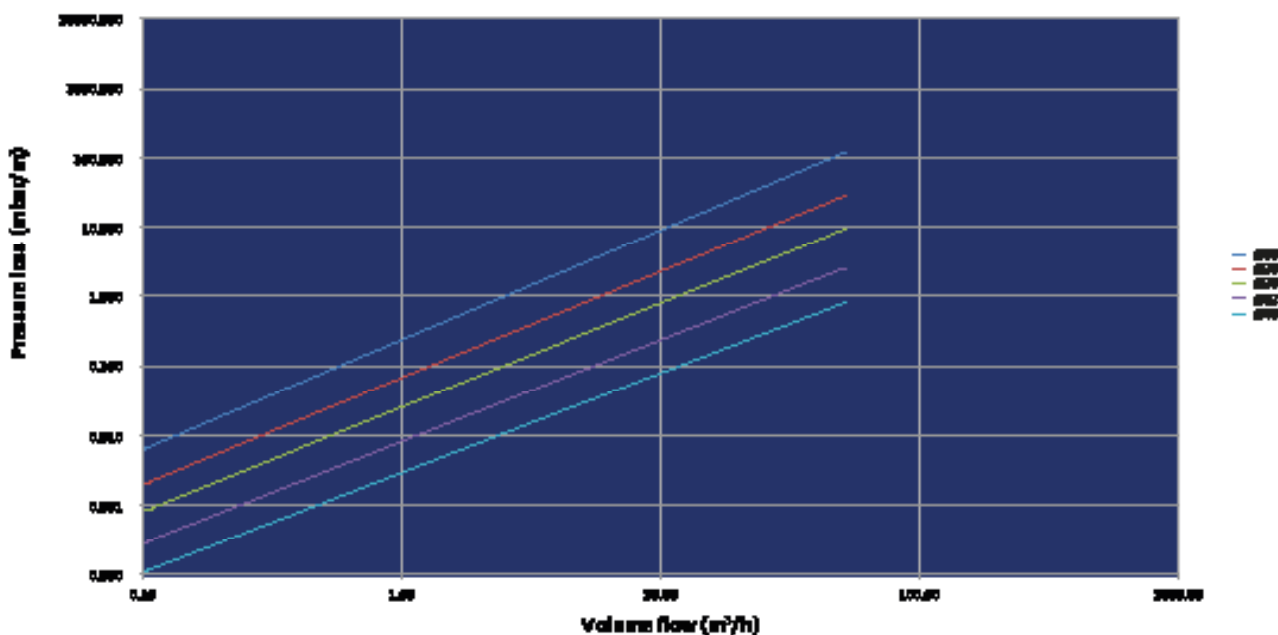





1 PIPES

1 Overview of flow loss coefficients (Zeta values)

Liquids do not only lose energy when they flow through a pipe. They also lose energy when they change direction. This is because liquids have to overcome extra

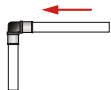
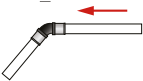
resistance. The table below provides an overview of the flow loss coefficients for the various fittings and the corresponding number of meters of piping.

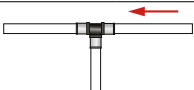
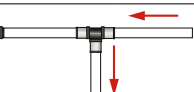
Zeta values*			Ø16	Ø20	Ø26	Ø32	Ø40
Bend 90°		zeta	21,9	12,1	9,3	6,3	6,1
		m	6,3	5	5,1	4,8	6,2
Bend 45°		zeta					2,6
		m					2,6
Straight coupling		zeta	7,9	3,8	2,9	1,7	1,3
		m	2,3	1,5	1,6	1,3	1,3
T-piece		zeta	8,1	4,1	3,2	1,9	1,7
		m	2,3	1,7	1,7	1,4	1,8
		zeta	22,8	12,8	10,7	7	6,7
		m	6,5	5,3	5,8	5,2	6,8

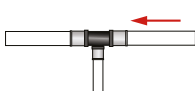
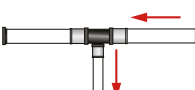
Zeta values*			Ø20- Ø16-Ø20	Ø26- Ø16-Ø26	Ø26- Ø20-Ø26	Ø32- Ø20-Ø32	Ø32- Ø26-Ø32	Ø40- Ø16-Ø40	Ø40- Ø26-Ø40	Ø40- Ø32-Ø40
T-piece reduction		zeta	4,1	2,7	2,8	1,5	1,6	1,6	1,5	1,7
		m	1,7	1,5	1,5	1,1	1,2	1,7	1,5	1,8
		zeta	40,5	75,3	20,1	49,5	17,2	na	42,3	15,8
		m	16,6	40,8	10,9	37,3	13	na	42,9	16

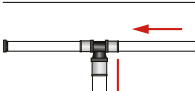
Zeta values*			Ø16- Ø20-Ø16	Ø20- Ø26-Ø20	Ø26- Ø32-Ø26	Ø32- Ø40-Ø32
T-piece enlarged		zeta	8,4	4,2	2,9	2,4
		m	2,4	1,7	1,6	1,8
		zeta	38,6	20	17,1	13,1
		m	15,9	10,9	12,9	13,3



Zeta values*			Ø20- Ø16-Ø16	Ø20- Ø20-Ø16	Ø26- Ø20-Ø20	Ø26- Ø26-Ø16	Ø26- Ø26-Ø20	Ø32- Ø26-Ø26	Ø40- Ø32-Ø32	Ø40- Ø40-Ø26	Ø40- Ø40-Ø32	Ø26- Ø16-Ø20	Ø26- Ø20-Ø16
T-piece 2x reduction		zeta	16,4	16,4	7,2	43,6	6,5	5,3	3,8	14,5	3,7	7,4	42,3
		m	6,7	6,7	3,9	23,6	3,5	4	3,9	14,7	3,7	4	22,9
	zeta	36,6	12,6	19,6	10,1	12,7	17,3	14,1	6,2	6,4	82,3	34,4	
	m	15	5,2	10,6	5,5	6,9	13	14,3	6,3	6,5	44,6	18,7	
			Ø26- Ø20-Ø16	Ø32- Ø20-Ø26	Ø40- Ø20-Ø32	Ø40- Ø26-Ø32	Ø50- Ø20-Ø40	Ø50- Ø26-Ø40	Ø50- Ø32-Ø40				
	zeta	42,3	5,5	3,5	3,8								
	m	22,9	4,2	3,6	3,8								
	zeta	34,4	46,8	113,4	40,6								
	m	18,7	35,2	115	41,2								

Zeta values*			Ø16-1/2"	Ø20-1/2"	Ø20-3/4"	Ø26-3/4"			
Backplate		zeta	19,3	9,4	13,1	7,1			
		m	5,5	3,9	5,4	3,8			
Double backplate			Ø16-1/2"-Ø16	Ø20-1/2"-Ø20					
		zeta	37,9	25,9					
	m	10,9	10,6						
		zeta	23,5	10,3					
m		6,7	4,2						
Reduction			Ø20-Ø16	Ø26-Ø16	Ø26-Ø20	Ø32-Ø20	Ø32-Ø26	Ø40-Ø26	Ø40-Ø32
		zeta	18,7	39,9	7,3	17,9	5,9	14,2	3,4
	m	7,7	21,6	4	13,4	4,5	14,4	3,5	

* Henco multilayer pipe GAS

Atmospheric pressure 1013
Gas temperature 12°C

Calorific value of natural gas
Initial precharge

35,17 MJ//m³
30 mbar



1 PIPES

1 1.2 SYNTHETIC PIPES

2 HENCO 5L PE-Xc

3 General

4 The Henco 5L PE-Xc synthetic pipe is made up of five layers.
 5 It has an inner and outer layer of electron-beam cross-linked
 6 polyethylene that has been cross-linked using electron beams
 7 EVOH oxygen barrier that conforms with with DIN 4726 which
 8 allows this synthetic pipe to be used in heating applications.
 9 These three different layers are bonded to each other by two
 10 high-quality, homogenous connecting layers.

11 See page 7 for more detailed information about cross-linking.

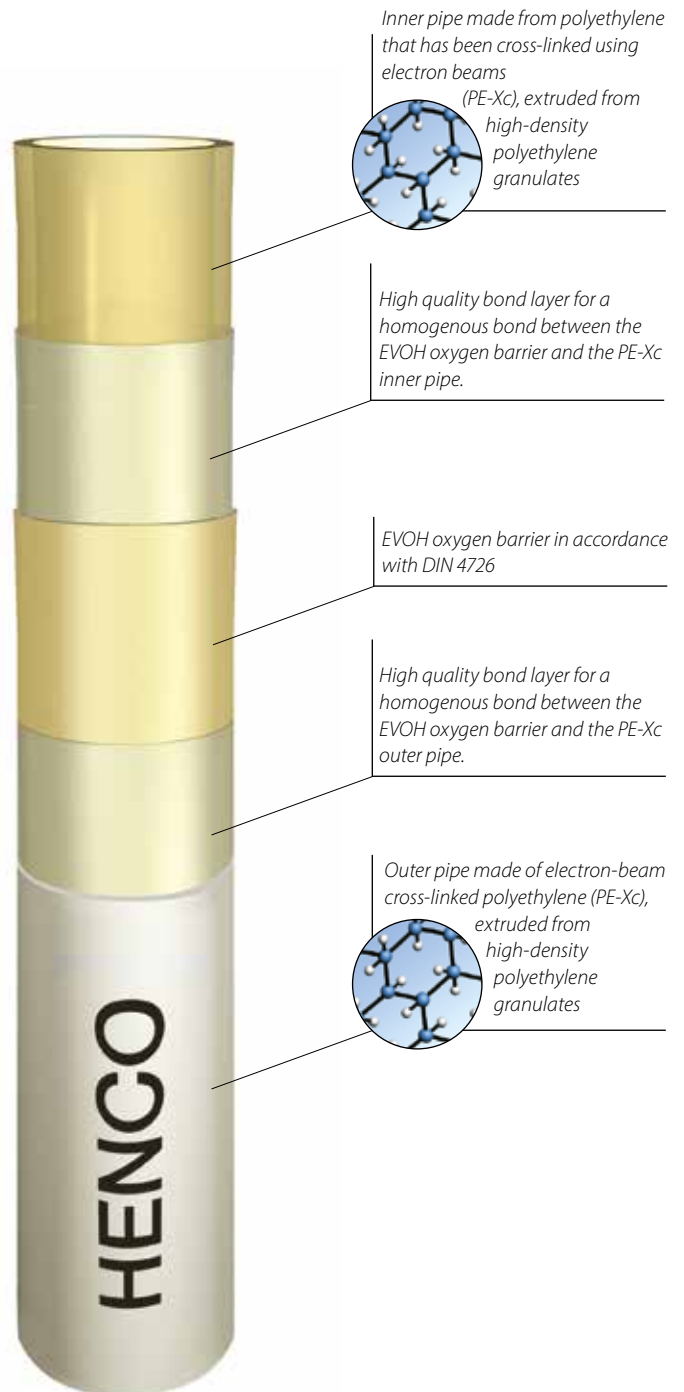

HENCO 5L PE-Xc WITH PROTECTION HOSE

See page 26 for the specifications of the protection hose



Technical characteristics of the HENCO 5L PE-Xc synthetic pipe

Technical profile of the HENCO 5L PE-Xc synthetic pipe

Outer diameter (mm)	12	14	16	17	18	20	25	32
Inner diameter (mm)	8	10	12	13	14	16	20.4	26.2
Wall thickness (mm)	2	2	2	2	2	2	2.3	2.9
Max. working temperature (°C)	Depending on the application classes and dimensions (see DIN EN ISO 15875-2 table)							
Application class (ISO10508)	2 - 4 - 5	2 - 4 - 5	2 - 4 - 5	2 - 4 - 5	2 - 4 - 5	2 - 4 - 5	2 - 4 - 5	2 - 4 - 5
Max. working pressure (bar)	Depending on the application classes and dimensions (see DIN EN ISO 15875-2 table)							
Coefficient of thermal conductivity (W/mK)	0.41	0.41	0.41	0.41	0.41	0.41	0.41	0.41
Coefficient of linear expansion (mm/mK)	0.18	0.18	0.18	0.18	0.18	0.18	0.18	0.18
Surface roughness of inner pipe (μ)	7	7	7	7	7	7	7	7
Oxygen diffusion DIN 4726 (g/m ³ /day)	< 0.1	< 0.1	< 0.1	< 0.1	< 0.1	< 0.1	< 0.1	< 0.1
Degree of cross-linking (%)	60	60	60	60	60	60	60	60
Weight (kg/m)	0.065	0.086	0.088	0.091	0.095	0.117	0.172	0.274
Flow (l/m)	0.050	0.079	0.113	0.133	0.154	0.201	0.327	0.539

Application class table (DIN EN ISO 15875-1)

Application class table (DIN EN ISO 15875-1)							
Application class	T_D		T_{max}		T_{mal}		Typical application
	°C	Time ^a years	°C	Time years	°C	Time h	
1 ^a	60	49	80	1	95	100	Hot water supply (60°C)
2 ^a	70	49	80	1	95	100	Hot water supply (70°C)
4 ^b	20 + cumulative 40 + cumulative 60	2.5 20 25	70	2.5	100	100	Underfloor heating and low-temperature radiators
5 ^b	20 + cumulative 60 + cumulative 80	14 25 10	90	1	100	100	High-temperature radiators

NOTE This international standard does not apply for T_D , T_{max} and T_{mal} greater than those shown in the table above.

a Countries can choose either class 1 or class 2 according to with their national legislation.

b Where there is more than 1 design temperature for a class, the times should be added together. "Plus cumulative" in the table implies a temperature profile for the aforementioned temperature over a certain period. (e.g. for class 5, the design temperature profile over 50 years is. This becomes 60 °C over 14 years, 80 °C over 10 years, 90 °C over 1 year and 100 °C over 100 hours respectively. .

DIN EN ISO 15875-2 TABLE

Maximum working pressure table 5L PE-Xc (DIN EN ISO 15875-2)								
Application class	Ø12 x 2	Ø14 x 2	Ø16 x 2	Ø17 x 2	Ø18 x 2	Ø20X 2	Ø25 x 2.3	Ø32 x 2.9
1	10	10	10	10	8	8	6	6
2	10	10	10	8	8	6	6	6
4	10	10	10	10	10	8	8	8
5	10	10	8	8	8	6	6	6

Value expressed in bar



2.1	Synthetic press fittings - standard	43
2.2	Synthetic press fittings - gas	47
2.3	Super sizes	48
2.4	Ecoline	53



2.1 HENCO PRESS - STANDARD

Technical details



PVDF

The synthetic press fittings are made from injection moulded PVDF (Polyvinylidene fluoride)*. PVDF offers the user a unique combination of properties:

- ▶ excellent mechanical strength and hardness
- ▶ high wear-resistance
- ▶ enormous flexibility: can be bent to 10°
- ▶ exceptional resistance to thermal aging
- ▶ extremely resistant to extreme temperatures: from -40°C to +150°C
- ▶ high purity
- ▶ no water absorption
- ▶ excellent chemical resistance against the most aggressive substances and solvents
- ▶ physiologically harmless, approved for contact with food products, drinking water and for use in the medical sector

PVDF is a synthetic material that is used for numerous applications in our society and has already proved its qualities for more than 30 years in a variety of fields.

PVDF should be used in:

- ▶ drinking water installations
- ▶ heating installations (radiator connecting pipes/ underfloor heating)
- ▶ domestic gas installations
- ▶ chemical industry (because of its good resistance to chemicals and its thermo-mechanical properties)
- ▶ cable manufacturing industries (because of its fire resistance and low smoke emission)
- ▶ food industry (because of its purity and surface qualities)

PVDF has extremely favourable properties, especially when compared to metal systems. For instance, PVDF is resistant to corrosion. The extremely smooth wall of the fitting makes it very resistant to any form of attack. Furthermore, PVDF also produces less noise and there is no possibility of water contamination. Finally PVDF is not only lighter but also considerably cheaper than metal fittings.

Brass

The synthetic transition fittings made by Henco (female thread, male thread) are made from PVDF and have inserts made from brass CW617N or CW602N (DZR: dezincification resistant brass).



2 HENCO PRESS

1

2

3

4

5

6

7

8

9

10

11

Leak detection (LBP)*

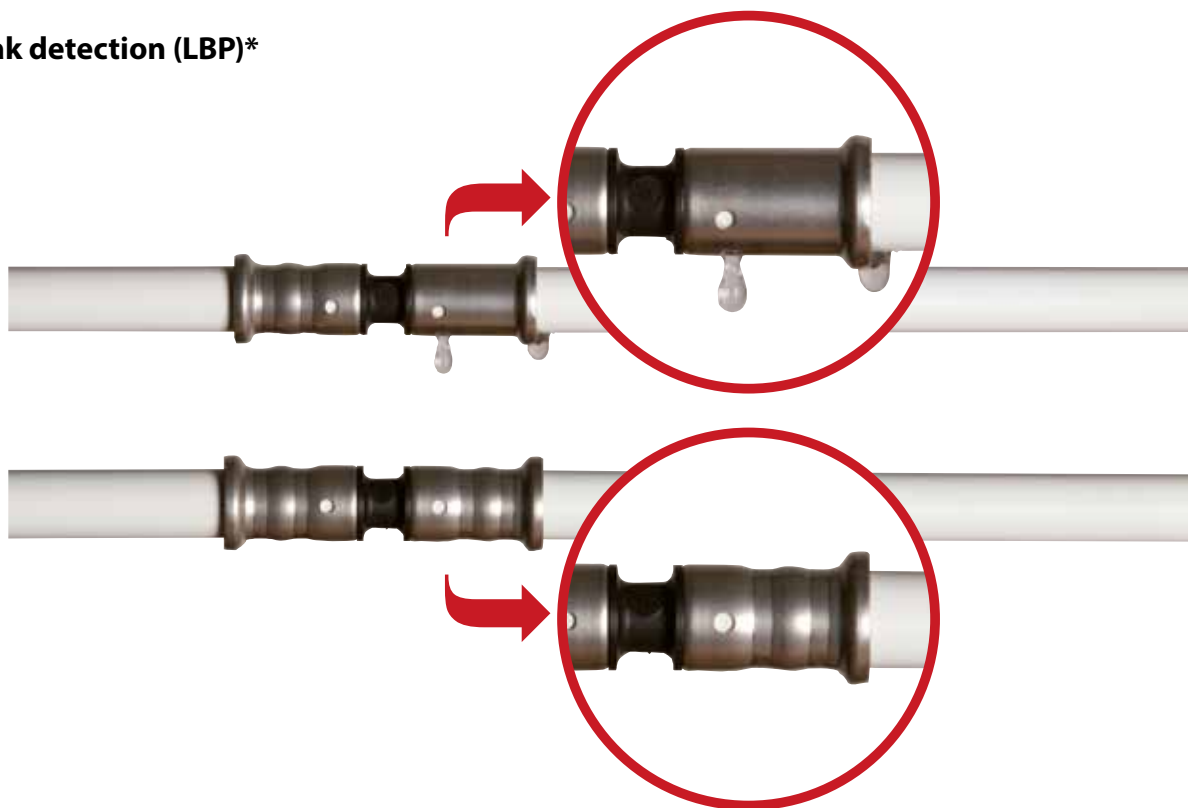

Henco synthetic press fittings are designed in such a way that they leak immediately if you forget to press the fitting during assembly.

Pressing the fitting has a two functions:

- ▶ It seals the O-ring
- ▶ It fastens the fitting to the pipe

If the fitting is not pressed it will leak when the system pressure is 0.5 Bar. This allows early detection of errors (during the required pressing of the piping system) and avoids damage caused by leaks.

Not pressed in the correct position

If the jaws of the pressing tool are incorrectly positioned on the fitting, the sleeve will not press sufficiently against the O-ring. In that case too, the fitting will leak when it is pressurised.

Poor functioning of pressing tool

If the pressing tool does not function well (insufficiently pressed), the fitting will also leak when pressed. So in addition to leak detection there is also press detection!



PRESSCHECK1432

* Up to diameter 26.



- 1
- 2
- 3
- 4
- 5
- 6
- 7
- 8
- 9
- 10
- 11

Instructions for the PRESSCHECK measurement tool



1. Check the \varnothing of the press connection.



2. Find the corresponding \varnothing on the measurement tool.



3. Place the corresponding cut-away section of the measurement tool on the indented section on the press sleeve.



4. Note that the measurement tool and the indented section fit together perfectly.



5. Rotate the tool 360° around the indented section and ensure that they mate perfectly together during this action as in step 4. Should this fail (for instance the distance is too great or there is an obstruction), then there is something wrong with the pressing in the connection. In this case we recommend that you make a completely new press connection and check the press machine using the jaws of the press tool.



NOTE! The PRESSCHECK measurement tool is only suitable for use on press connections made with the Henco profile (BE profile) or the TH profile (up to $\varnothing 26$) combined with a Henco PVDF or brass press connection.

NOTE! After pressing, the fitting may no longer be rotated in relation to the pipe.



2 HENCO PRESS

1

2

The strength and flexibility of the HENCO synthetic fitting

3

4

This test was carried out in the Henco laboratory. The brackets were intentionally attached to the pressure sleeves of the bottom fittings for rigidity.

5

6

The first photograph shows us how the pipes and the fittings behave when water at a temperature of 20°C is flowing through under a pressure of 10 bar.

7

8

Nothing happens to the original test setup.

9

10

The second photograph shows how the test setup responds when water at 95°C and under a pressure of 10 bar is pumped through the piping system. The setup leans in the direction of the flow. The T-pieces and also the bend fittings accommodate the expansion forces.

11

The test shows the strength and flexibility of the Henco PVDF synthetic fitting.

Henco guarantees that fittings will bend by no more than 10° at a water temperature of 95°C.

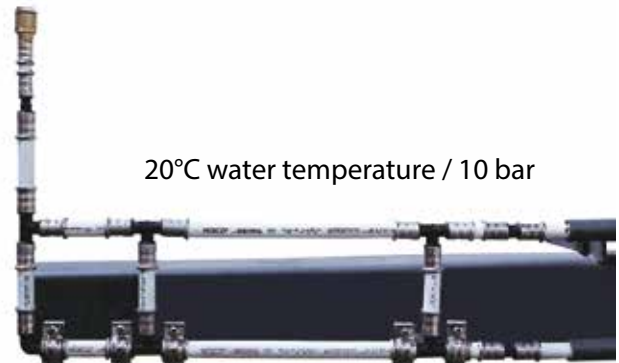

20°C water temperature / 10 bar

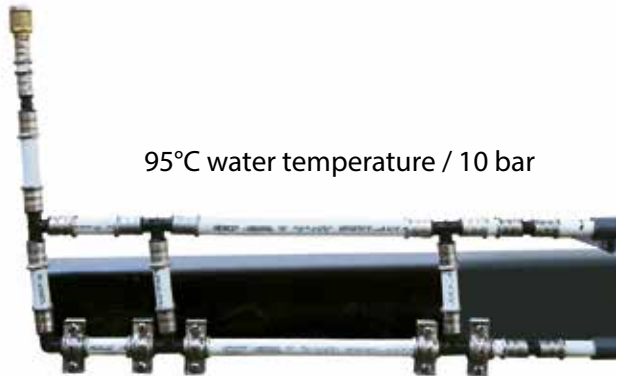

95°C water temperature / 10 bar

Technical characteristics

The table below shows the most important technical characteristics for PVDF.

Density	g/cm ³	1.78
Yield point	MPa	54
Tensile strength	MPa	46
Elongation at fracture	%	80
Modulus of elasticity	MPa	2400
Bending strength	MPa	74
Bending modulus	MPa	2300
Melting point	°C	174
Thermal conduction at 23°C	W/m.K	0.19
Thermal stability	°C	380



2.2 HENCO PRESS - GAS

The PVDF press fittings for gas differ in only one significant technical aspect compared to press fittings for sanitary and heating applications.

The fittings have a special O-ring that is made from the HNBR and is resistant to gas. To make this difference visible,

every pressure sleeve has a yellow band. The fittings for gas should never be used for sanitary applications or heating applications.

Similarly, fittings for gas should only be used in combination with the yellow Henco multilayer pipe for gas.



KIWA Gas quality mark

The Henco system for gas is only permitted in countries where a gas quality mark has been granted. Consult the regulations gas piping systems which apply in the country. The Henco synthetic gas system carries the KIWA-GASTEC gas quality mark 39581/01 and is intended for domestic gas installations and for transporting gas according to NPR-3378-5 and NPR-3378-6 of December 2012 and the amendments 3378-5/A1 and 3378-6/A1.

See page 28 for the installation options available for gas piping and gas fittings.



2 HENCO PRESS

2.3 HENCO SUPER SIZES



General

The Henco Super Size range refers to the Henco multilayer pipe and the Henco fittings in diameters 75 - 90 - 110 mm, with reducing couplings for diameters 32 - 40 - 50 - 63 mm. The fittings assure a complete multilayer piping system

with multiple variations for distribution and riser systems. The numerous combinations and the revolutionary connection technique make this system extremely flexible.

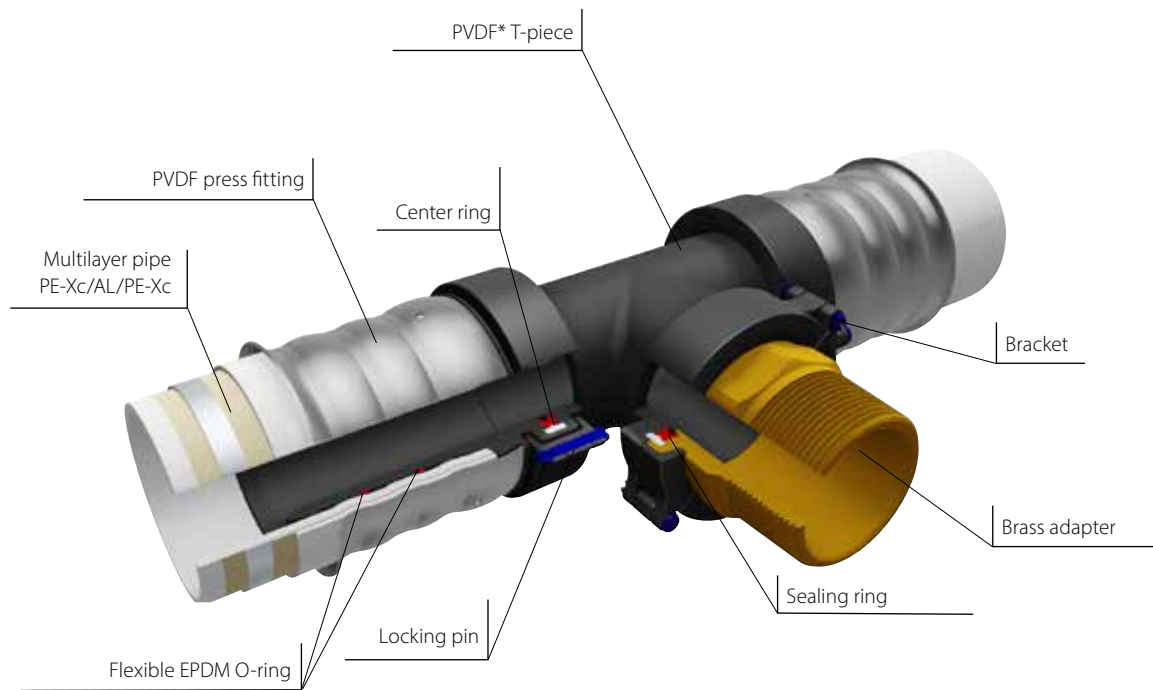

* Polyvinylidene Fluoride

The Henco Super Size fittings are made of the Polyvinylidene Fluoride (PVDF), a high quality synthetic material. The PVDF offers the user a unique combination of properties

- ▶ corrosion resistant
- ▶ excellent mechanical strength and hardness
- ▶ resistant to extreme temperatures: from -40°C to $+150^{\circ}\text{C}$
- ▶ approved for contact with water and food
- ▶ a maximum working pressure up till 10 bar and a maximum working temperature up till 95°C

All these favourable properties make this multilayer system suitable for numerous applications such as drinking water installations, heating installations and installations in the chemical and food industry.



The Henco Super Size fittings are just like all other Henco fittings designed with a leak before press detection. More information about this subject can be found on page 42.



2 HENCO PRESS

1

2

Easy use – making a press connection

The Henco toolset for Super Sizes allows a press connection in three simple steps. A specially designed table with pipe cutter, press jaw and hydraulic pump ensures a carefree press connection.

3

4

5

6

7

8

9

10

11

1 CUT



Cut the pipe squarely at 90° with the pipe cutter. The pipe cutter is provided with a clamp to hold the pipe in its proper position.

2 BEVEL



Bevel the inside of the pipe by positioning the bevel tool against the inner layer of the pipe and turn the tool 360° round.

3 PRESS

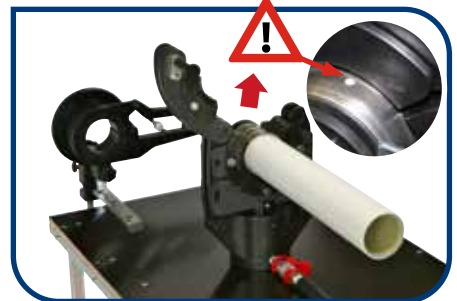

Position the fitting in the press jaw and ensure that the shoulder of the fitting is located in the aluminum positioning component. Afterwards insert the pipe all the way into the press fitting until the colour of the pipe is visible through the inspection windows. Now the fitting can be pressed by activating the hydraulic pump.



Easy use - assembly

Thanks to a revolutionary connection technique, the Henco multilayer pipe can easily be connected with the Henco Super Size fittings. The pressed pipe can be connected to the fitting using the bracket set consisting of a bracket, a center ring and

a sealing ring. The assembly can easily be made in small and narrow locations as the pressing takes place on the working table.

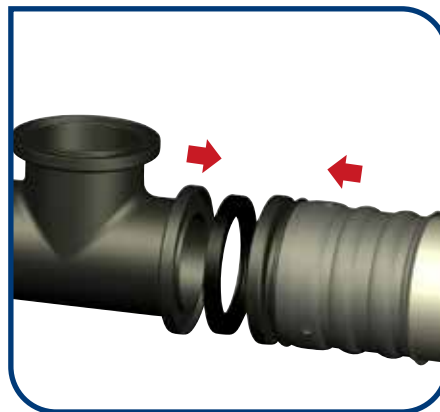
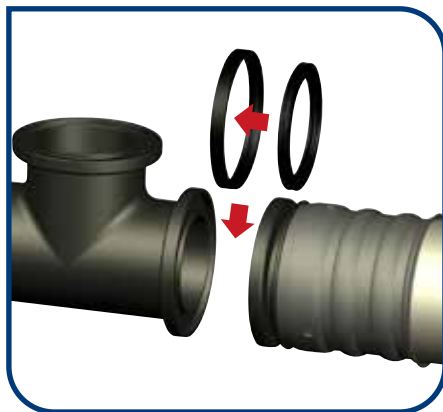

Position the sealing ring in the center ring before connecting the pressed pipe and the fitting.

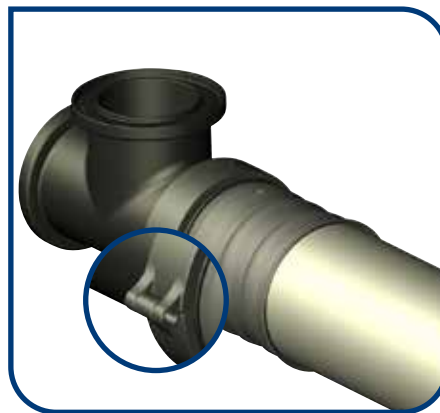
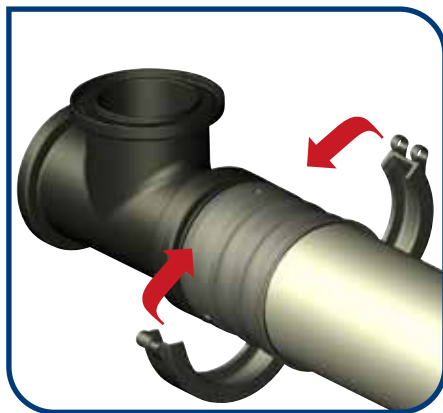

Match both pieces into each other and place the bracket around the shoulders of both fittings.



Make the connection complete by closing the bracket with the locking pin.

1

2

3

4

5

6

7

8

9

10

11











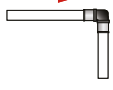

2 HENCO PRESS

1 Overview of flow loss coefficients (Zeta values)

2 Liquids do not only lose energy when they flow through a pipe. They also lose energy when they change direction. This is because liquids have to overcome extra resistance.

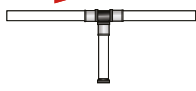
The table below provides an overview of the flow loss coefficients for the various fittings and the corresponding number of meters of piping.

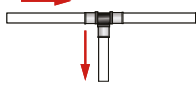
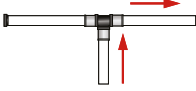
Zeta values (Medium: water at 20°C)

			Ø75	Ø90	
Straight coupling		zeta	0,409	1,533	
90° bend		zeta	1,796	1,749	
45° bend		zeta	-	0,695	
T-piece		zeta	0,409	0,108	
		zeta	1,869	1,895	
		zeta	1,869	1,820	
			Ø90-75		
Reduction		zeta	0,904		



2.4 HENCO ECOLINE

The HENCO ECO-line is an energy saving solution for recirculation loops, which limits heat loss between supply and return pipe.

Advantages

Only half the quantities needed

- ▶ Fittings
- ▶ Brackets
- ▶ Fire stop barriers
- ▶ Insulation
- ▶ Core drill holes
- ▶ Assembly

Energy saving

- ▶ Limited heat loss
- ▶ Always the required temperature at the draw-off point
- ▶ Legionella contamination can be prevented with temperature control

Less space consumption

- ▶ A separate pipe for the circulation water is no longer required.

Designed on the Henco Super Size concept, one concept for all dimensions from 40 up to 75 mm!

All assembly instructions for processing products of Henco are applicable.

Specifics

The return pipe flow is governed by means of a thermostatic circulation valve.

A circulation pump ensures the return flow to the heat source.

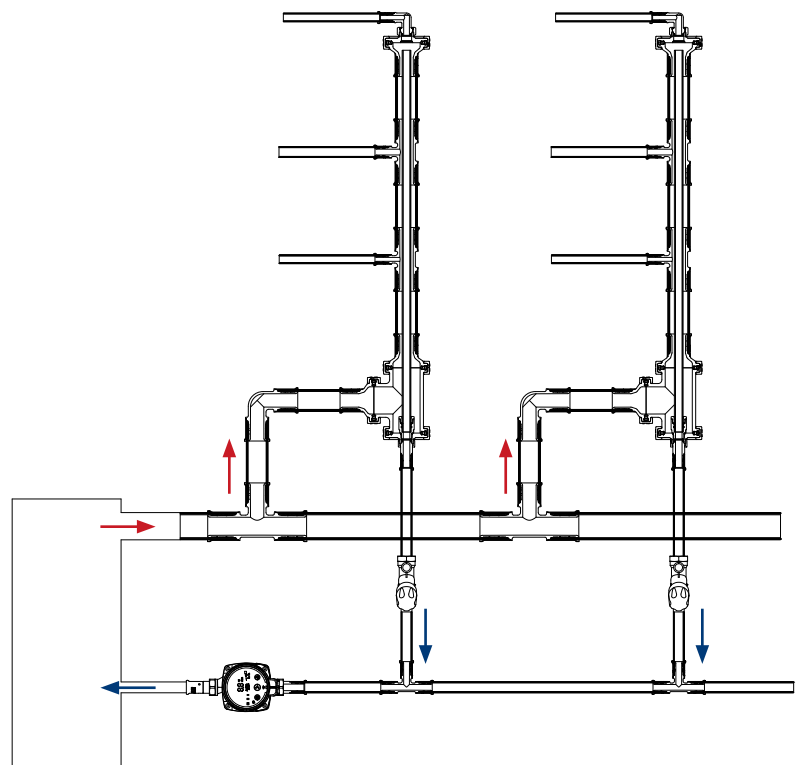



2 HENCO PRESS

Complementary products

- 1
- 2
- 3
- 4
- 5
- 6
- 7
- 8
- 9
- 10
- 11



Henco 1L PEXc



8HNA
Ø 40-50-63-75



19PK
Ø 16-20



19SK
Ø 16-20



19P
Ø 16-20



33P
Ø 16

To complete the Ecoline installation you need (not in Henco range)

- ▶ Circulator
- ▶ Thermostatic balancing valve



Details

Composition of the HNA-ECOLINE SET

- ▶ 1x 9HNA (T-piece)
- ▶ 4x HNA (bracket set)
- ▶ 1x HNA-EK05 (adapter HNA-EK)
- ▶ 1x HNA-INLB (base plate for ECO-LINE)

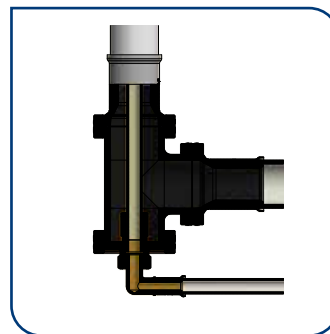



Montage

The base plate is fitted with a brass push fit fitting for a 16 mm PEXc pipe.

The PEXc pipe is shortened at the top for expansion purposes (X marking).

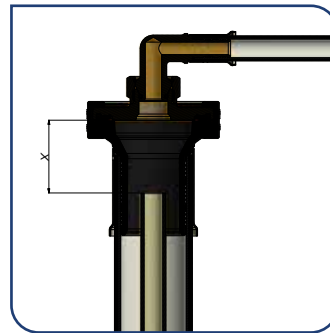

Expansion

$$\Delta L = L \times a \times \Delta T (+30 \text{ mm})$$

- ΔL = change in length
- L = length of pipe
- a = coefficient of expansion
- ΔT = temperature difference

and where the coefficient of expansion is 0.190 mm/mK irrespective of the diameter of the pipe.

Example:

- Given that:
- $L = 16 \text{ m}$
 - $a = 0,19 \text{ mm/mK}$
 - $\Delta T = 50^\circ\text{C}$ (montage at 15°C, supply 65°C)

Required: $\Delta L =$ change in length

Formula:

$$\Delta L = L \times a \times \Delta T$$

$$\Delta L = 16 \times 0,19 \times 50 = 152 \text{ mm (+ 30 mm)}$$

In the calculation example the inner return pipe is made 182 mm (18,2 cm) shorter than the supply pipe.

- 1
- 2
- 3
- 4
- 5
- 6
- 7
- 8
- 9
- 10
- 11



		40 x 3,5				50 x 4				63 x 4,5				75 x 6	
Flow		Pressure loss	Speed	Flow		Pressure loss	Speed	Flow		Pressure loss	Speed	Flow		Pressure loss	Speed
l/h	l/min	Mbar	v(m/s)	l/h	l/min	Mbar	v(m/s)	l/h	l/min	Mbar	v(m/s)	l/h	l/min	Mbar	v(m/s)
								21887	364,78	11,949	2,888	29541	492,35	9,407	2,820
								21930	365,50	11,994	2,893	29584	493,07	9,432	2,824
								21973	366,22	12,038	2,899	29627	493,78	9,458	2,828
								22016	366,93	12,082	2,905	29670	494,50	9,484	2,832
								22059	367,65	12,127	2,910	29713	495,22	9,510	2,836
								22102	368,37	12,171	2,916	29756	495,93	9,536	2,840
								22145	369,08	12,216	2,922	29799	496,65	9,562	2,844
								22188	369,80	12,261	2,927	29842	497,37	9,588	2,848
								22231	370,52	12,306	2,933	29885	498,08	9,614	2,852
								22274	371,23	12,351	2,939	29928	498,80	9,640	2,857
								22317	371,95	12,396	2,944	29971	499,52	9,666	2,861
								22360	372,67	12,441	2,950	30014	500,23	9,693	2,865
								22403	373,38	12,486	2,956	30057	500,95	9,719	2,869
								22446	374,10	12,531	2,961	30100	501,67	9,745	2,873
								22489	374,82	12,576	2,967	30143	502,38	9,771	2,877
								22532	375,53	12,622	2,973	30186	503,10	9,798	2,881
								22575	376,25	12,667	2,978	30229	503,82	9,824	2,885
								22618	376,97	12,713	2,984	30272	504,53	9,850	2,889
								22661	377,68	12,759	2,990	30315	505,25	9,877	2,894
								22704	378,40	12,804	2,995	30358	505,97	9,903	2,898
								22747	379,12	12,850	3,001	30401	506,68	9,930	2,902
												30444	507,40	9,956	2,906

Medium: water at 65°C

1 mbar/m = 100 Pa/m

Water velocity max. 3 m/s

- 1
- 2
- 3
- 4
- 5
- 6
- 7
- 8
- 9
- 10
- 11



3.1	Henco Vision push fittings	61
3.2	Henco Vision manifolds	66



3.1 HENCO Vision push fittings

Composition

The construction of the push fitting shows that Henco Vision is the result of sophisticated product development. All of its components have been made with the greatest precision and are manufactured from the best materials.

Henco Vision push fittings are made from PVDF. This is the same material used in the synthetic press fittings. PVDF is a high-quality synthetic material with a unique range of properties:

- ▶ Extremely resistant to pressure and temperature
- ▶ Outstanding mechanical strength
- ▶ Enormous flexibility: can bend up to 10° at 95°C
- ▶ Perfectly suitable for drinking water and foods

Henco Vision push fittings can be used for both sanitary and heating applications.

Ease of use - fast assembly

The Henco push fitting guarantees an extremely fast and reliable connection.

All you need to make a perfect connection is a pipe cutter and a calibrator. Pressing tools are not required.

You only need to follow three steps for a fast and reliable connection, in combination with the Henco PE-Xc/AL/PE-Xc multilayer pipe.

1 CUT



Always cut the pipe squarely at 90°.

2 CALIBRATE

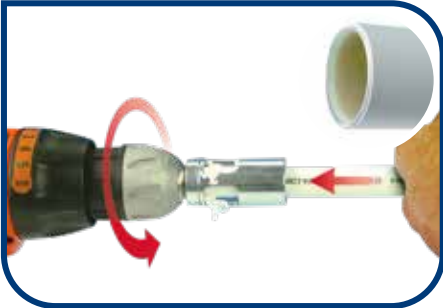

Use the Henco kalispeed for centring the pipe and deburring the inner and outer edges of the pipe.

3 INSTALL



Remove the black protective cap and insert the tube into the fitting until you can see the colour of the pipe through the inspection windows.

3 HENCO VISION

Composition of HENCO Vision Push Fitting

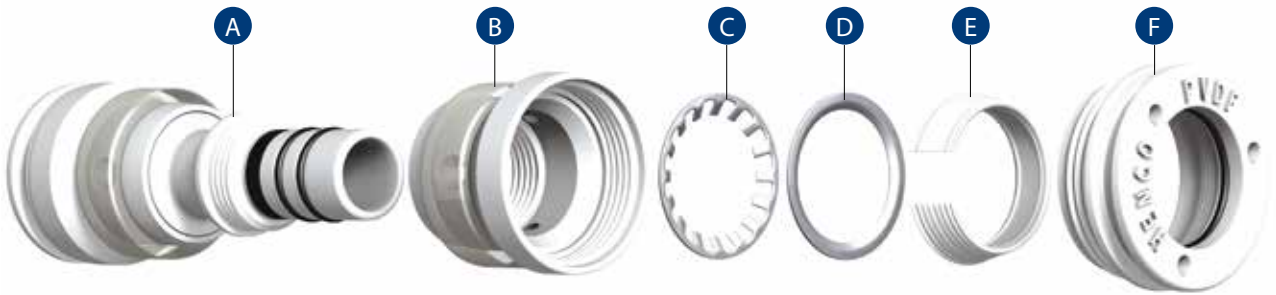

- A** PVDF body with 2 EPDM O-rings
- B** PVDF sleeve with inspection windows and transparent synthetic ring
- C** Stainless-steel grip ring
- D** Stainless-steel support ring
- E** Conical PVDF locking ring
- F** PVDF screw nut with an EPDM O-ring and three disassembly notches





- 1
- 2
- 3
- 4
- 5
- 6
- 7
- 8
- 9
- 10
- 11

The HENCO press fitting is reliable:



No dirt in the fitting

A protective cap prevents dirt from entering the fitting during transportation, storage and on the job.



Transparent sealing ring

This synthetic ring prevents any type of contamination from entering the push fittings. When installing push fittings in concrete or embedding into a screed floor, you should avoid the penetration of cement water and chemicals at all costs. This synthetic ring means that the RVS grip ring and the RVS support ring can never become contaminated. The seal remains guaranteed.



Internal O-rings

The two internal O-rings guarantee that the medium is sealed.



External O-ring

The external O-ring prevents dirt or chemicals along the pipe. The RVS grip ring and the RVS support ring are protected against external influences.

3 HENCO VISION

1

2

3

4

5

6

7

8

9

10

11



Conical PVDF ring

This ring, together with the RVS grip ring and the RVS support ring enable the pipe to be pulled from the fitting.



4 Inspection windows

The 4 inspection windows allow you to visually confirm that the pipe has been inserted sufficiently.

Advantages

- ▶ Fast installation.
- ▶ Pressing tool is not required.
- ▶ Allows installation in hard to reach places.
- ▶ Sealing of the medium within the tube.
- ▶ Does not require any additional protective measures permitted in (construction) concrete.
- ▶ A range of sizes, 16, 20 and 26 mm.



Pipestop 16 - 20 - 26 mm



Henco PE-Xc/Al/PE-Xc multilayer pipes can also be separately sealed after calibration using the SK-PIPESTOP.

Reusable pipestop 16 - 20 - 26 mm



Henco Vision fittings can be temporarily sealed using the SK-STOPCLIP.

The safety clip secures the reusable pipestop.



Please refer to our product overview for more product configurations.

3 HENCO VISION

3.2 HENCO Vision manifolds

General

Henco Vision synthetic manifolds (PVDF) have the same properties and ranges of use as Henco Vision synthetic push fittings. The compact dimensions (connections with centre-to-centre distance of 50 mm) of the manifold allow it

to be installed in small areas (for instance under a bathtub). Henco Vision manifolds offer an economical alternative if you need to use several T-pieces in a small space.

Modular

Henco Vision manifolds are modular and this means that they offer an appropriate solutions in many situations.



Manifold block

There are available in 2 versions:

- ▶ 2- connections
- ▶ 3- connections

Several groups can be put together. Using the special Henco threaded connection, the manifolds blocks in each group assembly can be connected to each other.

The seal is provided by a pre-assembled O-ring.

A stop ensures that the underlying manifolds blocks below are positioned in line. It is important that the manifold blocks are mounted onto the stop, so that the O-ring seal is guaranteed.

Since separate manifold blocks can be connected, every type of group assembly can be created.



- 1
- 2
- 3
- 4
- 5
- 6
- 7
- 8
- 9
- 10
- 11

Supply (VVSK)

The supply to the Henco Vision manifold is available in diameters of 20 and 26. The supply T-piece (VVSK-T26M26) for the Henco vision manifolds enables an even more compact arrangement. These fittings are screwed into the body of the manifold. The fittings are provided with a stop which prevents them from being turned too far. The 16 mm (19SK-1605) connection can also be used for the supply connection. The manifold block is sealed with a screw stop (VS-ENDCAP-M) and one of the groups is provided with a 16 mm screw-on Henco Vision push fitting (19SK-1605).

Extension (VDSK)

The extension fitting for the Henco Vision manifold is available in diameters of 20 and 26. These fittings are screwed into the body of the manifold. The fittings are provided with a stop which prevents them from being turned too far. If you do not require an extension, the body of the manifold can be fitted with an endcap on the extension side. (VS-ENDCAP).



VVSK



VS-ENDCAP-M



VDSK



VS-ENDCAP



VVSK-T



VVSK-90



VVSK-TM

Supply 20/26

Supply 16

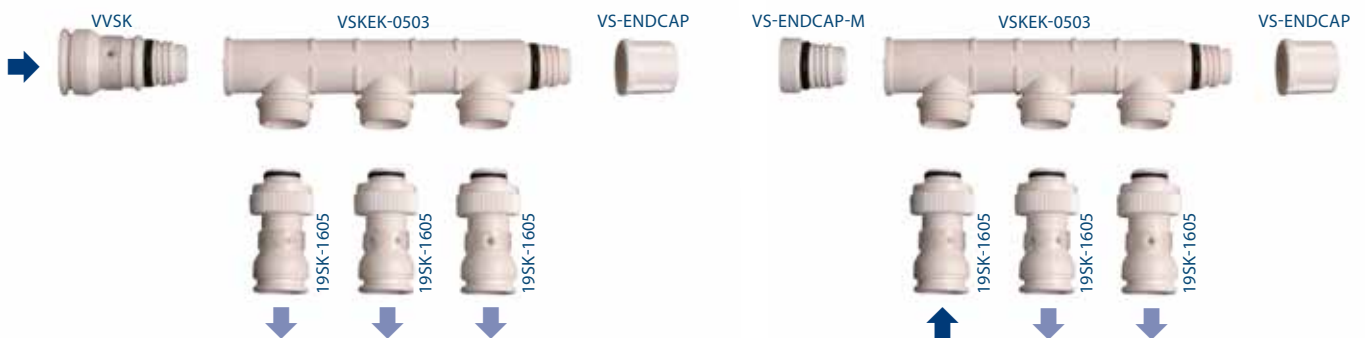

3 HENCO VISION

1

2

3

4

5

6

7

8

9

10

11

Various supply and extension (SKS) connectors

The supply and extension of the Henco Vision manifolds are provided with straight male (17SKS) and female (18SKS) threaded adapters.

These straight adapters are made from brass and

are available in diameters of 20 and 26 diameters. Both diameters are available with a $\frac{1}{2}$ or $\frac{3}{4}$ connector.

Combinations with Henco Vision push fittings are only available with 20 and 26 diameters.



17SKS



18SKS

Various connections to the manifold block

Below is a summary of the possible connections to the Henco Vision manifold block.

- ▶ Henco Vision type 19SK push fitting in diameters 16 and 20.



- ▶ Henco type 33P brass press fitting in diameter 16



- ▶ Henco PVDF type 19PK press fitting in diameters 16 and 20.



- ▶ Henco type VB-EK brass ball valve



- ▶ Henco type 19P brass press fitting in diameters 16, 18 and 20.



BRASS PRESS FITTINGS



4.1	Brass press fittings - standard	70
4.2	Brass press fittings - gas	73



4 BRASS PRESS FITTINGS

4.1 Brass press fittings - standard

Composition

The body of the fitting is made from CW617N brass. These fittings offer great advantages with regard to corrosion and they are also better for the environment.

The fitting has a buffer ring that prevents direct galvanic contact between the aluminium of the pipe and the brass of the fitting. This excludes the possibility of electrolysis occurring.

The fitting is equipped with O-rings made from EPDM and RVS pressure sleeves with 3 inspection windows.

In order to prevent assembly errors, the dimensions and type of press profile which can be pressed are shown on the RVS sleeves.

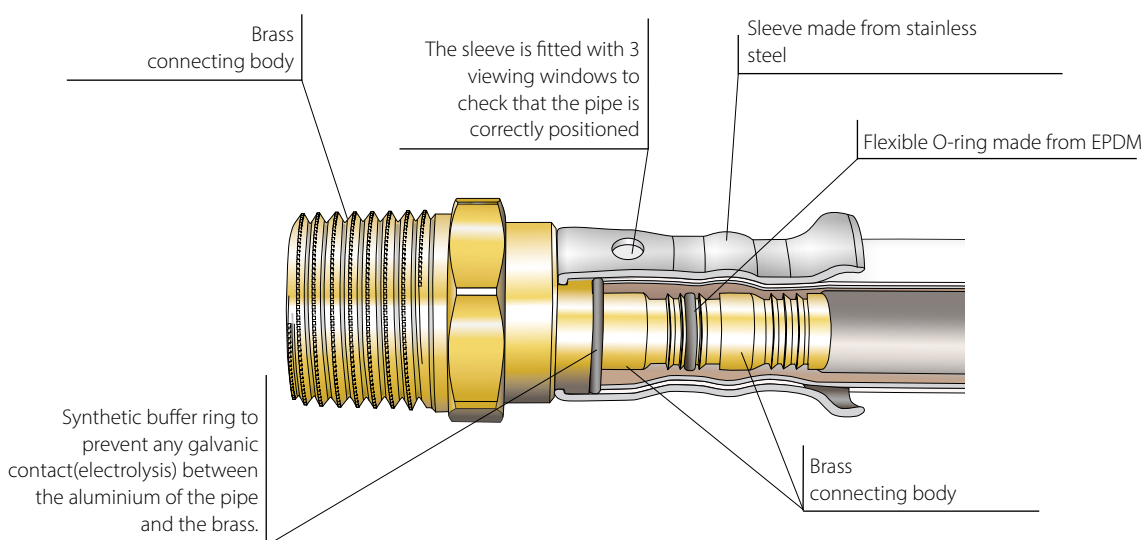

Application of 36P-fitting

Press-fit adapter to copper press or thin steel. This fitting is made of CuSi (alloy CW724), lead free and DZR.

To press with M, V & SA



Applicable tubes

Copper EN1057		Carbon-steel DIN EN10305		Stainless steel DIN EN10088/EN10312	
Diameter	S	Diameter	S	Diameter	S
12	0.8	12	1.5	12	1.0
15	1.0	15	1.5	15	1.0
18	1.0	18	1.5	18	1.0
22	1.2	22	1.5	22	1.2
28	1.5	28	1.5	28	1.2



- 1
- 2
- 3
- 4
- 5
- 6
- 7
- 8
- 9
- 10
- 11

Leak detection (LBP)*

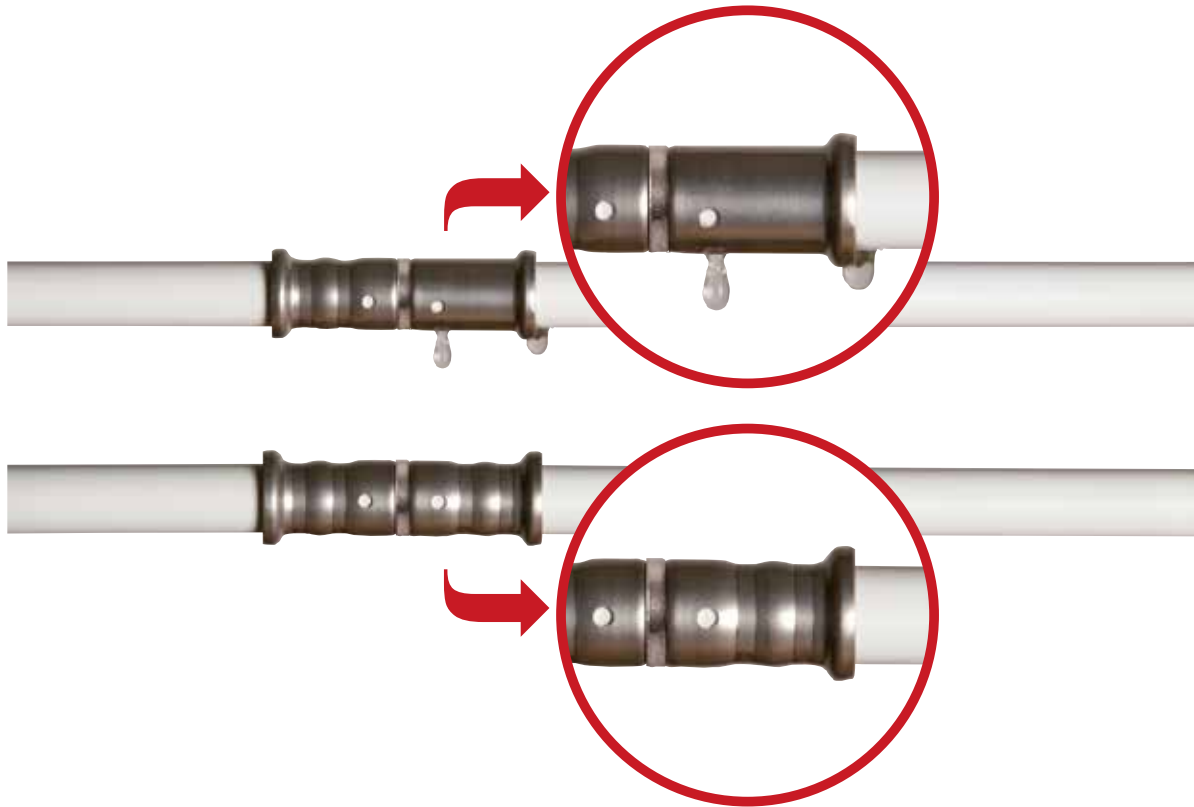

Henco brass press fittings are designed in such a way that they leak immediately if you forget to press the fitting during assembly.

Pressing the fitting has a two functions::

- ▶ It seals the O-ring
- ▶ It fastens the fitting to the pipe

If the fitting is not pressed it will leak when the system pressure is 0.5 BAR. This allows early detection of errors (during the required pressing of the piping system) and avoids damage caused by leaks.

Not pressed in the correct position

If the jaws of the pressing tool are incorrectly positioned on the fitting, the sleeve will not press sufficiently against the O-ring. In that case too, the fitting will leak when it is pressurised.

Poor functioning of pressing tool

If the pressing tool does not function well (insufficiently pressed), the fitting will also leak when pressed. So in addition to leak detection there is also press detection!



PRESSCHECK1432

* The blank brass press fittings are replaced at the same time by the tin-plated brass Henco press fittings with leak detection.

* *Leak Before Press*

4 BRASS PRESS FITTINGS

Instructions for the PRESSCHECK measurement tool



1. Check the \varnothing of the press connection.



2. Find the corresponding \varnothing on the measurement tool.



3. Place the corresponding cut-away section of the measurement tool on the indented section on the pressure sleeve.



4. Note that the measurement tool and the indented section fit together perfectly.



5. Rotate the tool 360° around the indented section on the pressure sleeve and ensure that they mate perfectly together during this action as in step 4. Should this fail (for instance the distance is too great or there is an obstruction), then there is something wrong with the impression on the connection. In this case we recommend that you make a completely new press connection and check the press machine using the jaws of the press tool.



NOTE! The PRESSCHECK measurement tool is only suitable for use on press connections made with the Henco profile (BE profile) or the TH profile (up to \varnothing 26) combined with a Henco PVDF or brass press fitting.



4.2 Brass press fittings - gas

Composition

The brass press fittings for gas only differ in one important technical aspect from the brass fittings for sanitary and heating applications. The fittings are provided with a special O-ring. This O-ring is made from HNBR and is resistant to gas. To make this easier to see, the fittings have a yellow

band on each pressure sleeve. Fittings for gas should never be used for sanitary applications or heating. Conversely, fittings for gas should only be used in combination with the yellow Henco multilayer pipe for gas.

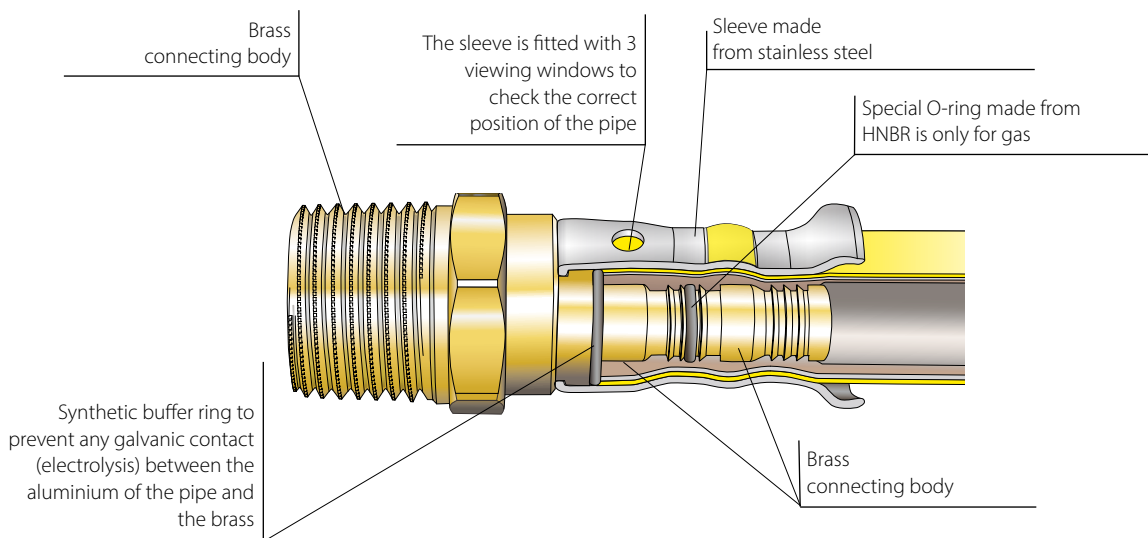

KIWA Gas quality mark

The Henco system for gas is only permitted in countries where quality mark has been granted. You should always consult the regulations which apply to gas piping systems in the country. The Henco gas system with brass press fittings carries the UNI/TS 11344 gas quality mark.

See page 28 for the installation options available for gas piping and gas fittings.

BRASS SCREW/COMPRESSION FITTINGS





5 Brass screw/compression fittings

Composition

The body of the Henco fittings is made from brass CuZn40Pb2 (CW617N).

The fittings are provided with O-rings and a union nut.

The compression fittings have a synthetic buffer ring to prevent electrolysis between the brass and the aluminium.

Henco screw/compression fittings can be used for all applications with a maximum working pressure up to 10 bar, except for pipes which are built in floors or walls.

The body of the Henco screw/compression fittings is manufactured from brass. The fittings are provided with O-rings and a union nut with a clamping ring. Just like the brass press fittings they are fitted with a synthetic buffer ring to prevent electrolysis between the brass and the aluminium.

As in the compression and press fittings range, there are a number of fittings available which allow you to connect copper or steel pipes to Henco pipes.

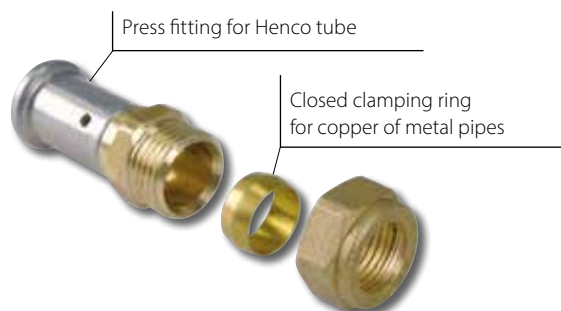
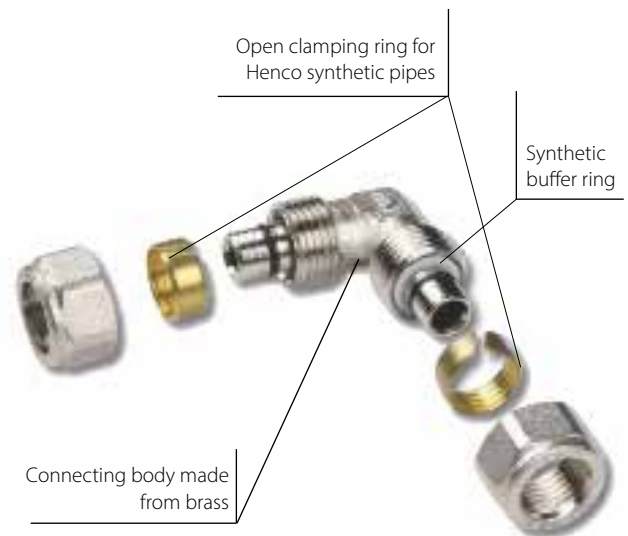

- 1
- 2
- 3
- 4
- 5**
- 6
- 7
- 8
- 9
- 10
- 11

5 BRASS SCREW/COMPRESSION FITTINGS

1

2

3

4

5

6

7

8

9

10

11

Furthermore the Henco range also includes a screw/compression fitting for fuel-oil applications.

It has a slightly longer thread than in the fittings for water and is slightly tapered. The fitting is also provided with a specific O-ring for fuel oil.



BRASS MANIFOLDS AND FITTINGS





6 BRASS MANIFOLDS AND FITTINGS

6 Brass manifolds

Henco's range includes manifolds for both sanitary and heating applications.

All manifolds are made from brass. The manifolds come in 3/4", 1" or 5/4" versions and have 2 to 10 branches. The branches are fitted with 3/8", 1/2" or euroconus connectors.

They are available with a 3/8" screw thread for the fitting of an automatic air vent.

Henco's range also includes galvanised manifolds made from brass. They are provided with ball valves and a euroconus connection on each outlet.

The manifolds are provided with 2, 3 or 4 connections. They are supplied with a female thread at one end and a 1" or 3/4" male thread at the other end so that they can be coupled together.

Advantages

- ▶ O-ring connection + alignment
- ▶ Universal euroconus connections



Only assemble with blindstop with O-ring

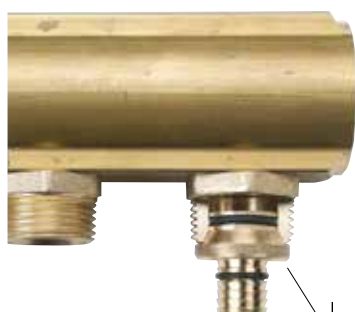

Euroconus connection



ASSEMBLY INSTRUCTIONS



7.1	General instructions for installing the pipe	80
7.2	Making a press connection	82
7.3	Making a repair	89
7.4	Making a screw connection	90
7.5	Making a screw/compression connection	93
7.6	Bending the Henco pipe	95
7.7	Accommodation of expansion	96
7.8	Embedded fittings	102
7.9	Pipes through holes	102
7.10	Pipes in danger zones	103
7.11	Pipe insulation	103
7.12	Frost protection and trace heating	103
7.13	Cleaning the pipe	103
7.14	Anti-frost	103
7.15	Installation temperatures	104
7.16	Disinfection and cleansing	104
7.17	Osmosis water	104
7.18	Earthing	105
7.19	Water quality	105
7.20	Hydrogen peroxide	105
7.21	Pressure tests	105
7.22	UV-resistance	111
7.23	Fire classification	111
7.24	Prefabrication of Henco pipes and press fittings	111
7.25	Henco TS: the guaranteed "TOTAL SAFE" piping system	112

7 ASSEMBLY INSTRUCTIONS

7.1 General instructions for installing the pipe

Transport and storage

The pipes should be transported and stored with care in the original manufacturer's packing. This protects the pipes against contamination and UV light.

Unpacking

The packaging should be carefully removed so that the pipe does not become damaged.

Henco recommends using the SAFECUT for this.

Unrolling

Pipes should be unrolled in the opposite direction to which they were rolled. In other words, start with the pipe end on the outside of the coil.

Damage

Do not use pipes which display any folds, cracks or damage. The pipes must be protected against any distortion, soiling and/or damage.

In order to avoid damage, Henco recommends that you use a protective sleeve or pre-insulated pipe.

Stress

The pipes and fittings must always be laid without stresses and twists.

Tools

We recommend that Henco tools are used when installing pipes and fittings.

Cutting – calibration

Pipes should be CUT SQUARE.

Calibration and bevelling of pipes is only allowed with Henco calibrated tools according to the specified instructions.

Bending

Pipes can be bent manually. To achieve bends with a minimum radius you should use the Henco bending tools.

Sharp objects - sharp edges

The pipe should not come into contact with sharp objects during installation. For example, piping running through ceiling holes may not be bent around sharp edges as there is a danger of cracking.

Bending pipes with mounted fittings

Pipes that run through recesses or floors must have about 10 mm free space all around. In case of collapse or smearing of passages through walls or floors, we recommend providing them with a piece of pipe insulation for protection on site.

Expansion in embedded pipes

When embedding pipes, you can use bare pipes if insulated expansion bends are provided at least every 10 m. It is nevertheless advisable to always provide the pipes with a sleeve or insulation from the manufacturer.

Henco recommends using a protective sleeve or pre-insulated pipe to accommodate any expansion.

Expansion when mounting pipes on surfaces

When mounting pipes on surfaces, pipe lengths should be adjusted for the sake of convenience (exposed parts).

You should also take expansion into consideration when mounting pipes on surfaces.

Painting pipes

You are allowed to paint the pipe, on the condition that the paint is water-based.





Compressed air

Compressed air is a valuable energy carrier. The following must be taken into account when installing compressed air pipes:

- ▶ 100 % leak-proof. Even the smallest leak can cost a lot of power;
- ▶ Corrosion-resistant pipelines;
- ▶ Maximum limitation of pressure loss; pipes with a smooth inner wall are therefore preferable; bends should be avoided as far as possible;
- ▶ Use pipes that are suitable for the transport of mineral and synthetic oils;
- ▶ Strong and impact-resistant pipes to minimise the risk of cracks or bursting;
- ▶ Adjustment of the right diameter in function of the use.

The Henco PEXc/AL/PEXc pipes are therefore extremely suitable for the transport of compressed air. The flexibility of the pipes, the wide diameter range from Ø14 up to Ø90 and the ease and certainty of splicing are an absolute advantage for the transport of compressed air.

The compressed air system must remain oil-free. Therefore, the installation of a pre-selected oil filter is necessary. Oil filters are not included in the Henco delivery programme.

When installing compressed air lines, it is important that they are installed as straight as possible with as little changes in direction as possible. For this purpose use metal brackets with a rubber insert. The recommended bracket distances are as follows:

Tube	Max. distance pipe brackets (cm)
14 X 2	80
16 X 2	80
18 X 2	100
20 X 2	120
26 X 3	150
32 X 3	160
40 X 35	170
50 X 4	180
63 X 4,5	200
75 X 6	200
90 X 7	200

Henco PEXc/AL/PEXc pipes and press fittings (PVDF & brass) are applicable for compressed air installations up to 10 bar (see characteristics per type of pipe as mentioned before in the underlying technical manual).

When installing compressed air systems, connections will be made from the wall plates to stopcocks, hoses, etc. This is often done by means of a pipe fitting. This is often done by

means of quick-release couplings. We recommend using our brass version for wall plates. For the other fittings, the choice is between PVDF (plastic) or brass press.

The indicated maximum pressure as stated in the underlying technical manual remains valid.

7 ASSEMBLY INSTRUCTIONS

7.2 Making a press connection

Step by step



Remove the packaging

Use the Henco SAFECUT for this.



Cutting

Always cut the pipe at an angle of 90° (squarely). Use Henco tools, a guillotine cutter or pipe cutter for this.

The guillotine cutter is provided with a shoulder to assist installation of the pipe under 90°.

Do not cut the pipe on a bended section. We recommend that you shorten pipes with larger diameters using a cutter.



Calibration

After the pipe has been cut squarely cut, it needs to be calibrated.

This should be done using the Henco kalispeed.

1. Place the pipe straight in the kalispeed and whilst turning, press until the stop is reached.
2. Turn the kalispeed until you see the bevels on the pipe and have evenly chamfered the inner and outer edges of the pipe.
3. Remove the kalispeed, and dispose of swarth from the pipe and kalispeed.

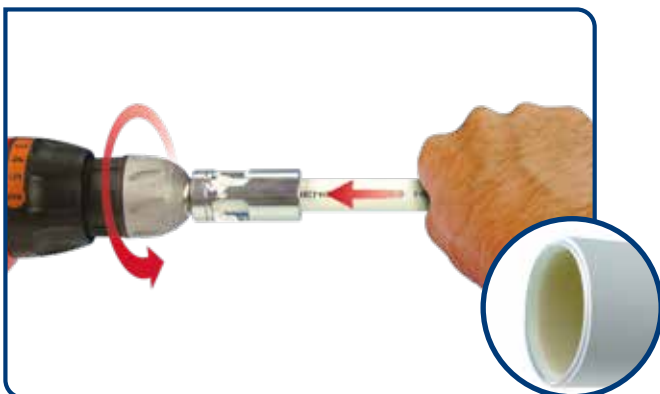

If the pipe is correctly calibrated (centered, chamfered, levelled off), the chamfering will be clearly visible around the inner and outer edges of the pipe.



- 1
- 2
- 3
- 4
- 5
- 6
- 7**
- 8
- 9
- 10
- 11



Position pipe

Slide the calibrated pipe all the way into the press fitting so the colour of the pipe is visible through the inspection windows.



Pressing

Open the jaws and ensure that the shoulder of the fitting is positioned in the groove of the jaws.

Close the positioned jaws and start pressing. The pressing machine needs to complete a full movement.

The positioned jaws should completely seal up the sleeve after pressing.

You should not press the same sleeve more than once.



Open the jaws after pressing and check whether the pipe is fully inserted so the colour of the pipe is visible through the inspection windows.



Guarantee

When a connection is pressed incorrectly, for example due to a wrong positioning of the fitting in the jaw or the use of a press jaw with a wrong profile, the entire connection has to be removed and replaced. Under no circumstances should the accessories be pressed twice. When removing an entire connection both fitting and pressed part of the pipe should be removed.

7 ASSEMBLY INSTRUCTIONS

1

2

3

4

5

6

7

8

9

10

11



Impact force on PVDF fittings is not allowed.

This also applies when the pipe detaches from a fitting for whatever reason.

All Henco press fittings have fixed mounted sleeves. The user should never remove the sleeve from the fitting. If this is the case, Henco reserves the right to refuse warranty.

It is not allowed to install a fitting and / or tube with other tools than mentioned in this technical manual.



Pressing without applying stresses

It is very important not to apply stresses to the pipe during pressing. Pipes with fittings should also be kept free of stresses any further assembly.

Once a fitting has been mounted to one end of the pipe using a press connection, no further stresses should be exerted on the fitting through the pipe. If further bending is required, you should fully support the pipe, not the fitting, with your hand.

When press and compression connections are used, the compression connection should be made first.



- 1
- 2
- 3
- 4
- 5
- 6
- 7
- 8
- 9
- 10
- 11

Required assembly space for the pressing jaw

Required assembly space for Henco pressing jaws (Type BE and BE-MINI*)									
	14X2	16x2	18X2	20X2	26X3	32X3	40X3.5	50X4.0	63X4.5
X1	30	30	30	30	35	35	50	55	90
Z1	65	65	65	65	70	75	110	115	120
X2	40	40	40	40	50	50	70	75	95
Y2	40	40	40	40	50	50	70	75	95
Z2	90	90	90	90	100	110	135	135	140

* BE-MINI to Ø 32

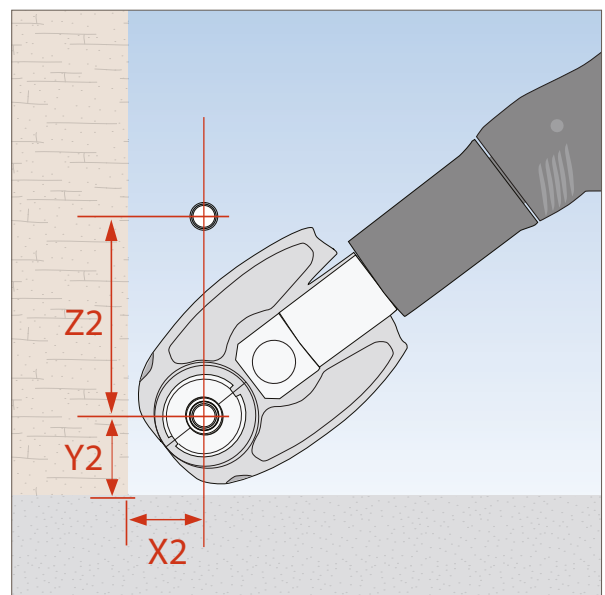
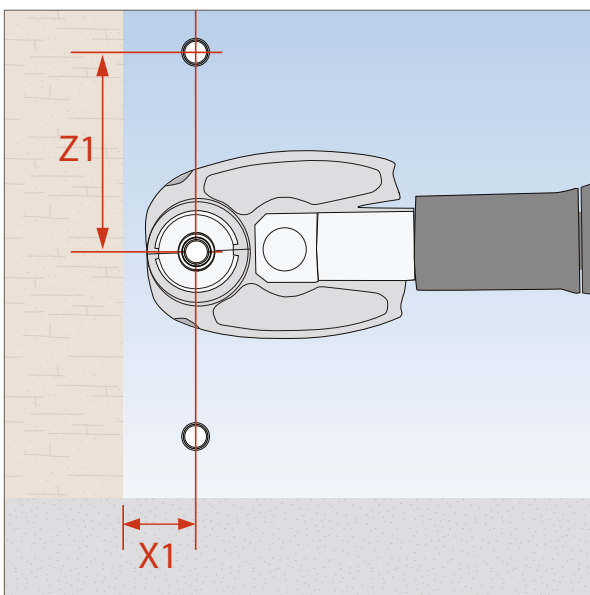



7 ASSEMBLY INSTRUCTIONS

1

Henco Press profiles

2

Henco press fittings should be pressed with profiles as shown below.

3

Methods of connection

BE PROFILE

TH PROFILE

4

FITTINGS Ø14 - Ø26

ALLOWED

ALLOWED

5

FITTINGS Ø32 - Ø40

ALLOWED

NOT ALLOWED

6

FITTINGS Ø50 - Ø90

ALLOWED

NOT ALLOWED

7

8

9

10

11



Compatibility of HENCO compression jaws

Henco press fittings should be pressed using Henco BE pressing jaws. In addition to the Henco pressing tools, there are also other pressing tools which are compatible with Henco BE pressing jaws. This compatibility does not apply for the Henco MINI jaws.

Compatibility with Henco press jaws							
Manufacturer	Type	Battery	Pressure KN	Type BE	Type BE..MINI3	Type BE..Mini2	
Klauke	UP 75	18V	32KN	x		no	
	UP 110	18V	32KN	x		no	
	UAP2	12V	32KN	x		no	
	UNP2	230V	32KN	x		no	
	UP2EL	230V	32KN	x		no	
	UAP3L	18V	32KN	x		no	
	UAP4	18V	32KN	x		no	
	UAP4L	12V	32KN	x		no	
	MAP2L19	18V	19KN			x	no
	Novopress	ECO 1 /PRESSBOY	230V	32KN	x		no
ECO 201		230V	32KN	x		no	
ECO 202/203		18 V	32KN	x		no	
EFP 103		230V	32KN	x		no	
EFP 203		230V	32KN	x		no	
ACO1/ PRESSBOY		12V	32KN	x		no	
ACO102/103		12V	19KN			x	no
ACO201/202/203		18V	32KN	x		no	
AFP 101		9,6V	19KN			x	no
AFP201/202		14,4V	32KN	x		no	
ACO 201/202		14,4V	32KN	x		no	
REMS		MINI PRESS ACC	14,4V	19KN			no
		MINI PRESS S22V ACC	14,4 V	19KN			no
	POWER-PRESS-SE	230V	32KN	x		no	
	POWER-PRESS	230V	32KN	x		no	
	POWER-PRESS ACC	230V	32KN	x		no	
	AKKU-PERS	14,4V	32KN	x		no	
	AKKU-PERS-ACC	14,4V	32KN	x		no	
	POWER-PRESS XL ACC	230V	32KN	x		no	
VETEC	SPM19	18V	19KN			x	no
	SPM32	14,4V	32KN	x		no	
	COMPACT CP700	18V	32KN	x		no	
Virax	VIPER P20	14,4V/220V	32KN	x		no	
	Viper P21	18V	32KN	x		no	
	Viper P21+	18V	32KN	x		no	
	VIPER P22	18V	32KN	x		no	
	VIPER ML21	18V	32KN	x		no	
	VIPER M21	18V	32KN	x		no	
	VIPER P25/ P25+	18V	32KN	x		no	

7 ASSEMBLY INSTRUCTIONS

Compatibility with Henco press jaws

Manufacturer	Type	Battery	Pressure KN	Type BE	Type BE..MINI3	Type BE..Mini2	
Roller	UNI-PRESS- SE	230V	32KN	x		no	
	UNI-PRESS	230V	32KN	x		no	
	UNI-PRESS-ACC	230V	32KN	x		no	
	UNI-PRESS-XL-ACC	230V	32KN	x		no	
	MULTI-PRESS-MINI-ACC	14,4V	19KN		x	no	
	MULTI-PRESS-MINI-22V-ACC	21,6V	19KN		x	no	
	MULTI-PRESS-MINIS-22V-ACC	21,6V	19KN		x	nn	
	MULTI-PRESS	14,4V	32KN	x		no	
	MULTI-PRESS-ACC	14,4V	32KN	x		no	
	Rothenberger	ROMAX PRESSLINER	18V	19KN		x	no
Romax Pressliner ECO		18V	19KN		x	no	
ROMAX AC ECO		230V	32KN	X		no	
ROMAX 3000 AC		230V	32KN	x		no	
ROMAX 4000		18V	32KN	x		no	
ROMAX COMPACT/TT		18V	19KN		x	no	
Viega		PRESS-GUN-PICCO	18V	19KN			no
		PRESS-GUN-5	18V	32KN	x		no
	PRESS-GUN-4E/5E	230V	32KN	x		no	
	PRESS-GUN-4B/5B	18V	32KN	x		no	
	TYPE-PT3-AH	14,4V	32KN	x		no	
	Type 1	230V	32KN	x		no	
	TYPE 2	230V	32KN	x		no	
Ridgid	RP-210-B	18V	24KN			no	
	RP-219	18V	19KN	x		nl	
	RP-240	12V	24KN			no	
	RP-241	12V	24KN			no	
	RP-350	18V	32KN	x		no	
	RP-351	18V	32KN	x		no	
Milwaukee	M18-BLHPT 202C	18V	32KN	x		no	
	M12-BLHPT 202C	12V	19KN		x	no	
CBC	EUROPRESS 2000	220V	32KN	x		no	
Hilty	NPR-019-IE-A22	18V	19KN		x	no	
	NPR-032-IE-A22	18V	32KN	x		no	





7.3 Making a repair

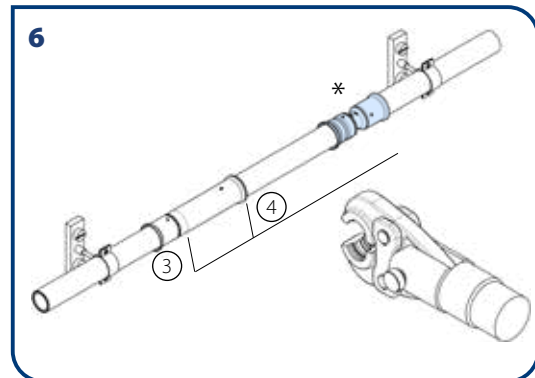
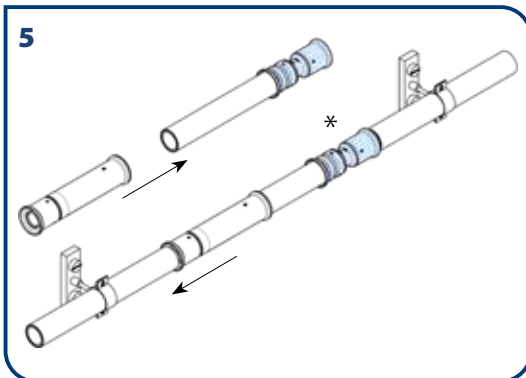
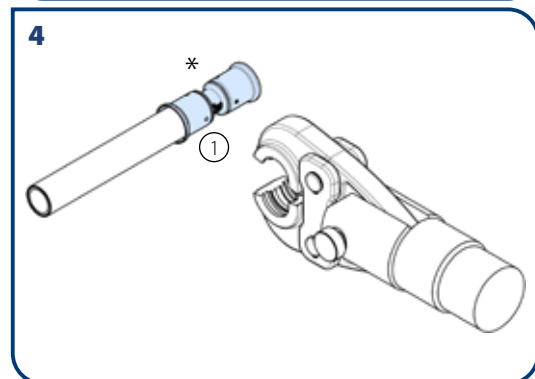
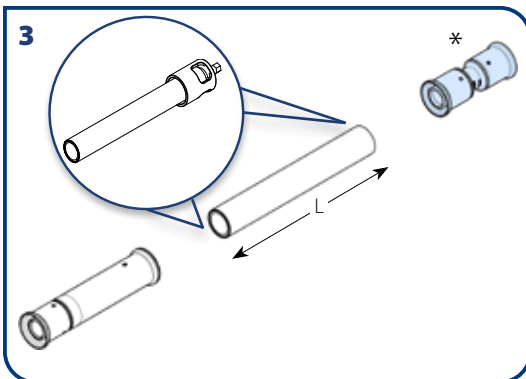
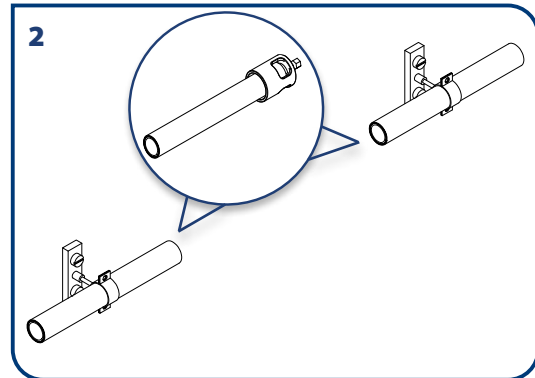
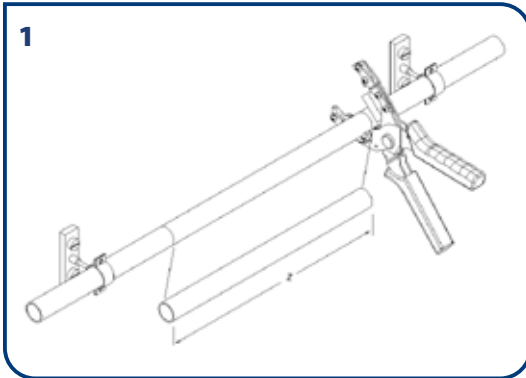

Numbers indicate the sequence of the press connection

* Straight coupling or T-piece



of

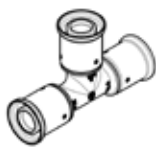

REPAIR FITTING	*ARTICLE	Z	L
52P16	15P-1616	200	115
52P20	15P-2020	200	115
52P26	15P-2626	200	115
52P32	15P-3232	270	160
52P16	9P-161616	232	115
52P16	12P-162016	239	115
52P20	10P-201620	243	115
52P20	9P-202020	243	115
52P20	12P-202620	243	115
52P26	10P-261626	249	115
52P26	10P-262026	249	115
52P26	9P-262626	249	115
52P26	12P-263226	260	115
52P32	10P-321632	318	160
52P32	10P-322032	318	160
52P32	10P-322632	318	160
52P32	9P-323232	318	160

7 ASSEMBLY INSTRUCTIONS

7.4 Making a push connection

Step by step



Remove the packaging

Use the Henco SAFECUT for this.



Cutting

Always cut the pipe at an angle of 90° (squarely). Use Henco tools, a guillotine cutter or pipe cutter for this.

The guillotine cutter is provided with a shoulder to assist installation of the pipe under 90°.

Do not cut the pipe on a bended section. We recommend that you shorten pipes with larger diameters using a cutter.



Calibration

After the pipe has been cut squarely cut, it needs to be calibrated.

This should be done using the Henco kalispeed.

1. Place the pipe straight in the kalispeed and whilst turning, press until the stop is reached.
2. Turn the kalispeed until you see the bevels on the pipe and have evenly chamfered the inner and outer edges of the pipe.
3. Remove the kalispeed, and dispose of swarth from the pipe and kalispeed.

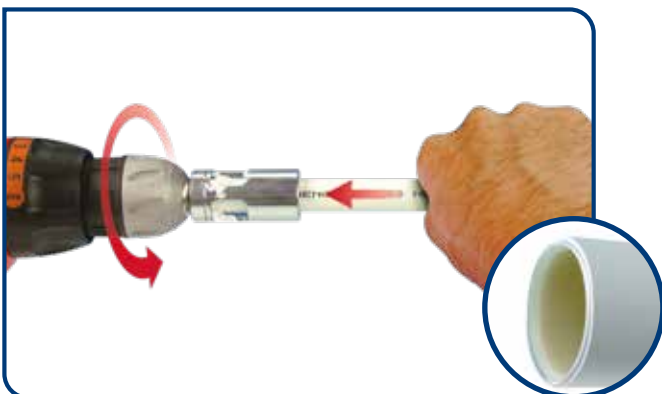

If the pipe is correctly calibrated (centered, chamfered, levelled off), the chamfering will be clearly visible around the inner and outer edges of the pipe.



Position pipe

Remove the black protective cap and slide the calibrated pipe into the push fitting as far as it will go, until you can see the colour of the pipe in the inspection windows.



It is not allowed to install a fitting and / or tube with other tools than mentioned in this technical manual.

1

2

3

4

5

6

7

8

9

10

11

7 ASSEMBLY INSTRUCTIONS

Disassembling a HENCO Vision push connection

The fitting can be disassembled very quickly if you have chosen an incorrect fitting or need to make changes to the installation.

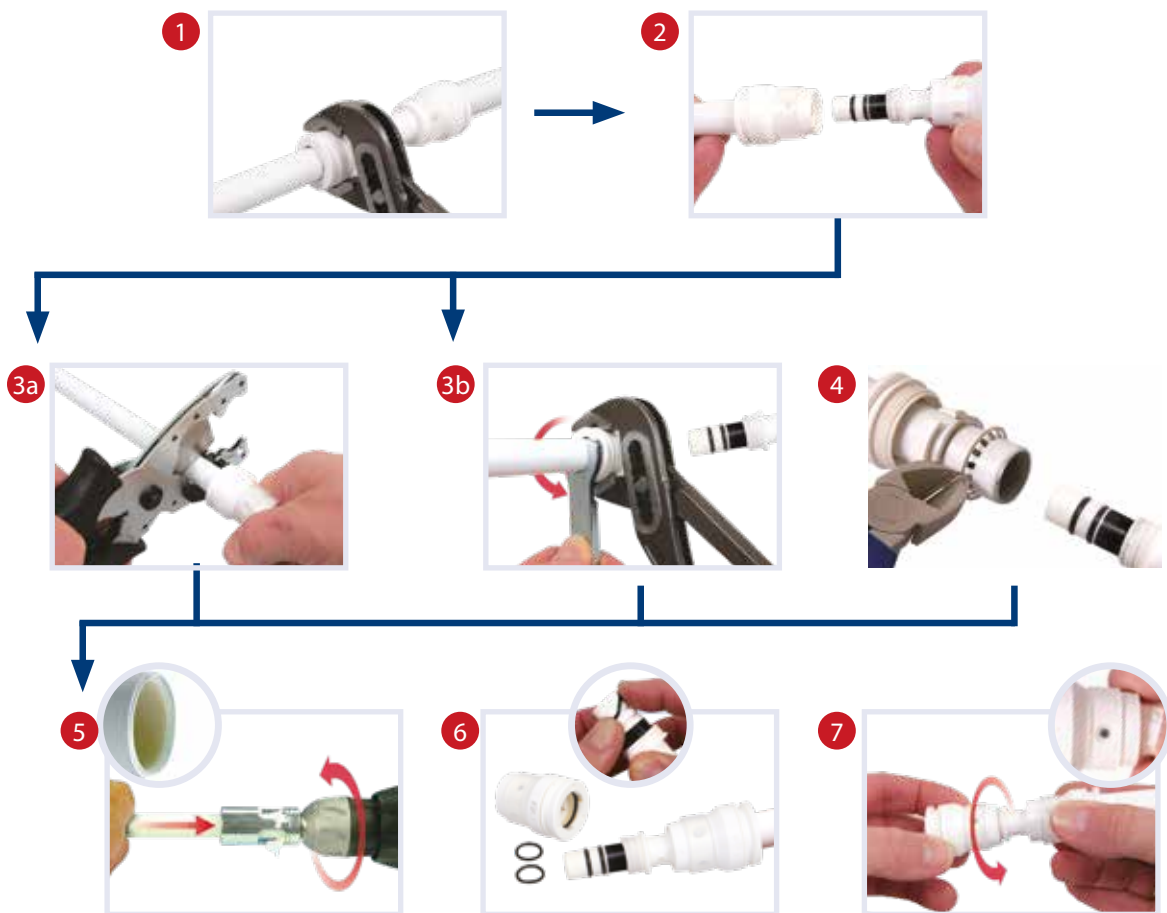

- 1 Twist off the sleeve.
- 2 Pull the pipe, together with the sleeve, from body of the fitting.
- 3a Method 1: Cut through the pipe behind the sleeve if the pipe is long enough and calibrate this.
- 3b Method 2: Open the sleeve using the HENCO Vision spanner if the pipe cannot be shortened.
- 4 Cut through the clamping ring and remove this together with the other parts which are on the pipe.
- 5 Calibrate.
- 6 Take a replacement set (sleeve + 2 O-rings) and carefully replace the damaged O-rings without damaging the body of the fitting and the new O-rings.
- 7 Slide the new sleeve onto the body of the fitting. Insert the calibrated pipe into the fitting. All done!



7.5 Making a screwed/compression connection

Step by step



Remove the packaging

Use the Henco SAFECUT for this.



Cutting

Always cut the pipe at an angle of 90° (squarely). Use Henco tools, a guillotine cutter or pipe cutter for this.

The guillotine cutter is provided with a shoulder to assist installation of the pipe under 90°.

Do not cut the pipe on a bended section. We recommend that you shorten pipes with larger diameters using a cutter.



Calibration

After the pipe has been cut squarely cut, it needs to be calibrated.

This should be done using the Henco kalispeed.

1. Place the pipe straight in the kalispeed and whilst turning, press until the stop is reached.
2. Turn the kalispeed until you see the bevels on the pipe and have evenly chamfered the inner and outer edges of the pipe.
3. Remove the kalispeed, and dispose of swarth from the pipe and kalispeed.

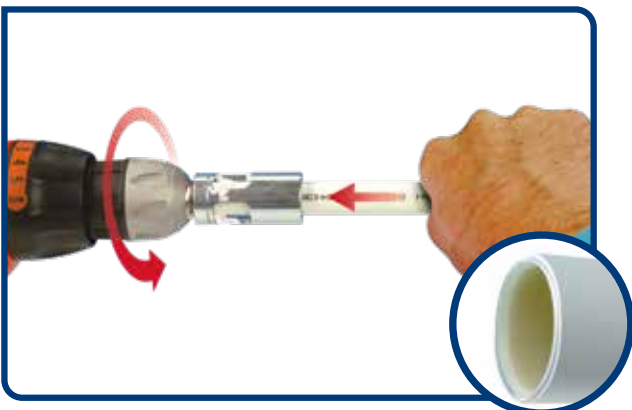

If the pipe is correctly calibrated (centered, chamfered, levelled off), the chamfering will be clearly visible around the inner and outer edges of the pipe.

7 ASSEMBLY INSTRUCTIONS

1

2

3

4

5

6

7

8

9

10

11



First slide the union nut and then the clamping ring over the pipe. You can grease the union nut with slide oil make it easier to slide on. Do not use mineral oil!



Insert the adapter or socket into the pipe and push to the end. Make sure a synthetic ring is always fitted to prevent electrolysis.



Now turn the union nut or the relevant tap, manifold or nipple. Always do this using two flat open-jawed spanners and respect the forces recommended by the manufacturer or those stated in the following table.



Forces required for creating a compression fitting

Pipe	Corresponding turning torque in Nm
14 x 2	40
16 x 2	50
18 x 2	55
20 x 2	60
26 x 3	75
32 x 3	100



7.6 Bending HENCO pipes

You should not use heat to bend Henco pipes. For pipes with diameters larger than $\text{Ø } 26$, press fittings should be used. The pipes can be bent manually but it is better to use an internal or external spiral spring for this. To form bends with the shortest possible radius, we recommend the use of Henco bending tools. When bending pipes, the following bending radii should be respected.

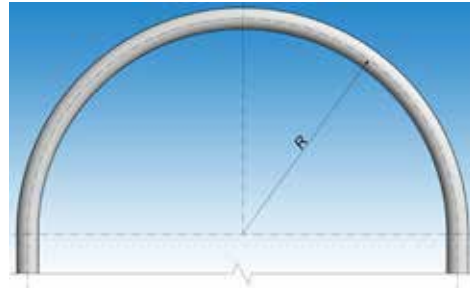

Pipe	Minimum bending radius manual / external spiral spring (mm)		Minimum bending radius internal spiral spring (mm)		Bending radius at BM16, BM20 and BM26		Manual bending
	Henco Standard	Henco RIXc	Henco Standard	Henco RIXc	Henco Standard	Henco RIXc	Henco PEXc
12 x 2	R 60 (5xDu)	-	R 30 (3xDu)	-	-	-	
14 x 2	R 70 (5xDu)	-	R 42 (3xDu)	-	-	-	
16 x 2	R 80 (5xDu)	R 80 (5xDu)	R 48 (3xDu)	R 48 (3xDu)	R 32 (2xDu)	R 32 (2xDu)	R 80 (5xDu)
18 x 2	R 90 (5xDu)	R 90 (5xDu)	R 54 (3xDu)	R 54 (3xDu)	-	-	R 90 (5xDu)
20 x 2	R 100 (5xDu)	R 100 (5xDu)	R 60 (3xDu)	R 60 (3xDu)	R 60 (3xDu)	-	R 100 (5xDu)
26 x 3	R 130 (5xDu)	R 130 (5xDu)	R 78 (3xDu)	R 78 (3xDu)	R 78 (3xDu)	R 78 (3xDu)	
32 x 3	R 160 (5xDu)	-	-	-	-	-	

Bending with a bending tool



Bending with an external bending spring



Bending with an internal bending spring



Manual bending



You should position the start of the bend (L) at a distance of at least 3x the outer diameter of the fitting.

Never use cracked pipes!

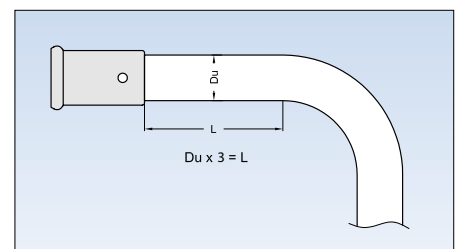

7.7 Accommodating length changes (expansion)

During embedding

In order to accommodate the expansion of the pipe, you should introduce at least 1 expansion bend for every 10 meters of pipe where there is no change of direction. We recommend that you use Henco pipe insulation for this. If you use this insulation, bare Henco pipe can be laid in floors and walls.

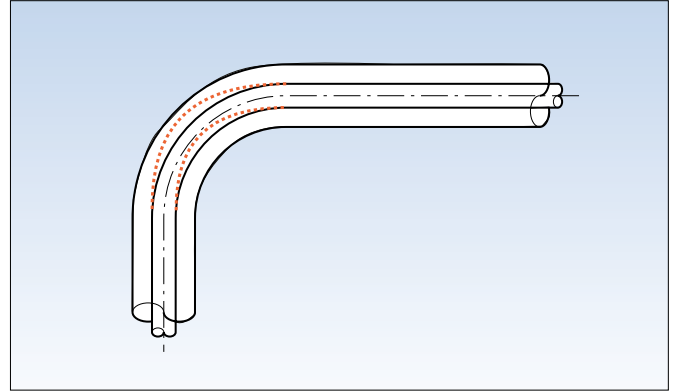

In terms of quality, it is best to always fit a sleeve, or better still insulation.

The sleeve has a protective function and the insulation not only protects and offers thermal insulation but also prevents the formation of condensation.

To determine the thickness of the insulation, you can apply the following rule: $1.5 \times \Delta L$ (change in length)

You should ensure that the distance between the two fastening points is no more than 2 metres.

The Henco multilayer pipe is naturally also ideal for underfloor heating where in which case the above guidelines naturally do not apply.

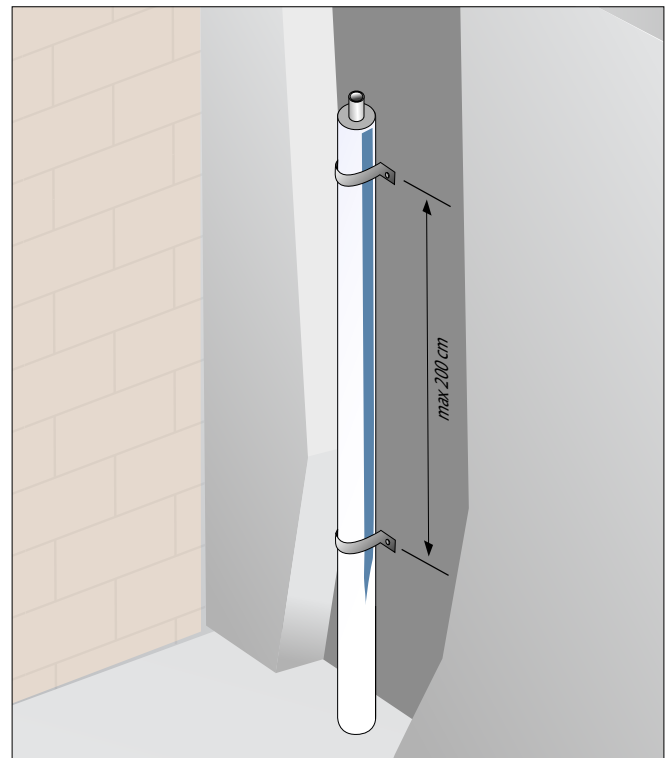



When mounting pipes on surfaces

For assembly Henco advises to use pipes in the form of rods (straight lengths). Do not attach Henco tube systems to other tube systems, like sewage pipes. When fixing the Henco multilayer tube to the wall or ceiling pipe brackets should be used. The pipe brackets are made of plastic or metal with a rubber insert to protect the pipe. The prescribed maximum distance between the brackets must be respected. See the table below. In order to compensate for the expansion of the pipe, at least one expansion bend must be provided every 10 metres without any change of direction.

Pipe	Max. distance pipe brackets (cm)
14 x 2	80
16 x 2	80
18 x 2	100
20 x 2	120
26 x 3	150
32 x 3	160
40 x 3.5	170
50 x 4	180
63 x 4.5	200
75 x 6	200
90 x 7	200

Pipe brackets

Pipe brackets have two purposes. Firstly they support the pipe network. Secondly they accommodate the length changes to pipes caused by heat by means of sliding and fixed points. The sliding points must be such that the pipe continuously has clearance. The sliding points should be positioned in such a way that the pipe always has clearance. The sliding point cannot become a fixed point when the pipe is mounted to a surface.

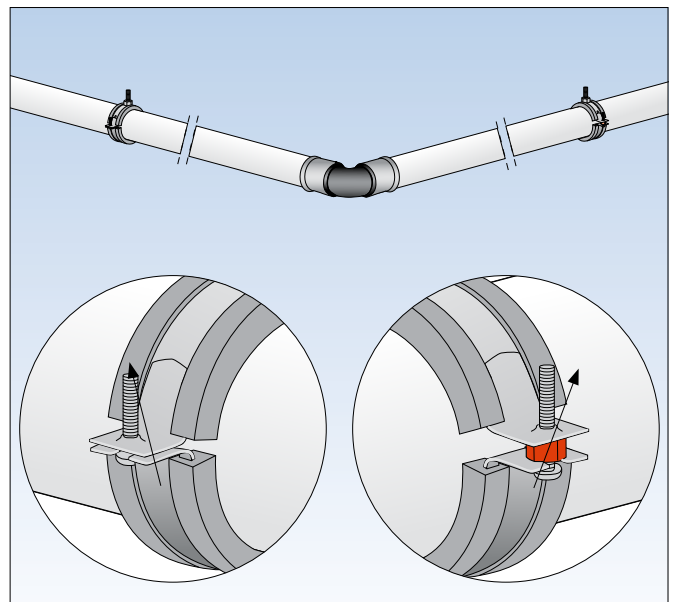
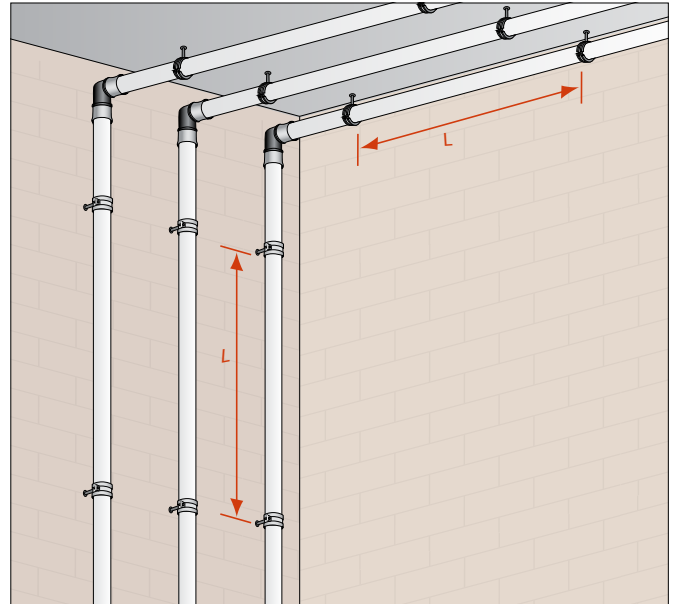

- 1
- 2
- 3
- 4
- 5
- 6
- 7
- 8
- 9
- 10
- 11



7 ASSEMBLY INSTRUCTIONS

- 1
- 2
- 3
- 4
- 5
- 6
- 7
- 8
- 9
- 10
- 11

Expansion bends

It is very important that sliding points and fixed points are positioned correctly when you use expansion bends and expansion loops. You should use expansion bends whenever the pipe changes direction.

We recommend that you always use fittings to make the direction change. For pipes with a diameter of 32 mm or greater this is compulsory.

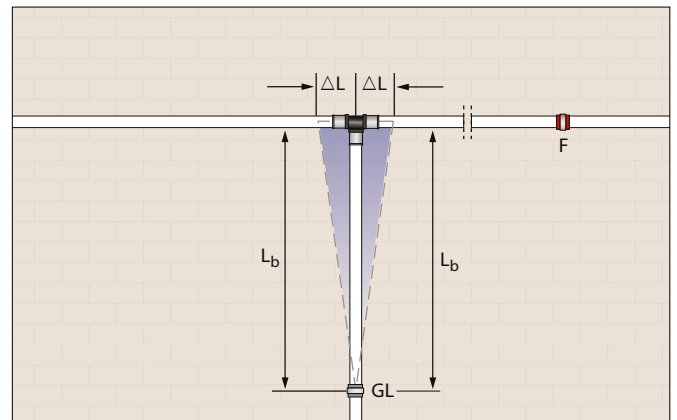
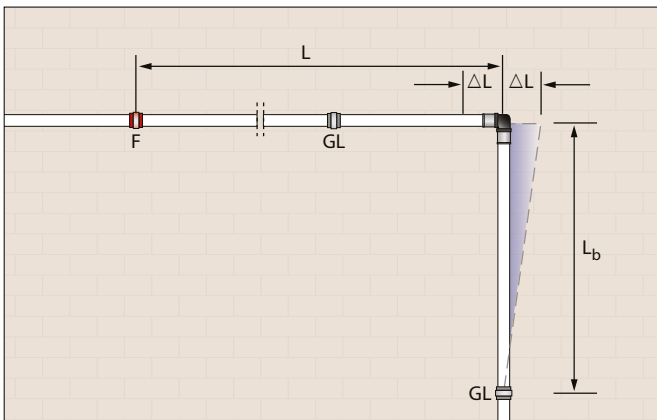

- | | |
|--------------------------------------|----------------------------------|
| L = length of the pipe | F = fixed point |
| L_b = length of the expansion bend | GL = sliding point |
| ΔL = change in length | Expansion bend for L (L_b) |

Expansion loops

When a long pipe does not have any change of direction, you should use expansion loops. An expansion loop is also called a lyra or omega bend. The drawing shows an expansion bend more clearly.

The expansion loop is formed in principle from two expansion bends. A fixed point must therefore be provided at the bottom in the middle of the loop.

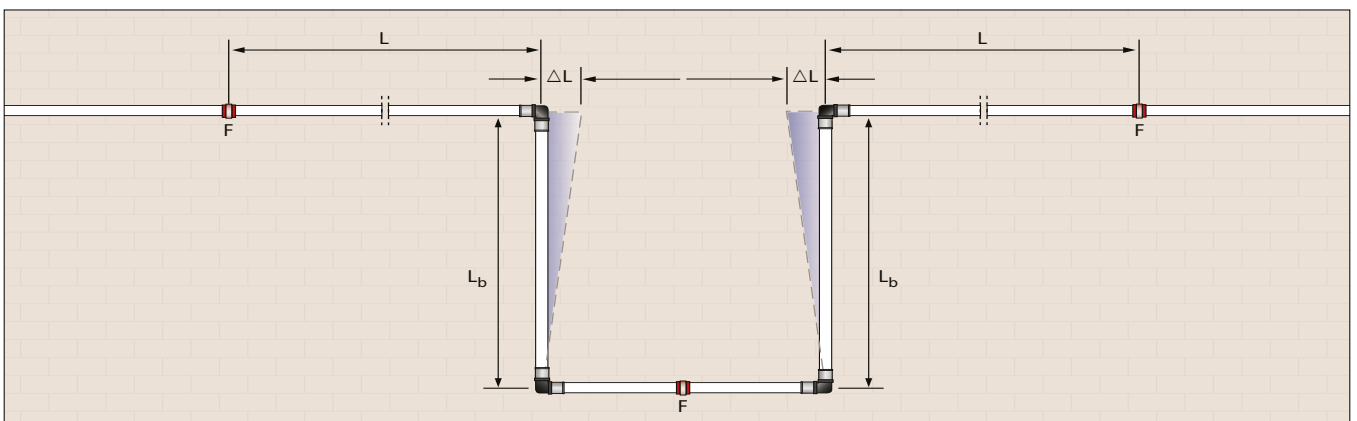



The minimum length of the expansion bend can be calculated using the following formula or you can read it from the diagram below:

$$L_b = C \times \sqrt{(D \times \Delta L)}$$

with: L_b = length of the expansion bend
 C = material constant (=33)
 D = outer diameter of the pipe
 ΔL = change in length

Example:

Given that: $L = 4 \text{ m}$
 $D = 26 \text{ mm}$
 $\Delta T = 50^\circ\text{C}$ ($T_{\text{min}}=10^\circ\text{C}$ en $T_{\text{max}}=60^\circ\text{C}$)

Asked: L_b

Solution: $L_b = C \times \sqrt{(D \times \Delta L)}$

where $\Delta L = L \times \alpha \times \Delta T$
 $= 4 \times 0.025 \times 50$
 $= 5 \text{ mm}$

$L_b = C \times \sqrt{(D \times \Delta L)}$
 $= 33 \times \sqrt{(26 \times 5)}$
 $= 376.25 \text{ mm}$

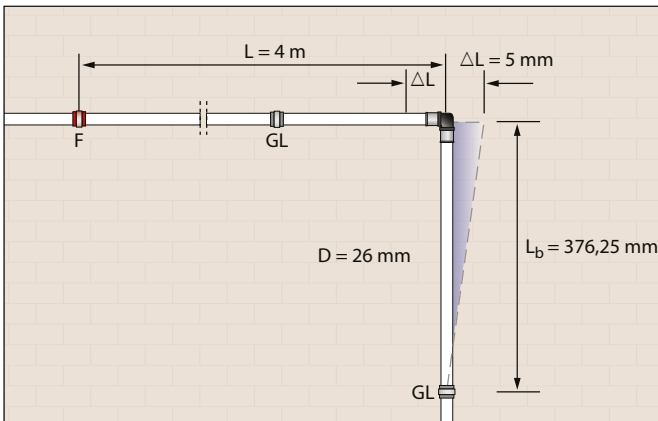

For a pipe with a diameter of 26 mm and a length of 4 m that has a change of direction, when there is a temperature difference of 50°C you will have to provide an expansion bend of 376.25 mm to accommodate the change in length.

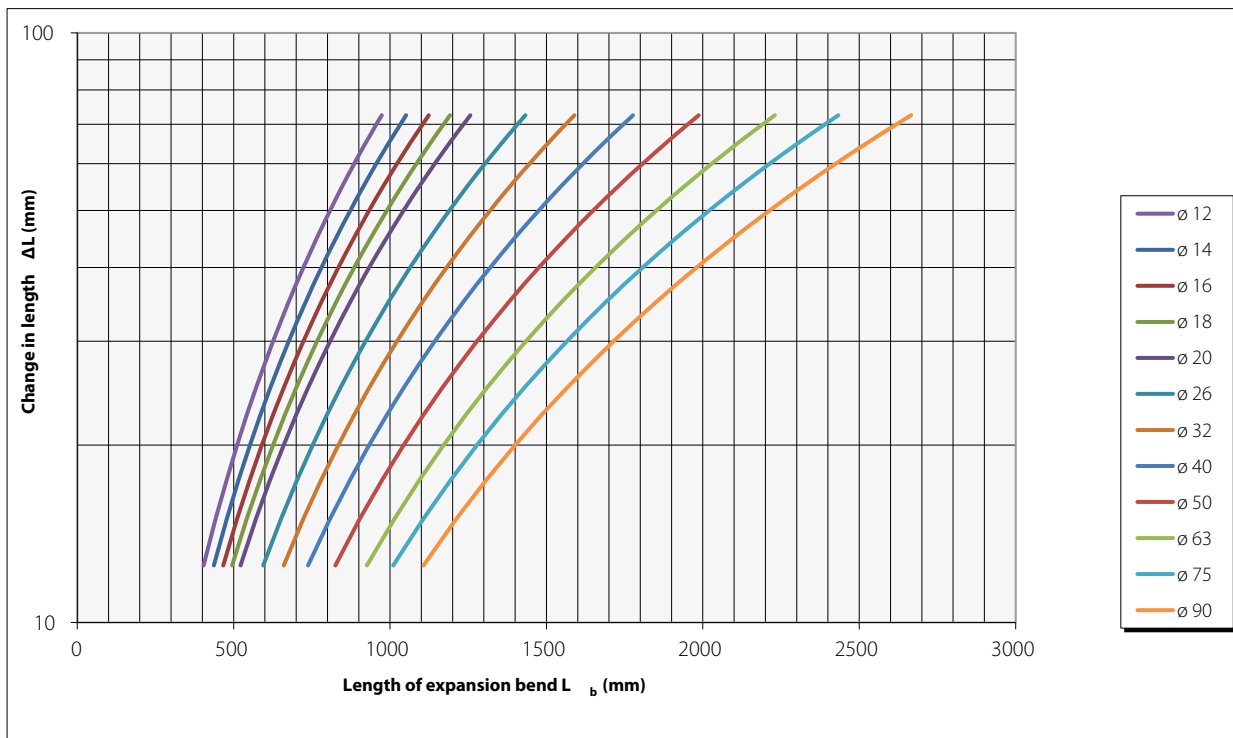

7 ASSEMBLY INSTRUCTIONS

1

2

3

4

5

6

7

8

9

10

11

Riser pipes

You should also ensure that pipes are able to move freely when they pass between floors to a riser pipe in a shaft. In this case too, the change in length can be accommodated here too by an expansion bend. The expansion bend will then accommodate the upward and downward movements.

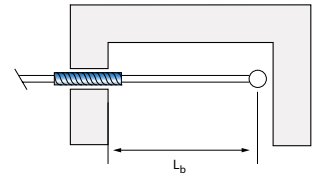
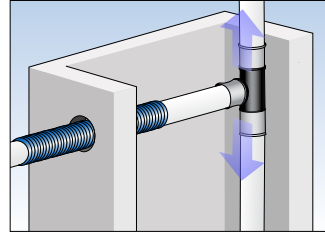

If there is sufficient room in the shaft, in other words, if there is space to accommodate the calculated expansion bend, then it is sufficient to fit a protective sleeve to the pipe where it passes through the wall.

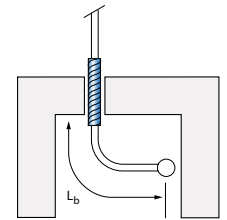
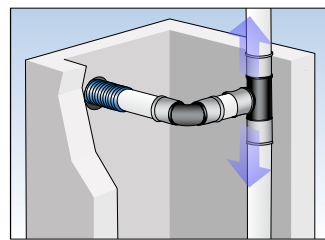

If the shaft is too small to fit the calculated expansion bend, the hole in the wall will have to be made larger to give the pipe sufficient room for movement. The pipe must be provided with insulation where it passes through the wall.

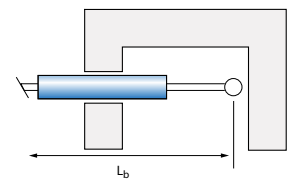
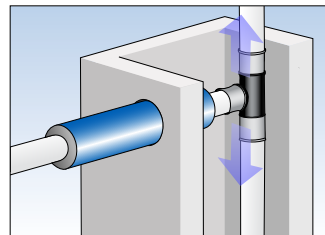

Laying pipes straight on a floor

For installations where HENCO multilayer pipes are laid straight on a floor, the maximum distance between fixtures is 80 cm. Fixtures should be positioned at 30 cm before and after a 90° bend and you should use pipe brackets.

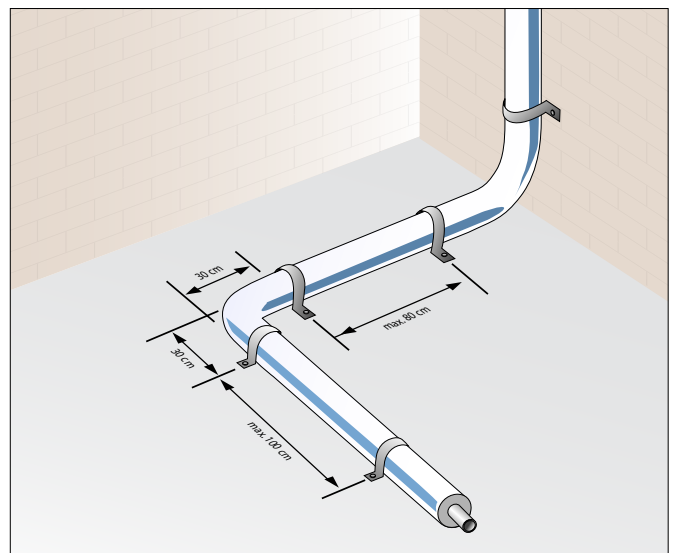



You should always provide a fixed point if the riser pipe is longer than 10 m. It is recommended that this point is located in the middle of the pipe as then lower expansion forces will be generated.

The drawings show that the total length of the expansion bends which need to be provided if the fixed point is situated in the middle of the riser pipe is much less than when the fixed point is at the start of the riser pipe.

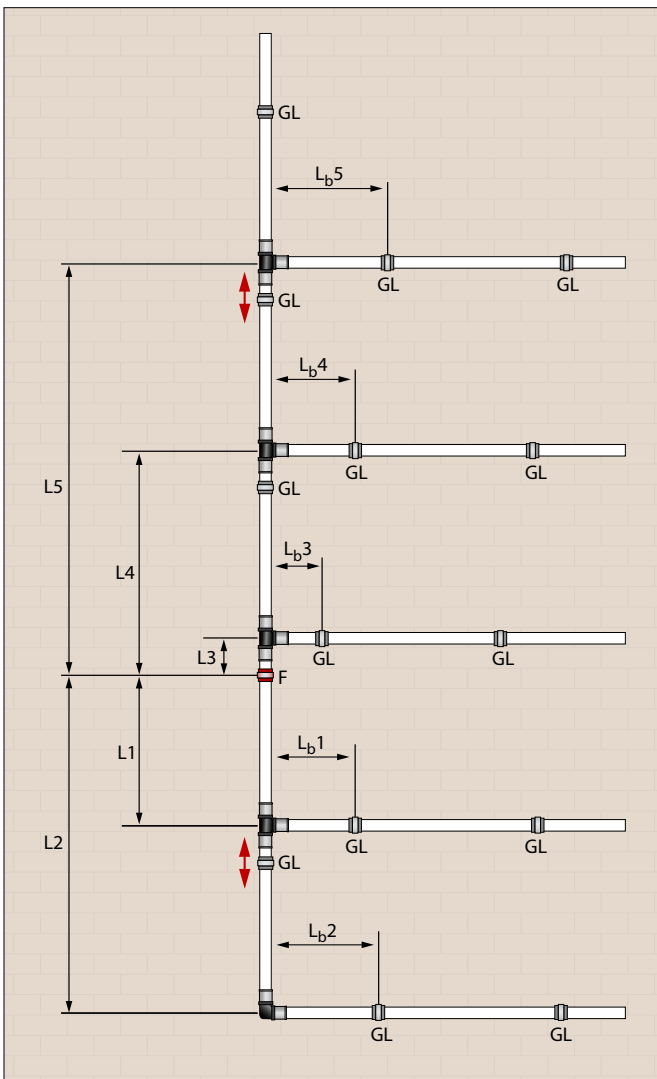

$$L_{b1} + L_{b2} + L_{b3} + L_{b4} + L_{b5}$$

<

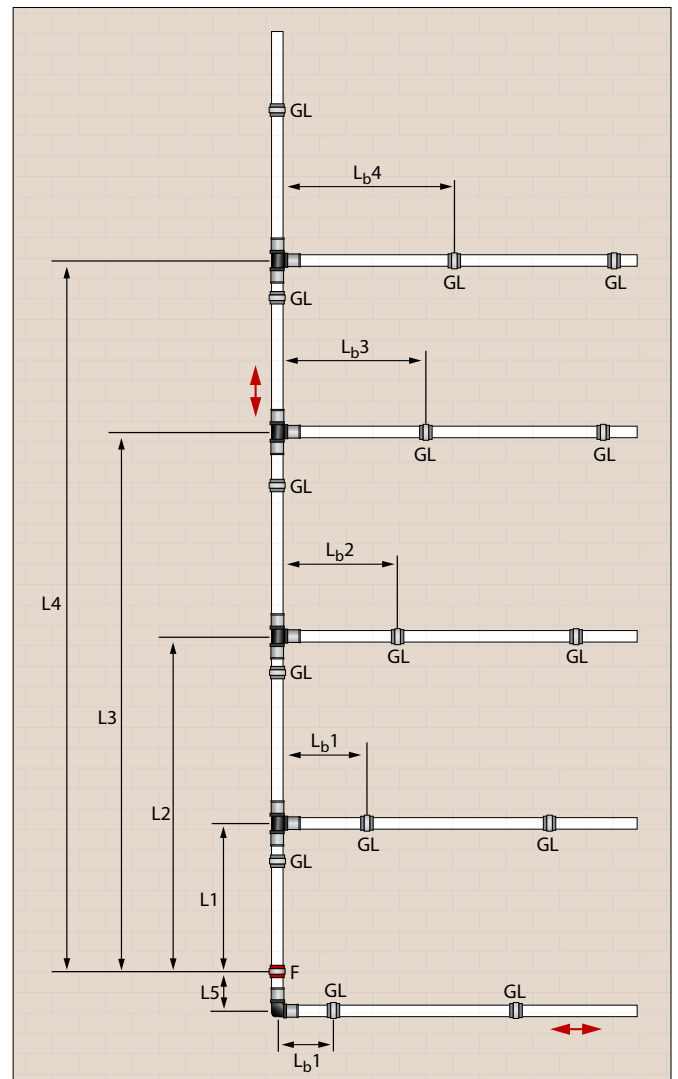

$$L_{b1} + L_{b2} + L_{b3} + L_{b4} + L_{b5}$$

- 1
- 2
- 3
- 4
- 5
- 6
- 7
- 8
- 9
- 10
- 11

7 ASSEMBLY INSTRUCTIONS

7.8 Embedding fittings

Synthetic press fittings (PVDF)

Synthetic (PVDF) press fittings can be embedded without the use of protective measures in:

- ▶ Pure sand-cement screed floors
- ▶ Anhydrite screed floors
- ▶ Construction concrete
- ▶ Polyurethane

Synthetic push fittings Henco Vision

Henco Vision Synthetic (PVDF) push fittings can be embedded without the use of protective measures in:

- ▶ Pure sand-cement screed floors
- ▶ Anhydrite screed floors
- ▶ Construction concrete
- ▶ Polyurethane

Brass Press fittings

Blank brass fittings should be protected against corrosion. You can do this by using protective silicone tape where each coil should overlap by at least 50%. You should start by wrapping the pipe side with one full 1 turn of tape.

Tin-plated brass press fittings

- ▶ Pure sand-cement screed floors
- ▶ Anhydrite screed floors

However, you should ensure that the tin-plated surface of the fitting is fully intact and does not exhibit any signs of damage.

Compression fittings

Henco recommends that brass compression fittings are not embedded but are rather used solely for surface mounting.

7.9 Pipes passing through openings

During installation you should ensure that bare pipes do not enter into contact with any sharp objects. For example, piping running through openings in ceilings may not be bent around sharp edges as there is a danger of cracking. You should replace any cracked pipes.

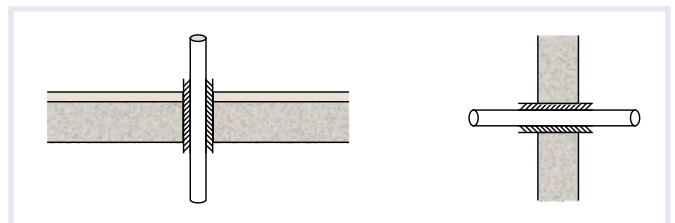

For wall and floor passages, we recommend sliding a piece of insulation around the pipe to protect the pipe.



- 1
- 2
- 3
- 4
- 5
- 6
- 7**
- 8
- 9
- 10
- 11

7.10 Pipes in hazardous areas

When laying Henco multilayer pipes in areas which are subject to aggressive gases (stables, etc.) or constantly exposed to humidity permanently penetrating humidity (industrial kitchens, swimming baths, etc), the metal connectors must be protected.

If you have any questions, please contact Henco's technical advisor.

7.11 Pipe insulation

When using pipe insulation other than that supplied by the manufacturer, please ensure that any adhesives used, even if not directly required to attach the insulation to the plastic pipe, do not contain any harmful products for the

pipe and fittings. Armacell's contact adhesive Armaflex 520 (polychloroprene based and free of aromatics) has been tested and approved for use with Henco pipes and Henco PVDF fittings.

7.12 Frost protection and trace heating

Freezing of water-filled pipes may cause damage to the pipe system, even if the freezing is only local. That is why Henco does not allow applications where the water in multilayer pipes is locally frozen to have a temporary plug. It should always be avoided that pipes filled with water can freeze.

Multilayer pipes are suitable for the use of ribbon heating. The aluminium pipe guarantees an even heat transfer over the entire pipe circumference. The additional heating is fixed to the pipe by means of cables or adhesive tape at normal

indoor temperatures. Henco should be consulted when adhesive tape is used to fix the heating ribbon on the pipe, or for a better heat distribution.

Heating ribbons have to have a technical approval. When using an additional heater the temperature of the drinking water may not exceed 60°C. Attention must be paid; in case of non-circulating water systems the auxiliary heating must be switched off.

7.13 Cleaning the pipe

Powerclean (Innotec) can be used.

7.14 Anti-freeze

A maximum of 45% ethylene glycol combined with 55% water is allowed in the Henco multilayer pipe system. It can withstand a minimum temperature of -10°C.

7 ASSEMBLY INSTRUCTIONS

7.15 Installation temperatures

The minimum temperatures at which multilayer pipes can be installed are as follows:

- ▶ - 20°C for PE-Xc/AL/PE-Xc multilayer pipes
- ▶ + 7° for synthetic pipes

7.16 Disinfection and cleaning

1. The manufacturer should be consulted before using disinfectant products or applying a thermal cycle where

- ▶ **Hadex**
Diluted with water at a concentration of 1:13000 (± 4 ppm Bleach) in accordance with the instructions. Treat for a maximum of 5 minutes at 90°C and only perform one treatment per year.
- ▶ **Herlisil**
Diluted with water at a concentration of 1:1000 (± 500 ppm hydrogen peroxide) in accordance with the instructions. Treat for a maximum of 5 minutes at 90°C and only perform one treatment per year.

temperatures exceed the specified usage temperature. The following products can be used:

- ▶ **Citric acid**
Maximum 10% diluted with water. Treat for a maximum of 5 minutes at 90°C and only perform one treatment per year.

It should be noted here that these treatments will only have a long-term effect if the source of the contamination is dealt with professionally.

2. Disinfection according to DVGW W557

The Henco Multilayer pipes will resist a short period of chemical disinfection in compliance with table 1 of DVGW guideline W557. The maximum allowed concentrations, the

maximum allowed temperature, the maximum allowed treatment time and active elements as shown in this table must be strictly observed.

Designation	Commercial packaging	max. concentration (*)	Max duration and max temperature
Hydrogen peroxide (H ₂ O ₂)	Solution in water 50%	150 mg/l H ₂ O ₂	Max. 24h Max. 25°C
Sodium hypochlorite NAOCl	Aqueous solution with max. 150g/l «free chlorine»	50 mg/l chlorine	Max. 12h Max. 25°C
Chlorine dioxide ClO ₂		6mg/l ClO ₂	Max. 12h Max. 25°C

(*) The concentration indicated is the concentration of free chlorine
Maximum frequency: once per year

7.17 Osmosis water

The Henco multilayer pipe PE-Xc/AL/PE-Xc is suitable for osmosis water (purified water). However, you should only

use synthetic fittings (PVDF) which do not contain brass components.



7.18 Softening water

The Henco multilayer pipes and PVDF fittings can be used without any problem in combination with water that has been softened up to 0°fH/0°dH. Brass fittings or fittings with brass parts like threaded fittings will corrode in case of heavily softened water. From 7°fH/4°dH onwards, this risk no longer exists for the brass type CW617N. If the water softening is

higher than 7°fH/4°dH and the use of brass fittings is still necessary, the addition of anti-corrosion substances can be a solution.

Translated with www.DeepL.com/Translator (free version)

7.19 Earthing (conduction)

The Henco system is not electrically conductive and as a result is not suitable for any kind of electrical earthing.



7.20 Water quality

The water quality must meet the standards of 99/83/EC.

7.21 Hydrogen peroxide

This is allowed on the condition that it is diluted to a maximum of 6%.

1

2

3

4

5

6

7

8

9

10

11



7 ASSEMBLY INSTRUCTIONS

1

7.22 Leak tightness and pressure resistance tests

2

A Testing with water as a test medium

3

A1: General

4

5

6

7

- ▶ Installation components that cannot be subjected to a pressure test with the required pressure must be disconnected.
- ▶ The fittings must be subjected to a visual inspection.
- ▶ The water medium must be filtered drinking water, i.e. not polluted
- ▶ Connections that need to be encased in concrete must be subjected to a pressure test before pouring the floors/walls
- ▶ Avoid stagnant water in the pipes for a long period of time
- ▶ The manometer must be installed at the lowest point of the installation.
- ▶ Use a manometer with a minimum range of up to 16 bar and an indication precision equal to or smaller than 0.5 bar. A digital manometer is also allowed.

8

9

10

11

A2: Tightness test

- ▶ The tightness test is intended to detect non-pressed connections.
- ▶ The testing pressure is 2.5 bar (± 0.5 bar). Close the system afterwards. Gradually increase the pressure.
- ▶ Test time: 10 minutes, if the pressure remains the same. In case of pressure loss: find the leak, eliminate the fault and repeat the test.

A3: Pressure test (DIN EN 806-4)

- ▶ After the tightness test the pressure must be increased to 1.1 times the maximum operating pressure (depending on the diameter and type of the pipe: 10 or 16 bar; DIN EN 806-4).
- ▶ Test time: 10 minutes, if the pressure remains the same. In case of pressure loss: find the leak, eliminate the fault and repeat the test

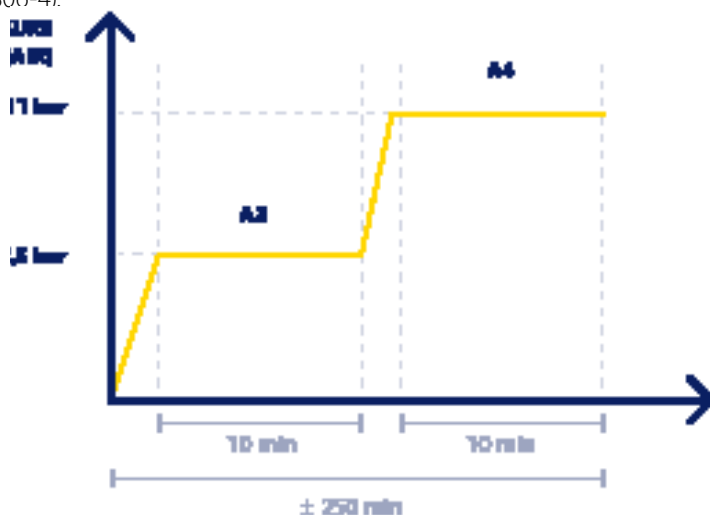



B Testing with compressed air or inert gas as a test medium

B1: General

- ▶ The compressed air or inert gas medium must be free of oil.
- ▶ Pay attention to the suffocating effect of inert gas in confined spaces.
- ▶ The ambient temperature must not be higher than 25°C when testing the connections.
- ▶ Use a manometer with a minimum range of up to
 - 0.25 bar and an indication precision of 1 mbar for the leak tightness.
 - 4.5 bar and an indication precision of 0,1 bar for the pressure resistance.
 - A digital manometer is also allowed

B2: Tightness test

- ▶ Testing pressure of 0.5 bar \pm 0.01 bar
- ▶ Test time after pressure stabilisation:
 - Up to 100 litres of pipeline volume: 120 minutes
 - For every additional 100 litres, extend the test time with 20 minutes
 - A pressure drop greater than 0.5% is not allowed.

B3: Pressure test

- ▶ Testing pressure:
 - 3 bar \pm 0.2 bar for pipes \leq \varnothing 63 mm
 - 1 bar \pm 0.1 bar for pipes $>$ \varnothing 63 mm
- ▶ Test time after pressure stabilisation: 10 minutes
- ▶ Release the pressure after completing the test.

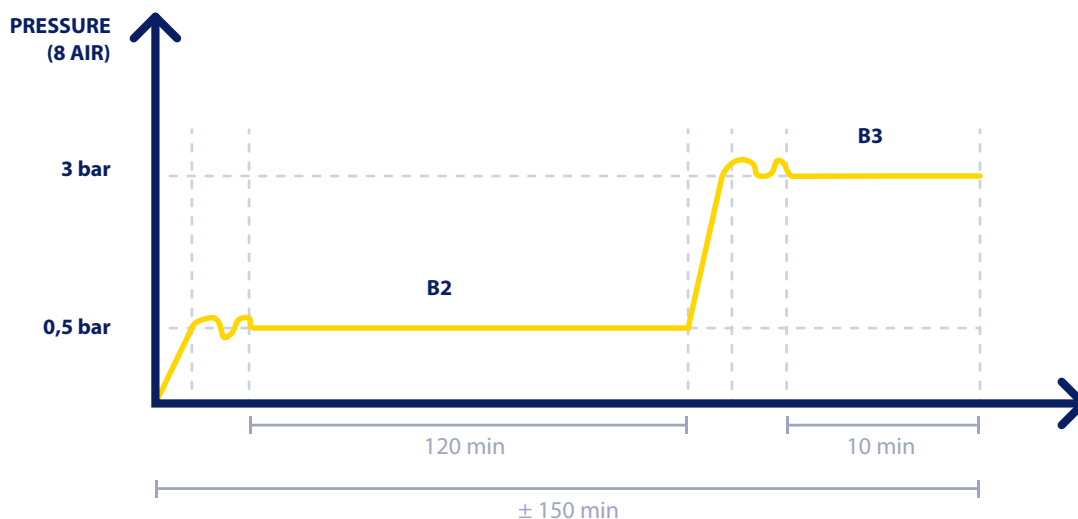



7 ASSEMBLY INSTRUCTIONS

- 1
- 2
- 3
- 4
- 5
- 6
- 7
- 8
- 9
- 10
- 11

Pressure test protocols

For sanitary installations with water

Henco PRESSURE TEST PROTOCOL FOR SANITARY APPLICATIONS (according to DIN 1988)

Project

Installation site

Client Installer

Name of person carrying out the test.....

Start test Date Time

Area of piping tested

Was the piping filled with filtered water and fully de-aerated? Yes No

Ambient temperature°C Water temperature°C

Type of Henco pipe Ø12 Ø14 Ø16 Ø18 Ø20 Ø26
 Ø32 Ø40 Ø50 Ø63 Ø75 Ø90

Total pipe length m

Were the fittings inspected visually? Yes No

INTRODUCTORY TEST

Pressure at start of test bar time

Test pressure (10 minutes after start of the test) bar time

Pressure loss per 5 minutes bar

(max. 0.1 bar per 5 minutes and max. 0.6 bar in total)

Did you detect a leak during the pressure test? Yes No

Was the max. pressure loss exceeded during the pressure test? Yes No

MAIN TEST (immediately after the preparatory test and lasting 10 minutes)

Test pressure (at start of main test) bar time

Test pressure (after 10 minutes) bar time

(pressure loss may be max. 0.2 bar)

Did you detect a leak during the pressure test? Yes No

Place Date

Signature of client

Signature of installer



- 1
- 2
- 3
- 4
- 5
- 6
- 7
- 8
- 9
- 10
- 11

Pressure test protocols

For sanitary installations with compressed air or inter gas

Henco PRESSURE TEST PROTOCOL FOR SANITARY APPLICATIONS (according to DIN 1988)

Project

Installation site.....

Client Installer

Name of person carrying out the test.....

Start test Date Time

Area of piping tested

Was the piping filled with filtered water and fully de-aerated? Yes No

Ambient temperature°C Water temperature°C

Type of Henco pipe Ø12 Ø14 Ø16 Ø18 Ø20 Ø26
 Ø32 Ø40 Ø50 Ø63 Ø75 Ø90

Total pipe length m

Were the fittings inspected visually? Yes No

INTRODUCTORY TEST

Pressure at start of test bar time

Test pressure (120 minutes after start of the test) bar time

Pressure loss per 5 minutes bar

(max. 0,5 % pressure loss)

Did you detect a leak during the pressure test? Yes No

Was the max. pressure loss exceeded during the pressure test? Yes No

MAIN TEST (immediately after the preparatory test and lasting 2 hours)

Test pressure (at start of main test) bar time

Test pressure (after 10 minutes) bar time

(pressure loss may be max. 0,5% bar)

Did you detect a leak during the pressure test? Yes No

Place Date

Signature of client

Signature of installer



7 ASSEMBLY INSTRUCTIONS

- 1
- 2
- 3
- 4
- 5
- 6
- 7
- 8
- 9
- 10
- 11

For installations with radiators with water

HENCO PRESSURE TEST FOR RADIATORS (according to DIN 18380)

1. INSTALLATION INFORMATION

Project:

Client:

Street/house number:

Postcode/city:

Maximum working pressure:

Maximum working temperature:

2. CARRY OUT PRESSURE TEST

For testing seals in a heating installation that uses the Henco piping system, the following items apply to the pressure test:

1. If a safety group or measurement facilities have to be provided in the future then replace these now with pipes or pipe connections
2. Fill the heating installation to filtered water and de-aerate.
3. Connect the pressure test device and put the installation under test pressure:
The test pressure should correspond with the pressure of the safety clip. Minimum test pressure: 1 bar.
4. Increase the test pressure again after 2 hours since there can be a drop in pressure due to expansion of the pipes.
5. Maintain the test pressure for at least 3 hours in the heating installation and observe that the pressure drop is < 0.2 bar.
6. Furthermore you should perform a full visual inspection on the heating system for leaks:
There should be no water leaking from the heating installation.
7. If there is a risk of frost, the necessary measures must be taken (use anti-freeze products or heat the building). Once the heating is no longer exposed to frost, the anti-freeze products must be fully removed from the piping. The installation must be rinsed at least 3 times with fresh water to achieve this.

Note!

When pouring the screed, the heating installation should be set to its maximum working pressure so that any leaks can be seen immediately.

3. CONFIRMATION

The pressure test was performed in accordance with the instructions. No leaks were detected during the test.

Test pressure: Test duration:

Pressure drop after 5 hours:

Client: Signature:

Contractor: Signature:

Place: Date:





7.23 UV resistance

Henco multilayer pipes should be protected against direct sunlight or UV-irradiation. You should cover the pipes during storage or transport once they have been removed from

their packaging. If the pipes are fitted with a protective sleeve or insulation when mounted to a surface, then they will be perfectly protected against UV radiation.

7.24 Fire classification

The Henco multilayer pipe, consisting of two cross-linked polyethylene layers and a butt-welded aluminium layer, is classified as E under EN 13501-1:2007+A1: 2009 and EN/TS 15117:2005.

7.25 Prefabrication of Henco pipes and press fittings

Increase your efficiency. By preparing repetitive work in your warehouse under the right (working) conditions and with the right tools, you can gain time and quality at the construction site. Time is money! Now more so than ever.

However, pipes with a diameter of 26 and larger do not allow this prefab option (with wound pipes), since they cause excessive winding stress in the pipe, in relation to the press fitting. This winding stress in relation to the fitting is unacceptable and therefore rejected by us.

We at Henco see this trend and even encourage it. However, some caution should be exercised, because not all pipe diameters allow this without a negative impact or even damage.

If you use Henco PEXc/Al/PEXc pipe Ø26 x 3,0 nonetheless, we recommend using straight pipe lengths of 3 to 5 metres. Prefabricated plastic piping systems must be transported with care, to avoid any excessive stresses on the material!

The Henco PEXc/Al/PEXc pipes with a diameter of 16 and 20 are easy to process. Pipes and press fittings are prepared in the proper configuration in your warehouse. They are unrolled and installed by a professional at the construction site.



Tools

Curved Henco pipes can be straightened when installing them on site, by means of our [pipe straightener](#) (available in Ø16 and Ø20). [Bending springs or bending tools](#) allow you to make upward bends in the concrete floor, if necessary.

Do not walk on the pipes during storage, transport and at the construction site. If this cannot be avoided for any reason whatsoever, use temporary protection for the pipes and press fittings to reduce the load as much as possible.

Henco pipes and PVDF press fittings can be encased without additional protection, thanks to the plastic pipes and fittings in combination with the stainless steel press sleeves.

7 ASSEMBLY INSTRUCTIONS

7.26 HENCO TS: the guaranteed "TOTAL SAFE" piping system

Heating installations in newly built homes usually have a piping network embedded in the screed floor. The Henco TS system is the perfect solution for this use. Whereas radiators are individually connected in systems using manifolds, the Henco TS system uses one main pipe for each floor, where the radiators are connected by means of crossover T-pieces in a two-pipe arrangement.

Advantages:

- ▶ No manifold required.
- ▶ Less piping is needed.
- ▶ Greatly reduces the thermal load on the floor.

A double crossover tee ensures that pipes do not have to be laid on top of each other.

Because heating installations are usually calculated with operating temperatures higher than 40°C, the piping to be laid must have a protective sleeve or insulation (NEN 2741 Ned.). We also recommend that the crossing-free T-pieces are provided with insulation boxes.

The Henco TS system is made up of the following components:

- ▶ Henco PE-Xc/AL/PE-Xc pipes with protective sleeve or insulation
- ▶ Double crossover tees with insulation boxes
- ▶ Press fittings and screw/compression fittings
- ▶ Connection sets for radiators
- ▶ Radiator valves for manual and thermostatic operation
- ▶ Fastening materials

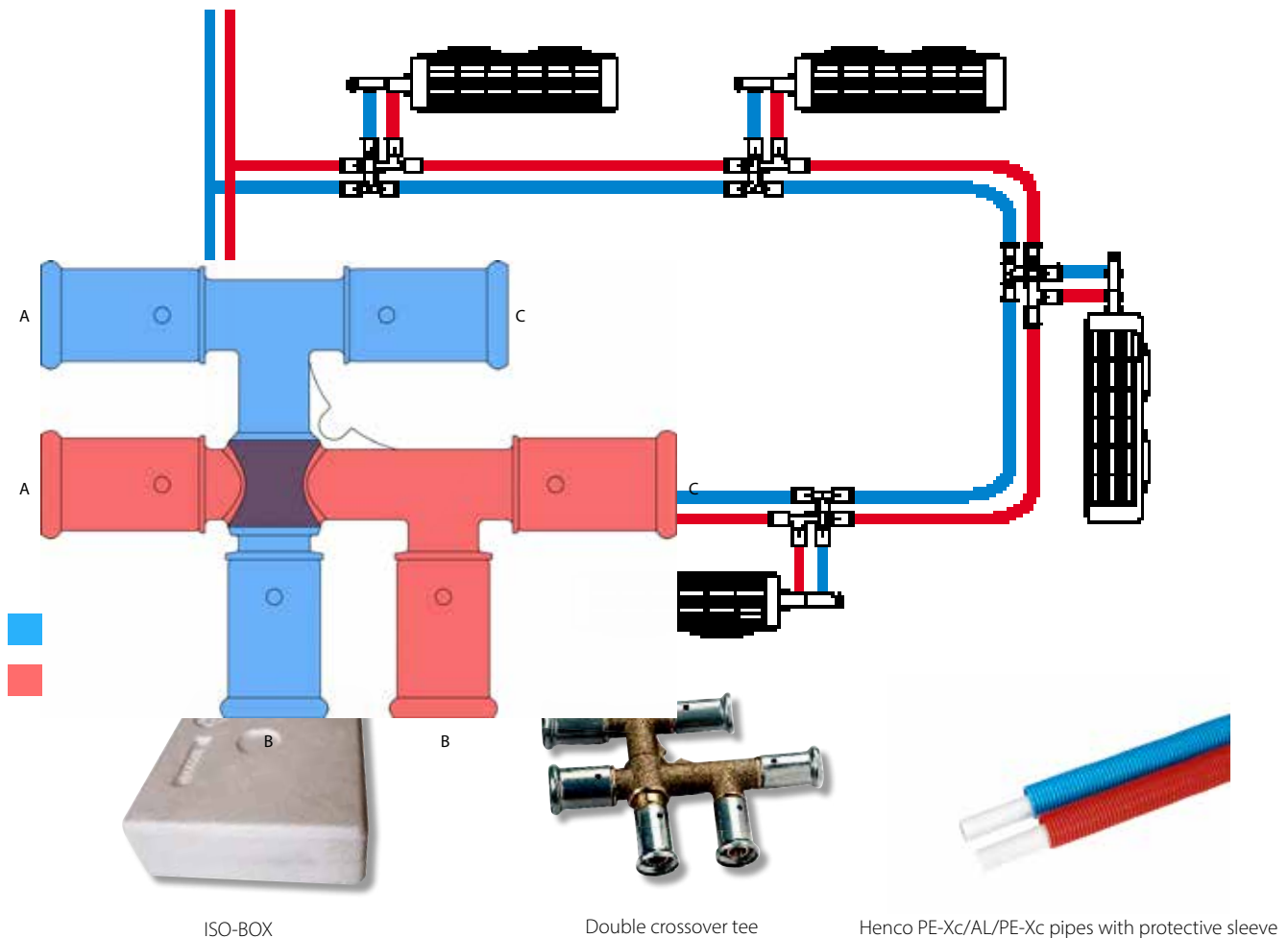



It goes without saying that for best performance from the installation using the Henco TS system, the radiators should be regulated individually.

Regulation diagrams

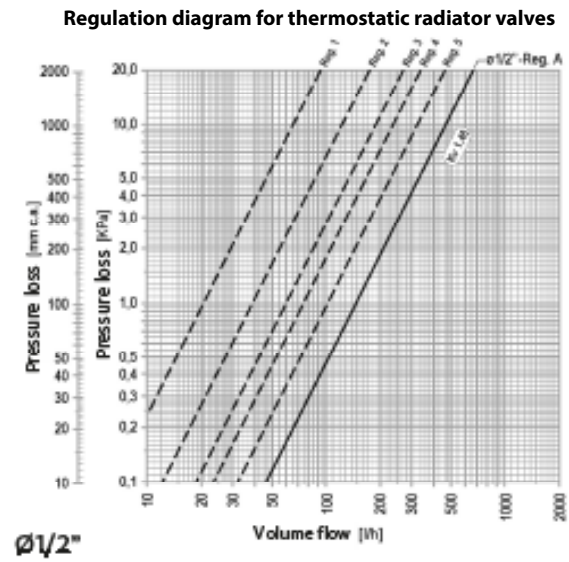
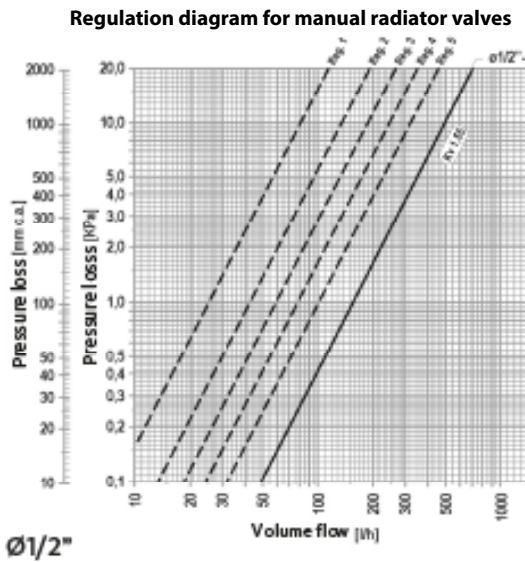

For pipe calculation purposes, the KV values of the crossing-free T-pieces are as follows

Circulation	31P-161616	kv value 1.2
	31P-201616	kv value 1.6
	31P-201620	kv value 3.3
	31P-202020	kv value 3.3

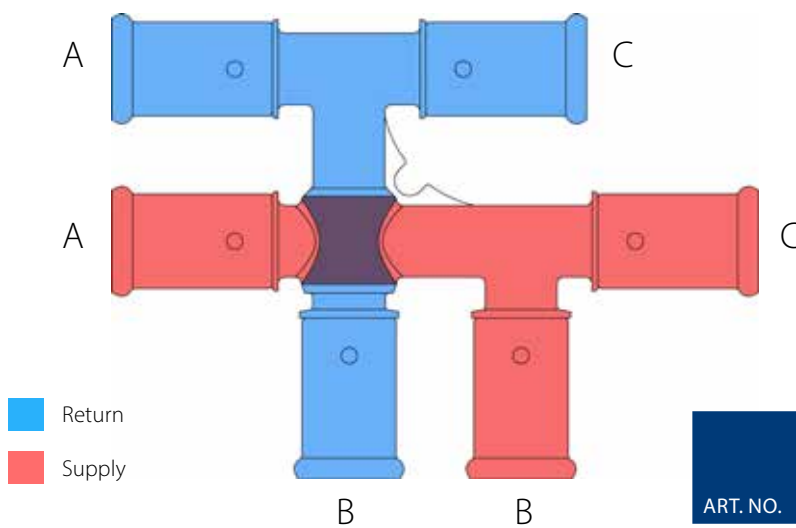

ART. NO.	DIAMETER mm			ZETAVALUES in equivalent m			
	A	B	C	A-B	A-B	A-C	A-C
31P-161616	16	16	16	2,26	3,7	0,83	1,35
31P-201616	20	16	16	1,51	1,41	1,34	1,54
31P-201620	20	16	20	1,57	1,82	0,64	0,74
31P-202020	20	20	20	5,08	3,54	1,94	2,23



7 ASSEMBLY INSTRUCTIONS

1

2

3

4

5

6

7

8

9

10

11

SPECIFICATIONS



8.1	Sanitary	116
8.2	Heating	121

8 SPECIFICATIONS

8.1 SANITARY

General description

The piping system for sanitary applications is comprised of multilayer pipes and press fittings. The entire system has

been technically approved and certified by the most important test institutes including DVGW, KIWA and ATG.

Material and characteristics

Pipes

Composition of pipes

The pipes consist of 5 layers:

- ▶ an inner pipe made from polyethylene (PE-Xc) that has been cross-linked using electron beams and extruded from high density polyethylene granulates
- ▶ a high quality bond layer to give homogenous bond between the aluminium pipe and the PE-Xc inner pipe.
- ▶ an aluminium pipe that has been welded seamlessly along its length and has been inspected 1x by machine
- ▶ a high quality bond layer to give homogenous bond between the aluminium pipe and the PE-Xc outer pipe
- ▶ an outer pipe made from polyethylene (PE-Xc) that has been cross-linked using electron beams and extruded from high density polyethylene granulates.

Technical profile

Outer diameter (mm)	12	14	16	16	18	18	20	20	26	26	32	40	50	63	75	90
				RIXC		RIXC		RIXC		RIXC						
Inner diameter (mm)	8.8	10	12	12	14	14	16	16	20	20	26	33	42	54	63	76
Wall thickness (mm)	1.6	2	2	2	2	2	2	2	3	3	3	3.5	4	4.5	6	7
Max. working temperature (°C) **	60	95	95	95	95	95	95	95	95	95	95	95	95	95	95	95
Max. working pressure (bar)	6	10	16	10	10	10	16	10	16	10	16	10	10	10	10	10
Application class (EN ISO21003-1)	4	2-4-5	2-4-5	2-4-5	2-4-5	2-4-5	2-4-5	2-4-5	2-4-5	2-4-5	2-4-5	2-4-5	2-4-5	2-4-5	2-4-5	2-4-5
Coefficient of thermal conductivity (W/mK)	0.43	0.43	0.43	0.43	0.43	0.43	0.43	0.43	0.43	0.43	0.43	0.43	0.43	0.43	0.43	0.43
Coefficient of linear expansion (mm/mK)	0.025	0.025	0.025	0.025	0.025	0.025	0.025	0.025	0.025	0.025	0.025	0.025	0.025	0.025	0.025	0.025
Minimum tensile strength of adhesive layer (N/10 mm)	30	30	30	30	30	30	30	30	30	30	30	30	30	30	30	30
Surface roughness of inner pipe (μ)	7	7	7	7	7	7	7	7	7	7	7	7	7	7	7	7
Oxygen diffusion (mg/L)	0	0	0	0	0	0	0	0	0	0	0	0	0	0	0	0
Min. bending radius, manual/external spiral spring (mm)	5XDU	5XDU	5XDU	5XDU	5XDU	5XDU	5XDU	5XDU	5XDU	5XDU	*	*	*	*	*	*
Min. bending radius, manual/internal spiral spring (mm)	3XDU	3XDU	3XDU ⁺	3XDU ⁺	3XDU	3XDU	3XDU	3XDU	3XDU	3XDU	*	*	*	*	*	*
Degree of cross-linking (%)	60	60	60	60	60	60	60	60	60	60	60	60	60	60	60	60
Weight (kg/m)	0,084	0,108	0,125	0,101	0,132	0,125	0,147	0,129	0,285	0,261	0,390	0,528	0,766	1,155	1,516	2,155
Flow (l/m)	0.061	0.079	0.113	0.113	0.154	0.154	0.201	0.201	0.314	0.314	0.531	0.855	1.385	2.29	3.117	4.536

* Elbow fittings should be used here

** Application class table (DIN EN ISO 21003-1)

+ 2xDu when using a BM-16 bending tool



Application class table (DIN EN ISO 21003-1)

Application class table (DIN EN ISO 21003-1)							
Application class	T_D		T_{max}		T_{mal}		Typical application
	°C	Time ^a years	°C	Time years	°C	Time h	
1 ^a	60	49	80	1	95	100	Hot water supply (60°C)
2 ^a	70	49	80	1	95	100	Hot water supply (70°C)
4 ^b	20 + cumulative 40 + cumulative 60	2.5 20 25	70	2.5	100	100	Underfloor heating and low-temperature radiators
5 ^b	20 + cumulative 60 + cumulative 80	14 25 10	90	1	100	100	High-temperature radiators

NOTE This international standard does not apply for T_D , T_{max} and T_{mal} greater than those shown in the table above.

- a Countries can choose either class 1 or class 2 according to with their national legislation.
 b Where there is more than 1 design temperature for a class, the times should be added together. "Plus cumulative" in the table implies a temperature profile for the aforementioned temperature over a certain period. (e.g. for class 5, the design temperature profile over 50 years is. This becomes 60 °C over 14 years, 80 °C over 10 years, 90 °C over 1 year and 100 °C over 100 hours respectively. .

Marking

The marking on the pipes (repeated every meter) is structured as follows:

Henco ®	Registered trademark
2200 HERENTALS - BELGIUM	Place of production
PE-Xc	Cross-linked high-density polyethylene
AL 0.4	0.4 Aluminium (depending on pipe Ø)
PE-Xc	Cross-linked high-density polyethylene
16*2	Outer diameter *wall thickness
201905	Date of production
L238	Line and time code
HN000	Code for Henco mark
10BAR / 95°C	Nominal working pressure = max. temp
KIWA CLASS 2 ISO 1/KOMO	Dutch certificate
DVGW DW...	German certificate
ÖVGWW1.377	Austrian certificate
ATG...	Belgian certificate
ÖN B5157 Typ1-A-TW	Australian certificate
y Sitac1422 0536/01;0138/98 10 bar/70°C SKZ	Swedish certificate
VA 1.14/12039	Danish certificate
UNI10954-1TIPOACLASSE1IIPUNI319	Italian certificate
SVGW...	Swedish certificate
NBI...	Norwegian certificate
STF	Finnish certificate
	
DIN...	German standard
001M< >	Meter indication



8 SPECIFICATIONS

1

2

3

4

5

6

7

8

9

10

11

Pipe with sleeve

The multilayer pipe and sleeve need to be manufactured by the same company. The sleeve is made from polyethylene and is red, blue or black in colour. The manufacturer's installation instructions describe when and under which

circumstances the pipe should be fitted with a sleeve. The pipe and sleeve should be available in the following dimensions:

Protective sleeve		
Dimensions	Coil length	Colour
14x2	25 m	blue/red/black
	50 m	blue/red/black
	100 m	blue/red/black
16x2	25 m	blue/red/black
	50 m	blue/red/black
	100 m	blue/red/black
18x2	50 m	blue/red/black
	100 m	blue/red/black
	100 m	blue/red/black
20x2	25 m	blue/red/black
	50 m	blue/red/black
	100 m	blue/red/black
26x3	25 m	blue/red/black
	50 m	blue/red/black
32x3	25 m	blue/red/black

Pre-insulated pipe

PE-Xc/Al/PE-Xc pipes come with a round or eccentric thermal insulating material made from extruded PR foam with a closed cell structure. The PE foam comes with a sturdy meshed PE outer casing in red or blue.

The multilayer pipes and insulation should be from the same manufacturer. The insulation should meet the following conditions:

Insulation value (DIN 52613 / ISO 8497)	0.040 W/mK at +40°C 0.036 W/MK AT +10°C
Fire classification	C _L -s1-d0 (EN 13501)
Temperature resistance	-40°C to + 100°C
Usage temperature	+5°C to +100°C (EN 14707)
Noise absorption	Up to 23 dB(A) (DIN 52218)
Thickness (round)	6, 10 or 13 mm
Water vapour diffusion resistance	6315 mu



The pre-insulated pipes are available in the following dimensions:

Round insulation						
Dimensions	6 mm		10 mm		13 mm	
	Coil length	Colour	Coil length	Colour	Coil length	Colour
14x2	100 m	red or blue	50 m	red or blue	-	-
16x2	100 m	red or blue	50 m	red or blue	50 m	blue
18x2	50 m	red or blue	50 m	red or blue	50 m	-
20x2	50 m	red or blue	50 m	red or blue	50 m	blue
26x3	25 - 50 m	red or blue	25 - 50 m	red or blue	50 m	blue
32x3	25 m	red or blue	25 m	red of blue	25 m	blue

Eccentric insulation				
Dimensions	6 mm above and 13 mm below		6 mm above and 26 mm below	
	Coil length	Colour	Coil length	Colour
16x2	50 m	blue	25 m	blue
18x2	50 m	blue	-	blue
20x2	25 m	blue	25 m	blue
26x3	25 m	blue	25 m	blue

Connections

The entire sanitary installation is connected using press fittings made from polyvinylidene fluoride (PVDF). The synthetic press fittings and the multilayer pipes should be made by the same manufacturer. You should always use press fittings with leak detection for any press connections up to diameter 26. This means that the press fittings will be designed such that there will be an immediate pressure drop in non-pressed connections when the installation is pressurised.

The PVDF press fittings must be fitted with O-rings to guarantee the seal between the pipe and the fitting.

The sleeves must be made from stainless steel. They are also provided with 3 openings for visual inspections, and a special rim that enables the fitting to be perfectly positioned in the pressing jaws specified by the manufacturer.

If brass press fittings are used, these must come from the same manufacturer and be provided with a synthetic insulating ring to prevent electrolysis between the aluminium of the pipe and the brass of the fitting. The fittings must also be provided with O-rings and sleeves made from stainless steel.



8 SPECIFICATIONS

1

2

3

4

5

6

7

8

Manifolds

All manifolds are made from brass and come in 1" and 3/4" versions and have 2 to 10 branches with eurokonus connections. They are also fitted with a 3/8" screw thread for fitting automatic air vent. The centre-to-centre distance between the branches is 50 mm, and the distance from the outside of the brass to the middle of the first branch is 26 mm.

The galvanised manifolds are provided with ball valves

and a eurokonus connection on each outlet. These manifolds are provided with 2, 3 or 4 connections. They are supplied as constituent elements that can be attached to each other, and have a female thread at one end and a 1" or 3/4" male thread at the other end.

You should only use the brackets supplied by the manufacturer to attach the manifolds to a wall. The cabinets for the manifolds should also be from the same manufacturer.

9

10

11

Connections

The connection between the piping and the manifold is guaranteed by press fittings made from polyvinylidene fluoride (PVDF). The synthetic press fittings and the multilayer pipes should be made by the same manufacturer. All press connections with diameters up to 26 should be made

using press fittings with leak detection. This means that the press fittings are designed so that there will be an immediate pressure drop in connections which are not pressed when the installation is under pressure.

Pressure tests

The entire sanitary installation must undergo pressure tests in accordance with DIN 1988 as specified by the manufacturer.

Insurance and guarantee

The manufacturer must be able to present a test certificate from the IKP university in Stuttgart demonstrating compliance with the DIN 4726 standard and/or DVGW approval and/or KIWA approval and/or ATG approval.

The pipe is insured against damage after delivery for a period of at least 10 years and for a sum of 10,000,000 euros for each incident of damage per year. A guarantee certificate is always supplied with the registration documents.



8.2 HEATING

General description

The piping for heating applications comprises multilayer pipes and press fittings. The entire system is technically approved

and certified by the most important test institutes including DVGW, KIWA and ATG.

Material and characteristics

Pipes

Composition of pipes

The pipes consist of 5 layers:

- ▶ an inner pipe made from polyethylene (PE-Xc) that has been cross-linked using electron beams and extruded from high density polyethylene granulates
- ▶ a high quality bond layer to give homogenous bond between the aluminium pipe and the PE-Xc inner pipe.
- ▶ an aluminium pipe that has been welded seamlessly along its length and has been inspected 1x by machine
- ▶ a high quality bond layer to give homogenous bond between the aluminium pipe and the PE-Xc outer pipe
- ▶ an outer pipe made from polyethylene (PE-Xc) that has been cross-linked using electron beams and extruded from high density polyethylene granulates.

Technical profile

Outer diameter (mm)	12	14	16	16	18	18	20	20	26	26	32	40	50	63	75	90
				RIXC		RIXC		RIXC		RIXC						
Inner diameter (mm)	8.8	10	12	12	14	14	16	16	20	20	26	33	42	54	63	76
Wall thickness (mm)	1.6	2	2	2	2	2	2	2	3	3	3	3.5	4	4.5	6	7
Max. working temperature (°C) **	60	95	95	95	95	95	95	95	95	95	95	95	95	95	95	95
Max. working pressure (bar)	6	10	16	10	10	10	16	10	16	10	16	10	10	10	10	10
Application class (EN ISO21003-1)	4	2-4-5	2-4-5	2-4-5	2-4-5	2-4-5	2-4-5	2-4-5	2-4-5	2-4-5	2-4-5	2-4-5	2-4-5	2-4-5	2-4-5	2-4-5
Coefficient of thermal conductivity (W/mK)	0.43	0.43	0.43	0.43	0.43	0.43	0.43	0.43	0.43	0.43	0.43	0.43	0.43	0.43	0.43	0.43
Coefficient of linear expansion (mm/mK)	0.025	0.025	0.025	0.025	0.025	0.025	0.025	0.025	0.025	0.025	0.025	0.025	0.025	0.025	0.025	0.025
Minimum tensile strength of adhesive layer (N/10 mm)	30	30	30	30	30	30	30	30	30	30	30	30	30	30	30	30
Surface roughness of inner pipe (μ)	7	7	7	7	7	7	7	7	7	7	7	7	7	7	7	7
Oxygen diffusion (mg/L)	0	0	0	0	0	0	0	0	0	0	0	0	0	0	0	0
Min. bending radius, manual/external spiral spring (mm)	5XDU	5XDU	5XDU	5XDU	5XDU	5XDU	5XDU	5XDU	5XDU	5XDU	*	*	*	*	*	*
Min. bending radius, manual/internal spiral spring (mm)	3XDU	3XDU	3XDU*	3XDU*	3XDU	3XDU	3XDU	3XDU	3XDU	3XDU	*	*	*	*	*	*
Degree of cross-linking (%)	60	60	60	60	60	60	60	60	60	60	60	60	60	60	60	60
Weight (kg/m)	0,084	0,108	0,125	0,101	0,132	0,125	0,147	0,129	0,285	0,261	0,390	0,528	0,766	1,155	1,516	2,155
Flow (l/m)	0,061	0,079	0,113	0,113	0,154	0,154	0,201	0,201	0,314	0,314	0,531	0,855	1,385	2,29	3,117	4,536

* Elbow fittings should be used here

** Application class table (DIN EN ISO 21003-1)

+ 2xDu when using a BM-16 bending tool

8 SPECIFICATIONS

Application class table (DIN EN ISO 21003-1)

Application class table (DIN EN ISO 21003-1)							
Application class	T_D		T_{max}		T_{mal}		Typical application
	°C	Time ^a years	°C	Time years	°C	Time h	
1 ^a	60	49	80	1	95	100	Hot water supply (60°C)
2 ^a	70	49	80	1	95	100	Hot water supply (70°C)
4 ^b	20 + cumulative	2.5	70	2.5	100	100	Underfloor heating and low-temperature radiators
	40 + cumulative	20					
	60	25					
5 ^b	20 + cumulative	14	90	1	100	100	High-temperature radiators
	60 + cumulative	25					
	80	10					

NOTE This international standard does not apply for T_D , T_{max} and T_{mal} greater than those shown in the table above.

a Countries can choose either class 1 or class 2 according to with their national legislation.

b Where there is more than 1 design temperature for a class, the times should be added together. "Plus cumulative" in the table implies a temperature profile for the aforementioned temperature over a certain period. (e.g. for class 5, the design temperature profile over 50 years is. This becomes 60 °C over 14 years, 80 °C over 10 years, 90 °C over 1 year and 100 °C over 100 hours respectively. .

Marking

The marking on the pipes (repeated every meter) is structured as follows:

Henco ®	Registered trademark
2200 HERENTALS - BELGIUM	Place of production
PE-Xc	Cross-linked high-density polyethylene
AL 0.4	0.4 Aluminium (depending on pipe Ø)
PE-Xc	Cross-linked high-density polyethylene
16*2	Outer diameter *wall thickness
201905	Date of production
L238	Line and time code
HN000	Code for Henco mark
10bar / 95°C	Nominal working pressure = max. temp
KIWA CLASS 2 ISO 1/KOMO	Dutch certificate
DVGW DW...	German certificate
ÖVGWW1.377	Austrian certificate
ATG...	Belgian certificate
ÖN B5157 Typ1-A-TW	Australian certificate
y Sitac1422 0536/01;0138/98 10 bar/70°C SKZ	Swedish certificate
VA 1.14/12039	Danish certificate
UNI10954-1tipoAclasse1IIPUNI319	Italian certificate
SVGW...	Swedish certificate
NBI...	Norwegian certificate
STF	Finnish certificate
	
DIN...	German standard
001m< >	Meter indication



- 1
- 2
- 3
- 4
- 5
- 6
- 7
- 8
- 9
- 10
- 11

Pipe with sleeve

The multilayer pipe and sleeve need to be manufactured by the same company. The sleeve is made from polyethylene and is red, blue or black in colour. The manufacturer's installation instructions describe when

and under which circumstances the pipe should be fitted with a sleeve.

The pipe and sleeve should be available in the following dimensions:

Protective sleeve		
Dimensions	Coil length	Colour
14x2	25 m	blue/red/black
	50 m	blue/red/black
	100 m	blue/red/black
16x2	25 m	blue/red/black
	50 m	blue/red/black
	100 m	blue/red/black
18x2	50 m	blue/red/black
	100 m	blue/red/black
	20x2	25 m
50 m		blue/red/black
100 m		blue/red/black
26x3	25 m	blue/red/black
	50 m	blue/red/black
32x3	25 m	blue/red/black

Pre-insulated pipe

PE-Xc/Al/PE-Xc pipes come with a round or eccentric thermal insulating material made from extruded PR foam with a closed cell structure. The PE foam comes with a sturdy meshed PE outer casing in red or blue. The multilayer pipes

and insulation should be from the same manufacturer. The insulation should meet the following conditions:

Insulation value (DIN 52613 / ISO 8497)	0.040 W/mK at +40°C 0.036 W/mK AT +10°C
Fire classification	C _L -s1-d0 (EN 13501)
Temperature resistance	-40°C to + 100°C
Usage temperature	+5°C to +100°C (EN 14707)
Noise absorption	Up to 23 dB(A) (DIN 52218)
Thickness (round)	6, 10 or 13 mm
Water vapour diffusion resistance	6315 mu

8 SPECIFICATIONS

The pre-insulated pipes are available in the following dimensions:

Round insulation						
Dimensions	6 mm		10 mm		13 mm	
	Coil length	Colour	Coil length	Colour	Coil length	Colour
14x2	100 m	red or blue	50 m	red or blue	-	-
16x2	100 m	red or blue	50 m	red or blue	50 m	blue
18x2	50 m	red or blue	50 m	red or blue	50 m	-
20x2	50 m	red or blue	50 m	red or blue	50 m	blue
26x3	25 - 50 m	red or blue	25 - 50 m	red or blue	50 m	blue
32x3	25 m	red or blue	25 m	red of blue	25 m	blue

Eccentric insulation				
Dimensions	6 mm above and 13 mm below		6 mm above and 26 mm below	
	Coil length	Colour	Coil length	Colour
16x2	50 m	blue	25 m	blue
18x2	50 m	blue	-	blue
20x2	25 m	blue	25 m	blue
26x3	25 m	blue	25 m	blue

Connections

The entire sanitary installation is connected using press fittings made from polyvinylidene fluoride (PVDF). The synthetic press fittings and the multilayer pipes should be made by the same manufacturer. You should always use press fittings with leak detection for any press connections up to diameter 26. This means that the press fittings will be designed such that there will be an immediate pressure drop in non-pressed connections when the installation is pressurised.

The PVDF press fittings must be fitted with O-rings to guarantee the seal between the pipe and the fitting.

The sleeves must be made from stainless steel. They are also provided with 3 openings for visual inspections, and a special rim that enables the fitting to be perfectly positioned in the pressing jaws specified by the manufacturer.

If brass press fittings are used, these must come from the same manufacturer and be provided with a synthetic insulating ring to prevent electrolysis between the aluminium of the pipe and the brass of the fitting. The fittings must also be provided with O-rings and sleeves made from stainless steel.



- 1
- 2
- 3
- 4
- 5
- 6
- 7
- 8**
- 9
- 10
- 11

Manifolds

All manifolds are made of brass. The manifolds exist in 1" or 3/4" designs and have 2 to 10 branches with eurokonus connections. They are also fitted with a 3/8" screw thread for the fitting of an automatic air vent. The centre-to-centre distance between the branches is 50 mm, and the distance from the outside of the brass to the middle of the first branch is 26 mm.

The galvanised manifolds are provided with ball valves

and a eurokonus connection on each outlet. These manifolds are provided with 2, 3 or 4 connections. They are supplied as constituent elements that can be attached to each other, with at one end a female thread and the other end a 1" or 3/4" male thread.

Assembly of the manifolds on the wall is exclusively using wall brackets specified by the manufacturer. The cabinets for the manifolds must also come from the same manufacturer.

Valves and fittings for radiators

The valves and fittings as well as all other parts of the system should originate from the same manufacturer.

The valves and fittings should be provided with eurokonus connections. You are not permitted to use connections that do not have a universal millimetric thread.

The thermostatic valve and fittings must be fitted with an adjustable KV valve. All heating bodies must be connected according to the two-pipe principle.

Connections

The connection between the piping and the manifold is ensured by press-fit connections made from polyvinylidene fluoride (PVDF). The synthetic press-fit connections and the multilayer pipes should be made by the same manufacturer. All press connections with diameters up to 26 should be made

using press-fit connections with leak detection. This means that the press-fit connections are designed such that there will be an immediate pressure drop in connections which are not pressed when the installation is under pressure.

Pressure tests

The entire sanitary installation must undergo pressure tests in accordance with DIN 1988 as specified by the manufacturer.



8 SPECIFICATIONS

1

2

3

4

5

6

7

8

9

10

11

Insurance and guarantee

The manufacturer must be able to present a test certificate from the IKP university in Stuttgart demonstrating compliance with the DIN 4726 standard and/or DVGW approval and/or KIWA approval and/or ATG approval.

The pipe is insured against damage after delivery for a period of at least 10 years and for a sum of 10,000,000 euros for each incident of damage per year. A guarantee certificate is always supplied with the registration documents.

DELIVERY PROGRAMME



9.1	Pipes	128
9.2	Henco Press	138
9.3	Henco Vision	162

9.1 Pipes

TYPE: STANDARD COIL (PE-Xc/AL/PE-Xc)

Henco multilayer pipe (Coil)

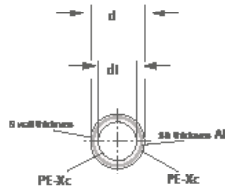
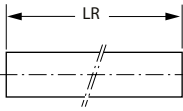
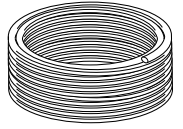

Coil			
d	di	s	LR
mm	mm	mm	m
12	8,8	1,6	100 - 200
14	10	2	50 - 100 - 200
16	12	2	50 - 100 - 200 - 500
18	14	2	100 - 200
20	16	2	25 - 50 - 100
26	20	3	50
32	26	3	50

TYPE: STANDARD STRAIGHT LENGTH (PE-Xc/AL/PE-Xc)

Henco multilayer pipe (Straight length)

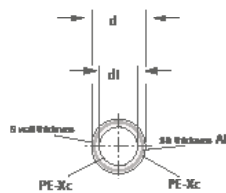
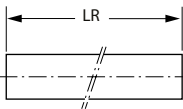
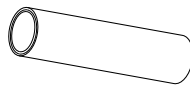

Straight length			
d	di	s	LR
mm	mm	mm	m
16	12	2	3 - 4 - 5
18	14	2	3 - 4 - 5
20	16	2	3 - 4 - 5
26	20	3	3 - 4 - 5
32	26	3	3 - 4 - 5
40	33	3,5	3 - 4 - 5
50	42	4	3 - 4 - 5
63	54	4,5	3 - 4 - 5
75	63	6	5
90	76	7	5



TYPE: RIXc COIL (PE-Xc/AL/PE-Xc)

Henco multilayer pipe (Coil)

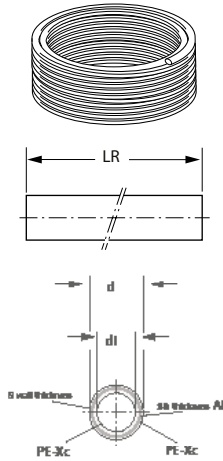

Coil			
d	di	s	LR
mm	mm	mm	m
16	12	2	50 - 100 - 200 - 500
18	14	2	100 - 200
20	16	2	100
26	20	3	50

TYPE: RIXc STRAIGHT LENGTH (PE-Xc/AL/PE-Xc)

Henco multilayer pipe (Straight length)

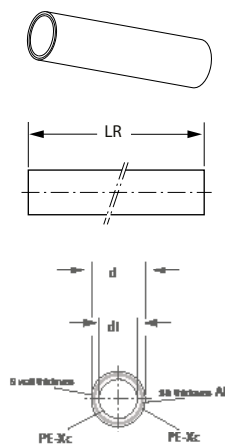

Straight length			
d	di	s	LR
mm	mm	mm	m
16	12	2	3 - 4 - 5
18	14	2	3 - 4 - 5
20	16	2	3 - 4 - 5
26	20	3	3 - 4 - 5

9 DELIVERY PROGRAMME

- 1
- 2
- 3
- 4
- 5
- 6
- 7
- 8
- 9
- 10
- 11

TYPE: STANDARD ISO (PE-Xc/AL/PE-Xc)

Pre-insulated (Coil) STANDARD

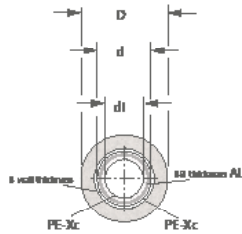
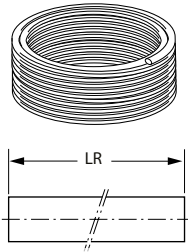

Coil: 6mm insulated

d	di	D	s	LR
mm	mm	mm	mm	m
14	10	26	2	100
16	12	28	2	100
18	14	30	2	50
20	16	32	2	50
26	20	38	3	25 - 50
32	26	44	3	25

Coil: 10mm insulated

d	di	D	s	LR
mm	mm	mm	mm	m
14	10	34	2	50
16	12	36	2	50
18	14	38	2	50
20	16	40	2	50
26	20	46	3	25 - 50
32	26	52	3	25

Coil: 13mm insulated

d	di	D	s	LR
mm	mm	mm	mm	m
16	12	42	2	50
18	14	44	2	50
20	16	46	2	50
26	20	52	3	50
32	26	58	3	25



TYPE: PROTECTION HOSE

Henco Colour coded conduit (coil)

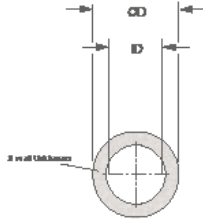
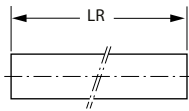
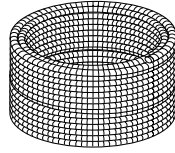

Coil				
d	OD	ID	s	LR
mm	mm	mm	mm	m
14	25,9	20,9	5	100
16	25,9	20,9	5	100
18	25,9	20,9	5	100
20	30,75	25,2	5,55	50
26	37,7	31,7	6	50
32	45,6	39	6,9	25

TYPE: STANDARD PIPE IN PIPE (PE-Xc/AL/PE-Xc)

Henco multilayer pipe with protection hose (coil)

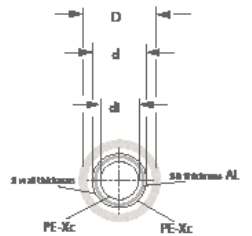
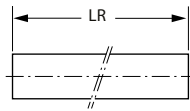
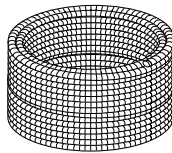

Coil				
d	di	D	s	LR
mm	mm	mm	mm	m
14	10	23	2	25 - 50 - 100
16	12	23	2	25 - 50 - 100
18	14	23	2	50 - 100
20	16	28	2	25 - 50 - 100
26	20	35	3	50
32	26	39	3	25

TYPE: RIXc PIPE IN PIPE (PE-Xc/AL/PE-Xc)

Henco multilayer pipe with protection hose (coil)

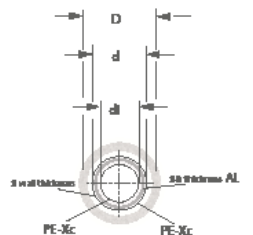
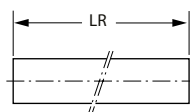
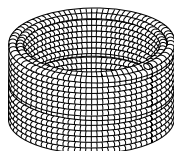

Coil				
d	di	D	s	LR
mm	mm	mm	mm	m
16	12	23	2	25 - 50 - 100
18	14	23	2	50 - 100
20	16	28	2	25 - 50 - 100
26	20	35	3	50

9 DELIVERY PROGRAMME

- 1
- 2
- 3
- 4
- 5
- 6
- 7
- 8
- 9
- 10
- 11

TYPE: HENCO COMBI®

Henco multilayer pipe with dual protection hose (coil)

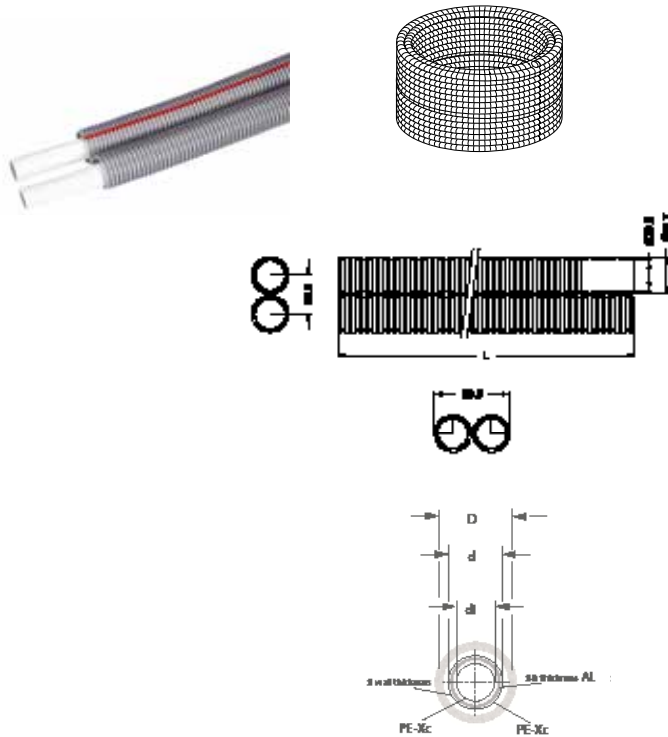

Coil				
d	di	D	s	LR
mm	mm	mm	mm	m
16	12	25	2	50

TYPE: COMBI ISO

Henco Combi iso 6 mm (Rol)

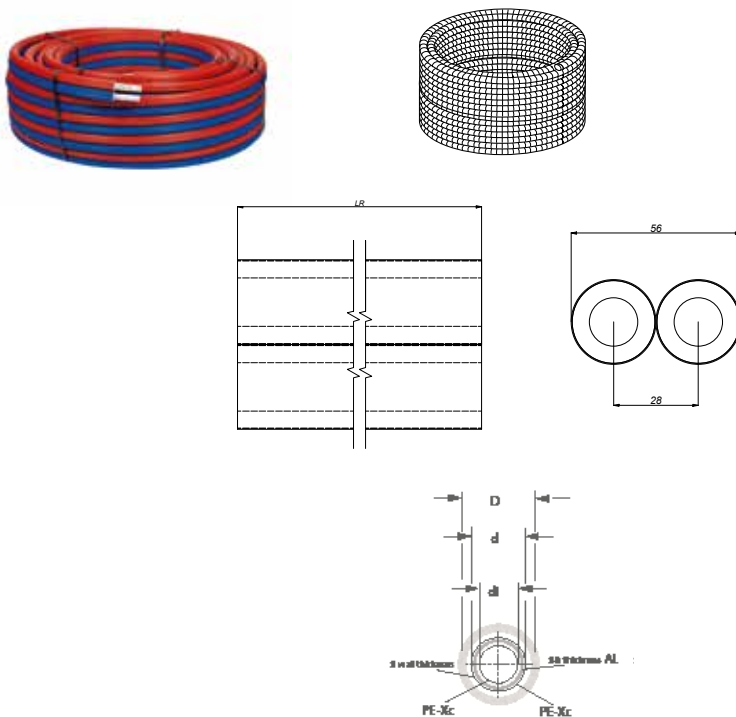

Coil				
d	di	D	s	LR
mm	mm	mm	mm	m
16	12	28	2	50



TYPE: LB

Henco carcassing pipe Ø 16

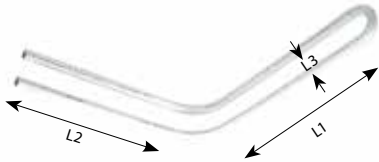

LB			
Art. Nr.	L1	L2	L3
	mm	mm	mm
LB50	420	358	50

TYPE: ISO-BLOCK-S

Henco carcassing pipe Ø 16 with insulation

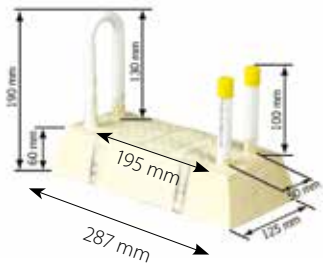

ISO-BLOCK		
Art. Nr.	Type	LR
		mm
ISO-BLOCK-S	S	1M

TYPE: ISO-BLOCK-L

Henco carcassing pipe Ø 16 with insulation

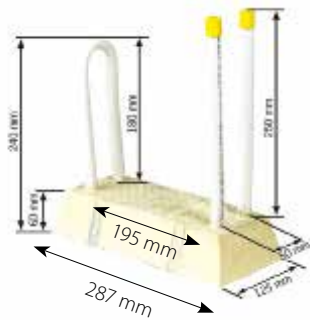

ISO-BLOCK		
Art. Nr.	Type	LR
		mm
ISO-BLOCK-L	L	1M

- 1
- 2
- 3
- 4
- 5
- 6
- 7
- 8
- 9
- 10
- 11



9 DELIVERY PROGRAMME

1

2

3

4

5

6

7

8

9

10

11

TYPE: ISO-BLOCK-XL

Henco carcassing pipe \varnothing 16 with insulation



ISO-BLOCK

Art. Nr.	Type	LR mm
ISO-BLOCK-XL	XL	1M

TYPE: FLOOR-RIXc (PE-Xc/AL/PE-Xc)

Henco multilayer pipe for underfloor heating (coil)*

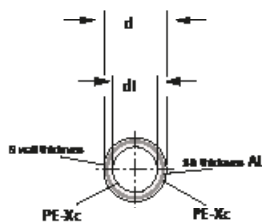
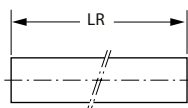
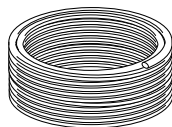

Coil

d mm	di mm	s mm	LR m
16	12	2	50 - 100 - 200 - 500
20	16	2	100 - 200 - 400

*60°C / 6 Bar



TYPE: 5L PE-Xc (PE-Xc/EVOH/PE-Xc)

Henco multilayer pipe for underfloor heating (coil)

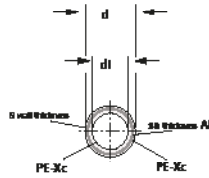
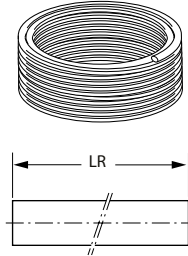

Coil			
d	di	s	LR
mm	mm	mm	m
16	12	2	200 - 600
17	13	2	200 - 600
18	14	2	240
20	16	2	200 - 600

TYPE: 5L PE-RT (PE-RT/EVOH/PE-RT)

Henco multilayer pipe for underfloor heating (coil)

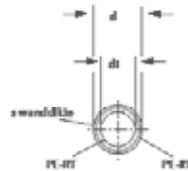
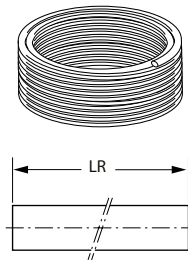

Coil			
d	di	s	LR
mm	mm	mm	m
16	12	2	120 - 200 - 600
17	13	2	600
18	14	2	600
20	16	2	600

- 1
- 2
- 3
- 4
- 5
- 6
- 7
- 8
- 9
- 10
- 11

9 DELIVERY PROGRAMME

- 1
- 2
- 3
- 4
- 5
- 6
- 7
- 8
- 9
- 10
- 11

TYPE: STANDARD GAS COIL (PE-Xc/AL/PE-Xc)

Henco multilayer pipe for gas (coil)

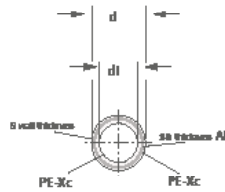
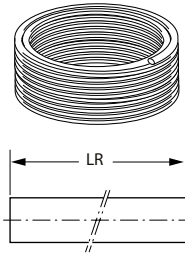

Coil			
d	di	s	LR
mm	mm	mm	m
16	12	2	25 - 50
20	16	2	25 - 50
26	20	3	50
32	26	3	50

TYPE: STANDARD GAS STRAIGHT LENGTH (PE-Xc/AL/PE-Xc)

Henco multilayer pipe for gas (straight length)

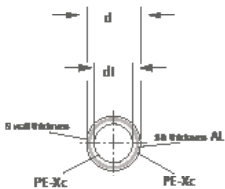
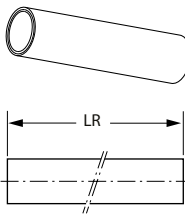

Straight length			
d	di	s	LR
mm	mm	mm	m
16	12	2	5
20	16	2	5
26	20	3	5
32	26	3	5
40	33	3,5	5



TYPE: PROTECTION HOSE GAS

Colour coded conduit (coil)

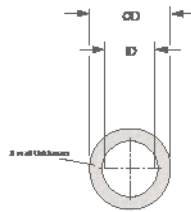
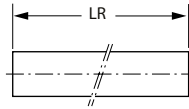
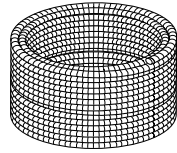

Coil				
d	OD	ID	s	LR
mm	mm	mm	mm	m
16	23	19	4	100
20	28	23	5	50
26	34	29,5	4,5	50
32	41,5	36,5	5	25

TYPE: STANDARD GAS PIPE IN PIPE (PE-Xc/AL/PE-Xc)

Henco multilayer pipe with colour coded conduit (coil)

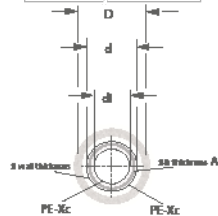
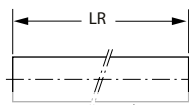
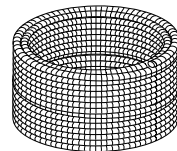

Coil				
d	di	D	s	LR
mm	mm	mm	mm	m
16	12	23	2	25 - 50
20	16	28	2	25 - 50
26	20	35	3	50
32	26	39	3	25

9 DELIVERY PROGRAMME

9.2 Henco Press

TYPE: 1PK
TYPE: 1PKW
 Elbow 90°

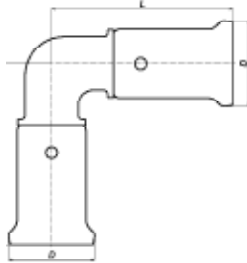

ART. NR.	L mm	D mm
1PK-1414	46	20
1PK-1616	47	22
1PK-1818	48	24
1PK-2020	49	26
1PK-2626	54	32
1PK-3232	72	39
1PK-4040	78	47
1PK-5050	100	57
1PK-6363	116	70
1PKW-1616	47	22
1PKW-2020	49	26
1PKW-2626	54	32
1PKW-3232	72	39

TYPE: 2PK
TYPE: 2PKW
TYPE: 2PKW-N
 Backplate elbow female

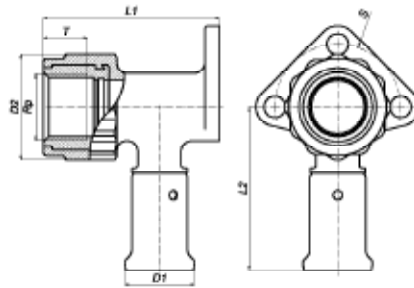

ART. NR.	L1 mm	L2 mm	D1 mm	D2 mm	Rp	T mm	S mm
2PK-1404BP*	56	52	20	33	1/2"	13,5	40
2PK-1603	56	52	22	33	3/8"	13,5	40
2PK-1604BP*	56	52	22	33	1/2"	13,5	40
2PK-1804BP*	56	52	24	33	1/2"	13,5	40
2PK-2004BP*	56	52	26	33	1/2"	13,5	40
2PK-2005	61	58	26	40	3/4"	15,5	46
2PK-2605	66	58	32	40	3/4"	15,5	46
2PKW-1604	56	52	22	33	1/2"	13,5	40
2PKW-2004	56	52	26	33	1/2"	13,5	40
2PKW-2005	61	58	26	40	3/4"	15,5	46
2PKW-2605	66	58	32	40	3/4"	15,5	46
2PKW-1604-N	56	52	22	33	1/2"	13,5	40
2PKW-2004-N	56	52	26	33	1/2"	13,5	40
2PKW-2005-N	61	58	26	40	3/4"	15,5	46
2PKW-2605-N	66	58	32	40	3/4"	15,5	46

* With black plug BP04 1/2"



TYPE: 2PK-K
TYPE: 2PKW-K

Backplate elbow female, short model

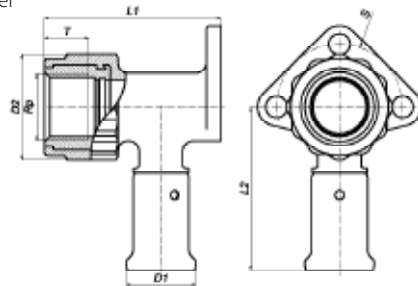

ART. NR.	L1	L2	D1	D2	Rp	T	S
	mm	mm	mm	mm		mm	mm
2PK-1604KBP*	40	52	22	33	1/2"	3,5	45
2PKW-1604K	40	52	22	33	1/2"	3,5	45

* Met zwarte plug BP04 1/2"

TYPE: 3PK
TYPE: 3PKW
TYPE: 3PKW-N

Double backplate elbow female, short model

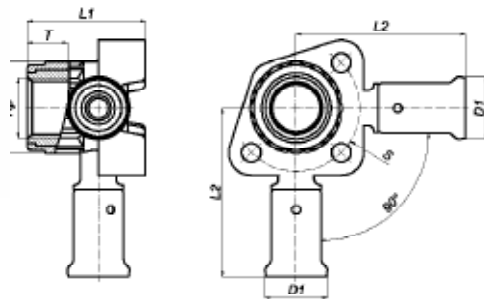

ART. NR.	L1	L2	D1	D2	Rp	T	S
	mm	mm	mm	mm		mm	mm
3PK-160416BP*	42	60	22	33	1/2"	14	45
3PK-200420BP*	43,5	60	26	33	1/2"	14	45
3PKW-160416	42	60	22	33	1/2"	14	45
3PKW-200420	43,5	60	26	33	1/2"	14	45
3PKW-160416-N	42	60	22	33	1/2"	14	45
3PKW-200420-N	43,5	60	26	33	1/2"	14	45

* With black plug BP04 1/2"

TYPE: BP04

Black plug for 1/2" female nipple

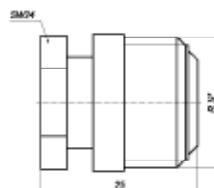

ART. NR.	L	R
	mm	
BP04*	25	1/2"

9 DELIVERY PROGRAMME

TYPE: 5PK

TYPE: 5PKW

TYPE: 5PKW-N

Bent 90° male iron adapter

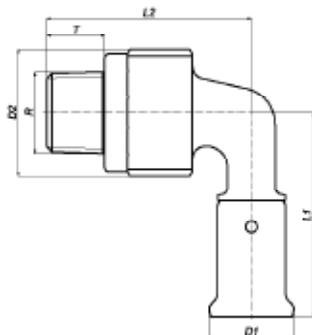

ART. NR.	L1 mm	L2 mm	D1 mm	D2 mm	R	T mm
5PK-1404	54	54	20	33	1/2"	13,5
5PK-1604	54	54	22	33	1/2"	13,5
5PK-1804	54	54	24	33	1/2"	13,5
5PK-2004	56	56	26	33	1/2"	13,5
5PK-2005	58	58	26	40	3/4"	14,5
5PK-2605	60	62	32	40	3/4"	14,5
5PK-3206	75	68,5	39	45,5	1"	16,5
5PK-4007	84	77	47	56,5	5/4"	19
5PK-5007	101	86	57	56,5	5/4"	19
5PK-5008	101	93	57	70	6/4"	20
5PK-6310	126	118	70	90	2"	23
5PKW-1604	54	54	22	33	1/2"	13,5
5PKW-2004	56	56	26	33	1/2"	13,5
5PKW-2005	58	58	26	40	3/4"	14,5
5PKW-2605	60	62	32	40	3/4"	14,5
5PKW-3206	75	68,5	39	45,5	1"	16,5
5PKW-1604-N	54	54	22	33	1/2"	13,5
5PKW-2004-N	56	56	26	33	1/2"	13,5
5PKW-2005-N	58	58	26	40	3/4"	14,5
5PKW-2605-N	60	62	32	40	3/4"	14,5
5PKW-3206-N	75	68,5	39	45,5	1"	16,5

TYPE: 6PK

TYPE: 6PKW

Bent 90° female iron adapter

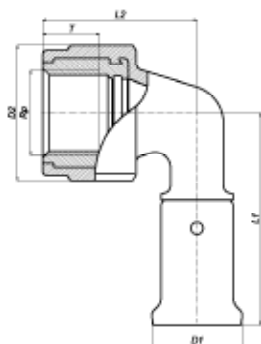

ART. NR.	L1 mm	L2 mm	D1 mm	D2 mm	Rp	T mm
6PK-1404BP*	53	39	20	33	1/2"	13,5
6PK-1603	53	39	22	33	3/8"	13,5
6PK-1604BP*	53	39	22	33	1/2"	13,5
6PK-1804BP*	53	39	24	33	1/2"	13,5
6PK-2004BP*	53	39	26	33	1/2"	13,5
6PK-2005	60	47,5	26	40	3/4"	15,5
6PK-2605	60	47,5	32	40	3/4"	15,5
6PK-3206	75	58,5	39	45,5	1"	18
6PK-4007	81	72	47	56,5	5/4"	21
6PK-5007	101	77	57	56,5	5/4"	21
6PK-5008	101	82	57	70	6/4"	25
6PK-6310	126	104	70	90	2"	30
6PKW-1603	53	39	22	33	3/8"	13,5
6PKW-1604	53	39	26	33	1/2"	13,5
6PKW-2004	53	39	26	33	1/2"	13,5
6PKW-2005	60	47,5	26	40	3/4"	15,5
6PKW-2605	60	47,5	32	40	3/4"	15,5
6PKW-3206	75	58,5	39	45,5	1"	18
6PKW-1603-N	53	39	22	33	3/8"	13,5
6PKW-1604-N	53	39	26	33	1/2"	13,5
6PKW-2004-N	53	39	26	33	1/2"	13,5
6PKW-2005-N	60	47,5	26	40	3/4"	15,5
6PKW-2605-N	60	47,5	32	40	3/4"	15,5
6PKW-3206-N	75	58,5	39	45,5	1"	18

* With black plug BP04 1/2"



TYPE: 9PK
TYPE: 9PKW

T-piece

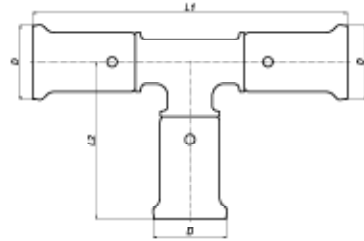

ART. NR.	L1 mm	L2 mm	D mm
9PK-141414	93	46	20
9PK-161616	94	47	22
9PK-181818	97	48,5	24
9PK-202020	98	49	26
9PK-262626	107	53	32
9PK-323232	140	70	39
9PK-404040	151	75	47
9PK-505050	191	95	57
9PK-636363	232	117	70
9PKW-161616	94	47	22
9PKW-202020	98	49	26
9PKW-262626	107	53	32
9PKW-323232	140	70	39

- 1
- 2
- 3
- 4
- 5
- 6
- 7
- 8
- 9
- 10
- 11

9 DELIVERY PROGRAMME

TYPE: 10PK

TYPE: 10PKW

T-reduced centre

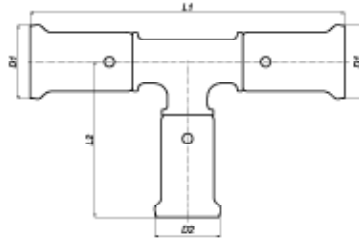

ART. NR.	L1 mm	L2 mm	D1 mm	D2 mm
10PK-161416	95	47,5	22	20
10PK-181418	97	49	24	20
10PK-181618	97	49	24	22
10PK-201420	95	49	26	20
10PK-201620	94	49	26	22
10PK-201820	98	50,5	26	24
10PK-261626	98	53	32	22
10PK-261826	100	53	32	24
10PK-262026	103	54	32	26
10PK-321632	133	58	39	22
10PK-321832	133	58	39	24
10PK-322032	133	58	39	26
10PK-322632	133	58	39	32
10PK-401640	120	59	47	22
10PK-402040	123	59	47	26
10PK-402640	136	61	47	32
10PK-403240	144	75	47	39
10PK-502050	153	65	57	26
10PK-502650	160	64	57	32
10PK-503250	167	77	57	39
10PK-504050	184	81	57	47
10PK-632663	187	71	70	32
10PK-633263	193	84	70	39
10PK-634063	212	87	70	47
10PK-635063	220	103	70	57
10PKW-201620	94	49	26	22
10PKW-261626	98	53	32	22
10PKW-262026	103	54	32	26
10PKW-321632	133	58	39	22
10PKW-322032	133	58	39	26
10PKW-322632	133	58	39	32



TYPE: 11PK
TYPE: 11PKW

T-branch and line reduced

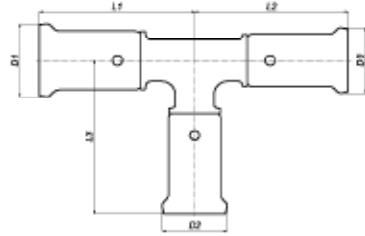

ART. NR.	L1 mm	L2 mm	L3 mm	D1 mm	D2 mm	D3 mm
11PK-161414	47,5	47,5	47	22	20	20
11PK-181616	48,5	49,3	49,3	24	22	22
11PK-201616	47,5	49,5	49,5	26	22	22
11PK-201818	49,5	50,3	50,2	26	24	24
11PK-202016	49,5	51	49,5	26	26	22
11PK-261616	51,8	51,8	51,8	32	22	22
11PK-261620	51,8	51,8	53,5	32	22	26
11PK-262016	51,5	51,5	53,2	32	26	22
11PK-262020	51,8	51,8	54	32	26	26
11PK-262616	53,5	56	53,5	32	32	22
11PK-262620	53,5	54,5	53,2	32	32	26
11PK-322026	66,8	60	58,5	39	26	32
11PK-322626	66,3	60	58,5	39	32	32
11PK-402032	62	62	59	47	26	39
11PK-402632	68	72	61,4	47	32	39
11PK-403232	70,5	70,5	72	47	39	39
11PK-404026	74,5	70,5	75,5	47	47	32
11PK-404032	74,5	74,5	75,5	47	47	39
11PK-502040	78	65	64	57	26	47
11PK-502640	80	65	64	57	32	47
11PK-503240	84	68	77	57	39	47
11PK-504040	88	73	77	57	47	47
11PKW-201616	47,5	49,5	49,5	26	22	22
11PKW-202016	49,5	51	49,5	26	26	22
11PKW-261616	51,8	51,8	51,8	32	22	22
11PKW-261620	51,8	51,8	53,5	32	22	26
11PKW-262016	51,5	51,5	53,2	32	26	22
11PKW-262020	51,8	51,8	54	32	26	26
11PKW-262616	53,5	56	53,5	32	32	22
11PKW-262620	53,5	54,5	53,2	32	32	26
11PKW-322026	66,8	60	58,5	39	26	32
11PKW-322626	66,3	60	58,5	39	32	32

TYPE: 12PK
TYPE: 12PKW

T-enlarged branch

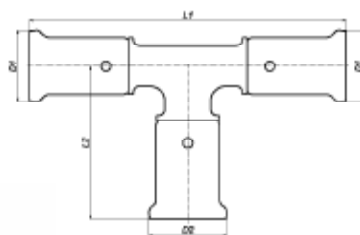

ART. NR.	L1 mm	L2 mm	D1 mm	D2 mm
12PK-161816	98	48,5	22	24
12PK-162016	101	48,5	22	26
12PK-202620	108	52	26	32
12PK-263226	114	66	32	39
12PK-324032	145	69	39	47
12PK-405040	154	88	47	57
12PKW-162016	101	48,5	22	26
12PKW-202620	108	52	26	32
12PKW-263226	114	66	32	39

9 DELIVERY PROGRAMME

TYPE: 13PK

TYPE: 13PKW

TYPE: 13PKW-N

T-female iron centred branch

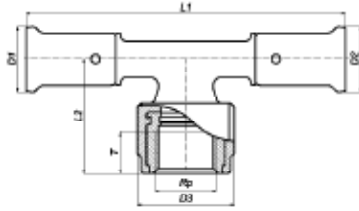

ART. NR.	L1	L2	D1	D2	D3	Rp	T
	mm	mm	mm	mm	mm		mm
13PK-160416BP*	109	39	22	22	33	1/2"	13,5
13PK-180418BP*	109	39	24	24	33	1/2"	13,5
13PK-200420BP*	109	39	26	26	33	1/2"	13,5
13PK-200520	119	47	26	26	40	3/4"	15,5
13PK-260420BP*	109	43	32	26	33	1/2"	13,5
13PK-260426BP*	109	43	32	32	33	1/2"	13,5
13PK-260526	119	47	32	32	40	3/4"	15,5
13PK-320532	146	52,5	39	39	40	3/4"	15,5
13PK-320632	149	56	39	39	45,5	1"	18
13PK-320732	161	66	39	39	56,5	5/4"	21
13PK-400640	153	63	47	47	45,5	1"	18
13PK-400740	158	69	47	47	56,5	5/4"	21
13PK-500850	202	84	57	57	70	6/4"	25
13PK-631063	242	104	70	70	90	2"	30
13PKW-160416	109	39	22	22	33	1/2"	13,5
13PKW-200420	109	39	26	26	33	1/2"	13,5
13PKW-200520	119	47	26	26	40	3/4"	15,5
13PKW-260426	109	43	32	32	33	1/2"	13,5
13PKW-260526	119	47	32	32	40	3/4"	15,5
13PKW-320532	146	52,5	39	39	40	3/4"	15,5
13PKW-320632	149	56	39	39	45,5	1"	18
13PKW-160416-N	109	39	22	22	33	1/2"	13,5
13PKW-200420-N	109	39	26	26	33	1/2"	13,5
13PKW-200520-N	119	47	26	26	40	3/4"	15,5
13PKW-260426-N	109	43	32	32	33	1/2"	13,5
13PKW-260526-N	119	47	32	32	40	3/4"	15,5
13PKW-320532-N	146	52,5	39	39	40	3/4"	15,5
13PKW-320632-N	149	56	39	39	45,5	1"	18

* With black plug BP04 1/2"



TYPE: 14PK
TYPE: 14PKW
TYPE: 14PKW-N

T-male iron centre

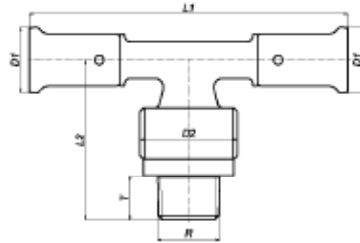

ART. NR.	L1	L2	D1	D2	R	T
	mm	mm	mm	mm		mm
14PK-160416	109	54	22	33	1/2"	13,5
14PK-180418	109	54	24	33	1/2"	13,5
14PK-200420	109	54	26	33	1/2"	13,5
14PK-200520	114	58	26	40	3/4"	14,5
14PK-260426	119	60	32	33	1/2"	13,5
14PK-260526	119	63	32	40	3/4"	14,5
14PK-260626	124	65	32	45,5	1"	16,5
14PK-320532	146	66	39	40	3/4"	14,5
14PK-400640	150	74	47	45,5	1"	16,5
14PK-400740	161	80	47	56,5	5/4"	19
14PK-500850	202	88	57	70	6/4"	20
14PK-631063	236	109	70	90	2"	23
14PKW-160416	109	54	22	33	1/2"	13,5
14PKW-200420	109	54	26	33	1/2"	13,5
14PKW-200520	114	58	26	40	3/4"	14,5
14PKW-320532	146	66	39	40	3/4"	14,5
14PKW-160416-N	109	54	22	33	1/2"	13,5
14PKW-200420-N	109	54	26	33	1/2"	13,5
14PKW-200520-N	114	58	26	40	3/4"	14,5

TYPE: 15PK
TYPE: 15PKW

Straight coupling

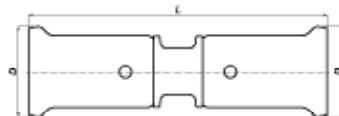

ART. NR.	L	D
	mm	mm
15PK-1414	74	20
15PK-1616	74	22
15PK-1818	75	24
15PK-2020	76	26
15PK-2626	81	32
15PK-3232	103	39
15PK-4040	106	47
15PK-5050	141	57
15PK-6363	171	70
15PKW-1616	74	22
15PKW-2020	76	26
15PKW-2626	81	32
15PKW-3232	103	39

9 DELIVERY PROGRAMME

TYPE: 16PK TYPE: 16PKW

Reducing coupling

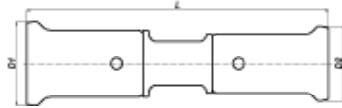

ART. NR.	L mm	D1 mm	D2 mm
16PK-1614	80,6	22	20
16PK-1814	82	24	20
16PK-1816	80,7	24	22
16PK-2014	78,9	26	20
16PK-2016	80,8	26	22
16PK-2018	80,7	26	24
16PK-2616	84	32	22
16PK-2618	85	32	24
16PK-2620	84	32	26
16PK-3216	107	38,5	22
16PK-3220	103	38,5	26
16PK-3226	102	38,5	32
16PK-4026	113,8	46,5	32
16PK-4032	115	46,5	38,5
16PK-5032	136	57	39
16PK-5040	143	57	46,5
16PK-6340	174	70	47
16PK-6350	173	70	57
16PKW-2016	80,8	26	22
16PKW-2616	84	32	22
16PKW-2620	84	32	26
16PKW-3216	107	38,5	22
16PKW-3220	103	38,5	26
16PKW-3226	102	38,5	32



TYPE: 17PK
TYPE: 17PKW
TYPE: 17PKW-N

Straight male iron adapter coupling

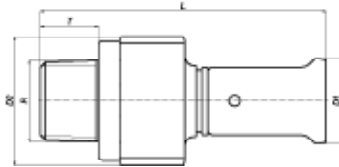

ART. NR.	L mm	D1 mm	D2 mm	R	T mm
17PK-1404	75	20	33	1/2"	13,5
17PK-1604	75	22	33	1/2"	13,5
17PK-1804	75	24	33	1/2"	13,5
17PK-1805	77	24	40	3/4"	14,5
17PK-2004	75	26	33	1/2"	13,5
17PK-2005	77	26	40	3/4"	14,5
17PK-2605	77	32	40	3/4"	14,5
17PK-2606	80	32	45,5	1"	16,5
17PK-3206	91	39	45,5	1"	16,5
17PK-3207	99	39	56,5	5/4"	19
17PK-4006	84	47	45,5	1"	16,5
17PK-4007	93	47	56,5	5/4"	19
17PK-5008	142	57	89	6/4"	20
17PK-6310	142	70	90	2"	23
17PKW-1604	75	22	33	1/2"	13,5
17PKW-2004	75	26	33	1/2"	13,5
17PKW-2005	77	26	40	3/4"	14,5
17PKW-2605	77	32	40	3/4"	14,5
17PKW-2606	80	32	45,5	1"	16,5
17PKW-3206	91	39	45,5	1"	16,5
17PKW-3207	99	39	56,5	5/4"	19
17PKW-1604-N	75	22	33	1/2"	13,5
17PKW-2004-N	75	26	33	1/2"	13,5
17PKW-2005-N	77	26	40	3/4"	14,5
17PKW-2605-N	77	32	40	3/4"	14,5
17PKW-2606-N	80	32	45,5	1"	16,5
17PKW-3206-N	91	39	45,5	1"	16,5
17PKW-3207-N	99	39	56,5	5/4"	19

- 1
- 2
- 3
- 4
- 5
- 6
- 7
- 8
- 9
- 10
- 11

9 DELIVERY PROGRAMME

TYPE: 18PK
TYPE: 18PKW
TYPE: 18PKW-N

Straight female iron adapter

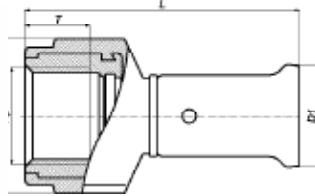

ART. NR.	L	D1	D2	Rp	T
	mm	mm	mm		mm
18PK-1404	59,5	20	33	1/2"	13,5
18PK-1604	59,5	22	33	1/2"	13,5
18PK-1804	59,5	24	33	1/2"	13,5
18PK-1805	63	24	40	3/4"	15,5
18PK-2004	59,5	26	33	1/2"	13,5
18PK-2005	63	26	40	3/4"	15,5
18PK-2605	63	32	40	3/4"	15,5
18PK-2606	70,5	32	45,5	1"	18
18PK-3206	82	39	45,5	1"	18
18PK-3207	90	39	56,5	5/4"	21
18PK-4006	74,5	47	45,5	1"	18
18PK-4007	85	47	56,5	5/4"	21
18PK-5008	107,5	57	70	6/4"	25
18PK-6310	131	70	90	2"	30
18PKW-1604	59,5	22	33	1/2"	13,5
18PKW-2004	59,5	26	33	1/2"	13,5
18PKW-2005	63	26	40	3/4"	15,5
18PKW-2605	63	32	40	3/4"	15,5
18PKW-2606	70,5	32	45,5	1"	18
18PKW-3206	82	39	45,5	1"	18
18PKW-3207	90	39	56,5	5/4"	21
18PKW-1604-N	59,5	22	33	1/2"	13,5
18PKW-2004-N	59,5	26	33	1/2"	13,5
18PKW-2005-N	63	26	40	3/4"	15,5
18PKW-2605-N	63	32	40	3/4"	15,5
18PKW-2606-N	70,5	32	45,5	1"	18
18PKW-3206-N	82	39	45,5	1"	18
18PKW-3207-N	90	39	56,5	5/4"	21



TYPE: 19PK
TYPE: 19PKW

Press fit to eurocone



ART. NR.	L mm	D mm	G
19PK-1605	55	22	3/4"
19PK-2005	55	26	3/4"
19PKW-1605	55	22	3/4"
19PKW-2005	55	26	3/4"

TYPE: 26PK
TYPE: 26PKW

Press fitting with flat sealing

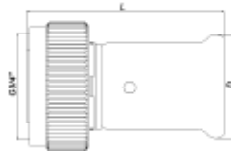

ART. NR.	L mm	D mm	G
26PK-1605	50	22	3/4"
26PK-2005	55	26	3/4"
26PKW-1605	50	22	3/4"
26PKW-2005	55	26	3/4"

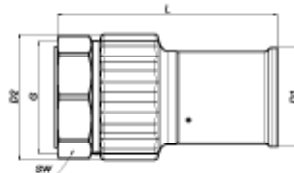

ART. NR	L mm	D1 mm	D2 mm	G mm	SW mm
26PK-4008	103,5	47	56,5	1 1/2"	53
26PK-5010	126,5	57	70	2"	64
26PK-6312	154,5	70	88	2 1/2"	80

TYPE: 27PK

45° bend

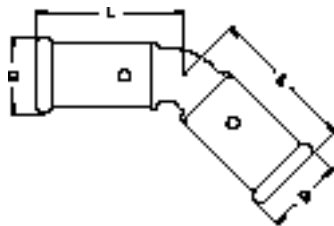

ART. NR.	L mm	D mm
27PK-4040	63	47
27PK-5050	84	57
27PK-6363	102	70



9 DELIVERY PROGRAMME

1

2

3

4

5

6

7

8

9

10

11

TYPE: 28PK-04

Clip for 28PK-2PK1604, 28PK-6PK1604 and 28PK-13PK160416

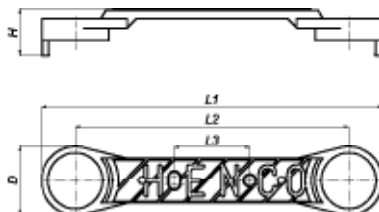

ART. NR.	L1	L2	L3	D	H
28PK-04	194	153	42	38	26

TYPE: 28PK-2PK1604

Double backplate 153mm centres for art.2PK-1604

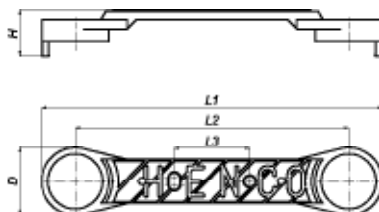

Art. Nr.	L1	L2	L3	D	H	TYPE
28PK-2PK1604BP*	194	153	42	38	56	2X(16X1/2")

* With black plug BP04 1/2"

TYPE: 28PK-6PK1604

Double backplate 153mm centres for art.6PK-1604

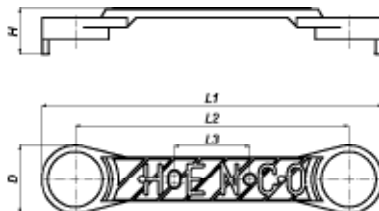

Art. Nr.	L1	L2	L3	D	H	TYPE
28PK-6PK1604BP*	194	153	42	38	64	2X(16X1/2")

* With black plug BP04 1/2"

TYPE: 53PK

Easy mounting fitting

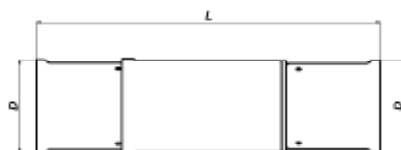

ART. NR.	L	D
53PK40	179	47
53PK50	210,5	57
53PK63	236,2	70



Henco Press for gas

TYPE: 1PKG

Elbow 90°

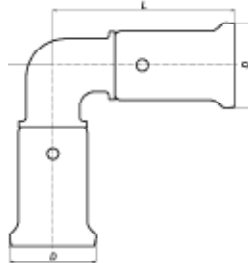

ART. NO.	L mm	D mm
1PKG-1616	47	22
1PKG-2020	49	26
1PKG-2626	54	32
1PKG-3232	72	39
1PKG-4040	78	47

TYPE: 2PKG

Backplate elbow female

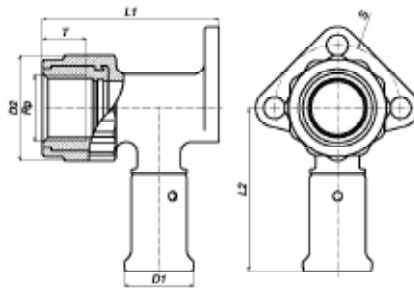

ART. NO.	L1 mm	L2 mm	D1 mm	D2 mm	Rp	T mm	S mm
2PKG-1603	56	52	22	33	3/8"	13,5	40
2PKG-1604BP*	56	52	22	33	1/2"	13,5	40
2PKG-2004BP*	56	52	26	33	1/2"	13,5	40
2PKG-2005	61	58	26	40	3/4"	15,5	46
2PKG-2605	66	58	32	40	3/4"	15,5	46

*With black plug BP04 1/2"

TYPE: 2PKG-K

Backplate elbow female, short model

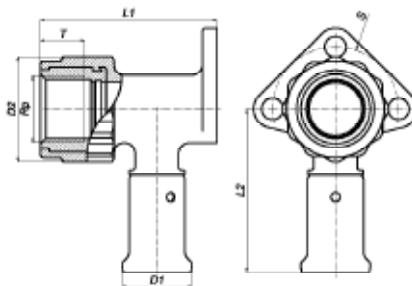

ART. NO.	L1 mm	L2 mm	D1 mm	D2 mm	Rp	T mm	S mm
2PKG-1604KBP*	40	52	22	33	1/2"	13,5	40

*With black plug BP04 1/2"

9 DELIVERY PROGRAMME

1
2
3
4
5
6
7
8
9
10
11

TYPE: 3PKG

Double backplate elbow female, short model

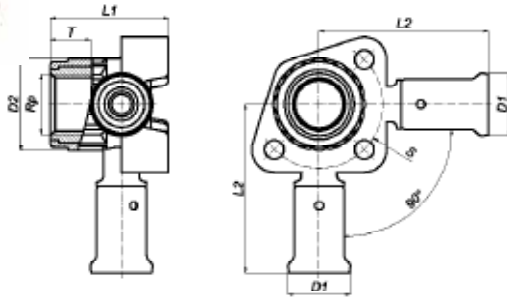

ART. NO.	L1	L2	D1	D2	Rp	T	S
	mm	mm	mm	mm		mm	mm
3PKG-160416BP*	60	42	22	33	1/2"	14	45
3PKG-200420BP*	60	43,5	26	33	1/2"	14	45

*With black plug BP04 1/2"

TYPE: 5PKG

Bent 90° male iron adapter

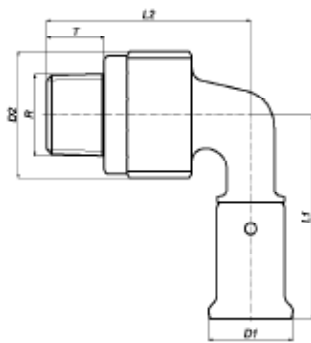

ART. NO.	L1	L2	D1	D2	R	T
	mm	mm	mm	mm		mm
5PKG-1604	54	54	22	33	1/2"	13,5
5PKG-2004	56	56	26	33	1/2"	13,5
5PKG-2005	58	58	26	40	3/4"	14,5
5PKG-2605	60	62	32	40	3/4"	14,5
5PKG-3206	75	68,5	39	45,5	1"	16,5
5PKG-4007	84	77	47	56,5	5/4"	19

TYPE: 6PKG

Bent 90° female iron adapter

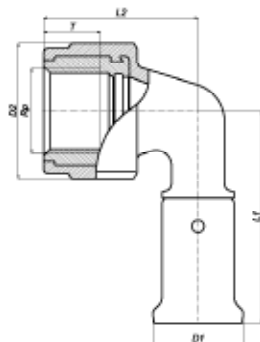

ART. NO.	L1	L2	D1	D2	Rp	T
	mm	mm	mm	mm		mm
6PKG-1604BP*	53	39	22	33	1/2"	13,5
6PKG-2004BP*	53	39	26	33	1/2"	13,5
6PKG-2005	60	47,5	26	40	3/4"	15,5
6PKG-2605	60	47,5	32	40	3/4"	15,5
6PKG-3206	75	58,5	39	45,5	1"	18
6PKG-4007	81	72	47	56,5	5/4"	19



TYPE: 9PKG

T-piece

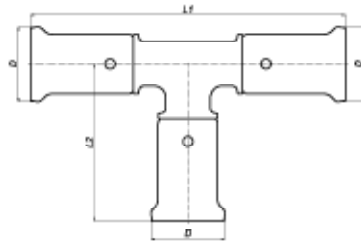

ART. NO.	L1 mm	L2 mm	D mm
9PKG-161616	94	47	22
9PKG-202020	98	49	26
9PKG-262626	107	53	32
9PKG-323232	140	70	39
9PKG-404040	150	75	47

TYPE: 10PKG

T-reduced centre

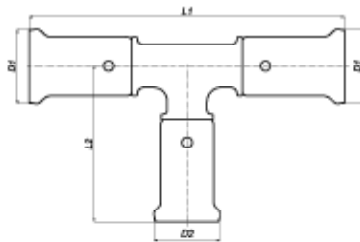

ART. NO.	L1 mm	L2 mm	D1 mm	D2 mm
10PKG-201620	94	49	26	22
10PKG-261626	98	53	32	22
10PKG-262026	103	54	32	26
10PKG-321632	133	58	39	22
10PKG-321832	133	58	39	24
10PKG-322032	133	58	39	26
10PKG-322632	133	58	39	32
10PKG-401640	118	59	47	22
10PKG-402040	122	59	47	26
10PKG-402640	134	31	47	32
10PKG-403240	143	75	47	39

- 1
- 2
- 3
- 4
- 5
- 6
- 7
- 8
- 9
- 10
- 11

9 DELIVERY PROGRAMME

1

2

3

4

5

6

7

8

9

10

11

TYPE: 11PKG

T-branch and line reduced

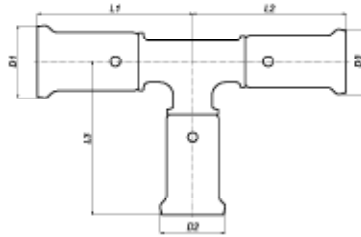

ART. NO.	L1	L2	L3	D1	D2	D3
	mm	mm	mm	mm	mm	mm
11PKG-201616	47,5	49,5	49,5	26	22	22
11PKG-202016	49,5	51	49,5	26	26	22
11PKG-261616	51,8	51,8	51,8	32	22	22
11PKG-261620	51,8	51,8	53,5	32	22	26
11PKG-262016	51,5	51,5	53,2	32	26	22
11PKG-262020	51,8	51,8	54	32	26	26
11PKG-262616	53,5	56	53,5	32	32	22
11PKG-262620	53,5	54,5	53,2	32	32	26
11PKG-322026	66,8	60	58,5	39	26	32
11PKG-322626	66,3	60	58,5	39	32	32
11PKG-402632	68	72	61,4	47	32	39
11PKG-402032	62	62	59	47	26	39
11PKG-403232	70,5	70,5	72	47	39	39
11PKG-404026	74,5	70,5	75,5	47	47	32
11PKG-404032	74,5	74,5	75,5	47	47	39

TYPE: 12PKG

T-enlarged branch

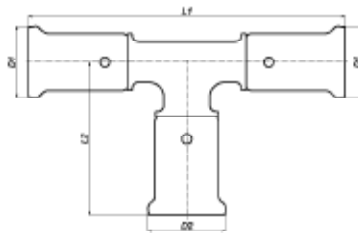

ART. NO.	L1	L2	D1	D2
	mm	mm	mm	mm
12PKG-162016	101	48,5	22	26
12PKG-202620	108	52	26	32
12PKG-263226	114	66	32	39
12PKG-324032	145	69	39	47



TYPE: 13PKG

T-female iron branch

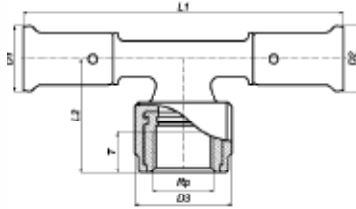

ART. NO.	L1 mm	L2 mm	D1 mm	D2 mm	D3 mm	Rp mm	T mm
13PKG-160416BP*	109	39	22	22	33	1/2"	13,5
13PKG-200420BP*	109	39	26	26	33	1/2"	13,5
13PKG-200520	119	47	26	26	40	3/4"	15,5
13PKG-260420BP*	109	43	32	26	33	1/2"	13,5
13PKG-260426BP*	109	43	32	32	33	1/2"	13,5
13PKG-260526	119	47	32	32	40	3/4"	15,5
13PKG-320532	145	52,5	39	39	40	3/4"	15,5
13PKG-320632	147	56	39	39	45,5	1"	16,5
13PKG-320732	161	66	39	39	56,5	5/4"	19
13PKG-400640	150	63	47	47	45,5	1"	16,5
13PKG-400740	158	69	47	47	56,5	5/4"	19

TYPE: 14PKG

T-male iron branch

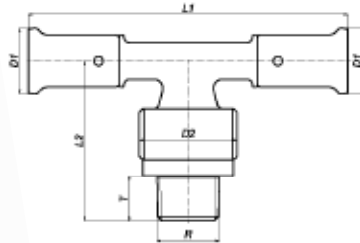

ART. NO.	L1 mm	L2 mm	D1 mm	D2 mm	R mm	T mm
14PKG-160416	109	54	22	33	1/2"	13,5
14PKG-200420	109	54	26	33	1/2"	13,5
14PKG-200520	114	58	26	40	3/4"	14,5
14PKG-260426	119	60	32	33	1/2"	13,5
14PKG-260526	119	63	32	40	3/4"	14,5
14PKG-260626	124	65	32	45,5	1"	16,5
14PKG-320532	146	66	39	40	3/4"	14,5
14PKG-400640	152	74	47	45,5	1"	16,5
14PKG-400740	159	80	47	56,5	5/4"	19

TYPE: 15PKG

Straight coupling

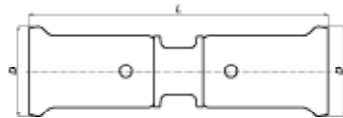

ART. NO.	L mm	D mm
15PKG-1616	74	22
15PKG-2020	76	26
15PKG-2626	81	32
15PKG-3232	103	39
15PKG-4040	105	47

9 DELIVERY PROGRAMME

TYPE: 16PKG

Reducing coupling

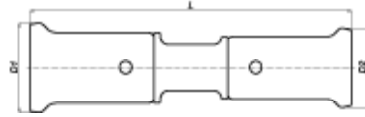

ART. NO.	L mm	D1 mm	D2 mm
16PKG-2016	80,8	26	22
16PKG-2616	84	32	22
16PKG-2620	84	32	26
16PKG-3216	107	39	22
16PKG-3220	103	39	26
16PKG-3226	102	39	32
16PKG-4026	112	47	32
16PKG-4032	115	47	39

TYPE: 17PKG

Straight male iron adapter

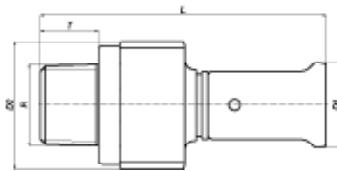

ART. NO.	L mm	D1 mm	D2 mm	R	T mm
17PKG-1604	75	22	33	1/2"	13,5
17PKG-2004	75	26	33	1/2"	13,5
17PKG-2005	77	26	40	3/4"	14,5
17PKG-2605	77	32	40	3/4"	14,5
17PKG-2606	80	32	45,5	1"	16,5
17PKG-3206	91	39	45,5	1"	16,5
17PKG-3207	99	39	56,5	5/4"	19
17PKG-4006	84	47	45,5	1"	16,5
17PKG-4007	91	47	56,5	5/4"	19

TYPE: 18PKG

Straight female iron adapter

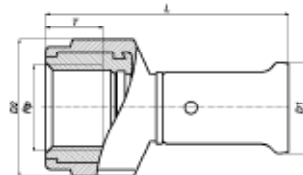

ART. NO.	L mm	D1 mm	D2 mm	Rp	T mm
18PKG-1604	59,5	22	33	1/2"	13,5
18PKG-2004	59,5	26	33	1/2"	13,5
18PKG-2005	63	26	40	3/4"	15,5
18PKG-2605	63	32	40	3/4"	15,5
18PKG-2606	70,5	32	45,5	1"	18
18PKG-3206	82	39	45,5	1"	18
18PKG-3207	90	39	56,5	5/4"	21
18PKG-4006	73	47	45,5	1"	18
18PKG-4007	84	47	56,5	5/4"	21



TYPE: 27PKG

45° bend

ART. NO.	L	D
	mm	mm
27PKG-4040	63	47

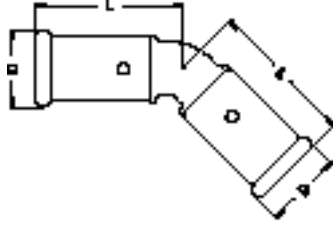

1

2

3

4

5

6

7

8

9

10

11

TYPE: 30PG

Press-fit adapter to copper compression

ART. NR.	L1	L2	L3	SW1	SW2	D1	D2
	mm	mm	mm	mm	mm	mm	mm
30PG-1615S	52,3	8	12,7	22	24	22	15
30PG-2022S	53,2	8,5	14	30	32	26	22
30PG-2622S	53,2	8,5	14	30	32	32	22

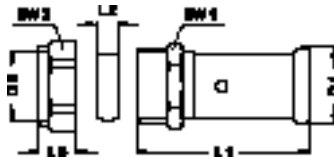

9 DELIVERY PROGRAMME

Super Sizes

TYPE: 1HN

Elbow 90°

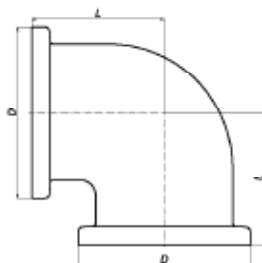

ART. NR.	L mm	D mm
1HNA	60	78
1HNB	77,5	114

TYPE: 8HN

Pressfitting

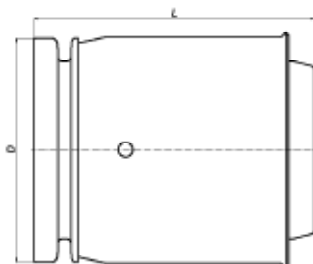

ART. NR.	L mm	D mm
8HNA-PK40	63,6	78
8HNA-PK50	74,5	78
8HNA-PK63	84,5	78
8HNA-PK75	97,5	78
8HNB-PK90	111,8	114

TYPE: 9HN

T-piece

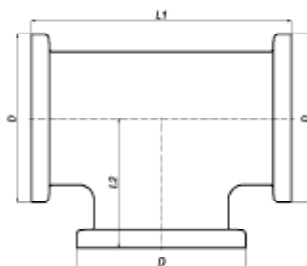

ART. NR.	L1 mm	L2 mm	D mm
9HNA	120	60	78
9HNB	155	77,5	114



- 1
- 2
- 3
- 4
- 5
- 6
- 7
- 8
- 9
- 10
- 11

TYPE: 16HN
Reducing coupling



ART. NR.	L	D
	mm	mm
16HNBA	34	114

TYPE: 17HN
Brass adapter male

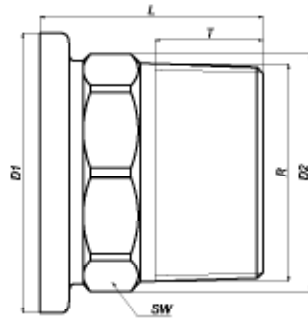

ART. NR.	L	D1	D2	SW	T	R
	mm	mm	mm	mm	mm	
17HNA-10	62	78	66	62	30	2"
17HNA-12	62	78	80	72	30	2,5"

TYPE: 18HN
Brass adapter female

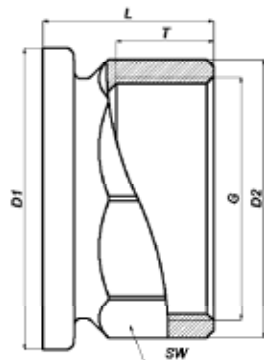

ART. NR.	L	D1	D2	SW	T	G
	mm	mm	mm	mm	mm	
18HNA-06	40	78	40	38	19,5	1"
18HNA-10	44	78	72	67	25	2"
18HNA-12	55	78	88	83	30	2,5"
18HNB-14	44	114	100	96	35	3"

9 DELIVERY PROGRAMME

1

2

3

4

5

6

7

8

9

10

11

TYPE: 27HN

Elbow 45°

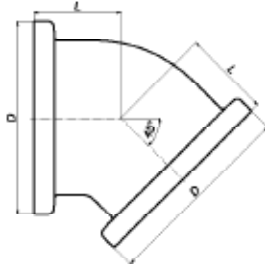

ART. NR.	L mm	D mm
27HNA	35	78
27HNB	43,6	114

TYPE: HN

Bracket set

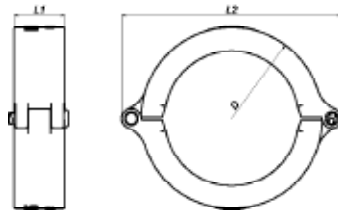

ART. NR.	L1 mm	L2 mm	D mm
HNA	23,5	102	41,6
HNB	23,7	158	120

TYPE: HN-PEN

Locking pin

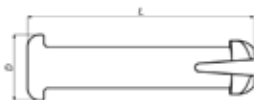

ART. NR.	L mm	D mm
HN-PEN	27,7	8



TYPE: HN-U

Sealing ring



ART. NR.	L	D
	mm	mm
HNA-U	6,9	67,3
HNB-U	6,9	102,5

TYPE: HN-STOP

Stop end for Super Size range



ART. NR.	L	D
	mm	mm
HNA-STOP	8,25	78
HNB-STOP	8,25	114

1

2

3

4

5

6

7

8

9

10

11

9 DELIVERY PROGRAMME

9.3 Henco Vision

TYPE: 1SK

Elbow 90°

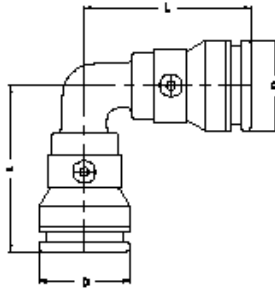

ART. NO.	L mm	D mm
1SK-1616	52	28
1SK-2020	53	33
1SK-2626	59	40

TYPE: 2SK

Backplate elbow female

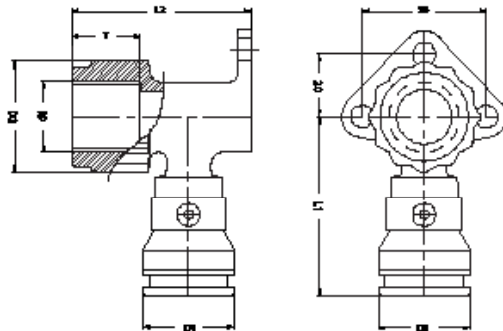

ART. NO.	L1 mm	L2 mm	D1 mm	D2 mm	Rp	T mm
2SK-1604BP*	54	55	28	33	1/2"	14
2SK-2004BP*	57	60	33	33	1/2"	14
2SK-2005	62	61	33	40	3/4"	16
2SK-2605	63	66	40	40	3/4"	16

*With black plug BP04 1/2"



TYPE: 3SK

Double backplate elbow female, short model

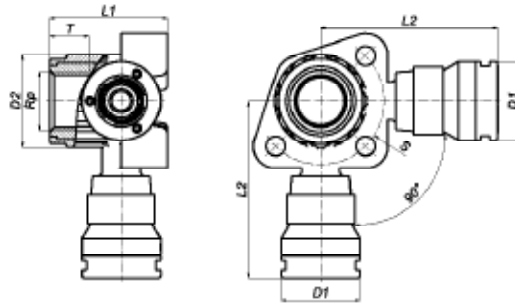

ART. NO.	L1	L2	D1	D2	Rp	T
	mm	mm	mm	mm		mm
3SK-160416BP*	62	42	28	33	1/2"	14
3SK-200420BP*	62	44	33	33	1/2"	14

*With black plug BP04 1/2"

TYPE: 5SK

Bent 90° male iron adapter

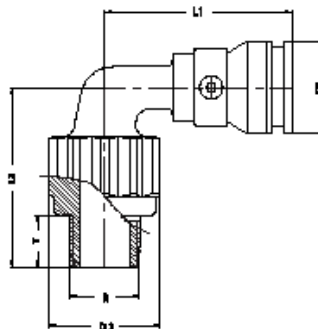

ART. NO.	L1	L2	D1	D2	R	T
	mm	mm	mm	mm		mm
5SK-1604	57	54	28	33	1/2"	14
5SK-2004	60	57	33	33	1/2"	14
5SK-2005	63	58	33	40	3/4"	16
5SK-2605	64	62	40	40	3/4"	16

TYPE: 6SK

Bent 90° female iron adapter

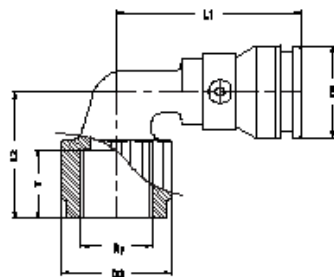

ART. NO.	L1	L2	D1	D2	Rp	T
	mm	mm	mm	mm		mm
6SK-1604BP*	56	40	28	33	1/2"	14
6SK-2004BP*	58	40	33	33	1/2"	14
6SK-2005	63	48	33	40	3/4"	16
6SK-2605	65	48	40	40	3/4"	16

*With black plug BP04 1/2"

9 DELIVERY PROGRAMME

1

2

3

4

5

6

7

8

9

10

11

TYPE: 9SK

T-piece

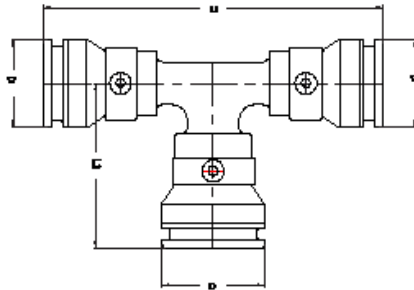

ART. NO.	L1 mm	L2 mm	D mm
9SK-161616	101	50,5	28
9SK-202020	106,5	53	33
9SK-262626	117	59	40

TYPE: 10SK

T-reduced centre

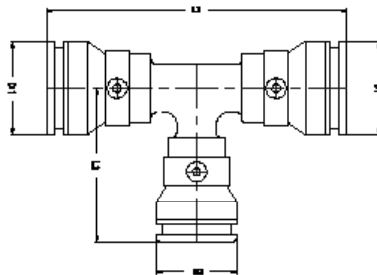

ART. NO.	L1 mm	L2 mm	D1 mm	D2 mm
10SK-201620	103	53	33	28
10SK-261626	109	57	40	28
10SK-262026	113	57	40	33

TYPE: 11SK

T-branch and line reduced

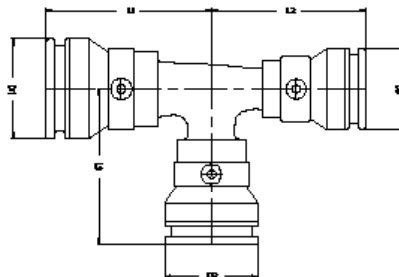

ART. NO.	L1 mm	L2 mm	L3 mm	D1 mm	D2 mm	D3 mm
11SK-201616	52	52	52	33	28	28
11SK-202016	55	53	53	33	33	28
11SK-261620	56	54	54	40	28	33
11SK-262016	57	55	57	40	33	28
11SK-262020	57	56	57	40	33	33
11SK-262616	60	58	58	40	40	28
11SK-262620	59	58	58	40	40	33



TYPE: 12SK

T-enlarged branch

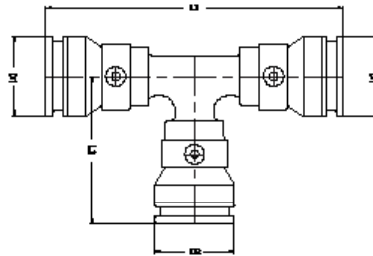

ART. NO.	L1 mm	L2 mm	D1 mm	D2 mm
12SK-162016	108	53	28	33
12SK-202620	116	57	33	40

TYPE: 13SK

T-female iron centre

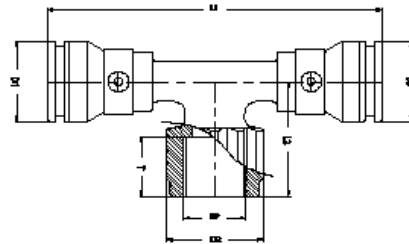

ART. NO.	L1 mm	L2 mm	L3 mm	D1 mm	D2 mm	D3 mm	Rp	T mm
13SK-160416BP*	116	39	28	33	28	28	1/2"	14
13SK-200420BP*	117	39	33	33	33	33	1/2"	14
13SK-200520	120	45	33	40	33	33	3/4"	16
13SK-260420BP*	118	42	40	33	33	33	1/2"	14
13SK-260426BP*	120	42	40	33	40	40	1/2"	14
13SK-260526	121	44	40	40	40	40	3/4"	16

*With black plug BP04 1/2"

TYPE: 14SK

T-male iron centre

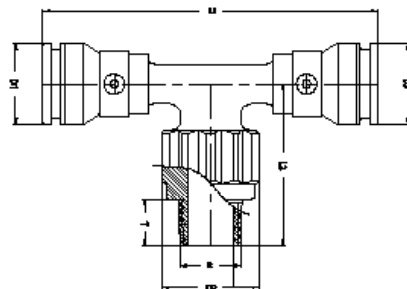

ART. NO.	L1 mm	L2 mm	D1 mm	D2 mm	D3 mm	R	T mm
14SK-160416	111	54	28	33	28	1/2"	14
14SK-200420	111	54	33	33	33	1/2"	14
14SK-260426	116	57	40	33	40	1/2"	14

9 DELIVERY PROGRAMME

1

2

3

4

5

6

7

8

9

10

11

TYPE: 15SK

Straight coupling

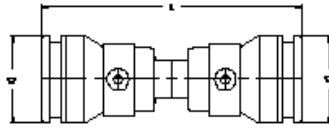

ART. NO.	L mm	D mm
15SK-1616	83,5	28
15SK-2020	85	33
15SK-2626	90	40

TYPE: 16SK

Reducing coupling

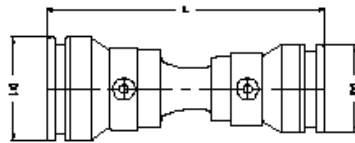

ART. NO.	L mm	D1 mm	D2 mm
16SK-2016	89	33	28
16SK-2616	93	40	28
16SK-2620	93	40	33

TYPE: 17SK

Straight male iron adapter

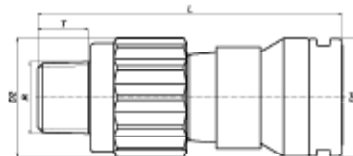

ART. NO.	L mm	D1 mm	D2 mm	R	T
17SK-1603	72	28	28	3/8"	14
17SK-1604	76	28	33	1/2"	14
17SK-2004	76,5	33	33	1/2"	14
17SK-2005	78	33	40	3/4"	16
17SK-2605	80	40	40	3/4"	16
17SK-2606	82	40	46	1"	18



TYPE: 18SK

Straight female iron adapter

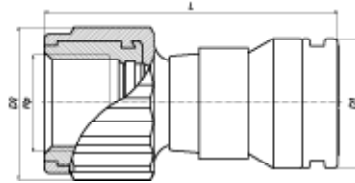

ART. NO.	L mm	D1 mm	D2 mm	R	T
18SK-1604	64	28	33	1/2"	14
18SK-2004	63	33	33	1/2"	14
18SK-2005	68	33	40	3/4"	16
18SK-2605	67	40	40	3/4"	16
18SK-2606	70	40	46	1"	18

TYPE: 19SK

Push fitting with eurocone connection

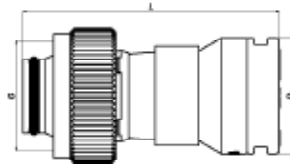

ART. NO.	L mm	D mm	G mm
19SK-1605	62	28	3/4"
19SK-2005	62	33	3/4"

TYPE: 26SK

Push fitting with flat sealing

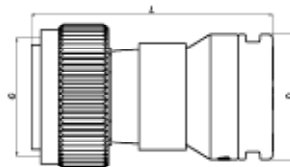

ART. NO.	L mm	D mm	G mm
26SK-1605	60	28	3/4"
26SK-2005	62	33	3/4"

9 DELIVERY PROGRAMME

1

2

3

4

5

6

7

8

9

10

11

TYPE: SK-PIPESTOP

Stop end for pipe

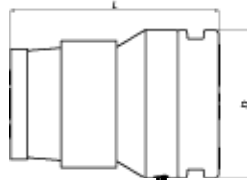

ART. NO.	L mm	D mm
SK-PIPESTOP16	40	28
SK-PIPESTOP20	40	33
SK-PIPESTOP26	42	40

TYPE: STOPCLIP

Reusable stop and clip for push fit connector



ART. NO.	L mm	D mm
SK-STOPCLIP16	29	35
SK-STOPCLIP20	30	40
SK-STOPCLIP26	30	49

TYPE: VISIONSET

Vision set

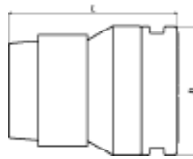

ART. NO.	L mm	D mm
VISION SET 16	36	28
VISION SET 20	37	33
VISION SET 26	38	40

TYPE: VISION KEY

Vision key



ART. NO.	L mm	D mm
VISION KEY 16	145	16
VISION KEY 20	145	20
VISION KEY 26	145	26



Henco Vision Manifolds

TYPE: VSK-1616

Extension or body for manifold, two SK connections Ø16

ART. NO.	L1	L2	L3	D1	D2	T
VSK-1616	100	50	50	30	28	Special thread

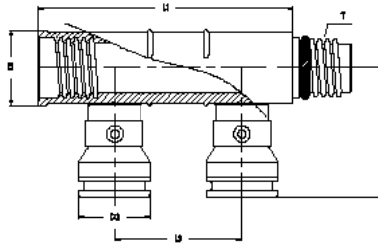

TYPE: VSK-161616

Extension or body for manifold, three SK connections Ø16

ART. NO.	L1	L2	L3	D1	D2	T
VSK-161616	150	50	50	30	28	Special thread

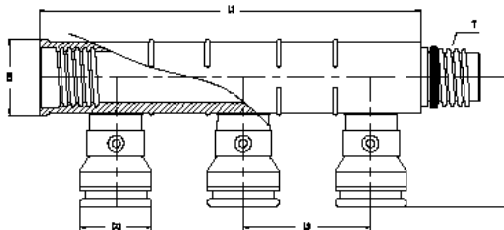

TYPE: VSKEK-0502

Extension or body for manifold, two eurocone connections

ART. NO.	L1	L2	L3	D1	D2	G	T
VSKEK-0502	100	30	50	29,5	29,8	3/4"	Special thread

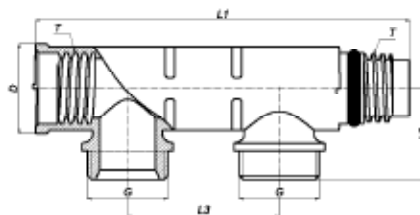

9 DELIVERY PROGRAMME

1

2

3

4

5

6

7

8

9

10

11

TYPE: VSKEK-0503

Extension or body for manifold, three eurocone connections

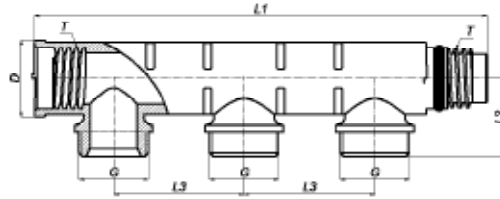

ART. NO.	L1	L2	L3	D	G	T
	mm	mm	mm	mm		
VSKEK-0503	149,5	30	50	29,5	3/4"	Special thread

TYPE: 19SK

Push fitting with eurocone connection

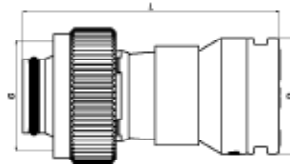

ART. NO.	L	D	G
	mm	mm	
19SK-1605	62	28	3/4"
19SK-2005	62	33	3/4"

TYPE: VVSK

Straight entry piece

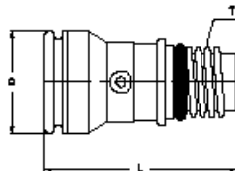

ART. NO.	L	D	T
	mm	mm	
VVSK-20	63	33	Special thread
VVSK-26	62	40	Special thread



TYPE: VVSK-TM

T-piece for supply for Vision manifold

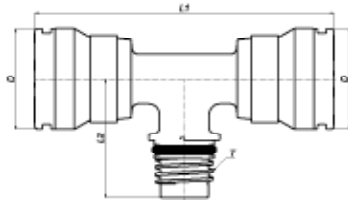

ART. NO.	L1	L2	D	T
	mm	mm	mm	
VVSK-T26M26	117,5	46,65	40	Special thread

TYPE: 17SKS

Straight nipple male

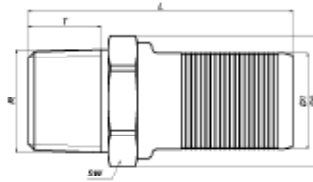

ART. NO.	L	D1	D2	R	SW
	mm	mm	mm		mm
17SKS-2004	54,5	20	27	1/2"	24
17SKS-2005	56	20	30	3/4"	27
17SKS-2604	54,6	26	34	1/2"	30
17SKS-2605	56	26	34	3/4"	30

TYPE: 18SKS

Straight nipple female

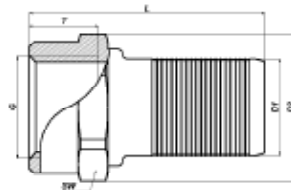

ART. NO.	L	D1	D2	R	SW
	mm	mm	mm		mm
18SKS-2004	48	20	30	1/2"	27
18SKS-2005	53	20	36	3/4"	32
18SKS-2604	47	26	34	1/2"	30
18SKS-2605	50,3	26	36	3/4"	32

9 DELIVERY PROGRAMME

1

2

3

4

5

6

7

8

9

10

11

TYPE: VVSK-90

Bent 90° for manifold

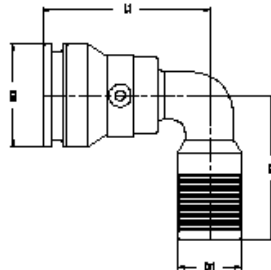

ART. NO.	L1	L2	D1	D2
	mm	mm	mm	mm
VVSK-20-90	52	47	20	33
VVSK-26-90	60	51	26	40

TYPE: VVSK-T

T for manifold

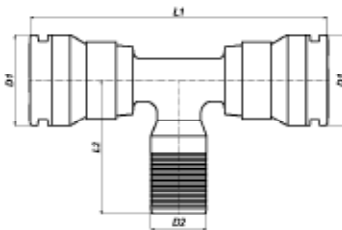

ART. NO.	L1	L2	D1	D2
	mm	mm	mm	mm
VVSK-T202020	106,8	46,6	20	33
VVSK-T262626	120	50,8	26	40

TYPE: VSK-ENDCAP

Stop and female for manifold

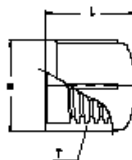

ART. NO.	L	D	T
	mm	mm	
VS-ENDCAP	29	30	26



TYPE: VSK-ENDCAP-M

Stop and female for manifold

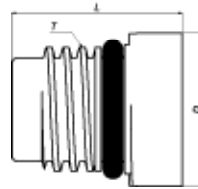

ART. NO.	L	D	T
	mm	mm	
VS-ENDCAP-M	31	28	Special thread

TYPE: VDSK

Straight female adapter for manifold or manifold extension

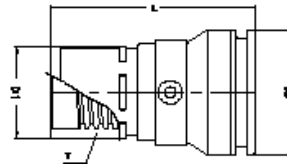

ART. NO.	L	D1	D2	T
	mm	mm	mm	
VDSK-20	68	30	33	Special thread
VDSK-26	65	30	40	Special thread

TYPE: STOPCLIP

Reusable stop and clip for push fit connection



ART. NO.	L	D
	mm	mm
SK-STOPCLIP16	29	35
SK-STOPCLIP20	30	40
SK-STOPCLIP26	30	49



9 DELIVERY PROGRAMME

- 1
- 2
- 3
- 4
- 5
- 6
- 7
- 8
- 9
- 10
- 11

TYPE: SK-B05
Bracket for Vision manifolds

ART. NO.	L1	L2	L3	L4	H1	H2
SK-B05	250	200	75	20	45,5	18,5

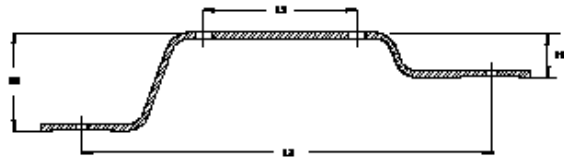
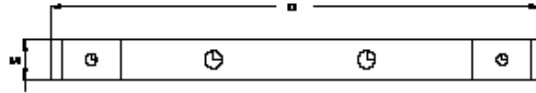

INSURANCE



1
2
3
4
5
6
7
8
9
10
11



HENCO
MADE IN BELGIUM

WE CARE TO CONNECT

Henco Industries NV | 2200 Herentals | Tel: +32 14 28 56 60
Toekomstlaan 27 | Belgium | www.henco.be



WV/ct/21-005

Herentals, January 2021

We herewith confirm that HENCO Sandwich tubes, as well as fittings belonging to the HENCO press- and/or HENCO screw- and/or HENCO Vision-product range, come with a ten years' guarantee on all consequential damage resulting from proven production faults.



HENCO INDUSTRIES NV
Wim Verhoeven
General Manager





GERMANY



AUSTRIA



FRANCE



THE NETHERLANDS

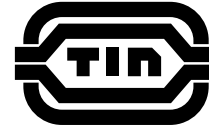

POLAND



DENMARK



ITALY



RUSSIA



SLOVAKIA



ATG SYSTEM CERTIFICATE BELGIUM



NORWAY



FINLAND



HUNGARY



ENGLAND



SWEDEN



USA



ESTONIA



SPAIN



CZECH REPUBLIC



SOUTH AFRICA



- 1
- 2
- 3
- 4
- 5
- 6
- 7
- 8
- 9
- 10
- 11

WE CARE TO CONNECT



Henco Industries NV | Toekomstlaan 27, 2200 Herentals | Tel. +32 14 28 56 60 | www.henco.be

Version: January 2022

This edition replaces and destroys all previous editions. Henco cannot be held responsible for any printing errors. The technical data in this edition are subject to change and are therefore of a non-binding character. Nothing in this edition may be copied, reproduced and/or published by reprinting, photocopying, transfer to microfilm, or by any other reproduction method whatsoever without the prior consent from Henco Industries NV.

The latest edition is available on the Henco website www.henco.be.