

# **FUEL/AIR SYSTEMS**







- WINDSHIELDS & FAIRINGS
- TOURING
- AUDIO & COMMUNICATION
- LUGGAGE
- SEATS & Sissy BARS
- EXHAUST
- FUEL/AIR SYSTEMS
- ENGINE
- TRANSMISSION & DRIVELINE
- GASKETS & SEALS
- ELECTRICAL
- LIGHTING
- HANDLEBARS, CONTROLS & MIRRORS
- CABLES
- BRAKES
- TANKS & OIL FILTERS
- DASHES & GAUGES
- FRAMES, SUSPENSION & FENDERS
- FOOTRESTS & LICENSE PLATE FRAMES
- WHEELS & AXLES
- HARDWARE, CHEMICALS & TOOLS
- COVERS, SECURITY & GENERAL

**POWER VISION**

- The quickest, most powerful flash tuner on the market
- The sophisticated, yet easy-to-use, 3.5" full-color touch-screen display mounts to handlebars with integrated Amps 4-hole threaded inserts; also mounts to most aftermarket accessory mounts that feature AMPs 4-mounting options
- The display's interface cable plugs directly to the bike's diagnostic connector
- NO COMPUTER REQUIRED; simply select the tune and follow the on-screen prompts to flash the bike; tunes can also be edited directly from the Power Vision
- Utilizes WinPV (Windows PC-based tuning application)
- Stores up to six different tunes that can be flashed to the bike
- Downloads and stores the stock calibration in case OEM restoration is needed; stock calibration can also be saved as an editable copy and used as a starting point
- Dynojet preconfigured tunes are preloaded on the unit; Power Vision will identify the bike's information and automatically sort hundreds of applicable, dyno-proven tunes
- Custom tunes can be loaded by a tuning shop or received via email and loaded onto the device
- Displays all J1850 H-D vehicle data, wide-band air fuel ratio<sup>2</sup> and various calculated channels (including MPG instant and trip MPG)
- AutoTune Basic and Pro<sup>3</sup> calculates and stores fuel trims to optimize fuel curve
- Checks and clears diagnostic codes
- Features adaptive trims and idle offset (with bike running)
- Black series features a flat black outer case

**NOTE:** The Power Vision "marries" to one individual ECM and may be used only on that bike for flashing the ECM. For this reason LeMans Corporation/Drag Specialties does not take back Power Visions for any reason, used or not. All returns and or adjustments must be made directly with Dynojet Research. The Power Vision may be used on any bike to read and clean trouble codes.



PART #	DESCRIPTION	SUG. RETAIL
<b>ORIGINAL</b>		
1020-1493	For all H-D models with Delphi EFI (except 11-14 FXS/FLS/FLST, 12-14 Dynas, 14 Dressers and 14 XL models)	\$549.95
1020-1494	For 11-14 FXS/FLS/FLST, 12-14 Dyna models, 14 FLHT/FLHX/FLHR and 14 XL and 15 XG models	549.95
<b>BLACK SERIES</b>		
1020-2324	For all H-D models with Delphi EFI (except 11-14 FXS/FLS/FLST, 12-14 Dynas, 14 Dressers, 14 XL, and 15 Street models)	549.95
1020-2325	For 11-14 FXS/FLS/FLST, 12-14 Dyna models, 14 FLHT/FLHX/FLHR, 14 XL, and 15 XG models	549.95

**POWER VISION VISOR**

- Quick-release ability to remove or attach the Power Vision to the Techmount
- "Nutserts" are embedded and allow you to attach the visor/quick clip to mounting systems or any other system with a 4-hole pattern
- Shades display screen, improving screen visibility
- Available in flat black or black chrome



PART #	DESCRIPTION	SUG. RETAIL	PART #	DESCRIPTION	SUG. RETAIL
1020-2045	Power vision visor (flat black)	\$19.95	1020-2046	Power vision visor (black chrome)	\$19.95

**POWER COMMANDER V**

- Fuel and timing control
- Rev Xtend increases Rev limit
- The Power Commander V can read the exact engine temperature through the bike's ECM, which allows the tuner to choose how much fuel to add during cold starts
- Cold starting on heavily modified engines should be more controllable and easy to adjust
- Software displays J1850 data from bike's stock ECU
- Reduced size from the PCIII USB
- Easy-to-install
- USB powered from computer
- Two position map-switching function built-in (switch not included)
- Can add any SPST switch and toggle between two different fuel/timing maps
- Gear/speed input allows for map adjustment based on gear
- Analog input allows user to install any 0-5 volt sensor
- Build an adjustment table based on analog input, such as boost or temperature
- Power Commander V is capable of allowing each cylinder to be mapped individually and for each gear with the gear position input connected
- Ten throttle position columns
- World's largest dyno tested map database
- Enhanced "accel pump" utility
- Made in the U.S.A.



PART #	DESCRIPTION	SUG. RETAIL	PART #	DESCRIPTION	SUG. RETAIL
1020-2376	For 15 FLHT/FLHX/FLHR/FLTR	\$379.95	1020-2372	For 15 XL883	\$379.95
1020-2068	For 14 FLHT/FLHX/FLHR/FLTR	379.95	1020-2072	For 14 XL883	379.95
1020-1121	For 08-13 FLHT/FLHX/FLHR/FLTR	379.95	1020-1118	For 10-13 XL883	379.95
1020-1868	For 07 FLHT/FLHX/FLHR/FLTR	379.95	1020-0839	For 07-09 XL883	379.95
1020-1867	For 02-06 FLHT/FLHX/FLHR/FLTR	379.95	1020-2373	For 15 XL1200	379.95
1020-2375	For 15 FXST/FLS/FLST	379.95	1020-2071	For 14 XL1200	379.95
1020-1555	For 12-14 FXS/FLS/FLST (except 12-14 CVO models)	379.95	1020-1119	For 10-13 XL1200	379.95
1020-0842	For 07-11 FXST/FLSTF/FCW (except 11 CVO models)	379.95	1020-0840	For 07-09 XL1200	379.95
1020-1869	For 01-06 FXST/FLST	379.95	1020-1120	For 09-12 XR1200	379.95
1020-0940	For 07-11 FLSTC/FLSTN	379.95	1020-1557	For 12-14 V-Rod	379.95
1020-2374	For 15 Dyna Glide	379.95	1020-0844	For 08-11 V-Rod	379.95
1020-1556	For 12-14 Dyna Glide	379.95	1020-1870	For 02-07 V-Rod	379.95
1020-0843	For 06-11 Dyna Glide	379.95	1020-2261	For 15 Street 500	379.95
1020-1871	For 04-05 Dyna Glide	379.95	1020-2262	For 15 Street 750	379.95

**IMPORTANT NOTE:** SEE PAGE 411 FOR IMPORTANT INFORMATION REGARDING CERTAIN WARRANTY AND EMISSION CONTROL REGULATORY COMPLIANCE INFORMATION.

All part numbers in **BLUE** are new for 2015.



WINDSHIELDS  
& FAIRINGS

TOURING

AUDIO &  
COMMUNICATION

LUGGAGE

SEATS &  
SISSY BARS

EXHAUST

FUEL/AIR  
SYSTEMS

ENGINE

TRANSMISSION  
& DRIVELINEGASKETS  
& SEALS

ELECTRICAL

LIGHTING

HANDLEBARS,  
CONTROLS  
& MIRRORS

CABLES

BRAKES

TANKS &  
OIL FILTERSDASHES  
& GAUGESFRAMES,  
SUSPENSION  
& FENDERSFOOTRESTS  
& LICENSE  
PLATE FRAMESWHEELS  
& AXLESHARDWARE,  
CHEMICALS  
& TOOLSCOVERS,  
SECURITY  
& GENERAL**Dynojet****POWER COMMANDER V-PTI**

- Uses the same great features as the Power Commander V, but is perfect for turbocharged or supercharged applications looking for precision, control and reliability
- Modify your fuel curve based off a pressure (boost) table and/or temperature table
- Pressure table provides 3D mapping capability based on boost vs. rpm
- Temperature table provides 2D mapping capability with up to 50 points of adjustments
- Comes with a Bosch 3 bar Map/Temp sensor

PART #	DESCRIPTION	SUG. RETAIL	PART #	DESCRIPTION	SUG. RETAIL
1020-1938	For 08-13 FLHT/FLHX/FLHR/FLTR	\$449.95	1020-1820	For 06-11 Dyna Glide	\$449.95
1020-1817	For 07-11 FXST/FLST	449.95	1020-1819	For 10-13 XL1200	449.95
1020-1818	For 08-11 V-Rod	449.95			

**POWER COMMANDER V EX**

- Offers virtually the same tuning functionality and installation ease as the Power Commander V line
- Meets and complies with all California Air Resources Board regulations
- Works with Dynojet patented Tuning Link Software
- Develop custom maps the same way as the PC-V version
- Load "race only" Power Commander models into the PC-V EX
- Automatically converts to the proper format

NOTE: C.A.R.B. EO# 619-2.

PART #	DESCRIPTION	SUG. RETAIL	PART #	DESCRIPTION	SUG. RETAIL
1020-2133	For 14 FLHR/FLHTCU/FLHTK/FLHX/FLXS	\$379.95	1020-1889	For 10-13 XL883	\$379.95
1020-1499	For 08-13 FLHT/FLHX/FLHR/FLTR	379.95	1020-1496	For 07-09 XL883	379.95
1020-1500	For 07-11 FXST/FLST	379.95	1020-2122	For 14 XL1200	379.95
1020-1788	For 12-14 FXST/FLST	379.95	1020-1890	For 10-13 XL1200	379.95
1020-1501	For 04-11 Dyna Glide	379.95	1020-1497	For 07-09 XL1200	379.95
1020-1789	For 12-14 Dyna Glide	379.95	1020-1502	For 02-14 V-Rod	379.95
1020-2132	For 14 XL883	379.95			

**IMPORTANT NOTE:** SEE PAGE 411 FOR IMPORTANT INFORMATION REGARDING CERTAIN WARRANTY AND EMISSION CONTROL REGULATORY COMPLIANCE INFORMATION.

All part numbers in **BLUE** are new for 2015.



# Dynojet



66116002



53409060



43811130



1020-0014

- WINDSHIELDS & FAIRINGS
- TOURING
- AUDIO & COMMUNICATION
- LUGGAGE
- SEATS & Sissy BARS
- EXHAUST
- FUEL/AIR SYSTEMS
- ENGINE
- TRANSMISSION & DRIVELINE
- GASKETS & SEALS
- ELECTRICAL
- LIGHTING
- HANDLEBARS, CONTROLS & MIRRORS
- CABLES
- BRAKES
- TANKS & OIL FILTERS
- DASHES & GAUGES
- FRAMES, SUSPENSION & FENDERS
- FOOTRESTS & LICENSE PLATE FRAMES
- WHEELS & AXLES
- HARDWARE, CHEMICALS & TOOLS
- COVERS, SECURITY & GENERAL

## POWER COMMANDER III USB

- USB (Universal Serial Bus) port provides an instant, problem-free way to connect your Power Commander to a computer
- Provides precise information for fine-tuning a fuel-injected motorcycle when changing an air filter, installing a new exhaust system or doing additional engine performance modifications
- Each unit includes a built-in microprocessor and a specific map designed to improve engine performance over stock; Dynojet continuously maps new calibrations for each bike, which are available for downloading at their website ([www.powercommander.com](http://www.powercommander.com))
- If you do not have a computer, you can change the settings with three touch-buttons on the faceplate
- OEM-style wiring connectors with improved harness protection are supplied; no wiring modifications required
- Includes easy-to-follow instructions
- Direct injector control technology manages the fuel curve
- Features an expansion port for future add-on modules from Dynojet
- Software is compatible with Windows 98se and newer; opens all maps with .djm extension
- USB special cable and 9V battery power adapter are included
- Adapters allow you to activate a Power Commander for changing or altering maps while disconnected from the bike
- Professional adapter is ideal for service/parts department applications, consumer adapter is for limited use
- Made in the U.S.A.

### POWER COMMANDER III USB

PART #	DESCRIPTION	SUG. RETAIL	PART #	DESCRIPTION	SUG. RETAIL
1020-0002	For 99-01 Twin Cam Touring models	\$359.95	1020-0005	For 97-98 Evolution Touring models	\$359.95

### POWER ADAPTERS/CABLE

PART #	DESCRIPTION	SUG. RETAIL	PART #	DESCRIPTION	SUG. RETAIL
66116002	Repl. USB consumer 9V battery power adapter	\$14.95	43811130	International plug adapter kit	\$12.95
53409060	USB dual volt 110V/220V professional power adapter	69.95	1020-0014	Repl. USB special cable	39.95

## AUTOTUNE KIT FOR POWER VISION

- Plugs directly into the Power Vision with a single cable
- Includes 18mm O<sub>2</sub> sensors and power connector that plugs into the bike's harness
- Provides real-time AFR feedback to the Power Vision
- Allows for semi-automated fuel corrections
- User can specify what air/fuel ratio to make each rpm and throttle position percentage combination
- Makes it possible to adjust cruise for best fuel economy as well as larger throttle openings for peak power
- Base settings included for air/fuel ratios, but are fully adjustable if need be
- Made in the U.S.A.



**NOTE:** Because of possible clearance issues, some aftermarket exhaust systems may require modifications or relocation of their sensor bungs.

PART #	DESCRIPTION	SUG. RETAIL	PART #	DESCRIPTION	SUG. RETAIL
1020-1532	For use with Power Vision PART #1020-1493, 2324	\$420.95	1020-1534	For use with Power Vision PART #1020-1494, 2325	\$420.95
1020-1533	For use with Power Vision PART #1020-1493, 2324; includes weld-in 18mm bungs	429.95	1020-1535	For use with Power Vision PART #1020-1494, 2325; includes weld-in 18mm bungs	429.95

**IMPORTANT NOTE:** SEE PAGE 411 FOR IMPORTANT INFORMATION REGARDING CERTAIN WARRANTY AND EMISSION CONTROL REGULATORY COMPLIANCE INFORMATION.

All part numbers in **BLUE** are new for 2015.



## AUTO TUNE KIT FOR POWER COMMANDER V

- Plugs directly into the Power Commander V with a single cable
- Includes 18mm O<sub>2</sub> sensors and power connector that plugs into the bike's harness
- Makes automatic fuel adjustments
- User can specify what air/fuel ratio to make each rpm and throttle position percentage combination
- Makes it possible to adjust cruise for best fuel economy as well as larger throttle openings for peak power
- Base settings included for air/fuel ratios, but are fully adjustable if need be
- Made in the U.S.A.



**NOTE:** Because of possible clearance issues, some aftermarket exhaust systems may require modifications or relocation of their sensor bungs.

PART #	DESCRIPTION	SUG. RETAIL
<b>1020-1559<sup>1</sup></b>	For 14 Dressers, FXS/FLS/FLST, Dyna Glide and 14 XL models w/ CAN-bus connector	<b>\$399.95</b>
<b>1020-1117<sup>1</sup></b>	For 10-13 Dresser models with 12mm O <sub>2</sub> sensor (except FXST/FLST, Dyna Glide models)	<b>399.95</b>
<b>1020-0857</b>	For all models with 18mm O <sub>2</sub> sensors (except 11 FXST/FLST models)	<b>389.95</b>
<b>1020-1558</b>	For 11 FXS/FLST models w/ CAN-bus connector	<b>389.95</b>

<sup>1</sup> Requires installation of two 18mm sensor bungs (included).

## MULTI-FUNCTION HUB ACCESSORY FOR POWER COMMANDER USB/USB-EX

- The Multi-Function Hub allows access to advanced expansion features of the Power Commander USB
- Compatible with the LCD display, but the display is not required
- Four separate functions can be accessed with the Multi-Function Hub
- The Map Selection Switch (7/8" bar mount) allows the rider to switch between two different maps in the Power Commander. This allows a map for economy, and a separate map for performance
- The Gear Position/Speed function allows fuel and timing adjustments to be made depending on the gear selected and the position of the throttle, up to +/-50% fuel and +/-10 degrees of timing
- Pressure input allows the fuel to be increased, along with the boost level on turbocharged installations. The change of boost level does not require a re-mapping of the Power Commander
- Relay outputs allow up to two warning lights or relays to be triggered independently to activate items such as shift lights, nitrous systems, or air shifter. The trigger can be by throttle percent, rpm, or both
- Comes complete with installation instructions, wiring diagrams and CD with the required software updates
- Made in the U.S.A.



PART #	DESCRIPTION	SUG. RETAIL
<b>1020-0326</b>	Multi-Function Hub and wiring harness for Map Selection Switch only	<b>\$179.95</b>
<b>1020-0327</b>	Multi-Function Hub and wiring harness for Map Selection, Gear Position, Speed sensor, Pressure Input and two relay outputs	<b>219.95</b>

## WIDE BAND 2 AIR/FUEL RATIO MONITOR WITH COLOR LCD

- The second generation of the Dynojet Wide Band Air/Fuel Ratio Monitor kit with digital technology
- The WB2 technical features include 0-5V calibrated analog AFR output (connects to external data acquisition device), one-wire rpm hookup, 0-5V analog input (TPS, MAF, boost, etc.), built-in sensor condition test, durable enclosure and wire sheathing for years of trouble-free operation and Dynojet CAN-Link communication to allow for expansion options
- WB2 comes with one Wide Band 2 module, color touch-screen LCD, one Bosch LSU 4.2 Wide Band oxygen sensor, one oxygen sensor cable, one oxygen sensor weld bung, plug and copper washer, two Dynojet CAN-Link port seals, three wire T-taps, one terminal strip plug, two dual-lock strips, one alcohol swab, three zip ties, two Dynojet decals and installation instructions
- Includes LCD Display PART #1020-0924



PART #	DESCRIPTION	SUG. RETAIL
<b>1020-0858</b>	Air/fuel ratio monitor	<b>\$499.95</b>

## LCD ACCESSORY FOR POWER COMMANDER III USB/USB-EX AND POWER COMMANDER V

- Connects to any Power Commander USB via a "quick-disconnect" cable
- Designed to remain on the bike at all times
- Displays all available data from the Power Commander when connected
- Stores and switches between multiple maps in the on-board memory; maps can be sent to the Power Commander "on the fly"
- Adjust maps using the controls on the display screen
- Logs data for later analysis
- Data storage for maps and logging by adding an SD Memory card; sold separately
- Can be easily removed from the bike to be programmed with a desktop computer
- USB programmable and upgradable
- Uses an active matrix TFT LCD 240 x 320 16-bit screen
- Made in the U.S.A.



**1020-0325**

PART #	DESCRIPTION	SUG. RETAIL
<b>1020-0325</b>	LCD for Power Commander III USB/USB-EX	<b>\$299.95</b>
<b>1020-0924</b>	LCD for Power Commander V	<b>299.95</b>



## POD-300 DIGITAL DISPLAY

- Real time fuel adjustment
- Display channels real-time: RPM, TP, map position (when using map switch), duty cycle, fuel exchange, ignition change and wideband air/fuel ratio (w/ WB2 or auto-tune connected)
- Weather resistant for use in all conditions
- Log channels saved to internal memory and can be viewed/analyzed with Dynojet's powercore software
- High contrast display, viewable in sunlight

PART #	DESCRIPTION	SUG. RETAIL
<b>1020-2371</b>	POD-300 digital display	<b>\$249.95</b>

**IMPORTANT NOTE:** SEE PAGE 411 FOR IMPORTANT INFORMATION REGARDING CERTAIN WARRANTY AND EMISSION CONTROL REGULATORY COMPLIANCE INFORMATION.

All part numbers in **BLUE** are new for 2015.



- WINDSHIELDS & FAIRINGS
- TOURING
- AUDIO & COMMUNICATION
- LUGGAGE
- SEATS & Sissy BARS
- EXHAUST
- FUEL/AIR SYSTEMS
- ENGINE
- TRANSMISSION & DRIVELINE
- GASKETS & SEALS
- ELECTRICAL
- LIGHTING
- HANDLEBARS, CONTROLS & MIRRORS
- CABLES
- BRAKES
- TANKS & OIL FILTERS
- DASHES & GAUGES
- FRAMES, SUSPENSION & FENDERS
- FOOTRESTS & LICENSE PLATE FRAMES
- WHEELS & AXLES
- HARDWARE, CHEMICALS & TOOLS
- COVERS, SECURITY & GENERAL

**FUELPAK FP3**

- The Fuelpak FP3 will revolutionize fuel management for all new Harley-Davidson models now using the HDLAN system
- Connecting wirelessly by Bluetooth® to any iPhone® or Android Smartphone, Fuelpak FP3 uses Flash technology to recalibrate engine parameters and mapping for exhaust systems and other performance upgrades downloaded from the expansive library of calibrations developed by Vance & Hines
- Also standard for the Fuelpak FP3 is an Autotune feature, making use of all factory sensors to add another layer of precision tuning for specific requirements, whether tuning for unique components or different grades of fuel
- With the Fuelpak FP3 module plugged-in, Live Sensor Data can be viewed through the smartphone to display speed, RPM, cylinder head temperature, voltage, gear selection and other vital information



PART #	DESCRIPTION	SUG. RETAIL
1020-2203 <sup>1</sup>	For 14-15 FLHT/FLHX/FLHR, 11-15 FXS/FLS/FLST, 12-15 FXD/FXDWG, 14-15 XL, 15 XG models	\$399.95

<sup>1</sup> See emissions note bottom of page.



1020-1521



1020-0538

**FUELPAK**

- Available in original version which is not legal for sale in CA or California A.R.B; approved version with all the same features as the original
- Throttle position sensor-based system simplifies the process of fuel-injection tuning
- Enables you to fine-tune the fuel mixture throughout the entire rpm range with the touch of a button
- Increases power and improves throttle response
- Very user friendly; plugs into the existing harness on the bike
- No computer or software is required; simply punch in the values provided on the V&H website
- Values provided are for use with Vance & Hines exhaust systems
- Fuelpak will also work with other exhaust systems (contact V&H tech support for tuning information)
- Includes all necessary mounting hardware

**NOTE:** Not legal for sale or use on pollution controlled vehicles (Original Fuelpak/LCD Fuelpak).

**NOTE:** EO #D-632-1 (C.A.R.B. Fuelpak).

**NOTE:** Requires the use of a high-performance air filter.

PART #	DESCRIPTION	SUG. RETAIL
<b>LCD FUELPAK FOR 49 STATE USE</b>		
1020-1521	For 11-13 FLHT, FLHR, FLHX, FLTR models	\$289.95
1020-1694	For 12-13 Softail, Dyna models (except FXSB/SE, 12 FLSTSE)	289.95
1020-1728	For 12-13 V-Rod models	289.95
1020-2023	For 07-13 XL	289.95
<b>ORIGINAL FUELPAK FOR 49 STATE USE</b>		
1020-0568	For 08-10 FLHT, FLHR, FLHX, FLTR models	289.95
1020-0361	For 02-07 FLHT, FLHR, FLHX, FLTR models	289.95
1020-2000	For 08-11 FXCW/C, 08-11 FLSTSB, 09 FXSTSSE	289.95
1020-0538	For 07-11 FXST/B/C, 07-11 FLSTF	289.95
1020-0560	For 01-06 FXST, 01-11 FLST (except 07-11 FLSTF, 08-11 FLSTSB)	289.95
1020-2000	For 04-11 Dyna, 02-11 V-Rod and 09-12 XR1200 models	289.95
<b>PART # DESCRIPTION SUG. RETAIL</b>		
<b>CALIFORNIA A.R.B. APPROVED</b>		
1020-0822	For 08 FLHR/FLHRC/FLHX/FLTR/FLHT/FLHTC/FLHTCU	\$289.95
1020-0819	For 07 FLHR/FLHRS/FLHRC/FLHX/FLTR/FLHT/FLHTC	289.95
1020-0823	For 08 FXCW/C, 08 FLSTSB	289.95
1020-0818	For 07 FLSTN/FLSTC/FLSTSC/FXSTD, 08 FLSTN/FLSTC	289.95
1020-0820	For 07 FXD/FXD/C/FXDB/FXDL/FXDWG, 08 FXD/FXD/C	289.95
1020-0821	For 07 XL883/XL883L/XL883C/XL883R/XL883N/XL1200N/XL1200C/x1200R/XL1200L, 08 XL883/XL883L/XL883C/XL1200N/XL1200L/XL1200C/XL1200R	289.95

**THROTTLEPAK™ THROTTLE MANAGEMENT SYSTEM**

- Brings back the quick throttle response lost in throttle by wire (TBW)
- One twist of the throttle and riders will notice the improved response and acceleration
- Works on any bike's configuration; stock, modified and any exhaust combination
- Possibly the easiest performance mod ever; installs in minutes, simply plug into factory connectors
- Made in the U.S.A.



PART #	DESCRIPTION	SUG. RETAIL
1020-1726	For all 08-13 H-D Throttle By Wire (TBW) models (Touring/CVO)	\$149.95

**IMPORTANT NOTE:** SEE PAGE 411 FOR IMPORTANT INFORMATION REGARDING CERTAIN WARRANTY AND EMISSION CONTROL REGULATORY COMPLIANCE INFORMATION.

All part numbers in **BLUE** are new for 2015.

WINDSHIELDS  
& FAIRINGS

TOURING

AUDIO  
COMMUNICATION

LUGGAGE

SEATS &  
SISSY BARS

EXHAUST

FUEL/AIR  
SYSTEMS

ENGINE

TRANSMISSION  
& DRIVELINEGASKETS  
& SEALS

ELECTRICAL

LIGHTING

HANDLEBARS,  
CONTROLS  
& MIRRORS

CABLES

BRAKES

TANKS &  
OIL FILTERSDASHES  
& GAUGESFRAMES,  
SUSPENSION  
& FENDERSFOOTRESTS  
& LICENSE  
PLATE FRAMESWHEELS  
& AXLESHARDWARE,  
CHEMICALS  
& TOOLSCOVERS,  
SECURITY  
& GENERAL

1020-1367



1020-1373



### PRECISION™ ENGINE MANAGEMENT SYSTEM

- Not like any other "self-tuning" controller, Revolution Performance's Precision EMS™ is a true self-optimizing system; adjusts almost instantly with little additional adjustment
- Simply set it up and ride; no laptop, no dyno and no downloads
- Delivers instant results instead of "a little better with each ride"; while most systems require the system to "learn" more than 2000 fuel cells over a tremendous number of rides, the Precision EMS factors in air/fuel ratio, timing parameters, load and temperature ranges, then adjusts to them instantly
- Will benefit everyone, from the owner of a stock bike to a full-blown 135"
- Takes full advantage of, and retains, the stock Delphi ECU
- Maintains OEM safeguards and features, like ion-sensing knock protection
- Only system with engine-load-based timing control
- Utilizes wide band O<sub>2</sub> sensors to constantly monitor and adjust
- Includes Precision EMS controller, two wide-band O<sub>2</sub> sensors, ECU shipment box and customer information sheet
- Requires 18mm sensor bungs in the exhaust system for proper installation
- Made in the U.S.A.

NOTE: ECU will be calibrated by Revolution Performance. Pre-paid, next-day-air package included.

NOTE: Not legal for operation on public highways in the state of California.

PART #	DESCRIPTION	SUG. RETAIL
1020-1526 <sup>2</sup>	For 11 FLHT, FLHR, FLTR, FLHX	\$820.95
1020-1374 <sup>2</sup>	For 10 FLHT, FLHR, FLTR, FLHX	820.95
1020-1373	For 09 FLHT, FLHR, FLTR, FLHX	820.95
1020-1372	For 08 FLHT, FLHR, FLTR, FLHX	820.95
1020-1371	For 07 FLHT, FLHR, FLTR, FLHX	820.95
1020-1370 <sup>3</sup>	For 02-06 FLHT, FLHR, FLTR, FLHX	820.95
1020-1367	For 07-10 FLST, FXST	820.95
1020-1366 <sup>1</sup>	For 01-06 FLST, FXST	820.95
1020-1369	For 06-10 FXD, FXDWG	820.95
1020-1368 <sup>1</sup>	For 01-05 FXD, FXDWG	820.95

<sup>1</sup> 01-04 models require an upgrade to 05-up ECU.

<sup>2</sup> Requires an exhaust system with 18mm sensor bungs.

<sup>3</sup> 02-04 models require an upgrade to 05-up ECU.

**IMPORTANT NOTE: SEE PAGE 411 FOR IMPORTANT INFORMATION REGARDING CERTAIN WARRANTY AND EMISSION CONTROL REGULATORY COMPLIANCE INFORMATION.**

All part numbers in **BLUE** are new for 2015.





### Fi2000 POWRPRO WITH CVT TECHNOLOGY

- Continuously Variable Tuning (CVT) is the key to the remarkable performance the Fi2000 PowrPro delivers
- PowrPro uses electronic control technology that calculates the bike's rate of acceleration by reading crankshaft rotation at the flywheel and changes in load just as a dynamometer measures acceleration at the rear wheel
- PowrPro measures and adjusts fuel flow during acceleration to the injectors in microseconds for super-fast fuel tuning – continuously and automatically; net result: precise EFI tuning now happens in the real world in real time, nonstop, up to 80 times per second
- New patented technology unlike any other system on the market
- PowrPro tunes to precise air-fuel mixture to create maximum power 80 times per second (does not tune to a predetermined arbitrary AFR)
- Creates that adjustment to maximum power on every squirt of the injector
- It's like having the best custom map writing, dyno operator tuning your fuel every time you crank the throttle
- Tunes every gear, every roll on, every environmental change, every engine mod, lugging the engine, winding it out to redline: it reacts, verifies and adjusts when the bike is accelerating
- Provides perfect acceleration fuel settings in any condition, with any exhaust system with any engine modifications
- No matter what kind of new hardware you install on your bike – a new exhaust system, a freer-flowing air filter setup or even a big-bore hop-up kit with high-performance cams – PowrPro continues to analyze and tune your engine for peak performance
- No external adjustments needed
- No dyno needed
- No additional components needed
- Does not require wide band oxygen sensors

**NOTE:** Not legal for operation on public highways in the state of California.

PART #	DESCRIPTION	SUG. RETAIL
<b>1020-2125</b>	For 14 FLHR, FLHT, FLHX	\$599.95
<b>1020-1362</b>	For 10-13 FLHT, FLHR, FLTR, FLHX	599.95
<b>1020-2017</b>	For 10-13 FLHT Police models	599.95
<b>1020-1359</b>	For 08-09 FLHT, FLHR, FLTR, FLHX	599.95
<b>1020-2016</b>	For 08-09 FLHT Police models	599.95
<b>1020-1355</b>	For 07 FLHT, FLHR, FLTR, FLHX	599.95
<b>1020-1351</b>	For 06 FLHT, FLHR, FLTR, FLHX	599.95
<b>1020-1349</b>	For 95-05 FLHT, FLHR, FLTR, FLHX	599.95
<b>1020-1798</b>	For 12-14 FLST CVO	599.95
<b>1020-1796</b>	For 10-11 FLST CVO	599.95
<b>1020-1553</b>	For 12-14 FXS/FLS/FLST (except FXSB/SE, CVO)	599.95
<b>1020-1361</b>	For 08-11 FXST/FLST (except CVO)	599.95
<b>1020-1354</b>	For 07 FXST/FLST, 08-09 FLHT Police Model	599.95
<b>1020-1352</b>	For 06 FXST/FLST	599.95
<b>1020-1353</b>	For 01-05 FXST/FLST and 04-05 Dyna Glide	599.95
<b>1020-1358</b>	For 08-11 FXCW/FXCWC	599.95
<b>1020-1551</b>	For 12-14 Dyna Glide	599.95
<b>1020-1357</b>	For 08-11 Dyna Glide	599.95
<b>1020-1364</b>	For 07 Dyna Glide	599.95
<b>1020-1356</b>	For 06 Dyna Glide	599.95
<b>1020-2123</b>	For 14 XL	599.95
<b>1020-1363</b>	For 07-13 XL (except 12-13 XL1200V)	599.95
<b>1020-1899</b>	For 12-13 XL1200V	599.95
<b>1020-1571</b>	For 12-13 V-Rod	599.95
<b>1020-1360</b>	For 08-11 VSCRA/B/R V-Rod	599.95
<b>1020-1350</b>	For 02-07 V-Rod	599.95

**IMPORTANT NOTE:** SEE PAGE 411 FOR IMPORTANT INFORMATION REGARDING CERTAIN WARRANTY AND EMISSION CONTROL REGULATORY COMPLIANCE INFORMATION.

All part numbers in **BLUE** are new for 2015.

WINDSHIELDS &amp; FAIRINGS

TOURING

AUDIO &amp; COMMUNICATION

LUGGAGE

SEATS &amp; Sissy BARS

EXHAUST

FUEL/AIR SYSTEMS

ENGINE

TRANSMISSION &amp; DRIVELINE

GASKETS &amp; SEALS

ELECTRICAL

LIGHTING

HANDLEBARS, CONTROLS &amp; MIRRORS

CABLES

BRAKES

TANKS &amp; OIL FILTERS

DASHES &amp; GAUGES

FRAMES, SUSPENSION &amp; FENDERS

FOOTRESTS &amp; LICENSE PLATE FRAMES

WHEELS &amp; AXLES

HARDWARE, CHEMICALS &amp; TOOLS

COVERS, SECURITY &amp; GENERAL

WINDSHIELDS  
& FAIRINGS

TOURING

AUDIO &  
COMMUNICATION

LUGGAGE

SEATS &  
SISSY BARS

EXHAUST

FUEL/AIR  
SYSTEMS

ENGINE

TRANSMISSION  
& DRIVELINEGASKETS  
& SEALS

ELECTRICAL

LIGHTING

HANDLEBARS,  
CONTROLS  
& MIRRORS

CABLES

BRAKES

TANKS &  
OIL FILTERSDASHES  
& GAUGESFRAMES,  
SUSPENSION  
& FENDERSFOOTRESTS  
& LICENSE  
PLATE FRAMESWHEELS  
& AXLESHARDWARE,  
CHEMICALS  
& TOOLSCOVERS,  
SECURITY  
& GENERAL**Fi2000****Fi2000R PLUG-IN FUEL PROCESSOR**

- Proven Fi2000R comes with leads that snap directly into the bike's injector bodies
- Standard open-loop design for 06 Dyna and all 07-08 models can use exhaust systems that do or do not have O<sub>2</sub> sensor bungs
- More advanced tuning for modified bikes
- Think of third tuning pot as an electronic main jet while thinking of the entire Fi2000R as a digital jet kit
- Full range of fuel adjustment (0-10 settings) across all rpm ranges
- Three easily identifiable lights: green – Fi2000R is adding more fuel to the air/fuel ratio approx. 14:1; green and yellow lights – these lights will be on in unison when throttle is open more quickly and air/fuel mixture is approx. 12.5:1; red – light comes on and stays on as long as the Fi2000R follows the fuel curve while adjusting to approx. 12.8:1 air/fuel ratio, which is where the engine will produce its best full-throttle power
- Step-by-step instructions
- Improves rideability by smoothing out the powerband and giving the bike more throttle response
- Corrects lean air/fuel mixture problems; eliminates overheating, hesitation on acceleration or an uneven cruising rpm
- Waterproof circuit board
- No fuel map adjustments or computer downloads required

NOTE: Standard models not legal for operation on public highways in the state of California.

NOTE: Exempt per C.A.R.B. E.O. # D-633-1.

PART #	DESCRIPTION	SUG. RETAIL
<b>STANDARD</b>		
1020-0561	For 08-09 FLHT, FLHR, FLTR, FLHX	\$249.95
1020-0304	For 07 FLHT, FLHR, FLTR, FLHX	249.95
1020-0204	For 06 FLHT, FLHR, FLTR, FLHX	249.95
1020-0093	For 95-05 FLHT, FLHR, FLTR, FLHX	249.95
1020-0301	For 07-11 FXST/FLST and 06-11 Dyna Glide	249.95

PART #	DESCRIPTION	SUG. RETAIL
<b>STANDARD (CONT)</b>		
1020-0544	For 08-11 FXCW/FXCWC	\$279.95
1020-0206	For 06 FXST/FLST	249.95
1020-0095	For 01-05 FXST/FLST and 04-05 Dyna Glide	249.95
1020-0306	For 07-13 XL (except XL1200V 12-13)	249.95
1020-0626	For 08-11 V-Rod	249.95
1020-0094	For 02-07 V-Rod	249.95
1020-0341	Repl. O <sub>2</sub> Sensor Eliminator kit	34.95

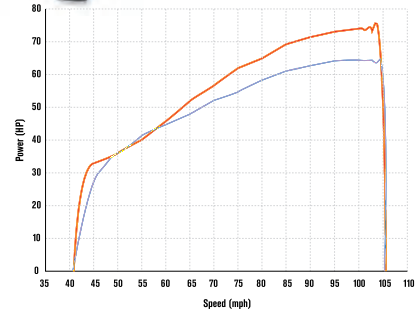

**COBRA:**  
Max Torque = 80.2  
Max Power = 74.53

**STOCK:**  
Max Torque = 73.1  
Max Power = 64.37

PART #	DESCRIPTION	SUG. RETAIL
<b>CALIFORNIA</b>		
1020-0548	For 06 FLHT, FLHR, FLTR, FLHX	\$249.95
1020-0546	For 95-05 FLHT, FLHR, FLTR, FLHX	249.95
1020-0549	For 06 FXST/FLST	249.95
1020-0550	For 01-05 FXST/FLST	249.95
1020-0547	For 02-07 V-Rod	249.95

**Fi2000****Fi2000R O<sub>2</sub> STANDARD MODEL FUEL PROCESSORS**

- The Fi2000R O<sub>2</sub> digital fuel processor is designed to work with all H-D exhaust systems (stock or aftermarket) equipped with oxygen sensors in place (closed-loop design)
- Works much like a carburetor jet kit with adjustments similar to the air-mixture screw, the needle and clip positions and the main jet
- The Fi2000R increases horsepower and torque by optimizing stock lean air/fuel mixtures (helps cool the engine temps as well)
- Quick and simple installation with plug-and-ride technology with OEM-style connectors
- No confusing computer downloads to install
- No expensive dyno-testing required
- Pre-configured from the factory for your make and model, but easy to adjust should your specific application need it
- Improves overall rideability

NOTE: Standard models not legal for operation on public highways in the state of California.

NOTE: Exempt per C.A.R.B. E.O. # D-633-1.

PART #	DESCRIPTION	SUG. RETAIL
<b>STANDARD</b>		
1020-2126	For 14 FLHT, FLHR, FLHX	\$279.95
1020-1144	For 10-13 FLHT, FLHR, FLTR, FLHX	279.95
1020-2019	For 10-13 FLHT Police models	279.95
1020-2018	For 08-09 FLHT Police models	279.95
1020-0562	For 08-09 FLHT, FLHR, FLTR, FLHX	279.95
1020-0305	For 07 FLHT, FLHR, FLTR, FLHX	279.95
1020-1554	For 12-14 FXS/FLS/FLST (except FXSB/SE, CVO)	279.95
1020-0938	For 08-11 FXST/FLST	279.95



**Low-Speed Screw**  
This control functions similar to the air mixture screw on a carburetor, controlling off-idle fuel demands and steady cruising.

**Mid-Speed Screw**  
This is the equivalent of the needle and clip position on a carburetor. Two increments correspond to dropping the clip on a needle one position. One increment is the same as adding a shim. This is where you get the proper fuel mixture under load and acceleration.

**High-Speed Screw**  
This is the electronic counterpart to your main jet. Each numbered increment is the same as going up one main jet size starting with the stock size at zero. This adjusts your fuel at full throttle.

**IMPORTANT NOTE: SEE PAGE 411 FOR IMPORTANT INFORMATION REGARDING CERTAIN WARRANTY AND EMISSION CONTROL REGULATORY COMPLIANCE INFORMATION.**All part numbers in **BLUE** are new for 2015.



# THUNDER MAX



## THUNDERMAX ECM WITH INTEGRAL AUTO TUNE SYSTEM

- ThunderMax ECM with Auto-Tune module mounts conveniently in place of the factory ECM and plugs in to the existing harness
- Utilizes wide-band O<sub>2</sub> sensors and works as a closed-loop control system to continuously self-adjust and properly tune the motorcycle's air/fuel ratio for all riding conditions
- Easy installation: replace the factory ECM, install new O<sub>2</sub> sensors and harness, load the correct map for your bike, and ride
- Includes ThunderMax ECM with Auto-Tune Module, plug-in harness and two wide-band sensors, TMax software and communication USB cable, Quick-Start Easy Install and Comprehensive User's Manual, technical support and free software and updates
- Hundreds of maps available to download for your bike (based on model, engine size, exhaust system air cleaner, pistons, cams, etc.) – load the map of your choice and the integral auto-tune will do the rest
- Improves throttle response, exhaust sound and driveability
- Does not require dyno tuning
- Rider can adjust idle speed, rev limit and speedometer calibration
- Adjustable front and rear cylinder AFR maps, ignition timing (spark) maps, and startup maps
- Works with all popular exhaust systems and is compatible with high-performance camshafts
- Supports turbo, nitrous and supercharger applications
- Software program allows live monitoring, recording and examination of diagnostic codes and datalogs including number of starts, engine temperature and rpm operation
- New maps, software, firmware updates, map analysis and tech support available online at no charge
- Made in the U.S.A.

**NOTE:** Because of possible clearance issues, some aftermarket exhaust systems may require modifications or relocation of their O<sub>2</sub> sensor port bungs.

**NOTE:** Legal in California only for racing vehicles which may never be used upon a highway. Some products may not be legal for sale or use on pollution-controlled vehicles; check your local laws and the manufacturer's information.

PART #	DESCRIPTION	SUG. RETAIL
1020-2118 <sup>1</sup>	For 14-15 FLHT, FLHR, FLHX, FLTR models and 14-15 FLSTNSE models	\$989.95
1020-0836 <sup>1</sup>	For 08-13 FLHT, FLHR, FLHX and FLTR models and 09-13 H-D FL Trike	989.95
1020-2360 <sup>1</sup>	For 12-15 FXS/FLS/FLST models, 12-15 FXD/FLD/FXDWG models and 14-15 XL models	899.95
1020-1848	For 11 FXS/FLST models	899.95
1020-1851	For 01-10 FXST/FLST, 02-07 FLHT/FLHR/FLTR/FLHX, 07-09 XL	899.95
1020-2361	For 08-10 FXCW/C, 04-11 FXD/FXDWG, 09 SE Softail, 10-13 XL models and 08-12 XR1200/X (includes mini USB pigtail)	919.95
1020-2359 <sup>1</sup>	For 11-13 FLSTSE CVO models	999.95
1020-1853 <sup>1</sup>	For 02-15 V-Rod models	919.95
1020-2382	For 15 XG500/750 models	899.95
1022-0039	Repl. 18mm oxygen sensor (ea.)	117.95

<sup>1</sup> Will require the use of an exhaust system with 18mm sensor bungs or headpipes must be modified to accept 18mm sensors.

**IMPORTANT NOTE:** SEE PAGE 411 FOR IMPORTANT INFORMATION REGARDING CERTAIN WARRANTY AND EMISSION CONTROL REGULATORY COMPLIANCE INFORMATION.

All part numbers in **BLUE** are new for 2015.

WINDSHIELDS  
& FAIRINGS

TOURING

AUDIO &  
COMMUNICATION

LUGGAGE

SEATS &  
SISSY BARS

EXHAUST

PIPET/VALVE  
SYSTEMS

ENGINE

TRANSMISSION  
& DRIVELINEGASKETS  
& SEALS

ELECTRICAL

LIGHTING

HANDLEBARS,  
CONTROLS  
& MIRRORS

CABLES

BRAKES

TANKS &  
OIL FILTERSDASHES  
& GAUGESFRAMES,  
SUSPENSION  
& FENDERSFOOTRESTS  
& LICENSE  
PLATE FRAMESWHEELS  
& AXLESHARDWARE,  
CHEMICALS  
& TOOLSCOVERS,  
SECURITY  
& GENERAL

WINDSHIELDS  
& FAIRINGS

TOURING

AUDIO &  
COMMUNICATION

LUGGAGE

SEATS &  
SISSY BARS

EXHAUST

PIGTAIL  
SYSTEMS

ENGINE

TRANSMISSION  
& DRIVELINEGASKETS  
& SEALS

ELECTRICAL

LIGHTING

HANDLEBARS,  
CONTROLS  
& MIRRORS

CABLES

BRAKES

TANKS &  
OIL FILTERSDASHES  
& GAUGESFRAMES,  
SUSPENSION  
& FENDERSFOOTRESTS  
& LICENSE  
PLATE FRAMESWHEELS  
& AXLESHARDWARE,  
CHEMICALS  
& TOOLSCOVERS,  
SECURITY  
& GENERAL**THUNDER  
MAX****THUNDERMAX NARROW BAND ECM FOR USE WITH BASSANI EXHAUST SYSTEMS**

- Loaded with custom-tuned maps specifically for Bassani exhaust systems
- ECM with integral auto-tune system utilizes the factory O<sub>2</sub> sensors and works as a closed-loop control system to continuously self-adjust and tune the motorcycle air/fuel ratio for all riding conditions
- Simple installation – replace the factory ECM, select the proper pre-loaded map for your motorcycle, and ride
- Improves power, torque and throttle response
- Maintains excellent fuel economy
- Does not require a computer – rider programming mode allows for map selection, idle speed adjustment, and speedometer calibration
- Upgradeable to wide-band version
- Made in the U.S.A.

**NOTE:** Legal for use in California only for racing vehicles which may never be used on a public highway.

PART #	DESCRIPTION	SUG. RETAIL
1020-1866	For 08-13 FLHT/FLHR/FLTR/FLHX w/ 96" or 103" stock motor and Bassani exhaust (PART #s 1800-1358/-1360/-1288/-1201/-1361)	\$499.95

**THUNDERMAX 50 ECM**

- California ARB-legal complete replacement engine-management system for Delphi®-equipped EFI model Harleys
- Integral auto-tune system utilizes wide-band O<sub>2</sub> sensors and works as a closed-loop control system to continuously self-adjust and properly tune the motorcycle's air/fuel ratio in all conditions
- Easy installation – replace the factory ECM, install new O<sub>2</sub> sensors and harness, and ride
- Improves throttle response and increases horsepower and torque
- Maintains excellent fuel economy
- Includes Thundermax 50 ECM, plug-in harness, two wide-band O<sub>2</sub> sensors, software, communication USB cable, comprehensive user's manual, full technical support and free software updates
- Software allows examination of vehicle diagnostic codes
- 01-06 models will require the exhaust system to be equipped with or modified for O<sub>2</sub> sensor bungs
- Made in the U.S.A.

**NOTE:** Because of possible clearance issues, some aftermarket exhaust systems may require modifications or relocation of their O<sub>2</sub> sensor port bungs.

**NOTE:** C.A.R.B. EO #s D-644, K-001, K-001-1, K-001-2.

PART #	DESCRIPTION	SUG. RETAIL	PART #	DESCRIPTION	SUG. RETAIL
1020-1133	For 08-10 Big Twins (except Touring models) (96" engine only)	\$899.95	1020-0837	For 01-05 Softail EFI, 02-05 Touring models (88" engine only)	\$899.95
1020-1132	For 06 FXST and Touring models (88" engine only)	899.95			

**THUNDERMAX PIGTAIL HARNESS**

- Allows a second port for the communication cable connection to the ThunderMax
- It is installed to the bike's wiring harness at the 36-pin ECM connector (connection requires harness plug disassembly; two terminated wires are inserted into two unused ports in the 36-pin connector, and a ground wire added)
- Handy for motorcycle models with tight clearances around the ECM such as Dyna, Softail Rocker and 02-05 V-Rod models
- Made in the U.S.A.

**NOTE:** PART # 1022-0059 requires ThunderMax ECM with serial number 114000 or higher (produced beginning August 2008). Will not work on previous model ThunderMax PART #232661 TBW unit.

**NOTE:** PART # 1020-1855 requires ThunderMax ECM with Mini USB communication port (beginning November 2012). Will not work on previous model ThunderMax ECM or PART #1020-0836 (Touring TBW units).

PART #	DESCRIPTION	SUG. RETAIL	PART #	DESCRIPTION	SUG. RETAIL
1022-0059	ThunderMax pigtail harness for V-Rod PART #1020-1853, Gen II PART #s 1020-0323, 1020-1279, 1020-1311 and AutoTune repl. module PART #1020-0322	\$18.95	1020-1855	ThunderMax Mini USB pigtail for remote access to modules PART #s 1020-1851, 1020-1852 and 1020-2361	\$18.95

**IMPORTANT NOTE:** SEE PAGE 411 FOR IMPORTANT INFORMATION REGARDING CERTAIN WARRANTY AND EMISSION CONTROL REGULATORY COMPLIANCE INFORMATION.

All part numbers in **BLUE** are new for 2015.





1021-0008



**TCFI GEN 5 FUEL-INJECTION CONTROLLER**

- Fully programmable plug-in replacement for the 36-pin controller with CAN data bus used on 12-13 Softail and Dyna models (not compatible with 2011 Softail that uses a different size controller)
- Quickly auto-tune fuel curves for front and rear cylinders on a dyno or on-road with new WEGO IIID dual-channel wide-band oxygen sensor interface
- Robust alpha-N (throttle position and rpm-based) fuel control eliminates problems with long duration/high overlap camshafts
- Extended data logging and diagnostics – DataFLASH memory stores full 60 minutes of operating data at 10 samples/second
- Powerful Windows software for custom programming and data analysis
- Programmable user input for functions such as two stage rpm limiter, nitrous retard and shift kill
- Programmable user output for functions such as shift light, nitrous activation, and electric shifter
- Billet aluminum housing with black anodized finish
- Easy plug-in installation
- Kit includes TCFI Gen 5 plug-in fuel injection controller, USB interface for PC link, software, WEGO IIID dual-channel wide-band exhaust gas oxygen sensor interface, two Bosch LSU 4.2 wide-band exhaust gas oxygen sensors and two 18 x 1.5mm weld nuts for exhaust pipes
- Made in the U.S.A.

**NOTE:** Not legal for sale or use on pollution-controlled vehicles.

PART #	DESCRIPTION	SUG. RETAIL
1021-0008	For 12-15 Dyna and Softail w/ CAN data bus	\$799.95
1020-2252	Bluetooth interface (provides wireless connectivity for TCFI/VRFI series engine controls; requires laptop PC w/ Bluetooth capability; Windows 7/8 recommended)	84.95

1020-2252



**TCFI GEN 4 AUTO-TUNE FUEL INJECTION CONTROLLER**

- Simultaneously auto-tune fuel curves for front and rear cylinders under actual riding conditions with WEGO IIID dual-channel wide-band oxygen sensor interface
- Fully programmable plug-in replacement for 36-pin Delphi® controller with J1850 data bus
- Robust alpha-N (throttle position and rpm based) fuel control eliminates problems with long-duration/high-overlap camshafts
- Powerful Windows software for custom programming and data analysis
- Full support for J1850 data bus used for communications with turn signal/security module (TSM/ TSSM) and instrument cluster on 04-13 models
- Support for new 6th gear indicator on 07-13 models
- Extended data logging and diagnostics; DataFLASH memory stores full 60 minutes of operating data at 10 samples/second
- Programmable user input and output
- Billet aluminum housing with black anodized finish
- Easy plug-in installation
- All outputs protected against short circuits
- Supports all sensors including theft/security module
- Includes TCFI Gen 4 plug-in fuel injection controller, USB interface for PC link, software, WEGO IIID dual-channel wide-band exhaust gas oxygen sensor interface, two Bosch LSU 4.2 wide-band exhaust gas oxygen sensors, and two 18 x 1.5mm weld nuts for exhaust pipes
- Made in the U.S.A.

**NOTE:** Not legal for sale or use on pollution-controlled vehicles.

PART #	DESCRIPTION	SUG. RETAIL
<b>AUTO-TUNE FUEL-INJECTION CONTROLLER</b>		
1021-0007	For 01-13 Twin Cam (except 08-13 Touring models)	\$799.95
1020-1895	For 02-13 V-Rod using 36-pin Delphi system with J1850 data bus	799.95
1020-1896	For 07-13 Sportster using 36-pin Delphi system with J1850 data bus	799.95
1020-2252	Bluetooth interface (provides wireless connectivity for TCFI/VRFI series engine controls; requires laptop PC w/ Bluetooth capability; Windows 7/8 recommended)	84.95

1021-0007



**REPLACEMENT COMPONENTS FOR AUTO-TUNE FUEL-INJECTION CONTROLLERS**

1022-0008	Repl. WEGO II oxygen sensor	95.95
7806-1563	18 x 1.5mm weld nut (for mounting sensor to exhaust pipe) (ea.)	6.95
1861-0831	18 x 1.5 mm stainless steel weld nut (for mounting sensor to exhaust pipe) (ea.)	10.95
7806-1564	18 x 1.5mm hex socket plug (for plugging 18 x 1.5 hole after tuning) (ea.)	6.95
1861-0833	18 x 1.5mm stainless steel hex socket plug (for plugging weld nut hole)	10.95
1861-0832	12 x 1.25mm hex socket plug (for plugging weld nut hole)	6.95

**IMPORTANT NOTE:** SEE PAGE 411 FOR IMPORTANT INFORMATION REGARDING CERTAIN WARRANTY AND EMISSION CONTROL REGULATORY COMPLIANCE INFORMATION.

All part numbers in **BLUE** are new for 2015.

- WINDSHIELDS & FAIRINGS
- TOURING
- AUDIO & COMMUNICATION
- LUGGAGE
- SEATS & SISSY BARS
- EXHAUST
- ENGINE
- TRANSMISSION & DRIVELINE
- GASKETS & SEALS
- ELECTRICAL
- LIGHTING
- HANDLEBARS, CONTROLS & MIRRORS
- CABLES
- BRAKES
- TANKS & OIL FILTERS
- DASHES & GAUGES
- FRAMES, SUSPENSION & FENDERS
- FOOTRESTS & LICENSE PLATE FRAMES
- WHEELS & AXLES
- HARDWARE, CHEMICALS & TOOLS
- COVERS, SECURITY & GENERAL

WINDSHIELDS  
& FAIRINGS

TOURING

AUDIO &  
COMMUNICATION

LUGGAGE

SEATS &  
SISSY BARS

EXHAUST

FUEL/AIR  
SYSTEMS

ENGINE

TRANSMISSION  
& DRIVELINEGASKETS  
& SEALS

ELECTRICAL

LIGHTING

HANDLEBARS,  
CONTROLS  
& MIRRORS

CABLES

BRAKES

TANKS &  
OIL FILTERSDASHES  
& GAUGESFRAMES,  
SUSPENSION  
& FENDERSFOOTRESTS  
& LICENSE  
PLATE FRAMESWHEELS  
& AXLESHARDWARE,  
CHEMICALS  
& TOOLSCOVERS,  
SECURITY  
& GENERAL

1020-0939

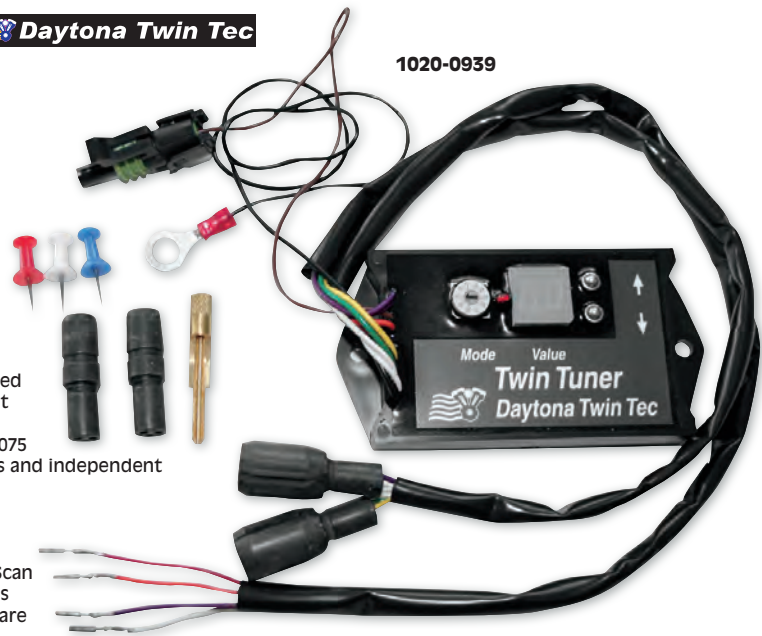
**TWIN TUNER FUEL-INJECTION CONTROLLER**

- Allows easy adjustments to OEM Delphi fuel-injection systems to improve performance and match the requirements of performance parts
- Mode and up/down pushbutton switches make fuel trim adjustments in the rpm and throttle position ranges required by most applications; fuel trim value is displayed on a bright daylight-readable LED display
- Advanced mode (using optional USB Interface PART #2101-0075 and PC Link Tuner software) allows precise fuel adjustments and independent adjustments to the front and rear cylinders
- May be compatible with other controller maps
- Easy plug-in installation and setup
- Compact size – only 4" L x 2" W x .5" H
- Compatible with Twin Scan II+ Tuning Aid – install the Twin Scan II+ and ride the bike, then copy the air/fuel ratio corrections calculated by the Twin Scan II+ into the PC Link Tuner software
- Made in the U.S.A.

**NOTE:** Not legal for sale or use on pollution-controlled vehicles.

PART #	DESCRIPTION	SUG. RETAIL
1020-1813	For 12-13 Softail and Dyna models w/ CAN data bus (except FXSB/SE)	\$254.95
1020-0358	For 01-11 Big Twin w/ 36-pin Delphi EFI (except 11 Softail, 08-11 Touring models) and 08-09 Buell XB, 1125R w/ DDFI fuel-injection system	229.95
1020-0939	For 08-13 FLHT, FLHR, FLTR and FLHX models w/ 73-pin Delphi EFI	254.95
1020-0951	For 11 Softail, 07-13 XL w/ 36-pin Delphi EFI	229.95
1020-0834	For 03-07 Buell w/ DDFI fuel-injection system	229.95

**TWIN TUNER II**

- Twin Tuner II has all the features of the original Twin Tuner and includes ignition timing control capability
- Easily adjusts the OEM Delphi fuel-injection and ignition to match the requirements of performance parts including high-compression pistons/heads, camshafts, free-flowing exhausts, and low-restriction air filters – add 30% or subtract 20% fuel and retard spark timing up to 10°
- You can use the mode and up/down pushbutton switches to make fuel trim adjustments in the rpm and throttle position ranges required by most applications. The fuel trim value is displayed on a bright daylight readable LED display
- The Twin Tuner also has an advanced mode, using the optional USB Interface and PC Link Tuner software to make precise fuel adjustments and allows independent adjustments to the front and rear cylinders
- May be compatible with other controller maps
- Easy plug-in installation and setup, with no splicing, cutting, crimping or bulky interconnections
- Compact size – only 4" L x 2" W x 1/2" H
- Compatible with Twin Scan II+ Tuning Aid – install the Twin Scan II+ and ride the bike, then copy the air/fuel ratio corrections calculated by the Twin Scan II+ into the PC Link Tuner software

**NOTE:** Not legal for sale or use on pollution-controlled vehicles.

1020-0948

PART #	DESCRIPTION	SUG. RETAIL
1020-1814	For 12-13 Softail and Dyna models w/ CAN data bus (except FXSB/SE)	\$313.95
1020-0948	For 01-11 Big Twin and 07-13 XL models w/ 36-pin Delphi EFI (except 08-11 Touring models)	263.95
1020-0949	For 08-13 FLHT, FLHR, FLTR and FLHX models w/ 73-pin Delphi EFI	313.95
1020-1328	For 02-13 V-Rod	263.95

**TWIN TUNER EX**

- Allows easy adjustments to OEM Delphi fuel-injection systems to improve performance and match the requirements of performance parts
- Mode and up/down pushbutton switches make fuel trim adjustments in the RPM and throttle position ranges required by most applications; fuel trim value is displayed on a bright daylight-readable LED display
- Advanced mode (using optional USB Interface PART #2101-0075 and PC Link Tuner software) allows precise fuel adjustments and independent adjustments to the front and rear cylinders
- Can use DynoJet Power Commander maps
- Easy plug-in installation and setup
- Compact size – only 4" L x 2" W x .5" H
- Compatible with Twin Scan II+ Tuning Aid – install the Twin Scan II+ and ride the bike, then copy the air/fuel ratio corrections calculated by the Twin Scan II+ into the PC Link Tuner software
- Note: (A.R.B. E.O. D-641) – fuel adjustments with the Twin Tuner EX are only allowed above 60% throttle position or 5000 rpm
- Made in the U.S.A.



PART #	DESCRIPTION	SUG. RETAIL
1020-0835	For 01-08 Big Twin w/ 36-pin Delphi EFI (except 08 Touring models) and 08-09 Buell XB, 1125R w/ DDFI fuel-injection system (Buell 1125R fitment not ARB certified)	\$229.95

**IMPORTANT NOTE:** SEE PAGE 411 FOR IMPORTANT INFORMATION REGARDING CERTAIN WARRANTY AND EMISSION CONTROL REGULATORY COMPLIANCE INFORMATION.All part numbers in **BLUE** are new for 2015.





1020-1794

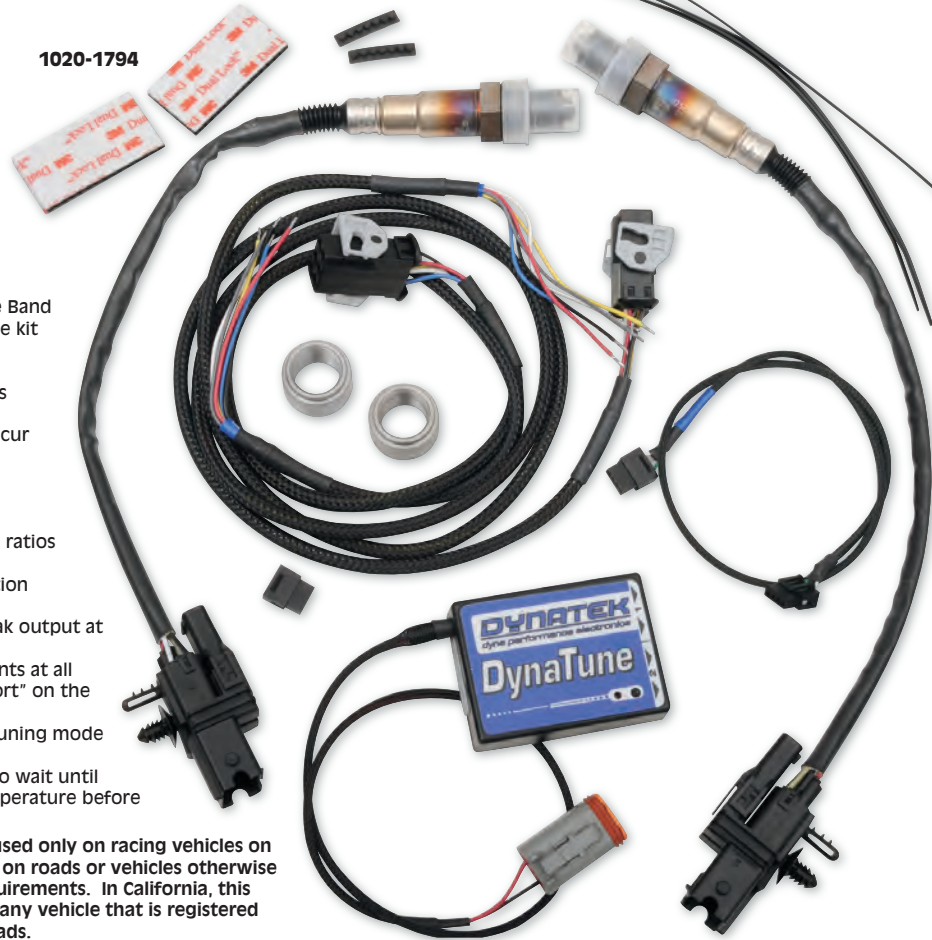

**DYNATEK DYNA TUNE AUTO TUNE KITS**

- By installing the included 18mm Wide Band O<sub>2</sub> sensor in the exhaust the Dynatune kit monitors the fuel mixture
- Send information to Dynatek control module, automatically correcting it as you ride
- Rider can feel the changes as they occur
- Each map has preset air/fuel ratio target values
- Allow the DynaTune to find the best overall settings
- For more advanced users the air/fuel ratios are fully adjustable from the baseline
- Each throttle opening/rpm combination is fully adjustable
- Allow the rider fuel economy and peak output at larger throttle openings
- Configure to run and make adjustments at all times or by using the "map switch port" on the Dynatek control module
- Switch back and forth between the tuning mode and the base map settings
- Also allow rider to configure the kit to wait until the bike is at a certain operating temperature before beginning to make adjustments

**NOTE:** This product is intended to be used only on racing vehicles on closed courses, and not for use on roads or vehicles otherwise subject to emission control requirements. In California, this product should not be used on any vehicle that is registered or licensed for use on public roads.

PART #	DESCRIPTION	SUG. RETAIL
1020-1794	For 01-10 Softail, 06-11 Dyna, 02-07 Dressers, 07-13 XL models w/ 18mm O <sub>2</sub> sensors	\$399.95
1020-1795	For 11-12 Softails, 12 Dynas	\$99.95

1020-0192

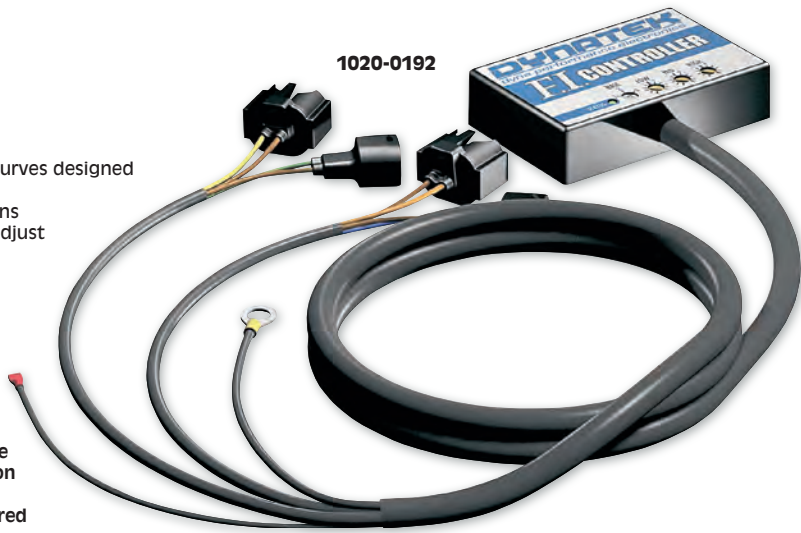

**FI CONTROLLER**

- Plug-in module offers three user-selectable base fuel curves designed to improve engine operation on fuel-injected models
- Can be configured to suit a wide variety of modifications
- Adjustments are made via three potentiometers that adjust the fuel curve in the proper ranges for the application
- Fuel mixture can be enriched or leaned as required
- Uses factory connectors for easy installation – there is no PC required for tuning or adjusting the fuel curves
- No modifications to the stock ECU
- Removing the FI controller returns vehicle to factory configuration
- Made in the U.S.A.

**NOTE:** This product is intended to be used only on racing vehicles on closed courses, and not for use on roads or vehicles otherwise subject to emission control requirements. In California, this product should not be used on any vehicle that is registered or licensed for use on public roads.

PART #	DESCRIPTION	SUG. RETAIL	PART #	DESCRIPTION	SUG. RETAIL
1020-0190	For 97-98 FLHT, FLHR, FLTR models	\$249.95	1020-0540	For 07-11 FXST/FLST	\$259.95
1020-0191	For 99-01 FLHT, FLHR, FLTR models	249.95	1020-0504	For 06 FXST/FLST	249.95
1020-0192	For 02-05 FLHT, FLHR, FLTR models	249.95	1020-0541	For 07-11 Dyna	259.95
1020-1225	For 09-13 FLHT, FLHR, FLHX, FLTR models	259.95	1020-0505	For 06 Dyna	258.95
1020-1224	For 08 FLHT, FLHR, FLHX, FLTR models	259.95	1020-0194	For 02-14 V-Rod models	249.95
1020-0539	For 07 FLHT, FLHR, FLHX, FLTR models	259.95	1020-0542	For 07-13 XL 883	259.95
1020-0503	For 06 FLHT, FLHR, FLHX, FLTR models	249.95	1020-0543	For 07-13 XL 1200	259.95
1020-0193	For 01-05 FXST/FLST, 04-05 Dyna Glide	249.95			

**IMPORTANT NOTE:** SEE PAGE 411 FOR IMPORTANT INFORMATION REGARDING CERTAIN WARRANTY AND EMISSION CONTROL REGULATORY COMPLIANCE INFORMATION.

All part numbers in **BLUE** are new for 2015.

- WINDSHIELDS & FAIRINGS
- TOURING
- AUDIO & COMMUNICATION
- LUGGAGE
- SEATS & Sissy BARS
- EXHAUST
- ENGINE
- TRANSMISSION & DRIVELINE
- GASKETS & SEALS
- ELECTRICAL
- LIGHTING
- HANDLEBARS, CONTROLS & MIRRORS
- CABLES
- BRAKES
- TANKS & OIL FILTERS
- DASHES & GAUGES
- FRAMES, SUSPENSION & FENDERS
- FOOTRESTS & LICENSE PLATE FRAMES
- WHEELS & AXLES
- HARDWARE, CHEMICALS & TOOLS
- COVERS, SECURITY & GENERAL

- WINDSHIELDS & FAIRINGS
- TOURING
- AUDIO & COMMUNICATION
- LUGGAGE
- SEATS & SISSY BARS
- EXHAUST
- FUEL/AIR SYSTEMS
- ENGINE
- TRANSMISSION & DRIVELINE
- GASKETS & SEALS
- ELECTRICAL
- LIGHTING
- HANDLEBARS, CONTROLS & MIRRORS
- CABLES
- BRAKES
- TANKS & OIL FILTERS
- DASHES & GAUGES
- FRAMES, SUSPENSION & FENDERS
- FOOTRESTS & LICENSE PLATE FRAMES
- WHEELS & AXLES
- HARDWARE, CHEMICALS & TOOLS
- COVERS, SECURITY & GENERAL



1020-2342

1020-1828



2130-0131

1861-0810

**RCX-CELERATOR CLOSED-LOOP FUEL MANAGEMENT SYSTEMS**

- Self-learning computer automatically adjusts the fuel/air mixture as you ride and compensates for changes in engine load conditions
- Automatically recalibrates for specific modifications made to your motorcycle – exhaust pipes, pistons, head work, cams, air cleaner, etc.
- Maximizes performance and engine efficiency while decreasing emissions and fuel consumption
- Quick-connect plugs for easy installation
- No downloads or adjustments required
- No dyno tuning required
- Works in conjunction with factory and race tuner downloads
- Quicker throttle response on TBW models
- Made in the U.S.A.

NOTE: Not for sale or use on California emissions-equipped motorcycles.

PART #	DESCRIPTION	SUG. RETAIL
<b>STANDARD</b>		
1020-2342	For 08-13 FLHT/FLHR/FLTR/FLHX with oval TPS connector, uses factory O <sub>2</sub> connector (6-pin)	\$449.95
1020-1836	For 12-13 Softail, 12-13 Dyna with round TPS connector (except FXSB/SE), uses factory O <sub>2</sub> connector (3-pin)	399.95
1020-1837	For 12-13 VRSC with flat TPS connector, uses factory O <sub>2</sub> connector (3-pin)	399.95
1020-1828	For 02-05 FLHT/FLHR/FLTR/FLHX, 01-05 FXST, 04-05 Dyna, 02-07 V-Rod with flat TPS connector, comes with one O <sub>2</sub> sensor (3-pin)	451.95
1020-1831	For 07-11 Softail (except 11-13 CVO), 06-11 Dyna, 07 FLHT/FLHR/FLTR/FLHX, 10 CVO with round TPS connector, uses factory O <sub>2</sub> sensors (3-pin)	399.95
1020-1829	For 06 Softail, 06 FLHT/FLHR/FLTR/FLHX with round TPS connector, comes with one O <sub>2</sub> sensor (3-pin)	451.95
1020-1830	For 95-01 Magneti Marelli models with flat TPS connector, comes with one O <sub>2</sub> sensor (3-pin)	451.95
1020-1833	For 07-13 XL with flat TPS connector, uses factory O <sub>2</sub> connector (3-pin)	399.95
1020-1834	For 08-11 VRSC with flat TPS connector, uses factory O <sub>2</sub> connector (3-pin)	399.95
<b>REPLACEMENT PARTS</b>		
2130-0131	Repl. 18MM O <sub>2</sub> sensor (ea.)	104.95
1861-0810	Repl. 18MM O <sub>2</sub> sensor bung (ea.)	15.95

**IMPORTANT NOTE: SEE PAGE 411 FOR IMPORTANT INFORMATION REGARDING CERTAIN WARRANTY AND EMISSION CONTROL REGULATORY COMPLIANCE INFORMATION.**

All part numbers in **BLUE** are new for 2015.



- WINDSHIELDS & FAIRINGS
- TOURING
- AUDIO & COMMUNICATION
- LUGGAGE
- SEATS & Sissy BARS
- EXHAUST
- ENGINE
- TRANSMISSION & DRIVELINE
- GASKETS & SEALS
- ELECTRICAL
- LIGHTING
- HANDLEBARS, CONTROLS & MIRRORS
- CABLES
- BRAKES
- TANKS & OIL FILTERS
- DASHES & GAUGES
- FRAMES, SUSPENSION & FENDERS
- FOOTRESTS & LICENSE PLATE FRAMES
- WHEELS & AXLES
- HARDWARE, CHEMICALS & TOOLS
- COVERS, SECURITY & GENERAL

**"CHEAP SHOT" FUEL TUNER**

- An economical solution to add needed fuel after installing exhaust and air cleaner performance upgrades
- Simple splice-in design saves money by eliminating costly plug-and-play connectors
- Load-based technology senses load on the engine in any riding situation to provide optimal fuel to the engine
- Adjusts like a carburetor
- Installation instructions included
- Made in the U.S.A.

**ARLEN NESS**

1020-0828



SUG. RETAIL

PART #	DESCRIPTION	SUG. RETAIL
1020-0829	For 07-09 Big Twin, 06-09 Dyna	\$149.95
1020-0828	For 95-06 Big Twin (except 06 Dyna)	149.95

NOTE: Not legal for road use in California.

**FUEL MANAGEMENT CONTROLLERS**

- Simple to use and understand system provides easy air/fuel ratio adjustment
- No computer or dyno required
- Tuning capabilities superior to Alpha N type controllers
- Easily adjusts for modifications – intake, exhaust, cams, etc.
- Easy push-button operation
- Load-based operation
- Three basic zones of operation, similar to a carburetor – one zone sets the “pilot jet” for idle and cruise, another sets the “needle jet” for acceleration and a third zone sets the “main jet” for heavy loading and wide-open throttle
- Plug and play installation
- Uses OEM base code; does not scramble base code
- Made in the U.S.A.



1020-1086

NOTE: Not legal for street use in California.

PART #	DESCRIPTION	SUG. RETAIL	PART #	DESCRIPTION	SUG. RETAIL
1020-1693	For 10-13 FLHT, FLHR, FLHX, FLTR models	\$224.95	1020-1087	For 06-11 FXD/FXDWG models	\$224.95
1020-1092	For 08-09 FLHT, FLHR, FLHX, FLTR models	224.95	1020-1086	For 95-05 Big Twin models	224.95
1020-1091	For 07 FLHT, FLHR, FLHX, FLTR models	224.95	1020-1093	For 02-07 V-Rod models	224.95
1020-1090	For 06 FLHT, FLHR, FLHX, FLTR models	224.95	1020-1094	For 08-11 V-Rod models	224.95
1020-1089	For 07-11 FXST/FLST models	224.95	1020-1095	For 07-13 XL models	224.95
1020-1088	For 06 FXST/FLST models	224.95	1020-1096	For 99-07 Buell models	224.95



**EFI POWER PROGRAMMER**

- Get riding quickly with this fuel-management unit and select the mode that suits your style
- Plugs into existing wiring using the stock connectors
- Unlike most other fuel-injection programmers, this one is load-sensitive
- No laptop or software required

NOTE: Professional installation is recommended.

PART #	DESCRIPTION	SUG. RETAIL
1020-1491	For 08-12 XR1200/1200X	\$359.95

**Daytona Twin Tec**

**FI-TO-CARBURETOR CONVERSION KIT**

- Allows most Big Twin and XL models with Delphi EFI to be converted to a carb fuel system
- Uses existing wiring harness with no modifications needed
- All functions of the turn signal/security module continue to function normally
- Includes required software and detailed instructions
- Made in the U.S.A.

NOTE: Requires the separate purchase of USB interface PART #2101-0075.

NOTE: Requires the separate purchase of a Pingel fuel injection-to-carb tank fitting kit PART #0705-0031.



1020-2033



2101-0075

PART #	DESCRIPTION	SUG. RETAIL
1020-2033	For 01-13 Big Twin and 07-13 XL models w/ 36-pin connector (except 11-13 Softail and 12-13 Dyna)	\$544.95
2101-0075	USB interface kit	84.90

**ADJUSTABLE O<sub>2</sub> ENRICHMENT DEVICES**

- Enrichment devices are intended to give riders the proper fuel mixture when adding performance mufflers, pipes and high flow air filter upgrades
- Adjustable version allows external adjustment of the air-fuel ratio in closed-loop mode
- Cheaper than other fuel management programmers or auto tuners
- Reduces engine temperature between 20-30 degrees
- Recommended for models with high-flow air intakes and exhaust
- PART #1020-1715 includes AFR display
- Made in the U.S.A.

NOTE: Not legal for street use on pollution controlled vehicles.

PART #	DESCRIPTION	SUG. RETAIL
1020-1717	For 10-15 Touring models, all 12-15 Softail, Dyna and V-Rod models	\$129.95
1020-1714	For all 08-09 XB9/XB12 Buell models w/ stock ECM	84.95
1020-1716	For 06-11 Dyna, 07-11 Softail, 07-13 XL and 07-08 Touring models	129.95
1020-1715	For 06-11 Dyna, 07-11 Softail, 07-13 XL and 07-08 Touring models (adjustable)	195.95



NM2 Custom Cycle Products



1020-1717



1020-1714



1020-1716



1020-1715

**O<sub>2</sub> ENRICHMENT DEVICE**

- Reduce your engine's temperature between 20 to 30 degrees
- Installs in a few minutes; simply plug in between the oxygen sensors and the OEM wiring harness
- Recommended for models with high-flow air intakes and exhausts
- Sold in pairs
- Made in the U.S.A.

NOTE: Not legal for street use on pollution controlled vehicles.

PART #	DESCRIPTION	SUG. RETAIL
1020-1296	For 10-15 Touring models and 12-15 Softail/Dyna models (all)	\$129.95
1020-1295	For 09 Touring models (all)	119.95
1020-1151	For 07-08 Touring models and all 07-11 Big Twin Race (except 08-11 Touring and H-D FL Trikes)	119.95
1020-0796	For 06 Dyna and all 07-11 models (except 08-12 Touring and H-D FL Trikes)	88.95
1020-1152	For 07-13 XL and 09-12 XR 1200	119.95



NM2 Custom Cycle Products



1020-0796

**IMPORTANT NOTE: SEE PAGE 411 FOR IMPORTANT INFORMATION REGARDING CERTAIN WARRANTY AND EMISSION CONTROL REGULATORY COMPLIANCE INFORMATION.**

All part numbers in **BLUE** are new for 2015.

- WINDSHIELDS & FAIRINGS
- TOURING
- AUDIO & COMMUNICATION
- LUGGAGE
- SEATS & SISSY BARS
- EXHAUST
- FUEL/AIR SYSTEMS
- ENGINE
- TRANSMISSION & DRIVELINE
- GASKETS & SEALS
- ELECTRICAL
- LIGHTING
- HANDLEBARS, CONTROLS & MIRRORS
- CABLES
- BRAKES
- TANKS & OIL FILTERS
- DASHES & GAUGES
- FRAMES, SUSPENSION & FENDERS
- FOOTRESTS & LICENSE PLATE FRAMES
- WHEELS & AXLES
- HARDWARE, CHEMICALS & TOOLS
- COVERS, SECURITY & GENERAL



**SINGLE-BORE THROTTLE BODIES AND MANIFOLDS**

- Designed for riders seeking the greatest possible performance gains from their fuel-injected engines
- For maximum tunability and performance gains an S&S Variable Fuel-Injection (VFI) module is recommended (sold separately), but any compatible, programmable module with enough capability and tuning range can be used
- Components must be purchased separately to complete a Single-Bore EFI assembly
- Made in the U.S.A.

NOTE: Appropriate air cleaner kit must be ordered separately, see page 628

PART #	DESCRIPTION	SUG. RETAIL
<b>THROTTLE BODIES</b>		
1022-0029	52mm for stock 01-05 EFI Big Twin and aftermarket models (Delphi-style)	\$723.95
1022-0081	58mm for 01-05 EFI Big Twin and aftermarket models (Delphi-style)	723.95
1022-0082	58mm for 06-15 Big Twin and aftermarket models (Delphi-style) (except 08-15 Touring models)	642.95
<b>MANIFOLDS</b>		
1050-0151	52mm for 80", 88", 89", 95", 96", 103" and 106" motors	144.95
1050-0243	58mm for 124" 01-05 Big Twin w/ 5.013" cylinder length	144.95
1050-0261	58mm for 96", 103" and 106" 06-14 Big Twins w/ stock or S&S heads w/ 4.937" cylinder length	144.95

**ELLIPTICAL HIGH-TORQUE THROTTLE BODY AND 58" MANIFOLD KIT**



- Replaces OEM throttle body and manifold
- Provides quicker throttle response through elliptical intake track design
- Wider manifold to fit most taller engines
- Compatible with all OEM electrical components, including throttle position sensors, air control motors and fuel injectors
- Electronic components not included (MAP sensor, fuel rails and injectors)
- Made in the U.S.A.

NOTE: Manifold may require custom fitting based on intake port location.



PART #	DESCRIPTION	SUG. RETAIL
1022-0048	For 06-10 Delphi EFI Twin Cam models (except 08-10 FLHT/FLHR/FLHX/FLTR and H-D FL trikes)	\$763.95

**IMPORTANT NOTE: SEE PAGE 411 FOR IMPORTANT INFORMATION REGARDING CERTAIN WARRANTY AND EMISSION CONTROL REGULATORY COMPLIANCE INFORMATION.**

All part numbers in **BLUE** are new for 2015.





**MAXFLOW™ THROTTLE BODIES**

- Large plenum design maximizes mid- and high-rpm power
- Specifically designed for larger cubic inch motors that require substantial airflow
- Fully machined and ported internally for unparalleled flow
- Feature a natural finish with split shaft design and stainless steel spring
- Equipped with a sealed double roller bearing for smooth throttle operation
- Brass throttle blade and shaft resist deflection, which helps maintain throttle position accuracy
- Completely replaces OEM throttle body and manifold; fully compatible with OEM components
- Made in the U.S.A.

NOTE: Size given for throttle bodies is measured at the butterfly.

PART #	THROTTLE BODY	MANIFOLD	INTAKE RUNNER	SUG. RETAIL
<b>FOR 06-15 TWIN CAM W/ DELPHI EFI (EXCEPT 08-15 FLHT, FLHR, FLHX, FLTR AND H-D FL TRIKES)</b>				
1022-0067	55mm	58mm	1.800"	\$785.95
1022-0088	58mm	62mm	1.710"	785.95
1022-0089	58mm	62mm	1.800"	785.95

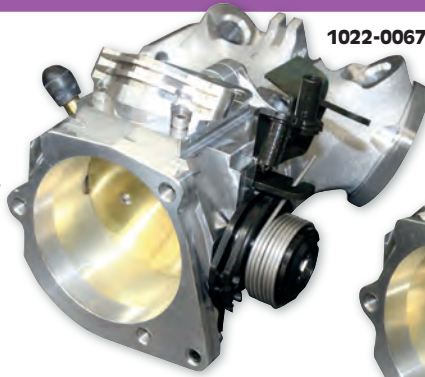

**BIG BORE THROTTLE BODIES**

- Flow bench-tested and dyno-proven to deliver increased airflow, horsepower and torque
- Fully machined and ported internally for unparalleled flow
- Feature a natural finish with split shaft design and stainless steel spring
- Equipped with a sealed double roller bearing for smooth throttle operation
- Brass throttle blade resists deflection, which helps maintain throttle position accuracy
- Completely replaces OEM throttle body and manifold; fully compatible with OEM components
- Made in the U.S.A.

NOTE: Size given for throttle bodies is measured at the butterfly.

PART #	DESCRIPTION	INTAKE RUNNER	SUG. RETAIL
<b>FOR 06-15 TWIN CAM WITH DELPHI EFI (EXCEPT 08-15 FLHT, FLHR, FLHX, FLTR AND H-D FL TRIKES)</b>			
1022-0064	51mm	1.710"	\$693.95
1022-0065	55mm	1.800"	693.95

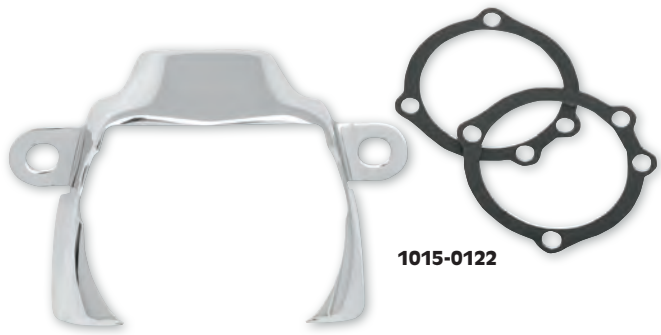

**THROTTLE BODY COVERS**

- Mount behind the air cleaner assembly
- Clean up the look and add a chrome finish



PART #	DESCRIPTION	SUG. RETAIL
1015-0121	For 02-07 FLHT/FLHR/FLTR/FLHX, 01-15 FLST/FXST, 04-15 Dyna w/ EFI and Kuryakyn Hypercharger™, Pro Series Hypercharger or Pro-R Hypercharger	\$49.95
1015-0122	For 02-07 FLHT/FLHR/FLTR/FLHX, 01-15 FLST/FXST, 04-15 Dyna w/ EFI and Kuryakyn air cleaner (except Hypercharger or Twin Velocity/Twin Velocity Plus), Arlen Ness Big Sucker Stage I or II air cleaner or Screamin' Eagle Stage I air cleaner and Heavy Breather	49.95



**INJECTI-COVERS™**

- Constructed from 16-gauge cold-rolled steel, polished, then chrome-plated
- Great looking covers hide the OEM throttle body
- Offer a true custom look
- Made in the U.S.A.



NOTE: Covers may not fit with all styles of breather kits and support brackets. Check clearance before mounting.

PART #	DESCRIPTION	SUG. RETAIL
1022-0002	For 01-15 FXST/FLST, 02-13 FLT w/ Screamin' Eagle air filter	\$59.95

**IMPORTANT NOTE: SEE PAGE 411 FOR IMPORTANT INFORMATION REGARDING CERTAIN WARRANTY AND EMISSION CONTROL REGULATORY COMPLIANCE INFORMATION.**

All part numbers in **BLUE** are new for 2015.

- WINDSHIELDS & FAIRINGS
- TOURING
- AUDIO & COMMUNICATION
- LUGGAGE
- SEATS & Sissy BARS
- EXHAUST
- ENGINE
- TRANSMISSION & DRIVELINE
- GASKETS & SEALS
- ELECTRICAL
- LIGHTING
- HANDLEBARS, CONTROLS & MIRRORS
- CABLES
- BRAKES
- TANKS & OIL FILTERS
- DASHES & GAUGES
- FRAMES, SUSPENSION & FENDERS
- FOOTRESTS & LICENSE PLATE FRAMES
- WHEELS & AXLES
- HARDWARE, CHEMICALS & TOOLS
- COVERS, SECURITY & GENERAL

WINDSHIELDS  
& FAIRINGS

TOURING

AUDIO &  
COMMUNICATION

LUGGAGE

SEATS &  
SISSY BARS

EXHAUST

RACE/TEAM  
SYSTEMS

ENGINE

TRANSMISSION  
& DRIVELINEGASKETS  
& SEALS

ELECTRICAL

LIGHTING

HANDLEBARS,  
CONTROLS  
& MIRRORS

CABLES

BRAKES

TANKS &  
OIL FILTERSDASHES  
& GAUGESFRAMES,  
SUSPENSION  
& FENDERSFOOTRESTS  
& LICENSE  
PLATE FRAMESWHEELS  
& AXLESHARDWARE,  
CHEMICALS  
& TOOLSCOVERS,  
SECURITY  
& GENERAL

1861-0887



1861-0884



1861-0978

**18 MM O<sub>2</sub> SENSORS**

- Precision manufactured with a ceramic body made of stabilized zirconium dioxide, surface coated with gas-permeable platinum electrodes and a porous ceramic to help prevent erosion due to contamination and particulates in the exhaust gases
- Slow reading oxygen sensors can cause a drop in fuel economy of 10-15%, excessive exhaust emissions and poor drivability
- Life expectancy of an average oxygen sensor in a properly tuned engine is typically 30,000-50,000 miles
- Narrow band O<sub>2</sub> sensors available in 12.5", 16.25" and 22.25" overall lengths
- Replacement Wide Band O<sub>2</sub> sensor for aftermarket ignition tuners also available; overall length is 30.25"
- All sensors meet or exceed OE specifications

**WIDE BAND O<sub>2</sub> SENSORS**

PART #	DESCRIPTION	SUG. RETAIL
<b>FOR AFTERMARKET TUNERS</b>		
1861-0887	30.25" length	\$119.95

**NARROW BAND O<sub>2</sub> SENSORS**

PART #	DESCRIPTION	LOCATION	SUG. RETAIL
1861-0884	For 07-08 Touring, 07-13 Sportster models	Front and rear (12.5")	\$59.95
1861-0884	For 09 Touring models	Rear (12.5")	59.95
1861-0885	For 07-11 Softail, 06-11 Dyna models	Front and rear (16.25")	59.95
1861-0885	For 09 Touring, 09 V-Rod models	Front (16.25")	59.95
1861-0886	For 08 V-Rod models	Front and rear (22.25")	59.95
1861-0886	For 09 V-Rod models	Rear (22.25")	59.95

**FUEL REGULATOR HOUSING**

- Anodized black housing is CNC machined from billet aluminum
- Replaces the plastic OEM housing
- Made in the U.S.A.



PART #	DESCRIPTION	SUG. RETAIL
1009-0025	For 01-07 FXST/FLST, 02-07 FLHT/FLHX/FLHR/FLTR models; repl. OEM #62373-01	\$48.95

**FUEL PRESSURE REGULATOR**

- 62 psi Delphi regulator
- Designed for greater fuel delivery
- Engineered for a direct fit in most OEM fuel-injection applications
- Made in the U.S.A.



PART #	DESCRIPTION	SUG. RETAIL
1009-0013	For 02-07 FLT/FLHT/FLHR/FLTR, 01-07 FXST/FLST	\$128.95

**FUEL PUMP COMPONENTS**

- All parts are OEM replacement
- Check OEM part # for the correct application
- Sold each

PART #	DESCRIPTION	SUG. RETAIL
<b>HOUSING END CAP</b>		
0706-0134	For 02-07 FLT/FLHT/FLHR/FLTR models, 01-07 FXST/FLST models; repl. OEM #62165-01	\$12.95
<b>FILTER END CAP</b>		
0706-0133	For 04-15 FXD models; repl. OEM #61013-04A	12.95
<b>FUEL PRESSURE REGULATOR</b>		
0706-0237	For 08-15 FLHT/FLTR/FLHR models, 04-15 FXD, FXDWG models, 08-15 FXST/FLST models; repl. OEM #61015-04A	28.95
0706-0236	For 02-07 FLT/FLHT/FLTR/FLHR models, 01-08 FXST/FLST models; repl. OEM #27408-01	36.95
<b>REGULATOR HOUSING</b>		
1009-0014	For 01-07 Softail and 02-07 Touring models; repl. OEM #62373-01	13.95

**IMPORTANT NOTE:** SEE PAGE 411 FOR IMPORTANT INFORMATION REGARDING CERTAIN WARRANTY AND EMISSION CONTROL REGULATORY COMPLIANCE INFORMATION.

**18MM O<sub>2</sub> SENSORS**

- Precision made for outstanding performance
- Meet or exceed OEM standards
- Easy fit with no modifications needed
- Extra high-temperature dual-shield end
- Sold each
- Made in the U.S.A.

PART #	DESCRIPTION	SUG. RETAIL
1861-0977	7.5" length; repl. OEM #27719-07	\$41.95
1861-0978	11.5" length; repl. OEM #27683-07	41.95
1861-0979	17.5" length; repl. OEM #27703-08	41.95

**WIDE-BAND BOSCH O<sub>2</sub> SENSOR**

- 18mm sensor for use with air/fuel ratio meters



PART #	DESCRIPTION	SUG. RETAIL
1861-0521	Bosch O <sub>2</sub> sensor	\$99.95

1020-1395



1020-1478



1020-1479

**OXYGEN SENSOR ELIMINATOR KITS AND ACTIVE INTAKE AND EXHAUST ELIMINATOR KIT**

- Oxygen Sensor Eliminator Kits allow air/fuel ratio changes for racing applications
- Active Intake and Exhaust Eliminator Kit is used to avoid setting a diagnostic trouble code when installing some aftermarket air filters and exhaust that require the removal of original equipment active systems; for off-road racing use only
- Made in the U.S.A.

NOTE: Not legal for sale or use on pollution-controlled vehicles.

PART #	DESCRIPTION	SUG. RETAIL
<b>OXYGEN SENSOR ELIMINATOR KITS</b>		
1020-1395	For 06-11 models (except 10-11 FLHR/FLHT/FLHX/FLTR and H-D FL Trikes)	\$25.95
1020-1478	For 10-13 FLHR/FLHT/FLHX/FLTR and H-D FL Trikes	36.95
<b>ACTIVE INTAKE AND EXHAUST ELIMINATOR KIT</b>		
1020-1479	For late-model European spec models w/ active intake and exhaust	28.95

**INDUCTION MODULE ASSEMBLY O-RING KIT**

- Kit contains fuel fitting O-rings
- Made in the U.S.A.



PART #	DESCRIPTION	SUG. RETAIL
DS-174988	For 95-01 FLT, FLHT, FLHR fuel-injected models; repl. OEM #17043-95	\$17.95

0706-0134



0706-0133



0706-0237



1009-0014





- WINDSHIELDS & FAIRINGS
- TOURING
- AUDIO & COMMUNICATION
- LUGGAGE
- SEATS & Sissy BARS
- EXHAUST
- FUEL/AIR SYSTEMS
- ENGINE
- TRANSMISSION & DRIVELINE
- GASKETS & SEALS
- ELECTRICAL
- LIGHTING
- HANDLEBARS, CONTROLS & MIRRORS
- CABLES
- BRAKES
- TANKS & OIL FILTERS
- DASHES & GAUGES
- FRAMES, SUSPENSION & FENDERS
- FOOTRESTS & LICENSE PLATE FRAMES
- WHEELS & AXLES
- HARDWARE, CHEMICALS & TOOLS
- COVERS, SECURITY & GENERAL



DS-289284



1022-0009



DS-289143



DS-289144



DS-289285



DS-189001



**ELECTRONIC FUEL-INJECTION COMPONENTS**

- High-quality OEM replacements
- Sold each

PART #	DESCRIPTION	SUG. RETAIL
<b>INJECTORS</b>		
DS-289284	For 01-05 FXST, FLST, 02-05 FLT and 04-05 Dyna models (32 lb. per hour) (ea.); repl. OEM #27609-01	\$178.95
1022-0009	For 01-05 FXST, FLST, 02-05 FLT and 04-05 Dyna models (high flow, 47 lb. per hour) (ea.); repl. OEM #27609-01	214.95
<b>FUEL REGULATORS</b>		
1009-0005	For 95-99 (350 kPa), (50 PSI); repl. OEM #27219-95	89.95
DS-289143	For 95-99 (300 kPa), (43 PSI); repl. OEM #27219-95	74.95
<b>AIR TEMPERATURE SENSOR</b>		
DS-289144	For 95-05; repl. OEM #27270-95	43.95
<b>ENGINE TEMPERATURE SENSOR</b>		
DS-289285	For 99-15; repl. OEM #32446-99	38.95
<b>BAROMETRIC PRESSURE SWITCH</b>		
DS-189001	For 95-98 (100 kPa); repl. OEM #32424-95	64.95



2103-1002



1022-0021



1022-0022



1050-0039

PART #	DESCRIPTION	SUG. RETAIL
<b>THROTTLE POSITION SENSORS</b>		
2103-1002	For 01-05 FXSTI, FLSTI, FXSTDI, 02-05 FLT, FLHT and 04-05 Dyna models; repl. OEM #27629-01	\$69.95
1022-0021	For 06-15 Dyna, FXST, FLST and 06-07 FLHT models; repl. OEM #27659-06	24.95
<b>IDLE AIR CONTROL MODULES</b>		
1022-0022	For 06-15 Dyna, FXST, FLST and 06-07 FLHT models; repl. OEM #27658-06	50.95
1022-0084	For 01-05 FXST/FLST, 02-05 FLHT/FLHR/FLTR, 04-05 Dyna and 02-10 VRSC models; repl. OEM #27628-01	56.95
<b>MAP SENSOR WITH SEAL</b>		
1050-0039	For 99-10 fuel-injected models (except 08-10 Dressers), 00-06 Big Twin Carb models and 04-06 XL; repl. OEM #32316-99	79.95

1022-0077



1022-0072



1009-0011



1009-0012



1050-0238



1050-0239



**ELECTRONIC FUEL-INJECTION COMPONENTS**

- OEM replacement parts
- See factory parts manual for part number and application
- Sold each

PART #	DESCRIPTION	SUG. RETAIL
<b>INJECTORS</b>		
1022-0077	For 01-05 FXST, FLST, 02-05 FLT and 04-05 Dyna models (32 lb. per hour) (ea.); repl. OEM #27609-01	\$188.95
1022-0072	For 01-05 FXST, FLST, 02-05 FLT and 04-05 Dyna models (high flow, 47 lb. per hour) (ea.); repl. OEM #27609-01	229.95
<b>FUEL REGULATORS</b>		
1009-0011	For 95-99 (350 kPa); repl. OEM #27219-95	94.95
1009-0012	For 95-99 (300 kPa); repl. OEM #27219-95	77.95
<b>AIR TEMPERATURE SENSOR</b>		
1050-0238	For 95-05; repl. OEM #27270-95	45.95
<b>ENGINE TEMPERATURE SENSOR</b>		
1050-0239	For 99-15; repl. OEM #32446-99	41.95

1022-0076



1022-0073



1022-0074



1022-0085



1022-0075



PART #	DESCRIPTION	SUG. RETAIL
<b>THROTTLE POSITION SENSORS</b>		
1022-0076	For 01-05 FXSTI, FLSTI, FXSTDI, 02-05 FLT, FLHT and 04-05 Dyna models; repl. OEM #27629-01	\$71.95
1022-0073	For 06-15 Dyna, FXST, FLST and 06-07 FLHT models; repl. OEM #27659-06	35.95
<b>IDLE AIR CONTROL MODULES</b>		
1022-0074	For 06-15 Dyna, FXST, FLST and 06-07 FLHT models; repl. OEM #27658-06	53.95
1022-0085	For 01-05 FXST/FLST, 02-05 FLHT/FLHR/FLTR, 04-05 Dyna and 02-10 VRSC models; repl. OEM #27628-01	58.95
<b>MAP SENSOR WITH SEAL</b>		
1022-0075	For 99-10 fuel-injected models (except 08-10 Dressers), 00-06 Big Twin Carb models and 04-06 XL; repl. OEM #32316-99	72.95



**HI FLOW FUEL INJECTORS**

- A must for any high-performance motor
- Flow 8.69 grams per second; provides more flexibility in tuning the motor
- Sold in pairs
- Made in the U.S.A.

PART #	DESCRIPTION	SUG. RETAIL
1022-0106	For 01-05 Softail, 02-05/08-13 FL Touring, 04-05 Dyna	\$379.95



1022-0105

**HI FLOW FUEL RAIL AND INJECTORS**

- Fuel rail is machined from T-6061 billet aluminum then black anodized
- High-flow injectors flow 8.69 grams per second
- Will support over 200 horsepower
- Made in the U.S.A.

PART #	DESCRIPTION	SUG. RETAIL
1022-0105	For 02-15 V-Rod	\$649.95



**"YELLOW BAND" FUEL INJECTORS**

- 43% increase in flow over stock injectors
- 6.2 gps (grams per second) "yellow band" fuel injector
- Recommended for "Big Inch" engines with large plenums (120 hp or greater)
- Sold in pairs
- Made in the U.S.A.

PART #	DESCRIPTION	SUG. RETAIL
1022-0083	For 02-05 FLHT/FLHR/FLHX/FLTR, 01-05 FLST/FXST and 04-05 FXD	\$285.95

**IMPORTANT NOTE: SEE PAGE 411 FOR IMPORTANT INFORMATION REGARDING CERTAIN WARRANTY AND EMISSION CONTROL REGULATORY COMPLIANCE INFORMATION.**

All part numbers in **BLUE** are new for 2015.

WINDSHIELDS  
& FAIRINGS

TOURING

AUDIO &  
COMMUNICATION

LUGGAGE

SEATS &  
SISSY BARS

EXHAUST

FUEL/AIR  
SYSTEMS

ENGINE

TRANSMISSION  
& DRIVELINEGASKETS  
& SEALS

ELECTRICAL

LIGHTING

HANDLEBARS,  
CONTROLS  
& MIRRORS

CABLES

BRAKES

TANKS &  
OIL FILTERSDASHES  
& GAUGESFRAMES,  
SUSPENSION  
& FENDERSFOOTRESTS  
& LICENSE  
PLATE FRAMESWHEELS  
& AXLESHARDWARE,  
CHEMICALS  
& TOOLSCOVERS,  
SECURITY  
& GENERAL

DS-0452



DS-0419

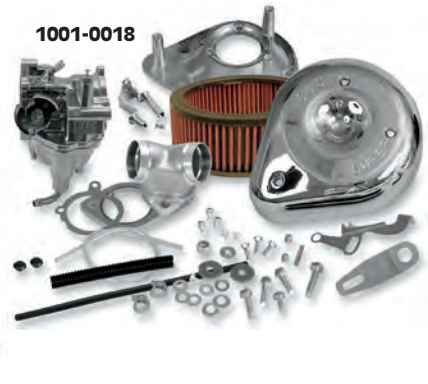

1001-0018



## SUPER E AND G SHORTY CARBURETOR KITS

•Each carb kit includes an S&S Super E or Super G gas carburetor with updated fuel delivery pots and idle screw, S&S teardrop air cleaner assembly, manifold (unless noted), mounting hardware, fuel line, clamps, overflow line, one extra intermediate jet and two main jets, VOES tubing (when applicable), installation and jetting instructions

•Super E has a 1.875" throat at the butterfly and a 1.5625" venturi and is recommended for use on Big Twin or Sportster engines up to 100-cubic-inch

•Super G has a 2.0625" throat at the butterfly and a 1.75" venturi and is recommended for use on 90-cubic-inch and larger high-performance and modified engines

•2.0625" G is not recommended for smaller, lower compression engines

•If there is a doubt as to which carburetor to use, we suggest the 1.875" Super E

•Individual carburetors also available

•Made in the U.S.A.

**NOTE:** S&S Super E & G carburetors require the use of a two-cable, pull open/pull close throttle assembly; S&S kits are compatible with stock cables except as noted.

**NOTE:** Recommended for racing only, this carburetor is not legal for use in California on motor vehicles operated on public highways or in other states where similar pollution laws may apply. User must determine the suitability of the product for his or her use and assumes all risk and liability in connection therewith.



DS-0448



1002-0025

DESCRIPTION	1.875" SUPER E CARB KIT	SUG. RETAIL	2.0625" SUPER G CARB KIT	SUG. RETAIL
<b>FOR BIG TWIN MODELS (INCLUDES MANIFOLD)</b>				
For 99-05 Twin Cam	DS-0452	\$579.95	DS-0453	\$599.95
For 92-99 Evolution Big Twin	DS-0419	579.95	DS-0434	599.95
For 84-91 Evolution Big Twin	DS-0407	579.95	DS-0427	599.95
<b>FOR BIG TWIN MODELS (NO MANIFOLD)</b>				
For 92-99 Evolution Big Twin	DS-0442	509.95	-	-
For 84-91 Evolution Big Twin	DS-0440	509.95	-	-
<b>FOR XL MODELS (INCLUDES MANIFOLD)</b>				
For 04-06 XL	1001-0018	579.95	-	-
For 91-03 XL	DS-0409	579.95	-	-
For 86-90 XL	DS-0408	579.95	-	-
<b>FOR BUELL MODELS (INCLUDES MANIFOLD)</b>				
For 94-02 Buell models	DS-0448	579.95	-	-

PART #	DESCRIPTION	SUG. RETAIL
<b>REPLACEMENT COMPONENTS</b>		
1002-0025	Super E carburetor only	\$349.95
1002-0026	Super G carburetor only	369.95
1014-0133	Repl. S&S air cleaner cover for E & G carb, black	121.95
1014-0040	Repl. Slasher-style air cleaner cover, chrome	143.95
DS-289404	Repl. S&S air cleaner cover, chrome	143.95
1011-1721	Repl. air cleaner element for E & G carbs	18.95
DS-289405	Repl. air cleaner screws (10-pk.)	.95 (ea.)
1011-0324	Repl. breather hose for 93-06 Big Twin and 91-03 XL	6.95
1011-0325	Breather screw seals (silicone-coated steel washer), .520" (10-pk.)	1.25 (ea.)
1011-0326	Breather screw seals (silicone-coated steel washer), .380" (10-pk.)	1.25 (ea.)



## CRUISE CONTROL ADAPTER KIT

•Super Shorty carbs can easily be installed on motorcycles equipped with stock H-D cruise control

•Includes all parts and instructions needed to complete installation

•Made in the U.S.A.

PART #	DESCRIPTION	SUG. RETAIL
1003-0022	For 98-06 Big Twin	\$67.95

**IMPORTANT NOTE:** SEE PAGE 411 FOR IMPORTANT INFORMATION REGARDING CERTAIN WARRANTY AND EMISSION CONTROL REGULATORY COMPLIANCE INFORMATION.

All part numbers in **BLUE** are new for 2015.



- WINDSHIELDS & FAIRINGS
- TOURING
- AUDIO & COMMUNICATION
- LUGGAGE
- SEATS & SISSY BARS
- EXHAUST
- ENGINE
- TRANSMISSION & DRIVELINE
- GASKETS & SEALS
- ELECTRICAL
- LIGHTING
- HANDLEBARS, CONTROLS & MIRRORS
- CABLES
- BRAKES
- TANKS & OIL FILTERS
- DASHES & GAUGES
- FRAMES, SUSPENSION & FENDERS
- FOOTRESTS & LICENSE PLATE FRAMES
- WHEELS & AXLES
- HARDWARE, CHEMICALS & TOOLS
- COVERS, SECURITY & GENERAL

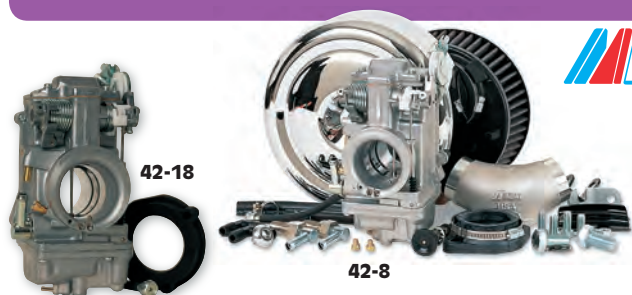

**HSR42 AND HSR45 SMOOTHBORE CARBURETOR KITS**

- Kits include the 42mm/45mm smoothbore carb in a natural finish
- Easier, faster installation using stock CV throttle cables
- Excellent throttle response, more power, improved acceleration and better gas mileage
- Order fewer part numbers to cover more applications
- HSR smoothbore carbs offer excellent throttle response and control
- Well made for years of dependable service
- See pages 596-597 for additional main and pilot jets
- Installation instructions and hardware included
- Made in Japan

**NOTE:** Kits are not for use on models with cruise controls.

**42MM/45MM EASY KITS**

- Accept the original H-D intake manifold, choke cable, air cleaner and throttle cables
- Keep the stock look of your bike
- Recommend the use of a high-flow air filter designed for the stock CV carb
- Made in Japan

**42/45MM TOTAL KITS**

- Include performance intake manifold, rubber flange, 42mm or 45mm carb, high-flow K&N filter, air cleaner cover, breather kit and hardware
- 84-89 models require the use of 90-95 Big Twin-style cables
- Made in Japan

**EASY KITS**

PART #	DESCRIPTION	SUG. RETAIL
<b>42MM</b>		
42-18	For 99-06 Twin Cam and 90-99 Evolution Big Twin (not for use with stock air cleaner; requires a hi-perf air cleaner; use stock air cleaner cover; may be used with a Screamin' Eagle air filter kit)	\$398.95
42-7	For 90-99 Evolution Big Twin (include chrome air cleaner cover)	459.95
42-10	For 94-03 XL 1200 models (include special backing plate and hardware; use stock oval air cleaner cover and high-flow filter)	459.95
42-11	For 94-06 XL 1200 models and 94-02 Buell must use aftermarket air filter (include air filter adapter)	438.95
<b>45MM</b>		
1002-0030	For 99-06 Twin Cam and 90-99 Evolution Big Twin; requires use of Screamin' Eagle manifold (use stock air cleaner cover; may be used with a Screamin' Eagle air filter kit)	459.95

**TOTAL KITS**

PART #	DESCRIPTION	SUG. RETAIL
<b>42MM CARB KITS</b>		
42-8 <sup>1</sup>	For 84-99 Evolution Big Twin (except 84-88 FLT)	\$598.95
42-19	For 99-06 Twin Cam	658.95
<b>45MM CARB KITS</b>		
45-2X <sup>1</sup>	For 84-99 Evolution Big Twin (except 84-88 FLT)	678.95
45-4X	For 99-06 Twin Cam	678.95

<sup>1</sup> 84-89 models will require 90-95 Big Twin intake manifold flanges and seals (sold separately).



**REPLACEMENT FILTER ELEMENT**

- Replacement 2 1/2" or 3" filter element for HSR42/45/48 carburetor
- Made in Japan

PART #	DESCRIPTION	SUG. RETAIL
HS42012-250	2 1/2" filter element	\$84.95
HS42/012-300	3" filter element	84.95

**HSR42 AND HSR45 SMOOTHBORE CARBURETORS**

- For the high-performance engine builder who needs a carb for specific custom applications
- Available in standard or highly-polished finishes
- HSR smoothbore carbs offer excellent throttle response and control
- Well made for years of dependable service
- See pages 596-597 for additional main and pilot jets
- Made in Japan

**NOTE:** Choke cable included, except for the TM42-6, which uses stock choke cable from CV-type carb.

**NOTE:** Airbox adapter HS42/001-K must be ordered separately.

**NOTE:** Kits are not for use on models with cruise controls.

PART #	DESCRIPTION	SUG. RETAIL
TM42-6	42mm carb, standard finish	\$374.95
TM42-6P	42mm carb, polished finish	508.95
TM45-2	45mm carb, standard finish	438.95
TM45-2P	45mm carb, polished finish	578.95



**HSR48 SMOOTHBORE CARBURETORS**

- These high-performance carbs are ideal for realizing the maximum potential from custom and race engines
- Available in standard or highly-polished finishes
- Recommended for engines over 1200ci or larger
- Include rubber mounting flange with 78mm bolt hole centers, choke cable and four different main jets
- Use stock H-D throttle cables
- HSR smoothbore carbs offer excellent throttle response and control
- Well made for years of dependable service
- See pages 596-597 for additional main and pilot jets
- For race and custom applications only
- Made in Japan

PART #	DESCRIPTION	SUG. RETAIL
48-2P	48mm carb, polished finish	\$638.95
482X	48mm carb, standard finish	459.95

**IMPORTANT NOTE:** SEE PAGE 411 FOR IMPORTANT INFORMATION REGARDING CERTAIN WARRANTY AND EMISSION CONTROL REGULATORY COMPLIANCE INFORMATION.

All part numbers in **BLUE** are new for 2015.

- WINDSHIELDS & FAIRINGS
- TOURING
- AUDIO & COMMUNICATION
- LUGGAGE
- SEATS & SISSY BARS
- EXHAUST
- FUEL/AIR SYSTEMS
- ENGINE
- TRANSMISSION & DRIVELINE
- GASKETS & SEALS
- ELECTRICAL
- LIGHTING
- HANDLEBARS, CONTROLS & MIRRORS
- CABLES
- BRAKES
- TANKS & OIL FILTERS
- DASHES & GAUGES
- FRAMES, SUSPENSION & FENDERS
- FOOTRESTS & LICENSE PLATE FRAMES
- WHEELS & AXLES
- HARDWARE, CHEMICALS & TOOLS
- COVERS, SECURITY & GENERAL



**38MM CARB KIT**

- Designed for easy installation and easy tuning capabilities
- Kit includes 38mm VM Mikuni carb, rubber manifold adapter flange, hose clamps, single throttle cable, two differently-sized main jets and a chrome reusable K&N air cleaner

**NOTE:** Does not include manifold.



PART #	DESCRIPTION	SUG. RETAIL
<b>DS-289086</b>	38mm Mikuni carb kit for 84-89 H-D Evo models w/ single-cable throttle control	<b>\$256.95</b>
<b>0650-1125</b>	Repl. throttle cable	<b>20.95</b>



**BENDIX CARBURETORS**

- High-performance Bendix carburetors are easy bolt-on replacements that don't require any extra fittings or linkage connections
- Most offer adjustable high-speed jets; all provide improved acceleration and easier, quicker starts
- Made in the U.S.A.

**NOTE:** All Bendix carbs may be used for other applications, provided correct cables are used.



PART #	DESCRIPTION	SUG. RETAIL
<b>DS-289078</b>	40mm high-performance carb w/ adjustable main jet, standard finish, for all 84-89 Big Twin and 86-87 XL w/ dual-throttle cable linkage (will not fit models w/ CV carbs unless choke hook-up is fabricated, intake manifold purchased and cables modified)	<b>\$508.95</b>
<b>DS-289079</b>	Choke cable accessory kit (required for installation of 40mm carb on 84-89 Big Twin, 86-87 XL Evolution)	<b>74.95</b>



**HIGH-PERFORMANCE CARB KIT**

- Kit includes chrome-plated 40mm carburetor, fittings, adapters and installation instructions
- Offers quicker starts and improved acceleration
- Designed to fit stock manifold and OEM or performance air filters
- Easy bolt-on installation

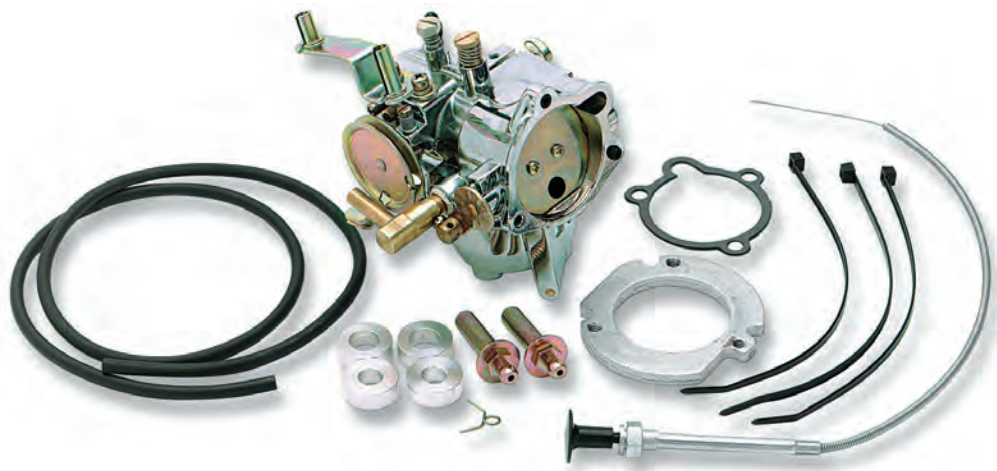

PART #	DESCRIPTION	SUG. RETAIL
<b>1002-0001</b>	For 90-99 Evolution Big Twin models	<b>\$407.95</b>

**IMPORTANT NOTE:** SEE PAGE 411 FOR IMPORTANT INFORMATION REGARDING CERTAIN WARRANTY AND EMISSION CONTROL REGULATORY COMPLIANCE INFORMATION.

All part numbers in **BLUE** are new for 2015.



- WINDSHIELDS & FAIRINGS
- TOURING
- AUDIO & COMMUNICATION
- LUGGAGE
- SEATS & SISSY BARS
- EXHAUST
- FUEL/AIR SYSTEMS
- ENGINE
- TRANSMISSION & DRIVELINE
- GASKETS & SEALS
- ELECTRICAL
- LIGHTING
- HANDLEBARS, CONTROLS & MIRRORS
- CABLES
- BRAKES
- TANKS & OIL FILTERS
- DASHES & GAUGES
- FRAMES, SUSPENSION & FENDERS
- FOOTRESTS & LICENSE PLATE FRAMES
- WHEELS & AXLES
- HARDWARE, CHEMICALS & TOOLS
- COVERS, SECURITY & GENERAL

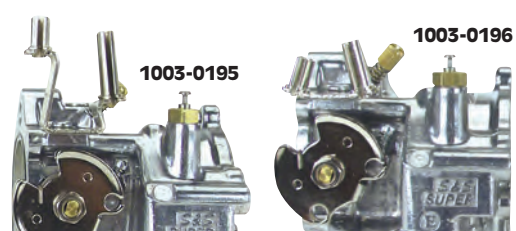
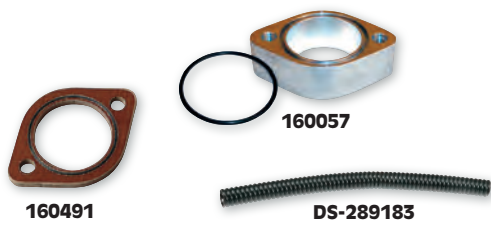
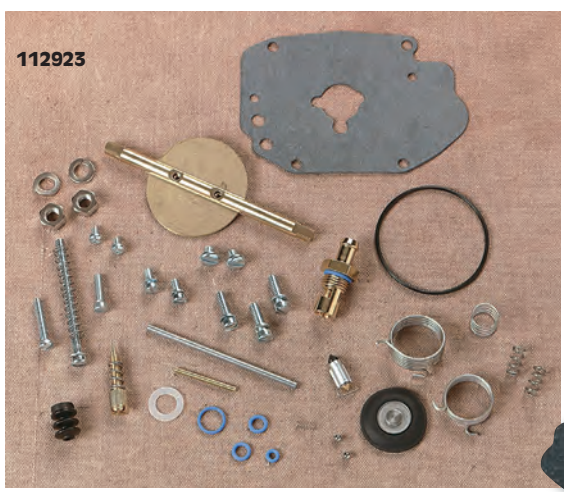

**CARBURETOR REBUILD KITS AND REPLACEMENT COMPONENTS**

- Rebuild kits are available in master kits, body-only kits and accelerator pump kits
- Replacement gaskets, O-rings and components are made from the highest-quality materials available
- Made in the U.S.A.

**REBUILD KITS**

PART #	DESCRIPTION	SUG. RETAIL
112923	Master rebuild kit Super E (body, accelerator pump, fasteners, springs, idle mixture screw, seat and needle assembly)	\$80.95
112924	Master rebuild kit Super G (body, accelerator pump, fasteners, springs, idle mixture screw, seat and needle assembly)	80.95
112903	Rebuild kit for Super B (body rebuild kit)	40.95
DS-289111	Rebuild kit for Super E (body rebuild kit)	40.95
DS-289112	Rebuild kit for Super G (body rebuild kit)	40.95
1003-0312	Rebuild kit for Super E & G basic	31.95
DS-289113	Accelerator pump rebuild kit for E & G (diaphragm, spring, check balls and springs, pushrod and required hardware)	19.95

**REPLACEMENT COMPONENTS**

PART #	DESCRIPTION	SUG. RETAIL (ea.)	PART #	DESCRIPTION	SUG. RETAIL (ea.)
DS-289934	Manifold to carburetor O-ring, Super G (10-pk.)	\$.95	1003-0052	Fuel inlet/seat for 1.875" E & 2.0625" G carb (uses needle 1003-0042) (ea.)	\$11.95
DS-289935	Manifold to carburetor O-ring, Super E (10-pk.)	.95	1003-0056	Breather conversion kit for Big Twin (converts early S&S air cleaners to new-style breather hardware)	32.95
DS-289933	Bowl gasket, Super E and G (10-pk.)	2.95	112084	Enrichment device for B series carb (will work on Super E & G carbs when changing air cleaners) (ea.)	33.95
112091	Bowl gasket, Super B and D (10-pk.)	1.95	1003-0195	Throttle cable guide/bracket for use w/ CV (constant velocity) cables (ea.)	11.95
160491	.25" Insulator block w/ O-ring Super E	20.95	1003-0196	Throttle cable guide/bracket for use w/ butterfly cables (ea.)	11.95
160492	.25" Insulator block w/ O-ring Super G	20.95	1003-0192	Accelerator pump ejector nozzle O-ring (10-pk.)	.95
160057	1" Spacer block Super E	53.95	1003-0194	Accelerator pump check ball only (10-pk.)	.95
160357	1" Spacer block Super G	58.95	1003-0193	Accelerator pump cap O-ring (two required) (10-pk.)	.95
DS-289183	Gas line insulator	10.95	1003-0188	Fuel bowl overflow hose; 24" long (5-pk.)	3.95
1003-0085	Idle mixture screw (5-pk.)	7.95	1050-0242	19" gas line w/ 90° end	5.95
1003-0040	Idle mixture screw spring (10-pk.)	.95	0706-0203	Straight gas hose for use with the new S&S carbs with 90° fuel inlet	5.95
1003-0041	Bowl plug (5-pk.)	2.95	1003-0237	Inlet, 90° carb fuel swivel	22.95
1003-0042	Needle: 1.875" E & 2.0625" G (ea.)	11.95	1003-0353	Carb float for Super B, E & G gas carbs	19.95
1003-0043	Bellows seal, accelerator pump (5-pk.)	3.95			
1003-0044	Diaphragm spring, accelerator pump (10-pk.)	.95			
1003-0045	Accelerator pump diaphragm (ea.)	13.95			
1003-0047	Fast idle plunger/enrichener (ea.)	11.95			
1003-0050	Ball check spring (5-pk.)	1.95			

**IMPORTANT NOTE: SEE PAGE 411 FOR IMPORTANT INFORMATION REGARDING CERTAIN WARRANTY AND EMISSION CONTROL REGULATORY COMPLIANCE INFORMATION.**

All part numbers in **BLUE** are new for 2015.

WINDSHIELDS & FAIRINGS

TOURING

AUDIO & COMMUNICATION

LUGGAGE

SEATS & Sissy BARS

EXHAUST

FUEL/AIR SYSTEMS

ENGINE

TRANSMISSION & DRIVELINE

GASKETS & SEALS

ELECTRICAL

LIGHTING

HANDLEBARS, CONTROLS & MIRRORS

CABLES

BRAKES

TANKS & OIL FILTERS

DASHES & GAUGES

FRAMES, SUSPENSION & FENDERS

FOOTRESTS & LICENSE PLATE FRAMES

WHEELS & AXLES

HARDWARE, CHEMICALS & TOOLS

COVERS, SECURITY & GENERAL



**HOTOP S&S ENRICHENER KNOB ASSEMBLY**

- Replaces the stock S&S enrichener lever on E and G carbs when changing to a different style air cleaner assembly
- Retains the stock plunger and spring
- Setscrew allows progressive enrichment
- Kit includes a chrome knob and a brass plunger nut
- Made in the U.S.A.



PART #	DESCRIPTION	SUG. RETAIL
DS-289138	Enrichener knob assembly	\$43.95



**ECON ENRICHENER CABLE RELOCATION BRACKETS**

- Relocates enrichener cable and knob out of the way
- For use with stock enrichener cables and knobs
- Made from stainless steel with ball-burnished finish
- Made in the U.S.A.

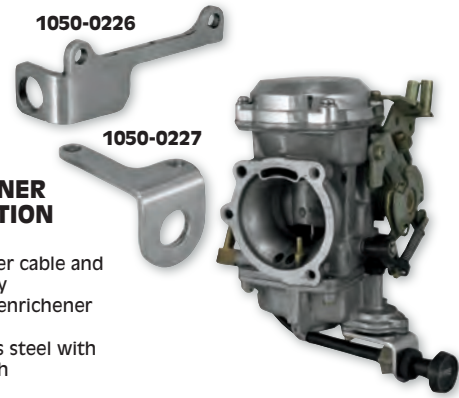

PART #	DESCRIPTION	SUG. RETAIL
1050-0226	For all Mikuni HSR carbs	\$31.95
1050-0227	For all Keihin CV carbs	\$1.95

**MIKUNI ENRICHENER CABLE RELOCATION BRACKET KIT AND KNOBS**

- Kit includes bracket, idle mixture screw knob and enrichener cable knob
- CNC-machined billet aluminum components
- Available in a black finish
- Made in the U.S.A.

NOTE: Must be used with Mikuni enrichener cable, Drag Specialties PART #990-662-002.



PART #	DESCRIPTION	SUG. RETAIL
1050-0183	Bracket kit w/ enrichener and idle knobs, chrome	\$134.95
1050-0262	Bracket kit w/ enrichener and idle knobs, black	134.95

1050-0184

PART #	DESCRIPTION	SUG. RETAIL
1050-0184	Bracket kit w/ enrichener and idle knobs, raw	\$99.95



**FUEL INLET FITTING**

- Solid brass fitting
- Accepts 1/4" fuel line
- For 84-06 Keihin butterfly and CV carburetors
- Sold each

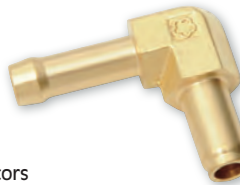

PART #	DESCRIPTION	SUG. RETAIL
1003-0257	Fuel inlet fitting; repl. OEM #27371-76A	\$5.95



**POWER-FLO™**  
Pass More Gas®

**-6AN FUEL LINE FITTING FOR S&S CARBS**

- Allows the use of -6AN fittings and fuel line for fuel supply
- For all S&S Super E and G series carbs
- Used with Pingel fuel valves PART #DS-390285 (22mm inlet) and PART #0705-0058 (3/8" NPT inlet); and The Guzzler® fuel valves PART #s 0705-0029/0705-0050 (22mm inlet) and PART #s 0705-0028/0705-0056 (3/8" NPT inlet)
- Sold each
- Made in the U.S.A.



PART #	DESCRIPTION	SUG. RETAIL
DS-289141	-6AN fuel fitting	\$38.95



**HI-FLOW FUEL NIPPLES**

- Flow more fuel than the stock OEM nipples
- Include removal tool
- Made in the U.S.A.



PART #	DESCRIPTION	SUG. RETAIL
<b>FOR ALL 76-06 KEIHIN CARBURETORS (BUTTERFLY AND CV)</b>		
1050-0123	Single outlet (brass)	\$42.95
1050-0208	Single outlet (stainless-steel)	47.95



**CV CARB TOP COVERS**

- Hand-polished investment cast CNC-machined 6061 T-6 billet aluminum available in gloss black powder-coated or raw polished aluminum or in polished stainless steel
- Fit CV carburetors on late model Harley-Davidson Sportster, Evolution, Twin Cam and custom applications where Keihin CV carb might be used
- Feature a classic finned look or the popular rippled-water-droplet look; a classic styling element

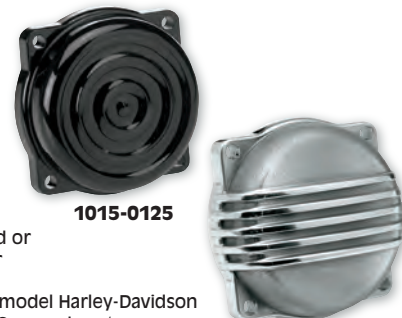

<b>FOR 88-06 H-D CV40/44 CARBURETORS</b>		
PART #	DESCRIPTION	SUG. RETAIL
<b>RIPPLE</b>		
1015-0133	Polished aluminum	\$29.95
1015-0125	Black powdercoat aluminum	29.95
1015-0126	Polished stainless steel	59.95
<b>FINNED</b>		
1015-0135	Polished aluminum	29.95
1015-0134	Black powdercoat aluminum	29.95

**SMOOTH CHROME CV CARB TOP COVER**

- Smooth die-cast chrome cover replaces the OEM black plastic top cover
- Installation is a snap; just remove the four OEM screws and bolt on the new cover with them



PART #	DESCRIPTION	SUG. RETAIL
DS-288801	For 88-06 Harley CV carb models; repl. OEM #27040-88	\$15.95

**IMPORTANT NOTE: SEE PAGE 411 FOR IMPORTANT INFORMATION REGARDING CERTAIN WARRANTY AND EMISSION CONTROL REGULATORY COMPLIANCE INFORMATION.**

All part numbers in **BLUE** are new for 2015.





**MIKUNI CHROME CARB TOP COVER**

- Highly polished chrome cover gives a unique custom look
- Available with or without embossed Mikuni logo
- Made in Japan

PART #	DESCRIPTION	SUG. RETAIL
<b>FOR MIKUNI HSR CARBURETORS</b>		
KHS-029	Chrome cover w/ Mikuni logo	\$28.95
KHS-028	Chrome cover w/o Mikuni logo	28.95

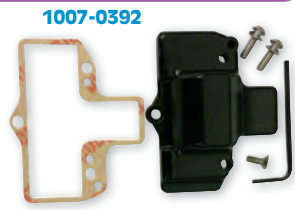
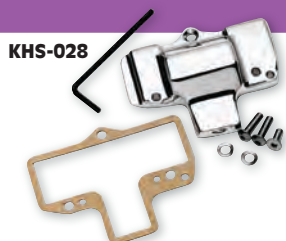
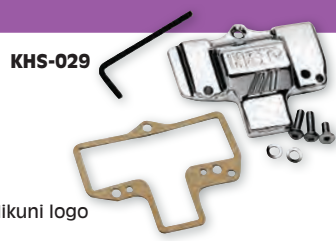

PART #	DESCRIPTION	SUG. RETAIL
<b>FOR MIKUNI HSR CARBURETORS (CONT)</b>		
1007-0392	Black cover w/o Mikuni logo	\$28.95

WINDSHIELDS & FAIRINGS

TOURING

AUDIO & COMMUNICATION

LUGGAGE

SEATS & SISSY BARS

EXHAUST

FUEL/AIR SYSTEMS

ENGINE

TRANSMISSION & DRIVELINE

GASKETS & SEALS

ELECTRICAL

LIGHTING

HANDLEBARS, CONTROLS & MIRRORS

CABLES

BRAKES

TANKS & OIL FILTERS

DASHES & GAUGES

FRAMES, SUSPENSION & FENDERS

FOOTRESTS & LICENSE PLATE FRAMES

WHEELS & AXLES

HARDWARE, CHEMICALS & TOOLS

COVERS, SECURITY & GENERAL

1015-0094



1015-0096



**CV CARBURETOR TOP COVERS**

- Machined from 6061 T-6 billet aluminum, polished to a high luster and chrome-plated
- Relocate choke cable for easier access
- Made in the U.S.A.

PART #	DESCRIPTION	SUG. RETAIL
<b>FOR 88-06 CV40/44 CARBURETORS ON BIG TWIN, XL AND BUELL</b>		
1015-0094	Smooth w/ logo and choke cable bracket	\$59.95
1015-0096	Smooth w/ choke cable bracket	59.95



1050-0158



**FLOAT BOWL SPEED SCREW KITS**

- Electropolished stainless steel for a great custom look
- Will not corrode in extreme climates
- Longer and stronger than the stock screws, makes them easier to handle; will not round off
- 5/16" hex head design eases bowl removal and jet changing
- Made in the U.S.A.



PART #	DESCRIPTION	SUG. RETAIL
1050-0158	For CV/HSR carbs	\$34.95
1050-0160	For S&S E&G carbs	34.95



DS-190129

**CARBURETOR SOCKET-HEAD BOLT KITS**

- Replace the stock screws with strong chrome socket-head bolts
- For use on CV carburetors and S&S carburetors
- Made in the U.S.A.



DS-190697

PART #	DESCRIPTION	SUG. RETAIL
DS-190129	For CV carburetor on 90-06 Big Twin and 88-03 XL models	\$28.95
DS-190695	For top cover only on 88-06 CV carburetors	11.95
DS-190697	For S&S E and G carburetor body and air cleaner	35.95



HS42/001-K

990-605-065

990-662-002

**REPLACEMENT PARTS FOR HSR 42/45 CARB KITS**

- Made in Japan

PART #	DESCRIPTION	SUG. RETAIL
HS42/001-K	Mikuni-to-CV carb air box adapter w/ three mounting screws	\$21.95
990-605-065	Short idle screw adjuster	16.95
990-662-002	Choke cable, for use with Mikuni plastic nut, spring and brass plunger	29.95



**HSR4 MAIN JET EXTENSION KIT**

- Increases amount of fuel to float bowl
- Completely submerges main jet within extender, eliminating chance of air bubbles getting through
- Made in Japan

PART #	DESCRIPTION	SUG. RETAIL
1006-0248	HSR4 main jet extension kit	\$29.95



**CRUISE CONTROL BRACKET FOR MIKUNI**

- Fits all years with Mikuni HSR42/45/48 using stock cables
- Retains cruise control when adding a Mikuni/Screamin' Eagle carb
- Made in the U.S.A.



PART #	DESCRIPTION	SUG. RETAIL
1013-0034	For Mikuni HSR42/45/48 carbs	\$147.95

KHS-016

KHS-031

**GENUINE MIKUNI HS CARBURETOR REBUILD KITS**

- Genuine Mikuni parts properly replace worn or mistreated components for HSR42/45/48 carburetors
- Include top cover gasket, jet needle E-ring and washer, throttle valve seal, pilot air O-ring, fuel joint O-ring, accelerator pump O-ring, needle valve O-ring, needle valve retainer screw, needle valve assembly, float bowl O-ring/gasket, overflow hose, float bowl screws, accelerator pump rod boot
- Includes all the parts needed to rebuild HSR42/45 or HSR48 carburetors

PART #	DESCRIPTION	SUG. RETAIL
KHS-016	HSR42/45 Carb rebuild kit	\$43.50
KHS-031	HSR48 Carb rebuild kit	43.50

**IMPORTANT NOTE:** SEE PAGE 411 FOR IMPORTANT INFORMATION REGARDING CERTAIN WARRANTY AND EMISSION CONTROL REGULATORY COMPLIANCE INFORMATION.

All part numbers in **BLUE** are new for 2015.

- WINDSHIELDS & FAIRINGS
- TOURING
- AUDIO & COMMUNICATION
- LUGGAGE
- SEATS & Sissy BARS
- EXHAUST
- FUEL/AIR SYSTEMS
- ENGINE
- TRANSMISSION & DRIVELINE
- GASKETS & SEALS
- ELECTRICAL
- LIGHTING
- HANDLEBARS, CONTROLS & MIRRORS
- CABLES
- BRAKES
- TANKS & OIL FILTERS
- DASHES & GAUGES
- FRAMES, SUSPENSION & FENDERS
- FOOTRESTS & LICENSE PLATE FRAMES
- WHEELS & AXLES
- HARDWARE, CHEMICALS & TOOLS
- COVERS, SECURITY & GENERAL

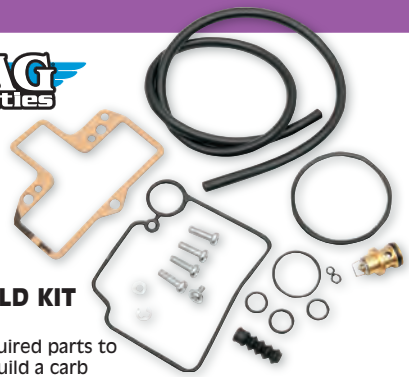

**CARB REBUILD KIT FOR MIKUNI**

- Includes all required parts to completely rebuild a carb
- For HSR42/45mm carburetors

PART #	DESCRIPTION	SUG. RETAIL
1003-0293	Rebuild kit for HSR42/45 mm carbs	\$36.95



**CARB REBUILD KITS FOR KEIHIN**

- Kits include all necessary parts to rebuild a butterfly-style or CV-style Keihin carb

PART #	DESCRIPTION	SUG. RETAIL
1003-0292	For 88-06 Keihin CV carbs	\$16.95
1003-0291	For 84-89 Keihin butterfly carbs	16.95



**GENUINE BENDIX CARB REBUILD KITS**

- Rebuild kit includes all necessary gaskets, seals, idle screw and accelerator pump

PART #	DESCRIPTION	SUG. RETAIL
DS-289084	40mm Bendix rebuild kit for 84-89	\$47.95



**CARB REBUILD KIT FOR KEIHIN CV**

- For use with all 90-06 Big Twin or 88-06 XL models using the CV carb
- Includes all the necessary needles, O-rings, seals and gaskets etc. for a complete rebuild



PART #	DESCRIPTION	SUG. RETAIL
DS-289109	For all 88-06 CV carbs	\$42.95



**KEIHIN CARB REBUILD KITS**

- Includes the parts necessary for rebuilding carbs
- PART #DS-289089 features Viton (not neoprene) needles

PART #	DESCRIPTION	SUG. RETAIL
DS-289089	For 84-89 butterfly carbs; repl. OEM #27006-76	\$21.95
DS-289098	For all 88-06 CV carbs	20.95



**ACCELERATOR PUMP DIAPHRAGM**

- Sold each
- Made in the U.S.A.



PART #	DESCRIPTION	SUG. RETAIL
DS-174445	For 85-89 Big Twin, 86-89 XL w/ OEM Keihin carb; repl. OEM #27361-76	\$13.95



**HIGH PERFORMANCE ACCELERATOR PUMP HOUSING KIT**

- High-flow accelerator pump housing will increase fuel flow through the pump, significantly improving the low-end and mid-range response
- Removing the float bowl and drilling one hole is all that is required; no need to remove the carb from the engine
- Made in the U.S.A.



PART #	DESCRIPTION	SUG. RETAIL
DS-289096	For any 84-89 Harley models w/ stock Keihin carburetors	\$19.95



**AIR MIXTURE SCREW KIT**

- Air mixture screw kit includes: washer, spring and ring air idle mixture needle repacking kit



PART #	DESCRIPTION	SUG. RETAIL
1003-0352	Packing kit mixture screw for CV carbs	\$7.95



**IDLE AIR ADJUSTING SCREWS FOR ALL CV CARBURETORS**

- Knurled and slotted head for easy adjustment
- Includes brass or stainless-steel screw, O-ring, washer and spring
- Made in the U.S.A.

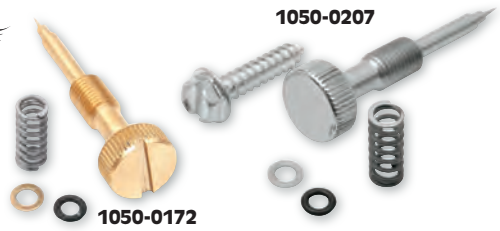

PART #	DESCRIPTION	SUG. RETAIL
1050-0172	Brass screw	\$29.95
1050-0207	Stainless-steel screw	29.95



**IDLE AIR ADJUSTING SCREWS**

- Available for both butterfly-type and CV-type carbs
- Knurled head is slotted for quick, simple adjustment



PART #	DESCRIPTION	SUG. RETAIL
1050-0289	For butterfly-type carbs	\$27.95
1050-0290	For CV-type carbs	27.95

**IMPORTANT NOTE: SEE PAGE 411 FOR IMPORTANT INFORMATION REGARDING CERTAIN WARRANTY AND EMISSION CONTROL REGULATORY COMPLIANCE INFORMATION.**

All part numbers in **BLUE** are new for 2015.





**DIAPHRAGM REBUILD KIT**

- Carburetor Diaphragm rebuild kit for all Keihin carbs (including late CV carb)
- Replace diaphragm on S&S "E" and "G" carbs
- Kit is complete with upgraded rubber components; diaphragm, 2 O-rings, boot and spring to complete rebuild

PART#	DESCRIPTION	SUG. RETAIL
1005-0351	Diaphragm rebuild kit	\$9.95



**VACUUM PISTON ASSEMBLY**

- Replaces the stock assembly

PART #	DESCRIPTION	SUG. RETAIL
1050-0288	For 88-06 CV and CVK Keihin carburetors; repl. OEM #27585-88	\$37.95



**40MM CV VACUUM PISTON**

- Genuine Keihin replacement
- Made in Japan

NOTE: No warranty on rubber diaphragm.

PART #	DESCRIPTION	SUG. RETAIL
2101-0008	For 88-06 40mm carb; repl. OEM #27585-88	\$41.95



**CARBURETOR SPACERS**

- Easy way to add extra torque and horsepower
- Machined from solid 6061 T-6 billet aluminum that completely eliminates porosity problems
- Machined finish can be polished to a bright luster
- Made in the U.S.A.

PART #	DESCRIPTION	SUG. RETAIL	PART #	DESCRIPTION	SUG. RETAIL
<b>FOR S&amp;S E &amp; B SERIES CARBURETORS (1 7/8")</b>			<b>FOR S&amp;S G &amp; D SERIES CARBURETORS (2 1/16")</b>		
1013-0004	1"	\$33.95	1013-0007	1"	\$33.95
1013-0005	1 1/2"	39.95	1013-0008	1 1/2"	39.95
1013-0006	2"	39.95	1013-0009	2"	39.95

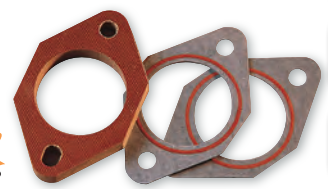

**CARBURETOR INSULATOR BLOCK KIT**

- Kit includes 3/8" fiber insulator block and gaskets
- Designed to reduce the risk of boiling fuel in the carb
- Made in the U.S.A.

PART #	DESCRIPTION	SUG. RETAIL
2011-1214	For custom applications; 1.86" i.d. w/ 2 3/4" center-to-center mounting holes	\$21.95



**INTAKE MANIFOLD AND CARB SEAL KIT**

- Kit contains one carburetor to intake seal (27002-89) and two intake to cylinder head seals (26995-86B)
- Made in the U.S.A.

PART #	DESCRIPTION	SUG. RETAIL
0935-0172	40mm seal kit for 99-06 Twin Cam, 90-99 90° Evolution and 88-06 XL w/ OEM carbs	\$8.95

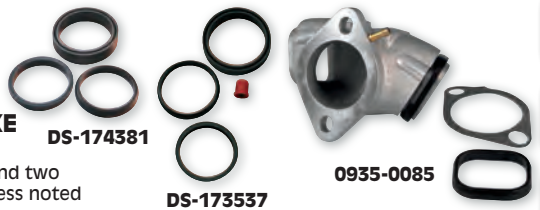

**CARBURETOR AND INTAKE MANIFOLD SEAL KITS**

- Kits contain carb-to-intake seal and two intake-to-cylinder head seals unless noted

PART #	DESCRIPTION	SUG. RETAIL
DS-174381	40mm seal kit for 99-06 Twin Cam, 90-99 80° Evolution and 88-06 XL w/ Original Equipment carbs	\$12.95
DS-173537	44mm seal kit for 99-06 Twin Cam, 90-99 80° Evolution and 88-06 XL w/ Screaming Eagle carbs	12.95
0935-0085	#1671 Edelbrock manifold seal kit	8.95



DS-289076



**THE ORIGINAL "POWER TUBE" ATOMIZER**

- Atomizer power tube and jets are CNC-machined from brass for consistency and accuracy
- Power tube jet kits provide fine tuning with increased horsepower when using a less restrictive air cleaner and exhaust
- Converts fuel from a squirting liquid to a fine mist
- Eliminates spitting and popping through the carburetor
- Master kits include slow jets, main jets, slide spring, drill bit and needles
- Made in the U.S.A.

NOTE: Covered under the following U.S. patent #: 5,233,180/5,562,868/5,662,836/5,810,264/6,270,060.

PART #	DESCRIPTION	SUG. RETAIL
DS-289076	Performance master kit for 88-06 stock 40mm CV carbs	\$105.95
DS-289075	Power Tube for HSR 42 and 45 w/ jets	60.95
1007-0157	Power Tube for HSR 42 and 45 (w/o jets)	56.95

DS-289075

1007-0157



DS-289121

DS-289120



**NO-HASSLE JET KITS FOR CV CARBURETORS**

- Genuine Keihin parts
- Includes two slow jets, three main jets and a jet needle
- No need for drilling
- Detailed instructions for jetting your motor from stock to modified

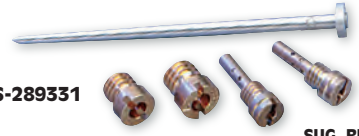

DS-289331

PART #	DESCRIPTION	SUG. RETAIL	PART #	DESCRIPTION	SUG. RETAIL
DS-289331	For 90-99 Evolution Big Twin	\$39.95	DS-289334	For 97-03 XL1200S, 94-98 Buell S1, S2/S2T, S3/S3T and M2	\$39.95
1007-0015	For 04-06 XL 883/1200	38.95	DS-289333	For 88-03 XL 883	39.95
DS-289332	For 88-03 XL 1200 (except 97-03 1200S)	39.95	DS-196002	Keihin slow jet screwdriver	15.95

**IMPORTANT NOTE: SEE PAGE 411 FOR IMPORTANT INFORMATION REGARDING CERTAIN WARRANTY AND EMISSION CONTROL REGULATORY COMPLIANCE INFORMATION.**

All part numbers in **BLUE** are new for 2015.

- WINDSHIELDS & FAIRINGS
- TOURING
- AUDIO & COMMUNICATION
- LUGGAGE
- SEATS & Sissy BARS
- EXHAUST
- ENGINE
- TRANSMISSION & DRIVELINE
- GASKETS & SEALS
- ELECTRICAL
- LIGHTING
- HANDLEBARS, CONTROLS & MIRRORS
- CABLES
- BRAKES
- TANKS & OIL FILTERS
- DASHES & GAUGES
- FRAMES, SUSPENSION & FENDERS
- FOOTRESTS & LICENSE PLATE FRAMES
- WHEELS & AXLES
- HARDWARE, CHEMICALS & TOOLS
- COVERS, SECURITY & GENERAL

WINDSHIELDS  
& FAIRINGS

TOURING

AUDIO &  
COMMUNICATION

LUGGAGE

SEATS &  
SISSY BARS

EXHAUST

FUEL/AIR  
SYSTEMS

ENGINE

TRANSMISSION  
& DRIVELINEGASKETS  
& SEALS

ELECTRICAL

LIGHTING

HANDLEBARS,  
CONTROLS  
& MIRRORS

CABLES

BRAKES

TANKS &  
OIL FILTERSDASHES  
& GAUGESFRAMES,  
SUSPENSION  
& FENDERSFOOTRESTS  
& LICENSE  
PLATE FRAMESWHEELS  
& AXLESHARDWARE,  
CHEMICALS  
& TOOLSCOVERS,  
SECURITY  
& GENERAL

## RECALIBRATION KITS

- Recalibrate your stock Keihin CV carb to make full use of the performance potential
- Include the jets, needles, instructions, etc. necessary to recalibrate stock engines with CV carbs
- Kits provide broad-range performance gains and maintain stock driveability

**NOTE:** This product is intended to be used only on racing vehicles on closed courses, and not for use on roads or vehicles otherwise subject to emission control requirements. In California, this product should not be used on any vehicle that is registered or licensed for use on public roads.

PART #	DESCRIPTION	SUG. RETAIL	PART #	DESCRIPTION	SUG. RETAIL
DS-290347	For 00-06 Twin Cam	\$96.95	1007-0001	For 04-06 XL 883	\$96.95
DS-290148	For 99 Twin Cam	96.95	DS-289451	For 98-03 XL1200 Sport	96.95
DS-289306	For 96-99 80" Big Twin and 96-03 XL	96.95	1007-0002	For 04-06 XL 1200	96.95
DS-289303	For 90-95 Big Twin, XL 883, 1200	96.95	DS-289309	For 99-02 Buell M2 Cyclone	96.95
DS-289450	For 89-03 XL 883 "race only"	96.95	DS-290348	For 00-02 Buell blast	96.95

## STAGE 1 JET KIT

- Designed for motorcycles with stock engines using stock airbox, air filter and stock or aftermarket exhaust
- Non-accelerator pump models
- Fully adjustable to allow for the use of well-designed aftermarket exhausts and stock replacement air filter
- Improves throttle response and driveability
- Power increases of approximately 5% throughout the entire power range

**NOTE:** This product is intended to be used only on racing vehicles on closed courses, and not for use on roads or vehicles otherwise subject to emission control requirements. In California, this product should not be used on any vehicle that is registered or licensed for use on public roads.

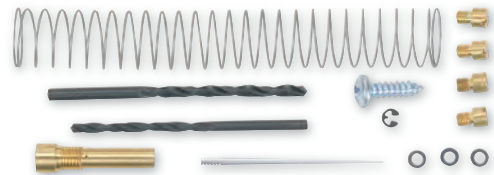

PART #	DESCRIPTION	SUG. RETAIL
DJ-8101	For 88-89 XL 883/1200 models	\$96.95



## STAGE 7 THUNDERSLIDE WITH JET KITS

- Stage 7 kits are for 80 plus horsepower engines and include a taller carburetor top for more slide movement
- Revolutionary composite plastic slide provides unparalleled performance gains in both horsepower and mileage
- Unique set of lift holes moderate how the slide moves with respect to throttle position; the faster the slide opens, the quicker the throttle response
- Kits include jets, needles, clips, carburetor top and other necessary parts for CV carbs
- Made in the U.S.A.

**NOTE:** This product is intended to be used only on racing vehicles on closed courses, and not for use on roads or vehicles otherwise subject to emission control requirements. In California, this product should not be used on any vehicle that is registered or licensed for use on public roads.

PART #	DESCRIPTION	SUG. RETAIL	PART #	DESCRIPTION	SUG. RETAIL
DS-290356	For 00-06 Twin Cam	\$164.95	DS-290351	For Screamin' Eagle 44mm Keihin CV Twin Cam 88	\$164.95
DS-290352	For 90-99 Big Twin Evolution	164.95	DS-290350	For Screamin' Eagle 44mm Keihin CV Evolution	164.95

## THUNDERSLIDE JET KITS

- Designed for engines with stock or aftermarket air filter and exhaust system
- Revolutionary composite plastic slide provides unparalleled performance gains in both horsepower and mileage
- Unique set of lift holes moderate how the slide moves with respect to throttle position; the faster the slide opens, the quicker the throttle response
- Kit also includes jets, needles, clips and other necessary parts for CV carbs
- Made in the U.S.A.

**NOTE:** This product is intended to be used only on racing vehicles on closed courses, and not for use on roads or vehicles otherwise subject to emission control requirements. In California, this product should not be used on any vehicle that is registered or licensed for use on public roads.

PART #	DESCRIPTION	SUG. RETAIL	PART #	DESCRIPTION	SUG. RETAIL
DS-290349	For 00-06 Twin Cam	\$149.95	DS-289308	For 89-03 XL 1200 (not Sport) (Stage 1)	\$149.95
DS-290149	For 99 Twin Cam	149.95	DS-289454	For 98-03 XL 1200 Sport (Stage 1)	149.95
DS-289307	For 90-99 Evolution Big Twin	149.95	1007-0005	For 04-06 XL 1200/C/R	149.95

**IMPORTANT NOTE:** SEE PAGE 411 FOR IMPORTANT INFORMATION REGARDING CERTAIN WARRANTY AND EMISSION CONTROL REGULATORY COMPLIANCE INFORMATION.



All part numbers in **BLUE** are new for 2015.





**CARBURETOR JET KITS**

- Designed to recalibrate OEM stock carburetors for use with Vance & Hines exhaust systems
- Include complete needle assemblies with five ranges of adjustment, main jets, clips, washer and appropriate drill bits
- Include detailed instructions for easy installation

**MANUFACTURER'S NOTE:** Not legal for street use on pollution-controlled vehicles.

PART #	DESCRIPTION	SUG. RETAIL
V22827	For 00-06 Twin Cam models	\$97.95
V22831	For 00-05 Buell Blast	97.95



**CV CARB JET KIT**

- Recalibrate your stock CV carb to make the most out of the air cleaner, exhaust and cam changes or head work
- Kit contains a #5 MAHR needle, 08 BOO jet holder, #45, #48 and #50 slow jets, and #190, #195, #200 and #205 main jets
- Suggested jetting guidelines are included with the kit
- Made in the U.S.A.

**NOTE:** Not for use on pollution-controlled vehicles used on streets or highways.

PART #	DESCRIPTION	SUG. RETAIL
DS-195100	For 99-06 Twin Cam	\$56.95



**RECALIBRATION KIT FOR 40MM KEIHIN CV CARB**

- Super high-quality recalibration kit for CV carbs
- Kit has all the components for dialing in a CV carb with or without an accelerator pump

**NOTE:** Not legal for street use on pollution-controlled vehicles.

PART #	DESCRIPTION	SUG. RETAIL
DS-289304	For all 88-99 CV carbs (except Twin Cam 88)	\$58.95



**CV MAIN JET KIT**

- Kit contains 195, 200, 205, 210, 215 and 220 main jets
- Made in the U.S.A.

PART #	DESCRIPTION	SUG. RETAIL
DS-289186	For CV carbs on 90-06 Big Twin and 88-06 XL models	\$20.95

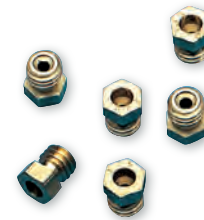

**QUICKSHOT**

- Cost-effective, bolt-on upgrade that allows accelerator pump fuel spray to be adjusted simply with the turn of a screw
- Patent-pending design
- Accelerator pump check valve stops bogging and coughing
- Adjustable fuel jet to control accelerator pump spray
- Precision single hole sprayer tip directs and injects the fuel more efficiently than stock
- A fine high-speed stream of fuel atomizes faster to improve roll-on acceleration
- Instant throttle response
- Improves low end performance and fuel economy
- Easy bolt-on; no modifications necessary



PART #	DESCRIPTION	SUG. RETAIL
1050-0241	Quickshot for S&S Super E & G carburetors	\$99.95



**TWINSHOT ADJUSTABLE FUEL CONTROL**

- Cost-effective, bolt-on upgrade eliminates the sluggish and inconstant throttle response of CV-40-carbureted H-D models
- Converts all OEM CV-40 carburetors to a standardized fuel system
- Precision twin-hole sprayer for improved roll-on acceleration
- Patented Quickshot accelerator pump technology eliminates low-speed bogging and coughing
- Adjustable fuel jet to control accelerator pump fuel spray
- Dual check valve system for consistent spray pressure
- Removable sprayer allows convenient service and maintenance
- Removable main jet cap for easy access tuning
- Precision accelerator pump plunger rod improves spray response
- Stiffer spring on activation arm delivers consistent spray response
- Available in polished aluminum or matte black finish
- Bolt-on, no modifications required
- Includes new float bowl O-ring, new plunger arm and plunger arm boot
- Made in the U.S.A.

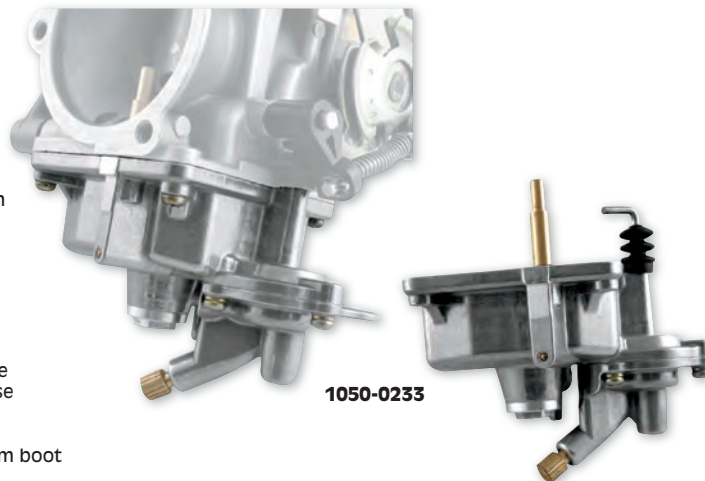

PART #	DESCRIPTION	SUG. RETAIL	PART #	DESCRIPTION	SUG. RETAIL
1050-0233	Polished aluminum	\$179.95	1050-0234	Matte black	\$179.95

**IMPORTANT NOTE:** SEE PAGE 411 FOR IMPORTANT INFORMATION REGARDING CERTAIN WARRANTY AND EMISSION CONTROL REGULATORY COMPLIANCE INFORMATION.

All part numbers in **BLUE** are new for 2015.

- WINDSHIELDS & FAIRINGS
- TOURING
- AUDIO & COMMUNICATION
- LUGGAGE
- SEATS & Sissy BARS
- EXHAUST
- EXHAUST
- ENGINE
- TRANSMISSION & DRIVELINE
- GASKETS & SEALS
- ELECTRICAL
- LIGHTING
- HANDLEBARS, CONTROLS & MIRRORS
- CABLES
- BRAKES
- TANKS & OIL FILTERS
- DASHES & GAUGES
- FRAMES, SUSPENSION & FENDERS
- FOOTRESTS & LICENSE PLATE FRAMES
- WHEELS & AXLES
- HARDWARE, CHEMICALS & TOOLS
- COVERS, SECURITY & GENERAL

WINDSHIELDS  
& FAIRINGS

TOURING

AUDIO &  
COMMUNICATION

LUGGAGE

SEATS &  
SISSY BARS

EXHAUST

PIPER/PAINT  
SYSTEMS

ENGINE

TRANSMISSION  
& DRIVELINEGASKETS  
& SEALS

ELECTRICAL

LIGHTING

HANDLEBARS,  
CONTROLS  
& MIRRORS

CABLES

BRAKES

TANKS &  
OIL FILTERSDASHES  
& GAUGESFRAMES,  
SUSPENSION  
& FENDERSFOOTRESTS  
& LICENSE  
PLATE FRAMESWHEELS  
& AXLESHARDWARE,  
CHEMICALS  
& TOOLSCOVERS,  
SECURITY  
& GENERAL**JET KITS FOR S&S CARBS**

- For jetting most stock and performance engines
- Dealer jet kit contains three each of all intermediate jets (except 1005-0008 and 1005-0009) and five each of all main jets (except 1006-0233, 1006-0234, 1006-0235, 1006-0236, 1006-0237 and 1006-0238) plus a main jet tool
- Low-range kit contains one each of the following intermediate jets (.025, .0265, .028, .0295) and one each of the following main jets (.062, .064, .066, .068, .070, .072, .074)
- High-range kit contains one each of the following intermediate jets (.0295, .031, .032, .033) and one each of the following main jets (.072, .074, .076, .078, .080, .082, .084)
- Replacement jets also available separately
- Made in the U.S.A.



DS-0451



PART #	DESCRIPTION	SUG. RETAIL (ea.)
<b>JET KITS</b>		
1003-0015	Dealer jet kit	\$317.95
DS-0450	Low-range kit	46.95
DS-0451	High-range kit	46.95
<b>INTERMEDIATE JETS</b>		
DS-94025	.025 intermediate jet (3-pk.)	7.95
DS-940265	.0265 intermediate jet (3-pk.)	7.95
DS-94028	.028 intermediate jet (3-pk.)	7.95
DS-940295	.0295 intermediate jet (3-pk.)	7.95
DS-94031	.031 intermediate jet (3-pk.)	7.95
DS-94032	.032 intermediate jet (3-pk.)	7.95
DS-94033	.033 intermediate jet (3-pk.)	7.95
1005-0008	.036 intermediate jet (3-pk.)	7.95
1005-0009	.040 intermediate jet (3-pk.)	7.95

PART #	DESCRIPTION	SUG. RETAIL (ea.)
<b>MAIN JETS</b>		
1006-0228	.040 main jet (5-pk.)	\$7.95
1006-0229	.042 main jet (5-pk.)	7.95
1006-0230	.044 main jet (5-pk.)	7.95
1006-0231	.046 main jet (5-pk.)	7.95
1006-0232	.048 main jet (5-pk.)	7.95
1006-0233	.050 main jet (5-pk.)	7.95
1006-0234	.052 main jet (5-pk.)	7.95
1006-0235	.054 main jet (5-pk.)	7.95
1006-0236	.056 main jet (5-pk.)	7.95
1006-0237	.058 main jet (5-pk.)	7.95
1006-0238	.060 main jet (5-pk.)	7.95
DS-72062	.062 main jet (5-pk.)	7.95
DS-72064	.064 main jet (5-pk.)	7.95

PART #	DESCRIPTION	SUG. RETAIL (ea.)
<b>MAIN JETS (CONT)</b>		
DS-72066	.066 main jet (5-pk.)	\$7.95
DS-72068	.068 main jet (5-pk.)	7.95
DS-72070	.070 main jet (5-pk.)	7.95
DS-72072	.072 main jet (5-pk.)	7.95
DS-72074	.074 main jet (5-pk.)	7.95
DS-72076	.076 main jet (5-pk.)	7.95
DS-72078	.078 main jet (5-pk.)	7.95
DS-72080	.080 main jet (5-pk.)	7.95
DS-72082	.082 main jet (5-pk.)	7.95
DS-72084	.084 main jet (5-pk.)	7.95

**MAIN JETS FOR CV-TYPE KEIHIN CARBS**

- Precision-made in Japan
- Master jet kit consists of 14 five-packs, includes jets from #140 to #250; you furnish box
- Individual jets sold to dealer in five-packs; sold to consumer each

PART #	DESCRIPTION	SUG. RETAIL (ea.)
<b>FOR 90-06 BIG TWIN AND 88-06 XL</b>		
DS289538	Master jet kit	\$231.95
DS289533	#140 main jet (5-pk.)	4.25
DS289534	#145 main jet (5-pk.)	4.25
DS289535	#150 main jet (5-pk.)	4.25
DS289536	#155 main jet (5-pk.)	4.25
DS-289521	#160 main jet (5-pk.)	4.25
DS-289522	#165 main jet (5-pk.)	4.25
DS-289523	#170 main jet (5-pk.)	4.25

PART #	DESCRIPTION	SUG. RETAIL (ea.)
<b>FOR 90-06 BIG TWIN AND 88-06 XL (CONT)</b>		
DS-289524	#175 main jet (5-pk.)	\$4.25
DS-289525	#180 main jet (5-pk.)	4.25
DS-289526	#185 main jet (5-pk.)	4.25
DS-289527	#190 main jet (5-pk.)	4.25
DS-289528	#195 main jet (5-pk.)	4.25
DS-289529	#200 main jet (5-pk.)	4.25
DS289537	#205 main jet (5-pk.)	4.25
1006-0279	#210 main jet (5-pk.)	4.25



DS-289521

PART #	DESCRIPTION	SUG. RETAIL (ea.)
<b>FOR 90-06 BIG TWIN AND 88-06 XL (CONT)</b>		
1006-0280	#220 main jet (5-pk.)	\$4.25
1006-0281	#230 main jet (5-pk.)	4.25
1006-0282	#240 main jet (5-pk.)	4.25
1006-0283	#250 main jet (5-pk.)	4.25

**PILOT JETS FOR KEIHIN CARBS**

- Available for both styles (butterfly and CV) of Keihin carbs 76-06
- Precision-made in Japan
- Master kit for CV-style consists of nine five-packs, includes jets from #40 to #55; you furnish box
- Individual jets sold to dealer in five-packs; sold to consumer each



DS-289510

**CV-STYLE CARB; 90-06 BIG TWIN AND 88-06 XL**

PART #	DESCRIPTION	SUG. RETAIL (ea.)
DS289542	Master jet kit	\$202.95
DS-289515	#40 pilot jet (5-pk.)	4.50
DS-289516	#42 pilot jet (5-pk.)	4.50
DS-289517	#44 pilot jet (5-pk.)	4.50
DS-289518	#45 pilot jet (5-pk.)	4.50
DS-289519	#46 pilot jet (5-pk.)	4.50

PART #	DESCRIPTION	SUG. RETAIL (ea.)
DS-289520	#48 pilot jet (5-pk.)	\$4.50
DS289539	#50 pilot jet (5-pk.)	4.50
DS289540	#52 pilot jet (5-pk.)	4.50
DS289541	#54 pilot jet (5-pk.)	4.50
1005-0155	#55 pilot jet (5-pk.)	4.50

**BUTTERFLY-STYLE CARB; FOR 86-89 BIG TWIN AND 86-87 XL**

PART #	DESCRIPTION	SUG. RETAIL (ea.)
DS-289510	#50 pilot jet (5-pk.)	\$4.50
DS-289511	#52 pilot jet (5-pk.)	4.50
DS-289512	#54 pilot jet (5-pk.)	4.50

PART #	DESCRIPTION	SUG. RETAIL (ea.)
DS-289513	#56 pilot jet (5-pk.)	\$4.50
DS-289514	#58 pilot jet (5-pk.)	4.50

**PILOT JET ASSORTMENT FOR KEIHIN CV CARBURETORS**

- Brass carburetor pilot jets are high precision and flow-calibrated
- Kit includes one pilot jet the following sizes: 35, 38, 40, 42, 45, 48, 50, 52, 55, 58, 60, 62 and 65

PART #	DESCRIPTION	SUG. RETAIL
1005-0157	Pilot jet assortment	\$50.95

**MAIN JET ASSORTMENT FOR KEIHIN CV CARBURETORS**

- High-precision brass carburetor jets
- Jets are flow-calibrated for extremely accurate fuel flow rate
- Kit includes two jets of the following sizes: 160, 165, 170, 175, 180, 185, 190, 195, 200, 205, 210 and 220
- Replacement jets available in 2-pack

PART #	DESCRIPTION	SUG. RETAIL
<b>DEALER KIT</b>		
1006-0288	Main jet assortment	\$49.95
<b>JETS (2-pk.)</b>		
1006-0289	165 main jet (2-pk.)	5.00
1006-0290	170 main jet (2-pk.)	5.00
1006-0291	175 main jet (2-pk.)	5.00
1006-0292	180 main jet (2-pk.)	5.00

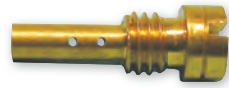
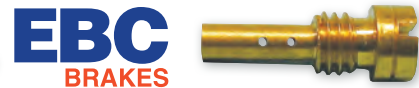
**KEIHIN-STYLE PILOT-SLOW JETS**

- Brass carburetor jets are high-precision and flow-calibrated for extremely accurate fuel flow rate
- Available in a range of sizes
- High-quality replacement for Keihin style pilot jet N424-25B; NOT original Keihin jets
- Sold to dealer as 4-pack, sold to consumer as each

**BUTTERFLY-STYLE CARB; FOR 86-89 BIG TWIN AND 86-87 XL**

JET		SUG.	JET		SUG.
PART #	SIZE	RETAIL	PART #	SIZE	RETAIL
1005-0142	35	\$3.95	1005-0149	52	\$3.95
1005-0143	38	3.95	1005-0150	55	3.95
1005-0144	40	3.95	1005-0151	58	3.95
1005-0145	42	3.95	1005-0152	60	3.95
1005-0146	45	3.95	1005-0153	62	3.95
1005-0147	48	3.95	1005-0154	65	3.95
1005-0148	50	3.95			



1006-0288

PART #	DESCRIPTION	SUG. RETAIL
<b>JETS (2-PK.) (CONT)</b>		
1006-0293	185 main jet (2-pk.)	\$5.00
1006-0294	190 main jet (2-pk.)	5.00
1006-0295	195 main jet (2-pk.)	5.00
1006-0296	200 main jet (2-pk.)	5.00
1006-0297	205 main jet (2-pk.)	5.00

**IMPORTANT NOTE: SEE PAGE 411 FOR IMPORTANT INFORMATION REGARDING CERTAIN WARRANTY AND EMISSION CONTROL REGULATORY COMPLIANCE INFORMATION.**

All part numbers in **BLUE** are new for 2015.



- WINDSHIELDS & FAIRINGS
- TOURING
- AUDIO & COMMUNICATION
- LUGGAGE
- SEATS & Sissy BARS
- EXHAUST
- ENGINE
- TRANSMISSION & DRIVELINE
- GASKETS & SEALS
- ELECTRICAL
- LIGHTING
- HANDLEBARS, CONTROLS & MIRRORS
- CABLES
- BRAKES
- TANKS & OIL FILTERS
- DASHES & GAUGES
- FRAMES, SUSPENSION & FENDERS
- FOOTRESTS & LICENSE PLATE FRAMES
- WHEELS & AXLES
- HARDWARE, CHEMICALS & TOOLS
- COVERS, SECURITY & GENERAL



**RD PRECISION MAIN JETS**

- Brass carburetor jets are high precision and flow-calibrated for extremely accurate fuel flow rate
- Available in a range of sizes for Mikuni and Keihin applications
- High-quality replacement; NOT original Mikuni or Keihin jets
- Individual jet sizes sold in 4-pack to dealers; sold each to consumer
- Dealer kits that include a range of sizes also available

1006-0012

**DEALER JET KITS**

PART #	TYPE	DESCRIPTION	SUG. RETAIL
1006-0012	Mikuni-style slot head (SJ prefix)	4-pc. each jet sizes 72.5 through 160	\$353.95
1006-0013	Mikuni-style hex head (HJ prefix)	2-pc. each jet sizes 70 through 230	113.95
1006-0014	Mikuni-style hex head (HJ prefix)	2-pc. each jet sizes 240 through 500	113.95
1006-0015	Keihin-style slot head (KJ prefix)	4-pc. each jet sizes 80 through 190	288.95
1006-0016	Keihin-style hex head (CR prefix)	2-pc. each jet sizes 80 through 158	133.95
1006-0017	Keihin-style hex head (CR prefix)	2-pc. each jet sizes 160 through 235	133.95

**MIKUNI-STYLE SLOT HEAD (SJ PREFIX)**

PART #	JET SIZE	SUG. RETAIL (ea.)	PART #	JET SIZE	SUG. RETAIL (ea.)	PART #	JET SIZE	SUG. RETAIL (ea.)	PART #	JET SIZE	SUG. RETAIL (ea.)
1006-0018	72.5	\$2.50	1006-0028	97.5	\$2.50	1006-0038	122.5	\$2.50	1006-0048	147.5	\$2.50
1006-0019	75	2.50	1006-0029	100	2.50	1006-0039	125	2.50	1006-0049	150	2.50
1006-0020	77.5	2.50	1006-0030	102.5	2.50	1006-0040	127.5	2.50	1006-0050	152.5	2.50
1006-0021	80	2.50	1006-0031	105	2.50	1006-0041	130	2.50	1006-0051	155	2.50
1006-0022	82.5	2.50	1006-0032	107.5	2.50	1006-0042	132.5	2.50	1006-0052	157.5	2.50
1006-0023	85	2.50	1006-0033	110	2.50	1006-0043	135	2.50	1006-0053	160	2.50
1006-0024	87.5	2.50	1006-0034	112.5	2.50	1006-0044	137.5	2.50	1006-0054	170	2.50
1006-0025	90	2.50	1006-0035	115	2.50	1006-0045	140	2.50			
1006-0026	92.5	2.50	1006-0036	117.5	2.50	1006-0046	142.5	2.50			
1006-0027	95	2.50	1006-0037	120	2.50	1006-0047	145	2.50			

**MIKUNI-STYLE HEX HEAD (HJ PREFIX)**

PART #	JET SIZE	SUG. RETAIL (ea.)	PART #	JET SIZE	SUG. RETAIL (ea.)	PART #	JET SIZE	SUG. RETAIL (ea.)	PART #	JET SIZE	SUG. RETAIL (ea.)
1006-0055	70	\$2.50	1006-0073	175	\$2.50	1006-0091	330	\$2.50	1006-0109	510	\$2.50
1006-0056	80	2.50	1006-0074	180	2.50	1006-0092	340	2.50	1006-0110	520	2.50
1006-0057	90	2.50	1006-0075	185	2.50	1006-0093	350	2.50	1006-0111	530	2.50
1006-0058	100	2.50	1006-0076	190	2.50	1006-0094	360	2.50	1006-0112	540	2.50
1006-0059	105	2.50	1006-0077	195	2.50	1006-0095	370	2.50	1006-0113	550	2.50
1006-0060	110	2.50	1006-0078	200	2.50	1006-0096	380	2.50	1006-0114	560	2.50
1006-0061	115	2.50	1006-0079	210	2.50	1006-0097	390	2.50	1006-0115	570	2.50
1006-0062	120	2.50	1006-0080	220	2.50	1006-0098	400	2.50	1006-0116	580	2.50
1006-0063	125	2.50	1006-0081	230	2.50	1006-0099	410	2.50	1006-0117	590	2.50
1006-0064	130	2.50	1006-0082	240	2.50	1006-0100	420	2.50	1006-0118	600	2.50
1006-0065	135	2.50	1006-0083	250	2.50	1006-0101	430	2.50	1006-0119	610	2.50
1006-0066	140	2.50	1006-0084	260	2.50	1006-0102	440	2.50	1006-0120	620	2.50
1006-0067	145	2.50	1006-0085	270	2.50	1006-0103	450	2.50	1006-0121	630	2.50
1006-0068	150	2.50	1006-0086	280	2.50	1006-0104	460	2.50	1006-0122	640	2.50
1006-0069	155	2.50	1006-0087	290	2.50	1006-0105	470	2.50	1006-0123	650	2.50
1006-0070	160	2.50	1006-0088	300	2.50	1006-0106	480	2.50	1006-0124	660	2.50
1006-0071	165	2.50	1006-0089	310	2.50	1006-0107	490	2.50	1006-0125	670	2.50
1006-0072	170	2.50	1006-0090	320	2.50	1006-0108	500	2.50	1006-0126	680	2.50

**KEIHIN-STYLE SLOT HEAD (KJ PREFIX)**

PART #	JET SIZE	SUG. RETAIL (ea.)	PART #	JET SIZE	SUG. RETAIL (ea.)	PART #	JET SIZE	SUG. RETAIL (ea.)	PART #	JET SIZE	SUG. RETAIL (ea.)
1006-0127	72.5	\$2.50	1006-0137	97.5	\$2.50	1006-0147	122.5	\$2.50	1006-0157	147.5	\$2.50
1006-0128	75	2.50	1006-0138	100	2.50	1006-0148	125	2.50	1006-0158	150	2.50
1006-0129	77.5	2.50	1006-0139	102.5	2.50	1006-0149	127.5	2.50	1006-0159	152.5	2.50
1006-0130	80	2.50	1006-0140	105	2.50	1006-0150	130	2.50	1006-0160	155	2.50
1006-0131	82.5	2.50	1006-0141	107.5	2.50	1006-0151	132.5	2.50	1006-0161	157.5	2.50
1006-0132	85	2.50	1006-0142	110	2.50	1006-0152	135	2.50	1006-0162	160	2.50
1006-0133	87.5	2.50	1006-0143	112.5	2.50	1006-0153	137.5	2.50	1006-0163	170	2.50
1006-0134	90	2.50	1006-0144	115	2.50	1006-0154	140	2.50	1006-0164	190	2.50
1006-0135	92.5	2.50	1006-0145	117.5	2.50	1006-0155	142.5	2.50			
1006-0136	95	2.50	1006-0146	120	2.50	1006-0156	145	2.50			

**KEIHIN-STYLE HEX HEAD (CR PREFIX)**

PART #	JET SIZE	SUG. RETAIL (ea.)	PART #	JET SIZE	SUG. RETAIL (ea.)	PART #	JET SIZE	SUG. RETAIL (ea.)	PART #	JET SIZE	SUG. RETAIL (ea.)
1006-0165	80	\$2.50	1006-0181	120	\$2.50	1006-0197	160	\$2.50	1006-0213	200	\$2.50
1006-0166	82	2.50	1006-0182	122	2.50	1006-0198	162	2.50	1006-0214	202	2.50
1006-0167	85	2.50	1006-0183	125	2.50	1006-0199	165	2.50	1006-0215	205	2.50
1006-0168	88	2.50	1006-0184	128	2.50	1006-0200	168	2.50	1006-0216	208	2.50
1006-0169	90	2.50	1006-0185	130	2.50	1006-0201	170	2.50	1006-0217	210	2.50
1006-0170	92	2.50	1006-0186	132	2.50	1006-0202	172	2.50	1006-0218	212	2.50
1006-0171	95	2.50	1006-0187	135	2.50	1006-0203	175	2.50	1006-0219	215	2.50
1006-0172	98	2.50	1006-0188	138	2.50	1006-0204	178	2.50	1006-0220	218	2.50
1006-0173	100	2.50	1006-0189	140	2.50	1006-0205	180	2.50	1006-0221	220	2.50
1006-0174	102	2.50	1006-0190	142	2.50	1006-0206	182	2.50	1006-0222	222	2.50
1006-0175	105	2.50	1006-0191	145	2.50	1006-0207	185	2.50	1006-0223	225	2.50
1006-0176	108	2.50	1006-0192	148	2.50	1006-0208	188	2.50	1006-0224	228	2.50
1006-0177	110	2.50	1006-0193	150	2.50	1006-0209	190	2.50	1006-0225	230	2.50
1006-0178	112	2.50	1006-0194	152	2.50	1006-0210	192	2.50	1006-0226	232	2.50
1006-0179	115	2.50	1006-0195	155	2.50	1006-0211	195	2.50	1006-0227	235	2.50
1006-0180	118	2.50	1006-0196	158	2.50	1006-0212	198	2.50			

**IMPORTANT NOTE:** SEE PAGE 411 FOR IMPORTANT INFORMATION REGARDING CERTAIN WARRANTY AND EMISSION CONTROL REGULATORY COMPLIANCE INFORMATION.

All part numbers in **BLUE** are new for 2015.

WINDSHIELDS & FAIRINGS

TOURING

AUDIO & COMMUNICATION

LUGGAGE

SEATS & Sissy BARS

EXHAUST

PIPERAIN SYSTEMS

ENGINE

TRANSMISSION & DRIVELINE

GASKETS & SEALS

ELECTRICAL

LIGHTING

HANDLEBARS, CONTROLS & MIRRORS

CABLES

BRAKES

TANKS & OIL FILTERS

DASHES & GAUGES

FRAMES, SUSPENSION & FENDERS

FOOTRESTS & LICENSE PLATE FRAMES

WHEELS & AXLES

HARDWARE, CHEMICALS & TOOLS

COVERS, SECURITY & GENERAL



**JET ASSORTMENT KITS AND REPLACEMENT PARTS FOR HSR42/HSR45/HSR48**

- HSR42 kit includes 150 through 170 main jets (2 each); 22.5 through 35 pilot jets (2 each); -96, -97 and -98 needles (1 each); 2 #60 a/p nozzles; needle clip; all necessary washers, special jet box
- HSR45 kit includes 165 through 185 main jets (2 each); 20 through 32.5 pilot jets (2 each); -95, -96 and -98 needles (1 each); 2 #60 a/p nozzles; 2 O-rings, 4 jet needle E-rings; all necessary washers
- HSR48 kit includes 180 through 210 main jets (2 each); 20 through 32.5 pilot jets (2 each); -95, -96 and -98 needles (1 each); 2 #60 a/p nozzles; 2 O-rings, 4 jet needle E-rings; all necessary washers
- Some Kit components are available separately
- Made in Japan



1007-0326



1007-0325

PART #	DESCRIPTION	SUG. RETAIL
<b>JET KITS</b>		
KHS-025	HSR42	\$116.95
1007-0323	HSR45	116.95
1007-0322	HSR48	116.95
<b>INDIVIDUAL PARTS</b>		
1007-0324 <sup>1</sup>	Jet washers (4-pk.) for HSR45	.95
1007-0327 <sup>1</sup>	O-rings (4-pk.) for HSR45	3.95
1007-0326 <sup>1</sup>	Pump nozzles (4-pk.) for HSR45/48	5.95
1007-0325 <sup>1</sup>	Needle jet E-rings (4-pk.) for HSR45/48	.95
1004-0010	-96 needle jet for HSR45/48	16.95
1004-0011	-98 needle jet for HSR45/48	16.95

<sup>1</sup> Sold to dealer as a 4-pk.; sold to consumer as each.

**GENUINE MIKUNI N100.604 MAIN JETS**

- N100.604 series main jets used in HSR and RS carburetors
- 8mm round head diameter, 9mm overall length
- Available in sizes 60-210
- Sold to dealer 4 per pack; sold to consumer as each
- Made in Japan

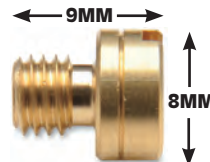

PART #	JET SIZE	SUG. RETAIL	PART #	JET SIZE	SUG. RETAIL	PART #	JET SIZE	SUG. RETAIL	PART #	JET SIZE	SUG. RETAIL
KN10060460	60	\$2.95	KN100604975	97.5	\$2.95	KN1006041375	137.5	\$2.95	KN100604175	175	\$2.95
KN100604625	62.5	2.95	KN100604100	100	2.95	KN100604140	140	2.95	KN1006041775	177.5	2.95
KN10060465	65	2.95	KN100604105	105	2.95	KN1006041425	142.5	2.95	KN100604180	180	2.95
KN100604675	67.5	2.95	KN1006041075	107.5	2.95	KN100604145	145	2.95	KN1006041825	182.5	2.95
KN10060470	70	2.95	KN100604110	110	2.95	KN1006041475	147.5	2.95	KN100604185	185	2.95
KN100604725	72.5	2.95	KN1006041125	112.5	2.95	KN100604150	150	2.95	KN1006041875	187.5	2.95
KN10060475	75	2.95	KN100604115	115	2.95	KN1006041525	152.5	2.95	KN100604190	190	2.95
KN100604775	77.5	2.95	KN1006041175	117.5	2.95	KN100604155	155	2.95	KN1006041925	192.5	2.95
KN10060480	80	2.95	KN100604120	120	2.95	KN1006041575	157.5	2.95	KN100604195	195	2.95
KN100604825	82.5	2.95	KN1006041225	122.5	2.95	KN100604160	160	2.95	KN100604200	200	2.95
KN10060485	85	2.95	KN100604125	125	2.95	KN1006041625	162.5	2.95	1006-0246	205	2.95
KN100604875	87.5	2.95	KN1006041275	127.5	2.95	KN100604165	165	2.95	1006-0247	210	2.95
KN10060490	90	2.95	KN100604130	130	2.95	KN1006041675	167.5	2.95			
KN100604925	92.5	2.95	KN1006041325	132.5	2.95	KN100604170	170	2.95			
KN10060495	95	2.95	KN100604135	135	2.95	KN1006041725	172.5	2.95			



**GENUINE MIKUNI VM22/210 PILOT JETS**

- These genuine Mikuni pilot jets fit most VM, TM and TMX carbs
- 4mm head diameter, 14mm overall length
- Sold to dealer in packs of 4; sold to consumer as each
- Made in Japan

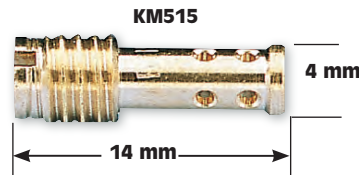

GENUINE MIKUNI VM22/210 FOR ALL TM, TMX & VM CARBS					
PART #	JET SIZE	SUG. RETAIL	PART #	JET SIZE	SUG. RETAIL
KM515	15	\$2.95	KM545	45	\$2.95
KM520	20	2.95	KM550	50	2.95
KM525	25	2.95	KM555	55	2.95
1005-0011	27.5	2.95	KM560	60	2.95
KM530	30	2.95	KM565	65	2.95
1005-0010	32.5	2.95	KM570	70	2.95
KM535	35	2.95	KM575	75	2.95
KM540	40	2.95	KM580	80	2.95

**IMPORTANT NOTE:** SEE PAGE 411 FOR IMPORTANT INFORMATION REGARDING CERTAIN WARRANTY AND EMISSION CONTROL REGULATORY COMPLIANCE INFORMATION.

All part numbers in **BLUE** are new for 2015.



WINDSHIELDS & FAIRINGS

TOURING

AUDIO & COMMUNICATION

LUGGAGE

SEATS & Sissy BARS

EXHAUST

PILOT/JET SYSTEMS

ENGINE

TRANSMISSION & DRIVELINE

GASKETS & SEALS

ELECTRICAL

LIGHTING

HANDLEBARS, CONTROLS & MIRRORS

CABLES

BRAKES

TANKS & OIL FILTERS

DASHES & GAUGES

FRAMES, SUSPENSION & FENDERS

FOOTRESTS & LICENSE PLATE FRAMES

WHEELS & AXLES

HARDWARE, CHEMICALS & TOOLS

COVERS, SECURITY & GENERAL

**GENUINE MIKUNI 4/042 MAIN JETS**  
**BRASS - LARGE HEX-TYPE**



- 6mm hex, 12mm overall length
- Fit most VM style carburetors
- Available in sizes 50-720
- Sold to dealer in packs of four; sold to consumer as each
- Made in Japan

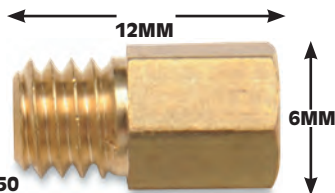

KM404250

PART #	JET SIZE	SUG. RETAIL	PART #	JET SIZE	SUG. RETAIL	PART #	JET SIZE	SUG. RETAIL	PART #	JET SIZE	SUG. RETAIL
KM404250	50	\$2.95	KM4042140	140	\$2.95	KM4042260	260	\$2.95	KM4042440	440	\$2.95
KM404255	55	2.95	KM4042145	145	2.95	KM4042270	270	2.95	KM4042450	450	2.95
KM404260	60	2.95	KM4042150	150	2.95	KM4042280	280	2.95	KM4042460	460	2.95
KM404265	65	2.95	KM4042155	155	2.95	KM4042290	290	2.95	KM4042470	470	2.95
KM404270	70	2.95	KM4042160	160	2.95	KM4042300	300	2.95	KM4042480	480	2.95
KM404275	75	2.95	KM4042165	165	2.95	KM4042310	310	2.95	KM4042490	490	2.95
KM404280	80	2.95	KM4042170	170	2.95	KM4042320	320	2.95	KM4042500	500	2.95
KM404285	85	2.95	KM4042175	175	2.95	KM4042330	330	2.95	KM4042540	540	2.95
KM404290	90	2.95	KM4042180	180	2.95	KM4042340	340	2.95	KM4042560	560	2.95
KM404295	95	2.95	KM4042185	185	2.95	KM4042350	350	2.95	KM4042580	580	2.95
KM4042100	100	2.95	KM4042190	190	2.95	KM4042360	360	2.95	KM4042600	600	2.95
KM4042105	105	2.95	KM4042195	195	2.95	KM4042370	370	2.95	KM4042620	620	2.95
KM4042110	110	2.95	KM4042200	200	2.95	KM4042380	380	2.95	KM4042640	640	2.95
KM4042115	115	2.95	KM4042210	210	2.95	KM4042390	390	2.95	KM4042660	660	2.95
KM4042120	120	2.95	KM4042220	220	2.95	KM4042400	400	2.95	KM4042680	680	2.95
KM4042125	125	2.95	KM4042230	230	2.95	KM4042410	410	2.95	KM4042700	700	2.95
KM4042130	130	2.95	KM4042240	240	2.95	KM4042420	420	2.95	KM4042720	720	2.95
KM4042135	135	2.95	KM4042250	250	2.95	KM4042430	430	2.95			



**GENUINE MIKUNI VM28/486 SERIES**  
**PILOT JETS**

- Fit HSR and RS Mikuni carburetors
- Available in sizes 15-60
- Sold to dealer as 4-pack; sold to consumer as each
- Made in Japan

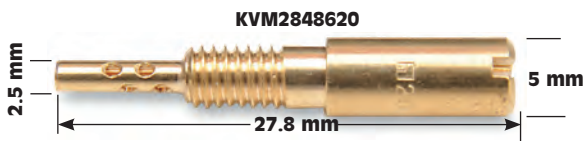

PART #	JET SIZE	SUG. RETAIL	PART #	JET SIZE	SUG. RETAIL	PART #	JET SIZE	SUG. RETAIL
KVM2848615	15	\$2.95	KVM28486275	27.5	\$2.95	KVM2848645	45	\$2.95
KVM28486175	17.5	2.95	KVM2848630	30	2.95	KVM2848650	50	2.95
KVM2848620	20	2.95	1005-0012	32.5	2.95	KVM2848655	55	2.95
KVM28486225	22.5	2.95	KVM2848635	35	2.95	KVM2848660	60	2.95
KVM2848625	25	2.95	KVM2848640	40	2.95			

**A-BAX PILOT JETS FOR**  
**MIKUNI VM28/486**



- Fit all RS, HS and HSR carburetors
- 28.1mm long
- Sold to dealer as 4-pack; sold to consumer as each



PART #	JET SIZE	SUG. RETAIL	PART #	JET SIZE	SUG. RETAIL
1005-0047	10	\$5.25	1005-0060	42.5	\$5.25
1005-0048	12.5	5.25	1005-0061	45	5.25
1005-0049	15	5.25	1005-0062	47.5	5.25
1005-0050	17.5	5.25	1005-0063	50	5.25
1005-0051	20	5.25	1005-0064	52.5	5.25
1005-0052	22.5	5.25	1005-0065	55	5.25
1005-0053	25	5.25	1005-0066	57.5	5.25
1005-0054	27.5	5.25	1005-0067	60	5.25
1005-0055	30	5.25	1005-0068	62.5	5.25
1005-0056	32.5	5.25	1005-0069	65	5.25
1005-0057	35	5.25	1005-0070	67.5	5.25
1005-0058	37.5	5.25	1005-0071	70	5.25
1005-0059	40	5.25			



**GENUINE MIKUNI JET NEEDLES**  
**FOR HSR42/45/48 CARBURETORS**

- Genuine Mikuni jet needles
- Needles are available in a variety of sizes to suit most applications
- Sold each
- Made in Japan



HSR42	HSR45/48	DESCRIPTION	SUG. RETAIL	HSR42	HSR45/48	DESCRIPTION	SUG. RETAIL
J8-8DDY01-95	J8-8CFY02-95	Richest	\$11.95	J8-8DDY01-97	J8-8CFY02-97	Standard	\$11.95
J8-8DDY01-96	J8-8CFY02-96	Richer	11.95	J8-8DDY01-98	J8-8CFY02-98	Leaner	11.95

**IMPORTANT NOTE:** SEE PAGE 411 FOR IMPORTANT INFORMATION REGARDING CERTAIN WARRANTY AND EMISSION CONTROL REGULATORY COMPLIANCE INFORMATION.

All part numbers in **BLUE** are new for 2015.

WINDSHIELDS  
& FAIRINGS

TOURING

AUDIO &  
COMMUNICATION

LUGGAGE

SEATS &  
SISSY BARS

EXHAUST

ENGINE

TRANSMISSION  
& DRIVELINEGASKETS  
& SEALS

ELECTRICAL

LIGHTING

HANDLEBARS,  
CONTROLS  
& MIRRORS

CABLES

BRAKES

TANKS &  
OIL FILTERSDASHES  
& GAUGESFRAMES,  
SUSPENSION  
& FENDERSFOOTRESTS  
& LICENSE  
PLATE FRAMESWHEELS  
& AXLESHARDWARE,  
CHEMICALS  
& TOOLSCOVERS,  
SECURITY  
& GENERAL**POWER X-WING**

- Patented air vane requires no modifications to install
- Acceleration gains from idle to wide-open throttle
- Dyno tests show 2-5 horsepower gains and 4-6 ft.-lbs. max torque increases on OEM H-D engines
- Independent tests were conducted on 88", 96" and 110" engines
- Complements popular air filter system upgrades
- Made in the U.S.A.

1050-0180

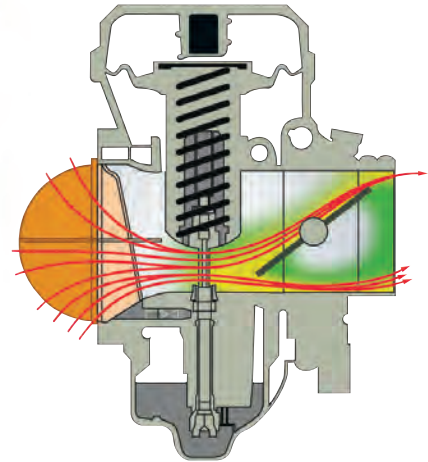

PART #	DESCRIPTION	SUG. RETAIL
1050-0194	For 08-15 FLHT/FLHX/FLHR/FLTR models	\$129.95
1050-0182	For 06-15 Softail/Dyna, 06-07 FLHT/FLHX/FLHR/FLTR w/ Delphi EFI	129.95
1050-0181	For 01-05 Softail, 04-05 Dyna, 02-05 FLHT/FLHR/FLTR, 07-15 XL w/ Delphi EFI	129.95
1050-0180	For 88-06 models w/ OEM CV carb	129.95
1050-0237	For 02-15 V-Rod models	179.95

PART #	DESCRIPTION	SUG. RETAIL
1050-0236	For 03-09 Buell XB12 models	\$129.95
1050-0195	For Mikuni HSR 42/45 carbs w/ early style 1.75" H-D adapter	129.95
1050-0196	For Mikuni HSR 42/45 carbs w/ late style 2" H-D adapter	129.95
1050-0197	For Mikuni HSR 48 carb w/ 2" adapter	129.95
1050-0205	For S&S Super E Shorty	129.95



DS-289146

**FLANGE MOUNT INTAKE MANIFOLDS**

- For mounting an S&S E and G series carburetor or flange mount carburetor on a 99-06 Twin Cam motor with S&S or stock cylinder heads
- Will also fit a 84-99 80" Evolution that requires a manifold with a map sensor port
- Come with a map sensor port and match OEM intake ports
- Made in the U.S.A.

PART #	DESCRIPTION	SUG. RETAIL
DS-289146	S&S E-series intake manifold	\$91.95
1050-0046	S&S G-series intake manifold	91.95

**FLANGE-MOUNT INTAKE MANIFOLDS**

- Can be used to replace stock "compliance fitting" manifold on 84-89 and stock rigid-mount manifold from 90-99
- Use with stock or S&S cylinder heads
- For use with stock 5.550" length cylinders
- Requires the use of S&S intake seals and flanges (sold separately)
- Made in the U.S.A.

PART #	DESCRIPTION	SUG. RETAIL
<b>FOR 84-99 EVOLUTION-STYLE BIG TWIN</b>		
1050-0109	For Super A, B, E, L, H-D Tillotson, Bendix, and Keihin carbs (no MAP sensor port)	\$91.95
1050-0110	For Super G carbs (no MAP sensor port)	91.95



1050-0109

**MANIFOLD CONVERSION KIT FOR 80" EVOLUTION**

- Kit converts stock 80" Evolution manifold to a more rigid-mount system
- Eliminates cracking and leaking problems associated with the stock rubber compliance fittings
- Includes an S&S Performance manifold, mounting flanges, two specially molded O-rings and two .350" spacers for spacing out the stock air cleaner or carb mount bracket
- Fits 84-99 80" models if flange-type carburetor or adapter is used
- Replacement flange seals also available
- Made in the U.S.A.

NOTE: Not for use with an S&amp;S G series carb.

PART #	DESCRIPTION	SUG. RETAIL
DS-289230	Manifold conversion kit	\$112.95

**SPIGOT-MOUNT INTAKE MANIFOLDS FOR S&S HEADS**

- Used to install a stock CV carburetor on S&S 3.625", 4" and 4.125" bore motors
- Will also fit S&S Hot Setup and Super Stock™ head kits
- PART #1050-0244 is used to install 48 mm CV or Mikuni carburetor on Twin Cam 88, 95 bore motors
- Made in the U.S.A.

NOTE: Requires the use of S&amp;S manifold O-rings and U-rings, sold separately.

PART #	ENGINE SIZE	CYLINDER LENGTH	SUG. RETAIL
<b>FOR S&amp;S TWIN CAM STYLE MOTORS AND HEAD KITS</b>			
161722	88"/95"	4.9365"	\$107.95
1050-0244	88"/95"	4.9365"	108.95
<b>FOR S&amp;S BIG TWIN EVOLUTION STYLE MOTORS AND HEAD KITS</b>			
161733	88"/107"	5.375"/4.870"	107.95
161734	93"/113"	4.995"	107.95
161736	80"/89"/96"	5.550"	107.95



1050-0244

**IMPORTANT NOTE: SEE PAGE 411 FOR IMPORTANT INFORMATION REGARDING CERTAIN WARRANTY AND EMISSION CONTROL REGULATORY COMPLIANCE INFORMATION.**All part numbers in **BLUE** are new for 2015.



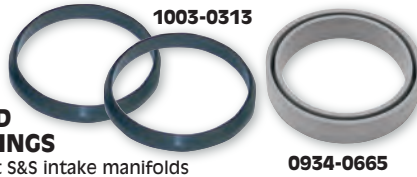

**INTAKE MANIFOLD O-RINGS AND U-RINGS**

- For use with all current S&S intake manifolds
- O-rings sold in 10-pack
- U-rings sold each
- Made in the U.S.A.

PART #	DESCRIPTION	SUG. RETAIL (ea.)
<b>O-RINGS (MANIFOLD TO CYLINDER HEADS)</b>		
1003-0060	For 84-06 Big Twin and 86-06 Sportster engines w/ S&S manifold (10-pk.)	\$4.95
1003-0313	For stock heads (OEM #26995-86A) (10-pk.)	3.95
<b>U-RINGS (CV CARB TO MANIFOLD)</b>		
0934-0666	40-42mm	16.95
0934-0665	44-45mm	14.95

**RUBBER FLANGE ADAPTERS FOR SPIGOT-TYPE CARBURETORS**



M-VM-40-200

- Adapters fit 38mm and 40mm spigot-type carburetors
- Includes clamp
- PART # M-VM-36-200 has mounting holes that are 70mm on center; i.d. of 39.5mm
- PART # M-VM-38-200 has mounting holes that are 74.6mm on center; i.d. of 38mm
- PART # M-VM-40-200 has mounting holes that are 74.6mm on center; i.d. of 47mm
- Sold individually
- Made in Japan

PART #	DESCRIPTION	SUG. RETAIL
M-VM-36-200	36mm-38mm rubber flange adapter	\$23.95
M-VM-38-200	40mm rubber flange adapter - 43mm carb spigot o.d. (fits RS40, RS42)	23.95
M-VM-40-200	40mm rubber flange adapter - 52mm carb spigot o.d.	23.95



**MANIFOLD SPACER KITS**

- For use with 116" JIMS Stroker kits when fitting standard-width manifolds, such as standard CV carb, H-D Delphi EFI, Screamin' Eagle® and S&S®
- Needed because 116" Stroker kits have .100" taller cylinders that increase the distance between heads by .080"
- Made in the U.S.A.



1022-0060

PART #	DESCRIPTION	SUG. RETAIL
1022-0061	For 06-15 Twin Cam	\$121.95
1022-0060	For 90-05 Big Twin	53.95



**WILD THINGS™ INTAKE FLANGES**

- Can be used with the stock throttle body
- Sold each
- Engineered by Mike Roland



PART #	DESCRIPTION	SUG. RETAIL
1022-0056	For 99-05 Twin Cam w/ Screamin' Eagle heads	\$83.95



**INTAKE FLANGES**

- CNC-machined 6061 billet aluminum construction
- Will not crack or warp like some forged flanges
- Made in the U.S.A.



1022-0068

PART #	DESCRIPTION	SUG. RETAIL
1022-0068	For 06-15 Big Twin models	\$61.95
1022-0069	For 01-05 Big Twin models	61.95

**BILLET FLANGE ADAPTER FOR SPIGOT-TYPE CARBS**



- Allows you to mount OEM late-model CV or Mikuni HSR-42 carbs on early Evolutions with two-bolt flange manifolds
- CNC machined from 6061 billet aluminum
- Mounting holes are 2.75" on center
- Can be polished, plated or painted
- Carb-to-manifold seal also available; see GASKETS & SEALS section
- Sold each
- Made in the U.S.A.

PART #	DESCRIPTION	SUG. RETAIL
DS-289219	Billet flange adapter	\$28.95

**BLACK FLANGE ADAPTERS**



HS42/062-48

- Rubber flange adapters fit 42mm, 45mm and 48mm spigot-type carburetors
- PART # HS42/018-42 has mounting holes that are 70mm on center; i.d. of 45mm
- PART # HS42/018-45 has mounting holes that are 70mm on center; i.d. of 48mm
- PART # HS42/062-48 has mounting holes that are 70mm on center; i.d. of 71mm
- Includes clamp
- Original straight-through design
- Sold individually
- Made in Japan

PART #	DESCRIPTION	SUG. RETAIL
HS42/018-42	42mm	\$31.95
HS42/018-45	45mm	31.95
HS42/062-48	48mm	31.95



**CHROME INTAKE MANIFOLD FLANGES**

- Chrome flanges replace the stock flanges
- Sold in pairs
- Replacement intake manifold seals also available; see GASKETS & SEALS section



PART #	DESCRIPTION	SUG. RETAIL
DS-289212	For 90-05 Big Twin and 86-06 XL models	\$25.95

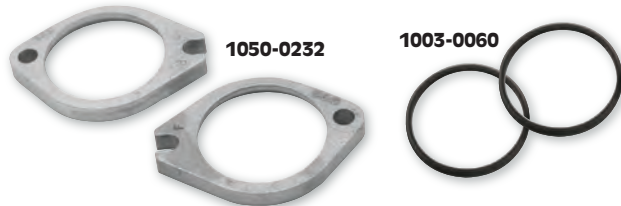

1050-0232

1003-0060

**INTAKE MANIFOLD FLANGES**

- Sold in pair (front/rear)
- Replacement seals also available
- Made in the U.S.A.



PART #	DESCRIPTION	SUG. RETAIL
<b>FOR 84-05 BIG TWIN AND 86-06 SPORTSTER ENGINES WITH S&amp;S INTAKE MANIFOLD</b>		
1050-0232	Front/rear flange; repl. H-D #27009-86B and #27010-86B	\$34.95 (pr.)
1003-0060	Repl. seals (10-pk.)	4.95 (ea.)



**ENGINE BREATHERS**

- Chromed, CNC-machined 6061 billet aluminum crankcase breathers screw directly into cylinder heads
- Allow a clean, simple way for the engine to "breathe" correctly
- Made in the U.S.A.

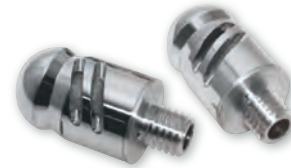

PART #	DESCRIPTION	SUG. RETAIL
2106-1001	For all 93-99 Evolution Big Twin and 91-14 XL	\$99.95

**IMPORTANT NOTE: SEE PAGE 411 FOR IMPORTANT INFORMATION REGARDING CERTAIN WARRANTY AND EMISSION CONTROL REGULATORY COMPLIANCE INFORMATION.**

All part numbers in **BLUE** are new for 2015.

WINDSHIELDS & FAIRINGS

TOURING

AUDIO & COMMUNICATION

LUGGAGE

SEATS & Sissy BARS

EXHAUST

FUEL/AIR SYSTEMS

ENGINE

TRANSMISSION & DRIVELINE

GASKETS & SEALS

ELECTRICAL

LIGHTING

HANDLEBARS, CONTROLS & MIRRORS

CABLES

BRAKES

TANKS & OIL FILTERS

DASHES & GAUGES

FRAMES, SUSPENSION & FENDERS

FOOTRESTS & LICENSE PLATE FRAMES

WHEELS & AXLES

HARDWARE, CHEMICALS & TOOLS

COVERS, SECURITY & GENERAL

WINDSHIELDS & FAIRINGS

TOURING

AUDIO & COMMUNICATION

LUGGAGE

SEATS & SISSY BARS

EXHAUST

FUEL/AIR SYSTEMS

ENGINE

TRANSMISSION & DRIVELINE

GASKETS & SEALS

ELECTRICAL

LIGHTING

HANDLEBARS, CONTROLS & MIRRORS

CABLES

BRAKES

TANKS & OIL FILTERS

DASHES & GAUGES

FRAMES, SUSPENSION & FENDERS

FOOTRESTS & LICENSE PLATE FRAMES

WHEELS & AXLES

HARDWARE, CHEMICALS & TOOLS

COVERS, SECURITY & GENERAL



**SUPPORT BRACKET/BREATHER KITS**

- Billet aluminum construction with a chrome, black or wrinkle-black finish
- Crankcase breathes back into the carb or throttle body so no external lines are necessary
- Allow custom air cleaners or velocity stacks to be installed in a horizontal or vertical position; no other adapters are required
- Include installation hardware
- Made in the U.S.A.



PART #	DESCRIPTION	SUG. RETAIL
<b>FOR 08-15 FLHT, FLHR, FLHX, FLTR, FLHTCUTG, FLHXXX W/ DELPHI EFI</b>		
1012-0095	Chrome	\$247.95
<b>FOR 93-06 BIG TWIN W/ 40MM CV CARB AND 01-15 BIG TWIN W/ DELPHI EFI (EXCEPT 08-15 DRESSER)</b>		
1012-0142	Chrome	188.95
1012-0143	Black	188.95
1012-0144	Wrinkle black	188.95

PART #	DESCRIPTION	SUG. RETAIL
<b>FOR 93-99 EVOLUTION BIG TWIN W/ S&amp;S E OR G CARB</b>		
1012-0145 <sup>1</sup>	Chrome	\$188.95
1012-0146 <sup>1</sup>	Black	188.95
1012-0147 <sup>1</sup>	Wrinkle black	188.95
<b>FOR 93-06 BIG TWIN W/ MIKUNI 42/45/48 CARB</b>		
1012-0148	Chrome	198.95
1012-0149	Black	198.95
1012-0150	Wrinkle black	198.95

PART #	DESCRIPTION	SUG. RETAIL
<b>FOR 91-15 XL W/ CV CARB OR DELPHI EFI</b>		
1012-0137	Chrome	\$207.95
1012-0138	Black	207.95
1012-0139	Wrinkle black	207.95

<sup>1</sup> Not for 100" S&S motors.



**SUPPORT BRACKET WITH BREATHER SYSTEM**

- Billet aluminum with chrome finish
- Clean, one-piece design support bracket with internal breather system
- Crankcase breathes back into the carb or throttle body so no external lines are necessary
- Accepts most CV/Delphi EFI-style air cleaners
- Includes installation hardware
- Made in the U.S.A.

PART #	DESCRIPTION	SUG. RETAIL
<b>FOR 93-15 BIG TWIN (EXCEPT 08-15 DRESSER)</b>		
1012-0079	For S&S E/G carb, Evolution	\$304.95
1012-0080	For S&S E/G carb, Twin Cam	304.95
1012-0082	For CV carb/Delphi EFI Twin Cam	304.95
1012-0083	For Mikuni HSR 42mm, Evolution	304.95



**CRANKCASE BREATHER KIT**

- One-piece chrome tube design
- Comes with breather bolts, washers and hardware
- Works with most aftermarket air cleaners

PART #	DESCRIPTION	SUG. RETAIL
DS-289620	For 93-15 Big Twin (except 08-15 Dressers)	\$32.95
2110-0316	For 91-15 XL	29.95

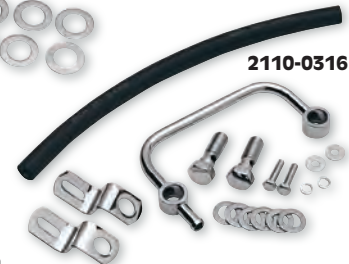

**HSR CARBURETOR HEAD-BREATHER KITS**

- For use with Mikuni air filter PART #HS42012250 and HS42012300
- For the installation of HSR carburetor kits using the K&N high-flow filter on Evo and Twin Cam Big Twins

PART #	DESCRIPTION	SUG. RETAIL
KHS-020	For HSR42/45 carb on Evo Big Twin	\$85.95
KHS-030	For HSR42/45 carb on Twin Cam	85.95



**IMPORTANT NOTE: SEE PAGE 411 FOR IMPORTANT INFORMATION REGARDING CERTAIN WARRANTY AND EMISSION CONTROL REGULATORY COMPLIANCE INFORMATION.**

All part numbers in **BLUE** are new for 2015.



WINDSHIELDS & FAIRINGS

TOURING

AUDIO & COMMUNICATION

LUGGAGE

SEATS & SISSY BARS

EXHAUST

FUEL/AIR SYSTEMS

ENGINE

TRANSMISSION & DRIVELINE

GASKETS & SEALS

ELECTRICAL

LIGHTING

HANDLEBARS, CONTROLS & MIRRORS

CABLES

BRAKES

TANKS & OIL FILTERS

DASHES & GAUGES

FRAMES, SUSPENSION & FENDERS

FOOTRESTS & LICENSE PLATE FRAMES

WHEELS & AXLES

HARDWARE, CHEMICALS & TOOLS

COVERS, SECURITY & GENERAL



DS-289082



1013-0036

1013-0030

**CRANKCASE BREATHER/SUPPORT BRACKET KITS**

- Kit allows the installation of aftermarket air cleaner assemblies on late model bikes equipped with OEM CV carb or Delphi EFI system
- Includes bracket, filter, hose and all mounting hardware necessary for installation except where noted

PART #	DESCRIPTION	SUG. RETAIL	PART #	DESCRIPTION	SUG. RETAIL
1013-0036	For 08-15 FLHT, FLTR, FLHX, FLHR models	\$74.95	1013-0030	For 07-15 XL models	\$69.95
DS-289082	For all 93-15 Big Twin models (except 08-15 Dressers)	69.95	DS-289126	For 91-06 XL models	64.95
DS-289060	For 93-15 Big Twin models (no hose or filter) (except 08-15 Dressers)	64.95	DS-289073	Repl. filter	12.95



**AIR CLEANER BREATHER KIT**

- Enables the mounting of most aftermarket air cleaners to late-style engines that breathe through the cylinder heads
- Fittings can be rotated 360° so that hoses can be routed as necessary
- Hose sold separately

PART #	DESCRIPTION	SUG. RETAIL
DS-289055	For 93-15 Big Twin and 91-15 XL models	\$49.95



**BRAIDED HOSE CRANKCASE BREATHER KIT**

- This kit provides the best looking alternative to black rubber hoses when mounting a crankcase breather system
- Features a 3/8" i.d. stainless steel braided hose crimped onto chrome banjo fittings
- Outlet side of assembly is long enough to custom-route the hose and mount the breather filter in an inconspicuous location
- Includes breather filter (with mounting stud), hardware and instructions
- Air cleaner and carb support bracket must be purchased separately

**NOTE: Not recommended for stock applications. Make sure the braided line does not contact anything (i.e. the gas tank, carb or wiring) as damage may result.**

PART #	DESCRIPTION	SUG. RETAIL
DS289118	For 93-15 Big Twin custom applications only	\$69.95



**CHROME CRANKCASE BREATHER**

- With this breather, as oil-laden air condenses in the breather body, the excess oil now runs back down into the engine rather than into the air cleaner
- A really clean setup

**NOTE: Not for use on fuel-injected models.**

PART #	DESCRIPTION	SUG. RETAIL	PART #	DESCRIPTION	SUG. RETAIL	PART #	DESCRIPTION	SUG. RETAIL
1012-0073	For 99-06 Twin Cam	\$62.95	1012-0072	For 93-99 Evolution Big Twin	\$63.95	1012-0200	For 07-15 XL	\$36.95

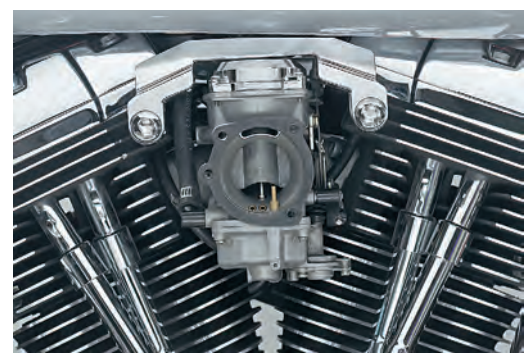

**3 1/4" CUT-TO-LENGTH CHROME BREATHER BOLT KITS**

- Solve the problem when mounting a carb support bracket
- Sold in pairs
- Made in the U.S.A.

PART #	DESCRIPTION	SUG. RETAIL
<b>BUTTONHEAD</b>		
1012-0017	3/8"-16 w/ 1/2" inserts	\$67.95
1012-0018	3/8"-16	67.95
1012-0019	5/16"-18	67.95



1012-0017



1012-0039

**BREATHER BOLT KITS**

- Chrome-plated button-head bolts fit most support brackets and breathers
- Kit for 93-99 Evolution-style engines comes with two 1/2"-13 x 1 3/4" bolts, four thick aluminum washers and four stainless steel washers
- Kit for 99-15 Twin Cam-style engines comes with two 3/8"-16 x 1 3/4" coarse-thread bolts, six stepped aluminum washers and four stainless steel washers
- Made in the U.S.A.

PART #	DESCRIPTION	SUG. RETAIL
1012-0039	For 99-15 Twin Cam	\$50.95
1012-0038	For 93-99 Evolution	40.95



1012-0038



**IMPORTANT NOTE: SEE PAGE 411 FOR IMPORTANT INFORMATION REGARDING CERTAIN WARRANTY AND EMISSION CONTROL REGULATORY COMPLIANCE INFORMATION.**

All part numbers in **BLUE** are new for 2015.

WINDSHIELDS & FAIRINGS

TOURING

AUDIO & COMMUNICATION

LUGGAGE

SEATS & Sissy BARS

EXHAUST

FUEL/AIR SYSTEMS

ENGINE

TRANSMISSION & DRIVELINE

GASKETS & SEALS

ELECTRICAL

LIGHTING

HANDLEBARS, CONTROLS & MIRRORS

CABLES

BRAKES

TANKS & OIL FILTERS

DASHES & GAUGES

FRAMES, SUSPENSION & FENDERS

FOOTRESTS & LICENSE PLATE FRAMES

WHEELS & AXLES

HARDWARE, CHEMICALS & TOOLS

COVERS, SECURITY & GENERAL

**TWIN CAM/ EVOLUTION BREATHER BOLT KITS**

- Chrome-plated hex-head breather bolts
- Fits most supports and breather brackets
- Includes sealing washers

PART #	DESCRIPTION	SUG. RETAIL
<b>1012-0161</b>	3/8"-16 (Twin cam)	\$16.95

1012-0161

1012-0162

PART #	DESCRIPTION	SUG. RETAIL
<b>1012-0162</b>	1/2"-13 (Evolution)	\$16.95

**DRAG Specialties**

**BREATHER BOLT WASHER KIT**

- Features four 3/8" and four 1/2" aluminum centering washers
- Also includes four nylon sealing washers

PART #	DESCRIPTION	SUG. RETAIL
<b>1012-0005</b>	For 91-15 breather systems	\$8.95



**BREATHER BOLT COVERS**

- Hide the zinc breather bolts with these chrome-plated covers
- Quick, easy upgrade; just press on and tighten the setscrew

PART #	DESCRIPTION	SUG. RETAIL
<b>1012-0169</b>	For 99-15 Twin Cam, 07-15 XL w/ Kuryakyn air cleaners and crankcase breather kits	\$19.95



**THREAD REDUCER**

- Used on 93-99 H-D cylinder heads when installing a carburetor support bracket that requires 5/16"-18 mounting bolts
- Reduces a 1/2"-13 threaded hole to 5/16"-18
- Sold each; two required per motor
- Made in the U.S.A.

PART #	DESCRIPTION	SUG. RETAIL
<b>7806-2940</b>	1/2"-13 to 5/16"-18 thread reducer	\$5.95



**MYSTFREE KIT**

- Machined T-6061 billet aluminum construction
- Helps oil drain more efficiently into the rocker
- Reduces oil misting coming from the engine breathers
- Made in the U.S.A.

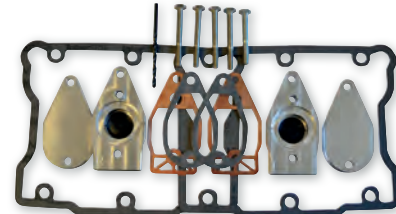

PART #	DESCRIPTION	SUG. RETAIL
<b>0920-0118</b>	For 99-15 FL Touring, 00-15 Softtail/Dyna models	\$229.95

**EMISSIONS NOTICE:** The California Air Resources Board (CARB) does not permit the use of emission-related parts or products that remove or alter OEM emission control devices unless issued an Executive Order (EO) by CARB, other than for closed course competition use only. Check your local laws and manufacturer's information.

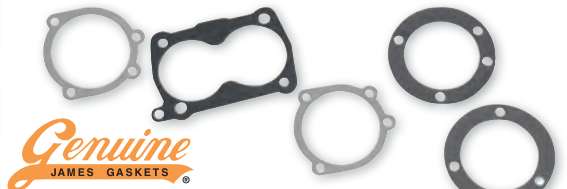

**BREATHER SHOP SERVICE KIT**

- Includes all gaskets, seals and O-rings to service OEM breather systems
- Made in the U.S.A.

PART #	DESCRIPTION	SUG. RETAIL
<b>0934-0942</b>	Breather service kit	\$10.95



**CARB SUPPORT BRACKET WITH CHOKE CABLE MOUNT**

- Chrome-plated stamped steel
- Provides support for carb and air cleaner
- Offers mounting of choke control under the carb for easy access

PART #	DESCRIPTION	SUG. RETAIL
<b>2110-1212</b>	For 92-06 Big Twin w/ Mikuni HSR 42/45 carb	\$39.95



**ADJUSTABLE CARBURETOR SUPPORT BRACKET**

- Adjusts from 5.25" to 6.375"
- Mounts from the center-case bolt between cylinders to the lower flange mount of the manifold
- Made in the U.S.A.

PART #	DESCRIPTION	SUG. RETAIL
<b>160471</b>	Support bracket	\$16.95

**THROTTLE BODY SUPPORT BRACKET COVER**

- Adds a chrome accent to the OEM support bracket
- A must-have when replacing the OEM air cleaner

PART #	DESCRIPTION	SUG. RETAIL
<b>1013-0073</b>	For 08-15 FLHT/FLHR/FLTR/FLHX and H-D FL Trikes	\$49.95



**SUPPORT BRACKETS**

- Chrome air cleaner braces provide additional support for the Dragtron™ II air cleaners or any flat-backed air cleaners
- Mount to the cylinder heads
- Can be used in conjunction with most breather kits (where applicable)
- Breather kits/bolts sold separately
- All gaskets and mounting hardware included
- For replacement gaskets, see Gaskets & Seals section

DS289190



1013-0017



PART #	DESCRIPTION	SUG. RETAIL	PART #	DESCRIPTION	SUG. RETAIL
<b>1013-0035</b>	For 08-15 FLHT, FLHR, FLHX, FLTR and H-D FL Trike	\$29.95	<b>DS-289053</b>	For 84-89 Big Twin Evolution (butterfly carb)	\$24.95
<b>DS289190</b>	For 90-15 Big Twin (except 08-15 Dressers) (CV carb/Delphi EFI)	33.95	<b>1013-0017</b>	For 07-15 XL	29.95
			<b>DS-289062</b>	For 88-06 XL	24.95

**IMPORTANT NOTE:** SEE PAGE 411 FOR IMPORTANT INFORMATION REGARDING CERTAIN WARRANTY AND EMISSION CONTROL REGULATORY COMPLIANCE INFORMATION.

All part numbers in **BLUE** are new for 2015.





- WINDSHIELDS & FAIRINGS
- TOURING
- AUDIO & COMMUNICATION
- LUGGAGE
- SEATS & Sissy BARS
- EXHAUST
- PIPET/AIR SYSTEMS

- ENGINE
- TRANSMISSION & DRIVELINE
- GASKETS & SEALS

- ELECTRICAL
- LIGHTING
- HANDLEBARS, CONTROLS & MIRRORS

- CABLES
- BRAKES
- TANKS & OIL FILTERS
- DASHES & GAUGES

- FRAMES, SUSPENSION & FENDERS
- FOOTRESTS & LICENSE PLATE FRAMES

- WHEELS & AXLES
- HARDWARE, CHEMICALS & TOOLS
- COVERS, SECURITY & GENERAL

**CLARITY AIR CLEANERS**

- CNC machined from billet aluminum
- Allows for viewing of the internal moving intake components
- Backing plate promotes smooth airflow into the carb/throttle body
- Includes high-volume K&N air filter
- All mounting hardware included
- Contrast Cut™ finish starts with a polished air cleaner that has been black anodized, then recut to open up the design
- Black Ops™ features gloss black on top of contrasting textured black for outstanding durability and good looks
- Machine Ops™, RSD's newest finish, is a fusion of textured natural aluminum and detailed machining that exposes the true beauty of our aluminum alloy, then dip the fresh machined parts in a slick clear anodize to protect the surface while keeping its raw aesthetic protected
- Matching Clarity derby and cam cover available
- Made in the U.S.A.

NOTE: Not legal for street use on pollution controlled vehicles.

PART #	DESCRIPTION	SUG. RETAIL
<b>FOR 08-15 FLT AND H-D TRIKE MODELS</b>		
1010-1042	Chrome	\$499.95
1010-1043	Contrast Cut	499.95
1010-1044	Black Ops	499.95
1010-1482	Machine Ops	499.95

PART #	DESCRIPTION	SUG. RETAIL
<b>FOR 01-15 SOFTAIL MODELS, 04-15 DYNA GLIDE MODELS, 02-07 FLT MODELS W/ DELPHI EFI, 93-06 BIG TWIN MODELS W/ STOCK CV CARB</b>		
1010-1039	Chrome	\$499.95
1010-1040	Contrast Cut	499.95
1010-1041	Black Ops	499.95
1010-1481	Machine Ops	499.95

PART #	DESCRIPTION	SUG. RETAIL
<b>FOR 91-15 XL W/ CV CARB/DELPHI EFI</b>		
1010-1045	Chrome	\$499.95
1010-1046	Contrast Cut	499.95
1010-1047	Black Ops	499.95
1010-1483	Machine Ops	499.95
<b>REPLACEMENT/OPTIONAL COMPONENTS</b>		
1011-3183	Repl. air filter	56.95



**BLUNT AIR CLEANERS**

- Revolutionary backing plate that promotes smooth airflow into the carb/throttle body
- Hidden crank case breathers
- High volume best in filtration K & N air filter included
- Smaller filter elements gives more knee clearance
- Available in Machine Ops™, chrome, Contrast Cut™ or Black Ops™
- Machine Ops™, RSD's newest finish, is a fusion of textured natural aluminum and detailed machining that exposes the true beauty of their aluminum alloy; they then dip the fresh machined parts in a slick clear anodize to protect the surface while keeping its raw aesthetic protected
- Includes all mounting hardware
- Made in the U.S.A.

NOTE: Not legal for street use on pollution controlled vehicles.

PART #	DESCRIPTION	SUG. RETAIL
<b>FOR 08-15 FLT MODELS AND H-D FL TRIKE MODELS</b>		
1010-1494	Radial, Machine Ops	\$421.95
1010-1433	Radial, Chrome	421.95
1010-1442	Radial, Contrast Cut	421.95
1010-1451	Radial, Black Ops	421.95
1010-1497	Split, Machine Ops	421.95
1010-1436	Split, Chrome	421.95
1010-1445	Split, Contrast Cut	421.95
1010-1454	Split, Black Ops	421.95
1010-1500	Power, Machine Ops	435.95
1010-1439	Power, Chrome	435.95
1010-1448	Power, Contrast Cut	435.95
1010-1457	Power, Black Ops	435.95

PART #	DESCRIPTION	SUG. RETAIL
<b>FOR 01-15 SOFTAIL MODELS, 04-15 DYNA GLIDE MODELS, 02-07 FLT MODELS W/ DELPHI EFI AND 93-06 BIG TWIN MODELS W/ STOCK CV CARB</b>		
1010-1493	Radial, Machine Ops	\$421.95
1010-1432	Radial, Chrome	421.95
1010-1441	Radial, Contrast Cut	421.95
1010-1450	Radial, Black Ops	421.95
1010-1496	Split, Machine Ops	421.95
1010-1435	Split, Chrome	421.95
1010-1444	Split, Contrast Cut	421.95
1010-1453	Split, Black Ops	421.95
1010-1499	Power, Machine Ops	435.95
1010-1438	Power, Chrome	435.95
1010-1447	Power, Contrast Cut	435.95
1010-1456	Power, Black Ops	435.95

PART #	DESCRIPTION	SUG. RETAIL
<b>FOR 91-15 XL W/ CV CARB/DELPHI EFI</b>		
1010-1495	Radial, Machine Ops	\$421.95
1010-1434	Radial, Chrome	421.95
1010-1443	Radial, Contrast Cut	421.95
1010-1452	Radial, Black Ops	421.95
1010-1498	Split, Machine Ops	421.95
1010-1437	Split, Chrome	421.95
1010-1446	Split, Contrast Cut	421.95
1010-1455	Split, Black Ops	421.95
1010-1501	Power, Machine Ops	435.95
1010-1440	Power, Chrome	435.95
1010-1449	Power, Contrast Cut	435.95
1010-1458	Power, Black Ops	435.95
<b>REPLACEMENT/OPTIONAL COMPONENTS</b>		
1011-3184	Repl. air filter	56.95
1011-3237	Optional pre-filter	34.95

**IMPORTANT NOTE: SEE PAGE 411 FOR IMPORTANT INFORMATION REGARDING CERTAIN WARRANTY AND EMISSION CONTROL REGULATORY COMPLIANCE INFORMATION.**

All part numbers in **BLUE** are new for 2015.



WINDSHIELDS & FAIRINGS

TOURING

AUDIO & COMMUNICATION

LUGGAGE

SEATS & SISSY BARS

EXHAUST

PISTON/PIN SYSTEMS

ENGINE

TRANSMISSION & DRIVELINE

GASKETS & SEALS

ELECTRICAL

LIGHTING

HANDLEBARS, CONTROLS & MIRRORS

CABLES

BRAKES

TANKS & OIL FILTERS

DASHES & GAUGES

FRAMES, SUSPENSION & FENDERS

FOOTRESTS & LICENSE PLATE FRAMES

WHEELS & AXLES

HARDWARE, CHEMICALS & TOOLS

COVERS, SECURITY & GENERAL

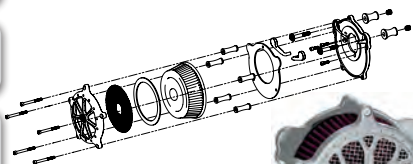

Delmar Machine Ops™

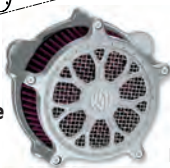

Delmar Contrast Cut Ops™



Raid Machine Ops™

Raid Contrast Cut Black Ops™



Morris Black Ops™



Speed 5 Chrome



Speed 5 Contrast Cut™



Speed 7 Chrome



Speed 7 Contrast Cut™



Mission Contrast Cut™



Ronin Contrast Cut™



Domino Contrast Cut™



Judge Contrast Cut™



Judge Black Ops™



Turbo Contrast Cut™



Boss Black Ops™

**VENTURI AIR CLEANERS**

- Exposed filter design that enhances airflow
- Backing plate promotes smooth airflow into carburetor/throttle body
- Built-in internal crank case breathers
- Contrast Cut™ finish starts with a polished venturi air cleaner faceplate that has been black anodized, then recut to open up the design
- Platinum Cut uses the same process as the Contrast Cut™, but the recut areas are hand polished to a brilliant shine
- Black Ops™ features gloss black on top of contrasting textured black for outstanding durability and good looks
- Contrast Cut Ops™ features a Contrast Cut™ with a Black Ops™ finish
- Machine Ops™, RSD's newest finish, is a fusion of textured natural aluminum and detailed machining that exposes the true beauty of our aluminum alloy, then dip the fresh machined parts in a slick clear anodize to protect the surface while keeping its raw aesthetic protected
- Includes high-volume air filter
- All mounting hardware included
- Made in the U.S.A.

NOTE: Not legal for street use on pollution controlled vehicles.



Boss Contrast Cut™

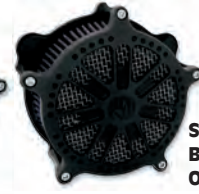

Slam Black Ops™



Slam Contrast Cut™



1011-2000



1011-1781

PART #	DESCRIPTION	SUG. RETAIL
<b>FOR 08-15 FLT MODELS AND H-D FL TRIKE MODELS</b>		
1010-1488	Delmar, Machine Ops	\$439.95
1010-1421	Delmar, Contrast Cut Ops	439.95
1010-1424	Delmar, Chrome	439.95
1010-1491	Raid, Machine Ops	439.95
1010-1427	Raid, Contrast Cut Ops	439.95
1010-1430	Raid, chrome	439.95
1010-1221	Morris, Black Ops	439.95
1010-0373	Speed 5, Chrome	439.95
1010-0374	Speed 5, Contrast Cut	439.95
1010-0422	Speed 7, chrome	439.95
1010-0423	Speed 7, Contrast Cut	439.95
1010-0792	Speed 7, Platinum Cut	439.95
1010-1068	Speed 7, Black Ops	439.95
1010-0718	Mission, Contrast Cut	439.95
1010-0724	Ronin, Contrast Cut	439.95
1010-0804	Domino, Contrast Cut	439.95
1010-0808	Judge, Contrast Cut	439.95
1010-1063	Judge, Black Ops	439.95
1010-0798	Turbo, chrome	439.95
1010-0797	Turbo, Contrast Cut	439.95
1010-0897	Boss, Black Ops	439.95
1010-0901	Boss, Contrast Cut	439.95
1010-0905	Slam, Black Ops	439.95
1010-0909	Slam, Contrast Cut	439.95

PART #	DESCRIPTION	SUG. RETAIL
<b>FOR 01-15 SOFTAIL MODELS, 04-15 DYNA GLIDE MODELS, 02-07 FLT MODELS W/ DELPHI EFI, 93-06 BIG TWIN MODELS W/ STOKP CV CARB</b>		
1010-1487	Delmar, Machine Ops	\$439.95
1010-1420	Delmar, Contrast Cut Ops	439.95
1010-1423	Delmar, Chrome	439.95
1010-1490	Raid, Machine Ops	439.95
1010-1426	Raid, Contrast Cut Ops	439.95
1010-1429	Raid, chrome	439.95
1010-1220	Morris, Black Ops	439.95
1010-0316	Speed 5, chrome	439.95
1010-0317	Speed 5, Contrast Cut	439.95
1010-0420	Speed 7, chrome	439.95
1010-0421	Speed 7, Contrast Cut	439.95
1010-0791	Speed 7, Platinum Cut	439.95
1010-1067	Speed 7, Black Ops	439.95
1010-0720	Mission, Contrast Cut	439.95
1010-0726	Ronin, Contrast Cut	439.95
1010-0803	Domino, Contrast Cut	439.95
1010-0807	Judge, Contrast Cut	439.95
1010-1064	Judge, Black Ops	439.95
1010-0796	Turbo, chrome	439.95
1010-0795	Turbo, Contrast Cut	439.95
1010-0896	Boss, Black Ops	439.95
1010-0900	Boss, Contrast Cut	439.95
1010-0904	Slam, Black Ops	439.95
1010-0908	Slam, Contrast Cut	439.95

PART #	DESCRIPTION	SUG. RETAIL
<b>FOR 91-15 XL W/ CV CARB/DELPHI EFI</b>		
1010-1489	Delmar, Machine Ops	\$439.95
1010-1422	Delmar, Contrast Cut Ops	439.95
1010-1425	Delmar, Chrome	439.95
1010-1492	Raid, Machine Ops	439.95
1010-1428	Raid, Contrast Cut Ops	439.95
1010-1431	Raid, chrome	439.95
1010-1222	Morris, Black Ops	439.95
1010-0402	Speed 5, chrome	439.95
1010-0403	Speed 5, Contrast Cut	439.95
1010-0424	Speed 7, chrome	439.95
1010-0425	Speed 7, Contrast Cut	439.95
1010-0793	Speed 7, Platinum Cut	439.95
1010-1069	Speed 7, Black Ops	439.95
1010-0722	Mission, Contrast Cut	439.95
1010-0728	Ronin, Contrast Cut	439.95
1010-0805	Domino, Contrast Cut	439.95
1010-0809	Judge, Contrast Cut	439.95
1010-1065	Judge, Black Ops	439.95
1010-0800	Turbo, chrome	439.95
1010-0799	Turbo, Contrast Cut	439.95
1010-0898	Boss, Black Ops	439.95
1010-0902	Boss, Contrast Cut	439.95
1010-0906	Slam, Black Ops	439.95
1010-0910	Slam, Contrast Cut	439.95

<b>REPLACEMENT/OPTIONAL COMPONENTS</b>		
1011-2000	Repl. air filter	57.95
1011-1781	Optional pre-filter style rain sock	29.95

**IMPORTANT NOTE: SEE PAGE 411 FOR IMPORTANT INFORMATION REGARDING CERTAIN WARRANTY AND EMISSION CONTROL REGULATORY COMPLIANCE INFORMATION.**

All part numbers in **BLUE** are new for 2015.





- WINDSHIELDS & FAIRINGS
- TOURING
- AUDIO & COMMUNICATION
- LUGGAGE
- SEATS & SISSY BARS
- EXHAUST
- PIPET/VALVE SYSTEMS
- ENGINE
- TRANSMISSION & DRIVELINE
- GASKETS & SEALS
- ELECTRICAL
- LIGHTING
- HANDLEBARS, CONTROLS & MIRRORS
- CABLES
- BRAKES
- TANKS & OIL FILTERS
- DASHES & GAUGES
- FRAMES, SUSPENSION & FENDERS
- FOOTRESTS & LICENSE PLATE FRAMES
- WHEELS & AXLES
- HARDWARE, CHEMICALS & TOOLS
- COVERS, SECURITY & GENERAL



1010-1195



Contrast Cut™



Chrome



Black Ops™



Machine Ops™

**NOSTALGIA VENTURI AIR CLEANER**

- RSD Nostalgia styling is finally available in our Venturi Air Cleaner
- Featuring trademark RSD hotrod styling with increased ventilation in the face plates, gives the Nostalgia Air Cleaner increased levels of ventilation while keeping it classic
- Design matched to the RSD Nostalgia line of products
- High-volume K&N Air Filter included
- Built-in crank case breathers
- Slotted breather bolts and oil tubes are included with all applications
- Available in Black Ops™, Contrast Cut™ chrome or Machine Ops™
- Machine Ops™, RSD's newest finish, is a fusion of textured natural aluminum and detailed machining that exposes the true beauty of our aluminum alloy, then dip the fresh machined parts in a slick clear anodize to protect the surface while keeping its raw aesthetic protected
- Made in the U.S.A.

NOTE: Not legal for street use on pollution controlled vehicles.

PART #	DESCRIPTION	SUG. RETAIL	PART #	DESCRIPTION	SUG. RETAIL	PART #	DESCRIPTION	SUG. RETAIL
<b>FOR 08-15 FLT MODELS AND H-D FL TRIKE MODELS</b>			<b>FOR 01-15 SOFTAIL MODELS, 04-15 DYNA GLIDE MODELS, 02-07 FLT MODELS W/ DELPHI EFI, 93-06 BIG TWIN MODELS W/ STOCK CV CARB</b>			<b>FOR 91-15 XL</b>		
1010-1192	Contrast Cut	\$439.95	1010-1191	Contrast Cut	\$439.95	1010-1190	Contrast Cut	\$439.95
1010-1196	Black Ops	439.95	1010-1195	Black Ops	439.95	1010-1194	Black Ops	439.95
1010-1200	Chrome	439.95	1010-1199	Chrome	439.95	1010-1198	Chrome	439.95
1010-1485	Machine Ops	439.95	1010-1484	Machine Ops	439.95	1010-1486	Machine Ops	439.95



**AIR CLEANER SCRUB BAG**

- Stretches over complete air cleaner to prevent water from entering engine while washing bike
- Helps to keep water or other debris from entering when bike is parked
- Made from waterproof denier material with an elastic enclosure
- Made in the U.S.A.

NOTE: Cannot be used while engine is running. For washing and storage purposes only.

PART #	DESCRIPTION	SUG. RETAIL
1011-2051	For all RSD Venturi and Turbine air cleaners	\$31.95



**RAIN SOCK**

- Stretches over complete air cleaner for quick and easy roadside installation (no tools required)
- Helps to prevent water from entering your engine when riding in wet conditions
- Compatible with all RSD Venturi and Turbine air cleaner assemblies
- Hydrophobic manufacturing process repels water
- Filters out larger particles of debris down to .005"
- Uniform micron openings allow air in while keeping debris and water out
- Made in the U.S.A.

PART #	DESCRIPTION	SUG. RETAIL
1011-2050	For all RSD Venturi and Turbine air cleaners	\$29.95



**IMPORTANT NOTE: SEE PAGE 411 FOR IMPORTANT INFORMATION REGARDING CERTAIN WARRANTY AND EMISSION CONTROL REGULATORY COMPLIANCE INFORMATION.**

All part numbers in **BLUE** are new for 2015.

WINDSHIELDS  
& FAIRINGS

TOURING

AUDIO &  
COMMUNICATION

LUGGAGE

SEATS &  
SISSY BARS

EXHAUST

FUEL/AIR  
SYSTEMS

ENGINE

TRANSMISSION  
& DRIVELINEGASKETS  
& SEALS

ELECTRICAL

LIGHTING

HANDLEBARS,  
CONTROLS  
& MIRRORS

CABLES

BRAKES

TANKS &  
OIL FILTERSDASHES  
& GAUGESFRAMES,  
SUSPENSION  
& FENDERSFOOTRESTS  
& LICENSE  
PLATE FRAMESWHEELS  
& AXLESHARDWARE,  
CHEMICALS  
& TOOLSCOVERS,  
SECURITY  
& GENERAL

1010-1248



### SLANT CARBON FIBER AIR INTAKE KIT

- Combines the best in performance and light weight with an ergo-friendly slanted carbon fiber body
- Includes carbon fiber ergo trimmed K&N filter element that is coupled with the newest backing plate shape from Vance & Hines for industry-leading filtration
- The slanted design of this kit provides more knee clearance that is easier on the rider during hard riding
- Features a laser-etched black-anodized outer cover, black-anodized backing plate with internal breathers and mounting hardware and a powder-coated inlet adapter
- Made in the U.S.A.

NOTE: Not legal for street use on pollution controlled vehicles.

PART #	DESCRIPTION	SUG. RETAIL
1010-1388	For 08-15 FLT and H-D FL Trike models	\$469.95
1010-1389	For 00-15 FXST/FLST, 99-15 FXD/FXDWG and 99-07 FLT/FLHT w/ CV carb/Delphi EFI	469.95
1010-1248	For 91-15 XL w/ CV carb/Delphi EFI	469.95

PART #	DESCRIPTION	SUG. RETAIL
<b>REPLACEMENT/OPTIONAL COMPONENTS</b>		
1011-3238	Optional pre-filter	\$34.95
1011-3160	Replacement air filter	159.95



Black

ROLAND  
SANDS  
DESIGNBLACK  
BLACK  
OPSContrast  
Cut

Contrast Cut™



Chrome

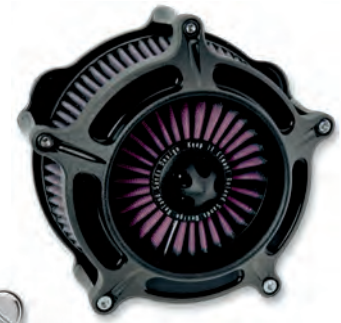

Black Ops™



Machine Ops™

### TURBINE AIR CLEANERS

- Exposed filter design offers enhanced airflow
- Backing plate promotes smooth airflow into carb/throttle body
- Built-in internal crankcase breathers
- Contrast Cut™ finish starts with a polished turbine air cleaner faceplate that has been black anodized, then recut to open up the design
- Black Ops™ is perhaps the toughest yet, featuring gloss black on top of a contrasting textured black finish
- Machine Ops™, RSD's newest finish, is a fusion of textured natural aluminum and detailed machining that exposes the true beauty of our aluminum alloy, then dip the fresh machined parts in a slick clear anodize to protect the surface while keeping its raw aesthetic protected
- High-volume K&N air filter
- Laser-engraved center nose cone
- All mounting hardware included
- Made in the U.S.A.

NOTE: Not legal for street use on pollution controlled vehicles.

PART #	DESCRIPTION	SUG. RETAIL
<b>FOR 08-15 FLT AND H-D FL TRIKE MODELS</b>		
1010-0845	Black	\$439.95
1010-0846	Contrast Cut	439.95
1010-0847	Chrome	439.95
1010-0963	Black Ops	439.95
1010-1479	Machine Ops	439.95
<b>FOR 01-15 SOFTAIL MODELS , 04-15 DYNA GLIDE MODELS, 02-07 FLT MODELS W/ DELPHI EFI, 93-06 BIG TWIN MODELS W/ STOCK CV CARB</b>		
1010-0842	Black	439.95
1010-0843	Contrast Cut	439.95
1010-0844	Chrome	439.95

PART #	DESCRIPTION	SUG. RETAIL
<b>FOR 01-15 SOFTAIL MODELS , 04-15 DYNA GLIDE MODELS, 02-07 FLT MODELS W/ DELPHI EFI, 93-06 BIG TWIN MODELS W/ STOCK CV CARB (CONT)</b>		
1010-0962	Black Ops	\$439.95
1010-1478	Machine Ops	439.95
<b>FOR 91-15 XL W/ CV CARB/DELPHI EFI</b>		
1010-0848	Black	439.95
1010-0849	Contrast Cut	439.95
1010-0850	Chrome	439.95
1010-0964	Black Ops	439.95
1010-1480	Machine Ops	439.95
<b>ACCESSORIES</b>		
1011-2000	Replacement high-volume K&N air filter	57.95

**IMPORTANT NOTE:** SEE PAGE 411 FOR IMPORTANT INFORMATION REGARDING CERTAIN WARRANTY AND EMISSION CONTROL REGULATORY COMPLIANCE INFORMATION.

All part numbers in **BLUE** are new for 2015.





1010-1594



- WINDSHIELDS & FAIRINGS
- TOURING
- AUDIO & COMMUNICATION
- LUGGAGE
- SEATS & Sissy BARS
- EXHAUST
- POCKET AIR SYSTEMS

**NAKED VO2 AIR INTAKES**

- For those wanting to keep the stock look, but not necessarily the stock performance
- Vance & Hines now offers its VO2 Air Intake as a high-flow replacement kit
- PART #s 1010-0738 and 1010-0739 use stock air cleaner cover unless noted; PART #s 1010-0865 and 1010-0866 must use air cleaner covers PART #s 1010-0867, 1010-0868, 1010-1051, 1010-1052
- Designed and manufactured entirely in-house, the VO2 Naked includes a high-flow washable filter element, larger inlet backing plate and billet venturi to get more air in rider's motor for more power
- Made in the U.S.A.



**NOTE: Not legal for street use on pollution controlled vehicles.**

PART #	DESCRIPTION	SUG. RETAIL
1010-0739 <sup>1</sup>	For 08-15 FLHT, FLHR, FLHX, FLTR and H-D FL Trike models	\$139.95
1010-0738	For 01-15 Twin Cam w/ Delphi EFI, 99-06 Twin Cam w/CV carb (except 08-15 Dressers, Dyna, X-Bones)	139.95
1010-0865	For 08-15 FXD/FXDWG models	139.95
1010-0866	For 04-15 XL models	139.95
1010-1594 <sup>1</sup>	For 15 XG 500/750	139.95

<sup>1</sup> Require air cleaner cover PART # 1010-0867, 1010-0868, 1010-1051 or 1010-1052.



1010-0475



1010-0479



1022-0052

**AIR INTAKES**

- It's all about how much air a motor can take in
- Here are systems that work better and look better than any other systems on the market
- An all-aluminum venturi in both designs helps shape the air for better flow
- Hand-formed steel covers for a distinctive look that is a perfect match for any Vance & Hines exhaust system
- Exhaust, fuel and now air is the complete package
- Each includes a high-flow washable and reusable air filter
- Made in the U.S.A.



1010-0407

**NOTE: Not legal for street use on pollution controlled vehicles.**

DUKE COVER		
PART #	DESCRIPTION	SUG. RETAIL
<b>CHROME</b>		
1010-0477	For 08-15 FLHT, FLHR, FLHX, FLTR and H-D FL Trikes	\$259.95
1010-0475	For 01-15 Twin Cam w/ Delphi EFI (except 08-15 FLHT, FLHR, FLHX, FLTR and H-D FL Trikes), 99-06 Twin Cam w/ CV carb	259.95
1010-0476	For 04-15 XL	259.95
<b>BLACK</b>		
1010-0478	For 01-15 Twin Cam w/ Delphi EFI (except 08-15 FLHT, FLHR, FLHX, FLTR), 99-06 Twin Cam w/ CV carb	279.95
1010-0479	For 04-15 XL	279.95

DRAK COVER		
PART #	DESCRIPTION	SUG. RETAIL
<b>CHROME</b>		
1022-0055	For 08-15 FLHT, FLHR, FLHX, FLTR and H-D FL Trikes	\$229.95
1022-0052	For 01-15 Twin Cam w/ Delphi EFI (except 08-15 FLHT, FLHR, FLHX, FLTR and H-D FL Trikes), 99-06 Twin Cam w/ CV carb	229.95
<b>BLACK</b>		
1010-0407	For 08-15 FLHT, FLHR, FLHX, FLTR and H-D FL Trikes	259.95
1010-0406	For 01-15 Twin Cam w/ Delphi EFI (except 08-15 FLHT, FLHR, FLHX, FLTR and H-D FL Trikes), 99-06 Twin Cam w/ CV carb	259.95

REPLACEMENT AIR FILTER		
PART #	DESCRIPTION	SUG. RETAIL
1011-2939	Repl. filter for VO2 air cleaners	\$65.95

**IMPORTANT NOTE: SEE PAGE 411 FOR IMPORTANT INFORMATION REGARDING CERTAIN WARRANTY AND EMISSION CONTROL REGULATORY COMPLIANCE INFORMATION.**

All part numbers in **BLUE** are new for 2015.

- ENGINE
- TRANSMISSION & DRIVELINE
- GASKETS & SEALS
- ELECTRICAL
- LIGHTING
- HANDLEBARS, CONTROLS & MIRRORS
- CABLES
- BRAKES
- TANKS & OIL FILTERS
- DASHES & GAUGES
- FRAMES, SUSPENSION & FENDERS
- FOOTRESTS & LICENSE PLATE FRAMES
- WHEELS & AXLES
- HARDWARE, CHEMICALS & TOOLS
- COVERS, SECURITY & GENERAL

WINDSHIELDS  
& FAIRINGS

TOURING

AUDIO &  
COMMUNICATION

LUGGAGE

SEATS &  
SISSY BARS

EXHAUST

PISTON  
SYSTEMS

ENGINE

TRANSMISSION  
& DRIVELINEGASKETS  
& SEALS

ELECTRICAL

LIGHTING

HANDLEBARS,  
CONTROLS  
& MIRRORS

CABLES

BRAKES

TANKS &  
OIL FILTERSDASHES  
& GAUGESFRAMES,  
SUSPENSION  
& FENDERSFOOTRESTS  
& LICENSE  
PLATE FRAMESWHEELS  
& AXLESHARDWARE,  
CHEMICALS  
& TOOLSCOVERS,  
SECURITY  
& GENERAL

## Contrast Cut™



## Chrome



1010-1324

## Black Ops™



1011-3189



1011-3187



## MAX HP AIR CLEANER

- CNC-machined aluminum backing plate
- Internal rubber breather tubes to eliminate oil leakage
- Internal power cone design for smooth, laminar air flow
- Innovative conical design for improved knee clearance
- Contrast Cut™ finish starts with a polished air cleaner that has been black anodized, then recut to open the design
- Black Ops™ finish features gloss black on top of a contrasting textured black finish for outstanding durability and looks
- All mounting hardware and gaskets included
- Made in the U.S.A.

NOTE: Not legal for street use on pollution controlled vehicles.

## AIR CLEANERS

PART #	DESCRIPTION	SUG. RETAIL	PART #	DESCRIPTION	SUG. RETAIL
<b>FOR 08-15 FLHT/FLHR/FLTR/FLHX AND H-D TRIKE</b>					
1010-1328	Contrast Cut	\$449.95	1010-1325	Contrast Cut	\$449.95
1010-1329	Chrome	449.95	1010-1326	Chrome	449.95
1010-1330	Black Ops	449.95	1010-1327	Black Ops	449.95
<b>FOR 01-15 SOFTAIL MODELS, 04-15 DYNA MODELS, 02-07 FLT MODELS W/ DELPHI EFI, 93-06 BIG TWIN MODELS W/ STOCK CV CARB</b>					
1010-1322	Contrast Cut	449.95	<b>OPTIONAL/REPL. COMPONENTS</b>		
1010-1323	Chrome	449.95	PART #	DESCRIPTION	SUG. RETAIL
1010-1324	Black Ops	449.95	1011-3187	Rain sock	\$31.95
			1011-3189	Repl. air filter	39.95

Array  
Contrast  
Cut™Array  
Black Ops™Scallop  
Contrast  
Cut™Scallop  
Chrome

1010-1342

1011-3190



1011-3188



## SCALLOP/ARRAY AIR CLEANERS

- Lightweight and low profile to maximize performance
- Features a proprietary K&N High Flow air filter
- Features PM's proven internal crankcase breather system
- Complements cylinder angles on H-D models
- Available in chrome, Contrast Cut™, Black Ops™ and Platinum Cut finishes
- Made in the U.S.A.

NOTE: Not legal for street use on pollution controlled vehicles.

## AIR CLEANERS

PART #	DESCRIPTION	SUG. RETAIL	PART #	DESCRIPTION	SUG. RETAIL	PART #	DESCRIPTION	SUG. RETAIL
<b>FOR 08-15 FLHT/FLHR/FLTR/FLHX AND H-D TRIKE</b>								
1010-1338	Array, Contrast Cut	\$419.95	<b>FOR 01-15 SOFTAIL MODELS, 04-15 DYNA MODELS, 02-07 FLT MODELS W/ DELPHI EFI, 93-06 BIG TWIN MODELS W/ STOCK CV CARB</b>			1010-1345	Array, Contrast Cut	\$419.95
1010-1339	Array, chrome	419.95	1010-1331	Array, Contrast Cut	\$419.95	1010-1346	Array, chrome	419.95
1010-1340	Array, Black Ops	419.95	1010-1332	Array, chrome	419.95	1010-1347	Array, Black Ops	419.95
1010-1341	Scallop, Contrast Cut	419.95	1010-1333	Array, Black Ops	419.95	1010-1348	Scallop, Contrast Cut	419.95
1010-1342	Scallop, Platinum Cut	419.95	1010-1334	Scallop, Contrast Cut	419.95	1010-1349	Scallop, Platinum Cut	419.95
1010-1343	Scallop, chrome	419.95	1010-1335	Scallop, Platinum Cut	419.95	1010-1350	Scallop, chrome	419.95
1010-1344	Scallop, Black Ops	419.95	1010-1336	Scallop, chrome	419.95	1010-1351	Scallop, Black Ops	419.95
			1010-1337	Scallop, Black Ops	419.95			

## OPTIONAL/REPL. COMPONENTS

PART #	DESCRIPTION	SUG. RETAIL	PART #	DESCRIPTION	SUG. RETAIL
1011-3188	Rain sock	\$36.95	1011-3190	Repl. air filter	\$39.95

**IMPORTANT NOTE:** SEE PAGE 411 FOR IMPORTANT INFORMATION REGARDING CERTAIN WARRANTY AND EMISSION CONTROL REGULATORY COMPLIANCE INFORMATION.

All part numbers in **BLUE** are new for 2015.





1010-0828

**Dixon Platinum Cut mounted on air cleaner**



1010-0829



**Domino Chrome**



**Element Platinum Cut faceplate shown mounted on air cleaner 1010-0826**

WINDSHIELDS & FAIRINGS

TOURING

AUDIO & COMMUNICATION

LUGGAGE

SEATS & SISSY BARS

EXHAUST

FUEL/AIR SYSTEMS

ENGINE

TRANSMISSION & DRIVELINE

GASKETS & SEALS

ELECTRICAL

LIGHTING

HANDLEBARS, CONTROLS & MIRRORS

CABLES

BRAKES

TANKS & OIL FILTERS

DASHES & GAUGES

FRAMES, SUSPENSION & FENDERS

FOOTRESTS & LICENSE PLATE FRAMES

WHEELS & AXLES

HARDWARE, CHEMICALS & TOOLS

COVERS, SECURITY & GENERAL

**Gatlin Contrast Cut™**



**Heathen Contrast Cut™**



**Hooligan Chrome**



**Judge Chrome**



**Revel Platinum Cut**



**Rivera Contrast Cut™**



**Rival Contrast Cut™ mounted on air cleaner**



**Supra Platinum Cut mounted on air cleaner**



**Torque Contrast Cut™**



**Virtue Platinum Cut**



**Wrath Platinum Cut**

1014-0050

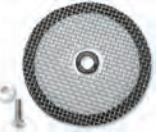

1101-0047



1011-3186

**SUPER GAS AIR CLEANERS AND UNIVERSAL FACEPLATES**

- Versatile design accepts interchangeable faceplates that are designed to match Performance Machine wheels
- Air cleaners include a K&N filter behind a stainless steel wire mesh screen to allow high-volume air flow, resulting in increased horsepower
- Air cleaners and universal faceplates are sold separately and available in chrome, Contrast Cut™ and Platinum Cut finishes
- Contrast Cut™ finish starts with a polished faceplate that has been black anodized, then recut to open up the design
- Platinum Cut uses the same process as the Contrast Cut™, only the recut areas are then hand polished to a brilliant finish
- Screamin' Eagle/Ness upgrade kit adapts a Performance Machine designed faceplate to fit the Screamin' Eagle/Arlen Ness air cleaners
- Screamin' Eagle/Ness upgrade kit includes mesh insert, spacer, hardware, and PM Logo badge
- Made in the U.S.A.

**AIR CLEANERS**

PART #	DESCRIPTION	SUG. RETAIL
<b>FOR 08-15 TOURING AND H-D FL TRIKE</b>		
1010-0828	Black	\$349.95
1010-0829	Chrome	349.95

PART #	DESCRIPTION	SUG. RETAIL
<b>FOR 01-15 TWIN CAM W/ DELPHI EFI (EXCEPT 08-15 TOURING), 93-06 BIG TWIN W/ CV CARB</b>		
1010-0826	Black	\$349.95
1010-0827	Chrome	349.95

PART #	DESCRIPTION	SUG. RETAIL
<b>FOR 91-15 XL W/ CV CARB/DELPHI EFI</b>		
1010-0830	Black	\$349.95
1010-0831	Chrome	349.95

**FACEPLATES/ACCESSORIES**

PART #	DESCRIPTION	SUG. RETAIL
<b>DIXON</b>		
1014-0213	Platinum Cut	\$95.95
1014-0214	Chrome	95.95
<b>DOMINO</b>		
1014-0054	Chrome	89.95
<b>ELEMENT</b>		
1014-0078	Chrome	89.95
1014-0077	Platinum Cut	95.95
<b>GATLIN</b>		
1014-0056	Contrast Cut	85.95
1014-0057	Chrome	89.95
<b>HEATHEN</b>		
1014-0058	Contrast Cut	85.95
1014-0059	Platinum Cut	95.95

PART #	DESCRIPTION	SUG. RETAIL
<b>HEATHEN (CONT)</b>		
1014-0060	Chrome	\$89.95
<b>HOOLIGAN</b>		
1014-0061	Chrome	89.95
<b>JUDGE</b>		
1014-0063	Chrome	89.95
<b>REVEL</b>		
1014-0166	Platinum Cut	95.95
<b>RIVERA</b>		
1014-0064	Contrast Cut	89.95
1014-0065	Chrome	89.95
<b>RIVAL</b>		
1014-0067	Contrast Cut	85.95
1014-0068	Chrome	89.95

PART #	DESCRIPTION	SUG. RETAIL
<b>SUPRA</b>		
1014-0215	Platinum Cut	\$95.95
1014-0216	Chrome	95.95
<b>TORQUE</b>		
1014-0070	Contrast Cut	89.95
1014-0071	Platinum Cut	95.95
1014-0072	Chrome	89.95
<b>VIRTUE</b>		
1014-0167	Platinum Cut	95.95
<b>WRATH</b>		
1014-0073	Platinum Cut	95.95
1014-0074	Chrome	89.95

PART #	DESCRIPTION	SUG. RETAIL
<b>OPTIONAL/REPL. COMPONENTS</b>		
1014-0050	Upgrade kit for Screamin' Eagle/Arlen Ness air cleaners	\$25.95
1101-0047	Internal rain sock	29.95
1011-2000	Repl. air filter	57.95
1011-3186	Pullover rain sock	31.95

**IMPORTANT NOTE:** SEE PAGE 411 FOR IMPORTANT INFORMATION REGARDING CERTAIN WARRANTY AND EMISSION CONTROL REGULATORY COMPLIANCE INFORMATION.

All part numbers in **BLUE** are cv for 2015.

WINDSHIELDS  
& FAIRINGS

TOURING

AUDIO &  
COMMUNICATION

LUGGAGE

SEATS &  
SISSY BARS

EXHAUST

FUEL/AIR  
SYSTEMS

ENGINE

TRANSMISSION  
& DRIVELINEGASKETS  
& SEALS

ELECTRICAL

LIGHTING

HANDLEBARS,  
CONTROLS  
& MIRRORS

CABLES

BRAKES

TANKS &  
OIL FILTERSDASHES  
& GAUGESFRAMES,  
SUSPENSION  
& FENDERSFOOTRESTS  
& LICENSE  
PLATE FRAMESWHEELS  
& AXLESHARDWARE,  
CHEMICALS  
& TOOLSCOVERS,  
SECURITY  
& GENERAL

1010-1585



1010-1586



1010-1587

**JET AIR CLEANERS**

- Low-profile and lightweight air cleaners are CNC-machined from billet aluminum
- Innovative and versatile design allows unit to be mounted in the vertical or horizontal position
- Compact design for improved knee clearance
- Features PM's proven internal crankcase venting system
- Feature a high-flow reusable air filter
- Available in Contrast Cut™, chrome and Black Ops™ finishes
- Contrast Cut™ finish starts with a polished air cleaner that has been black anodized, then recut to open the design
- Black Ops™ finish features gloss black on top of a contrasting textured black finish for outstanding durability and looks
- Made in the U.S.A.

NOTE: Not legal for street use on pollution controlled vehicles.

PART #	DESCRIPTION	SUG. RETAIL
<b>FOR 08-15 FLHT/FLHR/FLHX/FLTR</b>		
1010-1588	Contrast Cut	\$499.95
1010-1589	Chrome	499.95
1010-1590	Black Ops	499.95

PART #	DESCRIPTION	SUG. RETAIL
<b>FOR 01-15 TWIN CAM W/ DELPHI EFI (EXCEPT 08-15 TOURING), 93-06 TWIN CAM W/ CV CARB</b>		
1010-1585	Contrast Cut	\$499.95
1010-1586	Chrome	499.95
1010-1587	Black Ops	499.95

PART #	DESCRIPTION	SUG. RETAIL
<b>FOR 91-15 XL</b>		
1010-1591	Contrast Cut	\$499.95
1010-1592	Chrome	499.95
1010-1593	Black Ops	499.95



1010-1089

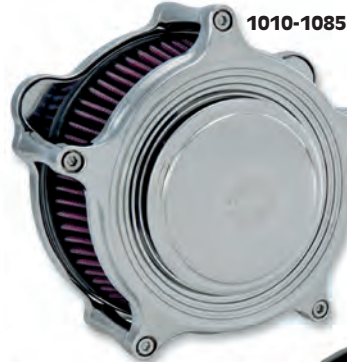

1010-1085



1010-1093

**SUPER GAS MERC AIR CLEANERS**

- CNC-machined aluminum backing plate
- Air cleaners include a high-volume K&N air filter
- Contrast Cut™ finish starts with a polished air cleaner that has been black anodized, then recut to open the design
- Black Ops™ finish features gloss black on top of a contrasting textured black finish for outstanding durability and looks
- All mounting hardware included
- Made in the U.S.A.

NOTE: May not be street legal in every state, please verify with local and state regulations for pollution controlled devices.

NOTE: Faceplates are not interchangeable.

PART #	DESCRIPTION	SUG. RETAIL
<b>FOR 08-15 FLHT/FLHR/FLHX/FLTR AND H-D FL TRIKE</b>		
1010-1090	Contrast Cut	\$419.95
1010-1086	Chrome	419.95
1010-1094	Black Ops	419.95

PART #	DESCRIPTION	SUG. RETAIL
<b>FOR 01-15 TWIN CAM W/ DELPHI EFI (EXCEPT 08-15 TOURING), 93-06 BIG TWIN W/ CV CARB</b>		
1010-1089	Contrast Cut	\$419.95
1010-1085	Chrome	419.95
1010-1093	Black Ops	419.95

PART #	DESCRIPTION	SUG. RETAIL
<b>FOR 91-15 XL W/ CV CARB/DELPHI EFI</b>		
1010-1091	Contrast Cut	\$419.95
1010-1087	Chrome	419.95
1010-1095	Black Ops	419.95

**IMPORTANT NOTE:** SEE PAGE 411 FOR IMPORTANT INFORMATION REGARDING CERTAIN WARRANTY AND EMISSION CONTROL REGULATORY COMPLIANCE INFORMATION.

All part numbers in **BLUE** are new for 2015.



WINDSHIELDS & FAIRINGS

TOURING

AUDIO & COMMUNICATION

LUGGAGE

SEATS & Sissy BARS

EXHAUST

FUEL/AIR SYSTEMS

ENGINE

TRANSMISSION & DRIVELINE

GASKETS & SEALS

ELECTRICAL

LIGHTING

HANDLEBARS, CONTROLS & MIRRORS

CABLES

BRAKES

TANKS & OIL FILTERS

DASHES & GAUGES

FRAMES, SUSPENSION & FENDERS

FOOTRESTS & LICENSE PLATE FRAMES

WHEELS & AXLES

HARDWARE, CHEMICALS & TOOLS

COVERS, SECURITY & GENERAL



1010-1392



1010-1394



1010-1395



**TRUFLO AIR CLEANERS**

- Custom front flow design maximizes airflow and performance
- Stylish low profile design
- Include a K&N high flow, reusable filter element
- CNC machined out of billet aluminum
- Backing plate features built-in breather ports
- Available in show quality chrome or black powdercoat
- Include all necessary hardware and gaskets
- Made in the U.S.A.

PART #	DESCRIPTION	SUG. RETAIL
<b>FOR 08-15 FLT/FLHT/FL TRIKE MODELS</b>		
1010-1392	Gatlin chrome finish	\$429.95
1010-1393	Blitz chrome finish	429.95
1010-1394	Gatlin black finish	429.95
1010-1395	Blitz black finish	429.95

PART #	DESCRIPTION	SUG. RETAIL
<b>FOR 93-06 BIG TWIN MODELS W/ STOCK CV CARB, 02-07 FLT MODELS W/ DELPHI EFI, 01-15 SOFTAIL MODELS, 04-15 DYNA GLIDE MODELS</b>		
1010-1396	Gatlin chrome finish	\$429.95
1010-1397	Blitz chrome finish	429.95
1010-1398	Gatlin black finish	429.95
1010-1399	Blitz black finish	429.95

PART #	DESCRIPTION	SUG. RETAIL
<b>FOR 91-15 XL MODELS W/ CV CARB/DELPHI EFI</b>		
1010-1400	Gatlin chrome finish	\$429.95
1010-1401	Blitz chrome finish	429.95
1010-1402	Gatlin black finish	429.95
1010-1403	Blitz black finish	429.95



1010-1404



1010-1404



**AIR CLEANER ASSEMBLY**

- Rugged aluminum construction with chrome finish
- Internal breather for clean look
- Increases airflow, yet maintains a low profile
- Made in the U.S.A.

PART #	DESCRIPTION	SUG. RETAIL
<b>FOR 08-15 FLHT/LFHR/FLTR/FLHX AND H-D FL TRIKES</b>		
1010-1404	Air cleaner	\$499.95
1011-3129	Repl. air filter	61.95

**IMPORTANT NOTE:** SEE PAGE 411 FOR IMPORTANT INFORMATION REGARDING CERTAIN WARRANTY AND EMISSION CONTROL REGULATORY COMPLIANCE INFORMATION.

All part numbers in **BLUE** are new for 2015.

WINDSHIELDS  
& FAIRINGS

TOURING

AUDIO &  
COMMUNICATION

LUGGAGE

SEATS &  
SISSY BARS

EXHAUST

ENGINE

TRANSMISSION  
& DRIVELINEGASKETS  
& SEALS

ELECTRICAL

LIGHTING

HANDLEBARS,  
CONTROLS  
& MIRRORS

CABLES

BRAKES

TANKS &  
OIL FILTERSDASHES  
& GAUGESFRAMES,  
SUSPENSION  
& FENDERSFOOTRESTS  
& LICENSE  
PLATE FRAMESWHEELS  
& AXLESHARDWARE,  
CHEMICALS  
& TOOLSCOVERS,  
SECURITY  
& GENERAL

1010-0698



1010-1172

1010-1175



1010-1178



1010-1184

1010-1187



1010-0561

**AIR CLEANER ASSEMBLIES**

- Machined from 6061 T-6 billet aluminum
- Kit replaces the OEM air cleaner assembly, maintaining balance and symmetry
- Custom-made AirRaid air filter provides increased airflow volume to the engine
- Dyno-designed AirLoad backing plate reduces turbulence and increases air intake velocity, boosting horsepower and torque
- Covers are triple chrome-plated or textured black powdercoat with laser-cut design
- Exposes more of the engine and brings out its aggressive nature
- Complete hardware kit and instructions included for easy installation
- Made in the U.S.A.

NOTE: Not legal for street use on pollution-controlled vehicles.

PART #	DESCRIPTION	SUG. RETAIL
<b>FOR 08-15 FLHT/FLHR/FLTR/FLHX AND H-D FL TRIKES</b>		
1010-0561	xXx, chrome	\$249.95
1010-0699	xXx, black	249.95
1010-1173	Standard cross, chrome	289.95
1010-1176	Standard cross, black	279.95
1010-1179	Spanish cross, chrome	279.95
1010-1182	Spanish cross, black	279.95
1010-1185	Celtic cross, chrome	279.95
1010-1188	Celtic cross, black	279.95
<b>FOR 01-15 TWIN CAM W/ DELPHI EFI (EXCEPT 08-15 FLHT/FLHR/FLTR/FLHX AND H-D FL TRIKES), 93-06 BIG TWIN W/ CV CARB</b>		
1010-0418	xXx, chrome	249.95
1010-0698	xXx, black	249.95
1010-1172	Standard cross, chrome	289.95
1010-1175	Standard cross, black	279.95
1010-1178	Spanish cross, chrome	279.95
1010-1181	Spanish cross, black	279.95
1010-1184	Celtic cross, chrome	279.95

1010-1182



PART #	DESCRIPTION	SUG. RETAIL
<b>FOR 01-15 TWIN CAM W/ DELPHI EFI (EXCEPT 08-15 FLHT/FLHR/FLTR/FLHX AND H-D FL TRIKES), 93-06 BIG TWIN W/ CV CARB (CONT)</b>		
1010-1187	Celtic cross, black	\$279.95
<b>FOR 91-15 XL W/ CV CARBURETOR OR DELPHI EFI</b>		
1010-0562	xXx, chrome	249.95
1010-0700	xXx, black	249.95
1010-1174	Standard cross, chrome	279.95
1010-1177	Standard cross, black	279.95
1010-1180	Spanish cross, chrome	279.95
1010-1183	Spanish cross, black	279.95
1010-1186	Celtic cross, chrome	279.95
1010-1189	Celtic cross, black	279.95
<b>REPLACEMENT FILTERS</b>		
1011-2052	Repl. filter for 08-15 FLHT/FLHR/FLTR/FLHX and H-D FL Trikes	39.95
1011-2053	Repl. filter for all except 08-15 FLHT/FLHR/FLTR/FLHX and H-D FL Trikes	36.95



1010-1111



1010-1112

**AFFLICTION AIR CLEANERS**

- Affliction has teamed up with LA Choppers to create the perfect marriage of performance and style
- Backing plate machined from 6061 T-6 billet aluminum and available in chrome or black
- Provides quicker, smoother, stronger acceleration
- Kit replaces the OEM air cleaner assembly, maintaining balance and symmetry
- Custom-made AirRaid filter provides increased airflow volume to the engine
- Dyno-designed AirLoad backing plate reduces turbulence and increases air intake velocity, boosting horsepower and torque
- Exposes more of the engine and brings out its aggressive nature
- Complete hardware kit and instructions included for easy installation
- Made in the U.S.A.

NOTE: Not legal for street use on pollution-controlled vehicles.

PART #	DESCRIPTION	SUG. RETAIL
<b>CHROME</b>		
1010-1113	For 08-15 FLHT/FLHR/FLTR/FLHX and H-D FL Trikes	\$349.95
1010-1111	For 01-15 Twin Cam w/ Delphi EFI, 93-06 Big Twin w/ CV carb (except 08-15 Dresser/H-D FL Trikes)	349.95
1010-1115	For 91-15 XL w/ CV carburetor or Delphi EFI	349.95
<b>BLACK</b>		
1010-1114	For 08-15 FLHT/FLHR/FLTR/FLHX and H-D FL Trikes	349.95
1010-1112	For 01-15 Twin Cam w/ Delphi EFI, 93-06 Big Twin w/ CV carb (except 08-15 Dresser/H-D FL Trikes)	349.95

PART #	DESCRIPTION	SUG. RETAIL
<b>BLACK (CONT)</b>		
1010-1116	For 91-15 XL w/ CV carburetor or Delphi EFI	\$349.95
<b>REPLACEMENT FILTERS</b>		
1011-2052	Repl. filter for 08-15 FLHT/FLHR/FLTR/FLHX and H-D FL Trikes	39.95
1011-2053	Repl. filter for all except 08-15 FLHT/FLHR/FLTR/FLHX and H-D FL Trikes	36.95

**IMPORTANT NOTE: SEE PAGE 411 FOR IMPORTANT INFORMATION REGARDING CERTAIN WARRANTY AND EMISSION CONTROL REGULATORY COMPLIANCE INFORMATION.**All part numbers in **BLUE** are new for 2015.





Smooth



Flame



Comet

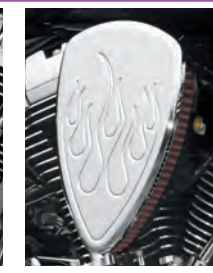

Enferno



Pinstripe (chrome)



Pinstripe (black)



Danni Doll pinup



Standard Cross



Spanish Cross



Celtic Cross



Smooth Black

- WINDSHIELDS & FAIRINGS
- TOURING
- AUDIO & COMMUNICATION
- LUGGAGE
- SEATS & SISSY BARS
- EXHAUST
- FUEL/AIR SYSTEMS

- ENGINE
- TRANSMISSION & DRIVELINE
- GASKETS & SEALS
- ELECTRICAL
- LIGHTING
- HANDLEBARS, CONTROLS & MIRRORS

- CABLES
- BRAKES
- TANKS & OIL FILTERS
- DASHES & GAUGES
- FRAMES, SUSPENSION & FENDERS
- FOOTRESTS & LICENSE PLATE FRAMES

- WHEELS & AXLES
- HARDWARE, CHEMICALS & TOOLS
- COVERS, SECURITY & GENERAL



**BIG AIR KIT (BAK)**

- Flow-bench and dyno-designed for substantially increased horsepower and torque
- Features beautifully chromed or powdercoat black billet covers in your choice of designs
- Innovative styling enhances and accentuates your "V" Twin engine
- Set-back, thin-line design does not interfere with rider's leg
- Slim 1 1/2" hi-flow reusable filter and specially designed back plate dynamically increases air flow and velocity
- Maximizes overall performance and fuel efficiency
- Easily supports engines producing over 120 HP
- Complete with breather kit, mounting hardware and micron-fabric raincoat for wet-weather riding
- Easy-to-follow instructions included for a do-it-yourself install
- Made in the U.S.A.

NOTE: Not legal for street use on pollution-controlled vehicles.

PART #	DESCRIPTION	SUG. RETAIL
<b>FOR 08-15 FLHT/FLHX/FLTR/FLHR AND H-D FL TRIKE MODELS</b>		
1010-0482	Smooth	\$299.95
1010-0527	Flame	299.95
1010-0528	Comet	299.95
1010-0529	Enferno	299.95
1010-0567	Pinstripe (chrome)	299.95
1010-0569	Pinstripe (black)	299.95
1010-1165	Danni Doll pinup	399.95
1010-1169	Standard cross	299.95
1010-1170	Spanish cross	299.95

PART #	DESCRIPTION	SUG. RETAIL
<b>FOR 08-15 FLHT/FLHX/FLTR/FLHR AND H-D FL TRIKE MODELS (CONT)</b>		
1010-1171	Celtic cross	\$329.95
1010-1316	Smooth, black	299.95
<b>FOR 01-15 TWIN CAM W/ DELPHI EFI (EXCEPT 08-15 DRESSERS, H-D FL TRIKES), 93-06 BIG TWIN W/ CV CARB</b>		
1010-0481	Smooth	299.95
1010-0524	Flame	299.95
1010-0525	Comet	299.95
1010-0526	Enferno	299.95

PART #	DESCRIPTION	SUG. RETAIL
<b>FOR 01-15 TWIN CAM W/ DELPHI EFI (EXCEPT 08-15 DRESSERS, H-D FL TRIKES), 93-06 BIG TWIN W/ CV CARB (CONT)</b>		
1010-0566	Pinstripe (chrome)	\$299.95
1010-0568	Pinstripe (black)	299.95
1010-1164	Danni Doll pinup	399.95
1010-1166	Standard cross	299.95
1010-1167	Spanish cross	299.95
1010-1168	Celtic cross	329.95
1010-1315	Smooth, black	299.95



Danni Doll pinup    Smooth    Smooth black    Flame    Comet    Enferno  
 Chrome pinstripe    Black pinstripe    Standard Cross    Spanish Cross    Celtic Cross



1011-2940

1011-2941



**RAINCOATS FOR BAK**

- Protect your BAK filter from moisture and dust
- BAK filters are water resistant, but extended riding in rain is not recommended
- Classic fits 2" W filter
- Slim fits 1 1/2" filter
- Classic will also work on any filter kit that uses a K&N E-3333 filter (does not fit K&N billet filter kits)

**BAK REPLACEMENT COVERS**

- For those wanting to alter the look of their BAK or replace a damaged cover
- Cover only, does not include hardware



PART #	DESCRIPTION	SUG. RETAIL
1014-0076	Danni Doll pinup	\$219.95
1014-0146	Smooth	119.95
1014-0164	Smooth black	119.95
1014-0147	Flame	119.95
1014-0148	Comet	119.95
1014-0149	Enferno	119.95

PART #	DESCRIPTION	SUG. RETAIL
1014-0152	Chrome pinstripe	119.95
1014-0153	Black pinstripe	119.95
1014-0154	Standard cross	119.95
1014-0155	Spanish cross	119.95
1014-0156	Celtic cross	139.95

PART #	DESCRIPTION	SUG. RETAIL
1011-2940	Classic	\$19.95
1011-2941	Slim	19.95

**IMPORTANT NOTE:** SEE PAGE 411 FOR IMPORTANT INFORMATION REGARDING CERTAIN WARRANTY AND EMISSION CONTROL REGULATORY COMPLIANCE INFORMATION.

All part numbers in **BLUE** are new for 2015.



WINDSHIELDS  
& FAIRINGS

TOURING

AUDIO &  
COMMUNICATION

LUGGAGE

SEATS &  
SISSY BARS

EXHAUST

ENGINE

TRANSMISSION  
& DRIVELINEGASKETS  
& SEALS

ELECTRICAL

LIGHTING

HANDLEBARS,  
CONTROLS  
& MIRRORS

CABLES

BRAKES

TANKS &  
OIL FILTERSDASHES  
& GAUGESFRAMES,  
SUSPENSION  
& FENDERSFOOTRESTS  
& LICENSE  
PLATE FRAMESWHEELS  
& AXLESHARDWARE,  
CHEMICALS  
& TOOLSCOVERS,  
SECURITY  
& GENERAL

1010-0673



1010-0675

**BATTISTINIS**  
CUSTOM CYCLES

**TRI-BAR AIR FILTER KITS**

- Stylish, clean custom look that complements the Battistinis collection of products
- Kits include a patented Arien Ness Stage-1 Big Sucker air filter kit with a unique design billet outer cover
- Available in show-winning chrome or black anodized with re-machined highlights
- Made in the U.S.A.

NOTE: Not legal for street use on pollution controlled vehicles.

PART #	DESCRIPTION	SUG. RETAIL
<b>FOR 08-15 FLHT, FLHR, FLHX, FLTR AND H-D FL TRIKE</b>		
1010-0674	Chrome	\$399.95
1010-0675	Black anodized	399.95

PART #	DESCRIPTION	SUG. RETAIL
<b>FOR 01-15 TWIN CAM DELPHI EFI, 99-06 TWIN CAM CV CARB MODELS (EXCEPT 08-15 FLHT, FLHR, FLHX, FLTR, H-D FL TRIKE)</b>		
1010-0672	Chrome	\$399.95
1010-0673	Black anodized	399.95



1010-0926

1010-0927



1010-0929

1010-1010



1010-0928

**HIGH-PERFORMANCE  
AIR CLEANER ASSEMBLIES**

- Super-clean design features all-CNC-machined billet aluminum construction throughout
- Equipped with a genuine K&N 4" diameter high-flow filter
- Has Joker's exclusive "baffle plate" crankcase breathing system, held all together with high-strength 12-point alloy mounting bolts
- Improves leg clearance over the stock air cleaner assembly due to its compact design
- Available in your choice of hard black anodized or chrome-plated finishes
- Made in the U.S.A.



NOTE: Some products may not be legal for sale or use on pollution controlled vehicles, check your local laws.

PART #	DESCRIPTION	SUG. RETAIL
<b>FOR 01-15 TWIN CAM W/ DELPHI EFI, 99-06 TWIN CAM W/ CV CARB (EXCEPT 08-15 FLHT/FLHR/FLHX/FLTR AND HD FL TRIKE)</b>		
1010-0926	Smooth black anodized	\$290.95
1010-0927	Smooth chrome	300.95
1010-0928	Finned black anodized	290.95
1010-0929	Finned chrome	300.95
1010-1007	Joker Racing, black anodized	290.95
1010-1008	Joker Racing, chrome	300.95
1010-1010	JM U.S.A., black anodized	290.95
<b>FOR 07-15 XL MODELS</b>		
1010-0930	Finned black anodized	250.95
1010-0931	Finned chrome	260.95
1010-0941	Joker Racing, black anodized	250.95
1010-0942	Joker Racing, chrome	260.95

PART #	DESCRIPTION	SUG. RETAIL
<b>FOR 07-15 XL MODELS (CONT)</b>		
1010-0692	Smooth, black anodized	\$250.95
1010-0693	Smooth, chrome	260.95
1010-0694	Smooth, clear anodized	250.95
<b>FOR 91-06 XL MODELS W/ CV CARB</b>		
1010-0932	Finned black anodized	250.95
1010-0933	Finned chrome	260.95
1010-0943	Joker Racing, black	250.95
1010-0695	Smooth, black anodized	250.95
1010-0696	Smooth, chrome	260.95
1010-0697	Smooth, clear anodized	250.95
<b>REPLACEMENT FILTER</b>		
1011-3217	K&N repl. filter	49.95

**RAIN SOCK FOR JOKER AIR CLEANERS**

- Water-repellent prefilter custom-made by Outerwears for riding in rainy weather
- Fits all Joker Machine air cleaners with 4" K&N filters
- Easy installation - attaches with hook-and-loop for easy installation and removal
- Made in the U.S.A.

PART #	DESCRIPTION	SUG. RETAIL
1011-2938	Air filter rain sock	\$13.95

**IMPORTANT NOTE:** SEE PAGE 411 FOR IMPORTANT INFORMATION REGARDING CERTAIN WARRANTY AND EMISSION CONTROL REGULATORY COMPLIANCE INFORMATION.

All part numbers in **BLUE** are new for 2015.





**POWER X INTAKE**

- Air is power and Boyesen has channeled that power like never before
- Patented X-Wing design for more power and acceleration; X-Wing venturi increases air speed for added throttle response
- Complete kit includes backing plate with internal breather passageways, filter and mounting hardware
- Oil-free/washable filter is a poly cotton blend with an extra-large filter area for increased airflow; filters to 40 microns
- Available in polished silver or matte black finish
- Accepts stock air filter cover

**NOTE:** Not legal for street use on pollution controlled vehicles.



PART #	DESCRIPTION	SUG. RETAIL
<b>FOR 08-15 FLHT, FLHR, FLHX, FLTR AND H-D FL TRIKE MODELS</b>		
1010-1017	Polished silver	\$229.95

PART #	DESCRIPTION	SUG. RETAIL
<b>FOR 08-15 FLHT, FLHR, FLHX, FLTR AND H-D FL TRIKE MODELS (CONT)</b>		
1010-1018	Matte black	\$229.95



**SKULL AIR CLEANER KITS**

- Extremely rigid, high-strength composite construction
- Include outer cover, backing plate, high-flow air filter element and all necessary brackets, crankcase breathers and other required hardware included
- Chrome or gloss black finish available
- Sold each

**NOTE:** Not legal for street use on pollution-controlled vehicles.



PART #	DESCRIPTION	SUG. RETAIL
<b>CHROME</b>		
1010-0220	For 99-15 Twin Cam w/ CV carb or Delphi EFI (except 08-15 FLHT, FLHR, FLTR, FLHX and H-D FL Trikes)	\$239.95
1010-1001	For 08-15 FLHT, FLHR, FLTR, FLHX and H-D FL Trikes	239.95
1010-0218	For 91-06 XL models w/ CV carb	239.95
1010-1060	For 07-15 XL	239.95

PART #	DESCRIPTION	SUG. RETAIL
<b>GLOSS BLACK</b>		
1010-1061	For 99-15 Twin Cam w/ CV carb or Delphi EFI (except 08-15 FLHT, FLHR, FLTR, FLHX and H-D FL Trikes)	\$269.95
1010-1062	For 08-15 FLHT, FLHR, FLTR, FLHX and H-D FL Trikes	269.95
<b>REPLACEMENT PARTS</b>		
1011-2909	Repl. air filter for all Skull air cleaners	72.95

**PRO R HYPERCHARGER™**

- The best-flowing Hypercharger™ ever produced
- Careful redesign of all interior shapes increases airflow
- Additional air scoop on outer cover directs air onto the high-flow, washable and reusable air filter
- Unrestricted air under high-load riding situations from huge front butterflies are vacuum operated
- Include all necessary mounting hardware and crankcase breather kit
- PART #1010-0217 is an assembly (CV bolt pattern) that can be used with adapters, brackets or mounting kits to cover applications that do not have a specific kit

**NOTE:** Not legal for street use on pollution-controlled vehicles.



PART #	DESCRIPTION	SUG. RETAIL
1010-0215	For 06-15 w/ Delphi EFI (except 08-15 FLHT, FLHR, FLTR, FLHX and H-D FL Trikes), 99-06 Twin Cam w/ CV carb	\$329.95
1010-1004	For 08-15 FLHT/FLHR/FLTR/FLHX and H-D FL Trikes	329.95
1010-0216	For 01-05 Twin Cam w/ Delphi EFI	329.95
1010-0214	For 93-99 Evolution Big Twin w/ CV carb	299.95
1010-0213	For 91-06 XL models w/ CV carb	299.95
1010-1058	For 07-15 XL	299.95

PART #	DESCRIPTION	SUG. RETAIL
1010-0217	Pro R cleaner assembly only	\$279.95
1011-1079	Repl. K&N air filter (ea.)	59.95
1011-3206	Repl. cage/foam filter assembly	16.95
1010-1547	Repl. butterfly shaft kit w/ screws, washers, bearings and springs (kit)	16.95
1010-1544	Repl. chrome butterflies	14.95
1010-1545	Repl. black butterflies	14.95

**IMPORTANT NOTE:** SEE PAGE 411 FOR IMPORTANT INFORMATION REGARDING CERTAIN WARRANTY AND EMISSION CONTROL REGULATORY COMPLIANCE INFORMATION.

All part numbers in **BLUE** are new for 2015.

- WINDSHIELDS & FAIRINGS
- TOURING
- AUDIO & COMMUNICATION
- LUGGAGE
- SEATS & Sissy BARS
- EXHAUST
- FUEL/AIR SYSTEMS
- ENGINE
- TRANSMISSION & DRIVELINE
- GASKETS & SEALS
- ELECTRICAL
- LIGHTING
- HANDLEBARS, CONTROLS & MIRRORS
- CABLES
- BRAKES
- TANKS & OIL FILTERS
- DASHES & GAUGES
- FRAMES, SUSPENSION & FENDERS
- FOOTRESTS & LICENSE PLATE FRAMES
- WHEELS & AXLES
- HARDWARE, CHEMICALS & TOOLS
- COVERS, SECURITY & GENERAL

WINDSHIELDS & FAIRINGS

TOURING

AUDIO & COMMUNICATION

LUGGAGE

SEATS & SISSY BARS

EXHAUST

ENGINE

TRANSMISSION & DRIVELINE

GASKETS & SEALS

ELECTRICAL

LIGHTING

HANDLEBARS, CONTROLS & MIRRORS

CABLES

BRAKES

TANKS & OIL FILTERS

DASHES & GAUGES

FRAMES, SUSPENSION & FENDERS

FOOTRESTS & LICENSE PLATE FRAMES

WHEELS & AXLES

HARDWARE, CHEMICALS & TOOLS

COVERS, SECURITY & GENERAL

DS-288938



1010-1003

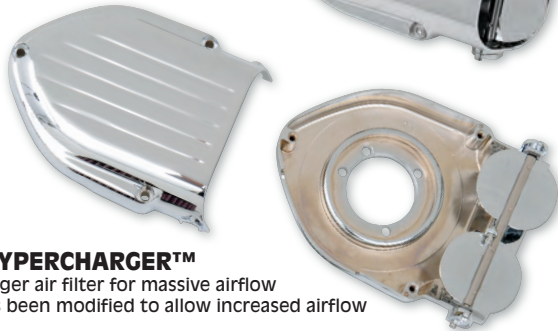

DS-288939

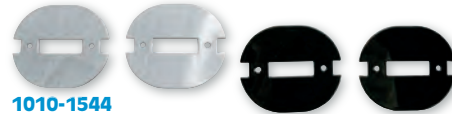

1010-1544

1010-1545

**PRO SERIES HYPERCHARGER™**

- Features a 50% larger air filter for massive airflow
- Internal shape has been modified to allow increased airflow and velocity
- One-piece construction, ball-milled, "speed lines" symmetrical butterflies and new "Pro" embossed bearing cups
- Edges of Pro Series Hypercharger™ are radiused for a more streamlined appearance
- An upgrade kit is available for new-style (replaceable bearing cup) Hyperchargers and includes a new "Pro" outer case half, bearing cups, butterflies, large K&N air filter and necessary hardware

NOTE: Not legal for street use on pollution-controlled vehicles.

PART #	DESCRIPTION	SUG. RETAIL
1010-0151	W/ chrome butterflies for 01-05 Twin Cam w/ Delphi EFI	\$299.95
1010-1542	W/ black butterflies for 01-05 Twin Cam w/ Delphi EFI	299.95
DS-288938	W/ chrome butterflies for 01-15 Delphi EFI (except 08-15 FLHT, FLHR, FLTR, FLHX and H-D FL Trikes), 99-06 Twin Cam w/ CV carb	289.95
1010-1003	W/ chrome butterflies for 08-15 FLHT/FLHR/FLTR/FLHX and H-D FL Trikes, 11-12 FLSTSE, 13-15 FXSBSE, 14-15 FLSTNSE	289.95
1010-1543	W/ black butterflies for 08-15 FLHT/FLHR/FLTR/FLHX and H-D FL Trikes, 11-12 FLSTSE, 13-15 FXSBSE, 14-15 FLSTNSE	289.95
1010-0147	W/ black butterflies for 01-15 Delphi EFI (except 08-15 FLHT, FLHR, FLTR, FLHX and H-D FL Trikes), 99-06 Twin Cam w/ CV carb	289.95
1010-0149	W/ chrome butterflies for 99-01 FLT (Dresser and Road King) w/ Magnetti-Marelli EFI	299.95
1010-0150	W/ chrome butterflies for 95-98 FLT (Dresser and Road King) w/ Magnetti-Marelli EFI	299.95
DS-288937	W/ chrome butterflies for 93-99 80" Evolution w/ CV carb	289.95
1010-1541	W/ chrome butterflies for 93-99 80" Evolution w/ CV carb	289.95
DS-288936	W/ chrome butterflies for 91-06 XL w/ CV carb	289.95
1010-1057	W/ chrome butterflies for 07-15 XL	289.95
DS-288939	Upgrade kit	139.95
1011-3206	Repl. cage/foam filter assembly	16.95
1010-1544	Chrome butterflies (pr.)	14.95
1010-1545	Black butterflies (pr.)	14.95
1010-1548	Case screws (set of 3)	6.95



**STINGER TRAP DOOR FOR HYPERCHARGER™**

- If you have a need for more performance, look no further
- Stinger trap door maximizes airflow into the carburetor or throttle body through a high-flow filter element
- Highly cost-effective way to boost airflow to any standard Hypercharger™
- Easy four-bolt replacement for standard trap door
- Chrome finish

NOTE: Not legal for street use on pollution-controlled vehicles.

PART #	DESCRIPTION	SUG. RETAIL
1010-0145	Stinger trap door (ea.)	\$59.95



**INFINITY STREAMLINER FOR HYPERCHARGER™**

- Transform this cover from smooth chrome to a stunning LED vortex of lights with just a flick of the switch
- Seven-color LED operates in three modes: single color steady illumination; single color flashing illumination with rheostat-adjustable rate; and paint mode - continuously fading in and out of seven colors (red, lime, ice blue, sky blue, dark blue, purple and green) with rheostat-adjustable rate of color change
- Installs on any standard Hypercharger air cleaner (except Pro R, Pro Series Hypercharger)
- Not for use with Stinger trap door

PART #	DESCRIPTION	SUG. RETAIL
1014-0130	Streamliner Infinity cover for Hypercharger™	\$199.95

**IMPORTANT NOTE: SEE PAGE 411 FOR IMPORTANT INFORMATION REGARDING CERTAIN WARRANTY AND EMISSION CONTROL REGULATORY COMPLIANCE INFORMATION.**

All part numbers in **BLUE** are new for 2015.



WINDSHIELDS & FAIRINGS

TOURING

AUDIO & COMMUNICATION

LUGGAGE

SEATS & SISSY BARS

EXHAUST

FUEL/AIR SYSTEMS

ENGINE

TRANSMISSION & DRIVELINE

GASKETS & SEALS

ELECTRICAL

LIGHTING

HANDLEBARS, CONTROLS & MIRRORS

CABLES

BRAKES

TANKS & OIL FILTERS

DASHES & GAUGES

FRAMES, SUSPENSION & FENDERS

FOOTRESTS & LICENSE PLATE FRAMES

WHEELS & AXLES

HARDWARE, CHEMICALS & TOOLS

COVERS, SECURITY & GENERAL



1010-1002



1010-1405

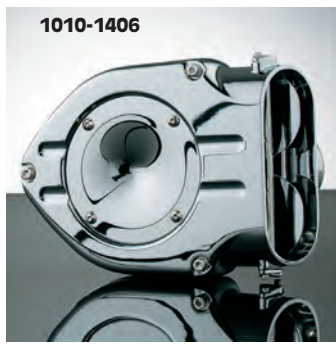

1010-1406



1010-1006

1012-0170



DS-288821

**HYPERCHARGER™ AIR CLEANERS**

- These air cleaners look great and work even better
- Outstanding performance on stock or mildly modified engines up to 90 horsepower
- Available with a standard (smooth) trap door or our Blood Groove design
- Chrome-plated or gloss black body and trapdoor with either chrome or black butterflies
- Provide excellent legroom for comfort while riding
- Include Kuryakyn's breather where applicable

**MANUFACTURER'S NOTE:** Not legal for street use on pollution-controlled vehicles.

PART #	DESCRIPTION	SUG. RETAIL	PART #	DESCRIPTION	SUG. RETAIL
<b>CHROME HYPERCHARGER WITH SMOOTH TRAP DOOR</b>			<b>GLOSS BLACK HYPERCHARGER WITH SMOOTH TRAP DOOR</b>		
1010-1566	W/ chrome butterflies for 08-15 FLHR, FLHT, FLHX, FLTR and H-D FL Trikes, 11-12 FLSTSE, 13-15 FXSBSE, 14-15 FLSTNSE	\$259.95	1010-1565	W/ black butterflies for 08-15 FLHR, FLHT, FLHX, FLTR and H-D FL Trikes, 11-12 FLSTSE, 13-15 FXSBSE, 14-15 FLSTNSE	\$259.95
1010-0156	W/ chrome butterflies for 06-15 Delphi EFI (except 08-15 FLHT, FLHR, FLTR, FLHX and H-D FL Trike), 99-06 Twin Cam w/ CV carb	259.95	1010-1538	W/ black butterflies for 84-91 Big Twin using S&S E or G, Mikuni, Screamin' Eagle or Rev Tech carburetor (late inlet)	229.95
1010-0157	W/ chrome butterflies for 01-05 Twin Cam w/ Delphi EFI	289.95	1010-1539	W/ black butterflies for 92 Big Twin using S&S E or G, Mikuni, Screamin' Eagle or Rev Tech carburetor (late inlet)	229.95
1010-0136	W/ chrome butterflies for 93-99 Big Twin w/ S&S E or G series carb	289.95	<b>CHROME HYPERCHARGER WITH BLOOD GROOVE TRAP DOOR</b>		
1010-0139	W/ chrome butterflies for 93-99 Big Twin w/ stock carb and Screamin' Eagle breather	229.95	DS-288845	W/ chrome butterflies for 99-01 FLTR, FLHT, FLHR w/ Magnetti-Marelli EFI	289.95
1010-0140	W/ chrome butterflies for 93-99 Big Twin w/ stock carb	239.95	DS-288844	W/ chrome butterflies for 06-15 Delphi EFI (except 08-15 FLHT, FLHR, FLTR, FLHX and H-D FL Trike), 99-06 Twin Cam w/ CV carb	259.95
1010-0144	W/ chrome butterflies for 92 Big Twin w/ stock carb	229.95	1010-1002	W/ chrome butterflies for 08-15 FLHR, FLHT, FLHX, FLTR and H-D FL Trikes, 11-12 FLSTSE, 13-15 FXSBSE, 14-15 FLSTNSE	259.95
1010-0143	W/ chrome butterflies for 90-91 Big Twin w/ stock carb	229.95	1010-1572	W/ black butterflies for 08-15 FLHR, FLHT, FLHX, FLTR and H-D FL Trikes, 11-12 FLSTSE, 13-15 FXSBSE, 14-15 FLSTNSE	269.95
1010-0142	W/ chrome butterflies for 84-89 Big Twin w/ stock or S&S B series carb	229.95	1010-0162	W/ chrome butterflies for 01-05 Twin Cam w/ Delphi EFI	289.95
1010-0155	W/ chrome butterflies for 95-98 Evolution Road King or Dresser w/ Magnetti-Marelli EFI	269.95	1010-0161	W/ black butterflies for 06-15 Delphi EFI (except 08-15 FLHT, FLTR, FLHR FLHX and H-D FL Trike), 99-06 Twin Cam w/ CV carb	269.95
1010-0137	W/ chrome butterflies for 91-06 XL w/ stock carb and H-D breather	229.95	DS-288821	W/ chrome butterflies for 93-99 Evolution Big Twin w/ stock carb	269.95
1010-0141	W/ chrome butterflies for 91-06 XL w/ stock carb	239.95	DS-288822	W/ black butterflies for 93-99 Evolution Big Twin w/ stock carb	269.95
1010-0135	W/ chrome butterflies for 88-90 XL w/ stock carb	229.95			
1010-0138	W/ metallic gray butterflies for 94-02 Buell w/ stock carburetor (requires mount kit 1010-0230)	199.95			
1010-1405	W/ black butterflies for 91-06 XL w/ stock carb	239.95			
1010-1406	W/ chrome butterflies for 07-15 XL w/ stock carb	239.95			

HYPERCHARGER™ AIR CLEANERS continued on next page

**IMPORTANT NOTE:** SEE PAGE 411 FOR IMPORTANT INFORMATION REGARDING CERTAIN WARRANTY AND EMISSION CONTROL REGULATORY COMPLIANCE INFORMATION.

All part numbers in BLUE are new for 2015.



## HYPERCHARGER™ AIR CLEANERS (CONT)

PART #	DESCRIPTION	SUG. RETAIL	PART #	DESCRIPTION	SUG. RETAIL
<b>CHROME HYPERCHARGER WITH BLOOD GROOVE TRAP DOOR (CONT)</b>			<b>HYPERCHARGER ACCESSORIES</b>		
<b>DS-288940</b>	W/ chrome butterflies for 93-99 80" Evolution w/ S&S E & G carb	<b>\$299.95</b>	<b>1013-0096</b>	Throttle body support bracket for 08-15 FLHT/FLHR/ FLTR/FLHX and H-D FL Trike, 11-12 FLSTSE, 13-15 FXSBSE, 14-15 FLSTNSE	<b>\$29.95</b>
<b>DS-288823</b>	W/ chrome butterflies for 91-06 XL models w/ stock carb	<b>269.95</b>	<b>1013-0098</b>	Carburetor support bracket for 93-99 Evolution Big Twin with stock CV, Mikuni or Screamin' Eagle carburetor	<b>34.95</b>
<b>1010-0163</b>	W/ chrome butterflies for 91-06 XL w/ stock carb and Screamin' Eagle crankcase breather	<b>239.95</b>	<b>1013-0101</b>	Bolt 1" mount	<b>8.95</b>
<b>DS-288824</b>	W/ black butterflies for 91-06 XL models w/ stock carb	<b>269.95</b>	<b>DS-288827</b>	Adapter to mount Hypercharger on S&S E and G carburetors for 93-99 Big Twin and 91-06 XL models (requires PART #DS-288826 adjustable enrichener and 1/2"-13 x 1 1/2" breather bolts)	<b>49.95</b>
<b>1010-1578</b>	W/ chrome butterflies for 95-98 Evolution Road King or Dresser w/ Magnetti-Marelli EFI	<b>289.95</b>	<b>DS-288826</b>	Adjustable enrichener for S&S E and G carbs on 93-99 Big Twin and 91-06 XL models	<b>21.95</b>
<b>1010-1568</b>	W/ chrome butterflies for 07-15 XL	<b>269.95</b>	<b>1010-0146</b>	Chrome blood groove trap door	<b>25.95</b>
<b>1010-1577</b>	W/ chrome butterflies for custom applications (must use adapters, brackets or custom mount kit, available separately)	<b>219.95</b>	<b>1010-1006</b>	Gloss black blood groove trap door	<b>24.95</b>
<b>GLOSS BLACK HYPERCHARGER WITH BLOOD GROOVE TRAP DOOR</b>			<b>1010-0329</b>	Chrome trap door	<b>21.95</b>
<b>1010-1571</b>	W/ black butterflies for 08-15 FLHR, FLHT, FLHX, FLTR and H-D FL Trikes, 11-12 FLSTSE, 13-15 FXSBSE, 14-15 FLSTNSE	<b>289.95</b>	<b>1010-0347</b>	Black trap door	<b>19.95</b>
<b>1010-1582</b>	W/ black butterflies for 01-05 Twin Cam w/ Delphi EFI	<b>309.95</b>	<b>1010-0331</b>	Candy blue butterflies	<b>15.95</b>
<b>1010-1579</b>	W/ black butterflies for 06-15 Delphi EFI (except 08-15 FLHT, FLHR, FLTR, FLHX and H-D FL Trike), 99-06 Twin Cam w/ CV carb	<b>289.95</b>	<b>1010-0332</b>	Chrome butterflies	<b>15.95</b>
<b>1010-1580</b>	W/ black butterflies for 93-99 Evolution Big Twin w/ stock carb	<b>289.95</b>	<b>1010-0348</b>	Black butterflies	<b>15.95</b>
<b>1010-1569</b>	W/ black butterflies for 07-15 XL	<b>289.95</b>	<b>1010-1540</b>	Repl. butterfly shaft	<b>9.95</b>
<b>1010-1581</b>	W/ black butterflies for 91-06 XL models w/ stock carb	<b>289.95</b>	<b>DS-288825</b>	Repl. K&N filter element for Hyperchargers listed above	<b>45.95</b>
<b>WRINKLE BLACK HYPERCHARGER WITH BLOOD GROOVE TRAP DOOR</b>			<b>1012-0170</b>	Repl. rubber boots and hoses for Evolution crankcase breather kit	<b>8.95</b>
<b>1010-1573</b>	W/ chrome butterflies for 08-15 FLHR, FLHT, FLHX, FLTR and H-D FL Trikes, 11-12 FLSTSE, 13-15 FXSBSE, 14-15 FLSTNSE	<b>289.95</b>	<b>1010-1583</b>	Repl. 1" breather bolts (pr.)	<b>10.95</b>
<b>1010-1575</b>	W/ chrome butterflies for 06-15 Delphi EFI (except 08-15 FLHT, FLTR, FLHR FLHX and H-D FL Trike), 99-06 Twin Cam w/ CV carb	<b>289.95</b>	<b>1010-1584</b>	Repl. 1 3/4" breather bolts (pr.)	<b>13.95</b>
<b>1010-1574</b>	W/ chrome butterflies for 01-05 Twin Cam w/ Delphi EFI	<b>299.95</b>	<b>1012-0198</b>	Repl. rubber hoses for PART #1012-0170	<b>5.95</b>
<b>1010-1576</b>	W/ chrome butterflies for 93-99 Evolution Big Twin w/ stock carb	<b>279.95</b>	<b>1012-0201</b>	Formed breather hoses for Twin Cam breather kit	<b>7.95</b>



### UPGRADE KIT FOR CV TYPE HYPERCHARGER™ WITH OLD SHAFT DESIGN

- Great way to update the look of your Hypercharger™
- Lets you keep your custom color doors and butterflies
- Has late-style carburetor inlet pattern

PART #	DESCRIPTION	SUG. RETAIL
<b>1010-1570</b>	Upgrade kit (includes chrome front and rear halves, shaft and end caps)	<b>\$89.95</b>

**IMPORTANT NOTE:** SEE PAGE 411 FOR IMPORTANT INFORMATION REGARDING CERTAIN WARRANTY AND EMISSION CONTROL REGULATORY COMPLIANCE INFORMATION.



### TWIN VELOCITY™ PLUS AIR CLEANER KITS

- Slots on both sides and enlarged openings at bottom of housing allow more air to enter the filter
- Large, round breather element underneath cover allows air to enter the end of the filter
- Teardrop center of cover provides improved airflow and a clean look
- Internal crankcase vent system directs gasses and oil droplets into the carburetor induction module, eliminating a mess on the outside of the engine
- The result is improved airflow for better performance
- Carb adapter and replacement K&N air filter elements sold each
- Available with a chrome finish

**NOTE:** Not legal for street use on pollution-controlled vehicles.

PART #	DESCRIPTION	SUG. RETAIL
<b>TWIN VELOCITY PLUS AIR CLEANERS</b>		
<b>1010-0342</b>	For 99-15 Twin Cam w/ stock CV carb or Delphi fuel injection (except 08-15 FLHT, FLHR, FLTR, FLHX and H-D FL Trike)	<b>\$229.95</b>
<b>1010-0341</b>	For 93-99 Evolution Big Twin w/ stock CV carburetor	<b>229.95</b>
<b>ACCESSORIES</b>		
<b>1013-0022</b>	Adapter for Mikuni HSR 42/54/48 carburetor for 93-06 Evolution or Twin Cam	<b>46.95</b>
<b>DS-288862</b>	Repl. primary K&N filter element	<b>59.95</b>
<b>DS-288863</b>	Repl. secondary K&N filter element	<b>11.95</b>

All part numbers in **BLUE** are new for 2015.





WINDSHIELDS &amp; FAIRINGS

TOURING

AUDIO &amp; COMMUNICATION

LUGGAGE

SEATS &amp; Sissy BARS

EXHAUST

FUEL/AIR SYSTEMS

ENGINE

TRANSMISSION &amp; DRIVELINE

GASKETS &amp; SEALS

ELECTRICAL

LIGHTING

HANDLEBARS, CONTROLS &amp; MIRRORS

CABLES

BRAKES

TANKS &amp; OIL FILTERS

DASHES &amp; GAUGES

FRAMES, SUSPENSION &amp; FENDERS

FOOTRESTS &amp; LICENSE PLATE FRAMES

WHEELS &amp; AXLES

HARDWARE, CHEMICALS &amp; TOOLS

COVERS, SECURITY &amp; GENERAL

### STREET SLEEPER™ II AIR CLEANERS

- Incorporates the Hi-Five high-flow air filter element in an air cleaner that retains the stock oval air cleaner cover
- High-flow parabolic curve air entry to the throttle body
- Low profile of stock air cleaner means plenty of legroom for comfort
- Has a re-usable K&N high-flow air filter element
- Can support engines making more than 150 horsepower

**NOTE:** Not legal for street use on pollution-controlled vehicles.

PART #	DESCRIPTION	SUG. RETAIL
<b>1010-1059</b>	For 99-15 Twin Cam w/ CV carb or Delphi EFI (except 08-15 FLHT/FLHR/FLTR/FLHX and H-D FL Trikes)	<b>\$179.95</b>
<b>1010-1418</b>	For 08-15 FLHT/FLHR/FLTR/FLHX and H-D FL Trikes	<b>179.95</b>



1010-1059



1010-1415

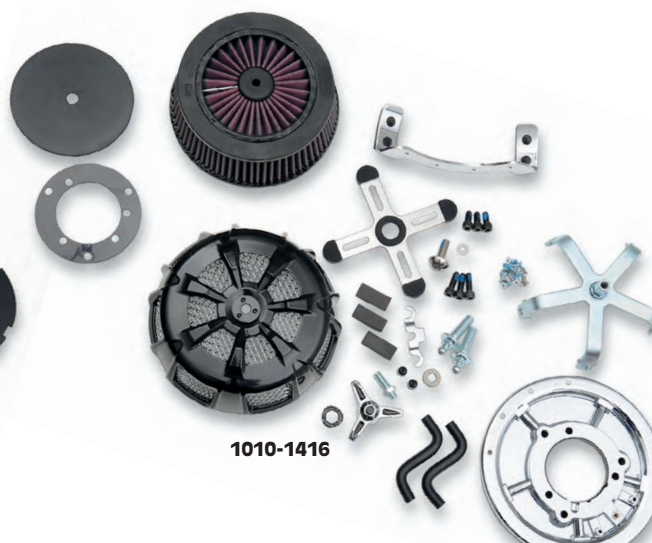

1010-1416

### ALLEY CAT AIR CLEANERS

- Combines Kuryakyn's high-flow Street Sweeper® air cleaner with the sleek new Alley Cat cover into one easy-to-install kit
- Features a high-flow parabolic curve entry to the throttle body
- Includes a re-useable high-flow K&N filter element
- Can support engine builds that produce more than 150 horsepower

**NOTE:** Not legal for street use on pollution-controlled vehicles.

PART #	DESCRIPTION	SUG. RETAIL
<b>CHROME</b>		
<b>1010-1410</b>	For 08-15 FLHT, FLHR, FLTR, FLHX and H-D FL Trikes, 11-12 FLSTSE, 13-15 FXSBSE	<b>\$289.95</b>
<b>1010-1415</b>	or 99-15 Twin Cam w/ CV carb or Delphi EFI (except 08-15 FLHT, FLHR, FLTR, FLHX and H-D FL Trikes, 11-12 FLSTSE, 13-15 FXSBSE)	<b>289.95</b>
<b>BLACK AND CHROME</b>		
<b>1010-1416</b>	For 08-15 FLHT, FLHR, FLTR, FLHX and H-D FL Trikes, 11-12 FLSTSE, 13-15 FXSBSE	<b>289.95</b>
<b>1010-1417</b>	For 99-15 Twin Cam w/ CV carb or Delphi EFI (except 08-15 FLHT, FLHR, FLTR, FLHX and H-D FL Trikes, 11-12 FLSTSE, 13-15 FXSBSE)	<b>289.95</b>

### VELOCIRAPTOR® AIR CLEANER

- Racing-inspired design and show bike styling
- Breathes well and filters the air
- Element is washable
- Insert covers up the mounting bolts, delivering smooth airflow into your motor
- Can support engines up to 90 hp
- PART # 1010-1567 is an assembly (CV bolt pattern) that can be used with adapters, brackets or mounting kits to cover applications that do not have a specific kit

**NOTE:** Not legal for street use on pollution-controlled vehicles.

PART #	DESCRIPTION	SUG. RETAIL
<b>1010-1414</b>	For 08-15 FLHT, FLHR, FLTR, FLHX and H-D FL Trikes, 11-12 FLSTSE, 13-15 FXSBSE	<b>\$169.95</b>
<b>1010-1413</b>	For 99-15 Twin Cam w/ CV Carb or Delphi EFI (except 08-15 FLHT, FLHR, FLTR, FLHX and H-D FL Trikes, 11-12 FLSTSE, 13-15 FXSBSE)	<b>169.95</b>
<b>1010-1412</b>	For 93-99 Evolution Big Twin w/ stock carb	<b>169.95</b>
<b>1010-1419</b>	For 07-15 XL models	<b>169.95</b>
<b>1010-1411</b>	For 91-06 XL models	<b>169.95</b>
<b>1010-1567</b>	Velociraptor air cleaner assembly only	<b>139.95</b>



1010-1411

**IMPORTANT NOTE:** SEE PAGE 411 FOR IMPORTANT INFORMATION REGARDING CERTAIN WARRANTY AND EMISSION CONTROL REGULATORY COMPLIANCE INFORMATION.

All part numbers in **BLUE** are new for 2015.

WINDSHIELDS  
& FAIRINGS

TOURING

AUDIO &  
COMMUNICATION

LUGGAGE

SEATS &  
SISSY BARS

EXHAUST

FUEL/PAINT  
SYSTEMS

ENGINE

TRANSMISSION  
& DRIVELINEGASKETS  
& SEALS

ELECTRICAL

LIGHTING

HANDLEBARS,  
CONTROLS  
& MIRRORS

CABLES

BRAKES

TANKS &  
OIL FILTERSDASHES  
& GAUGESFRAMES,  
SUSPENSION  
& FENDERSFOOTRESTS  
& LICENSE  
PLATE FRAMESWHEELS  
& AXLESHARDWARE,  
CHEMICALS  
& TOOLSCOVERS,  
SECURITY  
& GENERAL
**DRAG**  
Specialties

### HIGH PERFORMANCE 6" DRAGTRON™ II AIR CLEANER

- Dynamometer-designed radius entry backing plate maximizes airflow and horsepower
- 2" washable filter is encased in a heavy stainless steel mesh and is easily serviced
- Available in chrome finish
- Stainless steel hardware is included
- Replacement filters available; see page 643

NOTE: Not legal for street use on pollution controlled vehicles.

NOTE: Support brackets and breather kits are sold separately.

U.S. Design Patent #305,149; Taiwan Patent pending.

PART #	DESCRIPTION	SUG. RETAIL
<b>DS-289044</b>	For 90-06 Big Twin, 88-06 XL (CV carbs) (Delphi EFI applications will require adapters PART #s 1010-0552 or 1010-0553; sold separately)	<b>\$89.95</b>



1010-0450



1010-0270



### MO-FLOW™ BILLET AIR CLEANERS

- Made from aluminum, polished and chrome-plated
- Available in gloss black, chrome or wrinkle black powder coat
- Hidden fasteners and internal breather assembly make for a clean look
- Each air cleaner assembly contains a reusable pleated gauze performance filter that has been engineered and flow tested to obtain maximum flow and protection for your motor
- Seal breather assembly velocity plate and all necessary mounting hardware included
- Optional hardware kits available separately and only work with Cycle Visions Mo-Flow air cleaners

NOTE: This product can be used for street or racing application where you want maximum performance for the state of California; EO #D-668, for 00-09 EFI applications.

NOTE: Adapter for Mikuni carbs sold separately.



1010-0298



1010-0834

PART #	DESCRIPTION	SUG. RETAIL	PART #	DESCRIPTION	SUG. RETAIL
<b>GLOSS BLACK</b>			<b>WRINKLED BLACK POWDER-COAT</b>		
<b>1010-0450</b>	For 08-15 FLHT, FLHR, FLHX, FLTR and H-D FL Trikes	<b>\$299.95</b>	<b>1010-0350</b>	For 08-15 FLHT, FLHR, FLHX, FLTR and H-D FL Trikes	<b>\$299.95</b>
<b>1010-0446</b> <sup>1</sup>	For 91-15 XL w/ CV carb or HSR Mikuni carb/Delphi EFI	<b>299.95</b>	<b>1010-0300</b> <sup>1</sup>	For 91-15 XL w/ CV carb or HSR Mikuni carb/Delphi EFI	<b>299.95</b>
<b>1010-0445</b> <sup>1</sup>	For 99-06 Twin Cam w/ CV or HSR Mikuni carb, 01-14 Twin Cam w/ Delphi EFI (except 08-15 Dressers)	<b>299.95</b>	<b>1010-0301</b> <sup>1</sup>	For 99-06 Twin Cam w/ CV or HSR Mikuni carb, 01-15 Twin Cam w/ Delphi EFI (except 08-15 Dressers)	<b>299.95</b>
<b>1010-0444</b> <sup>1</sup>	For 93-99 Evolution Big Twin w/ CV or HSR Mikuni carbs	<b>299.95</b>	<b>1010-0298</b> <sup>1</sup>	For 93-99 Evolution Big Twin w/ CV or HSR Mikuni carbs	<b>299.95</b>
<b>CHROME</b>			<b>REPLACEMENT HARDWARE KITS</b>		
<b>1010-0349</b>	For 08-15 FLHT, FLHR, FLHX, FLTR and H-D FL Trikes	<b>299.95</b>	<b>1010-0834</b>	For 08-15 FLHT, FLHR, FLHX, FLTR and H-D FL Trikes	<b>36.95</b>
<b>1010-0212</b> <sup>1</sup>	For 91-15 XL w/ CV carb or HSR Mikuni carb/Delphi EFI	<b>299.95</b>	<b>1010-0832</b>	For 91-15 XL (all)	<b>36.95</b>
<b>1010-0270</b> <sup>1</sup>	For 99-06 Twin Cam w/ CV or HSR Mikuni carb, 01-15 Twin Cam w/ Delphi EFI (except 08-15 Dressers)	<b>299.95</b>	<b>1010-0832</b>	For 93-99 Evolution Big Twin (all)	<b>36.95</b>
<b>1010-0210</b> <sup>1</sup>	For 93-99 Evolution Big Twin w/ CV or HSR Mikuni carbs	<b>299.95</b>	<b>1010-0833</b>	For 99-06 Twin Cam (all)	<b>36.95</b>
<b>1010-0272</b>	For 93-99 Evolution Big Twin w/ S&S E or G carb	<b>299.95</b>	<b>REPLACEMENT AIR FILTER</b>		
			<b>1011-2002</b>	Repl. air filter	<b>59.95</b>

<sup>1</sup> Requires adapter for Mikuni.

**IMPORTANT NOTE: SEE PAGE 411 FOR IMPORTANT INFORMATION REGARDING CERTAIN WARRANTY AND EMISSION CONTROL REGULATORY COMPLIANCE INFORMATION.**

All part numbers in **BLUE** are new for 2015.



WINDSHIELDS & FAIRINGS

TOURING

AUDIO & COMMUNICATION

LUGGAGE

SEATS & Sissy BARS

EXHAUST

POLE/PIPE SYSTEMS

ENGINE

TRANSMISSION & DRIVELINE

GASKETS & SEALS

ELECTRICAL

LIGHTING

HANDLEBARS, CONTROLS & MIRRORS

CABLES

BRAKES

TANKS & OIL FILTERS

DASHES & GAUGES

FRAMES, SUSPENSION & FENDERS

FOOTRESTS & LICENSE PLATE FRAMES

WHEELS & AXLES

HARDWARE, CHEMICALS & TOOLS

COVERS, SECURITY & GENERAL



**MOTO INTAKE KITS**

- CNC-machined aluminum construction
- Increases airflow while maintaining a low profile
- Cleanable/reusable proprietary air filter has over 130 sq. in. of filter element
- Internal velocity stack with internal breathers breathe directly back into venturi
- Made in the U.S.A.

NOTE: Not legal for street use on pollution-controlled vehicles.

PART #	DESCRIPTION	SUG. RETAIL
<b>FOR 08-15 FLT/FLHT/FLHX/FLTR AND H-D FL TRIKE MODELS</b>		
1010-0860	Chrome	\$371.95
<b>FOR 01-15 SOFTAIL, 04-15 DYNA, 02-07 FLT, FLHT WITH DELPHI EFI, 93-06 BIG TWIN W/ STOCK CV CARB</b>		
1010-0714	Chrome	371.95
1010-0715	Black anodized	371.95
<b>FOR 93-06 BIG TWIN W/ MIKUNI HSR 42MM CARBS</b>		
1010-0712	Chrome	371.95



1010-1202



1010-1203



1010-1208



1010-1215

**ARLEN NESS**

**INVERTED SERIES AIR CLEANER KITS**

- The ultimate combination of performance and design for your V-Twin engine
- Inverted pleated top with pleated sides to maximize airflow
- Our pre-oiled black filter element is encapsulated in a stainless steel jacket for the ultimate in style and durability
- Forged air filter housings feature built-in velocity stacks that scream performance and enhance looks
- Forged billet backing plate features our proven radius inlet, hidden breather hardware and our industry leading Big Sucker patented technology
- Available in chrome or black anodized finishes
- All mounting hardware and gaskets are included
- Made in the U.S.A.

NOTE: Not legal for street use on pollution controlled vehicles.



PART #	DESCRIPTION	SUG. RETAIL
<b>FOR 08-15 FLHT/FLHR/FLHX/FLTR/H-D TRIKE MODELS</b>		
1010-1202	Slot Track, chrome	\$399.95
1010-1203	Slot Track, black anodized	399.95
1010-1208	Deep Cut, chrome	399.95
1010-1209	Deep Cut, black anodized	399.95
1010-1214	Bevelled, chrome	399.95
1010-1215	Bevelled, black anodized	399.95
1010-1502	10-Gauge, chrome	399.95
1010-1503	10-Gauge, black anodized	399.95
<b>FOR 01-15 TWIN CAM DELPHI EFI MODELS, 99-06 TWIN CAM CV CARB MODELS (EXCEPT 08-15 FLHT/FLHR/FLHX/FLTR/H-D TRIKE)</b>		
1010-1204	Slot Track, chrome	399.95
1010-1205	Slot Track, black anodized	399.95
1010-1210	Deep Cut, chrome	399.95
1010-1211	Deep Cut, black anodized	399.95
1010-1216	Bevelled, chrome	399.95
1010-1217	Bevelled, black anodized	399.95

PART #	DESCRIPTION	SUG. RETAIL
<b>FOR 01-15 TWIN CAM DELPHI EFI MODELS, 99-06 TWIN CAM CV CARB MODELS (EXCEPT 08-15 FLHT/FLHR/FLHX/FLTR/H-D TRIKE) (CONT)</b>		
1010-1504	10-Gauge, chrome	\$399.95
1010-1505	10-Gauge, black anodized	399.95
<b>FOR 91-15 XL</b>		
1010-1206 <sup>1</sup>	Slot Track, chrome	399.95
1010-1207 <sup>1</sup>	Slot Track, black anodized	399.95
1010-1212 <sup>1</sup>	Deep Cut, chrome	399.95
1010-1213 <sup>1</sup>	Deep Cut, black anodized	399.95
1010-1218 <sup>1</sup>	Bevelled, chrome	399.95
1010-1219 <sup>1</sup>	Bevelled, black anodized	399.95
1010-1506 <sup>1</sup>	10-Gauge, chrome	399.95
1010-1507 <sup>1</sup>	10-Gauge, black anodized	399.95
<b>REPLACEMENT AIR FILTER</b>		
1011-2942	Repl. air filter	64.95

<sup>1</sup> Will fit 88-90 models also, breather system is not applicable for these model years.

**IMPORTANT NOTE: SEE PAGE 411 FOR IMPORTANT INFORMATION REGARDING CERTAIN WARRANTY AND EMISSION CONTROL REGULATORY COMPLIANCE INFORMATION.**

All part numbers in **BLUE** are new for 2015.

WINDSHIELDS  
& FAIRINGS

TOURING

AUDIO &  
COMMUNICATION

LUGGAGE

SEATS &  
SISSY BARS

EXHAUST

FUEL/AIR  
SYSTEMS

ENGINE

TRANSMISSION  
& DRIVELINEGASKETS  
& SEALS

ELECTRICAL

LIGHTING

HANDLEBARS,  
CONTROLS  
& MIRRORS

CABLES

BRAKES

TANKS &  
OIL FILTERSDASHES  
& GAUGESFRAMES,  
SUSPENSION  
& FENDERSFOOTRESTS  
& LICENSE  
PLATE FRAMESWHEELS  
& AXLESHARDWARE,  
CHEMICALS  
& TOOLSCOVERS,  
SECURITY  
& GENERAL

## ARLEN NESS



1010-0187



1010-0187



1010-0621



1010-0617

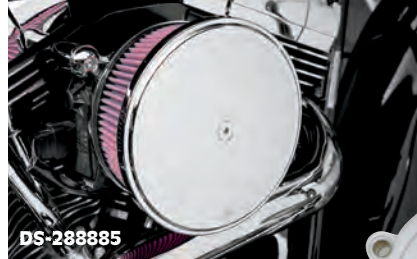

DS-288885



DS-288884

**"BILLET SUCKER" AIR CLEANER ASSEMBLIES**

- Available in Stage I and Stage II
- Both feature an oversized exposed filter design for tremendous airflow
- One-piece aluminum backing plate with patented hidden breather technology and radius air inlet for maximum airflow
- Breather passages exit at the mouth of the carb/throttle body, creating a virtually closed-loop system
- Eliminates the need for any external banjo fittings, hoses, and breather filters for an ultra clean look
- Kits include a high-flow air filter, outer cover, backing plate/support bracket and all necessary hardware
- Made in the U.S.A.

NOTE: Not legal for street use on pollution controlled vehicles.

PART #	DESCRIPTION	SUG. RETAIL
<b>STAGE I KITS</b>		
1010-0355	Smooth, for 08-15 FLHT, FLHR, FLHX, FLTR and H-D FL Trike models (chrome)	\$219.95
1010-0357	Scalloped, for 08-15 FLHT, FLHR, FLHX, FLTR and H-D FL Trike models (chrome)	229.95
1010-0613	Scalloped, for 08-15 FLHT, FLHR, FLHX, FLTR and H-D FL Trike models (black/raw)	229.95
1010-0186	Smooth, for all 01-15 Twin Cam Delphi EFI and 99-06 Twin Cam CV carb models (except 08-15 FLHT, FLHR, FLHX, FLTR and H-D FL Trike) (chrome)	219.95
1010-0187	Scalloped, for all 01-15 Twin Cam Delphi EFI and 99-06 Twin Cam CV carb models (except 08-15 FLHT, FLHR, FLHX, FLTR and H-D FL Trike) (chrome)	229.95
1010-0614	Scalloped, for all 01-15 Twin Cam Delphi EFI and 99-06 Twin Cam CV carb models (except 08-15 FLHT, FLHR, FLHX, FLTR and H-D FL Trike) (black/raw)	229.95
1010-0615	Scalloped, for all 93-99 Evolution Big Twin models w/ CV carb, (black/raw)	239.95
1010-0616 <sup>1</sup>	Scalloped, for 91-15 XL models w/ CV carb or Delphi EFI (black/raw)	249.95
<b>STAGE II KITS</b>		
1010-0356	Smooth, for 08-15 FLHT, FLHR, FLHX, FLTR and H-D FL Trike models (chrome)	224.95
1010-0358	Scalloped, for 08-15 FLHT, FLHR, FLHX, FLTR and H-D FL Trike models (chrome)	224.95
1010-0621	Scalloped, for 08-15 FLHT, FLHR, FLHX, FLTR and H-D FL Trike models (black/raw)	249.95
1010-0617	Retro, for 08-15 FLHT, FLHR, FLHX, FLTR and H-D FL Trike models (chrome)	249.95
1010-0188	Smooth, for all 01-15 Twin Cam Delphi EFI and 99-06 Twin Cam CV carb models (except 08-15 FLHT, FLHR, FLHX, FLTR and H-D FL Trike) (chrome)	224.95
1010-0189	Scalloped, for all 01-15 Twin Cam Delphi EFI and 99-06 Twin Cam CV carb models (except 08-15 FLHT, FLHR, FLHX, FLTR and H-D FL Trike) (chrome)	224.95
1010-0622	Scalloped, for all 01-15 Twin Cam Delphi EFI and 99-06 Twin Cam CV carb models (except 08-15 FLHT, FLHR, FLHX, FLTR and H-D FL Trike) (black/raw)	249.95
1010-0190	Grooved, for all 01-15 Twin Cam Delphi EFI and 99-06 Twin Cam CV carb models (except 08-15 FLHT, FLHR, FLHX, FLTR and H-D FL Trike) (chrome)	224.95
1010-0618	Retro, for all 01-15 Twin Cam Delphi EFI and 99-06 Twin Cam CV carb models (except 08-15 FLHT, FLHR, FLHX, FLTR and H-D FL Trike) (chrome)	249.95
DS-288885	Smooth, for all 93-99 Evolution Big Twin models w/ CV carb, (chrome)	219.95
1010-0066	Scalloped, for all 93-99 Evolution Big Twin models w/ CV carb, (chrome)	219.95
1010-0623	Scalloped, for all 93-99 Evolution Big Twin models w/ CV carb, (black/raw)	229.95
DS-288884	Grooved, for all 93-99 Evolution Big Twin models w/ CV carb, (chrome)	219.95
1010-0619	Retro, for all 93-99 Evolution Big Twin models w/ CV carb, (chrome)	249.95
1010-0065	Scalloped, for 99-01 Twin Cam FLT fuel-injected models (chrome)	249.95
1010-0596	Scalloped, for 99-01 Twin Cam FLT fuel-injected models (black/raw)	249.95
1010-0595	Retro, for 99-01 Twin Cam FLT fuel-injected models (chrome)	249.95
1010-0064 <sup>1</sup>	Scalloped, for 91-15 XL models (chrome)	229.95
1010-0624 <sup>1</sup>	Scalloped, for 91-15 XL models w/ CV carb or Delphi EFI (black/raw)	249.95
1010-0062 <sup>1</sup>	Grooved, for 91-15 XL models (chrome)	229.95
1010-0620 <sup>1</sup>	Retro, for 91-15 XL models w/ CV carb or Delphi EFI (chrome)	249.95

<sup>1</sup> Will fit 88-90 models, breather system is not applicable for these model years.

**IMPORTANT NOTE: SEE PAGE 411 FOR IMPORTANT INFORMATION REGARDING CERTAIN WARRANTY AND EMISSION CONTROL REGULATORY COMPLIANCE INFORMATION.**

All part numbers in **BLUE** are new for 2015.

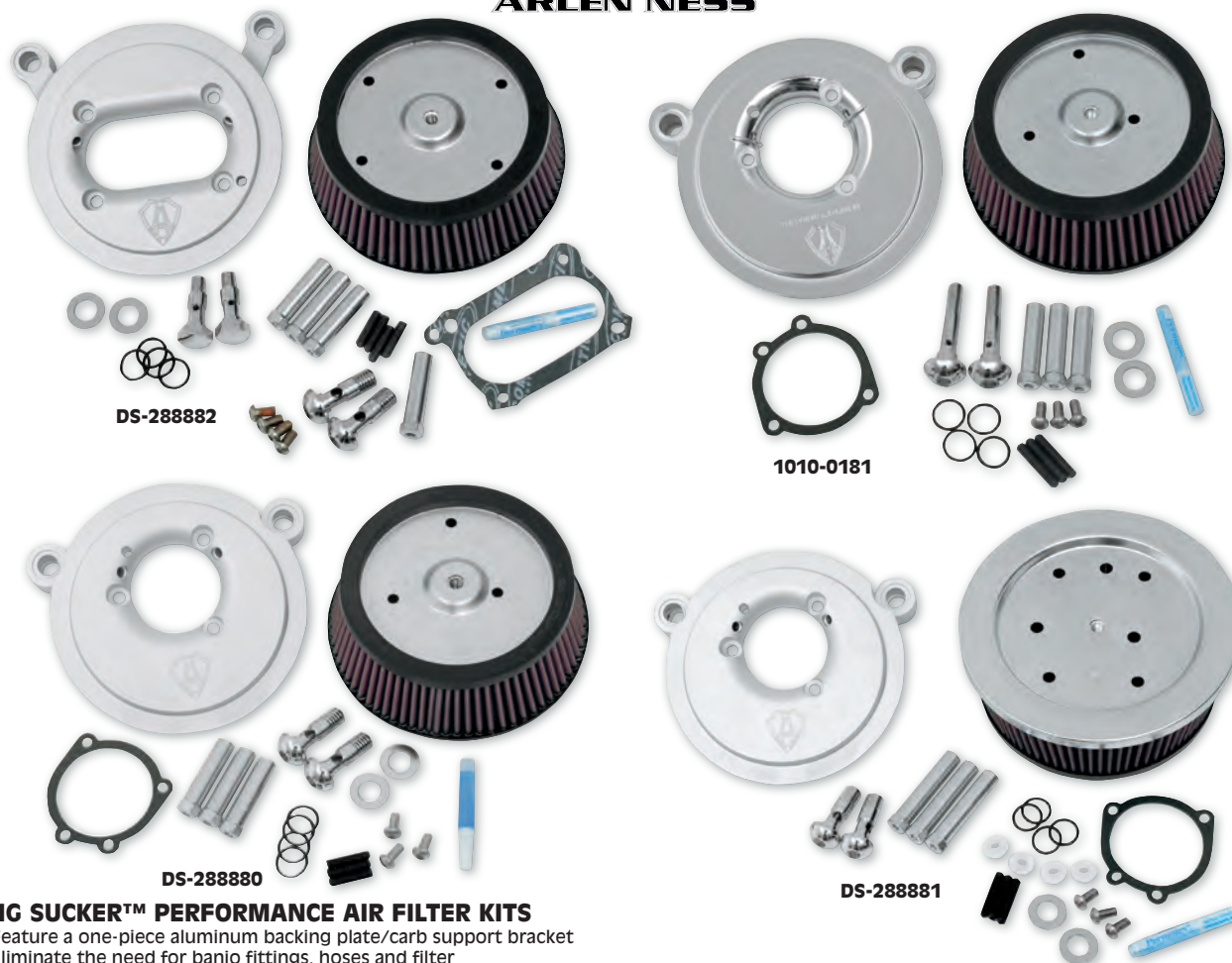

## ARLEN NESS

**BIG SUCKER™ PERFORMANCE AIR FILTER KITS**

- Feature a one-piece aluminum backing plate/carb support bracket
- Eliminate the need for banjo fittings, hoses and filter
- Breather passages exit at the mouth of the carburetor/throttle body, creating a virtually closed-loop system
- Stage I kit includes a high-flow filter and accepts 93-15 oval or round OEM outer cover (unless noted)
- Stage II kit includes a 20% larger high-flow filter and accepts an 8" round Ness or 8" round OEM outer cover
- All necessary hardware and instructions are included with each kit

NOTE: Exempt per C.A.R.B. ref. E.O. # D-639-2 for many 97-09 EFI applications.

PART #	DESCRIPTION	SUG. RETAIL
<b>STAGE I KITS (ACCEPT OEM COVERS)</b>		
1010-1461	For 14-15 FLHT/FLHR/FLHX/FLTR/H-D FL trike models (natural)	\$139.95
1010-1462	For 14-15 FLHT/FLHR/FLHX/FLTR/H-D FL trike models (chrome)	159.95
1010-1463	For 14-15 FLHT/FLHR/FLHX/FLTR/H-D FL trike models (black)	159.95
1010-0351	For 08-13 FLHT, FLHR, FLHX, FLTR and H-D FL Trike models (natural)	129.95
1010-0353	For 08-13 FLHT, FLHR, FLHX, FLTR and H-D FL Trike models (chrome)	149.95
DS-288882	For 99-01 FLHTI/FLHRI (natural)	129.95
1010-1013	For 08-15 FXD/FXDWG (natural)	139.95
1010-1012	For 08-15 FXD/FXDWG (chrome)	159.95
1010-1011	For 08-15 FXD/FXDWG (black)	159.95
1010-0179	For 01-15 Twin Cam Delphi EFI models and 99-06 Twin Cam CV carb models (except 08-15 FXD/FXDWG, 08-13 FLHT, FLHR, FLHX, FLTR and H-D FL Trike models) (natural)	129.95
1010-0181	For 01-15 Twin Cam Delphi EFI models and 99-06 Twin Cam CV carb models (except 08-15 FXD/FXDWG, 08-13 FLHT, FLHR, FLHX, FLTR and H-D FL Trike models) (chrome)	149.95
DS-288880	For 93-99 Evolution Big Twin models w/ CV carb (natural)	129.95
1010-1014 <sup>1</sup>	For 91-15 XL models (natural)	139.95
1010-0891 <sup>1</sup>	For 91-15 XL models (chrome)	159.95
1010-0892 <sup>1</sup>	For 91-15 XL models (black)	159.95
<b>STAGE I KITS (ACCEPT 8" ROUND AFTERMARKET COVERS ONLY)</b>		
1010-0179	For 08-15 FXD/FXDWG (natural)	129.95
1010-0181	For 08-15 FXD/FXDWG (chrome)	149.95
1010-0060 <sup>1</sup>	For 91-15 XL models (natural)	129.95
<b>STAGE II KITS (ACCEPT 8" ROUND AFTERMARKET OUTER COVERS)</b>		
1010-0352	For 08-15 FLHT, FLHR, FLHX, FLTR and H-D FL Trike models (natural)	139.95
1010-0354	For 08-15 FLHT, FLHR, FLHX, FLTR and H-D FL Trike models (chrome)	159.95
DS-288883	For 99-01 FLHTI/FLHRI (natural)	139.95
1010-0180	For 01-15 Twin Cam Delphi EFI models and 99-06 Twin Cam CV carb models (except 08-15 FLHT, FLHR, FLHX, FLTR and H-D FL Trike models) (natural)	139.95
1010-0185	For 01-15 Twin Cam Delphi EFI models and 99-06 Twin Cam CV carb models (except 08-15 FLHT, FLHR, FLHX, FLTR and H-D FL Trike models) (chrome)	159.95
DS-288881	For 93-99 Evolution Big Twin models w/ CV carb (natural)	139.95
1010-0061 <sup>1</sup>	For 91-15 XL models (natural)	139.95

<sup>1</sup> Will fit 88-90 models also; breather system is not applicable for these model years.

**IMPORTANT NOTE: SEE PAGE 411 FOR IMPORTANT INFORMATION REGARDING CERTAIN WARRANTY AND EMISSION CONTROL REGULATORY COMPLIANCE INFORMATION.**

All part numbers in **BLUE** are new for 2015.

WINDSHIELDS &amp; FAIRINGS

TOURING

AUDIO &amp; COMMUNICATION

LUGGAGE

SEATS &amp; Sissy BARS

EXHAUST

PIPET/AIR SYSTEMS

ENGINE

TRANSMISSION &amp; DRIVELINE

GASKETS &amp; SEALS

ELECTRICAL

LIGHTING

HANDLEBARS, CONTROLS &amp; MIRRORS

CABLES

BRAKES

TANKS &amp; OIL FILTERS

DASHES &amp; GAUGES

FRAMES, SUSPENSION &amp; FENDERS

FOOTRESTS &amp; LICENSE PLATE FRAMES

WHEELS &amp; AXLES

HARDWARE, CHEMICALS &amp; TOOLS

COVERS, SECURITY &amp; GENERAL

## ARLEN NESS

WINDSHIELDS  
& FAIRINGS

TOURING

AUDIO &  
COMMUNICATION

LUGGAGE

SEATS &  
SISSY BARS

EXHAUST

FUEL/AIR  
SYSTEMS

ENGINE

TRANSMISSION  
& DRIVELINEGASKETS  
& SEALS

ELECTRICAL

LIGHTING

HANDLEBARS,  
CONTROLS  
& MIRRORS

CABLES

BRAKES

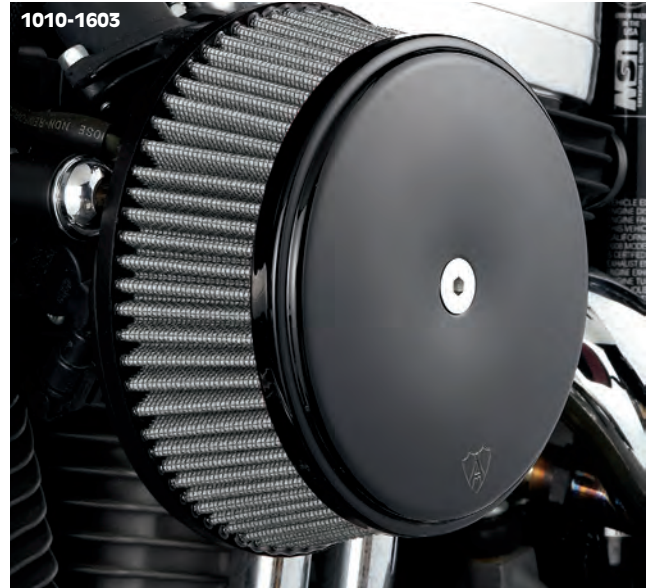
TANKS &  
OIL FILTERSDASHES  
& GAUGESFRAMES,  
SUSPENSION  
& FENDERSFOOTRESTS  
& LICENSE  
PLATE FRAMESWHEELS  
& AXLESHARDWARE,  
CHEMICALS  
& TOOLSCOVERS,  
SECURITY  
& GENERAL**BIG SUCKER™ STAGE I  
AIR FILTER KIT WITH COVER**

- Features a one-piece aluminum backing plate/carb support bracket with patented hidden breather technology and radius air inlet
- Eliminates the need for banjo fittings, hoses and filter
- Breather passages exit at the mouth of the carburetor/throttle body, creating a virtually closed-loop system
- Kit includes high-performance filter, backing plate and steel outer cover
- All necessary hardware and instructions are included with each kit

NOTE: Exempt per C.A.R.B. reference E.O. #D-639-2 for many 97-09 EFI applications.

PART # DESCRIPTION

**KITS WITH STANDARD FILTER**

PART #	DESCRIPTION	SUG. RETAIL
1010-0869	For 08-13 FLHT, FLHR, FLHX, FLTR and H-D FL Trike models (chrome)	\$159.95
1010-0874	For 08-13 FLHT, FLHR, FLHX, FLTR and H-D FL Trike models (black)	159.95
1010-0872	For 99-01 FLHTI/FLHRI (chrome)	159.95
1010-0877	For 99-01 FLHTI/FLHRI (black)	159.95
1010-0870	For 01-15 Twin Cam Delphi EFI and 99-06 Twin Cam CV carb models (except 08-15 FLHT, FLHR, FLHX, FLTR and H-D FL Trike models) (chrome)	159.95
1010-0875	For 01-15 Twin Cam Delphi EFI and 99-06 Twin Cam CV carb models (except 08-15 FLHT, FLHR, FLHX, FLTR and H-D FL Trike models) (black)	159.95
1010-0871	For 93-99 Evolution Big Twin models w/ CV carb (chrome)	159.95
1010-0876	For 93-99 Evolution Big Twin models w/ CV carb (black)	159.95
1010-0873 <sup>1</sup>	For 91-15 XL models w/ CV carb or Delphi EFI (chrome)	159.95
1010-0878 <sup>1</sup>	For 91-15 XL models w/ CV carb or Delphi EFI (black)	159.95

**KITS WITH STAINLESS-STEEL JACKETED FILTER**

1010-1600	For 08-13 FLHT, FLHR, FLHX, FLTR and H-D FL Trike models (chrome)	179.95
1010-1604	For 08-13 FLHT, FLHR, FLHX, FLTR and H-D FL Trike models (black)	179.95
1010-1601	For all 01-15 Twin Cam Delphi EFI and 99-06 Twin Cam CV carb models (except 08-15 FLHT, FLHR, FLHX, FLTR and H-D FL Trike models) (chrome)	179.95
1010-1605	For all 01-15 Twin Cam Delphi EFI and 99-06 Twin Cam CV carb models (except 08-15 FLHT, FLHR, FLHX, FLTR and H-D FL Trike models) (black)	179.95
1010-1602	For all 93-99 Evolution Big Twin models w/ CV carb (chrome)	179.95
1010-1606	For all 93-99 Evolution Big Twin models w/ CV carb (black)	179.95
1010-1603	For 91-15 XL models w/ CV carb or Delphi EFI (chrome)	179.95
1010-1607	For 91-15 XL models w/ CV carb or Delphi EFI (black)	179.95

<sup>1</sup> Will fit 88-90 models also, breather system is not applicable for these model years.

**IMPORTANT NOTE: SEE PAGE 411 FOR IMPORTANT INFORMATION REGARDING CERTAIN WARRANTY AND EMISSION CONTROL REGULATORY COMPLIANCE INFORMATION.**

All part numbers in **BLUE** are new for 2015.



## ARLEN NESS

WINDSHIELDS  
& FAIRINGS

TOURING

AUDIO &  
COMMUNICATION

LUGGAGE

SEATS &  
SISSY BARS

EXHAUST

FUEL/AIR  
SYSTEMS

ENGINE

TRANSMISSION  
& DRIVELINEGASKETS  
& SEALS

ELECTRICAL

LIGHTING

HANDLEBARS,  
CONTROLS  
& MIRRORS

CABLES

BRAKES

TANKS &  
OIL FILTERSDASHES  
& GAUGESFRAMES,  
SUSPENSION  
& FENDERSFOOTRESTS  
& LICENSE  
PLATE FRAMESWHEELS  
& AXLESHARDWARE,  
CHEMICALS  
& TOOLSCOVERS,  
SECURITY  
& GENERAL

1010-0430



1010-0434



Stainless steel jacketed filter

**BIG SUCKER™ STAGE II AIR FILTER KITS WITH COVER**

- Features a one-piece aluminum backing plate/carb support bracket with patented hidden breather technology and radius air inlet
- Eliminates the need for banjo fittings, hoses and filter
- Breather passages exit at the mouth of the carburetor/throttle body, creating a virtually closed-loop system
- Kit includes a 20% larger high-performance filter and steel outer cover
- Pre-oiled filters available in two styles: standard or stainless-steel jacketed
- All necessary hardware and instructions are included with each kit
- Made in the U.S.A.

**NOTE:** Exempt per C.A.R.B. ref. E.O. #D-639-2 for many 97-09 EFI applications.

PART #	DESCRIPTION	SUG. RETAIL
<b>KITS WITH STANDARD FILTER</b>		
1010-0432	For 08-15 FLHT, FLHR, FLHX, FLTR and H-D FL Trike models (chrome)	\$169.95
1010-0434	For 08-15 FLHT, FLHR, FLHX, FLTR and H-D FL Trike models (wrinkle black)	169.95
1010-0428	For 99-01 FLHTI/FLHRI (chrome)	169.95
1010-0431	For 01-15 Twin Cam Delphi EFI and 99-06 Twin Cam CV carb models (except 08-15 FLHT, FLHR, FLHX, FLTR and H-D FL Trike models) (chrome)	169.95
1010-0433	For 01-15 Twin Cam Delphi EFI and 99-06 Twin Cam CV carb models (except 08-15 FLHT, FLHR, FLHX, FLTR and H-D FL Trike models) (wrinkle black)	189.95
1010-0430	For 93-99 Evolution Big Twin models w/ CV carb (chrome)	169.95
1010-0429 <sup>1</sup>	For 91-15 XL models w/ CV carb or Delphi EFI (chrome)	169.95
<b>KITS WITH STAINLESS-STEEL JACKETED FILTER</b>		
1010-0635	For 08-15 FLHT, FLHR, FLHX, FLTR and H-D FL Trike models (chrome)	179.95
1010-0636	For 08-15 FLHT, FLHR, FLHX, FLTR and H-D FL Trike models (black)	199.95
1010-0582	For 99-01 Twin Cam FLT fuel-injected models (black)	199.95
1010-0641	For all 01-15 Twin Cam Delphi EFI and 99-06 Twin Cam CV carb models (except 08-15 FLHT, FLHR, FLHX, FLTR and H-D FL Trike models) (chrome)	179.95
1010-0642	For all 01-15 Twin Cam Delphi EFI and 99-06 Twin Cam CV carb models (except 08-15 FLHT, FLHR, FLHX, FLTR and H-D FL Trike models) (black)	199.95
1010-0625	For all 93-99 Evolution Big Twin models w/ CV carb (chrome)	179.95
1010-0626	For all 93-99 Evolution Big Twin models w/ CV carb (black)	199.95
1010-0581 <sup>1</sup>	For 91-15 XL models w/ CV carb or Delphi EFI (chrome)	179.95
1010-0570 <sup>1</sup>	For 91-15 XL models w/ CV carb or Delphi EFI (black)	189.95

<sup>1</sup> Will fit 88-90 models also, breather system is not applicable for these model years.

1010-0395

**LITTLE SUCKER AIR FILTER KITS**

- Features a steel backing plate integrated into the filter
- Steel backing plate includes urethane radius inlet
- Utilizes factory breather hoses and hardware
- Accepts factory outer air cleaner cover only
- Made in the U.S.A.

PART #	DESCRIPTION	SUG. RETAIL
1010-0396	For 08-15 FLHT, FLHR, FLHX, FLTR and H-D FL Trike models	\$99.95
1010-0395	For 01-15 Twin Cam w/ Delphi EFI and 99-06 Twin Cam w/ CV carb models (except 08-15 FLHT, FLHR, FLHX, FLTR and H-D FL Trike models)	99.95

**IMPORTANT NOTE:** SEE PAGE 411 FOR IMPORTANT INFORMATION REGARDING CERTAIN WARRANTY AND EMISSION CONTROL REGULATORY COMPLIANCE INFORMATION.

All part numbers in **BLUE** are new for 2015.



WINDSHIELDS  
& FAIRINGS

TOURING

AUDIO &  
COMMUNICATION

LUGGAGE

SEATS &  
SISSY BARS

EXHAUST

PUMP/PAINT  
SYSTEMS

ENGINE

TRANSMISSION  
& DRIVELINEGASKETS  
& SEALS

ELECTRICAL

LIGHTING

HANDLEBARS,  
CONTROLS  
& MIRRORS

CABLES

BRAKES

TANKS &  
OIL FILTERSDASHES  
& GAUGESFRAMES,  
SUSPENSION  
& FENDERSFOOTRESTS  
& LICENSE  
PLATE FRAMESWHEELS  
& AXLESHARDWARE,  
CHEMICALS  
& TOOLSCOVERS,  
SECURITY  
& GENERAL

## ARLEN NESS



**1010-0633**  
Shown w/ Battistinis derby cover



**1010-0627**  
Shown w/ Ness Tech derby cover

### BIG SUCKER DERBY COVER AIR FILTER KITS

- Unique air filter kits feature a five-hole mounting system, which allows Twin Cam derby covers (not included) to be bolted on as the outer cover
- Pre-oiled filters available in two styles: standard or stainless-steel jacketed
- All kits include patented Ness hidden breather Big Sucker backing plates in either chrome or powder-coated black wrinkle finish

NOTE: Exempt per C.A.R.B. ref. E.O. #D-639-2 for many 97-09 EFI applications.

PART #	DESCRIPTION	SUG. RETAIL
<b>KITS W/ STANDARD PRE-OILED FILTER</b>		
<b>1010-0631</b>	For 08-15 FLHT, FLHR, FLHX, FLTR and H-D FL Trike models (chrome)	\$169.95
<b>1010-0633</b>	For 08-15 FLHT, FLHR, FLHX, FLTR and H-D FL Trike models (black)	169.95
<b>1010-0575</b>	For 99-01 Twin Cam FLT fuel-injected models (chrome)	169.95
<b>1010-0577</b>	For 99-01 Twin Cam FLT fuel-injected models (black)	169.95
<b>1010-0639</b>	For all 01-15 Twin Cam Delphi EFI and 99-06 Twin Cam CV carb models (except 08-15 FLHT, FLHR, FLHX, FLTR and H-D FL Trike models) (chrome)	169.95
<b>1010-0640</b>	For all 01-15 Twin Cam Delphi EFI and 99-06 Twin Cam CV carb models (except 08-15 FLHT, FLHR, FLHX, FLTR and H-D FL Trike models) (black)	169.95
<b>1010-0632</b>	For all 93-99 Evolution Big Twin models w/ CV carb (chrome)	169.95
<b>1010-0634</b>	For all 93-99 Evolution Big Twin models w/ CV carb (black)	169.95
<b>1010-0576</b> <sup>1</sup>	For 91-15 XL models w/ CV carb or Delphi EFI (chrome)	169.95
<b>1010-0578</b> <sup>1</sup>	For 91-15 XL models w/ CV carb or Delphi EFI (black)	169.95
<b>KITS W/ STAINLESS-STEEL JACKETED PRE-OILED FILTER</b>		
<b>1010-0627</b>	For 08-15 FLHT, FLHR, FLHX, FLTR and H-D FL Trike models (chrome)	189.95
<b>1010-0629</b>	For 08-15 FLHT, FLHR, FLHX, FLTR and H-D FL Trike models (black)	189.95
<b>1010-0637</b>	For all 01-15 Twin Cam Delphi EFI and 99-06 Twin Cam CV carb models (except 08-15 FLHT, FLHR, FLHX, FLTR and H-D FL Trike models) (chrome)	189.95
<b>1010-0638</b>	For all 01-15 Twin Cam Delphi EFI and 99-06 Twin Cam CV carb models (except 08-15 FLHT, FLHR, FLHX, FLTR and H-D FL Trike models) (black)	189.95
<b>1010-0628</b>	For all 93-99 Evolution Big Twin models w/ CV carb (chrome)	189.95
<b>1010-0630</b>	For all 93-99 Evolution Big Twin models w/ CV carb (black)	189.95
<b>1010-0572</b> <sup>1</sup>	For 91-15 XL models w/ CV carb or Delphi EFI (chrome)	189.95
<b>1010-0574</b> <sup>1</sup>	For 91-15 XL models w/ CV carb or Delphi EFI (black)	189.95

<sup>1</sup> Will fit 88-90 models also, breather system is not applicable for these model years.



**1010-1053**



**1010-1054**

### DERBY SUCKER AIR FILTERS FOR SCREAMIN' EAGLE® BACKING PLATES

- Innovative filter upgrade for stock Screamin' Eagle® air cleaner
- Accepts any 5-hole Big Twin style derby cover (sold separately)
- Comes with everything needed to mount to a round Screamin' Eagle® backing plate
- Available with either red filter or stainless steel filter

PART #	DESCRIPTION	SUG. RETAIL	PART #	DESCRIPTION	SUG. RETAIL
<b>FOR 08-15 FLHT, FLHR, FLHX, FLTR AND H-D FL TRIKE MODELS</b>			<b>FOR 99-15 FXST/FLST, 02-07 FLHT, 97-07 FXD</b>		
<b>1010-1053</b>	Red	\$69.95	<b>1010-1055</b>	Red	\$69.95
<b>1010-1054</b>	Stainless steel	89.95	<b>1010-1056</b>	Stainless steel	89.95

**IMPORTANT NOTE: SEE PAGE 411 FOR IMPORTANT INFORMATION REGARDING CERTAIN WARRANTY AND EMISSION CONTROL REGULATORY COMPLIANCE INFORMATION.**

All part numbers in **BLUE** are new for 2015.



**ARLEN NESS**



WINDSHIELDS & FAIRINGS

TOURING

AUDIO & COMMUNICATION

LUGGAGE

SEATS & SISSY BARS

EXHAUST

ENGINE

TRANSMISSION & DRIVELINE

GASKETS & SEALS

ELECTRICAL

LIGHTING

HANDLEBARS, CONTROLS & MIRRORS

CABLES

BRAKES

TANKS & OIL FILTERS

DASHES & GAUGES

FRAMES, SUSPENSION & FENDERS

FOOTRESTS & LICENSE PLATE FRAMES

WHEELS & AXLES

HARDWARE, CHEMICALS & TOOLS

COVERS, SECURITY & GENERAL

**BILLET SUCKER AND BIG SUCKER COMPONENTS**

•Replacement and optional components for all Ness Billet Sucker and Big Sucker air filter kits

PART #	DESCRIPTION	SUG. RETAIL
<b>REPLACEMENT/OPTIONAL COMPONENTS</b>		
1010-0583	Stage I hardware kit for 99-06 Twin Cam CV carb and all 01-15 Twin Cam Delphi EFI models	\$34.95
1010-0584	Stage I hardware kit for 93-99 Evolution Big Twin models w/ CV carb	34.95
1010-0585	Stage I hardware kit for 99-01 Twin Cam FLT fuel-injected models	34.95
1010-0586	Stage I hardware kit for 91-15 XL models	34.95
1010-0591	Stage II hardware kit for 99-06 Twin Cam CV carb and all 01-15 Twin Cam Delphi EFI models	34.95
1010-0592	Stage II hardware kit for 93-99 Evolution Big Twin models w/ CV carb	34.95
1010-0593	Stage II hardware kit for 99-01 Twin Cam FLT fuel-injected models	34.95
1010-0594	Stage II hardware kit for 91-15 XL models	34.95
1011-3151	Stage I air filter for 14-15 FLHT, FLHX, FLTR and H-D FL Trike models	49.95
1010-0360	Stage I air filter for 08-15 FLHT, FLHR, FLHX, FLTR and H-D FL Trike models	49.95
2110-9494	Stage I air filter for 99-10 FXST, 02-07 FLHT, 97-07 FXD/FXDWG	49.95
2110-9496	Stage I air filter for DS-288882 only	49.95
1011-2851	Stage I air filter for PART #s 1010-1014, 1010-0891 and 1010-08092	49.95
1010-0561	Stage II air filter for 08-15 FLHT, FLHR, FLHX, FLTR and H-D FL Trike models	54.95
2110-9495	Stage II air filter element (except 08-15 FLHT/FLHR/FLHX/FLTR and H-D FL Trike models)	54.95
1011-2769	Big Sucker Derby Cover standard air filter for 08-15 FLHT, FLHR, FLHX, FLTR and H-D FL Trike models	64.95
1011-2768	Big Sucker Derby Cover stainless-steel jacketed air filter for 08-15 FLHT, FLHR, FLHX, FLTR and H-D FL Trike models	84.95
1011-2771	Big Sucker Derby Cover standard air filter for all 99-06 Twin Cam CV carb and 01-15 Twin Cam Delphi EFI models (except 08-15 FLHT, FLHR, FLHX, FLTR and H-D FL Trike models)	64.95
1011-2770	Big Sucker Derby Cover stainless-steel jacketed air filter for all 99-06 Twin Cam CV carb and 01-15 Twin Cam Delphi EFI models (except 08-15 FLHT, FLHR, FLHX, FLTR and H-D FL Trike models)	84.95
1011-2773	Big Sucker Derby Cover standard air filter for 99-01 Twin Cam FLT fuel-injected models	64.95
1011-2772	Big Sucker Derby Cover standard air filter for 99-01 Twin Cam FLT fuel-injected models	84.95
1011-2771	Big Sucker Derby Cover standard air filter for 91-15 XL models	64.95
1011-2770	Big Sucker Derby Cover stainless-steel jacketed air filter for 91-15 XL models	84.95
1010-0587	Gasket kit for 08-15 FLT and H-D FL Trike models	8.95
1010-0588	Gasket kit for 01-15 Twin Cam Delphi EFI, 99-06 Twin Cam CV carb (except 08-15 FLHT, FLHR, FLHX, FLTR and H-D FL Trike models), 93-99 Evolution Big Twin models w/ CV carb, 99-05 Twin Cam Carb and Delphi EFI models	8.95
1010-0589	Gasket kit for 99-01 Twin Cam FLT fuel-injected models	8.95
1010-0590	Gasket kit for 91-15 XL models	8.95
1014-0030 <sup>1</sup>	Optional Stage I scalloped outer cover (chrome)	119.95
1014-0044 <sup>1</sup>	Optional Stage I scalloped outer cover (black/raw)	119.95
1014-0091 <sup>1</sup>	Optional Stage I smooth outer cover (chrome)	49.95
1014-0092 <sup>1</sup>	Optional Stage I smooth outer cover (black)	49.95
1010-0067	Optional Stage II scalloped outer cover (chrome)	119.95
1014-0045	Optional Stage II scalloped outer cover (black/raw)	119.95
1014-0043	Optional Stage II retro outer cover (chrome)	119.95
1011-3242	Big Sucker Stage I pre-filter	39.95
1011-3243	Big Sucker Stage II pre-filter	39.95

<sup>1</sup> Not for PART #s 1010-0891, 1010-0892, 1010-1014, 1010-1011, 1010-1012 and 1010-1013.

**DOUBLE BARREL AIR FILTER ASSEMBLIES**

- Leading-edge design changes the look and performance of your bike
- Includes aluminum double-barrel outer cover, aluminum radius inlet backing plate, pre-oiled high-performance air filter and all necessary hardware
- Filter is reusable and washable
- Available in chrome or powder-coated black wrinkle finish

**NOTE:** Not legal for street use on pollution controlled vehicles.



PART #	DESCRIPTION	SUG. RETAIL
1010-0606	For 08-15 FLHT, FLHR, FLHX, FLTR and H-D FL Trike models (chrome)	\$249.95
1010-0607	For 08-15 FLHT, FLHR, FLHX, FLTR and H-D FL Trike models (black)	249.95
1010-0608	For all 01-15 Twin Cam Delphi EFI and 99-06 Twin Cam CV carb models (except 08-15 FLHT, FLHR, FLHX, FLTR and H-D FL Trike models) (chrome)	249.95
1010-0609	For all 01-15 Twin Cam Delphi EFI and 99-06 Twin Cam CV carb models (except 08-15 FLHT, FLHR, FLHX, FLTR and H-D FL Trike models) (black)	249.95
1010-0579	For 91-15 XL models w/ CV carb or Delphi EFI (chrome)	249.95
1010-0580	For 91-15 XL models w/ CV carb or Delphi EFI (black)	249.95

**IMPORTANT NOTE:** SEE PAGE 411 FOR IMPORTANT INFORMATION REGARDING CERTAIN WARRANTY AND EMISSION CONTROL REGULATORY COMPLIANCE INFORMATION.

All part numbers in **BLUE** are new for 2015.

WINDSHIELDS  
& FAIRINGS

TOURING

AUDIO &  
COMMUNICATION

LUGGAGE

SEATS &  
SISSY BARS

EXHAUST

FUEL/AIR  
SYSTEMS

ENGINE

TRANSMISSION  
& DRIVELINEGASKETS  
& SEALS

ELECTRICAL

LIGHTING

HANDLEBARS,  
CONTROLS  
& MIRRORS

CABLES

BRAKES

TANKS &  
OIL FILTERSDASHES  
& GAUGESFRAMES,  
SUSPENSION  
& FENDERSFOOTRESTS  
& LICENSE  
PLATE FRAMESWHEELS  
& AXLESHARDWARE,  
CHEMICALS  
& TOOLSCOVERS,  
SECURITY  
& GENERAL**AIR CLEANERS**

- Original S&S chrome teardrop air cleaner assemblies
- Include an S&S cover, backing plate and high-quality filter element and hardware kit
- Increase horsepower with no other changes
- Available for most OEM carburetors and S&S performance intake systems
- Available in chrome and black
- Made in the U.S.A.

NOTE: Not legal for street use on pollution controlled vehicles.

NOTE: Installation of an S&amp;S air cleaner may require re-jetting or engine re-tuning.

PART #	DESCRIPTION	SUG. RETAIL
<b>CHROME AIR CLEANERS FOR S&amp;S CARBURETORS</b>		
DS-289137	For E & G series carbs on 99-06 Twin Cam models	\$239.95
DS-289211	For E & G series carbs on 92-99 Evolution Big Twin models	239.95
DS-289129	For E & G series carbs on 84-92 Big Twin and 86-90 XL models	239.95

**AIR CLEANERS FOR STOCK H-D CARBURETORS/FUEL-INJECTION SYSTEMS**

PART #	DESCRIPTION	SUG. RETAIL
<b>CHROME</b>		
1010-0419	For 08-15 FLHT, FLHR, FLHX, FLTR and 09-15 H-D FL Trike models	\$239.95
1010-0325	For CV carbs on 93-06 Big Twin, 01-15 Big Twin w/ Delphi EFI models (except 08-15 Touring/HD FL Trike models)	239.95
1010-0326	For EFI and CV carbs on 91-14 XL	239.95
<b>POWDER-COAT WRINKLE BLACK</b>		
1010-1146	For CV carbs on 93-06 Big Twin, 01-15 Big Twin w/ Delphi EFI models (except 08-15 Touring/HD FL Trike models)	239.95
1010-1147	For EFI and CV carbs on 91-15 XL	239.95

PART #	DESCRIPTION	SUG. RETAIL
<b>REPLACEMENT COMPONENTS</b>		
DS-289404	Repl. S&S air cleaner cover for E & G carb, chrome	\$143.95
1014-0133	Repl. S&S air cleaner cover for E & G carb, black	121.95
DS-289403	Repl. S&S air cleaner cover for S&S CV air cleaner and Super B carbs, chrome	143.95
1014-0040	Repl. Slasher-style air cover; repl. for all E & G carbs, chrome	143.95
DS-289405	Repl. air cleaner cover screws (10-pk.)	.95 (ea.)
1011-0324	Repl. crankcase breather hose for 93-06 Big Twin, 91-06 XL and 94-02 Buells	6.95
1011-0325	Breather screw seals (silicone-coated steel washer), .520" i.d. (10-pk.)	1.25
1011-0326	Breather screw seals (silicone-coated steel washer), .380" i.d. (10-pk.)	1.25
1011-1721	Repl. filter element for DS-289137, DS-289211, DS-289128, DS-289129, DS-289130, 1010-0325, 1010-0326, 1010-0235, 1010-0236, 1010-0237, 1010-0419	18.95
DS-289409	Repl. filter element for DS-289070, DS-289400, DS-289401, DS-289402, DS-289410 and S&S Super B	16.95

**HIGH-FLOW AIR FILTER AND ADAPTER KIT**

- High-flow filter designed especially for Super E and G carburetors
- Filter is 1" taller than standard filter and features a low-restriction, pre-oiled filter element
- Allows for a 37% increase in airflow
- Filter and adapters extend the teardrop housing out 1" for better exposure and a high-performance street racer look
- Kit installs in minutes; no permanent modifications required
- Made in the U.S.A.

NOTE: Not legal for street use on pollution controlled vehicles.

NOTE: Not for use with S&amp;S Super B or Super D carburetors, or Super E and G Kits for Buells.

PART #	DESCRIPTION	SUG. RETAIL
1011-0323	For S&S Super E and G carbs	\$52.95
1011-2286	Repl. high-flow filter for S&S Super E and G carbs (also fits S&S air cleaners for stock carbs and EFI throttle bodies)	22.95

**IMPORTANT NOTE: SEE PAGE 411 FOR IMPORTANT INFORMATION REGARDING CERTAIN WARRANTY AND EMISSION CONTROL REGULATORY COMPLIANCE INFORMATION.**All part numbers in **BLUE** are new for 2015.



WINDSHIELDS & FAIRINGS

TOURING

AUDIO & COMMUNICATION

LUGGAGE

SEATS & Sissy BARS

EXHAUST

FUEL/AIR SYSTEMS

ENGINE

TRANSMISSION & DRIVELINE

GASKETS & SEALS

ELECTRICAL

LIGHTING

HANDLEBARS, CONTROLS & MIRRORS

CABLES

BRAKES

TANKS & OIL FILTERS

DASHES & GAUGES

FRAMES, SUSPENSION & FENDERS

FOOTRESTS & LICENSE PLATE FRAMES

WHEELS & AXLES

HARDWARE, CHEMICALS & TOOLS

COVERS, SECURITY & GENERAL



1010-1078



1010-1508



1010-1077



1010-1313



1011-3119

**SUPER STOCK™ STEALTH AIR CLEANER KITS**

- For stock and S&S fuel system applications
- Kits include backing plate, filter and hardware
- Built-in stinger cone directs air smoothly into the bore of the carburetor or EFI throttle body and reduces turbulence and increases flow
- Optional high-flow (1" taller) filter and pre-filter/rain sock also available
- Made in the U.S.A.

NOTE: Kits do not come with covers. Must use with stock Twin Cam 88®, 96™, or 103™ "football-style" air cleaner cover, or can be used with S&S Stealth air cleaner covers (sold separately).

NOTE: Exempt per CARB EXECUTIVE ORDER (E.O.) No. D-355-11. E.O. applies to 01-15 EFI models only.

NOTE: Stealth air cleaner kits for 01-15 EFI applications come with a special sticker and instructions for applying it to an inconspicuous location on the frame.

NOTE: Not legal for street use on pollution controlled vehicles (except per the E.O. above).

PART #	DESCRIPTION	SUG. RETAIL
<b>SUPER STOCK™ STEALTH AIR CLEANER KITS</b>		
1010-1509	For 08-15 FLHT, FLHX, FLTR and H-D Trike models w/ stock EFI	\$129.95
1010-1078	For 99-06 Twin Cam Big Twin w/ E/G series carb	129.95
1010-1508	For 01-15 Big Twin w/ Delphi EFI and 99-06 Twin Cam Big Twin w/ stock CV carb (except 08-15 Dresser/H-D trike)	129.95
1010-1075	For 93-99 Evo Big Twin w/ stock CV carb	129.95
1010-1077	For 93-99 Evo Big Twin w/ E/G series carb	129.95
1010-1313	For 84-92 Big Twin and 86-90 XL models w/ S&S E/G series carbs	129.95
1010-1510	For 91-15 XL w/ stock CV carb and Delphi EFI	129.95
<b>REPLACEMENT/OPTIONAL COMPONENTS</b>		
1011-2765	Repl. Stealth filter	39.95
1011-2766	Opt. Stealth hi-flo filter kit (1" taller)	59.95
1011-3119	Pre-filter/rain sock for Standard Stealth air filter	24.95
1011-3120	Pre-filter/rain sock for 1" tall Stealth air filter	24.95



1014-0116



1014-0119



1014-0121



1014-0120



1014-0122



1014-0123



1014-0177



1014-0171



1014-0172



1014-0173

**STEALTH AIR CLEANER COVERS**

- Fit the S&S Stealth air cleaner kits
- Bob and Muscle-style air cleaner covers are machined from billet aluminum, fit over the end of the air filter and leave the filter element exposed
- Powder-coated gloss black and highlight machined
- Air Stream-style is die-cast and features screened vents for more air without sucking in rain/road hazards
- Muscle-style features muscle car-style hood pins
- Made in the U.S.A.

PART #	DESCRIPTION	SUG. RETAIL	PART #	DESCRIPTION	SUG. RETAIL
<b>STEALTH AIR CLEANER COVERS</b>			<b>STEALTH AIR CLEANER COVERS (CONT)</b>		
1014-0116	Air Stream, chrome	\$139.95	1014-0122	Muscle, chrome	\$134.95
1014-0117	Air Stream, black wrinkle powder-coat	139.95	1014-0123	Muscle, black wrinkle powder-coat	129.95
1014-0118	Bob dish, chrome	94.95	1014-0177	Muscle, black wrinkle powder-coat w/ S&S logo	134.95
1014-0119	Bob dish, black wrinkle powder-coat	94.95	1014-0171	Tri-spoke	139.95
1014-0120	Bob dome, chrome	94.95	1014-0172	Torker	139.95
1014-0121	Bob dome, black wrinkle powder-coat	94.95	1014-0173	Air 1	139.95

**IMPORTANT NOTE:** SEE PAGE 411 FOR IMPORTANT INFORMATION REGARDING CERTAIN WARRANTY AND EMISSION CONTROL REGULATORY COMPLIANCE INFORMATION.

All part numbers in **BLUE** are new for 2015.



**COBRA****AIR CLEANER KITS**

- Flows better than stock or competing units, in large part because of its unique internal venturi design of the inner filter
- Optimizes overall performance
- High-flow K&N® Air Filter element ensures the maximum air intake and protection
- Four styles available in black or chrome finishes
- Slim profile keeps the unit away from the rider's leg
- The Cobra system consists of a laser-cut, formed steel cover, separate mounting ring, and all the fasteners, seals, backing plate and mounting hardware for easy installation
- Formed stainless steel mesh insert
- Made in the U.S.A.

NOTE: Not legal for street use on pollution controlled vehicles.

**CHROME**

PART #	DESCRIPTION	SUG. RETAIL	PART #	DESCRIPTION	SUG. RETAIL
<b>FOR 08-15 DRESSER</b>					
1010-1224	Swept	\$199.95	1010-1236	Plain	\$199.95
1010-1226	Cross	199.95	1010-1238	Spoke	199.95
1010-1228	Plain	199.95	<b>FOR 04-15 XL</b>		
1010-1230	Spoke	199.95	1010-1240	Swept	199.95
<b>FOR 99-15 TWIN CAM (EXCEPT 08-15 DRESSER, H-D FL TRIKE)</b>					
1010-1232	Swept	199.95	1010-1242	Cross	199.95
1010-1234	Cross	199.95	1010-1244	Plain	199.95
			1010-1246	Spoke	199.95

**BLACK**

PART #	DESCRIPTION	SUG. RETAIL	PART #	DESCRIPTION	SUG. RETAIL
<b>FOR 08-15 DRESSER</b>					
1010-1225	Swept	\$199.95	1010-1237	Plain	\$199.95
1010-1227	Cross	199.95	1010-1239	Spoke	199.95
1010-1229	Plain	199.95	<b>FOR 04-15 XL</b>		
1010-1231	Spoke	199.95	1010-1241	Swept	199.95
<b>FOR 99-15 TWIN CAM (EXCEPT 08-15 DRESSER, H-D FL TRIKE)</b>					
1010-1233	Swept	199.95	1010-1243	Cross	199.95
1010-1235	Cross	199.95	1010-1245	Plain	199.95
			1010-1247	Spoke	199.95



Chrome



Black

**POWRFLO AIR INTAKE**

- Unique internal venturi design promotes maximum airflow
- High-flow K&N® air filter element ensures the best air intake and maximum protection for your engine
- The PowrFlo Intake system consists of an aluminum cover and all the fasteners, seals, backing plate and mounting hardware to make for an easy installation
- Formed stainless steel mesh insert in the dual entry ports keeps out bugs and debris
- Available in black or chrome finish

NOTE: Not legal for street use on pollution controlled vehicles.

PART #	DESCRIPTION	SUG. RETAIL	PART #	DESCRIPTION	SUG. RETAIL	PART #	DESCRIPTION	SUG. RETAIL
<b>FOR 08-15 FLHT, FLHR, FLTR, FLHX AND H-D FL TRIKE</b>			<b>FOR 99-15 TWIN CAM (EXCEPT 08-15 DRESSER/H-D FL TRIKE) W/ CV CARB/DELPHI EFI</b>			<b>FOR 04-15 XL W/ CV CARB/DELPHI EFI</b>		
1010-0814	Chrome	\$269.95	1010-0816	Chrome	\$269.95	1010-0894	Chrome	\$269.95
1010-0815	Black	269.95	1010-0817	Black	269.95	1010-0895	Black	269.95

**IMPORTANT NOTE:** SEE PAGE 411 FOR IMPORTANT INFORMATION REGARDING CERTAIN WARRANTY AND EMISSION CONTROL REGULATORY COMPLIANCE INFORMATION.All part numbers in **BLUE** are new for 2015.**Internal Venturi**

1010-0814

WINDSHIELDS &amp; FAIRINGS

TOURING

AUDIO &amp; COMMUNICATION

LUGGAGE

SEATS &amp; SISSY BARS

EXHAUST

FUEL/INJ SYSTEMS

ENGINE

TRANSMISSION &amp; DRIVELINE

GASKETS &amp; SEALS

ELECTRICAL

LIGHTING

HANDLEBARS, CONTROLS &amp; MIRRORS

CABLES

BRAKES

TANKS &amp; OIL FILTERS

DASHES &amp; GAUGES

FRAMES, SUSPENSION &amp; FENDERS

FOOTRESTS &amp; LICENSE PLATE FRAMES

WHEELS &amp; AXLES

HARDWARE, CHEMICALS &amp; TOOLS

COVERS, SECURITY &amp; GENERAL



WINDSHIELDS & FAIRINGS

TOURING

AUDIO & COMMUNICATION

LUGGAGE

SEATS & SISSY BARS

EXHAUST

FUEL/AIR SYSTEMS

ENGINE

TRANSMISSION & DRIVELINE

GASKETS & SEALS

ELECTRICAL

LIGHTING

HANDLEBARS, CONTROLS & MIRRORS

CABLES

BRAKES

TANKS & OIL FILTERS

DASHES & GAUGES

FRAMES, SUSPENSION & FENDERS

FOOTRESTS & LICENSE PLATE FRAMES

WHEELS & AXLES

HARDWARE, CHEMICALS & TOOLS

COVERS, SECURITY & GENERAL

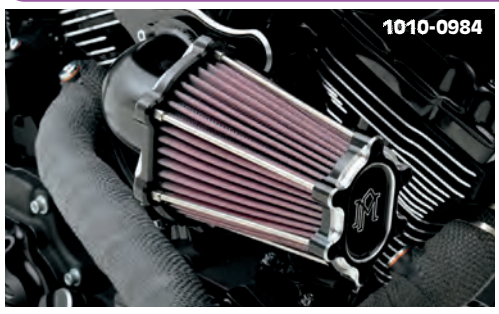

**FAST AIR INTAKE SOLUTION**

- The most innovative and aggressive-looking forward-facing air intake on the market
- Features an internal crank case breather system
- K&N Filter element allows for a significant horsepower increase over stock air cleaner
- Available in chrome or Contrast Cut™ finishes
- Includes rain sock
- Made in the U.S.A.

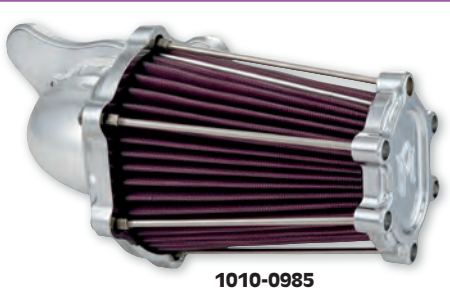

PART #	DESCRIPTION	SUG. RETAIL
<b>FOR 08-15 FLHT/FLHR/FLX/FLTR AND H-D FL TRIKE</b>		
1010-0986	Contrast Cut	\$499.95
1010-0987	Chrome	499.95
<b>FOR 01-15 TWIN CAM W/ DELPHI EFI (EXCEPT 08-15 TOURING), 93-06 BIG TWIN W/ CV CARB</b>		
1010-0984	Contrast Cut	499.95
1010-0985	Chrome	499.95

PART #	DESCRIPTION	SUG. RETAIL
<b>FOR 91-15 XL</b>		
1010-0988	Contrast Cut	\$499.95
1010-0989	Chrome	499.95
<b>REPLACEMENT COMPONENTS</b>		
1011-2485	Rain sock	33.95
1011-2486	Air filter	64.95



**DRAG SPECIALTIES DESIGN AIR CLEANERS**

- Chrome air cleaner kit with spear- or twister-style cone designed exclusively for Drag Specialties
- Increases airflow approximately 10% more than an OEM air cleaner
- Includes filter cone with 360° slots, K&N air filter, 90° chrome elbow and installation hardware
- Will accept D&M Bullet replacement cones
- Optional adapters allow mounting on various carbs (sold separately)
- Made in the U.S.A.

NOTE: Require the use of a D&M carb support bracket and breather kit (sold separately, see page 600).

PART #	DESCRIPTION	SUG. RETAIL
<b>FOR 01-15 BIG TWIN OR XL W/ DELPHI EFI AND 90-06 BIG TWIN AND 88-06 XL W/ 40MM CARB (EXCEPT MODELS W/ FAIRING LOWERS)</b>		
1015-0086	Drag Specialties Spear air cleaner	\$489.95
1015-0104	Drag Specialties Twister air cleaner	538.95



**THE BULLET AIR CLEANERS**

- Chrome air cleaner with a bullet-shaped cone with 360° slots
- Increase airflow approximately 10% more than an OEM air cleaner
- Include bullet-shaped filter cone, K&N air filter, 90° elbow and installation hardware
- Available with black or chrome elbow
- Diamond-cut cones also available; scalloped design
- Made in the U.S.A.

NOTE: Require the use of a D&M carb-support bracket and breather kit (sold separately, see page 600).

PART #	DESCRIPTION	SUG. RETAIL	PART #	DESCRIPTION	SUG. RETAIL	PART #	DESCRIPTION	SUG. RETAIL
<b>FOR 01-15 BIG TWIN OR XL W/ DELPHI EFI AND 90-06 BIG TWIN AND 88-06 XL W/ 40MM CARB (EXCEPT MODELS W/ FAIRING LOWERS)</b>								
<b>WITH CHROME ELBOW</b>			<b>WITH BLACK ELBOW</b>			<b>RAIN SOCK AND REPLACEMENT AIR FILTER</b>		
7807-0017	Chrome cone	\$489.95	1015-0065	Wrinkle black cone	\$489.95	1011-1780	Rain sock	\$26.95
1015-0071	Black diamond-cut cone	594.95	1015-0066	Black cone	489.95	7807-0018	Repl. air filter	70.95
			1015-0073	Black diamond-cut cone	594.95			



**IMPORTANT NOTE: SEE PAGE 411 FOR IMPORTANT INFORMATION REGARDING CERTAIN WARRANTY AND EMISSION CONTROL REGULATORY COMPLIANCE INFORMATION.**

All part numbers in **BLUE** are new for 2015.

WINDSHIELDS  
& FAIRINGS

TOURING

AUDIO &  
COMMUNICATION

LUGGAGE

SEATS &  
SISSY BARS

EXHAUST

FUEL/AIR  
SYSTEMS

ENGINE

TRANSMISSION  
& DRIVELINEGASKETS  
& SEALS

ELECTRICAL

LIGHTING

HANDLEBARS,  
CONTROLS  
& MIRRORS

CABLES

BRAKES

TANKS &  
OIL FILTERSDASHES  
& GAUGESFRAMES,  
SUSPENSION  
& FENDERSFOOTRESTS  
& LICENSE  
PLATE FRAMESWHEELS  
& AXLESHARDWARE,  
CHEMICALS  
& TOOLSCOVERS,  
SECURITY  
& GENERAL

1015-0107



DS-289544



1015-0021



1015-0036



1010-1119

### POWER FLOW AIR CLEANERS

- Provide the latest look and performance of forward-style intake systems
- Increase airflow approximately 20% more than an OEM air cleaner
- Can be installed horizontally or vertically when using a 3.5-gallon Fat Bob or smaller fuel tank; vertical adapter sold separately
- Includes a CNC-machined billet filter cone with tapered, straight or Superslot slots, a 90° elbow, K&N air filter, gasket, hardware and wrench
- Diamond-cut cones also available; feature unique diamond-cut design on the edges of the slot openings
- Optional adapters allow mounting on various carbs (sold separately, see below)
- Made in the U.S.A.

NOTE: Not legal for street use on pollution-controlled vehicles.

NOTE: Requires a D&M carburetor support bracket and breather kit; sold separately.

FOR 01-15 BIG TWIN AND XL W/ DELPHI EFI AND 90-06 BIG TWIN, 88-06 XL W/ 40MM CV CARBURETOR

PART #	DESCRIPTION	SUG. RETAIL	PART #	DESCRIPTION	SUG. RETAIL
<b>WITH CHROME ELBOW</b>			<b>WITH BLACK ELBOW (CONT)</b>		
1015-0107	Chrome cone, Superslot	\$489.95	1015-0036	Black diamond-cut cone, tapered slots	\$594.95
DS-289544	Chrome cone, straight slots	489.95	1010-1119	Black Machine Gun	514.95
DS-289543	Chrome cone, tapered slots	489.95	<b>RAIN SOCK AND REPLACEMENT FILTER</b>		
1010-1118	Chrome Machine Gun	514.95	1011-1779	Rain sock	29.95
<b>WITH BLACK ELBOW</b>			DS-289549	Repl. air filter	70.95
1015-0021	Wrinkle black cone, tapered slots	489.95			

### BOSS MACHINE GUN DUAL AIR CLEANER KIT

- Deliver an aggressive, sinister style with maximum airflow
- Fit with 5-gallon fuel tanks
- Made in the U.S.A.

NOTE: Not legal for street use on pollution-controlled vehicles.

PART #	DESCRIPTION	SUG. RETAIL
<b>FOR 01-15 DELPHI EFI OR 93-06 BIG TWIN WITH 40MM CV CARB (EXCEPT 08-15 DRESSERS/H-D FL TRIKES)</b>		
1010-0707	Evil Twin, chrome	\$1,393.95



1010-0707

### ULTIMATE FLOW AIR CLEANER KITS

- Deliver massive airflow for peak performance at an economical price
- Lifetime filter is produced using the latest materials for maximum filtration and powerful airflow
- Filter is black media with a stainless steel end cap; also available with stainless steel wire
- Elbow is available with chrome, gloss black or wrinkle black finish
- Kits include elbow, filter, clamp, pre-filter and mounting hardware
- Made in the U.S.A.

NOTE: Requires use of a D&M support bracket/breather kit (sold separately, see page 600).

NOTE: Not legal for street use on pollution-controlled vehicles.

FOR 01-15 BIG TWIN OR XL W/ DEPHI EFI, 90-06 BIG TWIN, 88-06 XL W/ 40MM CV CARB

PART #	DESCRIPTION	SUG. RETAIL	PART #	DESCRIPTION	SUG. RETAIL
<b>WITH CHROME ELBOW</b>			<b>WITH WRINKLE BLACK ELBOW</b>		
1010-0992	Black filter	\$262.95	1010-0994	Black filter	\$262.95
1010-0995	Black filter with stainless steel wire	267.95	1010-0997	Black filter with stainless steel wire	267.95
<b>WITH GLOSS BLACK ELBOW</b>			<b>REPLACEMENT COMPONENTS</b>		
1010-0993	Black filter	262.95	1011-2779	Black filter element	59.95
1010-0996	Black filter with stainless steel wire	267.95	1011-2780	Stainless steel filter element	65.95

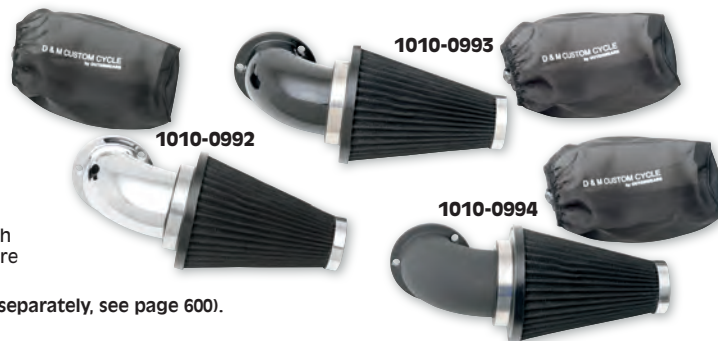

1010-0993

1010-0992

1010-0994

### AIR CLEANER ADAPTERS

- For D&M Power Flow, Bullet, Hustler and Drag Specialties air cleaners
- Made in the U.S.A.

PART #	DESCRIPTION	SUG. RETAIL
7807-0118	S&S E and G carburetor (vertical or horizontal)	\$41.95
DS-289547	40mm CV carburetor (vertical)	39.95



DS-289547



**IMPORTANT NOTE: SEE PAGE 411 FOR IMPORTANT INFORMATION REGARDING CERTAIN WARRANTY AND EMISSION CONTROL REGULATORY COMPLIANCE INFORMATION.**

All part numbers in **BLUE** are new for 2015.





1010-1079



1010-0705



1011-0898

1011-0897



1011-1336



**TUNED INDUCTION AIR CLEANERS**

- Swept forward, two-in-one design rams additional air into the cylinder
- Natural supercharging effect increases mid-range torque
- Nearly twice the filter area of a teardrop air cleaner
- Feature chrome runner and bracket (except where noted), backing plate, filters and hardware
- Made in the U.S.A.

**NOTE:** Exempt per CARB EXECUTIVE ORDER (EO) #D355-12. E.O. applies to 01-15 EFI models only.  
**NOTE:** Not legal for street use on pollution controlled vehicles except as noted for the EO above.

PART #	DESCRIPTION	SUG. RETAIL
1010-0705 <sup>1</sup>	For 08-15 FLHT, FLHR, FLHX, FLTR and H-D FL trike models (except models w/ fairing lowers)	\$449.95
1010-0706 <sup>2</sup>	For 08-15 FLHT, FLHR, FLHX, FLTR and H-D FL trike models (except models w/ fairing lowers)	459.95
1010-1080	For 91-15 XL w/ stock CV carb and Delphi EFI	539.95
1010-1079	For 01-15 Big Twin models w/ Delphi EFI and 93-06 Big Twin models w/ stock CV carb (except 08-15 Touring)	539.95
1010-1083	For 93-15 Big Twin models w/ S&S single-bore fuel-injection (except 08-15 Touring)	539.95
1010-1084	For 84-06 Big Twin models w/ S&S E/G series carb	539.95

PART #	DESCRIPTION	SUG. RETAIL
1010-1082	For S&S 124", 117", 111" motors w/ S&S 4 1/8" E/G series carb	\$539.95
1010-1081	For S&S 124", 117", 111" motors w/ S&S 4 1/8" single-bore fuel-injection	539.95

REPLACEMENT COMPONENTS		
1011-0897	Repl. red filter w/ clamp (ea.)	52.95
1011-0898	Opt. blue filter w/ clamp (ea.)	52.95
1011-1336	Moisture repellent rain cover for S&S tuned induction filters (pr.)	44.95

<sup>1</sup> Black wrinkle powder-coat runner and bracket.  
<sup>2</sup> Chrome runner w/ black wrinkle powder-coat bracket.

**ARLEN NESS  
 NESS-TECH® 90° AIR FILTERS**

- Carved from billet aluminum and then beautifully chrome-plated
- Feature patented "Big Sucker" breather technology
- Made in the U.S.A.

**NOTE:** Not legal for street use on pollution controlled vehicles.



1010-0120



1010-0122

PART #	DESCRIPTION	SUG. RETAIL
1010-0120	For Evolution and Twin Cam motors w/ CV carb or 01-05 Delphi EFI	\$299.95
1010-0121	For 107" and under S&S motors w/ S&S carb	299.95
1010-0122	For 111"-124" S&S motors w/ S&S carb (except 113")	299.95



1010-0560



**CORSAIR AIR CLEANER KITS**

- Aggressively styled, free-flowing high-performance air cleaner
- Chrome-plated die-cast housing features a high-flow air filter element supplied by Advanced Flow Engineering (aFe) for maximum performance, includes crankcase breather support bracket and all necessary installation hardware and brackets
- Will support engines making in excess of 100 horsepower
- Air cleaner extends approximately 6" straight out and 12 1/2" forward of the engine

**NOTE:** Installation of this air cleaner may decrease rider legroom.  
**NOTE:** Not for use on Twin-Cooled models.

**NOTE:** Not legal for street use on pollution-controlled vehicles.

PART #	DESCRIPTION	SUG. RETAIL	PART #	DESCRIPTION	SUG. RETAIL
1010-0560	For 08-15 FLHT/FLHR/FLTR/FLHX and H-D FL Trikes (except models w/ fairing lowers)	\$299.95	1010-0343	For 91-06 XL w/ CV carb	\$299.95
1010-0344	For 99-15 Twin Cam w/ CV carb or Delphi fuel injection (except 08-15 FLHT, FLHR, FLTR and FLHX), 93-99 Evolution Big Twin w/ CV carb	299.95	1011-1380	Repl. air filter element	69.95
			1011-1381	Repl. pre-filter element	32.95



1010-0344

**IMPORTANT NOTE:** SEE PAGE 411 FOR IMPORTANT INFORMATION REGARDING CERTAIN WARRANTY AND EMISSION CONTROL REGULATORY COMPLIANCE INFORMATION.

All part numbers in **BLUE** are new for 2015.

- WINDSHIELDS & FAIRINGS
- DURING
- AUDIO & COMMUNICATION
- LUGGAGE
- SEATS & Sissy BARS
- EXHAUST
- EXHAUST
- ENGINE
- TRANSMISSION & DRIVELINE
- GASKETS & SEALS
- ELECTRICAL
- LIGHTING
- HANDLEBARS, CONTROLS & MIRRORS
- CABLES
- BRAKES
- TANKS & OIL FILTERS
- DASHES & GAUGES
- FRAMES, SUSPENSION & FENDERS
- FOOTRESTS & LICENSE PLATE FRAMES
- WHEELS & AXLES
- HARDWARE, CHEMICALS & TOOLS
- COVERS, SECURITY & GENERAL

WINDSHIELDS  
& FAIRINGS

TOURING

AUDIO &  
COMMUNICATION

LUGGAGE

SEATS &  
SISSY BARS

EXHAUST

FUEL/AIR  
SYSTEMS

ENGINE

TRANSMISSION  
& DRIVELINEGASKETS  
& SEALS

ELECTRICAL

LIGHTING

HANDLEBARS,  
CONTROLS  
& MIRRORS

CABLES

BRAKES

TANKS &  
OIL FILTERSDASHES  
& GAUGESFRAMES,  
SUSPENSION  
& FENDERSFOOTRESTS  
& LICENSE  
PLATE FRAMESWHEELS  
& AXLESHARDWARE,  
CHEMICALS  
& TOOLSCOVERS,  
SECURITY  
& GENERAL

1010-1109



1010-0819



1010-1110



1010-1038



1011-1520

### AIRCHARGER PERFORMANCE INTAKE SYSTEMS

- K&N High-Flow air filter greatly increases performance and horsepower
- Mandrel bent aluminum intake tube available in two finishes: polished bright mirror or textured black
- Kit includes breather assembly and all necessary mounting hardware
- Optional Drycharger™ for increased protection from the elements is available separately
- Made in the U.S.A.

NOTE: Not legal for sale or use on any pollution controlled motor vehicle.

PART #	DESCRIPTION	SUG. RETAIL
<b>FOR 08-15 FLHR, FLHT, FLHX, FLTR AND H-D FL TRIKE (EXCEPT MODELS W/ FAIRING LOWERS)</b>		
1010-1109	Textured black	\$446.95
1010-0556	Polished	501.95
<b>FOR 01-15 TWIN CAM W/ DELPHI EFI (EXCEPT 08-15 FLHR, FLHT, FLHX, FLTR AND H-D FL TRIKE)</b>		
1010-1108	Textured black	478.95
1010-0819	Polished	492.95

PART #	DESCRIPTION	SUG. RETAIL
<b>FOR 07-15 XL</b>		
1010-1110	Textured black	\$526.95
1010-1038	Polished	430.95
<b>REPL. AIR FILTERS</b>		
1011-2620	For PART #s 1010-0811, 1010-0818 or 1010-0555; textured black	104.95
1011-2289	For PART #s 1010-0819 or 1010-0556; polished	64.95
<b>OPTIONAL DRYCHARGER</b>		
1011-1520	Drycharger	32.95



1010-0417



1010-1107



1011-2882



1010-0671

### RK-SERIES AIR INTAKE SYSTEMS

- Complete intake assembly fits neatly behind the stock air cleaner cover
- Provide a significant increase in airflow, smoother delivery to engine, while boosting performance and filtration
- Feature a K&N High-Flow air filter, pleated design for high airflow, specially designed lip seal for perfect seal, powder-coated aluminum backplate that eliminates external breathers and a built-in, dyno-tuned velocity stack
- Maintain factory appearance, utilizes the stock air cleaner outer cover
- Made in the U.S.A.

NOTE: Some intake systems are not legal for sale or use on any pollution controlled motor vehicle.

PART #	DESCRIPTION	SUG. RETAIL
<b>FOR 08-13 FLHT/FLHR/FLHX/FLTR</b>		
1010-0417	Large capacity filter assembly; 1 <sup>5</sup> / <sub>8</sub> " tall	\$287.95
1011-1509	Repl. air filter for large capacity filter assembly PART #1010-0417; 1 <sup>5</sup> / <sub>8</sub> " tall	96.95
<b>FOR 01-15 TWIN CAM W/ DELPHI EFI (EXCEPT 08-15 FLSTSB, DYNA AND DRESSER), 99-06 TWIN CAM W/CV CARB.</b>		
1010-1107	Large capacity filter assembly; 2 <sup>1</sup> / <sub>4</sub> " tall	214.95
1011-2868	Stock capacity filter assembly; 1 <sup>5</sup> / <sub>8</sub> " tall	267.95
1011-2882	Repl. air filter for large capacity filter assembly for PART #1010-1107; 2 <sup>1</sup> / <sub>4</sub> " tall	84.95

PART #	DESCRIPTION	SUG. RETAIL
<b>FOR 08, 10-15 FXDWG, 08-15 FXD/FXDB/FXDC/FXDF/FXDL (EXCEPT 13-15 FXDB)</b>		
1010-0671	Large capacity filter assembly; 2 <sup>1</sup> / <sub>8</sub> " tall	\$260.95
1011-1736	Repl. filter for PART #1010-0671; 2 <sup>1</sup> / <sub>4</sub> " tall	82.95
<b>FOR 04-15 XL (EXCEPT 13-15 1200V)</b>		
1010-0322 <sup>1</sup>	Large capacity filter assembly; 2 <sup>1</sup> / <sub>4</sub> " tall	474.95
1011-1451	Repl. air filter for large capacity filter assembly for PART #1010-0322; 2 <sup>3</sup> / <sub>8</sub> " tall	88.95

<sup>1</sup> Does not include cover.

**IMPORTANT NOTE: SEE PAGE 411 FOR IMPORTANT INFORMATION REGARDING CERTAIN WARRANTY AND EMISSION CONTROL REGULATORY COMPLIANCE INFORMATION.**

All part numbers in **BLUE** are new for 2015.



WINDSHIELDS & FAIRINGS

TOURING

AUDIO & COMMUNICATION

LUGGAGE

SEATS & SISSY BARS

EXHAUST

PIPET/AIR SYSTEMS

ENGINE

TRANSMISSION & DRIVELINE

GASKETS & SEALS

ELECTRICAL

LIGHTING

HANDLEBARS, CONTROLS & MIRRORS

CABLES

BRAKES

TANKS & OIL FILTERS

DASHES & GAUGES

FRAMES, SUSPENSION & FENDERS

FOOTRESTS & LICENSE PLATE FRAMES

WHEELS & AXLES

HARDWARE, CHEMICALS & TOOLS

COVERS, SECURITY & GENERAL

1010-1513



1010-1515



1010-1105



1010-1106

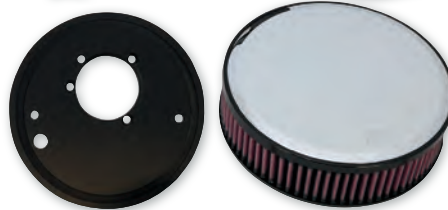

RK3901



1010-1598

**STREET METAL™ AIR INTAKE SYSTEMS**

- Developed around an over-sized K&N high-flow air filter that is designed to boost performance, filtration and service intervals
- Aluminum backing plate with an integrated breather system and velocity stack provides a solid mounting surface
- High-quality mirror finish aluminum cover
- Made in the U.S.A.

NOTE: Not legal for sale or use on any pollution controlled motor vehicle.

PART #	DESCRIPTION	SUG. RETAIL
<b>FOR 08-15 FLHR/FLHT/FLHX/FLTR AND H-D FL TRIKE</b>		
1010-1512	Grind	\$379.95
1010-1513	Flux	568.95
1010-1514	Weld	473.95
1010-1515	Torch	568.95
<b>FOR 01-15 TWIN CAM W/ DELPHI EFI, 99-06 TWIN CAM W/ CV CARB (EXCEPT 08-15 DRESSERS)</b>		
1010-1105	Flare	267.95
1010-1106	Hammer	267.95
1010-1596	Weld	491.95
1010-1597	Torch	567.95
<b>FOR 92-99 80" BIG TWIN W/ OEM CV CARB</b>		
RK3901	Weld	388.95
RK3911	Grind	370.95

PART #	DESCRIPTION	SUG. RETAIL
<b>FOR 92-99 80" BIG TWIN W/ OEM CV CARB (CONT)</b>		
RK3902	Torch	\$291.95
RK3912	Flux	388.95
<b>FOR 91-06 XL W/ OEM CV CARB</b>		
RK3903	Weld	291.95
RK3904	Torch	242.95
RK3914	Flux	291.95
1010-1598	Grind	370.95
<b>REPLACEMENT FILTERS/DRYCHARGERS</b>		
E-3333	For Flux/Torch	70.95
E-3336	For Grind/Weld	69.95
RK-3901PK	Drycharger for round filter assembly	27.95
RK-3902PK	Drycharger for teardrop filter assembly	27.95

1010-0314



1011-1058



1011-1059



1011-1060

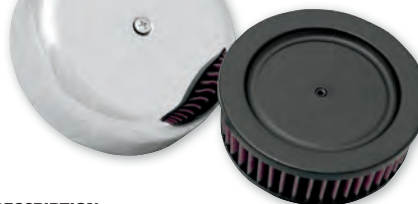

**CUSTOM AIR CLEANER ASSEMBLIES**

- Designed to fit Harley-Davidson motorcycles equipped with various carburetors
- Increase horsepower with proper carburetor calibration
- These air cleaners mount directly to the carburetor flange
- Made in the U.S.A.

PART #	DESCRIPTION	SUG. RETAIL
1010-0314	For 84-89 Keihin butterfly carbs; 5" dia. and polished outer cover (excluding all S&S E & G carbs)	\$99.95
1011-1058	36-38mm Mikuni air filter; 5" dia. open round style	74.95
1011-1059	36-38mm Mikuni air filter; 6" dia. chrome bonnet style	97.95

PART #	DESCRIPTION	SUG. RETAIL
RC-0920	40-45mm Mikuni air filter; 5" dia. open round style	\$79.95
1011-1060	40-45mm Mikuni air filter; 6" dia. chrome bonnet style	97.95
1011-2661	Repl. filter for 1011-1059	70.95
1011-2662	Repl. filter for 1011-1060	70.95

**IMPORTANT NOTE: SEE PAGE 411 FOR IMPORTANT INFORMATION REGARDING CERTAIN WARRANTY AND EMISSION CONTROL REGULATORY COMPLIANCE INFORMATION.**

All part numbers in **BLUE** are new for 2015.

WINDSHIELDS & FAIRINGS

TOURING

AUDIO & COMMUNICATION

LUGGAGE

SEATS & SISSY BARS

EXHAUST

FUEL/AIR SYSTEMS

ENGINE

TRANSMISSION & DRIVELINE

GASKETS & SEALS

ELECTRICAL

LIGHTING

HANDLEBARS, CONTROLS & MIRRORS

CABLES

BRAKES

TANKS & OIL FILTERS

DASHES & GAUGES

FRAMES, SUSPENSION & FENDERS

FOOTRESTS & LICENSE PLATE FRAMES

WHEELS & AXLES

HARDWARE, CHEMICALS & TOOLS

COVERS, SECURITY & GENERAL



**STAMPED STEEL DRAGTRON™-STYLE AIR CLEANER**

- Stamped steel version of our popular die-cast Dragtron air cleaner
- Fits Bendix, Keihin (not CV) and Tillotson carburetors



DS-288999

PART #	DESCRIPTION	SUG. RETAIL
DS-288999	Air cleaner	\$35.95
DS-289043	Repl. foam element	4.95



**"BOB" RETRO-STYLE AIR CLEANER**

- Retro-style chrome-plated air cleaner measures 5 1/2" in diameter
  - Has a reusable foam filter element
  - All necessary mounting hardware included
  - Replacement filter element available separately
- NOTE: Requires appropriate carb support bracket.



1010-0192

PART #	DESCRIPTION	SUG. RETAIL
1010-0191	For 01-15 models w/ Delphi fuel-injection (except 08-15 FLHT/FLHR/FLTR/FLHX and H-D FL Trikes), 99-06 models w/ OEM CV carb	\$69.95
1010-0192	For S&S E and G series carburetors	64.95
1011-0881	Repl. air filter element	14.95



DS-288903



DS-288903



**7" ROUND AIR CLEANERS**

- Chrome air cleaners fit Harley models equipped with Bendix, Keihin carburetors or Delphi EFI
- PART #DS-288903 will require a support brace or a brace/breather kit for models listed (sold separately)
- Air filter included

PART #	DESCRIPTION	SUG. RETAIL
DS-288903	For 01-15 Twin Cam w/ Delphi EFI, 90-06 Big Twin and 88-06 XL models w/ OEM CV carb (except 08-15 FLHT/FLHR/FLTR/FLHX and H-D FL Trike)	\$49.95
DS-288998	For Bendix and Keihin (not CV) carbs	39.95



1010-0710



**TEARDROP AIR CLEANER ASSEMBLIES**

- Chrome-plated cast aluminum construction
- Ribbed design
- Measures 8" L x 4 1/2" H x 2" D
- Include mini air filter and all necessary fittings and hardware
- Made in the U.S.A.

NOTE: PART #s 0708-0710 require the use of a support bracket and breather kit (as needed).

PART #	DESCRIPTION	SUG. RETAIL
1010-0710	For S&S Super E and Super G carbs	\$166.95
1010-0711	For 01-15 Delphi fuel injection and Keihin CV carbs (except 08-15 Dresser and H-D FL Trike)	166.95



**SMOOTH STYLE CARBURETOR COVER**

- Teardrop-style design
- Comes without element
- Available in chrome finish
- Made in the U.S.A.

PART #	DESCRIPTION	SUG. RETAIL
1015-0099	For 84-91 Big Twin w/ S&S carburetor	\$87.95



1010-0552

**AIR CLEANER ADAPTERS**

- Allows installation of a Dragtron II air cleaner (DS-289044) to models listed
- Plain machined finish

PART #	DESCRIPTION	SUG. RETAIL
1010-0552	For 08-15 FLHT, FLHX, FLHR, FLTR and H-D FL Trike models	\$27.95
1010-0553	For 01-15 models w/ Delphi EFI (except 08-15 Dressers and H-D FL Trike)	22.95

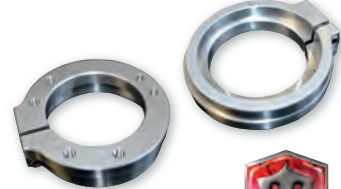

**MIKUNI AIR CLEANER ADAPTER**

- Machined T-6061 billet aluminum construction
- Use to mount either an S&S E/G or Keihin CV style air cleaners to a Mikuni HSR 42/45 carb
- Made in the U.S.A.

PART #	DESCRIPTION	SUG. RETAIL
1013-0099	Mikuni adapter	\$65.95



1013-0059



1013-0060

**AIR CLEANER ADAPTERS**

- Allows installation of an L.A. Choppers xxx air cleaner or Baron Big Air Kit to a Mikuni or S&S carburetor
- Will also work for mounting other air cleaner kits designed to mount stock CV carburetors
- Constructed from 6061 T-6 billet aluminum
- Made in the U.S.A.

PART #	DESCRIPTION	SUG. RETAIL
1013-0059	For Mikuni HSR42/45 carburetors	\$39.95
1013-0060	For S&S carburetors	39.95



**IMPORTANT NOTE: SEE PAGE 411 FOR IMPORTANT INFORMATION REGARDING CERTAIN WARRANTY AND EMISSION CONTROL REGULATORY COMPLIANCE INFORMATION.**

All part numbers in **BLUE** are new for 2015.





**WIRE FRAME AIR FILTER COVERS**

- Machined from 6061 T-6 aluminum
- Fit any Arlen Ness Big Sucker or Screamin' Eagle Stage I air filter kit
- Simple bolt-on installation
- Made in the U.S.A.



1014-0126



1014-0127



1014-0128



1014-0129

PART #	DESCRIPTION	SUG. RETAIL
<b>FOR STAGE 1 AIR FILTERS</b>		
1014-0126	Chrome	\$379.95
1014-0127	Black anodized	379.95

PART #	DESCRIPTION	SUG. RETAIL
<b>FOR STAGE 1 AIR FILTERS (CONT)</b>		
1014-0128	Chrome/black anodized	\$379.95
1014-0129	Black anodized/chrome	379.95

**SKULL AIR CLEANER COVER**



- Replacement cover for the standard teardrop cover on S&S E or G series air cleaners
- Skull motif flows cleanly down the side of the cover for a unique look
- High-strength composite material construction with a chrome-plated finish
- Installs quickly and easily with supplied hardware



1010-0164



1010-0165



1014-0132

PART #	DESCRIPTION	SUG. RETAIL	PART #	DESCRIPTION	SUG. RETAIL	PART #	DESCRIPTION	SUG. RETAIL
1010-0164	Hot Rod black	\$99.95	1010-0165	Chrome	\$99.95	1014-0132	Black chrome	\$99.95



**ALLEY CAT AIR CLEANER COVERS**

- Designed to fit Kuryakyn Street Sleeper II high-flow air cleaner
- Also fits select H-D Screamin' Eagle and some other aftermarket air cleaners (see chart)
- Features a unique chrome mesh insert and "knock-off" style end cap for a retro look
- Cover only, not a complete air filter assembly
- Sold each



NOTE: Will not work on Arlen Ness Stage II Big Sucker air cleaner or original Kuryakyn Street Sleeper.



**SCARAB AIR CLEANER COVER**

- Stylish upgrade for the OEM air cleaner assembly
- Contoured design adds a racy touch
- Chrome grille openings allow additional airflow



PART #	DESCRIPTION	SUG. RETAIL
1010-0716	For 02-13 FLHT, FLHR, FLTR, FLHX and H-D FL Trike (except CA models w/ carburetor), 01-15 FXST/FLST (except 08-15 FLSTSB and CA models w/ carburetor), 04-07 FXD/FXDWG	\$69.95

PART #	DESCRIPTION	SUG. RETAIL
<b>FOR 99-15 FLHT/FLHR/FLTR/FLHX W/ SCREAMIN' EAGLE STAGE I AIR CLEANER KIT, 00-15 FLST/FXST AND 99-07 DYNA; ALSO FITS KURYAKYN STREET SLEEPER II AIR CLEANER OR ARLEN NESS STAGE I BIG SUCKER AIR CLEANER</b>		
1014-0131	Chrome	\$109.95
1014-0168	Black and chrome	109.95



**FIVE-BOLT DOMED AIR CLEANER INSERT**

- Die-cast insert with a chrome finish
- Matches the five-bolt style of OEM derby cover

PART #	DESCRIPTION	SUG. RETAIL
DS288929	For 99-15 Original Equipment Twin Cam air cleaners (except 08-15 Dyna, 14-15 FLHT/FLHR/FLHX models)	\$37.95



1014-0114



1014-0115



**STRAIGHT-CUT AIR CLEANER INSERTS**

- Billet aluminum with machined highlights
- Available in chrome or gloss black powdercoat
- Include mounting hardware
- Design matches other Drag Specialties/Carl Brouhard Designs products



PART #	DESCRIPTION	SUG. RETAIL
<b>FOR 99-15 TWIN CAM W/ STOCK AIR CLEANER COVER (EXCEPT 08-15 DYNA, 14-15 FLHT/FLHR/FLHX MODELS)</b>		
1014-0114	Chrome	\$76.95
1014-0115	Gloss black/re-machined	76.95

**IMPORTANT NOTE: SEE PAGE 411 FOR IMPORTANT INFORMATION REGARDING CERTAIN WARRANTY AND EMISSION CONTROL REGULATORY COMPLIANCE INFORMATION.**

All part numbers in **BLUE** are new for 2015.

- WINDSHIELDS & FAIRINGS
- TOURING
- AUDIO & COMMUNICATION
- LUGGAGE
- SEATS & Sissy BARS
- EXHAUST
- FUEL/AIR SYSTEMS
- ENGINE
- TRANSMISSION & DRIVELINE
- GASKETS & SEALS
- ELECTRICAL
- LIGHTING
- HANDLEBARS, CONTROLS & MIRRORS
- CABLES
- BRAKES
- TANKS & OIL FILTERS
- DASHES & GAUGES
- FRAMES, SUSPENSION & FENDERS
- FOOTRESTS & LICENSE PLATE FRAMES
- WHEELS & AXLES
- HARDWARE, CHEMICALS & TOOLS
- COVERS, SECURITY & GENERAL

WINDSHIELDS & FAIRINGS

TOURING

AUDIO & COMMUNICATION

LUGGAGE

SEATS & SISSY BARS

EXHAUST

FUEL/AIR SYSTEMS

ENGINE

TRANSMISSION & DRIVELINE

GASKETS & SEALS

ELECTRICAL

LIGHTING

HANDLEBARS, CONTROLS & MIRRORS

CABLES

BRAKES

TANKS & OIL FILTERS

DASHES & GAUGES

FRAMES, SUSPENSION & FENDERS

FOOTRESTS & LICENSE PLATE FRAMES

WHEELS & AXLES

HARDWARE, CHEMICALS & TOOLS

COVERS, SECURITY & GENERAL

**AIR CLEANER INSERTS**

- High-quality inserts for a sleek, custom look
- Constructed of 6061 T-6 aluminum
- Available in two distinct styles with a choice of finish: chrome or black anodized with re-machined accents
- Easy installation
- Made in the U.S.A.



CARL BROUHARD DESIGNS LLC



1014-0046



1014-0047



1014-0112



1014-0113

PART #	DESCRIPTION	SUG. RETAIL
<b>FOR 99-15 TWIN CAM W/ STOCK AIR CLEANER COVER (EXCEPT 08-15 DYNA, 14-15 FLHT/FLHR/FLHX MODELS)</b>		
1014-0046	Lefty series, black	\$94.95
1014-0047	Lefty series, chrome	94.95

PART #	DESCRIPTION	SUG. RETAIL
<b>FOR 99-15 TWIN CAM W/ STOCK AIR CLEANER COVER (EXCEPT 08-15 DYNA, 14-15 FLHT/FLHR/FLHX MODELS) (CONT)</b>		
1014-0112	Cross series, black	\$94.95
1014-0113	Cross series, chrome	94.95



1014-0007



1014-0093

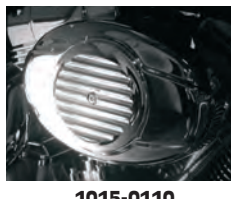

1015-0110



1010-1035



1010-1036



DS-288842



1014-0006



1010-1037



1014-0158



**BILLET AIR CLEANER INSERTS**

- Available in a variety of designs
- Chrome finish unless noted
- Sold each
- Made in the U.S.A.

PART #	DESCRIPTION	SUG. RETAIL
<b>FOR 99-15 TWIN CAM ROUND AIR CLEANER (EXCEPT 08-15 DYNA/ 14-15 FLHT/FLHR/FLTR)</b>		
1014-0007	Joker	\$70.95
1014-0093	Finned (black)	70.95
1015-0110	Finned	70.95
DS-288841	Flame	70.95
DS-288842	Smooth	70.95

PART #	DESCRIPTION	SUG. RETAIL
<b>FOR 99-15 TWIN CAM ROUND AIR CLEANER (EXCEPT 08-15 DYNA/ 14-15 FLHT/FLHR/FLTR) (CONT)</b>		
1014-0006	Hot Head	\$70.95
1010-0007	Ball-milled	70.95
<b>FOR 84-99 EVOLUTION ROUND AIR CLEANER</b>		
DS288829	Flame	80.95

**AIR CLEANER INSERTS**

- CNC-machined billet aluminum construction
- Finned style
- Made in the U.S.A.

<b>FOR 99-15 OEM TWIN CAM AIR CLEANER (EXCEPT 08-15 DYNA, 14-15 FLHT/FLHR/FLHX)</b>		
PART #	DESCRIPTION	SUG. RETAIL
<b>FINNED</b>		
1010-0415	Gloss black powdercoat	\$139.95
<b>MACHINE HEAD</b>		
1010-1035	Gloss black powdercoat	159.95
1010-1036	Chrome	159.95
1010-1037	Black diamond edge	219.95
<b>DIMPLED</b>		
1014-0157	Gloss black powdercoat	149.95
1014-0158	Chrome	149.95

**AIR CLEANER INSERTS**

- Fit VO2 Naked air intake, Screamin' Eagle and other aftermarket air cleaners with a round filter element and center-bolt mount
- 5 1/2" stamped steel covers feature subtle creasing reminiscent of old-school mag wheels
- Brilliant chrome, matte chrome or black ceramic finish
- Made in the U.S.A.



1010-0868



1010-0867



1014-0169



1010-1051



1010-1052

PART #	DESCRIPTION	SUG. RETAIL
<b>SKULLCAP</b>		
1010-0868	Chrome	\$49.95
1010-0867	Black	59.95

PART #	DESCRIPTION	SUG. RETAIL
<b>SKULLCAP CROWN</b>		
1010-1051	Chrome	\$49.95
1014-0169	Matte chrome	69.95

PART #	DESCRIPTION	SUG. RETAIL
<b>SKULLCAP CROWN (CONT)</b>		
1010-1052	Black	\$59.95



**AIR CLEANER INSERTS**

- Bolt-on inserts give a customized look to aftermarket or OEM air cleaner
- Constructed of billet aluminum and available in a chrome finish

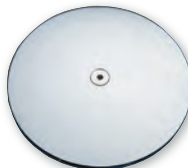

DS-288819



DS-288820



1010-1318



1010-1320

PART #	DESCRIPTION	SUG. RETAIL
<b>FOR 99-15 TWIN CAM WITH OEM AIR CLEANER (EXCEPT 08-15 DYNA, 14-15 FLHT/FLHR/FLHX MODELS)</b>		
DS-288819	Millennium smooth, chrome	\$80.95
DS-288820	Millennium ball-milled, chrome	84.95
1010-1321	Millennium smooth, black	80.95

PART #	DESCRIPTION	SUG. RETAIL
<b>FOR 84-99 BIG TWINS</b>		
1010-1317	Millennium smooth, chrome	\$80.95
1010-1318	Millennium smooth, black	80.95
1010-1319	Millennium ball-milled, chrome	80.95
1010-1320	Millennium ball-milled, black	80.95

**IMPORTANT NOTE:** SEE PAGE 411 FOR IMPORTANT INFORMATION REGARDING CERTAIN WARRANTY AND EMISSION CONTROL REGULATORY COMPLIANCE INFORMATION.

All part numbers in **BLUE** are new for 2015.





- WINDSHIELDS & FAIRINGS
- TOURING
- AUDIO & COMMUNICATION
- LUGGAGE
- SEATS & Sissy BARS
- EXHAUST



**STOP-N-POP BOTTLE OPENER**

- Add a visual kick to your air cleaner or custom location of your choice
- Aluminum base construction with stainless steel bottle opener
- Base is ball-furnished finish, bottle opener is polished finish
- Installs using original air cleaner center mount bolt; mounting hardware for bottle opener included
- Mounts in just minutes, adding both functionality and bling
- Made in the U.S.A.

PART #	DESCRIPTION	SUG. RETAIL
<b>1014-0110</b>	For 99-15 Twin Cam w/ stock oval air cleaner cover (except 14-15 FLHT/FLHR/FLHX, 08-15 Dyna)	<b>\$29.95</b>



**MACH 2™ AIR CLEANER INSERTS**

- Inserts are a direct replacement to your Kuryakyn Mach 2 Air Cleaner (available from Kuryakyn)
- Pick your favorite design and create a truly custom look
- Also have universal applications, just peel-and-stick almost anywhere there is a 4 1/2" diameter surface
- Sold individually

**NOTE:** Not recommended for use on engine cases.



PART #	DESCRIPTION	SUG. RETAIL	PART #	DESCRIPTION	SUG. RETAIL
<b>GLOSS BLACK</b>			<b>CHROME (CONT)</b>		
<b>0618-0003</b>	Widow	<b>\$19.95</b>	<b>0618-0009</b>	Widow	<b>\$19.95</b>
<b>0618-0004</b>	Zombie	<b>19.95</b>	<b>0618-0010</b>	Zombie	<b>19.95</b>
<b>CHROME</b>			<b>0618-0011</b>	Chauvinist	<b>19.95</b>
<b>0618-0006</b>	Firefighter	<b>19.95</b>	<b>0618-0012</b>	Patriot	<b>19.95</b>
<b>0618-0008</b>	Flame	<b>19.95</b>			

**IMPORTANT NOTE:** SEE PAGE 411 FOR IMPORTANT INFORMATION REGARDING CERTAIN WARRANTY AND EMISSION CONTROL REGULATORY COMPLIANCE INFORMATION.

All part numbers in **BLUE** are new for 2015.

- PUCE/ATP SYSTEMS
- ENGINE
- TRANSMISSION & DRIVELINE
- GASKETS & SEALS
- ELECTRICAL
- LIGHTING
- HANDLEBARS, CONTROLS & MIRRORS
- CABLES
- BRAKES
- TANKS & OIL FILTERS
- DASHES & GAUGES
- FRAMES, SUSPENSION & FENDERS
- FOOTRESTS & LICENSE PLATE FRAMES
- WHEELS & AXLES
- HARDWARE, CHEMICALS & TOOLS
- COVERS, SECURITY & GENERAL





- WINDSHIELDS & FAIRINGS
- TOURING
- AUDIO & COMMUNICATION
- LUGGAGE
- SEATS & SISSY BARS
- EXHAUST
- FUEL/AIR SYSTEMS
- ENGINE
- TRANSMISSION & DRIVELINE
- GASKETS & SEALS
- ELECTRICAL
- LIGHTING
- HANDLEBARS, CONTROLS & MIRRORS
- CABLES
- BRAKES
- TANKS & OIL FILTERS
- DASHES & GAUGES
- FRAMES, SUSPENSION & FENDERS
- FOOTRESTS & LICENSE PLATE FRAMES
- WHEELS & AXLES
- HARDWARE, CHEMICALS & TOOLS
- COVERS, SECURITY & GENERAL



**PREMIUM REUSABLE AIR FILTERS**

- Durable epoxy-coated wire mesh designed to maximize airflow and provide peak filtration
- 100% reusable and washable
- Pre-oiled for quick, easy installation
- High-flow four-layer surgical-grade cotton filtration
- Urethane body won't crack or curl like rubber
- Precision hand-poured design
- Made in the U.S.A.

YEAR	MODEL	DRAG SPECIALTIES #	K&N REF. #	OEM #	SUG. RETAIL
<b>FOR BIG TWIN</b>					
99-15	Twin Cam (except 08-15 Dresser/H-D FL Trike, 11-13 FXS, 12-15 FLS, 08-11 FLSTSB, 99-01 Magneti-Marelli EFI, 08-15 Dyna Glide)	<b>1011-0320</b>	HD1499	29461-99, 29400042	<b>\$74.95</b>
14-15	14-15 FLHT/FLHR/FLHX/FLTR/H-D FL Trike	<b>1011-3218</b>	-	29400045	<b>68.95</b>
08-15	12-15 FLS, 11-13 FXS, 08-11 FLSTSB, 13-15 FXDB	<b>1011-3219</b>	HD-1611	29314-08	<b>68.95</b>
08-13	FLHT/FLHR/FLTR/FLHX/H-D FL Trike	<b>1011-1203</b>	HD-1508	29633-08	<b>69.95</b>
08-15	FXD, FXDB, FXDC, FXDF, FXDL, FXDWG, FLD (except 13-15 FXDB)	<b>1011-1902</b>	HD-9608	29191-08	<b>69.95</b>
99-01	88" Twin Cam (w/ Magneti-Marelli EFI)	<b>1011-0322</b>	HD8899	29462-99	<b>77.95</b>
95-98	80" Evolution (w/ Magneti-Marelli EFI)	<b>1011-0319</b>	HD-1395	29291-95	<b>71.95</b>
90-99	80" Evolution (carbureted)	<b>1011-0318</b>	HD-1390	29259-91A, 29330-96	<b>59.95</b>
86-89	80" Evolution (carbureted)	<b>1011-0321</b>	HD-2086X	29259-86	<b>45.95</b>
02-15	V-Rod	<b>1011-0784</b>	HD-1102	29437-01	<b>67.95</b>
<b>FOR XL/BUELL</b>					
04-13	XL Evolution (except 13 1200V)	<b>1011-1067</b>	HD-8834	29331-04	<b>67.95</b>
88-03	XL Evolution	<b>1011-0317</b>	HD-1388	29036-88/A/B, 29331-96	<b>65.95</b>
96-02	Buell (except 96 S2/S2T, 00-02 Blast)	<b>1011-0312</b>	BU-1297	29239-96V, P0213.9	<b>54.95</b>

**IMPORTANT NOTE: SEE PAGE 411 FOR IMPORTANT INFORMATION REGARDING CERTAIN WARRANTY AND EMISSION CONTROL REGULATORY COMPLIANCE INFORMATION.**

All part numbers in **BLUE** are new for 2015.



**DRAG** Specialties **PREMIUM REUSABLE AIR FILTERS (CONT)**



- WINDSHIELDS & FAIRINGS
- TOURING
- AUDIO & COMMUNICATION
- LUGGAGE
- SEATS & Sissy BARS
- EXHAUST
- FUEL/AIR SYSTEMS

- ENGINE
- TRANSMISSION & DRIVELINE
- GASKETS & SEALS
- ELECTRICAL

- LIGHTING
- HANDLEBARS, CONTROLS & MIRRORS
- CABLES
- BRAKES
- WHEELS & AXLES
- TIRES & RIMS

- FRAMES, SUSPENSION & FENDERS
- FOOTRESTS & LICENSE PLATE FRAMES
- HARDWARE, CHEMICALS & TOOLS
- COVERS, SECURITY & GENERAL

YEAR	MODEL	DRAG SPECIALTIES #	K&N REF. #	OEM #	SUG. RETAIL
<b>FOR AFTERMARKET AIR CLEANERS</b>					
	S&S "D" teardrop air filter	1011-0313	E-3224	-	\$31.95
	S&S 6" x 2 <sup>3</sup> / <sub>16</sub> " air filter	1011-0314	E-3225	-	31.95
	S&S Super E and G series carb air filter	1011-0315	E-3226	-	31.95
	Screamin' Eagle Stage 1 air filter 08-14 FLHTCUSE/FLHRSE	1011-1204	HD-0818	29244-08	52.95
	Screamin' Eagle Stage 1 air filter Evolution Big Twin	1011-0316	HD-0600	29055-89	45.95
	Screamin' Eagle Stage 1 air filter Twin Cam (except 08-14 Dresser, 08-14 Dyna)	1011-0528	HD-0800	29442-99A	47.95
	Screamin' Eagle Stage 1 air filter 08-14 Dyna	1011-1943	HD-0808	29385-08	37.95
	Screamin' Eagle Stage 1 air filter 04-14 XL	1011-0783	HD-0900	29044-04	64.95
	Arlen Ness billet Sucker air filter Twin Cam (except 08-14 Dresser), Arlen Ness Stage 1 Big Sucker/Billet Sucker air filter for CV carb or Delphi EFI (except 08-14 Dresser)	1011-0528	HD-0800	29442-99A	47.95



**OEM STYLE REPLACEMENT AIR FILTER ELEMENTS**

- High-quality paper filter medium
- Meets or exceeds OEM specifications
- For use with OEM stock air filter housings

**NOTE:** Not for use with Screamin' Eagle air cleaners.

PART #	DESCRIPTION	SUG. RETAIL
1011-2956	For 99-15 Twin Cam (except 11-15 FXS, 12-15 FLS, 99-01 EFI models, 08-15 FLHT/FLHR/FLHX/FLTR and H-D FL Trike models, 08-15 Dyna Glide models, 08-11 FLSTSB); repl. OEM #s 29461-99/29400042	\$24.95
1011-3178	For 14-15 FLHT, FLHR, FLTR, FLHX and H-D FL Trikes; repl. OEM #29400045	26.95
1011-2957	For 08-13 FLHT, FLHR, FLTR, FLHX and H-D FL Trikes; repl. OEM #29633-08	24.95
1011-2958	For 08-15 FXD, FXDB, FXDC, FXDF, FXDL, FXDWG (except 13-15 FXDB); repl. OEM #29191-08	24.95
1011-3179	For 13-15 FXDB, 12-15 FLS, 11-13 FXS, 08-11 FLSTSB models; repl. OEM #29314-08	26.95
1011-2960	For 90-99 80" Evolution; repl. OEM #29330-96	24.95
1011-3177	For 14-15 XL models; repl. OEM #29400015	26.95
1011-2959	For 04-13 XL (except 13 1200V); repl. OEM #29331-04	24.95
1011-2961	For 88-03 XL; repl. OEM #29331-96	24.95

**IMPORTANT NOTE:** SEE PAGE 411 FOR IMPORTANT INFORMATION REGARDING CERTAIN WARRANTY AND EMISSION CONTROL REGULATORY COMPLIANCE INFORMATION.

All part numbers in **BLUE** are new for 2015.

- WINDSHIELDS & FAIRINGS
- TOURING
- AUDIO & COMMUNICATION
- LUGGAGE
- SEATS & SISSY BARS
- EXHAUST
- ENGINE
- TRANSMISSION & DRIVELINE
- GASKETS & SEALS
- ELECTRICAL
- LIGHTING
- HANDLEBARS, CONTROLS & MIRRORS
- CABLES
- BRAKES
- TANKS & OIL FILTERS
- DASHES & GAUGES
- FRAMES, SUSPENSION & FENDERS
- FOOTRESTS & LICENSE PLATE FRAMES
- WHEELS & AXLES
- HARDWARE, CHEMICALS & TOOLS
- COVERS, SECURITY & GENERAL



**HIGH-FLOW REPLACEMENT AIR FILTER**

- Designed to increase horsepower and torque
- Pleated media provides a large filtration area offering long service intervals
- Application-specific sealing bead ensures an airtight fit
- Multi-layers of woven cotton gauze media offers excellent filtration
- American-made for over 40 years
- Washable, reusable, pre-oiled and ready to ride
- Made in the U.S.A.



PART #	SUG. RETAIL	PART #	SUG. RETAIL	PART #	SUG. RETAIL	PART #	SUG. RETAIL	PART #	SUG. RETAIL
1011-0328	\$73.95	1011-1121	\$65.95	1011-2898	\$87.95	E-3225	\$51.95	HD-1396	\$93.95
1011-0332	79.95	1011-1289	94.95	1011-3093	55.95	E3226	50.95	HD-1499	87.95
1011-0532	85.95	1011-1409	86.95	1011-3217	49.95	E-3250	53.95	HD-2084	63.95
1011-0533	83.95	1011-1410	79.95	1011-3227	78.95	E-3325	47.95	HD-2085X	58.95
1011-0557	65.95	1011-1435	96.95	BU-1297	74.95	HD-0600	68.95	HD-2086X	66.95
1011-1061	80.95	1011-1725	65.95	BU-5000	78.95	HD-1388	90.95	HD-8899	101.95
1011-1062	77.95	1011-2359	82.95	DS-289057	48.95	HD-1390	86.95	RU-124	65.95
1011-1068	70.95	1011-2674	63.95	E-3224	51.95	HD-1395	94.95		



**AIR FILTER ELEMENTS**

- Top-quality replacement air filter elements from Uni, the OEM supplier to Harley-Davidson
- Constructed of a unique, open-cell polyurethane material that allows maximum airflow while still providing superior filtration
- Uni elements are available for a variety of Harley applications
- For cleaners and filter care products see HARDWARE, CHEMICALS & TOOLS section
- Sold individually
- Made in the U.S.A.



PART #	SUG. RETAIL	PART #	SUG. RETAIL	PART #	SUG. RETAIL	PART #	SUG. RETAIL	PART #	SUG. RETAIL	PART #	SUG. RETAIL
1011-0471	\$49.95	1011-1159	\$24.95	DS-289499	\$29.95	DS-289506	\$21.95	DS-289509	\$19.95	DS-289513	\$21.95
1011-0472	38.95	1011-1345	40.95	DS-289504	20.95	DS-289507	21.95	DS-289510	27.95	DS-289514	20.95
1011-0658	36.95	DS-289498	24.95	DS-289505	21.95	DS-289508	21.95	DS-289511	27.95	NU-3428	33.95

**IMPORTANT NOTE:** SEE PAGE 411 FOR IMPORTANT INFORMATION REGARDING CERTAIN WARRANTY AND EMISSION CONTROL REGULATORY COMPLIANCE INFORMATION.

All part numbers in **BLUE** are new for 2015.





- WINDSHIELDS & FAIRINGS
- TOURING
- AUDIO & COMMUNICATION
- LUGGAGE
- SEATS & Sissy BARS
- EXHAUST
- PIPET/AIR SYSTEMS
- ENGINE
- TRANSMISSION & DRIVELINE
- GASKETS & SEALS
- ELECTRICAL
- LIGHTING
- HANDLEBARS, CONTROLS & MIRRORS
- CABLES
- BRAKES
- TANKS & OIL FILTERS
- DASHES & GAUGES
- FRAMES, SUSPENSION & FENDERS
- FOOTRESTS & LICENSE PLATE FRAMES
- WHEELS & AXLES
- HARDWARE, CHEMICALS & TOOLS
- COVERS, SECURITY & GENERAL

## AIR FILTER APPLICATIONS

YEAR	MODEL	K&N #	UNI #	OEM #
<b>FOR BIG TWIN AND V-ROD</b>				
08-13	FLHT/FLHR/FLHX/FLTR and H-D FL Trikes	1011-1289	-	29633-08
08-15	Dyna Glide (except 13-15 FXDB)	1011-1435	-	29191-08
08-15	12-15 FLS, 11-13 FXS, 08-11 FLSTSB, 13-15 FXDB	1011-2898	-	29314-08
02-15	V-Rod	1011-0332	1011-1345	29437-01
99-15	99-06 Twin Cam (carb), 01-15 Softail (except FXS/FLS/FLSTSB), 02-07 Dresser and 04-07 Dyna Glide	HD-1499	-	29461-99, 29400042
99-01	88" Twin Cam Fuel-Injected Dressers	HD-8899	-	29462-99
95-98	80" Evolution Fuel-Injected	HD-1395	-	29291-95
95-99	80" Evolution International	HD-1396	-	29325-95A
93-00	80" Evolution (except Fuel-Injected)	HD-1390	DS-289499	29330-96
89-92	80" Evolution	HD-1390	DS-289511	29259-89/91A
86-89	80" Evolution	HD-2086X	DS-289507	29259-86
84-85	80" Evolution (except FLT, FLHT)	HD-2084	DS-289506	29259-83A
84-85	FLT and FLHT	-	DS-289508	29288-83
<b>FOR XL</b>				
14-15	XL, 13 1200V	1011-3227	-	29400015
04-13	XL Evolution (except 13 1200V)	1011-0532	-	29331-04
88-03	XL	HD-1388	DS-289510	29036-88A/88B, 29331-96
86-87	XL	HD-2085X	DS-289505	29036-86
08-12	XR 1200/XR 1200X	1011-2359	-	29377-08
<b>FOR BUELL</b>				
03-09	03-09 XB9/XB12/XB12S/SCG, 08 XV12SS/STT, 04-09 XB12R	1011-0328	1011-0658	P0213.0248
00-09	Blast	BU-5000	-	P0213.T
96-02	S1, S2, S3, M2 (except 94-95 S1, 94-98 S2/S2T, 94-96 S3/S3T)	BU-1297	NU-3428	29239-96Y
08-09	1125R/CR	1011-1725	-	P02131AMA
<b>FOR AFTERMARKET AIR CLEANERS</b>				
	Edelbrock single carb air filter	E-3250	-	-
	Edelbrock dual carb air filter	E-3325	-	-
	Evo reverse tapered: 7" dia. (top) x 6 1/4" dia. (base) x 2 3/4" (tall)	1011-1061	-	-
	Evo reverse tapered: 7" dia. (top) x 6 1/4" dia. (base) x 3 1/4" (tall)	1011-1062	-	-
	Early Evolution Screamin' Eagle air filter (w/ lid); 7" dia. (base) x 7" dia. (top)	HD-0600	1011-0471	29055-89
	Late Evolution Screamin' Eagle air filter (no lid)	-	1011-0472	-
	Screaming Eagle stage 1 filter for 08-15 Dyna	1011-1409	-	29385-08
	Screaming Eagle stage 1 filter for 08-15 FLT, FLHT, FLHR, FLHX, FLTR	1011-1410	-	29242-08, 29400019
	Twin Cam Screamin' Eagle tapered air filter (except 08-15 Dresser/Dyna) (no lid); 5 1/2" dia. (top) x 6 1/4" dia. (base)	1011-0557	-	29244-99A/B/C/D
	TC Screamin' Eagle, Arlen Ness Stage II, Custom Evolution reverse tapered: 7" dia. (top) x 6" dia. (base) x 3 1/4" (tall)	1011-0533	-	-
	Screamin' Eagle stage 1 for 04-15 XL	1011-1068	-	29044-04B
	Screamin' Eagle stage 1 for 09-15 Ventilator element, 10-15 CVO Dresser	1011-2674	-	29670-09
	Joker Machine high-performance air cleaner assemblies	1011-3217	-	-
	S&S dual-throat carb air filter	-	DS-289513	-
	S&S "D" teardrop air filter; 2 1/16" (53.4mm)	E-3224	-	-
	S&S Super E and G series carb air filter; 2 1/2" (63.5mm)	E3226	DS-289514	-
	S&S old style teardrop-shaped housing; 6" x 2 3/16" air filter	E-3225	DS-289504	-
	6" custom air filter	-	DS-289498	-
	Dragtron™ air filter	-	DS-289509	-
	Dragtron™ II air filter (5.25")	DS-289057	1011-1159	-
	Drag 7" round air filter (DS-288998)	-	DS-289504	-
	Revtech PART #58-284	1011-3093	-	-
	Mikuni 36-38mm dirt track air filter "D" Oval; 7" length; 10° angle; 2 1/2" flange	1011-1121	-	-
	Mikuni 36-38mm dirt track air filter oval; 7" L; 10° angle; 1" flange	RU-124	-	-

### ARLEN NESS

#### REPLACEMENT AIR FILTER ELEMENTS FOR SCREAMIN' EAGLE® AIR CLEANER

- Premium pre-oiled direct replacement element for **1011-2054** Screamin' Eagle® Kits
- Each is handmade one at a time in a urethane body that won't crack; four layers of surgical-grade cotton provide optimum air flow and protection
- 100% re-usable and washable
- Available in red cotton and stainless steel; fit with original Screamin' Eagle covers
- Can also be used with Ness Stage I top cover for an exposed filter high-performance look; no other hardware necessary



PART #	DESCRIPTION	SUG. RETAIL
<b>FOR 08-15 FLHT, FLHR, FLHX, FLTR AND H-D FL TRIKE MODELS W/ 58MM THROTTLE BODY</b>		
1011-2054	Red cotton	\$49.95
1011-2055	Stainless steel	69.95
<b>FOR 99-10 FXST, 02-07 FLHT, 97-07 FXD/FXDWC</b>		
2110-9494	Red cotton	49.95

### DRYCHARGERS

- Specially designed filter wrap made to extend the service interval of your K&N air filter when used in severe dusty or wet conditions
- Made from durable polyester material containing uniform micron openings, the DryCharger® will stop small dirt particles and is water repellent, yet adds little restriction to the airflow of your filter
- Feature double-stitched elastic openings to secure drycharger in place
- Designed to be run dry and can be cleaned with K&N filter cleaner
- Custom fit to each application
- Made in the U.S.A.



PART #	DESCRIPTION	SIZE	SUG. RETAIL
<b>DRYCHARGERS</b>			
1011-1501	For Custom Evolution reverse tapered air filter, PART #1011-0533	7" dia. (top) x 6" dia. (base) x 3 1/4" (tall)	\$35.95
1011-1502	For Twin Cam Screamin' Eagle tapered air filter (except 08-15 Dresser/Dyna), PART #1011-0557	5 1/2" dia. (top) x 6 1/4" dia. (base)	33.95
1011-1502	For 08-13 Touring Twin Cam Screamin' Eagle tapered air filter, PART #1011-1410	5 1/2" dia. (top) x 6 1/4" dia. (base)	33.95
<b>PRECHARGER</b>			
RU-1240PK	Precharger for Mikuni 36-38mm dirt track air filters, PART #s 1011-1121 and RU-124	3 3/4" inside width x 7" inside length (tall)	30.95

**IMPORTANT NOTE: SEE PAGE 411 FOR IMPORTANT INFORMATION REGARDING CERTAIN WARRANTY AND EMISSION CONTROL REGULATORY COMPLIANCE INFORMATION.**

All part numbers in **BLUE** are new for 2015.

WINDSHIELDS  
& FAIRINGS

TOURING

AUDIO &  
COMMUNICATION

LUGGAGE

SEATS &  
SISSY BARS

EXHAUST

FUEL/AIR  
SYSTEMS

ENGINE

TRANSMISSION  
& DRIVELINEGASKETS  
& SEALS

ELECTRICAL

LIGHTING

HANDLEBARS,  
CONTROLS  
& MIRRORS

CABLES

BRAKES

TANKS &  
OIL FILTERSDASHES  
& GAUGESFRAMES,  
SUSPENSION  
& FENDERSFOOTRESTS  
& LICENSE  
PLATE FRAMESWHEELS  
& AXLESHARDWARE,  
CHEMICALS  
& TOOLSCOVERS,  
SECURITY  
& GENERAL

### NOSTALGIA VELOCITY STACKS

- High-velocity stacks include backing plate with breathers and screen
- CNC-machined billet aluminum
- Available in chrome or black anodized finish
- All mounting hardware included
- Made in the U.S.A.

PART #	DESCRIPTION	SUG. RETAIL
<b>FOR 91-15 XL</b>		
1010-0836	Chrome	\$449.95



1010-0836



1010-0835

PART #	DESCRIPTION	SUG. RETAIL
<b>FOR 91-15 XL (CONT)</b>		
1010-0835	Black anodized	\$449.95

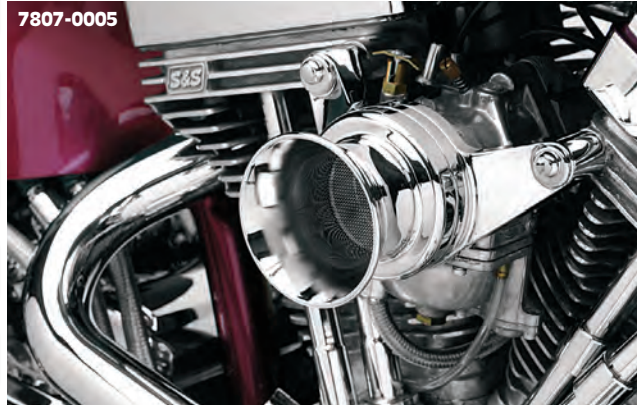

7807-0005

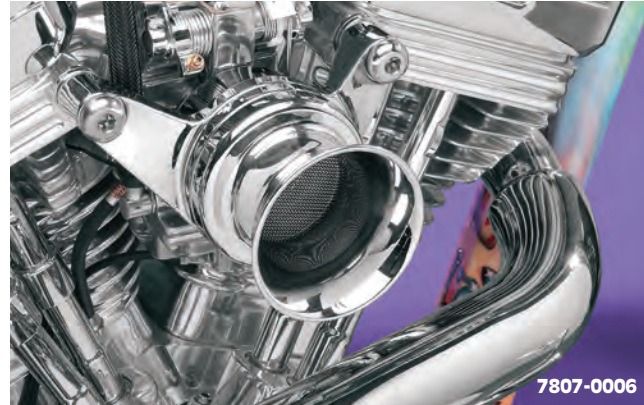

7807-0006

### SHORT CHROME VELOCITY STACKS

- Feature a one-piece breather/support bracket
- No external breather lines are necessary
- Include velocity stack with screen, breather support bracket and hardware
- Made in the U.S.A.

PART #	DESCRIPTION	SUG. RETAIL
7807-0005	For S&S E and G carb	\$345.95
7807-0006	For Mikuni 42/45/48 carb	377.95

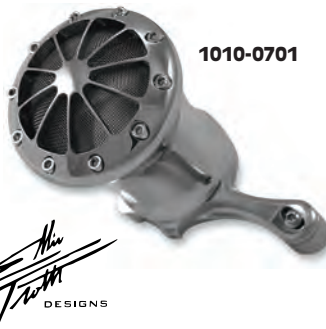

1010-0701

### V-CLEANER VELOCITY STACKS

- CNC-machined 6061 billet aluminum
- Available in chrome
- Two sizes available: 2" and 4"
- Breathers and mounting hardware included
- Made in the U.S.A.

PART #	DESCRIPTION	SUG. RETAIL
<b>FOR 01-15 MODELS W/ DELPHI EFI AND</b>		
<b>93-06 BIG TWIN W/ CV CARB (EXCEPT 08-15</b>		
<b>FLHT, FLHR, FLTR, FLHX AND H-D FL TRIKE)</b>		
1010-0912	2"	\$449.95



1010-0703

PART #	DESCRIPTION	SUG. RETAIL
<b>FOR 93-06 BIG TWIN W/ S&amp;S E AND G CARBS</b>		
1010-0701	4"	\$494.95
<b>FOR 93-06 BIG TWIN W/ MIKUNI 42/45 CARBS</b>		
1010-0703	4"	494.95



### 4" DEATH STACK

- Chromed, CNC-machined billet aluminum velocity stack
- Incorporates crankcase breathers into the mounting bracket
- Stack screws onto mounting bracket for clean installation
- Made in the U.S.A.

PART #	DESCRIPTION	SUG. RETAIL
2106-1008	For 93-06 Big Twin w/ Mikuni HSR 42/45/48 carbs	\$326.95

### REPLACEMENT SCREEN FOR VELOCITY STACKS

- Replacement debris-catching screen
- Diameter measures 2.55"
- Made in the U.S.A.

PART #	DESCRIPTION	SUG. RETAIL
DS28869	Repl. screen for velocity stacks	\$2.95



### VELOCITY STACK PRE-FILTER

- Compatible with all RSD velocity stacks
- Also fits on any 3<sup>3</sup>/<sub>4</sub>" velocity stack
- Hydrophobic manufacturing process repels water
- Filters out larger particles of debris down to .005"
- Uniform micron openings allow air in while keeping debris and water out
- Made in the U.S.A.

PART #	DESCRIPTION	SUG. RETAIL
1011-2763	Velocity stack pre-filter	\$19.95



**IMPORTANT NOTE:** SEE PAGE 411 FOR IMPORTANT INFORMATION REGARDING CERTAIN WARRANTY AND EMISSION CONTROL REGULATORY COMPLIANCE INFORMATION.

All part numbers in **BLUE** are new for 2015.