

GL

Communications Inc.

Test & Measurement for Telecom Networks

Ethernet Test Solutions

Voice and Data Testing

TDM Test Solutions

Telecom Protocol Emulation

Consulting Services

**TEST
ANALYZE
MONITOR**

Wireless
(5G, LTE, VoLTE, UMTS, GSM)

Fiber Optics



**NETWORKS
UNDER TEST**



IP End Points



TDM, PSTN



Ethernet
Testing



Wirespeed
Capture



Voice & Data
Testing

 **GL Communications Inc.**

818 West Diamond Avenue - Third Floor Gaithersburg, MD 20878
Phone: (301) 670-4784 Fax: (301) 670-9187 Email: info@gl.com

Table of Contents

Testing Solutions using GL Tools

Ethernet Testing

- [PacketExpert™ 10GX - Ethernet/IP Network Test Solutions](#)
- [PacketExpert™ 100G - Ethernet/IP Network Test Solutions](#)
- [PacketCheck™ - Software Ethernet/IP Tester](#)
- [PacketScan™ - IP Network Monitoring and Protocol Analysis](#)

Voice and Data Testing

- [VQuad™ Voice Quality Testing](#)
- [vMobile™ Hand-Portable Voice Quality Drive and Walk Testing](#)

TDM Testing

- [T1 E1 Monitoring, Analysis and Emulation Capabilities](#)
- [2-Wire Analog FXO/FXS Bulk Call Generator](#)

Telecom Protocol Emulation

- [Message Automation and Protocol Simulation \(MAPS™\)](#)
- [5G Core Network Emulation](#)
- [Automated Testing Solutions for LTE, VoLTE, and IMS Emulation](#)
- [MAPS™ SIP Protocol Emulator](#)
- [Testing ED-137 and ED-138 Interoperability Standards for VoIP Air Traffic Control](#)

Company Profile

GL Communications Inc. has over 35 years of experience in the telecommunications industry providing test and measurement equipment, custom hardware and software development and consulting services. GL offers testing solutions to verify network performance in various telecom networks including Ethernet, wireless, fiber optic and analog networks. GL's customers include service providers, equipment manufacturers, government agencies and contractors. GL offers support and services from its headquarters in Gaithersburg, MD as well as Bangalore, India.

GL's test solutions cover a wide array of networks:

- **WIRELESS (5G, 4G LTE, 3G, 2G, Land Mobile Radio)**
- **Ethernet and IP**
- **T1, E1, T3, E3, PSTN**
- **OC-3/STM-1, OC-12/STM-4**

Testing Solutions using GL Tools

GL has a comprehensive suite of telecom testing solutions to verify and ensure quality and reliability of telecom networks including Air Traffic Management (ATM), High Speed Ethernet Capture, Legacy Testing (T1/E1 and 2-Wire Analog), and Voice Quality Testing over any Network or Device.

Ethernet Testing for Wide Area Networks, Data Centers and Infrastructure

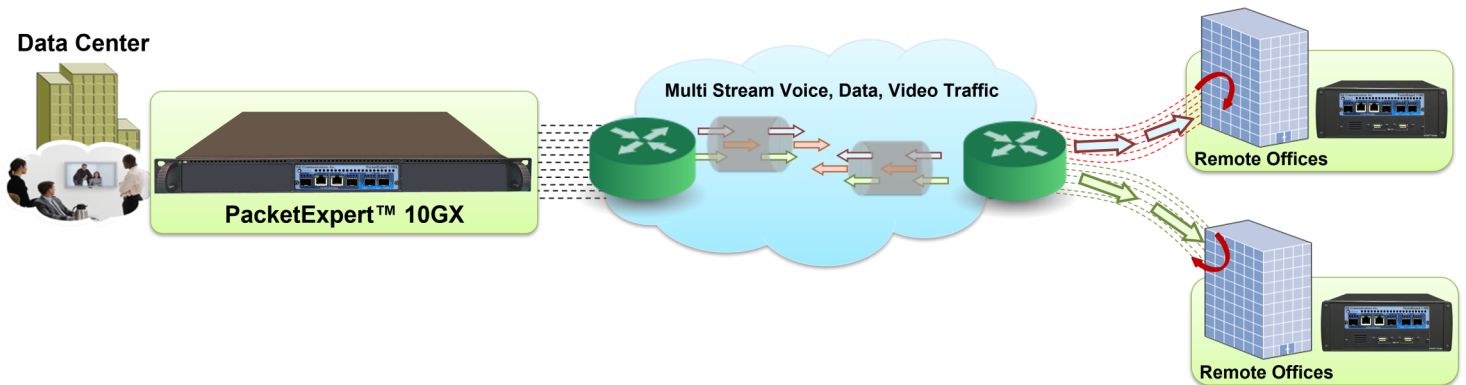

GL's [PacketExpert™ 10GX](#) provides comprehensive testing of 10/2.5/1 Gbps Ethernet/IP networks. It can generate and receive traffic with customizable protocol headers. Measurements include bit error rate testing, throughput, packet loss, latency, jitter and other fundamental packet statistics. PacketExpert™ 10GX can test a wide range of networks - from testing individual links/switches, testing local Ethernet/IP networks (LAN), end to end testing of Wide Area Networks (WAN), testing Core/MPLS networks, and more.

High Speed Ethernet Capture

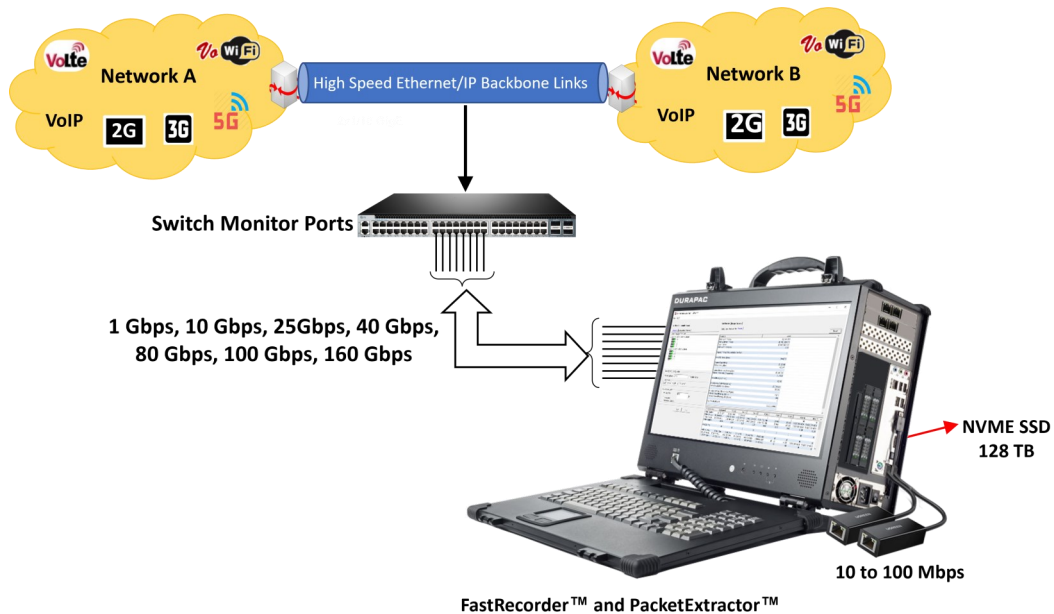

GL offers the portable or rackmount versions of [FastRecorder™](#) and [PacketExtractor™](#), providing the ultimate packet capture and analysis solutions for managing networks of all sizes. These tools ensure lossless capture of high-speed IP traffic. The FastRecorder™ and PacketExtractor™ applications are compatible with GL's network appliance, PacketScan™ HD, and can also be used with Wireshark® protocol analyzers.

Testing Solutions using GL Tools

Air Traffic Management

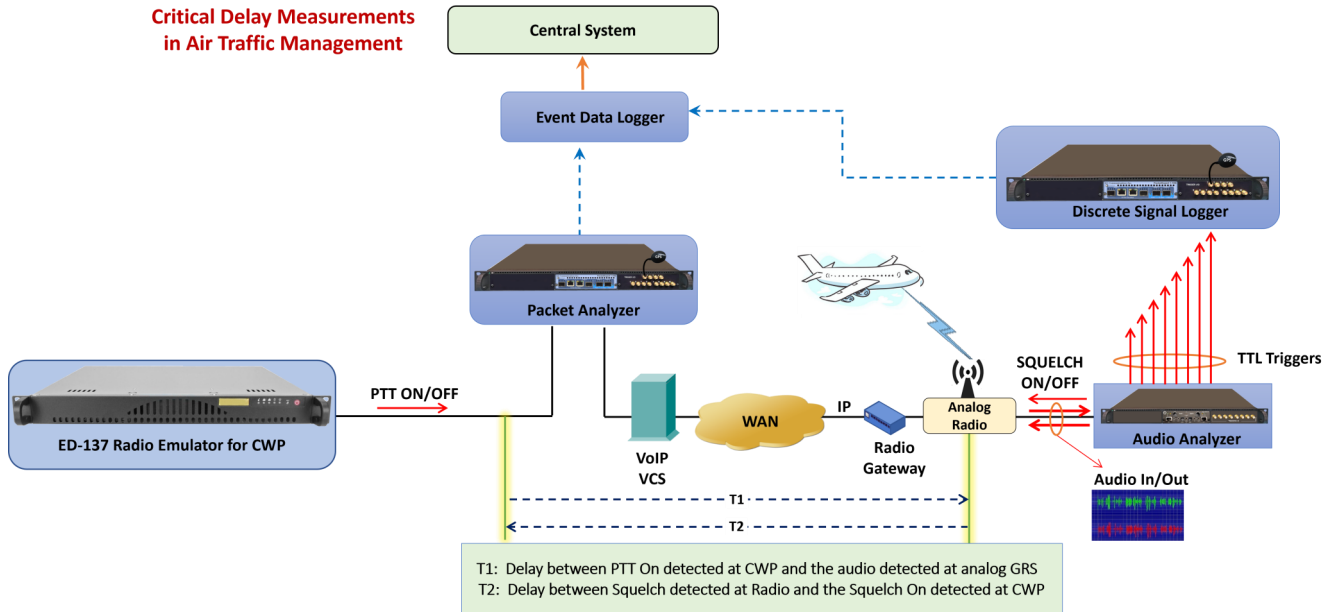

GL's [Timing Measurements in Air Traffic Management](#) (TM-ATM) test suite accurately emulates end points in ATM networks and provides critical timing measurements for various types of delay occurrences in signaling and voice transmission through the network. It includes all necessary hardware and software to identify, capture, timestamp, and correlate events at Analog, TDM and IP interfaces.

Legacy Testing (T1/E1 and 2-Wire Analog)

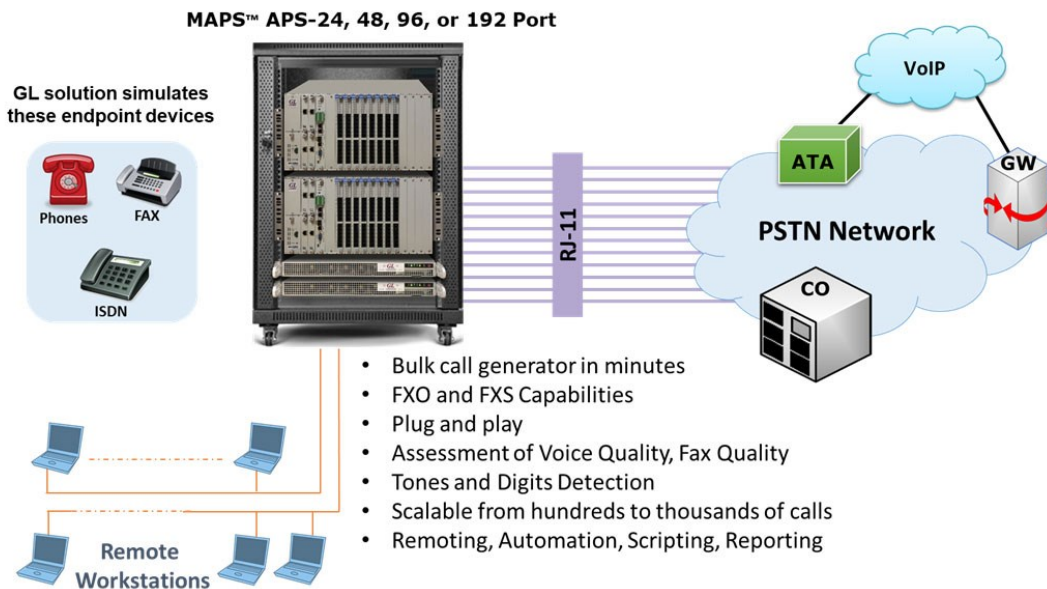

GL's high-capacity [Analog 2-Wire FXO/FXS](#) or (4-Wire E&M Bulk Call Generator) used to test a Central Office (CO), PBX, ATAs, Optical Network Terminal (ONT) / Optical Line Terminal (OLT), Gateway or other telecommunications equipment.

Testing Solutions using GL Tools

Voice Quality Testing over any Network or Device

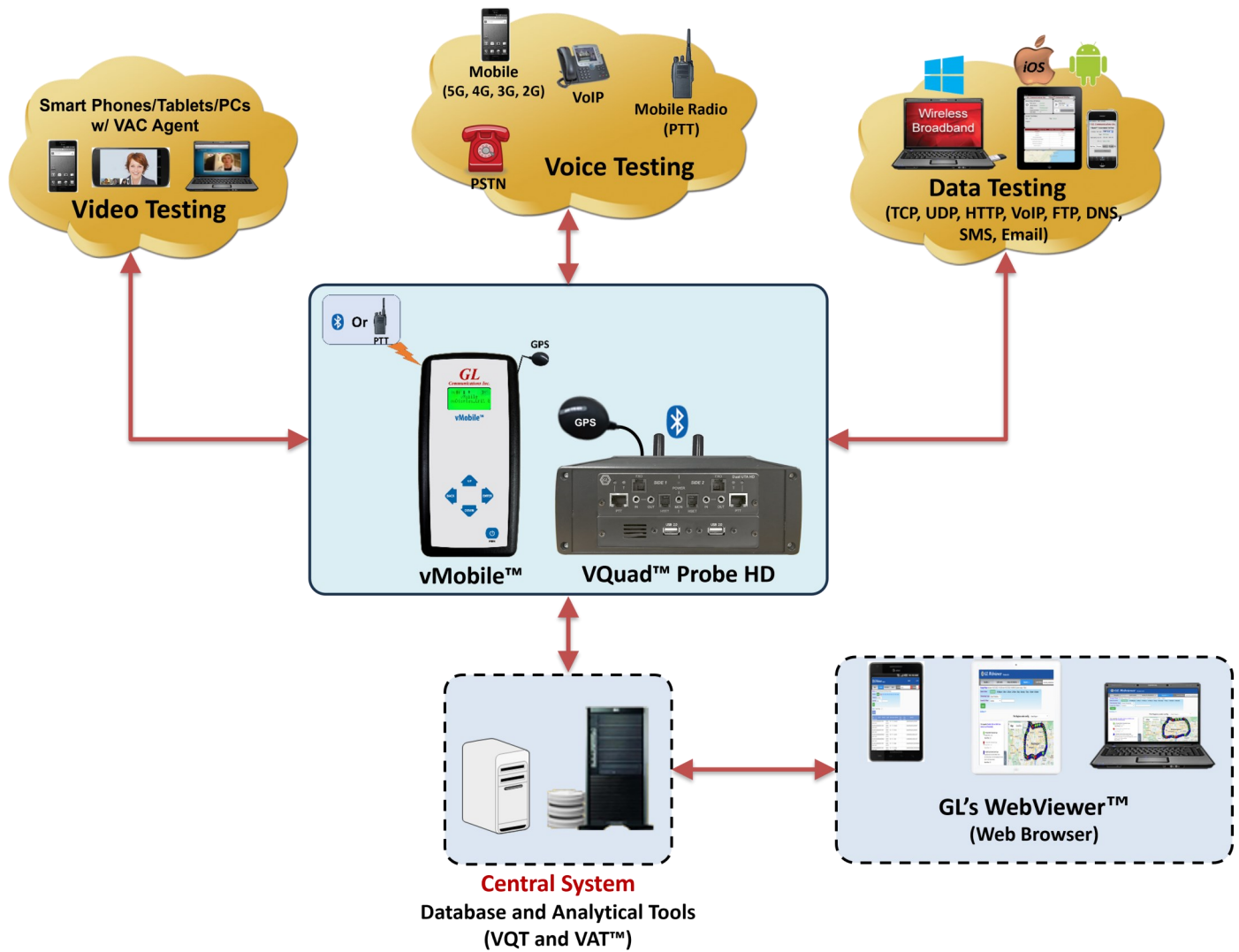

GL's [Voice Quality Testing \(VQT\)](#) software supports next-generation voice quality testing standards for fixed, mobile, and IP-based networks, utilizing POLQA version 2.4 and optional version 3 (ITU-T P.863), along with PESQ ITU-T P.862, PESQ LQ/LQO (P.862.1), and PESQ WB (P.862.2). VQT analyzes degraded files, comparing them with reference files through ITU-standard algorithms PESQ LQ/LQO/WB and POLQA (Narrowband, Wideband, Super wideband) to produce Mean Opinion Scores.

With **VQT**, **VQuad™**, **Voice Analysis Tool (VAT™)**, and **vMobile™** handheld device, this solution offers end-to-end assessment with automated call control and traffic simulation for tests on Wireless, IP, PSTN, and TDM networks. All the events/results from this solution are sent to Central Database, accessed through **GL WebViewer™** (web browser).

Ethernet/IP Network Test Solutions - PacketExpert™ (10G, 2.5G, 1G Carrier Grade Ethernet Networks)

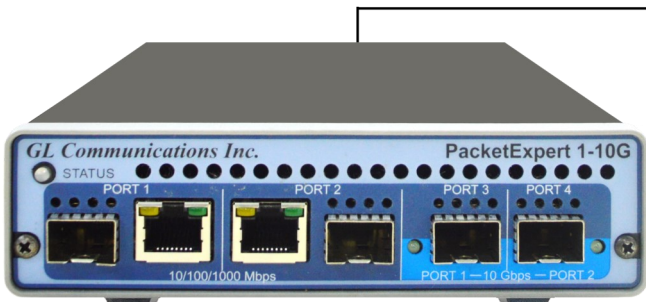

PacketExpert™ 10GX
(10G/2.5G/1G)

USB 3.0

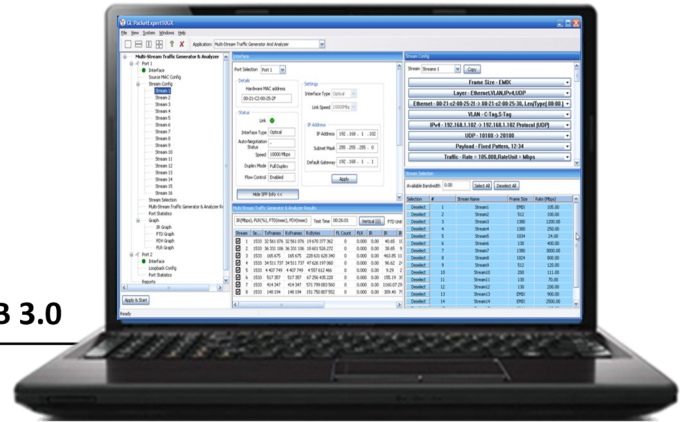

Overview

Testing the performance of high-speed Ethernet links is challenging and requires specialized hardware. [PacketExpert™ 10GX](#) is a multi-functional ethernet tester that supports both Electrical and Optical interfaces. It can conduct a wide variety of testing including Bit Error Rate Testing (BERT), RFC 2544, Wide Area Network Emulation, Packet Recording and Playback, Multi-stream UDP/TCP traffic generation and ITU-T Y.1564 testing for verifying service level agreements. It supports testing up to 10 Gbps. GL can also provide supporting SFPs and cables for a ready to use test solution.

The PacketExpert™ 10GX includes two 1/2.5/10 Gbps Ethernet ports and two 10/100/1000 Mbps Ethernet ports. The ports support Copper and Optical (single-mode and multi-mode) Small Form-Factor Pluggable (SFPs).

The test tool supports multiple functionalities - [Wire speed BERT](#), [Smart Loopback](#), [RFC 2544 Testing](#), [PacketBroker](#), [Record Playback](#), [ExpertSAM™](#), [Multi-Stream UDP/TCP Traffic Generator and Analyzer](#), and [ExpertTCP™](#).

PacketExpert™ 10GX is controlled by a Windows® PC via a USB 3.0 cable. The software features an easy-to-use Graphical User Interface where users can configure test parameters, start and stop tests, view real-time results and graphs, and export reports.

GL can supply the controlling computer in the same chassis as the PacketExpert™ 10GX. The chassis can come in a rack-mountable or Probe form factor. The rack-mount enclosure can include up to 6 PacketExpert™ 10GX devices. With additional CXN100 licensing, PacketExpert™ supports [Command line Interface](#) (CLI) to access all the functionalities remotely using Python, C# client APIs and MAPS™ CLI Client/Server architecture.

For more details, refer to [PacketExpert™- Multi-Functional Ethernet/IP Test Solution](#) webpage.

Ethernet/IP Network Test Solutions - PacketExpert™ (10G, 2.5G, 1G Carrier Grade Ethernet Networks)

Key Features

Ethernet / IP Testing

- Simultaneous generation /reception of Ethernet traffic at wirespeed
- Generate traffic up to the UDP layer with configurable frame length, and frame size with varying traffic rates
- User selectable Electrical and/or Optical interfaces for ports allows mixed technology testing
- Wire speed BERT, Loopback, RFC 2544, Record and Playback, ITU-T Y.1564 testing, IP Wide Area Network (WAN) Emulation capability, Network Tap Capability, Multi-stream Traffic Generation and Analysis, and RFC.6349 (TCP throughput testing)
- [Layer-wise Testing](#) - Generate traffic from Layer 1, Layer 2 (Ethernet), Layer 2.5 (Stacked MPLS), Layer 3 (IP) and Layer 4 (UDP/TCP)
- Customizable protocol headers

Automation and Remote Testing

- PacketExpert™ 10GX can be configured as server-side application based and controlled via standard C#, Python clients to automate execution of test scripts, read responses etc.
- Remotely control multiple PacketExpert™ 10GX from single client application

Wire speed BERT

- BERT is applicable for Layers 1, Ethernet (Layer 2), up to 3 Stacked VLAN (Q-in-Q), up to 3 Stacked MPLS (Layer 2.5), IP (Layer 3) and UDP (Layer 4)
- Capable of handling full wire speed BERT, in both directions Electrical/Optical ports
- Single as well as constant rate Bit Error and FCS Error Insertion
- User-defined header parameters for MAC, VLAN, MPLS, IPv4/IPv6 and UDP layers
- Multi-device support for wire-speed BERT and simultaneous BERT/Loopback applications

RFC 2544

- RFC 2544 is applicable for Layers Ethernet, MPLS, IPv4/IPv6
- Supports Throughput, Latency, Frame Loss, and Back-to-Back performance tests
- Uni-directional and bi-directional traffic can be generated and transmitted on single or dual Electrical/Optical ports
- User-defined configuration parameters such as frame size, trial duration, number of trials, etc.
- Multi-device support for single and dual ports RFC 2544 application

Loopback

- Loopback is applicable for Layers Ethernet, MPLS, IPv4/IPv6, and UDP
- Supports both smart loopback (auto layer detection) and user-defined layer-wise loopback capabilities for incoming traffic
- Multi-device support for all port loopback application

Ethernet/IP Network Test Solutions - PacketExpert™ (10G, 2.5G, 1G Carrier Grade Ethernet Networks)

mTOP™ Ethernet Probe

The PacketExpert™ 10GX can be placed in a mTOP™ Probe unit which includes a Single Board Computer making it suitable for field testing. Users do not need to carry a separate laptop. The mTOP™ Probe is lightweight and comes with all software and licenses pre-installed.

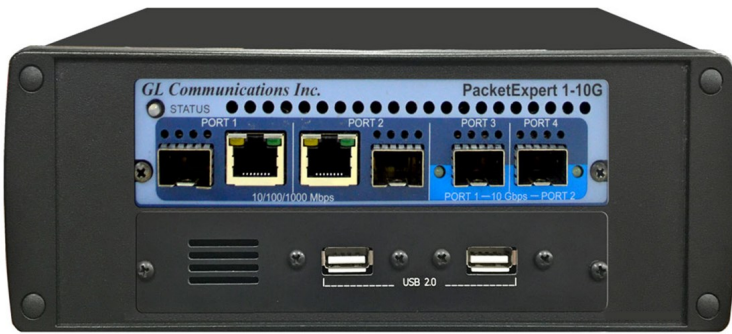

Front Panel



Back Panel

mTOP™ Multi-Port Rack-mount Enclosure

The PacketExpert™ 10GX can be placed in a mTOP™ 1U or 2U rack mount enclosure. Up to six devices can be housed in the 2U rack-mount enclosure. It is ideal for testing multiple ports simultaneously on industry grade switches and other network infrastructure.

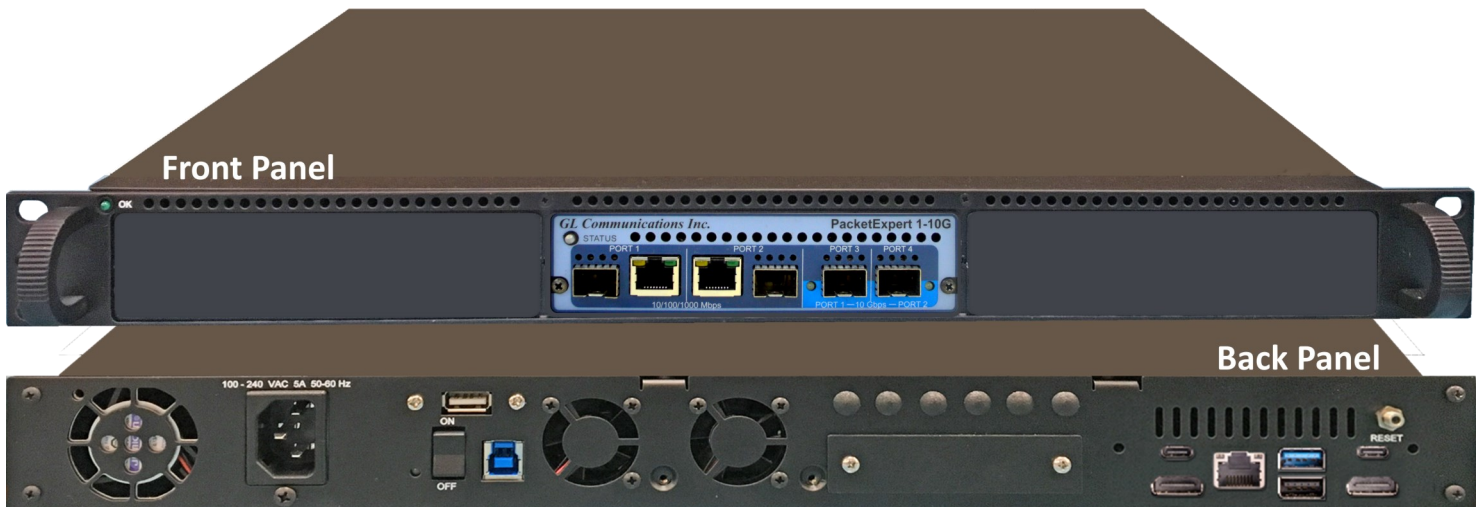

Front Panel

Back Panel

Ethernet/IP Network Test Solutions - PacketExpert™ 100G (Next-Generation 100G Carrier-Grade Ethernet Networks)

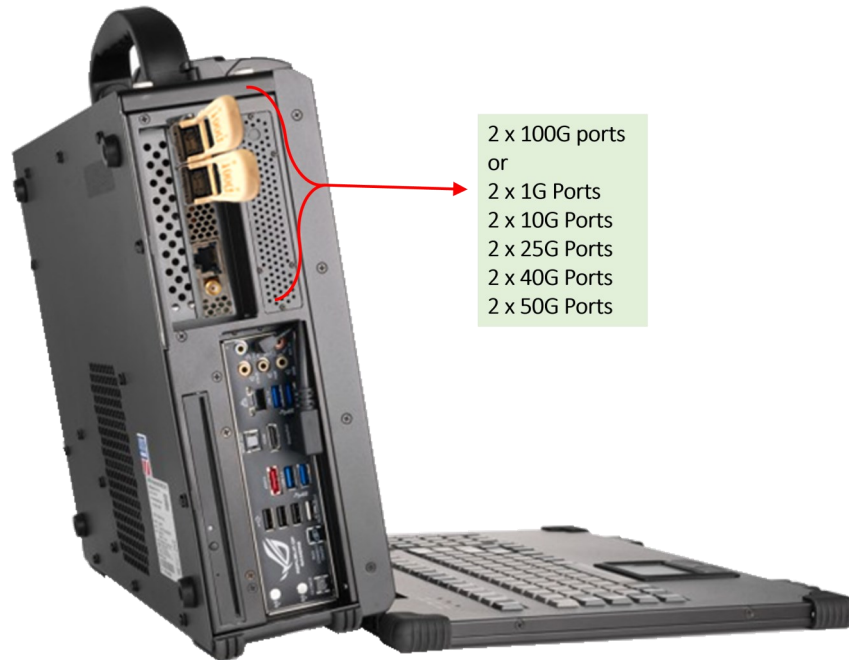

2 x 100G ports
or
2 x 1G Ports
2 x 10G Ports
2 x 25G Ports
2 x 40G Ports
2 x 50G Ports

Overview

GL's [PacketExpert™ 100G](#) is a cutting-edge hardware platform designed for extensive testing of wire-speed Ethernet and IP networks, supporting speeds of up to 100 Gbps. The PacketExpert™ 100G is a high performance appliance with specialized network interface cards, GL's proprietary PacketExpert™ software, large RAM and storage, with optimized processing, and cooling capability. It is available in rack-mount and portable platforms.

This versatile device comes with a web-based user interface. All functionalities can be easily accessed through any standard web browser, allowing convenient control from multiple locations and various access devices such as PCs, laptops, and tablets.

PacketExpert™ 100G can perform [Bit Error Rate Testing \(BERT\)](#), [Loopback Testing](#) and [RFC 2544 Testing](#) (throughput, packet loss and latency measurements) methodologies. Each 100G port provides independent Ethernet/VLAN/MPLS/IP/UDP layer-wise testing at wirespeed. BERT, RFC 2544, and Loopback applications are implemented on all transport Layers including Layer 2 (Ethernet), Layer 2.5 (VLAN / MPLS), Layer 3 (IPv4 / IPv6), and Layer 4 (UDP).

For more details, refer to [PacketExpert™ 100G - Comprehensive Ethernet/IP Testing Solution](#) webpage.

Ethernet/IP Network Test Solutions - PacketExpert™ 100G (Next-Generation 100G Carrier-Grade Ethernet Networks)

Key Features

PacketExpert™ 100G Hardware - Portable/Rack-mount

- Portable PCIe based hardware supports 2*100G ports
- Upgradeable to 4 x 100G ports or 10 x 100G ports with Portable Lunchbox PC
- Supports QSFP28 form factor
- Supports 1G, 10G, 25G, 40G, 50G and 100G speeds on the same ports

Web based User Interface

- Includes web-based interface, accessible through all standard web browsers across different operating systems
- The web interface allows multiple users to connect to a single web server and independently run tests on different hardware units
- Control multiple devices from a single GUI, multiplying the number of ports available per system

Wirespeed Ethernet/IP Testing

- Simultaneously generate and receive Ethernet traffic at 100% wire-speed (bidirectional 100 Gbps rate)
- User-configurable frame size and rate
- Wire speed BERT, Smart Loopback and RFC 2544 applications
- Test at Ethernet (Layer 2), VLAN / Stacked MPLS (Layer 2.5), IP (Layer 3 including IPv4 and IPv6) and UDP (Layer 4)
- Multi-board support for all the applications for high density testing
- Bit Error Rate Testing (BERT) supports industry standard PRBS patterns – 2^9-1 , $2^{11}-1$, $2^{15}-1$, $2^{20}-1$, $2^{23}-1$ and $2^{31}-1$, as well as user defined static patterns
- Python Application Programming Interfaces to allow scripting and automation (coming soon)
- Real-time results are displayed in both tabular and graphical representations
- Test result reports available in PDF and CSV file formats
- Detailed frame statistics presented in tabular format for all the ports

Wire speed BERT Across all layers

- BERT is applicable for Layers 1, Ethernet (Layer2), up to 3 Stacked VLAN (Q-in-Q), up to 3 Stacked MPLS (Layer 2.5), IP (Layer3) and UDP (Layer4)
- Intentionally introduce bit errors individually or at a desired rate
- User-defined header parameters for MAC, VLAN, MPLS, IPv4/IPv6 and UDP layers
- Multi-device support for wire-speed BERT and simultaneous BERT/Loopback applications to increase the number of parallel BERT tests
- Real-time graphical representation of the combined Throughput and Bit Error rate can be plotted over time for BERT testing

RFC 2544 Network Testing

- RFC 2544 is applicable for Layers Ethernet, VLAN, MPLS, IPv4/IPv6
- Supports Throughput, Latency, Frame Loss, and Back-to-Back performance tests
- Uni-directional and bi-directional RFC 2544 testing supported
- User-defined configuration parameters such as frame size, trial duration, number of trials, etc.
- User selectable single or dual ports RFC 2544 testing
- Multi-device support for multiple parallel RFC 2544 tests
- Graphs and Statistics for all the RFC 2544 tests

Smart Loopback Testing

- Supports smart loopback (auto layer detection)
- Multi-device support for all port loopback application to increase the number of simultaneous Loopback ports

Ethernet/IP Network Test Solutions - PacketExpert™ 100G (Next-Generation 100G Carrier-Grade Ethernet Networks)

Multiple Users with Multiple Servers and Boards

The PacketExpert™ 100G Web interface allows users to access multiple servers located in different areas within the same Local Area Network. This allows for seamless connectivity and management of multiple PacketExpert™ 100G devices from a single server, enhancing efficiency and control.

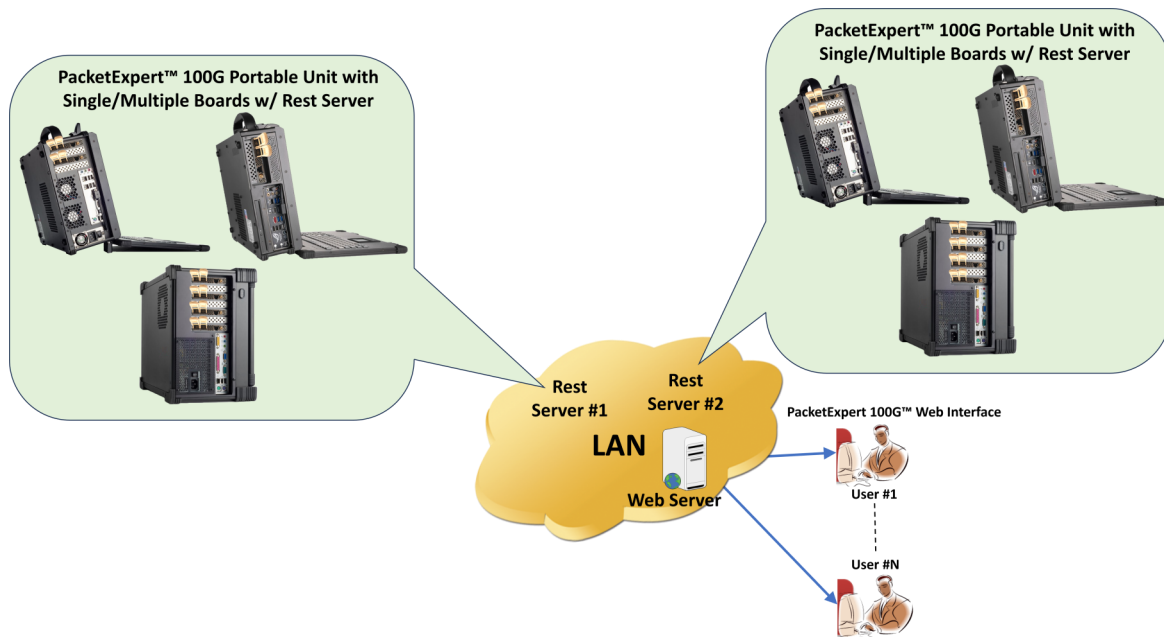

PacketExpert™ 100G - Multiple Users with Multiple Servers and Devices

PacketExpert™ 100G Web Interface Screenshot:

Navigation: Dashboard, Servers, Event Log, Admin

Menu: Devices, Ports, BERT, RFC 2544, Settings, SFP Info, SFP Monitor, Alarms/Errors

Buttons: Load, Save, Quick Config

Device	Port	SFP Description	Link Speed	FEC	Laser	MAC Address ✓ HW MAC Address	IP Address	Subnet Mask	Default Gateway	IPv6 Address
Device1	Port1	QSFP28+CWDM4	100 G	✓ MAC	ON	✓ 00-0D-E9-08-F1-96	192.168.1.201	255.255.255.0	192.168.1.1	1111:1111:1111:1111:1111:1111:0011
	Port2	QSFP28+SR	100 G	✓ MAC	ON	✓ 00-0D-E9-08-F1-97	192.168.1.202	255.255.255.0	192.168.1.1	2222:2222:2222:2222:2222:2222:0012
Device2	Port1	QSFP28+CWDM4	100 G	✓ MAC	ON	✓ 00-0D-E9-08-F1-7B	192.168.1.55	255.255.255.0	192.168.1.1	1111:1111:1111:1111:1111:1111:0021
	Port2	QSFP28+SR	100 G	✓ MAC	ON	✓ 00-0D-E9-08-F1-7C	192.168.1.56	255.255.255.0	192.168.1.1	2222:2222:2222:2222:2222:2222:0022
Device3	Port1	SFP/SFP+/SFP28+	25 G	✓ MAC	ON	✓ 00-0D-E9-08-F1-84	192.168.1.68	255.255.255.0	192.168.1.1	1111:1111:1111:1111:1111:1111:0011
	Port2	SFP/SFP+/SFP28+	25 G	✓ MAC	ON	✓ 00-0D-E9-08-F1-85	192.168.1.69	255.255.255.0	192.168.1.1	2222:2222:2222:2222:2222:2222:0012

PacketExpert™ 100G with Multiple Devices Link Status

PacketCheck™ - Software Ethernet/IP Tester

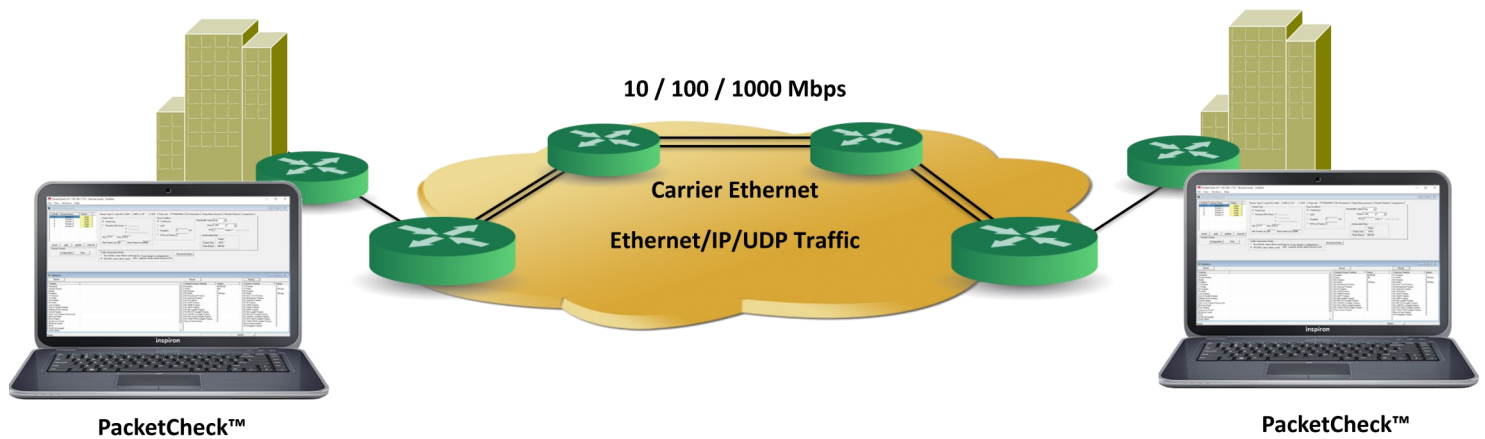

Overview

GL's [PacketCheck™](#) is a PC based Ethernet / IP test tool that provides multi stream capabilities with BERT, Throughput and Delay, and Impairment testing features with on-demand bandwidth (up to 500 Mbps). It is a general purpose network performance analysis tool for 10 Mbps, 100 Mbps and 1 Gbps LANs and WANs. Throughput up to 500 Mbps can be tested.

PacketCheck™ can generate traffic at multiple layers, from raw Ethernet frames to Stacked VLAN, Stacked MPLS, and IP packets (with UDP payloads). PacketCheck™ uses the host PC's Network Interface Card to transmit and receive Ethernet frames over the network.

The application measures end-to-end performance such as Bit Error Rate, Bit Error Count, Total Packets, Packet Loss, Out-of-Sequence Packets, Errored Packets, Round Trip Delay, and One Way Delay. Additional features include transmission of pre-recorded file traffic, recording per stream traffic to file, GTP traffic simulation, traffic generation with IFG (Inter Frame Gap) of up to 5 msec accuracy, impairment generation, and BER testing capability with provision to generate PRBS patterns or user-defined test patterns. Supports recording of the user defined stream traffic to a PCAP (PCAPNG/NTAR) or HDL (GL Proprietary) file format and playback the pre-recorded traffic from a PCAP (PCAPNG/NTAR) or HDL (GL Proprietary) file format.

For more information, refer to [PacketCheck™ - Software Ethernet/IP Tester](#) webpage.

Applications

- Create multiple streams of traffic for network testing from layer 2, 3, or 4
- Bit Error Rate Testing for checking networks for dropped packets, out-of-order, non-test frames, and so on. Write packet errors to an error log
- Determine Round Trip Delay between two IP addresses or two Ethernet MAC addresses with microsecond accuracy
- Determine One Way Delay between two Network Interface Cards on the same test PC with microsecond accuracy
- Record test traffic in binary and/or PCAPNG or NTAR file format
- Playback PCAPNG files for test traffic generation. Either recorded from test BERT traffic or recorded traffic of interest
- Record non-test packets to a PCAPNG file. i.e. Non-BERT traffic related packets

PacketCheck™ - Software Ethernet/IP Tester

Key Features

- Test Ethernet traffic of up to 500 Mbps bandwidth. Supports minimum line rate of 64 Bps
- Generate full duplex traffic at any of the four layers (Layer1, Layer2 (Ethernet) with stacked VLAN/ MPLS, Layer3 (IPv4), Layer4 (UDP)) with on-demand bandwidth
- Capture stream traffic in PCAP (PCAPNG/NTAR) or HDL file format
- Playback pre-recorded traffic from PCAP (PCAPNG/NTAR) or HDL file format
- Provides options to record unidentified network traffic which does not belongs to any user defined stream into a PCAP (PCAPNG/NTAR) or HDL file format and analyze the recorded traffic in Wireshark or PacketScan™ application
- Supports stacked VLAN (up to 3 stacks) and customizable stacked MPLS (up to 3 stacks)
- Measures throughput, round trip delay, one-way delay, total packets, packet loss, out of sequence frames, error frames, correct pattern frames
- BER Testing - Bit Error Rate, Sync Loss Count, Bit Error Count, PRBS Pattern Generation/Verification of various patterns like QRSS, 2^6-1 , 2^9-1 , $2^{11}-1$, $2^{15}-1$, $2^{20}-1$, and $2^{23}-1$
- Run-time impairments generation of various types including Insert/Delete Bytes, and Byte Level Impairments (AND, OR, XOR)
- Jumbo frames supported
- Display statistics for each stream independently as well as aggregate statistics
- Independently define each stream to operate as Layer 2 (Ethernet) or Layer 3 (IP) or Layer 4 (UDP)
- For Layer 3 or Layer 4 streams, analyzes the received payload based on the IP or UDP length and ignore any MAC padded bytes added in transit
- Define the frame size/rate to be generated for each stream independently
- Up to 500 Mbps total combined rate (all streams combined) is possible
- The transmission rate can be configured to operate in 2 modes – Burst mode or Inter Frame Gap (IFG) mode
 - ◆ In Burst mode, each stream's rate can be set in Mbps, Kbps, etc.
 - ◆ Burst mode tries to generate traffic with the configured rate, but also as smoothly and evenly distributed so that the Device Under Test (DUT) node buffers do not overflow due to a temporary spike in the peak traffic
 - ◆ In IFG mode, the Inter Frame gap in milliseconds can be configured. The estimated rate achievable based on the IFG and the frame size is displayed for user convenience
- Can be used as a Loopback device for sending traffic back to the source
- Capability to generate/respond to ARP requests, making it easy to work with Routers
- Measure One-Way Delay or Round Trip Delay
- Generate reports in XML or PDF formats
- Support to configure IP Protocol Type from 0 to 255
- Run multiple instances on a single PC to utilize all available Network Interface Cards

PacketScan™ - IP Network Monitoring and Protocol Analysis

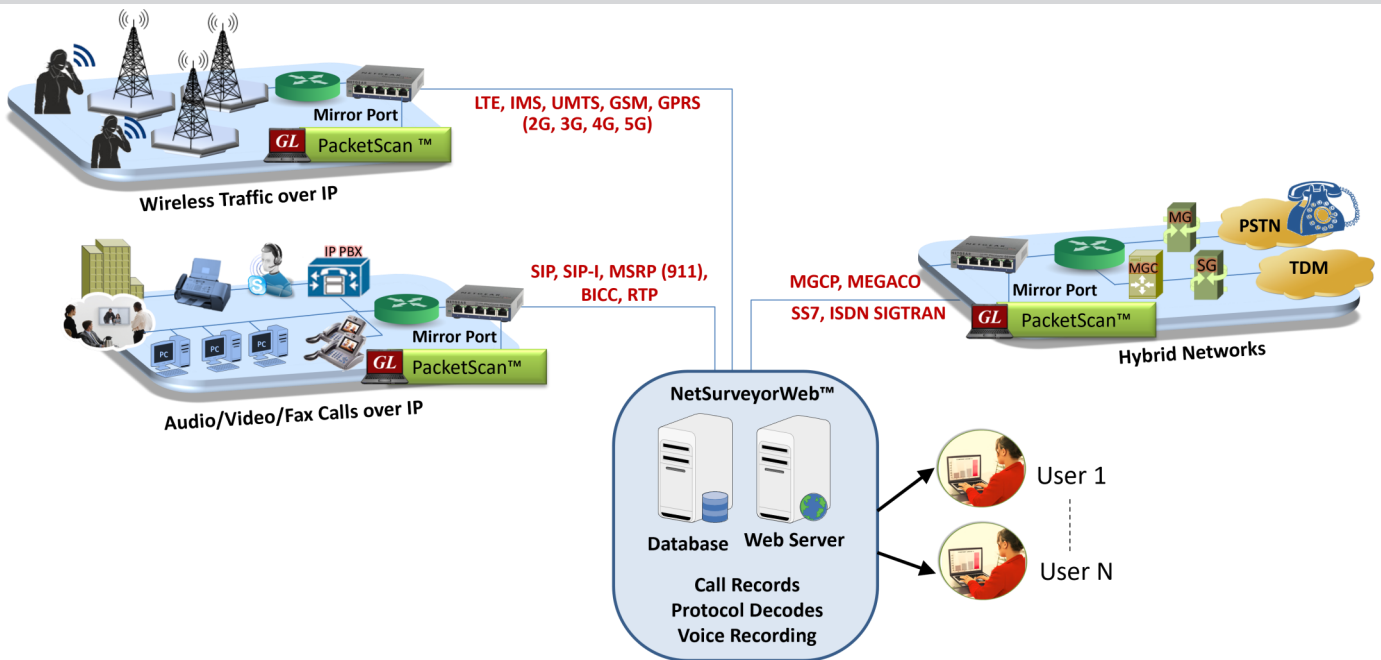

Overview

GL's [PacketScan™](#) - is a Protocol Analysis software for capturing Ethernet and IP traffic. The application captures packets and intelligently groups them into Call Detail Records. It can decode all VoIP and Wireless protocols and provides Quality of Service statistics on the voice calls. PacketScan™ is available both as a software solution and as a hardware appliance known as [PacketScan™ HD](#). This network monitoring appliance captures and analyzes high-speed Ethernet traffic over a range of network speeds including 1 Gbps, 10 Gbps, 25 Gbps, 40 Gbps, and 100 Gbps. It supports the [FastRecorder™](#) and [PacketExtractor™](#) application for wirespeed IP traffic filtering and recording capabilities of up to 320 Gbps directly onto disk for offline filtering, extraction, and analysis. These applications are equipped to support various Ethernet interfaces such as 4 x 1 Gbps or 2 or 4 x 1/10 Gbps or 2 x 25/40/100 or 8 x 10 Gbps Ethernet interfaces.

[Packet Data Analysis \(PDA\)](#) is part of the PacketScan™ software program and allows users to monitor live IP networks including capture, analysis, and reporting of every call in detail. Supported protocols include SIP, MSRP, MEGACO, MGCP, H.323, SCCP, RANAP (UMTS IuCS), GSM A, CAMEL, BICC, ISUP, MAP, Gb, and GTP. It can capture IP packets over different transmission lines, including IP, T1, E1, T3, E3, and OC -3 STM-1 / OC-12 STM-4. PDA then processes the captured packets, identifies, and segregates calls based on signaling and traffic parameters.

[PacketScan™ 5G](#) protocol analyzer efficiently captures, segregates, monitors, and gathers statistics for all calls conducted across N1, N2, N4, N8, N12, and N13 interfaces within the 5G network.

[TCP Analytics](#) application analyzes TCP connections between both internal Local Area Network (LAN) and external Wide Area Network (WAN) computers including servers and clients. The application helps troubleshoot large bandwidth consumption, failed TCP sessions, packet loss, poor TCP throughput and more. TCP Analytics is an optional application with PacketScan™.

In addition, PacketScan™ can work with [NetSurveyorWeb™](#) a web-based dashboard for centralized network monitoring. It features rich graphics, ladder diagrams and call detail records. NetSurveyorWeb™ collects data and provides comprehensive analysis of network health, detailed protocol monitoring with historical data retention.

For more details, refer to [PacketScan™ - All-IP Analyzer](#) webpage.

PacketScan™ - IP Network Monitoring and Protocol Analysis

Key Features

- Capture real-time calls over packet network for infinite time
- Enhanced to support Non Access Stratum (NAS), Next Generation Application Protocol (NGAP), Packet Forwarding Control Protocol (PFCP), Xn Application Protocol (XnAP) protocols
- PDA feature in Packetscan™ provide a complete call flow of a 5G session
- Analyze with rich graphics, ladder diagrams, call trace
- Flexibility to add any protocol field to the summary view, filtering, and search features
- Complex filtering and search capabilities to record all or filtered traffic into a trace file
- Option to create multiple aggregate column groups and prioritize the groups as per the requirement to display the summary results efficiently
- Allows the user to automatically create search/filter criteria from the current screen selection
- Consolidated interface allows access to all the important settings and auto-startup actions
- Permits analysis of adherence to protocol standards for the system under test or observation
- Graphical representation of statistics including ladder diagrams of VoIP calls
- Analyze recorded trace files offline
- Decrypt and analyze Voice over Long-Term Evolution (VoLTE) calls secured over Internet Protocol Security (IPsec) connection
- Decode support for multi-layer tunnelled traffic - GTP, GRE, VXLAN
- Supports BFD protocol decode
- Enhanced to support export frame summary for tunnelled traffic
- Supports decoding of [eCPRI](#) protocol
- Supports Encapsulating Security Payload (ESP) protocol to decrypt ESP packets on both IPv4 and IPv6 by providing ESP SAs value
- PacketScan™ can work with GL's [Voice Band Analyzer \(VBA\)](#) and [Call Data Records \(CDR\)](#) applications to generate CDRs as (*.CSV files) along with voice files for each direction
- The call detail records are used for further analysis using built-in [Excel®](#) tools
- Supports decoding of almost all industry standard signaling protocols
- SIP ED-137 / ED-138 for Air Traffic Monitoring (Air-to-Ground, Ground-to-Ground Calls and Record interface)
- Live monitoring Ipv4 and IPv6 (version 4 and version 6) networks; users can listen / record a session in real-time and extracts Fax images into TIFF format
- Monitors QoS on voice and video calls; perform power, frequency, spectral, tone and digit analysis, and video analysis with ease and precision; get an exact picture of QoS

VQuad™ Voice Quality Testing

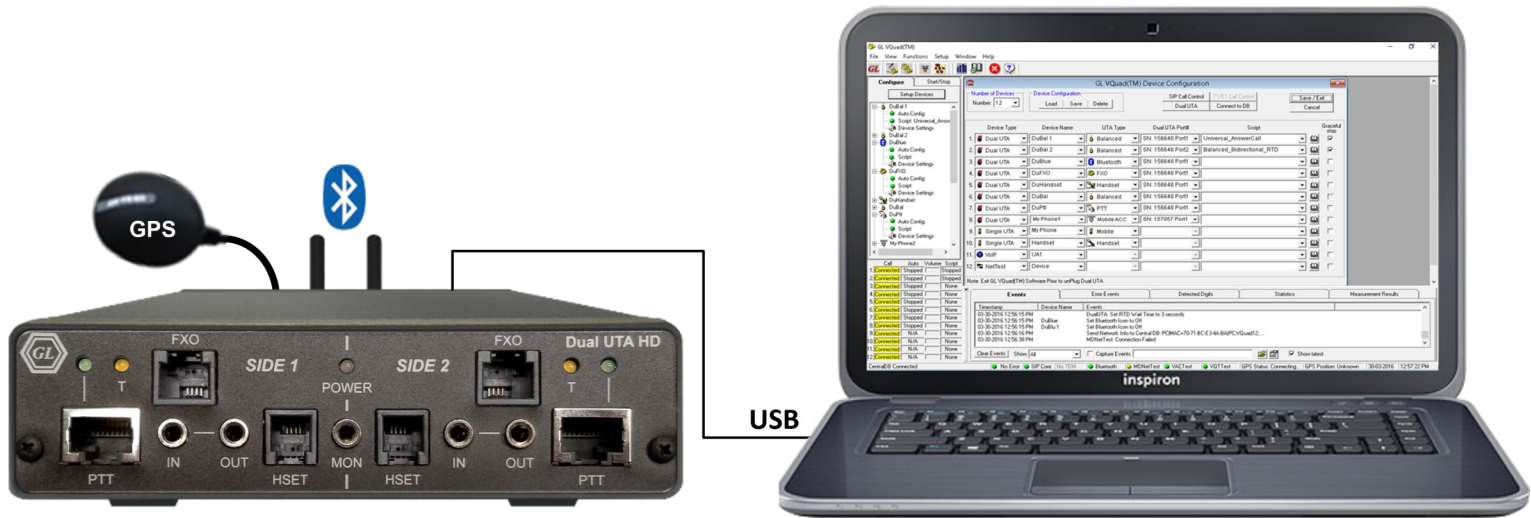

Overview

The VQuad™ with [Dual Universal Telephony Adapter \(UTA\) HD](#), offers a comprehensive solution for sending, recording, and testing voice, video, and data across diverse network interfaces. This one-box solution supports a wide array of interfaces, including Wireless (wired, Bluetooth®, Mobile ACC, Wi-fi, Broadband - 3G or 4G, LTE, 5G), VoIP, TDM, and Analog. The flexibility of VQuad™ extends to centralized and automated testing of Voice, Video, Data, and Fax quality, allowing seamless connection to any network, service, or interface.

The Dual UTA HD supports various interfaces and telephony devices. Noteworthy features include support for FXO Wide Band, hardware loopback controlled through the VQuad™ software (including self-test mechanisms), and compatibility with the Wired headset method. The latter facilitates the connection of mobile phones to the Dual UTA HD Push-to-Talk (PTT) interface using the GL Smartphone ACC cable. Additional enhancements include loopback functionality, increased flexibility in the VQuad™ Script, and comprehensive IPv6 support.

This solution analyzes the audio content within any Narrowband (NB), Wideband (WB), or Super Wideband (SWB) PCM audio file and generates a variety of audio metrics including Frequency Bandwidth, Speech Activity, Active Speech Level, Noise Level, DC Offset, and RMS Power. When both the Reference file (pre-defined file) and Recorded files are available, the solution can generate additional metrics such as Round Trip and One Way Delay measurement, Audio Dropout analysis, Double-Talk measurements, and Voice Quality Analysis (when also coupled with the [GL VQT POLQA solution](#)). Additional metrics of the captured audio includes Speech to Text analysis (IVR Testing) with pass/fail when coupled with the GL [Speech to Text Analysis solution](#).

Directed configurations enable the automatic sending and recording of sample voice files between telephony nodes, covering Bluetooth®, Mobile Monitor phones, wired Headset Smartphone ACC cable, PTT radios, RJ-11 POTS lines, Handset Phones (POTS, Digital, VoIP), and Balanced I/O networks. These files undergo analysis in GL's Voice Quality Testing (VQT) software, aligning with International Telecommunications Union (ITU) voice comparison algorithms.

Both VQuad™ and the stand-alone VQT software support the latest voice quality testing standard for fixed, mobile, and IP-based networks through POLQA (ITU-T P.863). POLQA analysis yields comprehensive results, including POLQA MOS, E-Model, Signal Level, Noise Level, and Jitter. Furthermore, VQT extends its support to other international voice quality test methods, such as PESQ (ITU-T P.862), PESQ LQ / LQO (P.862.1), PESQ WB (P.862.2). All the events/results from this solution are sent to Central Database, accessed through GL [WebViewer™](#) (web browser).

For more details, refer to [Dual UTA HD - HD Audio and Versatile Testing Capabilities](#) webpage.

VQuad™ Voice Quality Testing

Key Features

- Smaller (Compact) Hardware Design with PTT, FXO, GPS, In/Out Interfaces
- Interfaces to Mobile Phones, Smartphones, and Bluetooth® (NB and WB)
- Loopback Functionality with Cross-Loopback Support
- Interfaces to any Telephone Subscriber Instruments
- Supports WB FXO (HD Voice)
- Supports 2-Wire and 4-Wire Direct Loopback with or without Delay
- Supports 4-wire Outward Loopback for Codec Self-Test
- Voice, Data, Video Testing, Fax Events, Round Trip Delay and One-Way Delay Measurements
- Echo Identification and Analysis

Dual UTA HD - Hardware Interfaces

- **Mobile Phones:**
 - ♦ Bluetooth® – Works with all Bluetooth® phones for both call control and send/record audio functions. Bluetooth® also performs RSSI, Battery level functions, Network verification. Supports Bluetooth NB with Frequency Range 204Hz to 3404Hz, WB with Frequency Range: 204Hz to 7200Hz
 - ♦ Mobile audio interface for Smartphones (iPhone, Android) – includes Audio Headset Jack - 2.5mm (typical) for mobile phones, 3.5mm terminations for Smartphones (iPhone, Android)
 - ♦ Wired Headset Smartphone ACC connectivity - connects the mobile phone to the Dual UTA HD PTT interface using the GL Smartphone Automated Call Control (ACC) cable
- **Mobile Radios with Push-to-Talk functionality:** Provides radio keying and sends/records audio
- **RJ-11 POTS lines:** Detect dial tone, go off hook, CallerID detection, send digits (two stage dialing), answer calls, detect a variety of Special Information Tones (SIT), and much more as well as send/record audio for Voice Quality measurement
- **Handset Phones (POTS, Digital, VoIP):** Replaces handset of any telephone (POTS, Digital, VoIP) that contains a coiled cord and handset
- 2-wire Analog (WB, NB - FXO) supporting next generation gateways
- Dual UTA HD 4-wire analog interfaces supporting Tx/Rx Headset including HATS, Mobile Phone Headset, and any Handset Phone (RJ22 connection)

VQuad™ Voice Quality Testing

mTOP™ VQuad™ Dual UTA HD Probe

GL's VQuad™ mTOP™ Probe solution is an all-in-one self-contained VQuad™ with Dual UTA HD test instrument designed for conveniently testing multi-interface telephony devices for Smartphone/Handset Benchmark drive testing. A single VQuad™ mTOP™ Probe includes dual independent sides connecting to any type of telephony devices across various interfaces including FXO, 4-wire Analog, PTT, Handset Phones, Mobile audio, and Bluetooth.



Front Panel



Back Panel

mTOP™ Rack-mount VQuad™ Dual UTA HD

GL's VQuad™ mTOP™ solution is an all-in-one self-contained VQuad™ with Dual UTA HD test instrument designed for conveniently testing up to 12 independent telephony devices for Smartphone/Handset Benchmark Testing. A single VQuad™ along with up-to 6 Dual UTA HD units [Two-stacked 1U mTOPs], supports connection to 12 independent telephony devices. It has the ability to generate Wireless as well as 2-Wire and 4-wire analog calls using same hardware. Users can perform simultaneous Voice, Video, Data, Fax, and Time Delay Measurements from a single VQuad™ mTOP™ test solution - greatly reducing the licensing costs per device.



Front Panel

Back Panel

vMobile™ Hand-Portable Voice Quality Drive and Walk Testing



Overview

The GL [vMobile™](#) makes drive and walk testing simple and convenient. During the test you can connect to two mobile phones using the vMobile™ internal Bluetooth interfaces or connect to one mobile radio using the vMobile™ PTT analog interface. Automated testing is achieved using the vMobile™ scripting for placing and receiving calls as well as sending/recording audio during the established calls. Audio analytical metrics include Voice Quality MOS using the POLQA algorithm (ITU-P.863) or using the PESQ algorithm (ITU-P.862), with automated DAQ conversion if required. In addition to audio MOS, other metrics include one way and round-trip delay, signal and noise levels, audio dropout, frequency, and power analysis. In addition, call metrics such as failed or dropped calls are also provided. The vMobile™ can work with the VQuad™ solution where one end of the call is vMobile™ whereas other end of the call is VQuad™ with Dual UTA HD.

The vMobile™ includes embedded WiFi for control/status as well as sending results and recorded audio to a centralized system for real-time analysis. If WiFi is not available control and status of the vMobile™ can be done using a Bluetooth connection or directly from the onboard vMobile™ hardware menu. During the test, all results and events can be stamped with GPS coordinates using the onboard GPS receiver which includes external antenna to be used during drive testing while inside a vehicle. If testing inside a building or where GPS is not available, the vMobile™ [Indoor Tracking System \(ITS\)](#) can be used for plotting results.

vMobile™ Control including configuration, operation and status can be done using the vMobile™ Console web browser or Console app (installed on Android and IOS devices). If WiFi is unavailable all control can be done via Bluetooth connection and all captured audio files can be pulled off the vMobile™ for analysis by connecting the vMobile™ to a PC via the USB-C interface.

vMobile™ can also automate the GL NetTest (data testing) from any mobile device. NetTest includes an app (supports both Android and IOS devices) and can generate a variety of custom tests such as TCP (speed), UDP (capacity), HTTP, VoIP, FTP, DNS, and Video simulation. All results are sent to the same Central Database and can be plotted on Google Maps using the mobile device GPS receiver.

All results and events are sent to a Central database and accessed via the WebViewer™ (web browser). The WebViewer™ displays all measurements and call events and can generate Custom Reports which include line and bar graphs. Results can be plotted to Google Maps using custom pins depicting pass/fail and errors during the testing. From [WebViewer™](#) users can schedule automatic reports to be emailed to any address.

For more details, refer to [vMobile™ - Ultra-Portable Equipment for Voice & Data Testing](#) webpage.

vMobile™ Hand-Portable Voice Quality Drive and Walk Testing

Key Features

- Fully automated voice and data testing in any mobile network
- Automation includes remote operation of far-end vMobile™ or GL VQuad™ system
- Connect to any radio via wired headset
- Can operate either in Bluetooth mode or Analog mode (connect to any 4-wire Analog device including Mobile Radio with PTT)
- Automated mobile [Voice Quality Testing](#) using embedded Wi-Fi for connecting to Central system and supporting full remote configuration and operation
- Onboard battery with availability of small portable external battery providing up to 12 hours operation
- Hand Portable including several remote options for operation and configuration
- Operation and Configuration supported via web-browser Console or Android/IOS Console app
- Drive and Walk Testing fully supported using any Mobile Phone (any carrier) or Mobile Radio
- Supports GPS along with GL's ITS for automated drive and walk testing
- Supports Voice Quality Testing using POLQA (ITU-P.863) and PESQ (ITU-P.862) algorithms
- Supports several audio metrics including Signal and Noise levels, power, frequency, and Audio Dropout analysis
- vMobile™ scripting supports all operations including conditional statements
- Bluetooth supports both NB (8000 sampling) and WB, (16000 sampling)
- Supports fully automated operation including voice and enabling PTT
- Analog PTT supports NB, WB, and SWB (48000 sampling)
- Measure One Way Delay, PTT Audio Connection Delay time, PTT Grant Tone Delay time on Radio networks
- Fully automated tests while sending events/results to Central System for analysis and access (WebViewer™)
- Full Audio Analysis using GL VAT™ supports One Way and Round-Trip Delay measurements, Signal and Noise Levels, Speech Activity, Audio Dropout Analysis along with additional analytical functions
- Access all results via a web browser (WebViewer™) and view results on Google Maps and generates custom reports
- Network independent Drive/Walk Testing solution (supports any Network and any Carrier)
- Plot results using GPS coordinates or ITS (Indoor Tracking System) when GPS is not available
- The vMobile™ runs independent of Network connection and can be controlled directly from the onboard menu or via Bluetooth connection. All network drops (both data and voice) are recorded to the vMobile™ logs and can be retrieved through the vMobile™ Console
- Test measurements along with GPS and ITS information are sent to a central database. Results can be queried/filtered, plotted on Google Maps or ITS Viewer, and exported to a customizable report

vMobile™ Hand-Portable Voice Quality Drive and Walk Testing

Applications

[Indoor Tracking System \(ITS\)](#) functionality provides plotting of voice quality results to an indoor location in areas where GPS is not available. Indoor locations include underground train stations, inside buildings, tunnels, or any location where users wish to plot Voice Quality and GPS is not available. The ITS results include the voice quality measurements (based on user-defined ratings) plotted against the user-provided graphical location map. ITS is an optional application available within the **VQuad™** and **vMobile™** for both online and offline viewing of the results associated with the ITS.

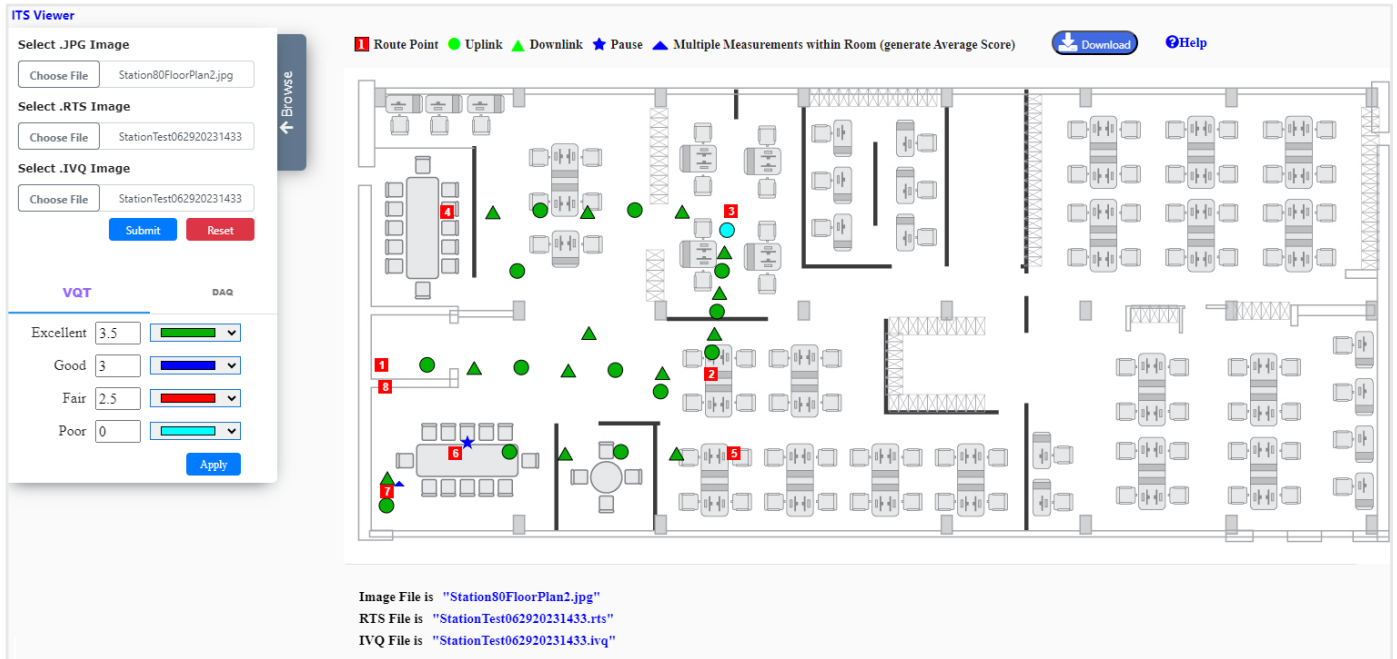

GL's [Voice Analysis Tool \(VAT™\)](#) application is used to analyze the audio content within PCM audio files and generates a variety of audio metrics. VAT™ has a user-friendly interface to perform manual and automated analysis of multiple tests using a single PCM audio file received from the VQuad™, vMobile™, or any other applications.

GL's [Voice Quality Testing \(VQT\)](#) software utilizes various ITU standard algorithms, including Perceptual Objective Listening Quality Assessment (POLQA) version 2.4 and optional upgrade version 3 (ITU-T P.863), Perceptual Evaluation of Speech Quality (PESQ ITU-T P.862), PESQ LQ/LQO (P.862.1), and PESQ WB (P.862.2) to support next-generation voice quality testing standards for fixed, mobile, and IP-based networks. The software evaluates voice quality across multiple parameters by analyzing received (degraded) files and comparing them with sent (reference) files using both manual and automated methods.

GL also offers an advanced, automated solution [AutoVQT™](#) that evaluates thousands of voice files in mere minutes, utilizing the industry benchmark algorithm POLQA (ITU-T P.863 version 2.4) to evaluate voice quality across various applications, including VoIP, Mobile, and PSTN networks.

vMobile™ Hand-Portable Voice Quality Drive and Walk Testing

Google Maps Plotting

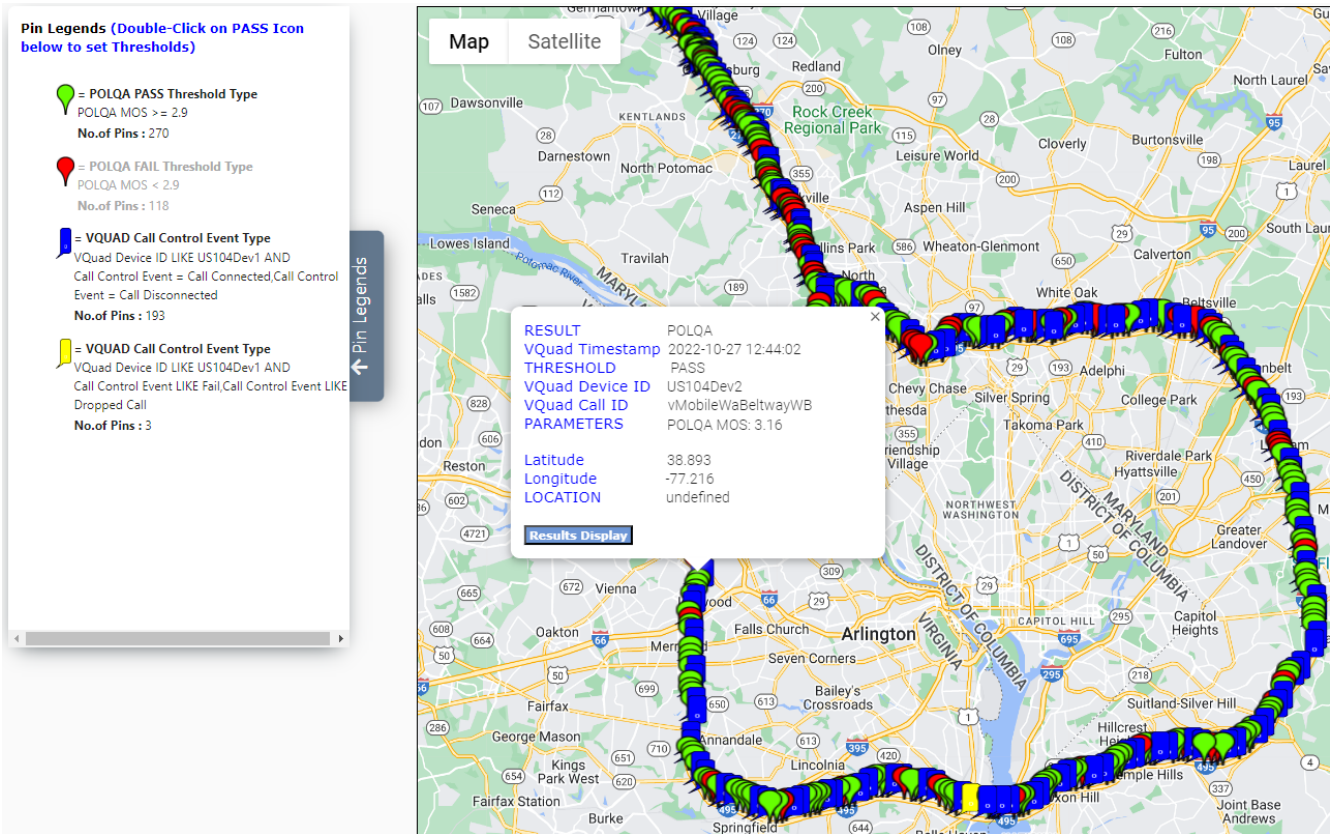

Google Maps plotting option is provided to display the GPS coordinates of various results, vMobile™, VQuad™ Nodes, and Mobile Devices. Results include PESQ and/or POLQA® scores, Data tests, Call Connect Events, EMU, FAX, and VBA tests. These are differentiated using color codes and text call-outs. Plotting can be done in real-time while drive testing and also while testing at a location.

Google Maps plotting can be customized based on the specific map configuration. The customized map plotting can be further refined by choosing the test parameter such as VQuad™ location, VQuad™ Phone ID, Call Events, Threshold Settings; and other result types.

Within the map, any node result details such as Result type, Device PhoneID, Device Name, GPS Position, and Location of the test result can be obtained. Users can also get the individual device or application status or result statistics.

The figure above depicts a real drive test conducted on the I-495 Beltway around Washington D.C. Periodic tests of voice quality using the POLQA® algorithm were computed and plotted in real time.

T1 E1 Monitoring, Analysis and Emulation Capabilities

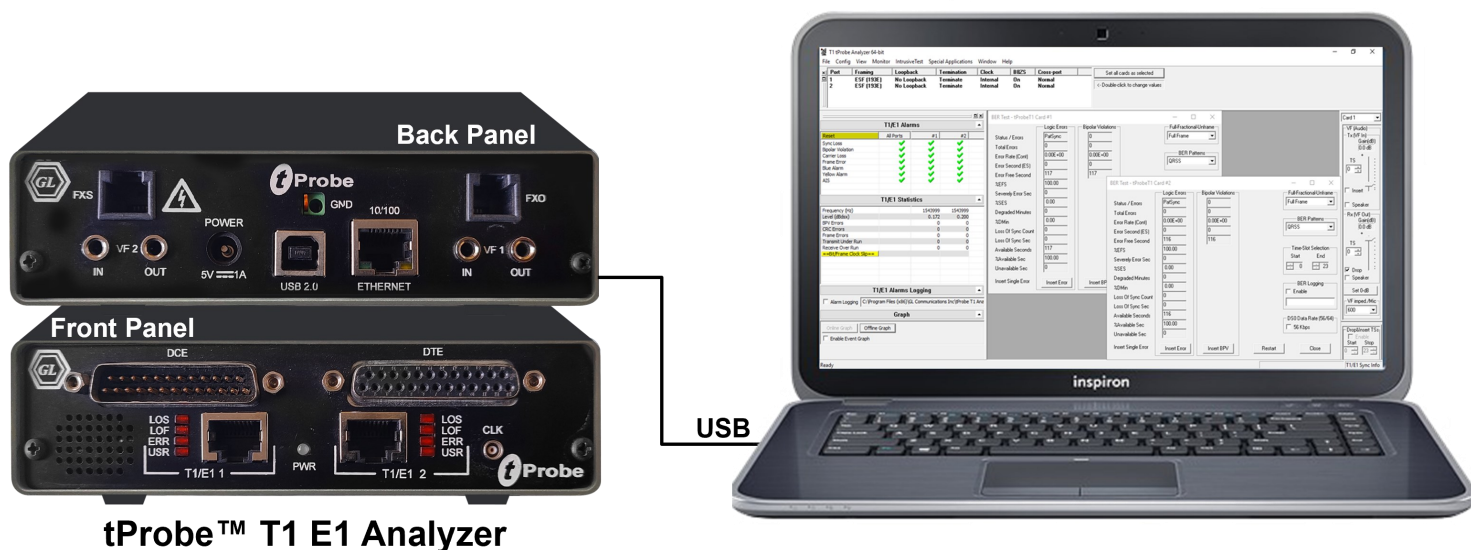

tProbe™ T1 E1 Analyzer

Overview

GL's [tProbe™](#) is a test and measurement device for many legacy networks including T1, E1, Analog and Datacom. These networks are still used throughout the world due to their reliability and the prohibitive expense of removing such infrastructure. The tProbe™ can monitor and emulate common voice protocols including ISDN, SS7, CAS, etc. The tProbe™ also includes optional boards such as Datacom (DCE or DTE) and FXO FXS ports. The FXO port on the tProbe™ can simulate a two-wire FXO device such as a telephone or a fax machine.

The [tProbe™ Datacom Analyzer](#) is designed for the installation, verification, and maintenance of data communication and telecom equipment. It offers a software-selectable interface for emulating DTE and DCE, as well as monitoring data communication lines for both synchronous (sync) and asynchronous (async) modes of operation.

The tProbe™ is controlled by a Windows® PC via a USB connection. The tProbe™ software includes an easy-to-use Graphical User Interface for configuring ports, test parameters, starting and stopping tests and exporting results. It also includes Python scripting capability.

In addition, GL also provides [T1 E1 Octal/Quad Card](#) PCIe based solution for higher density which supports multiple T1 E1 ports for analyzing and emulating TDM networks. Multiple PCIe cards can be placed in a single server grade PC for enhanced scalability.

For more details, refer to [tProbe™ - T1 E1 VF and Serial Data Analysis and Emulation Hardware](#) webpage.

T1 E1 Monitoring, Analysis and Emulation Capabilities

Key Features

- Comprehensive analysis/emulation of Voice, Data, Fax, Protocols (such as SS7, ISDN, Frame Relay, GSM, HDLC, PPP, V5.X, MLPPP, ATM, CAS), Analog, and Digital signals, including Echo and Voice Quality testing
- Monitor T1 E1 line conditions such as frame errors, violations, alarms, frequency, power level and clock (or frame/bit) slips. Monitor all timeslots in real-time
- T1 E1 Pulse Shape, Jitter Measurement Analysis, and Jitter Generation
- Software selectable T1 or E1 interface along with Drop and Insert
- tProbe™ FXO and FXS board allows simulating FXO and FXS ports. The FXO port is used to simulate a two-wire FXO device such as a telephone or a fax machine. The FXS port is used to simulate a 2-wire FXS service such as a telephone wall jack
- Datacom board supports V.24, V.35, V.36, RS-449, RS-485, EIA-530, and EIA-530A interfaces and can be configured as DTE or DCE to test Channel Service Unit (CSU) and Data Service Unit (DSU) entities
- Physical layer analysis includes the ability to send alarms and errors via SNMP Traps
- Enhanced VF Drop and VF Insert Capabilities using 3.5mm Balanced (Stereo), or Unbalanced (Mono) physical connections
- Python scripting support on both Windows® and Linux® operating systems
- Routing and Bridging emulation over Multi T1 E1 WAN interfaces using MLPPP (Multi Link PPP) and Multi Link Frame relay (MFR) protocols
- Call Recording, generation, and monitoring for hundreds to thousands of calls in one platform
- Capable of simulating as well as decoding and demodulating fax calls over T1 E1 lines using Fax Simulator and FaxScan™
- Cross-port Through and Cross-port Transmit modes configurations make cabling with Drop/Insert and Fail-Safe Inline monitoring easy
- Lightweight (1.24 lbs) and small footprint (6.05" x 5.55" x 1.60")

T1 E1 Monitoring, Analysis and Emulation Capabilities

mTOP™ Probe

The controlling computer can be placed into the same chassis as the tProbe™. This configuration is called the 'mTOP™ Probe'. The controlling computer comes pre-installed with all software and licenses. It contains an Ethernet port for remote accessibility (via Remote Desktop Protocol), HDMI and USB ports for monitor, mouse and keyboard. This solution retains portability and is ideal for field testing.



Front Panel



Back Panel

Rack-mount tProbe™

The tProbe™ and controlling computer can be placed into a 1U rack-mount chassis. This configuration is called the 'mTOP™' and is ideal for long term testing from a single location such as a network room or lab environment.



Front Panel

Back Panel

2-Wire Analog FXO/FXS Bulk Call Generator

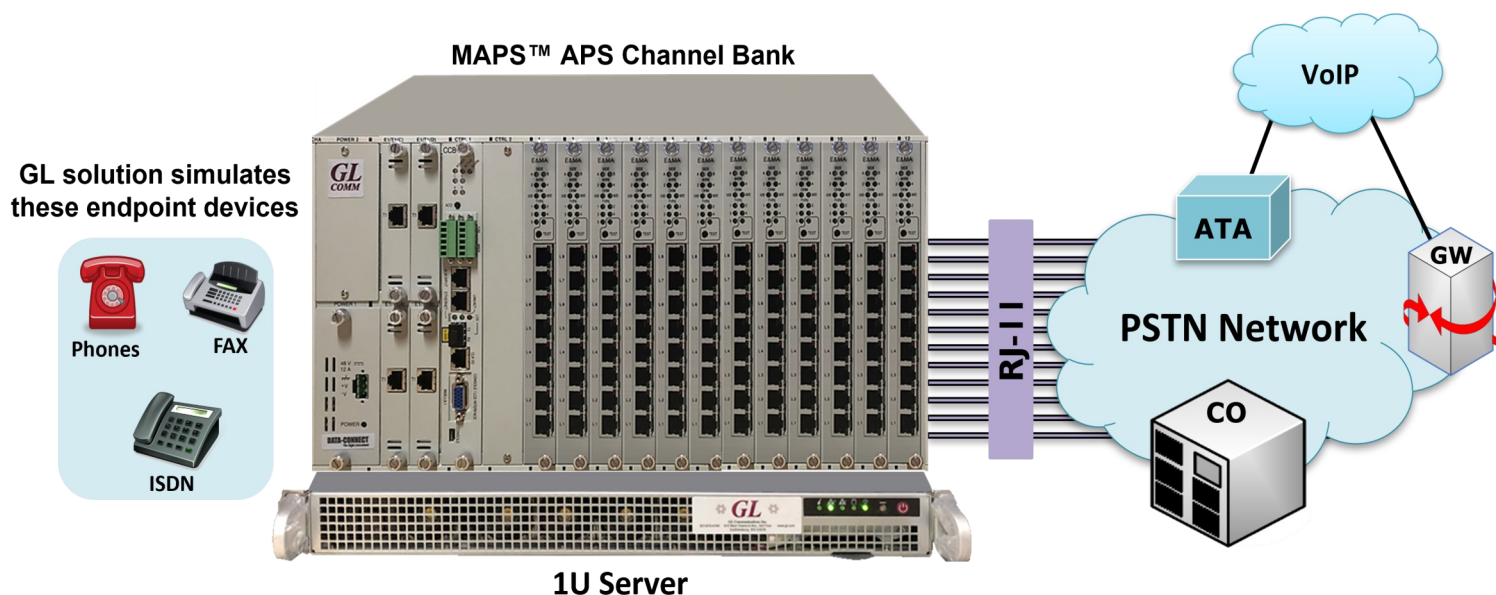

Overview

MAPS™ APS is a high capacity analog 2-Wire FXO/FXS (or 4-Wire E&M) Bulk Call Generator that performs quality assurance tests for Central Office, PBX, Analog Telephone Adapter, Gateway or other telecommunications equipment, which provide local loop interfaces. It includes server hardware, GL MAPS™ software, and channel bank(s), along with optional modules (Fax Emulation and Voice Quality Testing Analysis) in a compact rack-mount system. MAPS™ APS system supports up to 96 independent FXO ports or FXS ports per 1U MAPS™ APS/ALS server. More can be achieved by simply scaling the system with a 4U MAPS™ APS Server connected with 2 Octal T1 E1 Cards which can then support up to 384 analog ports.

MAPS™ APS supports Supplementary Service Testing and [Interactive Voice Response \(IVR\)](#) testing. Users can input DTMF digits or tones based on which the system presents a menu for automating various services. Provides high-density connection to any 2-wire analog interface for fully automated custom testing.

MAPS™ platforms offers automated, scripted, multi-user, multi-protocol, and high-capacity Bulk Call Generation. This platform is the basis for all signaling protocols and for traffic generation – whether voice, tones, digits, fax, data, or video, depending on the network support. MAPS™ covers legacy PSTN, TDM, SONET SDH, next generation VoIP, and wireless protocols, interfaces, and equipment. MAPS™ can support any of the following protocols in TDM networks for establishing signaling links and generate or receive traffic - CAS, FXO FXS, ISDN, SS7, PPP, GSM, INAP, CAP, and MAP.

For more information, refer to [2Wire Analog and 4Wire E and M Bulk Call Generator](#) webpage.

Supported Call Scenarios

- Caller ID
- Two-way Calling
- Three-way Conference Calling
- Three-way Calling with Calling Party Number ID
- VMWI – Voice Mail with MWI (message waiting indicator) and SDT (stutter dial tone)
- Call Waiting – Detect tone, Call ID, Flash to accept call
- Call Forwarding

2-Wire Analog FXO/FXS Bulk Call Generator

Key Features

- Up to 192 independent ports per MAPS™ APS
- Test central office, PBX, Gateway, Analog/Digital/VoIP networks
- Call monitoring and call recording
- Concurrent users and tests per system
- Fully Automated with CLI and external control
- Full FXO and FXS Functionality via flexible scripts
- Supports IVR using GL's Speech Transcription Server
- API support (Python, Java) for integration with automation frameworks
- Supports E&M (Type I, II, III, IV, V) signaling – immediate start, wink start, delay start
- Voiceband Measurement Tests using T1 E1 Ports and VF ports

FXO Capabilities

- Support for up to 96 independent FXO ports per MAPS™ APS
- Full FXO functionality via flexible scripts
- Narrowband supported
- Supports Loop Start and Ground Start signaling
- Supported call scenarios:
 - ◆ Caller ID
 - ◆ Two-way Calling
 - ◆ 3-way Conference Calling
 - ◆ 3-way Calling with Calling Party Number
 - ◆ VMWI – Voice Mail with MWI (message waiting indicator) , SDT (stutter dial tone) and SIT (special information tone)
 - ◆ Call Waiting – Detect tone, Call ID, Flash to accept call
 - ◆ Call Forwarding

FXS Capabilities

- Support Up to 96 independent FXS ports per MAPS™ APS
- Central office emulation with two way calling
- Supports Loop Start and Ground Start signaling
- User-programmable call progress tone generation for different countries/regions:
 - ◆ Dial tone
 - ◆ Ringback tone
 - ◆ Busy tone
 - ◆ Reorder tone
 - ◆ Howler tone (extended off-hook signal)
 - ◆ Ring generation with programmable ring cadence

Reporting

- Multi-User, Multi-Test reporting in PDF and CSV file formats
- Reports Executed, Successful, and Failed test cases
- Call Failure, Completion, and Call Drop (sustain calls) events
- Voice Quality Test MOS Scores
- Delay Measurements (one-way and round-trip)
- Summarization with Failure Details sufficient to determine root cause
- Central DB of events/results/errors

Message Automation and Protocol Simulation (MAPS™)

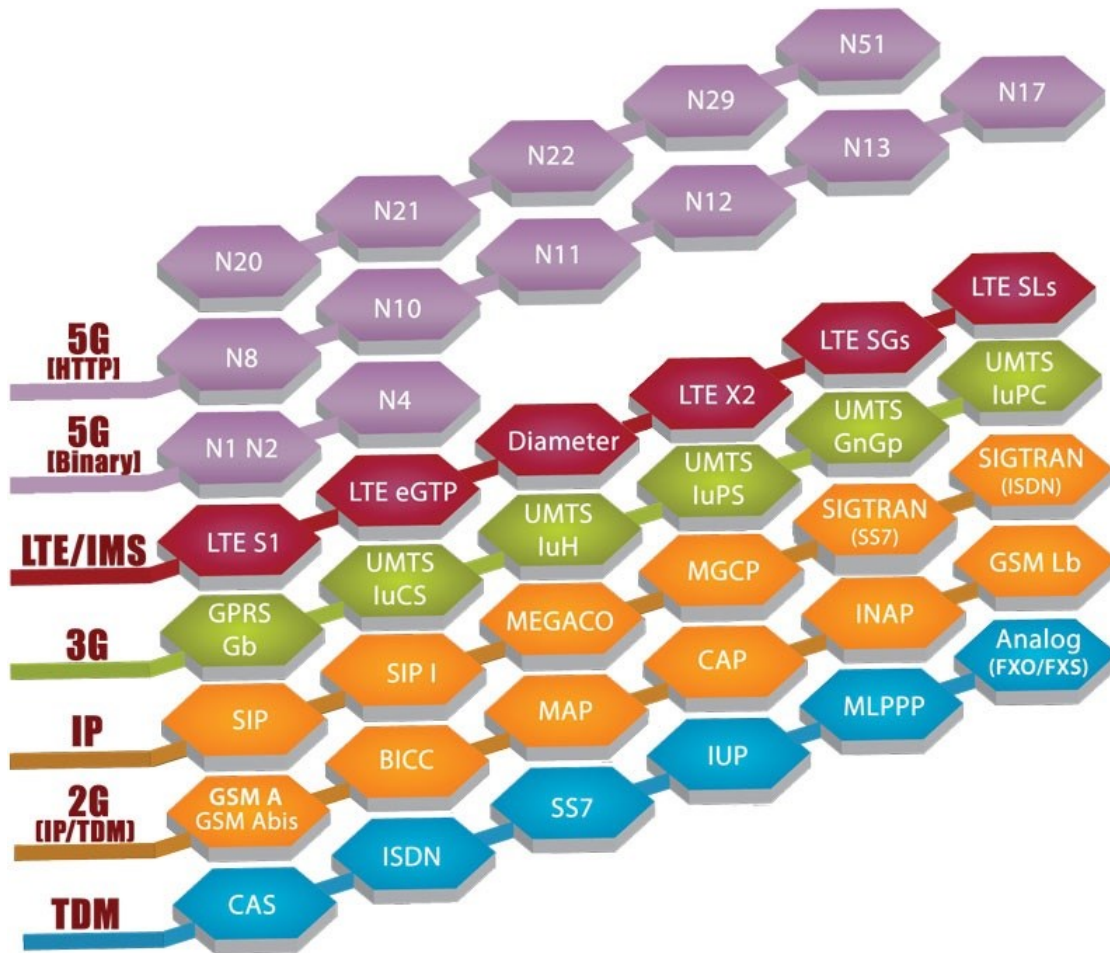

Overview

[Message Automation & Protocol Simulation \(MAPS™\)](#) is a protocol emulation and conformance test tool that supports a variety of protocols such as SIP, MEGACO, MGCP, SS7, ISDN, GSM, MAP, CAS, LTE, UMTS, SS7 SIGTRAN, ISDN SIGTRAN, SIP I, GSM A over IP, Diameter and others. Along with automation capability, the application gives users the unlimited ability to edit messages and control scenarios.

MAPS™ works on TDM, Ethernet and IP interfaces. TDM signaling protocols such as SS7, ISDN, MLPPP, CAS, MAP, CAP, GSM, INAP, and BICC operate over TDM networks, whereas VoIP protocols SIP, SIP-I, MEGACO, MGCP, SIGTRAN, Diameter, INAP, MAP, CAP, and BICC operate over IP networks. MAPS™ also supports 3G and 4G mobile protocol standards for testing the rapidly evolving mobile technologies. MAPS™ can emulate radio signaling protocols such as LTE (S1, eGTP, X2) interfaces and UMTS (luCS, luPS, luH), GPRS Gb, and GSM A, GSM Abis over IP transport layer.

MAPS™ framework is enhanced to emulate [End-to-End 5G core \(5GC\)](#) network elements - UE+gNB, AMF, SMF, UPF, AUSF, UDM, UDR, EIR, PCF along with data and voice traffic (VoLTE support) generation. GL's MAPS™ supports emulation of following 5GC network interfaces N1N2, N4, N8, N10, N11, N12, N13, N17, N20, N21, N22, N29, N51.

MAPS™ transmits and detects various traffic types over IP (RTP, GTP), ATM, GSM (TRAU), and TDM - such as, digits, voice file, single tone, dual tones, fax, SMS, email, http, ftp, and video. MAPS™ also includes support for wide range of codecs. In GPRS, packet data traffic can be generated and validated with GTP traffic modules. Circuit switched traffic can be generated and recorded using RTP core module.

For more details, refer to [Message Automation & Protocol Simulation \(MAPS™\)](#) webpage.

Message Automation and Protocol Simulation (MAPS™)

Key Features

- End-to-End Communications Network Lab (EE-CNL) provides reliable integrated solutions to vendors and service providers for emulation, monitoring, troubleshooting the network using [MAPS™ 5G 4G 3G 2G Wireless Lab Suite](#)
- Multi-protocol, Multi-interface emulation
- Flexible framework facilitates validation of any node functionality of any network element
- Provides complete access to user to customize any protocol IE's according to 3GPP standards
- Easily setup a test scenario within lab for educational purposes
- Powerful tool to test any element before deployment
- Supports both functionality and performance testing
- Easy to use GUI and also allows integration with Python and Java
- Runs on VMs and Containers
- Emulate negative test scenarios by impairing messages and call flows
- Script based architecture allows customization of test scenarios
- High density user plane traffic generation in any network capability
- Centralized Control and Remote Access with CLI
- Conformance Test suites
- Customized call scenarios, Test setup etc.
- Test Report and Statistics Generation
- Voice Quality measurements
- A single Remote Client GUI to remotely control/monitor multiple MAPS™ Servers
- Client-server communication is facilitated through a Listener over TCP/IP
- Single Licensing Server option available for controlling number of MAPS™ Server and Clients (users)
- Auto generate massive number of subscriber profiles using internal Database, and CSV methods

5G Core Network Emulation

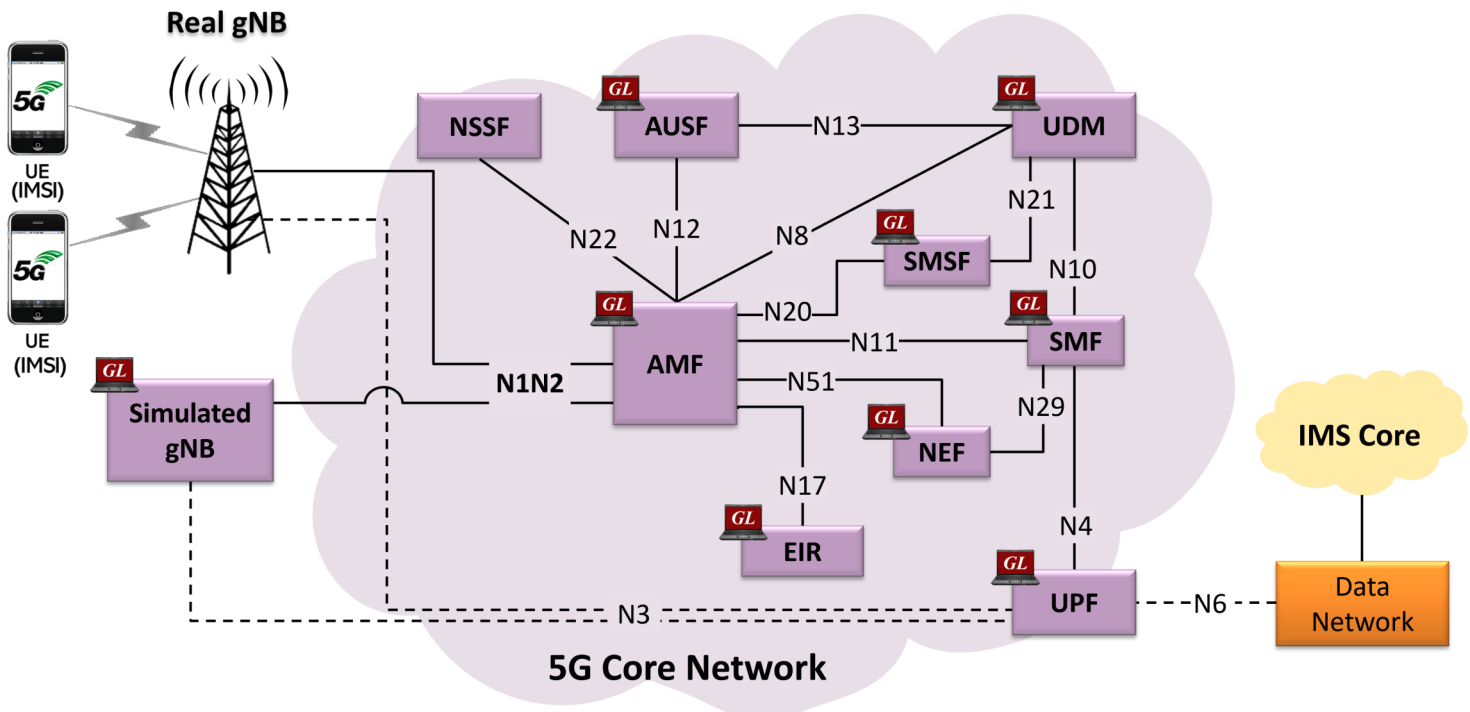

Overview

5G network testing involves the emulation of network traffic, data services, and signaling messages to ensure that the network's functionalities and performance meet the expected standards. GL's comprehensive Signaling and Traffic Emulation 5G test equipment suite, commonly referred to as MAPS™, provides a unique programmable, scriptable framework for 5G device testing, including 5G emulation, 5G network slicing, and 5G Core network testing.

In the [End-to-End 5G network](#) architecture, the network comprises various components, including the 5G Access Network (gNB), Access and Mobility Management Function (AMF), Authentication Server Function (AUSF), Network Slice Selection Function (NSSF), Unified Data Management (UDM), Session Management Function (SMF), Short Message Service Function (SMSF), Equipment Identity Register (EIR), and User Plane Function (UPF) connected to Data Server or Application Functions, and to EPC/IMS core for interoperability. All these underlying entities of the core network can be accurately tested for functionalities and performance with MAPS™ 5G test equipment suite.

With the capability of supporting enormous services and applications, massive connections, and new channel coding schemes at very high bandwidth, 5G network testing and troubleshooting are vital for ensuring the smooth operations of 5G networks. The use of a comprehensive 5G test equipment suite like MAPS™ is crucial for performing cross-domain testing, 5G signal Generation, 5G Emulation, 5G network slicing, and 5G analysis using [PacketScan™](#) application leading to the successful transition to new technology such as 5G.

The [PacketScan™ 5G protocol](#) analyzer supports monitoring of 5G networks. It captures, segregates, monitors, and collects statistics on all calls over N1N2, N4, N8, N10, N11, N12 and N13 interfaces of the 5G network. The 5G Protocol Analyzer is an optional module available within PacketScan™ on purchase of additional licensing. Monitoring Probes for 5G Wireless Networks capture CDRs, detect fraudulent activities, alert on critical parameters, measure KPIs, and performance statistics.

For more details, refer to [5G New Radio \(NR\) and 5G Core \(5GC\) Network Test Solution](#) webpage.

5G Core Network Emulation

Key Features

Emulate Core Network Functions

- End-to-End 5G Network Emulation
- Emulates 5G - UE+gNB, AMF, SMF, UPF, AUSF, UDM, SMSF and EIR
- Feature and Functional Testing
- Performance Testing
- Inter-Operability Testing
- Migration Testing
- Advanced Voice Feature Testing - IVR, Voice Recognition, Speech-to-Text

Performance based on Massive UEs, GTP Traffic and Voice Quality Metrics

- Emulate Massive UEs (up to 64,000) with Voice Traffic
- Emulate User-plane GTP traffic at high line rates (up to 40 Gbps)
- Assess Voice Quality (eModel, PESQ, POLQA)

Monitoring Core Network

- Voice Quality, Data Retention, Lawful Interception, Fraud Detection
- Record thousands of Voice Calls - Filter and Record Only Calls-Of-Interest
- Capture up to 30,000 Simultaneous Voice Calls

End-to-End Voice, Video, and Data QoS Testing

- Speech metrics such as PESQ, and POLQA
- Automated data testing - TCP, UDP, VoIP, Route, HTTP, FTP, DNS, SMS, Email and more
- Measure delay, packet loss, drops, and more
- True performance of VoLTE, 5G can be realized

Automated Testing Solutions for LTE, VoLTE, and IMS Emulation

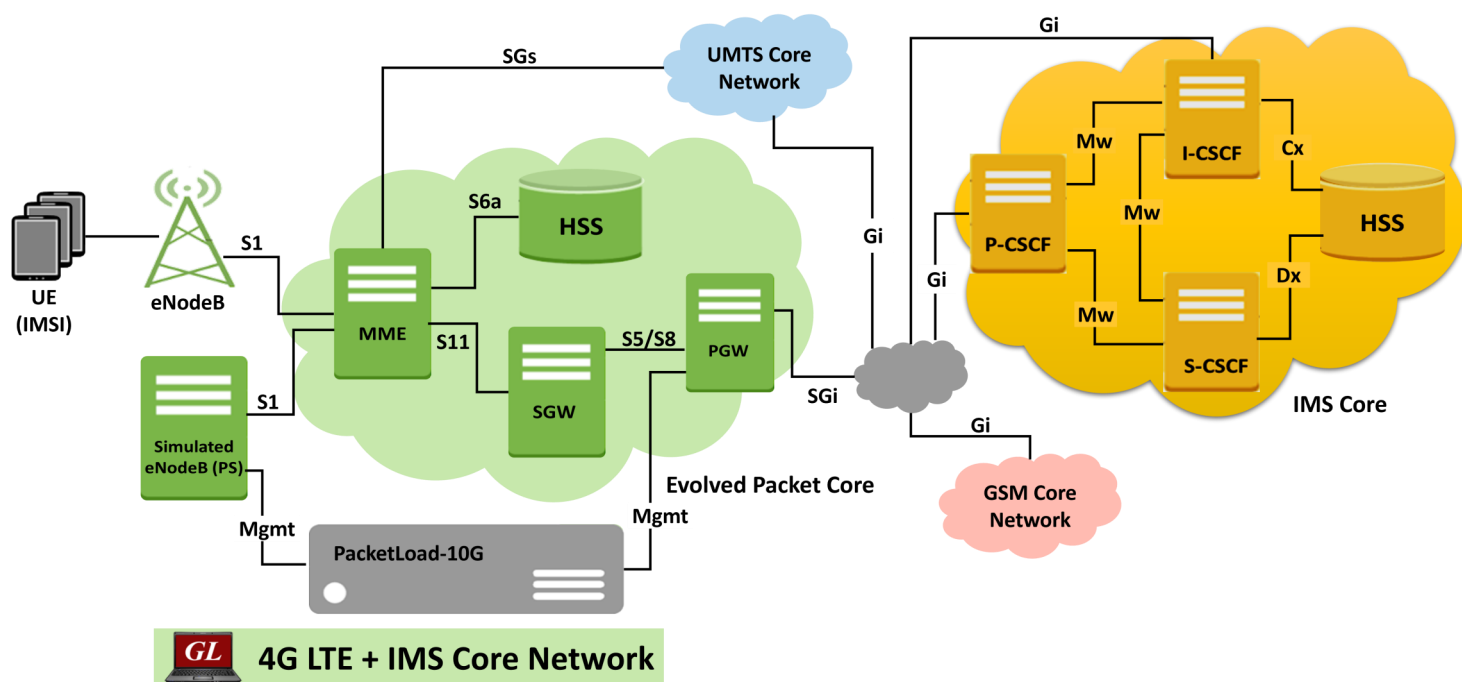

Overview

GL offers solutions for monitoring, emulating and troubleshooting LTE, VoLTE, and IMS networks. The [LTE IMS Test Tool](#) captures, decodes and conducts measurements across various interfaces in LTE and IMS wireless networks. MAPS™ can emulate nearly all elements in wireless 5G, and 4G VoLTE networks. When used in conjunction with the High-Density LTE Network Emulator, it can generate up to 100,000 UEs along with a high volume of mobile GTP and packet traffic to perform load testing on core LTE networks.

Users can establish a virtual real-time network with End-to-End 4G LTE-IMS Network Emulation Test Suite that emulates components such as Evolved NodeB (eNodeB), Mobility Management Entity (MME), Serving Gateway, PDN Gateway, Home Subscriber Server (HSS), Serving GPRS (General Packet Radio Service) Support Node (SGSN), Policy and Charging Rules Function (PCRF), Policy and Charging Enforcement Function (PCEF), Application Function (AF) and others to emulate Evolved Packet Core (EPC), allowing complete testing of the LTE network. All functionalities conform to industry standards. The End-to-End 4G LTE-IMS network emulation test suite offers reliable integrated solutions to vendors and service providers for emulating, monitoring and troubleshooting wireless networks.

LTE IMS Network Test Solutions Comprise:

- 4G LTE Communications Network Lab
- Emulate IMS Interfaces
- Centralized Web-based LTE Monitoring System
- LTE/5G Quality of Service (QoS) Test Suite for Voice, Video, and Data Quality Testing
- Massive LTE UE and Traffic Emulation
- Emulate LTE S1 Interface
- Emulate LTE eGTP Interfaces (S3, S4, S5, S8, S10, S11 and S16)
- Emulate LTE X2 AP Interface
- Emulate SMS and CS Fallback

Automated Testing Solutions for LTE, VoLTE, and IMS Emulation

Key Features

- MAPS™ SIP IMS test suite emulates multiple UEs and IMS core elements such as P-CSCF, I-CSCF, S-CSCF, PCRF, MGCF which provides the IMS core network
- VoLTE Lab setup can be operated in real-time for making VoLTE calls and also for interworking with PSTN and VoIP networks
- [MAPS™ 4G Wireless Lab Suite](#) supports emulation of S1-MME, S11, S5/S8, and other eGTP interfaces along with Diameter interfaces.
- Emulate several LTE interfaces such as S1, X2-AP, S3, S4, S5, S8, S10, S11 and S16, and IMS interfaces including Cx/Dx, Rx, Gx, Gm, SGI, Mw, Mi, Mj
- Generate and verify traffic over LTE, including VoLTE (Voice), Email, FTP, Web (HTTP), Video, and more with additional licenses - Mobile traffic core - GTP and Mobile Traffic Core – Gateway
- Supports IMS-based technologies such as VoLTE
- Emulate up to 500 Smartphones (UEs) powering up and down
- Integrate IMS core network easily with any other networks (wired or wireless) to test any call scenario It can emulate various nodes across LTE network –
 - ◆ [S1-MME interface](#) - eNodeB (also called Evolved NodeB), and MME (Mobility Management Entity) nodes in
 - ◆ [eGTP-c interfaces](#) - MME (Mobility Management Entity), SGSN (Serving GPRS Support Node), SGW (Serving Gateway), and PGW (Packet Data Network Gateway)
 - ◆ [X2-AP interface](#) - Two eNodeB (also called Evolved NodeB) end-points
 - ◆ [Diameter interfaces](#) - MME (Mobility Management Entity), HSS (Home Subscriber Server), AF (Application Function), PCRF (Policy and Charging Rules Function), CSCF (Call Session Control Function), SGSN (Serving GPRS Support Node), PCEF (Policy and Charging Enforcement Function), EIR (Equipment Identity Register) and PDN GW (Packet Data Network Gateway)
- Authenticate and confirm security procedures
- QoS requests for greater or lesser bandwidth
- Temporary addressing management for mobility and security
- 4G IMS network setup for inter-networking with 2G/3G and UE roaming scenarios emulation

MAPS™ SIP Protocol Emulator

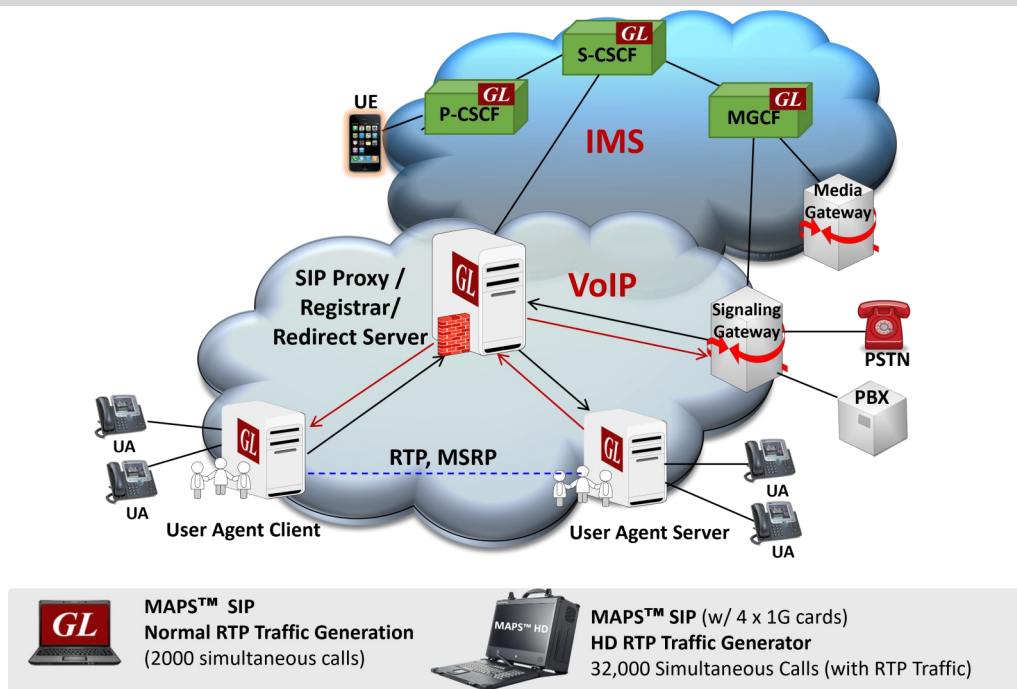

Overview

GL's MAPS™ designed for SIP testing can emulate User Agents (User Agent Client- UAC, User Agent Server-UAS) Redirect and Registrant servers. This test tool/traffic generator can emulate any interface in a SIP network and perform protocol conformance testing (SIP protocol implementations).

The application is available as:

- MAPS™ SIP Protocol Test Tool
- MAPS™ SIP Conformance Test Suite
- MAPS™ HD Call Generator
- MAPS™ SIP Message Session Relay Protocol

A single MAPS™ instance can act as more than one SIP entity at a time and can generate any SIP message on wire in the VoIP network. MAPS™ SIP supports UDP, TCP, TLS transport types. Secure Real-time Transport Protocol (or SRTP) traffic supported over TLS (Transport Layer Security) Transport and TLS Library (OpenSSL) uses a Certificate and Key.

MAPS™ SIP supports transmission and detection of various RTP traffic such as, digits, voice file, single tone, dual tones, IVR, FAX, and Video. With regular RTP traffic, the maximum simultaneous calls is 2000 and calls per second is 250. The MAPS™ SIP Conformance Scripts is designed with 400+ test cases, as per SIP specification of ETSI TS 102-027-2 v4.1.1 (2006-07) standard. Test cases include general messaging and call flow scenarios for multimedia call session setup and control over IP networks. Logging and pass/fail results are also reported. Test cases verify conformance of actions such as registration, call control, registrants, proxies and redirect servers.

MAPS™ SIP also supports generation of high volume of calls with traffic for load testing network using [MAPS™ RTP HD](#) network appliance. MAPS™ SIP provides the Bulk Video Call emulation capability using pre-recorded video traces supporting codecs like H.264, H.263, and VP8. On a high-performance computing platform (core-i7), it is possible to generate more than 500 simultaneous video calls. MAPS™ SIP supports FAX over IP (FoIP) simulation and monitoring. With Additional licensing, both RTP G.711 Pass Through Fax Simulation and T.38 Fax Simulation over UDPTL simulation are supported.

MAPS™ SIP supports Message Session Relay Protocol for instant messaging over SIP sessions, simulating SIP/MSRP User Agents end-points in an NG9-1-1 network and send and receive communications over ESInets.

For more details, refer to [MAPS™ SIP Protocol Emulator](#) webpage.

MAPS™ SIP Protocol Emulator

Key Features

Signaling

- Generates and processes SIP valid and invalid messages
- Supports IPv4 /IPv6 and transport over UDP and TCP, and TLS for secure transport
- Supports joining a conference call, unattended call transfer, attended call transfer, call hold, auto call rejection, early media, and silence packets generation
- Implement IP Spoofing for any network like Class C, Class B, etc.
- Supports in dialog and out of dialog transactions for SUBSCRIBE, NOTIFY, OPTIONS, REFER, and INFO SIP methods
- Generate custom SIP messages and call scenarios
- Feature with configurations to insert proprietary SIP headers in run time
- Automated the SUBSCRIBE transaction upon successful User Agent registration
- RTP Statistics log includes call detail record information for each call

Traffic

- Transmit and detect various RTP traffic such as digits, voice file, single tone, dual tones, IVR, FAX, and Video in IP networks
- Supports all industry-standard codec types - G.711 (mu-Law and A-Law), G.722, G.729, G.726, GSM, AMR, AMR -WB, EVRC, EVS, OPUS, SMV, iLBC, SPEEX, and more
- Supports Secure Real-time Transport Protocol (SRTP)
- Provides Voice Quality statistics such as Mean Opinion Score (MOS), Packet loss, and Jitter
- Supports both RTP G.711 Pass-Through Fax and T.38 emulation over IP
- Message Session Relay Protocol emulation (MSRP) supporting instant messaging
- Interactive Voice Response (IVR) testing that recognizes and responds to voice prompts using DTMF digits or voice, allowing automated IVR traversal and testing
- Supports Short Message Service (SMS) over IP/ IP Multimedia Subsystem (IMS) communication, SMS is encapsulated in a SIP message and carried over IMS core network

API / CLI

- MAPS™ CLI interface based on a client-server model allows users to control all features of MAPS™ through APIs
- Supported clients include Python and Java

Applications

- Complete SIP test environment
- Supports end-to-end gateway testing
- Supports conformance testing UAC, UAS, Proxy, Registrars, Registrants, Redirect Servers, and other SIP entities
- Handles strict routing and loose routing, when requests are routed through proxies
- Multi-protocol call trace for TDM / VoIP
- Testing NG9-1-1 emergency services and components within the ESInet

Testing ED-137 and ED-138 Interoperability Standards for VoIP Air Traffic Control

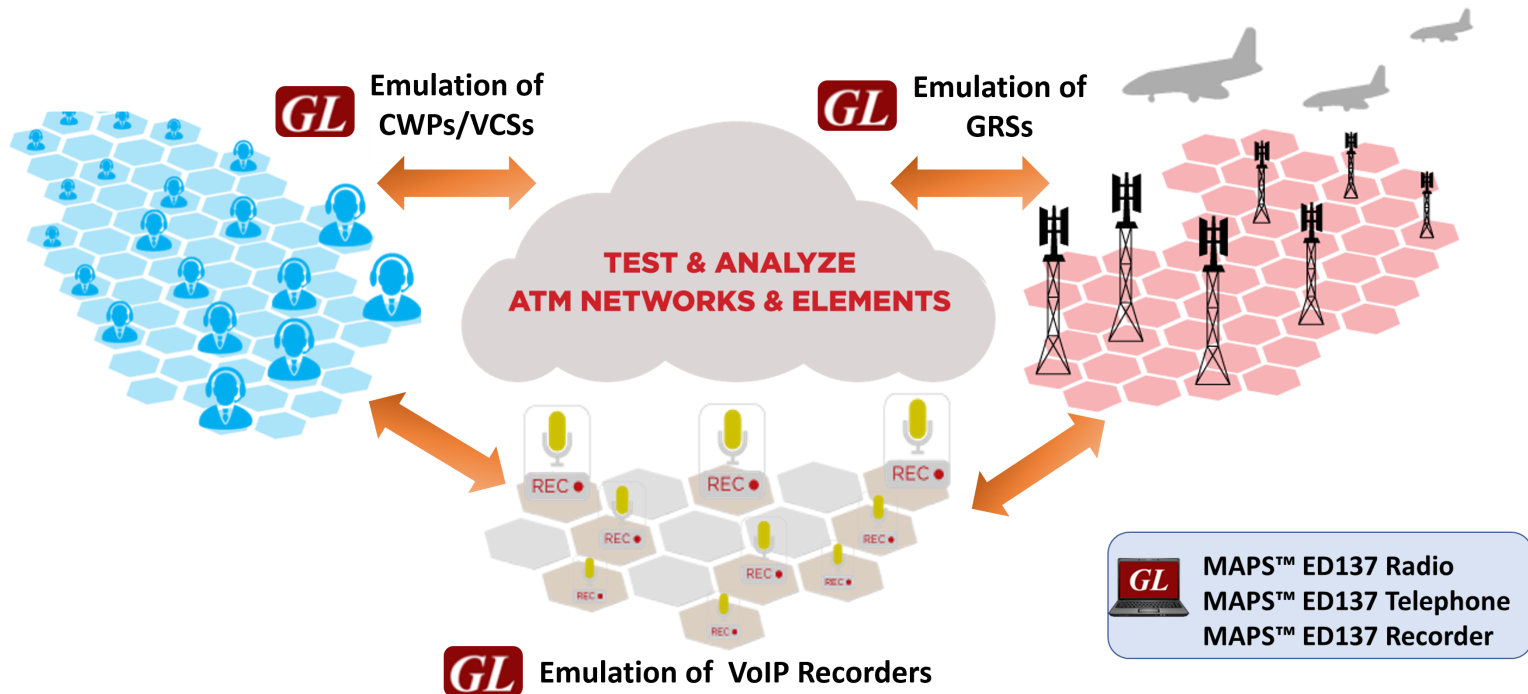

Overview

GL's [MAPS™ ED-137](#) can emulate both Air-to-Ground calls (as per ED137_1B and ED137_1C: Radio) and Ground-to-Ground (as per ED137_2B and ED137_2C: Telephone) calls as per EUROCAE (European Organization for Civil Aviation Equipment) ED-137 standards. MAPS™ ED-137 support can emulate many user agents (end points) without requiring analog interfaces.

The software also supports emulation of Recorder interface for both Air-to-Ground and Ground-to-Ground calls at CWP, GRS and Recorder endpoints as per ED137_4B and ED137_4C versions. Air Traffic Recorder is the next generation VoIP recorder implemented as per ED-137 inter-operability standards. Specially designed for all traffic control towers and centers to simplify the recording, archiving, and playback voice communications. It can emulate Air-to-Ground and Ground-to-Ground call recording towards Recorder and testing Recorder interface of CWP/VCS and GRS in the ATM network.

The following simulators are ED-137 B and C versions compliant and are VOTER validated:

- [MAPS™ ED-137 VoIP ATM Telephone](#) can emulate hundreds of Ground-to-Ground calls, supporting all Telephone call types and scenarios such as Call Hold and Call Transfer
- [MAPS™ ED-137 VoIP ATM Radio](#) can be configured as CWP and GRS to emulate outgoing and incoming messages in the Air-to-Ground call
- [MAPS™ ED-137 Air Traffic Recorder](#) can emulate call recording functionality at CWP, GRS and Recorder interfaces, generating more than hundreds of recording sessions to verify performance and load testing

For more details, refer to [Testing ED-137 and ED-138 Interoperability Standards for VoIP Air Traffic Control](#) webpage.

Testing ED-137 and ED-138 Interoperability Standards for VoIP Air Traffic Control

Key Features

Customized test solutions for VoIP Air Traffic Management networks

- Emulation Test Tools for ATM per ED-137
- ATM Network Quality Monitoring Tools per ED-138
- Critical Timing Measurement Tools for ATM
- Wide Area Network link emulation
- Inter-operability Test Tools

Emulation Test Tools for ATM per ED-137

- ED-137 B and C compliant and VOTER Validated
- **MAPS™ ED-137** tools generate Air-to-Ground calls and Ground-to-Ground calls as per EUROCAE ED-137 (1B and 1C)
- **MAPS™ ED-137 Recorder** (4B and 4C) emulates call recording functionality at CWP, GRS, and Recorder interfaces
- Test the functions of Controller Working Position, Ground Radio Station, or Radio Media Gateway entities
- Emulate hundreds of CWPs/Radios with unique IP addresses in a single instance
- Supports hundreds of simultaneous calls and complete automation of bulk call generation with traffic
- Fully integrated, complete test environment for Air Traffic Management
- Linked Session Management to group and identify all calls belonging to particular Radio
- Define DSCP (Differentiated Service Code Point) values for signaling and voice traffic
- Depicts easy to understand call flow graphs of SIP message exchanges and message contents (SIP headers and SDP attributes)
- Provides aggregated voice quality statistics such as MOS/R-Factor, packet loss, duplicate and out of sequence packets

ATM Network Quality Monitoring Tools per ED-138

- **PacketScan™** captures and monitors live signaling and traffic over Air Traffic Management network
- Waveform viewer, Call-flow graphs, and QoS monitoring - analyze calls for voice quality (MOS), packet loss, jitter, latency, etc.
- Real-time and/or historical data analysis
- Centralized monitoring of several probes deployed over the network with **NetSurveyorWeb™**
- Individual call recording and retrieval system - Requires additional system configurations

Precise Timing Measurement Tools for ATM

- **MAPS™ TM-ATM** (Timing Measurements in Air Traffic Management) test suite accurately emulates end points in ATM networks and provides critical timing measurements for various types of delay occurrences in signaling and voice transmission through the network
- Includes all necessary hardware and software to identify, capture, timestamp, and correlate events at Analog, TDM and IP interfaces
- Generate triggers based on PTT activation
- Capture, filter and record only packets of interest
- Generates a trigger (1 Microsecond pulse) for each packet that satisfies filter criteria
- Packet filtering can be based on all Layer 2 (Ethernet), Layer 3 (IP), Layer 4 (UDP/TCP) Headers
- Uses GPS time to perform precise timing measurement during deployment and field testing

Telecom and Information Technology Consulting Services



GL's expertise covers infrastructure design, installation and inspection as well as application configuration and management. Our team includes engineers, developers, scientists, and project managers. Our customer base includes large internet and wireless service providers, equipment manufacturers, government contractors, research laboratories and universities world-wide.

GL's vast skill set includes the following:

- Custom hardware development or board modification and validation
- Copper and Fiber cabling: Design, installation, maintenance, inspection, testing, validation
- Switches and Routers: Installation, configuration, design, and load testing
- Voice over IP: Installation, testing, monitoring, configuration
- Microsoft Windows®: OS installation, configuration, Windows Server and Active Directory management, file sharing, patching and updates, Windows Secure Host Baseline
- Linux®: Debian application development, installation, configuration
- Application Development: C++, JavaScript, Python, Visual Basic, Visual Studio, Android, iOS, TCL, Fortran, Database Management including Maximo
- PC hardware setup and assembly, printers, Keyboard Video Mouse systems, remote access management, uninterruptible power supplies, server racks
- Network Setup: Virtual Private Networks, network segmentation, Network Address Translation, IPv4 and IPv6, Virtual Local Area Networks, wireless networks, GigE and large infrastructure fiber-based Wide Area Networks with ruggedized networking equipment for harsh environments such as underground railroads, railyards and bus depots
- Wireless Testing: Signal strength, voice quality, drive testing, in-building testing as well as cellular coverage comparison and verification
- Digital Displays, Passenger Information Display System, Customer Information Systems using LED Signs
- Physical security: Access Control, Card readers, Video Management System, CCTV design, testing, and inspection
- Company specific hardware: CISCO, Juniper, Oracle, Microsoft, Polycom, Digium, Dell and more

GL is a certified small business and a minority owned business and can help large prime contractors satisfy their SBE and MBE requirements in the USA.

GL's services can be utilized at a daily or even hourly rate, or on a project basis. GL can often incorporate its own products into its services (often free of charge). GL's cost-effectiveness, flexibility, and unmatched expertise is why so many customers chose GL to solve their toughest telecom and IT challenges.

Training and Support



GL Communications is committed to providing comprehensive product training and support to ensure that our customers maximize the benefits of our cutting-edge solutions. Recognizing the critical importance of empowering users with the knowledge and skills needed to efficiently operate our products, our training and support programs are designed to meet the diverse needs of our clients.

Product Training

Customized Training Programs:

GL Communications offers tailored training programs to address the unique requirements of our clients. Whether you are a new user seeking basic training or an experienced professional looking for advanced insights, our programs cater to all skill levels.

Hands-on Learning:

Our training sessions emphasize practical, hands-on learning experiences. Participants work directly with our products, gaining valuable insights into their functionalities and applications.

Comprehensive Curriculum:

The training curriculum covers a wide range of topics, including product features, configuration, troubleshooting, and best practices. Participants acquire a thorough understanding of the capabilities of our solutions, enabling them to make the most of our products in real-world scenarios.

Flexible Training Options:

Recognizing the varied schedules and learning preferences of our clients, GL Communications offers flexible training options. Whether through on-site training sessions or web conferences, users can choose the format that best suits their needs.

Product Support

Dedicated Support Team:

GL Communications boasts a highly skilled and responsive support team dedicated to assisting customers with any queries or issues they may encounter. Our support staff is well-versed in the intricacies of our products and strives to provide timely and effective solutions. GL offers support across multiple time zones, from our Headquarters in Maryland, USA to our development office in Bangalore, India.

Multi-tiered Support Structure:

Our support services are organized into multiple tiers to ensure that inquiries are addressed with the appropriate level of expertise. This tiered structure enables us to efficiently resolve issues, whether they are routine queries or complex technical challenges.

Regular Updates and Resources:

Customers benefit from regular product updates, documentation, and knowledge base resources. These resources keep users informed about the latest features and enhancements, empowering them to stay current with our evolving product landscape.

GL Offices



Headquarters

GL Communications Inc.

818 West Diamond Avenue - Third Floor
Gaithersburg, MD 20878
Contact: Vikram Kulkarni Ext. 114
Phone: (301) 670-4784
Fax: (301) 670-9187
Email: info@gl.com

Branch Office

GL Shanghai, China Office

5H, Hua Min Empire Plaza,
728 West Yan An Road,
Shanghai 200050
China
Contact: Jianxiong Ding
Phone: +86 2162370268, +86 2162703066
Fax: 86-21-6237-0268 Ext:103
Email: glchina@gl.com

Branch Office

GL Bangalore, India Office

GL Communications India Pvt. Ltd.
#1, "Uma Admiralty", Ground Floor,
Bannerghatta Road,
Bangalore - 560029 | India
Contact: Sanjeev Kulkarni
Phone: 91-80-40488400 Ext. 404
Fax: 91-80-40488401
Email: glindia@gl.com