



41

Phone: +49 941 630 449-0 Fax: +49 941 630 449-1
E-mail: export@getrasport.com Web: www.getrasport.com

Mail: Getrasport Produktions+Distributions GmbH
 P.O. Box 101031 | 93010 Regensburg | Germany

SPORTS EQUIPMENT
SPORTGERÄTE
EQUIPMENTS SPORTIFS

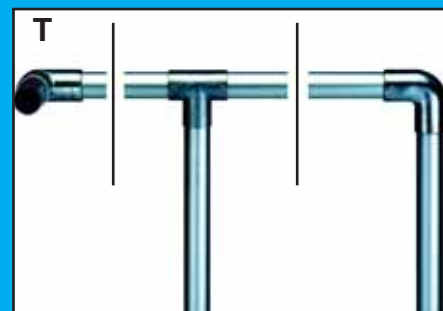
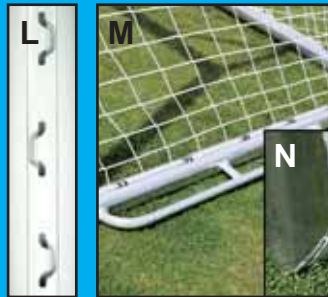
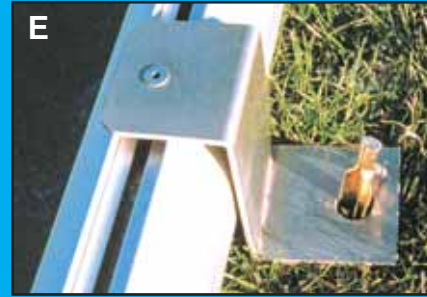
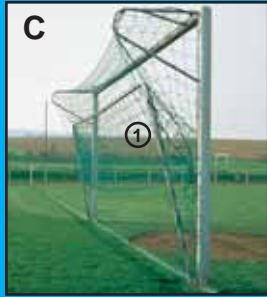

A FB 10693 **SOCCER GOALS 7,32 x 2,44m**
DIN 7900 EN 748 (complying with FIFA + UEFA regulations)

GOAL "FREE HANGING NET"

Made of alu profile 120x100mm for installation in ground sockets. Includes ground sockets, lids, net retainers and conversion set "free hanging net" (consisting: 4pcs. hot galvanized steel posts with ground sockets, guy ropes, snap hooks and turnbuckles). GS tested safety. White plastic-coated.

B FB 10692 **GOAL "FREE HANGING NET"**

Made of alu profile 120x100mm for installation in ground sockets. Includes ground sockets, lids, net retainers and conversion set "free hanging net" (consisting: 4pcs. hot galvanized steel posts with ground sockets, guy ropes, snap hooks and turnbuckles). GS tested safety.

B1 FB 10694 **CONVERSION SET "FREE HANGING.."**

Consisting of: 4pcs. hot galvanized steel posts with ground sockets, guy ropes, snap hooks and turnbuckles.

C FB 10695 **GOAL "GROUND SOCKETS"**

Made of alu profile 120x100mm for installation in ground sockets. Net hoops and braces made of strong alu tubes. Includes ground sockets, lids and net retainers. GS tested safety.

FB 10696 **GOAL "GROUND SOCKETS"**

As FB 10695, but white plastic-coated.

C1 FB 10697 **BASE FRAME FOLDABLE**

Made of strong alu tubes ca. 40 mm. Adjustable to any net depth. Comes with all necessary parts.

D FB 10698 **TRAINING GOAL "FREE STANDING"**

Made of alu profile 120x100mm. Base frame made also of alu profile 120x100mm. Net hoops, braces and supports made of strong alu tubes. Includes net retainers. GS tested safety.

E FB 10701 **GROUND ANCHOR DIN EN 748**

Strongly recommended. Prevents tipping over.

F FB 10005 **SOCCER GOALS 5,00 x 2,00m**
GOAL "GROUND SOCKETS"

Made of alu profile 80x 80mm. Net hoops and braces made of strong alu tubes. Includes ground sockets, lids and net retainers.

C FB 10705 **GOAL "GROUND SOCKETS"**

Made of alu profile 120x100mm. Net hoops and braces made of strong alu tubes. Includes ground sockets, lids and net retainers.

G FB 10008 **TRAINING GOAL "FREE STANDING"**

Made of alu profile 120x100mm. Base frame and net hoops made of strong alu tubes. Includes net retainers.

H FB 10686 **INDOOR GOAL "FREE STANDING"**

Made of alu profile 80x80mm. With hinged net hoops. Net hoops made of zinc steel. Includes floor pads and net retainers.

I FB 10699 **TRAINING GOAL "FREE STANDING"**

Made of alu profile 120x100mm. Base frame made also of alu profile 120x100mm. Depth of base frame 150cm. Net hoops made of alu tubes. Includes net retainers.

J FB 10700 **TRAINING GOAL "FREE STANDING"**

Made of alu profile 80x80mm. Back posts made also of alu profile 80x80mm. Cross tubes, net hoops, braces and supports made of alu tubes. Includes net retainers.

K FB 10730 **RISE FOR EDGE WELDED GOALS**

Edge sections stabilised by welded miters. (especially important at portable goals). Only the straight sections are screwed together.

L FB 10737 **RISE FOR INTEGRATED NET FIXATION**

M FB 10735 **RISE FOR WELDED CARRYING HANDLES**

N FB 10731 **RISE FOR FULLY WELDED GOALS**

All connections are welded. The perfect solution.

FB 10736 **RISE FOR WELDED NET RETAINERS**

O **GOAL MINI**

Size: 120 x 80cm. Including net.
Size: 180 x 120cm. Including net.

P FB 10706 **GOAL "CITY" 3,00 x 2,00m**

Stable, fully welded aluminium construction. Profile 80x80mm. Back construction made of round alu tubes. 4 plates are welded to the ground frame so that the goal can be firmly secured to the ground. Size: 3x2m.

Q FB 10690 **INDOOR SOCCER BARRIERS**

Please ask for further information and let us make you a special offer.

R FB 10691 **ADVERTISING BOARDS**

Made of weatherproofed and robust alu plates with turned over edges. Fixed by alu clamps. Different lengths and heights. Easy to attach to all types of barriers.

S FB 10033 **SEATING**

Different dimensions and colours. Basic measurements 45x45cm. The seats can be fixed directly onto concrete steps or to an appropriate metal frame.

T FB 10688 **BARRIERS**

Made of alu tubes. Height ca. 115cm, distance between the posts 250cm. T-joints and corner pieces made of cast aluminium.

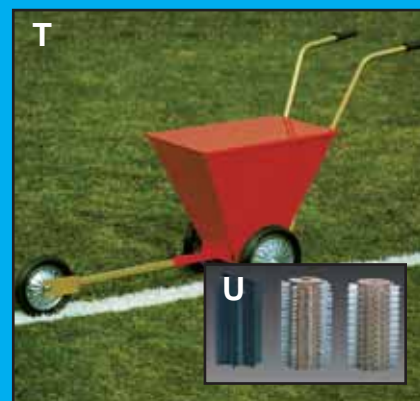
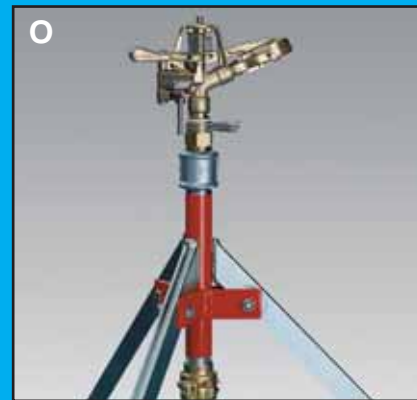
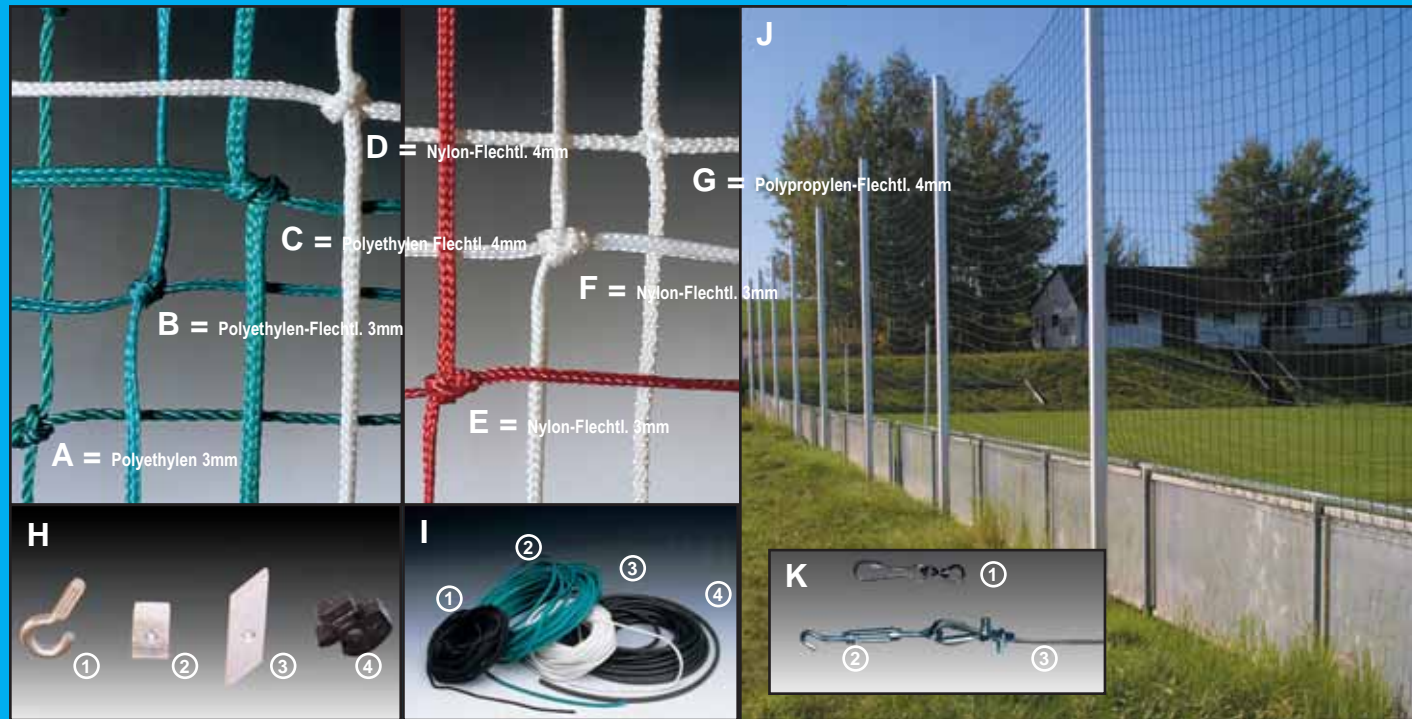

SOCCER GOAL NETS DIN EN 748

MATERIAL/SPECIFICATION pictures A-G:

A Polyethylene 3mm, **B** Polyethylene-Braided 3mm, **C** Polyethylene-Braided 4mm, **D** Nylon-Braided 4mm, **E** Nylon-Braided 3mm, **F** Nylon-Braided 3mm, **G** Polyester 4mm without knots.

NETS FOR GOALS 732x244CM

750cm wide and 250cm high, mesh approx. 12cm, with tensioning cord.

80CM AT ROOF/150CM AT BASE

FB10600/601 Polyethylene approx. 3mm, green or white

FB10602/603 Polyethylene approx. 4mm, green or white

FB10606/607 Polyethylene-Braided approx. 4mm, green or white

FB10604/605 Nylon-Braided approx. 4mm, green or white

80CM AT ROOF/200CM AT BASE

FB10608/609 Polyethylene approx. 3mm, green or white

FB10610/611 Polyethylene approx. 4mm, green or white

FB10614/615 Polyethylene-Braided approx. 4mm, green or white

FB10612/613 Nylon-Braided approx. 4mm, green or white

100CM AT ROOF/225CM AT BASE

FB10616/617 Polyethylene approx. 3mm, green or white

FB10618/619 Polyethylene approx. 4mm, green or white

FB10620/621 Polyethylen-Braided approx. 4mm, green or white

200CM AT ROOF/200CM AT BASE

FB10630/631 Polyethylene approx. 4mm, green or white

FB10622/623 Nylon-Braided approx. 4mm, green or white

100CM AT ROOF/250CM AT BASE

FB10065 Nylon-Braided approx. 4mm, white

FB10066 Nylon-Braided approx. 4mm, red

NETS FOR GOALS 5,00x2,00m

515cm wide and 205cm high, mesh approx. 12cm, with tensioning cord.

100CM AT ROOF/100CM AT BASE

FB10624/625 Polyethylene approx. 3mm, green or white

FB10626/627 Polyethylene approx. 4mm, green or white

FB10628/629 Polyethylene-Braided approx. 4mm, green or white

80CM AT ROOF/150CM AT BASE

FB10635/636 Polyethylene-Braided approx. 4mm, green or white

SPARE PARTS

H1 FB 10648 Stainless steel hook

H2 FB 10647 Aluminium nut rectangular

H3 FB 10646 Aluminium nut rhomboid

H4 FB 10645 Safety net holder

PROTECTION NETS FOR INSIDE AND OUTSIDE (dry steam heat set and safety line sewn)

Sizes at customer's request. Material and specifications as in pictures A-G. All nets come with a specially braided perimetral cord.

FB 10740 Hemmed lead weights 200g/lfm.

FB 10741 Hemmed lead weights 400g/lfm.

J FB 10745 ALUMINIUM POST FOR NETTING

K1 FB 10652 Spring-hook
K2 FB 10651 Tensioning lock set
K3 FB 10650 Steel rope, 4mm

LACING TWINES

I1 FB 10067 Polyester approx. 2mm, black
I2 FB 10072 Polyethylene approx. 4mm, green
I3 FB 10653 Polyethylene approx. 6mm, green
 FB 10071 Polyester approx. 3mm, white
I4 FB 10654 Kevlar approx. 5mm

AREA SPRINKLER

L FB 10406 AREA SPRINKLER
 The whole sprinkler is made of rust proof material with easy going rubber wheels. Equipped with 135m traction cable for a sprinkling range of 183x48m.

M FB 10506 HOSE REEL
 For 150m 3/4"-hose or 100m 1"-hose.

N FB 10504 HOSE 3/4", 50m
 FB 10505 HOSE 1", 50m

O FB 10507 TRIPOD SPRINKLER
 Tripod made of galvanized steel, head made of brass. For circular (approx. 30m diameter) and sectoral sprinkling. With GEKA-coupling.

LINE MARKING EQUIPMENT

P FB 10800 LINE MARKING MACHINE WET, TYPE 700
 Robust construction with 10l pressure tank and air wheels. Comes with pump, pressure gauge and safety valve. Lever operated. Line width can be adjusted from 50 to 120mm. Suitable for mixed line paint.

Q FB 10801 LINE MARKING MACHINE WET, TYPE 702
 Same as FB 10800, but pressure tank only 9l and 3 air wheels.

R FB 10805 LINE MARKING MACHINE DRY, TYPE 850
 Robust construction with air rubber wheels. The container holds 50l. Line width can be adjusted from 50 to 120mm. The outlet is regulated by an adjustable scattering plate. Suitable for chalk, sawdust or plaster.

S FB 10806 LINE MARKING MACHINE DRY, TYPE 601
 Robust construction with air rubber wheels. The container holds 35l. Line width is adjustable to 50 and 120mm. Self-cleaning roller nylon brush. Suitable for chalk, sawdust or plaster. *Info: on request with paddle wheel.*

T FB 10807 LINE MARKING MACHINE DRY, TYPE 502
 Same as FB 10806, but line width only 120mm and rubber wheels.

U FB 10810 BRUSH (SEPARATE)

V FB 10078 MIXED LINE PAINT
 The paint is non-toxic and will not damage grass or react with chemicals. It can be diluted with 3 parts water and gives extra white line on both wet and dry grass. Comes in a 20kg plastic can.

W FB 10080 PLIFIX-MARKER
 Gives permanent marking where the lines should be. Lining work can be done by a single person.



CORNER POSTS AND FLAGS
A FB 10689 CORNER POST
 Polyethylene 160cm long, diameter 50mm. Weather-proofed and colourfast. Comes with ground socket, lid and flag.
 FB 10082 FLAG FOR CORNER POST, RED approx. 40x40cm
 FB 10083 FLAG FOR CORNER POST, YELLOW approx. 40x40cm

B1 FB 10085 LINESMAN'S FLAG, WHITE approx. 30x40cm
B2 FB 10084 LINESMAN'S FLAG, RED approx. 30x40cm
B3 FB 10094 LINESMAN'S FLAG, YELLOW approx. 30x40cm
B4 FB 10088 LINESMAN'S FLAG, RED/YELLOW approx. 30x40cm

MEGAPHONE
C1 FB 10421 SHOULDER MEGAPHONE
 High performance transistor megaphone with max. 20W output. Powered by 6 batteries (UM-2), about 8 hrs. operating time. Range outdoors up to 1000m.
C2 FB 10420 HAND MEGAPHONE
 Output max. 10W, powered by 8 batteries (UM-3), about 6 hrs. operating time. Range outdoors up to 500m.

D FB 10400 **SHOE-CLEANER**

TEAM VESTS AND TEAM BANDS
 TEAM VEST GETRA
 Made of soft nylon. Perfect quality. Sizes: Kid's, Junior, Senior
E1 FB 10501 TEAM VEST, RED
E2 FB 10500 TEAM VEST, YELLOW

F1 FB 10502 TEAM VEST REVERSIBLE
 Made of nylon, can be worn either way out. Colour combinations: red/yellow, green/yellow, red/blue. Sizes: S/L/XL
F2 GY 81600 TEAM BAND
 5cm wide PP-strap. Length approx. 60/120cm. Colours: blue, yellow, red, green.
F3 FB 10503 TEAM VEST
 Made of nylon, colours: blue, yellow, red, green. Sizes: S/L/XL

TACTIC BOARDS
G1 FB 10407 TACTIC BOARD BIG (with magnetic buttons)
 Metal board with aluminium frame. Glossy front for magnets and board pens.
G2 FB 10408 TACTIC FOLDER
 Chart with magnets and note pad.

H RE 85002 BALL CARRYING BAG
 Made of strong nylon fabrics. Holds up to 12 balls.

BALLS AND BALL ACCESSORIES
I1 FB 10670 COMPETITION SOCCER BALL "WORLD CLASSIC"
 Top quality soccer ball with special multi layer laminate construction. Air-Foam-System with interior lamination. High abrasion resistance and excellent ball acceleration. Soft ball contact. Sizes: 5+4.
I2 FB 10671 COMPETITION SOCCER BALL "SPIDER"
 Made of Cordley-material with Air-Mattress-System. Very good play property, soft ball contact and very good rebound. High abrasion resistance. 4-layers. Size: 5.
I3 FB 10672 COMPETITION SOCCER BALL "HIGHLIGHT"
 Made of Cordley-material. In poor visibility. Very durable and water proofed. 4-layers. Size: 5.
I4 FB 10675 ALLROUND SOCCER BALL "TRAINER"
 Practice soccer ball made from durable Barex-material. Weather-proofed, suitable for all surfaces. 4-layers. A value for money ball. Sizes: 5+4+3.
I5 FB 10673 INDOOR SOCCER BALL "INDOOR EXTRA"
 Made of Cordley-material, surface robust velours. Excellent play properties. Limited rebound. Sizes: 5+4.
I6 FB 10674 INDOOR SOCCER BALL "FELT"
 Made of Cordley-material, surface English felt. Limited rebound. Good play properties. Sizes: 5+4.
I7 FB 10685 BALL SEAL
 For sealing and repairing bladders from the inside.
I8 RE 85001 BALL NET
 Made of braided nylon, mesh approx. 100mm. For approx. 8-10 balls.

SUBSTITUTE INDICATORS
 Light metal handle with flip-over plastic cards (No. 1-30).
J1 FB 10409 SUBSTITUTE INDICATOR "OUT"
J2 FB 10410 SUBSTITUTE INDICATOR "IN"
K BN 80000 COOLING SPRAY BODY NATURE 300ml

L FB 10401 BALL CART
 Aluminium. Lockable lid and 4 wheels. Takes approx. 65 to 80 balls.

M FB 10087 AIR COMPRESSOR FTC 110
 220 V electric inflator. Complete with pressure gauge, adapter set and air hose.

N FB 10655 AIR COMPRESSOR MK40
 Robust and oil-free membrane-compressor with low rotational speed (approx. 1700U/min.). Aluminium casing with handle. Capacity approx. 70l/min. with max. 3,5 bar. 230V/50Hz. Maintenance free. Comes with 120cm air hose and 2 needles.

O FB 10684 PRESSURE GAUGE 0-1,6bar

P FB 10669 BALL INFLATING PISTOL
 Aluminium casing with pressure deflate button. Pressure gauge with 0-10 bar display. With 120cm hose and connection adapter with inside thread VG 5.2.

Q1 FB 10679 SINGLE BARREL INFLATOR with needle.
Q2 FB 10680 HAND PUMP 36cm, with tapered needle.
Q3 FB 10683 SPECIAL NEEDLE
Q4 FB 10681 TAPERED NEEDLE
Q5 FB 10682 INFLATING NEEDLE

SOCCER & SPORTS HALL EQUIPMENT

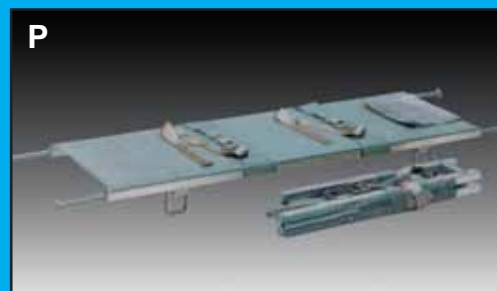
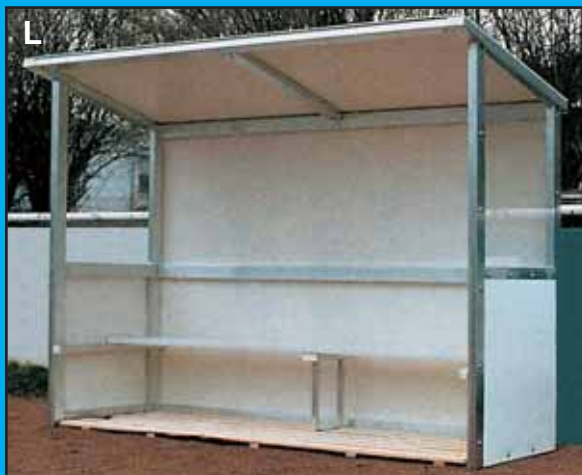
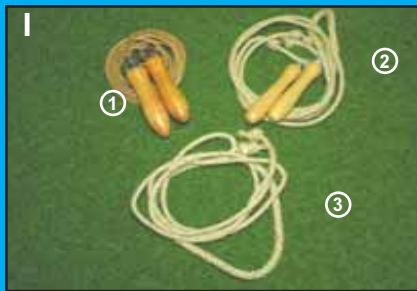
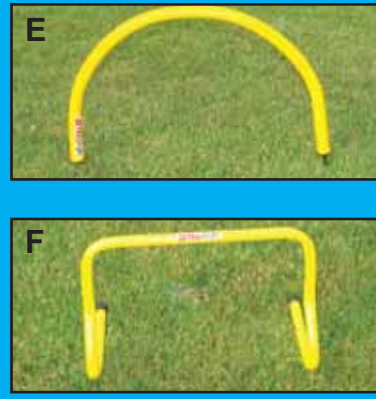
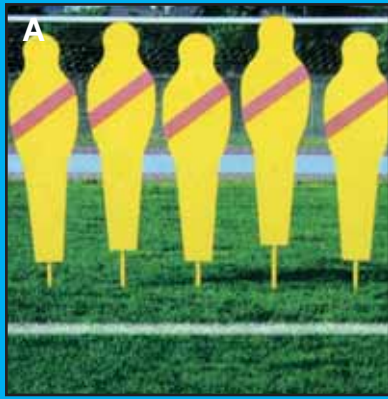

TRAINING EQUIPMENT

A FB 10300 PENALTY KICK WALL
Dummies made of reinforced plastic with steel pin. Height max. 190cm. Set of 5.

B FB 10660 HEADER PRACTICE STAND
Made of alu profile. Height 450cm, projection 165cm. Ball height adjustment possible. Comes with ground socket and lid.

STOPWATCHES

C1 RU 54760 HANHART CROWN STOPPER
chromed brass alloy case, shock and dirt protected. Water-resistant. Pinlever movement, 7 jewels
FUNCTIONS: Start, Stop, Reset. Accuracy 1/10 Sec. 15 min register. Case D=55mm, weight 120g.

C2 RU 54601 HANHART STOPSTAR
7 digits LCD-display, 7mm digit height. Range: 9 hrs 59 min 59.99 sec. Size: 82x61x28mm, weight: 70g
FUNCTIONS: Start, Stop, Reset, Addition, Split, Dual Timing.

C3 RU 54600 HANHART STRATOS 2
7 digits LCD-display, 6.5mm digit height. Range: 9 hrs 59 min 59.99 sec. Size: 66x70x21mm, weight: 62g
FUNCTIONS: Start, Stop, Reset, Addition, Split, Dual Timing.

D GY 81137 WHISTLE made of plastic with lanyard

TRAINING ACCESSORIES
Suitable for all kind of sports training. Develops coordination, quickness, agility and footwork. For an attractive, individual and effective training.

E FB 10041 PASSING ARC, 30cm (set of 8pcs)
F FB 10310 AGILITY HURDLE, 30cm (set of 5pcs)
G FB 10311 AGILITY HURDLE, 15cm (set of 5pcs)
G FB 10040 SLALOM POST (set of 8pcs)

H1 FB 10044 SOFT MARKER CONE VINYL, 20cm
H2 FB 10045 SOFT MARKER CONE VINYL, 30cm
H3 FB 10057 MARKER CONE, 28cm red or yellow
H4 FB 10056 MARKER CONE, 40cm yellow
H5 FB 10055 MARKER CONE, 40cm red
JA 71478 SELF ADHESIVE NUMBERS, 10cm black (n.p.)
H6 FB 10058 MARKER CONE in different colours, 6cm (set of 50pcs)

I1 GY 81127 SKIPPING ROPE LEATHER 275cm, with weighted wooden handle and ball bearings for smooth spin.
I2 GY 81129 SKIPPING ROPE 280cm, with wooden handles.
I3 GY 81128 SKIPPING ROPE HEMP 280cm, reinforced center

J FB 10305 AGILITY LADDER 8M

K1 RU 27025 TRAINING HURDLE
K2 RU 27021 REBOUND HURDLE MIDI 55-84CM
Returns automatically to upright position after being knocked down. Height adjustment through spring locks in steps of 5cm. Legs can be folded for storage.

TEAM SHELTERS
Aluminium frame construction. Roof, lower side and back panels made of white plastic. Acrylic upper side panels. Measurements: front height 180cm, back height 165cm. Comes with planed wooden footrest and bench.

FB 10035 TEAM SHELTER, width 250cm
FB 10036 TEAM SHELTER, width 400cm

ROOM LOCKER BENCHES
Made of sturdy, enamelled square steel tubes with plastic closing caps. Seat, back rest and shoe rack made of knotfree wood. Overall height approx. 168cm, seat height approx. 45cm, seat depth approx. 40cm.

M1 FB 10766 LOCKER ROOM BENCH TYPE B (one side bench with backrest and covered coat rail)
M2 FB 10765 LOCKER ROOM BENCH TYPE A (only bench)
FB 10767 LOCKER ROOM BENCH TYPE C (benches on both sides with backrest and covered coat rail)
FB 10770 SHOE RACK FOR LOCKER ROOM BENCHES
M3 FB 10771 COAT RAIL with 5 hooks per meter.

TRAINER'S/TEACHER'S ROOM

N FB 10759 STEEL FILING CABINET, Measurements: 950x500x1950 (WxDxH)
O FB 10555 MASSAGE BENCH
With adjustable head rest and foam padded top.
P FB 10554 STRETCHER
Made of aluminium. Officially approved.
Q FB 10556 MULTI PURPOSE FOLDING TABLE
Measurements: 134x67x72cm. With height adjustment. 19mm table top. Ideal for the umpire or ticket sales.
R FB 10558 MULTI PURPOSE CHAIR

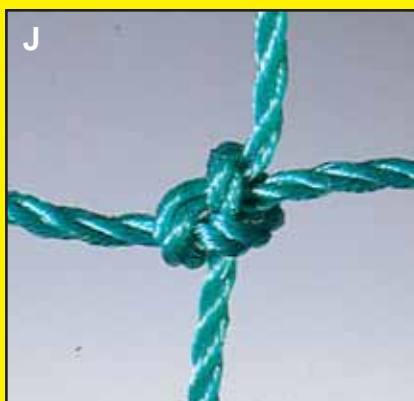

EQUIPMENT LOCKERS

Very robust and sturdy construction without sharp corners and edges (safety edges). Double reinforced doors. GS safety tested. All lockers treated with stoving varnish. Locks (cylinder locks) with safety grips. All lockers with airing holes. Standard colour light grey. Following colours are available at same cost: blue, orange, red, green, yellow.

- FB 10751 LOCKER TYPE I, (PERFORATED METAL DOORS)
For gymnastic equipment. With lockable compartment for valuables, hanger for clubs, rack for hoops, box for small devices. Dimensions: 120x50x195cm (WxDxH).
- A FB 10752 LOCKER TYPE I, (SOLID METAL DOORS)
As above, but with solid metal doors.
- FB 10753 LOCKER TYPE II, (PERFORATED METAL DOORS)
For balls, nets, ropes etc. One adjustable shelf with rail and hooks and three adjustable shelves. Dimensions: 120x50x195cm (WxDxH).
- B FB 10754 LOCKER TYPE II, (SOLID METAL DOORS)
As above, but with solid metal doors.
- FB 10755 LOCKER TYPE III, (PERFORATED METAL DOORS)
Especially for balls. With five adjustable shelves. Dimensions: 120x50x195cm (WxDxH).
- C FB 10756 LOCKER TYPE III, (SOLID METAL DOORS)
As above, but with solid metal doors.
- D FB 10757 LOCKER TYPE IV, (PERFORATED METAL DOORS)
Extra wide locker for balls. Partition wall in the middle and four adjustable shelves on each side. Sliding doors with safety locks. Dimensions: 200x50x195cm (WxDxH).
- FB 10758 LOCKER TYPE IV, (SOLID METAL DOORS)
As above, but with solid metal doors.

HANDBALL GOALS 3x2m EN 749

Made of reinforced aluminium profile 80x80mm. With extra solid corner joints. Break-proofed construction. With plugs to protect the surface. Net hoops and cross tubes made of aluminium or galvanized steel. Includes net retainers. GS safety tested.

- E HB 20210 GOAL FREE STANDING
- F HB 20601 GOAL FREE STANDING
As HB 20210, but with folding net hoops.
- HB 20600 GOAL "GROUND SOCKETS"
Includes ground sockets with lids.
- HB 20603 GOAL "GROUND SOCKETS"
As HB 20600, but without net hoops and base frame.
- HB 20602 GOAL "GROUND SOCKETS"
As HB 20600, but with folding net hoops.
- HB 20215 CONVERSION CROSSBAR
Made of aluprofile 80x80mm. Turns a competition goal into a mini goal. Includes all necessary mounting devices. (not pictured)
- G HB 20622 GROUND ANCHOR SET, INDOOR
Consists of 4 ground plates with fixing screws.
- H HB 20623 GROUND ANCHOR SET, OUTDOOR
Consists of 4 aluminium plungers with fixing screws.
- I HB 20624 RUBBER SUCKER, INDOOR
- HB 20625 REPLACEMENT GROUND SOCKET (picture p. 14 VB 30608)

GOAL NETS EN 749

MATERIAL/SPECIFICATION pictures J+K:

- J Polyethylene 3mm, K Nylon-Braided 4mm
- Measurements: 300x200cm, 80cm at top, 100cm at base, mesh approx. 10cm with tensioning cord.
- HB 20100/101 Polyethylene approx. 3mm, green or white
- HB 20103/102 Nylon-Braided approx. 4mm, green or white
- HB 20104 Nylon-Braided approx. 3mm, mesh ca. 4,5cm
- HB 20006 Drop net made of braided nylon approx. 3mm, white

- HB 20620 RUBBER TENSION LACES
Length 6,5m with hooks on both ends for fixing elastic net at the back of the goal frame.
- HB 20621 TENSION LACES
For net tensioning. One set consists of four pieces 6mm ropes with 3,5m length and tension chip.
- VB 30619 TENSION CHIP

SPARE PARTS

- L1 FB 10648 STAINLESS STEEL HOOKS
- L2 FB 10647 ALUMINIUM NUT RECTANGULAR
- L3 FB 10646 ALUMINIUM NUT RHOMBOID
- L4 FB 10645 SAFETY NET HOLDER

HANDBALLS

- M1 HB 20636 DIAMANT
Robust practice handball for schools and clubs made from Cordley-material with rubber coating. Shape retaining with excellent grip. Complies with IHF regulations. Sizes 3+2+1+0.
- M2 HB 20635 GRIPPY
Competition handball acc. IHF/DHB. Made from synthetic leather with rubber coating. Shape retaining and smooth with excellent rebound. Sizes 3+2+1+0.

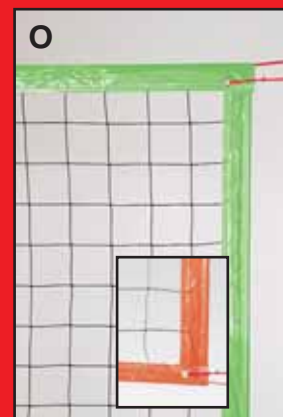
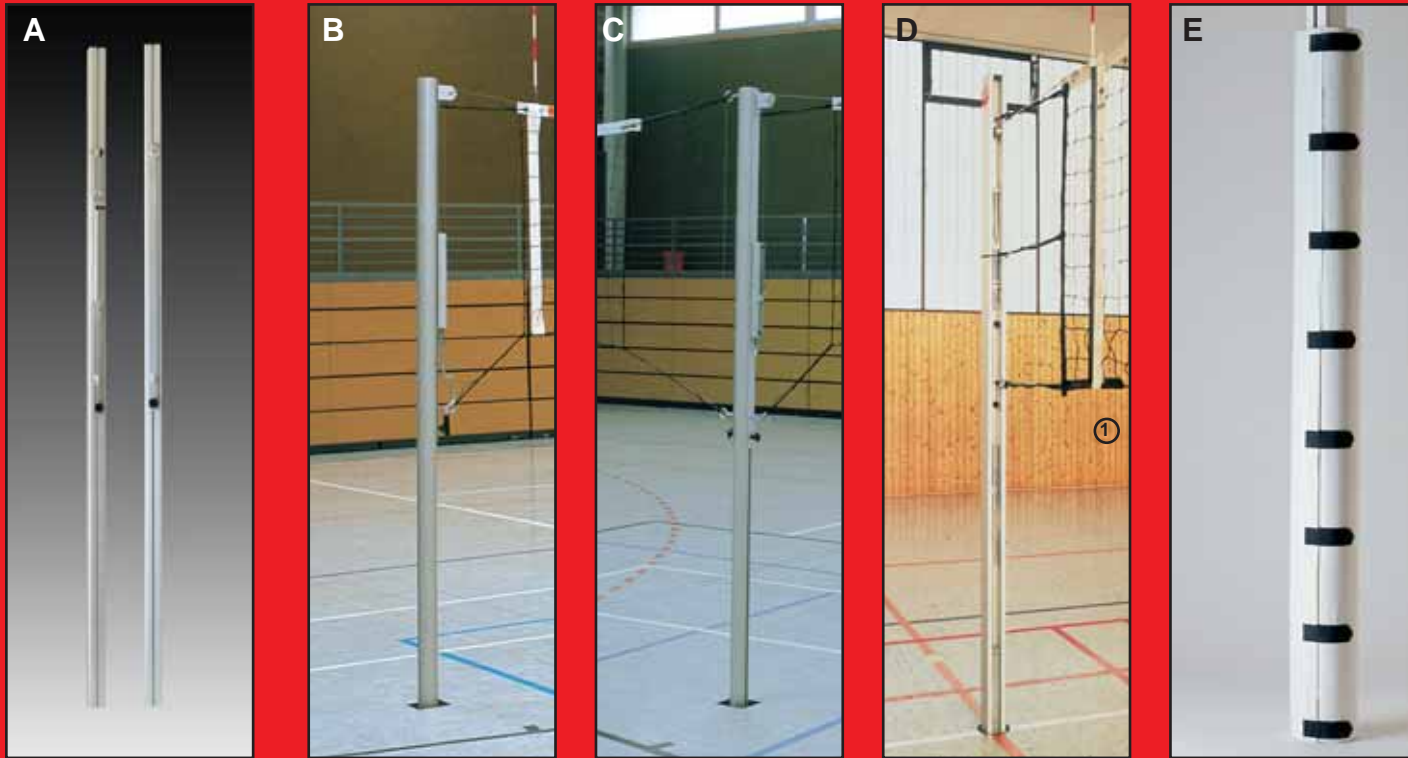

- VOLLEYBALL POSTS**
- A** VB 30600 VOLLEYBALL POSTS EN 1271
Made of thick walled aluminium profile 80x80mm, square. Maintenance free and weatherproof. High rigidity. Includes stainless steel hooks, ground sockets and lids.
- B** VB 30210 VOLLEYBALL POSTS EN 1271
Made of thick walled aluminium profile 83mm, round. Otherwise same as VB 30600.
- C** VB 30605 VOLLEYBALL CENTRAL POST EN 1271
Made of thick walled aluminium profile 83mm, round. Maintenance free and weatherproof. High rigidity. Separate net adjustment at each side of the post. Includes stainless steel hooks, ground socket and lid.
- VB 30606 VOLLEYBALL CENTRAL POST EN 1271
Made of thick walled aluminium profile 80x80mm, square. Otherwise same as VB 30605.
- D** VB 30602 VOLLEYBALL POSTS EN 1271 AND MARK I.
Made of thick walled and special reinforced aluminium profile 80x80mm, square. The net tensioner is level with the post. Exact net adjustment through two-piece net tensioner/holder with removable crank. (one-piece net tensioner with fixed crank can be delivered on request). Includes ground sockets and lids.
- VB 30603 VOLLEYBALL POSTS EN 1271 AND MARK I
Made of thick walled and special reinforced aluminium profile 83mm, round. Otherwise same as VB 30602.
- E** VB 30604 **POST PAD**
Core of soft polyether foam. Surface made from strong vinyl with velcro joints. Height 200cm. Fits all types of posts.
- GROUND SOCKETS**
- F1** FB 10657 GROUND SOCKET COVER
Made from cast aluminium. To be coated in plastic. Fits all square and round ground sockets up to 180mm inner diameter. Comes with frame, lid and lid remover.
- F2** VB 30608 GROUND SOCKET ALU 80x80mm, SQUARE
Aluminium with lid (VB 30608/01)
- F3** VB 30607 GROUND SOCKET ALU 83mm, ROUND
Aluminium with lid (VB 30607/01)
- G** VB 30009 **UMPIRE'S CHAIR**
Made of strong aluminium tubes. With adjustable platform and rubber feet. Includes writing board and two straps for fastening the chair to the post.
- VOLLEYBALL NETS + ACCESSORIES**
- H** VB 30016 VOLLEYBALL COMPETITION NET MARK I
Dimensions: length 9,5m, height 1,0m, mesh 10cm. 6-point suspension. Side bands reinforced with fibreglass rods. Kevlar cable 11,7m long. Made from approx. 4mm braided nylon. Head (70mm) and footband (50mm) made of polyester. Comes with tension laces and tension chips.

- D1** VB 30006 NET ANTENNA
One piece antenna complete with holder.
- I** VB 30615 VOLLEYBALL COMPETITION NET MARK II
Dimensions: length 9,5m, height 1,0m, mesh 10cm. 4-point suspension. Side bands reinforced with fibreglass rods. Kevlar cable 11,7m long. Made of approx. 3mm braided nylon. Head (70mm) and footband (50mm) made of polyester. Comes with tension laces and tension chips.
- J** VB 30616 VOLLEYBALL PRACTICE NET, PE
Dimensions: length 9,5m, height 1,0m, mesh 10cm. PVC coated galvanized steel cable 11,7m long. Made of approx. 2mm polyethylene. Head and footband made of polyester.
- VB 30015 VOLLEYBALL PRACTICE NET, NYLON
Dimensions: length 9,5m, height 1,0m, mesh 10cm. PVC coated galvanized steel cable 11,7m long. Made of approx. 3mm braided nylon. Head and footband made of polyester.
- VB 30619 TENSION CHIP
VB 30620 (SPARE)-STEEL CABLE (PVC COATED)
Length 11,7m, with 2 loops.
VB 30622 (SPARE)-CABLE KEVLAR
Length 11,7m, with 2 loops.
VB 30623 TENSIONING BELT
With self locking mechanism.
- VOLLEYBALLS**
- K1** VB 30640 MIKASA VL 200, FIVB approved
K2 VB 30642 MIKASA Standard, FIVB approved
K3 VB 30643 TRAINER
Handmade durable practice ball in white chrome leather. Perfect quality for perfect training.
- BEACH VOLLEYBALL**
- L** VB 30160 BEACH VOLLEYBALL POSTS "CITY"
Made of thick walled aluminium profile 83mm, round. Stainless steel hooks. Without ground sockets.
- M** VB 30102 COURTLINE
9x18m with corner loops, 4 anchors and reel.
- N1** VB 30165 SPECIAL-GROUND SOCKET bolted to concrete.
N2 VB 30166 SPECIAL-GROUND SOCKET for embedding.
- BEACH VOLLEYBALL NETS**
- O** VB 30100 COMPETITION NET POLYESTER
Dimensions: length 9,5m, height 1,0m, mesh approx. 10cm. 4-point suspension. Side bands reinforced with fibreglass rods. Made of approx. 3mm braided polyester. Comes with green or red headband and tension laces.
- P** VB 30630 PRACTICE-(LEISURE) NET POLYETHYLENE 2mm
Dimensions: length 9,0m, height 0,9m, mesh approx. 10cm. Top and bottom seamed.
- BEACH VOLLEYBALLS**
- Q** VB 30125 MIKASA BEACH CHAMP VS200
Hand sewn and waterproof.

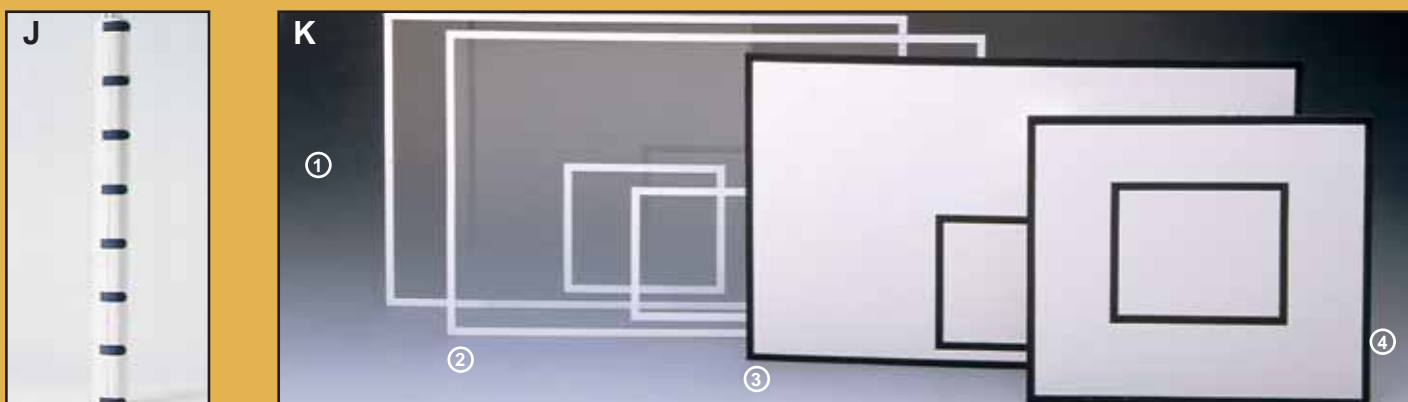

BASKETBALL STANDS ACC. TO EUROPEAN STANDARD (CEN)

- A** BB 40600 MOBILE BASKETBALL STAND
Made of robust aluminium, 1650mm projection. Basic frame with 3 rollers (one is height adjustable). Built-in support for cement tiles as counterweights. Easy to assemble. Comes with all necessary mounting hardware, but without backboards, rings, nets and counterweights.
- B** BB 40601 SINGLE POST BASKETBALL STAND
Made of reinforced aluminium profile 90x5mm. Special ground sockets (Length 600mm/insertion depth 500mm) with cotter and wedges to avoid distortion. Very sturdy backboard attachment construction. Projection 1650mm (Also available with 2250mm projection acc. DIN). Comes with ground sockets, lids and wedges, but without backboards, rings and nets.
- C** BB 40602 DOUBLE POST BASKETBALL STAND
Made of reinforced aluminium profile 90x5mm. Special ground sockets (Length 600mm/insertion depth 500mm) with cotter and wedges to avoid distortion. Very sturdy backboard attachment construction. Projection 2250mm acc. DIN. Comes with ground sockets, lids and wedges, but without backboards, rings and nets.
- D** BB 40605 SINGLE POST BASKETBALL STAND "CITY"
Specially constructed for public fields. Heavy duty construction of galvanized steel profile 90mm. Projection 1250mm. Backboards made of steel with "low-noise" cover. Comes with robust rings and chain nets.

BASKETBALL RINGS EN1270/DIN7899

- E** BB 40209 BASKETBALL RING with net suspension hooks
Conforms with international regulations.
- F** BB 40210 BASKETBALL RING with wire cable guidance
Complies with EN1270 / DIN7899. Powder-coated.
- G** BB 40212 BASKETBALL RING "SCHOOL"
With wire cable guidance
Sides with flat steel reinforcements as per EN1270 / DIN7899 (240kg). Powder-coated.
- H** BB 40213 BASKETBALL RING "OUTDOOR"
With wire cable guidance
Extra strong goal ring. Sides with flat steel reinforcements. Hot dip galvanized steel tubing. Weatherproof. Holds up to 500kg.
- I** BASKETBALL RING DEFLECTABLE
With wire cable guidance. Deflects by means of compression springs. Powder-coated.
BB 40215 deflects at approx. 35kg
BB 40216 deflects at approx. 75kg
BB 40217 deflects at approx. 105kg

- J** VB 30604 PROTECTION PAD
Core of soft polyether foam. Surface made from strong vinyl with velcro joints. Height 200cm. Fits all types of posts.

BACKBOARDS

- K1** BB 40033 SAFETY GLASS BACKBOARD
180x105x1,2cm with glass outcut according to international regulations. Includes mounting hardware.
- K2** BB 40034 ACRYLIC GLASS BACKBOARD
180x105x1,1cm on steel frame.
- K3** BB 40035 BACKBOARD FG
180x105cm fibreglass coated. Weatherproof.
- K4** BB 40036 BACKBOARD FG
120x90cm fibreglass coated. Weatherproof.

BASKETBALL NETS

- L** BB 40014 NET COTTON 6mm
- M** BB 40013 NET NYLON 3mm, braided
Conforms with international regulations.
- N** BB 40012 NET NYLON 4mm, braided
Conforms with international regulations.
- O** BB 40011 NET NYLON 6mm, braided
Conforms with international regulations.
- P** BB 40015 CHAIN NET
Made of galvanized steel.

BACKBOARD PADDING

- Q1** BB 40100 BACKBOARD PADDING "FIBA"
Made of heavy PU foam. To be screwed to steel frame. Fits all backboards with steel frame.
- Q2** BB 40101 BACKBOARD PADDING "SCHOOL"
Core of compounded chip foam faced with heavy PU foam. To be glued to the backbord. Fits all backboards.

BASKETBALLS

- R** BB 40611 MIKASA PERMALAST 1500
FIBA approved competition ball with nylon carcass and rubber cover for excellent grip. Size 7.
- S** BB 40612 TRAINING
Nylon carcass. Official size and weight. Size 7+5.

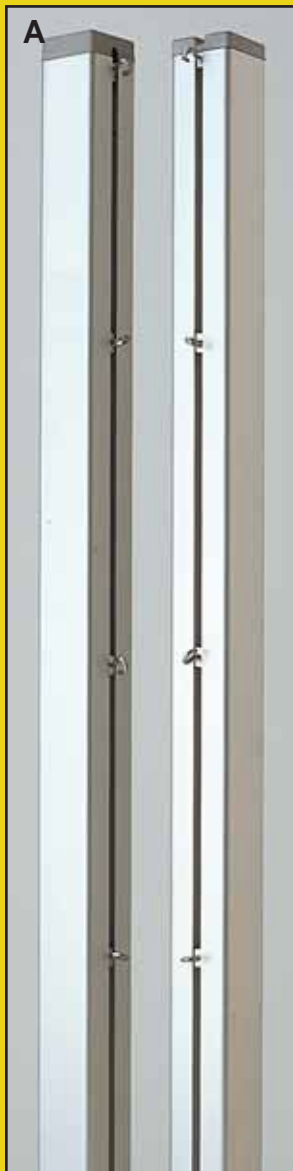

- TENNIS POSTS**
- A** TE 50600 TENNIS POSTS ACC. DIN 7895
Made of thick walled aluminium profile 80x80mm, square. Maintenance free and weatherproof. High rigidity. Internal spindle tension unit with detachable crank. Post caps made from cast aluminium. Includes stainless steel net hooks with retaining bar, ground sockets and lids. *Can also be delivered green or white powder coated.*
- B** TE 50601 TENNIS POSTS ACC. DIN 7895
Made of thick walled aluminium profile 83mm, round. Maintenance free and weatherproof. High rigidity. White powder coated. Internal spindle tension unit with detachable crank. Post caps made from cast aluminium. Includes stainless steel hooks with retaining bar, ground sockets and lids. *Can also be delivered green powder coated.*
- C** TE 50602 TENNIS POSTS ACC. DIN 7895
As above, but aluminium matt silver.
- GROUND SOCKETS/LIDS**
- D1** FB 10657 GROUND SOCKET COVER
Made from cast aluminium. Lid must be filled with synthetic material. Fits all square and round ground sockets up to 180mm inner diameter. Comes with frame, lid and lid remover.
- D2** VB 30608 GROUND SOCKET ALU 80x80mm, SQUARE
Of aluminium with lid (VB 30608/01)
- D3** VB 30607 GROUND SOCKET ALU 83mm, ROUND
Of aluminium with lid (VB 30607/01)
- E** TE 50004 SINGLES STICKS
Aluminium with flat bottom.

- TENNIS NETS**
- F** TE 50037 TENNIS NET POLYETHYLENE
Acc. ITF rules. Dimensions: 12,72x1,07m. PVC coated galvanized steel cable 13,2m long. Made of approx. 3mm braided polyethylene. Side bands reinforced with fibreglass rods. PVC head band. Colour: black.
- TE 50038 TENNIS NET POLYETHYLENE
As above, but colour green.
- TE 50039 TENNIS NET POLYESTER/NYLON
Acc. ITF rules. Dimensions: 12,72x1,07m. PVC coated galvanized steel cable 13,2m long. Made of approx. 3mm braided polyester. Side bands reinforced with fibreglass rods. PVC head band. Colour: black.
- G** TE 50040 TENNIS NET POLYESTER/NYLON
As above, but colour green.
- H** TE 50612 TENNIS NET POLYETHYLENE 10
Acc. ITF rules. Dimensions: 12,72x1,07m. PVC coated galvanized steel cable 13,2m long. Made of approx. 2mm twisted polyethylene. 10 double mesh at the top, one at the bottom. PVC head band. Rhombic mesh. Colour: black.
- TE 50608 REPLACEMENT HEADLINE
13,2m long, made of PVC coated galvanized steel cable with 2 loops.
- TE 50609 (REPLACEMENT)-HEADBAND PVC
- TE 50611 REPLACEMENT HEADLINE KEVLAR
13,2m long, with 2 loops.
- I** FB 10030 BENCH
Aluminium with plastic slatted seat.

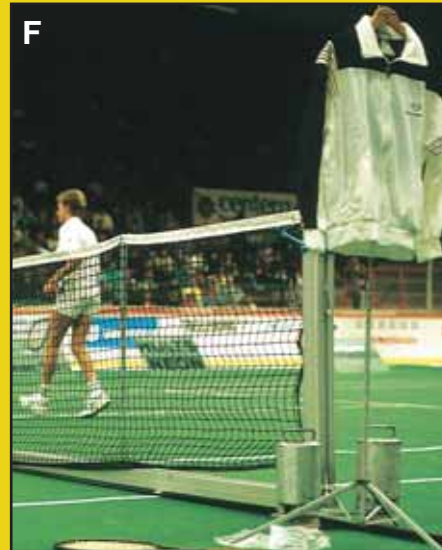
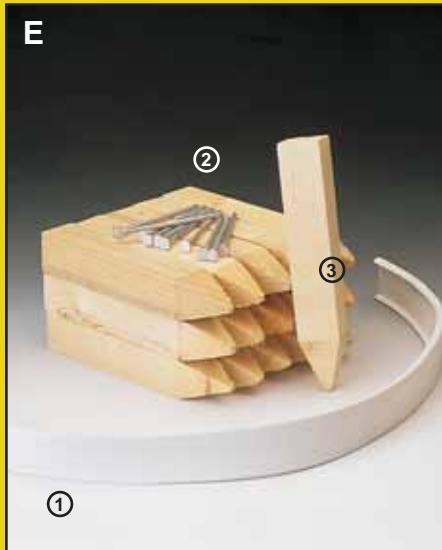
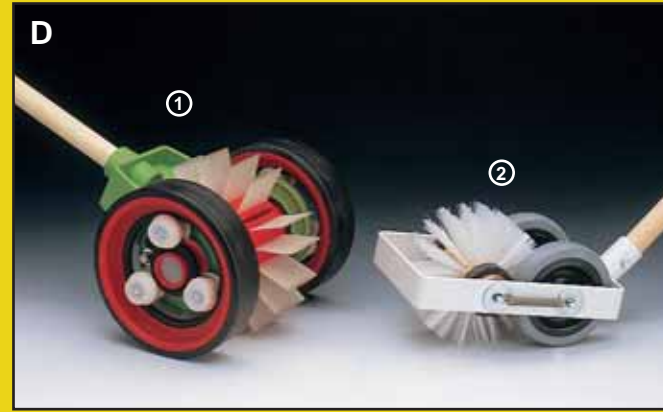
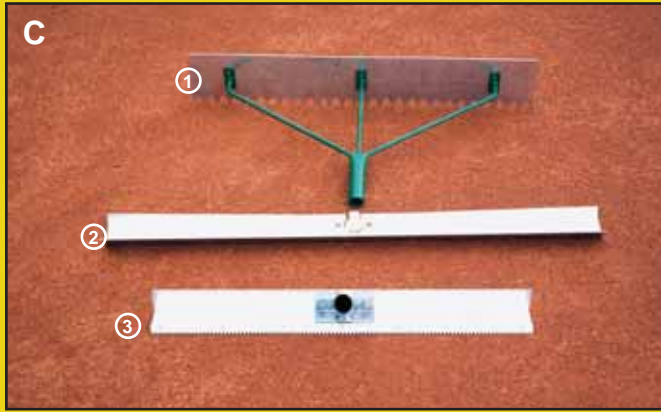
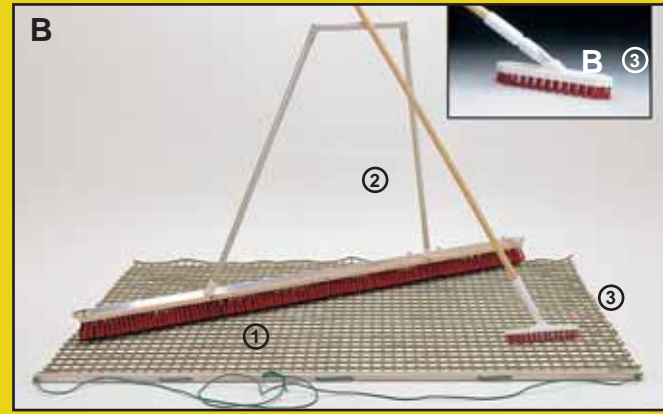

- A** TE 50034 **COURT MAINTENANCE**
WATER ABSORBING MACHINE
Technical details on request.
- TE 50033 **TRIPOD SPRINKLER**
Tripod made of galvanized steel, head made of brass. For circular (approx. 30m diameter) and sectoral sprinkling. With GEKA-coupling. Feet with flat bottom.
- B1** TE 50015 **SKIDDING NET**
Made of heavy, plastic covered PVC fabric with pulling cord. Working width 200cm.
- B2** TE 50005 **COURT BRUSH**
With aluminium handle and replaceable broom elements. Both ends equipped with rims to avoid snagging the net. Working width 210cm.
- B3** TE 50007 **LINE BRUSH**
Complete with robust adjustable handle.
- C1** TE 50651 **SERRATED ALUMINIUM BLADE**
Straight edge for levelling and planing, serrated edge for roughening clay surfaces. Working width 80cm. Comes without handle (D=28mm).
- C2** TE 50652 **STRAIGHT ALUMINIUM BLADE**
Straight edges for levelling and scraping clay surfaces. Working width 100cm. Comes without handle (D=30mm).
- C3** TE 50650 **CHARRING RAKE**
Sawbladed edge for levelling and planing clay surfaces. Working width 70cm. Comes without handle (D=30mm).
- D1** TE 50013 **LINE SWEEPERS**
LINE SWEEPER TYPE B
Full plastic construction with nylon paddle wheel. Weatherproof. All parts can be easily replaced.
- D2** TE 50006 **LINE SWEEPER**
Comes without handle.
- TE 50008 **SEPARATE BRUSH**
For TE 50006.
- E1** TE 50025 **TENNIS LINES**
TENNIS LINE "EXTRA"
Made from UV resistant and non-slip PVC tape profile. With 3 reinforcing ribs. One set is 150m for one court. *Other tennis lines on request.*
- E2** TE 50020 **FIXING NAILS**
For tennis lines. Ca. 10cm long, galvanized. Quantity per court approx. 5kg.
- E3** TE 50026 **WOODED FIXING DOWELS**
For tennis line junctions. Made of deep-impregnated wood. Quantity per court 16 pieces.

- F** TE 50220 **FREE STANDING TENNIS POSTS**
Made of thick walled-aluminium profile 80x80mm, square. Official competition size. The portable posts make it possible to play tennis where ground sockets are not available. For example tournaments in congress halls.
- NET ADJUSTER**
- G1** TE 50014 **CENTRE TAPE**
Made from covered polyester with velcro adjustment.
- G2** TE 50017 **FLOOR PLATE**
- H** TE 50016 **GROUND PLUNGER**
Made of aluminium, ca. 25cm with lid. Takes the centre tape.
- I** TE 50019 **TENNIS NET HANGER**
- J** TE 50009 **UMPIRE'S CHAIR**
Made of aluminium with wide steps. Feet with flat bottom. UV resistant, plastic moulded seat. Comes with hinged plastic writing board and net. Collapsible for space-saving storage.
- K** TE 50035 **WIND SCREEN**
Measurements: 12x2m, reinforced hems with brass eyes. Comes with mounting hooks. *Other colours and advertising prints on request.*
- L** TE 50010 **MATCH SCOREBOARD**
Shows 3 sets through 6 discs. Made of UV-resistant, hard-wearing and weatherproof plastic. *When ordering please specify "English version".*
- TENNIS RACKETS/BALLS**
- M1** TE 50681 **CLUB CARBON**
Aluminium/carbon frame with durable japanese string. For advanced players.
- M2** TE 50680 **JUNIOR ALU**
Robust alu frame with durable string. Especially designed for beginners. Very light.
- M3** TE 50684 **TENNIS BALLS "PRO-TRAINING"**
The perfect training ball for price conscious players.

TABLE TENNIS & BADMINTON

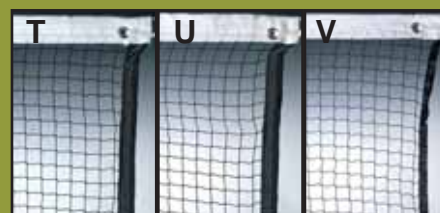

- TABLE TENNIS-TABLES**
- A** TT 55001 JOOLA "ROLLOMAT" EN 14468-1 A
Competition table ITTF approved. 22mm extremely fast competition playing surface (blue or green). Equipped with mobile automatic undercarriage, a safe construction with legs opening automatically. Storing size: 152x60x178cm. Weight 115kg.
- B** TT 55002 JOOLA "2000-S" EN 14468-1 A
Competition table ITTF approved. 22mm extremely fast competition playing surface (blue or green). 50mm metal frame with steel leg undercarriage, heavy duty wheels in series. Weight 97kg.
- C** TT 55003 JOOLA "TRANSPORT" EN 14468-1 B
Ideal for school and club sports. 19mm extremely fast competition playing surface (blue or green). 25mm metal frame with compact storing undercarriage and substantial twin rolls. Weight 90kg.
- D** TT 55004 JOOLA "WORLD CUP" EN 14468-1 B
Ideal for school and club sports. 22mm extremely fast competition playing surface (blue or green). 50mm metal frame with twin roller undercarriage. Easy Storing by telescoping the halves. Weight 115kg.
- E** TT 55006 JOOLA "VARIANT" EN 14468-1 B
For schools, clubs and youth groups. 19mm extremely fast competition playing surface (blue or green). 40mm metal frame with folding undercarriage. 3-height levels for quick and easy adjustment (76, 70 or 64cm). Weight 82kg.
- F** TT 55008 JOOLA "CLIMA" EN 14468-1 D
For schools and private use. Equipped with absolutely weatherproof 22mm sandwich aluminium plate and mobile undercarriage. Easy mounting. Weight 60kg.
- G** TT 55050 TABLE TENNIS TABLE B-2000
For outdoor use. 22mm thick surface with PVC frame made of steel-reinforced acrylic concrete. Undercarriage made of acrylic concrete with ground attachments. Weight 400kg (heaviest part 100kg).
- H** TT 55053 TABLE TENNIS TABLE S-2000
As above, but undercarriage made of galvanized steel. Weight 240kg (heaviest part 100kg).

- TABLE TENNIS NETS WITH POSTS**
- I** TT 55011 JOOLA "WM"
Top model, ITTF approved. Solid metal body with cotton-iron thread net. Net height adjustment by a special quick lock system
- J** TT 55012 JOOLA "EUROPALIGA"
Extra solid cotton-iron thread net and post set for clubs and schools. Micro vertical adjustment system. Comes with storing bag. Meets all ITTF regulations.

- K** TT 55013 JOOLA "COMPACT"
Weatherproof nylon net with durable posts and extra wide opening clamps. Adjustable height and tension.
- L** TT 55014 JOOLA "KLICK"
Solid metal-cotton net and post set with vertical adjustment clip system.
- TT 55010 ALUMINIUM NET 8mm for TT 55050 and TT 55053
- TT-BATS/BALLS**
- M** TT 55020 TWIST (straight handle), pimples inwards, with sponge.
- M** TT 55021 PROFI (straight handle - leather grip), pimples inwards, with sponge.
- N** TT 55022 MATCH (concave handle), pimples inwards, with sponge. Perfect for developing playing skills.
- N** TT 55023 TOP (anatom. handle), pimples inwards, with sponge. Perfect for developing playing skills.
- O** TT 55017 BALL "SPEZIAL", *
Leisure and practice ball. Ideal for schools. Set=6pcs.
- P** TT 55019 BALL "SELECT", ***
Choice quality for clubs. Hard and durable. Set=6pcs.
- Q** TT 55016 BALL TRAINING
Popular practice ball for schools and clubs. Bucket=144pcs.

- BADMINTON POSTS**
- R** BM 60600 BADMINTON POSTS WITH GROUND SOCKETS
Made of alu profile 80x80mm for installation in ground sockets. Complete with hooks, ground sockets and lids.

- S** BM 60005 BADMINTON POSTS COMPETITION
Made of strong steel tubes, complete with hooks and tensioning belt. Equipped with rubber wheels and rubber buffers.

- BADMINTON NETS**
- T** BM 60002 COMPETITION NET DIN EN 1509
Length 6,02m, height 0,76m, 18mm mesh. Fiberglass side sticks. Kevlar cable 8m long. Made from ca. 1,2mm braided polyester.

- U** BM 60012 COMPETITION NET DIN EN 1509
As BM60002, but made from ca. 1,8mm braided polyester.

- V** BM 60003 PRACTICE NET
Length 6,02m, height 0,76m, 18mm mesh. Pastified steel cable 6,60m. Made from ca. 1,2mm braided polyester.

- BADMINTON RACKETS/BALLS**
- w1** BM 60680 SCHOOL
Robust racket for beginners. Shaft and frame made of tempered steel. Japanese string. Weight approx. 125g
- w2** BM 60681 CLUB
Shaft made of triple tempered steel. Frame made of aluminium. Japanese string. Weight approx. 105g.

- w3** BM 60683 BALL "SCHOOL"
Made of PVC. Set=5pcs.

- w4** BM 60684 BALL "TOURNAMENT"
Made of nylon with cork head. Set=3pcs.

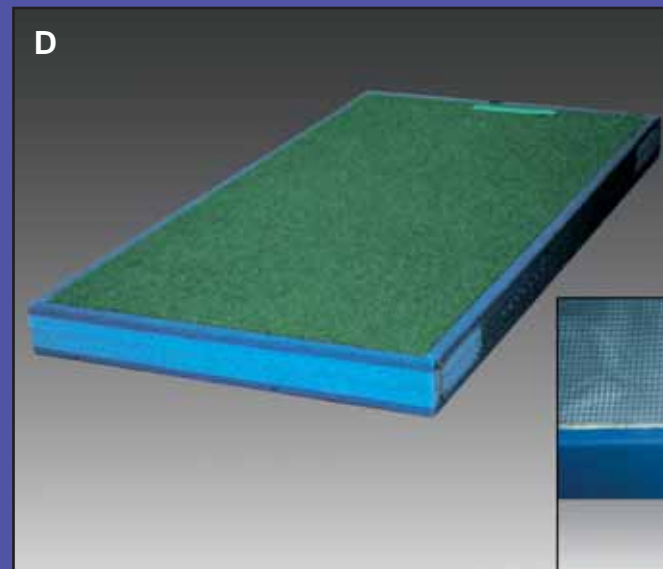
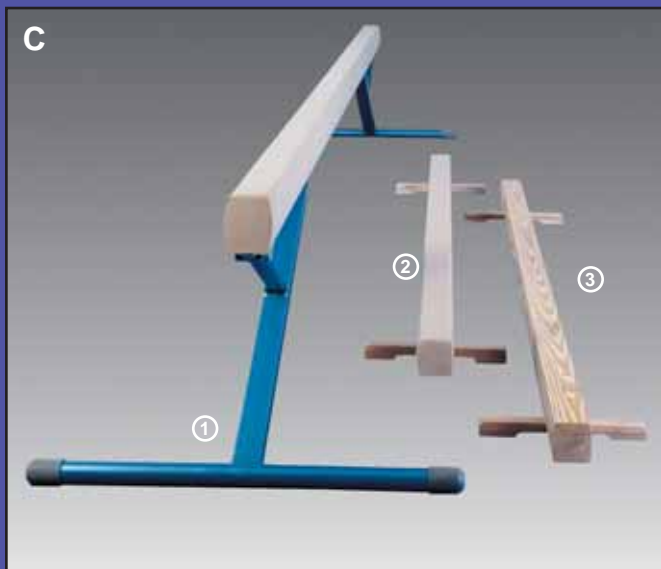
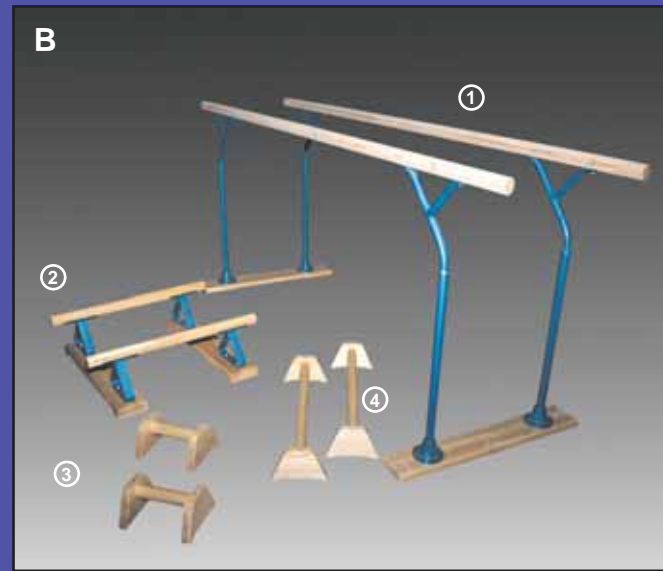

BARS FOR SCHOOLS AND CLUBS

Heavy base frame of steel tubes with cast iron sockets. Built in castors. Cross feet with non marking rubber buffers. Height adjustment stepwise with special locking mechanism. Strong laminated wooden bars of 350cm length.

- A** GY 81000 PARALLEL BAR, COMPETITION
Height adjustment 120-180cm. Width adjustment 42-54cm
- GY 81001 PARALLEL BAR, CLUB
Height adjustment 110-170cm. Width adjustment 38-50cm
- GY 81002 PARALLEL BAR, SCHOOL
Height adjustment 100-150cm. Width adjustment 34-46cm.

A1 GY 81003 CRASH MATS
Core of compounded foam covered with durable vinyl. Please specify sizes when ordering.

B1 GY 81004 PRACTICE BAR SENIOR
Very stable construction with anti-slip base. Adjustable width. Foldable for space-saving storage. Bar length 250cm, height 105cm. Perfect for school purposes.

GY 81005 PRACTICE BAR JUNIOR
As above, but height 80cm.

B2 GY 81006 HANDSTAND PRACTICE BAR
Beechwood bar, length 75cm. Steel fittings. Adjustable width.

B3 GY 81007 HANDSTAND PARALLETS
Official grip profile. Anti-slip base. Length 25cm.

B4 GY 81008 HANDSTAND PARALLETS
As above, but 70cm long.

BALANCE BEAMS

C1 GY 81071 BALANCE BEAM 5M
Competition and practice beam acc. DIN 7906. Height adjustment from 85 to 125cm. Mats can remain under the beam while adjusting height. Upholstered and covered with fleece. (without fleece on request).

C2 GY 81072 BALANCE BEAM 3M
Practice balance beam with specially milled wooden legs to fit a gymnastic bench. Upholstered and covered with fleece.

C3 GY 81070 BALANCE BEAM 3M
Practice balance beam with specially milled wooden legs to fit a gymnastic bench.

FITTED APPARATUS MATS FOR NATIONAL AND INTERNATIONAL COMPETITIONS (F.I.G.)

Sandwich constructed apparatus landing mats. Perfect shock absorption for safe and high-quality performance. Surface made from skin-friendly fleece, sides made of plain tarpaulin, underside (pic. D) made from slip-proof material. Standard model blue comes with velcro strips. Can also be delivered in other specifications or colours.

USED WITH: horizontal bar, vaulting horse, assymmetric bar, pommel horse, balance beam, still ring frame and men's bar. *Special orders possible.*

VAULTING TABLES

Vaulting tables for competition and training. Please ask for a special offer.

VAULTING + POMMEL HORSES (DIN)

With wooden legs, well-rounded. Height adjustment in steps through sliders with easy-to-handle lockings. Free sliding height adjustment of one leg instead of height adjustment in steps for perfect stability. The hoofs are made of vulcollan with transport wheels (2x). The corpus is a handcrafted wooden construction, reinforced at both short sides. Very good padding covered with very durable genuine cowhide.

Pommel horses with hygroscopic and synthetic pommels (roughened and width adjustable). GS-safety-tested.

With steel legs, as above, but legs made of steel with steel tube sliders for easy height adjustment.

- E1** GY 81014 POMMEL HORSE STEEL 95-150CM
- E2** GY 81015 POMMEL HORSE WOOD 95-150CM

- E3** GY 81012 VAULTING HORSE WOOD 110-170CM
- GY 81013 VAULTING HORSE WOOD 110-150CM

- E4** GY 81010 VAULTING HORSE STEEL 110-170CM
- GY 81011 VAULTING HORSE STEEL 110-150CM

GY 81021 GUY CHAIN

E5 GY 81016 PRACTICE POMMEL HORSE
With 2 cross feet of hard wood.

E6 GY 81017 MINI-POMMEL HORSE 90 BIS 130CM
Same construction as Pommel horse wood. Body length 80cm.

- E7** GY 81020 REPLACEMENT HOOF
- E8** GY 81019 REPLACEMENT ROLL HOOF

E9 GY 81018 POMMEL BOARD
Base board with built-in steel rail for sliding adjustment of the pommels. Underside covered with fleece.

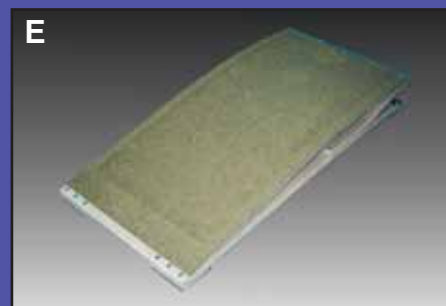

- A VAULTING BUCKS ACC. DIN**
With wooden legs, well-rounded. Height adjustment stepwise through sliders with easy-to-handle lockings. Free sliding height adjustment of one leg instead of height adjustment in steps for perfect stability. The hoofs are made of vulcollan with transport wheels (2x). The corpus is a handcrafted wooden construction, reinforced at both short sides. Very good padding covered with extremely durable genuine cowhide. GS-safety-tested.
With steel legs, as above, but legs made of steel with steel tube sliders for easy height adjustment.
- GY 81050 VAULTING BUCK STEEL 90-130CM
 - GY 81051 VAULTING BUCK STEEL 100-150CM
 - GY 81052 VAULTING BUCK STEEL 110-170CM
 - GY 81053 VAULTING BUCK WOOD 90-130CM
 - GY 81054 VAULTING BUCK WOOD 100-150CM
 - GY 81055 VAULTING BUCK WOOD 110-170CM
- GY 81059 PROTECTION PADS FOR VAULTING BUCKS/HORSES
 Core of PE-foam with surface of strong vinyl, velcro joints.
- B FI 90499 WHEELAWAY CHALK STAND**
C FI 90501 CHALK BLOCKS (8PCS, CA. 480G)
- D VAULTING BOXES ACC. DIN**
 Made of massive, knot-free and indigenous wood. Planed and varnished surface. Double mortised (hidden dovetailing), glued and bolted bevelled corners, reinforced with pilot blocks for perfect stability. Base sections are equipped with hard-wood cross feet with non marking rubber buffers. Top sections with very good padding covered with extremely durable genuine cowhide. GS- safety-tested.
- GY 81060 VAULTING BOX 1-SECTION, 70x50x40CM
 - GY 81061 VAULTING BOX 3-SECTIONS, 70x50x40CM
 - GY 81062 VAULTING BOX 4-SECTIONS, 150x50x90CM
 - GY 81063 VAULTING BOX 5-SECTIONS, 150x50x110CM
 - GY 81064 VAULTING BOX 6-SECTIONS, 150x50x110CM
 - GY 81065 HOLE IN BOX TOP
 For attaching gymnastic benches. The hole is reinforced with steel to protect the wood.
 - GY 81066 TRANSPORT WHEELS (built in or as conversion kit)
 2 wheels mounted on the short side of the base section.
 - GY 81067 SWING AXLE (built in or as conversion kit)
 For attaching to the centre of the box.
 - GY 81068 SWIVEL CASTERS (built in or as conversion kit)
 4 wheel construction with lever.
 - GY 81069 PROTECTION PAD FOR VAULTING BOXES
- E SPRINGBOARDS**
 GY 81046 SPRING BOARD WITH PADDING AND COVER
 Padding made of compound foam with needle-felt cover. Measurements: 120x60x14cm.
 GY 81045 SPRINGBOARD ACC. DIN 7915
 As above, but without padding and needelfelt cover.

- F GY 81041 MINITRAMPOLINE**
 Foldable frame made of galvanized steel tubes. Height and inclination adjustable. Bed 60x60cm made of durable nylon. Complete with frame pad. Size: 112x112cm.
- F1 GY 81042 FRAME PAD FOR MINITRAMPOLINE**
- G WALL BARS ACC. DIN**
 Official size. Strong softwood sides, oval rungs made of ash. Comes with all necessary fastening material.
- GY 81602 WALL BAR, 100x260CM (wxh)
 - GY 81603 WALL BAR, 200x260CM
 - GY 81604 WALL BAR WITH 14 RUNGS AND HEAD, 100x215CM
 - GY 81605 WALL BAR 14 RUNGS, 100x215CM
 - GY 81606 WALL BAR 7 RUNGS, 100x215CM
 - GY 81607 HOME WALL BAR, 100x215CM
 Comes dismantled. Size: 100x215cm. Complete with wall attachment set and exercise instructions.
 - GY 81608 ABDOMINAL BOARD
 Can be attached to all wall bars. 180x40cm with leather covered hooks.
 - GY 81609 PROJECTION BAR
- H ELASTIC SWING FLOORS**
 The swing floor base construction consists of max. 64 single elements with specially designed synthetic springs for world class performance. The floor exercise mat (can also be used without base construction) consists of max. 7 lines (14x2m), joined with velcro. It is made of closed-cell foam with carpet surface and anti-slip base (25/35mm).
- GY 81381 FLOOR EXERCISE MAT 6x2m, 25mm
 - GY 81382 FLOOR EXERCISE MAT 6x2m, 35mm
 - GY 81383 FLOOR EXERCISE MAT 12x2m, 25mm
 - GY 81384 FLOOR EXERCISE MAT 12x2m, 35mm
 - GY 81385 FLOOR EXERCISE MAT 14x2m, 35mm
- I (SWEDISH) GYMNASTIC BENCHES ACC. DIN**
 Made of multi laminated, knot-free and indigenous pine wood. Planed and varnished surface with bevelled corners. With firmly fixed attachment ledge to hook the benches to wall bars or vaulting boxes. 10cm wide balance beam. Two legs with screw-on, non marking floor buffers and a support in the middle. Steel angle joints between plate and legs/support.
- GY 81025 280CM LONG
 - GY 81026 300CM LONG
 - GY 81027 350CM LONG
 - GY 81029 350CM LONG, with wheels
 - GY 81028 400CM LONG
- J GY 81500 CLIMBING ROPES**
 Made of durable hemp. Diameter ca. 33mm. Lengths from 400cm on.
- K GY 81389 ROLL-UP DRUM WOOD 200CM**

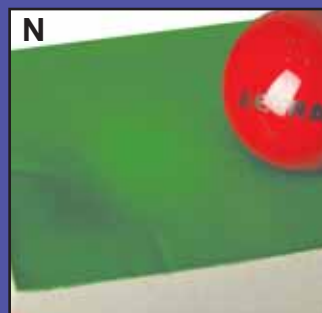
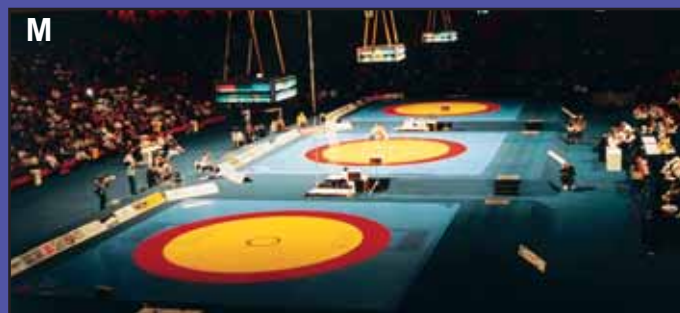
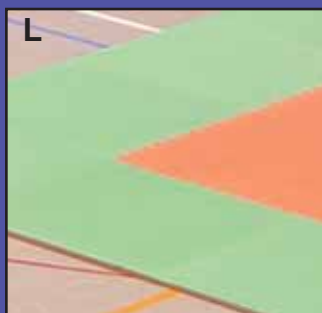
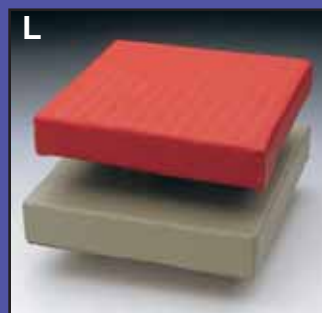
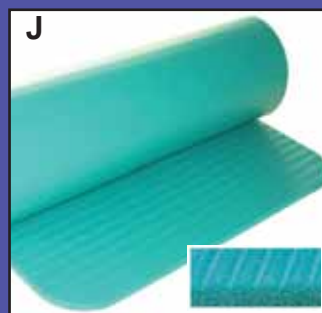
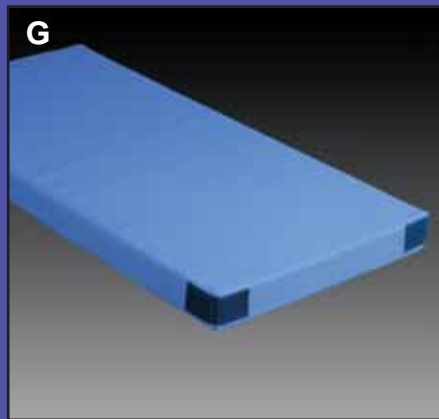
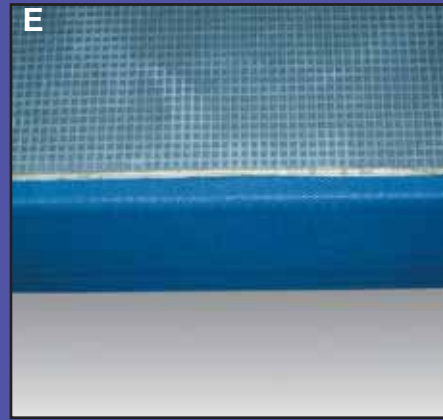
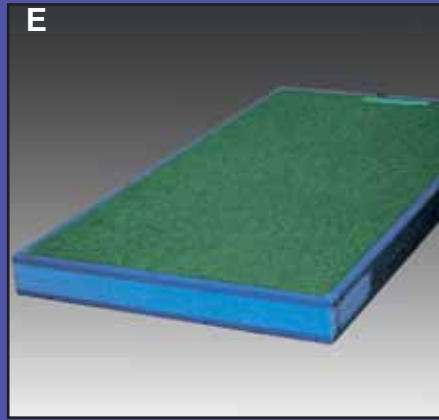
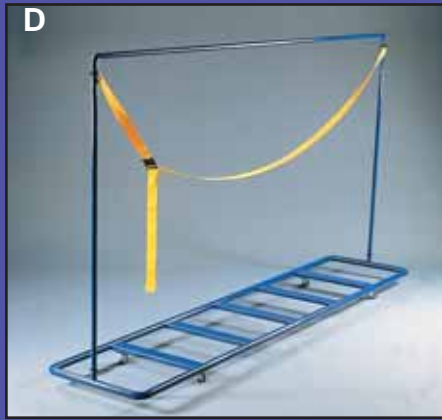
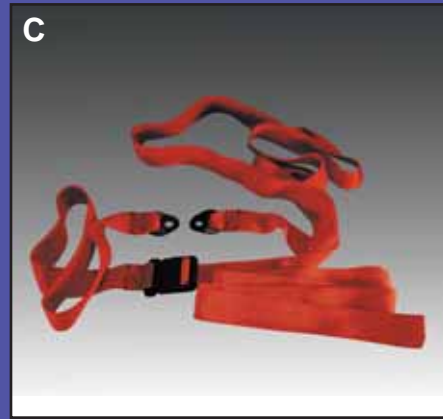
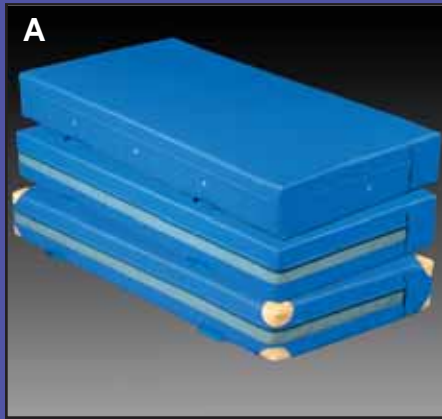

A SOFT LANDING MATS
Core of soft polyether foam. Top and sides of strong vinyl. Airing holes or tammy cloth on sides. Underside slip-proof. Standard model blue comes with airing holes or tammy cloth and 4 carrying straps and zipper on 3 sides. Can also be delivered in other sizes, specifications (e.g. handles, reinforced leather corners) or colours. We also deliver separate covers as spare parts.

- GY 81400 200x150x25cm, **RG18 = density 18kg/m3**
- GY 81401 200x150x30cm, RG18
- GY 81402 200x300x25cm, RG18
- GY 81403 200x300x30cm, RG18
- GY 81405 200x150x25cm, **RG20 = density 20kg/m3**
- GY 81406 200x150x30cm, RG20
- GY 81407 200x300x25cm, RG20
- GY 81408 200x300x30cm, RG20
- GY 81410 200x150x25cm, **RG22 = density 22kg/m3**
- GY 81411 200x150x30cm, RG22
- GY 81412 300x200x25cm, RG22
- GY 81413 300x200x30cm, **RG25 = density 25kg/m3** acc. DIN+GS

B FOLDING SOFT LANDING MAT
GY 81415 300x200x30cm, RG20
GY 81416 300x200x25cm, RG22
GY 81417 300x200x25cm, RG20
GY 81418 300x200x30cm, RG22

C WALL STRAP FOR LANDING MAT
500cm long with quick fastener.
GY 81423 WALL STRAP

D MAT TROLLEY
Transport and storage trolley for soft landing mats. Powder-painted steel construction.
GY 81420 TROLLEY

E LANDING MATS
Sandwich constructed apparatus landing mat. Perfect shock absorption for safe, high-quality performance. Surface made from skin-friendly fleece, sides made of plain tarpaulin, underside made from slip-proof material. Blue standard model comes with velcro strips. The multi-purpose mat for schools and clubs. Can also be delivered in other sizes, specifications or colours.

- | | |
|------------------------|-----------------------|
| GY 81350 300x200x8cm | GY 81356 200x125x12cm |
| GY 81351 300x200x12cm | GY 81357 200x125x15cm |
| GY 81352 300x200x15cm | GY 81358 200x125x20cm |
| GY 81353 300x200x20cm | GY 81359 200x100x8cm |
| GY 81354 200x150x12cm | GY 81360 200x100x12cm |
| GY 81355 200x125x8cm | GY 81361 200x100x15cm |
| GY 81369 RISE FOR FLAP | |

F APPARATUS GYMNASTIC MATS ACC. DIN EN
Core of compounded chip foam faced with fleece on both sides. We recommend at least a density of 100kg/m3 for satisfactory shock-absorption. Cover made of polyester reinforced textured tarpaulin. Standard colour: blue. Can also be delivered in other sizes, specifications (e.g. velcro corners) or colours. We also deliver separate covers and cores as spare parts.

- GY 81300 150x100x6cm, **density 100kg/m3**
- GY 81301 150x100x8cm, density 100
- GY 81302 200x100x6cm, density 100
- GY 81303 200x100x8cm, density 100
- GY 81304 200x125x6cm, density 100

APPARATUS GYMNASTIC MATS (to be continued)

- GY 81305 150x100x6cm, density 100 with leather corners
- GY 81306 150x100x8cm, density 100 with leather corners
- GY 81307 200x100x6cm, density 100 with leather corners
- GY 81308 200x100x8cm, density 100 with leather corners
- GY 81309 200x125x6cm, density 100 with leather corners
- GY 81310 150x100x6cm, density 100 with leather corners+straps
- GY 81311 150x100x8cm, density 100 with leather corners+straps
- GY 81312 200x100x6cm, density 100 with leather corners+straps
- GY 81313 200x100x8cm, density 100 with leather corners+straps
- GY 81314 200x125x6cm, density 100 with leather corners+straps
- GY 81315 150x100x6cm, **density 120kg/m3**
- GY 81316 150x100x8cm, density 120
- GY 81317 200x100x6cm, density 120
- GY 81318 200x100x8cm, density 120
- GY 81319 200x125x6cm, density 120
- GY 81320 150x100x6cm, density 120 with leather corners
- GY 81321 150x100x8cm, density 120 with leather corners
- GY 81322 200x100x6cm, density 120 with leather corners
- GY 81323 200x100x8cm, density 120 with leather corners
- GY 81324 200x125x6cm, density 120 with leather corners
- GY 81325 150x100x6cm, density 120 with leather corners+straps
- GY 81326 150x100x8cm, density 120 with leather corners+straps
- GY 81327 200x100x6cm, density 120 with leather corners+straps
- GY 81328 200x100x8cm, density 120 with leather corners+straps
- GY 81329 200x125x6cm, density 120 with leather corners+straps

G LIGHT GYMNASTIC MATS
Core of compounded special light chip foam faced with fleece on both sides. Cover made of vinyl. Very low weight. Perfect for beginners in schools, nursery and infant schools. Standard colour: blue.
GY 81330 200x100x6cm, with self-adhesive corners
GY 81331 200x100x8cm, with self-adhesive corners
GY 81332 200x100x6cm
GY 81333 200x100x8cm

H MAT TROLLEYS
Transport and storage trolleys for gymnastic and judo mats. Powder-painted steel tube construction.
GY 81340 TROLLEY 2x1m
GY 81341 TROLLEY 1,5x1m

GYMNASTIC MATS
Closed cell foam with special surface structure. Characteristics: light, slip-proof, hygienic, anti-bacterial, skin-friendly and easy to clean. Especially mats "Studio" and "Professional" are perfect for gymnastic(s), yoga and massage.
I GY 81150 GETRA Basic 1830x600x9mm
J GY 81156 GETRA Studio 1830x600x10mm
K GY 81157 GETRA Professional 1830x600x15mm

L GY 81034 JUDO/KARATE/TAEKWONDO MATS
Made of compounded chip foam with a density from 200 to 250kg/m3. Upper surface and sides come with red or green (washable) vinyl cover. The corners are welded and the bottom is made of anti-slip material. Sizes: 1x1m, 1x1,5m, 1x2m. Thickness: 30mm, 40mm, 50mm.

M GY 81035 WRESTLING MATS/COVERS
Different materials and combinations. Please ask for more information and samples.

N SHOT IMPRINT AREA
Made of special foam with an polyurethane coating mass injected into the outer layer. Slow absorption of the impact. An extremely robust mat.

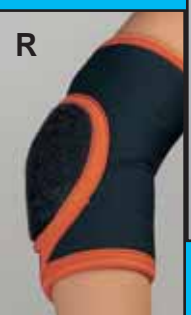
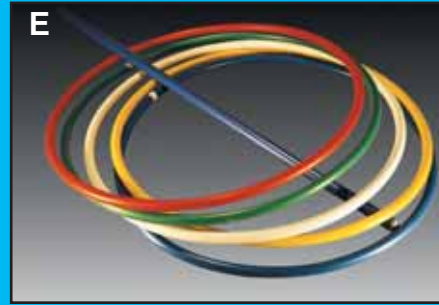
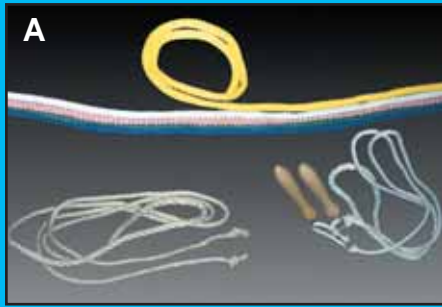

- A**
- SKIPPING ROPES**
- GY 81601 GYMNASTIC-SKIPPING ROPES FIG
Competition rope made of polypropylene. Length 300cm, diameter ca. 9mm. Colours: blue, green, pink, white and yellow.
- GY 81128 SKIPPING ROPE HEMP
Made of strong braided hemp, reinforced centre. Length 280cm.
- GY 81129 SKIPPING ROPE WITH WOODEN HANDLES
Reinforced centre, with swivel and wooden handles. Length 280cm, adjustable.
- B**
- GYMNASTIC RIBBONS**
- GY 81620 GYMNASTIC RIBBONS FIG 6M
Competition ribbon made of satin-band. With fiberglass stick and swivel. Colours: blue, green, pink, red and yellow.
- GY 81621 GYMNASTIC RIBBONS 5M
As GY 81620, but length 5m.
- GY 81624 (REPLACEMENT)-STICK WITH SWIVEL
- C**
- GYMNASTIC BALLS**
- RE 85017 GYMNASTIC BALLS FIG, 19CM
Made of ruton with rubber valve. Excellent bouncing qualities and very elastic. Glossy, grippy and antistatic surface. Weight ca. 420g. FIG-approved. Colours: black, blue, green, red, white and yellow.
- RE 85019 GYMNASTIC BALLS, 16CM
As GY 95017, but weight ca. 300g. Not approved.
- D**
- GYMNASTIC CLUBS**
- GY 81625 GYMNASTIC CLUBS COMPETITION
Made of plastic. Length ca. 42CM. FIG. Colours: blue, green, red, white and yellow.
- E**
- GYMNASTIC STICKS**
- GY 81630 GYMNASTIC STICKS
Made of waterproof, weatherproof and breakproof elastic plastic. Length 100cm, diameter 25mm. Colours: blue, green, red, white and yellow.
- E**
- GYMNASTIC HOOPS**
- GY 81640 GYMNASTIC HOOPS COMPETITION 80CM
Made of PVC. Round cross-section. FIG. Colours: blue, green, red, white and yellow.
- GY 81635 GYMNASTIC HOOPS 60CM
as GY 81640.
- F**
- GYMNASTIC CORDS CA. 8MM**
- Coated rubber cords. With 2 loops.
- GY 81645 8M | GY 81646 10M | GY 81647 12M
- GY 81648 GYMNASTIC CIRCLE 20M
With plastic fastener.
- G**
- GY 81515 **SWING ROPE 8M**
Made of robust hemp. Reinforced centre. With 2 loops and snap hook.
- H**
- GY 81660 **THROWING RINGS**
Made of Ruton with needle valve. Diameter ca. 18cm. Weight ca. 190g. Colours: red, blue, violet, yellow and green.

- I**
- PULLING ROPES POLYPROPYLENE**
Ca. 25mm diameter, marked centre with plastic ends.
- GY 81510 ROPE 10M | GY 81512 ROPE 15M
- GY 81511 ROPE 12M
- J**
- LATEX RUBBER TAPES**
Perfect for training agility, coordination, strength and stamina. With exercise instructions. Length can be cut individually. (tapes of 7,5cm width come with clip).
- GY 81670 120x7,5cm LIGHT GY81675 120x15cm LIGHT
- GY 81671 120x7,5cm MEDIUM GY81676 120x15cm MEDIUM
- GY 81672 120x7,5cm STRONG GY81677 120x15cm STRONG
- GY 81673 120x7,5cm EXTRA GY81678 120x15cm EXTRA
- K**
- RUBBER MEDICINE BALLS**
Rifflid surface with needle valve. Durable quality.
- JA 60080 800 G | JA 60200 2,0 KG | JA 60500 5,0 KG
- JA 60100 1,0 KG | JA 60300 3,0 KG
- JA 60150 1,5 KG | JA 60400 4,0 KG
- L**
- LEATHER MEDICINE BALLS**
Hand-sewn with very firm core. *Sling balls on request.*
- JA 61060 600 G | JA 61200 2,0 KG | JA 61500 5,0 KG
- JA 61080 800 G | JA 61300 3,0 KG
- JA 61100 1,0 KG | JA 61400 4,0 KG
- M**
- DUMBBELLS**
made of cast iron with vinyl cover.
- GY 81685 DUMBBELL 2KG | GY 81687 DUMBBELL 4KG
- GY 81686 DUMBBELL 3KG | GY 81688 DUMBBELL 5KG
- N**
- SOFT FOAM BALLS**
Density from 70-85kg/m³. PU covered soft balls are washable and can be disinfected.
- RE 85026 SOFT BALL PU-COVERED 8CM, blue or red
- RE 85011 SOFT BALL PU-COVERED 18CM, blue, red, green, yellow
- RE 85010 SOFT BALL PU-COVERED 21CM, yellow, white or red
- O**
- RE 85615 SOFT BALL 7CM | RE 85617 SOFT BALL 19CM
- RE 85616 SOFT BALL 9CM | RE 85618 SOFT BALL 21CM
- P**
- BURL BALLS MADE OF RUTON**
Of a piece, without seam. Long burls. For massage and gymnastics. With valve.
- RE 85640 8CM | RE 85642 10CM | RE 85661 16CM
- RE 85641 9CM | RE 85643 23CM | (Ring)
- Q**
- BA 86382 **NEOPRENE SUPPORTS**
ELBOW SUPPORT UNIVERSAL.
Sizes. S/M/L/XL
- R**
- BA 86392 ELBOW SUPPORT REINFORCED.
Sizes. S/M/L/XL
- S**
- BA 86342 KNEE SUPPORT UNIVERSAL.
Sizes. S/M/L/XL
- T**
- BA 86352 KNEE SUPPORT REINFORCED.
Sizes. S/M/L/XL
- U**
- BA 86292 BACK SUPPORT LUMBAGO.
Sizes. S/M/L/XL

Benches and Single Units / POWER & STAMINA



- TRAINING BENCHES & SMALL MACHINES**
(made from strong aluminium profiles)
- A** FI 80000 UNIVERSAL BENCH
Dimensions (LxWxH): 135x45x45cm. Weight about 40kg.
 - B** FI 80001 PRESS BENCH
Dimensions (LxWxH): 150x130x125cm. Weight about 88kg
 - C** FI 80002 SHOULDER PRESS BENCH
Dimensions (LxWxH): 170x130x125cm. Weight about 75kg
 - D** FI 80003 FLAT BENCH
Dimensions (LxWxH): 135x50x45cm. Weight about 30kg
 - E** FI 80004 INCLINE BENCH
Dimensions (LxWxH): 150x130x150cm. Weight about 80kg
 - F** FI 80005 DECLINE BENCH
Dimensions (LxWxH): 180x70x60cm. Weight about 44kg
 - G** FI 80006 CRUNCH BENCH
Dimensions (LxWxH): 160x170x40cm. Weight about 55kg
 - H** FI 80007 BACK EXTENSION 45
Dimensions (LxWxH): 120x75x90cm. Weight about 50kg
 - I** FI 80008 COMBITWISTER
Dimensions (LxWxH): 150x75x105cm. Weight about 90kg
 - J** FI 80009 SEATED CALF
Dimensions (LxWxH): 130x70x110cm. Weight about 70kg
 - K** FI 80010 SEATED SCOTT (CURL) BENCH
Dimensions (LxWxH): 120x80x110cm. Weight about 72kg
 - L** FI 80016 SQUAT RACK
Dimensions (LxWxH): 155x180x170cm. Weight about 94kg
- CLASSIC BIKES**
- M** FI 80220 CLASSIC BIKE
heavy 30kg balance wheel. Stainless shifts, stops and bolts. Stainless centre. Very silent.
(LxWxH): 120x55x120cm. Weight about 90kg.
 - N** FI 80225 CLASSIC BIKE horizontal

- TREADMILLS**
- O** FI 80200 TREADMILL PROFESSIONAL MTJ
- Heart Rate Monitoring: Chest Belt
- Trainings: Fast access, Cardio-Fitness, Fat-Burning, Displays Distance,-Time,-Calories / 6 individual Training Profiles / CHR,- CWL and Runner Test.
- Data-Display(LCD green):
Time/Speed/Distance/Calories/Heart-Rate/ Training-Profile/Language Choice.
- Technical Data:
Speed 0-20kmh / Shock Absorbing System / 2HPAC Motor / Inclination 0-16% / Handrail/ Steelframe with front wheels / RS232 Output.
- Specification:
max. users weight 150kg / Running Surface 140x50cm / Dimensions 70x195x150cm / Weight 145kg.
 - FI 80201 TREADMILL PROFESSIONAL MTR
- Heart Rate Monitoring: Chest Belt
- Trainings: Fast access
- Data-Display(LCD):
Time/Speed/Distance/Calories/Heart-Rate
- Technical Data:
Speed 0-20kmh / Shock Absorbing System / 2HPAC Motor / Inclination 0-16% / Handrail/ Steelframe with front wheels
- Specification:
max. users weight 150kg / Running Surface 140x50cm / Dimensions 70x195x150cm / Weight 145kg.
 - P** FI 80210 TREADMILL PROFESSIONAL 7404
- Heart Rate Monitoring: Chest Belt, Hand Grip
- Trainings: Profile fast access, Cardio-Fitness, Fat-Burning, Sonar-Security System, Displays Calories,-Time,-Distance / 10 individual Training Profiles / 10 Training-Programms / CHR,- CWL and Runner Test.
- Data-Display(15" Monitor):
Time/Speed/Distance/Calories/Heart-Rate/ Training-Profile/Language Choice.
- Technical Data:
Speed 0-25kmh / Shock Absorbing System / 3HPAC Motor / Inclination 3-23% / Handrail/ Steelframe with front wheels / RS232 Output.
- Specification:
max. users weight 180kg / Running Surface 154x54cm / Dimensions 88x220x155cm / Weight 245kg.
 - FI 80211 TREADMILL PROFESSIONAL 7403
- Heart Rate Monitoring: Chest Belt, Hand Grip
- Trainings: Profile fast access, Cardio-Fitness, Fat-Burning, Displays Calories,-Time,-Distance / 6 individual Training Profiles / 50 Training Programms / CHR,- CWL and Runner Test.
- Data-Display(LCD 320x240mm):
Time/Speed/Distance/Calories/Heart-Rate/ Training-Profile/Language Choice.
- Technical Data:
Speed 0-25kmh / Shock Absorbing System / 3HPAC Motor / Inclination 3-23% / Handrail/ Steelframe with front wheels / RS232 Output.
- Specification:
max. users weight 180kg / Running Surface 154x54cm / Dimensions 88x220x155cm / Weight 245kg.

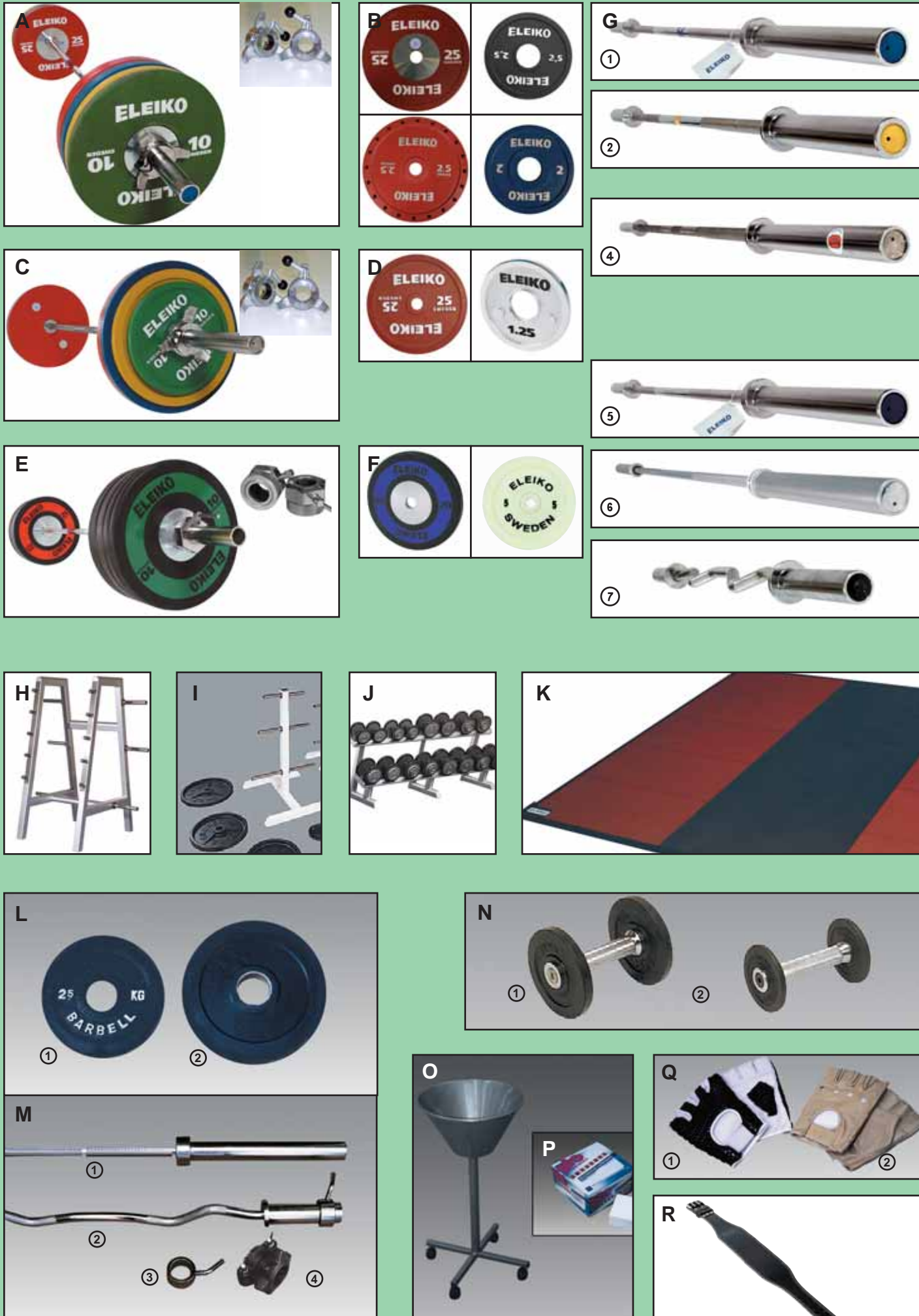

- A ELEIKO WEIGHTLIFTING IWF approved**
- EL 10190 COMPETITION BARBELL SET 190,00 kg
EL 10185 COMPETITION BARBELL SET 185,00 Women
- EL 25001 ELEIKO COMPETITION COLLARS 5kg IWF
- B** EL 20001 COMPETITION RUBBER DISC IWF 10,00 kg green
EL 20002 COMPETITION RUBBER DISC IWF 15,00 kg yellow
EL 20003 COMPETITION RUBBER DISC IWF 20,00 kg blue
EL 20004 COMPETITION RUBBER DISC IWF 25,00 kg red
- EL 20011 COMPETITION RUBBER DISC IWF 5,00 kg
EL 20012 COMPETITION RUBBER DISC IWF 2,50 kg
EL 20013 COMPETITION RUBBER DISC IWF 2,00 kg
EL 20014 COMPETITION RUBBER DISC IWF 1,50 kg
EL 20015 COMPETITION RUBBER DISC IWF 1,00 kg
EL 20016 COMPETITION RUBBER DISC IWF 0,50 kg
- EL 20006 COMPETITION DISC IWF METAL 5,00 kg white
EL 20121 COMPETITION DISC IWF PVC 5,00 kg white (D=450mm)
EL 20005 COMPETITION DISC IWF METAL 2,50 kg black
EL 20120 COMPETITION DISC IWF PVC 2,50 kg black(D=450mm)
EL 20007 COMPETITION DISC IWF METAL 1,25 kg chrome
EL 20008 COMPETITION DISC IWF METAL 0,50 kg chrome
EL 20009 COMPETITION DISC IWF METAL 0,25 kg chrome
- G1** EL 15001 COMP. BAR IWF Olympic 20kg/2200mm, grip 28mm
G2 EL 15002 COMP. BAR IWF Women 15kg/2010mm, grip 25mm
- C ELEIKO POWERLIFTING IPF approved**
- EL 11135 COMPETITION BARBELL SET 135,00 kg
EL 11185 COMPETITION BARBELL SET 185,00 kg
EL 11235 COMPETITION BARBELL SET 235,00 kg
EL 11285 COMPETITION BARBELL SET 285,00 kg
- D** EL 20101 COMPETITION METAL DISC IPF 10,00 kg green
EL 20102 COMPETITION METAL DISC IPF 15,00 kg yellow
EL 20103 COMPETITION METAL DISC IPF 20,00 kg blue
EL 20104 COMPETITION METAL DISC IPF 25,00 kg red
- G4** EL 15101 COMPETITION BAR IPF 20kg/2200mm, grip 29mm
- E ELEIKO INTERNATIONAL TRAINING**
- EL 12190 TRAINING BARBELL SET 190,00 kg
EL 12185 TRAINING BARBELL SET 185,00 kg Women
- F** EL 20201 TRAINING RUBBER DISC 10,00 kg black/green
EL 20202 TRAINING RUBBER DISC 15,00 kg black/yellow
EL 20203 TRAINING RUBBER DISC 20,00 kg black/blue
EL 20204 TRAINING RUBBER DISC 25,00 kg black/red
EL 20116 TECHNIQUE TRAINING DISC 5,00 kg white
EL 20115 TECHNIQUE TRAINING DISC 2,50 kg black
- G5** EL 15201 INT. TRAINING BAR 20kg/2200mm, grip 28mm
EL 15202 INT. WOMEN BAR 15kg/2010mm, grip 25mm
- G6** EL 15206 TECHNIQUE/YOUTH BAR 5kg/2200mm, grip 25mm
Made of aluminium. Max. load 20kg.
- G7** EL 15207 INT. CURL BAR 12kg/1350mm, grip 28mm

- RACKS**
- H** FI 80050 BAR RACK
I FI 80051 DISC RACK
J FI 80052 DUMBBELL RACK
- K WEIGHT LIFTING FLOORS**
Different materials, constructions and sizes. E.g. 3x2,5m (training), 4x4m (competition).
- DISCS/BARS 50mm DISCS**
- L1** FI 90731 IRON 1,25 kg
FI 90732 IRON 2,50 kg
FI 90733 IRON 5,00 kg
FI 90734 IRON 10,00 kg
FI 90735 IRON 15,00 kg
FI 90736 IRON 20,00 kg
FI 90737 IRON 25,00 kg
- L2** FI 90740 RUBBER 1,25 kg
FI 90741 RUBBER 2,50 kg
FI 90742 RUBBER 5,00 kg
FI 90743 RUBBER 10,00 kg
FI 90744 RUBBER 15,00 kg
FI 90745 RUBBER 20,00 kg
FI 90746 RUBBER 25,00 kg
- BARS/COLLARS**
- M1** FI 90770 BAR 2200mm (max. 140 kg)
M2 FI 90772 SZ-BAR 1300mm, incl. collars
M3 FI 90776 COLLAR
M4 FI 90777 COLLAR
- BARBELL SETS**
- FI 90750 BARBELL SET 140 KG, RUBBER COATED
FI 90751 BARBELL SET 140 KG, IRON
FI 90752 SZ-BARBELL SET 80 KG, IRON
- COMPACT DUMBBELLS**
available up to a maximum weight of 62,5 kg. Increments 2,5 kg.
- N1** FI 90610 RUBBER 2,50 kg
FI 90611 RUBBER 5,00 kg
FI 90612 RUBBER 7,50 kg
FI 90613 RUBBER 10,00 kg
FI 90614 RUBBER 12,50 kg
FI 90615 RUBBER 15,00 kg
- N2** FI 90600 IRON 2,50 kg
FI 90601 IRON 5,00 kg
FI 90602 IRON 7,50 kg
FI 90603 IRON 10,00 kg
FI 90604 IRON 12,50 kg
FI 90605 IRON 15,00 kg
- ACCESSORIES**
- O** FI 90499 CHALK STAND
P FI 90501 CHALK (8 blocks, ca. 480g)
Q1 FI 90115 TRAINING GLOVES leather/textile
Q2 FI 90120 TRAINING GLOVES genuine leather
R FI 90109 WEIGHT LIFTING BELT leather with padded back



Our "MASTER" training apparatus has been developed for the hard daily strength training in the clubs. The apparatus is perfect for athletes of all ages and all sports.

Maximum Physical Strength For All Sports

Our training apparatus is made with special attention to safety, efficiency (ergonomic seats, low-noise levels, can be disinfected), ease of use and appearance.

Our "MASTER" apparatus is robust constructed (120x100x3mm and 80x60x3mm tubes) and is excellent in gyms where it has to be used by many different people.

TARGET GROUPS:

Sports training centres, fitness and health centres, clubs, swimming pools, universities, clubs, public facilities and rehabilitation clinics.

- A** FI 80101 LEG PRESS Horizontal
Set of weights (total): 230kg. Dimensions LxWxH: 320x80x215cm. Weight: about 470kg.
- B** FI 80102 LEG PRESS Universal
Free weights. Dimensions LxWxH: 240x100x180cm. Weight: about 180kg.
- C** FI 80103 LEG PRESS Hackenschmidt
Free weights. Dimensions LxWxH: 230x100x180cm. Weight: about 175kg.
- D** FI 80104 LEG EXTENSION
Set of weights (total): 80kg. Dimensions LxWxH: 145x80x190cm. Weight: about 185kg.
- E** FI 80105 LEG CURL
Set of weights (total): 75kg. Dimensions LxWxH: 210x80x190cm. Weight: about 190kg.
- F** FI 80106 ABDUCTION MACHINE
Set of weights (total): 70kg. Dimensions LxWxH: 180x160x172cm. Weight: about 200kg.
- G** FI 80107 ADDUCTIONS MACHINE
Set of weights (total): 80kg. Dimensions LxWxH: 180x160x172cm. Weight: about 220kg.
- H** FI 80108 BUTTERFLY with start assistance
Set of weights (total): 75kg. Dimensions LxWxH: 140x110x190cm. Weight: about 190kg.

- I** FI 80109 LAT PULLEY
Set of weights (total): 85kg. Dimensions LxWxH: 130x76x225cm. Weight: about 160kg.
- J** FI 80110 LONG PULLEY
Set of weights (total): 90kg. Dimensions LxWxH: 215x76x227cm. Weight: about 170kg.
- K** FI 80111 TRICEPS DIPP MACHINE
Set of weights (total): 180kg. Dimensions LxWxH: 140x70x190cm. Weight: about 310kg.
- L** FI 80150 4-STATION-TOWER
Sets of weights: 105+100+85+55kg. Dimensions LxWxH: 430x200x235cm. Weight about 720kg.
- M** FI 80112 BICEPS-CURL MACHINE
Set of weights (total): 65kg. Dimensions LxWxH: 110x100x173cm. Weight: about 170kg.
- N** FI 80113 SHOULDER PRESS MACHINE with start assistance
Set of weights (total): 80kg. Dimensions LxWxH: 100x125x173cm. Weight: about 230kg.
- O** FI 80114 MULTI PRESS
Multifunctional. Easy running guide rods. Safety locking system. Incl. bar (25kg)
Free weights. Dimensions LxWxH: 110x220x220cm. Weight: about 150kg.
- P** FI 80115 CABLE CROSSOVER with chinning bar
Multifunctional.
Set of weights (total): 2x55kg. Dimensions LxWxH: 350x70x240cm. Weight: about 300kg.

Standard colour for upholstery is green, but any other colour can be done. Protective enclosure on request. Other machines available.



Accessories for Pulley Units:
Bar for Lat Pull / Bar for Lat Pull revolving / Triceps Bar straight revolving / Handle for Rowing / Triceps Bar curved revolving / Handle revolving / Pulley Straps / Triceps Rope

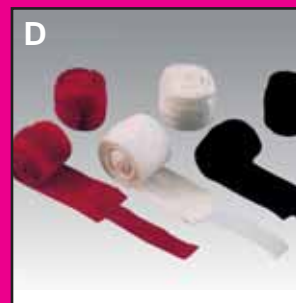

BOXING-EQUIPMENT

- A** BO 95100 **BOXING GLOVES "START"**
Gloves made of leather. Shape retaining foam/cotton padding. Velcro closure. The perfect glove for beginners. 8,10,12 or 14 ounces.
- B** BO 95101 **BAG GLOVES "PROFI"**
Cow hide glove, preshaped with padding. Elastic wrist stretch. Professional quality for working with bags and balls. Sizes: M/L/XL.
- C** BO 95102 **BAG GLOVES "PROTECT"**
Cow hide finger glove with knuckle protection. Elastic wrist stretch. Sizes: M/L/XL.
- D** BO 95103 **WRIST SUPPORT**
Made of cotton. Ca. 5cm wide with thumb loop and velcro fastener. Colours: red, white and black.
- E** BO 95130 **HEAD GUARD "PROFI"**
Cow hide head guard with inside non slip split leather for perfect fit. Special shock absorbing padding. With velcro closure. Sizes: M/L/XL.
- F** BO 95135 **MOUTH GUARD**
Made of soft plastic. Non-irritant.
- G** BO 95140 **ABDOMINAL GUARD "PROFI"**
Very strong padded guard with high impact plastic box. Sizes: M/L/XL.
- H** BO 95123 **PUNCHING BAG FREESTANDING**
Plastic base to be filled with water or sand. The padded upper part (100x35cm) is vinyl-covered. Height adjustment in 3 steps from 140 to 190cm.
- I** BO 95124 **PUNCHING BAG "REBOUND" FREESTANDING**
Plastic base made of 2 pieces for easier transportation. The padded upper part (75x35cm) is vinyl-covered. Height adjustment in 3 steps from 130 to 180cm).
- J** BO 95120 **PUNCHING BAG LEATHER 120x35CM**
Heavy-duty professional cow hide bag. With durable eyelets and extra strong TM-seams. Comes with chain attachment including swivel. Without filling.
- K** BO 95121 **PUNCHING BAG NYLON 90x30CM**
Made of durable nylon. With durable eyelets and strong TM-seams. Comes with chain attachment including swivel and inner reinforcement. Without filling.
- L** BO 95125 **PUNCHING BALL**
Made of split leather with rubber valve bladder.
- M** BO 95126 **FLOOR TO CEILING BALL**
Professional leather ball with fittings of artificial leather. Inside reinforced. Rubber valve bladder. Comes with attachment straps.

TRAINING EQUIPMENT

- N** BO 95150 **PUNCHING PLATFORM**
For adjustable wall attachment. Platform ca. 70cm made of thick plywood. Training device for coordination and reaction. With swivel.

- O** BO 95153 **BALL BEARING**
Smooth running. For punching platforms.
- P** BO 95154 **BOXING TRAINER**
Frame made of strong timber. Equipped with shock absorbing padding and cow hide cover.

BOXING RING

- BO 95170 **ELEVATED PLATFORM RING 750x750CM, MOVABLE**
Corner posts made of steel, base made of aluminium. Wooden floor. Comes with 2 stairs, 2 swivel seats, but without floor and ring cover, ropes and other accessories. Very easy to build up. Up to AIBA regulations.
- BO 95174 **FLOOR COVER**
Made of compound foam, approx. 15cm thick. *Floor covers made of hair felt can be delivered on request.*
- BO 95175 **RING COVER**
Made of canvas.
- BO 95176 **RING ROPES 40MM**
Consists of 4 ropes, (Fits 610x610cm). *Other diameters and sets can be delivered on request.*

TRAINING BOXING RING

- BO 95180 **TRAINING BOXING RING 600x600 CM**
Free standing and portable. *Boxing rings with ground sockets can be delivered on request.*
- BO 95184 **FLOOR COVER**
Made of compound foam.
- BO 95185 **RING COVER**
Made of canvas.
- BO 95186 **RING ROPES 23MM**
Consists of 3 ropes.

RING ACCESSORIES

- BO 95190 **LACING ROPE**
Fits all ring covers.
- BO 95191 **CORNER CUSHIONS (4PCS.)**
Made of vinyl with foam padding. Length: 120 or 150cm.
- BO 95192 **CONNECTING STRAPS**
For ring ropes. Suitable for all kinds of rings. (1set=4pcs.).
- BO 95193 **ROPE WRAPPING**
Ca. 35m, for one ring rope.
- BO 95194 **PATENTED TENSION KEEPER**
With chain, rope loop and winder. (Please state diameter of rope when ordering.)
- BO 95195 **TENSION LOCK**
With chain and rope loop. (Please state diameter of rope when ordering.)

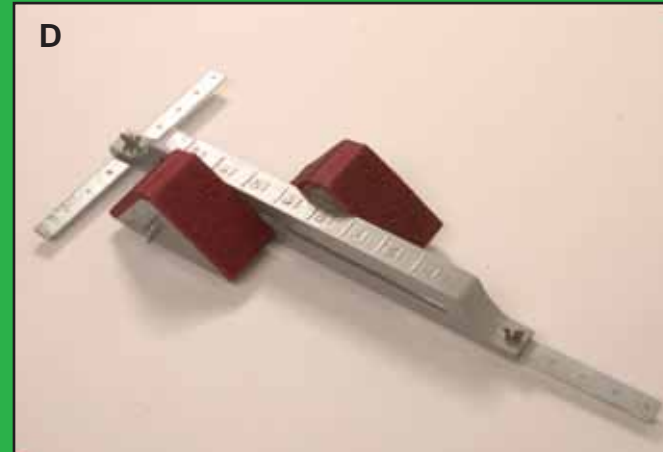

STARTING BLOCKS

A RU 09254 **GETRA PERFORMANCE** 
For international competition. Rail and pedals made of heavy cast aluminium. The wide, with hard synthetic rubber faced pedals are adjustable to four positions. The middle rail is equipped with carrying handle. IAAF certified.

B RU 09255 **SPIKE PLATE** for starting block performance

C RU 01500 **COMPETITION**
Rail and pedals made of aluminium. The rubber faced pedals are adjustable to four positions.

D RU 01405 **SCHOOL**
Rail and pedals made of cast aluminium. The rubber faced pedals can be used at two fixed angles. Comes complete with spike adaptors, spikes and anchor pins for cinder tracks.

STARTING REVOLVERS

E1 RU 10019 **STARTING REVOLVER 9MM**
Revolver for 9mm ammunition. Competition model providing heavy smoke and loud report.

E2 RU 50106 **STARTING REVOLVER 9MM**
For electronic timing.

STARTING EQUIPMENT

F RU 09600 **STARTING CLAP**
Stable clap of laminated wood. Very loud and excellent visibility.

G RU 00416 **LOUDSPEAKER SYSTEM 4**
To be placed in line behind the starting blocks. Consists of amplifier, 4 loudspeakers and microphone. Please ask for technical details.

RU 00417 **LOUDSPEAKER SYSTEM 8**
As above, but 8 loudspeakers.

H RU 09300 **STARTING BLOCK CART**
Carries up to 8 starting blocks.

I RU 09406 **STARTER'S PODIUM MOVABLE**
Stable podium with wooden platform and implement box.

J RU 09405 **STARTER'S PODIUM**
Stable podium with wooden platform.

K RU 09403 **LANE MARKER SUPER**
Made of white fiberglass with false start indicator. Comes with numbers on three sides. (Please specify when ordering). Height 60cm.

RU 09409 (SPARE)-ADHESIVE NUMBER 250MM

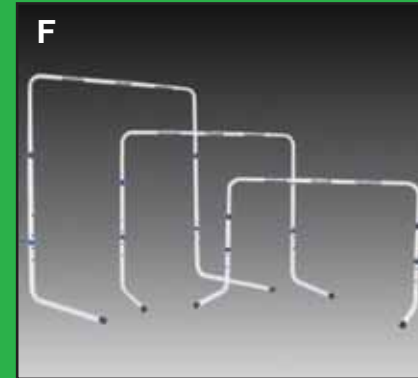
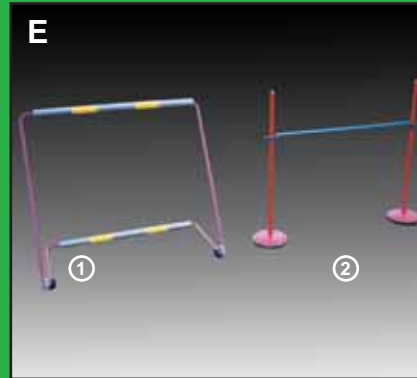
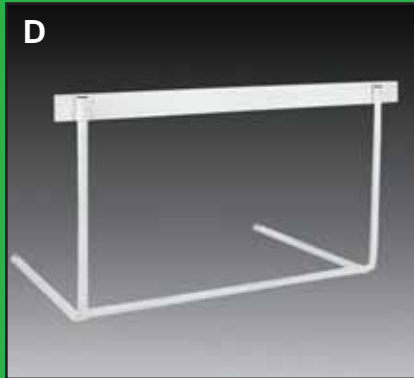
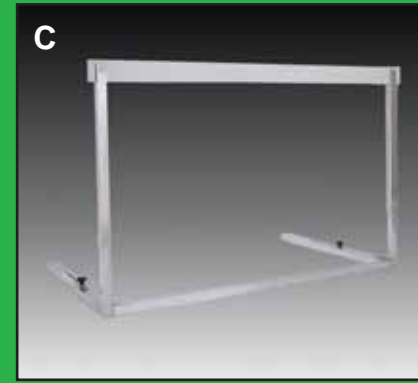
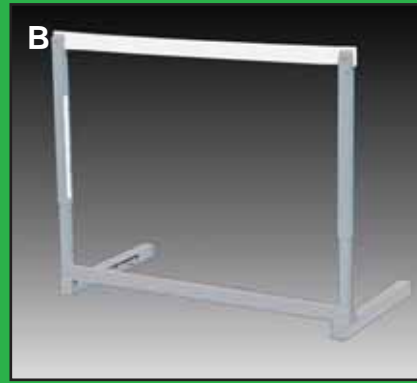
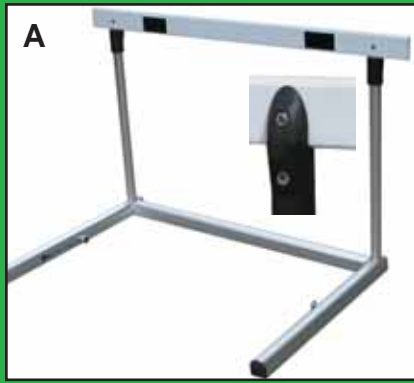

HURDLES



- A** RU 26426 **ALU INTERNATIONAL**
Heavy duty, weatherproof and maintenance-free hurdle made of aluminium. Base with integrated galvanized counterweights. Height adjustment through safety spring locks.
- B** RU 26421 **ALU COMPETITION II**
Heavy duty, weatherproof and maintenance-free hurdle made of aluminium. Base with integrated galvanized counterweights. Height adjustment through safety spring locks.
- C** RU 26420 **ALU COMPETITION I**
Weatherproof and maintenance-free hurdle made of aluminium. Base with integrated galvanized counterweights. Height adjustment through safety spring locks. (can be delivered also as IAAF certified version).
- RU 26428 (SPARE)-HURDLE BAR WOOD
Made of laminated hard-wood. Painted white and black acc. IAAF. When ordering please specify drillings and thickness, so it will fit your hurdles exactly. *Bars made of solid hard-wood can be delivered on request.*
- RU 26428/1 (SPARE)-HURDLE BAR PLASTIC
Made of nearly unbreakable plastic. White and black markings acc. IAAF.
- D** RU 26422 **PRACTICE HURDLE**
Heavy duty practice hurdle. Height adjustment through compression springs from 680-1067mm. Legs made of steel tubes, crossbar holders made of aluminium. Powder painted. Equipped with an extra robust crossbar.
- E1** RU 26600 **PRACTICE HURDLE ZACHARIAS**
Stepless height and width adjustment through disc adjusters. With robust foam pads to avoid injuries. Space saving storage.
- E2** RU 27025 **TRAINING HURDLE**
Simple training hurdle. Consists of 2 base units (can be filled), 3 gymnastic sticks and 2 joints.
- F** **PRACTICE HURDLES ALU MINI/MIDI/MAXI**
Returns automatically to upright position after being knocked down. Height adjustment through spring locks in steps of 5cm. Legs can be folded for storage.
- RU 27020 **PRACTICE HURDLE MINI 40-60CM**
RU 27021 **PRACTICE HURDLE MIDI 55-84CM**
RU 27022 **PRACTICE HURDLE MAXI 66-106CM**

HURDLE CARTS

- G** RU 26442 **HURDLE CART ALU**
Made of fully welded, reinforced aluminium profile. Walk in design for loading and unloading from the rear. Equipped with heavy duty pneumatic tyres. Very easy to handle. Takes 30-40 hurdles. *Other dimensions on request.*

STEEPLECHASE BARRIERS



- H** RU 26430 **WATER JUMP HURDLE**
Meets all IAAF specifications. The stable base legs (made of galvanized steel or strong aluminium) are height adjustable. Strong, multiple laminated, weatherproof wooden crossbar, black and white. Comes including ground sleeves and lids.
- H1** RU 26433 **PROTECTION COVER for water jump hurdle**
Made of strong vinyl. Squirt protection for athletes. Surface can be used for advertising.
- I** RU 26431 **WATER PIT COVER**
Made of aluminium. On request with raised edges for filling with synthetic track material. Can be adjusted both horizontal and vertical. When ordering please specify exact dimensions of the water pit.
- J** RU 26429 **STEEPLECHASE HURDLE FREESTANDING 396CM**
Meets all IAAF specifications. The stable base legs (made of galvanized steel or strong aluminium) are height adjustable. Strong, multiple laminated, weatherproof wooden crossbar, black and white. (can also be delivered as IAAF certified version).
- RU 26432 **STEEPLECHASE HURDLE FREESTANDING 500CM**
As above, but length 500cm.
- RU 26451 **TRANSPORTER FOR STEEPLECHASE BARRIERS**
Heavy duty steel construction. Can hold a complete set (4 barriers). Platforms of aluminium. Comes with eye coupling and fifth wheel steering. (not pictured).

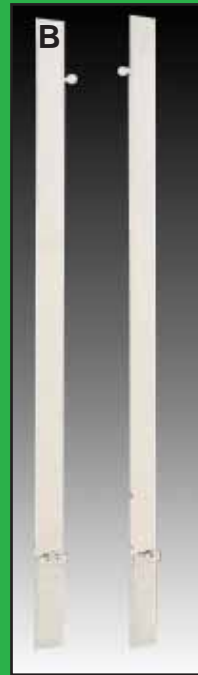

A RU 56420 **TIMEKEEPERS STAND**
Made of aluminium with 8 comfortable plastic seats. Foldable. Needs little storage space. Fitted with wheels for easy mobility. Comes with detachable signal board. *Timekeepers stands can also be delivered for more than 8 persons.*

B RU 10509 **FINISH LINE POSTS**
Made of painted light-weight metal. White. Come with ground sockets and lids.

RELAY BATONS
C1 RU 11409 **RELAY BATON ALU**
Made of anodized aluminium. Official size and weight. Rolled-in edges for safety. Different colours.

C2 RU 11408 **RELAY BATON PLASTIC**
Made of durable hollow polyethylene. Official size and weight. Different colours.

D RU 50320 **WIND GAUGE MACFINISH**
Electronic wind gauge without moving parts according to IAAF regulations. Necessary for international competitions (rule 163.11). Displays average wind speed over 5, 10 or 13 seconds. Complete with tripod and carrying case.

Wind Gauge Compact page 48 pic. Q.

LAP COUNTERS
E RU 30291 **ELECTRONIC LAP COUNTER**
Digits ca. 23cm high. Movable. With control panel.

F RU 30290 **LAP COUNTER**
Made of alu. With wheels, bell and 2 cassette numbers.

OFFICIALS FLAGS
Big textile flag with handle.
FB 10094 FLAG YELLOW
FB 10086 FLAG BLUE
FB 10085 FLAG WHITE
FB 10084 FLAG RED

H RU 00100 **TRACK CURBING**
Made of heavy aluminium, natural or white anodized. Easy to install and to maintain.

WINNERS STANDS
I RU 56424 **WINNERS STAND**
For 3 persons. Stable construction with wooden platforms.

RU 57424 **WINNERS STAND TEAM**
For 12 persons, otherwise same as RU56424.

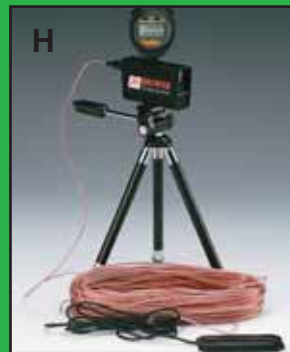
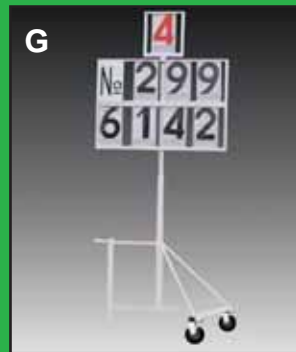

Printo Set bestehend aus:
 PRINTO Thermodrucker
 Modul 3 mit Druckeranschluss
 2 Papierrollen
 Reserve - Batterien

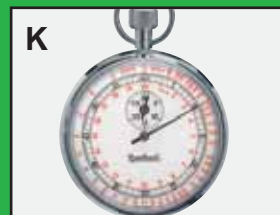

A RU 53102 PHOTOFINISH TIMING SYSTEM

Photofinish is a fully electronic system with a linear CCD-Linescan camera(b/w or coloured). The camera records as a standard 1000 lines per second and 500 pixels (as an option up to 2000 lines and 1000 pixels), which are stored in the memory. The final image results are shown on your computer screen in vertically recorded lines placed next to each other. Time results, number of athletes and lanes are easily entered in the screen report. The Photofinish Timing System comes inclusive carrying case complete with:

- Interface box for start&finish
- Required cables
- Software
- Power cable or charger with batterie
- Arrival remote control box
- Camera/lense
- Camera mounting
- Starting gun
- Infrared barriers

you can choose between different softwares, cameras/lenses and camera mountings depending on your needs and budget. Please ask for more information.

B RU 53201 FALSE START SYSTEM

Up to IAAF rule 162.10. Measures reaction times to 1/1000 sec. Battery operated. Comes with all required cables and starter-headset. *Printer as an option.*

C RU 53104 HEIGHT+DISTANCE MEASURING SYS.

Easy to use, accurate and affordable. Results inbetween 3,5 seconds. Max. 3mm deviation. Complete with tripod and carrying case. Can be connected to PC, printer, scoreboard.

D RU 50320 WIND GAUGE MACFINISH

Electronic wind gauge without moving parts according to IAAF regulations. Necessary for international competitions (rule 163.11). Displays average wind speed over 5, 10 or 13 seconds. Complete with tripod and carrying case.

E RU 05030 TIMING SCOREBOARD

Electronic scoreboard for keeping spectators and athletes well-informed. You can choose between 10,15 or 25cm high displays and double sided or not. Can be delivered with tripods.

F RU 05042 SCOREBOARDS ELECTRONIC SCOREBOARD

For jumping and throwing events. Operated by battery.

G RU 56425 MANUAL SCOREBOARD

Revolving fiberglass scoreboard mounted on a robust wheelaway base. Comes with 8 weatherproof cassette numbers (24cm high), which can be adjusted from 0-9.

- RU 56427 CASSETTE NUMBER "BLACK"
- RU 56426 CASSETTE NUMBER "RED"

H RU 53500 TIMING-SYSTEM TRAINING I

Times distances up to 50m. 1/100 sec. accuracy. Starts upon release of pressure on touch pad. Time is stopped when infrared finish line beam is tripped. Includes timer, start pad, 50m wire, sensor, stopwatch, tripod and carrying case.

I RU 53600 TIMING-SYSTEM TRAINING II

Wireless distance timing up to 800m. 1/100 sec. accuracy. 126 time recallable memory. Starts upon release of pressure on touch pad. Time is stopped when infrared finish line beam is tripped. Includes hand-held timer, one set of infrared electric eyes with built in transmitter, touch start pad, two tripods, microphone starting sensor and carrying case.
Extra sensors (additional) enable system to start on movement and record split times (up to 9)

J RU 54109 HANHART PRINTO & MODUL TYPE 3 STOPWATCH

for printing split-, lap and addition times (ca. 8000 printouts per battery)
Functions Modul 3 Stopwatch:

start / stop / reset / addition / split / lap / short lap(can be switched).

Separate system and memory reset, split time can be programmed with real time. Countdown, repeatable time, date. 60 memory for addition, split, lap.

LCD display 1.5 - lines, upper line 7- lower line 2-digits
 Range: 9 hrs 59 min 59.99 sec.

Size: 82 x 61 x 28 mm

Weight ca. 90 g

60 memory for addition, split, lap.

incl. mignon cell (AA) 1,5 V

RU 54602 HANHART MODUL TYPE 1, s.a. but without printer connection

K RU 54760 HANHART CROWN STOPPER

chromed brass alloy case, shock and dirt protected. Water-resistant. Pinlever movement, 7 jewels
FUNCTIONS: Start, Stop, Reset. Accuracy 1/10 Sec.
 15 min register. Case D=55mm, weight 120g.

L RU 54601 HANHART STOPSTAR

7 digits LCD-display, 7mm digit height. Range: 9 hrs 59 min 59.99 sec. Size: 82x61x28mm, weight: 70g
FUNCTIONS: Start, Stop, Reset, Addition, Split, Dual Timing.

M RU 54600 HANHART STRATOS 2

7 digits LCD-display, 6.5mm digit height. Range: 9 hrs 59 min 59.99 sec. Size: 66x70x21mm, weight: 62g
FUNCTIONS: Start, Stop, Reset, Addition, Split, Dual Timing.

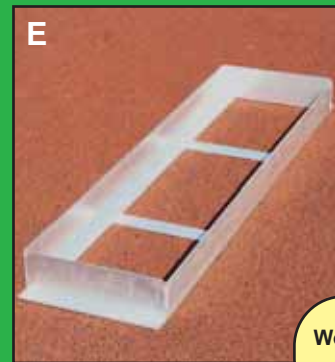

Take-off board
World Championship - European
Championship - German
Championship proven

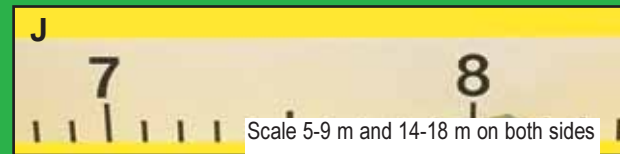
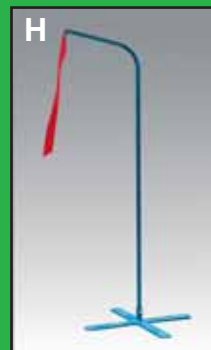

Scale 5-9 m and 14-18 m on both sides

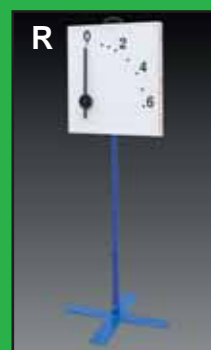
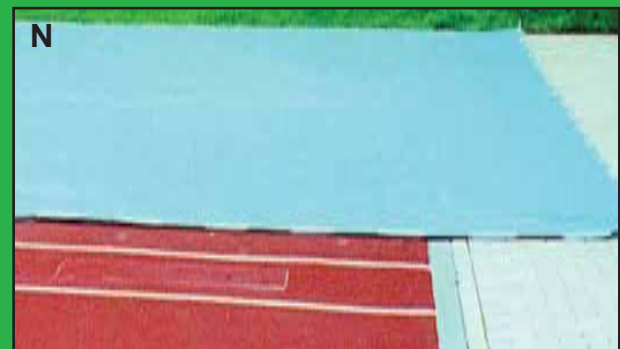

A TAKE OFF BOARDS 

GETRA PERFORMANCE
take-off board having a nonwearing basic construction made of nearly indistructable HDPE. On top of the basic construction you find a bolt fixed, white coated wooden top board. The combination of HDPE and wood results in a perfect push-off that is necessary for long jump records. The top board can easily be replaced (upon wearing). The Performance is through it's height adjustment optimal adjustable to all trays. A premium quality product made in Germany.

For international competitive sports, elite meets, club and school sports. Recommended by leading coaches and top-athletes. IAAF certified.

HJ 01248 Getra Performance 122x34cm / height adjustable (incl. black rubber insert HJ01652). Ca. 26kg
HJ 01249 Getra Performance 121x30cm / height adjustable (incl. black rubber insert HJ01652). Ca. 23kg

B GETRA UNIBLOCK COMPETITION
is a very special take-off board completely made of extra hard and fully grouted rubber with a white layer of uv-stabilised EPDM (-caoutchuc) surface. An optimized push off effect for the jumper is guaranteed. Compression-moulding ensures long life and low maintenance compared to time and effort on conventional take-off boards (like wood take-off board, screwed and pasted links, foam-fillings and others). There is no warping, weathering or swelling/maceration. A top quality product made in Germany. The UniBlock Competition is

- excellent value (low cost)
- maintenance free
- winter and water resistant
- long lasting and economic
- fitting perfect to the tray
- fully recyclable

Perfect use for competition, college and high school sports. Recommended by leading coaches. Measurements complying with IAAF regulations.

Weight approx. 31kg. (comes incl. black rubber insert #HJ01652)
HJ 01245 Getra UniBlock 122x34x10cm
HJ 01247 Getra UniBlock 122x30x10cm

C GETRA SCHOOL
for school use and training. Made of extra hard and fully grouted black rubber with white painted take off zone. (can be easily repainted maybe each 2 years. When spikes are used maybe earlier). No need of expensive wooden boards. There is no warping, weathering or swelling/maceration. Made in Germany. Weight approx. 30kg. (comes incl. black rubber insert #HJ01652)
HJ 01244 Getra School: 122x34x10cm

SPARE PARTS

HJ 01608 SURFACE BOARD PERFORMANCE made of white painted wood. No drillings. 1220 or 1210x200x16mm.
HJ 01652 RUBBER INSERT

D HJ 01651 INSERT BOARD for plasticine IAAF certified. (comes without plasticine) 

HJ 01655 **PLASTICINE STRIPS** 
Complete set. Consists of 12 strips, with regulation angle edges. IAAF certified.

E FOUNDATION TRAY ALUMINIUM
HJ 01600 for Take-off Boards 34cm
HJ 01602 for Take-off Boards 30cm

F COVER FOR FOUNDATION TRAY
height-adjustable cover to be placed in the foundation tray.

HJ 01255 Cover with synthetic surface 34cm
HJ 01256 Cover without synthetic surface 34cm
HJ 01257 Cover with synthetic surface 30cm
HJ 01258 Cover without synthetic surface 30cm

G HJ 01250 INSERT BOARD CART
Made of steel. With implement box.

H RU 50317 WIND INDICATOR
Made of steel. Helpful for athletes and trainers when timing an attempt.

I HJ 05250 OPTICAL MEASURING SYSTEM
Easy-to-operate optical measuring system for long and triple jump. The scope unit slides on a rail and is placed in line with the marker in the sand. The length of the jump is shown on a display.

J HJ 05242 MEASURING FRAME
For long jump and triple jump. Shows length 5-9m and 14-18m.

K HJ 01500 TAKE OFF MARKER
Roof-shaped, with highly visible black stripes on both sides. Placed either side of take-off board as visual aid.

L HJ 00432 RUNWAY MARKERS
Give a highly visible starting point to athletes.

M FB 10034 MOBILE BENCH

N HJ 00440 PIT COVER
Made of vinyl coated woven polyester mesh.

FACILITY ACCESSORIES

O1 HJ 00450 TRACK BROOM 100CM
O2 HJ 00452 SAND SHOVEL
O3 HJ 00454 PIT LEVELER ALUMINIUM 100 CM
P HJ 00434 PIT RAKE ALUMINIUM

Q RU 50319 WINDGAUGE COMPACT

R RU 30476 TIME ELAPSED CLOCK (s. p. 51)

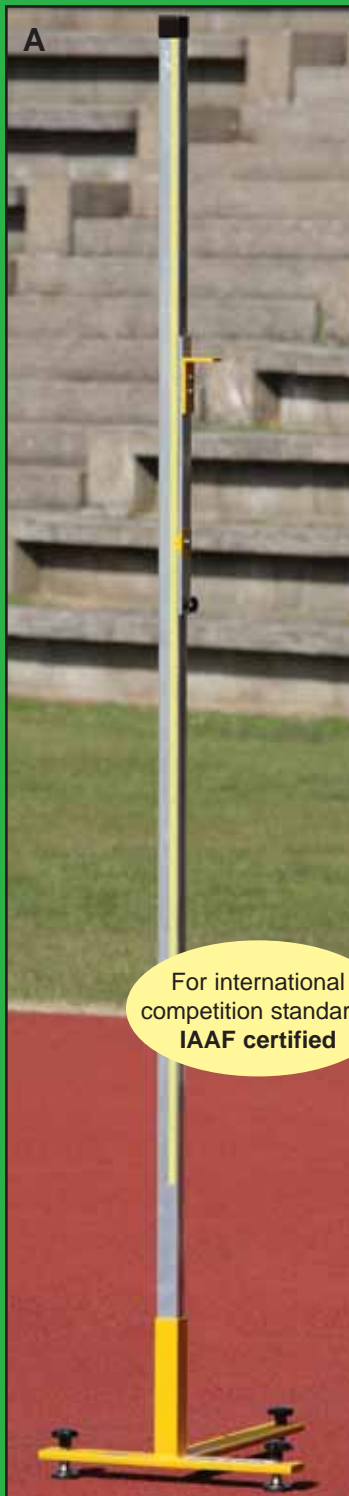

For international competition standards
IAAF certified

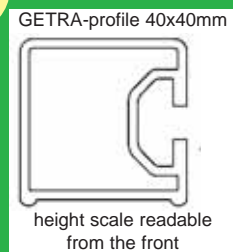

Ideal for sports clubs, schools + other sports facilities

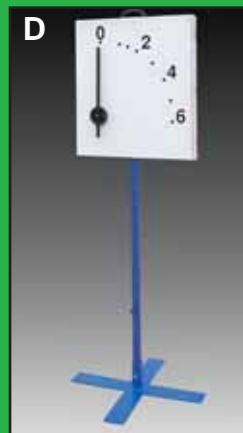
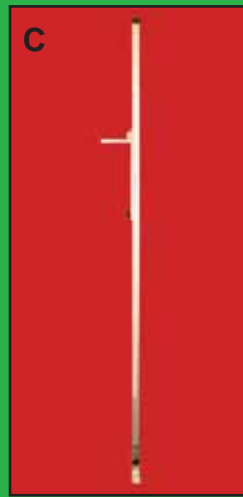

GETRA crossbars tested and proven in WC and EC championships as well as in countless meetings



A HJ 06240 **GETRA INTERNATIONAL** 
A high-quality high jump upright of a 260 cm aluminium profile with a back-standing and thus protected steel (tape) height indicator. User-friendly height adjustment with an aluminium sliding system. The slider carries the crossing bar and points the height for exact adjustment (see detail picture). With level. Heavy T-feet (circa 8.5 kg x 2) of massive, powder coated steel with adjustable and flexible stainless steel buffers that are also particularly suitable for indoor sports floors. Total weight ca. 26 kg. A premium quality product made in Germany. (IAAF certified)

B **GETRA CLUB**
A robust high jump upright of a strong aluminium profile with a back-standing and thus protected height indicator. Height adjustment with a slider running in the bar profile (see detail picture). Heavy T-feet (circa 8.5 kg x 2) of massive, powder coated steel with adjustable, floor protecting stands. Top quality made in Germany.
HJ 06231 GETRA CLUB 250CM. Weight per pair approx. 24kg
HJ 06230 GETRA CLUB 200CM. Weight per pair approx. 23kg
HJ 06208 ALU-UPRIGHT PROFILE GETRA, incl. height scale.
HJ 06209 (Spare)-HEIGHT SCALE
HJ 06207 CROSSBAR HOLDER, fits 40x40mm uprights. Up to IAAF regulations.

C HJ 06437 **MEASURING DEVICES**
HIGH JUMP MEASURING DEVICE
Made of aluminium with a sliding measurement pin. Easy and accurate reading. Measures 70 to 260cm.
PV 00445 TELESCOPIC MEASURING DEVICE PV/HJ (Page 71)
Made of aluminium. Eye level readout. Measures 107 to 500cm.

D RU 30476 **TIME ELAPSED CLOCK**
Shows the athlete the time left for an attempt, for example. Shows 0-6min. Equipped with a sturdy steel base.

E HJ 00432 **RUNWAY MARKERS**
Assorted colours.

F RU 56425 **SCOREBOARDS**
MANUAL SCOREBOARD
Revolving fibreglass scoreboard mounted on a robust wheelaway base. Comes with 8 weatherproof cassette numbers (24cm high), which can be adjusted from 0-9.
RU 56426 CASSETTE NUMBER "RED"
RU 56427 CASSETTE NUMBER "BLACK"

G HJ 26400 **HIGH JUMP CROSSBARS** 
GETRA POLYESTER "target"
the Premium competition crossbar with maximum weight for minimum vibration. Dark-yellow, made of WIN-Polyester. Excellent visual definition for jumpers and spectators. Minimum sag. Robust and nearly unbreakable. Heavy ends made from new material mixture for maximum allowed friction. A premium quality product made in Germany. (IAAF certified)

H HJ 25400 **GETRA POLYESTER 5-POINT** 
The dark-yellow heavy competition crossbar made of 5-point strengthened matrix-polyester. Colour up to athletes and trainers requests. Excellent visual definition for jumpers and spectators. Minimum sag. Robust and nearly unbreakable. Heavy ends made from new material mixture for maximum allowed friction. A top-of-the-line product made in Germany. (IAAF certified).

H HJ 24400 **GETRA FIBREGLASS 3-POINT**
The light-yellow competition and training crossbar made of 3-point strengthened fibreglass. Excellent visual definition for jumpers and spectators. Minimum sag. Robust and durable. Same ends than Getra 5-point crossbar. Top quality made in Germany. Complies to all IAAF certification demands.

I HJ 29400 **CROSSBAR ZACHARIAS**
Inflatable crossbar for practice.

J GY 81130 **JUMP CORD**
Made of braided cord and with weight bags.

K RU 00010 **RUNWAY MAT**
RUNWAY MAT/RUNWAY SQUARE
Made of all-weather PE/rubber compound. Water-, weather-, and spikeproof. For long jump, high jump, pole vault etc. (normal length 38-46m). Can be made in different lengths to customers request. Width 1250mm, different thicknesses.



Ideal for competition, sports clubs + other sports facilities

high performance equipment

IAAF und DLV Bestimmungen

www.getrasport.com...www.getrasport.com...www.getrasport.com

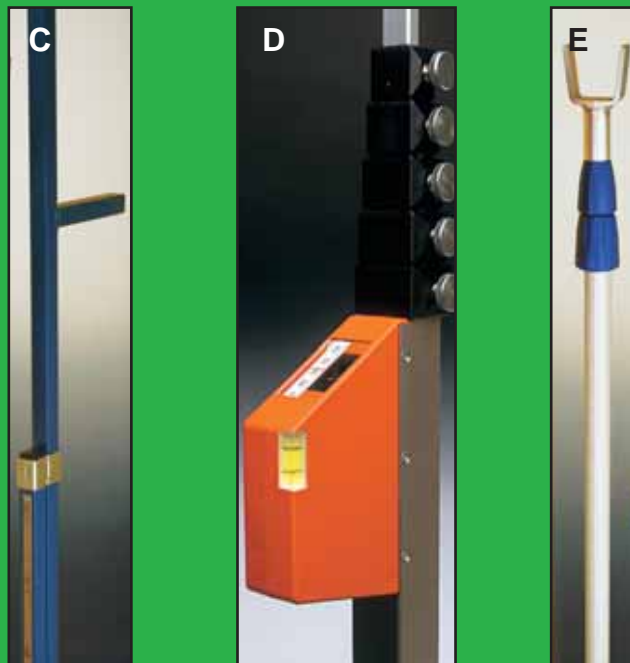

GETRA crossbars tested and proven in WC and EC championships as well as in countless meetings



POLE VAULT STANDARDS

A PV 00600 COMPETITION II
Made of reinforced aluminium profile 120x100cm. Height control by a crank (rust proof driving belt). Height can always be read at eye level. Robust, adjustable (40/80cm) and lockable base with 4 plastic wheels for easy adjustment. Heavy guide rail of aluminium. Height adjustment from 210 to 650cm.

B PV 00442 COMPETITION I
Made of strong aluminium. Height control by a lever. Comes with aluminium guide rails. Very quick to mount and to dismantle. Height adjustment from 250 to 600cm.

MEASURING DEVICES

C PV 00443 MEASURING DEVICE POLE VAULT
Made of aluminium with a sliding measurement pin. Easy and accurate reading. Measures 300 to 620cm.

D PV 00444 TELESCOPIC MEASURING DEVICE PV/HJ
made of aluminium. Eye level readout. Measures 155 to 800cm.

PV 00445 TELESCOPIC MEASURING DEVICE PV/HJ
As PV00444, measures 107 to 500cm.

CROSSBAR PLACER

E PV 42447 CROSSBAR PLACER
Made of aluminium. Telescopic.

CROSSBARS

F PV 26450 GETRA POLYESTER "target" 
the Premium competition crossbar with maximum weight for minimum vibration. Dark-yellow, made of WIN-Polyester.
Excellent visual definition for jumpers and spectators. Minimum sag. Robust and nearly unbreakable. Heavy ends made from new material mixture for maximum allowed friction. A premium quality product made in Germany. (IAAF certified)

G PV 25450 GETRA POLYESTER 5-POINT 
The dark-yellow heavy competition crossbar made of 5-point strengthened matrix-polyester. Colour up to athletes and trainers requests. Excellent visual definition for jumpers and spectators. Minimum sag. Robust and nearly unbreakable. Heavy ends made from new material mixture for maximum allowed friction. A top-of-the-line product made in Germany. (IAAF certified).

G PV 24450 GETRA FIBREGLASS 3-POINT
The light-yellow competition and training crossbar made of 3-point strengthened fibreglass. Excellent visual definition for jumpers and spectators. Minimum sag. Robust and durable. Same ends than Getra 5-point crossbar. Top quality made in Germany. Complies to all IAAF certification demands.

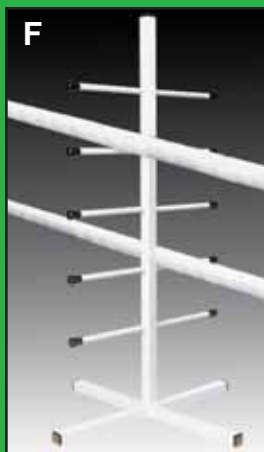
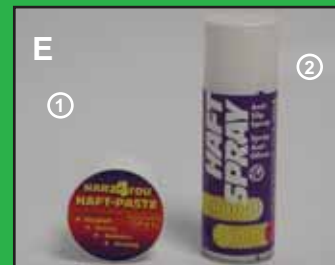
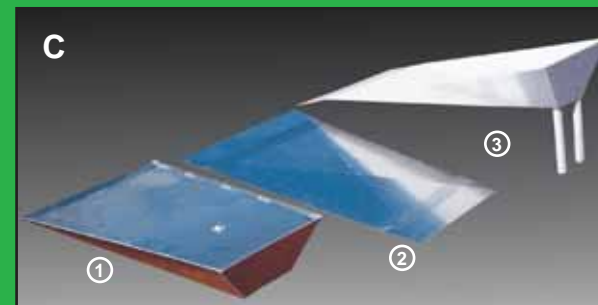

A VAULTING POLES UCS/spirit

PV 63000	5,20m 77-80-82-84-86-88-91-93-95-97-100kg
PV 62000	5,10m 77-80-82-84-86-88-91-93-95-97-100kg
PV 61000	5,00m 75-77-80-82-84-86-88-91-93-95-97-100kg
PV 60000	4,90m 66-68-70-73-75-77-80-82-84-86-88-91-93-95kg
PV 59000	4,75m 66-68-70-73-75-77-80-82-84-86-88-91kg
PV 58000	4,60m 59-61-63-66-68-70-73-75-77-80-82-84-86-88-91kg
PV 57000	4,45m 59-61-63-66-70-73-75-77-80-82-84-86kg
PV 56000	4,30m 54-57-59-61-63-66-68-70-73-75-77-80-82-84-86-88kg
PV 55000	4,15m 57-59-61-63-66-68-70-73-75-77-80-82kg
PV 54000	4,00m 50-52-54-57-59-61-63-66-68-70-73-75-77-80-82kg
PV 53000	3,70m 50-54-59-63-68-73-77kg
PV 52000	3,50m 30-35-40-45-50-54-59-63kg
PV 51000	3,25m 30-35-40-45-50-54-59kg

PV 00999 Plug UCS/spirit

B VAULTING POLES PACER PACER FX STANDARD

PV 83000	5,10m 84-86-88-91-93-95kg
PV 82000	5,00m 73-75-77-80-82-84-86-88-91kg
PV 81000	4,90m 73-75-77-80-82-84-86-88-91kg
PV 80000	4,70m 68-70-73-75-77-80-82-84-86-88kg
PV 78000	4,60m 63-66-68-70-73-75-77-80-82-84-86kg
PV 77000	4,40m 59-61-63-66-68-70-73-75-77-80-82-84kg
PV 76000	4,25m 57-59-61-63-66-68-70-73-75-77-80-82kg
PV 75000	4,15m 54-57-59-61-63-66-68-70-73-75-77-80kg
PV 74000	4,00m 50-52-54-57-59-61-63-66-68-70-73kg
PV 73000	3,75m 45-50-54-59-63-68kg
PV 72000	3,60m 41-45-50-54-59-63kg
PV 71000	3,50m 41-45-50-54-59-63kg

PACER CARBON FX WEAVE

PV 79010	5,10m 84-86-88-91-93-95kg
PV 79020	5,00m 77-80-82-84-86-88-91-93-95kg
PV 79030	4,90m 73-75-77-80-82-84-86-88-91kg
PV 79040	4,70m 68-70-73-75-77-80-82-84-86-88kg
PV 79050	4,60m 63-66-68-70-73-75-77-80-82-84-86kg

PACER MYSTIC WOMEN

PV 88000	4,00m 50-52-54-57-59-61-63-66-68-70-73kg
PV 87000	3,75m 45-47-50-52-54-57-59-61-63-66-68-70-73kg
PV 86000	3,60m 41-43-45-47-50-52-54-57-59-61-63-66-68kg
PV 85000	3,50m 41-45-50-54-59-63-68kg
PV 84000	3,35m 36-41-45-50-54-59-63-68kg
PV 83000	3,25m 36-41-45-50-54-59-63kg
PV 82000	3,10m 32-41-50-59kg

PACER CARBON MYSTIC WEAVE WEAVE

PV 89040	4,40m 61-63-66-68-70-73-75-77-80-82kg
PV 89030	4,25m 59-61-63-66-68-70-73-75-77-80-82kg
PV 89020	4,15m 57-59-61-63-66-68-70-73-75-77kg
PV 89010	4,00m 54-57-59-61-63-66-68-70-73kg

PV 00998 Plug Pacer

VAULT BOX

C1 PV 41600 INSERTION BLOCK FOR VAULT BOX
Made of aluminium. To be inserted in the vault box.. Can be coated with track surface or sport floor material. With lock on request.

C2 PV 43449 COVER FOR VAULT BOX
Made of strong aluminium, vaulted.

C3 PV 41449 VAULT BOX STEEL
With waterdrain and embedment device.



D POLE BAGS
Made of durable vinyl. Takes 4-8 poles. Standard colour is red.
PV 310.... Length 3,50m, 3,90m, 4,20m, 4,65m, 4,90m, 5,15m or 5,35m

ADHESIVE ACCESSORIES
Provides excellent grip on the pole.

E1 PV 99601 ADHESIVE PASTE 125g
E2 PV 99600 ADHESIVE SPRAY 200ml

F POLE RACKS
F PV 30000 POLE RACK
Protects the vaulting poles during training and competition. Takes 10 to 12 poles.

G PV 30001 POLE RACK MOBILE
Equipped with wheels and protective roof.



Detail Competition Elite: ④

③

① ②

Detail Top pad Competition Elite

Detail single unit Competition Elite

Detail single unit Competition Elite

Detail handle / Snap hook and D-ring Competition Elite

⑤

⑥



High jump landing area Competition



Indoor landing area GETRA EuroStar



PV Landing Area Competition Elite

with front extensions ① and slide rail covers ②

①

②

PRODUCT INFORMATION:

PRODUCT INFORMATION:

All our landing areas are designed with special regard to the health and safety of the athlete. We therefore avoid the use of cheap materials which do not conform to this philosophy and are very particular when we order the foam, the netting and the covers. We only use top-class materials in each of the competition classes. The number of the different poly foam blocks varies according to the size of the equipment.

In all our designs we make exclusive use of:

- special netting to enable optimum circulation of air,
- especially fitted openings for airing,
- weather-resistant seams and velcro closure..

CLASS COMPETITION:

USERS: Ambitious jumpers/vaulters. The apparatus is put to average use.

MATERIAL/DESIGN: Made of hollow (tunneled), shape-retaining foam blocks. The spike-protection-mat out of foam is laid directly onto the foam blocks. The top cover made of strengthened, untreated vinyl with integrated and bonded netting is put on to the foam blocks with spike-protection-mat and joined to the non-slip bottom cover.

CLASS COMPETITION ELITE:

USERS: good and very good jumpers/vaulters who demand the highest degree of comfort and function. The apparatus is put to very heavy use and can be frequently assembled, disassembled and transported from place to place.

MATERIAL/DESIGN: Made of hollow (tunneled), shape-retaining foam blocks, that are put-in individually in vinyl bags. The top cover of each vinyl bag is made of coated polyester fabric. The vinyl bags with foam blocks inside are joined together. The top-pad can be used at both sides and is laid directly on top of the joined vinyl bags and in addition is fastened.

FOAM: Cross tunnel construction for smoother landing. From top to bottom the foam weight is increasing.

TOP PAD: 70mm robust foam encased in red spike-proof netting on top and bottom. The top pad can be used from both sides and can be easily replaced when worn out after long term use.

CONSTRUCTION OF COVERS AND TOP PAD:

Pic. 1: ground parts and lower side parts of each single unit are made from heavy vinyl coated woven polyester.

Pic. 2: Joints (webbing closure)

Pic. 3: Upper parts and top parts of each single unit are made from black netting. Each single unit is equipped with velcro closures.

Pic. 4: Top pad

Pic. 5: Handles

Pic. 6: Snap hooks and D-rings ensure placement of weather cover

STANDARD SIZES COMPETITION+COMPETITION ELITE: (any other sizes available on request)

HIGH JUMP:

(min. 500x300x50cm acc. IAAF)

600x400x70 CM	600x300x60 CM	400x300x60 CM
600x400x60 CM	600x300x50 CM	400x300x50 CM
500x400x60 CM	500x300x60 CM	
500x400x50 CM	500x300x50 CM	

All high jump landing areas come with weather cover.

Indoor Landing Area GETRA "EuroStar" 400x300x40cm

Consists of 2 base foam units (each 200x300x40cm). Vinyl bottom and lower sides, black netting on top and upper sides for excellent air breezing. Very robust. Designed by GETRASPORT Germany. (Art. no. 175)

POLE VAULT:

(min. 500x650x80cm acc. IAAF).

600x800x80 CM	500x650x80 CM
500x800x80 CM	500x530x80 CM

All pole vault landing areas come with weather cover.

PROTECTION PADS POLE VAULT (Rule 183.9):

- Front extensions (red spike-proof netting on top).
- Slide rail covers (made of vinyl covered shape-retaining foam). Please specify dimensions of slide rails.
- Back extensions (red spike-proof netting on top).

EQUIPMENT FOR HIGH JUMP AND POLE VAULT LANDING AREAS:

LATH GRID ALUMINIUM

all parts made of aluminium. With side supports of aluminium. (wheels on request). Height approx. 100mm.

MOBILE SHELTER

Top and sides made of robust aluminium. Equipped with heavy duty wheels.

WEATHER COVER (EXTRA)

made of durable vinyl coated woven polyester.

Please contact us with your requirements and allow us to submit a detailed offer tailor-made to your needs.



For international competition standards IAAF certified









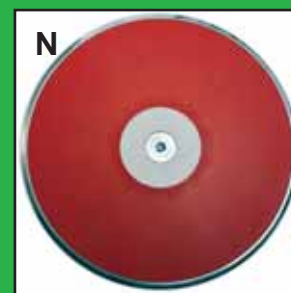

Ideal for sports clubs, schools + other sports facilities



Gold & Silber In World Championships with Denfi



- A CARBON SPECIAL** 
Competition discus. Carbon sides for high periphery mass. (IAAF certified)
DI 20200 GETRA CARBON SPEZIAL 2,00 kg
DI 20100 GETRA CARBON SPEZIAL 1,00 kg
- B HIGHSPIN** 
Competition discus of highest quality. Sides of fibreglass without centre plate. Very high rim weight for more spin, and less wobble. (IAAF certified)
DI 26200 HIGH SPIN 2,00 kg
DI 26175 HIGH SPIN 1,75 kg
DI 26150 HIGH SPIN 1,50 kg
DI 26100 HIGH SPIN 1,00 kg
- C GOLD** 
Competition discus. Sides of white fibreglass without centre plate. Brass rim with 85% rim weight. (IAAF certified)
DI 76200 GOLD 2,0 kg
DI 76100 GOLD 1,0 kg
- D GETRA EXTRA**
Competition discus. Robust construction without centre plate. High rim weight for smooth flying performance.
DI 38200 GETRA EXTRA 2,00 kg
DI 38175 GETRA EXTRA 1,75 kg
DI 38150 GETRA EXTRA 1,50 kg
DI 38100 GETRA EXTRA 1,00 kg
DI 38075 GETRA EXTRA 0,75 kg
- E FIBREGLASS** 
Competition discus. Special "Hook in" sides fasteners. Sides of tough fibreglass. With gauging screw. Multiple tempered steel rim. Different colours.
DI 34200 FIBREGLASS 2,00 kg
DI 34175 FIBREGLASS 1,75 kg
DI 34150 FIBREGLASS 1,50 kg
DI 34100 FIBREGLASS 1,00 kg
DI 34075 FIBREGLASS 0,75 kg
- F TRAINING ADJUSTABLE**
Comes with different, interchangeable centre weights. Easy and fast to change. Fibreglass plates and steel rim.
DI 32220 TRAINING ADJUSTABLE 1,75 to 2,20 kg
DI 32120 TRAINING ADJUSTABLE 0,85 to 1,20 kg
- G DISCUS BAGS**
Made of strong material.
DI 25201 GETRA DISCUS BAG BIG
DI 25101 GETRA DISCUS BAG SMALL
- H RUBBER**
A durable and well designed discus for training and indoor. Made of brown "Flex"-rubber with low abrasion in order not to scuff the indoor floor or walls.
DI 50200 RUBBER 2,00 kg
DI 50175 RUBBER 1,75 kg
DI 50150 RUBBER 1,50 kg
DI 50100 RUBBER 1,00 kg
DI 50075 RUBBER 0,75 kg
DI 50060 RUBBER 0,60 kg

- I WOOD**
Competition and training discus. Sides of laminated layered hard-wood for extra long durability. Balanced and tempered steel rim. With gauging screw.
DI 40200 WOOD 2,00 kg
DI 40175 WOOD 1,75 kg
DI 40150 WOOD 1,50 kg
DI 40125 WOOD 1,25 kg
DI 40100 WOOD 1,00 kg
DI 40075 WOOD 0,75 kg
DI 40060 WOOD 0,60 kg
- J FIBREGLASS RED**
Competition and training discus. Plates of fibreglass. Balanced and tempered steel rim. With gauging screw.
DI 30200 FIBREGLASS RED 2,00 kg
DI 30175 FIBREGLASS RED 1,75 kg
DI 30150 FIBREGLASS RED 1,50 kg
DI 30125 FIBREGLASS RED 1,25 kg
DI 30100 FIBREGLASS RED 1,00 kg
DI 30075 FIBREGLASS RED 0,75 kg
DI 30060 FIBREGLASS RED 0,60 kg
- K GETRA TRAINING DISCUS "OVERWEIGHT"**
DI 32225 TRAINING 2,25kg
DI 32250 TRAINING 2,50kg
DI 32300 TRAINING 3,00kg
- L DENFI JÜRGEN SCHULT ULTIMATE SPIN** 
Competition discus. Carbon sides. Steel rim. Designed for 0wind and headwind. (IAAF certified)
DI 70200 2,00 kg (86% rim weight)
DI 70175 1,75 kg (85% rim weight)
DI 70150 1,50 kg (84% rim weight)
DI 70100 1,00 kg (78% rim weight)
- M DENFI HYPER SUPER SPIN** 
Competition discus. Carbon sides. Steel rim. Designed for 0wind and tailwind. (IAAF certified)
DI 71200 2,00 kg (84% rim weight)
DI 71175 1,75 kg (81% rim weight)
DI 71150 1,50 kg (82% rim weight)
DI 71100 1,00 kg (75% rim weight)
- N DENFI JÜRGEN SCHULT SKYMASTER** 
Competition discus. Carbon sides. Steel rim. Designed for all wind conditions. (IAAF certified)
DI 72200 2,00 kg (78% rim weight)
DI 72100 1,00 kg (72% rim weight)
- O DENFI SPACE TRAVELLER** 
Competition discus. Carbon sides. Black chromed steel rim. Extremely high spinrate. (IAAF certified)
DI 73200 2,00 kg (90% rim weight)
DI 73100 1,00 kg (85% rim weight)



For international competition standards IAAF certified



A STEEL HAMMERS (TURNED)
Competition (gauged) and training hammers of high quality steel. Precise machine turned. Equipped with rotating swivel, stiff wire and "Special IAAF" handle.

SH 20300	STEEL 3,00 KG
SH 20400	STEEL 4,00 KG
SH 20500	STEEL 5,00 KG
SH 20600	STEEL 6,00 KG
SH 20726	STEEL 7,26 KG
SH 20800	STEEL 8,00 KG TRAINING
SH 20900	STEEL 9,00 KG TRAINING

B HIGH PERFORMANCE BRASS HAMMERS
Competition hammers made of brass casing with lead or tungsten core to achieve a hammer head of small diameter. Equipped with robust and smooth running swivel inclusive security screw and stiff wire with rounded eye. With aluminium handle "Special IAAF".

SH 25300	BRASS 3,00 KG, D=87mm
SH 25400	BRASS 4,00 KG, D=95mm
SH 25500	BRASS 5,00 KG, D=101mm
SH 25600	BRASS 6,00 KG, D=106mm
SH 25726	BRASS 7,26 KG, D=110mm

C HIGH PERFORMANCE STAINLESS STEEL HAMMERS
Competition hammers made of stainless steel casing with lead or tungsten core to achieve a hammer head of small diameter. Equipped with robust and smooth running swivel inclusive security screw and stiff wire with rounded eye. With aluminium handle "Special IAAF". Much less abrasion compared to brass hammers, extends the lifetime of the product.

SH 27400	STAINLESS STEEL 4,00 KG, D=95mm
SH 27500	STAINLESS STEEL 5,00 KG, D=101mm
SH 27600	STAINLESS STEEL 6,00 KG, D=106mm
SH 27726	STAINLESS STEEL 7,26 KG, D=110mm

D HIGH PERFORMANCE CARBON STEEL HAMMERS
Competition hammers made of carbon steel casing. Equipped with robust and smooth running swivel inclusive security screw and stiff wire with rounded eye.

SH 26400	CARBON STEEL 4,00 KG, D=103mm
SH 26600	CARBON STEEL 6,00 KG, D=115mm
SH 26726	CARBON STEEL 7,26 KG, D=120mm

E HAMMER HANDLES "rule 2006"
SPECIAL IAAF
Extra strong. Series production with proofed and constant weight. Gauged. Weight tolerance +- 2g.

SH 20001	EXTRA IAAF Very light. Made from aluminium.
----------	--

F HAMMER GLOVES
SH 20 ... Made of genuine leather, extra thick on the inside. Sizes: S/M/L/XL/XXL.

G HAMMER WIRES
SH 20 ... Made of multiple tempered and therefore rigid steel. Length: 101/100/99 98/97/96/95/78cm. Rounded eyes.

H STEEL SHOTS (TURNED)
Competition (gauged) and training shots made of high quality steel. Precise machine turned. Every weight is painted in a different colour.

SH 30100	STEEL 1,00 KG TRAINING
SH 30200	STEEL 2,00 KG TRAINING
SH 30250	STEEL 2,50 KG
SH 30300	STEEL 3,00 KG
SH 30400	STEEL 4,00 KG
SH 30500	STEEL 5,00 KG
SH 30600	STEEL 6,00 KG
SH 30726	STEEL 7,26 KG
SH 30900	STEEL 9,00 KG TRAINING
SH 30110	STEEL 10,0 KG TRAINING

I INDOOR SHOTS
Competition (gauged) and training shots made of thick rubber material casing with lead core.

SH 35250	2,50 KG	SH 35500	5,00 KG
SH 35300	3,00 KG	SH 35600	6,00 KG
SH 35400	4,00 KG	SH 35726	7,26 KG

J HIGH PERFORMANCE STEEL SHOTS
Precision machine turned for exact diameter specifications and correct weight. Gauged. (IAAF certified).

SH 33401	STEEL 4,00 KG, D=100mm
SH 33400	STEEL 4,00 KG, D=104mm
SH 33402	STEEL 4,00 KG, D=108mm
SH 31728	STEEL 7,26 KG, D=120mm
SH 31727	STEEL 7,26 KG, D=125mm
SH 31726	STEEL 7,26 KG, D=128mm

K HIGH PERFORMANCE STAINLESS STEEL SHOTS
Made of stainless steel casing with lead or tungsten core for small diameters. Much less abrasion compared to brass shots, extends the lifetime of the product. (4,00/6,00/7,26KG IAAF certified).

SH 34400	STAINLESS STEEL 4,00 KG, D=95mm
SH 34500	STAINLESS STEEL 5,00 KG, D=101mm
SH 34600	STAINLESS STEEL 6,00 KG, D=106mm
SH 34726	STAINLESS STEEL 7,26 KG, D=110mm

L HIGH PERFORMANCE BRASS SHOTS
Made of brass casing with lead or tungsten core for small diameters. (4,00/6,00/7,26KG IAAF certified).

SH 32300	BRASS 3,00 KG, D=87mm
SH 32400	BRASS 4,00 KG, D=95mm
SH 32500	BRASS 5,00 KG, D=101mm
SH 32600	BRASS 6,00 KG, D=106mm
SH 32726	BRASS 7,26 KG, D=110mm

M SH 30000 GETRA SHOT BAG



A COMPETITION JAVELIN GETRA "KINETIC" 

GETRA KINETIC javelins are a proprietary development by Getrasport/Germany and are all without exception certified by IAAF.

The body is a multi-hardened alu-alloy precisely manufactured and designed for extreme durability and stability. The tip is made of steel, the cord is tight fixed. Especially developed for advanced and ambitious throwers the Kinetic javelin is characterised by a backwards located center of gravity. Excellent gliding features combined with optimal power transmission make the Kinetic javelins special. An outstanding javelin at a fair price.

- JA 69800 Getra Kinetic 70, 800g
- JA 69801 Getra Kinetic 60, 800g
- JA 69700 Getra Kinetic 60, 700g
- JA 69600 Getra Kinetic 50, 600g
- JA 69601 Getra Kinetic 50, 600g

B COMPETITION JAVELIN GETRA "COMPETITION II" 

GETRA COMPETITION javelins are designed to provide a maximum performance even if the line of power application is not perfect.

These javelins are very durable and much more longer straight keeping. All Getra competition javelins are complying strictly to IAAF rules. Corpus made of special heat tempered alloys with steel tip and tight fixed cord. The carefully determined center of gravity gives excellent flight and length. High performance at an affordable price. The perfect competition equipment for clubs, schools and all other sports facilities. (800g+700g+600g are IAAF certified).

- JA 68800 Getra Competition II 800g
- JA 68700 Getra Competition II 700g
- JA 68600 Getra Competition II 600g
- JA 68500 Getra Competition II 500g
- JA 68400 Getra Competition II 400g

C JAVELIN GETRA "SUPERTRAINING"

GETRASPORT SUPERTRAINING is a sturdy and very well balanced aluminium javelin. Corpus made of heat tempered, strong alloys with steel tip and tight fixed cord. For excellent flight characteristics and excellent power transfer. The perfect equipment for beginners, clubs, schools and all others sports facilities. The best training javelin value available. Recommended by leading coaches.

- JA 67900 Getra Supertraining ST 900g
- JA 67800 Getra Supertraining ST 800g
- JA 67700 Getra Supertraining ST 700g
- JA 67600 Getra Supertraining ST 600g
- JA 67500 Getra Supertraining ST 500g
- JA 67400 Getra Supertraining ST 400g

D JA 00000 JAVELIN INDOOR DEVICE
is placed on the javelin tip, when throwing against a net.

E GETRA JAVELIN "COMPETITION AC SAFE"
with non marking rubber tip. All javelins meet the competition rules in centre of gravity and weight.

- JA 66800 Getra Competition Safe 800g
- JA 66700 Getra Competition Safe 700g
- JA 66600 Getra Competition Safe 600g

JA 66000 (Spare)-Rubber tip

F CARRYING BAGS
GETRA Javelin Bag made of heavy duty material. With reinforced ends.

- JA 00015 GETRA JAVELIN BAG CA. 275CM
- JA 00016 GETRA JAVELIN BAG CA. 235CM

G Holds 3 pieces javelins. With handle.

- JA 00010 JAVELIN TUBE CA. 275CM
- JA 00011 JAVELIN TUBE CA. 235CM

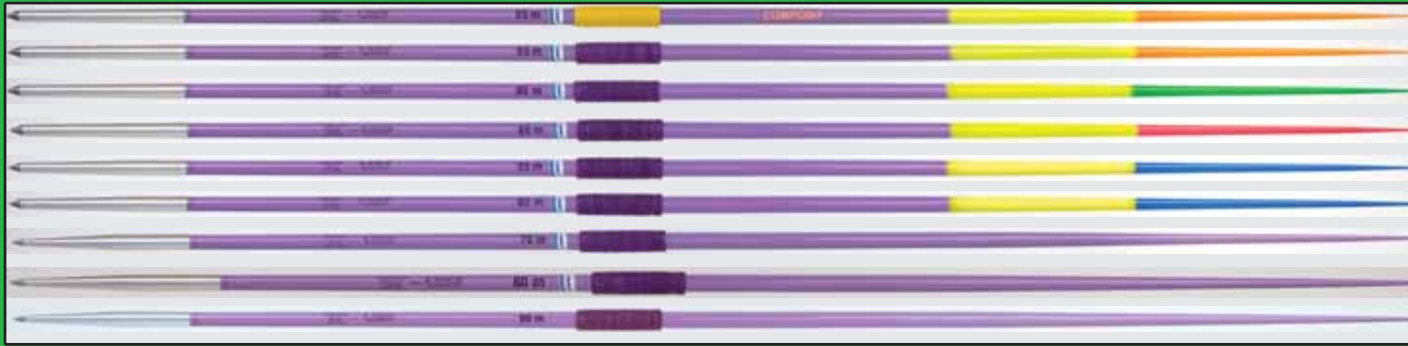

NEMETH JAVELINS 

JA 00992/10 NEMETH Classic Composit 95m, 800g
 JA 00992/13 NEMETH Classic 95m, 800g
 JA 00992/14 NEMETH Classic 90m, 800g
 JA 00992/15 NEMETH Classic 85m, 800g
 JA 00992/16 NEMETH Club 85m, 800g
 JA 00992/17 NEMETH Club 80m, 800g

JA 00992/20 NEMETH Standard (School) Alu 70m, 800g
 JA 00992/21 NEMETH Standard (School) Alu 60m, 800g
 JA 00992/22 NEMETH Standard (School) Alu 50m, 800g

JA 00992/01 NEMETH Classic Composit 85m, 600g
 JA 00992/02 NEMETH Classic Alu 80m, 600g
 JA 00992/03 NEMETH Classic Alu 75m, 600g
 JA 00992/05 NEMETH Club Alu 75m, 600g
 JA 00992/06 NEMETH Club Alu 70m, 600g

JA 00992/30 NEMETH Standard (School) Alu 70m, 600g
 JA 00992/31 NEMETH Standard (School) Alu 60m, 600g
 JA 00992/32 NEMETH Standard (School) Alu 50m, 600g
 JA 00992/33 NEMETH Standard (School) Alu 40m, 600g

JA 00992/09 NEMETH Special Competition 70m, 700g
 JA 00992/08 NEMETH Special Competition, 500g
 JA 00992/07 NEMETH Special Competition, 400g

OTE JAVELINS 

JA 00993/16 OTE Comp Tailwind 95m, 800g
 JA 00993/15 OTE Xtra Headwind 80m, 800g
 JA 00993/14 OTE Composite FX 90-95m, 800g
 JA 00993/13 OTE Composite FX 90-95m, 800g Headwind

JA 00993/04 OTE Xtra Tailwind 70m, 600g
 JA 00993/03 OTE Xtra Headwind 60m, 600g
 JA 00993/02 OTE Composite FX 80m, 600g
 JA 00993/01 OTE Composite FX 80m, 600g Headwind

SUPPORTS+BELTS
 When ordering neoprene supports please specify the circumference of the requested area. All neoprene supports are washable.

A BA 86292 **BACK SUPPORT LUMBAGO**
 Adjustable traction at the back with detachable vertical fibre-glass sticks. Double neoprene in back. Sizes S/M/L/XL.

B BA 86342 **KNEE SUPPORT UNIVERSAL**
 Offers support and protection. Heat conserving. 4 mm neoprene. Sizes S/M/L/XL.

C BA 86382 **ELBOW SUPPORT UNIVERSAL**
 Offers support and protection. Heat conserving. Used for e.g. tennis-elbow and bursitis. 4 mm neoprene. Ventilated. Sizes S/M/L/XL.

D FI 90109 **ATHLETIC BELT**
 For weight lifting and athletics. Supports the spine. Made of cowhide leather with padded back. Sizes S/M/L/XL.

E FI 90501 **CHALK**
 8 blocks, approx. 480g.



PROTECTIVE NET CAGES FOR HAMMER + DISCUS (RULE 192.3/4)

These net cages are constructed as combination net cages for discus and hammer (10 standards=9 fields, 2 doors). We use official weather treated protection nets acc. DIN EN 1263-1 and IAAF.



- SH 21468 NET CAGE 10m/7m "GROUND SOCKETS"
Robust and durable construction made of double reinforced heavy duty extruded aluminium. Two adjustable doors. All cantilevers and doors equipped with wheels. Outer net sloping from 7,0m to 10m. With pulley system for raising and lowering the nets. Comes with ground sockets and all necessary fittings.

PROTECTIVE NET CAGES FOR HAMMER + DISCUS

These net cages are constructed as combination net cages for discus and hammer (8 standards=7 fields). We use official weather treated protection nets acc. DIN EN 1263-1 and IAAF.

- SH 21600 NET CAGE 5,5/5m "GROUND SOCKETS"
Made of robust reinforced heavy duty extruded aluminium 80x80mm. Two adjustable doors 5,5m high. The outer net is 4,0m high, the inner net sloping from 5,0m to 5,5m. With pulley system for raising and lowering the nets. Comes with ground sockets and all necessary fittings.
- SH 21601 NET CAGE 5,5/5m "FREESTANDING"
Made from robust reinforced heavy duty extruded aluminium 80x80mm. Heavy duty ground frame made of special aluminium tubes. Two adjustable doors 5,5m high. The outer net is 4,0m high, the inner net sloping from 5,0m to 5,5m. With pulley system for raising and lowering the nets.
- SH 21602 NET CAGE 4,5m "GROUND SOCKETS"
As SH 21600, but without front doors. Single net construction. Pulley system on request.
- SH 21603 NET CAGE 4,5m "FREESTANDING"
As SH 21601, but without front doors. Single net construction. Pulley system on request.

PROTECTIVE NET CAGES FOR DISCUS (RULE 190.3)

These net cages are constructed especially for discus (10 standards=9 fields). We use official weather treated protection nets acc. DIN EN 1263-1 and IAAF.

- Di 21602 NET CAGE 4,5m "GROUND SOCKETS"
Made of robust reinforced heavy duty extruded aluminium 80x80mm. Single net construction. Net is 5,0m high. With pulley system for raising and lowering the nets. Comes with ground sockets and all necessary fittings.
- Di 21603 NET CAGE 4,5m "FREESTANDING"
Made from robust reinforced heavy duty extruded aluminium 80x80mm. Heavy duty ground frame made of special aluminium tubes. Single net construction. Net is 5,0m high. With pulley system for raising and lowering the nets.

THROWING CIRCLES

- DI 60452 DISCUS CIRCLE 250CM
70mm high, 2-pieces with braces for simple integration into the concrete. Made of galvanized steel or aluminium.
- DI 60600 DISCUS CIRCLE 250CM
25mm high, hinged portable design. Made of galvanized steel.
- SH 21458 SHOT/HAMMER CIRCLE 213,5CM
70mm high, 2-pieces with braces for simple integration into the concrete. Made of galvanized steel or aluminium.
- SH 21471 SHOT/HAMMER CIRCLE 213,5CM
25mm high, hinged portable design. Made of galvanized steel.
- SH 40455 INDOOR SHOT CIRCLE
- SH 70060 SHOT IMPRINT AREA
Made of special foam with a polyurethane coating mass injected to the outer layer. Slow absorption of the impact. An extremely robust mat.

SHOT CHANNEL

- SH 21459 HAMMER CONVERSION CIRCLE FIBERGLASS
Converts existing discus ring into an official hammer ring.

TOEBOARD

- SH 40264 TOEBOARD FIBREGLASS
Durable and water resistant. With clip for cord to mark the sector lines. Complies with regulations.
- SH 40265 TOEBOARD FIBREGLASS IAAF

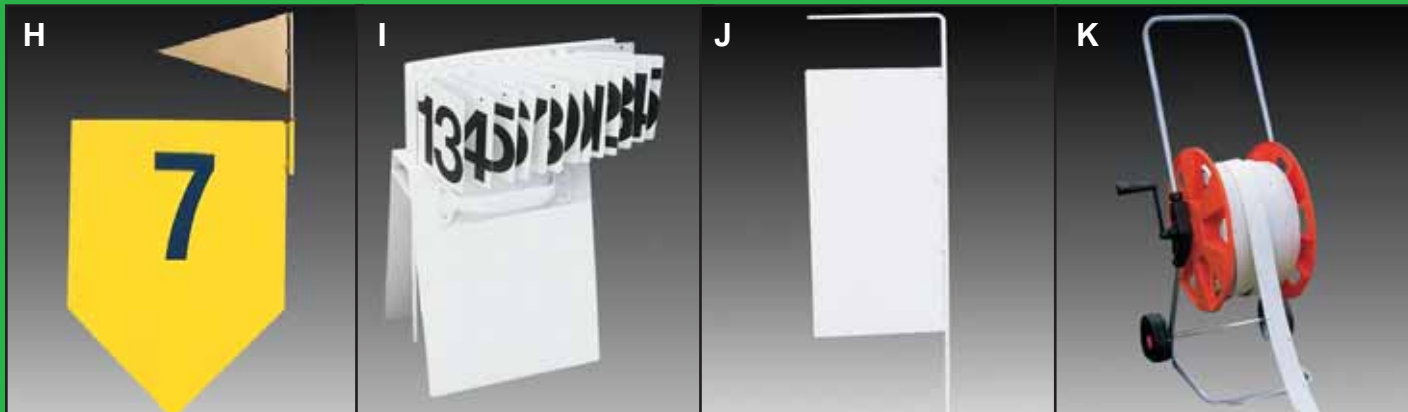
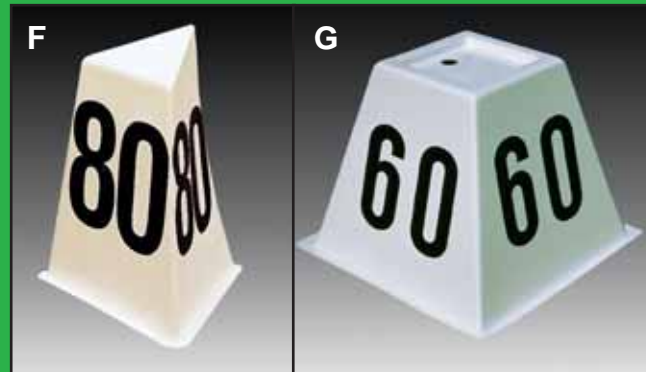
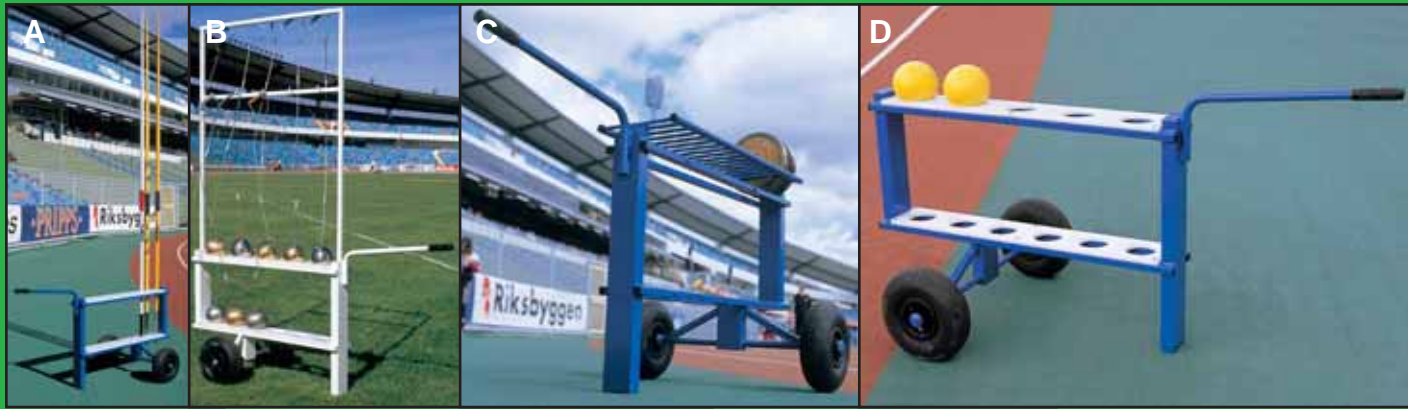

RACKS		L4 JA 71474	MARKER STAKE 40CM		
A	JA 00005	JAVELIN RACK	Holds about 24 javelins.		
B	SH 20460	HAMMER RACK	Holds about 11 hammers.		
C	DI 61460	DISCUS RACK	Holds about 18 discus.		
D	SH 40460	SHOT RACK	Holds about 11 shots.		
E	RU 26452	EQUIPMENT CART	Surface 200x100cm made of beechwood. Foldable sides 20cm high. Equipped with pneumatic tyres and bogie. Trailer coupling on request.		
MARKING EQUIPMENT		F	JA 71468	DISTANCE MARKER SUPER	Made of yellow or white fibreglass. Comes with numbers on three sides (Please specify when ordering).
G	JA 71464	DISTANCE MARKER COMPETITION	Made of white fibreglass. Comes with numbers on four sides (Please specify when ordering).		
	JA 71479	(SPARE)-ADHESIVE NUMBER FOR MARKERS			
H	JA 71469	COMPETITION MARKERS	Set of 13 markers each approx. 48x33cm, with flag for the leader. Numbers from 1 to 13.		
I	JA 71462	THROWING MARKERS	Set of 25 markers each approx. 10x13cm. Numbers from 1 to 25. Comes with stand.		
J	JA 71461	SECTOR FLAG	For marking length and end of safety areas.		
K	JA 71463	SECTOR LINE POLYAMIDE	50mm wide, made of 3mm perforated polyamide. Very robust and durable. Can be fixed to the ground with all kinds of nails. Comes in rolls of 40m.		
K	JA 71467	CART FOR SECTOR LINE POLYAMIDE			
L1	JA 71476	ROOF-SHAPED MARKER	Measurements approx. 15x12cm per side. Comes without numbers.		
L2	JA 71475	MARKING PINS	Set of 10 pins. Numbers from 1 to 10. Length approx. 20cm. Head approx. 9cm.		
L3	JA 71477	SQUARE MARKER	Measurements approx. 20x18cm. Comes without numbers.		
	JA 71478	(SPARE)-ADHESIVE NUMBER FOR MARKER			
M	JA 70001	NET FOR THROWING SECTOR	Made of braided polyethylene with 45mm mesh. Measurements to customer's request. Protects athletes, spectators and working staff.		

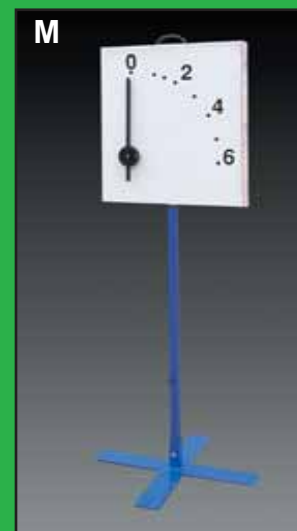
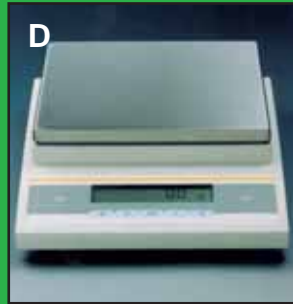
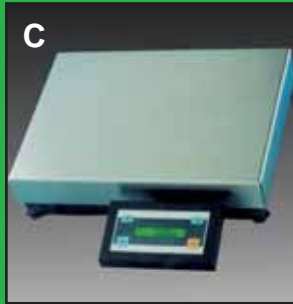

- MEASURING TAPES**
- A** SH 65100 FIBREGLASS 100M, OPEN REEL
 SH 65050 FIBREGLASS 50M, CASE
 SH 65030 FIBREGLASS 30M, CASE
 SH 65020 FIBREGLASS 20M, CASE
 SH 65015 FIBREGLASS 15M, CASE
 SH 65010 FIBREGLASS 10M, CASE
- B** SH 60100 STEEL 100M, OPEN REEL
 SH 60050 STEEL 50M, OPEN REEL
 SH 60030 STEEL 30M, CASE
 SH 60020 STEEL 20M, CASE
 SH 60015 STEEL 15M, CASE
 SH 60010 STEEL 10M, CASE
- C** JA 71501 SCALE (MAXIMUM WEIGHT 15000G)
 Accurate to 5g. Class III, calibrated by the manufacturer. Stainless steel scale pan 320x240mm. Comes with mains adapter, and assembling and operating instructions.
- D** JA 71500 SCALE (MAXIMUM WEIGHT 8100 G)
 Accurate to 0,1g. Class II, Calibrated by the manufacturer. Stainless steel scale pan 210x180mm. 8-segment display, DIN. Dust proof and splash proof. Comes with data interface. Conforms to ISO reporting standards when the printer is attached, cannot be damaged by excessive loads, antitheft alarm and mains adapter.
- MEASURING DEVICES**
- E** SH 20006 HAMMER TESTING DEVICE
 Made of aluminium. For checking the length of the hammer quickly and easily.
- F** PV 00444 TELESCOPIC MEASURING DEVICE PV/HJ 8M
 Made of aluminium. Eye level readout. Measures 155 to 800cm.
- PV 00445 TELESCOPIC MEASURING DEVICE PV/HJ 3M
 As PV00444, measures 107 to 300cm.
- G** HJ 06437 GETRA HIGH JUMP MEASURING DEVICE
 Made of aluminium with a sliding measurement pin. Easy and accurate reading. Measures 90 to 250cm.
- H** HJ 05250 OPTICAL MEASURING SYSTEM
 Easily operated optical measuring system for long and triple jump. The scope unit slides on a rail and is placed in line with the marker in the sand. The length of the jump is shown on a display.
- I** SH 20007 CENTRE OF GRAVITY TESTING DEVICE

- J1** JA 00462 JAVELIN TESTING DEVICE
 Made of aluminium. All dimensions can be checked. Complete with electronic sliding caliper and bag. Combined with an electronic scale you have a complete system of measurement.
- J2** DI 61461 DISCUS GAUGE 1KG/1,5KG
 Made of steel. Permanent check points for maximum and minimum diameter, rim radius, thickness and centre plate diameter.
- J3** DI 61462 DISCUS GAUGE 1,75KG/2KG
 As DI 61461.
- J4** DI 61463 SLIDING CALIPER
 Heavy precise sliding caliper for measuring all throwing appliances. With extra large opening in order to take diameters also of the big shots and hammers.
- LAP COUNTERS**
- K** RU 30291 ELECTRONIC LAP COUNTER
 Digits ca. 23cm high. Moveable. With control panel.
- L** RU 30290 LAP COUNTER
 Made of steel. With wheels, bell and 2 cassette numbers.
- M** RU 30476 **TIME ELAPSED CLOCK**
 Shows the athlete the time left for an attempt, for example. Shows 0-6min. Equipped with a sturdy steel base.



A RUBBER MEDICINE BALLS
Rifled surface with needle valve. Durable quality.

JA 60080 800 G
JA 60100 1,0 KG
JA 60150 1,5 KG
JA 60200 2,0 KG
JA 60300 3,0 KG
JA 60400 4,0 KG
JA 60500 5,0 KG

B LEATHER MEDICINE BALLS
Hand-sewn with very firm core.

JA 61060 600 G
JA 61080 800 G
JA 61100 1,0 KG
JA 61200 2,0 KG
JA 61300 3,0 KG
JA 61400 4,0 KG
JA 61500 5,0 KG

C SLING BALLS
Made of rubber, with adjustable leather loop.

RE 85610 SLING BALL 0,8 KG
RE 85611 SLING BALL 1,0 KG
RE 85612 SLING BALL 1,5 KG

D PRACTICE THROWING

JA 50400 NOCKEN BALL 400G
JA 50600 NOCKEN BALL 600G
JA 50800 NOCKEN BALL 800G

E THROWING BALL LEATHER (ROUNDERS), 80G
JA 62601 THROWING BALL LEATHER (ROUNDERS), 200G

F WV-THROWING BALL 80G
JA 62666 WV-THROWING BALL 200G
JA 62660 SPONGE BALL (MULTIPLE COLOURS)

G THROWING SHOT CAST IRON, 1000G
JA 62652 THROWING SHOT CAST IRON, 800G
JA 62651 THROWING SHOT CAST IRON, 600G
JA 62650 THROWING SHOT CAST IRON, 400G

H THROWING SHOT RUBBER (filled), 1000G
JA 62610 THROWING SHOT RUBBER (filled), 800G
JA 62611 THROWING SHOT RUBBER (filled), 600G
JA 62612 THROWING SHOT RUBBER (filled), 400G

I RUBBER TAPES
Perfect for training agility, coordination, strength and stamina. With exercise instructions. Length can be cut individually. (tapes of 7,5cm width come with clip).

GY 81670 120x7,5cm LIGHT
GY 81671 120x7,5cm MEDIUM
GY 81672 120x7,5cm STRONG
GY 81673 120x7,5cm EXTRA
GY 81675 120x15cm LIGHT
GY 81676 120x15cm MEDIUM
GY 81677 120x15cm STRONG
GY 81678 120x15cm EXTRA

J ANKLE/WRIST WEIGHTS

FI 90151 0,50 KG
FI 90153 1,00 KG
FI 90154 2,00 KG
FI 90155 3,00 KG

K SKIPPING ROPE

GY 81127 SKIPPING ROPE LEATHER 275cm, with weighted wooden handle and ball bearings for smooth spin.
GY 81129 SKIPPING ROPE WITH WOODEN HANDLES Reinforced centre, with swivel and wooden handles. Length 280cm, adjustable.
GY 81128 SKIPPING ROPE HEMP Made of strong braided hemp, reinforced centre. Length 280cm.

L AGILITY HURDLES

FB 10310 AGILITY HURDLE, 30cm
FB 10311 AGILITY HURDLE, 15cm

M WEIGHT VEST "PROFI"
Especially designed to prevent jolting even during punishing jump exercises. Comes with exchangeable weights from 1 to 10kgs. Sizes: M/L/XL.

N KID'S TRACK & FIELD SET
KIDS' TRACK & FIELD SET
For playfully contacting track and field athletics while running, jumping and throwing.
This package encourages coordination skills and physical exercising in an interesting way. Content and amount of the sets are composed by trainers and teachers.

FI 90200 KID'S TRACK & FIELD SET 6-9 YEARS

2 4 x Foam hurdles (FI90205)
4 10 x Marker cones high (FI 90215)
5 2 x Soft javelins 90cm (FI90220)
6 2 x Nerf Vortex (FI 90225)
8 2 x Soft discus 350g (FI 90235)
9 2 x Rubber shots 1000g (FI 90240)
10 4 x Skipping ropes (FI 90245)
13 1 x Stopwatch (FI 90260)
2 x Transport bags

FI 90201 KID'S TRACK & FIELD SET 9-12 YEARS

1 1 x Mat 3-pieces (FI 90211)
2 6 x Foam hurdles (FI 90205)
3 1 x Jump mat (FI 90210)
4 20 x Marker cones high (FI 90215)
5 2 x Soft javelins 90cm (FI90220)
6 2 x Nerf Vortex (FI 90225)
7 2 x Soft hammers 400g (FI 90230)
8 2 x Soft discus 350g (FI 90235)
9 2 x Rubber shots 1000g (FI 90240)
10 4 x Skipping ropes (FI 90245)
11 40x Marker cones (FI 90250)
12 1 x Speed ladder (FI 90255)
13 1 x Stopwatch (FI 90260)
2 x Transport bags

all items out of the "Kid's Track & Field Sets" can be ordered also piece by piece.

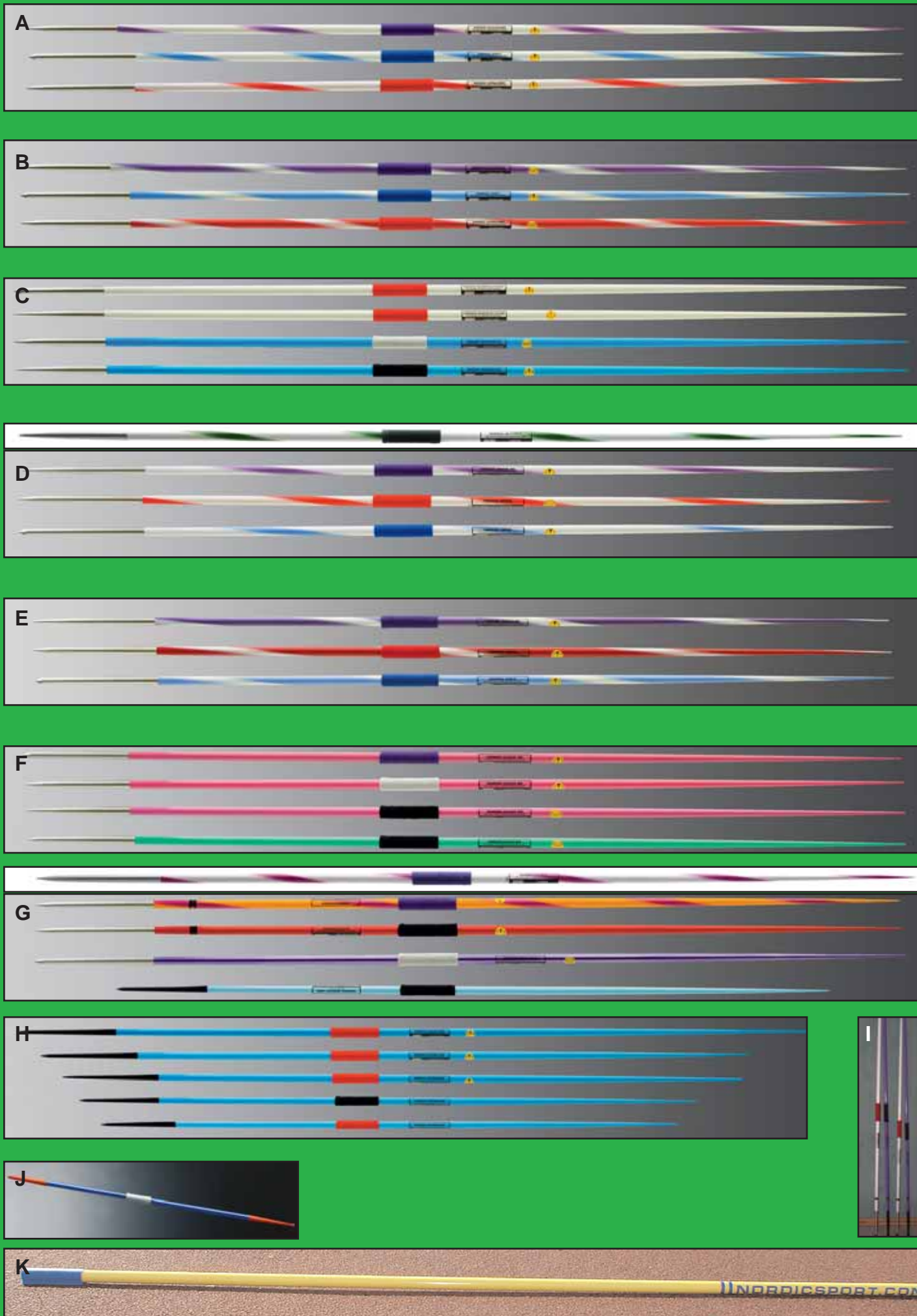

JAVELINS

- A** JA 16800C NORDIC CHAMPION CARBON 800g
JA 16808C NORDIC ORBIT CARBON 800g
JA 16803C NORDIC AIRGLIDER CARBON 800g
- B** JA 16800 NORDIC CHAMPION 800g
JA 16808 NORDIC ORBIT 800g
JA 16803 NORDIC AIRGLIDER 800g
- C** JA 16801 NORDIC SUPER ELITE 90, 800g
JA 16802 NORDIC SUPER ELITE 80, 800g
JA 13800 NORDIC MASTER 70, 800g
JA 12800 NORDIC MASTER 60, 800g
- D** JA 17606C NORDIC OLYMPIA CARBON, 600g
JA 17603C NORDIC DIANA CARBON, 600g
JA 17605C NORDIC INDRA CARBON, 600g
JA 17604C NORDIC XENA CARBON, 600g
- E** JA 17603 NORDIC DIANA 80, 600g
JA 17605 NORDIC INDRA, 600g
JA 17604 NORDIC XENA, 600g
- F** JA 17600 NORDIC DIANA 70, 600g
JA 17601 NORDIC DIANA 60, 600g
JA 17602 NORDIC DIANA 50, 600g
JA 15600 NORDIC STAR 50, 600g
- G** JA 14705C NORDIC EAGLE CARBON, 700g
JA 14705 NORDIC EAGLE, 700g
JA 14703 NORDIC RAPID, 700g
JA 14706 NORDIC PEGASUS, 700g
JA 16400 NORDIC ROCKET 400g
- H** JA 21000 NORDIC VIKING 1000g
JA 20900 NORDIC VIKING 900g
JA 22800 NORDIC VIKING PRO 800g
JA 24700 NORDIC VIKING PRO 700g
JA 24600 NORDIC VIKING PRO 600g
JA 25500 NORDIC VIKING 500g
JA 25400 NORDIC VIKING 400g
- I** JA 52800 NORDIC INDOOR VIKING 800g
JA 52700 NORDIC INDOOR VIKING 700g
JA 52600 NORDIC INDOOR VIKING 600g
JA 52500 NORDIC INDOOR VIKING 500g
JA 52400 NORDIC INDOOR VIKING 400g
- J** JA 00030 NORDIC FLY-HI

CROSSBARS

- K** PV 27450 POLE VAULT CROSSBAR NORDIC FIBERGLASS
- HJ 27400 HIGH JUMP CROSSBAR NORDIC FIBERGLASS

VAULTING POLES

NORDIC EVO CARBON

- PV40 ...C 5,20m 77-79-81-84-86-88-90-93-95-98-100kg
- PV38 ...C 5,00m 72-74-77-79-81-84-86-88-90-93-95-98-100kg
- PV37 ...C 4,75m 63-66-68-70-72-74-77-79-81-84-86kg
- PV36 ...C 4,50m 59-61-63-66-68-70-72-74-77-79-81-84kg
- PV34 ...C 4,25m 50-52-54-57-59-61-63-66-68-70-72-74-77-79kg
- PV33 ...C 4,00m 59-63-68-72kg

NORDIC 600 PLUS

- PV40 ... 5,20m 77-79-81-84-86-88-90-93-95-98-100kg
- PV38 ... 5,00m 72-74-77-79-81-84-86-88-90-93-95-98-100kg

NORDIC POLE

- PV37 ... 4,75m 63-66-68-70-72-74-77-79-81-84-86kg
- PV36 ... 4,50m 59-61-63-66-68-70-72-74-77-79-81-84kg
- PV34 ... 4,25m 50-52-54-57-59-61-63-66-68-70-72-74-77-79kg
- PV33 ... 4,00m 36-41-45-50-54-59-63-68-72kg
- PV32 ... 3,75m 36-41-45-50-54-59-63-68-72kg
- PV35 ... 3,55m 32-36-41-45-50-54-59-63-66kg
- PV31 ... 3,35m 27-32-36-41-45-50-54-59kg
- PV 00003 3,00m Fly-Hi flexible
- PV 00001 2,00m Fly-Hi stiff

Plug NORDIC

- PV 400.. 28mm, 30mm, 33mm, 37mm or 40mm



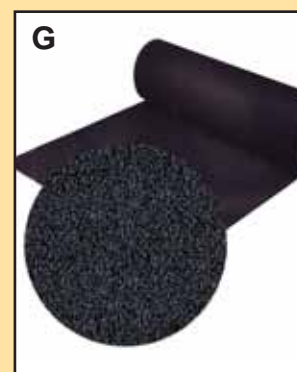
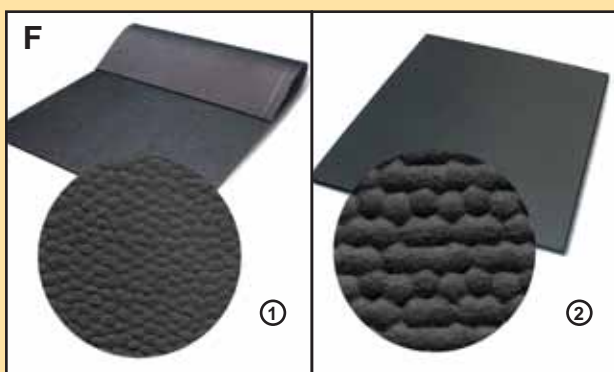
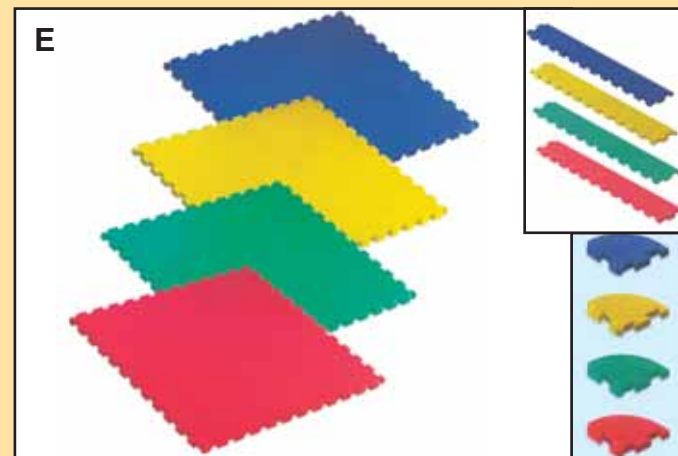
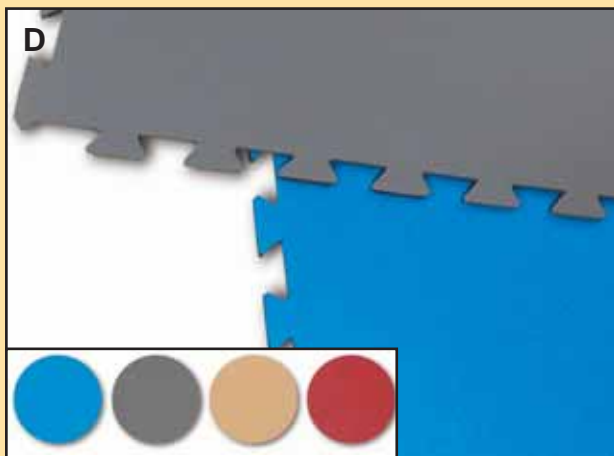
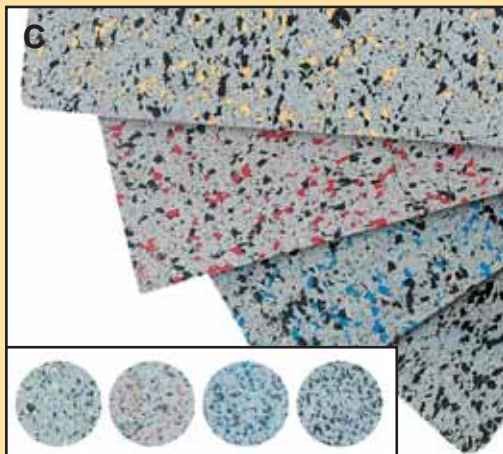
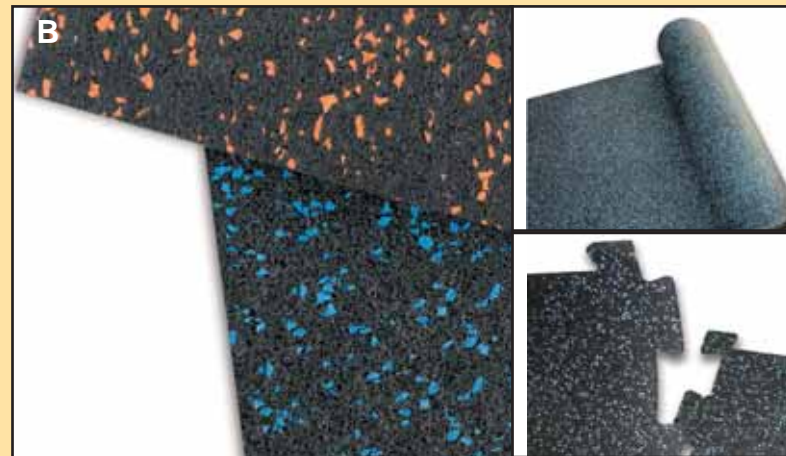
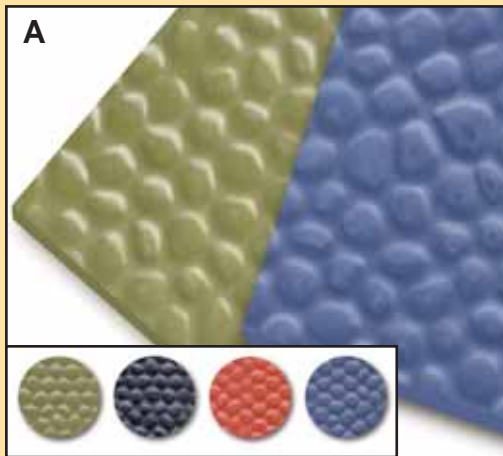

A FI 90902

FLOOR COVER SSB

APPLICATION: as floor cover for gyms, fitness&weightlifting rooms and as weight lifting floor pad. **ADVANTAGES:** very durable and robust. **SIZE:** 100x75x3cm, rubber mat with special surface cover. **COLOURS:** green, black, red, or blue.

B FI 90905

COLOR LINE "BLACK"

APPLICATION: as floor cover for indoor and outdoor facilities, like such as fitness rooms, golf clubs, health clubs, public pools, ice rings, soccer stadiums and working areas. **ADVANTAGES:** resistant to mechanical impact and point loads, extremely wear resistant, anti-slip, highly abrasion resistant, non-light reflecting, easy on the joints, impact sound absorbing. Spike resistant from 8mm. **MATERIAL:** rubber and granules PUR-binded. **COLOURS:** black/red, black/blue, black/grey, black/green. **INSTALLATION:** mats are simply rolled out or glued on a firm base. Can be sealed also.

STANDARD-DIMENSIONS:

1. Width 1,50m - Length 20m - Thickness 6mm
2. Width 1,50m - Length 15m - Thickness 8mm
3. Width 1,50m - Length 12m - Thickness 10mm
4. Width 1,50m - Length 10m - Thickness 12mm

DIMENSIONS UP TO CUSTOMERS REQUEST:

Width 1,25m - Length from 10m - Thickness 4,6,8,10 or 12mm.

PUZZLE ZIP TILES:

DIMENSIONS: 150x100cm Thickness 9mm.

C FI 90906

COLOR LINE "WHITE"

APPLICATION: as floor cover for indoor and outdoor facilities, like such as fitness rooms, golf clubs, health clubs, public pools, ice rings, soccer stadiums and working areas. **ADVANTAGES:** resistant to mechanical impact and point loads, extremely wear resistant, anti-slip, highly abrasion resistant, non-light reflecting, easy on the joints, impact sound absorbing. Spike resistant from 8mm. **MATERIAL:** PUR-binded granules. **COLOURS:** grey/black/beige, grey/black/red, grey/black/blue, grey/black. **INSTALLATION:** mats are simply rolled out or glued on a firm base. Can be sealed also.

DIMENSIONS UP TO CUSTOMERS REQUEST:

Width 1,25m - Length from 10m - Thickness 4,6,8,10 or 12mm.

D FI 90907

AEROFIT

APPLICATION: as floor cover for Aerobic + Step with thickness 10mm, and as floor cover for fitness and dumbbell areas with 12mm thickness. **ADVANTAGES:** point-elastic and anti-slip (however not braking!), extremely wear resistant. Water- and dirt rejecting, anti-bacterial. Impact sound absorbing. Shock absorbing. **COLOURS:** blue, grey, beige, red. **INSTALLATION:** tiles are simply laid out.

PUZZLE ZIP TILES:

1. Dimensions: 100x100cm Thickness 10mm.
2. Dimensions: 100x100cm Thickness 12mm.

INSTALLATION ACCESSORIES:

Wall piece (grey): 150cm.
Extension piece(grey): 150cm.

E FI 90908

AEROGYM

APPLICATION: as floor cover for Aerobic with thickness 14mm, and as floor cover for combatant sport and gymnastics with 20mm thickness. Perfect also for childrens garden, public and private use. **MATERIAL:** closed cell EVA-foam. **COLOURS:** red, green, yellow, blue. **INSTALLATION:** tiles are simply laid out.

PUZZLE ZIP TILES:

1. Dimensions: 100x100cm Thickness 14mm.
2. Dimensions: 100x100cm Thickness 20mm.

INSTALLATION ACCESSORIES:

Wall piece 100x15cm Thickness 14mm or 20mm
Corner piece 15x15cm Thickness 14mm or 20mm

FI 90909

PROTECTION TILES "UNIVERSAL"

APPLICATION: as protection cover for various doors, aisles, locker rooms etc. **MATERIAL:** rubber. **COLOUR:** black. **ADVANTAGES:** impact absorbing, elastic, easy to clean and easy to cut. **INSTALLATION:** tiles are simply laid out.

STANDARD-DIMENSIONS:

1. 100x200cm Thickness 10mm
2. 100x200cm Thickness 18mm

F1

F2

G FI 90910

PROTECTION MAT "RUBBER"

APPLICATION: as protection cover. **MATERIAL:** PUR-binded granules. **INSTALLATION:** tiles are simply laid/rolled out or glued on a firm base.

1. Width 1,00m - Length 20m - Thickness 5mm
2. Width 1,00m - Length 15m - Thickness 8mm
3. Width 1,00m - Length 12m - Thickness 10mm
4. Width 1,00m - Length 10m - Thickness 12mm
5. Width 1,00m - Length 7,5m - Thickness 16mm

DIMENSIONS UP TO CUSTOMERS REQUEST:

Width 1,25m - Length from 10m - Thickness 4,6,8,10 or 12mm. **COLOURS:** black, grey, green, blue, red.

H RU 00010

RUNWAY MAT

APPLICATION: as runway for long jump, high jump, pole vault etc. **MATERIAL:** PUR-binded granules. **ADVANTAGES:** elastic, spike-proof, waterpermeable, weatherproof, durable. **INSTALLATION:** mats are simply rolled out.

DIMENSIONS UP TO CUSTOMERS REQUEST:

Width 1,25m - Length from 10m - Thickness 6,8,10 or 12mm.

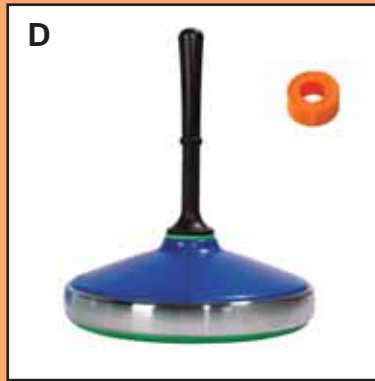

A IH 70500 ICE HOCKEY GOAL "CANADA" IIHF+DEL Icehockey Non-Plus-Ultra. Made of heavy duty steel tubes. With rubber strip. (183x122cm official size inside)
 IH 70534 GOAL NET "CANADA" made of 4mm braided polyester.
 IH 72735 GOAL PADDING for one goal.

IH 72743 LINE MARKERSET for 2 complete rings.
 IH 72744 GOAL AREA MARKERSET for 2 complete rings.

B IH 70505 (HOCKEY)-GOAL "FUN" multi-purpose goal with official hockey size. Stable powder coated steel tubing (5cm) with welded loops. Comes dismantled. Easy and quick to screw together. With net.

GETRA CHILDREN INDOOR AND OUTDOOR CURLING STONE (DGM registered)

A curling stone specially designed for children (diameter = 195 mm). Due to the soft ring of rubber you can play indoor or outdoor on almost any plane underground. With the steel ring "the play curling stone" quickly turns into a semi-professional ice bossel stick. Quality made in Germany.

GAME VARIATIONS:

CLASSIC BOWLING: You can take, for example, plastic bottles for a target.

TARGET BOWLING: Draw a target circle in chalk on the ground and try to place the curling stone/bossel stick nearest to the center of the circle.

TEAMGAME: Two teams of at least two players try to place the curling stone/bossel stick nearest to the puck. After a shot the team which is farthest from the puck is next to curl. It is allowed to shove aside other bossel sticks or the puck. It is only the leading team which gets points. Each curling stone of the team gets a point until a stone of another team is nearest to the puck. There are a number of innings to play until the fixed maximum score is reached.

C RE 85040 CHILDREN CURLING STONE WITH RUBBER RING (weight ca 0.6 kg) colors: orange, yellow, pink, blue or green

D RE 85041 CHILDREN CURLING STONE WITH STEEL RING (weight ca 1.5 kg) colors: orange, yellow, pink, blue or green

RE 85042 CHILDREN CURLING STONE WITH RUBBER AND STEEL RING

Alternative use

RE 85045 PUCK (target)

E DUMBBELLS made of cast iron with vinyl cover. Weights: 0,5 - 1 - 1,5 - 2 - 3 - 4 - 5kg

NEOPRENE SUPPORTS

F BA 86382 ELBOW SUPPORT UNIVERSAL. Sizes. S/M/L/XL

G BA 86392 ELBOW SUPPORT REINFORCED. Sizes. S/M/L/XL

H BA 86342 KNEE SUPPORT UNIVERSAL. Sizes. S/M/L/XL

I BA 86352 KNEE SUPPORT REINFORCED. Sizes. S/M/L/XL

J BA 86392 BACK SUPPORT LUMBAGO. Sizes. S/M/L/XL

K RU 54600 HANHART STRATOS 2 7 digits LCD-display, 6.5mm digit height. Range: 9 hrs 59 min 59.99 sec. Size: 66x70x21mm, weight: 62g
 FUNCTIONS: Start, Stop, Reset, Addition, Split, Dual Timing.

L BB 40009 BASKETBALL RING Conforms with international regulations. Drill-holes acc. DIN.

M BN 80000 COOLING SPRAY GETRA 300ML

N RE 85005 CATCHBALL Inflatable plastic ball with 6 large spokes. Each spoke is of different colour, numbered 0 to 4. Comes deflated. Weight: about 300g, diameter: about 30cm

O RE 85670 TURNTURTLE Ideal training aid to practice balance skills in standing, sitting and kneeling positions. Climb aboard this sturdy turtle and by shifting body weight from left to right, the turtle moves forward. Weight limit 150kg! Recommended for ages 3 and up.

P FI 90125 NERF VORTEX MEGA HOWLER Maximum distance (90m) and speed are guaranteed by this safe, rocket-like foam ball. Three howling whistles give off a shrill sound for accurate perception. Assorted colours. Recommended for ages 5 and up.