

100 Series



S Series

100 Series

VP Series

MCS Series

MC Series

M Series

MOD Series

- Operating voltage up to 100 kVDC
- Operating current up to 80 Amps
- Advanced contact technology
- Oil tight receptacles available
- High performance insulation materials PTFE

General characteristics and technical data Series 100

Housing	
Locking system	threaded coupling
Mounting type (panel mount connector)	round flange
Housing material	brass (CuZn)
Surface plating	nickel (Ni)
Protection class (mated connector)	IP67
Operating temperature	-30°C to +80°C

Contacts 2.5 mm (connector types SB1x0)	
Termination method	solder (male contact), solder / screw (female contact)
Rated current	30 A
Max. operating current	40 A
Pulse current	3000 A
Contact resistance	300 $\mu\Omega$
Contact diameter	2.5 mm [.173"]
Contact diameter	AWG 14 / 2.5 mm ²
Contact material	brass (CuZn)
Contact plating	silver (Ag)
Insertion / Withdrawal force	5,5 N / 4,0 N
Mating cycles	100000
Rated temperature	+120°C

Contacts 5 mm (connector types SB1x5)	
Termination method	solder (male contact), solder / screw (female contact)
Rated current	80 A
Max. operating current	110 A
Pulse current	10000 A
Contact resistance	150 $\mu\Omega$
Contact diameter	5 mm [.197"]
Max. wire size	AWG 8 / 10 mm ²
Contact material	brass (CuZn)
Contact plating	silver (Ag)
Insertion / Withdrawal force	15 N / 10 N
Mating cycles	100000
Rated temperature	+120°C

Insulation inserts	
Number of contacts	1
Insulation material	PTFE
CTI value	600
Flammability class PTFE	UL94 V-0
Operating temperature PTFE	-50°C to +200°C
Insulating material group PTFE / POM	I (DIN IEC 60664)

Suitable cable dimensions

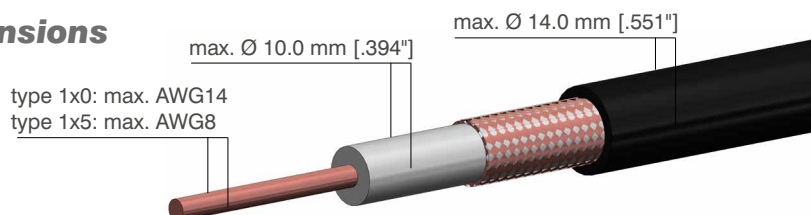



GB155 receptacle, panel mount



KS155 plug, cable mount

Electrical values	
Operating voltage (DC)	50 kV
Test voltage (DC)	75 kV
Rated current	80 A
Maximum operating current	110 A
Pulse current	10000 A
Characteristics	
Contact size	5 mm [.197"]
Insulation material	PTFE
Mounting type receptacle	round flange
Contact plating	silver (Ag)

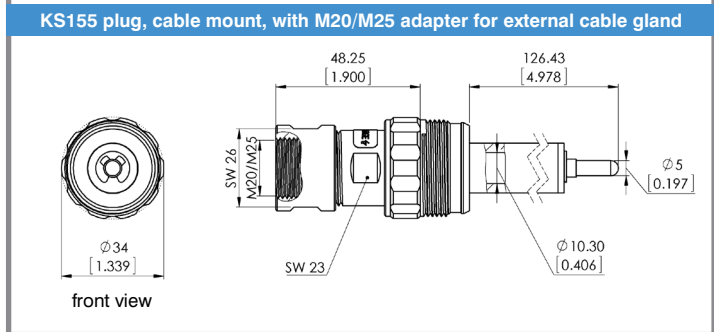
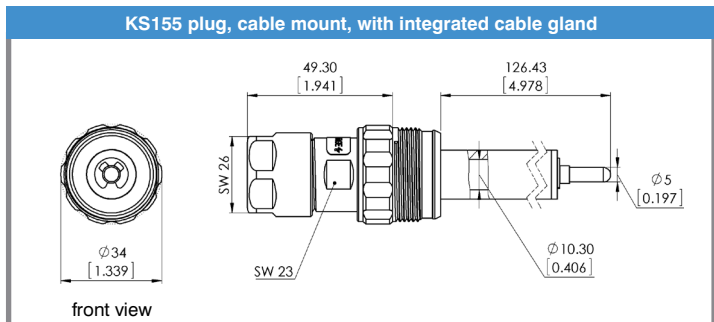
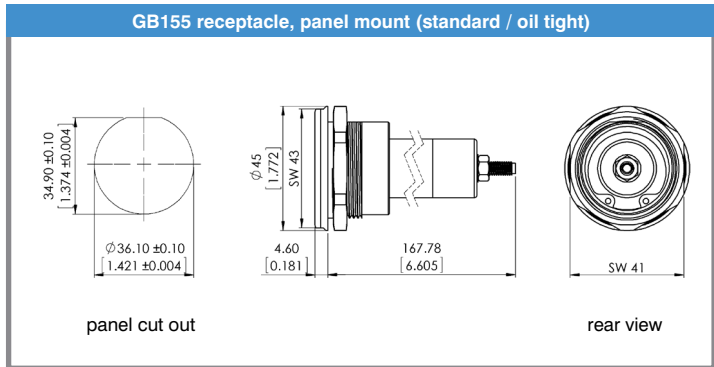

drawing - dimensions in mm [inch]

P/N	Description	Plug, cable mount	Receptacle, panel mount	clamping range for cables Ø 6.5 - 8 mm [.256" - .315"]	clamping range for cables Ø 8 - 9.5 mm [.315" - .374"]	clamping range for cables Ø 9.5 - 11 mm [.374" - .433"]	clamping range for cables Ø 11 - 12.5 mm [.433" - .492"]	clamping range for cables Ø 12.5 - 14 mm [.492" - .551"]	oil tight version
7200551	KS155/6,5-8 PTFE	•		•					
7200550	KS155/8-9,5 PTFE	•			•				
7200552	KS155/9,5-11 PTFE	•				•			
7200554	KS155/11-12,5 PTFE	•					•		
7200553	KS155/12,5-14 PTFE	•						•	
7200555	KS155/M20 PTFE	•		with adapter M20x1.5 for external cable gland					
7200556	KS155/M25 PTFE	•		with adapter M25x1.5 for external cable gland					
7200557	GB155 PTFE		•						
7200558	GB155/O PTFE		•						•

→ Accessories - page 42
 Mounting instructions - page 44-47
 Cables - page 48-49

*KV = screwed cable gland

Assembly Instructions Series 100 (plug, cable mount)

1.



Part as delivered

5.

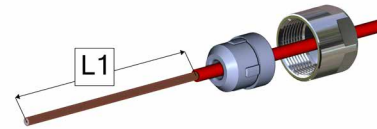

Remove cable jacket
⚠ Do not damage shield braid

2.



Components
Cap (1), sealing insert (2), housing (3),
insulator (4)

Types	min. L1 mm [inch]
S110 / S115	52 [2.037"]
S120 / S125 / S125 Pro	72 [2.824"]
S130 / S135	92 [3.611"]
S150 / S155	142 [5.580"]
S160 / S165	224 [8.828"]
S1100 / S1105	377 [14.852"]

3.

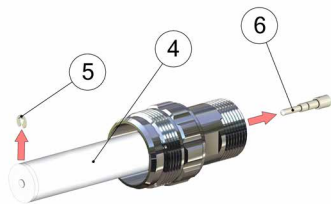

Remove snap ring (5) and take out male contact (6)

6.

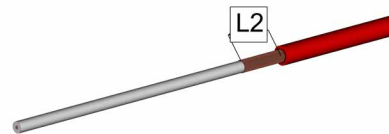

Cut shield braid roughly about 30 mm [1.181"] (=L2)
⚠ Carefully remove shield parts. Loose shield parts can cause electrical break down

4.

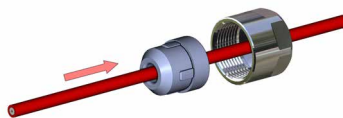

Place cap (1) and sealing insert (2) on cable
⚠ Respect correct order of parts (see picture)

7.

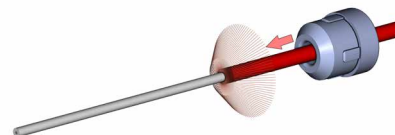

Completely widen shield braid. Push seal insert (2) under shield braid

8.

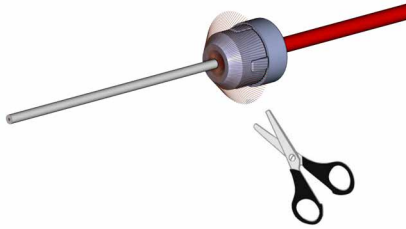

Cut shield to length.
⚠ For length see step 9.

12.



Completely insert cable in insulation part (4) until seal insert (2) plugs in housing (3)

9.

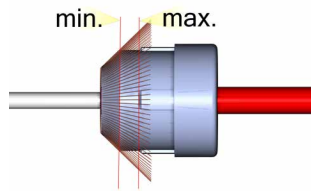

Make sure shield length is between min. and max. mark.

13.

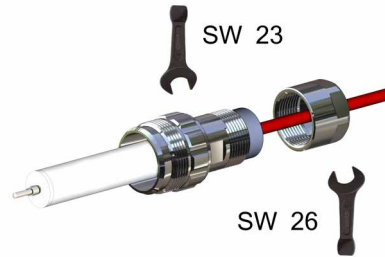

Screw cap (1) onto housing (3)
⚠ Wrench size housing SW23, Wrench size cap SW26, tightening torque 10 Nm

10.



Remove dielectric insulation

14.



Secure contact (6) with snap ring (5)

Types	min. L3 mm [inch]
KS 110/120/130/150/160/1100	5 [.197"]
KS 115/125/125 Pro/135/155/165/1105	8 [.315"]

⚠ Do not damage conductor

11.

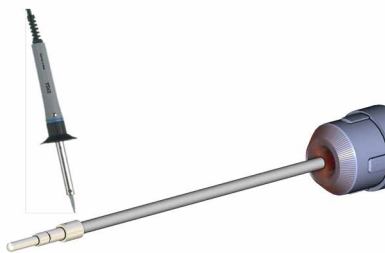

Solder contact (6) on conductor
⚠ Tin-solder must not remain on contact surface

15.



Assembly finished

Assembly Instructions Series 100 (receptacle, panel mount)

1.



Part as supplied

2.

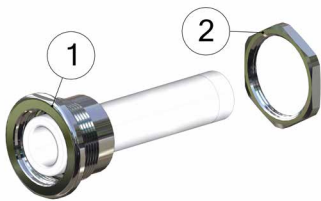

Remove counter nut (1) from housing (2)

3.

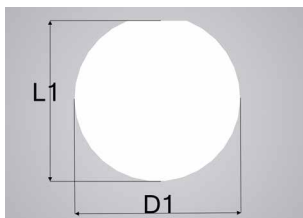

Panel cut out

Dimension	Value mm [inch]
D1	36.10 [1.421"]
L1	34.90 [1.374"]

4.

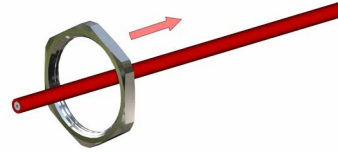

Place counter nut (1) on cable

5.

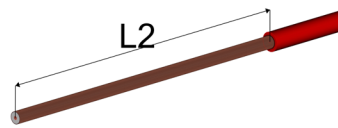

⚠ ONLY when using shielded cable:
Remove cable jacket

Type	min. L2 mm [inch]
B 110 / 115	40 [1.575"]
B 120 / 125	80 [3.150"]
B 130 / 135	120 [4.724"]
B 150 / 155	200 [7.874"]
B 160 / 165	240 [9.449"]
B 1100 / 1105	400 [15.748"]

⚠ Do not damage shield braid

6.

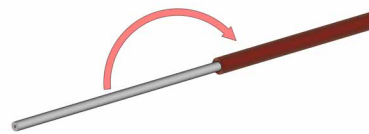

Fold back shield braid over jacket

7.

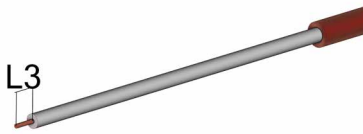

Remove dielectric insulation

Type	min. L3 mm [inch]
B 110 / 120 / 130 / 150 / 160 / 1100	5 [.197"]
B 115 / 125 / 135 / 155 / 165 / 1105	8 [.315"]

⚠ Do not damage conductor.

10.



Assembly finished

8.



Solder conductor on female contact or use a cable lug to connect conductor with contact
⚠ Tin-solder must not remain on contact surface

9.

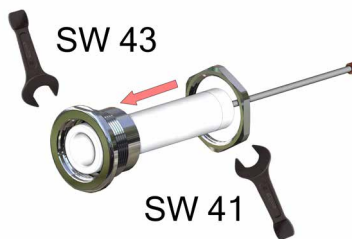

Screw on counter nut and tighten



Note – important!

1. Please carefully read assembly instructions before cable assembly.
2. Cable assembly must only be done by trained and qualified personnel.

IMPORTANT – PLEASE NOTE:

Stated stripping lengths are referring ONLY to jackets of shielded cables!

