

United States

Transfusion and Cell Technologies Product Catalog

Disclaimer: This document is intended for an international audience. Please contact your local sales representative for availability in Canada. For questions or product concerns please contact Fresenius Kabi Canada (165 Galaxy Blvd, Suite 100, Toronto, ON, M9W 0C8) at 1-877-779-7760 or visit the website at www.fresenius-kabi.ca.



2019

Directory

Fresenius Kabi USA, LLC
Three Corporate Drive
Lake Zurich, Illinois 60047

Main

800-333-6925

- Customer Service
- Field Service and Support
- Quality Assurance
- Product Information
- Accounts Receivable
- Accounts Payable

Plasma Support

800-448-5299

Refer to the product operator's manual, instructions for use, and other associated labeling and information for a complete list of warnings, cautions, contraindications, and other pertinent information associated with the use of the products in this catalog.

Table of Contents

Alyx Component Collection System	Pages 1 - 3
Apheresis Kits	Pages 1 - 2
Alyx Accessories	Pages 2 - 3
Data Management Accessories	Page 3
Amicus Separator	Pages 4 - 8
Apheresis Kits	Page 4
InterSol Platelet Additive Solution (PAS 3) and Apheresis Kits	Pages 5 - 6
Amicus Accessories and Ancillaries	Pages 6 - 8
Data Management Accessories	Page 8
Aurora Plasmapheresis System and Aurora Xi Plasmapheresis System	Pages 9 - 11
Plasmapheresis Disposable Sets	Page 9
Plasmapheresis Disposable Accessories	Page 10
Sealers and Accessories	Page 11
Data Management Accessories	Page 11
Blood-Pack Units	Pages 12 - 17
Red Cell Filter, BPUs with BioFlex RC Filter	Page 12
Red Cell Filter, BPUs with Flex-Excel Filter	Page 13
Whole Blood RS-2000 Filter, Fenwal Express BPUs	Page 14
Blood-Pack Units without Filters	Pages 15 - 17
Leukoreduction Filters for Lab Sets	Page 18
Amicus for Therapeutic Apheresis	Pages 19 - 23
Therapeutic Apheresis and Cell Collection Kits	Page 19
Amicus Accessories and Ancillaries	Pages 20 - 22
Data Management Accessories	Page 22
Ancillary Products	Page 23
Lovo Cell Processing System	Pages 24 - 26
Lovo Kits	Pages 24 - 25
Data Management Accessories	Page 25
Lovo Ancillaries	Page 26
Specialty Products	Pages 27 - 43
Bone Marrow Collection Kit	Page 27
CompoLab	Page 28
CompoGuard	Pages 28 - 30
CompoCool	Page 31
CompoMat G5	Page 32
CompoDock DM	Page 33
Sealers	Pages 34 - 36
Transfusion Sets	Page 37
Transfer-Pack Containers	Page 38
Bulk Solutions	Page 39
Storage/Freezing	Pages 40 - 41
Extractor	Page 42
Equipment	Pages 42 - 43
Sales Terms and Conditions	Pages 45 - 46
Index	Pages 47 - 48

Alyx Component Collection System

The Alyx System is a mobile, multi-component blood collection device designed to collect and separate whole blood from donors.

The Alyx System can collect:

- Two units of leukoreduced red cells
- One unit of leukoreduced red cells with up to three units of plasma
- Up to four units of plasma

Features

- Single Unit Recovery feature (2RBC protocol only) in the event a procedure is terminated early
- Wireless/wired data export – drive data informed decision making with DXT



6R5725 Alyx Component Collection System

Apheresis Kits



	Code	Item	Quantity
	X4R5700	Alyx RBC/Plasma Kit – closed system <ul style="list-style-type: none"> • (1) Separation chamber • (1) Umbilicus • (1) Cassette with return line filter with pore size of 170 microns • (1) 0.9% sodium chloride solution container • (1) ACD-A solution container • (1) Adsol red cell preservation solution container • (2) Blood component containers • (1) Red cell storage container • (1) Jumbo plasma storage container • (2) Satellite plasma storage containers • (1) 18 gauge needle • (1) Pre-donation sampling pouch • (1) Asahi Kasei Medical Co. Sepacell leukoreduction filter 	6 units/case
	X4R5720	Alyx 2RBC-LR Kit – closed system <ul style="list-style-type: none"> • (1) Separation chamber • (1) Umbilicus • (1) Cassette with return line filter with pore size of 170 microns • (1) 0.9% sodium chloride solution container • (1) ACD-A solution container • (1) Adsol red cell preservation solution container • (3) Blood component containers • (2) Red cell storage containers • (1) 18 gauge needle • (1) Pre-donation sampling pouch • (1) Asahi Kasei Medical Co. Sepacell leukoreduction filter 	6 units/case

Alyx Component Collection System

Apheresis Kits (Continued)

	Code	Item	Quantity
	4R5730	Alyx Plasma Kit – closed system <ul style="list-style-type: none"> • (1) Separation chamber • (1) Umbilicus • (1) Cassette with return line filter with pore size of 170 microns • (1) 0.9% sodium chloride solution container • (1) ACD-A solution container • (2) Blood component containers • (1) Jumbo plasma storage container • (3) Satellite plasma storage containers • (1) 18 gauge needle • (1) Pre-donation sampling pouch 	6 units/case

Alyx Accessories

	Code	Item	Quantity
	R4R5728	Alyx Cart <p>The Alyx Cart is designed to provide a means by which to easily transport the Alyx Component Collection System in the mobile environment.</p>	1 each
	6112705089	Alyx Quick Connect System <p>The Alyx Quick Connect System allows users to unlock and lift the unit from its base, without the need for tools. With the Quick Connect System installed, Alyx can easily be moved between locations.</p>	1 each
	6112705094	Stationary Template and Receivers <p>Use as a drilling guide when mounting Alyx on a work surface. Includes (1) template and (4) receivers.</p> <p>Re-usable template. Additional receivers available separately.</p>	

Alyx Component Collection System

Alyx Accessories (Continued)

Code	Item	Quantity
6112705091	Quick Connect Receivers Only (set of 4): Receivers can be mounted to the Alyx mobile cart platform or a counter in a bus, which allows the device to be used in multiple locations.	1 each
1571270280	Leukofilter Fixture Assembly	1 each
1571270382	RBC/Plasma Leukofilter Fixture Assembly	1 each
0212551465	Weight Set and Case	1 each
4078502050	Air Filter 0.3mm Thickness	1 each
5930007171	20' Power Cord	1 each
6112684974S	12' Coiled Tubing with Connectors for use with Large Adult Cuff	1 each
0112561297	Large Adult Cuff	1 each
556524003T	Regular Adult Cuff	1 each
6212702647	Spare Black Storage Bag to be used with Alyx Cart R4R5728	1 each
9027011	CompoSeal Mobilea II Set: Battery operated, radio frequency (RF) sealer for medical PVC tubing; includes yellow Handheld Sealer, Powerpack, Charger, RF Cable, Transport Case (gray) and operating instructions (see page 34).	1 unit
9027071	Shoulder Pouch for CompoSeal Mobilea II: Black nylon pouch holds CompoSeal Mobilea II Powerpack and Handheld Sealer; includes shoulder strap and belt loop (black) (see page 34).	1 unit
9029700	Splash Guard for Handsealer: Can be used with CompoSeal Mobilea II, CompoGuard handheld sealer, CompoSeal Slim and CompoSeal Universal optional handheld sealers (see page 34).	6 units

Data Management Accessories

Code	Item	Quantity
R4R5714	Barcode Scanner Programmed for use with the Alyx Component Collection System	1 each
X6S9830USB	DXT Software Data management software designed to capture, store and transmit procedure data compatible with Amicus Separator, Alyx Component Collection System, Aurora Plasmapheresis System and Aurora Xi Plasmapheresis System. DXT provides access to analytical dashboards and reports, auto-programming of instruments and enables paperless documentation. Software is provided on a USB; computer hardware not included.	1 unit

Amicus Separator

The Amicus Separator is an automated blood cell separator indicated for the collection of blood components with options to collect:

- Platelets
- Concurrent Plasma
- Concurrent Red Blood Cells (cRBCs)

Features:



- Wireless/wired data export – drive data informed decision making with DXT

6R4580 Amicus Separator

Amicus for Therapeutics – See pages 19-23



Apheresis Kits

Code	Item	Quantity
4R2355	 <p>Double Needle Kit Integral Saline and ACD-A</p> <ul style="list-style-type: none"> • (1) 1000 mL 0.9% Sodium Chloride Injection, USP (saline) • (1) 1000 mL Anticoagulant Citrate Dextrose Solution, USP, Formula A (ACD-A) • (2) 1000 mL plastic platelet storage containers • (1) 800 mL plastic plasma storage container • (1) 17 gauge needle (inlet line) • (1) 18 gauge needle (return line) 	3 units/case
4R2357	 <p>Single Needle Kit Integral Saline and ACD-A</p> <ul style="list-style-type: none"> • (1) 1000 mL 0.9% Sodium Chloride Injection, USP (saline) • (1) 1000 mL Anticoagulant Citrate Dextrose Solution, USP, Formula A (ACD-A) • (2) 1000 mL plastic platelet storage containers • (1) 800 mL plastic plasma storage container • (1) 600 mL plastic red blood cell storage container • (1) 17 gauge needle • (1) Antimicrobial filter with pore size of 0.2 microns 	3 units/case

Amicus Separator

InterSol Solution (Platelet Additive Solution 3) and Apheresis Kits

X6B7850 InterSol Solution



500 mL InterSol Solution with tubing and luer adaptor. Nutrient medium used to replace ~ 65% of plasma for platelet storage

12 units/case

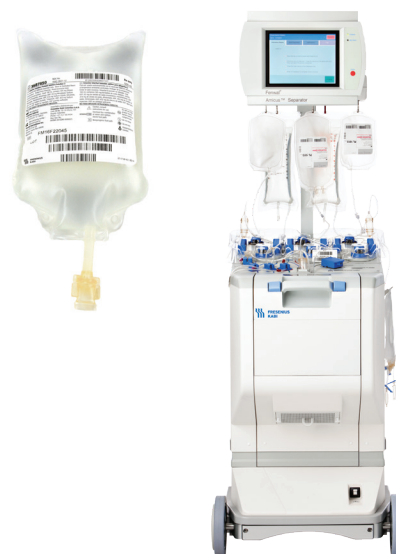
Warning: InterSol is not for direct intravenous infusion and has no pharmacological effect. Please refer to the instructions for use for a full list of warnings and precautions associated with the use of this product.



Apheresis Kits

Code	Item	Quantity
4R2337	 <p>Single Needle Kit with Platelet Additive Solution Connector Integral Saline and ACD-A</p> <ul style="list-style-type: none"> • (1) 1000 mL 0.9% Sodium Chloride Injection, USP (saline) • (1) 1000 mL Anticoagulant Citrate Dextrose Solution, USP, Formula A (ACD-A) • (2) 1000 mL plastic platelet storage containers • (1) 800 mL plastic plasma storage container • (1) 600 mL plastic red blood cell storage container • (1) 17 gauge needle • (1) Return line filter with pore size of 220 microns • (1) Antimicrobial filter with pore size of 0.2 microns 	3 units/case
4R2340	 <p>Double Needle Kit with Platelet Additive Solution Connector Integral Saline and ACD-A</p> <ul style="list-style-type: none"> • (1) 1000 mL 0.9% Sodium Chloride Injection, USP (saline) • (1) 1000 mL Anticoagulant Citrate Dextrose Solution, USP, Formula A (ACD-A) • (2) 1000 mL plastic platelet storage containers • (1) 800 mL plastic plasma storage container • (1) 17 gauge needle (inlet line) • (1) 18 gauge needle (return line) • (1) Return line filter with pore size of 220 microns • (1) Antimicrobial filter with pore size of 0.2 microns 	3 units/case

Amicus Separator

Apheresis Kits (Continued)

Code	Item	Quantity
4R2353	Single Needle Advanced Kit <ul style="list-style-type: none"> • (1) 1000 mL 0.9% Sodium Chloride Injection, USP (saline) • (1) 1000 mL Anticoagulant Citrate Dextrose Solution, USP, Formula A (ACD-A) • (2) 1000 mL plastic platelet storage containers • (2) 450 mL plastic plasma storage containers • (1) 600 mL plastic red blood cell storage container • (1) Platelet sampling system (10 mL chamber) • (1) 17 gauge needle (inlet line) • (1) Return line filter with pore size of 220 microns • (1) Antimicrobial filter with pore size of 0.2 microns 	3 units/case
4R2354	Double Needle Advanced Kit <ul style="list-style-type: none"> • (1) 1000 mL 0.9% Sodium Chloride Injection, USP (saline) • (1) 1000 mL Anticoagulant Citrate Dextrose Solution, USP, Formula A (ACD-A) • (2) 1000 mL plastic platelet storage containers • (2) 450 mL plastic plasma storage containers • (1) 17 gauge needle (inlet line) • (1) 18 gauge needle (return line) • (1) Return line filter with pore size of 220 microns • (1) Antimicrobial filter with pore size of 0.2 microns • (1) Platelet sampling system (10mL) 	3 units/case

Amicus Accessories and Ancillaries

Accessories

Code	Item	Quantity
X6R2350	Plastic Storage Container <ul style="list-style-type: none"> • 1000 mL container with tubing leads • Stores up to a maximum of 4.7×10^{11} platelets 	28 units/case
4R2335H	Fenwal Product Sample Pack <ul style="list-style-type: none"> • For sampling of collected blood and blood components. For laboratory testing only. • Holds up to 5 mL sample container • Use with sterile connection • One sample container 	200 units/case
A100750	SampLok Sampling Kit <ul style="list-style-type: none"> • For use with sterile docked tubing • Platelet and Cellular Sample Transfer Kit for Bacterial Detection Testing • 10 mL single unit chamber 	110 units/case

Amicus Separator

Amicus Accessories and Ancillaries (Continued)

Spools

Code	Item	Quantity
6112685306S	Platelet spool	1 each

Top Panel Overlays

Code	Item	Quantity
A20766001	Overlay – Single Needle	1 each
A20765001	Overlay – Double Needle	1 each

Ancillary Items/Tube Sealing Equipment

Code	Item	Quantity
9027011	CompoSeal Mobilea II Set: Battery operated, radio frequency (RF) sealer for medical PVC tubing; includes yellow Handheld Sealer, Powerpack, Charger, RF Cable, Transport Case (gray) and operating instructions (see page 34).	1 each
9027071	Shoulder Pouch for CompoSeal Mobilea II: Black nylon pouch holds CompoSeal Mobilea II Powerpack and Handheld Sealer; includes shoulder strap and belt loop (black) (see page 34).	1 unit
9029700	Splash Guard for Handsealer: Can be used with CompoSeal Mobilea II, CompoGuard handheld sealer, CompoSeal Slim and CompoSeal Universal optional handheld sealers (see page 34).	6 units

Amicus Separator

Amicus Accessories and Ancillaries (Continued)

Miscellaneous Supplies

Code	Item	Quantity
A10399001	Prompt Grip to promote proper blood flow	1 each
B70000089	Power Cord	1 each
6112685133	Large Wheel Assembly	1 each
0212680034	Protective Cover (for transport)	1 each
0212680035	Protective Foam for Touch Screen (for transport)	1 each
6112684974S	12' coiled tubing with connectors for use with Regular and Large Adult Cuff	1 each
6112684971T	Regular Adult Cuff with Tubing (Requires Part 6112684974S)	1 each
6112684972T	Large Adult Cuff (Requires part 6112684974S)	1 each
072730801	White Thermoformed Cassette Protective Cover for top panel	1 each

Instrument Care

Code	Item	Quantity
A30423002	Air Inlet Filter	1 set of 3
0112681131	Cassette Gaskets	1 each
4994000256	Lint Free Lens Cleaning Cloth	1 each

Data Management Accessories

Code	Item	Quantity
A10309001	Barcode Scanner Programmed for use with the Amicus Separator	1 each
0213017689	Scan Sheet Barcode scan sheet to support use of scanner	1 each
X6S9830USB	DXT Software Data management software designed to capture, store and transmit procedure data compatible with Amicus Separator, Alyx Component Collection System, Aurora Plasmapheresis System and Aurora Xi Plasmapheresis System. DXT provides access to analytical dashboards and reports, auto-programming of instruments and enables paperless documentation. Software is provided on a USB; computer hardware not included.	1 unit

Aurora Plasmapheresis System

The Aurora Plasmapheresis System automates the collection of plasma products for fractionation. Aurora is compatible with DXT Data Management System.

6R4601 Aurora Plasmapheresis System

Plasmapheresis Disposable Set for Aurora

Code	Item	Quantity
4R2256	Plasmacell-C Disposable Set with the Spikesmart System For use with the Aurora Plasmapheresis System or Autopheresis-C System	60 units/case



Aurora Xi Plasmapheresis System

The Aurora Xi Plasmapheresis System automates the collection of plasma products for fractionation. Aurora Xi is compatible with DXT Data Management System.

6R4612 Aurora Xi Plasmapheresis System

Plasmapheresis Disposable Set for Aurora Xi

Code	Item	Quantity
6R2600	Plasmacell Xi Disposable Set with the Spikesmart System For use with the Aurora Xi Plasmapheresis System	24 units/case



Aurora and Aurora Xi Plasmapheresis Systems

Plasmapheresis Disposable Accessories

Disposable Accessories for Aurora and Aurora Xi Plasmapheresis Systems

Code	Item	Quantity
6R2069	Plasmalink Bottle, 1000 mL: Plasmalink pooling bottle, with locking luer adapter and sampling site, 1000 mL.	12 units/case
4R2088P	Plasmalink Transfer-Pack: Plasmalink Transfer-Pack unit with needle adapter, sampling site, no outlet ports, 1000 mL.	100 units/case
4R2258	Triple Transfer-Pack Container with Male Luer Adapter: Transfer-Pack includes 1 needle adapter, (1) 1000 mL and (2) 600 mL containers.	30 units/case
4R2440	Apheresis Needle: Apheresis needle, 16 ga., with MasterGuard protector.	250 units/case
4R2441	Apheresis Needle: Apheresis needle, 17 ga., with MasterGuard protector.	250 units/case
4R5129	Multi-Sampling Connector: Semi-assembled multi-sample access device.	2,000 units/case

Aurora and Aurora Xi Plasmapheresis Systems

Plasmapheresis Accessories

Sealers and Accessories

Code	Item	Quantity
9027011	CompoSeal Mobilea II Set: Battery operated, radio frequency (RF) sealer for medical PVC tubing; includes yellow Handheld Sealer, Powerpack, Charger, RF Cable, Transport Case (gray) and operating instructions (see page 34).	1 unit
9027071	Shoulder Pouch for CompoSeal Mobilea II: Black nylon pouch holds CompoSeal Mobilea II Powerpack and Handheld Sealer; includes shoulder strap and belt loop (black) (see page 34).	1 unit
9029700	Splash Guard for Handsealer: Can be used with CompoSeal Mobilea II, CompoGuard handheld sealer, and CompoSeal Slim and CompoSeal Universal optional handheld sealers (see page 34).	6 units
9029701	CompoSeal Slim: Tabletop RF sealer for PVC tubing (see page 35).	1 unit

Data Management Accessories

Code	Item	Quantity
6112570076	Voyager 1400g Area Image Scanner: Barcode scanner programmed for use with the Aurora and Aurora Xi Plasmapheresis Systems.	1 unit
X6S9830USB	DXT Software: Data management software designed to capture, store and transmit procedure data compatible with Aurora and Aurora Xi Systems. DXT provides access to analytical dashboards and reports, auto-programming of instruments and enables paperless documentation. Software is provided on a USB; computer hardware not included.	1 unit

Blood-Pack Units

Red Cell Filter, BPU with BioFlex RC Filter

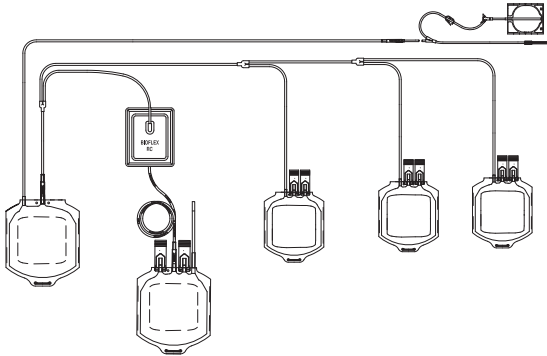

Sample Diversion System (SDS)

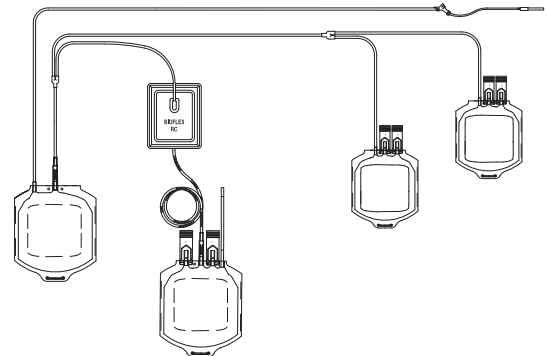

Y-Sampling Site (Y-Site)

	4R1782	4R1783	4R1784	4R1787	4R1790
Configuration	Double	Double	Triple	Triple	Quad
Anticoagulant/ Additive Solution	CPD ² /Adsol ³	CPD ² /Adsol ³	CPD ² /Adsol ³	CPD ² /Adsol ³	CPD ² /Adsol ³
Primary Container Volume	500 mL	500 mL	500 mL	500 mL	500 mL
Primary Container	PL 146	PL 146	PL 146	PL 146	PL 146
Satellite Container 1	PL 2209 ¹	PL 2209 ¹	PL 2209 ¹	PL 2209 ¹	PL 2209 ¹
Satellite Container 2	PL 2209 ¹	PL 2209 ¹	PL 2209 ¹	PL 2209 ¹	PL 2209 ¹
Satellite Container 3	N/A	N/A	PL 2209 ¹	PL 2209 ¹	PL 2209 ¹
Satellite Container 4	N/A	N/A	N/A	N/A	PL 2209 ¹
Sampling System	Y-Site	SDS	Y-Site	SDS	SDS
Unit of Measure	10 units/pouch 2 pouches/case	10 units/pouch 2 pouches/case	10 units/pouch 2 pouches/case	10 units/pouch 2 pouches/case	9 units/pouch 2 pouches/case
Total Units	20 units/case	20 units/case	20 units/case	20 units/case	18 units/case

¹Plastic 2209 containers use butyryl trihexyl citrate (BTHC) plasticizer, an alternative to plastics that contain DEHP.

²CPD=Anticoagulant Citrate Phosphate Dextrose Solution, USP

³Adsol=Adsol Red Cell Preservation Solution

Blood-Pack Units

Red Cell Filter, BPU with Flex-Excel Filter

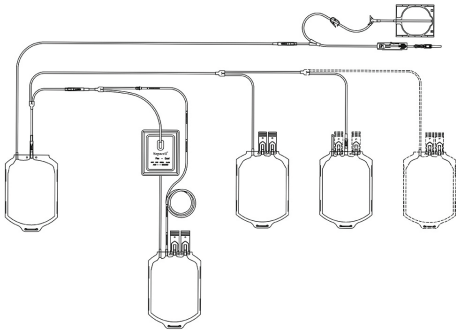

Sample Diversion System (SDS)

	4R1583	4R1587P	4R1590P
Configuration	Double	Triple	Quad
Anticoagulant/ Additive Solution	CPD ² /Adsol ³	CPD ² /Adsol ³	CPD ² /Adsol ³
Primary Container Volume	500 mL	500 mL	500 mL
Primary Container	PL 146	PL 146	PL 146
Satellite Container 1	PL 2209 ¹	PL 2209 ¹	PL 2209 ¹
Satellite Container 2	PL 2209 ¹	PL 2209 ¹	PL 2209 ¹
Satellite Container 3	N/A	PL 2209 ¹	PL 2209 ¹
Satellite Container 4	N/A	N/A	PL 2209 ¹
Sampling System	SDS	SDS	SDS
Unit of Measure	10 units/pouch 2 pouches/case	10 units/pouch 2 pouches/case	9 units/pouch 2 pouches/case
Total Units	20 units/case	20 units/case	18 units/case

¹Plastic 2209 containers use butyryl trihexyl citrate (BTHC) plasticizer, an alternative to plastics that contain DEHP.

²CPD=Anticoagulant Citrate Phosphate Dextrose Solution, USP

³Adsol=Adsol Red Cell Preservation Solution

Blood-Pack Units

Whole Blood RS-2000 Filter, Fenwal Express BPUs

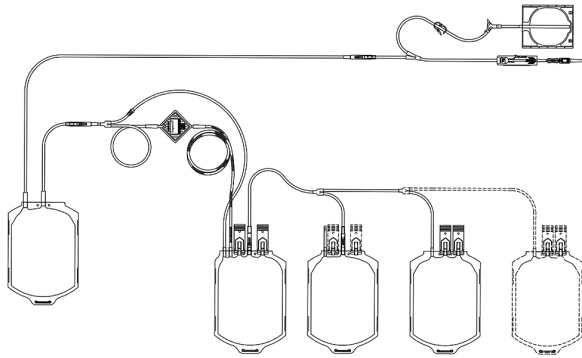

Sample Diversion System (SDS)

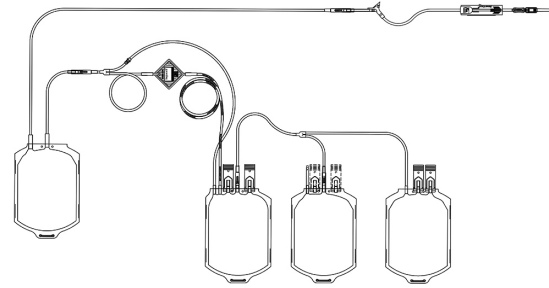

Y-Sampling Site (Y-Site)

	4R3327E	4R3313E	4R3332E
Configuration	Double	Double	Quad
Anticoagulant/ Additive Solution	CPDA-1 ⁴	CPDA-1 ⁴	CPDA-1 ⁴
Primary Container Volume	500 mL	500 mL	500 mL
Primary Container	PL 146	PL 146	PL 146
Satellite Container 1	PL 146	PL 146	PL 146
Satellite Container 2	PL 146	PL 146	PL 146
Satellite Container 3	N/A	N/A	PL 146
Satellite Container 4	N/A	N/A	PL 146
Sampling System	SDS	Y-Site	SDS
Unit of Measure	12 units/pouch 2 pouches/case	12 units/pouch 2 pouches/case	10 units/pouch 2 pouches/case
Total Units	24 units/case	24 units/case	20 units/case

⁴CPDA-1=Anticoagulant Citrate Phosphate Dextrose Adenine Solution, USP

Blood-Pack Units

Blood-Pack Units without Filters

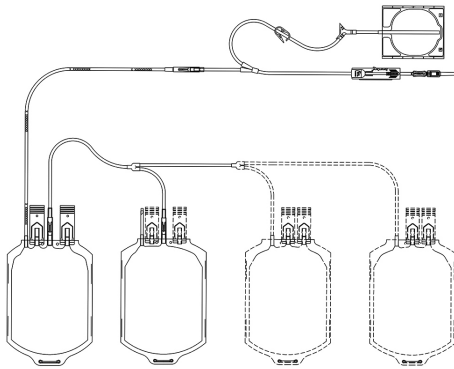

Sample Diversion System (SDS)

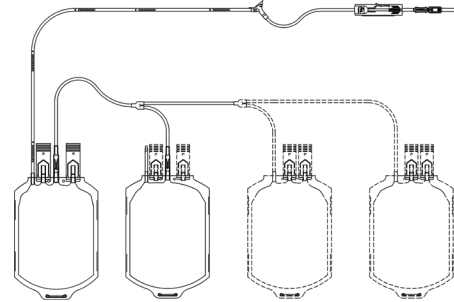

Y-Sampling Site (Y-Site)

	4R0012MC	4R0112MC	4R0499	4R0837MC	4R3611	4R3613
Configuration	Single	Single	Single w/ delivery tube	Single	Single	Single
Anticoagulant/ Additive Solution	CPD ²	ACD-A ⁵	CPD ²	CPD ²	CPDA-1 ⁴	CPDA-1 ⁴
Primary Container Volume	450 mL	450 mL	450 mL	250 mL	450 mL	500 mL
Primary Container	PL 146	PL 146	PL 146	PL 146	PL 146	PL 146
Satellite Container 1	N/A	N/A	N/A	N/A	N/A	N/A
Satellite Container 2	N/A	N/A	N/A	N/A	N/A	N/A
Satellite Container 3	N/A	N/A	N/A	N/A	N/A	N/A
Sampling System	N/A	N/A	N/A	N/A	Y-Site	SDS
Unit of Measure	1 unit/ pouch	12 units/ pouch	2 units/ pouch	1 unit/ pouch	12 units/ pouch	10 units/ pouch
	60 pouches/ case	6 pouches/ case	12 pouches/ case	60 pouches/ case	6 pouches/ case	6 pouches/ case
Total Units	60 units/ case	72 units/ case	24 units/ case	60 units/ case	72 units/ case	60 units/ case

²CPD=Anticoagulant Citrate Phosphate Dextrose Solution, USP

⁴CPDA-1=Anticoagulant Citrate Phosphate Dextrose Adenine Solution, USP

⁵ACD-A=Anticoagulant Citrate Dextrose Solution, USP

Blood-Pack Units

Blood-Pack Units without Filters

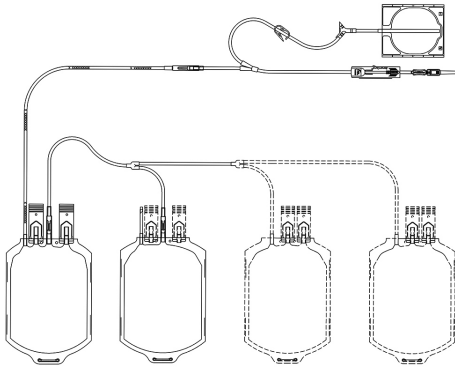

Sample Diversion System (SDS)

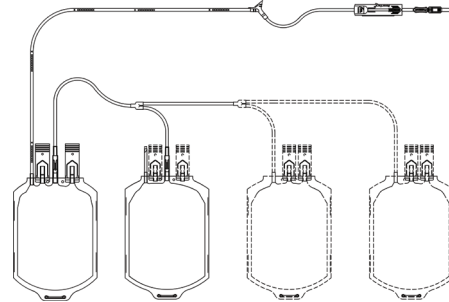

Y-Sampling Site (Y-Site)

	4R3428	4R3429	4R3468	4R3622	4R3647	4R3626
Configuration	Double	Double	Double	Double	Double	Double
Anticoagulant/ Additive Solution	CPD ² /Adsol ³	CPD ² /Adsol ³	CPD ² /Adsol ³	CPDA-1 ⁴	CPDA-1 ⁴	CPDA-1 ⁴
Primary Container Volume	450 mL	500 mL	500 mL	450 mL	500 mL	500 mL
Primary Container	PL 146	PL 146	PL 146	PL 146	PL 146	PL 146
Satellite Container 1	PL 146	PL 146	PL 146	PL 146	PL 146	PL 146
Satellite Container 2	N/A	N/A	N/A	N/A	N/A	N/A
Satellite Container 3	N/A	N/A	N/A	N/A	N/A	N/A
Sampling System	Y-Site	Y-Site	SDS	Y-Site	SDS	Y-Site
Unit of Measure	15 units/ pouch	15 units/ pouch	15 units/ pouch	6 units/ pouch	24 units/ pouch	24 units/ pouch
	2 pouches/ case	2 pouches/ case	2 pouches/ case	8 pouches/ case	2 pouches/ case	2 pouches/ case
Total Units	30 units/ case	30 units/ case	30 units/ case	48 units/ case	48 units/ case	48 units/ case

²CPD=Anticoagulant Citrate Phosphate Dextrose Solution, USP

³Adsol=Adsol Red Cell Preservation Solution

⁴CPDA-1=Anticoagulant Citrate Phosphate Dextrose Adenine Solution, USP

Blood-Pack Units

Blood-Pack Units without Filters

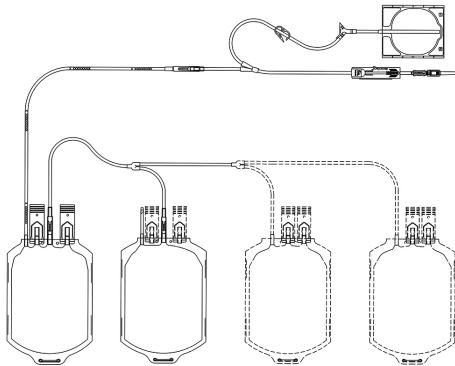

Sample Diversion System (SDS)

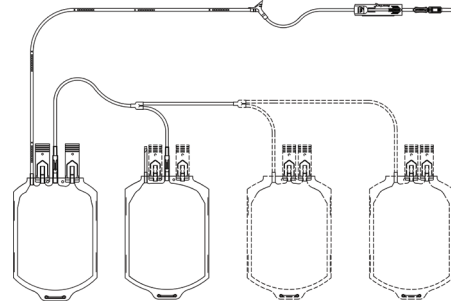

Y-Sampling Site (Y-Site)

	4R3629	4R3440	4R1250	4R3464	4R3644
Configuration	Triple	Triple	Quad	Quad	Quad
Anticoagulant/ Additive Solution	CPDA-1 ⁴	CPD ² /Adsol ³	CPDA-1 ⁴	CPD ² /Adsol ³	CPDA-1 ⁴
Primary Container Volume	450 mL	500 mL	450 mL	500 mL	500 mL
Primary Container	PL 146	PL 146	PL 146	PL 146	PL 146
Satellite Container 1	PL 1240	PL 2209 ¹	PL 1240	PL 2209 ¹	PL 146
Satellite Container 2	PL 1240	PL 2209 ¹	PL 1240	PL 2209 ¹	PL 146
Satellite Container 3	N/A	N/A	PL 1240	PL 2209 ¹	PL 146
Sampling System	SDS	SDS	SDS	SDS	SDS
Unit of Measure	20 units/pouch 2 pouches/case	15 units/pouch 2 pouches/case	3 units/pouch 8 pouches/case	12 units/pouch 2 pouches/case	12 units/pouch 2 pouches/case
Total Units	40 units/case	30 units/case	24 units/case	24 units/case	24 units/case

¹Plastic 2209 containers use butyryl trihexyl citrate (BTHC) plasticizer, an alternative to plastics that contain DEHP.

²CPD=Anticoagulant Citrate Phosphate Dextrose Solution, USP

³Adsol=Adsol Red Cell Preservation Solution

⁴CPDA-1=Anticoagulant Citrate Phosphate Dextrose Adenine Solution, USP

Leukoreduction Filters for Lab Sets

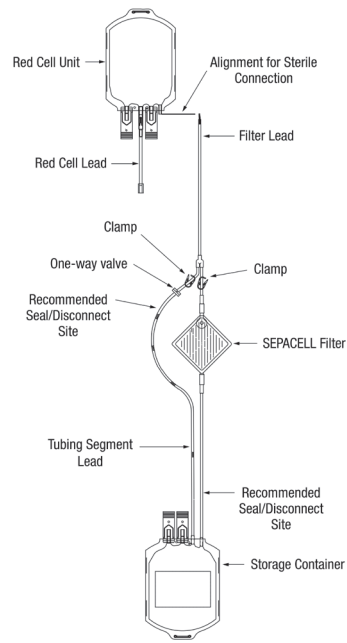

4C4300

Code	Item	Quantity
4C4300	<p>Leukoconnect Pre-Storage Sterile Connect Leukoreduction Set with Sepacell RS-2000 filter</p> <p>Leukoconnect pre-storage sterile connect leukocyte reduction set with Sepacell RS-2000 filter for red blood cells in additive solution.</p>	30 units/case

Amicus for Therapeutic Apheresis

Amicus is a platform device for therapeutic apheresis and cell collection. Currently available protocols:

- Therapeutic Plasma Exchange (TPE)
- Red Blood Cell Exchange (RBCX)
- Mononuclear Cell Collection (MNC)

4R4580TH Amicus Separator (includes Mobility Package)



Cell Collection

Code	Item	Quantity
X6R2326	Amicus MNC Apheresis Kit – Double Needle <ul style="list-style-type: none"> • (2) Spike connectors for solution attachment each with inline 0.2 micron filters • (1) 1000 mL plastic product storage container • (1) 800 mL plastic plasma storage container • (2) 17 gauge needles • Extracorporeal kit volume (ECV): 163 mL • Sterilized by irradiation. Sterile fluid path. 	6 units/case

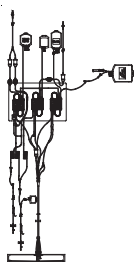

Therapeutic Apheresis

Code	Item	Quantity
X6R2339	Amicus Exchange Kit For Therapeutic Plasma Exchange (TPE) <ul style="list-style-type: none"> • (2) Vented spike connectors for replacement fluids • (2) Non-vented spike connectors for solutions • (2) Male luer connectors on inlet and return lines • Extracorporeal kit volume (ECV): 160 mL • Sterilized by irradiation. Sterile fluid path. 	6 units/case
X6R2349	Amicus Exchange Kit - Therapeutics For Therapeutic Plasma Exchange (TPE) & Red Blood Cell Exchange (RBCX) <ul style="list-style-type: none"> • (2) Vented spike connectors for replacement fluids • (2) Non-vented spike connectors for solutions • (2) Male luer connectors on inlet and return lines • Extracorporeal kit volume (ECV): 160 mL • Sterilized by irradiation. Sterile fluid path. 	6 units/case

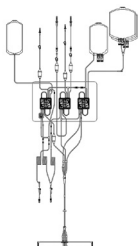
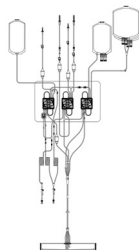

Amicus for Therapeutic Apheresis

Amicus Accessories and Ancillaries

Operator's Manuals

Code	Item	Quantity
6112684487	Amicus 5.1 Operator's Manual - Volume 1 Basic	1 each
6112684488	Amicus 5.1 Operator's Manual - Volume 2 Platelets	1 each
6112684489	Amicus 5.1 Operator's Manual - Volume 3 MNC	1 each
6112684490	Amicus 5.1 Operator's Manual - Volume 4 TPE	1 each
6112684491	Amicus 5.1 Operator's Manual - Volume 5 RBCX	1 each
6112688312	Amicus 5.1 Operator's Manual Volume 1-5 on USB	1 each

Protocol Specific Spools and Spool Holders

Code	Item	Quantity
6112685236S	MNC Spool	1 each
A10416001S	MNC Spool Holder	1 each
6112685237S	Exchange Spool	1 each
6112685241T	Exchange Spool Holder	1 each

Protocol Specific Top Panel Overlays

Code	Item	Quantity
472710759	Overlay – RBCX	1 each
472709743	Overlay – MNC	1 each
472709745	Overlay – TPE	1 each

Amicus for Therapeutic Apheresis

Amicus Accessories and Ancillaries (Continued)

Ancillary Items and Equipment

Code	Item	Quantity
X6C2170	Blood Component Filter Set with Vented Spike and Luer Adapter <ul style="list-style-type: none"> • (2) Protective caps • (1) Spike • (1) Vent cap • (1) Housing • (1) Standard 170 to 260 micron filter • (1) 7" (17.78 cm) of tubing • (1) Male luer adapter • Sterilized by irradiation. Sterile fluid path. 	48 units/case
X6C2172	Waste Transfer Set <ul style="list-style-type: none"> • (2) Vented Caps • (2) Spikes • (1) Roberts Clamp • Sterilized by irradiation. Sterile fluid path. 	20 units/case
6112685242S	Exchange Waste Bag Hanger	1 each
4B7891X	Anticoagulant Citrate Dextrose Solution, USP, Formula A, 1000 mL (see page 39)	14 units/case
4B7898Q	Anticoagulant Citrate Dextrose Solution, USP, Formula A, 500 mL (see page 39)	24 units/case
4R2032	Transfer-Pack Container with Coupler – 1000 mL (see page 38)	96 units/case
4R2023	Transfer-Pack Container with Coupler – 600 mL (see page 38)	96 units/case
6112685125	IV Pole (custom fit)	1 each
9027011	CompoSeal Mobilea II Set: Battery operated, radio frequency (RF) sealer for medical PVC tubing; includes yellow Handheld Sealer, Powerpack, Charger, RF Cable, Transport Case (gray) and operating instructions (see page 34).	1 unit
9027071	Shoulder Pouch for CompoSeal Mobilea II: Black nylon pouch holds CompoSeal Mobilea II Powerpack and Handheld Sealer; includes shoulder strap and belt loop (black) (see page 34).	1 unit
9029700	Splash Guard for Handsealer: Can be used with CompoSeal Mobilea II, CompoGuard handheld sealer, CompoSeal Slim and CompoSeal Universal optional handheld sealers (see page 34).	6 units
6B1275	Sodium Chloride Injection, USP 500 mL 0.9% Sodium Chloride, 500 mL is a sterile, nonpyrogenic solution in single dose containers.	20 units/case



9027011



9027071



9029700

Amicus for Therapeutic Apheresis

Amicus Accessories and Ancillaries (Continued)

Instrument Care

Code	Item	Quantity
A30423002	Air Inlet Filter	1 each
0112681131	Cassette Gaskets	1 set of 3
4994000256	Lint Free Lens Cleaning Cloth	1 each

Miscellaneous Supplies

Code	Item	Quantity
0212680034	Protective Cover (for transport)	1 each
0212680035	Protective Foam for Touch Screen (for transport)	1 each
072730801	White Thermoformed Cassette Protective Cover (for top panel)	1 each

Data Management Accessories

Code	Item	Quantity
A10309001	Barcode Scanner Programmed for use with the Amicus Separator	1 each
0213017689	Scan Sheet Barcode scan sheet to support use of scanner	1 each
5S9803	DXT Relay 2.2 Data management software designed to capture, store and transmit procedure data compatible with Amicus for Therapeutic Apheresis. DXT Relay provides access to analytical reports. Software is provided on a CD-Rom; computer hardware not included.	1 unit

Amicus for Therapeutic Apheresis

Ancillary Products

Code	Item	Quantity
4R0012MC	Single Blood-Pack Unit <ul style="list-style-type: none">• CPD anticoagulant• 450 mL primary container volume• PL 146 primary container	60 units/case
4R3611	Single Blood-Pack Unit <ul style="list-style-type: none">• CPDA-1 anticoagulant• 450 mL primary container volume• PL 146 primary container	72 units/case
4R2024	Transfer-Pack Container with Male Luer – 600 mL Empty bag with male luer lock.	96 units/case
4R2440	Apheresis Needle Apheresis needle, 16 ga., with MasterGuard protector.	250 units/case
4R2441	Apheresis Needle Apheresis needle, 17 ga., with MasterGuard protector.	250 units/case

Cell Processing

Lovo Cell Processing System

The Lovo Cell Processing System is a benchtop instrument that automates the washing and concentrating of cell products.

Features

- Processing Volume: up to 22 L
- Configurable processing parameters including levels of supernatant removal and final product volume.
- For laboratory use. Please see full disclaimer at bottom of page for more detail.



6R4900 Lovo Cell Processing System

Lovo Kits

Code	Item	Quantity
X6R4909	<p>Lovo Cell Processing Disposable Kit with Bag Access</p> <ul style="list-style-type: none"> • For use with Lovo version 3.0 software • (1) Source product line with 0.2 µm kit check vent • (2) Solution lines • (1) 800 mL in-process bag with a swabable, needlessly, female luer • (1) 800 mL retentate bag with a twist-off spike port and swabable, needlessly, female luer • (1) 2.5 L filtrate bag with a swabable, needlessly, female luer • (1) Spinning membrane separation device with 4 µm diameter pores • (1) Pressure sensor connector • Individually packaged in plastic overwraps • Sterilized by irradiation. Sterile fluid path. 	6 units/case

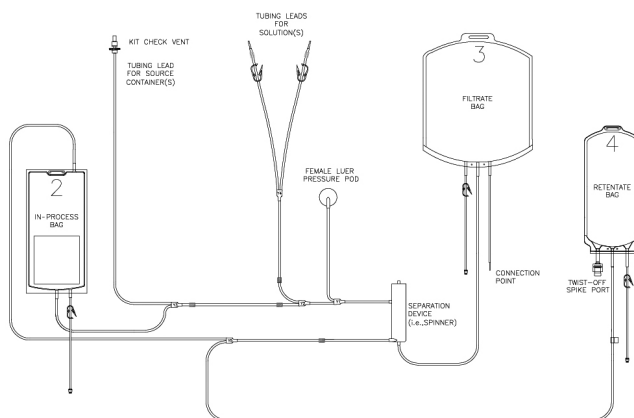

X6R4909

The Lovo Cell Processing system is for laboratory use only. Unless the user has obtained advance clearance or approval from the appropriate regulatory agency, cells processed on this system are not intended for diagnostic purposes, direct transfusion, or for use in the production of therapeutic products or vaccines for clinical use. For applications requiring regulatory clearance or approval, users may request the required Lovo technical documentation from Fresenius Kabi to support their submissions.

Cell Processing

Lovo Kits (Continued)

Code	Item	Quantity
X6R4906	Lovo Cell Processing Disposable Kit <ul style="list-style-type: none"> • For use with Lovo version 2.0 software • (1) Source product line with male Luer and cap • (2) Solution lines with male Luer and cap • (1) 800 mL in-process bag • (1) 800 mL retentate bag with a twist-off spike port and male Luer with cap • (1) 2.5 L filtrate bag with injection site and male Luer with cap • (1) Spinning membrane separation device with 4 µm diameter pores • (1) Pressure sensor connector • Individually packaged in plastic overwraps • Sterilized by irradiation. Sterile fluid path. 	6 units/case

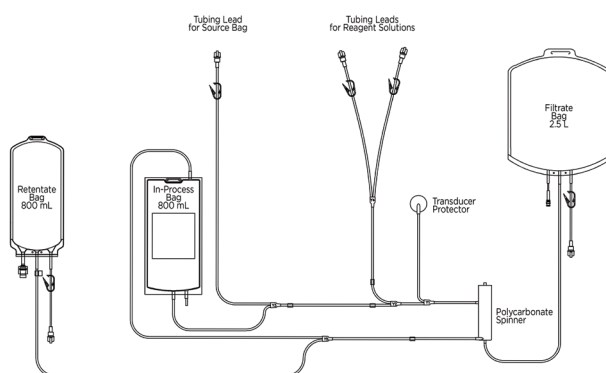



X6R4906

Data Management Accessories

Code	Item	Quantity
X6S4950USB	Lovo DXT Data Management System <p>Data management software designed to capture, store and transmit procedure data from Lovo instruments. Software is provided on a USB; computer hardware not included.</p>	1 unit

Cell Processing

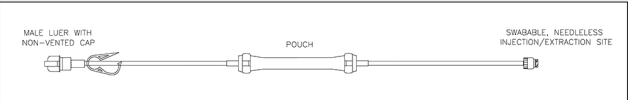
Lovo Ancillaries

Code	Item	Quantity
X6R4902	Lovo Ancillary Bag Kit <ul style="list-style-type: none"> • 2.5 L bag with injection site, male luer with cap, and female luer with cap • Sterile fluid path • Individually packaged in plastic overwraps 	20 units/case
		
X6R4907	Lovo Pouch Kit <ul style="list-style-type: none"> • For use with Lovo version 3.0 software and product code X6R4909 • 8 mL pouch swabable, needleless female luer site and male luer with cap • For reagent addition and/or sampling during cell processing • Sterile fluid path • Individually packaged in plastic overwraps 	6 units/case
		
X6R4917	Lovo Valve and Filter Kit <ul style="list-style-type: none"> • For use with Lovo version 3.0 software and product code X6R4909 • 0.2 µm filter with female luer, check valve, and male luer with cap • For reagent addition and/or sampling during cell processing • Sterile fluid path • Individually packaged in plastic overwraps 	6 units/case
		
YM020	20mm ViaLok Vented Vial Access Device <ul style="list-style-type: none"> • For use with Lovo version 3.0 software and product code X6R4909 • Plastic spike, 0.2 µm vent, and female luer with cap • For needle-free vial access • Sterile fluid path • Individually packaged in form fill seal pouch <p>Vialok is a medical device and can be sold only in the US and the EU.</p>	100 units/case
		

Specialty Products

Bone Marrow Collection Kit

Code	Item	Quantity
X6R2107	Bone Marrow Collection Kit with Flexible Pre-Filter and Inline Filters The sterile Bone Marrow Collection Kit is designed for the collection and filtration of up to 1.2 liters of aspirated bone marrow.	1 unit

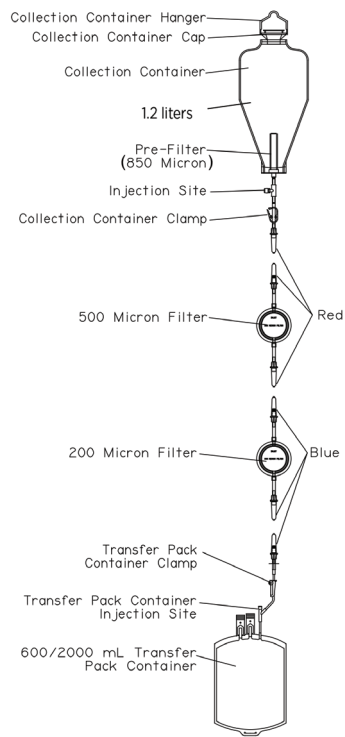

X6R2107



Code	Item	Quantity
4R2105	Bone Marrow Collection Stand Bone marrow collection stand for use with Bone Marrow Collection Kit (X6R2107).	1 unit



Specialty Products

CompoLab TS Hemoglobin Analyzer

CompoLab TS is a hemoglobin analyzer used prior to whole blood or component donations. Each analyzer comes with a transport case, power adapter, DFU and USB cable.



9033300 CompoLab TS Hemoglobin Analyzer 1 unit

Code	Item	Quantity
9033310	CompoLab TS Cuvettes 500 cuvettes per case (provided in 5 foil pouches containing 100 cuvettes each), single use disposable for CompoLab TS.	1 unit
90B.0014	Control Low-Medium-High QC controls for the CompoLab TS for low, medium and high hemoglobin. Each pack contains one 1.9 mL vial each of low, medium and high.	1 unit

CompoGuard & DonationMaster NET System Whole Blood Collection System

CompoGuard & DonationMaster NET System is a mixing scale and data management software system intended for the collection of whole blood at fixed sites and in mobile donor operations.

Code	Item	Quantity
9029661	CompoGuard COMPLETE Includes CompoGuard mixing scale, adapter, battery, tray, filter holders, gooseneck, donor display, optenna, scanner holder, hand sealer holder, sealing generator, and DECT* option.	1 unit



9029661

*DECT = Digital Enhanced Cordless Telecommunication technology

Specialty Products

CompoGuard & DonationMaster NET System Whole Blood Collection System (Continued)



9029651



9029641

Code	Item	Quantity
9029651	CompoGuard DATA Includes CompoGuard mixing scale, adapter, tray, filter holders, and DECT* option (battery sold separately).	1 unit
9029641	CompoGuard BASIC Includes CompoGuard mixing scale, tray, adapter, filter holders (battery sold separately).	1 unit
9029481	Transport Case Includes an integrated charging adapter to recharge the battery without unpacking the device.	1 unit
M687051SP	Rechargeable Battery Includes battery holder.	1 unit
9029491	Multi-Battery Charger for CompoGuard Recharges up to 4 CompoGuard rechargeable batteries.	1 unit
9029331	DonationMaster NET Data management software dedicated to the CompoGuard; designed to set up programs on and capture data after each whole blood collection from the CompoGuard; Software provided on CD-Rom; computer hardware not included; one DonationMaster NET required per computer set up; one DonationMaster NET can manage multiple CompoGuard devices.	1 unit
9029671	Barcode Scanner Barcode scanner with auto-sense function for hands-free scanning of barcodes; dedicated to CompoGuard for data capture during whole blood collections, such as operator barcode, donor and/or donation ID number, pass/fail result codes, sample tube numbers, etc.; one scanner required per CompoGuard.	1 unit

*DECT = Digital Enhanced Cordless Telecommunication technology

Specialty Products

CompoGuard & DonationMaster NET System Whole Blood Collection System (Continued)

Code	Item	Quantity
9029361	RF Converter (Fixed Part) Computer receiver for radio transmission of data signal via secured band width (DECT) to and from CompoGuard mixing scales; one Fixed Part required per computer set up.	1 unit
9028601	Network Converter (RS485) Computer receiver for wired data signal transmission to and from CompoGuard mixing scales; one network converter required per computer set up.	1 unit
M636701SP	Y-Piece For network wired data transfer between DonationMaster NET and multiple CompoGuard devices (one y-piece per CompoGuard device).	1 unit
M636672	Network Cable For network wired data transfer between DonationMaster NET and a CompoGuard device; when using y-piece to chain multiple devices to each other, one network cable is required per CompoGuard.	1 unit
9029531	Gooseneck Includes donor display and optenna.	1 unit
M635401SP	Optenna for use with the Gooseneck Signals end of donation, low- or high-flow mixing scale status.	1 unit
M689751SP	Handheld Sealer White handheld sealer with RF cable. The handheld sealer is included with the CompoGuard Complete and can be added optionally to the CompoSeal Slim.	1 unit
9029700	Splash Guard for Handsealer Can be used with CompoGuard handheld sealer, CompoSeal Mobile II, CompoSeal Slim, and CompoSeal Universal handheld sealers.	6 units
M636301	Modification Kit – Sealer Upgrade* Includes handsealer, generator and RF cable. Designed for upgrade of CompoGuard BASIC or CompoGuard DATA.	1 unit
M690041	Modification Kit – DECT Upgrade* Includes protected radio band (DECT) for wireless data transmission. Designed for upgrade of CompoGuard BASIC.	1 unit
9028391	Software License Software license key required when upgrading a CompoGuard BASIC to include data management (DATA or COMPLETE); One software license activates the data management option for one CompoGuard.	1 unit

*Upgrades require Depot Service and related charges.

Specialty Products

CompoCool Whole Blood Transport System

CompoCool is a transport system designed to cool whole blood directly after collection to room temperature.



9028841 and 9028751



9024251 and 9024261

Code	Item	Quantity
9028751	CompoCool WB Cooling Cartridge Cartridge with temperature indicator for rapid cooling of up to 6 whole blood units to room temperature; dedicated cartridge for CompoCool WB insulating box.	1 unit
9028841	CompoCool WB Insulating Box Insulating box with lid designed to hold CompoCool WB cartridge and up to 6 units of whole blood.	1 unit
9028831	Transport Trolley for CompoCool WB Cart to stack and transport up to 4 CompoCool WB insulation boxes with cooling cartridges and up to a total of 24 whole blood units.	1 unit
M658391	Box Seals Seals designed to lock CompoCool WB insulating box allowing blood center to check box was not tampered with during transportation; 2000 seals per bag.	1 unit
9024251	CompoCool Cooling Cartridge Cartridge for rapid cooling of up to 8 whole blood units to room temperature; dedicated cartridge for CompoCool crate.	4 units
9024261	CompoCool Crate Crate designed to hold CompoCool cartridge and up to 8 units of whole blood; crates easily stack for both transport and storage.	1 unit
9024271	Trolley Base Trolley base (360 deg wheels) designed to stack and transport up to 5 CompoCool crates, cartridges and 32 whole blood units.	1 unit
9024541	Trolley Push Bar Push bar for CompoCool trolley base.	1 unit

Specialty Products

CompoMat G5 and CompoMaster NET System

Automated whole blood and blood component separator (post-centrifugation). Includes 3 independent presses, up to 5 independent clamps/sealers, 2 detector types with up to 12 detector locations, 1 scale, 2 suspension pins; internal memory of 1000-2000 preparations. 5m cable for wired connection to CompoMaster Net included.



9025561 CompoMat G5 1 unit

Code	Item	Quantity
9025521	PLS Weighing Scale Weighing scale designed to provide tared or untared weight of a plasma blood product in BPU systems. Includes one scale, one clamp/sealer, one deaeration plate, one detector (One PLS Weighing Scale suggested per CompoMat G5).	1 unit
9025511	RBC Weighing Scale Weighing scale to provide tared or untared weights. One RBC Weighing Scale recommended per CompoMat G5 for processes using top & bottom BPU systems to weigh red cell blood products; includes a passive metal insert to assist in manual cannula breaking.	1 unit
9025571	CompoMaster NET Data management software dedicated to the CompoMat G5. Designed to set programs on, and capture data after, each separation process from the CompoMat G5. Software is provided on a CD-Rom; computer hardware not included; one CompoMaster NET required per computer set up; one CompoMaster NET can manage multiple CompoMat G5 devices.	1 unit
9025611	Scanner Barcode scanner dedicated to CompoMat G5 for data capture during whole blood or blood component processing, such as operator barcode, donation ID number, pass/fail result codes, centrifuge number, etc. (One scanner suggested per CompoMat G5).	1 unit
M684151	WLAN Access Point Dedicated electrical device designed to send and receive data wirelessly between a computer and the CompoMat G5.	1 unit
M689401	WLAN USB Stick USB stick designed to send data wirelessly from a single CompoMat G5 device to a WLAN Access Point and connected computer.	1 unit
M684211	LAN Hub 24-Port Dedicated electrical device designed to send and receive wired data from one computer to multiple CompoMat G5 devices. Up to 24 connection ports provided (5m cable for CompoMat G5 not included).	1 unit
M678101	Network Cable 5m Cable for wired communication between a CompoMat G5 device and a LAN hub with connected computer.	1 unit

Specialty Products

CompoDock DM & DockMaster NET System Sterile Connection Device

CompoDock DM & DockMaster NET System is a device for sterile connection of medical PVC tubing. Device does not require wafers and includes disposable counter (100-count) for training and validation.

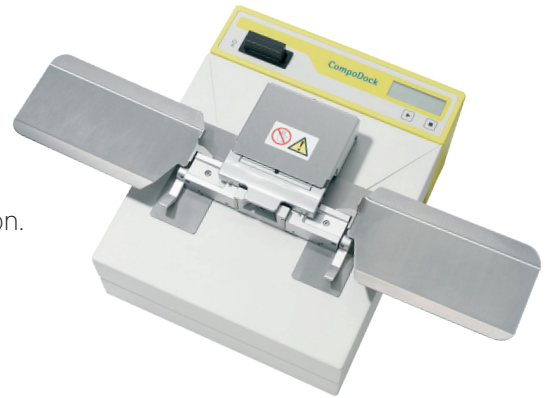



9028721 CompoDock DM 1 unit

Code	Item	Quantity
9028681	CompoDock Counter 2500 Disposable counter for up to 2500 docks and device QC testing.	1 unit
9028691	CompoDock Counter 1000 Disposable counter for up to 1000 docks and device QC testing.	1 unit
9028701	CompoDock Counter 500 Disposable counter for up to 500 docks and device QC testing.	1 unit
9028921	DockMaster NET Data management software dedicated to the CompoDock DM; designed to set up programs on and capture data after each tube docking process from the CompoDock DM. Software is provided on a CD-Rom; computer hardware not included; one DockMaster NET required per computer set up; one DockMaster NET can manage multiple CompoDock DM devices.	1 unit
9025611	Scanner Barcode scanner dedicated to CompoDock DM for data capture during the docking process, such as operator barcode, donation ID numbers, pass/fail result codes, leukoreduction filter or aliquot system batch numbers, etc.	1 unit
M672351	Serial Cable Female/Female, 10 ft. serial cable	1 unit
M672361	Serial Cable Male/Female, 15 ft. serial cable	1 unit
M672381	Interface converter, USB-serial, 2-port Includes USB cable 2.0, A USB master plug/B USB slave plug, 3 ft.	1 unit
M672371	Interface converter, USB-serial, 4-port Includes USB cable 2.0, A USB master plug/B USB slave plug, 3 ft.	1 unit
M672391	USB cable 2.0, full speed, A USB master plug/B USB slave plug, 15 ft. Extends Interface converter, USB-serial (2- or 4-ports) to 15 ft.	1 unit
M672401	USB cable 2.0, active extension, A USB master plug/A socket, 15 ft. Extends USB cable 2.0, full speed to 15 ft.	1 unit



Specialty Products

Sealers

Code	Item	Quantity
9027011	 <p>CompoSeal Mobilea II Set Battery operated, radio frequency (RF) sealer for medical PVC tubing; includes yellow Handheld Sealer, Powerpack, Charger, RF Cable, Transport Case (gray) and operating instructions.</p>	1 unit
9027071	 <p>Shoulder Pouch for CompoSeal Mobilea II Black nylon pouch holds CompoSeal Mobilea II Powerpack and Handheld sealer; includes shoulder strap and belt loop (black).</p>	1 unit
9029700	 <p>Splash Guard for Handsealer Can be used with CompoSeal Mobilea II, CompoGuard handheld sealer, CompoSeal Slim and CompoSeal Universal optional handheld sealers.</p>	6 units
9027021	<p>Handsealer Sealer/Wand Yellow handheld sealer/wand for CompoSeal Mobilea II (included in Set).</p>	1 unit
9027001	<p>Powerpack Aluminium housing holds generator and lithium polymer battery with up to 1000 seal capacity; intended for CompoSeal Mobilea II; charges in 2 hours (included in Set).</p>	1 unit
9027031	<p>Charger Intended for CompoSeal Mobilea II Powerpack; includes adapter (included in Set).</p>	1 unit



Specialty Products

Sealers (Continued)

Code	Item	Quantity
<p>9029701</p> 	<p>CompoSeal Slim Combine up to 8 slim-line CompoSeal Slim RF sealers for cascade segment sealing or use device as stand-alone tabletop RF sealer for PVC tubing. Power cable sold separately.</p>	1 unit
<p>M600221</p>	<p>Power Cord In cascade segment sealing configuration, 1 power cord can be used for up to 2 CompoSeal Slim devices (set up requires Cable Kit).</p>	1 unit
<p>M689751SP</p> 	<p>Handheld Sealer White handheld sealer/wand for use with CompoSeal Slim or CompoGuard Complete (includes RF coaxial cable).</p>	1 unit
<p>9029700</p> 	<p>Splash Guard for Handsealer Can be used with CompoSeal Mobilea II, CompoGuard handheld sealer, and CompoSeal Slim and CompoSeal Universal optional handheld sealers.</p>	6 units

Specialty Products





Sealers (Continued)

Code	Item	Quantity
ACC000014	<p>Foot Switch</p> <p>Foot switch for CompoSeal Slim initiates cascade segment sealing when hands are busy with a segment line.</p>	1 unit
 <p>ACC000038</p>	<p>Cable Kit for CompoSeal Slim</p> <p>Cable Kit for CompoSeal Slim cascade segment sealing reduces cable clutter; includes two short signal/communication cables and one short power cable.</p>	1 unit
M723541SP	<p>RF Cable for Handheld Sealer</p> <p>Radio frequency cable for handheld sealers (yellow, purple or white models).</p>	1 unit
 <p>9024031</p>	<p>Handheld Sealer</p> <p>Handheld sealer with RF cable doubles CompoSeal Universal sealing capacity (purple).</p>	1 unit
 <p>9028811</p>	<p>Transport Case for CompoSeal Universal</p> <p>Protective case to transport CompoSeal Universal (gray).</p>	1 unit

Specialty Products

Transfusion Sets



Multiple options and configurations to address your transfusion needs.

Code	Item	Quantity
4C2160	 Fenwal Blood Component Recipient Set with Standard Blood Filter and Female Luer Adapter Standard 170-260 micron filter, transfuses all components.	48 units/case
4C2161	 Fenwal Y-Type Blood Component Recipient Set with Standard Blood Filter and Luer Adapter Standard 170-260 micron filter with Y-set, transfuses all components.	48 units/case
4C2240	 2 Units Fenwal Plasma Transfer Set Plasma transfer set with coupler and male luer lock, 30" long.	96 units/case
4C2243	 2 Units Fenwal Plasma Transfer Set Plasma transfer set with two couplers, 30" long.	96 units/case
4C2498H	 Y-Type Connector Set with Luer Lock	48 units/case

Specialty Products

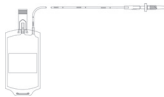

Transfer-Pack Containers

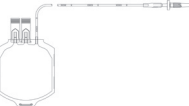
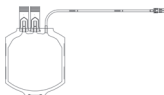
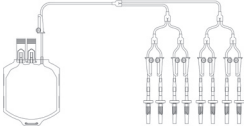
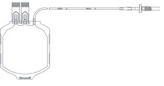
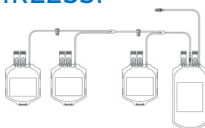
Transfer-Pack containers in multiple configurations to address your needs. Dispensing cartons available on most Transfer-Packs.

Code	Item	Quantity
4R2001 	Transfer-Pack container with Coupler – 150 mL	96 units/case
4R2004 	Quadruple Transfer-Pack container with Coupler – 150 mL (Not available in dispensing carton.)	48 units/case
4R2014 	Transfer-Pack container with Coupler – 300 mL	96 units/case
4R2023 	Transfer-Pack container with Coupler – 600 mL	96 units/case
4R2024 	Transfer-Pack container with Male Luer – 600 mL Empty bag with male luer lock.	96 units/case
4R2027 	Transfer-Pack container with 8 Couplers – 600 mL Eight couplers allow for pooling of products from multiple units.	48 units/case
4R2032 	Transfer-Pack container with Coupler – 1000 mL	96 units/case
4R2255P 	Quadruple Transfer-Pack container with Male Luer – 1000 mL Quadruple Transfer-Pack container intended for plasma collection with male luer adapter, one 1000 mL and three 300 mL containers. (Not available in dispensing carton.)	30 units/case

Specialty Products

Bulk Solutions

Code	Item	Quantity
6B1275	Sodium Chloride Injection, USP 500 mL 0.9% Sodium Chloride, 500 mL is a sterile, nonpyrogenic solution in single dose containers.	20 units/case
FUM4092	Anticoagulant Sodium Citrate Solution, USP 250 mL Sodium Citrate Solution, 250 mL, in plastic container, for use with cytappheresis devices.	36 units/case
4B7889Q	 Anticoagulant Sodium Citrate Solution, USP 500 mL Sodium Citrate Solution, 500 mL, in plastic container, for use with cytappheresis devices.	24 units/case
4B7891X	 Anticoagulant Citrate Dextrose Solution, USP 1000 mL, Formula A Anticoagulant Citrate Dextrose Solution, USP, Formula A, 1000 mL	14 units/case
4B7898Q	 Anticoagulant Citrate Dextrose Solution, USP 500 mL, Formula A Anticoagulant Citrate Dextrose Solution, USP, Formula A, 500 mL	24 units/case





Specialty Products

Storage/Freezing

Code	Item	Quantity
4A7831	 Glycerolyte 57 Buffered Glycerolyte – USP 400 mL bottle	12 units/case
4A7833	 Glycerolyte 57 Buffered Glycerolyte – USP 500 mL bottle	12 units/case
4B7870X	 1.6% Sodium Chloride Solution – USP 1000 mL Wash solution for glycerolyte.	14 units/case
4B7874Q	 12% Sodium Chloride – USP 150 mL Wash solution for glycerolyte.	36 units/case
4B7877X	 0.2% Dextrose and 0.9% Sodium Chloride Solution – USP 1000 mL Wash solution for glycerolyte.	14 units/case
4B7878	 0.2% Dextrose and 0.9% Sodium Chloride Solution – USP 2000 mL Wash solution for glycerolyte.	6 units/case

Specialty Products

Storage/Freezing (Continued)





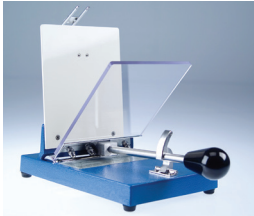

Code	Item	Quantity
4R4413P	 <p>Blood-Pack Unit Holder – 2000 mL Provides added protection to Blood-Pack unit during storage.</p>	150 units/case
4R2422	 <p>Red Blood Cell Freezing Pack with Drip Chamber and Coupler – 2000 mL Commonly used to glycerolize blood, large size allows for the RBCs glycerolyte and wash solution.</p>	48 units/case
4R4409	 <p>Plasma Container Carton Provides added protection during storage.</p>	144 units/case
4R4420	 <p>Cryoprecipitate Carton Provides added protection to cryoprecipitate during storage.</p>	144 units/case
4R4424	 <p>Plastic Centrifuge Bag Holds BPU together during centrifugation.</p>	1,000 units/case

Specialty Products

Extractor







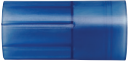

Code	Item	Quantity
4R4414	 <p>Manual Plasma Extractor Provides constant pressure from bottom up to extract plasma/platelets from whole blood.</p>	1 unit

Equipment

Code	Item	Quantity
6R4452	 <p>Tube Stripper Tube stripper used to strip undiluted blood from donor tubing into collection container.</p>	1 each
4R4454	 <p>Hand Sealer Create a hermetic seal of the tubing (use with code 4R4418).</p>	1 unit
4R4418	 <p>Clips, Hand Sealer Create a hermetic seal of the tubing (use with 4R4454).</p>	1,000 units/ case
FESRD0500	 <p>Leuko Pole with Blood-Pack Unit Holder, Tray Allows for filtration of blood, lower base makes the pole more stable, includes lower hooks.</p>	1 unit
4C2405	 <p>Fenwal Sampling Site Coupler Natural rubber sleeve stopper allows sampling with a 22 gauge or smaller needle.</p>	96 units/case
4R4350	 <p>Terumo Welding Wafers – Disposable Needed to seal, cut and connect to another tube while keeping internal sterility.</p>	140 units/case
4R4423H	 <p>Slide Clamps (bulk pack) Provide a temporary closure to the tubing.</p>	500 units/case

Specialty Products

Equipment (Continued)

Code	Item	Quantity
4R5126	 Hematype Segment Device Single use sampling device designed to help safely access blood from a segment.	2,000 units/ case
4R5128	 Hematype Segment Device Single use sampling device designed to help safely access blood from a segment.	1,000 units/ case
4R5125	 Needle Guard Post collection needle stick protection device.	1,000 units/ case
4R2335H	 Product Sample Pack <ul style="list-style-type: none"> • Up to 5 mL sample container • Use with sterile connection • One sample container 	200 units/case
A100645	 SampLok Safety Vacuum Tube Holder Multi-sample tube holder used to collect blood samples into vacuum test tubes and long neck culture bottles.	425 units/case
6R4011	 CompoSampler Multi-sample tube holder used to collect blood samples into vacuum test tubes and long neck culture bottles. Use with Fenwal HighFlo needle.*	425 units/case
A100750	 SampLok Sampling Kit <ul style="list-style-type: none"> • Sampling and transfer kit for bacterial detection testing • 10 mL single unit chamber 	110 units/case
A110Bulk	 Scissor Clamp Hemostat, used to clamp tubing off.	1 each

*van der Meer, P.F., & de Korte, D. "Increase of blood donation speed by optimizing the needle-to-tubing connection: an application of donation software." Vox Sanguinis 2009, 97: 21-25

Fresenius Kabi | Terms and Conditions

Over time this information may be subject to change based upon modifications in product manufacturing or changes in blood banking or clinical practice.

1. Orders. All orders are subject to acceptance by Fresenius Kabi USA, LLC. ACCEPTANCE SHALL BE ONLY BY ACCEPTANCE LETTER OR ACTUAL PERFORMANCE.

2. Delivery. Fresenius Kabi's delivery dates are provided for information purposes only and are non-binding. Fresenius Kabi shall not be liable for late delivery, unless late delivery would be such as to amount to Fresenius Kabi being freed from its obligations to deliver. Title to the Products and risk of loss or damage during shipment passes from Fresenius Kabi to Buyer ex works Fresenius Kabi's designated location (Incoterms 2000). To the extent permitted by law, Fresenius Kabi shall retain a security interest in the Products until Fresenius Kabi receives payment in full. Buyer will be responsible for all shipping and related charges. Fresenius Kabi shall not be held accountable for failure or delay of performance under this contract if it is due to force majeure or to any occurrence other than negligence on Fresenius Kabi's part. Force majeure includes, but is not limited to, acts of God, fire, weather conditions, strike, lockout or other industrial disturbance, act of the public enemy, war declared or undeclared, threat of war, terrorist act, act of government.

3. Delivery Complaints. Buyer shall immediately take possession of the Products and inspect them upon delivery. In the event of visible defects or nonconforming orders, Buyer shall ensure that this is recorded at the time of delivery. No complaints shall be accepted more than 7 days after delivery. Fresenius Kabi will be responsible for hidden defects only if Buyer has used reasonable due diligence to detect such defect, and Buyer has informed Fresenius Kabi of such defect in writing s to the warranty provided in Section 4.

4. Warranties and Exclusive Remedy. Fresenius Kabi warrants that all products furnished hereunder will be merchantable, free from defects in material and workmanship, and will conform to applicable specifications, drawings or descriptions. FRESENIUS KABI HEREBY EXPRESSLY DISCLAIMS ALL WARRANTIES EITHER EXPRESS OR IMPLIED, RELATED TO PRODUCTS SOLD SERVICES PROVIDED BY THIRD PARTIES OR AFFILIATES OF FRESENIUS KABI, INCLUDING, WITHOUT LIMITATION, ANY WARRANTY OF MERCHANTABILITY OR FITNESS FOR A PARTICULAR PURPOSE, OR WARRANTY OF NON-INFRINGEMENT. If any products are found and reported within one (1) year (for spare parts, within 3 months) from date of delivery to have been defective when delivered (any shortcoming which prevent performance to specified standards, if any, set forth in the specifications being deemed a defect) and provided immediate notification in writing is given to Fresenius Kabi, Fresenius Kabi will replace or repair such defect (defects caused by normal wear are excluded from warranty replacement). During repair, risk of loss will remain with Buyer. Replacement of products manufactured or supplied by others is subject to that manufacturer's or supplier's consent. No products can be returned without Fresenius Kabi's prior written consent. The remedies of Buyer set forth herein are exclusive and the total liability of Fresenius Kabi with respect to the performance or breach of this Agreement in connection with the manufacture, sale, delivery, installation or repair of the Products hereunder, or the technical direction covered by or furnished under this Agreement is limited to making within the time period set forth above such modifications as may be necessary to achieve performance to specified standards, if any, and to repairing any defective products that have been identified by Buyer. If Fresenius Kabi and Buyer are

unable to correct a defective or non-conforming product, Fresenius Kabi's sole liability shall be to repay any portion of the purchase price paid for it upon Buyer returning it to Fresenius Kabi.

Any modifications to Products without Fresenius Kabi's prior written approval, improper use of Products, whether intentional or unintentional, operation beyond capacity, failure to report to Fresenius Kabi within the warranty period, substitution or addition of components or parts, lack of proper maintenance, abuse, improper installation, or abnormal conditions of temperature, moisture, or corrosive matter, or alteration or repair by others in such manner which in Fresenius Kabi's judgment affects the Product materially and adversely shall void the foregoing warranty.

5. Limitation of Liability. FRESENIUS KABI WILL NOT BE LIABLE FOR LOST PROFITS, LOSS OF BUSINESS OR OTHER CONSEQUENTIAL, SPECIAL, INDIRECT OR PUNITIVE DAMAGES, EVEN IF ADVISED OF THE POSSIBILITY OF SUCH DAMAGES, OR FOR ANY CLAIM BY ANY THIRD PARTY. FRESENIUS KABI SHALL NOT BE SUBJECT TO ANY OTHER OBLIGATIONS OR LIABILITIES ARISING OUT OF BREACH OF CONTRACT OR WARRANTIES, ANY OBLIGATIONS WHATSOEVER ARISING FROM TORT CLAIMS, INCLUDING NEGLIGENCE AND STRICT LIABILITY, OR ARISING UNDER ANY OTHER THEORIES OF LAW. FRESENIUS KABI WILL NOT BE LIABLE FOR PRODUCTS NOT BEING AVAILABLE FOR USE OR FOR LOST OR CORRUPTED DATA OR SOFTWARE OR THE PROVISION OF SERVICES BY THIRD PARTIES. BUYER AGREES THAT FOR ANY LIABILITY RELATED TO THE PURCHASE OF PRODUCTS OR SERVICES PROVIDED DIRECTLY BY FRESENIUS KABI, FRESENIUS KABI WILL NOT BE LIABLE OR RESPONSIBLE FOR ANY AMOUNT OF DAMAGE IN EXCESS OF THE LESSOR OF: (i) THE DOLLAR AMOUNT PAID BY BUYER FOR THE PRODUCTS GIVING RISE TO THE CLAIM; OR (ii) \$50,000.

6. Prices. Prices are subject to change without notice. Prices do not include and Buyer is responsible for any applicable sales, use, transaction, excise or other similar taxes, and from any federal, state or local fees or charges (including, but not limited to, environmental or similar fees), imposed on, in respect of, or otherwise associated with an order. Buyer must provide Fresenius Kabi with any exemption documentation at the time of purchase.

7. Payment. Buyer shall pay for the Products (including applicable taxes and other charges) within thirty (30) days from the invoice date. Fresenius Kabi will invoice Buyer for Products on the date of shipment. Fresenius Kabi reserves the right to charge Buyer interest on all past due invoices one point five percent (1.5%) per month or the highest rate allowed by law, whichever is lesser. In the event of payment default, Buyer will be responsible for Fresenius Kabi's reasonable costs of collection, including court costs, filing fees and attorney's fees. Buyer may not deduct or offset any disputed amounts from Fresenius Kabi's invoice.

8. Termination of Orders. In the event Buyer terminates an order accepted by Fresenius Kabi prior to delivery, Buyer shall pay Fresenius Kabi 20% of the order price to cover Fresenius Kabi's fixed and variable costs incurred. Fresenius Kabi may terminate the Order without cause upon thirty (30) days prior written notice to the Buyer. Buyer shall pay for all Products ordered prior to the date of termination.

9. Minimum Orders. All Product orders of less than US \$250 (excluding taxes) shall be subject to a \$40 charge, representing the additional costs of processing, preparing and delivering such order.

Fresenius Kabi | Terms and Conditions

10. Own Use. Purchases of products from Fresenius Kabi must be for the customer's "own use" as defined by the United States Supreme Court in the case of Abbot Laboratories, et al. v. Portland Retail Druggist Association, Inc., 425 U.S. 1 (1976). Fresenius Kabi shall have the right to suspend sales of products to customers if Fresenius Kabi suspects a violation of this "own use" provision by a particular customer.

11. Compliance with Laws. Customer agrees to perform its obligations hereunder in compliance with all applicable laws, rules and regulations. In accordance with applicable law, Customer agrees to report prices paid for Orders (inclusive of any discounts, rebates, and other reductions in price) under any state or federal program that provides cost or charge based reimbursement for products ordered by Customer.

12. Assignment. Fresenius Kabi shall have the right to assign its rights and obligations under any agreement that is subject to these Terms and Conditions to a successor, affiliate, or unrelated third party without the consent of any other party.

13. Terms. List prices, delivery terms, terms of payment, returned goods policies, and other terms and policies may be changed by Fresenius Kabi at any time without notice. No changes to these Terms and Conditions, including any conflicting or additional terms contained in any purchase order or other document submitted by a customer, shall be valid unless approved by the Fresenius Kabi business unit in Lake Zurich, Illinois.

14. Returned Goods Policy. This policy is designed so that when Fresenius Kabi has made an error, in either product quality or service, Fresenius Kabi pays the cost of return. However, when the error is on Customer's part, Customer agrees to bear part of the cost.

Product quality issues should be reported immediately to 1-800-933-6925.

To ensure proper credit, please call Fresenius Kabi Customer Service at 1-800-766-1077 for authorization prior to returning any products and have a copy of the shipping documents or invoice when placing the call.

For a Fresenius Kabi error, credit will be issued at one hundred percent (100%) of the original price if the product is returned within sixty (60) days of original shipment date.

For a Customer error, return is subject to a twenty percent (20%) restocking charge. A credit will be issued at eighty percent (80%) of the original price if the product is returned in new, unused, saleable condition within sixty (60) days of original shipment date.

Under the following circumstances, credits will not be issued:

- a. More than sixty (60) days have elapsed since the original shipment date;
- b. Customer excess stock;
- c. Opened or partially used cases;
- d. Discontinued products;
- e. Product complaints over sixty (60) days from date of incidence.

Index

Code	Page	Code	Page	Code	Page	Code	Page
A100645	43	M689751SP	30, 35	1571270382	3	4R1783	12
A100750	6, 43	M690041	30	4078502050	3	4R1784	12
A10309001	8, 22	M723541SP	36	472709743	20	4R1787	12
A10399001	8	R4R5714	3	472709745	20	4R1790	12
A10416001S	20	R4R5728	2	472710759	20	4R2001	38
A110Bulk	43	X4R5700	1	4994000256	8, 22	4R2004	38
A20765001	7	X4R5720	1	4A7831	40	4R2014	38
A20766001	7	X6B7850	5	4A7833	40	4R2023	21, 38
A30423002	8, 22	X6C2170	21	4B7870X	40	4R2024	23, 38
ACC000014	36	X6C2172	21	4B7874Q	40	4R2027	38
ACC000038	36	X6R2107	27	4B7877X	40	4R2032	21, 38
B70000089	8	X6R2326	19	4B7878	40	4R2088P	10
FESRD0500	42	X6R2339	19	4B7889Q	39	4R2105	27
FUM4092	39	X6R2349	19	4B7891X	21, 39	4R2255P	38
M600221	35	X6R2350	6	4B7898Q	21, 39	4R2256	9
M635401SP	30	X6R4902	26	4C2160	37	4R2258	10
M636301	30	X6R4906	25	4C2161	37	4R2335H	6, 43
M636672	30	X6R4907	26	4C2240	37	4R2337	5
M636701SP	30	X6R4909	24	4C2243	37	4R2340	5
M658391	31	X6R4917	26	4C2405	42	4R2353	6
M672351	33	X6S4950USB	25	4C2498H	37	4R2354	6
M672361	33	X6S9830USB	3, 8, 11	4C4300	18	4R2355	4
M672371	33	YM020	26	4R0012MC	15, 23	4R2357	4
M672381	33	0112561297	3	4R0112MC	15	4R2422	41
M672391	33	0112681131	8, 22	4R0499	15	4R2440	10, 23
M672401	33	0212551465	3	4R0837MC	15	4R2441	10, 23
M678101	32	0212680034	8, 22	4R1250	17	4R3313E	14
M684151	32	0212680035	8, 22	4R1583	13	4R3327E	14
M684211	32	0213017689	8, 22	4R1587P	13	4R3332E	14
M687051SP	29	072730801	8, 22	4R1590P	13	4R3428	16
M689401	32	1571270280	3	4R1782	12	4R3429	16

Index

Code	Page	Code	Page	Code	Page	Code	Page
4R3440	17	6112684489	20	9024261	31	9029651	29
4R3464	17	6112684490	20	9024271	31	9029661	28
4R3468	16	6112684491	20	9024541	31	9029671	29
4R3611	15, 23	6112684971T	8	9025511	32	9029700	3, 7, 11, 21, 30, 34, 35
4R3613	15	6112684972T	8	9025521	32	9029701	11, 35
4R3622	16	6112684974S	3, 8	9025561	32	9033300	28
4R3626	16	6112685125	21	9025571	32	9033310	28
4R3629	17	6112685133	8	9025611	32, 33		
4R3644	17	6112685236S	20	9027001	34		
4R3647	16	6112685237S	20	9027011	3, 7, 11, 21, 34		
4R4350	42	6112685241T	20	9027021	34		
4R4409	41	6112685242S	21	9027031	34		
4R4413P	41	6112685306S	7	9027071	3, 7, 11, 21, 34		
4R4414	42	6112688312	20	9028391	30		
4R4418	42	6112705089	2	9028601	30		
4R4420	41	6112705091	3	9028681	33		
4R4423H	42	6112705094	2	9028691	33		
4R4424	41	6212702647	3	9028701	33		
4R4454	42	6B1275	21, 39	9028721	33		
4R4580TH	19	6R2069	10	9028751	31		
4R5125	43	6R2600	9	9028811	36		
4R5126	43	6R4011	43	9028831	31		
4R5128	43	6R4452	42	9028841	31		
4R5129	10	6R4580	4	9028921	33		
4R5730	2	6R4601	9	9029331	29		
556524003T	3	6R4612	9	9029361	30		
5930007171	3	6R4900	24	9029481	29		
5S9803	22	6R5725	1	9029491	29		
6112570076	11	90B.0014	28	9029531	30		
6112684487	20	9024031	36	9029641	29		
6112684488	20	9024251	31				

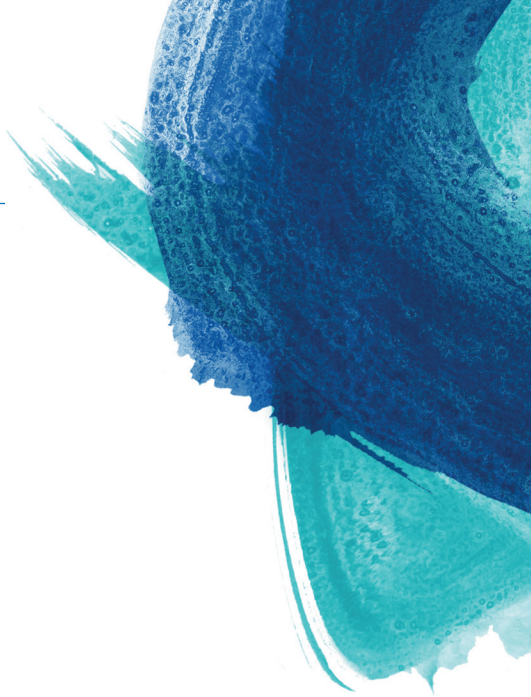

All trademarks referred to are property of their respective owners.
Copyright © 2019 Fresenius Kabi AG. All rights reserved.



Fresenius Kabi USA, LLC
Three Corporate Drive
Lake Zurich, IL 60047
www.fresenius-kabi.us