

UNIVERSAL COMPONENTS INC.

		1313 Hall Spencer Rd. Rock Hill, S.C.29730	
		CATALOG NO. UCI 0110	
E-Mail sales@ucimfg.com		WEB ADDRESS www.ucimfg.com	
PHONE 803/324-5176		FAX 803/324-2640	

Table Of Contents	pg. 1,2
How To Order Actuated Valves	pg. 3,4,5

BRASS ACTUATED BALL VALVES

Brass 2-Way Actuated Ball Valves	pg. 6
Nickel Plated Brass Compact Actuated Valves	pg. 33
Brass 3-Way Actuated Ball Valves	pg. 7



CARBON STEEL ACTUATED BALL VALVES

Carbon Steel 2-Way 2,000 PSI Actuated Ball Valves	pg. 8
Carbon Steel 2-Way High Pressure Pneumatically Actuated Ball Valves . .	pg. 9
Carbon Steel 3-Way High Pressure Pneumatically Actuated Ball Valves . .	pg. 9

316 STAINLESS STEEL ACTUATED BALL VALVES

Stainless Steel 2-Way 1,000 PSI Actuated Ball Valves	pg. 10
Stainless Steel 2-Way 2,000 PSI Actuated Ball Valves	pg. 11
Stainless Steel 2-Way 3,000 PSI Actuated Ball Valves	pg. 12
Stainless Steel 2-Way 3-Piece Actuated Ball Valves	pg. 13
Stainless Steel 2-Way 3-Piece NPT Actuated Ball Valves	pg. 14
Stainless Steel 2-Way 3-Piece Socket Weld Actuated Ball Valves	pg. 15
Stainless Steel 2-Way Actuated ANSI 150 Flanged Ball Valves	pg. 16
Stainless Steel 2-Way Actuated ANSI 300 Flanged Ball Valves	pg. 17
Stainless Steel 2-way Actuated Sanitary Tri-Clamp Ball Valves	pg. 18
Stainless Steel 3-Way 1,000 PSI Actuated Ball Valves	pg. 19

ACTUATED BUTTERFLY VALVES

Wafer Style Pneumatically Actuated Butterfly Valves	pg. 20
Lug Style Pneumatically Actuated Butterfly Valves	pg. 21

ACTUATED VALVE ACCESSORIES

Namur 4 - Way Single Solenoid Valves	pg. 22
Namur 4 - Way Double Solenoid Valves	pg. 23
Namur 3-Way Single Solenoid Valves	pg. 24
Limit Switch Indicators	pg. 25
Pneumatic and Electro-Pneumatic Positioners	pg. 26

MANUAL VALVES

Brass Ball Valves	pg. 27-29
Carbon Steel Ball Valves	pg. 30-31
Stainless Steel Ball Valves	pg. 32-35
Safety Exhaust Locking Ball Valves	pg. 36
Flanged Ball Valves	pg. 37-40
Gate Valves	pg. 40
Butterfly Valves	pg. 41-44

RELIEF VALVES

Relief Valves	pg. 45-54
-------------------------	-----------

CHECK VALVES

Check Valves	pg. 55-56
------------------------	-----------

GAUGES

Dry Gauges	pg. 57-60
Glycerin Filled Gauges	pg. 61-66
Process Gauges	pg. 67-68
Gauge Accessories	pg. 68
Thermometers	pg. 69

MUFFLERS

Mufflers	pg. 70-71
--------------------	-----------

IN-LINE FILTERS

In-Line Filters	pg. 72
---------------------------	--------

"Y" STRAINERS

"Y" Strainers	pg. 73
-------------------------	--------

CD inside Back Cover includes Catalog and Drawings



HOW TO ORDER A PNEUMATIC BALL VALVE ASSEMBLY

PNEUMATIC ACTUATOR ALUMINUM

(Standard)

PD = Double Acting

PC = Spring Closed

PO = Spring Open

* PS = Spring Return

NICKEL (Optional) STAINLESS STEEL

NPD = Double Acting

NPC = Spring Closed

NPO = Spring Open

* NPS = Spring Return

SPD = Double Acting

SPC = Spring Closed

SPO = Spring Open

* SPS = Spring Return

* 3-Way Valves Only

BALL VALVES

B2F=Brass 2 pcs. Full Port 600 PSI

* B2S=Brass 2 pcs. Std. Port 600 PSI

C2S=Carbon Steel pcs. Std. Port 2,000 PSI

CF75M=Carbon Steel Full Port 7,500 PSI

CF58M=Carbon Steel Full Port 5,880 PSI

CF51M=Carbon Steel Full Port 5,145 PSI

C51M=Carbon Steel Std. Port 5,145 PSI

CF61M=Carbon Steel Full Port 6,175 PSI

S2F=Stainless Steel 2-Piece Full Port 1,000 PSI

S2S=Stainless Steel 2-Piece Std. Port 2,000 PSI

S3F=Stainless Steel 3-Piece Full Port 1,500 PSI

S2FF150=Stainless Steel 2-pcs. Full Port Class 150

S2FF300=Stainless Steel 2-pcs. Full Port Class 300

* Available 3-Way Only



T=3-WAY VALVE

3-WAY PORT

L = L-Port
T = T-Port

LIMIT SWITCH

S2 = IP67/NEMA 4X
S4 = NEMA 4
S7 = NEMA 7

POSITIONER

M3 = 3-15 PSI
M4 = 4-20 Milliamp

VALVE SIZE

2 = 1/4"

3 = 3/8"

4 = 1/2"

6 = 3/4"

8 = 1"

10 = 1 1/4"

12 = 1 1/2"

16 = 2"

20 = 2 1/2"

24 = 3"

32 = 4"

48 = 6"

64 = 8"

NAMUR SOLENOID

CONDUIT

DIN

C1 = 110 VAC

D1 = 110 VAC

C2 = 24 VDC

D2 = 24 VDC

C12 = 12 VDC

D12 = 12 VDC

C22 = 220 VAC

D22 = 220 VAC

C24 = 24 VAC

D24 = 24 VAC

EXPLOSION PROOF

EX1 = 110 VAC

EX2 = 24VDC

EX12 = 12 VDC

EX22 = 220 VAC

HOW TO ORDER A ELECTRIC BALL VALVE ASSEMBLY

E115V / S2 / B2S - 2 T L

ELECTRIC ACTUATOR
 E115V = 115 Volts AC
 E240V = 240 Volts AC
 E012D = 12 Volts DC
 E024D = 24 Volts DC

ACTUATOR OPTIONS
 S2 = Two Auxillary SPDT Adjustable Switches
 SR = Spring Return
 TW = Two Wire Relay
 MB = Motor Break
 HT = Heater Option
 N7 = NEMA 7 Enclosure
 42 = 4-20 Milliamp Positioning Circuit Board
 4F = 4-20 Milliamp Positioning Circuit Board W/Feedback

VALVE SIZE
 2 = 1/4"
 3 = 3/8"
 4 = 1/2"
 6 = 3/4"
 8 = 1"
 10 = 1 1/4"
 12 = 1 1/2"
 16 = 2"
 20 = 2 1/2"
 24 = 3"
 32 = 4"
 48 = 6"
 64 = 8"

T=3-WAY VALVE

3-WAY PORT
 L = L-Port
 T = T-Port

BALL VALVE
 B2F=Brass 2 pcs. Full Port 600 PSI
 * B2S=Brass 2 pcs. Std. Port 600 PSI
 C2S=Carbon Steel pcs. Std. Port 2,000 PSI
 CF75M=Carbon Steel Full Port 7,500 PSI
 CF58M=Carbon Steel Full Port 5,880 PSI
 CF51M=Carbon Steel Full Port 5,145 PSI
 C51M=Carbon Steel Std. Port 5,145 PSI
 CF61M=Carbon Steel Full Port 6,175 PSI
 S2F=Stainless Steel 2-Piece Full Port 1,000 PSI
 S2S=Stainless Steel 2-Piece Std. Port 2,000 PSI
 S3F=Stainless Steel 3-Piece Full Port 1,500 PSI
 S2FF150=Stainless Steel 2-pcs. Full Port Class 150
 S2FF300=Stainless Steel 2-pcs. Full Port Class 300

* Available 3-Way Only



HOW TO ORDER A PNEUMATIC BUTTERFLY VALVE ASSEMBLY

PNEUMATIC ACTUATOR ALUMINUM (Standard)

PD = Double Acting
PC = Spring Closed
PO = Spring Open

NICKEL (Optional) STAINLESS STEEL

NPD = Double Acting SPD = Double Acting
NPC = Spring Closed SPC = Spring Closed
NPO = Spring Open SPO = Spring Open

BUTTERFLY VALVE WAFER

BNEW = EPDM Seats, Nylon Coated Disc
BNVW = Viton Seats, Nylon Coated Disc
BSEW = EPDM Seats, Stainless Steel Disc
BSVW = Viton Seats, Stainless Steel Disc

LUG

BNEL = EPDM Seats, Nylon Coated Disc
BNVL = Viton Seats, Nylon Coated Disc
BSEL = EPDM Seats, Stainless Steel Disc
BSVL = Viton Seats, Stainless Steel Disc

PD / BNEW - 2 C1 S2 M3

VALVE SIZE

2 = 1/4"
3 = 3/8"
4 = 1/2"
6 = 3/4"
8 = 1"
10 = 1 1/4"
12 = 1 1/2"
16 = 2"
20 = 2 1/2"
24 = 3"
32 = 4"
48 = 6"
64 = 8"

NAMUR SOLENOID

CONDUIT	DIN
C1 = 110 VAC	D1 = 110 VAC
C2 = 24 VDC	D2 = 24 VDC
C12 = 12 VDC	D12 = 12 VDC
C22 = 220 VAC	D22 = 220 VAC
C24 = 24 VAC	D24 = 24 VAC

EXPLOSION PROOF

EX1 = 110 VAC
EX2 = 24VDC
EX12 = 12 VDC
EX22 = 220 VAC

LIMIT SWITCH

S2 = IP67/NEMA 4X
S4 = NEMA 4
S7 = NEMA 7

POSITIONER

M3 = 3-15 PSI
M4 = 4-20 Milliamp

BRASS 2-WAY PNEUMATIC ACTUATED BALL VALVES

ALL SPECIFICATIONS AND DIMENSIONS SUBJECT TO CHANGE WITHOUT NOTICE



NPT SIZE	DOUBLE ACTING	SPRING CLOSED	SPRING OPEN
1/4"	PD/B2F-2	PC/B2F-2	PO/B2F-2
3/8"	PD/B2F-3	PC/B2F-3	PO/B2F-3
1/2"	PD/B2F-4	PC/B2F-4	PO/B2F-4
3/4"	PD/B2F-6	PC/B2F-6	PO/B2F-6
1"	PD/B2F-8	PC/B2F-8	PO/B2F-8
1 1/4"	PD/B2F-10	PC/B2F-10	PO/B2F-10
1 1/2"	PD/B2F-12	PC/B2F-12	PO/B2F-12
2"	PD/B2F-16	PC/B2F-16	PO/B2F-16
2 1/2"	PD/B2F-20	PC/B2F-20	PO/B2F-20
3"	PD/B2F-24	PC/B2F-24	PO/B2F-24
4"	PD/B2F-32	PC/B2F-32	PO/B2F-32



VALVE: Specifications

- 2-Way Brass Full Port
- 29 Hg-600 PSI W.O.G. Cold Non-Shock
- Brass Ball & Stem (hard chrome-plated) Standard
- Stainless Steel Ball & Stem (Optional)
- -20° F to 400° F

ACTUATOR: Specifications

- **80 PSI Min.** 120 PSI Max.
- -4° F to 185° F
- Aluminum Construction
- Anti-Blowout Pinion, Nickel-Plated Steel
- Nitrile Seals, Polyamid Friction Guides

BRASS 2-WAY ELECTRIC ACTUATED BALL VALVES

ALL SPECIFICATIONS AND DIMENSIONS SUBJECT TO CHANGE WITHOUT NOTICE



NPT SIZE	MODEL NUMBER
1/4"	*/B2F-2
3/8"	*/B2F-3
1/2"	*/B2F-4
3/4"	*/B2F-6
1"	*/B2F-8
1 1/4"	*/B2F-10
1 1/2"	*/B2F-12
2"	*/B2F-16
2 1/2"	*/B2F-20
3"	*/B2F-24
4"	*/B2F-32

SUFFIX OPTIONS

MB	Motor Break
S2	Two Auxillary SPDT Switches
HT	Heater
SR	Spring Return
N7	NEMA 7 Enclosure
TW	Two Wire Relay
42	4-20 mA Positioning Circuit Board
4F	4-20 mA Positioning Circuit Board W/Feedback

Part# Prefix	Voltages
* E115V	115 VAC
* E024D	24 VDC
* E012D	12 VDC
* E230V	230 VAC

ACTUATOR: Specifications

- Cast Aluminum Housing
- Thermal Overload Protection (Std.)
- Permanent Lubrication
- 0° F - 150° F (Normal Range)
- -40° F - 150° F (w/Heater)

VALVE: Specifications

- 2-Way Brass Full Port
- 29 Hg-600 PSI W.O.G. Cold Non-Shock
- Brass Ball & Stem (hard chrome-plated) Standard
- Stainless Steel Ball & Stem (Optional)
- -20° F to 400° F



BRASS 3-WAY PNEUMATIC ACTUATED BALL VALVES



ALL SPECIFICATIONS AND DIMENSIONS SUBJECT TO CHANGE WITHOUT NOTICE

NPT SIZE	DOUBLE ACTING	SPRING RETURN
1/4"	PD/B2S-2T*	PS/B2S-2T*
3/8"	PD/B2S-3T*	PS/B2S-3T*
1/2"	PD/B2S-4T*	PS/B2S-4T*
3/4"	PD/B2S-6T*	PS/B2S-6T*
1"	PD/B2S-8T*	PS/B2S-8T*
1 1/4"	PD/B2S-10T*	PS/B2S-10T*
1 1/2"	PD/B2S-12T*	PS/B2S-12T*
2"	PD/B2S-16T*	PS/B2S-16T*
2-1/2"	PD/B2S-20T*	PS/B2S-20T*
3"	PD/B2S-24T*	PS/B2S-24T*

"L" or "T" Port Available

- * For T-Port use "T" (i.e. PD/B2S-2TT)
- * For L-Port use "L" (i.e. PD/B2S-2TL)

VALVE: Specifications

- 3-Way Brass Reduced Bore
- 29 Hg-400 PSI W.O.G. Cold Non-Shock
- Brass Ball & Stem (hard chrome-plated) Standard
- Stainless Steel Ball & Stem (Optional)
- -20° F to 400° F

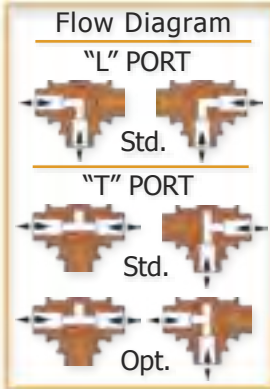

ACTUATOR: Specifications

- **80 PSI Min.** 120 PSI Max.
- -4° F to 185° F
- Aluminum Construction
- Anti-Blowout Pinion, Nickel-Plated Steel
- Nitrile Seals, Polyamid Friction Guides

BRASS 3-WAY ELECTRIC ACTUATED BALL VALVES

ALL SPECIFICATIONS AND DIMENSIONS SUBJECT TO CHANGE WITHOUT NOTICE



ACTUATOR: Specifications

- Cast Aluminum Housing
- Thermal Overload Protection (Std.)
- Permanent Lubrication
- 0° F - 150° F (Normal Range)
- -40° F - 150° F (w/Heater)

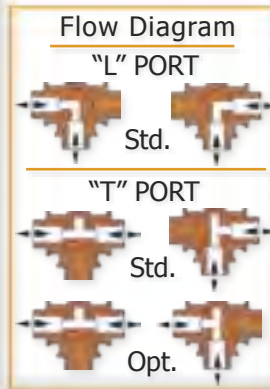

"L" or "T" Port Available

- * For T-Port use "T" (i.e. PD/B2S-2TT)
- * For L-Port use "L" (i.e. PD/B2S-2TL)

NPT SIZE	MODEL NUMBER	SUFFIX	OPTIONS
1/4"	*/B2S-2T*	MB	Motor Break
3/8"	*/B2S-3T*	S2	Two Auxillary SPDT Switches
1/2"	*/B2S-4T*	HT	Heater
3/4"	*/B2S-6T*	SR	Spring Return
1"	*/B2S-8T*	N7	NEMA 7 Enclosure
1 1/4"	*/B2S-10T*	TW	Two Wire Relay
1 1/2"	*/B2S-12T*	42	4-20 mA Positioning Circuit Board
2"	*/B2S-16T*	4F	4-20 mA Positioning Circuit Board
2-1/2"	*/B2S-20T*		W/Feedback
3"	*/B2S-24T*		

Part# Prefix	Voltages
* E115V	115 VAC
* E024D	24 VDC
* E012D	12 VDC
* E230V	230 VAC

VALVE: Specifications

- 3-Way Brass Reduced Bore
- 29 Hg-400 PSI W.O.G. Cold Non-Shock
- Brass Ball & Stem (hard chrome-plated) Standard
- Stainless Steel Ball & Stem (Optional)
- -20° F to 400° F



CARBON STEEL 2-WAY 2,000 PSI PNEUMATIC ACTUATED BALL VALVES

ALL SPECIFICATIONS AND DIMENSIONS SUBJECT TO CHANGE WITHOUT NOTICE



NPT SIZE	DOUBLE ACTING	SPRING CLOSED	SPRING OPEN
1/4"	PD/C2S-2	PC/C2S-2	PO/C2S-2
3/8"	PD/C2S-3	PC/C2S-3	PO/C2S-3
1/2"	PD/C2S-4	PC/C2S-4	PO/C2S-4
3/4"	PD/C2S-6	PC/C2S-6	PO/C2S-6
1"	PD/C2S-8	PC/C2S-8	PO/C2S-8
1 1/4"	PD/C2S-10	PC/C2S-10	PO/C2S-10
1 1/2"	PD/C2S-12	PC/C2S-12	PO/C2S-12
2"	PD/C2S-16	PC/C2S-16	PO/C2S-16
2 1/2"	PD/C2S-20	PC/C2S-20	PO/C2S-20
3"	PD/C2S-24	PC/C2S-24	PO/C2S-24



VALVE: Specifications

- 2-Way Carbon Steel Reduced Bore
- 29 Hg-2000 PSI W.O.G. 1/2" - 1" (1500 psi 1 1/4" - 2") Cold Non-Shock
- Stainless Steel Ball & Stem
- Multi-Fill Seats
- Blowout Proof Stem
- -20° F to 450° F

ACTUATOR: Specifications

- **80 PSI Min.** 120 PSI Max.
- -4° F to 185° F
- Aluminum Construction
- Anti-Blowout Pinion, Nickel-Plated Steel
- Nitrile Seals, Polyamid Friction Guides

CARBON STEEL 2-WAY 2,000 PSI ELECTRIC ACTUATED BALL VALVES

ALL SPECIFICATIONS AND DIMENSIONS SUBJECT TO CHANGE WITHOUT NOTICE



NPT SIZE	MODEL NUMBER
1/4"	*/C2S-2
3/8"	*/C2S-3
1/2"	*/C2S-4
3/4"	*/C2S-6
1"	*/C2S-8
1 1/4"	*/C2S-10
1 1/2"	*/C2S-12
2"	*/C2S-16
2 1/2"	*/C2S-20
3"	*/C2S-24

SUFFIX	OPTIONS
MB	Motor Break
S2	Two Auxillary SPDT Switches
HT	Heater
SR	Spring Return
N7	NEMA 7 Enclosure
TW	Two Wire Relay
42	4-20 mA Positioning Circuit Board
4F	4-20 mA Positioning Circuit Board W/Feedback

Part# Prefix	Voltages
* E115V	115 VAC
* E024D	24 VDC
* E012D	12 VDC
* E230V	230 VAC

ACTUATOR: Specifications

- Cast Aluminum Housing
- Thermal Overload Protection (Std.)
- Permanent Lubrication
- 0° F - 150° F (Normal Range)
- -40° F - 150° F (w/Heater)

VALVE: Specifications

- 2-Way Carbon Steel Reduced Bore
- 29 Hg-2000 PSI W.O.G. 1/2" - 1" (1500 psi 1 1/4" - 2") Cold Non-Shock
- Stainless Steel Ball & Stem
- Multi-Fill Seats
- Blowout Proof Stem
- -20° F to 450° F



CARBON STEEL 2-WAY HIGH PRESSURE PNEUMATIC ACTUATED BALL VALVES



ALL SPECIFICATIONS AND DIMENSIONS SUBJECT TO CHANGE WITHOUT NOTICE

NPT SIZE	DOUBLE ACTING	SPRING CLOSED	SPRING OPEN
1/4"	PD/CF75M-2	PC/CF75M-2	PO/CF75M-2
3/8"	PD/CF75M-3	PC/CF75M-3	PO/CF75M-3
1/2"	PD/CF75M-4	PC/CF75M-4	PO/CF75M-4
3/4"	PD/CF58M-6	PC/CF58M-6	PO/CF58M-6
1"	PD/CF51M-8	PC/CF51M-8	PO/CF51M-8
* 1 1/4"	PD/C51M-10	PC/C51M-10	PO/C51M-10
* 1 1/2"	PD/C51M-12	PC/C51M-12	PO/C51M-12
1 1/4"	PD/CF61M-10	PC/CF61M-10	PO/CF61M-10
1 1/2"	PD/CF61M-12	PC/CF61M-12	PO/CF61M-12
2"	PD/CF61M-16	PC/CF61M-16	PO/CF61M-16

Valve Pressure Ratings: 75=7,500 psi, 58=5,800 psi, 51=5,100 psi, 61=6,100 psi

* Reduced Port (C) 1 1/4" and 1 1/2"

VALVE: Specifications

- 2-Way Carbon Steel Full Port (CF) 1/4" - 2"
Reduced Port (C) Only 1 1/4" and 1 1/2"
- W.O.G. Cold Non-Shock
- Delrin Seats • Viton Seals
- Maximum Temperature 400° F.
- [Consult Factory for Stainless Steel Models](#)



ACTUATOR: Specifications

- **80 PSI Min.** 120 PSI Max.
- -4° F to 185° F
- Aluminum Construction
- Anti-Blowout Pinion, Nickel-Plated Steel
- Nitrile Seals, Polyamid Friction Guides

CARBON STEEL 3-WAY HIGH PRESSURE PNEUMATIC ACTUATED BALL VALVES

ALL SPECIFICATIONS AND DIMENSIONS SUBJECT TO CHANGE WITHOUT NOTICE



Flow Diagram

"L" PORT
Std.



NPT SIZE	DOUBLE ACTING	SPRING RETURN
1/4"	PD/CF58M-2TL	PS/CF58M-2TL
3/8"	PD/CF58M-3TL	PS/CF58M-3TL
1/2"	PD/CF51M-4TL	PS/CF51M-4TL
3/4"	PD/CF51M-6TL	PS/CF51M-6TL
1"	PD/CF51M-8TL	PS/CF51M-8TL
1 1/4"	PD/CF51M-10TL	PS/CF51M-10TL
1 1/2"	PD/CF51M-12TL	PS/CF51M-12TL
2"	PD/CF51M-16TL	PS/CF51M-16TL

Valve Pressure Ratings: 58=5,800 psi, 51=5,100 psi

Consult Factory For Optional Flow Path Configurations

ACTUATOR: Specifications

- **80 PSIG Min.** 120 PSIG Max.
- -4° F to 185° F
- Aluminum Construction
- Anti-Blowout Pinion, Nickel-Plated Steel
- Nitrile Seals, Polyamid Friction Guides

VALVE: Specifications

- 3-Way Carbon Steel Full Port 1/4" - 2"
- W.O.G. Cold Non-Shock
- Delrin Seats • Viton Seals
- Blowout Proof Stem
- Maximum Temperature 400° F.
- [Consult Factory for Stainless Steel Models](#)



STAINLESS STEEL 2-WAY 1,000 PSI PNEUMATIC ACTUATED BALL VALVES

ALL SPECIFICATIONS AND DIMENSIONS SUBJECT TO CHANGE WITHOUT NOTICE



NPT SIZE	DOUBLE ACTING	SPRING CLOSED	SPRING OPEN
1/2"	PD/S2F-4	PC/S2F-4	PO/S2F-4
3/4"	PD/S2F-6	PC/S2F-6	PO/S2F-6
1"	PD/S2F-8	PC/S2F-8	PO/S2F-8
1 1/4"	PD/S2F-10	PC/S2F-10	PO/S2F-10
1 1/2"	PD/S2F-12	PC/S2F-12	PO/S2F-12
2"	PD/S2F-16	PC/S2F-16	PO/S2F-16
2 1/2"	PD/S2F-20	PC/S2F-20	PO/S2F-20
3"	PD/S2F-24	PC/S2F-24	PO/S2F-24



VALVE: Specifications

- 2-Way Stainless Steel Full Port
- 316 Stainless Steel Ball + Stem, CF8M Stainless Steel Body
- 29 Hg-1000 PSI W.O.G. 1/2" - 2" (800 PSI 2 1/2" - 3") Cold Non-Shock
- RTFE Seats
- Blowout Proof Stem
- -20° F to 450° F

ACTUATOR: Specifications

- **80 PSI Min.** 120 PSI Max.
- -4° F to 185° F
- Aluminum Construction
- Anti-Blowout Pinion, Nickel-Plated Steel
- Nitrile Seals, Polyamid Friction Guides

STAINLESS STEEL 2-WAY 1,000 PSI ELECTRIC ACTUATED BALL VALVES

ALL SPECIFICATIONS AND DIMENSIONS SUBJECT TO CHANGE WITHOUT NOTICE



NPT SIZE	MODEL NUMBER
1/2"	*/S2F-4
3/4"	*/S2F-6
1"	*/S2F-8
1 1/4"	*/S2F-10
1 1/2"	*/S2F-12
2"	*/S2F-16
2 1/2"	*/S2F-20
3"	*/S2F-24

SUFFIX OPTIONS

MB	Motor Break
S2	Two Auxillary SPDT Switches
HT	Heater
SR	Spring Return
N7	NEMA 7 Enclosure
TW	Two Wire Relay
42	4-20 mA Positioning Circuit Board
4F	4-20 mA Positioning Circuit Board W/Feedback

ACTUATOR: Specifications

- Cast Aluminum Housing
- Thermal Overload Protection (Std.)
- Permanent Lubrication
- 0° F - 150° F (Normal Range)
- -40° F - 150° F (w/Heater)

VALVE: Specifications

- 2-Way Stainless Steel Full Port
- 316 Stainless Steel Ball + Stem, CF8M Stainless Steel Body
- 29 Hg-1000 PSI W.O.G. 1/2"- 2" (800 PSI 2 1/2" - 3") Cold Non-Shock
- RTFE Seats
- Blowout Proof Stem
- -20° F to 450° F

Part# Prefix	Voltages
* E115V	115 VAC
* E024D	24 VDC
* E012D	12 VDC
* E230V	230 VAC



STAINLESS STEEL 2-WAY 2,000 PSI PNEUMATIC ACTUATED BALL VALVES



ALL SPECIFICATIONS AND DIMENSIONS SUBJECT TO CHANGE WITHOUT NOTICE

NPT SIZE	DOUBLE ACTING	SPRING CLOSED	SPRING OPEN
1/4"	PD/S2S-2	PC/S2S-2	PO/S2S-2
3/8"	PD/S2S-3	PC/S2S-3	PO/S2S-3
1/2"	PD/S2S-4	PC/S2S-4	PO/S2S-4
3/4"	PD/S2S-6	PC/S2S-6	PO/S2S-6
1"	PD/S2S-8	PC/S2S-8	PO/S2S-8
1 1/4"	PD/S2S-10	PC/S2S-10	PO/S2S-10
1 1/2"	PD/S2S-12	PC/S2S-12	PO/S2S-12
2"	PD/S2S-16	PC/S2S-16	PO/S2S-16



VALVE: Specifications

- 2-Way Stainless Steel Reduced Bore
- 316 Stainless Steel Ball + Stem, CF8M Stainless Steel Body
- 29 Hg-2000 PSI W.O.G. 1/4" - 1" (1500 psi 1 1/2" - 2")
Cold Non-Shock
- RTFE Seats
- Blowout Proof Stem
- -20° F to 450° F

ACTUATOR: Specifications

- **80 PSI Min.** 120 PSI Max.
- -4° F to 185° F
- Aluminum Constuction
- Anti-Blowout Pinion, Nickel-Plated Steel
- Nitrile Seals, Polyamid Friction Guides

STAINLESS STEEL 2-WAY 2,000 PSI ELECTRIC ACTUATED BALL VALVES

ALL SPECIFICATIONS AND DIMENSIONS SUBJECT TO CHANGE WITHOUT NOTICE



ACTUATOR: Specifications

- Cast Aluminum Housing
- Thermal Overload Protection (Std.)
- Permanent Lubrication
- 0° F - 150° F (Normal Range)
- -40° F - 150° F (w/Heater)

NPT SIZE	MODEL NUMBER
1/4"	*/S2S-2
3/8"	*/S2S-3
1/2"	*/S2S-4
3/4"	*/S2S-6
1"	*/S2S-8
1 1/4"	*/S2S-10
1 1/2"	*/S2S-12
2"	*/S2S-16

SUFFIX OPTIONS

SUFFIX	OPTIONS
MB	Motor Break
S2	Two Auxillary SPDT Switches
HT	Heater
SR	Spring Return
N7	NEMA 7 Enclosure
TW	Two Wire Relay
42	4-20 mA Positioning Circuit Board
4F	4-20 mA Positioning Circuit Board W/Feedback

Part# Prefix	Voltages
* E115V	115 VAC
* E024D	24 VDC
* E012D	12 VDC
* E230V	230 VAC

VALVE: Specifications

- 2-Way Stainless Steel Reduced Bore
- 316 Stainless Steel Ball + Stem, CF8M Stainless Steel Body
- 29 Hg-2000 PSI W.O.G. 1/4" - 1" (1500 psi 1 1/2" - 2")
Cold Non-Shock
- RTFE Seats
- Blowout Proof Stem
- -20° F to 450° F



STAINLESS STEEL 2-WAY 3,000 PSI PNEUMATIC ACTUATED BALL VALVES

ALL SPECIFICATIONS AND DIMENSIONS SUBJECT TO CHANGE WITHOUT NOTICE



NPT SIZE	DOUBLE ACTING	SPRING CLOSED	SPRING OPEN
1/4"	PD/S2F3M-2	PC/S2F3M-2	PO/S2F3M-2
3/8"	PD/S2F3M-3	PC/S2F3M-3	PO/S2F3M-3
1/2"	PD/S2F3M-4	PC/S2F3M-4	PO/S2F3M-4
3/4"	PD/S2F3M-6	PC/S2F3M-6	PO/S2F3M-6
1"	PD/S2F3M-8	PC/S2F3M-8	PO/S2F3M-8
1 1/4"	PD/S2F3M-10	PC/S2F3M-10	PO/S2F3M-10
1 1/2"	PD/S2F3M-12	PC/S2F3M-12	PO/S2F3M-12
2"	PD/S2S3M-16	PC/S2S3M-16	PO/S2S3M-16



VALVE: Specifications

- 2-Way Stainless Steel (1/4"-1 1/2" Full Port, 2" Reduced Bore)
- 316 Stainless Steel Ball + Stem, CF8M Stainless Steel Body
- 29 Hg-3000 PSI W.O.G. Cold Non-Shock (To 100°F)
- Blowout Proof Stem
- Seats, Delrin Std. (-30°F to 300°F), Peek Optional (-70°F to 550°F) Consult Factory
- Fire Safe to API607-4

ACTUATOR: Specifications

- **80 PSI Min.** 120 PSI Max.
- -4° F to 185° F
- Aluminum Constuction
- Anti-Blowout Pinion, Nickel-Plated Steel
- Nitrile Seals, Polyamid Friction Guides

STAINLESS STEEL 2-WAY 3,000 PSI ELECTRIC ACTUATED BALL VALVES

ALL SPECIFICATIONS AND DIMENSIONS SUBJECT TO CHANGE WITHOUT NOTICE



NPT SIZE	MODEL NUMBER
1/4"	*/S2F3M-2
3/8"	*/S2F3M-3
1/2"	*/S2F3M-4
3/4"	*/S2F3M-6
1"	*/S2F3M-8
1 1/4"	*/S2F3M-10
1 1/2"	*/S2F3M-12
2"	*/S2S3M-16

SUFFIX	OPTIONS
MB	Motor Break
S2	Two Auxillary SPDT Switches
HT	Heater
SR	Spring Return
N7	NEMA 7 Enclosure
TW	Two Wire Relay
42	4-20 mA Positioning Circuit Board
4F	4-20 mA Positioning Circuit Board W/Feedback

Part# Prefix	Voltages
* E115V	115 VAC
* E024D	24 VDC
* E012D	12 VDC
* E230V	230 VAC

ACTUATOR: Specifications

- Cast Aluminum Housing
- Thermal Overload Protection (Std.)
- Permanent Lubrication
- 0° F - 150° F (Normal Range)
- -40° F - 150° F (w/Heater)

VALVE: Specifications

- 2-Way Stainless Steel (1/4"-1 1/2" Full Port, 2" Reduced Bore)
- 316 Stainless Steel Ball + Stem, CF8M Stainless Steel Body
- 29 Hg-3000 PSI W.O.G. Cold Non-Shock (To 100°F)
- Blowout Proof Stem
- Seats, Delrin Std. (-30°F to 300°F), Peek Optional (-70°F to 550°F) Consult Factory
- Fire Safe to API607-4



STAINLESS STEEL 2-WAY 3-PIECE PNEUMATIC ACTUATED BALL VALVES



ALL SPECIFICATIONS AND DIMENSIONS SUBJECT TO CHANGE WITHOUT NOTICE

NPT SIZE	DOUBLE ACTING	SPRING CLOSED	SPRING OPEN
1/4"	PD/S3F-2	PC/S3F-2	PO/S3F-2
3/8"	PD/S3F-3	PC/S3F-3	PO/S3F-3
1/2"	PD/S3F-4	PC/S3F-4	PO/S3F-4
3/4"	PD/S3F-6	PC/S3F-6	PO/S3F-6
1"	PD/S3F-8	PC/S3F-8	PO/S3F-8
1 1/4"	PD/S3F-10	PC/S3F-10	PO/S3F-10
1 1/2"	PD/S3F-12	PC/S3F-12	PO/S3F-12
2"	PD/S3F-16	PC/S3F-16	PO/S3F-16
2 1/2"	PD/S3F-20	PC/S3F-20	PO/S3F-20
3"	PD/S3F-24	PC/S3F-24	PO/S3F-24
4"	PD/S3F-32	PC/S3F-32	PO/S3F-32



VALVE: Specifications

- 2-Way Stainless Steel 3-Piece Full Port
- 316 Stainless Steel Ball + Stem, CF8M Stainless Steel Body
- 29 Hg-1500 PSI W.O.G. 1/4" - 1" (1250 PSI 1 1/4" - 1 1/2") (1000 PSI 2") (800 PSI 2 1/2"-3") Cold Non-Shock
- RTFE Seats
- -20° F to 450° F

ACTUATOR: Specifications

- **80 PSI Min.** 120 PSI Max.
- -4° F to 185° F
- Aluminum Construction
- Anti-Blowout Pinion, Nickel-Plated Steel
- Nitrile Seals, Polyamid Friction Guides

STAINLESS STEEL 2-WAY 3-PIECE ELECTRIC ACTUATED BALL VALVES

ALL SPECIFICATIONS AND DIMENSIONS SUBJECT TO CHANGE WITHOUT NOTICE



NPT SIZE	MODEL NUMBER
1/4"	*/S3F-2
3/8"	*/S3F-3
1/2"	*/S3F-4
3/4"	*/S3F-6
1"	*/S3F-8
1 1/4"	*/S3F-10
1 1/2"	*/S3F-12
2"	*/S3F-16
2 1/2"	*/S3F-20
3"	*/S3F-24
4"	*/S3F-32

SUFFIX OPTIONS

MB	Motor Break
S2	Two Auxillary SPDT Switches
HT	Heater
SR	Spring Return
N7	NEMA 7 Enclosure
TW	Two Wire Relay
42	4-20 mA Positioning Circuit Board
4F	4-20 mA Positioning Circuit Board W/Feedback

Part# Prefix	Voltages
* E115V	115 VAC
* E024D	24 VDC
* E012D	12 VDC
* E230V	230 VAC

ACTUATOR: Specifications

- Cast Aluminum Housing
- Thermal Overload Protection (Std.)
- Permanent Lubrication
- 0° F - 150° F (Normal Range)
- -40° F - 150° F (w/Heater)

VALVE: Specifications

- 2-Way Stainless Steel 3-Piece Full Port
- 316 Stainless Steel Ball + Stem, CF8M Stainless Steel Body
- 29 Hg-1500 PSI W.O.G. 1/4" - 1" (1250 PSI 1 1/4" - 1 1/2") (1000 PSI 2") (800 PSI 2 1/2"-3") Cold Non-Shock
- RTFE Seats
- -20° F to 450° F



STAINLESS STEEL 2-WAY 3-PIECE PNEUMATIC ACTUATED BALL VALVES NPT

ALL SPECIFICATIONS AND DIMENSIONS SUBJECT TO CHANGE WITHOUT NOTICE



NPT SIZE	DOUBLE ACTING	SPRING CLOSED	SPRING OPEN
1/4"	PD/S3F22-2	PC/S3F22-2	PO/S3F22-2
3/8"	PD/S3F22-3	PC/S3F22-3	PO/S3F22-3
1/2"	PD/S3F22-4	PC/S3F22-4	PO/S3F22-4
3/4"	PD/S3F22-6	PC/S3F22-6	PO/S3F22-6
1"	PD/S3F22-8	PC/S3F22-8	PO/S3F22-8
1 1/4"	PD/S3F22-10	PC/S3F22-10	PO/S3F22-10
1 1/2"	PD/S3F22-12	PC/S3F22-12	PO/S3F22-12
2"	PD/S3F22-16	PC/S3F22-16	PO/S3F22-16



VALVE: Specifications

- 2-Way Stainless Steel Full Port
- 29 Hg-2250 PSI W.O.G. Cold Non-Shock
- Body + Ball CF8M SS, Live Loaded Stem 17-4PH SS
- Seat Options, See Pg.35
- Fire Safe To API607-4, (with graphite packing)
- Temp. Rating determined by Seat Material, See Pg.35

ACTUATOR: Specifications

- **80 PSI Min.** 120 PSI Max.
- -4° F to 185° F
- Aluminum Constuction
- Anti-Blowout Pinion, Nickel-Plated Steel
- Nitrile Seals, Polyamid Friction Guides

STAINLESS STEEL 2-WAY 3-PIECE ELECTRIC ACTUATED BALL VALVES NPT

ALL SPECIFICATIONS AND DIMENSIONS SUBJECT TO CHANGE WITHOUT NOTICE

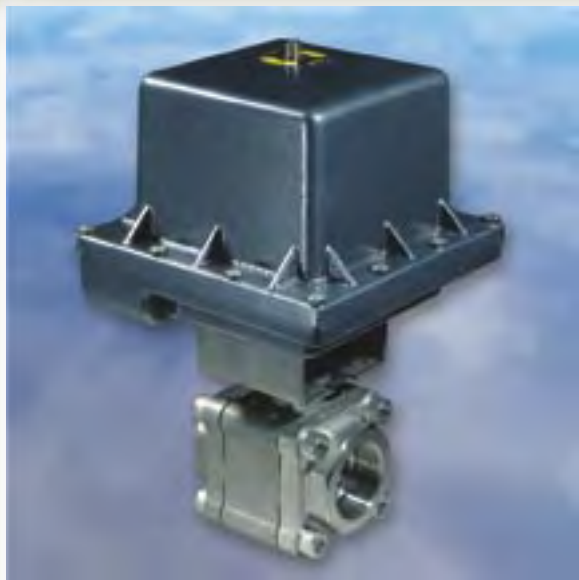

NPT SIZE	MODEL NUMBER
1/4"	*/S3F22-2
3/8"	*/S3F22-3
1/2"	*/S3F22-4
3/4"	*/S3F22-6
1"	*/S3F22-8
1 1/4"	*/S3F22-10
1 1/2"	*/S3F22-12
2"	*/S3F22-16

SUFFIX	OPTIONS
MB	Motor Break
S2	Two Auxillary SPDT Switches
HT	Heater
SR	Spring Return
N7	NEMA 7 Enclosure
TW	Two Wire Relay
42	4-20 mA Positioning Circuit Board
4F	4-20 mA Positioning Circuit Board W/Feedback

Part# Prefix	Voltages
* E115V	115 VAC
* E024D	24 VDC
* E012D	12 VDC
* E230V	230 VAC

ACTUATOR: Specifications

- Cast Aluminum Housing
- Thermal Overload Protection (Std.)
- Permanent Lubrication
- 0° F - 150° F (Normal Range)
- -40° F - 150° F (w/Heater)

VALVE: Specifications

- 2-Way Stainless Steel Full Port
- 29 Hg-2250 PSI W.O.G. Cold Non-Shock
- Body + Ball CF8M SS, Live Loaded Stem 17-4PH SS
- Seat Options, See Pg.35
- Fire Safe To API607-4, (with graphite packing)
- Temp. Rating determined by Seat Material, See Pg.35



STAINLESS STEEL 2-WAY 3-PIECE PNEUMATIC ACTUATED BALL VALVES SOCKET WELD



ALL SPECIFICATIONS AND DIMENSIONS SUBJECT TO CHANGE WITHOUT NOTICE

NPT SIZE	DOUBLE ACTING	SPRING CLOSED	SPRING OPEN
1/4"	PD/S3F22-2W	PC/S3F22-2W	PO/S3F22-2W
3/8"	PD/S3F22-3W	PC/S3F22-3W	PO/S3F22-3W
1/2"	PD/S3F22-4W	PC/S3F22-4W	PO/S3F22-4W
3/4"	PD/S3F22-6W	PC/S3F22-6W	PO/S3F22-6W
1"	PD/S3F22-8W	PC/S3F22-8W	PO/S3F22-8W
1 1/4"	PD/S3F22-10W	PC/S3F22-10W	PO/S3F22-10W
1 1/2"	PD/S3F22-12W	PC/S3F22-12W	PO/S3F22-12W
2"	PD/S3F22-16W	PC/S3F22-16W	PO/S3F22-16W

~ Weld-In Place Design ~

VALVE: Specifications

- 2-Way Stainless Steel Full Port
- 29 Hg-2250 PSI W.O.G. Cold Non-Shock
- Body + Ball CF8M SS, Live Loaded Stem 17-4PH SS
- Seat Options, See Pg.35
- Fire Safe To API607-4, (with graphite packing)
- Temp. Rating determined by Seat Material, See Pg.35



ACTUATOR: Specifications

- **80 PSI Min.** 120 PSI Max.
- -4° F to 185° F
- Aluminum Constuction
- Anti-Blowout Pinion, Nickel-Plated Steel
- Nitrile Seals, Polyamid Friction Guides

STAINLESS STEEL 2-WAY 3-PIECE ELECTRIC ACTUATED BALL VALVES SOCKET WELD

ALL SPECIFICATIONS AND DIMENSIONS SUBJECT TO CHANGE WITHOUT NOTICE

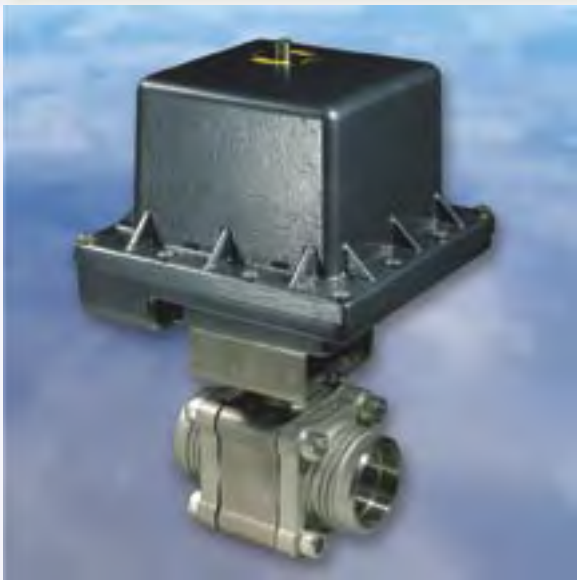

NPT SIZE	MODEL NUMBER
1/4"	*/S3F22-2W
3/8"	*/S3F22-3W
1/2"	*/S3F22-4W
3/4"	*/S3F22-6W
1"	*/S3F22-8W
1 1/4"	*/S3F22-10W
1 1/2"	*/S3F22-12W
2"	*/S3F22-16W

~ Weld-In Place Design ~

SUFFIX OPTIONS

SUFFIX	OPTIONS
MB	Motor Break
S2	Two Auxillary SPDT Switches
HT	Heater
SR	Spring Return
N7	NEMA 7 Enclosure
TW	Two Wire Relay
42	4-20 mA Positioning Circuit Board
4F	4-20 mA Positioning Circuit Board W/Feedback

ACTUATOR: Specifications

- Cast Aluminum Housing
- Thermal Overload Protection (Std.)
- Permanent Lubrication
- 0° F - 150° F (Normal Range)
- -40° F - 150° F (w/Heater)

VALVE: Specifications

- 2-Way Stainless Steel Full Port
- 29 Hg-2250 PSI W.O.G. Cold Non-Shock
- Body + Ball CF8M SS, Live Loaded Stem 17-4PH SS
- Seat Options, See Pg.35
- Fire Safe To API607-4, (with graphite packing)
- Temp. Rating determined by Seat Material, See Pg.35

Part# Prefix	Voltages
* E115V	115 VAC
* E024D	24 VDC
* E012D	12 VDC
* E230V	230 VAC



STAINLESS STEEL 2-WAY ANSI 150 FLANGED PNEUMATIC ACTUATED BALL VALVES

ALL SPECIFICATIONS AND DIMENSIONS SUBJECT TO CHANGE WITHOUT NOTICE



SIZE	DOUBLE ACTING	SPRING CLOSED	SPRING OPEN
1/2"	PD/S2FF150-4	PC/S2FF150-4	PO/S2FF150-4
3/4"	PD/S2FF150-6	PC/S2FF150-6	PO/S2FF150-6
1"	PD/S2FF150-8	PC/S2FF150-8	PO/S2FF150-8
1-1/2"	PD/S2FF150-12	PC/S2FF150-12	PO/S2FF150-12
2"	PD/S2FF150-16	PC/S2FF150-16	PO/S2FF150-16
3"	PD/S2FF150-24	PC/S2FF150-24	PO/S2FF150-24
4"	PD/S2FF150-32	PC/S2FF150-32	PO/S2FF150-32
6"	PD/S2FF150-48	PC/S2FF150-48	PO/S2FF150-48



VALVE: Specifications

- 2-Way Stainless Steel ANSI Class 150 Full Port
- 316 Stainless Steel Ball + Stem, CF8M Stainless Steel Body
- 29 Hg - 285 PSI W.O.G. Cold Non-Shock
- Blowout Proof Stem
- Adjustable Vee Style Stem Packing
- RTFE Seats
- -20° F to 450° F

ACTUATOR: Specifications

- **80 PSI Min.** 120 PSI Max.
- -4° F to 185° F
- Aluminum Construction
- Anti-Blowout Pinion, Nickel-Plated Steel
- Nitrile Seals, Polyamid Friction Guides

STAINLESS STEEL 2-WAY ANSI 150 FLANGED ELECTRIC ACTUATED BALL VALVES

ALL SPECIFICATIONS AND DIMENSIONS SUBJECT TO CHANGE WITHOUT NOTICE



SIZE	MODEL NUMBER
1/2"	*/S2FF150-4
3/4"	*/S2FF150-6
1"	*/S2FF150-8
1 1/2"	*/S2FF150-12
2"	*/S2FF150-16
3"	*/S2FF150-24
4"	*/S2FF150-32
6"	*/S2FF150-48

SUFFIX	OPTIONS
MB	Motor Break
S2	Two Auxillary SPDT Switches
HT	Heater
SR	Spring Return
N7	NEMA 7 Enclosure
TW	Two Wire Relay
42	4-20 mA Positioning Circuit Board
4F	4-20 mA Positioning Circuit Board W/Feedback

Part# Prefix	Voltages
* E115V	115 VAC
* E024D	24 VDC
* E012D	12 VDC
* E230V	230 VAC

ACTUATOR: Specifications

- Cast Aluminum Housing
- Thermal Overload Protection (Std.)
- Permanent Lubrication
- 0° F - 150° F (Normal Range)
- -40° F - 150° F (w/Heater)

VALVE: Specifications

- 2-Way Stainless Steel ANSI Class 150 Full Port
- 316 Stainless Steel Ball + Stem, CF8M Stainless Steel Body
- 29 Hg - 285 PSI W.O.G. Cold Non-Shock
- Blowout Proof Stem
- Adjustable Vee Style Stem Packing
- RTFE Seats
- -20° F to 450° F



STAINLESS STEEL 2-WAY ANSI 300 FLANGED PNEUMATIC ACTUATED BALL VALVES

ALL SPECIFICATIONS AND DIMENSIONS SUBJECT TO CHANGE WITHOUT NOTICE



SIZE	DOUBLE ACTING	SPRING CLOSED	SPRING OPEN
1/2"	PD/S2FF300-4	PC/S2FF300-4	PO/S2FF300-4
3/4"	PD/S2FF300-6	PC/S2FF300-6	PO/S2FF300-6
1"	PD/S2FF300-8	PC/S2FF300-8	PO/S2FF300-8
1 1/2"	PD/S2FF300-12	PC/S2FF300-12	PO/S2FF300-12
2"	PD/S2FF300-16	PC/S2FF300-16	PO/S2FF300-16
3"	PD/S2FF300-24	PC/S2FF300-24	PO/S2FF300-24
4"	PD/S2FF300-32	PC/S2FF300-32	PO/S2FF300-32
6"	PD/S2FF300-48	PC/S2FF300-48	PO/S2FF300-48
8"	PD/S2FF300-64	PC/S2FF300-64	PO/S2FF300-64



VALVE: Specifications

- 2-Way Stainless Steel ANSI Class 300 Full Port
- 316 Stainless Steel Ball + Stem, CF8M Stainless Steel Body
- 29 Hg - 700 PSI W.O.G. Cold Non-Shock
- Blowout Proof Stem
- Adjustable Vee Style Stem Packing
- RTFE Seats
- -20° F to 450° F

ACTUATOR: Specifications

- **80 PSI Min.** 120 PSI Max.
- -4° F to 185° F
- Aluminum Construction
- Anti-Blowout Pinion, Nickel-Plated Steel
- Nitrile Seals, Polyamid Friction Guides

STAINLESS STEEL 2-WAY ANSI 300 FLANGED ELECTRIC ACTUATED BALL VALVES

ALL SPECIFICATIONS AND DIMENSIONS SUBJECT TO CHANGE WITHOUT NOTICE



SIZE	MODEL NUMBER
1/2"	*/S2FF300-4
3/4"	*/S2FF300-6
1"	*/S2FF300-8
1 1/2"	*/S2FF300-12
2"	*/S2FF300-16
3"	*/S2FF300-24
4"	*/S2FF300-32
6"	*/S2FF300-48
8"	*/S2FF300-64

SUFFIX OPTIONS

MB	Motor Break
S2	Two Auxillary SPDT Switches
HT	Heater
SR	Spring Return
N7	NEMA 7 Enclosure
TW	Two Wire Relay
42	4-20 mA Positioning Circuit Board
4F	4-20 mA Positioning Circuit Board W/Feedback

Part# Prefix	Voltages
* E115V	115 VAC
* E024D	24 VDC
* E012D	12 VDC
* E230V	230 VAC

ACTUATOR: Specifications

- Cast Aluminum Housing
- Thermal Overload Protection (Std.)
- Permanent Lubrication
- 0° F - 150° F (Normal Range)
- -40° F - 150° F (w/Heater)

VALVE: Specifications

- 2-Way Stainless Steel ANSI Class 300 Full Port
- 316 Stainless Steel Ball + Stem, CF8M Stainless Steel Body
- 29 Hg - 700 PSI W.O.G. Cold Non-Shock
- Blowout Proof Stem
- Adjustable Vee Style Stem Packing
- RTFE Seats
- -20° F to 450° F



STAINLESS STEEL 2-WAY SANITARY TRI-CLAMP PNEUMATIC ACTUATED BALL VALVES

ALL SPECIFICATIONS AND DIMENSIONS SUBJECT TO CHANGE WITHOUT NOTICE



SIZE	DOUBLE ACTING	SPRING CLOSED	SPRING OPEN
1/2"	PD/STC-4	PC/STC-4	PO/STC-4
3/4"	PD/STC-6	PC/STC-6	PO/STC-6
1"	PD/STC-8	PC/STC-8	PO/STC-8
1 1/2"	PD/STC-12	PC/STC-12	PO/STC-12
2"	PD/STC-16	PC/STC-16	PO/STC-16
2 1/2"	PD/STC-20	PC/STC-20	PO/STC-20
3"	PD/STC-24	PC/STC-24	PO/STC-24
4"	PD/STC-32	PC/STC-32	PO/STC-32



VALVE: Specifications

- 2-Way Stainless Steel Full Port
- 29 Hg - 1000 PSI W.O.G. Cold Non-Shock
- 316 Stainless Steel Ball + Stem, CF8M Stainless Steel Body
- Blowout Proof Stem
- Cavity Filled Teflon Seats (standard seats optional)
- 0° F to 400° F
- Complies with FDA, USDA, and 3A

ACTUATOR: Specifications

- **80 PSI Min.** 120 PSI Max.
- -4° F to 185° F
- Aluminum Construction
- Anti-Blowout Pinion, Nickel-Plated Steel
- Nitrile Seals, Polyamid Friction Guides

STAINLESS STEEL 2-WAY SANITARY TRI-CLAMP ELECTRIC ACTUATED BALL VALVES

ALL SPECIFICATIONS AND DIMENSIONS SUBJECT TO CHANGE WITHOUT NOTICE



SIZE	MODEL NUMBER
1/2"	*/STC-4
3/4"	*/STC-6
1"	*/STC-8
1 1/2"	*/STC-12
2"	*/STC-16
2 1/2"	*/STC-20
3"	*/STC-24
4"	*/STC-32

SUFFIX OPTIONS

MB	Motor Break
S2	Two Auxillary SPDT Switches
HT	Heater
SR	Spring Return
N7	NEMA 7 Enclosure
TW	Two Wire Relay
42	4-20 mA Positioning Circuit Board
4F	4-20 mA Positioning Circuit Board W/Feedback

Part# Prefix	Voltages
* E115V	115 VAC
* E024D	24 VDC
* E012D	12 VDC
* E230V	230 VAC

ACTUATOR: Specifications

- Cast Aluminum Housing
- Thermal Overload Protection (Std.)
- Permanent Lubrication
- 0° F - 150° F (Normal Range)
- -40° F - 150° F (w/Heater)

VALVE: Specifications

- 2-Way Stainless Steel Full Port
- 29 Hg - 1000 PSI W.O.G. Cold Non-Shock
- 316 Stainless Steel Ball + Stem, CF8M Stainless Steel Body
- Blowout Proof Stem
- Cavity Filled Teflon Seats (standard seats optional)
- 0° F to 400° F
- Complies with FDA, USDA, and 3A



STAINLESS STEEL 3-WAY 1,000 PSI PNEUMATIC ACTUATED BALL VALVES

ALL SPECIFICATIONS AND DIMENSIONS SUBJECT TO CHANGE WITHOUT NOTICE



NPT SIZE	DOUBLE ACTING	SPRING RETURN
1/4"	PD/S2S-2T*	PS/S2S-2T*
3/8"	PD/S2S-3T*	PS/S2S-3T*
1/2"	PD/S2S-4T*	PS/S2S-4T*
3/4"	PD/S2S-6T*	PS/S2S-6T*
1"	PD/S2S-8T*	PS/S2S-8T*
1 1/4"	PD/S2S-10T*	PS/S2S-10T*
1 1/2"	PD/S2S-12T*	PS/S2S-12T*
2"	PD/S2S-16T*	PS/S2S-16T*

"L" or "T" Port Available

- * For T-Port use "T" (i.e. PD/S2S-2TT)
- * For L-Port use "L" (i.e. PD/S2S-2TL)

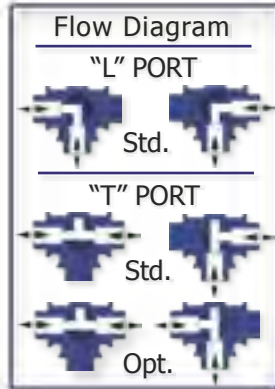

VALVE: Specifications

- 3-Way Stainless Steel Reduced Bore
- 29 Hg-1000 PSI W.O.G. 1/4" - 1", (800 PSI 1 1/4" - 2") Cold Non-Shock
- 316 Stainless Steel Ball + Stem, CF8M Stainless Steel Body
- Teflon Seats
- Blowout Proof Stem
- -20° F to 450° F

ACTUATOR: Specifications

- **80 PSI Min.** 120 PSI Max.
- -4° F to 185° F
- Aluminum Construction
- Anti-Blowout Pinion, Nickel-Plated Steel
- Nitrile Seals, Polyamid Friction Guides

STAINLESS STEEL 3-WAY 1,000 PSI ELECTRIC ACTUATED BALL VALVES

ALL SPECIFICATIONS AND DIMENSIONS SUBJECT TO CHANGE WITHOUT NOTICE

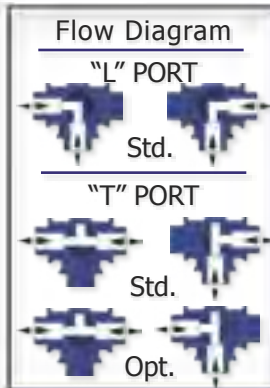

NPT SIZE	MODEL NUMBER
1/4"	*/S2S-2T*
3/8"	*/S2S-3T*
1/2"	*/S2S-4T*
3/4"	*/S2S-6T*
1"	*/S2S-8T*
1 1/4"	*/S2S-10T*
1 1/2"	*/S2S-12T*
2"	*/S2S-16T*

SUFFIX	OPTIONS
MB	Motor Break
S2	Two Auxillary SPDT Switches
HT	Heater
SR	Spring Return
N7	NEMA 7 Enclosure
TW	Two Wire Relay
42	4-20 mA Positioning Circuit Board
4F	4-20 mA Positioning Circuit Board W/Feedback

"L" or "T" Port Available

- * For T-Port use "T" (i.e. PD/S2S-2TT)
- * For L-Port use "L" (i.e. PD/S2S-2TL)

Part# Prefix	Voltages
* E115V	115 VAC
* E024D	24 VDC
* E012D	12 VDC
* E230V	230 VAC

ACTUATOR: Specifications

- Cast Aluminum Housing
- Thermal Overload Protection (Std.)
- Permanent Lubrication
- 0° F - 150° F (Normal Range)
- -40° F - 150° F (w/Heater)

VALVE: Specifications

- 3-Way Stainless Steel Reduced Bore
- 29 Hg-1000 PSI W.O.G. 1/4" - 1", (800 PSI 1 1/4" - 2") Cold Non-Shock
- 316 Stainless Steel Ball + Stem, CF8M Stainless Steel Body
- Teflon Seats
- Blowout Proof Stem
- -20° F to 450° F



WAFER STYLE PNEUMATIC ACTUATED BUTTERFLY VALVES

ALL SPECIFICATIONS AND DIMENSIONS SUBJECT TO CHANGE WITHOUT NOTICE

Cast Iron Body with Nylon Coated Disc

SIZE	DOUBLE ACTING	SPRING CLOSED	SPRING OPEN
1 1/2"	PD/BN*W-1.5	PC/BN*W-1.5	PO/BN*W-1.5
2"	PD/BN*W-2	PC/BN*W-2	PO/BN*W-2
2 1/2"	PD/BN*W-2.5	PC/BN*W-2.5	PO/BN*W-2.5
3"	PD/BN*W-3	PC/BN*W-3	PO/BN*W-3
4"	PD/BN*W-4	PC/BN*W-4	PO/BN*W-4
5"	PD/BN*W-5	PC/BN*W-5	PO/BN*W-5
6"	PD/BN*W-6	PC/BN*W-6	PO/BN*W-6
8"	PD/BN*W-8	PC/BN*W-8	PO/BN*W-8
10"	PD/BN*W-10	PC/BN*W-10	PO/BN*W-10
12"	PD/BN*W-12	PC/BN*W-12	PO/BN*W-12
14"	PD/BN*W-14	PC/BN*W-14	PO/BN*W-14
16"	PD/BN*W-16	PC/BN*W-16	PO/BN*W-16
18"	PD/BN*W-18	PC/BN*W-18	PO/BN*W-18
20"	PD/BN*W-20	PC/BN*W-20	PO/BN*W-20
24"	PD/BN*W-24	PC/BN*W-24	PO/BN*W-24



* OPTIONAL SEATS AVAILABLE

- * FOR EPDM Seats use "E" (i.e. PD/BNEW) Temperature Range -4° - 248°F
- * FOR Viton® Seats use "V" (i.e. PD/BNVW) Temperature Range 0°F - 399°F

~ CONSULT FACTORY FOR ELECTRIC ACTUATED BUTTERFLY VALVES ~

Cast Iron Body with 316 Stainless Disc

SIZE	DOUBLE ACTING	SPRING CLOSED	SPRING OPEN
1 1/2"	PD/BS*W-1.5	PC/BS*W-1.5	PO/BS*W-1.5
2"	PD/BS*W-2	PC/BS*W-2	PO/BS*W-2
2 1/2"	PD/BS*W-2.5	PC/BS*W-2.5	PO/BS*W-2.5
3"	PD/BS*W-3	PC/BS*W-3	PO/BS*W-3
4"	PD/BS*W-4	PC/BS*W-4	PO/BS*W-4
5"	PD/BS*W-5	PC/BS*W-5	PO/BS*W-5
6"	PD/BS*W-6	PC/BS*W-6	PO/BS*W-6
8"	PD/BS*W-8	PC/BS*W-8	PO/BS*W-8
10"	PD/BS*W-10	PC/BS*W-10	PO/BS*W-10
12"	PD/BS*W-12	PC/BS*W-12	PO/BS*W-12
14"	PD/BS*W-14	PC/BS*W-14	PO/BS*W-14
16"	PD/BS*W-16	PC/BS*W-16	PO/BS*W-16
18"	PD/BS*W-18	PC/BS*W-18	PO/BS*W-18
20"	PD/BS*W-20	PC/BS*W-20	PO/BS*W-20
24"	PD/BS*W-24	PC/BS*W-24	PO/BS*W-24

ACTUATOR: Specifications

- 80 PSI Min. 120 PSI Max.
- -4° F to 185° F
- Aluminum Constuction
- Anti-Blowout Pinion, Nickel-Plated Steel
- Nitrile Seals, Polyamid Friction Guides

VALVE: Specifications

- ANSI 125/150 Class
- Cast Iron Body, Resin Coated Baked Finish
- Nylon Coated Ductile Iron Disk or CF8M Stainless Steel Disc
- 1 1/2" - 12" 230 PSI, 14" - 24" 150 PSI



® Viton is a registered trademark of E.I.Dupont de Nemours & Co.

UNIVERSAL COMPONENTS, INC. Phone: 803/324-5176 Fax: 803/324-2640

LUG STYLE PNEUMATIC ACTUATED BUTTERFLY VALVES

ALL SPECIFICATIONS AND DIMENSIONS SUBJECT TO CHANGE WITHOUT NOTICE

Ductile Iron Body with Nylon Coated Disc

SIZE	DOUBLE ACTING	SPRING CLOSED	SPRING OPEN
1 1/2"	PD/BN*L-1.5	PC/BN*L-1.5	PO/BN*L-1.5
2"	PD/BN*L-2	PC/BN*L-2	PO/BN*L-2
2 1/2"	PD/BN*L-2.5	PC/BN*L-2.5	PO/BN*L-2.5
3"	PD/BN*L-3	PC/BN*L-3	PO/BN*L-3
4"	PD/BN*L-4	PC/BN*L-4	PO/BN*L-4
5"	PD/BN*L-5	PC/BN*L-5	PO/BN*L-5
6"	PD/BN*L-6	PC/BN*L-6	PO/BN*L-6
8"	PD/BN*L-8	PC/BN*L-8	PO/BN*L-8
10"	PD/BN*L-10	PC/BN*L-10	PO/BN*L-10
12"	PD/BN*L-12	PC/BN*L-12	PO/BN*L-12
14"	PD/BN*L-14	PC/BN*L-14	PO/BN*L-14
16"	PD/BN*L-16	PC/BN*L-16	PO/BN*L-16
18"	PD/BN*L-18	PC/BN*L-18	PO/BN*L-18
20"	PD/BN*L-20	PC/BN*L-20	PO/BN*L-20
24"	PD/BN*L-24	PC/BN*L-24	PO/BN*L-24



* OPTIONAL SEATS AVAILABLE

- * FOR EPDM Seats use "E" (i.e. PD/BNEL) Temperature Range -4° - 248°F
- * FOR Viton® Seats use "V" (i.e. PD/BNVL) Temperature Range 0°F - 399°F

~ CONSULT FACTORY FOR ELECTRIC ACTUATED BUTTERFLY VALVES ~

Ductile Iron Body with 316 Stainless Disc

SIZE	DOUBLE ACTING	SPRING CLOSED	SPRING OPEN
1 1/2"	PD/BS*L-1.5	PC/BS*L-1.5	PO/BS*L-1.5
2"	PD/BS*L-2	PC/BS*L-2	PO/BS*L-2
2 1/2"	PD/BS*L-2.5	PC/BS*L-2.5	PO/BS*L-2.5
3"	PD/BS*L-3	PC/BS*L-3	PO/BS*L-3
4"	PD/BS*L-4	PC/BS*L-4	PO/BS*L-4
5"	PD/BS*L-5	PC/BS*L-5	PO/BS*L-5
6"	PD/BS*L-6	PC/BS*L-6	PO/BS*L-6
8"	PD/BS*L-8	PC/BS*L-8	PO/BS*L-8
10"	PD/BS*L-10	PC/BS*L-10	PO/BS*L-10
12"	PD/BS*L-12	PC/BS*L-12	PO/BS*L-12
14"	PD/BS*L-14	PC/BS*L-14	PO/BS*L-14
16"	PD/BS*L-16	PC/BS*L-16	PO/BS*L-16
18"	PD/BS*L-18	PC/BS*L-18	PO/BS*L-18
20"	PD/BS*L-20	PC/BS*L-20	PO/BS*L-20
24"	PD/BS*L-24	PC/BS*L-24	PO/BS*L-24

ACTUATOR: Specifications

- **80 PSI Min.** 120 PSI Max.
- -4° F to 185° F
- Aluminum Constuction
- Anti-Blowout Pinion, Nickel-Plated Steel
- Nitrile Seals, Polyamid Friction Guides

VALVE: Specifications

- ANSI 125/150 Class
- Ductile Iron Body, Resin Coated Baked Finish
- Nylon Coated or Stainless Steel Disc
- 1 1/2" - 12" 230 PSI, 14" - 24" 150 PSI

NAMUR 4 - WAY SINGLE SOLENOID CONDUIT CONNECTION

ALL SPECIFICATIONS ARE SUBJECT TO CHANGE WITHOUT NOTICE

MODEL	VOLTAGE	INRUSH
N4S-C1	110 VAC	62 mA
N4S-C2	24 VDC	108 mA
N4S-C12	12 VDC	204 mA
N4S-C22	220 VAC	31 mA
N4S-C24	24 VAC	Consult Factory

VALVE OPERATING DATA

Cv= 1.68
 Pressure Range= 20-120 PSI
 Ports= 1/4" NPT
 Duty Cycle= 100% Continuous
 Power Consumption= 2.5 watts

Molded IP65

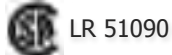

Temperature Range

35 - 130 Degrees Fahrenheit (Normal)
 0 - 130 Degrees Fahrenheit (With dry Media)

NAMUR 4 - WAY SINGLE SOLENOID DIN CONNECTION

ALL SPECIFICATIONS ARE SUBJECT TO CHANGE WITHOUT NOTICE



Temperature Range

35 - 130 Degrees Fahrenheit (Normal)
 0 - 130 Degrees Fahrenheit (With dry Media)

MODEL	VOLTAGE	INRUSH
N4S-D1	110 VAC	62 mA
N4S-D2	24 VDC	108 mA
N4S-D12	12 VDC	204 mA
N4S-D22	220 VAC	31 mA
N4S-D24	24 VAC	Consult Factory

VALVE OPERATING DATA

Cv= 1.68
 Pressure Range= 20-120 PSI
 Ports= 1/4" NPT
 Duty Cycle= 100% Continuous
 Power Consumption= 2.5 watts

Molded IP65

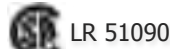

NAMUR 4 - WAY SINGLE SOLENOID EXPLOSION PROOF

ALL SPECIFICATIONS ARE SUBJECT TO CHANGE WITHOUT NOTICE

MODEL	VOLTAGE	INRUSH
N4S-EX1	110 VAC	74 mA
N4S-EX2	24 VDC	190 mA
N4S-EX12	12 VDC	372 mA
N4S-EX22	220 VAC	36 mA

VALVE OPERATING DATA

Cv= 1.68
 Pressure Range= 20-120 PSI
 Ports= 1/4" NPT
 Duty Cycle= 100% Continuous
 Power Consumption= 4.6 watts

Molded IP65 202633x

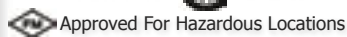

Approved For Hazardous Locations
 CL.I; Zone 1, Ex mII T4; AEx mII
 CL.I; Div.1; GR. A,B,C,D
 CL.II; GR. E,F,G - CL.III
 T4 Ta = -20°C...+60°C
 100% Duty Cycle



Temperature Range

35 - 130 Degrees Fahrenheit (Normal)
 0 - 130 Degrees Fahrenheit (With dry Media)



NAMUR 4 - WAY DOUBLE SOLENOID CONDUIT CONNECTION

ALL SPECIFICATIONS ARE SUBJECT TO CHANGE WITHOUT NOTICE



Temperature Range

35 - 130 Degrees Fahrenheit (Normal)
0 - 130 Degrees Fahrenheit (With dry Media)

MODEL	VOLTAGE	INRUSH
N4D-C1	110 VAC	62 mA
N4D-C2	24 VDC	108 mA
N4D-C12	12 VDC	204 mA
N4D-C22	220 VAC	31 mA
N4D-C24	24 VAC	Consult Factory

VALVE OPERATING DATA

Cv= 1.68
Pressure Range= 20-120 PSI
Ports= 1/4" NPT
Duty Cycle= 100% Continuous
Power Consumption= 2.5 watts

Molded IP65

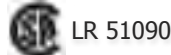

NAMUR 4 - WAY DOUBLE SOLENOID DIN CONNECTION

ALL SPECIFICATIONS ARE SUBJECT TO CHANGE WITHOUT NOTICE

MODEL	VOLTAGE	INRUSH
N4D-D1	110 VAC	62 mA
N4D-D2	24 VDC	108 mA
N4D-D12	12 VDC	204 mA
N4D-D22	220 VAC	31 mA
N4D-D24	24 VAC	Consult Factory

VALVE OPERATING DATA

Cv= 1.68
Pressure Range= 20-120 PSI
Ports= 1/4" NPT
Duty Cycle= 100% Continuous
Power Consumption= 2.5 watts

Molded IP65

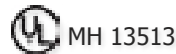

Temperature Range

35 - 130 Degrees Fahrenheit (Normal)
0 - 130 Degrees Fahrenheit (With dry Media)

NAMUR 4 - WAY DOUBLE SOLENOID EXPLOSION PROOF

ALL SPECIFICATIONS ARE SUBJECT TO CHANGE WITHOUT NOTICE



Temperature Range

35 - 130 Degrees Fahrenheit (Normal)
0 - 130 Degrees Fahrenheit (With dry Media)

MODEL	VOLTAGE	INRUSH
N4D-EX1	110 VAC	74 mA
N4D-EX2	24 VDC	190 mA
N4D-EX12	12 VDC	372 mA
N4D-EX22	220 VAC	36 mA

VALVE OPERATING DATA

Cv= 1.68
Pressure Range= 20-120 PSI
Ports= 1/4" NPT
Duty Cycle= 100% Continuous
Power Consumption= 4.6 watts

Molded IP65 202633x

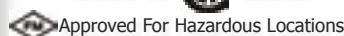

CL.I; Zone 1, Ex mII T4; AEx mII
CL.I; Div.1; GR. A,B,C,D
CL.II; GR. E,FG - CL.III
T4 Ta = -20°C...+60°C
100% Duty Cycle



NAMUR 3 - WAY SINGLE SOLENOID EXPLOSION PROOF



Temperature Range:
 35 - 130 Degrees Fahrenheit (Normal)
 0 - 130 Degrees Fahrenheit (With dry Media)

ALL SPECIFICATIONS ARE SUBJECT TO CHANGE WITHOUT NOTICE

MODEL	VOLTAGE	INRUSH
N3S- EX1	110 VAC	74 mA
N3S- EX2	24 VDC	190 mA
N3S- EX12	12 VDC	372 mA
N3S- EX22	220 VAC	36 mA

Molded IP65  202633x
 Approved For Hazardous Locations
 CL.I; Zone 1, Ex mII T4; AEx mII
 CL.I; Div.1; GR. A,B,C,D
 CL.II; GR. E,F,G - CL.III
 T4 Ta = -20°C...+60°C
 100% Duty Cycle

VALVE OPERATING DATA:

Cv= 1.68
 Pressure Range= 20-120 PSI
 Ports= 1/4" NPT
 Duty Cycle= 100% Continuous
 Power Consumption= 4.6 watts

NAMUR 3 - WAY SINGLE SOLENOID CONDUIT CONNECTION

ALL SPECIFICATIONS ARE SUBJECT TO CHANGE WITHOUT NOTICE

MODEL	VOLTAGE	INRUSH
N3S- C1	110 VAC	62 mA
N3S- C2	24 VDC	108 mA
N3S- C12	12 VDC	204 mA
N3S- C22	220 VAC	31 mA
N3S- C24	24 VAC	Consult Factory

VALVE OPERATING DATA:

Cv= 1.68
 Pressure Range= 20-120 PSI
 Ports= 1/4" NPT
 Duty Cycle= 100% Continuous
 Power Consumption= 2.5 watts

Molded IP65
 LR 51090
 MH 13513



Temperature Range:

35 - 130 Degrees Fahrenheit (Normal)
 0 - 130 Degrees Fahrenheit (With dry Media)

NAMUR 3 - WAY SINGLE SOLENOID DIN CONNECTION





Temperature Range:
 35 - 130 Degrees Fahrenheit (Normal)
 0 - 130 Degrees Fahrenheit (With dry Media)

ALL SPECIFICATIONS ARE SUBJECT TO CHANGE WITHOUT NOTICE

MODEL	VOLTAGE	INRUSH
N3S- D1	110 VAC	62 mA
N3S- D2	24 VDC	108 mA
N3S- D12	12 VDC	204 mA
N3S- D22	220 VAC	31 mA
N3S- D24	24 VAC	Consult Factory

VALVE OPERATING DATA:

Molded IP65
 LR 51090
 MH 13513
 Cv= 1.68
 Pressure Range= 20-120 PSI
 Ports= 1/4" NPT
 Duty Cycle= 100% Continuous
 Power Consumption= 2.5 watts

NEMA 4 and NEMA 7 LIMIT SWITCH INDICATORS



S2 FEATURES

- **Body Material** is auto extinguish reinforced technopolymer VO
- **Cover Material** is poly-carbonate (UV resistant and auto extinguish)
- **Shaft Material** is reinforced techno-polymer
- **Screws** are stainless steel

S2 SPECIFICATIONS

- **Working Temperature** is -15° C to +80° C
- **Cable Entry** is PG 13.5 • IP 67/NEMA 4x
- **2 Electromechanical SPDT limit switches** max 5A 250 VAC/3A 24 VDC

S4 and S7 FEATURES

- **Clear Ektar Cover** offers excellent chemical resistance and strength
- **Environmentally Sealed Indicator** on the top prevents fogging or entry of contaminants
- **Indicator is 100% Adjustable** to any valve or actuator
- **Internal Switches and Terminal Block are Labeled** for easier installation
- **Visual Valve Position Indicator Available** for multi-port valves, adjustable to match physical location of the valve
- **"Flat Cover" Version** available without indicator
- **Optional Thermoplastic** quick-mount bracket for Namur actuators
- **Available** with wide variety of switches and sensors for advanced control systems



S4 and S7 SPECIFICATIONS

Model: S4 Black/Yellow Indicator - Aluminum Housing
 Low Profile NAMUR Shaft - Bronze Bearings
 NEMA 4,4x (2) 1/2" NPT Inputs - 2 SPDT 15A switches

Model: S7 Black/Yellow Indicator - Aluminum Housing
Explosion-Proof Low Profile NAMUR Shaft - Bronze Bearings
 NEMA 4,4x,7,9 (2) 3/4" NPT Inputs - 2 SPDT 15A switches

Mechanical Switches: UL/CSA for Class 1, Division 1, Groups C+D; Class II, Division 1, Groups E,F+G
TTL Switches: UL/CSA for Class 1, Division 1 groups C+D; Class II, Division 1, Groups E,F+G; Class 1, Division 2, Group



ALL SPECIFICATIONS AND DIMENSIONS SUBJECT TO CHANGE WITHOUT NOTICE

S 4 - I Y B 1 3

MODEL
 S4 = NEMA 4,4x
 S7 = NEMA 7,9

COVER
 I = With Indicator
 F = Flat Cover

INDICATOR
 N = No Indicator
 Y = Black/Yellow
 1 = 180° T Port
 3 = 120°
 G = Green/White
 R = Red/White
 B = Blue/White
 A = Green/Red
 C = Red/Green
 P = 0-100%
 S = 4-Way Path
 O,T,F = 3-Way Path O,T,F

BEARING
 B = Bronze
 S = Stainless Steel

SHAFT
 3 = NAMUR 303 SS
 6 = NAMUR 316 SS

SWITCH TYPE (2 Switches)
 1 = Cherry 15A SPDT Mechanical
 2 = Tungsten TTL 3A SPDT Non-Contact
 3 = Prism Gold Plated 1A SPDT Mechanical
 4 = ITW 10A DPDT Mechanical
 T = Rhodium TTL 1A SPDT Non-Contact
 B = Bifurcated TTL SPDT Non-Contact
 8 = P&F NJ2-V3 NAMUR Inductive Sensor
 A = NEO-X No Sensor

NEMA 4 3-15 PSI AND 4-20mA VARIABLE POSITIONERS



Features:

Pneumatic (3-15 PSI) and Electro-Pneumatic (4-20 mA) rotary positioners are control devices which provide stability in difficult environments.

Stainless Steel Gauges Standard, Optional Limit switches and 4 - 20mA Feedback.

Rugged Aluminum Housing with a triple corrosion resistant interior and exterior coating

Reduced Bleed Pilot Valve reduces air consumption by more than 50%

No Spool Valves are used for air delivery, improving resistance to dirty plant air

Precision Calibration with simple SPAN and ZERO adjustments

Precision Zero - Hysteresis coupling System for NAMUR actuators provides superior accuracy and repeatability by eliminating "slop"

Unique Magnetic 4 - 20mA I/P automatically compensates for supply pressure, atmospheric pressure and ambient temperature changes, and is unaffected by EMF. The vibration resistant design has no resonance effects from 5 - 200 Hz

Each Positioner Performance Tested - test results included with each positioner

ALL SPECIFICATIONS AND DIMENSIONS SUBJECT TO CHANGE WITHOUT NOTICE

Specifications:	3-15 PSI Pneumatic	4-20 mA Electro-Pneumatic
Input Signal:	* 3 - 15 PSI	4 - 20mA @ 24VDC Split Range Standard
Impedance:	N/A	250 +/- 15 Ohms
Stroke Range:	0 - 90°	0 - 90°
Supply Range:	20 to 100 PSI	20 to 100 PSI
Air Delivery:	7 SCFM	7 SCFM
Air Consumption:	0.26 SCFM	0.15 SCFM
Operating Temperature:	- 4° to +158° F	- 4° to +158° F
Linearity:	+/- 1%	+/- 1%
Hysteresis:	1% Max.	1% Max.
Sensitivity:	+/- 0.5%	+/- 0.5%
Repeatability:	+/- 0.5%	+/- 0.5%
Pneumatic Connections:	1/8" NPT Gauge Port, 1/4" NPT Supply I/O (Both Models)	
Enclosure:	Designed to NEMA 4, 4x	Designed to NEMA 4, 4x
Enclosure Weight:	Approx. 4.8 lbs.	Approx. 6.5 lbs.

* Split Range Available

M 4 - S 1 N F

MODEL

M3 = Pneumatic
M4 = Electro - Pneumatic

ELECTRICAL RATING

S = Standard/None
E = Ex md IIT6
I = Intrinsically Safe

PILOT VALVE

1 = Standard Oriface
2 = Small Oriface
3 = Extra-Small Oriface

INDICATION

F = Flat Dial
D = Dome

POSITION FEEDBACK

N = None
T = 4 - 20mA
S = 2 SPDT Limit Switches
P = 2 PNP Sensors
I = 2 IS Sensors



BGF SERIES BRASS 600 PSI WOG BALL VALVES

ALL SPECIFICATIONS AND DIMENSIONS SUBJECT TO CHANGE WITHOUT NOTICE



BGF & BGF-LL SERIES

- Brass Full Port
- 29"Hg - 600 PSIG WOG, Cold Non-Shock
- Blowout-Proof Stem, with Adjustable Packing
- PTFE Seats, 150 PSIG WSP
- Second O-Ring Stem Seal
- Temperature: -20°F to 366°F

NPT SIZE	PART #	PART # W/LOCK
1/4"	BGF-2	BGF-2LL
3/8"	BGF-3	BGF-3LL
1/2"	BGF-4	BGF-4LL
3/4"	BGF-6	BGF-6LL
1"	BGF-8	BGF-8LL
1 1/4"	BGF-10	BGF-10LL
1 1/2"	BGF-12	BGF-12LL
2"	BGF-16	BGF-16LL
2 1/2"	BGF-20	----
3"	BGF-24	----
4"	BGF-32	----

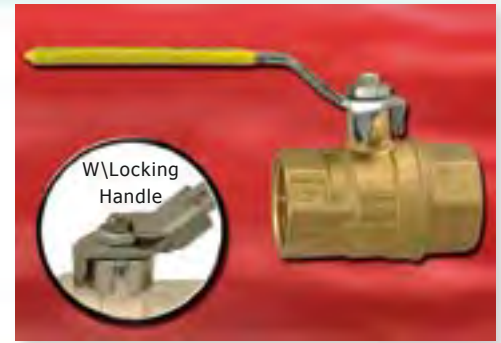

BGF-NP SERIES NICKEL PLATED BRASS 600 PSI WOG BALL VALVES

BGF-NP & BGF-NP-LL SERIES

- Brass Full Port, Nickel Plated
- 29"Hg - 600 PSIG WOG, Cold Non-Shock
- Blowout-Proof Stem, with Adjustable Packing
- PTFE Seats, 150 PSIG WSP
- Second O-Ring Stem Seal
- Temperature: -20°F to 366°F

NPT SIZE	PART #	PART # W/LOCK
1/4"	BGF-2NP	BGF-2NPLL
3/8"	BGF-3NP	BGF-3NPLL
1/2"	BGF-4NP	BGF-4NPLL
3/4"	BGF-6NP	BGF-6NPLL
1"	BGF-8NP	BGF-8NPLL
1 1/4"	BGF-10NP	BGF-10NPLL
1 1/2"	BGF-12NP	BGF-12NPLL
2"	BGF-16NP	BGF-16NPLL
2 1/2"	BGF-20NP	----
3"	BGF-24NP	----
4"	BGF-32NP	----



BGF-M SERIES BRASS 600 PSI WOG MALE/FEMALE BALL VALVES

BGF-M & BGF-M-LL SERIES

- Brass Full Port
- 29"Hg - 600 PSIG WOG, Cold Non-Shock
- Blowout-Proof Stem, with Adjustable Packing
- PTFE Seats, 150 PSIG WSP
- Second O-Ring Stem Seal
- Temperature: -20°F to 366°F

NPT SIZE	PART #	PART # W/LOCK
1/4"	BGF-2M	BGF-2MLL
3/8"	BGF-3M	BGF-3MLL
1/2"	BGF-4M	BGF-4MLL
3/4"	BGF-6M	BGF-6MLL
1"	BGF-8M	BGF-8MLL

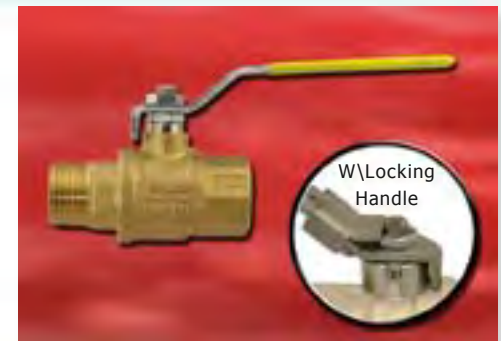

BGF-TEE SERIES BRASS 600 PSI WOG TEE HANDLE BALL VALVES

BGF-TEE & BGF-MTEE SERIES

- Brass Full Port
- 29"Hg - 600 PSIG WOG, Cold Non-Shock
- Blowout-Proof Stem, with Adjustable Packing
- PTFE Seats, 150 PSIG WSP
- Second O-Ring Stem Seal
- Temperature: -20°F to 366°F

NPT SIZE	PART # Female/female	PART # Male/Female
1/4"	BGF-2TEE	BGF-2MTEE
3/8"	BGF-3TEE	BGF-3MTEE
1/2"	BGF-4TEE	BGF-4MTEE
3/4"	BGF-6TEE	BGF-6MTEE
1"	BGF-8TEE	BGF-8MTEE



NB SERIES NICKEL PLATED BRASS 450 PSI WOG MINI BALL VALVES

ALL SPECIFICATIONS AND DIMENSIONS SUBJECT TO CHANGE WITHOUT NOTICE



NB & NB-M SERIES

- 29"Hg - 450 PSIG WOG, Cold Non-Shock
- Blowout-Proof Stem
- PTFE Seats
- Chrome Plated Brass Ball
- Second O-Ring Stem Seal
- Temperature: -20°F to 200°F

NPT SIZE	PART # Female/female	PART # Male/Female
1/8"	NB-1	NB-M1
1/4"	NB-2	NB-M2
3/8"	NB-3	NB-M3
1/2"	NB-4	NB-M4
3/4"	NB-6	NB-M6



B2 SERIES BRASS 1500 PSI WOG PANEL MOUNT BALL VALVES

B2 SERIES

- Brass 2-Way Ball Valve
- 29"Hg - 1500 PSIG WOG, Cold Non-Shock
- Blowout-Proof Stem
- Teflon® Ball Seats
- Nickel Plated Brass Ball
- Double O-Ring Stem Seals (Primary Viton; Secondary-Aflas)
- Temperature: 10°F to 350°F

NPT SIZE	PART #
1/8"	B2-F1
1/4"	B2-F2
3/8"	B2-F3
1/2"	B2-F4



B290 SERIES BRASS 1500 PSI WOG 90° PANEL MOUNT BALL VALVES

B290 SERIES

- Brass 2-Way Ball Valve
- 29"Hg - 1500 PSIG WOG, Cold Non-Shock
- Blowout-Proof Stem
- Teflon® Ball Seats
- Nickel Plated Brass Ball
- Double O-Ring Stem Seals (Primary Viton; Secondary-Aflas)
- Temperature: 10°F to 350°F

NPT SIZE	PART #
1/8"	B290-F1
1/4"	B290-F2
3/8"	B290-F3
1/2"	B290-F4



B3 SERIES BRASS 1500 PSI WOG 3-WAY PANEL MOUNT BALL VALVES

B3 SERIES

- Brass 3-Way Ball Valve
- L-Port 180° Rotation
- 29"Hg - 1500 PSIG WOG, Cold Non-Shock
- Blowout-Proof Stem
- Teflon® Ball Seats
- Nickel Plated Brass Ball
- Double O-Ring Stem Seals (Primary Viton; Secondary-Aflas)
- Temperature: 10°F to 350°F

NPT SIZE	PART #
1/8"	B3-F1
1/4"	B3-F2
3/8"	B3-F3
1/2"	B3-F4



BHM-T SERIES BRONZE 3-WAY L-PORT BALL VALVES

ALL SPECIFICATIONS AND DIMENSIONS SUBJECT TO CHANGE WITHOUT NOTICE



BHM-T SERIES

- 29"Hg - 400 PSIG WOG, Cold Non-Shock
- Blowout-Proof Stem, with Adjustable Packing
- Chrome Plated Brass Ball
- RTFE Seats
- 150 PSIG Saturated Steam
- Temperature: -35°F to 400°F



NPT SIZE	PART #	PART # W/LOCK
1/4"	BHM-2T	BHM-2TLL
3/8"	BHM-3T	BHM-3TLL
1/2"	BHM-4T	BHM-4TLL
3/4"	BHM-6T	BHM-6TLL
1"	BHM-8T	BHM-8TLL
1-1/4"	BHM-10T	BHM-10TLL
1-1/2"	BHM-12T	BHM-12TLL
2"	BHM-16T	BHM-16TLL

Flow Diagram "L" Port



B2S-TL SERIES BRASS 3-WAY L-PORT & T-PORT BALL VALVES

B2S-TL + TT SERIES

- 29"Hg - 400 PSIG WOG, Cold Non-Shock
- Blowout-Proof Stem, with Adjustable Packing
- Chrome Plated Brass Ball & Stem
- RTFE Seats
- 100 PSIG Saturated Steam
- Temperature: -20°F to 400°F
- Direct Mount for Activation (See Actuated Valves pg.7)



NPT SIZE	L-PORT	T-PORT
1/4"	B2S-2TL	B2S-2TT
3/8"	B2S-3TL	B2S-3TT
1/2"	B2S-4TL	B2S-4TT
3/4"	B2S-6TL	B2S-6TT
1"	B2S-8TL	B2S-8TT
1-1/4"	B2S-10TL	B2S-10TT
1-1/2"	B2S-12TL	B2S-12TT
2"	B2S-16TL	B2S-16TT
2-1/2"	B2S-20TL	B2S-20TT
3"	B2S-24TL	B2S-24TT

Flow Diagram

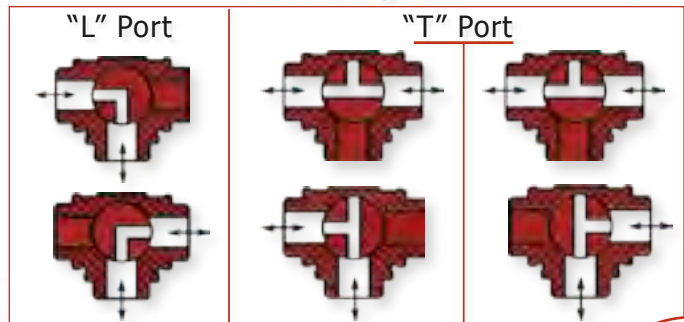

C3F SERIES CARBON STEEL 3-PIECE 1000 PSI BALL VALVES

ALL SPECIFICATIONS AND DIMENSIONS SUBJECT TO CHANGE WITHOUT NOTICE



C3F SERIES

- 29"Hg - 1000 PSIG WOG, Cold Non-Shock
- 150 PSIG Saturated Steam
- Stainless Steel Ball and Stem
- Blowout Proof Stem, W/Adjustable Packing
- PTFE Seats
- Temperature -35°F to 366°F
- 3-Piece, Full Port
- Butt Weld Suffix "B"; Socket Weld Suffix "W"

NPT SIZE	NPT PART #	SOCKET WELD PART #
1/4"	C3F-2	C3F-2W
3/8"	C3F-3	C3F-3W
1/2"	C3F-4	C3F-4W
3/4"	C3F-6	C3F-6W
1"	C3F-8	C3F-8W
1-1/4"	C3F-10	C3F-10W
1-1/2"	C3F-12	C3F-12W
2"	C3F-16	C3F-16W
2-1/2"	C3F-20	C3F-20W
3"	C3F-24	C3F-24W
4"	C3F-32	C3F-32W



CG SERIES CARBON STEEL 2000 PSI BALL VALVES

CG + CG-LL SERIES

- 29"Hg - 2000 PSIG WOG, Cold Non-Shock (1/4"-1")
- 29"Hg - 1500 PSIG WOG, Cold Non-Shock (1-1/4"-2")
- Blowout-Proof Stem, with Adjustable Packing
- Chrome Plated Steel Ball
- RTFE Seats
- 150 PSIG Saturated Steam
- Temperature: -20°F to 425°F

NPT SIZE	PART #	PART # W/LOCK
1/4"	CG-2	CG-2LL
3/8"	CG-3	CG-3LL
1/2"	CG-4	CG-4LL
3/4"	CG-6	CG-6LL
1"	CG-8	CG-8LL
1-1/4"	CG-10	CG-10LL
1-1/2"	CG-12	CG-12LL
2"	CG-16	CG-16LL



CFH SERIES CARBON STEEL 3000 PSI BALL VALVES

CFH & CFH-LL SERIES

- 29" Hg-3000 PSIG WOG, Cold Non-Shock
- 150 PSIG Saturated Steam
- Blowout-Proof Stem, W/Adjustable Packing
- Temperature -20°F to 425°F
- RTFE Seats & Seals
- Chrome Plated Steel Ball
- Full Port

NPT SIZE	NPT PART #	PART # W/LOCK	SAE SIZE	SAE PART #	PART # W/LOCK
1/4"	CFH-2	CFH-2LP	7/16"-20	CFH-S4	CFH-S4LL
3/8"	CFH-3	CFH-3LP	9/16"-18	CFH-S6	CFH-S6LL
1/2"	CFH-4	CFH-4LP	3/4"-16	CFH-S8	CFH-S8LL
3/4"	CFH-6	CFH-6LP	1-1/16"-12	CFH-S12	CFH-S12LL
1"	CFH-8	CFH-8LP	1-5/16"-12	CFH-S16	CFH-S16LL
1-1/4"	CFH-10	CFH-10LP	1-5/8"-12	CFH-S20	CFH-S20LL
1-1/2"	CFH-12	CFH-12LP	1-7/8"-12	CFH-S24	CFH-S24LL
2"	CFH-16	CFH-16LP	2-1/2"-12	CFH-S32	CFH-S32LL



CF58M SERIES CARBON 2-WAY HIGH PRESSURE BALL VALVES

ALL SPECIFICATIONS AND DIMENSIONS SUBJECT TO CHANGE WITHOUT NOTICE



CF58M & CF58M-LP SERIES

- Blowout-Proof Stem
- Delrin Seats & Viton Seals
- Temp. 14°F to 140°F (1/4"-1")
- Temp. 14°F to 176°F (1-1/4"-2")
- Full Port, (C51M Models Reduced Port)
- Option: Suffix "LP" for Locking Plate
- All Working Pressures are Cold Non-Shock

NPT SIZE	NPT PART #	SAE SIZE	SAE PART #	PORT	WORKING PRESSURE
1/4"	CF75M-2	7/16"-20	CF75M-S4	Full Port	7500 PSI
3/8"	CF75M-3	9/16"-18	CF75M-S6	Full Port	7500 PSI
1/2"	CF75M-4	3/4"-16	CF75M-S8	Full Port	7500 PSI
3/4"	CF58M-6	1-1/16"-12	CF58M-S12	Full Port	5880 PSI
1"	CF51M-8	1-5/16"-12	CF51M-S16	Full Port	5145 PSI
1-1/4"	C51M-10	1-5/8"-12	C51M-S20	Reduced Port	5145 PSI
1-1/2"	C51M-12	1-7/8"-12	C51M-S24	Reduced Port	5145 PSI
1-1/4"	CF61M-10	1-5/8"-12	CF61M-S20	Full Port	6175 PSI
1-1/2"	CF61M-12	1-7/8"-12	CF61M-S24	Full Port	6175 PSI
2"	CF61M-16	2-1/2"-12	CF61M-S32	Full Port	6175 PSI



CF58M-TL SERIES CARBON 3-WAY HIGH PRESSURE BALL VALVES

CF58M-TL & CF58M-TL-LP SERIES

- Blowout-Proof Stem
- Delrin Seats & Viton Seals
- Temp. 14°F to 140°F (1/4"-1")
- Temp. 14°F to 176°F (1-1/4"-2")
- "L" Port
- Option: Suffix "LP" for Locking Plate
- All Working Pressures are Cold Non-Shock

NPT SIZE	NPT PART #	SAE SIZE	SAE PART #	WORKING PRESSURE
1/4"	CF58M-2TL	7/16"-20	CF58M-S4TL	5880 PSI
3/8"	CF58M-3TL	9/16"-18	CF58M-S6TL	5880 PSI
1/2"	CF51M-4TL	3/4"-16	CF51M-S8TL	5145 PSI
3/4"	CF51M-6TL	1-1/16"-12	CF51M-S12TL	5145 PSI
1"	CF51M-8TL	1-5/16"-12	CF51M-S16TL	5145 PSI
1-1/4"	CF51M-10TL	1-5/8"-12	CF51M-S20TL	5145 PSI
1-1/2"	CF51M-12TL	1-7/8"-12	CF51M-S24TL	5145 PSI
2"	CF51M-16TL	2-1/2"-12	CF51M-S32TL	5145 PSI



C11M SERIES CARBON 2-WAY ULTRA HIGH PRESSURE BALL VALVES

C11M + C11M-LL SERIES

- Blowout Proof Stem
- Delrin Seats
- Viton Seals
- Temperature 14°F to 140°F
- Option: Suffix "LP" for Locking Plate
- All Working Pressure are Cold Non-Shock

NPT SIZE	NPT PART #	PART # W/LOCK	WORKING PRESSURE
1/4"	C11M-2	C11M-2LP	11,760 PSI
3/8"	C11M-3	C11M-3LP	11,760 PSI
1/2"	C11M-4	C11M-4LP	11,760 PSI
3/4"	C11M-6	C11M-6LP	11,760 PSI
1"	C11M-8	C11M-8LP	11,760 PSI



SGF SERIES STAINLESS 2-WAY FULL PORT 1000 PSI BALL VALVES

ALL SPECIFICATIONS AND DIMENSIONS SUBJECT TO CHANGE WITHOUT NOTICE



~ Available Only with Locking Device ~

SGF SERIES

- Stainless Steel, Full Port
- 29"Hg - 1000 PSIG WOG, Cold Non-Shock
- CF8M Body, 316 Stainless Steel Ball and Stem
- Blowout Proof Stem
- RTFE Seats
- Temperature -20°F to 450°F

NPT SIZE	PART #
1/4"	SGF-2
3/8"	SGF-3
1/2"	SGF-4
3/4"	SGF-6
1"	SGF-8
1-1/4"	SGF-10
1-1/2"	SGF-12
2"	SGF-16
2-1/2"	SGF-20
3"	SGF-24
4"	SGF-32



S2S SERIES STAINLESS 2-WAY STD. PORT 2000 PSI BALL VALVES

~ Available Only with Locking Device ~

S2S SERIES

- Stainless Steel, Standard Port
- 29"Hg - 2000 PSIG WOG, Cold Non-Shock (1/4"-1") (1500 PSI 1-1/4"-2")
- CF8M Body, 316 Stainless Steel Ball and Stem
- Blowout Proof Stem
- RTFE Seats
- Temperature -20°F to 450°F

NPT SIZE	PART #
1/4"	S2S-2
3/8"	S2S-3
1/2"	S2S-4
3/4"	S2S-6
1"	S2S-8
1-1/4"	S2S-10
1-1/2"	S2S-12
2"	S2S-16



S3F SERIES STAINLESS 3-PIECE 2-WAY 1000 PSI NPT BALL VALVES

~ Available Only with Locking Device ~

S3F SERIES

- Stainless Steel, Full Port
- 29"Hg - 1000 PSIG WOG, Cold Non-Shock (1/4"-2") (800 PSI 2-1/2"-3")
- CF8M Body, 316 Stainless Steel Ball and Stem
- RTFE Seats
- Temperature -20°F to 450°F

NPT SIZE	PART #
1/4"	S3F-2
3/8"	S3F-3
1/2"	S3F-4
3/4"	S3F-6
1"	S3F-8
1-1/4"	S3F-10
1-1/2"	S3F-12
2"	S3F-16
2-1/2"	S3F-20
3"	S3F-24



S3F-W SERIES STAINLESS 3-PIECE 2-WAY 1000 PSI SOCKET WELD

~ Available Only with Locking Device ~

S3F SERIES

- Stainless Steel, Full Port
- 29"Hg - 1000 PSIG WOG, Cold Non-Shock (1/4"-2") (800 PSI 2-1/2"-3")
- CF8M Body, 316 Stainless Steel Ball and Stem
- RTFE Seats
- Temperature -20°F to 450°F

NPT SIZE	PART #
1/4"	S3F-2W
3/8"	S3F-3W
1/2"	S3F-4W
3/4"	S3F-6W
1"	S3F-8W
1-1/4"	S3F-10W
1-1/2"	S3F-12W
2"	S3F-16W
2-1/2"	S3F-20W
3"	S3F-24W



SF58M SERIES STAINLESS HIGH PRESSURE 2-WAY BALL VALVES

ALL SPECIFICATIONS AND DIMENSIONS SUBJECT TO CHANGE WITHOUT NOTICE



SF58M SERIES

- Blowout Proof Stem
- Delrin seats
- Viton Seats
- Temperature -22°F to 176°F
- 316 Stainless Steel
- Options; Suffix "LP" for Locking Plate
- All Working Pressures are Cold Non-Shock

NPT SIZE	NPT PART #	SAE SIZE	SAE PART #	PORT	WORKING PRESSURE
1/4"	SF58M-2	7/16"-20	SF58M-S4	Full Port	5880 PSI
3/8"	SF58M-3	9/16"-18	SF58M-S6	Full Port	5880 PSI
1/2"	SF58M-4	3/4"-16	SF58M-S8	Full Port	5880 PSI
3/4"	SF58M-6	1-1/16"-12	SF58M-S12	Full Port	5880 PSI
1"	SF58M-8	1-5/16"-12	SF58M-S16	Full Port	5880 PSI
1-1/4"	S51M-10	1-5/8"-12	S51M-S20	Reduced Port	5145 PSI
1-1/2"	S51M-12	1-7/8"-12	S51M-S24	Reduced Port	5145 PSI
1-1/4"	SF51M-10	1-5/8"-12	SF51M-S20	Full Port	5145 PSI
1-1/2"	SF51M-12	1-7/8"-12	SF51M-S24	Full Port	5145 PSI
2"	SF51M-16	2-1/2"-12	SF51M-S32	Full Port	5145 PSI



IB2F SERIES NICKEL PLATED BRASS COMPACT ACTUATED VALVES

IB2F VALVE ONLY

NPT SIZE	DOUBLE ACTING	SPRING CLOSED	Cv
3/8"	PD/IB2F-3	PC/IB2F-3	8
1/2"	PD/IB2F-4	PC/IB2F-4	10
3/4"	PD/IB2F-6	PC/IB2F-6	13
1"	PD/IB2F-8	PC/IB2F-8	17
1-1/4"	PD/IB2F-10	PC/IB2F-10	28
1-1/2"	PD/IB2F-12	PC/IB2F-12	57
2"	PD/IB2F-16	PC/IB2F-16	81



IB2F SERIES

- 2-Way Nickel Plated Brass Body
- FKM Seats and Seals
- Full Flow, Operates Independently of the Up/Downstream Pressures
- Pilot Port 1/8" BSP
- Temperature -4°F to 275°F
- Working Pressure 740mm Hg to 150 PSI
- Pilot Pressure 60 PSI to 115 PSI, with Filtered Air
- Extremely Compact, No External Moving Parts
- NAMUR Interface

IB2F VALVE WITH NAMUR SOLENOID ATTACHED

NPT SIZE	DOUBLE ACTING	SPRING CLOSED	Cv
3/8"	PD/IB2F-3*	PC/IB2F-3*	8
1/2"	PD/IB2F-4*	PC/IB2F-4*	10
3/4"	PD/IB2F-6*	PC/IB2F-6*	13
1"	PD/IB2F-8*	PC/IB2F-8*	17
1-1/4"	PD/IB2F-10*	PC/IB2F-10*	28
1-1/2"	PD/IB2F-12*	PC/IB2F-12*	57
2"	PD/IB2F-16*	PC/IB2F-16*	81

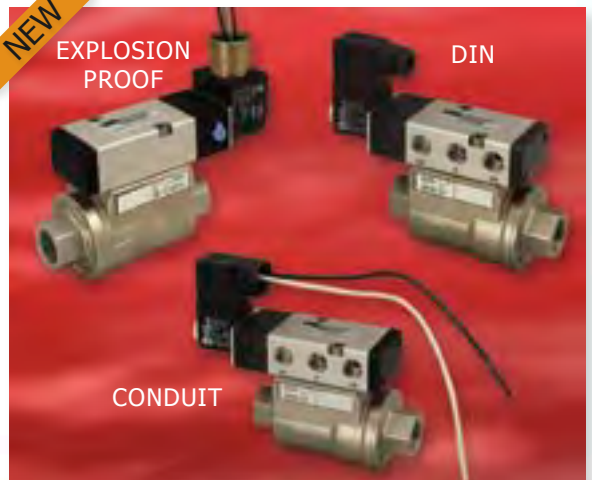

* Suffix: Connector Type and Voltage

CONDUIT	DIN	EXPLOSION PROOF
C1 = 110 VAC	D1 = 110 VAC	EX1 = 110 VAC
C2 = 24 VDC	D2 = 24 VDC	EX2 = 24VDC
C12 = 12 VDC	D12 = 12 VDC	EX12 = 12 VDC
C22 = 220 VAC	D22 = 220 VAC	EX22 = 220 VAC
C24 = 24 VAC	D24 = 24 VAC	



SHM-T SERIES STAINLESS 3-WAY 800 PSI BALL VALVES

ALL SPECIFICATIONS AND DIMENSIONS SUBJECT TO CHANGE WITHOUT NOTICE



SHM-T SERIES

- 29"Hg - 800 PSIG WOG, Cold Non-Shock
- 150 PSIG Saturated Steam
- CF8M Body, 316 Stainless Ball & Stem
- Blowout Proof Stem W/Adjustable Packing
- RTFE Seats & Seals
- Temperature -35°F to 400°F

NPT SIZE	PART #	PART # W/LOCK
1/4"	SHM-2T	SHM-2TLL
3/8"	SHM-3T	SHM-3TLL
1/2"	SHM-4T	SHM-4TLL
3/4"	SHM-6T	SHM-6TLL
1"	SHM-8T	SHM-8TLL
1-1/2"	SHM-12T	SHM-12TLL
2"	SHM-16T	SHM-16TLL



W/Locking Handle

S2S SERIES STAINLESS STEEL 3-WAY L-PORT & T-PORT BALL VALVES



VALVE: Specifications

- 3-Way Stainless Steel Reduced Bore
- 29 Hg-1000 PSI W.O.G. 1/4" - 1" (800 PSI 1 1/4" - 2") Cold Non-Shock
- CF8M Body, 316 Stainless Ball + Stem
- Teflon Seats
- Blowout Proof Stem
- -20° F to 450° F

Flow Diagram

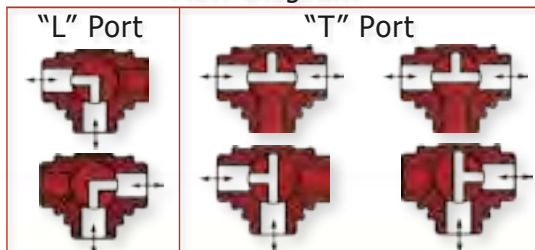

NPT SIZE	L-PORT	T-PORT
1/4"	S2S-2TL	S2S-2TT
3/8"	S2S-3TL	S2S-3TT
1/2"	S2S-4TL	S2S-4TT
3/4"	S2S-6TL	S2S-6TT
1"	S2S-8TL	S2S-8TT
1-1/4"	S2S-10TL	S2S-10TT
1-1/2"	S2S-12TL	S2S-12TT
2"	S2S-16TL	S2S-16TT

SF58M-TL SERIES STAINLESS HIGH PRESSURE 3-WAY BALL

SF58M-TL SERIES

- Blowout Proof Stem
- Delrin seats
- Viton Seats

- Temperature 14°F to 140°F (1/4"-1") 14°F to 176°F (1-1/4"-2")
- 316 Stainless Steel, L - Port
- Options; Suffix "LP" for Locking Plate
- All Working Pressures are Cold Non-Shock

NPT SIZE	NPT SIZE	SAE SIZE	SAE PART #	WORKING PRESSURE
1/4"	SF58M-2TL	7/16"-20	SF58M-S4TL	5880 PSI
3/8"	SF58M-3TL	9/16"-18	SF58M-S6TL	5880 PSI
1/2"	SF51M-4TL	3/4"-16	SF51M-S8TL	5145 PSI
3/4"	SF51M-6TL	1-1/16"-12	SF51M-S12TL	5145 PSI
1"	SF51M-8TL	1-5/16"-12	SF51M-S16TL	5145 PSI
1-1/4"	SF51M-10TL	1-5/8"-12	SF51M-S20TL	5145 PSI
1-1/2"	SF51M-12TL	1-7/8"-12	SF51M-S24TL	5145 PSI
2"	SF51M-16TL	2-1/2"-12	SF51M-S32TL	5145 PSI



W/Locking Plate



S3F22 SERIES 3-PIECE STAINLESS 2-WAY FIRE SAFE BALL VALVES



ALL SPECIFICATIONS AND DIMENSIONS SUBJECT TO CHANGE WITHOUT NOTICE



VALVE: Specifications

- 2-Way Stainless Steel Full Port
- 29Hg-2250 PSI W.O.G. Cold Non-Shock, 250 PSI WSP
- Body + Ball CF8M Stainless Steel, Live Loaded Stem 17-4PH Stainless Steel
- Seats, TFM standard, *See Chart Below*
- Fire Safe to API607-4, (w/suffix "G", G=graphite stem packing)
- Temperature Determined by Seat Material, *See Chart Below*
- ASME/ANSI B16-34 Class 600
- Meets NACE MRO175
- Federal Specification WW-V-35C Type
- All Valves Tested to API-598

VALVE SIZE	THREADED PART #	SOCKET WELD PART #	BUTT WELD PART #
1/4"	S3F22-2	S3F22-2W	S3F22-2B
3/8"	S3F22-3	S3F22-3W	S3F22-3B
1/2"	S3F22-4	S3F22-4W	S3F22-4B
3/4"	S3F22-6	S3F22-6W	S3F22-6B
1"	S3F22-8	S3F22-8W	S3F22-8B
1-1/4"	S3F22-10	S3F22-10W	S3F22-10B
1-1/2"	S3F22-12	S3F22-12W	S3F22-12B
2"	S3F22-16	S3F22-16W	S3F22-16B

Pressure/Temperature Specifications

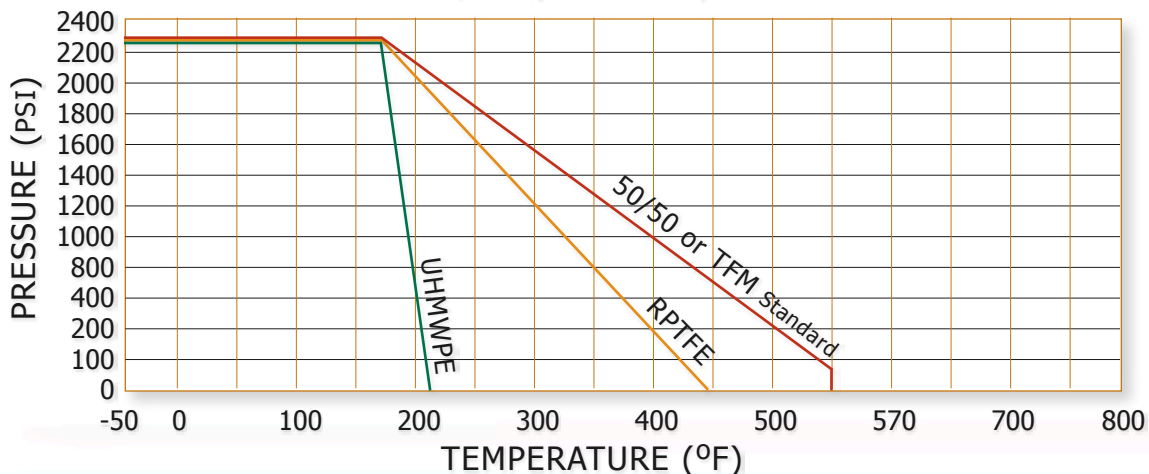

SEL SERIES BRASS 2-WAY SAFETY EXHAUST LOCKING BALL VALVES

ALL SPECIFICATIONS AND DIMENSIONS SUBJECT TO CHANGE WITHOUT NOTICE



SEL SERIES

- 29"Hg - 125 PSIG AIR, Cold Non-Shock
- Locking Handle
- Blowout-Proof Stem W/Adjustable Packing
- RTFE Seats & Seals
- Temperature -35°F to 150°F

~ Available Only with Locking Device ~

NPT SIZE	PART #
1/4"	SEL-2
3/8"	SEL-3
1/2"	SEL-4
3/4"	SEL-6
1"	SEL-8
1-1/4"	SEL-10
1-1/2"	SEL-12
2"	SEL-16
2-1/2"	SEL-20
3"	SEL-24

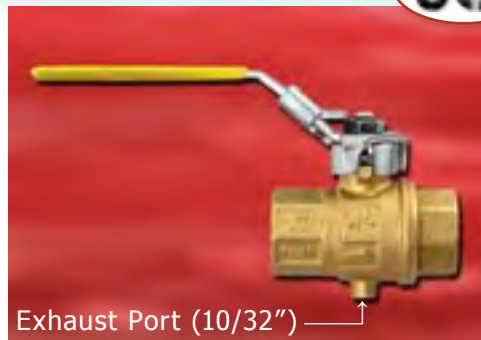

SEL SERIES STAINLESS SAFETY EXHAUST LOCKING BALL VALVES

SSEL SERIES

- 29"Hg - 125 PSIG AIR, Cold Non-Shock
- Locking Handle
- Blowout-Proof Stem W/Adjustable Packing
- RTFE Seats & Seals
- Temperature -35°F to 400°F

~ Available Only with Locking Device ~

NPT SIZE	PART #
1/4"	SSEL-2
3/8"	SSEL-3
1/2"	SSEL-4
3/4"	SSEL-6
1"	SSEL-8
1-1/4"	SSEL-10
1-1/2"	SSEL-12
2"	SSEL-16



SELH & SSELH SERIES HIGH FLOW SAFETY EXHAUST LOCKING BALL VALVES

SELH SERIES

- 29"Hg - 125 PSIG AIR, Cold Non-Shock
- Locking Handle
- Blowout-Proof Stem W/Adjustable Packing
- RTFE Seats & Seals
- Temperature -35°F to 400°F

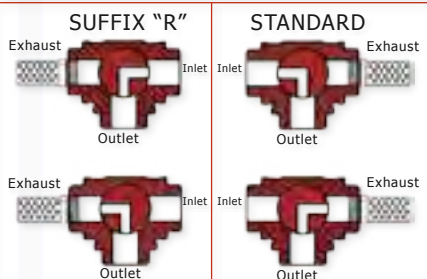

SSELH SERIES

- 29"Hg - 125 PSIG AIR, Cold Non-Shock
- Locking Handle
- Blowout-Proof Stem W/Adjustable Packing
- RTFE Seats & Seals
- Temperature -35°F to 400°F

BRONZE

NPT SIZE	PART #
1/4"	SELH-2
3/8"	SELH-3
1/2"	SELH-4
3/4"	SELH-6
1"	SELH-8
1-1/4"	SELH-10
1-1/2"	SELH-12
2"	SELH-16



~ Available Only with Locking Device ~

STAINLESS STEEL

NPT SIZE	PART #
1/4"	SSELH-2
3/8"	SSELH-3
1/2"	SSELH-4
3/4"	SSELH-6
1"	SSELH-8
1-1/4"	SSELH-10
1-1/2"	SSELH-12
2"	SSELH-16



CWFF150 SERIES CARBON ANSI 150 WAFER FLANGED VALVES

ALL SPECIFICATIONS AND DIMENSIONS SUBJECT TO CHANGE WITHOUT NOTICE



CWFF150 SERIES

- Full Port
- 29"hg - 285 PSI, Cold Non-Shock
- Carbon Steel A105 ANSI 150
- Stainless Steel Ball and Stem
- Temperature -4°F to 366°F
- P.T.F.E. Seats, Packing & Thrust Washer
- Blow Out Proof Stem, Adjustable Stem Packing

SIZE	PART #
1/2"	CWFF150-4
3/4"	CWFF150-6
1"	CWFF150-8
1-1/4"	CWFF150-10
1-1/2"	CWFF150-12
2"	CWFF150-16
2-1/2"	CWFF150-20
3"	CWFF150-24
4"	CWFF150-32
5"	CWFF150-40
6"	CWFF150-48
8"	CWFF150-64



CWFF300 SERIES CARBON ANSI 300 WAFER FLANGED VALVES

CWFF300 SERIES

- Full Port
- 29"hg - 740 PSI, Cold Non-Shock
- Carbon Steel A105 ANSI 300
- Stainless Steel Ball and Stem
- Temperature -4°F to 366°F
- P.T.F.E. Seats, Packing & Thrust Washer
- Blow Out Proof Stem, Adjustable Stem Packing

SIZE	PART #
1/2"	CWFF300-4
3/4"	CWFF300-6
1"	CWFF300-8
1-1/4"	CWFF300-10
1-1/2"	CWFF300-12
2"	CWFF300-16
2-1/2"	CWFF300-20
3"	CWFF300-24
4"	CWFF300-32
6"	CWFF300-48



C2FF150 SERIES CARBON FULL PORT ANSI 150 FLANGED VALVES

C2FF150 SERIES

- Full Port
- 29"hg - 285 PSI, Cold Non-Shock
- Carbon Steel A216 WCB, ANSI 150
- Live Loaded Stem Design, Anti-Static Device
- Standard Locking Device
- P.T.F.E. Seats, Packing & Thrust Washer
- Blow Out Proof Stem, Adjustable Stem Packing
- Temperature -50°F to 400°F
- Fire Safe Approved API 607-4 (w/suffix "G", G=graphite stem packing)

SIZE	PART #
1/2"	C2FF150-4
3/4"	C2FF150-6
1"	C2FF150-8
1-1/2"	C2FF150-12
2"	C2FF150-16
3"	C2FF150-24
4"	C2FF150-32
6"	C2FF150-48
8"	C2FF150-64



C2FF300 SERIES CARBON FULL PORT ANSI 300 FULL FLANGED VALVES

ALL SPECIFICATIONS AND DIMENSIONS SUBJECT TO CHANGE WITHOUT NOTICE



C2FF300 SERIES

- Full Port
- 29"hg - 740 PSI, Cold Non-Shock
- Carbon Steel ASTM A216 WCB, ANSI 300
- Trunnion Type Ball Support (6" to 12" Only)
- Locking Device Standard
- Live Loaded Stem Design, Anti-Static Device
- Spiral Wound Body Gasket with Secondary Metal to Metal Seal
- Temperature -50°F to 400°F
- Fire Safe Approved API 607-4

SIZE	PART #
1/2"	C2FF300-4
3/4"	C2FF300-6
1"	C2FF300-8
1-1/4"	C2FF300-10
1-1/2"	C2FF300-12
2"	C2FF300-16
2-1/2"	C2FF300-20
3"	C2FF300-24
4"	C2FF300-32
6"	C2FF300-48
8"	C2FF300-64
10"	C2FF300-80
12"	C2FF300-96



CWFS150 SERIES CARBON 3-WAY L PORT ANSI 150 FULL FLANGED

CWFS150 SERIES

- 3-Way, Diverter, Two Seats, Reduced L-Port
- 29"hg - 285 PSI, Cold Non-Shock
- Carbon Steel A105, ANSI 150
- Temperature -4°F to 344°F
- P.T.F.E. Seats, Packing & Thrust Washer
- Blow Out Proof Stem, Adjustable Stem Packing
- Fire Safe Approved API 6FA-BS6755/2

SIZE	PART #
1/2"	CWFS150-4TL
3/4"	CWFS150-6TL
1"	CWFS150-8TL
1-1/4"	CWFS150-10TL
1-1/2"	CWFS150-12TL
2"	CWFS150-16TL
2-1/2"	CWFS150-20TL
3"	CWFS150-24TL
4"	CWFS150-32TL
5"	CWFS150-40TL
6"	CWFS150-48TL

Flow Diagram

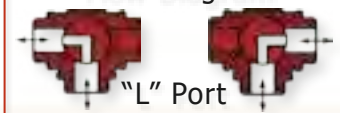

"L" Port



SWFF150 SERIES STAINLESS ANSI 150 WAFER FLANGED VALVES

SWFF150 SERIES

- Full Port
- 29"hg - 285 PSI, Cold Non-Shock
- Stainless Steel ASTM A351-CF8M ANSI 150
- Temperature -4°F to 366°F
- P.T.F.E. Seats, Packing & Thrust Washer
- Blow Out Proof Stem, Adjustable Stem Packing

SIZE	PART #
1/2"	SWFF150-4
3/4"	SWFF150-6
1"	SWFF150-8
1-1/4"	SWFF150-10
1-1/2"	SWFF150-12
2"	SWFF150-16
2-1/2"	SWFF150-20
3"	SWFF150-24
4"	SWFF150-32
5"	SWFF150-40
6"	SWFF150-48
8"	SWFF150-64



SWFF300 SERIES STAINLESS ANSI 300 WAFER FLANGED VALVES

ALL SPECIFICATIONS AND DIMENSIONS SUBJECT TO CHANGE WITHOUT NOTICE



SWFF300 SERIES

- Full Port
- 29"hg - 740 PSI, Cold Non-Shock
- Stainless Steel ASTM A351-CF8M ANSI 300
- Temperature -4°F to 366°F
- P.T.F.E. Seats, Packing & Thrust Washer
- Blow Out Proof Stem, Adjustable Stem Packing

SIZE	PART #
1/2"	SWFF300-4
3/4"	SWFF300-6
1"	SWFF300-8
1-1/4"	SWFF300-10
1-1/2"	SWFF300-12
2"	SWFF300-16
2-1/2"	SWFF300-20
3"	SWFF300-24
4"	SWFF300-32
6"	SWFF300-48
8"	SWFF300-64



S2FF150 SERIES STAINLESS FULL PORT ANSI 150 FULL FLANGED VALVES

S2FF150 SERIES

- Full Port
- 29"hg - 285 PSI, Cold Non-Shock
- Stainless Steel ASTM A351-CF8M, ANSI 150
- Live Loaded Stem Design, Anti-Static Device
- Standard Locking Device
- P.T.F.E. Seats, Packing & Thrust Washer
- Blow Out Proof Stem, Adjustable Stem Packing
- Temperature -50°F to 400°F
- Fire Safe Approved API 607-4 (w/suffix "G"
G= graphite stem packing)

SIZE	PART #
1/2"	S2FF150-4
3/4"	S2FF150-6
1"	S2FF150-8
1-1/2"	S2FF150-12
2"	S2FF150-16
3"	S2FF150-24
4"	S2FF150-32
6"	S2FF150-48
8"	S2FF150-64



S2FF300 SERIES STAINLESS FULL PORT ANSI 300 FULL FLANGED VALVES

S2FF300 SERIES

- Full Port
- 29"hg - 740 PSI, Cold Non-Shock
- Stainless Steel ASTM A351-CF8M, ANSI 300
- Trunnion Type Ball Support (6" to 12" Only)
- Locking Device Standard
- Live Loaded Stem Design, Anti-Static Device
- Spiral Wound Body Gasket with Secondary Metal to Metal Seal
- Temperature -50°F to 400°F
- Fire Safe Approved API 607-4 (w/suffix "G"
G=graphite stem packing)

SIZE	PART #
1/2"	S2FF300-4
3/4"	S2FF300-6
1"	S2FF300-8
1-1/4"	S2FF300-10
1-1/2"	S2FF300-12
2"	S2FF300-16
2-1/2"	S2FF300-20
3"	S2FF300-24
4"	S2FF300-32
6"	S2FF300-48
8"	S2FF300-64
10"	S2FF300-80
12"	S2FF300-96



SWFS150 SERIES STAINLESS 3-WAY L-PORT ANSI 150 FLANGED VALVES

ALL SPECIFICATIONS AND DIMENSIONS SUBJECT TO CHANGE WITHOUT NOTICE



SWFS150 SERIES

- 29"hg - 285 PSI, Cold Non-Shock
- Stainless Steel AISI 316, ANSI 150
- 3-Way, Diverter, Two Seats, Reduced L-Port
- Temperature -4°F to 344°F
- P.T.F.E. Seats, Packing & Thrust Washer, w/Adjustable Stem Packing

SIZE	PART #
1/2"	SWFS150-4TL
3/4"	SWFS150-6TL
1"	SWFS150-8TL
1-1/2"	SWFS150-12TL
2"	SWFS150-16TL
3"	SWFS150-24TL
4"	SWFS150-32TL
6"	SWFS150-48TL
8"	SWFS150-64TL

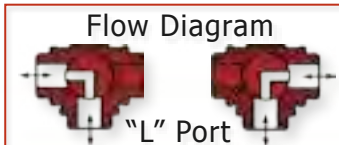

BGV SERIES BRASS 2-WAY GATE VALVES



BGV SERIES

- Suitable For Water-Works, Domestic & Agricultural
- Finely Cast Sand Blasted Heavy Brass Body
- Low Pressure Drop
- P.T.F.E. Seats and Seals
- Non Rising Stem
- Cast Steel Hand-Wheel
- NPT Female by Female Threads
- 200 PSI Cold Non-Shock Working Pressure
- +40°F to +200°F Temperature Range
- Optional Solder End Connections

SIZE	PART #
1/2"	BGV-4
3/4"	BGV-6
1"	BGV-8
1-1/4"	BGV-10
1-1/2"	BGV-12
2"	BGV-16
2-1/2"	BGV-20
3"	BGV-24
4"	BGV-32

PART MATERIAL

- Body - OT58 Brass
- Gate - OT58 Brass
- Stem - OT58 Brass
- Body Cap Sealing - PTFE
- Cap - OT58 Brass
- Stem Ring - OT58 Brass
- Package Gland Seal - PTFE
- Packing Gland - OT58 Brass
- Packing Gland Nut - OT58 Brass
- Red Round Handle - Steel
- Disc - OT58 Brass
- Handle Nut - OT58 Brass



BNEW & BSEW SERIES CARBON STEEL WAFER STYLE BUTTERFLY VALVES

ALL SPECIFICATIONS AND DIMENSIONS SUBJECT TO CHANGE WITHOUT NOTICE



BNEW & BSEW SERIES

- ANSI 125 & ANSI 150 Class
- Cast Iron Body, with Resin Coated Baked Finish
- Nickel Coated Steel (BNEW) or Stainless Steel Disc (BSEW)
- Maximum Pressure 1-1/2" to 12" 230 PSI, 14" to 24" 150 PSI
- Available with EPDM or VITON® Seats
- Temperature Range, EPDM -4°F to 248°F, VITON 0°F to 399°F
- Standard: H=Handle, G=Gear Box, Options: For Gear Box operation on smaller valve sizes, consult factory

BNEW & BNWV SERIES

Cast Iron Body with Nickel Coated Disc

SIZE	PART #	
	EPDM Seats	VITON Seats
1-1/2"	BNEW-1.5H	BNVW-1.5H
2"	BNEW-2H	BNVW-2H
2-1/2"	BNEW-2.5H	BNVW-2.5H
3"	BNEW-3H	BNVW-3H
4"	BNEW-4H	BNVW-4H
5"	BNEW-5H	BNVW-5H
6"	BNEW-6H	BNVW-6H
8"	BNEW-8H	BNVW-8H
10"	BNEW-10H	BNVW-10H
12"	BNEW-12H	BNVW-12H
14"	BNEW-14G	BNVW-14G
16"	BNEW-16G	BNVW-16G
18"	BNEW-18G	BNVW-18G
20"	BNEW-20G	BNVW-20G
24"	BNEW-24G	BNVW-24G

BSEW & BSVW SERIES

Cast Iron Body with 316 Stainless Steel Disc

SIZE	PART #	
	EPDM Seats	VITON Seats
1-1/2"	BSEW-1.5H	BSVW-1.5H
2"	BSEW-2H	BSVW-2H
2-1/2"	BSEW-2.5H	BSVW-2.5H
3"	BSEW-3H	BSVW-3H
4"	BSEW-4H	BSVW-4H
5"	BSEW-5H	BSVW-5H
6"	BSEW-6H	BSVW-6H
8"	BSEW-8H	BSVW-8H
10"	BSEW-10H	BSVW-10H
12"	BSEW-12H	BSVW-12H
14"	BSEW-14G	BSVW-14G
16"	BSEW-16G	BSVW-16G
18"	BSEW-18G	BSVW-18G
20"	BSEW-20G	BSVW-20G
24"	BSEW-24G	BSVW-24G



BNEL & BSEL SERIES CARBON STEEL LUG STYLE BUTTERFLY VALVES

ALL SPECIFICATIONS AND DIMENSIONS SUBJECT TO CHANGE WITHOUT NOTICE



BNEL & BSEL SERIES

- ANSI 125 & ANSI 150 Class
- Cast Iron Body, with Resin Coated Baked Finish
- Nickel Coated Steel (BNEW) or Stainless Steel Disc (BSEW)
- Maximum Pressure 1-1/2" to 12" 230 PSI, 14" to 24" 150 PSI
- Available with EPDM or VITON® Seats
- Temperature Range, EPDM -4°F to 248°F, VITON 0°F to 399°F
- Standard: H=Handle, G=Gear Box, Options: For Gear Box operation on smaller valve sizes, consult factory

BNEL & BNVL SERIES

Cast Iron Body with Nickel Coated Disc

SIZE	PART # EPDM Seats	PART # VITON Seats
1-1/2"	BNEL-1.5H	BNVL-1.5H
2"	BNEL-2H	BNVL-2H
2-1/2"	BNEL-2.5H	BNVL-2.5H
3"	BNEL-3H	BNVL-3H
4"	BNEL-4H	BNVL-4H
5"	BNEL-5H	BNVL-5H
6"	BNEL-6H	BNVL-6H
8"	BNEL-8H	BNVL-8H
10"	BNEL-10H	BNVL-10H
12"	BNEL-12H	BNVL-12H
14"	BNEL-14G	BNVL-14G
16"	BNEL-16G	BNVL-16G
18"	BNEL-18G	BNVL-18G
20"	BNEL-20G	BNVL-20G
24"	BNEL-24G	BNVL-24G

BSEL & BSVL SERIES

Cast Iron Body with 316 Stainless Steel Disc

SIZE	PART # EPDM Seats	PART # VITON Seats
1-1/2"	BSEL-1.5H	BSVL-1.5H
2"	BSEL-2H	BSVL-2H
2-1/2"	BSEL-2.5H	BSVL-2.5H
3"	BSEL-3H	BSVL-3H
4"	BSEL-4H	BSVL-4H
5"	BSEL-5H	BSVL-5H
6"	BSEL-6H	BSVL-6H
8"	BSEL-8H	BSVL-8H
10"	BSEL-10H	BSVL-10H
12"	BSEL-12H	BSVL-12H
14"	BSEL-14G	BSVL-14G
16"	BSEL-16G	BSVL-16G
18"	BSEL-18G	BSVL-18G
20"	BSEL-20G	BSVL-20G
24"	BSEL-24G	BSVL-24G



® VITON is a registered trademark of E.I. DuPont de Nemours & Co.

UNIVERSAL COMPONENTS, INC. Phone: 803/324-5176 Fax: 803/324-2640

HBCW SERIES CARBON STEEL WAFER STYLE BUTTERFLY VALVES

ALL SPECIFICATIONS AND DIMENSIONS SUBJECT TO CHANGE WITHOUT NOTICE



HBCW SERIES

ANSI Class 150 ANSI 300 Class ANSI Class 600

- **PSI Rating:** 285 PSI 740 PSI 1440 PSI
- **Body:** Carbon Steel (A216-WCB)
- **Disc:** 316 Stainless Steel (A351-CF8M)
- **Stem:** Stainless Steel 17/4PH (A564-630)

• **CONSULT FACTORY FOR ALL APPLICATIONS •**

SIZE	PART # Class 150	PART # Class 300	PART # Class 600
2"	HBCW150*-2*	HBCW300*-2*	-----
2-1/2"	HBCW150*-2.5*	HBCW300*-2.5*	-----
3"	HBCW150*-3*	HBCW300*-3*	HBCW600*-3*
4"	HBCW150*-4*	HBCW300*-4*	HBCW600*-4*
5"	HBCW150*-5*	HBCW300*-5*	HBCW600*-5*
6"	HBCW150*-6*	HBCW300*-6*	HBCW600*-6*
8"	HBCW150*-8*	HBCW300*-8*	HBCW600*-8*
10"	HBCW150*-10*	HBCW300*-10*	HBCW600*-10*
12"	HBCW150*-12*	HBCW300*-12*	HBCW600*-12*
14"	HBCW150*-14*	HBCW300*-14*	HBCW600*-14*
16"	HBCW150*-16*	HBCW300*-16*	HBCW600*-16*
18"	HBCW150*-18*	HBCW300*-18*	HBCW600*-18*
20"	HBCW150*-20*	HBCW300*-20*	HBCW600*-20*
24"	HBCW150*-24*	HBCW300*-24*	HBCW600*-24*

* Optional Seats Suffix

P= PTFE I= Inconel
 R= RTFE SP= 316 S.S.+ PTFE
 S= 316 S.S. SR= S.S.+ RTFE

* Suffix: H=Handle, G=Gear Operator, omit for no operator

HBCL SERIES CARBON STEEL LUG STYLE BUTTERFLY VALVES

HBCL SERIES

ANSI Class 150 ANSI 300 Class ANSI Class 600

- **PSI Rating:** 285 PSI 740 PSI 1440 PSI
- **Body:** Carbon Steel (A216-WCB)
- **Disc:** 316 Stainless Steel (A351-CF8M)
- **Stem:** Stainless Steel 17/4PH (A564-630)

• **CONSULT FACTORY FOR ALL APPLICATIONS •**



SIZE	PART # Class 150	PART # Class 300	PART # Class 600
2"	HBCL150*-2*	HBCL300*-2*	-----
2-1/2"	HBCL150*-2.5*	HBCL300*-2.5*	-----
3"	HBCL150*-3*	HBCL300*-3*	HBCL600*-3*
4"	HBCL150*-4*	HBCL300*-4*	HBCL600*-4*
5"	HBCL150*-5*	HBCL300*-5*	HBCL600*-5*
6"	HBCL150*-6*	HBCL300*-6*	HBCL600*-6*
8"	HBCL150*-8*	HBCL300*-8*	HBCL600*-8*
10"	HBCL150*-10*	HBCL300*-10*	HBCL600*-10*
12"	HBCL150*-12*	HBCL300*-12*	HBCL600*-12*
14"	HBCL150*-14*	HBCL300*-14*	HBCL600*-14*
16"	HBCL150*-16*	HBCL300*-16*	HBCL600*-16*
18"	HBCL150*-18*	HBCL300*-18*	HBCL600*-18*
20"	HBCL150*-20*	HBCL300*-20*	HBCL600*-20*
24"	HBCL150*-24*	HBCL300*-24*	HBCL600*-24*

* Suffix: H=Handle, G=Gear Operator, omit for no operator

* Optional Seats Suffix

P= PTFE I= Inconel
 R= RTFE SP= 316 S.S.+ PTFE
 S= 316 S.S. SR= S.S.+ RTFE



HBSW SERIES STAINLESS STEEL WAFER STYLE BUTTERFLY VALVES

ALL SPECIFICATIONS AND DIMENSIONS SUBJECT TO CHANGE WITHOUT NOTICE



HBSW SERIES

ANSI Class 150 ANSI 300 Class ANSI Class 600

- **PSI Rating:** 285 PSI 740 PSI 1440 PSI
- **Body:** 316 Stainless Steel (A351-CF8M)
- **Disc:** 316 Stainless Steel (A351-CF8M)
- **Stem:** Stainless Steel 17/4PH (A564-630)

• **CONSULT FACTORY FOR ALL APPLICATIONS •**

SIZE	PART # Class 150	PART # Class 300	PART # Class 600
2"	HBSW150*-2*	HBSW300*-2*	-----
2-1/2"	HBSW150*-2.5*	HBSW300*-2.5*	-----
3"	HBSW150*-3*	HBSW300*-3*	HBSW600*-3*
4"	HBSW150*-4*	HBSW300*-4*	HBSW600*-4*
5"	HBSW150*-5*	HBSW300*-5*	HBSW600*-5*
6"	HBSW150*-6*	HBSW300*-6*	HBSW600*-6*
8"	HBSW150*-8*	HBSW300*-8*	HBSW600*-8*
10"	HBSW150*-10*	HBSW300*-10*	HBSW600*-10*
12"	HBSW150*-12*	HBSW300*-12*	HBSW600*-12*
14"	HBSW150*-14*	HBSW300*-14*	HBSW600*-14*
16"	HBSW150*-16*	HBSW300*-16*	HBSW600*-16*
18"	HBSW150*-18*	HBSW300*-18*	HBSW600*-18*
20"	HBSW150*-20*	HBSW300*-20*	HBSW600*-20*
24"	HBSW150*-24*	HBSW300*-24*	HBSW600*-24*

* Optional Seats Suffix

P= PTFE I= Inconel
 R= RTFE SP= 316 S.S.+ PTFE
 S= 316 S.S. SR= S.S.+ RTFE

* Suffix: H=Handle, G=Gear Operator, omit for no operator

HBSL SERIES STAINLESS STEEL LUG STYLE BUTTERFLY VALVES

HBCL SERIES

ANSI Class 150 ANSI 300 Class ANSI Class 600

- **PSI Rating:** 285 PSI 740 PSI 1440 PSI
- **Body:** 316 Stainless Steel (A351-CF8M)
- **Disc:** 316 Stainless Steel (A351-CF8M)
- **Stem:** Stainless Steel 17/4PH (A564-630)

• **CONSULT FACTORY FOR ALL APPLICATIONS •**

SIZE	PART # Class 150	PART # Class 300	PART # Class 600
2"	HBCL150*-2*	HBCL300*-2*	-----
2-1/2"	HBCL150*-2.5*	HBCL300*-2.5*	-----
3"	HBCL150*-3*	HBCL300*-3*	HBCL600*-3*
4"	HBCL150*-4*	HBCL300*-4*	HBCL600*-4*
5"	HBCL150*-5*	HBCL300*-5*	HBCL600*-5*
6"	HBCL150*-6*	HBCL300*-6*	HBCL600*-6*
8"	HBCL150*-8*	HBCL300*-8*	HBCL600*-8*
10"	HBCL150*-10*	HBCL300*-10*	HBCL600*-10*
12"	HBCL150*-12*	HBCL300*-12*	HBCL600*-12*
14"	HBCL150*-14*	HBCL300*-14*	HBCL600*-14*
16"	HBCL150*-16*	HBCL300*-16*	HBCL600*-16*
18"	HBCL150*-18*	HBCL300*-18*	HBCL600*-18*
20"	HBCL150*-20*	HBCL300*-20*	HBCL600*-20*
24"	HBCL150*-24*	HBCL300*-24*	HBCL600*-24*



* Optional Seats Suffix

P= PTFE I= Inconel
 R= RTFE SP= 316 S.S.+ PTFE
 S= 316 S.S. SR= S.S.+ RTFE

* Suffix: H=Handle, G=Gear Operator, omit for no operator



CV19 SERIES RELIEF VALVES

ALL SPECIFICATIONS AND DIMENSIONS SUBJECT TO CHANGE WITHOUT NOTICE



CV19 SERIES

- Bronze Construction
- Stainless Steel Spring
- Brass Cap
- ASME and CRN Certifications (CE optional)
- Teflon® PFA Fluorocarbon Seat
- Optional, Anti-vibration Dampened Lever
- Maximum Temperature 400°F

NPT SIZE INLET X OUTLET	PART#
1/2" x 3/4"	CV19-0406- **
3/4" x 3/4"	CV19-0606- **
3/4" x 1"	CV19-0608- **
1" x 1"	CV19-0808- **
1" x 1-1/4"	CV19-0810- **
1-1/4" x 1-1/4"	CV19-1010- **
1-1/4" x 1-1/2"	CV19-1012- **
1-1/2" x 1-1/2"	CV19-1212- **
1-1/2" x 2"	CV19-1216- **
2" x 2"	CV19-1616- **
2" x 2-1/2"	CV19-1620- **
2-1/2" x 2-1/2"	CV19-2020- **

HOW TO ORDER CV19 SERIES

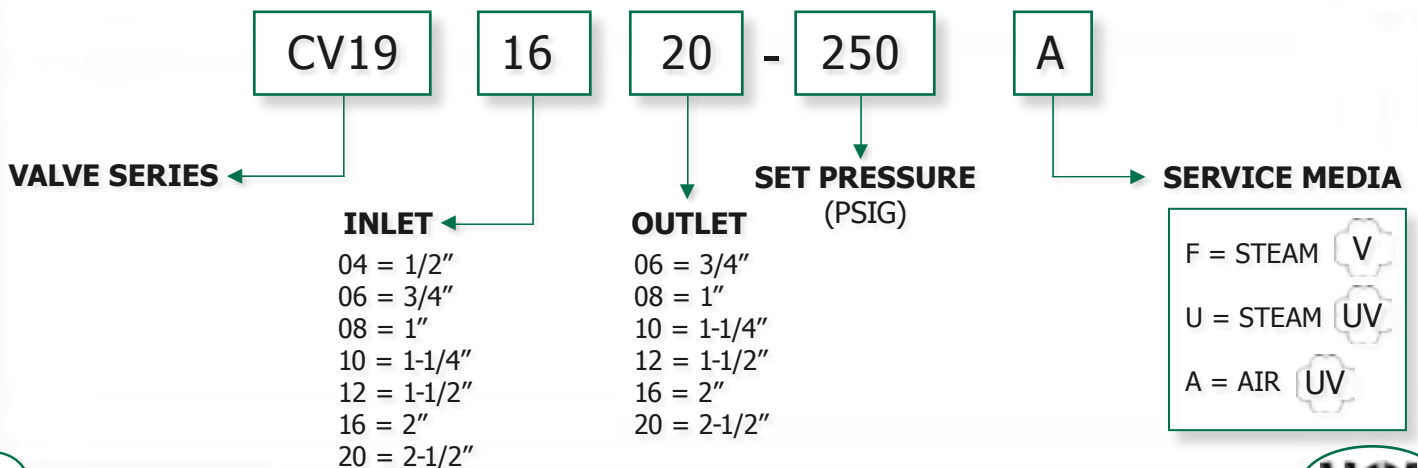

CV19 SERIES FLOW DATA

ALL SPECIFICATIONS AND DIMENSIONS SUBJECT TO CHANGE WITHOUT NOTICE



F = STEAM

U = STEAM

A = AIR

FIRED VESSELS

ASME SECTION I-POWER BOILERS
19 SERIES BRONZE SAFETY VALVES STEAM
CAPACITY CHART - POWER BOILER CODE
A.S.M.E. (V) RATING-90% OF ACTUAL
CAPACITY AT 3% ACCUMULATION CAPACITY
IN POUNDS OF SATURATED STEAM PER HOUR

UNFIRED VESSELS

ASME SECTION VIII-PRESSURE VESSEL
19 SERIES BRONZE SAFETY VALVES STEAM
CAPACITY CHART - PRESSURE VESSEL CODE
A.S.M.E. (UV) RATING-90% OF ACTUAL
CAPACITY AT 10% ACCUMULATION CAPACITY
IN POUNDS OF SATURATED STEAM PER HOUR

UNFIRED VESSELS

ASME SECTION VIII-PRESSURE VESSEL
19 SERIES BRONZE SAFETY VALVES AIR
CAPACITY CHART - PRESSURE VESSEL CODE
A.S.M.E. (UV) RATING-90% OF ACTUAL
CAPACITY AT 10% ACCUMULATION CAPACITY
IN CUBIC FEET OF PER MINUTE AT 14.7 P.S.I.A.-
60°F

SET Pressure (PSIG)	MODEL CV19-0406-** CV19-0606-**			MODEL CV19-0608-** CV19-0808-**			MODEL CV19-0810-** CV19-1010-**			MODEL CV19-1012-** CV19-1212-**			MODEL CV19-1216-** CV19-1616-**			MODEL CV19-1620-** CV19-2020-**		
	F	U	A	F	U	A	F	U	A	F	U	A	F	U	A	F	U	A
15	174	179	64	310	320	114	484	499	178	794	820	292	1240	1279	455	2035	2100	747
20	201	207	74	359	369	131	561	576	205	920	945	336	1435	1474	525	2356	2421	862
25	229	234	83	408	418	149	637	652	232	1045	1070	381	1631	1670	594	2677	2742	976
30	256	262	93	457	467	166	713	729	259	1170	1195	426	1826	1865	664	2998	3063	1090
35	284	292	104	506	521	185	790	813	289	1296	1333	475	2022	2080	740	3319	3416	1216
40	311	322	115	555	574	204	866	897	319	1421	1471	524	2217	2295	817	3641	3769	1342
45	339	352	125	604	628	224	942	981	349	1546	1609	573	2413	2510	894	3962	4122	1467
50	366	383	136	653	682	243	1019	1065	379	1672	1747	622	2608	2725	970	4283	4475	1593
55	394	413	147	702	736	262	1095	1149	409	1797	1885	671	2804	2941	1047	4604	4828	1719
60	421	443	158	751	790	281	1172	1233	439	1922	2022	720	2999	3156	1123	4925	5181	1844
65	448	473	168	800	844	300	1248	1317	469	2048	2160	769	3195	3371	1200	5246	5535	1970
70	476	503	179	849	897	319	1326	1401	499	2175	2298	818	3394	3586	1276	5573	5888	2096
75	505	534	190	900	951	339	1405	1485	528	2304	2436	867	3596	3801	1353	5904	6241	2221
80	533	564	201	950	1005	358	1483	1569	558	2433	2574	916	3797	4016	1429	6234	6594	2347
85	561	594	211	1001	1059	377	1562	1653	588	2563	2712	965	3998	4231	1506	6565	6947	2473
90	590	624	222	1051	1113	396	1641	1737	618	2692	2849	1014	4200	4446	1583	6896	7300	2598
95	618	654	233	1101	1167	415	1719	1821	648	2821	2987	1063	4401	4661	1659	7226	7653	2724
100	646	684	244	1152	1220	434	1798	1905	678	2950	3125	1112	4602	4876	1736	7557	8007	2850
105	674	715	254	1202	1274	454	1877	1989	708	3079	3263	1161	4804	5091	1812	7888	8360	2976
110	703	745	265	1253	1328	473	1955	2073	738	3208	3401	1211	5005	5306	1889	8218	8713	3101
115	731	775	276	1303	1382	492	2034	2157	768	3337	3539	1260	5207	5521	1965	8549	9066	3227
120	759	805	287	1353	1436	511	2113	2241	798	3466	3677	1309	5408	5736	2042	8880	9419	3353
125	787	835	297	1404	1489	530	2191	2325	828	3595	3814	1358	5609	5951	2118	9210	9772	3478
130	816	866	308	1454	1543	549	2270	2409	857	3724	3952	1407	5811	6167	2195	9541	10125	3604
135	844	896	319	1505	1597	568	2349	2493	887	3853	4090	1456	6012	6382	2271	9872	10479	3730
140	872	926	330	1555	1651	588	2427	2577	917	3982	4228	1505	6213	6597	2348	10202	10832	3855
145	900	956	340	1605	1705	607	2506	2661	947	4111	4366	1554	6415	6812	2425	10533	11185	3981
150	929	986	351	1656	1759	626	2585	2745	977	4240	4504	1603	6616	7027	2501	10864	11538	4107
160	985	1047	373	1757	1866	664	2742	2913	1037	4499	4779	1701	7019	7457	2654	11525	12224	4358
170	1042	1107	394	1857	1974	703	2899	3081	1097	4757	5055	1799	7422	7887	2807	12186	12951	4610
180	1098	1167	416	1958	2082	741	3057	3249	1156	5015	5331	1897	7824	8317	2960	12848	13657	4861
190	1155	1228	437	2059	2189	779	3214	3417	1216	5273	5606	1996	8227	8747	3114	13509	14363	5112
200	1211	1288	459	2160	2297	818	3371	3585	1276	5531	5882	2094	8630	9177	3267	14170	15069	5364
210	1268	1349	480	2261	2405	856	3529	3753	1336	5789	6158	2192	9033	9608	3420	14832	15776	5615
220	1324	1409	502	2361	2512	894	3686	3921	1396	6047	6433	2290	9436	10038	3573	15493	16482	5867
230	1381	1469	523	2462	2620	932	3843	4089	1456	6305	6709	2388	9838	10468	3726	16154	17188	6118
240	1438	1530	545	2563	2727	971	4001	4257	1515	6564	6985	2486	10241	10898	3879	16816	17894	6369
250	1494	1590	566	2664	2835	1009	4158	4425	1575	6822	7260	2584	10644	11328	4032	17477	18601	6621
260	1551	1651	587	2765	2943	1047	4315	4593	1635	7080	7536	2682	11047	11758	4185	18138	19307	6872
270	1607	1711	609	2865	3050	1086	4473	4761	1695	7338	7812	2781	11449	12188	4338	18800	20013	7124
280	1664	1771	630	2966	3158	1124	4630	4929	1755	7596	8087	2879	11852	12618	4491	19461	20720	7375
290	1720	1832	652	3067	3266	1162	4787	5097	1814	7854	8363	2977	12255	13049	4645	20122	21426	7626
300	1777	1892	673	3168	3373	1201	4945	5265	1873	8112	8639	3075	12658	13479	4798	20784	22132	7878

** Designates Pressure Setting of Valve, (Example: CV19-1212-150A)



CV119 SERIES RELIEF VALVES

ALL SPECIFICATIONS AND DIMENSIONS SUBJECT TO CHANGE WITHOUT NOTICE



CV119 SERIES

- Cast Iron Construction
- Plated Steel Washer & Stem
- ASME and CRN Certifications
- Stainless Steel Wetted Trim, Standard
- Drip Pan Elbow (Optional)
- Maximum Temperature 450°F

PART#	ORIFICE AREA	ORIFICE AREA DIA.	GROUP	INLET/OUTLET
CV119-F1220-**	1.358	1.315	A	1-1/2" 250# x 2-1/2" FNPT
CV119-1624-**	1.926	1.566	B	2" FNPT X 3" FNPT
CV119-F1624-**	1.926	1.566	B	2" 250# X 3" FNPT
CV119-F2024-**	1.926	1.566	B	2-1/2" 250# X 3" FNPT
CV119-F2424-**	1.926	1.566	B	3" 250# X 3" FNPT
CV119-2032-**	2.990	1.951	C	2-1/2" FNPT X 4" FNPT
CV119-F2032-**	2.990	1.951	C	2-1/2" 250# X 4" FNPT
CV119-F2432-**	2.990	1.951	C	3" 250# X 4" FNPT
CV119-F3232-**	2.990	1.951	C	4" 250# X 4" FNPT
CV119-2432-**	3.774	2.192	D	3" FNPT X 4" FNPT
CV119-F2432-**	3.774	2.192	D	3" 250# X 4" FNPT
CV119-F3232-**	3.774	2.192	D	4" 250# X 4" FNPT
CV119-F32F48-**	4.550	2.407	E	4" 250# X 6" 125#
CV119-F32F48-**	6.692	2.919	F	4" 250# X 6" 125#
CV119-F48F64-**	11.593	3.842	G	6" 250# X 8" 125#
CV119-F48F64-**	16.768	4.623	H	6" 250# X 8" 125#

HOW TO ORDER CV119 SERIES

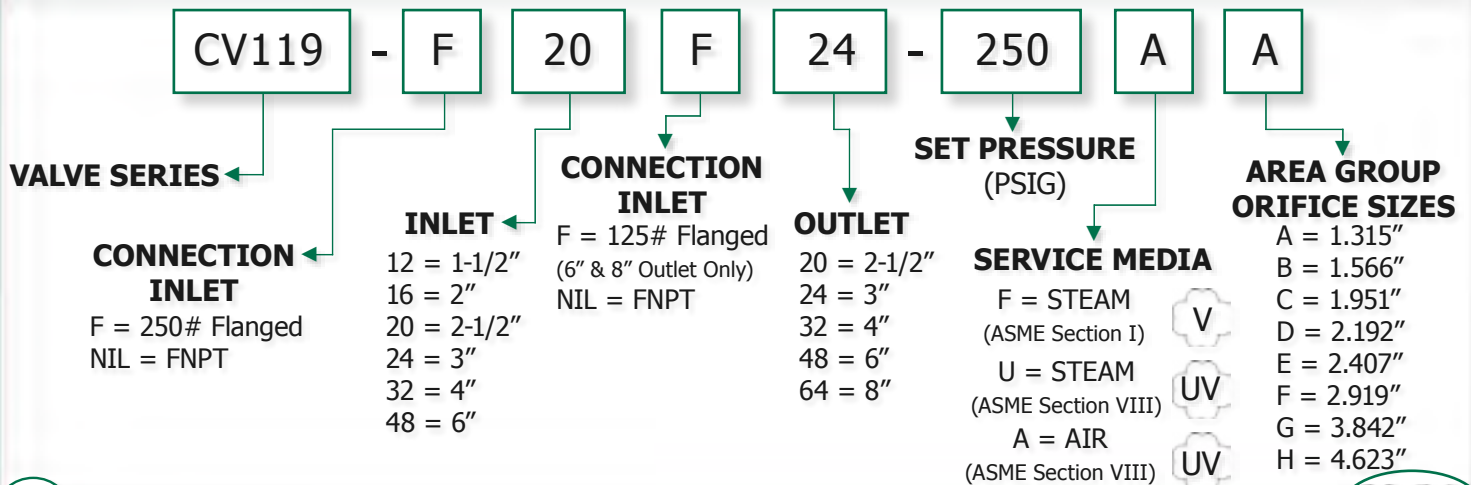

CV119 SERIES RELIEF VALVES

ALL SPECIFICATIONS AND DIMENSIONS SUBJECT TO CHANGE WITHOUT NOTICE



F = V STEAM

FIRED VESSELS

ASME SECTION I-POWER BOILERS
119 SERIES SAFETY VALVES STEAM
CAPACITY CHART - POWER BOILER CODE
A.S.M.E. (V) RATING-90% OF ACTUAL
CAPACITY AT 3% ACCUMULATION CAPACITY
IN POUNDS OF SATURATED STEAM PER HOUR

U = UV STEAM

UNFIRED VESSELS

ASME SECTION VIII-PRESSURE VESSEL
119 SERIES SAFETY VALVES STEAM
CAPACITY CHART - PRESSURE VESSEL CODE
A.S.M.E. (UV) RATING-90% OF ACTUAL
CAPACITY AT 10% ACCUMULATION CAPACITY
IN POUNDS OF SATURATED STEAM PER HOUR

A = UV AIR

UNFIRED VESSELS

ASME SECTION VIII-PRESSURE VESSEL
119 SERIES SAFETY VALVES AIR
CAPACITY CHART - PRESSURE VESSEL CODE
A.S.M.E. (UV) RATING-90% OF ACTUAL
CAPACITY AT 10% ACCUMULATION CAPACITY
IN CUBIC FEET OF PER MINUTE AT 14.7 P.S.I.A.-
60°F

A			B			C			D			E			F			G			H			
AREA SQ.IN 1.358			1.926			2.990			3.774			4.550			6.692			11.593			16.768			
SET PRESSURE	F	U	A	F	U	A	F	U	A	F	U	A	F	U	A	F	U	A	F	U	A	F	U	A
	U	UV	UV	U	UV	UV	U	UV	UV	U	UV	UV	U	UV	UV	U	UV	UV	U	UV	UV	U	UV	UV
15	1947	2008	715	2761	2848	1014	4286	4421	1574	5410	5580	1986	6522	6728	2395	9592	9895	3522	16617	17141	6101	24061	24820	8834
20	2254	2315	824	3196	3283	1169	4962	5097	1814	6263	6433	2290	7551	7756	2761	11105	11408	4060	19238	19762	7034	27856	28615	10185
25	2561	2622	933	3632	3719	1324	5638	5773	2055	7116	7287	2594	8579	8785	3127	12618	12921	4599	21859	22383	7967	31651	32410	11536
30	2868	2929	1043	4067	4154	1479	6314	6449	2295	7969	8140	2897	9608	9814	3493	14313	14434	5138	24480	25004	8900	35446	36205	12887
35	3175	3267	1163	4502	4633	1649	6990	7193	2560	8823	9079	3231	10637	10945	3896	15644	16098	5730	27101	27887	9926	39241	40379	14373
40	3482	3604	1283	4938	5112	1820	7666	7936	2825	9676	10017	3566	11665	12077	4299	17157	17762	6322	29722	30771	10953	43036	44554	15859
45	3789	3942	1403	5373	5591	1990	8342	8680	3089	10529	10956	3900	12694	13208	4701	18670	19426	6915	32343	33654	11979	46831	48729	17345
50	4096	4280	1523	5809	6070	2161	9018	9423	3354	11382	11894	4234	13723	14340	5104	20183	21091	7507	34964	36537	13005	50626	52903	18830
55	4403	4618	1644	6244	6549	2331	9694	10167	3619	12236	12833	4568	14751	15471	5507	21696	22755	8099	37585	39420	14031	54421	57078	20316
60	4710	4955	1764	6680	7028	2502	10370	10911	3884	13089	13771	4902	15780	16603	5910	23209	24419	8692	40206	42303	15057	58216	61252	21802
65	5017	5293	1884	7115	7507	2672	11046	11654	4148	13942	14710	5236	16809	17735	6312	24722	26083	9284	42827	45186	16084	62011	65427	23288
70	5330	5631	2004	7559	7986	2843	11735	12398	4413	14812	15649	5570	17858	18866	6715	26265	27748	9877	45501	48069	17110	65882	69601	24774
75	5646	5969	2124	8008	8465	3013	12432	13141	4678	15691	16587	5904	18918	19998	7118	27823	29412	10469	48200	50952	18136	69791	73776	26260
80	5962	6306	2245	8456	8944	3184	13128	13885	4942	16570	17526	6238	19977	21129	7521	29382	31076	11061	50900	53835	19162	73700	77951	27746
85	6279	6644	2365	8905	9423	3354	13824	14629	5207	17449	18464	6572	21037	22261	7924	30940	32740	11654	53600	56719	20188	77609	82125	29232
90	6595	6982	2485	9353	9902	3524	14520	15372	5472	18328	19403	6906	22096	23392	8326	32498	34405	12246	56299	59602	21215	81518	86300	30718
95	6911	7319	2605	9802	10381	3695	15217	16116	5736	19207	20341	7240	23156	24524	8729	34057	36069	12838	58999	62485	22241	85427	90474	32204
100	7227	7657	2726	10250	10860	3865	15913	16859	6001	20085	21280	7574	24215	25655	9132	35615	37733	13431	61698	65368	23267	89336	94649	33689
105	7544	7995	2846	10699	11339	4036	16609	17603	6266	20964	22218	7908	25275	26787	9535	37173	39397	14023	64398	68251	24293	93245	98823	35175
110	7860	8333	2966	11147	11818	4206	17305	18346	6530	21843	23157	8243	26334	27919	9937	38732	41062	14616	67098	71134	25320	97154	102998	36661
115	8176	8670	3086	11596	12297	4377	18002	19090	6795	22722	24096	8577	27394	29050	10340	40290	42726	15208	69797	74017	26346	101063	107173	38147
120	8492	9008	3206	12044	12776	4547	18698	19834	7060	23601	25034	8911	28453	30182	10743	41848	44390	15800	72497	76900	27372	104971	111347	39633
125	8809	9346	3327	12493	13255	4718	19394	20577	7324	24480	25973	9245	29513	31313	11146	43407	46055	16393	75197	79783	28398	108880	115522	41119
130	9125	9684	3447	12941	13734	4888	20091	21321	7589	25358	26911	9579	30573	32445	11548	44965	47719	16985	77896	82666	29424	112789	119696	42605
135	9441	10021	3567	13390	14213	5059	20787	22064	7854	26237	27850	9913	31632	33576	11951	46524	49383	17577	80596	85550	30451	116698	123871	44091
140	9757	10359	3687	13838	14692	5229	21483	22808	8118	27116	28788	10247	32692	34708	12354	48082	51047	18170	83295	88533	31477	120607	128045	45577
145	10073	10697	3807	14287	15171	5400	22179	23552	8383	27995	29727	10581	33751	35839	12757	49640	52712	18762	85995	91316	32503	124516	132220	47063
150	10390	11034	3928	14735	15650	5570	22876	24295	8648	28874	30666	10915	34811	36971	13160	51199	54376	19355	88695	94199	33529	128425	136395	48549
155	10706	11372	4048	15184	16129	5741	23572	25039	8912	29753	31604	11249	35870	38103	13562	52757	56040	19947	91394	97082	34556	132334	140569	50034
160	11022	11710	4168	15632	16608	5911	24268	25782	9177	30631	32543	11583	36930	39234	13965	54315	57704	20539	94094	99965	35582	136243	144744	51520
165	11338	12048	4288	16081	17087	6082	24964	26526	9442	31510	33481	11917	37989	40366	14368	55874	59369	21132	96794	102848	36608	140152	148918	53006
170	11655	12385	4408	16529	17566	6252	25661	27270	9706	32389	34420	12251	39049	41497	14771	57432	61033	21724	99493	105731	37634	144061	153093	54492
175	11971	12723	4529	16978	18045	6423	26357	28013	9971	33268	35358	12586	40108	42629	15173	58990	62697	22317	102193	108614	38660	147969	157267	55978
180	12287	13061	4649	17426	18524	6593	27053	28757	10236	34147	36297	12920	41168	43760	15576	60549	64361	22909	104893	111497	39687	151878	161442	57464
185	12603	13399	4769	17875	19003	6764	27750	29500	10500	35026	37236	13254	42228	44892	15979	62107	66026	23501	107592	114381	40713	155787	165617	58950
190	12920	13736	4889	18323	19482	6934	28446	30244	10765	35905	38174	13588	43287	46023	16382	63665	67690	24094	110292	117264	41739	159696	169791	60436
195	13236	14074	5010	18772	19961	7105	29142	30988	11030	36783	39113	13922	44347	47155	16784	65224	69354	24686	112991	120147	42765	163605	173966	61922
200	13552	14412	5130	19220	20440	7275	29838	31731	11294	37662	40051	14256	45406	48287	17187	66782	71018	25278	115691	123030	43791	167514	178140	63408
205	13868	14749	5250	19669	20919	7446	30535	32475	11559	38541	40990	14590	46466	49418	17590	68340	72683	25871	118391	125913	44818	171423	182315	64893
210	14184	15087	5370	20117	21398	7616	31231	33218	11824	39420	41928	14924	47525	50550	17993	69899	74347	26463	121090	128796	45844	175332	186489	66379
215	14501	15425	5490	20566	21876	7787	31927	33962	12088	40299	42867	15258	48585	51681	18396	71457	76011	27056	123790	131679	46870	179241	190664	67865
220	14817	15763	5611	21014	22355	7957	32623	34706	12353	41178	43806	15592	49644	52813	18798	73015	77675	27648	126490	134562	47896	183150	194839	69351
225	15133	16100	5731	21463	22834	8128	33320	35449	12618	42056	44744	15926	50704	53944	19201	74574	79340	28240	129189	137445	48923	187059	199013	70837
230	15449	16438	5851	21911	23313	8298	34016	36193	12883	42935	45683	16260	51764	55076	19604	76132	81004	28833	131889	140329	49949	190958	203188	72323
235	15766	16776	5971	22360	23782	8469	34702	36936	13147	43814	46621	16594	52823	56207	200									

CV14 SERIES LOW PRESSURE STEAM RELIEF VALVES

ALL SPECIFICATIONS AND DIMENSIONS SUBJECT TO CHANGE WITHOUT NOTICE



CV14 SERIES (Steam)

- ASME Sec.IV,NB & CRN #0G8547.5C Certified (15 PSI only)
- One piece body, all bronze construction, Rust proof steel spring
- Chrome plated seat, PTFE coated disc, PTFE coated EPDM O-ring
- 3/8" NPT side tapping for drain connection
- Maximum Temperature 400°F
- OPTION: test gag available to prevent the valve from opening during hydrostatic testing of the boiler. Add "G" to end of part number to specify gag option



STEAM PART#	INLET/OUTLET
CV14-1616-**LS	2"MNPT X 2"FNPT
CV14-2020-**LS	2-1/2"MNPT X 2-1/2"FNPT
CV14-2424-**LS	3"MNPT X 3"FNPT

** Set Pressures Available (05, 10, 15 PSIG)

CV14 SERIES LOW PRESSURE AIR RELIEF VALVES

CV14 SERIES (Air)

- Non-ASME code high volume relief valves for low pressure air and gas
- One piece unified bronze body design, Stainless Steel Spring
- High flow "top-guided" design, Vibration resistant soft seat is standard
- Set pressures available 4 to 22 PSIG
- Maximum temperature 400°F



AIR PART#	INLET/OUTLET
CV14-1616-**LorP A	2"MNPT X 2"FNPT
CV14-2020-**LorP A	2-1/2"MNPT X 2-1/2"FNPT
CV14-2424-**LorP A	3"MNPT X 3"FNPT

** Set Pressures Available (05, 10, 15 PSIG)
 "L" = Test Lever, "P" = Plain Cap

CV14 SERIES LOW PRESSURE VACUUM RELIEF VALVES

CV14 SERIES (Vacuum)

- One piece unified bronze body & High capacity "top-guided" design
- Weather resistant construction, Stainless Steel Spring
- Elastomer soft seat is vibration resistant
- TFE / Chrome plated internals
- Maximum temperature 400°F, Relief settings available 6 to 30 Hg



VACUUM PART#	INLET/OUTLET
CV14-1616-**PV	2"MNPT X 2"FNPT
CV14-2020-**PV	2-1/2"MNPT X 2-1/2"FNPT
CV14-2424-**PV	3"MNPT X 3"FNPT

** Set Pressures Available (05, 10, 15 PSIG)



CV14 SERIES RELIEF VALVES

ALL SPECIFICATIONS AND DIMENSIONS SUBJECT TO CHANGE WITHOUT NOTICE



STEAM (Pounds per hour saturated steam)

SET Pressure (PSIG)	2" x 2"	2 ¹ / ₂ " x 2 ¹ / ₂ "	3" x 3"
5	1815	2695	3944
10	2483	3686	5394
15	3150	4676	6843

VACUUM (Standard cubic feet of air)

SET Pressure (in.Hg)	2" x 2"	2 ¹ / ₂ " x 2 ¹ / ₂ "	3" x 3"
	2.238 in ²	3.339 in ²	5.155 in ²
6	355	539	780
7	375	570	823
8	395	600	865
9	405	618	890
10	415	635	915
11	421	642	927
12	426	649	939
13	430	653	943
14	430	653	943
15	430	653	943
20	430	653	943
25	430	653	943
30	430	653	943

AIR (Standard cubic feet of air)

SET Pressure (PSIG)	2" x 2"	2 ¹ / ₂ " x 2 ¹ / ₂ "	3" x 3"
	2.238 in ²	3.339 in ²	5.155 in ²
4	615	914	1338
5	651	967	1415
6	687	1020	1492
7	722	1072	1569
8	758	1125	1646
9	793	1178	1723
10	829	1231	1801
11	864	1283	1878
12	900	1336	1955
13	935	1389	2032
14	971	1441	2109
15	1006	1494	2186
16	1041	1547	2263
17	1076	1600	2340
18	1111	1653	2417
19	1146	1706	2494
20	1181	1756	2571
21	1216	1809	2648
22	1252	1861	2725

HOW TO ORDER CV14 SERIES

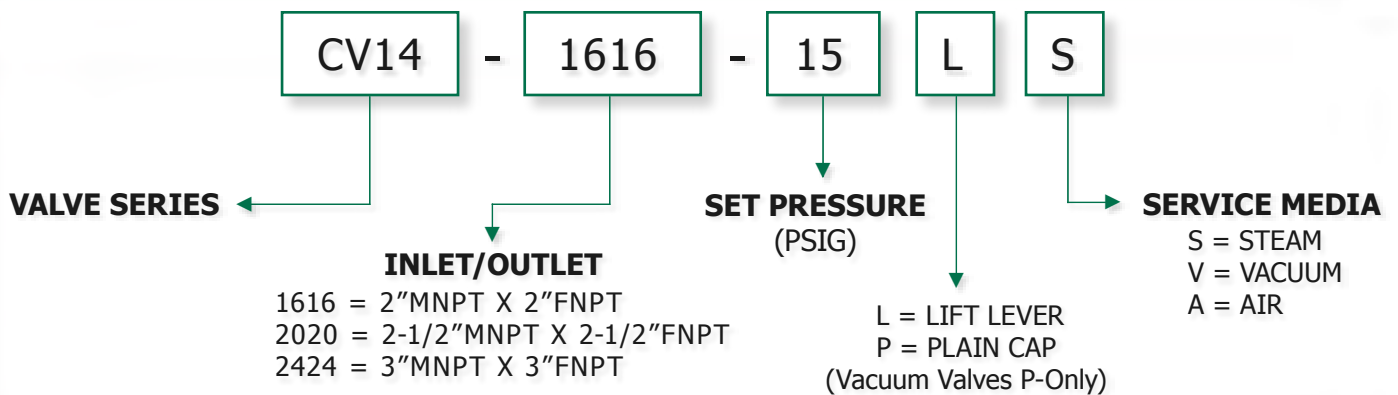

CV500 SERIES RELIEF VALVES

ALL SPECIFICATIONS AND DIMENSIONS SUBJECT TO CHANGE WITHOUT NOTICE



CV500 SERIES

- Bronze, Carbon Steel or all Stainless Steel Construction
- One trim design is suitable for Steam, Air, Gas, Liquid applications
- Metal to Metal, PCTFE or Elastomer O-ring Seats
- Short tuned blowdown and back pressure tight body minimizes fugitive emissions and product loss
- ASME Section VIII Air, Steam and Liquid Service, Sizes 1/2" to 2" NPT available
- Set pressure range 5-900 PSIG @ 800°F maximum
- High Capacity Full Nozzle Design, Stainless Steel Springs
- Integral Lift Stop, Self-Aligning Pivoting Disc
- API 527 Seat Tightness, Standard for all Models
- CSA B51 CRN OG8547.5C

Options

- Screwed Cap (standard), Packed Lift Lever, Special Cleaning and Test Gags Available
- Elastomer or PCTFE Soft Seats for Exceptional Seat Tightness
- High Temperature Alloy Springs for 422°F To 800°F Service ("HT" Suffix)
- Cryogenic Preparation to -400°F (consult factory)



Soft Seat Pressure & Temperature Limits

Seat Material	Set Pressure		Temperature	
	Min.	Max.	Min.	Max.
VITON	15	900	-15°F	400°F
EPDM	15	900	-70°F	250°F
SILICONE	15	900	-60°F	450°F
NEOPRENE	15	900	-35°F	225°F
NITRILE/BUNA-N	15	900	-30°F	250°F
PCTFE	15	500	-320°F	250°F

Metal to Metal Pressure/Temperature Ratings

Series	CV51	CV52	CV53	CV54
Body	Bronze	Bronze	Carbon	Stainless
Trim	Brass	Stainless	Stainless	Stainless
Max.Set-Steam	250 PSI	300 PSI	900 PSI(D/E) 600 PSI(F/G) 500 PSI(H/J)	900 PSI(D/E) 600 PSI(F/G) 500 PSI(H/J)
Max.Set-Air/Gas/Liq.	300 PSI	900 PSI(D/E) 600 PSI(F/G) 600 PSI(F/G)	900 PSI(D/E) 600 PSI(F/G) 500 PSI(H/J)	900 PSI(D/E) 600 PSI(F/G) 500 PSI(H/J)
Temp. Limits	-60/406°F	-60/422°F	-20/800°F	-60/800°F

PART#	ORIFICE GROUP	INLET/OUTLET	PART#	ORIFICE GROUP	INLET/OUTLET
CV5**-0406	D	1/2" MNPT X 3/4" FNPT*	CV5**-1012	F	1-1/4" MNPT X 1-1/2" FNPT
CV5**-0408	D	1/2" MNPT X 1" FNPT	CV5**-1016	G	1-1/4" MNPT X 2" FNPT
CV5**-0606	D	3/4" MNPT X 3/4" FNPT*	CV5**-1216	G	1-1/2" MNPT X 2" FNPT
CV5**-0608	D	3/4" MNPT X 1" FNPT	CV5**-1220	H	1-1/2" MNPT X 2-1/2" FNPT
CV5**-0610	E	3/4" MNPT x 1-1/4" FNPT	CV5**-1620	H	2" MNPT X 2-1/2" FNPT
CV5**-0810	E	1" MNPT X 1-1/4" FNPT	CV5**-1624	J	2" MNPT X 3" FNPT
CV5**-0812	F	1" MNPT X 1-1/2" FNPT			

* Available in Series CV51 & CV52 ONLY

HOW TO ORDER CV500 SERIES

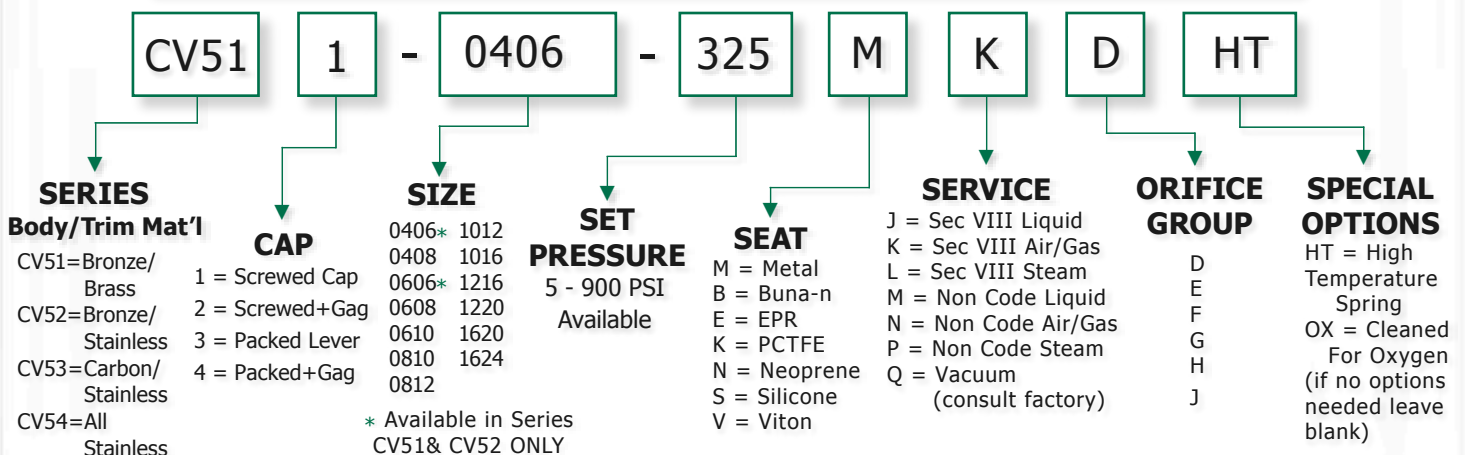

Notes: 1. The ASME Code Section VIII requires a lift lever for the following services: air, steam, or hot water over 140°F
 2. Maximum back pressure is 50 PSIG
 3. High temperature stainless steel alloy spring is required above 422°F / 217°C. Specify option "HT"



CV500 SERIES RELIEF VALVES

ALL SPECIFICATIONS AND DIMENSIONS SUBJECT TO CHANGE WITHOUT NOTICE



AIR

ASME Section VIII Air
Standard Cubic Feet Per Minute
of Air at 10% Overpressure
National Board Certified
Ratings are 90% of Actual

STEAM

ASME Section VIII Steam
Pounds per Hour Steam at 10%
Overpressure
National Board Certified
Ratings are 90% of Actual

LIQUID

ASME Section VIII Liquid
U.S. Gallons Per Minute of Water
at 10% Overpressure
National Board Certified
Ratings are 90% of Actual

SET PRESSURE	D			E			F			G			H			J			
	0.1295			0.2282			0.3589			0.5890			0.9195			1.5044			
	AREA SQ.IN	SCFM	LB/hr	GPM	SCFM	LB/hr	GPM	SCFM	LB/hr	GPM	SCFM	LB/hr	GPM	SCFM	LB/hr	GPM	SCFM	LB/hr	GPM
5*	39	122	13	69	216	24	108	339	37	178	557	61	277	869	95	454	1422	156	
10*	54	168	14	96	295	24	151	465	38	248	762	63	387	1190	98	633	1947	161	
15	67	188	14	118	331	25	185	520	40	304	853	65	474	1332	102	776	2180	167	
20	77	216	16	136	381	29	213	600	45	350	984	74	547	1536	115	895	2513	189	
25	87	245	18	154	432	32	242	679	50	397	1114	82	619	1740	127	1013	2846	208	
30	97	274	19	172	482	34	270	759	54	443	1245	89	692	1943	138	1132	3180	226	
35	109	305	21	191	538	37	301	846	58	494	1388	96	772	2168	149	1262	3546	244	
40	120	337	22	211	593	40	332	934	62	545	1532	102	851	2392	160	1393	3913	261	
45	131	368	24	231	649	42	363	1021	66	596	1676	108	931	2616	169	1523	4280	277	
50	142	400	25	251	705	44	395	1108	70	648	1819	114	1011	2840	178	1654	4646	292	
55	154	431	26	271	760	46	426	1196	73	699	1963	120	1091	3064	187	1784	5013	306	
60	165	463	28	290	816	48	457	1283	76	750	2106	125	1170	3288	195	1915	5380	320	
65	176	494	29	310	872	50	488	1371	79	801	2250	130	1250	3512	203	2045	5746	333	
70	187	526	30	330	927	52	519	1458	82	852	2393	135	1330	3736	211	2176	6113	345	
75	198	558	31	350	983	54	550	1546	85	903	2537	140	1410	3960	218	2306	6479	357	
80	210	589	32	370	1038	56	581	1633	88	954	2680	145	1489	4184	226	2437	6846	369	
85	221	621	33	389	1094	58	612	1721	91	1005	2824	149	1569	4408	233	2567	7213	381	
90	232	652	34	409	1150	59	644	1808	93	1056	2968	153	1649	4632	239	2698	7579	392	
95	243	684	35	429	1205	61	675	1896	96	1107	3111	158	1729	4857	246	2828	7946	402	
100	255	715	36	449	1261	63	706	1983	98	1158	3255	162	1808	5081	252	2959	8313	413	
125	311	873	40	548	1539	70	862	2421	110	1414	3972	181	2207	6201	282	3611	10146	462	
150	367	1031	44	647	1817	77	1017	2858	121	1669	4690	198	2606	7322	309	4264	11979	506	
175	423	1189	47	746	2095	83	1173	3295	130	1925	5408	214	3005	8442	334	4916	13812	546	
200	479	1346	50	845	2373	89	1329	3733	139	2180	6126	229	3404	9562	357	5569	15645	584	
225	535	1504	53	944	2651	94	1484	4170	148	2436	6843	242	3802	10683	378	6221	17478	619	
250	592	1662	56	1043	2929	99	1640	4607	156	2691	7561	256	4201	11803	399	6874	19312	653	
275	648	1820	59	1142	3207	104	1796	5045	163	2947	8279	268	4600	12924	418	7526	21145	685	
300	704	1977	62	1240	3485	108	1951	5482	171	3202	8997	280	4999	14044	437	8179	22978	715	
325	760	2135	64	1339	3763	113	2107	5919	178	3458	9714	291	5398	15165	455	8831	24811	744	
350	816	2293	66	1438	4041	117	2263	6357	184	3713	10432	302	5796	16285	472	9484	26644	772	
375	872	2451	69	1537	4319	121	2418	6794	191	3969	11150	313	6195	17405	489	10136	28477	799	
400	928	2608	71	1636	4597	125	2574	7231	197	4224	11867	323	6594	18526	505	10789	30311	826	
425	985	2766	73	1735	4875	129	2730	7669	203	4480	12585	333	6993	19646	520	11441	32144	851	
450	1041	2924	75	1834	5153	133	2885	8106	209	4735	13303	343	7392	20767	535	12094	33977	876	
475	1097	3082	77	1933	5431	136	3041	8543	215	4991	14021	352	7791	21887	550	12746	35810	900	
500	1153	3239	79	2032	5709	140	3197	8981	220	5246	14738	361	8189	23008	564	13399	37643	923	
525	1209	3397	81	2131	5987	143	3352	9418	226	5501	15456	370							
550	1265	3555	83	2230	6266	147	3508	9855	231	5757	16174	379							
575	1321	3713	85	2329	6544	150	3664	10293	236	6012	16892	388							
600	1378	3870	87	2428	6822	153	3819	10730	241	6268	17609	396							
625	1434	4028	89	2527	7100	157													
650	1490	4186	91	2626	7378	160													
675	1546	4344	92	2725	7656	163													
700	1602	4501	94	2824	7934	166													
725	1658	4659	96	2923	8212	169													
750	1715	4817	97	3022	8490	171													
775	1771	4975	99	3121	8768	174													
800	1827	5132	100	3220	9046	177													
825	1883	5290	102	3319	9324	180													
850	1939	5448	104	3418	9602	183													
875	1995	5606	105	3517	9880	185													
900	2051	5763	107	3616	10158	188													

* Pressure Settings Below 15 PSIG are Non-ASME Code



NCA and NCVR SERIES RELIEF VALVES

ALL SPECIFICATIONS AND DIMENSIONS SUBJECT TO CHANGE WITHOUT NOTICE

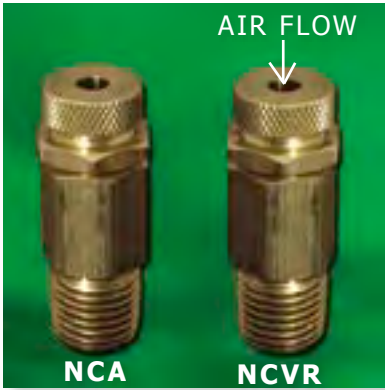

NCA2 & NCA3 SERIES

- Brass Body
- Stainless Steel Spring
- Proportional Relief Valve
- Stainless Steel Ball & Poppet (NCA2)
- Nylon Poppet With Nitrile Seals (NCA3)
- Unfired Pressure Vessel
- Temperature -65°F to 250°F

NPT SIZE	PART#	Pressure Range	HEX
1/4"	NCA2-20	0-20 PSI	5/8"
1/4"	NCA2-60	20-60 PSI	5/8"
1/4"	NCA2-125	50-125 PSI	5/8"
1/4"	NCA2-200	100-200 PSI	5/8"
3/8"	NCA3-20	0-20 PSI	3/4"

NCVR SERIES

- Brass Body
- Stainless Steel Spring
- Nylon Poppet With Nitrile Seals
- Proportional Relief Valve
- Unfired Pressure Vessel
- Temperature -65°F to 250°F

NPT SIZE	PART#	Max. Vacuum Pump Size	HEX
1/4"	NCVR-2	1/4 HP	9/16"
3/8"	NCVR-3	1 HP	1-1/16"
3/4"	NCVR-6	3 HP	1-1/16"

NCHL2 SERIES RELIEF VALVES



NCHL2 SERIES

- Machined Brass Body, Poppet & Sleeve
- 302 Stainless Steel Spring
- Viton Seal, Suffix "V" Standard
- Unfired Pressure Vessel
- Temperature 0°F to 350°F

NPT SIZE	PART#	HEX
1/4"	NCHL2-*	5/8"

* Pressure Settings Available From 5 to 75 PSI in 5 PSI Increments

NCM1 & NCM2 SERIES RELIEF VALVES



NCM1 & NCM2 SERIES

- Brass Body
- Stainless Steel Spring
- Silicon Seal, Standard
- Unfired Pressure Vessel
- Temperature -65°F to 250°F

NPT SIZE	PART#	HEX
1/8"	NCM1-*	9/16"
1/4"	NCM2-*	9/16"

* Pressure Settings Available From 80 to 225 PSI in 5 PSI Increments

CVM1 & CVM2 SERIES RELIEF VALVES



CVM1 & CVM2 SERIES

- Brass Body
- Stainless Steel Spring
- Silicon Seal, Standard
- Viton Seal, Suffix "V" (Optional)
- ASME, NB, UV & CRN# 03378.0-9
- Unfired Pressure Vessel
- Temperature -65°F to 250°F

NPT SIZE	PART#	HEX
1/8"	CVM1-*	9/16"
1/4"	CVM2-*	9/16"

* Pressure Settings Available From 80 to 225 PSI in 5 PSI Increments



CVH2 & CV3 SERIES RELIEF VALVES

ALL SPECIFICATIONS AND DIMENSIONS SUBJECT TO CHANGE WITHOUT NOTICE



CVH2 & CV3 SERIES

- Brass Body
- Plated Steel Spring
- Silicon Seal, Standard
- Viton Seal, Suffix "V" (Optional)
- ASME, NB, UV & CRN# 03378.0-9
- Unfired Pressure Vessel
- Temperature -65°F to 250°F

NPT SIZE	PART#	HEX
1/4"	CVH2-*	5/8"
3/8"	CV3-*	11/16"

* Pressure Settings Available From 25 to 350 PSI in 5 PSI Increments

CV4 SERIES RELIEF VALVES



CV4 SERIES

- Brass Body
- Plated Steel Spring
- Silicon Seal, Standard
- Viton Seal, Suffix "V" (Optional)
- ASME, NB, UV & CRN# 03378.0-9
- Unfired Pressure Vessel
- Temperature -65°F to 250°F

NPT SIZE	PART#	HEX
1/2"	CV4-*	7/8"

* Pressure Settings Available From 50 to 250 PSI in 5 PSI Increments

CVH4 & CV6 SERIES RELIEF VALVES



CVH4 & CV6 SERIES

- Brass Body
- Stainless Steel Spring
- Silicon Seal, Standard
- Viton Seal, Suffix "V" (Optional)
- ASME, NB, UV & CRN# 03378.0-9
- Unfired Pressure Vessel
- Temperature -65°F to 250°F

NPT SIZE	PART#	HEX
1/2"	CVH4-*	1-1/16"
3/4"	CV6-*	1-1/16"

* Pressure Settings Available From 25 to 300 PSI in 5 PSI Increments

CV8 & CV10 SERIES RELIEF VALVES



CV8 & CV10 SERIES

- Brass Body
- Stainless Steel Spring
- Silicon Seal, Standard
- Viton Seal, Suffix "V" (Optional)
- ASME, NB, UV & CRN# 03378.0-9
- Unfired Pressure Vessel
- Temperature -65°F to 250°F

NPT SIZE	PART#	HEX
1"	CV8-*	1-3/4"
1-1/4"	CV10-*	1-3/4"

* Pressure Settings Available From 25 to 300 PSI in 5 PSI Increments



BPC SERIES 250 PSI CHECK VALVE

ALL SPECIFICATIONS AND DIMENSIONS SUBJECT TO CHANGE WITHOUT NOTICE



BPC SERIES

- 250 Max. Working Pressure
- Body: Extra-Heavy Walled Cast Brass
- Poppets: Glass-Filled Fluoropolymer
- Spring: Stainless Steel
- 450°F Max. Temperature

NPT SIZE	PART#	MAX. FLOW RATE
1/8"	BPC-1	12 SCFM
1/4"	BPC-2	12 SCFM
3/8"	BPC-3	22 SCFM
1/2"	BPC-4	38 SCFM
3/4"	PBC-6	60 SCFM
1"	BPC-8	115 SCFM
1-1/4"	PBC-10	160 SCFM
1-1/2"	BPC-12	160 SCFM
2"	BPC-16	220 SCFM

BC, BCS and SC SERIES 400 PSIG CHECK VALVES



BC only



NSF 61 Certified

BC and BCS SERIES

- 1/4"-2" 400 PSIG WOG, 2-1/2"-4" 175 PSIG
- Body: Brass
- Seat: (BC) NBR or VITON, (BCS) NBR only
- Spring: (BC) Steel, (BCS) Stainless Steel
- (Viton) 320°F, (NBR)210°F Max. Temperature
- Check Module: Polyethereimide
- NSF 61 Certified (BC only)

SC SERIES

- 400 PSIG WOG
- 125 PSIG Saturated Steam
- Body: Stainless Steel
- Ball Check: RTFE
- Spring: 316 Stainless Steel
- 350°F Max. Temperature

NPT SIZE	BC		BC		BCS		SC	
	NBR Seat	CV	VITON Seat	CV	NBR Seat	CV	TEFLON Seat	CV
1/4"	BC-2	4.55	BC-2V	4.55	—	—	SC-2	0.85
3/8"	BC-3	4.55	BC-3V	4.55	—	—	SC-3	1.21
1/2"	BC-4	6.07	BC-4V	6.07	BCS-4	4.5	SC-4	1.40
3/4"	BC-6	10.97	BC-6V	10.97	BCS-6	6.1	SC-6	3.53
1"	BC-8	16.92	BC-8V	16.92	BCS-8	11.0	SC-8	6.00
1-1/4"	BC-10	27.42	BC-10V	27.42	BCS-10	16.9	SC-10	CF
1-1/2"	BC-12	39.09	BC-12V	39.09	BCS-12	27.4	SC-12	CF
2"	BC-16	60.68	BC-16V	60.68	BCS-16	39.1	SC-16	CF
2-1/2"	BC-20	98.40	BC-20V	98.40	—	—	—	—
3"	BC-24	158.01	BC-24V	158.01	—	—	—	—
4"	BC-32	225.46	BC-32V	225.46	—	—	—	—

CF = Consult Factory



CHC, CHSC and SHSC SERIES HIGH PRESSURE CHECK VALVES

ALL SPECIFICATIONS AND DIMENSIONS SUBJECT TO CHANGE WITHOUT NOTICE



NPT SIZE	Part# 5 PSIG Cracking Pressure	Part# 65 PSIG Cracking Pressure	Working Pressure	Flow Rate
1/4"	CHC-2-5	CHC-2-65	6,000 PSIG	6 GPM
3/8"	CHC-3-5	CHC-3-65	6,000 PSIG	9.5 GPM
1/2"	CHC-4-5	CHC-4-65	5,000 PSIG	18 GPM
3/4"	CHC-6-5	CHC-6-65	5,000 PSIG	30 GPM
1"	CHC-8-5	CHC-8-65	5,000 PSIG	35 GPM
1-1/4"	CHC-10-5	CHC-10-65	3,000 PSIG	60 GPM
1-1/2"	CHC-12-5	CHC-12-65	3,000 PSIG	90 GPM
2"	CHC-16-5	CHC-16-65	3,000 PSIG	145 GPM

SAE SIZE	Part# 5 PSIG Cracking Pressure	Part# 65 PSIG Cracking Pressure	Working Pressure	Flow Rate
7/16-20	CHC-S4-5	CHC-S4-65	6,000 PSIG	6 GPM
9/16-18	CHC-S6-5	CHC-S6-65	6,000 PSIG	9.5 GPM
3/4-16	CHC-S8-5	CHC-S8-65	5,000 PSIG	18 GPM
1-1/16-12	CHC-S12-5	CHC-S12-65	5,000 PSIG	30 GPM
1-5/16-12	CHC-S16-5	CHC-S16-65	5,000 PSIG	35 GPM
1-5/8-12	CHC-S20-5	CHC-S20-65	3,000 PSIG	60 GPM
1-7/8-12	CHC-S24-5	CHC-S24-65	3,000 PSIG	90 GPM

NPT SIZE	Part# 7 PSIG Cracking Pressure	Part# 70 PSIG Cracking Pressure	Working Pressure	Flow Rate
1/4"	CHSC-2-7	CHSC-2-70	10,000 PSIG	5.8 GPM
3/8"	CHSC-3-7	CHSC-3-70	10,000 PSIG	9.4 GPM
1/2"	CHSC-4-7	CHSC-4-70	7,350 PSIG	17.9 GPM
3/4"	CHSC-6-7	CHSC-6-70	7,350 PSIG	29.7 GPM
1"	CHSC-8-7	CHSC-8-70	7,350 PSIG	35.8 GPM
1-1/4"	CHSC-10-7	CHSC-10-70	4,410 PSIG	59.7 GPM
1-1/2"	CHSC-12-7	CHSC-12-70	4,410 PSIG	90.8 GPM
2"	CHSC-16-7	CHSC-16-70	4,410 PSIG	144.7 GPM

NPT SIZE	Part#	Working Pressure	Flow Rate
1/4"	SHSC-2-7	5,145 PSIG	4.7 GPM
3/8"	SHSC-3-7	5,145 PSIG	10.5 GPM
1/2"	SHSC-4-7	5,145 PSIG	13.1 GPM
3/4"	SHSC-6-7	4,400 PSIG	23.7 GPM
1"	SHSC-8-7	3,675 PSIG	36.9 GPM
1-1/4"	SHSC-10-7	3,675 PSIG	71.0 GPM
1-1/2"	SHSC-12-7	3,675 PSIG	97.4 GPM



CHC SERIES

- 5 or 65 PSIG Cracking Pressure
- Body: Carbon Steel, Zinc Plated
- Spring: Carbon Steel
- Guide & Poppet: Case Hardened Steel
- Temperature: -40°F to 500°F

CHSC SERIES

- Body: Carbon Steel, Zinc Plated
- Poppet: Carbon Steel, Zinc Plated
- Springs: Stainless Steel
- Buna N Poppet "o" Rings
- Temperature: -13°F to 185°F

SHSC SERIES

- Body: 316 Stainless Steel
- Poppet: 316 Stainless Steel
- Springs: 304 Stainless Steel
- VITON Poppet "o" Rings
- Temperature: -13°F to 392°F



PAD1001 SERIES 1" CENTER BACK CONNECT DRY GAUGES

ALL SPECIFICATIONS AND DIMENSIONS SUBJECT TO CHANGE WITHOUT NOTICE



PAD1001 SERIES

- **Case:** Black Plastic
- **Dial:** Aluminum, White, Black Type
- **Scale:** lb/in²
- **Bourdon Tube:** Brass
- **Connection:** Brass 1/8" NPT
- **Lens:** Acrylic
- **Surge Protection:** Standard
- **Accuracy:** ANSI Grade C

PART#	RANGE
PAD1001-30	0-30 PSI
PAD1001-60	0-60 PSI
PAD1001-100	0-100 PSI
PAD1001-160	0-160 PSI



SPM1501 SERIES 1.5" PANEL MOUNT DRY GAUGES

SPM1501 SERIES

- **Case:** Black Painted Steel, Chrome Ring
- **Dial:** Aluminum, White, Black, & Blue Type
- **Scale:** Dual (lb/in² - bar - x 100 kpa)
- **Bourdon Tube:** Brass
- **Connection:** Brass 1/8" NPT
- **Lens:** Acrylic
- **Surge Protection:** Standard
- **Accuracy:** ANSI Grade B, 3%-2%-3%

PART#	RANGE
SPM1501-V	30hg-0
SPM1501-C	30hg-0-30 PSI
SPM1501-15	0-15 PSI
SPM1501-30	0-30 PSI
SPM1501-60	0-60 PSI
SPM1501-100	0-100 PSI
SPM1501-160	0-160 PSI
SPM1501-200	0-200 PSI
SPM1501-300	0-300 PSI



SAD1501 SERIES 1.5" CENTER BACK CONNECT DRY GAUGES

SAD1501 SERIES

- **Case:** Black Painted Steel, Chrome Ring
- **Dial:** Aluminum, White, Black, & Blue Type
- **Scale:** Dual (lb/in² - bar - x 100 kpa)
- **Bourdon Tube:** Brass
- **Connection:** Brass 1/8" NPT
- **Lens:** Acrylic
- **Surge Protection:** Standard
- **Accuracy:** ANSI Grade B, 3%-2%-3%

PART#	RANGE
SAD1501-V	30hg-0
SAD1501-C	30hg-0-30 PSI
SAD1501-15	0-15 PSI
SAD1501-30	0-30 PSI
SAD1501-60	0-60 PSI
SAD1501-100	0-100 PSI
SAD1501-160	0-160 PSI
SAD1501-200	0-200 PSI
SAD1501-300	0-300 PSI



SAD1511 SERIES 1.5" LOWER CONNECT DRY GAUGES

SAD1511 SERIES

- **Case:** Black Painted Steel, Chrome Ring
- **Dial:** Aluminum, White, Black, & Blue Type
- **Scale:** Dual (lb/in² - bar - x 100 kpa)
- **Bourdon Tube:** Brass
- **Connection:** Brass 1/8" NPT
- **Lens:** Acrylic
- **Surge Protection:** Standard
- **Accuracy:** ANSI Grade B, 3%-2%-3%

PART#	RANGE
SAD1511-V	30hg-0
SAD1511-C	30hg-0-30 PSI
SAD1511-15	0-15 PSI
SAD1511-30	0-30 PSI
SAD1511-60	0-60 PSI
SAD1511-100	0-100 PSI
SAD1511-160	0-160 PSI
SAD1511-200	0-200 PSI
SAD1511-300	0-300 PSI



SPM2001 & 2002 SERIES 2" PANEL MOUNT DRY GAUGES

ALL SPECIFICATIONS AND DIMENSIONS SUBJECT TO CHANGE WITHOUT NOTICE



SPM2001 & 2002 SERIES

- **Case:** Black Painted Steel, Chrome Ring
- **Dial:** Aluminum, White, Black, & Blue Type
- **Scale:** Dual (lb/in² - bar - x 100 kpa)
- **Bourdon Tube:** Brass
- **Connection:** SAD2001- Brass 1/8" NPT
SAD2002- Brass 1/4" NPT
- **Lens:** Acrylic
- **Surge Protection:** Standard
- **Accuracy:** ANSI Grade B, 3%-2%-3%

PART#	RANGE
SPM200*-V	30hg-0
SPM200*-C	30hg-0-30 PSI
SPM200*-15	0-15 PSI
SPM200*-30	0-30 PSI
SPM200*-60	0-60PSI
SPM200*-100	0-100 PSI
SPM200*-160	0-160 PSI
SPM200*-200	0-200 PSI
SPM200*-300	0-300 PSI



* Denotes Connection 1=1/8"NPT, 2=1/4"NPT

SAD2001 & 2002 SERIES 2" CENTER BACK CONNECT DRY GAUGES

SAD2001 & 2002 SERIES

- **Case:** Black Painted Steel, Chrome Ring
- **Dial:** Aluminum, White, Black, & Blue Type
- **Scale:** Dual (lb/in² - bar - x 100 kpa)
- **Bourdon Tube:** Brass
- **Connection:** SAD2001- Brass 1/8" NPT
SAD2002- Brass 1/4" NPT
- **Lens:** Acrylic
- **Surge Protection:** Standard
- **Accuracy:** ANSI Grade B, 3%-2%-3%

PART#	RANGE
SAD200*-V	30hg-0
SAD200*-C	30hg-0-30PSI
SAD200*-15	0-15 PSI
SAD200*-30	0-30 PSI
SAD200*-60	0-60 PSI
SAD200*-100	0-100 PSI
SAD200*-160	0-160 PSI
SAD200*-200	0-200 PSI
SAD200*-300	0-300 PSI



* Denotes Connection 1=1/8"NPT, 2=1/4"NPT

SAD2011 & 2012 SERIES 2" LOWER CONNECT DRY GAUGES

SAD2011 & 2012 SERIES

- **Case:** Black Painted Steel, Chrome Ring
- **Dial:** Aluminum, White, Black, & Blue Type
- **Scale:** Dual (lb/in² - bar - x 100 kpa)
- **Bourdon Tube:** Brass
- **Connection:** SAD2011- Brass 1/8" NPT
SAD2012- Brass 1/4" NPT
- **Lens:** Acrylic
- **Surge Protection:** Standard
- **Accuracy:** ANSI Grade B, 3%-2%-3%

PART#	RANGE
SAD201*-V	30hg-0
SAD201*-C	30hg-0-30 PSI
SAD201*-15	0-15 PSI
SAD201*-30	0-30 PSI
SAD201*-60	0-60 PSI
SAD201*-100	0-100 PSI
SAD201*-160	0-160 PSI
SAD201*-200	0-200 PSI
SAD201*-300	0-300 PSI



* Denotes Connection 1=1/8"NPT, 2=1/4"NPT

SPM2502 SERIES 2.5" PANEL MOUNT DRY GAUGES

SPM2502 SERIES

- **Case:** Black Painted Steel, Chrome Ring
- **Dial:** Aluminum, White, Black, & Blue Type
- **Scale:** Dual (lb/in² - bar - x 100 kpa)
- **Bourdon Tube:** Brass
- **Connection:** Brass 1/4" NPT
- **Lens:** Acrylic
- **Surge Protection:** Standard
- **Accuracy:** ANSI Grade B, 3%-2%-3%

PART#	RANGE
SPM2502-V	30hg-0
SPM2502-C	30hg-0-30 PSI
SPM2502-15	0-15 PSI
SPM2502-30	0-30 PSI
SPM2502-60	0-60 PSI
SPM2502-100	0-100 PSI
SPM2502-160	0-160 PSI
SPM2502-200	0-200 PSI
SPM2502-300	0-300 PSI
SPM2502-400	0-400 PSI
SPM2502-600	0-600 PSI

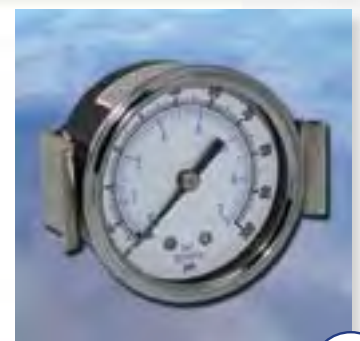

SAD2502 SERIES 2.5" CENTER BACK CONNECT DRY GAUGES

ALL SPECIFICATIONS AND DIMENSIONS SUBJECT TO CHANGE WITHOUT NOTICE



SAD2502 SERIES

- **Case:** Black Painted Steel, Chrome Ring
- **Dial:** Aluminum, White, Black, & Blue Type
- **Scale:** Dual (lb/in² - bar - x 100 kpa)
- **Bourdon Tube:** Brass
- **Connection:** Brass 1/4" NPT
- **Lens:** Acrylic
- **Surge Protection:** Standard
- **Accuracy:** ANSI Grade B, 3%-2%-3%

PART#	RANGE
SAD2502-V	30hg-0
SAD2502-C	30hg-0-30 PSI
SAD2502-15	0-15 PSI
SAD2502-30	0-30 PSI
SAD2502-60	0-60 PSI
SAD2502-100	0-100 PSI
SAD2502-160	0-160 PSI
SAD2502-200	0-200 PSI
SAD2502-300	0-300 PSI
SAD2502-400	0-400 PSI
SAD2502-600	0-600 PSI
SAD2502-1K	0-1000 PSI
SAD2502-2K	0-2000 PSI
SAD2502-3K	0-3000 PSI
SAD2502-5K	0-5000 PSI



SAD2512 SERIES 2.5" LOWER CONNECT DRY GAUGES

SAD2512 SERIES

- **Case:** Black Painted Steel, Chrome Ring
- **Dial:** Aluminum, White, Black, & Blue Type
- **Scale:** Dual (lb/in² - bar - x 100 kpa)
- **Bourdon Tube:** Brass
- **Connection:** Brass 1/4" NPT
- **Lens:** Acrylic
- **Surge Protection:** Standard
- **Accuracy:** ANSI Grade B, 3%-2%-3%

PART#	RANGE
SAD2512-V	30hg-0
SAD2512-C	30hg-0-30PSI
SAD2512-15	0-15 PSI
SAD2512-30	0-30 PSI
SAD2512-60	0-60 PSI
SAD2512-100	0-100 PSI
SAD2512-160	0-160 PSI
SAD2512-200	0-200 PSI
SAD2512-300	0-300 PSI
SAD2512-400	0-400 PSI
SAD2512-500	0-500 PSI
SAD2512-600	0-600 PSI
SAD2512-1K	0-1000 PSI
SAD2512-1.5K	0-1500 PSI
SAD2512-2K	0-2000 PSI
SAD2512-3K	0-3000 PSI
SAD2512-5K	0-5000 PSI



SAD3512 SERIES 3.5" LOWER CONNECT DRY GAUGES

SAD3512 SERIES

- **Case:** Black Painted Steel, Chrome Ring
- **Dial:** Aluminum, White, Black, & Blue Type
- **Scale:** Dual (lb/in² - bar - x 100 kpa)
- **Bourdon Tube:** Brass
- **Connection:** Brass 1/4" NPT
- **Lens:** Acrylic
- **Surge Protection:** Standard
- **Accuracy:** ANSI Grade B, 3%-2%-3%

PART#	RANGE
SAD3512-V	30hg-0
SAD3512-C	30hg-0-30 PSI
SAD3512-15	0-15 PSI
SAD3512-30	0-30 PSI
SAD3512-60	0-60 PSI
SAD3512-100	0-100 PSI
SAD3512-160	0-160 PSI
SAD3512-200	0-200 PSI
SAD3512-300	0-300 PSI
SAD3512-400	0-400 PSI
SAD3512-600	0-600 PSI
SAD3512-1K	0-1000 PSI
SAD3512-2K	0-2000 PSI
SAD3512-3K	0-3000 PSI
SAD3512-5K	0-5000 PSI



SAD3502 SERIES 3.5" CENTER BACK CONNECT DRY GAUGES

ALL SPECIFICATIONS AND DIMENSIONS SUBJECT TO CHANGE WITHOUT NOTICE



SAD3502 SERIES

- **Case:** Black Painted Steel, Chrome Ring
- **Dial:** Aluminum, White, Black, & Blue Type
- **Scale:** Dual (lb/in² - bar - x 100 kpa)
- **Bourdon Tube:** Brass
- **Connection:** Brass 1/4" NPT
- **Lens:** Acrylic
- **Surge Protection:** Standard
- **Accuracy:** ANSI Grade B, 3%-2%-3%

PART#	RANGE
SAD3502-V	30hg-0
SAD3502-C	30hg-0-30 PSI
SAD3502-15	0-15 PSI
SAD3502-30	0-30 PSI
SAD3502-60	0-60 PSI
SAD3502-100	0-100 PSI
SAD3502-160	0-160 PSI
SAD3502-200	0-200 PSI
SAD3502-300	0-300 PSI
SAD3502-400	0-400 PSI
SAD3502-600	0-600 PSI

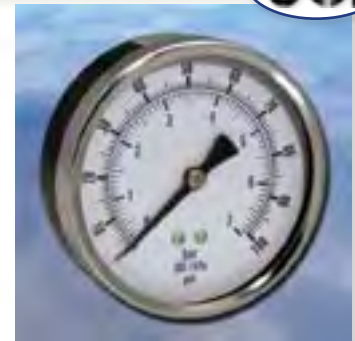

SPM3502 SERIES 3.5" PANEL MOUNT DRY GAUGE

SPM3502 SERIES

- **Case:** Black Painted Steel, Plastic Ring
- **Dial:** Aluminum, White, Black, & Blue Type
- **Scale:** Dual (lb/in² - bar - x 100 kpa)
- **Bourdon Tube:** Brass
- **Connection:** Brass 1/4" NPT
- **Lens:** Acrylic
- **Surge Protection:** Standard
- **Accuracy:** ANSI Grade B, 3%-2%-3%

PART#	RANGE
SPM3502-V	30hg-0
SPM3502-C	30hg-0-30 PSI
SPM3502-15	0-15 PSI
SPM3502-30	0-30 PSI
SPM3502-60	0-60 PSI
SPM3502-100	0-100 PSI
SPM3502-160	0-160 PSI
SPM3502-200	0-200 PSI
SPM3502-300	0-300 PSI
SPM3502-400	0-400 PSI
SPM3502-600	0-600 PSI



SAD4512 SERIES 4.5" LOWER CONNECT DRY GAUGES

SAD4512 SERIES

- **Case:** Black Painted Steel, Chrome Ring
- **Dial:** Aluminum, White, Black, & Blue Type
- **Scale:** Dual (lb/in² - bar - x 100 kpa)
- **Bourdon Tube:** Brass
- **Connection:** Brass 1/4" NPT
- **Lens:** Acrylic
- **Surge Protection:** Standard
- **Accuracy:** ANSI Grade B, 3%-2%-3%

PART#	RANGE
SAD4512-V	30hg-0
SAD4512-15	0-15 PSI
SAD4512-30	0-30 PSI
SAD4512-60	0-60 PSI
SAD4512-100	0-100 PSI
SAD4512-160	0-160 PSI
SAD4512-200	0-200 PSI
SAD4512-300	0-300 PSI
SAD4512-400	0-400 PSI
SAD4512-600	0-600 PSI
SAD4512-1K	0-1000 PSI



SAD4502 SERIES 4.5" CENTER BACK CONNECT DRY GAUGES

SAD4502 SERIES

- **Case:** Black Painted Steel, Chrome Ring
- **Dial:** Aluminum, White, Black, & Blue Type
- **Scale:** Dual (lb/in² - bar - x 100 kpa)
- **Bourdon Tube:** Brass
- **Connection:** Brass 1/4" NPT
- **Lens:** Acrylic
- **Surge Protection:** Standard
- **Accuracy:** ANSI Grade B, 3%-2%-3%

PART#	RANGE
SAD4502-30	0-30 PSI
SAD4502-60	0-60 PSI
SAD4502-100	0-100 PSI
SAD4502-160	0-160 PSI
SAD4502-200	0-200 PSI
SAD4502-300	0-300 PSI



SSG1501 SERIES 1.5" CENTER BACK GLYCERIN FILLED GAUGES

ALL SPECIFICATIONS AND DIMENSIONS SUBJECT TO CHANGE WITHOUT NOTICE



SSG1501 SERIES

- **Case:** 304 Stainless Steel
- **Dial:** Aluminum, White, Black, & Blue Type
- **Scale:** Dual (lb/in² - bar - x 100 kpa)
- **Bourdon Tube:** Brass
- **Connection:** Brass 1/8" NPT
- **Lens:** Acrylic
- **Surge Protection:** Standard
- **Accuracy:** ANSI Grade B, 3%-2%-3%

PART#	RANGE
SSG1501-V	30hg-0
SSG1501-C	30hg-0-30 PSI
SSG1501-15	0-15 PSI
SSG1501-30	0-30 PSI
SSG1501-60	0-60 PSI
SSG1501-100	0-100 PSI
SSG1501-160	0-160 PSI
SSG1501-200	0-200 PSI
SSG1501-300	0-300 PSI
SSG1501-400	0-400 PSI
SSG1501-600	0-600 PSI
SSG1501-1K	0-1000 PSI
SSG1501-2K	0-2000 PSI
SSG1501-3K	0-3000 PSI
SSG1501-5K	0-5000 PSI



LSS1501 SERIES 1.5" CENTER BACK GLYCERIN FILLED GAUGES

LSS1501 SERIES ALL STAINLESS

- **Case:** 304 Stainless Steel
- **Dial:** Aluminum, White, Black, & Blue Type
- **Scale:** Dual (lb/in² - bar - x 100 kpa)
- **Bourdon Tube:** 316 Stainless Steel
- **Connection:** 316 Stainless Steel 1/8" NPT
- **Lens:** Acrylic
- **Surge Protection:** Standard
- **Accuracy:** ANSI Grade B, 3%-2%-3%

ALL STAINLESS

PART#	RANGE
LSS1501-30	0-30 PSI
LSS1501-60	0-60 PSI
LSS1501-100	0-100 PSI
LSS1501-160	0-160 PSI
LSS1501-200	0-200 PSI
LSS1501-300	0-300 PSI
LSS1501-2K	0-2000 PSI
LSS1501-3K	0-3000 PSI



SSG1511 SERIES 1.5" LOWER CONNECT GLYCERIN FILLED GAUGES

SSG1511 SERIES

- **Case:** 304 Stainless Steel
- **Dial:** Aluminum, White, Black, & Blue Type
- **Scale:** Dual (lb/in² - bar - x 100 kpa)
- **Bourdon Tube:** Brass
- **Connection:** Brass 1/8" NPT
- **Lens:** Acrylic
- **Surge Protection:** Standard
- **Accuracy:** ANSI Grade B, 3%-2%-3%

PART#	RANGE
SSG1511-15	0-15 PSI
SSG1511-30	0-30 PSI
SSG1511-60	0-60 PSI
SSG1511-100	0-100 PSI
SSG1511-160	0-160 PSI
SSG1511-200	0-200 PSI
SSG1511-300	0-300 PSI



LSS1511 SERIES 1.5" LOWER CONNECT GLYCERIN FILLED GAUGES

LSS1511 SERIES ALL STAINLESS

- **Case:** 304 Stainless Steel
- **Dial:** Aluminum, White, Black, & Blue Type
- **Scale:** Dual (lb/in² - bar - x 100 kpa)
- **Bourdon Tube:** 316 Stainless Steel
- **Connection:** 316 Stainless Steel 1/8" NPT
- **Lens:** Acrylic
- **Surge Protection:** Standard
- **Accuracy:** ANSI Grade B, 3%-2%-3%

ALL STAINLESS

PART#	RANGE
LSS1511-30	0-30 PSI
LSS1511-60	0-60 PSI
LSS1511-100	0-100 PSI
LSS1511-300	0-300 PSI
LSS1511-600	0-600 PSI
LSS1511-2K	0-2000 PSI
LSS1511-3K	0-3000 PSI



SSG2001 & 2002 SERIES 2" CENTER BACK GLYCERIN FILLED GAUGES

ALL SPECIFICATIONS AND DIMENSIONS SUBJECT TO CHANGE WITHOUT NOTICE



SSG2001 & 2002 SERIES

- **Case:** 304 Stainless Steel
- **Dial:** Aluminum, White, Black, & Blue Type
- **Scale:** Dual (lb/in² - bar - x 100 kpa)
- **Bourdon Tube:** Brass
- **Connection:**
SSG2001- Brass 1/8" NPT
SSG2002- Brass 1/4" NPT
- **Lens:** Acrylic
- **Surge Protection:** Standard
- **Accuracy:** ANSI Grade B, 3%-2%-3%

PART#	RANGE
SSG200*-V	30hg-0
SSG200*-15	0-15 PSI
SSG200*-30	0-30 PSI
SSG200*-60	0-60 PSI
SSG200*-100	0-100 PSI
SSG200*-160	0-160 PSI
SSG200*-200	0-200 PSI
SSG200*-300	0-300 PSI
SSG200*-400	0-400 PSI
SSG200*-600	0-600 PSI
SSG200*-1K	0-1000 PSI
SSG200*-2K	0-2000 PSI
SSG200*-3K	0-3000 PSI
SSG200*-5K	0-5000 PSI

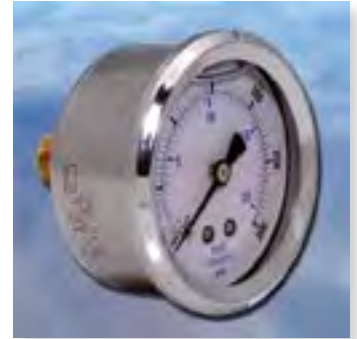

* Denotes Connection 1=1/8"NPT, 2=1/4"NPT

LSS2002 SERIES 2" CENTER BACK GLYCERIN FILLED GAUGES

LSS2002 SERIES ALL STAINLESS

- **Case:** 304 Stainless Steel
- **Dial:** Aluminum, White, Black, & Blue Type
- **Scale:** Dual (lb/in² - bar - x 100 kpa)
- **Bourdon Tube:** 316 Stainless Steel
- **Connection:** 316 Stainless Steel 1/4" NPT
- **Lens:** Acrylic
- **Surge Protection:** Standard
- **Accuracy:** ANSI Grade B, 3%-2%-3%

PART#	RANGE
LSS2002-V	30hg-0
LSS2002-30	0-30 PSI
LSS2002-60	0-60 PSI
LSS2002-200	0-200 PSI
LSS2002-300	0-300 PSI
LSS2002-400	0-400 PSI
LSS2002-2K	0-2000 PSI
LSS2002-3K	0-3000 PSI
LSS2002-5K	0-5000 PSI

ALL STAINLESS



SSG2011 & 2012 SERIES 2" LOWER CONNECT GLYCERIN FILLED GAUGES

SSG2011 & 2012 SERIES

- **Case:** 304 Stainless Steel
- **Dial:** Aluminum, White, Black, & Blue Type
- **Scale:** Dual (lb/in² - bar - x 100 kpa)
- **Bourdon Tube:** Brass
- **Connection:**
SSG2011- Brass 1/8" NPT
SSG2012- Brass 1/4" NPT
- **Lens:** Acrylic
- **Surge Protection:** Standard
- **Accuracy:** ANSI Grade B, 3%-2%-3%

PART#	RANGE
SSG201*-V	30hg-0
SSG201*-15	0-15 PSI
SSG201*-30	0-30 PSI
SSG201*-60	0-60 PSI
SSG201*-100	0-100 PSI
SSG201*-160	0-160 PSI
SSG201*-200	0-200 PSI
SSG201*-300	0-300 PSI
SSG201*-400	0-400 PSI
SSG201*-600	0-600 PSI
SSG201*-1K	0-1000 PSI
SSG201*-2K	0-2000 PSI
SSG201*-3K	0-3000 PSI
SSG201*-5K	0-5000 PSI



* Denotes Connection 1=1/8"NPT, 2=1/4"NPT



LSS2012 SERIES 2" LOWER CONNECT GLYCERIN FILLED GAUGES

ALL SPECIFICATIONS AND DIMENSIONS SUBJECT TO CHANGE WITHOUT NOTICE



LSS2012 SERIES ALL STAINLESS

- **Case:** 304 Stainless Steel
- **Dial:** Aluminum, White, Black, & Blue Type
- **Scale:** Dual (lb/in² - bar - x 100 kpa)
- **Bourdon Tube:** 316 Stainless Steel
- **Connection:** 316 Stainless Steel 1/4" NPT
- **Lens:** Acrylic
- **Surge Protection:** Standard
- **Accuracy:** ANSI Grade B, 3%-2%-3%

ALL STAINLESS

PART#	RANGE
LSS2012-60	0-60 PSI
LSS2012-100	0-100 PSI
LSS2012-160	0-160 PSI
LSS2012-300	0-300 PSI
LSS2012-400	0-400 PSI
LSS2012-600	0-600 PSI
LSS2012-3K	0-3000 PSI
LSS2012-5K	0-5000 PSI



SSG2502 SERIES 2.5" CENTER BACK GLYCERIN FILLED GAUGES

SSG2502 SERIES

- **Case:** 304 Stainless Steel
- **Dial:** Aluminum, White, Black, & Blue Type
- **Scale:** Dual (lb/in² - bar - x 100 kpa)
- **Bourdon Tube:** Brass
- **Connection:** Brass 1/4" NPT
- **Lens:** Acrylic
- **Surge Protection:** Standard
- **Accuracy:** ANSI Grade B, 3%-2%-3%

PART#	RANGE
SSG2502-V	30hg-0
SSG2502-C	30hg-0-30 PSI
SSG2502-15	0-15 PSI
SSG2502-30	0-30 PSI
SSG2502-60	0-60 PSI
SSG2502-100	0-100 PSI
SSG2502-160	0-160 PSI
SSG2502-200	0-200 PSI
SSG2502-300	0-300 PSI
SSG2502-400	0-400 PSI
SSG2502-600	0-600 PSI
SSG2502-1K	0-1000 PSI
SSG2502-1.5K	0-1500 PSI
SSG2502-2K	0-2000 PSI
SSG2502-3K	0-3000 PSI
SSG2502-5K	0-5000 PSI
SSG2502-6K	0-6000 PSI
SSG2502-10K	0-10000 PSI
SSG2502-15K	0-15000 PSI



LSS2502 SERIES 2.5" CENTER BACK GLYCERIN FILLED GAUGES

LSS2502 SERIES ALL STAINLESS

- **Case:** 304 Stainless Steel
- **Dial:** Aluminum, White, Black, & Blue Type
- **Scale:** Dual (lb/in² - bar - x 100 kpa)
- **Bourdon Tube:** 316 Stainless Steel
- **Connection:** 316 Stainless Steel 1/4" NPT
- **Lens:** Acrylic
- **Surge Protection:** Standard
- **Accuracy:** ANSI Grade B, 3%-2%-3%

PART#	RANGE
SSG2502-V	30hg-0
SSG2502-C60	30hg-0-60 PSI
SSG2502-15	0-15 PSI
SSG2502-30	0-30 PSI
SSG2502-60	0-60 PSI
SSG2502-100	0-100 PSI
SSG2502-160	0-160 PSI
SSG2502-200	0-200 PSI
SSG2502-300	0-300 PSI
SSG2502-400	0-400 PSI
SSG2502-600	0-600 PSI
SSG2502-1K	0-1000 PSI
SSG2502-1.5K	0-1500 PSI
SSG2502-2K	0-2000 PSI
SSG2502-3K	0-3000 PSI
SSG2502-5K	0-5000 PSI
SSG2502-10K	0-10000 PSI

ALL STAINLESS



SSG2512 SERIES 2.5" LOWER CONNECT GLYCERIN FILLED GAUGES

ALL SPECIFICATIONS AND DIMENSIONS SUBJECT TO CHANGE WITHOUT NOTICE



SSG2512 SERIES

- **Case:** 304 Stainless Steel
- **Dial:** Aluminum, White, Black, & Blue Type
- **Scale:** Dual (lb/in² - bar - x 100 kpa)
- **Bourdon Tube:** Brass
- **Connection:** Brass 1/4" NPT
- **Lens:** Acrylic
- **Surge Protection:** Standard
- **Accuracy:** ANSI Grade B, 3%-2%-3%

PART#	RANGE
SSG2512-V	30hg-0
SSG2512-C	30hg-0-30 PSI
SSG2512-15	0-15 PSI
SSG2512-30	0-30 PSI
SSG2512-60	0-60 PSI
SSG2512-100	0-100 PSI
SSG2512-160	0-160 PSI
SSG2512-200	0-200 PSI
SSG2512-300	0-300 PSI
SSG2512-400	0-400 PSI
SSG2512-600	0-600 PSI
SSG2512-1K	0-1000 PSI
SSG2512-1.5K	0-1500 PSI
SSG2512-2K	0-2000 PSI
SSG2512-3K	0-3000 PSI
SSG2512-5K	0-5000 PSI
SSG2512-6K	0-6000 PSI
SSG2512-10K	0-10000 PSI
SSG2512-15K	0-15000 PSI



LSS2512 SERIES 2.5" LOWER CONNECT GLYCERIN FILLED GAUGES

LSS2512 SERIES ALL STAINLESS

- **Case:** 304 Stainless Steel
- **Dial:** Aluminum, White, Black, & Blue Type
- **Scale:** Dual (lb/in² - bar - x 100 kpa)
- **Bourdon Tube:** 316 Stainless Steel
- **Connection:** 316 Stainless Steel 1/4" NPT
- **Lens:** Acrylic
- **Surge Protection:** Standard
- **Accuracy:** ANSI Grade B, 3%-2%-3%

PART#	RANGE
LSS2512-V	30hg-0
LSS2512-C	30hg-0-30 PSI
LSS2512-15	0-15 PSI
LSS2512-30	0-30 PSI
LSS2512-60	0-60 PSI
LSS2512-100	0-100 PSI
LSS2512-160	0-160 PSI
LSS2512-200	0-200 PSI
LSS2512-300	0-300 PSI
LSS2512-400	0-400 PSI
LSS2512-600	0-600 PSI
LSS2512-1K	0-1000 PSI
LSS2512-1.5K	0-1500 PSI
LSS2512-2K	0-2000 PSI
LSS2512-3K	0-3000 PSI
LSS2512-5K	0-5000 PSI
LSS2512-10K	0-10000 PSI
LSS2512-15K	0-15000 PSI

ALL STAINLESS



BGG2512 SERIES 2.5" LOWER CONNECT GLYCERIN FILLED GAUGES

BGG2512 SERIES ALL BRASS

- **Case:** Brass
- **Dial:** Aluminum, White, Black, & Blue Type
- **Scale:** Dual (lb/in² - bar - x 100 kpa)
- **Bourdon Tube:** Brass
- **Connection:** Brass 1/4" NPT
- **Lens:** Glass
- **Surge Protection:** Standard
- **Accuracy:** ANSI Grade B, 3%-2%-3%

PART#	RANGE
BGG2512-V	30hg-0
BGG2512-C	30hg-0-30 PSI
BGG2512-15	0-15 PSI
BGG2512-30	0-30 PSI
BGG2512-60	0-60 PSI
BGG2512-100	0-100 PSI
BGG2512-160	0-160 PSI
BGG2512-200	0-200 PSI
BGG2512-300	0-300 PSI
BGG2512-400	0-400 PSI
BGG2512-600	0-600 PSI
BGG2512-1K	0-1000 PSI
BGG2512-1.5K	0-1500 PSI
BGG2512-2K	0-2000 PSI
BGG2512-3K	0-3000 PSI
BGG2512-5K	0-5000 PSI
BGG2512-6K	0-6000 PSI
BGG2512-10K	0-10000 PSI

ALL BRASS



PGG2512 SERIES 2.5" LOWER CONNECT GLYCERIN FILLED GAUGES

ALL SPECIFICATIONS AND DIMENSIONS SUBJECT TO CHANGE WITHOUT NOTICE



PGG2512 SERIES

- **Case:** Plastic
- **Dial:** Aluminum, White, Black, & Blue Type
- **Scale:** Dual (lb/in² - bar - x 100 kpa)
- **Bourdon Tube:** Brass
- **Connection:** Brass 1/4" NPT
- **Lens:** Glass
- **Surge Protection:** Standard
- **Accuracy:** ANSI Grade B, 3%-2%-3%

PART#	RANGE
PGG2512-V	30hg-0
PGG2512-15	0-15 PSI
PGG2512-30	0-30 PSI
PGG2512-60	0-60 PSI
PGG2512-100	0-100 PSI
PGG2512-160	0-160 PSI
PGG2512-200	0-200 PSI
PGG2512-300	0-300 PSI
PGG2512-400	0-400 PSI
PGG2512-600	0-600 PSI
PGG2512-1K	0-1000 PSI
PGG2512-1.5K	0-1500 PSI
PGG2512-2K	0-2000 PSI
PGG2512-3K	0-3000 PSI
PGG2512-5K	0-5000 PSI



SSG4002 SERIES 4" CENTER BACK GLYCERIN FILLED GAUGES

SSG4002 SERIES

- **Case:** 304 Stainless Steel
- **Dial:** Aluminum, White, Black, & Blue Type
- **Scale:** Dual (lb/in² - bar - x 100 kpa)
- **Bourdon Tube:** Brass
- **Connection:** Brass 1/4" NPT
- **Lens:** Acrylic
- **Surge Protection:** Standard
- **Accuracy:** ANSI Grade B, 3%-2%-3%

PART#	RANGE
SSG4002-V	30hg-0
SSG4002-C	30Hg-0-30 PSI
SSG4002-15	0-15 PSI
SSG4002-30	0-30 PSI
SSG4002-60	0-60 PSI
SSG4002-100	0-100 PSI
SSG4002-160	0-160 PSI
SSG4002-200	0-200 PSI
SSG4002-300	0-300 PSI
SSG4002-400	0-400 PSI
SSG4002-600	0-600 PSI
SSG4002-1K	0-1000 PSI
SSG4002-1.5K	0-1500 PSI
SSG4002-2K	0-2000 PSI
SSG4002-3K	0-3000 PSI
SSG4002-5K	0-5000 PSI
SSG4002-6K	0-6000 PSI
SSG4002-10K	0-10000 PSI
SSG4002-15K	0-15000 PSI



SSG4012 SERIES 4" LOWER CONNECT GLYCERIN FILLED GAUGES

ALL SPECIFICATIONS AND DIMENSIONS SUBJECT TO CHANGE WITHOUT NOTICE



SSG4012 SERIES

- **Case:** 304 Stainless Steel
- **Dial:** Aluminum, White, Black, & Blue Type
- **Scale:** Dual (lb/in² - bar - x 100 kpa)
- **Bourdon Tube:** Brass
- **Connection:** Brass 1/4" NPT
- **Lens:** Acrylic
- **Surge Protection:** Standard
- **Accuracy:** ANSI Grade B, 3%-2%-3%

PART#	RANGE
SSG4012-V	30hg-0
SSG4012-C	30Hg-0-30 PSI
SSG4012-15	0-15 PSI
SSG4012-30	0-30 PSI
SSG4012-60	0-60 PSI
SSG4012-100	0-100 PSI
SSG4012-160	0-160 PSI
SSG4012-200	0-200 PSI
SSG4012-300	0-300 PSI
SSG4012-400	0-400 PSI
SSG4012-600	0-600 PSI
SSG4012-1K	0-1000 PSI
SSG4012-1.5K	0-1500 PSI
SSG4012-2K	0-2000 PSI
SSG4012-3K	0-3000 PSI
SSG4012-5K	0-5000 PSI
SSG4012-6K	0-6000 PSI
SSG4012-10K	0-10000 PSI
SSG4012-15K	0-15000 PSI



LSS4012 & 4014 SERIES 4" LOWER CONNECT GLYCERIN FILLED GAUGES

LSS4012 & 4014 SERIES

All Stainless

- **Case:** 304 Stainless Steel
- **Dial:** Aluminum, White, Black, & Blue Type
- **Scale:** Dual (lb/in² - bar - x 100 kpa)
- **Bourdon Tube:** 316 Stainless Steel
- **Connection:**
 - LSS4012- 316 Stainless Steel 1/4" NPT
 - LSS4014- 316 Stainless Steel 1/2" NPT
- **Lens:** Acrylic
- **Surge Protection:** Standard
- **Accuracy:** ANSI Grade B, 3%-2%-3%

PART#	RANGE
LSS401*-V	30hg-0
LSS401*-C	30Hg-0-30 PSI
LSS401*-15	0-15 PSI
LSS401*-30	0-30 PSI
LSS401*-60	0-60 PSI
LSS401*-100	0-100 PSI
LSS401*-160	0-160 PSI
LSS401*-200	0-200 PSI
LSS401*-300	0-300 PSI
LSS401*-400	0-400 PSI
LSS401*-600	0-600 PSI
LSS401*-1K	0-1000 PSI
LSS401*-1.5K	0-1500 PSI
LSS401*-2K	0-2000 PSI
LSS401*-3K	0-3000 PSI
LSS401*-5K	0-5000 PSI
LSS401*-10K	0-10000 PSI
LSS401*-15K	0-15000 PSI

ALL STAINLESS



* Denotes Connection 2=1/4"NPT, 4=1/2"NPT



DPG4502 & 4504 SERIES 4.5" CENTER BACK PROCESS GAUGES

ALL SPECIFICATIONS AND DIMENSIONS SUBJECT TO CHANGE WITHOUT NOTICE



DPG4502 & 4504 SERIES

- **Case:** Phenolic Solid Front / Blow-Out Back
- **Dial:** Aluminum, White, Black Type
- **Pointer:** Knife Edge Micro-Adjustable
- **Bourdon Tube:** 316 Stainless Steel
- **Connection:**
 - DPG4502- 316 Stainless Steel 1/4" NPT
 - DPG4504 316 Stainless Steel 1/2" NPT
- **Lens:** Plastic With Gasket
- **Surge Protection:** Standard
- **Accuracy:** ANSI Grade 2A .5%

STANDARD FEATURES

- Overload And Underload Stops
- Knife Blade Pointer For Precision Reading
- Hermetically Sealed / Weather Proof
- Liquid Fillable / No Kit Required

PART#	RANGE
DPG450*-V	30hg-0
DPG450*-C15	30Hg-0-15 PSI
DPG450*-C	30Hg-0-30 PSI
DPG450*-C60	30Hg-0-60 PSI
DPG450*-C100	30Hg-0-100 PSI
DPG450*-C150	30Hg-0-150 PSI
DPG450*-C200	30Hg-0-200 PSI
DPG450*-C300	30Hg-0-300 PSI
DPG450*-C600	30Hg-0-600 PSI
DPG450*-15	0-15 PSI
DPG450*-30	0-30 PSI
DPG450*-60	0-60 PSI
DPG450*-100	0-100 PSI
DPG450*-160	0-160 PSI
DPG450*-200	0-200 PSI
DPG450*-300	0-300 PSI
DPG450*-400	0-400 PSI
DPG450*-600	0-600 PSI
DPG450*-800	0-800 PSI
DPG450*-1K	0-1000 PSI
DPG450*-1.5K	0-1500 PSI
DPG450*-2K	0-2000 PSI
DPG450*-3K	0-3000 PSI
DPG450*-5K	0-5000 PSI
DPG450*-10K	0-10000 PSI
DPG450*-15K	0-15000 PSI
DPG450*-20K	0-20000 PSI



* Denotes Connection 2=1/4"NPT, 4=1/2"NPT

DPG4512 & 4514 SERIES 4.5" LOWER CONNECT PROCESS GAUGES

DPG4512 & 4514 SERIES

- **Case:** Phenolic Solid Front / Blow-Out Back
- **Dial:** Aluminum, White, Black Type
- **Pointer:** Knife Edge Micro-Adjustable
- **Bourdon Tube:** 316 Stainless Steel
- **Connection:**
 - DPG4512- 316 Stainless Steel 1/4" NPT
 - DPG4514 316 Stainless Steel 1/2" NPT
- **Lens:** Plastic With Gasket
- **Surge Protection:** Standard
- **Accuracy:** ANSI Grade 2A .5%

STANDARD FEATURES

- Overload And Underload Stops
- Knife Blade Pointer For Precision Reading
- Hermetically Sealed / Weather Proof
- Liquid Fillable / No Kit Required

PART#	RANGE
DPG451*-V	30hg-0
DPG451*-C15	30Hg-0-15 PSI
DPG451*-C30	30Hg-0-30 PSI
DPG451*-C60	30Hg-0-60 PSI
DPG451*-C100	30Hg-0-100 PSI
DPG451*-C150	30Hg-0-150 PSI
DPG451*-C200	30Hg-0-200 PSI
DPG451*-C300	30Hg-0-300 PSI
DPG451*-C600	30Hg-0-600 PSI
DPG451*-15	0-15 PSI
DPG451*-30	0-30 PSI
DPG451*-60	0-60 PSI
DPG451*-100	0-100 PSI
DPG451*-160	0-160 PSI
DPG451*-200	0-200 PSI
DPG451*-300	0-300 PSI
DPG451*-400	0-400 PSI
DPG451*-600	0-600 PSI
DPG451*-800	0-800 PSI
DPG451*-1K	0-1000 PSI
DPG451*-1.5K	0-1500 PSI
DPG451*-2K	0-2000 PSI
DPG451*-3K	0-3000 PSI
DPG451*-5K	0-5000 PSI
DPG451*-10K	0-10000 PSI
DPG451*-15K	0-15000 PSI
DPG451*-20K	0-20000 PSI



* Denotes Connection 2=1/4"NPT, 4=1/2"NPT



DPF4502 & 4504 SERIES 4.5" CENTER BACK PROCESS GAUGES

ALL SPECIFICATIONS AND DIMENSIONS SUBJECT TO CHANGE WITHOUT NOTICE



DPF4502 & 4504 SERIES

- **Case:** Aluminum Case, W/Black Enamel
- **Dial:** Aluminum, White, Black Type
- **Pointer:** Knife Edge Micro-Adjustable
- **Bourdon Tube:** 316 Stainless Steel
- **Connection:**
 - DPF4502- 316 Stainless Steel 1/4" NPT
 - DPF4504 316 Stainless Steel 1/2" NPT
- **Lens:** Plastic With Gasket
- **Surge Protection:** Standard
- **Accuracy:** ANSI Grade 2A .5%

STANDARD FEATURES

- Overload And Underload Stops
- Knife Blade Pointer For Precision Reading
- Hermetically Sealed / Weather Proof
- Liquid Fillable / No Kit Required

PART#	RANGE
DPF450*-V	30hg-0
DPF450*-C15	30Hg-0-15 PSI
DPF450*-C	30Hg-0-30 PSI
DPF450*-C60	30Hg-0-60 PSI
DPF450*-C100	30Hg-0-100 PSI
DPF450*-C150	30Hg-0-150 PSI
DPF450*-C200	30Hg-0-200 PSI
DPF450*-C300	30Hg-0-300 PSI
DPF450*-C600	30Hg-0-600 PSI
DPF450*-15	0-15 PSI
DPF450*-30	0-30 PSI
DPF450*-60	0-60 PSI
DPF450*-100	0-100 PSI
DPF450*-160	0-160 PSI
DPF450*-200	0-200 PSI
DPF450*-300	0-300 PSI
DPF450*-400	0-400 PSI
DPF450*-600	0-600 PSI
DPF450*-800	0-800 PSI
DPF450*-1K	0-1000 PSI
DPF450*-1.5K	0-1500 PSI
DPF450*-2K	0-2000 PSI
DPF450*-3K	0-3000 PSI
DPF450*-5K	0-5000 PSI
DPF450*-10K	0-10000 PSI
DPF450*-15K	0-15000 PSI
DPF450*-20K	0-20000 PSI

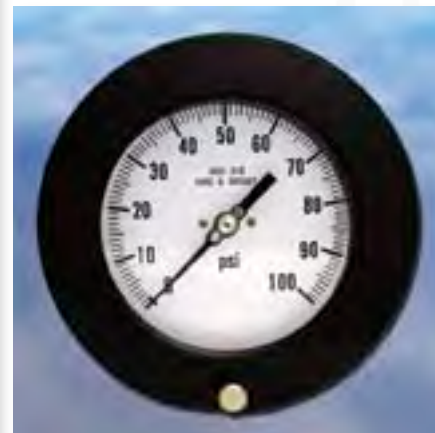

* Denotes Connection 2=1/4"NPT, 4=1/2"NPT

ACCESSORIES



BPS

BPS SERIES

- **Body:** Brass
- **Element:** Sintered Bronze, 40 Micron Standard
- **Pressure:** 8,000 PSIG WOG
- **Temperature:** -65°F to 400°F



Diaphragm Seal

Diaphragm Seals

Consult Factory for detailed information

PART#	MICRON	MEDIA
BPS-2	40	Viscous Fluids (Over 500 SSU)
BPS-230	30	Med. Type Oils (225 to 500 SSU)
BPS-225	25	Water & Light Oils (30 to 225 SSU)
BPS-220	20	Low Viscosity Fluids Under 30 SSU)
BPS-210	10	Air & Other Gases



SSG-U

PART#	GAUGE	
	PART#	DIA.
SSG15-U	1.5"	
SSG20-U	2"	
SSG25-U	2.5"	
SSG40-U	4"	

For Center Back Connection
Liquid Filled Only



SSG-FF

PART#	GAUGE	
	PART#	DIA.
SSG15-FF	1.5"	
SSG20-FF	2"	
SSG25-FF	2.5"	
SSG40-FF	4"	

For Center Back Connection
Liquid Filled Only



BTF SERIES 3" AND 5" BIMETAL THERMOMETERS

ALL SPECIFICATIONS AND DIMENSIONS SUBJECT TO CHANGE WITHOUT NOTICE



STANDARD FEATURES

- All Stainless Steel Construction
- With Glass Lens
- Anti-Parallax Dial
- Vibration Resistant (No Needle Flutter)
- Fast Response To Temperature Change
- Hermetically Sealed (Moisture Proof)
- +/- 1% Full Scall Accuracy
- Stem Welded To Connection
- Zero Adjustment on Back of Case



3" Diameter Dial

PART#	TEMP. RANGE
BTF3004-A-**-	-40/120 F&C
BTF3004-B-**-	-40/160 F&C
BTF3004-E-**-	0/150 F&C
BTF3004-G-**-	0/200 F&C
BTF3004-J-**-	20/240 F&C
BTF3004-I-**-	0/250 F&C
BTF3004-M-**-	50/300 F&C
BTF3004-P-**-	50/400 F&C
BTF3004-R-**-	50/550 F&C
BTF3004-S-**-	150/750 F&C
BTF3004-T-**-	200/1000 F&C

** Denotes Stem Length

STEM LENGTH

Suffix	Length
2.5	= 2 1/2"
4	= 4"
6	= 6"
9	= 9"
12	= 12"
15	= 15"
18	= 18"
24	= 24"

5" Diameter Dial

PART#	TEMP. RANGE
BTF5004-A-**-	-40/120 F&C
BTF5004-B-**-	-40/160 F&C
BTF5004-E-**-	0/150 F&C
BTF5004-G-**-	0/200 F&C
BTF5004-J-**-	20/240 F&C
BTF5004-I-**-	0/250 F&C
BTF5004-M-**-	50/300 F&C
BTF5004-P-**-	50/400 F&C
BTF5004-R-**-	50/550 F&C
BTF5004-S-**-	150/750 F&C
BTF5004-T-**-	200/1000 F&C

** Denotes Stem Length

BTA SERIES ADJUSTABLE 3" AND 5" BIMETAL THERMOMETERS

STANDARD FEATURES

- All Stainless Steel Construction
- Fully Adjustable Both Rotation and Angle
- With Glass Lens
- Anti-Parallax Dial
- Vibration Resistant (No Needle Flutter)
- Fast Response To Temperature Change
- Hermetically Sealed (Moisture Proof)
- +/- 1% Full Scall Accuracy
- Stem Welded To Connection
- Zero Adjustment on Back of Case

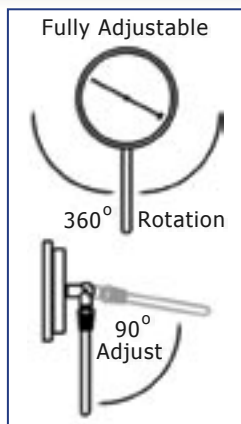

3" Diameter Dial

PART#	TEMP. RANGE
BTA3004-A-**-	-40/120 F&C
BTA3004-B-**-	-40/160 F&C
BTA3004-E-**-	0/150 F&C
BTA3004-G-**-	0/200 F&C
BTA3004-J-**-	20/240 F&C
BTA3004-I-**-	0/250 F&C
BTA3004-M-**-	50/300 F&C
BTA3004-P-**-	50/400 F&C
BTA3004-R-**-	50/550 F&C
BTA3004-S-**-	150/750 F&C
BTA3004-T-**-	200/1000 F&C

** Denotes Stem Length

STEM LENGTH

Suffix	Length
2.5	= 2 1/2"
4	= 4"
6	= 6"
9	= 9"
12	= 12"
15	= 15"
18	= 18"
24	= 24"

5" Diameter Dial

PART#	TEMP. RANGE
BTA5004-A-**-	-40/120 F&C
BTA5004-B-**-	-40/160 F&C
BTA5004-E-**-	0/150 F&C
BTA5004-G-**-	0/200 F&C
BTA5004-J-**-	20/240 F&C
BTA5004-I-**-	0/250 F&C
BTA5004-M-**-	50/300 F&C
BTA5004-P-**-	50/400 F&C
BTA5004-R-**-	50/550 F&C
BTA5004-S-**-	150/750 F&C
BTA5004-T-**-	200/1000 F&C

** Denotes Stem Length



BV and SSBV SERIES MUFFLERS

ALL SPECIFICATIONS AND DIMENSIONS SUBJECT TO CHANGE WITHOUT NOTICE



BV

SSBV

BV SERIES

- Electroless Nickel Plated Steel Fitting
- 40 Micron Sintered Bronze Element
- 150 PSIG Maximum Working Pressure
- Temperature -65°F to 300°F

SSBV SERIES

- 303 Stainless Steel Body, 316 Stainless Steel Element
- 70 Micron Sintered Element
- 150 PSIG Maximum Working Pressure
- Temperature 35°F to 392°F

NPT SIZE	PART#	LENGTH	HEX	NPT SIZE	PART#	LENGTH	HEX
1/8"	BV-1	7/16"	7/16"	1/8"	SSBV-1	19/32"	1/2"
1/4"	BV-2	5/8"	9/16"	1/4"	SSBV-2	49/64	5/8"
3/8"	BV-3	3/4"	11/16	3/8"	SSBV-3	29/32	3/4
1/2"	BV-4	7/8"	7/8"	1/2"	SSBV-4	1-1/32"	15/16"
3/4"	BV-6	1"	1-1/16"	3/4"	SSBV-6	1-11/64"	1-1/8"
1"	BV-8	1-5/16"	1-5/16"	1"	SSBV-8	1-1/4"	1-1/2"
1-1/4"	BV-10	1-13/32"	1-11/16"				
1-1/2"	BV-12	1-1/2"	2"				

SBM and SSBM SERIES MUFFLERS



SBM

SSBM

SBM SERIES

- Electroless Nickel Plated Steel Fitting
- 40 Micron Sintered Bronze Element
- 300 PSIG Maximum Working Pressure
- Temperature -65°F to 300°F

SSBM SERIES

- 303 Stainless Steel Body, 316 Stainless Steel Element
- 70 Micron Sintered Element
- 300 PSIG Maximum Working Pressure
- Temperature 35°F to 392°F

NPT SIZE	PART#	LENGTH	HEX	NPT SIZE	PART#	LENGTH	HEX
10/32"	SBM-M	45/64"	5/16"	10/32"	SSBM-M	23/32"	5/16"
1/8"	SBM-1	1-1/8"	7/16"	1/8"	SSBM-1	1-3/32"	1/2"
1/4"	SBM-2	1-3/8"	9/16"	1/4"	SSBM-2	1-3/8"	5/8"
3/8"	SBM-3	1-1/2"	11/16"	3/8"	SSBM-3	1-7/8"	3/4"
1/2"	SBM-4	1-7/8"	7/8"	1/2"	SSBM-4	2-1/4"	15/16"
3/4"	SBM-6	2-1/4"	1-1/16"	3/4"	SSBM-6	2-51/64"	1-1/8"
1"	SBM-8	2-7/8"	1-5/16"	1"	SSBM-8	3-11/64"	1-1/2"
1-1/4"	SBM-10	3-1/4"	1-11/16"				
1-1/2"	SBM-12	3-11/16"	2"				

SCM and SSCM SERIES MUFFLERS



SCM

SSCM

SCM SERIES

- Brass Construction
- 40 Micron Sintered Bronze Element
- 300 PSIG Maximum Working Pressure
- Temperature -65°F to 300°F

SSCM SERIES

- 303 Stainless Steel Body, 316 Stainless Steel Element
- 70 Micron Sintered Element
- 300 PSIG Maximum Working Pressure
- Temperature 35°F to 392°F

NPT SIZE	PART#	LENGTH	HEX	NPT SIZE	PART#	LENGTH	HEX
1/8"	SCM-1	1-5/16"	1/2"	1/8"	SSCM-1	1-17/32"	1/2"
1/4"	SCM-2	1-9/16"	9/16"	1/4"	SSCM-2	1-59/64"	9/16"
3/8"	SCM-3	1-5/8"	11/16"	3/8"	SSCM-3	2-1/16"	11/16"
1/2"	SCM-4	2"	7/8"	1/2"	SSCM-4	2-25/64"	7/8"
3/4"	SCM-6	2-3/8"	1-1/16"	3/4"	SSCM-6	2-27/32"	1-1/16"
1"	SCM-8	2-1/2"	1-5/16"	1"	SSCM-8	3-1/16"	1-3/8"



HPM SERIES MUFFLERS



ALL SPECIFICATIONS AND DIMENSIONS SUBJECT TO CHANGE WITHOUT NOTICE



HPM SERIES

- Nylon Housing
- Stainless Steel Wire Element
- 150 PSIG Maximum Working Pressure
- Temperature -40°F to 120°F

NPT SIZE	PART#	LENGTH	HEX
1/8"	HPM-1	2-1/8"	13/16"
1/4"	HPM-2	2-1/4"	13/16"
3/8"	HPM-3	3-7/16"	1-1/4"
1/2"	HPM-4	3-9/16"	1-1/4"

MHS and MHA SERIES MUFFLERS



MHS SERIES

- Steel Housing
- Stainless Steel Wire Element
- 300 PSIG Maximum Working Pressure
- Temperature -65°F to 160°F

MHA SERIES

- Aluminum Housing
- 50 Mesh Stainless Steel Screen
- 300 PSIG Maximum Working Pressure
- Temperature 35°F to 160°F

NPT				NPT			
SIZE	PART#	LENGTH	HEX	SIZE	PART#	LENGTH	HEX
1/8"	MHS-1	1-3/8"	7/16"	1/8"	MHA-1	1-7/16"	7/16"
1/4"	MHS-2	1-3/4"	9/16"	1/4"	MHA-2	1-51/64"	9/16"
3/8"	MHS-3	2-1/4"	11/16"	3/8"	MHA-3	2-19/64"	11/16"
1/2"	MHS-4	2-3/4"	7/8"	1/2"	MHA-4	2-25/32"	7/8"
3/4"	MHS-6	3-1/16"	1-1/16"	3/4"	MHA-6	3-3/16"	1-1/16"
1"	MHS-8	3-7/8"	1-5/16"	1"	MHA-8	3-57/64"	1-5/16"
1-1/4"	MHS-10	4-1/2"	1-11/16"				
1-1/2"	MHS-12	5"	2"				
2"	MHS-16	5-1/2"	2-3/8"				

MHM SERIES MUFFLERS



MHM SERIES

- Aluminum Housing
- Stainless Steel Wire Screen
- 300 PSIG Maximum Working Pressure
- Temperature -40°F to 160°F

NPT SIZE	PART#	LENGTH	HEX
1/8"	MHM-1	1-7/8"	5/8"
1/4"	MHM-2	1-7/8"	5/8"
3/8"	MHM-3	3-1/4"	1"
1/2"	MHM-4	3-1/4"	1"
3/4"	MHM-6	4-5/8"	1-5/8"
1"	MHM-8	4-5/8"	1-5/8"



HYDRAULIC IN-LINE T-TYPE FILTERS

ALL SPECIFICATIONS AND DIMENSIONS SUBJECT TO CHANGE WITHOUT NOTICE



HIT

HIT SERIES

- T-Type Filter
- Aluminum Housing
- 25 Micron Sintered Bronze Element
- 3,000 PSIG (Hydraulic only) Max. Working Pressure
- Buna "N" Seals -40°F to 200°F
- OPTIONS: Viton Seals, Suffix "V" -40°F to 400°F
Micron Size, Suffiz "10", "40", "90"
(Example HIT-290),(Kit Example EK2-90)

NPT SIZE	PART#	Element Kits	Spring Kits
1/4"	HIT-2	EK2	SK2T
1/4"	HIT-2V	EK2V	SK2T
3/8"	HIT-3	EK2	SK2T
3/8"	HIT-3V	EK2V	SK2T

SAE SIZE	PART#	Element Kits	Spring Kits
9/16"-18	HIT-S6	EK2	SK2T
9/16"-18	HIT-S6V	EK2V	SK2T

HYDRAULIC IN-LINE FILTERS



HIF

HIF SERIES

- Aluminum Housing
- 25 Micron Sintered Bronze Element
- 3,000 PSIG (Hydraulic only) Max. Working Pressure
- Buna "N" Seals -40°F to 200°F
- OPTIONS: Viton Seals, Suffix "V" -40°F to 400°F
Micron Size, Suffiz "10", "40", "90"
(Example HIF-290),(Kit Example EK2-90)

NPT SIZE	PART#	Element Kits	Spring Kits
1/4"	HIF-2	EK2	SK2
1/4"	HIF-2V	EK2V	SK2
3/8"	HIF-3	EK2	SK2
3/8"	HIF-3V	EK2V	SK2
1/2"	HIF-4	EK4	SK4
1/2"	HIF-4V	EK4V	SK4
3/4"	HIF-6	EK4	SK4
3/4"	HIF-6V	EK4V	SK4

SAE SIZE	PART#	Element Kits	Spring Kits
9/16"-18	HIF-S6	EK2	SK2
9/16"-18	HIF-S6V	EK2V	SK2
3/4"-16	HIF-S8	EK2	SK2
3/4"-16	HIF-S8V	EK2V	SK2

PNEUMATIC IN-LINE FILTERS



PIF

PIFB

PIF and PIFB SERIES

- (PIF) Aluminum Housing, (PIFB) Brass
- 40 Micron Sintered Bronze Element
- 500 PSIG Maximum Working Pressure
- Buna "N" Seals -40°F to 200°F
- M=Female Inlet/Male Outlet
- Female Inlet/Female Outlet: PIF-4 & PIF-6
- OPTIONS: Viton Seals, Suffix "V" -40°F to 400°F
Micron Size, Suffiz "20", "90"
(Example PIF-1M90),(Kit Example EK2-90)

NPT SIZE	PART#	Element Kits	Spring Kits
1/8"	PIFB-1M	EKP2	SKP2
1/8"	PIF-1M	EKP2	SKP2
1/4"	PIF-2M	EKP2	SKP2
3/8"	PIF-3M	EKP2	SKP2
1/2"	PIF-4	EKP4	SKP4
1/2"	PIF-4M	EKP4	SKP4
3/4"	PIF-6	EKP4	SKP4
3/4"	PIF-6M	EKP4	SKP4



YSB SERIES BRONZE "Y" STRAINER



ALL SPECIFICATIONS AND DIMENSIONS SUBJECT TO CHANGE WITHOUT NOTICE



YSB SERIES

Working Pressure (non-shock):

300 psig @ 350°F Steam
400 psig @ 150°F Water, Oil, Gas

Temperature: -20°F to 465.5°F

Standard Screens:

1/8" thru 1/2" (50 Mesh)

3/4" thru 3" (20 Mesh)

4" (.125 Perf)

For Optional wire mesh's, tapped cap and perforated metals consult factory

Materials:

Body: Bronze

Cap: Rod Brass (1/8"-1")

Bronze (1-1/4" - 4")

Screens: Stainless Steel

O-Ring: Teflon 1/8"-1/2"

Gasket: PTFE 3/4"-4"

NPT
SIZE

PART #

1/4"	YSB-2
3/8"	YSB-3
1/2"	YSB-4
3/4"	YSB-6
1"	YSB-8
1-1/4"	YSB-10
1-1/2"	YSB-12
2"	YSB-16
2-1/2"	YSB-20
3"	YSB-24
4"	YSB-32

YSCI SERIES CLASS 250 CAST IRON "Y" STRAINER



YSCI SERIES Class 250

STEAM

W.O.G.

- **Working PSI:** 150 PSI@350° 200 PSI@150°
- **Std Screen:** 1/4"-2" 30 Mesh 20 Mesh
2 1/2"-3" 3/64 perf. 1/16 perf.
- **Screen Material:** 304 Stainless Steel
- **Body, Cap, Plug:** Epoxy Coated Cast Iron ASTM A126 Gr. B
- **Gasket:** Non-Asbestos
- **Temperature:** -20°F to 436.5°F

For Optional wire mesh's and perforated metals consult factory

NPT
SIZE

PART #

1/4"	YSCI-2
3/8"	YSCI-3
1/2"	YSCI-4
3/4"	YSCI-6
1"	YSCI-8
1-1/4"	YSCI-10
1-1/2"	YSCI-12
2"	YSCI-16
2-1/2"	YSCI-24
3"	YSCI-32

YSCS CARBON & YSSS STAINLESS SERIES CLASS 600 "Y" STRAINER



YSCS CARBON

NPT SIZE	PART #
1/4"	YSCS-2
3/8"	YSCS-3
1/2"	YSCS-4
3/4"	YSCS-6
1"	YSCS-8
1-1/4"	YSCS-10
1-1/2"	YSCS-12
2"	YSCS-16
2-1/2"	YSCS-24
3"	YSCS-32

YSCS & YSSS SERIES Class 600

Pressure Ratings:

STEAM

W.O.G.

YSCS 1,010 PSI @ 750°F 1,480 PSI @ 750°F

YSSS 845 PSI @ 750°F 1,440 PSI @ 750°F

Sizes 1/4" thru 3" 1/4" thru 3"

Temperature: -20°F to 750°F -20°F to 750°F

Standard Screen Selections

Sizes	Water	Steam	Open Area
1/2" to 3"	0.062 (1/16)	0.033 (1/32)	37%9(w), 28%(s)

*For Optional wire mesh's and perforated metals consult factory
For Socket Weld consult factory*

Materials

YSCS

YSSS

Carbon Steel

Stainless Steel

Body: ASTM A216 Web ASTM A351 CF8M/316

Cap: ASTM A216 Web ASTM A351 CF8M/316

Screen: 304 SS 304 SS

Gasket: Non-Asbestos Non-Asbestos

Blowoff Plug: Carbon Steel 316 SS

(Tapped NPT)



YSSS STAINLESS STEEL

NPT SIZE	PART #
1/4"	YSSS-2
3/8"	YSSS-3
1/2"	YSSS-4
3/4"	YSSS-6
1"	YSSS-8
1-1/4"	YSSS-10
1-1/2"	YSSS-12
2"	YSSS-16
2-1/2"	YSSS-24
3"	YSSS-32





WARRANTY, LIMITED WARRANTY, AND DISCLAIMER

Universal Components, Inc. warrants all products sold to be free from defect in materials and workmanship under normal use and service for two years from the date of delivery. Warranty is provided that said products are used in accordance to Universal Components, Inc.'s recommended usage and specifications.

Warranty is not extended to any products or parts which have been modified, altered, or repaired in the field. Universal Components, Inc.'s total liability for any and all losses and damages arising from any cause shall, in no event, exceed the purchase price of the product. All equipment requiring repair or replacement under warranty must be returned to our factory or alternate location as we may determine postage and transportation prepaid.

Universal Components, Inc. makes no other warranty, express or implied, including, but not limited to, the implied warrants of merchantability and fitness for particular purpose, with respect to its product and parts whether used alone or in combination with others. The remedy provided for under terms of this warranty is the exclusive remedy of the purchaser.

Under no circumstances will Universal Components, Inc. be responsible for direct, incidental, or consequential damages, even if the possibility of such damages had been made known to Universal Components, Inc. All pricing and specifications are subject to change without notice.

Universal Components, Inc.
1313 Hall Spencer Road
Rock Hill, S.C. 29730
Phone: 803/324-5176
Fax: 803/324-2640
www.ucimfg.com
sales@ucimfg.com

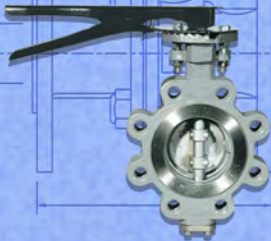

Universal Components, Inc.
 1313 Hall Spencer Rd.
 Rock Hill, S.C. 29730
 Phone: 803/324-5176
 Fax: 803/324-2640
www.ucimfg.com
sales@ucimfg.com

