

GL240 Data Logger



- ✓ 10 analog input channels
 - ✓ Programmable per channel
 - ✓ ± 20 mV to ± 100 V over 12 ranges
 - ✓ Supports direct-connected thermocouples of any type
 - ✓ Full isolation per channel
- ✓ 4 discrete input channels
 - ✓ Programmable as a group as logic or pulse inputs
 - ✓ Pulse inputs support counter or frequency inputs
- ✓ 4 discrete alarm outputs
- ✓ Optional WiFi wireless operation
- ✓ Flexible triggering
- ✓ Built-in, 4.3-inch color display
- ✓ Built-in Web server operation for remote operations
- ✓ Removable SD memory support up to 32 GB capacity
- ✓ Operates either stand-alone or PC-connected.
- ✓ PC-side software included

GL240 Description

Model GL240 is a third-generation data logger product with exceptional price/performance. It's a 10 analog channel device augmented by four discrete inputs and outputs. Its discrete inputs can be configured as a group to be either logic inputs or pulse inputs. When configured for pulse, each of the four channels can be configured to measure frequency or to count. The four discrete outputs are alarms that can be triggered by a variety of easily-defined analog and pulse/discrete input channel conditions. The 10 GL240 analog input channels may each be configured to measure a direct connected voltage in the range of 20 mV to 100 V full scale across 12 ranges, or for a direct-connected thermocouple of any type to measure temperature. Each of the GL240's analog input channels is electrically isolated from other channels and from power ground allowing off-ground measurements using shunts, as well as powered or grounded thermocouples.

The most powerful GL240 feature is its triggering flexibility. Data recording can be independently started or stopped as a function of analog and pulse/discrete signal level (single or windowed), alarm, date and time, and day-of-the-week. Triggers can also be configured to operate only once, or to automatically repeat. The ability of the GL240 to adapt to virtually any desired trigger condition allows the instrument to operate unattended for long periods of time with complete autonomy.

The GL240 operates either connected to a PC or entirely stand-alone. Connection to a PC may be over a standard USB or optional wireless connection. Either connection approach may take advantage of supplied PC-side software to configure, acquire, display, and record digitized information for storage directly to the PC's HDD. Acquired data may be retrieved for review and analysis after recording, including the ability to export to Microsoft Excel. Using the GL240's wireless option enables the instrument's networking features, allowing it to be remotely configured and managed using the standard Web browser of any computer or smart phone. Automatic backup of data acquired to a user-accessible SD memory card is also supported via its FTP facility.

Finally, the measurement reach of a wireless-enabled GL240 is further extended by use of the GL100 accessory. The GL100 wirelessly enables measurements of temperature/humidity, acceleration, CO2, illuminance, ac current, and more.

GL240 Close Up

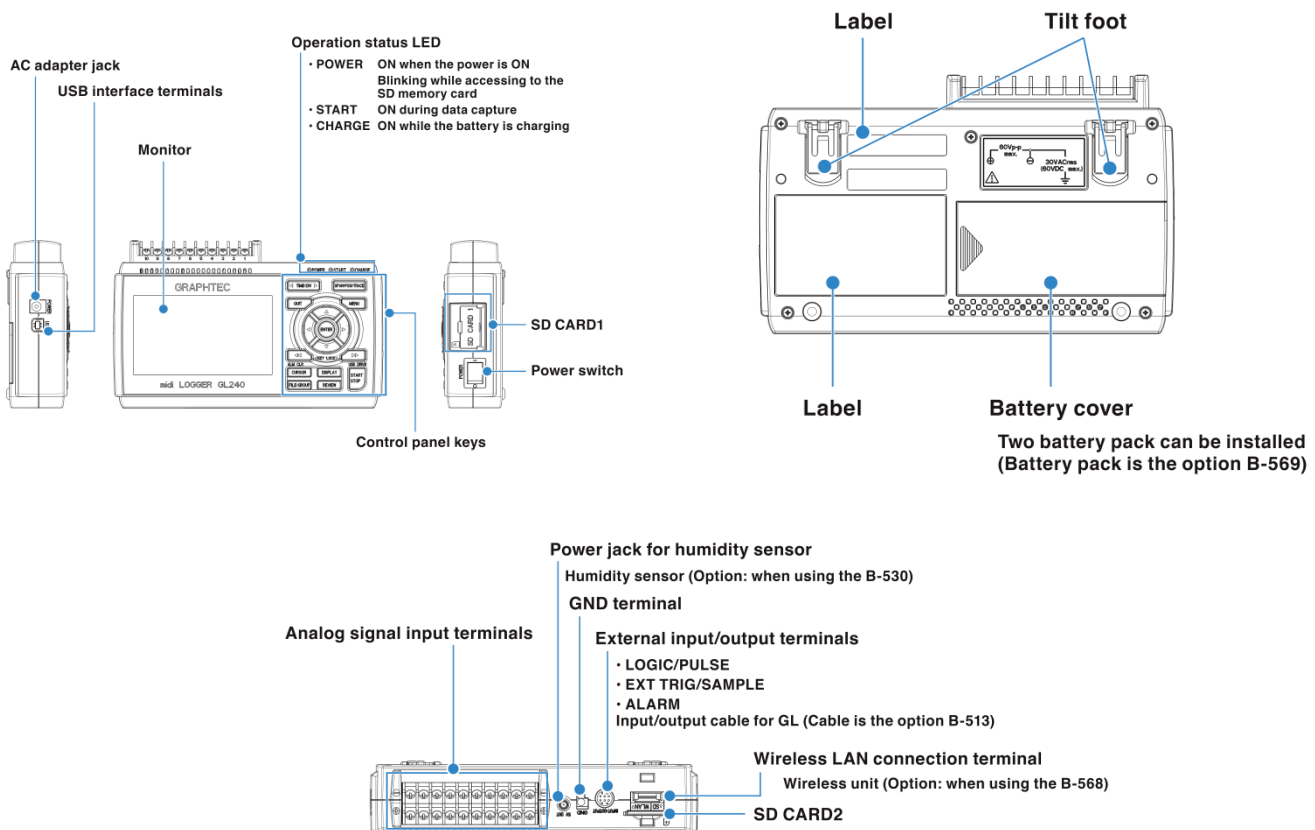

GL240 External Dimensions

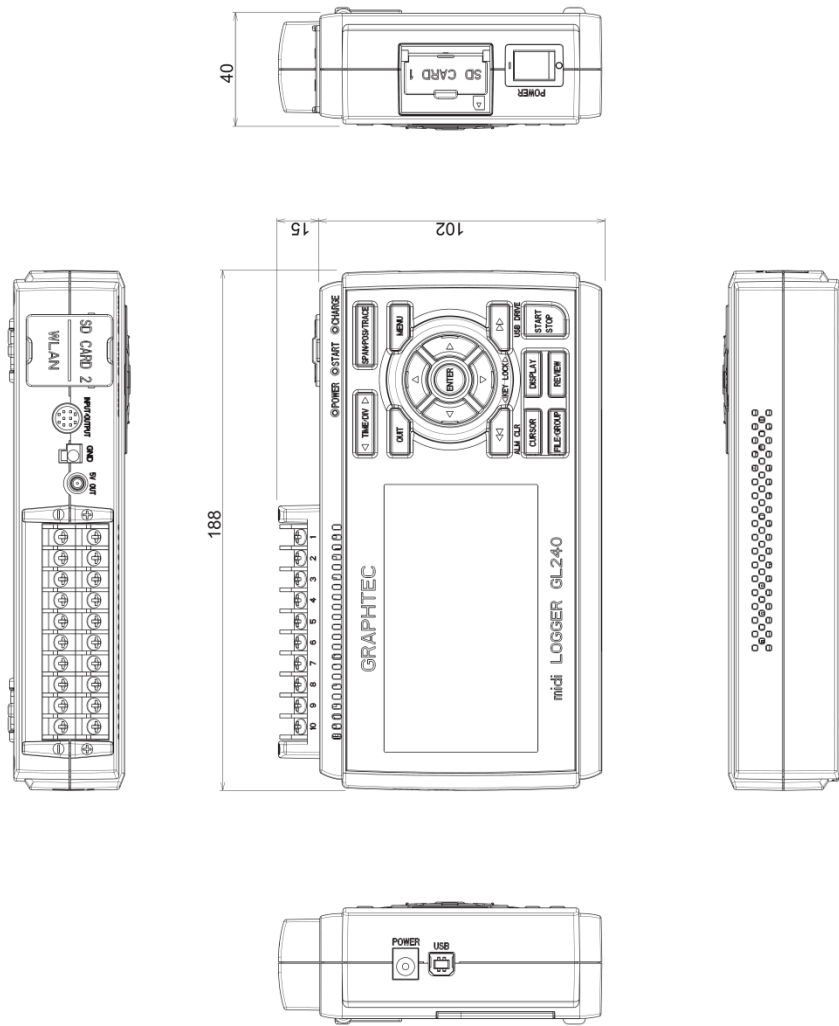

Dimension: mm
Precision: ± 5 mm

GL240 Analog Input Circuit and Measurement Ranges

Each of the ten GL240 analog input channels offers isolation between them and ground. That means that a potential difference in the ground of one or more channels relative to each other, or relative to the power ground of the GL240 have little or no effect on measurements when used within spec. The isolation feature provides a tremendous advantage in terms of noise immunity while making typical measurements, and extends the reach of the instrument to include those that can only be made with an isolated configuration, like current shunts and powered and grounded thermocouples.

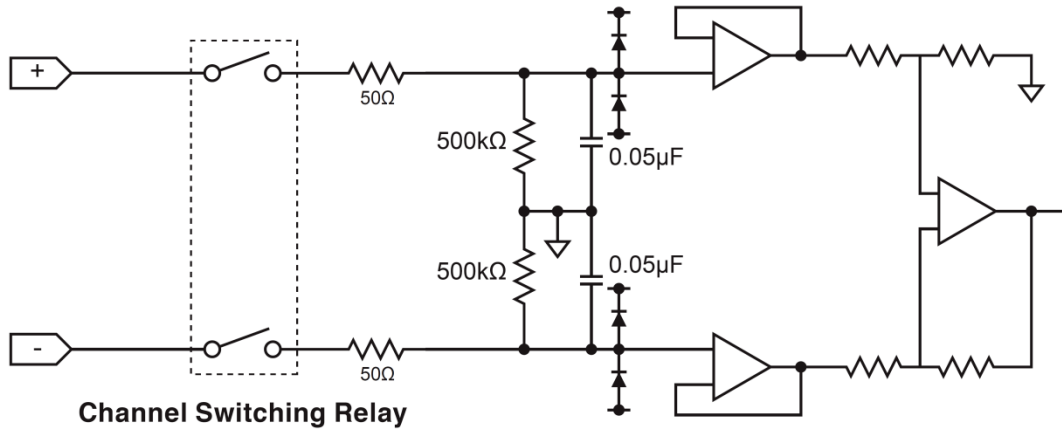

Analog Measurement Range (typical per channel)

Item	Description
Input configuration	Isolated input, scanning
Measurement range	20, 50, 100, 200, 500 mV/F.S.; 1, 2, 5, 10, 20, 50, 100 V/F.S.; 1-5V
Thermocouples	K, J, E, T, R, S, B, N, W (WRe 5-26)
A/D resolution	16-bit (Effective resolution: Approx. 1/40,000 of the +/- range)
Filter	Off, 2, 5, 10, 20, 40 Filter operation is on a moving average basis. The average value of the set sampling count is used. If the sample interval exceeds 5 seconds, the average value of data obtained in a sub-sample (5 seconds) is used.

Typical Signal Connections

DC voltage input

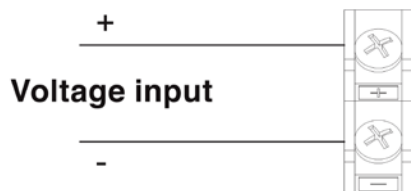

Thermocouple input

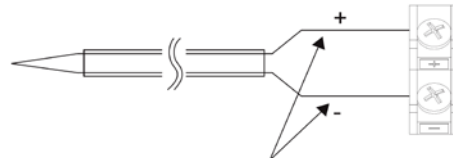

4-20 mA process current input

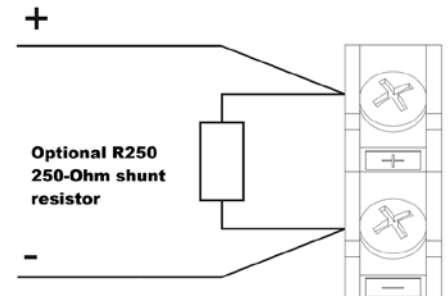

GL240 Discrete I/O and Pulse Inputs

Depending upon the application, discrete I/O and pulse inputs can play a crucial data logging role. The GL240 supports four discrete alarm outputs that can signal alarm or event states that are a function of virtually any combinations of analog and pulse or discrete input values. These alarm outputs may be used to handshake with a PLC or other devices to start or stop processes or simply signal the beginning or end of events. The GL240 also offers four discrete input ports, which may be configured as simple binary true/false input flags, or for pulse and counter inputs. Pulse inputs can be used to acquire frequency data such as rpm or flow, or reconfigured to acquire count data to derive volume from flow or simply count the number of iterations from a process. Pulse data is neatly folded into acquired analog data so that all measured parameters can be evaluated in the same timeframe during analysis to easily identify cause and effect. A final discrete input is reserved for externally triggering the GL240's A-D conversion to allow the instrument to synchronize to external processes. Access to all discrete I/O requires the B-513 cable option.

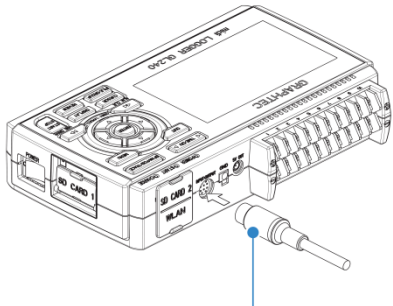

Input/output cable for GL (B-513: Option)

Logic/Pulse Input Specifications

Item	Description
Number of input channels	4 (switch between logic and pulse)
Input voltage range	0 to +24V max. (single-ended ground input)
Threshold level	Approx. +2.5V
Hysteresis	Approx. 0.5 V (+2.5 to +3 V)

Trigger Input/External Sampling Input Specifications

Item	Description
Number of input channels	1
Input voltage range	0 to +24V max. (single-ended ground input)
Threshold level	Approx. +2.5V
Hysteresis	Approx. 0.5 V (+2.5 to +3 V)

Alarm Output Specifications

Item	Description
Number of output channels	4
Output format	Open collector output +5 V, 10 K Ω pull-up resistance

Discrete I/O Instrument-side Equivalent Circuits

Alarm output

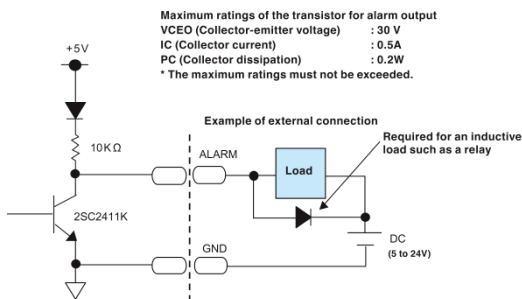

Logic/Pulse input

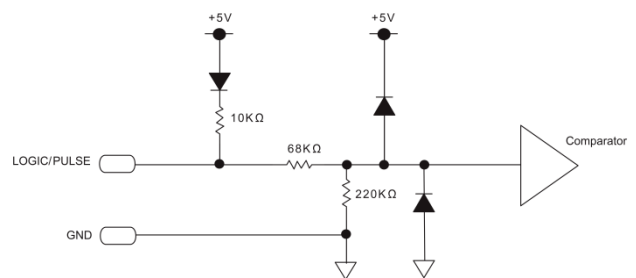

Trigger input/External sampling input

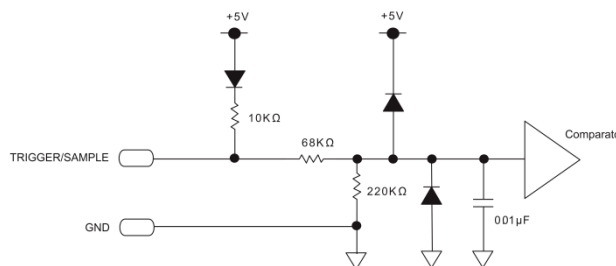

SD Memory Card and Wireless Option Access

The GL240 supports two SD memory slots. SD Card 1 is provided with a 4 GB SD memory for data recording. Any SDHC memory card can be used to a 32 GB capacity. SD Card 2 can be populated with a secondary SD memory card, or with the B-568 wireless option. Model B-568 enables the networking features of the GL240, and its installation in a secondary SD slot without affecting the primary SD slot does not compromise the GL240's storage capacity. The wireless option supports IEEE 802.11b/g/n with the following security protocols: WEP64, WEP128, WPA-PSK/WPA2-PSK, AKIP/AES. The B-568 wireless option may be configured as either an access point to allow peer-to-peer communication (such as with the GL100-WL data logger option), or as a router-managed device on a LAN.

SD Memory and B-568 Wireless Access

Inserting the SD memory into SD Card1 Slot

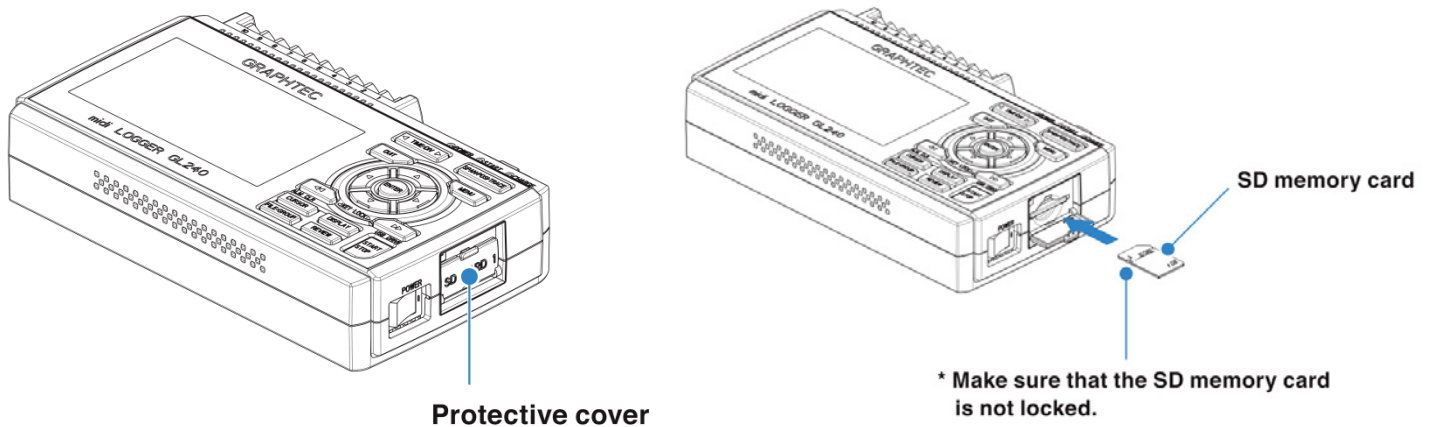

SD Card2 Slot and Wireless Installation

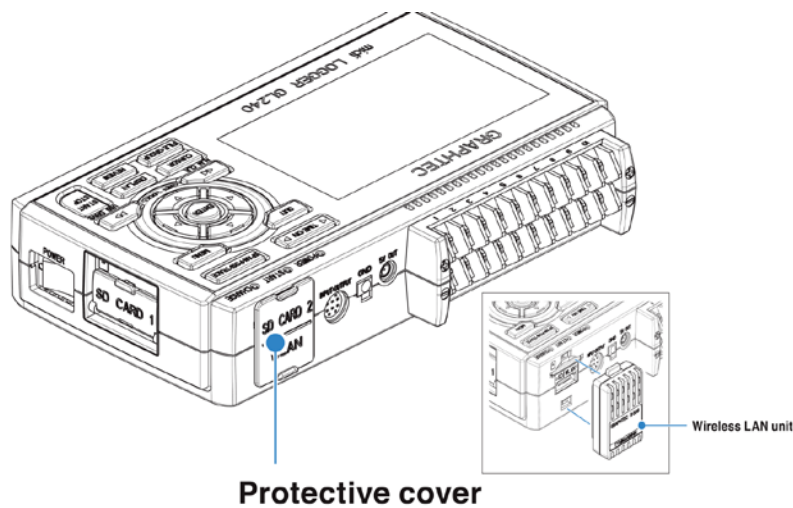

Programmable Sampling Interval Speed versus Measurement

Interval	10mS	20mS	50mS	100mS	200mS	500mS	1S	2S	>2S
Number of channels	1	2	5	10	10	10	10	10	10
Measurement Voltage	Yes								
Measurement TC	No			Yes					

(Chart applies when the captured data format is binary. Limited sampling speed when GL100-WL sensors are in use.)

B-568 Wireless Option Networking Modes

Use the B-568's access point mode to network the GL240 with the optional GL100-WL to expand measurement flexibility, or to provide direct peer-to-peer access to a PC and even a smart phone. Alternatively, the B-568's router mode neatly folds the GL240 into an existing LAN. The B-568 wireless option enables an entire upper level of GL240 performance in terms of FTP backup, Web server operation, and email notification. Web server mode supports all popular Web browsers and allows remote operation of the GL240 and real time screen monitoring.

As a Wireless Access Point

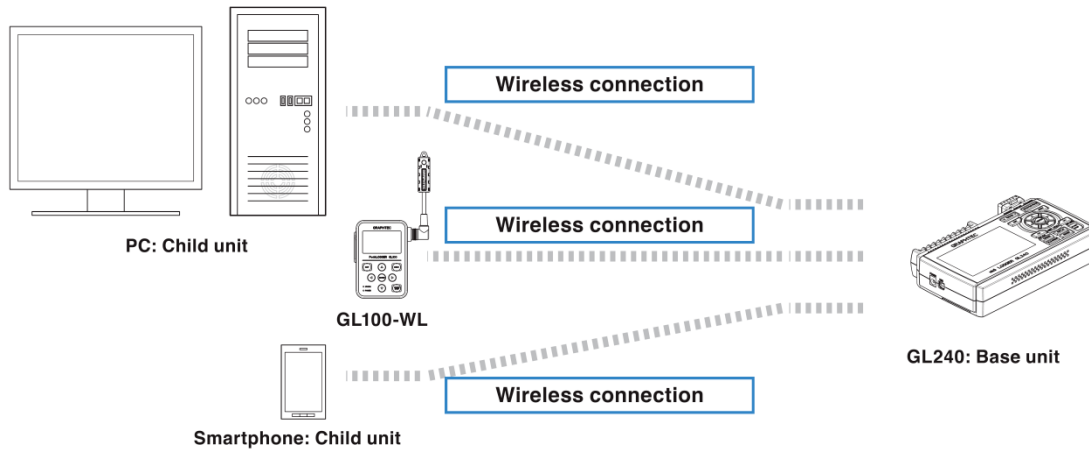

As a Router-managed Device

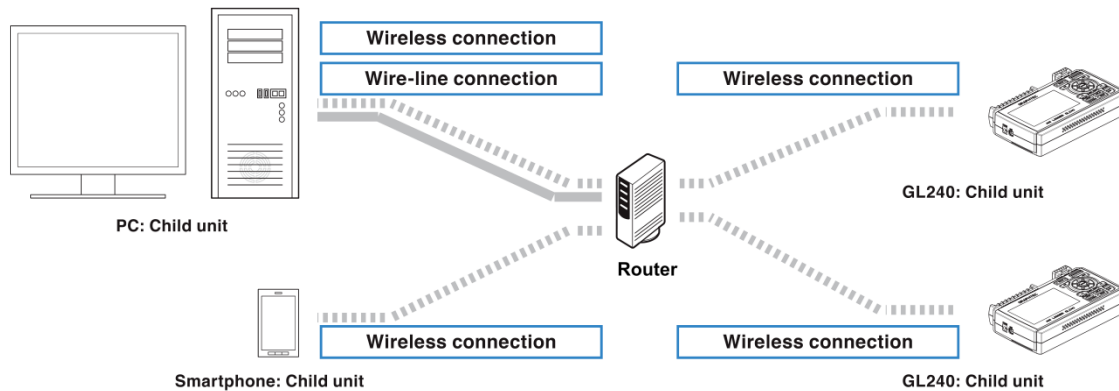

E-mail Configurations

Selection item	Description	
E-mail address	TO:	Set the e-mail address of the e-mail destination. (Up to 63 characters)
	CC1: to CC3:	Up to three e-mail addresses can be set as CC (carbon copy). (Up to 63 characters)
	Subject:	The e-mail subject. (Up to 63 characters)
Notification	Alarm	When it is set to On, the occurrence of alarm is notified.
	Low battery	When it is set to On, the low battery information is notified.
	Low communication strength	When it is set to On, the low communication strength information is notified.
	SD memory card free space	When it is set to On, the SD memory card free space information is notified.
	Periodic notification	Set the time to send the notification setting information with the e-mail to any address.

Connecting the GL240 Directly To A PC

Don't need a wireless LAN? No problem. The GL240's integral USB port allows it to connect directly to a PC on to which is typically installed the included Graphtec APS software for real time data acquisition.

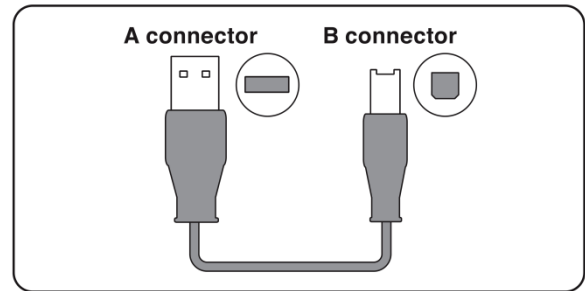
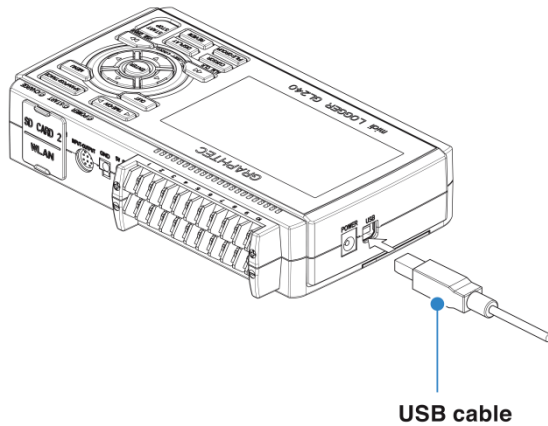

Internal Battery Pack Option B-569

The GL240 supports a battery pack option (B-569) that allows operation independent of ac power. A fully charged battery allows an operating time of 5-7 hours depending upon data logging configuration. Further, the battery can operate as a UPS (uninterruptable power supply.) In the event that ac power is lost, the GL240 will seamlessly continue operation on battery power without interrupting the data logging process.

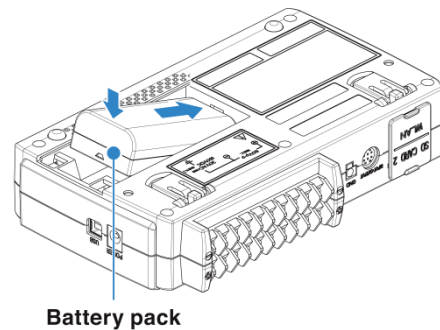
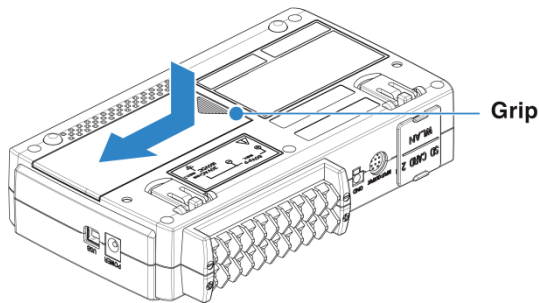

GL240 Display Close Up

The GL240's 4.3-inch display shows acquired analog and discrete/pulse data in real time as it is acquired. Values can be scaled into meaningful engineering units, and one of three selectable modes can displayed with a simple button push.

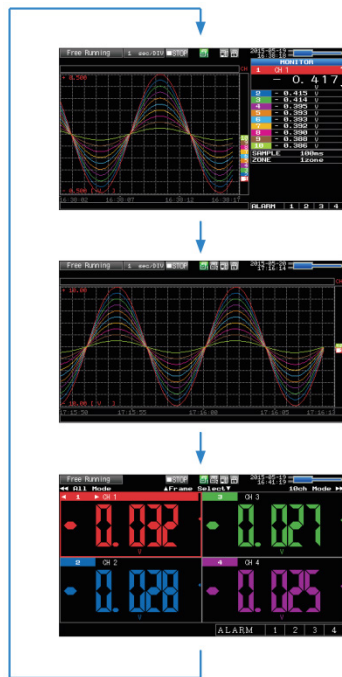
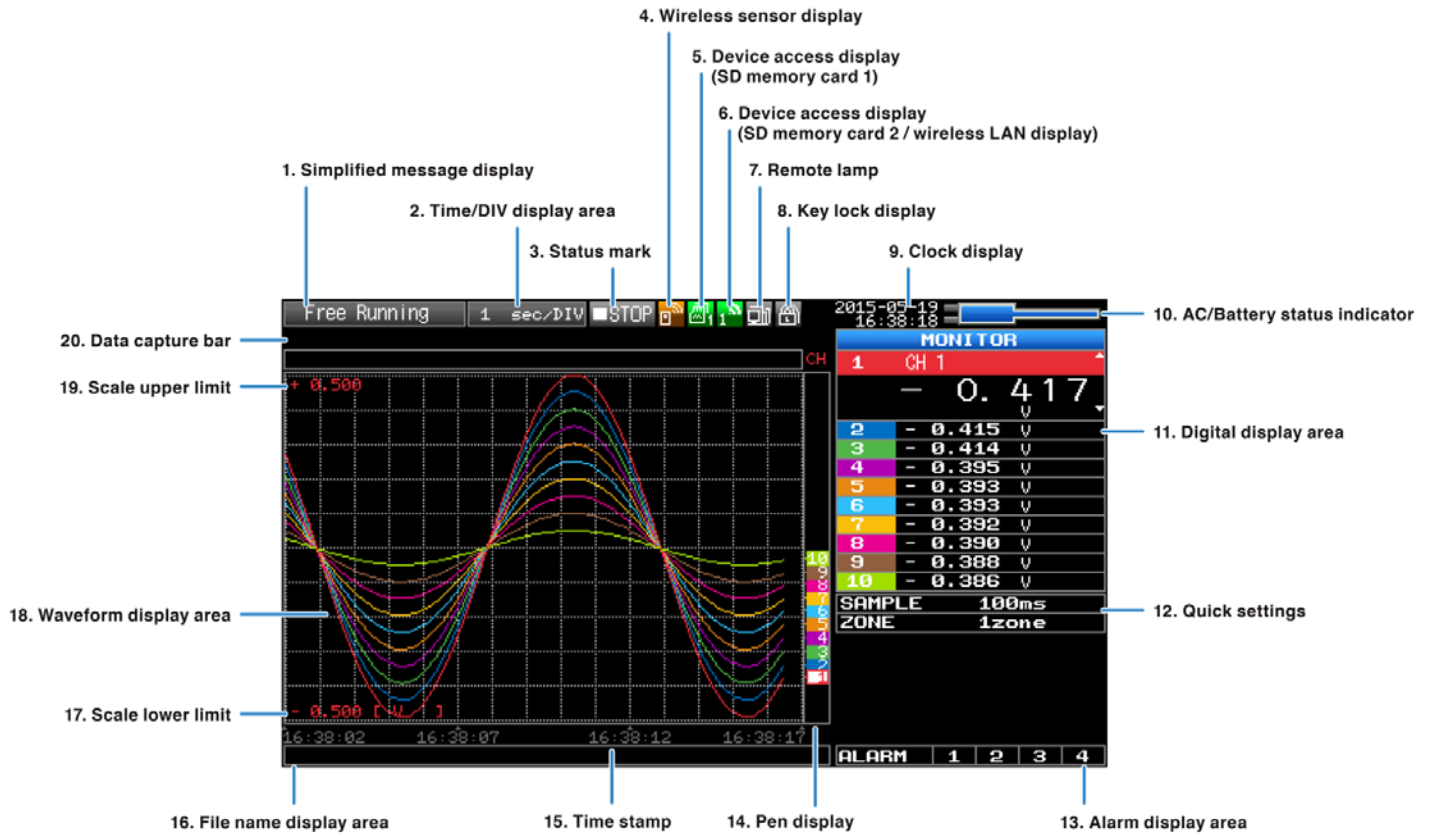

Waveform and digital screen

Expanded waveform screen

Digital display screen

GL240 Analog Measurement Modes

The GL240 in tandem with the optional GL100-WL wireless add-on is capable of a remarkable range of measurements. Measurements that the GL240 can make on its own are voltage, 4-20 mA process current (with optional R250 shunt resistor), thermocouple, and humidity (with optional B-530 sensor.) When a GL100-WL is added to the mix (requires the optional B-568 wireless interface), the GL240 has wireless access to an additional range of measurements.

Direct GL240 Measurements

Function	Channels	Measurements	Comments
Analog	10	Voltage	±20 mV to ±100 V
		Thermocouple	Types K, J, E, T, R, S, B, N, W (WRe 5-26)
		4-20 mA	Requires R250, 250-Ohm current shunt
		Humidity	Requires B-530 humidity sensor option
Discrete	4	Logic	True/false
		Pulse	Count, instantaneous count, revolution

GL100-WL Add-on Modules (refer to the GL100 Accessories datasheet for details)

Model	Channels	Measurements	Alarms	Comments
GL100-WL	-	-	1*	Provides wireless access to the GL240
GS-TH	4	Ambient temperature and RH	-	
GS-3AT	4	Temp + 3-axis acceleration	-	
GS-4VT	4	Thermocouple/voltage	-	Programmable per channel. Supports K and J TCs
GS-4TSR	4	Thermistor	-	
GS-LXUV	4	Illuminance / Ultraviolet	-	
GS-CO2	1	CO ₂	-	
GS-DPA-AC	4	AC current sensor (1 or 3 phase)	-	
GS-DPA	-	Dual branch adaptor	-	Used to combine (pair) the indicated modules
	8	GS-TH + GS-LXUV	-	
	5	GS-TH + GS-CO2	-	
	5	GS-CO2 + GS-LXUV	-	

* GS modules support a level alarm function that is detected by the GL100-WL and communicated to a wireless-equipped GL240.

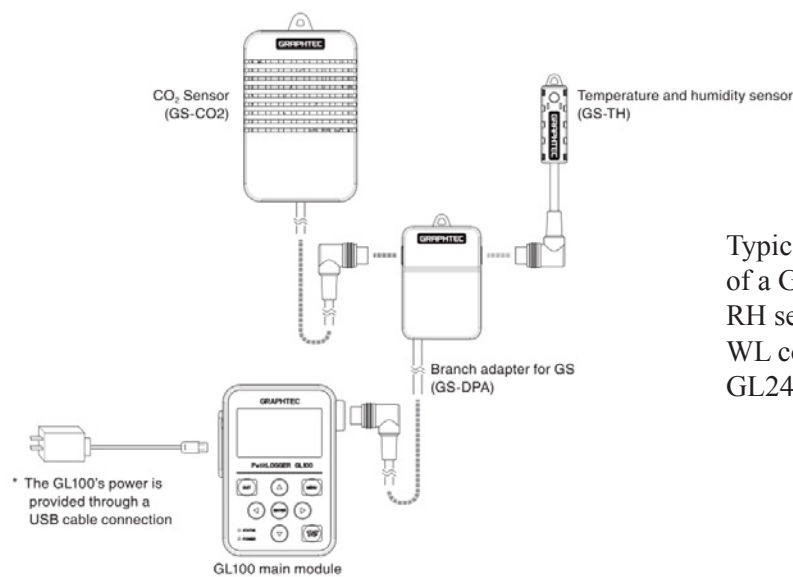

Typical interconnections of a GL100-WL add-on consisting of a GL100-WL, GS-CO2 CO2 sensor, GS-TH Temp and RH sensor, and the GS-DPA Branch Adaptor. The GL100-WL communicates these measurements wirelessly to a GL240 equipped with the B-568 wireless option.

GL240 Global Device Measurement Settings

The GL240 allows an array of settings that define how all of its channel information is acquired. The following table provides an overview of the major setting categories and selections within them:

Measurements		Comments
Sampling		10, 20, 50, 100, 125, 200, 250, 500ms, 1, 2, 5, 10, 20, 30s, 1, 2, 5, 10, 20, 30min, 1h; External
Capture destination		SD CARD 1, SD CARD 2
	File Name	Name of the recorded data file
Ring/Relay capture		Off, Ring, Relay
	Ring capture	Number of recording points
AC Line Filter		Off, On
Backup	Backup Interval	Off, 1, 2, 6, 12, 24 hours
	Backup Destination	SD CARD 1 (SD1), SD CARD 2 (SD2), FTP
	Save Folder	Folder name
Calc. Settings 1		Off, Average, Max, Min, Peak, RMS
Calc. Settings 2		Off, Average, Max, Min, Peak, RMS

“Ring Capture” and “Relay Capture” Explained

In addition to continuous data logging, the GL240 supports two special-purpose recording modes: Ring and Relay Capture.

The Ring Capture feature allows the GL240 to acquire a definable number of data values to consecutive data files while automatically deleting the oldest file. For example, if 1,000 data points are specified, data is acquired to File 1 until 1,000 data values have been recorded. Recording then seamlessly continues to File 2 for another 1,000 values. Before data recording continues to File 3 for another 1,000 data values, File 1 is deleted. When File 3 is full, File 2 is deleted and recording continues to File 4. This process continues until recording stops. In this manner Ring Capture allows data logging to continue indefinitely without concern for filling the target memory. Further, since the number of data values recorded to each file and sampling interval are definable and constant, the timeframe before data is erased is precisely known in advance. Thus, all critical data leading up to, during, and after an event can be captured for analysis. Maximum file size is 2 GB, but SD memory sizes as large as 32 GB are supported.

The Relay Capture feature of the GL240 is almost identical to Ring Capture, except that data files are never deleted. The feature essentially exchanges unlimited record time for an entire history of recorded data. Like Ring Capture, maximum file size is 2 GB, but SD memory sizes as large as 32 GB are supported.

“External Sampling” Explained

Sometimes asynchronous sampling rates just won't do. If you need to acquire data at a precise moment that's coincident with an event, and you can generate a trigger signal for that occurrence, External sampling can be used. The following diagram describes the timing relationship between the various components that define an externally triggered application.

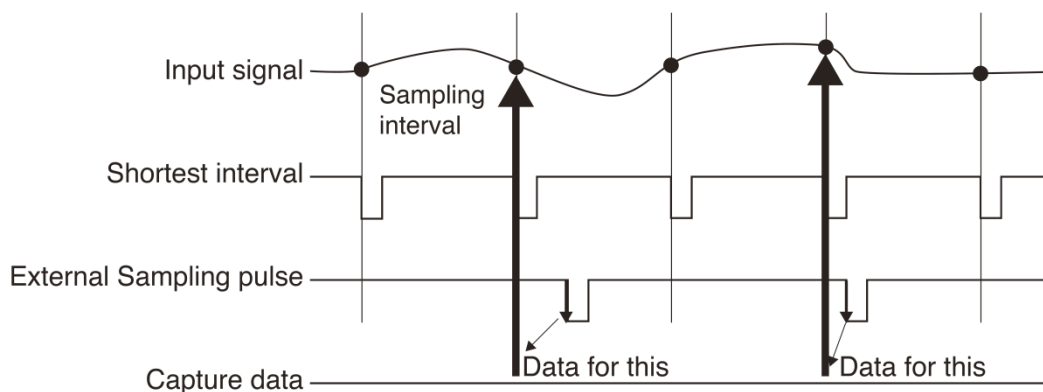

Start or Stop Recording on Any Trigger Condition

The GL240's range of stop and start trigger conditions is massive and unrivaled. Select from single or windowed levels to the day and time of the week with everything in between per pulse or analog channel. Want to start or stop acquiring data when the signal level on channel 1 is above 200 psi, but only on Saturday at 12 noon? No problem. When the GL100-WL is folded into the instrument's array of channels, you can even trigger off its alarm. Finally, select Boolean AND/OR operators to tie any variety of trigger conditions together.

Finally, trigger conditions can be independently set for the GL240's alarm output ports as a function of virtually any combination of analog or pulse input values. The following table describes the array of GL240 trigger conditions to stop, start, or alarm the instrument:

Setting		Selections available	
Start Side Source Setting		Off, Level, Alarm, External Input, Date, Weekly, Time	
	[Level]	Mode	Analog: Off, H, L, Window In, Window Out Logic: Off, H, L Pulse: Off, H, L, Window In, Window Out
		Combination	Level OR, Level AND, Edge OR, Edge AND
		Level	Set numeric value
	[Alarm]	Alarm port number	1, 2, 3, 4, WL1
	[Date]	Date	From 2005.1.1 to 2035.12.31
		Time	From 0:0:0 to 23:59:59
	[Weekly]	Day of week	Off or On setting for each of Sunday through Saturday
		Time	From 0:0:0 to 23:59:59
	[Time]		From 0:0:1 to 9999:59:59
Stop Side Source Setting		Off, Level, Alarm, External Input, Date, Weekly, Time	
	[Level]	Mode	Analog: Off, H, L, Window In, Window Out Logic: Off, H, L Pulse: Off, H, L, Window In, Window Out
		Combination	Level OR, Level AND, Edge OR, Edge AND
		Level	Set numeric value
	[Alarm]	Alarm port number	1, 2, 3, 4, WL1
	[Date]	Date	From 2005.1.1 to 2035.12.31
		Time	From 0:0:0 to 23:59:59
	[Weekly]	Day of week	Off or On setting for each of Sunday through Saturday
		Time	From 0:0:0 to 23:59:59
	[Time]		From 0:0:1 to 9999:59:59
Repeated Capturing		Off, On	
Alarm Level Settings	Mode	Analog: Off, H, L, Window In, Window Out Logic: Off, H, L Pulse: Off, H, L, Window In, Window Out	
	Level	Set numeric value	
	Output	1, 2, 3, 4, WL1	
	Detection Method	Level, Edge	
	Alarm Hold	Held or Not held	
	Send Burnout Alarm	Sent or not sent	

Trigger Operations Close Up

Trigger and Alarm Operations

Rising

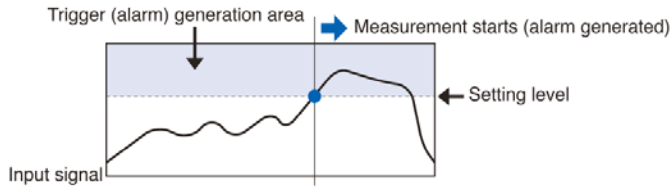

Falling

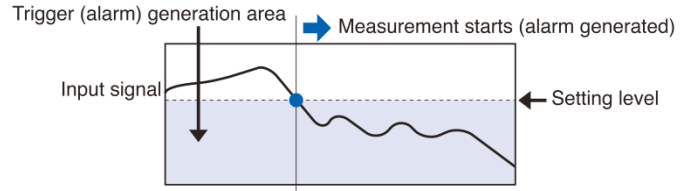

Window-in

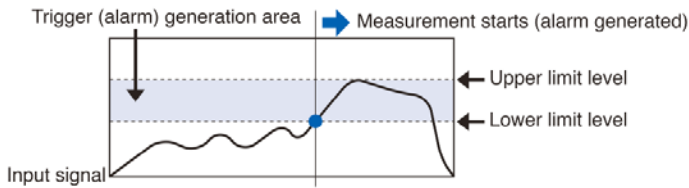

Window-out

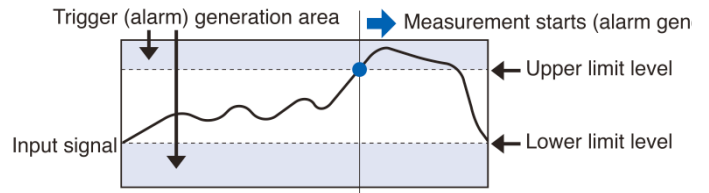

General Record Time

The following record time table assumes analog channels only with Logic/Pulse inputs disabled. Figures are approximate. File size of captured data is 2GB in GBD or CSV file format. Sampling interval is limited by the number of channels in use.

		Sampling Interval (10 acquired channels)						
Storage Format		10mS	50mS	100mS	200mS	500mS	1S	10S
Binary		41 days	88 days	103 days	207 days	>365 days	>365 days	>365 days
CSV		3 days	11 days	16 days	36 days	91 days	182 days	>365 days

GL240 Specifications

Overall Specifications

Number of analog inputs: 10 channels

External input/output: Trigger input or External sample pulse (1ch), Logic input (4ch) or Pulse input (4ch), Alarm output (4ch)

Data backup functions: Setup parameters: EEPROM/Clock: Lithium battery

Clock accuracy: $\pm 0.002\%$ (accurate within about 50 seconds per month) (23°C environment)

Operating environment: 0 to 45°C, 5 to 85% RH
(0 to 40°C when operated in batteries/15 to 35°C when battery is charging)

Withstand voltage: Between each input ch and GND terminal: 350Vp-p 1 minute
Between each input terminals: 350Vp-p 1 minute

Power supply:

- AC adapter : 100 to 240 VAC, 50 to 60 Hz
- DC input : 8.5 to 24 VDC (26.4 V max.)
- Battery pack (option) : 7.2 VDC (2900 mAh)

Power Consumption: AC Power consumption (when AC adapter is used)

Condition	Normal Consumption	Consumption during battery recharge
LCD on	16 VA	36 VA
Screensaver on	15 VA	35 VA

DC Power consumption

DC Voltage	Condition	Normal Consumption	Consumption during battery recharge
+24V	LCD on	0.24 A	0.61 A
+24V	Screensaver on	0.22 A	0.59 A
+12V	LCD on	0.42 A	Can't Recharge
+12V	Screensaver on	0.37 A	Can't Recharge
+8.5V	LCD on	0.58 A	Can't Recharge
+8.5V	Screensaver on	0.53 A	Can't Recharge

*Set the LCD to "Bright" as normal condition.

External Dimensions: 188×117×42mm (not including protruding parts)

Weight: 500 (excluding AC adapter and battery)

Vibration-tested conditions: Equivalent to automobile parts Type 1 Category A classification

Memory devices

Memory capacity: SD CARD Slot: 2 (Compatible with SDHC, up to approx. 32GB memory available)

- Approx. 4GB SD memory card included
- Possible to save up to 2GB for one file

Memory contents: Setup conditions, Measured data, Screen copy

PC I/F

Interface types: USB 2.0; Wireless LAN (Option)

Functions: Data transfer to the PC (realtime, SD memory card data)
PC control of the GL240
Control of wireless sensor (GL100-WL), Data capture (only when connected to the wireless LAN: up to 1 units)

USB functions: USB drive mode: Transfer and delete the captured data in the SD memory card.

Realtime data transfer speed: 10 ms/1 ch maximum (dependant on number of channels).

Monitor

Display: 4.3-inch TFT color LCD (WQVGA: 480×272 dots)

Displayed languages: Japanese, English, French, German, Chinese, Korean, Russian, Spanish

Backlight life: 50,000 hrs (until the brightness is reduced to 50%), It varies with operating environment.

Backlight: Screen saver function provided (10, 30 sec., 1, 2, 5, 10, 30, 60 min.)

Input Unit Specifications

Number of input channels: 10 channels

Input terminal type: M3 screw type terminals (Rectangular flat washer)

Input method: Photo MOS relay scanning system
All channels isolated, balanced input

Scan speed: 10 ms/1 ch maximum

Measurement ranges: Voltage: 20, 50, 100, 200, 500 mV; 1, 2, 5, 10, 20, 50, 100 V; 1-5 V F.S.
Temperature Thermocouples : K, J, E, T, R, S, B, N, W (WRe5-26)
Humidity: 0 to 100% (voltage 0 to 1 V scaling conversion) * Use the B-530 (optional)

Measurement accuracy: Voltage: 0.1% of F.S.
23°C $\pm 5^\circ\text{C}$; When 30 minutes or more have elapsed after power was switched on; Sampling 1 s/10 ch; Filter ON (10); GND connected

TC	Measurement Temperature Range (°C)	Measurement Accuracy (°C)
R/S	0 \leq TS \leq 100	± 5.2
	100 $<$ TS \leq 300	± 3.0
	R : 300 $<$ TS \leq 1600 S : 300 $<$ TS \leq 1760	$\pm (0.05\% \text{ of rdg} + 2.0)$ $\pm (0.05\% \text{ of rdg} + 2.0)$
B	400 \leq TS \leq 600	± 3.5
	600 $<$ TS \leq 1820	$\pm (0.05\% \text{ of rdg} + 2.0)$
K	-200 \leq TS \leq -100	$\pm (0.05\% \text{ of rdg} + 2.0)$
	-100 $<$ TS \leq 1370	$\pm (0.05\% \text{ of rdg} + 1.0)$
E	-200 \leq TS \leq -100	$\pm (0.05\% \text{ of rdg} + 2.0)$
	-100 $<$ TS \leq 800	$\pm (0.05\% \text{ of rdg} + 1.0)$
T	-200 \leq TS \leq -100	$\pm (0.1\% \text{ of rdg} + 1.5)$
	-100 $<$ TS \leq 400	$\pm (0.1\% \text{ of rdg} + 0.5)$
J	-200 \leq TS \leq -100	± 2.7
	-100 $<$ TS \leq 100	± 1.7
	100 $<$ TS \leq 1100	$\pm (0.05\% \text{ of rdg} + 1.0)$
N	-200 \leq TS $<$ 0	$\pm (0.1\% \text{ of rdg} + 2.0)$
	0 \leq TS \leq 1300	$\pm (0.1\% \text{ of rdg} + 1.0)$
W	0 \leq TS \leq 2000	$\pm (0.1\% \text{ of rdg} + 1.5)$
Reference contact compensation accuracy		± 0.5

* Thermocouple diameters T, K: 0.32 ϕ , others: 0.65 ϕ

Reference contact compensation accuracy: Internal/External switching

A/D converter: Method : $\Delta\Sigma$ method; Resolution : 16-bit (Effective resolution: About 1/40,000 of the +/- range)

Temperature coefficient: Gain : 0.01% of F.S./°C; Zero : 0.02% of F.S./°C (Occurs when sampling speed is 10, 20, or 50 ms.)

Input resistance: 1 M Ω $\pm 5\%$

Allowable signal source resistance: Within 300 Ω

Maximum permissible input voltage: Between +/- input terminals :20mV to 1V range (60Vp-p); 2V to 100V range (110Vp-p)
Between input terminal/input terminal :60 Vp-p
Between input terminal/GND :60 Vp-p

Withstand voltage: Between input terminal/input terminal : 350 Vp-p 1 minute
Between input terminal/GND : 350 Vp-p 1 minute

Insulation resistance: Between input terminal/GND : 50M Ω or more (at 500 VDC)

Common mode rejection ratio: 90 dB or more (50/60 Hz; signal source 300 Ω or less)

Noise: 48 dB or more (with +/- terminals shorted)

Filter: Off, 2, 5, 10, 20, 40

Filter operation is on a moving average basis.
The average value of the number of set samples is used.
If the sample interval exceeds 5 seconds, the average value of data obtained in a sub-sample (5 seconds) is used.

GL240 Specifications (cont.)

Function Specifications

Display screen:	Waveform + Digital screen, All Waveform screen, Digital + Calculation Display screen, Expanded digital screen * Can be switched using the dedicated key (toggle operation) * For the Expanded Digital screen, the number of channels and the display channel must be specified
Sampling interval:	10 ms/1 ch maximum (GBD/CSV-formatted) 10, 20, 50, 100, 125, 200, 250, 500 ms; 1, 2, 5, 10, 20, 30 sec.; 1, 2, 5, 10, 20, 30 min.; 1 hour; External * The settings of 50 ms or below can be used depending on the input settings and the measuring channel.
EU (scaling function):	4 points can be set for each channel The temperature range scaling function is available.
Functions during capture:	Confirmation of the captured data (Switchable between 1-screen and 2-screen); Saving of data between cursors; Replacement of the SD memory card. When the wireless sensor (GL100-WL) is connected, the sample interval among 10, 20, and 50ms cannot be replaced during recording. Possible to save in the GBD- or CSV-formatted data.
Data save function:	Capture destination: SD memory card (Available both slot 1 and 2) Captured data: Settings, Screen data, Measurement data
Capture function:	Function: Standard recording, Ring recording, Relay recording
Ring recording:	Number of recording points: 1000 to 2000000 When ring capture is ON, the memory space that can be used for capture is one-third of the free space.
Relay recording:	The data is continuously recorded in 2GB-separated files without missing data.
Replaying data:	GBD/CSV-formatted data file (only data captured in this GL240)
Calculation between channels:	Calculation type: Four arithmetic operations (+, -, ×, ÷) Target input: Analog CH1 to CH10 Wireless sensor: WL1 to WL8
Statistical calculation:	Statistical calculation type: Average value, peak value, maximum value, minimum value, root mean square value; Number of calculations: Two arithmetic operations can be set to each channel; Calculation method: Real-time calculation and specified between cursors (during replay) Real-time calculation results are displayed on the Digital screen + Calculation Display screen.
Search functions:	Function : Search the captured data for the required number of points Search type : Channel Pulse, Logic, Level, Alarm search
Annotation input function:	Function : A comment can be entered for each channel Input table characters : Alphanumerics Number of characters : 31 (The number of characters can be displayed on the screen is up to eight characters.)

Trigger/Alarm Functions

Repeat Trigger:	Off, On
Trigger types:	Start: Data capture starts when a trigger is generated; Stop: Data capture stops when a trigger is generated
Trigger conditions:	Start: Off, Level, Alarm, External, Time, Date, Weekly Stop: Off, Level, Alarm, External, Time, Date, Weekly

Trigger judgment modes:	Combination: Level OR, Level AND, Edge OR, Edge AND; Analog channel judgment mode: H (↑), L (↓), Window In, Window Out; Logic channel judgment mode: H (↑), L (↓); Pulse channel judgment mode: H (↑), L (↓), Window In, Window Out
Alarm judgment modes:	Detection method : Level, Edge; Analog channel judgment mode : H (↑), L (↓), Window In, Window Out; Logic channel judgment mode : H (↑), L (↓); Pulse channel judgment mode : H (↑), L (↓), Window In, Window Out

External Input/Output Functions

Input/output types:	Trigger input (1 ch) or External sampling input (1 ch); Logic input (4 ch) or Pulse input (4 ch); Alarm output (4 ch); Switch between Logic and Pulse; Switch between Trigger and External sampling.; The GL B-513 (option) is required to use the external output function.
Input specifications:	Input voltage range : 0 to +24 V (single-ended ground input); Input signal : No-voltage contact (a-contact, b-contact, NO, NC), Open collector, Voltage input; Input threshold voltage : Approx. +2.5 V Hysteresis : Approx. 0.5 V (+2.5 to +3 V)
Alarm output specifications:	Output format: Open collector output (5 V, pull-up resistance 10KΩ) <Maximum ratings of output transistor> • Collector-GND voltage : 30 V • Collector current : 0.5 A • Collector dissipation : 0.2 W Output conditions: Level judgment, window judgment, logic pattern judgment, pulse judgment
Pulse input:	Revolutions mode (engines, etc.): Counts the number of pulses per sampling interval, and converts them to RPM. Set the number of pulses per revolution during revolution. Spans : 50, 500, 5000, 50 k, 500 k, 5 M, 50 M, 500 M PRM/F.S. Counts mode (electric meters, etc.): Counts the number of pulses for each sampling interval from the start of measurement. Spans : 50, 500, 5000, 50 k, 500 k, 5 M, 50 M, 500 M C/F.S. Inst. mode: Counts the number of pulses for each sampling interval. Resets the count value after each sampling interval. Spans : 50, 500, 5000, 50 k, 500 k, 5 M, 50 M, 500 M C/F.S. Maximum input frequency : 50kHz Maximum number of count : 50kC/sampling (16-bit counter)

Control Software

Compatible OS:	Windows8.1/Windows8/Windows7/Windows Vista
Function:	Main unit control, realtime data capture, data conversion
Number of groups:	4 groups MAX
Number of CHs per group:	Up to number of connected module
Max number of channels:	1000 ch maximum
Settings:	AMP settings, capture settings, trigger/alarm settings, report settings, others
Captured data:	Realtime data (CSV, GBD Binary) Data in SD memory card (CSV, GBD binary)
Display:	Analog waveforms, logic waveforms, pulse waveforms, digital values
Display modes:	Y-T View, Digital View, X-Y View between Cursors (only during replay)
File conversion:	Between cursors, All data
Monitor functions:	Alarm monitor enables sending of email to the specified address
Statistic/History:	Displays max, min and average values
Report function:	Enables creation of daily or monthly files
E-mail function:	E-mail sent to specified address on alarm

Ordering Guide

Description		Order No.	
GL240 Compact, lightweight, multi-channel data logger with 10 analog measurement channels, 20mV to 100V Full Scale measurement range, 4 discrete input channels, and 4 alarm outputs. Includes GL240 data logger, 4 GB flash memory card, AC adapter, software on CD, and an NIST-traceable calibration certificate.		GL240	
Accessories			
Description	Order No.	Description	Order No.
Battery pack 7.2V/2900mAh lithium battery pack.	B-569	Humidity Sensor 3-meter with dedicated power connector.	B-530
DC Power Cable 2-meter DC power cable, bare tips.	B-514	Logic/Alarm Cable 2-meter logic/alarm cable, bare tips.	B-513
B-536-US-240 Carrying case.	B-536US-240	Wireless Option Wireless communication option. 802.11/b/g/n	B-568
R250 4-20mA shunt resistor.	R250	Power supply Spare AC power supply.	GLACP
GL100-WL Wireless GS series sensor coupler.	GL100-WL	GS-4VT GL100 Voltage/thermocouple terminal.	GS-4VT
GS-4TSR GL100 terminal for thermistor temperature.	GS-4TSR	GS-3AT GL100 sensor for acceleration and temperature.	GS-3AT
GS-103AT-4P GL100 3m thermistor sensor (-40 to 105°C).	GS-103AT-4P	GS-DPA-AC GL100 adapter for AC power measurements.	GS-DPA-AC
GS-103JT-4P GL100 3m thermistor sensor (-40 to 120°C).	GS-103JT-4P	GS-AC50A Dedicated 50A current transformer.	GS-AC50A
GS-CO2 GL100 Sensor for CO2	GS-CO2	GS-AC100A Dedicated 100A current transformer.	GS-AC100A
GS-LXUV GL100 Sensor illuminance/UV.	GS-LXUV	GS-AC200A Dedicated 200A current transformer.	GS-AC200A
GS-TH GL100 sensor for ambient temperature/RH.	GS-TH	GS-EXC 1.5m extension cable for GL100 sensors.	GS-EXC
GS-DPA GL100 adapter for two sensors.	GS-DPA		



DATAQ Instruments, Inc.
 241 Springside Drive
 Akron, Ohio 44333
 Phone: 330-668-1444
 Fax: 330-666-5434

Data Acquisition Product Links

(click on text to jump to page)

[Data Acquisition](#) | [Data Logger](#)