

## Protistor® Square-body Fuses PSC aR sizes 3x - 450V to 700 VAC Main characteristics

### 450 TO 700VAC / 63 TO 2800A

 Recognized

- Exceptionally low  $I^2t$ , Watt losses.
- Non-magnetic construction,
- Highly reliable low voltage
- Trip-indicator system, conformity to UL, IEC, DIN and VDE standards.
- Increased technical performance
  - Higher ratings
  - Reduction in volume and weight



This fuse preselection table indicates, for each size:

- rated current (or rating)  $I_n$
- pre-arcing  $I^2t$  ( $I^2t_p$ ) at 1 ms
- total operating  $I^2t$  ( $I^2t_t$ ) at 660 V,  $f=50\text{Hz}$   $\cos \varphi=0.15$ , and for a total operating time from 8 to 10 ms
- dissipated power  $P_n$  at the rated current  $I_n$ , and at  $0.8 I_n$ , in steady state
- breaking capacity at various voltages, checked by tests made in accordance with IEC and American standards.

# Semiconductor (AC) fuses



## Protistor® Square-body Fuses PSC aR sizes 3x - 450V to 700 VAC Main characteristics

Estimated breaking capacity: 300kA

Size	Nominal Voltage (VAC)		Ampere Rating (A)	Pre-arcing I <sup>2</sup> t @ 1ms (kA <sup>2</sup> s)	Total I <sup>2</sup> t @ 660V (*) @ Un (kA <sup>2</sup> s)	Power Pn (W)		Tested Breaking capacity (kA)	
	IEC	USA				End contact	Blades	IEC @ 690V (*) @ Un	USA @ 700V (*) @ Un
30	690	700	50	0,116	0,62	9	9	200	200
			63	0,2	1,1	14	14		
			80	0,33	1,8	19	19		
			100	0,47	2,5	26	26		
			125	0,85	4,5	30	30		
			160	1,6	8,5	37	37		
			200	3	15,5	42	43		
			250	5,8	30	48	50		
			315	12	62	53	55		
			350	15,5	80	57	60		
			400	23	120	60	65		
			450	26	150	80	88		
			500	41	240	80	88		
			550	52	300	80	90		
31	690	700	630	84	450(*)	85	95	200	200
			160	1,3	7	35	35		
			200	2,6	13,5	45	45		
			250	4,7	25	52	52		
			315	7,5	40	65	65		
			350	10,5	55	67	67		
			400	19	100	68	68		
			450	26,5	140	70	70		
			500	37	195	70	72		
			550	52	280	70	75		
			630	75	390	75	85		
			700	95	490	85	95		
			800	140	800	105	120		
			315	5,2	28,9	71	71		
350	8,9	48,8	71	74					
400	15	80	72	75					
450	22	115	77	80					
500	28	145	85	90					
550	37	195	90	95					
630	54	280	95	105					
700	76	400	100	110					
800	115	600	110	120					
900	170	900	110	125					
1000	240	1250	115	135					
1100	270	1450(*)	140	165					
550	600	1250	150	180					
1400	555	2300(*)	160	200					
1600	870	3600(*)	165	205					
450	500	1800	195	230					
32	690	700	450	13,45	74,1	84	88	200	200
			500	19	100	105	105		
			550	27	140	105	110		
			630	40	210	110	120		
			700	55	300	115	125		
			800	95	490	120	130		
			900	135	700	120	135		
			1000	170	900	135	155		
			1100	240	1260	135	160		
			1250	350	1850	150	180		
			1400	480	2500	160	200		
			1500	500	2500(*)	210	240		
			1600	555	2900(*)	210	240		
			1800	720	3870(*)	225	260		
2000	950	4500(*)	250	290					
2250	1250	5160(*)	280	320					
2500	1870	6540(*)	280	330					
33	690	700	800	60	320	144		200	200
			1000	110	590	165			
			1250	220	1100	190			
			1400	300	1600	200			
			1600	450	2400	220			
			1800	700	3500	225			
			2000	950	5000	235			
			2200	1100	5250(*)	280			
			1000	76	395	220			
			1250	160	850	230			
			1400	225	1200	240			
			1600	375	1900	250			
			1800	530	2800	250			
			2000	700	3100(*)	280			
2200	950	4400(*)	280						
2500	1400	6600(*)	310						
2800	1900	8800(*)	330						
2X32	690	700	800	60	320	144		200	200
			1000	110	590	165			
			1250	220	1100	190			
			1400	300	1600	200			
			1600	450	2400	220			
			1800	700	3500	225			
2000	950	5000	235						
2200	1100	5250(*)	280						
2x33	690	700	1000	76	395	220		170	170
			1250	160	850	230			
			1400	225	1200	240			
			1600	375	1900	250			
			1800	530	2800	250			
			2000	700	3100(*)	280			
2200	950	4400(*)	280						
2500	1400	6600(*)	310						
2800	1900	8800(*)	330						
2x33	600	650	1600	870	3600(*)	165	205	160(*)	160(*)
			1800	1100	5250(*)	280			
			2000	1400	6600(*)	310			
			2200	1900	8800(*)	330			
			2500	2500	10000(*)	360			
			2800	3200	13600(*)	440			

For others Ampere ratings consult us  
12/04

# Semiconductor (AC) fuses

## Protistor® Square-body Fuses PSC aR sizes 3x - 450V to 700 VAC IEC Terminals French - 30 - 33 End contacts

Size	Designation	Reference Number	Weight (g)	Packaging	Catalog Number
30	6,9 URD 30 TTF 0050	S300373	245	3	PC30UD69V50TF
	6,9 URD 30 TTF 0063	M300000			PC30UD69V63TF
	6,9 URD 30 TTF 0080	S300051			PC30UD69V80TF
	6,9 URD 30 TTF 0100	T300052			PC30UD69V100TF
	6,9 URD 30 TTF 0125	V300053			PC30UD69V125TF
	6,9 URD 30 TTF 0160	W300054			PC30UD69V160TF
	6,9 URD 30 TTF 0200	X300055			PC30UD69V200TF
	6,9 URD 30 TTF 0250	Y300056			PC30UD69V250TF
	6,9 URD 30 TTF 0315	Z300057			PC30UD69V315TF
	6,9 URD 30 TTF 0350	A300058			PC30UD69V350TF
	6,9 URD 30 TTF 0400	B300059			PC30UD69V400TF
	6,9 URD 30 TTF 0450	V300398			PC30UD69V450TF
	6,9 URD 30 TTF 0500	W300399			PC30UD69V500TF
	6,9 URD 30 TTF 0550	X300400			PC30UD69V550TF
	6 URD 30 TTF 0630	L301770			PC30UD60V630TF
	31	6,9 URD 31 TTF 0160			M300299
6,9 URD 31 TTF 0200		N300001	PC31UD69V200TF		
6,9 URD 31 TTF 0250		P300002	PC31UD69V250TF		
6,9 URD 31 TTF 0315		Q300003	PC31UD69V315TF		
6,9 URD 31 TTF 0350		M300046	PC31UD69V350TF		
6,9 URD 31 TTF 0400		R300004	PC31UD69V400TF		
6,9 URD 31 TTF 0450		S300005	PC31UD69V450TF		
6,9 URD 31 TTF 0500		T300006	PC31UD69V500TF		
6,9 URD 31 TTF 0550		V300007	PC31UD69V550TF		
6,9 URD 31 TTF 0630		W300008	PC31UD69V630TF		
6,9 URD 31 TTF 0700		X300009	PC31UD69V700TF		
6,9 URD 31 TTF 0800		Y300401	PC31UD69V800TF		
32	6,9 URD 32 TTF 0315	M302162	510	3	PC32UD69V315TF
	6,9 URD 32 TTF 0350	N302163			PC32UD69V350TF
	6,9 URD 32 TTF 0400	H300065			PC32UD69V400TF
	6,9 URD 32 TTF 0450	J300066			PC32UD69V450TF
	6,9 URD 32 TTF 0500	K300067			PC32UD69V500TF
	6,9 URD 32 TTF 0550	L300068			PC32UD69V550TF
	6,9 URD 32 TTF 0630	M300069			PC32UD69V630TF
	6,9 URD 32 TTF 0700	N300070			PC32UD69V700TF
	6,9 URD 32 TTF 0800	P300071			PC32UD69V800TF
	6,9 URD 32 TTF 0900 **	Q300072			PC32UD69V900TF
	6,9 URD 32 TTF 1000 **	S300074			PC32UD69V1000TF
	6 URD 32 TTF 1100 **	M300759			PC32UD60V100TF
	5,5 URD 32 TTF 1250 **	P301060			PC32UD55V1250TF
	5 URD 32 TTF 1400 **	Q301061			PC32UD50V1400TF
	5 URD 32 TTF 1600 **	H300893			PC32UD50V1600TF
	4,5 URD 32 TTF 1800 **	R301062			PC32UD45V1800TF
33	6,9 URD 33 TTF 0450	W302170	790	3	PC33UD69V450TF
	6,9 URD 33 TTF 0500	V300076			PC33UD69V500TF
	6,9 URD 33 TTF 0550	W300077			PC33UD69V550TF
	6,9 URD 33 TTF 0630	X300078			PC33UD69V630TF
	6,9 URD 33 TTF 0700	Y300079			PC33UD69V700TF
	6,9 URD 33 TTF 0800	Z300080			PC33UD69V800TF
	6,9 URD 33 TTF 0900	A300081			PC33UD69V900TF
	6,9 URD 33 TTF 1000	B300082			PC33UD69V1000TF
	6,9 URD 33 TTF 1100	C300083			PC33UD69V1100TF
	6,9 URD 33 TTF 1250 **	D300084			PC33UD69V1250TF
	6,9 URD 33 TTF 1400 **	E300085			PC33UD69V1400TF
	6 URD 33 TTF 1500 **	Y300585			PC33UD60V1500TF
	6 URD 33 TTF 1600 **	Z300586			PC33UD60V1600TF
	6 URD 33 TTF 1800 **	A300587			PC33UD60V1800TF
	5,5 URD 33 TTF 2000 **	B300588			PC33UD55V2000TF
	5 URD 33 TTF 2250 **	K300757			PC33UD50V2250TF
4,5 URD 33 TTF 2500 **	L300758	PC33UD45V2500TF			

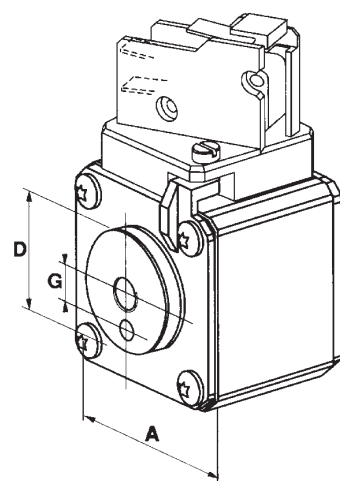
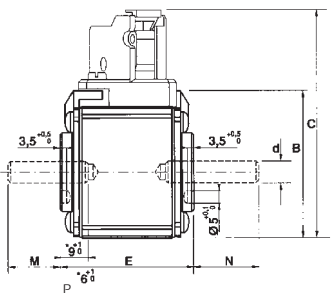

**Note:**  
dimensions in mm  
dimensions in inches

Threaded studs and microswitches  
supplied separately  
see microswitches PSC 3x & 7x and  
Metric studs sections

Size	A	B	C	D	M*	N*	E±1	d	G±0.1	P
30	40 1-9/16"	46,5 1-27/32"	82 3-7/32"	26 1-1/64"	22	27	50,6 2"	M8	9 23/64"	6 15/64"
31	51 2"	56,5 2-7/32"	91 3-37/64"	30 1-3/16"	19	24	50,6 2"	M8	9 23/64"	9 23/64"
32	60 2-3/8"	65,5 2-37/64"	100 3-15/16"	38 ; (42mm **) 1-1/2" ; (1-21/32" **)	19	39	50,6 2"	M10	15 19/32"	9 23/64"
33	74,5 2-15/16"	79,5 3-1/8"	114 4-1/2"	46 ; (52mm **) 1-13/16" ; (2-1/16" **)	24	39	50,6 2"	M12	15 19/32"	9 23/64"

# Semiconductor (AC) fuses



## Protistor® Square-body Fuses PSC aR sizes 3x - 450V to 700 VAC IEC Terminals French - 30 - 33 End contacts

Size	Designation					Reference Number	Weight (g)	Packaging	Catalog Number
2 x 32	6,9	URD	232	TTF	0800	T300305			PC232UD69V8CTF
	6,9	URD	232	TTF	1000	T300213			PC232UD69V10CTF
	6,9	URD	232	TTF	1250	V300214	1240		PC232UD69V13CTF
	6,9	URD	232	TTF	1400	G300087		1	PC232UD69V14CTF
	6,9	URD	232	TDF	1600	W300215			PC232UD69V16CTD
	6,9	URD	232	TDF	1800	X300216	3300		PC232UD69V18CTD
	6,9	URD	232	TDF	2000	Y300217			PC232UD69V20CTD
	5,5	URD	232	TDF	2200	D301993			PC232UD55V22CTD
2 x 33	6,9	URD	233	TTF	1000	B301186			PC233UD69V10CTF
	6,9	URD	233	TTF	1250	D300268			PC233UD69V13CTF
	6,9	URD	233	TTF	1400	E300269	1900		PC233UD69V14CTF
	6,9	URD	233	TTF	1600	F300270			PC233UD69V16CTF
	6,9	URD	233	PLAF	1800	B300427			PC36UD69V18CP11
	6	URD	233	PLAF	2000	R302235			PC36UD60V20CP11
	6	URD	233	PLAF	2200	O302234			PC36UD60V22CP11
	6	URD	233	PLAF	2500	P302233		1	PC36UD60V25CP11
	6	URD	233	PLAF	2800	N302232			PC36UD60V28CP11
	5,5	URD	233	PLAF	3000*	L301977			PC36UD55V30CP11
	5,5	URD	233	PLAF	3200*	M301978	2000		PC36UD55V32CP11
	5	URD	233	PLAF	3600*	N301979			PC36UD50V36CP11
	5	URD	233	PLAF	4000*	P301980			PC36UD50V40CP11
	4	URD	233	PLAF	4500*	O301981			PC36UD40V45CP11
	4	URD	233	PLAF	5000*	R301982			PC36UD40V50CP11

\*Consult us

Size	A	B	C	D	E	F	G	H	J	K	d	e	L	M	N
2x32 TT	60	138,5	172	11	67,6	66,5	100	35	61	40	M 10	4	107,5	48	72
2x33 TT	74,5	167	200	13	67,6	81	114	50	80	40	M 12	4	107,5	54	86
2x32 TD	65,5	147	182	-	91,5	-	-	30	-	60	M 10	12	140	-	-
2x33 PLAF	75	171,5	207	-	55,5	-	115	40	-	71	M 10	15	81	-	-

### TT

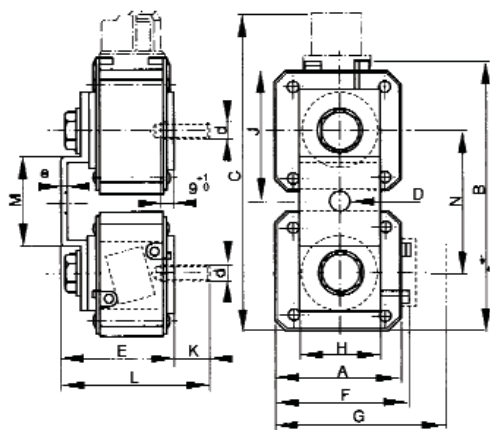

### TD

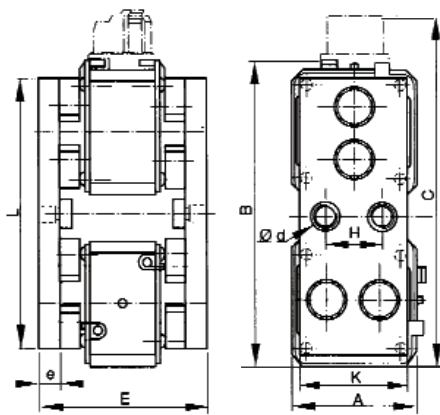

### PLAF

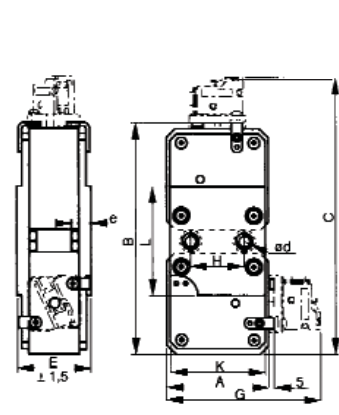

## Protistor® Square-body Fuses PSC aR sizes 3x - 450V to 700 VAC IEC Terminals French - 30 - 33 End contacts

### 33 PPAF Standard Press-Pack

Size	Designation	Reference Number	Weight (g)	Packaging	Catalog Number
33	6,9 URD 33 PPAF 1250	D301855	910	3	PC33UD69V13CPP
	6,9 URD 33 PPAF 1400	E301856			PC33UD69V14CPP
	6 URD 33 PPAF 1600	G301927			PC33UD60V16CPP
2x33	6,9 URD 233 PPAF 1800	R300694	2450	1	PC36UD69V18CP12
	6 URD 233 PPAF 2000	H302250			PC36UD60V20CP12
	6 URD 233 PPAF 2200	K302252			PC36UD60V22CP13
	6 URD 233 PPAF 2500	M302254			PC36UD60V25CP12
	6 URD 233 PPAF 2800	L302253			PC36UD60V28CP13
	5,5 URD 233 PPAF 3000	to be given - contact us			to be given - contact us
	5,5 URD 233 PPAF 3200	V301985			PC36UD55V32CP12
	5,5 URD 233 PPAF 3600	to be given - contact us			to be given - contact us
	5 URD 233 PPAF 4000	X301987			PC36UD50V40CP12
	4,5 URD 233 PPAF 4500	to be given - contact us			to be given - contact us
	4 URD 233 PPAF 5000	M301932			PC36UD40V50CP12

Studs and microswitches supplied separately

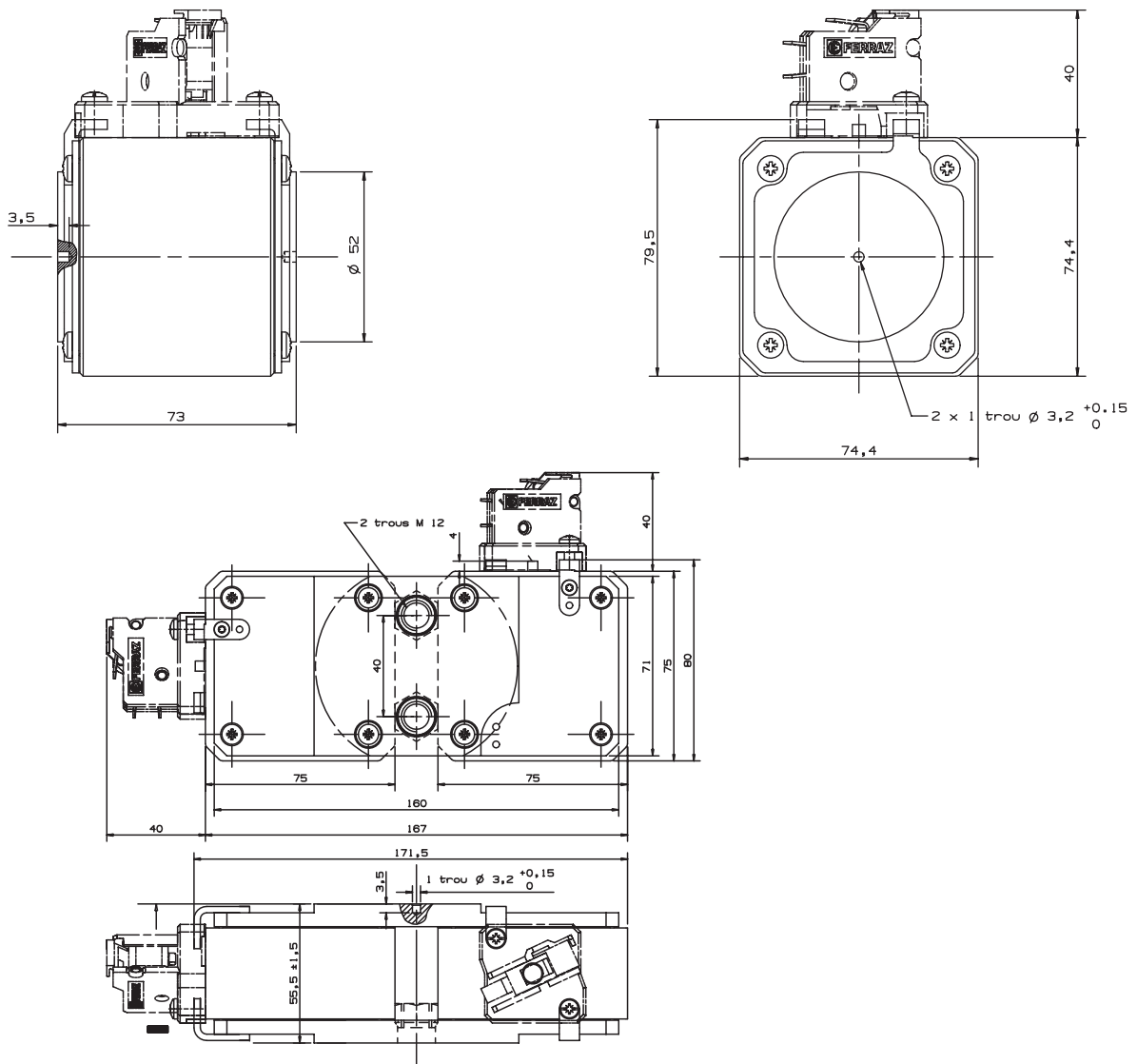



# Semiconductor (AC) fuses

## Protistor® Square-body Fuses PSC aR sizes 3x - 450V to 700 VAC Curves set

Sizes 30 - 31 - 32 - 33

### I<sup>2</sup>t Multiplier coefficient

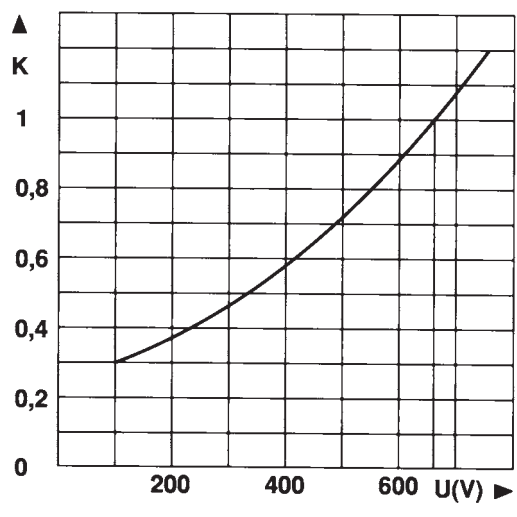

Mean curve indicating variation of total I<sup>2</sup>t (I<sup>2</sup>t<sub>t</sub>) and total operating time T<sub>t</sub> in accordance with working voltage U.

#### Example:

Fuse 350 A in size 30.  
I<sub>p</sub> = 10 000 A U = 500 V

At 660 V  
I<sup>2</sup>t<sub>t</sub> = 80 000 A<sup>2</sup>s T<sub>t</sub> = 6 ms

At 500 V  
I<sup>2</sup>t<sub>t</sub> = 80 000 x 0.72 = 57 600 A<sup>2</sup>s  
T<sub>t</sub> = 6 x 0.72 = 4.3 ms

### Dissipated power

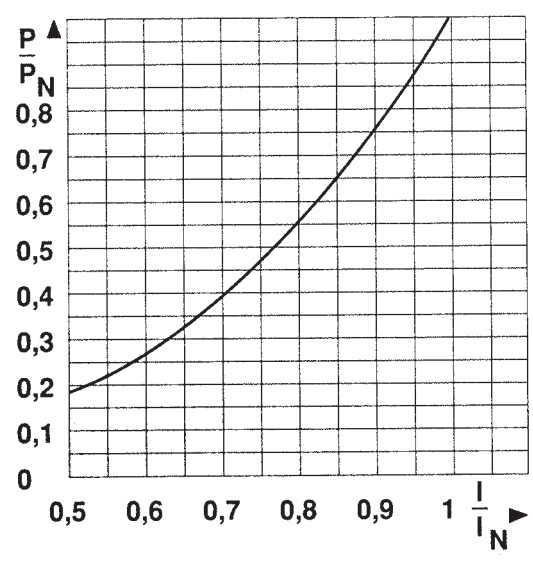

Curve enabling calculation of dissipated power P by a fuse rated I<sub>N</sub>, as a function of the RMS current I, in multiples of I<sub>N</sub>, in a steady state.

### Arc voltage

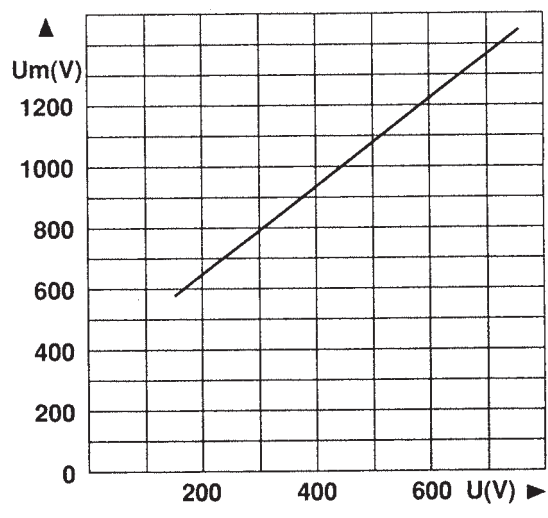

Curve indicating peak arc voltage U<sub>m</sub> which may appear across fuse terminals as function of working voltage U at cos φ = 0.15



## Protistor® Square-body Fuses PSC aR sizes 3x - 450V to 700 VAC Curves set

### Size 30

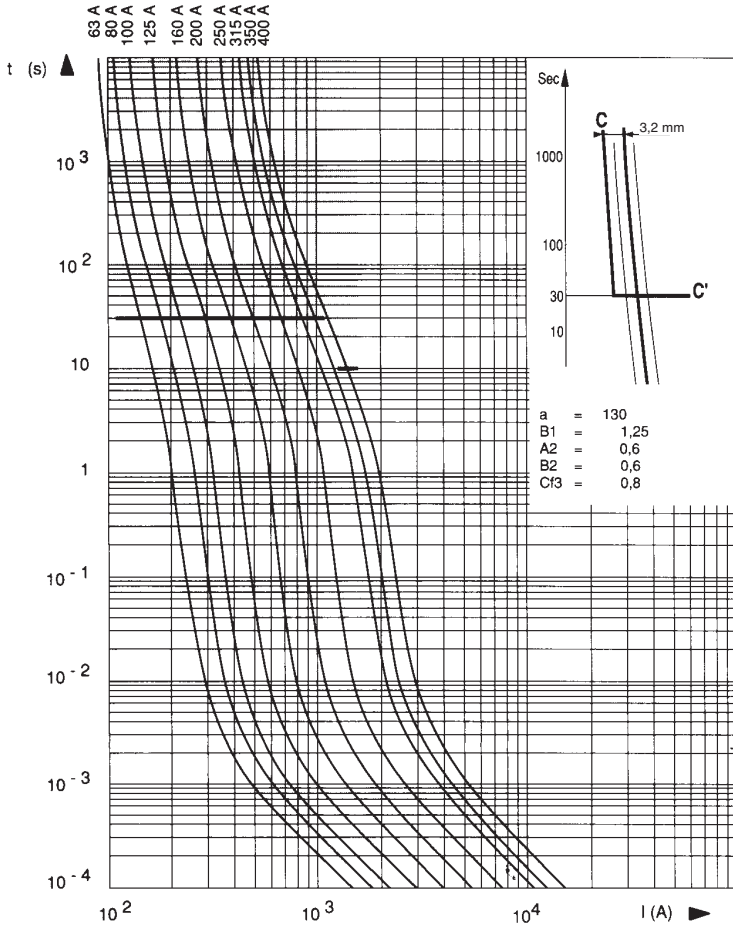

### ↓ Cut-off characteristics

Below, right: Curves indicating for each rated-current the peak value  $I_C$  that the current may reach as a function of the prospective fault current  $I_p$ .

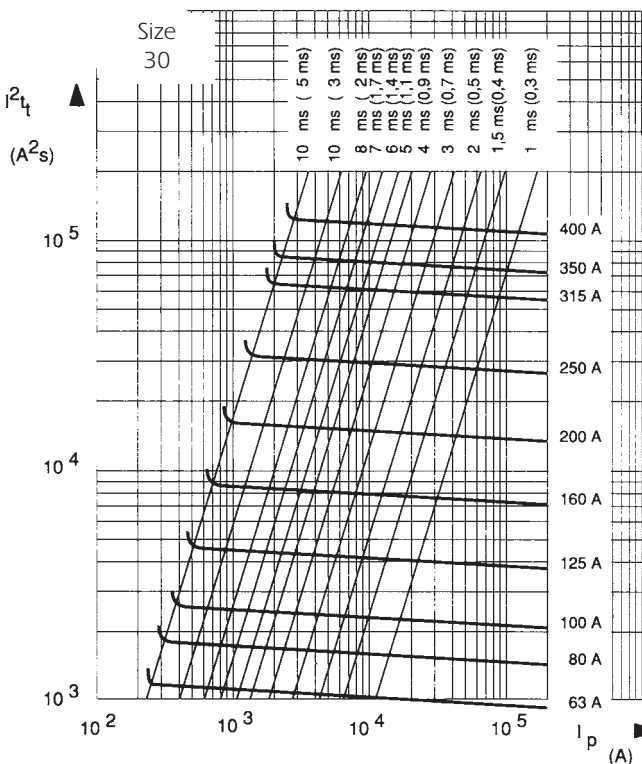
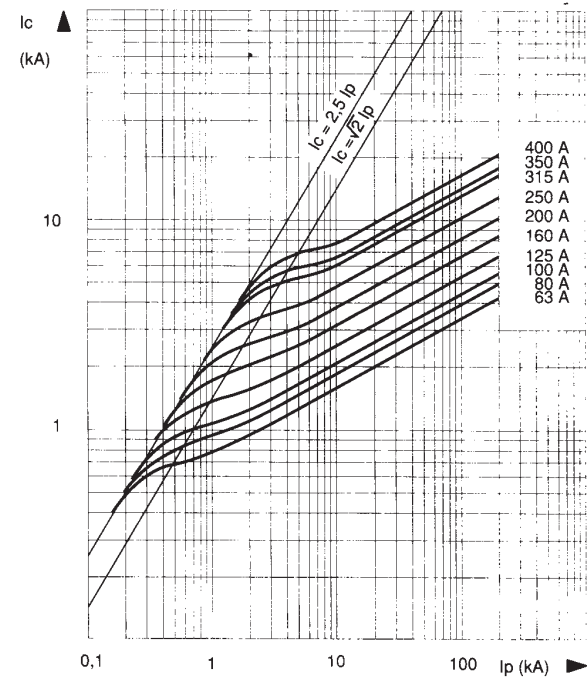

### ↑ Time-current characteristics

Above, left: Curves indicating pre-arcing time for each rated current as a function of RMS value of pre-arcing current  $I$ .

- Tolerances on this current  $\pm 8\%$ .
- Beyond 30 sec or 10 sec, small overloads must be eliminated by another device.
- Curve CC' represents the maximum times taken by the associated device to clear small overloads; only its horizontal line is represented. Its oblique line must be plotted according to sketch, top right corner.
- The intersection of the fuse and CC' curves indicates the minimum breaking current  $I_{pm}$  of the fuse.

### ← Maximum values of total operating $I^2t$ and total operating times

Left: Horizontal curves indicating the maximum values of total operating  $I^2t$  ( $I^2t_t$ ) as function of the prospective current  $I_p$  at 660 V,  $\cos \varphi = 0.15$ . The oblique lines indicate the corresponding total operating time  $T_T$ , with pre-arcing time in brackets.

## Protistor® Square-body Fuses PSC aR sizes 3x - 450V to 700 VAC Curves set

Size 31

### ↓ Cut-off characteristics

Below, right: Curves indicating for each rated current the peak value  $I_C$  that the current may reach as a function of the prospective fault current  $I_P$ .

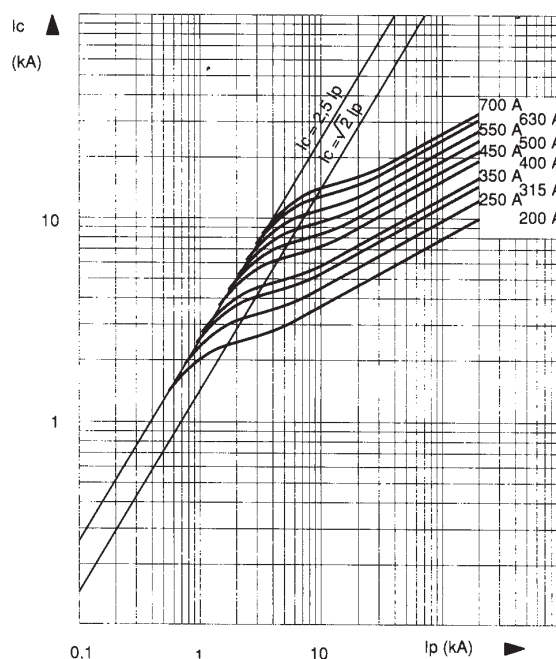
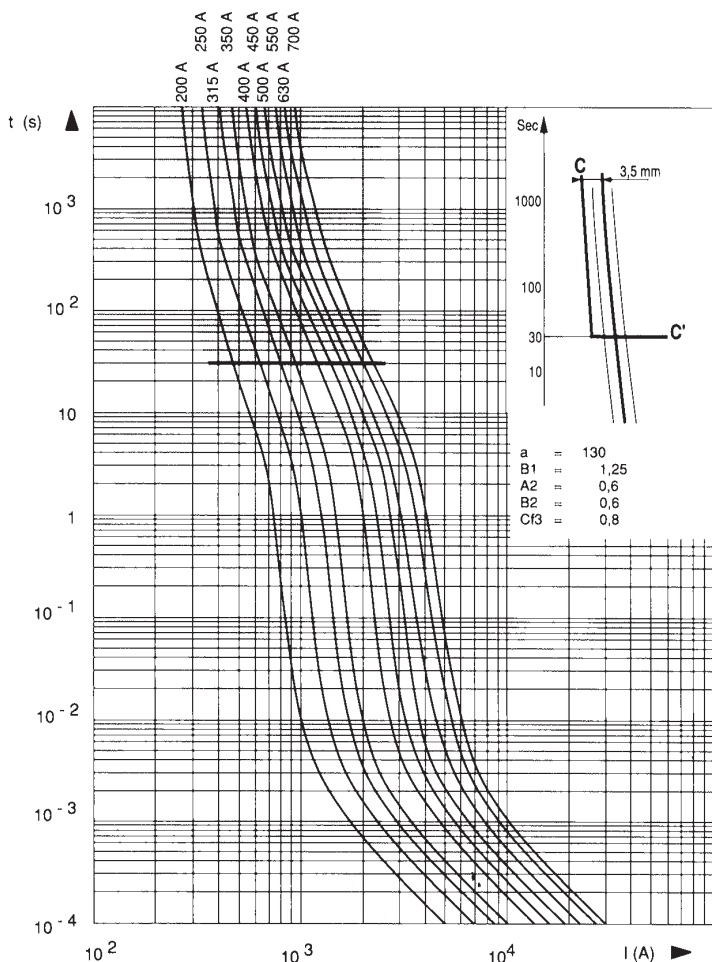

### ↑ Time-current characteristics

Above, left: Curves indicating pre-arcing time for each rated current as a function of RMS value of pre-arcing current  $I$ .

- Tolerances on this current  $\pm 8\%$ .
- Beyond 30 sec or 10 sec, small overloads must be eliminated by another device.
- Curve  $CC'$  represents the maximum times taken by the associated device to clear small overloads; only its horizontal line is represented. Its oblique line must be plotted according to sketch, top right corner.
- The intersection of the fuse and  $CC'$  curves indicates the minimum breaking current  $I_{pm}$  of the fuse.

### ← Maximum values of total operating $I^2t$ and total operating times

Left: Horizontal curves indicating the maximum values of total operating  $I^2t$  ( $I^2t_t$ ) as function of the prospective current  $I_P$  at 660 V,  $\cos \varphi = 0.15$ . The oblique lines indicate the corresponding total operating time  $T_T$ , with pre-arcing time in brackets.

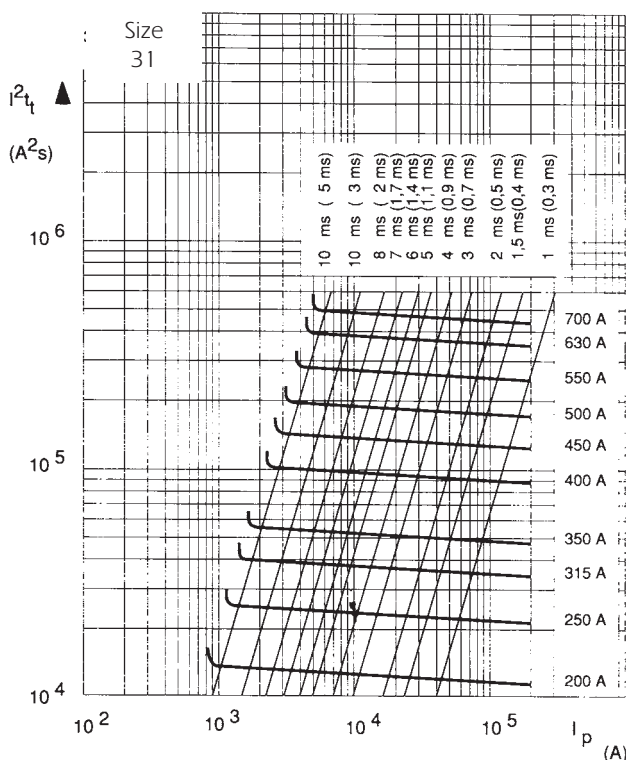





## Protistor® Square-body Fuses PSC aR sizes 3x - 450V to 700 VAC Curves set

### Size 32

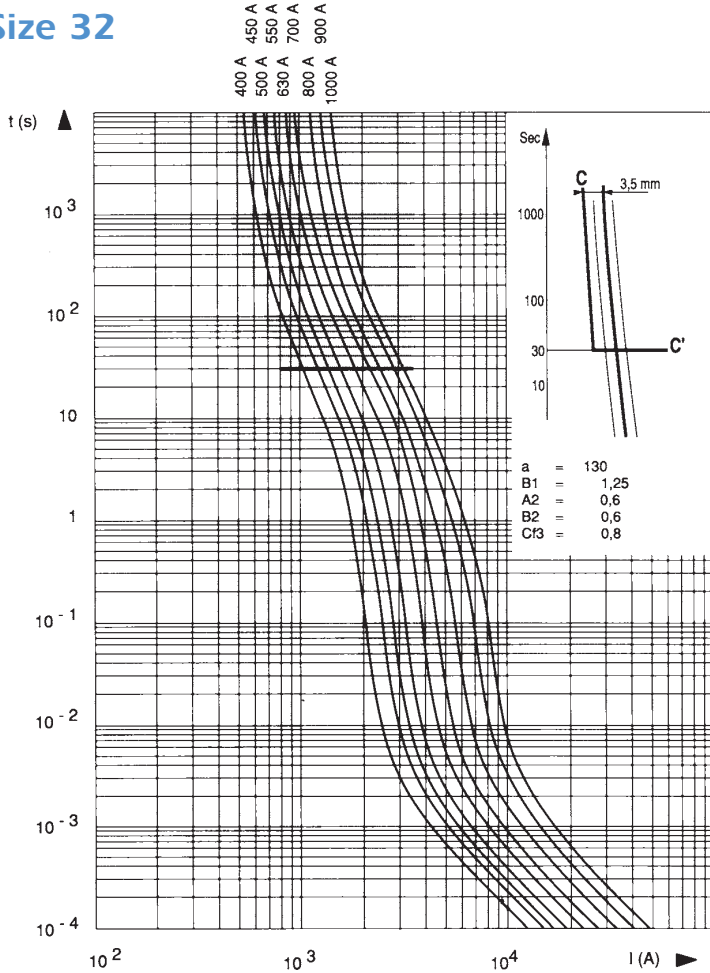

### ↓ Cut-off characteristics

Below, right: Curves indicating for each rated-current the peak value  $I_C$  that the current may reach as a function of the prospective fault current  $I_p$ .

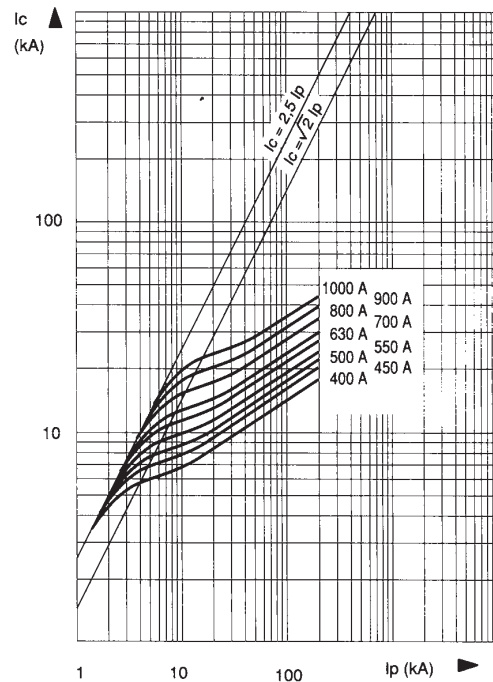

### ↑ Time-current characteristics

Above, left: Curves indicating pre-arcing time for each rated current as a function of RMS value of pre-arcing current  $I$ .

- Tolerances on this current  $\pm 8\%$ .
- Beyond 30 sec or 10 sec, small overloads must be eliminated by another device.
- Curve CC' represents the maximum times taken by the associated device to clear small overloads; only its horizontal line is represented. Its oblique line must be plotted according to sketch, top right corner.
- The intersection of the fuse and CC' curves indicates the minimum breaking current  $I_{pm}$  of the fuse.

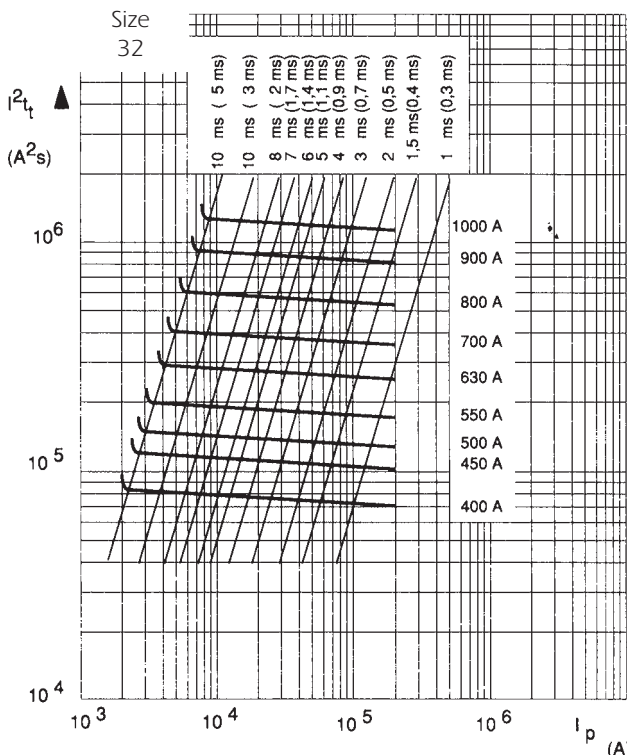

### ← Maximum values of total operating $I^2t$ and total operating times

Left: Horizontal curves indicating the maximum values of total operating  $I^2t$  ( $I^2t_t$ ) as function of the prospective current  $I_p$  at 660 V,  $\cos \varphi = 0.15$ . The oblique lines indicate the corresponding total operating time  $T_t$ , with pre-arcing time in brackets.

# Semiconductor (AC) fuses

## Protistor® Square-body Fuses PSC aR sizes 3x - 450V to 700 VAC Curves set

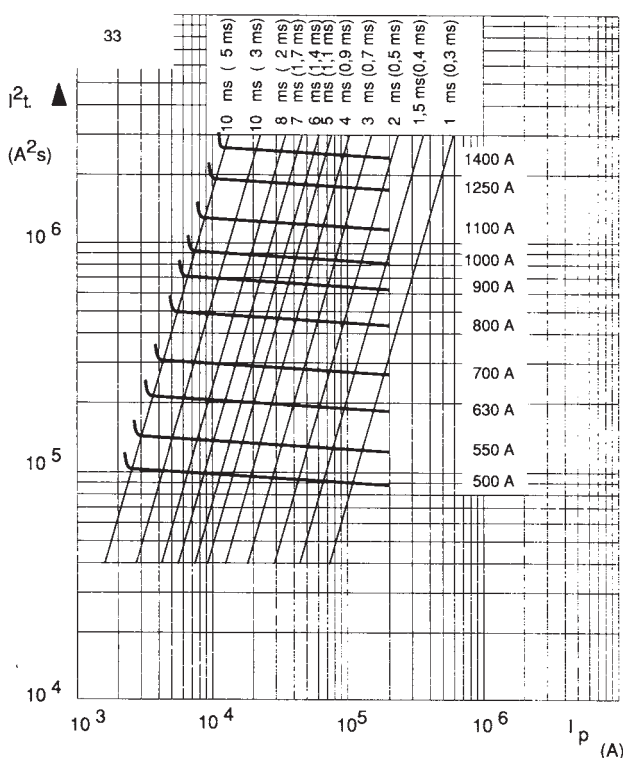

### ↑ Time-current characteristics

Above, left: Curves indicating pre-arcing time for each rated current as a function of RMS value of pre-arcing current  $I$ .

- Tolerances on this current  $\pm 8\%$ .
- Beyond 30 sec or 10 sec, small overloads must be eliminated by another device.

### ← Maximum values of total operating $I^2t$ and total operating times

Left: Horizontal curves indicating the maximum values of total operating  $I^2t$  ( $I^2t_t$ ) as function of the prospective current  $I_p$  at 660 V,  $\cos \varphi = 0.15$ . The oblique lines indicate the corresponding total operating time  $T_t$ , with pre-arcing time in brackets.



## Protistor® Square-body Fuses PSC aR sizes 3x - 450V to 700 VAC Curves set

### Sizes 2x32

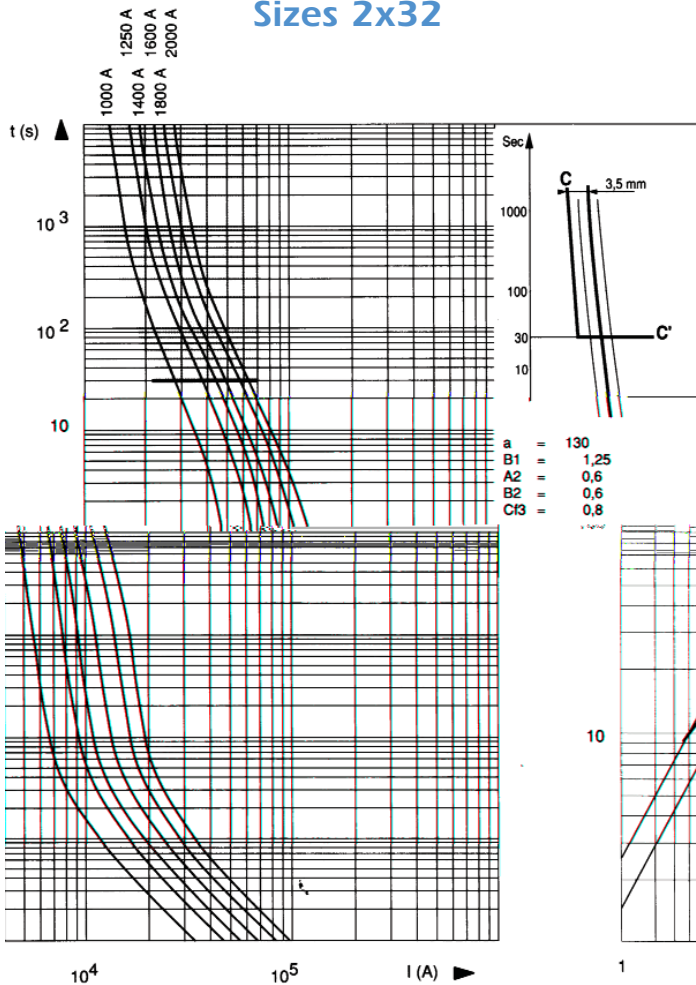

### ↓ Cut-off characteristics

Below, right: Curves indicating for each rated current the peak value  $I_C$  that the current may reach as a function of the prospective fault current  $I_p$ .

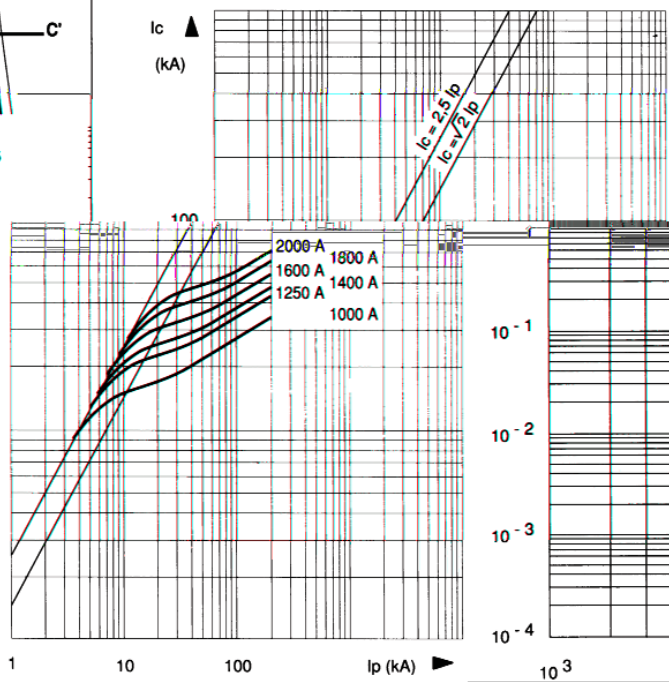

### ↑ Time-current characteristics

Above, left: Curves indicating pre-arcing time for each rated current as a function of RMS value of pre-arcing current  $I$ .

- Tolerances on this current  $\pm 8\%$ .
- Beyond 30 sec or 10 sec, small overloads must be eliminated by another device.
- Curve CC' represents the maximum times taken by the associated device to clear small overloads; only its horizontal line is represented. Its oblique line must be plotted according to sketch, top right corner.
- The intersection of the fuse and CC' curves indicates the minimum breaking current  $I_{pm}$  of the fuse.

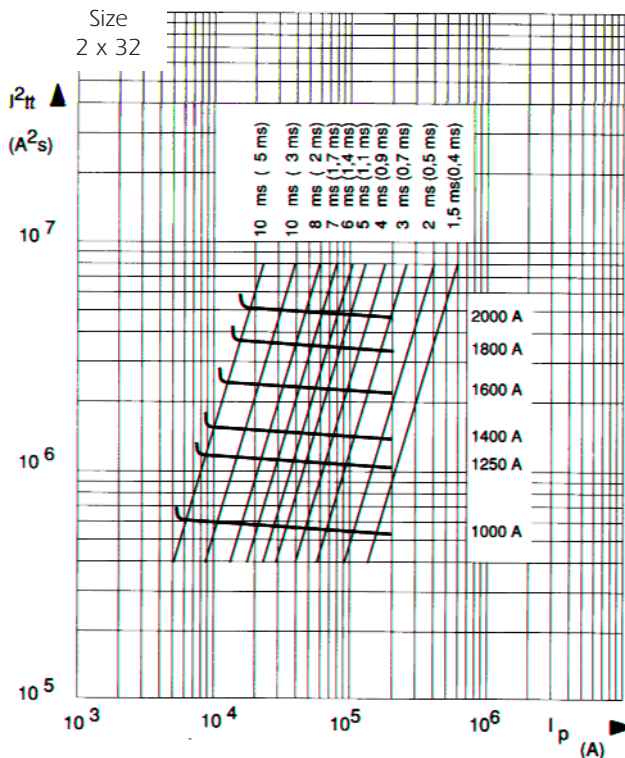

### ← Maximum values of total operating $I^2t$ and total operating times

Left: Horizontal curves indicating the maximum values of total operating  $I^2t$  ( $I^2t_t$ ) as function of the prospective current  $I_p$  at 660 V,  $\cos \varphi = 0.15$ . The oblique lines indicate the corresponding total operating time  $T_t$ , with pre-arcing time in brackets.

## Protistor® Square-body Fuses PSC aR sizes 3x - 450V to 700 VAC Curves set

Size 2x33

### ↓ Cut-off characteristics

Below, right: Curves indicating for each rated current the peak value  $I_C$  that the current may reach as a function of the prospective fault current  $I_p$ .

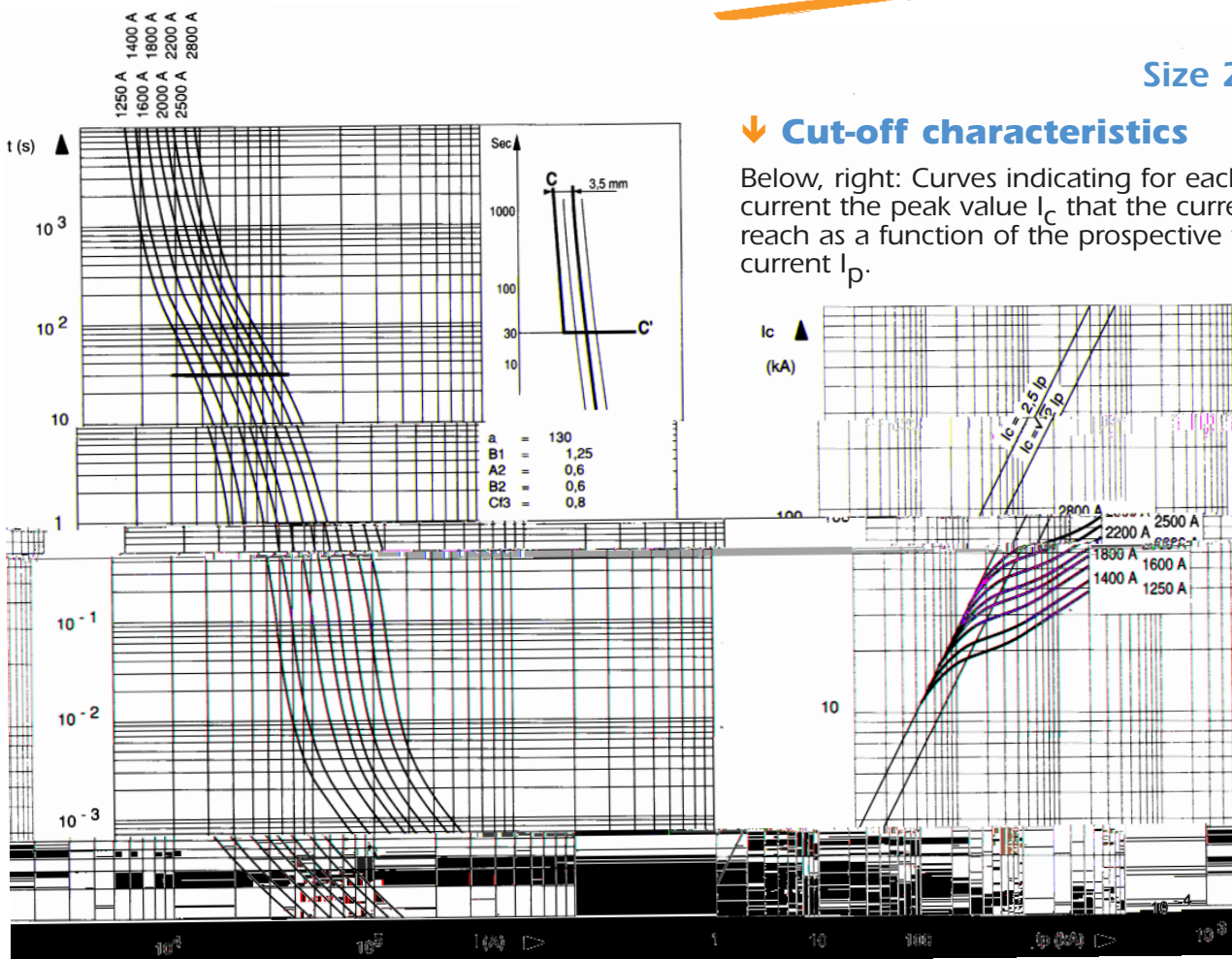

### ↑ Time-current characteristics

Above, left: Curves indicating pre-arcing time for each rated current as a function of RMS value of pre-arcing current  $I$ .

- Tolerances on this current  $\pm 8\%$ .
- Beyond 30 sec or 10 sec, small overloads must be eliminated by another device.
- Curve CC' represents the maximum times taken by the associated device to clear small overloads; only its horizontal line is represented. Its oblique line must be plotted according to sketch, top right corner.
- The intersection of the fuse and CC' curves indicates the minimum breaking current  $I_{pm}$  of the fuse.

### ← Maximum values of total operating $I^2t$ and total operating times

Left: Horizontal curves indicating the maximum values of total operating  $I^2t$  ( $I^2t_t$ ) as function of the prospective current  $I_p$  at 660 V,  $\cos \varphi = 0.15$ . The oblique lines indicate the corresponding total operating time  $T_t$ , with pre-arcing time in brackets.

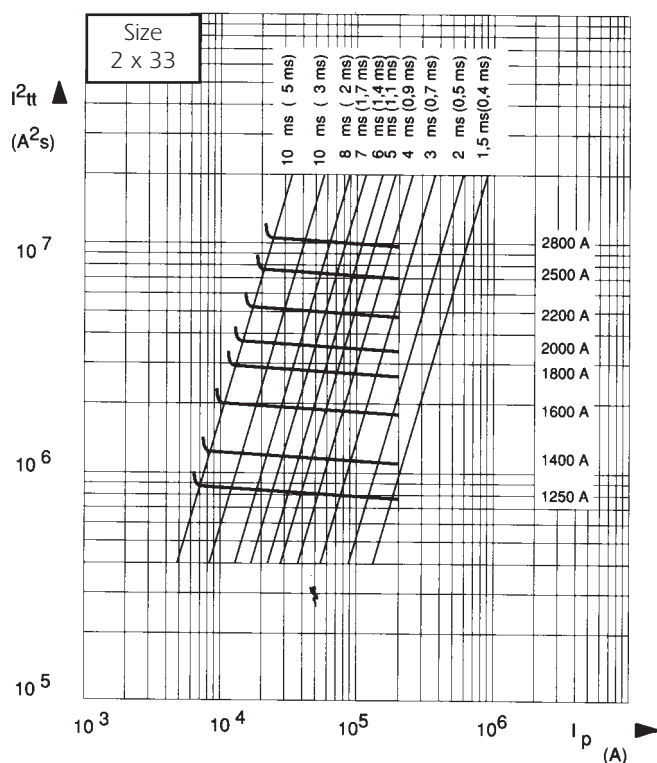



## Protistor® Square-body Fuses PSC aR sizes 3x - 450V to 700 VAC Curves set

Sizes 30 - 31 - 32 - 33

### DC working voltage possibilities

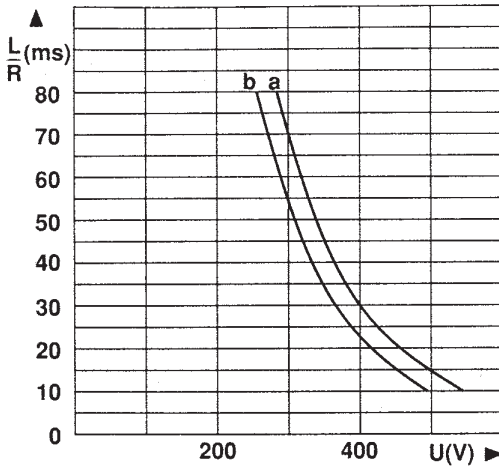

Rated current In (A)	Curves (*) and Ipm (I) corresponding to the rating					
	30 * Ipm (A)	31 * Ipm (A)	32 * Ipm (A)	33 * Ipm (A)	2 x 32 * Ipm (A)	2 x 33 * Ipm (A)
63	a 230					
80	a 300					
100	a 360					
125	a 460					
160	a 650					
200	a 880	a 850				
250	a 1300	a 1150				
315	a 1700	a 1450				
350	a 1900	a 1600				
400	a 2300	a 2200	a 2000			
450		a 2500	a 2300			
500		a 3000	a 2600	a 2300		
550		a 3400	a 3150	a 2500		
630		a 5000	a 3700	a 3250		
700		a 5600	a 4300	a 3900		
800			a 5300	a 4800		
900			a 7800	a 5600		
1000			b 9000	a 6600	a 5200	
1100				a 7700		
1250				b 11000	a 7400	a 6500
1400				b 12500	a 8600	a 7800
1600					a 10600	a 9600
1800					a 15600	a 11200
2000					b 18000	a 13200
2200						a 15400
2500						b 22000
2800						b 25000

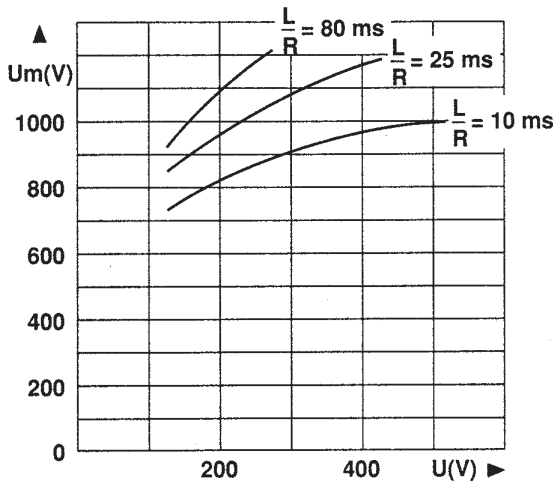

**Top:** Curves indicating the maximum time constant  $L/R$  of the fault path as a function of the DC voltage  $U$  for the rated currents in the sizes indicated in the table.

Ipm (I) values indicate the minimum breaking current in Amperes (A).

**Remark:**

When the fault current  $di/dt$  is very large, this condition can be exceeded. This is the case for faults occurring in voltage commutated inverters.

**Below:** Curves indicating peak arc voltage  $U_m$  which may appear across fuse terminals as a function of the DC working voltage  $U$ , for various time constant  $L/R$  of fault path.

## Protistor® Square-body Fuses PSC aR sizes 3x - 450V to 700 VAC Microswitches PSC 3x & 7x

- MICROSWITCH SYSTEMS ADAPTED

TO THE FOLLOWING FERRAZ SHAWMUT FUSES ONLY:

- PSC sizes 30, 31, 32, 33, 2x32, 2x33 / 70, 71, 72, 73, 272, 273  
except plain blades

- PSC LR sizes 33, 233, 73, 273

- PERMANENT INDICATION OF FUSE STATE: CONDUCTIVE  
BLOWN

- MANUAL RESETTING

- STANDARD AND LOW ELECTRICAL LEVEL WITH DIFFERENT INSULATION LEVELS

- BS TYPE FOR USE IN CORROSIVE ATMOSPHERE

- MS 3V 1-5 UR AND MS 7V 1-5 UR TYPE UL ARE RECOGNIZED



MS 7V 1-5

### Main Characteristics

Code	AC Insulation voltage rating (***)	Positive operating voltage/current	Current rating	Current	Breaking Capacity						AC voltage withstand test (*)	Impulse voltage test Uimp1.2/50 µs (**)	Fire class according to UL 94
					Non inductive circuit			Inductive circuit : L/R = 25ms					
					30V	110V	250V	30V	110V	250V			
MS 3V 1-5	1000 V	20 V 50 mA	10 A	50/60 Hz	10 A	10 A	10 A	10 A	10 A	10 A	8,5 kV	14 kV	H.B
MS 3V 1-5 UR				DC	8 A	0,4 A	0,2 A	4 A	0,2 A	0,1 A			
MS 7V 1-5	1500V	10 V 10 mA	3 A	50/60 Hz	3 A	3 A	3 A	2 A	1 A	1 A	8,5 kV	14 kV	
MS 7V 1-5 UR				DC	3 A	0,5 A	0,25 A	3 A	0,2 A	0,1 A			
MS 3V 1-5 BS	1000 V	10 V 10 mA	3 A	50/60 Hz	3 A	3 A	3 A	2 A	1 A	1 A	8,5 kV	14 kV	
MS 3V 1-9 BS				DC	3 A	0,5 A	0,25 A	3 A	0,2 A	0,1 A			
MS 7V 1-5 BS	1500V	10 V 10 mA	3 A	50/60 Hz	3 A	3 A	3 A	2 A	1 A	1 A	8,5 kV	14 kV	
MS 7V 1-9 BS				DC	3 A	0,5 A	-	2 A	0,2 A	-			
MS 3V 1-5 ET	1000V	10 V	3 A	50/60 Hz	3 A	3 A	3 A	2 A	1 A	1 A	8,5 kV	14 kV	
MS 7V 1-5 ET	1500V	10 mA	3 A	DC	3 A	0,5 A	-	2 A	0,2 A	-	12 kV	20 kV	

\* Between power circuit and microswitch terminals as per IEC 60 and 694 and NFC 64010 (50/60 Hz 1 min duration in dry air)

\*\* Between power circuit and microswitch terminals Uimp: impulse voltage as per IEC 60947-1

\*\*\* Between power circuit and microswitch terminals

**Warning:** microswitch systems exclusively designed for FERRAZ SHAWMUT.  
PSC Fuses fitted a patented trip-indicator, saving use of EDV

# Semiconductor (AC) fuses

## Protistor® Square-body Fuses PSC aR sizes 3x - 450V to 700 VAC Microswitches for PSC 3x & 7x

### Indication systems for PSC Fuse sizes 30 to 73

#### MS 3V...

These patented indication systems are exclusively hand resettable.

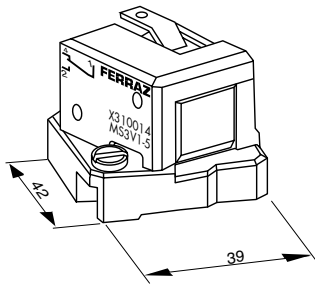

(fig. 1)

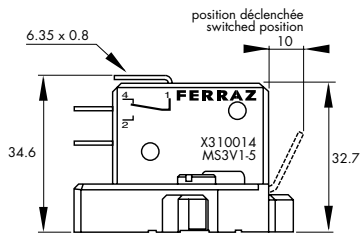

Fuse size	Designation	Ref. Number	Indication style	Weight (g)	Pack.	Catalog Number
30, 31	MS 3V 1-5 (fig.1)	X310014	Standard NO-NC	34	3 pieces	MS3 V1-5
	MS 3V 1-5 UR	Y310038				MS3 V1-5UR
32, 33	MS 3V 1-5 BS (3)	K310013	Low level NO-NC	34	3 pieces	MS3-V1-5BS
	MS 3V 1-9 BS (4)	P310011	Double pole Low level	44	3 pieces	MS3V1-9BS
	MS 3V 1-5 ET (fig.2)	S310009	Low level NO-NC IP 50 (9)	34	3 pieces	MS3V1-5 ETANCHE

(3) Same as fig.1

(4) Same dimensions as figure 1 but with 2 microswitches side by side

(9) Watertightness class

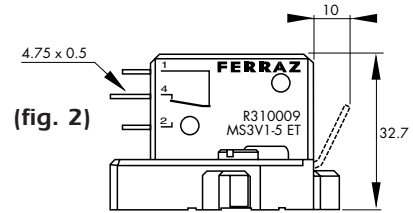

(fig. 2)

#### MS 7V...

Fuse size	Designation	Ref. Number
3 pieces		
3 pieces		
3 pieces		

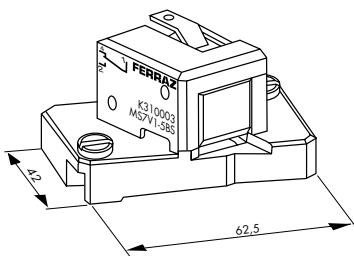

(fig. 5)

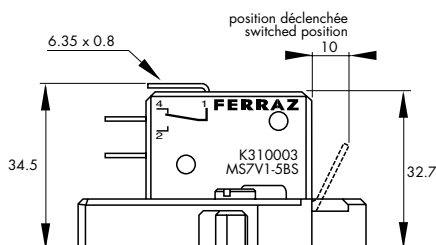

(7) Same as fig. 5

(8) Same dimensions as figure 5 but with 2 microswitches side by side

(9) Watertightness class

**Warning:** Microswitch systems exclusively designed for FERRAZ SHAWMUT PSC fuses fitted with a patented trip-indicator, saving use of EDV.

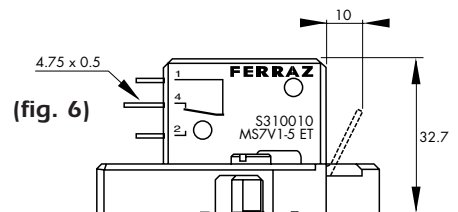



(fig. 6)

## Protistor® Square-body Fuses PSC aR sizes 3x - 450V to 700 VAC Metric-studs

### Metric studs for threaded terminal fuses



Type and fuse size	Designation	Ref. Number	Unit weight (g)	Pack.	Catalog Number
 Sizes 0 and 1  Size 2  Size 3	HC stud pair M8x30 & M8x35	S098801	23	6 pairs	STUM8x30M8x35
	HC stud pair M10x30 & M10x50	T098802	40	6 pairs	STUM10x30M10x50
	HC stud pair M12x35 & M12x50	V098803	60	6 pairs	STUM12x35M12x50
 Size 2  Size 3	HC stud pair M10x50	W098804	45	6 pairs	STUM10x50
	HC stud pair M12x50	X098805	45	6 pairs	STUM12x50

We recommend the use of studs, whose quality is suited to all FERRAZ SHAWMUT square-body fuses with terminals

### Stud mounting

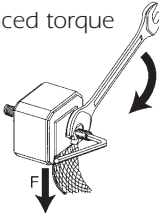
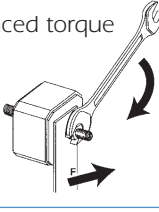
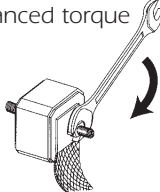
Torque type	Stud type	Maximum stud tightning torque (Nm) (1)	Maximum nut tightning torque (Nm) (1)
Balanced torque 	M8x30 & M8x35	10	13.5
	M10x30 & M10x50	15	26
	M12x35 & M12x50	15	46
Balanced torque 	M8x30 & M8x35	10	13.5
	M10x30 & M10x50	15	26
	M12x35 & M12x50	15	46
Unbalanced torque 	M8x30 & M8x35	10	13.5
	M10x30 & M10x50	15	26
	M12x35 & M12x50	15	46