



element14

---

**EN** - For pricing and availability in your local country please visit one of the below links:

**DE** - Informationen zu Preisen und Verfügbarkeit in Ihrem Land erhalten Sie über die unten aufgeführten Links:

**FR** - Pour connaître les tarifs et la disponibilité dans votre pays, cliquez sur l'un des liens suivants:

[DLPLIGHTCRAFTER](#)

**EN**

This Datasheet is presented by  
the manufacturer

**DE**

Dieses Datenblatt wird vom  
Hersteller bereitgestellt

**FR**

Cette fiche technique est  
présentée par le fabricant

# DLP® LightCrafter™ Evaluation Module (EVM)

## User's Guide



Literature Number: DLPU006  
January 2012



---



---



---

<b>Preface</b> .....	<b>5</b>
<b>1 DLP® LightCrafter™ Module Overview</b> .....	<b>7</b>
1.1 Welcome .....	7
1.2 What is in this Module? .....	7
1.2.1 Light Engine .....	8
1.2.2 LED Currents .....	9
1.2.3 Driver Board .....	9
1.2.4 System Board .....	11
1.3 DLP® LightCrafter™'s Connections .....	12
1.4 DLP® LightCrafter™'s Dimensions .....	13
<b>2 Software Overview</b> .....	<b>15</b>
2.1 DLP® LightCrafter™ Software .....	15
2.2 Embedded Linux Kernel .....	15
2.3 First Time Connection to a Windows PC .....	16
2.4 First Time Connection to a Windows 7 PC .....	16
2.5 PC Software .....	19
2.5.1 LED Current Settings .....	20
2.5.2 Static Image Mode .....	21
2.5.3 Internal Test Pattern .....	21
2.5.4 HDMI Video .....	22
2.5.5 Pattern Sequence .....	22
2.6 Firmware Upgrades .....	23
2.7 Solutions .....	24
<b>3 Pattern Sequences</b> .....	<b>27</b>
3.1 Pattern Sequence Background .....	27
3.2 External Patterns .....	28
3.3 Internal Patterns .....	29
<b>4 Connectors</b> .....	<b>31</b>
4.1 Trigger Connector .....	31
4.2 Camera Connector .....	31
4.3 UART .....	32
4.4 I <sup>2</sup> C .....	32
4.5 Fan .....	32
4.6 Power .....	33

## List of Figures

1.	DLP® LightCrafter™ Evaluation Module .....	5
1-1.	DLP® LightCrafter™ Block Diagram .....	8
1-2.	0.3" DMD Pixel Geometry.....	8
1-3.	DLP® LightCrafter™ Driver Board Block Diagram.....	10
1-4.	DLP® LightCrafter™ System Board Block Diagram.....	11
1-5.	DLP® LightCrafter™ Connector Locations.....	13
1-6.	LightDLP® LightCrafter™ Crafter Module Dimensions .....	14
2-1.	DVSDK Software Platform .....	15
2-2.	DLP® LightCrafter™ GUI.....	19
2-3.	DLP® LightCrafter™ GUI Functionality.....	20
2-4.	GUI - Static Image Mode .....	21
2-5.	GUI - Internal Test Pattern .....	22
2-6.	Trigger Period.....	23
2-7.	Pattern Sequence .....	23
2-8.	Firmware Upgrades .....	24
2-9.	Solutions .....	25
3-1.	The Relationship between Bit Planes and 24-bit RGB Images .....	27
3-2.	Bit Partition .....	27
3-3.	Bit Planes and Triggers.....	28

## List of Tables

1-1.	DLP® LightCrafter™ Light Engine Specifications .....	9
2-1.	LED Current Settings .....	20
3-1.	Allowable External Pattern Combinations .....	29
3-2.	Maximum Internal Pattern Rate .....	29
3-3.	Internal Pattern Exposure Time .....	30
4-1.	Trigger Connector Pins .....	31
4-2.	Camera Connector Pins .....	31
4-3.	UART Connector Pins .....	32
4-4.	I <sup>2</sup> C Connector Pins .....	32
4-5.	Fan Connector Pins .....	33
4-6.	Power Connector Pins .....	33

## Read This First

---

---

### About This Guide

The DLP® LightCrafter™ is a third party implementation of a next generation DLP Pico reference design to enable faster development cycles for applications requiring small form factor, and intelligent pattern display.

This guide is an introductory document for the DLP® LightCrafter™ that provides an overview of the system and its software. Other documents provide more in-depth information of the hardware and software features of DLP® LightCrafter™'s components.



**Figure 1. DLP® LightCrafter™ Evaluation Module**

### Related Documentation From Texas Instruments

DLPC300 Data Sheet: *DLP Digital Controller for DLP3000 DMD*, TI literature number [DLPS023](#)

DLP3000 Data Sheet: *DLP 0.3 WVGA DDR Series 220 DMD*, TI literature number [DLPS022](#)

*DLPC300 Software Programmer's Guide*, TI literature number [DLPS023](#)

DLP® LightCrafter™ DM365 Command Interface Guide, TI literature number [DLPU007](#)

### If You Need Assistance

Refer to the [DLP and MEMS TI E2E Community support forums](#).



## **DLP® LightCrafter™ Module Overview**

---

---

This chapter introduces the DLP® LightCrafter™ module.

### **1.1 Welcome**

Your new DLP® LightCrafter™ module will allow you to evaluate TI's DLP Pico platform along with TI's DaVinci Technology and the DM365 architecture.

This technology brings together a set of components providing an efficient and compelling system solution for:

- Small display projector: Embedded display, Interactive display, Information overlay
- Structured light applications: 3D modeling/design, Biometric: fingerprint identification and face recognition, Machine vision and inspection
- Medical and life sciences: Vascular imaging, Dental impression scanner, Intraoral dental scanners, Orthopaedics, Prosthesis, CT/MRI/X-ray marking, Retail cosmetics

### **1.2 What is in this Module?**

The DLP® LightCrafter™ module is a flexible, ready to use evaluation module (EVM). However, DLP® LightCrafter™ EVM does not ship with any cables, power supply, or additional hardware components. To use the EVM, you will need:

- Power supply: 5-V output with 2- to 3-A current rating and a plug of 0.7 mm inner diameter x 2.35 mm outer diameter and 9.5-mm female shaft.
- Mini USB cable
- RS232 cable with 2.5-mm stereo plug

The DLP® LightCrafter™ module consists of three subsystems:

- Light engine – includes the optics, red, green, and blue LEDs, and the 608 x 684 diamond pixel 0.3" WVGA DMD. Capable of 20 lumens out-of-the-box with support to 50 lumens with user's addition of active cooling.
- Driver board – includes the LED driver circuits, DLPC300 DMD Controller, power management circuits and MSP430.
- System board – includes TMS320DM365, FPGA, and several connectors for external inputs.

[Figure 1-1](#) shows the major hardware components.



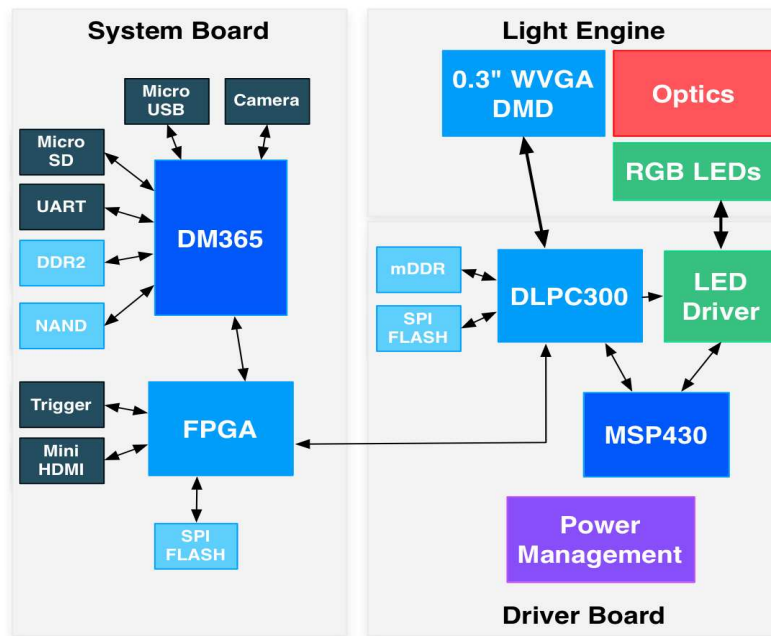

Figure 1-1. DLP® LightCrafter™ Block Diagram

### 1.2.1 Light Engine

Young Optics, Inc. developed the DLP® LightCrafter™'s light engine. The light engine includes the DLP3000 0.3" DMD with 415,872 mirrors arranged in a 608 by 684 with the diamond pattern geometry shown in Figure 1-2

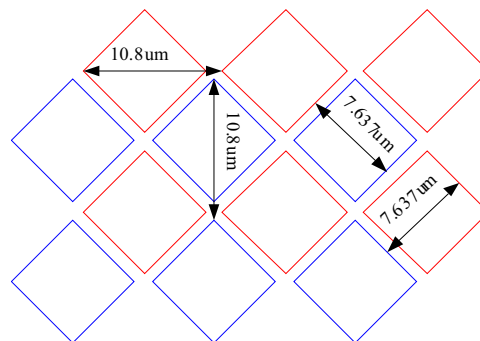

Figure 1-2. 0.3" DMD Pixel Geometry

The DMD is vertically mounted at the end of the light engine. The light engine, including the LEDs and not including the heat sinks, has a length of 39.3 mm, width of 41.6 mm, and height of 11 mm. Table 1-1 lists the specifications of the light engine:

**Table 1-1. DLP® LightCrafter™ Light Engine Specifications**

	MIN	TYP	MAX	UNIT
Brightness	10 @ 0.6W LED			lm
	25 @ 1.85W LED			
	30 @ 2.25W LED			
Brightness uniformity (JBMA)	70			%
ANSI contrast	43:1			
Full-on full-off contrast	685:1			
Color uniformity (CIE x)	0.03			
Color Uniformity (CIE y)	0.04			
Throw ratio	1.66			
Offset	100			%
Focus range	364		2169	mm
Image diagonal size	10		60	inch
Focus stroke	1			mm

### 1.2.2 LED Currents

DLP® LightCrafter™ passively cooled systems (no extra heat sinks or fans) have a thermal limit resulting in LED currents under 633 mA.

DLP® LightCrafter™ actively cooled systems (extra heat sink and fan) have a thermal limit resulting in LED currents under 1.5 A.

To be used as part of an overall thermal management system, the current software has a safety shutdown if excessive heat is measured at the DMD.

### 1.2.3 Driver Board

[Figure 1-3](#) shows the DLP® LightCrafter™'s driver board block diagram.

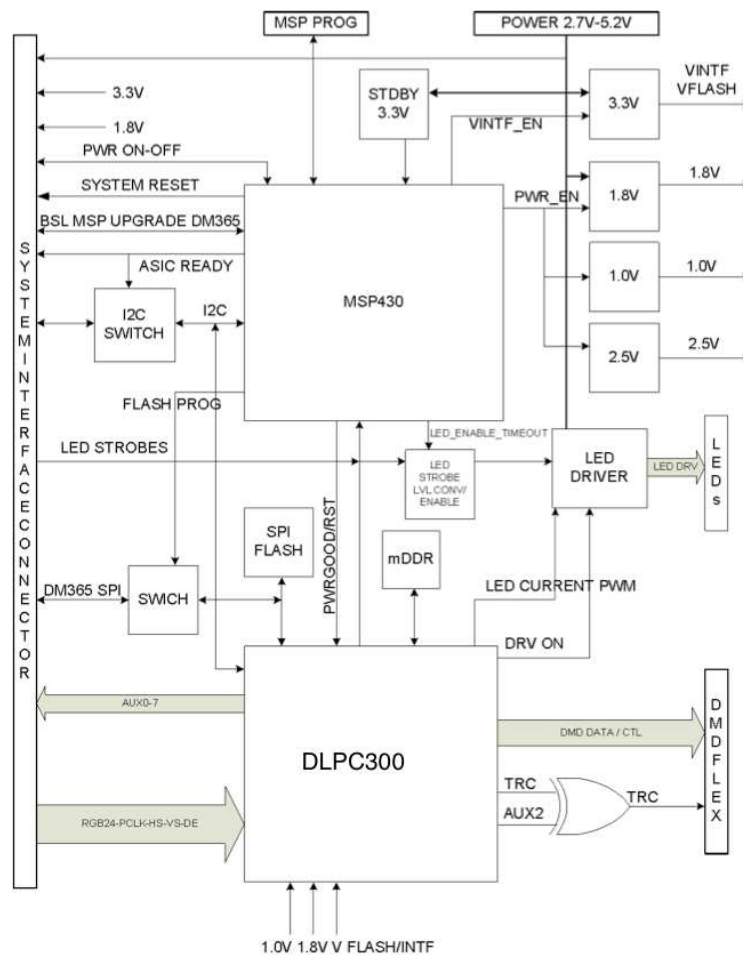

Figure 1-3. DLP® LightCrafter™ Driver Board Block Diagram

The major components of the DLP® LightCrafter™'s driver board are:

- DLP3000 – 0.3" DMD
- DLPC300: DLP3000 controller with
  - 2MB SPI FLASH that contains DLPC300 firmware
  - 32MB mDDR that buffers images for the DLP3000
- MSP430:
  - Controls power supply sequencing and system initialization
  - LED driver control
  - Shutdown system upon detection of low input voltage
  - Measure thermistors and shutdown system when maximum temperature ratings are exceeded.
- LED driver circuitry
- Power management:
  - TPS63020: Buck/Boost Regulator for LED supplies
  - TPS63020: Buck/Boost Regulator for 3.3 V supply
  - TPS62260: Step Down Converter for DLPC300 2.5 V supply
  - TPS62400: Step Down Converter for DLPC300 1.0 V and 1.8 V supply
  - TPS65120: 4-CH Bias for DMD VRST and VBIAS supplies
  - TPS71501: LDO for DMD VOFS supply

### 1.2.4 System Board

Figure 1-4 shows the DLP® LightCrafter™'s system board.

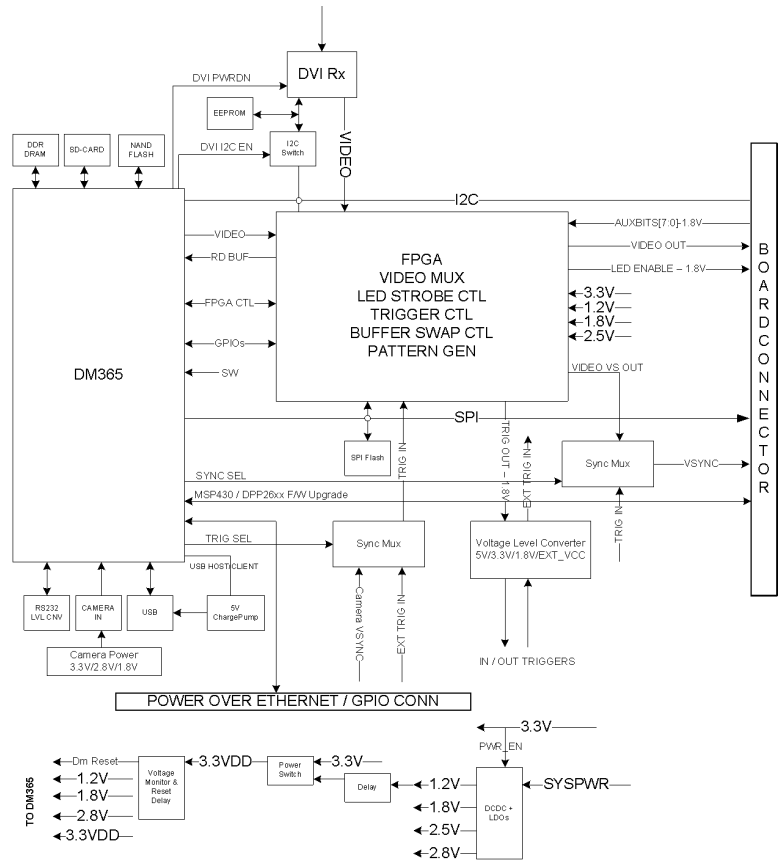

Figure 1-4. DLP® LightCrafter™ System Board Block Diagram

The major components of the system board are:

- Altera Cyclone IV FPGA:
  - Controls video muxing (external miniHDMI or DM365)
  - Controls LEDs enables
  - Generates programmable camera triggers
  - Manages four internal buffers for fast pattern display
- DM365: Embedded Linux main processor that controls camera interface, connectivity with PC, non-volatile storage (Micro-SD and NAND Flash), FPGA control, video output, and video buffer in DDR2.
  - 64MB DDR2 memory
  - Micro-SD connector
  - Mini-USB connector
  - UART mini-plug
- miniHDMI connector
- Power management:
  - TPS650531: 2-Step Down Converter for FPGA's and DM365's 1.2 V and 1.8 V supplies with three LDOs for FPGA's 2.5V supply and camera interface optional 2.8 V supply

### 1.3 DLP® LightCrafter™'s Connections

DLP® LightCrafter™ offers the following connectivity options:

- Mini-HDMI: supports external video input with 608\*684 resolution at 60 Hz.
- Micro-SD: tested to support up to 4GB, class 10, high capacity cards for DM365 software and local data storage.
- Mini USB: interfaces to PC as a slave device. A program running on the PC will issue commands to the DLP® LightCrafter™ module.
- Camera Connector: 28-pin connector using ITU-R BT.656 compatible camera interface. The camera interface supports up to 12-bit data.
- Trigger connector: supports external or internally generated triggers for camera capture.
- Serial FLASH programming connectors:
  - Driver board: programs the MSP430 FLASH and the DLPC300 serial FLASH.
  - System board: programs the FPGA serial FLASH.
- UART mini-plug: allows serial messages with the following serial configuration:
  - Bits per second: 115200
  - Data Bits: 8
  - Parity: None
  - Stops Bits: 1
  - Flow Control: None

[Figure 1-5](#) depicts the connectors and their respective locations.

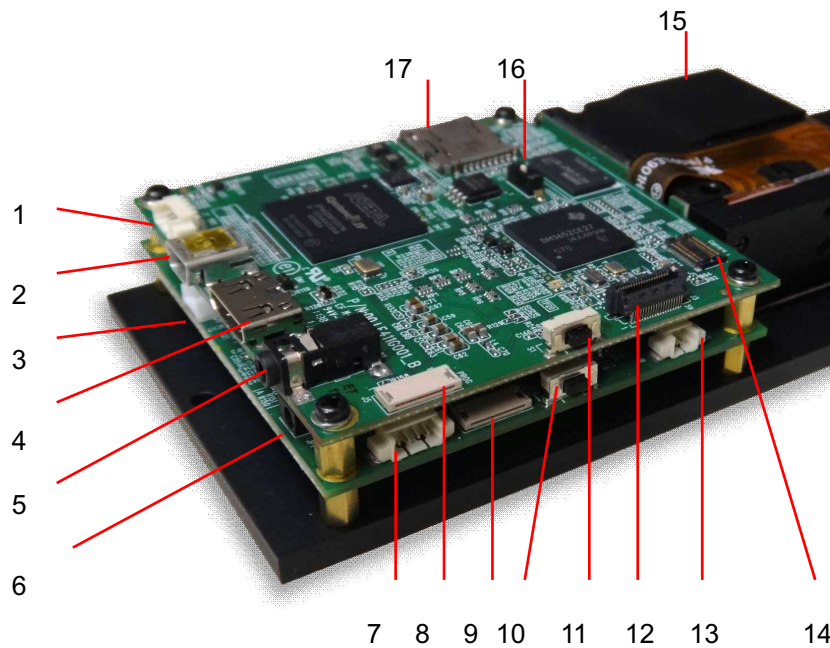

1. Trigger Input/Output
2. Mini USB
3. Power Connector
4. Mini HDMI
5. UART
6. Power Socket
7. I<sup>2</sup>C
8. FPGA SPI Flash Programming Interface
9. MSP430/DLPC300 Flash Programming Interface
10. On/Off Button – Do not turn off while the Linux system is booting
11. Input Selection Button (DM365/Internal Test Pattern/ HDMI input)
12. Ethernet PHY
13. Fan
14. Camera
15. Focus Control
16. Boot Mode Selection Switch
17. Micro-SD card

**Figure 1-5. DLP® LightCrafter™ Connector Locations**

## 1.4 DLP® LightCrafter™'s Dimensions

The DLP® LightCrafter™ optical engine is mounted on top of a thermal plate to provide passive cooling to the module. The DLP3000, 0.3" DMD, is vertically mounted at the end of the optical engine and attached with a connector to the Driver Board. The System Board is mounted on top of the Driver Board. This module has dimensions of 116.5 mm long, 65 mm wide, and 23 mm tall. [Figure 1-6](#) illustrates DLP® LightCrafter™ dimensions.

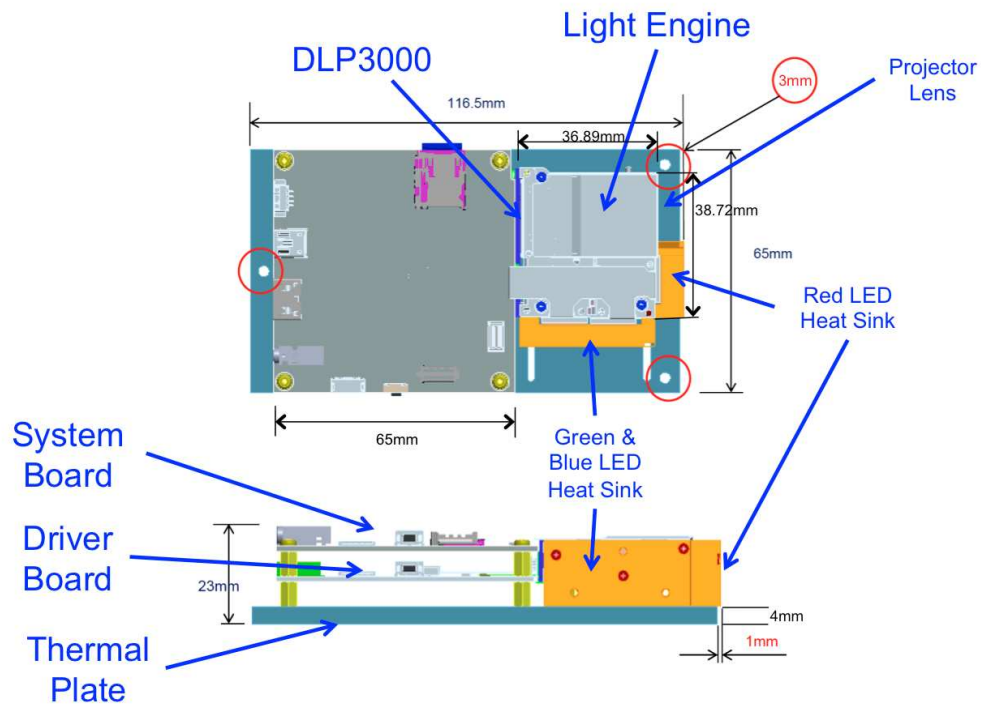

Figure 1-6. LightDLP® LightCrafter™ Crafter Module Dimensions

## Software Overview

This chapter introduces the PC software provided with the DLP® LightCrafter™ Module.

### 2.1 DLP® LightCrafter™ Software

The DLP® LightCrafter™ module software is based on TI's DVSDK platform. The DVSDK platform is a collection of royalty free software components built upon Linux operating system and pre-tested by TI. The software components include Linux kernel, Linux filesystem, Linux product support package (PSP), application framework (APIs), codec libraries (MPEG4, H.264, MPEG2, G.711, JPEG), example programs, DSP Codegen, and CodeSourcery tool chain with IDE for cross-compiling and debugging target systems.

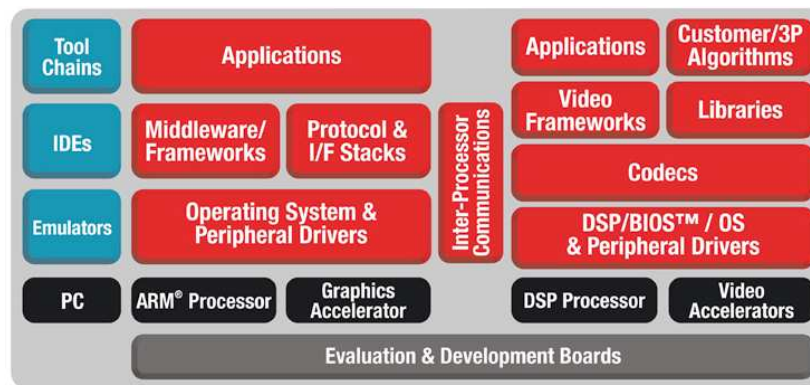

Figure 2-1. DVSDK Software Platform

### 2.2 Embedded Linux Kernel

Out of the box, the DLP® LightCrafter™ boots from the on-board NAND FLASH. The DM365 acts as the main processor of the system and boots as an embedded Linux device. The Linux filesystem resides on the micro-SD card. Thus, the DLP® LightCrafter™ does not require an NFS mount nor a TFTP server to run. The embedded Linux system utilizes Remote Network Drivers Interface Specification (RNDIS) to send packets through USB. Currently, DLP® LightCrafter™ has a fixed IP address of 192.168.1.100.

DLP® LightCrafter™'s UART port serves as a console output of the embedded Linux device. The DM365 will send error messages through the UART and accept root level commands. A 2.5 mm stereo plug to female DB9 connector as shown below is needed to connect the DLP® LightCrafter™'s UART port to a PC. For PCs with only USB ports, a USB to RS232 adapter with FTDI chipset is recommended.

To view UART console messages, configure a terminal emulator with the following parameters:

- Baud: 115,200
- Data Bits: 8
- Stop Bits: 1
- Parity: None
- Flow Control: None



### 2.3 First Time Connection to a Windows PC

The first time the cable is connected on Windows XP systems a pop-up window appears stating that a new hardware device called a "RNDIS/Ethernet Gadget" was found. Then follow these steps:

1. This should bring up the "Found New Hardware" dialog, select "Install the software automatically (Recommended)." Click on Next. Windows XP Service Pack 2 or greater includes the RNDIS drivers, so these drivers should be found by the OS.

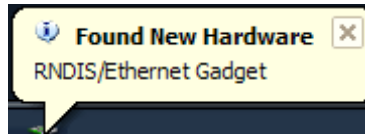

2. Verify "USB Ethernet/RNDIS Gadget" is detected by the hardware wizard.

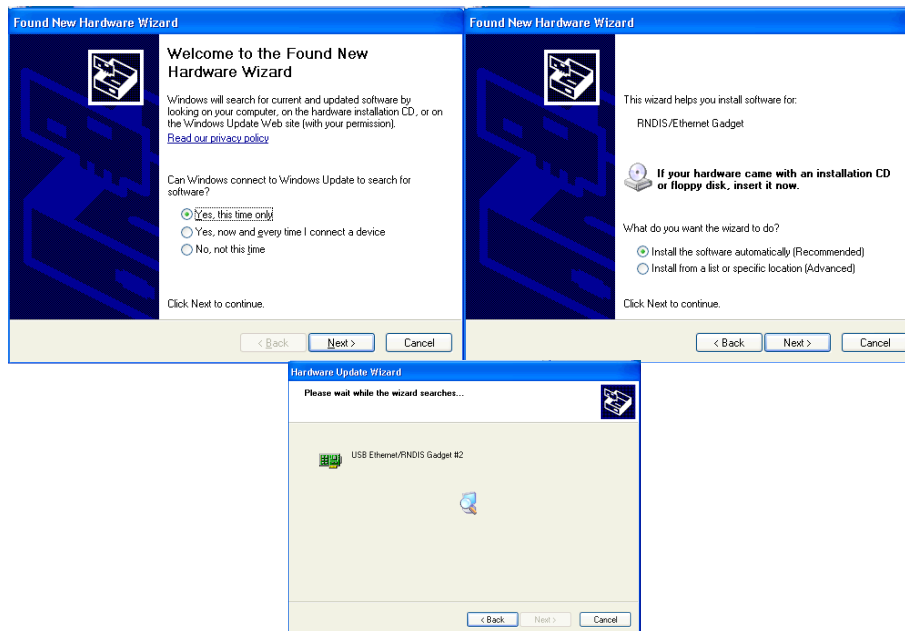

### 2.4 First Time Connection to a Windows 7 PC

The first time the cable is connected on Windows 7 systems a pop-up window appears stating that a new hardware device called a "RNDIS/Ethernet Gadget" was found. Then follow these steps:

1. This should bring up the "Driver Software Installation" dialog. Windows 7 will try to automatically download the driver and fail. A message indicating that the "device driver software was not successfully installed is displayed."

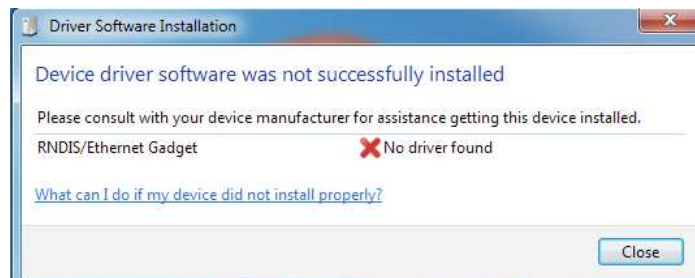

2. Right click on "My Computer," choose manage and open the Device Manager.
3. Expand Other Devices and right click on "RNDIS Kit."
4. Select "Update Driver Software."

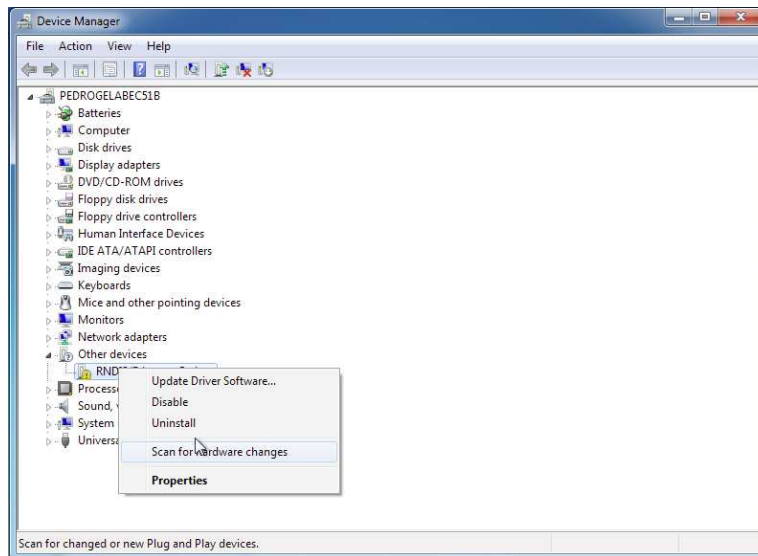

5. On the “Update Driver Software” dialog, select “Browse my computer for driver software.”

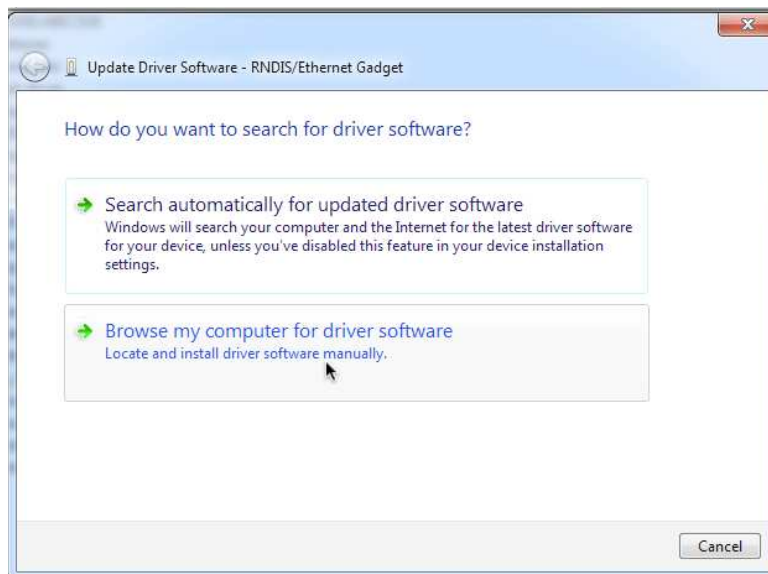

6. On the next dialog, select “Let me pick from a list of device drivers on my computer.”

7. Select Network Adapter.

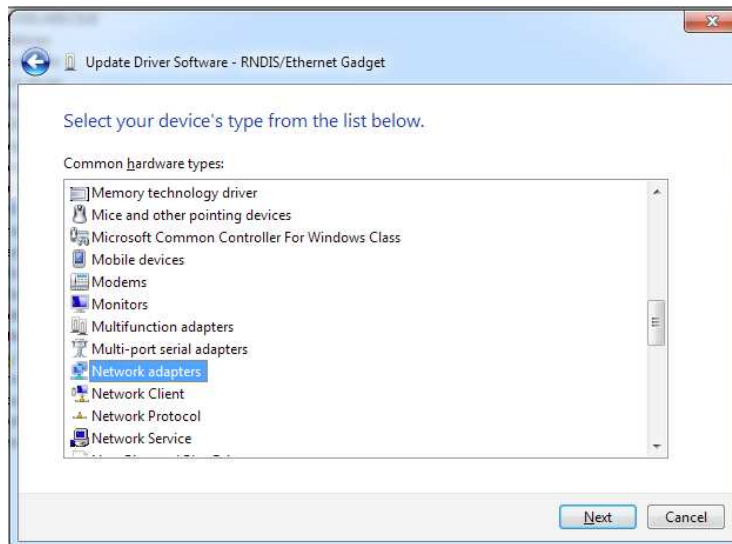

8. Select Microsoft Corporation as the manufacturer. For network adapter, select "Remote NDIS Compatible Device."

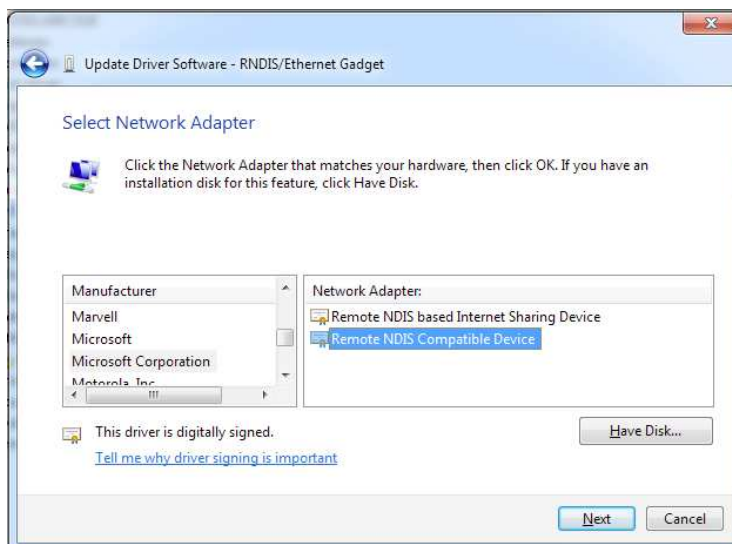

9. After clicking on "Next," a dialog confirming that the driver software was installed successfully will be displayed.

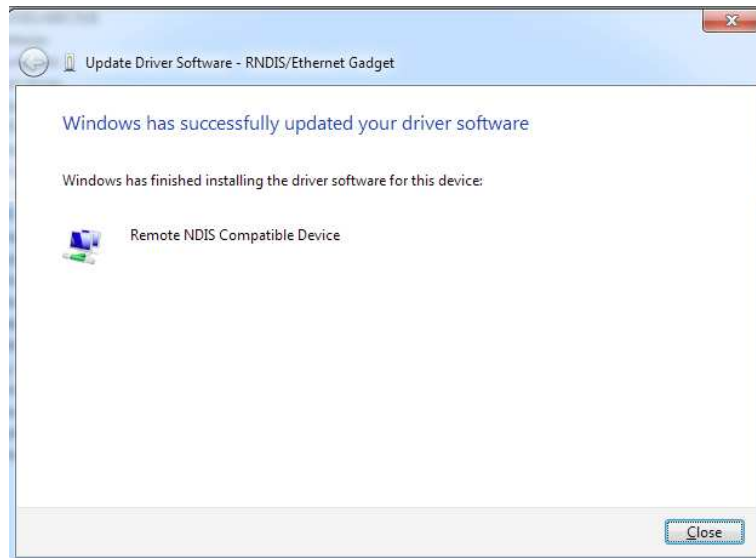

## 2.5 PC Software

DLP® LightCrafter™ includes a QT-based Graphical User Interface (GUI) to control the module through USB. QT is a Nokia cross-platform application and user interface framework with open source and commercial licenses. To install the QT GUI, just expand the LightCrafter\_UI.zip file into a directory and double click on the LightCrafterUI.exe.

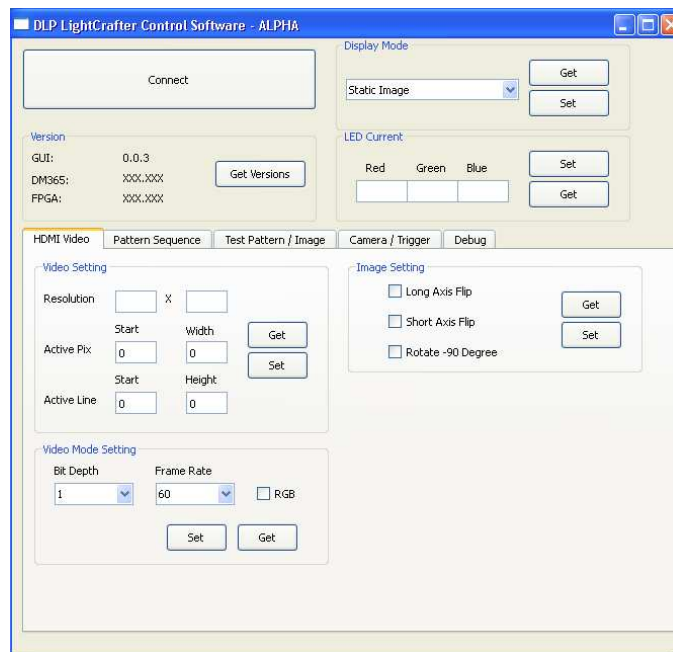

Figure 2-2. DLP® LightCrafter™ GUI

The GUI has four main sections:

1. *USB Connection*: upper left portion of the window
2. *Display Mode*: upper right portion of the window
3. *Display Mode Parameters*: lower half of the window
4. *Command Results*: status bar at the bottom of the window

Clicking on a “Get” button will read the current settings of the module. Clicking on “Set” button will program the settings in the respective fields, of the Window, to the module.

After powering on the module wait for the splash screen to disappear, then connect the USB cable to the PC. Now, run the DLP® LightCrafter™ GUI. The first action is to connect the module by clicking on the Connect button. At the bottom of the window, you will see the message “Connection Open.”

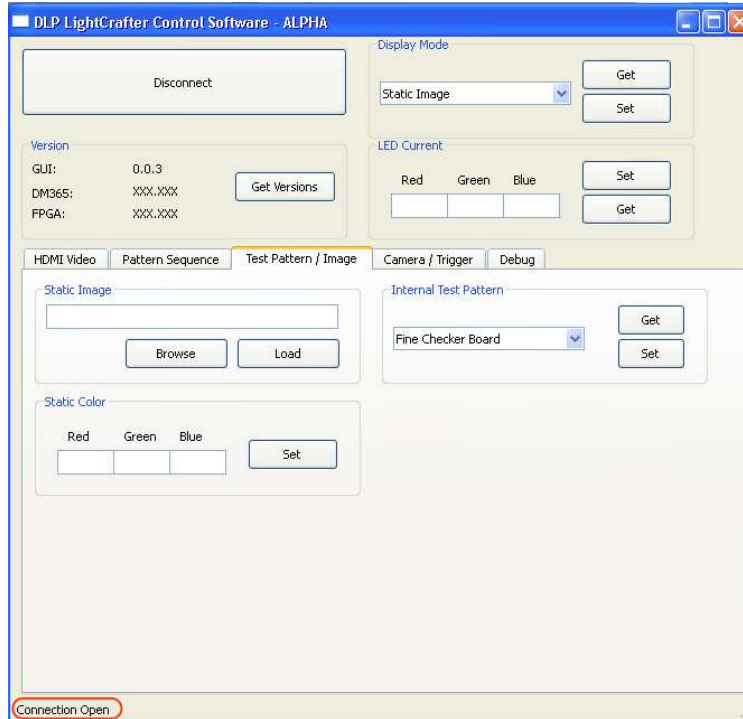

**Figure 2-3. DLP® LightCrafter™ GUI Functionality**

The GUI allows the following functionality:

1. Display a bitmap image by setting **Display Mode** to *Static Image*
2. Display DLPC300 test patterns by setting **Display Mode** to *Internal Test Pattern*
3. Display HDMI video input by setting **Display Mode** to *HDMI Video*
4. Display a pattern sequence by setting **Display Mode** to *Pattern Sequence*

### 2.5.1 LED Current Settings

The LED current is computed as follows:

$$\text{LED Current (mA)} = 1.8 * (\text{LED Current Value}) + 140 \tag{1}$$

When at room temperature the maximum value allowed is dependent on the DLP® LightCrafter™ cooling system. DLP® LightCrafter™ passively cooled systems (no extra heat sinks or fans) have a thermal limit resulting in LED currents under 633 mA. DLP® LightCrafter™ actively cooled systems (extra heat sink and fan) have a thermal limit resulting in LED currents under 1.5 A. [Table 2-1](#) summarizes these constraints.

**Table 2-1. LED Current Settings**

DLP® LightCrafter™ COOLING SYSTEM	LED CURRENT VALUE		LED CURRENT
	MINIMUM	MAXIMUM	MAXIMUM
Passively cooled	0	274	633 mA
Actively cooled	0	758	1.5 A

## 2.5.2 Static Image Mode

To upload a 608x684 pixel 24-bit RGB Windows bit-mapped image (\*.BMP), follow these steps and refer to Figure 2-4:

1. Set Display Mode on upper left portion of the window to “Static Image” and click on “Set.”
2. Select “Test Pattern/Image” tab on the lower half of the window.
3. Click on the “Browse” button to navigate the folders and select the bit-mapped file (\*.BMP).
4. You also display a solid color screen by setting the LED current under the Static Color portion of the bottom of the display. The LED values allowed lie between 0 and 274, with 274 corresponding the highest current setting (633 mA).

---

**NOTE:** Static images must be in 608x684, 24-bit RGB, \*.bmp format.

---

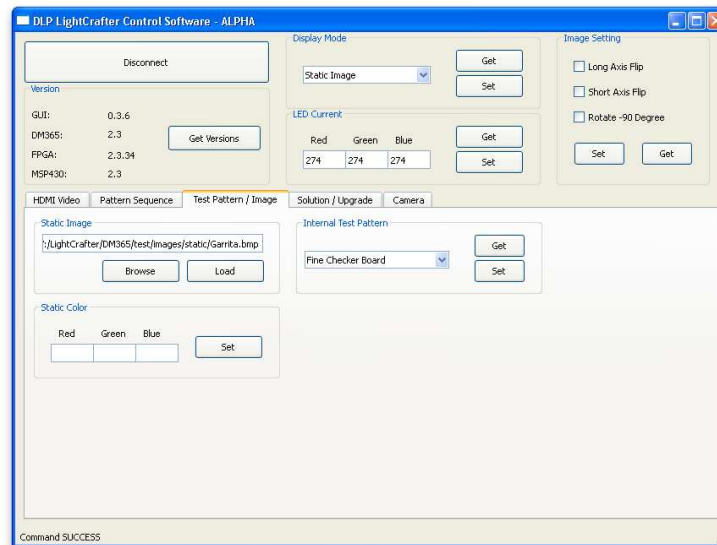

**Figure 2-4. GUI - Static Image Mode**

## 2.5.3 Internal Test Pattern

To display DLPC300 internal test patterns, follow these steps and refer to Figure 2-5:

1. Set Display Mode on upper left portion of the window to “Internal Test Pattern” and click on “Set.”
2. Select “Test Pattern/Image” tab on the lower half of the window.
3. Pull down the menu under “Internal Test Pattern” and select the desired option. The options are:
  - Fine Checker Board
  - Solid Black
  - Solid White
  - Solid Blue
  - Solid Red
  - Vertical Lines
  - Horizontal Lines
  - Vertical Lines (Fine)
  - Horizontal Lines (Fine)
  - Diagonal Lines
  - Vertical Gray Ramp

- Horizontal Gray Ramp
  - ANSI 4x4 Checker Board
4. Click on the “Set” button to display the selected pattern.
  5. You can set the LED current values by writing a value between 0 and 274, with 274 corresponding the highest current setting (633mA) and clicking on “Set.”

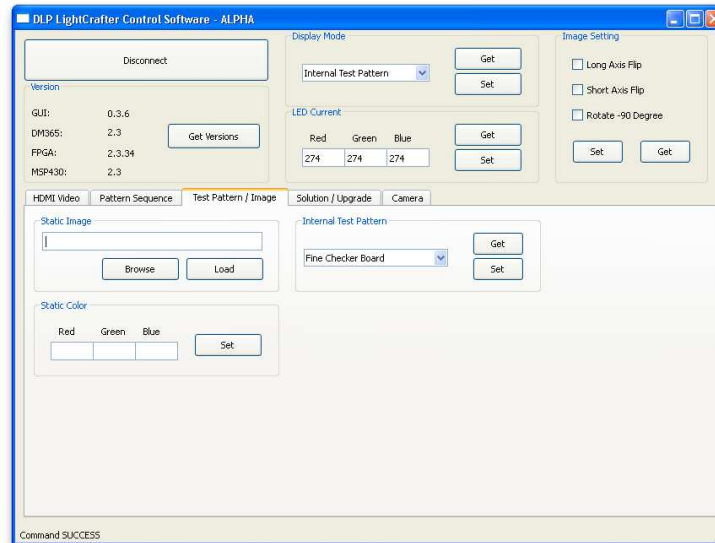

**Figure 2-5. GUI - Internal Test Pattern**

### 2.5.4 HDMI Video

To display the HDMI video input, follow these steps:

1. Connect an active HDMI source to the mini HDMI connector showing in Figure 1-5.
2. Set Display Mode on upper left portion of the window to “HDMI Video.”
3. Click on “Set.”

### 2.5.5 Pattern Sequence

To display a sequence of patterns, follow these steps and refer to Figures 2-6 and 2-7:

1. Set Display Mode on upper left portion of the window to “Pattern Sequence” and click on “Set.” The display will go dark.
2. Select “Pattern Sequence” tab on the lower half of the window.
3. Set Pattern settings by updating the following parameters inside the Pattern Setting box:
  - Bit Depth: bit depth of the image. Allowed values are from 1-8.
  - Number of Patterns: amount of patterns to display in sequence. Allowed values 1 to 96 divided by the bit depth. For example, if the bit depth is 8, the maximum amount of patterns is  $96/8 = 12$ . If the bit depth is 1, the maximum amount of patterns is  $96/1 = 96$ .
  - Include Inverted Patterns: display a pattern sequence with one pattern followed by its inverted pattern.
  - Trigger Type: selects how the patterns are triggered.
    - Auto: patterns displayed after end of Trigger Period.
    - Command: patterns displayed when the Next button is pressed.
    - External (Positive): patterns displayed after an external active high trigger signal.
    - External (Negative): patterns display after an external active low trigger signal.
  - LED Select: selects which color LED is active (Red, Green, or Blue).

- Trigger Delay: number of microseconds delay after trigger is received and pattern is displayed. See Figure 2-6.
- Exposure Time: number of microseconds the pattern is displayed. Input 0 to display the pattern through the whole trigger period. See Figure 2-6.
- Trigger Period: number of microseconds delay between two consecutive patterns are displayed. See Figure 2-6.

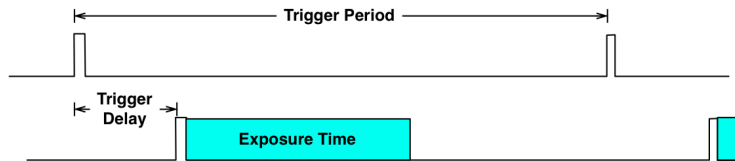

Figure 2-6. Trigger Period

4. Click on “Set” inside the Pattern Setting box.
5. Click on “...” to select the number of bitmap patterns matching the bit depth and number previously set.
6. Click on “Upload All.” Wait for the command success and button to be deselected before proceeding.
7. Set Output Trigger Settings by updating the following parameters inside the Output Trigger Setting box.
  - Enable: enable output trigger on the Trigger Input/Output connector.
  - Delay: number of microseconds delay after pattern is displayed and trigger output is pulsed.
  - Pulse Width: width of trigger output pulse.
  - Invert: invert output trigger pulse from active high to active low pulse.
8. Click on “Set” inside the Output Trigger Setting box.
9. Click on “Start” to start the sequence. If Trigger Type “Command” is selected, then click “Next” to display the next pattern.

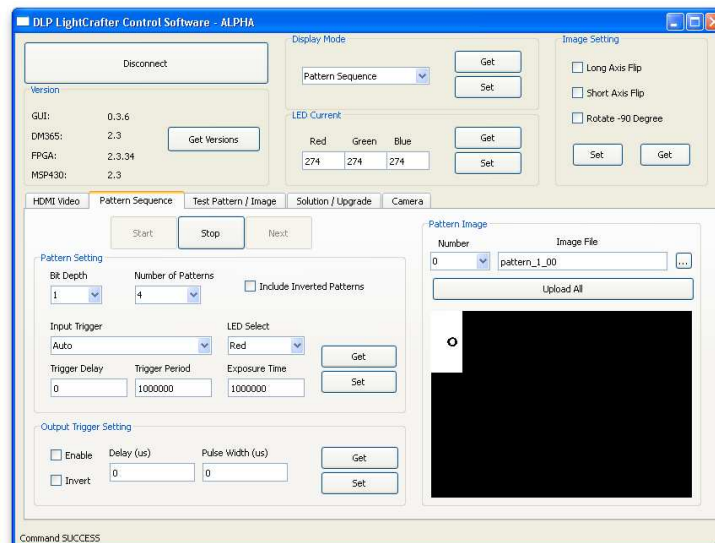

Figure 2-7. Pattern Sequence

Exposure Time is dependent on the bit-depth. See [Section 3.3](#) for allowed exposure times.

## 2.6 Firmware Upgrades

Periodic upgrades to the firmware of the FPGA, DLPC300, MSP430, and EDID are accomplished through the DLP® LightCrafter™ GUI. To upgrade the DM365 firmware, a micro-SD card with the new software is needed to load the NAND flash.



To upgrade the FPGA, DLPC300, MSP430, or EDID, perform the following steps:

1. Select the Solution/Upgrade Tab.
2. At the bottom of this tab, there is a “SW Package” section.
3. Select the appropriate device and then browse the file by clicking on “Browse”
  - To upgrade MSP430 firmware, select a TI-tagged file (\*.txt).
  - To upgrade FPGA, select an “.rbf” file.
  - To upgrade DLPC300 firmware, select a binary file (\*.bin).
  - To upgrade EDID, select a binary file (\*.bin).
4. Once the file is selected, click Install.

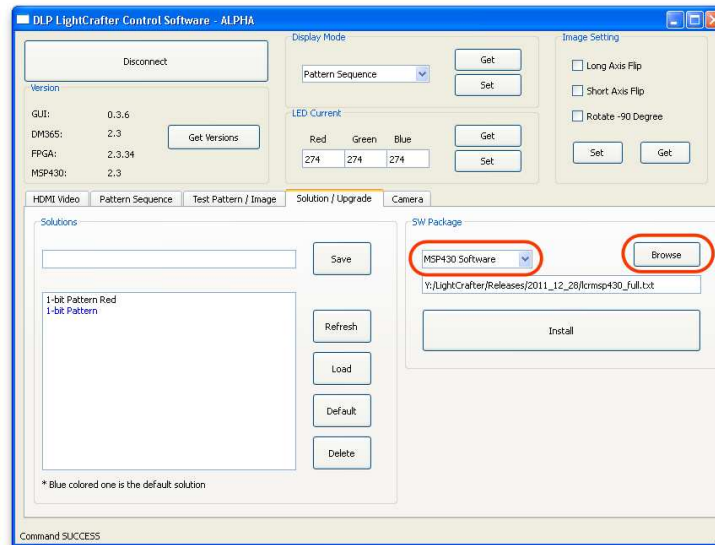

**Figure 2-8. Firmware Upgrades**

## 2.7 Solutions

Any of the parameters set on the GUI can be stored as a solution. This solution can later be recalled with a single button or set to run on Default. To create a solution, follow these steps and refer to Figure 2-8:

1. Set the appropriate settings such as LED Current, Pattern Sequence bit depth, number of patterns, input trigger, trigger period, exposure, time, display mode, etc.
2. Click on Solution/Upgrade tab.
3. Under Solutions box, enter a name and click “Save.”
4. To manage stored solutions, use the following buttons:
  - Refresh: lists stored solutions
  - Load: load the currently selected solution
  - Default: sets the currently selected solution as the default solution when DLP® LightCrafter™ boots.
  - Delete: erases the currently selected solution

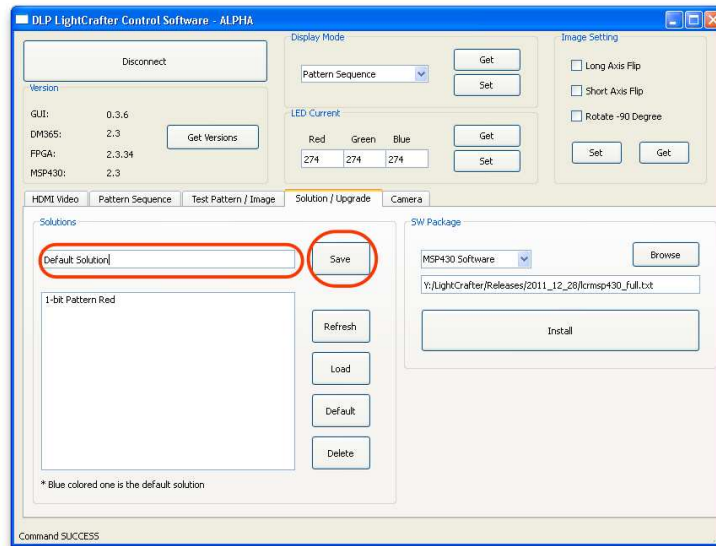

Figure 2-9. Solutions



## Pattern Sequences

This chapter describes the pattern sequences supported by the DLP® LightCrafter™ Module

### 3.1 Pattern Sequence Background

The DLPC300 takes as input 16-, 18- or 24-bit RGB data at up to 60-Hz frame rate. This frame rate is composed of three colors (red, green, and blue) with each color equally divided in the 60-Hz frame rate. Thus, each color has a 5.55 ms time slot allocated. Because each color has 5-, 6-, or 8-bit depth, each color time slot is further divided into bit-planes. A bit-plane is just one-bit representation of all the pixels in the image. A 24-bit image is decomposed into its bit planes in [Figure 3-1](#).

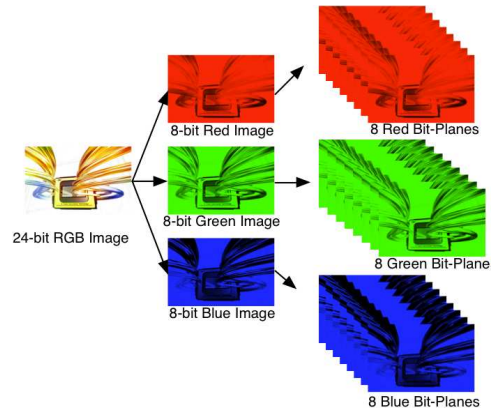

**Figure 3-1. The Relationship between Bit Planes and 24-bit RGB Images**

The length of each bit-plane in the time slot is weighted by the corresponding power of 2 of its binary representation. This provides a binary pulse-width modulation of the image. For example, a 24-bit RGB input has three colors with 8-bit depth each. Each color time slot is divided into eight bit-planes, with the sum of all bit planes in the time slot equal to 256. Figure 3-2 illustrates this partition of bits in a frame.

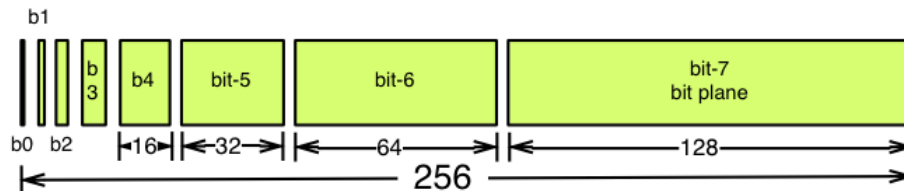

**Figure 3-2. Bit Partition**

Therefore, a single video frame is composed of a series of bit planes. Because the DMD mirrors can be either on or off, an image is created by turning on the mirrors corresponding to the bit set in a bit plane. With the binary pulse-width modulation, the intensity level of the color is reproduced by controlling the amount of time the mirror is on. For a 24-bit RGB frame image inputted to the DLPC300, the DLPC300

creates 24 bit planes, stores them on the mDDR, and sends them to the DLP3000 DMD, one bit plane at a time. Depending on the bit weight of the bit plane, the DLPC300 controls the time this bit plane is exposed to light, controlling the intensity of the bit plane. To improve image quality in video frames, the bit planes, time slots, and color frames are intertwined and interleaved with spatial-temporal algorithms by the DLPC300.

For other applications where this image enhancement is not desired, the video processing algorithms can be bypassed and replaced with a specific set of bit planes. The bit depth of the pattern is then allocated into the corresponding time slots. Furthermore, an output trigger signal is also synchronized with these time slots to indicate when the image is displayed. For structured light applications this mechanism provides the capability to display a set of patterns and signal a camera to capture these patterns overlaid on an object.

### 3.2 External Patterns

Using the mechanism described in the previous section, an external device can feed patterns to the DLPC300 for display. [Figure 3-3](#) illustrates the bit planes and corresponding output triggers for 3-bit, 6-bit, and 12-bit RGB.

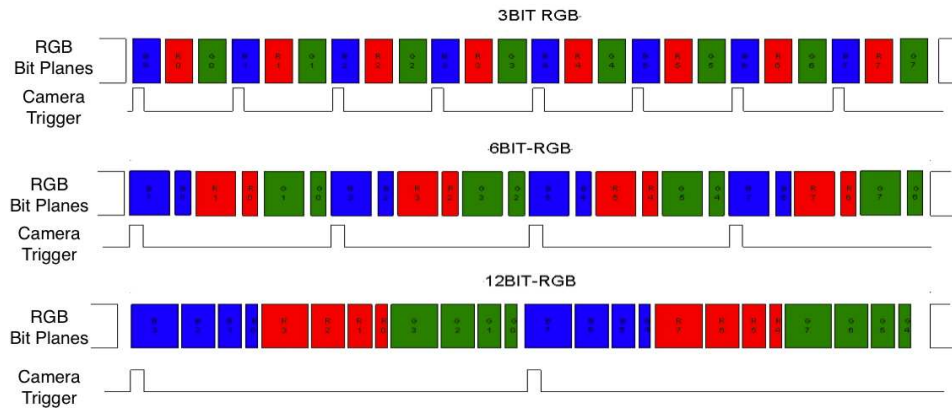

**Figure 3-3. Bit Planes and Triggers**

While an external device is writing a frame to the DLPC300, the previous frame is displayed. Therefore, there is a lag of one video frame in relation to the output trigger signal.

[Table 3-1](#) shows the allowed pattern combinations in relation to the bit depth of the external pattern.

**Table 3-1. Allowable External Pattern Combinations**

COLOR MODE		NUMBER OF PATTERNS PER FRAME	FRAME RATE	PATTERN RATE
Monochrome	1-bit per pixel	24	15, 30, 45, or 60 Hz	24 * Frame Rate
	2-bit per pixel	12		12 * Frame Rate
	3-bit per pixel	8		8 * Frame Rate
	4-bit per pixel	6		6 * Frame Rate
	5-bit per pixel	4		4 * Frame Rate
	6-bit per pixel	4		4 * Frame Rate
	7-bit per pixel	3		3 * Frame Rate
	8-bit per pixel	2		2 * Frame Rate
RGB	1-bit per color pixel (3-bit per pixel)	24		4 * Frame Rate
	2-bit per color pixel (6-bit per pixel)	12		3 * Frame Rate
	4-bit per color pixel (12-bit per pixel)	8		2 * Frame Rate
	8-bit per color pixel (24-bit per pixel)	1		Frame Rate

### 3.3 Internal Patterns

In addition to the externally provided sequences through the 24-bit RGB interface of the DLPC300, DLP® LightCrafter™ offers the ability to pre-load patterns into the DLPC300's memory (mDDR) to achieve faster frame rates. Once the patterns are pre-loaded, the FPGA manages the bit planes stored in the mDDR. The mDDR accommodates four 608 × 684 images of 24-bit RGB data or 96 bit planes (24 bit planes × 4 images). The 96 bit-plane buffer is arranged in a circular buffer style, meaning that the last bit plane addition to the buffer replaces the oldest stored bit plane.

The oldest set of bit planes in the bit-plane buffer is displayed. Thus, the displayed patterns will lag by 16.66 ms at 60 Hz frame rate while the circular buffer is filled. After the initial 16.66 ms delay, there is no additional delay for subsequent patterns since the circular buffer is filled.

With the FPGA, the pattern frame rate can be calculated with the following equation:

$$\text{Pattern Rate} = (1/\text{Pattern Exposure Period}) + (\text{Bit Plane Load Time}) + (\text{Buffer Rotate Overhead})$$

where

- Typical bit plane load time = 230 μs
- Typical buffer rotate overhead = 135 μs

Table 3-2 shows the maximum pattern rate that can be achieved by using a single FPGA's internal buffer in continuous mode.

**Table 3-2. Maximum Internal Pattern Rate**

COLOR MODE		MAXIMUM NUMBER OF PATTERNS	MAXIMUM PATTERN RATE
Monochrome	1-bit per pixel	96	4000 Hz
	2-bit per pixel	48	1600 Hz
	3-bit per pixel	32	480 Hz
	4-bit per pixel	24	360 Hz
	5-bit per pixel	16	240 Hz
	6-bit per pixel	16	240 Hz
	7-bit per pixel	12	180 Hz
	8-bit per pixel	12	120 Hz

These locally stored patterns have a pre-defined exposure time that is detailed in [Table 3-3](#). Note that the exposure time decrements by 500  $\mu$ s from the maximum exposure time. Thus, the minimum might not be a step size decrease from the second to last minimum exposure time.

**Table 3-3. Internal Pattern Exposure Time**

<b>BIT DEPTH</b>	<b>MAXIMUM EXPOSURE TIME (<math>\mu</math>s)</b>	<b>MINIMUM EXPOSURE TIME (<math>\mu</math>s)</b>	<b>STEP SIZE DECREASE (<math>\mu</math>s)</b>
8-bit	20,000	8,333	500
7-bit	20,000	4,500	500
6-bit	20,000	2,500	500
5-bit	20,000	2,000	500
4-bit	20,000	1,600	500
3-bit	20,000	1,470	500
2-bit	20,000	666	500
1-bit	100,000	250	500

## Connectors

This chapter describes the connector pins of the DLP® LightCrafter™ Module.

### 4.1 Trigger Connector

The trigger connector pins are listed in [Table 4-1](#). Two matching four pin mating connector part numbers are:

- Molex part number: 51021-0400
- Digi-Key part number: WM1722-ND

The corresponding crimps part numbers are:

- Molex part number: 50079-8000
- Digi-Key part number: WM1142CT-ND

**Table 4-1. Trigger Connector Pins**

DESCRIPTION	PIN	SUPPLY RANGE
Trigger Supply	1	3.3 V
Trigger Input	2	3.3 V
Trigger Output	3	3.3 V
Ground	4	3.3 V

### 4.2 Camera Connector

The camera connector pins are shown in [Table 4-2](#). The supplies are configurable through resistor population options between 1.8 V, 2.8 V, and 3.3 V.

**Table 4-2. Camera Connector Pins**

DESCRIPTION	PIN	SUPPLY RANGE
Camera Data[2]	1	2.8 V (CAM_IO)
Camera Data[3]	2	2.8 V (CAM_IO)
Camera Data[4]	3	2.8 V (CAM_IO)
Camera Data[5]	4	2.8 V (CAM_IO)
Camera Data[6]	5	2.8 V (CAM_IO)
Camera Data[7]	6	2.8 V (CAM_IO)
Camera Data[8]	7	2.8 V (CAM_IO)
Camera Data[9]	8	2.8 V (CAM_IO)
Camera PCLK	9	2.8 V (CAM_IO)
Digital Supply	10	1.8 V (CAM_DIGITAL)
I/O Supply	11	2.8 V (CAM_IO)
Ground	12	0 V
Analog Supply	13	2.8 V (CAM_ANALOG)
Camera VSYNC	14	2.8 V (CAM_IO)
Camera HSYNC	15	2.8 V (CAM_IO)



**Table 4-2. Camera Connector Pins (continued)**

DESCRIPTION	PIN	SUPPLY RANGE
CLKIN 24 MHz	16	2.8 V (CAM_IO)
Ground	17	0 V
I <sup>2</sup> C SDA	18	2.8 V (CAM_IO)
I <sup>2</sup> C SCL	19	2.8 V (CAM_IO)
Camera Reset	20	2.8 V (CAM_IO)
Camera StandBy	21	2.8 V (CAM_IO)
Camera SubAddr	22	2.8 V (CAM_IO)
Camera Data[0]	23	2.8 V (CAM_IO)
Camera Data[1]	24	2.8 V (CAM_IO)
No Connect	25	
Camera Trigger	26	2.8 V (CAM_IO)
Camera DataEn	27	2.8 V (CAM_IO)
No Connect	28	

### 4.3 UART

The UART connector pins are shown in [Table 4-3](#).

**Table 4-3. UART Connector Pins**

DESCRIPTION	PIN	SUPPLY RANGE
Ground	1	0 V
RX	2	3.3 V
TX	3	3.3 V

### 4.4 I<sup>2</sup>C

The I<sup>2</sup>C connector pins are shown in [Table 4-4](#). Two matching four pin mating connector part numbers are:

- Molex part number: 51021-0400
- Digi-Key part number: WM1722-ND

The corresponding crimps part numbers are:

- Molex part number: 50079-8000
- Digi-Key part number: WM1142CT-ND

**Table 4-4. I<sup>2</sup>C Connector Pins**

DESCRIPTION	PIN	SUPPLY RANGE
I <sup>2</sup> C SDA	1	3.3 V
I <sup>2</sup> C SCL	2	3.3 V
Ground	3	0 V
3.3 V Supply	4	3.3 V

### 4.5 Fan

The fan connector pins are shown in [Table 4-5](#). Two matching connector part numbers are:

- Molex part number: 51021-0200
- Digi-Key part number: WM1720-ND

The corresponding crimps part numbers are:

- Molex part number: 50079-8000
- Digi-Key part number: WM1142CT-ND

**Table 4-5. Fan Connector Pins**

DESCRIPTION	PIN	SUPPLY RANGE
Power	1	5 V (SYSPWR)
Switch to Ground	2	0 V

#### 4.6 Power

The power connector pins are shown in [Table 4-6](#). Two matching connector part numbers are:

- JST part number: PHR-2(P)
- Digi-Key part number: 455-1165-ND

The corresponding crimps part numbers are:

- JST part number: SPH-002T-P0.5L
- Digi-Key part number: 455-2148-1-ND

**Table 4-6. Power Connector Pins**

DESCRIPTION	PIN	SUPPLY RANGE
Input Supply	1	5 V (SYSPWR)
Ground	2	0 V

## IMPORTANT NOTICE

Texas Instruments Incorporated and its subsidiaries (TI) reserve the right to make corrections, modifications, enhancements, improvements, and other changes to its products and services at any time and to discontinue any product or service without notice. Customers should obtain the latest relevant information before placing orders and should verify that such information is current and complete. All products are sold subject to TI's terms and conditions of sale supplied at the time of order acknowledgment.

TI warrants performance of its hardware products to the specifications applicable at the time of sale in accordance with TI's standard warranty. Testing and other quality control techniques are used to the extent TI deems necessary to support this warranty. Except where mandated by government requirements, testing of all parameters of each product is not necessarily performed.

TI assumes no liability for applications assistance or customer product design. Customers are responsible for their products and applications using TI components. To minimize the risks associated with customer products and applications, customers should provide adequate design and operating safeguards.

TI does not warrant or represent that any license, either express or implied, is granted under any TI patent right, copyright, mask work right, or other TI intellectual property right relating to any combination, machine, or process in which TI products or services are used. Information published by TI regarding third-party products or services does not constitute a license from TI to use such products or services or a warranty or endorsement thereof. Use of such information may require a license from a third party under the patents or other intellectual property of the third party, or a license from TI under the patents or other intellectual property of TI.

Reproduction of TI information in TI data books or data sheets is permissible only if reproduction is without alteration and is accompanied by all associated warranties, conditions, limitations, and notices. Reproduction of this information with alteration is an unfair and deceptive business practice. TI is not responsible or liable for such altered documentation. Information of third parties may be subject to additional restrictions.

Resale of TI products or services with statements different from or beyond the parameters stated by TI for that product or service voids all express and any implied warranties for the associated TI product or service and is an unfair and deceptive business practice. TI is not responsible or liable for any such statements.

TI products are not authorized for use in safety-critical applications (such as life support) where a failure of the TI product would reasonably be expected to cause severe personal injury or death, unless officers of the parties have executed an agreement specifically governing such use. Buyers represent that they have all necessary expertise in the safety and regulatory ramifications of their applications, and acknowledge and agree that they are solely responsible for all legal, regulatory and safety-related requirements concerning their products and any use of TI products in such safety-critical applications, notwithstanding any applications-related information or support that may be provided by TI. Further, Buyers must fully indemnify TI and its representatives against any damages arising out of the use of TI products in such safety-critical applications.

TI products are neither designed nor intended for use in military/aerospace applications or environments unless the TI products are specifically designated by TI as military-grade or "enhanced plastic." Only products designated by TI as military-grade meet military specifications. Buyers acknowledge and agree that any such use of TI products which TI has not designated as military-grade is solely at the Buyer's risk, and that they are solely responsible for compliance with all legal and regulatory requirements in connection with such use.

TI products are neither designed nor intended for use in automotive applications or environments unless the specific TI products are designated by TI as compliant with ISO/TS 16949 requirements. Buyers acknowledge and agree that, if they use any non-designated products in automotive applications, TI will not be responsible for any failure to meet such requirements.

Following are URLs where you can obtain information on other Texas Instruments products and application solutions:

### Products

Audio	<a href="http://www.ti.com/audio">www.ti.com/audio</a>
Amplifiers	<a href="http://amplifier.ti.com">amplifier.ti.com</a>
Data Converters	<a href="http://dataconverter.ti.com">dataconverter.ti.com</a>
DLP® Products	<a href="http://www.dlp.com">www.dlp.com</a>
DSP	<a href="http://dsp.ti.com">dsp.ti.com</a>
Clocks and Timers	<a href="http://www.ti.com/clocks">www.ti.com/clocks</a>
Interface	<a href="http://interface.ti.com">interface.ti.com</a>
Logic	<a href="http://logic.ti.com">logic.ti.com</a>
Power Mgmt	<a href="http://power.ti.com">power.ti.com</a>
Microcontrollers	<a href="http://microcontroller.ti.com">microcontroller.ti.com</a>
RFID	<a href="http://www.ti-rfid.com">www.ti-rfid.com</a>
OMAP Mobile Processors	<a href="http://www.ti.com/omap">www.ti.com/omap</a>
Wireless Connectivity	<a href="http://www.ti.com/wirelessconnectivity">www.ti.com/wirelessconnectivity</a>

### Applications

Automotive and Transportation	<a href="http://www.ti.com/automotive">www.ti.com/automotive</a>
Communications and Telecom	<a href="http://www.ti.com/communications">www.ti.com/communications</a>
Computers and Peripherals	<a href="http://www.ti.com/computers">www.ti.com/computers</a>
Consumer Electronics	<a href="http://www.ti.com/consumer-apps">www.ti.com/consumer-apps</a>
Energy and Lighting	<a href="http://www.ti.com/energy">www.ti.com/energy</a>
Industrial	<a href="http://www.ti.com/industrial">www.ti.com/industrial</a>
Medical	<a href="http://www.ti.com/medical">www.ti.com/medical</a>
Security	<a href="http://www.ti.com/security">www.ti.com/security</a>
Space, Avionics and Defense	<a href="http://www.ti.com/space-avionics-defense">www.ti.com/space-avionics-defense</a>
Video and Imaging	<a href="http://www.ti.com/video">www.ti.com/video</a>

TI E2E Community Home Page

[e2e.ti.com](http://e2e.ti.com)

Mailing Address: Texas Instruments, Post Office Box 655303, Dallas, Texas 75265  
Copyright © 2012, Texas Instruments Incorporated



element14

---

**EN** - For pricing and availability in your local country please visit one of the below links:

**DE** - Informationen zu Preisen und Verfügbarkeit in Ihrem Land erhalten Sie über die unten aufgeführten Links:

**FR** - Pour connaître les tarifs et la disponibilité dans votre pays, cliquez sur l'un des liens suivants:

[DLPLIGHTCRAFTER](#)

**EN**

This Datasheet is presented by  
the manufacturer

**DE**

Dieses Datenblatt wird vom  
Hersteller bereitgestellt

**FR**

Cette fiche technique est  
présentée par le fabricant