

SHARK[®] MP200[™]

Data Logging Multipoint WiFi Energy Meter



MP200-S
24 Single Phase
8 Throo Phase

Multi-Circuit Motoring System

MDLN
Touch Screen
HMI Display

For Remote Meter Reading

User Manual

V.1.15

March 22, 2024



This page intentionally left blank.

Shark® Series MP200™ Metering System User Manual Version 1.15

Published by:

Electro Industries/GaugeTech

1800 Shames Drive

Westbury, NY 11590

Copyright Notice

All rights reserved. No part of this publication may be reproduced or transmitted in any form or by any means, electronic or mechanical, including photocopying, recording, or information storage or retrieval systems or any future forms of duplication, for any purpose other than the purchaser's use, without the expressed written permission of Electro Industries/GaugeTech.

© 2024 Electro Industries/GaugeTech

Shark®, CommunicatorPQA®, MeterManagerPQA®, EnergyPQA.com®, and EnergyPQA® are registered trademarks of Electro Industries/GaugeTech. The distinctive shapes, styles, and overall appearances of all Shark® devices are trademarks of Electro Industries/GaugeTech. HMIPQA™, EnergyReporterPQA™, MP200™, and V-Switch™ are trademarks of Electro Industries/GaugeTech.

Microsoft® and Windows® are either registered trademarks or trademarks of Microsoft Corporation in the United States and/or other countries.

This page intentionally left blank.

Customer Service and Support

Customer support is available 8:00 am to 8:00 pm, Eastern Standard Time, Monday through Friday. Please have the model, serial number and a detailed problem description available. If the problem concerns a particular reading, please have all meter readings available. When returning any merchandise to EIG, a return materials authorization number is required. For customer or technical assistance, repair or calibration, phone 516-334-0870 or fax 516-338-4741.

Product Limited Warranty Certificate

1. Electro Industries/Gauge Tech ("Electro") warrants its metering products ("the Product") against defects in material and workmanship, subject to the terms and conditions stated herein. This limited warranty extends to and covers only the Customer, as the purchaser of Electro's Product; the Customer represents and warrants to Electro that the Customer is subject to and bound by the limited warranty and disclaimer of warranty contained herein.

2. PRODUCT LIMITED WARRANTY

Electro warrants that commencing from the Product's date of delivery (the date the Product leaves Electro's manufacturing facility) and continuing immediately following thereafter for a period of four (4) consecutive years, that the Product will be free from defects in material and workmanship, and except for the foregoing, the Product is sold AS IS with all faults. This warranty does not apply to defects resulting from unauthorized modification, misuse, or use of the Product for any use other than electrical power monitoring, which is the intended and normal use of the Product. The Customer's sole and exclusive remedy and the entire liability of Electro under this limited warranty will be, at Electro's option, as follows: (i) the Product's repair; or (ii) shipment of a replacement Product within the above stated warranty period. To exercise this limited warranty, the Customer must give notice (See Section 5) to Electro's customer-support department and give additional notice to Electro's customer-support department by facsimile or by telephone for Electro's instructions for the Product's return or repair. If the Product is repaired, Electro will ship the repaired Product to the Customer. THE FOREGOING WARRANTIES ARE THE SOLE WARRANTIES, EXPRESS OR IMPLIED, GIVEN BY ELECTRO IN CONNECTION WITH THE PRODUCT, AND ELECTRO DISCLAIMS ALL OTHER WARRANTIES, INCLUDING BUT NOT LIMITED TO WARRANTIES OF MERCHANTABILITY, FITNESS FOR A PARTICULAR PURPOSE, NON-INFRINGEMENT OF THIRD-PARTY RIGHTS AND WARRANTIES AGAINST LATENT DEFECTS. The Cus-

customer must notify Electro promptly, but in no event more than four (4) year after the Product's date of delivery of any claimed breach of this warranty, or such claim shall be time barred.

3.PRODUCT LIMITED WARRANTY RESTRICTIONS

THE LIMITED WARRANTY CONTAINED HEREIN WILL NOT BE GIVEN OR APPLY, AND NO EXPRESS OR IMPLIED WARRANTY, INCLUDING BUT NOT LIMITED TO WARRANTIES OF MERCHANTABILITY, FITNESS FOR A PARTICULAR PURPOSE NON-INFRINGEMENT OF THIRD PARTY RIGHTS AND WARRANTIES AGAINST LATENT DEFECTS SHALL BE DEEMED APPLICABLE, GIVEN OR PROVIDED BY ELECTRO WITH RESPECT TO OR CONCERNING THE PRODUCT, IF: (a) the Product has been altered, except by Electro or Electro's authorized representative; (b) the Product has not been installed, operated, repaired, or maintained in accordance with instructions supplied by Electro; (c) the Product has been subjected to abnormal physical or electrical stress, abnormal environmental conditions, misuse, negligence, or accident; (d) the Product is used in ultrahazardous activities; or (e) the Customer failed to pay Electro the Product's purchase price pursuant the Terms of Sale published by Electro at <https://www.electroind.com/pdf/docs/electro-terms-of-sale.pdf>.

4.DISCLAIMER OF WARRANTY AND LIMITATIONS OF LIABILITY

EXCEPT AS EXPRESSLY GIVEN IN THIS LIMITED WARRANTY SECTION, ALL EXPRESS OR IMPLIED CONDITIONS, REPRESENTATIONS, AND WARRANTIES INCLUDING, WITHOUT LIMITATION, ANY IMPLIED WARRANTY OR CONDITION OF MERCHANTABILITY, FITNESS FOR A PARTICULAR PURPOSE, NON- INFRINGEMENT, SATISFACTORY QUALITY, NON-INTERFERENCE, ACCURACY OF INFORMATIONAL CONTENT, OR ARISING FROM A COURSE OF DEALING, LAW, USAGE, OR TRADE PRACTICE, ARE HEREBY EXCLUDED IN THEIR ENTIRETY TO THE FULL EXTENT ALLOWED BY APPLICABLE LAW AND ARE EXPRESSLY DISCLAIMED BY ELECTRO, AND ARE WAIVED BY THE CUSTOMER. TO THE EXTENT AN IMPLIED WARRANTY CANNOT BE EXCLUDED, SUCH WARRANTY IS LIMITED IN DURATION TO THE EXPRESS WARRANTY PERIOD STATED HEREIN. THIS DISCLAIMER AND EXCLUSION SHALL APPLY EVEN IF THE EXPRESS LIMITED WARRANTY SET FORTH ABOVE FAILS OF ITS ESSENTIAL PURPOSE.

EXCEPT AS EXPRESSLY PROVIDED IN THIS SECTION, ELECTRO HEREBY DISCLAIMS AND CUSTOMER WAIVES ALL REPRESENTATIONS, CONDITIONS AND WARRANTIES (WHETHER EXPRESS, IMPLIED, OR STATUTORY), INCLUDING, WITHOUT LIMITATION,

ANY WARRANTY OR CONDITION (A) OF MERCHANTABILITY, FITNESS FOR A PARTICULAR PURPOSE, NONINFRINGEMENT, TITLE, SATISFACTORY QUALITY, QUIET ENJOYMENT, ACCURACY, OR SYSTEM INTEGRATION, OR (B) ARISING FROM ANY COURSE OF DEALING, COURSE OF PERFORMANCE, OR USAGE IN THE INDUSTRY. TO THE EXTENT AN IMPLIED WARRANTY OR CONDITION CANNOT BE DISCLAIMED, SUCH WARRANTY OR CONDITION IS LIMITED IN DURATION TO THE APPLICABLE EXPRESS WARRANTY PERIOD. CUSTOMER SHALL NOT IN ANY EVENT BE ENTITLED TO, AND ELECTRO SHALL NOT BE LIABLE FOR, INDIRECT, SPECIAL, INCIDENTAL, PUNITATIVE OR CONSEQUENTIAL DAMAGES OF ANY NATURE INCLUDING, BUT NOT LIMITED TO AND WITHOUT LIMITATION, BUSINESS INTERRUPTION COSTS, REMOVAL OR REINSTALLATION COSTS, REPROCUREMENT COSTS, LOSS OF PROFIT OR REVENUE, LOSS OF DATA, PROMOTIONAL OR MANUFACTURING EXPENSES, OVERHEAD, INJURY TO REPUTATION OR LOSS, EVEN IF ELECTRO HAS BEEN ADVISED OF THE POSSIBILITY OF SUCH DAMAGES.

ELECTRO'S LIABILITY TO THE CUSTOMER, AND CUSTOMER'S RECOVERY FROM ELECTRO FOR ANY CLAIM, INCLUDING BUT NOT LIMITED TO A WARRANTY CLAIM, SHALL NOT EXCEED CUSTOMER'S PURCHASE PRICE FOR THE PRODUCT PAID BY THE CUSTOMER FOR THE PRODUCT, WHICH GAVE RISE TO SUCH CLAIM IRRESPECTIVE OF THE NATURE OF THE CLAIM, WHETHER IN CONTRACT, TORT, WARRANTY OR OTHERWISE. ELECTRO SHALL NOT BE LIABLE FOR, AND THE CUSTOMER SHALL INDEMNIFY, DEFEND AND HOLD ELECTRO HARMLESS FROM THE FOLLOWING: ANY CLAIMS BASED ON ELECTRO'S COMPLIANCE WITH END USER'S OR CUSTOMER'S DESIGNS, SPECIFICATIONS OR INSTRUCTIONS; MODIFICATION OF ANY PRODUCT BY A PARTY OTHER THAN ELECTRO; MODIFICATION OF ANY SOFTWARE MADE BY A PARTY OTHER THAN ELECTRO; THE USE OF THE PRODUCT OR SOFTWARE FOR ANY USE OTHER THAN ELECTRICAL POWER MONITORING; AUTHORIZED OR UNAUTHORIZED USE OF THE PRODUCT OR SOFTWARE; MISUSE OF THE PRODUCT OR SOFTWARE; THE SOFTWARE'S OR PRODUCT'S USE IN COMBINATION WITH OTHER EQUIPMENT, GOODS, SOFTWARE OR PRODUCT. IF, FOR ANY REASON, THE FOREGOING LIMITATIONS ARE FOUND BY AN ARBITRATION PANEL OR COURT OF COMPETENT JURISDICTION TO BE INVALID OR INAPPLICABLE UNDER ANY APPLICABLE LAW, CUSTOMER AGREES THAT ELECTRO'S TOTAL LIABILITY FOR ALL DAMAGES, LOSSES, OR CAUSES OF ACTION OF ANY KIND OR NATURE SHALL BE LIMITED TO CUSTOMER'S PURCHASE PRICE FOR THE PRODUCT LICENSED BY THE CUSTOMER FROM ELECTRO, WHICH GAVE RISE TO SUCH CLAIM, WITHOUT REGARD TO ANY ACTUAL DAMAGES; INDIRECT, SPECIAL,

DIRECT OR CONSEQUENTIAL DAMAGES; PUNITIVE OR EXEMPLARY DAMAGES PROVIDED FOR BY ANY SUCH APPLICABLE LAW.

5. NOTICES

All notices required or permitted under this limited warranty will be in writing and will be deemed given one (1) day after deposit with a commercial express courier specifying next day delivery (or two (2) days for international courier packages specifying 2-day delivery), with written verification of receipt. All communications will be sent to the address set forth below, and notices to Electro shall be further addressed to Attn: Customer Support.

Electro Industries/Gauge Tech
1800 Shames Drive
Westbury, NY 11590
Attn: Customer Support

Use of Product for Protection

Our products are not to be used for primary over-current protection. Any protection feature in our products is to be used for alarm or secondary protection only.

Statement of Calibration

Our instruments are inspected and tested in accordance with specifications published by Electro Industries/GaugeTech. The accuracy and a calibration of our instruments are traceable to the National Institute of Standards and Technology through equipment that is calibrated at planned intervals by comparison to certified standards. For optimal performance, EIG recommends that any meter, including those manufactured by EIG, be verified for accuracy every five years using NIST traceable accuracy standards. In general, EIG metering devices should not require regular adjustments to maintain published accuracy. If the meter is to be used for revenue purposes, follow the verification and calibration guidelines adopted by your local utility.

Disclaimer

The information presented in this publication has been carefully checked for reliability; however, no responsibility is assumed for inaccuracies. The information contained in this document is subject to change without notice.

Safety Symbols



In this manual, this symbol indicates that the operator must refer to an important WARNING or CAUTION in the operating instructions. Please see Chapter 4 for important safety information regarding installation and hookup of the MP200™ metering system.

Dans ce manuel, ce symbole indique que l'opérateur doit se référer à un important AVERTISSEMENT ou une MISE EN GARDE dans les instructions opérationnelles. Veuillez consulter le chapitre 4 pour des informations importantes relatives à l'installation et branchement du compteur.

The following safety symbols are used on the MP200™ unit itself:

Les symboles de sécurité suivante peuvent être utilisés sur le compteur même:



This symbol alerts you to the presence of high voltage, which can cause dangerous electrical shock.

Ce symbole vous indique la présence d'une haute tension qui peut provoquer une décharge électrique dangereuse.



This symbol indicates the field wiring terminal that must be connected to earth ground before operating the MP200™ unit, which protects against electrical shock in case of a fault condition.

Ce symbole indique que la borne de pose des canalisations in-situ qui doit être branchée dans la mise à terre avant de faire fonctionner le compteur qui est protégé contre une décharge électrique ou un état défectue



This symbol indicates that the user must refer to this manual for specific WARNING or CAUTION information to avoid personal injury or damage to the product.

Ce symbole indique que l'utilisateur doit se référer à ce manuel pour AVERTISSEMENT ou MISE EN GARDE l'information pour éviter toute blessure ou tout endommagement du produit.

Our Focus at Electro Industries/GaugeTech (EIG)

EIG exclusively delivers integrated energy and power quality monitoring solutions utilizing AI and deep industry expertise to improve reliability, efficiency, and sustainability. With over 50 years' experience in the electrical industry, EIG has developed extensive energy management and power quality expertise to help customers find ideal solutions to complex challenges. Our corporate culture promotes being cutting edge and investing in R&D to continually improve our customer experience.

Our solutions are designed to deliver results in days, not years. Known for our reputation as being a dependable provider and for exemplary service and support, EIG is committed to customer satisfaction.

Table of Contents

Customer Service and Support	iii
Product Warranty	iii
Use Of Product for Protection	iv
Statement of Calibration	iv
Disclaimer	iv
Safety Symbols	vi
About Electro Industries/GaugeTech (EIG)	vii
Revision History	viii
1: Three-Phase Power Measurement	1-1
1.1: Three-Phase System Configurations	1-1
1.1.1: Wye Connection	1-1
1.1.2: Delta Connection	1-4
1.1.3: Blondel's Theorem and Three Phase Measurement	1-6
1.2: Power, Energy and Demand	1-8
1.3: Reactive Energy and Power Factor	1-12
1.4: Harmonic Distortion	1-14
1.5: Power Quality	1-17
2: MP200™ Metering System Overview and Specifications	2-1
2.1: Shark® Series MP200™ Metering System Overview	2-1
2.1.1: Voltage and Current Inputs	2-3
2.1.2: Ordering Information	2-4

2.1.3: V-Switch™ Key Technology	2-4
2.1.4: Measured Values	2-7
2.1.5: Utility Peak Demand	2-9
2.2: Specifications	2-10
2.3: Compliance	2-16
2.4: Accuracy	2-17
3: Mechanical Installation and Maintenance	3-1
3.1: MP200™ Unit Dimensions	3-1
3.2: Mounting the MP200™ Unit	3-2
3.3: Cleaning the MP200™ Unit	3-3
4: Electrical Installation	4-1
4.1: Considerations When Installing the MP200™ Metering System	4-1
4.2: Ground Connections	4-4
4.3: Voltage and Power Supply Connections	4-5
4.4: Voltage Fuses	4-5
4.6: Electrical Connection Diagrams	4-8
4.7: Removing the MP200™ Unit From Service/Reinstalling the MP200 Unit	4-16
4.7.1: Removing the MP200™ Unit Using the EI SB-6TC Shorting Block	4-17
4.7.1.1: Reinstalling the MP200™ Unit Using the EI SB-6TC Shorting Block	4-20
4.7.2: Removing the MP200™ Unit Using a Shorting Block Other than the EI SB-6TC	4-20

4.7.2.1: Reinstalling the MP200™ Unit Using a Shorting Block Other than the EI SB-6TC	4-21
5: Communicating with the Meter	5-1
5.1: MP200™ Metering System Communication	5-1
5.1.1: RS485 / Ethernet or WiFi (Com 1)	5-2
5.1.2: RS485 Communication	5-2
5.1.2.1: Using the Unicom 2500	5-5
5.1.3: USB Port (Com 2)	5-6
5.1.4: RS485/Display Port (Com 3)	5-7
5.2: MP200™ Metering System Communication and Programming Overview	5-8
5.2.1: Connecting to the MP200™ Unit through CommunicatorPQA® Software	5-8
5.2.1.1: Additional MP200™ Unit Device Profile Settings	5-15
6: Using the MP200™ Metering System's Watt-Hour Test Pulses	6-1
6.1: Overview	6-1
6.2: Performing Watt-Hour Accuracy Testing (Verification)	6-1
6.2.1: Examples	6-2
6.2.2: Kh Testing Procedure	6-4
7: Using the MP200™ Metering System's I/O	7-1
7.1: Overview	7-1
7.2: Digital Output (Relay Contact) / Digital Input Board	7-1
7.2.1: Wiring Diagram	7-2

8: Using Ethernet Communication (WiFi and RJ45)	8-1
8.1: Overview	8-1
8.2: Telnet WiFi/Ethernet Module Configuration	8-3
8.2.1: Factory Default Settings	8-3
8.2.2: Modbus/TCP to RTU Bridge Setup Default Settings	8-4
8.3: Configure Network Module	8-5
8.3.1: Configuration Requirements	8-5
8.3.2: Configuring the Ethernet Adapter	8-6
8.3.3: Detailed Configuration Parameters	8-9
8.3.4: Setup Details	8-10
8.4: Network Module Hardware Initialization	8-15
8.5: Web Manager WiFi/Ethernet Module Configuration	8-16
8.5.1: Configuring a WiFi Connection	8-20
8.5.2: Configuring an Ethernet Connection	8-22
8.5.3: Serial Port and Modbus TCP Configuration	8-24
8.5.4: Administrative Webpage	8-25
9: Data Logging	9-1
9.1: Overview	9-1
9.2: Available Logs	9-1
10: Using the Optional Display	10-1
10.2: Display Features	10-1
10.2.1: Contents of Display Kit	10-2
10.3: MDSN/MDLN Specifications	10-3

10.3.1: General Specifications	10-3
10.3.2: Communication Port Specifications	10-5
10.3.3: Important Safety and Product Usage Information	10-6
10.4: Display Dimensions	10-11
10.5: Display Installation	10-14
10.6: Display Configuration	10-16
10.6.1: RS485 Communication Configuration	10-19
10.6.2: RJ45 Ethernet Configuration	10-21
10.7: Display Screens	10-24
10.8: Offline Mode	10-38
10.8.1: Making Selections and Entering Information in Offline Mode	10-40
10.8.2: Setting Communication through Offline Mode	10-41
10.9: Maintenance	10-46
10.10: Compliance Standards	10-47
A: Installing the USB Virtual COM Port	A-1
A.1: Introduction	A-1
A.2: Installing the Virtual Port's Driver	A-1
A.3: Connecting to the Virtual Port	A-2
B: Modbus Map Overview	B-1
B.1: Introduction	B-1
B.2: Modbus Register Map Sections	B-1
B.3: Data Formats	B-1
B.4: Floating Point Values	B-2

B.5: Important Note Concerning the MP200™ Unit's Modbus Map	B-3
B.5.1: Hex Representation	B-3
B.5.2: Decimal Representation	B-4
B.6: Modbus Register Maps and Retrieving Logs	B-5
C: MP200-Y Three Phase Modbus Map	C-1
D: MP200-S Single Phase Modbus Map	D-1
E: Retrieving Logs Using the MP200™ Metering System's Modbus Map	E-1
E.1: Overview	E-1
E.2: Data Formats	E-2
E.3: MP200™ Metering System Logs	E-2
E.4: Block Definitions	E-4
E.5: Log Retrieval	E-14
E.5.1: Auto-Increment	E-14
E.5.2: Modbus Function Code 0x23	E-15
E.5.3: Log Retrieval Procedure	E-17
E.5.4: Log Retrieval Example	E-20
E.5.5: Log Record Interpretation	E-29
E.6: Examples	E-38

1: Three-Phase Power Measurement

This introduction to three-phase power and power measurement is intended to provide only a brief overview of the subject. The professional meter engineer or meter technician should refer to more advanced documents such as the EEI Handbook for Electricity Metering and the application standards for more in-depth and technical coverage of the subject.

1.1: Three-Phase System Configurations

Three-phase power is most commonly used in situations where large amounts of power will be used because it is a more effective way to transmit the power and because it provides a smoother delivery of power to the end load. There are two commonly used connections for three-phase power, a wye connection or a delta connection. Each connection has several different manifestations in actual use.

When attempting to determine the type of connection in use, it is a good practice to follow the circuit back to the transformer that is serving the circuit. It is often not possible to conclusively determine the correct circuit connection simply by counting the wires in the service or checking voltages. Checking the transformer connection will provide conclusive evidence of the circuit connection and the relationships between the phase voltages and ground.

1.1.1: Wye Connection

The wye connection is so called because when you look at the phase relationships and the winding relationships between the phases it looks like a Y. Figure 1.1 depicts the winding relationships for a wye-connected service. In a wye service the neutral (or center point of the wye) is typically grounded. This leads to common voltages of 208/120 and 480/277 (where the first number represents the phase-to-phase voltage and the second number represents the phase-to-ground voltage).

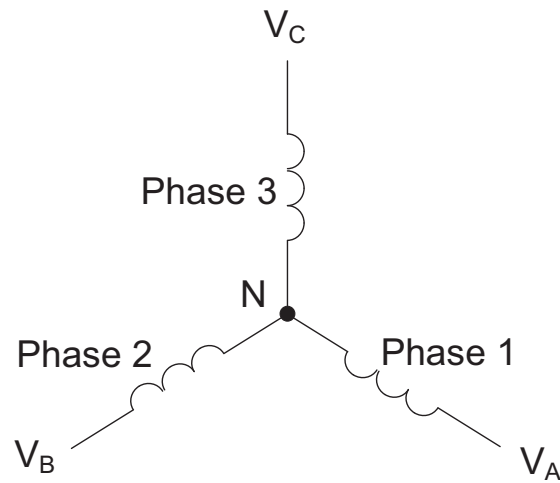

Figure 1.1: Three-phase Wye Winding

The three voltages are separated by 120° electrically. Under balanced load conditions the currents are also separated by 120° . However, unbalanced loads and other conditions can cause the currents to depart from the ideal 120° separation. Three-phase voltages and currents are usually represented with a phasor diagram. A phasor diagram for the typical connected voltages and currents is shown in Figure 1.2.

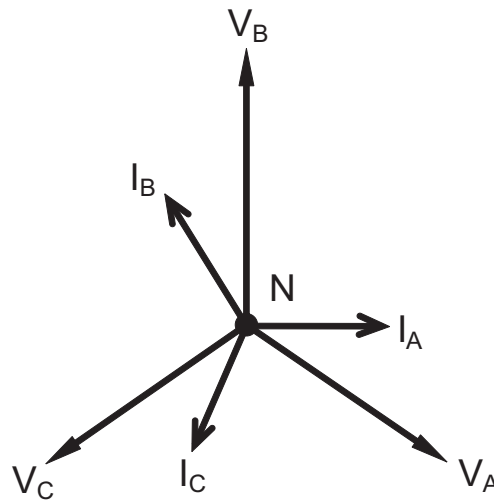

Figure 1.2: Phasor Diagram Showing Three-phase Voltages and Currents

The phasor diagram shows the 120° angular separation between the phase voltages. The phase-to-phase voltage in a balanced three-phase wye system is 1.732 times the phase-to-neutral voltage. The center point of the wye is tied together and is typically grounded. Table 1.1 shows the common voltages used in the United States for wye-connected systems.

Phase to Ground Voltage	Phase to Phase Voltage
120 volts	208 volts
277 volts	480 volts
2,400 volts	4,160 volts
7,200 volts	12,470 volts
7,620 volts	13,200 volts

Table 1: Common Phase Voltages on Wye Services

Usually a wye-connected service will have four wires: three wires for the phases and one for the neutral. The three-phase wires connect to the three phases (as shown in Figure 1.1). The neutral wire is typically tied to the ground or center point of the wye.

In many industrial applications the facility will be fed with a four-wire wye service but only three wires will be run to individual loads. The load is then often referred to as a delta-connected load but the service to the facility is still a wye service; it contains four wires if you trace the circuit back to its source (usually a transformer). In this type of connection the phase to ground voltage will be the phase-to-ground voltage indicated in Table 1, even though a neutral or ground wire is not physically present at the load. The transformer is the best place to determine the circuit connection type because this is a location where the voltage reference to ground can be conclusively identified.

1.1.2: Delta Connection

Delta-connected services may be fed with either three wires or four wires. In a three-phase delta service the load windings are connected from phase-to-phase rather than from phase-to-ground. Figure 1.3 shows the physical load connections for a delta service.

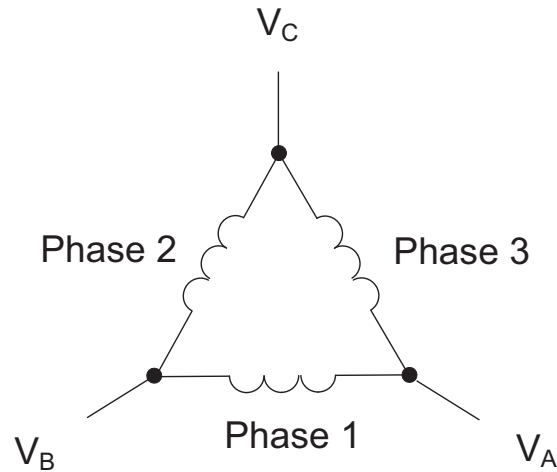

Figure 1.3: Three-phase Delta Winding Relationship

In this example of a delta service, three wires will transmit the power to the load. In a true delta service, the phase-to-ground voltage will usually not be balanced because the ground is not at the center of the delta.

Figure 1.4 shows the phasor relationships between voltage and current on a three-phase delta circuit.

In many delta services, one corner of the delta is grounded. This means the phase to ground voltage will be zero for one phase and will be full phase-to-phase voltage for the other two phases. This is done for protective purposes.

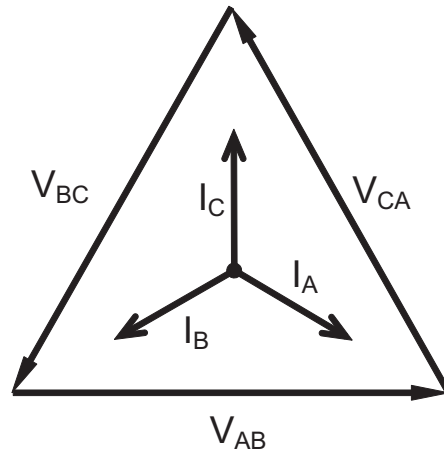

Figure 1.4: Phasor Diagram, Three-Phase Voltages and Currents, Delta-Connected

Another common delta connection is the four-wire, grounded delta used for lighting loads. In this connection the center point of one winding is grounded. On a 120/240 volt, four-wire, grounded delta service the phase-to-ground voltage would be 120 volts on two phases and 208 volts on the third phase. Figure 1.5 shows the phasor diagram for the voltages in a three-phase, four-wire delta system.

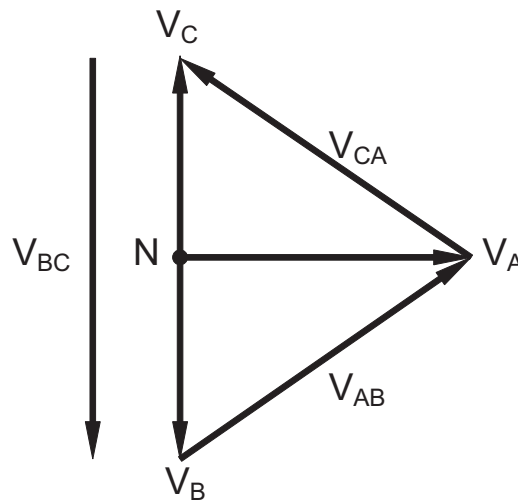

Figure 1.5: Phasor Diagram Showing Three-phase Four-Wire Delta-Connected System

1.1.3: Blondel's Theorem and Three Phase Measurement

In 1893 an engineer and mathematician named Andre E. Blondel set forth the first scientific basis for polyphase metering. His theorem states:

If energy is supplied to any system of conductors through N wires, the total power in the system is given by the algebraic sum of the readings of N wattmeters so arranged that each of the N wires contains one current coil, the corresponding potential coil being connected between that wire and some common point. If this common point is on one of the N wires, the measurement may be made by the use of N-1 Wattmeters.

The theorem may be stated more simply, in modern language:

In a system of N conductors, N-1 meter elements will measure the power or energy taken provided that all the potential coils have a common tie to the conductor in which there is no current coil.

Three-phase power measurement is accomplished by measuring the three individual phases and adding them together to obtain the total three phase value. In older analog meters, this measurement was accomplished using up to three separate elements. Each element combined the single-phase voltage and current to produce a torque on the meter disk. All three elements were arranged around the disk so that the disk was subjected to the combined torque of the three elements. As a result the disk would turn at a higher speed and register power supplied by each of the three wires.

According to Blondel's Theorem, it was possible to reduce the number of elements under certain conditions. For example, a three-phase, three-wire delta system could be correctly measured with two elements (two potential coils and two current coils) if the potential coils were connected between the three phases with one phase in common.

In a three-phase, four-wire wye system it is necessary to use three elements. Three voltage coils are connected between the three phases and the common neutral conductor. A current coil is required in each of the three phases.

In modern digital meters, Blondel's Theorem is still applied to obtain proper metering. The difference in modern meters is that the digital meter measures each phase voltage and current and calculates the single-phase power for each phase. The meter then sums the three phase powers to a single three-phase reading.

Some digital meters measure the individual phase power values one phase at a time. This means the meter samples the voltage and current on one phase and calculates a power value. Then it samples the second phase and calculates the power for the second phase. Finally, it samples the third phase and calculates that phase power. After sampling all three phases, the meter adds the three readings to create the equivalent three-phase power value. Using mathematical averaging techniques, this method can derive a quite accurate measurement of three-phase power.

More advanced meters actually sample all three phases of voltage and current simultaneously and calculate the individual phase and three-phase power values. The advantage of simultaneous sampling is the reduction of error introduced due to the difference in time when the samples were taken.

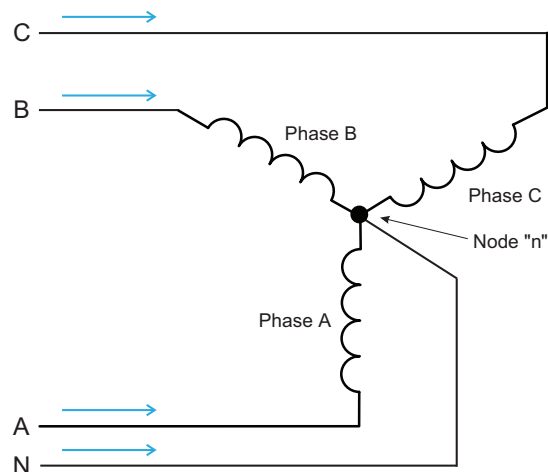

Figure 1.6: Three-Phase Wye Load Illustrating Kirchhoff's Law and Blondel's Theorem

Blondell's Theorem is a derivation that results from Kirchhoff's Law. Kirchhoff's Law states that the sum of the currents into a node is zero. Another way of stating the same thing is that the current into a node (connection point) must equal the current out of the node. The law can be applied to measuring three-phase loads. Figure 1.6 shows a typical connection of a three-phase load applied to a three-phase, four-wire service. Kirchhoff's Law holds that the sum of currents A, B, C and N must equal zero or that the sum of currents into Node "n" must equal zero.

If we measure the currents in wires A, B and C, we then know the current in wire N by Kirchhoff's Law and it is not necessary to measure it. This fact leads us to the conclusion of Blondel's Theorem- that we only need to measure the power in three of

the four wires if they are connected by a common node. In the circuit of Figure 1.6 we must measure the power flow in three wires. This will require three voltage coils and three current coils (a three-element meter). Similar figures and conclusions could be reached for other circuit configurations involving Delta-connected loads.

1.2: Power, Energy and Demand

It is quite common to exchange power, energy and demand without differentiating between the three. Because this practice can lead to confusion, the differences between these three measurements will be discussed.

Power is an instantaneous reading. The power reading provided by a meter is the present flow of watts. Power is measured immediately just like current. In many digital meters, the power value is actually measured and calculated over a one second interval because it takes some amount of time to calculate the RMS values of voltage and current. But this time interval is kept small to preserve the instantaneous nature of power.

Energy is always based on some time increment; it is the integration of power over a defined time increment. Energy is an important value because almost all electric bills are based, in part, on the amount of energy used.

Typically, electrical energy is measured in units of kilowatt-hours (kWh). A kilowatt-hour represents a constant load of one thousand watts (one kilowatt) for one hour. Stated another way, if the power delivered (instantaneous watts) is measured as 1,000 watts and the load was served for a one hour time interval then the load would have absorbed one kilowatt-hour of energy. A different load may have a constant power requirement of 4,000 watts. If the load were served for one hour it would absorb four kWh. If the load were served for 15 minutes it would absorb $\frac{1}{4}$ of that total or one kWh.

Figure 1.7 shows a graph of power and the resulting energy that would be transmitted as a result of the illustrated power values. For this illustration, it is assumed that the power level is held constant for each minute when a measurement is taken. Each bar in the graph will represent the power load for the one-minute increment of time. In real life the power value moves almost constantly.

The data from Figure 1.7 is reproduced in Table 2 to illustrate the calculation of energy. Since the time increment of the measurement is one minute and since we

specified that the load is constant over that minute, we can convert the power reading to an equivalent consumed energy reading by multiplying the power reading times 1/60 (converting the time base from minutes to hours).

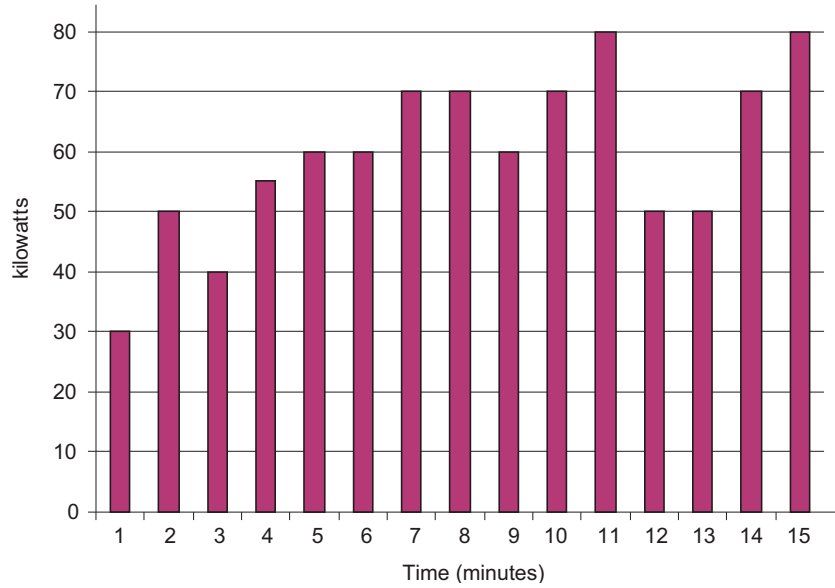

Figure 1.7: Power Use over Time

Time Interval (minute)	Power (kW)	Energy (kWh)	Accumulated Energy (kWh)
1	30	0.50	0.50
2	50	0.83	1.33
3	40	0.67	2.00
4	55	0.92	2.92
5	60	1.00	3.92
6	60	1.00	4.92
7	70	1.17	6.09
8	70	1.17	7.26
9	60	1.00	8.26
10	70	1.17	9.43
11	80	1.33	10.76
12	50	0.83	12.42
13	50	0.83	12.42
14	70	1.17	13.59
15	80	1.33	14.92

Table 1.2: Power and Energy Relationship over Time

As in Table 1.2, the accumulated energy for the power load profile of Figure 1.7 is 14.92 kWh.

Demand is also a time-based value. The demand is the average rate of energy use over time. The actual label for demand is kilowatt-hours/hour but this is normally reduced to kilowatts. This makes it easy to confuse demand with power, but demand is not an instantaneous value. To calculate demand it is necessary to accumulate the energy readings (as illustrated in Figure 1.7) and adjust the energy reading to an hourly value that constitutes the demand.

In the example, the accumulated energy is 14.92 kWh. But this measurement was made over a 15-minute interval. To convert the reading to a demand value, it must be normalized to a 60-minute interval. If the pattern were repeated for an additional three 15-minute intervals the total energy would be four times the measured value or

59.68 kWh. The same process is applied to calculate the 15-minute demand value. The demand value associated with the example load is 59.68 kWh/hr or 59.68 kWd. Note that the peak instantaneous value of power is 80 kW, significantly more than the demand value.

Figure 1.8 shows another example of energy and demand. In this case, each bar represents the energy consumed in a 15-minute interval. The energy use in each interval typically falls between 50 and 70 kWh. However, during two intervals the energy rises sharply and peaks at 100 kWh in interval number 7. This peak of usage will result in setting a high demand reading. For each interval shown the demand value would be four times the indicated energy reading. So interval 1 would have an associated demand of 240 kWh/hr. Interval 7 will have a demand value of 400 kWh/hr. In the data shown, this is the peak demand value and would be the number that would set the demand charge on the utility bill.

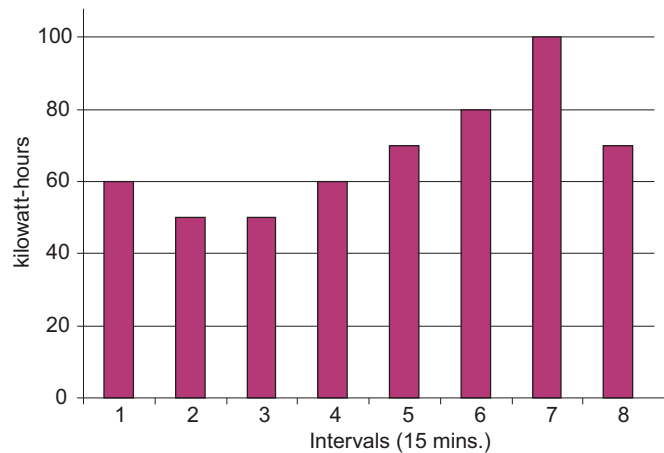

Figure 1.8: Energy Use and Demand

As can be seen from this example, it is important to recognize the relationships between power, energy and demand in order to control loads effectively or to monitor use correctly.

1.3: Reactive Energy and Power Factor

The real power and energy measurements discussed in the previous section relate to the quantities that are most used in electrical systems. But it is often not sufficient to only measure real power and energy. Reactive power is a critical component of the total power picture because almost all real-life applications have an impact on reactive power. Reactive power and power factor concepts relate to both load and generation applications. However, this discussion will be limited to analysis of reactive power and power factor as they relate to loads. To simplify the discussion, generation will not be considered.

Real power (and energy) is the component of power that is the combination of the voltage and the value of corresponding current that is directly in phase with the voltage. However, in actual practice the total current is almost never in phase with the voltage. Since the current is not in phase with the voltage, it is necessary to consider both the inphase component and the component that is at quadrature (angularly rotated 90° or perpendicular) to the voltage. Figure 1.9 shows a single-phase voltage and current and breaks the current into its in-phase and quadrature components.

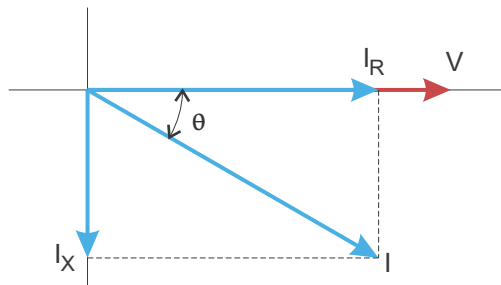

Figure 1.9: Voltage and Complex Current

The voltage (V) and the total current (I) can be combined to calculate the apparent power or VA. The voltage and the in-phase current (I_R) are combined to produce the real power or watts. The voltage and the quadrature current (I_X) are combined to calculate the reactive power.

The quadrature current may be lagging the voltage (as shown in Figure 1.9) or it may lead the voltage. When the quadrature current lags the voltage the load is requiring both real power (watts) and reactive power (VARs). When the quadrature current

leads the voltage the load is requiring real power (watts) but is delivering reactive power (VARs) back into the system; that is VARs are flowing in the opposite direction of the real power flow.

Reactive power (VARs) is required in all power systems. Any equipment that uses magnetization to operate requires VARs. Usually the magnitude of VARs is relatively low compared to the real power quantities. Utilities have an interest in maintaining VAR requirements at the customer to a low value in order to maximize the return on plant invested to deliver energy. When lines are carrying VARs, they cannot carry as many watts. So keeping the VAR content low allows a line to carry its full capacity of watts. In order to encourage customers to keep VAR requirements low, some utilities impose a penalty if the VAR content of the load rises above a specified value.

A common method of measuring reactive power requirements is power factor. Power factor can be defined in two different ways. The more common method of calculating power factor is the ratio of the real power to the apparent power. This relationship is expressed in the following formula:

$$\text{Total PF} = \text{real power} / \text{apparent power} = \text{watts/VA}$$

This formula calculates a power factor quantity known as Total Power Factor. It is called Total PF because it is based on the ratios of the power delivered. The delivered power quantities will include the impacts of any existing harmonic content. If the voltage or current includes high levels of harmonic distortion the power values will be affected. By calculating power factor from the power values, the power factor will include the impact of harmonic distortion. In many cases this is the preferred method of calculation because the entire impact of the actual voltage and current are included.

A second type of power factor is Displacement Power Factor. Displacement PF is based on the angular relationship between the voltage and current. Displacement power factor does not consider the magnitudes of voltage, current or power. It is solely based on the phase angle differences. As a result, it does not include the impact of harmonic distortion. Displacement power factor is calculated using the following equation:

$$\text{Displacement PF} = \cos\theta$$

where θ is the angle between the voltage and the current (see Fig. 1.9).

In applications where the voltage and current are not distorted, the Total Power Factor will equal the Displacement Power Factor. But if harmonic distortion is present, the two power factors will not be equal.

1.4: Harmonic Distortion

Harmonic distortion is primarily the result of high concentrations of non-linear loads. Devices such as computer power supplies, variable speed drives and fluorescent light ballasts make current demands that do not match the sinusoidal waveform of AC electricity. As a result, the current waveform feeding these loads is periodic but not sinusoidal. Figure 1.10 shows a normal, sinusoidal current waveform. This example has no distortion.

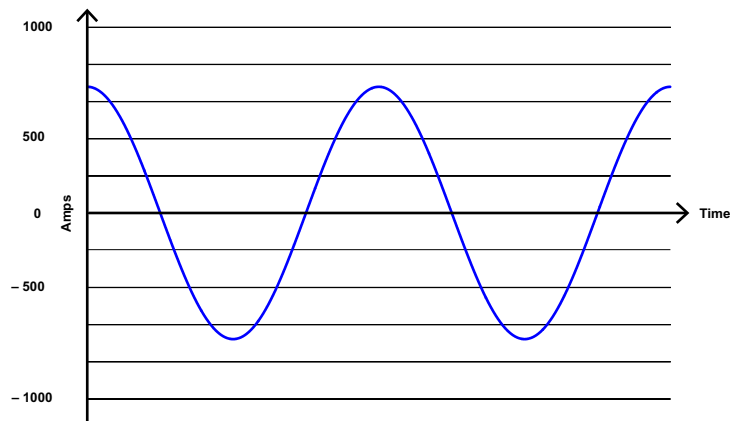

Figure 1.10: Nondistorted Current Waveform

Figure 1.11 shows a current waveform with a slight amount of harmonic distortion. The waveform is still periodic and is fluctuating at the normal 60 Hz frequency. However, the waveform is not a smooth sinusoidal form as seen in Figure 1.10.

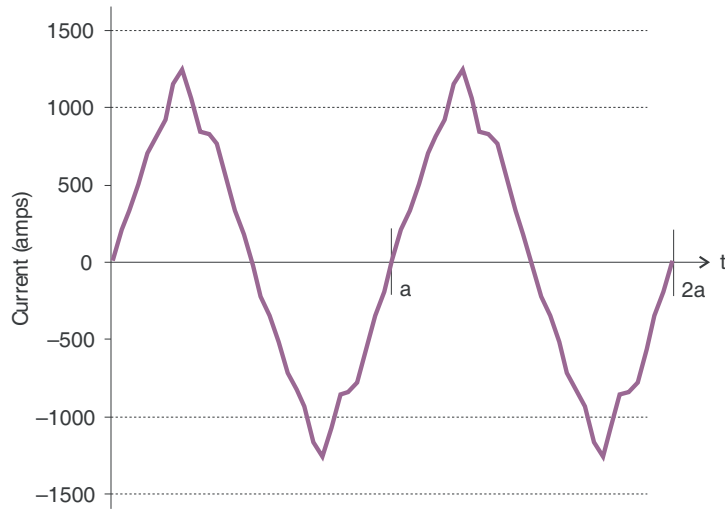

Figure 1.11: Distorted Current Waveform

The distortion observed in Figure 1.11 can be modeled as the sum of several sinusoidal waveforms of frequencies that are multiples of the fundamental 60 Hz frequency. This modeling is performed by mathematically disassembling the distorted waveform into a collection of higher frequency waveforms.

These higher frequency waveforms are referred to as harmonics. Figure 1.12 shows the content of the harmonic frequencies that make up the distortion portion of the waveform in Figure 1.11.

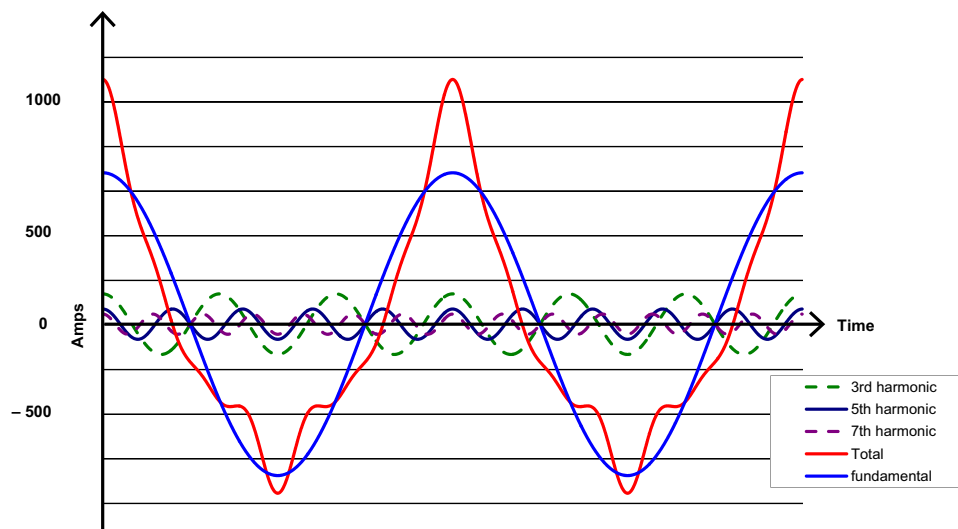

Figure 1.12: Waveforms of the Harmonics

The waveforms shown in Figure 1.12 are not smoothed but do provide an indication of the impact of combining multiple harmonic frequencies together.

When harmonics are present it is important to remember that these quantities are operating at higher frequencies. Therefore, they do not always respond in the same manner as 60 Hz values.

Inductive and capacitive impedance are present in all power systems. We are accustomed to thinking about these impedances as they perform at 60 Hz. However, these impedances are subject to frequency variation.

$$X_L = j\omega L \quad \text{and}$$

$$X_C = 1/j\omega C$$

At 60 Hz, $\omega = 377$; but at 300 Hz (5th harmonic) $\omega = 1,885$. As frequency changes impedance changes and system impedance characteristics that are normal at 60 Hz may behave entirely differently in the presence of higher order harmonic waveforms.

Traditionally, the most common harmonics have been the low order, odd frequencies, such as the 3rd, 5th, 7th, and 9th. However newer, non-linear loads are introducing significant quantities of higher order harmonics.

Since much voltage monitoring and almost all current monitoring is performed using instrument transformers, the higher order harmonics are often not visible. Instrument transformers are designed to pass 60 Hz quantities with high accuracy. These devices, when designed for accuracy at low frequency, do not pass high frequencies with high accuracy; at frequencies above about 1200 Hz they pass almost no information. So when instrument transformers are used, they effectively filter out higher frequency harmonic distortion making it impossible to see.

However, when monitors can be connected directly to the measured circuit (such as direct connection to a 480 volt bus) the user may often see higher order harmonic distortion. An important rule in any harmonics study is to evaluate the type of equipment and connections before drawing a conclusion. Not being able to see harmonic distortion is not the same as not having harmonic distortion.

It is common in advanced meters to perform a function commonly referred to as waveform capture. Waveform capture is the ability of a meter to capture a present picture of the voltage or current waveform for viewing and harmonic analysis.

Typically a waveform capture will be one or two cycles in duration and can be viewed as the actual waveform, as a spectral view of the harmonic content, or a tabular view showing the magnitude and phase shift of each harmonic value. Data collected with waveform capture is typically not saved to memory. Waveform capture is a real-time data collection event.

Waveform capture should not be confused with waveform recording that is used to record multiple cycles of all voltage and current waveforms in response to a transient condition.

1.5: Power Quality

Power quality can mean several different things. The terms "power quality" and "power quality problem" have been applied to all types of conditions. A simple definition of "power quality problem" is any voltage, current or frequency deviation that results in mis-operation or failure of customer equipment or systems. The causes of power quality problems vary widely and may originate in the customer equipment, in an adjacent customer facility or with the utility.

In his book *Power Quality Primer*, Barry Kennedy provided information on different types of power quality problems. Some of that information is summarized in Table 1.3.

Cause	Disturbance Type	Source
Impulse transient	Transient voltage disturbance, sub-cycle duration	Lightning Electrostatic discharge Load switching Capacitor switching
Oscillatory transient with decay	Transient voltage, sub-cycle duration	Line/cable switching Capacitor switching Load switching
Sag/swell	RMS voltage, multiple cycle duration	Remote system faults
Interruptions	RMS voltage, multiple seconds or longer duration	System protection Circuit breakers Fuses Maintenance
Under voltage/over voltage	RMS voltage, steady state, multiple seconds or longer duration	Motor starting Load variations Load dropping
Voltage flicker	RMS voltage, steady state, repetitive condition	Intermittent loads Motor starting Arc furnaces
Harmonic distortion	Steady state current or voltage, long-term duration	Non-linear loads System resonance

Table 1.3: Typical Power Quality Problems and Sources

It is often assumed that power quality problems originate with the utility. While it is true that power quality problems can originate with the utility system, many problems originate with customer equipment. Customer-caused problems may manifest themselves inside the customer location or they may be transported by the utility system to another adjacent customer. Often, equipment that is sensitive to power quality problems may in fact also be the cause of the problem.

If a power quality problem is suspected, it is generally wise to consult a power quality professional for assistance in defining the cause and possible solutions to the problem.

2: MP200™ Metering System Overview and Specifications

2.1: Shark® Series MP200™ Metering System Overview

The Shark® Series MP200™ unit is a multi-port, high-density power and energy metering system, designed for high-density metering environments, such as data centers, commercial high-rise complexes, high-density power distribution panels, and branch circuits. The MP200™ metering system provides 8 three phase or 24 single phase meters served by one central processing unit, which delivers the measured data in multiple formats via RS485 serial communication, USB port communication, and simultaneous RJ45 Ethernet and 802.11 WiFi Ethernet (prior to July 2021, the Ethernet option supported either RJ45 or WiFi). The MP200™ metering system also has data logging and load profiling capability to provide historical data analysis.



Figure 2.1: Shark® MP200™ Metering System

The MP200™ unit can be ordered as either an MP200-Y for three phase Wye/Delta systems or as an MP200-S for single phase systems. The MP200™ unit is designed to be a cost-effective instrument for high density metering. It is important to note that for this design to function properly, all loads must be powered from a common voltage (or three phase voltage) set.

The MP200™ metering system was designed using the following concept:

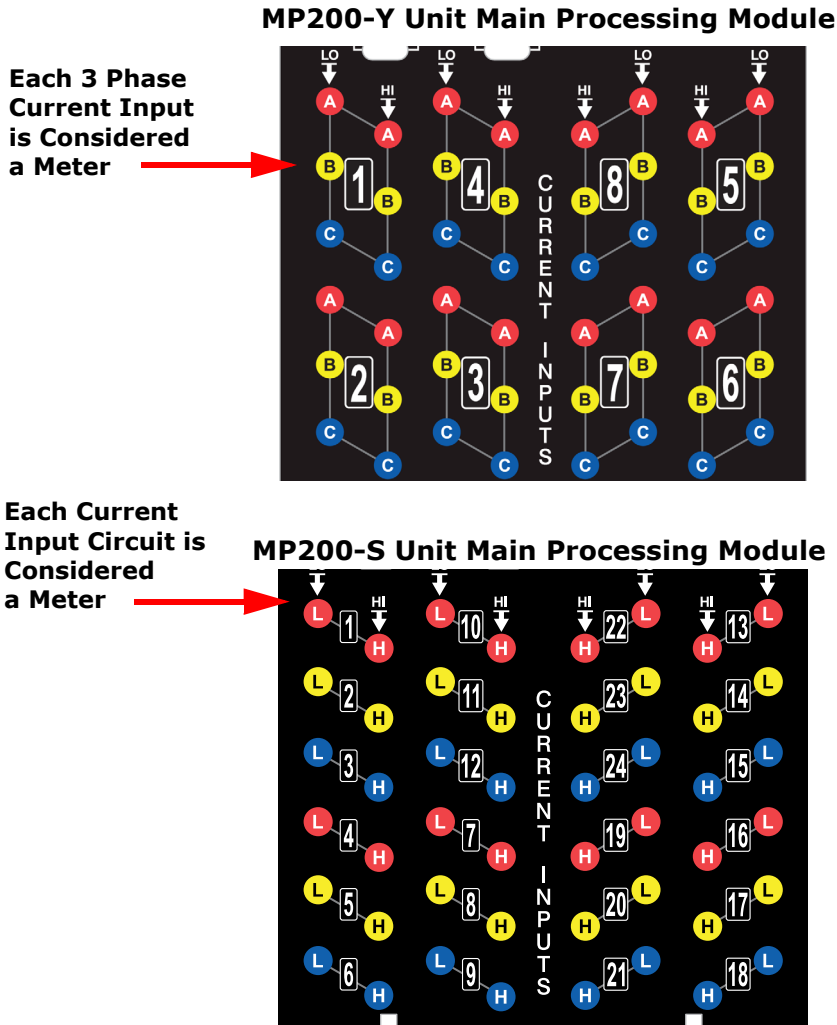

The MP200™ metering system offers up to 32 MegaBytes of non-volatile memory for per-circuit Energy usage trending. The MP200™ unit provides you with up to 5 logs: two historical logs, a log of limit alarms, a log of I/O changes, and a sequence of events log.

The MP200™ metering system is designed with advanced measurement capabilities, allowing it to achieve high performance accuracy. It is rated as a 0.5% Class accuracy metering device, meeting ANSI C12.20 and IEC 62053-22 0.5% classes.

Additional features of the MP200™ metering system include:

- Multifunction measurement including voltage, current, power, frequency, energy, interval energy, etc.

- V-Switch™ Key technology - field upgradeable without removing installed MP200™ unit.
- Alarm and Control - used to control load or alarm when over-load or other programmed conditions exist.
- Digital Inputs - designed to count pulses from other units, such as gas, water, and condensate.

Optional Display

The MP200™ unit offers an optional touch-screen color LED display. The display is available in two sizes: 3.5" (MDSN) and 5.7" (MDLN). The display lets you view readings from all of the meters on the MP200™ unit. See Chapter 10 for MDLN/MDSN display details.

2.1.1: Voltage and Current Inputs

Universal Voltage Inputs

Voltage inputs allow measurement up to Nominal 480 V AC (Phase to Reference) and 600 V AC (Phase to Phase). The MP200™ unit will perform to specification when directly connected to 69 volt, 120 volt, 230 volt, 277 volt, and 347 volt power systems.

Higher voltages require the use of potential transformers (PTs). The MP200™ unit is programmable to any PT ratio needed.

Current Inputs

The MP200™ unit can be ordered with either a 5 A or a 1 A secondary for current measurements. Depending on the MP200™ metering system model, there are either 8 three phase current inputs, or 24 single phase current inputs. The current inputs are only to be connected to external current transformers that are approved or certified.

The 5 A or 1 A secondary is an ordering option and as such it cannot be changed in the field. The 5 A secondary model (-10) allows the unit to over-range to 10 A per current circuit. The 1 A secondary model allows the unit to over-range to 2 A per current circuit.

2.1.2: Ordering Information

Model	Circuit Configuration	Frequency	Current Class	Vswitch™ Key Pack*	Com
MP200	-Y Three Phase	-60 60 Hz	-10 10 A Secondary	-V1 Transducer	-X RS485 Only
	-S Single Phase	-50 50 Hz	-2 2 A Secondary	-V2 Basic Logger	-WIFI Ethernet and WIFI
				-V3 Advanced Logger	

*See Section 2.1.3 for more information and instructions on obtaining a V-Switch™ key.

Example:

MP200-Y-60-10-V2-X

(MP200™ metering system with three phase circuit configuration, 60 Hz Frequency, 10 A Secondary, V-2 V-Switch™ key, and RS485-only communication.)

NOTE on Frequency: It is important to specify the frequency to insure the highest possible calibration accuracy from the factory.

2.1.3: V-Switch™ Key Technology

The MP200™ metering system is equipped with V-Switch™ key technology, a virtual firmware-based switch that lets you enable features through software communication. V-Switch™ key technology allows feature upgrades after installation without removal from service.

Available V-Switch™ key upgrades are as follows:

- V-Switch™ key 1 (V1): Multifunction measurement
- V-Switch™ key 2 (V2): Multifunction measurement and 2 MegaBytes* for data logging

- V-Switch™ key 3 (V3): Multifunction measurement and 32 MegaBytes* for data logging

* The table below shows the number of days of logging available with V2 and V3, for the MP200-Y and MP200-S circuit configurations, based on a 15 minute logging interval. Note that both MP200-Y and MP200-S units have Historical Log 1; Historical Log 2 is used for MP200-Y units, only; and Historical Log 3 is used for MP200-S units, only.

Model	Wiring	Log 1 V2**	Log 2/3 V2	Log 1 V3**	Log 2/3 V3
MP200-Y	Three Phase/ 8 circuits	68 days	105 days	500+ days	2700+ days
MP200-S	Single Phase/24 circuits	136 days	47 days	500+ days	1200+ days

** The number of days shown for Log 1 is based on the default configuration at shipping. Since this log is configurable, the actual number of days depends on the number of parameters chosen, as well as the logging interval.

Obtaining a V-Switch™ Key:

Contact EIG’s inside sales staff at sales@electroind.com or by calling (516) 334-0870 (USA) and provide the following information:

1. Serial number(s) of the MP200™ unit(s) you are upgrading. Use the number(s), with leading zeros, shown in the CommunicatorPQA® Device Status screen (from the CommunicatorPQA® Main screen, click **Tools>Device Status**).
2. Desired V-Switch™ key.
3. Credit card or Purchase Order number. EIG will issue you the V-Switch™ key.

Enabling the V-Switch™ Key:

1. Open CommunicatorPQA® software.
2. Power up your MP200™ unit.

3. Connect to the MP200™ unit through CommunicatorPQA® software (see Chapter 5).

4. Click **Tools>Change**

V-Switch from the Title Bar. A screen opens, requesting the encrypted key. Enter the V-Switch™ key provided by EIG.

5. Click the **OK** button.

The V-Switch™ key is enabled and the MP200™ unit resets.

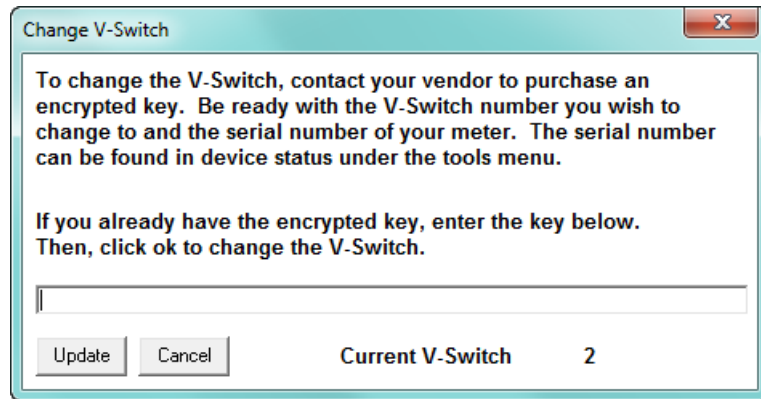

NOTE: For more details on the MP200™ unit's software configuration, refer to Chapter 10 in the *CommunicatorPQA®, MeterManagerPQA®, and EnergyPQA.com® Software User Manual*. You can download this manual at:

<https://www.electroind.com/products/communicatorpqa-power-monitoring-software/>
You can also access the manual from the software by clicking Help>Contents from the top of the Main screen.

2.1.4: Measured Values

The MP200™ metering system provides the following measured values, all in real time instantaneous. As the following tables show, some values are also available in average, maximum and minimum.

Single Phase Circuit Configuration

Measured Values	Instantaneous	Avg	Max	Min
Voltage L-N	X		X	X
Current	X	X	X	X
Watt	X	X	X	X
VAR	X	X	X	X
VA	X	X	X	X
PF	X	X	X	X
+Watt-Hour	X			
-Watt-Hour	X			
Watt-Hour Net	X			
+VAR-Hour	X			
-VAR-Hour	X			
VAR-Hour Net	X			
VA-Hour	X			
Frequency	X		X	X
Current Angle	X			

Three Phase Circuit Configuration

Measured Values	Instantaneous	Avg	Max	Min
Voltage L-N	X		X	X
Voltage L-L	X		X	X
Current per Phase	X	X	X	X
Current Neutral (see NOTE, below)	X	X	X	X
Watt(A,B,C,Tot.)	X	X	X	X
VAR (A,B,C,Tot.)	X	X	X	X
VA (A,B,C,Tot.)	X	X	X	X
PF (A,B,C,Tot.)	X	X	X	X
+Watt-Hour (A,B,C,Tot.)	X			
-Watt-Hour (A,B,C,Tot.)	X			
Watt-Hour Net	X			
+VAR-Hour (A,B,C,Tot.)	X			
-VAR-Hour (A,B,C,Tot.)	X			
VAR-Hour Net (A,B,C,Tot.)	X			
VA-Hour (A,B,C,Tot.)	X			
Frequency	X		X	X
Voltage Angles	X			
Current Angles	X			

NOTE: Neutral current is calculated only when the voltages are connected; if voltages are not connected, the neutral current will not be calculated.

2.1.5: Utility Peak Demand

The MP200™ metering system provides user-configured Block (Fixed) window or Rolling window Demand modes. This feature lets you set up a customized Demand profile. Block window Demand mode records the average demand for time intervals you define (usually 5, 15 or 30 minutes). Rolling window Demand mode functions like multiple, overlapping Block windows. You define the subintervals at which an average of Demand is calculated. An example of Rolling window Demand mode would be a 15-minute Demand block using 5-minute subintervals, thus providing a new Demand reading every 5 minutes, based on the last 15 minutes.

Utility Demand features can be used to calculate W, VAR, VA and PF readings. Voltage provides an instantaneous Max and Min reading which displays the highest surge and lowest sag seen by the meters. All other parameters offer Max and Min capability over the user-selectable averaging period.

2.2: Specifications

Power Supply

Range: Universal, (90-300) V AC
@50/60 Hz or (100-150) V DC

Power Consumption: 18 VA, 12 W, Maximum

Voltage Inputs (Measurement Category III)

(For Accuracy specifications, see Section 2.4.)

Range: Universal, Auto-ranging up to
576 V AC L-N, 721 V AC L-L

Supported hookups: MP200-Y: 3 Element Wye; 2 CT
Delta

MP200-S: Single Phase, 2 wire, 3
wire

Input Impedance: 4.2 M Ω /Phase

Burden: 0.09 VA/Phase Max at 600 V;
0.014 VA at 120 V

Pickup Voltage: 20 V AC

Connection: 7 Pin 0.400" Pluggable Terminal
Block

AWG#12 -26/ (0.08 -2.5) mm²

Fault Withstand: Meets IEEE C37.90.1

Reading: Programmable Full Scale to any PT
ratio

Current Inputs

(For Accuracy specifications, see Section 2.4.)

Class 10:	5 A Nominal CT Secondary, 10 A Maximum
Class 2:	1 A Nominal CT Secondary, 2 A Maximum
Burden:	0.005 VA Per Input Max at 11 A
Pickup Current:	0.1% of Nominal: Class 10: 5 mA Class 2: 1 mA
Current Input Terminals:	8-32 Threaded Studs
Reading:	Programmable Full Scale to any CT ratio
Continuous Current Withstand:	20 A
Maximum Voltage across Current Inputs:	1 V AC
Maximum Voltage from Current Inputs to Ground:	50 V AC

Wh Pulses

Red LED light pulses through top cover (see Section 6.2 for Kh values):

Peak Spectral wavelength: 574nm

Output timing:

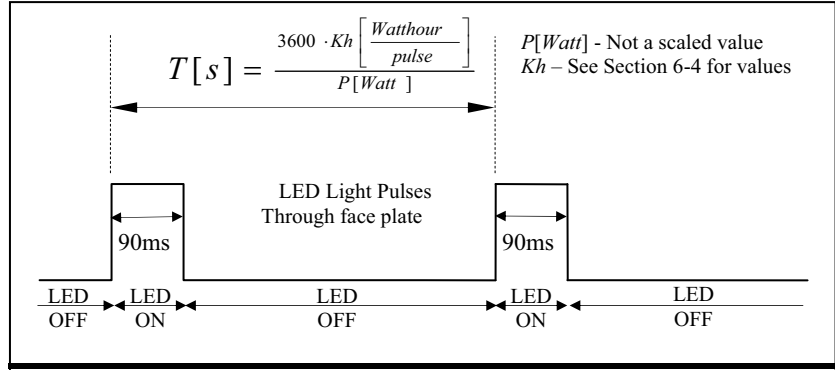

Isolation

All Inputs and Outputs are galvanically isolated to 2500 V AC

Environmental Rating

Storage: (-20 to +70) °C/(-4 to +158) °F

Operating: (-20 to +60) °C/(-4 to +140) °F

Humidity: To 95% RH Non-condensing

Measurement Methods

Voltage, current: True RMS

Power: Sampling at over 400 samples per cycle on each channel simultaneously

Update Rate

All parameters: Every 60 cycles (e.g., 1 s @ 60 Hz)

Communication

Standard:

1. RS485 port (Com 1)
2. USB port (Com 2)
3. RS485 (Com 3) - this port can be used for RS485 or the optional Ethernet/Wifi.
4. Energy pulse output LED for meter testing: there are 8 pulses, one for each of the three phase loads of the MP200-Y; for the MP200-S, the test pulses are shared, with one pulse for every three loads (see Chapter 6 for more details and instructions for using the Test pulses).

Optional:

Ethernet/WiFi port (Com 1)	Pre - 7/2021, either wireless or wired Ethernet; post 7/2021, simultaneous 802.11b Wireless and RJ45 10/100BaseT Ethernet - 10 sockets for each mode
----------------------------	--

NOTE: 802.11b supports 11 Mbps; 802.11g supports 54 Mbps, and 802.11n supports 600 Mbps.

Com Specifications

RS485 Ports (Com 1 and Com3):

RS485 Transceiver; meets or exceeds EIA/TIA-485 Standard

Type:	Two-wire, half duplex
Min. input impedance:	96 kΩ
Max. output current:	±60 mA
Protocol:	Modbus RTU, Modbus ASCII
Com port baud rates:	9,600 to 57,600 bps
Device address:	001-247
Data format:	8 Bit

WiFi/Ethernet Port (optional Com 1):

Wireless security:	Pre- 7/2021 module:64 or 128 bit WEP; WPA; or WPA2; post 7/2021 module: WPA/WPA2/WPA2-Enterprise/WPS, Trust & Go 608 chip, with AES/RSA/ECC/SHA encryption
Protocol:	Modbus TCP/IP
Device address:	001-247

USB Port (Com 2):

Protocol:	Modbus ASCII
Com port baud rate:	57,600 bps
Device address:	1

Relay Output/Digital Input Board Specifications at 25 °CRelay outputs:

Number of outputs:	2
Contact type:	Changeover (SPDT)
Relay type:	Mechanically latching
Switching voltage:	AC 150 V / DC 30 V
Switching power:	750 VA / 150 W
Switching current:	5 A
Switching rate max.:	10/s
Mechanical life:	5 x 10 ⁷ switching operations
Electrical life:	10 ⁵ switching operations at rated current
Breakdown voltage:	AC 1000 V between open contacts
Isolation:	AC 3000 V / 5000 V surge system to contacts
Reset/power down state:	No change - last state is retained

Inputs:

Number of inputs:	4
Sensing type:	Wet or dry contact status detection
Wetting voltage:	DC (1-24) V, internally generated
Input current:	2.5 mA – constant current regulated
Minimum input voltage:	0 V (input shorted to common)
Maximum input voltage:	DC 150 V (diode protected against polarity reversal)
Filtering:	De-bouncing with 50 ms delay time
Detection scan rate:	100 ms
Isolation:	AC 2500 V system to inputs
External Connection:	AWG 12-26/(0.129 - 3.31) mm ² 11 pin, 0.200" pluggable terminal block

Mechanical Parameters

Dimensions:	7.6(L) x 11.28(W) x 4.36(H) in / 19.3(L) x 28.65(W) x 11.07(H) cm
Weight:	7 pounds (3.18 kg)

2.3: Compliance

- ANSI C12.20 Accuracy, 0.5 CL
- IEC 62053-22 Accuracy, 0.5S
- CE (IEC 61000-6-2 & IEC 61000-6-4 & IEC 61326-1)
 - IEC 61000-4-2 Class B Ed. 1.2 2001*
 - IEC 61000-4-3 Ed. 2.1 2002 Class A*
 - IEC 61000-4-4 Ed. 2 2004 Class A*
 - IEC 61000-4-5 Class A Ed.1.1 2001*
 - IEC 61000-4-6 Class A Ed. 2.1 2004*
 - IEC 61000-4-8 Ed. 1.1 Class A 2001*
 - IEC 61000-4-11 Ed. 2 2004 Class B*
- CISPR11 Class A Ed. 4.2 2002*
- CISPR22 Class A Fifth Ed. 2005*
- (WIFI Module) ERM: Wideband transmission system operating in the 2.4 GHz ISM band using wideband modulation techniques. V1.6.1 (WIFI Module) Information technology equipment-Safety-part 1: General requirements: 2001
- EU Directive 2011/65/EU (RoHS 3 Directive)
- REACH Compliant
- Certified to UL 61010-1 and CSA C22.2 No. 61010-1, UL File: E250818*

* Third party lab tested

2.4: Accuracy

(For full Range specifications see Section 2.2.)

MP200™ metering system Clock accuracy: ± 3.5 ppm max. (± 0.3024 second/day) over the rated temperature range

For 23 °C, three phase or single phase 3 wire connected balanced load:

Parameter	Accuracy	Accuracy Input Range
Voltage L-N [V]	0.3% of reading*	(69 to 480) V
Voltage L-L [V]	0.5% of reading	(120 to 600) V
Current Phase [A]	0.3% of reading	(0.15 to 5) A
Current Neutral (calculated) [A]	2.0% of Full Scale	(0.15 to 5) A @ (45 to 65) Hz
Active Power Total [W]	0.5% of reading*	(0.15 to 5) A @ (69 to 480) V @ +/- (0.5 to 1) lag/lead PF
Active Energy Total [Wh]	0.5% of reading*	(0.15 to 5) A @ (69 to 480) V @ +/- (0.5 to 1) lag/lead PF
Reactive Power Total [VAR]	1.0% of reading*	(0.15 to 5) A @ (69 to 480) V @ +/- (0 to 0.8) lag/lead PF
Reactive Energy Total [VARh]	1.0% of reading*	(0.15 to 5) A @ (69 to 480) V @ +/- (0 to 0.8) lag/lead PF
Apparent Power Total [VA]	1.0% of reading*	(0.15 to 5) A @ (69 to 480) V @ +/- (0.5 to 1) lag/lead PF
Apparent Energy Total [VAh]	1.0% of reading*	(0.15 to 5) A @ (69 to 480) V @ +/- (0.5 to 1) lag/lead PF
Power Factor	1.0% of reading*	(0.15 to 5) A @ (69 to 480) V @ +/- (0.5 to 1) lag/lead PF
Frequency	+/- 0.01Hz	(45 to 65) Hz

* For unbalanced voltage inputs where at least one crosses the 150 V auto-scale threshold (for example, 120 V/120 V/208 V system), degrade accuracy by additional 0.4%.

The MP200™ metering system's accuracy meets the IEC 62053-22 and ANSI C12.20 Accuracy Standards for 0.5% Class Energy meters.

This page intentionally left blank.

3: Mechanical Installation and Maintenance

3.1: MP200™ Unit Dimensions

NOTE: The drawings shown below and on the next page give you the MP200™ unit dimensions in inches and millimeters [mm shown in brackets]. Tolerance is +/- 0.1" [.25 cm].

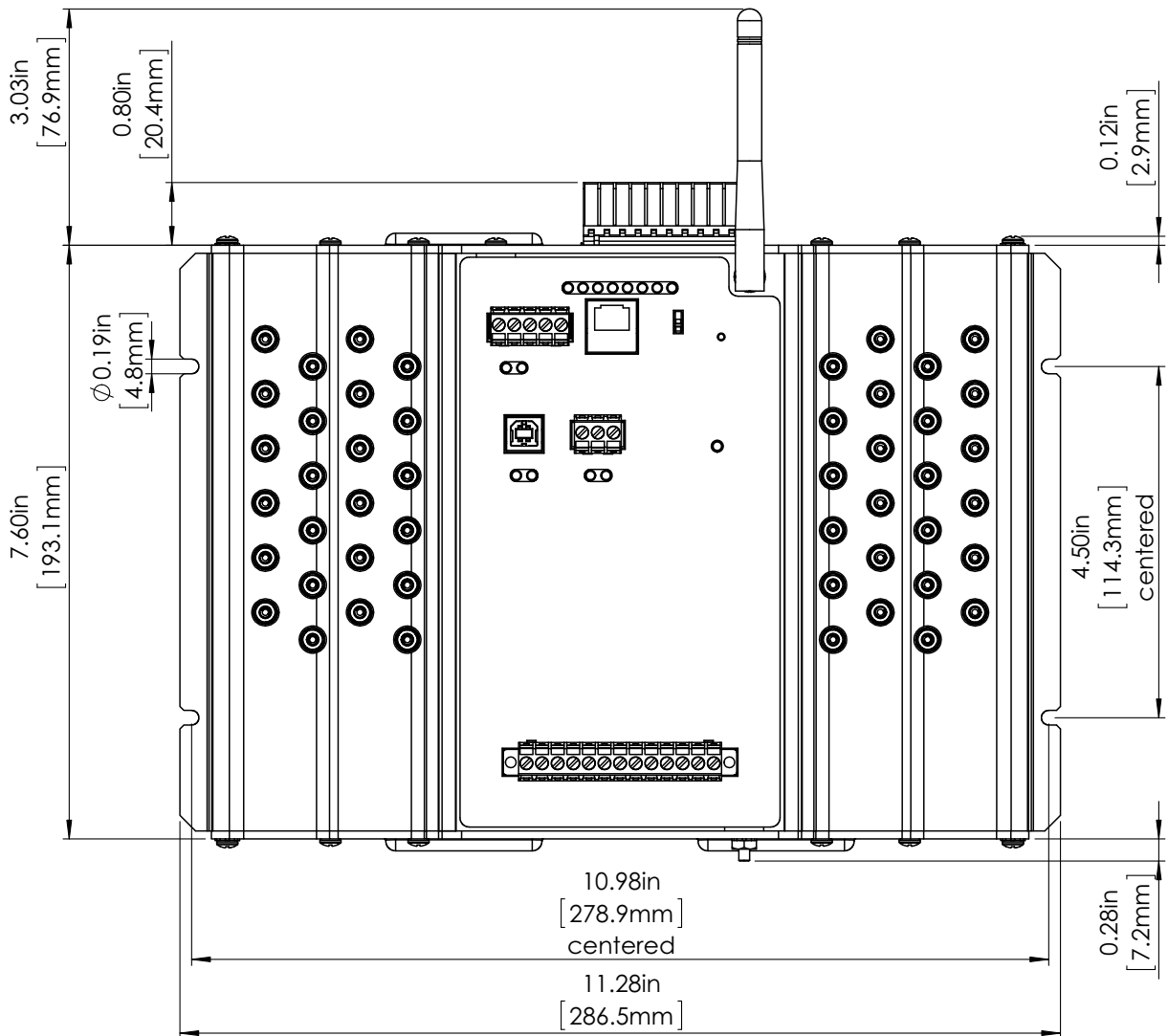

Figure 3.1: MP200™ Unit Front Dimensions

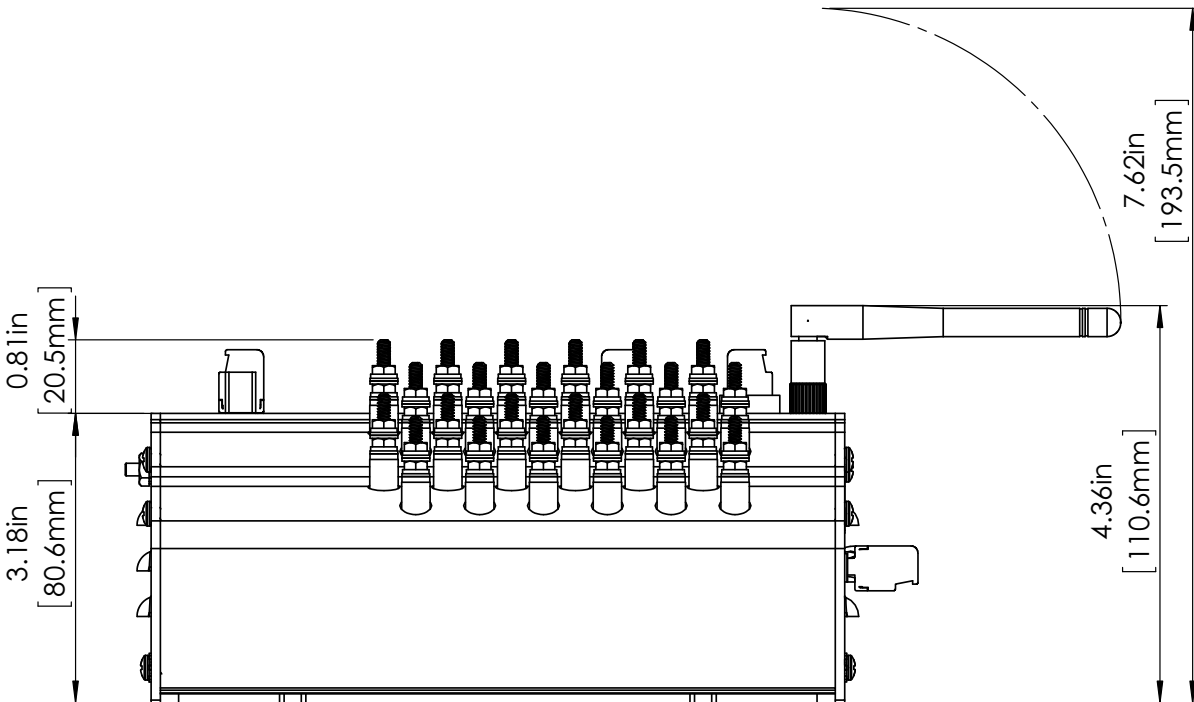

Figure 3.2: MP200™ Unit Side Dimensions

3.2: Mounting the MP200™ Unit

The MP200™ unit is designed to mount against any firm, flat surface. Use a #8 screw in each of the four slots on the flange to ensure that the MP200™ unit is installed securely. For safety reasons, mount the MP200™ unit in an enclosed and protected environment, such as in a switchgear cabinet. Install a switch or circuit breaker nearby; label it clearly as the MP200™ unit's disconnecting mechanism.

Recommended tools for MP200™ unit installation:

- #2 Phillips screwdriver
- 1/4-inch (0.25") nut driver, socket, box, or open-end wrench
- Wire cutters

The MP200™ unit is designed to withstand harsh environmental conditions; however it is recommended you install it in a dry location, free from dirt and corrosive substances. See Chapter 4 for electrical installation instructions.

3.3: Cleaning the MP200™ Unit



CAUTION! Do **NOT** clean with power applied. Disconnect power from the MP200™ metering system **before** following the cleaning procedure.

Ne PAS nettoyer lorsque le compteur est alimenté. Débranchez l'alimentation du système de mesure MP200™ avant d'entreprendre la procédure de nettoyage.

1. Wipe the MP200™ unit with a dry cloth. If stains or other material cannot be removed with a dry cloth, slightly moisten a cloth with a consumer window cleaner and use this to remove the stains or other material. Immediately wipe the unit down with a dry cloth to eliminate remaining moisture. The unit must be completely dry before being re-energized.
2. Dust may be blown off using room temperature compressed air at a maximum of 20 PSI.

This page intentionally left blank.

4: Electrical Installation

4.1: Considerations When Installing the MP200 Metering System



Installation of the MP200™ metering system must be performed only by qualified personnel who follow standard safety precautions during all procedures. Those personnel should have appropriate training and experience with high voltage devices. Appropriate safety gloves, safety glasses and protective clothing is recommended.

During normal operation of the MP200™ unit, dangerous voltages are present in many parts of the unit, including: terminals and any connected CTs (current transformers) and PTs (potential transformers), all I/O Modules (inputs and outputs) and their circuits.

All Primary and Secondary circuits can, at times, produce lethal voltages and currents. Avoid contact with any current-carrying surfaces.

Do not use the MP200™ metering system or any I/O output device for primary protection or in an energy-limiting capacity. The MP200™ metering system can only be used as secondary protection.

Do not use the MP200™ unit for applications where failure of the MP200™ unit may cause harm or death.

Do not use the MP200™ unit for any application where there may be a risk of fire.

All MP200™ unit terminals should be inaccessible after installation.

Do not apply more than the maximum voltage the MP200™ unit or any attached device can withstand. Refer to MP200™ unit and/or device labels and to the specifications for all devices before applying voltages. Do not HIPOT/Dielectric test any outputs, inputs or communication terminals.

EIG recommends the use of fuses for voltage leads and power supply, and shorting blocks to prevent hazardous voltage conditions or damage to CTs, if the MP200™ unit needs to be removed from service. One side of the CT must be grounded.

NOTE: The current inputs are only to be connected to external current transformers provided by the installer. The CTs shall be Approved or Certified and rated for the current of the meter used.



L'installation des compteurs de MP200™ doit être effectuée seulement par un personnel qualifié qui suit les normes relatives aux précautions de sécurité pendant toute la procédure. Le personnel doit avoir la formation appropriée et l'expérience avec les appareils de haute tension. Des gants de sécurité, des verres et des vêtements de protection appropriés sont recommandés.

AVERTISSEMENT! Pendant le fonctionnement normal du compteur MP200™ des tensions dangereuses suivant de nombreuses pièces, notamment, les bornes et tous les transformateurs de courant branchés, les transformateurs de tension, toutes les sorties, les entrées et leurs circuits. **Tous les circuits secondaires et primaires peuvent parfois produire des tensions de léthal et des courants. Évitez le contact avec les surfaces sous tensions. Avant de faire un travail dans le compteur, assurez-vous d'éteindre l'alimentation et de mettre tous les circuits branchés hors tension.**

Ne pas utiliser les compteurs ou sorties d'appareil pour une protection primaire ou capacité de limite d'énergie. Le compteur peut seulement être utilisé comme une protection secondaire.

Ne pas utiliser le compteur pour application dans laquelle une panne de compteur peut causer la mort ou des blessures graves.

Ne pas utiliser le compteur ou pour toute application dans laquelle un risque d'incendie est susceptible.

Toutes les bornes de compteur doivent être inaccessibles après l'installation.

Ne pas appliquer plus que la tension maximale que le compteur ou appareil relatif peut résister. Référez-vous au compteur ou aux étiquettes de l'appareil et les spécifications de tous les appareils avant d'appliquer les tensions. Ne pas faire de test HIPOT/diélectrique, une sortie, une entrée ou un terminal de réseau.

Les entrées actuelles doivent seulement être branchées aux transformateurs externes actuels.

EIG recommande d'utiliser les fusibles pour les fils de tension et alimentations électriques, ainsi que des coupe-circuits pour prévenir les tensions dangereuses ou endommagements de transformateur de courant si l'unité MP200™ doit être enlevée du service. Un côté du transformateur de courant doit être mis à terre.

NOTE: les entrées actuelles doivent seulement être branchées dans le transformateur externe actuel par l'installateur. Le transformateur de courant doit être approuvé ou certifié et déterminé pour le compteur actuel utilisé.

IMPORTANT!



IF THE EQUIPMENT IS USED IN A MANNER NOT SPECIFIED BY THE MANUFACTURER, THE PROTECTION PROVIDED BY THE EQUIPMENT MAY BE IMPAIRED.

- THERE IS NO REQUIRED PREVENTIVE MAINTENANCE OR INSPECTION NECESSARY FOR SAFETY. HOWEVER, ANY REPAIR OR MAINTENANCE SHOULD BE PERFORMED BY THE FACTORY.



DISCONNECT DEVICE: The following part is considered the equipment disconnect device. A SWITCH OR CIRCUIT-BREAKER SHALL BE INCLUDED IN THE END-USE EQUIPMENT OR BUILDING INSTALLATION. THE SWITCH SHALL BE IN CLOSE PROXIMITY TO THE EQUIPMENT AND WITHIN EASY REACH OF THE OPERATOR. THE SWITCH SHALL BE MARKED AS THE DISCONNECTING DEVICE FOR THE EQUIPMENT.



IMPORTANT! SI L'ÉQUIPEMENT EST UTILISÉ D'UNE FAÇON NON SPÉCIFIÉE PAR LE FABRICANT, LA PROTECTION FOURNIE PAR L'ÉQUIPEMENT PEUT ÊTRE ENDOMMAGÉE.

NOTE: IL N'Y A AUCUNE MAINTENANCE REQUISE POUR LA PRÉVENTION OU INSPECTION NÉCESSAIRE POUR LA SÉCURITÉ. CEPENDANT, TOUTE RÉPARATION OU MAINTENANCE DEVRAIT ÊTRE RÉALISÉE PAR LE FABRICANT.



DÉBRANCHEMENT DE L'APPAREIL : la partie suivante est considérée l'appareil de débranchement de l'équipement.

UN INTERRUPTEUR OU UN DISJONCTEUR DEVRAIT ÊTRE INCLUS DANS L'UTILISATION FINALE DE L'ÉQUIPEMENT OU L'INSTALLATION. L'INTERRUPTEUR DOIT ÊTRE DANS UNE PROXIMITÉ PROCHE DE L'ÉQUIPEMENT ET A LA PORTÉE DE L'OPÉRATEUR. L'INTERRUPTEUR DOIT AVOIR LA MENTION DÉBRANCHEMENT DE L'APPAREIL POUR L'ÉQUIPEMENT.

4.2: Ground Connections

The MP200™ unit's Ground terminal should be connected directly to the installation's protective earth ground. Use AWG# 12/2.5 mm² wire for this connection. See the figure below.

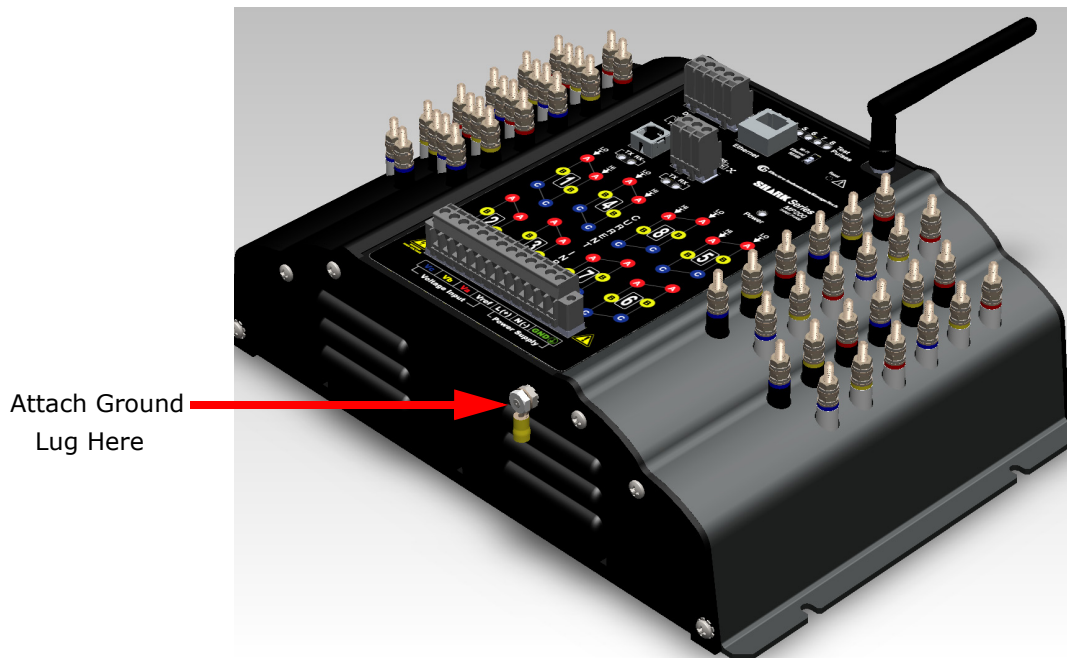

Figure 4.1: Ground Lug Connection

4.3: Voltage and Power Supply Connections

Voltage inputs are connected to the bottom of the MP200™ unit via wire connectors. The connectors accommodate AWG# 12 -26/ (0.129 - 3.31) mm².

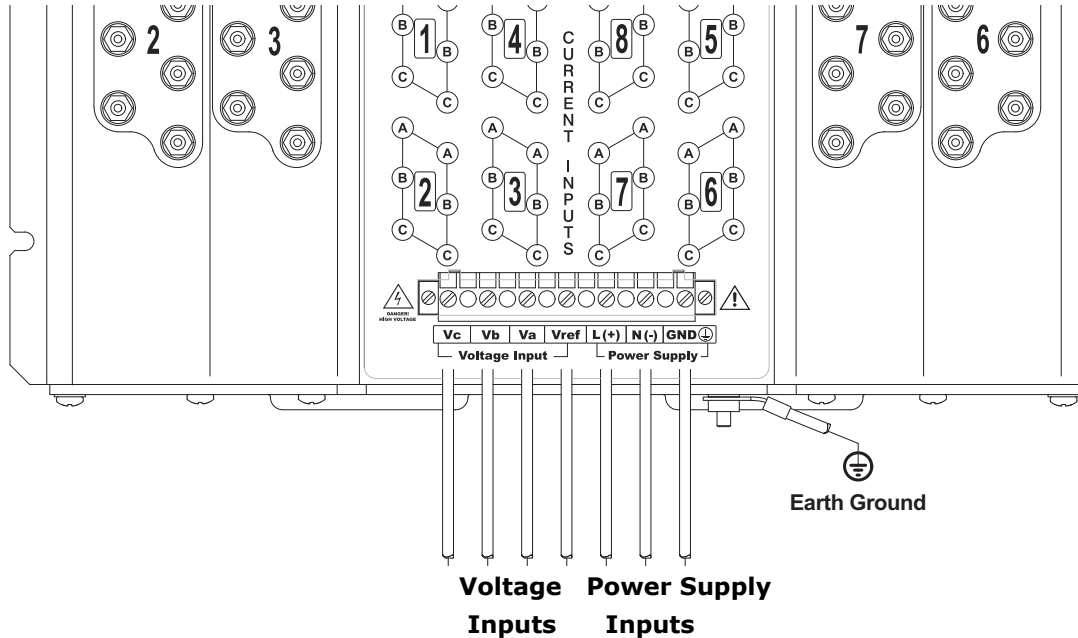

Figure 4.2: MP200™ Unit Connections

4.4: Voltage Fuses

EIG recommends the use of fuses on each of the sense voltages and on the control power, even though the wiring diagrams in this chapter do not show them.

- Use a 0.1 A fuse on each voltage input (rated for 600 volts).
- Use a 3 A Slow Blow fuse on the power supply (rated at 500 volts).

EIG offers the EI-CP Panel meter protective fuse kit, which can be ordered from EIG's website:

<https://electroind.com/product/panel-meter-protective-fuse-kit/>.

4.5: Wiring the Monitored Inputs - Currents

The cables to the current inputs shall be rated for a minimum of 600 V AC and 10 A (14 AWG copper cable, cross sectional area of 2.08mm²).

Mount the current transformers (CTs) as close as possible to the MP200™ unit's meters. The following table illustrates the maximum recommended distances for various CT sizes, assuming the connection is via 14 AWG copper cable.

CT size (VA)	Maximum Distance from CT to MP200™ Unit's Meters (Ft)
2.5	10
5	15
7.5	30
10	40
15	60
30	120



WARNING! DO NOT leave the secondary of the CT open when primary current is flowing. This may cause high voltage, which will overheat the CT. If the CT is not connected, provide a shorting block on the secondary of the CT.

AVERTISSEMENT! NE PAS laisser le transformateur de courant secondaire ouvert lorsque le courant primaire est fluent. Cela peut provoquer une haute tension qui surchauffera le transformateur de courant. Si ce dernier n'est pas branché, fournir un court-circuit sur le transformateur de courant secondaire.

EIG highly recommends using shorting blocks to allow removal of the MP200™ unit from an energized circuit, if necessary (see 4.7: Removing the MP200 Unit From Service/Reinstalling the MP200 Unit, on page 4-15, for instructions). EIG recommends using a three phase shorting block for every three phase load. An example of that shorting block is the EI SB-6TC, shown on the next page. It can be ordered from our website: <https://electroind.com/product/sb-6tc/>.

You will need 8 shorting blocks for the 8 three phase circuits.

Shorting blocks allow you to short an installed current transformer so that the meter can be uninstalled, if necessary, for servicing. This is a **highly important** safety feature.



Figure 4.3: EI SB-6TC Shorting Block (Good for 1 set of three phase CTs)

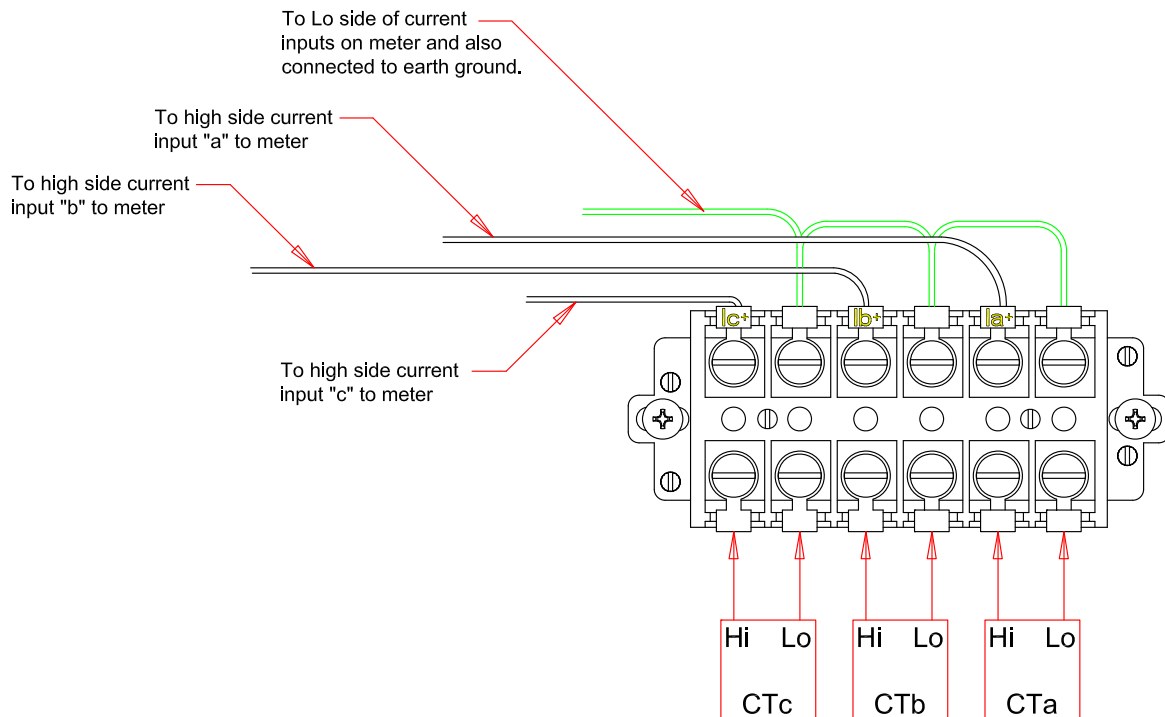

Figure 4.4: EI SB-6TC Shorting Block Wiring Diagram

It is important to maintain the polarity of the CT circuit when connecting to the MP200™ unit's meters. If the polarity is reversed, the meters will not provide accurate readings. CT polarities are dependent upon correct connection of CT leads and the direction CTs are facing when clamped around the conductors.

EIG recommande fortement d'utiliser les blocs de court-circuit pour permettre le retrait de l'unité MP200™ d'un circuit sous tension, si nécessaire (voir Section 4.7 pour les instructions). EIG recommande l'aide d'un bloc de court-circuit triphasé pour chaque charge en trois phases. Un exemple de ce bloc de court-circuit est le EI SB-6TC, figurant sur la page suivante. Il peut être commandé à partir de notre site Web : www.electroind.com. Vous aurez besoin de huit blocs de court-circuit pour les huit circuits triphasés. Les blocs de court-circuit vous permettent de court-circuiter un transformateur de courant installé de telle sorte que le compteur peut être désinstallé, si nécessaire, pour l'entretien. C'est une fonction sécuritaire très importante.

4.6: Electrical Connection Diagrams

The following pages contain electrical connection diagrams for the MP200™ unit's meters, which now support Delta connections as well as Wye. Choose the diagram that best suits your application. Be sure to maintain the CT polarity when wiring.

The diagrams are presented in the following order:

1. Three Phase, 4-Wire Wye Service with Direct Voltage and 3 CT Connection for Metering 8 Three Phase Loads (MP200-Y)
2. Three-Phase, 4-Wire Wye Service with 3 PT Voltage and 3 CT Connection for Metering 8 Three Phase Loads (MP200-Y)
3. Three-Phase, 3-Wire Delta Service with Direct Voltage and 2 CT Connection for Metering 8 three Phase Loads (MP200-Y)
4. Single Phase, 2-Wire Service with Direct Voltage and 3 CT Connection for Metering 24 Single Phase Loads (MP200-S)
5. Single Phase, 3-Wire Service with Direct Voltage and 2 CT Connection for Metering 8 Single Phase Loads (MP200-S)
6. Single phase, 3-Wire Service with Direct Voltage and 1 CT Connection for Metering 24 Single Phase Loads(MP200-S)

IMPORTANT! Tous les transformateurs de courant doivent avoir un côté à la terre pour réduire les risques de choc. EIG recommande fortement d'utiliser les blocs de court-circuit comme le EI SB-6TC de sorte que le compteur peut être retiré de sa fonction tandis que le transformateur de courant est sous tension.

1. Service: Three Phase, 4-Wire WYE Service Direct Voltage and 3 CT Connection for Metering 8 Three Phase Loads: MP200-Y

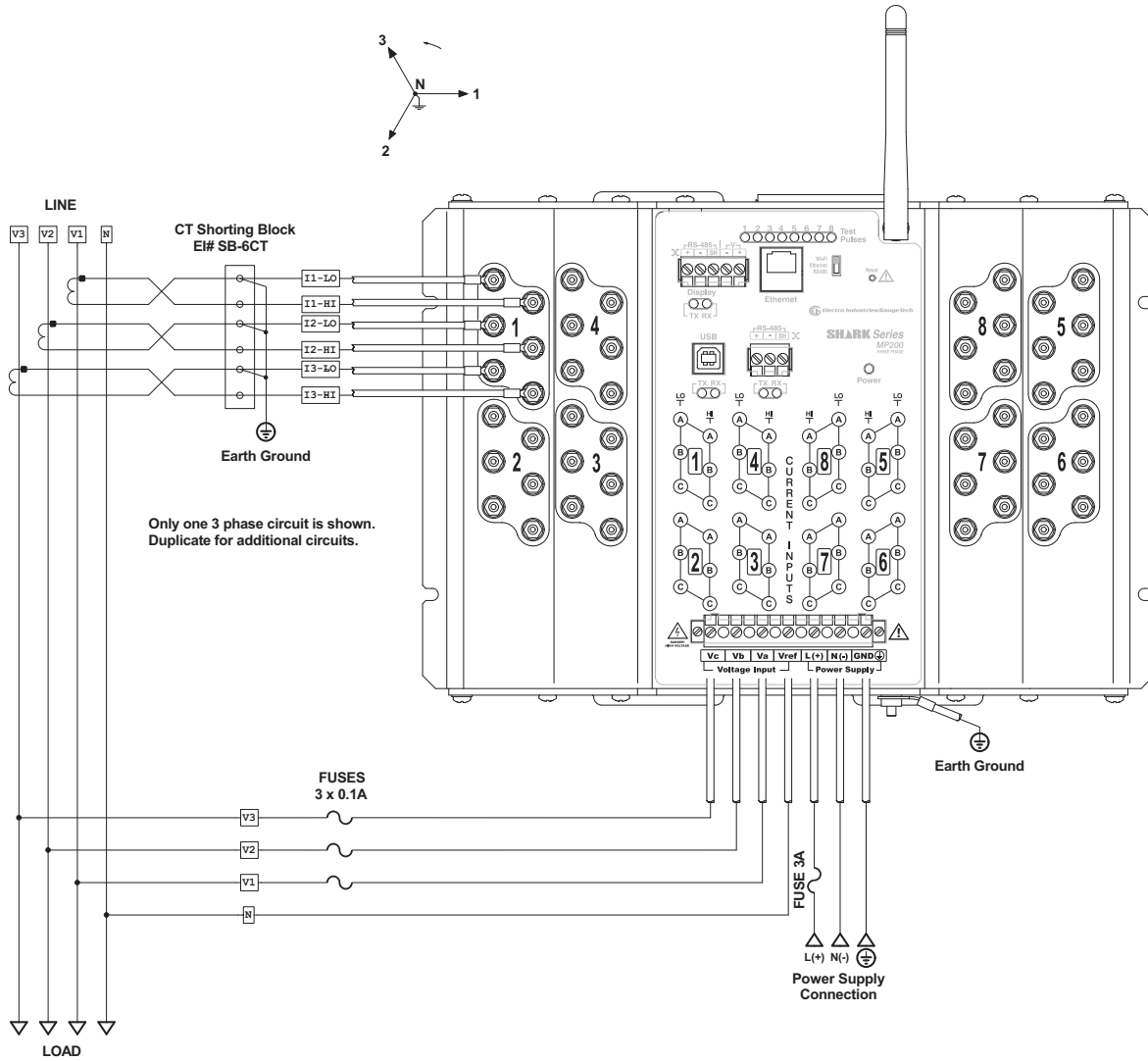

NOTES:

- All CTs must have one side grounded to reduce shock hazard.
- You must order the MP200-Y unit for the three phase operation.
- EIG highly recommends using shorting blocks like the EI SB-6TC so that the meter can be removed from service while the CT is energized.
- 8 shorting blocks should be used for all 8 three phase circuits.

2. Service: Three Phase, 4-Wire WYE Service with 3 PT Voltage and 3 CT Connection for Metering 8 Three Phase Loads: MP200-Y

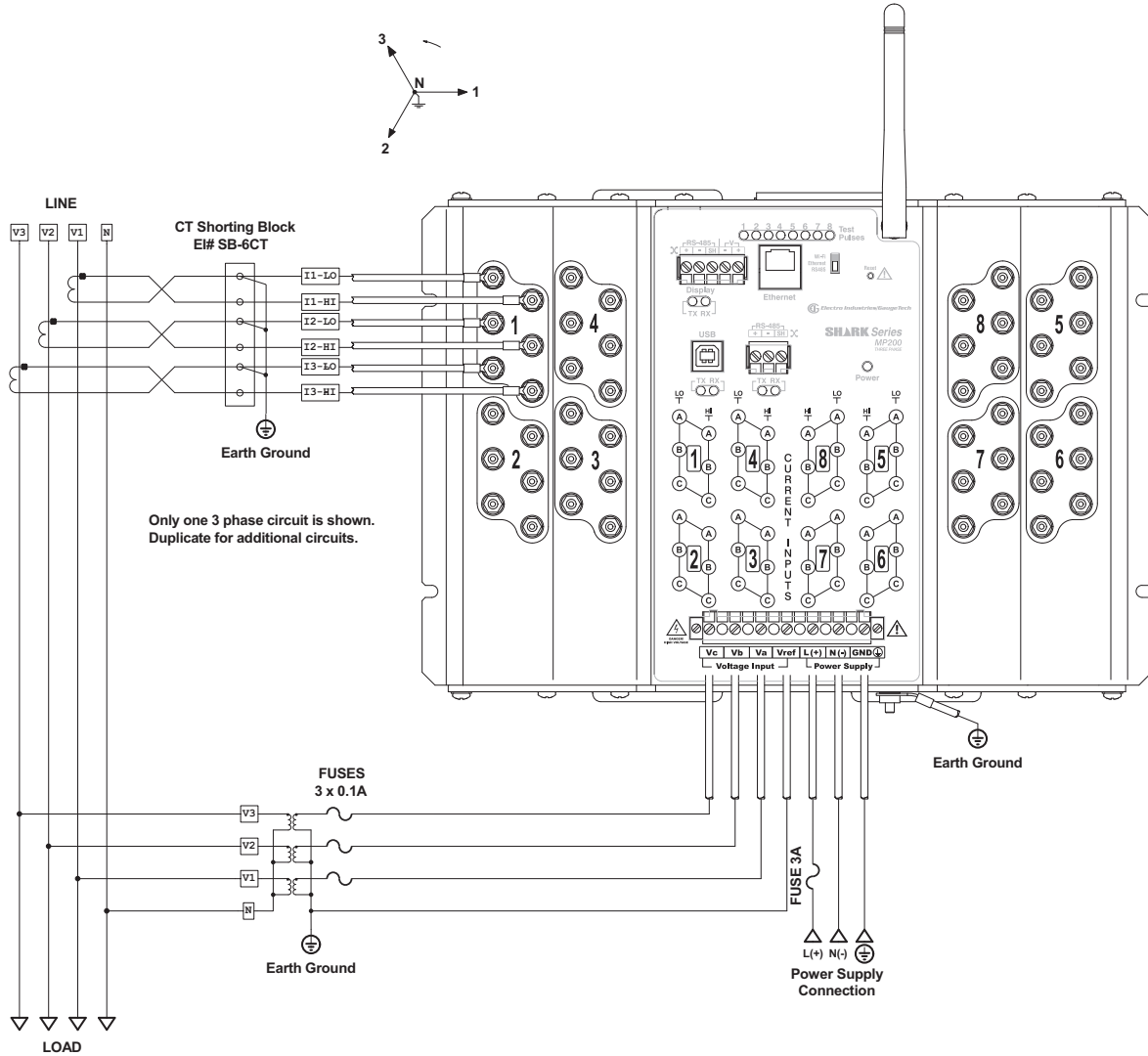

NOTES:

- All CTs must have one side grounded to reduce shock hazard.
- You must order the MP200-Y unit for the three phase operation.
- EIG highly recommends using shorting blocks like the EI SB-6TC so that the meter can be removed from service while the CT is energized.
- 8 shorting blocks should be used for all 8 three phase circuits.

3. Service: Three Phase, 3-Wire Delta Service with Direct Voltage and 2 CT Connection for Metering 8 Three Phase Loads: MP200-Y

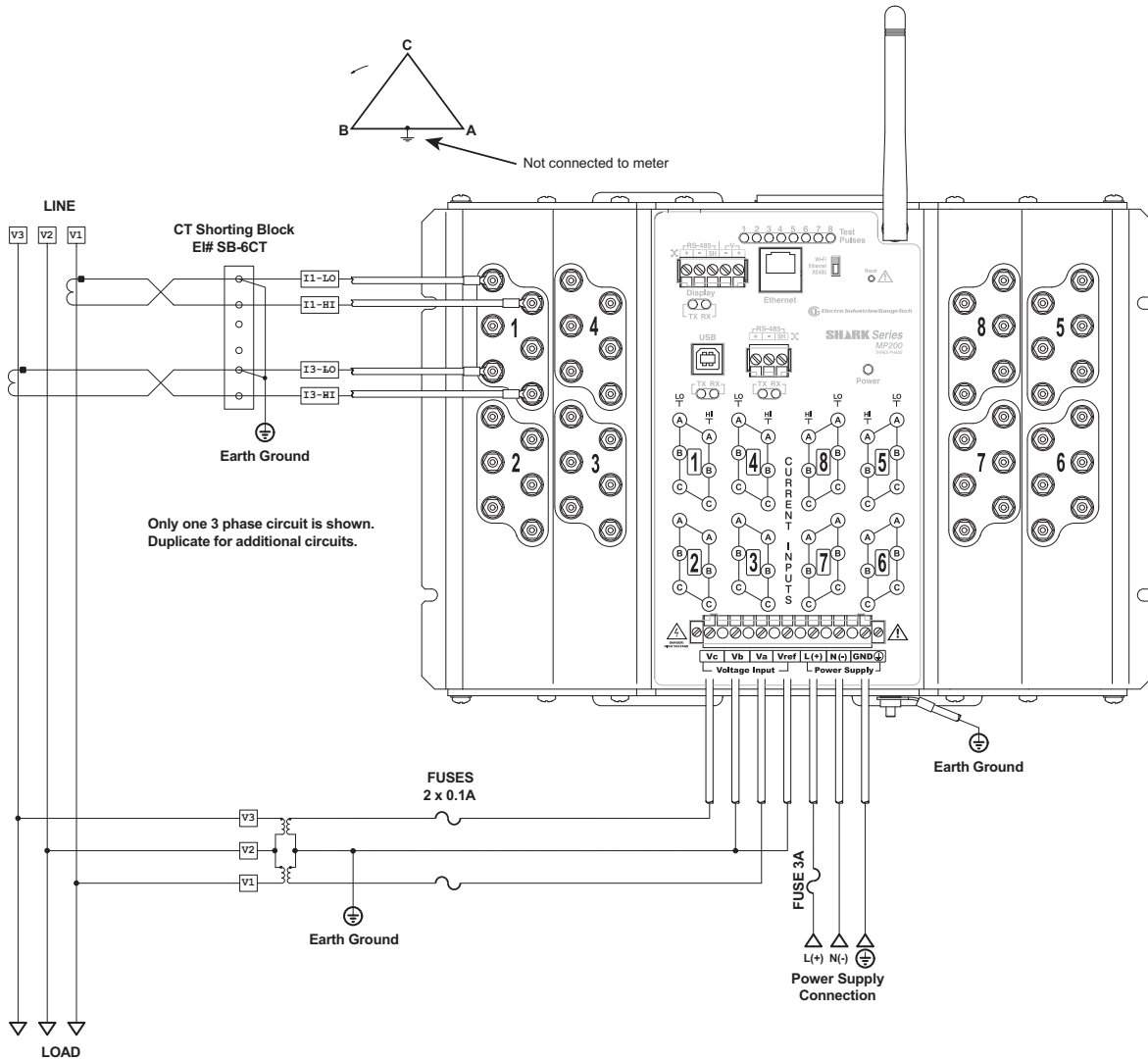

NOTES:

- All CTs must have one side grounded to reduce shock hazard.
- You must order the MP200-Y unit for the three phase operation.
- EIG highly recommends using shorting blocks like the EI SB-6TC so that the meter can be removed from service while the CT is energized.
- 8 shorting blocks should be used for all 8 three phase circuits.

4. Single Phase, 2-Wire Service with Direct Voltage and 3 CT Connection for Metering 24 Single Phase Loads: MP200-S

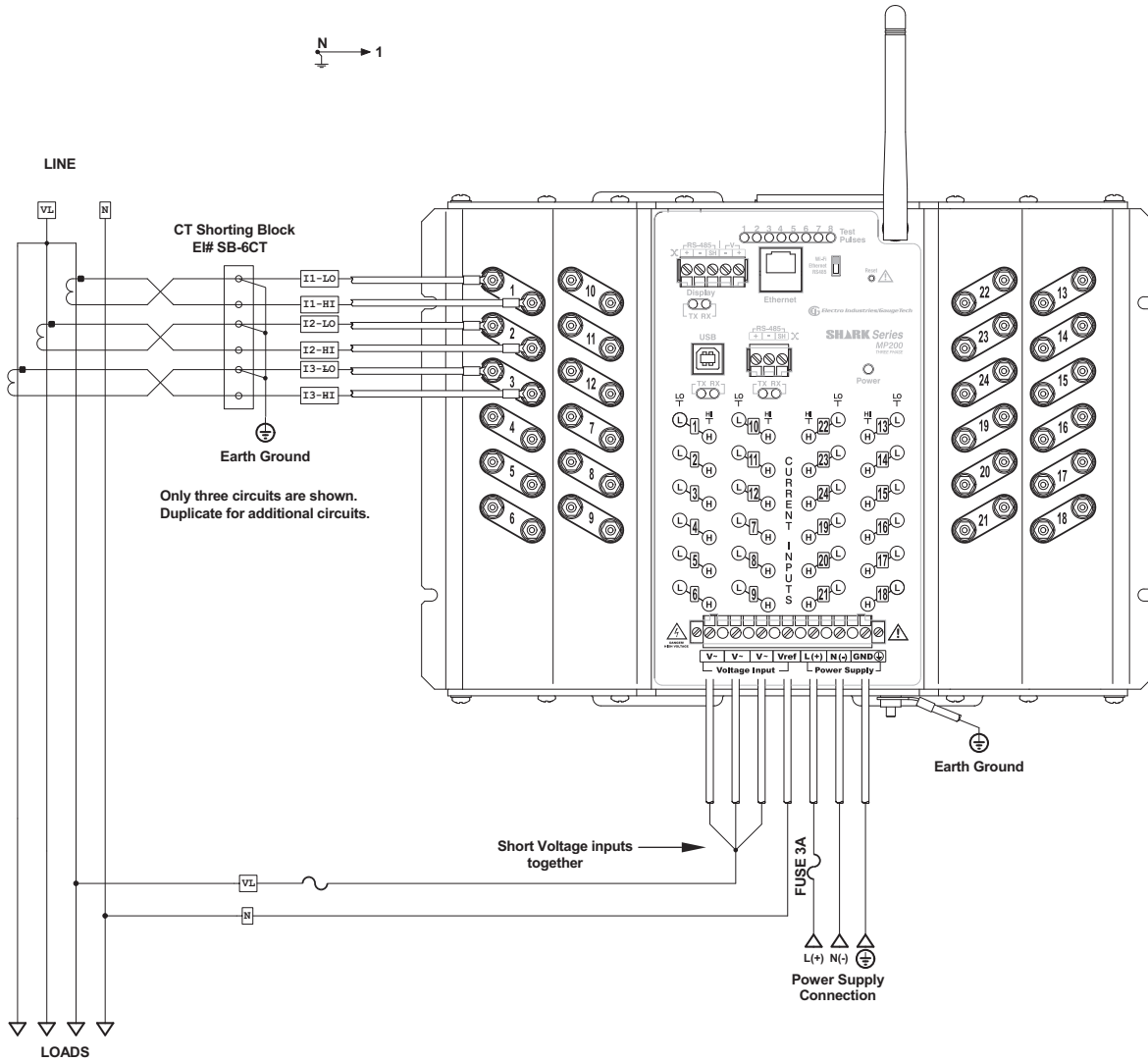

NOTES:

- All CTs must have one side grounded to reduce shock hazard.
- You must order the MP200-S unit for single phase 2-wire operation.
- EIG highly recommends using shorting blocks like the EI SB-6TC so that the meter can be removed from service while the CT is energized.

5. Service: Single Phase, 3-Wire Service with Direct Voltage and 2 CT Connection for Metering 8 Single Phase Loads: MP200-Y

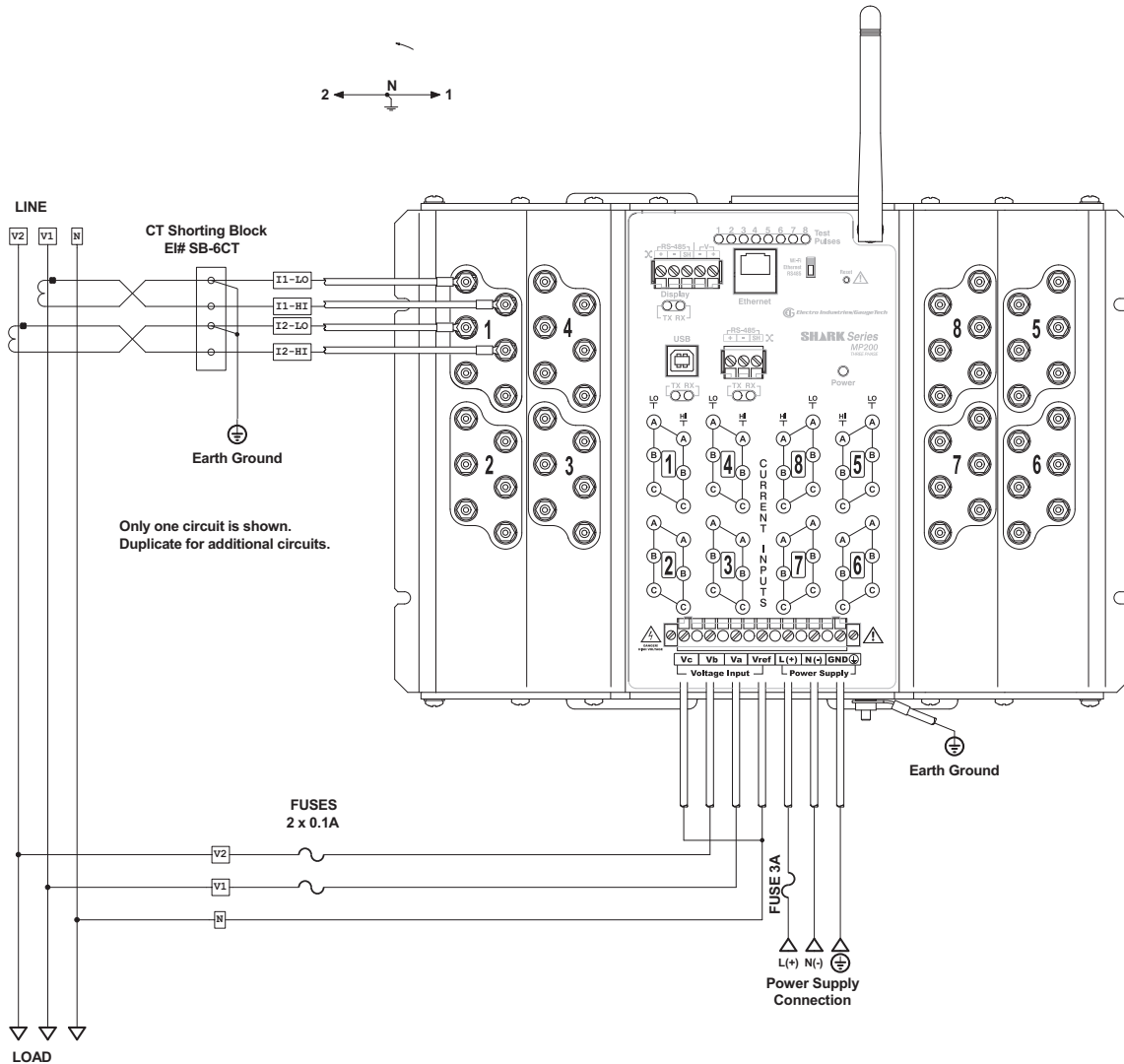

NOTES:

- All CTs must have one side grounded to reduce shock hazard.
- You must order the MP200-Y unit for this operation.
- EIG highly recommends using shorting blocks like the EI SB-6TC so that the meter can be removed from service while the CT is energized.
- A higher density connection is available using the single phase version of the meter. The difference is that the higher density uses a single CT for both legs of a three wire system.

6. Service: Single Phase, 3-Wire Service with Direct Voltage and 1 CT Connection for Metering 24 Single Phase Loads: MP200-S

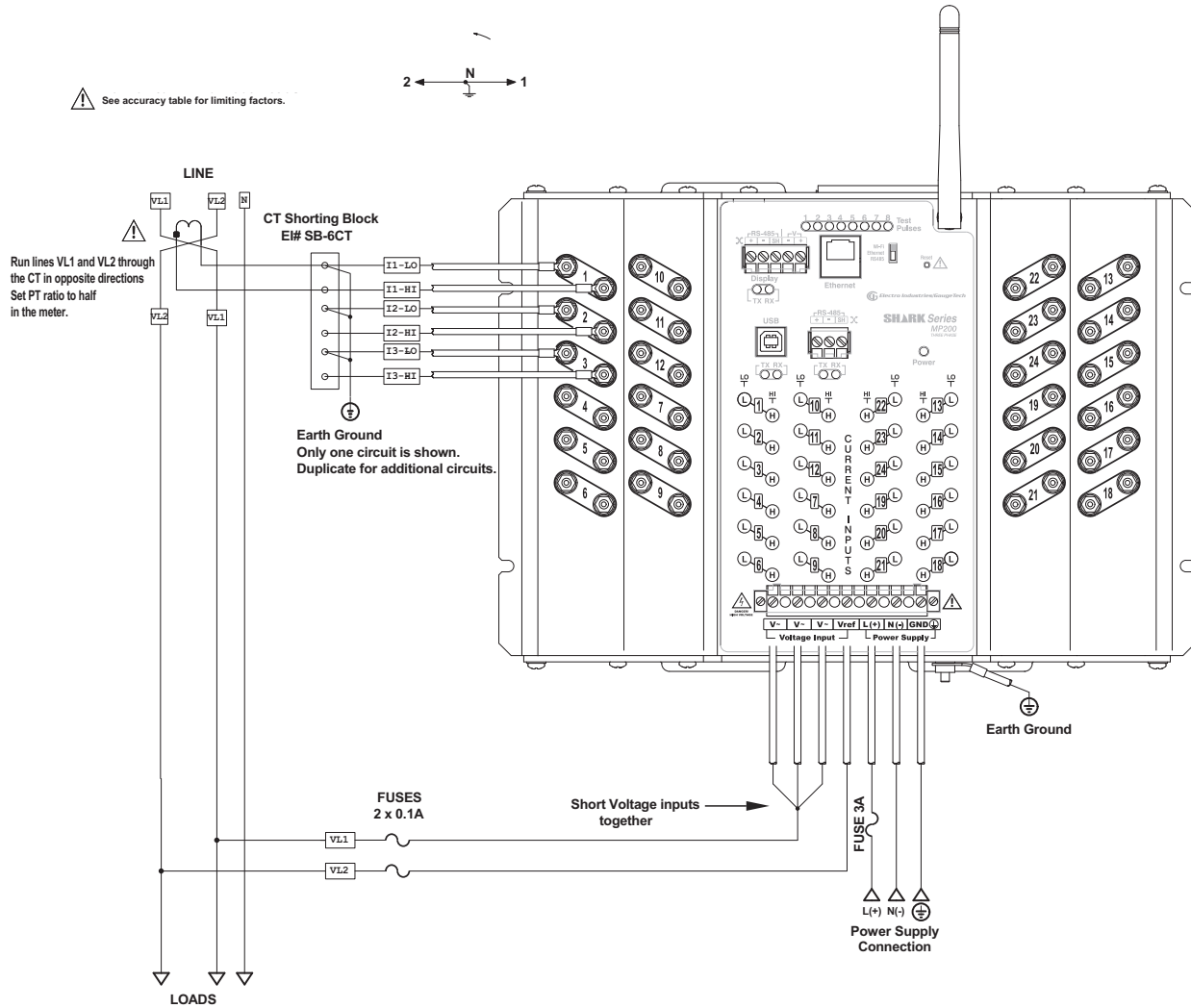

NOTES:

- All CTs must have one side grounded to reduce shock hazard.
- You must order the MP200-S unit for single phase operation.
- EIG highly recommends using shorting blocks like the EI SB-6TC so that the meter can be removed from service while the CT is energized.

4.7: Removing the MP200 Unit From Service/Reinstalling the MP200 Unit



WARNINGS!

- Before attempting any work on the MP200™ unit or associated components, all power must be removed and all circuits de-energized. Verify the de-energized status of all circuitry with appropriate portable measuring equipment.
- If the MP200™ unit was directly wired to the CTs without a shorting block as disclosed in this manual, then all the electrical primary circuits **must be shut down** prior to removing the meter. Failure to do so could result in possible high voltage on the open CT terminals.

AVERTISSEMENT!

- Avant de tenter un travail sur l'unité MP200™ ou sur les composants associés, toutes les alimentations doivent être enlevées et tous les circuits mis hors tension. Vérifiez le statut de mise hors tension de tous les circuits avec l'équipement de mesure portable approprié.
- Si l'unité MP200™ a été directement branchée sur le transformateur de courant dans un court-circuit comme indiqué dans ce manuel, alors tous les circuits électriques primaires doivent être éteints avant d'enlever le compteur. Le non-respect de cette indication pourrait résulter à une haute tension sur les bornes de transformateur de courant ouvert.

4.7.1: Removing the MP200 Unit Using the EI SB-6TC Shorting Block

NOTE: This procedure uses the EI SB-6TC shorting block. For shorting blocks other than that, see the instructions in 4.7.2: Removing the MP200 Unit Using a Shorting Block Other than the EI SB-6TC, on page 4-19.

1. Verify that all circuits are de-energized and locked out.
2. All shorting blocks shall be wired as per the wiring diagrams in this manual with one side of each CT at ground potential. Refer to Figure 4.4: EI SB-6TC Shorting Block Wiring Diagram, on page 4-7.
3. All shorting blocks are equipped with 4 brass shorting screws stored in the four corners of the base. Refer to the figure below.

IMPORTANT! If all 4 brass shorting screws are not on the shorting blocks do not continue until replacements are obtained.

IMPORTANT! Si toutes les quatre vis de court-circuit en laiton ne sont pas sur les blocs de court-circuit, ne pas continuer jusqu'à ce que vous obteniez des remplacements.

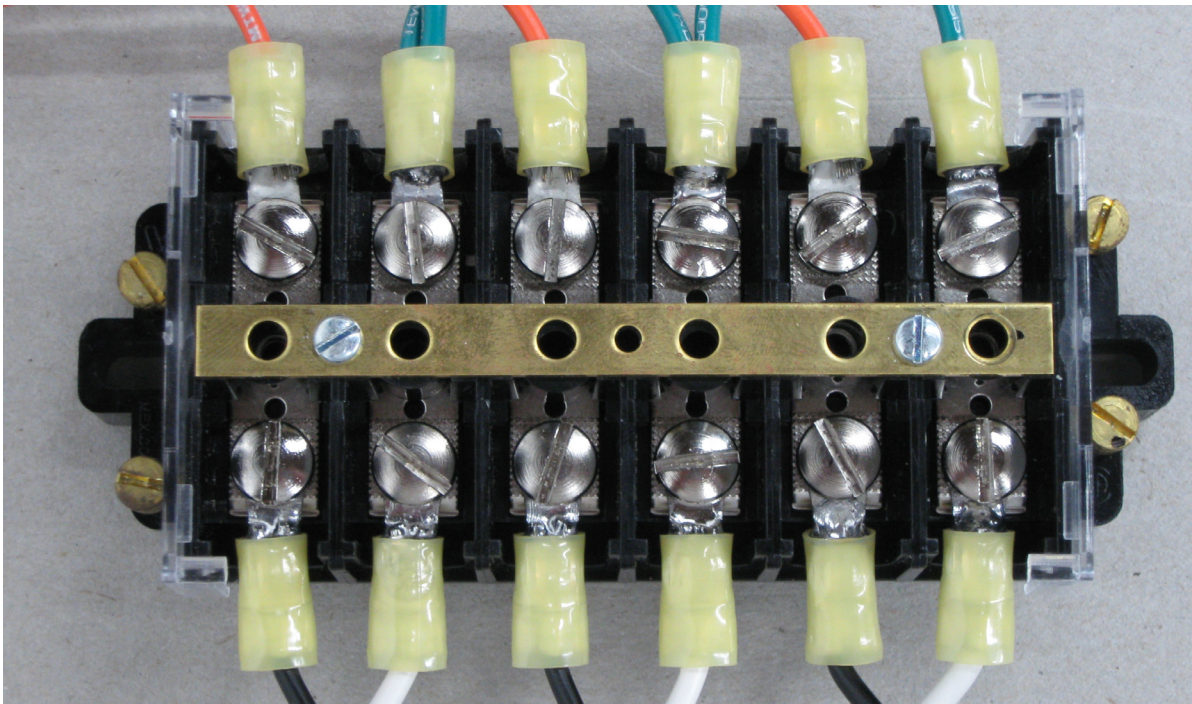

Figure 4.5: EI SB-6TC Shorting Block with Wiring Installed

4. Select one of the shorting blocks.

5. Remove one of the brass shorting screws from the plastic base and place it through the brass shorting bar over one of the grounded terminals and tighten (max torque of 16.2 in-lb, 1.8 N-m).
 - a. Verify that, when tightened, the screw head is in full contact with the brass bar.

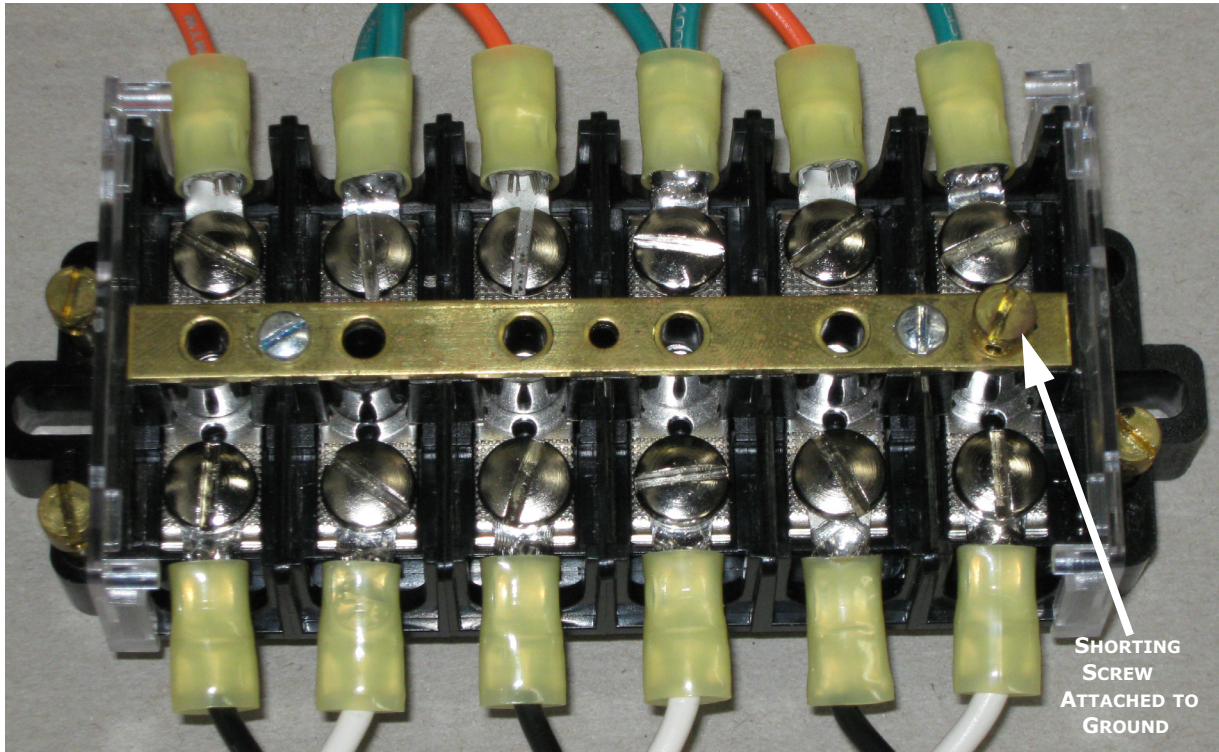

Figure 4.6: EI SB-6TC with Shorting Screw Attached to Ground Terminal

6. Remove another brass shorting screw and place it through the brass bar over an un-grounded lead of a CT and tighten (max torque of 16.2 in-lb, 1.8 N-m).
 - a. Verify that, when tightened, the screw head is in full contact with the brass bar.
7. If necessary, remove another brass shorting screw and place it through the brass bar over an un-grounded lead of the second CT and tighten (max torque of 16.2 in-lb, 1.8 N-m).
 - a. Verify that, when tightened, the screw head is in full contact with the brass bar.
8. If necessary, remove another brass shorting screw and place it through the brass bar over an un-grounded lead of the third CT and tighten (max torque of 16.2 in-lb, 1.8 N-m).
 - a. Verify that, when tightened, the screw head is in full contact with the brass bar.

9. If necessary, repeat steps 4 through 8a until all CTs are shorted.

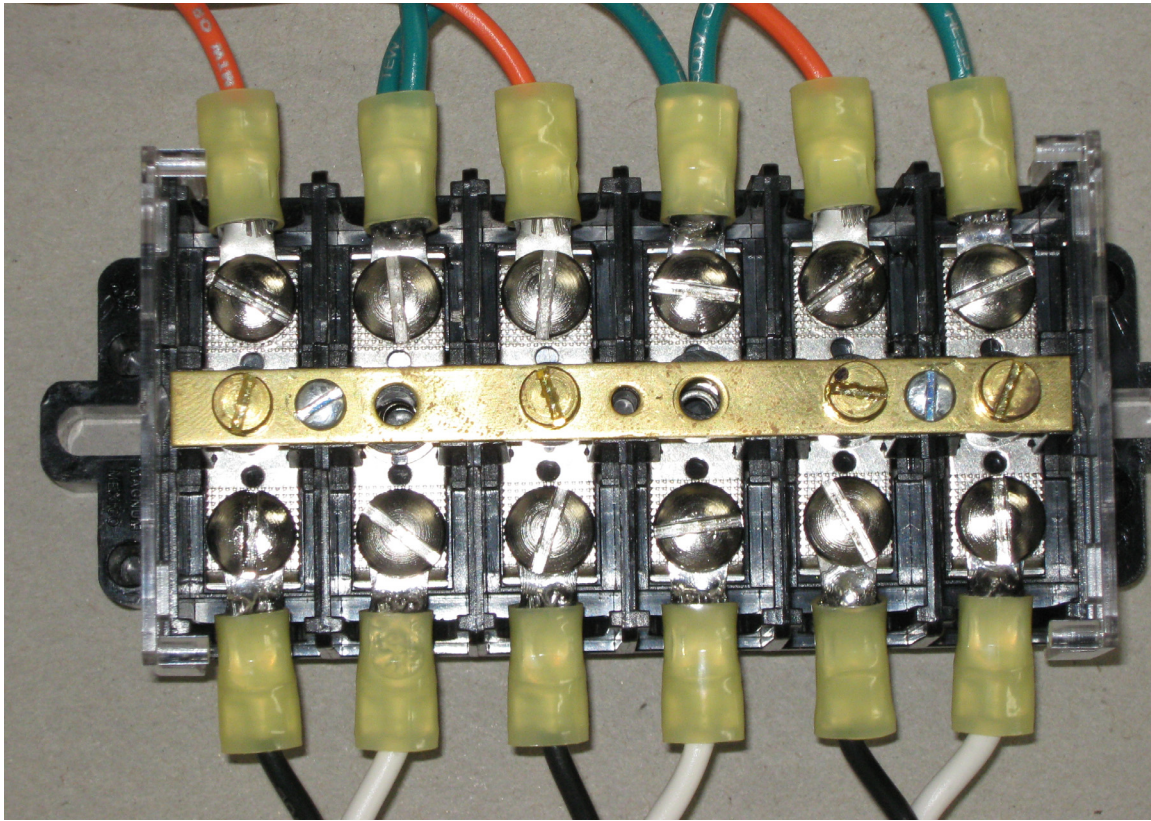

Figure 4.7: EI SB-6TC with All CTs Shorted Properly

10. Mark or record the location of the current input wires on the MP200™ unit.
11. Disconnect all current input wires from the MP200™ unit.
12. Remove all connectors from the MP200™ unit.
13. Remove the Ground connection from the stud on the MP200™ unit (see Figure 4.2: MP200™ Unit Connections, on page 4-5).
14. Remove the 4 mounting screws holding the MP200™ unit in place.
15. Remove the MP200™ unit.

4.7.1.1: Reinstalling the MP200 Unit Using the EI SB-6TC Shorting Block

1. Place the MP200™ unit in the desired location over the mounting holes.
2. Insert and tighten all 4 mounting screws.
3. Connect the Ground wire to the stud on the MP200™ unit and tighten the nut to 8.8 in-lb (1 N-m) (see Figure 4.2: MP200™ Unit Connections, on page 4-5).
4. Connect the current inputs to the MP200™ unit as per the locations marked on the wires or recorded. Refer to Figure 4.4: EI SB-6TC Shorting Block Wiring Diagram, on page 4-7, and the wiring diagrams in this manual.
5. Tighten nuts to 8.8 in-lb (1 N-m).
6. Insert all connectors into the MP200™ unit.
7. Select a shorting block and remove the screws shorting the un-grounded side of the CTs and screw them into their storage locations in the corner of the block (max torque of 1 in-lb, 0.11 N-m).
IMPORTANT! The screw that is grounding the brass bar should be removed last and also stored on the block.
IMPORTANT! La vis qui met la barre en laiton à la terre doit être retirée en dernier et également stocké sur le bloc.
8. If necessary, repeat step 7 until all shorting blocks are returned to their operating configuration.
9. Apply power to the meter and energize all circuits.
10. Verify correct operation of the MP200™ unit.

4.7.2: Removing the MP200 Unit Using a Shorting Block Other than the EI SB-6TC

1. Verify that all circuits are de-energized and locked out.
2. All shorting blocks shall be wired as per the wiring diagrams in this manual with one side of each CT at ground potential.
3. Using the shorting blocks short the ungrounded side of all CTs to ground.

4. Mark or record the location of the current input wires on the MP200™ unit.
5. Disconnect all current input wires from the MP200™ unit.
6. Remove all connectors from the MP200™ unit.
7. Remove the Ground connection from the stud on the MP200™ unit (see Figure 4.2: MP200™ Unit Connections, on page 4-5).
8. Remove the 4 mounting screws holding the MP200™ unit in place.

4.7.2.1: Reinstalling the MP200 Unit Using a Shorting Block Other than the EI SB-6TC

1. Place the MP200™ unit in the desired location over the mounting holes.
2. Insert and tighten all 4 mounting screws.
3. Connect the Ground wire to the stud on the MP200™ unit and tighten the nut to 8.8 in-lb (1 N-m) (see Figure 4.2: MP200™ Unit Connections, on page 4-5).
4. Connect the current inputs to the MP200™ unit as per the locations marked on the wires or recorded.
5. Tighten nuts to 8.8 in-lb (1 N-m).
6. Insert all connectors into the MP200 unit.
7. Remove the short from all the ungrounded sides of all the CTs.
8. Apply power to the meter and energize all circuits.
9. Verify correct operation of the MP200™ unit.

5: Communicating with the Meter

5.1: MP200 Metering System Communication

The MP200™ metering system provides three independent Communication ports.

The first port, Com 1, is an RS485 port speaking Modbus ASCII or Modbus RTU. This port also has an optional Ethernet/WiFi that supports both RJ45 and wireless Ethernet and that uses Modbus TCP protocol. The MP200™ unit has a switch that enables either the standard RS485 or optional Ethernet for Port 1.

The second port, Com 2, provides USB serial connection.

The third port, Com3, is an RS485 port. It can be used for the optional display (see Chapter10: Using the Optional Display, on page 10-1).

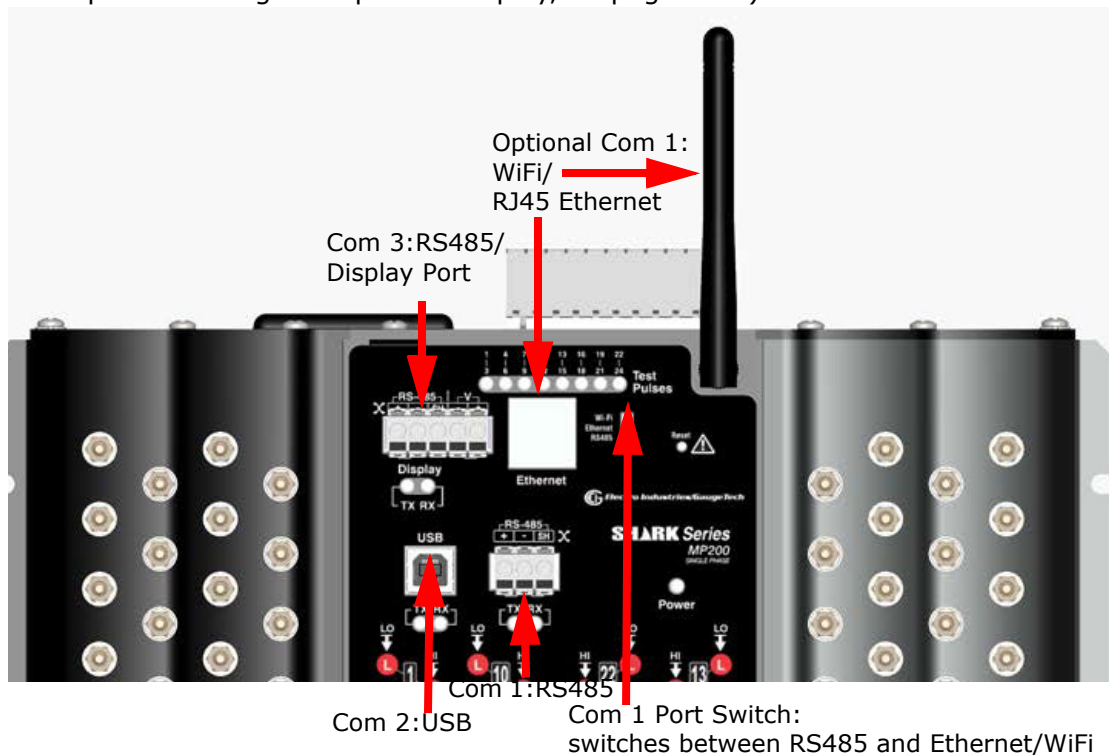

Figure 5.1: MP200™ Unit Communication Ports

NOTE: If the installation requires that the WiFi antenna be remotely located, a 50 Ohm coaxial cable (approved for use at 2.4 GHz) with M/F SMA connectors shall be used. Make the cable as short as possible (maximum 20 foot, 6.1 m) to avoid losing too much power.

5.1.1: RS485 / Ethernet and WiFi (Com 1)

Com 1 provides RS485 standard and optional Ethernet/WiFi communication.

It supports Modbus RTU/ASCII/TCP. The RJ45 port and the WiFi antenna will be present if this option was ordered. If you did not order the option, they will not be present.

The following sections explain the RS485 configuration in detail. Refer to Chapter 8 for the Ethernet/WiFi configuration. Note that there are Transmission (TX) and Receiving (RX) LED indicators under the RS485 port. These lights also work with the Ethernet option, if it is being used.

NOTE: Com 3 also provides RS485 communication - see 5.1.4: RS485/Display Port (Com 3), on page 5-7.

5.1.2: RS485 Communication

RS485 allows you to connect one or multiple MP200™ units to a PC or other device, at either a local or remote site. All RS485 connections are viable for up to 4000 feet (1219.20 meters).

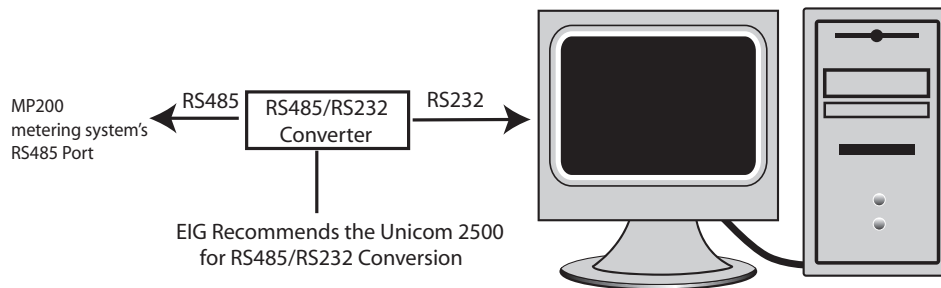

Figure 5.2: MP200™ Unit Connected to a PC via RS485 bus

As shown in Figure 5.2, to connect an MP200™ unit to a PC using RS485 communication, you need to use an RS485 to RS232 converter, such as EIG's Unicom 2500. See 5.1.2.1: Using the Unicom 2500, on page 5-5, for information on using the Unicom 2500 with the MP200™ unit.

Figure 5.3 shows the detail of a 2-wire RS485 connection.



Figure 5.3: 2-wire RS485 Connection

NOTES:

For All RS485 Connections:

- Use a shielded twisted pair cable and ground the shield, preferably at one location only.
- Establish point-to-point configurations for each device on an RS485 bus: connect (+) terminals to (+) terminals; connect (-) terminals to (-) terminals.
- You may connect up to 31 devices on a single bus using RS485. Before assembling the bus, each device must have a unique address: refer to Chapter 10 in the *CommunicatorPQA®*, *MeterManagerPQA®*, and *EnergyPQA.com® Software User Manual*. You can download this manual at:
<http://www.electroind.com>
- Protect cables from sources of electrical noise.
- Avoid both "Star" and "Tee" connections (see Figure 5.5: Incorrect "T" and "Star" Topologies, on page 5-4).
- No more than two cables should be connected at any one point on an RS485 network, whether the connections are for devices, converters, or terminal strips.
- Include all segments when calculating the total cable length of a network. If you are not using an RS485 repeater, the maximum length for cable connecting all devices is 4000 feet (1219.20 meters).
- Connect shield to RS485 Master and individual devices as shown in Figure 5.4: RS485 Daisy Chain Connection, on page 5-4. You may also connect the shield to earth-ground at one point.
- Termination Resistors (RT) may be needed on both ends for longer length transmission lines. When they are used, the value of the Termination Resistors is determined by the electrical parameters of the cable.

Figure 5.4 shows a representation of an RS485 Daisy Chain connection. Refer to 5.1.2.1: Using the Unicom 2500, on page 5-5 for details on RS485 connection for the Unicom 2500.

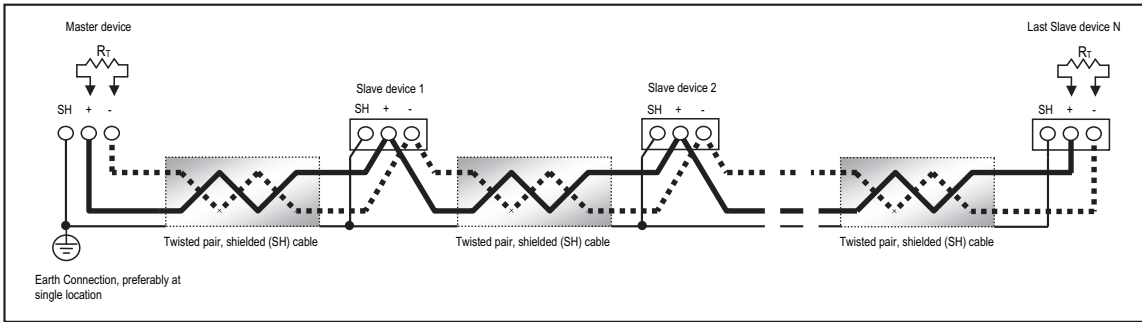

Figure 5.4: RS485 Daisy Chain Connection

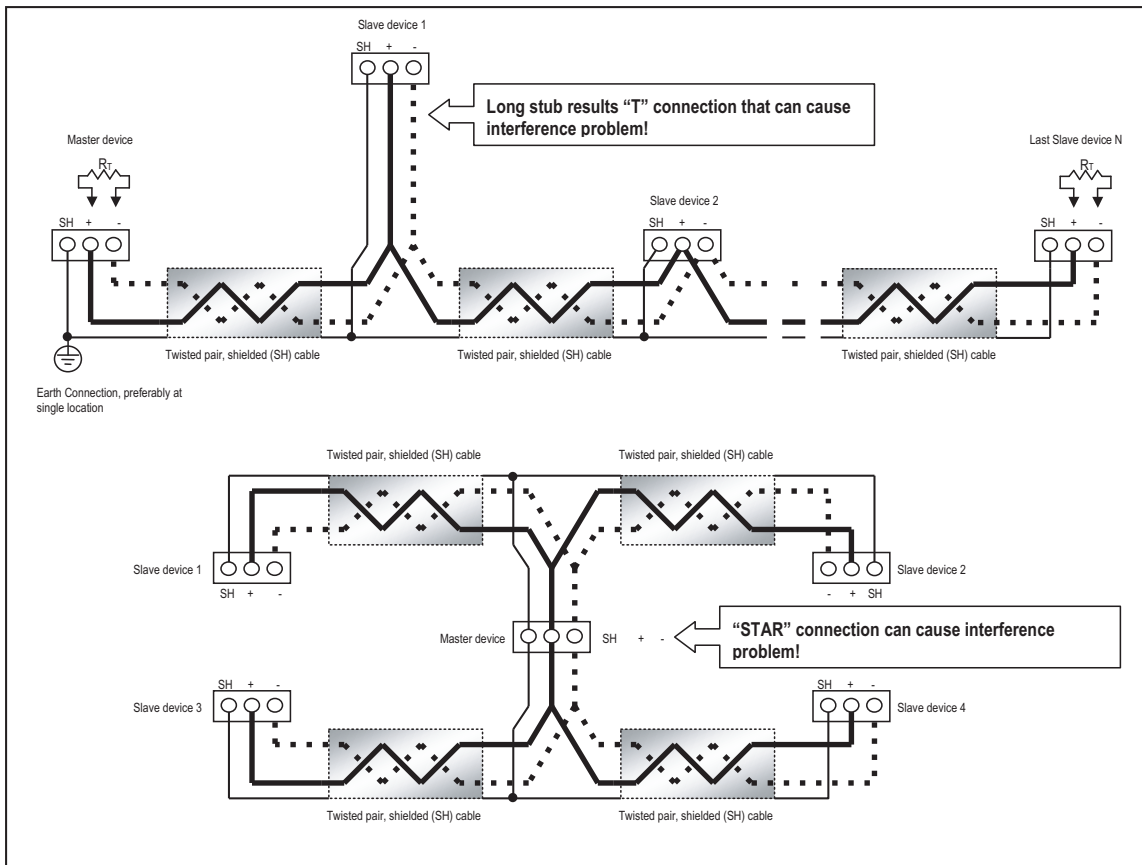

Figure 5.5: Incorrect "T" and "Star" Topologies

5.1.2.1: Using the Unicom 2500

The Unicom 2500 provides RS485/RS232 and Fiber Optic/RS232 conversion. In doing so it allows an MP200™ unit with RS485 communication to communicate with a PC. See the *Unicom 2500 Installation and Operation Manual* for additional information.

You can order the Unicom 2500 and the recommended communication cable for it from EIG's webstore: www.electroind.com/store. From the left side of the webpage, select Communication Products for the Unicom 2500 and Cables and Accessories for the RS485 4-wire to 2-wire cable. Figure 5.6 illustrates the Unicom 2500 connections for RS485.

NOTE: We recommend you use EIG's 4-wire to 2-wire communication cable so you do not have to use jumper wires.

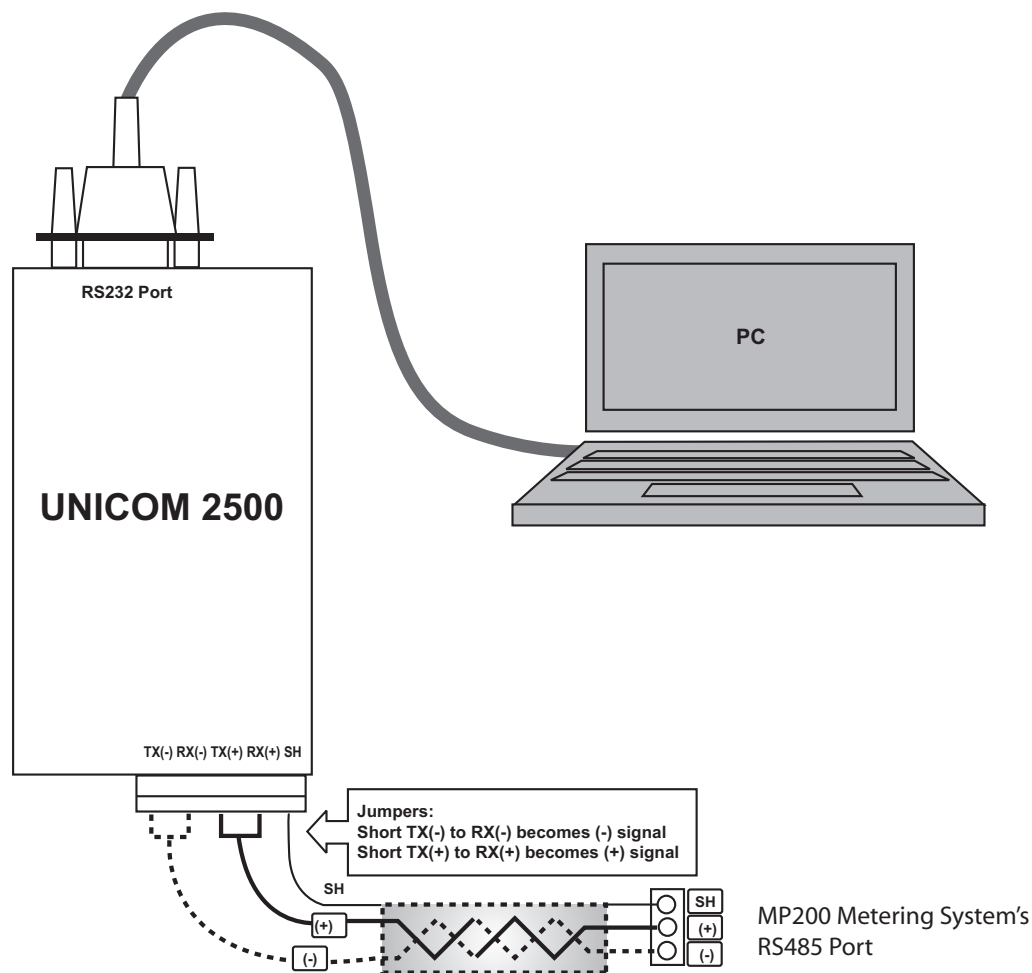

Figure 5.6: Unicom 2500 with Connections

The Unicom 2500 can be configured for either 4-wire or 2-wire RS485 connections. Since the MP200™ unit uses a 2-wire connection, **unless you are using the RS485 4-wire to 2-wire communication cable available from EIG's online store**, you will need to add jumper wires to convert the Unicom 2500 to the 2-wire configuration. As shown in Figure 5.6, you connect the "RX-" and "TX-" terminals with a jumper wire to make the "-" terminal, and connect the "RX+" and "TX+" terminals with a jumper wire to make the "+" terminal. See the figure on the right for the Unicom 2500's settings. The Unicom's baud rate must match the baud rate of the MP200™ unit's RS485 port: you set the baud rate by turning the screw to point at the rate you want.

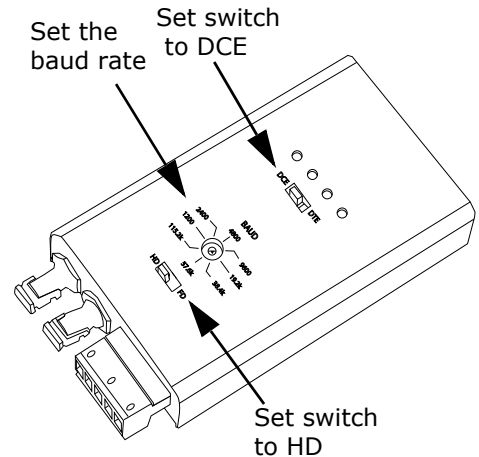

Figure 5.7: Unicom 2500 Settings

5.1.3: USB Port (Com 2)

The MP200™ unit's Com 2 USB port allows it to communicate with a computer that has a USB 1.1 or USB 2.0 Host port. The MP200™ unit's USB port is configured to operate as a virtual serial communication channel that the PC sees as a simple COM port. The USB virtual serial communication channel:

- Is compatible with standard USB cables that terminate with a USB Type B plug (see Figure 5.8)
- The maximum length of the USB cable is 5 meters. Greater lengths require hubs or active extension cables (active repeaters).



Figure 5.8: USB Type B Plug

If you are using a PC with the Windows® 7 (or later) Operating System, connect the USB cable from your PC to the unit's USB port on the front panel. The Windows® 7 Operating System will install a driver for you. For earlier operating systems, EIG provides a driver for PC compatible computers. The driver configures the computer's USB

Host port as a virtual serial port compatible with the MP200™ unit's USB device port. See Appendix A for instructions on installing the driver.

The MP200™ unit's USB port settings are:

Address: 1

Protocol: Modbus ASCII

Baud rate: 57600 bps

Note that there are Transmission (TX) and Receiving (RX) LED indicators under the port.

The Virtual Com Port (USB serial port) settings are:

Bits per second: 57600

Data bits: 8

Parity: None

Stop bits: 1

Flow control: None

5.1.4: RS485/Display Port (Com 3)

This port supports RS485 communication, and can be used for the optional display - see Chapter 10 for instructions. (Note that the voltage connections ($\pm V$) also on this port are not currently used.) There are Transmission (TX) and Receiving (RX) LED indicators under the port.

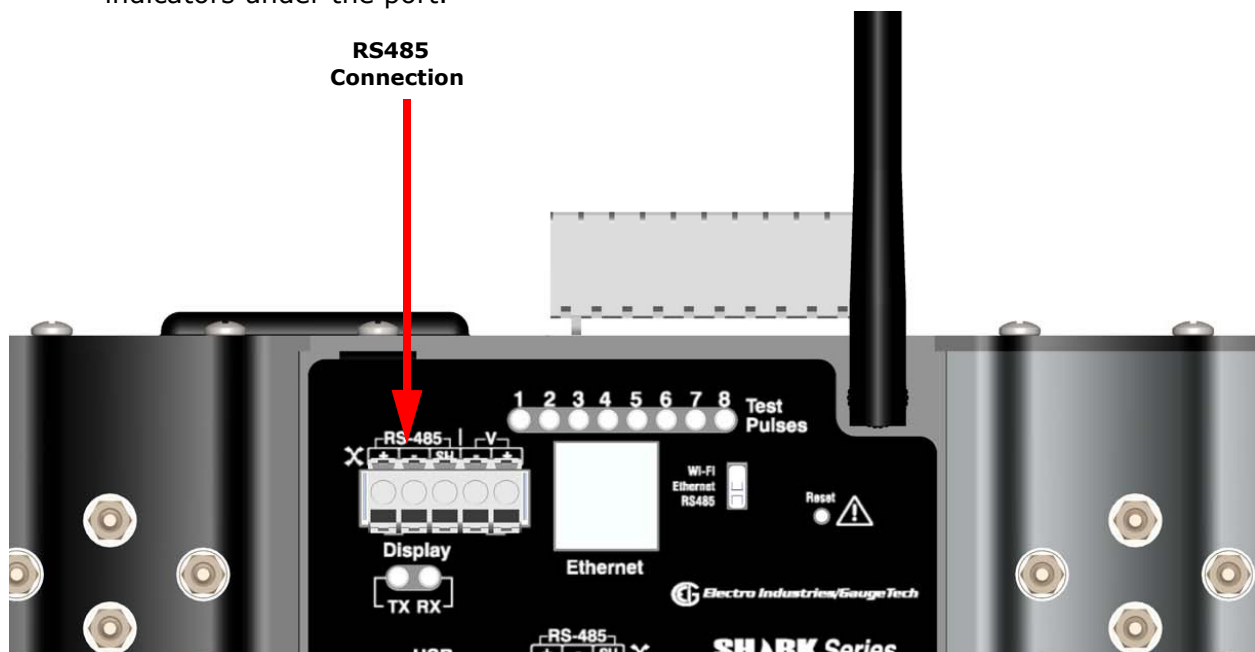

Figure 5.9: Com 3 RS485/Display Port

To use Com 3, connect the communication wires of the supplied RS485 cable to the MP200™ unit's Com 3 port - see Figure 5.9. Set the port's baud rate to 9600, address to 1, protocol to Modbus RTU or Modbus ASCII and mode to Slave using the communication software.

RS485 communication is viable for up to 4000 feet (1219 meters). Be sure to do the following (see Section 5.1.2 for additional information on RS485 communication):

1. Connect the shield to the shield (S) terminal on the other device's port. The (S) terminal on the MP200™ unit is used to reference its port to the same potential as the source. Connect the shield to protective earth-ground at one point.
2. Provide termination resistors at each end, connected to the + and - lines. RT is approximately 120 Ohms.

5.2: MP200 Metering System Communication and Programming Overview

Only the basic MP200™ metering system's Device Profile settings are explained in this manual. Refer to Chapter 10 in the *CommunicatorPQA®*, *MeterManagerPQA®*, and *EnergyPQA.com® Software User Manual* for detailed instructions on configuring all settings of the MP200™ metering system's Device Profile. You can download this manual at:

<https://www.electroind.com/products/communicatorpqa-power-monitoring-software/>

You can also view the manual online by clicking **Help>Contents** from the CommunicatorPQA® Main screen.

5.2.1: Connecting to the MP200 Unit through CommunicatorPQA® Software

How to Connect:

1. Open the CommunicatorPQA® software.
2. Click the **Connect** icon in the Icon bar.

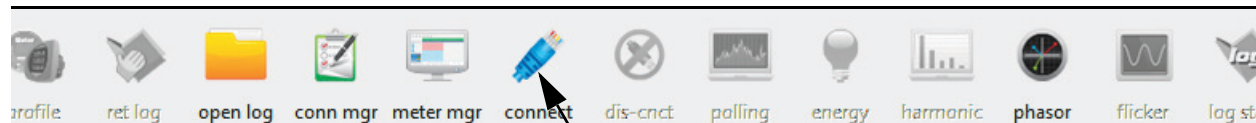

Connect Icon

3. You can connect to the MP200™ unit using RS485, Ethernet, or the USB port (for Ethernet connection, the Ethernet/WiFi option must be installed). See the screens below.

Connect

Serial Port Network

Device Address 1

Baud Rate 9600

Available Ports All Ports

Port COM1

Protocol Modbus RTU

Flow Control None

Echo Mode No Echo

Parity None

Connect Cancel Help

RS485
connection

Connect

Serial Port Network

Device Address 1

Baud Rate 57600

Available Ports All Ports

Port COM3 (USB Serial Port (COM3))

Protocol Modbus ASCII

Flow Control None

Echo Mode No Echo

Parity None

Connect Cancel Help

USB
connection

Connect

Serial Port Network

Device Address 1

Host 172.20.167.100

Network Port 502

Protocol Modbus TCP

Connect Cancel Help

Ethernet
connection

4. Click the **Connect** button. You will see the Device Status screen, confirming connection to the MP200™ unit. Click **OK**.

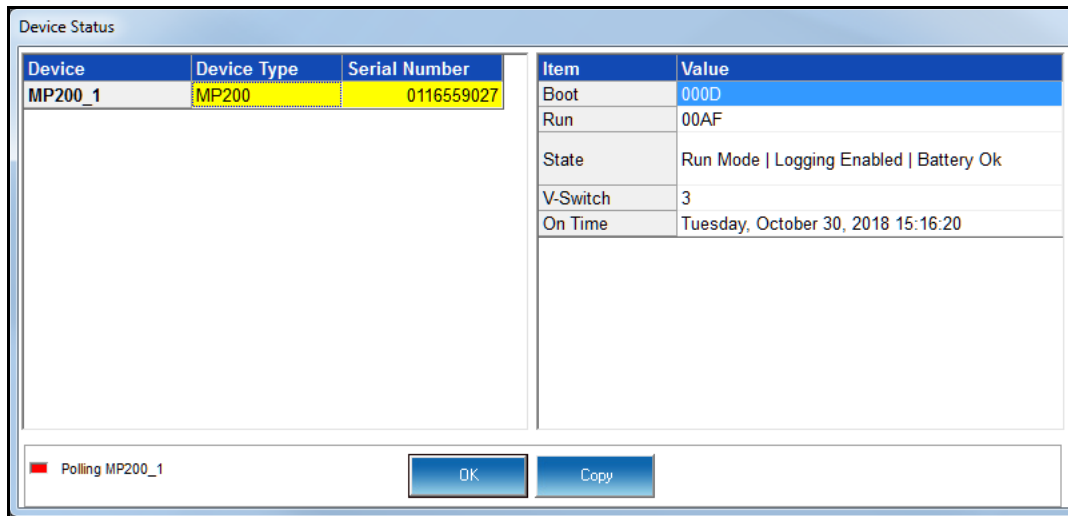

The fields on the right of the screen give you information about the connected MP200™ unit:

- **Boot:** the version of the Boot firmware the meter currently has.
- **Run:** the version of the Runtime firmware the meter currently has.
- **State:** information about the meter, e.g., shown above Run Mode, Logging Enabled, Battery OK means that the meter is running, logging is enabled for the meter, and the meter battery has sufficient operating power.
- **V-Switch:** the number of the V-Switch™ key currently installed in the meter.
- **On Time:** the date and time the meter was last powered on.

5. Click the **Profile** icon in the Title Bar.

6. You will see the MP200™ metering system's Device Profile screen. The menu on the left side of the screen lets you navigate between Settings screens (see screens on next page).

NOTE: The settings you see on the first screen depend on your MP200™ unit's circuit configuration.

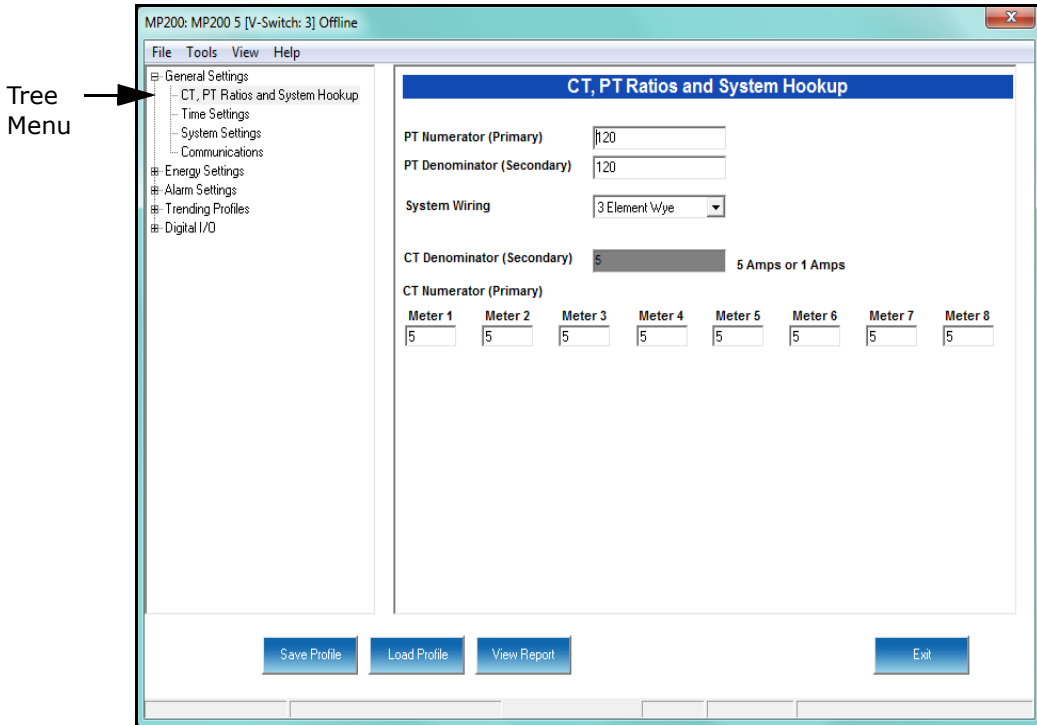

MP200 Unit with Three Phase Configuration - MP200-Y

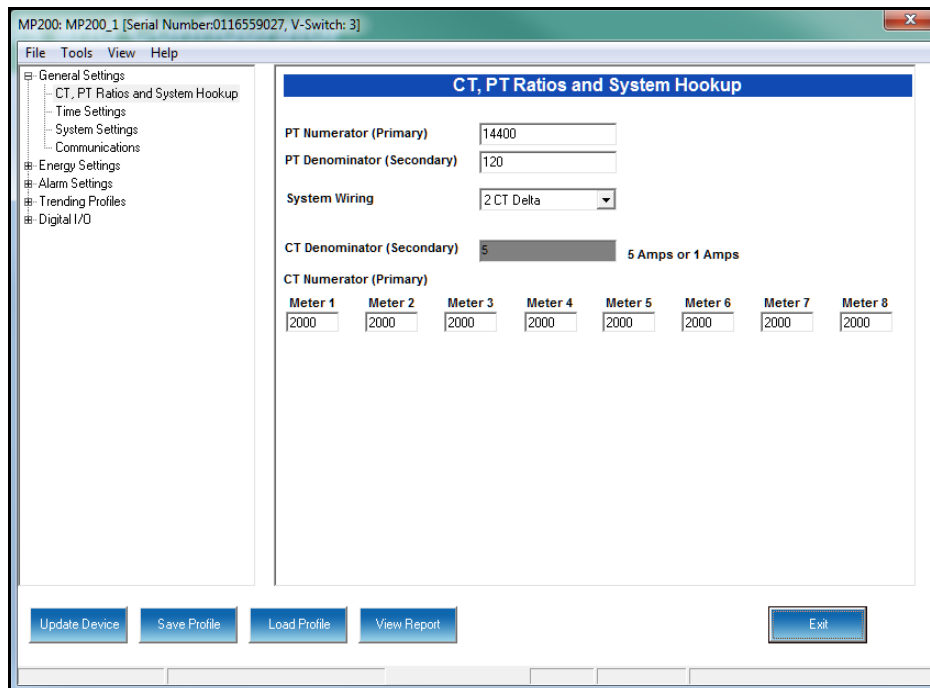

MP200 Unit with Three Phase Configuration - MP200-Y: 2 CT Delta

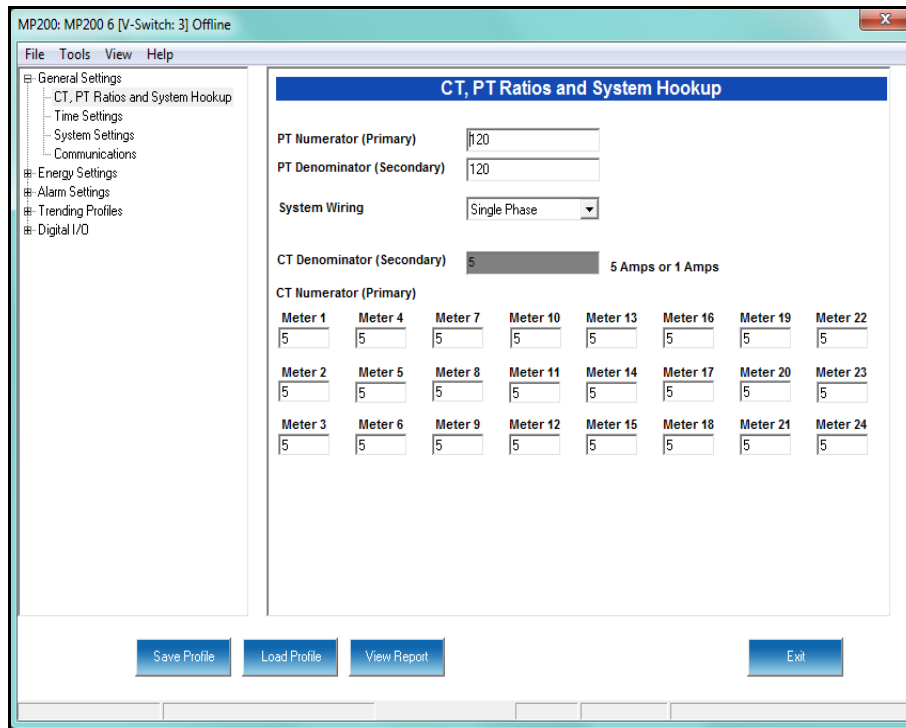

MP200 Unit with Single Phase Configuration - MP200-S

NOTE: See 5.2.1.1: Additional MP200 Unit Device Profile Settings, on page 5-15, for instructions on using the screens shown above and on the previous page.

7. Click **Communications**. You will see the screen shown below. Use this screen to enter communication settings for the MP200™ unit's communications ports.

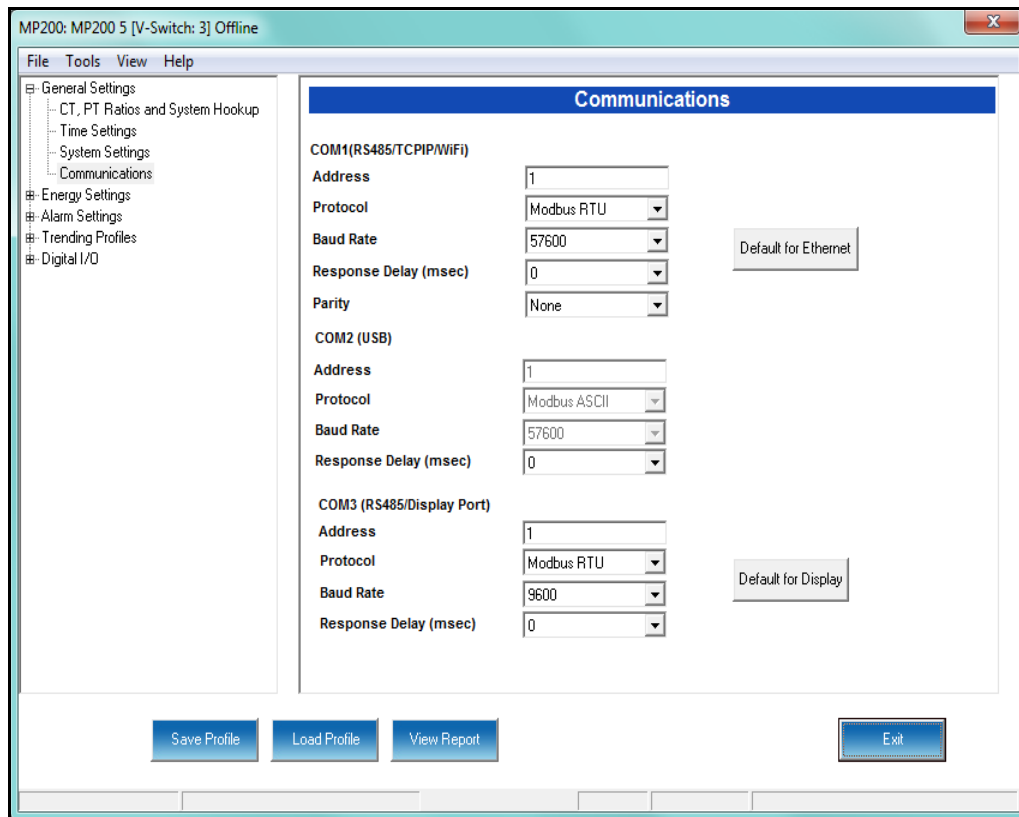

Valid Communication Settings are as follows:

COM 1: RS485/ Ethernet/WIFI (optional)

Address: 1-247

Baud Rate: 9600, 19200, 38400, 57600 (For WiFi/Ethernet, only 57600)

Protocol: Modbus RTU/ASCII (For WiFi/Ethernet, only Modbus RTU)

Response Delay: 0-750ms

Parity: Odd, Even or None

COM 2: USB port

Protocol: MODBUS ASCII

Baud Rate: 57600

Address: 1

NOTE: The USB port settings are fixed, i.e., they cannot be changed.

COM 3: RS485/Display Port

Address: 1-247

Protocol: Modbus RTU/ASCII

Baud Rate: 9600, 19200, 38400, 57600

Response Delay: 0-750ms

NOTE: Click the (1)Default to Ethernet or (2)Default to Display button to set either the (1)Ethernet settings for COM1 or (2)Display settings for COM3, to their default values.

See Chapter 10 in the *CommunicatorPQA®*, *MeterManagerPQA®*, and *EnergyPQA.com® Software User Manual*. You can download this manual at: <https://electroind.com>

8. When changes are complete, click the **Update Device** button to send a new profile to the meter.
9. Click **Exit** to leave the Device Profile or click other menu items to change other aspects of the Device Profile (see the following section for instructions).

5.2.1.1: Additional MP200 Unit Device Profile Settings

CT, PT Ratios and System Hookup

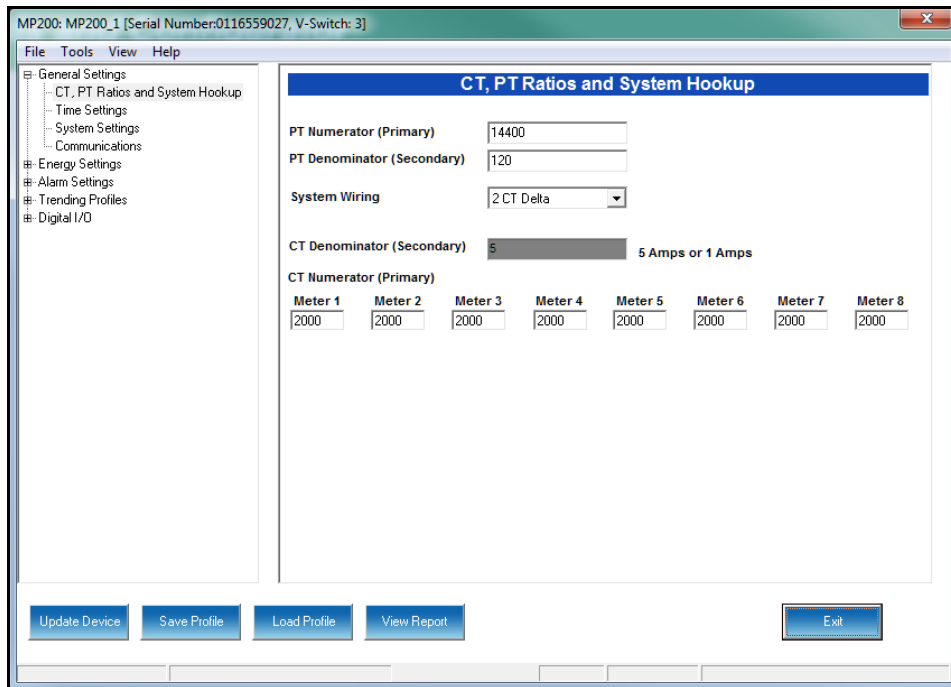
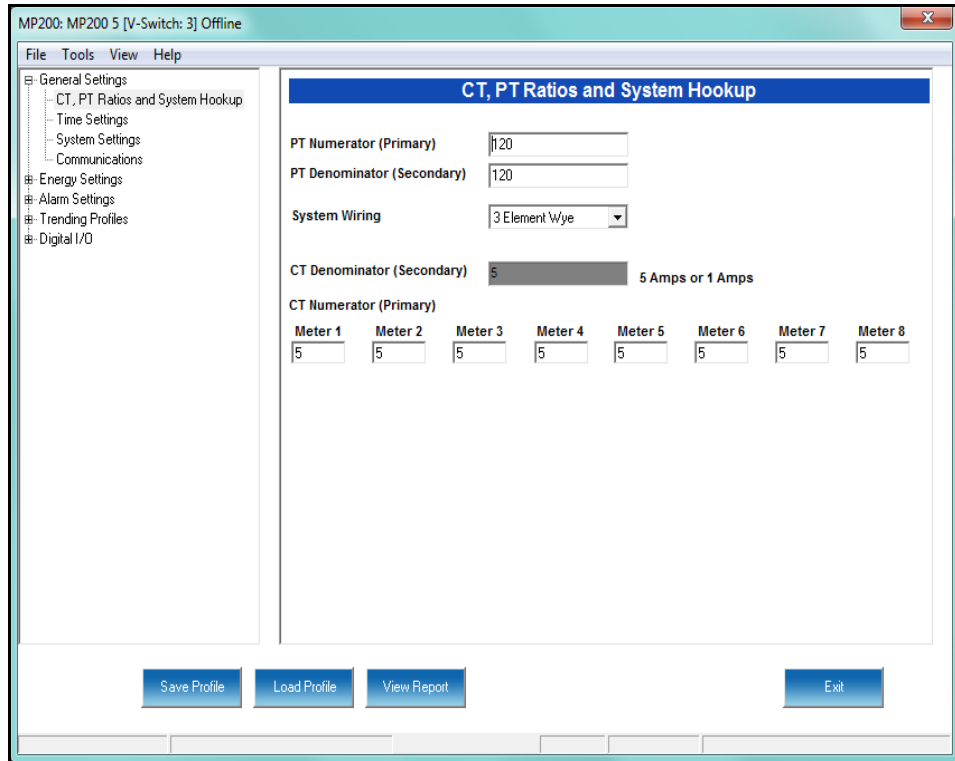

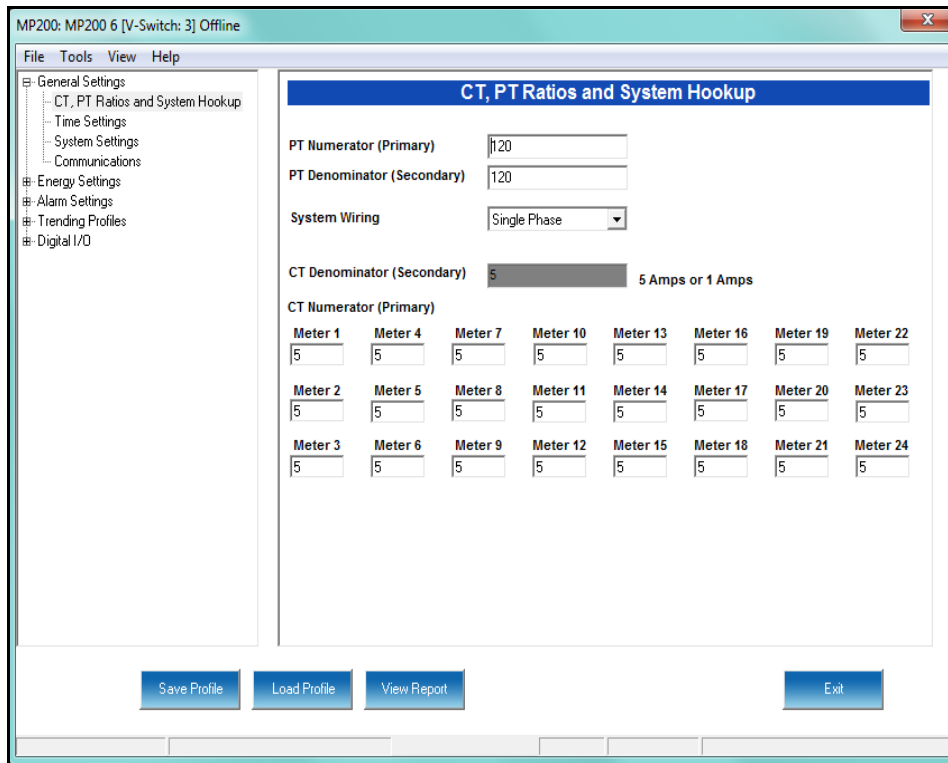

Note that the settings you see on the screen depend on your MP200™ unit's circuit configuration. The top screen on the previous page is for an MP200™ unit with the three phase Wye circuit configuration; the bottom screen is for an MP200™ unit with the three phase 2 CT Delta circuit configuration, and the screen on this page is for an MP200™ unit with the single phase circuit configuration.

The settings for this screen are as follows:

PT Ratios

PT Numerator (Primary): 1 - 99999999

PT Denominator (Secondary): 40 - 65535

System Wiring

3 Element Wye; Single Phase; 2 CT Delta

CT Ratios

CT Numerator (Primary): 1 - 65535

CT Denominator (Secondary): 5 or 1 Amp, depending on the MP200™ unit's ordered option. This field is display only - it cannot be changed.

Example Settings:

For a system that has 14400V primary with a 120V secondary line to neutral (PT Ratio of 120:1), set the following PT Ratios in the entry fields:

PT Numerator (Primary): 14400

PT Denominator (Secondary): 120

For a CT of 2000/5A, set the following:

CT Numerator (Primary): 2000

Energy, Power Scaling, and Averaging Method

The screenshot shows the 'Energy, Power Settings, and Averaging Method' configuration window in the MP200 software. The window title is 'MP200: MP200 6 [V-Switch: 3] Offline'. The interface includes a menu bar (File, Tools, View, Help) and a tree view on the left with the following items: General Settings, CT, PT Ratios and System Hookup, Time Settings, System Settings, Communications, Energy Settings, Energy, Power Settings, and Averaging, Alarm Settings, Trending Profiles, and Digital I/O. The main configuration area is divided into three sections:

- Energy Settings:** Energy Digits (8), Energy Decimal Places (2), Energy Scale (Kilo (k)). A note states 'Settings apply to all meters in CPU' with an example: 'Example: 999999.99 kWh'.
- Power Settings:** Apparent Power (VA) Calculation Method (Arithmetic Sum), Power Direction (View as load), Flip Power Factor Sign (No), and Watts Direction (Unidirectional selected, Bidirectional unselected).
- Demand Averaging:** Type (Block), Interval (Minutes) (15).

At the bottom of the window are buttons for 'Save Profile', 'Load Profile', 'View Report', and 'Exit'.

The screen fields and acceptable entries are as follows:

Energy Settings

Energy Digits: 5; 6; 7; 8

Energy Decimal Places: 0 - 6

Energy Scale: unit; kilo (K); Mega (M)

Example: a reading for Digits: 8; Decimals: 3; Scale: K would be formatted as

00123.456k

Power Settings

Apparent Power (VA) Calculation Method: Arithmetic Sum; Vector Sum

Power Direction: View as Load; View as Generator

Flip Power Factor Sign: No; Yes

Watts Direction: Unidirectional; Bidirectional

Demand Averaging

Type: Block or Rolling

Interval (Block demand) or Sub-Interval (Rolling demand) in minutes: 5; 15; 30; 60

Number of Subintervals: 1; 2; 3; 4

Interval Window: This field is display only. It is the product of the values entered in the Sub-Interval and Number of Subintervals fields.

NOTE: You will only see the Number of Subintervals and Interval Window fields if you select Rolling Demand.

System Settings

MP200: MP200 5 [V-Switch: 3] Offline

File Tools View Help

- General Settings
 - CT, PT Ratios and System Hookup
 - Time Settings
 - System Settings
 - Communications
- Energy Settings
- Alarm Settings
- Trending Profiles
- Digital I/O

System Settings

Data Protection

Require password for resetting items Yes No

Require password for configuration Yes No

Change Password

CPU Identifier (Main Unit)

Meter Names

Meter 1	<input type="text" value="Meter 1"/>	Meter 5	<input type="text" value="Meter 5"/>
Meter 2	<input type="text" value="Meter 2"/>	Meter 6	<input type="text" value="Meter 6"/>
Meter 3	<input type="text" value="Meter 3"/>	Meter 7	<input type="text" value="Meter 7"/>
Meter 4	<input type="text" value="Meter 4"/>	Meter 8	<input type="text" value="Meter 8"/>

Save Profile Load Profile View Report Exit

MP200: MP200 6 [V-Switch: 3] Offline

File Tools View Help

- General Settings
 - CT, PT Ratios and System Hookup
 - Time Settings
 - System Settings
 - Communications
- Energy Settings
- Alarm Settings
- Trending Profiles
- Digital I/O

System Settings

Data Protection

Require password for resetting items Yes No

Require password for configuration Yes No

Change Password

CPU Identifier (Main Unit)

Meter Names

Meter 1	<input type="text" value="Meter 1"/>	Meter 13	<input type="text" value="Meter 13"/>
Meter 2	<input type="text" value="Meter 2"/>	Meter 14	<input type="text" value="Meter 14"/>
Meter 3	<input type="text" value="Meter 3"/>	Meter 15	<input type="text" value="Meter 15"/>
Meter 4	<input type="text" value="Meter 4"/>	Meter 16	<input type="text" value="Meter 16"/>
Meter 5	<input type="text" value="Meter 5"/>	Meter 17	<input type="text" value="Meter 17"/>
Meter 6	<input type="text" value="Meter 6"/>	Meter 18	<input type="text" value="Meter 18"/>
Meter 7	<input type="text" value="Meter 7"/>	Meter 19	<input type="text" value="Meter 19"/>
Meter 8	<input type="text" value="Meter 8"/>	Meter 20	<input type="text" value="Meter 20"/>
Meter 9	<input type="text" value="Meter 9"/>	Meter 21	<input type="text" value="Meter 21"/>
Meter 10	<input type="text" value="Meter 10"/>	Meter 22	<input type="text" value="Meter 22"/>
Meter 11	<input type="text" value="Meter 11"/>	Meter 23	<input type="text" value="Meter 23"/>
Meter 12	<input type="text" value="Meter 12"/>	Meter 24	<input type="text" value="Meter 24"/>

Save Profile Load Profile View Report Exit

Note that the settings you see on the System Settings screen depend on your MP200™ unit's circuit configuration. The top screen on the previous page is for an MP200™ unit with the three phase circuit configuration, either Wye or Delta. That configuration has eight meters. The bottom screen is for an MP200 unit with a single phase configuration, which has 24 meters.

From this screen, you can do the following:

- Enable or disable password for Reset (reset max/min Energy settings, Energy accumulators, and the individual logs) and/or Configuration (Device profile): click the radio button next to Yes or No.

NOTES:

- If you enable a password for reset, you must also enable it for configuration.
- The MP200 unit's default is password disabled.
- Enabling Password protection prevents unauthorized tampering with devices. When a user attempts to make a change that is under Password protection, CommunicatorPQA® software opens a screen asking for the password. If the correct password is not entered, the change does not take place.

IMPORTANT! You must set up a password before enabling Password protection. Click the **Change Password** button if you have not already set up a password.

- Change the Password: click the **Change Password** button. You will see the Enter the New Password screen, shown below.

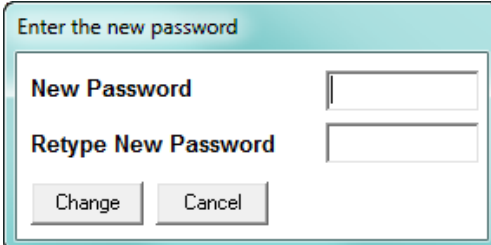

1. Type in the new password (0 - 9999).
2. Retype the password.
3. Click **Change**. The new password is saved and the MP200™ unit restarts.

NOTE: If Password protection has already been enabled for configuration and you attempt to change the password, you will see the Enter Password screen

after you click **Change Password**. Enter the old password and click **OK** to proceed with the password change.

- Change the MP200™ metering system's identification label: input a new label for the MP200™ unit into the CPU Identifier field.
- Enter a name for the eight meters in a three phase circuit configuration, or the 24 meters in a single phase circuit configuration, so that you can easily identify each meter's information. These names are used throughout the software, e.g., in the logging and polling screens.

For example, if you have a shopping mall with 8 stores, each having a three phase system that is attached to the MP200-Y, you can name the meters Store 1 - Store 8, to identify each meter with its store. Then when you look at the polling screens or logging screens, you can easily identify each store's data, without needing to check the circuit configuration.

Limits

Limits are transition points used to separate acceptable and unacceptable measurements. When a value goes above or below the limit, an out-of-limit condition occurs. Once they are configured, you can view the out-of-limits (or alarm) conditions in the Limits log or Limits polling screen. You can also use limits to trigger relays.

Limit ID	Assigned Limit (Double Click to Edit)	Setting	Setpoint		Return Hysteresis		Full Scale
			% of Fullscale	Primary	% of Fullscale	Primary	
1	Voltage A-N	Above	110.0	132.00	110.0	132.00	120.00
		Below	90.0	108.00	90.0	108.00	
2	Voltage B-N	Above	110.0	132.00	110.0	132.00	120.00
		Below	90.0	108.00	90.0	108.00	
3	Voltage C-N	Above	110.0	132.00	110.0	132.00	120.00
		Below	90.0	108.00	90.0	108.00	
4	Frequency	Above	102.0	61.20	102.0	61.20	60.00
		Below	98.0	58.80	98.0	58.80	
5	Not Assigned	Above					
		Below					
6	Not Assigned	Above					
		Below					
7	Not Assigned	Above					
		Below					
8	Not Assigned	Above					
		Below					

Buttons at the bottom: Save Profile, Load Profile, View Report, Exit.

The current settings for limits are shown in the screen. You can set and configure up to eight limits for the MP200™ unit. To set up a limit:

1. Select a limit by double-clicking on the Assigned Channel field.

2. You will see the screen shown below.

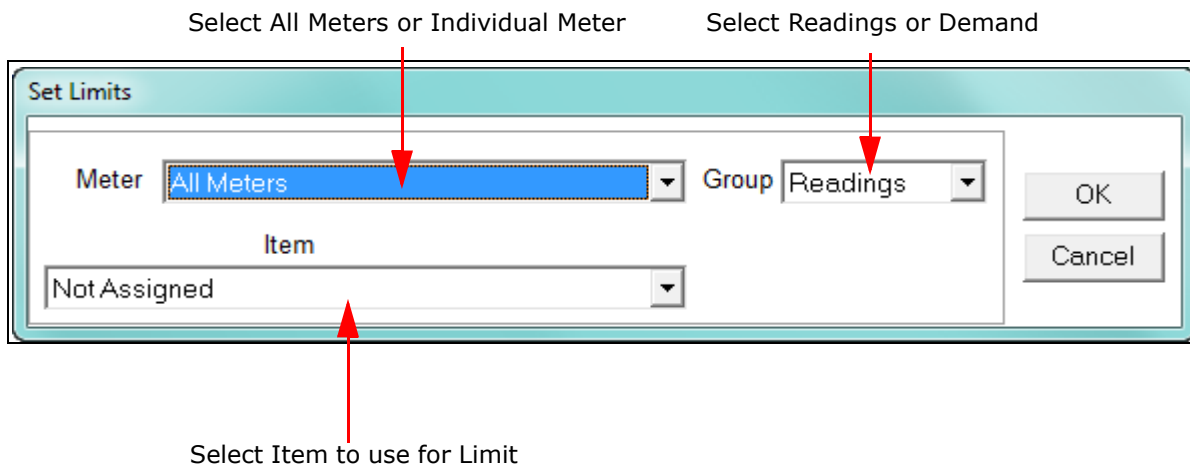

This screen lets you configure the limits. The settings you can make depend on your MP200™ unit's configuration:

- For a three phase configuration, you can set up limits from the Readings group's items for all meters or any individual meter (select from the Meter pull-down menu).

The items you can select for Readings limits for All Meters are: Phase to Neutral voltage, Phase to Phase Voltage, and Frequency.

The items you can select for Reading limits for individual meters are: Current phases A, B, and C, Total Watts, Total VAR, Total VA, Total PF, Current Neutral, Watts per Phase, VAR per Phase, VA per Phase, and PF per Phase.

The Demand group (select from the Group pull-down menu) can only have limits set for individual meters (not All Meters).

The items you can select for Demand limits are: Current phases A, B, and C, Total +Watts, Total +VAR, Total -Watts, Total -VAR, Total VA, Total +PF, Total -PF, +Watts per Phase, -Watts per Phase, +VAR per Phase, -VAR per Phase, VA per Phase, + PF per Phase, and -PF per Phase.

- For a single phase configuration, you can set up limits from the Readings group's items for All meters or any individual meter (select from the Meter pull-down menu).

The Items you can select for Readings limits for All Meters are: Voltage and Frequency.

The items you can select for Reading limits for individual meters are: Current, Watts, VAR, VA, and PF.

The Demand group (select from the Group pull-down menu) can only have limits set for individual meters (not All Meters).

The items you can select for Demand limits are: Current, +Watts, +VAR, -Watts, -VAR, VA, +PF, and -PF.

Click **OK**. The limit item you selected is displayed in the Limit field.

Example Limit:
Frequency for
Meter 4

← Setting Fields for the Limit →

Limits							
Limit ID	Assigned Limit (Double Click to Edit)	Setting	Setpoint		Return Hysteresis		Full Scale
			% of Fullscale	Primary	% of Fullscale	Primary	
1	Voltage A-N	Above	110.0	132.00	110.0	132.00	120.00
		Below	90.0	108.00	90.0	108.00	
2	Voltage B-N	Above	110.0	132.00	110.0	132.00	120.00
		Below	90.0	108.00	90.0	108.00	
3	Voltage C-N	Above	110.0	132.00	110.0	132.00	120.00
		Below	90.0	108.00	90.0	108.00	
4	Frequency	Above	102.0	61.20	102.0	61.20	60.00
		Below	98.0	58.80	98.0	58.80	

3.To configure a limit, double-click on the field to set the following values:

- **Above and Below Setpoint:** % of Full Scale (the point at which the reading goes out of limit)

Examples:

100% of 120V Full Scale = 120V

90% of 120V Full Scale = 108V

- **Above and Below Return Hysteresis:** the point at which the reading goes back within limit (see figure below)

Examples:

Above Setpoint = 110%; Below Setpoint = 90%

(Out of Limit above 132V);(Out of Limit below 108V)

Above Return Hysteresis = 105%; Below Return Hysteresis = 95%

(Stay out of Limit until below 126V)(Stay out of Limit until above 114V)

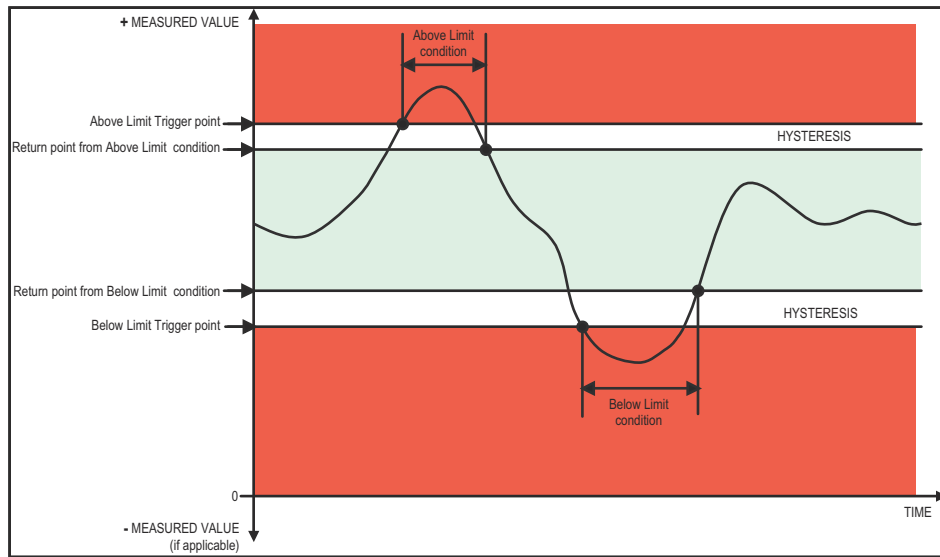

- **Primary Fields:** These fields are display only. They show what the setpoint and return hysteresis value are for each limit.

NOTES:

- If you are entering negative limits, be aware that the negative value affects the way the above and below limits function, since negative numbers are processed as signed values.
- If the Above Return Hysteresis is greater than the Above Setpoint, the Above Limit is Disabled; if the Below Return Hysteresis is less than the Below Setpoint, the Below Limit is Disabled. You may want to use this feature to disable either Above or Below Limit conditions for a reading.

Time Settings

Use this setting to enable or disable Daylight Savings Time for the MP200™ unit and to set the beginning and ending times for Daylight Savings Time.

From the Tree Menu, click **General Settings>Time Settings**.

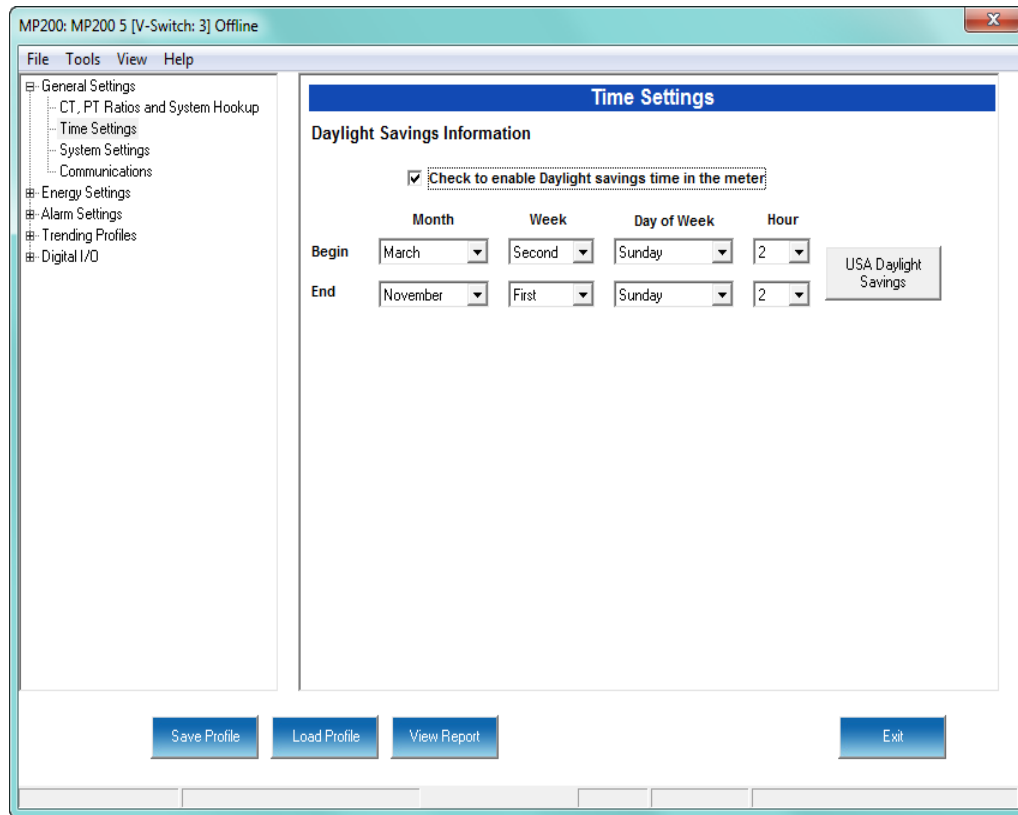

Check the box to enable Daylight Savings time, or un-check it to disable Daylight Savings Time.

Click the USA Daylight Savings button to fill the entry fields with the US DST beginning and ending times, or use the entry fields to manually set the start and end times for the Daylight Savings Time feature, if enabled.

NOTE: The Hour field uses a 24-Hour clock.

IMPORTANT! When you finish making changes to the Device Profile, click **Update Device** to send the new Device Profile settings to the connected MP200™ unit.

NOTE: Refer to Chapter 10 in the *CommunicatorPQA®*, *MeterManagerPQA®*, and *EnergyPQA.com® Software User Manual*. You can download this manual at:
<https://electroind.com>

This page intentionally left blank.

6: Using the MP200 Metering System's Watt-Hour Test Pulses

6.1: Overview

To be certified for revenue metering, power providers and utility companies must verify that a billing energy meter performs to the stated accuracy. To confirm the meter's performance and calibration, power providers use field test standards to ensure that the MP200 metering system's energy measurements are correct. Since the MP200 unit contains traceable revenue meters, it has utility grade test pulses that can be used to gate an accuracy standard. This is an essential feature required of all billing grade meters.

The MP200 unit has 8 Watt-hour test pulses. These pulses are located at the top of the MP200 unit. Each test pulse is set up to provide a visible red LED output that is proportional to the energy of each of the meters, as follows:

- For the MP200-Y unit, test pulses 1-8 are matched to the three phase meters 1-8.
- For the MP200-S unit with 24 single phase metering points, the pulses are shared, with three metering points being set up for each pulse. To test one of the metering points, you must be sure that no load is on the other two metering points assigned to the pulse.

See the following sections for details, examples, and procedures for using the test pulses. For information on the pulse specifications, see Chapter 2.

6.2: Performing Watt-Hour Accuracy Testing (Verification)

Table 6.1 shows the Wh/Pulse constants for accuracy testing.

Input Voltage Level	Class 10 Models	Class 2 Models
Below 150 V	0.125004444	0.025000889
Above 150 V	0.500017776	0.100003555

Table 6.1: LED Pulse Constants for Accuracy Testing - Kh Watt-hour per pulse

NOTE: Minimum pulse width is 90 milliseconds.

6.2.1: Examples

For the MP200-Y unit, use the test pulse assigned to each meter. For example, to verify meter 1, you would measure the pulses from test pulse 1. See the figure below.

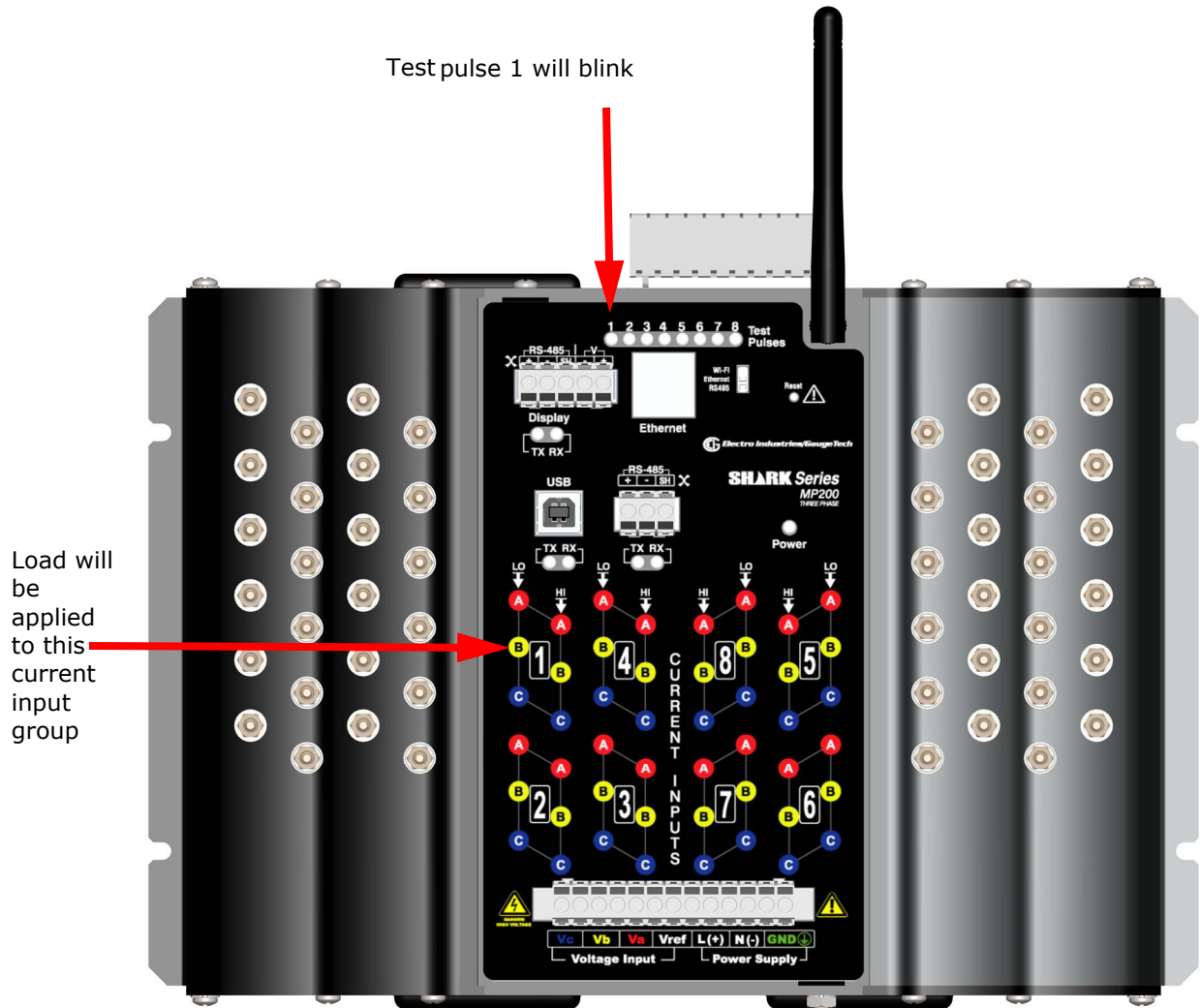

Figure 6.1: Meter 1 and Test Pulse 1 for MP200-Y Unit

NOTE: Each test pulse will work for the respective meter number. Be careful to test only one meter group at a time, because the light can “bleed,” affecting accuracy of pulse counts.

For the MP200-S unit, use the test pulse assigned to the metering point, **but be sure that there is no load on the other two metering points assigned to the test pulse.** So to measure meter 1, you would use test pulse 1, making sure that meters 2 and 3 had no load. See the figure below.

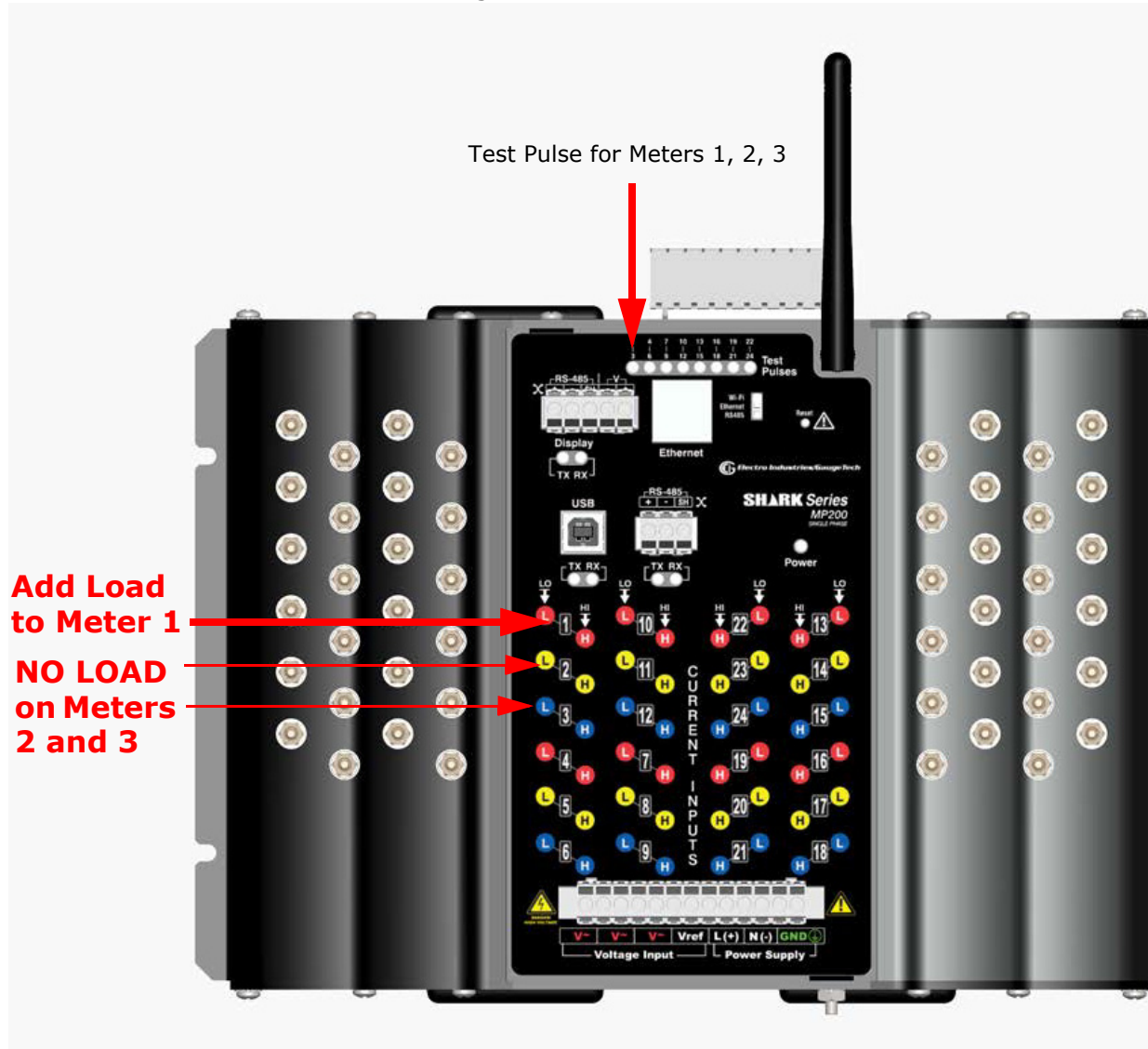

Figure 6.2: Meter 1 and Test Pulse 1 for MP200-S Unit: NO LOAD on Meters 2 and 3

If you want to measure meter 2, make sure that meters 1 and 3 have no load; and if you want to measure meter 3, make sure that meters 1 and 2 have no load.

NOTE: Make sure you measure only one meter at a time, because additional meters measured simultaneously will cause errors in pulse counts.

The table on the next page shows the meters that are associated with each of the test pulses.

Test Pulse 1	Test Pulse 2	Test Pulse 3	Test Pulse 4	Test Pulse 5	Test Pulse 6	Test Pulse 7	Test Pulse 8
Meter 1	Meter 4	Meter 7	Meter 10	Meter 13	Meter 16	Meter 19	Meter 22
Meter 2	Meter 5	Meter 8	Meter 11	Meter 14	Meter 17	Meter 20	Meter 23
Meter 3	Meter 6	Meter 9	Meter 12	Meter 15	Meter 18	Meter 21	Meter 24

Table 6.2: Test Pulses and Their Single Phase Meters - MP200-S

6.2.2: Kh Testing Procedure

As mentioned earlier, the MP200 unit is equipped with eight light pulse outputs, each of which generates one pulse when a defined unit of energy is measured by the meter. The defined unit of energy is given as Kh (Pulse Constant) times "1 kilowatt-hour." The Pulse Constants are given in Table 6.1 and are printed on the MP200 unit's serial number label next to "Kh-TV<150V" and "Kh-TV>150V."

The diagram below shows a typical test setup:

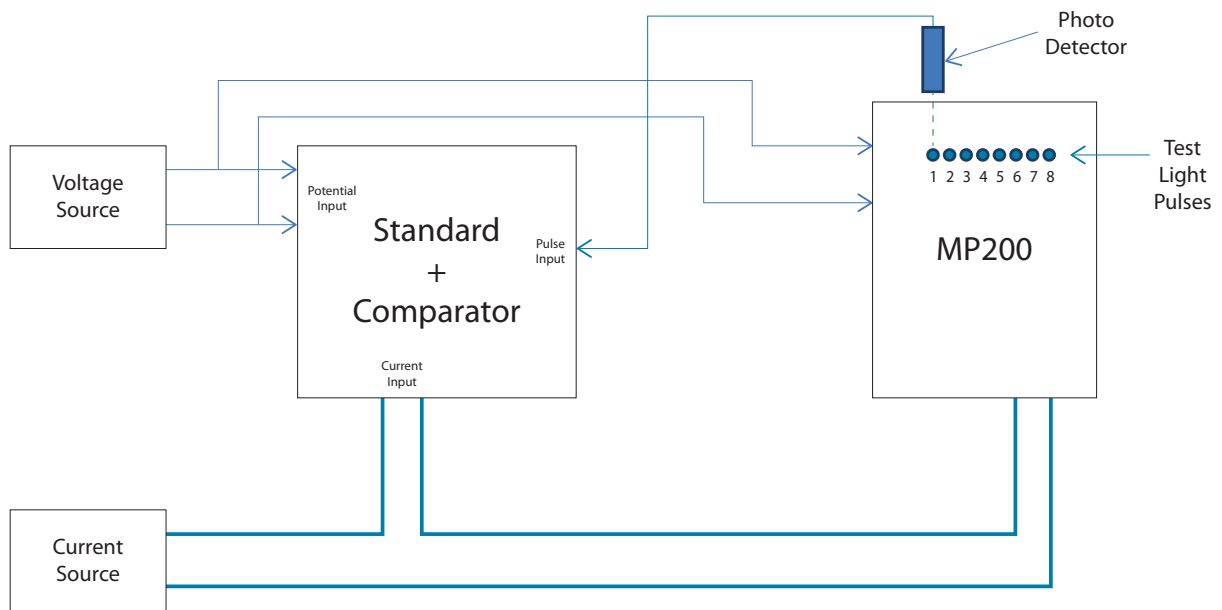

Figure 6.3: Typical Kh Test Setup

Typical standards are: Radian Research RD20 & RD21 or a Watt-hour Engineering Company Three Phase Automated Test System.

NOTE: Watt-hour Standards offer pulse inputs that take in the CPU's test pulses. The accuracy is computed by ratio-metrically comparing the period of the meter's pulse to the period of the Standard's internal pulse. You must program the test pulse value (Kh) into the Standard for the results to be accurate.

The example test procedure that follows covers only the testing of the three phase and single phase versions of the MP200 unit. The test procedure used for the Standard shall be determined by the manufacturer of the Standard used.

Three Phase Test Procedure

1. All circuits and equipment must be de-energized.
2. Connect the three phase potential input lines to "Va", "Vb", and "Vc" and the neutral to "V-Ref" & "GND."
3. Connect power leads to the "L" and "N" connections.
4. Monitor the #1 test pulse by placing the photo detector over the #1 LED.
5. Connect the three phase current inputs to the current terminals associated with the test pulse LED being monitored. There must be no other current inputs connected.
6. Energize the Standard and the MP200 unit. To assure accuracy, both must be on for a minimum of 30 minutes.
7. Energize the sources and wait for the outputs to stabilize before starting the test.
8. Start the test as per the appropriate procedure for the Standard and/or comparator used.
9. When the test is completed, de-energize the sources.
10. Place the photo detector over the next test pulse to be monitored.
11. Repeat steps 5 through 10 until all test pulses are checked.
12. De-energize all circuits and remove power from the Standard, sources, and the MP200 unit.
13. Disconnect all connections from the MP200 unit.

Single Phase Test Procedure

NOTE: Unlike the three phase configuration, the single phase configuration uses each test pulse LED to display the energy measured for three current inputs (see Table 6.2).

1. All circuits and equipment must be de-energized.
2. Connect one line of the potential source to the three "V~" inputs and connect the other line to the "V-Ref" input and "GND."
3. Connect power to the "L" and "N" connections.
4. Monitor the #1 test pulse by placing the photo detector over the #1 LED.
5. Connect the current input to the first pair of current terminals associated with the test pulse LED being monitored. Make sure that no other current inputs (refer to Table 6.2) are connected.
6. Energize the Standard and the MP200 unit. To assure accuracy, both must be on for a minimum of 30 minutes.
7. Energize the sources and wait for the outputs to stabilize before starting the test.
8. Start the test as per the appropriate procedure for the Standard used.
9. When the test is completed, de-energize the sources.
10. Remove the current connections to the MP200 unit and connect them to the second current input pair for the test pulse LED being monitored.
11. Energize the sources and wait at least 5 seconds before starting of test.
12. Start the test as per the appropriate procedure for the Standard and/or comparator used.
13. When the test is completed, de-energize the sources.
14. Remove the current connections from the MP200 unit and connect them to the third current input pair for the test pulse LED being monitored.
15. Energize the sources and wait at least 5 seconds before starting of test.

16. Start the test as per the appropriate procedure for the Standard used.
17. When the test is completed, remove the current inputs from the meter.
18. Remove power from the sources.
19. Place the photo detector over the next test pulse LED to be monitored.
20. Repeat 5 through 19 until all current inputs and test pulses have been tested.
21. De-energize all circuits and remove power from the Standard, sources, and the MP200 unit.
22. Disconnect all connections from the MP200 unit.

This page intentionally left blank.

7: Using the MP200 Metering System's I/O

7.1: Overview

The MP200 unit has an embedded relay outputs/digital inputs board.

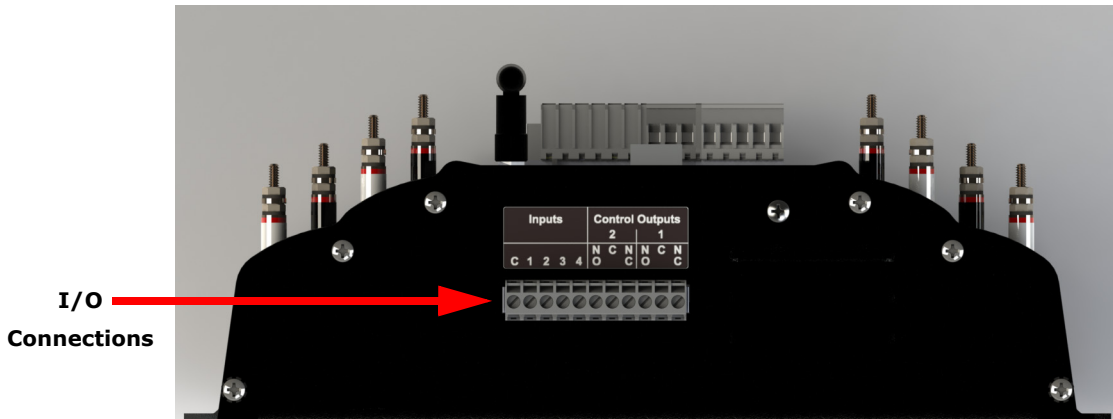

Figure 7.1: Location of I/O Board

7.2: Digital Output (Relay Contact) / Digital Input Board

The Digital Output/Input card is a combination of relay contact outputs for load switching or alarming and dry/wet contact sensing or KYZ pulse counting digital inputs. The outputs are electrically isolated from the inputs and from any other internal circuits.

- The I/O board's 2 relay outputs are used for control applications. This is an essential feature when looking to control equipment on alarm condition or to reduce peak demand by shutting down equipment or generating a peak demand alarm. The meter can be configured to trigger relay output when an alarm condition occurs. Up to 16 limits can be assigned through CommunicatorPQA® software - see Chapter 5 in this manual and Chapter 10 in the *CommunicatorPQA®*, *MeterManagerPQA®*, and *EnergyPQA.com® Software User Manual* for instructions.
- The I/O board has 4 KYZ pulse counting inputs. These dry contact inputs are designed to count pulses from other devices such as gas meters, water meters, condensate (steam) meters or any other commodity meter that provides a pulse output. This feature is ideal for a total energy management solution; the information it provides can be used as part of a comprehensive energy usage reporting system.

7.2.1: Wiring Diagram

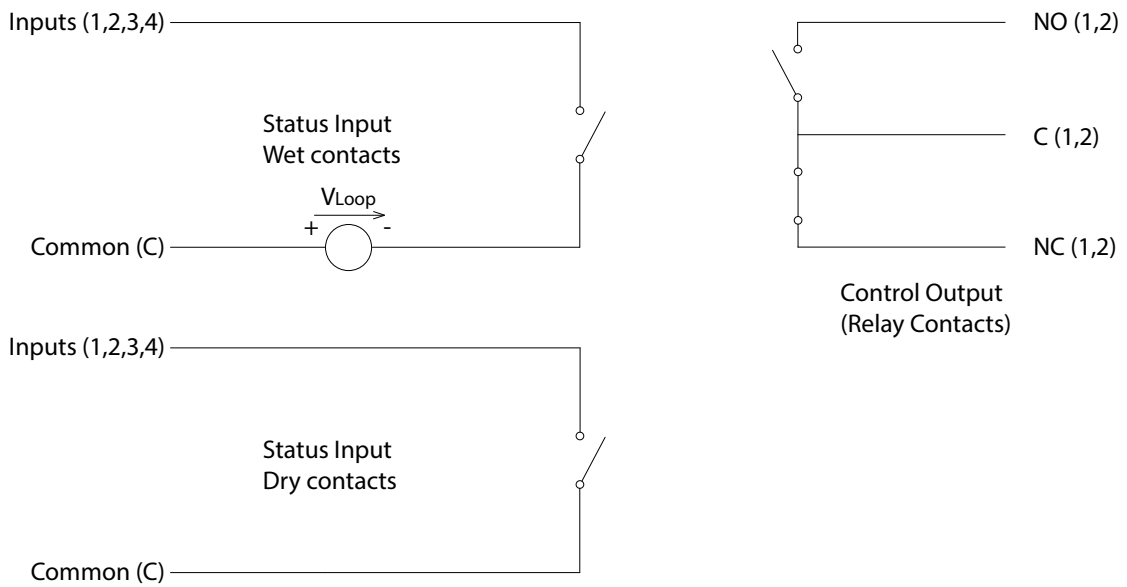
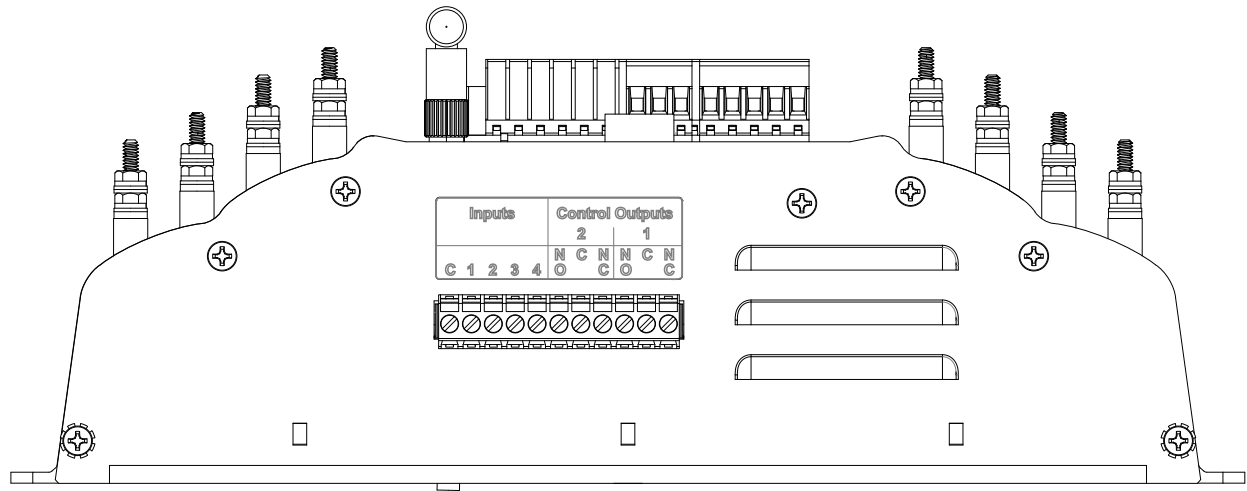

Figure 7.2: Relay Contact (4) / Status Input (2) I/O Wiring

External Connection:

AWG#12-26/ (0.08 -2.5) mm²
11-pin, 0.200" pluggable terminal block

8: Using Ethernet Communication (WiFi and RJ45)

8.1: Overview

The WiFi/Ethernet option for the MP200 metering system gives Ethernet communication to Com 1 via either WiFi (Wireless) or RJ45 connections for the earlier module version or both WiFi and RJ45 Ethernet for the module shipping 7/2021 and after. See [2.2: Specifications, on page 2-10](#) for Ethernet module specifications.

- The MP200 unit's WiFi connection lets you set it up for use in a LAN (Local Area Network), using standard WiFi base stations. Then you can access the MP200 unit to perform functions directly through any computer on your LAN: the MP200 unit does not need to be directly connected (wired) to these computers for it to be accessed.
- The MP200 unit's RJ45 connection lets you use standard Ethernet cable to connect the MP200 unit to a wired Ethernet network.

To enable Ethernet communication for Com 1, set the switch to WiFi/Ethernet - see Figure 8.1.

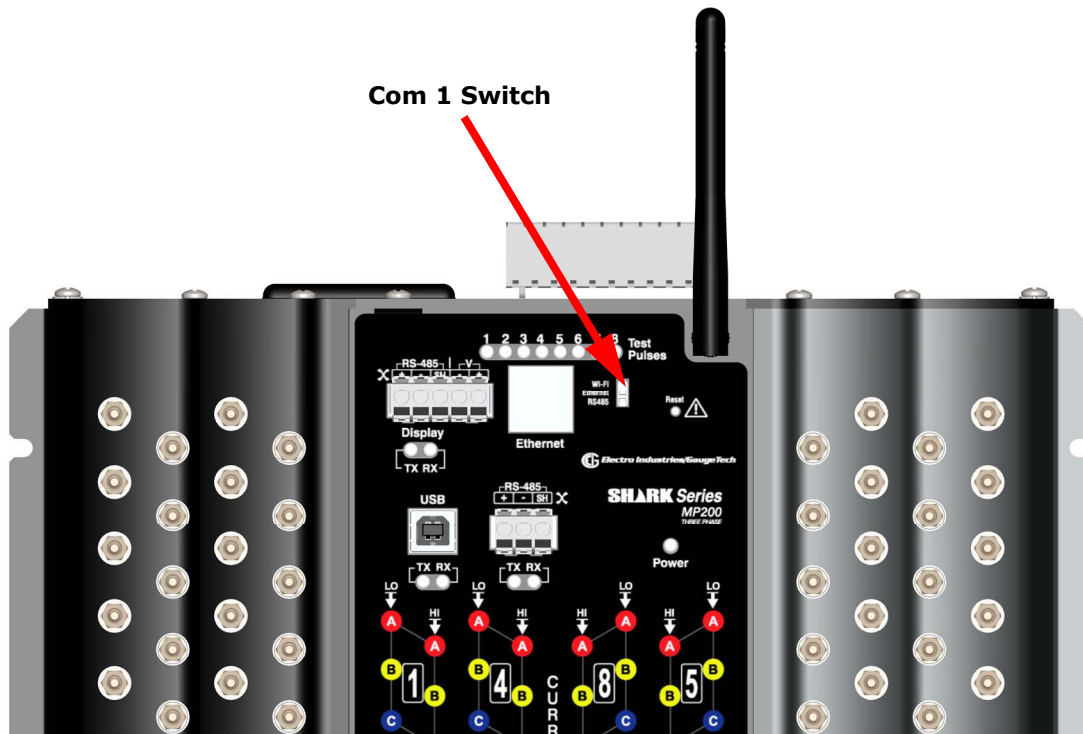

Figure 8.1: Location of Com 1 Switch

If you are using RJ45 Ethernet, connect the Ethernet cable to the MP200 unit as shown in Figure 8.2.

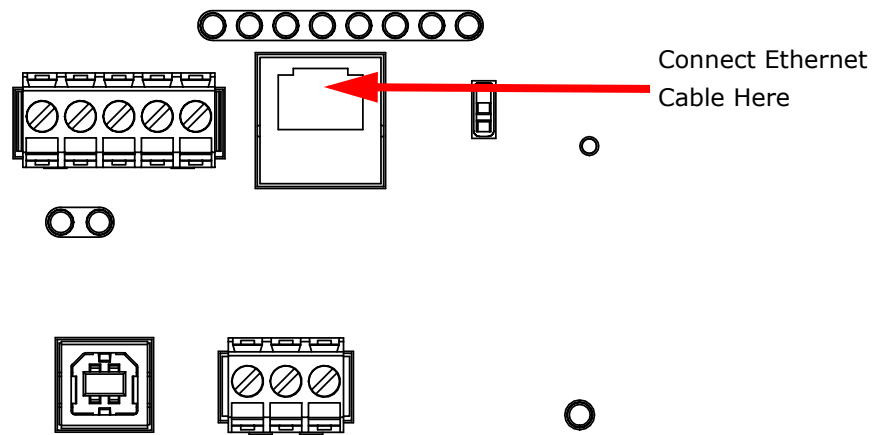

Figure 8.2: RJ45 Ethernet Connection

Configuration for both WiFi and RJ45 connections is easily accomplished through your PC. There are two methods, depending on the WiFi/Ethernet module's hardware and firmware. Modules shipped before July 2021 use a Telnet configuration; modules shipped after July 2021 use a webpage configuration. There is a simple way to determine which hardware/firmware your WiFi/Ethernet module is using:

To determine the firmware version, follow these instructions:

1. From the Windows Start menu, enter **Run** and then enter 'cmd'.
2. In the Command Prompt window, type:

telnet 10.0.0.1 9999 and press the **Enter** key.

NOTE: Make sure to include a space between the IP address and 9999.

- If you are prompted to enter a username and password, you have the newer hardware/firmware. Proceed to [8.5: Web Manager WiFi/Ethernet Module Configuration, on page 8-16](#) for configuration instructions.
- If you are not prompted to enter a password, continue to the next section to configure WiFi/Ethernet communication.

8.2: Telnet WiFi/Ethernet Module Configuration

The following sections explain how to configure the pre-July 2021 version of the WiFi/Ethernet module.

8.2.1: Factory Default Settings

The settings shown in [8.2.2: Modbus/TCP to RTU Bridge Setup Default Settings, on page 8-4](#), are the default settings for the MP200 metering system, i.e., they are the settings programmed into your MP200 unit when it is shipped to you. You may need to modify some of these settings (for example, IP address) when you set up your Ethernet configuration.

NOTES:

- You should **ONLY** change the settings that are shown in bold (Settings 1, 6, and 7). Settings 2, 3, and 4 must be the same as shown in Section 8.2.2. If they are not, reset them to the values shown in Section 8.2.1, using the reset instructions in [8.4: Network Module Hardware Initialization, on page 8-15](#).
- If setting 3 is not CP0..! Defaults (In), the procedure for Network Module Hardware Initialization (Section 8.4) will not work.

8.2.2: Modbus/TCP to RTU Bridge Setup Default Settings

1) Network/IP Settings:

Network Mode.....Wired Only

IP Address.....10.0.0.1

Default Gateway.....--- not set ---

Netmask.....255.255.255.0

2) Serial & Mode Settings:

Protocol.....Modbus/RTU,Slave<s> attached

Serial Interface.....57600,8,N,1,RS232,CH1

3) Modem/Configurable Pin Settings:

CP0..! Defaults <In> Wired CP1..! GPIO <In> CP2..! GPIO <In>

CP3..! GPIO <In> CP4..! GPIO <In> CP5..! GPIO <In>

CP6..! GPIO <In> CP7..! GPIO <In> CP8..! GPIO <In>

CP9..! GPIO <In> CP10..! GPIO <In>

RTS OutputFixed High/Active

4) Advanced Modbus Protocol settings:

Slave Addr/Unit Id Source.....Modbus/TCP header

Modbus Serial Broadcasts.....Disabled (Id=0 auto-mapped to 1)

MB/TCP Exception Codes.....Yes (return 00AH and 00BH)

Char, Message Timeout.....00050msec, 05000msec

6) WLAN Settings:

WLAN.....Disabled, network:LTRX_IBSS

Topology.....AdHoc, Country: US, Channel: 11

Security.....none
TX Data rate.....54 Mbps auto fallback
Power management.....Disabled
Soft AP Roaming.....N/A
Ad-hoc merging.....Enabled
WLAN Max failed packets.....0

7) Security Settings:

SNMP.....Enabled
SNMP Community Name.....public
Telnet Setup.....Enabled
TFTP Download.....Enabled
Port 77FEh.....Enabled
Enhanced Password.....Disabled

D)efault settings, S)ave, Q)uit without save

Select Command or parameter set (1..7) to change:

8.3: Configure Network Module

These procedures explain how to set up the MP200 unit on the Network Module.

Only one person at a time can be logged into the network port. This eliminates the possibility of several people trying to configure the Ethernet interface simultaneously.

8.3.1: Configuration Requirements

- You may want to consult your Network Administrator before performing these procedures, since some functions may be restricted to the Network Administrator.
- If you have only one Ethernet adapter (network card), the screen displays only that configuration. You will use this Ethernet adapter to access the MP200 unit's Network Module. You may have to configure the Ethernet adapter in order to use it

with the MP200 unit's Network Module, using the instructions in [8.3.2: Configuring the Ethernet Adapter](#), on page 8-6.

- If you have multiple Ethernet adapters (network cards) installed on your computer, you must choose, configure and use the correct one to access the Network Module.
- The Ethernet Adapter must be set up for point-to-point connection in order for it to connect to the MP200 unit's Network module, as follows:

IP Address should be 10.0.0.2

Subnet Mask should be 255.255.255.0

These settings can be made in the Ethernet Adapter. Follow the procedure in the following section.

8.3.2: Configuring the Ethernet Adapter

1. From the PC's Start Menu, select **Settings>Network Connections** or **Control Panel>Network Connections**. You will see a screen showing your network connections. An example is shown below. Depending on your Operating system, the screen you see may look a bit different.

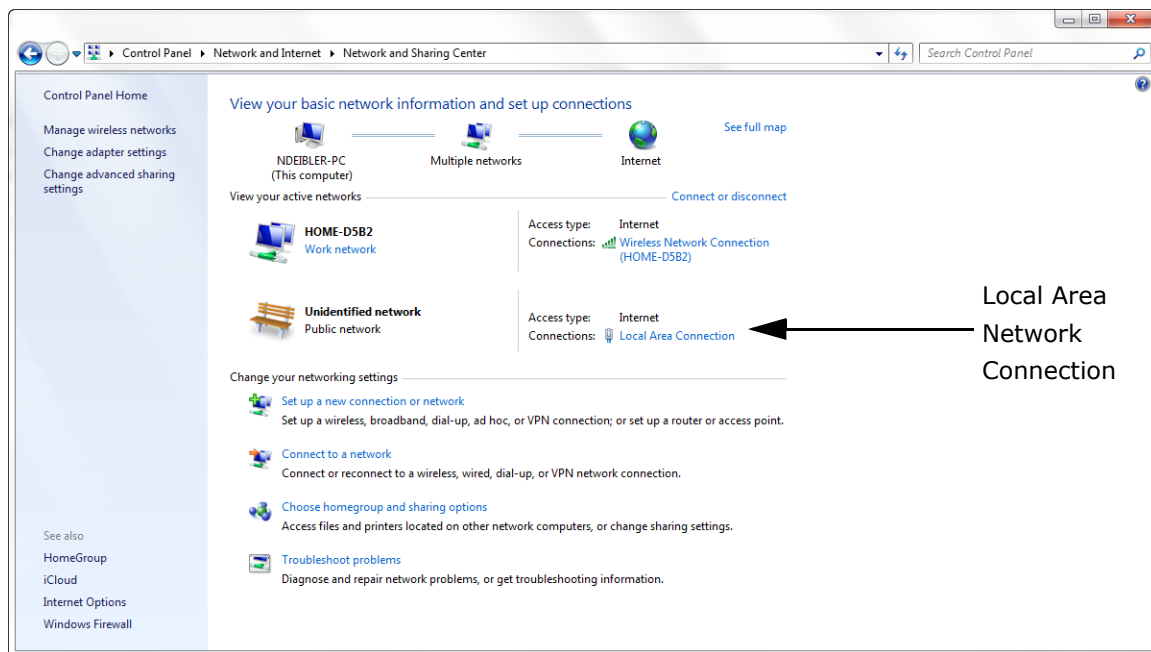

2. Right click on the Local Area Network connection you will be using to connect to the MP200 unit, and select Properties from the pull-down menu. You will see a screen similar to the one shown below.

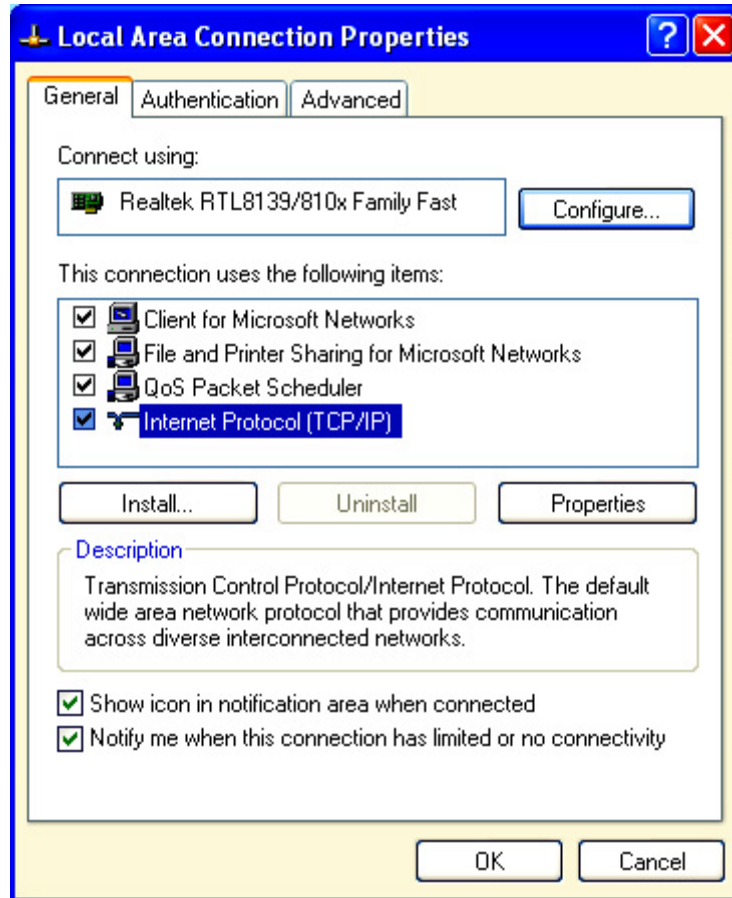

3. Select Internet Protocol [TCP/IP] from the middle of the screen and click the Properties button. You will see the screen shown on the next page.

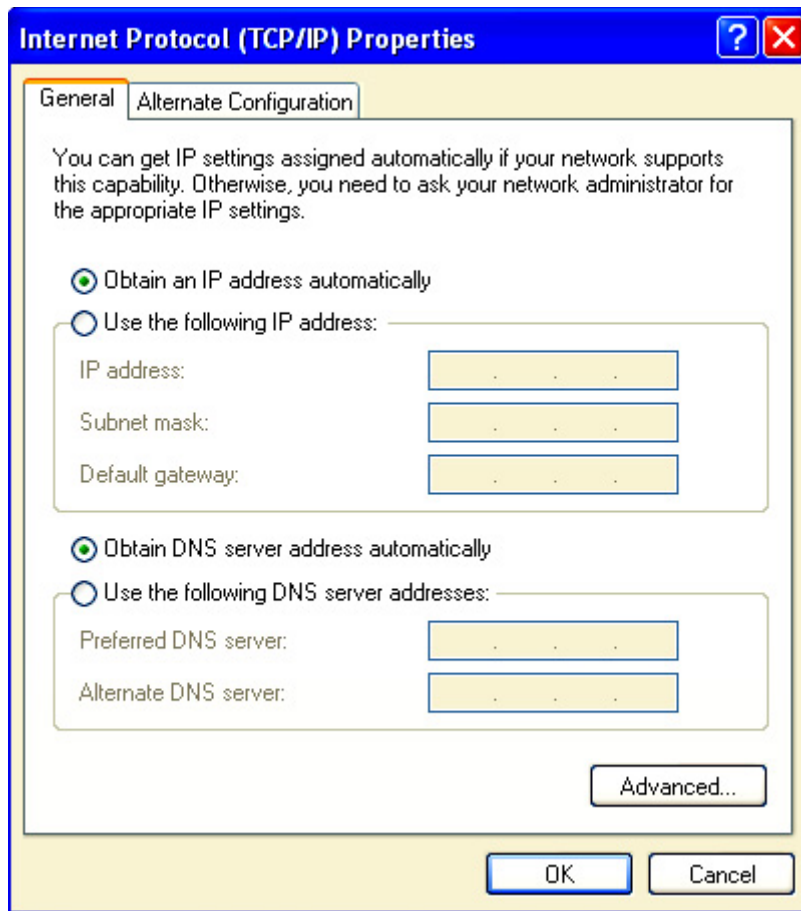

4. Click the Use the Following IP Address radio button. The screen changes to allow you to enter the IP Address and Subnet Mask.
 - a. Enter 10.0.0.2 in the IP Address field.
 - b. Enter 255.255.255.0 in the Subnet Mask field.
3. Click the **OK** button.
4. You can now close the Local Area Connection Properties and Network Connection windows.

8.3.3: Detailed Configuration Parameters

Certain parameters must be configured before the Ethernet interface can function on a network. The following procedure can be locally or remotely configured.

Use a Telnet connection to configure the MP200 unit over the network. The Ethernet interface's configuration is stored in meter memory and is retained without power. The configuration can be changed at any time. The Ethernet interface performs a reset after the configuration has been changed and stored.

NOTE: If your PC is running the Windows® 7 Operating System, you need to enable Telnet before using it.

1. Open the Control Panel.
2. Select Programs and Features.
3. Select Turn Windows features on or off.
4. Check the box for Telnet Client.
5. Click OK. The Telnet client is now available.

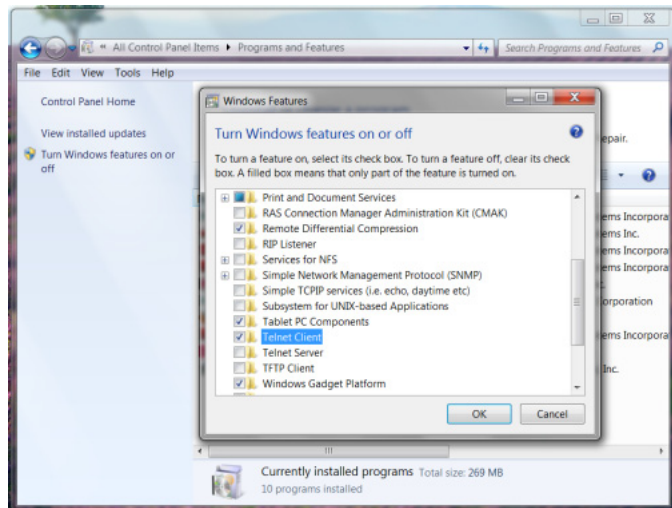

Establish a Telnet connection to port 9999:

1. From the Windows Start menu, click **Run** and type 'cmd'.
2. Click the **OK** button to bring up Windows Command Prompt window.
3. In the Command Prompt window, type:
telnet 10.0.0.1 9999 and press the **Enter** key.

NOTE: Make sure to include a space between the IP address and 9999. You will see the following information.

```
Telnet 172.20.167.133
Modbus/TCP to RTU Bridge
MAC address 00204ACED2DC
Software version U3.3.25.0RC3 <130429>
Press Enter for Setup Mode
```

4. Press **Enter**.

5. You are now in Setup Mode. You can configure the parameters for the software you are using by either:
 - Keying a new value next to a setting and pressing Enter
 - Keeping the default value (the value in brackets after a setting) by just pressing Enter without keying in anything
6. Be sure to press "S" once you are finished, in order to store any new settings. The Ethernet interface will then perform a power reset.

8.3.4: Setup Details

This section illustrates how each section of settings appears on the screen, when you select the setting number (1, 6, or 7).

CAUTION! Change Settings 1, 6, and 7 ONLY. Settings 2, 3, and 4 MUST be the same as shown in 8.2.2: Modbus/TCP to RTU Bridge Setup Default Settings, on page 8-4. If they are not, reset them to the values shown in Section 8.2.1, using the reset instructions in 8.4: Network Module Hardware Initialization, on page 8-15.

Network IP Settings Detail (1) (Set device with static IP Address.)

Network Mode: 0=Wired only, 1=Wireless Only <0> ? Key 1 and press Enter for WiFi mode.

IP Address <010> 192.<000> 168.<000> .<000> .<001> You can change the IP address in this setting.

Set Gateway IP Address <N> ? Y (If you want to change the Gateway address.)

Gateway IP Address: <192> .<168> .<000> .<001> (You can change the Gateway address in this setting.)

Set Netmask <N for default> <Y> ? Y (If you want to change the Netmask.)

<255> .<255> .<255> .<000> (You can change the Netmask in this setting.)

Change telnet config password <N> ? N

WLAN Settings Detail (6) (The settings shown are recommended by EIG for use with the MP200 metering system. You will only be able to access these settings if you have set Network Mode to "1" (to select Wireless mode) in the Network IP Settings Detail, shown previously.)

Topology: 0=Infrastructure, 1=Ad-Hoc <1> ? 0

Network Name: EIG_SHARKS

Security suite: 0=none, 1=WEP, 2=WPA, 3=WPA2/802.11i <0> ? Enter the number of the encryption method are using, e.g., 3 for WPA2/802.11i.

- **If you select "1" (WEP), you will see the following settings:**

Authentication 0=open/none, 1=shared <0> ? (Enter 1 if you want the encryption key matched with a communication partner before messages are passed through.)

Encryption 1=WEP64, 2=WEP128 <1> 2

Change Key <N> Y

Display Key <N> N

Key Type 0=hex, 1=passphrase <0> 0

Enter Key:

You can manually enter 26 hexadecimal characters (required for 128-bit encryption) or you can use a WEP Key provider online (for example: www.pow-erdog.com/wepkey.cgi). WEP Key providers should note on their website that their encryption algorithm is for the Wired Equivalent Privacy portion of IEEE 802.11b/g.

WEP Key Provider Steps

1. Input 26 alphanumeric characters as your Passphrase.

IMPORTANT! Remember your Passphrase.

PASSPHRASE TO HEXADECIMAL WEP KEYS

Enter the passphrase below.

1009egbck001036ab

2. Click the Generate Keys button. Your Hexadecimal WEP Keys display.

PASSPHRASE TO HEXADECIMAL WEP KEYS

The passphrase 1009egbcke001306ab produces the following keys:

64-BIT (40-BIT KEYS)

1. AA43FB768D
2. 637D8DB9CE
3. AFDE50AF61
4. 0c35E73E25

128-BIT (104-BIT) KEY

041D7773D8B2C1D97BE9531DC

3. Enter the 128-bit Key.

TX Key Index <1> ? 1 (The WEP key used for transmissions - must be a value between 1 and 4.)

TX Data Rate: 0=fixed, 1=auto fallback <1> ? 1

TX Data rate: 0=1, 1=2, 2=5.5, 3=11, 4=18, 5=24, 6=36, 7=54 Mbps <7> ?
Enter data transmission rate, e.g., 7 for 54Mbps.

Minimum Tx Data rate: 0=1, 1=2, 2=5.5, 3=11, 4=18, 5=24, 6=36,
7=54 Mbps <0> ? 0

Enable Power management <N> ? Y

Enable Soft AP Roaming <N> ? N

Max Failed Packets (6-64, 255=disable) <6>? 6

• **If you select "2" (WPA), you will make the following settings:**

Change Key <N> Y

Display Key <N> N

Key Type 0=hex, 1=passphrase <0> 1

Enter Key: (The maximum length of the passphrase is 63 characters. EIG recommends using a passphrase of 20 characters or more for maximum security.)

Encryption: 0=TKIP, 1=TKIP+WEP <0> ? Set the type to the minimum required security level. The "+" sign indicates that the group (broadcast) encryption method is different from the pairwise (unicast) encryption (WEP and TKIP).

TX Data rate: 0=fixed, 1=auto fallback <1>? 1

TX Data rate: 0=1, 1=2, 2=5.5, 3=11, 4=18, 5=24, 6=36, 7=54 Mbps <7>?
Enter data transmission rate, e.g., 7 for 54Mbps.

Minimum Tx Data rate: 0=1, 1=2, 2=5.5, 3=11, 4=18, 5=24, 6=36,
7=54 Mbps <0>? 0

Enable Power management <N>? Y

Enable Soft AP Roaming <N>? N

Max Failed Packets (6-64, 255=disable) <6>? 6

- **If you select "3" (WPA2/802.11i), you will make the following settings:**

Change Key <N> Y

Display Key <N> N

Key Type 0=hex, 1=passphrase <0> 1

Enter Key: (The maximum length of the passphrase is 63 characters. EIG recommends using a passphrase of 20 characters or more for maximum security.)

Encryption: 0=CCMP, 1=CCMP+TKIP, 2=CCMP+WEP, 3=TKIP, 4=TKIP+WEP
<3>? (Set the type to the minimum required security level. The "+" sign indicates that the group (broadcast) encryption method is different from the pair-

wise (unicast) encryption. For example, for CCMP+TKIP, CCMP is the pairwise encryption and TKIP is the group encryption. CCMP is the default for WPA2.)

TX Data rate: 0=fixed, 1=auto fallback <1>? 1

TX Data rate: 0=1, 1=2, 2=5.5, 3=11, 4=18, 5=24, 6=36, 7=54 Mbps <7>?
Enter data transmission rate, e.g., 7 for 54Mbps.

Minimum Tx Data rate: 0=1, 1=2, 2=5.5, 3=11, 4=18, 5=24, 6=36,
7=54 Mbps <0>? 0

Enable Power management <N>? Y

Enable Soft AP Roaming <N>? N

Max Failed Packets (6-64, 255=disable) <6>? 6

Security Settings (7)

Disable SNMP <N>? N

SNMP Community Name <public>: (You can enter an SNMP community name here.)

Disable Telnet Setup <N>? N (If you change this setting to Y, you will not be able to use Telnet to re-configure the Network card once you save the settings, without resetting the Network card, as shown in Section 8.4. However, you may want to disable Telnet setup and Port 77FEh to prevent users from accessing the setup from the network.)

Disable TFTP Firmware Update <N>? N

Disable Port 77FEh <N>? N (For security purposes, you may want to disable Telnet setup and Port 77FEh to prevent users from accessing the setup from the network.)

Enable Enhanced Password <N>? N

Exiting the screen

CAUTION! DO NOT PRESS 'D': that will restore the Default Settings.

Press 'S' to Save the settings you've entered.

8.4: Network Module Hardware Initialization

If you don't know your current Network Module settings, or if the settings are lost, you can use the meter's Reset button to initialize the hardware with known settings you can then work with. The Reset button is located to the right of the RS485/Ethernet/WiFi switch.

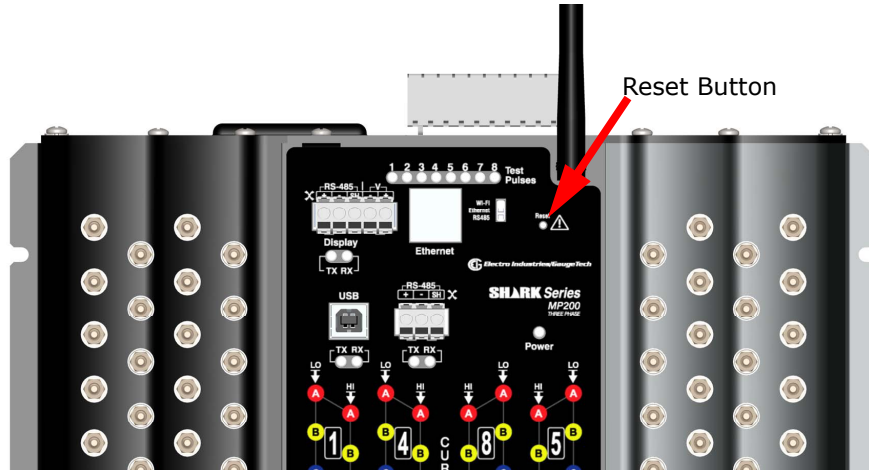

Figure 8.3: Location of Reset Button

Using a pointed implement such as a ballpoint pen tip, press and release the **Reset** button. The Network card settings will return to the default settings shown in [8.2.2: Modbus/TCP to RTU Bridge Setup Default Settings, on page 8-4](#). [8.3.2: Configuring the Ethernet Adapter, on page 8-6](#).

NOTE: For the WiFi/Ethernet module shipping in July 2021 and later, you can also reset the module using the web server - see [8.5.4: Administrative Webpage, on page 8-25](#) for instructions.

8.5: Web Manager WiFi/Ethernet Module Configuration

The following sections contain instructions for configuring the newer WiFi/Ethernet module (July 2021 and later). Note that you can still use the Telnet procedure with this module if you wish - see the instructions earlier in this chapter.

Features of this module include:

- Supports up to 10 simultaneous sockets of both WiFi and RJ45 Ethernet.
- Has username and password protection.
- Allows you to save and upload configuration settings.
- Has a timeout after six minutes of no response to “keep alive” messages to free the socket for communication.

The first thing you will do is connect to the Web Manager.

1. Make the connection from your PC to the meter:

- If you are connecting via the RJ45 port, connect an Ethernet cable from the PC you are using for configuration to the meter’s RJ45 connector (see page 5-9). If your PC is on a network see [8.3: Configure Network Module, on page 8-5](#) and [8.3.2: Configuring the Ethernet Adapter, on page 8-6](#).
- If you are connecting via the WiFi port:
 1. Click on the wireless connection status icon in the Tool tray or use the network and internet settings to make a wireless connection.

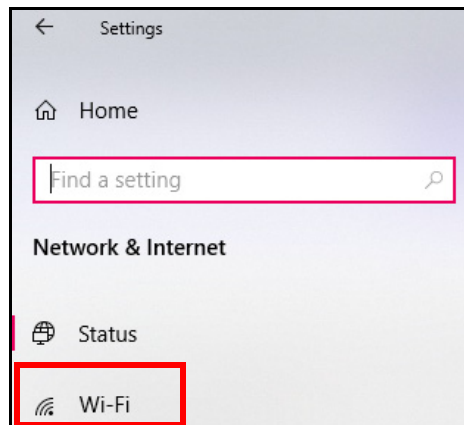
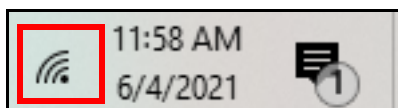

2. You will see a list of wireless connections with one called ESP32port_xxxxxx (xxxxxx is the last six characters of the unique ESPort module serial number). Select that connection and click Connect.

3. Once you are connected via RJ45 or WiFi, open a web browser and enter the following default IP address in the address bar:
`http://10.0.0.1`
4. You will be prompted to enter a username and password. The default values are:
Username: Admin
Password: Password
5. The Web Manager Device Dashboard webpage displays. Use the Web Manager to configure additional settings. See the example webpage shown below and on the next two pages.

The screenshot shows the 'Device Dashboard' webpage. On the left is a dark sidebar with a 'CONFIGURATION' header and several menu items: Dashboard (selected), WiFi, Ethernet, Serial Port, Modbus/TCP, and Administrative. The main content area has a header with a gear icon, the title 'Device Dashboard', and the subtitle 'Here you can see the current status of your device.' Below this are two sections: 'Device' and 'WiFi', each with a table of status information.

Device	
Firmware version	1.0.9
Build Date	04/15/2022
WiFi	Enabled
Ethernet	Enabled

WiFi	
Link	Connected to ElectroIndustries
Signal	78%
RSSI	-61 dBm
Mac address	78:E3:6D:F5:EE:6C
Hostname	Smart_meter_wifi_F5EE6C

CONFIGURATION

- Dashboard
- WiFi
- Ethernet**
- Serial Port
- Modbus/TCP
- Administrative

IPV4	172.20.204.16 (DHCP)
Network Mask	255.255.254.0
Default Gateway	172.20.204.1
Primary DNS	172.20.200.11
Secondary DNS	172.20.200.10
IPV6	fe80:0000:0000:0000:7ae3:6dff:fef5:ee6c

Ethernet

Link	Connected
Speed	Full Duplex, 100Mbps
Mac address	78:E3:6D:F5:EE:6F
Hostname	Smart_meter_eth_F5EE6C
IPV4	172.20.166.240 (Static IP)
Network Mask	255.255.248.0
Default Gateway	172.20.161.23
Primary DNS	172.20.200.11
Secondary DNS	172.20.200.10

The screenshot displays a configuration interface with a dark sidebar on the left and a main content area on the right. The sidebar contains the following menu items: Dashboard, WiFi, Ethernet, Serial Port, Modbus/TCP, and Administrative. The main content area is divided into three sections:

- IPV6**: Shows the address `fe80:0000:0000:0000:7ae3:6dff:fe5:ee6f`.
- Serial Port**: A table of settings:

Baud Rate	57600
Data Bits	8
Parity	no
Stop Bits	1
Flow Control	Disabled
- Modbus/TCP**: A table of settings:

Mode	TCP
Local Port (as server)	502
- Administrative**: A table of settings:

Web/telnet user	Admin
Web/telnet password	*****

- This page shows detailed information on the WiFi/Ethernet module configuration.
- When you first access this screen, you may not see all of the information shown in the above example, e.g., the detailed WiFi settings.
- The links in the list on the left side of the screen bring you to the specific configuration screens, explained in the following sections.

8.5.1: Configuring a WiFi Connection

EIG recommends that you speak with your company's IT department personnel to verify network settings, specifically any static IP address or DHCP hostname you should use for the WiFi configuration.

To configure WiFi settings:

1. Click WiFi from the left side of the page.

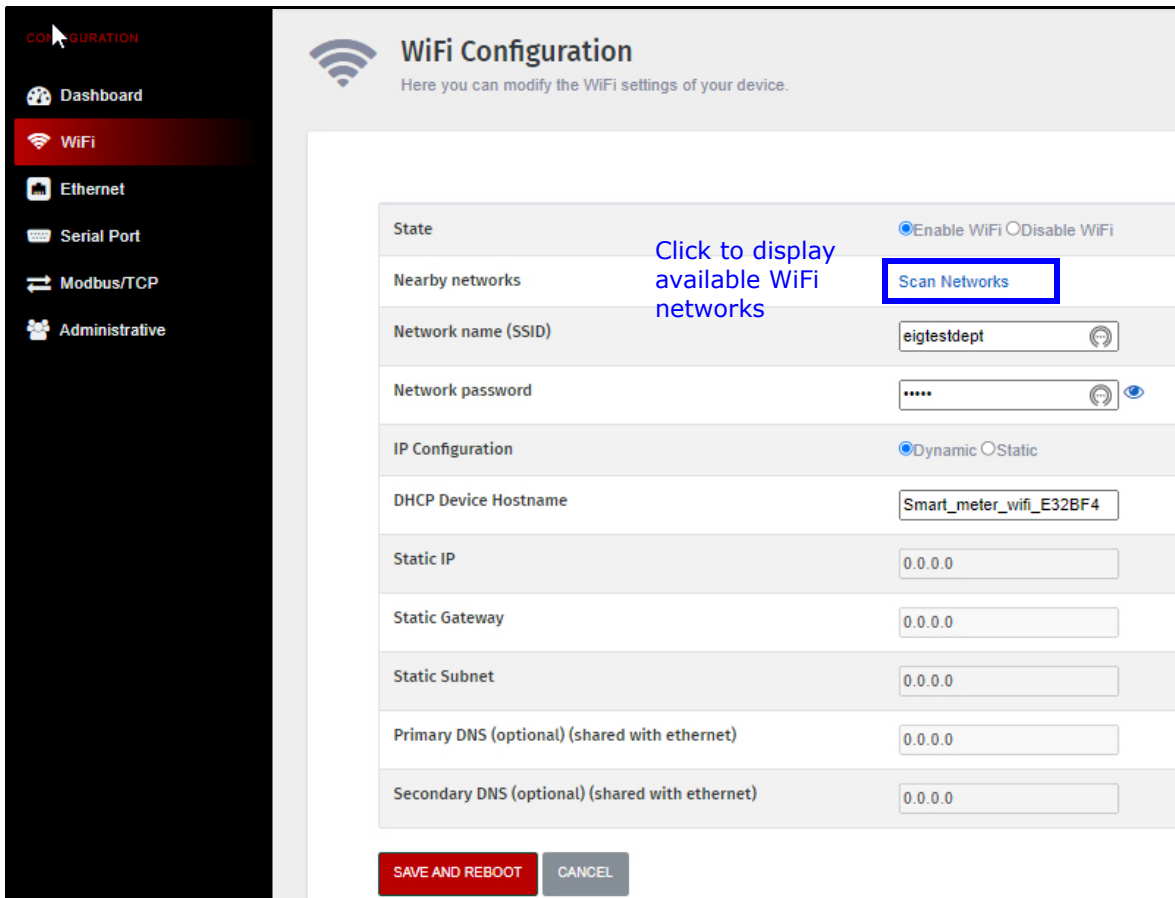

1. Make these settings:

- State - click Enable Wifi to use WiFi communication. Note that this setting is enabled by default.
- Nearby Networks - click Scan Networks to display a list of local WiFi networks along with their signal strength. Click on the network you want to use.
- Network Name (SSID) - the name of the WiFi network you are using.

- Network password - enter the password for the WiFi network. To see the actual characters, click on the eye symbol to the right of the password field.
NOTE: The password must not use the % character.
 - IP Configuration - DHCP if your network uses a DHCP server or Static if you have a specific IP address which doesn't change.
 - DHCP Device Hostname - the name of the DHCP device if your network uses one. The default hostname for WiFi is "Smart_meter_wifi_MACADR" (MACADR is the last 6 digits of the MAC address).
 - Static IP- the default IP address is 10.0.0.1. You can change this to another static IP address on your network.
 - Static Gateway - the gateway device address if the connection to your meter is through a gateway.
 - Static Subnet - the default subnet mask is 255.255.255.0. You can change this to another subnet mask on your network.
 - Primary DNS and Secondary DNS - these are the same for WiFi and Ethernet. They are not required.
2. If you have made any changes, click Save and Reboot. Save and Reboot will save the settings you have made and reboot the Wifi/Ethernet module. You can then configure other settings if you wish.

NOTE: After saving and rebooting, you will use the Network Connect CommunicatorPQA® application screen to connect to the meter over WiFi, using either:

- The static IP address you entered.
- The DHCP hostname you entered.
- The IP address that DHCP assigns to your module - speak to your IT department personnel to find out the address you should use.
- Your IPv6 address, as shown in the Dashboard screen.

8.5.2 Configuring an Ethernet Connection

EIG recommends that you speak with your company's IT department personnel to verify network settings, specifically any static IP addresses or DHCP hostnames you will need for these settings. To configure Ethernet settings:

1. Click Ethernet from the left side of the page.

1. Make these settings:

- State - click Enable Ethernet to use Ethernet communication. Note that this will automatically be selected if you connected to the PC through the RJ45 Ethernet port.
- IP Configuration - DHCP if your network uses a DHCP server** or Static if you assign a specific IP address which doesn't change.
- DHCP Device Hostname - the name of the DHCP device if your network uses one. The default hostname for Ethernet is "Smart_meter_eth_MACADR" (MACADR is the last 6 digits of the MAC address).

- Static IP - the default IP address is 10.0.0.1. You can change this to another static IP address on your network.*
 - Static Gateway - the gateway device address if the connection to your meter is through a gateway.*
 - Static Subnet - the default subnet mask is 255.255.255.0. You can change this to another subnet mask on your network.*
 - Primary DNS and Secondary DNS - these are the same for WiFi and Ethernet. They are not required.
2. If you have made any changes, click Save and Reboot. Save and Reboot will save the settings you have made and reboot the Wifi/Ethernet module. You can then configure other settings if you wish.

NOTE: After saving and rebooting, you will use the Network Connect CommunicatorPQA® application screen to connect to the meter over RJ45 Ethernet, using either:

- The static IP address you entered.
- The DHCP hostname you entered.
- The IP address that DHCP assigns to your module - speak to your IT department personnel to find out the address you should use.
- Your IPv6 address, as shown in the Dashboard screen.

8.5.3: Serial Port and Modbus TCP Configuration

These pages are used to configure the connections for the module's communication with a serial port (this is also known as a Modbus bridge). You should not need to make any changes to these webpages. Leave the defaults as shown below.

Serial Port Configuration

Here you can modify the Serial Port settings of your device.

Baud Rate	57600 ▼
Data Bits	8 bits ▼
Parity	Disable UART parity ▼
Stop bits	1 bit ▼
Flow Control	None ▼
Data Terminal Ready (DTR)	<input type="radio"/> Variable <input checked="" type="radio"/> Fixed

Modbus/TCP Configuration

Here you can modify the Modbus/TCP settings of your device.

Modbus Type	<input checked="" type="radio"/> RTU <input type="radio"/> ASCII
Network Protocol	<input checked="" type="radio"/> TCP
Local Port (as server)	502

Advanced options

Report Modbus bridge errors	<input checked="" type="radio"/> Enable <input type="radio"/> Disable
Modbus timeout	1000 ms
Transmit delay after receive	0 ms
Fixed Slave Address	<input type="radio"/> Enable <input checked="" type="radio"/> Disable <input type="text" value="0"/>

8.5.4: Administrative Webpage

1. Click Administrative from the left side of the page.

Administrative Configuration
Here you can modify the Administrative settings of your device.

Web/telnet user	Admin
Web/telnet password
Device Location/Description	No description
Generate WiFi network for configuration (AP)	<input checked="" type="radio"/> Enable <input type="radio"/> Disable
Telnet configuration	<input checked="" type="radio"/> Enable <input type="radio"/> Disable
Telnet port	9999

SAVE AND REBOOT **CANCEL**

Download Settings

Generate a file with current settings of device, this can be used as backup and to configure other modules with the same settings

DOWNLOAD SETTINGS **CANCEL**

Upload Settings

Upload a settings file from a backup or generated by another device

Choose File No file chosen

UPLOAD SETTINGS **CANCEL**

Factory Reset

Restore module settings as it comes from the factory
It is recommended to download the current setting first as backup

FACTORY RESET **CANCEL**

Firmware update

Upload the latest firmware below

Choose File No file chosen

FIRMWARE UPDATE **CANCEL**

2. The Administrative Configuration webpage lets you perform the following tasks:

- Change username and password - enter a new username and/or password.
- Enter a device location or description - if you need this to identify the meter.
- Enable WiFi network configuration and/or Telnet configuration - when enabled, you can configure the module through the specific method. For example, to be able to configure the module over WiFi, "Generate WiFi network for configuration" must be set to Enabled. The default of both settings is Enabled.

- Change the Telnet port (not recommended) - EIG recommends that you keep the telnet port at 9999.



Download a file with the device's settings - when you click Download Settings, a .json file is downloaded on your PC with the currently connected module's settings.

- Upload a saved settings file - click Choose File to locate the .json settings file and then click Upload Settings to upload the file settings to the currently connected module.
 - You will see the message below when your file has uploaded correctly.

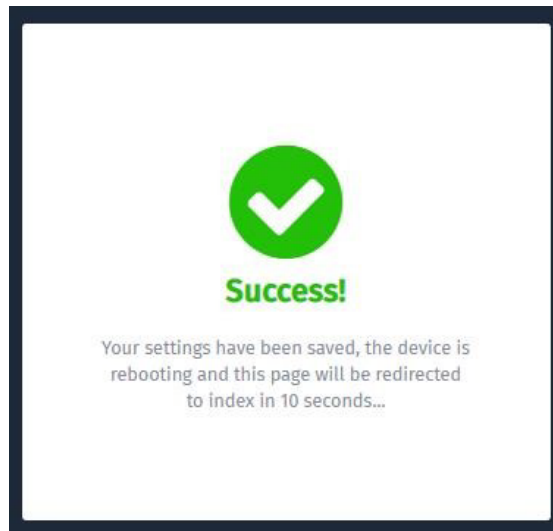

- If there was a problem, e.g., if you didn't choose any file before clicking Upload Settings, you will see the message.

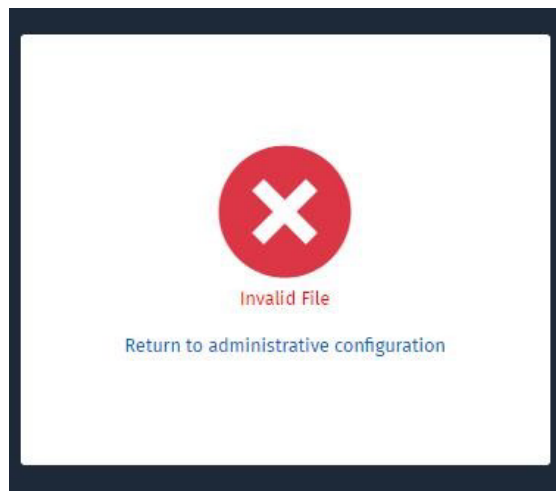

- Perform a factory reset - to reset the module to its default factory settings, click Factory Reset.



CAUTION! Be aware that the factory reset occurs immediately after you click the button - there is no warning message. Make sure you want to reset and that you read the IMPORTANT note below, before clicking Factory Reset.

NOTE: You can also reset the module through the meter's hardware by following the instructions in [8.4: Network Module Hardware Initialization, on page 8-15](#).

- Perform a firmware update for the WiFi/Ethernet module - click Choose File to locate the update file and then click Firmware Update to process the module's firmware update.
3. If you have made any changes, click Save and Reboot. Your changes are saved and the module reboots.

This page intentionally left blank.

9: Data Logging

9.1: Overview

Optional V-Switch™ keys 2 and 3 (V2 and V3) give the MP200 metering system memory for data logging. The MP200 metering system can log historical trends, limit alarms, I/O changes, and sequence of events. In addition, the MP200 unit has a real-time clock that allows all events to be time-stamped when they occur. Refer to Chapter 10 (Configuring MP200 Metering System) and Chapter 19 (Viewing Logs) in the *CommunicatorPQA®*, *MeterManagerPQA®*, and *EnergyPQA.com® Software User Manual* for additional information and instructions. You can download this manual at: <http://www.electroind.com>

9.2: Available Logs

The following logs are available for an MP200 unit equipped with V2 and V3. These meters have 2 and 32 MB, respectively, of non-volatile memory for data logging.

- Historical logs: Each MP200 unit with V2 or V3 has two historical logs. Log 1 is configurable through CommunicatorPQA® software. Log 2 is pre-configured to log energy usage for each metered circuit over time for the three phase meter model. Log 3 is pre-configured to log energy usage for each metered circuit over time for the single phase meter model. If your MP200 unit has the single phase configuration it will have Historical logs 1 and 3; if it has the three phase configuration it will have Historical logs 1 and 2.

Note that the meter is configured to automatically store logs and that the logs default to a 15 minute interval, though the logging interval can be changed.

- For the MP200-Y unit, Historical log 1 records, as a factory default, readings for Volts Line-to-Line and Line to Neutral, and Frequency; however, the data channels recorded can be changed using CommunicatorPQA® software. Historical log 2 records readings for Watt-hours, Interval Energy for each of the eight meters, and accumulator readings for the four digital inputs.
- For the MP200-S unit, Historical log 1 records, as a factory default, readings for voltage and frequency; however, the data channels recorded can be changed using CommunicatorPQA® software. Historical log 2 records readings for Interval Energy for each of the 24 meters, and accumulator readings for the four digital inputs.

- Interval Energy is the amount of energy consumed during the storage interval. For example, if you choose a 15 minute interval (the typical setting), the meter profiles the load used during the 15 minute period for each storage period. This lets you trend and graph an energy use profile for each meter (circuit).
- The MP200 metering system's logging capability works with EIG's CommunicatorPQA® and EnergyReporterPQA™ software applications to enable you to create detailed usage reports for analysis and to easily generate sub-tenant billing. The digital input accumulators can be used to accumulate pulses from other than electrical energy usage, e.g., gas or condensate (steam); to offer you a multi-commodity billing solution.
- Limit/Alarm log: This log provides the magnitude and duration of alarms that fall outside of configured acceptable limits. Time stamps and alarm value are provided in the log. Up to 16,382 events can be logged.
- I/O Change log: This log provides a time-stamped record of the Relay Output/Digital Input board's output or input status changes. Up to 16,382 events can be logged.
- System Events log: In order to protect critical billing information, the MP200 unit records and logs the following information with a timestamp:
 - Demand resets
 - Password requests
 - System startup
 - Energy resets
 - Log resets
 - Log reads
 - Programmable settings changes

All of the MP200 unit logs can be viewed through the EIG Log Viewer. Refer to chapters 16 and 19 of the *CommunicatorPQA®*, *MeterManagerPQA®*, and *EnergyPQA.com® Software User Manual* for additional information and instructions regarding logs and the Log Viewer.

See Appendix E for instructions on retrieving logs using the MP200 unit's Modbus map.

This page intentionally left blank.

10: Using the Optional Display

10.1: Overview

This chapter describes the optional display for the MP200 metering unit. The display lets you view meter readings remotely. The display come pre-configured, but you can change the default settings, for example, the IP address, if necessary. There are two available display models:

- The MDSN display has a 3.5" screen.
- The MDLN display has a 5.7" screen.



10.1: MDSN/MDLN Displays

The displays are touch-screen capable and offer both serial and Ethernet communication:

- Serial port configured for 2-wire RS485 communication
- RJ45 Ethernet Port for 10/100BaseT communication

10.2: Display Features

- Low power consumption - MDSN uses 6.5 W or less; MDLN uses 6.8 W or less
- Compact size
- Easy installation - fits in standard 22 mm/0.87 in. mounting hole

- Easy communication connection - RJ45 Ethernet and RS485 serial communication options
- Display automatically detects communication connection
- 65k color touch screen
- Pre-programmed MP200-Y and MP200-S readings and status display screens

10.2.1: Contents of Display Kit

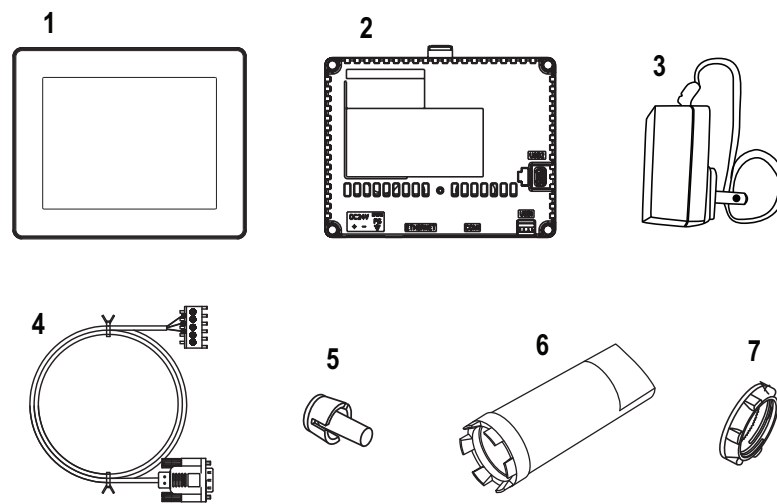

Figure 10.2: Display Kit Contents

- (1) Display
 - (2) Rear Module
 - (3) Power Supply
 - (4) RS485 Serial Cable (10 feet)
- Mounting Hardware:
- (5) anti-rotation tee
 - (6) socket wrench
 - (7) installation nut, attached to the back of the display

10.3: MDSN/MDLN Specifications

Following are the display specifications and important safety information.

10.3.1: General Specifications

Electrical Specifications

Display Model	Rated Input Voltage	Input Voltage Limits	Voltage Drop	Power Consumption	In-Rush Current	Voltage Endurance	Insulation Resistance
MDSN	24 V DC	(20.4 to 28.8) V DC	10 ms or less	6.5 W or less	30 A or less	1,000 V AC 20 mA for 1 min (between charging and FG terminals)	500 V DC, 10 M Ω or more (between charging and FG terminals)
MDLN	24 V DC	(20.4 to 28.8) V DC	7 ms or less	6.8 W or less	30 A or less	1,000 V AC 20 mA for 1 min (between charging and FG terminals)	500 V DC, 10 M Ω or more (between charging and FG terminals)

Environmental Specifications

		MDSN	MDLN
Physical Environment	Surrounding Air Temperature	(0 to 50) °C/(32 to 122) °F	(0 to 50) °C/(32 to 122) °F
	Storage Temperature	(-20 to +60) °C/(-4 to +140) °F	(-20 to +60) °C/(-4 to +140) °F
	Surrounding Air and Storage Humidity	85% RH (Wet bulb temperature: 39 °C/102.2 °F or less - no condensation.)	85% RH (Wet bulb temperature: 39 °C/102.2 °F) or less - no condensation.)
	Dust	0.1 mg/m ³ /10 ⁻⁷ oz/ft ³ or less (non-conductive levels)	0.1 mg/m ³ /10 ⁻⁷ oz/ft ³ or less (non-conductive levels)
	Pollution Degree	For use in Pollution Degree 2 environment	For use in Pollution Degree 2 environment
	Corrosive Gases	Free of corrosive gases	Free of corrosive gases
	Atmospheric Pressure (Operating Altitude)	800 to 1,114 hPa (2,000 m / 6,561 ft or lower)	800 to 1,114 hPa (2,000 m / 6,561 ft or lower)
Mechanical Environment	Vibration Resistance	EN61131-2 compliant 5 to 9 Hz Single amplitude: 3.5 mm/ 0.14 in.	EN61131-2 compliant 5 to 9 Hz Single amplitude: 3.5 mm/ 0.14 in.

		MDSN	MDLN
Electrical Environment	Electrical fast transient/burst	IEC 61000-4-4 2 kV Power port 1 kV Signal ports	IEC 61000-4-4 2 kV Power port 1 kV Signal ports
	Electrostatic Discharge Immunity	IEC 61000-4-2 6 kV Contact discharge 8 kV Air discharge	IEC 61000-4-2 6 kV Contact discharge 8 kV Air discharge

Structural Specifications

	MDSN	MDLN
Structure	Rated for indoor use Front panel: IP 65f Rear panel: IP 20	Rated for indoor use Front panel: IP 65f Rear panel: IP 20
Cooling Method	Natural air circulation	Natural air circulation
Weight	0.36 kg /0.79 lb. or less (main unit only)	0.62 kg/1.36 lb. or less (main unit only)
Grounding	Functional grounding: grounding resistance of 1000 hms, 2 mm ² (AWG 14) or thicker wire, or your country's applicable standard.	

Display Specifications

		MDSN	MDLN
Display Type		TFT Color LCD	TFT Color LCD
Resolution		320 x 240 pixels (QVGA)	320 x 240 pixels (QVGA)
Effective Display Area		W70.56 x H52.92 mm/ W2.78 x H2.08 in.	W115.2 x H86.4 mm/ W4.53 x H3.40 in.
Display Colors		65,536 colors	65,536 colors
Backlight		White LED (User non-replaceable part)	White LED (User non-replaceable part)
Backlight Service Life		50,000 hrs. or more (continuous operation at 25 °C/ 77°F before backlight brightness decreases to 50%)	50,000 hrs. or more (continuous operation at 25 °C/77 °F before backlight brightness decreases to 50%)
Brightness Control		16 Levels (Adjusted with the touch panel or the software)	16 Levels (Adjusted with the touch panel or the software)
Character Sizes (2)		Standard font: 8 x 8, 8 x 16, 16 x 16 and 32 x 32 pixel fonts Stroke font: 6 to 127 pixel fonts Image font: 8 to 72 pixel fonts	Standard font: 8 x 8, 8 x 16, 16 x 16 and 32 x 32 pixel fonts Stroke font: 6 to 127 pixel fonts Image font: 8 to 72 pixel fonts
Font Sizes		Standard font: Width can be expanded up to 8 times; height can be expanded up to 8 times	Standard font: Width can be expanded up to 8 times; height can be expanded up to 8 times
Text	8 x 8 pixels	40 characters x 30 rows	40 characters x 30 rows
	8 x 16 pixels	40 characters x 15 rows	40 characters x 15 rows
	16 x 16 pixels	20 characters x 15 rows	20 characters x 15 rows
	32 x 32 pixels	10 characters x 7 rows	10 characters x 7 rows

10.3.2: Communication Port Specifications

Serial Interface COM1

Asynchronous Transmission	RS232C / RS422 / RS485
Data Length	7 or 8 bits
Stop Bit	1 or 2 bits
Parity	None, odd or even
Data Transmission Speed	2,400 to 115.200 kbps, 187,500 bps
Connector	D-Sub 9 pin (plug)

Ethernet Interface

Ethernet (LAN)	IEEE802.3i/ IEEE802.3u, 10BASE-T/100BASE-TX
Connector	Modular jack (RJ45) x 1

NOTE: Ethernet networks must be installed by a trained and qualified person.

LED:

LED		Contents
Green	lit	Data transmission is available
	blinking	Data transmission is occurring

Specs for Com 1 D-Sub 9 pin plug connector via an RS485 cable. Interfit bracket is #4-40 (UNC).

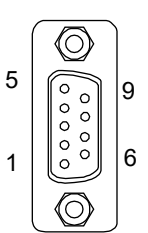
Pin Arrangement	Pin No.	RS485		
		Signal Name	Direction	Meaning
 (Display unit)	1	RDA	Input	Receive Data A(+)
	2	RDB	Input	Receive Data B(-)
	3	SDA	Output	Send Data A(+)
	4	ERA	Output	Data Terminal Ready A(+)
	5	SG	-	Signal Ground
	6	CSB	Input	Send Possible B(-)
	7	SDB	Output	Send Data B(-)
	8	CSA	Input	Send Possible A(+)
	9	ERB	Output	Data Terminal Ready B(-)
	Shell	FG	-	Frame Ground (Common with SG)

10.3.3: Important Safety and Product Usage Information

Handling the LCD Panel

The following characteristics are specific to the LCD unit and are considered normal behavior:

- The LCD screen may show unevenness in the brightness of certain images or may appear different when seen from outside the specified viewing angle. Extended shadows, or cross-talk, may also appear on the sides of screen images.
- The LCD screen pixels may contain black and white colored spots and color display may seem to have changed over time.
- When the same image is displayed on the screen for a long period, an afterimage may appear when the image is changed.

NOTE: Do not display the same image for a long time: change the screen image periodically.



WARNING! SERIOUS EYE AND SKIN INJURY

The liquid present in the LCD panel contains an irritant:

- Avoid direct skin contact with the liquid.
- Wear gloves when you handle a broken or leaking unit.
- Do not use sharp objects or tools in the vicinity of the LCD touch panel.
- Handle the LCD panel carefully to prevent puncture, bursting, or cracking of the panel material.
- If the panel is damaged and any liquid comes in contact with your skin, immediately rinse the area with running water for at least 15 minutes.
- If the liquid gets in your eyes, immediately rinse your eyes with running water for at least 15 minutes and consult a doctor.

Failure to follow these instructions can result in serious injury or equipment damage.

**AVERTISSEMENT! BLESSURES GRAVES DANS LES YEUX ET SUR LA PEAU**

Le liquide présent dans le panneau ACL contient des irritants:

- Évitez le contact direct avec la peau.
- Portez des gants lorsque vous fixez une unité endommagée ou une fuite
- N'utilisez pas des objets tranchants ou outils aux environs du panneau ACL
- Utilisez soigneusement le panneau ACL pour prévenir la crevaison, l'explosion ou le cassage du matériel de panneau
- Si le panneau est endommagé et le liquide vient en contact avec votre peau, rincez immédiatement l'endroit avec de l'eau pour au moins 15 minutes.
- Si le liquide entre en contact avec vos yeux, rincez immédiatement vos yeux avec de l'eau pendant au moins 15 minutes ou consultez un médecin.

Le non-respect de ces instructions peut provoquer des blessures graves ou un endommagement de l'appareil.

Using the Touch Panel Correctly

- Use only one finger to select an object on the touch panel.
- If the touch panel receives pressure at two or more points at the same time, an unintended object could be selected.

**CAUTION: UNINTENDED EQUIPMENT OPERATION**

- Operate the display's touch panel with only one finger.
- Do not activate two or more points of the touch panel simultaneously.

Failure to follow these instructions can result in serious injury, or equipment damage.

COM 1 Serial Port Warning and Cautions**WARNING! DANGER OF ELECTRIC SHOCK!**

The serial port is not isolated. The SG (signal ground) and the FG (frame ground) terminals are connected inside the unit. When using the SG terminal to connect an external device to the unit:

- Verify that a short-circuit loop is not created when you set up the system.
- Connect the #5 SG terminal to remote equipment when the host (PLC) unit is not isolated. Connect the #5 SG terminal to a known reliable ground connection to reduce the risk of damaging the RS485 circuit.

Failure to follow these instructions can result in death or serious injury.

Avertissement et mise en garde du port série COM 1Port**AVERTISSEMENT! RISQUE D'UNE DÉCHARGE ÉLECTRIQUE!**

Le port série n'est pas isolé. Le retour commun du signal et de la masse du châssis sont branchés dans l'unité. Lorsque vous utilisez le retour commun du signal pour brancher un pareil externe dans l'unité:

- Vérifiez que la boucle de court-circuit n'est pas créée lorsque vous mettez en place le système.
- Branchez la borne no 5 SG pour utiliser l'équipement à distance lorsque que l'unité hôte (PLC) n'est pas isolée. Branchez la borne no 5 SG dans un branchement de mise à terre connue pour réduire le risque d'endommagement du circuit RS485.

Le non-respect de ces instructions peut provoquer la mort et des blessures graves.

**CAUTION: LOSS OF COMMUNICATION**

- All connections to the communication ports must not put excessive stress on the ports.
- Securely attach communication cables to the panel or cabinet.

Failure to follow these instructions can result in injury or equipment damage.

Critical systems, Detected Alarms and Handling Requirements

Critical detected alarm indicators require independent and redundant protection hardware and/or mechanical interlocks. If the display unit for any reason becomes inoperative (for example, an inoperative backlight) it may be difficult or impossible to identify an alarm condition. Alarms tied to critical functions, such as emergency stop, must be provided independently of the display unit. The design of the control system must take into account an inoperative unit (backlight) and that the operator is unable to view alarms using the display unit.

When the power is cycled, wait at least 10 seconds before restoring the power to the GP Unit. Switching the power OFF and ON quickly can damage the unit.



WARNING! LOSS OF CONTROL

Consider the potential failure modes of alarm notification, such as:

- The possibility of backlight failure
 - Unanticipated link transmission delays or failures
 - The operator being unable to operate the display correctly
- Provide a means to achieve a safe state during and after a path failure for critical alarms.
- Provide separate or redundant control paths for critical alarms.
- Test individually and thoroughly each implementation of the display unit for correct operation before service.

Failure to follow these instructions can result in serious injury or equipment damage.



WARNING! UNINTENDED EQUIPMENT OPERATION

Do not use the unit as the only notification device for critical alarms, such as device overheating or over-current.

Failure to follow this instruction can result in death, serious injury, or equipment damage.

Exigences relatives aux systèmes importants, détections d'alarmes et manutentions

Les indicateurs importants d'alarmes détectés exigent un appareil de protection redondant et indépendant ou un verrouillage mécanique. Si l'unité pour toute raison devient inopérante (par exemple, un rétroéclairage lumineux inopérant), il peut être difficile ou impossible d'identifier une situation d'alarme. Les alarmes ficelées aux fonctions importantes comme arrêt d'urgence, doivent être fournis indépendamment de l'unité d'affichage, le modèle du système de contrôle doivent rendre en compte une unité inopérante (rétroéclairage) et que l'opérateur est incapable de voir les alarmes utilisant l'unité d'affichage.

Lorsque l'alimentation est cyclé, attendre au moins 10 secondes avant de restaurer l'alimentation de l'unité GP. Le fait d'allumer et d'éteindre rapidement l'alimentation peut endommager l'unité.

**AVERTISSEMENT! PERTE DE CONTRÔLE**

Considérer des modes de panne potentielle de notification d'alarme comme:

- La possibilité de panne de rétroéclairage
- Délai de lien de transmission non anticipé ou panne
- L'opérateur incapable de faire fonctionner l'affichage correctement
- Fournir un moyen d'achever un état de sécurité pendant et après la panne de voie pour les alarmes critique.
- Fournir des voies de contrôles séparés ou redondants pour des larmes critiques.
- Testez individuellement et soigneusement chaque implantation de l'unité d'affichage pour un fonctionnement correct avant le service.

Le non-respect de ces instructions peut provoquer des blessures graves ou endommagements de l'équipement.



AVERTISSEMENT! FONCTIONNEMENT ACCIDENTEL DE L'ÉQUIPEMENT

Ne pas utiliser l'unité comme seul appareil de notification pour alarmes critiques, comme une surchauffe ou une surintensité.

Le non-respect de ces instructions peut provoquer des blessures graves ou endommagements de l'équipement ou la mort.

10.4: Display Dimensions

The following figures give the dimensions of the MDSN and MDLN displays and the back of the displays (the back dimensions are the same for both display models).

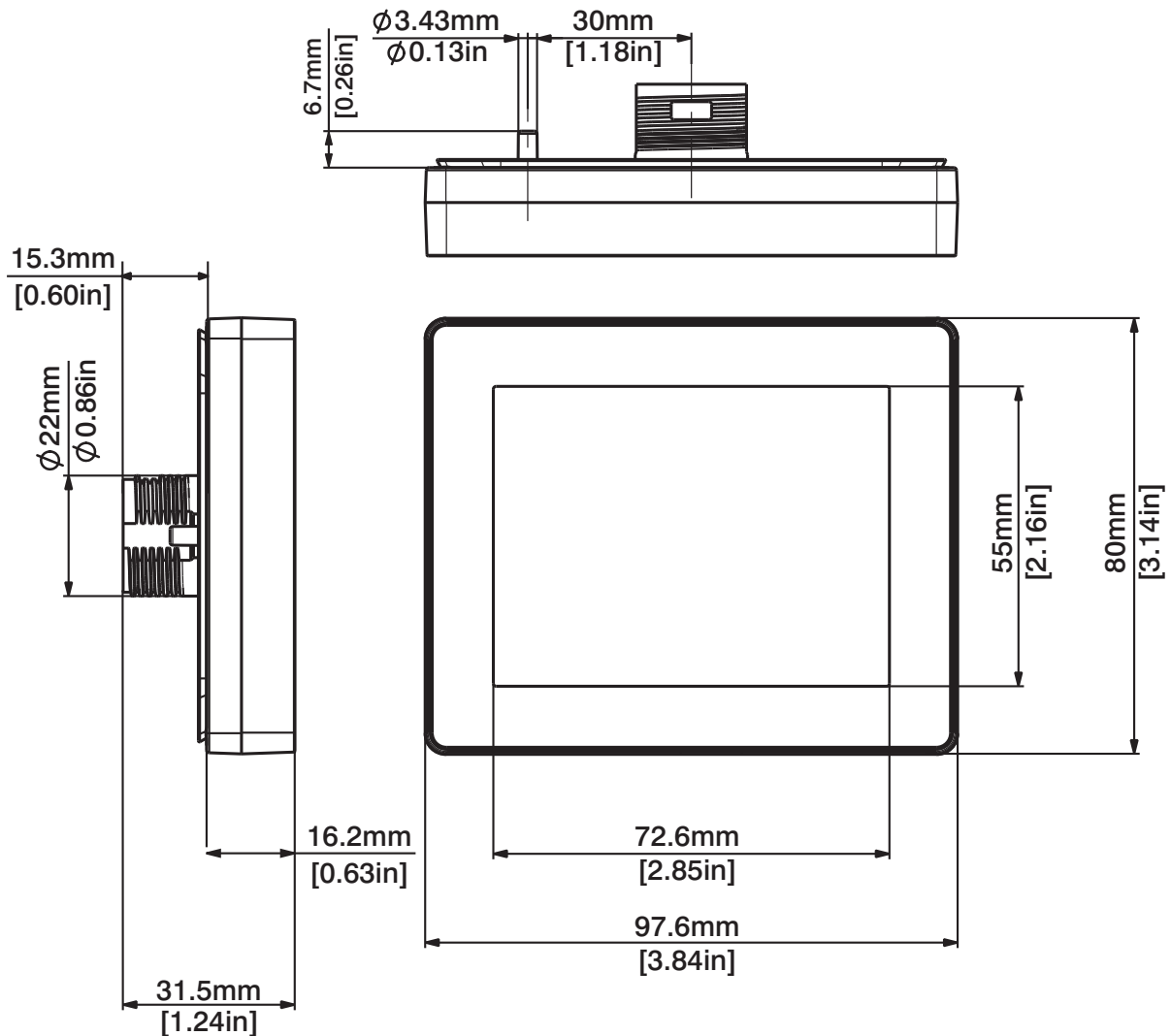

Figure 10.3: MDSN Dimensions

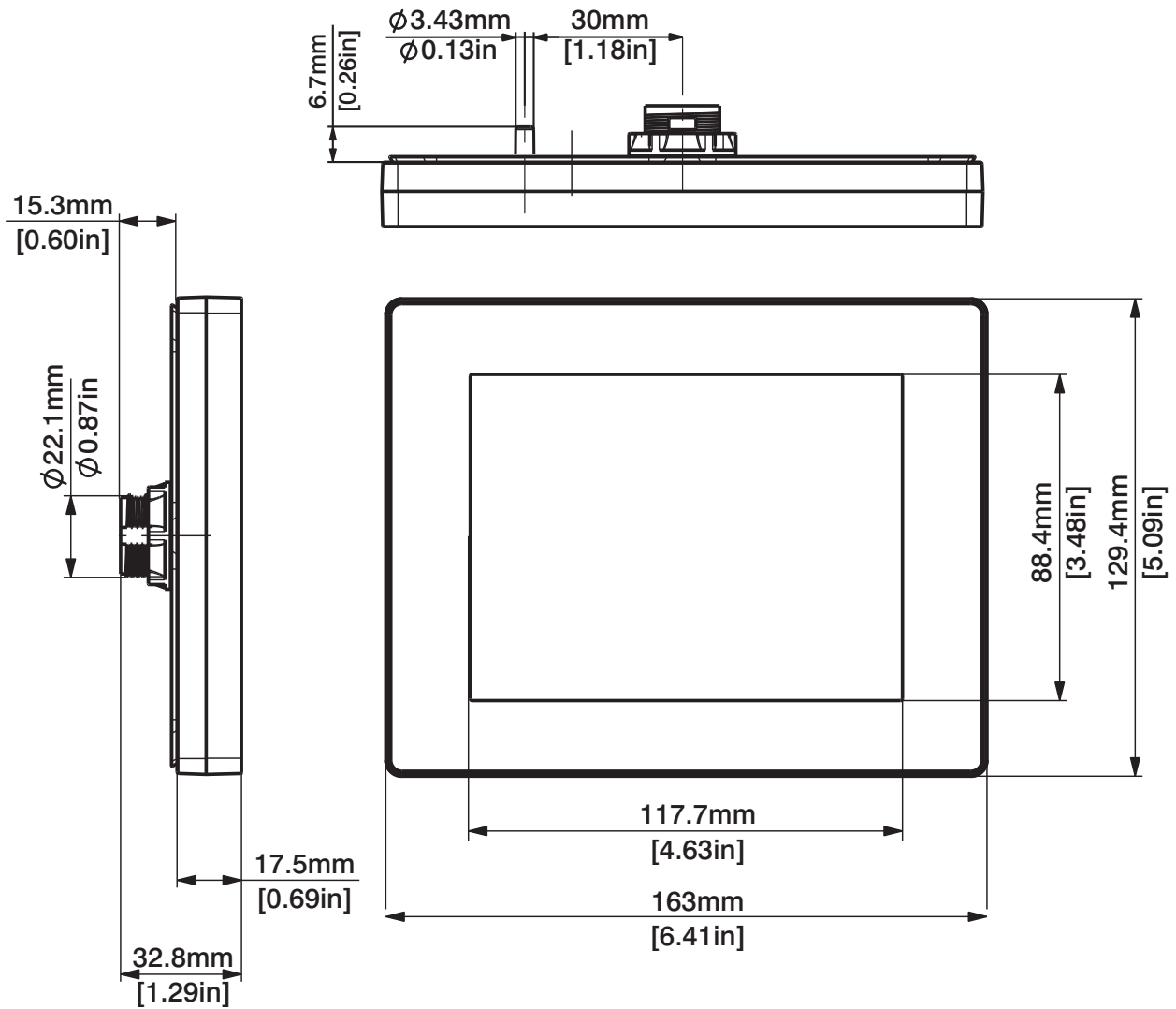

Figure 10.4: MDLN Dimensions

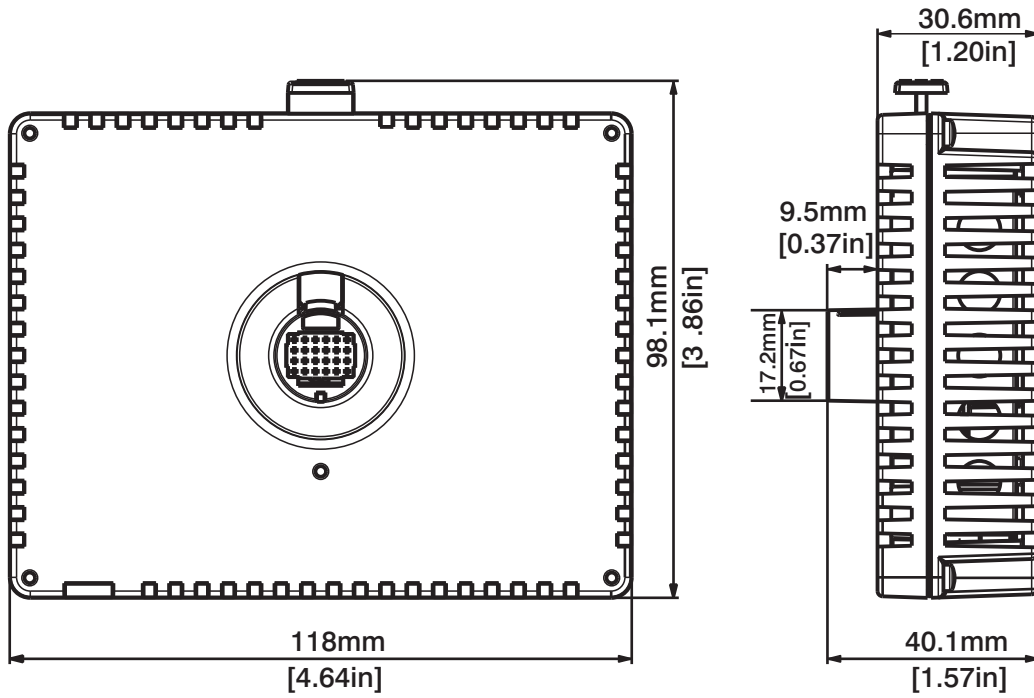

Figure 10.5: MDSN/MDLN Back Dimensions

10.5: Display Installation

Mount the unit in an enclosure that provides a clean, dry, and controlled environment (IP65f enclosure or UL508 4x, if indoors). Before installing the display verify that:

- The gasket is flat and undamaged.
- The installation panel or cabinet surface is flat (the planarity tolerance is 0.5 mm/ 0.019 in.) and in good condition with no jagged edges. Metal reinforcing strips may be attached to the inside of the panel, near the panel cut-out, to increase the rigidity.
- The panel must be designed to avoid any induced vibration resonance on the rear module that exceeds a punctual factor of 10, and to avoid any induced permanent vibration resonance.
- The ambient operating temperature and the ambient humidity are within their specified ranges (see environmental specifications in 10.3.1: General Specifications, on page 10-3).
- The heat from surrounding equipment does not cause the unit to exceed its specified operating temperature (see environmental specifications in 10.3.1: General Specifications, on page 10-3).
- The panel face is not inclined more than 30° when installing the unit in a slanted panel.
- When mounting the display vertically, the right side of the unit faces up (the yellow button should be on the left).
- The unit is at least 100 mm/3.94 in. away from adjacent structures and other equipment for easier maintenance, operation, and improved ventilation.

Follow this procedure to install the MDSN/MDLN:

1. Create a panel cutout based on the following information, and install the display from the front. You can use a tee insert (included with the display) to stop display rotation when you apply torque during installation. With the tee option, the rotating

torque is 6 Nm/53.10 in-lb. Without the tee option the rotating torque is 2.5 Nm/ 22.12 in-lb.

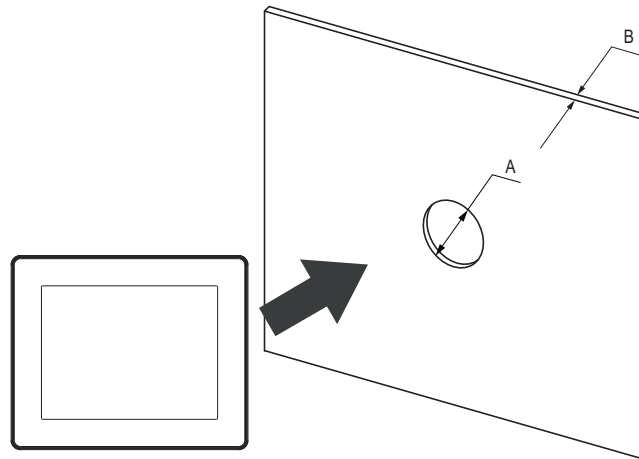

Unit	A (mm)	A (in.)	B (mm) (1)	B (in.) (1)	B (mm) (2)	B (in.) (2)
MDSN	+0	+0				
MDLN	22.50	0.88	1.5 to 6	0.06 to 0.23	3 to 6	0.11 to 0.23
	-0.30	-0.01				

The Material of the panel
(1) Steel sheet
(2) Fiberglass (minimum GF30)

Figure 10.6: Cutout Dimensions without Tee Insert

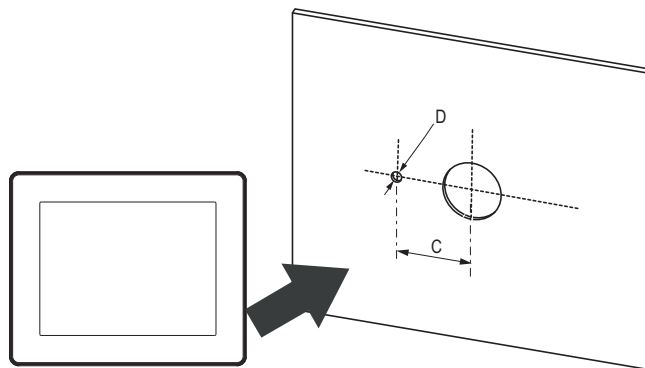

Unit	C (mm)	C (in.)	D (mm)	D (in.)
MDSN	+0	+0	+0	+0
MDLN	30.00	1.18	4.00	0.15
	-0.20	-0.007	-0.20	-0.007

Figure 10.7: Cutout Dimensions with Tee Insert

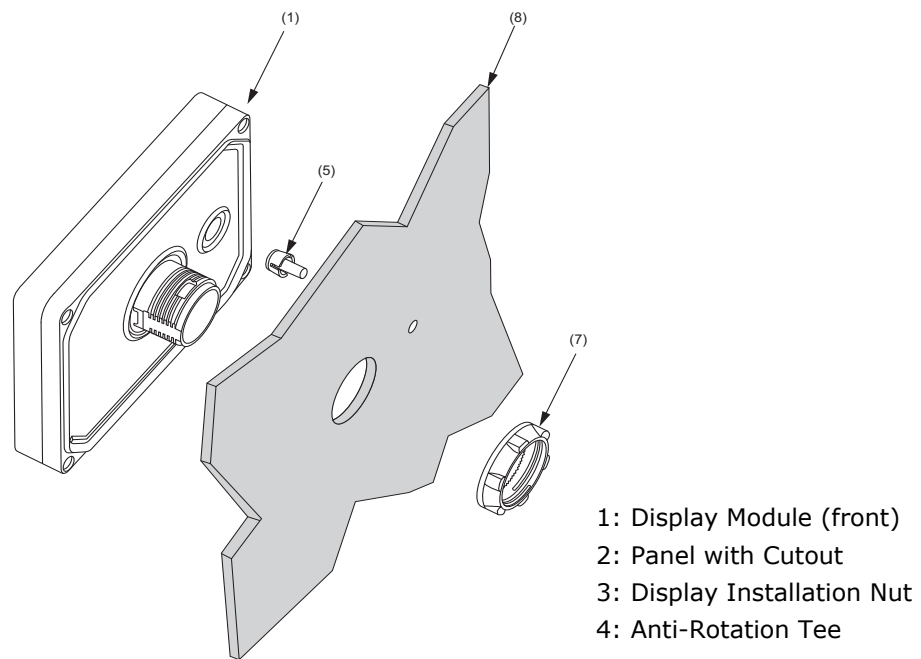

Figure 10.8: Installation Components

2. Insert the display module (along with the tee insert if you are using it) into the panel hole (see Figure 10.8).
3. Screw the nut using the socket wrench with a torque between 1.2 and 2Nm/10.62 and 17.70 in-lb - see figure below.

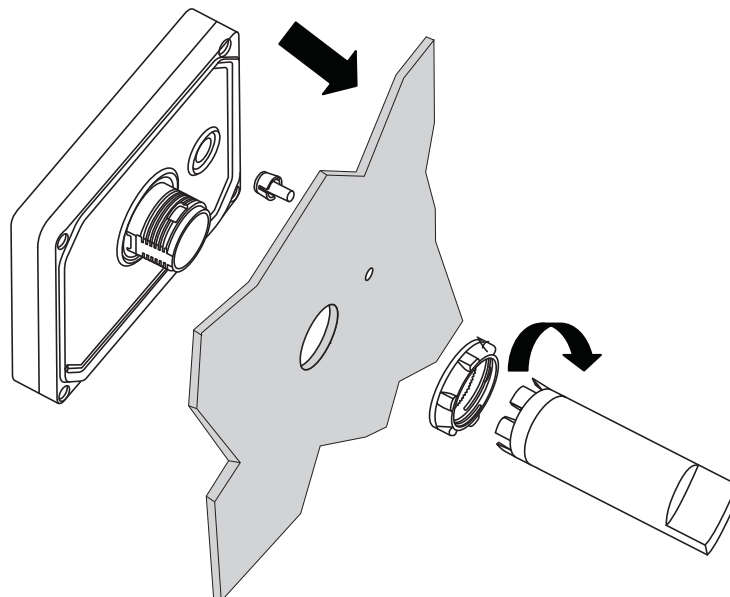

Figure 10.9: Attaching the Nut Using the Socket Wrench

4. Insert and push the rear module until it locks into place.

NOTE: Install the display module and the rear module as shown in Figure 10.10, below. If either unit is installed incorrectly, the connector may be damaged.

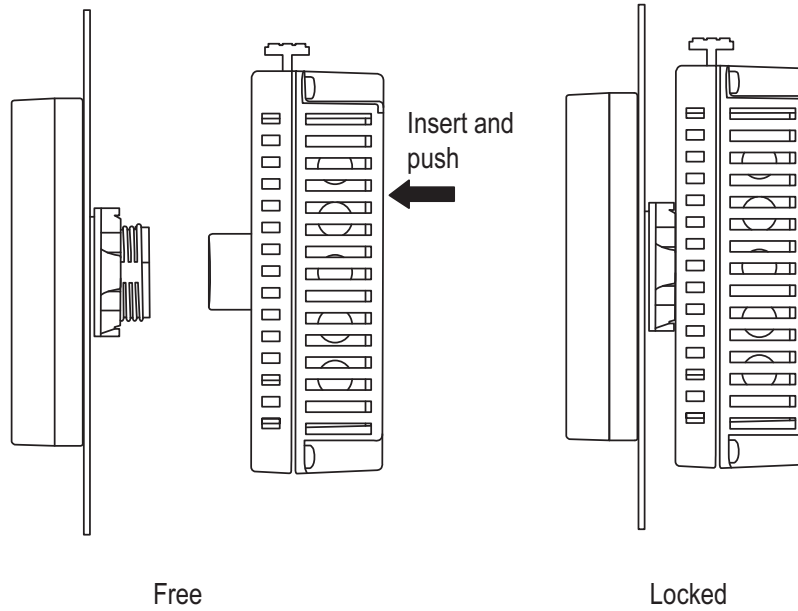

Figure 10.10: Connecting the Rear Module to the Display Module

To remove the rear module, press the yellow button to unlock it and pull the rear module away from the display module.

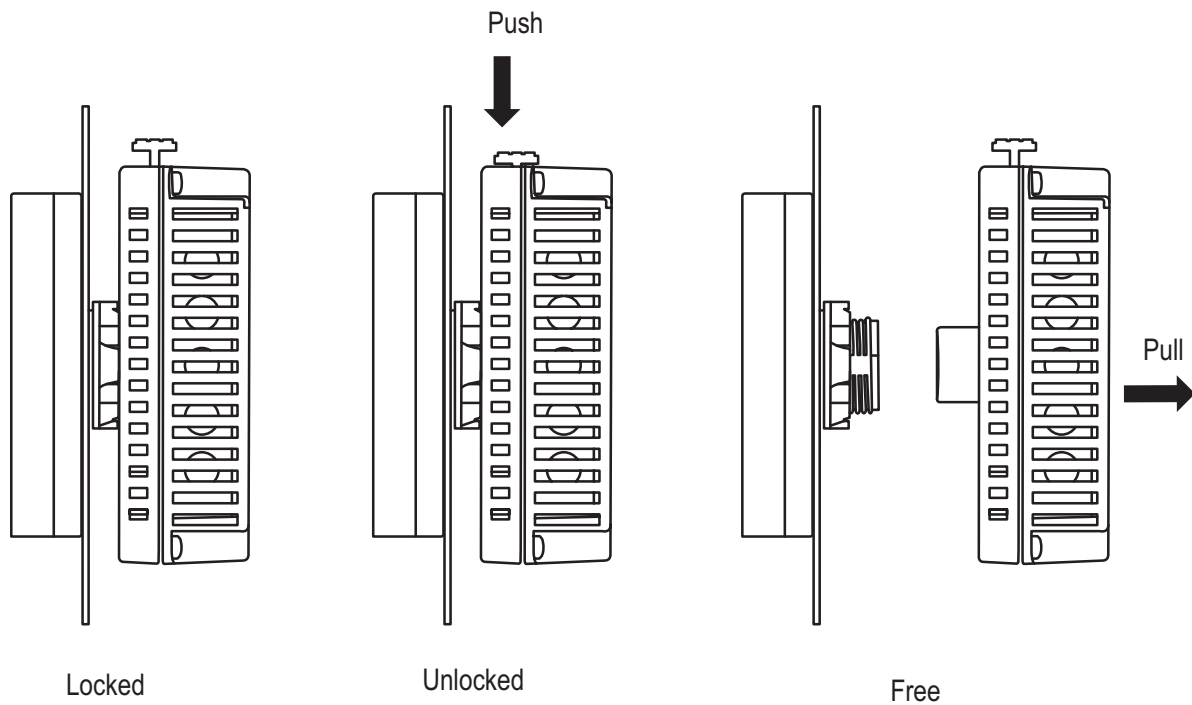

Figure 10.11: Removing the Rear Module from the Display Module

10.6: Display Configuration

The optional display can communicate with the MP200 metering system through either of two ways:

- RS485 serial communication through the MP200 unit's Com 3 serial port
- RJ45 Ethernet through the MP200 unit's optional Ethernet/WiFi on Com 1

Both the MP200 unit and the display need to have specific settings to enable their communication. The display is pre-programmed to communicate with the MP200 metering system's default IP address and RS485 Com port settings. If you have changed the MP 200 unit's IP address, follow the procedure in 10.8.2: Setting Communication through Offline Mode, on page 10-41, to set a different, compatible IP address for the display. Also, if you receive a communication error message, follow the instructions in 10.8.2: Setting Communication through Offline Mode, on page 10-41, to correct it.

10.6.1: RS485 Communication Configuration

RS485 serial communication is set up between the MP200 unit's Com 3 and the MDSN/MDLN's RS485 port.

NOTE: See 5.1.2: RS485 Communication, on page 5-2, for general information concerning RS485 communication.

Follow this procedure:

1. For the MP200 unit:
 - a. From the MP200 unit's Device Profile (see Chapter 5), open the Communications screen.
 - b. Make sure the Com3 settings are the same as those shown in the screen below. If they are not, click the Default for Display button to bring these settings into the Com 3 fields.

The screenshot shows the 'Communications' configuration window for an MP200 unit. The window title is 'MP200: MP200 5 [V-Switch: 3] Offline'. The left sidebar contains a tree view with categories: General Settings (CT, PT Ratios and System Hookup, Time Settings, System Settings, Communications), Energy Settings, Alarm Settings, Trending Profiles, and Digital I/O. The main area is titled 'Communications' and contains three sections for COM1, COM2, and COM3. Each section has fields for Address, Protocol, Baud Rate, Response Delay (msec), and Parity. COM1 is set to Modbus RTU with a baud rate of 57600. COM2 is set to Modbus ASCII with a baud rate of 57600. COM3 is set to Modbus RTU with a baud rate of 9600. There are buttons for 'Default for Ethernet' and 'Default for Display' next to the COM1 and COM3 sections respectively. At the bottom of the window are buttons for 'Save Profile', 'Load Profile', 'View Report', and 'Exit'.

- c. If you have changed the Com 3 settings to make them match those shown above, click Update Device to send the new settings to the meter. If you did not need to make any changes, click Exit to close the Device Profile screen.

2. Connect the MP200 unit's Com 3 to the MDLN/MDSN display's 9-pin RS485 connection, at the bottom of the display.

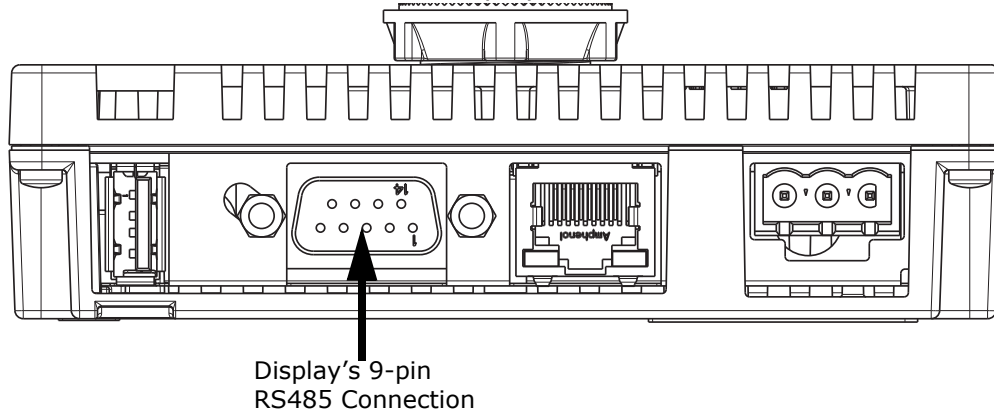
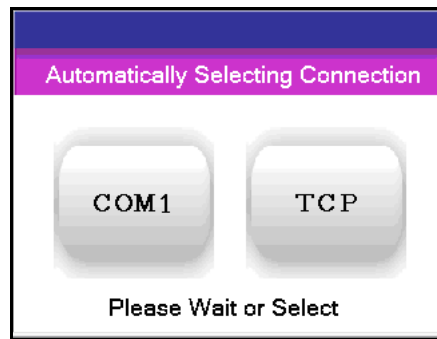
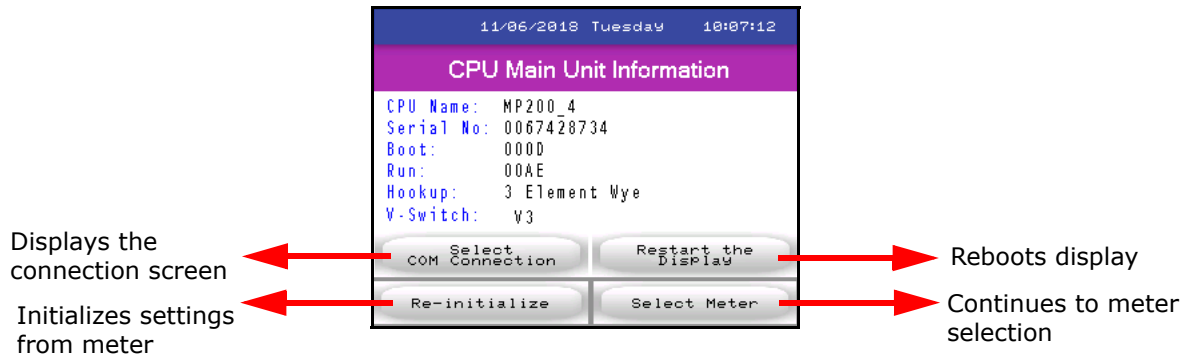

Figure 10.11: Display's RS485 Connection

3. Plug in the display. The display will show messages as it boots up. You will then see the screen below. You can either click the COM 1 button or else wait for the display to select the RS485 connection automatically.



4. The display will initialize and then show the first screen, which lists information about the MP200 unit. An example screen is shown below. Continue to 10.7: Display Screens, on page 10-24.



10.6.2: RJ45 Ethernet Configuration

Ethernet communication is set up between the MP200 unit's Com 1 RJ45 port and the MDSN/MDLN's RJ45 port.

Follow this procedure:

1. Set the MP200 unit's Com1 switch to Ethernet/WiFi.

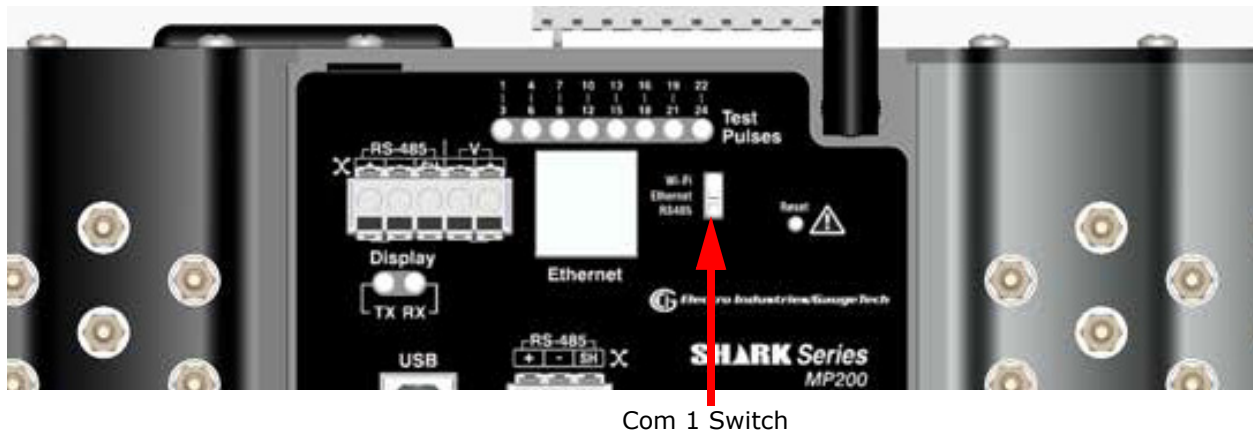
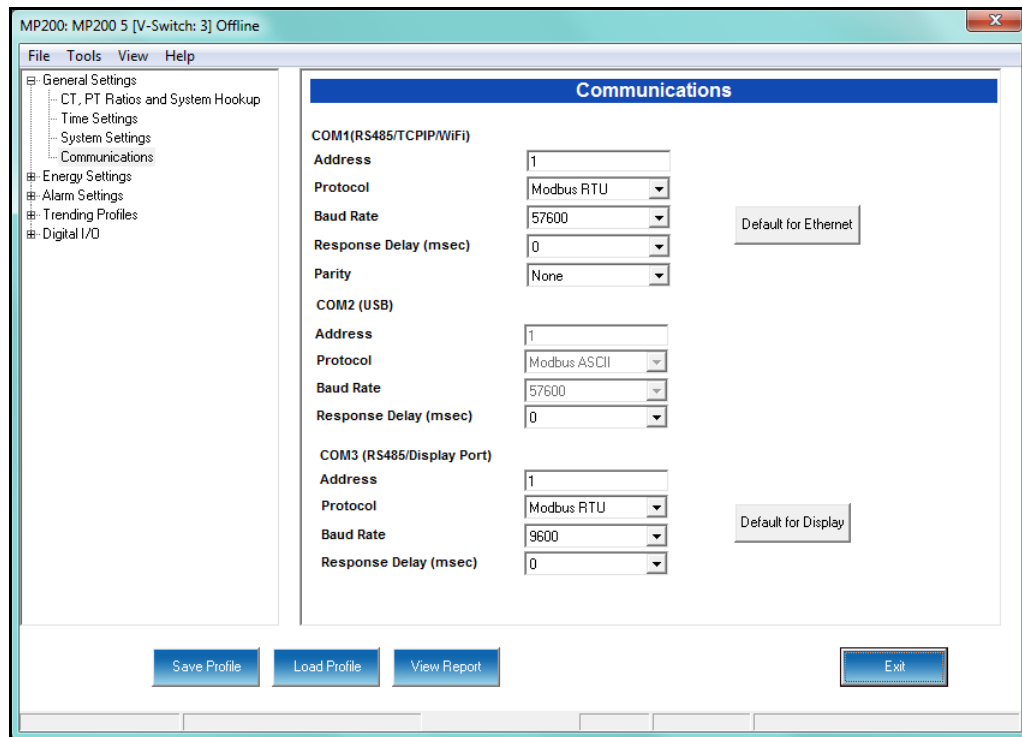

Figure 10.12: Com 1 Switch Set to Ethernet/WiFi

2. Configure the MP200 unit:
 - a. From the MP200 unit's Device Profile (see Chapter 5), open the Communications screen.

- b. Make sure the Com1 settings are the same as those shown in the screen below. If they are not, click the Default for Ethernet button to bring these settings into the Com 1 fields.



- c. If you changed the Com 1 settings to make them match those shown above, click Update Device to send the new settings to the meter. If you did not need to make any changes, click Exit to close the Device Profile screen.

- Use an Ethernet cable to connect the MP200 unit's RJ45 port to the MDLN/MDSN display's RJ45 port, at the bottom of the display.

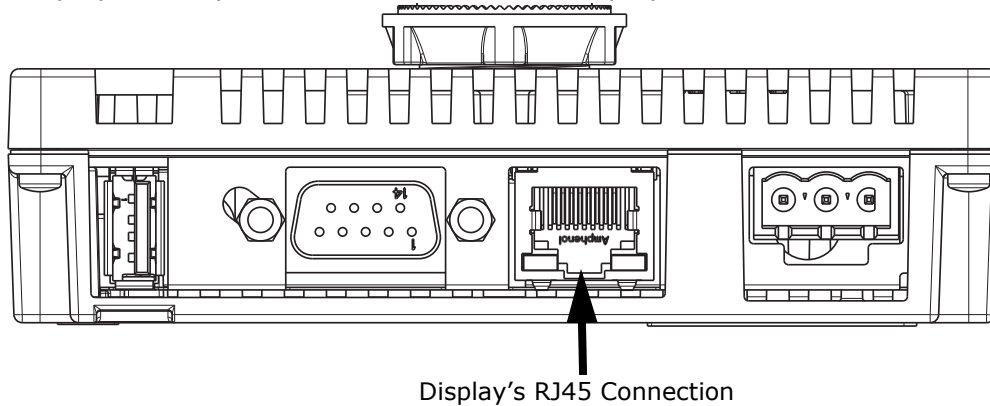
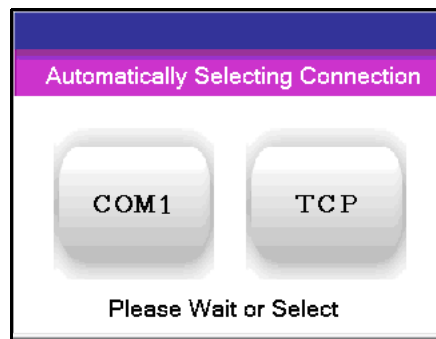
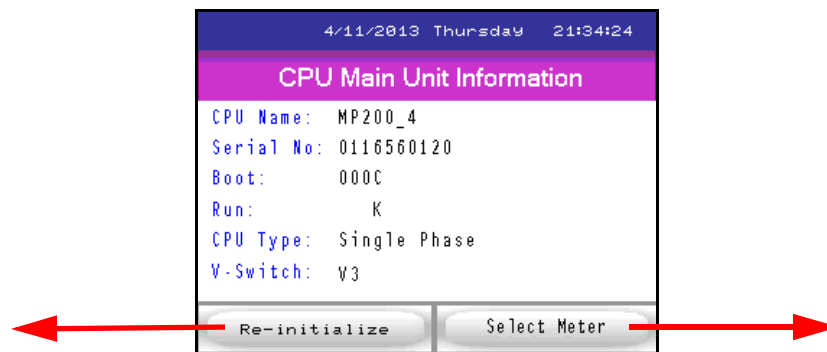

Figure 10.13: RJ45 Connection

- Plug in the display. The display will show messages as it boots up. You will then see the screen below. You can either click the TCP button or else wait for the display to select the TCP connection automatically.



- The display will initialize and then show the first screen, which lists information about the MP200 unit. An example screen is shown below. Continue to 10.7: Display Screens, on page 10-24.



10.7: Display Screens

The CPU Main Unit Information screen (shown on the previous page) is shown as the display is being initialized. You can touch the Re-initialize button if you need to restart the display initialization, or press the Select Meter button to proceed directly to the Home screen (shown below); the Home screen, listing the individual meters, will appear on its own if you don't touch either button. Depending on your system configuration, you will see either the screen on the left (MP200-Y with 8 three phase circuits/meters) or the one on the screen on the right (MP200-S with 24 single phase circuits/meters).

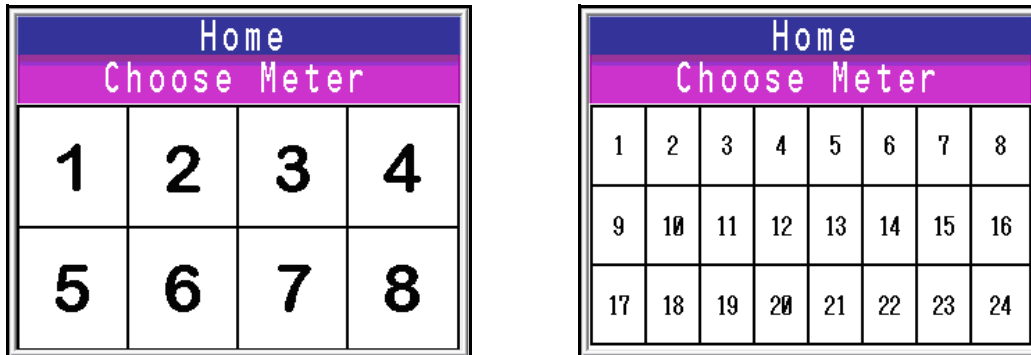

Click on a number to view readings for that meter. The first screen of readings for the display is shown (an example screen is shown below).

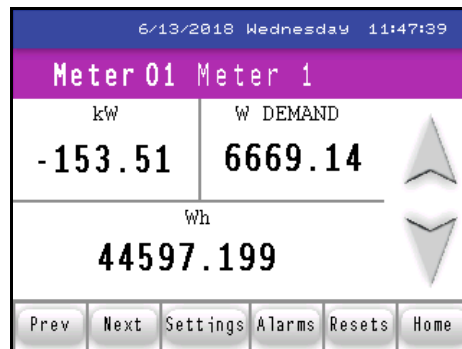

Readings Screens

The first Readings screen is the Watt, Whr, Watt Demand. This screen is the same for both the MP200-Y and MP200-S units, though some of the screens are different for the three phase (MP200-Y) and single phase (MP200-S) configurations. To access the

next screen in sequence, either touch the down arrow button or the Next button. See the figure below for an explanation of the arrow and button actions.

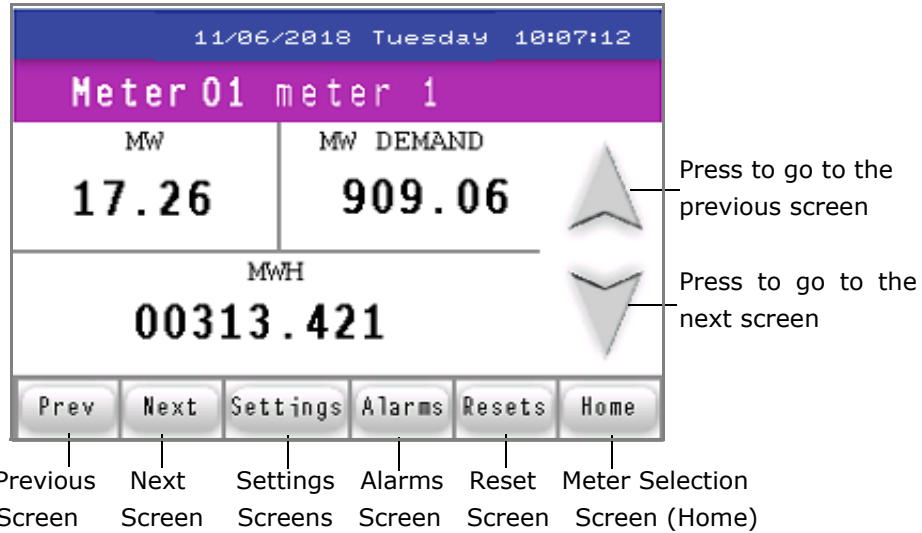

Following are example Readings screens, in the sequence they appear if you keep touching the Next button or the Down arrow. The caption underneath the screen tells you whether it is for the MP200-Y unit's three phase configuration or the MP200-S unit's single phase configuration. Some screens are shared by both MP200 unit configurations.

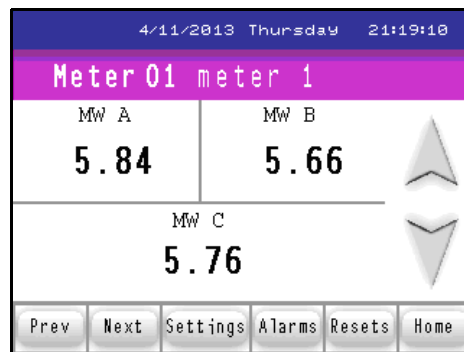

Three Phase Watts per Phase screen (Wye configuration only, not Delta configuration)

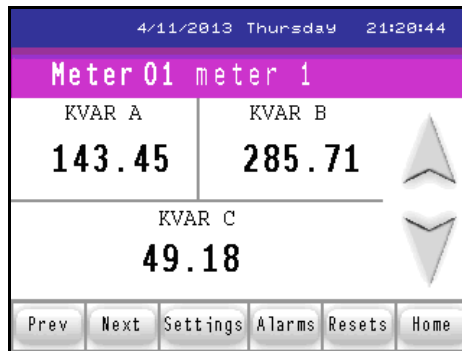

Three Phase VAR per Phase screen (Wye configuration only, not Delta configuration)

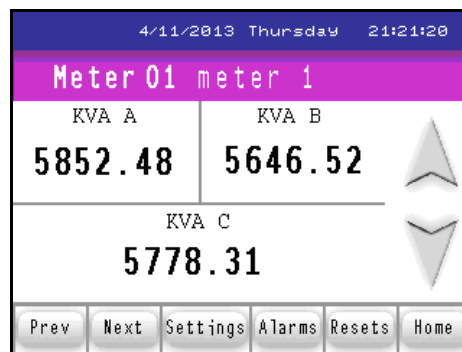

Three Phase VA per Phase screen (Wye configuration only, not Delta configuration)

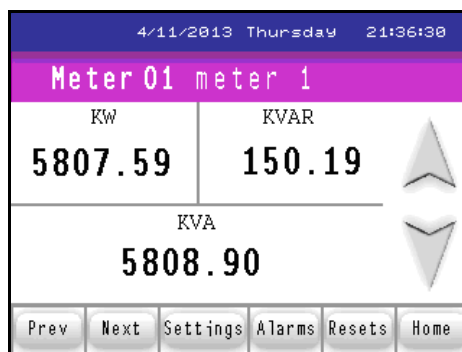

Single Phase KW, KVAR, KVA screen

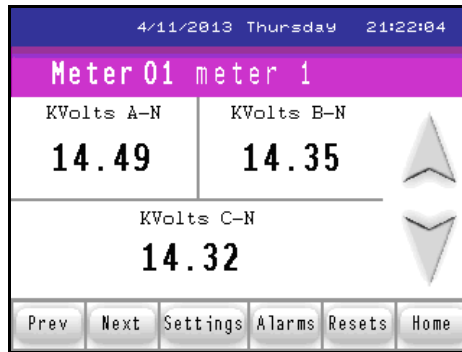

Three Phase Volts Line to Neutral screen (Wye configuration only, not Delta configuration)

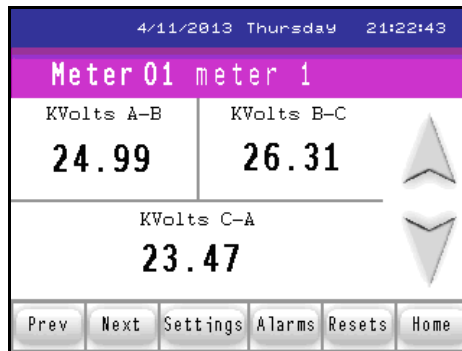

Three Phase Volts Line to Line screen

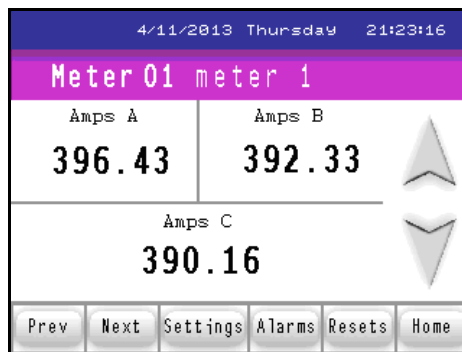

Three Phase Amperes per Phase screen

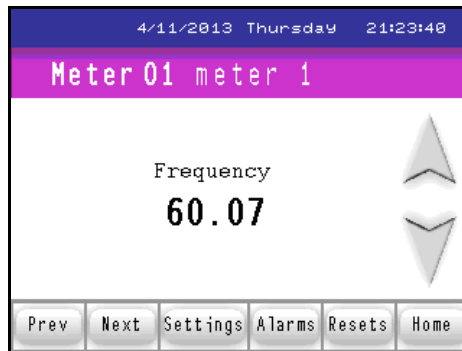

Three Phase Frequency screen

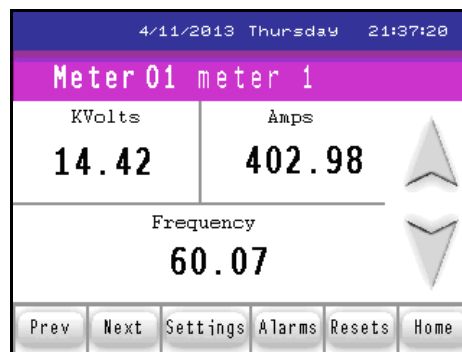

Single Phase Volt, Ampere, Frequency screen

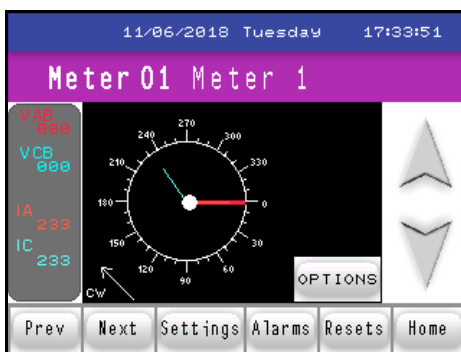

2 CT Delta Phasor screen

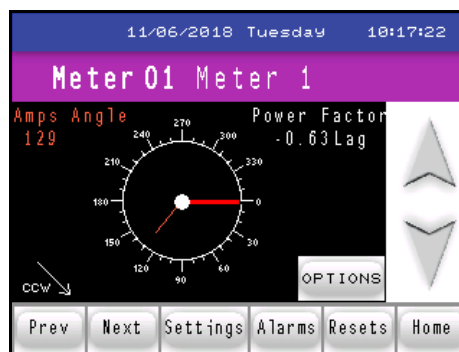

Single Phase Phasor screen

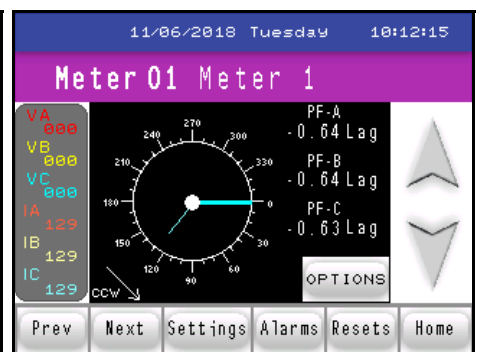

Three Phase Phasor screen

Touch the Options button to display the following screen.

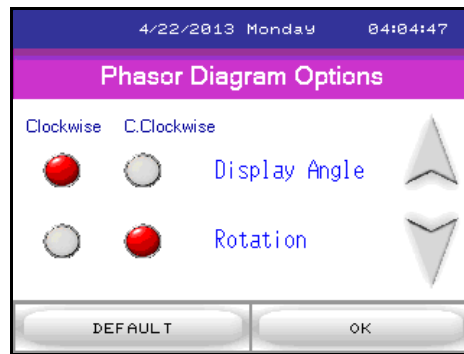

Phasor Options Screen

Touch the buttons to change the Display Angle and/or Rotation. Touch the Default button to return to the original settings. Click OK to redisplay the Phasor Diagram screen.

	SCALED	UNSCALED
Gas	0.000	0
Water	33.000	33
Condensate	0.000	0
Accumulator 4	0.000	0

6/13/2018 Wednesday 13:28:56

Back Settings Alarms Resets Home

Pulse Inputs screen

Touch the down arrow to display the following screen.

	SCALED	UNSCALED
Relay01	0.000	0
Relay02	0.000	0

6/03/2018 Monday 19:44:18

Back Settings Alarms Resets Home

Relay Outputs screen

This is the last Readings screen. From here you can:

- Touch the Back button to begin at the first screen of readings for the meter.
- Touch Settings to access the Settings screens (shown next).
- Touch Alarms to see the Alarm/Limits screens (continue on to read about these screens).
- Touch Resets to reset the meter (continue on to read about these screens).
- Touch Home to choose another meter.

Settings Screens

When you touch the Settings button, you see the screen shown below. It has the settings for the MP200 unit's Com 1.

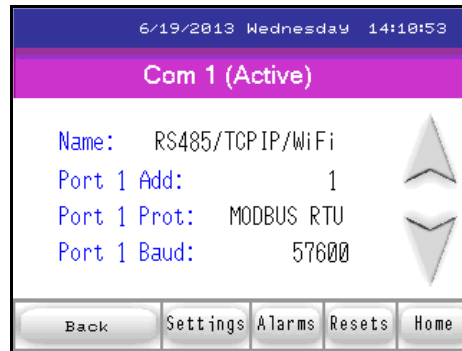

Com 1 Settings for MP200 Unit

Touch the Down arrow to see the screen shown below, which displays the settings for the MP200 unit's Com 2.

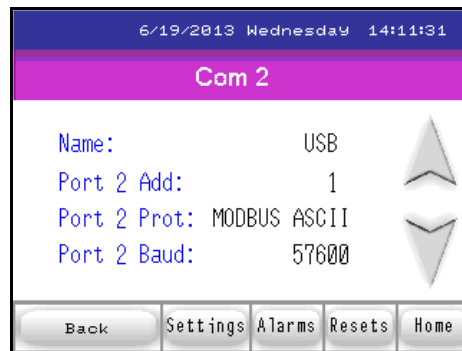

Com 2 Settings for MP200 Unit

Touch the Down arrow to see the following, which displays the settings for the MP200 unit's Com 3.

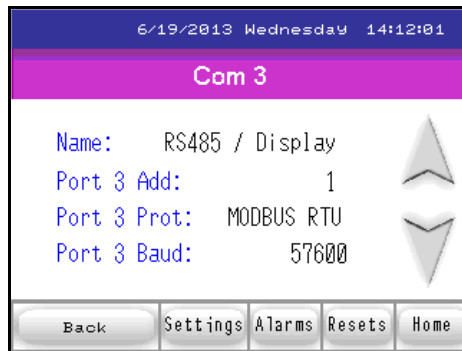

Com 3 Settings for MP200 Unit

Touch the Down arrow to see the screen shown below, which displays information about the MP200 unit: hookup, run state, battery state, whether logging is enabled, and firmware version.

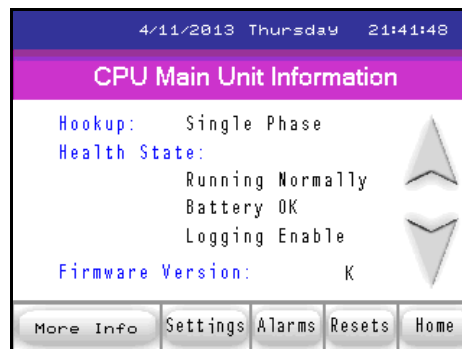

CPU Main Unit Information screen

Touch the Down arrow to see the following screen, which displays information about the display: firmware version and active connection.

NOTE: If you touch the More Info button, you will see the screen shown during initialization, which lists the CPU's name, serial number, boot and runtime firmware versions, circuit connection and V-Switch. This screen is shown at the end of Section 10.6.

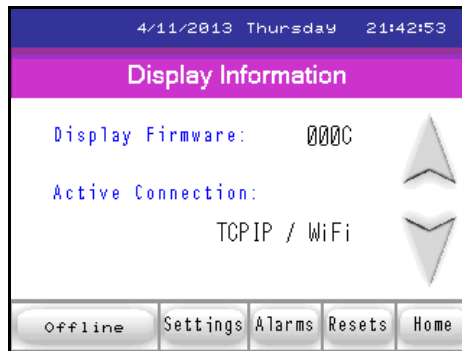

Display Information screen

This is the last **Settings** screen. From here you can:

- Touch the Offline button to access Offline mode (described in 10.8: Offline Mode, on page 10-38).
- Touch Alarms to see the Alarm/Limits screens (described next).
- Touch Resets to reset the meter (continue on to read about these screens).
- Touch Home to choose another meter.

Alarms/Limits Screens

Label	Value	Limit 1 (Above)	Limit 2 (Below)
Meter 01 Watts 3Ph Total	42.5K	IN	OUT
All Meters Volts A-N	87.9	OUT	IN
Meter 03 VAs 3Ph Total	127.5K	IN	OUT
Meter 08 VARs 3Ph Total	-81.8	IN	OUT

Out of Limit Alarm screen

When you touch Alarm you will see the Out of Limits screen, which displays the first four limits. Touch the down button to display limits 5-8, shown below.

Label	Value	Limit 1 (Above)	Limit 2 (Below)
Not Assigned	0.0	IN	IN
Not Assigned	0.0	IN	IN
Not Assigned	0.0	IN	IN
Not Assigned	0.0	IN	IN

Out of Limit Alarm screen #2

Touch the Down button to display the screen shown below, which gives you the status of the I/O card's inputs.

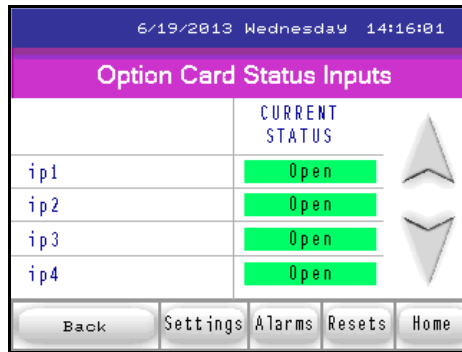

Option Card Status Inputs screen

Touch the Down arrow to display the following screen, which displays the status of the I/O card's relays.

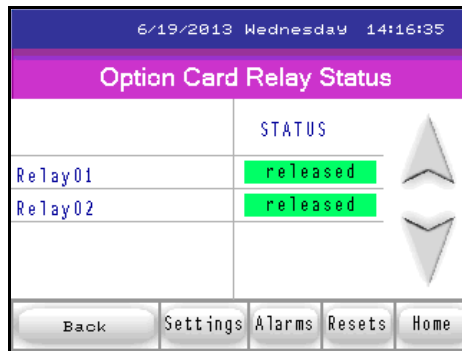

Option Card Relay Status screen

This is the last Alarms/Limits screen. From here you can:

- Touch the Back button to return to the first Readings screen.
- Touch Settings to access the Settings screens.
- Touch Resets to reset the meter (described next).
- Touch Home to choose another meter.

Reset Screens



Reset Device Information screen

When you touch the Resets button you see the screen shown above.

Touch either Reset option to reset either the Max/Min Demand and/or Max/Min Voltage and Frequency for all of the meters in the MP200 unit. Touch the Down arrow to display the following screen.

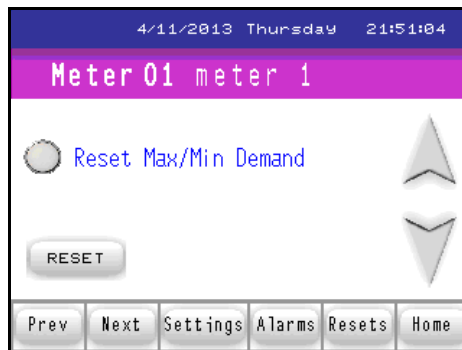

Reset Demand screen

Touch the button to reset Max/Min Demand for the current meter. This is the meter you selected from the Home screen.

Touch the Reset button to perform the reset.

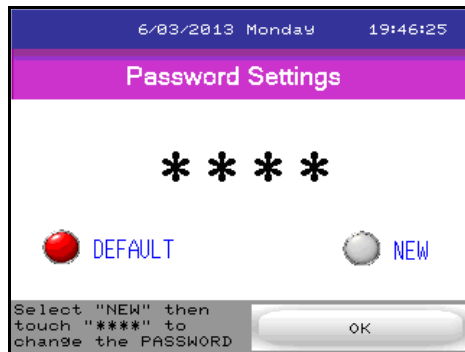

Password screen

If a password has been set for Reset, this screen will be displayed after you select one of the Reset options. You can touch the Default button to enter the password that has already been set up. To set a new password touch the New button to display the screen below.

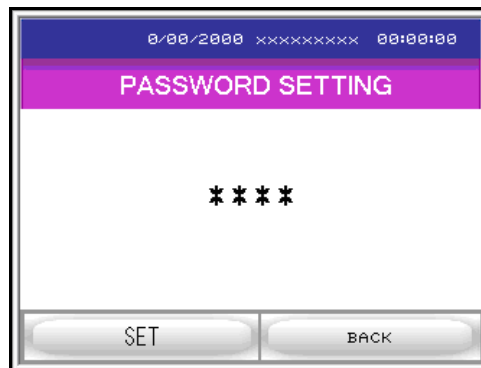

Password Entry screen

10.8: Offline Mode

The display's Offline mode lets you can change settings for the display. To access Offline mode, touch the Offline button from the Display Information screen: the display will beep and then will enter Offline mode.

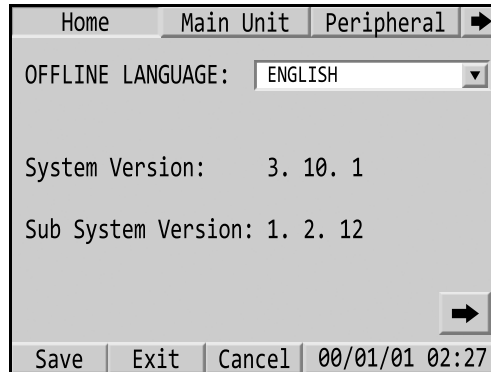

The screen above is the Home screen, which is the first screen you will see in Offline mode. It tells you information about the system and lets you select a language for Offline mode (the choices are English and Japanese; English is the default). Press the right arrow button at the bottom of the screen to see additional system information.

To access this screen from one of the other Offline screens, touch the Home tab at the top of the screen.

The buttons at the bottom of the screen let you save any setting changes and stay in Offline mode (Save), Exit Offline mode, with or without saving changes (Exit - you will see a confirmation screen that asks if you want to save changes and exit, or exit without saving changes), return settings to their previous state (Cancel).

NOTE: In this manual we only describe in detail the Offline screen's whose settings you may need to change when working with the MP200 metering system.

Main Unit tab

Touch the Main Unit tab to access the following setting:

- Screen settings
- Operation
- Display
- Menu and Error

- Window Settings
- System Area
- Ethernet (see 10.8.2: Setting Communication through Offline Mode, on page 10-41, for information on this setting)
- Logic
- Extended
- Remote Viewer

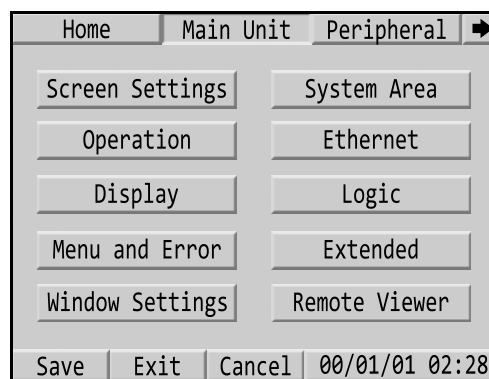

To access a setting, touch its button. Other screens will display that will let you make changes to the settings.

Peripheral Tab

Touch the Peripheral tab to access the following settings:

- Device/PLC Settings (see 10.8.2: Setting Communication through Offline Mode, on page 10-41, for information on this setting)
- Printer Settings
- Bar Code Settings
- USB
- Script Settings

To access a setting, touch its button. Other settings screens will display.

10.8.1: Making Selections and Entering Information in Offline Mode

The Offline screens operate in the same touch-screen mode as the display's other screens: touch the buttons you want to select. For certain settings you may need to enter letters and/or numbers. If an entry field calls for letters/numbers, a numeric or letter window opens up. These windows operate the same as a normal computer keyboard. See the examples below.

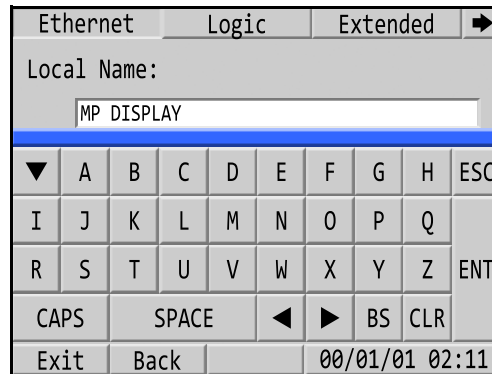
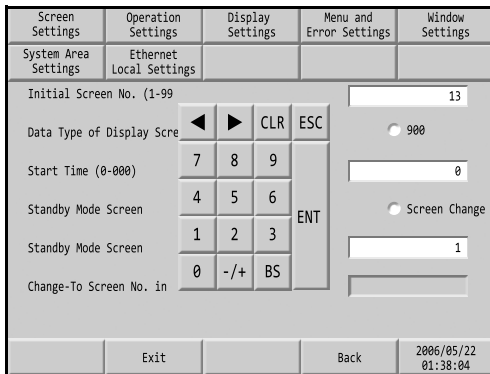

To make an entry, you touch the numbers or letters you want to enter in the field. You can use the arrow buttons to move forward or backward in the entry field. When you are done, touch ENT (Enter) to save the new settings.

- You can touch CLR (Clear) to remove all data from the entry field.
- You can touch ESC (Escape) to close the numeric or letter window without saving any changes.
- You can touch BS (Backspace) to delete the character or number to the left of where the cursor is.
- You can touch CAPS to toggle between uppercase and lowercase letters in the letter window.
- You can touch SPACE to insert a space in a letter entry.

10.8.2: Setting Communication through Offline Mode

If the display is not able to communicate with the MP200 metering system (for example, if you have changed the default IP address of the MP200 unit), you will see an error message similar to the one shown below, at the bottom of the display screen. The exact message you see depends on whether an RS485 or RJ45 cable is displayed: the message will say MP200_T: TCP for an RJ45 communication error and MP200_C: Com1 for an RS485 communication error.

NOTE: Refer to 10.8.1: Making Selections and Entering Information in Offline Mode, on page 10-40 for instructions on making entries in Offline mode.

1. Touch the black screen button at the bottom of the display.

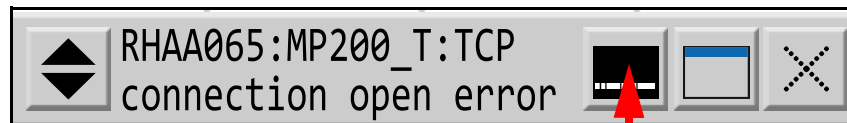

Touch this button

2. The bottom of the screen will display the Offline and Reset buttons, as shown below. Touch the Offline button.

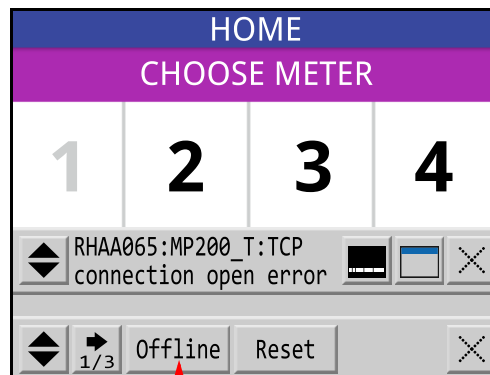

Touch this button

3. From the Offline Home screen, touch the Peripheral tab.

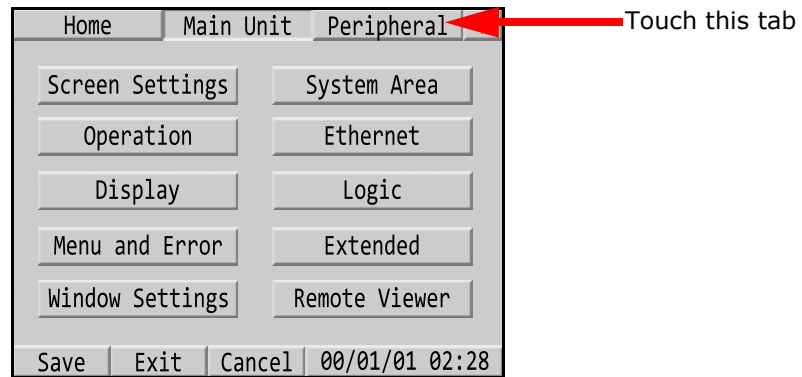

4. From the Peripheral menu, touch the Device/PLC Settings button.

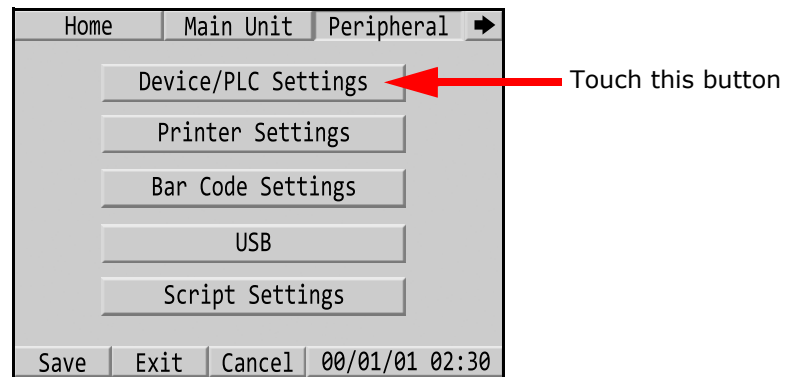

5. What you do now depends on your communication connection.

- If you are connecting via RS485:
 - a. Click the second button for Com1.

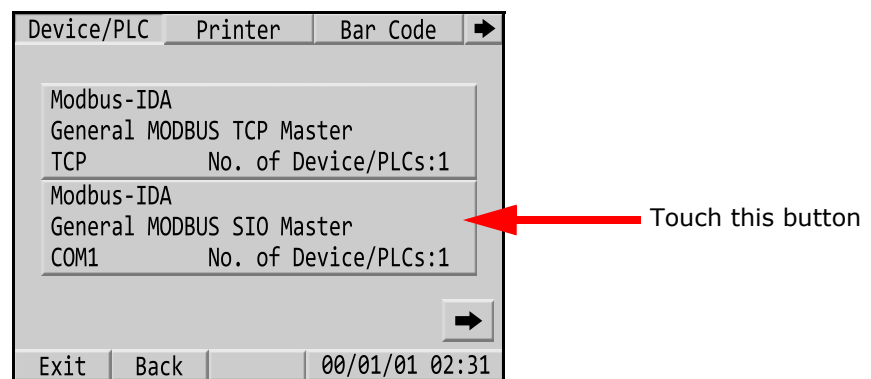

- b. You will see the screen shown below- make sure the settings match the ones shown here. Then press the right arrow at the bottom of the screen.

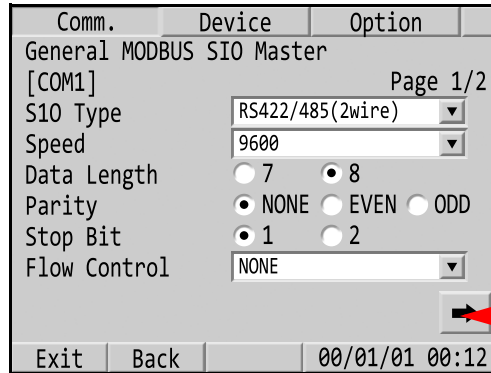

Make sure the fields are the same as this; then
Touch this button

- c. You will see the screen shown below- make sure the settings match the ones shown here.

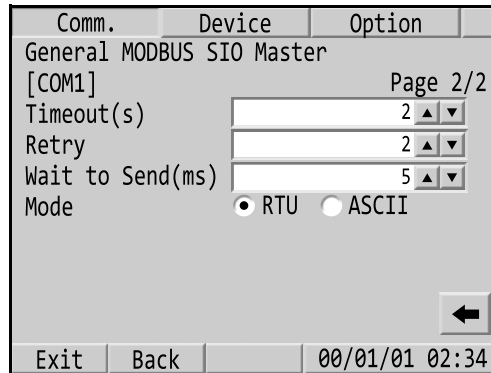

Make sure the fields are the same as this

- d. Touch Exit at the bottom of the screen. You will see a confirmation screen with the buttons shown below.

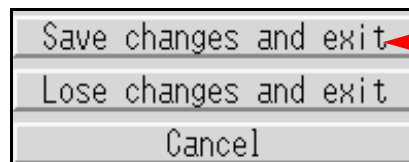

Touch this button

- e. Touch the Save Changes and Exit button. The display should begin to communicate with the MP200 unit as shown in 10.6.1: RS485 Communication Configuration, on page 10-19.

- If you are connecting via Ethernet:

- a. Click the first button for TCP.

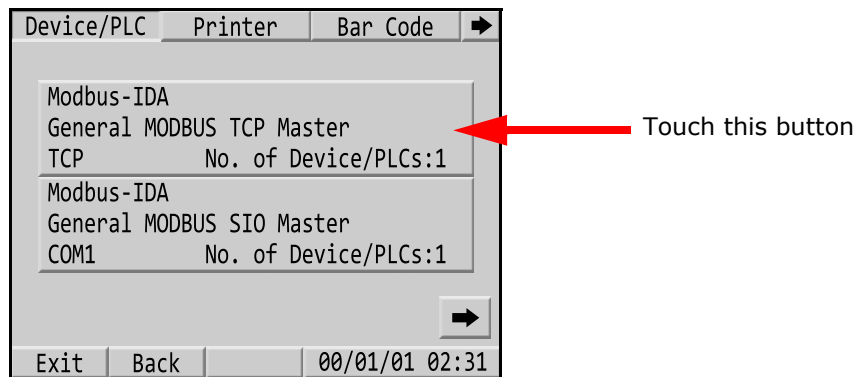

- b. Make sure your settings match those shown below.

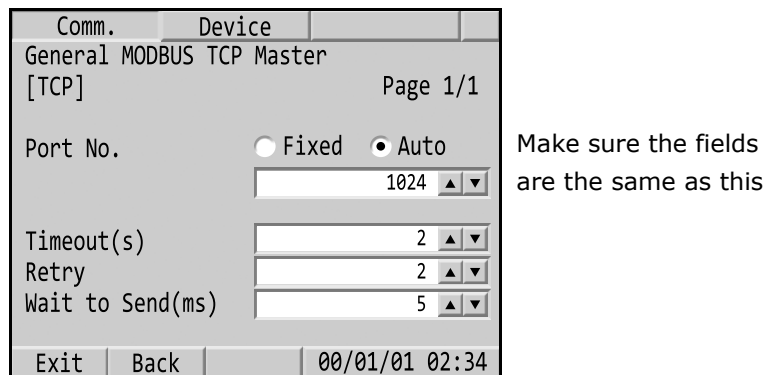

- c. Click the Device tab. Enter the MP200 unit's IP address (when you touch the IP address field, a numeric window opens - see 10.8.1: Making Selections and Entering Information in Offline Mode, on page 10-40). The other settings should be the same as shown below.

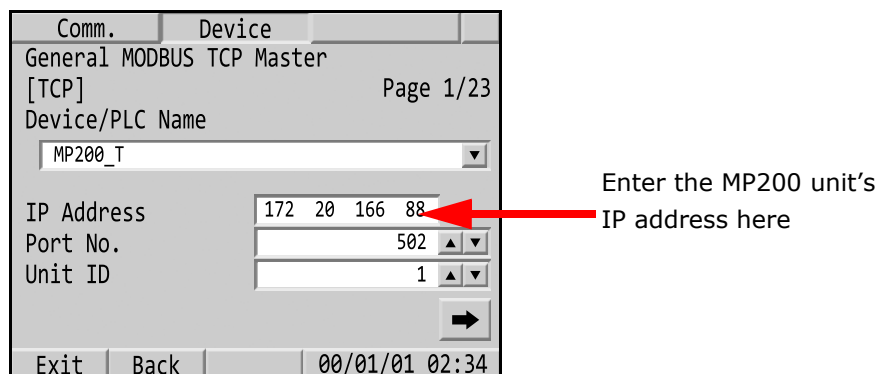

- d. Touch the Back button at the bottom of the display two times; then touch the Main Unit tab. You will see the screen below - touch the Ethernet button.

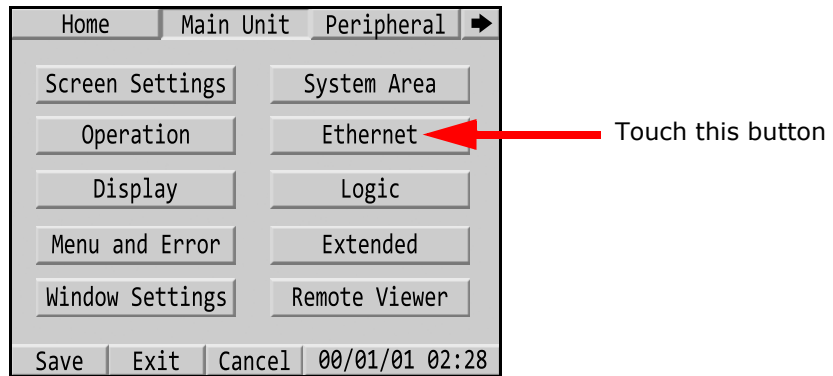

- e. Enter the IP address of the display. It must be on the same network and subnet mask as the MP200 unit's IP address and subnet mask. The port should be 8000. Then touch the right arrow at the bottom of the display.

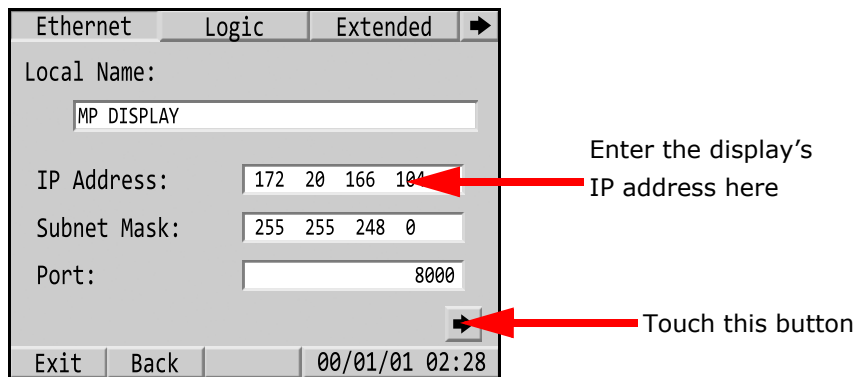

- f. You will see the screen shown below. This is where you enter the display's gateway IP address if the display and MP200 unit are not on the same sub-

net. (If they are on the same subnet you do not need to make any entries on this screen.) The other fields should remain the same.

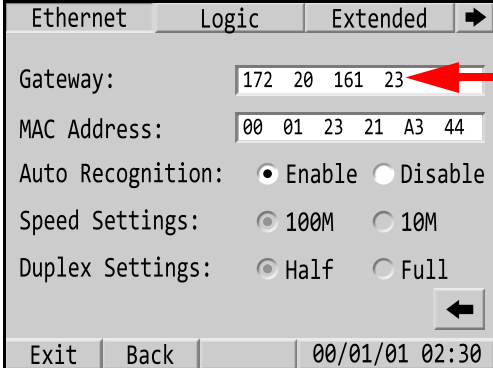

The screenshot shows the Ethernet configuration screen with the following fields and options:

- Gateway: 172 20 161 23 (A red arrow points to this field with the text "Enter the gateway's IP address here, if applicable")
- MAC Address: 00 01 23 21 A3 44
- Auto Recognition: Enable Disable
- Speed Settings: 100M 10M
- Duplex Settings: Half Full

At the bottom of the screen, there are buttons for "Exit", "Back", and a timestamp "00/01/01 02:30".

- g. Touch the Exit button at the bottom of the screen. You will a confirmation window with the buttons shown below.

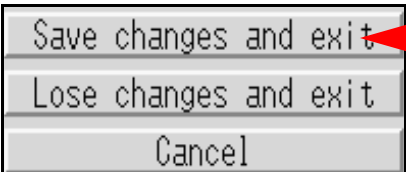

The confirmation window has three buttons:

- Save changes and exit (A red arrow points to this button with the text "Touch this button")
- Lose changes and exit
- Cancel

- h. Touch the Save Changes and Exit button. The display will begin to communicate with the MP200 unit as shown in 10.6.2: RJ45 Ethernet Configuration, on page 10-21.

10.9: Maintenance

Cleaning the Display



CAUTION: EQUIPMENT DAMAGE

- Power off the unit before cleaning it.
- Do not use hard or pointed objects to operate the touch panel, since it can damage the panel surface.
- Do not use paint thinner, organic solvents, or a strong acid compound to clean the unit.

Failure to follow these instructions can result in equipment damage.

When the surface or the frame of the display gets dirty, soak a soft cloth in water with a neutral detergent, wring the cloth tightly and wipe the display.

Periodic Checks

Operation Environment

Refer to the Environmental Specifications in 10.3.1: General Specifications, on page 10-3.

Electrical Specifications

The input voltage must be within 20.4 to 28.8 VDC.

Related Items

- Are all power cords and cables connected properly? Are there any loose cables?
- Is the display installation nut holding the unit securely?
- Are there scratches or traces of dirt on the installation gasket?

NOTE: A gasket with scratches or dirt may have lost much of its water resistance. Make sure to change the gasket for one with a water resistance equivalent to IP65f when scratches or dirt become visible.

10.10: Compliance and Standards

- ANSI/UL 61010-1 / ANSI/UL 61010-2-201 for Programmable Controllers
- CSA C22.2 no. 142 for Industrial Control Equipment
- IEC 61010-1/IEC 610010-2-201 for Programmable Controllers
- ANSI/ISA 12.12.01 and CSA C22.2 no. 213 for Electrical Equipment for Use in Class I, Division 2 Groups A, B, C and D Hazardous (classified) Locations Hazardous Substances
- WEEE, Directive 2012/19/EU
- RoHS, Directive 2011/65/EU and 2015/863/EU
- RoHS China, Standard (GB/T 26572)

UL Conditions of Acceptability and Handling Cautions for Unit:

The GP unit is suitable for use in hazardous locations in accordance with Class I, Division 2 Groups A, B, C and D standards. All relevant local, state, and regional codes must be followed.

CE Markings:

This product conforms to the necessary requirements of the following Directives for applying the CE label:

- Directive 2014/35/EU (Low voltage)
- Directive 2014/30/EU (EMC)

This conformity is based on compliance with IEC 61131-2.

A: Installing the USB Virtual COM Port

A.1: Introduction

As mentioned in Chapter 5, EIG provides a driver (for operating systems earlier than Windows® 7) that lets you configure the MP200 unit's USB port as a Virtual Serial port. The driver is on the CD that came with your meter. Follow the instructions in this chapter to install the driver and connect to the meter's Virtual port.

A.2: Installing the Virtual Port's Driver

1. Insert the CD that came with your meter into your PC's CD drive.
2. Click the **Software** button.
3. Click the **USB Driver** button at the bottom of the webpage.
4. The setup program opens a DOS command screen on your PC, as shown below. You will see a message indicating that the driver is being installed.

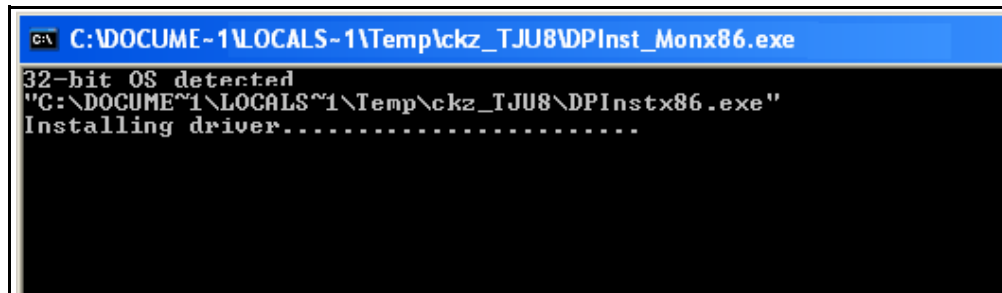

```
C:\ C:\DOCUME~1\LOCALS~1\Temp\ckz_TJU8\DPInst_Monx86.exe
32-bit OS detected
"C:\DOCUME~1\LOCALS~1\Temp\ckz_TJU8\DPInstx86.exe"
Installing driver.....
```

Once the driver installation is complete, you will see the following message on the DOS command screen.

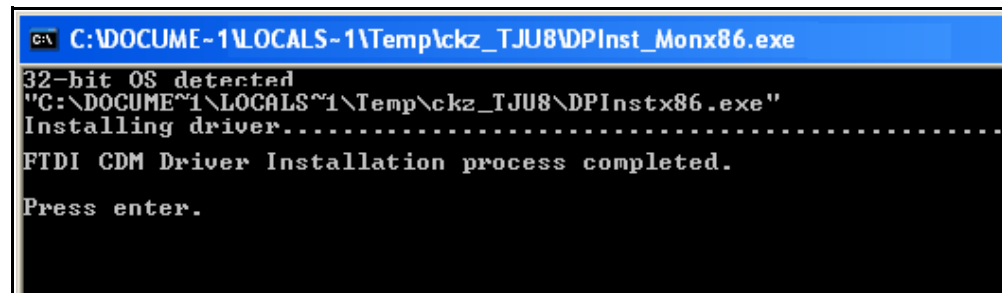

```
C:\ C:\DOCUME~1\LOCALS~1\Temp\ckz_TJU8\DPInst_Monx86.exe
32-bit OS detected
"C:\DOCUME~1\LOCALS~1\Temp\ckz_TJU8\DPInstx86.exe"
Installing driver.....
FTDI CDM Driver Installation process completed.
Press enter.
```

5. Press **Enter**. The DOS screen closes.
6. Plug a USB cable into your PC and the MP200 unit's USB port. You will see pop-up message windows telling you that new hardware has been found and that it is installed and ready to use.

A.3: Connecting to the Virtual Port

1. Open the CommunicatorPQA® application.
2. Click the **Connect** icon. You will see the Connect screen, shown below.

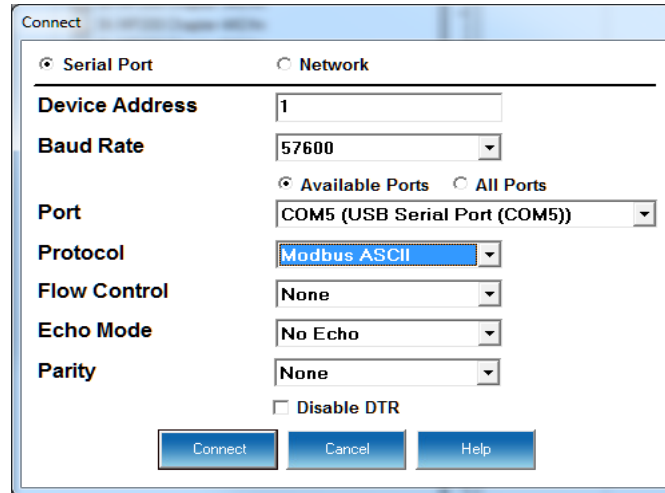

Connect

Serial Port Network

Device Address: 1

Baud Rate: 57600

Available Ports All Ports

Port: COM5 (USB Serial Port (COM5))

Protocol: Modbus ASCII

Flow Control: None

Echo Mode: No Echo

Parity: None

Disable DTR

Connect Cancel Help

3. Click the **Serial Port** and **Available Ports** radio buttons and select the Port labelled as the USB Serial Port.
4. Click **Connect**.

B: Modbus Map Overview

B.1: Introduction

The Modbus map for the MP200 metering system gives details and information about its possible readings and its programming. The MP200 unit can be programmed using CommunicatorPQA® software. For a programming overview, see Section 5.2. For further details see the *CommunicatorPQA®*, *MeterManagerPQA®*, and *EnergyPQA.com® Software User Manual*.

B.2: Modbus Register Map Sections

The MP200 unit's Modbus Register map includes the following sections:

Fixed Data Section, Registers 1- 37, details the MP200 unit's fixed information.

Meter Data Section, Registers 1000 - 12011, details the MP200 unit's readings, including Primary Readings, Energy Block, Demand Block, Phase Angle Block, Status Block, Minimum and Maximum in Regular and Time Stamp Blocks, Interval Energy Blocks, I/O Card Blocks, and Accumulators.

Commands Section, Registers 20000 - 26011, details the MP200 unit's Resets Block, Privileged Commands Block and Encryption Block.

Programmable Settings Section, Registers 30000 - 32575, details all the settings you can program to configure your MP200 unit.

Log Retrieval Section, Registers 49997 - 51095, details Log Retrieval Block and Log Status Block. See Appendix E for instructions on retrieving logs using the Modbus registers.

B.3: Data Formats

ASCII:	ASCII characters packed 2 per register in high, low order and without any termination characters
SINT16/UINT16:	16-bit signed/unsigned integer

SINT32/UINT32: 32-bit signed/unsigned integer spanning 2 registers - the lower-addressed register is the high order half

FLOAT: 32-bit IEEE floating point number spanning 2 registers - the lower-addressed register is the high order half (i.e., contains the exponent)

B.4: Floating Point Values

Floating Point Values are represented in the following format:

Register	0																1															
Byte	0								1								0								1							
Bit	7	6	5	4	3	2	1	0	7	6	5	4	3	2	1	0	7	6	5	4	3	2	1	0	7	6	5	4	3	2	1	0
Meaning	s	e	e	e	e	e	e	e	e	m	m	m	m	m	m	m	m	m	m	m	m	m	m	m	m	m	m	m	m	m	m	m
	sign		exponent						mantissa																							

The formula to interpret a Floating Point Value is:

$$-1^{sign} \times 2^{exponent-127} \times 1.mantissa = 0x0C4E11DB9$$

$$-1^{sign} \times 2^{137-127} \times 1.1000010001110110111001$$

$$-1 \times 2^{10} \times 1.75871956$$

$$-1800.929$$

Register	0x0C4E1																0x01DB9															
Byte	0x0C4								0x0E1								0x01D								0x0B9v							
Bit	7	6	5	4	3	2	1	0	7	6	5	4	3	2	1	0	7	6	5	4	3	2	1	0	7	6	5	4	3	2	1	0
	1	1	0	0	0	1	0	0	1	1	1	0	0	0	0	1	0	0	0	1	1	1	0	1	1	1	0	1	1	1	0	0
Meaning	s	e	e	e	e	e	e	e	e	m	m	m	m	m	m	m																
	m	m	m	m	m	m	m	m	m	m	m	m	m	m	m	m																
	sign		exponent						mantissa																							
	1		0x089 + 137						0b011000010001110110111001																							

Formula Explanation:

C4E11DB9 (hex)

11000100 11100001 00011101 10111001

(binary)

The sign of the mantissa (and therefore the number) is 1, which represents a negative value.

The Exponent is 10001001 (binary) or 137 decimal.

The Exponent is a value in excess 127. So, the Exponent value is 10.

The Mantissa is 11000010001110110111001 binary.

With the implied leading 1, the Mantissa is (1).611DB9 (hex).

The Floating Point Representation is therefore -1.75871956 times 2 to the 10.

Decimal equivalent: -1800.929

NOTES:

- Exponent = the whole number before the decimal point.
- Mantissa = the positive fraction after the decimal point.

B.5: Important Note Concerning the MP200 Unit's Modbus Map

In depicting Modbus registers (Addresses), the MP200 unit's Modbus map uses Holding Registers only.

B.5.1: Hex Representation

The representation shown in the table below is used by developers of Modbus drivers and libraries, SEL 2020/2030 programmers and Firmware Developers. The MP200 unit's Modbus map also uses this representation.

Hex	Description
0008 - 000F	MP200 Unit Serial Number

B.5.2: Decimal Representation

The MP200 unit's Modbus map defines Holding Registers as (4X) registers. Many popular SCADA and HMI packages and their Modbus drivers have user interfaces that require users to enter these Registers starting at 40001. So instead of entering two separate values, one for register type and one for the actual register, they have been combined into one number.

The MP200 unit's Modbus map uses a shorthand version to depict the decimal fields, i.e., not all of the digits required for entry into the SCADA package UI are shown. For example:

You need to display the MP200 unit's serial number in your SCADA application. The MP200 unit's Modbus map shows the following information for MP200 unit serial number:

Decimal	Description
9 - 16	MP200 Unit Serial Number

In order to retrieve the MP200 unit's serial number, enter 40009 into the SCADA UI as the starting register, and 8 as the number of registers.

- In order to work with SCADA and Driver packages that use the 40001 to 49999 method for requesting holding registers, take 40000 and add the value of the register (Address) in the decimal column of the Modbus map. Then enter the number (e.g., 4009) into the UI as the starting register.
- For SCADA and Driver packages that use the 400001 to 465536 method for requesting holding registers take 400000 and add the value of the register (Address) in the decimal column of the Modbus map. Then enter the number (e.g., 400009) into the UI as the starting register. The drivers for these packages strip off the leading four and subtract 1 from the remaining value. This final value is used as the starting register or register to be included when building the actual modbus message.

B.6: Modbus Register Maps and Retrieving Logs

- Appendix C contains the MP200-Y unit's Modbus map.
- Appendix D contains the MP200-S unit's Modbus map.
- Appendix E contains instructions on retrieving MP200 unit logs via the Modbus map.

This page intentionally left blank.

Modbus Address		Description	Format	Range	Units or Resolution	Comments	# Reg
Hex	Decimal						
Fixed Data Section							
Identification Block						read-only	
0000 - 0007	1 - 8	CPU Name	ASCII	16 char	none		8
0008 - 000F	9 - 16	CPU Serial Number	ASCII	16 char	none		8
0010 - 0010	17 - 17	CPU Type	UINT16	bit-mapped	-----m vvvvvvvv	m = CPU type 0: Three phase 1: Single Phase vvvvvvv = V-switch 1: V1 2: V2 3: V3	1
0011 - 0012	18 - 19	Firmware Version	ASCII	4 char	none		2
0013 - 0013	20 - 20	Map Version	UINT16	0 to 65535	none		1
0014 - 0014	21 - 21	CPU Configuration	UINT16	bit-mapped	-----ccc -- ffffff	ccc = CT denominator (1 or 5), ffffff = calibration frequency (50 or 60)	1
0015 - 0015	22 - 22	ASIC Version Meter1	UINT16	0-65535	none		1
0016 - 0016	23 - 23	ASIC Version Meter2	UINT16	0-65536	none		1
0017 - 0017	24 - 24	ASIC Version Meter3	UINT16	0-65537	none		1
0018 - 0018	25 - 25	ASIC Version Meter4	UINT16	0-65538	none		1
0019 - 0019	26 - 26	ASIC Version Meter5	UINT16	0-65539	none		1
001A - 001A	27 - 27	ASIC Version Meter6	UINT16	0-65540	none		1
001B - 001B	28 - 28	ASIC Version Meter7	UINT16	0-65541	none		1
001C - 001C	29 - 29	ASIC Version Meter8	UINT16	0-65542	none		1
001D - 001E	30 - 31	Boot Firmware Version	ASCII	4 char	none		2
001F - 001F	32 - 32	Relay card id			none		1
0020 - 0020	33 - 33	Reserved					1
0021 - 0024	34 - 37	CPU Type Name	ASCII	8 char	none		4
						Block Size:	37

Modbus Address		Description	Format	Range	Units or Resolution	Comments	# Reg
Hex	Decimal						
CPU Data Section							
Primary Voltage Readings Block						read-only	
03E7 -	03E8	1000 - 1001	Volts A-N	FLOAT	0 to 9999 M	volts	2
03E9 -	03EA	1002 - 1003	Volts B-N	FLOAT	0 to 9999 M	volts	2
03EB -	03EC	1004 - 1005	Volts C-N	FLOAT	0 to 9999 M	volts	2
03ED -	03EE	1006 - 1007	Volts A-B	FLOAT	0 to 9999 M	volts	2
03EF -	03F0	1008 - 1009	Volts B-C	FLOAT	0 to 9999 M	volts	2
03F1 -	03F2	1010 - 1011	Volts C-A	FLOAT	0 to 9999 M	volts	2
03F3 -	03F4	1012 - 1013	Frequency	FLOAT	0 to 65.00	Hz	2
Block Size:							12
Primary Readings Block Meter 1						read-only	
044B -	044C	1100 - 1101	Amps A	FLOAT	0 to 9999 M	amps	2
044D -	044E	1102 - 1103	Amps B	FLOAT	0 to 9999 M	amps	2
044F -	0450	1104 - 1105	Amps C	FLOAT	0 to 9999 M	amps	2
0451 -	0452	1106 - 1107	Watts, 3-Ph total	FLOAT	-9999 M to +9999 M	watts	2
0453 -	0454	1108 - 1109	VARs, 3-Ph total	FLOAT	-9999 M to +9999 M	VARs	2
0455 -	0456	1110 - 1111	VAs, 3-Ph total	FLOAT	0 to +9999 M	VAs	2
0457 -	0458	1112 - 1113	Power Factor, 3-Ph total	FLOAT	-1.00 to +1.00	none	2
0459 -	045A	1114 - 1115	Neutral Current	FLOAT	0 to 9999 M	amps	2
045B -	045C	1116 - 1117	Watts, Phase A	FLOAT	-9999 M to +9999 M	watts	2
045D -	045E	1118 - 1119	Watts, Phase B	FLOAT	-9999 M to +9999 M	watts	2
045F -	0460	1120 - 1121	Watts, Phase C	FLOAT	-9999 M to +9999 M	watts	2
0461 -	0462	1122 - 1123	VARs, Phase A	FLOAT	-9999 M to +9999 M	VARs	2
0463 -	0464	1124 - 1125	VARs, Phase B	FLOAT	-9999 M to +9999 M	VARs	2
0465 -	0466	1126 - 1127	VARs, Phase C	FLOAT	-9999 M to +9999 M	VARs	2
0467 -	0468	1128 - 1129	VAs, Phase A	FLOAT	0 to +9999 M	VAs	2

Per phase power and PF have values only for WYE hookup and will be zero for all other hookups.
For single phase hook up only per phase values are valid. Please note that the total values are invalid.

Modbus Address		Description	Format	Range	Units or Resolution	Comments	# Reg	
Hex	Decimal							
0469 -	046A	1130 - 1131	VAs, Phase B	FLOAT	0 to +9999 M	VAs	(Cont'd)	2
046B -	046C	1132 - 1133	VAs, Phase C	FLOAT	0 to +9999 M	VAs		2
046D -	046E	1134 - 1135	Power Factor, Phase A	FLOAT	-1.00 to +1.00	none		2
046F -	0470	1136 - 1137	Power Factor, Phase B	FLOAT	-1.00 to +1.00	none		2
0471 -	0472	1138 - 1139	Power Factor, Phase C	FLOAT	-1.00 to +1.00	none		2
						Block size:	40	
Primary Readings Block Meter 2						read-only		
04AF -	04B0	1200 - 1201	Amps A	FLOAT	0 to 9999 M	amps		2
04B1 -	04B2	1202 - 1203	Amps B	FLOAT	0 to 9999 M	amps		2
04B3 -	04B4	1204 - 1205	Amps C	FLOAT	0 to 9999 M	amps		2
04B5 -	04B6	1206 - 1207	Watts, 3-Ph total	FLOAT	-9999 M to +9999 M	watts		2
04B7 -	04B8	1208 - 1209	VARs, 3-Ph total	FLOAT	-9999 M to +9999 M	VARs		2
04B9 -	04BA	1210 - 1211	VAs, 3-Ph total	FLOAT	0 to +9999 M	VAs		2
04BB -	04BC	1212 - 1213	Power Factor, 3-Ph total	FLOAT	-1.00 to +1.00	none		2
04BD -	04BE	1214 - 1215	Neutral Current	FLOAT	0 to 9999 M	amps		2
04BF -	04C0	1216 - 1217	Watts, Phase A	FLOAT	-9999 M to +9999 M	watts	Per phase power and PF have values only for WYE hookup and will be zero for all other hookups.	2
04C1 -	04C2	1218 - 1219	Watts, Phase B	FLOAT	-9999 M to +9999 M	watts		2
04C3 -	04C4	1220 - 1221	Watts, Phase C	FLOAT	-9999 M to +9999 M	watts	For single phase hook up only per phase values are valid. Please note that the total values are invalid.	2
04C5 -	04C6	1222 - 1223	VARs, Phase A	FLOAT	-9999 M to +9999 M	VARs		2
04C7 -	04C8	1224 - 1225	VARs, Phase B	FLOAT	-9999 M to +9999 M	VARs		2
04C9 -	04CA	1226 - 1227	VARs, Phase C	FLOAT	-9999 M to +9999 M	VARs		2
04CB -	04CC	1228 - 1229	VAs, Phase A	FLOAT	0 to +9999 M	VAs		2

C: MP200-Y (Three Phase) Modbus Map

Modbus Address		Description	Format	Range	Units or Resolution	Comments	# Reg
Hex	Decimal						
04CD -	04CE	1230 - 1231	VAs, Phase B	FLOAT	0 to +9999 M	(Cont'd)	2
04CF -	04D0	1232 - 1233	VAs, Phase C	FLOAT	0 to +9999 M		2
04D1 -	04D2	1234 - 1235	Power Factor, Phase A	FLOAT	-1.00 to +1.00		2
04D3 -	04D4	1236 - 1237	Power Factor, Phase B	FLOAT	-1.00 to +1.00		2
04D5 -	04D6	1238 - 1239	Power Factor, Phase C	FLOAT	-1.00 to +1.00		2
							Block size:
Primary Readings Block Meter 3						read-only	
0513 -	0514	1300 - 1301	Amps A	FLOAT	0 to 9999 M		2
0515 -	0516	1302 - 1303	Amps B	FLOAT	0 to 9999 M		2
0517 -	0518	1304 - 1305	Amps C	FLOAT	0 to 9999 M		2
0519 -	051A	1306 - 1307	Watts, 3-Ph total	FLOAT	-9999 M to +9999 M		2
051B -	051C	1308 - 1309	VARs, 3-Ph total	FLOAT	-9999 M to +9999 M		2
051D -	051E	1310 - 1311	VAs, 3-Ph total	FLOAT	0 to +9999 M		2
051F -	0520	1312 - 1313	Power Factor, 3-Ph total	FLOAT	-1.00 to +1.00		2
0521 -	0522	1314 - 1315	Neutral Current	FLOAT	0 to 9999 M		2
0523 -	0524	1316 - 1317	Watts, Phase A	FLOAT	-9999 M to +9999 M	Per phase power and PF have values only for WYE hookup and will be zero for all other hookups.	2
0525 -	0526	1318 - 1319	Watts, Phase B	FLOAT	-9999 M to +9999 M		2
0527 -	0528	1320 - 1321	Watts, Phase C	FLOAT	-9999 M to +9999 M	For single phase hook up only per phase values are valid. Please note that the total values are invalid.	2
0529 -	052A	1322 - 1323	VARs, Phase A	FLOAT	-9999 M to +9999 M		2
052B -	052C	1324 - 1325	VARs, Phase B	FLOAT	-9999 M to +9999 M		2
052D -	052E	1326 - 1327	VARs, Phase C	FLOAT	-9999 M to +9999 M		2
052F -	0530	1328 - 1329	VAs, Phase A	FLOAT	0 to +9999 M		2

Modbus Address		Description	Format	Range	Units or Resolution	Comments	# Reg	
Hex	Decimal							
0531 -	0532	1330 - 1331	VAs, Phase B	FLOAT	0 to +9999 M	VAs	(Cont'd)	2
0533 -	0534	1332 - 1333	VAs, Phase C	FLOAT	0 to +9999 M	VAs		2
0535 -	0536	1334 - 1335	Power Factor, Phase A	FLOAT	-1.00 to +1.00	none		2
0537 -	0538	1336 - 1337	Power Factor, Phase B	FLOAT	-1.00 to +1.00	none		2
0539 -	053A	1338 - 1339	Power Factor, Phase C	FLOAT	-1.00 to +1.00	none		2
						Block size:	40	
Primary Readings Block Meter 4						read-only		
0577 -	0578	1400 - 1401	Amps A	FLOAT	0 to 9999 M	amps		2
0579 -	057A	1402 - 1403	Amps B	FLOAT	0 to 9999 M	amps		2
057B -	057C	1404 - 1405	Amps C	FLOAT	0 to 9999 M	amps		2
057D -	057E	1406 - 1407	Watts, 3-Ph total	FLOAT	-9999 M to +9999 M	watts		2
057F -	0580	1408 - 1409	VARs, 3-Ph total	FLOAT	-9999 M to +9999 M	VARs		2
0581 -	0582	1410 - 1411	VAs, 3-Ph total	FLOAT	0 to +9999 M	VAs		2
0583 -	0584	1412 - 1413	Power Factor, 3-Ph total	FLOAT	-1.00 to +1.00	none		2
0585 -	0586	1414 - 1415	Neutral Current	FLOAT	0 to 9999 M	amps		2
0587 -	0588	1416 - 1417	Watts, Phase A	FLOAT	-9999 M to +9999 M	watts	Per phase power and PF have values only for WYE hookup and will be zero for all other hookups.	2
0589 -	058A	1418 - 1419	Watts, Phase B	FLOAT	-9999 M to +9999 M	watts		2
058B -	058C	1420 - 1421	Watts, Phase C	FLOAT	-9999 M to +9999 M	watts	For single phase hook up only per phase values are valid. Please note that the total values are invalid.	2
058D -	058E	1422 - 1423	VARs, Phase A	FLOAT	-9999 M to +9999 M	VARs		2
058F -	0590	1424 - 1425	VARs, Phase B	FLOAT	-9999 M to +9999 M	VARs		2
0591 -	0592	1426 - 1427	VARs, Phase C	FLOAT	-9999 M to +9999 M	VARs		2
0593 -	0594	1428 - 1429	VAs, Phase A	FLOAT	0 to +9999 M	VAs		2

Modbus Address		Description	Format	Range	Units or Resolution	Comments	# Reg	
Hex	Decimal							
0595 -	0596	1430 - 1431	VAs, Phase B	FLOAT	0 to +9999 M	VAs	(Cont'd)	2
0597 -	0598	1432 - 1433	VAs, Phase C	FLOAT	0 to +9999 M	VAs		2
0599 -	059A	1434 - 1435	Power Factor, Phase A	FLOAT	-1.00 to +1.00	none		2
059B -	059C	1436 - 1437	Power Factor, Phase B	FLOAT	-1.00 to +1.00	none		2
059D -	059E	1438 - 1439	Power Factor, Phase C	FLOAT	-1.00 to +1.00	none		2
						Block size:	40	
Primary Readings Block Meter 5						read-only		
05DB -	05DC	1500 - 1501	Amps A	FLOAT	0 to 9999 M	amps		2
05DD -	05DE	1502 - 1503	Amps B	FLOAT	0 to 9999 M	amps		2
05DF -	05E0	1504 - 1505	Amps C	FLOAT	0 to 9999 M	amps		2
05E1 -	05E2	1506 - 1507	Watts, 3-Ph total	FLOAT	-9999 M to +9999 M	watts		2
05E3 -	05E4	1508 - 1509	VARs, 3-Ph total	FLOAT	-9999 M to +9999 M	VARs		2
05E5 -	05E6	1510 - 1511	VAs, 3-Ph total	FLOAT	0 to +9999 M	VAs		2
05E7 -	05E8	1512 - 1513	Power Factor, 3-Ph total	FLOAT	-1.00 to +1.00	none		2
05E9 -	05EA	1514 - 1515	Neutral Current	FLOAT	0 to 9999 M	amps		2
05EB -	05EC	1516 - 1517	Watts, Phase A	FLOAT	-9999 M to +9999 M	watts	Per phase power and PF have values only for WYE hookup and will be zero for all other hookups.	2
05ED -	05EE	1518 - 1519	Watts, Phase B	FLOAT	-9999 M to +9999 M	watts		2
05EF -	05F0	1520 - 1521	Watts, Phase C	FLOAT	-9999 M to +9999 M	watts		2
05F1 -	05F2	1522 - 1523	VARs, Phase A	FLOAT	-9999 M to +9999 M	VARs	For single phase hook up only per phase values are valid. Please note that the total values are invalid.	2
05F3 -	05F4	1524 - 1525	VARs, Phase B	FLOAT	-9999 M to +9999 M	VARs		2
05F5 -	05F6	1526 - 1527	VARs, Phase C	FLOAT	-9999 M to +9999 M	VARs		2
05F7 -	05F8	1528 - 1529	VAs, Phase A	FLOAT	0 to +9999 M	VAs		2

Modbus Address		Description	Format	Range	Units or Resolution	Comments	# Reg	
Hex	Decimal							
05F9 -	05FA	1530 - 1531	VAs, Phase B	FLOAT	0 to +9999 M	VAs	(Cont'd)	2
05FB -	05FC	1532 - 1533	VAs, Phase C	FLOAT	0 to +9999 M	VAs		2
05FD -	05FE	1534 - 1535	Power Factor, Phase A	FLOAT	-1.00 to +1.00	none		2
05FF -	0600	1536 - 1537	Power Factor, Phase B	FLOAT	-1.00 to +1.00	none		2
0601 -	0602	1538 - 1539	Power Factor, Phase C	FLOAT	-1.00 to +1.00	none		2
						Block size:	40	
Primary Readings Block Meter 6						read-only		
063F -	0640	1600 - 1601	Amps A	FLOAT	0 to 9999 M	amps		2
0641 -	0642	1602 - 1603	Amps B	FLOAT	0 to 9999 M	amps		2
0643 -	0644	1604 - 1605	Amps C	FLOAT	0 to 9999 M	amps		2
0645 -	0646	1606 - 1607	Watts, 3-Ph total	FLOAT	-9999 M to +9999 M	watts		2
0647 -	0648	1608 - 1609	VARs, 3-Ph total	FLOAT	-9999 M to +9999 M	VARs		2
0649 -	064A	1610 - 1611	VAs, 3-Ph total	FLOAT	0 to +9999 M	VAs		2
064B -	064C	1612 - 1613	Power Factor, 3-Ph total	FLOAT	-1.00 to +1.00	none		2
064D -	064E	1614 - 1615	Neutral Current	FLOAT	0 to 9999 M	amps		2
064F -	0650	1616 - 1617	Watts, Phase A	FLOAT	-9999 M to +9999 M	watts	Per phase power and PF have values only for WYE hookup and will be zero for all other hookups.	2
0651 -	0652	1618 - 1619	Watts, Phase B	FLOAT	-9999 M to +9999 M	watts		2
0653 -	0654	1620 - 1621	Watts, Phase C	FLOAT	-9999 M to +9999 M	watts	For single phase hook up only per phase values are valid. Please note that the total values are invalid.	2
0655 -	0656	1622 - 1623	VARs, Phase A	FLOAT	-9999 M to +9999 M	VARs		2
0657 -	0658	1624 - 1625	VARs, Phase B	FLOAT	-9999 M to +9999 M	VARs		2
0659 -	065A	1626 - 1627	VARs, Phase C	FLOAT	-9999 M to +9999 M	VARs		2
065B -	065C	1628 - 1629	VAs, Phase A	FLOAT	0 to +9999 M	VAs		2

Modbus Address		Description	Format	Range	Units or Resolution	Comments	# Reg	
Hex	Decimal							
065D -	065E	1630 - 1631	VAs, Phase B	FLOAT	0 to +9999 M	VAs	(Cont'd)	2
065F -	0660	1632 - 1633	VAs, Phase C	FLOAT	0 to +9999 M	VAs		2
0661 -	0662	1634 - 1635	Power Factor, Phase A	FLOAT	-1.00 to +1.00	none		2
0663 -	0664	1636 - 1637	Power Factor, Phase B	FLOAT	-1.00 to +1.00	none		2
0665 -	0666	1638 - 1639	Power Factor, Phase C	FLOAT	-1.00 to +1.00	none		2
						Block size:	40	
Primary Readings Block Meter 7						read-only		
06A3 -	06A4	1700 - 1701	Amps A	FLOAT	0 to 9999 M	amps		2
06A5 -	06A6	1702 - 1703	Amps B	FLOAT	0 to 9999 M	amps		2
06A7 -	06A8	1704 - 1705	Amps C	FLOAT	0 to 9999 M	amps		2
06A9 -	06AA	1706 - 1707	Watts, 3-Ph total	FLOAT	-9999 M to +9999 M	watts		2
06AB -	06AC	1708 - 1709	VARs, 3-Ph total	FLOAT	-9999 M to +9999 M	VARs		2
06AD -	06AE	1710 - 1711	VAs, 3-Ph total	FLOAT	0 to +9999 M	VAs		2
06AF -	06B0	1712 - 1713	Power Factor, 3-Ph total	FLOAT	-1.00 to +1.00	none		2
06B1 -	06B2	1714 - 1715	Neutral Current	FLOAT	0 to 9999 M	amps		2
06B3 -	06B4	1716 - 1717	Watts, Phase A	FLOAT	-9999 M to +9999 M	watts	Per phase power and PF have values only for WYE hookup and will be zero for all other hookups.	2
06B5 -	06B6	1718 - 1719	Watts, Phase B	FLOAT	-9999 M to +9999 M	watts		2
06B7 -	06B8	1720 - 1721	Watts, Phase C	FLOAT	-9999 M to +9999 M	watts	For single phase hook up only per phase values are valid. Please note that the total values are invalid.	2
06B9 -	06BA	1722 - 1723	VARs, Phase A	FLOAT	-9999 M to +9999 M	VARs		2
06BB -	06BC	1724 - 1725	VARs, Phase B	FLOAT	-9999 M to +9999 M	VARs		2
06BD -	06BE	1726 - 1727	VARs, Phase C	FLOAT	-9999 M to +9999 M	VARs		2
06BF -	06C0	1728 - 1729	VAs, Phase A	FLOAT	0 to +9999 M	VAs		2

Modbus Address		Description	Format	Range	Units or Resolution	Comments	# Reg	
Hex	Decimal							
06C1 -	06C2	1730 - 1731	VAs, Phase B	FLOAT	0 to +9999 M	VAs	(Cont'd)	2
06C3 -	06C4	1732 - 1733	VAs, Phase C	FLOAT	0 to +9999 M	VAs		2
06C5 -	06C6	1734 - 1735	Power Factor, Phase A	FLOAT	-1.00 to +1.00	none		2
06C7 -	06C8	1736 - 1737	Power Factor, Phase B	FLOAT	-1.00 to +1.00	none		2
06C9 -	06CA	1738 - 1739	Power Factor, Phase C	FLOAT	-1.00 to +1.00	none		2
						Block size:	40	
Primary Readings Block Meter 8						read-only		
0707 -	0708	1800 - 1801	Amps A	FLOAT	0 to 9999 M	amps		2
0709 -	070A	1802 - 1803	Amps B	FLOAT	0 to 9999 M	amps		2
070B -	070C	1804 - 1805	Amps C	FLOAT	0 to 9999 M	amps		2
070D -	070E	1806 - 1807	Watts, 3-Ph total	FLOAT	-9999 M to +9999 M	watts		2
070F -	0710	1808 - 1809	VARs, 3-Ph total	FLOAT	-9999 M to +9999 M	VARs		2
0711 -	0712	1810 - 1811	VAs, 3-Ph total	FLOAT	0 to +9999 M	VAs		2
0713 -	0714	1812 - 1813	Power Factor, 3-Ph total	FLOAT	-1.00 to +1.00	none		2
0715 -	0716	1814 - 1815	Neutral Current	FLOAT	0 to 9999 M	amps		2
0717 -	0718	1816 - 1817	Watts, Phase A	FLOAT	-9999 M to +9999 M	watts	Per phase power and PF have values only for WYE hookup and will be zero for all other hookups.	2
0719 -	071A	1818 - 1819	Watts, Phase B	FLOAT	-9999 M to +9999 M	watts		2
071B -	071C	1820 - 1821	Watts, Phase C	FLOAT	-9999 M to +9999 M	watts	For single phase hook up only per phase values are valid. Please note that the total values are invalid.	2
071D -	071E	1822 - 1823	VARs, Phase A	FLOAT	-9999 M to +9999 M	VARs		2
071F -	0720	1824 - 1825	VARs, Phase B	FLOAT	-9999 M to +9999 M	VARs		2
0721 -	0722	1826 - 1827	VARs, Phase C	FLOAT	-9999 M to +9999 M	VARs		2
0723 -	0724	1828 - 1829	VAs, Phase A	FLOAT	0 to +9999 M	VAs		2

C: MP200-Y (Three Phase) Modbus Map

Modbus Address		Description	Format	Range	Units or Resolution	Comments	# Reg	
Hex	Decimal							
0725 -	0726	1830 - 1831	VAs, Phase B	FLOAT	0 to +9999 M	VAs	(Cont'd)	2
0727 -	0728	1832 - 1833	VAs, Phase C	FLOAT	0 to +9999 M	VAs		2
0729 -	072A	1834 - 1835	Power Factor, Phase A	FLOAT	-1.00 to +1.00	none		2
072B -	072C	1836 - 1837	Power Factor, Phase B	FLOAT	-1.00 to +1.00	none		2
072D -	072E	1838 - 1839	Power Factor, Phase C	FLOAT	-1.00 to +1.00	none		2
						Block Size:	40	
Primary Energy Block Meter 1						read-only		
076B -	076C	1900 - 1901	W-hours, Received	SINT32	0 to 99999999 or 0 to - 99999999	Wh per energy format	* Wh received & delivered always have opposite signs	2
076D -	076E	1902 - 1903	W-hours, Delivered	SINT32	0 to 99999999 or 0 to - 99999999	Wh per energy format	* Wh received is positive for "view as load", delivered is positive for "view as generator"	2
076F -	0770	1904 - 1905	W-hours, Net	SINT32	-99999999 to 99999999	Wh per energy format	* 5 to 8 digits * decimal point implied, per energy format	2
0771 -	0772	1906 - 1907	W-hours, Total	SINT32	0 to 99999999	Wh per energy format	* resolution of digit before decimal point = units, kilo, or mega, per energy format	2
0773 -	0774	1908 - 1909	VAR-hours, Positive	SINT32	0 to 99999999	VARh per energy format	* see note 10	2
0775 -	0776	1910 - 1911	VAR-hours, Negative	SINT32	0 to - 99999999	VARh per energy format		2
0777 -	0778	1912 - 1913	VAR-hours, Net	SINT32	-99999999 to 99999999	VARh per energy format		2
0779 -	077A	1914 - 1915	VAR-hours, Total	SINT32	0 to 99999999	VARh per energy format		2

Modbus Address		Description	Format	Range	Units or Resolution	Comments	# Reg	
Hex	Decimal							
077B -	077C	1916 - 1917	VA-hours, Total	SINT32	0 to 99999999	VAh per energy format	(Cont'd)	2
077D -	077E	1918 - 1919	W-hours, Received, Phase A	SINT32	0 to 99999999 or 0 to - 99999999	Wh per energy format		2
077F -	0780	1920 - 1921	W-hours, Received, Phase B	SINT32	0 to 99999999 or 0 to - 99999999	Wh per energy format		2
0781 -	0782	1922 - 1923	W-hours, Received, Phase C	SINT32	0 to 99999999 or 0 to - 99999999	Wh per energy format		2
0783 -	0784	1924 - 1925	W-hours, Delivered, Phase A	SINT32	0 to 99999999 or 0 to - 99999999	Wh per energy format		2
0785 -	0786	1926 - 1927	W-hours, Delivered, Phase B	SINT32	0 to 99999999 or 0 to - 99999999	Wh per energy format		2
0787 -	0788	1928 - 1929	W-hours, Delivered, Phase C	SINT32	0 to 99999999 or 0 to - 99999999	Wh per energy format		2
0789 -	078A	1930 - 1931	W-hours, Net, Phase A	SINT32	-99999999 to 99999999	Wh per energy format		2
078B -	078C	1932 - 1933	W-hours, Net, Phase B	SINT32	-99999999 to 99999999	Wh per energy format		2
078D -	078E	1934 - 1935	W-hours, Net, Phase C	SINT32	-99999999 to 99999999	Wh per energy format		2
078F -	0790	1936 - 1937	W-hours, Total, Phase A	SINT32	0 to 99999999	Wh per energy format	2	

Modbus Address		Description	Format	Range	Units or Resolution	Comments	# Reg	
Hex	Decimal							
0791 -	0792	1938 - 1939	W-hours, Total, Phase B	SINT32	0 to 99999999	Wh per energy format	(Cont'd)	2
0793 -	0794	1940 - 1941	W-hours, Total, Phase C	SINT32	0 to 99999999	Wh per energy format		2
0795 -	0796	1942 - 1943	VAR-hours, Positive, Phase A	SINT32	0 to 99999999	VARh per energy format		2
0797 -	0798	1944 - 1945	VAR-hours, Positive, Phase B	SINT32	0 to 99999999	VARh per energy format		2
0799 -	079A	1946 - 1947	VAR-hours, Positive, Phase C	SINT32	0 to 99999999	VARh per energy format		2
079B -	079C	1948 - 1949	VAR-hours, Negative, Phase A	SINT32	0 to -99999999	VARh per energy format		2
079D -	079E	1950 - 1951	VAR-hours, Negative, Phase B	SINT32	0 to -99999999	VARh per energy format		2
079F -	07A0	1952 - 1953	VAR-hours, Negative, Phase C	SINT32	0 to -99999999	VARh per energy format		2
07A1 -	07A2	1954 - 1955	VAR-hours, Net, Phase A	SINT32	-99999999 to 99999999	VARh per energy format		2
07A3 -	07A4	1956 - 1957	VAR-hours, Net, Phase B	SINT32	-99999999 to 99999999	VARh per energy format		2
07A5 -	07A6	1958 - 1959	VAR-hours, Net, Phase C	SINT32	-99999999 to 99999999	VARh per energy format		2
07A7 -	07A8	1960 - 1961	VAR-hours, Total, Phase A	SINT32	0 to 99999999	VARh per energy format		2
07A9 -	07AA	1962 - 1963	VAR-hours, Total, Phase B	SINT32	0 to 99999999	VARh per energy format		2

Modbus Address		Description	Format	Range	Units or Resolution	Comments	# Reg	
Hex	Decimal							
07AB -	07AC	1964 - 1965	VAR-hours, Total, Phase C	SINT32	0 to 99999999	VARh per energy format	(Cont'd)	2
07AD -	07AE	1966 - 1967	VA-hours, Phase A	SINT32	0 to 99999999	VAh per energy format		2
07AF -	07B0	1968 - 1969	VA-hours, Phase B	SINT32	0 to 99999999	VAh per energy format		2
07B1 -	07B2	1970 - 1971	VA-hours, Phase C	SINT32	0 to 99999999	VAh per energy format		2
						Block Size:	72	
Primary Energy Block Meter 2						read-only		
07CF -	07D0	2000 - 2001	W-hours, Received	SINT32	0 to 99999999 or 0 to - 99999999	Wh per energy format	* Wh received & delivered always have opposite signs	2
07D1 -	07D2	2002 - 2003	W-hours, Delivered	SINT32	0 to 99999999 or 0 to - 99999999	Wh per energy format	* Wh received is positive for "view as load", delivered is positive for "view as generator"	2
07D3 -	07D4	2004 - 2005	W-hours, Net	SINT32	-99999999 to 99999999	Wh per energy format	* 5 to 8 digits	2
07D5 -	07D6	2006 - 2007	W-hours, Total	SINT32	0 to 99999999	Wh per energy format	* decimal point implied, per energy format	2
07D7 -	07D8	2008 - 2009	VAR-hours, Positive	SINT32	0 to 99999999	VARh per energy format	* resolution of digit before decimal point = units, kilo, or mega, per energy format	2
07D9 -	07DA	2010 - 2011	VAR-hours, Negative	SINT32	0 to - 99999999	VARh per energy format	* see note 10	2
07DB -	07DC	2012 - 2013	VAR-hours, Net	SINT32	-99999999 to 99999999	VARh per energy format		2
07DD -	07DE	2014 - 2015	VAR-hours, Total	SINT32	0 to 99999999	VARh per energy format		2

Modbus Address		Description	Format	Range	Units or Resolution	Comments	# Reg
Hex	Decimal						
07DF -	07E0	2016 - 2017	VA-hours, Total	SINT32	0 to 99999999	VAh per energy format	2
07E1 -	07E2	2018 - 2019	W-hours, Received, Phase A	SINT32	0 to 99999999 or 0 to - 99999999	Wh per energy format	2
07E3 -	07E4	2020 - 2021	W-hours, Received, Phase B	SINT32	0 to 99999999 or 0 to - 99999999	Wh per energy format	2
07E5 -	07E6	2022 - 2023	W-hours, Received, Phase C	SINT32	0 to 99999999 or 0 to - 99999999	Wh per energy format	2
07E7 -	07E8	2024 - 2025	W-hours, Delivered, Phase A	SINT32	0 to 99999999 or 0 to - 99999999	Wh per energy format	2
07E9 -	07EA	2026 - 2027	W-hours, Delivered, Phase B	SINT32	0 to 99999999 or 0 to - 99999999	Wh per energy format	2
07EB -	07EC	2028 - 2029	W-hours, Delivered, Phase C	SINT32	0 to 99999999 or 0 to - 99999999	Wh per energy format	2
07ED -	07EE	2030 - 2031	W-hours, Net, Phase A	SINT32	-99999999 to 99999999	Wh per energy format	2
07EF -	07F0	2032 - 2033	W-hours, Net, Phase B	SINT32	-99999999 to 99999999	Wh per energy format	2
07F1 -	07F2	2034 - 2035	W-hours, Net, Phase C	SINT32	-99999999 to 99999999	Wh per energy format	2
07F3 -	07F4	2036 - 2037	W-hours, Total, Phase A	SINT32	0 to 99999999	Wh per energy format	2

Modbus Address		Description	Format	Range	Units or Resolution	Comments	# Reg
Hex	Decimal						
07F5 -	07F6	2038 - 2039	SINT32	0 to 99999999	Wh per energy format	(Cont'd)	2
07F7 -	07F8	2040 - 2041	SINT32	0 to 99999999	Wh per energy format		2
07F9 -	07FA	2042 - 2043	SINT32	0 to 99999999	VARh per energy format		2
07FB -	07FC	2044 - 2045	SINT32	0 to 99999999	VARh per energy format		2
07FD -	07FE	2046 - 2047	SINT32	0 to 99999999	VARh per energy format		2
07FF -	0800	2048 - 2049	SINT32	0 to -99999999	VARh per energy format		2
0801 -	0802	2050 - 2051	SINT32	0 to -99999999	VARh per energy format		2
0803 -	0804	2052 - 2053	SINT32	0 to -99999999	VARh per energy format		2
0805 -	0806	2054 - 2055	SINT32	-99999999 to 99999999	VARh per energy format		2
0807 -	0808	2056 - 2057	SINT32	-99999999 to 99999999	VARh per energy format		2
0809 -	080A	2058 - 2059	SINT32	-99999999 to 99999999	VARh per energy format		2
080B -	080C	2060 - 2061	SINT32	0 to 99999999	VARh per energy format		2
080D -	080E	2062 - 2063	SINT32	0 to 99999999	VARh per energy format		2

Modbus Address		Description	Format	Range	Units or Resolution	Comments	# Reg	
Hex	Decimal							
080F -	0810	2064 - 2065	VAR-hours, Total, Phase C	SINT32	0 to 99999999	VARh per energy format	(Cont'd)	2
0811 -	0812	2066 - 2067	VA-hours, Phase A	SINT32	0 to 99999999	VAh per energy format		2
0813 -	0814	2068 - 2069	VA-hours, Phase B	SINT32	0 to 99999999	VAh per energy format		2
0815 -	0816	2070 - 2071	VA-hours, Phase C	SINT32	0 to 99999999	VAh per energy format		2
Block Size:								72
Primary Energy Block Meter 3							read-only	
0833 -	0834	2100 - 2101	W-hours, Received	SINT32	0 to 99999999 or 0 to - 99999999	Wh per energy format	* Wh received & delivered always have opposite signs	2
0835 -	0836	2102 - 2103	W-hours, Delivered	SINT32	0 to 99999999 or 0 to - 99999999	Wh per energy format	* Wh received is positive for "view as load", delivered is positive for "view as generator"	2
0837 -	0838	2104 - 2105	W-hours, Net	SINT32	-99999999 to 99999999	Wh per energy format	* 5 to 8 digits	2
0839 -	083A	2106 - 2107	W-hours, Total	SINT32	0 to 99999999	Wh per energy format	* decimal point implied, per energy format	2
083B -	083C	2108 - 2109	VAR-hours, Positive	SINT32	0 to 99999999	VARh per energy format	* resolution of digit before decimal point = units, kilo, or mega, per energy format	2
083D -	083E	2110 - 2111	VAR-hours, Negative	SINT32	0 to - 99999999	VARh per energy format	* see note 10	2
083F -	0840	2112 - 2113	VAR-hours, Net	SINT32	-99999999 to 99999999	VARh per energy format		2
0841 -	0842	2114 - 2115	VAR-hours, Total	SINT32	0 to 99999999	VARh per energy format		2

Modbus Address		Description	Format	Range	Units or Resolution	Comments	# Reg
Hex	Decimal						
0843 -	0844	2116 - 2117	VA-hours, Total	SINT32	0 to 99999999	(Cont'd)	2
0845 -	0846	2118 - 2119	W-hours, Received, Phase A	SINT32	0 to 99999999 or 0 to - 99999999		2
0847 -	0848	2120 - 2121	W-hours, Received, Phase B	SINT32	0 to 99999999 or 0 to - 99999999		2
0849 -	084A	2122 - 2123	W-hours, Received, Phase C	SINT32	0 to 99999999 or 0 to - 99999999		2
084B -	084C	2124 - 2125	W-hours, Delivered, Phase A	SINT32	0 to 99999999 or 0 to - 99999999		2
084D -	084E	2126 - 2127	W-hours, Delivered, Phase B	SINT32	0 to 99999999 or 0 to - 99999999		2
084F -	0850	2128 - 2129	W-hours, Delivered, Phase C	SINT32	0 to 99999999 or 0 to - 99999999		2
0851 -	0852	2130 - 2131	W-hours, Net, Phase A	SINT32	-99999999 to 99999999		2
0853 -	0854	2132 - 2133	W-hours, Net, Phase B	SINT32	-99999999 to 99999999		2
0855 -	0856	2134 - 2135	W-hours, Net, Phase C	SINT32	-99999999 to 99999999		2
0857 -	0858	2136 - 2137	W-hours, Total, Phase A	SINT32	0 to 99999999		2

Modbus Address		Description	Format	Range	Units or Resolution	Comments	# Reg
Hex	Decimal						
0859 -	085A	2138 - 2139	SINT32	0 to 99999999	Wh per energy format	(Cont'd)	2
085B -	085C	2140 - 2141	SINT32	0 to 99999999	Wh per energy format		2
085D -	085E	2142 - 2143	SINT32	0 to 99999999	VARh per energy format		2
085F -	0860	2144 - 2145	SINT32	0 to 99999999	VARh per energy format		2
0861 -	0862	2146 - 2147	SINT32	0 to 99999999	VARh per energy format		2
0863 -	0864	2148 - 2149	SINT32	0 to -99999999	VARh per energy format		2
0865 -	0866	2150 - 2151	SINT32	0 to -99999999	VARh per energy format		2
0867 -	0868	2152 - 2153	SINT32	0 to -99999999	VARh per energy format		2
0869 -	086A	2154 - 2155	SINT32	-99999999 to 99999999	VARh per energy format		2
086B -	086C	2156 - 2157	SINT32	-99999999 to 99999999	VARh per energy format		2
086D -	086E	2158 - 2159	SINT32	-99999999 to 99999999	VARh per energy format		2
086F -	0870	2160 - 2161	SINT32	0 to 99999999	VARh per energy format		2
0871 -	0872	2162 - 2163	SINT32	0 to 99999999	VARh per energy format		2

Modbus Address		Description	Format	Range	Units or Resolution	Comments	# Reg	
Hex	Decimal							
0873 -	0874	2164 - 2165	VAR-hours, Total, Phase C	SINT32	0 to 99999999	VARh per energy format	(Cont'd)	2
0875 -	0876	2166 - 2167	VA-hours, Phase A	SINT32	0 to 99999999	VAh per energy format		2
0877 -	0878	2168 - 2169	VA-hours, Phase B	SINT32	0 to 99999999	VAh per energy format		2
0879 -	087A	2170 - 2171	VA-hours, Phase C	SINT32	0 to 99999999	VAh per energy format		2
						Block Size:	72	
Primary Energy Block Meter 4						read-only		
0897 -	0898	2200 - 2201	W-hours, Received	SINT32	0 to 99999999 or 0 to - 99999999	Wh per energy format	* Wh received & delivered always have opposite signs * Wh received is positive for "view as load", delivered is positive for "view as generator" * 5 to 8 digits * decimal point implied, per energy format * resolution of digit before decimal point = units, kilo, or mega, per energy format * see note 10	2
0899 -	089A	2202 - 2203	W-hours, Delivered	SINT32	0 to 99999999 or 0 to - 99999999	Wh per energy format		2
089B -	089C	2204 - 2205	W-hours, Net	SINT32	-99999999 to 99999999	Wh per energy format		2
089D -	089E	2206 - 2207	W-hours, Total	SINT32	0 to 99999999	Wh per energy format		2
089F -	08A0	2208 - 2209	VAR-hours, Positive	SINT32	0 to 99999999	VARh per energy format		2
08A1 -	08A2	2210 - 2211	VAR-hours, Negative	SINT32	0 to - 99999999	VARh per energy format		2
08A3 -	08A4	2212 - 2213	VAR-hours, Net	SINT32	-99999999 to 99999999	VARh per energy format		2
08A5 -	08A6	2214 - 2215	VAR-hours, Total	SINT32	0 to 99999999	VARh per energy format		2

C: MP200-Y (Three Phase) Modbus Map
 Three Phase Modbus Map

Modbus Address		Description	Format	Range	Units or Resolution	Comments	# Reg
Hex	Decimal						
08A7 -	08A8	2216 - 2217	SINT32	0 to 99999999	VAh per energy format	(Cont'd)	2
08A9 -	08AA	2218 - 2219	SINT32	0 to 99999999 or 0 to - 99999999	Wh per energy format		2
08AB -	08AC	2220 - 2221	SINT32	0 to 99999999 or 0 to - 99999999	Wh per energy format		2
08AD -	08AE	2222 - 2223	SINT32	0 to 99999999 or 0 to - 99999999	Wh per energy format		2
08AF -	08B0	2224 - 2225	SINT32	0 to 99999999 or 0 to - 99999999	Wh per energy format		2
08B1 -	08B2	2226 - 2227	SINT32	0 to 99999999 or 0 to - 99999999	Wh per energy format		2
08B3 -	08B4	2228 - 2229	SINT32	0 to 99999999 or 0 to - 99999999	Wh per energy format		2
08B5 -	08B6	2230 - 2231	SINT32	-99999999 to 99999999	Wh per energy format		2
08B7 -	08B8	2232 - 2233	SINT32	-99999999 to 99999999	Wh per energy format		2
08B9 -	08BA	2234 - 2235	SINT32	-99999999 to 99999999	Wh per energy format		2
08BB -	08BC	2236 - 2237	SINT32	0 to 99999999	Wh per energy format		2

Modbus Address		Description	Format	Range	Units or Resolution	Comments	# Reg	
Hex	Decimal							
08BD -	08BE	2238 - 2239	W-hours, Total, Phase B	SINT32	0 to 99999999	Wh per energy format	(Cont'd)	2
08BF -	08C0	2240 - 2241	W-hours, Total, Phase C	SINT32	0 to 99999999	Wh per energy format		2
08C1 -	08C2	2242 - 2243	VAR-hours, Positive, Phase A	SINT32	0 to 99999999	VARh per energy format		2
08C3 -	08C4	2244 - 2245	VAR-hours, Positive, Phase B	SINT32	0 to 99999999	VARh per energy format		2
08C5 -	08C6	2246 - 2247	VAR-hours, Positive, Phase C	SINT32	0 to 99999999	VARh per energy format		2
08C7 -	08C8	2248 - 2249	VAR-hours, Negative, Phase A	SINT32	0 to -99999999	VARh per energy format		2
08C9 -	08CA	2250 - 2251	VAR-hours, Negative, Phase B	SINT32	0 to -99999999	VARh per energy format		2
08CB -	08CC	2252 - 2253	VAR-hours, Negative, Phase C	SINT32	0 to -99999999	VARh per energy format		2
08CD -	08CE	2254 - 2255	VAR-hours, Net, Phase A	SINT32	-99999999 to 99999999	VARh per energy format		2
08CF -	08D0	2256 - 2257	VAR-hours, Net, Phase B	SINT32	-99999999 to 99999999	VARh per energy format		2
08D1 -	08D2	2258 - 2259	VAR-hours, Net, Phase C	SINT32	-99999999 to 99999999	VARh per energy format		2
08D3 -	08D4	2260 - 2261	VAR-hours, Total, Phase A	SINT32	0 to 99999999	VARh per energy format		2
08D5 -	08D6	2262 - 2263	VAR-hours, Total, Phase B	SINT32	0 to 99999999	VARh per energy format		2

C: MP200-Y (Three Phase) Modbus Map

Modbus Address		Description	Format	Range	Units or Resolution	Comments	# Reg	
Hex	Decimal							
08D7 -	08D8	2264 - 2265	VAR-hours, Total, Phase C	SINT32	0 to 99999999	VARh per energy format	(Cont'd)	2
08D9 -	08DA	2266 - 2267	VA-hours, Phase A	SINT32	0 to 99999999	VAh per energy format		2
08DB -	08DC	2268 - 2269	VA-hours, Phase B	SINT32	0 to 99999999	VAh per energy format		2
08DD -	08DE	2270 - 2271	VA-hours, Phase C	SINT32	0 to 99999999	VAh per energy format		2
							Block Size:	72
Primary Energy Block Meter 5							read-only	
08FB -	08FC	2300 - 2301	W-hours, Received	SINT32	0 to 99999999 or 0 to - 99999999	Wh per energy format	* Wh received & delivered always have opposite signs * Wh received is positive for "view as load", delivered is positive for "view as generator" * 5 to 8 digits * decimal point implied, per energy format * resolution of digit before decimal point = units, kilo, or mega, per energy format * see note 10	2
08FD -	08FE	2302 - 2303	W-hours, Delivered	SINT32	0 to 99999999 or 0 to - 99999999	Wh per energy format		2
08FF -	0900	2304 - 2305	W-hours, Net	SINT32	-99999999 to 99999999	Wh per energy format		2
0901 -	0902	2306 - 2307	W-hours, Total	SINT32	0 to 99999999	Wh per energy format		2
0903 -	0904	2308 - 2309	VAR-hours, Positive	SINT32	0 to 99999999	VARh per energy format		2
0905 -	0906	2310 - 2311	VAR-hours, Negative	SINT32	0 to - 99999999	VARh per energy format		2
0907 -	0908	2312 - 2313	VAR-hours, Net	SINT32	-99999999 to 99999999	VARh per energy format		2
0909 -	090A	2314 - 2315	VAR-hours, Total	SINT32	0 to 99999999	VARh per energy format		2

Modbus Address		Description	Format	Range	Units or Resolution	Comments	# Reg
Hex	Decimal						
090B -	090C	2316 - 2317	SINT32	0 to 99999999	VAh per energy format	(Cont'd)	2
090D -	090E	2318 - 2319	SINT32	0 to 99999999 or 0 to - 99999999	Wh per energy format		2
090F -	0910	2320 - 2321	SINT32	0 to 99999999 or 0 to - 99999999	Wh per energy format		2
0911 -	0912	2322 - 2323	SINT32	0 to 99999999 or 0 to - 99999999	Wh per energy format		2
0913 -	0914	2324 - 2325	SINT32	0 to 99999999 or 0 to - 99999999	Wh per energy format		2
0915 -	0916	2326 - 2327	SINT32	0 to 99999999 or 0 to - 99999999	Wh per energy format		2
0917 -	0918	2328 - 2329	SINT32	0 to 99999999 or 0 to - 99999999	Wh per energy format		2
0919 -	091A	2330 - 2331	SINT32	-99999999 to 99999999	Wh per energy format		2
091B -	091C	2332 - 2333	SINT32	-99999999 to 99999999	Wh per energy format		2
091D -	091E	2334 - 2335	SINT32	-99999999 to 99999999	Wh per energy format		2
091F -	0920	2336 - 2337	SINT32	0 to 99999999	Wh per energy format		2

Modbus Address		Description	Format	Range	Units or Resolution	Comments	# Reg
Hex	Decimal						
0921 -	0922	2338 - 2339	W-hours, Total, Phase B	SINT32	0 to 99999999	Wh per energy format	2
0923 -	0924	2340 - 2341	W-hours, Total, Phase C	SINT32	0 to 99999999	Wh per energy format	2
0925 -	0926	2342 - 2343	VAR-hours, Positive, Phase A	SINT32	0 to 99999999	VARh per energy format	2
0927 -	0928	2344 - 2345	VAR-hours, Positive, Phase B	SINT32	0 to 99999999	VARh per energy format	2
0929 -	092A	2346 - 2347	VAR-hours, Positive, Phase C	SINT32	0 to 99999999	VARh per energy format	2
092B -	092C	2348 - 2349	VAR-hours, Negative, Phase A	SINT32	0 to -99999999	VARh per energy format	2
092D -	092E	2350 - 2351	VAR-hours, Negative, Phase B	SINT32	0 to -99999999	VARh per energy format	2
092F -	0930	2352 - 2353	VAR-hours, Negative, Phase C	SINT32	0 to -99999999	VARh per energy format	2
0931 -	0932	2354 - 2355	VAR-hours, Net, Phase A	SINT32	-99999999 to 99999999	VARh per energy format	2
0933 -	0934	2356 - 2357	VAR-hours, Net, Phase B	SINT32	-99999999 to 99999999	VARh per energy format	2
0935 -	0936	2358 - 2359	VAR-hours, Net, Phase C	SINT32	-99999999 to 99999999	VARh per energy format	2
0937 -	0938	2360 - 2361	VAR-hours, Total, Phase A	SINT32	0 to 99999999	VARh per energy format	2
0939 -	093A	2362 - 2363	VAR-hours, Total, Phase B	SINT32	0 to 99999999	VARh per energy format	2

(Cont'd)

C: MP200-Y (Three Phase) Modbus Map

Modbus Address		Description	Format	Range	Units or Resolution	Comments	# Reg	
Hex	Decimal							
093B -	093C	2364 - 2365	VAR-hours, Total, Phase C	SINT32	0 to 99999999	VARh per energy format	(Cont'd)	2
093D -	093E	2366 - 2367	VA-hours, Phase A	SINT32	0 to 99999999	VAh per energy format		2
093F -	0940	2368 - 2369	VA-hours, Phase B	SINT32	0 to 99999999	VAh per energy format		2
0941 -	0942	2370 - 2371	VA-hours, Phase C	SINT32	0 to 99999999	VAh per energy format		2
-							Block Size:	72
Primary Energy Block Meter 6							read-only	
095F -	0960	2400 - 2401	W-hours, Received	SINT32	0 to 99999999 or 0 to - 99999999	Wh per energy format	* Wh received & delivered always have opposite signs	2
0961 -	0962	2402 - 2403	W-hours, Delivered	SINT32	0 to 99999999 or 0 to - 99999999	Wh per energy format	* Wh received is positive for "view as load", delivered is positive for "view as generator"	2
0963 -	0964	2404 - 2405	W-hours, Net	SINT32	-99999999 to 99999999	Wh per energy format	* 5 to 8 digits	2
0965 -	0966	2406 - 2407	W-hours, Total	SINT32	0 to 99999999	Wh per energy format	* decimal point implied, per energy format	2
0967 -	0968	2408 - 2409	VAR-hours, Positive	SINT32	0 to 99999999	VARh per energy format	* resolution of digit before decimal point = units, kilo, or mega, per energy format	2
0969 -	096A	2410 - 2411	VAR-hours, Negative	SINT32	0 to - 99999999	VARh per energy format	* see note 10	2
096B -	096C	2412 - 2413	VAR-hours, Net	SINT32	-99999999 to 99999999	VARh per energy format		2
096D -	096E	2414 - 2415	VAR-hours, Total	SINT32	0 to 99999999	VARh per energy format		2

Modbus Address		Description	Format	Range	Units or Resolution	Comments	# Reg
Hex	Decimal						
096F -	0970	2416 - 2417	SINT32	0 to 99999999	VAh per energy format	----- (Cont'd) -----	2
0971 -	0972	2418 - 2419	SINT32	0 to 99999999 or 0 to - 99999999	Wh per energy format		2
0973 -	0974	2420 - 2421	SINT32	0 to 99999999 or 0 to - 99999999	Wh per energy format		2
0975 -	0976	2422 - 2423	SINT32	0 to 99999999 or 0 to - 99999999	Wh per energy format		2
0977 -	0978	2424 - 2425	SINT32	0 to 99999999 or 0 to - 99999999	Wh per energy format		2
0979 -	097A	2426 - 2427	SINT32	0 to 99999999 or 0 to - 99999999	Wh per energy format		2
097B -	097C	2428 - 2429	SINT32	0 to 99999999 or 0 to - 99999999	Wh per energy format		2
097D -	097E	2430 - 2431	SINT32	-99999999 to 99999999	Wh per energy format		2
097F -	0980	2432 - 2433	SINT32	-99999999 to 99999999	Wh per energy format		2
0981 -	0982	2434 - 2435	SINT32	-99999999 to 99999999	Wh per energy format		2
0983 -	0984	2436 - 2437	SINT32	0 to 99999999	Wh per energy format		2

Modbus Address		Description	Format	Range	Units or Resolution	Comments	# Reg
Hex	Decimal						
0985 -	0986	2438 - 2439	W-hours, Total, Phase B	SINT32	0 to 99999999	Wh per energy format	2
0987 -	0988	2440 - 2441	W-hours, Total, Phase C	SINT32	0 to 99999999	Wh per energy format	2
0989 -	098A	2442 - 2443	VAR-hours, Positive, Phase A	SINT32	0 to 99999999	VARh per energy format	2
098B -	098C	2444 - 2445	VAR-hours, Positive, Phase B	SINT32	0 to 99999999	VARh per energy format	2
098D -	098E	2446 - 2447	VAR-hours, Positive, Phase C	SINT32	0 to 99999999	VARh per energy format	2
098F -	0990	2448 - 2449	VAR-hours, Negative, Phase A	SINT32	0 to -99999999	VARh per energy format	2
0991 -	0992	2450 - 2451	VAR-hours, Negative, Phase B	SINT32	0 to -99999999	VARh per energy format	2
0993 -	0994	2452 - 2453	VAR-hours, Negative, Phase C	SINT32	0 to -99999999	VARh per energy format	2
0995 -	0996	2454 - 2455	VAR-hours, Net, Phase A	SINT32	-99999999 to 99999999	VARh per energy format	2
0997 -	0998	2456 - 2457	VAR-hours, Net, Phase B	SINT32	-99999999 to 99999999	VARh per energy format	2
0999 -	099A	2458 - 2459	VAR-hours, Net, Phase C	SINT32	-99999999 to 99999999	VARh per energy format	2
099B -	099C	2460 - 2461	VAR-hours, Total, Phase A	SINT32	0 to 99999999	VARh per energy format	2
099D -	099E	2462 - 2463	VAR-hours, Total, Phase B	SINT32	0 to 99999999	VARh per energy format	2

(Cont'd)

Modbus Address		Description	Format	Range	Units or Resolution	Comments	# Reg	
Hex	Decimal							
099F -	09A0	2464 - 2465	VAR-hours, Total, Phase C	SINT32	0 to 99999999	VARh per energy format	(Cont'd)	2
09A1 -	09A2	2466 - 2467	VA-hours, Phase A	SINT32	0 to 99999999	VAh per energy format		2
09A3 -	09A4	2468 - 2469	VA-hours, Phase B	SINT32	0 to 99999999	VAh per energy format		2
09A5 -	09A6	2470 - 2471	VA-hours, Phase C	SINT32	0 to 99999999	VAh per energy format		2
							Block Size:	72
Primary Energy Block Meter 7							read-only	
09C3 -	09C4	2500 - 2501	W-hours, Received	SINT32	0 to 99999999 or 0 to - 99999999	Wh per energy format	* Wh received & delivered always have opposite signs	2
09C5 -	09C6	2502 - 2503	W-hours, Delivered	SINT32	0 to 99999999 or 0 to - 99999999	Wh per energy format	* Wh received is positive for "view as load", delivered is positive for "view as generator"	2
09C7 -	09C8	2504 - 2505	W-hours, Net	SINT32	-99999999 to 99999999	Wh per energy format	* decimal point implied, per energy format	2
09C9 -	09CA	2506 - 2507	W-hours, Total	SINT32	0 to 99999999	Wh per energy format	* resolution of digit before decimal point = units, kilo, or mega, per energy format	2
09CB -	09CC	2508 - 2509	VAR-hours, Positive	SINT32	0 to 99999999	VARh per energy format	* see note 10	2
09CD -	09CE	2510 - 2511	VAR-hours, Negative	SINT32	0 to - 99999999	VARh per energy format		2
09CF -	09D0	2512 - 2513	VAR-hours, Net	SINT32	-99999999 to 99999999	VARh per energy format		2
09D1 -	09D2	2514 - 2515	VAR-hours, Total	SINT32	0 to 99999999	VARh per energy format		2

Modbus Address		Description	Format	Range	Units or Resolution	Comments	# Reg
Hex	Decimal						
09D3 - 09D4	2516 - 2517	VA-hours, Total	SINT32	0 to 99999999	VAh per energy format	(Cont'd)	2
09D5 - 09D6	2518 - 2519	W-hours, Received, Phase A	SINT32	0 to 99999999 or 0 to - 99999999	Wh per energy format		2
09D7 - 09D8	2520 - 2521	W-hours, Received, Phase B	SINT32	0 to 99999999 or 0 to - 99999999	Wh per energy format		2
09D9 - 09DA	2522 - 2523	W-hours, Received, Phase C	SINT32	0 to 99999999 or 0 to - 99999999	Wh per energy format		2
09DB - 09DC	2524 - 2525	W-hours, Delivered, Phase A	SINT32	0 to 99999999 or 0 to - 99999999	Wh per energy format		2
09DD - 09DE	2526 - 2527	W-hours, Delivered, Phase B	SINT32	0 to 99999999 or 0 to - 99999999	Wh per energy format		2
09DF - 09E0	2528 - 2529	W-hours, Delivered, Phase C	SINT32	0 to 99999999 or 0 to - 99999999	Wh per energy format		2
09E1 - 09E2	2530 - 2531	W-hours, Net, Phase A	SINT32	-99999999 to 99999999	Wh per energy format		2
09E3 - 09E4	2532 - 2533	W-hours, Net, Phase B	SINT32	-99999999 to 99999999	Wh per energy format		2
09E5 - 09E6	2534 - 2535	W-hours, Net, Phase C	SINT32	-99999999 to 99999999	Wh per energy format		2
09E7 - 09E8	2536 - 2537	W-hours, Total, Phase A	SINT32	0 to 99999999	Wh per energy format		2

Modbus Address		Description	Format	Range	Units or Resolution	Comments	# Reg
Hex	Decimal						
09E9 - 09EA	2538 - 2539	W-hours, Total, Phase B	SINT32	0 to 99999999	Wh per energy format	(Cont'd)	2
09EB - 09EC	2540 - 2541	W-hours, Total, Phase C	SINT32	0 to 99999999	Wh per energy format		2
09ED - 09EE	2542 - 2543	VAR-hours, Positive, Phase A	SINT32	0 to 99999999	VARh per energy format		2
09EF - 09F0	2544 - 2545	VAR-hours, Positive, Phase B	SINT32	0 to 99999999	VARh per energy format		2
09F1 - 09F2	2546 - 2547	VAR-hours, Positive, Phase C	SINT32	0 to 99999999	VARh per energy format		2
09F3 - 09F4	2548 - 2549	VAR-hours, Negative, Phase A	SINT32	0 to -99999999	VARh per energy format		2
09F5 - 09F6	2550 - 2551	VAR-hours, Negative, Phase B	SINT32	0 to -99999999	VARh per energy format		2
09F7 - 09F8	2552 - 2553	VAR-hours, Negative, Phase C	SINT32	0 to -99999999	VARh per energy format		2
09F9 - 09FA	2554 - 2555	VAR-hours, Net, Phase A	SINT32	-99999999 to 99999999	VARh per energy format		2
09FB - 09FC	2556 - 2557	VAR-hours, Net, Phase B	SINT32	-99999999 to 99999999	VARh per energy format		2
09FD - 09FE	2558 - 2559	VAR-hours, Net, Phase C	SINT32	-99999999 to 99999999	VARh per energy format		2
09FF - 0A00	2560 - 2561	VAR-hours, Total, Phase A	SINT32	0 to 99999999	VARh per energy format		2
0A01 - 0A02	2562 - 2563	VAR-hours, Total, Phase B	SINT32	0 to 99999999	VARh per energy format		2

Modbus Address		Description	Format	Range	Units or Resolution	Comments	# Reg	
Hex	Decimal							
0A03 -	0A04	2564 - 2565	VAR-hours, Total, Phase C	SINT32	0 to 99999999	VARh per energy format	(Cont'd)	2
0A05 -	0A06	2566 - 2567	VA-hours, Phase A	SINT32	0 to 99999999	VAh per energy format		2
0A07 -	0A08	2568 - 2569	VA-hours, Phase B	SINT32	0 to 99999999	VAh per energy format		2
0A09 -	0A0A	2570 - 2571	VA-hours, Phase C	SINT32	0 to 99999999	VAh per energy format		2
Block Size:								72
Primary Energy Block Meter 8							read-only	
0A27 -	0A28	2600 - 2601	W-hours, Received	SINT32	0 to 99999999 or 0 to - 99999999	Wh per energy format	* Wh received & delivered always have opposite signs	2
0A29 -	0A2A	2602 - 2603	W-hours, Delivered	SINT32	0 to 99999999 or 0 to - 99999999	Wh per energy format	* Wh received is positive for "view as load", delivered is positive for "view as generator"	2
0A2B -	0A2C	2604 - 2605	W-hours, Net	SINT32	-99999999 to 99999999	Wh per energy format	* decimal point implied, per energy format	2
0A2D -	0A2E	2606 - 2607	W-hours, Total	SINT32	0 to 99999999	Wh per energy format	* resolution of digit before decimal point = units, kilo, or mega, per energy format	2
0A2F -	0A30	2608 - 2609	VAR-hours, Positive	SINT32	0 to 99999999	VARh per energy format	* see note 10	2
0A31 -	0A32	2610 - 2611	VAR-hours, Negative	SINT32	0 to - 99999999	VARh per energy format		2
0A33 -	0A34	2612 - 2613	VAR-hours, Net	SINT32	-99999999 to 99999999	VARh per energy format		2
0A35 -	0A36	2614 - 2615	VAR-hours, Total	SINT32	0 to 99999999	VARh per energy format		2

Modbus Address		Description	Format	Range	Units or Resolution	Comments	# Reg
Hex	Decimal						
0A37 - 0A38	2616 - 2617	VA-hours, Total	SINT32	0 to 99999999	VAh per energy format	(Cont'd)	2
0A39 - 0A3A	2618 - 2619	W-hours, Received, Phase A	SINT32	0 to 99999999 or 0 to - 99999999	Wh per energy format		2
0A3B - 0A3C	2620 - 2621	W-hours, Received, Phase B	SINT32	0 to 99999999 or 0 to - 99999999	Wh per energy format		2
0A3D - 0A3E	2622 - 2623	W-hours, Received, Phase C	SINT32	0 to 99999999 or 0 to - 99999999	Wh per energy format		2
0A3F - 0A40	2624 - 2625	W-hours, Delivered, Phase A	SINT32	0 to 99999999 or 0 to - 99999999	Wh per energy format		2
0A41 - 0A42	2626 - 2627	W-hours, Delivered, Phase B	SINT32	0 to 99999999 or 0 to - 99999999	Wh per energy format		2
0A43 - 0A44	2628 - 2629	W-hours, Delivered, Phase C	SINT32	0 to 99999999 or 0 to - 99999999	Wh per energy format		2
0A45 - 0A46	2630 - 2631	W-hours, Net, Phase A	SINT32	-99999999 to 99999999	Wh per energy format		2
0A47 - 0A48	2632 - 2633	W-hours, Net, Phase B	SINT32	-99999999 to 99999999	Wh per energy format		2
0A49 - 0A4A	2634 - 2635	W-hours, Net, Phase C	SINT32	-99999999 to 99999999	Wh per energy format		2
0A4B - 0A4C	2636 - 2637	W-hours, Total, Phase A	SINT32	0 to 99999999	Wh per energy format		2

Modbus Address		Description	Format	Range	Units or Resolution	Comments	# Reg
Hex	Decimal						
0A4D -	0A4E	2638 - 2639	W-hours, Total, Phase B	SINT32	0 to 99999999	Wh per energy format	2
0A4F -	0A50	2640 - 2641	W-hours, Total, Phase C	SINT32	0 to 99999999	Wh per energy format	2
0A51 -	0A52	2642 - 2643	VAR-hours, Positive, Phase A	SINT32	0 to 99999999	VARh per energy format	2
0A53 -	0A54	2644 - 2645	VAR-hours, Positive, Phase B	SINT32	0 to 99999999	VARh per energy format	2
0A55 -	0A56	2646 - 2647	VAR-hours, Positive, Phase C	SINT32	0 to 99999999	VARh per energy format	2
0A57 -	0A58	2648 - 2649	VAR-hours, Negative, Phase A	SINT32	0 to -99999999	VARh per energy format	2
0A59 -	0A5A	2650 - 2651	VAR-hours, Negative, Phase B	SINT32	0 to -99999999	VARh per energy format	2
0A5B -	0A5C	2652 - 2653	VAR-hours, Negative, Phase C	SINT32	0 to -99999999	VARh per energy format	2
0A5D -	0A5E	2654 - 2655	VAR-hours, Net, Phase A	SINT32	-99999999 to 99999999	VARh per energy format	2
0A5F -	0A60	2656 - 2657	VAR-hours, Net, Phase B	SINT32	-99999999 to 99999999	VARh per energy format	2
0A61 -	0A62	2658 - 2659	VAR-hours, Net, Phase C	SINT32	-99999999 to 99999999	VARh per energy format	2
0A63 -	0A64	2660 - 2661	VAR-hours, Total, Phase A	SINT32	0 to 99999999	VARh per energy format	2
0A65 -	0A66	2662 - 2663	VAR-hours, Total, Phase B	SINT32	0 to 99999999	VARh per energy format	2

(Cont'd)

Modbus Address		Description	Format	Range	Units or Resolution	Comments	# Reg
Hex	Decimal						
0A67 - 0A68	2664 - 2665	VAR-hours, Total, Phase C	SINT32	0 to 99999999	VARh per energy format	----- (Cont'd) -----	2
0A69 - 0A6A	2666 - 2667	VA-hours, Phase A	SINT32	0 to 99999999	VAh per energy format		2
0A6B - 0A6C	2668 - 2669	VA-hours, Phase B	SINT32	0 to 99999999	VAh per energy format		2
0A6D - 0A6E	2670 - 2671	VA-hours, Phase C	SINT32	0 to 99999999	VAh per energy format		2
						Block Size:	72
Primary Demand Block Meter 1						read-only	
0A8B - 0A8C	2700 - 2701	Amps A, Average	FLOAT	0 to 9999 M	amps		2
0A8D - 0A8E	2702 - 2703	Amps B, Average	FLOAT	0 to 9999 M	amps		2
0A8F - 0A90	2704 - 2705	Amps C, Average	FLOAT	0 to 9999 M	amps		2
0A91 - 0A92	2706 - 2707	Positive Watts, 3-Ph, Average	FLOAT	-9999 M to +9999 M	watts		2
0A93 - 0A94	2708 - 2709	Positive VARs, 3-Ph, Average	FLOAT	-9999 M to +9999 M	VARs		2
0A95 - 0A96	2710 - 2711	Negative Watts, 3-Ph, Average	FLOAT	-9999 M to +9999 M	watts		2
0A97 - 0A98	2712 - 2713	Negative VARs, 3-Ph, Average	FLOAT	-9999 M to +9999 M	VARs		2
0A99 - 0A9A	2714 - 2715	VAs, 3-Ph, Average	FLOAT	-9999 M to +9999 M	VAs		2
0A9B - 0A9C	2716 - 2717	Positive PF, 3-Ph, Average	FLOAT	-1.00 to +1.00	none		2
0A9D - 0A9E	2718 - 2719	Negative PF, 3-PF, Average	FLOAT	-1.00 to +1.00	none		2
0A9F - 0AA0	2720 - 2721	Neutral Current, Average	FLOAT	0 to 9999 M	amps		2
0AA1 - 0AA2	2722 - 2723	Positive Watts, Phase A, Average	FLOAT	-9999 M to +9999 M	watts		2
0AA3 - 0AA4	2724 - 2725	Positive Watts, Phase B, Average	FLOAT	-9999 M to +9999 M	watts		2
0AA5 - 0AA6	2726 - 2727	Positive Watts, Phase C, Average	FLOAT	-9999 M to +9999 M	watts		2
0AA7 - 0AA8	2728 - 2729	Positive VARs, Phase A, Average	FLOAT	-9999 M to +9999 M	VARs		2

Modbus Address		Description	Format	Range	Units or Resolution	Comments	# Reg
Hex	Decimal						
0AA9 -	0AAA	2730 - 2731	Positive VARs, Phase B, Average	FLOAT	-9999 M to +9999 M	VARs	2
0AAB -	0AAC	2732 - 2733	Positive VARs, Phase C, Average	FLOAT	-9999 M to +9999 M	VARs	2
0AAD -	0AAE	2734 - 2735	Negative Watts, Phase A, Average	FLOAT	-9999 M to +9999 M	watts	2
0AAF -	0AB0	2736 - 2737	Negative Watts, Phase B, Average	FLOAT	-9999 M to +9999 M	watts	2
0AB1 -	0AB2	2738 - 2739	Negative Watts, Phase C, Average	FLOAT	-9999 M to +9999 M	watts	2
0AB3 -	0AB4	2740 - 2741	Negative VARs, Phase A, Average	FLOAT	-9999 M to +9999 M	VARs	2
0AB5 -	0AB6	2742 - 2743	Negative VARs, Phase B, Average	FLOAT	-9999 M to +9999 M	VARs	2
0AB7 -	0AB8	2744 - 2745	Negative VARs, Phase C, Average	FLOAT	-9999 M to +9999 M	VARs	2
0AB9 -	0ABA	2746 - 2747	VAs, Phase A, Average	FLOAT	-9999 M to +9999 M	VAs	2
0ABB -	0ABC	2748 - 2749	VAs, Phase B, Average	FLOAT	-9999 M to +9999 M	VAs	2
0ABD -	0ABE	2750 - 2751	VAs, Phase C, Average	FLOAT	-9999 M to +9999 M	VAs	2
0ABF -	0AC0	2752 - 2753	Positive PF, Phase A, Average	FLOAT	-1.00 to +1.00	none	2
0AC1 -	0AC2	2754 - 2755	Positive PF, Phase B, Average	FLOAT	-1.00 to +1.00	none	2
0AC3 -	0AC4	2756 - 2757	Positive PF, Phase C, Average	FLOAT	-1.00 to +1.00	none	2
0AC5 -	0AC6	2758 - 2759	Negative PF, Phase A, Average	FLOAT	-1.00 to +1.00	none	2
0AC7 -	0AC8	2760 - 2761	Negative PF, Phase B, Average	FLOAT	-1.00 to +1.00	none	2
0AC9 -	0ACA	2762 - 2763	Negative PF, Phase C, Average	FLOAT	-1.00 to +1.00	none	2
						Block Size:	64
Primary Demand Block Meter 2							
read-only							
0AEF -	0AF0	2800 - 2801	Amps A, Average	FLOAT	0 to 9999 M	amps	2
0AF1 -	0AF2	2802 - 2803	Amps B, Average	FLOAT	0 to 9999 M	amps	2
0AF3 -	0AF4	2804 - 2805	Amps C, Average	FLOAT	0 to 9999 M	amps	2

Modbus Address		Description	Format	Range	Units or Resolution	Comments	# Reg
Hex	Decimal						
0AF5 - 0AF6	2806 - 2807	Positive Watts, 3-Ph, Average	FLOAT	-9999 M to +9999 M	watts		2
0AF7 - 0AF8	2808 - 2809	Positive VARs, 3-Ph, Average	FLOAT	-9999 M to +9999 M	VARs		2
0AF9 - 0AFA	2810 - 2811	Negative Watts, 3-Ph, Average	FLOAT	-9999 M to +9999 M	watts		2
0AFB - 0AFC	2812 - 2813	Negative VARs, 3-Ph, Average	FLOAT	-9999 M to +9999 M	VARs		2
0AFD - 0AFE	2814 - 2815	VAs, 3-Ph, Average	FLOAT	-9999 M to +9999 M	VAs		2
0AFF - 0B00	2816 - 2817	Positive PF, 3-Ph, Average	FLOAT	-1.00 to +1.00	none		2
0B01 - 0B02	2818 - 2819	Negative PF, 3-PF, Average	FLOAT	-1.00 to +1.00	none		2
0B03 - 0B04	2820 - 2821	Neutral Current, Average	FLOAT	0 to 9999 M	amps		2
0B05 - 0B06	2822 - 2823	Positive Watts, Phase A, Average	FLOAT	-9999 M to +9999 M	watts		2
0B07 - 0B08	2824 - 2825	Positive Watts, Phase B, Average	FLOAT	-9999 M to +9999 M	watts		2
0B09 - 0B0A	2826 - 2827	Positive Watts, Phase C, Average	FLOAT	-9999 M to +9999 M	watts		2
0B0B - 0B0C	2828 - 2829	Positive VARs, Phase A, Average	FLOAT	-9999 M to +9999 M	VARs		2
0B0D - 0B0E	2830 - 2831	Positive VARs, Phase B, Average	FLOAT	-9999 M to +9999 M	VARs		2
0B0F - 0B10	2832 - 2833	Positive VARs, Phase C, Average	FLOAT	-9999 M to +9999 M	VARs		2
0B11 - 0B12	2834 - 2835	Negative Watts, Phase A, Average	FLOAT	-9999 M to +9999 M	watts		2
0B13 - 0B14	2836 - 2837	Negative Watts, Phase B, Average	FLOAT	-9999 M to +9999 M	watts		2
0B15 - 0B16	2838 - 2839	Negative Watts, Phase C, Average	FLOAT	-9999 M to +9999 M	watts		2
0B17 - 0B18	2840 - 2841	Negative VARs, Phase A, Average	FLOAT	-9999 M to +9999 M	VARs		2
0B19 - 0B1A	2842 - 2843	Negative VARs, Phase B, Average	FLOAT	-9999 M to +9999 M	VARs		2
0B1B - 0B1C	2844 - 2845	Negative VARs, Phase C, Average	FLOAT	-9999 M to +9999 M	VARs		2

Modbus Address		Description	Format	Range	Units or Resolution	Comments	# Reg
Hex	Decimal						
0B1D - 0B1E	2846 - 2847	VAs, Phase A, Average	FLOAT	-9999 M to +9999 M	VAs		2
0B1F - 0B20	2848 - 2849	VAs, Phase B, Average	FLOAT	-9999 M to +9999 M	VAs		2
0B21 - 0B22	2850 - 2851	VAs, Phase C, Average	FLOAT	-9999 M to +9999 M	VAs		2
0B23 - 0B24	2852 - 2853	Positive PF, Phase A, Average	FLOAT	-1.00 to +1.00	none		2
0B25 - 0B26	2854 - 2855	Positive PF, Phase B, Average	FLOAT	-1.00 to +1.00	none		2
0B27 - 0B28	2856 - 2857	Positive PF, Phase C, Average	FLOAT	-1.00 to +1.00	none		2
0B29 - 0B2A	2858 - 2859	Negative PF, Phase A, Average	FLOAT	-1.00 to +1.00	none		2
0B2B - 0B2C	2860 - 2861	Negative PF, Phase B, Average	FLOAT	-1.00 to +1.00	none		2
0B2D - 0B2E	2862 - 2863	Negative PF, Phase C, Average	FLOAT	-1.00 to +1.00	none		2
						Block Size:	64
Primary Demand Block Meter 3							read-only
0B53 - 0B54	2900 - 2901	Amps A, Average	FLOAT	0 to 9999 M	amps		2
0B55 - 0B56	2902 - 2903	Amps B, Average	FLOAT	0 to 9999 M	amps		2
0B57 - 0B58	2904 - 2905	Amps C, Average	FLOAT	0 to 9999 M	amps		2
0B59 - 0B5A	2906 - 2907	Positive Watts, 3-Ph, Average	FLOAT	-9999 M to +9999 M	watts		2
0B5B - 0B5C	2908 - 2909	Positive VARs, 3-Ph, Average	FLOAT	-9999 M to +9999 M	VARs		2
0B5D - 0B5E	2910 - 2911	Negative Watts, 3-Ph, Average	FLOAT	-9999 M to +9999 M	watts		2
0B5F - 0B60	2912 - 2913	Negative VARs, 3-Ph, Average	FLOAT	-9999 M to +9999 M	VARs		2
0B61 - 0B62	2914 - 2915	VAs, 3-Ph, Average	FLOAT	-9999 M to +9999 M	VAs		2
0B63 - 0B64	2916 - 2917	Positive PF, 3-Ph, Average	FLOAT	-1.00 to +1.00	none		2
0B65 - 0B66	2918 - 2919	Negative PF, 3-PF, Average	FLOAT	-1.00 to +1.00	none		2
0B67 - 0B68	2920 - 2921	Neutral Current, Average	FLOAT	0 to 9999 M	amps		2
0B69 - 0B6A	2922 - 2923	Positive Watts, Phase A, Average	FLOAT	-9999 M to +9999 M	watts		2

Modbus Address		Description	Format	Range	Units or Resolution	Comments	# Reg
Hex	Decimal						
0B6B - 0B6C	2924 - 2925	Positive Watts, Phase B, Average	FLOAT	-9999 M to +9999 M	watts		2
0B6D - 0B6E	2926 - 2927	Positive Watts, Phase C, Average	FLOAT	-9999 M to +9999 M	watts		2
0B6F - 0B70	2928 - 2929	Positive VARs, Phase A, Average	FLOAT	-9999 M to +9999 M	VARs		2
0B71 - 0B72	2930 - 2931	Positive VARs, Phase B, Average	FLOAT	-9999 M to +9999 M	VARs		2
0B73 - 0B74	2932 - 2933	Positive VARs, Phase C, Average	FLOAT	-9999 M to +9999 M	VARs		2
0B75 - 0B76	2934 - 2935	Negative Watts, Phase A, Average	FLOAT	-9999 M to +9999 M	watts		2
0B77 - 0B78	2936 - 2937	Negative Watts, Phase B, Average	FLOAT	-9999 M to +9999 M	watts		2
0B79 - 0B7A	2938 - 2939	Negative Watts, Phase C, Average	FLOAT	-9999 M to +9999 M	watts		2
0B7B - 0B7C	2940 - 2941	Negative VARs, Phase A, Average	FLOAT	-9999 M to +9999 M	VARs		2
0B7D - 0B7E	2942 - 2943	Negative VARs, Phase B, Average	FLOAT	-9999 M to +9999 M	VARs		2
0B7F - 0B80	2944 - 2945	Negative VARs, Phase C, Average	FLOAT	-9999 M to +9999 M	VARs		2
0B81 - 0B82	2946 - 2947	VAs, Phase A, Average	FLOAT	-9999 M to +9999 M	VAs		2
0B83 - 0B84	2948 - 2949	VAs, Phase B, Average	FLOAT	-9999 M to +9999 M	VAs		2
0B85 - 0B86	2950 - 2951	VAs, Phase C, Average	FLOAT	-9999 M to +9999 M	VAs		2
0B87 - 0B88	2952 - 2953	Positive PF, Phase A, Average	FLOAT	-1.00 to +1.00	none		2
0B89 - 0B8A	2954 - 2955	Positive PF, Phase B, Average	FLOAT	-1.00 to +1.00	none		2
0B8B - 0B8C	2956 - 2957	Positive PF, Phase C, Average	FLOAT	-1.00 to +1.00	none		2
0B8D - 0B8E	2958 - 2959	Negative PF, Phase A, Average	FLOAT	-1.00 to +1.00	none		2

Modbus Address		Description	Format	Range	Units or Resolution	Comments	# Reg
Hex	Decimal						
0B8F -	0B90	2960 - 2961	Negative PF, Phase B, Average	FLOAT	-1.00 to +1.00	none	2
0B91 -	0B92	2962 - 2963	Negative PF, Phase C, Average	FLOAT	-1.00 to +1.00	none	2
						Block Size:	64
Primary Demand Block Meter 4						read-only	
0BB7 -	0BB8	3000 - 3001	Amps A, Average	FLOAT	0 to 9999 M	amps	2
0BB9 -	0BBA	3002 - 3003	Amps B, Average	FLOAT	0 to 9999 M	amps	2
0BBB -	0BBC	3004 - 3005	Amps C, Average	FLOAT	0 to 9999 M	amps	2
0BBD -	0BBE	3006 - 3007	Positive Watts, 3-Ph, Average	FLOAT	-9999 M to +9999 M	watts	2
0BBF -	0BC0	3008 - 3009	Positive VARs, 3-Ph, Average	FLOAT	-9999 M to +9999 M	VARs	2
0BC1 -	0BC2	3010 - 3011	Negative Watts, 3-Ph, Average	FLOAT	-9999 M to +9999 M	watts	2
0BC3 -	0BC4	3012 - 3013	Negative VARs, 3-Ph, Average	FLOAT	-9999 M to +9999 M	VARs	2
0BC5 -	0BC6	3014 - 3015	VAs, 3-Ph, Average	FLOAT	-9999 M to +9999 M	VAs	2
0BC7 -	0BC8	3016 - 3017	Positive PF, 3-Ph, Average	FLOAT	-1.00 to +1.00	none	2
0BC9 -	0BCA	3018 - 3019	Negative PF, 3-PF, Average	FLOAT	-1.00 to +1.00	none	2
0BCB -	0BCC	3020 - 3021	Neutral Current, Average	FLOAT	0 to 9999 M	amps	2
0BCD -	0BCE	3022 - 3023	Positive Watts, Phase A, Average	FLOAT	-9999 M to +9999 M	watts	2
0BCF -	0BD0	3024 - 3025	Positive Watts, Phase B, Average	FLOAT	-9999 M to +9999 M	watts	2
0BD1 -	0BD2	3026 - 3027	Positive Watts, Phase C, Average	FLOAT	-9999 M to +9999 M	watts	2
0BD3 -	0BD4	3028 - 3029	Positive VARs, Phase A, Average	FLOAT	-9999 M to +9999 M	VARs	2
0BD5 -	0BD6	3030 - 3031	Positive VARs, Phase B, Average	FLOAT	-9999 M to +9999 M	VARs	2
0BD7 -	0BD8	3032 - 3033	Positive VARs, Phase C, Average	FLOAT	-9999 M to +9999 M	VARs	2
0BD9 -	0BDA	3034 - 3035	Negative Watts, Phase A, Average	FLOAT	-9999 M to +9999 M	watts	2
0BDB -	0BDC	3036 - 3037	Negative Watts, Phase B, Average	FLOAT	-9999 M to +9999 M	watts	2

Modbus Address		Description	Format	Range	Units or Resolution	Comments	# Reg
Hex	Decimal						
0BDD - 0BDE	3038 - 3039	Negative Watts, Phase C, Average	FLOAT	-9999 M to +9999 M	watts		2
0BDF - 0BE0	3040 - 3041	Negative VARs, Phase A, Average	FLOAT	-9999 M to +9999 M	VARs		2
0BE1 - 0BE2	3042 - 3043	Negative VARs, Phase B, Average	FLOAT	-9999 M to +9999 M	VARs		2
0BE3 - 0BE4	3044 - 3045	Negative VARs, Phase C, Average	FLOAT	-9999 M to +9999 M	VARs		2
0BE5 - 0BE6	3046 - 3047	VAs, Phase A, Average	FLOAT	-9999 M to +9999 M	VAs		2
0BE7 - 0BE8	3048 - 3049	VAs, Phase B, Average	FLOAT	-9999 M to +9999 M	VAs		2
0BE9 - 0BEA	3050 - 3051	VAs, Phase C, Average	FLOAT	-9999 M to +9999 M	VAs		2
0BEB - 0BEC	3052 - 3053	Positive PF, Phase A, Average	FLOAT	-1.00 to +1.00	none		2
0BED - 0BEE	3054 - 3055	Positive PF, Phase B, Average	FLOAT	-1.00 to +1.00	none		2
0BEF - 0BF0	3056 - 3057	Positive PF, Phase C, Average	FLOAT	-1.00 to +1.00	none		2
0BF1 - 0BF2	3058 - 3059	Negative PF, Phase A, Average	FLOAT	-1.00 to +1.00	none		2
0BF3 - 0BF4	3060 - 3061	Negative PF, Phase B, Average	FLOAT	-1.00 to +1.00	none		2
0BF5 - 0BF6	3062 - 3063	Negative PF, Phase C, Average	FLOAT	-1.00 to +1.00	none		2
						Block Size:	64
Primary Demand Block Meter 5						read-only	
0C1B - 0C1C	3100 - 3101	Amps A, Average	FLOAT	0 to 9999 M	amps		2
0C1D - 0C1E	3102 - 3103	Amps B, Average	FLOAT	0 to 9999 M	amps		2
0C1F - 0C20	3104 - 3105	Amps C, Average	FLOAT	0 to 9999 M	amps		2
0C21 - 0C22	3106 - 3107	Positive Watts, 3-Ph, Average	FLOAT	-9999 M to +9999 M	watts		2
0C23 - 0C24	3108 - 3109	Positive VARs, 3-Ph, Average	FLOAT	-9999 M to +9999 M	VARs		2
0C25 - 0C26	3110 - 3111	Negative Watts, 3-Ph, Average	FLOAT	-9999 M to +9999 M	watts		2
0C27 - 0C28	3112 - 3113	Negative VARs, 3-Ph, Average	FLOAT	-9999 M to +9999 M	VARs		2

Modbus Address		Description	Format	Range	Units or Resolution	Comments	# Reg
Hex	Decimal						
0C29 - 0C2A	3114 - 3115	VAs, 3-Ph, Average	FLOAT	-9999 M to +9999 M	VAs		2
0C2B - 0C2C	3116 - 3117	Positive PF, 3-Ph, Average	FLOAT	-1.00 to +1.00	none		2
0C2D - 0C2E	3118 - 3119	Negative PF, 3-PF, Average	FLOAT	-1.00 to +1.00	none		2
0C2F - 0C30	3120 - 3121	Neutral Current, Average	FLOAT	0 to 9999 M	amps		2
0C31 - 0C32	3122 - 3123	Positive Watts, Phase A, Average	FLOAT	-9999 M to +9999 M	watts		2
0C33 - 0C34	3124 - 3125	Positive Watts, Phase B, Average	FLOAT	-9999 M to +9999 M	watts		2
0C35 - 0C36	3126 - 3127	Positive Watts, Phase C, Average	FLOAT	-9999 M to +9999 M	watts		2
0C37 - 0C38	3128 - 3129	Positive VARs, Phase A, Average	FLOAT	-9999 M to +9999 M	VARs		2
0C39 - 0C3A	3130 - 3131	Positive VARs, Phase B, Average	FLOAT	-9999 M to +9999 M	VARs		2
0C3B - 0C3C	3132 - 3133	Positive VARs, Phase C, Average	FLOAT	-9999 M to +9999 M	VARs		2
0C3D - 0C3E	3134 - 3135	Negative Watts, Phase A, Average	FLOAT	-9999 M to +9999 M	watts		2
0C3F - 0C40	3136 - 3137	Negative Watts, Phase B, Average	FLOAT	-9999 M to +9999 M	watts		2
0C41 - 0C42	3138 - 3139	Negative Watts, Phase C, Average	FLOAT	-9999 M to +9999 M	watts		2
0C43 - 0C44	3140 - 3141	Negative VARs, Phase A, Average	FLOAT	-9999 M to +9999 M	VARs		2
0C45 - 0C46	3142 - 3143	Negative VARs, Phase B, Average	FLOAT	-9999 M to +9999 M	VARs		2
0C47 - 0C48	3144 - 3145	Negative VARs, Phase C, Average	FLOAT	-9999 M to +9999 M	VARs		2
0C49 - 0C4A	3146 - 3147	VAs, Phase A, Average	FLOAT	-9999 M to +9999 M	VAs		2
0C4B - 0C4C	3148 - 3149	VAs, Phase B, Average	FLOAT	-9999 M to +9999 M	VAs		2
0C4D - 0C4E	3150 - 3151	VAs, Phase C, Average	FLOAT	-9999 M to +9999 M	VAs		2
0C4F - 0C50	3152 - 3153	Positive PF, Phase A, Average	FLOAT	-1.00 to +1.00	none		2

Modbus Address		Description	Format	Range	Units or Resolution	Comments	# Reg		
Hex	Decimal								
0C51 -	0C52	3154 - 3155		Positive PF, Phase B, Average	FLOAT	-1.00 to +1.00	none		2
0C53 -	0C54	3156 - 3157		Positive PF, Phase C, Average	FLOAT	-1.00 to +1.00	none		2
0C55 -	0C56	3158 - 3159		Negative PF, Phase A, Average	FLOAT	-1.00 to +1.00	none		2
0C57 -	0C58	3160 - 3161		Negative PF, Phase B, Average	FLOAT	-1.00 to +1.00	none		2
0C59 -	0C5A	3162 - 3163		Negative PF, Phase C, Average	FLOAT	-1.00 to +1.00	none		2
							Block Size:	64	
Primary Demand Block Meter 6							read-only		
0C7F -	0C80	3200 - 3201		Amps A, Average	FLOAT	0 to 9999 M	amps		2
0C81 -	0C82	3202 - 3203		Amps B, Average	FLOAT	0 to 9999 M	amps		2
0C83 -	0C84	3204 - 3205		Amps C, Average	FLOAT	0 to 9999 M	amps		2
0C85 -	0C86	3206 - 3207		Positive Watts, 3-Ph, Average	FLOAT	-9999 M to +9999 M	watts		2
0C87 -	0C88	3208 - 3209		Positive VARs, 3-Ph, Average	FLOAT	-9999 M to +9999 M	VARs		2
0C89 -	0C8A	3210 - 3211		Negative Watts, 3-Ph, Average	FLOAT	-9999 M to +9999 M	watts		2
0C8B -	0C8C	3212 - 3213		Negative VARs, 3-Ph, Average	FLOAT	-9999 M to +9999 M	VARs		2
0C8D -	0C8E	3214 - 3215		VAs, 3-Ph, Average	FLOAT	-9999 M to +9999 M	VAs		2
0C8F -	0C90	3216 - 3217		Positive PF, 3-Ph, Average	FLOAT	-1.00 to +1.00	none		2
0C91 -	0C92	3218 - 3219		Negative PF, 3-PF, Average	FLOAT	-1.00 to +1.00	none		2
0C93 -	0C94	3220 - 3221		Neutral Current, Average	FLOAT	0 to 9999 M	amps		2
0C95 -	0C96	3222 - 3223		Positive Watts, Phase A, Average	FLOAT	-9999 M to +9999 M	watts		2
0C97 -	0C98	3224 - 3225		Positive Watts, Phase B, Average	FLOAT	-9999 M to +9999 M	watts		2
0C99 -	0C9A	3226 - 3227		Positive Watts, Phase C, Average	FLOAT	-9999 M to +9999 M	watts		2
0C9B -	0C9C	3228 - 3229		Positive VARs, Phase A, Average	FLOAT	-9999 M to +9999 M	VARs		2
0C9D -	0C9E	3230 - 3231		Positive VARs, Phase B, Average	FLOAT	-9999 M to +9999 M	VARs		2

Modbus Address		Description	Format	Range	Units or Resolution	Comments	# Reg
Hex	Decimal						
0C9F - 0CA0	3232 - 3233	Positive VARs, Phase C, Average	FLOAT	-9999 M to +9999 M	VARs		2
0CA1 - 0CA2	3234 - 3235	Negative Watts, Phase A, Average	FLOAT	-9999 M to +9999 M	watts		2
0CA3 - 0CA4	3236 - 3237	Negative Watts, Phase B, Average	FLOAT	-9999 M to +9999 M	watts		2
0CA5 - 0CA6	3238 - 3239	Negative Watts, Phase C, Average	FLOAT	-9999 M to +9999 M	watts		2
0CA7 - 0CA8	3240 - 3241	Negative VARs, Phase A, Average	FLOAT	-9999 M to +9999 M	VARs		2
0CA9 - 0CAA	3242 - 3243	Negative VARs, Phase B, Average	FLOAT	-9999 M to +9999 M	VARs		2
0CAB - 0CAC	3244 - 3245	Negative VARs, Phase C, Average	FLOAT	-9999 M to +9999 M	VARs		2
0CAD - 0CAE	3246 - 3247	VAs, Phase A, Average	FLOAT	-9999 M to +9999 M	VAs		2
0CAF - 0CB0	3248 - 3249	VAs, Phase B, Average	FLOAT	-9999 M to +9999 M	VAs		2
0CB1 - 0CB2	3250 - 3251	VAs, Phase C, Average	FLOAT	-9999 M to +9999 M	VAs		2
0CB3 - 0CB4	3252 - 3253	Positive PF, Phase A, Average	FLOAT	-1.00 to +1.00	none		2
0CB5 - 0CB6	3254 - 3255	Positive PF, Phase B, Average	FLOAT	-1.00 to +1.00	none		2
0CB7 - 0CB8	3256 - 3257	Positive PF, Phase C, Average	FLOAT	-1.00 to +1.00	none		2
0CB9 - 0CBA	3258 - 3259	Negative PF, Phase A, Average	FLOAT	-1.00 to +1.00	none		2
0CBB - 0CBC	3260 - 3261	Negative PF, Phase B, Average	FLOAT	-1.00 to +1.00	none		2
0CBD - 0CBE	3262 - 3263	Negative PF, Phase C, Average	FLOAT	-1.00 to +1.00	none		2
						Block Size:	64
Primary Demand Block Meter 7						read-only	
0CE3 - 0CE4	3300 - 3301	Amps A, Average	FLOAT	0 to 9999 M	amps		2
0CE5 - 0CE6	3302 - 3303	Amps B, Average	FLOAT	0 to 9999 M	amps		2
0CE7 - 0CE8	3304 - 3305	Amps C, Average	FLOAT	0 to 9999 M	amps		2
0CE9 - 0CEA	3306 - 3307	Positive Watts, 3-Ph, Average	FLOAT	-9999 M to +9999 M	watts		2

Modbus Address		Description	Format	Range	Units or Resolution	Comments	# Reg
Hex	Decimal						
0CEB - 0CEC	3308 - 3309	Positive VARs, 3-Ph, Average	FLOAT	-9999 M to +9999 M	VARs		2
0CED - 0CEE	3310 - 3311	Negative Watts, 3-Ph, Average	FLOAT	-9999 M to +9999 M	watts		2
0CEF - 0CF0	3312 - 3313	Negative VARs, 3-Ph, Average	FLOAT	-9999 M to +9999 M	VARs		2
0CF1 - 0CF2	3314 - 3315	VAs, 3-Ph, Average	FLOAT	-9999 M to +9999 M	VAs		2
0CF3 - 0CF4	3316 - 3317	Positive PF, 3-Ph, Average	FLOAT	-1.00 to +1.00	none		2
0CF5 - 0CF6	3318 - 3319	Negative PF, 3-PF, Average	FLOAT	-1.00 to +1.00	none		2
0CF7 - 0CF8	3320 - 3321	Neutral Current, Average	FLOAT	0 to 9999 M	amps		2
0CF9 - 0CFA	3322 - 3323	Positive Watts, Phase A, Average	FLOAT	-9999 M to +9999 M	watts		2
0CFB - 0CFC	3324 - 3325	Positive Watts, Phase B, Average	FLOAT	-9999 M to +9999 M	watts		2
0CFD - 0CFE	3326 - 3327	Positive Watts, Phase C, Average	FLOAT	-9999 M to +9999 M	watts		2
0CFF - 0D00	3328 - 3329	Positive VARs, Phase A, Average	FLOAT	-9999 M to +9999 M	VARs		2
0D01 - 0D02	3330 - 3331	Positive VARs, Phase B, Average	FLOAT	-9999 M to +9999 M	VARs		2
0D03 - 0D04	3332 - 3333	Positive VARs, Phase C, Average	FLOAT	-9999 M to +9999 M	VARs		2
0D05 - 0D06	3334 - 3335	Negative Watts, Phase A, Average	FLOAT	-9999 M to +9999 M	watts		2
0D07 - 0D08	3336 - 3337	Negative Watts, Phase B, Average	FLOAT	-9999 M to +9999 M	watts		2
0D09 - 0D0A	3338 - 3339	Negative Watts, Phase C, Average	FLOAT	-9999 M to +9999 M	watts		2
0D0B - 0D0C	3340 - 3341	Negative VARs, Phase A, Average	FLOAT	-9999 M to +9999 M	VARs		2
0D0D - 0D0E	3342 - 3343	Negative VARs, Phase B, Average	FLOAT	-9999 M to +9999 M	VARs		2
0D0F - 0D10	3344 - 3345	Negative VARs, Phase C, Average	FLOAT	-9999 M to +9999 M	VARs		2
0D11 - 0D12	3346 - 3347	VAs, Phase A, Average	FLOAT	-9999 M to +9999 M	VAs		2

Modbus Address		Description	Format	Range	Units or Resolution	Comments	# Reg		
Hex	Decimal								
0D13 -	0D14	3348 - 3349		VAs, Phase B, Average	FLOAT	-9999 M to +9999 M	VAs		2
0D15 -	0D16	3350 - 3351		VAs, Phase C, Average	FLOAT	-9999 M to +9999 M	VAs		2
0D17 -	0D18	3352 - 3353		Positive PF, Phase A, Average	FLOAT	-1.00 to +1.00	none		2
0D19 -	0D1A	3354 - 3355		Positive PF, Phase B, Average	FLOAT	-1.00 to +1.00	none		2
0D1B -	0D1C	3356 - 3357		Positive PF, Phase C, Average	FLOAT	-1.00 to +1.00	none		2
0D1D -	0D1E	3358 - 3359		Negative PF, Phase A, Average	FLOAT	-1.00 to +1.00	none		2
0D1F -	0D20	3360 - 3361		Negative PF, Phase B, Average	FLOAT	-1.00 to +1.00	none		2
0D21 -	0D22	3362 - 3363		Negative PF, Phase C, Average	FLOAT	-1.00 to +1.00	none		2
						Block Size:		64	
Primary Demand Block Meter 8								read-only	
0D47 -	0D48	3400 - 3401		Amps A, Average	FLOAT	0 to 9999 M	amps		2
0D49 -	0D4A	3402 - 3403		Amps B, Average	FLOAT	0 to 9999 M	amps		2
0D4B -	0D4C	3404 - 3405		Amps C, Average	FLOAT	0 to 9999 M	amps		2
0D4D -	0D4E	3406 - 3407		Positive Watts, 3-Ph, Average	FLOAT	-9999 M to +9999 M	watts		2
0D4F -	0D50	3408 - 3409		Positive VARs, 3-Ph, Average	FLOAT	-9999 M to +9999 M	VARs		2
0D51 -	0D52	3410 - 3411		Negative Watts, 3-Ph, Average	FLOAT	-9999 M to +9999 M	watts		2
0D53 -	0D54	3412 - 3413		Negative VARs, 3-Ph, Average	FLOAT	-9999 M to +9999 M	VARs		2
0D55 -	0D56	3414 - 3415		VAs, 3-Ph, Average	FLOAT	-9999 M to +9999 M	VAs		2
0D57 -	0D58	3416 - 3417		Positive PF, 3-Ph, Average	FLOAT	-1.00 to +1.00	none		2
0D59 -	0D5A	3418 - 3419		Negative PF, 3-PF, Average	FLOAT	-1.00 to +1.00	none		2
0D5B -	0D5C	3420 - 3421		Neutral Current, Average	FLOAT	0 to 9999 M	amps		2
0D5D -	0D5E	3422 - 3423		Positive Watts, Phase A, Average	FLOAT	-9999 M to +9999 M	watts		2
0D5F -	0D60	3424 - 3425		Positive Watts, Phase B, Average	FLOAT	-9999 M to +9999 M	watts		2

Modbus Address		Decimal	Description	Format	Range	Units or Resolution	Comments	# Reg
Hex								
0D61 -	0D62	3426 - 3427	Positive Watts, Phase C, Average	FLOAT	-9999 M to +9999 M	watts		2
0D63 -	0D64	3428 - 3429	Positive VARs, Phase A, Average	FLOAT	-9999 M to +9999 M	VARs		2
0D65 -	0D66	3430 - 3431	Positive VARs, Phase B, Average	FLOAT	-9999 M to +9999 M	VARs		2
0D67 -	0D68	3432 - 3433	Positive VARs, Phase C, Average	FLOAT	-9999 M to +9999 M	VARs		2
0D69 -	0D6A	3434 - 3435	Negative Watts, Phase A, Average	FLOAT	-9999 M to +9999 M	watts		2
0D6B -	0D6C	3436 - 3437	Negative Watts, Phase B, Average	FLOAT	-9999 M to +9999 M	watts		2
0D6D -	0D6E	3438 - 3439	Negative Watts, Phase C, Average	FLOAT	-9999 M to +9999 M	watts		2
0D6F -	0D70	3440 - 3441	Negative VARs, Phase A, Average	FLOAT	-9999 M to +9999 M	VARs		2
0D71 -	0D72	3442 - 3443	Negative VARs, Phase B, Average	FLOAT	-9999 M to +9999 M	VARs		2
0D73 -	0D74	3444 - 3445	Negative VARs, Phase C, Average	FLOAT	-9999 M to +9999 M	VARs		2
0D75 -	0D76	3446 - 3447	VAs, Phase A, Average	FLOAT	-9999 M to +9999 M	VAs		2
0D77 -	0D78	3448 - 3449	VAs, Phase B, Average	FLOAT	-9999 M to +9999 M	VAs		2
0D79 -	0D7A	3450 - 3451	VAs, Phase C, Average	FLOAT	-9999 M to +9999 M	VAs		2
0D7B -	0D7C	3452 - 3453	Positive PF, Phase A, Average	FLOAT	-1.00 to +1.00	none		2
0D7D -	0D7E	3454 - 3455	Positive PF, Phase B, Average	FLOAT	-1.00 to +1.00	none		2
0D7F -	0D80	3456 - 3457	Positive PF, Phase C, Average	FLOAT	-1.00 to +1.00	none		2
0D81 -	0D82	3458 - 3459	Negative PF, Phase A, Average	FLOAT	-1.00 to +1.00	none		2
0D83 -	0D84	3460 - 3461	Negative PF, Phase B, Average	FLOAT	-1.00 to +1.00	none		2
0D85 -	0D86	3462 - 3463	Negative PF, Phase C, Average	FLOAT	-1.00 to +1.00	none		2
							Block Size:	64

Modbus Address		Description	Format	Range	Units or Resolution	Comments	# Reg	
Hex	Decimal							
Phase Angle Block (voltage)								
0DAB -	0DAB	3500 - 3500	Angle, Volts A-B	SINT16	-1800 to +1800	0.1 degree	1	
0DAC -	0DAC	3501 - 3501	Angle, Volts B-C	SINT16	-1800 to +1800	0.1 degree	1	
0DAD -	0DAD	3502 - 3502	Angle, Volts C-A	SINT16	-1800 to +1800	0.1 degree	1	
Phase Angle Block (Current Meter 1)								
0DAE -	0DAE	3503 - 3503	Angle, Phase A current	SINT16	-1800 to +1800	0.1 degree	1	
0DAF -	0DAF	3504 - 3504	Angle, Phase B current	SINT16	-1800 to +1800	0.1 degree	1	
0DB0 -	0DB0	3505 - 3505	Angle, Phase C current	SINT16	-1800 to +1800	0.1 degree	1	
							Block Size:	3
Phase Angle Block (Current Meter 2)								
0DB1 -	0DB1	3506 - 3506	Angle, Phase A current	SINT16	-1800 to +1800	0.1 degree	1	
0DB2 -	0DB2	3507 - 3507	Angle, Phase B current	SINT16	-1800 to +1800	0.1 degree	1	
0DB3 -	0DB3	3508 - 3508	Angle, Phase C current	SINT16	-1800 to +1800	0.1 degree	1	
							Block Size:	3
Phase Angle Block (Current Meter 3)								
0DB4 -	0DB4	3509 - 3509	Angle, Phase A current	SINT16	-1800 to +1800	0.1 degree	1	
0DB5 -	0DB5	3510 - 3510	Angle, Phase B current	SINT16	-1800 to +1800	0.1 degree	1	
0DB6 -	0DB6	3511 - 3511	Angle, Phase C current	SINT16	-1800 to +1800	0.1 degree	1	
							Block Size:	3
Phase Angle Block (Current Meter 4)								
0DB7 -	0DB7	3512 - 3512	Angle, Phase A current	SINT16	-1800 to +1800	0.1 degree	1	
0DB8 -	0DB8	3513 - 3513	Angle, Phase B current	SINT16	-1800 to +1800	0.1 degree	1	
0DB9 -	0DB9	3514 - 3514	Angle, Phase C current	SINT16	-1800 to +1800	0.1 degree	1	
							Block Size:	3

Modbus Address		Description	Format	Range	Units or Resolution	Comments	# Reg
Hex	Decimal						
Phase Angle Block (Current Meter 5)							
0DBA -	0DBA	3515 - 3515	Angle, Phase A current	SINT16	-1800 to +1800	0.1 degree	1
0DBB -	0DBB	3516 - 3516	Angle, Phase B current	SINT16	-1800 to +1800	0.1 degree	1
0DBC -	0DBC	3517 - 3517	Angle, Phase C current	SINT16	-1800 to +1800	0.1 degree	1
						Block Size:	3
Phase Angle Block (Current Meter 6)							
0DBD -	0DBD	3518 - 3518	Angle, Phase A current	SINT16	-1800 to +1800	0.1 degree	1
0DBE -	0DBE	3519 - 3519	Angle, Phase B current	SINT16	-1800 to +1800	0.1 degree	1
0DBF -	0DBF	3520 - 3520	Angle, Phase C current	SINT16	-1800 to +1800	0.1 degree	1
						Block Size:	3
Phase Angle Block (Current Meter 7)							
0DC0 -	0DC0	3521 - 3521	Angle, Phase A current	SINT16	-1800 to +1800	0.1 degree	1
0DC1 -	0DC1	3522 - 3522	Angle, Phase B current	SINT16	-1800 to +1800	0.1 degree	1
0DC2 -	0DC2	3523 - 3523	Angle, Phase C current	SINT16	-1800 to +1800	0.1 degree	1
						Block Size:	3
Phase Angle Block (Current Meter 8)							
0DC3 -	0DC3	3524 - 3524	Angle, Phase A current	SINT16	-1800 to +1800	0.1 degree	1
0DC4 -	0DC4	3525 - 3525	Angle, Phase B current	SINT16	-1800 to +1800	0.1 degree	1
0DC5 -	0DC5	3526 - 3526	Angle, Phase C current	SINT16	-1800 to +1800	0.1 degree	1

Modbus Address		Description	Format	Range	Units or Resolution	Comments	# Reg	
Hex	Decimal							
Status Block							read-only	
0DC9 -	0DC9	3530 - 3530	Port ID	UINT16	1 to 3	none	Identifies which COM port a master is connected to; 1 for COM1, 2 for COM2, etc.	3
0DCA -	0DCA	3531 - 3531	CPU Status	UINT16	bit-mapped	mmmpch-- bffee-cc	mmm = measurement state (0=off, 1=running normally, 2=limp mode, 3=warmup, 6&7=boot, others unused) See note 15. pch = NVMEM block OK flags (p=profile, c=calibration, h=header), flag is 1 if OK b - Battery status. (0=battery low, 1=battery OK) ff = flash state (0=initializing, 1=logging disabled by Vswitch, 3=logging) ee = edit state (0=startup, 1=normal, 2=privileged command session, 3=profile update mode) cc = port enabled for edit(0=none, 1-3=COM1-COM3)	1
0DCB -	0DCB	3532 - 3532	Limits Status	UINT16	bit-mapped	87654321 87654321	high byte is setpt 1, 0=in, 1=out low byte is setpt 2, 0=in, 1=out see notes 11, 12, 17	1
0DCC -	0DCD	3533 - 3534	Time Since Reset	UINT32	0 to 4294967294	4 msec		2
0DCE -	0DD0	3535 - 3537	CPU On Time	TSTAMP	1Jan2000 - 31Dec2099	1 sec		3
0DD1 -	0DD3	3538 - 3540	Current Date and Time	TSTAMP	1Jan2000 - 31Dec2099	1 sec		3
0DD4 -	0DD4	3541 - 3541	Reserved				Reserved	1
0DD5 -	0DD5	3542 - 3542	Current Day of Week	UINT16	1 to 7	1 day	1=Sun, 2=Mon, etc.	1
Short term Primary Minimum Block							read-only	
0DDD -	0DDE	3550 - 3551	Volts A-N, previous Demand interval Short Term Minimum	FLOAT	0 to 9999 M	volts	Minimum instantaneous value measured during the demand interval before the one most recently completed.	2
0DDF -	0DE0	3552 - 3553	Volts B-N, previous Demand interval Short Term Minimum	FLOAT	0 to 9999 M	volts		2
0DE1 -	0DE2	3554 - 3555	Volts C-N, previous Demand interval Short Term Minimum	FLOAT	0 to 9999 M	volts		2
0DE3 -	0DE4	3556 - 3557	Volts A-B, previous Demand interval Short Term Minimum	FLOAT	0 to 9999 M	volts		2
0DE5 -	0DE6	3558 - 3559	Volts B-C, previous Demand interval Short Term Minimum	FLOAT	0 to 9999 M	volts		2

Modbus Address		Description	Format	Range	Units or Resolution	Comments	# Reg
Hex	Decimal						
0DE7 - 0DE8	3560 - 3561	Volts C-A, previous Demand interval Short Term Minimum	FLOAT	0 to 9999 M	volts	(Cont'd)	2
0DE9 - 0DEA	3562 - 3563	Volts A-N, Short Term Minimum	FLOAT	0 to 9999 M	volts	Minimum instantaneous value measured during the most recently completed demand interval.	2
0DEB - 0DEC	3564 - 3565	Volts B-N, Short Term Minimum	FLOAT	0 to 9999 M	volts		2
0DED - 0DEE	3566 - 3567	Volts C-N, Short Term Minimum	FLOAT	0 to 9999 M	volts		2
0DEF - 0DF0	3568 - 3569	Volts A-B, Short Term Minimum	FLOAT	0 to 9999 M	volts		2
0DF1 - 0DF2	3570 - 3571	Volts B-C, Short Term Minimum	FLOAT	0 to 9999 M	volts		2
0DF3 - 0DF4	3572 - 3573	Volts C-A, Short Term Minimum	FLOAT	0 to 9999 M	volts		2
0DF5 - 0DF6	3574 - 3575	Volts B-C, Short Term Minimum	FLOAT	0 to 9999 M	volts		2
0DF7 - 0DF8	3576 - 3577	Volts C-A, Short Term Minimum	FLOAT	0 to 9999 M	volts		2
Primary Minimum Block (Voltage)							Block Size: 24
							read-only
0DFB - 0DFC	3580 - 3581	Volts A-N, Minimum	FLOAT	0 to 9999 M	volts		2
0DFD - 0DFE	3582 - 3583	Volts B-N, Minimum	FLOAT	0 to 9999 M	volts		2
0DFE - 0E00	3584 - 3585	Volts C-N, Minimum	FLOAT	0 to 9999 M	volts		2
0E01 - 0E02	3586 - 3587	Volts A-B, Minimum	FLOAT	0 to 9999 M	volts		2
0E03 - 0E04	3588 - 3589	Volts B-C, Minimum	FLOAT	0 to 9999 M	volts		2
0E05 - 0E06	3590 - 3591	Volts C-A, Minimum	FLOAT	0 to 9999 M	volts		2
0E07 - 0E08	3592 - 3593	Frequency, Minimum	FLOAT	0 to 65.00	Hz		2
Primary Minimum Block Meter 1							Block Size: 14
							read-only
0E0F - 0E10	3600 - 3601	Amps A, Minimum Avg Demand	FLOAT	0 to 9999 M	amps		2
0E11 - 0E12	3602 - 3603	Amps B, Minimum Avg Demand	FLOAT	0 to 9999 M	amps		2
0E13 - 0E14	3604 - 3605	Amps C, Minimum Avg Demand	FLOAT	0 to 9999 M	amps		2
0E15 - 0E16	3606 - 3607	Positive Watts, 3-Ph, Minimum Avg Demand	FLOAT	0 to +9999 M	watts		2
0E17 - 0E18	3608 - 3609	Positive VARs, 3-Ph, Minimum Avg Demand	FLOAT	0 to +9999 M	VARs		2
0E19 - 0E1A	3610 - 3611	Negative Watts, 3-Ph, Minimum Avg Demand	FLOAT	0 to +9999 M	watts		2
0E1B - 0E1C	3612 - 3613	Negative VARs, 3-Ph, Minimum Avg Demand	FLOAT	0 to +9999 M	VARs		2
0E1D - 0E1E	3614 - 3615	VAs, 3-Ph, Minimum Avg Demand	FLOAT	-9999 M to +9999 M	VAs		2
0E1F - 0E20	3616 - 3617	Positive Power Factor, 3-Ph, Minimum Avg Demand	FLOAT	-1.00 to +1.00	none		2
0E21 - 0E22	3618 - 3619	Negative Power Factor, 3-Ph, Minimum Avg Demand	FLOAT	-1.00 to +1.00	none		2
0E23 - 0E24	3620 - 3621	Neutral Current, Minimum Avg Demand	FLOAT	0 to 9999 M	amps		2

Modbus Address		Description	Format	Range	Units or Resolution	Comments	# Reg
Hex	Decimal						
0E25 - 0E26	3622 - 3623	Positive Watts, Phase A, Minimum Avg Demand	FLOAT	-9999 M to +9999 M	watts		2
0E27 - 0E28	3624 - 3625	Positive Watts, Phase B, Minimum Avg Demand	FLOAT	-9999 M to +9999 M	watts		2
0E29 - 0E2A	3626 - 3627	Positive Watts, Phase C, Minimum Avg Demand	FLOAT	-9999 M to +9999 M	watts		2
0E2B - 0E2C	3628 - 3629	Positive VARs, Phase A, Minimum Avg Demand	FLOAT	-9999 M to +9999 M	VARs		2
0E2D - 0E2E	3630 - 3631	Positive VARs, Phase B, Minimum Avg Demand	FLOAT	-9999 M to +9999 M	VARs		2
0E2F - 0E30	3632 - 3633	Positive VARs, Phase C, Minimum Avg Demand	FLOAT	-9999 M to +9999 M	VARs		2
0E31 - 0E32	3634 - 3635	Negative Watts, Phase A, Minimum Avg Demand	FLOAT	-9999 M to +9999 M	watts		2
0E33 - 0E34	3636 - 3637	Negative Watts, Phase B, Minimum Avg Demand	FLOAT	-9999 M to +9999 M	watts		2
0E35 - 0E36	3638 - 3639	Negative Watts, Phase C, Minimum Avg Demand	FLOAT	-9999 M to +9999 M	watts		2
0E37 - 0E38	3640 - 3641	Negative VARs, Phase A, Minimum Avg Demand	FLOAT	-9999 M to +9999 M	VARs		2
0E39 - 0E3A	3642 - 3643	Negative VARs, Phase B, Minimum Avg Demand	FLOAT	-9999 M to +9999 M	VARs		2
0E3B - 0E3C	3644 - 3645	Negative VARs, Phase C, Minimum Avg Demand	FLOAT	-9999 M to +9999 M	VARs		2
0E3D - 0E3E	3646 - 3647	VAs, Phase A, Minimum Avg Demand	FLOAT	-9999 M to +9999 M	VAs		2
0E3F - 0E40	3648 - 3649	VAs, Phase B, Minimum Avg Demand	FLOAT	-9999 M to +9999 M	VAs		2
0E41 - 0E42	3650 - 3651	VAs, Phase C, Minimum Avg Demand	FLOAT	-9999 M to +9999 M	VAs		2
0E43 - 0E44	3652 - 3653	Positive PF, Phase A, Minimum Avg Demand	FLOAT	-1.00 to +1.00	none		2
0E45 - 0E46	3654 - 3655	Positive PF, Phase B, Minimum Avg Demand	FLOAT	-1.00 to +1.00	none		2
0E47 - 0E48	3656 - 3657	Positive PF, Phase C, Minimum Avg Demand	FLOAT	-1.00 to +1.00	none		2
0E49 - 0E4A	3658 - 3659	Negative PF, Phase A, Minimum Avg Demand	FLOAT	-1.00 to +1.00	none		2

Modbus Address		Description	Format	Range	Units or Resolution	Comments	# Reg
Hex	Decimal						
0E4B -	0E4C	3660 - 3661	Negative PF, Phase B, Minimum Avg Demand	FLOAT	-1.00 to +1.00	none	2
0E4D -	0E4E	3662 - 3663	Negative PF, Phase C, Minimum Avg Demand	FLOAT	-1.00 to +1.00	none	2
						Block Size:	64
Primary Minimum Block Meter 2						read-only	
0E73 -	0E74	3700 - 3701	Amps A, Minimum Avg Demand	FLOAT	0 to 9999 M	amps	2
0E75 -	0E76	3702 - 3703	Amps B, Minimum Avg Demand	FLOAT	0 to 9999 M	amps	2
0E77 -	0E78	3704 - 3705	Amps C, Minimum Avg Demand	FLOAT	0 to 9999 M	amps	2
0E79 -	0E7A	3706 - 3707	Positive Watts, 3-Ph, Minimum Avg Demand	FLOAT	0 to +9999 M	watts	2
0E7B -	0E7C	3708 - 3709	Positive VARs, 3-Ph, Minimum Avg Demand	FLOAT	0 to +9999 M	VARs	2
0E7D -	0E7E	3710 - 3711	Negative Watts, 3-Ph, Minimum Avg Demand	FLOAT	0 to +9999 M	watts	2
0E7F -	0E80	3712 - 3713	Negative VARs, 3-Ph, Minimum Avg Demand	FLOAT	0 to +9999 M	VARs	2
0E81 -	0E82	3714 - 3715	VAs, 3-Ph, Minimum Avg Demand	FLOAT	-9999 M to +9999 M	VAs	2
0E83 -	0E84	3716 - 3717	Positive Power Factor, 3-Ph, Minimum Avg Demand	FLOAT	-1.00 to +1.00	none	2
0E85 -	0E86	3718 - 3719	Negative Power Factor, 3-Ph, Minimum Avg Demand	FLOAT	-1.00 to +1.00	none	2
0E87 -	0E88	3720 - 3721	Neutral Current, Minimum Avg Demand	FLOAT	0 to 9999 M	amps	2
0E89 -	0E8A	3722 - 3723	Positive Watts, Phase A, Minimum Avg Demand	FLOAT	-9999 M to +9999 M	watts	2
0E8B -	0E8C	3724 - 3725	Positive Watts, Phase B, Minimum Avg Demand	FLOAT	-9999 M to +9999 M	watts	2
0E8D -	0E8E	3726 - 3727	Positive Watts, Phase C, Minimum Avg Demand	FLOAT	-9999 M to +9999 M	watts	2
0E8F -	0E90	3728 - 3729	Positive VARs, Phase A, Minimum Avg Demand	FLOAT	-9999 M to +9999 M	VARs	2
0E91 -	0E92	3730 - 3731	Positive VARs, Phase B, Minimum Avg Demand	FLOAT	-9999 M to +9999 M	VARs	2
0E93 -	0E94	3732 - 3733	Positive VARs, Phase C, Minimum Avg Demand	FLOAT	-9999 M to +9999 M	VARs	2
0E95 -	0E96	3734 - 3735	Negative Watts, Phase A, Minimum Avg Demand	FLOAT	-9999 M to +9999 M	watts	2

Modbus Address		Description	Format	Range	Units or Resolution	Comments	# Reg
Hex	Decimal						
0E97 - 0E98	3736 - 3737	Negative Watts, Phase B, Minimum Avg Demand	FLOAT	-9999 M to +9999 M	watts		2
0E99 - 0E9A	3738 - 3739	Negative Watts, Phase C, Minimum Avg Demand	FLOAT	-9999 M to +9999 M	watts		2
0E9B - 0E9C	3740 - 3741	Negative VARs, Phase A, Minimum Avg Demand	FLOAT	-9999 M to +9999 M	VARs		2
0E9D - 0E9E	3742 - 3743	Negative VARs, Phase B, Minimum Avg Demand	FLOAT	-9999 M to +9999 M	VARs		2
0E9F - 0EA0	3744 - 3745	Negative VARs, Phase C, Minimum Avg Demand	FLOAT	-9999 M to +9999 M	VARs		2
0EA1 - 0EA2	3746 - 3747	VAs, Phase A, Minimum Avg Demand	FLOAT	-9999 M to +9999 M	VAs		2
0EA3 - 0EA4	3748 - 3749	VAs, Phase B, Minimum Avg Demand	FLOAT	-9999 M to +9999 M	VAs		2
0EA5 - 0EA6	3750 - 3751	VAs, Phase C, Minimum Avg Demand	FLOAT	-9999 M to +9999 M	VAs		2
0EA7 - 0EA8	3752 - 3753	Positive PF, Phase A, Minimum Avg Demand	FLOAT	-1.00 to +1.00	none		2
0EA9 - 0EAA	3754 - 3755	Positive PF, Phase B, Minimum Avg Demand	FLOAT	-1.00 to +1.00	none		2
0EAB - 0EAC	3756 - 3757	Positive PF, Phase C, Minimum Avg Demand	FLOAT	-1.00 to +1.00	none		2
0EAD - 0EAE	3758 - 3759	Negative PF, Phase A, Minimum Avg Demand	FLOAT	-1.00 to +1.00	none		2
0EAF - 0EB0	3760 - 3761	Negative PF, Phase B, Minimum Avg Demand	FLOAT	-1.00 to +1.00	none		2
0EB1 - 0EB2	3762 - 3763	Negative PF, Phase C, Minimum Avg Demand	FLOAT	-1.00 to +1.00	none		2
						Block Size:	64
Primary Minimum Block Meter 3						read-only	
0ED7 - 0ED8	3800 - 3801	Amps A, Minimum Avg Demand	FLOAT	0 to 9999 M	amps		2
0ED9 - 0EDA	3802 - 3803	Amps B, Minimum Avg Demand	FLOAT	0 to 9999 M	amps		2
0EDB - 0EDC	3804 - 3805	Amps C, Minimum Avg Demand	FLOAT	0 to 9999 M	amps		2
0EDD - 0EDE	3806 - 3807	Positive Watts, 3-Ph, Minimum Avg Demand	FLOAT	0 to +9999 M	watts		2
0EDF - 0EE0	3808 - 3809	Positive VARs, 3-Ph, Minimum Avg Demand	FLOAT	0 to +9999 M	VARs		2
0EE1 - 0EE2	3810 - 3811	Negative Watts, 3-Ph, Minimum Avg Demand	FLOAT	0 to +9999 M	watts		2

Modbus Address		Description	Format	Range	Units or Resolution	Comments	# Reg
Hex	Decimal						
0EE3 - 0EE4	3812 - 3813	Negative VARs, 3-Ph, Minimum Avg Demand	FLOAT	0 to +9999 M	VARs		2
0EE5 - 0EE6	3814 - 3815	VAs, 3-Ph, Minimum Avg Demand	FLOAT	-9999 M to +9999 M	VAs		2
0EE7 - 0EE8	3816 - 3817	Positive Power Factor, 3-Ph, Minimum Avg Demand	FLOAT	-1.00 to +1.00	none		2
0EE9 - 0EEA	3818 - 3819	Negative Power Factor, 3-Ph, Minimum Avg Demand	FLOAT	-1.00 to +1.00	none		2
0EEB - 0EEC	3820 - 3821	Neutral Current, Minimum Avg Demand	FLOAT	0 to 9999 M	amps		2
0EED - 0EEE	3822 - 3823	Positive Watts, Phase A, Minimum Avg Demand	FLOAT	-9999 M to +9999 M	watts		2
0EEF - 0EF0	3824 - 3825	Positive Watts, Phase B, Minimum Avg Demand	FLOAT	-9999 M to +9999 M	watts		2
0EF1 - 0EF2	3826 - 3827	Positive Watts, Phase C, Minimum Avg Demand	FLOAT	-9999 M to +9999 M	watts		2
0EF3 - 0EF4	3828 - 3829	Positive VARs, Phase A, Minimum Avg Demand	FLOAT	-9999 M to +9999 M	VARs		2
0EF5 - 0EF6	3830 - 3831	Positive VARs, Phase B, Minimum Avg Demand	FLOAT	-9999 M to +9999 M	VARs		2
0EF7 - 0EF8	3832 - 3833	Positive VARs, Phase C, Minimum Avg Demand	FLOAT	-9999 M to +9999 M	VARs		2
0EF9 - 0EFA	3834 - 3835	Negative Watts, Phase A, Minimum Avg Demand	FLOAT	-9999 M to +9999 M	watts		2
0EFB - 0EFC	3836 - 3837	Negative Watts, Phase B, Minimum Avg Demand	FLOAT	-9999 M to +9999 M	watts		2
0EFD - 0EFE	3838 - 3839	Negative Watts, Phase C, Minimum Avg Demand	FLOAT	-9999 M to +9999 M	watts		2
0EFF - 0F00	3840 - 3841	Negative VARs, Phase A, Minimum Avg Demand	FLOAT	-9999 M to +9999 M	VARs		2
0F01 - 0F02	3842 - 3843	Negative VARs, Phase B, Minimum Avg Demand	FLOAT	-9999 M to +9999 M	VARs		2
0F03 - 0F04	3844 - 3845	Negative VARs, Phase C, Minimum Avg Demand	FLOAT	-9999 M to +9999 M	VARs		2
0F05 - 0F06	3846 - 3847	VAs, Phase A, Minimum Avg Demand	FLOAT	-9999 M to +9999 M	VAs		2
0F07 - 0F08	3848 - 3849	VAs, Phase B, Minimum Avg Demand	FLOAT	-9999 M to +9999 M	VAs		2
0F09 - 0FOA	3850 - 3851	VAs, Phase C, Minimum Avg Demand	FLOAT	-9999 M to +9999 M	VAs		2

Modbus Address		Description	Format	Range	Units or Resolution	Comments	# Reg
Hex	Decimal						
0F0B -	0F0C	3852 - 3853	Positive PF, Phase A, Minimum Avg Demand	FLOAT	-1.00 to +1.00	none	2
0F0D -	0F0E	3854 - 3855	Positive PF, Phase B, Minimum Avg Demand	FLOAT	-1.00 to +1.00	none	2
0F0F -	0F10	3856 - 3857	Positive PF, Phase C, Minimum Avg Demand	FLOAT	-1.00 to +1.00	none	2
0F11 -	0F12	3858 - 3859	Negative PF, Phase A, Minimum Avg Demand	FLOAT	-1.00 to +1.00	none	2
0F13 -	0F14	3860 - 3861	Negative PF, Phase B, Minimum Avg Demand	FLOAT	-1.00 to +1.00	none	2
0F15 -	0F16	3862 - 3863	Negative PF, Phase C, Minimum Avg Demand	FLOAT	-1.00 to +1.00	none	2
						Block Size:	64
Primary Minimum Block Meter 4						read-only	
0F3B -	0F3C	3900 - 3901	Amps A, Minimum Avg Demand	FLOAT	0 to 9999 M	amps	2
0F3D -	0F3E	3902 - 3903	Amps B, Minimum Avg Demand	FLOAT	0 to 9999 M	amps	2
0F3F -	0F40	3904 - 3905	Amps C, Minimum Avg Demand	FLOAT	0 to 9999 M	amps	2
0F41 -	0F42	3906 - 3907	Positive Watts, 3-Ph, Minimum Avg Demand	FLOAT	0 to +9999 M	watts	2
0F43 -	0F44	3908 - 3909	Positive VARs, 3-Ph, Minimum Avg Demand	FLOAT	0 to +9999 M	VARs	2
0F45 -	0F46	3910 - 3911	Negative Watts, 3-Ph, Minimum Avg Demand	FLOAT	0 to +9999 M	watts	2
0F47 -	0F48	3912 - 3913	Negative VARs, 3-Ph, Minimum Avg Demand	FLOAT	0 to +9999 M	VARs	2
0F49 -	0F4A	3914 - 3915	VAs, 3-Ph, Minimum Avg Demand	FLOAT	-9999 M to +9999 M	VAs	2
0F4B -	0F4C	3916 - 3917	Positive Power Factor, 3-Ph, Minimum Avg Demand	FLOAT	-1.00 to +1.00	none	2
0F4D -	0F4E	3918 - 3919	Negative Power Factor, 3-Ph, Minimum Avg Demand	FLOAT	-1.00 to +1.00	none	2
0F4F -	0F50	3920 - 3921	Neutral Current, Minimum Avg Demand	FLOAT	0 to 9999 M	amps	2
0F51 -	0F52	3922 - 3923	Positive Watts, Phase A, Minimum Avg Demand	FLOAT	-9999 M to +9999 M	watts	2
0F53 -	0F54	3924 - 3925	Positive Watts, Phase B, Minimum Avg Demand	FLOAT	-9999 M to +9999 M	watts	2
0F55 -	0F56	3926 - 3927	Positive Watts, Phase C, Minimum Avg Demand	FLOAT	-9999 M to +9999 M	watts	2

Modbus Address		Description	Format	Range	Units or Resolution	Comments	# Reg
Hex	Decimal						
0F57 - 0F58	3928 - 3929	Positive VARs, Phase A, Minimum Avg Demand	FLOAT	-9999 M to +9999 M	VARs		2
0F59 - 0F5A	3930 - 3931	Positive VARs, Phase B, Minimum Avg Demand	FLOAT	-9999 M to +9999 M	VARs		2
0F5B - 0F5C	3932 - 3933	Positive VARs, Phase C, Minimum Avg Demand	FLOAT	-9999 M to +9999 M	VARs		2
0F5D - 0F5E	3934 - 3935	Negative Watts, Phase A, Minimum Avg Demand	FLOAT	-9999 M to +9999 M	watts		2
0F5F - 0F60	3936 - 3937	Negative Watts, Phase B, Minimum Avg Demand	FLOAT	-9999 M to +9999 M	watts		2
0F61 - 0F62	3938 - 3939	Negative Watts, Phase C, Minimum Avg Demand	FLOAT	-9999 M to +9999 M	watts		2
0F63 - 0F64	3940 - 3941	Negative VARs, Phase A, Minimum Avg Demand	FLOAT	-9999 M to +9999 M	VARs		2
0F65 - 0F66	3942 - 3943	Negative VARs, Phase B, Minimum Avg Demand	FLOAT	-9999 M to +9999 M	VARs		2
0F67 - 0F68	3944 - 3945	Negative VARs, Phase C, Minimum Avg Demand	FLOAT	-9999 M to +9999 M	VARs		2
0F69 - 0F6A	3946 - 3947	VAs, Phase A, Minimum Avg Demand	FLOAT	-9999 M to +9999 M	VAs		2
0F6B - 0F6C	3948 - 3949	VAs, Phase B, Minimum Avg Demand	FLOAT	-9999 M to +9999 M	VAs		2
0F6D - 0F6E	3950 - 3951	VAs, Phase C, Minimum Avg Demand	FLOAT	-9999 M to +9999 M	VAs		2
0F6F - 0F70	3952 - 3953	Positive PF, Phase A, Minimum Avg Demand	FLOAT	-1.00 to +1.00	none		2
0F71 - 0F72	3954 - 3955	Positive PF, Phase B, Minimum Avg Demand	FLOAT	-1.00 to +1.00	none		2
0F73 - 0F74	3956 - 3957	Positive PF, Phase C, Minimum Avg Demand	FLOAT	-1.00 to +1.00	none		2
0F75 - 0F76	3958 - 3959	Negative PF, Phase A, Minimum Avg Demand	FLOAT	-1.00 to +1.00	none		2
0F77 - 0F78	3960 - 3961	Negative PF, Phase B, Minimum Avg Demand	FLOAT	-1.00 to +1.00	none		2
0F79 - 0F7A	3962 - 3963	Negative PF, Phase C, Minimum Avg Demand	FLOAT	-1.00 to +1.00	none		2
						Block Size:	64

Modbus Address		Description	Format	Range	Units or Resolution	Comments	# Reg
Hex	Decimal						
Primary Minimum Block Meter 5						read-only	
0F9F -	0FA0	4000 - 4001	Amps A, Minimum Avg Demand	FLOAT	0 to 9999 M	amps	2
0FA1 -	0FA2	4002 - 4003	Amps B, Minimum Avg Demand	FLOAT	0 to 9999 M	amps	2
0FA3 -	0FA4	4004 - 4005	Amps C, Minimum Avg Demand	FLOAT	0 to 9999 M	amps	2
0FA5 -	0FA6	4006 - 4007	Positive Watts, 3-Ph, Minimum Avg Demand	FLOAT	0 to +9999 M	watts	2
0FA7 -	0FA8	4008 - 4009	Positive VARs, 3-Ph, Minimum Avg Demand	FLOAT	0 to +9999 M	VARs	2
0FA9 -	0FAA	4010 - 4011	Negative Watts, 3-Ph, Minimum Avg Demand	FLOAT	0 to +9999 M	watts	2
0FAB -	0FAC	4012 - 4013	Negative VARs, 3-Ph, Minimum Avg Demand	FLOAT	0 to +9999 M	VARs	2
0FAD -	0FAE	4014 - 4015	VAs, 3-Ph, Minimum Avg Demand	FLOAT	-9999 M to +9999 M	VAs	2
0FAF -	0FB0	4016 - 4017	Positive Power Factor, 3-Ph, Minimum Avg Demand	FLOAT	-1.00 to +1.00	none	2
0FB1 -	0FB2	4018 - 4019	Negative Power Factor, 3-Ph, Minimum Avg Demand	FLOAT	-1.00 to +1.00	none	2
0FB3 -	0FB4	4020 - 4021	Neutral Current, Minimum Avg Demand	FLOAT	0 to 9999 M	amps	2
0FB5 -	0FB6	4022 - 4023	Positive Watts, Phase A, Minimum Avg Demand	FLOAT	-9999 M to +9999 M	watts	2
0FB7 -	0FB8	4024 - 4025	Positive Watts, Phase B, Minimum Avg Demand	FLOAT	-9999 M to +9999 M	watts	2
0FB9 -	0FBA	4026 - 4027	Positive Watts, Phase C, Minimum Avg Demand	FLOAT	-9999 M to +9999 M	watts	2
0FBB -	0FBC	4028 - 4029	Positive VARs, Phase A, Minimum Avg Demand	FLOAT	-9999 M to +9999 M	VARs	2
0FBD -	0FBE	4030 - 4031	Positive VARs, Phase B, Minimum Avg Demand	FLOAT	-9999 M to +9999 M	VARs	2
0FBF -	0FC0	4032 - 4033	Positive VARs, Phase C, Minimum Avg Demand	FLOAT	-9999 M to +9999 M	VARs	2
0FC1 -	0FC2	4034 - 4035	Negative Watts, Phase A, Minimum Avg Demand	FLOAT	-9999 M to +9999 M	watts	2
0FC3 -	0FC4	4036 - 4037	Negative Watts, Phase B, Minimum Avg Demand	FLOAT	-9999 M to +9999 M	watts	2
0FC5 -	0FC6	4038 - 4039	Negative Watts, Phase C, Minimum Avg Demand	FLOAT	-9999 M to +9999 M	watts	2
0FC7 -	0FC8	4040 - 4041	Negative VARs, Phase A, Minimum Avg Demand	FLOAT	-9999 M to +9999 M	VARs	2

Modbus Address		Description	Format	Range	Units or Resolution	Comments	# Reg
Hex	Decimal						
0FC9 - 0FCA	4042 - 4043	Negative VARs, Phase B, Minimum Avg Demand	FLOAT	-9999 M to +9999 M	VARs		2
0FCB - 0FCC	4044 - 4045	Negative VARs, Phase C, Minimum Avg Demand	FLOAT	-9999 M to +9999 M	VARs		2
0FCD - 0FCE	4046 - 4047	VAs, Phase A, Minimum Avg Demand	FLOAT	-9999 M to +9999 M	VAs		2
0FCF - 0FD0	4048 - 4049	VAs, Phase B, Minimum Avg Demand	FLOAT	-9999 M to +9999 M	VAs		2
0FD1 - 0FD2	4050 - 4051	VAs, Phase C, Minimum Avg Demand	FLOAT	-9999 M to +9999 M	VAs		2
0FD3 - 0FD4	4052 - 4053	Positive PF, Phase A, Minimum Avg Demand	FLOAT	-1.00 to +1.00	none		2
0FD5 - 0FD6	4054 - 4055	Positive PF, Phase B, Minimum Avg Demand	FLOAT	-1.00 to +1.00	none		2
0FD7 - 0FD8	4056 - 4057	Positive PF, Phase C, Minimum Avg Demand	FLOAT	-1.00 to +1.00	none		2
0FD9 - 0FDA	4058 - 4059	Negative PF, Phase A, Minimum Avg Demand	FLOAT	-1.00 to +1.00	none		2
0FDB - 0FDC	4060 - 4061	Negative PF, Phase B, Minimum Avg Demand	FLOAT	-1.00 to +1.00	none		2
0FDD - 0FDE	4062 - 4063	Negative PF, Phase C, Minimum Avg Demand	FLOAT	-1.00 to +1.00	none		2
						Block Size:	64
Primary Minimum Block Meter 6						read-only	
1003 - 1004	4100 - 4101	Amps A, Minimum Avg Demand	FLOAT	0 to 9999 M	amps		2
1005 - 1006	4102 - 4103	Amps B, Minimum Avg Demand	FLOAT	0 to 9999 M	amps		2
1007 - 1008	4104 - 4105	Amps C, Minimum Avg Demand	FLOAT	0 to 9999 M	amps		2
1009 - 100A	4106 - 4107	Positive Watts, 3-Ph, Minimum Avg Demand	FLOAT	0 to +9999 M	watts		2
100B - 100C	4108 - 4109	Positive VARs, 3-Ph, Minimum Avg Demand	FLOAT	0 to +9999 M	VARs		2
100D - 100E	4110 - 4111	Negative Watts, 3-Ph, Minimum Avg Demand	FLOAT	0 to +9999 M	watts		2
100F - 1010	4112 - 4113	Negative VARs, 3-Ph, Minimum Avg Demand	FLOAT	0 to +9999 M	VARs		2
1011 - 1012	4114 - 4115	VAs, 3-Ph, Minimum Avg Demand	FLOAT	-9999 M to +9999 M	VAs		2
1013 - 1014	4116 - 4117	Positive Power Factor, 3-Ph, Minimum Avg Demand	FLOAT	-1.00 to +1.00	none		2

Modbus Address		Description	Format	Range	Units or Resolution	Comments	# Reg		
Hex	Decimal								
1015 -	1016	4118 - 4119		Negative Power Factor, 3-Ph, Minimum Avg Demand	FLOAT	-1.00 to +1.00	none		2
1017 -	1018	4120 - 4121		Neutral Current, Minimum Avg Demand	FLOAT	0 to 9999 M	amps		2
1019 -	101A	4122 - 4123		Positive Watts, Phase A, Minimum Avg Demand	FLOAT	-9999 M to +9999 M	watts		2
101B -	101C	4124 - 4125		Positive Watts, Phase B, Minimum Avg Demand	FLOAT	-9999 M to +9999 M	watts		2
101D -	101E	4126 - 4127		Positive Watts, Phase C, Minimum Avg Demand	FLOAT	-9999 M to +9999 M	watts		2
101F -	1020	4128 - 4129		Positive VARs, Phase A, Minimum Avg Demand	FLOAT	-9999 M to +9999 M	VARs		2
1021 -	1022	4130 - 4131		Positive VARs, Phase B, Minimum Avg Demand	FLOAT	-9999 M to +9999 M	VARs		2
1023 -	1024	4132 - 4133		Positive VARs, Phase C, Minimum Avg Demand	FLOAT	-9999 M to +9999 M	VARs		2
1025 -	1026	4134 - 4135		Negative Watts, Phase A, Minimum Avg Demand	FLOAT	-9999 M to +9999 M	watts		2
1027 -	1028	4136 - 4137		Negative Watts, Phase B, Minimum Avg Demand	FLOAT	-9999 M to +9999 M	watts		2
1029 -	102A	4138 - 4139		Negative Watts, Phase C, Minimum Avg Demand	FLOAT	-9999 M to +9999 M	watts		2
102B -	102C	4140 - 4141		Negative VARs, Phase A, Minimum Avg Demand	FLOAT	-9999 M to +9999 M	VARs		2
102D -	102E	4142 - 4143		Negative VARs, Phase B, Minimum Avg Demand	FLOAT	-9999 M to +9999 M	VARs		2
102F -	1030	4144 - 4145		Negative VARs, Phase C, Minimum Avg Demand	FLOAT	-9999 M to +9999 M	VARs		2
1031 -	1032	4146 - 4147		VAs, Phase A, Minimum Avg Demand	FLOAT	-9999 M to +9999 M	VAs		2
1033 -	1034	4148 - 4149		VAs, Phase B, Minimum Avg Demand	FLOAT	-9999 M to +9999 M	VAs		2
1035 -	1036	4150 - 4151		VAs, Phase C, Minimum Avg Demand	FLOAT	-9999 M to +9999 M	VAs		2
1037 -	1038	4152 - 4153		Positive PF, Phase A, Minimum Avg Demand	FLOAT	-1.00 to +1.00	none		2
1039 -	103A	4154 - 4155		Positive PF, Phase B, Minimum Avg Demand	FLOAT	-1.00 to +1.00	none		2
103B -	103C	4156 - 4157		Positive PF, Phase C, Minimum Avg Demand	FLOAT	-1.00 to +1.00	none		2

Modbus Address		Description	Format	Range	Units or Resolution	Comments	# Reg
Hex	Decimal						
103D -	103E	4158 - 4159					2
		Negative PF, Phase A, Minimum Avg Demand	FLOAT	-1.00 to +1.00	none		
103F -	1040	4160 - 4161					2
		Negative PF, Phase B, Minimum Avg Demand	FLOAT	-1.00 to +1.00	none		
1041 -	1042	4162 - 4163					2
		Negative PF, Phase C, Minimum Avg Demand	FLOAT	-1.00 to +1.00	none		
						Block Size:	64
Primary Minimum Block Meter 7						read-only	
1067 -	1068	4200 - 4201					2
		Amps A, Minimum Avg Demand	FLOAT	0 to 9999 M	amps		
1069 -	106A	4202 - 4203					2
		Amps B, Minimum Avg Demand	FLOAT	0 to 9999 M	amps		
106B -	106C	4204 - 4205					2
		Amps C, Minimum Avg Demand	FLOAT	0 to 9999 M	amps		
106D -	106E	4206 - 4207					2
		Positive Watts, 3-Ph, Minimum Avg Demand	FLOAT	0 to +9999 M	watts		
106F -	1070	4208 - 4209					2
		Positive VARs, 3-Ph, Minimum Avg Demand	FLOAT	0 to +9999 M	VARs		
1071 -	1072	4210 - 4211					2
		Negative Watts, 3-Ph, Minimum Avg Demand	FLOAT	0 to +9999 M	watts		
1073 -	1074	4212 - 4213					2
		Negative VARs, 3-Ph, Minimum Avg Demand	FLOAT	0 to +9999 M	VARs		
1075 -	1076	4214 - 4215					2
		VAs, 3-Ph, Minimum Avg Demand	FLOAT	-9999 M to +9999 M	VAs		
1077 -	1078	4216 - 4217					2
		Positive Power Factor, 3-Ph, Minimum Avg Demand	FLOAT	-1.00 to +1.00	none		
1079 -	107A	4218 - 4219					2
		Negative Power Factor, 3-Ph, Minimum Avg Demand	FLOAT	-1.00 to +1.00	none		
107B -	107C	4220 - 4221					2
		Neutral Current, Minimum Avg Demand	FLOAT	0 to 9999 M	amps		
107D -	107E	4222 - 4223					2
		Positive Watts, Phase A, Minimum Avg Demand	FLOAT	-9999 M to +9999 M	watts		
107F -	1080	4224 - 4225					2
		Positive Watts, Phase B, Minimum Avg Demand	FLOAT	-9999 M to +9999 M	watts		
1081 -	1082	4226 - 4227					2
		Positive Watts, Phase C, Minimum Avg Demand	FLOAT	-9999 M to +9999 M	watts		
1083 -	1084	4228 - 4229					2
		Positive VARs, Phase A, Minimum Avg Demand	FLOAT	-9999 M to +9999 M	VARs		
1085 -	1086	4230 - 4231					2
		Positive VARs, Phase B, Minimum Avg Demand	FLOAT	-9999 M to +9999 M	VARs		
1087 -	1088	4232 - 4233					2
		Positive VARs, Phase C, Minimum Avg Demand	FLOAT	-9999 M to +9999 M	VARs		

Modbus Address		Description	Format	Range	Units or Resolution	Comments	# Reg
Hex	Decimal						
1089 -	108A	4234 - 4235	Negative Watts, Phase A, Minimum Avg Demand	FLOAT	-9999 M to +9999 M	watts	2
108B -	108C	4236 - 4237	Negative Watts, Phase B, Minimum Avg Demand	FLOAT	-9999 M to +9999 M	watts	2
108D -	108E	4238 - 4239	Negative Watts, Phase C, Minimum Avg Demand	FLOAT	-9999 M to +9999 M	watts	2
108F -	1090	4240 - 4241	Negative VARs, Phase A, Minimum Avg Demand	FLOAT	-9999 M to +9999 M	VARs	2
1091 -	1092	4242 - 4243	Negative VARs, Phase B, Minimum Avg Demand	FLOAT	-9999 M to +9999 M	VARs	2
1093 -	1094	4244 - 4245	Negative VARs, Phase C, Minimum Avg Demand	FLOAT	-9999 M to +9999 M	VARs	2
1095 -	1096	4246 - 4247	VAs, Phase A, Minimum Avg Demand	FLOAT	-9999 M to +9999 M	VAs	2
1097 -	1098	4248 - 4249	VAs, Phase B, Minimum Avg Demand	FLOAT	-9999 M to +9999 M	VAs	2
1099 -	109A	4250 - 4251	VAs, Phase C, Minimum Avg Demand	FLOAT	-9999 M to +9999 M	VAs	2
109B -	109C	4252 - 4253	Positive PF, Phase A, Minimum Avg Demand	FLOAT	-1.00 to +1.00	none	2
109D -	109E	4254 - 4255	Positive PF, Phase B, Minimum Avg Demand	FLOAT	-1.00 to +1.00	none	2
109F -	10A0	4256 - 4257	Positive PF, Phase C, Minimum Avg Demand	FLOAT	-1.00 to +1.00	none	2
10A1 -	10A2	4258 - 4259	Negative PF, Phase A, Minimum Avg Demand	FLOAT	-1.00 to +1.00	none	2
10A3 -	10A4	4260 - 4261	Negative PF, Phase B, Minimum Avg Demand	FLOAT	-1.00 to +1.00	none	2
10A5 -	10A6	4262 - 4263	Negative PF, Phase C, Minimum Avg Demand	FLOAT	-1.00 to +1.00	none	2
						Block Size:	64
Primary Minimum Block Meter 8						read-only	
10CB -	10CC	4300 - 4301	Amps A, Minimum Avg Demand	FLOAT	0 to 9999 M	amps	2
10CD -	10CE	4302 - 4303	Amps B, Minimum Avg Demand	FLOAT	0 to 9999 M	amps	2
10CF -	10D0	4304 - 4305	Amps C, Minimum Avg Demand	FLOAT	0 to 9999 M	amps	2
10D1 -	10D2	4306 - 4307	Positive Watts, 3-Ph, Minimum Avg Demand	FLOAT	0 to +9999 M	watts	2
10D3 -	10D4	4308 - 4309	Positive VARs, 3-Ph, Minimum Avg Demand	FLOAT	0 to +9999 M	VARs	2

Modbus Address		Description	Format	Range	Units or Resolution	Comments	# Reg
Hex	Decimal						
10D5 -	10D6	4310 - 4311	Negative Watts, 3-Ph, Minimum Avg Demand	FLOAT	0 to +9999 M	watts	2
10D7 -	10D8	4312 - 4313	Negative VARs, 3-Ph, Minimum Avg Demand	FLOAT	0 to +9999 M	VARs	2
10D9 -	10DA	4314 - 4315	VAs, 3-Ph, Minimum Avg Demand	FLOAT	-9999 M to +9999 M	VAs	2
10DB -	10DC	4316 - 4317	Positive Power Factor, 3-Ph, Minimum Avg Demand	FLOAT	-1.00 to +1.00	none	2
10DD -	10DE	4318 - 4319	Negative Power Factor, 3-Ph, Minimum Avg Demand	FLOAT	-1.00 to +1.00	none	2
10DF -	10E0	4320 - 4321	Neutral Current, Minimum Avg Demand	FLOAT	0 to 9999 M	amps	2
10E1 -	10E2	4322 - 4323	Positive Watts, Phase A, Minimum Avg Demand	FLOAT	-9999 M to +9999 M	watts	2
10E3 -	10E4	4324 - 4325	Positive Watts, Phase B, Minimum Avg Demand	FLOAT	-9999 M to +9999 M	watts	2
10E5 -	10E6	4326 - 4327	Positive Watts, Phase C, Minimum Avg Demand	FLOAT	-9999 M to +9999 M	watts	2
10E7 -	10E8	4328 - 4329	Positive VARs, Phase A, Minimum Avg Demand	FLOAT	-9999 M to +9999 M	VARs	2
10E9 -	10EA	4330 - 4331	Positive VARs, Phase B, Minimum Avg Demand	FLOAT	-9999 M to +9999 M	VARs	2
10EB -	10EC	4332 - 4333	Positive VARs, Phase C, Minimum Avg Demand	FLOAT	-9999 M to +9999 M	VARs	2
10ED -	10EE	4334 - 4335	Negative Watts, Phase A, Minimum Avg Demand	FLOAT	-9999 M to +9999 M	watts	2
10EF -	10F0	4336 - 4337	Negative Watts, Phase B, Minimum Avg Demand	FLOAT	-9999 M to +9999 M	watts	2
10F1 -	10F2	4338 - 4339	Negative Watts, Phase C, Minimum Avg Demand	FLOAT	-9999 M to +9999 M	watts	2
10F3 -	10F4	4340 - 4341	Negative VARs, Phase A, Minimum Avg Demand	FLOAT	-9999 M to +9999 M	VARs	2
10F5 -	10F6	4342 - 4343	Negative VARs, Phase B, Minimum Avg Demand	FLOAT	-9999 M to +9999 M	VARs	2
10F7 -	10F8	4344 - 4345	Negative VARs, Phase C, Minimum Avg Demand	FLOAT	-9999 M to +9999 M	VARs	2
10F9 -	10FA	4346 - 4347	VAs, Phase A, Minimum Avg Demand	FLOAT	-9999 M to +9999 M	VAs	2
10FB -	10FC	4348 - 4349	VAs, Phase B, Minimum Avg Demand	FLOAT	-9999 M to +9999 M	VAs	2

Modbus Address		Description	Format	Range	Units or Resolution	Comments	# Reg	
Hex	Decimal							
10FD -	10FE	4350 - 4351	VAs, Phase C, Minimum Avg Demand	FLOAT	-9999 M to +9999 M	VAs	2	
10FF -	1100	4352 - 4353	Positive PF, Phase A, Minimum Avg Demand	FLOAT	-1.00 to +1.00	none	2	
1101 -	1102	4354 - 4355	Positive PF, Phase B, Minimum Avg Demand	FLOAT	-1.00 to +1.00	none	2	
1103 -	1104	4356 - 4357	Positive PF, Phase C, Minimum Avg Demand	FLOAT	-1.00 to +1.00	none	2	
1105 -	1106	4358 - 4359	Negative PF, Phase A, Minimum Avg Demand	FLOAT	-1.00 to +1.00	none	2	
1107 -	1108	4360 - 4361	Negative PF, Phase B, Minimum Avg Demand	FLOAT	-1.00 to +1.00	none	2	
1109 -	110A	4362 - 4363	Negative PF, Phase C, Minimum Avg Demand	FLOAT	-1.00 to +1.00	none	2	
							Block Size:	64
Primary Minimum Timestamp Block								
112F -	1131	4400 - 4402	Volts A-N, Min Timestamp	TSTAMP	1Jan2000 - 31Dec2099	1 sec	3	
1132 -	1134	4403 - 4405	Volts B-N, Min Timestamp	TSTAMP	1Jan2000 - 31Dec2099	1 sec	3	
1135 -	1137	4406 - 4408	Volts C-N, Min Timestamp	TSTAMP	1Jan2000 - 31Dec2099	1 sec	3	
1138 -	113A	4409 - 4411	Volts A-B, Min Timestamp	TSTAMP	1Jan2000 - 31Dec2099	1 sec	3	
113B -	113D	4412 - 4414	Volts B-C, Min Timestamp	TSTAMP	1Jan2000 - 31Dec2099	1 sec	3	
113E -	1140	4415 - 4417	Volts C-A, Min Timestamp	TSTAMP	1Jan2000 - 31Dec2099	1 sec	3	
1141 -	1143	4418 - 4420	Frequency, Min Timestamp	TSTAMP	1Jan2000 - 31Dec2099	1 sec	3	
							Block Size:	21
Primary Minimum Timestamp Block Meter 1								
1193 -	1195	4500 - 4502	Amps A, Min Avg Dmd Timestamp	TSTAMP	1Jan2000 - 31Dec2099	1 sec	3	
1196 -	1198	4503 - 4505	Amps B, Min Avg Dmd Timestamp	TSTAMP	1Jan2000 - 31Dec2099	1 sec	3	
1199 -	119B	4506 - 4508	Amps C, Min Avg Dmd Timestamp	TSTAMP	1Jan2000 - 31Dec2099	1 sec	3	
119C -	119E	4509 - 4511	Positive Watts, 3-Ph, Min Avg Dmd Timestamp	TSTAMP	1Jan2000 - 31Dec2099	1 sec	3	

Modbus Address		Description	Format	Range	Units or Resolution	Comments	# Reg
Hex	Decimal						
119F -	11A1	4512 - 4514	Positive VARs, 3-Ph, Min Avg Dmd Timestamp	TSTAMP	1Jan2000 - 31Dec2099	1 sec	3
11A2 -	11A4	4515 - 4517	Negative Watts, 3-Ph, Min Avg Dmd Timestamp	TSTAMP	1Jan2000 - 31Dec2099	1 sec	3
11A5 -	11A7	4518 - 4520	Negative VARs, 3-Ph, Min Avg Dmd Timestamp	TSTAMP	1Jan2000 - 31Dec2099	1 sec	3
11A8 -	11AA	4521 - 4523	VAs, 3-Ph, Min Avg Dmd Timestamp	TSTAMP	1Jan2000 - 31Dec2099	1 sec	3
11AB -	11AD	4524 - 4526	Positive Power Factor, 3-Ph, Min Avg Dmd Timestamp	TSTAMP	1Jan2000 - 31Dec2099	1 sec	3
11AE -	11B0	4527 - 4529	Negative Power Factor, 3-Ph, Min Avg Dmd Timestamp	TSTAMP	1Jan2000 - 31Dec2099	1 sec	3
11B1 -	11B3	4530 - 4532	Neutral Current, Min Avg Dmd Timestamp	TSTAMP	1Jan2000 - 31Dec2100	1 sec	3
11B4 -	11B6	4533 - 4535	Positive Watts, Phase A, Min Avg Dmd Timestamp	TSTAMP	1Jan2000 - 31Dec2099	1 sec	3
11B7 -	11B9	4536 - 4538	Positive Watts, Phase B, Min Avg Dmd Timestamp	TSTAMP	1Jan2000 - 31Dec2099	1 sec	3
11BA -	11BC	4539 - 4541	Positive Watts, Phase C, Min Avg Dmd Timestamp	TSTAMP	1Jan2000 - 31Dec2099	1 sec	3
11BD -	11BF	4542 - 4544	Positive VARs, Phase A, Min Avg Dmd Timestamp	TSTAMP	1Jan2000 - 31Dec2099	1 sec	3
11C0 -	11C2	4545 - 4547	Positive VARs, Phase B, Min Avg Dmd Timestamp	TSTAMP	1Jan2000 - 31Dec2099	1 sec	3
11C3 -	11C5	4548 - 4550	Positive VARs, Phase C, Min Avg Dmd Timestamp	TSTAMP	1Jan2000 - 31Dec2099	1 sec	3
11C6 -	11C8	4551 - 4553	Negative Watts, Phase A, Min Avg Dmd Timestamp	TSTAMP	1Jan2000 - 31Dec2099	1 sec	3
11C9 -	11CB	4554 - 4556	Negative Watts, Phase B, Min Avg Dmd Timestamp	TSTAMP	1Jan2000 - 31Dec2099	1 sec	3
11CC -	11CE	4557 - 4559	Negative Watts, Phase C, Min Avg Dmd Timestamp	TSTAMP	1Jan2000 - 31Dec2099	1 sec	3
11CF -	11D1	4560 - 4562	Negative VARs, Phase A, Min Avg Dmd Timestamp	TSTAMP	1Jan2000 - 31Dec2099	1 sec	3
11D2 -	11D4	4563 - 4565	Negative VARs, Phase B, Min Avg Dmd Timestamp	TSTAMP	1Jan2000 - 31Dec2099	1 sec	3
11D5 -	11D7	4566 - 4568	Negative VARs, Phase C, Min Avg Dmd Timestamp	TSTAMP	1Jan2000 - 31Dec2099	1 sec	3
11D8 -	11DA	4569 - 4571	VAs, Phase A, Min Avg Dmd Timestamp	TSTAMP	1Jan2000 - 31Dec2099	1 sec	3

Modbus Address		Description	Format	Range	Units or Resolution	Comments	# Reg
Hex	Decimal						
11DB - 11DD	4572 - 4574	VAs, Phase B, Min Avg Dmd Timestamp	TSTAMP	1Jan2000 - 31Dec2099	1 sec		3
11DE - 11E0	4575 - 4577	VAs, Phase C, Min Avg Dmd Timestamp	TSTAMP	1Jan2000 - 31Dec2099	1 sec		3
11E1 - 11E3	4578 - 4580	Positive PF, Phase A, Min Avg Dmd Timestamp	TSTAMP	1Jan2000 - 31Dec2099	1 sec		3
11E4 - 11E6	4581 - 4583	Positive PF, Phase B, Min Avg Dmd Timestamp	TSTAMP	1Jan2000 - 31Dec2099	1 sec		3
11E7 - 11E9	4584 - 4586	Positive PF, Phase C, Min Avg Dmd Timestamp	TSTAMP	1Jan2000 - 31Dec2099	1 sec		3
11EA - 11EC	4587 - 4589	Negative PF, Phase A, Min Avg Dmd Timestamp	TSTAMP	1Jan2000 - 31Dec2099	1 sec		3
11ED - 11EF	4590 - 4592	Negative PF, Phase B, Min Avg Dmd Timestamp	TSTAMP	1Jan2000 - 31Dec2099	1 sec		3
11F0 - 11F2	4593 - 4595	Negative PF, Phase C, Min Avg Dmd Timestamp	TSTAMP	1Jan2000 - 31Dec2099	1 sec		3
						Block Size:	96
Primary Minimum Timestamp Block Meter 2						read-only	
11F7 - 11F9	4600 - 4602	Amps A, Min Avg Dmd Timestamp	TSTAMP	1Jan2000 - 31Dec2099	1 sec		3
11FA - 11FC	4603 - 4605	Amps B, Min Avg Dmd Timestamp	TSTAMP	1Jan2000 - 31Dec2099	1 sec		3
11FD - 11FF	4606 - 4608	Amps C, Min Avg Dmd Timestamp	TSTAMP	1Jan2000 - 31Dec2099	1 sec		3
1200 - 1202	4609 - 4611	Positive Watts, 3-Ph, Min Avg Dmd Timestamp	TSTAMP	1Jan2000 - 31Dec2099	1 sec		3
1203 - 1205	4612 - 4614	Positive VARs, 3-Ph, Min Avg Dmd Timestamp	TSTAMP	1Jan2000 - 31Dec2099	1 sec		3
1206 - 1208	4615 - 4617	Negative Watts, 3-Ph, Min Avg Dmd Timestamp	TSTAMP	1Jan2000 - 31Dec2099	1 sec		3
1209 - 120B	4618 - 4620	Negative VARs, 3-Ph, Min Avg Dmd Timestamp	TSTAMP	1Jan2000 - 31Dec2099	1 sec		3
120C - 120E	4621 - 4623	VAs, 3-Ph, Min Avg Dmd Timestamp	TSTAMP	1Jan2000 - 31Dec2099	1 sec		3
120F - 1211	4624 - 4626	Positive Power Factor, 3-Ph, Min Avg Dmd Timestamp	TSTAMP	1Jan2000 - 31Dec2099	1 sec		3
1212 - 1214	4627 - 4629	Negative Power Factor, 3-Ph, Min Avg Dmd Timestamp	TSTAMP	1Jan2000 - 31Dec2099	1 sec		3
1215 - 1217	4630 - 4632	Neutral Current, Min Avg Dmd Timestamp	TSTAMP	1Jan2000 - 31Dec2100	1 sec		3

Modbus Address		Description	Format	Range	Units or Resolution	Comments	# Reg	
Hex	Decimal							
1218 -	121A	4633 - 4635	Positive Watts, Phase A, Min Avg Dmd Timestamp	TSTAMP	1Jan2000 - 31Dec2099	1 sec		3
121B -	121D	4636 - 4638	Positive Watts, Phase B, Min Avg Dmd Timestamp	TSTAMP	1Jan2000 - 31Dec2099	1 sec		3
121E -	1220	4639 - 4641	Positive Watts, Phase C, Min Avg Dmd Timestamp	TSTAMP	1Jan2000 - 31Dec2099	1 sec		3
1221 -	1223	4642 - 4644	Positive VARs, Phase A, Min Avg Dmd Timestamp	TSTAMP	1Jan2000 - 31Dec2099	1 sec		3
1224 -	1226	4645 - 4647	Positive VARs, Phase B, Min Avg Dmd Timestamp	TSTAMP	1Jan2000 - 31Dec2099	1 sec		3
1227 -	1229	4648 - 4650	Positive VARs, Phase C, Min Avg Dmd Timestamp	TSTAMP	1Jan2000 - 31Dec2099	1 sec		3
122A -	122C	4651 - 4653	Negative Watts, Phase A, Min Avg Dmd Timestamp	TSTAMP	1Jan2000 - 31Dec2099	1 sec		3
122D -	122F	4654 - 4656	Negative Watts, Phase B, Min Avg Dmd Timestamp	TSTAMP	1Jan2000 - 31Dec2099	1 sec		3
1230 -	1232	4657 - 4659	Negative Watts, Phase C, Min Avg Dmd Timestamp	TSTAMP	1Jan2000 - 31Dec2099	1 sec		3
1233 -	1235	4660 - 4662	Negative VARs, Phase A, Min Avg Dmd Timestamp	TSTAMP	1Jan2000 - 31Dec2099	1 sec		3
1236 -	1238	4663 - 4665	Negative VARs, Phase B, Min Avg Dmd Timestamp	TSTAMP	1Jan2000 - 31Dec2099	1 sec		3
1239 -	123B	4666 - 4668	Negative VARs, Phase C, Min Avg Dmd Timestamp	TSTAMP	1Jan2000 - 31Dec2099	1 sec		3
123C -	123E	4669 - 4671	VAs, Phase A, Min Avg Dmd Timestamp	TSTAMP	1Jan2000 - 31Dec2099	1 sec		3
123F -	1241	4672 - 4674	VAs, Phase B, Min Avg Dmd Timestamp	TSTAMP	1Jan2000 - 31Dec2099	1 sec		3
1242 -	1244	4675 - 4677	VAs, Phase C, Min Avg Dmd Timestamp	TSTAMP	1Jan2000 - 31Dec2099	1 sec		3
1245 -	1247	4678 - 4680	Positive PF, Phase A, Min Avg Dmd Timestamp	TSTAMP	1Jan2000 - 31Dec2099	1 sec		3
1248 -	124A	4681 - 4683	Positive PF, Phase B, Min Avg Dmd Timestamp	TSTAMP	1Jan2000 - 31Dec2099	1 sec		3
124B -	124D	4684 - 4686	Positive PF, Phase C, Min Avg Dmd Timestamp	TSTAMP	1Jan2000 - 31Dec2099	1 sec		3
124E -	1250	4687 - 4689	Negative PF, Phase A, Min Avg Dmd Timestamp	TSTAMP	1Jan2000 - 31Dec2099	1 sec		3
1251 -	1253	4690 - 4692	Negative PF, Phase B, Min Avg Dmd Timestamp	TSTAMP	1Jan2000 - 31Dec2099	1 sec		3

Modbus Address		Description	Format	Range	Units or Resolution	Comments	# Reg
Hex	Decimal						
1254 -	1256	4693 - 4695	Negative PF, Phase C, Min Avg Dmd Timestamp	TSTAMP	1Jan2000 - 31Dec2099	1 sec	3
Block Size:							96
Primary Minimum Timestamp Block Meter 3							read-only
125B -	125D	4700 - 4702	Amps A, Min Avg Dmd Timestamp	TSTAMP	1Jan2000 - 31Dec2099	1 sec	3
125E -	1260	4703 - 4705	Amps B, Min Avg Dmd Timestamp	TSTAMP	1Jan2000 - 31Dec2099	1 sec	3
1261 -	1263	4706 - 4708	Amps C, Min Avg Dmd Timestamp	TSTAMP	1Jan2000 - 31Dec2099	1 sec	3
1264 -	1266	4709 - 4711	Positive Watts, 3-Ph, Min Avg Dmd Timestamp	TSTAMP	1Jan2000 - 31Dec2099	1 sec	3
1267 -	1269	4712 - 4714	Positive VARs, 3-Ph, Min Avg Dmd Timestamp	TSTAMP	1Jan2000 - 31Dec2099	1 sec	3
126A -	126C	4715 - 4717	Negative Watts, 3-Ph, Min Avg Dmd Timestamp	TSTAMP	1Jan2000 - 31Dec2099	1 sec	3
126D -	126F	4718 - 4720	Negative VARs, 3-Ph, Min Avg Dmd Timestamp	TSTAMP	1Jan2000 - 31Dec2099	1 sec	3
1270 -	1272	4721 - 4723	VAs, 3-Ph, Min Avg Dmd Timestamp	TSTAMP	1Jan2000 - 31Dec2099	1 sec	3
1273 -	1275	4724 - 4726	Positive Power Factor, 3-Ph, Min Avg Dmd Timestamp	TSTAMP	1Jan2000 - 31Dec2099	1 sec	3
1276 -	1278	4727 - 4729	Negative Power Factor, 3-Ph, Min Avg Dmd Timestamp	TSTAMP	1Jan2000 - 31Dec2099	1 sec	3
1279 -	127B	4730 - 4732	Neutral Current, Min Avg Dmd Timestamp	TSTAMP	1Jan2000 - 31Dec2100	1 sec	3
127C -	127E	4733 - 4735	Positive Watts, Phase A, Min Avg Dmd Timestamp	TSTAMP	1Jan2000 - 31Dec2099	1 sec	3
127F -	1281	4736 - 4738	Positive Watts, Phase B, Min Avg Dmd Timestamp	TSTAMP	1Jan2000 - 31Dec2099	1 sec	3
1282 -	1284	4739 - 4741	Positive Watts, Phase C, Min Avg Dmd Timestamp	TSTAMP	1Jan2000 - 31Dec2099	1 sec	3
1285 -	1287	4742 - 4744	Positive VARs, Phase A, Min Avg Dmd Timestamp	TSTAMP	1Jan2000 - 31Dec2099	1 sec	3
1288 -	128A	4745 - 4747	Positive VARs, Phase B, Min Avg Dmd Timestamp	TSTAMP	1Jan2000 - 31Dec2099	1 sec	3
128B -	128D	4748 - 4750	Positive VARs, Phase C, Min Avg Dmd Timestamp	TSTAMP	1Jan2000 - 31Dec2099	1 sec	3
128E -	1290	4751 - 4753	Negative Watts, Phase A, Min Avg Dmd Timestamp	TSTAMP	1Jan2000 - 31Dec2099	1 sec	3

Modbus Address		Description	Format	Range	Units or Resolution	Comments	# Reg
Hex	Decimal						
1291 -	1293	4754 - 4756					3
		Negative Watts, Phase B, Min Avg Dmd Timestamp	TSTAMP	1Jan2000 - 31Dec2099	1 sec		
1294 -	1296	4757 - 4759					3
		Negative Watts, Phase C, Min Avg Dmd Timestamp	TSTAMP	1Jan2000 - 31Dec2099	1 sec		
1297 -	1299	4760 - 4762					3
		Negative VARs, Phase A, Min Avg Dmd Timestamp	TSTAMP	1Jan2000 - 31Dec2099	1 sec		
129A -	129C	4763 - 4765					3
		Negative VARs, Phase B, Min Avg Dmd Timestamp	TSTAMP	1Jan2000 - 31Dec2099	1 sec		
129D -	129F	4766 - 4768					3
		Negative VARs, Phase C, Min Avg Dmd Timestamp	TSTAMP	1Jan2000 - 31Dec2099	1 sec		
12A0 -	12A2	4769 - 4771					3
		VAs, Phase A, Min Avg Dmd Timestamp	TSTAMP	1Jan2000 - 31Dec2099	1 sec		
12A3 -	12A5	4772 - 4774					3
		VAs, Phase B, Min Avg Dmd Timestamp	TSTAMP	1Jan2000 - 31Dec2099	1 sec		
12A6 -	12A8	4775 - 4777					3
		VAs, Phase C, Min Avg Dmd Timestamp	TSTAMP	1Jan2000 - 31Dec2099	1 sec		
12A9 -	12AB	4778 - 4780					3
		Positive PF, Phase A, Min Avg Dmd Timestamp	TSTAMP	1Jan2000 - 31Dec2099	1 sec		
12AC -	12AE	4781 - 4783					3
		Positive PF, Phase B, Min Avg Dmd Timestamp	TSTAMP	1Jan2000 - 31Dec2099	1 sec		
12AF -	12B1	4784 - 4786					3
		Positive PF, Phase C, Min Avg Dmd Timestamp	TSTAMP	1Jan2000 - 31Dec2099	1 sec		
12B2 -	12B4	4787 - 4789					3
		Negative PF, Phase A, Min Avg Dmd Timestamp	TSTAMP	1Jan2000 - 31Dec2099	1 sec		
12B5 -	12B7	4790 - 4792					3
		Negative PF, Phase B, Min Avg Dmd Timestamp	TSTAMP	1Jan2000 - 31Dec2099	1 sec		
12B8 -	12BA	4793 - 4795					3
		Negative PF, Phase C, Min Avg Dmd Timestamp	TSTAMP	1Jan2000 - 31Dec2099	1 sec		
						Block Size:	96
Primary Minimum Timestamp Block Meter 4						read-only	
12BF -	12C1	4800 - 4802					3
		Amps A, Min Avg Dmd Timestamp	TSTAMP	1Jan2000 - 31Dec2099	1 sec		
12C2 -	12C4	4803 - 4805					3
		Amps B, Min Avg Dmd Timestamp	TSTAMP	1Jan2000 - 31Dec2099	1 sec		
12C5 -	12C7	4806 - 4808					3
		Amps C, Min Avg Dmd Timestamp	TSTAMP	1Jan2000 - 31Dec2099	1 sec		
12C8 -	12CA	4809 - 4811					3
		Positive Watts, 3-Ph, Min Avg Dmd Timestamp	TSTAMP	1Jan2000 - 31Dec2099	1 sec		
12CB -	12CD	4812 - 4814					3
		Positive VARs, 3-Ph, Min Avg Dmd Timestamp	TSTAMP	1Jan2000 - 31Dec2099	1 sec		

Modbus Address		Description	Format	Range	Units or Resolution	Comments	# Reg	
Hex	Decimal							
12CE -	12D0	4815 - 4817	Negative Watts, 3-Ph, Min Avg Dmd Timestamp	TSTAMP	1Jan2000 - 31Dec2099	1 sec		3
12D1 -	12D3	4818 - 4820	Negative VARs, 3-Ph, Min Avg Dmd Timestamp	TSTAMP	1Jan2000 - 31Dec2099	1 sec		3
12D4 -	12D6	4821 - 4823	VAs, 3-Ph, Min Avg Dmd Timestamp	TSTAMP	1Jan2000 - 31Dec2099	1 sec		3
12D7 -	12D9	4824 - 4826	Positive Power Factor, 3-Ph, Min Avg Dmd Timestamp	TSTAMP	1Jan2000 - 31Dec2099	1 sec		3
12DA -	12DC	4827 - 4829	Negative Power Factor, 3-Ph, Min Avg Dmd Timestamp	TSTAMP	1Jan2000 - 31Dec2099	1 sec		3
12DD -	12DF	4830 - 4832	Neutral Current, Min Avg Dmd Timestamp	TSTAMP	1Jan2000 - 31Dec2100	1 sec		3
12E0 -	12E2	4833 - 4835	Positive Watts, Phase A, Min Avg Dmd Timestamp	TSTAMP	1Jan2000 - 31Dec2099	1 sec		3
12E3 -	12E5	4836 - 4838	Positive Watts, Phase B, Min Avg Dmd Timestamp	TSTAMP	1Jan2000 - 31Dec2099	1 sec		3
12E6 -	12E8	4839 - 4841	Positive Watts, Phase C, Min Avg Dmd Timestamp	TSTAMP	1Jan2000 - 31Dec2099	1 sec		3
12E9 -	12EB	4842 - 4844	Positive VARs, Phase A, Min Avg Dmd Timestamp	TSTAMP	1Jan2000 - 31Dec2099	1 sec		3
12EC -	12EE	4845 - 4847	Positive VARs, Phase B, Min Avg Dmd Timestamp	TSTAMP	1Jan2000 - 31Dec2099	1 sec		3
12EF -	12F1	4848 - 4850	Positive VARs, Phase C, Min Avg Dmd Timestamp	TSTAMP	1Jan2000 - 31Dec2099	1 sec		3
12F2 -	12F4	4851 - 4853	Negative Watts, Phase A, Min Avg Dmd Timestamp	TSTAMP	1Jan2000 - 31Dec2099	1 sec		3
12F5 -	12F7	4854 - 4856	Negative Watts, Phase B, Min Avg Dmd Timestamp	TSTAMP	1Jan2000 - 31Dec2099	1 sec		3
12F8 -	12FA	4857 - 4859	Negative Watts, Phase C, Min Avg Dmd Timestamp	TSTAMP	1Jan2000 - 31Dec2099	1 sec		3
12FB -	12FD	4860 - 4862	Negative VARs, Phase A, Min Avg Dmd Timestamp	TSTAMP	1Jan2000 - 31Dec2099	1 sec		3
12FE -	1300	4863 - 4865	Negative VARs, Phase B, Min Avg Dmd Timestamp	TSTAMP	1Jan2000 - 31Dec2099	1 sec		3
1301 -	1303	4866 - 4868	Negative VARs, Phase C, Min Avg Dmd Timestamp	TSTAMP	1Jan2000 - 31Dec2099	1 sec		3
1304 -	1306	4869 - 4871	VAs, Phase A, Min Avg Dmd Timestamp	TSTAMP	1Jan2000 - 31Dec2099	1 sec		3
1307 -	1309	4872 - 4874	VAs, Phase B, Min Avg Dmd Timestamp	TSTAMP	1Jan2000 - 31Dec2099	1 sec		3

Modbus Address		Description	Format	Range	Units or Resolution	Comments	# Reg	
Hex	Decimal							
130A -	130C	4875 - 4877	VAs, Phase C, Min Avg Dmd Timestamp	TSTAMP	1Jan2000 - 31Dec2099	1 sec		3
130D -	130F	4878 - 4880	Positive PF, Phase A, Min Avg Dmd Timestamp	TSTAMP	1Jan2000 - 31Dec2099	1 sec		3
1310 -	1312	4881 - 4883	Positive PF, Phase B, Min Avg Dmd Timestamp	TSTAMP	1Jan2000 - 31Dec2099	1 sec		3
1313 -	1315	4884 - 4886	Positive PF, Phase C, Min Avg Dmd Timestamp	TSTAMP	1Jan2000 - 31Dec2099	1 sec		3
1316 -	1318	4887 - 4889	Negative PF, Phase A, Min Avg Dmd Timestamp	TSTAMP	1Jan2000 - 31Dec2099	1 sec		3
1319 -	131B	4890 - 4892	Negative PF, Phase B, Min Avg Dmd Timestamp	TSTAMP	1Jan2000 - 31Dec2099	1 sec		3
131C -	131E	4893 - 4895	Negative PF, Phase C, Min Avg Dmd Timestamp	TSTAMP	1Jan2000 - 31Dec2099	1 sec		3
							Block Size:	96
Primary Minimum Timestamp Block Meter 5							read-only	
1323 -	1325	4900 - 4902	Amps A, Min Avg Dmd Timestamp	TSTAMP	1Jan2000 - 31Dec2099	1 sec		3
1326 -	1328	4903 - 4905	Amps B, Min Avg Dmd Timestamp	TSTAMP	1Jan2000 - 31Dec2099	1 sec		3
1329 -	132B	4906 - 4908	Amps C, Min Avg Dmd Timestamp	TSTAMP	1Jan2000 - 31Dec2099	1 sec		3
132C -	132E	4909 - 4911	Positive Watts, 3-Ph, Min Avg Dmd Timestamp	TSTAMP	1Jan2000 - 31Dec2099	1 sec		3
132F -	1331	4912 - 4914	Positive VARs, 3-Ph, Min Avg Dmd Timestamp	TSTAMP	1Jan2000 - 31Dec2099	1 sec		3
1332 -	1334	4915 - 4917	Negative Watts, 3-Ph, Min Avg Dmd Timestamp	TSTAMP	1Jan2000 - 31Dec2099	1 sec		3
1335 -	1337	4918 - 4920	Negative VARs, 3-Ph, Min Avg Dmd Timestamp	TSTAMP	1Jan2000 - 31Dec2099	1 sec		3
1338 -	133A	4921 - 4923	VAs, 3-Ph, Min Avg Dmd Timestamp	TSTAMP	1Jan2000 - 31Dec2099	1 sec		3
133B -	133D	4924 - 4926	Positive Power Factor, 3-Ph, Min Avg Dmd Timestamp	TSTAMP	1Jan2000 - 31Dec2099	1 sec		3
133E -	1340	4927 - 4929	Negative Power Factor, 3-Ph, Min Avg Dmd Timestamp	TSTAMP	1Jan2000 - 31Dec2099	1 sec		3
1341 -	1343	4930 - 4932	Neutral Current, Min Avg Dmd Timestamp	TSTAMP	1Jan2000 - 31Dec2100	1 sec		3
1344 -	1346	4933 - 4935	Positive Watts, Phase A, Min Avg Dmd Timestamp	TSTAMP	1Jan2000 - 31Dec2099	1 sec		3

Modbus Address		Description	Format	Range	Units or Resolution	Comments	# Reg	
Hex	Decimal							
1347 -	1349	4936 - 4938	Positive Watts, Phase B, Min Avg Dmd Timestamp	TSTAMP	1Jan2000 - 31Dec2099	1 sec		3
134A -	134C	4939 - 4941	Positive Watts, Phase C, Min Avg Dmd Timestamp	TSTAMP	1Jan2000 - 31Dec2099	1 sec		3
134D -	134F	4942 - 4944	Positive VARs, Phase A, Min Avg Dmd Timestamp	TSTAMP	1Jan2000 - 31Dec2099	1 sec		3
1350 -	1352	4945 - 4947	Positive VARs, Phase B, Min Avg Dmd Timestamp	TSTAMP	1Jan2000 - 31Dec2099	1 sec		3
1353 -	1355	4948 - 4950	Positive VARs, Phase C, Min Avg Dmd Timestamp	TSTAMP	1Jan2000 - 31Dec2099	1 sec		3
1356 -	1358	4951 - 4953	Negative Watts, Phase A, Min Avg Dmd Timestamp	TSTAMP	1Jan2000 - 31Dec2099	1 sec		3
1359 -	135B	4954 - 4956	Negative Watts, Phase B, Min Avg Dmd Timestamp	TSTAMP	1Jan2000 - 31Dec2099	1 sec		3
135C -	135E	4957 - 4959	Negative Watts, Phase C, Min Avg Dmd Timestamp	TSTAMP	1Jan2000 - 31Dec2099	1 sec		3
135F -	1361	4960 - 4962	Negative VARs, Phase A, Min Avg Dmd Timestamp	TSTAMP	1Jan2000 - 31Dec2099	1 sec		3
1362 -	1364	4963 - 4965	Negative VARs, Phase B, Min Avg Dmd Timestamp	TSTAMP	1Jan2000 - 31Dec2099	1 sec		3
1365 -	1367	4966 - 4968	Negative VARs, Phase C, Min Avg Dmd Timestamp	TSTAMP	1Jan2000 - 31Dec2099	1 sec		3
1368 -	136A	4969 - 4971	VAs, Phase A, Min Avg Dmd Timestamp	TSTAMP	1Jan2000 - 31Dec2099	1 sec		3
136B -	136D	4972 - 4974	VAs, Phase B, Min Avg Dmd Timestamp	TSTAMP	1Jan2000 - 31Dec2099	1 sec		3
136E -	1370	4975 - 4977	VAs, Phase C, Min Avg Dmd Timestamp	TSTAMP	1Jan2000 - 31Dec2099	1 sec		3
1371 -	1373	4978 - 4980	Positive PF, Phase A, Min Avg Dmd Timestamp	TSTAMP	1Jan2000 - 31Dec2099	1 sec		3
1374 -	1376	4981 - 4983	Positive PF, Phase B, Min Avg Dmd Timestamp	TSTAMP	1Jan2000 - 31Dec2099	1 sec		3
1377 -	1379	4984 - 4986	Positive PF, Phase C, Min Avg Dmd Timestamp	TSTAMP	1Jan2000 - 31Dec2099	1 sec		3
137A -	137C	4987 - 4989	Negative PF, Phase A, Min Avg Dmd Timestamp	TSTAMP	1Jan2000 - 31Dec2099	1 sec		3
137D -	137F	4990 - 4992	Negative PF, Phase B, Min Avg Dmd Timestamp	TSTAMP	1Jan2000 - 31Dec2099	1 sec		3
1380 -	1382	4993 - 4995	Negative PF, Phase C, Min Avg Dmd Timestamp	TSTAMP	1Jan2000 - 31Dec2099	1 sec		3

Modbus Address		Description	Format	Range	Units or Resolution	Comments	# Reg
Hex	Decimal						
						Block Size:	96
Primary Minimum Timestamp Block Meter 6						read-only	
1387 -	1389	5000 - 5002	Amps A, Min Avg Dmd Timestamp	TSTAMP	1Jan2000 - 31Dec2099	1 sec	3
138A -	138C	5003 - 5005	Amps B, Min Avg Dmd Timestamp	TSTAMP	1Jan2000 - 31Dec2099	1 sec	3
138D -	138F	5006 - 5008	Amps C, Min Avg Dmd Timestamp	TSTAMP	1Jan2000 - 31Dec2099	1 sec	3
1390 -	1392	5009 - 5011	Positive Watts, 3-Ph, Min Avg Dmd Timestamp	TSTAMP	1Jan2000 - 31Dec2099	1 sec	3
1393 -	1395	5012 - 5014	Positive VARs, 3-Ph, Min Avg Dmd Timestamp	TSTAMP	1Jan2000 - 31Dec2099	1 sec	3
1396 -	1398	5015 - 5017	Negative Watts, 3-Ph, Min Avg Dmd Timestamp	TSTAMP	1Jan2000 - 31Dec2099	1 sec	3
1399 -	139B	5018 - 5020	Negative VARs, 3-Ph, Min Avg Dmd Timestamp	TSTAMP	1Jan2000 - 31Dec2099	1 sec	3
139C -	139E	5021 - 5023	VAs, 3-Ph, Min Avg Dmd Timestamp	TSTAMP	1Jan2000 - 31Dec2099	1 sec	3
139F -	13A1	5024 - 5026	Positive Power Factor, 3-Ph, Min Avg Dmd Timestamp	TSTAMP	1Jan2000 - 31Dec2099	1 sec	3
13A2 -	13A4	5027 - 5029	Negative Power Factor, 3-Ph, Min Avg Dmd Timestamp	TSTAMP	1Jan2000 - 31Dec2099	1 sec	3
13A5 -	13A7	5030 - 5032	Neutral Current, Min Avg Dmd Timestamp	TSTAMP	1Jan2000 - 31Dec2100	1 sec	3
13A8 -	13AA	5033 - 5035	Positive Watts, Phase A, Min Avg Dmd Timestamp	TSTAMP	1Jan2000 - 31Dec2099	1 sec	3
13AB -	13AD	5036 - 5038	Positive Watts, Phase B, Min Avg Dmd Timestamp	TSTAMP	1Jan2000 - 31Dec2099	1 sec	3
13AE -	13B0	5039 - 5041	Positive Watts, Phase C, Min Avg Dmd Timestamp	TSTAMP	1Jan2000 - 31Dec2099	1 sec	3
13B1 -	13B3	5042 - 5044	Positive VARs, Phase A, Min Avg Dmd Timestamp	TSTAMP	1Jan2000 - 31Dec2099	1 sec	3
13B4 -	13B6	5045 - 5047	Positive VARs, Phase B, Min Avg Dmd Timestamp	TSTAMP	1Jan2000 - 31Dec2099	1 sec	3
13B7 -	13B9	5048 - 5050	Positive VARs, Phase C, Min Avg Dmd Timestamp	TSTAMP	1Jan2000 - 31Dec2099	1 sec	3
13BA -	13BC	5051 - 5053	Negative Watts, Phase A, Min Avg Dmd Timestamp	TSTAMP	1Jan2000 - 31Dec2099	1 sec	3
13BD -	13BF	5054 - 5056	Negative Watts, Phase B, Min Avg Dmd Timestamp	TSTAMP	1Jan2000 - 31Dec2099	1 sec	3

Modbus Address		Description	Format	Range	Units or Resolution	Comments	# Reg
Hex	Decimal						
13C0 -	13C2	5057 - 5059	Negative Watts, Phase C, Min Avg Dmd Timestamp	TSTAMP	1Jan2000 - 31Dec2099	1 sec	3
13C3 -	13C5	5060 - 5062	Negative VARs, Phase A, Min Avg Dmd Timestamp	TSTAMP	1Jan2000 - 31Dec2099	1 sec	3
13C6 -	13C8	5063 - 5065	Negative VARs, Phase B, Min Avg Dmd Timestamp	TSTAMP	1Jan2000 - 31Dec2099	1 sec	3
13C9 -	13CB	5066 - 5068	Negative VARs, Phase C, Min Avg Dmd Timestamp	TSTAMP	1Jan2000 - 31Dec2099	1 sec	3
13CC -	13CE	5069 - 5071	VAs, Phase A, Min Avg Dmd Timestamp	TSTAMP	1Jan2000 - 31Dec2099	1 sec	3
13CF -	13D1	5072 - 5074	VAs, Phase B, Min Avg Dmd Timestamp	TSTAMP	1Jan2000 - 31Dec2099	1 sec	3
13D2 -	13D4	5075 - 5077	VAs, Phase C, Min Avg Dmd Timestamp	TSTAMP	1Jan2000 - 31Dec2099	1 sec	3
13D5 -	13D7	5078 - 5080	Positive PF, Phase A, Min Avg Dmd Timestamp	TSTAMP	1Jan2000 - 31Dec2099	1 sec	3
13D8 -	13DA	5081 - 5083	Positive PF, Phase B, Min Avg Dmd Timestamp	TSTAMP	1Jan2000 - 31Dec2099	1 sec	3
13DB -	13DD	5084 - 5086	Positive PF, Phase C, Min Avg Dmd Timestamp	TSTAMP	1Jan2000 - 31Dec2099	1 sec	3
13DE -	13E0	5087 - 5089	Negative PF, Phase A, Min Avg Dmd Timestamp	TSTAMP	1Jan2000 - 31Dec2099	1 sec	3
13E1 -	13E3	5090 - 5092	Negative PF, Phase B, Min Avg Dmd Timestamp	TSTAMP	1Jan2000 - 31Dec2099	1 sec	3
13E4 -	13E6	5093 - 5095	Negative PF, Phase C, Min Avg Dmd Timestamp	TSTAMP	1Jan2000 - 31Dec2099	1 sec	3
						Block Size:	96
Primary Minimum Timestamp Block Meter 7						read-only	
13EB -	13ED	5100 - 5102	Amps A, Min Avg Dmd Timestamp	TSTAMP	1Jan2000 - 31Dec2099	1 sec	3
13EE -	13F0	5103 - 5105	Amps B, Min Avg Dmd Timestamp	TSTAMP	1Jan2000 - 31Dec2099	1 sec	3
13F1 -	13F3	5106 - 5108	Amps C, Min Avg Dmd Timestamp	TSTAMP	1Jan2000 - 31Dec2099	1 sec	3
13F4 -	13F6	5109 - 5111	Positive Watts, 3-Ph, Min Avg Dmd Timestamp	TSTAMP	1Jan2000 - 31Dec2099	1 sec	3
13F7 -	13F9	5112 - 5114	Positive VARs, 3-Ph, Min Avg Dmd Timestamp	TSTAMP	1Jan2000 - 31Dec2099	1 sec	3
13FA -	13FC	5115 - 5117	Negative Watts, 3-Ph, Min Avg Dmd Timestamp	TSTAMP	1Jan2000 - 31Dec2099	1 sec	3

Modbus Address		Description	Format	Range	Units or Resolution	Comments	# Reg
Hex	Decimal						
13FD - 13FF	5118 - 5120	Negative VARs, 3-Ph, Min Avg Dmd Timestamp	TSTAMP	1Jan2000 - 31Dec2099	1 sec		3
1400 - 1402	5121 - 5123	VAs, 3-Ph, Min Avg Dmd Timestamp	TSTAMP	1Jan2000 - 31Dec2099	1 sec		3
1403 - 1405	5124 - 5126	Positive Power Factor, 3-Ph, Min Avg Dmd Timestamp	TSTAMP	1Jan2000 - 31Dec2099	1 sec		3
1406 - 1408	5127 - 5129	Negative Power Factor, 3-Ph, Min Avg Dmd Timestamp	TSTAMP	1Jan2000 - 31Dec2099	1 sec		3
1409 - 140B	5130 - 5132	Neutral Current, Min Avg Dmd Timestamp	TSTAMP	1Jan2000 - 31Dec2100	1 sec		3
140C - 140E	5133 - 5135	Positive Watts, Phase A, Min Avg Dmd Timestamp	TSTAMP	1Jan2000 - 31Dec2099	1 sec		3
140F - 1411	5136 - 5138	Positive Watts, Phase B, Min Avg Dmd Timestamp	TSTAMP	1Jan2000 - 31Dec2099	1 sec		3
1412 - 1414	5139 - 5141	Positive Watts, Phase C, Min Avg Dmd Timestamp	TSTAMP	1Jan2000 - 31Dec2099	1 sec		3
1415 - 1417	5142 - 5144	Positive VARs, Phase A, Min Avg Dmd Timestamp	TSTAMP	1Jan2000 - 31Dec2099	1 sec		3
1418 - 141A	5145 - 5147	Positive VARs, Phase B, Min Avg Dmd Timestamp	TSTAMP	1Jan2000 - 31Dec2099	1 sec		3
141B - 141D	5148 - 5150	Positive VARs, Phase C, Min Avg Dmd Timestamp	TSTAMP	1Jan2000 - 31Dec2099	1 sec		3
141E - 1420	5151 - 5153	Negative Watts, Phase A, Min Avg Dmd Timestamp	TSTAMP	1Jan2000 - 31Dec2099	1 sec		3
1421 - 1423	5154 - 5156	Negative Watts, Phase B, Min Avg Dmd Timestamp	TSTAMP	1Jan2000 - 31Dec2099	1 sec		3
1424 - 1426	5157 - 5159	Negative Watts, Phase C, Min Avg Dmd Timestamp	TSTAMP	1Jan2000 - 31Dec2099	1 sec		3
1427 - 1429	5160 - 5162	Negative VARs, Phase A, Min Avg Dmd Timestamp	TSTAMP	1Jan2000 - 31Dec2099	1 sec		3
142A - 142C	5163 - 5165	Negative VARs, Phase B, Min Avg Dmd Timestamp	TSTAMP	1Jan2000 - 31Dec2099	1 sec		3
142D - 142F	5166 - 5168	Negative VARs, Phase C, Min Avg Dmd Timestamp	TSTAMP	1Jan2000 - 31Dec2099	1 sec		3
1430 - 1432	5169 - 5171	VAs, Phase A, Min Avg Dmd Timestamp	TSTAMP	1Jan2000 - 31Dec2099	1 sec		3
1433 - 1435	5172 - 5174	VAs, Phase B, Min Avg Dmd Timestamp	TSTAMP	1Jan2000 - 31Dec2099	1 sec		3
1436 - 1438	5175 - 5177	VAs, Phase C, Min Avg Dmd Timestamp	TSTAMP	1Jan2000 - 31Dec2099	1 sec		3

Modbus Address		Description	Format	Range	Units or Resolution	Comments	# Reg	
Hex	Decimal							
1439 -	143B	5178 - 5180	Positive PF, Phase A, Min Avg Dmd Timestamp	TSTAMP	1Jan2000 - 31Dec2099	1 sec		3
143C -	143E	5181 - 5183	Positive PF, Phase B, Min Avg Dmd Timestamp	TSTAMP	1Jan2000 - 31Dec2099	1 sec		3
143F -	1441	5184 - 5186	Positive PF, Phase C, Min Avg Dmd Timestamp	TSTAMP	1Jan2000 - 31Dec2099	1 sec		3
1442 -	1444	5187 - 5189	Negative PF, Phase A, Min Avg Dmd Timestamp	TSTAMP	1Jan2000 - 31Dec2099	1 sec		3
1445 -	1447	5190 - 5192	Negative PF, Phase B, Min Avg Dmd Timestamp	TSTAMP	1Jan2000 - 31Dec2099	1 sec		3
1448 -	144A	5193 - 5195	Negative PF, Phase C, Min Avg Dmd Timestamp	TSTAMP	1Jan2000 - 31Dec2099	1 sec		3
							Block Size:	96
Primary Minimum Timestamp Block Meter 8							read-only	
144F -	1451	5200 - 5202	Amps A, Min Avg Dmd Timestamp	TSTAMP	1Jan2000 - 31Dec2099	1 sec		3
1452 -	1454	5203 - 5205	Amps B, Min Avg Dmd Timestamp	TSTAMP	1Jan2000 - 31Dec2099	1 sec		3
1455 -	1457	5206 - 5208	Amps C, Min Avg Dmd Timestamp	TSTAMP	1Jan2000 - 31Dec2099	1 sec		3
1458 -	145A	5209 - 5211	Positive Watts, 3-Ph, Min Avg Dmd Timestamp	TSTAMP	1Jan2000 - 31Dec2099	1 sec		3
145B -	145D	5212 - 5214	Positive VARs, 3-Ph, Min Avg Dmd Timestamp	TSTAMP	1Jan2000 - 31Dec2099	1 sec		3
145E -	1460	5215 - 5217	Negative Watts, 3-Ph, Min Avg Dmd Timestamp	TSTAMP	1Jan2000 - 31Dec2099	1 sec		3
1461 -	1463	5218 - 5220	Negative VARs, 3-Ph, Min Avg Dmd Timestamp	TSTAMP	1Jan2000 - 31Dec2099	1 sec		3
1464 -	1466	5221 - 5223	VAs, 3-Ph, Min Avg Dmd Timestamp	TSTAMP	1Jan2000 - 31Dec2099	1 sec		3
1467 -	1469	5224 - 5226	Positive Power Factor, 3-Ph, Min Avg Dmd Timestamp	TSTAMP	1Jan2000 - 31Dec2099	1 sec		3
146A -	146C	5227 - 5229	Negative Power Factor, 3-Ph, Min Avg Dmd Timestamp	TSTAMP	1Jan2000 - 31Dec2099	1 sec		3
146D -	146F	5230 - 5232	Neutral Current, Min Avg Dmd Timestamp	TSTAMP	1Jan2000 - 31Dec2100	1 sec		3
1470 -	1472	5233 - 5235	Positive Watts, Phase A, Min Avg Dmd Timestamp	TSTAMP	1Jan2000 - 31Dec2099	1 sec		3
1473 -	1475	5236 - 5238	Positive Watts, Phase B, Min Avg Dmd Timestamp	TSTAMP	1Jan2000 - 31Dec2099	1 sec		3

Modbus Address		Description	Format	Range	Units or Resolution	Comments	# Reg	
Hex	Decimal							
1476 -	1478	5239 - 5241	Positive Watts, Phase C, Min Avg Dmd Timestamp	TSTAMP	1Jan2000 - 31Dec2099	1 sec		3
1479 -	147B	5242 - 5244	Positive VARs, Phase A, Min Avg Dmd Timestamp	TSTAMP	1Jan2000 - 31Dec2099	1 sec		3
147C -	147E	5245 - 5247	Positive VARs, Phase B, Min Avg Dmd Timestamp	TSTAMP	1Jan2000 - 31Dec2099	1 sec		3
147F -	1481	5248 - 5250	Positive VARs, Phase C, Min Avg Dmd Timestamp	TSTAMP	1Jan2000 - 31Dec2099	1 sec		3
1482 -	1484	5251 - 5253	Negative Watts, Phase A, Min Avg Dmd Timestamp	TSTAMP	1Jan2000 - 31Dec2099	1 sec		3
1485 -	1487	5254 - 5256	Negative Watts, Phase B, Min Avg Dmd Timestamp	TSTAMP	1Jan2000 - 31Dec2099	1 sec		3
1488 -	148A	5257 - 5259	Negative Watts, Phase C, Min Avg Dmd Timestamp	TSTAMP	1Jan2000 - 31Dec2099	1 sec		3
148B -	148D	5260 - 5262	Negative VARs, Phase A, Min Avg Dmd Timestamp	TSTAMP	1Jan2000 - 31Dec2099	1 sec		3
148E -	1490	5263 - 5265	Negative VARs, Phase B, Min Avg Dmd Timestamp	TSTAMP	1Jan2000 - 31Dec2099	1 sec		3
1491 -	1493	5266 - 5268	Negative VARs, Phase C, Min Avg Dmd Timestamp	TSTAMP	1Jan2000 - 31Dec2099	1 sec		3
1494 -	1496	5269 - 5271	VAs, Phase A, Min Avg Dmd Timestamp	TSTAMP	1Jan2000 - 31Dec2099	1 sec		3
1497 -	1499	5272 - 5274	VAs, Phase B, Min Avg Dmd Timestamp	TSTAMP	1Jan2000 - 31Dec2099	1 sec		3
149A -	149C	5275 - 5277	VAs, Phase C, Min Avg Dmd Timestamp	TSTAMP	1Jan2000 - 31Dec2099	1 sec		3
149D -	149F	5278 - 5280	Positive PF, Phase A, Min Avg Dmd Timestamp	TSTAMP	1Jan2000 - 31Dec2099	1 sec		3
14A0 -	14A2	5281 - 5283	Positive PF, Phase B, Min Avg Dmd Timestamp	TSTAMP	1Jan2000 - 31Dec2099	1 sec		3
14A3 -	14A5	5284 - 5286	Positive PF, Phase C, Min Avg Dmd Timestamp	TSTAMP	1Jan2000 - 31Dec2099	1 sec		3
14A6 -	14A8	5287 - 5289	Negative PF, Phase A, Min Avg Dmd Timestamp	TSTAMP	1Jan2000 - 31Dec2099	1 sec		3
14A9 -	14AB	5290 - 5292	Negative PF, Phase B, Min Avg Dmd Timestamp	TSTAMP	1Jan2000 - 31Dec2099	1 sec		3
14AC -	14AE	5293 - 5295	Negative PF, Phase C, Min Avg Dmd Timestamp	TSTAMP	1Jan2000 - 31Dec2099	1 sec		3
							Block Size:	96

Modbus Address		Description	Format	Range	Units or Resolution	Comments	# Reg
Hex	Decimal						
Short term Primary Maximum Block						read-only	
14B3 -	14B4	5300 - 5301	FLOAT	0 to 9999 M	volts	Maximum instantaneous value measured during the demand interval before the one most recently completed.	2
14B5 -	14B6	5302 - 5303	FLOAT	0 to 9999 M	volts		2
14B7 -	14B8	5304 - 5305	FLOAT	0 to 9999 M	volts		2
14B9 -	14BA	5306 - 5307	FLOAT	0 to 9999 M	volts		2
14BB -	14BC	5308 - 5309	FLOAT	0 to 9999 M	volts		2
14BD -	14BE	5310 - 5311	FLOAT	0 to 9999 M	volts		2
14BF -	14C0	5312 - 5313	FLOAT	0 to 9999 M	volts	Maximum instantaneous value measured during the most recently completed demand interval.	2
14C1 -	14C2	5314 - 5315	FLOAT	0 to 9999 M	volts		2
14C3 -	14C4	5316 - 5317	FLOAT	0 to 9999 M	volts		2
14C5 -	14C6	5318 - 5319	FLOAT	0 to 9999 M	volts		2
14C7 -	14C8	5320 - 5321	FLOAT	0 to 9999 M	volts		2
14C9 -	14CA	5322 - 5323	FLOAT	0 to 9999 M	volts		2
						Block Size:	24
Primary Maximum Block (Voltage and frequency)						read-only	
14D1 -	14D2	5330 - 5331	FLOAT	0 to 9999 M	volts		2
14D3 -	14D4	5332 - 5333	FLOAT	0 to 9999 M	volts		2
14D5 -	14D6	5334 - 5335	FLOAT	0 to 9999 M	volts		2
14D7 -	14D8	5336 - 5337	FLOAT	0 to 9999 M	volts		2
14D9 -	14DA	5338 - 5339	FLOAT	0 to 9999 M	volts		2
14DB -	14DC	5340 - 5341	FLOAT	0 to 9999 M	volts		2
14DD -	14DE	5342 - 5343	FLOAT	0 to 65.00	Hz		2
						Block Size:	14
Primary Maximum Block Meter 1						read-only	
1517 -	1518	5400 - 5401	FLOAT	0 to 9999 M	amps		2
1519 -	151A	5402 - 5403	FLOAT	0 to 9999 M	amps		2
151B -	151C	5404 - 5405	FLOAT	0 to 9999 M	amps		2
151D -	151E	5406 - 5407	FLOAT	0 to +9999 M	watts		2
151F -	1520	5408 - 5409	FLOAT	0 to +9999 M	VARs		2

Modbus Address		Description	Format	Range	Units or Resolution	Comments	# Reg
Hex	Decimal						
1521 -	1522	5410 - 5411	Negative Watts, 3-Ph, Maximum Avg Demand	FLOAT	0 to +9999 M	watts	2
1523 -	1524	5412 - 5413	Negative VARs, 3-Ph, Maximum Avg Demand	FLOAT	0 to +9999 M	VARs	2
1525 -	1526	5414 - 5415	VAs, 3-Ph, Maximum Avg Demand	FLOAT	-9999 M to +9999 M	VAs	2
1527 -	1528	5416 - 5417	Positive Power Factor, 3-Ph, Maximum Avg Demand	FLOAT	-1.00 to +1.00	none	2
1529 -	152A	5418 - 5419	Negative Power Factor, 3-Ph, Maximum Avg Demand	FLOAT	-1.00 to +1.00	none	2
152B -	152C	5420 - 5421	Neutral Current, Maximum Avg Demand	FLOAT	0 to 9999 M	amps	2
152D -	152E	5422 - 5423	Positive Watts, Phase A, Maximum Avg Demand	FLOAT	-9999 M to +9999 M	watts	2
152F -	1530	5424 - 5425	Positive Watts, Phase B, Maximum Avg Demand	FLOAT	-9999 M to +9999 M	watts	2
1531 -	1532	5426 - 5427	Positive Watts, Phase C, Maximum Avg Demand	FLOAT	-9999 M to +9999 M	watts	2
1533 -	1534	5428 - 5429	Positive VARs, Phase A, Maximum Avg Demand	FLOAT	-9999 M to +9999 M	VARs	2
1535 -	1536	5430 - 5431	Positive VARs, Phase B, Maximum Avg Demand	FLOAT	-9999 M to +9999 M	VARs	2
1537 -	1538	5432 - 5433	Positive VARs, Phase C, Maximum Avg Demand	FLOAT	-9999 M to +9999 M	VARs	2
1539 -	153A	5434 - 5435	Negative Watts, Phase A, Maximum Avg Demand	FLOAT	-9999 M to +9999 M	watts	2
153B -	153C	5436 - 5437	Negative Watts, Phase B, Maximum Avg Demand	FLOAT	-9999 M to +9999 M	watts	2
153D -	153E	5438 - 5439	Negative Watts, Phase C, Maximum Avg Demand	FLOAT	-9999 M to +9999 M	watts	2
153F -	1540	5440 - 5441	Negative VARs, Phase A, Maximum Avg Demand	FLOAT	-9999 M to +9999 M	VARs	2
1541 -	1542	5442 - 5443	Negative VARs, Phase B, Maximum Avg Demand	FLOAT	-9999 M to +9999 M	VARs	2
1543 -	1544	5444 - 5445	Negative VARs, Phase C, Maximum Avg Demand	FLOAT	-9999 M to +9999 M	VARs	2
1545 -	1546	5446 - 5447	VAs, Phase A, Maximum Avg Demand	FLOAT	-9999 M to +9999 M	VAs	2
1547 -	1548	5448 - 5449	VAs, Phase B, Maximum Avg Demand	FLOAT	-9999 M to +9999 M	VAs	2

Modbus Address		Description	Format	Range	Units or Resolution	Comments	# Reg
Hex	Decimal						
1549 -	154A	5450 - 5451	VAs, Phase C, Maximum Avg Demand	FLOAT	-9999 M to +9999 M	VAs	2
154B -	154C	5452 - 5453	Positive PF, Phase A, Maximum Avg Demand	FLOAT	-1.00 to +1.00	none	2
154D -	154E	5454 - 5455	Positive PF, Phase B, Maximum Avg Demand	FLOAT	-1.00 to +1.00	none	2
154F -	1550	5456 - 5457	Positive PF, Phase C, Maximum Avg Demand	FLOAT	-1.00 to +1.00	none	2
1551 -	1552	5458 - 5459	Negative PF, Phase A, Maximum Avg Demand	FLOAT	-1.00 to +1.00	none	2
1553 -	1554	5460 - 5461	Negative PF, Phase B, Maximum Avg Demand	FLOAT	-1.00 to +1.00	none	2
1555 -	1556	5462 - 5463	Negative PF, Phase C, Maximum Avg Demand	FLOAT	-1.00 to +1.00	none	2
						Block Size:	64
Primary Maximum Block Meter 2						read-only	
157B -	157C	5500 - 5501	Amps A, Maximum Avg Demand	FLOAT	0 to 9999 M	amps	2
157D -	157E	5502 - 5503	Amps B, Maximum Avg Demand	FLOAT	0 to 9999 M	amps	2
157F -	1580	5504 - 5505	Amps C, Maximum Avg Demand	FLOAT	0 to 9999 M	amps	2
1581 -	1582	5506 - 5507	Positive Watts, 3-Ph, Maximum Avg Demand	FLOAT	0 to +9999 M	watts	2
1583 -	1584	5508 - 5509	Positive VARs, 3-Ph, Maximum Avg Demand	FLOAT	0 to +9999 M	VARs	2
1585 -	1586	5510 - 5511	Negative Watts, 3-Ph, Maximum Avg Demand	FLOAT	0 to +9999 M	watts	2
1587 -	1588	5512 - 5513	Negative VARs, 3-Ph, Maximum Avg Demand	FLOAT	0 to +9999 M	VARs	2
1589 -	158A	5514 - 5515	VAs, 3-Ph, Maximum Avg Demand	FLOAT	-9999 M to +9999 M	VAs	2
158B -	158C	5516 - 5517	Positive Power Factor, 3-Ph, Maximum Avg Demand	FLOAT	-1.00 to +1.00	none	2
158D -	158E	5518 - 5519	Negative Power Factor, 3-Ph, Maximum Avg Demand	FLOAT	-1.00 to +1.00	none	2
158F -	1590	5520 - 5521	Neutral Current, Maximum Avg Demand	FLOAT	0 to 9999 M	amps	2
1591 -	1592	5522 - 5523	Positive Watts, Phase A, Maximum Avg Demand	FLOAT	-9999 M to +9999 M	watts	2
1593 -	1594	5524 - 5525	Positive Watts, Phase B, Maximum Avg Demand	FLOAT	-9999 M to +9999 M	watts	2

C: MP200-Y (Three Phase) Modbus Map

Modbus Address		Description	Format	Range	Units or Resolution	Comments	# Reg		
Hex	Decimal								
1595 -	1596	5526 - 5527		Positive Watts, Phase C, Maximum Avg Demand	FLOAT	-9999 M to +9999 M	watts		2
1597 -	1598	5528 - 5529		Positive VARs, Phase A, Maximum Avg Demand	FLOAT	-9999 M to +9999 M	VARs		2
1599 -	159A	5530 - 5531		Positive VARs, Phase B, Maximum Avg Demand	FLOAT	-9999 M to +9999 M	VARs		2
159B -	159C	5532 - 5533		Positive VARs, Phase C, Maximum Avg Demand	FLOAT	-9999 M to +9999 M	VARs		2
159D -	159E	5534 - 5535		Negative Watts, Phase A, Maximum Avg Demand	FLOAT	-9999 M to +9999 M	watts		2
159F -	15A0	5536 - 5537		Negative Watts, Phase B, Maximum Avg Demand	FLOAT	-9999 M to +9999 M	watts		2
15A1 -	15A2	5538 - 5539		Negative Watts, Phase C, Maximum Avg Demand	FLOAT	-9999 M to +9999 M	watts		2
15A3 -	15A4	5540 - 5541		Negative VARs, Phase A, Maximum Avg Demand	FLOAT	-9999 M to +9999 M	VARs		2
15A5 -	15A6	5542 - 5543		Negative VARs, Phase B, Maximum Avg Demand	FLOAT	-9999 M to +9999 M	VARs		2
15A7 -	15A8	5544 - 5545		Negative VARs, Phase C, Maximum Avg Demand	FLOAT	-9999 M to +9999 M	VARs		2
15A9 -	15AA	5546 - 5547		VAs, Phase A, Maximum Avg Demand	FLOAT	-9999 M to +9999 M	VAs		2
15AB -	15AC	5548 - 5549		VAs, Phase B, Maximum Avg Demand	FLOAT	-9999 M to +9999 M	VAs		2
15AD -	15AE	5550 - 5551		VAs, Phase C, Maximum Avg Demand	FLOAT	-9999 M to +9999 M	VAs		2
15AF -	15B0	5552 - 5553		Positive PF, Phase A, Maximum Avg Demand	FLOAT	-1.00 to +1.00	none		2
15B1 -	15B2	5554 - 5555		Positive PF, Phase B, Maximum Avg Demand	FLOAT	-1.00 to +1.00	none		2
15B3 -	15B4	5556 - 5557		Positive PF, Phase C, Maximum Avg Demand	FLOAT	-1.00 to +1.00	none		2
15B5 -	15B6	5558 - 5559		Negative PF, Phase A, Maximum Avg Demand	FLOAT	-1.00 to +1.00	none		2
15B7 -	15B8	5560 - 5561		Negative PF, Phase B, Maximum Avg Demand	FLOAT	-1.00 to +1.00	none		2
15B9 -	15BA	5562 - 5563		Negative PF, Phase C, Maximum Avg Demand	FLOAT	-1.00 to +1.00	none		2
							Block Size:	64	

Modbus Address		Description	Format	Range	Units or Resolution	Comments	# Reg
Hex	Decimal						
Primary Maximum Block Meter 3						read-only	
15DF -	15E0	5600 - 5601	Amps A, Maximum Avg Demand	FLOAT	0 to 9999 M	amps	2
15E1 -	15E2	5602 - 5603	Amps B, Maximum Avg Demand	FLOAT	0 to 9999 M	amps	2
15E3 -	15E4	5604 - 5605	Amps C, Maximum Avg Demand	FLOAT	0 to 9999 M	amps	2
15E5 -	15E6	5606 - 5607	Positive Watts, 3-Ph, Maximum Avg Demand	FLOAT	0 to +9999 M	watts	2
15E7 -	15E8	5608 - 5609	Positive VARs, 3-Ph, Maximum Avg Demand	FLOAT	0 to +9999 M	VARs	2
15E9 -	15EA	5610 - 5611	Negative Watts, 3-Ph, Maximum Avg Demand	FLOAT	0 to +9999 M	watts	2
15EB -	15EC	5612 - 5613	Negative VARs, 3-Ph, Maximum Avg Demand	FLOAT	0 to +9999 M	VARs	2
15ED -	15EE	5614 - 5615	VAs, 3-Ph, Maximum Avg Demand	FLOAT	-9999 M to +9999 M	VAs	2
15EF -	15F0	5616 - 5617	Positive Power Factor, 3-Ph, Maximum Avg Demand	FLOAT	-1.00 to +1.00	none	2
15F1 -	15F2	5618 - 5619	Negative Power Factor, 3-Ph, Maximum Avg Demand	FLOAT	-1.00 to +1.00	none	2
15F3 -	15F4	5620 - 5621	Neutral Current, Maximum Avg Demand	FLOAT	0 to 9999 M	amps	2
15F5 -	15F6	5622 - 5623	Positive Watts, Phase A, Maximum Avg Demand	FLOAT	-9999 M to +9999 M	watts	2
15F7 -	15F8	5624 - 5625	Positive Watts, Phase B, Maximum Avg Demand	FLOAT	-9999 M to +9999 M	watts	2
15F9 -	15FA	5626 - 5627	Positive Watts, Phase C, Maximum Avg Demand	FLOAT	-9999 M to +9999 M	watts	2
15FB -	15FC	5628 - 5629	Positive VARs, Phase A, Maximum Avg Demand	FLOAT	-9999 M to +9999 M	VARs	2
15FD -	15FE	5630 - 5631	Positive VARs, Phase B, Maximum Avg Demand	FLOAT	-9999 M to +9999 M	VARs	2
15FF -	1600	5632 - 5633	Positive VARs, Phase C, Maximum Avg Demand	FLOAT	-9999 M to +9999 M	VARs	2
1601 -	1602	5634 - 5635	Negative Watts, Phase A, Maximum Avg Demand	FLOAT	-9999 M to +9999 M	watts	2
1603 -	1604	5636 - 5637	Negative Watts, Phase B, Maximum Avg Demand	FLOAT	-9999 M to +9999 M	watts	2
1605 -	1606	5638 - 5639	Negative Watts, Phase C, Maximum Avg Demand	FLOAT	-9999 M to +9999 M	watts	2

Modbus Address		Description	Format	Range	Units or Resolution	Comments	# Reg
Hex	Decimal						
1607 -	1608	5640 - 5641					2
		Negative VARs, Phase A, Maximum Avg Demand	FLOAT	-9999 M to +9999 M	VARs		
1609 -	160A	5642 - 5643					2
		Negative VARs, Phase B, Maximum Avg Demand	FLOAT	-9999 M to +9999 M	VARs		
160B -	160C	5644 - 5645					2
		Negative VARs, Phase C, Maximum Avg Demand	FLOAT	-9999 M to +9999 M	VARs		
160D -	160E	5646 - 5647					2
		VAs, Phase A, Maximum Avg Demand	FLOAT	-9999 M to +9999 M	VAs		
160F -	1610	5648 - 5649					2
		VAs, Phase B, Maximum Avg Demand	FLOAT	-9999 M to +9999 M	VAs		
1611 -	1612	5650 - 5651					2
		VAs, Phase C, Maximum Avg Demand	FLOAT	-9999 M to +9999 M	VAs		
1613 -	1614	5652 - 5653					2
		Positive PF, Phase A, Maximum Avg Demand	FLOAT	-1.00 to +1.00	none		
1615 -	1616	5654 - 5655					2
		Positive PF, Phase B, Maximum Avg Demand	FLOAT	-1.00 to +1.00	none		
1617 -	1618	5656 - 5657					2
		Positive PF, Phase C, Maximum Avg Demand	FLOAT	-1.00 to +1.00	none		
1619 -	161A	5658 - 5659					2
		Negative PF, Phase A, Maximum Avg Demand	FLOAT	-1.00 to +1.00	none		
161B -	161C	5660 - 5661					2
		Negative PF, Phase B, Maximum Avg Demand	FLOAT	-1.00 to +1.00	none		
161D -	161E	5662 - 5663					2
		Negative PF, Phase C, Maximum Avg Demand	FLOAT	-1.00 to +1.00	none		
						Block Size:	64
Primary Maximum Block Meter 4						read-only	
1643 -	1644	5700 - 5701					2
		Amps A, Maximum Avg Demand	FLOAT	0 to 9999 M	amps		
1645 -	1646	5702 - 5703					2
		Amps B, Maximum Avg Demand	FLOAT	0 to 9999 M	amps		
1647 -	1648	5704 - 5705					2
		Amps C, Maximum Avg Demand	FLOAT	0 to 9999 M	amps		
1649 -	164A	5706 - 5707					2
		Positive Watts, 3-Ph, Maximum Avg Demand	FLOAT	0 to +9999 M	watts		
164B -	164C	5708 - 5709					2
		Positive VARs, 3-Ph, Maximum Avg Demand	FLOAT	0 to +9999 M	VARs		
164D -	164E	5710 - 5711					2
		Negative Watts, 3-Ph, Maximum Avg Demand	FLOAT	0 to +9999 M	watts		
164F -	1650	5712 - 5713					2
		Negative VARs, 3-Ph, Maximum Avg Demand	FLOAT	0 to +9999 M	VARs		
1651 -	1652	5714 - 5715					2
		VAs, 3-Ph, Maximum Avg Demand	FLOAT	-9999 M to +9999 M	VAs		

Modbus Address		Description	Format	Range	Units or Resolution	Comments	# Reg
Hex	Decimal						
1653 -	1654	5716 - 5717	Positive Power Factor, 3-Ph, Maximum Avg Demand	FLOAT	-1.00 to +1.00	none	2
1655 -	1656	5718 - 5719	Negative Power Factor, 3-Ph, Maximum Avg Demand	FLOAT	-1.00 to +1.00	none	2
1657 -	1658	5720 - 5721	Neutral Current, Maximum Avg Demand	FLOAT	0 to 9999 M	amps	2
1659 -	165A	5722 - 5723	Positive Watts, Phase A, Maximum Avg Demand	FLOAT	-9999 M to +9999 M	watts	2
165B -	165C	5724 - 5725	Positive Watts, Phase B, Maximum Avg Demand	FLOAT	-9999 M to +9999 M	watts	2
165D -	165E	5726 - 5727	Positive Watts, Phase C, Maximum Avg Demand	FLOAT	-9999 M to +9999 M	watts	2
165F -	1660	5728 - 5729	Positive VARs, Phase A, Maximum Avg Demand	FLOAT	-9999 M to +9999 M	VARs	2
1661 -	1662	5730 - 5731	Positive VARs, Phase B, Maximum Avg Demand	FLOAT	-9999 M to +9999 M	VARs	2
1663 -	1664	5732 - 5733	Positive VARs, Phase C, Maximum Avg Demand	FLOAT	-9999 M to +9999 M	VARs	2
1665 -	1666	5734 - 5735	Negative Watts, Phase A, Maximum Avg Demand	FLOAT	-9999 M to +9999 M	watts	2
1667 -	1668	5736 - 5737	Negative Watts, Phase B, Maximum Avg Demand	FLOAT	-9999 M to +9999 M	watts	2
1669 -	166A	5738 - 5739	Negative Watts, Phase C, Maximum Avg Demand	FLOAT	-9999 M to +9999 M	watts	2
166B -	166C	5740 - 5741	Negative VARs, Phase A, Maximum Avg Demand	FLOAT	-9999 M to +9999 M	VARs	2
166D -	166E	5742 - 5743	Negative VARs, Phase B, Maximum Avg Demand	FLOAT	-9999 M to +9999 M	VARs	2
166F -	1670	5744 - 5745	Negative VARs, Phase C, Maximum Avg Demand	FLOAT	-9999 M to +9999 M	VARs	2
1671 -	1672	5746 - 5747	VAs, Phase A, Maximum Avg Demand	FLOAT	-9999 M to +9999 M	VAs	2
1673 -	1674	5748 - 5749	VAs, Phase B, Maximum Avg Demand	FLOAT	-9999 M to +9999 M	VAs	2
1675 -	1676	5750 - 5751	VAs, Phase C, Maximum Avg Demand	FLOAT	-9999 M to +9999 M	VAs	2
1677 -	1678	5752 - 5753	Positive PF, Phase A, Maximum Avg Demand	FLOAT	-1.00 to +1.00	none	2
1679 -	167A	5754 - 5755	Positive PF, Phase B, Maximum Avg Demand	FLOAT	-1.00 to +1.00	none	2

Modbus Address		Description	Format	Range	Units or Resolution	Comments	# Reg		
Hex	Decimal								
167B -	167C	5756 - 5757		Positive PF, Phase C, Maximum Avg Demand	FLOAT	-1.00 to +1.00	none		2
167D -	167E	5758 - 5759		Negative PF, Phase A, Maximum Avg Demand	FLOAT	-1.00 to +1.00	none		2
167F -	1680	5760 - 5761		Negative PF, Phase B, Maximum Avg Demand	FLOAT	-1.00 to +1.00	none		2
1681 -	1682	5762 - 5763		Negative PF, Phase C, Maximum Avg Demand	FLOAT	-1.00 to +1.00	none		2
							Block Size:	64	
Primary Maximum Block Meter 5							read-only		
16A7 -	16A8	5800 - 5801		Amps A, Maximum Avg Demand	FLOAT	0 to 9999 M	amps		2
16A9 -	16AA	5802 - 5803		Amps B, Maximum Avg Demand	FLOAT	0 to 9999 M	amps		2
16AB -	16AC	5804 - 5805		Amps C, Maximum Avg Demand	FLOAT	0 to 9999 M	amps		2
16AD -	16AE	5806 - 5807		Positive Watts, 3-Ph, Maximum Avg Demand	FLOAT	0 to +9999 M	watts		2
16AF -	16B0	5808 - 5809		Positive VARs, 3-Ph, Maximum Avg Demand	FLOAT	0 to +9999 M	VARs		2
16B1 -	16B2	5810 - 5811		Negative Watts, 3-Ph, Maximum Avg Demand	FLOAT	0 to +9999 M	watts		2
16B3 -	16B4	5812 - 5813		Negative VARs, 3-Ph, Maximum Avg Demand	FLOAT	0 to +9999 M	VARs		2
16B5 -	16B6	5814 - 5815		VAs, 3-Ph, Maximum Avg Demand	FLOAT	-9999 M to +9999 M	VAs		2
16B7 -	16B8	5816 - 5817		Positive Power Factor, 3-Ph, Maximum Avg Demand	FLOAT	-1.00 to +1.00	none		2
16B9 -	16BA	5818 - 5819		Negative Power Factor, 3-Ph, Maximum Avg Demand	FLOAT	-1.00 to +1.00	none		2
16BB -	16BC	5820 - 5821		Neutral Current, Maximum Avg Demand	FLOAT	0 to 9999 M	amps		2
16BD -	16BE	5822 - 5823		Positive Watts, Phase A, Maximum Avg Demand	FLOAT	-9999 M to +9999 M	watts		2
16BF -	16C0	5824 - 5825		Positive Watts, Phase B, Maximum Avg Demand	FLOAT	-9999 M to +9999 M	watts		2
16C1 -	16C2	5826 - 5827		Positive Watts, Phase C, Maximum Avg Demand	FLOAT	-9999 M to +9999 M	watts		2
16C3 -	16C4	5828 - 5829		Positive VARs, Phase A, Maximum Avg Demand	FLOAT	-9999 M to +9999 M	VARs		2
16C5 -	16C6	5830 - 5831		Positive VARs, Phase B, Maximum Avg Demand	FLOAT	-9999 M to +9999 M	VARs		2

Modbus Address		Description	Format	Range	Units or Resolution	Comments	# Reg
Hex	Decimal						
16C7 - 16C8	5832 - 5833	Positive VARs, Phase C, Maximum Avg Demand	FLOAT	-9999 M to +9999 M	VARs		2
16C9 - 16CA	5834 - 5835	Negative Watts, Phase A, Maximum Avg Demand	FLOAT	-9999 M to +9999 M	watts		2
16CB - 16CC	5836 - 5837	Negative Watts, Phase B, Maximum Avg Demand	FLOAT	-9999 M to +9999 M	watts		2
16CD - 16CE	5838 - 5839	Negative Watts, Phase C, Maximum Avg Demand	FLOAT	-9999 M to +9999 M	watts		2
16CF - 16D0	5840 - 5841	Negative VARs, Phase A, Maximum Avg Demand	FLOAT	-9999 M to +9999 M	VARs		2
16D1 - 16D2	5842 - 5843	Negative VARs, Phase B, Maximum Avg Demand	FLOAT	-9999 M to +9999 M	VARs		2
16D3 - 16D4	5844 - 5845	Negative VARs, Phase C, Maximum Avg Demand	FLOAT	-9999 M to +9999 M	VARs		2
16D5 - 16D6	5846 - 5847	VAs, Phase A, Maximum Avg Demand	FLOAT	-9999 M to +9999 M	VAs		2
16D7 - 16D8	5848 - 5849	VAs, Phase B, Maximum Avg Demand	FLOAT	-9999 M to +9999 M	VAs		2
16D9 - 16DA	5850 - 5851	VAs, Phase C, Maximum Avg Demand	FLOAT	-9999 M to +9999 M	VAs		2
16DB - 16DC	5852 - 5853	Positive PF, Phase A, Maximum Avg Demand	FLOAT	-1.00 to +1.00	none		2
16DD - 16DE	5854 - 5855	Positive PF, Phase B, Maximum Avg Demand	FLOAT	-1.00 to +1.00	none		2
16DF - 16E0	5856 - 5857	Positive PF, Phase C, Maximum Avg Demand	FLOAT	-1.00 to +1.00	none		2
16E1 - 16E2	5858 - 5859	Negative PF, Phase A, Maximum Avg Demand	FLOAT	-1.00 to +1.00	none		2
16E3 - 16E4	5860 - 5861	Negative PF, Phase B, Maximum Avg Demand	FLOAT	-1.00 to +1.00	none		2
16E5 - 16E6	5862 - 5863	Negative PF, Phase C, Maximum Avg Demand	FLOAT	-1.00 to +1.00	none		2
						Block Size:	64
Primary Maximum Block Meter 6						read-only	
170B - 170C	5900 - 5901	Amps A, Maximum Avg Demand	FLOAT	0 to 9999 M	amps		2
170D - 170E	5902 - 5903	Amps B, Maximum Avg Demand	FLOAT	0 to 9999 M	amps		2
170F - 1710	5904 - 5905	Amps C, Maximum Avg Demand	FLOAT	0 to 9999 M	amps		2
1711 - 1712	5906 - 5907	Positive Watts, 3-Ph, Maximum Avg Demand	FLOAT	0 to +9999 M	watts		2

Modbus Address		Description	Format	Range	Units or Resolution	Comments	# Reg
Hex	Decimal						
1713 -	1714	5908 - 5909	Positive VARs, 3-Ph, Maximum Avg Demand	FLOAT	0 to +9999 M	VARs	2
1715 -	1716	5910 - 5911	Negative Watts, 3-Ph, Maximum Avg Demand	FLOAT	0 to +9999 M	watts	2
1717 -	1718	5912 - 5913	Negative VARs, 3-Ph, Maximum Avg Demand	FLOAT	0 to +9999 M	VARs	2
1719 -	171A	5914 - 5915	VAs, 3-Ph, Maximum Avg Demand	FLOAT	-9999 M to +9999 M	VAs	2
171B -	171C	5916 - 5917	Positive Power Factor, 3-Ph, Maximum Avg Demand	FLOAT	-1.00 to +1.00	none	2
171D -	171E	5918 - 5919	Negative Power Factor, 3-Ph, Maximum Avg Demand	FLOAT	-1.00 to +1.00	none	2
171F -	1720	5920 - 5921	Neutral Current, Maximum Avg Demand	FLOAT	0 to 9999 M	amps	2
1721 -	1722	5922 - 5923	Positive Watts, Phase A, Maximum Avg Demand	FLOAT	-9999 M to +9999 M	watts	2
1723 -	1724	5924 - 5925	Positive Watts, Phase B, Maximum Avg Demand	FLOAT	-9999 M to +9999 M	watts	2
1725 -	1726	5926 - 5927	Positive Watts, Phase C, Maximum Avg Demand	FLOAT	-9999 M to +9999 M	watts	2
1727 -	1728	5928 - 5929	Positive VARs, Phase A, Maximum Avg Demand	FLOAT	-9999 M to +9999 M	VARs	2
1729 -	172A	5930 - 5931	Positive VARs, Phase B, Maximum Avg Demand	FLOAT	-9999 M to +9999 M	VARs	2
172B -	172C	5932 - 5933	Positive VARs, Phase C, Maximum Avg Demand	FLOAT	-9999 M to +9999 M	VARs	2
172D -	172E	5934 - 5935	Negative Watts, Phase A, Maximum Avg Demand	FLOAT	-9999 M to +9999 M	watts	2
172F -	1730	5936 - 5937	Negative Watts, Phase B, Maximum Avg Demand	FLOAT	-9999 M to +9999 M	watts	2
1731 -	1732	5938 - 5939	Negative Watts, Phase C, Maximum Avg Demand	FLOAT	-9999 M to +9999 M	watts	2
1733 -	1734	5940 - 5941	Negative VARs, Phase A, Maximum Avg Demand	FLOAT	-9999 M to +9999 M	VARs	2
1735 -	1736	5942 - 5943	Negative VARs, Phase B, Maximum Avg Demand	FLOAT	-9999 M to +9999 M	VARs	2
1737 -	1738	5944 - 5945	Negative VARs, Phase C, Maximum Avg Demand	FLOAT	-9999 M to +9999 M	VARs	2
1739 -	173A	5946 - 5947	VAs, Phase A, Maximum Avg Demand	FLOAT	-9999 M to +9999 M	VAs	2

Modbus Address		Description	Format	Range	Units or Resolution	Comments	# Reg
Hex	Decimal						
173B -	173C	5948 - 5949	VAs, Phase B, Maximum Avg Demand	FLOAT	-9999 M to +9999 M	VAs	2
173D -	173E	5950 - 5951	VAs, Phase C, Maximum Avg Demand	FLOAT	-9999 M to +9999 M	VAs	2
173F -	1740	5952 - 5953	Positive PF, Phase A, Maximum Avg Demand	FLOAT	-1.00 to +1.00	none	2
1741 -	1742	5954 - 5955	Positive PF, Phase B, Maximum Avg Demand	FLOAT	-1.00 to +1.00	none	2
1743 -	1744	5956 - 5957	Positive PF, Phase C, Maximum Avg Demand	FLOAT	-1.00 to +1.00	none	2
1745 -	1746	5958 - 5959	Negative PF, Phase A, Maximum Avg Demand	FLOAT	-1.00 to +1.00	none	2
1747 -	1748	5960 - 5961	Negative PF, Phase B, Maximum Avg Demand	FLOAT	-1.00 to +1.00	none	2
1749 -	174A	5962 - 5963	Negative PF, Phase C, Maximum Avg Demand	FLOAT	-1.00 to +1.00	none	2
						Block Size:	64
Primary Maximum Block Meter 7						read-only	
176F -	1770	6000 - 6001	Amps A, Maximum Avg Demand	FLOAT	0 to 9999 M	amps	2
1771 -	1772	6002 - 6003	Amps B, Maximum Avg Demand	FLOAT	0 to 9999 M	amps	2
1773 -	1774	6004 - 6005	Amps C, Maximum Avg Demand	FLOAT	0 to 9999 M	amps	2
1775 -	1776	6006 - 6007	Positive Watts, 3-Ph, Maximum Avg Demand	FLOAT	0 to +9999 M	watts	2
1777 -	1778	6008 - 6009	Positive VARs, 3-Ph, Maximum Avg Demand	FLOAT	0 to +9999 M	VARs	2
1779 -	177A	6010 - 6011	Negative Watts, 3-Ph, Maximum Avg Demand	FLOAT	0 to +9999 M	watts	2
177B -	177C	6012 - 6013	Negative VARs, 3-Ph, Maximum Avg Demand	FLOAT	0 to +9999 M	VARs	2
177D -	177E	6014 - 6015	VAs, 3-Ph, Maximum Avg Demand	FLOAT	-9999 M to +9999 M	VAs	2
177F -	1780	6016 - 6017	Positive Power Factor, 3-Ph, Maximum Avg Demand	FLOAT	-1.00 to +1.00	none	2
1781 -	1782	6018 - 6019	Negative Power Factor, 3-Ph, Maximum Avg Demand	FLOAT	-1.00 to +1.00	none	2
1783 -	1784	6020 - 6021	Neutral Current, Maximum Avg Demand	FLOAT	0 to 9999 M	amps	2
1785 -	1786	6022 - 6023	Positive Watts, Phase A, Maximum Avg Demand	FLOAT	-9999 M to +9999 M	watts	2

Modbus Address		Description	Format	Range	Units or Resolution	Comments	# Reg		
Hex	Decimal								
1787 -	1788	6024 - 6025		Positive Watts, Phase B, Maximum Avg Demand	FLOAT	-9999 M to +9999 M	watts		2
1789 -	178A	6026 - 6027		Positive Watts, Phase C, Maximum Avg Demand	FLOAT	-9999 M to +9999 M	watts		2
178B -	178C	6028 - 6029		Positive VARs, Phase A, Maximum Avg Demand	FLOAT	-9999 M to +9999 M	VARs		2
178D -	178E	6030 - 6031		Positive VARs, Phase B, Maximum Avg Demand	FLOAT	-9999 M to +9999 M	VARs		2
178F -	1790	6032 - 6033		Positive VARs, Phase C, Maximum Avg Demand	FLOAT	-9999 M to +9999 M	VARs		2
1791 -	1792	6034 - 6035		Negative Watts, Phase A, Maximum Avg Demand	FLOAT	-9999 M to +9999 M	watts		2
1793 -	1794	6036 - 6037		Negative Watts, Phase B, Maximum Avg Demand	FLOAT	-9999 M to +9999 M	watts		2
1795 -	1796	6038 - 6039		Negative Watts, Phase C, Maximum Avg Demand	FLOAT	-9999 M to +9999 M	watts		2
1797 -	1798	6040 - 6041		Negative VARs, Phase A, Maximum Avg Demand	FLOAT	-9999 M to +9999 M	VARs		2
1799 -	179A	6042 - 6043		Negative VARs, Phase B, Maximum Avg Demand	FLOAT	-9999 M to +9999 M	VARs		2
179B -	179C	6044 - 6045		Negative VARs, Phase C, Maximum Avg Demand	FLOAT	-9999 M to +9999 M	VARs		2
179D -	179E	6046 - 6047		VAs, Phase A, Maximum Avg Demand	FLOAT	-9999 M to +9999 M	VAs		2
179F -	17A0	6048 - 6049		VAs, Phase B, Maximum Avg Demand	FLOAT	-9999 M to +9999 M	VAs		2
17A1 -	17A2	6050 - 6051		VAs, Phase C, Maximum Avg Demand	FLOAT	-9999 M to +9999 M	VAs		2
17A3 -	17A4	6052 - 6053		Positive PF, Phase A, Maximum Avg Demand	FLOAT	-1.00 to +1.00	none		2
17A5 -	17A6	6054 - 6055		Positive PF, Phase B, Maximum Avg Demand	FLOAT	-1.00 to +1.00	none		2
17A7 -	17A8	6056 - 6057		Positive PF, Phase C, Maximum Avg Demand	FLOAT	-1.00 to +1.00	none		2
17A9 -	17AA	6058 - 6059		Negative PF, Phase A, Maximum Avg Demand	FLOAT	-1.00 to +1.00	none		2

Modbus Address		Description	Format	Range	Units or Resolution	Comments	# Reg
Hex	Decimal						
17AB -	17AC	6060 - 6061		Float	-1.00 to +1.00	none	2
17AD -	17AE	6062 - 6063		Float	-1.00 to +1.00	none	2
						Block Size:	64
Primary Maximum Block Meter 8						read-only	
17D3 -	17D4	6100 - 6101		Float	0 to 9999 M	amps	2
17D5 -	17D6	6102 - 6103		Float	0 to 9999 M	amps	2
17D7 -	17D8	6104 - 6105		Float	0 to 9999 M	amps	2
17D9 -	17DA	6106 - 6107		Float	0 to +9999 M	watts	2
17DB -	17DC	6108 - 6109		Float	0 to +9999 M	VARs	2
17DD -	17DE	6110 - 6111		Float	0 to +9999 M	watts	2
17DF -	17E0	6112 - 6113		Float	0 to +9999 M	VARs	2
17E1 -	17E2	6114 - 6115		Float	-9999 M to +9999 M	VAs	2
17E3 -	17E4	6116 - 6117		Float	-1.00 to +1.00	none	2
17E5 -	17E6	6118 - 6119		Float	-1.00 to +1.00	none	2
17E7 -	17E8	6120 - 6121		Float	0 to 9999 M	amps	2
17E9 -	17EA	6122 - 6123		Float	-9999 M to +9999 M	watts	2
17EB -	17EC	6124 - 6125		Float	-9999 M to +9999 M	watts	2
17ED -	17EE	6126 - 6127		Float	-9999 M to +9999 M	watts	2
17EF -	17F0	6128 - 6129		Float	-9999 M to +9999 M	VARs	2
17F1 -	17F2	6130 - 6131		Float	-9999 M to +9999 M	VARs	2
17F3 -	17F4	6132 - 6133		Float	-9999 M to +9999 M	VARs	2
17F5 -	17F6	6134 - 6135		Float	-9999 M to +9999 M	watts	2

Modbus Address		Description	Format	Range	Units or Resolution	Comments	# Reg
Hex	Decimal						
17F7 - 17F8	6136 - 6137	Negative Watts, Phase B, Maximum Avg Demand	FLOAT	-9999 M to +9999 M	watts		2
17F9 - 17FA	6138 - 6139	Negative Watts, Phase C, Maximum Avg Demand	FLOAT	-9999 M to +9999 M	watts		2
17FB - 17FC	6140 - 6141	Negative VARs, Phase A, Maximum Avg Demand	FLOAT	-9999 M to +9999 M	VARs		2
17FD - 17FE	6142 - 6143	Negative VARs, Phase B, Maximum Avg Demand	FLOAT	-9999 M to +9999 M	VARs		2
17FF - 1800	6144 - 6145	Negative VARs, Phase C, Maximum Avg Demand	FLOAT	-9999 M to +9999 M	VARs		2
1801 - 1802	6146 - 6147	VAs, Phase A, Maximum Avg Demand	FLOAT	-9999 M to +9999 M	VAs		2
1803 - 1804	6148 - 6149	VAs, Phase B, Maximum Avg Demand	FLOAT	-9999 M to +9999 M	VAs		2
1805 - 1806	6150 - 6151	VAs, Phase C, Maximum Avg Demand	FLOAT	-9999 M to +9999 M	VAs		2
1807 - 1808	6152 - 6153	Positive PF, Phase A, Maximum Avg Demand	FLOAT	-1.00 to +1.00	none		2
1809 - 180A	6154 - 6155	Positive PF, Phase B, Maximum Avg Demand	FLOAT	-1.00 to +1.00	none		2
180B - 180C	6156 - 6157	Positive PF, Phase C, Maximum Avg Demand	FLOAT	-1.00 to +1.00	none		2
180D - 180E	6158 - 6159	Negative PF, Phase A, Maximum Avg Demand	FLOAT	-1.00 to +1.00	none		2
180F - 1810	6160 - 6161	Negative PF, Phase B, Maximum Avg Demand	FLOAT	-1.00 to +1.00	none		2
1811 - 1812	6162 - 6163	Negative PF, Phase C, Maximum Avg Demand	FLOAT	-1.00 to +1.00	none		2
						Block Size:	64
Primary maximum Timestamp Block						read-only	
1837 - 1839	6200 - 6202	Volts A-N, max Timestamp	TSTAMP	1Jan2000 - 31Dec2099	1 sec		3
183A - 183C	6203 - 6205	Volts B-N, max Timestamp	TSTAMP	1Jan2000 - 31Dec2099	1 sec		3
183D - 183F	6206 - 6208	Volts C-N, max Timestamp	TSTAMP	1Jan2000 - 31Dec2099	1 sec		3
1840 - 1842	6209 - 6211	Volts A-B, max Timestamp	TSTAMP	1Jan2000 - 31Dec2099	1 sec		3
1843 - 1845	6212 - 6214	Volts B-C, max Timestamp	TSTAMP	1Jan2000 - 31Dec2099	1 sec		3

Modbus Address		Description	Format	Range	Units or Resolution	Comments	# Reg
Hex	Decimal						
1846 -	1848	6215 - 6217					3
		Volts C-A, max Timestamp	TSTAMP	1Jan2000 - 31Dec2099	1 sec		
1849 -	184B	6218 - 6220					3
		Frequency, max Timestamp	TSTAMP	1Jan2000 - 31Dec2099	1 sec		
						Block Size:	21
Primary maximum Timestamp Block Meter 1						read-only	
189B -	189D	6300 - 6302					3
		Amps A, max Avg Dmd Timestamp	TSTAMP	1Jan2000 - 31Dec2099	1 sec		
189E -	18A0	6303 - 6305					3
		Amps B, max Avg Dmd Timestamp	TSTAMP	1Jan2000 - 31Dec2099	1 sec		
18A1 -	18A3	6306 - 6308					3
		Amps C, max Avg Dmd Timestamp	TSTAMP	1Jan2000 - 31Dec2099	1 sec		
18A4 -	18A6	6309 - 6311					3
		Positive Watts, 3-Ph, max Avg Dmd Timestamp	TSTAMP	1Jan2000 - 31Dec2099	1 sec		
18A7 -	18A9	6312 - 6314					3
		Positive VARs, 3-Ph, max Avg Dmd Timestamp	TSTAMP	1Jan2000 - 31Dec2099	1 sec		
18AA -	18AC	6315 - 6317					3
		Negative Watts, 3-Ph, max Avg Dmd Timestamp	TSTAMP	1Jan2000 - 31Dec2099	1 sec		
18AD -	18AF	6318 - 6320					3
		Negative VARs, 3-Ph, max Avg Dmd Timestamp	TSTAMP	1Jan2000 - 31Dec2099	1 sec		
18B0 -	18B2	6321 - 6323					3
		VAs, 3-Ph, max Avg Dmd Timestamp	TSTAMP	1Jan2000 - 31Dec2099	1 sec		
18B3 -	18B5	6324 - 6326					3
		Positive Power Factor, 3-Ph, max Avg Dmd Timestamp	TSTAMP	1Jan2000 - 31Dec2099	1 sec		
18B6 -	18B8	6327 - 6329					3
		Negative Power Factor, 3-Ph, max Avg Dmd Timestamp	TSTAMP	1Jan2000 - 31Dec2099	1 sec		
18B9 -	18BB	6330 - 6332					3
		Neutral Current, max Avg Dmd Timestamp	TSTAMP	1Jan2000 - 31Dec2100	1 sec		
18BC -	18BE	6333 - 6335					3
		Positive Watts, Phase A, max Avg Dmd Timestamp	TSTAMP	1Jan2000 - 31Dec2099	1 sec		
18BF -	18C1	6336 - 6338					3
		Positive Watts, Phase B, max Avg Dmd Timestamp	TSTAMP	1Jan2000 - 31Dec2099	1 sec		
18C2 -	18C4	6339 - 6341					3
		Positive Watts, Phase C, max Avg Dmd Timestamp	TSTAMP	1Jan2000 - 31Dec2099	1 sec		
18C5 -	18C7	6342 - 6344					3
		Positive VARs, Phase A, max Avg Dmd Timestamp	TSTAMP	1Jan2000 - 31Dec2099	1 sec		
18C8 -	18CA	6345 - 6347					3
		Positive VARs, Phase B, max Avg Dmd Timestamp	TSTAMP	1Jan2000 - 31Dec2099	1 sec		
18CB -	18CD	6348 - 6350					3
		Positive VARs, Phase C, max Avg Dmd Timestamp	TSTAMP	1Jan2000 - 31Dec2099	1 sec		

Modbus Address		Description	Format	Range	Units or Resolution	Comments	# Reg	
Hex	Decimal							
18CE -	18D0	6351 - 6353	Negative Watts, Phase A, max Avg Dmd Timestamp	TSTAMP	1Jan2000 - 31Dec2099	1 sec		3
18D1 -	18D3	6354 - 6356	Negative Watts, Phase B, max Avg Dmd Timestamp	TSTAMP	1Jan2000 - 31Dec2099	1 sec		3
18D4 -	18D6	6357 - 6359	Negative Watts, Phase C, max Avg Dmd Timestamp	TSTAMP	1Jan2000 - 31Dec2099	1 sec		3
18D7 -	18D9	6360 - 6362	Negative VARs, Phase A, max Avg Dmd Timestamp	TSTAMP	1Jan2000 - 31Dec2099	1 sec		3
18DA -	18DC	6363 - 6365	Negative VARs, Phase B, max Avg Dmd Timestamp	TSTAMP	1Jan2000 - 31Dec2099	1 sec		3
18DD -	18DF	6366 - 6368	Negative VARs, Phase C, max Avg Dmd Timestamp	TSTAMP	1Jan2000 - 31Dec2099	1 sec		3
18E0 -	18E2	6369 - 6371	VAs, Phase A, max Avg Dmd Timestamp	TSTAMP	1Jan2000 - 31Dec2099	1 sec		3
18E3 -	18E5	6372 - 6374	VAs, Phase B, max Avg Dmd Timestamp	TSTAMP	1Jan2000 - 31Dec2099	1 sec		3
18E6 -	18E8	6375 - 6377	VAs, Phase C, max Avg Dmd Timestamp	TSTAMP	1Jan2000 - 31Dec2099	1 sec		3
18E9 -	18EB	6378 - 6380	Positive PF, Phase A, max Avg Dmd Timestamp	TSTAMP	1Jan2000 - 31Dec2099	1 sec		3
18EC -	18EE	6381 - 6383	Positive PF, Phase B, max Avg Dmd Timestamp	TSTAMP	1Jan2000 - 31Dec2099	1 sec		3
18EF -	18F1	6384 - 6386	Positive PF, Phase C, max Avg Dmd Timestamp	TSTAMP	1Jan2000 - 31Dec2099	1 sec		3
18F2 -	18F4	6387 - 6389	Negative PF, Phase A, max Avg Dmd Timestamp	TSTAMP	1Jan2000 - 31Dec2099	1 sec		3
18F5 -	18F7	6390 - 6392	Negative PF, Phase B, max Avg Dmd Timestamp	TSTAMP	1Jan2000 - 31Dec2099	1 sec		3
18F8 -	18FA	6393 - 6395	Negative PF, Phase C, max Avg Dmd Timestamp	TSTAMP	1Jan2000 - 31Dec2099	1 sec		3
						Block Size:		96
Primary maximum Timestamp Block Meter 2						read-only		
18FF -	1901	6400 - 6402	Amps A, max Avg Dmd Timestamp	TSTAMP	1Jan2000 - 31Dec2099	1 sec		3
1902 -	1904	6403 - 6405	Amps B, max Avg Dmd Timestamp	TSTAMP	1Jan2000 - 31Dec2099	1 sec		3
1905 -	1907	6406 - 6408	Amps C, max Avg Dmd Timestamp	TSTAMP	1Jan2000 - 31Dec2099	1 sec		3
1908 -	190A	6409 - 6411	Positive Watts, 3-Ph, max Avg Dmd Timestamp	TSTAMP	1Jan2000 - 31Dec2099	1 sec		3

Modbus Address		Description	Format	Range	Units or Resolution	Comments	# Reg	
Hex	Decimal							
190B -	190D	6412 - 6414	Positive VARs, 3-Ph, max Avg Dmd Timestamp	TSTAMP	1Jan2000 - 31Dec2099	1 sec		3
190E -	1910	6415 - 6417	Negative Watts, 3-Ph, max Avg Dmd Timestamp	TSTAMP	1Jan2000 - 31Dec2099	1 sec		3
1911 -	1913	6418 - 6420	Negative VARs, 3-Ph, max Avg Dmd Timestamp	TSTAMP	1Jan2000 - 31Dec2099	1 sec		3
1914 -	1916	6421 - 6423	VAs, 3-Ph, max Avg Dmd Timestamp	TSTAMP	1Jan2000 - 31Dec2099	1 sec		3
1917 -	1919	6424 - 6426	Positive Power Factor, 3-Ph, max Avg Dmd Timestamp	TSTAMP	1Jan2000 - 31Dec2099	1 sec		3
191A -	191C	6427 - 6429	Negative Power Factor, 3-Ph, max Avg Dmd Timestamp	TSTAMP	1Jan2000 - 31Dec2099	1 sec		3
191D -	191F	6430 - 6432	Neutral Current, max Avg Dmd Timestamp	TSTAMP	1Jan2000 - 31Dec2100	1 sec		3
1920 -	1922	6433 - 6435	Positive Watts, Phase A, max Avg Dmd Timestamp	TSTAMP	1Jan2000 - 31Dec2099	1 sec		3
1923 -	1925	6436 - 6438	Positive Watts, Phase B, max Avg Dmd Timestamp	TSTAMP	1Jan2000 - 31Dec2099	1 sec		3
1926 -	1928	6439 - 6441	Positive Watts, Phase C, max Avg Dmd Timestamp	TSTAMP	1Jan2000 - 31Dec2099	1 sec		3
1929 -	192B	6442 - 6444	Positive VARs, Phase A, max Avg Dmd Timestamp	TSTAMP	1Jan2000 - 31Dec2099	1 sec		3
192C -	192E	6445 - 6447	Positive VARs, Phase B, max Avg Dmd Timestamp	TSTAMP	1Jan2000 - 31Dec2099	1 sec		3
192F -	1931	6448 - 6450	Positive VARs, Phase C, max Avg Dmd Timestamp	TSTAMP	1Jan2000 - 31Dec2099	1 sec		3
1932 -	1934	6451 - 6453	Negative Watts, Phase A, max Avg Dmd Timestamp	TSTAMP	1Jan2000 - 31Dec2099	1 sec		3
1935 -	1937	6454 - 6456	Negative Watts, Phase B, max Avg Dmd Timestamp	TSTAMP	1Jan2000 - 31Dec2099	1 sec		3
1938 -	193A	6457 - 6459	Negative Watts, Phase C, max Avg Dmd Timestamp	TSTAMP	1Jan2000 - 31Dec2099	1 sec		3
193B -	193D	6460 - 6462	Negative VARs, Phase A, max Avg Dmd Timestamp	TSTAMP	1Jan2000 - 31Dec2099	1 sec		3
193E -	1940	6463 - 6465	Negative VARs, Phase B, max Avg Dmd Timestamp	TSTAMP	1Jan2000 - 31Dec2099	1 sec		3
1941 -	1943	6466 - 6468	Negative VARs, Phase C, max Avg Dmd Timestamp	TSTAMP	1Jan2000 - 31Dec2099	1 sec		3
1944 -	1946	6469 - 6471	VAs, Phase A, max Avg Dmd Timestamp	TSTAMP	1Jan2000 - 31Dec2099	1 sec		3

Modbus Address		Description	Format	Range	Units or Resolution	Comments	# Reg
Hex	Decimal						
1947 - 1949	6472 - 6474	VAs, Phase B, max Avg Dmd Timestamp	TSTAMP	1Jan2000 - 31Dec2099	1 sec		3
194A - 194C	6475 - 6477	VAs, Phase C, max Avg Dmd Timestamp	TSTAMP	1Jan2000 - 31Dec2099	1 sec		3
194D - 194F	6478 - 6480	Positive PF, Phase A, max Avg Dmd Timestamp	TSTAMP	1Jan2000 - 31Dec2099	1 sec		3
1950 - 1952	6481 - 6483	Positive PF, Phase B, max Avg Dmd Timestamp	TSTAMP	1Jan2000 - 31Dec2099	1 sec		3
1953 - 1955	6484 - 6486	Positive PF, Phase C, max Avg Dmd Timestamp	TSTAMP	1Jan2000 - 31Dec2099	1 sec		3
1956 - 1958	6487 - 6489	Negative PF, Phase A, max Avg Dmd Timestamp	TSTAMP	1Jan2000 - 31Dec2099	1 sec		3
1959 - 195B	6490 - 6492	Negative PF, Phase B, max Avg Dmd Timestamp	TSTAMP	1Jan2000 - 31Dec2099	1 sec		3
195C - 195E	6493 - 6495	Negative PF, Phase C, max Avg Dmd Timestamp	TSTAMP	1Jan2000 - 31Dec2099	1 sec		3
						Block Size:	96
Primary maximum Timestamp Block Meter 3						read-only	
1963 - 1965	6500 - 6502	Amps A, max Avg Dmd Timestamp	TSTAMP	1Jan2000 - 31Dec2099	1 sec		3
1966 - 1968	6503 - 6505	Amps B, max Avg Dmd Timestamp	TSTAMP	1Jan2000 - 31Dec2099	1 sec		3
1969 - 196B	6506 - 6508	Amps C, max Avg Dmd Timestamp	TSTAMP	1Jan2000 - 31Dec2099	1 sec		3
196C - 196E	6509 - 6511	Positive Watts, 3-Ph, max Avg Dmd Timestamp	TSTAMP	1Jan2000 - 31Dec2099	1 sec		3
196F - 1971	6512 - 6514	Positive VARs, 3-Ph, max Avg Dmd Timestamp	TSTAMP	1Jan2000 - 31Dec2099	1 sec		3
1972 - 1974	6515 - 6517	Negative Watts, 3-Ph, max Avg Dmd Timestamp	TSTAMP	1Jan2000 - 31Dec2099	1 sec		3
1975 - 1977	6518 - 6520	Negative VARs, 3-Ph, max Avg Dmd Timestamp	TSTAMP	1Jan2000 - 31Dec2099	1 sec		3
1978 - 197A	6521 - 6523	VAs, 3-Ph, max Avg Dmd Timestamp	TSTAMP	1Jan2000 - 31Dec2099	1 sec		3
197B - 197D	6524 - 6526	Positive Power Factor, 3-Ph, max Avg Dmd Timestamp	TSTAMP	1Jan2000 - 31Dec2099	1 sec		3
197E - 1980	6527 - 6529	Negative Power Factor, 3-Ph, max Avg Dmd Timestamp	TSTAMP	1Jan2000 - 31Dec2099	1 sec		3
1981 - 1983	6530 - 6532	Neutral Current, max Avg Dmd Timestamp	TSTAMP	1Jan2000 - 31Dec2100	1 sec		3

Modbus Address		Description	Format	Range	Units or Resolution	Comments	# Reg
Hex	Decimal						
1984 - 1986	6533 - 6535	Positive Watts, Phase A, max Avg Dmd Timestamp	TSTAMP	1Jan2000 - 31Dec2099	1 sec		3
1987 - 1989	6536 - 6538	Positive Watts, Phase B, max Avg Dmd Timestamp	TSTAMP	1Jan2000 - 31Dec2099	1 sec		3
198A - 198C	6539 - 6541	Positive Watts, Phase C, max Avg Dmd Timestamp	TSTAMP	1Jan2000 - 31Dec2099	1 sec		3
198D - 198F	6542 - 6544	Positive VARs, Phase A, max Avg Dmd Timestamp	TSTAMP	1Jan2000 - 31Dec2099	1 sec		3
1990 - 1992	6545 - 6547	Positive VARs, Phase B, max Avg Dmd Timestamp	TSTAMP	1Jan2000 - 31Dec2099	1 sec		3
1993 - 1995	6548 - 6550	Positive VARs, Phase C, max Avg Dmd Timestamp	TSTAMP	1Jan2000 - 31Dec2099	1 sec		3
1996 - 1998	6551 - 6553	Negative Watts, Phase A, max Avg Dmd Timestamp	TSTAMP	1Jan2000 - 31Dec2099	1 sec		3
1999 - 199B	6554 - 6556	Negative Watts, Phase B, max Avg Dmd Timestamp	TSTAMP	1Jan2000 - 31Dec2099	1 sec		3
199C - 199E	6557 - 6559	Negative Watts, Phase C, max Avg Dmd Timestamp	TSTAMP	1Jan2000 - 31Dec2099	1 sec		3
199F - 19A1	6560 - 6562	Negative VARs, Phase A, max Avg Dmd Timestamp	TSTAMP	1Jan2000 - 31Dec2099	1 sec		3
19A2 - 19A4	6563 - 6565	Negative VARs, Phase B, max Avg Dmd Timestamp	TSTAMP	1Jan2000 - 31Dec2099	1 sec		3
19A5 - 19A7	6566 - 6568	Negative VARs, Phase C, max Avg Dmd Timestamp	TSTAMP	1Jan2000 - 31Dec2099	1 sec		3
19A8 - 19AA	6569 - 6571	VAs, Phase A, max Avg Dmd Timestamp	TSTAMP	1Jan2000 - 31Dec2099	1 sec		3
19AB - 19AD	6572 - 6574	VAs, Phase B, max Avg Dmd Timestamp	TSTAMP	1Jan2000 - 31Dec2099	1 sec		3
19AE - 19B0	6575 - 6577	VAs, Phase C, max Avg Dmd Timestamp	TSTAMP	1Jan2000 - 31Dec2099	1 sec		3
19B1 - 19B3	6578 - 6580	Positive PF, Phase A, max Avg Dmd Timestamp	TSTAMP	1Jan2000 - 31Dec2099	1 sec		3
19B4 - 19B6	6581 - 6583	Positive PF, Phase B, max Avg Dmd Timestamp	TSTAMP	1Jan2000 - 31Dec2099	1 sec		3
19B7 - 19B9	6584 - 6586	Positive PF, Phase C, max Avg Dmd Timestamp	TSTAMP	1Jan2000 - 31Dec2099	1 sec		3
19BA - 19BC	6587 - 6589	Negative PF, Phase A, max Avg Dmd Timestamp	TSTAMP	1Jan2000 - 31Dec2099	1 sec		3

Modbus Address		Description	Format	Range	Units or Resolution	Comments	# Reg
Hex	Decimal						
19BD -	19BF	6590 - 6592	Negative PF, Phase B, max Avg Dmd Timestamp	TSTAMP	1Jan2000 - 31Dec2099	1 sec	3
19C0 -	19C2	6593 - 6595	Negative PF, Phase C, max Avg Dmd Timestamp	TSTAMP	1Jan2000 - 31Dec2099	1 sec	3
						Block Size:	96
Primary maximum Timestamp Block Meter 4						read-only	
19C7 -	19C9	6600 - 6602	Amps A, max Avg Dmd Timestamp	TSTAMP	1Jan2000 - 31Dec2099	1 sec	3
19CA -	19CC	6603 - 6605	Amps B, max Avg Dmd Timestamp	TSTAMP	1Jan2000 - 31Dec2099	1 sec	3
19CD -	19CF	6606 - 6608	Amps C, max Avg Dmd Timestamp	TSTAMP	1Jan2000 - 31Dec2099	1 sec	3
19D0 -	19D2	6609 - 6611	Positive Watts, 3-Ph, max Avg Dmd Timestamp	TSTAMP	1Jan2000 - 31Dec2099	1 sec	3
19D3 -	19D5	6612 - 6614	Positive VARs, 3-Ph, max Avg Dmd Timestamp	TSTAMP	1Jan2000 - 31Dec2099	1 sec	3
19D6 -	19D8	6615 - 6617	Negative Watts, 3-Ph, max Avg Dmd Timestamp	TSTAMP	1Jan2000 - 31Dec2099	1 sec	3
19D9 -	19DB	6618 - 6620	Negative VARs, 3-Ph, max Avg Dmd Timestamp	TSTAMP	1Jan2000 - 31Dec2099	1 sec	3
19DC -	19DE	6621 - 6623	VAs, 3-Ph, max Avg Dmd Timestamp	TSTAMP	1Jan2000 - 31Dec2099	1 sec	3
19DF -	19E1	6624 - 6626	Positive Power Factor, 3-Ph, max Avg Dmd Timestamp	TSTAMP	1Jan2000 - 31Dec2099	1 sec	3
19E2 -	19E4	6627 - 6629	Negative Power Factor, 3-Ph, max Avg Dmd Timestamp	TSTAMP	1Jan2000 - 31Dec2099	1 sec	3
19E5 -	19E7	6630 - 6632	Neutral Current, max Avg Dmd Timestamp	TSTAMP	1Jan2000 - 31Dec2100	1 sec	3
19E8 -	19EA	6633 - 6635	Positive Watts, Phase A, max Avg Dmd Timestamp	TSTAMP	1Jan2000 - 31Dec2099	1 sec	3
19EB -	19ED	6636 - 6638	Positive Watts, Phase B, max Avg Dmd Timestamp	TSTAMP	1Jan2000 - 31Dec2099	1 sec	3
19EE -	19F0	6639 - 6641	Positive Watts, Phase C, max Avg Dmd Timestamp	TSTAMP	1Jan2000 - 31Dec2099	1 sec	3
19F1 -	19F3	6642 - 6644	Positive VARs, Phase A, max Avg Dmd Timestamp	TSTAMP	1Jan2000 - 31Dec2099	1 sec	3
19F4 -	19F6	6645 - 6647	Positive VARs, Phase B, max Avg Dmd Timestamp	TSTAMP	1Jan2000 - 31Dec2099	1 sec	3
19F7 -	19F9	6648 - 6650	Positive VARs, Phase C, max Avg Dmd Timestamp	TSTAMP	1Jan2000 - 31Dec2099	1 sec	3

Modbus Address		Description	Format	Range	Units or Resolution	Comments	# Reg
Hex	Decimal						
19FA - 19FC	6651 - 6653	Negative Watts, Phase A, max Avg Dmd Timestamp	TSTAMP	1Jan2000 - 31Dec2099	1 sec		3
19FD - 19FF	6654 - 6656	Negative Watts, Phase B, max Avg Dmd Timestamp	TSTAMP	1Jan2000 - 31Dec2099	1 sec		3
1A00 - 1A02	6657 - 6659	Negative Watts, Phase C, max Avg Dmd Timestamp	TSTAMP	1Jan2000 - 31Dec2099	1 sec		3
1A03 - 1A05	6660 - 6662	Negative VARs, Phase A, max Avg Dmd Timestamp	TSTAMP	1Jan2000 - 31Dec2099	1 sec		3
1A06 - 1A08	6663 - 6665	Negative VARs, Phase B, max Avg Dmd Timestamp	TSTAMP	1Jan2000 - 31Dec2099	1 sec		3
1A09 - 1A0B	6666 - 6668	Negative VARs, Phase C, max Avg Dmd Timestamp	TSTAMP	1Jan2000 - 31Dec2099	1 sec		3
1A0C - 1A0E	6669 - 6671	VAs, Phase A, max Avg Dmd Timestamp	TSTAMP	1Jan2000 - 31Dec2099	1 sec		3
1A0F - 1A11	6672 - 6674	VAs, Phase B, max Avg Dmd Timestamp	TSTAMP	1Jan2000 - 31Dec2099	1 sec		3
1A12 - 1A14	6675 - 6677	VAs, Phase C, max Avg Dmd Timestamp	TSTAMP	1Jan2000 - 31Dec2099	1 sec		3
1A15 - 1A17	6678 - 6680	Positive PF, Phase A, max Avg Dmd Timestamp	TSTAMP	1Jan2000 - 31Dec2099	1 sec		3
1A18 - 1A1A	6681 - 6683	Positive PF, Phase B, max Avg Dmd Timestamp	TSTAMP	1Jan2000 - 31Dec2099	1 sec		3
1A1B - 1A1D	6684 - 6686	Positive PF, Phase C, max Avg Dmd Timestamp	TSTAMP	1Jan2000 - 31Dec2099	1 sec		3
1A1E - 1A20	6687 - 6689	Negative PF, Phase A, max Avg Dmd Timestamp	TSTAMP	1Jan2000 - 31Dec2099	1 sec		3
1A21 - 1A23	6690 - 6692	Negative PF, Phase B, max Avg Dmd Timestamp	TSTAMP	1Jan2000 - 31Dec2099	1 sec		3
1A24 - 1A26	6693 - 6695	Negative PF, Phase C, max Avg Dmd Timestamp	TSTAMP	1Jan2000 - 31Dec2099	1 sec		3
						Block Size:	96
Primary maximum Timestamp Block Meter 5						read-only	
1A2B - 1A2D	6700 - 6702	Amps A, max Avg Dmd Timestamp	TSTAMP	1Jan2000 - 31Dec2099	1 sec		3
1A2E - 1A30	6703 - 6705	Amps B, max Avg Dmd Timestamp	TSTAMP	1Jan2000 - 31Dec2099	1 sec		3
1A31 - 1A33	6706 - 6708	Amps C, max Avg Dmd Timestamp	TSTAMP	1Jan2000 - 31Dec2099	1 sec		3
1A34 - 1A36	6709 - 6711	Positive Watts, 3-Ph, max Avg Dmd Timestamp	TSTAMP	1Jan2000 - 31Dec2099	1 sec		3

Modbus Address		Description	Format	Range	Units or Resolution	Comments	# Reg
Hex	Decimal						
1A37 -	1A39	6712 - 6714	Positive VARs, 3-Ph, max Avg Dmd Timestamp	TSTAMP	1Jan2000 - 31Dec2099	1 sec	3
1A3A -	1A3C	6715 - 6717	Negative Watts, 3-Ph, max Avg Dmd Timestamp	TSTAMP	1Jan2000 - 31Dec2099	1 sec	3
1A3D -	1A3F	6718 - 6720	Negative VARs, 3-Ph, max Avg Dmd Timestamp	TSTAMP	1Jan2000 - 31Dec2099	1 sec	3
1A40 -	1A42	6721 - 6723	VAs, 3-Ph, max Avg Dmd Timestamp	TSTAMP	1Jan2000 - 31Dec2099	1 sec	3
1A43 -	1A45	6724 - 6726	Positive Power Factor, 3-Ph, max Avg Dmd Timestamp	TSTAMP	1Jan2000 - 31Dec2099	1 sec	3
1A46 -	1A48	6727 - 6729	Negative Power Factor, 3-Ph, max Avg Dmd Timestamp	TSTAMP	1Jan2000 - 31Dec2099	1 sec	3
1A49 -	1A4B	6730 - 6732	Neutral Current, max Avg Dmd Timestamp	TSTAMP	1Jan2000 - 31Dec2100	1 sec	3
1A4C -	1A4E	6733 - 6735	Positive Watts, Phase A, max Avg Dmd Timestamp	TSTAMP	1Jan2000 - 31Dec2099	1 sec	3
1A4F -	1A51	6736 - 6738	Positive Watts, Phase B, max Avg Dmd Timestamp	TSTAMP	1Jan2000 - 31Dec2099	1 sec	3
1A52 -	1A54	6739 - 6741	Positive Watts, Phase C, max Avg Dmd Timestamp	TSTAMP	1Jan2000 - 31Dec2099	1 sec	3
1A55 -	1A57	6742 - 6744	Positive VARs, Phase A, max Avg Dmd Timestamp	TSTAMP	1Jan2000 - 31Dec2099	1 sec	3
1A58 -	1A5A	6745 - 6747	Positive VARs, Phase B, max Avg Dmd Timestamp	TSTAMP	1Jan2000 - 31Dec2099	1 sec	3
1A5B -	1A5D	6748 - 6750	Positive VARs, Phase C, max Avg Dmd Timestamp	TSTAMP	1Jan2000 - 31Dec2099	1 sec	3
1A5E -	1A60	6751 - 6753	Negative Watts, Phase A, max Avg Dmd Timestamp	TSTAMP	1Jan2000 - 31Dec2099	1 sec	3
1A61 -	1A63	6754 - 6756	Negative Watts, Phase B, max Avg Dmd Timestamp	TSTAMP	1Jan2000 - 31Dec2099	1 sec	3
1A64 -	1A66	6757 - 6759	Negative Watts, Phase C, max Avg Dmd Timestamp	TSTAMP	1Jan2000 - 31Dec2099	1 sec	3
1A67 -	1A69	6760 - 6762	Negative VARs, Phase A, max Avg Dmd Timestamp	TSTAMP	1Jan2000 - 31Dec2099	1 sec	3
1A6A -	1A6C	6763 - 6765	Negative VARs, Phase B, max Avg Dmd Timestamp	TSTAMP	1Jan2000 - 31Dec2099	1 sec	3
1A6D -	1A6F	6766 - 6768	Negative VARs, Phase C, max Avg Dmd Timestamp	TSTAMP	1Jan2000 - 31Dec2099	1 sec	3
1A70 -	1A72	6769 - 6771	VAs, Phase A, max Avg Dmd Timestamp	TSTAMP	1Jan2000 - 31Dec2099	1 sec	3

Modbus Address		Description	Format	Range	Units or Resolution	Comments	# Reg
Hex	Decimal						
1A73 - 1A75	6772 - 6774	VAs, Phase B, max Avg Dmd Timestamp	TSTAMP	1Jan2000 - 31Dec2099	1 sec		3
1A76 - 1A78	6775 - 6777	VAs, Phase C, max Avg Dmd Timestamp	TSTAMP	1Jan2000 - 31Dec2099	1 sec		3
1A79 - 1A7B	6778 - 6780	Positive PF, Phase A, max Avg Dmd Timestamp	TSTAMP	1Jan2000 - 31Dec2099	1 sec		3
1A7C - 1A7E	6781 - 6783	Positive PF, Phase B, max Avg Dmd Timestamp	TSTAMP	1Jan2000 - 31Dec2099	1 sec		3
1A7F - 1A81	6784 - 6786	Positive PF, Phase C, max Avg Dmd Timestamp	TSTAMP	1Jan2000 - 31Dec2099	1 sec		3
1A82 - 1A84	6787 - 6789	Negative PF, Phase A, max Avg Dmd Timestamp	TSTAMP	1Jan2000 - 31Dec2099	1 sec		3
1A85 - 1A87	6790 - 6792	Negative PF, Phase B, max Avg Dmd Timestamp	TSTAMP	1Jan2000 - 31Dec2099	1 sec		3
1A88 - 1A8A	6793 - 6795	Negative PF, Phase C, max Avg Dmd Timestamp	TSTAMP	1Jan2000 - 31Dec2099	1 sec		3
						Block Size:	96
Primary maximum Timestamp Block Meter 6						read-only	
1A8F - 1A91	6800 - 6802	Amps A, max Avg Dmd Timestamp	TSTAMP	1Jan2000 - 31Dec2099	1 sec		3
1A92 - 1A94	6803 - 6805	Amps B, max Avg Dmd Timestamp	TSTAMP	1Jan2000 - 31Dec2099	1 sec		3
1A95 - 1A97	6806 - 6808	Amps C, max Avg Dmd Timestamp	TSTAMP	1Jan2000 - 31Dec2099	1 sec		3
1A98 - 1A9A	6809 - 6811	Positive Watts, 3-Ph, max Avg Dmd Timestamp	TSTAMP	1Jan2000 - 31Dec2099	1 sec		3
1A9B - 1A9D	6812 - 6814	Positive VARs, 3-Ph, max Avg Dmd Timestamp	TSTAMP	1Jan2000 - 31Dec2099	1 sec		3
1A9E - 1AA0	6815 - 6817	Negative Watts, 3-Ph, max Avg Dmd Timestamp	TSTAMP	1Jan2000 - 31Dec2099	1 sec		3
1AA1 - 1AA3	6818 - 6820	Negative VARs, 3-Ph, max Avg Dmd Timestamp	TSTAMP	1Jan2000 - 31Dec2099	1 sec		3
1AA4 - 1AA6	6821 - 6823	VAs, 3-Ph, max Avg Dmd Timestamp	TSTAMP	1Jan2000 - 31Dec2099	1 sec		3
1AA7 - 1AA9	6824 - 6826	Positive Power Factor, 3-Ph, max Avg Dmd Timestamp	TSTAMP	1Jan2000 - 31Dec2099	1 sec		3
1AAA - 1AAC	6827 - 6829	Negative Power Factor, 3-Ph, max Avg Dmd Timestamp	TSTAMP	1Jan2000 - 31Dec2099	1 sec		3
1AAD - 1AAF	6830 - 6832	Neutral Current, max Avg Dmd Timestamp	TSTAMP	1Jan2000 - 31Dec2100	1 sec		3

Modbus Address		Description	Format	Range	Units or Resolution	Comments	# Reg
Hex	Decimal						
1AB0 - 1AB2	6833 - 6835	Positive Watts, Phase A, max Avg Dmd Timestamp	TSTAMP	1Jan2000 - 31Dec2099	1 sec		3
1AB3 - 1AB5	6836 - 6838	Positive Watts, Phase B, max Avg Dmd Timestamp	TSTAMP	1Jan2000 - 31Dec2099	1 sec		3
1AB6 - 1AB8	6839 - 6841	Positive Watts, Phase C, max Avg Dmd Timestamp	TSTAMP	1Jan2000 - 31Dec2099	1 sec		3
1AB9 - 1ABB	6842 - 6844	Positive VARs, Phase A, max Avg Dmd Timestamp	TSTAMP	1Jan2000 - 31Dec2099	1 sec		3
1ABC - 1ABE	6845 - 6847	Positive VARs, Phase B, max Avg Dmd Timestamp	TSTAMP	1Jan2000 - 31Dec2099	1 sec		3
1ABF - 1AC1	6848 - 6850	Positive VARs, Phase C, max Avg Dmd Timestamp	TSTAMP	1Jan2000 - 31Dec2099	1 sec		3
1AC2 - 1AC4	6851 - 6853	Negative Watts, Phase A, max Avg Dmd Timestamp	TSTAMP	1Jan2000 - 31Dec2099	1 sec		3
1AC5 - 1AC7	6854 - 6856	Negative Watts, Phase B, max Avg Dmd Timestamp	TSTAMP	1Jan2000 - 31Dec2099	1 sec		3
1AC8 - 1ACA	6857 - 6859	Negative Watts, Phase C, max Avg Dmd Timestamp	TSTAMP	1Jan2000 - 31Dec2099	1 sec		3
1ACB - 1ACD	6860 - 6862	Negative VARs, Phase A, max Avg Dmd Timestamp	TSTAMP	1Jan2000 - 31Dec2099	1 sec		3
1ACE - 1AD0	6863 - 6865	Negative VARs, Phase B, max Avg Dmd Timestamp	TSTAMP	1Jan2000 - 31Dec2099	1 sec		3
1AD1 - 1AD3	6866 - 6868	Negative VARs, Phase C, max Avg Dmd Timestamp	TSTAMP	1Jan2000 - 31Dec2099	1 sec		3
1AD4 - 1AD6	6869 - 6871	VAs, Phase A, max Avg Dmd Timestamp	TSTAMP	1Jan2000 - 31Dec2099	1 sec		3
1AD7 - 1AD9	6872 - 6874	VAs, Phase B, max Avg Dmd Timestamp	TSTAMP	1Jan2000 - 31Dec2099	1 sec		3
1ADA - 1ADC	6875 - 6877	VAs, Phase C, max Avg Dmd Timestamp	TSTAMP	1Jan2000 - 31Dec2099	1 sec		3
1ADD - 1ADF	6878 - 6880	Positive PF, Phase A, max Avg Dmd Timestamp	TSTAMP	1Jan2000 - 31Dec2099	1 sec		3
1AE0 - 1AE2	6881 - 6883	Positive PF, Phase B, max Avg Dmd Timestamp	TSTAMP	1Jan2000 - 31Dec2099	1 sec		3
1AE3 - 1AE5	6884 - 6886	Positive PF, Phase C, max Avg Dmd Timestamp	TSTAMP	1Jan2000 - 31Dec2099	1 sec		3
1AE6 - 1AE8	6887 - 6889	Negative PF, Phase A, max Avg Dmd Timestamp	TSTAMP	1Jan2000 - 31Dec2099	1 sec		3

Modbus Address		Description	Format	Range	Units or Resolution	Comments	# Reg
Hex	Decimal						
1AE9 - 1AEB	6890 - 6892	Negative PF, Phase B, max Avg Dmd Timestamp	TSTAMP	1Jan2000 - 31Dec2099	1 sec		3
1AEC - 1AEE	6893 - 6895	Negative PF, Phase C, max Avg Dmd Timestamp	TSTAMP	1Jan2000 - 31Dec2099	1 sec		3
						Block Size:	96
Primary maximum Timestamp Block Meter 7							read-only
1AF3 - 1AF5	6900 - 6902	Amps A, max Avg Dmd Timestamp	TSTAMP	1Jan2000 - 31Dec2099	1 sec		3
1AF6 - 1AF8	6903 - 6905	Amps B, max Avg Dmd Timestamp	TSTAMP	1Jan2000 - 31Dec2099	1 sec		3
1AF9 - 1AFB	6906 - 6908	Amps C, max Avg Dmd Timestamp	TSTAMP	1Jan2000 - 31Dec2099	1 sec		3
1AFC - 1AFE	6909 - 6911	Positive Watts, 3-Ph, max Avg Dmd Timestamp	TSTAMP	1Jan2000 - 31Dec2099	1 sec		3
1AFF - 1B01	6912 - 6914	Positive VARs, 3-Ph, max Avg Dmd Timestamp	TSTAMP	1Jan2000 - 31Dec2099	1 sec		3
1B02 - 1B04	6915 - 6917	Negative Watts, 3-Ph, max Avg Dmd Timestamp	TSTAMP	1Jan2000 - 31Dec2099	1 sec		3
1B05 - 1B07	6918 - 6920	Negative VARs, 3-Ph, max Avg Dmd Timestamp	TSTAMP	1Jan2000 - 31Dec2099	1 sec		3
1B08 - 1B0A	6921 - 6923	VAs, 3-Ph, max Avg Dmd Timestamp	TSTAMP	1Jan2000 - 31Dec2099	1 sec		3
1B0B - 1B0D	6924 - 6926	Positive Power Factor, 3-Ph, max Avg Dmd Timestamp	TSTAMP	1Jan2000 - 31Dec2099	1 sec		3
1B0E - 1B10	6927 - 6929	Negative Power Factor, 3-Ph, max Avg Dmd Timestamp	TSTAMP	1Jan2000 - 31Dec2099	1 sec		3
1B11 - 1B13	6930 - 6932	Neutral Current, max Avg Dmd Timestamp	TSTAMP	1Jan2000 - 31Dec2100	1 sec		3
1B14 - 1B16	6933 - 6935	Positive Watts, Phase A, max Avg Dmd Timestamp	TSTAMP	1Jan2000 - 31Dec2099	1 sec		3
1B17 - 1B19	6936 - 6938	Positive Watts, Phase B, max Avg Dmd Timestamp	TSTAMP	1Jan2000 - 31Dec2099	1 sec		3
1B1A - 1B1C	6939 - 6941	Positive Watts, Phase C, max Avg Dmd Timestamp	TSTAMP	1Jan2000 - 31Dec2099	1 sec		3
1B1D - 1B1F	6942 - 6944	Positive VARs, Phase A, max Avg Dmd Timestamp	TSTAMP	1Jan2000 - 31Dec2099	1 sec		3
1B20 - 1B22	6945 - 6947	Positive VARs, Phase B, max Avg Dmd Timestamp	TSTAMP	1Jan2000 - 31Dec2099	1 sec		3
1B23 - 1B25	6948 - 6950	Positive VARs, Phase C, max Avg Dmd Timestamp	TSTAMP	1Jan2000 - 31Dec2099	1 sec		3

C: MP200-Y (Three Phase) Modbus Map

Modbus Address		Description	Format	Range	Units or Resolution	Comments	# Reg
Hex	Decimal						
1B26 -	1B28	6951 - 6953	Negative Watts, Phase A, max Avg Dmd Timestamp	TSTAMP	1Jan2000 - 31Dec2099	1 sec	3
1B29 -	1B2B	6954 - 6956	Negative Watts, Phase B, max Avg Dmd Timestamp	TSTAMP	1Jan2000 - 31Dec2099	1 sec	3
1B2C -	1B2E	6957 - 6959	Negative Watts, Phase C, max Avg Dmd Timestamp	TSTAMP	1Jan2000 - 31Dec2099	1 sec	3
1B2F -	1B31	6960 - 6962	Negative VARs, Phase A, max Avg Dmd Timestamp	TSTAMP	1Jan2000 - 31Dec2099	1 sec	3
1B32 -	1B34	6963 - 6965	Negative VARs, Phase B, max Avg Dmd Timestamp	TSTAMP	1Jan2000 - 31Dec2099	1 sec	3
1B35 -	1B37	6966 - 6968	Negative VARs, Phase C, max Avg Dmd Timestamp	TSTAMP	1Jan2000 - 31Dec2099	1 sec	3
1B38 -	1B3A	6969 - 6971	VAs, Phase A, max Avg Dmd Timestamp	TSTAMP	1Jan2000 - 31Dec2099	1 sec	3
1B3B -	1B3D	6972 - 6974	VAs, Phase B, max Avg Dmd Timestamp	TSTAMP	1Jan2000 - 31Dec2099	1 sec	3
1B3E -	1B40	6975 - 6977	VAs, Phase C, max Avg Dmd Timestamp	TSTAMP	1Jan2000 - 31Dec2099	1 sec	3
1B41 -	1B43	6978 - 6980	Positive PF, Phase A, max Avg Dmd Timestamp	TSTAMP	1Jan2000 - 31Dec2099	1 sec	3
1B44 -	1B46	6981 - 6983	Positive PF, Phase B, max Avg Dmd Timestamp	TSTAMP	1Jan2000 - 31Dec2099	1 sec	3
1B47 -	1B49	6984 - 6986	Positive PF, Phase C, max Avg Dmd Timestamp	TSTAMP	1Jan2000 - 31Dec2099	1 sec	3
1B4A -	1B4C	6987 - 6989	Negative PF, Phase A, max Avg Dmd Timestamp	TSTAMP	1Jan2000 - 31Dec2099	1 sec	3
1B4D -	1B4F	6990 - 6992	Negative PF, Phase B, max Avg Dmd Timestamp	TSTAMP	1Jan2000 - 31Dec2099	1 sec	3
1B50 -	1B52	6993 - 6995	Negative PF, Phase C, max Avg Dmd Timestamp	TSTAMP	1Jan2000 - 31Dec2099	1 sec	3
						Block Size:	96
Primary maximum Timestamp Block Meter 8						read-only	
1B57 -	1B59	7000 - 7002	Amps A, max Avg Dmd Timestamp	TSTAMP	1Jan2000 - 31Dec2099	1 sec	3
1B5A -	1B5C	7003 - 7005	Amps B, max Avg Dmd Timestamp	TSTAMP	1Jan2000 - 31Dec2099	1 sec	3
1B5D -	1B5F	7006 - 7008	Amps C, max Avg Dmd Timestamp	TSTAMP	1Jan2000 - 31Dec2099	1 sec	3
1B60 -	1B62	7009 - 7011	Positive Watts, 3-Ph, max Avg Dmd Timestamp	TSTAMP	1Jan2000 - 31Dec2099	1 sec	3

Modbus Address		Description	Format	Range	Units or Resolution	Comments	# Reg
Hex	Decimal						
1B63 - 1B65	7012 - 7014	Positive VARs, 3-Ph, max Avg Dmd Timestamp	TSTAMP	1Jan2000 - 31Dec2099	1 sec		3
1B66 - 1B68	7015 - 7017	Negative Watts, 3-Ph, max Avg Dmd Timestamp	TSTAMP	1Jan2000 - 31Dec2099	1 sec		3
1B69 - 1B6B	7018 - 7020	Negative VARs, 3-Ph, max Avg Dmd Timestamp	TSTAMP	1Jan2000 - 31Dec2099	1 sec		3
1B6C - 1B6E	7021 - 7023	VAs, 3-Ph, max Avg Dmd Timestamp	TSTAMP	1Jan2000 - 31Dec2099	1 sec		3
1B6F - 1B71	7024 - 7026	Positive Power Factor, 3-Ph, max Avg Dmd Timestamp	TSTAMP	1Jan2000 - 31Dec2099	1 sec		3
1B72 - 1B74	7027 - 7029	Negative Power Factor, 3-Ph, max Avg Dmd Timestamp	TSTAMP	1Jan2000 - 31Dec2099	1 sec		3
1B75 - 1B77	7030 - 7032	Neutral Current, max Avg Dmd Timestamp	TSTAMP	1Jan2000 - 31Dec2100	1 sec		3
1B78 - 1B7A	7033 - 7035	Positive Watts, Phase A, max Avg Dmd Timestamp	TSTAMP	1Jan2000 - 31Dec2099	1 sec		3
1B7B - 1B7D	7036 - 7038	Positive Watts, Phase B, max Avg Dmd Timestamp	TSTAMP	1Jan2000 - 31Dec2099	1 sec		3
1B7E - 1B80	7039 - 7041	Positive Watts, Phase C, max Avg Dmd Timestamp	TSTAMP	1Jan2000 - 31Dec2099	1 sec		3
1B81 - 1B83	7042 - 7044	Positive VARs, Phase A, max Avg Dmd Timestamp	TSTAMP	1Jan2000 - 31Dec2099	1 sec		3
1B84 - 1B86	7045 - 7047	Positive VARs, Phase B, max Avg Dmd Timestamp	TSTAMP	1Jan2000 - 31Dec2099	1 sec		3
1B87 - 1B89	7048 - 7050	Positive VARs, Phase C, max Avg Dmd Timestamp	TSTAMP	1Jan2000 - 31Dec2099	1 sec		3
1B8A - 1B8C	7051 - 7053	Negative Watts, Phase A, max Avg Dmd Timestamp	TSTAMP	1Jan2000 - 31Dec2099	1 sec		3
1B8D - 1B8F	7054 - 7056	Negative Watts, Phase B, max Avg Dmd Timestamp	TSTAMP	1Jan2000 - 31Dec2099	1 sec		3
1B90 - 1B92	7057 - 7059	Negative Watts, Phase C, max Avg Dmd Timestamp	TSTAMP	1Jan2000 - 31Dec2099	1 sec		3
1B93 - 1B95	7060 - 7062	Negative VARs, Phase A, max Avg Dmd Timestamp	TSTAMP	1Jan2000 - 31Dec2099	1 sec		3
1B96 - 1B98	7063 - 7065	Negative VARs, Phase B, max Avg Dmd Timestamp	TSTAMP	1Jan2000 - 31Dec2099	1 sec		3
1B99 - 1B9B	7066 - 7068	Negative VARs, Phase C, max Avg Dmd Timestamp	TSTAMP	1Jan2000 - 31Dec2099	1 sec		3
1B9C - 1B9E	7069 - 7071	VAs, Phase A, max Avg Dmd Timestamp	TSTAMP	1Jan2000 - 31Dec2099	1 sec		3

Modbus Address		Description	Format	Range	Units or Resolution	Comments	# Reg
Hex	Decimal						
1B9F -	1BA1	7072 - 7074	VAs, Phase B, max Avg Dmd Timestamp	TSTAMP	1Jan2000 - 31Dec2099	1 sec	3
1BA2 -	1BA4	7075 - 7077	VAs, Phase C, max Avg Dmd Timestamp	TSTAMP	1Jan2000 - 31Dec2099	1 sec	3
1BA5 -	1BA7	7078 - 7080	Positive PF, Phase A, max Avg Dmd Timestamp	TSTAMP	1Jan2000 - 31Dec2099	1 sec	3
1BA8 -	1BAA	7081 - 7083	Positive PF, Phase B, max Avg Dmd Timestamp	TSTAMP	1Jan2000 - 31Dec2099	1 sec	3
1BAB -	1BAD	7084 - 7086	Positive PF, Phase C, max Avg Dmd Timestamp	TSTAMP	1Jan2000 - 31Dec2099	1 sec	3
1BAE -	1BB0	7087 - 7089	Negative PF, Phase A, max Avg Dmd Timestamp	TSTAMP	1Jan2000 - 31Dec2099	1 sec	3
1BB1 -	1BB3	7090 - 7092	Negative PF, Phase B, max Avg Dmd Timestamp	TSTAMP	1Jan2000 - 31Dec2099	1 sec	3
1BB4 -	1BB6	7093 - 7095	Negative PF, Phase C, max Avg Dmd Timestamp	TSTAMP	1Jan2000 - 31Dec2099	1 sec	3
Block Size:							96
Interval Energy Block Meter 1						read-only	
1F3F -	1F40	8000 - 8001	W-hours, Received	SINT32	0 to 99999999 or 0 to - 99999999	Wh per energy format	2
1F41 -	1F42	8002 - 8003	W-hours, Delivered	SINT32	0 to 99999999 or 0 to - 99999999	Wh per energy format	2
1F43 -	1F44	8004 - 8005	W-hours, Net	SINT32	-99999999 to 99999999	Wh per energy format	2
1F45 -	1F46	8006 - 8007	W-hours, Total	SINT32	0 to 99999999	Wh per energy format	2
1F47 -	1F48	8008 - 8009	VAR-hours, Positive	SINT32	0 to 99999999	VARh per energy format	2
1F49 -	1F4A	8010 - 8011	VAR-hours, Negative	SINT32	0 to - 99999999	VARh per energy format	2

Modbus Address		Description	Format	Range	Units or Resolution	Comments	# Reg
Hex	Decimal						
1F4B - 1F4C	8012 - 8013	VAR-hours, Net	SINT32	-99999999 to 99999999	VARh per energy format	(Cont'd)	2
1F4D - 1F4E	8014 - 8015	VAR-hours, Total	SINT32	0 to 99999999	VARh per energy format		2
1F4F - 1F50	8016 - 8017	VA-hours, Total	SINT32	0 to 99999999	VAh per energy format		2
1F51 - 1F52	8018 - 8019	W-hours, Received, Phase A	SINT32	0 to 99999999 or 0 to -99999999	Wh per energy format		2
1F53 - 1F54	8020 - 8021	W-hours, Received, Phase B	SINT32	0 to 99999999 or 0 to -99999999	Wh per energy format		2
1F55 - 1F56	8022 - 8023	W-hours, Received, Phase C	SINT32	0 to 99999999 or 0 to -99999999	Wh per energy format		2
1F57 - 1F58	8024 - 8025	W-hours, Delivered, Phase A	SINT32	0 to 99999999 or 0 to -99999999	Wh per energy format		2
1F59 - 1F5A	8026 - 8027	W-hours, Delivered, Phase B	SINT32	0 to 99999999 or 0 to -99999999	Wh per energy format		2
1F5B - 1F5C	8028 - 8029	W-hours, Delivered, Phase C	SINT32	0 to 99999999 or 0 to -99999999	Wh per energy format		2
1F5D - 1F5E	8030 - 8031	W-hours, Net, Phase A	SINT32	-99999999 to 99999999	Wh per energy format		2
1F5F - 1F60	8032 - 8033	W-hours, Net, Phase B	SINT32	-99999999 to 99999999	Wh per energy format		2

Modbus Address		Description	Format	Range	Units or Resolution	Comments	# Reg
Hex	Decimal						
1F61 -	1F62	8034 - 8035	W-hours, Net, Phase C	SINT32	-99999999 to 99999999	Wh per energy format	2
1F63 -	1F64	8036 - 8037	W-hours, Total, Phase A	SINT32	0 to 99999999	Wh per energy format	2
1F65 -	1F66	8038 - 8039	W-hours, Total, Phase B	SINT32	0 to 99999999	Wh per energy format	2
1F67 -	1F68	8040 - 8041	W-hours, Total, Phase C	SINT32	0 to 99999999	Wh per energy format	2
1F69 -	1F6A	8042 - 8043	VAR-hours, Positive, Phase A	SINT32	0 to 99999999	VARh per energy format	2
1F6B -	1F6C	8044 - 8045	VAR-hours, Positive, Phase B	SINT32	0 to 99999999	VARh per energy format	2
1F6D -	1F6E	8046 - 8047	VAR-hours, Positive, Phase C	SINT32	0 to 99999999	VARh per energy format	2
1F6F -	1F70	8048 - 8049	VAR-hours, Negative, Phase A	SINT32	0 to -99999999	VARh per energy format	2
1F71 -	1F72	8050 - 8051	VAR-hours, Negative, Phase B	SINT32	0 to -99999999	VARh per energy format	2
1F73 -	1F74	8052 - 8053	VAR-hours, Negative, Phase C	SINT32	0 to -99999999	VARh per energy format	2
1F75 -	1F76	8054 - 8055	VAR-hours, Net, Phase A	SINT32	-99999999 to 99999999	VARh per energy format	2
1F77 -	1F78	8056 - 8057	VAR-hours, Net, Phase B	SINT32	-99999999 to 99999999	VARh per energy format	2
1F79 -	1F7A	8058 - 8059	VAR-hours, Net, Phase C	SINT32	-99999999 to 99999999	VARh per energy format	2

C: MP200-Y (Three Phase) Modbus Map

Modbus Address		Description	Format	Range	Units or Resolution	Comments	# Reg
Hex	Decimal						
1F7B - 1F7C	8060 - 8061	VAR-hours, Total, Phase A	SINT32	0 to 99999999	VARh per energy format	(Cont'd)	2
1F7D - 1F7E	8062 - 8063	VAR-hours, Total, Phase B	SINT32	0 to 99999999	VARh per energy format		2
1F7F - 1F80	8064 - 8065	VAR-hours, Total, Phase C	SINT32	0 to 99999999	VARh per energy format		2
1F81 - 1F82	8066 - 8067	VA-hours, Phase A	SINT32	0 to 99999999	VAh per energy format		2
1F83 - 1F84	8068 - 8069	VA-hours, Phase B	SINT32	0 to 99999999	VAh per energy format		2
1F85 - 1F86	8070 - 8071	VA-hours, Phase C	SINT32	0 to 99999999	VAh per energy format		2
							Block Size:
Interval Energy Block Meter 2							read-only
1FA3 - 1FA4	8100 - 8101	W-hours, Received	SINT32	0 to 99999999 or 0 to -99999999	Wh per energy format	* Wh received & delivered always have opposite signs * Wh received is positive for "view as load", delivered is positive for "view as generator" * 5 to 8 digits * decimal point implied, per energy format * resolution of digit before decimal point = units, kilo, or mega, per energy format * see note 10	2
1FA5 - 1FA6	8102 - 8103	W-hours, Delivered	SINT32	0 to 99999999 or 0 to -99999999	Wh per energy format		2
1FA7 - 1FA8	8104 - 8105	W-hours, Net	SINT32	-99999999 to 99999999	Wh per energy format		2
1FA9 - 1FAA	8106 - 8107	W-hours, Total	SINT32	0 to 99999999	Wh per energy format		2
1FAB - 1FAC	8108 - 8109	VAR-hours, Positive	SINT32	0 to 99999999	VARh per energy format		2
1FAD - 1FAE	8110 - 8111	VAR-hours, Negative	SINT32	0 to -99999999	VARh per energy format		2

Modbus Address		Description	Format	Range	Units or Resolution	Comments	# Reg
Hex	Decimal						
1FAF - 1FB0	8112 - 8113	VAR-hours, Net	SINT32	-99999999 to 99999999	VARh per energy format	(Cont'd)	2
1FB1 - 1FB2	8114 - 8115	VAR-hours, Total	SINT32	0 to 99999999	VARh per energy format		2
1FB3 - 1FB4	8116 - 8117	VA-hours, Total	SINT32	0 to 99999999	VAh per energy format		2
1FB5 - 1FB6	8118 - 8119	W-hours, Received, Phase A	SINT32	0 to 99999999 or 0 to -99999999	Wh per energy format		2
1FB7 - 1FB8	8120 - 8121	W-hours, Received, Phase B	SINT32	0 to 99999999 or 0 to -99999999	Wh per energy format		2
1FB9 - 1FBA	8122 - 8123	W-hours, Received, Phase C	SINT32	0 to 99999999 or 0 to -99999999	Wh per energy format		2
1FBB - 1FBC	8124 - 8125	W-hours, Delivered, Phase A	SINT32	0 to 99999999 or 0 to -99999999	Wh per energy format		2
1FBD - 1FBE	8126 - 8127	W-hours, Delivered, Phase B	SINT32	0 to 99999999 or 0 to -99999999	Wh per energy format		2
1FBF - 1FC0	8128 - 8129	W-hours, Delivered, Phase C	SINT32	0 to 99999999 or 0 to -99999999	Wh per energy format		2
1FC1 - 1FC2	8130 - 8131	W-hours, Net, Phase A	SINT32	-99999999 to 99999999	Wh per energy format		2
1FC3 - 1FC4	8132 - 8133	W-hours, Net, Phase B	SINT32	-99999999 to 99999999	Wh per energy format		2

Modbus Address		Description	Format	Range	Units or Resolution	Comments	# Reg
Hex	Decimal						
1FC5 - 1FC6	8134 - 8135	W-hours, Net, Phase C	SINT32	-99999999 to 99999999	Wh per energy format	(Cont'd)	2
1FC7 - 1FC8	8136 - 8137	W-hours, Total, Phase A	SINT32	0 to 99999999	Wh per energy format		2
1FC9 - 1FCA	8138 - 8139	W-hours, Total, Phase B	SINT32	0 to 99999999	Wh per energy format		2
1FCB - 1FCC	8140 - 8141	W-hours, Total, Phase C	SINT32	0 to 99999999	Wh per energy format		2
1FCD - 1FCE	8142 - 8143	VAR-hours, Positive, Phase A	SINT32	0 to 99999999	VARh per energy format		2
1FCF - 1FD0	8144 - 8145	VAR-hours, Positive, Phase B	SINT32	0 to 99999999	VARh per energy format		2
1FD1 - 1FD2	8146 - 8147	VAR-hours, Positive, Phase C	SINT32	0 to 99999999	VARh per energy format		2
1FD3 - 1FD4	8148 - 8149	VAR-hours, Negative, Phase A	SINT32	0 to -99999999	VARh per energy format		2
1FD5 - 1FD6	8150 - 8151	VAR-hours, Negative, Phase B	SINT32	0 to -99999999	VARh per energy format		2
1FD7 - 1FD8	8152 - 8153	VAR-hours, Negative, Phase C	SINT32	0 to -99999999	VARh per energy format		2
1FD9 - 1FDA	8154 - 8155	VAR-hours, Net, Phase A	SINT32	-99999999 to 99999999	VARh per energy format		2
1FDB - 1FDC	8156 - 8157	VAR-hours, Net, Phase B	SINT32	-99999999 to 99999999	VARh per energy format		2
1FDD - 1FDE	8158 - 8159	VAR-hours, Net, Phase C	SINT32	-99999999 to 99999999	VARh per energy format		2

Modbus Address		Description	Format	Range	Units or Resolution	Comments	# Reg
Hex	Decimal						
1FDF - 1FE0	8160 - 8161	VAR-hours, Total, Phase A	SINT32	0 to 99999999	VARh per energy format	(Cont'd)	2
1FE1 - 1FE2	8162 - 8163	VAR-hours, Total, Phase B	SINT32	0 to 99999999	VARh per energy format		2
1FE3 - 1FE4	8164 - 8165	VAR-hours, Total, Phase C	SINT32	0 to 99999999	VARh per energy format		2
1FE5 - 1FE6	8166 - 8167	VA-hours, Phase A	SINT32	0 to 99999999	VAh per energy format		2
1FE7 - 1FE8	8168 - 8169	VA-hours, Phase B	SINT32	0 to 99999999	VAh per energy format		2
1FE9 - 1FEA	8170 - 8171	VA-hours, Phase C	SINT32	0 to 99999999	VAh per energy format		2
Block Size:							72
Interval Energy Block Meter 3							read-only
2007 - 2008	8200 - 8201	W-hours, Received	SINT32	0 to 99999999 or 0 to -99999999	Wh per energy format	* Wh received & delivered always have opposite signs * Wh received is positive for "view as load", delivered is positive for "view as generator"	2
2009 - 200A	8202 - 8203	W-hours, Delivered	SINT32	0 to 99999999 or 0 to -99999999	Wh per energy format	* 5 to 8 digits	2
200B - 200C	8204 - 8205	W-hours, Net	SINT32	-99999999 to 99999999	Wh per energy format	* decimal point implied, per energy format	2
200D - 200E	8206 - 8207	W-hours, Total	SINT32	0 to 99999999	Wh per energy format	* resolution of digit before decimal point = units, kilo, or mega, per energy format	2
200F - 2010	8208 - 8209	VAR-hours, Positive	SINT32	0 to 99999999	VARh per energy format	* see note 10	2
2011 - 2012	8210 - 8211	VAR-hours, Negative	SINT32	0 to -99999999	VARh per energy format		2

Modbus Address		Description	Format	Range	Units or Resolution	Comments	# Reg
Hex	Decimal						
2013 -	2014	8212 - 8213	VAR-hours, Net	SINT32	-99999999 to 99999999	VARh per energy format	2
2015 -	2016	8214 - 8215	VAR-hours, Total	SINT32	0 to 99999999	VARh per energy format	2
2017 -	2018	8216 - 8217	VA-hours, Total	SINT32	0 to 99999999	VAh per energy format	2
2019 -	201A	8218 - 8219	W-hours, Received, Phase A	SINT32	0 to 99999999 or 0 to -99999999	Wh per energy format	2
201B -	201C	8220 - 8221	W-hours, Received, Phase B	SINT32	0 to 99999999 or 0 to -99999999	Wh per energy format	2
201D -	201E	8222 - 8223	W-hours, Received, Phase C	SINT32	0 to 99999999 or 0 to -99999999	Wh per energy format	2
201F -	2020	8224 - 8225	W-hours, Delivered, Phase A	SINT32	0 to 99999999 or 0 to -99999999	Wh per energy format	2
2021 -	2022	8226 - 8227	W-hours, Delivered, Phase B	SINT32	0 to 99999999 or 0 to -99999999	Wh per energy format	2
2023 -	2024	8228 - 8229	W-hours, Delivered, Phase C	SINT32	0 to 99999999 or 0 to -99999999	Wh per energy format	2
2025 -	2026	8230 - 8231	W-hours, Net, Phase A	SINT32	-99999999 to 99999999	Wh per energy format	2
2027 -	2028	8232 - 8233	W-hours, Net, Phase B	SINT32	-99999999 to 99999999	Wh per energy format	2

(Cont'd)

Modbus Address		Description	Format	Range	Units or Resolution	Comments	# Reg
Hex	Decimal						
2029 -	202A	8234 - 8235	W-hours, Net, Phase C	SINT32	-99999999 to 99999999	Wh per energy format	2
202B -	202C	8236 - 8237	W-hours, Total, Phase A	SINT32	0 to 99999999	Wh per energy format	2
202D -	202E	8238 - 8239	W-hours, Total, Phase B	SINT32	0 to 99999999	Wh per energy format	2
202F -	2030	8240 - 8241	W-hours, Total, Phase C	SINT32	0 to 99999999	Wh per energy format	2
2031 -	2032	8242 - 8243	VAR-hours, Positive, Phase A	SINT32	0 to 99999999	VARh per energy format	2
2033 -	2034	8244 - 8245	VAR-hours, Positive, Phase B	SINT32	0 to 99999999	VARh per energy format	2
2035 -	2036	8246 - 8247	VAR-hours, Positive, Phase C	SINT32	0 to 99999999	VARh per energy format	2
2037 -	2038	8248 - 8249	VAR-hours, Negative, Phase A	SINT32	0 to -99999999	VARh per energy format	2
2039 -	203A	8250 - 8251	VAR-hours, Negative, Phase B	SINT32	0 to -99999999	VARh per energy format	2
203B -	203C	8252 - 8253	VAR-hours, Negative, Phase C	SINT32	0 to -99999999	VARh per energy format	2
203D -	203E	8254 - 8255	VAR-hours, Net, Phase A	SINT32	-99999999 to 99999999	VARh per energy format	2
203F -	2040	8256 - 8257	VAR-hours, Net, Phase B	SINT32	-99999999 to 99999999	VARh per energy format	2
2041 -	2042	8258 - 8259	VAR-hours, Net, Phase C	SINT32	-99999999 to 99999999	VARh per energy format	2

Modbus Address		Description	Format	Range	Units or Resolution	Comments	# Reg	
Hex	Decimal							
2043 -	2044	8260 - 8261	VAR-hours, Total, Phase A	SINT32	0 to 99999999	VARh per energy format	(Cont'd)	2
2045 -	2046	8262 - 8263	VAR-hours, Total, Phase B	SINT32	0 to 99999999	VARh per energy format		2
2047 -	2048	8264 - 8265	VAR-hours, Total, Phase C	SINT32	0 to 99999999	VARh per energy format		2
2049 -	204A	8266 - 8267	VA-hours, Phase A	SINT32	0 to 99999999	VAh per energy format		2
204B -	204C	8268 - 8269	VA-hours, Phase B	SINT32	0 to 99999999	VAh per energy format		2
204D -	204E	8270 - 8271	VA-hours, Phase C	SINT32	0 to 99999999	VAh per energy format		2
Block Size:							72	
Interval Energy Block Meter 4							read-only	
206B -	206C	8300 - 8301	W-hours, Received	SINT32	0 to 99999999 or 0 to - 99999999	Wh per energy format	* Wh received & delivered always have opposite signs * Wh received is positive for "view as load", delivered is positive for "view as generator" * 5 to 8 digits * decimal point implied, per energy format * resolution of digit before decimal point = units, kilo, or mega, per energy format * see note 10	2
206D -	206E	8302 - 8303	W-hours, Delivered	SINT32	0 to 99999999 or 0 to - 99999999	Wh per energy format		2
206F -	2070	8304 - 8305	W-hours, Net	SINT32	-99999999 to 99999999	Wh per energy format		2
2071 -	2072	8306 - 8307	W-hours, Total	SINT32	0 to 99999999	Wh per energy format		2
2073 -	2074	8308 - 8309	VAR-hours, Positive	SINT32	0 to 99999999	VARh per energy format		2
2075 -	2076	8310 - 8311	VAR-hours, Negative	SINT32	0 to - 99999999	VARh per energy format		2

Modbus Address		Description	Format	Range	Units or Resolution	Comments	# Reg
Hex	Decimal						
2077 -	2078	8312 - 8313	VAR-hours, Net	SINT32	-99999999 to 99999999	VARh per energy format	2
2079 -	207A	8314 - 8315	VAR-hours, Total	SINT32	0 to 99999999	VARh per energy format	2
207B -	207C	8316 - 8317	VA-hours, Total	SINT32	0 to 99999999	VAh per energy format	2
207D -	207E	8318 - 8319	W-hours, Received, Phase A	SINT32	0 to 99999999 or 0 to -99999999	Wh per energy format	2
207F -	2080	8320 - 8321	W-hours, Received, Phase B	SINT32	0 to 99999999 or 0 to -99999999	Wh per energy format	2
2081 -	2082	8322 - 8323	W-hours, Received, Phase C	SINT32	0 to 99999999 or 0 to -99999999	Wh per energy format	2
2083 -	2084	8324 - 8325	W-hours, Delivered, Phase A	SINT32	0 to 99999999 or 0 to -99999999	Wh per energy format	2
2085 -	2086	8326 - 8327	W-hours, Delivered, Phase B	SINT32	0 to 99999999 or 0 to -99999999	Wh per energy format	2
2087 -	2088	8328 - 8329	W-hours, Delivered, Phase C	SINT32	0 to 99999999 or 0 to -99999999	Wh per energy format	2
2089 -	208A	8330 - 8331	W-hours, Net, Phase A	SINT32	-99999999 to 99999999	Wh per energy format	2
208B -	208C	8332 - 8333	W-hours, Net, Phase B	SINT32	-99999999 to 99999999	Wh per energy format	2

Modbus Address		Description	Format	Range	Units or Resolution	Comments	# Reg
Hex	Decimal						
208D -	208E	8334 - 8335	W-hours, Net, Phase C	SINT32	-99999999 to 99999999	Wh per energy format	2
208F -	2090	8336 - 8337	W-hours, Total, Phase A	SINT32	0 to 99999999	Wh per energy format	2
2091 -	2092	8338 - 8339	W-hours, Total, Phase B	SINT32	0 to 99999999	Wh per energy format	2
2093 -	2094	8340 - 8341	W-hours, Total, Phase C	SINT32	0 to 99999999	Wh per energy format	2
2095 -	2096	8342 - 8343	VAR-hours, Positive, Phase A	SINT32	0 to 99999999	VARh per energy format	2
2097 -	2098	8344 - 8345	VAR-hours, Positive, Phase B	SINT32	0 to 99999999	VARh per energy format	2
2099 -	209A	8346 - 8347	VAR-hours, Positive, Phase C	SINT32	0 to 99999999	VARh per energy format	2
209B -	209C	8348 - 8349	VAR-hours, Negative, Phase A	SINT32	0 to -99999999	VARh per energy format	2
209D -	209E	8350 - 8351	VAR-hours, Negative, Phase B	SINT32	0 to -99999999	VARh per energy format	2
209F -	20A0	8352 - 8353	VAR-hours, Negative, Phase C	SINT32	0 to -99999999	VARh per energy format	2
20A1 -	20A2	8354 - 8355	VAR-hours, Net, Phase A	SINT32	-99999999 to 99999999	VARh per energy format	2
20A3 -	20A4	8356 - 8357	VAR-hours, Net, Phase B	SINT32	-99999999 to 99999999	VARh per energy format	2
20A5 -	20A6	8358 - 8359	VAR-hours, Net, Phase C	SINT32	-99999999 to 99999999	VARh per energy format	2

(Cont'd)

Modbus Address		Description	Format	Range	Units or Resolution	Comments	# Reg		
Hex	Decimal								
20A7 -	20A8	8360 - 8361	VAR-hours, Total, Phase A	SINT32	0 to 99999999	VARh per energy format	(Cont'd)	2	
20A9 -	20AA	8362 - 8363	VAR-hours, Total, Phase B	SINT32	0 to 99999999	VARh per energy format		2	
20AB -	20AC	8364 - 8365	VAR-hours, Total, Phase C	SINT32	0 to 99999999	VARh per energy format		2	
20AD -	20AE	8366 - 8367	VA-hours, Phase A	SINT32	0 to 99999999	VAh per energy format		2	
20AF -	20B0	8368 - 8369	VA-hours, Phase B	SINT32	0 to 99999999	VAh per energy format		2	
20B1 -	20B2	8370 - 8371	VA-hours, Phase C	SINT32	0 to 99999999	VAh per energy format		2	
Block Size:							72		
Interval Energy Block Meter 5							read-only		
20CF -	20D0	8400 - 8401	W-hours, Received	SINT32	0 to 99999999 or 0 to -99999999	Wh per energy format	* Wh received & delivered always have opposite signs * Wh received is positive for "view as load", delivered is positive for "view as generator" * 5 to 8 digits * decimal point implied, per energy format * resolution of digit before decimal point = units, kilo, or mega, per energy format * see note 10	2	
20D1 -	20D2	8402 - 8403	W-hours, Delivered	SINT32	0 to 99999999 or 0 to -99999999	Wh per energy format		2	
20D3 -	20D4	8404 - 8405	W-hours, Net	SINT32	-99999999 to 99999999	Wh per energy format		2	
20D5 -	20D6	8406 - 8407	W-hours, Total	SINT32	0 to 99999999	Wh per energy format		2	
20D7 -	20D8	8408 - 8409	VAR-hours, Positive	SINT32	0 to 99999999	VARh per energy format		2	
20D9 -	20DA	8410 - 8411	VAR-hours, Negative	SINT32	0 to -99999999	VARh per energy format		2	

Modbus Address		Description	Format	Range	Units or Resolution	Comments	# Reg	
Hex	Decimal							
20DB -	20DC	8412 - 8413	VAR-hours, Net	SINT32	-99999999 to 99999999	VARh per energy format	(Cont'd)	2
20DD -	20DE	8414 - 8415	VAR-hours, Total	SINT32	0 to 99999999	VARh per energy format		2
20DF -	20E0	8416 - 8417	VA-hours, Total	SINT32	0 to 99999999	VAh per energy format		2
20E1 -	20E2	8418 - 8419	W-hours, Received, Phase A	SINT32	0 to 99999999 or 0 to -99999999	Wh per energy format		2
20E3 -	20E4	8420 - 8421	W-hours, Received, Phase B	SINT32	0 to 99999999 or 0 to -99999999	Wh per energy format		2
20E5 -	20E6	8422 - 8423	W-hours, Received, Phase C	SINT32	0 to 99999999 or 0 to -99999999	Wh per energy format		2
20E7 -	20E8	8424 - 8425	W-hours, Delivered, Phase A	SINT32	0 to 99999999 or 0 to -99999999	Wh per energy format		2
20E9 -	20EA	8426 - 8427	W-hours, Delivered, Phase B	SINT32	0 to 99999999 or 0 to -99999999	Wh per energy format		2
20EB -	20EC	8428 - 8429	W-hours, Delivered, Phase C	SINT32	0 to 99999999 or 0 to -99999999	Wh per energy format		2
20ED -	20EE	8430 - 8431	W-hours, Net, Phase A	SINT32	-99999999 to 99999999	Wh per energy format		2
20EF -	20F0	8432 - 8433	W-hours, Net, Phase B	SINT32	-99999999 to 99999999	Wh per energy format		2

Modbus Address		Description	Format	Range	Units or Resolution	Comments	# Reg
Hex	Decimal						
20F1 - 20F2	8434 - 8435	W-hours, Net, Phase C	SINT32	-99999999 to 99999999	Wh per energy format	(Cont'd)	2
20F3 - 20F4	8436 - 8437	W-hours, Total, Phase A	SINT32	0 to 99999999	Wh per energy format		2
20F5 - 20F6	8438 - 8439	W-hours, Total, Phase B	SINT32	0 to 99999999	Wh per energy format		2
20F7 - 20F8	8440 - 8441	W-hours, Total, Phase C	SINT32	0 to 99999999	Wh per energy format		2
20F9 - 20FA	8442 - 8443	VAR-hours, Positive, Phase A	SINT32	0 to 99999999	VARh per energy format		2
20FB - 20FC	8444 - 8445	VAR-hours, Positive, Phase B	SINT32	0 to 99999999	VARh per energy format		2
20FD - 20FE	8446 - 8447	VAR-hours, Positive, Phase C	SINT32	0 to 99999999	VARh per energy format		2
20FF - 2100	8448 - 8449	VAR-hours, Negative, Phase A	SINT32	0 to -99999999	VARh per energy format		2
2101 - 2102	8450 - 8451	VAR-hours, Negative, Phase B	SINT32	0 to -99999999	VARh per energy format		2
2103 - 2104	8452 - 8453	VAR-hours, Negative, Phase C	SINT32	0 to -99999999	VARh per energy format		2
2105 - 2106	8454 - 8455	VAR-hours, Net, Phase A	SINT32	-99999999 to 99999999	VARh per energy format		2
2107 - 2108	8456 - 8457	VAR-hours, Net, Phase B	SINT32	-99999999 to 99999999	VARh per energy format		2
2109 - 210A	8458 - 8459	VAR-hours, Net, Phase C	SINT32	-99999999 to 99999999	VARh per energy format		2

Modbus Address		Description	Format	Range	Units or Resolution	Comments	# Reg
Hex	Decimal						
210B - 210C	8460 - 8461	VAR-hours, Total, Phase A	SINT32	0 to 99999999	VARh per energy format	(Cont'd)	2
210D - 210E	8462 - 8463	VAR-hours, Total, Phase B	SINT32	0 to 99999999	VARh per energy format		2
210F - 2110	8464 - 8465	VAR-hours, Total, Phase C	SINT32	0 to 99999999	VARh per energy format		2
2111 - 2112	8466 - 8467	VA-hours, Phase A	SINT32	0 to 99999999	VAh per energy format		2
2113 - 2114	8468 - 8469	VA-hours, Phase B	SINT32	0 to 99999999	VAh per energy format		2
2115 - 2116	8470 - 8471	VA-hours, Phase C	SINT32	0 to 99999999	VAh per energy format		2
							Block Size:
Interval Energy Block Meter 6							read-only
2133 - 2134	8500 - 8501	W-hours, Received	SINT32	0 to 99999999 or 0 to -99999999	Wh per energy format	* Wh received & delivered always have opposite signs * Wh received is positive for "view as load", delivered is positive for "view as generator" * 5 to 8 digits * decimal point implied, per energy format * resolution of digit before decimal point = units, kilo, or mega, per energy format * see note 10	2
2135 - 2136	8502 - 8503	W-hours, Delivered	SINT32	0 to 99999999 or 0 to -99999999	Wh per energy format		2
2137 - 2138	8504 - 8505	W-hours, Net	SINT32	-99999999 to 99999999	Wh per energy format		2
2139 - 213A	8506 - 8507	W-hours, Total	SINT32	0 to 99999999	Wh per energy format		2
213B - 213C	8508 - 8509	VAR-hours, Positive	SINT32	0 to 99999999	VARh per energy format		2
213D - 213E	8510 - 8511	VAR-hours, Negative	SINT32	0 to -99999999	VARh per energy format		2

Modbus Address		Description	Format	Range	Units or Resolution	Comments	# Reg	
Hex	Decimal							
213F -	2140	8512 - 8513	VAR-hours, Net	SINT32	-99999999 to 99999999	VARh per energy format	(Cont'd)	2
2141 -	2142	8514 - 8515	VAR-hours, Total	SINT32	0 to 99999999	VARh per energy format		2
2143 -	2144	8516 - 8517	VA-hours, Total	SINT32	0 to 99999999	VAh per energy format		2
2145 -	2146	8518 - 8519	W-hours, Received, Phase A	SINT32	0 to 99999999 or 0 to -99999999	Wh per energy format		2
2147 -	2148	8520 - 8521	W-hours, Received, Phase B	SINT32	0 to 99999999 or 0 to -99999999	Wh per energy format		2
2149 -	214A	8522 - 8523	W-hours, Received, Phase C	SINT32	0 to 99999999 or 0 to -99999999	Wh per energy format		2
214B -	214C	8524 - 8525	W-hours, Delivered, Phase A	SINT32	0 to 99999999 or 0 to -99999999	Wh per energy format		2
214D -	214E	8526 - 8527	W-hours, Delivered, Phase B	SINT32	0 to 99999999 or 0 to -99999999	Wh per energy format		2
214F -	2150	8528 - 8529	W-hours, Delivered, Phase C	SINT32	0 to 99999999 or 0 to -99999999	Wh per energy format		2
2151 -	2152	8530 - 8531	W-hours, Net, Phase A	SINT32	-99999999 to 99999999	Wh per energy format		2
2153 -	2154	8532 - 8533	W-hours, Net, Phase B	SINT32	-99999999 to 99999999	Wh per energy format		2

C: MP200-Y (Three Phase) Modbus Map

Modbus Address		Description	Format	Range	Units or Resolution	Comments	# Reg
Hex	Decimal						
2155 -	2156	8534 - 8535	SINT32	-99999999 to 99999999	Wh per energy format	(Cont'd)	2
2157 -	2158	8536 - 8537	SINT32	0 to 99999999	Wh per energy format		2
2159 -	215A	8538 - 8539	SINT32	0 to 99999999	Wh per energy format		2
215B -	215C	8540 - 8541	SINT32	0 to 99999999	Wh per energy format		2
215D -	215E	8542 - 8543	SINT32	0 to 99999999	VARh per energy format		2
215F -	2160	8544 - 8545	SINT32	0 to 99999999	VARh per energy format		2
2161 -	2162	8546 - 8547	SINT32	0 to 99999999	VARh per energy format		2
2163 -	2164	8548 - 8549	SINT32	0 to -99999999	VARh per energy format		2
2165 -	2166	8550 - 8551	SINT32	0 to -99999999	VARh per energy format		2
2167 -	2168	8552 - 8553	SINT32	0 to -99999999	VARh per energy format		2
2169 -	216A	8554 - 8555	SINT32	-99999999 to 99999999	VARh per energy format		2
216B -	216C	8556 - 8557	SINT32	-99999999 to 99999999	VARh per energy format		2
216D -	216E	8558 - 8559	SINT32	-99999999 to 99999999	VARh per energy format		2

Modbus Address		Description	Format	Range	Units or Resolution	Comments	# Reg	
Hex	Decimal							
216F -	2170	8560 - 8561	VAR-hours, Total, Phase A	SINT32	0 to 99999999	VARh per energy format	(Cont'd)	2
2171 -	2172	8562 - 8563	VAR-hours, Total, Phase B	SINT32	0 to 99999999	VARh per energy format		2
2173 -	2174	8564 - 8565	VAR-hours, Total, Phase C	SINT32	0 to 99999999	VARh per energy format		2
2175 -	2176	8566 - 8567	VA-hours, Phase A	SINT32	0 to 99999999	VAh per energy format		2
2177 -	2178	8568 - 8569	VA-hours, Phase B	SINT32	0 to 99999999	VAh per energy format		2
2179 -	217A	8570 - 8571	VA-hours, Phase C	SINT32	0 to 99999999	VAh per energy format		2
								Block Size:
Interval Energy Block Meter 7								read-only
2197 -	2198	8600 - 8601	W-hours, Received	SINT32	0 to 99999999 or 0 to - 99999999	Wh per energy format	* Wh received & delivered always have opposite signs * Wh received is positive for "view as load", delivered is positive for "view as generator" * 5 to 8 digits * decimal point implied, per energy format * resolution of digit before decimal point = units, kilo, or mega, per energy format * see note 10	2
2199 -	219A	8602 - 8603	W-hours, Delivered	SINT32	0 to 99999999 or 0 to - 99999999	Wh per energy format		2
219B -	219C	8604 - 8605	W-hours, Net	SINT32	-99999999 to 99999999	Wh per energy format		2
219D -	219E	8606 - 8607	W-hours, Total	SINT32	0 to 99999999	Wh per energy format		2
219F -	21A0	8608 - 8609	VAR-hours, Positive	SINT32	0 to 99999999	VARh per energy format		2
21A1 -	21A2	8610 - 8611	VAR-hours, Negative	SINT32	0 to - 99999999	VARh per energy format		2

Modbus Address		Description	Format	Range	Units or Resolution	Comments	# Reg	
Hex	Decimal							
21A3 -	21A4	8612 - 8613	VAR-hours, Net	SINT32	-99999999 to 99999999	VARh per energy format	(Cont'd)	2
21A5 -	21A6	8614 - 8615	VAR-hours, Total	SINT32	0 to 99999999	VARh per energy format		2
21A7 -	21A8	8616 - 8617	VA-hours, Total	SINT32	0 to 99999999	VAh per energy format		2
21A9 -	21AA	8618 - 8619	W-hours, Received, Phase A	SINT32	0 to 99999999 or 0 to -99999999	Wh per energy format		2
21AB -	21AC	8620 - 8621	W-hours, Received, Phase B	SINT32	0 to 99999999 or 0 to -99999999	Wh per energy format		2
21AD -	21AE	8622 - 8623	W-hours, Received, Phase C	SINT32	0 to 99999999 or 0 to -99999999	Wh per energy format		2
21AF -	21B0	8624 - 8625	W-hours, Delivered, Phase A	SINT32	0 to 99999999 or 0 to -99999999	Wh per energy format		2
21B1 -	21B2	8626 - 8627	W-hours, Delivered, Phase B	SINT32	0 to 99999999 or 0 to -99999999	Wh per energy format		2
21B3 -	21B4	8628 - 8629	W-hours, Delivered, Phase C	SINT32	0 to 99999999 or 0 to -99999999	Wh per energy format		2
21B5 -	21B6	8630 - 8631	W-hours, Net, Phase A	SINT32	-99999999 to 99999999	Wh per energy format		2
21B7 -	21B8	8632 - 8633	W-hours, Net, Phase B	SINT32	-99999999 to 99999999	Wh per energy format		2

Modbus Address		Description	Format	Range	Units or Resolution	Comments	# Reg
Hex	Decimal						
21B9 - 21BA	8634 - 8635	W-hours, Net, Phase C	SINT32	-99999999 to 99999999	Wh per energy format	(Cont'd)	2
21BB - 21BC	8636 - 8637	W-hours, Total, Phase A	SINT32	0 to 99999999	Wh per energy format		2
21BD - 21BE	8638 - 8639	W-hours, Total, Phase B	SINT32	0 to 99999999	Wh per energy format		2
21BF - 21C0	8640 - 8641	W-hours, Total, Phase C	SINT32	0 to 99999999	Wh per energy format		2
21C1 - 21C2	8642 - 8643	VAR-hours, Positive, Phase A	SINT32	0 to 99999999	VARh per energy format		2
21C3 - 21C4	8644 - 8645	VAR-hours, Positive, Phase B	SINT32	0 to 99999999	VARh per energy format		2
21C5 - 21C6	8646 - 8647	VAR-hours, Positive, Phase C	SINT32	0 to 99999999	VARh per energy format		2
21C7 - 21C8	8648 - 8649	VAR-hours, Negative, Phase A	SINT32	0 to -99999999	VARh per energy format		2
21C9 - 21CA	8650 - 8651	VAR-hours, Negative, Phase B	SINT32	0 to -99999999	VARh per energy format		2
21CB - 21CC	8652 - 8653	VAR-hours, Negative, Phase C	SINT32	0 to -99999999	VARh per energy format		2
21CD - 21CE	8654 - 8655	VAR-hours, Net, Phase A	SINT32	-99999999 to 99999999	VARh per energy format		2
21CF - 21D0	8656 - 8657	VAR-hours, Net, Phase B	SINT32	-99999999 to 99999999	VARh per energy format		2
21D1 - 21D2	8658 - 8659	VAR-hours, Net, Phase C	SINT32	-99999999 to 99999999	VARh per energy format		2

Modbus Address		Description	Format	Range	Units or Resolution	Comments	# Reg
Hex	Decimal						
21D3 - 21D4	8660 - 8661	VAR-hours, Total, Phase A	SINT32	0 to 99999999	VARh per energy format	(Cont'd)	2
21D5 - 21D6	8662 - 8663	VAR-hours, Total, Phase B	SINT32	0 to 99999999	VARh per energy format		2
21D7 - 21D8	8664 - 8665	VAR-hours, Total, Phase C	SINT32	0 to 99999999	VARh per energy format		2
21D9 - 21DA	8666 - 8667	VA-hours, Phase A	SINT32	0 to 99999999	VAh per energy format		2
21DB - 21DC	8668 - 8669	VA-hours, Phase B	SINT32	0 to 99999999	VAh per energy format		2
21DD - 21DE	8670 - 8671	VA-hours, Phase C	SINT32	0 to 99999999	VAh per energy format		2
Block Size:							72
Interval Energy Block Meter 8							
21FB - 21FC	8700 - 8701	W-hours, Received	SINT32	0 to 99999999 or 0 to -99999999	Wh per energy format	* Wh received & delivered always have opposite signs * Wh received is positive for "view as load", delivered is positive for "view as generator" * 5 to 8 digits * decimal point implied, per energy format * resolution of digit before decimal point = units, kilo, or mega, per energy format * see note 10	2
21FD - 21FE	8702 - 8703	W-hours, Delivered	SINT32	0 to 99999999 or 0 to -99999999	Wh per energy format		2
21FF - 2200	8704 - 8705	W-hours, Net	SINT32	-99999999 to 99999999	Wh per energy format		2
2201 - 2202	8706 - 8707	W-hours, Total	SINT32	0 to 99999999	Wh per energy format		2
2203 - 2204	8708 - 8709	VAR-hours, Positive	SINT32	0 to 99999999	VARh per energy format		2
2205 - 2206	8710 - 8711	VAR-hours, Negative	SINT32	0 to -99999999	VARh per energy format		2

Modbus Address		Description	Format	Range	Units or Resolution	Comments	# Reg	
Hex	Decimal							
2207 -	2208	8712 - 8713	VAR-hours, Net	SINT32	-99999999 to 99999999	VARh per energy format	(Cont'd)	2
2209 -	220A	8714 - 8715	VAR-hours, Total	SINT32	0 to 99999999	VARh per energy format		2
220B -	220C	8716 - 8717	VA-hours, Total	SINT32	0 to 99999999	VAh per energy format		2
220D -	220E	8718 - 8719	W-hours, Received, Phase A	SINT32	0 to 99999999 or 0 to -99999999	Wh per energy format		2
220F -	2210	8720 - 8721	W-hours, Received, Phase B	SINT32	0 to 99999999 or 0 to -99999999	Wh per energy format		2
2211 -	2212	8722 - 8723	W-hours, Received, Phase C	SINT32	0 to 99999999 or 0 to -99999999	Wh per energy format		2
2213 -	2214	8724 - 8725	W-hours, Delivered, Phase A	SINT32	0 to 99999999 or 0 to -99999999	Wh per energy format		2
2215 -	2216	8726 - 8727	W-hours, Delivered, Phase B	SINT32	0 to 99999999 or 0 to -99999999	Wh per energy format		2
2217 -	2218	8728 - 8729	W-hours, Delivered, Phase C	SINT32	0 to 99999999 or 0 to -99999999	Wh per energy format		2
2219 -	221A	8730 - 8731	W-hours, Net, Phase A	SINT32	-99999999 to 99999999	Wh per energy format		2
221B -	221C	8732 - 8733	W-hours, Net, Phase B	SINT32	-99999999 to 99999999	Wh per energy format		2

Modbus Address		Description	Format	Range	Units or Resolution	Comments	# Reg
Hex	Decimal						
221D -	221E	8734 - 8735	SINT32	-99999999 to 99999999	Wh per energy format	(Cont'd)	2
221F -	2220	8736 - 8737	SINT32	0 to 99999999	Wh per energy format		2
2221 -	2222	8738 - 8739	SINT32	0 to 99999999	Wh per energy format		2
2223 -	2224	8740 - 8741	SINT32	0 to 99999999	Wh per energy format		2
2225 -	2226	8742 - 8743	SINT32	0 to 99999999	VARh per energy format		2
2227 -	2228	8744 - 8745	SINT32	0 to 99999999	VARh per energy format		2
2229 -	222A	8746 - 8747	SINT32	0 to 99999999	VARh per energy format		2
222B -	222C	8748 - 8749	SINT32	0 to -99999999	VARh per energy format		2
222D -	222E	8750 - 8751	SINT32	0 to -99999999	VARh per energy format		2
222F -	2230	8752 - 8753	SINT32	0 to -99999999	VARh per energy format		2
2231 -	2232	8754 - 8755	SINT32	-99999999 to 99999999	VARh per energy format		2
2233 -	2234	8756 - 8757	SINT32	-99999999 to 99999999	VARh per energy format		2
2235 -	2236	8758 - 8759	SINT32	-99999999 to 99999999	VARh per energy format		2

Modbus Address		Description	Format	Range	Units or Resolution	Comments	# Reg	
Hex	Decimal							
2237 -	2238	8760 - 8761	VAR-hours, Total, Phase A	SINT32	0 to 99999999	VARh per energy format	(Cont'd)	2
2239 -	223A	8762 - 8763	VAR-hours, Total, Phase B	SINT32	0 to 99999999	VARh per energy format		2
223B -	223C	8764 - 8765	VAR-hours, Total, Phase C	SINT32	0 to 99999999	VARh per energy format		2
223D -	223E	8766 - 8767	VA-hours, Phase A	SINT32	0 to 99999999	VAh per energy format		2
223F -	2240	8768 - 8769	VA-hours, Phase B	SINT32	0 to 99999999	VAh per energy format		2
2241 -	2242	8770 - 8771	VA-hours, Phase C	SINT32	0 to 99999999	VAh per energy format		2
Card Identification and Configuration Block (Note 13) (IO Interface Board)							read-only	
270F -	270F	10000 - 10000	EEPROM version and Board ID	UINT16	bit-mapped	eeeeeeee cccccccc	eeeeeeee: eeprom version cccccccc: Board id	1
2710 -	2710	10001 - 10001	Board Revision	UINT16	bit-mapped	bbbbbbbb -----	bbbbbbbb : board revision	1
2711 -	2718	10002 - 10009	Board number	ASCII	16 char	none	ASCII name of the installed card	8
2719 -	2720	10010 - 10017	Serial number	ASCII	16 char	none	Serial Number in ASCII of the installed card	8
2721 -	2722	10018 - 10019	Test info and operator	UINT16	bit-mapped	sscc---- oooooooo	sscc---- where ss- Test status bits - 00 : Reserved - 01 : Test Failed - 10 : Test Passed - 11 : Test not performed cc - Calibration status bits - 00 : No calibration needed - 01 : Calibration Failed - 10 : Calibration Passed - 11 : Calibration not performed ooooooo: operator id	2

C: MP200-Y (Three Phase) Modbus Map

Modbus Address		Description	Format	Range	Units or Resolution	Comments	# Reg
Hex	Decimal						
2723 - 2746	10020 - 10055	Timestamp	UINT16	bit-mapped	yyyyyyymmddd ddd	yyyyyy - year mmmm - month dddd - day	36
2747 - 2748	10056 - 10057	Reserved				Reserved	2
2749 - 274A	10058 - 10059	Reserved				Reserved	2
274B - 290E	10060 - 10511	Reserved				Reserved	452
						Block Size:	512
Card Identification and Configuration Block (Note 13) (Relay/Digital IO Card)						read-only	
2AF7 - 2AF7	11000 - 11000	EEPROM version and Board ID	UINT16	bit-mapped	eeeeeeee cccccccc	eeeeeeee: eeprom version cccccccc: Board id	1
2AF8 - 2AF8	11001 - 11001	Board Revision	UINT16	bit-mapped	bbbbbbbb -----	bbbbbbbb : board revision	1
2AF9 - 2B00	11002 - 11009	Board number	ASCII	16 char	none	ASCII name of the installed card	8
2B01 - 2B08	11010 - 11017	Serial number	ASCII	16 char	none	Serial Number in ASCII of the installed card	8
2B09 - 2B09	11018 - 11018	Test info and operator	UINT16	bit-mapped	sscc---- 00000000	sscc---- where ss- Test status bits - 00 : Reserved - 01 : Test Failed - 10 : Test Passed - 11 : Test not performed cc - Calibration status bits - 00 : No calibration needed - 01 : Calibration Failed - 10 : Calibration Passed - 11 : Calibration not performed 00000000: operator id	1

Modbus Address		Description	Format	Range	Units or Resolution	Comments	# Reg
Hex	Decimal						
2B0A - 2B0A	11019 - 11019	Timestamp	UINT16	bit-mapped	yyyyyyymmddd ddd	yyyyyy - year mmmm - month dddd - day	1
2B0B - 2B16	11020 - 11031	Reserved				Reserved	12
2B17 - 2B17	11032 - 11032	Digital input descriptor				Reserved	1
2B18 - 2B18	11033 - 11033	Digital output descriptor				Reserved	1
2B19 - 2B19	11034 - 11034	Digital output latency					1
2B1A - 2B35	11035 - 11062	Reserved					28
2B36 - 2B36	11063 - 11063	CRC					1
						Block Size:	64
Data and Control Block -- Digital I/O Relay Card Overlay (Note 14)						read-only except as indicated	
2B3F - 2B3F	11072 - 11072	Digital Input States	UINT16	bit-mapped	44443333 22221111	Two nibble fields: (2222) for input#2 and (1111) for input #1. Lsb in each nibble is the current state of the input. Msb in each nibble is the oldest registered state.	1
2B40 - 2B40	11073 - 11073	Digital Relay States	UINT16	bit-mapped	----- --ab -cd	If "a" is 1 then state of Relay#2 is unknown, otherwise state of Relay#2 is in "c": (1=tripped, 0=released). If "b" is 1 then state of Relay#1 is unknown, otherwise state of Relay#1 is in "d": (1=tripped, 0=released).	1
2B41 - 2B41	11074 - 11074	Turn relay on	UINT16	bit-mapped	----- -21	Writing a 1 in bit N turns relay N+1 ON (this register is writeable only in privileged session)	1
2B42 - 2B42	11075 - 11075	Turn relay off	UINT16	bit-mapped	----- -21	Writing a 1 in bit N turns relay N+1 OFF (this register is writeable only in privileged session)	1
2B43 - 2B43	11076 - 11076	Trip/Release delay timer for Relay 1	UINT16	0 to 9999	0.1 sec	time to trip or release	1
2B44 - 2B44	11077 - 11077	Trip/Release delay timer for Relay 2	UINT16	0 to 9999	0.1 sec	time to trip or release	1
2B45 - 2B46	11078 - 11079	Reserved				Reserved	2
2B47 - 2B47	11080 - 11080	Input 1 Accumulator, Scaled	UINT16	0 to 9999	resolution is 1, 10, 100, 1000, 10000, or 100000 counts	Disabled accumulators always read 0.	1
2B48 - 2B48	11081 - 11081	Input 2 Accumulator, Scaled	UINT16	0 to 9999			1
2B49 - 2B49	11082 - 11082	Input 3 Accumulator, Scaled	UINT16	0 to 9999			2
2B4B - 2B4B	11084 - 11084	Relay 1 Accumulator, Scaled	UINT16	0 to 9999	resolution is 1, 10, 100, 1000, 10000, or 100000 counts	Disabled accumulators always read 0.	1
2B4C - 2B4C	11085 - 11085	Relay 2 Accumulator, Scaled	UINT16	0 to 9999			1
2B4D - 2B78	11086 - 11129	Reserved				Reserved	44

Modbus Address		Description	Format	Range	Units or Resolution	Comments	# Reg
Hex	Decimal						
						Block Size:	58
Accumulators Block						read-only	
2EDF - 2EE0	12000 - 12001	Input 1 Accumulator	UINT32	0 to 999999999	number of transitions		2
2EE1 - 2EE6	12002 - 12007	Inputs 2-4 Accumulators	UINT32	0 to 999999999	number of transitions		6
2EE7 - 2EE8	12008 - 12009	Output or Relay 1 Accumulator	UINT32	0 to 999999999	number of transitions		2
2EE9 - 2EEA	12010 - 12011	Output or Relay 2 Accumulator	UINT32	0 to 999999999	number of transitions		6
						Block Size:	16
Commands Section (Note 4)							
Resets Block (Note 9)						write-only	
4E1F - 4E1F	20000 - 20000	Reset Max/Min Blocks	UINT16	password (Note 5)		Reply to a reset log command indicates that the command was accepted but not necessarily that the reset is finished. Poll log status block to determine this.	1
4E20 - 4E20	20001 - 20001	Reset Energy Accumulators	UINT16	password (Note 5)			1
4E21 - 4E21	20002 - 20002	System Event log (note 18)	UINT16	password (Note 5)			1
4E22 - 4E22	20003 - 20003	Reset Historical Log 1 (note 18)	UINT16	password (Note 5)			1
4E23 - 4E23	20004 - 20004	Reset Historical Log 2 (note 18)	UINT16	password (Note 5)			1
4E24 - 4E24	20005 - 20005	Reset Historical Log 3 (note 18)	UINT16	password (Note 5)			1
4E25 - 4E25	20006 - 20006	Reset Alarm Log (note 18)	UINT16	password (Note 5)			1
4E26 - 4E26	20007 - 20007	Reset IO Log (note 18)	UINT16	password (Note 5)			1
4E27 - 4E27	20008 - 20008	Reset I/O Card Input Accumulators	UINT16	password (Note 5)			1
4E28 - 4E28	20009 - 20009	Reset I/O Card Output Accumulators	UINT16	password (Note 5)			1
4E29 - 4E29	20010 - 20010	Reset voltage/Frequency	UINT16	password (Note 5)			1
4E2A - 4E2A	20011 - 20011	Reset Max/Min Blocks Meter 1	UINT16	password (Note 5)			1
4E2B - 4E2B	20012 - 20012	Reset Max/Min Blocks Meter 2	UINT16	password (Note 5)		1	

Modbus Address		Description	Format	Range	Units or Resolution	Comments	# Reg
Hex	Decimal						
4E2C - 4E2C	20013 - 20013	Reset Max/Min Blocks Meter 3	UINT16	password (Note 5)			1
4E2D - 4E2D	20014 - 20014	Reset Max/Min Blocks Meter 4	UINT16	password (Note 5)			1
4E2E - 4E2E	20015 - 20015	Reset Max/Min Blocks Meter 5	UINT16	password (Note 5)			1
4E2F - 4E2F	20016 - 20016	Reset Max/Min Blocks Meter 6	UINT16	password (Note 5)			1
4E30 - 4E30	20017 - 20017	Reset Max/Min Blocks Meter 7	UINT16	password (Note 5)			1
4E31 - 4E31	20018 - 20018	Reset Max/Min Blocks Meter 8	UINT16	password (Note 5)			1
4E32 - 4E32	20019 - 20019	Reset Energy Accumulators Meter 1	UINT16	password (Note 5)			1
4E33 - 4E33	20020 - 20020	Reset Energy Accumulators Meter 2	UINT16	password (Note 5)			1
4E34 - 4E34	20021 - 20021	Reset Energy Accumulators Meter 3	UINT16	password (Note 5)			1
4E35 - 4E35	20022 - 20022	Reset Energy Accumulators Meter 4	UINT16	password (Note 5)			1
4E36 - 4E36	20023 - 20023	Reset Energy Accumulators Meter 5	UINT16	password (Note 5)			1
4E37 - 4E37	20024 - 20024	Reset Energy Accumulators Meter 6	UINT16	password (Note 5)			1
4E38 - 4E38	20025 - 20025	Reset Energy Accumulators Meter 7	UINT16	password (Note 5)			1
4E39 - 4E39	20026 - 20026	Reset Energy Accumulators Meter 8	UINT16	password (Note 5)			1
4E3A - 4E69	20027 - 20074	Reserved				Reserved	48
						Block Size:	75
Priviledged Commands Block						conditional write	
5207 - 5207	21000 - 21000	Initiate CPU Firmware Reprogramming	UINT16	password (Note 5)			1
5208 - 5208	21001 - 21001	Force CPU Restart	UINT16	password (Note 5)		causes a watchdog reset, always reads 0	1
5209 - 5209	21002 - 21002	Open Priviledged Command Session	UINT16	password (Note 5)		CPU will process command registers (this register through 'Close Priviledged Command Session' register below) for 5 minutes or until the session is closed, whichever comes first.	1

Modbus Address		Description	Format	Range	Units or Resolution	Comments	# Reg	
Hex	Decimal							
520A - 520A	21003 - 21003	Initiate Programmable Settings Update	UINT16	password (Note 5)		CPU enters PS update mode	1	
520B - 520B	21004 - 21004	Calculate Programmable Settings Checksum (Note 3)	UINT16	0000 to 9999		CPU calculates checksum on RAM copy of PS block	1	
520C - 520C	21005 - 21005	Programmable Settings Checksum (Note 3)	UINT16	0000 to 9999		read/write checksum register; PS block saved in nonvolatile memory on write (Note 8)	1	
520D - 520D	21006 - 21006	Write New Password (Note 3)	UINT16	0000 to 9999		write-only register; always reads zero	1	
520E - 520E	21007 - 21007	Terminate Programmable Settings Update (Note 3)	UINT16	any value		CPU leaves PS update mode via reset	1	
520F - 5211	21008 - 21010	Set CPU Clock	TSTAMP	1Jan2000 - 31Dec2099	1 sec	saved only when 3rd register is written	3	
5212 - 5212	21011 - 21011	Reserved	UINT16	any value		Reserved	1	
5213 - 5219	21012 - 21018	Reserved				Reserved	7	
521A - 521A	21019 - 21019	Close Privileged Command Session	UINT16	any value		ends an open command session	1	
							Block Size:	20
Encryption Block							read/write	
658F - 659A	26000 - 26011	Perform a Secure Operation	UINT16			encrypted command to read password or change CPU type	12	
							Block Size:	12
Programmable Settings Section								
Basic Setups Block							write only in PS update mode	
752F	752F	30000 30000	CT denominator	UINT16	1 or 5	none	1	
7530	7530	30001 30001	CT numerator Meter 1 , Phase A	UINT16	1 to 65535	none	1	
7531	7531	30002 30002	CT numerator Meter 1 , Phase B	UINT16	1 to 65535	none	1	
7532	7532	30003 30003	CT numerator Meter 1 , Phase C	UINT16	1 to 65535	none	1	
7533	7533	30004 30004	CT numerator Meter 2 , Phase A	UINT16	1 to 65535	none	1	
7534	7534	30005 30005	CT numerator Meter 2 , Phase B	UINT16	1 to 65535	none	1	
7535	7535	30006 30006	CT numerator Meter 2 , Phase C	UINT16	1 to 65535	none	1	
7536	7536	30007 30007	CT numerator Meter 3 , Phase A	UINT16	1 to 65535	none	1	
7537	7537	30008 30008	CT numerator Meter 3 , Phase B	UINT16	1 to 65535	none	1	
7538	7538	30009 30009	CT numerator Meter 3 , Phase C	UINT16	1 to 65535	none	1	
7539	7539	30010 30010	CT numerator Meter 4 , Phase A	UINT16	1 to 65535	none	1	
753A	753A	30011 30011	CT numerator Meter 4 , Phase B	UINT16	1 to 65535	none	1	
753B	753B	30012 30012	CT numerator Meter 4 , Phase C	UINT16	1 to 65535	none	1	
753C	753C	30013 30013	CT numerator Meter 5 , Phase A	UINT16	1 to 65535	none	1	

Modbus Address		Description	Format	Range	Units or Resolution	Comments	# Reg
Hex	Decimal						
753D	753D	30014 30014	UINT16	1 to 65535	none	(Cont'd)	1
753E	753E	30015 30015	UINT16	1 to 65535	none		1
753F	753F	30016 30016	UINT16	1 to 65535	none		1
7540	7540	30017 30017	UINT16	1 to 65535	none		1
7541	7541	30018 30018	UINT16	1 to 65535	none		1
7542	7542	30019 30019	UINT16	1 to 65535	none		1
7543	7543	30020 30020	UINT16	1 to 65535	none		1
7544	7544	30021 30021	UINT16	1 to 65535	none		1
7545	7545	30022 30022	UINT16	1 to 65535	none		1
7546	7546	30023 30023	UINT16	1 to 65535	none		1
7547	7547	30024 30024	UINT16	1 to 65535	none		1
7548	7549	30025 30026	UINT32	1 to 99999999	none		2
754A	754A	30027 30027	UINT16	1 to 65535	none		1
754B	754B	30028 30028	UINT16	bit-mapped	----- hhhh	hhhh = hookup enumeration (0 = 3 element wye[9S], 1 = 2 CT Delta, 3 = reserved,4=Single Phase)	1
754C	754C	30029 30029	UINT16	bit-mapped	--iiii b--- sss	iiii = interval (5,15,30,60) b = 0-block or 1-rolling sss = # subintervals (1,2,3,4)	1
754D	754D	30030 30030	UINT16	bit-mapped	-----nn -eee- ddd	nn = number of energy digits (5-8 --> 0-3) eee = energy scale (0-unit, 3-kilo, 6-mega) ddd = energy digits after decimal point (0-6) See note 10.	1
754E	754E	30031 30031	UINT16	bit-mapped	hhhhwww - dddmmmm	applies only if daylight savings in User Settings Flags = on; specifies when to make changeover	1
754F	754F	30032 30032	UINT16	bit-mapped	hhhhwww - dddmmmm	hhhhh = hour, 0-23 www = week, 1-4 for 1st - 4th, 5 for last ddd = day of week, 1-7 for Sun - Sat mmmm = month, 1-12 Example: 2AM on the 4th Sunday of March hhhhh=2, www=4, ddd=1, mmmm=3	1

C: MP200-Y (Three Phase) Modbus Map

Modbus Address		Description	Format	Range	Units or Resolution	Comments	# Reg	
Hex	Decimal							
7550	7550	30033 30033	User Settings Flags	UINT16	bit-mapped	----- urpdywfa	u = Energy direction. (0 = bi directional, 1=unit directional) r = password for reset in use (1=on, 0=off) p = password for configuration in use (1=on, 0=off) d = daylight saving time changes (0=off, 1=on) y = diagnostic events in system log (1=yes, 0=no) w = power direction (0=view as load, 1=view as generator) f = flip power factor sign (1=yes, 0=no) a = apparent power computation method (0=arithmetic sum, 1=vector sum)	1
7551	7558	30034 30041	CPU designation					8
7559	7559	30042 30042	COM1 setup	UINT16	bit-mapped	----dddd -ppp- bbb	dddd = reply delay (* 50 msec) ppp = protocol (1-Modbus RTU, 2-Modbus ASCII)	1
755A	755A	30043 30043	COM2 setup	UINT16	bit-mapped	----dddd -ppp- bbb	bbb = baud rate (1-9600, 2-19200, 4-38400, 6-57600)	1
755B	755B	30044 30044	COM3 setup	UINT16	bit-mapped	----dddd -ppp- bbb		1
755C	755D	30045 30046	Reserved					2
755E	755E	30047 30047	COM1 address	UINT16	1 to 247	none		1
755F	755F	30048 30048	COM2 address	UINT16	1 to 247	none		1
7560	7560	30049 30049	COM3 address	UINT16	1 to 247	none		1
7561	7578	30050 30073	Reserved	UINT16			Reserved	24
7579	7579	30074 30074	Programmable Settings Update Counter	UINT16	0-65535		Increments each time programmable settings are changed; occurs when new checksum is calculated.	1
757A	75B9	30075 30138	Reserved for Software Use				Reserved	64
75BA	- 75BA	30139 - 30139	Limit #1 Identifier	UINT16	0 to 65535		use Modbus address as the identifier (see notes 7, 11, 12)	1
75BB	- 75BB	30140 - 30140	Limit #1 Out High Setpoint	SINT16	-200.0 to +200.0	0.1% of full scale	Setpoint for the "above" limit (LM1), see notes 11-12.	1
75BC	- 75BC	30141 - 30141	Limit #1 In High Threshold	SINT16	-200.0 to +200.0	0.1% of full scale	Threshold at which "above" limit clears; normally less than or equal to the "above" setpoint; see notes 11-12.	1
75BD	- 75BD	30142 - 30142	Limit #1 Out Low Setpoint	SINT16	-200.0 to +200.0	0.1% of full scale	Setpoint for the "below" limit (LM2), see notes 11-12.	1

C: MP200-Y (Three Phase) Modbus Map

Modbus Address		Description	Format	Range	Units or Resolution	Comments	# Reg	
Hex	Decimal							
75BE - 75BE	30143 - 30143	Limit #1 In Low Threshold	SINT16	-200.0 to +200.0	0.1% of full scale	Threshold at which "below" limit clears; normally greater than or equal to the "below" setpoint; see notes 11-12.	1	
75BF - 75C3	30144 - 30148	Limit #2	SINT16	same as Limit #1	same as Limit #1	same as Limit #1	5	
75C4 - 75C8	30149 - 30153	Limit #3	SINT16				5	
75C9 - 75CD	30154 - 30158	Limit #4	SINT16				5	
75CE - 75D2	30159 - 30163	Limit #5	SINT16				5	
75D3 - 75D7	30164 - 30168	Limit #6	SINT16				5	
75D8 - 75DC	30169 - 30173	Limit #7	SINT16				5	
75DD - 75E1	30174 - 30178	Limit #8	SINT16				5	
75E2 - 75E9	30179 - 30186	Meter 1 Designation, Phase A	ASCII				16 char	none
75EA - 75F1	30187 - 30194	Meter 1 Designation, Phase B	ASCII	16 char	none	8		
75F2 - 75F9	30195 - 30202	Meter 1 Designation, Phase C	ASCII	16 char	none	8		
75FA - 7601	30203 - 30210	Meter 2 Designation, Phase A	ASCII	16 char	none	8		
7602 - 7609	30211 - 30218	Meter 2 Designation, Phase B	ASCII	16 char	none	8		
760A - 7611	30219 - 30226	Meter 2 Designation, Phase C	ASCII	16 char	none	8		
7612 - 7619	30227 - 30234	Meter 3 Designation, Phase A	ASCII	16 char	none	8		
761A - 7621	30235 - 30242	Meter 3 Designation, Phase B	ASCII	16 char	none	8		
7622 - 7629	30243 - 30250	Meter 3 Designation, Phase C	ASCII	16 char	none	8		
762A - 7631	30251 - 30258	Meter 4 Designation, Phase A	ASCII	16 char	none	8		
7632 - 7639	30259 - 30266	Meter 4 Designation, Phase B	ASCII	16 char	none	8		
763A - 7641	30267 - 30274	Meter 4 Designation, Phase C	ASCII	16 char	none	8		
7642 - 7649	30275 - 30282	Meter 5 Designation, Phase A	ASCII	16 char	none	8		
764A - 7651	30283 - 30290	Meter 5 Designation, Phase B	ASCII	16 char	none	8		
7652 - 7659	30291 - 30298	Meter 5 Designation, Phase C	ASCII	16 char	none	8		
765A - 7661	30299 - 30306	Meter 6 Designation, Phase A	ASCII	16 char	none	8		
7662 - 7669	30307 - 30314	Meter 6 Designation, Phase B	ASCII	16 char	none	8		
766A - 7671	30315 - 30322	Meter 6 Designation, Phase C	ASCII	16 char	none	8		
7672 - 7679	30323 - 30330	Meter 7 Designation, Phase A	ASCII	16 char	none	8		
767A - 7681	30331 - 30338	Meter 7 Designation, Phase B	ASCII	16 char	none	8		
7682 - 7689	30339 - 30346	Meter 7 Designation, Phase C	ASCII	16 char	none	8		
768A - 7691	30347 - 30354	Meter 8 Designation, Phase A	ASCII	16 char	none	8		
7692 - 7699	30355 - 30362	Meter 8 Designation, Phase B	ASCII	16 char	none	8		
769A - 76A1	30363 - 30370	Meter 8 Designation, Phase C	ASCII	16 char	none	8		
						Block Size:	371	



Modbus Address		Description	Format	Range	Units or Resolution	Comments	# Reg	
Hex	Decimal							
Log Setups Block								
write only in PS update mode								
7917	7917	31000 31000	Historical Log #1 Sizes	UINT16	bit-mapped	eeeeeeee ssssssss	high byte is number of registers to log in each record (0-117), low byte is number of flash sectors for the log (see note 17) 0 in either byte disables the log	1
7918	7918	31001 31001	Historical Log #1 Interval	UINT16	bit-mapped	00000000 hgfedcba	only 1 bit set: a=1 min, b=3 min, c=5 min, d=10 min, e=15 min, f=30 min, g=60 min, h=EOI pulse	1
7919	7919	31002 31002	Historical Log #1, Register #1 Identifier	UINT16	0 to 65535		use Modbus address as the identifier (see note 7)	1
791A	798D	31003 31118	Historical Log #1, Register #2 - #117 Identifiers	UINT16	0 to 65535		same as Register #1 Identifier	116
798E	79D6	31119 31191	Historical Log #1 Software Buffer				Reserved for software use.	73
79D7	7A96	31192 31383	Historical Log #2 Sizes, Interval, Registers & Software Buffer				same as Historical Log #1	192
7A97	7B56	31384 31575	Historical Log #3 Sizes, Interval, Registers & Software Buffer				same as Historical Log #1	192
7B57	7B75	31576 31606	Reserved				Reserved	31
Block Size:							608	
Settings Registers for Digital I/O Relay Card					First Overlay	write only in PS update mode		
7D00 - 7D00	32001 - 32001	Input#1 - 4 bindings & logging enables	UINT16	bit-mapped	44443333 22221111	One nibble for each input. Assuming "abcc" as the bits in each nibble: "a": select this input for EOI (End Of Interval)pulse sensing. "b": log this input when pulse is detected "cc": Input event trigger mode - Contact sensing method; 00 = none; 01 = open to close; 10 = close to open; 11 = any change. Every input has an associated internal accumulator (See input Accumulator Scaling), which is incremented every time the input changes according with the trigger mode criteria "cc"	1	
7D01 - 7D01	32002 - 32002	Relay #1 Delay to Operate	UINT16	0.1 second units		Delay to operate the relay since request.	1	
7D02 - 7D02	32003 - 32003	Relay #1 Delay to Release	UINT16	0.1 second units		Delay to release the relay since request.	1	
7D03 - 7D08	32004 - 32009	Reserved	UINT16			Set to 0.	6	

Modbus Address		Description	Format	Range	Units or Resolution	Comments	# Reg
Hex	Decimal						
7D09 - 7D09	32010 - 32010	Relay #2 Delay to Operate	UINT16	0.1 second units		Delay to operate the relay since request.	1
7D0A - 7D0A	32011 - 32011	Relay #2 Delay to Release	UINT16	0.1 second units		Delay to release the relay since request.	1
7D0B - 7D20	32012 - 32033	Reserved	UINT16			Set to 0.	22
7D21 - 7D21	32034 - 32034	Input Accumulators Scaling	UINT16	bit-mapped	44443333 22221111	4 bits per input or output accumulator The nibble informs what should be the scaling of the accumulator 0=no-scaling, 1=0.1, 2=0.01, 3= 1m, 4=0.1m, 5=0.01m, 6=1u, 7=0.1u; the value 15 disable the accumulator.	1
7D22 - 7D22	32035 - 32035	Relay Accumulators Scaling	UINT16	bit-mapped	44443333 22221111	Example: suppose that the internal input accumulator #1 is 12345, and its corresponding scaling setting is "0011" (3 decimal). Then, the accumulator will be read as: Scaling 3, means 1m or 0.001. Scaled accumulator = 12345 * 0.001 = 12 (Twelve).	1
7D23 - 7D3E	32037 - 32063	Reserved				Set to 0.	8
7D3F - 7D46	32064 - 32071	Input#1 Label	ASCII	16 char			8
7D47 - 7D4E	32072 - 32079	Input#1 Low State Name	ASCII	16 char			8
7D4F - 7D56	32080 - 32087	Input#1 High State Name	ASCII	16 char			8
7D57 - 7D6E	32088 - 32111	Input#2 Label and State Names				same as Input#1	24
7D6F - 7D86	32112 - 32135	Input#3 Label and State Names				same as Input#1	24
7D87 - 7D9E	32136 - 32159	Input#4 Label and State Names				same as Input#1	24
7D9F - 7DA6	32160 - 32167	Relay#1 Label	ASCII	16 char			8
7DA7 - 7DAE	32168 - 32175	Relay#1 Open State Name	ASCII	16 char			8
7DAF - 7DB6	32176 - 32183	Relay#1 Closed State Name	ASCII	16 char			8
7DB7 - 7DCE	32184 - 32207	Relay#2 Label and State Names				same as Relay#1	24
7DCF - 7DFE	32208 - 32255	Reserved				Reserved	48
7DFE - 7E06	32256 - 32263	Input#1 Accumulator Label	ASCII	16 char			8
7E07 - 7E0E	32264 - 32271	Input#2 Accumulator Label	ASCII	16 char			8
7E0F - 7E14	32272 - 32277	Input#3 Accumulator Label	ASCII	16 char			8
7E15 - 7E1E	32278 - 32287	Input#4 Accumulator Label	ASCII	16 char			8

Modbus Address		Description	Format	Range	Units or Resolution	Comments	# Reg
Hex	Decimal						
7E1F - 7E1F	32288 - 32288	Input#1 Accumulator Kt	UINT16	bit-mapped	ddvvvvvv vvvvvvvv	KT power factor for the Pulse Output "V" is raw power value in Wh/pulse from 0 to 9999.	1
7E20 - 7E20	32289 - 32289	Input#2 Accumulator Kt	UINT16	bit-mapped	ddvvvvvv vvvvvvvv	"dd"=decimal point position: 00=0.XXXX, 01=X.XXX, 10=XX.XX, 11= X.XXX.	1
7E21 - 7E21	32290 - 32290	Input#3 Accumulator Kt	UINT16	bit-mapped	ddvvvvvv vvvvvvvv		1
7E22 - 7E22	32291 - 32291	Input#4 Accumulator Kt	UINT16	bit-mapped	ddvvvvvv vvvvvvvv		1
7E23 - 7F53	32292 - 32596	Reserved				Reserved	305
						Block Size:	576
Log Retrieval Section							
Log Retrieval Block						read/write except as noted	
C34C - C34D	49997 - 49998	Log Retrieval Session Duration	UINT32	0 to 4294967294	4 msec	0 if no session active; wraps around after max count	2
C34E - C34E	49999 - 49999	Log Retrieval Session Com Port	UINT16	0 to 3		0 if no session active, 1-3 for session active on COM1 - COM3	1
C34F - C34F	50000 - 50000	Log Number, Enable, Scope	UINT16	bit-mapped	nnnnnnnn esssssss	high byte is the log number (0-system, 1-history1, 2-history2, 3-history3,4-alarm log, 5-I/O changes) e is retrieval session enable(1) or disable(0) sssssss is what to retrieve (0-normal record, 1-timestamps only, 2-complete memory image (no data validation if image))	1
C350 - C350	50001 - 50001	Records per Window or Batch, Record Scope Selector, Number of Repeats	UINT16	bit-mapped	wwwwwww snnnnnnn	high byte is records per window if s=0 or records per batch if s=1, low byte is number of repeats for function 35 or 0 to suppress auto-incrementing; max number of repeats is 8 (RTU) or 4 (ASCII) total windows, a batch is all the windows	1
C351 - C352	50002 - 50003	Offset of First Record in Window	UINT32	bit-mapped	ssssssss nnnnnnnn nnnnnnnn nnnnnnnn	ssssssss is window status (0 to 7-window number, 0xFF-not ready); this byte is read-only. nn...nn is a 24-bit record number. The log's first record is latched as a reference point when the session is enabled. This offset is a record index relative to that point. Value provided is the relative index of the whole or partial record that begins the window.	2

C: MP200-Y (Three Phase) Modbus Map

Modbus Address		Description	Format	Range	Units or Resolution	Comments	# Reg
Hex	Decimal						
C353 - C3CD	50004 - 50126	Log Retrieve Window	UINT16	see comments	none	mapped per record layout and retrieval scope, read-only	2
						Block Size:	9
Log Status Block							3
		System Log Status Block				read only	3
C737 - C738	51000 - 51001	Log Size in Records	UINT32	0 to 4,294,967,294	record		4
C739 - C73A	51002 - 51003	Number of Records Used	UINT32	1 to 4,294,967,294	record		23
C73B - C73B	51004 - 51004	Record Size in Bytes	UINT16	14 to 242	byte		16
C73C - C73C	51005 - 51005	Log Availability	UINT16		none	0=available, 1-3=in use by COM1-3, 0xFFFF=not available (log size=0)	16
C73D - C73F	51006 - 51008	Timestamp, First Record	TSTAMP	1Jan2000 - 31Dec2099	1 sec		16
C740 - C742	51009 - 51011	Timestamp, Last Record	TSTAMP	1Jan2000 - 31Dec2099	1 sec		16
C743 - C746	51012 - 51015	Reserved				Reserved	16
						Individual Log Status Block Size:	110
C747 - C756	51016 - 51031	Historical Log 1 Status Block				same as system log status block	110
C757 - C766	51032 - 51047	Historical Log 2 Status Block				same as system log status block	110
C767 - C776	51048 - 51063	Historical Log 3 Status Block				same as system log status block	110
C777 - C786	51064 - 51079	Alarm Log Status Block				same as system log status block	110
C787 - C796	51080 - 51095	I/O Log Status Block				same as system log status block	110
						Block Size:	660
End of Map							

Modbus Address		Description	Format	Range	Units or Resolution	Comments	# Reg
Hex	Decimal						
Data Formats							
ASCII		ASCII characters packed 2 per register in high, low order and without any termination characters.					
SINT16 / UINT16		16-bit signed / unsigned integer.					
SINT32 / UINT32		32-bit signed / unsigned integer spanning 2 registers. The lower-addressed register is the high order half.					
FLOAT		32-bit IEEE floating point number spanning 2 registers. The lower-addressed register is the high order half (i.e., contains the exponent).					
TSTAMP		3 adjacent registers, 2 bytes each. First (lowest-addressed) register high byte is year (0-99), low byte is month (1-12). Middle register high byte is day(1-31), low byte is hour (0-23 plus DST bit). DST (daylight saving time) bit is bit 6 (0x40). Third register high byte is minutes (0-59), low byte is seconds (0-59). For example, 9:35:07AM on October 12, 2049 would be 0x310A, 0x0C49, 0x2307, assuming DST is in effect.					
Notes							

- 1 All registers not explicitly listed in the table read as 0. Writes to these registers will be accepted but won't actually change the register (since it doesn't exist).
- 2 CPU Data Section items read as 0 until first readings are available or if the CPU is not in operating mode. Writes to these registers will be accepted but won't actually change the register.
- 3 Register valid only in programmable settings update mode. In other modes these registers read as 0 and return an illegal data address exception if a write is attempted.
- 4 CPU command registers always read as 0. They may be written only when the CPU is in a suitable mode. The registers return an illegal data address exception if a write is attempted in an incorrect mode.
- 5 If the password is incorrect, a valid response is returned but the command is not executed. Use 5555 for the password if passwords are disabled in the programmable settings.
- 6 M denotes a 1,000,000 multiplier.
- 7 Each identifier is a Modbus register. For entities that occupy multiple registers (FLOAT, SINT32, etc.) all registers making up the entity must be listed, in ascending order. For example, to log phase A volts, VAs and VA hours, the register list would be 0x3E7, 0x3E8, 0x411, 0x412, 0x176F, 0x61D, 0x61E and the number of registers (0x7917 high byte) would be 7.
- 8 Writing this register causes data to be saved permanently in nonvolatile memory. Reply to the command indicates that it was accepted but not whether or not the save was successful. This can only be determined after the CPU has restarted.
- 9 Reset commands make no sense if the CPU state is LIMP. An illegal function exception will be returned.
- 10 Energy registers should be reset after a format change. For single phase option only perphase values are valid. Please note that the three phase total values are invalid in this case. Also the test pulses are invalid since it is based on Total values.
- 11 Entities to be monitored against limits are identified by Modbus address. Entities occupying multiple Modbus registers, such as floating point values, are identified by the lower register address. If any of the 8 limits is unused, set its identifier to zero. If the indicated Modbus register is not used or is a nonsensical entity for limits, it will behave as an unused limit.
- 12 There are 2 setpoints per limit, one above and one below the expected range of values. LM1 is the "too high" limit, LM2 is "too low". The entity goes "out of limit" on LM1 when its value is greater than the setpoint. It remains "out of limit" until the value drops below the in threshold. LM2 works similarly, in the opposite direction. If limits in only one direction are of interest, set the in threshold on the "wrong" side of the setpoint. Limits are specified as % of full scale, where full scale is automatically set appropriately for the entity being monitored:

$$\begin{aligned} \text{current FS} &= \text{CT numerator} \\ \text{voltage FS} &= \text{PT numerator} * \text{PT multiplier} \\ \text{3 phase power FS} &= \text{CT numerator} * \text{PT numerator} * 3 \text{ [* SQRT(3) for delta hookup]} \end{aligned}$$

single phase power FS = CT numerator * PT numerator [* SQRT(3) for delta hookup]

frequency FS = 60 (or 50)

power factor FS = 1.0

percentage FS = 100.0

angle FS = 180.0

- 13 Card Identification Block is an image of the EEPROM on the card.
- 14 A block of data and control registers is allocated for the I/O card.
- 15 Measurement states: Off occurs during programmable settings updates; Run is the normal measuring state; Limp indicates that an essential non-volatile memory block is corrupted; and Warmup occurs briefly (approximately 4 seconds) at startup while the readings stabilize. Run state is required for measurement, historical logging, demand interval processing, limit alarm evaluation, min/max comparisons. Resetting min/max or energy is allowed only in run and off states; warmup will return a busy exception. In limp state, the CPU reboots at 5 minute intervals in an effort to clear the problem.
- 16 Limits evaluation for all entites except demand averages commences immediately after the warmup period. Evaluation for demand averages, maximum demands, and minimum demands commences at the end of the first demand interval after startup.
- 17 Depending on the V-switch setting, there are 3 or 106 flash sectors available in a common pool for distribution among the 3 historical logs. The pool size, number of sectors for each log, and the number of registers per record together determine the maximum number of records a log can hold.
S = number of sectors assigned to the log,
H = number of Modbus registers to be monitored in each historical record (up to 117)
R = number of bytes per record = (12 + 2H) for historical logs
N = number of records per sector = 65516 / R, rounded down to an integer value (no partial records in a sector)
T = total number of records the log can hold = S * N
- 18 Logs cannot be reset during log retrieval. Busy exception will be returned.
- 19 Combination of class and type currently defined are:
0x01 =IO interface board
0x02 = Relay Card

Modbus Address		Description	Format	Range	Units or Resolution	Comments
Hex	Decimal					
Fixed Data Section						
Identification Block						read-only
0000 - 0007	1 - 8	CPU Name	ASCII	16 char	none	
0008 - 000F	9 - 16	CPU Serial Number	ASCII	16 char	none	
0010 - 0010	17 - 17	CPU Type	UINT16	bit-mapped	-----m vvvvvvvv	m = CPU type 0: Three phase 1: Single Phase vvvvvvv = V-switch 1: V1 2: V2 3: V3
0011 - 0012	18 - 19	Firmware Version	ASCII	4 char	none	
0013 - 0013	20 - 20	Map Version	UINT16	0 to 65535	none	
0014 - 0014	21 - 21	CPU Configuration	UINT16	bit-mapped	-----ccc --ffffff	ccc = CT denominator (1 or 5), ffffff = calibration frequency (50 60)
0015 - 0015	22 - 22	ASIC Version Meter1	UINT16	0-65535	none	
0016 - 0016	23 - 23	ASIC Version Meter2	UINT16	0-65536	none	
0017 - 0017	24 - 24	ASIC Version Meter3	UINT16	0-65537	none	
0018 - 0018	25 - 25	ASIC Version Meter4	UINT16	0-65538	none	
0019 - 0019	26 - 26	ASIC Version Meter5	UINT16	0-65539	none	
001A - 001A	27 - 27	ASIC Version Meter6	UINT16	0-65540	none	
001B - 001B	28 - 28	ASIC Version Meter7	UINT16	0-65541	none	
001C - 001C	29 - 29	ASIC Version Meter8	UINT16	0-65542	none	
001D - 001E	30 - 31	Boot Firmware Version	ASCII	4 char	none	
001F - 001F	32 - 32	Relay card id			none	
0020 - 0020	33 - 33	Reserved				
0021 - 0024	34 - 37	CPU Type Name	ASCII	8 char	none	
						Block Size:
CPU Data Section						
Primary Voltage Readings Block						read-only
03E7 - 03E8	1000 - 1001	Volts	FLOAT	0 to 9999 M	volts	
03E9 - 03EA	1002 - 1003	Reserved				
03EB - 03EC	1004 - 1005	Reserved				
03ED - 03EE	1006 - 1007	Reserved				
03EF - 03F0	1008 - 1009	Reserved				
03F1 - 03F2	1010 - 1011	Reserved				
03F3 - 03F4	1012 - 1013	Frequency	FLOAT	0 to 65.00	Hz	

Modbus Address		Description	Format	Range	Units or Resolution	Comments	# Reg
Hex	Decimal						
						Block Size:	12
Primary Readings Block						read-only	
044B - 044C	1100 - 1101	Amps Meter 1	FLOAT	0 to 9999 M	amps		2
044D - 044E	1102 - 1103	Amps Meter 2	FLOAT	0 to 9999 M	amps		2
044F - 0450	1104 - 1105	Amps Meter 3	FLOAT	0 to 9999 M	amps		2
0451 - 0452	1106 - 1107	Reserved					2
0453 - 0454	1108 - 1109	Reserved					2
0455 - 0456	1110 - 1111	Reserved					2
0457 - 0458	1112 - 1113	Reserved					2
0459 - 045A	1114 - 1115	Reserved					2
045B - 045C	1116 - 1117	Watts, Meter 1	FLOAT	-9999 M to +9999 M	watts	Per phase power and PF have values only for WYE hookup and will be zero for all other hookups. For single phase hook up only per phase values are valid. Please note that the total values are invalid.	2
045D - 045E	1118 - 1119	Watts, Meter 2	FLOAT	-9999 M to +9999 M	watts		2
045F - 0460	1120 - 1121	Watts, Meter 3	FLOAT	-9999 M to +9999 M	watts		2
0461 - 0462	1122 - 1123	VARs, Meter 1	FLOAT	-9999 M to +9999 M	VARs		2
0463 - 0464	1124 - 1125	VARs, Meter 2	FLOAT	-9999 M to +9999 M	VARs		2
0465 - 0466	1126 - 1127	VARs, Meter 3	FLOAT	-9999 M to +9999 M	VARs		2
0467 - 0468	1128 - 1129	VAs, Meter 1	FLOAT	0 to +9999 M	VAs		2
0469 - 046A	1130 - 1131	VAs, Meter 2	FLOAT	0 to +9999 M	VAs		2
046B - 046C	1132 - 1133	VAs, Meter 3	FLOAT	0 to +9999 M	VAs		2
046D - 046E	1134 - 1135	Power Factor, Meter 1	FLOAT	-1.00 to +1.00	none		2
046F - 0470	1136 - 1137	Power Factor, Meter 2	FLOAT	-1.00 to +1.00	none	2	
0471 - 0472	1138 - 1139	Power Factor, Meter 3	FLOAT	-1.00 to +1.00	none	2	
						Block size:	40

Modbus Address		Description	Format	Range	Units or Resolution	Comments
Hex	Decimal					
04AF - 04B0	1200 - 1201	Amps Meter 4	FLOAT	0 to 9999 M	amps	
04B1 - 04B2	1202 - 1203	Amps Meter 5	FLOAT	0 to 9999 M	amps	
04B3 - 04B4	1204 - 1205	Amps Meter 6	FLOAT	0 to 9999 M	amps	
04B5 - 04B6	1206 - 1207	Reserved				
04B7 - 04B8	1208 - 1209	Reserved				
04B9 - 04BA	1210 - 1211	Reserved				
04BB - 04BC	1212 - 1213	Reserved				
04BD - 04BE	1214 - 1215	Reserved				
04BF - 04C0	1216 - 1217	Watts, Meter 4	FLOAT	-9999 M to +9999 M	watts	Per phase power and PF have values only for WYE hookup and will be zero for all other hookups.
04C1 - 04C2	1218 - 1219	Watts, Meter 5	FLOAT	-9999 M to +9999 M	watts	
04C3 - 04C4	1220 - 1221	Watts, Meter 6	FLOAT	-9999 M to +9999 M	watts	For single phase hook up only phase values are valid. Please note that the total values are invalid.
04C5 - 04C6	1222 - 1223	VARs, Meter 4	FLOAT	-9999 M to +9999 M	VARs	
04C7 - 04C8	1224 - 1225	VARs, Meter 5	FLOAT	-9999 M to +9999 M	VARs	
04C9 - 04CA	1226 - 1227	VARs, Meter 6	FLOAT	-9999 M to +9999 M	VARs	
04CB - 04CC	1228 - 1229	VAs, Meter 4	FLOAT	0 to +9999 M	VAs	
04CD - 04CE	1230 - 1231	VAs, Meter 5	FLOAT	0 to +9999 M	VAs	
04CF - 04D0	1232 - 1233	VAs, Meter 6	FLOAT	0 to +9999 M	VAs	
04D1 - 04D2	1234 - 1235	Power Factor, Meter 4	FLOAT	-1.00 to +1.00	none	
04D3 - 04D4	1236 - 1237	Power Factor, Meter 5	FLOAT	-1.00 to +1.00	none	
04D5 - 04D6	1238 - 1239	Power Factor, Meter 6	FLOAT	-1.00 to +1.00	none	
						Block size:
0513 - 0514	1300 - 1301	Amps Meter 7	FLOAT	0 to 9999 M	amps	
0515 - 0516	1302 - 1303	Amps Meter 8	FLOAT	0 to 9999 M	amps	
0517 - 0518	1304 - 1305	Amps Meter 9	FLOAT	0 to 9999 M	amps	
0519 - 051A	1306 - 1307	Reserved				

Modbus Address		Description	Format	Range	Units or Resolution	Comments	# Reg	
Hex	Decimal							
051B - 051C	1308 - 1309	Reserved					2	
051D - 051E	1310 - 1311	Reserved					2	
051F - 0520	1312 - 1313	Reserved					2	
0521 - 0522	1314 - 1315	Reserved					2	
0523 - 0524	1316 - 1317	Watts, Meter 7	FLOAT	-9999 M to +9999 M	watts	Per phase power and PF have values only for WYE hookup and will be zero for all other hookups. For single phase hook up only per phase values are valid. Please note that the total values are invalid.	2	
0525 - 0526	1318 - 1319	Watts, Meter 8	FLOAT	-9999 M to +9999 M	watts		2	
0527 - 0528	1320 - 1321	Watts, Meter 9	FLOAT	-9999 M to +9999 M	watts		2	
0529 - 052A	1322 - 1323	VARs, Meter 7	FLOAT	-9999 M to +9999 M	VARs		2	
052B - 052C	1324 - 1325	VARs, Meter 8	FLOAT	-9999 M to +9999 M	VARs		2	
052D - 052E	1326 - 1327	VARs, Meter 9	FLOAT	-9999 M to +9999 M	VARs		2	
052F - 0530	1328 - 1329	VAs, Meter 7	FLOAT	0 to +9999 M	VAs		2	
0531 - 0532	1330 - 1331	VAs, Meter 8	FLOAT	0 to +9999 M	VAs		2	
0533 - 0534	1332 - 1333	VAs, Meter 9	FLOAT	0 to +9999 M	VAs		2	
0535 - 0536	1334 - 1335	Power Factor, Meter 7	FLOAT	-1.00 to +1.00	none		2	
0537 - 0538	1336 - 1337	Power Factor, Meter 8	FLOAT	-1.00 to +1.00	none		2	
0539 - 053A	1338 - 1339	Power Factor, Meter 9	FLOAT	-1.00 to +1.00	none		2	
Block size:							40	
0577 - 0578	1400 - 1401	Amps Meter 10	FLOAT	0 to 9999 M	amps			2
0579 - 057A	1402 - 1403	Amps Meter 11	FLOAT	0 to 9999 M	amps			2
057B - 057C	1404 - 1405	Amps Meter 12	FLOAT	0 to 9999 M	amps		2	
057D - 057E	1406 - 1407	Reserved					2	
057F - 0580	1408 - 1409	Reserved					2	
0581 - 0582	1410 - 1411	Reserved					2	
0583 - 0584	1412 - 1413	Reserved					2	
0585 - 0586	1414 - 1415	Reserved					2	

Modbus Address		Description	Format	Range	Units or Resolution	Comments	# Reg
Hex	Decimal						
0587 - 0588	1416 - 1417	Watts, Meter 10	FLOAT	-9999 M to +9999 M	watts	Per phase power and PF have values only for WYE hookup and will be zero for all other hookups. For single phase hook up only per phase values are valid. Please note that the total values are invalid.	2
0589 - 058A	1418 - 1419	Watts, Meter 11	FLOAT	-9999 M to +9999 M	watts		2
058B - 058C	1420 - 1421	Watts, Meter 12	FLOAT	-9999 M to +9999 M	watts		2
058D - 058E	1422 - 1423	VARs, Meter 10	FLOAT	-9999 M to +9999 M	VARs		2
058F - 0590	1424 - 1425	VARs, Meter 11	FLOAT	-9999 M to +9999 M	VARs		2
0591 - 0592	1426 - 1427	VARs, Meter 12	FLOAT	-9999 M to +9999 M	VARs		2
0593 - 0594	1428 - 1429	VAs, Meter 10	FLOAT	0 to +9999 M	VAs		2
0595 - 0596	1430 - 1431	VAs, Meter 11	FLOAT	0 to +9999 M	VAs		2
0597 - 0598	1432 - 1433	VAs, Meter 12	FLOAT	0 to +9999 M	VAs		2
0599 - 059A	1434 - 1435	Power Factor, Meter 10	FLOAT	-1.00 to +1.00	none		2
059B - 059C	1436 - 1437	Power Factor, Meter 11	FLOAT	-1.00 to +1.00	none		2
059D - 059E	1438 - 1439	Power Factor, Meter 12	FLOAT	-1.00 to +1.00	none		2
							Block size:
05DB - 05DC	1500 - 1501	Amps Meter 13	FLOAT	0 to 9999 M	amps		2
05DD - 05DE	1502 - 1503	Amps Meter 14	FLOAT	0 to 9999 M	amps		2
05DF - 05E0	1504 - 1505	Amps Meter 15	FLOAT	0 to 9999 M	amps		2
05E1 - 05E2	1506 - 1507	Reserved					2
05E3 - 05E4	1508 - 1509	Reserved					2
05E5 - 05E6	1510 - 1511	Reserved					2
05E7 - 05E8	1512 - 1513	Reserved					2
05E9 - 05EA	1514 - 1515	Reserved					2

Modbus Address		Description	Format	Range	Units or Resolution	Comments	# Reg
Hex	Decimal						
05EB - 05EC	1516 - 1517	Watts, Meter 13	FLOAT	-9999 M to +9999 M	watts	Per phase power and PF have values only for WYE hookup and will be zero for all other hookups. For single phase hook up only per phase values are valid. Please note that the total values are invalid.	2
05ED - 05EE	1518 - 1519	Watts, Meter 14	FLOAT	-9999 M to +9999 M	watts		2
05EF - 05F0	1520 - 1521	Watts, Meter 15	FLOAT	-9999 M to +9999 M	watts		2
05F1 - 05F2	1522 - 1523	VARs, Meter 13	FLOAT	-9999 M to +9999 M	VARs		2
05F3 - 05F4	1524 - 1525	VARs, Meter 14	FLOAT	-9999 M to +9999 M	VARs		2
05F5 - 05F6	1526 - 1527	VARs, Meter 15	FLOAT	-9999 M to +9999 M	VARs		2
05F7 - 05F8	1528 - 1529	VAs, Meter 13	FLOAT	0 to +9999 M	VAs		2
05F9 - 05FA	1530 - 1531	VAs, Meter 14	FLOAT	0 to +9999 M	VAs		2
05FB - 05FC	1532 - 1533	VAs, Meter 15	FLOAT	0 to +9999 M	VAs		2
05FD - 05FE	1534 - 1535	Power Factor, Meter 13	FLOAT	-1.00 to +1.00	none		2
05FF - 0600	1536 - 1537	Power Factor, Meter 14	FLOAT	-1.00 to +1.00	none		2
0601 - 0602	1538 - 1539	Power Factor, Meter 15	FLOAT	-1.00 to +1.00	none		2
							Block size:
063F - 0640	1600 - 1601	Amps Meter 16	FLOAT	0 to 9999 M	amps		2
0641 - 0642	1602 - 1603	Amps Meter 17	FLOAT	0 to 9999 M	amps		2
0643 - 0644	1604 - 1605	Amps Meter 18	FLOAT	0 to 9999 M	amps		2
0645 - 0646	1606 - 1607	Reserved					2
0647 - 0648	1608 - 1609	Reserved					2
0649 - 064A	1610 - 1611	Reserved					2
064B - 064C	1612 - 1613	Reserved					2
064D - 064E	1614 - 1615	Reserved					2

Modbus Address		Description	Format	Range	Units or Resolution	Comments	# Reg
Hex	Decimal						
064F - 0650	1616 - 1617	Watts, Meter 16	FLOAT	-9999 M to +9999 M	watts	Per phase power and PF have values only for WYE hookup and will be zero for all other hookups. For single phase hook up only per phase values are valid. Please note that the total values are invalid.	2
0651 - 0652	1618 - 1619	Watts, Meter 17	FLOAT	-9999 M to +9999 M	watts		2
0653 - 0654	1620 - 1621	Watts, Meter 18	FLOAT	-9999 M to +9999 M	watts		2
0655 - 0656	1622 - 1623	VARs, Meter 16	FLOAT	-9999 M to +9999 M	VARs		2
0657 - 0658	1624 - 1625	VARs, Meter 17	FLOAT	-9999 M to +9999 M	VARs		2
0659 - 065A	1626 - 1627	VARs, Meter 18	FLOAT	-9999 M to +9999 M	VARs		2
065B - 065C	1628 - 1629	VAs, Meter 16	FLOAT	0 to +9999 M	VAs		2
065D - 065E	1630 - 1631	VAs, Meter 17	FLOAT	0 to +9999 M	VAs		2
065F - 0660	1632 - 1633	VAs, Meter 18	FLOAT	0 to +9999 M	VAs		2
0661 - 0662	1634 - 1635	Power Factor, Meter 16	FLOAT	-1.00 to +1.00	none		2
0663 - 0664	1636 - 1637	Power Factor, Meter 17	FLOAT	-1.00 to +1.00	none		2
0665 - 0666	1638 - 1639	Power Factor, Meter 18	FLOAT	-1.00 to +1.00	none		2
Block size:							40
06A3 - 06A4	1700 - 1701	Amps Meter 19	FLOAT	0 to 9999 M	amps		2
06A5 - 06A6	1702 - 1703	Amps Meter 20	FLOAT	0 to 9999 M	amps		2
06A7 - 06A8	1704 - 1705	Amps Meter 21	FLOAT	0 to 9999 M	amps		2
06A9 - 06AA	1706 - 1707	Reserved					2
06AB - 06AC	1708 - 1709	Reserved					2
06AD - 06AE	1710 - 1711	Reserved					2
06AF - 06B0	1712 - 1713	Reserved					2
06B1 - 06B2	1714 - 1715	Reserved					2

Modbus Address		Description	Format	Range	Units or Resolution	Comments	# Reg
Hex	Decimal						
06B3 - 06B4	1716 - 1717	Watts, Meter 19	FLOAT	-9999 M to +9999 M	watts	Per phase power and PF have values only for WYE hookup and will be zero for all other hookups. For single phase hook up only per phase values are valid. Please note that the total values are invalid.	2
06B5 - 06B6	1718 - 1719	Watts, Meter 20	FLOAT	-9999 M to +9999 M	watts		2
06B7 - 06B8	1720 - 1721	Watts, Meter 21	FLOAT	-9999 M to +9999 M	watts		2
06B9 - 06BA	1722 - 1723	VARs, Meter 19	FLOAT	-9999 M to +9999 M	VARs		2
06BB - 06BC	1724 - 1725	VARs, Meter 20	FLOAT	-9999 M to +9999 M	VARs		2
06BD - 06BE	1726 - 1727	VARs, Meter 21	FLOAT	-9999 M to +9999 M	VARs		2
06BF - 06C0	1728 - 1729	VAs, Meter 19	FLOAT	0 to +9999 M	VAs		2
06C1 - 06C2	1730 - 1731	VAs, Meter 20	FLOAT	0 to +9999 M	VAs		2
06C3 - 06C4	1732 - 1733	VAs, Meter 21	FLOAT	0 to +9999 M	VAs		2
06C5 - 06C6	1734 - 1735	Power Factor, Meter 19	FLOAT	-1.00 to +1.00	none		2
06C7 - 06C8	1736 - 1737	Power Factor, Meter 20	FLOAT	-1.00 to +1.00	none		2
06C9 - 06CA	1738 - 1739	Power Factor, Meter 21	FLOAT	-1.00 to +1.00	none		2
							Block size:
0707 - 0708	1800 - 1801	Amps Meter 22	FLOAT	0 to 9999 M	amps		2
0709 - 070A	1802 - 1803	Amps Meter 23	FLOAT	0 to 9999 M	amps		2
070B - 070C	1804 - 1805	Amps Meter 24	FLOAT	0 to 9999 M	amps		2
070D - 070E	1806 - 1807	Reserved					2
070F - 0710	1808 - 1809	Reserved					2
0711 - 0712	1810 - 1811	Reserved					2
0713 - 0714	1812 - 1813	Reserved					2
0715 - 0716	1814 - 1815	Reserved					2

Modbus Address		Description	Format	Range	Units or Resolution	Comments	# Reg
Hex	Decimal						
0717 - 0718	1816 - 1817	Watts, Meter 22	FLOAT	-9999 M to +9999 M	watts	Per phase power and PF have values only for WYE hookup and will be zero for all other hookups. For single phase hook up only per phase values are valid. Please note that the total values are invalid.	2
0719 - 071A	1818 - 1819	Watts, Meter 23	FLOAT	-9999 M to +9999 M	watts		2
071B - 071C	1820 - 1821	Watts, Meter 24	FLOAT	-9999 M to +9999 M	watts		2
071D - 071E	1822 - 1823	VARs, Meter 22	FLOAT	-9999 M to +9999 M	VARs		2
071F - 0720	1824 - 1825	VARs, Meter 23	FLOAT	-9999 M to +9999 M	VARs		2
0721 - 0722	1826 - 1827	VARs, Meter 24	FLOAT	-9999 M to +9999 M	VARs		2
0723 - 0724	1828 - 1829	VAs, Meter 22	FLOAT	0 to +9999 M	VAs		2
0725 - 0726	1830 - 1831	VAs, Meter 23	FLOAT	0 to +9999 M	VAs		2
0727 - 0728	1832 - 1833	VAs, Meter 24	FLOAT	0 to +9999 M	VAs		2
0729 - 072A	1834 - 1835	Power Factor, Meter 22	FLOAT	-1.00 to +1.00	none		2
072B - 072C	1836 - 1837	Power Factor, Meter 23	FLOAT	-1.00 to +1.00	none		2
072D - 072E	1838 - 1839	Power Factor, Meter 24	FLOAT	-1.00 to +1.00	none		2
							Block Size:

Modbus Address		Description	Format	Range	Units or Resolution	Comments	# Reg
Hex	Decimal						
Primary Energy Block							
076B - 076C	1900 - 1901	Reserved				* Wh received & delivered always have opposite signs	2
076D - 076E	1902 - 1903	Reserved					2
076F - 0770	1904 - 1905	Reserved					2
0771 - 0772	1906 - 1907	Reserved				* Wh received is positive for "view as load", delivered is positive for "view as generator"	2
0773 - 0774	1908 - 1909	Reserved					2
0775 - 0776	1910 - 1911	Reserved					2
0777 - 0778	1912 - 1913	Reserved					2
0779 - 077A	1914 - 1915	Reserved				* 5 to 8 digits	2
077B - 077C	1916 - 1917	Reserved					2
077D - 077E	1918 - 1919	W-hours, Received, Meter 1	SINT32	0 to 99999999 or 0 to -99999999	Wh per energy format	* decimal point implied, per energy format * resolution of digit before decimal point = units, kilo, or mega, per energy format	2
077F - 0780	1920 - 1921	W-hours, Received, Meter 2	SINT32	0 to 99999999 or 0 to -99999999	Wh per energy format	* see note 10	2
0781 - 0782	1922 - 1923	W-hours, Received, Meter 3	SINT32	0 to 99999999 or 0 to -99999999	Wh per energy format		2
0783 - 0784	1924 - 1925	W-hours, Delivered, Meter 1	SINT32	0 to 99999999 or 0 to -99999999	Wh per energy format		2
0785 - 0786	1926 - 1927	W-hours, Delivered, Meter 2	SINT32	0 to 99999999 or 0 to -99999999	Wh per energy format		2
0787 - 0788	1928 - 1929	W-hours, Delivered, Meter 3	SINT32	0 to 99999999 or 0 to -99999999	Wh per energy format		2

Modbus Address		Description	Format	Range	Units or Resolution	Comments	# Reg
Hex	Decimal						
0789 - 078A	1930 - 1931	W-hours, Net, Meter 1	SINT32	-99999999 to 99999999	Wh per energy format	(Cont'd)	2
078B - 078C	1932 - 1933	W-hours, Net, Meter 2	SINT32	-99999999 to 99999999	Wh per energy format		2
078D - 078E	1934 - 1935	W-hours, Net, Meter 3	SINT32	-99999999 to 99999999	Wh per energy format		2
078F - 0790	1936 - 1937	W-hours, Total, Meter 1	SINT32	0 to 99999999	Wh per energy format		2
0791 - 0792	1938 - 1939	W-hours, Total, Meter 2	SINT32	0 to 99999999	Wh per energy format		2
0793 - 0794	1940 - 1941	W-hours, Total, Meter 3	SINT32	0 to 99999999	Wh per energy format		2
0795 - 0796	1942 - 1943	VAR-hours, Positive, Meter 1	SINT32	0 to 99999999	VARh per energy format		2
0797 - 0798	1944 - 1945	VAR-hours, Positive, Meter 2	SINT32	0 to 99999999	VARh per energy format		2
0799 - 079A	1946 - 1947	VAR-hours, Positive, Meter 3	SINT32	0 to 99999999	VARh per energy format		2
079B - 079C	1948 - 1949	VAR-hours, Negative, Meter 1	SINT32	0 to -99999999	VARh per energy format		2
079D - 079E	1950 - 1951	VAR-hours, Negative, Meter 2	SINT32	0 to -99999999	VARh per energy format		2
079F - 07A0	1952 - 1953	VAR-hours, Negative, Meter 3	SINT32	0 to -99999999	VARh per energy format		2
07A1 - 07A2	1954 - 1955	VAR-hours, Net, Meter 1	SINT32	-99999999 to 99999999	VARh per energy format		2
07A3 - 07A4	1956 - 1957	VAR-hours, Net, Meter 2	SINT32	-99999999 to 99999999	VARh per energy format		2
07A5 - 07A6	1958 - 1959	VAR-hours, Net, Meter 3	SINT32	-99999999 to 99999999	VARh per energy format		2
07A7 - 07A8	1960 - 1961	VAR-hours, Total, Meter 1	SINT32	0 to 99999999	VARh per energy format		2
07A9 - 07AA	1962 - 1963	VAR-hours, Total, Meter 2	SINT32	0 to 99999999	VARh per energy format		2
07AB - 07AC	1964 - 1965	VAR-hours, Total, Meter 3	SINT32	0 to 99999999	VARh per energy format		2
07AD - 07AE	1966 - 1967	VA-hours, Meter 1	SINT32	0 to 99999999	VAh per energy format		2
07AF - 07B0	1968 - 1969	VA-hours, Meter 2	SINT32	0 to 99999999	VAh per energy format		2

Modbus Address		Description	Format	Range	Units or Resolution	Comments	# Reg
Hex	Decimal						
07B1 - 07B2	1970 - 1971	VA-hours, Meter 3	SINT32	0 to 99999999	VAh per energy format	(Cont'd)	2
Block Size:							72
07CF - 07D0	2000 - 2001	Reserved				* Wh received & delivered always have opposite signs	2
07D1 - 07D2	2002 - 2003	Reserved					2
07D3 - 07D4	2004 - 2005	Reserved					2
07D5 - 07D6	2006 - 2007	Reserved				* Wh received is positive for "view as load", delivered is positive for "view as generator"	2
07D7 - 07D8	2008 - 2009	Reserved					2
07D9 - 07DA	2010 - 2011	Reserved					2
07DB - 07DC	2012 - 2013	Reserved				* 5 to 8 digits	2
07DD - 07DE	2014 - 2015	Reserved					2
07DF - 07E0	2016 - 2017	Reserved				* decimal point implied, per energy format	2
07E1 - 07E2	2018 - 2019	W-hours, Received, Meter 4	SINT32	0 to 99999999 or 0 to - 99999999	Wh per energy format	* resolution of digit before decimal point = units, kilo, or mega, per energy format	2
07E3 - 07E4	2020 - 2021	W-hours, Received, Meter 5	SINT32	0 to 99999999 or 0 to - 99999999	Wh per energy format	* see note 10	2
07E5 - 07E6	2022 - 2023	W-hours, Received, Meter 6	SINT32	0 to 99999999 or 0 to - 99999999	Wh per energy format		2
07E7 - 07E8	2024 - 2025	W-hours, Delivered, Meter 4	SINT32	0 to 99999999 or 0 to - 99999999	Wh per energy format		2
07E9 - 07EA	2026 - 2027	W-hours, Delivered, Meter 5	SINT32	0 to 99999999 or 0 to - 99999999	Wh per energy format		2

Modbus Address		Description	Format	Range	Units or Resolution	Comments	# Reg
Hex	Decimal						
07EB - 07EC	2028 - 2029	W-hours, Delivered, Meter 6	SINT32	0 to 99999999 or 0 to -99999999	Wh per energy format	(Cont'd)	2
07ED - 07EE	2030 - 2031	W-hours, Net, Meter 4	SINT32	-99999999 to 99999999	Wh per energy format		2
07EF - 07F0	2032 - 2033	W-hours, Net, Meter 5	SINT32	-99999999 to 99999999	Wh per energy format		2
07F1 - 07F2	2034 - 2035	W-hours, Net, Meter 6	SINT32	-99999999 to 99999999	Wh per energy format		2
07F3 - 07F4	2036 - 2037	W-hours, Total, Meter 4	SINT32	0 to 99999999	Wh per energy format		2
07F5 - 07F6	2038 - 2039	W-hours, Total, Meter 5	SINT32	0 to 99999999	Wh per energy format		2
07F7 - 07F8	2040 - 2041	W-hours, Total, Meter 6	SINT32	0 to 99999999	Wh per energy format		2
07F9 - 07FA	2042 - 2043	VAR-hours, Positive, Meter 4	SINT32	0 to 99999999	VARh per energy format		2
07FB - 07FC	2044 - 2045	VAR-hours, Positive, Meter 5	SINT32	0 to 99999999	VARh per energy format		2
07FD - 07FE	2046 - 2047	VAR-hours, Positive, Meter 6	SINT32	0 to 99999999	VARh per energy format		2
07FF - 0800	2048 - 2049	VAR-hours, Negative, Meter 4	SINT32	0 to -99999999	VARh per energy format		2
0801 - 0802	2050 - 2051	VAR-hours, Negative, Meter 5	SINT32	0 to -99999999	VARh per energy format		2
0803 - 0804	2052 - 2053	VAR-hours, Negative, Meter 6	SINT32	0 to -99999999	VARh per energy format		2
0805 - 0806	2054 - 2055	VAR-hours, Net, Meter 4	SINT32	-99999999 to 99999999	VARh per energy format		2
0807 - 0808	2056 - 2057	VAR-hours, Net, Meter 5	SINT32	-99999999 to 99999999	VARh per energy format		2
0809 - 080A	2058 - 2059	VAR-hours, Net, Meter 6	SINT32	-99999999 to 99999999	VARh per energy format		2
080B - 080C	2060 - 2061	VAR-hours, Total, Meter 4	SINT32	0 to 99999999	VARh per energy format		2
080D - 080E	2062 - 2063	VAR-hours, Total, Meter 5	SINT32	0 to 99999999	VARh per energy format		2
080F - 0810	2064 - 2065	VAR-hours, Total, Meter 6	SINT32	0 to 99999999	VARh per energy format		2

Modbus Address		Description	Format	Range	Units or Resolution	Comments	# Reg
Hex	Decimal						
0811 - 0812	2066 - 2067	VA-hours, Meter 4	SINT32	0 to 99999999	VAh per energy format	(Cont'd)	2
0813 - 0814	2068 - 2069	VA-hours, Meter 5	SINT32	0 to 99999999	VAh per energy format		2
0815 - 0816	2070 - 2071	VA-hours, Meter 6	SINT32	0 to 99999999	VAh per energy format		2
Block Size:							72
0833 - 0834	2100 - 2101	Reserved				* Wh received & delivered always have opposite signs	2
0835 - 0836	2102 - 2103	Reserved					2
0837 - 0838	2104 - 2105	Reserved				* Wh received is positive for "view as load", delivered is positive for "view as generator"	2
0839 - 083A	2106 - 2107	Reserved					2
083B - 083C	2108 - 2109	Reserved					2
083D - 083E	2110 - 2111	Reserved				* 5 to 8 digits	2
083F - 0840	2112 - 2113	Reserved					2
0841 - 0842	2114 - 2115	Reserved				* decimal point implied, per energy format	2
0843 - 0844	2116 - 2117	Reserved					2
0845 - 0846	2118 - 2119	W-hours, Received, Meter 7	SINT32	0 to 99999999 or 0 to -99999999	Wh per energy format	* resolution of digit before decimal point = units, kilo, or mega, per energy format	2
0847 - 0848	2120 - 2121	W-hours, Received, Meter 8	SINT32	0 to 99999999 or 0 to -99999999	Wh per energy format		* see note 10
0849 - 084A	2122 - 2123	W-hours, Received, Meter 9	SINT32	0 to 99999999 or 0 to -99999999	Wh per energy format		2
084B - 084C	2124 - 2125	W-hours, Delivered, Meter 7	SINT32	0 to 99999999 or 0 to -99999999	Wh per energy format		2

Modbus Address		Description	Format	Range	Units or Resolution	Comments	# Reg
Hex	Decimal						
084D - 084E	2126 - 2127	W-hours, Delivered, Meter 8	SINT32	0 to 99999999 or 0 to -99999999	Wh per energy format	(Cont'd)	2
084F - 0850	2128 - 2129	W-hours, Delivered, Meter 9	SINT32	0 to 99999999 or 0 to -99999999	Wh per energy format		2
0851 - 0852	2130 - 2131	W-hours, Net, Meter 7	SINT32	-99999999 to 99999999	Wh per energy format		2
0853 - 0854	2132 - 2133	W-hours, Net, Meter 8	SINT32	-99999999 to 99999999	Wh per energy format		2
0855 - 0856	2134 - 2135	W-hours, Net, Meter 9	SINT32	-99999999 to 99999999	Wh per energy format		2
0857 - 0858	2136 - 2137	W-hours, Total, Meter 7	SINT32	0 to 99999999	Wh per energy format		2
0859 - 085A	2138 - 2139	W-hours, Total, Meter 8	SINT32	0 to 99999999	Wh per energy format		2
085B - 085C	2140 - 2141	W-hours, Total, Meter 9	SINT32	0 to 99999999	Wh per energy format		2
085D - 085E	2142 - 2143	VAR-hours, Positive, Meter 7	SINT32	0 to 99999999	VARh per energy format		2
085F - 0860	2144 - 2145	VAR-hours, Positive, Meter 8	SINT32	0 to 99999999	VARh per energy format		2
0861 - 0862	2146 - 2147	VAR-hours, Positive, Meter 9	SINT32	0 to 99999999	VARh per energy format		2
0863 - 0864	2148 - 2149	VAR-hours, Negative, Meter 7	SINT32	0 to -99999999	VARh per energy format		2
0865 - 0866	2150 - 2151	VAR-hours, Negative, Meter 8	SINT32	0 to -99999999	VARh per energy format		2
0867 - 0868	2152 - 2153	VAR-hours, Negative, Meter 9	SINT32	0 to -99999999	VARh per energy format		2
0869 - 086A	2154 - 2155	VAR-hours, Net, Meter 7	SINT32	-99999999 to 99999999	VARh per energy format		2
086B - 086C	2156 - 2157	VAR-hours, Net, Meter 8	SINT32	-99999999 to 99999999	VARh per energy format		2
086D - 086E	2158 - 2159	VAR-hours, Net, Meter 9	SINT32	-99999999 to 99999999	VARh per energy format		2
086F - 0870	2160 - 2161	VAR-hours, Total, Meter 7	SINT32	0 to 99999999	VARh per energy format		2
0871 - 0872	2162 - 2163	VAR-hours, Total, Meter 8	SINT32	0 to 99999999	VARh per energy format	2	

Modbus Address		Description	Format	Range	Units or Resolution	Comments	# Reg
Hex	Decimal						
0873 - 0874	2164 - 2165	VAR-hours, Total, Meter 9	SINT32	0 to 99999999	VARh per energy format	(Cont'd)	2
0875 - 0876	2166 - 2167	VA-hours, Meter 7	SINT32	0 to 99999999	VAh per energy format		2
0877 - 0878	2168 - 2169	VA-hours, Meter 8	SINT32	0 to 99999999	VAh per energy format		2
0879 - 087A	2170 - 2171	VA-hours, Meter 9	SINT32	0 to 99999999	VAh per energy format		2
Block Size:							72
0897 - 0898	2200 - 2201	Reserved				* Wh received & delivered always have opposite signs * Wh received is positive for "view as load", delivered is positive for "view as generator" * 5 to 8 digits * decimal point implied, per energy format * resolution of digit before decimal point = units, kilo, or mega, per energy format	2
0899 - 089A	2202 - 2203	Reserved					2
089B - 089C	2204 - 2205	Reserved					2
089D - 089E	2206 - 2207	Reserved					2
089F - 08A0	2208 - 2209	Reserved					2
08A1 - 08A2	2210 - 2211	Reserved					2
08A3 - 08A4	2212 - 2213	Reserved					2
08A5 - 08A6	2214 - 2215	Reserved					2
08A7 - 08A8	2216 - 2217	Reserved					2
08A9 - 08AA	2218 - 2219	W-hours, Received, Meter 10	SINT32	0 to 99999999 or 0 to -99999999	Wh per energy format		2
08AB - 08AC	2220 - 2221	W-hours, Received, Meter 11	SINT32	0 to 99999999 or 0 to -99999999	Wh per energy format	* see note 10	2
08AD - 08AE	2222 - 2223	W-hours, Received, Meter 12	SINT32	0 to 99999999 or 0 to -99999999	Wh per energy format		2

Modbus Address		Description	Format	Range	Units or Resolution	Comments	# Reg
Hex	Decimal						
08AF - 08B0	2224 - 2225	W-hours, Delivered, Meter 10	SINT32	0 to 99999999 or 0 to -99999999	Wh per energy format	(Cont'd)	2
08B1 - 08B2	2226 - 2227	W-hours, Delivered, Meter 11	SINT32	0 to 99999999 or 0 to -99999999	Wh per energy format		2
08B3 - 08B4	2228 - 2229	W-hours, Delivered, Meter 12	SINT32	0 to 99999999 or 0 to -99999999	Wh per energy format		2
08B5 - 08B6	2230 - 2231	W-hours, Net, Meter 10	SINT32	-99999999 to 99999999	Wh per energy format		2
08B7 - 08B8	2232 - 2233	W-hours, Net, Meter 11	SINT32	-99999999 to 99999999	Wh per energy format		2
08B9 - 08BA	2234 - 2235	W-hours, Net, Meter 12	SINT32	-99999999 to 99999999	Wh per energy format		2
08BB - 08BC	2236 - 2237	W-hours, Total, Meter 10	SINT32	0 to 99999999	Wh per energy format		2
08BD - 08BE	2238 - 2239	W-hours, Total, Meter 11	SINT32	0 to 99999999	Wh per energy format		2
08BF - 08C0	2240 - 2241	W-hours, Total, Meter 12	SINT32	0 to 99999999	Wh per energy format		2
08C1 - 08C2	2242 - 2243	VAR-hours, Positive, Meter 10	SINT32	0 to 99999999	VARh per energy format		2
08C3 - 08C4	2244 - 2245	VAR-hours, Positive, Meter 11	SINT32	0 to 99999999	VARh per energy format		2
08C5 - 08C6	2246 - 2247	VAR-hours, Positive, Meter 12	SINT32	0 to 99999999	VARh per energy format		2
08C7 - 08C8	2248 - 2249	VAR-hours, Negative, Meter 10	SINT32	0 to -99999999	VARh per energy format		2
08C9 - 08CA	2250 - 2251	VAR-hours, Negative, Meter 11	SINT32	0 to -99999999	VARh per energy format		2
08CB - 08CC	2252 - 2253	VAR-hours, Negative, Meter 12	SINT32	0 to -99999999	VARh per energy format		2
08CD - 08CE	2254 - 2255	VAR-hours, Net, Meter 10	SINT32	-99999999 to 99999999	VARh per energy format		2

Modbus Address		Description	Format	Range	Units or Resolution	Comments	# Reg
Hex	Decimal						
08CF - 08D0	2256 - 2257	VAR-hours, Net, Meter 11	SINT32	-99999999 to 99999999	VARh per energy format	(Cont'd)	2
08D1 - 08D2	2258 - 2259	VAR-hours, Net, Meter 12	SINT32	-99999999 to 99999999	VARh per energy format		2
08D3 - 08D4	2260 - 2261	VAR-hours, Total, Meter 10	SINT32	0 to 99999999	VARh per energy format		2
08D5 - 08D6	2262 - 2263	VAR-hours, Total, Meter 11	SINT32	0 to 99999999	VARh per energy format		2
08D7 - 08D8	2264 - 2265	VAR-hours, Total, Meter 12	SINT32	0 to 99999999	VARh per energy format		2
08D9 - 08DA	2266 - 2267	VA-hours, Meter 10	SINT32	0 to 99999999	VAh per energy format		2
08DB - 08DC	2268 - 2269	VA-hours, Meter 11	SINT32	0 to 99999999	VAh per energy format		2
08DD - 08DE	2270 - 2271	VA-hours, Meter 12	SINT32	0 to 99999999	VAh per energy format		2
Block Size:							72
08FB - 08FC	2300 - 2301	Reserved				* Wh received & delivered always have opposite signs	2
08FD - 08FE	2302 - 2303	Reserved					2
08FF - 0900	2304 - 2305	Reserved				* Wh received is positive for "view as load", delivered is positive for "view as generator"	2
0901 - 0902	2306 - 2307	Reserved					2
0903 - 0904	2308 - 2309	Reserved				* 5 to 8 digits	2
0905 - 0906	2310 - 2311	Reserved					2
0907 - 0908	2312 - 2313	Reserved				* decimal point implied, per energy format	2
0909 - 090A	2314 - 2315	Reserved					2
090B - 090C	2316 - 2317	Reserved				* resolution of digit before decimal point = units, kilo, or mega, per energy format	2
090D - 090E	2318 - 2319	W-hours, Received, Meter 13	SINT32	0 to 99999999 or 0 to -99999999	Wh per energy format		2
090F - 0910	2320 - 2321	W-hours, Received, Meter 14	SINT32	0 to 99999999 or 0 to -99999999	Wh per energy format	* see note 10	2
0911 - 0912	2322 - 2323	W-hours, Received, Meter 15	SINT32	0 to 99999999 or 0 to -99999999	Wh per energy format		2

Modbus Address		Description	Format	Range	Units or Resolution	Comments	# Reg
Hex	Decimal						
0913 - 0914	2324 - 2325	W-hours, Delivered, Meter 13	SINT32	0 to 99999999 or 0 to -99999999	Wh per energy format	(Cont'd)	2
0915 - 0916	2326 - 2327	W-hours, Delivered, Meter 14	SINT32	0 to 99999999 or 0 to -99999999	Wh per energy format		2
0917 - 0918	2328 - 2329	W-hours, Delivered, Meter 15	SINT32	0 to 99999999 or 0 to -99999999	Wh per energy format		2
0919 - 091A	2330 - 2331	W-hours, Net, Meter 13	SINT32	-99999999 to 99999999	Wh per energy format		2
091B - 091C	2332 - 2333	W-hours, Net, Meter 14	SINT32	-99999999 to 99999999	Wh per energy format		2
091D - 091E	2334 - 2335	W-hours, Net, Meter 15	SINT32	-99999999 to 99999999	Wh per energy format		2
091F - 0920	2336 - 2337	W-hours, Total, Meter 13	SINT32	0 to 99999999	Wh per energy format		2
0921 - 0922	2338 - 2339	W-hours, Total, Meter 14	SINT32	0 to 99999999	Wh per energy format		2
0923 - 0924	2340 - 2341	W-hours, Total, Meter 15	SINT32	0 to 99999999	Wh per energy format		2
0925 - 0926	2342 - 2343	VAR-hours, Positive, Meter 13	SINT32	0 to 99999999	VARh per energy format		2
0927 - 0928	2344 - 2345	VAR-hours, Positive, Meter 14	SINT32	0 to 99999999	VARh per energy format		2
0929 - 092A	2346 - 2347	VAR-hours, Positive, Meter 15	SINT32	0 to 99999999	VARh per energy format		2
092B - 092C	2348 - 2349	VAR-hours, Negative, Meter 13	SINT32	0 to -99999999	VARh per energy format		2

Modbus Address		Description	Format	Range	Units or Resolution	Comments	# Reg
Hex	Decimal						
092D - 092E	2350 - 2351	VAR-hours, Negative, Meter 14	SINT32	0 to -99999999	VARh per energy format	(Cont'd)	2
092F - 0930	2352 - 2353	VAR-hours, Negative, Meter 15	SINT32	0 to -99999999	VARh per energy format		2
0931 - 0932	2354 - 2355	VAR-hours, Net, Meter 13	SINT32	-99999999 to 99999999	VARh per energy format		2
0933 - 0934	2356 - 2357	VAR-hours, Net, Meter 14	SINT32	-99999999 to 99999999	VARh per energy format		2
0935 - 0936	2358 - 2359	VAR-hours, Net, Meter 15	SINT32	-99999999 to 99999999	VARh per energy format		2
0937 - 0938	2360 - 2361	VAR-hours, Total, Meter 13	SINT32	0 to 99999999	VARh per energy format		2
0939 - 093A	2362 - 2363	VAR-hours, Total, Meter 14	SINT32	0 to 99999999	VARh per energy format		2
093B - 093C	2364 - 2365	VAR-hours, Total, Meter 15	SINT32	0 to 99999999	VARh per energy format		2
093D - 093E	2366 - 2367	VA-hours, Meter 13	SINT32	0 to 99999999	VAh per energy format		2
093F - 0940	2368 - 2369	VA-hours, Meter 14	SINT32	0 to 99999999	VAh per energy format		2
0941 - 0942	2370 - 2371	VA-hours, Meter 15	SINT32	0 to 99999999	VAh per energy format		2
Block Size:							72
095F - 0960	2400 - 2401	Reserved				* Wh received & delivered always have opposite signs	2
0961 - 0962	2402 - 2403	Reserved					2
0963 - 0964	2404 - 2405	Reserved				* Wh received is positive for "view as load", delivered is positive for "view as generator"	2
0965 - 0966	2406 - 2407	Reserved					2
0967 - 0968	2408 - 2409	Reserved					2
0969 - 096A	2410 - 2411	Reserved				* 5 to 8 digits	2
096B - 096C	2412 - 2413	Reserved					2
096D - 096E	2414 - 2415	Reserved				* decimal point implied, per energy format	2
096F - 0970	2416 - 2417	Reserved					2
0971 - 0972	2418 - 2419	W-hours, Received, Meter 16	SINT32	0 to 99999999 or 0 to -99999999	Wh per energy format		2
						* resolution of digit before decimal point = units, kilo, or mega, per energy format	

Modbus Address		Description	Format	Range	Units or Resolution	Comments	# Reg
Hex	Decimal						
0973 - 0974	2420 - 2421	W-hours, Received, Meter 17	SINT32	0 to 99999999 or 0 to -99999999	Wh per energy format	(Cont'd) * see note 4	2
0975 - 0976	2422 - 2423	W-hours, Received, Meter 18	SINT32	0 to 99999999 or 0 to -99999999	Wh per energy format		2
0977 - 0978	2424 - 2425	W-hours, Delivered, Meter 16	SINT32	0 to 99999999 or 0 to -99999999	Wh per energy format		2
0979 - 097A	2426 - 2427	W-hours, Delivered, Meter 17	SINT32	0 to 99999999 or 0 to -99999999	Wh per energy format		2
097B - 097C	2428 - 2429	W-hours, Delivered, Meter 18	SINT32	0 to 99999999 or 0 to -99999999	Wh per energy format		2
097D - 097E	2430 - 2431	W-hours, Net, Meter 16	SINT32	-99999999 to 99999999	Wh per energy format		2
097F - 0980	2432 - 2433	W-hours, Net, Meter 17	SINT32	-99999999 to 99999999	Wh per energy format		2
0981 - 0982	2434 - 2435	W-hours, Net, Meter 18	SINT32	-99999999 to 99999999	Wh per energy format		2
0983 - 0984	2436 - 2437	W-hours, Total, Meter 16	SINT32	0 to 99999999	Wh per energy format		2
0985 - 0986	2438 - 2439	W-hours, Total, Meter 17	SINT32	0 to 99999999	Wh per energy format		2
0987 - 0988	2440 - 2441	W-hours, Total, Meter 18	SINT32	0 to 99999999	Wh per energy format		2
0989 - 098A	2442 - 2443	VAR-hours, Positive, Meter 16	SINT32	0 to 99999999	VARh per energy format		2
098B - 098C	2444 - 2445	VAR-hours, Positive, Meter 17	SINT32	0 to 99999999	VARh per energy format		2

Modbus Address		Description	Format	Range	Units or Resolution	Comments	# Reg
Hex	Decimal						
098D - 098E	2446 - 2447	VAR-hours, Positive, Meter 18	SINT32	0 to 99999999	VARh per energy format	(Cont'd)	2
098F - 0990	2448 - 2449	VAR-hours, Negative, Meter 16	SINT32	0 to -99999999	VARh per energy format		2
0991 - 0992	2450 - 2451	VAR-hours, Negative, Meter 17	SINT32	0 to -99999999	VARh per energy format		2
0993 - 0994	2452 - 2453	VAR-hours, Negative, Meter 18	SINT32	0 to -99999999	VARh per energy format		2
0995 - 0996	2454 - 2455	VAR-hours, Net, Meter 16	SINT32	-99999999 to 99999999	VARh per energy format		2
0997 - 0998	2456 - 2457	VAR-hours, Net, Meter 17	SINT32	-99999999 to 99999999	VARh per energy format		2
0999 - 099A	2458 - 2459	VAR-hours, Net, Meter 18	SINT32	-99999999 to 99999999	VARh per energy format		2
099B - 099C	2460 - 2461	VAR-hours, Total, Meter 16	SINT32	0 to 99999999	VARh per energy format		2
099D - 099E	2462 - 2463	VAR-hours, Total, Meter 17	SINT32	0 to 99999999	VARh per energy format		2
099F - 09A0	2464 - 2465	VAR-hours, Total, Meter 18	SINT32	0 to 99999999	VARh per energy format		2
09A1 - 09A2	2466 - 2467	VA-hours, Meter 16	SINT32	0 to 99999999	VAh per energy format		2
09A3 - 09A4	2468 - 2469	VA-hours, Meter 17	SINT32	0 to 99999999	VAh per energy format		2
09A5 - 09A6	2470 - 2471	VA-hours, Meter 18	SINT32	0 to 99999999	VAh per energy format		2
							Block Size:

Modbus Address		Description	Format	Range	Units or Resolution	Comments	# Reg
Hex	Decimal						
09C3 - 09C4	2500 - 2501	Reserved				* Wh received & delivered always have opposite signs	2
09C5 - 09C6	2502 - 2503	Reserved					2
09C7 - 09C8	2504 - 2505	Reserved				* Wh received is positive for "view as load", delivered is positive for "view as generator"	2
09C9 - 09CA	2506 - 2507	Reserved					2
09CB - 09CC	2508 - 2509	Reserved					2
09CD - 09CE	2510 - 2511	Reserved					2
09CF - 09D0	2512 - 2513	Reserved					2
09D1 - 09D2	2514 - 2515	Reserved			* 5 to 8 digits		2
09D3 - 09D4	2516 - 2517	Reserved				2	
09D5 - 09D6	2518 - 2519	W-hours, Received, Meter 19	SINT32	0 to 99999999 or 0 to -99999999	Wh per energy format	* decimal point implied, per energy format * resolution of digit before decimal point = units, kilo, or mega, per energy format	2
09D7 - 09D8	2520 - 2521	W-hours, Received, Meter 20	SINT32	0 to 99999999 or 0 to -99999999	Wh per energy format	* see note 10	2
09D9 - 09DA	2522 - 2523	W-hours, Received, Meter 21	SINT32	0 to 99999999 or 0 to -99999999	Wh per energy format		2
09DB - 09DC	2524 - 2525	W-hours, Delivered, Meter 19	SINT32	0 to 99999999 or 0 to -99999999	Wh per energy format		2
09DD - 09DE	2526 - 2527	W-hours, Delivered, Meter 20	SINT32	0 to 99999999 or 0 to -99999999	Wh per energy format		2

Modbus Address		Description	Format	Range	Units or Resolution	Comments	# Reg
Hex	Decimal						
09DF - 09E0	2528 - 2529	W-hours, Delivered, Meter 21	SINT32	0 to 99999999 or 0 to -99999999	Wh per energy format	(Cont'd)	2
09E1 - 09E2	2530 - 2531	W-hours, Net, Meter 19	SINT32	-99999999 to 99999999	Wh per energy format		2
09E3 - 09E4	2532 - 2533	W-hours, Net, Meter 20	SINT32	-99999999 to 99999999	Wh per energy format		2
09E5 - 09E6	2534 - 2535	W-hours, Net, Meter 21	SINT32	-99999999 to 99999999	Wh per energy format		2
09E7 - 09E8	2536 - 2537	W-hours, Total, Meter 19	SINT32	0 to 99999999	Wh per energy format		2
09E9 - 09EA	2538 - 2539	W-hours, Total, Meter 20	SINT32	0 to 99999999	Wh per energy format		2
09EB - 09EC	2540 - 2541	W-hours, Total, Meter 21	SINT32	0 to 99999999	Wh per energy format		2
09ED - 09EE	2542 - 2543	VAR-hours, Positive, Meter 19	SINT32	0 to 99999999	VARh per energy format		2
09EF - 09F0	2544 - 2545	VAR-hours, Positive, Meter 20	SINT32	0 to 99999999	VARh per energy format		2
09F1 - 09F2	2546 - 2547	VAR-hours, Positive, Meter 21	SINT32	0 to 99999999	VARh per energy format		2
09F3 - 09F4	2548 - 2549	VAR-hours, Negative, Meter 19	SINT32	0 to -99999999	VARh per energy format		2
09F5 - 09F6	2550 - 2551	VAR-hours, Negative, Meter 20	SINT32	0 to -99999999	VARh per energy format		2
09F7 - 09F8	2552 - 2553	VAR-hours, Negative, Meter 21	SINT32	0 to -99999999	VARh per energy format		2
09F9 - 09FA	2554 - 2555	VAR-hours, Net, Meter 19	SINT32	-99999999 to 99999999	VARh per energy format		2
09FB - 09FC	2556 - 2557	VAR-hours, Net, Meter 20	SINT32	-99999999 to 99999999	VARh per energy format		2
09FD - 09FE	2558 - 2559	VAR-hours, Net, Meter 21	SINT32	-99999999 to 99999999	VARh per energy format		2
09FF - 0A00	2560 - 2561	VAR-hours, Total, Meter 19	SINT32	0 to 99999999	VARh per energy format		2
0A01 - 0A02	2562 - 2563	VAR-hours, Total, Meter 20	SINT32	0 to 99999999	VARh per energy format		2
0A03 - 0A04	2564 - 2565	VAR-hours, Total, Meter 21	SINT32	0 to 99999999	VARh per energy format		2

Modbus Address		Description	Format	Range	Units or Resolution	Comments	# Reg
Hex	Decimal						
0A05 - 0A06	2566 - 2567	VA-hours, Meter 19	SINT32	0 to 99999999	VAh per energy format	(Cont'd)	2
0A07 - 0A08	2568 - 2569	VA-hours, Meter 20	SINT32	0 to 99999999	VAh per energy format		2
0A09 - 0A0A	2570 - 2571	VA-hours, Meter 21	SINT32	0 to 99999999	VAh per energy format		2
Block Size:							72
0A27 - 0A28	2600 - 2601	Reserved				* Wh received & delivered always have opposite signs * Wh received is positive for "view as load", delivered is positive for "view as generator" * 5 to 8 digits * decimal point implied, per energy format * resolution of digit before decimal point = units, kilo, or mega, per energy format * see note 10	2
0A29 - 0A2A	2602 - 2603	Reserved					2
0A2B - 0A2C	2604 - 2605	Reserved					2
0A2D - 0A2E	2606 - 2607	Reserved					2
0A2F - 0A30	2608 - 2609	Reserved					2
0A31 - 0A32	2610 - 2611	Reserved					2
0A33 - 0A34	2612 - 2613	Reserved					2
0A35 - 0A36	2614 - 2615	Reserved					2
0A37 - 0A38	2616 - 2617	Reserved					2
0A39 - 0A3A	2618 - 2619	W-hours, Received, Meter 22	SINT32	0 to 99999999 or 0 to -99999999	Wh per energy format		2
0A3B - 0A3C	2620 - 2621	W-hours, Received, Meter 23	SINT32	0 to 99999999 or 0 to -99999999	Wh per energy format	2	
0A3D - 0A3E	2622 - 2623	W-hours, Received, Meter 24	SINT32	0 to 99999999 or 0 to -99999999	Wh per energy format	2	
0A3F - 0A40	2624 - 2625	W-hours, Delivered, Meter 22	SINT32	0 to 99999999 or 0 to -99999999	Wh per energy format	2	

Modbus Address		Description	Format	Range	Units or Resolution	Comments	# Reg
Hex	Decimal						
0A41 - 0A42	2626 - 2627	W-hours, Delivered, Meter 23	SINT32	0 to 99999999 or 0 to -99999999	Wh per energy format	(Cont'd)	2
0A43 - 0A44	2628 - 2629	W-hours, Delivered, Meter 24	SINT32	0 to 99999999 or 0 to -99999999	Wh per energy format		2
0A45 - 0A46	2630 - 2631	W-hours, Net, Meter 22	SINT32	-99999999 to 99999999	Wh per energy format		2
0A47 - 0A48	2632 - 2633	W-hours, Net, Meter 23	SINT32	-99999999 to 99999999	Wh per energy format		2
0A49 - 0A4A	2634 - 2635	W-hours, Net, Meter 24	SINT32	-99999999 to 99999999	Wh per energy format		2
0A4B - 0A4C	2636 - 2637	W-hours, Total, Meter 22	SINT32	0 to 99999999	Wh per energy format		2
0A4D - 0A4E	2638 - 2639	W-hours, Total, Meter 23	SINT32	0 to 99999999	Wh per energy format		2
0A4F - 0A50	2640 - 2641	W-hours, Total, Meter 24	SINT32	0 to 99999999	Wh per energy format		2
0A51 - 0A52	2642 - 2643	VAR-hours, Positive, Meter 22	SINT32	0 to 99999999	VARh per energy format		2
0A53 - 0A54	2644 - 2645	VAR-hours, Positive, Meter 23	SINT32	0 to 99999999	VARh per energy format		2
0A55 - 0A56	2646 - 2647	VAR-hours, Positive, Meter 24	SINT32	0 to 99999999	VARh per energy format		2
0A57 - 0A58	2648 - 2649	VAR-hours, Negative, Meter 22	SINT32	0 to -99999999	VARh per energy format		2
0A59 - 0A5A	2650 - 2651	VAR-hours, Negative, Meter 23	SINT32	0 to -99999999	VARh per energy format		2
0A5B - 0A5C	2652 - 2653	VAR-hours, Negative, Meter 24	SINT32	0 to -99999999	VARh per energy format		2

Modbus Address		Description	Format	Range	Units or Resolution	Comments	# Reg
Hex	Decimal						
0A5D - 0A5E	2654 - 2655	VAR-hours, Net, Meter 22	SINT32	-99999999 to 99999999	VARh per energy format	(Cont'd)	2
0A5F - 0A60	2656 - 2657	VAR-hours, Net, Meter 23	SINT32	-99999999 to 99999999	VARh per energy format		2
0A61 - 0A62	2658 - 2659	VAR-hours, Net, Meter 24	SINT32	-99999999 to 99999999	VARh per energy format		2
0A63 - 0A64	2660 - 2661	VAR-hours, Total, Meter 22	SINT32	0 to 99999999	VARh per energy format		2
0A65 - 0A66	2662 - 2663	VAR-hours, Total, Meter 23	SINT32	0 to 99999999	VARh per energy format		2
0A67 - 0A68	2664 - 2665	VAR-hours, Total, Meter 24	SINT32	0 to 99999999	VARh per energy format		2
0A69 - 0A6A	2666 - 2667	VA-hours, Meter 22	SINT32	0 to 99999999	VAh per energy format		2
0A6B - 0A6C	2668 - 2669	VA-hours, Meter 23	SINT32	0 to 99999999	VAh per energy format		2
0A6D - 0A6E	2670 - 2671	VA-hours, Meter 24	SINT32	0 to 99999999	VAh per energy format		2
						Block Size:	72
Primary Demand Block							read-only
0A8B - 0A8C	2700 - 2701	Amps Meter 1, Average	FLOAT	0 to 9999 M	amps		2
0A8D - 0A8E	2702 - 2703	Amps Meter 2, Average	FLOAT	0 to 9999 M	amps		2
0A8F - 0A90	2704 - 2705	Amps Meter 3, Average	FLOAT	0 to 9999 M	amps		2
0A91 - 0A92	2706 - 2707	Reserved					2
0A93 - 0A94	2708 - 2709	Reserved					2
0A95 - 0A96	2710 - 2711	Reserved					2
0A97 - 0A98	2712 - 2713	Reserved					2
0A99 - 0A9A	2714 - 2715	Reserved					2
0A9B - 0A9C	2716 - 2717	Reserved					2
0A9D - 0A9E	2718 - 2719	Reserved					2
0A9F - 0AA0	2720 - 2721	Reserved					2
0AA1 - 0AA2	2722 - 2723	Positive Watts, Meter 1, Average	FLOAT	-9999 M to +9999 M	watts		2
0AA3 - 0AA4	2724 - 2725	Positive Watts, Meter 2, Average	FLOAT	-9999 M to +9999 M	watts		2
0AA5 - 0AA6	2726 - 2727	Positive Watts, Meter 3, Average	FLOAT	-9999 M to +9999 M	watts		2
0AA7 - 0AA8	2728 - 2729	Positive VARs, Meter 1, Average	FLOAT	-9999 M to +9999 M	VARs		2
0AA9 - 0AAA	2730 - 2731	Positive VARs, Meter 2, Average	FLOAT	-9999 M to +9999 M	VARs		2
0AAB - 0AAC	2732 - 2733	Positive VARs, Meter 3, Average	FLOAT	-9999 M to +9999 M	VARs		2

Modbus Address		Description	Format	Range	Units or Resolution	Comments	# Reg
Hex	Decimal						
0AAD - 0AAE	2734 - 2735	Negative Watts, Meter 1, Average	FLOAT	-9999 M to +9999 M	watts		2
0AAF - 0AB0	2736 - 2737	Negative Watts, Meter 2, Average	FLOAT	-9999 M to +9999 M	watts		2
0AB1 - 0AB2	2738 - 2739	Negative Watts, Meter 3, Average	FLOAT	-9999 M to +9999 M	watts		2
0AB3 - 0AB4	2740 - 2741	Negative VARs, Meter 1, Average	FLOAT	-9999 M to +9999 M	VARs		2
0AB5 - 0AB6	2742 - 2743	Negative VARs, Meter 2, Average	FLOAT	-9999 M to +9999 M	VARs		2
0AB7 - 0AB8	2744 - 2745	Negative VARs, Meter 3, Average	FLOAT	-9999 M to +9999 M	VARs		2
0AB9 - 0ABA	2746 - 2747	VAs, Meter 1, Average	FLOAT	-9999 M to +9999 M	VAs		2
0ABB - 0ABC	2748 - 2749	VAs, Meter 2, Average	FLOAT	-9999 M to +9999 M	VAs		2
0ABD - 0ABE	2750 - 2751	VAs, Meter 3, Average	FLOAT	-9999 M to +9999 M	VAs		2
0ABF - 0AC0	2752 - 2753	Positive PF, Meter 1, Average	FLOAT	-1.00 to +1.00	none		2
0AC1 - 0AC2	2754 - 2755	Positive PF, Meter 2, Average	FLOAT	-1.00 to +1.00	none		2
0AC3 - 0AC4	2756 - 2757	Positive PF, Meter 3, Average	FLOAT	-1.00 to +1.00	none		2
0AC5 - 0AC6	2758 - 2759	Negative PF, Meter 1, Average	FLOAT	-1.00 to +1.00	none		2
0AC7 - 0AC8	2760 - 2761	Negative PF, Meter 2, Average	FLOAT	-1.00 to +1.00	none		2
0AC9 - 0ACA	2762 - 2763	Negative PF, Meter 3, Average	FLOAT	-1.00 to +1.00	none		2
						Block Size:	64

Modbus Address		Description	Format	Range	Units or Resolution	Comments	# Reg
Hex	Decimal						
0AEF - 0AF0	2800 - 2801	Amps Meter 4, Average	FLOAT	0 to 9999 M	amps		2
0AF1 - 0AF2	2802 - 2803	Amps Meter 5, Average	FLOAT	0 to 9999 M	amps		2
0AF3 - 0AF4	2804 - 2805	Amps Meter 6, Average	FLOAT	0 to 9999 M	amps		2
0AF5 - 0AF6	2806 - 2807	Reserved					2
0AF7 - 0AF8	2808 - 2809	Reserved					2
0AF9 - 0AFA	2810 - 2811	Reserved					2
0AFB - 0AFC	2812 - 2813	Reserved					2
0AFD - 0AFE	2814 - 2815	Reserved					2
0AFF - 0B00	2816 - 2817	Reserved					2
0B01 - 0B02	2818 - 2819	Reserved					2
0B03 - 0B04	2820 - 2821	Reserved					2
0B05 - 0B06	2822 - 2823	Positive Watts, Meter 4, Average	FLOAT	-9999 M to +9999 M	watts		2
0B07 - 0B08	2824 - 2825	Positive Watts, Meter 5, Average	FLOAT	-9999 M to +9999 M	watts		2
0B09 - 0B0A	2826 - 2827	Positive Watts, Meter 6, Average	FLOAT	-9999 M to +9999 M	watts		2
0B0B - 0B0C	2828 - 2829	Positive VARs, Meter 4, Average	FLOAT	-9999 M to +9999 M	VARs		2
0B0D - 0B0E	2830 - 2831	Positive VARs, Meter 5, Average	FLOAT	-9999 M to +9999 M	VARs		2
0B0F - 0B10	2832 - 2833	Positive VARs, Meter 6, Average	FLOAT	-9999 M to +9999 M	VARs		2
0B11 - 0B12	2834 - 2835	Negative Watts, Meter 4, Average	FLOAT	-9999 M to +9999 M	watts		2
0B13 - 0B14	2836 - 2837	Negative Watts, Meter 5, Average	FLOAT	-9999 M to +9999 M	watts		2
0B15 - 0B16	2838 - 2839	Negative Watts, Meter 6, Average	FLOAT	-9999 M to +9999 M	watts		2
0B17 - 0B18	2840 - 2841	Negative VARs, Meter 4, Average	FLOAT	-9999 M to +9999 M	VARs		2
0B19 - 0B1A	2842 - 2843	Negative VARs, Meter 5, Average	FLOAT	-9999 M to +9999 M	VARs		2
0B1B - 0B1C	2844 - 2845	Negative VARs, Meter 6, Average	FLOAT	-9999 M to +9999 M	VARs		2
0B1D - 0B1E	2846 - 2847	VAs, Meter 4, Average	FLOAT	-9999 M to +9999 M	VAs		2
0B1F - 0B20	2848 - 2849	VAs, Meter 5, Average	FLOAT	-9999 M to +9999 M	VAs		2

Modbus Address		Description	Format	Range	Units or Resolution	Comments	# Reg
Hex	Decimal						
0B21 - 0B22	2850 - 2851	VAs, Meter 6, Average	FLOAT	-9999 M to +9999 M	VAs		2
0B23 - 0B24	2852 - 2853	Positive PF, Meter 4, Average	FLOAT	-1.00 to +1.00	none		2
0B25 - 0B26	2854 - 2855	Positive PF, Meter 5, Average	FLOAT	-1.00 to +1.00	none		2
0B27 - 0B28	2856 - 2857	Positive PF, Meter 6, Average	FLOAT	-1.00 to +1.00	none		2
0B29 - 0B2A	2858 - 2859	Negative PF, Meter 4, Average	FLOAT	-1.00 to +1.00	none		2
0B2B - 0B2C	2860 - 2861	Negative PF, Meter 5, Average	FLOAT	-1.00 to +1.00	none		2
0B2D - 0B2E	2862 - 2863	Negative PF, Meter 6, Average	FLOAT	-1.00 to +1.00	none		2
						Block Size:	64
0B53 - 0B54	2900 - 2901	Amps Meter 7, Average	FLOAT	0 to 9999 M	amps		2
0B55 - 0B56	2902 - 2903	Amps Meter 8, Average	FLOAT	0 to 9999 M	amps		2
0B57 - 0B58	2904 - 2905	Amps Meter 9, Average	FLOAT	0 to 9999 M	amps		2
0B59 - 0B5A	2906 - 2907	Reserved					2
0B5B - 0B5C	2908 - 2909	Reserved					2
0B5D - 0B5E	2910 - 2911	Reserved					2
0B5F - 0B60	2912 - 2913	Reserved					2
0B61 - 0B62	2914 - 2915	Reserved					2
0B63 - 0B64	2916 - 2917	Reserved					2
0B65 - 0B66	2918 - 2919	Reserved					2
0B67 - 0B68	2920 - 2921	Reserved					2
0B69 - 0B6A	2922 - 2923	Positive Watts, Meter 7, Average	FLOAT	-9999 M to +9999 M	watts		2
0B6B - 0B6C	2924 - 2925	Positive Watts, Meter 8, Average	FLOAT	-9999 M to +9999 M	watts		2
0B6D - 0B6E	2926 - 2927	Positive Watts, Meter 9, Average	FLOAT	-9999 M to +9999 M	watts		2
0B6F - 0B70	2928 - 2929	Positive VARs, Meter 7, Average	FLOAT	-9999 M to +9999 M	VARs		2
0B71 - 0B72	2930 - 2931	Positive VARs, Meter 8, Average	FLOAT	-9999 M to +9999 M	VARs		2
0B73 - 0B74	2932 - 2933	Positive VARs, Meter 9, Average	FLOAT	-9999 M to +9999 M	VARs		2
0B75 - 0B76	2934 - 2935	Negative Watts, Meter 7, Average	FLOAT	-9999 M to +9999 M	watts		2
0B77 - 0B78	2936 - 2937	Negative Watts, Meter 8, Average	FLOAT	-9999 M to +9999 M	watts		2

Modbus Address		Description	Format	Range	Units or Resolution	Comments	# Reg
Hex	Decimal						
0BB7 - 0BB8	3000 - 3001	Amps Meter 10, Average	FLOAT	0 to 9999 M	amps		2
0BB9 - 0BBA	3002 - 3003	Amps Meter 11, Average	FLOAT	0 to 9999 M	amps		2
0BBB - 0BBC	3004 - 3005	Amps Meter 12, Average	FLOAT	0 to 9999 M	amps		2
0BBD - 0BBE	3006 - 3007	Reserved					2
0BBF - 0BC0	3008 - 3009	Reserved					2
0BC1 - 0BC2	3010 - 3011	Reserved					2
0BC3 - 0BC4	3012 - 3013	Reserved					2
0BC5 - 0BC6	3014 - 3015	Reserved					2
0BC7 - 0BC8	3016 - 3017	Reserved					2
0BC9 - 0BCA	3018 - 3019	Reserved					2
0BCB - 0BCC	3020 - 3021	Reserved					2
0BCD - 0BCE	3022 - 3023	Positive Watts, Meter 10, Average	FLOAT	-9999 M to +9999 M	watts		2
0BCF - 0BD0	3024 - 3025	Positive Watts, Meter 11, Average	FLOAT	-9999 M to +9999 M	watts		2
0BD1 - 0BD2	3026 - 3027	Positive Watts, Meter 12, Average	FLOAT	-9999 M to +9999 M	watts		2
0BD3 - 0BD4	3028 - 3029	Positive VARs, Meter 10, Average	FLOAT	-9999 M to +9999 M	VARs		2
0BD5 - 0BD6	3030 - 3031	Positive VARs, Meter 11, Average	FLOAT	-9999 M to +9999 M	VARs		2
0BD7 - 0BD8	3032 - 3033	Positive VARs, Meter 12, Average	FLOAT	-9999 M to +9999 M	VARs		2
0BD9 - 0BDA	3034 - 3035	Negative Watts, Meter 10, Average	FLOAT	-9999 M to +9999 M	watts		2
0BDB - 0BDC	3036 - 3037	Negative Watts, Meter 11, Average	FLOAT	-9999 M to +9999 M	watts		2
0BDD - 0BDE	3038 - 3039	Negative Watts, Meter 12, Average	FLOAT	-9999 M to +9999 M	watts		2
0BDF - 0BE0	3040 - 3041	Negative VARs, Meter 10, Average	FLOAT	-9999 M to +9999 M	VARs		2
0BE1 - 0BE2	3042 - 3043	Negative VARs, Meter 11, Average	FLOAT	-9999 M to +9999 M	VARs		2
0BE3 - 0BE4	3044 - 3045	Negative VARs, Meter 12, Average	FLOAT	-9999 M to +9999 M	VARs		2
0BE5 - 0BE6	3046 - 3047	VAs, Meter 10, Average	FLOAT	-9999 M to +9999 M	VAs		2
0BE7 - 0BE8	3048 - 3049	VAs, Meter 11, Average	FLOAT	-9999 M to +9999 M	VAs		2

Modbus Address		Description	Format	Range	Units or Resolution	Comments	# Reg
Hex	Decimal						
0BE9 - 0BEA	3050 - 3051	VAs, Meter 12, Average	FLOAT	-9999 M to +9999 M	VAs		2
0BEB - 0BEC	3052 - 3053	Positive PF, Meter 10, Average	FLOAT	-1.00 to +1.00	none		2
0BED - 0BEE	3054 - 3055	Positive PF, Meter 11, Average	FLOAT	-1.00 to +1.00	none		2
0BEF - 0BF0	3056 - 3057	Positive PF, Meter 12, Average	FLOAT	-1.00 to +1.00	none		2
0BF1 - 0BF2	3058 - 3059	Negative PF, Meter 10, Average	FLOAT	-1.00 to +1.00	none		2
0BF3 - 0BF4	3060 - 3061	Negative PF, Meter 11, Average	FLOAT	-1.00 to +1.00	none		2
0BF5 - 0BF6	3062 - 3063	Negative PF, Meter 12, Average	FLOAT	-1.00 to +1.00	none		2
						Block Size:	64
0C1B - 0C1C	3100 - 3101	Amps Meter 13, Average	FLOAT	0 to 9999 M	amps		2
0C1D - 0C1E	3102 - 3103	Amps Meter 14, Average	FLOAT	0 to 9999 M	amps		2
0C1F - 0C20	3104 - 3105	Amps Meter 15, Average	FLOAT	0 to 9999 M	amps		2
0C21 - 0C22	3106 - 3107	Reserved					2
0C23 - 0C24	3108 - 3109	Reserved					2
0C25 - 0C26	3110 - 3111	Reserved					2
0C27 - 0C28	3112 - 3113	Reserved					2
0C29 - 0C2A	3114 - 3115	Reserved					2
0C2B - 0C2C	3116 - 3117	Reserved					2
0C2D - 0C2E	3118 - 3119	Reserved					2
0C2F - 0C30	3120 - 3121	Reserved					2
0C31 - 0C32	3122 - 3123	Positive Watts, Meter 13, Average	FLOAT	-9999 M to +9999 M	watts		2
0C33 - 0C34	3124 - 3125	Positive Watts, Meter 14, Average	FLOAT	-9999 M to +9999 M	watts		2
0C35 - 0C36	3126 - 3127	Positive Watts, Meter 15, Average	FLOAT	-9999 M to +9999 M	watts		2
0C37 - 0C38	3128 - 3129	Positive VARs, Meter 13, Average	FLOAT	-9999 M to +9999 M	VARs		2
0C39 - 0C3A	3130 - 3131	Positive VARs, Meter 14, Average	FLOAT	-9999 M to +9999 M	VARs		2
0C3B - 0C3C	3132 - 3133	Positive VARs, Meter 15, Average	FLOAT	-9999 M to +9999 M	VARs		2
0C3D - 0C3E	3134 - 3135	Negative Watts, Meter 13, Average	FLOAT	-9999 M to +9999 M	watts		2
0C3F - 0C40	3136 - 3137	Negative Watts, Meter 14, Average	FLOAT	-9999 M to +9999 M	watts		2

Modbus Address		Description	Format	Range	Units or Resolution	Comments	# Reg
Hex	Decimal						
0C41 - 0C42	3138 - 3139	Negative Watts, Meter 15, Average	FLOAT	-9999 M to +9999 M	watts		2
0C43 - 0C44	3140 - 3141	Negative VARs, Meter 13, Average	FLOAT	-9999 M to +9999 M	VARs		2
0C45 - 0C46	3142 - 3143	Negative VARs, Meter 14, Average	FLOAT	-9999 M to +9999 M	VARs		2
0C47 - 0C48	3144 - 3145	Negative VARs, Meter 15, Average	FLOAT	-9999 M to +9999 M	VARs		2
0C49 - 0C4A	3146 - 3147	VAs, Meter 13, Average	FLOAT	-9999 M to +9999 M	VAs		2
0C4B - 0C4C	3148 - 3149	VAs, Meter 14, Average	FLOAT	-9999 M to +9999 M	VAs		2
0C4D - 0C4E	3150 - 3151	VAs, Meter 15, Average	FLOAT	-9999 M to +9999 M	VAs		2
0C4F - 0C50	3152 - 3153	Positive PF, Meter 13, Average	FLOAT	-1.00 to +1.00	none		2
0C51 - 0C52	3154 - 3155	Positive PF, Meter 14, Average	FLOAT	-1.00 to +1.00	none		2
0C53 - 0C54	3156 - 3157	Positive PF, Meter 15, Average	FLOAT	-1.00 to +1.00	none		2
0C55 - 0C56	3158 - 3159	Negative PF, Meter 13, Average	FLOAT	-1.00 to +1.00	none		2
0C57 - 0C58	3160 - 3161	Negative PF, Meter 14, Average	FLOAT	-1.00 to +1.00	none		2
0C59 - 0C5A	3162 - 3163	Negative PF, Meter 15, Average	FLOAT	-1.00 to +1.00	none		2
						Block Size:	64

Modbus Address		Description	Format	Range	Units or Resolution	Comments	# Reg
Hex	Decimal						
0C7F - 0C80	3200 - 3201	Amps Meter 16, Average	FLOAT	0 to 9999 M	amps		2
0C81 - 0C82	3202 - 3203	Amps Meter 17, Average	FLOAT	0 to 9999 M	amps		2
0C83 - 0C84	3204 - 3205	Amps Meter 18, Average	FLOAT	0 to 9999 M	amps		2
0C85 - 0C86	3206 - 3207	Reserved					2
0C87 - 0C88	3208 - 3209	Reserved					2
0C89 - 0C8A	3210 - 3211	Reserved					2
0C8B - 0C8C	3212 - 3213	Reserved					2
0C8D - 0C8E	3214 - 3215	Reserved					2
0C8F - 0C90	3216 - 3217	Reserved					2
0C91 - 0C92	3218 - 3219	Reserved					2
0C93 - 0C94	3220 - 3221	Reserved					2
0C95 - 0C96	3222 - 3223	Positive Watts, Meter 16, Average	FLOAT	-9999 M to +9999 M	watts		2
0C97 - 0C98	3224 - 3225	Positive Watts, Meter 17, Average	FLOAT	-9999 M to +9999 M	watts		2
0C99 - 0C9A	3226 - 3227	Positive Watts, Meter 18, Average	FLOAT	-9999 M to +9999 M	watts		2
0C9B - 0C9C	3228 - 3229	Positive VARs, Meter 16, Average	FLOAT	-9999 M to +9999 M	VARs		2
0C9D - 0C9E	3230 - 3231	Positive VARs, Meter 17, Average	FLOAT	-9999 M to +9999 M	VARs		2
0C9F - 0CA0	3232 - 3233	Positive VARs, Meter 18, Average	FLOAT	-9999 M to +9999 M	VARs		2
0CA1 - 0CA2	3234 - 3235	Negative Watts, Meter 16, Average	FLOAT	-9999 M to +9999 M	watts		2
0CA3 - 0CA4	3236 - 3237	Negative Watts, Meter 17, Average	FLOAT	-9999 M to +9999 M	watts		2
0CA5 - 0CA6	3238 - 3239	Negative Watts, Meter 18, Average	FLOAT	-9999 M to +9999 M	watts		2
0CA7 - 0CA8	3240 - 3241	Negative VARs, Meter 16, Average	FLOAT	-9999 M to +9999 M	VARs		2
0CA9 - 0CAA	3242 - 3243	Negative VARs, Meter 17, Average	FLOAT	-9999 M to +9999 M	VARs		2
0CAB - 0CAC	3244 - 3245	Negative VARs, Meter 18, Average	FLOAT	-9999 M to +9999 M	VARs		2
0CAD - 0CAE	3246 - 3247	VAs, Meter 16, Average	FLOAT	-9999 M to +9999 M	VAs		2
0CAF - 0CB0	3248 - 3249	VAs, Meter 17, Average	FLOAT	-9999 M to +9999 M	VAs		2

Modbus Address		Description	Format	Range	Units or Resolution	Comments	# Reg
Hex	Decimal						
0CB1 - 0CB2	3250 - 3251	VAs, Meter 18, Average	FLOAT	-9999 M to +9999 M	VAs		2
0CB3 - 0CB4	3252 - 3253	Positive PF, Meter 16, Average	FLOAT	-1.00 to +1.00	none		2
0CB5 - 0CB6	3254 - 3255	Positive PF, Meter 17, Average	FLOAT	-1.00 to +1.00	none		2
0CB7 - 0CB8	3256 - 3257	Positive PF, Meter 18, Average	FLOAT	-1.00 to +1.00	none		2
0CB9 - 0CBA	3258 - 3259	Negative PF, Meter 16, Average	FLOAT	-1.00 to +1.00	none		2
0CBB - 0CBC	3260 - 3261	Negative PF, Meter 17, Average	FLOAT	-1.00 to +1.00	none		2
0CBD - 0CBE	3262 - 3263	Negative PF, Meter 18, Average	FLOAT	-1.00 to +1.00	none		2
						Block Size:	64
0CE3 - 0CE4	3300 - 3301	Amps Meter 19, Average	FLOAT	0 to 9999 M	amps		2
0CE5 - 0CE6	3302 - 3303	Amps Meter 20, Average	FLOAT	0 to 9999 M	amps		2
0CE7 - 0CE8	3304 - 3305	Amps Meter 21, Average	FLOAT	0 to 9999 M	amps		2
0CE9 - 0CEA	3306 - 3307	Reserved					2
0CEB - 0CEC	3308 - 3309	Reserved					2
0CED - 0CEE	3310 - 3311	Reserved					2
0CEF - 0CF0	3312 - 3313	Reserved					2
0CF1 - 0CF2	3314 - 3315	Reserved					2
0CF3 - 0CF4	3316 - 3317	Reserved					2
0CF5 - 0CF6	3318 - 3319	Reserved					2
0CF7 - 0CF8	3320 - 3321	Reserved					2
0CF9 - 0CFA	3322 - 3323	Positive Watts, Meter 19, Average	FLOAT	-9999 M to +9999 M	watts		2
0CFB - 0CFC	3324 - 3325	Positive Watts, Meter 20, Average	FLOAT	-9999 M to +9999 M	watts		2
0CFD - 0CFE	3326 - 3327	Positive Watts, Meter 21, Average	FLOAT	-9999 M to +9999 M	watts		2
0CFF - 0D00	3328 - 3329	Positive VARs, Meter 19, Average	FLOAT	-9999 M to +9999 M	VARs		2
0D01 - 0D02	3330 - 3331	Positive VARs, Meter 20, Average	FLOAT	-9999 M to +9999 M	VARs		2
0D03 - 0D04	3332 - 3333	Positive VARs, Meter 21, Average	FLOAT	-9999 M to +9999 M	VARs		2
0D05 - 0D06	3334 - 3335	Negative Watts, Meter 19, Average	FLOAT	-9999 M to +9999 M	watts		2

Modbus Address		Description	Format	Range	Units or Resolution	Comments	# Reg
Hex	Decimal						
0D07 - 0D08	3336 - 3337	Negative Watts, Meter 20, Average	FLOAT	-9999 M to +9999 M	watts		2
0D09 - 0D0A	3338 - 3339	Negative Watts, Meter 21, Average	FLOAT	-9999 M to +9999 M	watts		2
0D0B - 0D0C	3340 - 3341	Negative VARs, Meter 19, Average	FLOAT	-9999 M to +9999 M	VARs		2
0D0D - 0D0E	3342 - 3343	Negative VARs, Meter 20, Average	FLOAT	-9999 M to +9999 M	VARs		2
0D0F - 0D10	3344 - 3345	Negative VARs, Meter 21, Average	FLOAT	-9999 M to +9999 M	VARs		2
0D11 - 0D12	3346 - 3347	VAs, Meter 19, Average	FLOAT	-9999 M to +9999 M	VAs		2
0D13 - 0D14	3348 - 3349	VAs, Meter 20, Average	FLOAT	-9999 M to +9999 M	VAs		2
0D15 - 0D16	3350 - 3351	VAs, Meter 21, Average	FLOAT	-9999 M to +9999 M	VAs		2
0D17 - 0D18	3352 - 3353	Positive PF, Meter 19, Average	FLOAT	-1.00 to +1.00	none		2
0D19 - 0D1A	3354 - 3355	Positive PF, Meter 20, Average	FLOAT	-1.00 to +1.00	none		2
0D1B - 0D1C	3356 - 3357	Positive PF, Meter 21, Average	FLOAT	-1.00 to +1.00	none		2
0D1D - 0D1E	3358 - 3359	Negative PF, Meter 19, Average	FLOAT	-1.00 to +1.00	none		2
0D1F - 0D20	3360 - 3361	Negative PF, Meter 20, Average	FLOAT	-1.00 to +1.00	none		2
0D21 - 0D22	3362 - 3363	Negative PF, Meter 21, Average	FLOAT	-1.00 to +1.00	none		2
						Block Size:	64
0D47 - 0D48	3400 - 3401	Amps Meter 22, Average	FLOAT	0 to 9999 M	amps		2
0D49 - 0D4A	3402 - 3403	Amps Meter 23, Average	FLOAT	0 to 9999 M	amps		2
0D4B - 0D4C	3404 - 3405	Amps Meter 24, Average	FLOAT	0 to 9999 M	amps		2
0D4D - 0D4E	3406 - 3407	Reserved					2
0D4F - 0D50	3408 - 3409	Reserved					2
0D51 - 0D52	3410 - 3411	Reserved					2
0D53 - 0D54	3412 - 3413	Reserved					2
0D55 - 0D56	3414 - 3415	Reserved					2
0D57 - 0D58	3416 - 3417	Reserved					2
0D59 - 0D5A	3418 - 3419	Reserved					2
0D5B - 0D5C	3420 - 3421	Reserved					2

Modbus Address		Description	Format	Range	Units or Resolution	Comments	# Reg
Hex	Decimal						
0D5D - 0D5E	3422 - 3423	Positive Watts, Meter 22, Average	FLOAT	-9999 M to +9999 M	watts		2
0D5F - 0D60	3424 - 3425	Positive Watts, Meter 23, Average	FLOAT	-9999 M to +9999 M	watts		2
0D61 - 0D62	3426 - 3427	Positive Watts, Meter 24, Average	FLOAT	-9999 M to +9999 M	watts		2
0D63 - 0D64	3428 - 3429	Positive VARs, Meter 22, Average	FLOAT	-9999 M to +9999 M	VARs		2
0D65 - 0D66	3430 - 3431	Positive VARs, Meter 23, Average	FLOAT	-9999 M to +9999 M	VARs		2
0D67 - 0D68	3432 - 3433	Positive VARs, Meter 24, Average	FLOAT	-9999 M to +9999 M	VARs		2
0D69 - 0D6A	3434 - 3435	Negative Watts, Meter 22, Average	FLOAT	-9999 M to +9999 M	watts		2
0D6B - 0D6C	3436 - 3437	Negative Watts, Meter 23, Average	FLOAT	-9999 M to +9999 M	watts		2
0D6D - 0D6E	3438 - 3439	Negative Watts, Meter 24, Average	FLOAT	-9999 M to +9999 M	watts		2
0D6F - 0D70	3440 - 3441	Negative VARs, Meter 22, Average	FLOAT	-9999 M to +9999 M	VARs		2
0D71 - 0D72	3442 - 3443	Negative VARs, Meter 23, Average	FLOAT	-9999 M to +9999 M	VARs		2
0D73 - 0D74	3444 - 3445	Negative VARs, Meter 24, Average	FLOAT	-9999 M to +9999 M	VARs		2
0D75 - 0D76	3446 - 3447	VAs, Meter 22, Average	FLOAT	-9999 M to +9999 M	VAs		2
0D77 - 0D78	3448 - 3449	VAs, Meter 23, Average	FLOAT	-9999 M to +9999 M	VAs		2
0D79 - 0D7A	3450 - 3451	VAs, Meter 24, Average	FLOAT	-9999 M to +9999 M	VAs		2
0D7B - 0D7C	3452 - 3453	Positive PF, Meter 22, Average	FLOAT	-1.00 to +1.00	none		2
0D7D - 0D7E	3454 - 3455	Positive PF, Meter 23, Average	FLOAT	-1.00 to +1.00	none		2

Modbus Address		Description	Format	Range	Units or Resolution	Comments	# Reg
Hex	Decimal						
0D7F - 0D80	3456 - 3457	Positive PF, Meter 24, Average	FLOAT	-1.00 to +1.00	none		2
0D81 - 0D82	3458 - 3459	Negative PF, Meter 22, Average	FLOAT	-1.00 to +1.00	none		2
0D83 - 0D84	3460 - 3461	Negative PF, Meter 23, Average	FLOAT	-1.00 to +1.00	none		2
0D85 - 0D86	3462 - 3463	Negative PF, Meter 24, Average	FLOAT	-1.00 to +1.00	none		2
						Block Size:	64
Phase Angle Block (voltage)							
0DAB - 0DAB	3500 - 3500	Reserved					1
0DAC - 0DAC	3501 - 3501	Reserved					1
0DAD - 0DAD	3502 - 3502	Reserved					1
						read-only	
0DAE - 0DAE	3503 - 3503	Angle, Meter 1 current	SINT16	-1800 to +1800	0.1 degree		1
0DAF - 0DAF	3504 - 3504	Angle, Meter 2 current	SINT16	-1800 to +1800	0.1 degree		1
0DB0 - 0DB0	3505 - 3505	Angle, Meter 3 current	SINT16	-1800 to +1800	0.1 degree		1
						Block Size:	3
0DB1 - 0DB1	3506 - 3506	Angle, Meter 4 current	SINT16	-1800 to +1800	0.1 degree		1
0DB2 - 0DB2	3507 - 3507	Angle, Meter 5 current	SINT16	-1800 to +1800	0.1 degree		1
0DB3 - 0DB3	3508 - 3508	Angle, Meter 6 current	SINT16	-1800 to +1800	0.1 degree		1
						Block Size:	3
0DB4 - 0DB4	3509 - 3509	Angle, Meter 7 current	SINT16	-1800 to +1800	0.1 degree		1
0DB5 - 0DB5	3510 - 3510	Angle, Meter 8 current	SINT16	-1800 to +1800	0.1 degree		1
0DB6 - 0DB6	3511 - 3511	Angle, Meter 9 current	SINT16	-1800 to +1800	0.1 degree		1
						Block Size:	3
0DB7 - 0DB7	3512 - 3512	Angle, Meter 10 current	SINT16	-1800 to +1800	0.1 degree		1

Modbus Address		Description	Format	Range	Units or Resolution	Comments	# Reg
Hex	Decimal						
0DB8 - 0DB8	3513 - 3513	Angle, Meter 11 current	SINT16	-1800 to +1800	0.1 degree		1
0DB9 - 0DB9	3514 - 3514	Angle, Meter 12 current	SINT16	-1800 to +1800	0.1 degree		1
						Block Size:	3
0DBA - 0DBA	3515 - 3515	Angle, Meter 13 current	SINT16	-1800 to +1800	0.1 degree		1
0DBB - 0DBB	3516 - 3516	Angle, Meter 14 current	SINT16	-1800 to +1800	0.1 degree		1
0DBC - 0DBC	3517 - 3517	Angle, Meter 15 current	SINT16	-1800 to +1800	0.1 degree		1
						Block Size:	3
0DBD - 0DBD	3518 - 3518	Angle, Meter 16 current	SINT16	-1800 to +1800	0.1 degree		1
0DBE - 0DBE	3519 - 3519	Angle, Meter 17 current	SINT16	-1800 to +1800	0.1 degree		1
0DBF - 0DBF	3520 - 3520	Angle, Meter 18 current	SINT16	-1800 to +1800	0.1 degree		1
						Block Size:	3
0DC0 - 0DC0	3521 - 3521	Angle, Meter 19 current	SINT16	-1800 to +1800	0.1 degree		1
0DC1 - 0DC1	3522 - 3522	Angle, Meter 20 current	SINT16	-1800 to +1800	0.1 degree		1
0DC2 - 0DC2	3523 - 3523	Angle, Meter 21 current	SINT16	-1800 to +1800	0.1 degree		1
						Block Size:	3
0DC3 - 0DC3	3524 - 3524	Angle, Meter 22 current	SINT16	-1800 to +1800	0.1 degree		1
0DC4 - 0DC4	3525 - 3525	Angle, Meter 23 current	SINT16	-1800 to +1800	0.1 degree		1
0DC5 - 0DC5	3526 - 3526	Angle, Meter 24 current	SINT16	-1800 to +1800	0.1 degree		1
						Block Size:	3

Modbus Address		Description	Format	Range	Units or Resolution	Comments	# Reg
Hex	Decimal						
Status Block						read-only	
0DC9 - 0DC9	3530 - 3530	Port ID	UINT16	1 to 3	none	Identifies which COM port a master is connected to; 1 for COM1, 2 for COM2, etc.	1
0DCA - 0DCA	3531 - 3531	CPU Status	UINT16	bit-mapped	mmmpch-- bffee-cc	mmm = measurement state (0=off, 1=running normally, 2=limp mode, 3=warmup, 6&7=boot, others unused) See note 15. pch = NVMEM block OK flags (p=profile, c=calibration, h=header), flag is 1 if OK b - Battery status. (0=battery low, 1=battery OK) ff = flash state (0=initializing, 1=logging disabled by Vswitch, 3=logging) ee = edit state (0=startup, 1=normal, 2=privileged command session, 3=profile update mode) cc = port enabled for edit(0=none, 1-3=COM1-COM3)	1
0DCB - 0DCB	3532 - 3532	Limits Status	UINT16	bit-mapped	87654321 87654321	high byte is setpt 1, 0=in, 1=out low byte is setpt 2, 0=in, 1=out see notes 11, 12, 17	1
0DCC - 0DCD	3533 - 3534	Time Since Reset	UINT32	0 to 4294967294	4 msec	wraps around after max count	2
0DCE - 0DD0	3535 - 3537	CPU On Time	TSTAMP	1Jan2000 - 31Dec2099	1 sec		3
0DD1 - 0DD3	3538 - 3540	Current Date and Time	TSTAMP	1Jan2000 - 31Dec2099	1 sec		3
0DD4 - 0DD4	3541 - 3541	Reserved				Reserved	1
0DD5 - 0DD5	3542 - 3542	Current Day of Week	UINT16	1 to 7	1 day	1=Sun, 2=Mon, etc.	1
Block Size:							13

Modbus Address		Description	Format	Range	Units or Resolution	Comments	# Reg
Hex	Decimal						
Short term Primary Minimum Block							
0DDD - 0DDE	3550 - 3551	Volts , previous Demand interval Short Term Minimum	FLOAT	0 to 9999 M	volts	Minimum instantaneous value measured during the demand interval before the one most recently completed.	2
0DDF - 0DE0	3552 - 3553	Reserved					2
0DE1 - 0DE2	3554 - 3555	Reserved					2
0DE3 - 0DE4	3556 - 3557	Reserved					2
0DE5 - 0DE6	3558 - 3559	Reserved					2
0DE7 - 0DE8	3560 - 3561	Reserved					2
0DE9 - 0DEA	3562 - 3563	Volts , Short Term Minimum	FLOAT	0 to 9999 M	volts	Minimum instantaneous value measured during the most recently completed demand interval.	2
0DEB - 0DEC	3564 - 3565	Reserved					2
0DED - 0DEE	3566 - 3567	Reserved					2
0DEF - 0DF0	3568 - 3569	Reserved					2
0DF1 - 0DF2	3570 - 3571	Reserved					2
0DF3 - 0DF4	3572 - 3573	Reserved					2
0DF5 - 0DF6	3574 - 3575	Reserved					2
0DF7 - 0DF8	3576 - 3577	Reserved					2
							Block Size:
Primary Minimum Block (Voltage)							
0DFB - 0DFC	3580 - 3581	Volts , Minimum	FLOAT	0 to 9999 M	volts		2
0DFD - 0DFE	3582 - 3583	Reserved					2
0DFF - 0E00	3584 - 3585	Reserved					2
0E01 - 0E02	3586 - 3587	Reserved					2
0E03 - 0E04	3588 - 3589	Reserved					2
0E05 - 0E06	3590 - 3591	Reserved					2
0E07 - 0E08	3592 - 3593	Frequency, Minimum	FLOAT	0 to 65.00	Hz		2
						Block Size:	14
Primary Minimum Block							
0E0F - 0E10	3600 - 3601	Amps Meter 1, Minimum Avg Demand	FLOAT	0 to 9999 M	amps		2
0E11 - 0E12	3602 - 3603	Amps Meter 2, Minimum Avg Demand	FLOAT	0 to 9999 M	amps		2
0E13 - 0E14	3604 - 3605	Amps Meter 3, Minimum Avg Demand	FLOAT	0 to 9999 M	amps		2
0E15 - 0E16	3606 - 3607	Reserved					2
0E17 - 0E18	3608 - 3609	Reserved					2
0E19 - 0E1A	3610 - 3611	Reserved					2
0E1B - 0E1C	3612 - 3613	Reserved					2
0E1D - 0E1E	3614 - 3615	Reserved					2
0E1F - 0E20	3616 - 3617	Reserved					2
0E21 - 0E22	3618 - 3619	Reserved					2
0E23 - 0E24	3620 - 3621	Reserved					2
0E25 - 0E26	3622 - 3623	Positive Watts, Meter 1 , Minimum Avg Demand	FLOAT	-9999 M to +9999 M	watts		2

Modbus Address		Description	Format	Range	Units or Resolution	Comments	# Reg
Hex	Decimal						
0E27 - 0E28	3624 - 3625	Positive Watts, Meter 2, Minimum Avg Demand	FLOAT	-9999 M to +9999 M	watts		2
0E29 - 0E2A	3626 - 3627	Positive Watts, Meter 3, Minimum Avg Demand	FLOAT	-9999 M to +9999 M	watts		2
0E2B - 0E2C	3628 - 3629	Positive VARs, Meter 1, Minimum Avg Demand	FLOAT	-9999 M to +9999 M	VARs		2
0E2D - 0E2E	3630 - 3631	Positive VARs, Meter 2, Minimum Avg Demand	FLOAT	-9999 M to +9999 M	VARs		2
0E2F - 0E30	3632 - 3633	Positive VARs, Meter 3, Minimum Avg Demand	FLOAT	-9999 M to +9999 M	VARs		2
0E31 - 0E32	3634 - 3635	Negative Watts, Meter 1, Minimum Avg Demand	FLOAT	-9999 M to +9999 M	watts		2
0E33 - 0E34	3636 - 3637	Negative Watts, Meter 2, Minimum Avg Demand	FLOAT	-9999 M to +9999 M	watts		2
0E35 - 0E36	3638 - 3639	Negative Watts, Meter 3, Minimum Avg Demand	FLOAT	-9999 M to +9999 M	watts		2
0E37 - 0E38	3640 - 3641	Negative VARs, Meter 1, Minimum Avg Demand	FLOAT	-9999 M to +9999 M	VARs		2
0E39 - 0E3A	3642 - 3643	Negative VARs, Meter 2, Minimum Avg Demand	FLOAT	-9999 M to +9999 M	VARs		2
0E3B - 0E3C	3644 - 3645	Negative VARs, Meter 3, Minimum Avg Demand	FLOAT	-9999 M to +9999 M	VARs		2
0E3D - 0E3E	3646 - 3647	VAs, Meter 1, Minimum Avg Demand	FLOAT	-9999 M to +9999 M	VAs		2
0E3F - 0E40	3648 - 3649	VAs, Meter 2, Minimum Avg Demand	FLOAT	-9999 M to +9999 M	VAs		2
0E41 - 0E42	3650 - 3651	VAs, Meter 3, Minimum Avg Demand	FLOAT	-9999 M to +9999 M	VAs		2
0E43 - 0E44	3652 - 3653	Positive PF, Meter 1, Minimum Avg Demand	FLOAT	-1.00 to +1.00	none		2
0E45 - 0E46	3654 - 3655	Positive PF, Meter 2, Minimum Avg Demand	FLOAT	-1.00 to +1.00	none		2
0E47 - 0E48	3656 - 3657	Positive PF, Meter 3, Minimum Avg Demand	FLOAT	-1.00 to +1.00	none		2

Modbus Address		Description	Format	Range	Units or Resolution	Comments	# Reg
Hex	Decimal						
0E49 - 0E4A	3658 - 3659	Negative PF, Meter 1, Minimum Avg Demand	FLOAT	-1.00 to +1.00	none		2
0E4B - 0E4C	3660 - 3661	Negative PF, Meter 2, Minimum Avg Demand	FLOAT	-1.00 to +1.00	none		2
0E4D - 0E4E	3662 - 3663	Negative PF, Meter 3, Minimum Avg Demand	FLOAT	-1.00 to +1.00	none		2
						Block Size:	64
0E73 - 0E74	3700 - 3701	Amps Meter 4, Minimum Avg Demand	FLOAT	0 to 9999 M	amps		2
0E75 - 0E76	3702 - 3703	Amps Meter 5, Minimum Avg Demand	FLOAT	0 to 9999 M	amps		2
0E77 - 0E78	3704 - 3705	Amps Meter 6, Minimum Avg Demand	FLOAT	0 to 9999 M	amps		2
0E79 - 0E7A	3706 - 3707	Reserved					2
0E7B - 0E7C	3708 - 3709	Reserved					2
0E7D - 0E7E	3710 - 3711	Reserved					2
0E7F - 0E80	3712 - 3713	Reserved					2
0E81 - 0E82	3714 - 3715	Reserved					2
0E83 - 0E84	3716 - 3717	Reserved					2
0E85 - 0E86	3718 - 3719	Reserved					2
0E87 - 0E88	3720 - 3721	Reserved					2
0E89 - 0E8A	3722 - 3723	Positive Watts, Meter 4 , Minimum Avg Demand	FLOAT	-9999 M to +9999 M	watts		2
0E8B - 0E8C	3724 - 3725	Positive Watts, Meter 5, Minimum Avg Demand	FLOAT	-9999 M to +9999 M	watts		2
0E8D - 0E8E	3726 - 3727	Positive Watts, Meter 6, Minimum Avg Demand	FLOAT	-9999 M to +9999 M	watts		2
0E8F - 0E90	3728 - 3729	Positive VARs, Meter 4, Minimum Avg Demand	FLOAT	-9999 M to +9999 M	VARs		2
0E91 - 0E92	3730 - 3731	Positive VARs, Meter 5, Minimum Avg Demand	FLOAT	-9999 M to +9999 M	VARs		2
0E93 - 0E94	3732 - 3733	Positive VARs, Meter 6, Minimum Avg Demand	FLOAT	-9999 M to +9999 M	VARs		2
0E95 - 0E96	3734 - 3735	Negative Watts, Meter 4, Minimum Avg Demand	FLOAT	-9999 M to +9999 M	watts		2
0E97 - 0E98	3736 - 3737	Negative Watts, Meter 5, Minimum Avg Demand	FLOAT	-9999 M to +9999 M	watts		2
0E99 - 0E9A	3738 - 3739	Negative Watts, Meter 6, Minimum Avg Demand	FLOAT	-9999 M to +9999 M	watts		2

Modbus Address		Description	Format	Range	Units or Resolution	Comments	# Reg
Hex	Decimal						
0E9B - 0E9C	3740 - 3741	Negative VARs, Meter 4, Minimum Avg Demand	FLOAT	-9999 M to +9999 M	VARs		2
0E9D - 0E9E	3742 - 3743	Negative VARs, Meter 5, Minimum Avg Demand	FLOAT	-9999 M to +9999 M	VARs		2
0E9F - 0EA0	3744 - 3745	Negative VARs, Meter 6, Minimum Avg Demand	FLOAT	-9999 M to +9999 M	VARs		2
0EA1 - 0EA2	3746 - 3747	VAs, Meter 4, Minimum Avg Demand	FLOAT	-9999 M to +9999 M	VAs		2
0EA3 - 0EA4	3748 - 3749	VAs, Meter 5, Minimum Avg Demand	FLOAT	-9999 M to +9999 M	VAs		2
0EA5 - 0EA6	3750 - 3751	VAs, Meter 6, Minimum Avg Demand	FLOAT	-9999 M to +9999 M	VAs		2
0EA7 - 0EA8	3752 - 3753	Positive PF, Meter 4, Minimum Avg Demand	FLOAT	-1.00 to +1.00	none		2
0EA9 - 0EAA	3754 - 3755	Positive PF, Meter 5, Minimum Avg Demand	FLOAT	-1.00 to +1.00	none		2
0EAB - 0EAC	3756 - 3757	Positive PF, Meter 6, Minimum Avg Demand	FLOAT	-1.00 to +1.00	none		2
0EAD - 0EAE	3758 - 3759	Negative PF, Meter 4, Minimum Avg Demand	FLOAT	-1.00 to +1.00	none		2
0EAF - 0EB0	3760 - 3761	Negative PF, Meter 5, Minimum Avg Demand	FLOAT	-1.00 to +1.00	none		2
0EB1 - 0EB2	3762 - 3763	Negative PF, Meter 6, Minimum Avg Demand	FLOAT	-1.00 to +1.00	none		2
						Block Size:	64
0ED7 - 0ED8	3800 - 3801	Amps Meter 7, Minimum Avg Demand	FLOAT	0 to 9999 M	amps		2
0ED9 - 0EDA	3802 - 3803	Amps Meter 8, Minimum Avg Demand	FLOAT	0 to 9999 M	amps		2
0EDB - 0EDC	3804 - 3805	Amps Meter 9, Minimum Avg Demand	FLOAT	0 to 9999 M	amps		2
0EDD - 0EDE	3806 - 3807	Reserved					2
0EDF - 0EE0	3808 - 3809	Reserved					2
0EE1 - 0EE2	3810 - 3811	Reserved					2
0EE3 - 0EE4	3812 - 3813	Reserved					2
0EE5 - 0EE6	3814 - 3815	Reserved					2
0EE7 - 0EE8	3816 - 3817	Reserved					2
0EE9 - 0EEA	3818 - 3819	Reserved					2
0EEB - 0EEC	3820 - 3821	Reserved					2
0EED - 0EEE	3822 - 3823	Positive Watts, Meter 7 , Minimum Avg Demand	FLOAT	-9999 M to +9999 M	watts		2
0EEF - 0EF0	3824 - 3825	Positive Watts, Meter 8, Minimum Avg Demand	FLOAT	-9999 M to +9999 M	watts		2

Modbus Address		Description	Format	Range	Units or Resolution	Comments	# Reg
Hex	Decimal						
0EF1 - 0EF2	3826 - 3827	Positive Watts, Meter 9, Minimum Avg Demand	FLOAT	-9999 M to +9999 M	watts		2
0EF3 - 0EF4	3828 - 3829	Positive VARs, Meter 7, Minimum Avg Demand	FLOAT	-9999 M to +9999 M	VARs		2
0EF5 - 0EF6	3830 - 3831	Positive VARs, Meter 8, Minimum Avg Demand	FLOAT	-9999 M to +9999 M	VARs		2
0EF7 - 0EF8	3832 - 3833	Positive VARs, Meter 9, Minimum Avg Demand	FLOAT	-9999 M to +9999 M	VARs		2
0EF9 - 0EFA	3834 - 3835	Negative Watts, Meter 7, Minimum Avg Demand	FLOAT	-9999 M to +9999 M	watts		2
0EFB - 0EFC	3836 - 3837	Negative Watts, Meter 8, Minimum Avg Demand	FLOAT	-9999 M to +9999 M	watts		2
0EFD - 0EFE	3838 - 3839	Negative Watts, Meter 9, Minimum Avg Demand	FLOAT	-9999 M to +9999 M	watts		2
0EFF - 0F00	3840 - 3841	Negative VARs, Meter 7, Minimum Avg Demand	FLOAT	-9999 M to +9999 M	VARs		2
0F01 - 0F02	3842 - 3843	Negative VARs, Meter 8, Minimum Avg Demand	FLOAT	-9999 M to +9999 M	VARs		2
0F03 - 0F04	3844 - 3845	Negative VARs, Meter 9, Minimum Avg Demand	FLOAT	-9999 M to +9999 M	VARs		2
0F05 - 0F06	3846 - 3847	VAs, Meter 7, Minimum Avg Demand	FLOAT	-9999 M to +9999 M	VAs		2
0F07 - 0F08	3848 - 3849	VAs, Meter 8, Minimum Avg Demand	FLOAT	-9999 M to +9999 M	VAs		2
- 0F0A	3850 - 3851	VAs, Meter 9, Minimum Avg Demand	FLOAT	-9999 M to +9999 M	VAs		2
0F0B - 0F0C	3852 - 3853	Positive PF, Meter 7, Minimum Avg Demand	FLOAT	-1.00 to +1.00	none		2
0F0D - 0F0E	3854 - 3855	Positive PF, Meter 8, Minimum Avg Demand	FLOAT	-1.00 to +1.00	none		2
0F0F - 0F10	3856 - 3857	Positive PF, Meter 9, Minimum Avg Demand	FLOAT	-1.00 to +1.00	none		2

Modbus Address		Description	Format	Range	Units or Resolution	Comments	# Reg
Hex	Decimal						
0F11 - 0F12	3858 - 3859	Negative PF, Meter 7, Minimum Avg Demand	FLOAT	-1.00 to +1.00	none		2
0F13 - 0F14	3860 - 3861	Negative PF, Meter 8, Minimum Avg Demand	FLOAT	-1.00 to +1.00	none		2
0F15 - 0F16	3862 - 3863	Negative PF, Meter 9, Minimum Avg Demand	FLOAT	-1.00 to +1.00	none		2
						Block Size:	64
0F3B - 0F3C	3900 - 3901	Amps Meter 10, Minimum Avg Demand	FLOAT	0 to 9999 M	amps		2
0F3D - 0F3E	3902 - 3903	Amps Meter 11, Minimum Avg Demand	FLOAT	0 to 9999 M	amps		2
0F3F - 0F40	3904 - 3905	Amps Meter 12, Minimum Avg Demand	FLOAT	0 to 9999 M	amps		2
0F41 - 0F42	3906 - 3907	Reserved					2
0F43 - 0F44	3908 - 3909	Reserved					2
0F45 - 0F46	3910 - 3911	Reserved					2
0F47 - 0F48	3912 - 3913	Reserved					2
0F49 - 0F4A	3914 - 3915	Reserved					2
0F4B - 0F4C	3916 - 3917	Reserved					2
0F4D - 0F4E	3918 - 3919	Reserved					2
0F4F - 0F50	3920 - 3921	Reserved					2
0F51 - 0F52	3922 - 3923	Positive Watts, Meter 10 , Minimum Avg Demand	FLOAT	-9999 M to +9999 M	watts		2
0F53 - 0F54	3924 - 3925	Positive Watts, Meter 11, Minimum Avg Demand	FLOAT	-9999 M to +9999 M	watts		2
0F55 - 0F56	3926 - 3927	Positive Watts, Meter 12, Minimum Avg Demand	FLOAT	-9999 M to +9999 M	watts		2
0F57 - 0F58	3928 - 3929	Positive VARs, Meter 10, Minimum Avg Demand	FLOAT	-9999 M to +9999 M	VARs		2
0F59 - 0F5A	3930 - 3931	Positive VARs, Meter 11, Minimum Avg Demand	FLOAT	-9999 M to +9999 M	VARs		2
0F5B - 0F5C	3932 - 3933	Positive VARs, Meter 12, Minimum Avg Demand	FLOAT	-9999 M to +9999 M	VARs		2
0F5D - 0F5E	3934 - 3935	Negative Watts, Meter 10, Minimum Avg Demand	FLOAT	-9999 M to +9999 M	watts		2
0F5F - 0F60	3936 - 3937	Negative Watts, Meter 11, Minimum Avg Demand	FLOAT	-9999 M to +9999 M	watts		2
0F61 - 0F62	3938 - 3939	Negative Watts, Meter 12, Minimum Avg Demand	FLOAT	-9999 M to +9999 M	watts		2

Modbus Address		Description	Format	Range	Units or Resolution	Comments	# Reg
Hex	Decimal						
0F63 - 0F64	3940 - 3941	Negative VARs, Meter 10, Minimum Avg Demand	FLOAT	-9999 M to +9999 M	VARs		2
0F65 - 0F66	3942 - 3943	Negative VARs, Meter 11, Minimum Avg Demand	FLOAT	-9999 M to +9999 M	VARs		2
0F67 - 0F68	3944 - 3945	Negative VARs, Meter 12, Minimum Avg Demand	FLOAT	-9999 M to +9999 M	VARs		2
0F69 - 0F6A	3946 - 3947	VAs, Meter 10, Minimum Avg Demand	FLOAT	-9999 M to +9999 M	VAs		2
0F6B - 0F6C	3948 - 3949	VAs, Meter 11, Minimum Avg Demand	FLOAT	-9999 M to +9999 M	VAs		2
0F6D - 0F6E	3950 - 3951	VAs, Meter 12, Minimum Avg Demand	FLOAT	-9999 M to +9999 M	VAs		2
0F6F - 0F70	3952 - 3953	Positive PF, Meter 10, Minimum Avg Demand	FLOAT	-1.00 to +1.00	none		2
0F71 - 0F72	3954 - 3955	Positive PF, Meter 11, Minimum Avg Demand	FLOAT	-1.00 to +1.00	none		2
0F73 - 0F74	3956 - 3957	Positive PF, Meter 12, Minimum Avg Demand	FLOAT	-1.00 to +1.00	none		2
0F75 - 0F76	3958 - 3959	Negative PF, Meter 10, Minimum Avg Demand	FLOAT	-1.00 to +1.00	none		2
0F77 - 0F78	3960 - 3961	Negative PF, Meter 11, Minimum Avg Demand	FLOAT	-1.00 to +1.00	none		2
0F79 - 0F7A	3962 - 3963	Negative PF, Meter 12, Minimum Avg Demand	FLOAT	-1.00 to +1.00	none		2
						Block Size:	64
						read-only	
0F9F - 0FA0	4000 - 4001	Amps Meter 13, Minimum Avg Demand	FLOAT	0 to 9999 M	amps		2
0FA1 - 0FA2	4002 - 4003	Amps Meter 14, Minimum Avg Demand	FLOAT	0 to 9999 M	amps		2
0FA3 - 0FA4	4004 - 4005	Amps Meter 15, Minimum Avg Demand	FLOAT	0 to 9999 M	amps		2
0FA5 - 0FA6	4006 - 4007	Reserved					2
0FA7 - 0FA8	4008 - 4009	Reserved					2
0FA9 - 0FAA	4010 - 4011	Reserved					2
0FAB - 0FAC	4012 - 4013	Reserved					2
0FAD - 0FAE	4014 - 4015	Reserved					2
0FAF - 0FB0	4016 - 4017	Reserved					2
0FB1 - 0FB2	4018 - 4019	Reserved					2
0FB3 - 0FB4	4020 - 4021	Reserved					2
0FB5 - 0FB6	4022 - 4023	Positive Watts, Meter 13, Minimum Avg Demand	FLOAT	-9999 M to +9999 M	watts		2
0FB7 - 0FB8	4024 - 4025	Positive Watts, Meter 14, Minimum Avg Demand	FLOAT	-9999 M to +9999 M	watts		2

Modbus Address		Description	Format	Range	Units or Resolution	Comments	# Reg
Hex	Decimal						
0FB9 - 0FBA	4026 - 4027	Positive Watts, Meter 15, Minimum Avg Demand	FLOAT	-9999 M to +9999 M	watts		2
0FBB - 0FBC	4028 - 4029	Positive VARs, Meter 13, Minimum Avg Demand	FLOAT	-9999 M to +9999 M	VARs		2
0FBD - 0FBE	4030 - 4031	Positive VARs, Meter 14, Minimum Avg Demand	FLOAT	-9999 M to +9999 M	VARs		2
0FBF - 0FC0	4032 - 4033	Positive VARs, Meter 15, Minimum Avg Demand	FLOAT	-9999 M to +9999 M	VARs		2
0FC1 - 0FC2	4034 - 4035	Negative Watts, Meter 13, Minimum Avg Demand	FLOAT	-9999 M to +9999 M	watts		2
0FC3 - 0FC4	4036 - 4037	Negative Watts, Meter 14, Minimum Avg Demand	FLOAT	-9999 M to +9999 M	watts		2
0FC5 - 0FC6	4038 - 4039	Negative Watts, Meter 15, Minimum Avg Demand	FLOAT	-9999 M to +9999 M	watts		2
0FC7 - 0FC8	4040 - 4041	Negative VARs, Meter 13, Minimum Avg Demand	FLOAT	-9999 M to +9999 M	VARs		2
0FC9 - 0FCA	4042 - 4043	Negative VARs, Meter 14, Minimum Avg Demand	FLOAT	-9999 M to +9999 M	VARs		2
0FCB - 0FCC	4044 - 4045	Negative VARs, Meter 15, Minimum Avg Demand	FLOAT	-9999 M to +9999 M	VARs		2
0FCD - 0FCE	4046 - 4047	VAs, Meter 13, Minimum Avg Demand	FLOAT	-9999 M to +9999 M	VAs		2
0FCF - 0FD0	4048 - 4049	VAs, Meter 14, Minimum Avg Demand	FLOAT	-9999 M to +9999 M	VAs		2
0FD1 - 0FD2	4050 - 4051	VAs, Meter 15, Minimum Avg Demand	FLOAT	-9999 M to +9999 M	VAs		2
0FD3 - 0FD4	4052 - 4053	Positive PF, Meter 13, Minimum Avg Demand	FLOAT	-1.00 to +1.00	none		2
0FD5 - 0FD6	4054 - 4055	Positive PF, Meter 14, Minimum Avg Demand	FLOAT	-1.00 to +1.00	none		2
0FD7 - 0FD8	4056 - 4057	Positive PF, Meter 15, Minimum Avg Demand	FLOAT	-1.00 to +1.00	none		2
0FD9 - 0FDA	4058 - 4059	Negative PF, Meter 13, Minimum Avg Demand	FLOAT	-1.00 to +1.00	none		2
0FDB - 0FDC	4060 - 4061	Negative PF, Meter 14, Minimum Avg Demand	FLOAT	-1.00 to +1.00	none		2

Modbus Address		Description	Format	Range	Units or Resolution	Comments	# Reg
Hex	Decimal						
0FDD - 0FDE	4062 - 4063	Negative PF, Meter 15, Minimum Avg Demand	FLOAT	-1.00 to +1.00	none		2
						Block Size:	64
1003 - 1004	4100 - 4101	Amps Meter 16, Minimum Avg Demand	FLOAT	0 to 9999 M	amps		2
1005 - 1006	4102 - 4103	Amps Meter 17, Minimum Avg Demand	FLOAT	0 to 9999 M	amps		2
1007 - 1008	4104 - 4105	Amps Meter 18, Minimum Avg Demand	FLOAT	0 to 9999 M	amps		2
1009 - 100A	4106 - 4107	Reserved					2
100B - 100C	4108 - 4109	Reserved					2
100D - 100E	4110 - 4111	Reserved					2
100F - 1010	4112 - 4113	Reserved					2
1011 - 1012	4114 - 4115	Reserved					2
1013 - 1014	4116 - 4117	Reserved					2
1015 - 1016	4118 - 4119	Reserved					2
1017 - 1018	4120 - 4121	Reserved					2
1019 - 101A	4122 - 4123	Positive Watts, Meter 16, Minimum Avg Demand	FLOAT	-9999 M to +9999 M	watts		2
101B - 101C	4124 - 4125	Positive Watts, Meter 17, Minimum Avg Demand	FLOAT	-9999 M to +9999 M	watts		2
101D - 101E	4126 - 4127	Positive Watts, Meter 18, Minimum Avg Demand	FLOAT	-9999 M to +9999 M	watts		2
101F - 1020	4128 - 4129	Positive VARs, Meter 16, Minimum Avg Demand	FLOAT	-9999 M to +9999 M	VARs		2
1021 - 1022	4130 - 4131	Positive VARs, Meter 17, Minimum Avg Demand	FLOAT	-9999 M to +9999 M	VARs		2
1023 - 1024	4132 - 4133	Positive VARs, Meter 18, Minimum Avg Demand	FLOAT	-9999 M to +9999 M	VARs		2
1025 - 1026	4134 - 4135	Negative Watts, Meter 16, Minimum Avg Demand	FLOAT	-9999 M to +9999 M	watts		2
1027 - 1028	4136 - 4137	Negative Watts, Meter 17, Minimum Avg Demand	FLOAT	-9999 M to +9999 M	watts		2
1029 - 102A	4138 - 4139	Negative Watts, Meter 18, Minimum Avg Demand	FLOAT	-9999 M to +9999 M	watts		2
102B - 102C	4140 - 4141	Negative VARs, Meter 16, Minimum Avg Demand	FLOAT	-9999 M to +9999 M	VARs		2
102D - 102E	4142 - 4143	Negative VARs, Meter 17, Minimum Avg Demand	FLOAT	-9999 M to +9999 M	VARs		2

Modbus Address		Description	Format	Range	Units or Resolution	Comments	# Reg
Hex	Decimal						
102F - 1030	4144 - 4145	Negative VARs, Meter 18, Minimum Avg Demand	FLOAT	-9999 M to +9999 M	VARs		2
1031 - 1032	4146 - 4147	VAs, Meter 16, Minimum Avg Demand	FLOAT	-9999 M to +9999 M	VAs		2
1033 - 1034	4148 - 4149	VAs, Meter 17, Minimum Avg Demand	FLOAT	-9999 M to +9999 M	VAs		2
1035 - 1036	4150 - 4151	VAs, Meter 18, Minimum Avg Demand	FLOAT	-9999 M to +9999 M	VAs		2
1037 - 1038	4152 - 4153	Positive PF, Meter 16, Minimum Avg Demand	FLOAT	-1.00 to +1.00	none		2
1039 - 103A	4154 - 4155	Positive PF, Meter 17, Minimum Avg Demand	FLOAT	-1.00 to +1.00	none		2
103B - 103C	4156 - 4157	Positive PF, Meter 18, Minimum Avg Demand	FLOAT	-1.00 to +1.00	none		2
103D - 103E	4158 - 4159	Negative PF, Meter 16, Minimum Avg Demand	FLOAT	-1.00 to +1.00	none		2
103F - 1040	4160 - 4161	Negative PF, Meter 17, Minimum Avg Demand	FLOAT	-1.00 to +1.00	none		2
1041 - 1042	4162 - 4163	Negative PF, Meter 18, Minimum Avg Demand	FLOAT	-1.00 to +1.00	none		2
						Block Size:	64
1067 - 1068	4200 - 4201	Amps Meter 19, Minimum Avg Demand	FLOAT	0 to 9999 M	amps		2
1069 - 106A	4202 - 4203	Amps Meter 20, Minimum Avg Demand	FLOAT	0 to 9999 M	amps		2
106B - 106C	4204 - 4205	Amps Meter 21, Minimum Avg Demand	FLOAT	0 to 9999 M	amps		2
106D - 106E	4206 - 4207	Reserved					2
106F - 1070	4208 - 4209	Reserved					2
1071 - 1072	4210 - 4211	Reserved					2
1073 - 1074	4212 - 4213	Reserved					2
1075 - 1076	4214 - 4215	Reserved					2
1077 - 1078	4216 - 4217	Reserved					2
1079 - 107A	4218 - 4219	Reserved					2
107B - 107C	4220 - 4221	Reserved					2
107D - 107E	4222 - 4223	Positive Watts, Meter 19, Minimum Avg Demand	FLOAT	-9999 M to +9999 M	watts		2
107F - 1080	4224 - 4225	Positive Watts, Meter 20, Minimum Avg Demand	FLOAT	-9999 M to +9999 M	watts		2
1081 - 1082	4226 - 4227	Positive Watts, Meter 21, Minimum Avg Demand	FLOAT	-9999 M to +9999 M	watts		2
1083 - 1084	4228 - 4229	Positive VARs, Meter 19, Minimum Avg Demand	FLOAT	-9999 M to +9999 M	VARs		2

Modbus Address		Description	Format	Range	Units or Resolution	Comments	# Reg
Hex	Decimal						
1085 - 1086	4230 - 4231	Positive VARs, Meter 20, Minimum Avg Demand	FLOAT	-9999 M to +9999 M	VARs		2
1087 - 1088	4232 - 4233	Positive VARs, Meter 21, Minimum Avg Demand	FLOAT	-9999 M to +9999 M	VARs		2
1089 - 108A	4234 - 4235	Negative Watts, Meter 19, Minimum Avg Demand	FLOAT	-9999 M to +9999 M	watts		2
108B - 108C	4236 - 4237	Negative Watts, Meter 20, Minimum Avg Demand	FLOAT	-9999 M to +9999 M	watts		2
108D - 108E	4238 - 4239	Negative Watts, Meter 21, Minimum Avg Demand	FLOAT	-9999 M to +9999 M	watts		2
108F - 1090	4240 - 4241	Negative VARs, Meter 19, Minimum Avg Demand	FLOAT	-9999 M to +9999 M	VARs		2
1091 - 1092	4242 - 4243	Negative VARs, Meter 20, Minimum Avg Demand	FLOAT	-9999 M to +9999 M	VARs		2
1093 - 1094	4244 - 4245	Negative VARs, Meter 21, Minimum Avg Demand	FLOAT	-9999 M to +9999 M	VARs		2
1095 - 1096	4246 - 4247	VAs, Meter 19, Minimum Avg Demand	FLOAT	-9999 M to +9999 M	VAs		2
1097 - 1098	4248 - 4249	VAs, Meter 20, Minimum Avg Demand	FLOAT	-9999 M to +9999 M	VAs		2
1099 - 109A	4250 - 4251	VAs, Meter 21, Minimum Avg Demand	FLOAT	-9999 M to +9999 M	VAs		2
109B - 109C	4252 - 4253	Positive PF, Meter 19, Minimum Avg Demand	FLOAT	-1.00 to +1.00	none		2
109D - 109E	4254 - 4255	Positive PF, Meter 20, Minimum Avg Demand	FLOAT	-1.00 to +1.00	none		2
109F - 10A0	4256 - 4257	Positive PF, Meter 21, Minimum Avg Demand	FLOAT	-1.00 to +1.00	none		2
10A1 - 10A2	4258 - 4259	Negative PF, Meter 19, Minimum Avg Demand	FLOAT	-1.00 to +1.00	none		2
10A3 - 10A4	4260 - 4261	Negative PF, Meter 20, Minimum Avg Demand	FLOAT	-1.00 to +1.00	none		2
10A5 - 10A6	4262 - 4263	Negative PF, Meter 21, Minimum Avg Demand	FLOAT	-1.00 to +1.00	none		2

Modbus Address		Description	Format	Range	Units or Resolution	Comments	# Reg
Hex	Decimal						
						Block Size:	64
10CB - 10CC	4300 - 4301	Amps Meter 22, Minimum Avg Demand	FLOAT	0 to 9999 M	amps		2
10CD - 10CE	4302 - 4303	Amps Meter 23, Minimum Avg Demand	FLOAT	0 to 9999 M	amps		2
10CF - 10D0	4304 - 4305	Amps Meter 24, Minimum Avg Demand	FLOAT	0 to 9999 M	amps		2
10D1 - 10D2	4306 - 4307	Reserved					2
10D3 - 10D4	4308 - 4309	Reserved					2
10D5 - 10D6	4310 - 4311	Reserved					2
10D7 - 10D8	4312 - 4313	Reserved					2
10D9 - 10DA	4314 - 4315	Reserved					2
10DB - 10DC	4316 - 4317	Reserved					2
10DD - 10DE	4318 - 4319	Reserved					2
10DF - 10E0	4320 - 4321	Reserved					2
10E1 - 10E2	4322 - 4323	Positive Watts, Meter 22, Minimum Avg Demand	FLOAT	-9999 M to +9999 M	watts		2
10E3 - 10E4	4324 - 4325	Positive Watts, Meter 23, Minimum Avg Demand	FLOAT	-9999 M to +9999 M	watts		2
10E5 - 10E6	4326 - 4327	Positive Watts, Meter 24, Minimum Avg Demand	FLOAT	-9999 M to +9999 M	watts		2
10E7 - 10E8	4328 - 4329	Positive VARs, Meter 22, Minimum Avg Demand	FLOAT	-9999 M to +9999 M	VARs		2
10E9 - 10EA	4330 - 4331	Positive VARs, Meter 23, Minimum Avg Demand	FLOAT	-9999 M to +9999 M	VARs		2
10EB - 10EC	4332 - 4333	Positive VARs, Meter 24, Minimum Avg Demand	FLOAT	-9999 M to +9999 M	VARs		2
10ED - 10EE	4334 - 4335	Negative Watts, Meter 22, Minimum Avg Demand	FLOAT	-9999 M to +9999 M	watts		2
10EF - 10F0	4336 - 4337	Negative Watts, Meter 23, Minimum Avg Demand	FLOAT	-9999 M to +9999 M	watts		2
10F1 - 10F2	4338 - 4339	Negative Watts, Meter 24, Minimum Avg Demand	FLOAT	-9999 M to +9999 M	watts		2
10F3 - 10F4	4340 - 4341	Negative VARs, Meter 22, Minimum Avg Demand	FLOAT	-9999 M to +9999 M	VARs		2
10F5 - 10F6	4342 - 4343	Negative VARs, Meter 23, Minimum Avg Demand	FLOAT	-9999 M to +9999 M	VARs		2
10F7 - 10F8	4344 - 4345	Negative VARs, Meter 24, Minimum Avg Demand	FLOAT	-9999 M to +9999 M	VARs		2

Modbus Address		Description	Format	Range	Units or Resolution	Comments	# Reg
Hex	Decimal						
10F9 - 10FA	4346 - 4347	VAs, Meter 22, Minimum Avg Demand	FLOAT	-9999 M to +9999 M	VAs		2
10FB - 10FC	4348 - 4349	VAs, Meter 23, Minimum Avg Demand	FLOAT	-9999 M to +9999 M	VAs		2
10FD - 10FE	4350 - 4351	VAs, Meter 24, Minimum Avg Demand	FLOAT	-9999 M to +9999 M	VAs		2
10FF - 1100	4352 - 4353	Positive PF, Meter 22, Minimum Avg Demand	FLOAT	-1.00 to +1.00	none		2
1101 - 1102	4354 - 4355	Positive PF, Meter 23, Minimum Avg Demand	FLOAT	-1.00 to +1.00	none		2
1103 - 1104	4356 - 4357	Positive PF, Meter 24, Minimum Avg Demand	FLOAT	-1.00 to +1.00	none		2
1105 - 1106	4358 - 4359	Negative PF, Meter 22, Minimum Avg Demand	FLOAT	-1.00 to +1.00	none		2
1107 - 1108	4360 - 4361	Negative PF, Meter 23, Minimum Avg Demand	FLOAT	-1.00 to +1.00	none		2
1109 - 110A	4362 - 4363	Negative PF, Meter 24, Minimum Avg Demand	FLOAT	-1.00 to +1.00	none		2
						Block Size:	64
Primary Minimum Timestamp Block							
112F - 1131	4400 - 4402	Volts Min Timestamp	TSTAMP	1Jan2000 - 31Dec2099	1 sec	read-only	3
1132 - 1134	4403 - 4405	Reserved					3
1135 - 1137	4406 - 4408	Volts C-N, Min Timestamp	TSTAMP	1Jan2000 - 31Dec2099	1 sec		3
1138 - 113A	4409 - 4411	Volts A-B, Min Timestamp	TSTAMP	1Jan2000 - 31Dec2099	1 sec		3
113B - 113D	4412 - 4414	Volts B-C, Min Timestamp	TSTAMP	1Jan2000 - 31Dec2099	1 sec		3
113E - 1140	4415 - 4417	Volts C-A, Min Timestamp	TSTAMP	1Jan2000 - 31Dec2099	1 sec		3
1141 - 1143	4418 - 4420	Frequency, Min Timestamp	TSTAMP	1Jan2000 - 31Dec2099	1 sec		3
						Block Size:	21
Primary Minimum Timestamp Block							
1193 - 1195	4500 - 4502	Amps Meter 1, Min Avg Dmd Timestamp	TSTAMP	1Jan2000 - 31Dec2099	1 sec		3
1196 - 1198	4503 - 4505	Amps Meter 2, Min Avg Dmd Timestamp	TSTAMP	1Jan2000 - 31Dec2099	1 sec		3
1199 - 119B	4506 - 4508	Amps Meter 3, Min Avg Dmd Timestamp	TSTAMP	1Jan2000 - 31Dec2099	1 sec		3
119C - 119E	4509 - 4511	Reserved					3
119F - 11A1	4512 - 4514	Reserved					3
11A2 - 11A4	4515 - 4517	Reserved					3

Modbus Address		Description	Format	Range	Units or Resolution	Comments	# Reg
Hex	Decimal						
11A5 - 11A7	4518 - 4520	Reserved					3
11A8 - 11AA	4521 - 4523	Reserved					3
11AB - 11AD	4524 - 4526	Reserved					3
11AE - 11B0	4527 - 4529	Reserved					3
11B1 - 11B3	4530 - 4532	Reserved					3
11B4 - 11B6	4533 - 4535	Positive Watts, Meter 1, Min Avg Dmd Timestamp	TSTAMP	1Jan2000 - 31Dec2099	1 sec		3
11B7 - 11B9	4536 - 4538	Positive Watts, Meter 2, Min Avg Dmd Timestamp	TSTAMP	1Jan2000 - 31Dec2099	1 sec		3
11BA - 11BC	4539 - 4541	Positive Watts, Meter 3, Min Avg Dmd Timestamp	TSTAMP	1Jan2000 - 31Dec2099	1 sec		3
11BD - 11BF	4542 - 4544	Positive VARs, Meter 1, Min Avg Dmd Timestamp	TSTAMP	1Jan2000 - 31Dec2099	1 sec		3
11C0 - 11C2	4545 - 4547	Positive VARs, Meter 2, Min Avg Dmd Timestamp	TSTAMP	1Jan2000 - 31Dec2099	1 sec		3
11C3 - 11C5	4548 - 4550	Positive VARs, Meter 3, Min Avg Dmd Timestamp	TSTAMP	1Jan2000 - 31Dec2099	1 sec		3
11C6 - 11C8	4551 - 4553	Negative Watts, Meter 1, Min Avg Dmd Timestamp	TSTAMP	1Jan2000 - 31Dec2099	1 sec		3
11C9 - 11CB	4554 - 4556	Negative Watts, Meter 2, Min Avg Dmd Timestamp	TSTAMP	1Jan2000 - 31Dec2099	1 sec		3
11CC - 11CE	4557 - 4559	Negative Watts, Meter 3, Min Avg Dmd Timestamp	TSTAMP	1Jan2000 - 31Dec2099	1 sec		3
11CF - 11D1	4560 - 4562	Negative VARs, Meter 1, Min Avg Dmd Timestamp	TSTAMP	1Jan2000 - 31Dec2099	1 sec		3
11D2 - 11D4	4563 - 4565	Negative VARs, Meter 2, Min Avg Dmd Timestamp	TSTAMP	1Jan2000 - 31Dec2099	1 sec		3
11D5 - 11D7	4566 - 4568	Negative VARs, Meter 3, Min Avg Dmd Timestamp	TSTAMP	1Jan2000 - 31Dec2099	1 sec		3
11D8 - 11DA	4569 - 4571	VAs, Meter 1, Min Avg Dmd Timestamp	TSTAMP	1Jan2000 - 31Dec2099	1 sec		3
11DB - 11DD	4572 - 4574	VAs, Meter 2, Min Avg Dmd Timestamp	TSTAMP	1Jan2000 - 31Dec2099	1 sec		3
11DE - 11E0	4575 - 4577	VAs, Meter 3, Min Avg Dmd Timestamp	TSTAMP	1Jan2000 - 31Dec2099	1 sec		3
11E1 - 11E3	4578 - 4580	Positive PF, Meter 1, Min Avg Dmd Timestamp	TSTAMP	1Jan2000 - 31Dec2099	1 sec		3
11E4 - 11E6	4581 - 4583	Positive PF, Meter 2, Min Avg Dmd Timestamp	TSTAMP	1Jan2000 - 31Dec2099	1 sec		3
11E7 - 11E9	4584 - 4586	Positive PF, Meter 3, Min Avg Dmd Timestamp	TSTAMP	1Jan2000 - 31Dec2099	1 sec		3
11EA - 11EC	4587 - 4589	Negative PF, Meter 1, Min Avg Dmd Timestamp	TSTAMP	1Jan2000 - 31Dec2099	1 sec		3

Modbus Address		Description	Format	Range	Units or Resolution	Comments	# Reg
Hex	Decimal						
11ED - 11EF	4590 - 4592	Negative PF, Meter 2, Min Avg Dmd Timestamp	TSTAMP	1Jan2000 - 31Dec2099	1 sec		3
11F0 - 11F2	4593 - 4595	Negative PF, Meter 3, Min Avg Dmd Timestamp	TSTAMP	1Jan2000 - 31Dec2099	1 sec		3
						Block Size:	96
11F7 - 11F9	4600 - 4602	Amps Meter 4, Min Avg Dmd Timestamp	TSTAMP	1Jan2000 - 31Dec2099	1 sec		3
11FA - 11FC	4603 - 4605	Amps Meter 5, Min Avg Dmd Timestamp	TSTAMP	1Jan2000 - 31Dec2099	1 sec		3
11FD - 11FF	4606 - 4608	Amps Meter 6, Min Avg Dmd Timestamp	TSTAMP	1Jan2000 - 31Dec2099	1 sec		3
1200 - 1202	4609 - 4611	Reserved					3
1203 - 1205	4612 - 4614	Reserved					3
1206 - 1208	4615 - 4617	Reserved					3
1209 - 120B	4618 - 4620	Reserved					3
120C - 120E	4621 - 4623	Reserved					3
120F - 1211	4624 - 4626	Reserved					3
1212 - 1214	4627 - 4629	Reserved					3
1215 - 1217	4630 - 4632	Reserved					3
1218 - 121A	4633 - 4635	Positive Watts, Meter 4, Min Avg Dmd Timestamp	TSTAMP	1Jan2000 - 31Dec2099	1 sec		3
121B - 121D	4636 - 4638	Positive Watts, Meter 5, Min Avg Dmd Timestamp	TSTAMP	1Jan2000 - 31Dec2099	1 sec		3
121E - 1220	4639 - 4641	Positive Watts, Meter 6, Min Avg Dmd Timestamp	TSTAMP	1Jan2000 - 31Dec2099	1 sec		3
1221 - 1223	4642 - 4644	Positive VARs, Meter 4, Min Avg Dmd Timestamp	TSTAMP	1Jan2000 - 31Dec2099	1 sec		3
1224 - 1226	4645 - 4647	Positive VARs, Meter 5, Min Avg Dmd Timestamp	TSTAMP	1Jan2000 - 31Dec2099	1 sec		3
1227 - 1229	4648 - 4650	Positive VARs, Meter 6, Min Avg Dmd Timestamp	TSTAMP	1Jan2000 - 31Dec2099	1 sec		3
122A - 122C	4651 - 4653	Negative Watts, Meter 4, Min Avg Dmd Timestamp	TSTAMP	1Jan2000 - 31Dec2099	1 sec		3

Modbus Address		Description	Format	Range	Units or Resolution	Comments	# Reg
Hex	Decimal						
122D - 122F	4654 - 4656	Negative Watts, Meter 5, Min Avg Dmd Timestamp	TSTAMP	1Jan2000 - 31Dec2099	1 sec		3
1230 - 1232	4657 - 4659	Negative Watts, Meter 6, Min Avg Dmd Timestamp	TSTAMP	1Jan2000 - 31Dec2099	1 sec		3
1233 - 1235	4660 - 4662	Negative VARs, Meter 4, Min Avg Dmd Timestamp	TSTAMP	1Jan2000 - 31Dec2099	1 sec		3
1236 - 1238	4663 - 4665	Negative VARs, Meter 5, Min Avg Dmd Timestamp	TSTAMP	1Jan2000 - 31Dec2099	1 sec		3
1239 - 123B	4666 - 4668	Negative VARs, Meter 6, Min Avg Dmd Timestamp	TSTAMP	1Jan2000 - 31Dec2099	1 sec		3
123C - 123E	4669 - 4671	VAs, Meter 4, Min Avg Dmd Timestamp	TSTAMP	1Jan2000 - 31Dec2099	1 sec		3
123F - 1241	4672 - 4674	VAs, Meter 5, Min Avg Dmd Timestamp	TSTAMP	1Jan2000 - 31Dec2099	1 sec		3
1242 - 1244	4675 - 4677	VAs, Meter 6, Min Avg Dmd Timestamp	TSTAMP	1Jan2000 - 31Dec2099	1 sec		3
1245 - 1247	4678 - 4680	Positive PF, Meter 4, Min Avg Dmd Timestamp	TSTAMP	1Jan2000 - 31Dec2099	1 sec		3
1248 - 124A	4681 - 4683	Positive PF, Meter 5, Min Avg Dmd Timestamp	TSTAMP	1Jan2000 - 31Dec2099	1 sec		3
124B - 124D	4684 - 4686	Positive PF, Meter 6, Min Avg Dmd Timestamp	TSTAMP	1Jan2000 - 31Dec2099	1 sec		3
124E - 1250	4687 - 4689	Negative PF, Meter 4, Min Avg Dmd Timestamp	TSTAMP	1Jan2000 - 31Dec2099	1 sec		3
1251 - 1253	4690 - 4692	Negative PF, Meter 5, Min Avg Dmd Timestamp	TSTAMP	1Jan2000 - 31Dec2099	1 sec		3
1254 - 1256	4693 - 4695	Negative PF, Meter 6, Min Avg Dmd Timestamp	TSTAMP	1Jan2000 - 31Dec2099	1 sec		3
						Block Size:	96
125B - 125D	4700 - 4702	Amps Meter 7, Min Avg Dmd Timestamp	TSTAMP	1Jan2000 - 31Dec2099	1 sec		3
125E - 1260	4703 - 4705	Amps Meter 8, Min Avg Dmd Timestamp	TSTAMP	1Jan2000 - 31Dec2099	1 sec		3
1261 - 1263	4706 - 4708	Amps Meter 9, Min Avg Dmd Timestamp	TSTAMP	1Jan2000 - 31Dec2099	1 sec		3
1264 - 1266	4709 - 4711	Reserved					3
1267 - 1269	4712 - 4714	Reserved					3
126A - 126C	4715 - 4717	Reserved					3
126D - 126F	4718 - 4720	Reserved					3
1270 - 1272	4721 - 4723	Reserved					3
1273 - 1275	4724 - 4726	Reserved					3
1276 - 1278	4727 - 4729	Reserved					3

Modbus Address		Description	Format	Range	Units or Resolution	Comments	# Reg
Hex	Decimal						
1279 - 127B	4730 - 4732	Reserved					3
127C - 127E	4733 - 4735	Positive Watts, Meter 7, Min Avg Dmd Timestamp	TSTAMP	1Jan2000 - 31Dec2099	1 sec		3
127F - 1281	4736 - 4738	Positive Watts, Meter 8, Min Avg Dmd Timestamp	TSTAMP	1Jan2000 - 31Dec2099	1 sec		3
1282 - 1284	4739 - 4741	Positive Watts, Meter 9, Min Avg Dmd Timestamp	TSTAMP	1Jan2000 - 31Dec2099	1 sec		3
1285 - 1287	4742 - 4744	Positive VARs, Meter 7, Min Avg Dmd Timestamp	TSTAMP	1Jan2000 - 31Dec2099	1 sec		3
1288 - 128A	4745 - 4747	Positive VARs, Meter 8, Min Avg Dmd Timestamp	TSTAMP	1Jan2000 - 31Dec2099	1 sec		3
128B - 128D	4748 - 4750	Positive VARs, Meter 9, Min Avg Dmd Timestamp	TSTAMP	1Jan2000 - 31Dec2099	1 sec		3
128E - 1290	4751 - 4753	Negative Watts, Meter 7, Min Avg Dmd Timestamp	TSTAMP	1Jan2000 - 31Dec2099	1 sec		3
1291 - 1293	4754 - 4756	Negative Watts, Meter 8, Min Avg Dmd Timestamp	TSTAMP	1Jan2000 - 31Dec2099	1 sec		3
1294 - 1296	4757 - 4759	Negative Watts, Meter 9, Min Avg Dmd Timestamp	TSTAMP	1Jan2000 - 31Dec2099	1 sec		3
1297 - 1299	4760 - 4762	Negative VARs, Meter 7, Min Avg Dmd Timestamp	TSTAMP	1Jan2000 - 31Dec2099	1 sec		3
129A - 129C	4763 - 4765	Negative VARs, Meter 8, Min Avg Dmd Timestamp	TSTAMP	1Jan2000 - 31Dec2099	1 sec		3
129D - 129F	4766 - 4768	Negative VARs, Meter 9, Min Avg Dmd Timestamp	TSTAMP	1Jan2000 - 31Dec2099	1 sec		3
12A0 - 12A2	4769 - 4771	VAs, Meter 7, Min Avg Dmd Timestamp	TSTAMP	1Jan2000 - 31Dec2099	1 sec		3
12A3 - 12A5	4772 - 4774	VAs, Meter 8, Min Avg Dmd Timestamp	TSTAMP	1Jan2000 - 31Dec2099	1 sec		3
12A6 - 12A8	4775 - 4777	VAs, Meter 9, Min Avg Dmd Timestamp	TSTAMP	1Jan2000 - 31Dec2099	1 sec		3
12A9 - 12AB	4778 - 4780	Positive PF, Meter 7, Min Avg Dmd Timestamp	TSTAMP	1Jan2000 - 31Dec2099	1 sec		3
12AC - 12AE	4781 - 4783	Positive PF, Meter 8, Min Avg Dmd Timestamp	TSTAMP	1Jan2000 - 31Dec2099	1 sec		3
12AF - 12B1	4784 - 4786	Positive PF, Meter 9, Min Avg Dmd Timestamp	TSTAMP	1Jan2000 - 31Dec2099	1 sec		3

Modbus Address		Description	Format	Range	Units or Resolution	Comments	# Reg
Hex	Decimal						
12B2 - 12B4	4787 - 4789	Negative PF, Meter 7, Min Avg Dmd Timestamp	TSTAMP	1Jan2000 - 31Dec2099	1 sec		3
12B5 - 12B7	4790 - 4792	Negative PF, Meter 8, Min Avg Dmd Timestamp	TSTAMP	1Jan2000 - 31Dec2099	1 sec		3
12B8 - 12BA	4793 - 4795	Negative PF, Meter 9, Min Avg Dmd Timestamp	TSTAMP	1Jan2000 - 31Dec2099	1 sec		3
						Block Size:	96
12BF - 12C1	4800 - 4802	Amps Meter 10, Min Avg Dmd Timestamp	TSTAMP	1Jan2000 - 31Dec2099	1 sec		3
12C2 - 12C4	4803 - 4805	Amps Meter 11, Min Avg Dmd Timestamp	TSTAMP	1Jan2000 - 31Dec2099	1 sec		3
12C5 - 12C7	4806 - 4808	Amps Meter 12, Min Avg Dmd Timestamp	TSTAMP	1Jan2000 - 31Dec2099	1 sec		3
12C8 - 12CA	4809 - 4811	Reserved					3
12CB - 12CD	4812 - 4814	Reserved					3
12CE - 12D0	4815 - 4817	Reserved					3
12D1 - 12D3	4818 - 4820	Reserved					3
12D4 - 12D6	4821 - 4823	Reserved					3
12D7 - 12D9	4824 - 4826	Reserved					3
12DA - 12DC	4827 - 4829	Reserved					3
12DD - 12DF	4830 - 4832	Reserved					3
12E0 - 12E2	4833 - 4835	Positive Watts, Meter 10, Min Avg Dmd Timestamp	TSTAMP	1Jan2000 - 31Dec2099	1 sec		3
12E3 - 12E5	4836 - 4838	Positive Watts, Meter 11, Min Avg Dmd Timestamp	TSTAMP	1Jan2000 - 31Dec2099	1 sec		3
12E6 - 12E8	4839 - 4841	Positive Watts, Meter 12, Min Avg Dmd Timestamp	TSTAMP	1Jan2000 - 31Dec2099	1 sec		3
12E9 - 12EB	4842 - 4844	Positive VARs, Meter 10, Min Avg Dmd Timestamp	TSTAMP	1Jan2000 - 31Dec2099	1 sec		3
12EC - 12EE	4845 - 4847	Positive VARs, Meter 11, Min Avg Dmd Timestamp	TSTAMP	1Jan2000 - 31Dec2099	1 sec		3
12EF - 12F1	4848 - 4850	Positive VARs, Meter 12, Min Avg Dmd Timestamp	TSTAMP	1Jan2000 - 31Dec2099	1 sec		3
12F2 - 12F4	4851 - 4853	Negative Watts, Meter 10, Min Avg Dmd Timestamp	TSTAMP	1Jan2000 - 31Dec2099	1 sec		3
12F5 - 12F7	4854 - 4856	Negative Watts, Meter 11, Min Avg Dmd Timestamp	TSTAMP	1Jan2000 - 31Dec2099	1 sec		3
12F8 - 12FA	4857 - 4859	Negative Watts, Meter 12, Min Avg Dmd Timestamp	TSTAMP	1Jan2000 - 31Dec2099	1 sec		3
12FB - 12FD	4860 - 4862	Negative VARs, Meter 10, Min Avg Dmd Timestamp	TSTAMP	1Jan2000 - 31Dec2099	1 sec		3

Modbus Address		Description	Format	Range	Units or Resolution	Comments	# Reg
Hex	Decimal						
12FE - 1300	4863 - 4865	Negative VARs, Meter 11, Min Avg Dmd Timestamp	TSTAMP	1Jan2000 - 31Dec2099	1 sec		3
1301 - 1303	4866 - 4868	Negative VARs, Meter 12, Min Avg Dmd Timestamp	TSTAMP	1Jan2000 - 31Dec2099	1 sec		3
1304 - 1306	4869 - 4871	VAs, Meter 10, Min Avg Dmd Timestamp	TSTAMP	1Jan2000 - 31Dec2099	1 sec		3
1307 - 1309	4872 - 4874	VAs, Meter 11, Min Avg Dmd Timestamp	TSTAMP	1Jan2000 - 31Dec2099	1 sec		3
130A - 130C	4875 - 4877	VAs, Meter 12, Min Avg Dmd Timestamp	TSTAMP	1Jan2000 - 31Dec2099	1 sec		3
130D - 130F	4878 - 4880	Positive PF, Meter 10, Min Avg Dmd Timestamp	TSTAMP	1Jan2000 - 31Dec2099	1 sec		3
1310 - 1312	4881 - 4883	Positive PF, Meter 11, Min Avg Dmd Timestamp	TSTAMP	1Jan2000 - 31Dec2099	1 sec		3
1313 - 1315	4884 - 4886	Positive PF, Meter 12, Min Avg Dmd Timestamp	TSTAMP	1Jan2000 - 31Dec2099	1 sec		3
1316 - 1318	4887 - 4889	Negative PF, Meter 10, Min Avg Dmd Timestamp	TSTAMP	1Jan2000 - 31Dec2099	1 sec		3
1319 - 131B	4890 - 4892	Negative PF, Meter 11, Min Avg Dmd Timestamp	TSTAMP	1Jan2000 - 31Dec2099	1 sec		3
131C - 131E	4893 - 4895	Negative PF, Meter 12, Min Avg Dmd Timestamp	TSTAMP	1Jan2000 - 31Dec2099	1 sec		3
						Block Size:	96
1323 - 1325	4900 - 4902	Amps Meter 13, Min Avg Dmd Timestamp	TSTAMP	1Jan2000 - 31Dec2099	1 sec		3
1326 - 1328	4903 - 4905	Amps Meter 14, Min Avg Dmd Timestamp	TSTAMP	1Jan2000 - 31Dec2099	1 sec		3
1329 - 132B	4906 - 4908	Amps Meter 15, Min Avg Dmd Timestamp	TSTAMP	1Jan2000 - 31Dec2099	1 sec		3
132C - 132E	4909 - 4911	Reserved					3
132F - 1331	4912 - 4914	Reserved					3
1332 - 1334	4915 - 4917	Reserved					3
1335 - 1337	4918 - 4920	Reserved					3
1338 - 133A	4921 - 4923	Reserved					3
133B - 133D	4924 - 4926	Reserved					3
133E - 1340	4927 - 4929	Reserved					3
1341 - 1343	4930 - 4932	Reserved					3
1344 - 1346	4933 - 4935	Positive Watts, Meter 13, Min Avg Dmd Timestamp	TSTAMP	1Jan2000 - 31Dec2099	1 sec		3
1347 - 1349	4936 - 4938	Positive Watts, Meter 14, Min Avg Dmd Timestamp	TSTAMP	1Jan2000 - 31Dec2099	1 sec		3

Modbus Address		Description	Format	Range	Units or Resolution	Comments	# Reg
Hex	Decimal						
134A - 134C	4939 - 4941	Positive Watts, Meter 15, Min Avg Dmd Timestamp	TSTAMP	1Jan2000 - 31Dec2099	1 sec		3
134D - 134F	4942 - 4944	Positive VARs, Meter 13, Min Avg Dmd Timestamp	TSTAMP	1Jan2000 - 31Dec2099	1 sec		3
1350 - 1352	4945 - 4947	Positive VARs, Meter 14, Min Avg Dmd Timestamp	TSTAMP	1Jan2000 - 31Dec2099	1 sec		3
1353 - 1355	4948 - 4950	Positive VARs, Meter 15, Min Avg Dmd Timestamp	TSTAMP	1Jan2000 - 31Dec2099	1 sec		3
1356 - 1358	4951 - 4953	Negative Watts, Meter 13, Min Avg Dmd Timestamp	TSTAMP	1Jan2000 - 31Dec2099	1 sec		3
1359 - 135B	4954 - 4956	Negative Watts, Meter 14, Min Avg Dmd Timestamp	TSTAMP	1Jan2000 - 31Dec2099	1 sec		3
135C - 135E	4957 - 4959	Negative Watts, Meter 15, Min Avg Dmd Timestamp	TSTAMP	1Jan2000 - 31Dec2099	1 sec		3
135F - 1361	4960 - 4962	Negative VARs, Meter 13, Min Avg Dmd Timestamp	TSTAMP	1Jan2000 - 31Dec2099	1 sec		3
1362 - 1364	4963 - 4965	Negative VARs, Meter 14, Min Avg Dmd Timestamp	TSTAMP	1Jan2000 - 31Dec2099	1 sec		3
1365 - 1367	4966 - 4968	Negative VARs, Meter 15, Min Avg Dmd Timestamp	TSTAMP	1Jan2000 - 31Dec2099	1 sec		3
1368 - 136A	4969 - 4971	VAs, Meter 13, Min Avg Dmd Timestamp	TSTAMP	1Jan2000 - 31Dec2099	1 sec		3
136B - 136D	4972 - 4974	VAs, Meter 14, Min Avg Dmd Timestamp	TSTAMP	1Jan2000 - 31Dec2099	1 sec		3
136E - 1370	4975 - 4977	VAs, Meter 15, Min Avg Dmd Timestamp	TSTAMP	1Jan2000 - 31Dec2099	1 sec		3
1371 - 1373	4978 - 4980	Positive PF, Meter 13, Min Avg Dmd Timestamp	TSTAMP	1Jan2000 - 31Dec2099	1 sec		3
1374 - 1376	4981 - 4983	Positive PF, Meter 14, Min Avg Dmd Timestamp	TSTAMP	1Jan2000 - 31Dec2099	1 sec		3
1377 - 1379	4984 - 4986	Positive PF, Meter 15, Min Avg Dmd Timestamp	TSTAMP	1Jan2000 - 31Dec2099	1 sec		3
137A - 137C	4987 - 4989	Negative PF, Meter 13, Min Avg Dmd Timestamp	TSTAMP	1Jan2000 - 31Dec2099	1 sec		3
137D - 137F	4990 - 4992	Negative PF, Meter 14, Min Avg Dmd Timestamp	TSTAMP	1Jan2000 - 31Dec2099	1 sec		3

Modbus Address		Description	Format	Range	Units or Resolution	Comments	# Reg
Hex	Decimal						
1380 - 1382	4993 - 4995	Negative PF, Meter 15, Min Avg Dmd Timestamp	TSTAMP	1Jan2000 - 31Dec2099	1 sec		3
						Block Size:	96
1387 - 1389	5000 - 5002	Amps Meter 16, Min Avg Dmd Timestamp	TSTAMP	1Jan2000 - 31Dec2099	1 sec		3
138A - 138C	5003 - 5005	Amps Meter 17, Min Avg Dmd Timestamp	TSTAMP	1Jan2000 - 31Dec2099	1 sec		3
138D - 138F	5006 - 5008	Amps Meter 18, Min Avg Dmd Timestamp	TSTAMP	1Jan2000 - 31Dec2099	1 sec		3
1390 - 1392	5009 - 5011	Reserved					3
1393 - 1395	5012 - 5014	Reserved					3
1396 - 1398	5015 - 5017	Reserved					3
1399 - 139B	5018 - 5020	Reserved					3
139C - 139E	5021 - 5023	Reserved					3
139F - 13A1	5024 - 5026	Reserved					3
13A2 - 13A4	5027 - 5029	Reserved					3
13A5 - 13A7	5030 - 5032	Reserved					3
13A8 - 13AA	5033 - 5035	Positive Watts, Meter 16, Min Avg Dmd Timestamp	TSTAMP	1Jan2000 - 31Dec2099	1 sec		3
13AB - 13AD	5036 - 5038	Positive Watts, Meter 17, Min Avg Dmd Timestamp	TSTAMP	1Jan2000 - 31Dec2099	1 sec		3
13AE - 13B0	5039 - 5041	Positive Watts, Meter 18, Min Avg Dmd Timestamp	TSTAMP	1Jan2000 - 31Dec2099	1 sec		3
13B1 - 13B3	5042 - 5044	Positive VARs, Meter 16, Min Avg Dmd Timestamp	TSTAMP	1Jan2000 - 31Dec2099	1 sec		3
13B4 - 13B6	5045 - 5047	Positive VARs, Meter 17, Min Avg Dmd Timestamp	TSTAMP	1Jan2000 - 31Dec2099	1 sec		3
13B7 - 13B9	5048 - 5050	Positive VARs, Meter 18, Min Avg Dmd Timestamp	TSTAMP	1Jan2000 - 31Dec2099	1 sec		3
13BA - 13BC	5051 - 5053	Negative Watts, Meter 16, Min Avg Dmd Timestamp	TSTAMP	1Jan2000 - 31Dec2099	1 sec		3
13BD - 13BF	5054 - 5056	Negative Watts, Meter 17, Min Avg Dmd Timestamp	TSTAMP	1Jan2000 - 31Dec2099	1 sec		3
13C0 - 13C2	5057 - 5059	Negative Watts, Meter 18, Min Avg Dmd Timestamp	TSTAMP	1Jan2000 - 31Dec2099	1 sec		3
13C3 - 13C5	5060 - 5062	Negative VARs, Meter 16, Min Avg Dmd Timestamp	TSTAMP	1Jan2000 - 31Dec2099	1 sec		3
13C6 - 13C8	5063 - 5065	Negative VARs, Meter 17, Min Avg Dmd Timestamp	TSTAMP	1Jan2000 - 31Dec2099	1 sec		3

Modbus Address		Description	Format	Range	Units or Resolution	Comments	# Reg
Hex	Decimal						
13C9 - 13CB	5066 - 5068	Negative VARs, Meter 18, Min Avg Dmd Timestamp	TSTAMP	1Jan2000 - 31Dec2099	1 sec		3
13CC - 13CE	5069 - 5071	VAs, Meter 16, Min Avg Dmd Timestamp	TSTAMP	1Jan2000 - 31Dec2099	1 sec		3
13CF - 13D1	5072 - 5074	VAs, Meter 17, Min Avg Dmd Timestamp	TSTAMP	1Jan2000 - 31Dec2099	1 sec		3
13D2 - 13D4	5075 - 5077	VAs, Meter 18, Min Avg Dmd Timestamp	TSTAMP	1Jan2000 - 31Dec2099	1 sec		3
13D5 - 13D7	5078 - 5080	Positive PF, Meter 16, Min Avg Dmd Timestamp	TSTAMP	1Jan2000 - 31Dec2099	1 sec		3
13D8 - 13DA	5081 - 5083	Positive PF, Meter 17, Min Avg Dmd Timestamp	TSTAMP	1Jan2000 - 31Dec2099	1 sec		3
13DB - 13DD	5084 - 5086	Positive PF, Meter 18, Min Avg Dmd Timestamp	TSTAMP	1Jan2000 - 31Dec2099	1 sec		3
13DE - 13E0	5087 - 5089	Negative PF, Meter 16, Min Avg Dmd Timestamp	TSTAMP	1Jan2000 - 31Dec2099	1 sec		3
13E1 - 13E3	5090 - 5092	Negative PF, Meter 17, Min Avg Dmd Timestamp	TSTAMP	1Jan2000 - 31Dec2099	1 sec		3
13E4 - 13E6	5093 - 5095	Negative PF, Meter 18, Min Avg Dmd Timestamp	TSTAMP	1Jan2000 - 31Dec2099	1 sec		3
						Block Size:	96
13EB - 13ED	5100 - 5102	Amps Meter 19, Min Avg Dmd Timestamp	TSTAMP	1Jan2000 - 31Dec2099	1 sec		3
13EE - 13F0	5103 - 5105	Amps Meter 20, Min Avg Dmd Timestamp	TSTAMP	1Jan2000 - 31Dec2099	1 sec		3
13F1 - 13F3	5106 - 5108	Amps Meter 21, Min Avg Dmd Timestamp	TSTAMP	1Jan2000 - 31Dec2099	1 sec		3
13F4 - 13F6	5109 - 5111	Reserved					3
13F7 - 13F9	5112 - 5114	Reserved					3
13FA - 13FC	5115 - 5117	Reserved					3
13FD - 13FF	5118 - 5120	Reserved					3
1400 - 1402	5121 - 5123	Reserved					3
1403 - 1405	5124 - 5126	Reserved					3
1406 - 1408	5127 - 5129	Reserved					3
1409 - 140B	5130 - 5132	Reserved					3
140C - 140E	5133 - 5135	Positive Watts, Meter 19, Min Avg Dmd Timestamp	TSTAMP	1Jan2000 - 31Dec2099	1 sec		3
140F - 1411	5136 - 5138	Positive Watts, Meter 20, Min Avg Dmd Timestamp	TSTAMP	1Jan2000 - 31Dec2099	1 sec		3
1412 - 1414	5139 - 5141	Positive Watts, Meter 21, Min Avg Dmd Timestamp	TSTAMP	1Jan2000 - 31Dec2099	1 sec		3

Modbus Address		Description	Format	Range	Units or Resolution	Comments	# Reg
Hex	Decimal						
1415 - 1417	5142 - 5144	Positive VARs, Meter 19, Min Avg Dmd Timestamp	TSTAMP	1Jan2000 - 31Dec2099	1 sec		3
1418 - 141A	5145 - 5147	Positive VARs, Meter 20, Min Avg Dmd Timestamp	TSTAMP	1Jan2000 - 31Dec2099	1 sec		3
141B - 141D	5148 - 5150	Positive VARs, Meter 21, Min Avg Dmd Timestamp	TSTAMP	1Jan2000 - 31Dec2099	1 sec		3
141E - 1420	5151 - 5153	Negative Watts, Meter 19, Min Avg Dmd Timestamp	TSTAMP	1Jan2000 - 31Dec2099	1 sec		3
1421 - 1423	5154 - 5156	Negative Watts, Meter 20, Min Avg Dmd Timestamp	TSTAMP	1Jan2000 - 31Dec2099	1 sec		3
1424 - 1426	5157 - 5159	Negative Watts, Meter 21, Min Avg Dmd Timestamp	TSTAMP	1Jan2000 - 31Dec2099	1 sec		3
1427 - 1429	5160 - 5162	Negative VARs, Meter 19, Min Avg Dmd Timestamp	TSTAMP	1Jan2000 - 31Dec2099	1 sec		3
142A - 142C	5163 - 5165	Negative VARs, Meter 20, Min Avg Dmd Timestamp	TSTAMP	1Jan2000 - 31Dec2099	1 sec		3
142D - 142F	5166 - 5168	Negative VARs, Meter 21, Min Avg Dmd Timestamp	TSTAMP	1Jan2000 - 31Dec2099	1 sec		3
1430 - 1432	5169 - 5171	VAs, Meter 19, Min Avg Dmd Timestamp	TSTAMP	1Jan2000 - 31Dec2099	1 sec		3
1433 - 1435	5172 - 5174	VAs, Meter 20, Min Avg Dmd Timestamp	TSTAMP	1Jan2000 - 31Dec2099	1 sec		3
1436 - 1438	5175 - 5177	VAs, Meter 21, Min Avg Dmd Timestamp	TSTAMP	1Jan2000 - 31Dec2099	1 sec		3
1439 - 143B	5178 - 5180	Positive PF, Meter 19, Min Avg Dmd Timestamp	TSTAMP	1Jan2000 - 31Dec2099	1 sec		3
143C - 143E	5181 - 5183	Positive PF, Meter 20, Min Avg Dmd Timestamp	TSTAMP	1Jan2000 - 31Dec2099	1 sec		3
143F - 1441	5184 - 5186	Positive PF, Meter 21, Min Avg Dmd Timestamp	TSTAMP	1Jan2000 - 31Dec2099	1 sec		3
1442 - 1444	5187 - 5189	Negative PF, Meter 19, Min Avg Dmd Timestamp	TSTAMP	1Jan2000 - 31Dec2099	1 sec		3
1445 - 1447	5190 - 5192	Negative PF, Meter 20, Min Avg Dmd Timestamp	TSTAMP	1Jan2000 - 31Dec2099	1 sec		3
1448 - 144A	5193 - 5195	Negative PF, Meter 21, Min Avg Dmd Timestamp	TSTAMP	1Jan2000 - 31Dec2099	1 sec		3
						Block Size:	96

Modbus Address		Description	Format	Range	Units or Resolution	Comments	# Reg
Hex	Decimal						
144F - 1451	5200 - 5202	Amps Meter 22, Min Avg Dmd Timestamp	TSTAMP	1Jan2000 - 31Dec2099	1 sec		3
1452 - 1454	5203 - 5205	Amps Meter 23, Min Avg Dmd Timestamp	TSTAMP	1Jan2000 - 31Dec2099	1 sec		3
1455 - 1457	5206 - 5208	Amps Meter 24, Min Avg Dmd Timestamp	TSTAMP	1Jan2000 - 31Dec2099	1 sec		3
1458 - 145A	5209 - 5211	Reserved					3
145B - 145D	5212 - 5214	Reserved					3
145E - 1460	5215 - 5217	Reserved					3
1461 - 1463	5218 - 5220	Reserved					3
1464 - 1466	5221 - 5223	Reserved					3
1467 - 1469	5224 - 5226	Reserved					3
146A - 146C	5227 - 5229	Reserved					3
146D - 146F	5230 - 5232	Reserved					3
1470 - 1472	5233 - 5235	Positive Watts, Meter 22, Min Avg Dmd Timestamp	TSTAMP	1Jan2000 - 31Dec2099	1 sec		3
1473 - 1475	5236 - 5238	Positive Watts, Meter 23, Min Avg Dmd Timestamp	TSTAMP	1Jan2000 - 31Dec2099	1 sec		3
1476 - 1478	5239 - 5241	Positive Watts, Meter 24, Min Avg Dmd Timestamp	TSTAMP	1Jan2000 - 31Dec2099	1 sec		3
1479 - 147B	5242 - 5244	Positive VARs, Meter 22, Min Avg Dmd Timestamp	TSTAMP	1Jan2000 - 31Dec2099	1 sec		3
147C - 147E	5245 - 5247	Positive VARs, Meter 23, Min Avg Dmd Timestamp	TSTAMP	1Jan2000 - 31Dec2099	1 sec		3
147F - 1481	5248 - 5250	Positive VARs, Meter 24, Min Avg Dmd Timestamp	TSTAMP	1Jan2000 - 31Dec2099	1 sec		3
1482 - 1484	5251 - 5253	Negative Watts, Meter 22, Min Avg Dmd Timestamp	TSTAMP	1Jan2000 - 31Dec2099	1 sec		3
1485 - 1487	5254 - 5256	Negative Watts, Meter 23, Min Avg Dmd Timestamp	TSTAMP	1Jan2000 - 31Dec2099	1 sec		3
1488 - 148A	5257 - 5259	Negative Watts, Meter 24, Min Avg Dmd Timestamp	TSTAMP	1Jan2000 - 31Dec2099	1 sec		3
148B - 148D	5260 - 5262	Negative VARs, Meter 22, Min Avg Dmd Timestamp	TSTAMP	1Jan2000 - 31Dec2099	1 sec		3
148E - 1490	5263 - 5265	Negative VARs, Meter 23, Min Avg Dmd Timestamp	TSTAMP	1Jan2000 - 31Dec2099	1 sec		3
1491 - 1493	5266 - 5268	Negative VARs, Meter 24, Min Avg Dmd Timestamp	TSTAMP	1Jan2000 - 31Dec2099	1 sec		3

Modbus Address		Description	Format	Range	Units or Resolution	Comments	# Reg
Hex	Decimal						
1494 - 1496	5269 - 5271	VAs, Meter 22, Min Avg Dmd Timestamp	TSTAMP	1Jan2000 - 31Dec2099	1 sec		3
1497 - 1499	5272 - 5274	VAs, Meter 23, Min Avg Dmd Timestamp	TSTAMP	1Jan2000 - 31Dec2099	1 sec		3
149A - 149C	5275 - 5277	VAs, Meter 24, Min Avg Dmd Timestamp	TSTAMP	1Jan2000 - 31Dec2099	1 sec		3
149D - 149F	5278 - 5280	Positive PF, Meter 22, Min Avg Dmd Timestamp	TSTAMP	1Jan2000 - 31Dec2099	1 sec		3
14A0 - 14A2	5281 - 5283	Positive PF, Meter 23, Min Avg Dmd Timestamp	TSTAMP	1Jan2000 - 31Dec2099	1 sec		3
14A3 - 14A5	5284 - 5286	Positive PF, Meter 24, Min Avg Dmd Timestamp	TSTAMP	1Jan2000 - 31Dec2099	1 sec		3
14A6 - 14A8	5287 - 5289	Negative PF, Meter 22, Min Avg Dmd Timestamp	TSTAMP	1Jan2000 - 31Dec2099	1 sec		3
14A9 - 14AB	5290 - 5292	Negative PF, Meter 23, Min Avg Dmd Timestamp	TSTAMP	1Jan2000 - 31Dec2099	1 sec		3
14AC - 14AE	5293 - 5295	Negative PF, Meter 24, Min Avg Dmd Timestamp	TSTAMP	1Jan2000 - 31Dec2099	1 sec		3
Block Size:							96
Short term Primary Maximum Block							read-only
14B3 - 14B4	5300 - 5301	Volts previous Demand interval Short Term Maximum	FLOAT	0 to 9999 M	volts	Maximum instantaneous value measured during the demand interval before the one most recently completed.	2
14B5 - 14B6	5302 - 5303	Reserved					2
14B7 - 14B8	5304 - 5305	Reserved					2
14B9 - 14BA	5306 - 5307	Reserved					2
14BB - 14BC	5308 - 5309	Reserved					2
14BD - 14BE	5310 - 5311	Reserved					2
14BF - 14C0	5312 - 5313	Volts , Maximum	FLOAT	0 to 9999 M	volts	Maximum instantaneous value measured during the most recently completed demand interval.	2
14C1 - 14C2	5314 - 5315	Reserved					2
14C3 - 14C4	5316 - 5317	Reserved					2
14C5 - 14C6	5318 - 5319	Reserved					2
14C7 - 14C8	5320 - 5321	Reserved					2
14C9 - 14CA	5322 - 5323	Volts , Maximum	FLOAT	0 to 9999 M	volts		2
Block Size:							24
Primary Maximum Block (Voltage and frequency)							read-only
14D1 - 14D2	5330 - 5331	Volts A-N, Maximum	FLOAT	0 to 9999 M	volts		2
14D3 - 14D4	5332 - 5333	Reserved					2
14D5 - 14D6	5334 - 5335	Reserved					2
14D7 - 14D8	5336 - 5337	Reserved					2
14D9 - 14DA	5338 - 5339	Reserved					2
14DB - 14DC	5340 - 5341	Reserved					2

Modbus Address		Description	Format	Range	Units or Resolution	Comments	# Reg
Hex	Decimal						
14DD - 14DE	5342 - 5343	Frequency, Maximum	FLOAT	0 to 65.00	Hz		2
						Block Size:	14
Primary Maximum Block						read-only	
1517 - 1518	5400 - 5401	Amps Meter 1, Maximum Avg Demand	FLOAT	0 to 9999 M	amps		2
1519 - 151A	5402 - 5403	Amps Meter 2, Maximum Avg Demand	FLOAT	0 to 9999 M	amps		2
151B - 151C	5404 - 5405	Amps Meter 3, Maximum Avg Demand	FLOAT	0 to 9999 M	amps		2
151D - 151E	5406 - 5407	Reserved					2
151F - 1520	5408 - 5409	Reserved					2
1521 - 1522	5410 - 5411	Reserved					2
1523 - 1524	5412 - 5413	Reserved					2
1525 - 1526	5414 - 5415	Reserved					2
1527 - 1528	5416 - 5417	Reserved					2
1529 - 152A	5418 - 5419	Reserved					2
152B - 152C	5420 - 5421	Reserved					2
152D - 152E	5422 - 5423	Positive Watts, Meter 1, Maximum Avg Demand	FLOAT	-9999 M to +9999 M	watts		2
152F - 1530	5424 - 5425	Positive Watts, Meter 2, Maximum Avg Demand	FLOAT	-9999 M to +9999 M	watts		2
1531 - 1532	5426 - 5427	Positive Watts, Meter 3, Maximum Avg Demand	FLOAT	-9999 M to +9999 M	watts		2
1533 - 1534	5428 - 5429	Positive VARs, Meter 1, Maximum Avg Demand	FLOAT	-9999 M to +9999 M	VARs		2
1535 - 1536	5430 - 5431	Positive VARs, Meter 2, Maximum Avg Demand	FLOAT	-9999 M to +9999 M	VARs		2
1537 - 1538	5432 - 5433	Positive VARs, Meter 3, Maximum Avg Demand	FLOAT	-9999 M to +9999 M	VARs		2
1539 - 153A	5434 - 5435	Negative Watts, Meter 1, Maximum Avg Demand	FLOAT	-9999 M to +9999 M	watts		2
153B - 153C	5436 - 5437	Negative Watts, Meter 2, Maximum Avg Demand	FLOAT	-9999 M to +9999 M	watts		2
153D - 153E	5438 - 5439	Negative Watts, Meter 3, Maximum Avg Demand	FLOAT	-9999 M to +9999 M	watts		2
153F - 1540	5440 - 5441	Negative VARs, Meter 1, Maximum Avg Demand	FLOAT	-9999 M to +9999 M	VARs		2

Modbus Address		Description	Format	Range	Units or Resolution	Comments	# Reg
Hex	Decimal						
1541 - 1542	5442 - 5443	Negative VARs, Meter 2, Maximum Avg Demand	FLOAT	-9999 M to +9999 M	VARs		2
1543 - 1544	5444 - 5445	Negative VARs, Meter 3, Maximum Avg Demand	FLOAT	-9999 M to +9999 M	VARs		2
1545 - 1546	5446 - 5447	VAs, Meter 1, Maximum Avg Demand	FLOAT	-9999 M to +9999 M	VAs		2
1547 - 1548	5448 - 5449	VAs, Meter 2, Maximum Avg Demand	FLOAT	-9999 M to +9999 M	VAs		2
1549 - 154A	5450 - 5451	VAs, Meter 3, Maximum Avg Demand	FLOAT	-9999 M to +9999 M	VAs		2
154B - 154C	5452 - 5453	Positive PF, Meter 1, Maximum Avg Demand	FLOAT	-1.00 to +1.00	none		2
154D - 154E	5454 - 5455	Positive PF, Meter 2, Maximum Avg Demand	FLOAT	-1.00 to +1.00	none		2
154F - 1550	5456 - 5457	Positive PF, Meter 3, Maximum Avg Demand	FLOAT	-1.00 to +1.00	none		2
1551 - 1552	5458 - 5459	Negative PF, Meter 1, Maximum Avg Demand	FLOAT	-1.00 to +1.00	none		2
1553 - 1554	5460 - 5461	Negative PF, Meter 2, Maximum Avg Demand	FLOAT	-1.00 to +1.00	none		2
1555 - 1556	5462 - 5463	Negative PF, Meter 3, Maximum Avg Demand	FLOAT	-1.00 to +1.00	none		2
						Block Size:	64
157B - 157C	5500 - 5501	Amps Meter 4, Maximum Avg Demand	FLOAT	0 to 9999 M	amps		2
157D - 157E	5502 - 5503	Amps Meter 5, Maximum Avg Demand	FLOAT	0 to 9999 M	amps		2
157F - 1580	5504 - 5505	Amps Meter 6, Maximum Avg Demand	FLOAT	0 to 9999 M	amps		2
1581 - 1582	5506 - 5507	Reserved					2
1583 - 1584	5508 - 5509	Reserved					2
1585 - 1586	5510 - 5511	Reserved					2
1587 - 1588	5512 - 5513	Reserved					2
1589 - 158A	5514 - 5515	Reserved					2
158B - 158C	5516 - 5517	Reserved					2
158D - 158E	5518 - 5519	Reserved					2
158F - 1590	5520 - 5521	Reserved					2
1591 - 1592	5522 - 5523	Positive Watts, Meter 4, Maximum Avg Demand	FLOAT	-9999 M to +9999 M	watts		2
1593 - 1594	5524 - 5525	Positive Watts, Meter 5, Maximum Avg Demand	FLOAT	-9999 M to +9999 M	watts		2

Modbus Address		Description	Format	Range	Units or Resolution	Comments	# Reg
Hex	Decimal						
1595 - 1596	5526 - 5527	Positive Watts, Meter 6, Maximum Avg Demand	FLOAT	-9999 M to +9999 M	watts		2
1597 - 1598	5528 - 5529	Positive VARs, Meter 4, Maximum Avg Demand	FLOAT	-9999 M to +9999 M	VARs		2
1599 - 159A	5530 - 5531	Positive VARs, Meter 5, Maximum Avg Demand	FLOAT	-9999 M to +9999 M	VARs		2
159B - 159C	5532 - 5533	Positive VARs, Meter 6, Maximum Avg Demand	FLOAT	-9999 M to +9999 M	VARs		2
159D - 159E	5534 - 5535	Negative Watts, Meter 4, Maximum Avg Demand	FLOAT	-9999 M to +9999 M	watts		2
159F - 15A0	5536 - 5537	Negative Watts, Meter 5, Maximum Avg Demand	FLOAT	-9999 M to +9999 M	watts		2
15A1 - 15A2	5538 - 5539	Negative Watts, Meter 6, Maximum Avg Demand	FLOAT	-9999 M to +9999 M	watts		2
15A3 - 15A4	5540 - 5541	Negative VARs, Meter 4, Maximum Avg Demand	FLOAT	-9999 M to +9999 M	VARs		2
15A5 - 15A6	5542 - 5543	Negative VARs, Meter 5, Maximum Avg Demand	FLOAT	-9999 M to +9999 M	VARs		2
15A7 - 15A8	5544 - 5545	Negative VARs, Meter 6, Maximum Avg Demand	FLOAT	-9999 M to +9999 M	VARs		2
15A9 - 15AA	5546 - 5547	VAs, Meter 4, Maximum Avg Demand	FLOAT	-9999 M to +9999 M	VAs		2
15AB - 15AC	5548 - 5549	VAs, Meter 5, Maximum Avg Demand	FLOAT	-9999 M to +9999 M	VAs		2
15AD - 15AE	5550 - 5551	VAs, Meter 6, Maximum Avg Demand	FLOAT	-9999 M to +9999 M	VAs		2
15AF - 15B0	5552 - 5553	Positive PF, Meter 4, Maximum Avg Demand	FLOAT	-1.00 to +1.00	none		2
15B1 - 15B2	5554 - 5555	Positive PF, Meter 5, Maximum Avg Demand	FLOAT	-1.00 to +1.00	none		2
15B3 - 15B4	5556 - 5557	Positive PF, Meter 6, Maximum Avg Demand	FLOAT	-1.00 to +1.00	none		2
15B5 - 15B6	5558 - 5559	Negative PF, Meter 4, Maximum Avg Demand	FLOAT	-1.00 to +1.00	none		2
15B7 - 15B8	5560 - 5561	Negative PF, Meter 5, Maximum Avg Demand	FLOAT	-1.00 to +1.00	none		2
15B9 - 15BA	5562 - 5563	Negative PF, Meter 6, Maximum Avg Demand	FLOAT	-1.00 to +1.00	none		2
						Block Size:	64
15DF - 15E0	5600 - 5601	Amps Meter 7, Maximum Avg Demand	FLOAT	0 to 9999 M	amps		2
15E1 - 15E2	5602 - 5603	Amps Meter 8, Maximum Avg Demand	FLOAT	0 to 9999 M	amps		2

Modbus Address		Description	Format	Range	Units or Resolution	Comments	# Reg
Hex	Decimal						
15E3 - 15E4	5604 - 5605	Amps Meter 9, Maximum Avg Demand	FLOAT	0 to 9999 M	amps		2
15E5 - 15E6	5606 - 5607	Reserved					2
15E7 - 15E8	5608 - 5609	Reserved					2
15E9 - 15EA	5610 - 5611	Reserved					2
15EB - 15EC	5612 - 5613	Reserved					2
15ED - 15EE	5614 - 5615	Reserved					2
15EF - 15F0	5616 - 5617	Reserved					2
15F1 - 15F2	5618 - 5619	Reserved					2
15F3 - 15F4	5620 - 5621	Reserved					2
15F5 - 15F6	5622 - 5623	Positive Watts, Meter 7, Maximum Avg Demand	FLOAT	-9999 M to +9999 M	watts		2
15F7 - 15F8	5624 - 5625	Positive Watts, Meter 8, Maximum Avg Demand	FLOAT	-9999 M to +9999 M	watts		2
15F9 - 15FA	5626 - 5627	Positive Watts, Meter 9, Maximum Avg Demand	FLOAT	-9999 M to +9999 M	watts		2
15FB - 15FC	5628 - 5629	Positive VARs, Meter 7, Maximum Avg Demand	FLOAT	-9999 M to +9999 M	VARs		2
15FD - 15FE	5630 - 5631	Positive VARs, Meter 8, Maximum Avg Demand	FLOAT	-9999 M to +9999 M	VARs		2
15FF - 1600	5632 - 5633	Positive VARs, Meter 9, Maximum Avg Demand	FLOAT	-9999 M to +9999 M	VARs		2
1601 - 1602	5634 - 5635	Negative Watts, Meter 7, Maximum Avg Demand	FLOAT	-9999 M to +9999 M	watts		2
1603 - 1604	5636 - 5637	Negative Watts, Meter 8, Maximum Avg Demand	FLOAT	-9999 M to +9999 M	watts		2
1605 - 1606	5638 - 5639	Negative Watts, Meter 9, Maximum Avg Demand	FLOAT	-9999 M to +9999 M	watts		2
1607 - 1608	5640 - 5641	Negative VARs, Meter 7, Maximum Avg Demand	FLOAT	-9999 M to +9999 M	VARs		2
1609 - 160A	5642 - 5643	Negative VARs, Meter 8, Maximum Avg Demand	FLOAT	-9999 M to +9999 M	VARs		2
160B - 160C	5644 - 5645	Negative VARs, Meter 9, Maximum Avg Demand	FLOAT	-9999 M to +9999 M	VARs		2
160D - 160E	5646 - 5647	VAs, Meter 7, Maximum Avg Demand	FLOAT	-9999 M to +9999 M	VAs		2
160F - 1610	5648 - 5649	VAs, Meter 8, Maximum Avg Demand	FLOAT	-9999 M to +9999 M	VAs		2
1611 - 1612	5650 - 5651	VAs, Meter 9, Maximum Avg Demand	FLOAT	-9999 M to +9999 M	VAs		2
1613 - 1614	5652 - 5653	Positive PF, Meter 7, Maximum Avg Demand	FLOAT	-1.00 to +1.00	none		2

Modbus Address		Description	Format	Range	Units or Resolution	Comments	# Reg
Hex	Decimal						
1615 - 1616	5654 - 5655	Positive PF, Meter 8, Maximum Avg Demand	FLOAT	-1.00 to +1.00	none		2
1617 - 1618	5656 - 5657	Positive PF, Meter 9, Maximum Avg Demand	FLOAT	-1.00 to +1.00	none		2
1619 - 161A	5658 - 5659	Negative PF, Meter 7, Maximum Avg Demand	FLOAT	-1.00 to +1.00	none		2
161B - 161C	5660 - 5661	Negative PF, Meter 8, Maximum Avg Demand	FLOAT	-1.00 to +1.00	none		2
161D - 161E	5662 - 5663	Negative PF, Meter 9, Maximum Avg Demand	FLOAT	-1.00 to +1.00	none		2
						Block Size:	64
1643 - 1644	5700 - 5701	Amps Meter 10, Maximum Avg Demand	FLOAT	0 to 9999 M	amps		2
1645 - 1646	5702 - 5703	Amps Meter 11, Maximum Avg Demand	FLOAT	0 to 9999 M	amps		2
1647 - 1648	5704 - 5705	Amps Meter 12, Maximum Avg Demand	FLOAT	0 to 9999 M	amps		2
1649 - 164A	5706 - 5707	Reserved					2
164B - 164C	5708 - 5709	Reserved					2
164D - 164E	5710 - 5711	Reserved					2
164F - 1650	5712 - 5713	Reserved					2
1651 - 1652	5714 - 5715	Reserved					2
1653 - 1654	5716 - 5717	Reserved					2
1655 - 1656	5718 - 5719	Reserved					2
1657 - 1658	5720 - 5721	Reserved					2
1659 - 165A	5722 - 5723	Positive Watts, Meter 10 , Maximum Avg Demand	FLOAT	-9999 M to +9999 M	watts		2
165B - 165C	5724 - 5725	Positive Watts, Meter 11, Maximum Avg Demand	FLOAT	-9999 M to +9999 M	watts		2
165D - 165E	5726 - 5727	Positive Watts, Meter 12, Maximum Avg Demand	FLOAT	-9999 M to +9999 M	watts		2
165F - 1660	5728 - 5729	Positive VARs, Meter 10, Maximum Avg Demand	FLOAT	-9999 M to +9999 M	VARs		2
1661 - 1662	5730 - 5731	Positive VARs, Meter 11, Maximum Avg Demand	FLOAT	-9999 M to +9999 M	VARs		2
1663 - 1664	5732 - 5733	Positive VARs, Meter 12, Maximum Avg Demand	FLOAT	-9999 M to +9999 M	VARs		2
1665 - 1666	5734 - 5735	Negative Watts, Meter 10, Maximum Avg Demand	FLOAT	-9999 M to +9999 M	watts		2
1667 - 1668	5736 - 5737	Negative Watts, Meter 11, Maximum Avg Demand	FLOAT	-9999 M to +9999 M	watts		2

Modbus Address		Description	Format	Range	Units or Resolution	Comments	# Reg
Hex	Decimal						
1669 - 166A	5738 - 5739	Negative Watts, Meter 12, Maximum Avg Demand	FLOAT	-9999 M to +9999 M	watts		2
166B - 166C	5740 - 5741	Negative VARs, Meter 10, Maximum Avg Demand	FLOAT	-9999 M to +9999 M	VARs		2
166D - 166E	5742 - 5743	Negative VARs, Meter 11, Maximum Avg Demand	FLOAT	-9999 M to +9999 M	VARs		2
166F - 1670	5744 - 5745	Negative VARs, Meter 12, Maximum Avg Demand	FLOAT	-9999 M to +9999 M	VARs		2
1671 - 1672	5746 - 5747	VAs, Meter 10, Maximum Avg Demand	FLOAT	-9999 M to +9999 M	VAs		2
1673 - 1674	5748 - 5749	VAs, Meter 11, Maximum Avg Demand	FLOAT	-9999 M to +9999 M	VAs		2
1675 - 1676	5750 - 5751	VAs, Meter 12, Maximum Avg Demand	FLOAT	-9999 M to +9999 M	VAs		2
1677 - 1678	5752 - 5753	Positive PF, Meter 10, Maximum Avg Demand	FLOAT	-1.00 to +1.00	none		2
1679 - 167A	5754 - 5755	Positive PF, Meter 11, Maximum Avg Demand	FLOAT	-1.00 to +1.00	none		2
167B - 167C	5756 - 5757	Positive PF, Meter 12, Maximum Avg Demand	FLOAT	-1.00 to +1.00	none		2
167D - 167E	5758 - 5759	Negative PF, Meter 10, Maximum Avg Demand	FLOAT	-1.00 to +1.00	none		2
167F - 1680	5760 - 5761	Negative PF, Meter 11, Maximum Avg Demand	FLOAT	-1.00 to +1.00	none		2
1681 - 1682	5762 - 5763	Negative PF, Meter 12, Maximum Avg Demand	FLOAT	-1.00 to +1.00	none		2
						Block Size:	64
16A7 - 16A8	5800 - 5801	Amps Meter 13, Maximum Avg Demand	FLOAT	0 to 9999 M	amps		2
16A9 - 16AA	5802 - 5803	Amps Meter 14, Maximum Avg Demand	FLOAT	0 to 9999 M	amps		2
16AB - 16AC	5804 - 5805	Amps Meter 15, Maximum Avg Demand	FLOAT	0 to 9999 M	amps		2
16AD - 16AE	5806 - 5807	Reserved					2
16AF - 16B0	5808 - 5809	Reserved					2
16B1 - 16B2	5810 - 5811	Reserved					2
16B3 - 16B4	5812 - 5813	Reserved					2
16B5 - 16B6	5814 - 5815	Reserved					2
16B7 - 16B8	5816 - 5817	Reserved					2
16B9 - 16BA	5818 - 5819	Reserved					2
16BB - 16BC	5820 - 5821	Reserved					2

Modbus Address		Description	Format	Range	Units or Resolution	Comments	# Reg
Hex	Decimal						
16BD - 16BE	5822 - 5823	Positive Watts, Meter 13, Maximum Avg Demand	FLOAT	-9999 M to +9999 M	watts		2
16BF - 16C0	5824 - 5825	Positive Watts, Meter 14, Maximum Avg Demand	FLOAT	-9999 M to +9999 M	watts		2
16C1 - 16C2	5826 - 5827	Positive Watts, Meter 15, Maximum Avg Demand	FLOAT	-9999 M to +9999 M	watts		2
16C3 - 16C4	5828 - 5829	Positive VARs, Meter 13, Maximum Avg Demand	FLOAT	-9999 M to +9999 M	VARs		2
16C5 - 16C6	5830 - 5831	Positive VARs, Meter 14, Maximum Avg Demand	FLOAT	-9999 M to +9999 M	VARs		2
16C7 - 16C8	5832 - 5833	Positive VARs, Meter 15, Maximum Avg Demand	FLOAT	-9999 M to +9999 M	VARs		2
16C9 - 16CA	5834 - 5835	Negative Watts, Meter 13, Maximum Avg Demand	FLOAT	-9999 M to +9999 M	watts		2
16CB - 16CC	5836 - 5837	Negative Watts, Meter 14, Maximum Avg Demand	FLOAT	-9999 M to +9999 M	watts		2
16CD - 16CE	5838 - 5839	Negative Watts, Meter 15, Maximum Avg Demand	FLOAT	-9999 M to +9999 M	watts		2
16CF - 16D0	5840 - 5841	Negative VARs, Meter 13, Maximum Avg Demand	FLOAT	-9999 M to +9999 M	VARs		2
16D1 - 16D2	5842 - 5843	Negative VARs, Meter 14, Maximum Avg Demand	FLOAT	-9999 M to +9999 M	VARs		2
16D3 - 16D4	5844 - 5845	Negative VARs, Meter 15, Maximum Avg Demand	FLOAT	-9999 M to +9999 M	VARs		2
16D5 - 16D6	5846 - 5847	VAs, Meter 13, Maximum Avg Demand	FLOAT	-9999 M to +9999 M	VAs		2
16D7 - 16D8	5848 - 5849	VAs, Meter 14, Maximum Avg Demand	FLOAT	-9999 M to +9999 M	VAs		2
16D9 - 16DA	5850 - 5851	VAs, Meter 15, Maximum Avg Demand	FLOAT	-9999 M to +9999 M	VAs		2
16DB - 16DC	5852 - 5853	Positive PF, Meter 13, Maximum Avg Demand	FLOAT	-1.00 to +1.00	none		2
16DD - 16DE	5854 - 5855	Positive PF, Meter 14, Maximum Avg Demand	FLOAT	-1.00 to +1.00	none		2
16DF - 16E0	5856 - 5857	Positive PF, Meter 15, Maximum Avg Demand	FLOAT	-1.00 to +1.00	none		2
16E1 - 16E2	5858 - 5859	Negative PF, Meter 13, Maximum Avg Demand	FLOAT	-1.00 to +1.00	none		2
16E3 - 16E4	5860 - 5861	Negative PF, Meter 14, Maximum Avg Demand	FLOAT	-1.00 to +1.00	none		2
16E5 - 16E6	5862 - 5863	Negative PF, Meter 15, Maximum Avg Demand	FLOAT	-1.00 to +1.00	none		2
						Block Size:	64

Modbus Address		Description	Format	Range	Units or Resolution	Comments	# Reg
Hex	Decimal						
170B - 170C	5900 - 5901	Amps Meter 16, Maximum Avg Demand	FLOAT	0 to 9999 M	amps		2
170D - 170E	5902 - 5903	Amps Meter 17, Maximum Avg Demand	FLOAT	0 to 9999 M	amps		2
170F - 1710	5904 - 5905	Amps Meter 18, Maximum Avg Demand	FLOAT	0 to 9999 M	amps		2
1711 - 1712	5906 - 5907	Reserved					2
1713 - 1714	5908 - 5909	Reserved					2
1715 - 1716	5910 - 5911	Reserved					2
1717 - 1718	5912 - 5913	Reserved					2
1719 - 171A	5914 - 5915	Reserved					2
171B - 171C	5916 - 5917	Reserved					2
171D - 171E	5918 - 5919	Reserved					2
171F - 1720	5920 - 5921	Reserved					2
1721 - 1722	5922 - 5923	Positive Watts, Meter 16, Maximum Avg Demand	FLOAT	-9999 M to +9999 M	watts		2
1723 - 1724	5924 - 5925	Positive Watts, Meter 17, Maximum Avg Demand	FLOAT	-9999 M to +9999 M	watts		2
1725 - 1726	5926 - 5927	Positive Watts, Meter 18, Maximum Avg Demand	FLOAT	-9999 M to +9999 M	watts		2
1727 - 1728	5928 - 5929	Positive VARs, Meter 16, Maximum Avg Demand	FLOAT	-9999 M to +9999 M	VARs		2
1729 - 172A	5930 - 5931	Positive VARs, Meter 17, Maximum Avg Demand	FLOAT	-9999 M to +9999 M	VARs		2
172B - 172C	5932 - 5933	Positive VARs, Meter 18, Maximum Avg Demand	FLOAT	-9999 M to +9999 M	VARs		2
172D - 172E	5934 - 5935	Negative Watts, Meter 16, Maximum Avg Demand	FLOAT	-9999 M to +9999 M	watts		2
172F - 1730	5936 - 5937	Negative Watts, Meter 17, Maximum Avg Demand	FLOAT	-9999 M to +9999 M	watts		2
1731 - 1732	5938 - 5939	Negative Watts, Meter 18, Maximum Avg Demand	FLOAT	-9999 M to +9999 M	watts		2
1733 - 1734	5940 - 5941	Negative VARs, Meter 16, Maximum Avg Demand	FLOAT	-9999 M to +9999 M	VARs		2
1735 - 1736	5942 - 5943	Negative VARs, Meter 17, Maximum Avg Demand	FLOAT	-9999 M to +9999 M	VARs		2
1737 - 1738	5944 - 5945	Negative VARs, Meter 18, Maximum Avg Demand	FLOAT	-9999 M to +9999 M	VARs		2
1739 - 173A	5946 - 5947	VAs, Meter 16, Maximum Avg Demand	FLOAT	-9999 M to +9999 M	VAs		2
173B - 173C	5948 - 5949	VAs, Meter 17, Maximum Avg Demand	FLOAT	-9999 M to +9999 M	VAs		2

Modbus Address		Description	Format	Range	Units or Resolution	Comments	# Reg
Hex	Decimal						
173D - 173E	5950 - 5951	VAs, Meter 18, Maximum Avg Demand	FLOAT	-9999 M to +9999 M	VAs		2
173F - 1740	5952 - 5953	Positive PF, Meter 16, Maximum Avg Demand	FLOAT	-1.00 to +1.00	none		2
1741 - 1742	5954 - 5955	Positive PF, Meter 17, Maximum Avg Demand	FLOAT	-1.00 to +1.00	none		2
1743 - 1744	5956 - 5957	Positive PF, Meter 18, Maximum Avg Demand	FLOAT	-1.00 to +1.00	none		2
1745 - 1746	5958 - 5959	Negative PF, Meter 16, Maximum Avg Demand	FLOAT	-1.00 to +1.00	none		2
1747 - 1748	5960 - 5961	Negative PF, Meter 17, Maximum Avg Demand	FLOAT	-1.00 to +1.00	none		2
1749 - 174A	5962 - 5963	Negative PF, Meter 18, Maximum Avg Demand	FLOAT	-1.00 to +1.00	none		2
						Block Size:	64
176F - 1770	6000 - 6001	Amps Meter 19, Maximum Avg Demand	FLOAT	0 to 9999 M	amps		2
1771 - 1772	6002 - 6003	Amps Meter 20, Maximum Avg Demand	FLOAT	0 to 9999 M	amps		2
1773 - 1774	6004 - 6005	Amps Meter 21, Maximum Avg Demand	FLOAT	0 to 9999 M	amps		2
1775 - 1776	6006 - 6007	Reserved					2
1777 - 1778	6008 - 6009	Reserved					2
1779 - 177A	6010 - 6011	Reserved					2
177B - 177C	6012 - 6013	Reserved					2
177D - 177E	6014 - 6015	Reserved					2
177F - 1780	6016 - 6017	Reserved					2
1781 - 1782	6018 - 6019	Reserved					2
1783 - 1784	6020 - 6021	Reserved					2
1785 - 1786	6022 - 6023	Positive Watts, Meter 19, Maximum Avg Demand	FLOAT	-9999 M to +9999 M	watts		2
1787 - 1788	6024 - 6025	Positive Watts, Meter 20, Maximum Avg Demand	FLOAT	-9999 M to +9999 M	watts		2
1789 - 178A	6026 - 6027	Positive Watts, Meter 21, Maximum Avg Demand	FLOAT	-9999 M to +9999 M	watts		2
178B - 178C	6028 - 6029	Positive VARs, Meter 19, Maximum Avg Demand	FLOAT	-9999 M to +9999 M	VARs		2
178D - 178E	6030 - 6031	Positive VARs, Meter 20, Maximum Avg Demand	FLOAT	-9999 M to +9999 M	VARs		2
178F - 1790	6032 - 6033	Positive VARs, Meter 21, Maximum Avg Demand	FLOAT	-9999 M to +9999 M	VARs		2

Modbus Address		Description	Format	Range	Units or Resolution	Comments	# Reg
Hex	Decimal						
1791 - 1792	6034 - 6035	Negative Watts, Meter 19, Maximum Avg Demand	FLOAT	-9999 M to +9999 M	watts		2
1793 - 1794	6036 - 6037	Negative Watts, Meter 20, Maximum Avg Demand	FLOAT	-9999 M to +9999 M	watts		2
1795 - 1796	6038 - 6039	Negative Watts, Meter 21, Maximum Avg Demand	FLOAT	-9999 M to +9999 M	watts		2
1797 - 1798	6040 - 6041	Negative VARs, Meter 19, Maximum Avg Demand	FLOAT	-9999 M to +9999 M	VARs		2
1799 - 179A	6042 - 6043	Negative VARs, Meter 20, Maximum Avg Demand	FLOAT	-9999 M to +9999 M	VARs		2
179B - 179C	6044 - 6045	Negative VARs, Meter 21, Maximum Avg Demand	FLOAT	-9999 M to +9999 M	VARs		2
179D - 179E	6046 - 6047	VAs, Meter 19, Maximum Avg Demand	FLOAT	-9999 M to +9999 M	VAs		2
179F - 17A0	6048 - 6049	VAs, Meter 20, Maximum Avg Demand	FLOAT	-9999 M to +9999 M	VAs		2
17A1 - 17A2	6050 - 6051	VAs, Meter 21, Maximum Avg Demand	FLOAT	-9999 M to +9999 M	VAs		2
17A3 - 17A4	6052 - 6053	Positive PF, Meter 19, Maximum Avg Demand	FLOAT	-1.00 to +1.00	none		2
17A5 - 17A6	6054 - 6055	Positive PF, Meter 20, Maximum Avg Demand	FLOAT	-1.00 to +1.00	none		2
17A7 - 17A8	6056 - 6057	Positive PF, Meter 21, Maximum Avg Demand	FLOAT	-1.00 to +1.00	none		2
17A9 - 17AA	6058 - 6059	Negative PF, Meter 19, Maximum Avg Demand	FLOAT	-1.00 to +1.00	none		2
17AB - 17AC	6060 - 6061	Negative PF, Meter 20, Maximum Avg Demand	FLOAT	-1.00 to +1.00	none		2
17AD - 17AE	6062 - 6063	Negative PF, Meter 21, Maximum Avg Demand	FLOAT	-1.00 to +1.00	none		2
						Block Size:	64
17D3 - 17D4	6100 - 6101	Amps Meter 22, Maximum Avg Demand	FLOAT	0 to 9999 M	amps		2
17D5 - 17D6	6102 - 6103	Amps Meter 23, Maximum Avg Demand	FLOAT	0 to 9999 M	amps		2
17D7 - 17D8	6104 - 6105	Amps Meter 24, Maximum Avg Demand	FLOAT	0 to 9999 M	amps		2
17D9 - 17DA	6106 - 6107	Reserved					2
17DB - 17DC	6108 - 6109	Reserved					2
17DD - 17DE	6110 - 6111	Reserved					2
17DF - 17E0	6112 - 6113	Reserved					2
17E1 - 17E2	6114 - 6115	Reserved					2

Modbus Address		Description	Format	Range	Units or Resolution	Comments	# Reg
Hex	Decimal						
17E3 - 17E4	6116 - 6117	Reserved					2
17E5 - 17E6	6118 - 6119	Reserved					2
17E7 - 17E8	6120 - 6121	Reserved					2
17E9 - 17EA	6122 - 6123	Positive Watts, Meter 22, Maximum Avg Demand	FLOAT	-9999 M to +9999 M	watts		2
17EB - 17EC	6124 - 6125	Positive Watts, Meter 23, Maximum Avg Demand	FLOAT	-9999 M to +9999 M	watts		2
17ED - 17EE	6126 - 6127	Positive Watts, Meter 24, Maximum Avg Demand	FLOAT	-9999 M to +9999 M	watts		2
17EF - 17F0	6128 - 6129	Positive VARs, Meter 22, Maximum Avg Demand	FLOAT	-9999 M to +9999 M	VARs		2
17F1 - 17F2	6130 - 6131	Positive VARs, Meter 23, Maximum Avg Demand	FLOAT	-9999 M to +9999 M	VARs		2
17F3 - 17F4	6132 - 6133	Positive VARs, Meter 24, Maximum Avg Demand	FLOAT	-9999 M to +9999 M	VARs		2
17F5 - 17F6	6134 - 6135	Negative Watts, Meter 22, Maximum Avg Demand	FLOAT	-9999 M to +9999 M	watts		2
17F7 - 17F8	6136 - 6137	Negative Watts, Meter 23, Maximum Avg Demand	FLOAT	-9999 M to +9999 M	watts		2
17F9 - 17FA	6138 - 6139	Negative Watts, Meter 24, Maximum Avg Demand	FLOAT	-9999 M to +9999 M	watts		2
17FB - 17FC	6140 - 6141	Negative VARs, Meter 22, Maximum Avg Demand	FLOAT	-9999 M to +9999 M	VARs		2
17FD - 17FE	6142 - 6143	Negative VARs, Meter 23, Maximum Avg Demand	FLOAT	-9999 M to +9999 M	VARs		2
17FF - 1800	6144 - 6145	Negative VARs, Meter 24, Maximum Avg Demand	FLOAT	-9999 M to +9999 M	VARs		2
1801 - 1802	6146 - 6147	VAs, Meter 22, Maximum Avg Demand	FLOAT	-9999 M to +9999 M	VAs		2
1803 - 1804	6148 - 6149	VAs, Meter 23, Maximum Avg Demand	FLOAT	-9999 M to +9999 M	VAs		2
1805 - 1806	6150 - 6151	VAs, Meter 24, Maximum Avg Demand	FLOAT	-9999 M to +9999 M	VAs		2
1807 - 1808	6152 - 6153	Positive PF, Meter 22, Maximum Avg Demand	FLOAT	-1.00 to +1.00	none		2
1809 - 180A	6154 - 6155	Positive PF, Meter 23, Maximum Avg Demand	FLOAT	-1.00 to +1.00	none		2
180B - 180C	6156 - 6157	Positive PF, Meter 24, Maximum Avg Demand	FLOAT	-1.00 to +1.00	none		2
180D - 180E	6158 - 6159	Negative PF, Meter 22, Maximum Avg Demand	FLOAT	-1.00 to +1.00	none		2
180F - 1810	6160 - 6161	Negative PF, Meter 23, Maximum Avg Demand	FLOAT	-1.00 to +1.00	none		2

Modbus Address		Description	Format	Range	Units or Resolution	Comments	# Reg
Hex	Decimal						
1811 - 1812	6162 - 6163	Negative PF, Meter 24, Maximum Avg Demand	FLOAT	-1.00 to +1.00	none		2
						Block Size:	64
Primary maximum Timestamp Block						read-only	
1837 - 1839	6200 - 6202	Volts , max Timestamp	TSTAMP	1Jan2000 - 31Dec2099	1 sec		3
183A - 183C	6203 - 6205	Reserved					3
183D - 183F	6206 - 6208	Reserved					3
1840 - 1842	6209 - 6211	Reserved					3
1843 - 1845	6212 - 6214	Reserved					3
1846 - 1848	6215 - 6217	Reserved					3
1849 - 184B	6218 - 6220	Frequency, max Timestamp	TSTAMP	1Jan2000 - 31Dec2099	1 sec		3
						Block Size:	21
Primary maximum Timestamp Block						read-only	
189B - 189D	6300 - 6302	Amps Meter 1, Max Avg Dmd Timestamp	TSTAMP	1Jan2000 - 31Dec2099	1 sec		3
189E - 18A0	6303 - 6305	Amps Meter 2, Max Avg Dmd Timestamp	TSTAMP	1Jan2000 - 31Dec2099	1 sec		3
18A1 - 18A3	6306 - 6308	Amps Meter 3, Max Avg Dmd Timestamp	TSTAMP	1Jan2000 - 31Dec2099	1 sec		3
18A4 - 18A6	6309 - 6311	Reserved					3
18A7 - 18A9	6312 - 6314	Reserved					3
18AA - 18AC	6315 - 6317	Reserved					3
18AD - 18AF	6318 - 6320	Reserved					3
18B0 - 18B2	6321 - 6323	Reserved					3
18B3 - 18B5	6324 - 6326	Reserved					3
18B6 - 18B8	6327 - 6329	Reserved					3
18B9 - 18BB	6330 - 6332	Reserved					3
18BC - 18BE	6333 - 6335	Positive Watts, Meter 1, Max Avg Dmd Timestamp	TSTAMP	1Jan2000 - 31Dec2099	1 sec		3
18BF - 18C1	6336 - 6338	Positive Watts, Meter 2, Max Avg Dmd Timestamp	TSTAMP	1Jan2000 - 31Dec2099	1 sec		3
18C2 - 18C4	6339 - 6341	Positive Watts, Meter 3, Max Avg Dmd Timestamp	TSTAMP	1Jan2000 - 31Dec2099	1 sec		3
18C5 - 18C7	6342 - 6344	Positive VARs, Meter 1, Max Avg Dmd Timestamp	TSTAMP	1Jan2000 - 31Dec2099	1 sec		3
18C8 - 18CA	6345 - 6347	Positive VARs, Meter 2, Max Avg Dmd Timestamp	TSTAMP	1Jan2000 - 31Dec2099	1 sec		3
18CB - 18CD	6348 - 6350	Positive VARs, Meter 3, Max Avg Dmd Timestamp	TSTAMP	1Jan2000 - 31Dec2099	1 sec		3

Modbus Address		Description	Format	Range	Units or Resolution	Comments	# Reg
Hex	Decimal						
18CE - 18D0	6351 - 6353	Negative Watts, Meter 1, Max Avg Dmd Timestamp	TSTAMP	1Jan2000 - 31Dec2099	1 sec		3
18D1 - 18D3	6354 - 6356	Negative Watts, Meter 2, Max Avg Dmd Timestamp	TSTAMP	1Jan2000 - 31Dec2099	1 sec		3
18D4 - 18D6	6357 - 6359	Negative Watts, Meter 3, Max Avg Dmd Timestamp	TSTAMP	1Jan2000 - 31Dec2099	1 sec		3
18D7 - 18D9	6360 - 6362	Negative VARs, Meter 1, Max Avg Dmd Timestamp	TSTAMP	1Jan2000 - 31Dec2099	1 sec		3
18DA - 18DC	6363 - 6365	Negative VARs, Meter 2, Max Avg Dmd Timestamp	TSTAMP	1Jan2000 - 31Dec2099	1 sec		3
18DD - 18DF	6366 - 6368	Negative VARs, Meter 3, Max Avg Dmd Timestamp	TSTAMP	1Jan2000 - 31Dec2099	1 sec		3
18E0 - 18E2	6369 - 6371	VAs, Meter 1, Max Avg Dmd Timestamp	TSTAMP	1Jan2000 - 31Dec2099	1 sec		3
18E3 - 18E5	6372 - 6374	VAs, Meter 2, Max Avg Dmd Timestamp	TSTAMP	1Jan2000 - 31Dec2099	1 sec		3
18E6 - 18E8	6375 - 6377	VAs, Meter 3, Max Avg Dmd Timestamp	TSTAMP	1Jan2000 - 31Dec2099	1 sec		3
18E9 - 18EB	6378 - 6380	Positive PF, Meter 1, Max Avg Dmd Timestamp	TSTAMP	1Jan2000 - 31Dec2099	1 sec		3
18EC - 18EE	6381 - 6383	Positive PF, Meter 2, Max Avg Dmd Timestamp	TSTAMP	1Jan2000 - 31Dec2099	1 sec		3
18EF - 18F1	6384 - 6386	Positive PF, Meter 3, Max Avg Dmd Timestamp	TSTAMP	1Jan2000 - 31Dec2099	1 sec		3
18F2 - 18F4	6387 - 6389	Negative PF, Meter 1, Max Avg Dmd Timestamp	TSTAMP	1Jan2000 - 31Dec2099	1 sec		3
18F5 - 18F7	6390 - 6392	Negative PF, Meter 2, Max Avg Dmd Timestamp	TSTAMP	1Jan2000 - 31Dec2099	1 sec		3
18F8 - 18FA	6393 - 6395	Negative PF, Meter 3, Max Avg Dmd Timestamp	TSTAMP	1Jan2000 - 31Dec2099	1 sec		3
						Block Size:	96
18FF - 1901	6400 - 6402	Amps Meter 4, Max Avg Dmd Timestamp	TSTAMP	1Jan2000 - 31Dec2099	1 sec		3
1902 - 1904	6403 - 6405	Amps Meter 5, Max Avg Dmd Timestamp	TSTAMP	1Jan2000 - 31Dec2099	1 sec		3
1905 - 1907	6406 - 6408	Amps Meter 6, Max Avg Dmd Timestamp	TSTAMP	1Jan2000 - 31Dec2099	1 sec		3
1908 - 190A	6409 - 6411	Reserved					3
190B - 190D	6412 - 6414	Reserved					3
190E - 1910	6415 - 6417	Reserved					3
1911 - 1913	6418 - 6420	Reserved					3
1914 - 1916	6421 - 6423	Reserved					3

Modbus Address		Description	Format	Range	Units or Resolution	Comments	# Reg
Hex	Decimal						
1917 - 1919	6424 - 6426	Reserved					3
191A - 191C	6427 - 6429	Reserved					3
191D - 191F	6430 - 6432	Reserved					3
1920 - 1922	6433 - 6435	Positive Watts, Meter 4, Max Avg Dmd Timestamp	TSTAMP	1Jan2000 - 31Dec2099	1 sec		3
1923 - 1925	6436 - 6438	Positive Watts, Meter 5, Max Avg Dmd Timestamp	TSTAMP	1Jan2000 - 31Dec2099	1 sec		3
1926 - 1928	6439 - 6441	Positive Watts, Meter 6, Max Avg Dmd Timestamp	TSTAMP	1Jan2000 - 31Dec2099	1 sec		3
1929 - 192B	6442 - 6444	Positive VARs, Meter 4, Max Avg Dmd Timestamp	TSTAMP	1Jan2000 - 31Dec2099	1 sec		3
192C - 192E	6445 - 6447	Positive VARs, Meter 5, Max Avg Dmd Timestamp	TSTAMP	1Jan2000 - 31Dec2099	1 sec		3
192F - 1931	6448 - 6450	Positive VARs, Meter 6, Max Avg Dmd Timestamp	TSTAMP	1Jan2000 - 31Dec2099	1 sec		3
1932 - 1934	6451 - 6453	Negative Watts, Meter 4, Max Avg Dmd Timestamp	TSTAMP	1Jan2000 - 31Dec2099	1 sec		3
1935 - 1937	6454 - 6456	Negative Watts, Meter 5, Max Avg Dmd Timestamp	TSTAMP	1Jan2000 - 31Dec2099	1 sec		3
1938 - 193A	6457 - 6459	Negative Watts, Meter 6, Max Avg Dmd Timestamp	TSTAMP	1Jan2000 - 31Dec2099	1 sec		3
193B - 193D	6460 - 6462	Negative VARs, Meter 4, Max Avg Dmd Timestamp	TSTAMP	1Jan2000 - 31Dec2099	1 sec		3
193E - 1940	6463 - 6465	Negative VARs, Meter 5, Max Avg Dmd Timestamp	TSTAMP	1Jan2000 - 31Dec2099	1 sec		3
1941 - 1943	6466 - 6468	Negative VARs, Meter 6, Max Avg Dmd Timestamp	TSTAMP	1Jan2000 - 31Dec2099	1 sec		3
1944 - 1946	6469 - 6471	VAs, Meter 4, Max Avg Dmd Timestamp	TSTAMP	1Jan2000 - 31Dec2099	1 sec		3
1947 - 1949	6472 - 6474	VAs, Meter 5, Max Avg Dmd Timestamp	TSTAMP	1Jan2000 - 31Dec2099	1 sec		3
194A - 194C	6475 - 6477	VAs, Meter 6, Max Avg Dmd Timestamp	TSTAMP	1Jan2000 - 31Dec2099	1 sec		3
194D - 194F	6478 - 6480	Positive PF, Meter 4, Max Avg Dmd Timestamp	TSTAMP	1Jan2000 - 31Dec2099	1 sec		3
1950 - 1952	6481 - 6483	Positive PF, Meter 5, Max Avg Dmd Timestamp	TSTAMP	1Jan2000 - 31Dec2099	1 sec		3
1953 - 1955	6484 - 6486	Positive PF, Meter 6, Max Avg Dmd Timestamp	TSTAMP	1Jan2000 - 31Dec2099	1 sec		3
1956 - 1958	6487 - 6489	Negative PF, Meter 4, Max Avg Dmd Timestamp	TSTAMP	1Jan2000 - 31Dec2099	1 sec		3
1959 - 195B	6490 - 6492	Negative PF, Meter 5, Max Avg Dmd Timestamp	TSTAMP	1Jan2000 - 31Dec2099	1 sec		3

Modbus Address		Description	Format	Range	Units or Resolution	Comments	# Reg
Hex	Decimal						
195C - 195E	6493 - 6495	Negative PF, Meter 6, Max Avg Dmd Timestamp	TSTAMP	1Jan2000 - 31Dec2099	1 sec		3
						Block Size:	96
1963 - 1965	6500 - 6502	Amps Meter 7, Max Avg Dmd Timestamp	TSTAMP	1Jan2000 - 31Dec2099	1 sec		3
1966 - 1968	6503 - 6505	Amps Meter 8, Max Avg Dmd Timestamp	TSTAMP	1Jan2000 - 31Dec2099	1 sec		3
1969 - 196B	6506 - 6508	Amps Meter 9, Max Avg Dmd Timestamp	TSTAMP	1Jan2000 - 31Dec2099	1 sec		3
196C - 196E	6509 - 6511	Reserved					3
196F - 1971	6512 - 6514	Reserved					3
1972 - 1974	6515 - 6517	Reserved					3
1975 - 1977	6518 - 6520	Reserved					3
1978 - 197A	6521 - 6523	Reserved					3
197B - 197D	6524 - 6526	Reserved					3
197E - 1980	6527 - 6529	Reserved					3
1981 - 1983	6530 - 6532	Reserved					3
1984 - 1986	6533 - 6535	Positive Watts, Meter 7, Max Avg Dmd Timestamp	TSTAMP	1Jan2000 - 31Dec2099	1 sec		3
1987 - 1989	6536 - 6538	Positive Watts, Meter 8, Max Avg Dmd Timestamp	TSTAMP	1Jan2000 - 31Dec2099	1 sec		3
198A - 198C	6539 - 6541	Positive Watts, Meter 9, Max Avg Dmd Timestamp	TSTAMP	1Jan2000 - 31Dec2099	1 sec		3
198D - 198F	6542 - 6544	Positive VARs, Meter 7, Max Avg Dmd Timestamp	TSTAMP	1Jan2000 - 31Dec2099	1 sec		3
1990 - 1992	6545 - 6547	Positive VARs, Meter 8, Max Avg Dmd Timestamp	TSTAMP	1Jan2000 - 31Dec2099	1 sec		3
1993 - 1995	6548 - 6550	Positive VARs, Meter 9, Max Avg Dmd Timestamp	TSTAMP	1Jan2000 - 31Dec2099	1 sec		3
1996 - 1998	6551 - 6553	Negative Watts, Meter 7, Max Avg Dmd Timestamp	TSTAMP	1Jan2000 - 31Dec2099	1 sec		3
1999 - 199B	6554 - 6556	Negative Watts, Meter 8, Max Avg Dmd Timestamp	TSTAMP	1Jan2000 - 31Dec2099	1 sec		3
199C - 199E	6557 - 6559	Negative Watts, Meter 9, Max Avg Dmd Timestamp	TSTAMP	1Jan2000 - 31Dec2099	1 sec		3
199F - 19A1	6560 - 6562	Negative VARs, Meter 7, Max Avg Dmd Timestamp	TSTAMP	1Jan2000 - 31Dec2099	1 sec		3
19A2 - 19A4	6563 - 6565	Negative VARs, Meter 8, Max Avg Dmd Timestamp	TSTAMP	1Jan2000 - 31Dec2099	1 sec		3
19A5 - 19A7	6566 - 6568	Negative VARs, Meter 9, Max Avg Dmd Timestamp	TSTAMP	1Jan2000 - 31Dec2099	1 sec		3

Modbus Address		Description	Format	Range	Units or Resolution	Comments	# Reg
Hex	Decimal						
19A8 - 19AA	6569 - 6571	VAs, Meter 7, Max Avg Dmd Timestamp	TSTAMP	1Jan2000 - 31Dec2099	1 sec		3
19AB - 19AD	6572 - 6574	VAs, Meter 8, Max Avg Dmd Timestamp	TSTAMP	1Jan2000 - 31Dec2099	1 sec		3
19AE - 19B0	6575 - 6577	VAs, Meter 9, Max Avg Dmd Timestamp	TSTAMP	1Jan2000 - 31Dec2099	1 sec		3
19B1 - 19B3	6578 - 6580	Positive PF, Meter 7, Max Avg Dmd Timestamp	TSTAMP	1Jan2000 - 31Dec2099	1 sec		3
19B4 - 19B6	6581 - 6583	Positive PF, Meter 8, Max Avg Dmd Timestamp	TSTAMP	1Jan2000 - 31Dec2099	1 sec		3
19B7 - 19B9	6584 - 6586	Positive PF, Meter 9, Max Avg Dmd Timestamp	TSTAMP	1Jan2000 - 31Dec2099	1 sec		3
19BA - 19BC	6587 - 6589	Negative PF, Meter 7, Max Avg Dmd Timestamp	TSTAMP	1Jan2000 - 31Dec2099	1 sec		3
19BD - 19BF	6590 - 6592	Negative PF, Meter 8, Max Avg Dmd Timestamp	TSTAMP	1Jan2000 - 31Dec2099	1 sec		3
19C0 - 19C2	6593 - 6595	Negative PF, Meter 9, Max Avg Dmd Timestamp	TSTAMP	1Jan2000 - 31Dec2099	1 sec		3
						Block Size:	96
19C7 - 19C9	6600 - 6602	Amps Meter 10, Max Avg Dmd Timestamp	TSTAMP	1Jan2000 - 31Dec2099	1 sec		3
19CA - 19CC	6603 - 6605	Amps Meter 11, Max Avg Dmd Timestamp	TSTAMP	1Jan2000 - 31Dec2099	1 sec		3
19CD - 19CF	6606 - 6608	Amps Meter 12, Max Avg Dmd Timestamp	TSTAMP	1Jan2000 - 31Dec2099	1 sec		3
19D0 - 19D2	6609 - 6611	Reserved					3
19D3 - 19D5	6612 - 6614	Reserved					3
19D6 - 19D8	6615 - 6617	Reserved					3
19D9 - 19DB	6618 - 6620	Reserved					3
19DC - 19DE	6621 - 6623	Reserved					3
19DF - 19E1	6624 - 6626	Reserved					3
19E2 - 19E4	6627 - 6629	Reserved					3
19E5 - 19E7	6630 - 6632	Reserved					3
19E8 - 19EA	6633 - 6635	Positive Watts, Meter 10, Max Avg Dmd Timestamp	TSTAMP	1Jan2000 - 31Dec2099	1 sec		3
19EB - 19ED	6636 - 6638	Positive Watts, Meter 11, Max Avg Dmd Timestamp	TSTAMP	1Jan2000 - 31Dec2099	1 sec		3
19EE - 19F0	6639 - 6641	Positive Watts, Meter 12, Max Avg Dmd Timestamp	TSTAMP	1Jan2000 - 31Dec2099	1 sec		3
19F1 - 19F3	6642 - 6644	Positive VARs, Meter 10, Max Avg Dmd Timestamp	TSTAMP	1Jan2000 - 31Dec2099	1 sec		3

Modbus Address		Description	Format	Range	Units or Resolution	Comments	# Reg
Hex	Decimal						
19F4 - 19F6	6645 - 6647	Positive VARs, Meter 11, Max Avg Dmd Timestamp	TSTAMP	1Jan2000 - 31Dec2099	1 sec		3
19F7 - 19F9	6648 - 6650	Positive VARs, Meter 12, Max Avg Dmd Timestamp	TSTAMP	1Jan2000 - 31Dec2099	1 sec		3
19FA - 19FC	6651 - 6653	Negative Watts, Meter 10, Max Avg Dmd Timestamp	TSTAMP	1Jan2000 - 31Dec2099	1 sec		3
19FD - 19FF	6654 - 6656	Negative Watts, Meter 11, Max Avg Dmd Timestamp	TSTAMP	1Jan2000 - 31Dec2099	1 sec		3
1A00 - 1A02	6657 - 6659	Negative Watts, Meter 12, Max Avg Dmd Timestamp	TSTAMP	1Jan2000 - 31Dec2099	1 sec		3
1A03 - 1A05	6660 - 6662	Negative VARs, Meter 10, Max Avg Dmd Timestamp	TSTAMP	1Jan2000 - 31Dec2099	1 sec		3
1A06 - 1A08	6663 - 6665	Negative VARs, Meter 11, Max Avg Dmd Timestamp	TSTAMP	1Jan2000 - 31Dec2099	1 sec		3
1A09 - 1A0B	6666 - 6668	Negative VARs, Meter 12, Max Avg Dmd Timestamp	TSTAMP	1Jan2000 - 31Dec2099	1 sec		3
1A0C - 1A0E	6669 - 6671	VAs, Meter 10, Max Avg Dmd Timestamp	TSTAMP	1Jan2000 - 31Dec2099	1 sec		3
1A0F - 1A11	6672 - 6674	VAs, Meter 11, Max Avg Dmd Timestamp	TSTAMP	1Jan2000 - 31Dec2099	1 sec		3
1A12 - 1A14	6675 - 6677	VAs, Meter 12, Max Avg Dmd Timestamp	TSTAMP	1Jan2000 - 31Dec2099	1 sec		3
1A15 - 1A17	6678 - 6680	Positive PF, Meter 10, Max Avg Dmd Timestamp	TSTAMP	1Jan2000 - 31Dec2099	1 sec		3
1A18 - 1A1A	6681 - 6683	Positive PF, Meter 11, Max Avg Dmd Timestamp	TSTAMP	1Jan2000 - 31Dec2099	1 sec		3
1A1B - 1A1D	6684 - 6686	Positive PF, Meter 12, Max Avg Dmd Timestamp	TSTAMP	1Jan2000 - 31Dec2099	1 sec		3
1A1E - 1A20	6687 - 6689	Negative PF, Meter 10, Max Avg Dmd Timestamp	TSTAMP	1Jan2000 - 31Dec2099	1 sec		3
1A21 - 1A23	6690 - 6692	Negative PF, Meter 11, Max Avg Dmd Timestamp	TSTAMP	1Jan2000 - 31Dec2099	1 sec		3
1A24 - 1A26	6693 - 6695	Negative PF, Meter 12, Max Avg Dmd Timestamp	TSTAMP	1Jan2000 - 31Dec2099	1 sec		3
						Block Size:	96
1A2B - 1A2D	6700 - 6702	Amps Meter 13, Max Avg Dmd Timestamp	TSTAMP	1Jan2000 - 31Dec2099	1 sec		3
1A2E - 1A30	6703 - 6705	Amps Meter 14, Max Avg Dmd Timestamp	TSTAMP	1Jan2000 - 31Dec2099	1 sec		3
1A31 - 1A33	6706 - 6708	Amps Meter 15, Max Avg Dmd Timestamp	TSTAMP	1Jan2000 - 31Dec2099	1 sec		3
1A34 - 1A36	6709 - 6711	Reserved					3
1A37 - 1A39	6712 - 6714	Reserved					3

Modbus Address		Description	Format	Range	Units or Resolution	Comments	# Reg
Hex	Decimal						
1A3A - 1A3C	6715 - 6717	Reserved					3
1A3D - 1A3F	6718 - 6720	Reserved					3
1A40 - 1A42	6721 - 6723	Reserved					3
1A43 - 1A45	6724 - 6726	Reserved					3
1A46 - 1A48	6727 - 6729	Reserved					3
1A49 - 1A4B	6730 - 6732	Reserved					3
1A4C - 1A4E	6733 - 6735	Positive Watts, Meter 13, Max Avg Dmd Timestamp	TSTAMP	1Jan2000 - 31Dec2099	1 sec		3
1A4F - 1A51	6736 - 6738	Positive Watts, Meter 14, Max Avg Dmd Timestamp	TSTAMP	1Jan2000 - 31Dec2099	1 sec		3
1A52 - 1A54	6739 - 6741	Positive Watts, Meter 15, Max Avg Dmd Timestamp	TSTAMP	1Jan2000 - 31Dec2099	1 sec		3
1A55 - 1A57	6742 - 6744	Positive VARs, Meter 13, Max Avg Dmd Timestamp	TSTAMP	1Jan2000 - 31Dec2099	1 sec		3
1A58 - 1A5A	6745 - 6747	Positive VARs, Meter 14, Max Avg Dmd Timestamp	TSTAMP	1Jan2000 - 31Dec2099	1 sec		3
1A5B - 1A5D	6748 - 6750	Positive VARs, Meter 15, Max Avg Dmd Timestamp	TSTAMP	1Jan2000 - 31Dec2099	1 sec		3
1A5E - 1A60	6751 - 6753	Negative Watts, Meter 13, Max Avg Dmd Timestamp	TSTAMP	1Jan2000 - 31Dec2099	1 sec		3
1A61 - 1A63	6754 - 6756	Negative Watts, Meter 14, Max Avg Dmd Timestamp	TSTAMP	1Jan2000 - 31Dec2099	1 sec		3
1A64 - 1A66	6757 - 6759	Negative Watts, Meter 15, Max Avg Dmd Timestamp	TSTAMP	1Jan2000 - 31Dec2099	1 sec		3
1A67 - 1A69	6760 - 6762	Negative VARs, Meter 13, Max Avg Dmd Timestamp	TSTAMP	1Jan2000 - 31Dec2099	1 sec		3
1A6A - 1A6C	6763 - 6765	Negative VARs, Meter 14, Max Avg Dmd Timestamp	TSTAMP	1Jan2000 - 31Dec2099	1 sec		3
1A6D - 1A6F	6766 - 6768	Negative VARs, Meter 15, Max Avg Dmd Timestamp	TSTAMP	1Jan2000 - 31Dec2099	1 sec		3
1A70 - 1A72	6769 - 6771	VAs, Meter 13, Max Avg Dmd Timestamp	TSTAMP	1Jan2000 - 31Dec2099	1 sec		3
1A73 - 1A75	6772 - 6774	VAs, Meter 14, Max Avg Dmd Timestamp	TSTAMP	1Jan2000 - 31Dec2099	1 sec		3
1A76 - 1A78	6775 - 6777	VAs, Meter 15, Max Avg Dmd Timestamp	TSTAMP	1Jan2000 - 31Dec2099	1 sec		3
1A79 - 1A7B	6778 - 6780	Positive PF, Meter 13, Max Avg Dmd Timestamp	TSTAMP	1Jan2000 - 31Dec2099	1 sec		3
1A7C - 1A7E	6781 - 6783	Positive PF, Meter 14, Max Avg Dmd Timestamp	TSTAMP	1Jan2000 - 31Dec2099	1 sec		3
1A7F - 1A81	6784 - 6786	Positive PF, Meter 15, Max Avg Dmd Timestamp	TSTAMP	1Jan2000 - 31Dec2099	1 sec		3

Modbus Address		Description	Format	Range	Units or Resolution	Comments	# Reg
Hex	Decimal						
1A82 - 1A84	6787 - 6789	Negative PF, Meter 13, Max Avg Dmd Timestamp	TSTAMP	1Jan2000 - 31Dec2099	1 sec		3
1A85 - 1A87	6790 - 6792	Negative PF, Meter 14, Max Avg Dmd Timestamp	TSTAMP	1Jan2000 - 31Dec2099	1 sec		3
1A88 - 1A8A	6793 - 6795	Negative PF, Meter 15, Max Avg Dmd Timestamp	TSTAMP	1Jan2000 - 31Dec2099	1 sec		3
						Block Size:	96
1A8F - 1A91	6800 - 6802	Amps Meter 16, Max Avg Dmd Timestamp	TSTAMP	1Jan2000 - 31Dec2099	1 sec		3
1A92 - 1A94	6803 - 6805	Amps Meter 17, Max Avg Dmd Timestamp	TSTAMP	1Jan2000 - 31Dec2099	1 sec		3
1A95 - 1A97	6806 - 6808	Amps Meter 18, Max Avg Dmd Timestamp	TSTAMP	1Jan2000 - 31Dec2099	1 sec		3
1A98 - 1A9A	6809 - 6811	Reserved					3
1A9B - 1A9D	6812 - 6814	Reserved					3
1A9E - 1AA0	6815 - 6817	Reserved					3
1AA1 - 1AA3	6818 - 6820	Reserved					3
1AA4 - 1AA6	6821 - 6823	Reserved					3
1AA7 - 1AA9	6824 - 6826	Reserved					3
1AAA - 1AAC	6827 - 6829	Reserved					3
1AAD - 1AAF	6830 - 6832	Reserved					3
1AB0 - 1AB2	6833 - 6835	Positive Watts, Meter 16, Max Avg Dmd Timestamp	TSTAMP	1Jan2000 - 31Dec2099	1 sec		3
1AB3 - 1AB5	6836 - 6838	Positive Watts, Meter 17, Max Avg Dmd Timestamp	TSTAMP	1Jan2000 - 31Dec2099	1 sec		3
1AB6 - 1AB8	6839 - 6841	Positive Watts, Meter 18, Max Avg Dmd Timestamp	TSTAMP	1Jan2000 - 31Dec2099	1 sec		3
1AB9 - 1ABB	6842 - 6844	Positive VARs, Meter 16, Max Avg Dmd Timestamp	TSTAMP	1Jan2000 - 31Dec2099	1 sec		3
1ABC - 1ABE	6845 - 6847	Positive VARs, Meter 17, Max Avg Dmd Timestamp	TSTAMP	1Jan2000 - 31Dec2099	1 sec		3
1ABF - 1AC1	6848 - 6850	Positive VARs, Meter 18, Max Avg Dmd Timestamp	TSTAMP	1Jan2000 - 31Dec2099	1 sec		3
1AC2 - 1AC4	6851 - 6853	Negative Watts, Meter 16, Max Avg Dmd Timestamp	TSTAMP	1Jan2000 - 31Dec2099	1 sec		3

Modbus Address		Description	Format	Range	Units or Resolution	Comments	# Reg
Hex	Decimal						
1AC5 - 1AC7	6854 - 6856	Negative Watts, Meter 17, Max Avg Dmd Timestamp	TSTAMP	1Jan2000 - 31Dec2099	1 sec		3
1AC8 - 1ACA	6857 - 6859	Negative Watts, Meter 18, Max Avg Dmd Timestamp	TSTAMP	1Jan2000 - 31Dec2099	1 sec		3
1ACB - 1ACD	6860 - 6862	Negative VARs, Meter 16, Max Avg Dmd Timestamp	TSTAMP	1Jan2000 - 31Dec2099	1 sec		3
1ACE - 1AD0	6863 - 6865	Negative VARs, Meter 17, Max Avg Dmd Timestamp	TSTAMP	1Jan2000 - 31Dec2099	1 sec		3
1AD1 - 1AD3	6866 - 6868	Negative VARs, Meter 18, Max Avg Dmd Timestamp	TSTAMP	1Jan2000 - 31Dec2099	1 sec		3
1AD4 - 1AD6	6869 - 6871	VAs, Meter 16, Max Avg Dmd Timestamp	TSTAMP	1Jan2000 - 31Dec2099	1 sec		3
1AD7 - 1AD9	6872 - 6874	VAs, Meter 17, Max Avg Dmd Timestamp	TSTAMP	1Jan2000 - 31Dec2099	1 sec		3
1ADA - 1ADC	6875 - 6877	VAs, Meter 18, Max Avg Dmd Timestamp	TSTAMP	1Jan2000 - 31Dec2099	1 sec		3
1ADD - 1ADF	6878 - 6880	Positive PF, Meter 16, Max Avg Dmd Timestamp	TSTAMP	1Jan2000 - 31Dec2099	1 sec		3
1AE0 - 1AE2	6881 - 6883	Positive PF, Meter 17, Max Avg Dmd Timestamp	TSTAMP	1Jan2000 - 31Dec2099	1 sec		3
1AE3 - 1AE5	6884 - 6886	Positive PF, Meter 18, Max Avg Dmd Timestamp	TSTAMP	1Jan2000 - 31Dec2099	1 sec		3
1AE6 - 1AE8	6887 - 6889	Negative PF, Meter 16, Max Avg Dmd Timestamp	TSTAMP	1Jan2000 - 31Dec2099	1 sec		3
1AE9 - 1AEB	6890 - 6892	Negative PF, Meter 17, Max Avg Dmd Timestamp	TSTAMP	1Jan2000 - 31Dec2099	1 sec		3
1AEC - 1AEE	6893 - 6895	Negative PF, Meter 18, Max Avg Dmd Timestamp	TSTAMP	1Jan2000 - 31Dec2099	1 sec		3
						Block Size:	96
1AF3 - 1AF5	6900 - 6902	Amps Meter 19, Max Avg Dmd Timestamp	TSTAMP	1Jan2000 - 31Dec2099	1 sec		3
1AF6 - 1AF8	6903 - 6905	Amps Meter 20, Max Avg Dmd Timestamp	TSTAMP	1Jan2000 - 31Dec2099	1 sec		3
1AF9 - 1AFB	6906 - 6908	Amps Meter 21, Max Avg Dmd Timestamp	TSTAMP	1Jan2000 - 31Dec2099	1 sec		3
1AFC - 1AFE	6909 - 6911	Reserved					3
1AFF - 1B01	6912 - 6914	Reserved					3
1B02 - 1B04	6915 - 6917	Reserved					3
1B05 - 1B07	6918 - 6920	Reserved					3
1B08 - 1B0A	6921 - 6923	Reserved					3
1B0B - 1B0D	6924 - 6926	Reserved					3
1B0E - 1B10	6927 - 6929	Reserved					3

Modbus Address		Description	Format	Range	Units or Resolution	Comments	# Reg
Hex	Decimal						
1B11 - 1B13	6930 - 6932	Reserved					3
1B14 - 1B16	6933 - 6935	Positive Watts, Meter 19, Max Avg Dmd Timestamp	TSTAMP	1Jan2000 - 31Dec2099	1 sec		3
1B17 - 1B19	6936 - 6938	Positive Watts, Meter 20, Max Avg Dmd Timestamp	TSTAMP	1Jan2000 - 31Dec2099	1 sec		3
1B1A - 1B1C	6939 - 6941	Positive Watts, Meter 21, Max Avg Dmd Timestamp	TSTAMP	1Jan2000 - 31Dec2099	1 sec		3
1B1D - 1B1F	6942 - 6944	Positive VARs, Meter 19, Max Avg Dmd Timestamp	TSTAMP	1Jan2000 - 31Dec2099	1 sec		3
1B20 - 1B22	6945 - 6947	Positive VARs, Meter 20, Max Avg Dmd Timestamp	TSTAMP	1Jan2000 - 31Dec2099	1 sec		3
1B23 - 1B25	6948 - 6950	Positive VARs, Meter 21, Max Avg Dmd Timestamp	TSTAMP	1Jan2000 - 31Dec2099	1 sec		3
1B26 - 1B28	6951 - 6953	Negative Watts, Meter 19, Max Avg Dmd Timestamp	TSTAMP	1Jan2000 - 31Dec2099	1 sec		3
1B29 - 1B2B	6954 - 6956	Negative Watts, Meter 20, Max Avg Dmd Timestamp	TSTAMP	1Jan2000 - 31Dec2099	1 sec		3
1B2C - 1B2E	6957 - 6959	Negative Watts, Meter 21, Max Avg Dmd Timestamp	TSTAMP	1Jan2000 - 31Dec2099	1 sec		3
1B2F - 1B31	6960 - 6962	Negative VARs, Meter 19, Max Avg Dmd Timestamp	TSTAMP	1Jan2000 - 31Dec2099	1 sec		3
1B32 - 1B34	6963 - 6965	Negative VARs, Meter 20, Max Avg Dmd Timestamp	TSTAMP	1Jan2000 - 31Dec2099	1 sec		3
1B35 - 1B37	6966 - 6968	Negative VARs, Meter 21, Max Avg Dmd Timestamp	TSTAMP	1Jan2000 - 31Dec2099	1 sec		3
1B38 - 1B3A	6969 - 6971	VAs, Meter 19, Max Avg Dmd Timestamp	TSTAMP	1Jan2000 - 31Dec2099	1 sec		3
1B3B - 1B3D	6972 - 6974	VAs, Meter 20, Max Avg Dmd Timestamp	TSTAMP	1Jan2000 - 31Dec2099	1 sec		3
1B3E - 1B40	6975 - 6977	VAs, Meter 21, Max Avg Dmd Timestamp	TSTAMP	1Jan2000 - 31Dec2099	1 sec		3
1B41 - 1B43	6978 - 6980	Positive PF, Meter 19, Max Avg Dmd Timestamp	TSTAMP	1Jan2000 - 31Dec2099	1 sec		3
1B44 - 1B46	6981 - 6983	Positive PF, Meter 20, Max Avg Dmd Timestamp	TSTAMP	1Jan2000 - 31Dec2099	1 sec		3
1B47 - 1B49	6984 - 6986	Positive PF, Meter 21, Max Avg Dmd Timestamp	TSTAMP	1Jan2000 - 31Dec2099	1 sec		3
1B4A - 1B4C	6987 - 6989	Negative PF, Meter 19, Max Avg Dmd Timestamp	TSTAMP	1Jan2000 - 31Dec2099	1 sec		3
1B4D - 1B4F	6990 - 6992	Negative PF, Meter 20, Max Avg Dmd Timestamp	TSTAMP	1Jan2000 - 31Dec2099	1 sec		3
1B50 - 1B52	6993 - 6995	Negative PF, Meter 21, Max Avg Dmd Timestamp	TSTAMP	1Jan2000 - 31Dec2099	1 sec		3
						Block Size:	96

Modbus Address		Description	Format	Range	Units or Resolution	Comments	# Reg
Hex	Decimal						
1B57 - 1B59	7000 - 7002	Amps Meter 22, Max Avg Dmd Timestamp	TSTAMP	1Jan2000 - 31Dec2099	1 sec		3
1B5A - 1B5C	7003 - 7005	Amps Meter 23, Max Avg Dmd Timestamp	TSTAMP	1Jan2000 - 31Dec2099	1 sec		3
1B5D - 1B5F	7006 - 7008	Amps Meter 24, Max Avg Dmd Timestamp	TSTAMP	1Jan2000 - 31Dec2099	1 sec		3
1B60 - 1B62	7009 - 7011	Reserved					3
1B63 - 1B65	7012 - 7014	Reserved					3
1B66 - 1B68	7015 - 7017	Reserved					3
1B69 - 1B6B	7018 - 7020	Reserved					3
1B6C - 1B6E	7021 - 7023	Reserved					3
1B6F - 1B71	7024 - 7026	Reserved					3
1B72 - 1B74	7027 - 7029	Reserved					3
1B75 - 1B77	7030 - 7032	Reserved					3
1B78 - 1B7A	7033 - 7035	Positive Watts, Meter 22, Max Avg Dmd Timestamp	TSTAMP	1Jan2000 - 31Dec2099	1 sec		3
1B7B - 1B7D	7036 - 7038	Positive Watts, Meter 23, Max Avg Dmd Timestamp	TSTAMP	1Jan2000 - 31Dec2099	1 sec		3
1B7E - 1B80	7039 - 7041	Positive Watts, Meter 24, Max Avg Dmd Timestamp	TSTAMP	1Jan2000 - 31Dec2099	1 sec		3
1B81 - 1B83	7042 - 7044	Positive VARs, Meter 22, Max Avg Dmd Timestamp	TSTAMP	1Jan2000 - 31Dec2099	1 sec		3
1B84 - 1B86	7045 - 7047	Positive VARs, Meter 23, Max Avg Dmd Timestamp	TSTAMP	1Jan2000 - 31Dec2099	1 sec		3
1B87 - 1B89	7048 - 7050	Positive VARs, Meter 24, Max Avg Dmd Timestamp	TSTAMP	1Jan2000 - 31Dec2099	1 sec		3
1B8A - 1B8C	7051 - 7053	Negative Watts, Meter 22, Max Avg Dmd Timestamp	TSTAMP	1Jan2000 - 31Dec2099	1 sec		3

Modbus Address		Description	Format	Range	Units or Resolution	Comments	# Reg
Hex	Decimal						
1B8D - 1B8F	7054 - 7056	Negative Watts, Meter 23, Max Avg Dmd Timestamp	TSTAMP	1Jan2000 - 31Dec2099	1 sec		3
1B90 - 1B92	7057 - 7059	Negative Watts, Meter 24, Max Avg Dmd Timestamp	TSTAMP	1Jan2000 - 31Dec2099	1 sec		3
1B93 - 1B95	7060 - 7062	Negative VARs, Meter 22, Max Avg Dmd Timestamp	TSTAMP	1Jan2000 - 31Dec2099	1 sec		3
1B96 - 1B98	7063 - 7065	Negative VARs, Meter 23, Max Avg Dmd Timestamp	TSTAMP	1Jan2000 - 31Dec2099	1 sec		3
1B99 - 1B9B	7066 - 7068	Negative VARs, Meter 24, Max Avg Dmd Timestamp	TSTAMP	1Jan2000 - 31Dec2099	1 sec		3
1B9C - 1B9E	7069 - 7071	VAs, Meter 22, Max Avg Dmd Timestamp	TSTAMP	1Jan2000 - 31Dec2099	1 sec		3
1B9F - 1BA1	7072 - 7074	VAs, Meter 23, Max Avg Dmd Timestamp	TSTAMP	1Jan2000 - 31Dec2099	1 sec		3
1BA2 - 1BA4	7075 - 7077	VAs, Meter 24, Max Avg Dmd Timestamp	TSTAMP	1Jan2000 - 31Dec2099	1 sec		3
1BA5 - 1BA7	7078 - 7080	Positive PF, Meter 22, Max Avg Dmd Timestamp	TSTAMP	1Jan2000 - 31Dec2099	1 sec		3
1BA8 - 1BAA	7081 - 7083	Positive PF, Meter 23, Max Avg Dmd Timestamp	TSTAMP	1Jan2000 - 31Dec2099	1 sec		3
1BAB - 1BAD	7084 - 7086	Positive PF, Meter 24, Max Avg Dmd Timestamp	TSTAMP	1Jan2000 - 31Dec2099	1 sec		3
1BAE - 1BB0	7087 - 7089	Negative PF, Meter 22, Max Avg Dmd Timestamp	TSTAMP	1Jan2000 - 31Dec2099	1 sec		3
1BB1 - 1BB3	7090 - 7092	Negative PF, Meter 23, Max Avg Dmd Timestamp	TSTAMP	1Jan2000 - 31Dec2099	1 sec		3
1BB4 - 1BB6	7093 - 7095	Negative PF, Meter 24, Max Avg Dmd Timestamp	TSTAMP	1Jan2000 - 31Dec2099	1 sec		3
						Block Size:	96

Modbus Address		Description	Format	Range	Units or Resolution	Comments	# Reg
Hex	Decimal						
Interval Energy Block						read-only	
1F3F - 1F40	8000 - 8001	Reserved				* Wh received & delivered always have opposite signs	2
1F41 - 1F42	8002 - 8003	Reserved					2
1F43 - 1F44	8004 - 8005	Reserved					2
1F45 - 1F46	8006 - 8007	Reserved				* Wh received is positive for "view as load", delivered is positive for "view as generator"	2
1F47 - 1F48	8008 - 8009	Reserved					2
1F49 - 1F4A	8010 - 8011	Reserved					2
1F4B - 1F4C	8012 - 8013	Reserved					2
1F4D - 1F4E	8014 - 8015	Reserved				* 5 to 8 digits	2
1F4F - 1F50	8016 - 8017	Reserved					2
1F51 - 1F52	8018 - 8019	W-hours, Received, Meter 1	SINT32	0 to 99999999 or 0 to -99999999	Wh per energy format	* decimal point implied, per energy format * resolution of digit before decimal point = units, kilo, or mega, per energy format	2
1F53 - 1F54	8020 - 8021	W-hours, Received, Meter 2	SINT32	0 to 99999999 or 0 to -99999999	Wh per energy format	* see note 10	2
1F55 - 1F56	8022 - 8023	W-hours, Received, Meter 3	SINT32	0 to 99999999 or 0 to -99999999	Wh per energy format		2
1F57 - 1F58	8024 - 8025	W-hours, Delivered, Meter 1	SINT32	0 to 99999999 or 0 to -99999999	Wh per energy format		2
1F59 - 1F5A	8026 - 8027	W-hours, Delivered, Meter 2	SINT32	0 to 99999999 or 0 to -99999999	Wh per energy format		2
1F5B - 1F5C	8028 - 8029	W-hours, Delivered, Meter 3	SINT32	0 to 99999999 or 0 to -99999999	Wh per energy format		2
1F5D - 1F5E	8030 - 8031	W-hours, Net, Meter 1	SINT32	-99999999 to 99999999	Wh per energy format		2
1F5F - 1F60	8032 - 8033	W-hours, Net, Meter 2	SINT32	-99999999 to 99999999	Wh per energy format		2

Modbus Address		Description	Format	Range	Units or Resolution	Comments	# Reg
Hex	Decimal						
1F61 - 1F62	8034 - 8035	W-hours, Net, Meter 3	SINT32	-99999999 to 99999999	Wh per energy format	(Cont'd)	2
1F63 - 1F64	8036 - 8037	W-hours, Total, Meter 1	SINT32	0 to 99999999	Wh per energy format		2
1F65 - 1F66	8038 - 8039	W-hours, Total, Meter 2	SINT32	0 to 99999999	Wh per energy format		2
1F67 - 1F68	8040 - 8041	W-hours, Total, Meter 3	SINT32	0 to 99999999	Wh per energy format		2
1F69 - 1F6A	8042 - 8043	VAR-hours, Positive, Meter 1	SINT32	0 to 99999999	VARh per energy format		2
1F6B - 1F6C	8044 - 8045	VAR-hours, Positive, Meter 2	SINT32	0 to 99999999	VARh per energy format		2
1F6D - 1F6E	8046 - 8047	VAR-hours, Positive, Meter 3	SINT32	0 to 99999999	VARh per energy format		2
1F6F - 1F70	8048 - 8049	VAR-hours, Negative, Meter 1	SINT32	0 to -99999999	VARh per energy format		2
1F71 - 1F72	8050 - 8051	VAR-hours, Negative, Meter 2	SINT32	0 to -99999999	VARh per energy format		2
1F73 - 1F74	8052 - 8053	VAR-hours, Negative, Meter 3	SINT32	0 to -99999999	VARh per energy format		2
1F75 - 1F76	8054 - 8055	VAR-hours, Net, Meter 1	SINT32	-99999999 to 99999999	VARh per energy format		2
1F77 - 1F78	8056 - 8057	VAR-hours, Net, Meter 2	SINT32	-99999999 to 99999999	VARh per energy format		2
1F79 - 1F7A	8058 - 8059	VAR-hours, Net, Meter 3	SINT32	-99999999 to 99999999	VARh per energy format		2
1F7B - 1F7C	8060 - 8061	VAR-hours, Total, Meter 1	SINT32	0 to 99999999	VARh per energy format		2
1F7D - 1F7E	8062 - 8063	VAR-hours, Total, Meter 2	SINT32	0 to 99999999	VARh per energy format		2
1F7F - 1F80	8064 - 8065	VAR-hours, Total, Meter 3	SINT32	0 to 99999999	VARh per energy format		2
1F81 - 1F82	8066 - 8067	VA-hours, Meter 1	SINT32	0 to 99999999	VAh per energy format		2
1F83 - 1F84	8068 - 8069	VA-hours, Meter 2	SINT32	0 to 99999999	VAh per energy format		2

Modbus Address		Description	Format	Range	Units or Resolution	Comments	# Reg
Hex	Decimal						
1F85 - 1F86	8070 - 8071	VA-hours, Meter 3	SINT32	0 to 99999999	VAh per energy format	(Cont'd)	2
Block Size:							72
1FA3 - 1FA4	8100 - 8101	Reserved				* Wh received & delivered always have opposite signs	2
1FA5 - 1FA6	8102 - 8103	Reserved					2
1FA7 - 1FA8	8104 - 8105	Reserved					2
1FA9 - 1FAA	8106 - 8107	Reserved				* Wh received is positive for "view as load", delivered is positive for "view as generator"	2
1FAB - 1FAC	8108 - 8109	Reserved					2
1FAD - 1FAE	8110 - 8111	Reserved					2
1FAF - 1FB0	8112 - 8113	Reserved				* 5 to 8 digits	2
1FB1 - 1FB2	8114 - 8115	Reserved					2
1FB3 - 1FB4	8116 - 8117	Reserved				* decimal point implied, per energy format	2
1FB5 - 1FB6	8118 - 8119	W-hours, Received, Meter 4	SINT32	0 to 99999999 or 0 to -99999999	Wh per energy format	* resolution of digit before decimal point = units, kilo, or mega, per energy format	2
1FB7 - 1FB8	8120 - 8121	W-hours, Received, Meter 5	SINT32	0 to 99999999 or 0 to -99999999	Wh per energy format	* see note 10	2
1FB9 - 1FBA	8122 - 8123	W-hours, Received, Meter 6	SINT32	0 to 99999999 or 0 to -99999999	Wh per energy format		2
1FBB - 1FBC	8124 - 8125	W-hours, Delivered, Meter 4	SINT32	0 to 99999999 or 0 to -99999999	Wh per energy format		2
1FBD - 1FBE	8126 - 8127	W-hours, Delivered, Meter 5	SINT32	0 to 99999999 or 0 to -99999999	Wh per energy format		2
1FBF - 1FC0	8128 - 8129	W-hours, Delivered, Meter 6	SINT32	0 to 99999999 or 0 to -99999999	Wh per energy format		2

Modbus Address		Description	Format	Range	Units or Resolution	Comments	# Reg
Hex	Decimal						
1FC1 - 1FC2	8130 - 8131	W-hours, Net, Meter 4	SINT32	-99999999 to 99999999	Wh per energy format	(Cont'd)	2
1FC3 - 1FC4	8132 - 8133	W-hours, Net, Meter 5	SINT32	-99999999 to 99999999	Wh per energy format		2
1FC5 - 1FC6	8134 - 8135	W-hours, Net, Meter 6	SINT32	-99999999 to 99999999	Wh per energy format		2
1FC7 - 1FC8	8136 - 8137	W-hours, Total, Meter 4	SINT32	0 to 99999999	Wh per energy format		2
1FC9 - 1FCA	8138 - 8139	W-hours, Total, Meter 5	SINT32	0 to 99999999	Wh per energy format		2
1FCB - 1FCC	8140 - 8141	W-hours, Total, Meter 6	SINT32	0 to 99999999	Wh per energy format		2
1FCD - 1FCE	8142 - 8143	VAR-hours, Positive, Meter 4	SINT32	0 to 99999999	VARh per energy format		2
1FCF - 1FD0	8144 - 8145	VAR-hours, Positive, Meter 5	SINT32	0 to 99999999	VARh per energy format		2
1FD1 - 1FD2	8146 - 8147	VAR-hours, Positive, Meter 6	SINT32	0 to 99999999	VARh per energy format		2
1FD3 - 1FD4	8148 - 8149	VAR-hours, Negative, Meter 4	SINT32	0 to -99999999	VARh per energy format		2
1FD5 - 1FD6	8150 - 8151	VAR-hours, Negative, Meter 5	SINT32	0 to -99999999	VARh per energy format		2
1FD7 - 1FD8	8152 - 8153	VAR-hours, Negative, Meter 6	SINT32	0 to -99999999	VARh per energy format		2
1FD9 - 1FDA	8154 - 8155	VAR-hours, Net, Meter 4	SINT32	-99999999 to 99999999	VARh per energy format		2
1FDB - 1FDC	8156 - 8157	VAR-hours, Net, Meter 5	SINT32	-99999999 to 99999999	VARh per energy format		2
1FDD - 1FDE	8158 - 8159	VAR-hours, Net, Meter 6	SINT32	-99999999 to 99999999	VARh per energy format		2
1FDF - 1FE0	8160 - 8161	VAR-hours, Total, Meter 4	SINT32	0 to 99999999	VARh per energy format		2
1FE1 - 1FE2	8162 - 8163	VAR-hours, Total, Meter 5	SINT32	0 to 99999999	VARh per energy format	2	
1FE3 - 1FE4	8164 - 8165	VAR-hours, Total, Meter 6	SINT32	0 to 99999999	VARh per energy format	2	

Modbus Address		Description	Format	Range	Units or Resolution	Comments	# Reg
Hex	Decimal						
1FE5 - 1FE6	8166 - 8167	VA-hours, Meter 4	SINT32	0 to 99999999	VAh per energy format	(Cont'd)	2
1FE7 - 1FE8	8168 - 8169	VA-hours, Meter 5	SINT32	0 to 99999999	VAh per energy format		2
1FE9 - 1FEA	8170 - 8171	VA-hours, Meter 6	SINT32	0 to 99999999	VAh per energy format		2
Block Size:							72
2007 - 2008	8200 - 8201	Reserved				* Wh received & delivered always have opposite signs	2
2009 - 200A	8202 - 8203	Reserved					2
200B - 200C	8204 - 8205	Reserved				* Wh received is positive for "view as load", delivered is positive for "view as generator"	2
200D - 200E	8206 - 8207	Reserved					2
200F - 2010	8208 - 8209	Reserved					2
2011 - 2012	8210 - 8211	Reserved					2
2013 - 2014	8212 - 8213	Reserved				* 5 to 8 digits	2
2015 - 2016	8214 - 8215	Reserved					2
2017 - 2018	8216 - 8217	Reserved				* decimal point implied, per energy format	2
2019 - 201A	8218 - 8219	W-hours, Received, Meter 7	SINT32	0 to 99999999 or 0 to - 99999999	Wh per energy format		* resolution of digit before decimal point = units, kilo, or mega, per energy format
201B - 201C	8220 - 8221	W-hours, Received, Meter 8	SINT32	0 to 99999999 or 0 to - 99999999	Wh per energy format	* see note 10	2
201D - 201E	8222 - 8223	W-hours, Received, Meter 9	SINT32	0 to 99999999 or 0 to - 99999999	Wh per energy format		2
201F - 2020	8224 - 8225	W-hours, Delivered, Meter 7	SINT32	0 to 99999999 or 0 to - 99999999	Wh per energy format		2
2021 - 2022	8226 - 8227	W-hours, Delivered, Meter 8	SINT32	0 to 99999999 or 0 to - 99999999	Wh per energy format		2

Modbus Address		Description	Format	Range	Units or Resolution	Comments	# Reg
Hex	Decimal						
2023 - 2024	8228 - 8229	W-hours, Delivered, Meter 9	SINT32	0 to 99999999 or 0 to -99999999	Wh per energy format	(Cont'd)	2
2025 - 2026	8230 - 8231	W-hours, Net, Meter 7	SINT32	-99999999 to 99999999	Wh per energy format		2
2027 - 2028	8232 - 8233	W-hours, Net, Meter 8	SINT32	-99999999 to 99999999	Wh per energy format		2
2029 - 202A	8234 - 8235	W-hours, Net, Meter 9	SINT32	-99999999 to 99999999	Wh per energy format		2
202B - 202C	8236 - 8237	W-hours, Total, Meter 7	SINT32	0 to 99999999	Wh per energy format		2
202D - 202E	8238 - 8239	W-hours, Total, Meter 8	SINT32	0 to 99999999	Wh per energy format		2
202F - 2030	8240 - 8241	W-hours, Total, Meter 9	SINT32	0 to 99999999	Wh per energy format		2
2031 - 2032	8242 - 8243	VAR-hours, Positive, Meter 7	SINT32	0 to 99999999	VARh per energy format		2
2033 - 2034	8244 - 8245	VAR-hours, Positive, Meter 8	SINT32	0 to 99999999	VARh per energy format		2
2035 - 2036	8246 - 8247	VAR-hours, Positive, Meter 9	SINT32	0 to 99999999	VARh per energy format		2
2037 - 2038	8248 - 8249	VAR-hours, Negative, Meter 7	SINT32	0 to -99999999	VARh per energy format		2
2039 - 203A	8250 - 8251	VAR-hours, Negative, Meter 8	SINT32	0 to -99999999	VARh per energy format		2
203B - 203C	8252 - 8253	VAR-hours, Negative, Meter 9	SINT32	0 to -99999999	VARh per energy format		2
203D - 203E	8254 - 8255	VAR-hours, Net, Meter 7	SINT32	-99999999 to 99999999	VARh per energy format		2
203F - 2040	8256 - 8257	VAR-hours, Net, Meter 8	SINT32	-99999999 to 99999999	VARh per energy format		2
2041 - 2042	8258 - 8259	VAR-hours, Net, Meter 9	SINT32	-99999999 to 99999999	VARh per energy format		2

Modbus Address		Description	Format	Range	Units or Resolution	Comments	# Reg
Hex	Decimal						
2043 - 2044	8260 - 8261	VAR-hours, Total, Meter 7	SINT32	0 to 99999999	VARh per energy format	(Cont'd)	2
2045 - 2046	8262 - 8263	VAR-hours, Total, Meter 8	SINT32	0 to 99999999	VARh per energy format		2
2047 - 2048	8264 - 8265	VAR-hours, Total, Meter 9	SINT32	0 to 99999999	VARh per energy format		2
2049 - 204A	8266 - 8267	VA-hours, Meter 7	SINT32	0 to 99999999	VAh per energy format		2
204B - 204C	8268 - 8269	VA-hours, Meter 8	SINT32	0 to 99999999	VAh per energy format		2
204D - 204E	8270 - 8271	VA-hours, Meter 9	SINT32	0 to 99999999	VAh per energy format		2
Block Size:							72
206B - 206C	8300 - 8301	Reserved				* Wh received & delivered always have opposite signs	2
206D - 206E	8302 - 8303	Reserved					2
206F - 2070	8304 - 8305	Reserved				* Wh received is positive for "view as load", delivered is positive for "view as generator"	2
2071 - 2072	8306 - 8307	Reserved					2
2073 - 2074	8308 - 8309	Reserved					2
2075 - 2076	8310 - 8311	Reserved					2
2077 - 2078	8312 - 8313	Reserved					2
2079 - 207A	8314 - 8315	Reserved					2
207B - 207C	8316 - 8317	Reserved				* decimal point implied, per energy format	2
207D - 207E	8318 - 8319	W-hours, Received, Meter 10	SINT32	0 to 99999999 or 0 to -99999999	Wh per energy format		2
207F - 2080	8320 - 8321	W-hours, Received, Meter 11	SINT32	0 to 99999999 or 0 to -99999999	Wh per energy format	* resolution of digit before decimal point = units, kilo, or mega, per energy format	2
2081 - 2082	8322 - 8323	W-hours, Received, Meter 12	SINT32	0 to 99999999 or 0 to -99999999	Wh per energy format		2
2083 - 2084	8324 - 8325	W-hours, Delivered, Meter 10	SINT32	0 to 99999999 or 0 to -99999999	Wh per energy format	* see note 10	2

Modbus Address		Description	Format	Range	Units or Resolution	Comments	# Reg
Hex	Decimal						
2085 - 2086	8326 - 8327	W-hours, Delivered, Meter 11	SINT32	0 to 99999999 or 0 to -99999999	Wh per energy format	(Cont'd)	2
2087 - 2088	8328 - 8329	W-hours, Delivered, Meter 12	SINT32	0 to 99999999 or 0 to -99999999	Wh per energy format		2
2089 - 208A	8330 - 8331	W-hours, Net, Meter 10	SINT32	-99999999 to 99999999	Wh per energy format		2
208B - 208C	8332 - 8333	W-hours, Net, Meter 11	SINT32	-99999999 to 99999999	Wh per energy format		2
208D - 208E	8334 - 8335	W-hours, Net, Meter 12	SINT32	-99999999 to 99999999	Wh per energy format		2
208F - 2090	8336 - 8337	W-hours, Total, Meter 10	SINT32	0 to 99999999	Wh per energy format		2
2091 - 2092	8338 - 8339	W-hours, Total, Meter 11	SINT32	0 to 99999999	Wh per energy format		2
2093 - 2094	8340 - 8341	W-hours, Total, Meter 12	SINT32	0 to 99999999	Wh per energy format		2
2095 - 2096	8342 - 8343	VAR-hours, Positive, Meter 10	SINT32	0 to 99999999	VARh per energy format		2
2097 - 2098	8344 - 8345	VAR-hours, Positive, Meter 11	SINT32	0 to 99999999	VARh per energy format		2
2099 - 209A	8346 - 8347	VAR-hours, Positive, Meter 12	SINT32	0 to 99999999	VARh per energy format		2
209B - 209C	8348 - 8349	VAR-hours, Negative, Meter 10	SINT32	0 to -99999999	VARh per energy format		2
209D - 209E	8350 - 8351	VAR-hours, Negative, Meter 11	SINT32	0 to -99999999	VARh per energy format		2
209F - 20A0	8352 - 8353	VAR-hours, Negative, Meter 12	SINT32	0 to -99999999	VARh per energy format		2
20A1 - 20A2	8354 - 8355	VAR-hours, Net, Meter 10	SINT32	-99999999 to 99999999	VARh per energy format		2

Modbus Address		Description	Format	Range	Units or Resolution	Comments	# Reg
Hex	Decimal						
20A3 - 20A4	8356 - 8357	VAR-hours, Net, Meter 11	SINT32	-99999999 to 99999999	VARh per energy format	(Cont'd)	2
20A5 - 20A6	8358 - 8359	VAR-hours, Net, Meter 12	SINT32	-99999999 to 99999999	VARh per energy format		2
20A7 - 20A8	8360 - 8361	VAR-hours, Total, Meter 10	SINT32	0 to 99999999	VARh per energy format		2
20A9 - 20AA	8362 - 8363	VAR-hours, Total, Meter 11	SINT32	0 to 99999999	VARh per energy format		2
20AB - 20AC	8364 - 8365	VAR-hours, Total, Meter 12	SINT32	0 to 99999999	VARh per energy format		2
20AD - 20AE	8366 - 8367	VA-hours, Meter 10	SINT32	0 to 99999999	VAh per energy format		2
20AF - 20B0	8368 - 8369	VA-hours, Meter 11	SINT32	0 to 99999999	VAh per energy format		2
20B1 - 20B2	8370 - 8371	VA-hours, Meter 12	SINT32	0 to 99999999	VAh per energy format		2
Block Size:							72
20CF - 20D0	8400 - 8401	Reserved				* Wh received & delivered always have opposite signs	2
20D1 - 20D2	8402 - 8403	Reserved					2
20D3 - 20D4	8404 - 8405	Reserved				* Wh received is positive for "view as load", delivered is positive for "view as generator"	2
20D5 - 20D6	8406 - 8407	Reserved					2
20D7 - 20D8	8408 - 8409	Reserved				* 5 to 8 digits	2
20D9 - 20DA	8410 - 8411	Reserved					2
20DB - 20DC	8412 - 8413	Reserved				* decimal point implied, per energy format	2
20DD - 20DE	8414 - 8415	Reserved					2
20DF - 20E0	8416 - 8417	Reserved				* resolution of digit before decimal point = units, kilo, or mega, per energy format	2
20E1 - 20E2	8418 - 8419	W-hours, Received, Meter 13	SINT32	0 to 99999999 or 0 to -99999999	Wh per energy format		2
20E3 - 20E4	8420 - 8421	W-hours, Received, Meter 14	SINT32	0 to 99999999 or 0 to -99999999	Wh per energy format	* see note 10	2

Modbus Address		Description	Format	Range	Units or Resolution	Comments	# Reg
Hex	Decimal						
20E5 - 20E6	8422 - 8423	W-hours, Received, Meter 15	SINT32	0 to 99999999 or 0 to -99999999	Wh per energy format	(Cont'd)	2
20E7 - 20E8	8424 - 8425	W-hours, Delivered, Meter 13	SINT32	0 to 99999999 or 0 to -99999999	Wh per energy format		2
20E9 - 20EA	8426 - 8427	W-hours, Delivered, Meter 14	SINT32	0 to 99999999 or 0 to -99999999	Wh per energy format		2
20EB - 20EC	8428 - 8429	W-hours, Delivered, Meter 15	SINT32	0 to 99999999 or 0 to -99999999	Wh per energy format		2
20ED - 20EE	8430 - 8431	W-hours, Net, Meter 13	SINT32	-99999999 to 99999999	Wh per energy format		2
20EF - 20F0	8432 - 8433	W-hours, Net, Meter 14	SINT32	-99999999 to 99999999	Wh per energy format		2
20F1 - 20F2	8434 - 8435	W-hours, Net, Meter 15	SINT32	-99999999 to 99999999	Wh per energy format		2
20F3 - 20F4	8436 - 8437	W-hours, Total, Meter 13	SINT32	0 to 99999999	Wh per energy format		2
20F5 - 20F6	8438 - 8439	W-hours, Total, Meter 14	SINT32	0 to 99999999	Wh per energy format		2
20F7 - 20F8	8440 - 8441	W-hours, Total, Meter 15	SINT32	0 to 99999999	Wh per energy format		2
20F9 - 20FA	8442 - 8443	VAR-hours, Positive, Meter 13	SINT32	0 to 99999999	VARh per energy format		2
20FB - 20FC	8444 - 8445	VAR-hours, Positive, Meter 14	SINT32	0 to 99999999	VARh per energy format		2

Modbus Address		Description	Format	Range	Units or Resolution	Comments	# Reg
Hex	Decimal						
20FD - 20FE	8446 - 8447	VAR-hours, Positive, Meter 15	SINT32	0 to 99999999	VARh per energy format	----- (Cont'd)	2
20FF - 2100	8448 - 8449	VAR-hours, Negative, Meter 13	SINT32	0 to -99999999	VARh per energy format		2
2101 - 2102	8450 - 8451	VAR-hours, Negative, Meter 14	SINT32	0 to -99999999	VARh per energy format		2
2103 - 2104	8452 - 8453	VAR-hours, Negative, Meter 15	SINT32	0 to -99999999	VARh per energy format		2
2105 - 2106	8454 - 8455	VAR-hours, Net, Meter 13	SINT32	-99999999 to 99999999	VARh per energy format		2
2107 - 2108	8456 - 8457	VAR-hours, Net, Meter 14	SINT32	-99999999 to 99999999	VARh per energy format		2
2109 - 210A	8458 - 8459	VAR-hours, Net, Meter 15	SINT32	-99999999 to 99999999	VARh per energy format		2
210B - 210C	8460 - 8461	VAR-hours, Total, Meter 13	SINT32	0 to 99999999	VARh per energy format		2
210D - 210E	8462 - 8463	VAR-hours, Total, Meter 14	SINT32	0 to 99999999	VARh per energy format		2
210F - 2110	8464 - 8465	VAR-hours, Total, Meter 15	SINT32	0 to 99999999	VARh per energy format		2
2111 - 2112	8466 - 8467	VA-hours, Meter 13	SINT32	0 to 99999999	VAh per energy format		2
2113 - 2114	8468 - 8469	VA-hours, Meter 14	SINT32	0 to 99999999	VAh per energy format		2
2115 - 2116	8470 - 8471	VA-hours, Meter 15	SINT32	0 to 99999999	VAh per energy format		2
							Block Size:

Modbus Address		Description	Format	Range	Units or Resolution	Comments	# Reg
Hex	Decimal						
2133 - 2134	8500 - 8501	Reserved				* Wh received & delivered always have opposite signs	2
2135 - 2136	8502 - 8503	Reserved					2
2137 - 2138	8504 - 8505	Reserved					2
2139 - 213A	8506 - 8507	Reserved				* Wh received is positive for "view as load", delivered is positive for "view as generator"	2
213B - 213C	8508 - 8509	Reserved					2
213D - 213E	8510 - 8511	Reserved					2
213F - 2140	8512 - 8513	Reserved					2
2141 - 2142	8514 - 8515	Reserved				* 5 to 8 digits	2
2143 - 2144	8516 - 8517	Reserved					2
2145 - 2146	8518 - 8519	W-hours, Received, Meter 16	SINT32	0 to 99999999 or 0 to -99999999	Wh per energy format	* decimal point implied, per energy format * resolution of digit before decimal point = units, kilo, or mega, per energy format	2
2147 - 2148	8520 - 8521	W-hours, Received, Meter 17	SINT32	0 to 99999999 or 0 to -99999999	Wh per energy format	* see note 10	2
2149 - 214A	8522 - 8523	W-hours, Received, Meter 18	SINT32	0 to 99999999 or 0 to -99999999	Wh per energy format		2
214B - 214C	8524 - 8525	W-hours, Delivered, Meter 16	SINT32	0 to 99999999 or 0 to -99999999	Wh per energy format		2
214D - 214E	8526 - 8527	W-hours, Delivered, Meter 17	SINT32	0 to 99999999 or 0 to -99999999	Wh per energy format		2
214F - 2150	8528 - 8529	W-hours, Delivered, Meter 18	SINT32	0 to 99999999 or 0 to -99999999	Wh per energy format		2
2151 - 2152	8530 - 8531	W-hours, Net, Meter 16	SINT32	-99999999 to 99999999	Wh per energy format		2
2153 - 2154	8532 - 8533	W-hours, Net, Meter 17	SINT32	-99999999 to 99999999	Wh per energy format		2

Modbus Address		Description	Format	Range	Units or Resolution	Comments	# Reg
Hex	Decimal						
2155 - 2156	8534 - 8535	W-hours, Net, Meter 18	SINT32	-99999999 to 99999999	Wh per energy format	(Cont'd)	2
2157 - 2158	8536 - 8537	W-hours, Total, Meter 16	SINT32	0 to 99999999	Wh per energy format		2
2159 - 215A	8538 - 8539	W-hours, Total, Meter 17	SINT32	0 to 99999999	Wh per energy format		2
215B - 215C	8540 - 8541	W-hours, Total, Meter 18	SINT32	0 to 99999999	Wh per energy format		2
215D - 215E	8542 - 8543	VAR-hours, Positive, Meter 16	SINT32	0 to 99999999	VARh per energy format		2
215F - 2160	8544 - 8545	VAR-hours, Positive, Meter 17	SINT32	0 to 99999999	VARh per energy format		2
2161 - 2162	8546 - 8547	VAR-hours, Positive, Meter 18	SINT32	0 to 99999999	VARh per energy format		2
2163 - 2164	8548 - 8549	VAR-hours, Negative, Meter 16	SINT32	0 to -99999999	VARh per energy format		2
2165 - 2166	8550 - 8551	VAR-hours, Negative, Meter 17	SINT32	0 to -99999999	VARh per energy format		2
2167 - 2168	8552 - 8553	VAR-hours, Negative, Meter 18	SINT32	0 to -99999999	VARh per energy format		2
2169 - 216A	8554 - 8555	VAR-hours, Net, Meter 16	SINT32	-99999999 to 99999999	VARh per energy format		2
216B - 216C	8556 - 8557	VAR-hours, Net, Meter 17	SINT32	-99999999 to 99999999	VARh per energy format		2
216D - 216E	8558 - 8559	VAR-hours, Net, Meter 18	SINT32	-99999999 to 99999999	VARh per energy format		2
216F - 2170	8560 - 8561	VAR-hours, Total, Meter 16	SINT32	0 to 99999999	VARh per energy format		2
2171 - 2172	8562 - 8563	VAR-hours, Total, Meter 17	SINT32	0 to 99999999	VARh per energy format		2
2173 - 2174	8564 - 8565	VAR-hours, Total, Meter 18	SINT32	0 to 99999999	VARh per energy format		2
2175 - 2176	8566 - 8567	VA-hours, Meter 16	SINT32	0 to 99999999	VAh per energy format		2
2177 - 2178	8568 - 8569	VA-hours, Meter 17	SINT32	0 to 99999999	VAh per energy format		2

Modbus Address		Description	Format	Range	Units or Resolution	Comments	# Reg
Hex	Decimal						
2179 - 217A	8570 - 8571	VA-hours, Meter 18	SINT32	0 to 99999999	VAh per energy format	(Cont'd)	2
Block Size:							72
2197 - 2198	8600 - 8601	Reserved				* Wh received & delivered always have opposite signs	2
2199 - 219A	8602 - 8603	Reserved					2
219B - 219C	8604 - 8605	Reserved					2
219D - 219E	8606 - 8607	Reserved				* Wh received is positive for "view as load", delivered is positive for "view as generator"	2
219F - 21A0	8608 - 8609	Reserved					2
21A1 - 21A2	8610 - 8611	Reserved					2
21A3 - 21A4	8612 - 8613	Reserved				* 5 to 8 digits	2
21A5 - 21A6	8614 - 8615	Reserved					2
21A7 - 21A8	8616 - 8617	Reserved				* decimal point implied, per energy format	2
21A9 - 21AA	8618 - 8619	W-hours, Received, Meter 19	SINT32	0 to 99999999 or 0 to -99999999	Wh per energy format	* resolution of digit before decimal point = units, kilo, or mega, per energy format	2
21AB - 21AC	8620 - 8621	W-hours, Received, Meter 20	SINT32	0 to 99999999 or 0 to -99999999	Wh per energy format	* see note 10	2
21AD - 21AE	8622 - 8623	W-hours, Received, Meter 21	SINT32	0 to 99999999 or 0 to -99999999	Wh per energy format		2
21AF - 21B0	8624 - 8625	W-hours, Delivered, Meter 19	SINT32	0 to 99999999 or 0 to -99999999	Wh per energy format		2
21B1 - 21B2	8626 - 8627	W-hours, Delivered, Meter 20	SINT32	0 to 99999999 or 0 to -99999999	Wh per energy format		2
21B3 - 21B4	8628 - 8629	W-hours, Delivered, Meter 21	SINT32	0 to 99999999 or 0 to -99999999	Wh per energy format		2

Modbus Address		Description	Format	Range	Units or Resolution	Comments	# Reg
Hex	Decimal						
21B5 - 21B6	8630 - 8631	W-hours, Net, Meter 19	SINT32	-99999999 to 99999999	Wh per energy format	(Cont'd)	2
21B7 - 21B8	8632 - 8633	W-hours, Net, Meter 20	SINT32	-99999999 to 99999999	Wh per energy format		2
21B9 - 21BA	8634 - 8635	W-hours, Net, Meter 21	SINT32	-99999999 to 99999999	Wh per energy format		2
21BB - 21BC	8636 - 8637	W-hours, Total, Meter 19	SINT32	0 to 99999999	Wh per energy format		2
21BD - 21BE	8638 - 8639	W-hours, Total, Meter 20	SINT32	0 to 99999999	Wh per energy format		2
21BF - 21C0	8640 - 8641	W-hours, Total, Meter 21	SINT32	0 to 99999999	Wh per energy format		2
21C1 - 21C2	8642 - 8643	VAR-hours, Positive, Meter 19	SINT32	0 to 99999999	VARh per energy format		2
21C3 - 21C4	8644 - 8645	VAR-hours, Positive, Meter 20	SINT32	0 to 99999999	VARh per energy format		2
21C5 - 21C6	8646 - 8647	VAR-hours, Positive, Meter 21	SINT32	0 to 99999999	VARh per energy format		2
21C7 - 21C8	8648 - 8649	VAR-hours, Negative, Meter 19	SINT32	0 to -99999999	VARh per energy format		2
21C9 - 21CA	8650 - 8651	VAR-hours, Negative, Meter 20	SINT32	0 to -99999999	VARh per energy format		2
21CB - 21CC	8652 - 8653	VAR-hours, Negative, Meter 21	SINT32	0 to -99999999	VARh per energy format		2
21CD - 21CE	8654 - 8655	VAR-hours, Net, Meter 19	SINT32	-99999999 to 99999999	VARh per energy format		2
21CF - 21D0	8656 - 8657	VAR-hours, Net, Meter 20	SINT32	-99999999 to 99999999	VARh per energy format		2
21D1 - 21D2	8658 - 8659	VAR-hours, Net, Meter 21	SINT32	-99999999 to 99999999	VARh per energy format		2
21D3 - 21D4	8660 - 8661	VAR-hours, Total, Meter 19	SINT32	0 to 99999999	VARh per energy format		2
21D5 - 21D6	8662 - 8663	VAR-hours, Total, Meter 20	SINT32	0 to 99999999	VARh per energy format	2	
21D7 - 21D8	8664 - 8665	VAR-hours, Total, Meter 21	SINT32	0 to 99999999	VARh per energy format	2	

Modbus Address		Description	Format	Range	Units or Resolution	Comments	# Reg
Hex	Decimal						
21D9 - 21DA	8666 - 8667	VA-hours, Meter 19	SINT32	0 to 99999999	VAh per energy format	(Cont'd)	2
21DB - 21DC	8668 - 8669	VA-hours, Meter 20	SINT32	0 to 99999999	VAh per energy format		2
21DD - 21DE	8670 - 8671	VA-hours, Meter 21	SINT32	0 to 99999999	VAh per energy format		2
						Block Size:	72
21FB - 21FC	8700 - 8701	Reserved				* Wh received & delivered always have opposite signs	2
21FD - 21FE	8702 - 8703	Reserved					2
21FF - 2200	8704 - 8705	Reserved				* Wh received is positive for "view as load", delivered is positive for "view as generator"	2
2201 - 2202	8706 - 8707	Reserved					2
2203 - 2204	8708 - 8709	Reserved					2
2205 - 2206	8710 - 8711	Reserved					2
2207 - 2208	8712 - 8713	Reserved					2
2209 - 220A	8714 - 8715	Reserved					2
220B - 220C	8716 - 8717	Reserved					2
220D - 220E	8718 - 8719	W-hours, Received, Meter 22	SINT32	0 to 99999999 or 0 to -99999999	Wh per energy format		* decimal point implied, per energy format * resolution of digit before decimal point = units, kilo, or mega, per energy format
220F - 2210	8720 - 8721	W-hours, Received, Meter 23	SINT32	0 to 99999999 or 0 to -99999999	Wh per energy format	* see note 10	2
2211 - 2212	8722 - 8723	W-hours, Received, Meter 24	SINT32	0 to 99999999 or 0 to -99999999	Wh per energy format		2
2213 - 2214	8724 - 8725	W-hours, Delivered, Meter 22	SINT32	0 to 99999999 or 0 to -99999999	Wh per energy format		2
2215 - 2216	8726 - 8727	W-hours, Delivered, Meter 23	SINT32	0 to 99999999 or 0 to -99999999	Wh per energy format		2

Modbus Address		Description	Format	Range	Units or Resolution	Comments	# Reg
Hex	Decimal						
2217 - 2218	8728 - 8729	W-hours, Delivered, Meter 24	SINT32	0 to 99999999 or 0 to -99999999	Wh per energy format	(Cont'd)	2
2219 - 221A	8730 - 8731	W-hours, Net, Meter 22	SINT32	-99999999 to 99999999	Wh per energy format		2
221B - 221C	8732 - 8733	W-hours, Net, Meter 23	SINT32	-99999999 to 99999999	Wh per energy format		2
221D - 221E	8734 - 8735	W-hours, Net, Meter 24	SINT32	-99999999 to 99999999	Wh per energy format		2
221F - 2220	8736 - 8737	W-hours, Total, Meter 22	SINT32	0 to 99999999	Wh per energy format		2
2221 - 2222	8738 - 8739	W-hours, Total, Meter 23	SINT32	0 to 99999999	Wh per energy format		2
2223 - 2224	8740 - 8741	W-hours, Total, Meter 24	SINT32	0 to 99999999	Wh per energy format		2
2225 - 2226	8742 - 8743	VAR-hours, Positive, Meter 22	SINT32	0 to 99999999	VARh per energy format		2
2227 - 2228	8744 - 8745	VAR-hours, Positive, Meter 23	SINT32	0 to 99999999	VARh per energy format		2
2229 - 222A	8746 - 8747	VAR-hours, Positive, Meter 24	SINT32	0 to 99999999	VARh per energy format		2
222B - 222C	8748 - 8749	VAR-hours, Negative, Meter 22	SINT32	0 to -99999999	VARh per energy format		2
222D - 222E	8750 - 8751	VAR-hours, Negative, Meter 23	SINT32	0 to -99999999	VARh per energy format		2
222F - 2230	8752 - 8753	VAR-hours, Negative, Meter 24	SINT32	0 to -99999999	VARh per energy format		2
2231 - 2232	8754 - 8755	VAR-hours, Net, Meter 22	SINT32	-99999999 to 99999999	VARh per energy format		2
2233 - 2234	8756 - 8757	VAR-hours, Net, Meter 23	SINT32	-99999999 to 99999999	VARh per energy format		2
2235 - 2236	8758 - 8759	VAR-hours, Net, Meter 24	SINT32	-99999999 to 99999999	VARh per energy format		2
2237 - 2238	8760 - 8761	VAR-hours, Total, Meter 22	SINT32	0 to 99999999	VARh per energy format		2
2239 - 223A	8762 - 8763	VAR-hours, Total, Meter 23	SINT32	0 to 99999999	VARh per energy format		2

Modbus Address		Description	Format	Range	Units or Resolution	Comments	# Reg
Hex	Decimal						
223B - 223C	8764 - 8765	VAR-hours, Total, Meter 24	SINT32	0 to 99999999	VARh per energy format	(Cont'd)	2
223D - 223E	8766 - 8767	VA-hours, Meter 22	SINT32	0 to 99999999	VAh per energy format		2
223F - 2240	8768 - 8769	VA-hours, Meter 23	SINT32	0 to 99999999	VAh per energy format		2
2241 - 2242	8770 - 8771	VA-hours, Meter 24	SINT32	0 to 99999999	VAh per energy format		2
Card Identification and Configuration Block (Note 13) (IO Interface Board)							
						read-only	
270F - 270F	10000 - 10000	EEPROM version and Board ID	UINT16	bit-mapped	eeeeeeee cccccccc	eeeeeeee: eeprom version ccccccc: Board id	1
2710 - 2710	10001 - 10001	Board Revision	UINT16	bit-mapped	bbbbbbb -----	bbbbbbb : board revision	1
2711 - 2718	10002 - 10009	Board number	ASCII	16 char	none	ASCII name of the installed card	8
2719 - 2720	10010 - 10017	Serial number	ASCII	16 char	none	Serial Number in ASCII of the installed card	8
2721 - 2722	10018 - 10019	Test info and operator	UINT16	bit-mapped	sscc---- 00000000	sscc---- where ss- Test status bits - 00 : Reserved - 01 : Test Failed - 10 : Test Passed - 11 : Test not performed cc - Calibration status bits - 00 : No calibration needed - 01 : Calibration Failed - 10 : Calibration Passed - 11 : Calibration not performed 00000000: operator id	2
2723 - 2746	10020 - 10055	timestamp	UINT16	bit-mapped	yyyyyyymmmdddd	yyyyyy - year mmmm - month dddd - day	36
2747 - 2748	10056 - 10057	Reserved				Reserved	2
2749 - 274A	10058 - 10059	Reserved				Reserved	2
274B - 290E	10060 - 10511	Reserved				Reserved	452
Block Size:							512

Modbus Address		Description	Format	Range	Units or Resolution	Comments	# Reg	
Hex	Decimal							
Card Identification and Configuration Block (Note 13) (Relay/Digital IO Card)							read-only	
2AF7 - 2AF7	11000 - 11000	EEPROM version and Board ID	UINT16	bit-mapped	eeeeeeee cccccccc	eeeeeeee: eeprom version ccccccc: Board id	1	
2AF8 - 2AF8	11001 - 11001	Board Revision	UINT16	bit-mapped	bbbbbbbb -----	bbbbbbbb : board revision	1	
2AF9 - 2B00	11002 - 11009	Board number	ASCII	16 char	none	ASCII name of the installed card	8	
2B01 - 2B08	11010 - 11017	Serial number	ASCII	16 char	none	Serial Number in ASCII of the installed card	8	
2B09 - 2B09	11018 - 11018	Test info and operator	UINT16	bit-mapped	none	sscc---- where ss- Test status bits - 00 : Reserved - 01 : Test Failed - 10 : Test Passed - 11 : Test not performed cc - Calibration status bits - 00 : No calibration needed - 01 : Calibration Failed - 10 : Calibration Passed - 11 : Calibration not performed oooooooo: operator id	1	
2B0A - 2B0A	11019 - 11019	timestamp	UINT16	bit-mapped	yyyyyyymmmdddd	yyyyyy - year mmmm - month dddd - day	1	
2B0B - 2B16	11020 - 11031	Reserved				Reserved	12	
2B17 - 2B17	11032 - 11032	Digital input descriptor				Reserved	1	
2B18 - 2B18	11033 - 11033	Digital output descriptor				Reserved	1	
2B19 - 2B19	11034 - 11034	Digital output latency					1	
2B1A - 2B35	11035 - 11062	Reserved					28	
2B36 - 2B36	11063 - 11063	GRC					1	
							Block Size:	64
Data and Control Block -- Digital I/O Relay Card Overlay (Note 14)							read-only except as indicated	
2B3F - 2B3F	11072 - 11072	Digital Input States	UINT16	bit-mapped	44443333 22221111	Two nibble fields: (2222) for input#2 and (1111) for input #1. Lsb in each nibble is the current state of the input. Msb in each nibble is the oldest registered state.	1	

Modbus Address		Description	Format	Range	Units or Resolution	Comments	# Reg
Hex	Decimal						
2B40 - 2B40	11073 - 11073	Digital Relay States	UINT16	bit-mapped	----- --ab--cd	If "a" is 1 then state of Relay#2 is unknown, otherwise state of Relay#2 is in "c": (1=tripped, 0=released). If "b" is 1 then state of Relay#1 is unknown, otherwise state of Relay#1 is in "d": (1=tripped, 0=released).	1
2B41 - 2B41	11074 - 11074	Turn relay on	UINT16	bit-mapped	----- -----21	Writing a 1 in bit N turns relay N+1 ON (this register is writeable only in privileged session)	1
2B42 - 2B42	11075 - 11075	Turn relay off	UINT16	bit-mapped	----- -----21	Writing a 1 in bit N turns relay N+1 OFF (this register is writeable only in privileged session)	1
2B43 - 2B43	11076 - 11076	Trip/Release delay timer for Relay 1	UINT16	0 to 9999	0.1 sec	time to trip or release	1
2B44 - 2B44	11077 - 11077	Trip/Release delay timer for Relay 2	UINT16	0 to 9999	0.1 sec	time to trip or release	1
2B45 - 2B46	11078 - 11079	Reserved				Reserved	2
2B47 - 2B47	11080 - 11080	Input 1 Accumulator, Scaled	UINT16	0 to 9999	resolution is 1, 10, 100, 1000, 10000, or 100000 counts	Disabled accumulators always read 0.	1
2B48 - 2B48	11081 - 11081	Input 2 Accumulator, Scaled	UINT16	0 to 9999			1
2B49 - 2B49	11082 - 11082	Input 3 Accumulator, Scaled	UINT16	0 to 9999			2
2B4A - 2B4A	11083 - 11083	Input 4 Accumulator, Scaled	UINT16	0 to 9999			
2B4B - 2B4B	11084 - 11084	Relay 1 Accumulator, Scaled	UINT16	0 to 9999	resolution is 1, 10, 100, 1000, 10000, or 100000 counts	Disabled accumulators always read 0.	1
2B4C - 2B4C	11085 - 11085	Relay 2 Accumulator, Scaled	UINT16	0 to 9999			1
2B4D - 2B78	11086 - 11129	Reserved				Reserved	44
						Block Size:	58
Accumulators Block						read-only	
2EDF - 2EE0	12000 - 12001	Option Card , Input 1 Accumulator	UINT32	0 to 999999999	number of transitions		2
2EE1 - 2EE6	12002 - 12007	Option Card , Inputs 2-4 Accumulators	UINT32	0 to 999999999	number of transitions		6
2EE7 - 2EE8	12008 - 12009	Option Card , Output or Relay 1 Accumulator	UINT32	0 to 999999999	number of transitions		2
2EE9 - 2EEA	12010 - 12011	Option Card , Output or Relay 2 Accumulator	UINT32	0 to 999999999	number of transitions		6
						Block Size:	16

Modbus Address		Description	Format	Range	Units or Resolution	Comments	# Reg
Hex	Decimal						
Commands Section (Note 4)							
Resets Block (Note 9)						write-only	
4E1F - 4E1F	20000 - 20000	Reset Max/Min Blocks	UINT16	password (Note 5)			1
4E20 - 4E20	20001 - 20001	Reset Energy Accumulators	UINT16	password (Note 5)			1
4E21 - 4E21	20002 - 20002	System Event log (note 18)	UINT16	password (Note 5)		Reply to a reset log command indicates that the command was accepted but not necessarily that the reset is finished. Poll log status block to determine this.	1
4E22 - 4E22	20003 - 20003	Reset Historical Log 1 (note 18)	UINT16	password (Note 5)			1
4E23 - 4E23	20004 - 20004	Reset Historical Log 2 (note 18)	UINT16	password (Note 5)			1
4E24 - 4E24	20005 - 20005	Reset Historical Log 3 (note 18)	UINT16	password (Note 5)			1
4E25 - 4E25	20006 - 20006	Reset Alarm Log (note 18)	UINT16	password (Note 5)			1
4E26 - 4E26	20007 - 20007	Reset IO Log (note 18)	UINT16	password (Note 5)			1
4E27 - 4E27	20008 - 20008	Reset Option Card Input Accumulators	UINT16	password (Note 5)			1
4E28 - 4E28	20009 - 20009	Reset Option Card Output Accumulators	UINT16	password (Note 5)		1	
4E29 - 4E29	20010 - 20010	Reset voltage/Frequency	UINT16	password (Note 5)		1	
4E2A - 4E39	20011 - 20026	Reserved					16
4E3A - 4E3A	20027 - 20027	Reset Max/Min block Meter 1	UINT16	password (Note 5)			1
4E3B - 4E3B	20028 - 20028	Reset Max/Min block Meter 2	UINT16	password (Note 5)			1
4E3C - 4E3C	20029 - 20029	Reset Max/Min block Meter 3	UINT16	password (Note 5)			1
4E3D - 4E3D	20030 - 20030	Reset Max/Min block Meter 4	UINT16	password (Note 5)			1
4E3E - 4E3E	20031 - 20031	Reset Max/Min block Meter 5	UINT16	password (Note 5)			1
4E3F - 4E3F	20032 - 20032	Reset Max/Min block Meter 6	UINT16	password (Note 5)			1
4E40 - 4E40	20033 - 20033	Reset Max/Min block Meter 7	UINT16	password (Note 5)			1
4E41 - 4E41	20034 - 20034	Reset Max/Min block Meter 8	UINT16	password (Note 5)			1
4E42 - 4E42	20035 - 20035	Reset Max/Min block Meter 9	UINT16	password (Note 5)			1

Modbus Address		Description	Format	Range	Units or Resolution	Comments	# Reg
Hex	Decimal						
4E43 - 4E43	20036 - 20036	Reset Max/Min block Meter 10	UINT16	password (Note 5)			1
4E44 - 4E44	20037 - 20037	Reset Max/Min block Meter 11	UINT16	password (Note 5)			1
4E45 - 4E45	20038 - 20038	Reset Max/Min block Meter 12	UINT16	password (Note 5)			1
4E46 - 4E46	20039 - 20039	Reset Max/Min block Meter 13	UINT16	password (Note 5)			1
4E47 - 4E47	20040 - 20040	Reset Max/Min block Meter 14	UINT16	password (Note 5)			1
4E48 - 4E48	20041 - 20041	Reset Max/Min block Meter 15	UINT16	password (Note 5)			1
4E49 - 4E49	20042 - 20042	Reset Max/Min block Meter 16	UINT16	password (Note 5)			1
4E4A - 4E4A	20043 - 20043	Reset Max/Min block Meter 17	UINT16	password (Note 5)			1
4E4B - 4E4B	20044 - 20044	Reset Max/Min block Meter 18	UINT16	password (Note 5)			1
4E4C - 4E4C	20045 - 20045	Reset Max/Min block Meter 19	UINT16	password (Note 5)			1
4E4D - 4E4D	20046 - 20046	Reset Max/Min block Meter 20	UINT16	password (Note 5)			1
4E4E - 4E4E	20047 - 20047	Reset Max/Min block Meter 21	UINT16	password (Note 5)			1
4E4F - 4E4F	20048 - 20048	Reset Max/Min block Meter 22	UINT16	password (Note 5)			1
4E50 - 4E50	20049 - 20049	Reset Max/Min block Meter 23	UINT16	password (Note 5)			1
4E51 - 4E51	20050 - 20050	Reset Max/Min block Meter 24	UINT16	password (Note 5)			1
4E52 - 4E52	20051 - 20051	Reset Energy Accumulators Meter 1	UINT16	password (Note 5)			1
4E53 - 4E53	20052 - 20052	Reset Energy Accumulators Meter 2	UINT16	password (Note 5)			1
4E54 - 4E54	20053 - 20053	Reset Energy Accumulators Meter 3	UINT16	password (Note 5)			1
4E55 - 4E55	20054 - 20054	Reset Energy Accumulators Meter 4	UINT16	password (Note 5)			1
4E56 - 4E56	20055 - 20055	Reset Energy Accumulators Meter 5	UINT16	password (Note 5)			1
4E57 - 4E57	20056 - 20056	Reset Energy Accumulators Meter 6	UINT16	password (Note 5)			1

Modbus Address		Description	Format	Range	Units or Resolution	Comments	# Reg
Hex	Decimal						
4E58 - 4E58	20057 - 20057	Reset Energy Accumulators Meter 7	UINT16	password (Note 5)			1
4E59 - 4E59	20058 - 20058	Reset Energy Accumulators Meter 8	UINT16	password (Note 5)			1
4E5A - 4E5A	20059 - 20059	Reset Energy Accumulators Meter 9	UINT16	password (Note 5)			1
4E5B - 4E5B	20060 - 20060	Reset Energy Accumulators Meter 10	UINT16	password (Note 5)			1
4E5C - 4E5C	20061 - 20061	Reset Energy Accumulators Meter 11	UINT16	password (Note 5)			1
4E5D - 4E5D	20062 - 20062	Reset Energy Accumulators Meter 12	UINT16	password (Note 5)			1
4E5E - 4E5E	20063 - 20063	Reset Energy Accumulators Meter 13	UINT16	password (Note 5)			1
4E5F - 4E5F	20064 - 20064	Reset Energy Accumulators Meter 14	UINT16	password (Note 5)			1
4E60 - 4E60	20065 - 20065	Reset Energy Accumulators Meter 15	UINT16	password (Note 5)			1
4E61 - 4E61	20066 - 20066	Reset Energy Accumulators Meter 16	UINT16	password (Note 5)			1
4E62 - 4E62	20067 - 20067	Reset Energy Accumulators Meter 17	UINT16	password (Note 5)			1
4E63 - 4E63	20068 - 20068	Reset Energy Accumulators Meter 18	UINT16	password (Note 5)			1
4E64 - 4E64	20069 - 20069	Reset Energy Accumulators Meter 19	UINT16	password (Note 5)			1
4E65 - 4E65	20070 - 20070	Reset Energy Accumulators Meter 20	UINT16	password (Note 5)			1
4E66 - 4E66	20071 - 20071	Reset Energy Accumulators Meter 21	UINT16	password (Note 5)			1
4E67 - 4E67	20072 - 20072	Reset Energy Accumulators Meter 22	UINT16	password (Note 5)			1
4E68 - 4E68	20073 - 20073	Reset Energy Accumulators Meter 23	UINT16	password (Note 5)			1
4E69 - 4E69	20074 - 20074	Reset Energy Accumulators Meter 24	UINT16	password (Note 5)			1
						Block Size:	75
Priviledged Commands Block						conditional write	
5207 - 5207	21000 - 21000	Initiate CPU Firmware Reprogramming	UINT16	password (Note 5)			1

Modbus Address		Description	Format	Range	Units or Resolution	Comments	# Reg	
Hex	Decimal							
5208 - 5208	21001 - 21001	Force CPU Restart	UINT16	password (Note 5)		causes a watchdog reset, always reads 0	1	
5209 - 5209	21002 - 21002	Open Privileged Command Session	UINT16	password (Note 5)		CPU will process command registers (this register through 'Close Privileged Command Session' register below) for 5 minutes or until the session is closed, whichever comes first.	1	
520A - 520A	21003 - 21003	Initiate Programmable Settings Update	UINT16	password (Note 5)		CPU enters PS update mode	1	
520B - 520B	21004 - 21004	Calculate Programmable Settings Checksum (Note 3)	UINT16	0000 to 9999		CPU calculates checksum on RAM copy of PS block	1	
520C - 520C	21005 - 21005	Programmable Settings Checksum (Note 3)	UINT16	0000 to 9999		read/write checksum register; PS block saved in nonvolatile memory on write (Note 8)	1	
520D - 520D	21006 - 21006	Write New Password (Note 3)	UINT16	0000 to 9999		write-only register; always reads zero	1	
520E - 520E	21007 - 21007	Terminate Programmable Settings Update (Note 3)	UINT16	any value		CPU leaves PS update mode via reset	1	
520F - 5211	21008 - 21010	Set CPU Clock	TSTAMP	1Jan2000 - 31Dec2099	1 sec	saved only when 3rd register is written	3	
5212 - 5212	21011 - 21011	Reserved	UINT16	any value		Reserved	1	
5213 - 5219	21012 - 21018	Reserved				Reserved	7	
521A - 521A	21019 - 21019	Close Privileged Command Session	UINT16	any value		ends an open command session	1	
							Block Size:	20
Encryption Block							read/write	
658F - 659A	26000 - 26011	Perform a Secure Operation	UINT16			encrypted command to read password or change CPU type	12	
							Block Size:	12
Programmable Settings Section								
Basic Setups Block							write only in PS update mode	
752F - 752F	30000 - 30000	CT denominator	UINT16	1 or 5	none		1	
7530 - 7530	30001 - 30001	CT numerator Meter 1	UINT16	1 to 65535	none		1	
7531 - 7531	30002 - 30002	CT numerator Meter 2	UINT16	1 to 65535	none		1	
7532 - 7532	30003 - 30003	CT numerator Meter 3	UINT16	1 to 65535	none		1	
7533 - 7533	30004 - 30004	CT numerator Meter 4	UINT16	1 to 65535	none		1	
7534 - 7534	30005 - 30005	CT numerator Meter 5	UINT16	1 to 65535	none		1	
7535 - 7535	30006 - 30006	CT numerator Meter 6	UINT16	1 to 65535	none		1	

Modbus Address		Description	Format	Range	Units or Resolution	Comments	# Reg		
Hex	Decimal								
7536	7536	30007	30007	CT numerator Meter 7	UINT16	1 to 65535	none		1
7537	7537	30008	30008	CT numerator Meter 8	UINT16	1 to 65535	none		1
7538	7538	30009	30009	CT numerator Meter 9	UINT16	1 to 65535	none		1
7539	7539	30010	30010	CT numerator Meter 10	UINT16	1 to 65535	none		1
753A	753A	30011	30011	CT numerator Meter 11	UINT16	1 to 65535	none		1
753B	753B	30012	30012	CT numerator Meter 12	UINT16	1 to 65535	none		1
753C	753C	30013	30013	CT numerator Meter 13	UINT16	1 to 65535	none		1
753D	753D	30014	30014	CT numerator Meter 14	UINT16	1 to 65535	none		1
753E	753E	30015	30015	CT numerator Meter 15	UINT16	1 to 65535	none		1
753F	753F	30016	30016	CT numerator Meter 16	UINT16	1 to 65535	none		1
7540	7540	30017	30017	CT numerator Meter 17	UINT16	1 to 65535	none		1
7541	7541	30018	30018	CT numerator Meter 18	UINT16	1 to 65535	none		1
7542	7542	30019	30019	CT numerator Meter 19	UINT16	1 to 65535	none		1
7543	7543	30020	30020	CT numerator Meter 20	UINT16	1 to 65535	none		1
7544	7544	30021	30021	CT numerator Meter 21	UINT16	1 to 65535	none		1
7545	7545	30022	30022	CT numerator Meter 22	UINT16	1 to 65535	none		1
7546	7546	30023	30023	CT numerator Meter 23	UINT16	1 to 65535	none		1
7547	7547	30024	30024	CT numerator Meter 24	UINT16	1 to 65535	none		1
7548	7549	30025	30026	PT numerator	UINT32	1 to 4294967295	none		2
754A	754A	30027	30027	PT denominator	UINT16	1 to 65535	none		1
754B	754B	30028	30028	Hookup	UINT16	bit-mapped	----- hhhh	hhhh = hookup enumeration (0 = 3 element wye[9S], 1 = reserved, 3 = reserved,4=Single Phase)	1
754C	754C	30029	30029	Averaging Method	UINT16	bit-mapped	--iiiiii b----sss	iiiiii = interval (5,15,30,60) b = 0-block or 1-rolling sss = # subintervals (1,2,3,4)	1
754D	754D	30030	30030	Power & Energy Format	UINT16	bit-mapped	-----nn -eee-ddd	nn = number of energy digits (5-8 --> 0-3) eee = energy scale (0-unit, 3-kilo, 6-mega) ddd = energy digits after decimal point (0-6) See note 10.	1
754E	754E	30031	30031	Daylight Saving On Rule	UINT16	bit-mapped	hhhhwww -ddmmmm	applies only if daylight savings in User Settings Flags = on; specifies when to	1

Modbus Address		Description	Format	Range	Units or Resolution	Comments	# Reg		
Hex	Decimal								
754F	754F	30032	30032	Daylight Saving Off Rule	UINT16	bit-mapped	hhhhhhww - dddmmmm	make changeover hhhhh = hour, 0-23 www = week, 1-4 for 1st - 4th, 5 for last ddd = day of week, 1-7 for Sun - Sat mmmm = month, 1-12 Example: 2AM on the 4th Sunday of March hhhhh=2, www=4, ddd=1, mmmm=3	1
7550	7550	30033	30033	User Settings Flags	UINT16	bit-mapped	----- urpdywfa	u = Energy direction. (0 = bi directional, 1=unit directional) r = password for reset in use (1=on, 0=off) p = password for configuration in use (1=on, 0=off) d = daylight saving time changes (0=off, 1=on) y = diagnostic events in system log (1=yes, 0=no) w = power direction (0=view as load, 1=view as generator) f = flip power factor sign (1=yes, 0=no) a = apparent power computation method (0=arithmetic sum, 1=vector sum)	1
7551	7558	30034	30041	CPU designation					8
7559	7559	30042	30042	COM1 setup	UINT16	bit-mapped	----dddd -ppp-bbb	dddd = reply delay (* 50 msec) ppp = protocol (1-Modbus RTU, 2-Modbus ASCII)	1
755A	755A	30043	30043	COM2 setup	UINT16	bit-mapped	----dddd -ppp-bbb	bbb = baud rate (1-9600, 2-19200, 4-38400, 6-57600)	1
755B	755B	30044	30044	COM3 setup	UINT16	bit-mapped	----dddd -ppp-bbb		1
755C	755D	30045	30046	Reserved					2
755E	755E	30047	30047	COM1 address	UINT16	1 to 247	none		1
755F	755F	30048	30048	COM2 address	UINT16	1 to 247	none		1
7560	7560	30049	30049	COM3 address	UINT16	1 to 247	none		1
7561	7578	30050	30073	Reserved	UINT16			Reserved	24
7579	7579	30074	30074	Programmable Settings Update Counter	UINT16	0-65535		Increments each time programmable settings are changed; occurs when new checksum is calculated.	1
757A	75B9	30075	30138	Reserved for Software Use				Reserved	64
75BA	75BA	30139	30139	Limit #1 Identifier	UINT16	0 to 65535		use Modbus address as the identifier (see notes 7, 11, 12)	1
75BB	75BB	30140	30140	Limit #1 Out High Setpoint	SINT16	-200.0 to +200.0	0.1% of full scale	Setpoint for the "above" limit (LM1), see notes 11-12.	1

Modbus Address		Description	Format	Range	Units or Resolution	Comments	# Reg
Hex	Decimal						
75BC - 75BC	30141 - 30141	Limit #1 In High Threshold	SINT16	-200.0 to +200.0	0.1% of full scale	Threshold at which "above" limit clears; normally less than or equal to the "above" setpoint; see notes 11-12.	1
75BD - 75BD	30142 - 30142	Limit #1 Out Low Setpoint	SINT16	-200.0 to +200.0	0.1% of full scale	Setpoint for the "below" limit (LM2), see notes 11-12.	1
75BE - 75BE	30143 - 30143	Limit #1 In Low Threshold	SINT16	-200.0 to +200.0	0.1% of full scale	Threshold at which "below" limit clears; normally greater than or equal to the "below" setpoint; see notes 11-12.	1
75BF - 75C3	30144 - 30148	Limit #2	SINT16	same as Limit #1	same as Limit #1	same as Limit #1	5
75C4 - 75C8	30149 - 30153	Limit #3	SINT16				5
75C9 - 75CD	30154 - 30158	Limit #4	SINT16				5
75CE - 75D2	30159 - 30163	Limit #5	SINT16				5
75D3 - 75D7	30164 - 30168	Limit #6	SINT16				5
75D8 - 75DC	30169 - 30173	Limit #7	SINT16				5
75DD - 75E1	30174 - 30178	Limit #8	SINT16				5
75E2 - 75E9	30179 - 30186	Meter 1 Designation	ASCII				16 char
75EA - 75F1	30187 - 30194	Meter 2 Designation	ASCII	16 char	none	8	
75F2 - 75F9	30195 - 30202	Meter 3 Designation	ASCII	16 char	none	8	
75FA - 7601	30203 - 30210	Meter 4 Designation	ASCII	16 char	none	8	
7602 - 7609	30211 - 30218	Meter 5 Designation	ASCII	16 char	none	8	
760A - 7611	30219 - 30226	Meter 6 Designation	ASCII	16 char	none	8	
7612 - 7619	30227 - 30234	Meter 7 Designation	ASCII	16 char	none	8	
761A - 7621	30235 - 30242	Meter 8 Designation	ASCII	16 char	none	8	
7622 - 7629	30243 - 30250	Meter 9 Designation	ASCII	16 char	none	8	
762A - 7631	30251 - 30258	Meter 10 Designation	ASCII	16 char	none	8	
7632 - 7639	30259 - 30266	Meter 11 Designation	ASCII	16 char	none	8	
763A - 7641	30267 - 30274	Meter 12 Designation	ASCII	16 char	none	8	
7642 - 7649	30275 - 30282	Meter 13 Designation	ASCII	16 char	none	8	
764A - 7651	30283 - 30290	Meter 14 Designation	ASCII	16 char	none	8	
7652 - 7659	30291 - 30298	Meter 15 Designation	ASCII	16 char	none	8	
765A - 7661	30299 - 30306	Meter 16 Designation	ASCII	16 char	none	8	
7662 - 7669	30307 - 30314	Meter 17 Designation	ASCII	16 char	none	8	
766A - 7671	30315 - 30322	Meter 18 Designation	ASCII	16 char	none	8	
7672 - 7679	30323 - 30330	Meter 19 Designation	ASCII	16 char	none	8	
767A - 7681	30331 - 30338	Meter 20 Designation	ASCII	16 char	none	8	
7682 - 7689	30339 - 30346	Meter 21 Designation	ASCII	16 char	none	8	
768A - 7691	30347 - 30354	Meter 22 Designation	ASCII	16 char	none	8	

Modbus Address				Description	Format	Range	Units or Resolution	Comments	# Reg
Hex	Decimal								
7692	7699	30355	30362	Meter 23 Designation	ASCII	16 char	none		8
769A	76A1	30363	30370	Meter 24 Designation	ASCII	16 char	none		8
								Block Size:	371
Log Setups Block								write only in PS update mode	
7917	7917	31000	31000	Historical Log #1 Sizes	UINT16	bit-mapped	eeeeeeee ssssssss	high byte is number of registers to log in each record (0-117), low byte is number of flash sectors for the log (see note 17) 0 in either byte disables the log	1
7918	7918	31001	31001	Historical Log #1 Interval	UINT16	bit-mapped	00000000 hgfedcba	only 1 bit set: a=1 min, b=3 min, c=5 min, d=10 min, e=15 min, f=30 min, g=60 min, h=EOI pulse	1
7919	7919	31002	31002	Historical Log #1, Register #1 Identifier	UINT16	0 to 65535		use Modbus address as the identifier (see note 7)	1
791A	798D	31003	31118	Historical Log #1, Register #2 - #117 Identifiers	UINT16	0 to 65535		same as Register #1 Identifier	116
798E	79D6	31119	31191	Historical Log #1 Software Buffer				Reserved for software use.	73
79D7	7A96	31192	31383	Historical Log #2 Sizes, Interval, Registers & Software Buffer			same as Historical Log #1		192
7A97	7B56	31384	31575	Historical Log #3 Sizes, Interval, Registers & Software Buffer			same as Historical Log #1		192
7B57	7B75	31576	31606	Reserved				Reserved	31
								Block Size:	608

Modbus Address		Description	Format	Range	Units or Resolution	Comments	# Reg
Hex	Decimal						
Settings Registers for Digital I/O Relay Card					First Overlay	write only in PS update mode	
7D00 - 7D00	32001 - 32001	Input#1 - 4 bindings & logging enables	UINT16	bit-mapped	44443333 22221111	One nibble for each input. Assuming "abcc" as the bits in each nibble: "a": select this input for EOI (End Of Interval)pulse sensing. "b": log this input when pulse is detected "cc": Input event trigger mode - Contact sensing method; 00 = none; 01 = open to close; 10 = close to open; 11 = any change. Every input has an associated internal accumulator (See input Accumulator Scaling), which is incremented every time the input changes according with the trigger mode criteria "cc"	1
7D01 - 7D01	32002 - 32002	Relay #1 Delay to Operate	UINT16	0.1 second units		Delay to operate the relay since request.	1
7D02 - 7D02	32003 - 32003	Relay #1 Delay to Release	UINT16	0.1 second units		Delay to release the relay since request.	1
7D03 - 7D08	32004 - 32009	Reserved	UINT16			Set to 0.	6
7D09 - 7D09	32010 - 32010	Relay #2 Delay to Operate	UINT16	0.1 second units		Delay to operate the relay since request.	1
7D0A - 7D0A	32011 - 32011	Relay #2 Delay to Release	UINT16	0.1 second units		Delay to release the relay since request.	1
7D0B - 7D20	32012 - 32033	Reserved	UINT16			Set to 0.	22

Modbus Address		Description	Format	Range	Units or Resolution	Comments	# Reg
Hex	Decimal						
7D21 - 7D21	32034 - 32034	Input Accumulators Scaling	UINT16	bit-mapped	44443333 22221111	4 bits per input or output accumulator The nibble informs what should be the scaling of the accumulator 0=no-scaling, 1=0.1, 2=0.01, 3= 1m, 4=0.1m, 5=0.01m, 6=1u, 7=0.1u; the value 15 disable the accumulator. Example: suppose that the internal input accumulator #1 is 12345, and its corresponding scaling setting is "0011" (3 decimal). Then, the accumulator will be read as: Scaling 3, means 1m or 0.001. Scaled accumulator = 12345 * 0.001 = 12 (Twelve).	1
7D22 - 7D22	32035 - 32035	Relay Accumulators Scaling	UINT16	bit-mapped	44443333 22221111	"0011" (3 decimal). Then, the accumulator will be read as: Scaling 3, means 1m or 0.001. Scaled accumulator = 12345 * 0.001 = 12 (Twelve).	1
7D23 - 7D3E	32037 - 32063	Reserved				Set to 0.	8
7D3F - 7D46	32064 - 32071	Input#1 Label	ASCII	16 char			8
7D47 - 7D4E	32072 - 32079	Input#1 Low State Name	ASCII	16 char			8
7D4F - 7D56	32080 - 32087	Input#1 High State Name	ASCII	16 char			8
7D57 - 7D6E	32088 - 32111	Input#2 Label and State Names			same as Input#1		24
7D6F - 7D86	32112 - 32135	Input#3 Label and State Names			same as Input#1		24
7D87 - 7D9E	32136 - 32159	Input#4 Label and State Names			same as Input#1		24
7D9F - 7DA6	32160 - 32167	Relay#1 Label	ASCII	16 char			8
7DA7 - 7DAE	32168 - 32175	Relay#1 Open State Name	ASCII	16 char			8
7DAF - 7DB6	32176 - 32183	Relay#1 Closed State Name	ASCII	16 char			8
7DB7 - 7DCE	32184 - 32207	Relay#2 Label and State Names			same as Relay#1		24
7DCF - 7DFE	32208 - 32255	Reserved				Reserved	48
7DFE - 7E06	32256 - 32263	Input#1 Accumulator Label	ASCII	16 char			8
7E07 - 7E0E	32264 - 32271	Input#2 Accumulator Label	ASCII	16 char			8
7E0F - 7E14	32272 - 32277	Input#3 Accumulator Label	ASCII	16 char			8
7E15 - 7E1E	32278 - 32287	Input#4 Accumulator Label	ASCII	16 char			8
7E1F - 7E1F	32288 - 32288	Input#1 Accumulator Kt	UINT16	bit-mapped	ddvvvvvv vvvvvvvv	KT power factor for the Pulse Output "V" is raw power value in Wh/pulse from 0 to 9999. "dd"=decimal point position: 00=0.XXXX, 01=X.XXX, 10=XX.XX, 11= X.XXX.	1
7E20 - 7E20	32289 - 32289	Input#2 Accumulator Kt	UINT16	bit-mapped	ddvvvvvv vvvvvvvv	KT power factor for the Pulse Output "V" is raw power value in Wh/pulse from 0 to 9999. "dd"=decimal point position: 00=0.XXXX, 01=X.XXX, 10=XX.XX, 11= X.XXX.	1

Modbus Address		Description	Format	Range	Units or Resolution	Comments	# Reg
Hex	Decimal						
7E21	7E21	32290 - 32290	UINT16	bit-mapped	ddvvvvvv vvvvvvvv	(Cont'd)	1
7E22	7E22	32291 - 32291	UINT16	bit-mapped	ddvvvvvv vvvvvvvv		1
7E23	7F53	32292 - 32596				Reserved	305
						Block Size:	576
Log Retrieval Section							
Log Retrieval Block						read/write except as noted	
C34C - C34D	49997 - 49998	Log Retrieval Session Duration	UINT32	0 to 4294967294	4 msec	0 if no session active; wraps around after max count	2
C34E - C34E	49999 - 49999	Log Retrieval Session Com Port	UINT16	0 to 3		0 if no session active, 1-3 for session active on COM1 - COM3	1
C34F - C34F	50000 - 50000	Log Number, Enable, Scope	UINT16	bit-mapped	nnnnnnnn e s s s s s s s	high byte is the log number (0-system, 1-history1, 2-history2, 3-history3, 4-alarm log, 5-I/O changes) e is retrieval session enable(1) or disable(0) s s s s s s is what to retrieve (0-normal record, 1-timestamps only, 2-complete memory image (no data validation if image)	1
C350 - C350	50001 - 50001	Records per Window or Batch, Record Scope Selector, Number of Repeats	UINT16	bit-mapped	wwwwwww s n n n n n n n	high byte is records per window if s=0 or records per batch if s=1, low byte is number of repeats for function 35 or 0 to suppress auto-incrementing; max number of repeats is 8 (RTU) or 4 (ASCII) total windows, a batch is all the windows	1

Modbus Address		Description	Format	Range	Units or Resolution	Comments	# Reg		
Hex	Decimal								
C351	C352	50002	50003	Offset of First Record in Window	UINT32	bit-mapped	ssssssss nnnnnnnn nnnnnnnn nnnnnnnn	ssssssss is window status (0 to 7-window number, 0xFF-not ready); this byte is read-only. nn...nn is a 24-bit record number. The log's first record is latched as a reference point when the session is enabled. This offset is a record index relative to that point. Value provided is the relative index of the whole or partial record that begins the window.	2
C353	C3CD	50004	50126	Log Retrieve Window	UINT16	see comments	none	mapped per record layout and retrieval scope, read-only	2
							Block Size:	9	
Log Status Block							read only	3	
-		-		System Log Status Block				3	
C737	C738	51000	51001	Log Size in Records	UINT32	0 to 4,294,967,294	record		4
C739	C73A	51002	51003	Number of Records Used	UINT32	1 to 4,294,967,294	record		23
C73B	C73B	51004	51004	Record Size in Bytes	UINT16	14 to 242	byte		16
C73C	C73C	51005	51005	Log Availability	UINT16		none	0=available, 1-3=in use by COM1-3, 0xFFFF=not available (log size=0)	16
C73D	C73F	51006	51008	Timestamp, First Record	TSTAMP	1Jan2000 - 31Dec2099	1 sec		16
C740	C742	51009	51011	Timestamp, Last Record	TSTAMP	1Jan2000 - 31Dec2099	1 sec		16
C743	C746	51012	51015	Reserved				Reserved	16
-		-						Individual Log Status Block Size:	110
C747	C756	51016	51031	Historical Log 1 Status Block				same as system log status block	110
C757	C766	51032	51047	Historical Log 2 Status Block				same as system log status block	110
C767	C776	51048	51063	Historical Log 3 Status Block				same as system log status block	110
C777	C786	51064	51079	Alarm Log Status Block				same as system log status block	110
C787	C796	51080	51095	I/O Log Status Block				same as system log status block	110
							Block Size:	660	
End of Map									



Data Formats	
ASCII	ASCII characters packed 2 per register in high, low order and without any termination characters.
SINT16 / UINT16	16-bit signed / unsigned integer.
SINT32 / UINT32	32-bit signed / unsigned integer spanning 2 registers. The lower-addressed register is the high order half.
FLOAT	32-bit IEEE floating point number spanning 2 registers. The lower-addressed register is the high order half (i.e., contains the exponent).
TSTAMP	3 adjacent registers, 2 bytes each. First (lowest-addressed) register high byte is year (0-99), low byte is month (1-12). Middle register high byte is day(1-31), low byte is hour (0-23 plus DST bit). DST (daylight saving time) bit is bit 6 (0x40). Third register high byte is minutes (0-59), low byte is seconds (0-59). For example, 9:35:07AM on October 12, 2049 would be 0x310A, 0x0C49, 0x2307, assuming DST is in effect.

Notes

- 1 All registers not explicitly listed in the table read as 0. Writes to these registers will be accepted but won't actually change the register (since it doesn't exist).
- 2 CPU Data Section items read as 0 until first readings are available or if the CPU is not in operating mode. Writes to these registers will be accepted but won't actually change the register.
- 3 Register valid only in programmable settings update mode. In other modes these registers read as 0 and return an illegal data address exception if a write is attempted.
- 4 CPU command registers always read as 0. They may be written only when the CPU is in a suitable mode. The registers return an illegal data address exception if a write is attempted in an incorrect mode.
- 5 If the password is incorrect, a valid response is returned but the command is not executed. Use 5555 for the password if passwords are disabled in the programmable settings.
- 6 M denotes a 1,000,000 multiplier.
- 7 Each identifier is a Modbus register. For entities that occupy multiple registers (FLOAT, SINT32, etc.) all registers making up the entity must be listed, in ascending order. For example, to log phase A volts, VAs, voltage THD, and VA hours, the register list would be 0x3E7, 0x3E8, 0x411, 0x412, 0x176F, 0x61D, 0x61E and the number of registers (0x7917 high byte) would be 7.
- 8 Writing this register causes data to be saved permanently in nonvolatile memory. Reply to the command indicates that it was accepted but not whether or not the save was successful. This can only be determined after the CPU has restarted.
- 9 Reset commands make no sense if the CPU state is LIMP. An illegal function exception will be returned.
- 10 Energy registers should be reset after a format change. For single phase option only perphase values are valid. Please note that the three phase total values are invalid in this case. Also the test pulses are invalid since it is based on Total values.
- 11 Entities to be monitored against limits are identified by Modbus address. Entities occupying multiple Modbus registers, such as floating point values, are identified by the lower register address. If any of the 8 limits is unused, set its identifier to zero. If the indicated Modbus register is not used or is a nonsensical entity for limits, it will behave as an unused limit.
- 12 There are 2 setpoints per limit, one above and one below the expected range of values. LM1 is the "too high" limit, LM2 is "too low". The entity goes "out of limit" on LM1 when its value is greater than the setpoint. It remains "out of limit" until the value drops below the in threshold. LM2 works similarly, in the opposite direction. If limits in only one direction are of interest, set the in threshold on the "wrong" side of the setpoint. Limits are specified as % of full scale, where full scale is automatically set appropriately for the entity being monitored:

current FS = CT numerator
 voltage FS = PT numerator * PT multiplier
 3 phase power FS = CT numerator * PT numerator * 3 [* SQRT(3) for delta hookup]
 single phase power FS = CT numerator * PT numerator [* SQRT(3) for delta hookup]
 frequency FS = 60 (or 50)
 power factor FS = 1.0
 percentage FS = 100.0
 angle FS = 180.0

- 13 Card Identification Block is an image of the EEPROM on the card.
- 14 A block of data and control registers is allocated for each option card. Interpretation of the register data depends if the card is installed.
- 15 Measurement states: Off occurs during programmable settings updates; Run is the normal measuring state; Limp indicates that an essential non-volatile memory block is corrupted; and Warmup occurs briefly (approximately 4 seconds) at startup while the readings stabilize. Run state is required for measurement, historical logging, demand interval processing, limit alarm evaluation, min/max comparisons, and THD calculations. Resetting min/max or energy is allowed only in run and off states; warmup will return a busy exception. In limp state, the CPU reboots at 5 minute intervals in an effort to clear the problem.
- 16 Limits evaluation for all entites except demand averages commences immediately after the warmup period. Evaluation for demand averages, maximum demands, and minimum demands commences at the end of the first demand interval after startup.
- 17 Depending on the V-switch setting, there are 3 or 106 flash sectors available in a common pool for distribution among the 3 historical logs. The pool size, number of sectors for each log, and the number of registers per record together determine the maximum number of records a log can hold.

S = number of sectors assigned to the log,

H = number of Modbus registers to be monitored in each historical record (up to 117),

R = number of bytes per record = (12 + 2H) for historical logs

N = number of records per sector = 65516 / R, rounded down to an integer value (no partial records in a sector)

T = total number of records the log can hold = S * N

T = S * 2 for the waveform log.

- 18 Logs cannot be reset during log retrieval. Busy exception will be returned.
- 19 Combination of class and type currently defined are:
 - 0x01 =IO interface board
 - 0x02 = Relay Card

This page intentionally left blank.

E: Retrieving Logs Using the MP200 Metering System's Modbus Map

E.1: Overview

This appendix describes the log interface system of the MP200 unit from a programming point of view. It is intended for programmers implementing independent drivers for log retrieval from the MP200 unit. It describes the meaning of the MP200's Modbus Registers related to log retrieval and conversion, and details the procedure for retrieving a log's records.

NOTES:

- All references assume the use of Modbus function codes 0x03, 0x06, and 0x10, where each register is a 2 byte MSB (Most Significant Byte) word, except where otherwise noted.
- The carat symbol (^) notation is used to indicate mathematical "power." For example, 2^8 is $2 \times 2 \times 2 \times 2 \times 2 \times 2 \times 2 \times 2$, which equals 256.

E.2: Data Formats

Time stamp: Stores a date from 2000 to 2099. Time stamp has a Minimum resolution of 1 second.

Byte	0	1	2	3	4	5
Value	Year	Month	Day	Hour	Minute	Second
Range	0-99 (+2000)	1-12	1-31	0-23	0-59	0-59
Mask	0x7F	0x0F	0x1F	0x1F	0x3F	0x3F

The high bits of each time stamp byte are used as flags to record MP200 unit state information at the time of the time stamp. These bits should be masked out, unless needed.

E.3: MP200 Metering System Logs

The MP200 unit has 6 logs: System Event, Alarm (Limits), 3 Historical, and I/O Change. Each log is described below.

1. **System Event (0)**: The System Event log is used to store events which happen in, and to, the MP200 unit. Events include Startup, Reset Commands, Log Retrievals, etc. The System Event Log Record takes 20 bytes, 14 bytes of which are available when the log is retrieved.

Byte	0	1	2	3	4	5	6	7	8	9	10	11	12	13
Value	timestamp						Group	Event	Mod	Chan	Param1	Param2	Param3	Param4

NOTE: The complete Systems Events table is shown in Section E.5.5 on page E-29.

2. **Alarm Log (1)**: The Alarm Log records the states of the 8 Limits programmed in the MP200 unit.

- Whenever a limit goes out (above or below), a record is stored with the value that caused the limit to go out.
- Whenever a limit returns within limit, a record is stored with the "most out of limit" value for that limit while it was out of limit.

The Alarm Log Record uses 16 bytes, 10 bytes of which are available when the log is retrieved.

Byte	0	1	2	3	4	5	6	7	8	9	
Value	timestamp						direction	limit#	Value%		

The limit # byte is broken into a type and an ID.

Bit	0	1	2	3	4	5	6	7
Value	type	0	0	0	0	Limit ID		

3. **Historical Log 1 (2)**: The Historical Log records the values of its assigned registers at the programmed interval.

NOTE: See E.4: Block Definitions, on page E-4, for details on programming and interpreting the log.

Byte	0	1	2	3	4	5	6	-	-	N
Value	timestamp						values . . .			

4. **Historical Log 2 (3)**: Same as Historical Log 1.

5. **Historical Log 3 (4)**: Same as Historical Log 1.

6. **I/O Change Log (5)**: The I/O Change Log records changes in the input and output of the Digital I/O Board (Relay Contact Outputs/Contact Sensing Inputs).

I/O Change Log tables:

Table 1:

Byte	0	1	2	3	4	5	6	7
Value	Timestamp						Card 1 Changes	Card 1 States

Card Change Flags:

Bit	7	6	5	4	3	2	1	0
Value	Out 4 Change	Out 3 Change	Out 2 Change	Out 1 Change	In 4 Change	In 3 Change	In 2 Change	In 1 Change

Block Size: 192 registers per log (384 bytes)

The Historical Log programmable settings are comprised of 3 blocks, one for each log. Each is identical to the others, so only Historical Log 1 is described here. All register addresses in this section are given as the Historical Log 1 address (0x7917).

Each Historical Log Block is composed of 3 sections: The header, the list of registers to log, and the list of item descriptors.

Header:

Registers: 0x7917 - 0x7918

Size: 2 registers

Byte	0	1	2	3
Value	# Registers	# Sectors		Interval

- # Registers: The number of registers to log in the record. The size of the record in memory is $[12 + (\# \text{ Registers} \times 2)]$. The size during normal log retrieval is $[6 + (\# \text{ Registers} \times 2)]$. If this value is 0, the log is disabled. Valid values are {0-117}.
- # Sectors: The number of Flash Sectors allocated to this log. Each sector is 262114 bytes, minus a sector header of 20 bytes. 3 sectors for V-Switch key 2, and 111 sectors for V-Switch key 3, are available for allocation between Historical Logs 1, 2, and 3. The sum of all Historical Logs may be less than 3 sectors for V-Switch key 2, and 111 sectors for V-Switch key 3. If this value is 0, the log is disabled. Valid values are {0-111}.
- Interval: The interval at which the Historical Log's Records are captured. This value is an enumeration:

0x01	1 minute
0x02	3 minute
0x04	5 minute
0x08	10 minute
0x10	15 minute

0x20	30 minute
0x40	60 minute
0x80	End of Interval (EOI) Pulse*

* Setting the interval to EOI causes a record to be logged whenever an EOI pulse event is generated. This is most commonly used in conjunction with the Digital I/O Option Cards.

NOTE: The interval between records will not be even (fixed), and thus should not be used with programs that expect a fixed interval.

Register List:

Registers: 0x7919 - 0x798D

Size: 1 register per list item, 117 list items

The Register List controls what Modbus Registers are recorded in each record of the Historical Log. Since many items, such as Voltage, Energy, etc., take up more than 1 register, multiple registers need to be listed to record those items.

For example: Registers 0x03E7 and 0x03E8 are programmed to be recorded by the historical log. These registers program the log to record "Primary Readings Volts A-N."

- Each unused register item should be set to 0x0000 or 0xFFFF to indicate that it should be ignored.
- The actual size of the record, and the number of items in the register list which are used, is determined by the # registers in the header.
- Each register item is the Modbus Address in the range of 0x0000 to 0xFFFF.

Item Descriptor List:

Registers: 0x798E - 0x79C8

Size: 1 byte per item, 117 bytes (59 registers)

While the Register List describes what to log, the Item Descriptor List describes how to interpret that information. Each descriptor describes a group of register items, and what they mean.

Each descriptor is composed of 2 parts:

- **Type:** The data type of this descriptor, such as signed integer, IEEE floating point, etc. This is the high nibble of the descriptor byte, with a value in the range of 0-14. If this value is 0xFF, the descriptor should be ignored.

0	ASCII: An ASCII string, or byte array
1	Bitmap: A collection of bit flags
2	Signed Integer: A 2's Complement integer
3	Float: An IEEE floating point
4	Energy: Special Signed Integer, where the value is adjusted by the energy settings in the MP200 unit's Programmable Settings.
5	Unsigned Integer
6	Signed Integer 0.1 scale: Special Signed Integer, where the value is divided by 10 to give a 0.1 scale.
7-14	Unused
15	Disabled: used as end list marker.

- **Size:** The size in bytes of the item described. This number is used to determine the pairing of descriptors with register items.

For example: If the first descriptor is 4 bytes, and the second descriptor is 2 bytes, then the first 2 register items belong to the 1st descriptor, and the 3rd register item belongs to the 2nd descriptor.

NOTE: As can be seen from the example, above, there is not a 1-to-1 relation between the register list and the descriptor list. A single descriptor may refer to multiple register items.

Register Items	Descriptors
0x03C7/ 0x03C8	Float, 4 byte
0x1234	Signed Int, 2 byte

NOTE: The sum of all descriptor sizes must equal the number of bytes in the data portion of the Historical Log record.

Log Status Block:

The Log Status Block describes the current status of the log in question. There is one header block for each of the logs. Each log's header has the following base address:

Log	Base Address
System:	0xC737
Historical 1:	0xC747
Historical 2:	0xC757
Historical 3:	0xC767
Alarm:	0xC777
I/O Change:	0xC787

Bytes	Value	Type	Range	# Bytes
0-3	Max Records	UINT32	0 to 4,294,967,294	4
4-7	Number of Records Used	UINT32	1 to 4,294,967,294	4
8-9	Record Size in Bytes	UINT16	4 to 250	2
10-11	Log Availability	UINT16		2
12-17	Timestamp, First Record	TSTAMP	1Jan2000 - 31Dec2099	6
18-23	Timestamp, Last Record	TSTAMP	1Jan2000 - 31Dec2099	6
24-31	Reserved			8

- Max Records: The maximum number of records the log can hold given the record size, and sector allocation. The data type is an unsigned integer from 0 - 2^{32} .

- **Records Used:** The number of records stored in the log. This number will equal the Max Records when the log has filled. This value will be set to 1 when the log is reset. The data type is an unsigned integer from 1 - 2^{32} .

NOTE: The first record in every log before it has rolled over is a "dummy" record, filled with all 0xFF's. When the log is filled and rolls over, this record is overwritten.

- **Record Size:** The number of bytes in this record, including the timestamp. The data type is an unsigned integer in the range of 14 - 242.
- **Log Availability:** A flag indicating if the log is available for retrieval, or if it is in use by another port.

0	Log Available for retrieval
1	In use by COM1 (RS485/Ethernet/WiFi)
2	In use by COM2 (USB)
3	In use by COM3 (RS485)
0xFFFF	Log Not Available - the log cannot be retrieved. This indicates that the log is disabled.

NOTE: To query the port by which you are currently connected, use the Port ID register:

Register: 0x1193
Size: 1 register

Description: A value from 1-4, which enumerates the port that the requestor is currently connected on.

NOTES:

- When Log Retrieval is engaged, the Log Availability value will be set to the port that engaged the log. The Log Availability value will stay the same until either the log has been disengaged, or 5 minutes have passed with no activity. It will then reset to 0 (available).
- Each log can only be retrieved by one port at a time.

- Only one log at a time can be retrieved.
- First Timestamp: Timestamp of the oldest record.
- Last Timestamp: Timestamp of the newest record.

Log Retrieval Block:

The Log Retrieval Block is the main interface for retrieving logs. It is comprised of 2 parts: the header and the window. The header is used to program the particular data the MP200 unit presents when a log window is requested. The window is a sliding block of data that can be used to access any record in the specified log.

Session Com Port: The MP200 unit's Com Port which is currently retrieving logs. Only one Com Port can retrieve logs at any one time.

Registers:	0xC34E - 0xC34E
Size:	1 register
0	No Session Active
1	COM1 (RS485/Ethernet/WiFi)
2	COM2 (USB)
3	COM3 (RS485)

To get the current Com Port, see the NOTE on querying the port, on the previous page.

Log Retrieval Header:

The Log Retrieval Header is used to program the log to be retrieved, the record(s) of that log to be accessed, and other settings concerning the log retrieval.

Registers: 0xC34F - 0xC350

Size: 2 registers

Bytes	Value	Type	Format	Description	# Bytes
0-1	Log Number, Enable, Scope	UINT16	nnnnnnnn essssss	nnnnnnnn - log to retrieve, e - retrieval session enable ssssss - retrieval mode	2
2-3	Records per Window, Number of Repeats	UINT16	wwwwwww nnnnnnn	wwwwww - records per window, nnnnnnn - repeat count	2

- Log Number: The log to be retrieved. Write this value to set which log is being retrieved.

0	System Events
1	Historical Log 1
2	Historical Log 2
3	Historical Log 3
4	Alarm Log
5	I/O Change Log

- **Number of Repeats:** Specifies the number of repeats to use for the Modbus Function Code 0x23 (35). Since the MP200 unit must pre-build the response to each log window request, this value must be set once, and each request must use the same repeat count. Upon reading the last register in the specified window, the record index will increment by the number of repeats, if auto-increment is enabled. Section E.5.2 has additional information on Function Code 0x23.

0	Disables auto-increment
1	No Repeat count, each request will only get 1 window.
2-8	2-8 windows returned for each Function Code 0x23 request.

Bytes	Value	Type	Format	Description	# Bytes
0-3	Offset of First Record in Window	UINT32	ssssssss nnnnnnnn nnnnn- nnn nnnnnnnn	ssssssss - window status nn...nn - 24-bit record index number.	4
4-249	Log Retrieve Window	UINT16			246

Log Retrieval Window Block:

The Log Retrieval Window block is used to program the data you want to retrieve from the log. It also provides the interface used to retrieve that data.

Registers: 0xC351 - 0xC3CD

Size: 125 registers

- **Window Status:** The status of the current window. Since the time to prepare a window may exceed an acceptable modbus delay (1 second), this acts as a state flag, signifying when the window is ready for retrieval. When this value indicates that the window is not ready, the data in the window should be ignored. Window Status is Read-only, any writes are ignored.

0	Window is Ready
---	-----------------

0xFF Window is Not Ready

- Record Number: The record number of the first record in the data window. Setting this value controls which records will be available in the data window.
- When the log is engaged, the first (oldest) record is "latched." This means that record number 0 will always point to the oldest record at the time of latching, until the log is disengaged (unlocked).
- To retrieve the entire log using auto-increment, set this value to 0, and retrieve the window repeatedly, until all records have been retrieved.

NOTES:

- When auto-increment is enabled, this value will automatically increment so that the window will "page" through the records, increasing by RecordsPerWindow each time that the last register in the window is read.
 - When auto-increment is not enabled, this value must be written-to manually, for each window to be retrieved.
- Log Retrieval Data Window: The actual data of the records, arranged according to the above settings.

E.5: Log Retrieval

Log Retrieval is accomplished in 3 basic steps:

1. Engage the log.
2. Retrieve each of the records.
3. Disengage the log.

E.5.1: Auto-Increment

In EIG's traditional Modbus retrieval system, you write the index of the block of data to retrieve, then read that data from a buffer (window). To improve the speed of retrieval, the index can be automatically incremented each time the buffer is read.

In the MP200 unit, when the last register in the data window is read, the record index is incremented by the Records per Window.

E.5.2: Modbus Function Code 0x23

QUERY

<u>Field Name</u>	<u>Example (Hex)</u>
Slave Address	01
Function	23
Starting Address Hi	C3
Starting Address Lo	51
# Points Hi	00
# Points Lo	7D
Repeat Count	04

RESPONSE

<u>Field Name</u>	<u>Example (Hex)</u>
Slave Address	01
Function	23
# Bytes Hi	03
# Bytes Lo	E0
Data	...

Function Code 0x23 is a user defined Modbus function code, which has a format similar to Function Code 0x03, except for the inclusion of a "repeat count." The repeat count (RC) is used to indicate that the same N registers should be read RC number of times. (See the Number of Repeats bullet on page E-13.)

NOTES:

- By itself this feature would not provide any advantage, as the same data will be returned RC times. However, when used with auto-incrementing, this function condenses up to 8 requests into 1 request, which decreases communication time, as fewer transactions are being made.
- Keep in mind that the contents of the response data is the block of data you requested, repeated N times. For example, when retrieving log windows, you normally request both the window index, and the window data. This means that the first couple of bytes of every repeated block will contain the index of that window.
- In the MP200 unit repeat counts are limited to 8 times for Modbus RTU, and 4 times for Modbus ASCII.

The response for Function Code 0x23 is the same as for Function Code 0x03, with the data blocks in sequence.

IMPORTANT! Before using Function code 0x23, always check to see if the current connection supports it. Some relay devices do not support user defined function codes; if that is the case, the message will stall. Other devices don't support 8 repeat counts.

E.5.3: Log Retrieval Procedure

The following procedure documents how to retrieve a single log from the oldest record to the newest record, using the "normal" record type (see **Scope**). All logs are retrieved using the same method. See E.5.4: Log Retrieval Example, on page E-20, for an example retrieval.

NOTES:

- This example uses auto-increment.
- In this example, Function Code 0x23 is not used.
- You will find referenced topics in Section E.4 Block Definitions.
- Modbus Register numbers are listed in brackets.

1. Engage the Log:

a. Read the Log Status Block.

- i. Read the contents of the specific logs' status block [0xC737+, 16 registers] (see Log Headers).
- ii. Store the # of Records Used, the Record Size, and the Log Availability.
- iii. If the Log Availability is not 0, stop Log Retrieval; this log is not available at this time. If Log Availability is 0, proceed to step 1b (Engage the log).

This step is done to ensure that the log is available for retrieval, as well as retrieving information for later use.

- ##### b. Engage the log: write log to engage to Log Number, 1 to Enable, and the desired mode to Scope (default 0 (Normal)) [0xC34F, 1 register]. This is best done as a single-register write.

This step will latch the first (oldest) record to index 0, and lock the log so that only this port can retrieve the log, until it is disengaged.

- c. Verify the log is engaged: read the contents of the specific logs' status block [0xC737+, 16 registers] again to see if the log is engaged for the current port (see Log Availability). If the Log is not engaged for the current port, repeat step 1b (Engage the log).
- d. Write the retrieval information.
 - i. Compute the number of records per window, as follows:
$$\text{RecordsPerWindow} = (246 \setminus \text{RecordSize})$$
 - If using 0x23, set the repeat count to 2-8. Otherwise, set it to 1.
 - Since we are starting from the beginning for retrieval, the first record index is 0.
 - ii. Write the Records per window, the Number of repeats (1), and Record Index (0) [0xC350, 3 registers].

This step tells the MP200 unit what data to return in the window.

2. Retrieve the records:

- a. Read the record index and window: read the record index, and the data window [0xC351, 125 registers].
 - If the MP200 unit Returns a Slave Busy Exception, repeat the request.
 - If the Window Status is 0xFF, repeat the request.
 - If the Window Status is 0, go to step 2b (Verify record index).

NOTES:

- We read the index and window in 1 request to minimize communication time, and to ensure that the record index matches the data in the data window returned.
- Space in the window after the last specified record (RecordSize x Record-PerWindow) is padded with 0xFF, and can be safely discarded.

b. Verify that the record index incremented by Records Per Window. The record index of the retrieved window is the index of the first record in the window. This value will increase by Records Per Window each time the window is read, so it should be 0, N, N x 2, N x 3. . . for each window retrieved.

- If the record index matches the expected record index, go to step 2c (Compute next expected record index).
- If the record index does not match the expected record index, then go to step 1d (Write the retrieval information), where the record index will be the same as the expected record index. This will tell the MP200 unit to repeat the records you were expecting.

c. Compute next Expected Record Index.

- If there are no remaining records after the current record window, go to step 3 (Disengage the log).
- Compute the next expected record index by adding Records Per Window, to the current expected record index. If this value is greater than the number of records, re-size the window so it only contains the remaining records and go to step 1d (Write the retrieval information), where the Records Per Window will be the same as the remaining records.

3. Disengage the log: write the Log Number (of log being disengaged) to the Log Index and 0 to the Enable bit [0xC34F, 1 register].

E.5.4: Log Retrieval Example

The following example illustrates a log retrieval session. The example makes the following assumptions:

- Log Retrieved is Historical Log 1 (Log Index 1).
- Auto-Incrementing is used.
- Function Code 0x23 is not used (Repeat Count of 1).
- The Log contains Volts-AN, Volts-BN, Volts-CN (12 bytes).
- 100 Records are available (0-99).
- COM Port 2 (USB) is being used (see Log Availability).
- There are no Errors.
- Retrieval is starting at Record Index 0 (oldest record).
- Protocol used is Modbus ASCII. The checksum is left off for simplicity.
- The MP200 unit is at device address 1.
- No new records are recorded to the log during the log retrieval process.

1. Read [0xC747, 16 registers], Historical Log 1 Header Block.

Send: 0103 C747 0010

Command:

Register Address: 0xC747

Registers: 16

Receive: 010320 00000100 00000064 0012 0000
0C0717101511 0C0718101511***
0000000000000000

Data:

Max Records: 0x100 = 256 records maximum.

Num Records: 0x64 = 100 records currently logged.

Record Size: 0x12 = 18 bytes per record.

Log Availability: 0x00 = 0, not in use, available for retrieval.

First Timestamp: 0x0C0717101511 = July 23, 2012, 16:21:17

Last Timestamp: 0x0C0717101511 = July 24, 2012, 16:21:17

NOTE: This indicates that Historical Log 1 is available for retrieval.

2. Write 0x0180 -> [0xC34F, 1 register], Log Enable.

Send: 0106 C34F 0180

Command:

Register Address: 0xC34F

Registers: 1 (Write Single Register Command)

Data:

Log Number: 1 (Historical Log 1)

Enable: 1 (Engage log)

Scope: 0 (Normal Mode)

Receive: 0106C34F0180 (echo)

NOTE: This engages the log for use on this COM Port, and latches the oldest record as record index 0.

3. Read [0xC747, 16 registers], Availability is 0.

Send: 0103 C747 0010

Command:

Register Address: 0xC747

Registers: 16

Receive: 010320 00000100 00000064 0012 0002
0C0717101511 0C0718101511
0000000000000000

Data:

Max Records: 0x100 = 256 records maximum.

Num Records: 0x64 = 100 records currently logged.

Record Size: 0x12 = 18 bytes per record.

Log Availability: 0x02 = 1, In use by COM2, USB (the current port)

First Timestamp: 0x0C0717101511 = July 23, 2012, 16:21:17

Last Timestamp: 0x0C0717101511 = July 24, 2012, 16:21:17

NOTE: This indicates that the log has been engaged properly in step 2. Proceed to retrieve the log.

4. Compute #RecPerWin as $(246 \setminus 18) = 13$. Write 0x0D01 0000 0000 -> [0xC350, 3 registers] Write Retrieval Info. Set Current Index as 0.

Send: 0110 C350 0003 06 0D01 00 000000

Command:

Register Address: 0xC350

Registers: 3, 6 bytes

Data:

Records per Window: 13. Since the window is 246 bytes, and the record is 18 bytes, $246 \setminus 18 = 13.66$, which means that 13 records evenly fit into a single window. This is 234 bytes, which means later on, we only need to read 234 bytes (117 registers) of the window to retrieve the records.

of Repeats: 1. We are using auto-increment (so not 0), but not function code 0x23.

Window Status: 0 (ignore)

Record Index: 0, start at the first record.

Receive: 0110C3500003 (command ok)

NOTES:

- This sets up the window for retrieval; now we can start retrieving the records.
- As noted above, we compute the records per window as $246 \setminus 18 = 13.66$, which is rounded to 13 records per window. This allows the minimum number of requests to be made to the MP200 unit, which increases retrieval speed.

5. Read [0xC351, 125 registers], first 2 registers are status/index, last 123 registers are window data. Status OK.

Send: 0103 C351 007D

Command:

Register Address: 0xC351

Registers: 0x7D, 125 registers

Receive: 0103FA 00000000
0C0717101511FFFFFFFFFFFFFFFFFFFFFFFF
0C071710160042FAAACF42FAAD1842FAA9A8. . .

Data:

Window Status: 0x00 = the window is ready.

Index: 0x00 = 0, The window starts with the 0'th record, which is the oldest record.

Record 0: The next 18 bytes is the 0'th record (filler).

Timestamp: 0x0C0717101511, = July 23, 2012, 16:21:17

Data: This record is the "filler" record. It is used by the MP200 unit so that there is never 0 records. It should be ignored. It can be identified by the data being all 0xFF.

NOTE: Once a log has rolled over, the 0'th record will be a valid record, and the filler record will disappear.

Record 1: The next 18 bytes is the 1'st record.

Timestamp: 0x0C0717101600 July 23, 2012, 16:22:00

Data:

Volts AN: 0x42FAAACF, float = 125.33~

Volts BN: 0x42FAAD18, float = 125.33~

Volts CN: 0x42FAA9A8, float = 125.33~

. . . 13 records

NOTES:

- This retrieves the actual window. Repeat this command as many times as necessary to retrieve all of the records when auto-increment is enabled.
- Note the filler record. When a log is reset (cleared) in the MP200 unit, the MP200 unit always adds a first "filler" record, so that there is always at least 1 record in the log. This "filler" record can be identified by the data being all 0xFF, and it being index 0. If a record has all 0xFF for data, the timestamp is valid, and the index is NOT 0, then the record is legitimate.
- When the "filler" record is logged, its timestamp may not be "on the interval." The next record taken will be on the next "proper interval," adjusted to the hour. For example, if the interval is 1 minute, the first "real" record will be taken on the next minute (no seconds). If the interval is 15 minutes, the next record will be taken at :15, :30, :45, or :00 - whichever of those values is next in sequence.

6. Compare the index with Current Index.

NOTES:

- The Current Index is 0 at this point, and the record index retrieved in step 5 is 0: thus we go to step 8.
- If the Current Index and the record index do not match, go to step 7. The data that was received in the window may be invalid, and should be discarded.

7. Write the Current Index to [0xC351, 2 registers].

Send: 0110 C351 0002 04 00 00000D

Command:

Register Address: 0xC351

Registers: 2, 4 bytes

Data:

Window Status: 0 (ignore)

Record Index: 0x0D = 13, start at the 14th record.

Receive: 0110C3510002 (command ok)

NOTES:

- This step manually sets the record index, and is primarily used when an out-of-order record index is returned on a read (step 6).
 - The example assumes that the second window retrieval failed somehow, and we need to recover by requesting the records starting at index 13 again.
8. For each record in the retrieved window, copy and save the data for later interpretation.
 9. Increment Current Index by RecordsPerWindow.

NOTES:

- This is the step that determines how much more of the log we need to retrieve.
 - On the first N passes, Records Per Window should be 13 (as computed in step 4), and the current index should be a multiple of that (0, 13, 26, . . .). This amount will decrease when we reach the end (see step 10).
 - If the current index is greater than or equal to the number of records (in this case 100), then all records have been retrieved; go to step 12. Otherwise, go to step 10 to check if we are nearing the end of the records.
10. If number records - current index < RecordsPerWindow, decrease to match.

NOTES:

- Here we bounds-check the current index, so we don't exceed the records available.

- If the number of remaining records ($\#records - \text{current index}$) is less than the Records per Window, then the next window is the last, and contains less than a full window of records. Make records per window equal to remaining records ($\#records - \text{current index}$). In this example, this occurs when current index is 91 (the 8'th window). There are now 9 records available (100-91), so make Records per Window equal 9.

11. Repeat steps 5 through 10.

NOTES:

- Go back to step 5, where a couple of values have changed.

Pass	CurIndex	FirstRecIndex	RecPerWindow
0	0	0	13
1	13	13	13
2	26	26	13
3	39	39	13
4	52	52	13
5	65	65	13
6	78	78	13
7	91	91	9
8	100	-----	-----

- At pass 8, since Current Index is equal to the number of records (100), log retrieval should stop; go to step 12 (see step 9 Notes).

12. No more records available, clean up.

13. Write 0x0000 -> [0xC34F, 1 register], disengage the log.

Send: 0106 C34F 0000

Command:

Register Address: 0xC34F

Registers: 1 (Write Single Register Command)

Data:

Log Number: 0 (ignore)

Enable: 0 (Disengage log)

Scope: 0 (ignore)

Receive: 0106C34F0000 (echo)

NOTES:

- This disengages the log, allowing it to be retrieved by other COM ports.
- The log will automatically disengage if no log retrieval action is taken for 5 minutes.

E.5.5: Log Record Interpretation

The records of each log are composed of a 6 byte timestamp, and N data. The content of the data portion depends on the log.

System Event Record:

Byte	0	1	2	3	4	5	6	7	8	9	10	11	12	13
Value	timestamp						Group	Event	Mod	Chan	Param1	Param2	Param3	Param4

Size: 14 bytes (20 bytes image).

Data: The System Event data is 8 bytes; each byte is an enumerated value.

- Group: Group of the event.
- Event: Event within a group.
- Modifier: Additional information about the event, such as number of sectors or log number.
- Channel: The port of the MP200 unit that caused the event.

0	Firmware
1	COM 1 (RS485/Ethernet/WiFi)
2	COM 2 (USB)
3	COM 3 (RS485)

Param 1-4: These are defined for each event (see following table).

NOTE: The System Log Record is 20 bytes, consisting of the Record Header (12 bytes) and Payload (8 bytes). The Timestamp (6 bytes) is in the header. Typically, software will retrieve only the timestamp and payload, yielding a 14-byte record. The table below shows all defined payloads.

Group (Event group)	Event (Event within group)	Mod (Event modifier)	Channel (1-3 for COMs, 0 for FW)	Parm1	Parm2	Parm3	Parm4	Comments
0								Startup
	0	0	0	FW version				Meter Run Firmware Startup
1								Log Activity
	1	log#	1-3	0xFF	0xFF	0xFF	0xFF	Reset
	2	log#	1-3	0xFF	0xFF	0xFF	0xFF	Log Retrieval Begin
	3	log#	0-3	0xFF	0xFF	0xFF	0xFF	Log Retrieval End
2								Clock Activity
	1	old year	1-3	old month, day, hour, minute, second				Clock Changed
	2	0	0	0xFF	0xFF	0xFF	0xFF	Daylight Time On
	3	0	0	0xFF	0xFF	0xFF	0xFF	Daylight Time Off
3								System Resets
	1	0	0-3	0xFF	id mm#	0xFF	0xFF	Max & Min Reset
	2	0	0-3	0xFF	id e#	0xFF	0xFF	Energy Reset
	3	slot#	0-3	0xFF	acc_-typ#	0xFF	0xFF	Reset Relay Board Accumulators
4								Settings Activity
	1	0	1-3	0xFF	0xFF	0xFF	0xFF	Password Changed
	2	0	1-3	old V-Switch	new V-Switch	0xFF	0xFF	V-Switch Changed

	3	0	1-3	0xFF	0xFF	0xFF	0xFF	Programmable Settings Changed
	4	0	1-3	0xFF	0xFF	0xFF	0xFF	Measurement Stopped
5								Boot Activity
	1	0	1-3	FW version				Exit to Boot
6								Error Reporting & Recovery
	4	log #	0	0xFF	0xFF	0xFF	0xFF	Log Babbling Detected
	5	log #	0	# records discarded		time in seconds		Babbling Log Periodic Summary
	6	log #	0	# records discarded		time in seconds		Log Babbling End Detected
	7	sector#	0	error count		stimulus		Flash Sector Error
	8	0	0	0xFF	0xFF	0xFF	0xFF	Flash Error Counters Reset
	9	0	0	0xFF	0xFF	0xFF	0xFF	Flash Job Queue Overflow
0x88								
	1	sector#	0	log #	0xFF	error count		acquire sector
	2	sector#	0	log #	0xFF	0xFF	0xFF	release sector
	3	sector#	0	erase count				erase sector
	4	log#	0	0xFF	0xFF	0xFF	0xFF	write log start record

NOTES:

- log# values: 0 = system log, 1-3 = historical logs, 4 = alarm log, 5 = I/O change log
- sector# values: 0-128
- slot# values: 1

- The clock changed event shows the clock value just before the change in the Mod and Parm bytes. Parms are bit-mapped:
 - b31 - b28 month
 - b27 - b23 day
 - b22 daylight savings time flag
 - b20 - b16 hour
 - b13 - b8 minute
 - b5 - b0 second
 - unused bits are always 0
- Stimulus for a flash sector error indicates what the flash was doing when the error occurred: 1 = acquire sector, 2 = startup, 3 = empty sector, 4 = release sector, 5 = write data.
- Flash error counters are reset to zero in the unlikely event that both copies in EEPROM are corrupted.
- The flash job queue is flushed (and log records are lost) in the unlikely event that the queue runs out of space.
- A "babbling log" is one that is saving records faster than the MP200 unit can handle long term. When babbling is detected, the log is frozen and no records are appended until babbling ceases. For as long as babbling persists, a summary of records discarded is logged every 60 minutes. Normal logging resumes when there have been no new append attempts for 30 seconds. Onset of babbling occurs when a log fills a flash sector in less than an hour (applies only to Alarm, I/O Change, and Historical logs), when the log fills, or when a log grows so far beyond its normal bounds that it is in danger of crashing the system. This applies to all logs except the System log, which does not babble. It is possible for the other logs during an extended log retrieval session.
- Logging of diagnostic records may be suppressed via a bit in programmable settings.

0 High Limit

1 Low Limit

- Limit ID: The specific limit this record represents. A value in the range 0-7, Limit ID represents Limits 1-8. The specific details for this limit are stored in the programmable settings.
- Value: Depends on the Direction:
 - If the record is "Going out of limit," this is the value of the limit when the "Out" condition occurred.
 - If the record is "Coming back into limit," this is the "worst" value of the limit during the period of being "out": for High (above) limits, this is the highest value during the "out" period; for Low (below) limits, this is the lowest value during the "out" period.

Byte	0	1	2	3	4	5	6	7	8	9
Value	Identifier		Above Setpoint		Above Hyst.		Below Setpoint		Below Hyst.	

Interpretation of Alarm Data:

To interpret the data from the alarm records, you need the limit data from the Programmable Settings [0x754B, 40 registers].

There are 8 limits, each with an Above Setpoint, and a Below Setpoint. Each setpoint also has a threshold (hysteresis), which is the value at which the limit returns "into" limit after the setpoint has been exceeded. This prevents "babbling" limits, which can be caused by the limit value fluttering over the setpoint, causing it to go in and out of limit continuously.

- Identifier: The first modbus register of the value that is being watched by this limit. While any modbus register is valid, only values that can have a Full Scale will be used by the MP200 unit.
- Above Setpoint: The percent of the Full Scale above which the value for this limit will be considered "out."

- Valid in the range of -200.0% to +200.0%
- Stored as an integer with 0.1 resolution. (Multiply % by 10 to get the integer, divide integer by 10 to get %. For example, 105.2% = 1052.)
- Above Hysteresis: The percent of the Full Scale below which the limit will return "into" limit, if it is out. If this value is above the Above Setpoint, this Above limit will be disabled.
- Valid in the range of -200.0% to +200.0%.
- Stored as an integer with 0.1 resolution. (Multiply % by 10 to get the integer, divide integer by 10 to get %. For example, 104.1% = 1041.)
- Below Setpoint: The percent of the Full Scale below which the value for this limit will be considered "out."
- Valid in the range of -200.0% to +200.0%.
- Stored as an integer with 0.1 resolution. (Multiply % by 10 to get the integer, divide integer by 10 to get %. For example, 93.5% = 935.)
- Below Hysteresis: The percent of the Full Scale above which the limit will return "into" limit, if it is out. If this value is below the Below Setpoint, this Below limit will be disabled.
- Valid in the range of -200.0% to +200.0%.
- Stored as an integer with 0.1 resolution. (Multiply % by 10 to get the integer, divide integer by 10 to get %. For example, 94.9% = 949.)

NOTES:

- The Full Scale is the "nominal" value for each of the different types of readings. To compute the Full Scale, use the following formulas:

Current [CT Numerator]

Voltage [PT Numerator]

Power 3-Phase (WYE) [CT Numerator] x [PT Numerator] x 3

Power 3-Phase (Delta)	$[CT \text{ Numerator}] \times [PT \text{ Numerator}] \times 3 \times \text{sqrt}(3)$
Power Single Phase (WYE)	$[CT \text{ Numerator}] \times [PT \text{ Numerator}]$
Power Single Phase (Delta)	$[CT \text{ Numerator}] \times [PT \text{ Numerator}] \times \text{sqrt}(3)$
Frequency (Calibrated at 60 Hz)	60
Frequency (Calibrated at 50 Hz)	50
Power Factor	1.0
Angles	180°

- To interpret a limit alarm fully, you need both the start and end record (for duration).
- There are a few special conditions related to limits:
 - When the MP200 unit powers up, it detects limits from scratch. This means that multiple "out of limit" records can be in sequence with no "into limit" records. Cross- reference the System Events for Power Up events.
 - This also means that if a limit is "out," and it goes back in during the power off condition, no "into limit" record will be recorded.
 - The "worst" value of the "into limit" record follows the above restrictions; it only represents the values since power up. Any values before the power up condition are lost.

Historical Log Record:

Byte	0	1	2	3	4	5	6	-	-	N	
Value	timestamp						values . . .				

Size: 6+2 x N bytes (12+2 x N bytes), where N is the number of registers stored.

Data: The Historical Log Record data is 2 x N bytes, which contains snapshots of the values of the associated registers at the time the record was taken. Since the MP200 unit uses specific registers to log, with no knowledge of the data it contains, the Programmable Settings need to be used to interpret the data in the record. See Historical Logs Programmable Settings for details.

I/O Change Log Record:

I/O Change Log tables:

Byte	0	1	2	3	4	5	6	7	8	9	
Value	Timestamp						Card 1 Changes	Card 1 States	Card 2 Changes	Card 2 States	

I/O Board Change Flags:

Bit	7	6	5	4	3	2	1	0
Value	Out 4 Change	Out 3 Change	Out 2 Change	Out 1 Change	In 4 Change	In 3 Change	In 2 Change	In 1 Change

I/O Board Current States:

Bit	7	6	5	4	3	2	1	0
Value	Out 4 State	Out 3 State	Out 2 State	Out 1 State	In 4 State	In 3 State	In 2 State	In 1 State

Size: 10 bytes (16 bytes)

Data: The states of the relay and digital inputs at the time of capture for the I/O board.

NOTES:

- An I/O Change log record will be taken for each Relay and Digital Input that has been configured in the Programmable Settings to record when its state changes.

send: 01 03 C3 4F 00 01 - **Log Retrieval header**

recv: 01 03 02 FF FF FC

send: 01 06 C3 4F 01 80 - **Engage the log**

recv: 01 06 C3 4F 01 80 66

send: 01 03 C7 47 00 10 - **Historical Log 1 status block**

recv: 01 03 20 00 05 7F DF 00 00 01 3D 00 22 00 00 0D 01 15 10 10 56 0D 01
16 0B 39 00 00 00 00 00 00 00 00 18

send: 01 10 C3 51 00 02 04 00 00 00 01 - **Set the retrieval index**

recv: 01 10 C3 51 00 02 D9

send: 01 23 C3 51 00 79 04 00 00 - **Read the first Window**

recv: 01 23 03 C8 00 00 00 01 0D 01 17 0D 17 00 00 00 00 00 00 00 00 00 00
00 00 00 00 00 00 00 00 00 00 00 00 00 00 00 00 00 00 0D 01 17 0D
18 00
00 00 00 00 00 0D 01 1B 00 00 00 00 00 00 00 00 00 00 00 00 00 00
00 00 00 00 00 00 00 00 00 00 00 00 00 00 00 0D 01 17 0D 1C 00 00 00
00
00 00 0D 01 17 0D 1D 00 00 00 00 00 00 00 00 00 00 00 00 00 00 00
00 00 00 00 00 00 00 00 00 00 00 00 00 0D 01 17 0D 1E 00 00 00 00
00
0D 01 17 0D 1F 00 00 00 00 00 00 00 00 00 00 00 00 00 00 00 00 00
00 00 00 00 00 00 00 00 00 00 00 00 0D 01 01 00 00 03 17 0D 19 00 00 00
00
00 00 0D 01 17 0D 1A 00 00 00 00 00 00 00 00 00 00 00 00 00 00 00
00 00 00 00 00 00 00 00 00 00 00 00 0D 01 17 0D 00 00 00 00 00 00
00 0D 01
17 0D 1E 00 00 00 00 00 00 00 00 00 00 00 00 00 00 00 00 00 00 00
00 00 00 00 00 00 00 00 0D 01 17 0D 1F 00 00 00 00 00 00 00 00
00 00 00 00 00 00 00 00 00 00 00 00 00 00 00 00 00 00 00 0D 01 17
0D 20 00
00 00 00 00 00 00 0D 01 17 0D 21 00 00 00 00 00 00 00 00 00 00 00
00 00 00 00 00 00 00 00 00 00 00 00 00 00 00 00 0D 01 17 0D 02
00 00 05 1B 00 00 00 00 00 00 00 00 00 00 00 00 00 00 00 00 00 00
00 00 00 00 00 00 00 00 0D 01 17 0D 1C 00 00 00 00 00 00 00 00
00 00 00 00 00 00 00 00 00 00 00 00 00 00 00 00 00 00 0D 01 17

0D 1D 00
00 00 00 00 00 00 0D 01 17 0D 20 00 00 00 00 00 00 00 00 00 00 00
00 00 00 00 00 00 00 00 00 00 00 00 00 00 00 00 00 0D 01 17 0D 21 00
00
00 00 00 00 0D 01 17 0D 22 00 00 00 00 00 00 00 00 00 00 00 00 00
00 00 00 00 00 00 00 00 00 00 00 00 00 00 00 0D 01 17 0D 23 00 00 00
00
00 00 0D 01 17 0D 24 00 03 00 00 07 00 00 00 00 00 00 00 00 00 00 00
00 00 00 00 00 00 00 00 00 00 00 00 00 00 00 00 0D 01 17 0D 1E 00
00
00 00 00 00 0D 01 17 0D 1F 00 00 00 00 00 00 00 00 00 00 00 00 00 00
00 00 00 00 00 00 00 00 00 00 00 00 00 0D 01 17 0D 22 00 00 00 00 00
00
D0 11 70 D2 30 00 00 00 00 00 00 00 00 00 00 00 00 00 00 00 00 00
00 00 00 00 00 00 00 00 00 00 00 00 00 00 D0 11 70 D2 40 00 00 00 00 00
00
00
00 00 00 00 00 00 00 00 0D 01 17 0D 26 00 00 00 15

send: 01 23 C3 51 00 79 04 00 00 - **Read the last Window**

recv: 01 23 03 C8 04 00 00 09 00 00 00 00 00 00 00 00 00 00 00 00 00 00
00 00 00 00 00 00 00 00 00 00 0D 01 17 0D 20 00 00 00 00 00 00 00
00 00 00 00 00 00 00 00 00 00 00 00 00 00 00 00 00 00 00 0D 01 17
0D 21 00
00 00 00 00 0D 01 17 0D 24 00 00 00 00 00 00 00 00 00 00 00 00 00
00 00 00 00 00 00 00 00 00 00 00 00 00 00 00 0D 01 17 0D 25 00 00
00
00 00 00 0D 01 17 0D 26 00 00 00 00 00 00 00 00 00 00 00 00 00 00
00 00 00 00 00 00 00 00 00 00 00 00 00 00 0D 01 17 0D 27 00 00 00 00
00
00 0D 01 17 0D 28 00 00 00 00 00 05 00 00 0B 00 00 00 00 00 00 00 00
00 00 00 00 00 00 00 00 00 00 00 00 00 00 00 00 0D 01 17 0D 22 00 00
00
00 00 00 0D 01 17 0D 23 00 00 00 00 00 00 00 00 00 00 00 00 00 00 00
00 00 00 00 00 00 00 00 00 00 00 00 0D 01 17 0D 26 00 00 00 00 00 00
00 0D

01 17 0D 27 00 00 00 00 00 00 00 00 00 00 00 00 00 00 00 00 00 00
00 00 00 00 00 00 00 00 00 00 0D 01 17 0D 28 00 00 00 00 00 00 00 00
00 0D 01 17
0D 29 00
00 00 00 00 00 00 00 0D 01 17 0D 2A 00 00 00 00 00 00 00 06 00 00 0D
00 0D 01
17 0D 24 00
00 00 00 00 00 00 00 0D 01 17 0D 25 00 00 00 00 00 00 00 00 00 00
00 00 00 00 00 00 00 00 00 00 00 00 00 00 00 00 0D 01 17 0D 28 00
00
00 00 00 00 0D 01 17 0D 29 00 00 00 00 00 00 00 00 00 00 00 00 00 00
00 00 00 00 00 00 00 00 00 00 00 00 00 00 00 0D 01 17 0D 2A 00 00 00
00
00 00 0D 01 17 0D 2B 00 00 00 00 00 00 00 00 00 00 00 00 00 00 00 00
00 00 00 00 00 00 00 00 00 00 00 00 00 0D 01 17 0D 2C 00 00 00 00 00
00 00 00 00 07 00 00 0F 00 00 00 00 00 00 00 00 00 00 00 00 00 00 00
00 00 00 00 0D 01 17 0D 26 00 00 00 00 00 00 00 00 00 00 00 00 00 00
00 00 00 00 00 00 00 00 00 00 00 00 00 00 00 0D 01 17 0D 27 00 00 00
00
0D 01 17 0D 2A 00 00 00 00 00 00 00 00 00 00 00 00 00 00 00 00 00 00
00 00 00 00 00 00 00 00 00 00 00 00 0D 01 17 0D 2B 00 00 00 00 00 00
00 0D 01
17 0D 2C 00
00 00 00 00 00 00 00 00 0D 01 17 0D 2D 00 00 00 00 00 00 00 00 00
00 00 00 00 00 00 00 00 00 00 00 00 00 00 00 00 00 00 00 0D 01 17
0D 2E 00 00 00 00 00 00 00 00 00 00 00 00 03

send: 01 06 C3 4F 00 00 - **Disengage Log**

recv: 01 06 C3 4F 00 00 E7

Sample Historical Log 1 Record:

Historical Log 1 Record and Programmable Settings

```

14 0D 01 17 0D 16 15 00 14 0D 01 17 0D 24 00 00
22 00 00 00 0E 00 00 00 00 00 00 00 00 00 00 |07| 00
DF 7F 05 00 00 00 00 00 00 00 00 00 00 00 00 00
|37| 00 00 00 |01| 00 00 00 00 00 00 00 00 00 00 00 00
00 00 00.....
|E7 03|04| 00 |0A| 00 00 00 00 00 00 00 00 00 00 00 00
|E9 03|04 00 |0A| 00 00 00 00 00 00 00 00 00 00 00 00
|EB 03|04| 00 |0A| 00 00 00 00 00 00 00 00 00 00 00 00
|ED 03|04| 00 |0A| 00 00 00 00 00 00 00 00 00 00 00 00
|EF 03|04| 00 |0A| 00 00 00 00 00 00 00 00 00 00 00 00
|F1 03|04| 00 |0A| 00 00 00 00 00 00 00 00 00 00 00 00
|F3 03|04| 00 |0A| 00 00 00 00 00 00 00 00 00 00 00 00
    
```

Item values	Type and Size	Descriptions
07		# registers
37		# sectors
01		interval
E7 03	0A 04	(SINT 2 byte)Voltage A-N
E9 03	0A 04	(SINT 2 byte)Voltage B-N
EB 03	0A 04	(SINT 2 byte)Voltage C-N
ED 03	0A 04	(SINT 2 byte)Voltage A-B
EF 03	0A 04	(SINT 2 byte)Voltage B-C

This page intentionally left blank.