

LED Display Installation Manual

LH015IFH* (P1.5)**

LH020IFH* (P2.0)**

LH025IFH* (P2.5)**

SBB-SNOWH3U



Check first before Installation

- All Power cables and OCM cable must be connected firmly

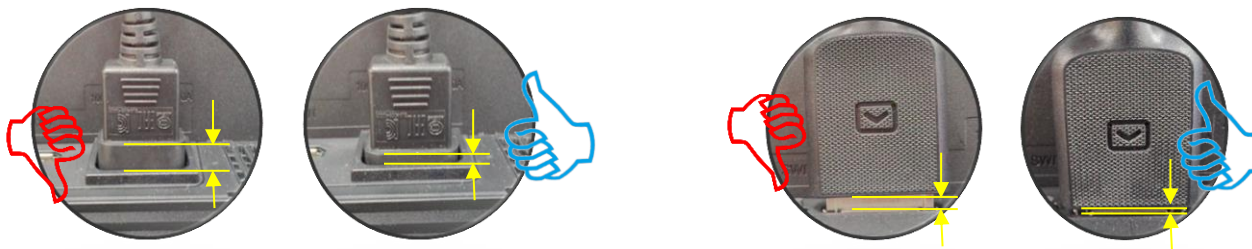

- For HDBT signal stability, use the cable above CAT6 *STP, *FTP level. (Length 15m~100m)
- Do not use "comb" or "pinstripe" cable. *"CAT6 UTP can not be allowed"*
- Do not mix cabinet which have different Project number, each cabinet have its own project number.



- 1. Product Information and Precautions for Installation**
- 2. Preparation for Cabinet Installation**
- 3. Frame Installation**
- 4. Cabinet + Frame Installation**
- 5. SBOX Connection**
- 6. Settings and How to Use**
- 7. Issue and Solution**
- 8. Cable Connection**
- 9. Seam Adjustment**

1. Product Information and Precautions for Installation

◇ Frame Kit Composition (Refer to Page 9)

Frame Kit	Composition	Note
VG-LFH15FWA	6*3(18 Set)	FHD Installation for P1.5 Standard
VG-LFH20FWA	8*4(32 Set)	FHD Installation for P2.0 Standard
VG-LFH25FWA	10*5(50 Set)	FHD Installation for P2.5 Standard

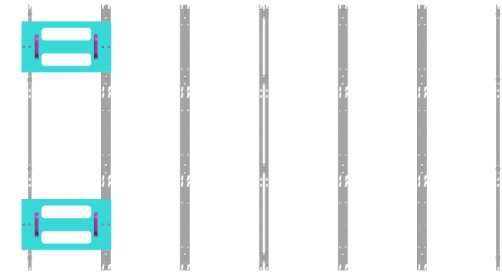

<6*3 Frame>

◇ Cabinet Product Information

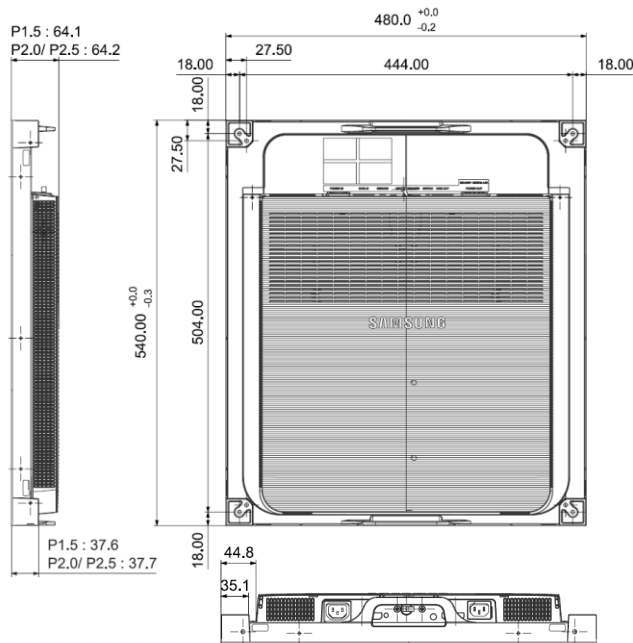

◇ SBB-SNOWH3F/U (S-Box, I/G)

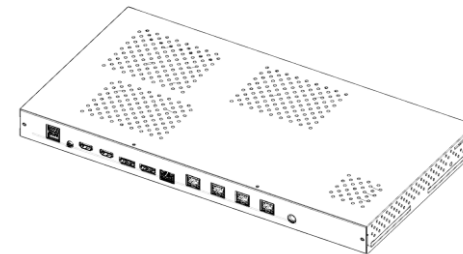

Fig.3 S-Box

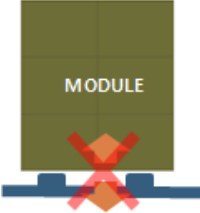
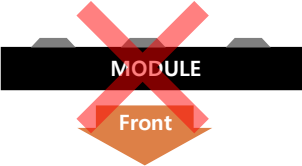

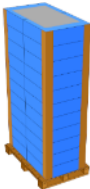
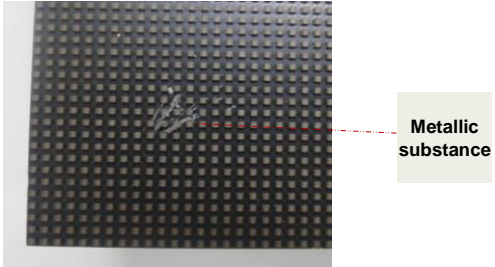

Fig.4 I/G
(Interface Gender)

1. Product Information and Precautions for Installation



• Precautions for Installation (LED damage)

Precautions		
<p>[Beware of Outside Impact, Fall]</p> <p>① Beware not to cause any impact on the LED screen or drop the product on the floor after the protection gets taken off for installation.</p> <p>② Beware not to put the LED side headed downwards to the floor after the protection gets taken off for installation.</p> <p>③ Beware not to have the corner area of LED module be damaged due to the contact with the outside.</p> <p>④ Beware not to put more than 12 layers.</p>	 <p>①</p>	 <p>②</p>
<p>[Beware of LED Damage due to Static Electricity]</p> <p>▶ Beware not to touch LED screen with bare hands without putting gloves on.</p>	 <p>③</p>	 <p>④</p>
<p>[Beware of LED Damage due to Metallic Substances]</p> <p>▶ Beware not to have metallic substances pulled in to the surface due to the magnetic force on the front side of the LED.</p> <p>▶ If any metallic substances get drawn in on the surface, please disassemble the module and then remove the pollutants by using a magnet.</p>	 <p>Metallic substance</p>	

1. Product Information and Precautions for Installation

◇ Ventilation Guide

▪ Standard and condition for indoor installation

※ Written under 'Full white, 650nit (back light 7)' standard
Written under 'Video, (back light 10)' standard

- Standard for using 'SAMSUNG WALL MOUNT' (Fulfill ADA)

※ ADA(American's with Disabilities Act)

- The gap between the front of a product and a wall: 90mm
- The gap between the back of a product and a wall: 25mm

- When sunlight enters

- If a sunlight enters through a window or outside walls of a building, an additional inquiry is needed.

- The effect of warm/cold air from a duct system

- Make sure the warm/cold breeze(especially warm air) from a duct system not to affect a product.

- The measuring location for ambient temperature

- Either right in the center of a product or inlet part

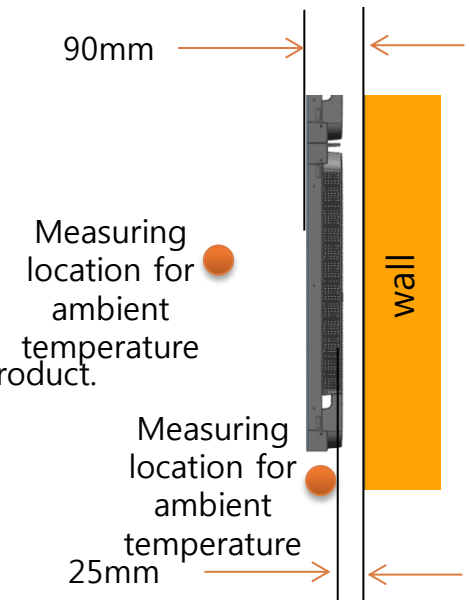

1. Product Information and Precautions for Installation

▪ Minimum spacing for buried installation

(Specification for no Fan & Samsung Frame Kit installation)

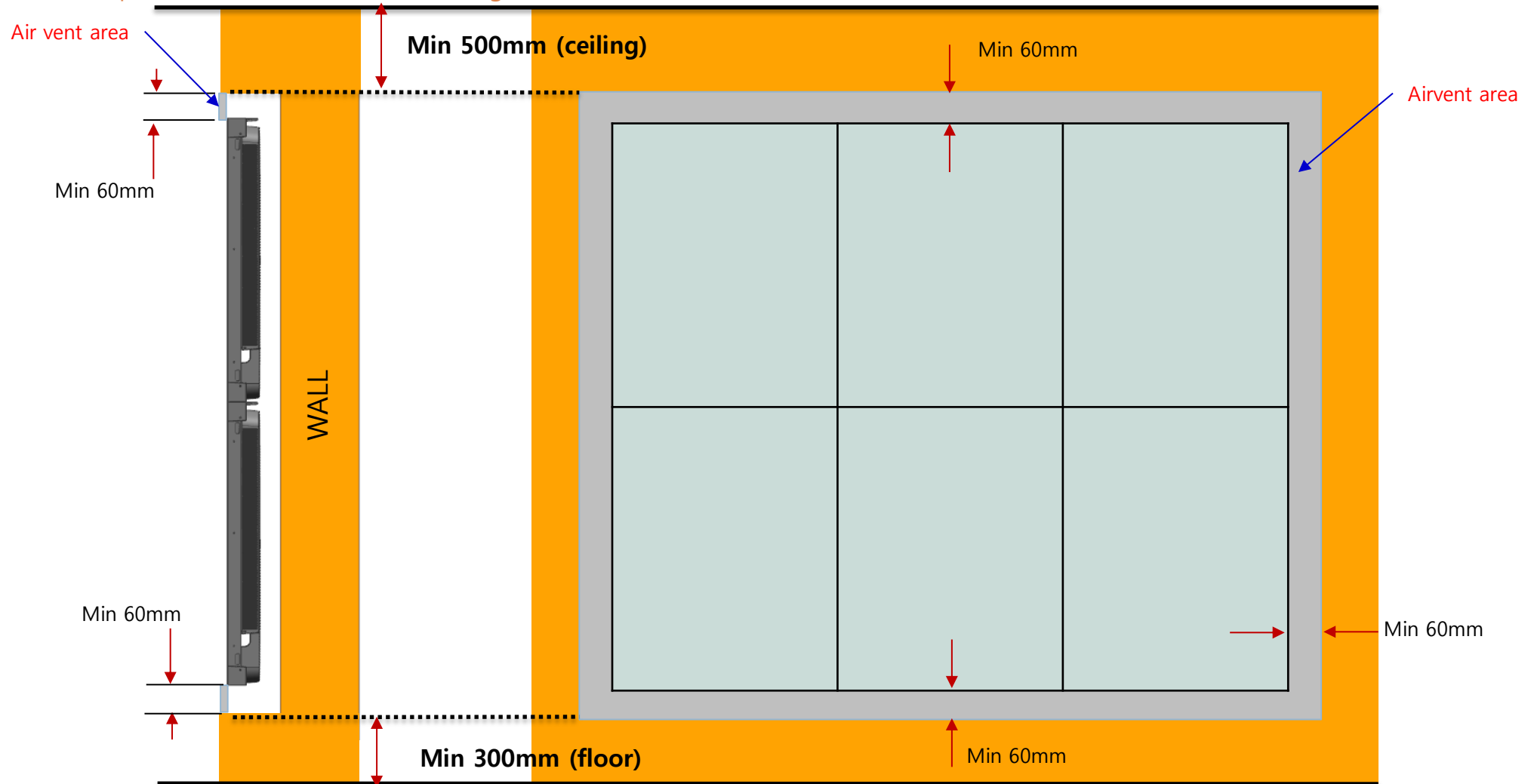

1. Product Information and Precautions for Installation

▪ Minimum spacing for wall installation

(Specification for no Fan & Samsung Frame Kit installation)

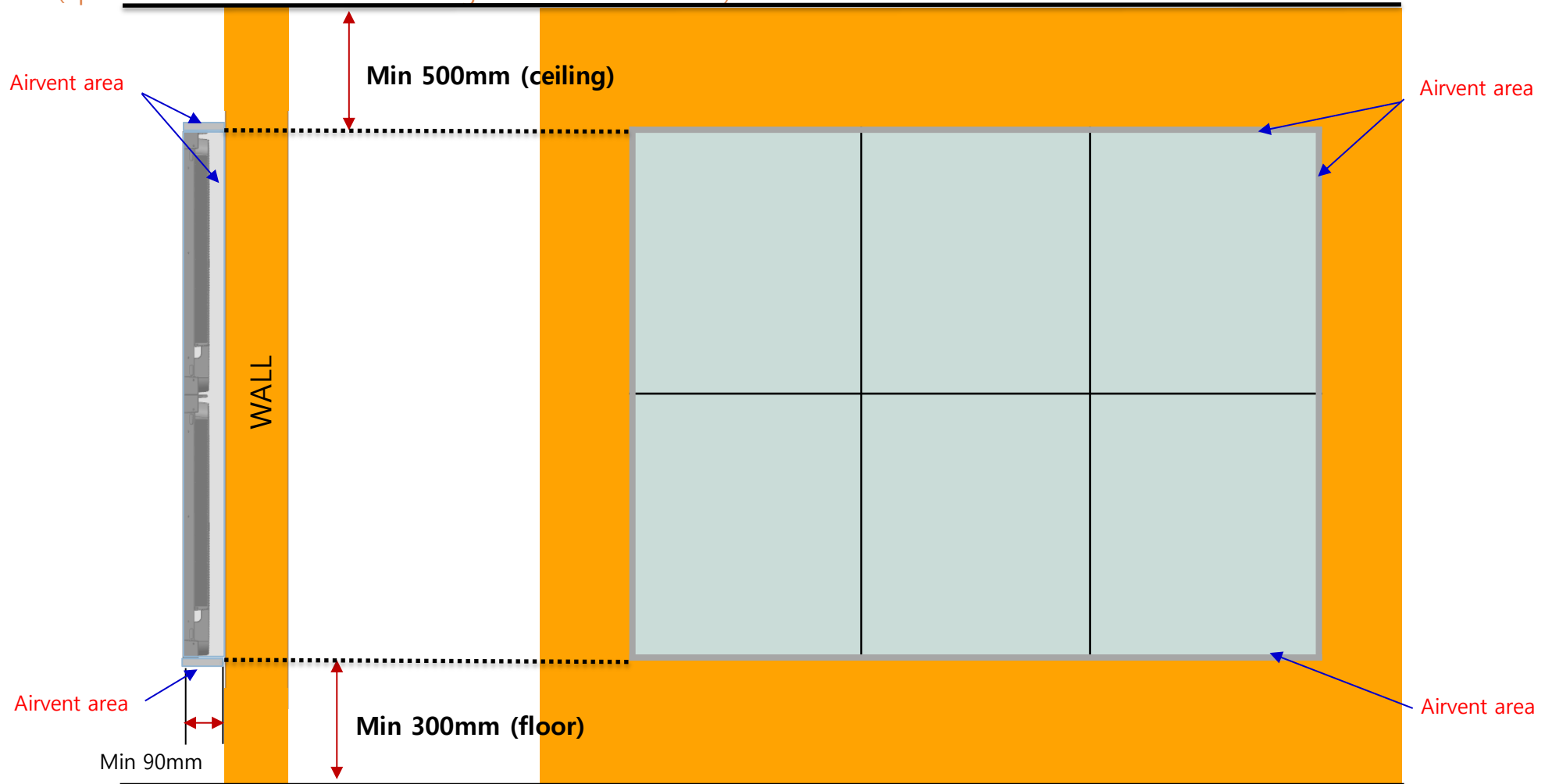

1. Product Information and Precautions for Installation

▪ Example of choice for Axial Fan

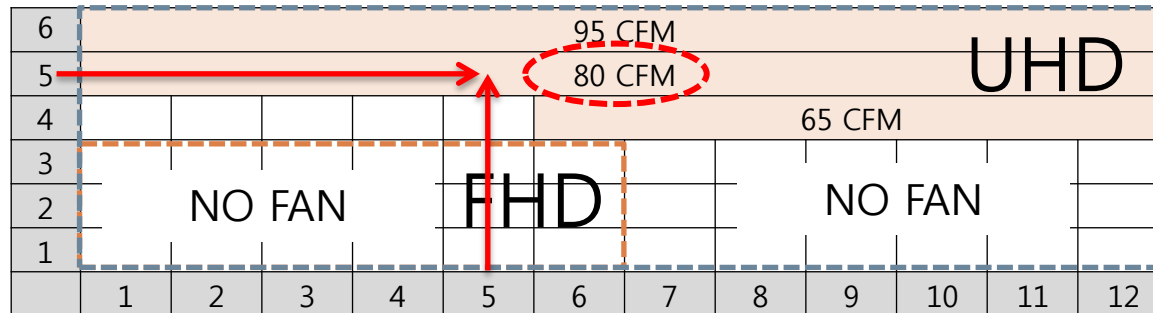

※ Ex) When ambient temperature is 30°C,
and installed cabinet has a configuration of 5 by 5
how much would total CFM be ?

$$\rightarrow 80 \text{ [CFM/column]} \times 5 \text{ [column]} = \mathbf{400 \text{ [CFM]}}$$

※ FAN CFM is not the Maximum, but the actual flow

- Ebm papst : <http://www.ebmpapst.com>

• Model : 614 J/2 HHP Size : 60*60*32

• Flow : MAX 48.3 CFM Installation Qty : 3 fans per column
 ※ Considering to pressure drop/flow loss

- delta-fan : <http://www.delta-fan.com>

• Model : AFB0612HHE Size : 60*60*38

• Flow : MAX 54.5 CFM Installation Qty : 3 fans per column
 ※ Considering to pressure drop/flow loss

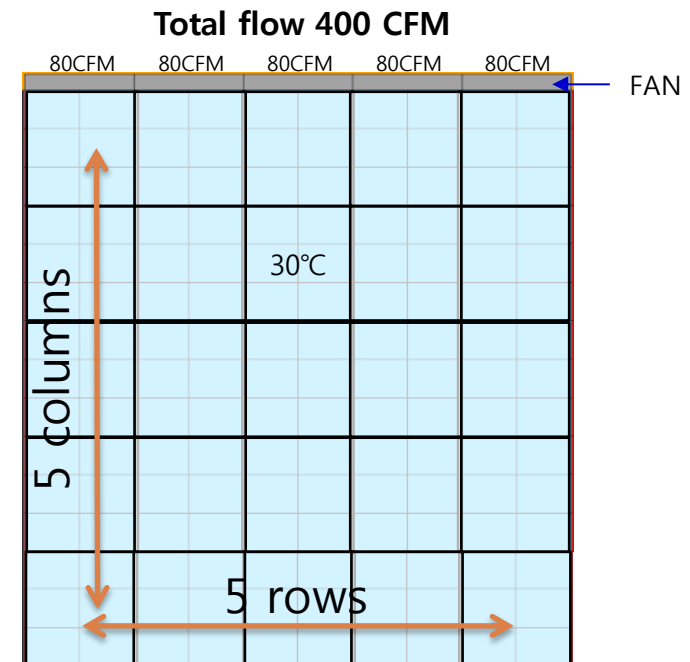

1. Product Information and Precautions for Installation

▪ FAN using condition

- Air Vent : Install only on the bottom
- Upper part: Seal except the fan opening

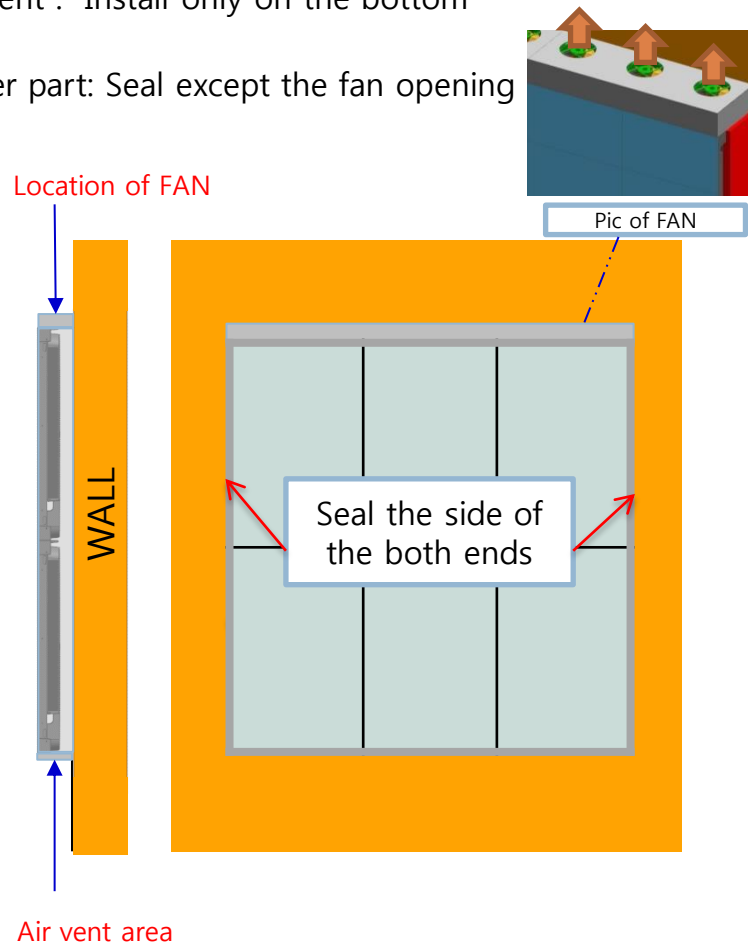

▪ Vent Specification

- Use the vent with more than 70% of aperture ratio
- Aperture ratio (%) = $\frac{(c \times d) \times \text{No. of vent hole}}{A \times B}$

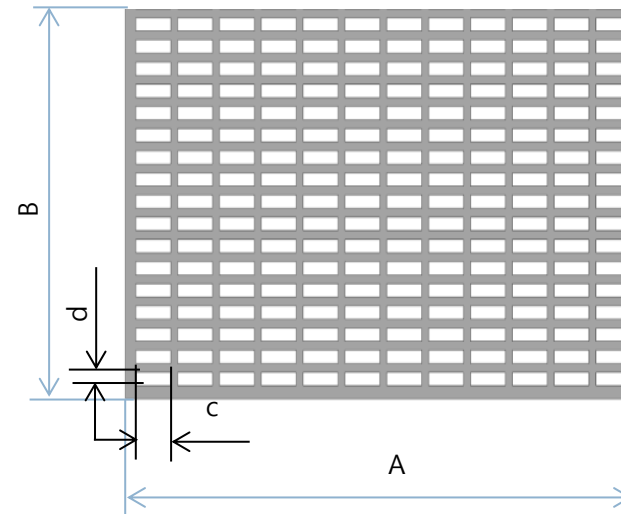

1. Product Information and Precautions for Installation

- IFH P1.5 (under 25°C) Guidance

※ When Using SAMSUNG Frame Kit , Full white, back light 7, Top/bottom VENT 50%

6													UHD
5									No Fan				
4													
3						FHD							
2			No Fan										
1													
	1	2	3	4	5	6	7	8	9	10	11	12	

1. Product Information and Precautions for Installation

- IFH P1.5 (25~30°C)

※ When Using SAMSUNG Frame Kit , Full white, back light 7, Top/bottom VENT 50%

Columns	6	95 CFM											UHD	
	5	80 CFM												
	4						65 CFM							
	3						FHD							
	2		No Fan							No Fan				
	1													
		1	2	3	4	5	6	7	8	9	10	11	12	
		Rows												

1. Product Information and Precautions for Installation

- IFH P2.0 (under 25°C)

※ When Using SAMSUNG Frame Kit , Full white, back light 7, Top/bottom VENT 50%

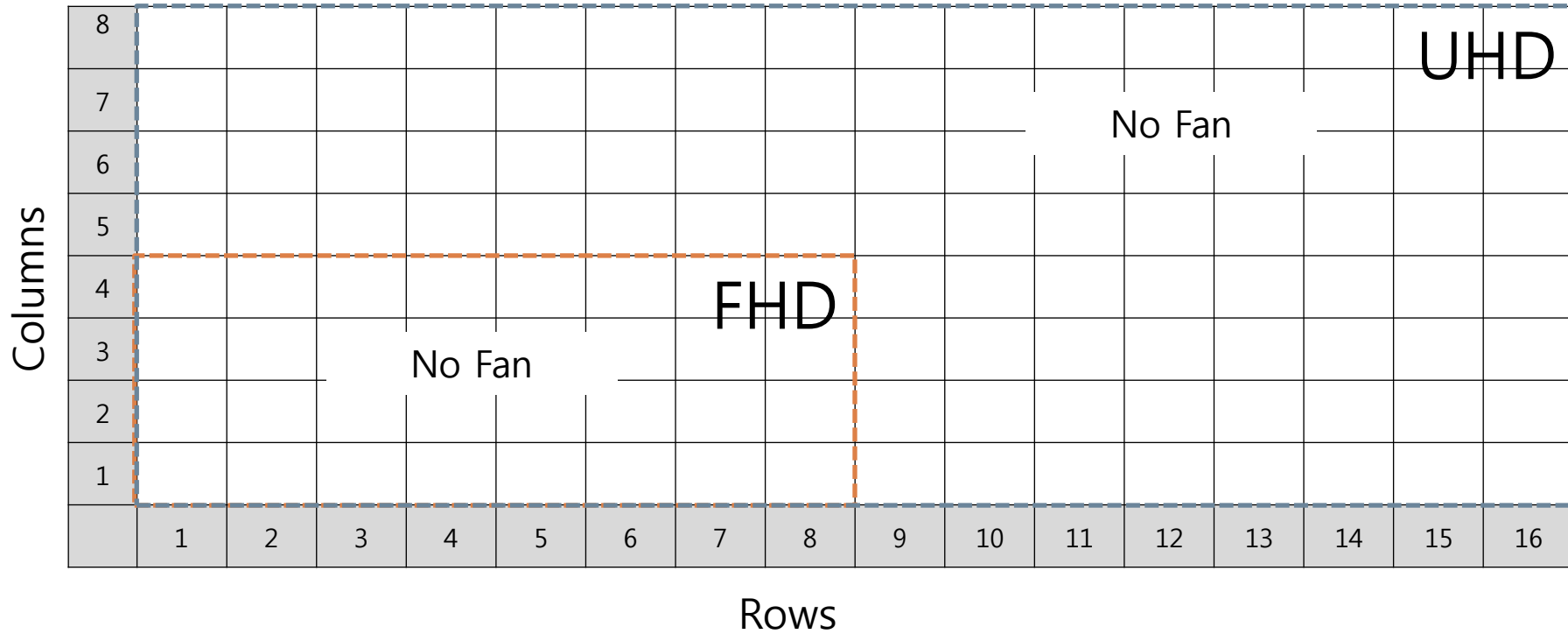

1. Product Information and Precautions for Installation

- IFH P2.0 (25~30°C)

※ When Using SAMSUNG Frame Kit , Full white, back light 7, Top/bottom VENT 50%

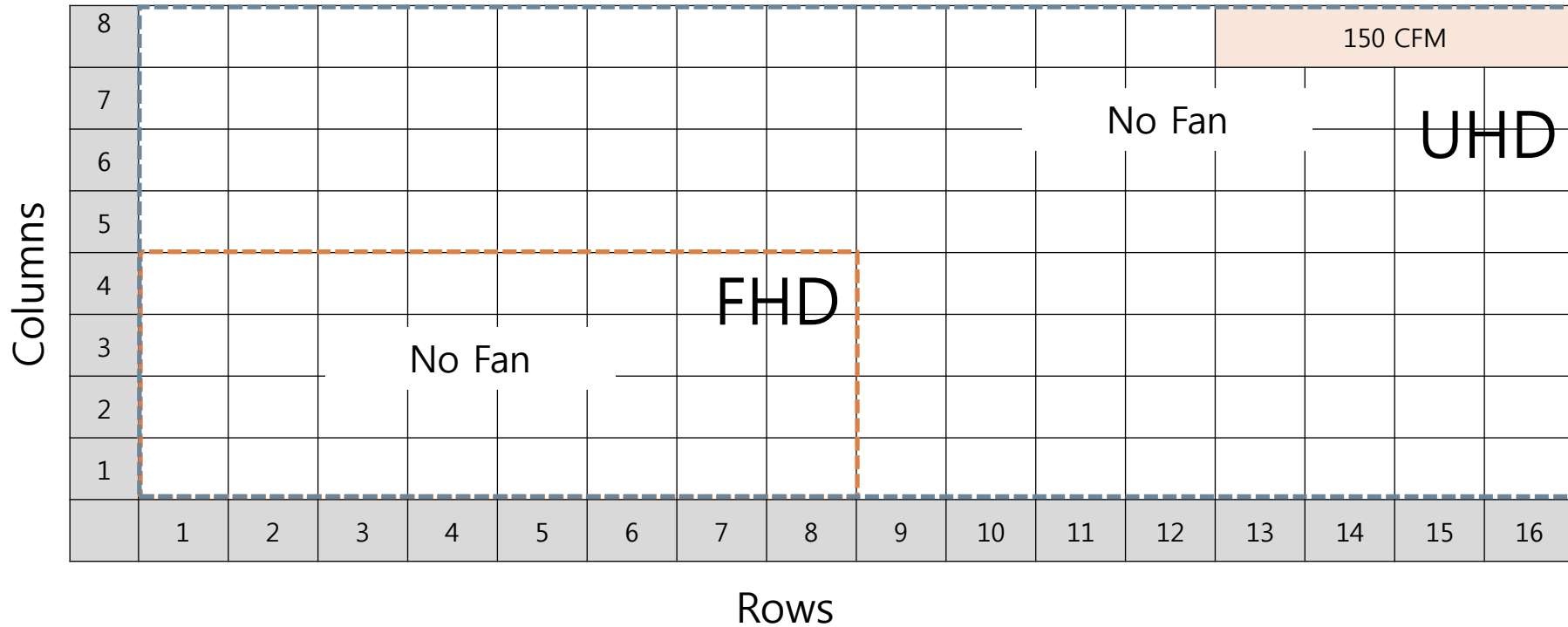

1. Product Information and Precautions for Installation

- IFH P2.5 (under 25°C)

※ When Using SAMSUNG Frame Kit , Full white, back light 7, Top/bottom VENT 50%

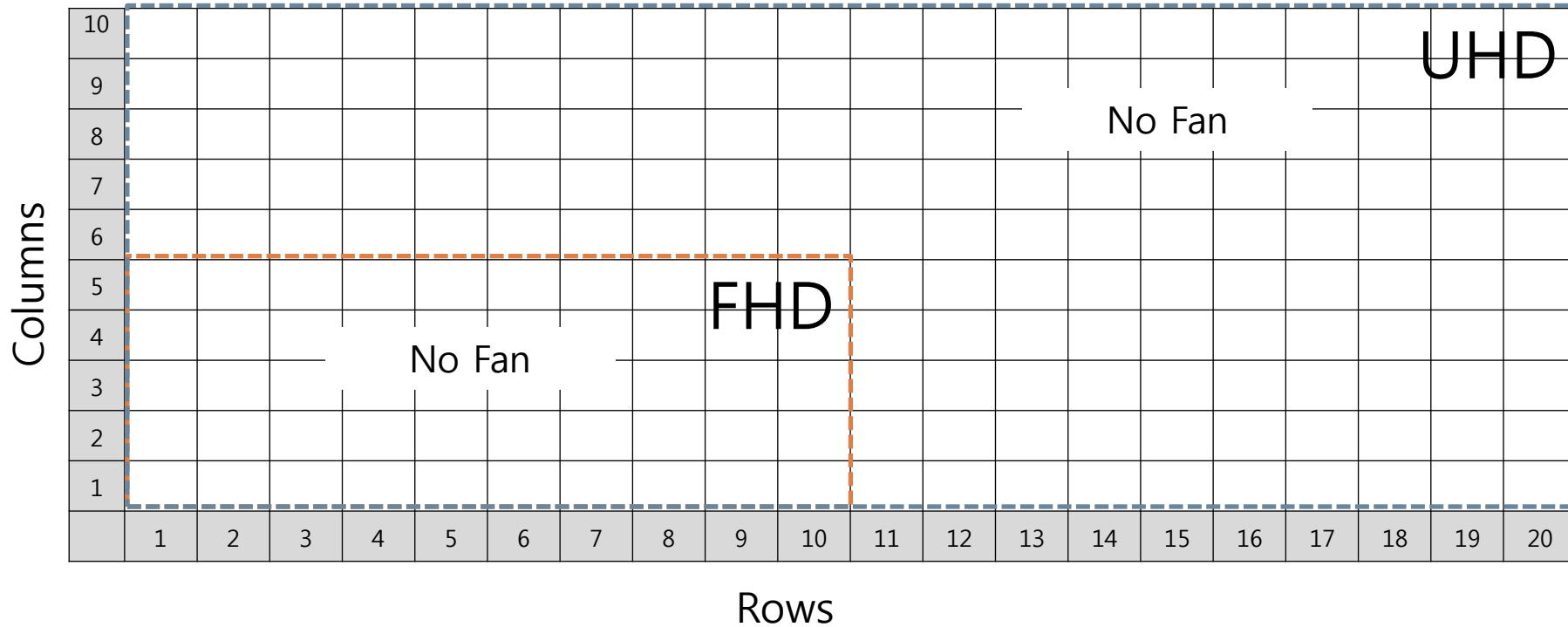

1. Product Information and Precautions for Installation

- IFH P2.5 (25~30°C)

※ When Using SAMSUNG Frame Kit , Full white, back light 7, Top/bottom VENT 50%

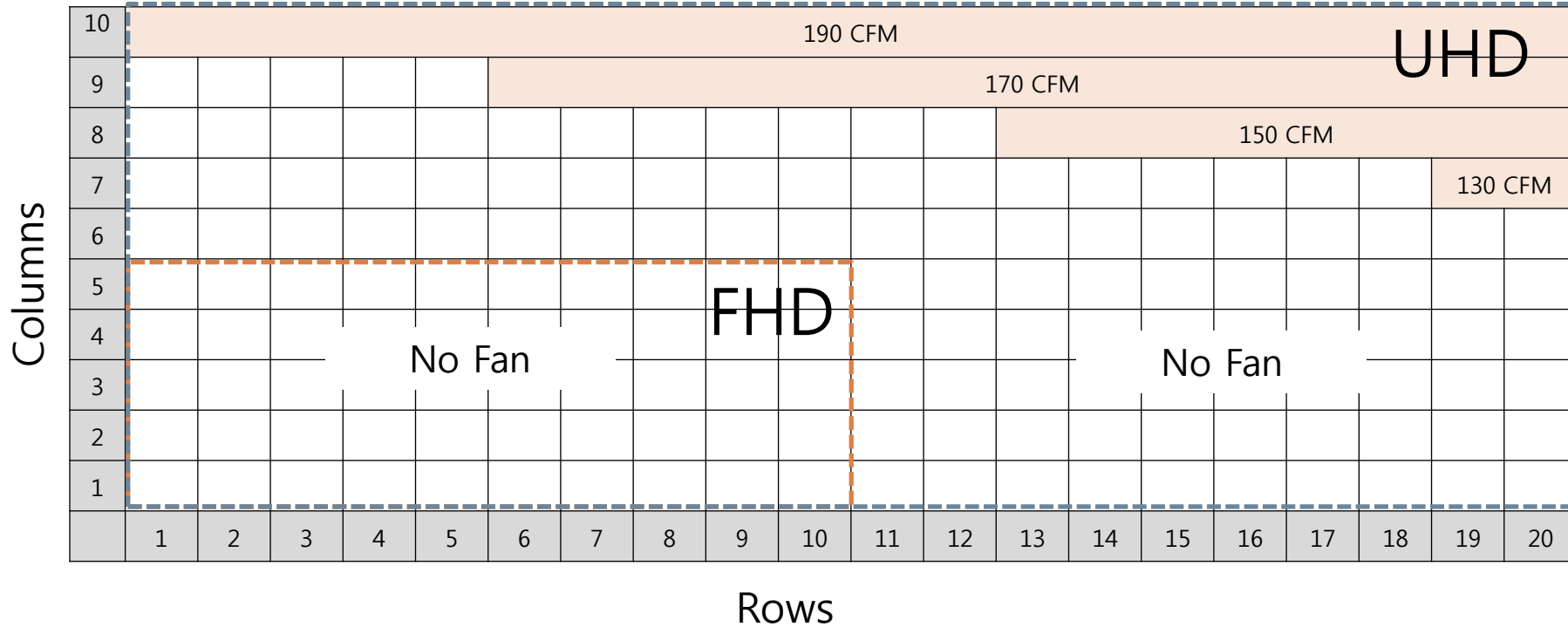

1. Product Information and Precautions for Installation

Samsung Electronics

• Preparations for Installation



10.0mm Wrench



Electric Driver



(-) (+) Driver



LED MODULE JIG
(model name: CY-LJFNAS)



Service JIG
(BH81-00001A)



Holder Magnet Tool



Plier



Antistatic Glove

2. Preparation for Cabinet Installation

• Preparations Before Installation

- ① Remove the Box tape at the upper area and then open up the box. (Fig.2)
- ② Remove the Top-Cushion and hold the handle inside PE-Bag and pull out the set then remove PE bag. (Fig.2)
- ③ Press the hook area and then bend backwards to separate the Cover-Connector. (Fig.3)
- ④ Assemble four(4) Sliding Screw for installation at the hole located at the outermost part of the Corner. (Fig.4)

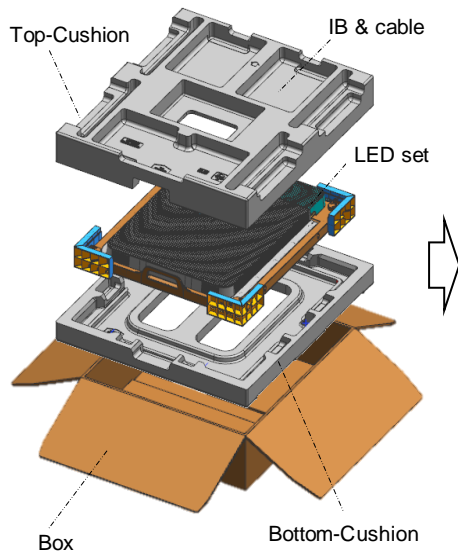

Fig.1 Packing & Product



Fig. 2 Opening up

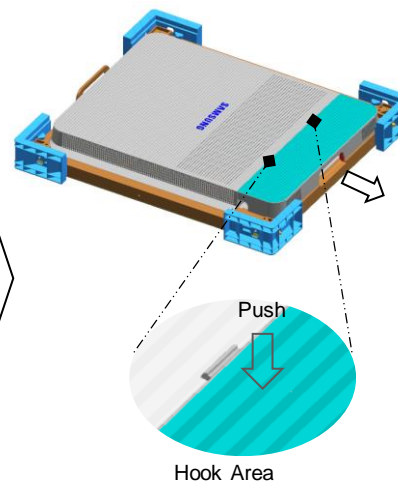
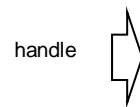

Fig.3 Cover Connector Removal

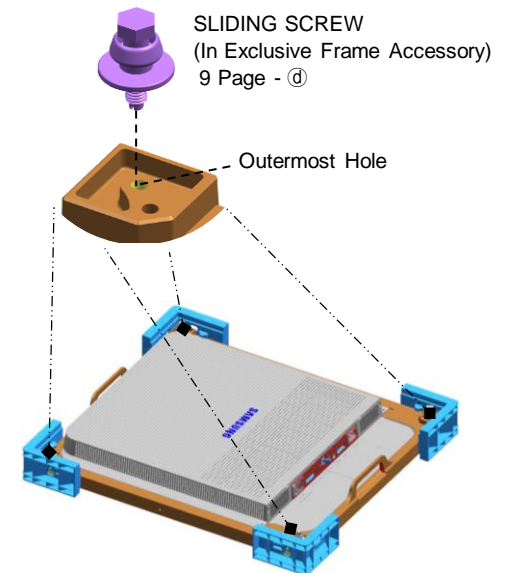

Fig.4 Bolt Assembly

2. Preparation for Cabinet Installation

⑤ Check whether there is any abnormality on the screen by connecting the power cable.(Fig.5)

※ Press the 'Switch' button for five(5) seconds after applying the electricity.

If the information screen comes out, press the Switch button to switch the screens on W/Pattern and check the screens.

⑥ Unfasten the screws (total of four[4]) on the Cover Corner area to separate those screws. (Fig.6)

⑦ Put the Cabinet on the Cushion Top so that the LED screen will head upwards. (Fig.7)

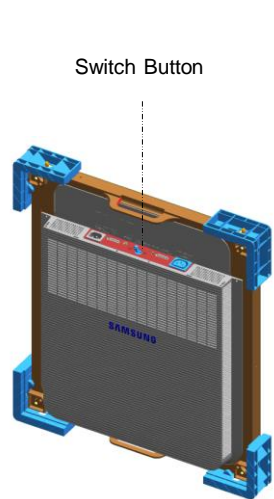

Fig.5 Check the Screen

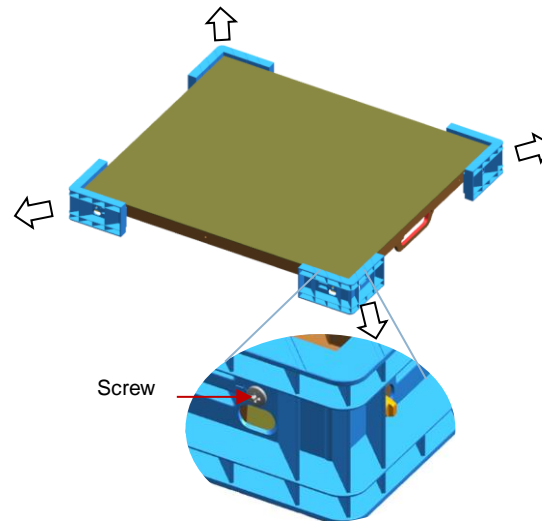

Fig.6 Cover Corner Removal

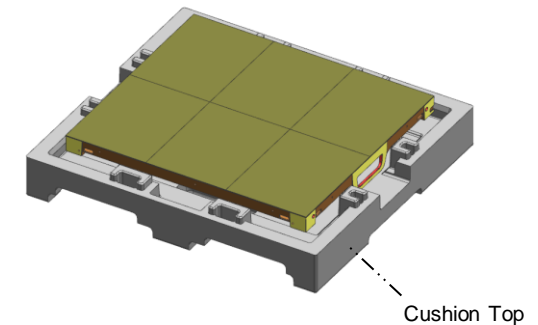

Fig.7 Cabinet Storage

2. Preparation for Cabinet Installation

◆ Reference : Process of Screen check



◇ Connect Power Cable to SET.

Use internal pattern to check dead pixel or any damage with screen

※ Internal white pattern :  **IMPORTANT**

- Turn on Power
- Push Source button 5 seconds and release,
- Wait for display, push one more times. (color rotation : White → Blue → Red → Green)
- Push button for 5 seconds again to exit factory OSD

2. Preparation for Cabinet Installation

⑧ Attach the PET Sheet and assemble Cover PCB for the Cabinet that is located at the exterior.

- ※ PET Sheet & Cover PCB should be at the boundary of whole screen. **(Blue area at the exterior of Fig.1)**
- ※ Attach PET Sheet as shown below.(Fig.3), The areas where there is no tape should guide the LED module.
- ※ Assemble the Cover PCB as shown below.(Fig.4)

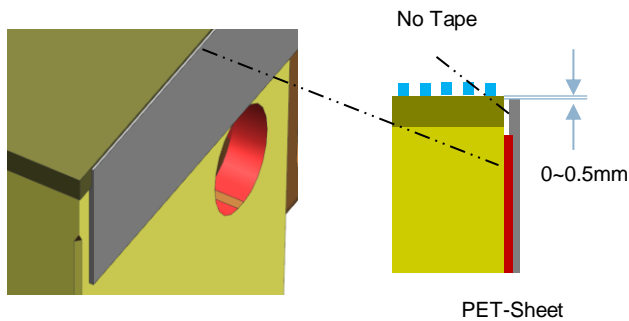

Fig.3

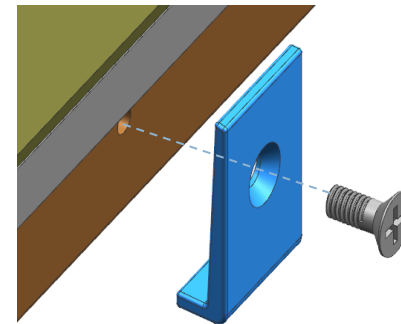

Fig.4

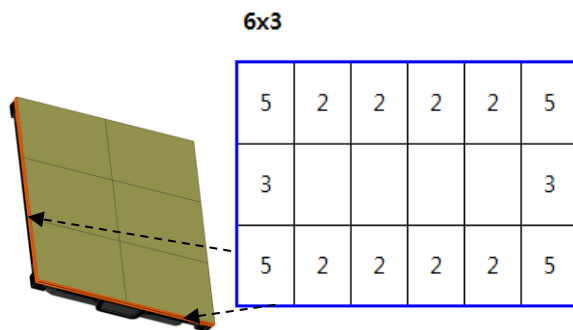

Fig.1 Attach point of Sheet PET

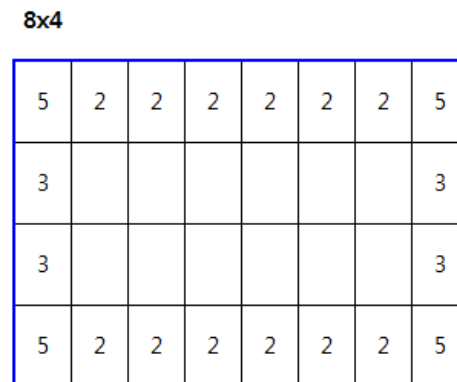

Fig.1 Sheet PET/ Cover PCB

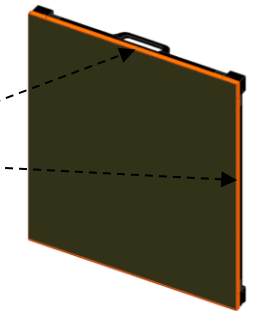
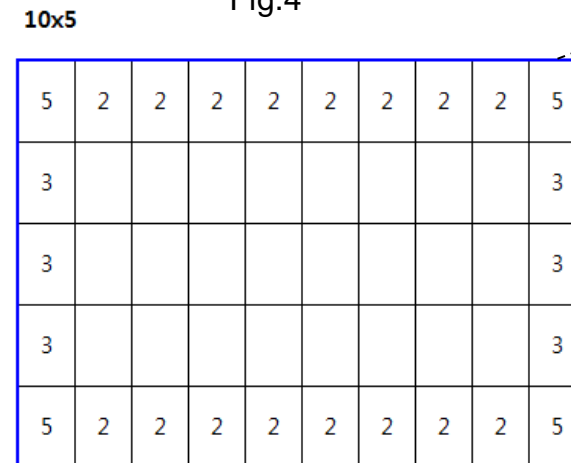
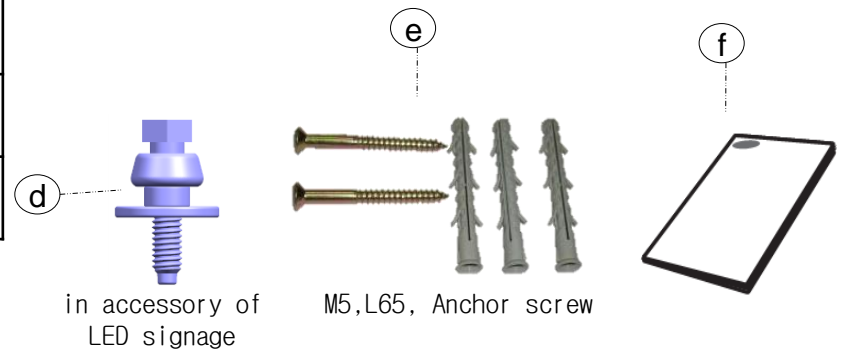
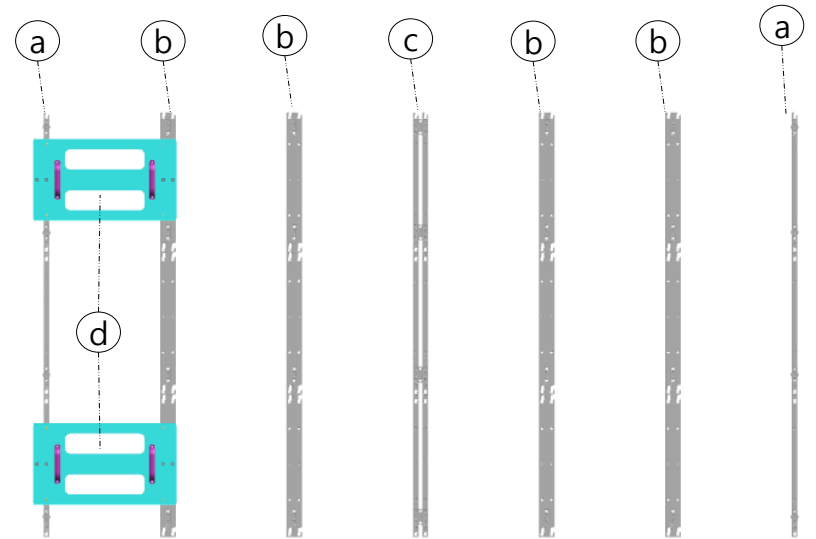

Fig.1 Attach point of Sheet PET

3. Frame Installation

① Check Frame Kit Composition.

No.	Item	VG-LFH15FWA	VG-LFH20FWA	VG-LFH25FWA
		6X3	8X4	10X5
		Units	Units	Units
Ⓐ	ASSY BRACKET SIDE	2	2	2
Ⓑ	ASSY BRACKET MIDDLE	4	6	8
Ⓒ	ASSY BRACKET CENTER	2	2	2
Ⓓ	ASSY BRACKET JIG	2	2	2
Ⓔ	ASSY SLIDING SCREW	-	-	-
Ⓕ	ASSY ANCHOR SCREW	28	45	66
Ⓖ	MANUAL-INSTALL	1	1	1
Size of the Installation Screen(mm)		2880X1620	3840X2160	4800X2700



3. Frame Installation

② Put the ① Bracket Side the end of the left side and then fasten the screws to install. (Fig.3)

※ After fastening one(1) screw, use the device for vertical positioning to set up straight vertical alignment. Then fasten up the remaining holes. (Refer to Page 22 for the Precautions for fixing the Screws)

Order of Fastening the Screws (No. 1 → No. 2 → No. 3). (Fig.1)

① Bracket Side is located at 7mm of the end line of the screen. (Fig.4)

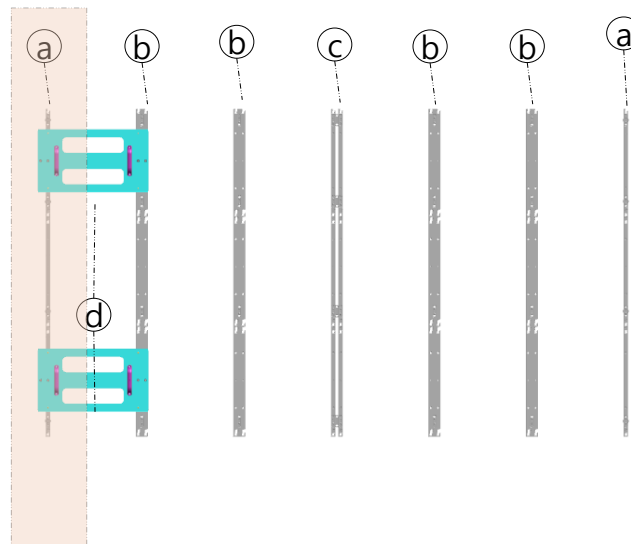
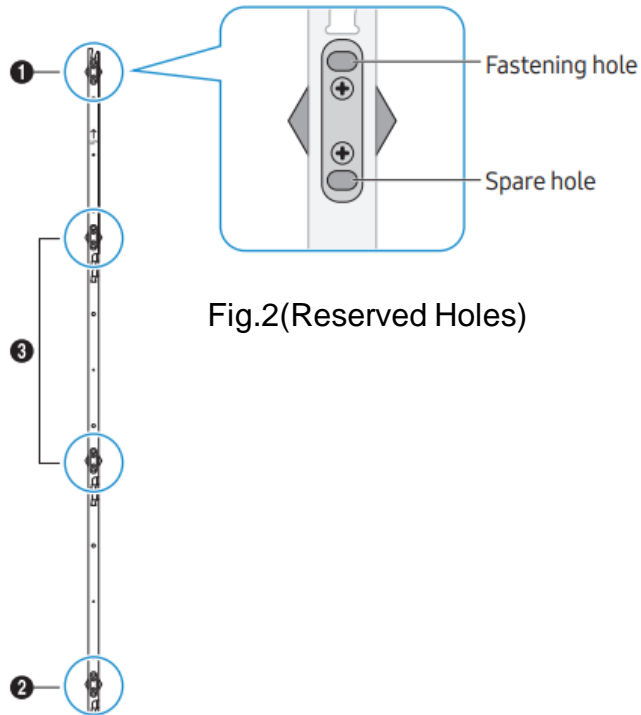

Fig.3 (Location of Components)

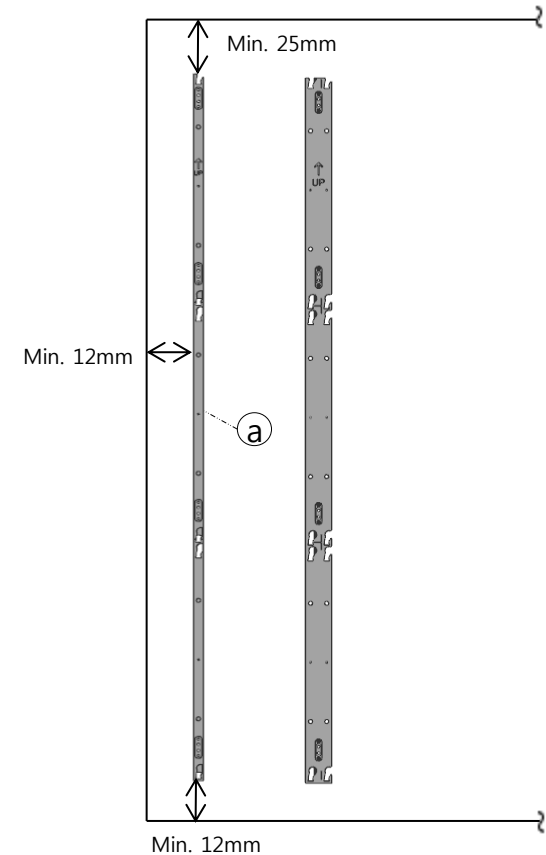

Fig.4 (Distance between Screen and Bracket side)

Fig.1 (Order of Work)

3. Frame Installation

※ Precautions for Fastening the Screws

Standard Installation Requirements by Wall Type

⚠ Check the wall type before installing.

- Can only be mounted on a concrete or interior wall of sufficient thickness. See the diagrams below.

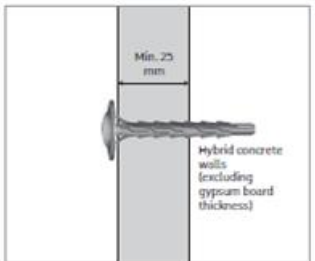
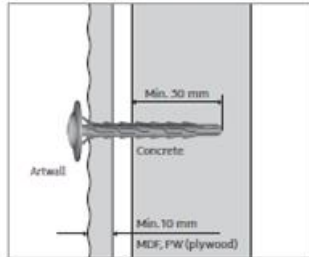
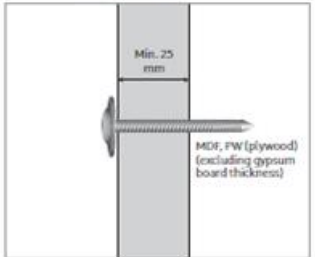
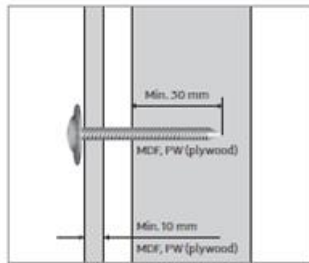
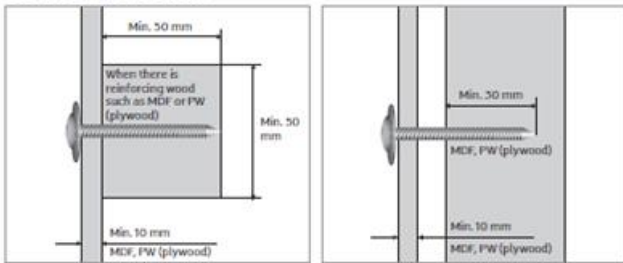

• **Note**
MDF = Medium Density Fiberboard
PW = Plywood

- First, check the status of the wall (type, thickness, flatness).

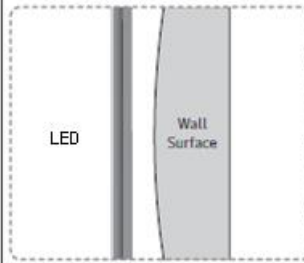

If the wall surface is not completely flat, gaps may form after installation.

① Walls made of thick enough concrete

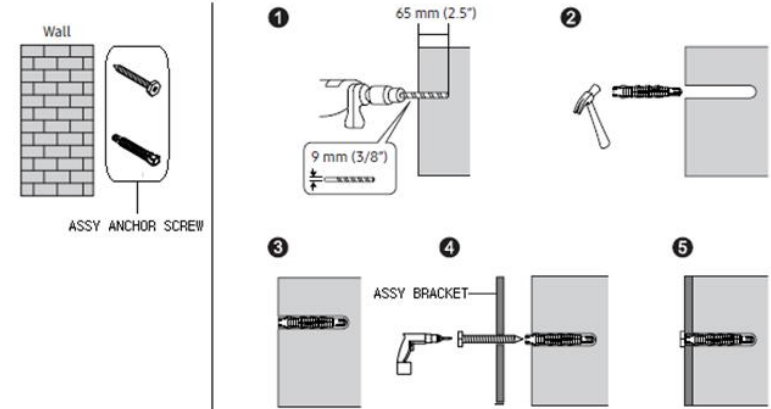

② Walls made of gypsum board with wood studs or MDF

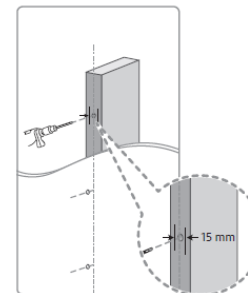
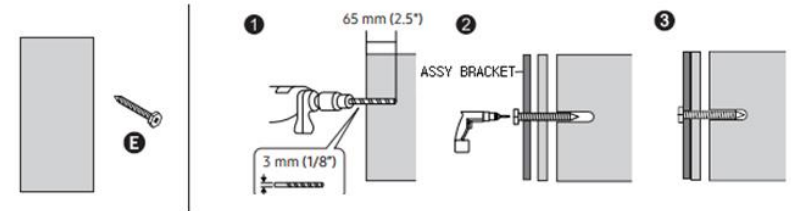

Installation Requirements

- Be sure to check the location of wooden studs in the wall before installing screws.
- Minimum wood stud size: 51 x 102 mm (2 x 4 in) Make holes (3 mm) first before installing screws.
- Holes for screws must be made at the center of studs.

⚠ Samsung is not responsible for problems that arise when the installation guide is not followed.

3. Frame Installation

③ Install ② Bracket Middle.

- ※ First, check the Hole to fix the ③ JIG. [Fig.1]
- ※ Second, Mount the ③ JIG inside the Bracket Hole and fasten up four(4) Screws [Fig.2]
- ※ Third, fasten the ② Bracket Middle using Screws. [Fig.3]
- ※ Warning. ①, ② and ③ sides should be attached, and the three(3) sides of Wall/Frame side/Jig side should be parallel.[Fig.4]

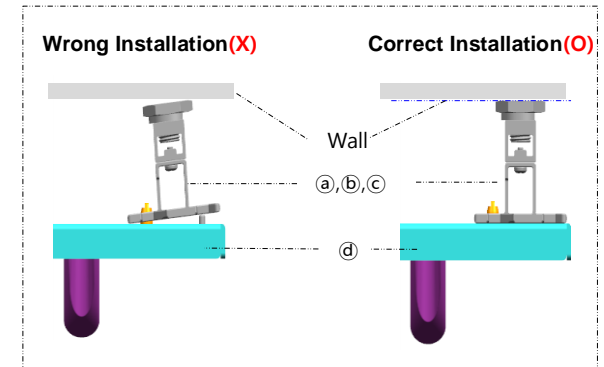

Fig4. Maintain the Parallel Frame

④ Install ② Bracket Middle in the same way (from left to right)

- ※ Install Bracket Center at the center of Frame KIT.

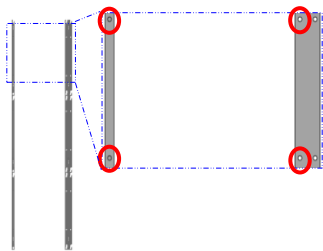

Fig1. Check the Hole

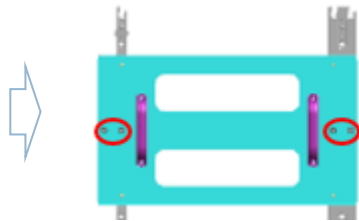

Fig2. Fix the Jig (Screw)

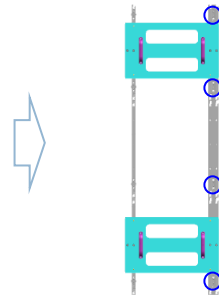

Fig3. Fasten the Screw

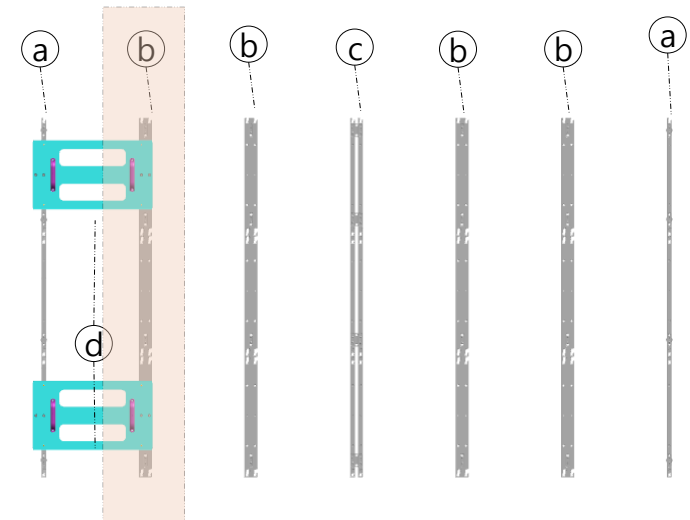

Fig5 (Location of Components)

3. Frame Installation

※ When installing three or more ASSY BRACKETs, adjust their levels because they may be distorted by walls or structures.

– After installing three or more ASSY BRACKETs, place another ASSY BRACKET horizontally on them and measure if there is a height difference among them. If a height difference is found, adjust the Z-Bolt heights of ASSY BRACKETs to make them level with each other.

– Adjusting the heights

1. To adjust the Z-Bolt height of the frame, first remove the washer.
2. After removing the washer, use a wrench (28 mm) to adjust the Z-Bolt height.

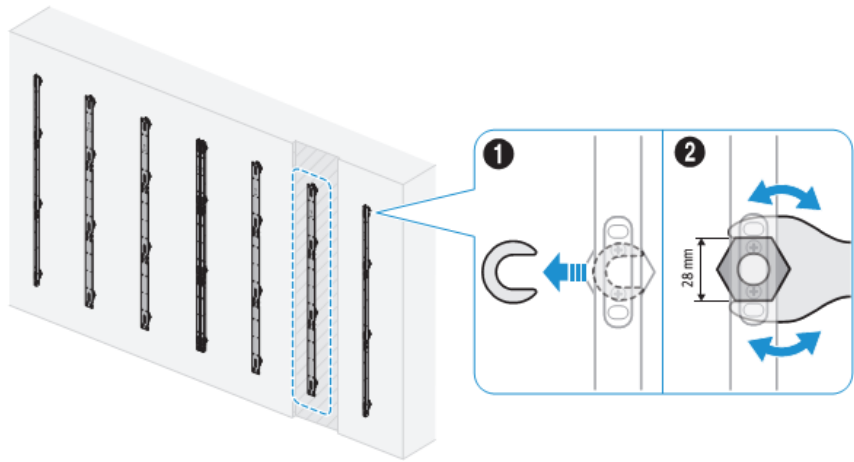
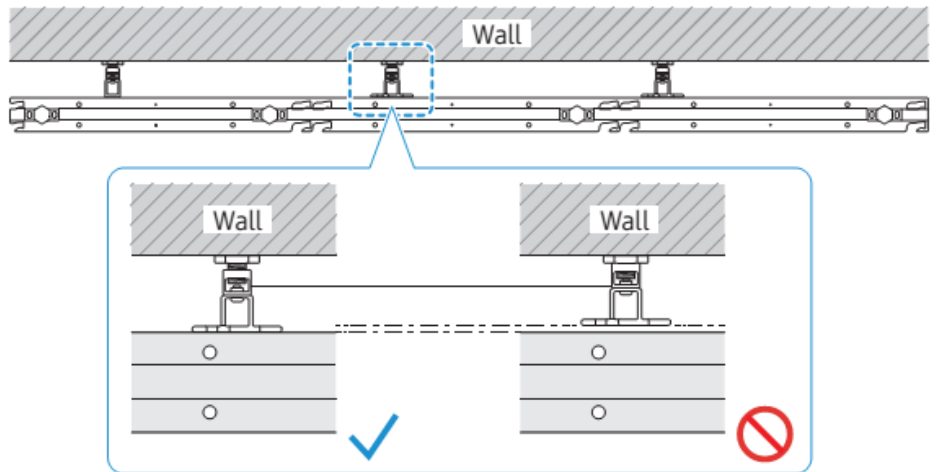
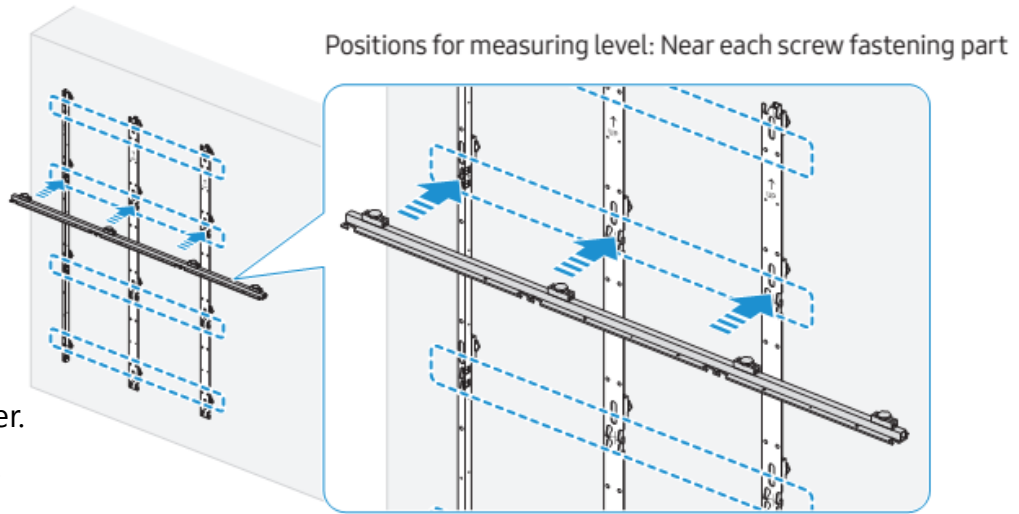

3. Frame Installation

- ⑤ After installing Bracket Center, install cabinets on the bottom line.. [Fig.6]
- ⑥ When the cabinet installation is finished, slide the LED modules toward the center and check the flushes between the cabinets and the LED modules at both ends. [Fig.7]
- ⑦ Make the left and right flushes equal, and then adjust the flushes according to the following criteria. [Fig.8]
 - If the flush is more than 0.5 mm, move the Frame outward.
 - If the flush is less than 0.0 mm, move the Frame inward.
 - Adjust the flush each time you install a cabinet additionally. If the flush is 0.0 to 0.5 mm, you don't need to adjust.
- ⑧ When the flush adjustment is finished, install the next Bracket Middle. For the installation method, refer to Step 2 and the following steps.
- ⑨ Finally, install Bracket Side. [Fig.9]

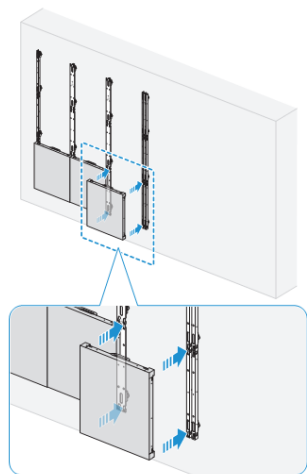

Fig6. Install cabinets

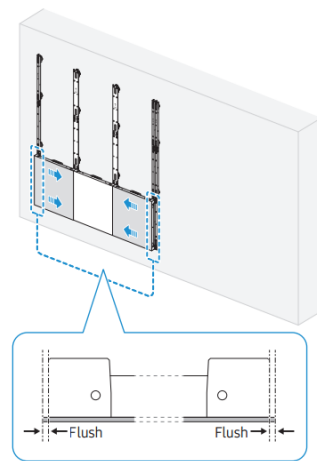

Fig7. Check flushes

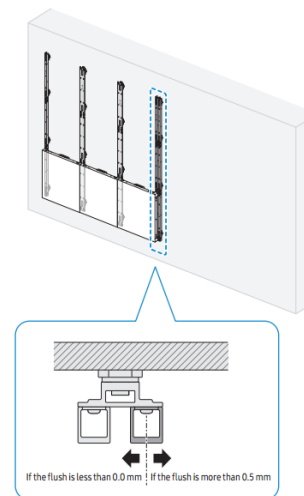

Fig8. Adjust flushes



Fig9. Installation of 6x3

4. Cabinet + Frame Installation

• Fix I/G Location

① Install I/G first on the back side of the Cabinet of each Type. (Fig.1)

※ Location to Install: Locate the I/G at the point 35~40mm below, which is the standard for carving at the right side of the frame, and then fasten the screws.(Fig.2)

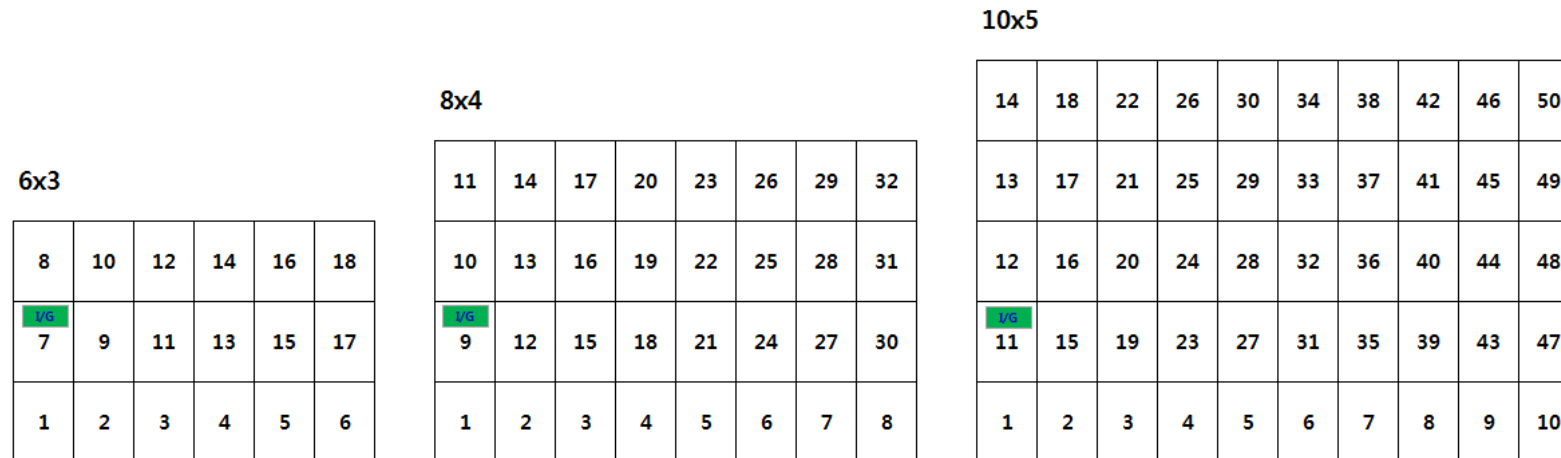

Fig1. Location to Fix the I/G and Order of Installing the Cabinet

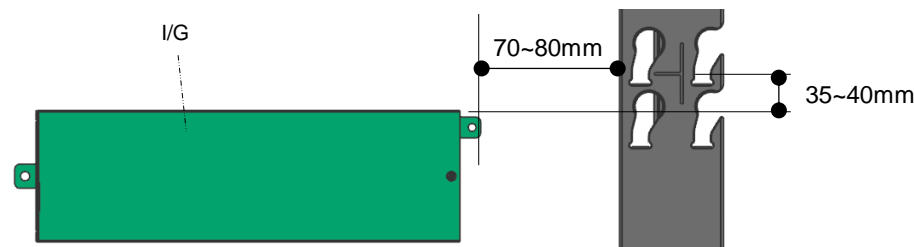

Fig2. Location to Fix I/G

4. Cabinet + Frame Installation

- ② Adjust the Corners of the Cabinet to each of the cravings to be closer to the Frame.
 - ※ Order of Cabinet Installation (26 Page Fig. 1)
 - ※ Check whether all the four(4) bolts are put into the frame. (Fig.1)
- ③ Press the upper side of the Frame and assemble so that it slides towards downward diagonal direction. (Fig.2)
- ④ From the layers above the second floor, insert the Service Jig between each Cabinet, remove the Service Jig, slowly lower the Cabinet. (Fig.3)
 - ※ Beware not to have the Service Jig touch the LED Module.
 - ※ Check whether the gap between each module widens, whether the size of the pitch differs every time of installation.

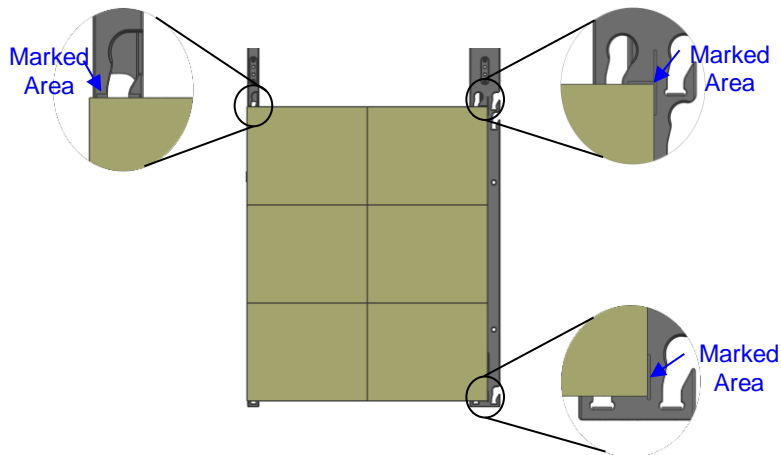

Fig.1

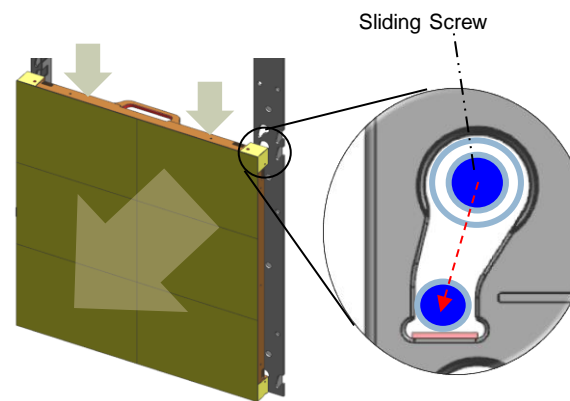

Fig.2

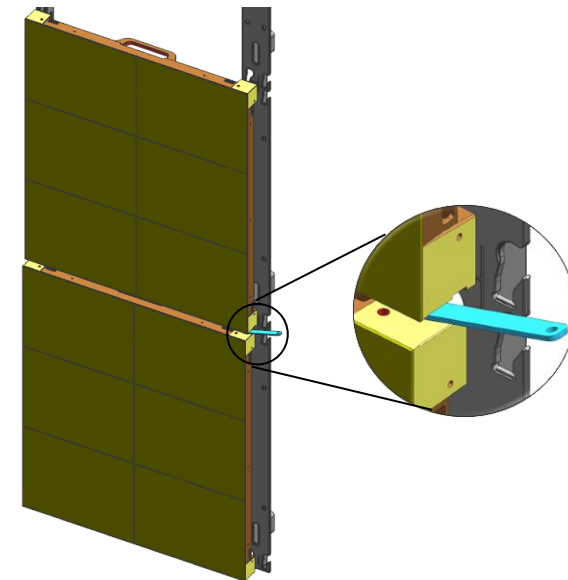
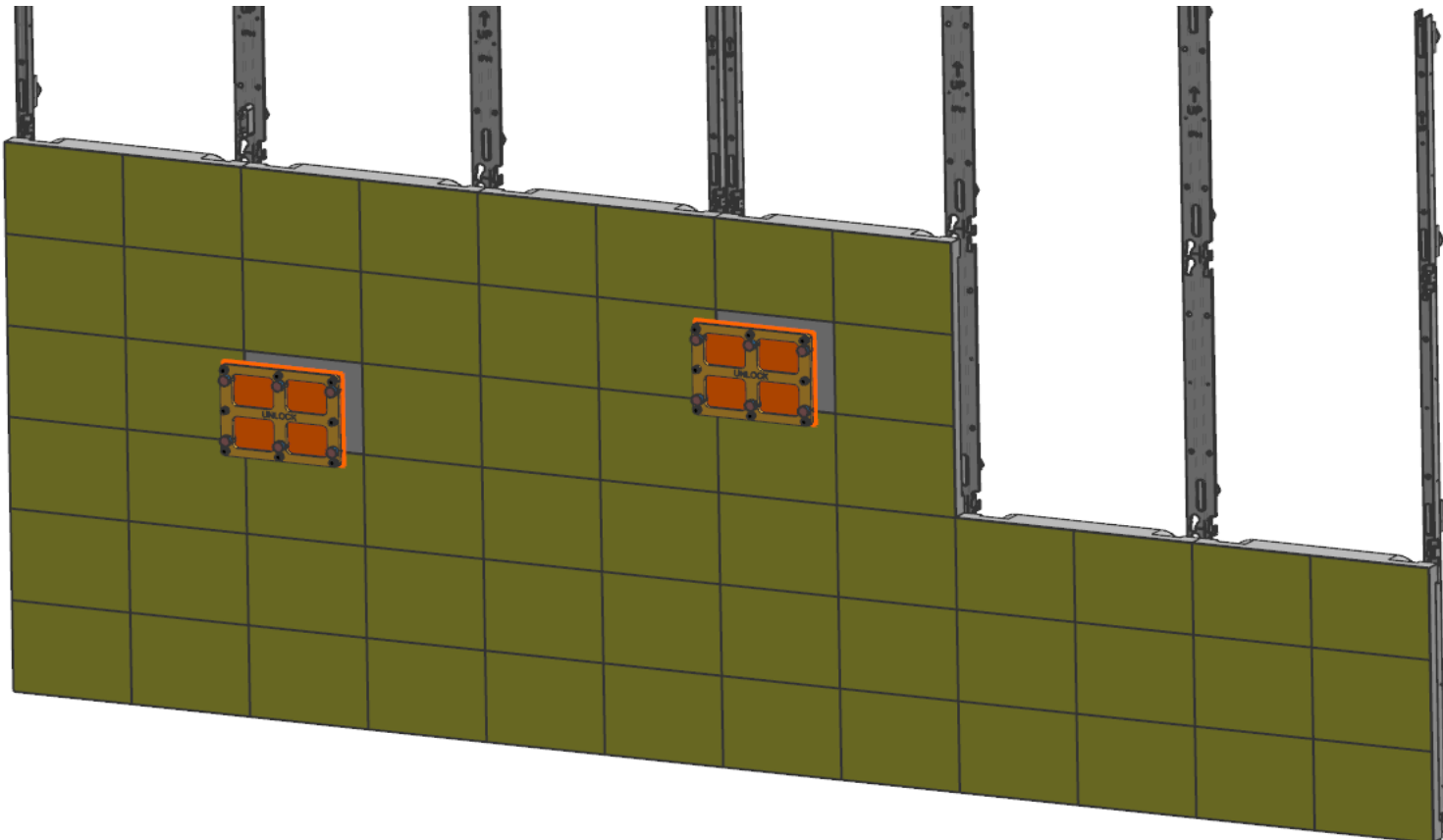

Fig.3

4. Cabinet + Frame Installation

- ⑤ If modules are too tight, it could be difficult to pick out.

During the installation process,
select some modules and make sure they are easily picked out and reassembled.



4. Cabinet + Frame Installation

◇ Protection of I/G

■ To prevent unexpected removing IG box, the Protection Bracket should be attached on left / right side of the display (Fig.1)

* In case of pocket installation, do not need to attach the protection.

* Keep free space on Top and Bottom for ventilation

Recommended specification for Protection Bracket

- ① Material: Aluminum or steel, thickness 1.0mm~2.0mm, black coating.
- ② Dimension: Width 49mm, Length 1610,8mm / 2150,5mm / 2690,2mm (same with Frame, Fig.2)
- ③ Screw hole position: interval 200mm, first screw has distance 90mm to bottom line (Fig.3)
- ④ Screw: M4*0.7mm , length 6mm.

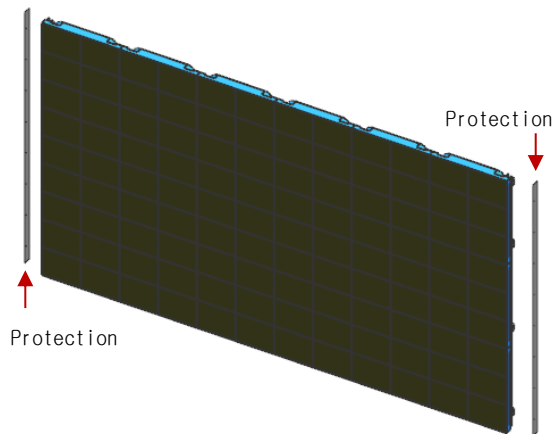

Fig.1 Protection

	CY-LFH15	CY-LFH20	CY-LFH25
Width (mm)	49.0	49.0	49.0
Length (mm)	1,610.8	2,150.5	2,690.2

Fig.2 Protection dimension

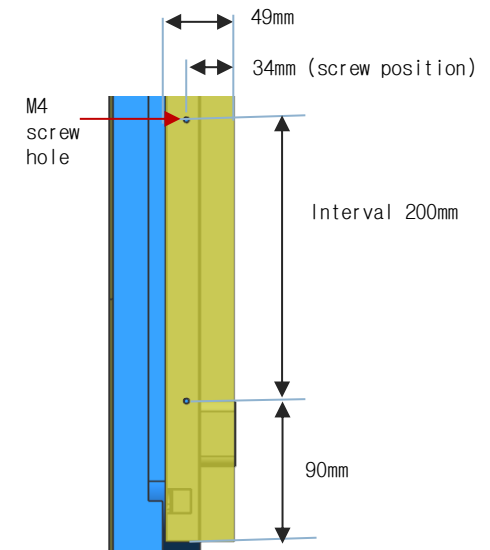

Fig.3 Screw location

8. Cable/Power Connection

8-1 Cable Connection



- If using 110V, you can connect at most three IF015H/IF020H devices. To use IF025H devices with the same voltage, connecting a maximum of four devices is recommended.
- If using 220V, you can connect at most 4 IF015H/IF020H/IF025H devices.
- Exceeding the recommended maximum number of devices can cause the circuit breaker of the product to trigger due to overload
- The Label info which is attached behind product shows rated power of cabinet and rated current of outlet.

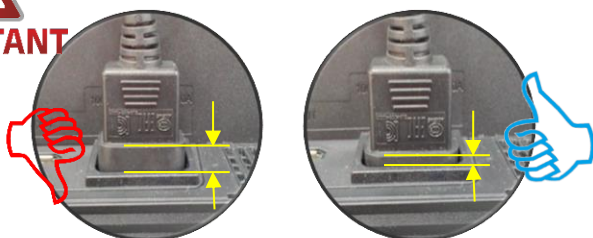
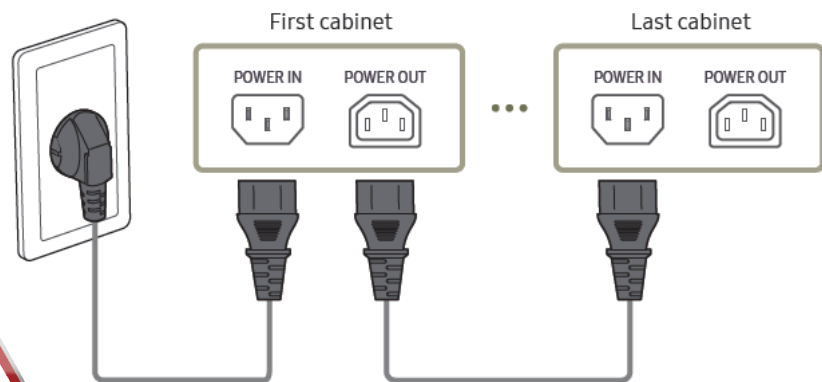

SAMSUNG Color Display Unit
Type No.: LH015IFHS

USA/CANADA : AC100-240V~50/60Hz 6.0A
MEXICO : 100-240V~50/60Hz 600W 6.0A

Consumo de energía en operación(Wh) : n/a
Consumo de energía en modo de espera(Wh) : n/a

OUTLET : 4.0A

Model / MODELE NO / Modelo.: IF015H
Model Code : LH015IFHSAS/ZA



This device complies with Part 15 of the FCC Rules. Operation is subject to the following two conditions: (1) this device may not cause harmful interference, and (2) this device must accept any interference received, including interference that may cause undesired operation.

CAN ICES-3 (A) / NMB-3 (A)
MFD./FABRIQUE: APRIL 2017
MADE IN KOREA(SEC)
FABRIQUE AU CORÉE(SEC)
HECHO EN COREA(SEC)

S/N / Serie No :*****Z



WARNING : TO PREVENT FIRE OR SHOCK HAZARD
DO NOT EXPOSE THIS UNIT TO RAIN OR MOISTURE
AVIS : RISQUE DE CHOC ELECTRIQUE - NE PAS OUVRIR



Version No : XXXX

5. S-BOX Connection

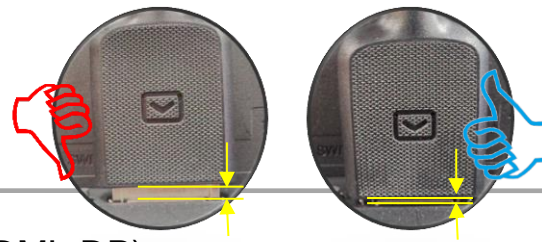

Samsung Electronics

- ① Input the video signal to the S-BOX. (Input terminal : HDMI, DP)
- ② Check the signal input from SOURCE STATUS.(RED : HDMI1 , GREEN : HDMI2, Blue : DISPLAY PORT)
- ③ Connect from the HDBT OUT port of S-BOX to HDBT IN port of Interface Gender using LAN cable.
- ④ Connect from DATA OUT port of Interface Gender to DATA IN port of the first cabinet using OCM Cable.
- ⑤ When HDMI UHD Color is set to On, up to the 3840 x 2160 @ 60 Hz resolution is supported by S-BOX. When HDMI UHD Color is set to Off, up to 1920 x 1080 @ 60 Hz resolution is supported.

※ Menu – Picture – Advanced Settings – HDMI UHD Color : ON

(Default: OFF, S-BOX will be reboot when it is changed.)

- ⑥ One SNOW-1703U supports only one type of LED pitch cabinets. Do not connect different types of LED pitch cabinets.
- ⑦ SNOW-1703U displays the screen starting from the upper left cabinet. To view the screen, connect the HDBT cable to the HDBT OUT 1 port on S-BOX.

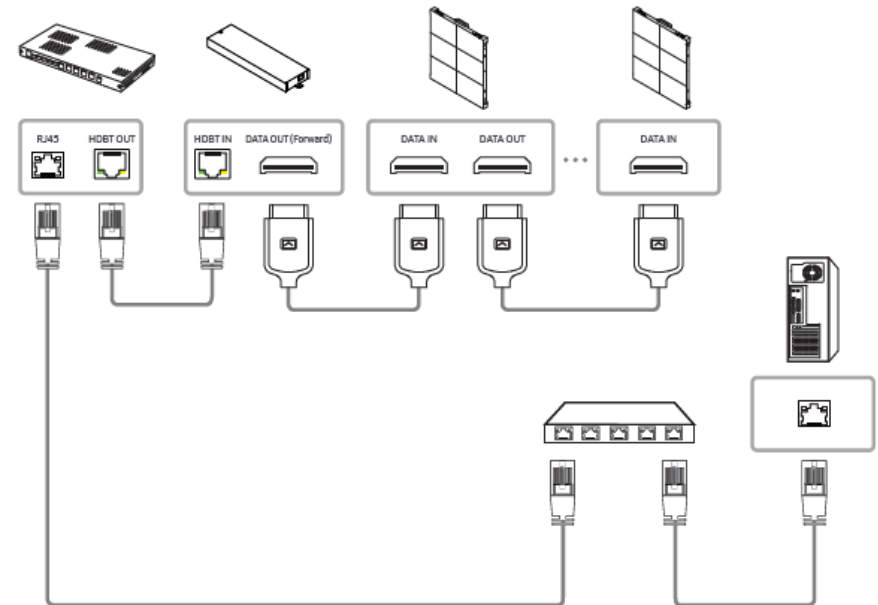

- For HDBT signal stability, use the cable above CAT6
*STP, *FTP level. (Length 15m~100m)
- Do not use "comb" or "pinstripe" cable.



5. S-BOX Connection (Grouping)

⑤ Picture menu setting

- Both "Dynamic Contrast" and "Black Tone" should be off when using S-Box Grouping, since it may causes a color difference between S-Box.
- Menu → Picture → Advanced Settings,
 - Dynamic Contrast : default "Medium" → Off
 - Black Tone : default "Darker" → Off

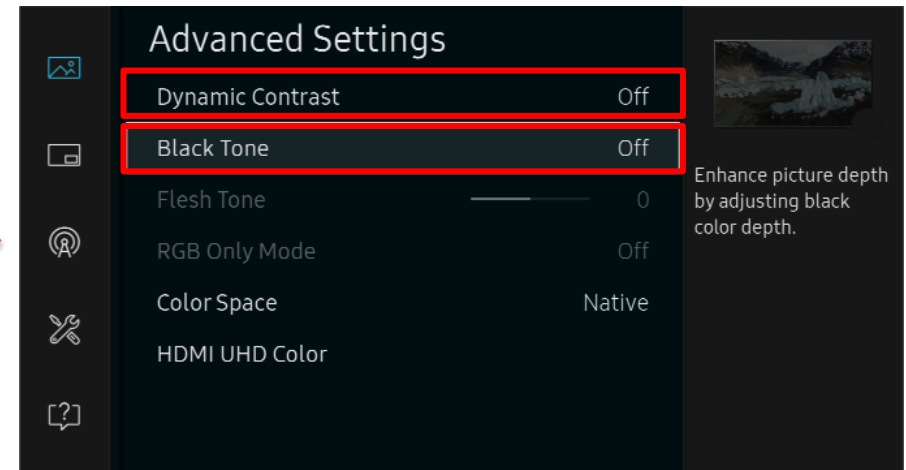
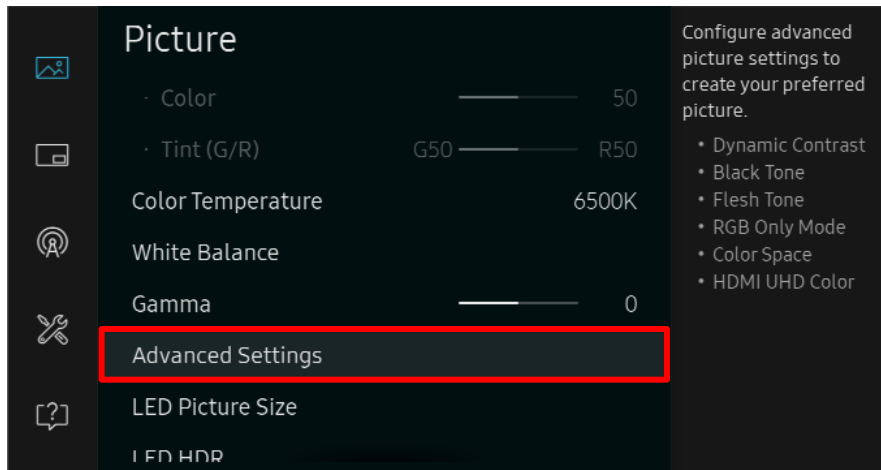

5. S-BOX Connection

⑧ The Instructions for handling Cable

- For HDBT signal stability, use the cable above CAT6 *STP, *FTP level. (Length 15m~100m)
 - Do not use "comb" or "pinstripe" cable.



★ Orderly Rolled (Recommend)



★ Random Rolled (Not Recommend)



- In case of cables in a bundle, permissible number of cables depends on a length and a type of cable.
 - If you mix more than 6-cables per bundle may affect the HDBT signal integrity due to EMI or signal interference between the cables.

Table 4: HDBaseT Cabling - Permissible Number of Cables in a Bundle

Type	30m	50m	70m	100m
CAT6a	6	6	6	6

- Don't overbend your cables for cable integrity.
- Keep your cables away from power sources.
 - Cables should be kept at a distance of at least 12 inches from power cables. In an environment prone to high EMI, it is best to use shielded cables.

5. S-BOX Connection (Redundancy)

① If Redundant Spec should be used,

Connect from DATA IN port of Interface Gender to DATA OUT port of the last cabinet by using OCM Cable.

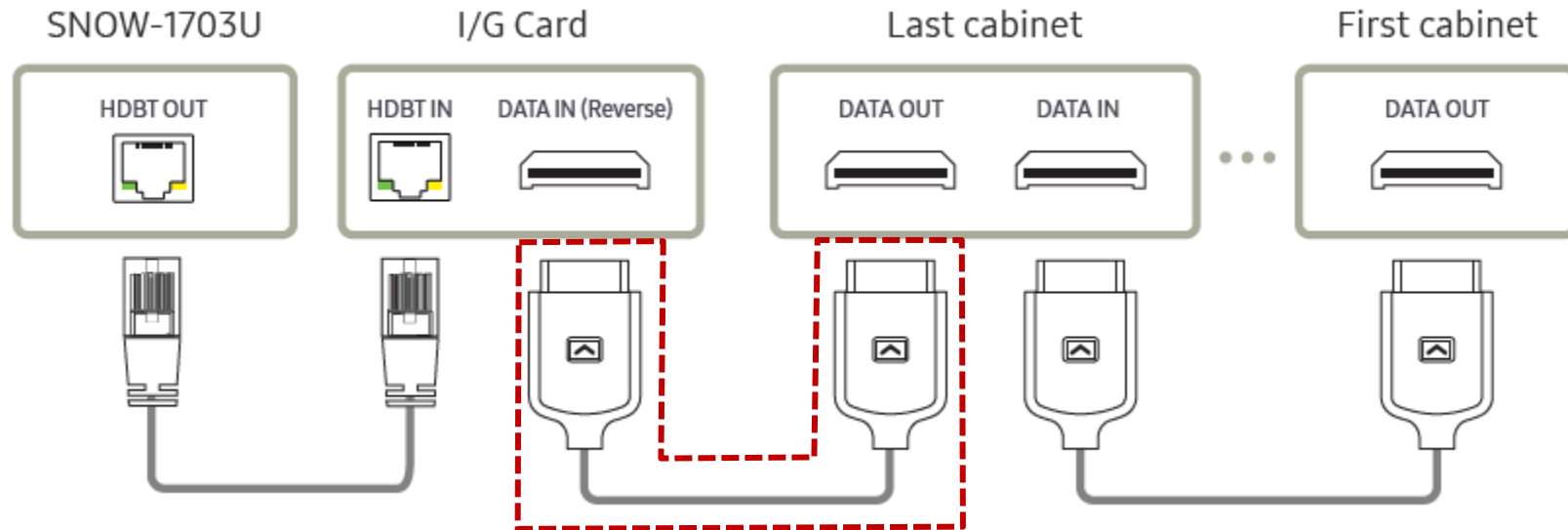

- For HDBT signal stability, use the cable above CAT6 *STP, *FTP level. (Length 15m~100m)
- Do not use "comb" or "pinstripe" cable.



5. S-BOX Connection (Panel Configuration) Samsung Electronics

① S-Box Picture Setting according to model

- The default picture configurations are optimized for LH015IFH in Samsung factory.
- The picture configurations will be configured automatically when you finish the installation.
- For the best picture quality, Please connect S-Box and LED displays via LSM software properly.
- The 1st LED Display(I/G) must be connected to HDBT port #1 in S-Box
- The Picture configuration will be set based on the model of the 1st Master LED display which is connected to HDBT port #1 in S-Box.

* If the S-Box and LED Displays are not connected properly by LSM, the picture quality might not be correct.

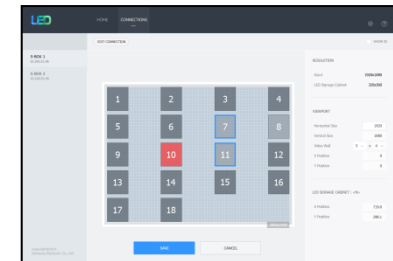
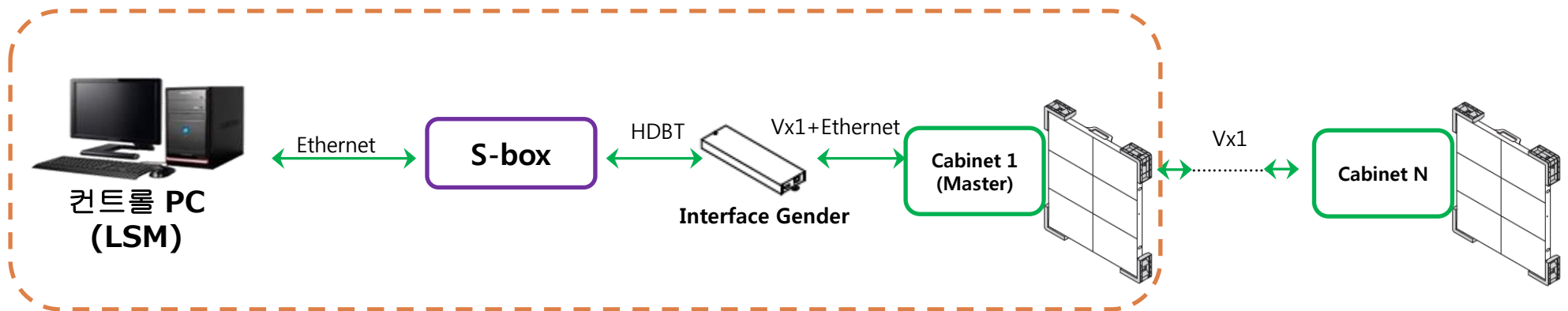

<Connected condition in LSM>

5. S-BOX Connection (Grouping)

- S-Box Grouping is a function used to configure a single screen using multi S-Box.
If you configure one screen with a single S-Box, do not use this function !!
When S-Box Grouping is set up, the quality improvement function(LED HDR) does not work.

① Factory menu setting

[1] Access path by remocon

- General remocon : Power OFF → MUTE → 1 → 8 → 2 → Power ON
- Factory remocon : Info → Factory

[2] Turn on the function

- Control → LFD Option → Video Wall Settings → Frame Lock Support
- Change the Frame Lock Support : OFF → ON

[★ Warning!] If another menu setting is changed, s-box can not work normally.

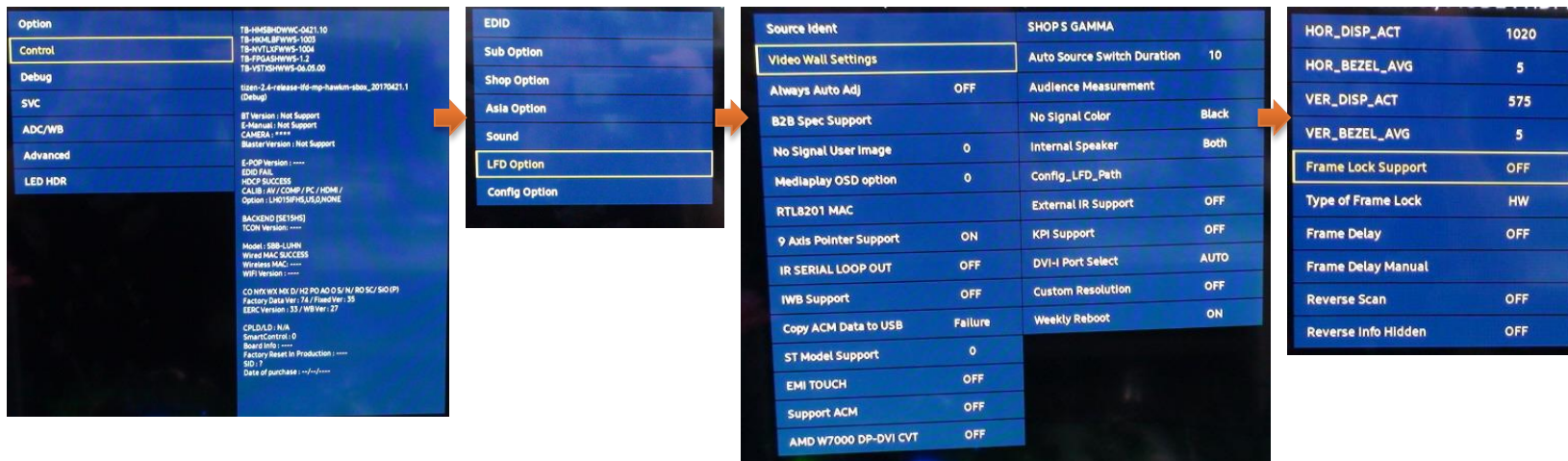

- Turn off the power after you change the setting of item. S-box grouping function will apply from next booting.

5. S-BOX Connection (Grouping)

② Enable S-Box Grouping

- Home → Video Wall : OFF → On

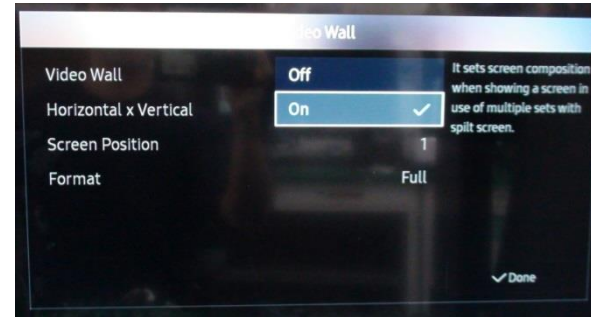
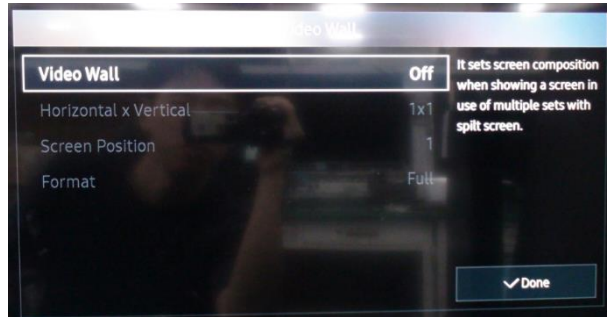
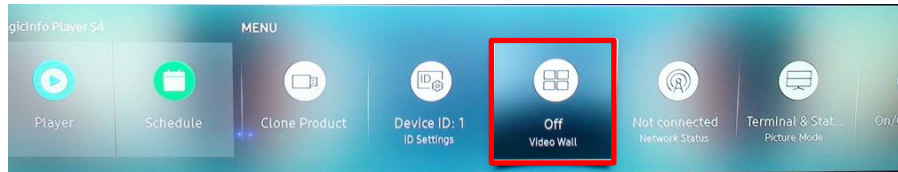

[Cautions!!]

- 1) Setup supported resolution for grouping before the grouping function of multi s-box is run by LSM.
- 2) It can cause the noise of picture or blackout, if resolution is not supported.

Please change the Video Wall is to OFF, and setup the resolution to supported timing.

Refer to the next page for supported resolution.

※ From '17.06, LSM support S-Box Grouping. Check the latest LSM version.

5. S-BOX Connection (Grouping)

③ Setup the resolution of input PC

- PC: Click the right button of mouse → Click Screen resolution → Click Advanced settings

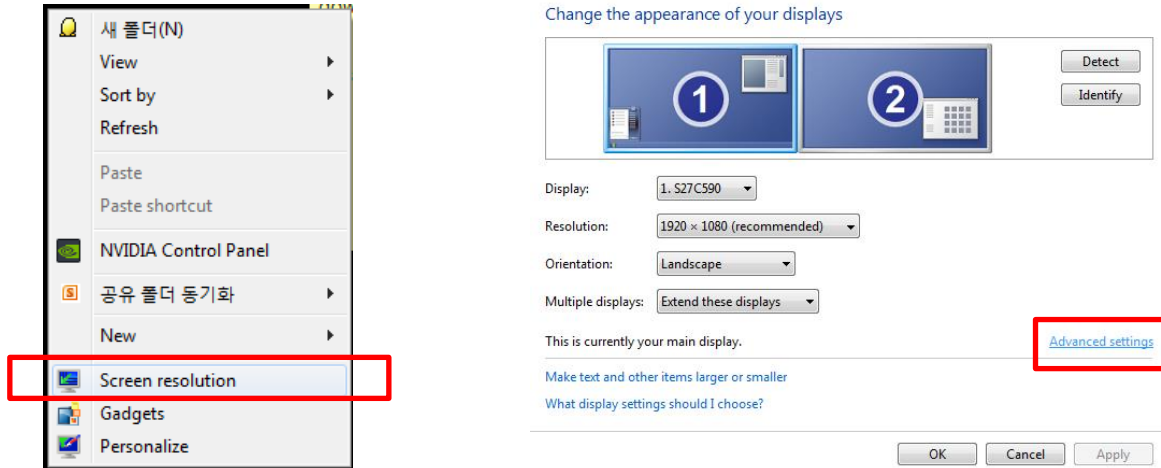

- Click "Monitor" tap → Monitor Settings → Setup "Screen refresh rate" to 60Hz

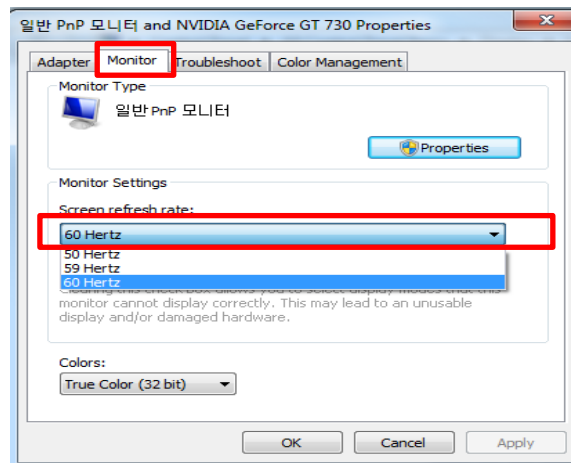

5. S-BOX Connection (Grouping)

④ Supported resolution for S-box grouping

Resolution	Horizontal Frequency (kHz)	Vertical Frequency (Hz)	Pixel Clock (MHz)	Sync Polarity (H/V)	S-Box Grouping Supported
VESA, 640 x 480	37.861	72.809	31.500	-/-	-
VESA, 640 x 480	37.500	75.000	31.500	-/-	-
VESA, 800 x 600	35.156	56.250	36.000	+/+	-
VESA, 800 x 600	37.879	60.317	40.000	+/+	-
VESA, 800 x 600	48.077	72.188	50.000	+/+	-
VESA, 800 x 600	46.875	75.000	49.500	+/+	-
VESA, 1024 x 768	48.363	60.004	65.000	-/-	0
VESA, 1024 x 768	56.476	70.069	75.000	-/-	-
VESA, 1024 x 768	60.023	75.029	78.750	+/+	-
VESA, 1152 x 864	67.500	75.000	108.000	+/+	-
VESA, 1280 x 720	45.000	60.000	74.250	+/+	-
VESA, 1280 x 800	49.702	59.810	83.500	-/+	-
VESA, 1280 x 1024	63.981	60.020	108.000	+/+	0
VESA, 1280 x 1024	79.976	75.025	135.000	+/+	-
VESA, 1366 x 768	47.712	59.790	85.500	+/+	-
VESA, 1440 x 900	55.935	59.887	106.500	-/+	-
VESA, 1600 x 900	60.000	60.000	108.000	+/+	0
VESA, 1680 x 1050	65.290	59.954	146.250	-/+	-
VESA, 1920 x 1080	67.500	60.000	148.500	+/+	0
VESA, 3840 x 2160	67.500	30.000	297.000	+/+	-
VESA, 3840 x 2160	135.000	60.000	594.000	+/+	0

5. S-BOX Connection (Using Service Port)

- Service Port is used to check full screen, when working of S-box is not abnormal. Refer to the available monitors as below,
 - Available monitors for service port: LH**PMF, LH**PHF, LU28E590DS , LU24E590DS

[Cautions!] This port is for servicing only and has no user function. Do not connect a cable to this port.

※ LH**PMF, LH**PHF : Change the "HDMI UHD Color" to "On" on OSD.

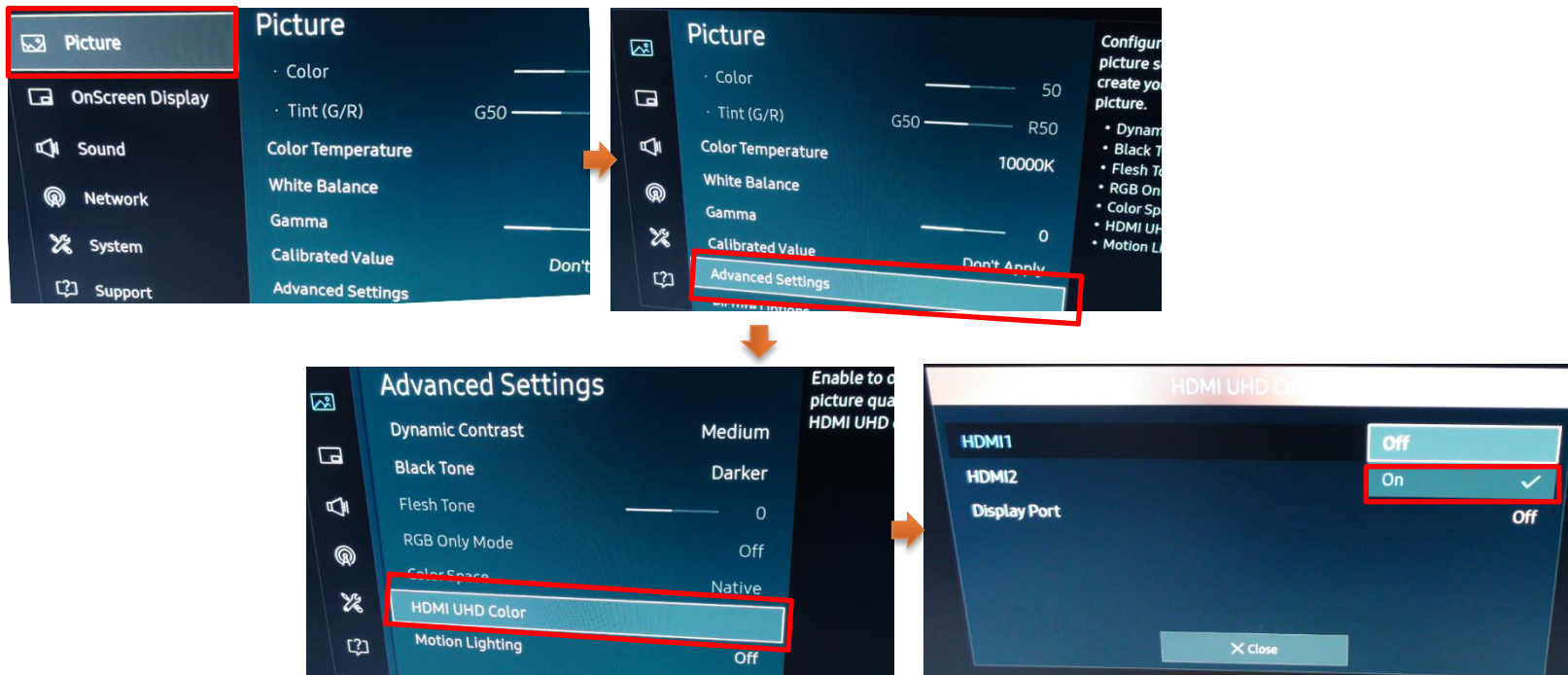

6. Settings and How to Use

6-1 Control Program for PCs

LSM(LED Signage Manager)

- LSM Download Path : GSBN - SLM - Display solution download -> "LED SIGNAGE MANAGER" or "LSM"
- GSBN : <http://v3.samsunggsbn.com/ep>

SLM
Display Solution Download Center

Hide Search Options ^

Category: VD
Title: LED SIGNAGE MANAGER
Level 1: -- Select --
Level 3: -- Select --
Post Date: ~
Contents:
Level 2: -- Select --
Display Order: descending Total Download

Reset Search

List Generate

No	Category Name	Title	Level 1	Level 2	Level 3	Attached file	Total Download	Registered By	Registered On
1074	VD	LED Signage Manager (A-LEDMGDSP-1002.02)	LFD	Software		2	128	Kim 김석범 Seokb	28.04.2016
1292	VD	LED Signage Manager (A-LEDMGDSP-1003.03)	LFD	Software		2	93	Kim 김석범 Seokb	29.07.2016
1739	VD	LED Signage Manager (A-LEDMGDSP-1004.02)	LFD	Software		2	55	Kim 김석범 Seokb	09.12.2016
1589	VD	[User Manual] LED Signage Manager user manual	LFD	Manuals		2	49	Kim 김석범 Seokb	09.11.2016
1047	VD	LED Signage Manager (A-LEDMGDSP-1001.08)	LFD	Software		2	34	Kim 김석범 Seokb	01.04.2016
1984	VD	LED Signage Manager (A-LEDMGDSP1005.00)	LFD	Software		2	10	Kim 김석범 Seokb	14.03.2017

6. Settings and How to Use

6-1 Control Program for PCs

Network IP Setting Tool

Execute : [Start] – Program – Samsung – LED Signage Manager – Network Configuration

1. Connect PC and Sbox with RS232C Cable, select connected SerialPort(COM*). And click "open" button.
2. Default ID of SBox is 1.
3. Enter IP, SubnetMask, Gateway, DNS of S-box, and click "Apply" button.
4. Check the result of connection and status of MDC Protocol.
5. When IP address is normally setup, "Change Type to RJ45" button is appear. If LSM and SBox is connected successfully, click "Change Type to RJ45". Then, PC connection with s-box is changed to RJ45 from RS232.

[★ Cautions!] Recommend to use static IP address for the S-Box. If DHCP is used, IP address is changed automatically and LSM can be disconnected.
The 192.168.10.x band is used for internal communication of the LED Cabinet. Please use IP another IP band (except 192.168.10.x band)
Do not assign the temporary IP, assign the S-Box IP (1 EA) through IT manager.

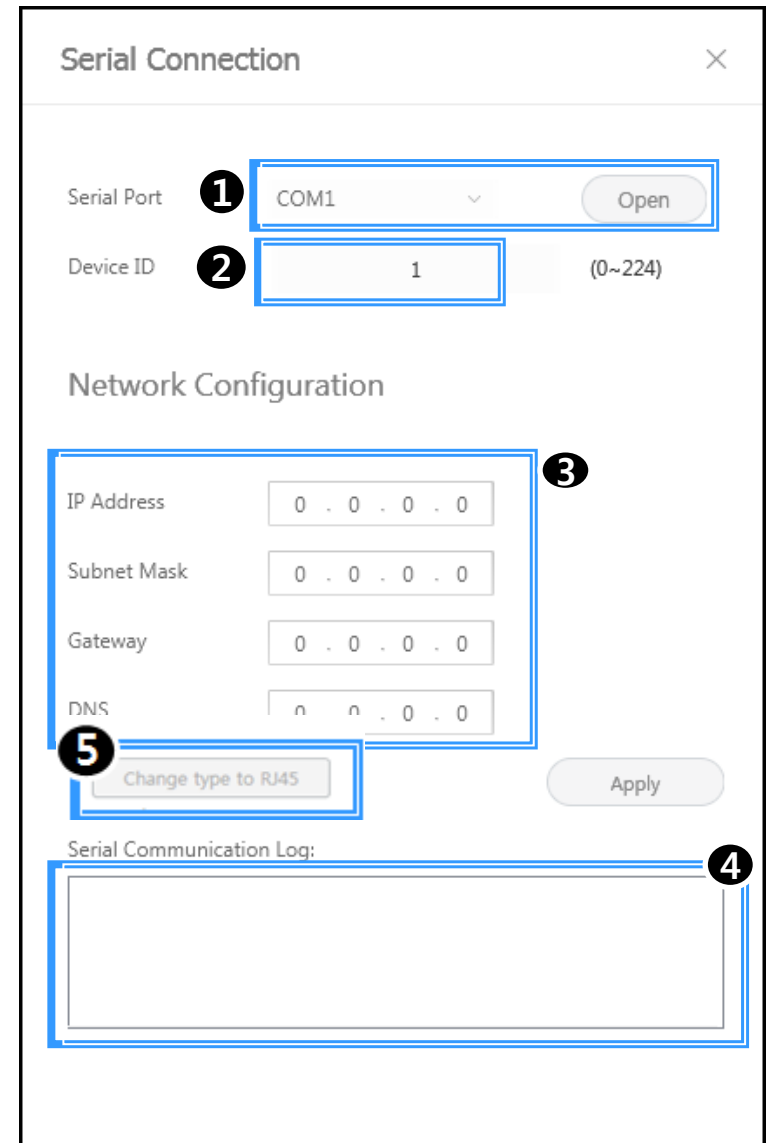

6. Settings and How to Use

6-1 Control Program for PCs

LSM(LED Signage Manager)

- Software that adjusts the LED Cabinet Layout in Remote

1. PC and S-box should be connected through Ethernet connection.
2. S-box is connected to Interface Gender using HDB-T Lan Cable
3. Interface Gender is connected to the first LED Cabinet using OCM cable
4. LED cabinets are connected in daisy chain method using OCM cable.

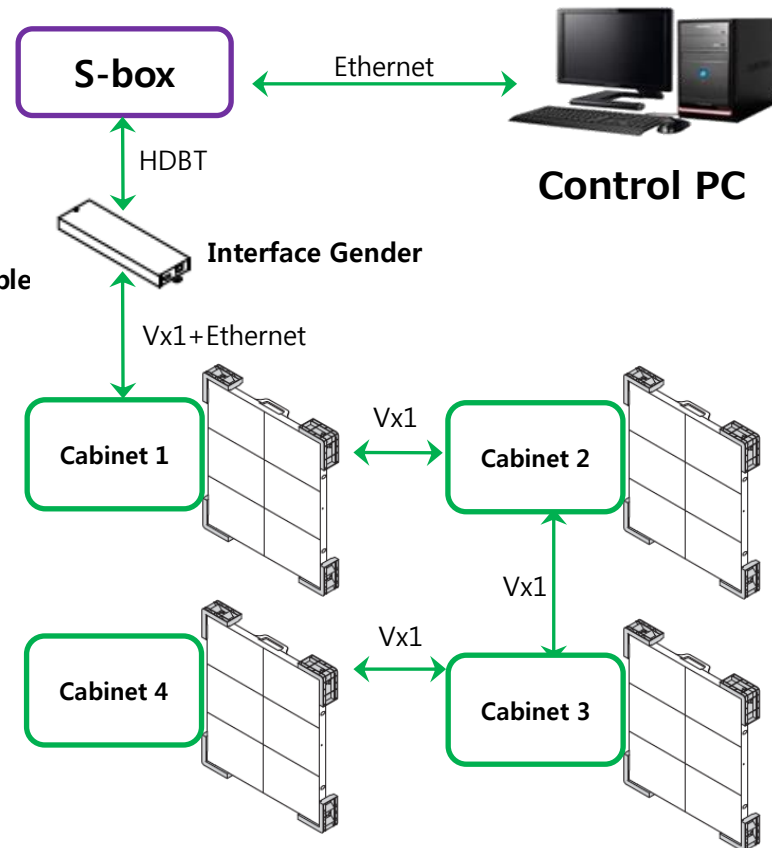

6-1 Control Program for PCs

LED Signage Manager

Start- Login Page

1. If the LSM gets operated for the first time, the page to set the password will appear.
2. To set the password, users have to input the same password two times and then click the "Start" button.
3. If the user does not want to use a password, then please select "Don't use password" option. Then, password input would no longer be required whenever the LSM gets operated.

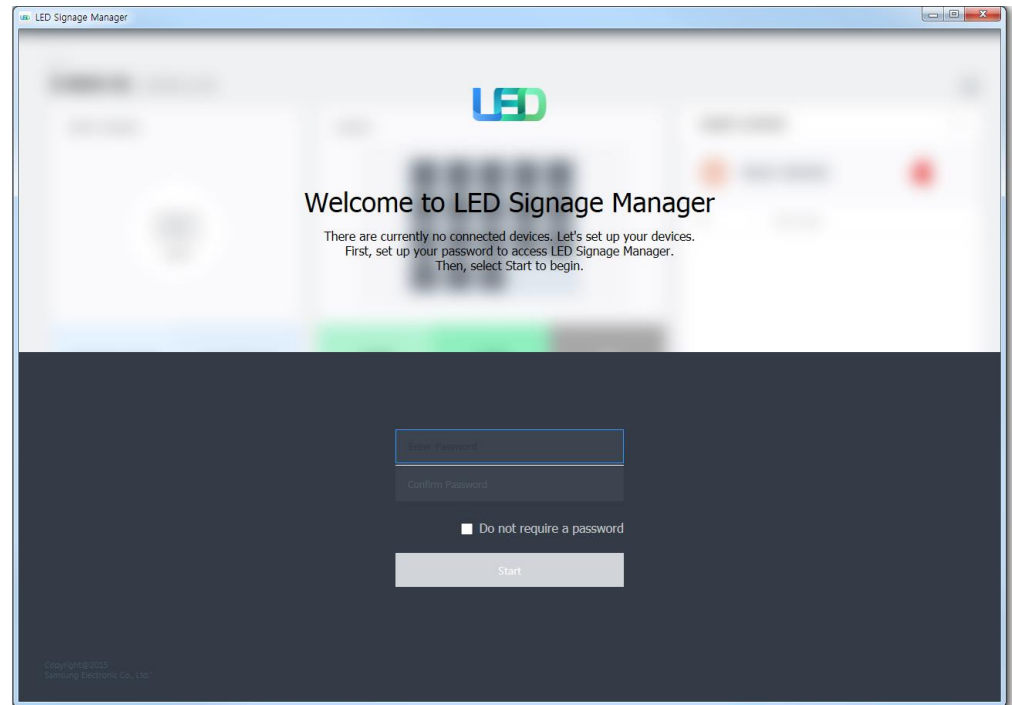

6-1 Control Program for PCs

LSM(LED Signage Manager)

New Connection

1. To add connection information, you can either use Search function or input the IP address by yourself. If you click on the Search button, the IP addresses available on S-BOX in the same network will appear. If you know the IP address of the S-BOX, then you can input the address by yourself.
2. If you click Add button, the relevant connection information will be added on Setup and Connect.
3. Users can select the Model Type of S-Box. There are three(3) Model Types (Without Cabinet IP / With Cabinet IP(FHD) / With Cabinet IP(UHD)).

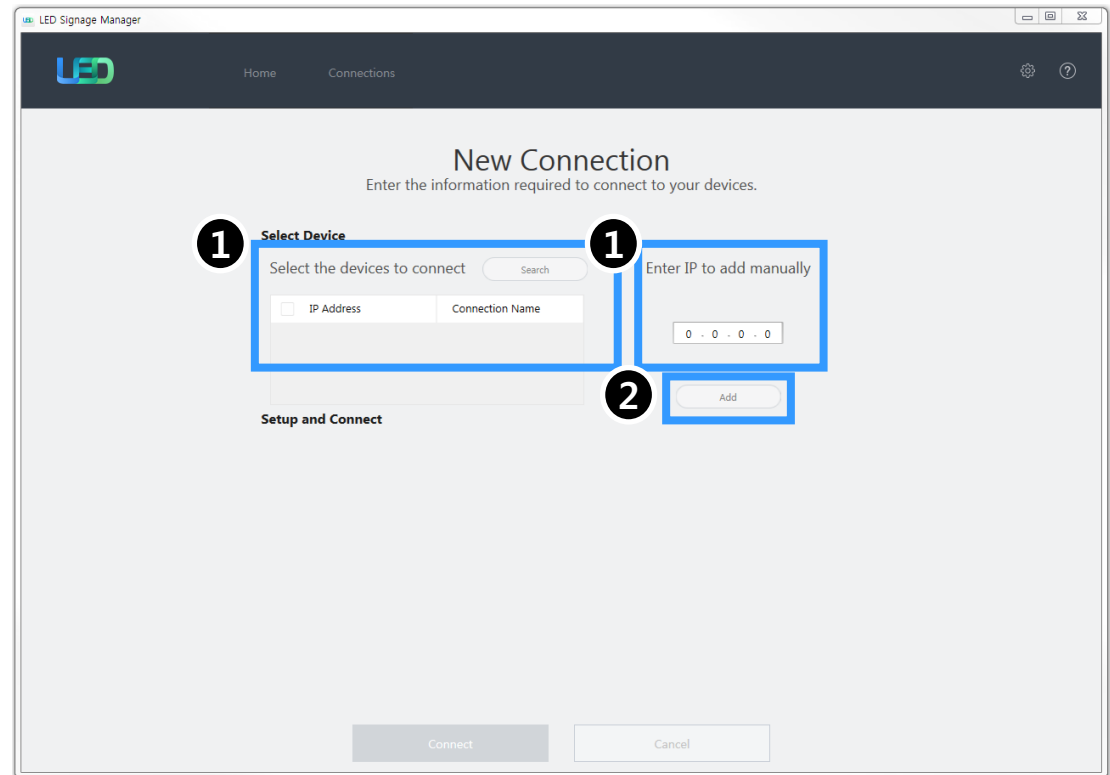

6. Settings and How to Use

6-1 Control Program for PCs

LSM(LED Signage Manager)

[★ Cautions!] Recommend to use static IP address for the LED devices. If DHCP is used, IP address is changed automatically and LSM can be disconnected.
The 192.168.10.x band is used for internal communication of the LED Cabinet. Please use IP another IP band (except 192.168.10.x band)
Do not assign the temporary IPs, assign the LED IPs (4 EA) through IT manager.

New Connection-Connect

1. When you are using the previous version of S-BOX, select "Without Cabinet IP" option.
2. If you are using UHD S-BOX, select "With Cabinet IP (UHD)" option. You should designate the IP Address of the LED Cabinet by each port. Set the number of units connected, and then click "Connect".
3. If you are using FHD S-BOX, select "With Cabinet IP(FHD)". Set the IP Address and the number of units connected in LED Cabinet, and then click "Connect".

※ If you have already set the IP on the Cabinet, check "Connect with existing settings" option.

※ For the case of UHD, if you are going to use only some of the four(4) ports, input the IP Address only for that particular Group relevant with your use.

The screenshot shows the 'Setup and Connect' window with the following settings:
S-Box: 192.168.1.1
Model Type: Without Cabinet IP
Cabinets: 1
Checkboxes: Connect with existing settings, Assign IDs and Positions Automatically

The screenshot shows the 'Setup and Connect' window for 'With Cabinet IP (UHD)'. It features a table for Group settings and a warning icon.

Group	IP Address	Cabinets	Assign IDs and Positions Automatically
Group 1	0 . 0 . 0 . 0	1	<input checked="" type="checkbox"/>
Group 2	0 . 0 . 0 . 0	1	<input checked="" type="checkbox"/>
Group 3	0 . 0 . 0 . 0	1	<input checked="" type="checkbox"/>
Group 4	0 . 0 . 0 . 0	1	<input checked="" type="checkbox"/>

Annotations:
- A red triangle warning icon with the word "IMPORTANT" is placed above the table.
- A red line highlights the IP address fields for all groups, with the text "※ Different setting from S-box IP & Different Setting from each Group" next to it.
- A green box highlights the IP address field for Group 1, with the text "※ Same S-box IP" below it.

The screenshot shows the 'Setup and Connect' window for 'With Cabinet IP (FHD)'. It features a table for Group settings.

Group	IP Address	Cabinets	Assign IDs and Positions Automatically
Group 1	0 . 0 . 0 . 0	1	<input checked="" type="checkbox"/>

6. Settings and How to Use

6-1 Control Program for PCs

LSM(LED Signage Manager)

- Main Window-Home Window

1. Home Screen : Information of the connected device, input source, cabinet composition, and error device are shown.

[★ Cautions!]

The network port 1515 and 48485 are used for internal communication between S-BOX and LED Cabinet.

It should be include the firewall or network exception if customer used secured network.

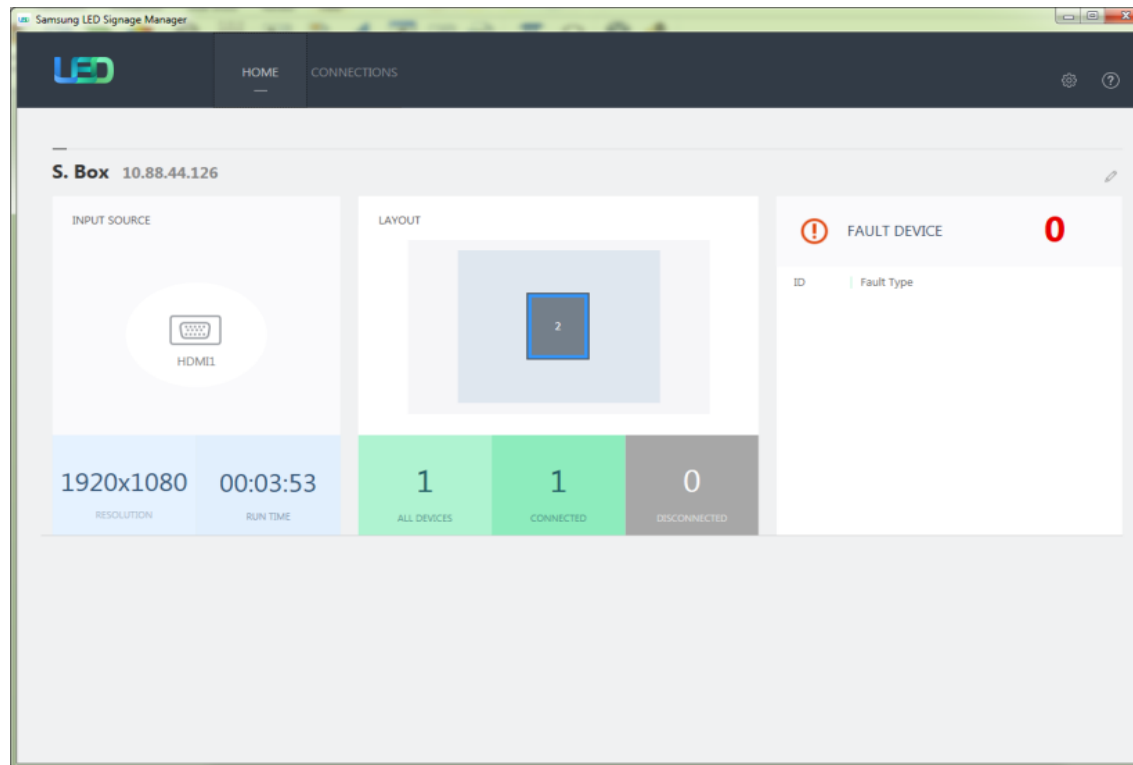

6. Settings and How to Use

6-1 Control Program for PCs

LSM(LED Signage Manager)

- **Main Window-Home Window**

1. **Input source:** Input source, resolution, connection time of S-BOX are shown.

2. **Cabinet Layout :** Layout, number of units, number of connections and number of disconnections in all LED cabinets are shown.

3. **Faulty device:** ID of the LED cabinet in error status and the content of the error are shown.

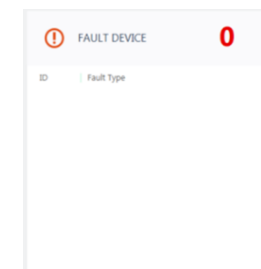
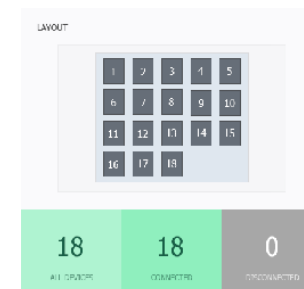
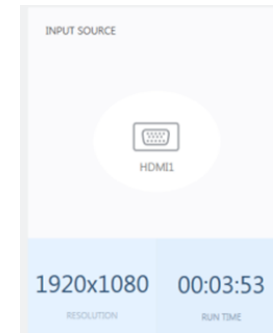

6. Settings and How to Use

6-1 Control Program for PCs

LSM(LED Signage Manager)

Main Window-Edit Connection Layout Window

1. **Connection layout:** The location and the layout of each LED cabinet are adjusted in the output source area of the S-BOX.
2. **Feature View:** Edit button to modify the connection information and LED cabinet automatic alignment function, etc. are provided.
3. **Device Information/Setting View:** The LED cabinet information is shown for in three different categories below:
 - (i) **Resolution:** Resolution information of the input source
 - (ii) **View Port:** Width/Length size, Video wall matrix, x/y coordinate settings
 - (iii) **LED Signage Cabinet:** x, y location of LED cabinet
4. **Show ID:** IDs of each will be shown in all connected LED cabinets when this option is selected.
5. **Save/Apply and Cancel**

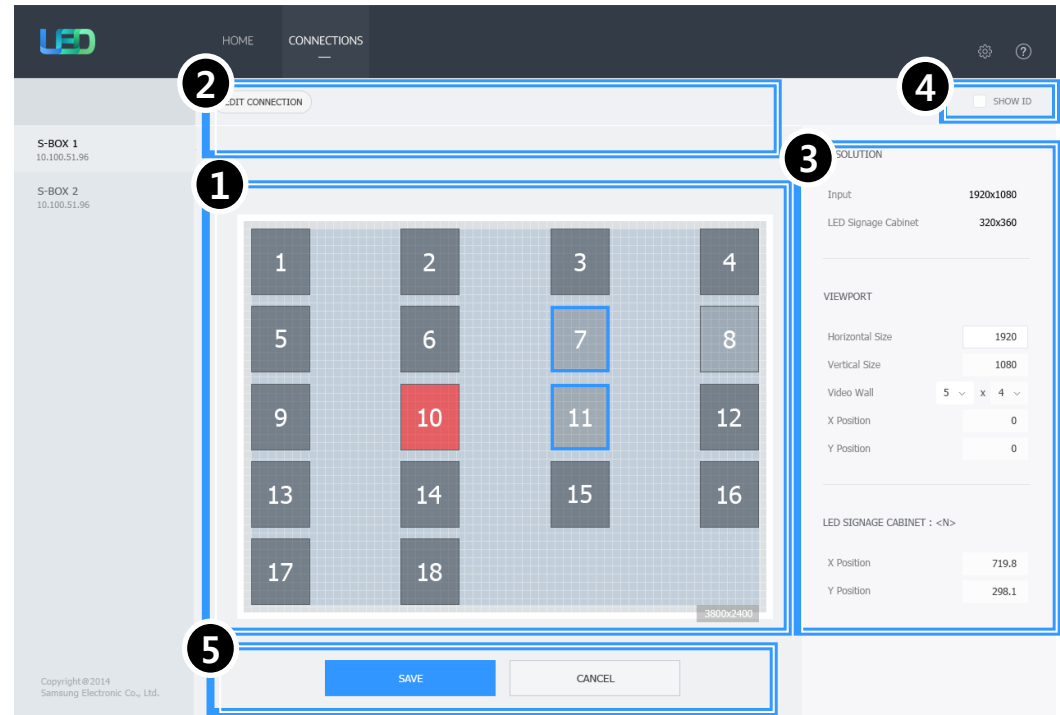

6. Settings and How to Use

6-1 Control Program for PCs

LSM(LED Signage Manager)

Main Window-Connection Window

1. **Device connection list view:**
Check S-BOX composition, modify and delete S-BOX connection, show by each LED Cabinet Group
2. **Connection layout (View Port):**
Check the location and layout of each LED cabinet
3. **Category View:**
Home / Connections tab and settings
4. **Device Information/Setting View:**
Change S-BOX settings (screen settings, etc.)
5. **Sub Information View: Displays:**
Monitoring log, S-BOX and LED cabinet information

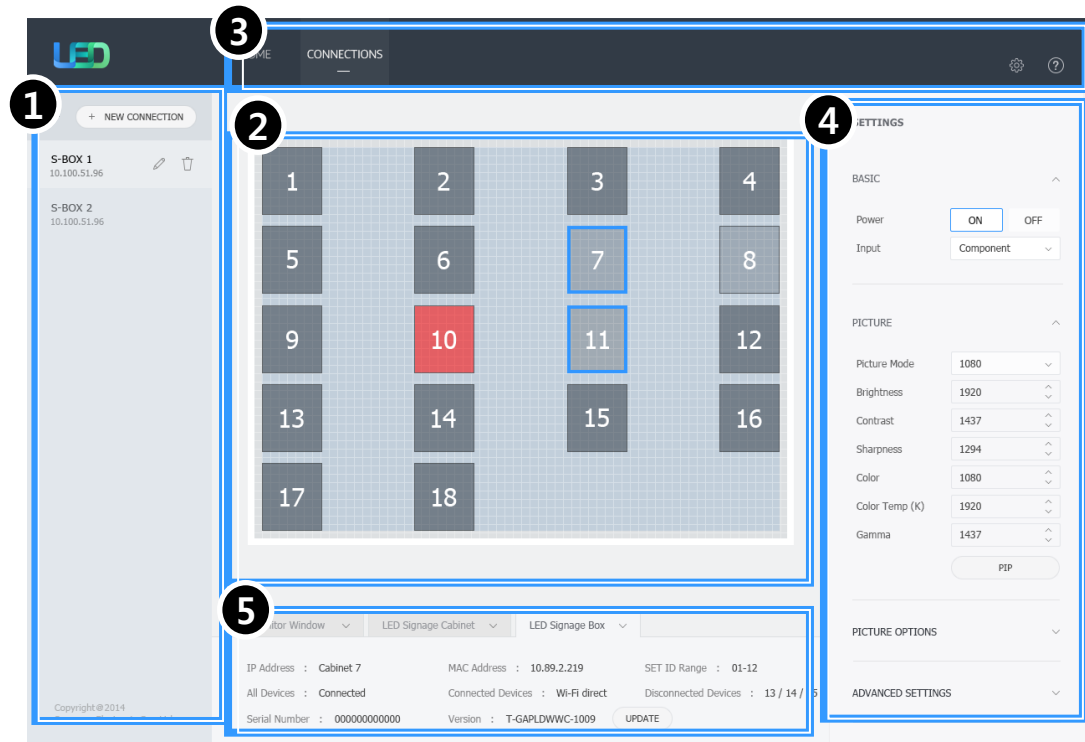

6. Settings and How to Use

6-1 Control Program for PCs

LSM(LED Signage Manager)

Main Window-Connection Window - Device Information/Setting View

- 1. Basic :**
 - . Power On/Off, Change input source, Screen Mute / Freeze
- 2. Picture**
 - . Change Picture Mode, Brightness / Contrast / Sharpness, Color, Tint(G/R), Color Temp(K), Gamma, White Balance adjustment
- 3. Picture Options**
 - . Color Tone, HDMI Black Level, Film Mode, etc.
- 4. Advanced Settings**
 - . Adjust Black Tone, Flesh Tone, Color Space, etc.
- 5. System**
 - . Auto Power On/Off, Standby Control Clock, Timer, System Restart Interval Software Update function

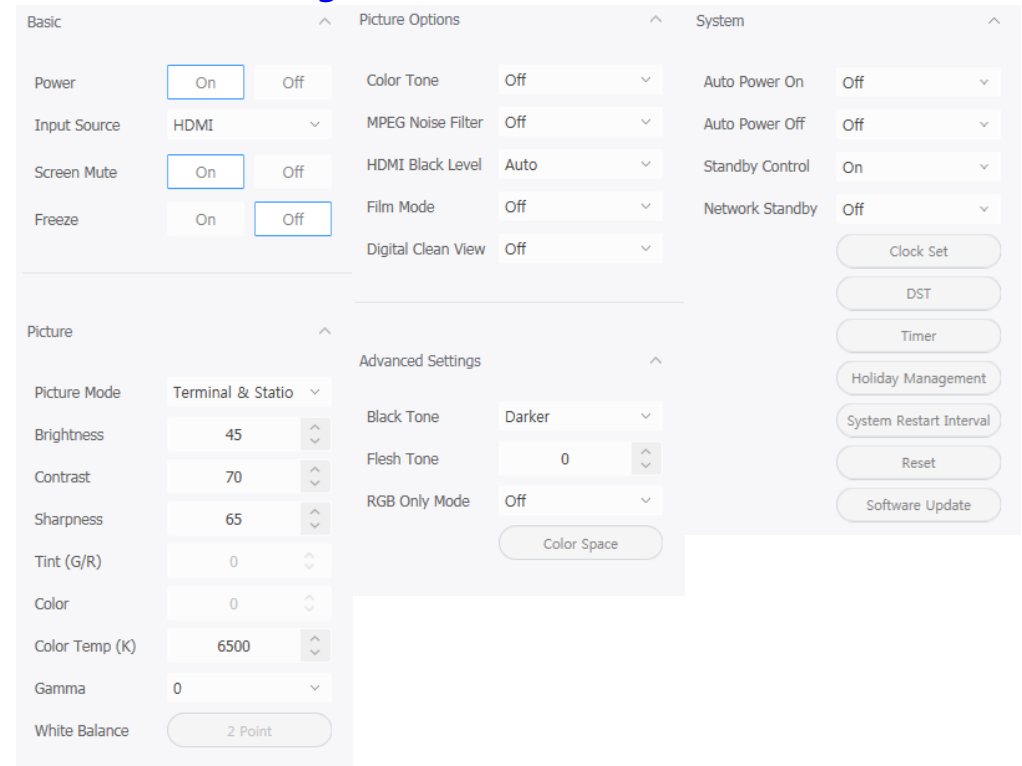

6. Settings and How to Use

6-1 Control Program for PCs

LSM(LED Signage Manager)

System - System Restart Interval (Cont'd)

- To stabilize the S-box(SBB-SNOWH3U), execute a reboot automatically at a weekly time.
- Default setting : 4:00am, Monday. (Reboot will be executed 4:00am.~5:00am actually.)
- Reboot time can be changed by LSM – System restart Interval

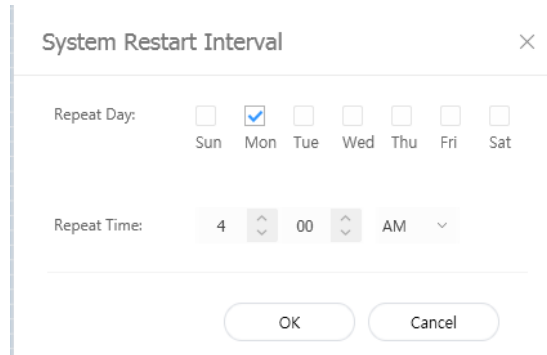
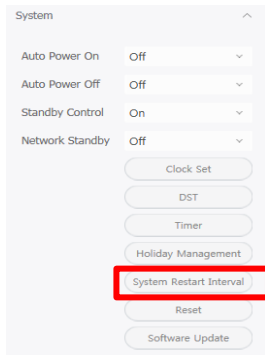

※ Check whether the clock setting of S-box is correct, or not. If clock is not correct, S-box may reboot at undesired time.

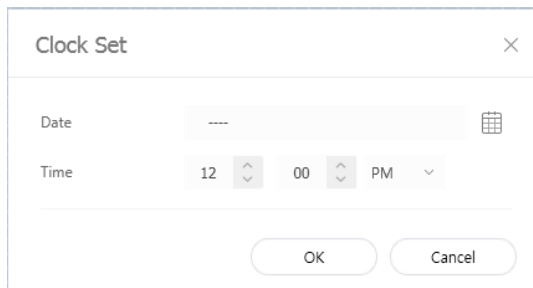
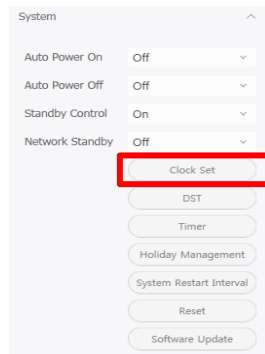

6. Settings and How to Use

6-1 Control Program for PCs

LSM(LED Signage Manager)

- System - System Restart Interval

- If you don't want to be rebooted once a week, you must change the option of factory menu.

: Factory – Control – LFD Option – Weekly Reboot : ON → OFF

※ How to access Factory menu : Refer to P. 19

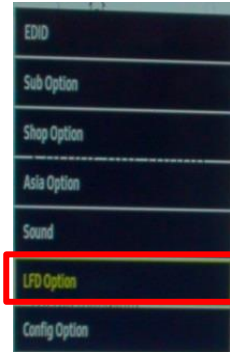
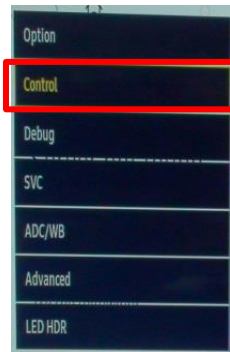

A screenshot of the LFD Option menu showing various settings. The 'Weekly Reboot' setting is highlighted with a red rectangular box.

Source Ident	SHOPS GAMMA		
Video Wall Settings	Auto Source Switch Duration	10	
Always Auto Adj	OFF	Audience Measurement	
B2B Spec Support	No Signal Color	Black	
No Signal User Image	0	Internal Speaker	Both
Mediaplay OSD option	0	Config_LFD_Path	
RTL8201 MAC	External IR Support	OFF	
9 Axis Pointer Support	ON	KPI Support	OFF
IR SERIAL LOOP OUT	OFF	DVI-I Port Select	AUTO
IWB Support	OFF	Custom Resolution	OFF
Copy ACM Data to USB	Failure	Weekly Reboot	ON
ST Model Support	0		
EMI TOUCH	OFF		

6. Settings and How to Use

6-1 Control Program for PCs

LSM(LED Signage Manager)

Main Window-Connection Window - Device Information/Setting View

6. Cabinet Settings

- . ABL, Gamut, Backlight
- . Software Update function (FPGA, Calibration data, etc.)

7. Cabinet Calibration

- . RGB CC Calibration of each Module
- . Edge Correction of each Module
- . CC On/Off and Edge On/Off
- . Batch Upload/Download of module calibration data available through Import / Export

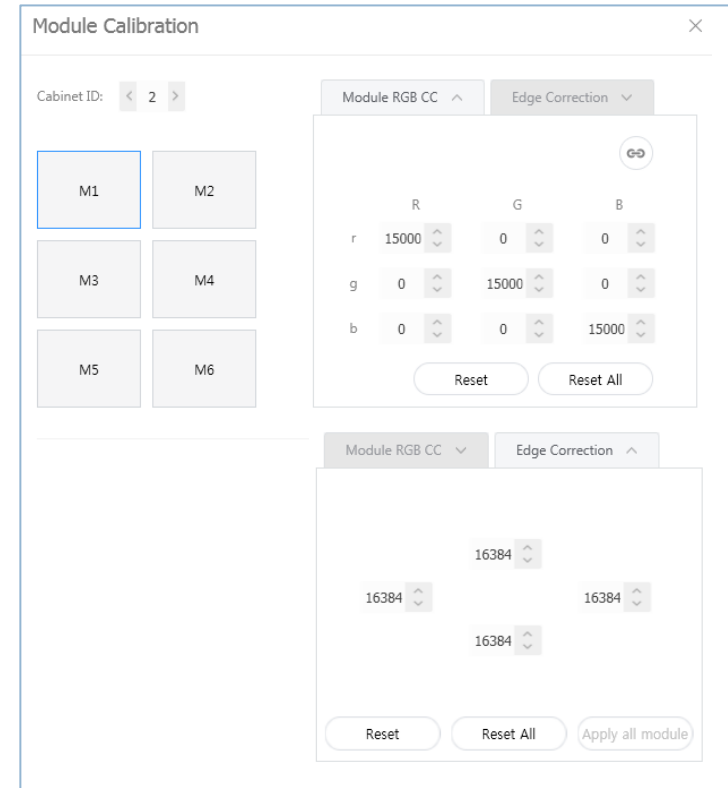
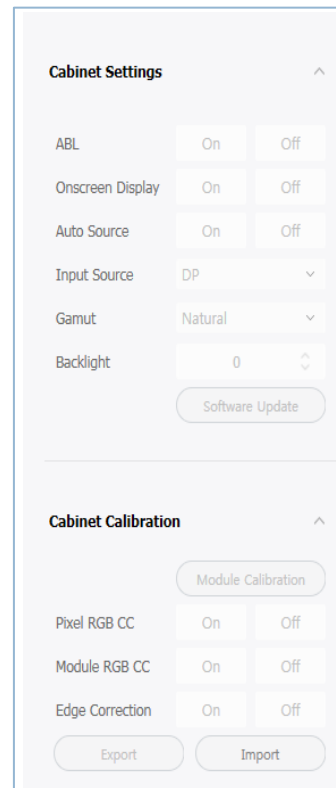

6. Settings and How to Use

6-1 Control Program for PCs

LSM(LED Signage Manager)

Main Window-Connection Window - Sub Information View

- 1. Monitor Window:**
Checking MDC communication log and connected device information available, able to be extracted via file
- 2. LED Signage Cabinet:**
IC information and Power information of LED cabinet
- 3. LED Signage Box:**
IP address, MAC address, ID range of LED cabinet, number of LED cabinet (all/connected/not connected), serial number, version information

The image displays three screenshots of the LSM software interface, illustrating the 'Sub Information View' for different components.

Top Screenshot (Monitor Window): Shows the 'Monitor Window' tab selected. The 'LED Signage Cabinet' and 'LED Signage Box' tabs are also visible. The 'Communications' checkbox is checked, and the 'MDC Commands' checkbox is unchecked. There are 'Clear' and 'Export' buttons. The log shows the following entries:
[26/06/2015 10.11.42] S. Box(10.88.44.126): Failed to connect.
[26/06/2015 10.11.42] Connection cancelled.
[26/06/2015 10.19.51] S. Box(10.88.44.126): ID 2: Power Status - FPGA OK, STM ERROR, PW Detector ERROR, 13V OK, 5V OK, 3.3V ERROR, 1.8V ERROR, 1.2V OK
[26/06/2015 10.19.51] S. Box(10.88.44.126): ID 2: Temperature - 0(°C)

Middle Screenshot (LED Signage Cabinet): Shows the 'LED Signage Cabinet' tab selected. It displays a table of IC and Power information:

IC	Power
FPGA : Available	5W : Available
STM32 : Not Available	3.3W : Available
Power Detect IC : Available	1.8W : Available
	1.2W : Available

Bottom Screenshot (LED Signage Box): Shows the 'LED Signage Box' tab selected. It displays the following information:

IP Address : 10.88.44.126	MAC Address : 90:F1:AA:72:EF:BE	SET ID Range : 2-19
All Devices : 1	Connected Devices : 1	Disconnected Devices : 0
Serial Number :	Version : T-GFSLDWWC-1025.2	UPDATE

6. Settings and How to Use

6-1 Control Program for PCs

LSM(LED Signage Manager)

- **Main Window-Preference**

1. **Options**
number of times the command retried
interval of checking error status
alarm temperature warnings
2. **Support**
program language
Log data management
notify device error through Mail
Password settings option
3. **About Software**
the current version of LSM and update
function

The screenshot shows the 'Preferences' window for the LSM application, divided into three main sections: Options, Support, and About Software.

- Options:** Includes settings for Command Retry Count (1), Error Status Interval (30 min), Temperature Alert (checked, 65 °C), and Auto Brightness (Off). There are 'Edit' buttons for Brightness Sensor, Multiple Display ABL, and Location.
- Support:** Includes Language (English), Advance Log Management (checked, 1 days), Log Backup, Delete Log, Use Password, Change Password, Fault Device Alert (10 min), and Mail Server.
- About Software:** Shows Current Version (A-LEDMG DSP-1004.03), Auto Update (unchecked), Check for Updates, Open Source License, and View details.

At the bottom, a disclaimer states: 'This program is protected by copyright laws and international treaties. Unauthorized reproduction or distribution of this program, or any portion thereof, may result in serious civil and criminal penalties.'

7. Issue and Solution

Problem Case 1

Rule 1: The 1st Cabinet from I/G board must be ID #2 for the LSM Setup

Rule 2: The 1st Cabinet from I/G board must be set as Master. The 2nd Master cabinet is not allowed for the LSM connection.

Situation: After changing Main board or Cabinet, If the original Master cabinet is move the other place,

LSM configuration will be fail because of violation of rule 1.

during the LSM setup it cause a network fail because the 1st cabinet is not ID #2.

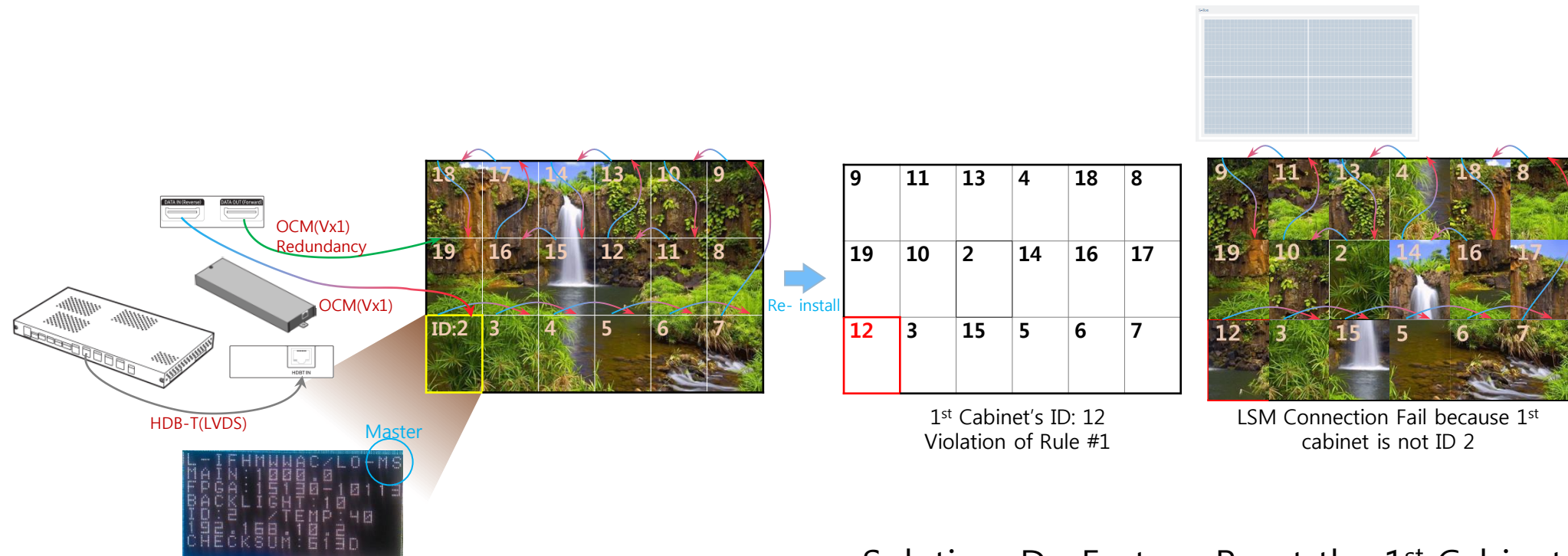

Solution: Do Factory Reset the 1st Cabinet

7. Issue and Solution

Problem Case 1

Rule 1: The 1st Cabinet from I/G board must be ID #2 for the LSM Setup

Rule 2: The 1st Cabinet from I/G board must be set as Master. The 2nd Master cabinet is not allowed for the LSM connection.

Situation: After changing Main board or Cabinet, If the original Master cabinet is move to slave cabinet area.

Although the 1st cabinet is set as a Master after doing factory reset, LSM configuration will be still fail

because of violation of rule 2. LSM setup can be start, but can't be complete because of the 2nd Master cabinet.

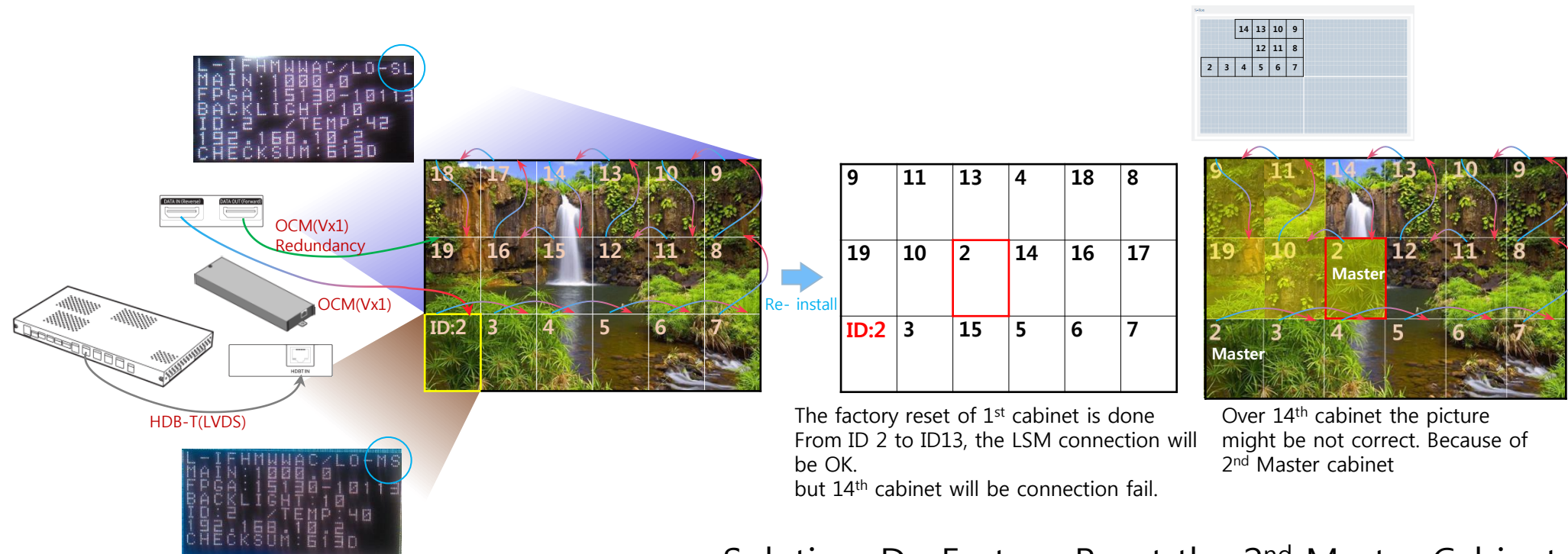

The factory reset of 1st cabinet is done
From ID 2 to ID13, the LSM connection will be OK.
but 14th cabinet will be connection fail.

Over 14th cabinet the picture might be not correct. Because of 2nd Master cabinet

Solution: Do Factory Reset the 2nd Master Cabinet

7. Issue and Solution

How to do Factory Reset

After checking cable connection order, the cabinet which is not display the proper picture position will be Wrong positioned Master cabinet. In this case, Do factory reset to change to slave cabinet .

Refer the below guide to do factory reset in front side and backside.

The 1st cabinet is not ID number 2. Because all cabinets connection are failed.



The 14th cabinet which is displaying the not proper picture position might be wrong positioned Master cabinet.

Hook

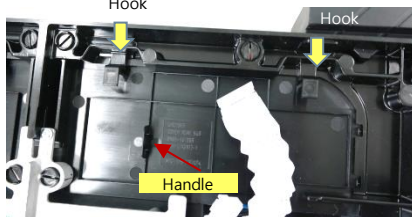

Press hook unlock cover

Factory Reset in back side

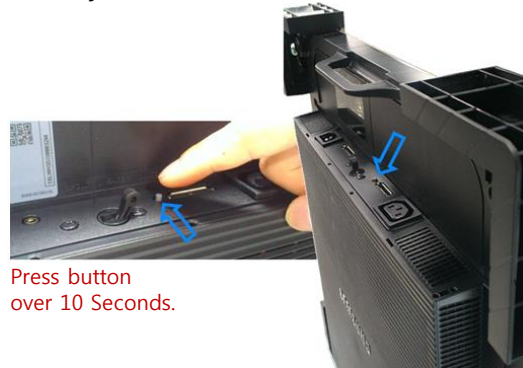

Press button over 10 Seconds.

Remove module in the front



Factory Reset in front side

Remove Cover

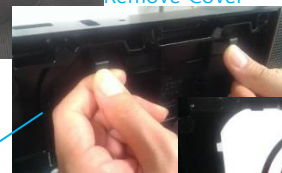

Do Factory Reset



Set LSM again.

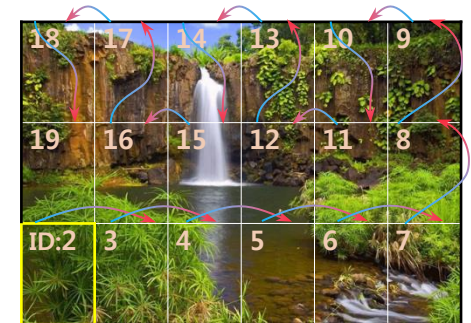

8. Cable/Power Connection

8-2. The caution for Cabinet installation and Cable connection(Full Front)

1) The set installation order Must be Left -> Right direction. Because The structure of Wall mount hole for cabinet installation is downward diagonal direction.

→ The set installation order and The cable connection order are different.

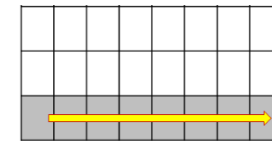

2) After installing cabinets one line is complete, make sure the connection is OK by connecting OCM/Power cable. Then, Install next line.



3) In case of connecting OCM cable upward, Connect OCM cable to Lower set first.

4) The two output of Interface gender should be connected to First cabinet and Last cabinet each
→ Interface Gender should be installed at Left-Center side of LED wall (refer to page13)
(Within 2~4M compared to first and last cabinet for connecting OCM cable)

8. Cable/Power Connection

8-3 The direction for Cabinet installation

- 1) Installation of First row cabinet starts at the bottom of Left-end.
- 2) After installing cabinets one line is complete, make sure the connection is OK by connecting OCM/Power cable. Then, Install next line.
- 3) From Second row, it starts from bottom to top.

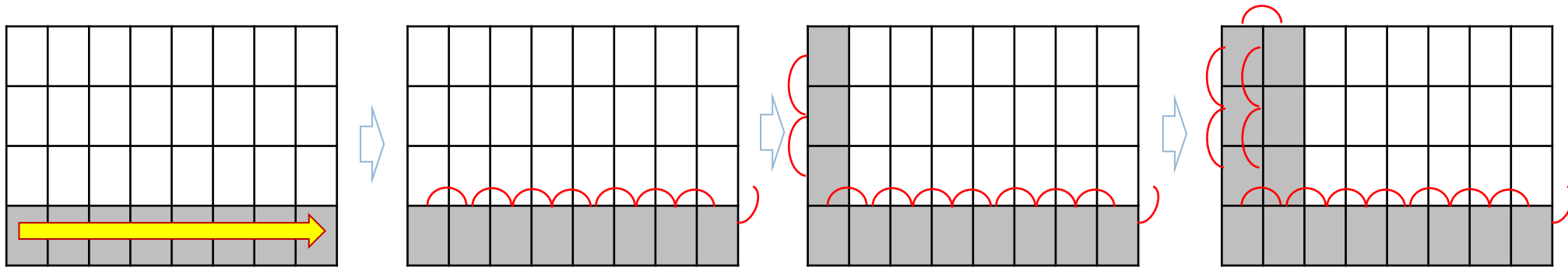

1) 1st row :
Install set form Left-end

Check Gap between module
inside cabinet

2) Connect
Power/Signal Cables

3) 2nd row :
Bottom to top

Check Gap between cabinets and
whether installed in a straight direction.

4) Same way

8. Cable Connection

8-4 Cable Connection : Data flow standard

◎ Connect OCM cable Forward direction

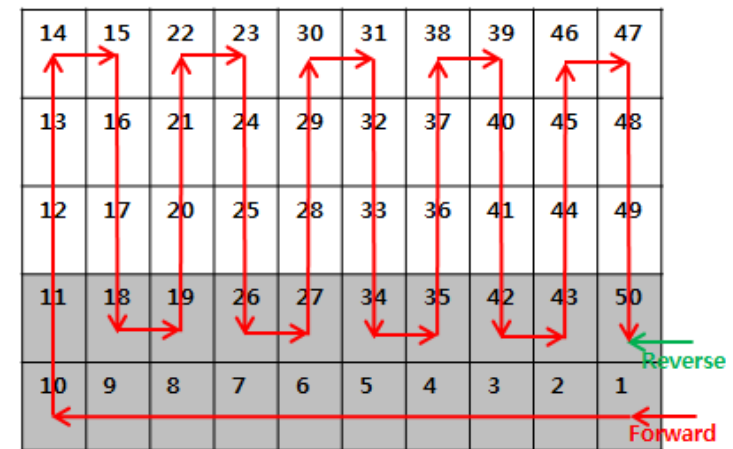
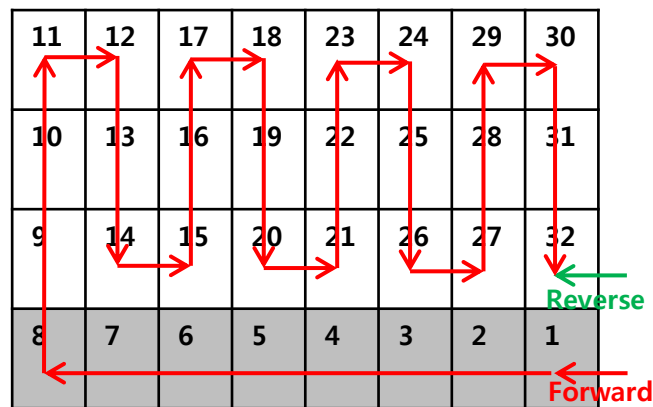
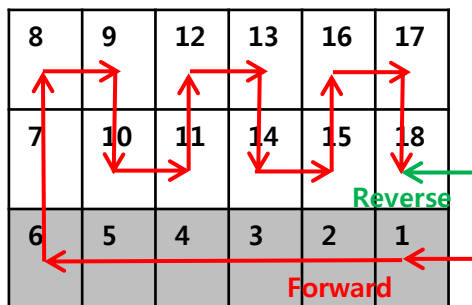
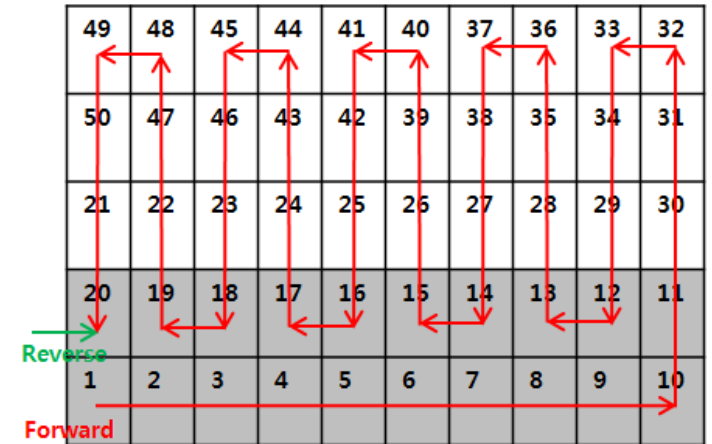
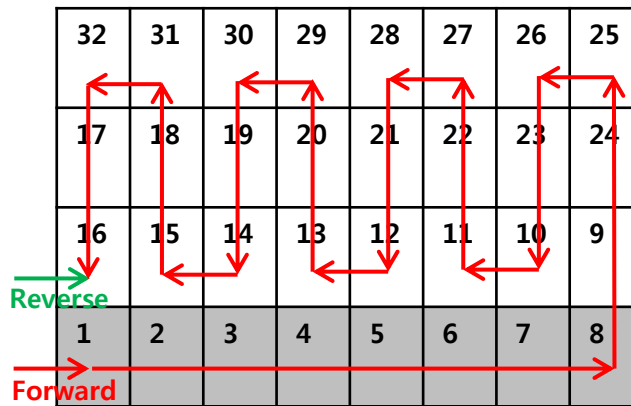
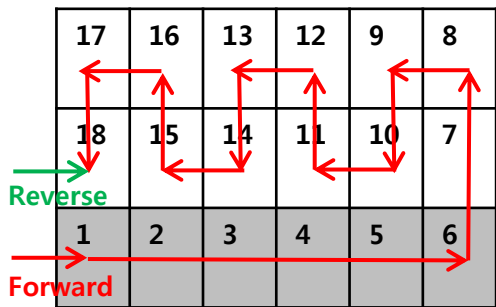

P1.5 FHD

P2.0 FHD

P2.5 FHD

8. Cable Connection

8-5 Cable Connection : OCM cable installation standard

- © Whenever one number of cabinet gets installed, connect necessary cable for each.
P1.5 FHD

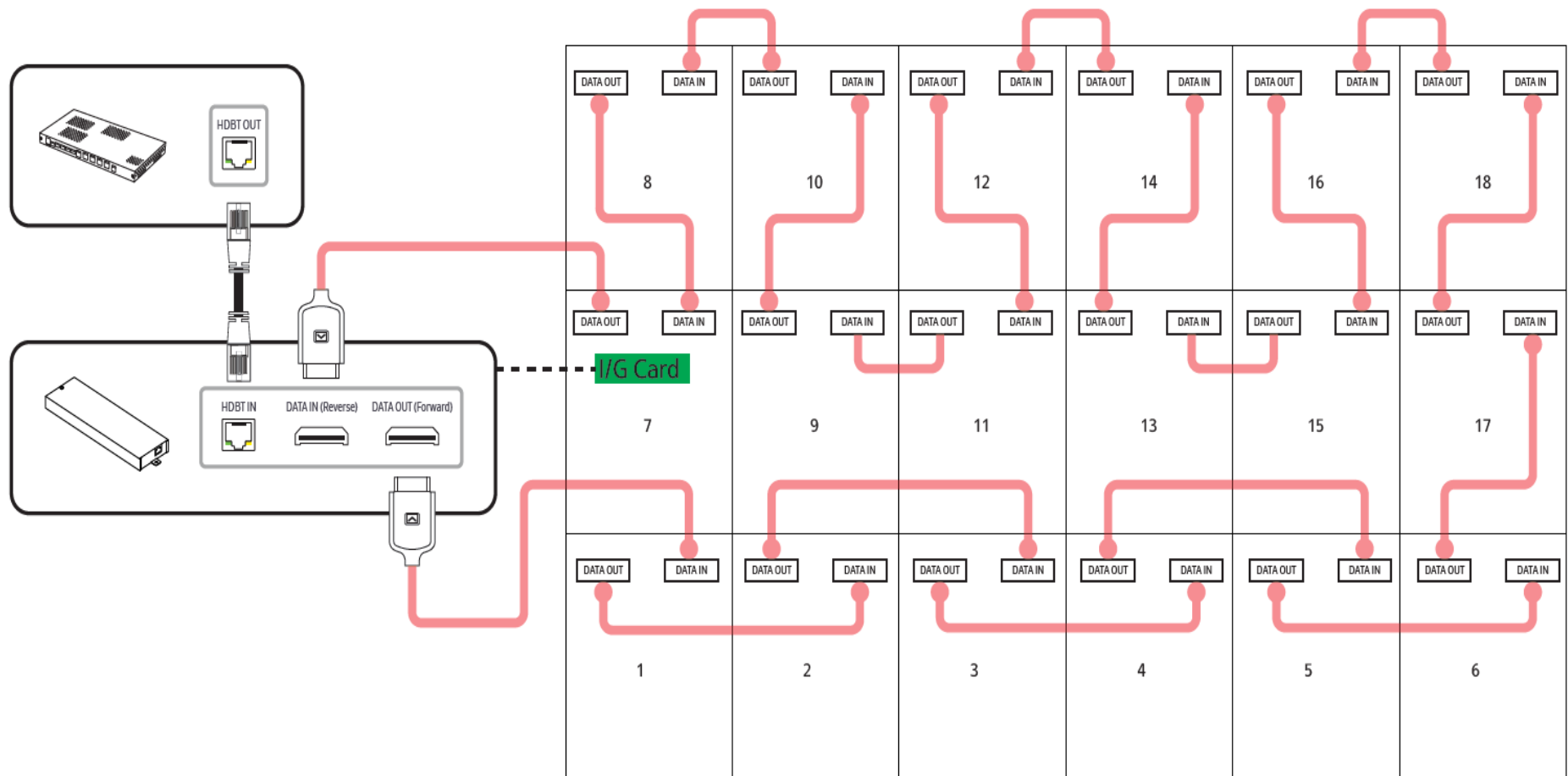

8. Cable Connection

8-5 Cable Connection : OCM cable installation standard

© Whenever one number of cabinet gets installed, connect necessary cable for each.

P2.0 FHD

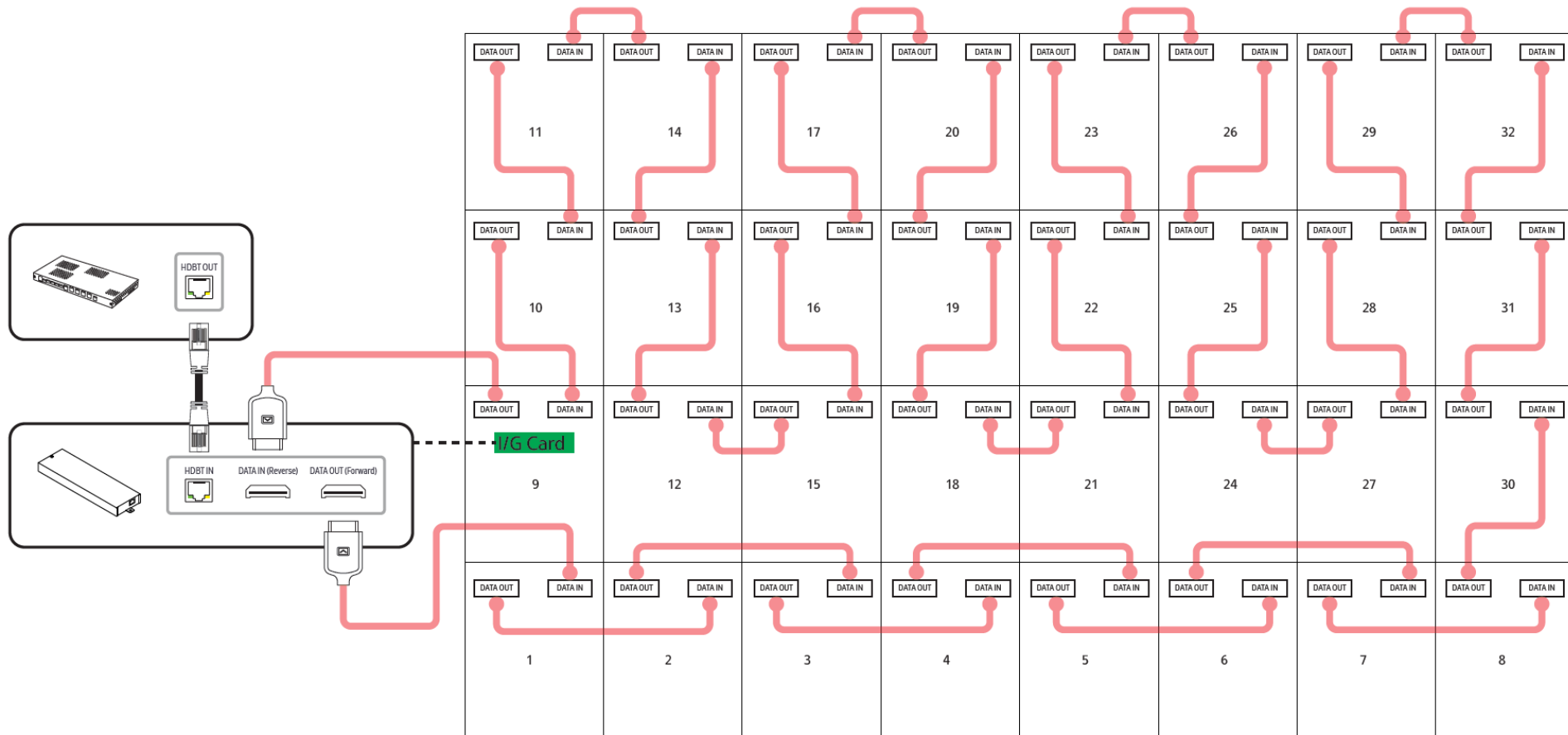

8. Cable Connection

8-5 Cable Connection : OCM cable installation standard

- © Whenever one number of cabinet gets installed, connect necessary cable for each.
P2.5 FHD

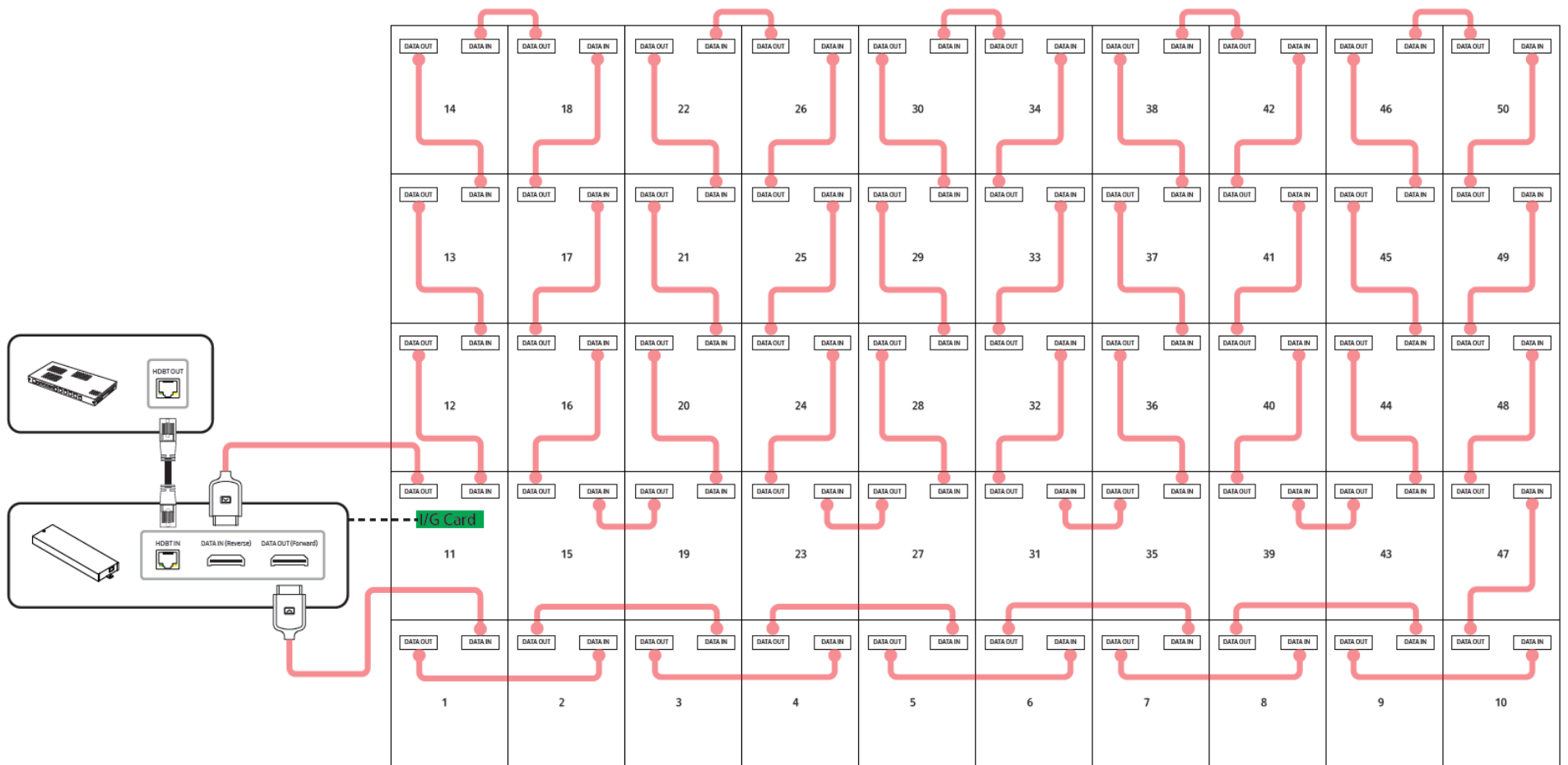

9. Seam Adjustment

• Check and Adjust Seam

- ① Check whether there is any Black Line between the cabinets in White Screen. (Fig.1)
- ② Check whether gap, differences occur between each module. (Fig.2)
 - ※ Gap: appears as a black line in every direction.
 - ※ Difference: A bright white line occurs in one direction whereas a black line occurs in the opposite direction.
- ③ If gap occurs, use module with hand from the outermost corner.
- ④ If differences occur, disassemble low LED module, and spin the Holder-Magnet using tools to adjust the height.
 - ※ If the Tool spins 0.5 rotation first, and then spins 36 degrees later, the module height will be moved by 0.1mm. (Fig.3)
 - ※ Modules are at the lowest face at first, you can only adjust the difference by raising it.
 - ※ If the flatness of the frame and the wall is bad, lots of modules would need adjustment.

So, it is very important to check the flatness of the wall and Frame before you install the cabinet.

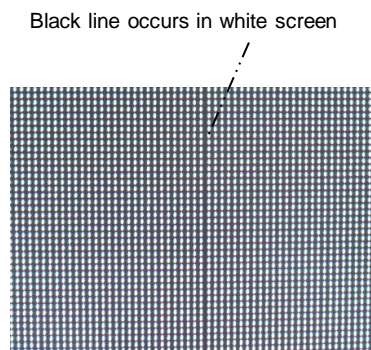

Fig.1 Black line

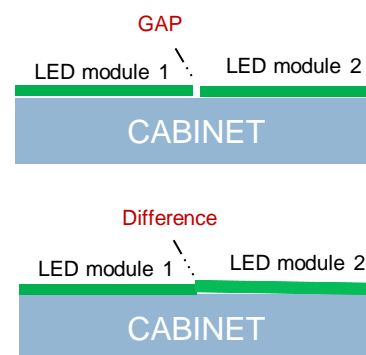

Fig.2 Gap/Difference between Modules

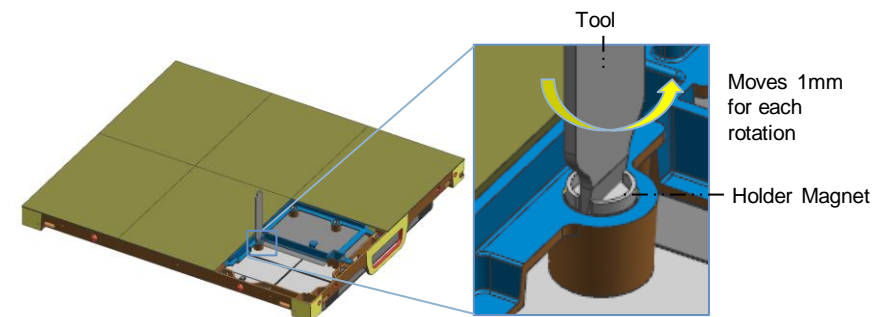
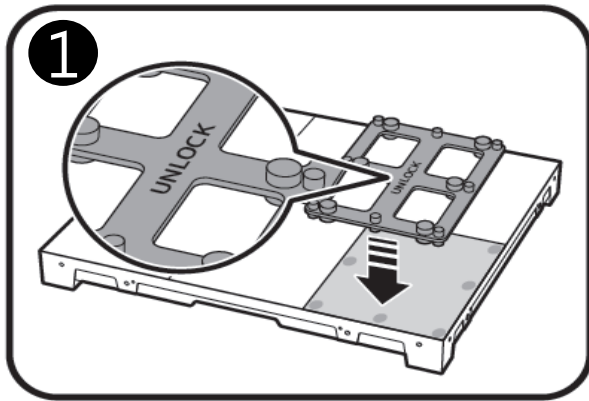

Fig.3 How to adjust Difference

9. Seam Adjustment

• Module Disassembly/Assembly

Have the Unlock mark head upwards.



Place to LED module.

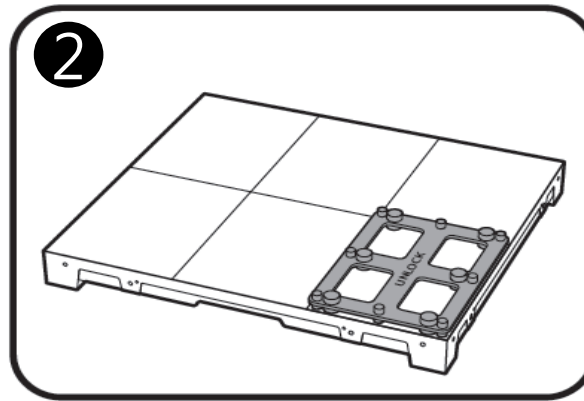

Separate the JIG and module at the same time.

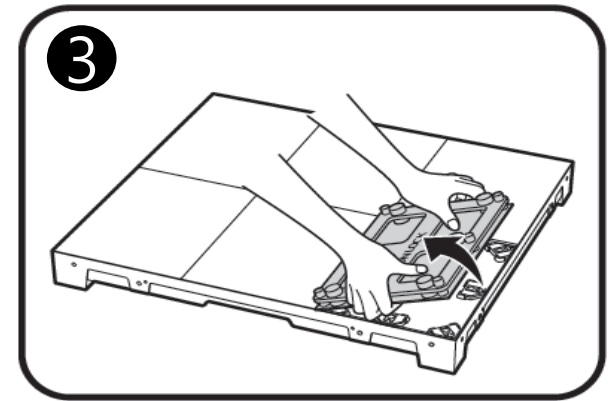

Put the replaced module up on the cabinet.

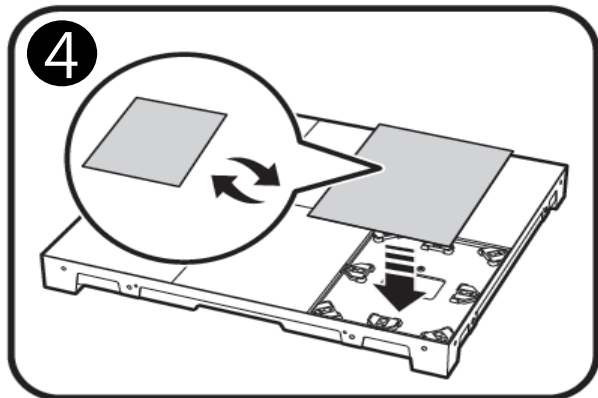

Have the Lock mark head upwards.

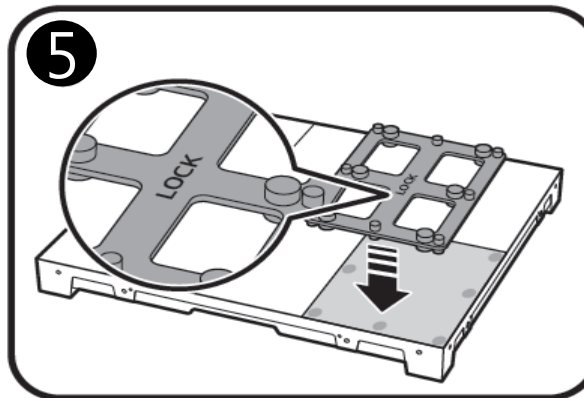

Lock after placing on LED module.

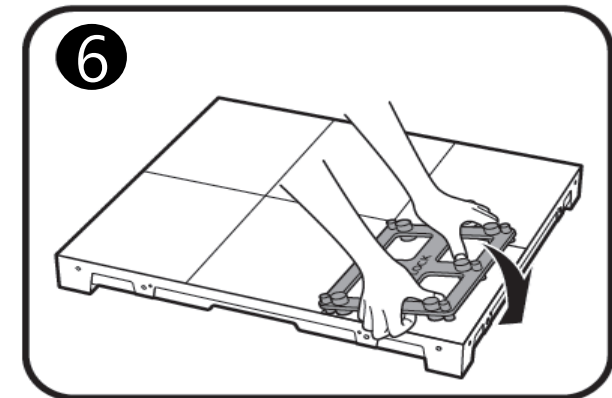

Aluminum profile & Frame Kit Installation Manual

- 1. Information and Installation Guide of Aluminum profile**
- 2. Installation of Aluminum profile**
- 3. Installation of Frame Kit**

1. Product Info & Installation Guide

- Aluminum profile & Frame Kit composition
- Aluminum profile specification

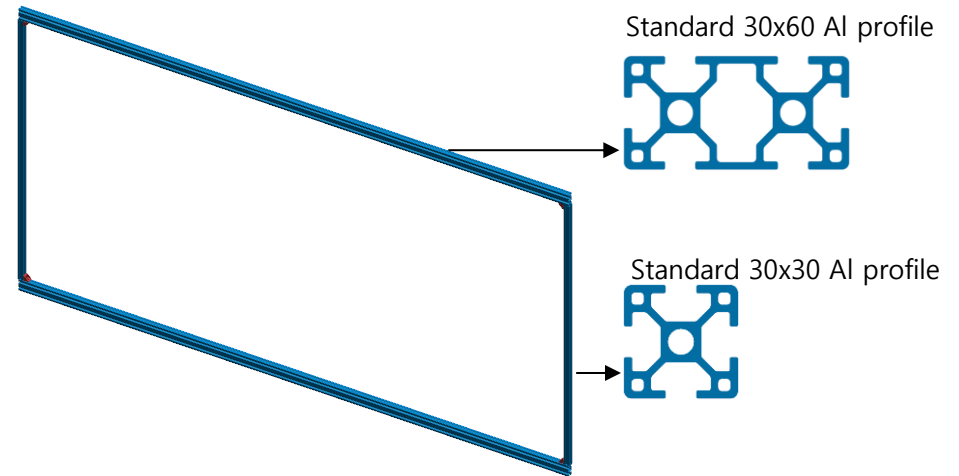
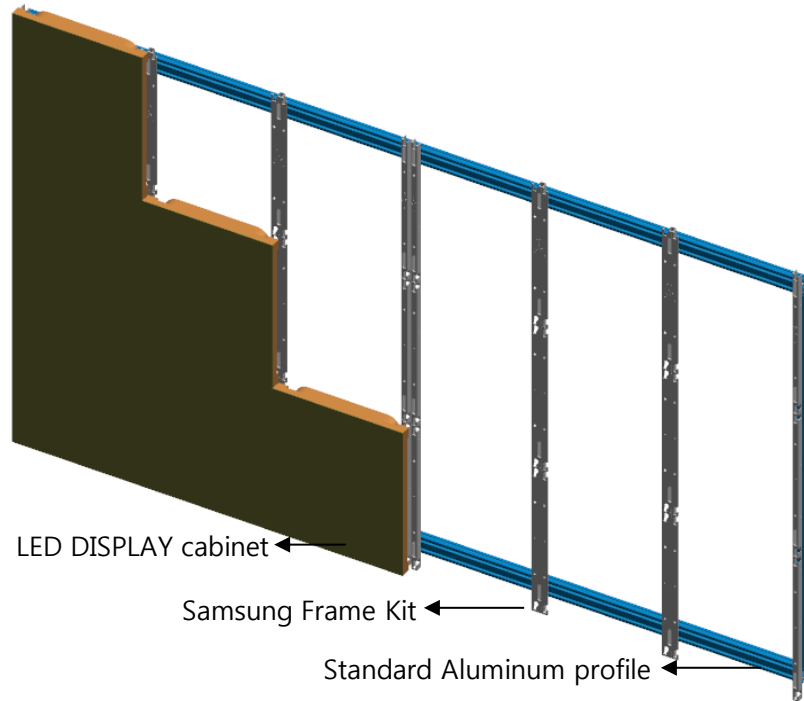

• Installation example

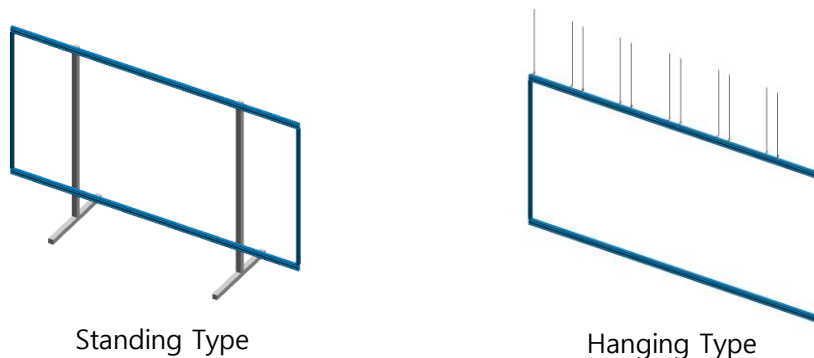

• Accessories for Aluminum profile assembly

Standard 30x60 gusset

Standard slot 8, M6 Nut

M6*L10 Screw



2. Installation of Aluminum profile

• Aluminum profile installation

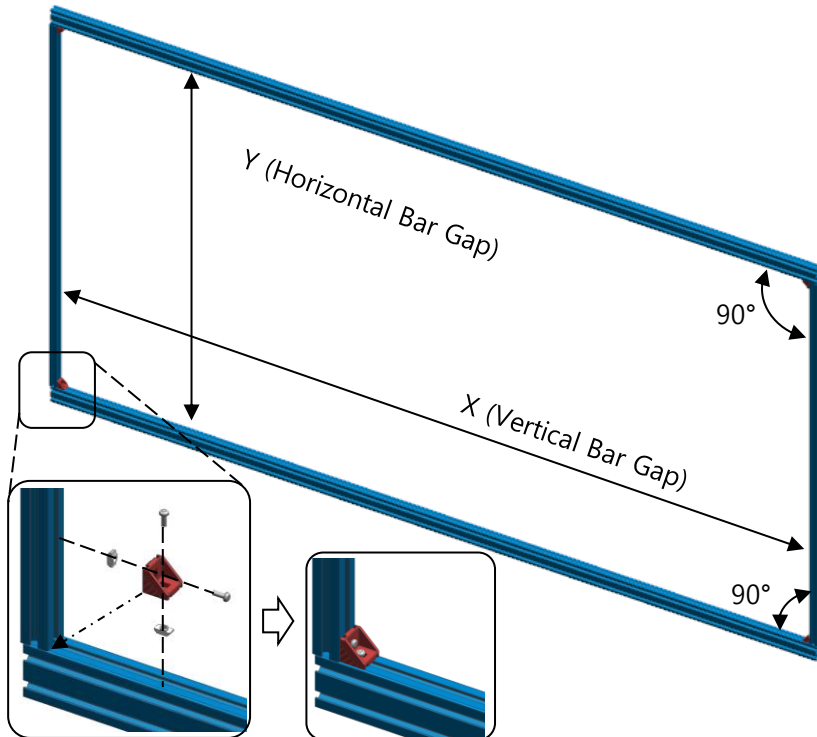

1. Keep the spacing of Aluminum profiles as below.
2. When assembling, the joint angle should be 90° .

Frame Kit	X (mm)	Y(mm)
CY-LFH15FWA (6x3)	2874	1526
CY-LFH20FWA (8x4)	3834	2066
CY-LFH25FWA (10x5)	4794	2604

• Bolster Aluminum profile

1. When Aluminum profile needs enhancement in its strength, add more Aluminum profile as the picture below.

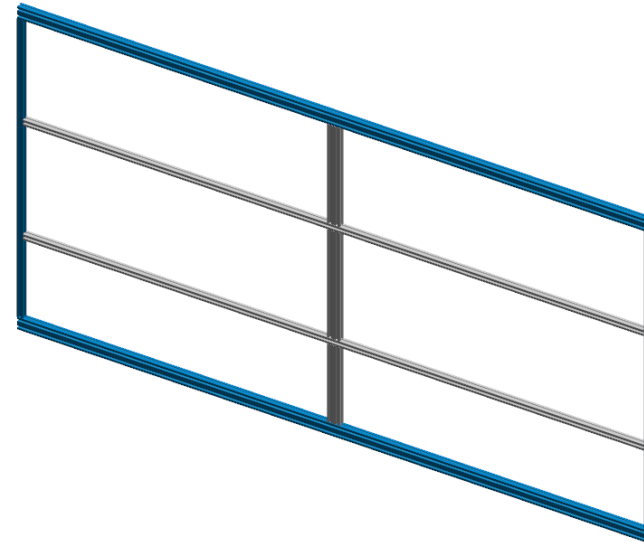

2. All added Al profile material should not block air-vent nor cable connector.

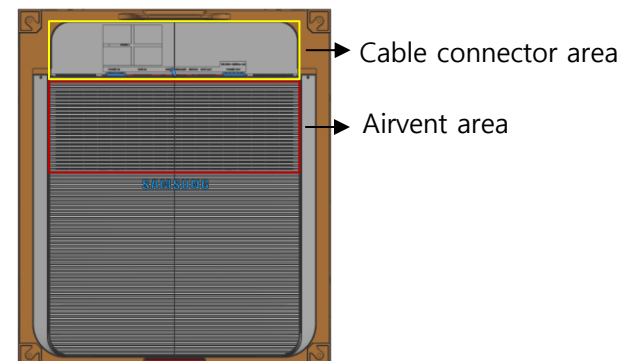

3. Installation of Frame kit

• Prepare Frame Kit

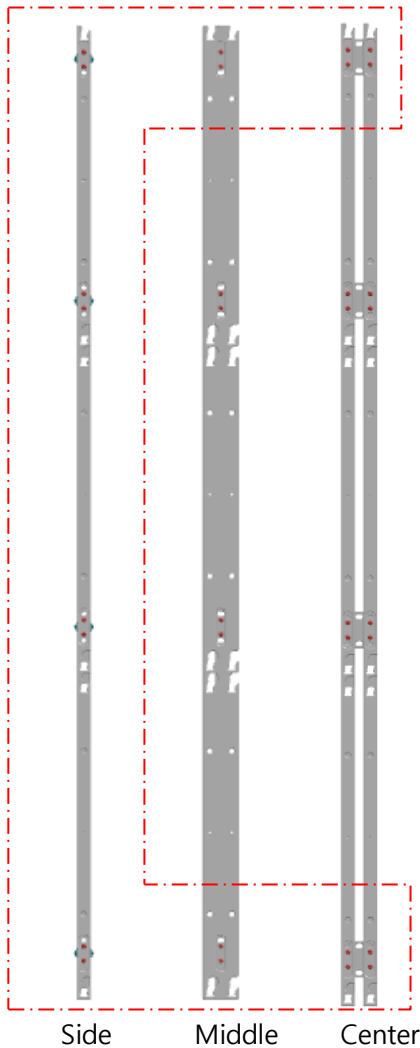

1. Disassemble holder screws for the needed area of Frame Kit.
(Relevant Frame : Holders in the side & Holders in the Middle/Center)
* When using AI profile, do not use holder.

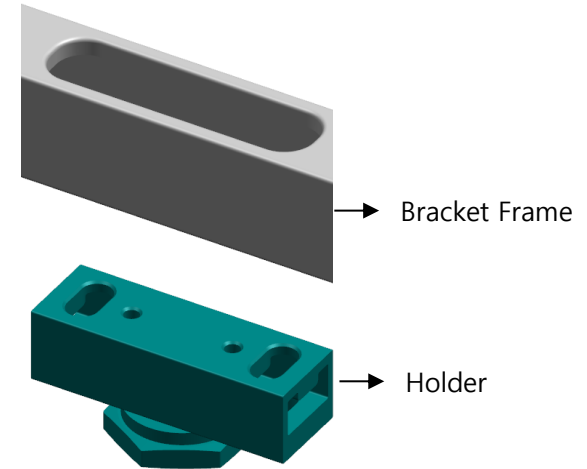
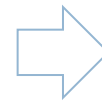
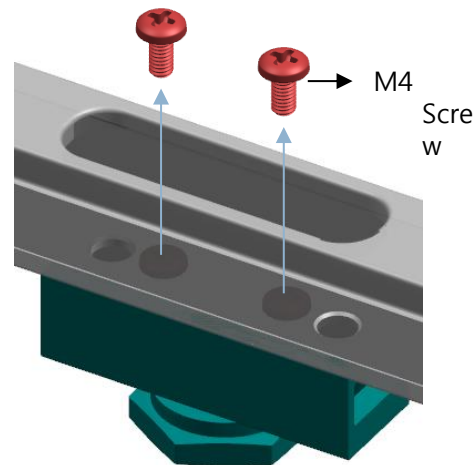

< Holder disassemble required area >





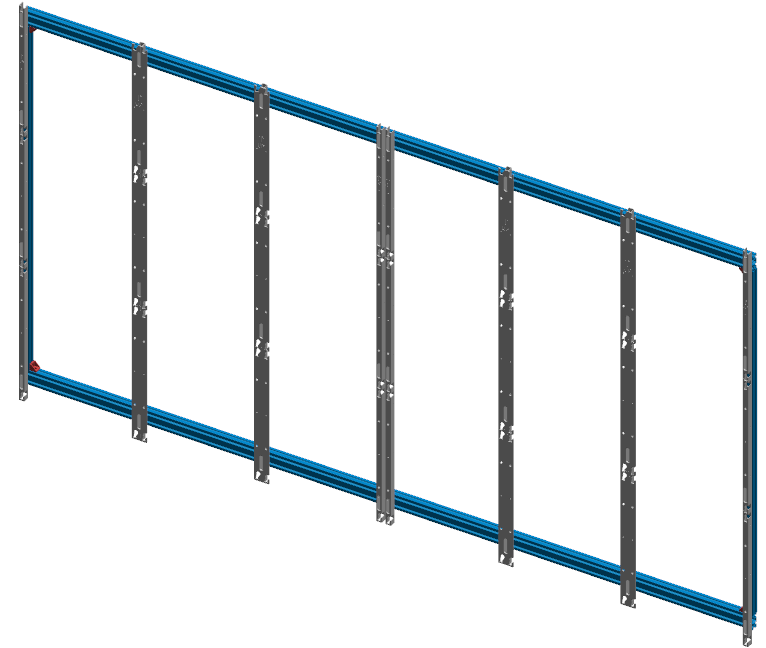
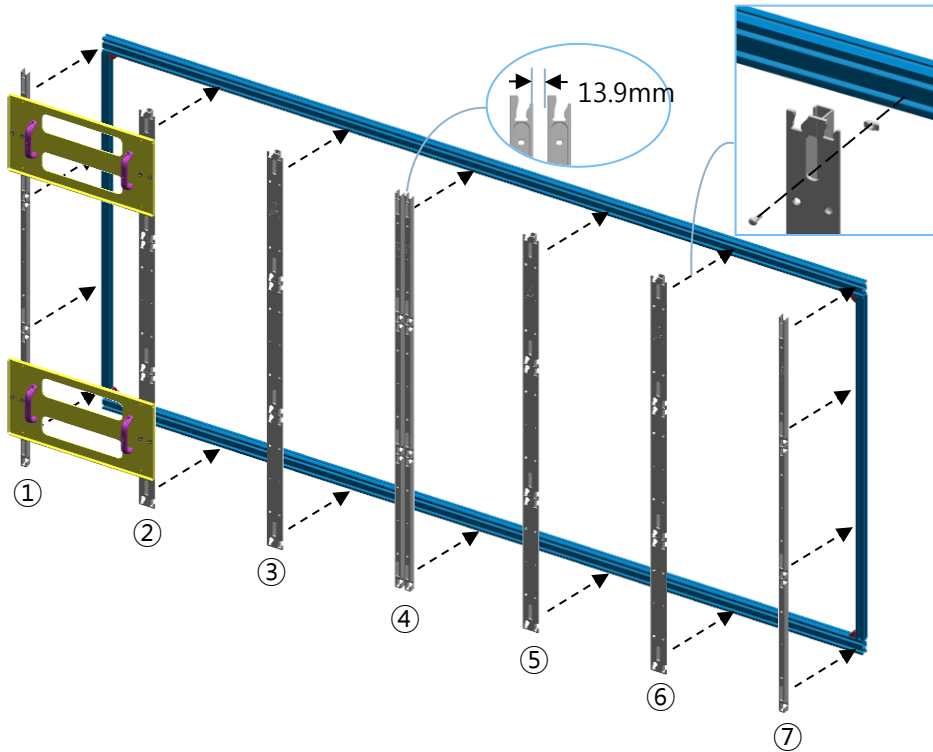







3. Installation of Frame kit

• Assemble Aluminum profile into Frame Kit

















1. Assemble ASSY BRACKET SIDE starting from the left. (Assembly order : Left→Right)
2. For the locking, use M6 screw and nut to fix it onto Al profile.
3. After fixing BRACKET, use ASSY BRACKET JIG to fix next BRACKET to Al Profile.
4. When assembling ASSY BRACKET CENTER, markings should equally have gap of 13.9mm.
5. Proceed with the right side assembly with in the same manner. (Detailed installation method → refer to 'Frame Kit Manual')

- Appendix ✂ Certified Cable by HDBaseT Samsung Electronics

Vendor	Model Name	Vendor	Model Name
SCP 	HNCPRO(TM) HOME NETWORK CABLE PROFESSIONAL HNCPRO(TM) HOME NETWORK CABLE PROFESSIONAL PLUS	Trends Electronics 	Cat 5E/SHLD-BLU Cat 5e/350 Mhz Cat 6 STP Cat 6/550mhz
Be;dem 	West Penn Wire 4246F West Penn Wire 4246AF West Penn Wire 254246F West Penn Wire 254246AF AV6SHP AV6SHR 2183R- F/UTP 2183P- F/UTP	Vertical Cable 	350-CAT5E 550-CAT6
Extron Electronics 	XTP-DTP-24	Metz Connect GmbH 	Cat.7A AWG 22 S/FTP
C2G 	23AWGX4P	Bluestream	CAT6HDBT
Crestron 	DM-CBL-8G-NP DM-CBL-8G-P DM-CBL-ULTRA-P	Leviton 	Leviton Extreme 6A UTP Leviton CAT6A F/UTP
FS Cables 	TruHD Cat 5E UTP 350MHz PVC TruHD Cat 5E UTP 350MHz LSZH TruHD Cat 6 UTP 500MHz PVC TruHD Cat 6 UTP 500MHz LSZH TruHD Cat 6 F/UTP 500MHz LSZH TruHD Cat 6A F/UTP 650MHz LSZH	Huaxun 	CAT6 AWG23 U/UTP CAT7A AWG22 S/FTP (CMR) CAT6A AWG23 F/UTP (CM) CAT6A AWG23 F/UTP (CMR) HT-A0423AF6A- PMS-001 Cat6A F/UTP
ICE Cable Systems 	ICE Cat 5e 350mhz ICE Cat 6 550mhz ICE Cat 5e Plenum ICE Cat 5e Direct Burial ICE Cat 5e Shielded ICE Cat 5e LSZH ICE Cat 6 Plenum ICE Cat 6 Direct Burial ICE Cat 6 Shielded ICE Cat 6 LSZH ICE Cat 6 Shielded LSZH ICE Cat 5e Siamese ICE Cat 6A ICE Cat 6 Outdoor ICE Cat 5e Outdoor	Black Box 	GigaTrue® 650 Cat 6A, 650-MHz UTP Plenum GigaTrue® 650 Cat 6A, 650-MHz UTP PVC GigaBase® 350 Cat 5e, 350-MHz UTP Plenum GigaBase® 350 Cat 5e, 350-MHz UTP LSZH GigaTrue® 550 Cat 6, 550-MHz UTP PVC GigaTrue® 550 Cat 6, 550-MHz UTP Plenum GigaTrue® 550 Cat 6, 550-MHz UTP LSZH Black Box Cat 5e, Shielded F/UTP PVC Black Box Cat 5e, Shielded F/UTP Plenum Black Box Cat 5e, Shielded F/UTP LSZH Black Box Cat 6, Shielded F/UTP PVC Black Box Cat 6, Shielded F/UTP Plenum Black Box Cat 6, Shielded F/UTP LSZH GigaTrue® 650 Cat 6A, 650-MHz UTP LSZH Black Box Cat 6A, Shielded F/UTP PVC Black Box Cat 6A, Shielded F/UTP Plenum Black Box Cat 6A, Shielded F/UTP LSZH

- Appendix ※ Certified Cable by HDBaseT Samsung Electronics

Vendor	Model Name	Vendor	Model Name
Kramer Electronics 	BC-HDKat6a BC-UNIKat	Snap AV 	SP-CAT6A-1000-BLU
IDK 	CAT. 5E HDC-CABLE (SF/UTP)	Nien-Yi Industrial Corp. 	NY-CAT.5E-UTP NY-CAT.6-UTP
Hitachi Cable America 	Category 7 HDBaseT	Panduit 	PUP6AM04 – Cat. 6A, Advanced MaTriX, U/UTP cable, Plenum (CMP) Rated PFP6X04 – Cat. 6A, F/UTP cable, Plenum (CMP) Rated
Superior Essex 	10Gain XP CAT 6A PowerWise CAT 5e+ CAT 6+ F/UTP	Webro Limited 	Cat5e U/UTP Cat6 U/UTP
Wonderful Hi-Tech 	WONDERFUL CAT.6 LAN CABLE WONDERFUL CAT.6A LAN CABLE WONDERFUL CAT.7A LAN CABLE TSP2304SXX Cat6A FTP	Aten Internation Inc. 	2L-2910
connectorCo 	VELOCITY PREMIUM CAT6 UUTP VELOCITY PREMIUM C5E UUTP Maxxam_Cat6A UFTP	Absolute Acoustics 	Videonet 650 – Storm Videonet 750 – Thunder
Purelink 	CAT6A U/FTP	General Cable Corp 	Genn Speed GS- 10 MTP CMP Cat6A F/UTP
CommScope Inc. 	1291B 1091B 2091B 3091B 2291B 3291B 10GS4 10G4 10GNS4ZH-i 10GNS4 10GN4	Haiyan 	CAT5E CAT6 CAT6A
		Samson 	CAT5E CAT6 CAT6A