

**Copeland™
EazyCool™**

Application Guidelines

Outdoor Condensing Unit - ZX Range

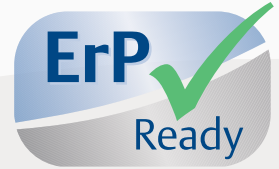

About these guidelines	1
1 Safety instructions.....	1
1.1 Icon explanation	1
1.2 Safety statements	1
1.3 General instructions	2
2 Product description	3
2.1 Common information about Copeland EazyCool™ ZX condensing units.....	3
2.2 Product range	3
2.3 Product nameplate	3
2.4 Nomenclature.....	3
2.5 Application range	3
2.5.1 <i>Qualified refrigerants and oils</i>	3
2.5.2 <i>Application limits</i>	4
2.6 Bill of material history	4
2.7 Main component description.....	4
2.7.1 <i>Compressor</i>	4
2.7.2 <i>Condenser fan(s)</i>	5
2.7.3 <i>Housing</i>	5
2.7.4 <i>P&I diagram for ZXME units</i>	6
2.7.5 <i>P&I diagram for ZXLE units</i>	7
2.7.6 <i>P&I diagram for ZXDE units</i>	8
2.8 Electronic controller XCM25D – Features	9
2.8.1 <i>Description</i>	9
2.8.2 <i>Functionality</i>	9
2.8.3 <i>Main control & safety features</i>	10
2.8.4 <i>Additional features for customization</i>	11
2.9 Electronic controller XCM25D – Programming.....	15
2.9.1 <i>Programming the local display</i>	15
2.9.2 <i>Single commands</i>	16
2.9.3 <i>Double commands – Entering programming level 1 “Pr1”</i>	16
2.9.4 <i>How to program the parameters (Pr1 and Pr2)</i>	17
2.9.5 <i>Entering programming level 2 “Pr2”</i>	17
2.9.6 <i>Fast access menu</i>	17
2.10 Controller keyboard	18
2.10.1 <i>How to lock the keyboard</i>	18
2.10.2 <i>How to unlock the keyboard</i>	18
2.11 Parameters level 1 – Required settings	18
2.12 Pumpdown – General.....	19
2.12.1 <i>External pumpdown – Without XCM-25D integration</i>	19
2.12.2 <i>Pumpdown with room thermostat</i>	19

2.12.3	<i>Pumpdown with temperature sensor</i>	20
2.13	Reset to factory settings – Emerson "Hot Key"	21
2.13.1	<i>How to save factory settings or user settings</i>	21
2.13.2	<i>Applicable hot keys for ZX units with XCM25D controller</i>	22
2.13.3	<i>Location of the "Hot Key" plug connection on the XCM25D controller</i>	22
2.13.4	<i>How to program a "Hot Key" from the controller (upload)</i>	22
2.13.5	<i>How to program a controller using an Emerson "Hot Key" (download)</i>	22
2.14	Troubleshooting	23
2.14.1	<i>Alarm menu</i>	23
2.15	Compressor motor protection	23
2.16	System pressure protection.....	24
2.16.1	<i>High-pressure safety switch</i>	24
2.16.2	<i>High pressure: pressure relief valve / burst disc</i>	24
2.16.3	<i>Low-pressure safety switch – Optional</i>	24
2.17	Other inputs at the plant controller XCM25D.....	24
2.17.1	<i>Customer-supplied control (room thermostat)</i>	24
2.17.2	<i>Case temperature controller</i>	24
2.17.3	<i>Ambient temperature sensor</i>	24
2.18	Other outputs of the electronic controller	24
2.18.1	<i>Alarm output (D05)</i>	24
2.19	Dimensions in mm.....	25
3	Installation	26
3.1	Condensing unit handling	26
3.1.1	<i>Transport and storage</i>	26
3.1.2	<i>Weights</i>	26
3.2	Electrical connection	27
3.2.1	<i>Power supply connections</i>	27
3.2.2	<i>Maximum operating currents for cable selection</i>	27
3.2.3	<i>Electrical wiring</i>	27
3.2.4	<i>Electrical protection standard (protection class)</i>	28
3.3	Refrigeration piping connections.....	28
3.3.1	<i>Refrigeration piping installation</i>	28
3.3.2	<i>Brazing recommendations</i>	29
3.3.3	<i>Brazing procedure</i>	29
3.4	Location & fixings	30
3.5	Required distances	30
4	Starting up & operation.....	32
4.1	Evacuation	32
4.2	Charging procedure.....	32
4.2.1	<i>Refrigerant charging procedure</i>	32

4.2.2	Oil charging procedure.....	33
4.3	Rotation direction of Scroll compressors.....	33
4.4	Maximum compressor cycle.....	33
4.5	Checks before starting & during operation.....	33
5	Maintenance & repair.....	34
5.1	Replacing a compressor.....	34
5.2	Condenser fins.....	34
5.3	Electrical connections.....	34
5.4	Routine leak testing.....	35
5.5	Condenser fan(s) & motor(s).....	35
6	Certification & approval.....	35
7	Dismantling & disposal.....	35
	DISCLAIMER.....	35
	Appendix 1: Overview of the ZX unit components.....	36
	Appendix 2: Wiring diagram – ZXME / ZXLE / ZXDE units (380-420V / 3Ph / 50 Hz).....	37
	Appendix 3: Parameter list level 1 (Pr1).....	38
	Appendix 4: Parameter list level 1 (Pr1) & 2 (Pr2).....	39
	Appendix 5: Alarm menu.....	55
	Appendix 6: Additional features for customization.....	59
	Appendix 7:.....	63
	Appendix 8: List of tables and figures.....	64

About these guidelines

The purpose of these application guidelines is to provide guidance in the application of Copeland EazyCool™ ZX condensing units. They are intended to answer the questions raised while designing, assembling and operating a system with these products.

Besides the support they provide, the instructions listed herein are also critical for the proper and safe functioning of the condensing units. Emerson Climate Technologies will not guarantee the performance and reliability of the product if it is misused in regard of these guidelines.

These application guidelines cover stationary applications only. For mobile applications, contact Application Engineering as other considerations may apply.

1 Safety instructions







Copeland EazyCool™ ZX outdoor refrigeration condensing units are manufactured according to the latest European and US Safety Standards. Particular emphasis has been placed on the user's safety.

These condensing units are intended for installation in machines and systems according to the Machinery directive MD 2006/42/EC. They may be put to service only if they have been installed in these systems according to instructions and conform to the corresponding provisions of legislation. For relevant standards please refer to the Manufacturer's Declaration, available at www.emersonclimate.eu.

These instructions should be retained throughout the lifetime of the compressor as well as the condensing unit.

You are strongly advised to follow these safety instructions.

1.1 Icon explanation

 <p>WARNING This icon indicates instructions to avoid personal injury and material damage.</p>	 <p>CAUTION This icon indicates instructions to avoid property damage and possible personal injury.</p>
 <p>High voltage This icon indicates operations with a danger of electric shock.</p>	 <p>IMPORTANT This icon indicates instructions to avoid malfunction of the compressor.</p>
 <p>Danger of burning or frost burn This icon indicates operations with a danger of burning or frost burn.</p>	<p>NOTE This word indicates a recommendation for easier operation.</p>
 <p>Explosion hazard This icon indicates operations with a danger of explosion.</p>	

1.2 Safety statements

- Refrigeration compressors must be employed only for their intended use.
- Only qualified and authorized HVAC or refrigeration personnel are permitted to install, commission and maintain this equipment.
- Electrical connections must be made by qualified electrical personnel.
- All valid standards for connecting electrical and refrigeration equipment must be observed.
- The national legislation and regulations regarding personnel protection must be observed.



Use personal safety equipment. Safety goggles, gloves, protective clothing, safety boots and hard hats should be worn where necessary.

1.3 General instructions



WARNING

System breakdown! Personal injuries! Never install a system in the field and leave it unattended when it has no charge, a holding charge, or with the service valves closed without electrically locking out the system.

System breakdown! Personal injuries! Only approved refrigerants and refrigeration oils must be used.



WARNING

High shell temperature! Burning! Do not touch the compressor until it has cooled down. Ensure that other materials in the area of the compressor do not get in touch with it. Lock and mark accessible sections.



CAUTION

Overheating! Bearing damage! Do not operate compressors without refrigerant charge or without being connected to the system.



IMPORTANT

Transit damage! Compressor malfunction! Use original packaging. Avoid collisions and tilting.

The contractor is responsible for the installation of the unit and should ensure the follow points:

- sufficient liquid sub-cooling in the line to the expansion valve(s) to avoid “flash-gas” in the liquid line;
- sufficient amount of oil in the compressor (in case of long piping additional oil must be added).

2 Product description

2.1 Common information about Copeland EazyCool™ ZX condensing units

Emerson Climate Technologies has developed the Copeland EazyCool™ ZX outdoor condensing unit of second generation to meet primarily the demands of the food retail and food service sectors. It is a refrigeration air-cooled condensing unit that uses the latest Copeland™ brand products patented Scroll technology as the main driver and has electronic protection and diagnostics features built in the compact chassis. The combination of large condensers and low speed fans allows particularly quiet operation.

2.2 Product range

Copeland EazyCool ZX outdoor condensing units are released for multiple refrigerants. They have two cabinet sizes and are equipped with one or two fans. Depending on the compressor in use they are designed for medium temperature or low temperature refrigeration applications.

2.3 Product nameplate

The condensing unit nameplate shows model designation and serial number, as well as locked rotor amps, maximum operating current, safety pressures and weight.

The compressor has its own nameplate with all electrical characteristics.

2.4 Nomenclature

The model designation contains the following technical information about the condensing unit:

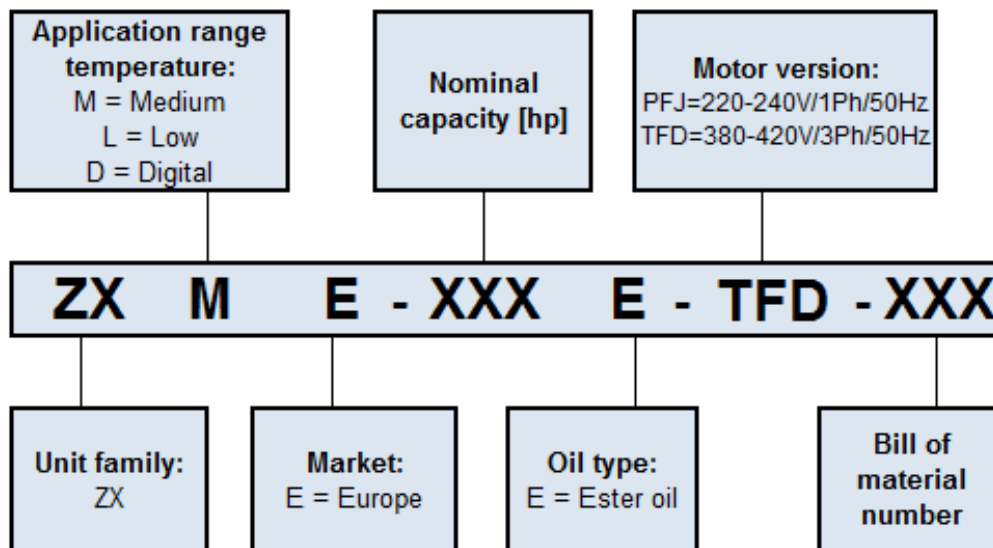

Figure 1: Nomenclature ZX units

2.5 Application range

2.5.1 Qualified refrigerants and oils

Qualified refrigerants	R404A, R407A, R407F, R507, R448A, R449A R134a*, R450A*, R513A* (* = Not for ZXLE)						
Qualified servicing oils	Emkarate RL 32 3MAF Mobil EAL Arctic 22CC						
Oil charge in litres	ZXME020E ZXME025E	ZXME030E ZXLE020E ZXLE030E	ZXDE040E	ZXLE040E ZXLE050E	ZXDE050E ZXDE060E ZXDE075E	ZXME060E ZXME075E	ZXLE060E
	1	1.1	1.24	1.75	1.77	1.85	2.3

Table 1: Qualified refrigerants and oils

2.5.2 Application limits

For application envelopes, please refer to the compressor application envelopes available in Copeland™ brand products Select software.

ZX condensing units can be used with an ambient temperature from -15°C to 45°C. For lower ambient temperatures please contact your local Application Engineering representative.

2.6 Bill of material history

BOM	Family	Introduction	Controller concept
302	ZXME	08/2008	Electronic main board
452	ZXLE / ZXDE	07/2010	ZXLE: Electronic main board ZXDE: EC2-552 (Emerson - Alco)
303	ZXME	03/2013	Electronic main board
453	ZXLE / ZXDE	03/2013	ZXLE: Electronic main board ZXDE: XC645 (Emerson - Dixell)
304	ZXME	01/2015	XCM25D (Emerson - Dixell)
454	ZXLE / ZXDE	01/2015	XCM25D (Emerson - Dixell)

Table 2: BOM history

Legend

30* Medium temperature units: without oil separator; without suction accumulator

45* Digital/medium temperature units: with oil separator without suction accumulator

45* Low temperature units: with oil separator with suction accumulator

NOTE: These guidelines are of application only for BOM 304 and 454. For previous generations (BOM 302/452 & BOM 303/453) dedicated guidelines can be downloaded from www.emersonclimate.eu.

2.7 Main component description

2.7.1 Compressor

Medium temperature		Low temperature	
Unit model	Compressor model	Unit model	Compressor model
Standard			
ZXME020E	ZX15KCE-TFD/PFJ	ZXLE020E	ZXI06KCE-TFD/PFJ
ZXME025E	ZX19KCE-TFD/PFJ	ZXLE025E	ZXI08KCE-TFD/PFJ
ZXME030E	ZX21KCE-TFD/PFJ	ZXLE030E	ZXI09KCE-TFD/PFJ
ZXME040E	ZX29KCE-TFD/PFJ	ZXLE040E	ZXI14KCE-TFD
ZXME050E	ZX38KCE-TFD	ZXLE050E	ZXI15KCE-TFD
ZXME060E	ZX45KCE-TFD	ZXLE060E	ZXI18KCE-TFD
ZXME075E	ZX51KCE-TFD	ZXLE075E	ZXI21KCE-TFD
Digital			
ZXDE040E	ZBD29KQE-TFD		
ZXDE050E	ZBD38KQE-TFD		
ZXDE060E	ZBD45KQE-TFD		
ZXDE075E	ZBD48KQE-TFD		

Table 3: Compressor models cross reference

2.7.2 Condenser fan(s)

The condensers of the ZX condensing units are equipped with single-phase fans.

Condensing units			Nr. of Fans	Fan speed	Diameter	Voltage	Power input
Medium temperature		Low temperature					
Standard	Digital			Pcs	(rpm)	(mm)	V/ph/Hz
ZXME020E		ZXLE020E	1	830	450	220-240V / 1 Ph / 50 Hz	123
ZXME025E		ZXLE025E					
ZXME030E		ZXLE030E					
ZXME040E		ZXLE040E					
	ZXDE040E		2				246
ZXME050E	ZXDE050E	ZXLE050E					
ZXME060E	ZXDE060E	ZXLE060E					
ZXME075E	ZXDE075E	ZXLE075E					

Table 4: Condenser fans technical data

2.7.3 Housing

ZX condensing units with BOM 304 & 454 have additional housing features:

- Controller-window in front of the cabinet door. The window is IP54 and shows the current value of the electronic controller.
- The main power switch is installed on cabinet door and allows to de-energize the unit without opening of the cabinet door. To open the door the main power switch must be in Off position.
- The quick-locks allows easy and quick opening of the cabinet door by means of the cabinet key.
- The cabinet key is delivered with the unit. It is fixed on one of the piping connections by means of a cable strap.

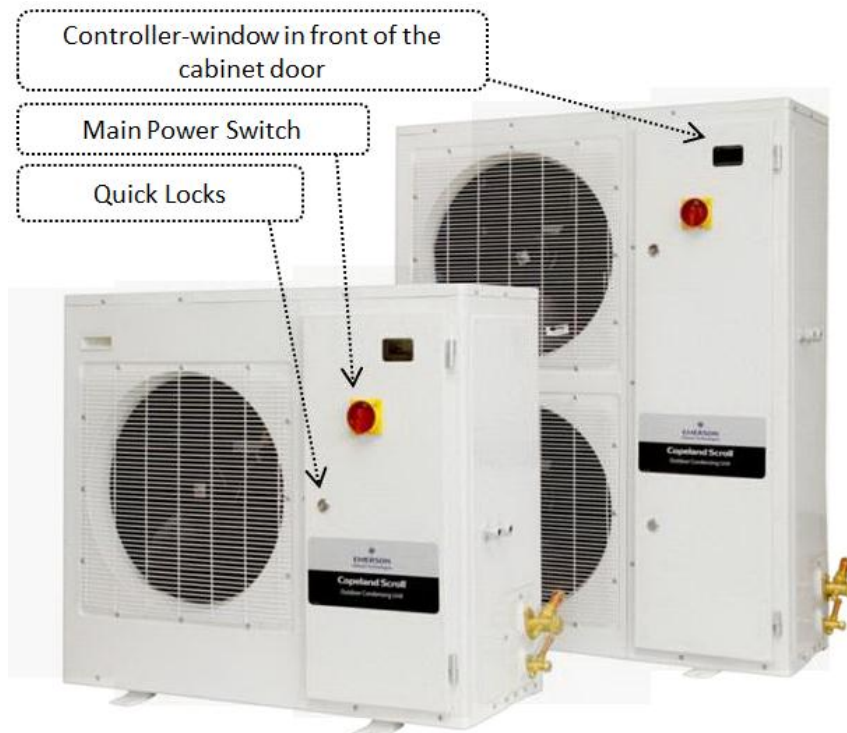

Figure 2: ZX unit housing

2.7.4 P&I diagram for ZXME units

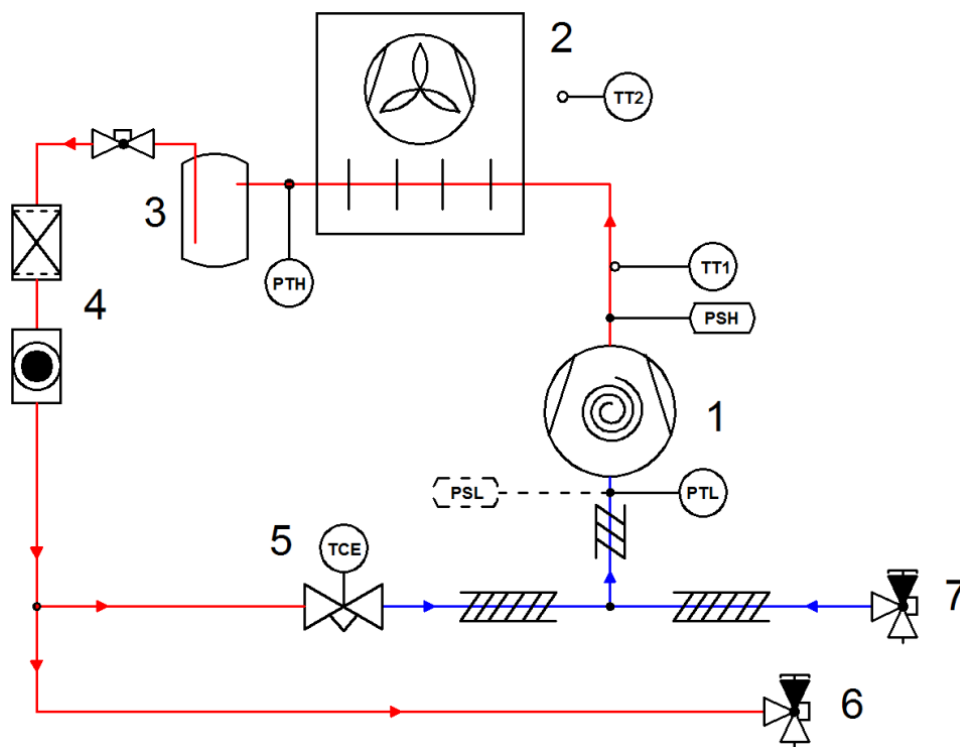

Figure 3: P&I diagram for ZXME units

Position	Description	Comments
1	High efficient Copeland Scroll ZX	
2	Condenser with 1 or 2 fans	
3	Liquid receiver with service valve	
4	Filter drier / sight glass combination	
5	Expansion device for suction line injection	
6	Service valve, liquid line	
7	Service valve, suction line	
PSL	Pressure switch, adjustable, low pressure, not factory mounted	System safety option
PSH	Pressure switch, not adjustable, high pressure	System safety
PTL	Suction pressure sensor, low pressure	Compressor setpoint
PTH	Pressure sensor, high pressure	Fan speed control
TT1	Discharge temperature sensor	Compressor safety
TT2	Ambient temperature sensor	Additional functions

Table 5: Legend of the P&I diagram for ZXME units

2.7.5 P&I diagram for ZXLE units



IMPORTANT

No insulation on liquid line! Air moisture condensation and lack of performance! Moisture will condensate on the liquid line and cause water droplets. The liquid line can pick up additional heat from the ambient which will adversely affect the sub-cooling desirable for the liquid refrigerant before it enters the expansion valve. Insulate both the suction and liquid interconnecting piping between the ZX unit and the evaporator.

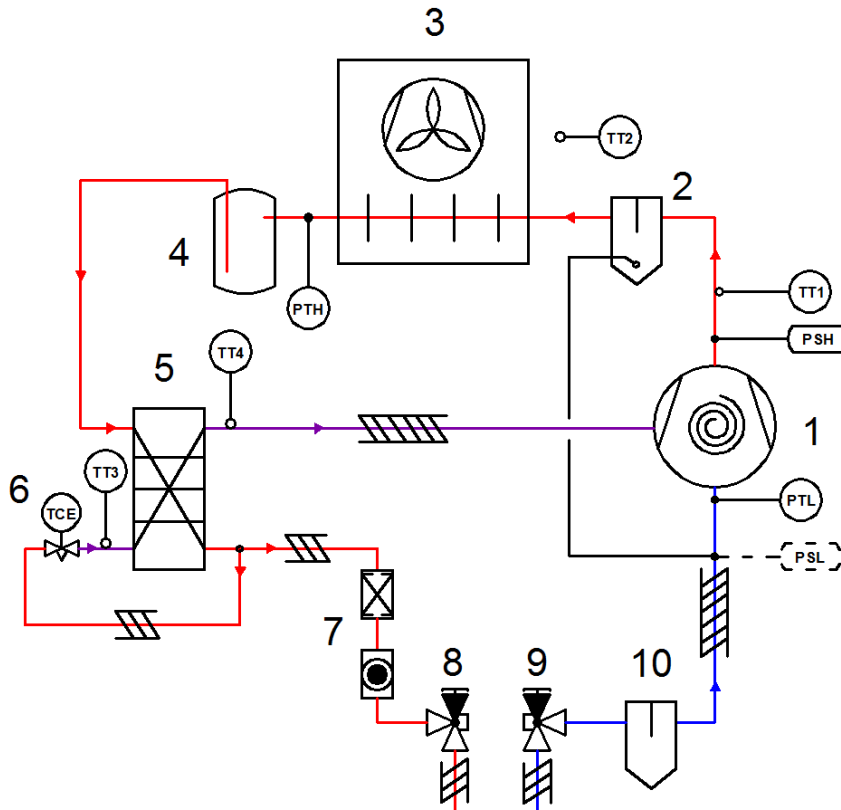

Figure 4: P&I diagram for ZXLE units

Position	Description	Comments
1	High efficient Copeland Scroll ZX	
2	Oil separator	
3	Condenser with 1 or 2 fans	
4	Liquid receiver with service valve	
5	Plate heat exchanger for enhanced vapour injection (EVI)	
6	Expansion device for enhanced vapour injection (EVI)	
7	Filter drier / sight glass combination	
8	Service valve, liquid line	
9	Service valve, suction line	
10	Liquid separator	
PSL	Pressure switch, adjustable, low pressure, not factory mounted	System safety option
PSH	Pressure safety switch, not adjustable, high pressure	System safety
PTL	Suction pressure sensor, low pressure	Compressor setpoint
PTH	Pressure sensor, high pressure	Fan speed control
TT1	Discharge temperature sensor	Compressor safety
TT2	Ambient temperature sensor	Additional functions
TT3	Vapour in temperature sensor	EVI control
TT4	Vapour out temperature sensor	EVI control

Table 6: Legend of the P&I Diagram for ZXLE units

2.7.6 P&I diagram for ZXDE units

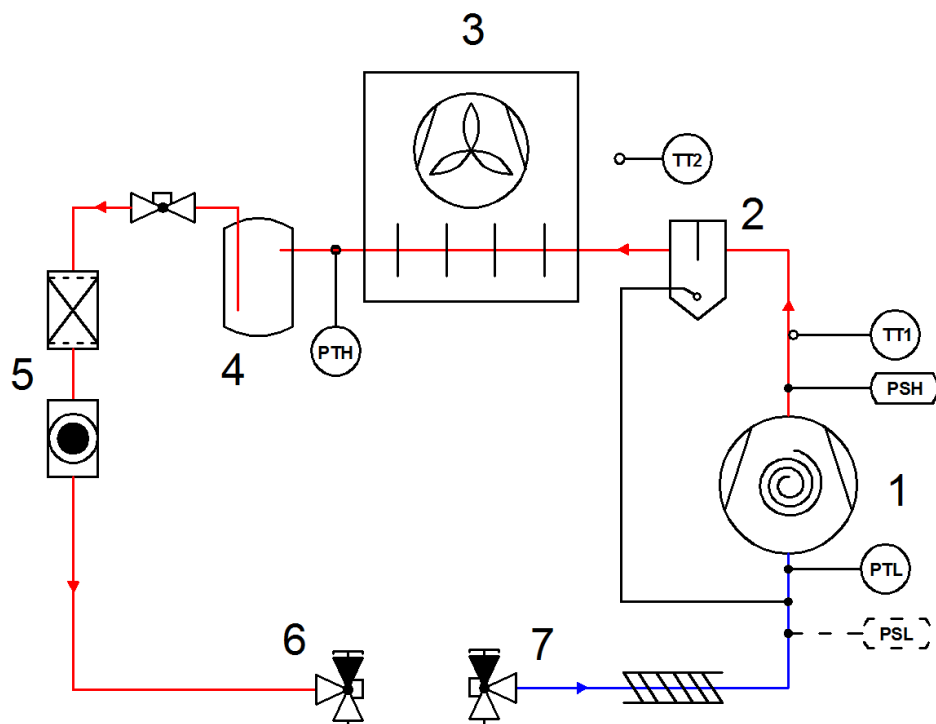

Figure 5: P&I diagram for ZXDE units

Position	Description	Comments
1	High efficient Copeland Scroll ZX (ZBD for Digital)	
2	Oil separator	
3	Condenser with 1 or 2 fans	
4	Liquid receiver with service valve	
5	Filter drier / sight glass combination	
6	Service valve, liquid line	
7	Service valve, suction line	
PSL	Pressure switch, adjustable, low pressure, not factory mounted	System safety option
PSH	Pressure switch, not adjustable, high pressure	System safety
PTH	Pressure sensor, high pressure	Fan speed control
PTL	Suction pressure sensor, low pressure	Compressor setpoint
TT1	Discharge temperature sensor	Compressor safety
TT2	Ambient temperature sensor	Additional functions

Table 7: Legend of the P&I diagram for ZXDE units

2.8 Electronic controller XCM25D – Features

The XCM25D controller is designed to be a powerful, flexible controller for use in multiple applications. It has been developed for condensing units and allows the adjustment of all relevant parameters by the user.

2.8.1 Description



WARNING

Electrical shock hazard! Serious personal injuries! There are unused fast-on pins (C1 & D02) on the XCM25D which could be under voltage. They are covered by insulated fast-on flags in the factory. Handle carefully when removing insulating flags during service on site.

The controller is designed for usage in an outdoor refrigeration unit. It is rated to be used for the following environment:

- Outdoor controller ambient temperature for operation: -40°C to 60°C
- Ambient temperature for storage: -40°C to 80°C
- Maximum humidity: 90% at 48°C (non-condensing)
- Board power: 24V AC +15%/-20%
- Voltage sensing capabilities - Single phase: 100-120, 200-240V AC ± 10%
- Voltage sensing capabilities - Three phase: 200-240, 380-460, 575V AC ± 10%

The units of measure are selectable. The factory default unit is [bar] (always considered relative) for pressure and [°C] for temperature.



Figure 6: Electronic controller

2.8.2 Functionality

The controller allows easy commissioning by the technician with the factory settings at the highest program level. It also offers the possibility to make substantial changes to the system optimization in further programming levels. Advanced functionality can also be activated.

The following functions are covered by the controller:

- Condensing unit control
- Case control
- Condenser fan control
- Defrost
- Voltage and current sensing (compressor protection)
- Liquid and vapour injection
- System EXV control
- Digital compressor control

NOTE: The XCM25D controller on the ZX*E units includes all the functions necessary for unit control. For additional functionalities please contact your local Application Engineering representative.

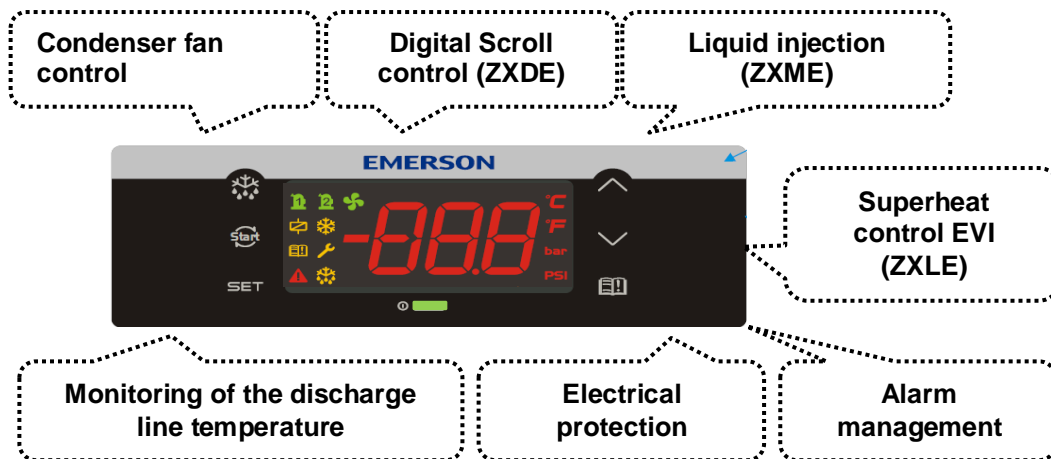

Figure 7: XCM25D controller functionality overview

2.8.3 Main control & safety features

Suction pressure control: Each unit is equipped with a suction pressure transmitter. The XCM25D controls the suction pressure by evaluating the input signal of the pressure transmitter. Setpoint and proportional band need to be defined during commissioning. The signal of the suction pressure transmitter is also used for additional functionalities, eg, pump-down and keeping the compressor running inside the approved envelopes.

Condensing pressure control: Each unit is equipped with a high pressure transmitter. The XCM25D controls the condensing pressure by regulating the fan speed corresponding to the high pressure transmitter signal.

Automatic liquid injection on ZXME: The electronic controller automatically instructs liquid refrigerant to be injected into the suction line of the Scroll compressor to reduce discharge temperatures generated when the unit operates at increasing compression ratios. The electronic controller reacts automatically to a thermistor which is attached to the discharge line on all ZXME models. The controller converts this signal for the linear stepper motor driving the liquid injection valve to a position that enables the compressor to continue operating within its safe envelope.

Automatic enhanced vapour injection (EVI) on ZXLE: Control of an electronic expansion device based on the superheat in the additional heat exchanger for the EVI Scroll compressor to create subcooling in liquid refrigerant coming from the receiver. In case of excessive discharge line temperatures (DLT) the superheat control is ignored and the controller will work in liquid injection mode in order to reduce the discharge gas temperature.

Compressor phase reversal (ZXME/ZXLE): Ensures that the compressor remains running in one direction only (clockwise = right rotation) – necessary for a compliant Scroll compressor to compress and pump refrigerant. Reset is automatic once the phase rotation is correct for the compressor.

Motor current overload protection (ZXME/ZXLE/ZXDE): This feature eliminates the need for external current protection for the compressor motor.

Fixed high-pressure switches: This is a non-adjustable protection device designed to prevent the compressor from operating outside of its safe high pressure range. Reset is automatic for a set number of trips (7), then the unit will lock out and require manual restart. This feature is important to prevent the ZX unit from cycling under these controls for a long period of time.

- ZXLE & ZXME models: 28 bar cut-out / 21 bar cut-in.
- ZXDE models: 28.8 bar cut-out / 24 bar cut-in.

Discharge temperature protection: Each unit is equipped with a discharge line sensor (NTC). The information from the NTC sensor is used to activate liquid injection when required. The XCM25D controller will stop the compressor if discharge temperatures reach unacceptable levels.

Option: Adjustable low-pressure switches PS1: This device protects the system against low pressure operation. It must be adjusted depending on running conditions and potential special requirements like pumpdown. The compressor envelopes published in Select must be respected

at all times. In case of controller breakdown the low pressure switch could be used for emergency operation (rewiring required).

A **crankcase heater** is directly connected to the controller. The crankcase heater will be energized when the ambient sensor is below a given value (10°C) and the compressor has been off for a period of time (5 minutes). The minimum off time does not apply at initial power up.

In addition to the above, the ZX condensing unit has the following features:

- Liquid line assembly (filter drier and sight glass/moisture indicator)
- Anti-corrosion treatment to the condenser fins

The electronic controller is also the base controller for the connection of many optional and customer supplied functions such as:

- Main load controller (or thermostat)
- Evaporator electric defrost heater contactor
- Evaporator fan contactor
- Superheat controller for one electronic expansion device (not available on ZXLE models)

2.8.4 Additional features for customization

A lot of additional features are provided by the XCM-25D controller. In the European design of the electrical panel a few of the additional functionalities are prearranged and can easily be installed by connecting additional hardware to the electrical terminals. The tables in **Appendix 6** show the parameters that have to be changed in case a special feature of the controller should be activated. The tables do not show the required settings which have to be done by the system operator, eg, choosing correct set points for different components and different applications.

Component	Description	Prearranged terminals / Wiring diagram
S2	Low pressure switch, optional; can be ordered factory-installed.	Terminals: X1.2 / X1.7
Y3	Solenoid valve liquid line	Terminals: X1.N / X1.8
S3	Room thermostat for pump-down or direct control	Terminals: X1.9 / X1.10
Alarm-Contact	Sensor for evaporator or room	Terminals: X1.11 / X1.12
Sensor B7	Sensor for evaporator or room (NTC10kΩ)	Terminals: X1.13 / X1.14

Table 8: Prearranged additional connections

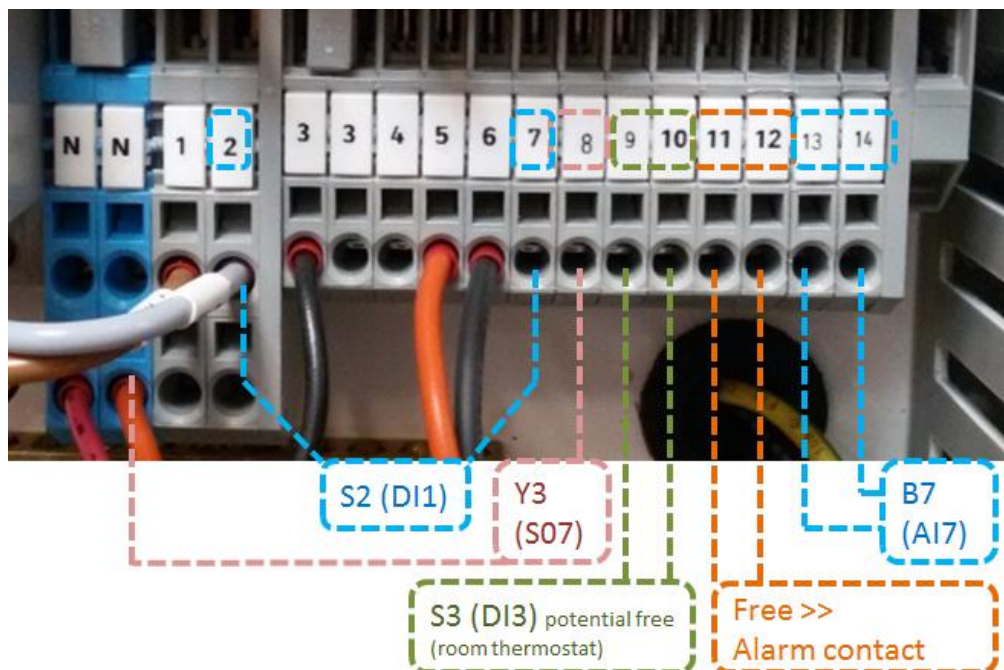

Figure 8: Prearranged additional connections

Temperature control by means of external room thermostat

The temperature of a cold room or cooling cabinet can be controlled by means of an external room thermostat (Digital Input DI3, parameter R07).

The following parameters need to be changed to control a cooling cabinet or a cold room with a room thermostat:

Parameter	Description	Factory settings / Range	Recommended setting / Comments
C05	Compressor regulation probe selection	1 = Suction pressure probe = SUP	Suction pressure switch / Room thermostat input = 3 = diS
G56	Use the liquid line solenoid	NO	NO >> If a solenoid is used in liquid line, see Chapter 2.12 "Pumpdown - General" for parameter settings
R07	Digital Input 3 function	0 = Not used = NU	Suction pressure switch / Room thermostat input = 1 = SUS
R08	Digital Input 3 polarity	1 = Closed = CL	1 = Closed = CL (no change)

Table 9: Room thermostat external parameters

With these settings the controller will switch the compressor according to the status of the connected device (room thermostat):

- If the Input is closed, turn the compressor on (On-Off-compressor)
- If the Input is open, turn the compressor off (On-Off-compressor)

Temperature control by means of external temperature probe

The temperature of a cold room or cooling cabinet can be controlled by means of an additional temperature (Analog Input AI7, component B7 in wiring diagram) probe (NTC, 10kΩ, detailed temperature-resistance-curve, see **Appendix 7**). The probe can be located in the evaporator or in the room. The location of the probe needs to be considered for the configuration of the P7C/A19 setting. Based on the value provided by the B7-temperature sensor the compressor will be switched on and off according to the following graphic:

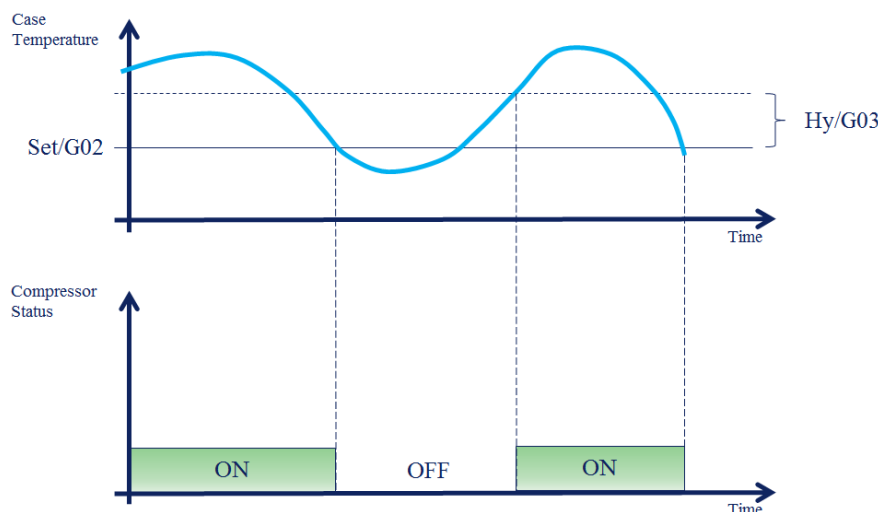

Figure 9: External temperature sensor – Functionality

The following parameters need to be changed to control a cooling cabinet or a cold room with a temperature sensor:

Parameter	Description	Factory settings / Range	Recommended setting / Comments
A19	Probe 7 configuration	0 = Not used = NU	Thermostat temp (NTC10K) = 2 = TMT or Evaporator temp (NTC10K) = 5 = EPT
C05	Compressor regulation probe selection	1 = Suction pressure probe = SUP	Case temperature = 2 = CST
G01	Case temperature probe selection	0 = Not used = NU	Thermostat temperature = 4 = TMT or Evaporator temperature = 5 = EPT
G02	Setpoint case temperature	2°C	Choose setpoint according to requirements of cooled goods
G03	Position differential case temperature	1K / 0.1 – 25.5K	Setpoint G02 + positive differential G03 results in cut-out value for compressor
G04	Case temperature lower limit G02	-10°C / -40°C to G05	Define limits to avoid wrong operator settings for G02
G05	Case temperature upper limit G02	+15°C / G04 to 110°C	Define limits to avoid wrong operator settings for G02
G06	Emergency run On-time	2 min / 0 to 255 min	In case of probe failure the compressor will be cycled on time based on G06 & G07
G07	Emergency run Off-Time	1 min / 0 to 255 min	In case of probe failure the compressor will be cycled on time based on G06 & G07

Table 10: External temperature sensor – Parameters

Please check that the setting for G56 is "**NO**" (means no Solenoid valve in the liquid line) and no additional digital inputs are configured (Digital Input DI3; Parameter R07 has to be "not used" = NU = 0).

Defrost

The XCM-25D is able to control defrost on evaporators. The controller can handle electrical defrost or natural / fan defrost (select by G17). The defrost probe (G12) provides the XCM-25D with the information about the temperatures in the evaporator.

The intervals between the defrost cycles are controlled by parameter G23. This can be done by means of the integrated real time clock or by fixed intervals.

Parameter	Description	Factory settings / Range	Recommended setting / Comments
A19	Probe 7 configuration	0 = Not used = NU	Evaporator temp (NTC10K) = 5 = EPT
G12	Defrost probe selection	0 = Not used = NU	5 = Evaporator temperature sensor = EPT
G17*	Defrost type	0 = Electrical = EL	0 = Electrical = EL ; 1 = Hot gas defrost = IN ; 2 = Natural defrost (pulse defrost) = PLS
G18	Interval between defrost cycles	4 hours	0 – 120 hours range; adjust to individual requirements
G19	Maximum duration of defrost	20 minutes	0 – 255 minutes; adjust to individual requirements
G20	Duration of pulse defrost	15 minutes	0 – G19
G21	Defrost termination temperature	10°C	-40°C – 110°C
G22	Defrost delay time	15 minutes	0 – 255 minutes

Parameter	Description	Factory settings / Range	Recommended setting / Comments
G23**	Defrost interval mode	0 = Not used = NU	0 = NU = Not used; 1 = IN = Interval; 2 = rtC = Real time clock
G24***	Display during defrost	DEFROST " dEF "	0 = DEF = Defrost; 1 = Set = Case temp. setpoint; 2 = it = Case temp. value; 3 = rt = Standard operation
G25	Maximum display delay after defrost	0 minute	0 – 255 minutes
G26	Drip time	1 minute	0 – 120 minutes
G27	Defrost at power-on	0 = NO	Avoids defrost after initial power up. If "YES", the controller will decide on defrost related parameters if a defrost sequence is required after initial start-up
G28	Workday defrost start 1	00:00	00:00 – 23:50 or NU = Not used
G29	Workday defrost start 2	04:00	00:00 – 23:50 or NU = Not used
G30	Workday defrost start 3	08:00	00:00 – 23:50 or NU = Not used
G31	Workday defrost start 4	12:00	00:00 – 23:50 or NU = Not used
G32	Workday defrost start 5	16:00	00:00 – 23:50 or NU = Not used
G33	Workday defrost start 6	20:00	00:00 – 23:50 or NU = Not used
G34	Holiday defrost start 1	00:00	00:00 – 23:50 or NU = Not used
G35	Holiday defrost start 2	04:00	00:00 – 23:50 or NU = Not used
G36	Holiday defrost start 3	08:00	00:00 – 23:50 or NU = Not used
G37	Holiday defrost start 4	12:00	00:00 – 23:50 or NU = Not used
G38	Holiday defrost start 5	16:00	00:00 – 23:50 or NU = Not used
G39	Holiday defrost start 6	20:00	00:00 – 23:50 or NU = Not used
G40	First weekly holiday	SUN = Sunday	0 = SUN ; 1 = MON ; 2 = TUE ; 3 = WED ; 4 = THU ; 5 = FRI ; 6 = SAT ; 7 = NU = Not used
G41	Second weekly holiday	SUN = Sunday	0 = SUN ; 1 = MON ; 2 = TUE ; 3 = WED ; 4 = THU ; 5 = FRI ; 6 = SAT ; 7 = NU = Not used
G42****	Fan operating mode	0 = cn = Stopped during defrost	0 = cn ; 1 = on ; 2 = cy ; 3 = oy
G43	Fan stop Temperature	0°C	-40°C – 110°C
G55	Fan delay after defrost / drip time	1 minute	0 – 255 minutes
S05	Relay output 2 configuration	0 = Not Used = NU	6 = Defrost = DEF

Table 11: Defrost parameters

*** G17 parameter >> Three defrost modes are available:**

- G17 = EL → Defrost through electrical heater Compressor Off
- G17 = in → Hot gas defrost Compressor On
- G17 = pulse → Pulse / natural defrost Compressor Off

**** G23 parameter >> Defrost interval mode:**

- G23 = nu (0) → Defrost functionality not used
- G23 = in (1) → Defrost in intervals G18
- G23 = rtC (2) → Enables defrost for RTC (real clock time), allows timing of defrost cycles with G28 - G41

***** G24 parameter >> Display during defrost:**

- G24 = DEF (0) → Display shows "DEF" for defrost
- G24 = SET (1) → Display shows "G02" parameter value = Case temperature setpoint
- G24 = IT (2) → Display shows display case temperature value
- G24 = RT (3) → Display will stay in standard operation

****** G42 parameter >> Evaporator fans function:**

- G42 = cn (0) → will switch On and Off with the compressor, Off during defrost
- G42 = on (1) → Fans On, even if the compressor is off, Off during defrost
 - After defrost, there is a timed fan delay allowing for drip time, set by means of the "G55" parameter.
- G42 = cy (2) → fans will switch On and Off with the compressor and On during defrost
- G42 = oy (3) → fans will run continuously also during defrost

Manual defrost

Please check settings for evaporator fans. The XCM-25D is able to control the evaporator fan.

NOTE: For additional features please contact your local Application Engineering representative.

2.9 Electronic controller XCM25D – Programming

2.9.1 Programming the local display



Figure 10: Local display

LED	Mode	Function
	On	Compressor 1 enabled
	Flashing	Anti-short cycle delay enabled
	On	Condensing fans enabled
	On	Bar display
	Flashing	Programming mode
	On	PSI display
	Flashing	Programming mode
	On	When browsing the service menu
	Flashing	In fast access menu
	On	When browsing the alarm menu
	Flashing	A new alarm occurred





LED	Mode	Function
	On	An alarm is occurring
	On	Digital unloader solenoid On
	On	In defrost
	On	Evaporator fans - Liquid line solenoid valve On

Table 12: LED functions description

NOTE: By default the local display will show the value of the suction pressure during operation. This can be changed by choosing another value for parameter B03 (Remote Display visualization).

Setting for B03	Value shown on the display	Comments
0	P1 value = Suction pressure	
1	P2 value = Mid-coil temperature (condenser)	
2	P3 value = Discharge line temperature	
3	P4 value = Vapour inlet EVI	Only for ZXLE
4	P5 value = Vapour outlet EVI	Only for ZXLE
5	P6 value = Ambient temperature	
6	P7 value = Not used in factory setting	
7	PEr value = Probe error	
8	Aou value = Analog output	

Table 13: Display visualisation

2.9.2 Single commands







	Press the SET button to display the target setpoint. In programming mode, this allows to select a parameter or to confirm an operation.
	Press the RESET button and hold for 5 seconds to reset any lockouts if the current state of the controller allows for it to be reset.
	(UP) To view the fast access menu. In programming mode, this browses the parameter codes or increases the displayed value.
	(DOWN) In programming mode, this browses the parameter codes or decreases the displayed value.
	(SERVICE) To enter the service and alarm menu.
	Hold for 3 seconds to start a manual defrost or terminate an active defrost.

Table 14: Single commands

2.9.3 Double commands – Entering programming level 1 “Pr1”



	Press simultaneously for about 3 seconds to lock (PoF) or unlock (Pon) the keyboard.
	Press simultaneously to leave the programming mode or menu. On submenus rtC and EEV this combination allows to go back to the previous level.
	Press simultaneously for about 3 seconds to access the first level of programming mode.

Table 15: Double commands

The device provides 2 programming levels:

- **Pr1** with direct access
- **Pr2** protected with a password (intended for experts)

2.9.4 How to program the parameters (Pr1 and Pr2)

Access pre-program level		Press simultaneously for about 3 seconds to access the pre-programming level. The message rtC (real time clock) appears.
Access program level	or	Press the Up or Down key until the message PAR appears.
Access Pr1		Press the SET button to enter the program level. First parameter C01 appears.
Select item	or	Select the parameter or submenu using the arrows.
Show value		Press the SET button.
Modify	or	Use the arrows to modify the value.
Confirm and store		Press the SET button: the value will blink for 3 seconds, then the display will show the next parameter.
EXIT		Press simultaneously to exit the programming mode, or wait for 30 seconds (MTO) without pressing any key.

Table 16: Programming level 1 parameters

When entering the programming level for the first time the display will show the **rtC** (real time clock) label.

- Press to access parameters N01/02/03/04/05 to adjust time & date. For further details see Chapter 2.11, "Parameters level 1 – Required settings".
- Press or to change from the **rtC** label to the **Par** label, in order to access the programming level 1. Press : the parameters of programming level 1 can be changed.

2.9.5 Entering programming level 2 “Pr2”

To enter the Pr2 programming menu:

- To access a **Pr1** menu, press simultaneously for 3 seconds. The first parameter label will be displayed.
- Press till the **T18** label is displayed, then press the key;
- The blinking **PAS** label will be displayed; wait for a few seconds;
- The display will show "0 - -" with blinking 0: insert the password [**321**] using the and keys and confirming with the key.

2.9.6 Fast access menu

This menu contains the list of probes and some values that are automatically evaluated by the board such as the superheat and the percentage of valve opening. **nP** or **noP** stands for "probe not present" or "value not evaluated", **Err** means "value out of range", "probe damaged, not connected or incorrectly configured".

Entering fast access menu		Press and release the UP arrow. The duration of the menu in case of inactivity is 3 minutes. The values that will be displayed depend on the configuration of the board.
Use the or arrow to select an entry, then press to see the value or to go on with another value.		<ul style="list-style-type: none"> • P1P: Pressure value of the P1 probe. • P2t: Temperature value of the P2 probe. • P2P: Pressure value of the P2 probe (if P2 present). • P3t: Temperature value of the P3 probe (if P3 present). • P4t: Temperature value of the P4 probe (if P4 present). • P5t: Temperature value of the P5 probe (if P5 present). • P6t: Temperature value of the P6 probe (if P6 present). • P7t: Temperature value of the P7 probe (if P7 present). • SH: Value of superheat. nA = not Available. • oPP: Percentage of step valve opening. • LInJ: Status of the Liquid Line Solenoid (“OFF” – “OFF”). This information is available only if one relay is set as “Liquid Line Solenoid”. • SEtd: Value of the Dynamic setpoint (condenser fan SET). This information is available only if the Dynamic setpoint function is enabled.



	<ul style="list-style-type: none"> • AOO: Percentage of the analog output (0-10V or TRIAC PWM Mod.). This information is available only if the 0-10V or TRIAC PWM Mod is enabled. • dStO: Percentage of the PWM output driving the valve of the Digital Scroll compressor. • L°t: Minimum room temperature. • H°t: Maximum room temperature. • HM: Menu.
Exit	 Press simultaneously or wait for the timeout of about 60 sec.



Table 17: Fast access menu

2.10 Controller keyboard

2.10.1 How to lock the keyboard

Keep the  and  keys pressed simultaneously for more than 3 seconds. The "PoF" message will be displayed and the keyboard will be locked. At this point it is only possible to see the setpoint or the maximum or minimum temperatures stored. If a key is pressed for more than 3 seconds the "PoF" message will be displayed.

2.10.2 How to unlock the keyboard

Keep the  and  keys pressed simultaneously for more than 3 seconds, till the "Pon" message is displayed.

2.11 Parameters level 1 – Required settings

The XCM25D is preconfigured to reduce the required settings on job-site to a minimum. In most cases it will not be necessary to enter programming level 2 "Pr2". Here is the overview about the parameters which are in programming level 1 "Pr1".

Parameter	Description	Unit	Factory setting	Comments
C01	Compressor cut-in pressure setpoint	[bar]	4.0	Not used for Digital ZXDE
C02	Compressor cut-out pressure setpoint	[bar]	2.0	Not used for Digital ZXDE
C07	Refrigerant selection for regulation	[-]	R404A	R22, R407A, R407F, R507, R448A, R449A, R134a, R407C
C16	Digital compressor setpoint	[bar]	3.3	Not used for ZXM & ZXL
C17	Proportional band for compressor regulation	[bar]	2.0	Not used for ZXM & ZXL
C21	Cycle time for digital compressor	[sec]	10	Not used for ZXM & ZXL
C24	Minimum capacity for digital compressor	[%]	20	Not used for ZXM & ZXL
C25	Maximum capacity for digital compressor	[%]	100	Not used for ZXM & ZXL
E39	Condenser setpoint	[°C]	35.0	
E46	Regulation band of variable fan	[°C]	10.0	
N01	Current minute	[-]	[-]	
N02	Current hour	[-]	[-]	
N03	Day of month	[-]	[-]	
N04	Month	[-]	[-]	
N05	Year	[-]	[-]	
T18	Access to Pr2 level	[-]	[-]	Password: 3 2 1

Table 18: Parameters in Pr1

The full list of parameters in programming level 2 "Pr2" can be found in **Appendix 4**.

2.12 Pumpdown – General

Pumpdown functionality is provided by the XCM25D for condensing unit models ZXME & ZXLE. It is not recommended for Digital units ZXDE.

In case of pumpdown the user needs to install an additional solenoid valve in the liquid line which is not part of the standard delivery equipment. In addition to the liquid line solenoid valve a digital input signal from a room thermostat or a case temperature sensor must be connected to the XCM25D. There are additional terminals available in the unit which allow the easy connection of additional hardware if required. The wiring diagram also shows these optional features. The liquid line solenoid valve Y3 can be connected on terminals X1.N & X1.8. The terminals X1.9 & X1.10 can be used for a room thermostat (connected to **DI3**).

If a temperature sensor is preferred use analog input **AI7** (Caution: terminals are not preconfigured for temperature sensor). For details about different options please see Chapters 2.12.2 "Pumpdown with room thermostat" and 2.12.3 "Pumpdown with temperature sensor".

In any case there are limitations for the cut-out values of the compressors given by the envelopes. The minimum cut-out settings are shown in **Table 19** below. Those values are also applicable in case pumpdown is realized by means of an additional low pressure switch. Operation of the unit below the suction pressures shown in the table could result in tripping of the compressor internal motor protector (Klixon, error code E28). The envelopes are in accordance with Select software.

Unit family	R134a	R404A/R507	R407A	R407F
ZXME	-20°C = 0.3 bar rel	-20°C = 2 bar rel	-23°C* = 1.1bar rel	-25°C = 1bar rel
ZXLE	[-]	-40°C = 0.3 bar rel	-40°C = 0 bar rel	-40°C = 0 bar rel
ZXDE	Not approved for pumpdown			

* For ZXME020 it is limited to -20°C (1.35 bar rel)

Table 19: Minimum cut-out value for pumpdown

NOTE: The values in Table 19 show the lowest suction temperatures / pressures in the envelopes. Depending on the condensing temperature in the real system it might be required to adjust / increase the cut-out value according to the approved envelope published in Select.

2.12.1 External pumpdown – Without XCM-25D integration

The easiest solution for pumpdown is to switch a solenoid in the liquid directly with a room thermostat or other external devices. The settings on the unit for compressor cut-in and cut-out (C01 & C02) can easily be adjusted for pumpdown. The disadvantage of this easy solution is that the controller is not aware that there is a solenoid valve installed and therefore some protection features of the controller, eg, maximum pumpdown time in case of blocked solenoid, will not work.

2.12.2 Pumpdown with room thermostat

Configure parameter **C05** "Compressor regulation probe selection" to 3 (Suction pressure switch / Room thermostat input). In addition change setting for **G56** from "0" to "1". This is information to the controller that a solenoid valve exists.

Change the functionality of Digital Input 3 (**DI3**) (Parameter R07) to setting 1 (Suction pressure switch / Room thermostat input) and adjust the relay output configuration **S07** to 7 (Liquid line solenoid).

Parameter	Factory settings	Pumpdown settings
C05	1 = Suction pressure probe = SUP	3 = Suction pressure switch / Room thermostat = diS
G56	0 = No	1 = Yes
R07	0 = Not used = NU	1 = Suction pressure switch / Room thermostat = SUS
S07	0 = Not used = NU	7 = Liquid line solenoid = LLS
G11	3 minutes	Maximum pumpdown time
C02	2 bar relative	Cut-out value for pumpdown, eg, 0.2 bar rel

Table 20: Pumpdown 1

Room thermostat switch status	Liquid line solenoid valve status
Close	Switch on / Energized
Open	Switch off / De-energized

Table 21: Pumpdown 2

For example, if the room thermostat switch is closed, the liquid line solenoid valve is activated, and the compressor will run when the suction pressure value is higher than the compressor cut-in value **C01**.

The liquid line solenoid valve will be switched off if the room thermostat switch is open, then pumpdown will start. The compressor will stop once the suction pressure value is lower than the compressor cut-out value **C02** or when the pumpdown time duration is longer than the maximum pumpdown time **G11** setting.

The functionality of parameter **G11** protects the cooled goods in case of component damage, eg, the liquid line solenoid is mechanically blocked and not able to stop refrigerant mass flow. In that case the compressor cut-out pressure will not be reached and the compressor will continue to run. The only limitation to stop the compressor is the maximum pumpdown time. **G11** should be adjusted in a way that, in all operating conditions, it allows pumpdown to compressor cut-out value **C02** plus a certain safety time, eg, 2 minutes).

2.12.3 Pumpdown with temperature sensor

It is also possible to use a temperature sensor for pumpdown functionality (not part of the standard delivery). Parameters **G56** and **S07** have to be set up as described in Chapter 2.12.2 "Pumpdown with room thermostat".

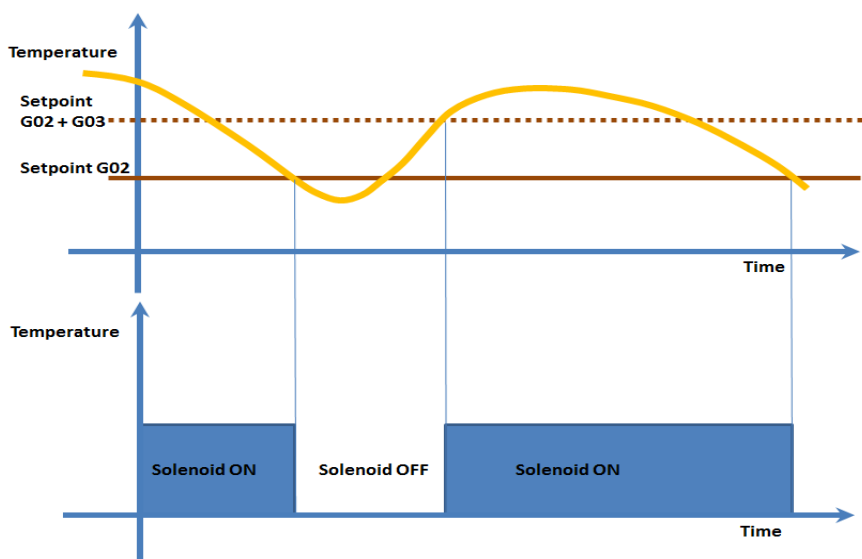

Figure 11: Pumpdown functionality with temperature sensor

The control of a cold room or cooling cabinet can be realized with a temperature sensor (change parameter **G01** according to the probe location). Parameter **A19** must be set up as thermostat temperature. The temperature setpoint is defined by parameter **G02**. Adjust the temperature range by means of positive differential value **G03**.

If the temperature increases and reaches setpoint plus differential, the liquid line solenoid output relay will energize the coil to open the valve. The compressor will be controlled by suction pressure.

The temperature value is to be set between two parameters (**G04** and **G05**).

In case of fault in the thermostat probe the opening and the closing of the solenoid valve relay are timed through limp along parameters (**G06** and **G07**).

Parameter	Factory settings	Pumpdown settings / Comments
A19	0 = Not used = NU	2 = Thermostat temperature = TMT
C02	2 bar rel	Cut-out value for pumpdown, eg, 0.2 bar rel
C05	1 = Suction pressure probe = SUP	2 = Case temperature probe = CST
G01	0 = Not used = NU	4 = Thermostat temperature = TMT
G02	+2°C	Setpoint for temperature, eg, +2°C for meat
G03	+1°C	Positive differential defines upper cut-out value
G04	-10°C	Lower setpoint limit
G05	+15°C	Upper setpoint limit
G06	2 minutes	On time in case of probe failure
G07	1 minute	Off time in case of probe failure
G11	3 minutes	Maximum pumpdown time
G56	0 = Not used = NU	1 = Yes
S07	0 = Not used = NU	7 = Liquid line solenoid = LLS

Table 22: Pumpdown 3

If temperature \geq **G02** + **G03**, switch on liquid line solenoid.

If temperature \leq **G02**, switch off liquid line solenoid, and the compressor will continue to operate until most of the refrigerant on the low side boils off and is pumped through the compressor into the condenser and receiver. As the suction pressure falls below the low pressure cut-out value (**C02**), the compressor will cycle off.

The temperature value depends both on parameter **G02** and parameter **G11** (maximum pumpdown time). It means that when the liquid line solenoid is off, the compressor will stop because of suction pressure decrease within **G11** time. If the running time of the compressor exceeds **G11** value, the compressor will be forced to shut down and the controller will generate a pumpdown alarm.

The functionality of parameter **G11** protects the cooled goods in case of component damage, eg, the liquid line solenoid is mechanically blocked and not able to stop refrigerant mass flow. In that case the compressor cut-out pressure will not be reached and the compressor will continue to run. The only limitation to stop the compressor is the maximum pumpdown time. **G11** should be set in a way that, in all operating conditions, it allows pumpdown to compressor cut-out value **C02** plus a defined safety time.

2.13 Reset to factory settings – Emerson "Hot Key"

2.13.1 How to save factory settings or user settings

There is no way to reset the XCM25D controller to factory settings other than with additional equipment. Emerson Climate Technologies recommends to use the Emerson "Hot Key" to save the factory settings at initial power up. The same hot key can also be used to save user settings.

By means of a special programming software (Emerson Wizmate) and corresponding hardware (Emerson Prog-Tool), the user can:

- preprogram hot keys
- copy hot keys
- change parameter levels
- compare parameter lists

For further information please visit our website at www.emersonclimate.eu or contact your local Application Engineering representative.

2.13.2 Applicable hot keys for ZX units with XCM25D controller

The Emerson "Hot Key" **DK00000300** can be used for up- and downloading of parameter lists. Copeland Ident Number 3226456.



Figure 12: Emerson "Hot Key"

2.13.3 Location of the "Hot Key" plug connection on the XCM25D controller

The "Hot Key" plug connection is located on the upper left corner of the XCM25D.

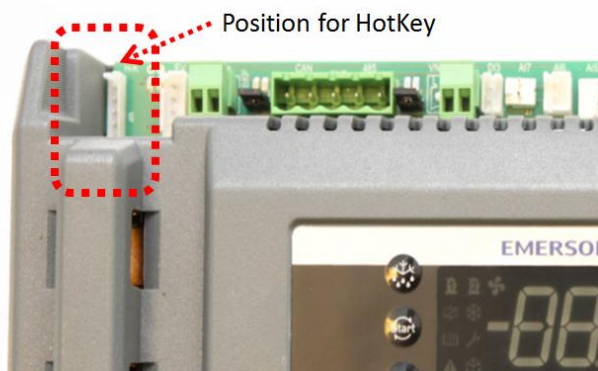

Figure 13: Location of "Hot Key" plug connection

2.13.4 How to program a "Hot Key" from the controller (upload)

- Program one controller with the front keypad.
- When the controller is on, insert the "Hot Key" and press the **UP** key; the "uPL" message appears followed a by a flashing "End" label.
- Press the **SET** key and the "End" label will stop flashing.
- Turn the controller off, remove the "Hot Key" and then turn it on again.

NOTE: The "Err" message appears in case of a failed programming operation. In this case push the key again if you want to restart the upload again or remove the "Hot Key" to abort the operation.

2.13.5 How to program a controller using an Emerson "Hot Key" (download)

- Turn the controller off.
- Insert a pre-programmed "Hot Key" into the 5-pin receptacle and turn the controller on.
- The parameter list of the hot key will be automatically downloaded into the controller memory. The "doL" message will blink followed a by a flashing "End" label.
- After 10 seconds the controller will restart working with the new parameters.
- Remove the "Hot Key".

NOTE: The message "Err" is displayed in case of a failed programming operation. In this case turn the unit off, then on again if you want to restart the download, or remove the "Hot Key" to abort the operation.

2.14 Troubleshooting

2.14.1 Alarm menu

The controller records in the Alarm menu the total number of alarm activations (max 50) according to the alarm list in **Appendix 5**.



















Action	Key or display	Notes
Enter menu		Push and release the ALR key.
Waiting for action	SEC	The menu to change the section will be entered. The alarm list section is active.
Enter section list	SET	Press SET to confirm. The following list will be available to select the proper network function.
Select active alarm code from list	 or 	Scroll the list of alarms and see the list of active alarms with the number of the alarm (letter + number, A01-A50). Press  to see the alarm name or code. Press  to see the next active alarm.
Select the alarm to see the detailed rtC information	SET	Enter the sub menu with alarm time details.
Select detailed information from active alarm list	 or 	<u>With the rtC activated:</u> The Hur (hour) parameter is displayed. Press  to see the alarm hour. Press  : Min is displayed. Press  to see the alarm minute. Press  : dAy is displayed. Press  to see the alarm day. Press  : Mon is displayed. Press  to see the alarm month. Press  : YEA is displayed. Press  to see the alarm year. <u>Note: The clock info indicates the START time of the alarm.</u> <u>Without the rtC activated:</u> The CO n (hours) parameter is displayed. Press  to see the compressor working hours. To exit: press SET or wait for 15 seconds without pressing any key.
Exit menu	SET + 	Press SET +  simultaneously or wait for about 10 seconds without pressing any key.

Table 23: How to check the alarm list

2.15 Compressor motor protection

The electronic controller protects the compressor motor against the following:

- over current;
- phase loss;
- incorrect phase rotation.

If the compressor motor current exceeds a predefined (non-adjustable) current limit, the electronic controller shuts down the unit and generates an error signal. For this function two of the main phase supply lines to the compressor (compressor via the contactor) are routed through the current sensors.

2.16 System pressure protection

2.16.1 High-pressure safety switch

A high pressure switch is registered by the electronic board. The sensing device is a non-adjustable, high-pressure switch that will open in the event of an abnormally high discharge pressure (above 28 bar on ZXME & ZXLE models, 28.8 bar on ZXDE models).

- The unit will stop then and restart automatically after a 5-minute delay and after unit pressure has decreased to 21 bar (24 bar for ZXDE models).
- After 7 successive HP cut-outs over 1 hour, the unit will lock out.

2.16.2 High pressure: pressure relief valve / burst disc

There is a connection port sideways on the top of the unit liquid receiver for a pressure relief valve or a burst disc. It is a thread with a 3/8"-NPT connection. The pressure relief valve and/or burst disc are not factory assembled.

2.16.3 Low-pressure safety switch – Optional

In a way similar to the high-pressure sensor, the electronic controller registers the switching action of the adjustable low-pressure switch, which will open in the event of an abnormally low suction pressure:

- The unit will stop then restart automatically after a 3-minute delay and when the unit reaches cut-in pressure level.

The unit is always equipped with a suction pressure transmitter which is also taking care for protection against vacuum operation. The use of the optional low-pressure cut-out will provide the highest protection level for the unit. In rare instances of controller breakdown the optional low-pressure switch would allow to run the unit in emergency mode.

2.17 Other inputs at the plant controller XCM25D

2.17.1 Customer-supplied control (room thermostat)

The electronic controller is equipped with a digital input (**DI3**) open/close signal (such as the switching action of a normal commercial thermostat) and relays a similar action as an output to the compressor contactor in the case of a thermostat-controlled (parameter "**C05**") system (see wiring diagrams in **Appendix 2**). If the system is controlled by low-pressure cut-out for a multiple evaporator system and/or pumpdown system, the controller XCM25D accepts signals directly from an adjustable low-pressure switch (optional).

2.17.2 Case temperature controller

An alternative method of system temperature control can be used. The electronic controller accepts an input from a common commercial thermostat (**DI3**, digital input). For details see Chapter **Error! Reference source not found.** "Additional features for customization").

2.17.3 Ambient temperature sensor

An ambient temperature sensor is supplied by Emerson Climate Technologies and connected to the electronic controller. This temperature sensor has several functionalities like emergency mode control, lower fan speed limitation and crankcase heater control. The sensor is located at the housing on the backside of compressor compartment.

2.18 Other outputs of the electronic controller

2.18.1 Alarm output (D05)

The digital output **D05** is pre-configured as an alarm contact. The contact is activated in case of alarms and lock-outs. Warnings will be shown only on the controller display.

2.19 Dimensions in mm

The figures hereafter show the overall physical dimensions of the ZX condensing units:

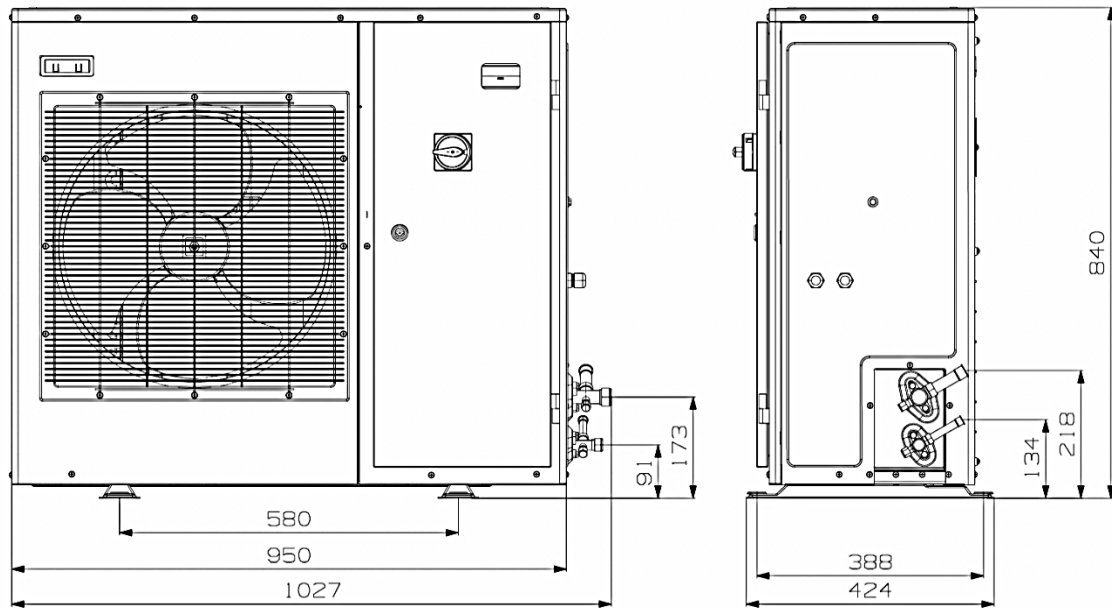

Figure 14: Dimensions of models ZXME020E, ZXME025E, ZXME030E & ZXME040E and models ZXLE020E, ZXLE030E & ZXLE040E (single-fan units)

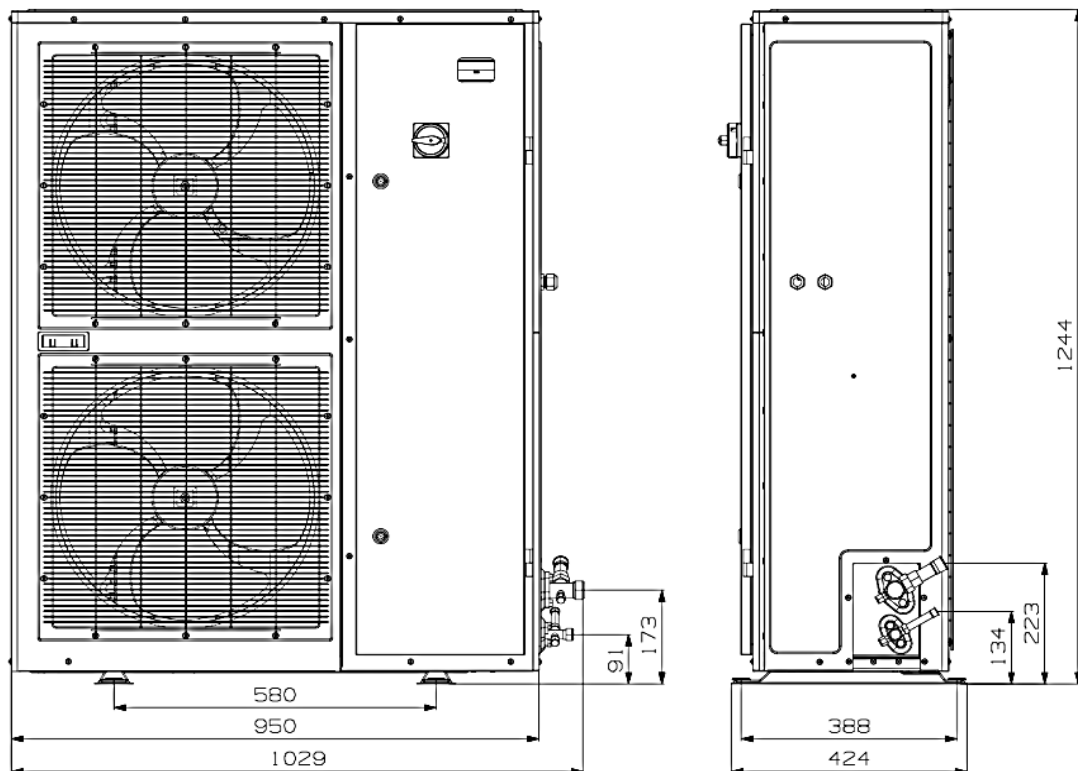

Figure 15: Dimensions of models ZXME050E, ZXME060E, ZXME075E, ZXDE040E, ZXDE050E, ZXDE060E, ZXDE075E, ZXLE050E, ZXLE060E & ZXLE075E (dual-fan units)

3 Installation



WARNING

High pressure! Injury to skin and eyes possible! Be careful when opening connections on a pressurized item.

Copeland EazyCool ZX condensing units are delivered with a holding charge of neutral gas.

The condensing unit should be located in such a place to prevent any dirt, dust, plastic bag, leaves or papers from covering the condenser and its fins.

The unit must be installed without restricting the airflow.

A clogged condenser will increase the condensing temperature, thus reduce the cooling capacity, and lead to a high-pressure switch tripping. Clean the condenser fins on a regular basis.

3.1 Condensing unit handling

3.1.1 Transport and storage



WARNING

Risk of collapse! Personal injuries! Move condensing unit only with appropriate mechanical or handling equipment according to weight. Keep in the upright position. Stack pallets on top of each other when not exceeding 300 kg. Do not stack single boxes on top of each other. Keep the packaging dry at all times.

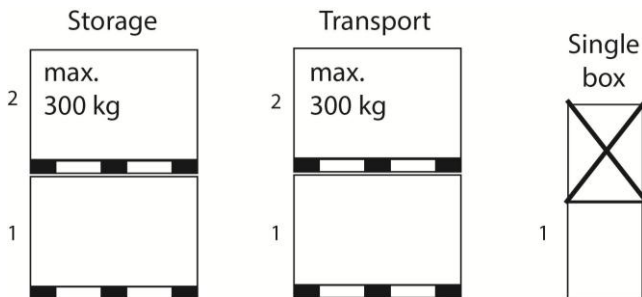

Figure 16: Transport and storage

3.1.2 Weights

Condensing units					
Standard compressors				Digital compressors	
Medium temperature	Weight (kg)	Low temperature	Weight (kg)	Medium temperature	Weight (kg)
ZXME020E	76	ZXLE020E	79		
ZXME025E	79	ZXLE025E	81		
ZXME030E	79	ZXLE030E	81		
ZXME040E	91	ZXLE040E	93	ZXDE040E	104
ZXME050E	108	ZXLE050E	106	ZXDE050E	108
ZXME060E	112	ZXLE060E	116	ZXDE060E	112
ZXME075E	118	ZXLE075E	126	ZXDE075E	118

Table 24: Weights

3.2 Electrical connection

3.2.1 Power supply connections

The electrical connection of the condensing unit to the power supply must be made by qualified technicians according to the valid electrical directives, for instance DIN EN 60204-1. Also the voltage drop and temperatures on line must be considered for cable selection.

Copeland EazyCool ZX units are designed for a 380-420V / 3Ph / 50 Hz power supply for TFD and 220-240V / 1Ph / 50 Hz power supply for PFJ. A voltage tolerance of $\pm 10\%$ is acceptable.

The circuit breaker must be switched off before opening the front door.



WARNING

Electrical shock hazard! Serious personal injuries! There are unused fast-on pins (**C1** & **D02**) on the XCM25D which could be under voltage. They are covered by insulated fast-on flags in the factory. Handle carefully when removing insulating flags during service on site.

3.2.2 Maximum operating currents for cable selection

Unit model	Locked rotor	Rated current A
ZXME Medium temperature units, single phase PFJ		
ZXME-020-PFJ	58.0	13.3
ZXME-025-PFJ	61.0	12.9
ZXME-030-PFJ	82.0	16.9
ZXME-040-PFJ	114.0	24.0
ZXME Medium temperature units, three phase TFD		
ZXME-020-TFD	26.0	5.4
ZXME-030-TFD	40.0	7.7
ZXME-040-TFD	49.3	10.8
ZXME-050-TFD	65.5	13.8
ZXME-060-TFD	74.0	14.1
ZXME-075-TFD	101.0	15.0
ZXDE Medium temperature Digital units, three phase TFD		
ZXDE-040-TFD	48.0	8.9
ZXDE-050-TFD	64.0	12.3
ZXDE-060-TFD	74.0	12.4
ZXDE-075-TFD	100.0	15.0
ZXLE Low temperature units, single phase PFJ		
ZXLE-020-PFJ	56.6	14.1
ZXLE-025-PFJ	73.7	16.1
ZXLE-030-PFJ	82.3	18.3
ZXLE Low temperature units, three phase TFD		
ZXLE-020-TFD	39.2	6.2
ZXLE-030-TFD	35.7	7.2
ZXLE-040-TFD	51.5	9.7
ZXLE-050-TFD	51.5	12.9
ZXLE-060-TFD	74.0	14.7
ZXLE-075-TFD	101.0	15.6

Table 25: Maximum operating currents for cable selection

3.2.3 Electrical wiring

Before commissioning, ensure that the neutral "N" and ground protection "PE" wires are connected to the main switch.

3.2.4 Electrical protection standard (protection class)

- Units: IP class IPX4.
- Scroll compressors up to ZX51: IP21 according to IEC 34.
- Fan: IP44 according to IEC 34.
- Solenoid valve coils: IP65 according to DIN 43650.

3.3 Refrigeration piping connections

3.3.1 Refrigeration piping installation



WARNING

High pressure! Risk of personal injury! The units are pressurized with dry air. Be careful when opening connections on a pressurized item.



WARNING

Low surface temperature! Danger of frostbite! The liquid line should be insulated with 19 mm insulation thickness. Temperature could be as low as -15°C.



IMPORTANT

Tubing quality! Installation contamination! All interconnecting piping should be of refrigeration grade, clean, dehydrated and must remain capped at both ends until installation. Even during installation, if the system is left for any reasonable period of time (say 2 hours), pipes should be re-capped to prevent moisture and contaminant from entering the system.

Connection sizes! Unsuitable refrigerant flow rate! Do not assume that the service connection sizes on the unit (at the service valves) are in fact the correct size to run your interconnecting refrigeration pipes. The service valve sizes have been selected for convenience of installation and in some cases (larger units) these may be considered too small. However for the very short pipe run within our units these service connection sizes are adequate. All interconnecting piping should be sized to satisfy the duty required.



IMPORTANT

No insulation on liquid line in ZXLE units! Air moisture condensation and lack of performance! Moisture will condensate on the liquid line and cause water droplets. The liquid line can pick up additional heat from the ambient which will adversely affect the sub-cooling desirable for the liquid refrigerant before it enters the expansion valve. Insulate both the suction and liquid interconnecting piping between the ZX unit and the evaporator.

The pipe should be sized to ensure optimum performance and good oil return. The sizing must also take into account the full capacity range through which this particular unit will need to operate.

Pipe runs should be kept as short as possible, using the minimum number of directional changes. Use large radius bends and avoid trapping of oil and refrigerant. This is particularly important for the suction line. The suction line should ideally slope gently towards the unit. Recommendation slope is 1/200 to 1/250. Upper and lower oil traps, double risers and reduced pipe diameters may be required for suction lines where long vertical risers cannot be avoided.

All pipes should be adequately supported to prevent sagging which can create oil traps. The recommended pipe clamp support distance is shown in **Table 26** below:

Tube size	Max distance between 2 clamp supports
12.7 mm (1/2 inch)	1.20 m
16.0 mm (5/8 inch)	1.50 m
22.0 mm (7/8 inch)	1.85 m
28.5 mm (1 1/8 inch)	2.20 m

Table 26: Maximum distance between 2 clamp supports

NOTE: It is strongly advisable to insulate both the suction and liquid interconnecting piping between the ZX unit and the evaporator.

3.3.2 Brazing recommendations

IMPORTANT

Blockage! Compressor breakdown! Maintain a flow of oxygen-free nitrogen through the system at very low pressure during brazing. Nitrogen displaces the air and prevents the formation of copper oxides in the system. If allowed to form, the copper oxide material can later be swept through the system and block screens such as those protecting capillary tubes, thermal expansion valves, and accumulator oil return holes.

Contamination or moisture! Bearing failure! Do not remove the plugs until the compressor is set into the unit. This minimises any entry of contaminants and moisture.

- Remove the discharge connection cap.
- Remove the suction connection cap.
- Open both valves mid-way. Care should be taken to avoid the holding charge releasing too quickly.
- Be sure tube fitting inner surface and tube outer surface are clean prior to assembly.
- Both tubes are extended from the condensing unit housing, therefore we recommend to isolate the housing by using a wet cloth on the copper tubing.
- Recommended brazing materials: a copper/phosphorous or copper/phosphorous/silver alloy rod should be used for joining copper to copper whereas to join dissimilar or ferric metals a silver alloy rod either flux coated or with a separate flux would be used.
- Use a double-tipped torch.

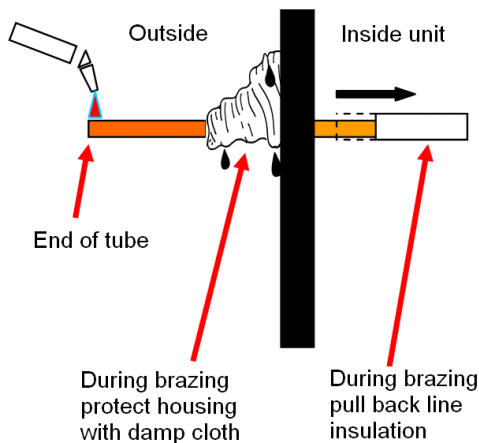

Figure 17: Brazing - Sectional view

3.3.3 Brazing procedure

For brazing of the tubes, please refer to **Figure 18** and procedure hereunder:

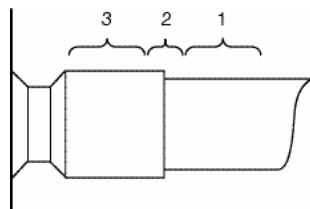

Figure 18: Suction tube brazing areas

- Fit the copper tube into the unit tube.
- Heat area 1. As the tube approaches brazing temperature,
- Heat area 2 until braze temperature is attained. It is necessary to heat the tube evenly. Move the torch up and down and rotating around the tube.
- Add braze material to the joint while moving the torch around the joint to flow braze material around the circumference.
- Then heat area 3. This will draw the brazing material down into the joint.

NOTE: The time spent heating area 3 should be minimal. As with any brazed joint, overheating may be detrimental to the final result.

To disconnect:

- Heat joint areas 2 and 3 slowly and uniformly until solder softens and tube can be pulled out of the fitting.

To reconnect:

- See procedure above.

3.4 Location & fixings

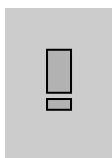

IMPORTANT

Dust and dirt contamination! Unit lifetime reduction! The unit should always be installed in a location that ensures clean air flow. External fouling of the condenser fins also leads to high condensing temperatures, and will reduce the lifetime of the unit.

It is recommended that a clearance of 300 mm from the wall (or the next unit) be maintained from the unit left and rear panels whereas a clearance of 500 mm must be maintained from the unit right, top and front panels (seen facing the front of the unit). Both service access and airflow have been considered in making these recommendations.

Where multiple units are to be installed in the same location, the contractor needs to consider each individual case carefully. There can be many variations of unit quantities and available space and it is not the intention of this manual to go over these. However, in general terms, air by-pass around each condenser and between the units should be avoided at all times.

Ideally, the unit should be mounted level on a solid concrete slab with anti-vibration pads between unit feet and concrete. However the ZX condensing unit has also been designed for wall mounting on suitable brackets. In this case it is equally important that the dimensional guidelines given in Chapter 3.5 "Required distances" are followed and that additional consideration is given for possible air recycling if units are stacked above and below each other. Wall mounting brackets are not included.

Another factor to consider in finding a good installation site is the direction of the prevailing wind. For example if the air leaving the condenser faces the prevailing wind, the air flow through the condenser can be impeded, causing high condensing temperatures and ultimately resulting in reducing the life of the unit. A baffle is a remedy for this situation.

3.5 Required distances

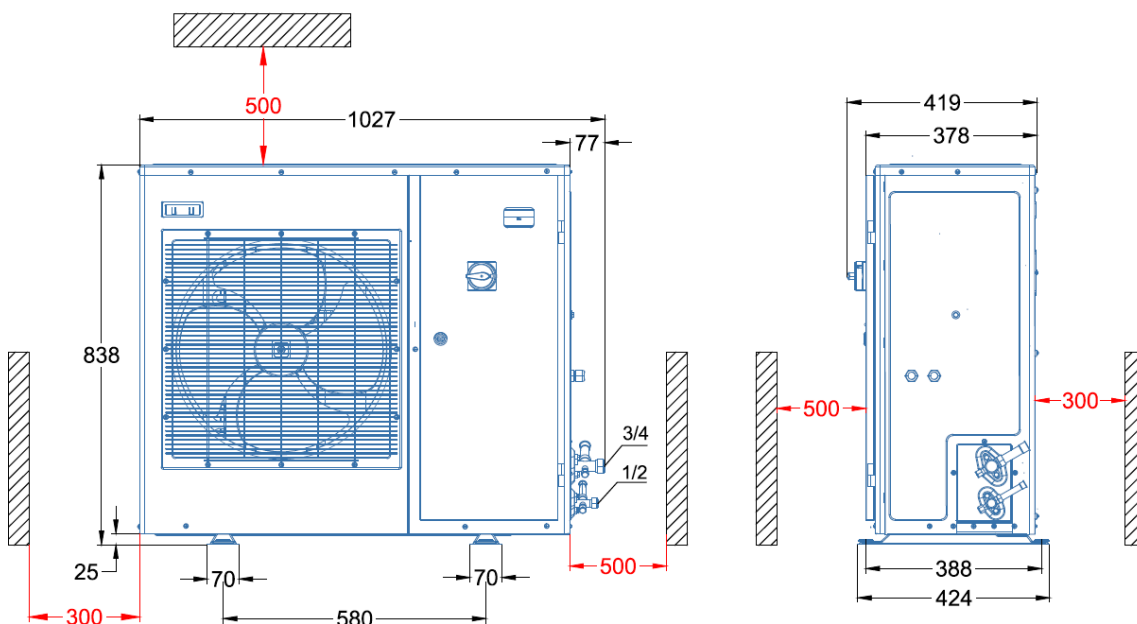

Figure 19: Fixing dimensions and distances - Single-fan unit

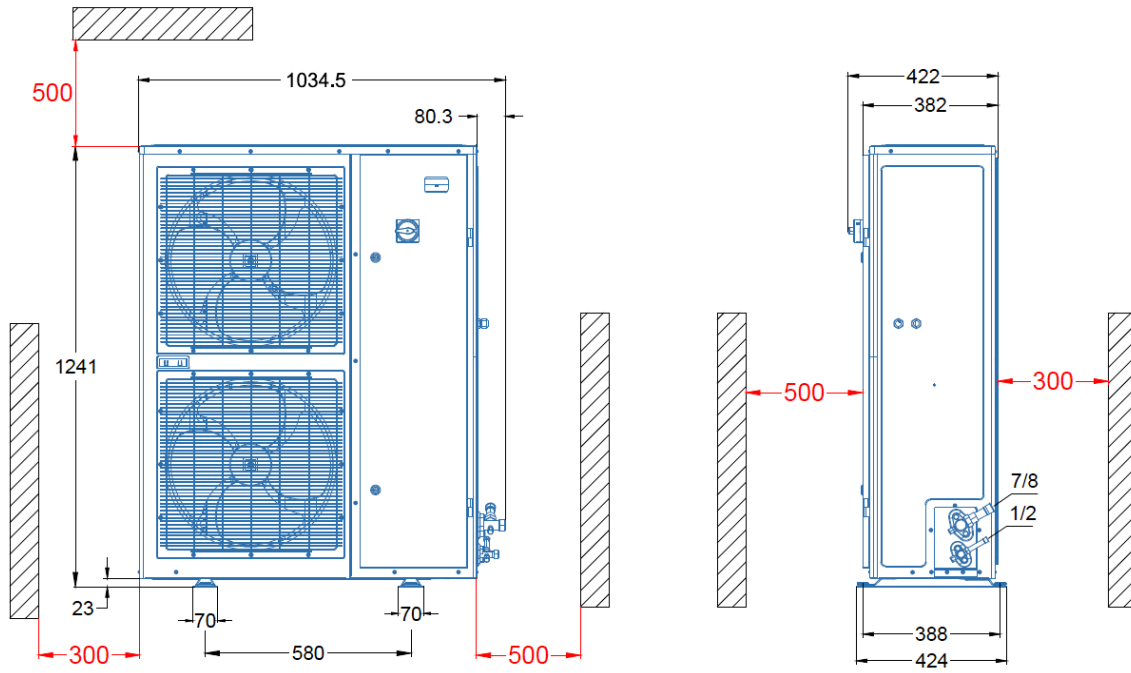

Figure 20: Fixing dimensions and distances – Dual-fan unit

Safety instructions

Product description

Installation

Starting up & operation

Maintenance & repair

Certification & approval

Dismantling & disposal

4 Starting up & operation

Before commissioning, ensure that all valves on the condensing unit are fully opened.

4.1 Evacuation

IMPORTANT

The evacuation procedure is based upon achieving an actual system vacuum standard and is NOT TIME DEPENDENT! Before commissioning the system must be evacuated by the vacuum pump. Before the installation is put into commission, it has to be evacuated with a vacuum pump. Proper evacuation reduces residual moisture to 50 ppm. The installation of adequately sized access valves at the furthest point from the compressor in the suction and liquid lines is advisable. The system must be evacuated down less than 3 mbar and if required break the vacuum by the dry nitrogen repeated. Pressure must be measured using a vacuum pressure gauge on the access valves and not on the vacuum pump; this serves to avoid incorrect measurements resulting from the pressure gradient along the connecting lines to the pump.

4.2 Charging procedure

4.2.1 Refrigerant charging procedure

The pre-charging must be done with liquid refrigerant through the service valve on the liquid line. It is advisable to pre-fill the suction side with a partial filling to avoid the vacuum operation. Further charging can be effected by careful filling into the suction line during observation of the sight glass.

IMPORTANT

Inadequate charge! Overheating! The Scroll compressor design requires system charging as quickly as possible with liquid refrigerant into the liquid line. This will avoid running the compressor under conditions whereby insufficient suction gas is available to cool not only the motor but also the scrolls. Temperature builds up very quickly in the scrolls if this is not done!

Service valve closed! Compressor damage! Do not charge the ZX Scroll unit by vapour (gas). The suction service valve must not be fully closed at any time when the compressor is running. To do so would cause damage to the compressor in the same manner as explained above. This valve is provided for ease of connection and for the fitting of service gauges without removing the unit panel.

It is recommended to charge the ZX unit with refrigerant via its service valves.

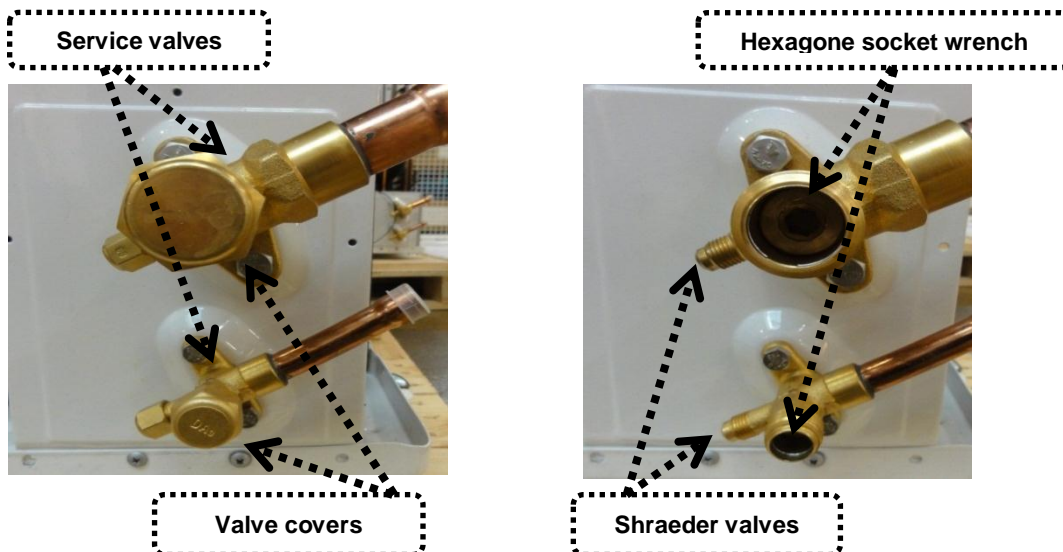

Figure 21: Service valves for refrigerant charging



Figure 22: Liquid line service port

An additional Schraeder connection is fitted on the liquid line below the filter drier in the compressor chamber. It is also possible to use this connection for charging or servicing.

Recommendation is to break vacuum in the system with partial charge of refrigerant, then start the system.

For charge adjustment it is recommended to check the liquid sight glass just before the expansion valve.

NOTE: During the charging process on low temperature ZXLE units, an error message E47 and/or E48 could occur. Both warnings are indicators for lack of refrigerant charge in the system. The operation of the unit is not affected by the warning signals. Continue charging the system: when the charge is sufficient the warnings will disappear automatically.

4.2.2 Oil charging procedure

Copeland EazyCool ZX condensing units are supplied only with a compressor oil charge. After commissioning, the oil level should be checked and topped up if necessary.

NOTE: The oil level should be approximately halfway up the sight glass.

Emerson Climate Technologies recommends charging the oil with one of the following oil types:

- Emkarate RL 32 3MAF
- Mobil EAL Arctic 22 CC

Charging is done through the Schraeder valve located on the suction valve.

NOTE: ZXDE & ZXLE units are equipped with an oil separator. This separator is pre-charged with 0.5 litre of oil.

4.3 Rotation direction of Scroll compressors

Scroll compressors, like several other types of compressors, will only compress in one rotational direction. Direction of rotation is not an issue with single-phase compressors since they will always start and run in the proper direction. Three-phase compressors are protected against wrong rotation field by help of the unit controller.

4.4 Maximum compressor cycle

Maximum permitted starts per hour: 10. The factory setting of the system controller XCM25D already takes into account the maximum permitted starts and stops of the compressor and also controls running time and minimal downtime. It is recommended to change these settings only in exceptional cases.

4.5 Checks before starting & during operation



IMPORTANT

Liquid valves not fully opened! Liquid trap! Both valves should be fully opened on the liquid line, in order to prevent trapping liquid.

- Check that all valves are fully opened.
- Set the essential parameters of the electronic controller in the programming level 1 (Refrigerant type, Compressor cut-out/in settings (ZXDE only), Fan setpoint....) according to the required application.
- We recommend to check the oil level in compressor after starting and operation conditions have stabilised, and to add oil if needed to ensure a sufficient oil level (halfway up the sight glass).

5 Maintenance & repair

5.1 Replacing a compressor



CAUTION

Inadequate lubrication! Bearing destruction! Exchange the accumulator after replacing a compressor with a burned out motor. The accumulator oil return orifice or screen may be plugged with debris or may become plugged. This will result in starvation of oil to the new compressor and a second failure.

In the case of a motor burnout, the majority of contaminated oil will be removed with the compressor. The rest of the oil is cleaned through the use of suction and liquid line filter driers. A 100% activated alumina suction line filter drier is recommended but must be removed after 72 hours. **It is highly recommended to replace the suction accumulator, if the system contains one.** This is because the accumulator oil return orifice or screen may be plugged with debris or may become plugged shortly after a compressor failure. This will result in starvation of oil to the replacement compressor and a second failure. When a compressor is exchanged in the field, it is possible that a major portion of the oil may still be in the system. While this may not affect the reliability of the replacement compressor, the extra oil will add to rotor drag and increase power usage.

- De-energize the condensing unit before any intervention.
- Close valves to isolate the unit from the system.
- Recover the refrigerant from the unit and make sure that the compressor is not under pressure.
- Release the compressor mounting parts then lift it to replace with a new compressor.

NOTE: For more detailed instructions, please refer to the compressor application guidelines.

5.2 Condenser fins



CAUTION

Acid cleaning! Corrosion of condenser fins! Do not use acidic solutions to clean the coil. After cleaning, the fins should be brushed lightly with a proper fin comb.

Condenser fins become dirty over time as ambient air is induced to the condenser. Dirty coil surfaces result in high condensing temperatures and poor unit performance. Regular cleaning is recommended, the frequency of doing so being dependent on the installation and the surrounding environment. As a general guide it is advisable to do this at least once every two months.

As a general rule and for a clean environment we recommend the fins be cleaned with liquid detergent diluted with clean water. The ZX has a well-designed chassis with falling levels towards a large drainage hole and provided the unit is installed level, any cleaning solution should be able to drain away. A light brush downward (in the direction of the fins) should be done before washing to remove heavy deposits.

5.3 Electrical connections



WARNING

Isolating switch "On"! Danger of electric shock! Turn off the unit isolating switch before undertaking this task!

All condensing units will generate some degree of vibration. Copeland EazyCool ZX units are no exception. However the vibration level from the compliant scroll technology is less severe than in units using reciprocating compressor technology. Thanks to this reduced vibration, ZX condensing units can be mounted on simple, less expensive rubber mounting pads.

Nevertheless, over time, due to these slight vibrations and to temperature fluctuations within the unit housing, electrical terminations might become loose. The components most likely to be affected are the main terminal strip and the compressor contactor. It is suggested to check the

main electrical terminations for tightness and to carry out a visual inspection of the low voltage crimped terminals at least once every 6 months.

5.4 Routine leak testing

All joints within the system should be leak-tested as part of a regular maintenance schedule.

5.5 Condenser fan(s) & motor(s)

A yearly inspection of these items is recommended. Fastenings can become loose, bearings may wear and fans may require cleaning of solid deposits that can cause rotational imbalance. Motors come with lifelong lubrication bearings that do not require lubricating on a routine basis, but just need to be checked for wear.

6 Certification & approval

- The piping is in compliance with the Pressure Equipment Directive PED 97/23/EC (Art.3 §3 - Sound Engineering Practice).
- The components of the condensing units carry a CE mark as far as required and thereby establish conformity with the relevant directives.
- Conformity Declarations for components are available as far as required.
- The units are in conformity with the low voltage directive. The applied harmonised standard is EN 60335-2-891 (Safety Household and Similar Electrical Appliance, Part 2: Particular requirements for commercial refrigerating appliances with an incorporated or remote refrigerant condensing unit or compressor).
- To incorporate these products into a machine the Manufacturer's Declaration of Incorporation has to be respected.

7 Dismantling & disposal



Removing oil and refrigerant:

1. **Do not disperse in the environment.**
2. **Use the correct equipment and method of removal.**
3. **Dispose of oil and refrigerant properly".**
4. **Dispose of unit properly.**

DISCLAIMER

1. The contents of this publication are presented for informational purposes only and are not to be construed as warranties or guarantees, express or implied, regarding the products or services described herein or their use or applicability.
2. Emerson Climate Technologies GmbH and/or its affiliates (collectively "Emerson"), as applicable, reserve the right to modify the design or specifications of such products at any time without notice.
3. Emerson does not assume responsibility for the selection, use or maintenance of any product. Responsibility for proper selection, use and maintenance of any Emerson product remains solely with the purchaser or end user.
4. Emerson does not assume responsibility for possible typographic errors contained in this publication.

Appendix 1: Overview of the ZX unit components

Components	Medium temperature	Medium temperature	Low temperature
	Standard	Digital	Standard
	ZXME	ZXDE	ZXLE
Compressor M1	✓	✓	✓
Fan M2.1	✓	✓	✓
Fan M2.2	ZXME050 – ZXME075	✓	ZXLE050 & ZXLE060
Y1 Stepper valve EVI	[-]	[-]	✓
Y1 Stepper valve liquid	✓	[-]	[-]
Y2 DGS solenoid valve	[-]	✓	[-]
E1 Crankcase heater	✓	✓	✓
S1 High pressure switch	✓	✓	✓
S2 Low pressure switch	✓	✓	✓
S3 Room thermostat (optional)	[-]	[-]	[-]
B1 Pressure transducer suction	✓	✓	✓
B2 Pressure transducer discharge	✓	✓	✓
B3 DLT NTC discharge	✓	✓	✓
B4 EVI vapour in sensor NTC	[-]	[-]	✓
B5 EVI vapour out sensor NTC	[-]	[-]	✓
B6 Ambient temperature sensor NTC	✓	✓	✓
B7 Temperature sensor (optional)	[-]	[-]	[-]

Table 27: Overview of the ZX unit components

Appendix 2: Wiring diagram – ZXME / ZXLE / ZXDE units (380-420V / 3Ph / 50 Hz)

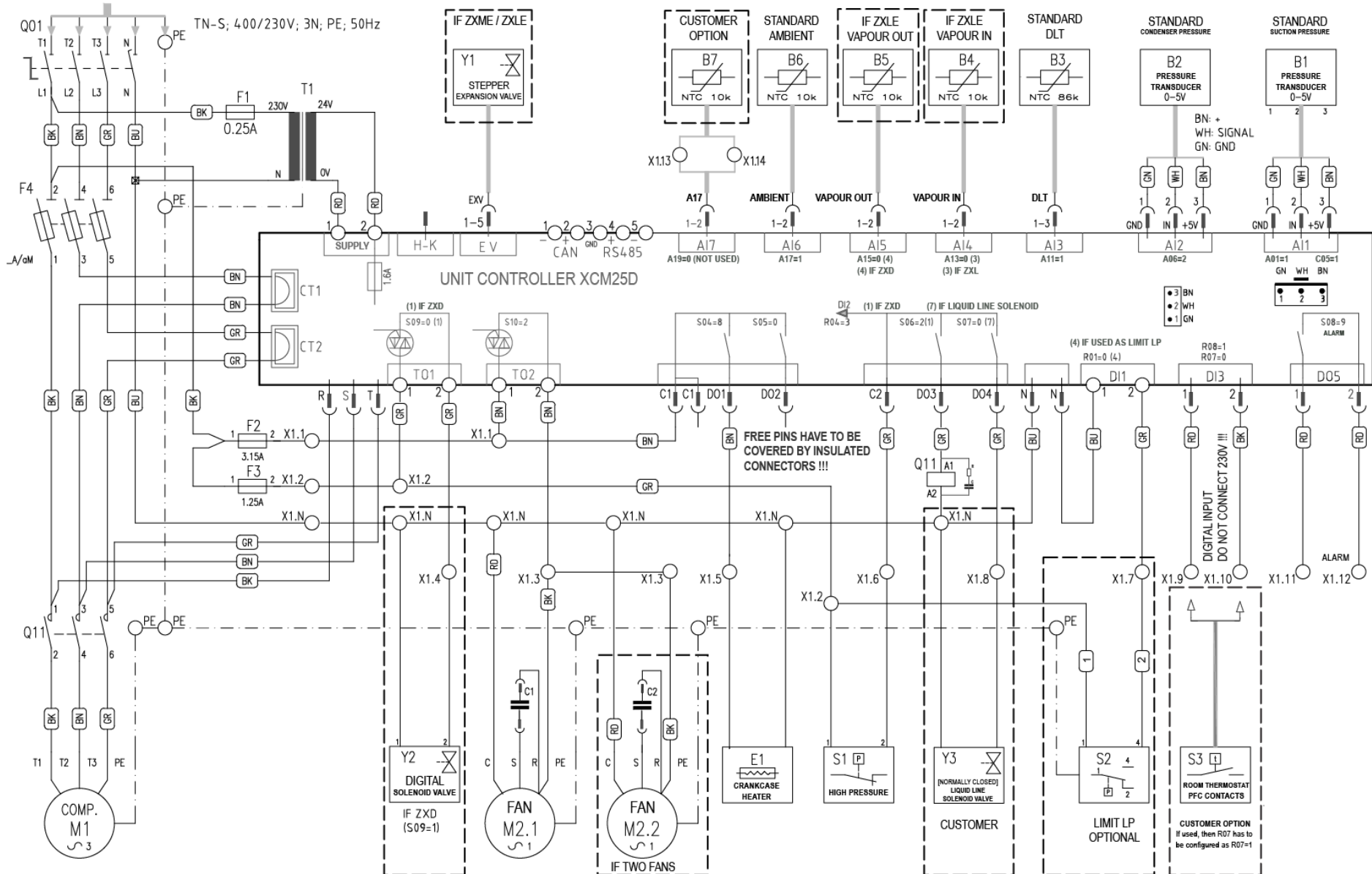

Figure 23: Wiring diagram

Appendix 3: Parameter list level 1 (Pr1)

Legend

L1 = Parameter in Level 1 (without password)

L2 = Parameter in Level 2 (with password = 3 2 1)

N.V. = Parameter not accessible

Parameter	Description	Range	ZXDE	ZXME	ZXLE
C01	Compressor cut-in pressure setpoint	CoU to US; C02 to C04	N.V.	L1	L1
C02	Compressor cut-out pressure setpoint	LS to Cin; C03 to C01	L2	L1	L1
C07	Refrigerant selection for regulation	R404A (0-404) - R507 (1-507) - R134A (2-134) - R22 (3-R22) - R407C (4-07C) - R407A (5-07A) - R407F (6-07F) - N40 (7N40) - DR33 (8-R33) - R410A (9-410)	L1	L1	L1
C16	Digital compressor setpoint	LS to US; C03 to C04	L1	N.V.	N.V.
C17	Proportional band for compressor regulation	0.1 to 9.9 bar; 0.1 to 99.9 PSI; 1 to 999 KPA; 0.1°C to 25.5°C	L1	N.V.	N.V.
C21	Cycle time for digital compressor	10 to 40 sec	L1	N.V.	N.V.
C24	Minimum capacity for digital compressor	0 to PMA; 0 to C25	L1	N.V.	N.V.
C25	Maximum capacity for digital compressor	PMi to 100; C24 to 100	L1	N.V.	N.V.
E39	Condenser temperature setpoint when fan setpoint modulation is disabled	-40°C to 110°C	L1	L1	L1
E46	Regulation band of variable fan	0.1°C to 25.5°C	L1	L1	L1
N01	Current minute	0 to 59	L1	L1	L1
N02	Current hour	0 to 23	L1	L1	L1
N03	Date of month	1 to 31	L1	L1	L1
N04	Month	1 to 12	L1	L1	L1
N05	Year	0 to 99	L1	L1	L1
T18	Access to Pr2 level	[0÷999]	L1	L1	L1

Table 28: Parameters level 1

Appendix 4: Parameter list level 1 (Pr1) & 2 (Pr2)

Legend

L1 = Parameter in Level 1 (without password)

L2 = Parameter in Level 2 (with password = 3 2 1)

N.V. = Parameter not accessible

Code	Description	Range	Factory Setting	ZXDE	ZXME	ZXLE
A01	Probe P1 configuration	Not used (0-NU) Suction pressure (0-5V)(1-SUP)	Suction pressure (0-5V)	L2	L2	L2
A02	Start of scaling for probe 1 (0-5V)	0-5V: -1.5 bar to P1E; -21 PSI to P1E	0	L2	L2	L2
A03	End of scaling for probe 1 (0-5V)	0-5V: P1i to 99.9 bar; P1i to 999 PSI	15	L2	L2	L2
A04	Probe P1 calibration	0-5V: -12.0 bar to 12.0 bar; -12.0 PSI to 12.0 PSI	0	L2	L2	L2
A05	Probe P1 reading error delay (P1C=0-5V)	0-255 min	5	L2	L2	L2
A06	Probe P2 configuration	Not used (0-NU) Mid coil temperature (NTC10K)(1-MCT) Mid coil pressure (0-5V)(2-MCP)	Mid coil pressure (0-5V)	L2	L2	L2
A07	Start of scaling for probe 2	0-5V: -1.5 bar to P2E; -21 PSI to P2E NTC10K: -40°C to P2E	0	L2	L2	L2
A08	End of scaling for probe 2	0-5V: P2i to 99.9 bar; P2i to 999 PSI NTC10K: P2i to 110°C	35	L2	L2	L2
A09	Probe P2 calibration	0-5V: -12.0 bar to 12.0 bar; -12.0 PSI to 12.0 PSI NTC10K: -12°C to 12°C	0	L2	L2	L2
A10	Probe P2 reading error delay (P2C=0-5V)	0-255 min	0	L2	L2	L2
A11	Probe P3 configuration	Not used (0-NU) Discharge line temperature (1-DLT)	Discharge line temperature	L2	L2	L2
A12	Probe P3 calibration	-12°C to 12°C	0	L2	L2	L2
A13	Probe P4 configuration	Not used (0-NU) Ambient temp (NTC10K)(1-AMT) Thermostat temp (NTC10K)(2-TMT) Vapour inlet temp (NTC10K)(3-UIT) Vapour outlet temp (NTC10K)(4-UOT) Evaporator temp (NTC10K)(5-EPT) Liquid temp (NTC10K)(6-LLT) Suction line temp (7-SLT) Coil temp (8-COT)	Not used	L2	L2	L2
A14	Probe P4 calibration	-12°C to 12°C	0	L2	L2	L2

Code	Description	Range	Factory Setting	ZXDE	ZXME	ZXLE
A15	Probe P5 configuration	Not used (0-NU) Ambient temp (NTC10K)(1-AMT) Thermostat temp (NTC10K)(2-TMT) Vapour inlet temp (NTC10K)(3-UIT) Vapour outlet temp (NTC10K)(4-UOT) Evaporator temp (NTC10K)(5-EPT) Liquid temp (NTC10K)(6-LLT) Suction line temp (7-SLT) Coil temp (8-COT)	Not used	L2	L2	L2
A16	Probe P5 calibration	-12°C to 12°C	0	L2	L2	L2
A17	Probe P6 configuration	Not used (0-NU) Ambient temp (NTC10K)(1-AMT) Thermostat temp (NTC10K)(2-TMT) Vapour inlet temp (NTC10K)(3-UIT) Vapour outlet temp (NTC10K)(4-UOT) Evaporator temp (NTC10K)(5-EPT) Liquid temp (NTC10K)(6-LLT) Suction line temp (7-SLT) Coil temp (8-COT)	Ambient Temp(NTC10K)	L2	L2	L2
A18	Probe P6 calibration	-12°C to 12°C; -21°F to 21 °F	0.0	L2	L2	L2
A19	Probe P7 configuration	Not used (0-NU) Ambient temp (NTC10K)(1-AMT) Thermostat temp (NTC10K)(2-TMT) Vapour inlet temp (NTC10K)(3-UIT) Vapour outlet temp (NTC10K)(4-UOT) Evaporator temp (NTC10K)(5-EPT) Liquid temp (NTC10K)(6-LLT) Suction line temp (7-SLT) Coil temp (8-COT)	Not used	L2	L2	L2
A20	Probe P7 calibration	-12°C to 12°C	0	L2	L2	L2
A21	Delay before activating probe error	0-255 sec	0	L2	L2	L2
B01	Measurement unit for pressure	bar(0-BAR) - PSI(1-PSI) - KPA(2-TPA)	bar	L2	L2	L2
B02	Measurement unit for temperature	°C(0-C) - °F(1-F)	°C	L2	L2	L2
B03	Remote display visualization	P1(0-P1) - P2(1-P2) - P3(2-P3) - P4(3-P4) - P5(4-P5) - P6(5-P6) - P7(6-P7) - PER(7-PER) - Aou(8-AOU)	P1	L2	L2	L2
B04	Filter enabling for probe reading	n (0-NO) - Y (1-YES)	YES	N.V.	N.V.	N.V.
B05	Coefficient for probe reading filter (0 = max, 100 = disable)	0 to 100, mEd(101)	50	N.V.	N.V.	N.V.

Code	Description	Range	Factory Setting	ZXDE	ZXME	ZXLE
C01	Compressor cut in pressure set point	CoU to US;	4	N.V.	L1	L1
C02	Compressor cut out pressure set point	LS to Cin;	2	L2	L1	L1
C03	Minimum set point for suction pressure/temperature	P1i to US; -50.0°C to US	0.6	L2	L2	L2
C04	Maximum set point for suction pressure/temperature	LS to P1E; LS to 60.0°C;	6.3	L2	L2	L2
C05	Compressor regulation probe selection	NU (0-NU) Suction pressure probe (1-SUP) Case temperature (2-CST) Suction pressure switch (3-DIS)	Suction pressure probe	L2	L2	L2
C06	EXV closing time before compressor off	0 to 999 sec	0	L2	L2	L2
C07	Refrigerant selection for regulation	R404A(0-404) - R507(1-507) - R134A(2-134) - R22(3-R22) - R407C(4-07C) - R407A(5-07A) - R407F(6-07F) - N40(7N40) - DR33(8-R33) - R410A(9-410)	R404A	L1	L1	L1
C08	Set point offset	NU (0-NU) Small offset (1-SOF) Medium offset (2-MOF) Large offset (3-LOF) LAO (4-FOF)	NV	L2	L2	L2
C09	Ambient temperature operation set point	-40°C to 110°C; -40 to 230°F	-20	L2	L2	L2
C10	Pressure/Temperature operation for ambient differential	0.0Bar to 9.9Bar; 0.0PSI to 99.9PSI 0.0°C to 25.5 °C	1	L2	L2	L2
C11	Ambient temperature recover differential	0.1°C to 25.5 °C	5	L2	L2	L2
C12	Ambient temperature threshold for low ambient operation	-40°C to 110°C	-10	L2	L2	L2
C13	Temperature/Pressure to end low ambient timer and resume normal operation	-40°C to 110°C -1.5 to 99.9 bar; -21 to 999 PSI	10	L2	L2	L2
C14	Compressor minimum on time in low ambient operation	0 to 255 sec	10	L2	L2	L2
C15	Pressure to end low ambient timer and shut off the compressor	-1.5 to 99.9 bar; -21.0 to 999 PSI	0.5	L2	L2	L2
C16	Digital compressor set point	LS to US	3.3	L1	N.V.	N.V.
C17	Proportional band for compressor regulation	0.1 to 9.9 bar; 0.1 to 99.9 PSI; 0.1°C to 25.5°C	2	L1	N.V.	N.V.
C18	Band offset for compressor regulation	0 to 9.9 bar; 0 to 99.9 PSI; 0.0°C to 25.5°C	0	L2	N.V.	N.V.
C19	Integral time	0 to 999 sec	250	L2	L2	N.V.
C20	Startup time: interval time with digital valve energized before start regulation	0.0 to 10.0 sec	10	L2	N.V.	N.V.
C21	Cycle time for digital compressor	10 to 40 sec	10	L1	N.V.	N.V.
C22	Safety value for PI regulator (in case of probe error)	0 to 100%	50	L2	N.V.	N.V.

Code	Description	Range	Factory Setting	ZXDE	ZXME	ZXLE
C23	Number of active compressor when probe error	0(0) - 1(1) - 2(2)	1	L2	N.V.	N.V.
C24	Minimum capacity for digital compressor	0 to PMA	20	L1	N.V.	N.V.
C25	Maximum capacity for digital compressor	PMi to 100	100	L1	N.V.	N.V.
C26	Time with DGS at PMA before starting another load	0 to 255 sec	0	L2	L2	N.V.
C27	Time with DGS at PMi before switching off another load	0 to 255 sec	0	L2	L2	N.V.
C28	R404A Enable function	Disable (0-NO) - Enable (1-YES)	Enable	N.V.	N.V.	N.V.
C29	R507 Enable function	Disable (0-NO) - Enable (1-YES)	Enable	N.V.	N.V.	N.V.
C30	R134A Enable function	Disable (0-NO) - Enable (1-YES)	Enable	N.V.	N.V.	N.V.
C31	R22 Enable function	Disable (0-NO) - Enable (1-YES)	Enable	N.V.	N.V.	N.V.
C32	R407C Enable function	Disable (0-NO) - Enable (1-YES)	Enable	N.V.	N.V.	N.V.
C33	R407A Enable function	Disable (0-NO) - Enable (1-YES)	Enable	N.V.	N.V.	N.V.
C34	R407F Enable function	Disable (0-NO) - Enable (1-YES)	Enable	N.V.	N.V.	N.V.
C35	R448A Enable function	Disable (0-NO) - Enable (1-YES)	Enable	N.V.	N.V.	N.V.
C36	R449A Enable function	Disable (0-NO) - Enable (1-YES)	Enable	N.V.	N.V.	N.V.
C37	R410A Enable function	Disable (0-NO) - Enable (1-YES)	Disable	N.V.	N.V.	N.V.
C38	Compressor regulation control signal	Pressure (0-PRS) - temperature (1-TMP)	Pressure	L2	L2	L2
D01	Output delay at start up	0 to 255 sec	5	L2	L2	L2
D02	Compressor On time with faulty probe	0 to 255 min	5	L2	L2	L2
D03	Compressor Off time with faulty probe	0 to 255 min	3	L2	L2	L2
D04	Minimum time between two starts (same compressor)	0 to 15 min	4	L2	L2	L2
D05	Delay between compressor switch-off and start-up (same compressor)	1 to 900 sec	120	L2	L2	L2
D06	Delay between two different loads start-up	[0+99.5] min res.10sec	10	N.V.	N.V.	N.V.
D07	Delay between two different loads switch-off	[0+99.5] min res.10sec	10	N.V.	N.V.	N.V.
D08	Minimum time a stage stays switched On	[0+99.5] min res.10sec	0	N.V.	N.V.	N.V.
D09	Maximum time a stage stays switched On	[0.00+24.00] hour res.10min	0:00	N.V.	N.V.	N.V.
D10	don delay enabled also for the first request	no (0-NU) - YES (1-YES)	NO	N.V.	N.V.	N.V.
D11	doF delay enable also for the first switching off	no (0-NU) - YES (1-YES)	NO	N.V.	N.V.	N.V.

Code	Description	Range	Factory Setting	ZXDE	ZXME	ZXLE
D12	Low suction pressure alarm delay	0 to 999 sec	0	L2	L2	L2
D13	Low suction pressure error signal enabling	no (0-NU) - YES (1-YSE)	NO	L2	L2	L2
D14	Compressor minimum off time for high pressure switch protection	0 - 15 min	5	L2	L2	L2
D15	Number of high pressure switch activation before compressor lock	0 - 15	7	L2	L2	L2
D16	Bump start enable	no (0-NO) - YES (1-YES)	NO	N.V.	L2	L2
D17	Bump start ambient threshold	-40°C to 110°C	0	N.V.	L2	L2
D18	Compressor stop time for next bump start	0.0 to 23h50 minutes	1:00	N.V.	L2	L2
D19	Compressor on time during bump function	1 to 15 sec	2	N.V.	L2	L2
D20	Compressor off time during bump function	1 to 15 sec	15	N.V.	L2	L2
D21	Number of cycles during bump start	1 to 15	3	N.V.	L2	L2
D22	DLT alarm temperature to stop compressor	-40 to 180°C	130	L2	L2	L2
D23	DLT alarm recover temperature to turn on compressor	-40 to 180°C	90	L2	L2	L2
D24	DLT alarm activation delay	0 to 255 sec	30	L2	L2	L2
D25	Compressor minimum off time for DLT Alarm	0 to 255 min	5	L2	L2	L2
D26	Number of DLT alarm activation before compressor lock	0 to 15	10	L2	L2	L2
D27	Time to ignore low DLT sensor error at start-up	0 to 255 min	5	L2	L2	L2
D28	Compressor minimum off time for low pressure switch protection	0 - 15 min	3	L2	L2	L2
E01	Condenser fan motor modulation type	Not Used (0-NU) Fan cycling (1-CYC) Modulated fan (2-MOD)	Modulated fan	L2	L2	L2
E02	Low set point for condenser fan map 1 (for R404A, R507)	-40 °C to HT1	10	N.V.	N.V.	N.V.
E03	Lower suction pressure point for condenser fan map 1 (for R404A, R507)	-1.5Bar to HP1; -21PSI to HP1	3.3	N.V.	N.V.	N.V.
E04	High set point for condenser fan map 1 (for R404)	LT1 to 110 °C	30	N.V.	N.V.	N.V.
E05	High suction pressure point for condenser fan map 1 (for R404A, R507)	LP1 to 99.9 Bar; LP1 to 999 PSI	7.2	N.V.	N.V.	N.V.
E06	Low set point for condenser fan map 2 (for R134)	-40 °C to HT2	25	N.V.	N.V.	N.V.
E07	Lower suction pressure point for condenser fan map 2 (for R404)	-1.5Bar to HP2; -21PSI to HP2	2.5	N.V.	N.V.	N.V.
E08	High set point for condenser fan map 2 (for R134)	LT2 to 110 °C	40	N.V.	N.V.	N.V.
E09	High suction pressure point for condenser fan map 2 (for R404)	LP2 to 99.9 Bar; LP2 to 999 PSI	3.9	N.V.	N.V.	N.V.

Code	Description	Range	Factory Setting	ZXDE	ZXME	ZXLE
E10	Low set point for condenser fan map 3 (for R22)	-40 °C to HT3	20	N.V.	N.V.	N.V.
E11	Low suction pressure point for condenser fan map 3 (for R22)	-1.5Bar to HP3; -21PSI to HP3	5.2	N.V.	N.V.	N.V.
E12	High set point for condenser fan map 3 (for R22)	LT3 to 110 °C ; LT3 to 230°F	30	N.V.	N.V.	N.V.
E13	High suction pressure point for condenser fan map 3 (for R22)	LP3 to 99.9 Bar; LP3 to 999 PSI	6.4	N.V.	N.V.	N.V.
E14	Low set point for condenser fan map 4 (for R407C)	-40 °C to HT4; -40°F to HT4	10	N.V.	N.V.	N.V.
E15	Lower suction pressure point for condenser fan map 4 (for R404)	-1.5Bar to HP4; -21PSI to HP4	1.3	N.V.	N.V.	N.V.
E16	High set point for condenser fan map 4 (for R407C)	LT4 to 110 °C	38	N.V.	N.V.	N.V.
E17	High suction pressure point for condenser fan map 4 (for R404)	LP4 to 99.9 Bar; LP4 to 999 PSI	5.4	N.V.	N.V.	N.V.
E18	Low set point for condenser fan map 5 (for R407A)	-40 °C to HT5	10	N.V.	N.V.	N.V.
E19	Low suction pressure point for condenser fan map 5 (for R407A)	-1.5Bar to HP5; -21PSI to HP5	2.5	N.V.	N.V.	N.V.
E20	High set point for condenser fan map 5 (for R407A)	LT5 to 110 °C	27	N.V.	N.V.	N.V.
E21	High suction pressure point for condenser fan map 5 (for R407A)	LP5 to 99.9 Bar; LP5 to 999 PSI	5.3	N.V.	N.V.	N.V.
E22	Low set point for condenser fan map 6 (for R407F)	-40 °C to HT6	10	N.V.	N.V.	N.V.
E23	Low suction pressure point for condenser fan map 6 (for R407F)	-1.5Bar to HP6; -21PSI to HP6	1.7	N.V.	N.V.	N.V.
E24	High set point for condenser fan map 6 (for R407F)	LT6 to 110 °C	38	N.V.	N.V.	N.V.
E25	High suction pressure point for condenser fan map 6 (for R407F)	LP6 to 99.9 Bar; LP6 to 999 PSI	6.3	N.V.	N.V.	N.V.
E26	Low set point for condenser fan map 7 (for R448A)	-40 °C to HT7	10	N.V.	N.V.	N.V.
E27	Low suction pressure point for condenser fan map 7 (for R448A)	-1.5Bar to HP7; -21PSI to HP7	3.3	N.V.	N.V.	N.V.
E28	High set point for condenser fan map 7 (for R448A)	LT7 to 110 °C	30	N.V.	N.V.	N.V.
E29	High suction pressure point for condenser fan map 7 (for R448A)	LP7 to 99.9 Bar; LP7 to 999 PSI	7.2	N.V.	N.V.	N.V.
E30	Low set point for condenser fan map 8 (for R449A)	-40 °C to HT8	10	N.V.	N.V.	N.V.
E31	Low suction pressure point for condenser fan map 8 (for R449A)	-1.5Bar to HP8; -21PSI to HP8	3.3	N.V.	N.V.	N.V.
E32	High set point for condenser fan map 8 (for R449A)	LT8 to 110 °C	30	N.V.	N.V.	N.V.
E33	High suction pressure point for condenser fan map 8 (for R449A)	LP8 to 99.9 Bar; LP8 to 999 PSI	7.2	N.V.	N.V.	N.V.
E34	Low set point for condenser fan map 9 (for R410A)	-40 °C to HT9	10	N.V.	N.V.	N.V.
E35	Low suction pressure point for condenser fan map 9 (for R410A)	-1.5Bar to HP9; -21PSI to HP9	3.3	N.V.	N.V.	N.V.
E36	High set point for condenser fan map 9 (for R410A)	LT9 to 110 °C	30	N.V.	N.V.	N.V.

Code	Description	Range	Factory Setting	ZXDE	ZXME	ZXLE
E37	High suction pressure point for condenser fan map 9 (for R410A)	LP9 to 99.9 Bar; LP9 to 999 PSI	7.2	N.V.	N.V.	N.V.
E38	Fan set point modulation enabling	no (0-NO) - YES (1-YES)	NO	L2	L2	L2
E39	Condenser temperature set point when fan set point modulation is disabled	-40°C to 110°C	35	L1	L1	L1
E40	Minimum condenser temperature set point	-40°C to 110°C	10	L2	L2	L2
E41	High ambient fan motor override enabled	no (0-NO) - YES (1-YES)	YES	L2	L2	L2
E42	High ambient fan motor override differential	0.1°C to 25.5 °C	5	L2	L2	L2
E43	High DLT fan motor override enabled	no (0-NO) - YES (1-YES)	YES	L2	L2	L2
E44	High DLT fan motor override differential	-40°C to 180°C	120	L2	L2	L2
E45	Minimum fan motor speed	0 to 100%	40	N.V.	N.V.	N.V.
E46	Regulation band of variable fan	0.1°C to 25.5 °C	10	L1	L1	L1
E47	Integration time for fan	0 to 999 sec	500	L2	L2	L2
E48	Fan full speed duration at fan start-up	0 to 255 sec	0	L2	L2	L2
E49	Fan minimum on time	0 to 255 sec	5	L2	L2	L2
E50	Fan minimum off time	0 to 255 sec	10	L2	L2	L2
E51	Fixed condenser fan set point	-40°C to 110°C	23	L2	L2	L2
E52	Fan 1 differential	0.1°C to 25.5 °C	7	L2	L2	L2
E53	Fan 1 to fan 2 differential	0.1°C to 25.5 °C	10	L2	L2	L2
E54	Fan 2 differential	0.1°C to 25.5 °C	7	L2	L2	L2
E55	Fan control with ambient sensor - Min ambient	-40°C to E56	0	L2	L2	L2
E56	Fan control with ambient sensor - Max ambient	E55 to 110°C	20	L2	L2	L2
E57	Fan speed control with ambient sensor	0 to 100%	60	L2	L2	L2
E58	Condenser temperature/pressure threshold for high alarm	-40°C to 110°C -1.5 to 99.9 Bar; -21 to 999 PSI	27.8	L2	L2	L2
E59	High condenser temperature alarm delay	0 - 255 min	0	L2	L2	L2
E60	High condenser temperature alarm with compressor off	no (0-NO) - YES (1-YES)	YES	L2	L2	L2
E61	Condenser temperature/pressure threshold for alarm recovery	-40°C to E58°C -1.5 to E58 Bar; -21 to E58 PSI	23	L2	L2	L2
F01	Liquid injection set point	-40°C to 180°C	110	N.V.	L2	L2
F02	Max DLT temperature before full open injection	LIS°C to 180°C	118	N.V.	L2	L2

Code	Description	Range	Factory Setting	ZXDE	ZXME	ZXLE
F03	Min DLT temperature before close injection	-40°C to LIS°C	40	N.V.	L2	L2
F04	Mid-coil limp along for DLT failure - Mid-coil 1	LA2 to 110°C	60	N.V.	L2	N.V.
F05	Mid-coil limp along for DLT failure - Mid-coil 2	LA3 to LA1	50	N.V.	L2	N.V.
F06	Mid-coil limp along for DLT failure - Mid-coil 3	LA4 to LA2	40	N.V.	L2	N.V.
F07	Mid-coil limp along for DLT failure - Mid-coil 4	LA5 to LA3	30	N.V.	L2	N.V.
F08	Mid-coil limp along for DLT failure - Mid-coil 5	-40°C to LA4	20	N.V.	L2	N.V.
F09	Mid-coil limp along for DLT failure - Valve opening 1	LE2 to 100%	100	N.V.	L2	N.V.
F10	Mid-coil limp along for DLT failure - Valve opening 2	LE3 to LE1%	80	N.V.	L2	N.V.
F11	Mid-coil limp along for DLT failure - Valve opening 3	LE4 to LE2%	60	N.V.	L2	N.V.
F12	Mid-coil limp along for DLT failure - Valve opening 4	LE5 to LE3%	35	N.V.	L2	N.V.
F13	Mid-coil limp along for DLT failure - Valve opening 5	0 to LE4%	15	N.V.	L2	N.V.
F14	Ambient limp along for DLT and mid-coil failure - Temperature 1	MA2 to 110°C	30	N.V.	L2	N.V.
F15	Ambient limp along for DLT and mid-coil failure - Temperature 2	-40°C to MA1	20	N.V.	L2	N.V.
F16	Ambient limp along for DLT and mid-coil failure - Valve opening 1	ME2 to 100%	80	N.V.	L2	N.V.
F17	Ambient limp along for DLT and mid-coil failure - Valve opening 2	0 to ME1%	35	N.V.	L2	N.V.
F18	EVI EXV initial opening – Ambient 1	EA2 to 110°C	35	N.V.	N.V.	L2
F19	EVI EXV initial opening – Ambient 2	EA3 to EA1	30	N.V.	N.V.	L2
F20	EVI EXV initial opening – Ambient 3	EA4 to EA2	25	N.V.	N.V.	L2
F21	EVI EXV initial opening – Ambient 4	-40.0°C to EA3	15	N.V.	N.V.	L2
F22	EVI EXV initial opening – Valve opening 1	EO2 to 100%	60	N.V.	N.V.	L2
F23	EVI EXV initial opening – Valve opening 2	EO3 to EO1%	40	N.V.	N.V.	L2
F24	EVI EXV initial opening – Valve opening 3	EO4 to EO2%	30	N.V.	N.V.	L2
F25	EVI EXV initial opening – Valve opening 4	EO5 to EO3%	20	N.V.	N.V.	L2
F26	EVI EXV initial opening – Valve opening 5	0 to EO4%	10	N.V.	N.V.	L2
F27	EVI EXV initial opening with sensor failure	0~100%	40	N.V.	N.V.	L2
F28	Differential between the vapour inlet and the vapour outlet temperature for R404A	0.0 to 25.5°C	5	N.V.	N.V.	L2
F29	Differential between the vapour inlet and the vapour outlet temperature for R507	0.0 to 25.5°C	5	N.V.	N.V.	L2

Code	Description	Range	Factory Setting	ZXDE	ZXME	ZXLE
F30	Differential between the vapour inlet and the vapour outlet temperature for R134A	0.0 to 25.5°C	5	N.V.	N.V.	N.V.
F31	Differential between the vapour inlet and the vapour outlet temperature for R22	0.0 to 25.5°C	5	N.V.	N.V.	L2
F32	Differential between the vapour inlet and the vapour outlet temperature for R407C	0.0 to 25.5°C	10	N.V.	N.V.	L2
F33	Differential between the vapour inlet and the vapour outlet temperature for R407A	0.0 to 25.5°C	10	N.V.	N.V.	L2
F34	Differential between the vapour inlet and the vapour outlet temperature for R407F	0.0 to 25.5°C	10	N.V.	N.V.	L2
F35	Differential between the vapour inlet and the vapour outlet temperature for R448A	0.0 to 25.5°C	10	N.V.	N.V.	L2
F36	Differential between the vapour inlet and the vapour outlet temperature for R449A	0.0 to 25.5°C	10	N.V.	N.V.	L2
F37	Differential between the vapour inlet and the vapour outlet temperature for R410A	0.0 to 25.5°C	5	N.V.	N.V.	N.V.
F38	Max DLT temperature before changing from vapour to liquid injection control	-40°C to 180°C	110	N.V.	N.V.	L2
F39	Differential before resuming vapour injection	0.0°C to 25.5 °C	15	N.V.	N.V.	L2
F40	Max open EXV warning time	0~255 minutes	2	N.V.	N.V.	L2
F41	Delta between set point and shortage of refrigerant error during max open warning	0.0°C to 25.5°C	8	N.V.	N.V.	L2
F42	Constant liquid temperature mode enabled for low ambient EVI injection	no (0-NO) - YES (1-YES)	NO	N.V.	N.V.	L2
F43	Constant liquid temperature set point	-40°C to 110°C	0	N.V.	N.V.	L2
F44	Constant liquid temperature enable temperature	-40°C to 110°C	-20	N.V.	N.V.	L2
G01	Case temperature probe selection	NU (0-NU) Mid-coil temperature (1-MCT) Discharge Line temperature (2-DLT) Ambient temperature (3-AMT) Thermostat temperature (4-TMT) Evaporator temperature (5-EPT) Vapour inlet temp (6-UIT) Vapour outlet temp (7-UOT) Liquid temp (8-LLT) Suction line temperature (9-SLT) Coil temperature (10-COT)	Not used	L2	L2	L2
G02	Case temperature set point	CLS to CUS	2	L2	L2	L2
G03	Case temperature differential	0.1°C to 25.5 °C	1	L2	L2	L2

Code	Description	Range	Factory Setting	ZXDE	ZXME	ZXLE
G04	Case temperature low range	-40°C to CUS	-10	L2	L2	L2
G05	Case temperature high range	CLS to 110°C	15	L2	L2	L2
G06	Case probe failure limp along on time	0 to 255 min	2	L2	L2	L2
G07	Case probe failure limp along off time	0 to 255 min	1	L2	L2	L2
G08	Compressor and fan status when open door >> no = normal operation; Fn = Fans off; cP = Compressor off; Fc = Compr. & fans off	no (0-NO) Fn (1-FAN) cP (2-CPR) Fc (3-F-C)	NO	L2	L2	L2
G09	Regulation with door open	no (0-NO) - YES (1-YES)	YES	L2	L2	L2
G10	Liquid line solenoid control	Compressor (0-CPR) Liquid line solenoid (1-LLS)	Compressor	L2	L2	L2
G11	Maximum pumpdown time	0 to 255 min	3	L2	L2	L2
G12	Defrost probe selection	NU (0-NU) Mid-coil temperature (1-MCT) Discharge Line temperature (2-DLT)	Not used	L2	L2	L2
G13	Defrost in probe selection	Ambient temperature (3-AMT) Thermostat temperature (4-TMT) Evaporator temperature (5-EPT)	Not used	L2	L2	L2
G14	Defrost out probe selection	Vapour inlet temp (6-UIT) Vapour outlet temp (7-UOT) Liquid temp (8-LLT) Suction line temperature (9-SLT) Coil temperature (10-COT)	Not used	L2	L2	L2
G15	Threshold percentage to enable intelligent defrost	0 to 100	40	L2	L2	L2
G16	Duration to calculate the average difference between the diP and doP	0 to 100 min	5	L2	L2	L2
G17	Defrost type	EL (0-EL) in (1-IN) Pulse (2-PLS)	EL	L2	L2	L2
G18	Interval between defrost cycles	0 to 120 h	4	L2	L2	L2
G19	Maximum length for defrost	0 to 255 min	20	L2	L2	L2
G20	Duration of pulse defrost	0 to G19	15	L2	L2	L2
G21	Defrost termination temperature	-40°C to 110°C	10	L2	L2	L2
G22	Defrost delay time	0 to 255 min	0	L2	L2	L2
G23	Defrost interval mode	nu (0-NU) in (1-IN) rtC (2-rtC) Intelligent (3-INT)	Not used	L2	L2	L2

Code	Description	Range	Factory Setting	ZXDE	ZXME	ZXLE
G24	Display during defrost dEF = Defrost; Set = Set point case temp; It = Case temp; rt = Display in standard operation	dEF (0-DEF) Set (1-SET) It (2-IT) rt (3-RT)	dEF	L2	L2	L2
G25	Maximum display delay after defrost	0 to 255 min	0	L2	L2	L2
G26	Drip time	0 to 120 min	1	L2	L2	L2
G27	Defrost at power-on	no (0-NO) - YES (1-YES)	NO	L2	L2	L2
G28	Workday defrost start 1	0 to 23h50 minutes; nu;	0:00	L2	L2	L2
G29	Workday defrost start 2	0 to 23h50 minutes; nu;	4:00	L2	L2	L2
G30	Workday defrost start 3	0 to 23h50 minutes; nu;	8:00	L2	L2	L2
G31	Workday defrost start 4	0 to 23h50 minutes; nu;	12:00	L2	L2	L2
G32	Workday defrost start 5	0 to 23h50 minutes; nu;	16:00	L2	L2	L2
G33	Workday defrost start 6	0 to 23h50 minutes; nu;	20:00	L2	L2	L2
G34	Holiday defrost start 1	0 to 23h50 minutes; nu;	0:00	L2	L2	L2
G35	Holiday defrost start 2	0 to 23h50 minutes; nu;	4:00	L2	L2	L2
G36	Holiday defrost start 3	0 to 23h50 minutes; nu;	8:00	L2	L2	L2
G37	Holiday defrost start 4	0 to 23h50 minutes; nu;	12:00	L2	L2	L2
G38	Holiday defrost start 5	0 to 23h50 minutes; nu;	16:00	L2	L2	L2
G39	Holiday defrost start 6	0 to 23h50 minutes; nu;	20:00	L2	L2	L2
G40	First weekly holiday	SUN(0-SUN) MON(1-MON) TUE(2-TUE) WED(3-WED)	SUN	L2	L2	L2
G41	Second weekly holiday	THU(4-THU) FRI(5-FRI) SAT(6-SAT) nu(7-NU)	SUN	L2	L2	L2
G42	Fans operating mode cn = Parallel to compressor, off during defrost; on = Fans always on, only off during defrost; cy = Parallel to compressor, on during defrost; oy = Fans permanently in operation	cn(0-CN) on(1-ON) cy(2-CY) oy(3-OY);	cn	L2	L2	L2
G43	Fans stop temperature	-40°C to 110°C	0	L2	L2	L2

Code	Description	Range	Factory Setting	ZXDE	ZXME	ZXLE
G44	Temperature differential avoiding short cycles of fans	0 to 59 °C	2	L2	L2	L2
G45	Fan On time	0 to 255 min	1	L2	L2	L2
G46	Fan Off time	0 to 255 min	1	L2	L2	L2
G47	Room probe selection for evaporator fan management	NU (0-NU) Mid-coil temperature (1-MCT) Discharge line temperature (2-DLT) Ambient temperature (3-AMT) Thermostat temperature (4-TMT)	Not used	L2	L2	L2
G48	Maximum case temperature alarm threshold	G49 to 110°C	10	L2	L2	L2
G49	Minimum case temperature alarm threshold	-40°C to G48	-25	L2	L2	L2
G50	Case temperature alarm restart differential	0.1°C to 25.5 °C	3	L2	L2	L2
G51	Case temperature alarm delay	0~255 seconds	60	L2	L2	L2
G52	Exclusion of temperature alarm at start-up	0~255 minutes	20	L2	L2	L2
G53	Maximum door open time before alarm	0~255 minutes	3	L2	L2	L2
G54	Maximum length for light when door switch is closed	0~255 minutes	1	L2	L2	L2
G55	Fan delay after defrost	0 to 255 minutes	1	L2	L2	L2
G56	Use the liquid line solenoid	no; yes	NO	L2	L2	L2
H01	Current sensing 1	no; yes	YES	L2	L2	L2
H02	Current sensing 2	no; yes	YES	L2	L2	L2
H03	Voltage sensing 1	no; yes	NO	L2	L2	L2
H04	Voltage sensing 2	no; yes	NO	L2	L2	L2
H05	Voltage sensing 3	no; yes	NO	L2	L2	L2
H06	Voltage and current protection enabled	no; yes	YES	L2	L2	L2
H07	Maximum continuous current limit	3PE=0: 0.0 to 70.0 A 3PE=1: 0.0 to 35.0 A	Unit dependent	L2	L2	L2
H08	Voltage/current sensing trip minimum off time	0 to 255 min	5	L2	L2	L2
H09	Adjustable current limit before trip	0.0 to MCC Ampere	9.5	L2	L2	L2
H10	Ignore current sensing duration at startup duration	0 to 255 seconds	3	L2	L2	L2
H11	Number of over current trips before lock	0 to 15	5	L2	L2	L2
H12	Number of loss of phase trips before lock	0 to 15	5	L2	L2	L2

Code	Description	Range	Factory Setting	ZXDE	ZXME	ZXLE
H13	Minimum voltage to trip compressor	0 to 400 V	320	N.V.	N.V.	N.V.
H14	Maximum voltage to trip compressor	0 to 800 V	485	N.V.	N.V.	N.V.
H15	Over or under voltage minimum time	0 to 255 seconds	60	N.V.	N.V.	N.V.
H16	Compressor minimum off time because of voltage error	0 to 255 minutes	3	N.V.	N.V.	N.V.
H17	Number of compressor trips before lockout because of voltage	0 to 15	5	N.V.	N.V.	N.V.
H18	Adjustable under average voltage percentage	0 to 100%	85	N.V.	N.V.	N.V.
H19	Generate warning or shut down compressor when phase imbalance	0: Generate warning (0-ARN) 1: off the unit (1-Off)	Off the unit	L2	L2	L2
H20	Missing current duration before warning	0 to 255 sec	10	L2	L2	L2
H21	Minimum high side superheat	-40 to 110 °C	10	N.V.	N.V.	N.V.
H22	Amount of time allowed in an interval to check for floodback	0 to H23 min	30	N.V.	N.V.	N.V.
H23	Interval to check for floodback	H22 to 120 min	45	N.V.	N.V.	L2
H24	Duration of checking anti-flood back alarm reset condition	1~255 minutes	20	N.V.	N.V.	L2
H25	Three phase enable	no; yes	YES	L2	L2	L2
I01	Ambient temperature threshold to off crankcase heater	-40°C to 180°C	10	L2	L2	L2
I02	Compressor minimum off time before turning on the crankcase heater	0~255 minutes	5	L2	L2	L2
L01	Steps for initial regulation	SH2-SH1 step	15	N.V.	N.V.	N.V.
L02	Superheating set point	0.0°C to 25.5 °C	5	L2	L2	N.V.
L03	Threshold of low superheating	0.0-SH18 °C	1	N.V.	N.V.	N.V.
L04	Threshold of high superheating	SH17-80.0 °C	15	N.V.	N.V.	N.V.
L05	Extra % of valve close in case of low superheating	0-100%	0	N.V.	N.V.	N.V.
L06	Delay high superheating	0-255 sec	30	N.V.	N.V.	N.V.
L07	Delay low superheating	0-255 sec	30	N.V.	N.V.	N.V.
L08	Threshold of MOP	SH23 to 60.0°C	35	N.V.	N.V.	N.V.
L09	Threshold of LOP	-50°C to SH22°C	-20	N.V.	N.V.	N.V.
L10	Delay activation MOP	0-255 sec	1	N.V.	N.V.	N.V.
L11	Delay activation LOP	0-255 sec	1	N.V.	N.V.	N.V.
L12	Steps close/open in case of MOP/LOP	0-SH1 step	20	N.V.	N.V.	N.V.
M01	Max step valve	SH2-800 steps	250	L2	L2	N.V.
M02	Min step valve	0-SH1 steps	0	L2	L2	N.V.
M03	Extra steps of valve close	0-100 steps	20	L2	L2	N.V.

Code	Description	Range	Factory Setting	ZXDE	ZXME	ZXLE
M04	Relax steps	0-100 steps	0	L2	L2	N.V.
M05	Step rate	10-100 steps	35	L2	L2	N.V.
M06	Regulation of the valve 0: automatic, 1:manual	AUTOMATIC (0-AUT) MANUAL (1-MAN)	Automatic	L2	L2	N.V.
M07	Steps if manual regulation	SH2-SH1 step	15	L2	L2	N.V.
M08	Proportional band (if 0 the regulation is auto adaptive)	0 to 50°C	0	L2	L2	N.V.
M09	Integral time	0-255 sec	20	L2	L2	N.V.
M10	Derivative	0-255 sec	0	L2	L2	N.V.
M11	Dead band	0-10°C	1	L2	L2	N.V.
M12	Min % of the valve	0 - SH15	0	L2	L2	L2
M13	Max % of the valve	SH14 - 100	100	L2	L2	N.V.
M14	Filter on the pressure	1-255 sec	1	L2	L2	N.V.
M15	Interval of updating valve	1-255 sec	20	L2	L2	N.V.
M16	Filter on the temperature [1-100] sec	1-255 sec	1	L2	L2	N.V.
M17	Delay activation probe error	0-255 sec	1	L2	L2	N.V.
M18	% Valve in case of probe error	0-100	50	L2	L2	N.V.
M19	Time at initial steps at the start time	0-255	30	L2	L2	N.V.
N01	Current minute	0 to 59		L1	L1	L1
N02	Current hour	0 to 23		L1	L1	L1
N03	Day of month	1 to 31		L1	L1	L1
N04	Month	1 to 12		L1	L1	L1
N05	Year	0 to 99		L1	L1	L1
P01	Compressor set point hysteresis in energy saving mode	0.0 Bar to 9.9 Bar; 0.0PSI to 99.9 PSI; 0.0°C to 25.5 °C	0	L2	L2	L2
P02	Condenser set point hysteresis in energy saving mode	0.0°C to 25.5 °C	0	L2	L2	L2
R01	Digital input 1 function	Not used (0-NU) Suction pressure switch (1-SUS) Thermostat input (2-DEF) High pressure input (3-HP) Low pressure input (4-LP) Door switch (5-DOR) Energy saving enable (6-ES) On/Off (7-ONF)	Not used	L2	L2	L2
R02	Digital input 1 polarity	oP (0) - CL (1)	CL	L2	L2	L2

Code	Description	Range	Factory Setting	ZXDE	ZXME	ZXLE
R03	Activation delay for digital input 1	0 to 255 min	0	L2	L2	L2
R04	Digital input 2 function	Not used (0-NU) Suction pressure switch (1-SUS) Thermostat input (2-DEF) High pressure input (3-HP) Low pressure input (4-LP) Door switch (5-DOR) Energy saving enable (6-ES) On/Off (7-ONF)	High pressure input	N.V.	N.V.	N.V.
R05	Digital input 2 polarity	oP (0) - CL (1)	oP	N.V.	N.V.	N.V.
R06	Activation delay for digital input 2	0 to 255 min	0	N.V.	N.V.	N.V.
R07	Digital input 3 function	Not used (0-NU) Suction pressure switch (1-SUS) Thermostat input (2-DEF) High pressure input (3-HP) Low pressure input (4-LP) Door switch (5-DOR) Energy saving enable (6-ES) On/Off (7-ONF)	Not used	L2	L2	L2
R08	Digital input 3 polarity	oP (0-OP) - CL (1-CL)	CL	L2	L2	L2
R09	Activation delay for digital input 3	0 to 255 min	0	L2	L2	L2
S01	Alarm contact activation in a warning, alarm, lockout	Warning(0-ARN) - Alarm(1-ALM) - Lockout(2-LOC)	Alarm	L2	L2	L2
S02	Alarm relay deactivation	No (0-NO) - Yes (1-YES)	YES	L2	L2	L2
S03	Buzzer enabled	No (0-NO) - Yes (1-YES)	NO	L2	L2	L2
S04	Relay output 1 configuration	Not used (0-NU)	Crankcase heater	N.V.	N.V.	N.V.
S05	Relay output 2 configuration	DGS compressor (1-DGS) On-Off compressor (2-CPR) Condenser fan 1 (3-CF1)	Not used	L2	L2	L2
S06	Relay output 3 configuration	Condenser fan 2 (4-CF2) Evaporator fan (5-EPF)	DGS compressor	N.V.	N.V.	N.V.
S07	Relay output 4 configuration	Defrost (6-DEF) Liquid line solenoid (7-LLS) Crankcase heater (8-HTR)	Not used	L2	L2	L2
S08	Relay output 5 configuration	Alarm (9-ALM) Light (10-LIG)	Alarm	L2	L2	L2
S09	Triac output 1 configuration	Not used (0-NU) Digital solenoid (1-DGT) Wave Form chopper for fan speed (2-PCF) PWM fan speed (3-PEF) 0-10V (4-UEF)	Digital solenoid	L2	L2	L2

Code	Description	Range	Factory Setting	ZXDE	ZXME	ZXLE
S10	Triac output 2 configuration	Not used (0-NU) Digital solenoid (1-DGT) Wave-form chopper for fan speed (2-PCF)	Wave-form chopper for fan speed	L2	L2	L2
S11	EXV Configuration	Not used (0-NU) Liquid injection EXV (1-LIN) EVI EXV (2-UIN) System EXV (3-SHT)	Not used	L2	L2	L2
S12	Output 1 polarity	CL (0-CL) - oP (1-OP)	CL	N.V.	N.V.	N.V.
S13	Output 2 polarity	CL (0-CL) - oP (1-OP)	CL	L2	L2	L2
T01	Serial address	1 to 247	1	L2	L2	L2
T02	Reset key configuration	nP (0-NU) - rSt (1-RST)	rSt	L2	L2	L2
T03	Period time of menu exit without key press	10 to 120 sec	30	N.V.	N.V.	N.V.
T04	Time for showing firmware version at start-up	0 to 60 sec	3	N.V.	N.V.	N.V.
T05	Time for showing program name at start-up	0 to 60 sec	3	N.V.	N.V.	N.V.
T06	P1 visualization	0~999		L2	L2	L2
T07	P2 visualization	0~999		L2	L2	L2
T08	P3 visualization	0~999		L2	L2	L2
T09	P4 visualization	0~999		L2	L2	L2
T10	P5 visualization	0~999		L2	L2	L2
T11	P6 visualization	0~999		L2	L2	L2
T12	P7 visualization	0~999		L2	L2	L2
T13	Firmware release: day	[1÷31]		L2	L2	L2
T14	Firmware release: month	[1÷12]		L2	L2	L2
T15	Firmware release: year	[0÷999]		L2	L2	L2
T16	Firmware release code	[0÷999]		L2	L2	L2
T17	EEPROM map identification	[0÷999]	6	L2	L2	L2
T18	Enter into PR2 level	[0÷999]		L1	L1	L1

Table 29: Parameter list level 1 (Pr1) & 2 (Pr2)

Appendix 5: Alarm menu

Code	Description	Cause	Action	Reset
E01	A11 error (Probe 1/Suction pressure transducer failure alarm)	Probe failure or out of range	Only in digital unit - compressor is activated according to C23, and compressor on & off time is according to D02 & D03	Automatically as soon as the probe restarts working
E02	A12 error (Probe 2/mid-coil temperature sensor failure alarm)	Probe failure or out of range	The fan speed control is disabled	Automatically as soon as the probe restarts working
E03	A13 error (Probe 3/discharge line temperature sensor failure alarm)	Probe failure or out of range	Discharge temperature control is disabled	Automatically as soon as the probe restarts working
E04	A14 error (Probe 4/PHE vapor inlet temperature sensor failure alarm)	Probe failure or out of range	PHE super heat control is disabled (ZXL/ZXB unit)	Automatically as soon as the probe restarts working
E05	A15 error (Probe 5/PHE vapor outlet temperature sensor failure alarm)	Probe failure or out of range	PHE super heat control is disabled (ZXL/ZXB unit)	Automatically as soon as the probe restarts working
E06	A16 error (Probe 6/ambient temperature sensor failure alarm)	Probe failure or out of range	The functions related to probe 6 (ambient sensor) is disabled	Automatically as soon as the probe restarts working
E07	A17 error (not used in Asia)	Probe failure or out of range(not used in Asia)		
E08	Battery error			
E09	Current sensor 1 error	Probe out of range	The functions related to current sensor is disabled	Automatically as soon as the probe restarts working
E10	Current sensor 2 error	Probe out of range	The functions related to current sensor is disabled	Automatically as soon as the probe restarts working
E11	Voltage sensor 1 error	Probe out of range	The functions related to voltage sensor is disabled	Automatically as soon as the probe restarts working
E12	Voltage sensor 2 error	Probe out of range	The functions related to voltage sensor is disabled	Automatically: as soon as the probe restarts working
E13	Voltage sensor 3 error	Probe out of range	The functions related to voltage sensor is disabled	Automatically as soon as the probe restarts working
E14-E19	Reserved			

Code	Description	Cause	Action	Reset
E20	Lost phase error	Power supply phase loss (3-phases unit)	The compressor will be tripped	Automatically: Lost phase recover and H08 delay time out
L20	Lost phase lockout	Power supply phase loss happened for H12 time within one hour (3-phases unit)	The compressor will be locked	Hold “start” button for 5s or manual power off and on
L21	Phase sequence lockout	Incorrect phase sequence (3-ph unit)	The compressor will be locked, rotation field has to be changed	Manual power off, invert 2 phases and power on
E22	Phase imbalance	One phase voltage lower than H18 percentage of 3 phases average voltage (3-ph unit)	The compressor is activated according to H19	Automatically: Voltage recover and H16 setting delay time out
E23	Over current	Electrical current larger than H09 setting	The compressor will be tripped	Automatically: H08 delay time out
L23	Over current lockout	Over current happened for H11 times within one hour	The compressor will be locked (if H11 equal to 0, compressor no lockout)	Hold “start” button for 5s or manual power off and on (if H11 equal to 0, compressor automatically start after H08 delay time out)
E24	Open run circuit error	Motor running winding open (1 Ph)	The compressor will be tripped	Automatically: H08 delay time out
L24	Open run circuit lockout	Motor running winding open error happened for H12 times within one hour(single phase)	The compressor will be locked(if H12 equal to 0, compressor no lockout)	Hold “start” button for 5s or manual power off and on (if H12 equal to 0, compressor automatically start after H08 delay time out)
E25	Open start circuit error	Motor start winding open (single phase)	The compressor will be tripped	Automatically: H08 delay time out
L25	Open start circuit lockout	Motor start winding open error happened for H12 times within one hour (1 Ph)	The compressor will be locked (if H12 equal to 0, compressor no lockout)	Hold “start” button for 5s or manual power off and on (if H12 equal to 0, compressor automatically start after H08 delay time out)
E26	Under voltage alarm	Voltage lower than H13 setting for H15 seconds	The compressor will be tripped	Automatically: voltage is back within acceptable range and H16 delay time out

Code	Description	Cause	Action	Reset
L26	Under voltage lockout	Under voltage happened for H17 times within one hour	The compressor will be locked (if H17 equal to 0, compressor no lockout)	Hold "start" button for 5s or manual power off and on (if H17 equal to 0, compressor automatically start when voltage is back within acceptable range and H16 delay time out)
E27	Over voltage alarm	Voltage larger than H14 setting for H15 seconds	The compressor will be tripped	Automatically: voltage is back within acceptable range and H16 delay time out
L27	Over voltage lockout	Over voltage happened for H17 times within one hour	The compressor will be locked (if H17 equal to 0, compressor no lockout)	Hold "start" button for 5s or manual power off and on (if H17 equal to 0, compressor automatically start when voltage is back within acceptable range and H16 delay time out)
E28	Compressor Build-in protector trip	Compressor build-in thermal protector trips	Warning signal only	Automatically: as soon as electrical current detected
E30	Main power lost	Controller power supply lost		
E40	High pressure switch	High pressure switch open	The compressor will be tripped	Automatically: High pressure switch closed and D14 delay time out
L40	High pressure switch lockout	High pressure switch open error happened for D15 times within one hour	The compressor will be locked(if D15 equal to 0, compressor no lockout)	Hold "start" button for 5s or manual power off and on (if D15 equal to 0, compressor automatically start when high pressure switch closed and D14 delay time out)
E41	Low pressure switch	Low pressure switch open	The compressor will be tripped	Automatically: low pressure switch closed and D28 delay time out
E43	Low pressure alarm	Not used in Asia		
E44	Discharge line temperature alarm	Discharge line temperature higher than D22 for D24 seconds	The compressor will be tripped	Automatically: discharge line temperature lower than D23 setting and D25 delay time out
L44	Discharge line temperature lockout	Discharge line temperature over-heat happened for D26 times within one hour	The compressor will be locked(if D26 equal to 0, compressor no lockout)	Hold "start" button for 5s or manual power off and on (if D26 equal to 0, compressor automatically start when discharge line temperature lower than D23 setting and D25 delay time out)

Code	Description	Cause	Action	Reset
E45	High condenser pressure alarm	Not used in Asia		
E46	High condenser temperature alarm	Condenser temperature larger than E58 for E59 minutes	The compressor is activated according to E60	Automatically: as soon as condenser temperature lower than E61
E47	EXV full open in EVI	EXV full open for F40 minutes	Warning signal only	Automatically: as soon as EXV is not at maximum steps
E48	Refrigerant shortage error in EVI	EXV full open and PHE super heat is larger than (F28/F29.../F37 + F39) (F28/F29.../F37 depends on refrigerant type)	Warning signal only	Automatically: as soon as PHE super heat is lower than (F28/F29.../F37 + F39)
E49	Pumpdown alarm	Not used		
E50	High side floodback alarm	The differential temperature between discharge and mid-coil is lower than H21 for accumulated H22 minutes in H23 minutes	Warning signal only	Automatically: as soon as differential temperature between discharge and mid-coil is larger than H21 for H24 minutes
E60	Max pressure alarm of superheating	Not used		
E61	Min pressure alarm of superheating	Not used		
E62	High superheating alarm	Not used		
E63	Low superheating alarm	Not used		
E64	High room temperature alarm	Not used		
E65	Low room temperature alarm	Not used		

Table 30: Alarm code overview

Appendix 6: Additional features for customization

Required setting for proper functionality

Setting needs to be adjusted according to application

Room thermostat or pressure switch			
Parameter	Parameter description	Factory setting	Required setting
C05	Compressor regulation probe selection	SUP = Suction pressure probe	diS = Suction pressure switch / Room thermostat
R07	Digital input 3 configuration	NU = Not used	SUS = Suction pressure switch / Room thermostat

Temperature sensor (case temperature)			
Parameter	Parameter description	Factory setting	Required setting
C05	Compressor regulation probe selection	SUP = Suction pressure probe	CST = Case temperature
A19	Probe 7 configuration	NU = Not used	TMT = Thermostat temperature
G01	Case temperature probe selection	NU = Not used	TMT = Thermostat temperature
G02	Cut-out temperature	+2°C	Adjust to application requirements
G03	Positive differential defines upper cut-in temperature	1K	Adjust to application requirements

Pumpdown with room thermostat			
Parameter	Parameter description	Factory setting	Required setting
C05	Compressor regulation probe selection	SUP = Suction pressure probe	diS = Suction pressure switch / Room thermostat
G56	Use the liquid line solenoid	No	Yes
R07	Digital input 3 configuration	NU = Not used	SUS = Suction pressure switch / Room thermostat
R08	Digital input 3 polarity	CI = Closed	CI = Closed
S07	Relay Output 4	NU = Not used	LLS = Liquid line solenoid
C01	Compressor cut in pressure setpoint	4 bar rel	Adjust to application requirements
C02	Compressor cut out pressure setpoint	2 bar rel	Adjust to application requirements

Pumpdown with temperature sensor			
Parameter	Parameter description	Factory setting	Required setting
A19	Probe 7 configuration	NU = Not used	TMT = Thermostat temperature
C05	Compressor regulation probe selection	SUP = Suction pressure probe	CST = Case temperature
G01	Case temperature probe selection	NU = Not used	TMT = Thermostat temperature
G56	Use the liquid line solenoid	No	Yes
S07	Relay Output 4	NU = Not used	LLS = Liquid line solenoid
C01	Compressor cut in pressure setpoint	4 bar rel	Adjust to application requirements
C02	Compressor cut out pressure setpoint	2 bar rel	Adjust to application requirements
G02	Cut-out temperature	+2°C	Adjust to application requirements
G03	Positive differential defines upper cut-in temperature	1K	Adjust to application requirements

Defrost with time intervals			
Parameter	Parameter description	Factory setting	Required setting
A19	Probe 7 configuration	NU = Not used	EPT = Evaporator temperature
G12	Defrost probe selection	NU = Not used	EPT = Evaporator temperature
G23	Defrost interval mode	NU = Not used	IN - by time (G18)
S05	Relay Output 2	NU = Not used	DEF = Defrost
G18	interval between defrost cycles	4	Adjust to application requirements
G19	Maximum length for defrost	20	Adjust to application requirements
G21	Defrost termination temperature	10	Adjust to application requirements
G26	Drip time	1	Adjust to application requirements

Defrost with Real Time Clock			
Parameter	Parameter description	Factory setting	Required setting
A19	Probe 7 configuration	NU = Not used	Ept = Evaporator temperature
G12	Defrost probe selection	NU = Not used	Ept = Evaporator temperature
G23	Defrost interval mode	NU = Not used	Rtc - Real time clock
S05	Relay Output 2	NU = Not used	DEF = Defrost
G18	interval between defrost cycles	4	Adjust to application requirements
G19	Maximum length for defrost	20	Adjust to application requirements
G21	Defrost termination temperature	10	Adjust to application requirements
G26	Drip time	1	Adjust to application requirements
G28-41	See tables "Parameter list level 2"	[-]	Adjust to application requirements

Defrost with evaporator fan			
Parameter	Parameter description	Factory setting	Required setting
A19	Probe 7 configuration	NU = Not used	Ept = Evaporator temperature
G12	Defrost probe selection	NU = Not used	Ept = Evaporator temperature
G23	Defrost interval mode	NU = Not used	IN - by time (G18)
G42	Fans operating mode	Cn	OY
S05	Relay Output 2	NU = Not used	EPF = Evaporator fan
G18	interval between defrost cycles	4	Adjust to application requirements
G19	Maximum length for defrost	20	Adjust to application requirements
G21	Defrost termination temperature	10	Adjust to application requirements
G26	Drip time	1	Adjust to application requirements
G55	Fan delay after defrost	1	Adjust to application requirements

Evaporator fans			
Parameter	Parameter description	Factory setting	Required setting
A19	Probe 7 configuration	NU = Not used	tnt = Thermostat temperature
G47	Room probe selection for evaporator fan management	NU = Not used	tnt = Thermostat temperature
S05	Relay Output 2	NU = Not used	EPF = Evaporator fan
G42	Fans operating mode	Cn	Adjust to application requirements
G43	Fans stop temperature	0	Adjust to application requirements
G44	Temperature differential avoiding short cycles of fans	2	Adjust to application requirements
G45	Fan On time	1	Adjust to application requirements
G46	Fan Off time	1	Adjust to application requirements
G55	Fan delay after defrost	1	Adjust to application requirements

System EXV			
Parameter	Parameter description	Factory setting	Required setting
A19	Probe 7 configuration	NU = Not used	SLt = Suction line temp
L02	Set of superheating	5	7
S11	EXV configuration	UIN or LIN	SHT = System superheat

Door switch			
Parameter	Parameter description	Factory setting	Required setting
G08	Compressor and fan status when open door	Fn	Fn - Stop fan
R07	Digital input 3 configuration	NU = Not used	DOR = Door
G53	Maximum door open time before alarm	3	Adjust to application requirements
R08	Digital input 3 polarity	Cl = Closed	Adjust to application requirements

Table 31: Additional features for customization

Appendix 7:

R25 = 10kΩ B25/85=3435K

Temp. [°C]	Resistance [kΩ]	Temp. [°C]	Resistance [kΩ]	Temp. [°C]	Resistance [kΩ]	Temp. [°C]	Resistance [kΩ]	Temp. [°C]	Resistance [kΩ]	Temp. [°C]	Resistance [kΩ]
-50	329.2	-21	71.07	8	19.48	37	6.468	66	2.512	95	1.108
-49	310.7	-20	67.74	9	18.70	38	6.246	67	2.437	96	1.080
-48	293.3	-19	64.54	10	17.96	39	6.033	68	2.365	97	1.052
-47	277.0	-18	61.52	11	17.24	40	5.829	69	2.296	98	1.025
-46	261.3	-17	58.65	12	16.55	41	5.630	70	2.229	99	0.999
-45	247.5	-16	55.95	13	15.90	42	5.439	71	2.163	100	0.974
-44	234.1	-15	53.39	14	15.28	43	5.256	72	2.101	101	0.949
-43	221.6	-14	50.95	15	14.68	44	5.080	73	2.040	102	0.925
-42	209.8	-13	48.66	16	14.12	45	4.912	74	1.981	103	0.902
-41	198.7	-12	46.48	17	13.57	46	7.749	75	1.924	104	0.879
-40	188.4	-11	44.44	18	13.06	47	4.594	76	1.870	105	0.858
-39	178.3	-10	42.45	19	12.56	48	4.444	77	1.817	106	0.836
-38	168.9	-9	40.56	20	12.09	49	4.300	78	1.766	107	0.816
-37	160.1	-8	38.76	21	11.63	50	4.161	79	1.716	108	0.796
-36	151.8	-7	37.05	22	11.20	51	4.026	80	1.669	109	0.777
-35	144.0	-6	35.43	23	10.78	52	3.897	81	1.622	110	0.758
-34	136.6	-5	33.89	24	10.38	53	3.772	82	1.577	111	0.740
-33	129.7	-4	32.43	25	10.00	54	3.652	83	1.534	112	0.722
-32	123.2	-3	31.04	26	9.632	55	3.537	84	1.492	113	0.705
-31	117.1	-2	29.72	27	9.281	56	3.426	85	1.451	114	0.688
-30	111.3	-1	28.47	28	8.944	57	3.319	86	1.412	115	0.672
-29	105.7	0	27.28	29	8.622	58	3.216	87	1.374	116	0.656
-28	100.4	1	26.13	30	8.313	59	3.116	88	1.337	117	0.641
-27	95.47	2	25.03	31	8.015	60	3.021	89	1.301	118	0.626
-26	90.80	3	23.99	32	7.725	61	2.928	90	1.266	119	0.611
-25	86.39	4	22.99	33	7.455	62	2.838	91	1.233	120	0.597
-24	82.22	5	22.05	34	7.192	63	2.752	92	1.200		
-23	78.29	6	21.15	35	6.941	64	2.669	93	1.169		
-22	74.58	7	20.30	36	6.699	65	2.589	94	1.138		

Table 32: B7 AI7 optional sensor >> Resistance / temperature curve

Appendix 8: List of tables and figures

Tables

Table 1: Qualified refrigerants and oils	3
Table 2: BOM history	4
Table 3: Compressor models cross reference	4
Table 4: Condenser fans technical data	5
Table 5: Legend of the P&I diagram for ZXME units	6
Table 6: Legend of the P&I Diagram for ZXLE units	7
Table 7: Legend of the P&I diagram for ZXDE units	8
Table 8: Prearranged additional connections.....	11
Table 9: Room thermostat external parameters	12
Table 10: External temperature sensor – Parameters.....	13
Table 11: Defrost parameters.....	14
Table 12: LED functions description	16
Table 13: Display visualisation	16
Table 14: Single commands.....	16
Table 15: Double commands	16
Table 16: Programming level 1 parameters	17
Table 17: Fast access menu	18
Table 18: Parameters in Pr1	18
Table 19: Minimum cut-out value for pumpdown	19
Table 20: Pumpdown 1	19
Table 21: Pumpdown 2	20
Table 22: Pumpdown 3	21
Table 23: How to check the alarm list.....	23
Table 24: Weights.....	26
Table 25: Maximum operating currents for cable selection	27
Table 26: Maximum distance between 2 clamp supports.....	28
Table 27: Overview of the ZX unit components	36
Table 28: Parameters level 1	38
Table 29: Parameter list level 1 (Pr1) & 2 (Pr2)	54
Table 30: Alarm code overview	58
Table 31: Additional features for customization	62
Table 32: B7 AI7 optional sensor >> Resistance / temperature curve	63

Figures

Figure 1: Nomenclature ZX units..... 3

Figure 2: ZX unit housing 5

Figure 3: P&I diagram for ZXME units 6

Figure 4: P&I diagram for ZXLE units 7

Figure 5: P&I diagram for ZXDE units..... 8

Figure 6: Electronic controller..... 9

Figure 7: XCM25D controller functionality overview..... 10

Figure 8: Prearranged additional connections..... 11

Figure 9: External temperature sensor – Functionality 12

Figure 10: Local display 15

Figure 11: Pumpdown functionality with temperature sensor 20

Figure 12: Emerson "Hot Key" 22

Figure 13: Location of "Hot Key" plug connection 22

Figure 14: Dimensions of models ZXME020E, ZXME025E, ZXME030E & ZXME040E and models ZXLE020E, ZXLE030E & ZXLE040E (single-fan units)..... 25

Figure 15: Dimensions of models ZXME050E, ZXME060E, ZXME075E, ZXDE040E, ZXDE050E, ZXDE060E, ZXDE075E, ZXLE050E, ZXLE060E & ZXLE075E (dual-fan units)..... 25

Figure 16: Transport and storage 26

Figure 17: Brazing - Sectional view 29

Figure 18: Suction tube brazing areas 29

Figure 19: Fixing dimensions and distances - Single-fan unit..... 30

Figure 20: Fixing dimensions and distances – Dual-fan unit 31

Figure 21: Service valves for refrigerant charging..... 32

Figure 22: Liquid line service port..... 33

Figure 23: Wiring diagram..... 38



BENELUX

Josephinastraat 19
NL-6462 EL Kerkrade
Tel. +31 77 324 02 34
Fax +31 77 324 02 35
benelux.sales@emerson.com

UK & IRELAND

Unit 17, Theale Lakes Business Park
Reading, Berkshire RG7 4GB
Tel: +44 1189 83 80 00
Fax: +44 1189 83 80 01
uk.sales@emerson.com

BALKAN

Selska cesta 93
HR-10 000 Zagreb
Tel. +385 1 560 38 75
Fax +385 1 560 38 79
balkan.sales@emerson.com

GERMANY, AUSTRIA & SWITZERLAND

Senefeldler Str. 3
DE-63477 Maintal
Tel. +49 6109 605 90
Fax +49 6109 60 59 40
ECTGermany.sales@emerson.com

SWEDEN, DENMARK, NORWAY & FINLAND

Norra Koxåsvägen 7
SW-443 38 Lerum
Tel. +46 725 386486
nordic.sales@emerson.com

UKRAINE

Kurenevskiy lane, 12, build. A, office 302
UA-04073 Kiev
T +38 044 492 99 24 Ext. 232
F +38 044 492 99 28
Andrey.Gladchenko@emerson.com

FRANCE, GREECE & MAGHREB

8, Allée du Moulin Berger
FR-69134 Ecully Cédex
Tel. +33 4 78 66 85 70
Fax +33 4 78 66 85 71
mediterranean.sales@emerson.com

EASTERN EUROPE & TURKEY

Pascalstr. 65
DE-52076 Aachen
Tel. +49 2408 929 0
Fax +49 2408 929 525
easterneurope.sales@emerson.com

ROMANIA

Tel. +40 374 13 23 50
Fax +40 374 13 28 11
Ancuta.Ionescu@Emerson.com

ITALY

Via Ramazzotti, 26
IT-21047 Saronno (VA)
Tel. +39 02 96 17 81
Fax +39 02 96 17 88 88
italy.sales@emerson.com

POLAND

Szturmowa 2
PL-02678 Warsaw
Tel. +48 22 458 92 05
Fax +48 22 458 92 55
poland.sales@emerson.com

MIDDLE EAST & AFRICA

PO Box 26382
Jebel Ali Free Zone - South, Dubai - UAE
Tel. +971 4 811 81 00
Fax +971 4 886 54 65
mea.sales@emerson.com

SPAIN & PORTUGAL

C/ LLull, 321 (Edifici CINC)
ES-08019 Barcelona
Tel. +34 93 412 37 52
Fax +34 93 412 42 15
iberica.sales@emerson.com

RUSSIA & CIS

Emerson LLC
Dubininskaya str. 53, build. 5, 4th floor
115054 Moscow, Russia
Phone: +7 (495) 995 95 59
Fax: +7 (495) 424 88 50

ASIA PACIFIC

Suite 2503-8, 25/F., Exchange Tower
33 Wang Chiu Road, Kowloon Bay
Kowloon, Hong Kong
Tel: +852 2866 3108
Fax: +852 2520 6227

For more details, see www.emersonclimate.eu

Connect with us: facebook.com/EmersonClimateEurope



Emerson Climate Technologies - European Headquarters - Pascalstrasse 65 - 52076 Aachen, Germany
Tel. +49 (0) 2408 929 0 - Fax: +49 (0) 2408 929 570 - Internet: www.emersonclimate.eu

The Emerson Climate Technologies logo is a trademark and service mark of Emerson Electric Co. Emerson Climate Technologies Inc. is a subsidiary of Emerson Electric Co. Copeland is a registered trademark and Copeland Scroll is a trademark of Emerson Climate Technologies Inc. All other trademarks are property of their respective owners. Emerson Climate Technologies GmbH shall not be liable for errors in the stated capacities, dimensions, etc., as well as typographic errors. Products, specifications, designs and technical data contained in this document are subject to modification by us without prior notice. Illustrations are not binding.
© 2015 Emerson Climate Technologies, Inc.

