

earlswood

SUPPLIES LTD



———— CATALOGUE - Edition 21 ————

SADDLERS

carrimore

surefoot

Welcome to our Version 21 catalogue

Packed full of innovative products

our unique range allows you to fulfil your customers hardware and equipment requirements in full, on time, every time.

Knowledgeable operators

are on hand 07:00 – 16:45 hrs Monday – Friday offering industry leading customer service, product knowledge and fast bespoke quotations.

Our New Website

allows you to access live stock availability and to place orders 24/7

Sales: **01295 758734**
Email: **sales@earlswoodsupplies.com**
Web: **www.earlswoodsupplies.com**



SADDLERS

carrimore

surefoot

CONTENTS

SECTION	PRODUCTS	PAGE
ONE	Rubber Matting	5-14
TWO	Wheelbarrows & Tools	15-28
THREE	Buckets & Storage Containers	29-36
FOUR	Stable & Tack Room Equipment	37-56
FIVE	Grooming & Hi Viz	57-72
SIX	Electric Fencing	73-118
SEVEN	Pest Control	119-122
EIGHT	GateMate Hardware	123-136
NINE	Hardware & Gate Fittings (Incorporating Security)	137-152
TEN	Smallholder Range	153-159
ELEVEN	Agricultural Products	161-170
TWELVE	Hygiene & Cleaning	171-174
INDEX	Index	175-177
TERMS	Terms & Conditions	178-179



Patura Electric Fencing

...ONE OF THE BEST ELECTRIC FENCING SYSTEMS IN THE WORLD...

When you invest in electric fencing, you'll want to be sure you can depend on it, without question, without fail - whether it's to keep animals in or to keep them out! Already the "system of choice" across Continental Europe, Patura is a respected brand with an enviable reputation for practical, efficient yet innovative products.

As part of our ongoing commitment to and investment in our stockists, we offer branded merchandisers free of charge with an initial order over £1,000.

Call your Account Manager today!

Combining the latest technologies and materials with guaranteed quality, reliability and durability, plus German attention to detail from the acknowledged experts in electric fencing.

Patura won't let you down, guaranteed.



GOLD STAMP OF QUALITY

Patura is a German manufacturer of a quality product with outstanding strength and durability.

*Terms and conditions apply, for more information please contact your supplier.



5-YEAR WARRANTY

All Patura products are manufactured to the highest industry standards and this is backed by a no-quibble guarantee policy. All energisers have a 3-year warranty* and some insulators have a 10-year warranty.



surefoot



Rubber Matting

STANBRIDGE STABLE MAT

The Stanbridge stable mat is made from solid rubber with a moulded bubble top surface. Our best selling and most popular stable mat has a wide rib base which allows for easy drainage.

Application: **Stables, Walkways, Horseboxes**



CODE	SIZE MM	WEIGHT KG
4089-1857	1830 x 1220 (6'x4') x 17	35

WYCOMBE STABLE MAT

Manufactured from high quality non-porous solid rubber. The hammer top / tortoiseshell surface makes mucking out and sweeping very easy, with a wide rib base allowing for easy drainage.

Application: **Stables, Walkways, Horseboxes**



CODE	SIZE MM	WEIGHT KG
4091-1857	1830 x 1220 (6'x4') x 17mm	35kg
4093-1857	1830 x 1220 (6'x4') x 10mm	25kg

PREMIUM STABLE MAT

Manufactured to our own pattern and specification, we have created a mat with extremely high abrasion resistant properties. The top surface has a diamond chequer plate finish giving very good grip but still allowing for easy cleaning and sweeping.

Application: **Stables, Walkways, Horseboxes, Horse Walkers**



CODE	SIZE MM	WEIGHT KG
4083-1857	1830 x 1220 (6'x4') x 18mm	40

LOKMAT

Manufactured from high quality non-porous solid rubber, this mat is easy to handle due to its size. It has an interlocking edge on four sides of the mat, allowing any size to be created, preventing gapping, and can be used in areas without walls.

Application: **Stables, Walkways**



CODE	SIZE MM	WEIGHT KG
4090-1227	1220 x 910 x (4'x3') 17mm	20

CONTINUOUS ROLL RUBBER

Hardwearing anti-slip rubber matting - the ultimate for joint-free walkways and horse transporter flooring. Up to 2.4m wide. Hammer blow top with micro rib base.

Application: **Horseboxes, Stables, Walkways**



CODE	SIZE
4110-2407	2.4m x 10mm x 40m. Available cut to length
4110-2417	2.4m x 15mm x 40m. Available cut to length

TUDOR INTERLOCKING MAT

Very high abrasion resistant interlocking mat for the most demanding of areas. Easy clean hammer top and mats will not separate due to interlocking system.

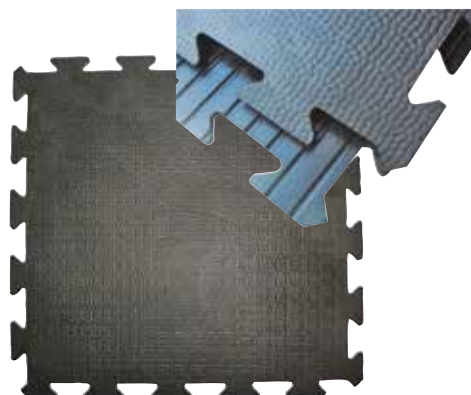

CODE	SIZE MM
4308-1010	1000 x 1000 x 17mm

RUBBERLITE MAT

This unique mat is made from a mixture of rubber and EVA. This gives the lightweight characteristics of EVA but with added durability for long lasting use.

Application: **Stables, Horseboxes**

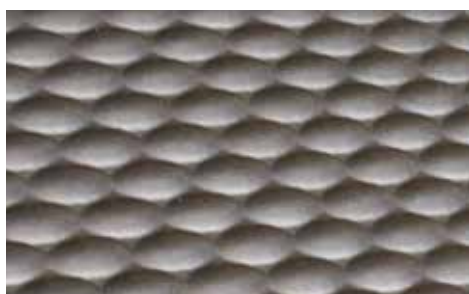

CODE	SIZE MM	WEIGHT KG
4094-0320	1850 x 1200 x 20mm	9

GRANULISTIC LIQUID RUBBER FLOORING

A trowel applied latex rubber flooring that cures to form an impervious hard wearing equestrian flooring. Suitable for veterinary situations, stables, lorries and trailers. Pack coverage 1.8m² @ 12mm thick. Use a spiked roller to finish and seal the surface.

Application: **Stables, Horseboxes**

SPIKED ROLLER

Used to remove air bubbles and help seal and finish the surface of Granulistic Rubber Flooring.



CODE	WEIGHT KG
4097-0907	24
4097-1000	Spiked Roller

DURAFLOOR

Hard wearing rubber matting with a linen surface to provide a lighter weight flooring for single piece trailer and vehicle floors. Rubber top surface with a polyester backing gives exceptional strength and ease of bonding.



CODE

Code 4111-2021C

SIZE

2m wide x 4mm cut to length.

MOULDED RUBBER RAMP MAT

Ribbed ramp mat with integral rubber bars. The superb rib texture offers maximum slip resistance while the integral rubber bars, spaced to conform to DEFRA regulations, are also ribbed to ensure a secure foothold for both horse and handler. The mat is non-absorbent 100% rubber and can be hosed clean in seconds. The premium choice of most horsebox manufacturers. Available in two sizes with the largest mat designed to cover the gap between ramp and lorry.

Application:

Horsebox Ramps



CODE

4100-2257

2.3 x 2.48m (single piece)

4100-2387

2.3 x 2.8m (single piece)

GRIP TOP MATTING

Hard wearing grip-top rubber matting providing excellent grip for all ramps. Available in two widths.

Application: **Horsebox Ramps**

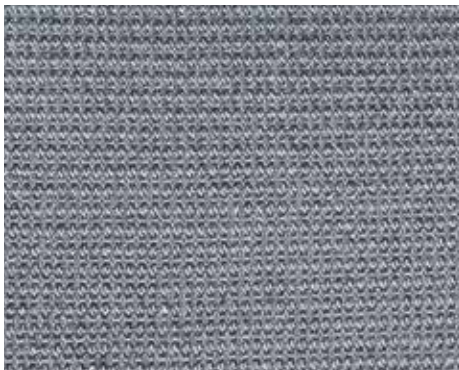

CODE

4105-1507

1.5m wide x 50m. Available cut to length

4106-1207

1.2m wide x 50m. Available cut to length

SIZE

RAMP CARPET

Latex backed ribbed ramp carpet. Stocked in dark grey but other colours available to order. Available in two widths.

Application: **Horsebox Ramps**



CODE

4103-2008

2m wide x 25m. Available cut to length

4104-2009

1m wide x 25m. Available cut to length

SIZE

BROAD RIB RUBBER

An economical ribbed rubber suitable for many applications from ramps to living areas and general walkways.

Application: **Horsebox ramps & General Walkways**



CODE **SIZE**
4107-1207 1.2m x 6mm x 10m. Available cut to length.

FINE RIB RUBBER

Suitable for many applications where low cost, easy clean protection is required.

Application: **Application: Horsebox Ramps, Living Areas & Walkways**



CODE **SIZE**
4108-1207 1.2m x 3mm x 10m. Available cut to length

INSERTION RUBBER

Smooth finish rubber with a cotton insertion for use on partitions and walls.

Application: **Horsebox Partitions**



CODE **SIZE**
4120-1407 1.4m x 5mm x 10m. Available cut to length
4121-1207 1.4m x 3mm x 10m. Available cut to length

RUBBER SHEETING

Smooth finish rubber.

Application: **Horsebox Partitions & Walls**



CODE **SIZE**
4114-1407 1.4m x 10mm x 5m

CLEAR PVC SHEETING

Exceptionally strong clear PVC sheeting for use on horsebox partitions and doorways.



CODE	SIZE
4125-1208	1.2m x 4mm x 10m
4125-1208C	1.2 x 4mm cut to length

EVA WALL BOARDS

Suitable for lining horsebox and stable walls. These lightweight energy absorbing wallboards are of the highest quality and will provide ultimate protection for your horse. Surface finished in a random pattern.

Application: **Horsebox & Stable Walls & Floors**



CODE	SIZE MM	WEIGHT KG
4094-0127	1800 x 1200 x 11mm.	4.5
4094-0167	1800 x 1200 x 15mm	6
4094-0227	1800 x 1200 x 22mm	9

EVA WALL BOARDS – STANDARD QUALITY

Energy absorbing EVA boards with a cross hatch surface pattern.

Application: **Horsebox & Stable Walls**



CODE	SIZE MM	WEIGHT KG
4094-0107	1800 x 1200 x 10mm	4.5
4094-0117	1800 x 1200 x 20mm	9

EVA WALL FIXINGS

Recessed plastic washer. Set includes 1 x stainless steel screw, 1 x plug, 1 x plastic recessed washer.



CODE	DESCRIPTION
4094-1000	s/s screw, plug & recessed washer
4094-1001	Recessed black finishing washer

GROUND RING MAT

The ideal solution for muddy gateways. Free draining perforated mats reduce poaching and create a stable walking surface.

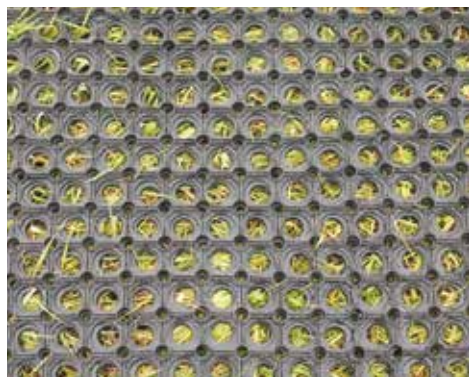

CODE	SIZE MM	WEIGHT KG
4191-1507	1500 x 1000 x 16mm	14
4192-1507	1500 x 1000 x 23mm	18

SUREFOOT RUBBER ADHESIVE

A trowel applied polyurethane adhesive specially suited for gap filling and used widely to bond horsebox floors and ramp mats.

Application: **Horsebox Floor & Ramp bonding.**



CODE	WEIGHT KG
4128-6001	9

SUREFOOT MAT ADHESIVE

Formulated for bonding stable mats, this moisture cure adhesive will foam to fill and seal gaps as it cures.

Application:
**Stable floors –
bond rubber to
concrete.**



CODE	WEIGHT KG
4130-1000	10
4130-2501	22.5

SUREFOOT JOINT SEALANT

Our joint sealer is specially formulated to seal joints around the perimeter and between rubber mats. The 600ml tube has to be used with a barrel applicator gun (available part No 4129-2000).

Application: **Sealing rubber matting
– Horseboxes, Stables etc.**



CODE	SIZE MM
4129-1000	600ml
4129-2000	Sealant Applicator Gun. For 600ml Joint.

BROUGHTON FITNESS MAT

Solid rubber matting suited to the most demanding areas. Ideal for weights training as they protect the floor from heavy weights. Two thicknesses are available.



CODE	SIZE MM	WEIGHT KG
4091-1857	1830 x 1220 x 17mm	35
4093-1857	1830 x 1220 x 10mm	25

GYM FLOOR

1m square tiles which interlock together to form an energy absorbing soft warm floor. Suitable for all workout areas.

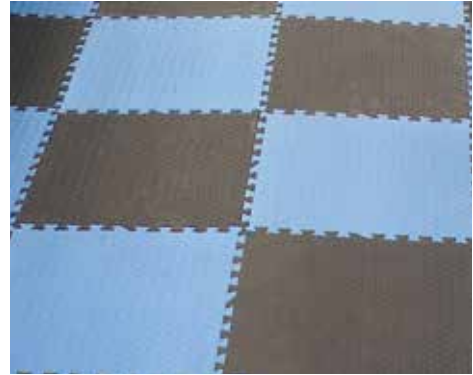

CODE	SIZE MM	WEIGHT KG
4302-1007BL	1000 x 1000 x 20mm	3
4302-1007BK	1000 x 1000 x 20mm	3

RUBBER BRIQUETTES

Interlocking bricks made from thick composite rubber. Specifically developed in extra heavy-duty quality for horse walkers. They provide a higher level of shock absorption with greater slip resistance and are free draining. Choice of red, green or black.

Application: **Horse Walkers**



CODE	FINISH
4089-1000	Red

ULTI-MAT

Hollow top mat ideal for cleaning boots and shoes. Raised design on surface provided for greater traction and ramped edges for non-trip safety. This makes an excellent entrance mat or economical anti fatigue mat for behind a counter.

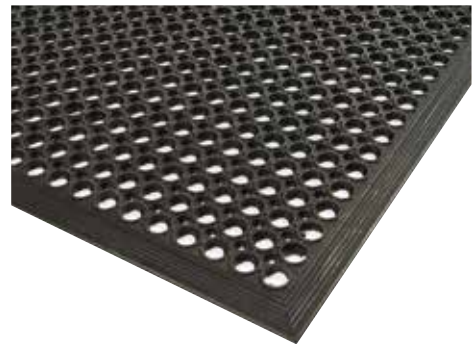

CODE	SIZE MM
4202-1527	910 x 1550mm

MAXI GUARD ENTRANCE MAT

Thousands of rubber bristles clean boots and shoes fast. Exceptionally hardwearing and will not clog with dirt. Ramped edges for non-trip safety.



CODE	SIZE MM
4217-0617	800 x 600mm
4217-1617	1000 x 600mm

GALVANISED BOOT SCRAPER ENTRANCE MAT

A galvanised boot scraper complete with side brushes.



CODE	SIZE MM
4096-1007	1007mm

ANTI-FATIGUE MATTING

ERGO-TRED

The ultimate anti-fatigue mat for behind any counter. Air-cushioned surface is designed to create a comfortable working environment. Heavy duty construction with flexible dome designed surface to reduce fatigue and increase productivity. 5 star rating for comfort.

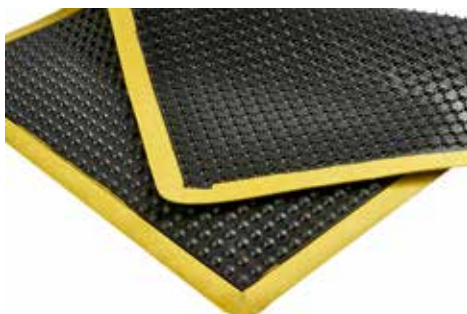

CODE	SIZE MM
4200-2917	900 x 1200 (black with yellow safety border)

FOOT BATH MAT

Ramped edges contain any sanitising solution for boot dipping. The base of our boot dips are constructed with hundreds of rubber bristles which trap dirt and grit and scrub boots clean.



CODE	SIZE MM
4213-1707	700 x 900 x 25mm
4213-2507	980 x 810 x 48mm

DIRT-BUSTER MAT

Heavy duty product that provides an economic upgrade for your entrance. Rubber backing to prevent movement on carpeted surfaces. Absorbs dirt and moisture, considerably reduces your cleaning work and lengthens the life of your floors. Easy to clean and lightweight.



CODE	SIZE MM	FINISH
4210-1507	850 x 1500mm	Black Steel, Black Blue, Black Mink, Granite

LOGO ENTRANCE MAT

Couple the first impression of your company with custom Logo Entrance Mats. We offer in-house graphic design, all that we require is an electronic copy of what you are seeking to promote. Choose up to 8 colours from our huge 30 colour palette to 'show your true colours'. Tough nitrile rubber backing ensures no slipping will occur.



CODE	SIZE MM
4214-1207	850 x 1200mm

carrimore[®]



Wheelbarrows & Tools



PREMIUM JUNIOR WHEELBARROW

High quality children's wheelbarrow with an easy clean polypropylene pan. Supplied flat packed in a display box.

COLOURS AVAILABLE:

CODE **FINISH**
695-0125 Blue, Pink, Green



JUNIOR WHEELBARROW

This specially designed wheelbarrow is ideal for small children. Its all steel construction gives it increased strength and durability whilst being lightweight for children to use. It comes flat packed in a box and is easily assembled, with a solid puncture free wheel.

COLOUR AVAILABLE: 

CODE **FINISH**
695-0100 Red

COLOURS AVAILABLE:



SUPER BARROW

A 90-litre wheelbarrow with a strong single piece black epoxy frame. This wheelbarrow comes with a high-quality polypropylene body available in 4 different colours. An excellent wheelbarrow for light duty general purpose work. Comes as standard with pneumatic wheels and roller bearings. Optional puncture proof wheel available. Available assembled or unassembled – simple assembly, 6 bolts supplied.

CODE	DESCRIPTION	FINISH
695-1090	Unassembled	Blue, Green, Pink, Purple
695-1090A	Assembled	Blue, Green, Pink, Purple
695-9090	Spare wheel	Black
695-9190PP	Puncture proof wheel	Black



ECONOMY BARROW

An 85-litre general purpose wheelbarrow with a durable plated steel pan. Its epoxy black one-piece welded frame gives it a smart attractive appearance. An excellent wheelbarrow for lighter duty requirements. Comes as standard with pneumatic wheels and roller bearings. Optional puncture proof wheel available. Available assembled or unassembled – simple assembly, 6 bolts supplied.

CODE	DESCRIPTION
695-0900	Unassembled
695-0900A	Assembled
695-9090	Spare wheel
695-9150PP	Puncture proof wheel

NEW PRODUCT GENERAL PURPOSE WHEELBARROW

Strong all metal wheelbarrow complete with a puncture proof wheel. 80Litre metal pan general purpose wheelbarrow will handle heavy loads for years. Supplied unassembled.



COLOURS AVAILABLE:



CODE	DESCRIPTION	FINISH
695-0850	Unassembled	Blue, Red, Green

METAL PAN WHEELBARROW

An excellent quality all steel wheelbarrow that will take the toughest of punishment. Its generous size 120 litre pan makes it ideal for use around the stables and yard. It has a single piece welded galvanised frame for increased strength, as well as having a front support for the wheelbarrow body. Comes as standard with a pneumatic wheel and roller bearings. Optional puncture proof wheel is available. Available assembled or unassembled – simple assembly, 7 bolts supplied.



FINISH:
GALVANISED

CODE	DESCRIPTION	FINISH
695-1300	Unassembled	
695-1300A	Assembled	
695-9050	Spare wheel	
695-9150PP	Puncture proof wheel	Black

DUAL WHEEL 120 LITRE STABLE BARROW

Our smallest wheelbarrow with two wheels. The dual wheel design gives increased stability and ease of use for the operator. It has a single piece welded galvanised frame for increased strength, as well as having a front support for the wheelbarrow body. This wheelbarrow has a polypropylene body which is available in 4 different colours. Comes as standard with pneumatic wheels and roller bearings. Optional puncture proof wheels available. Supplied assembled.



COLOURS AVAILABLE:



CODE	DESCRIPTION	FINISH
695-1120	Assembled	Blue, Red, Green, Pink
695-9050	Spare Wheel	Blue, Red, Green, Pink
695-9150PP	Puncture Proof Wheel	Black

STABLE BARROW

Our 120 litre exceptionally versatile wheelbarrow ideal for use in the stables. With a generous capacity of 120 litre, the body design allows it to pass through standard doorways with ease, aided by its exceptional balance. This wheelbarrow comes with a polypropylene body available in 4 different colours. Comes as standard with a pneumatic wheel and roller bearings. Optional puncture proof wheel available.

Available assembled or unassembled – simple assembly, 7 bolts supplied.



COLOURS AVAILABLE:



CODE	DESCRIPTION	FINISH
695-1200	Unassembled	Blue, Red, Green, Pink
695-1200A	Assembled	Blue, Red, Green, Pink
695-9050	Spare wheel	Blue, Red, Green, Pink
695-9150PP	Puncture proof wheel	Black



LARGE CAPACITY WHEELBARROW

With a huge capacity of 160 litre, this is our ultimate single wheel wheelbarrow. Its large capacity makes mucking out just that much easier. This wheelbarrow is perfectly suited around the stables or in the yard. Comes as standard with a pneumatic wheel. Optional puncture proof wheel available. Available assembled or unassembled – simple assembly, 7 bolts supplied.

COLOUR AVAILABLE:



CODE	DESCRIPTION	FINISH
695-1500	Unassembled	Black
695-1500A	Assembled	
695-9010	Spare wheel	
695-9100PP	Puncture Proof Wheel	



TWIN WHEEL BARROW

The most popular wheelbarrow from the Carrimore® wheelbarrow range. It has a huge 200 litre capacity and is superbly balanced by its twin wheels, can be easily tipped and stored upright when not in use.

This improved wheelbarrow now has a full under tray support to increase the strength and durability of the pan, giving you longer life from your wheelbarrow. New upgrades to the wheel bearings now include semi-precision wheel bearings as standard, with a lifetime guarantee. Be sure your wheels will stay on with the new bolted wheel fixture on the axle replacing the split pin fixing. This wheelbarrow comes as standard with pneumatic wheels. Optional puncture proof wheels available. Available assembled or unassembled – assembly requires approximately 30 minutes.



COLOUR AVAILABLE:

CODE	DESCRIPTION	FINISH
695-2000	Unassembled	Blue
695-2000A	Assembled	
695-8000	Spare body	
695-9000	Spare wheel	
695-9100PP	Puncture proof wheel	



SACK TRUCK

Our extendible heavy duty sack truck has pneumatic tyres and a flip down base to carry large items. Ideal for use around the yard or at shows.

COLOUR AVAILABLE:

CODE
695-2200



HEAVY DUTY PLATFORM TROLLEY

Ideal for transporting feed around making light of heavy loads. With a 200KG load capacity this trolley is ideal around the store, warehouse, workshop or yard. A robust tubular steel frame with a wooden platform. Heavy duty 5" casters (2 x swivel and 2 x fixed).

COLOUR AVAILABLE:

CODE **SIZE (MM)**
695-2150 935 x 500 x 955



H2GO BAG

The H2GO bag is a problem solver for the equestrian, allotment, garden and building markets. A way of transporting up to 80 litres of water in a wheelbarrow where there is no hosepipe available. Fitted with a spout and cap which is permanently attached. Comes with an anti-slide mat to prevent the bag from slipping out of the wheelbarrow. Display options available; free standing floor unit holding 32 packs or counter display unit with 12 packs.



CODE	DESCRIPTION
696-1080	H2Go single pack
696-1081	Counter display unit with 12 packs
696-1082	Free standing floor unit with 32 packs



BARROW BAG

Triple the capacity of your wheelbarrow. Made from heavy duty laminated woven polypropylene making the bag durable and mould and rot resistant. Cut the number of trips when using your wheelbarrow with this 270 litre capacity bag. Display options available; free standing floor unit holding 30 packs or counter display unit with 10 packs.



CODE	DESCRIPTION	SIZE
695-2070	Barrow bag	90 x 60 x 50cm
695-2071	Counter display unit with 8 packs	
695-2072	Free standing floor unit with 30 packs	

SADDLERS

FORGED FORKS

Saddlers forged steel forks are exceptional quality with great balancing for easy use. Its forged steel construction gives added strength for the user.

This fork is available with 4 or 5 tines, and in long handle or D-handle with colour options.

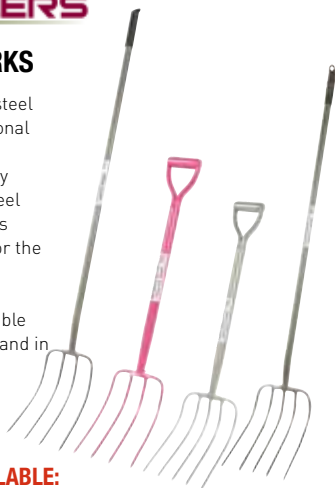

COLOURS AVAILABLE:



CODE	DESCRIPTION	FINISH
679-6110	4 Prong Long Handle	Grey, Pink
679-6120	4 Prong D-Handle	Grey, Pink
679-6150	5 Prong Long Handle	Grey
679-6160	5 Prong D-Handle	Grey

SADDLERS

SHAVINGS FORK

High quality polypropylene head shavings forks. This fork makes mucking out easier due to it being very lightweight.

Its aluminium handle gives it strength yet keeps weight to a minimum. Available in long handle or D-handle with colour options for the heads.

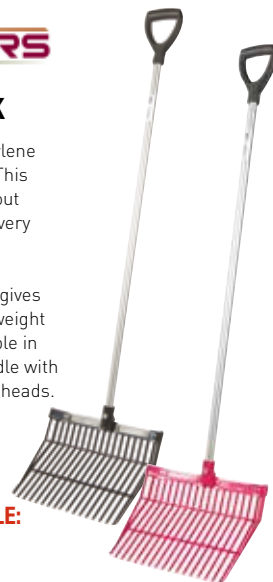

COLOURS AVAILABLE:



CODE	DESCRIPTION	FINISH
674-1021	D-Handle	Black, Pink
674-1521	Long Handle	Black, Pink

SADDLERS**HEAVY DUTY
ECONOMY
SHAVINGS FORK**

This heavy-duty shavings fork has a long wooden handle and a steel head which is galvanised for increased durability.

A good economical option for mucking out which is available to purchase as a complete fork or just the head or handle.



CODE	DESCRIPTION
671-0259	Head & Handle
671-0250	Head only
603-0040	Wooden Handle

SADDLERS**ALUMINIUM
SHOVEL**

An essential tool around the yard and stables. The aluminium shovel has a large blade ideal for scraping and clearing.

It has a fibreglass handle for increased strength and reduction of weight, and a D-handle grip for ease of use. An exceptionally lightweight shovel.

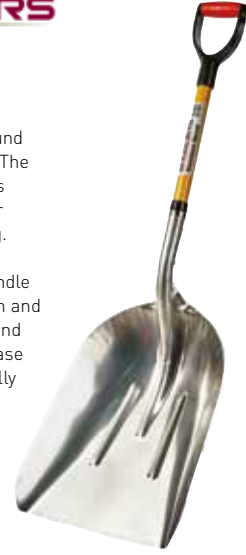

CODE	DESCRIPTION
672-6559	D-Handle

SADDLERS**LARGE
PLASTIC SHOVEL**

A versatile and essential product for use around the stables. With a wide blade and a sturdy wooden handle this shovel is extremely durable.

This shovel is lightweight for easy use.



CODE	DESCRIPTION
672-1009	D-Handle

SADDLERS**YARD SCOOP**

Handling of bedding and waste couldn't be much easier. With a long wooden handle and a lightweight plastic head, this scoop is an extremely versatile tool to have around the stable and yard.

Whether it be clearing bedding or rubbish, this scoop makes the job easier every time.



CODE	DESCRIPTION
673-1509	Long Handle

HAROLD MOORE STANDARD SHOVEL

Self-assembly shovel, standard sized blade with hollow D-grip cone shaft. This shovel is ultra lightweight and easy to handle. A perfect all rounder.



COLOURS AVAILABLE:



CODE	DESCRIPTION	FINISH
670-0309	D-Handle	Red, Orange Lime Green, Yellow

HAROLD MOORE HAND SHOVEL

Hand shovel with small reinforced flared blade and end cap. A must have versatile tool ideal for general stable and yard applications and cleaning small areas such as trailers.



COLOURS AVAILABLE:



CODE	FINISH
670-0019	Magenta, Blue, Red, Orange



SHAVINGS FORK

A trusted popular shavings fork manufactured to high specifications. This fork is engineered to last through its superior quality. It is light, strong and easy to use.

The perfect balance makes mucking out much easier. This fork is suitable for use on multiple types of bedding including; shavings, wood pellets, wood chip, hemp, and paper.

Available in long handle or D-handle.

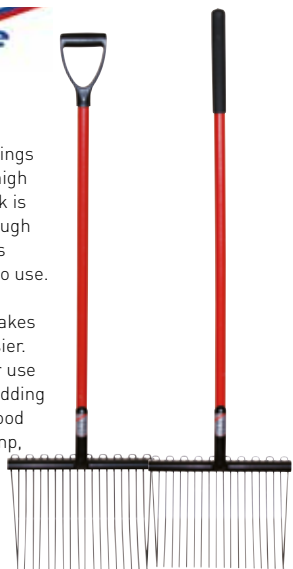

CODE	DESCRIPTION
681-1100	D-Handle - 110cm
681-1200	Long Handle - 120cm



RUBBER MATTING FORK

Rounded tines pick up manure and wet bedding with ease but will not damage the rubber matting in the stable. This fork is perfectly balanced and makes mucking out less back breaking. Tough long-lasting finish handles.

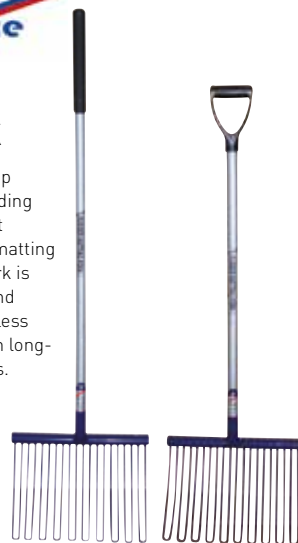

CODE	DESCRIPTION
684-1020	D-Handle
684-1220	Long Handle



PELLET MASTER

Ingenious design traps debris but allows bedding to fall between the tines. The tines are much closer together than the Fynalite Shavings Fork.

Rounded tines pick up manure and wet bedding but will not damage the rubber matting in the stable. It is strong light and easy to use.

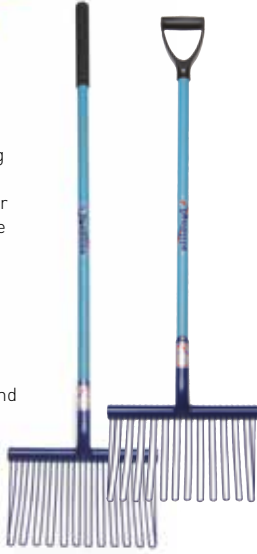

CODE	DESCRIPTION
690-1100	D-Handle
690-1200	Long Handle



SUPER LITE FORK

Many people find that a standard adult stable fork is too long and wieldy and a junior fork is however too short. This fork has been developed to be shorter in length and has a narrower head to reduce the weight. This lightweight fork reduces back strain and makes mucking out a breeze.

Available in long handle.



CODE	DESCRIPTION
686-1200	Long Handle



MULTI MUCKA

The Multi Mucka is designed to work on all bedding types. With sharpened and pointed prongs, it allows bedding to be removed with ease.

This fork is made from high specification lightweight steel and high-carbon spring steel wire tines. It is perfectly balanced and is strong, light and easy to use. It is very well suited to field clean up as the prongs slide easily under debris without becoming clogged with grass.



CODE	DESCRIPTION
683-1010	D-Handle
683-1210	Long Handle



GROOVY FORK

A trusted popular shavings fork manufactured to high specifications. This fork is engineered to last through its superior quality and it is light, strong and easy to use. The perfect balance makes mucking out much easier. This fork is suitable for use on multiple types of bedding including; shavings, wood pellets, wood chip, hemp, and paper.

Available in long handle or D-handle.



CODE	DESCRIPTION
687-1200	Senior - Long Handle
687-7500	Junior - Long Handle



JUNIOR SHAVINGS FORK

A scaled down version of the Fynalite Shavings Fork designed for the younger user. A smaller more appropriate fork meet children's needs allowing them to become more involved and helps establish good stable practise and responsibility for the horse. Available in D-Handle.



CODE	DESCRIPTION
682-7500	D-Handle



MINI MUCKA

This fork is specially designed for the very young users (5 to 8 years). Its special lightweight construction allows children to learn good stable management at an early age.



COLOURS AVAILABLE:



CODE	DESCRIPTION	FINISH
688-7500	Long Handle	Blue, Pink



ASH HANDLE MANURE FORKS

Manufactured with high quality forged high carbon heads which are designed for long life and strength. The fork head is forged out of a single piece of steel resulting in them being less likely to snap, shatter or bend.

Strong wooden ash handles light in weight yet exceptionally strong. Choice of handles available in D or Long. Superbly balanced to ease back strain.



CODE	DESCRIPTION
680-2120	2 Prong Pitch Fork – Long Ash Handle
680-3120	3 Prong Hay Fork – Long Ash Handle
680-4110	4 Prong Manure Fork – Ash D-Handle
680-4120	4 Prong Manure Fork – Long Ash Handle
680-4540	4 Prong Manure Fork – Extra-Long Ash Handle



HI-STRENGTH FORKS

Fynalite Hi-Strength forks have steel heads forged in one piece giving added strength meaning they are less likely to snap, shatter or bend.

The handles are high tensile steel (BS 6323) which is light in weight yet stronger than mild steel, and the handle precision is shaped to fit for extra strength whilst maintaining a superb balance.



COLOURS AVAILABLE:



CODE	DESCRIPTION	FINISH
680-6110	4 prong Manure Fork – Hi-Strength D-Handle	Green, Pink
680-6120	4 Prong Manure fork – Hi-Strength Long Handle	Green, Pink
680-6130	5 Prong Manure Fork – Hi-Strength T Handle	Green



MULTI WEEDA

An exceptional all-round weeding tool. This excellent tool easily removes the most difficult and toxic weeds. Its sharpened prongs dig easily in the ground, even when the ground is hard or stony.

It allows the whole weed to be removed with minimal disturbance to the soil and prevents the need for harmful chemicals.



COLOURS AVAILABLE:



CODE	DESCRIPTION	FINISH
685-0800	T-Handle	Red, Purple, Pink, Blue



ARENA RAKE

Plastic ménage rakes make moving and grading arena spaces an easy task. Single sided head to pull and reshape the surface back into the centre of the arena. This rake is also perfect for use on hay and straw clean up tasks.



CODE
691-1620

YARD / LEAF RAKE

Plastic lightweight leaf rake that is ideally suited for clearing lawns or gravel areas.

It is all plastic construction with 20 tines in the head. An ideal lightweight solution for around the yard or garden.



CODE	DESCRIPTION
691-1220	Plastic

METAL YARD / LEAF RAKE

All metal construction leaf rake that is ideally suited to more demanding clearing up operations.

The metal head has 16 tines with a 1200mm handle. Its comfortable grip allows for heavy use.



CODE	DESCRIPTION
691-1320	Metal

SADDLERS

DUSTPAN & BRUSH

Heavy duty metal dustpan with a quality PVC hand brush to suit. Dustpan and brush are sold separately.



CODE	DESCRIPTION
603-0080	Metal Dustpan
603-0082	PVC Banister Brush to Suit Dustpan

SADDLERS

GENERAL PURPOSE HEAVY DUTY BROOM

For tough sweeping in all conditions, this broom is made in Germany to high specification. It has a plastic head with a metal screw in handle.

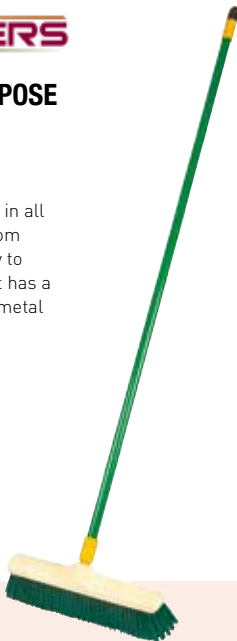

CODE	SIZE
603-0065	40cm

SADDLERS

PVC BROOMS

High quality British made PVC brooms are designed for tough sweeping and cleaning in wet or dry surfaces. The PVC bristles provide a stiff head to remove the most difficult of debris. Available in 13", 18" and 24", all brooms come assembled with a wooden handle and 18" and 24" have a stay.



CODE	SIZE
603-0064	13"
603-0060	18"
603-0062	24"

SADDLERS**BASS BROOM**

British made stiff bass brooms are ideal for using around the stable and yard. Available in 12", 18" and 24", all brooms come assembled with a wooden handle and 18" and 24" have a stay.



CODE	SIZE
603-0030	12"
603-0010	18"
603-0020	24"

SADDLERS**COCO BROOM**

British made, these brooms are filled with natural Coco, this broom is excellent at leaving a clean well swept area. Its soft bristles are ideal for sweeping indoors or on smooth surfaces.

Available in 12", 18" and 24", all brooms come assembled with a wooden handle and 18" and 24" have a stay.



CODE	SIZE
603-0054	12"
603-0052	18"
603-0053	24"

SADDLERS**CORN BROOM**

Traditional style Corn Broom made from natural corn bristles with a wooden handle.



CODE
603-0070

SADDLERS**ALL-PURPOSE BROOM**

Long lasting plastic bristles that provide excellent sweeping qualities. A suitable alternative to corn brooms. Comes with a wooden handle.



CODE	FINISH
603-0072	Assorted Colours

SADDLERS



Feed Buckets & Storage Containers

SADDLERS**3 GALLON STABLE BUCKET**

Our heavy duty stable bucket is not to be confused with inferior alternatives. Will also fit in our bucket holder. Has a moulded spout for easy pouring.

**COLOURS AVAILABLE:**

CODE	DESCRIPTION	FINISH
957-0003	3 Gallon	Black, Blue, Green, Pink, Purple, Red, Yellow

SADDLERS**SUPERBUCKET
3 GALLON**

An exceptional unbreakable quality bucket. This superior bucket will squash but not break and can be returned to its shape. Moulded spout for easy pouring.

**COLOURS AVAILABLE:**

CODE	DESCRIPTION	FINISH
957-0033	3 Gallon	Black, Blue, Green, Pink, Purple, Red

SADDLERS**BUCKET HOLDER HEAVY DUTY**

Two types of bucket holder are available and will suit most types of bucket. Our light duty version is available in a powder-coated finish and the heavy duty version is constructed from thicker material and comes in a galvanised finish. Both versions are available for fixing to a wall or for hooking over.



CODE	DESCRIPTION	FINISH
937-0321	Heavy duty wall fix	Galvanised
938-0321	Heavy duty hook over	Galvanised

SADDLERS**2 GALLON AGRICULTURAL
BUCKET**

A useful size bucket calibrated in gallons and litres.

**COLOURS AVAILABLE:**

CODE	DESCRIPTION	FINISH
957-0002	2 Gallon	Green

SADDLERS**FEED/MIXER BUCKET**

COLOURS AVAILABLE:



CODE	DESCRIPTION	FINISH
959-0008	3 Gallon	Black, Blue, Green, Pink, Purple, Red, Yellow

SADDLERS**FEED / CALF BUCKET**

5 litre flexible bucket



COLOURS AVAILABLE:



CODE	DESCRIPTION	FINISH
957-0022	5 litre	Blue, Green, Red

SADDLERS**12 LITRE GALVANISED BUCKET**

A durable bucket which can be cleaned easily.

FINISH:
GALVANISED

CODE	DESCRIPTION
963-0121	12 Litre

SADDLERS**4 GALLON FLAT SIDED BUCKET**

COLOURS AVAILABLE:



CODE	DESCRIPTION	FINISH
958-0039	4 Gallon	Black, Blue, Green, Red

SADDLERS**MUCK BUCKET**

69 litre bucket with rope handle with a very strong construction for durability.



COLOUR AVAILABLE:



CODE	DESCRIPTION	FINISH
956-0003	69 Litre	Black

SADDLERS**6 GALLON HEAVY DUTY BUCKET**

A very heavy duty bucket for water or mixing feed.



CODE	FINISH
957-0066	White

SADDLERS**RUBBER FEED SKIP**

Durable heavy duty skips made from recycled rubber.



CODE	DESCRIPTION
967-2250	Small 21/4 gallons
967-2500	Large 51/4 gallons

SADDLERS**SUPER SIZE FLEXI CONTAINER**

Ideally suited for water or feed, this container with carry handles is manufactured from the strongest flexible plastic. Use of this material results in no injury risk to animals and exceptionally long life. 50L capacity.



CODE	DESCRIPTION	FINISH
961-1500	50L	Blue

SADDLERS

SUPERTUB

Exclusive range of flexible tubs.

SuperTubs are manufactured from specialist high quality raw material to give them an unrivalled strength/weight/flexibility ratio.



COLOURS AVAILABLE:



CODE	DESCRIPTION	FINISH
961-1123	15 Litre	Black, Blue, Green, Pink, Purple, Red, Yellow
961-1253	25 Litre	Black, Blue, Green, Pink, Purple, Red, Yellow
961-1403	40 Litre	Black, Blue, Green, Pink, Purple, Red, Yellow
961-1753	75 Litre	Black, Blue, Red, Yellow.
961-1273	15 Litre Shallow	Blue. Red.

SADDLERS

HOOK-OVER MANGER

A very popular feeder which will fit over any fence or gate. Durable and strong.



COLOURS AVAILABLE:



CODE	FINISH
917-0399	Black, Blue, Green, Pink, Purple, Red, White

SADDLERS

HOOK-OVER MANGER WITH HANDLE

Similar in design and construction to our standard hook-over manger. This product has the added versatility of a handle.



COLOURS AVAILABLE:



CODE	FINISH
932-0399	Black, Blue, Green, Pink, Purple, Red, White

SADDLERS

CORNER MANGER

Our popular feeder is normally used with a support frame.



COLOURS AVAILABLE:



CODE	DESCRIPTION	FINISH
921-0649	Corner Manger	Blue, Green, Pink, Purple, Red, White
926-0642	Support Frame	BZP

SADDLERS

TYRE BOWL

Our round feeding bowl will fit into any old 14" tyre. Made from strong polyethylene.



COLOUR AVAILABLE:



CODE	FINISH
920-0539	White

SADDLERS

WATER CARRIER

High quality, plastic, stackable water carriers.



COLOURS AVAILABLE:



CODE	DESCRIPTION	FINISH
957-3259	25 litre	Black, Blue, White
957-3309	Tap cap	

SADDLERS

FEEDING BOWL & LID

A sturdy plastic food safe feeding bowl and lid suitable for pets and horses.



CODE	DESCRIPTION	FINISH
957-0020	2 Litre	Grey, Green, Blue
957-0026	6 Litre	Grey, Green, Blue

SADDLERS**28 LITRE PET FEED CONTAINER & LID**

Heavy duty storage container with lid. Ideal for storage of pet and animal feed.

**COLOURS AVAILABLE:**

CODE	DESCRIPTION	FINISH
957-0060	28 Litre	Blue, Green, Pink, Red

SADDLERS**70 LITRE DUSTBIN & LID**

This good quality smaller bin is ideal for storage of feed. Complete with clip on lid.

**COLOURS AVAILABLE:**

CODE	DESCRIPTION	FINISH
957-0070	70 Litre	Black, Blue, Red

SADDLERS**50 LITRE HEAVY DUTY DUSTBIN & LID**

A durable heavy duty small dustbin with clip on lid. Ideal for storage of feed.

**COLOURS AVAILABLE:**

CODE	DESCRIPTION	FINISH
957-0050	50 Litre	Black, Blue, Green, Pink, Purple, Red

SADDLERS**85 LITRE HEAVY DUTY DUSTBIN & LID WITH METAL CLIP HANDLES**

A durable heavy duty dustbin & lid with metal clip handles. Ideal for feeds storage.

**COLOURS AVAILABLE:**

CODE	DESCRIPTION	FINISH
957-0085	85 Litre	Black

SADDLERS**GALVANISED DUSTBIN**

A galvanised dustbin and lid..



FINISH:
GALVANISED

CODE	SIZE (MM)	FINISH
957-1001	600 x 450	Galvanised

SADDLERS**110 LITRE
HEAVY DUTY
DUSTBIN & LID**

A durable heavy duty dustbin with a clip on lid. 110 litre. Ideal for storing feed.



COLOURS AVAILABLE:



CODE	DESCRIPTION	FINISH
957-0090	110 Litre	Black, Blue, Pink, Purple, Red

SADDLERS**GALVANISED INCINERATOR**

A galvanised incinerator and lid.



FINISH:
GALVANISED

CODE	SIZE (MM)	FINISH
957-1101	600 x 450	Galvanised

SADDLERS**WATER CONSERVER / HAY SOAKER**

A strong 110 litre bin complete with a tap. Ideal for soaking hay or use as a water butt.



COLOUR
AVAILABLE:



CODE	DESCRIPTION	FINISH
957-0099	110 Litre	Black

SADDLERS



Stable & Tack Room Equipment

SADDLERS**ANTI-WEAVER GRILLES**

Our anti-weaver grille panels will fit most stable door openings. Each panel is supplied with two sockets and can be easily moved. Available in three sizes. Robust construction from 12 mm rod and galvanised finish.

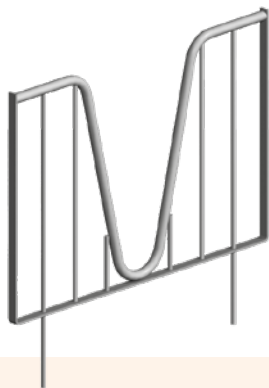

CODE	DESCRIPTION	FINISH
900-0891	890W x 610H (35 x 24)	Galvanised
900-1041	1040W x 760H (41 x 30)	Galvanised
900-1171	1170W x 760H (46 x 30)	Galvanised

SADDLERS**ANTI-WEAVER INFIL PANELS**

Designed to fit the anti-weaver grilles, our infill panels are manufactured to the same quality and are available in two sizes with galvanised finish.

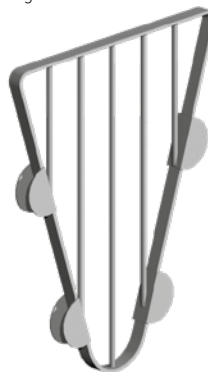

CODE	DESCRIPTION	FINISH
901-0891	Small - fits item 900-0891	Galvanised
901-1171	Large - fits item 900-1041 & 900-1171	Galvanised

SADDLERS**DOOR GRILLES**

These door grilles will effectively enclose a stable. Available in three sizes and supplied with two sockets per grille. They are interchangeable with anti-weaver panels, strong construction and galvanised finish.

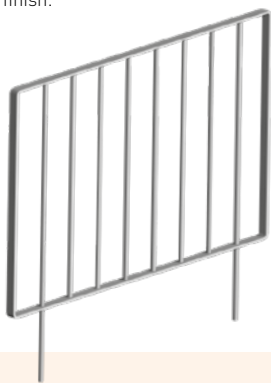

CODE	DESCRIPTION	FINISH
902-0891	890W x 610H (35 x 24)	Galvanised
902-1041	1040W x 760H (41 x 30)	Galvanised
902-1171	1170W x 760H (46 x 24)	Galvanised

SADDLERS**GRILLE SOCKETS**

Additional sockets for securing all of our door grilles. Designed for continuous use and galvanised for good protection.



CODE	FINISH
903-0001	Galvanised

SADDLERS**INTERNAL STABLE GRILLES**

Manufactured to the same specification as the door grilles, our internal grilles are designed for building into a dividing wall between stables. Robust construction with 12mm rods and galvanised finish. Available in three sizes, complete with holes for fixing.

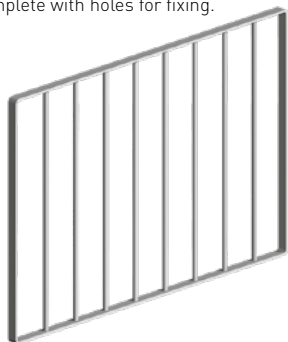

CODE	DESCRIPTION	FINISH
934-0891	890W x 610H (35 x 24)	Galvanised
934-1041	1040W x 760H (41 x 30)	Galvanised
934-1171	1170W x 760H (46 x 30)	Galvanised

SADDLERS**HEAVY DUTY STABLE GRILLES**

Our heavy duty grilles can be used for internal stables, or built into partition walls. Constructed from 22mm diameter bars with narrower spacing than our other grilles for safety. Available in two sizes although other sizes are available for special order. Galvanised finish for durability, complete with fixing holes.

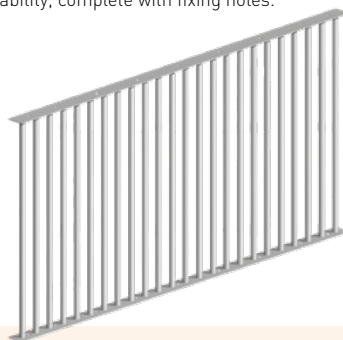

CODE	SIZE MM (INS)	FINISH
941-1221	1215W x 760H (48 x 30)	Galvanised
941-1831	1823W x 760H (72 x 30)	Galvanised

SADDLERS**HEAVY DUTY WALL HAYRACK**

This large traditionally designed hayrack will fit onto any flat surface. Manufactured to the same quality standard as our heavy-duty corner hayrack, galvanised finish for durability.



CODE	SIZE MM	FINISH
904-0761	500H x 760W x 420D	Galvanised

SADDLERS**HEAVY DUTY CORNER HAYRACK**

This robust hayrack will fit into any 90° corner and has a good capacity. Heavy 12mm diameter bars welded to a strong frame in galvanised finish for durability.

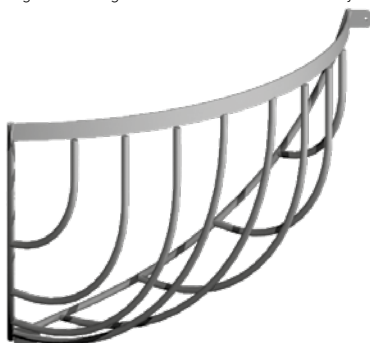

CODE	SIZE MM	FINISH
904-0631	630H x 860W x 530D	Galvanised

SADDLERS**WALL HAYRACK**

Our popular hayrack can be fitted to any flat surface and will suffice for most feeding requirements. Strong mesh construction, supplied with four fixing clips, BZP finish.



CODE 906-0902 **SIZE MM** 500H x 900W x 400D **FINISH** BZP

SADDLERS**CORNER HAYRACK**

A lighter duty but strong hayrack to fit any 90° corner of a stable. Welded wire mesh construction and supplied with four fixing clips. BZP finish for protection.



CODE 905-0872 **SIZE MM** 530H x 870W x 610D **FINISH** BZP

SADDLERS**WALL HAYLAGE RACK**

This angled feeder will fit onto a flat surface. It has a finer mesh like the corner version and comes complete with four fixing clips, in BZP finish.

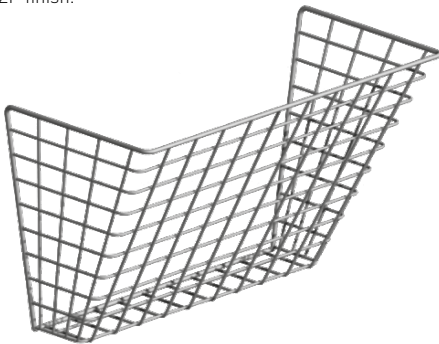

CODE 908-0902 **SIZE MM** 500H x 900W x 400D **FINISH** BZP

SADDLERS**CORNER HAYLAGE RACK**

Our haylage rack has a finer mesh to reduce wastage and is made to the same standard as our corner hayrack. Versatile and functional, this is supplied with four fixing clips, BZP finish.



CODE 907-0872 **SIZE MM** 530H x 870W x 610D **FINISH** BZP

SADDLERS**HAYRACK FIXING CLIPS**

Spare clips for fixing all our standard hayracks.
Packed in a set of four. BZP finish.

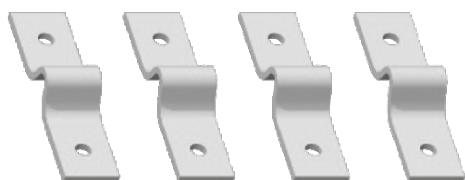

CODE	FINISH
909-0002	BZP

SADDLERS**CORNER FEEDING STATION**

Heavy duty plastic corner feed station that holds a small bale of hay and two buckets for feed or minerals. By incorporating the buckets within the feeding station the risk of trapped hooves, broken buckets and hay wastage are minimised. The feeding station ensures horses eat at a natural level which results in a healthy respiratory system and reduction in the risk of colic. Easy to clean smooth, non-porous surface. Available in horse or pony size. Bucket holders are removable.

CODE	SIZE MM	FINISH
909-0859	Pony (does not hold buckets)	Black, green
909-1209	Horse (buckets not included)	Black, green

SADDLERS**HAY-GRAZE FEEDER**

Reduce hay wastage by up to 50%. Keeps the paddock tidy. Minimise poaching by rotating around the field. Quick & easy to fill. Strong frost resistant plastic. 250L capacity. Alleviated boredom with slower feeding. Use in field, yard or stable. Allows horses to eat at natural level. Ideal for laminitics and horses on restrictive diets.

Size: 110 x 75 x 55 cm.



CODE
909-2209

SADDLERS**BLANKET HANGER & RAIL**

An innovative, versatile and effective rug hanging system allows storage of up to 20 rugs in a compact but accessible way. Its horizontal bars also enable the hanger to be used for smaller items such as Numnahs and Saddle Pads. Galvanised finish.

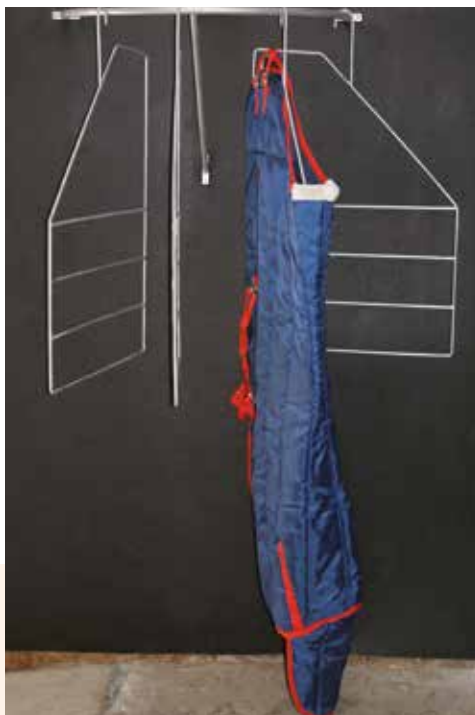

CODE	DESCRIPTION
947-0002	Rail
948-1002	Hanger

SADDLERS**RUG HANGER**

Uniquely designed tubular rug hanging rail can be screwed to a wall in any suitable location. The folding arms make for convenient storage when not in use. Available with three or five arms in the highest quality epoxy finish. An excellent quality British made product.

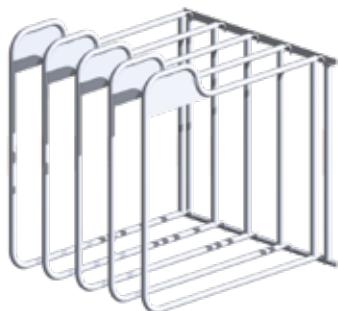

CODE	DESCRIPTION
945-3002	3 Arm
945-5002	5 Arm

SADDLERS**RUG RAIL**

Heavy duty tubular steel rail designed for hanging horse rugs. Steel construction gives it increased strength. Complete with two hanging hooks for extra storage.

**COLOURS AVAILABLE:**

CODE	FINISH
930-0913	Black, Red

SADDLERS**HEAD COLLAR HOOK**

A fixed position heavy duty hook. Its large size makes it an exceptionally useful product.

**COLOURS AVAILABLE:**

CODE **FINISH**
924-0233 Black, Red

SADDLERS**STANDARD HOOK SET**

Set of five standard wall fixed hooks. A general purpose hook ideal for many applications in the stables, tack rooms or horse transporters.

**COLOURS AVAILABLE:**

CODE **FINISH**
943-1003 Black, Red

SADDLERS**BRIDLE RACK**

Heavy duty bridle rack made from steel for added durability. Rounded design for safe storage of bridles, complete with a lip to help prevent the bridle falling off.

**COLOURS AVAILABLE:**

CODE **FINISH**
913-0113 Black, Red

SADDLERS**SADDLE DISPLAY STAND**

Designed to hold a full saddle for display or storage. With three detachable legs, transporting this product couldn't be easier.

A sturdy yet portable design. Available in two sizes, tall or short (short only available in black).

**COLOURS AVAILABLE:**

CODE	DESCRIPTION	FINISH
914-0653	Short	Black
914-0843	Tall	Black, Blue, Pink, Purple, Red

SADDLERS**STANDARD SADDLE RACK**

Fixed position saddle rack that suits almost every need. Complete with a handy hook, it is ideal for hanging tack together. Strong tubular design and support bars give it exceptional durability.

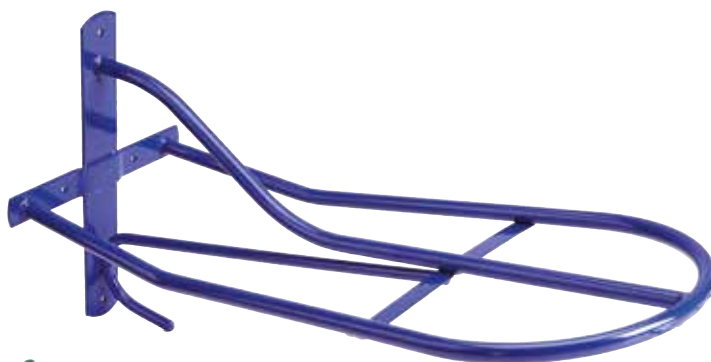
**COLOURS AVAILABLE:****CODE**

912-0543

FINISH

Black, Blue, Green, Pink, Red

SADDLERS**WESTERN SADDLE RACK**

Wall fix saddle rack with extra wide rest for Western Saddles, complete with bridle hanging hook.

**CODE**

912-0653

FINISH

Black

SADDLERS**FOLDING SADDLE RACK**

Superior design folding saddle rack is ideal for displaying saddles face out, reducing wear against the wall. This saddle rack can be folded against the wall when not in use, reducing space giving you added flexibility.

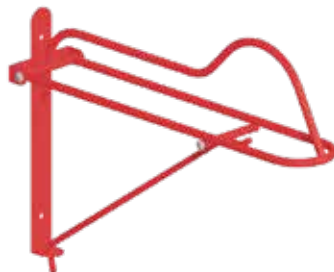
**COLOURS AVAILABLE:****CODE**

925-0583

FINISH

Black, Red

SADDLERS**FOLDING POLE SADDLE RACK**

Simple, sturdy design. The folding pole saddle rack is ideal for use in your stable or horse transporter where space is a premium. The folding pole always stays attached to the wall bracket and cannot be detached when fixed to the wall. When the pole saddle rack is out, it has a very useful bridle hook underneath.

COLOURS AVAILABLE:**CODE****933-0463****FINISH**

Black, Red, Pink, Purple

SADDLERS**HOOK OVER SADDLE RACK**

An extremely versatile saddle rack with two fixed position arms. Its hooks design allows the saddle rack to be placed over a gate or fence and used in an environment where permanent fixing is not available. Complete with a bridle hook underneath for increased versatility.

**COLOURS AVAILABLE:****CODE****940-5403****FINISH**

Black

SADDLERS**CLIP-ON SADDLE RACK**

Extreme practicality with this clip-on design. It is ideal for use in areas where a saddle rack is not always required, and space is limited. It can be removed by simply lifting from its two brackets and storing safely.

With fixed brackets it is easy to put back in place when required. It is available in two versions; two or three arms. The arms are in fixed positions.

**COLOURS AVAILABLE:****CODE****939-4503****DESCRIPTION**

Double Hook

FINISH

Black

939-7003

Triple Hook

Black

SADDLERS**HANDY HANGER**

Useful wherever it is used. With two hooks and four hangers, it can be used almost anywhere; doors, fences, gates etc. Its steel construction gives it exceptional strength.

COLOURS AVAILABLE:**CODE****927-0363****FINISH**

Black, Red

SADDLERS**HELMET HANGER**

Simple design helmet hanger with hook. Designed for storage of helmets and the hook is ideal for holding riding gear.

This can be fixed to any suitable surface using the screw holes provided. Strong steel construction with a durable black finish.

**COLOUR AVAILABLE:****CODE****928-0253****FINISH**

Black

SADDLERS**CLEANING HOOK**

Very versatile three prong cleaning hook for hanging items whilst cleaning. Comes with a hanging eye and can be hung from any suitable location.

**COLOURS AVAILABLE:****CODE****929-0253****FINISH**

Black, Red

SADDLERS**LUGGAGE RACK**

A versatile luggage rack designed for effective storage of products. It is ideally located in horse transporters or tack rooms. This luggage rack comes complete with two hanging hooks for convenient storage of hanging items.

Available in two widths:

Small: 660W x 355D x 330H mm (25x14x13")

Large: 1200W x 355D x 330H mm (48x14x13")

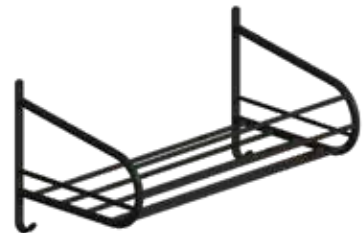
**COLOUR AVAILABLE:****CODE****949-0673****DESCRIPTION**

Small

FINISH

Black

949-1203

Large

Black

SADDLERS

WELLINGTON RACK

Storing wellingtons has never been so easy. Our wellington rack is available in two designs; wall mounted or portable version, suitable for both indoor and outdoor use.

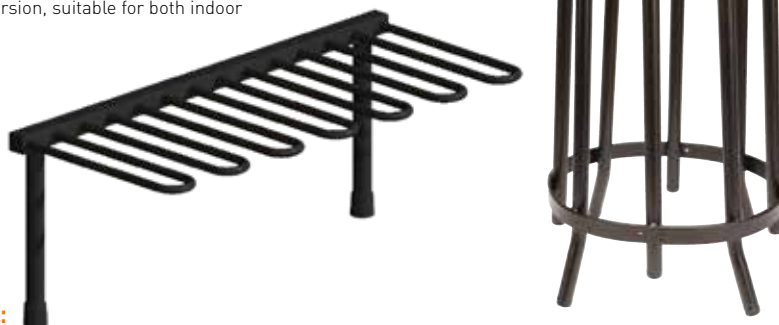

COLOUR AVAILABLE:



CODE	DESCRIPTION	FINISH
950-1003	Wall mounted	Black
950-2502	Portable	Black

SADDLERS

SADDLERS TOOL HOLDER

This tool holder is an original design and is ideal for use where space is minimal. The folding design allows the holder to be flat against the wall when not in use. To use simply slide the tool handle behind the bottom of the hook and the rubber sleeve will grip any tool.



CODE	FINISH
952-1502	BZP

SADDLERS

FUNCTIONAL TOOL HOLDER

Holds up to three tools securely by the handle. Simply place the tool handle in the gap and it is immediately gripped and held in place. To remove the tool, lift the handle back up and the grip will release. 350mm long



CODE	FINISH
952-3502	Plastic

SADDLERS**SCREW IN
TOOL HOLDERS**

A versatile tool holder which can be fixed to any suitable location. The screw in tool holder comes in a pack of 5.



CODE **FINISH**
952-0702 BZP

SADDLERS**BOOT JACK**

Incredibly useful product that ensures removing wellingtons or boots is not difficult. The boot jack comes with a vinyl sleeve to protect the boots.



CODE
969-1023

SADDLERS**MANURE COLLECTOR
AND RAKE SET**

Our high quality moulded manure scoop is complemented by a rake with rear scraper blade. Excellent for use on all types of bedding and all floors including grass. It is manufactured in one piece construction with a PVC grip.

COLOURS AVAILABLE:

CODE **FINISH**
MANURE COLLECTOR AND RAKE SET (TALL)
916-2582 Black, Blue, Green, Pink,
Purple, Red
916-2582PACK Pack of 10 - Assorted colours

CODE **FINISH**
MANURE RAKE (TALL)
915-0802 BZP
MANURE COLLECTOR (TALL)
916-0582 Black, Blue, Green, Pink, Purple, Red

SADDLERS**LARGE MANURE SHAKER & RAKE SET**

Unique design allows fast and easy sorting of dung and bedding / sand/arena surface. High quality, strong plastic tine rake makes clearing up fast, simple and easy.

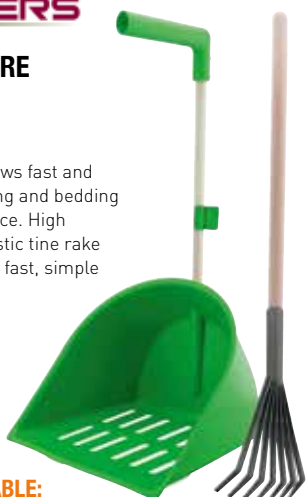
**COLOURS AVAILABLE:****CODE****916-3582****FINISH**

Black, Blue, Green, Red

SADDLERS**JUNIOR MANURE COLLECTOR & RAKE SET**

Manure collector and rake just for kids! Optimal size of the rake and height of the handles were designed so that the filling volume and carrying comfort are perfect for up and coming riders. The plastic rake made from break-proof ABS ensures the Weight is kept low and functionality remains high. Weight 1.2kg, height 60cm.

**COLOURS AVAILABLE:****CODE****916-2283****FINISH**

Blue, Green, Pink

MULTI-PURPOSE KNIFE

10cm long wooden handle & stainless-steel blades. Contains; hoof pick, universal blade, hoof knife, bottle and can opener, and mane blade.

**CODE****637-1200****TRADITIONAL SPRING BALANCE**

Traditional spring balance for quick weight control. Sturdy suspension ring and hook for weighing up to 25kg.

**CODE****825-1250**

HEAVY DUTY SPRAY NOZZLE

High quality metal spray nozzle which is hard-wearing and anti-slip for fatigueless working. Continuously adjustable spray nozzle from fine spray to full water jet. Complete with standardised hose couplings – ½"



CODE
965-1201

4 PIECE HOSE FITTING

Economy hose connector set including; 1 x ½" quick connector with water stop, 1 x ½" quick connector without water stop, 1 x ¾" BSP tap connector, 1 x ½" BSP tap connector and 1 x 100mm spray nozzle with infinite variable spray pattern.



CODE
965-3010

HEAVY DUTY REINFORCED PVC WATER HOSE

Heavy duty PVC water hose with high tensile, polyester cord reinforcement. Highly flexible, kink-resistant with extra thick outer sheath for rugged environments.



CODE **SIZE**
965-2300 30m

SADDLERS

HOSE HOLDER

A useful yard essential for keeping the hose tidy and out of the way. Removes any trip hazards for when the hose is not in use. Strong steel construction with powder coated finish.



COLOURS AVAILABLE:



CODE **FINISH**
946-0223 Black, Red

SADDLERS**PLASTIC FEED SCOOP**

Marked with graduations for accurate measuring.

**COLOURS AVAILABLE:****CODE****919-0009****FINISH**

Black, Blue, Green, Red

SADDLERS**SMALL PLASTIC FEED SCOOP**

A high quality smaller feed scoop. Holds approximately 0.5kg.

**COLOURS AVAILABLE:****CODE****919-0029****FINISH**

Blue, Green, Pink, Purple

PLASTIC STIRRER

This product complements our round bowl scoop. Made from heavy duty material and complete with hanging hook.

**COLOURS AVAILABLE:****CODE****955-0519****SIZE**

Black, Blue, Lime Green, Magenta, Purple, Red, Yellow

PLASTIC ROUND BOWL SCOOP

Plastic scoop is very strong and marked with graduations.

**COLOURS AVAILABLE:****CODE****954-0049****FINISH**

Black, Blue, Green, Pink, Purple, Red, Yellow

SADDLERS**STALL CHAINS**

Rubber coated chain supplied with a clip on each end, it ensures that the horse remains in its stable whilst having access to more fresh air and light.

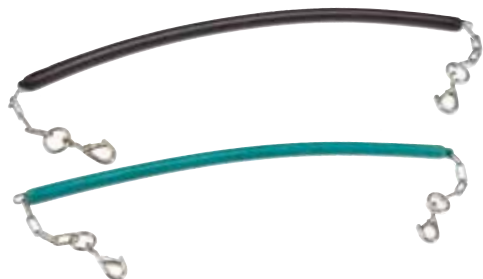
**COLOURS AVAILABLE:****CODE****942-1241****FINISH**

Black, Blue, Green, Red

SADDLERS**BUNGEE TRAILER TIES**

Our trailer tie is 24" long and made from strong bungee cord with a heavy duty bull snap on one end and a quick release clip the other.

**COLOURS AVAILABLE:****CODE****953-5246****FINISH**

Black, Blue, Red, White

CROSS TIE CHAIN

Cross tie chain available in two lengths; 70cm or 140cm. Chain with plastic coating. Comes complete with a carbine hook and a panic hook

**CODE****942-1470****942-1471****DESCRIPTION**

70cm

140cm

SADDLERS**ADJUSTABLE JUMP CUP SUPPORT BARS**

Our U-shaped heavy duty bar can be screwed onto any jump stand. 'Keyhole' slotted holes along the whole length of the support bar enable a jump bar to be positioned at a wide range of different heights. Available in galvanised finish.

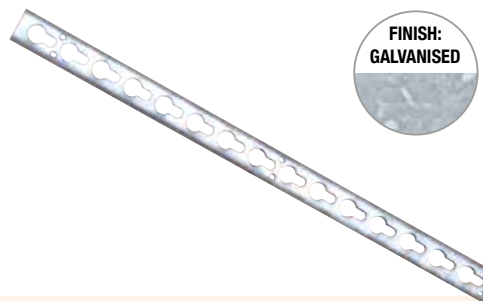
FINISH:
GALVANISED
CODE**256-1521****SIZE**

1520mm

FINISH

Galvanised

SADDLERS**ADJUSTABLE JUMP CUPS**

We offer three versions of jump cups to fit our 256-1521 support bar. Simple and effective, our jump cups are of heavy construction.



CODE	DESCRIPTION	FINISH
256-0001	Adjustable Cup for Round Bar	Galvanised
256-0021	Adjustable Cup for Flat Bar	Galvanised
256-0031	Safety Spring-loaded Adjustable Cup for Round Bar	Galvanised

SADDLERS**SHOW JUMP / DRESSAGE MARKERS**

A wide range of markers are available including numbers, letters, start and finish, as well as spare self adhesive labels. All are good quality and strong construction.



CODE	DESCRIPTION
931-0693	Show jump number markers (1 - 12)
931-0793	Dressage markers (A,B,C,E,F,H,K,M)
931-0803	Show jump number markers (R,S,V,P)
931-0813	Show jump number markers (A,B,C,E,F,H,K,M,R,S,V,P)
9931-0993	Show jump start / finish markers

SADDLERS**SALT LICK HOLDER**

A traditional holder manufactured from plastic designed to hold standard brick type salt blocks.

**COLOURS AVAILABLE:**

CODE	FINISH
922-0123	Black, Red

SADDLERS**SALT LICK HOLDER (WIRE TYPE)**

Our wire formed holder will retain a salt block securely and can be fixed anywhere.

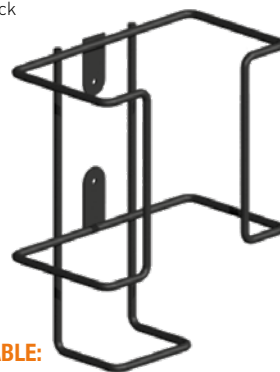
**COLOURS AVAILABLE:**

CODE	FINISH
922-0113	Black, Red

SADDLERS

PURE HIMALAYAN SALT LICK

Saddlers Pure Himalayan Salt Licks provide the essential minerals Sodium and Chloride, which are often short in diets of working horses. Salt (Sodium Chloride) is such an important mineral for good health that horses seek it out if they are short. Therefore, offering a block is a good way to ensure they can help themselves to what they need. One of the purest, most natural sources of salt available, the Himalayan blocks are mined out of the ground at the foot hills of the Himalayan mountains. The blocks are 550 million years old, a completely natural source of salt for your horse.

The blocks are very hard so they won't crumble and the horse will not be able to bite off large chunks as they may do with pressed salt blocks. The hardness also makes them more resistant to rain so they can be hung in the field. Saddlers Pure Himalayan Salt Licks contain mostly salt, with a small amount of other essential minerals including magnesium, potassium and iron.



CODE	SIZE	BOX QTY
6008-100	1kg	12
6008-110	3kg	6
6008-120	5kg	4

HAY BALL

Playfully promotes slow and horse-friendly roughage intake. The ball is suitable for use in stables or pastures. Contains 19 x 70mm food openings to ensure sufficient food supply. Durable UV-resistant plastic. Holds up to 3kg of hay. 40cm diameter / 1.7kg empty weight. Filling opening 116mm, secured with a screw cap.



COLOURS AVAILABLE:



CODE	FINISH
980-2700BL	Blue
980-2700PK	Pink
980-2700PP	Purple
980-2700RD	Red

EQUINE PLAY BALL

Made from hard-wearing, robust but soft material. The ultimate ball to relieve boredom and stress.



COLOURS AVAILABLE:



CODE	SIZE	FINISH
980-2600	25cm diameter	Blue, Red

SADDLERS

STUD CARD HOLDER

Securely displays horse details on stable door. The card is reversible and comes in a PVC wallet for durability. Spare cards are available.



COLOURS AVAILABLE:



CODE	SIZE	FINISH
923-0103	Small	Black, Red
923-0153	Large	Black, Red
923-0175	Small replacement cards	
923-0205	Large replacement cards	

DRINKING BOWLS

We offer two types of drinking bowls. Both are self filling with a float switch. Easy to install. Available in Galvanised or Plastic.



CODE	SIZE	FINISH
968-1001	2.5L	Galvanised
968-2009	4L	Plastic

TACK CABINET

High quality saddle cabinet, comes flatpack for simple assembly. Made from sendzimir galvanised sheet steel. Comes with a storage compartment, 2 saddle hooks, and hook and holder. Cabinets are lockable, air vented and stackable. The small size does not contain saddle hooks or hook and holders. This is an ideal attachment to the medium or large tack cabinet.



CODE	DESCRIPTION	SIZE
966-6000	Small	60 x 60 x 60cm
966-6001	Medium	60 x 60 x 106cm
966-6002	Large	60 x 60 x 150cm

SADDLERS

LEAD ROPE

An essential piece of tack for use anywhere, our lead ropes are high quality and have either a Walsal or Trigger clip on one end. Available in random colours.



CODE	SIZE M	FINISH
953-3006	2m long	Cotton, two tone
953-3056	2.25m long	Extra thick soft touch acrylic

SADDLERS**STANDARD HAYNET**

Large 42" haynet available with standard or small size mesh. They have top rings for long life and easy opening.

**COLOURS AVAILABLE:**

CODE	DESCRIPTION	FINISH
953-5003	42" Standard Hole	Black, Dark Green, Purple, Red
953-6006	42" small hole.	Black, Bright Green, Navy, Dark Green, Pink, Purple.
953-6306	30" small hole	Black, Red, Royal Blue.

SADDLERS**EXTRA STRONG HAYNET**

These haynets have an extra thick hanging rope with metal rings top and bottom for extra long life and ease of use. Available with standard and fine mesh.

**COLOURS AVAILABLE:**

CODE	DESCRIPTION	FINISH
953-7006	Standard hole	Black, Red, Royal Blue
953-8006	Small hole	Black, Red, Royal Blue

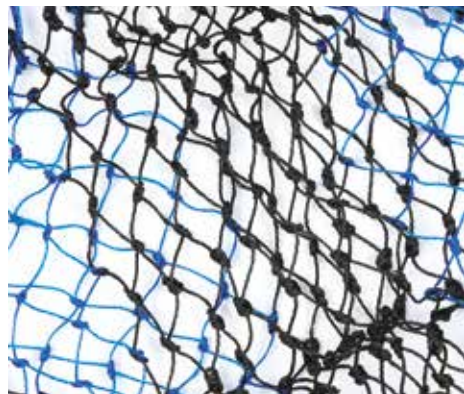
SADDLERS**HAYLAGE NET**

CODE	DESCRIPTION	FINISH
953-6056	Large 42"	Blue/Black, Red/ Black
953-6356	Medium 30"	Black, Royal Blue, Red
953-8356	Extra Strong Medium 30"	Green, Purple, Royal Blue

LARGE RECTANGULAR HAYNET

- Extremely strong and durable
- Use indoors and outdoors
- 3cm x 3cm mesh promotes slow feeding



CODE	SIZE
953-9010	90 x 60cm
953-9030	120x90cm
953-9020	160 x 100cm



Grooming Products & High Viz

GRIPPEE DANDY BRUSH

Multi coloured overmoulded dandy brush with polypropylene fill. The back is made of a combination of plastic and rubber giving superb grip and making the brush very comfortable on the hands. Available in packs of 6 assorted colours



CODE **SIZE MM**
633-1026 175 x 55, 55 trim

GRIPPEE BODY BRUSH

Multi coloured overmoulded body brush with polypropylene fill and matching woven strap. The back is made of a combination of plastic and rubber giving superb grip and making the brush easy and comfortable to use. Available in packs of 6 assorted colours.



CODE **SIZE MM**
633-2026 175 x 75, 30 trim

GRIPPEE BUCKET BRUSH

The ultimate multi coloured bucket brush with polypropylene fill is angled to get into the corners of the bucket. The brush is overmoulded with rubber making it soft on the hands and easy to grip. Available in packs of 6 assorted colours.



CODE **SIZE MM**
633-3026 260 x 65, 47-40 wedge trim

BEASTIE DANDY BRUSH

Multi coloured very hard wearing Beastie dandy brush. Plastic back filled with fine flexible polypropylene. Available in packs of assorted colours.



CODE **DESCRIPTION** **SIZE MM**
634-1016 Pack of 12 brushes Mini: 159 x 60, 40 trim
634-1026 Pack of 8 brushes Large: 210 x 65, 45 trim

BEASTIE BODY BRUSH

Multi coloured durable Beastie body brush. Plastic back, hardwearing PVC fill and woven strap. Available in packs of 12 assorted colours.



CODE
634-2016

QUANTITY
173 x 76, 27 trim

SWEAT SCRAPER



CODE
636-1015

SOFT TOUCH HOOF PICK

Coloured hoof pick with hanging loop.



CODE
632-2620

COLOUR
Assorted colours

BUCKET BRUSH

Bucket Brush with bassine bristles.



CODE
622-0020

HOOF OIL BRUSH

Traditional hoof oil brush. Plastic handle with hanging hole filled with white bristle.



CODE **SIZE MM**
632-1620 162

COVALLIERO RANGE**COVALLIERO BODY BRUSH**

Non-slip plastic back with elastic wrist loop. Polypropylene plastic bristles.



CODE **SIZE**
623-2010 17 x 8cm, 3cm trim

COVALLIERO HORSE HAIR BODY BRUSH

Non-slip plastic back with elastic wrist loop. Horsehair bristles.



CODE **SIZE**
623-2011 17 x 8cm, 3cm trim

COVALLIERO DANDY BRUSH

Non-slip plastic back with polypropylene plastic bristles.



CODE **SIZE**
623-2012 18 x 5cm, 4cm trim

COVALLIERO HOOF PICK WITH BRUSH

Made of robust plastic with metal scraper and cleaning brushes made from polypropylene bristles.



CODE
623-2014

COVALLIERO CURRY COMB

Made of robust plastic with nylon wrist loop.



CODE **SIZE**
623-2013 16 x 11cm

LILLI STARLIGHT BODY BRUSH

Non-slip plastic back with elastic wrist loop.
Polypropylene plastic bristles.



CODE
623-3010

LILLI STARLIGHT HORSE HAIR BODY BRUSH

Non-slip plastic back with elastic wrist loop.
Horsehair bristles.



CODE **SIZE**
623-3011

LILLI STARLIGHT DANDY BRUSH

Non-slip plastic back with polypropylene plastic bristles.



CODE
623-3012

LILLI STARLIGHT HOOF PICK

Made of robust plastic with metal scraper and cleaning brushes made from polypropylene bristles.



CODE
623-3014

LILLI STARLIGHT CURRY COMB

Made of robust plastic with nylon wrist loop.



CODE
623-3013

MAGIC BRUSH SOFT

Care brush ideal for sensitive areas of ponies and horses. Ultra-soft Quadro bristles clean gently leaving a great shine. Individually packed.



CODE	DESCRIPTION
635-1420	White Lilly
635-1421	Turquoise

MAGICBRUSH

MAGICBRUSH

- Magic brushes 3 in a box
- Cleanses
- Massages
- Grooms
- Ideal for use with cases of moulting
- Removes horse hair and dirt effortlessly from riding clothes, saddlecloths and riding boots



CODE	DESCRIPTION
635-1314	Starlight
635-1315	Water Lilly
635-1318	Classic

KBF99



The new range of KBF99 products brings a revolution to Horse Health Care. KBF99 will assist in the prevention of infection and reinfection of these troublesome and painful diseases. Laboratory tests resulted in KBF99 material killing 99% of the bacteria test culture.

Any reduction of harmful bacteria and fungus in the stable environment assists in reducing the chances of the diseases being transmitted from horse to horse. The KBF99 product range has been developed to help protect and safeguard horses and in some cases humans from contracting these and other conditions.

BODY BRUSH



CODE
636-1010

DANDY BRUSH



CODE
636-1011

HOOF BRUSH



CODE
636-1013

MANE & TAIL BRUSH



CODE **SIZE**
636-1014 180 x 65mm

SWEAT SCRAPER



CODE
636-1015

JUMBO GROOMING BOX

The ultimate grooming box, large enough to store all care utensils including high bottles. Can be locked with a padlock. Accessories not included.



COLOURS AVAILABLE:



CODE

966-2034

FINISH

Red/ Black, Blue/Black

TACK BOX - LARGE

A high quality, strong tack box complete with divider, tray and hoof oil brush holder. (Accessories not included).



COLOURS AVAILABLE:



CODE

966-2033

FINISH

Grey/Pink, Dark Blue.

TACK BOX - MEDIUM

Strongly constructed tack box large enough to store all the essential grooming equipment. Comes complete with tack tray and hoof oil brush holder.

Accessories not included.

**COLOURS AVAILABLE:****CODE****966-2023****FINISH**

Navy/Light Blue. Grey/Pink. Dark blue

TACK BOX - STANDARD

Strong tack box with double clip lid and split insert to allow bottles to be stored standing up.

Accessories not included.

**COLOURS AVAILABLE:****CODE****966-2024****FINISH**

Black/Pistachio. Black/Fuchsia

ALUMINIUM TACK BOX

Lightweight aluminium construction for effortless carrying and comes with a carrying strap. Reinforced corners, lockable clips and comes with keys. Foam padding throughout the inside.



CODE **SIZE**
966-3003 40 x 30 x 30cm

TACK TRAY

Solid plastic tack tray with smooth edges and comfortable hand grip.



COLOUR AVAILABLE:



CODE **SIZE MM**
635-1400 400 x 300 x 135

TACK CABINET

High quality saddle cabinet, comes flatpack for simple assembly. Made from sendzimir galvanised sheet steel. Comes with a storage compartment, 2 saddle hooks, and hook and holder. Cabinets are lockable, air vented and stackable.

The small size does not contain saddle hooks or hook and holders. This is an ideal attachment to the medium or large tack cabinet.



FINISH:
GALVANISED

CODE	DESCRIPTION	SIZE
966-6000	Small	60 x 60 x 60cm
966-6001	Medium	60 x 60 x 106cm
966-6002	Large	60 x 60 x 150cm

SEALING TAPE

Sealing Tape is a heavy duty, reinforced tape, designed for holding bandages and poultices in position for prolonged periods. Ideal for use on awkward to access areas and hooves. Individually wrapped, 7.5cm wide, 50cm long, the Sealing Tape is very economical in use.



CODE	PACK QUANTITY
800-0125	Single Roll
800-0126	Pack 16 Rolls

WRAPTEC

The VetSet Wrap Tec is a self-adhering bandage, ideal for holding dressings and providing support during strenuous exercise. Care must be taken when used over padding to avoid restriction to blood flow. Easy to tear, WrapTec will conform to hold dressings securely, allowing movement without slippage. Individually packed to avoid contamination and available in a variety of colours.



COLOURS AVAILABLE:



CODE	SIZE	COLOUR	PACK QTY
800-0085	10 cm	Black, Blue, Red	12 rolls

POLDRESS

PolDress is a highly absorbent, multi-layered and impregnated dressing making it the preferred choice of many veterinarians. PolDress contains a mild anti-septic, Boric Acid, to minimise the risk of infection and promote the healing process. For maximum effect, the PolDress should be impregnated with water. This will activate the Tragacanth, a poulticing agent, which will help draw out infected wounds. Each PolDress poultice is wrapped individually to ensure a clean dressing is immediately available. Use wet or dry, cut to the required size and secure with ElasTec or WrapTec cohesive bandage.



CODE	SIZE	PACK QUANTITY
800-0015	20 x 40 cm	10 dressings

POLDRESS HOOF

The PolDress Hoof Poultice is a highly absorbent, multi-layered and impregnated dressing, made in the same way as the PolDress Poultice Dressing. PolDress Hoof Poultice contains a mild anti-septic, Boric Acid, to minimise the risk of infection and promote the healing process. For maximum effect, the PolDress should be impregnated with water. This will activate the Tragacanth, a poulticing agent, which will help draw out infected wounds. The PolDress Hoof Poultice is packed individually to ensure a clean dressing every time.



CODE	SIZE	PACK QUANTITY
800-0025	Hoof	40 dressings

COMBEE T

ComBee T is a highly absorbent cotton padding covered in a gauze tissue. The ComBee T is the traditional medical grade cotton padding - ideal for protection, insulation and absorbency. ComBee T is known for its insulating properties which cushions and protects wounds from external trauma. The low-adherent surface avoids any wound disruption and prevents contamination from loose fibres or harmful particles. ComBee T can be applied over dressings prior to bandaging or cut to size to be used as a primary wound dressing. Ideal for infected and discharging wounds. Can be autoclave sterilized and used as a protective wound padding for all animals. ComBee T should be cut to the required size and secured with ElasTec or WrapTec cohesive bandage. To avoid pressure points do not overlap or fold.



CODE	SIZE	PACK QUANTITY
800-0055	30 cm	18 rolls
800-0056	45 cm	12 rolls

COTTON WOOL

VetSet Cotton Wool is manufactured specifically for Veterinary use. Premium quality fibres are used to produce this highly absorbent veterinary quality cotton wool, which can be used for a variety of applications, including cleansing and padding.



CODE	SIZE	PACK QUANTITY
800-0035	500 g	15 rolls
800-0036	500 g	1 roll

REFLECTIVE BLANKET

- For a safer ride in low visibility conditions.
- 100% polyester
- Reflective strips
- Saddle notch and broad Velcro fastener at the withers for fixing
- Tail straps for a non-slip fit
- Washable up to 30°C



CODE	SIZE
2100-101	135cm
2100-102	145cm

REFLECTIVE TAIL GUARD

- Bright yellow with reflective stripes
- Fleece lining
- Easy to adjust with Velcro fasteners
- Perfect hold with fastener strap



CODE	SIZE
2100-201	44 x 28cm

REFLECTIVE CHEST STRAP

- For optimal visibility & safety when riding at night
- Increases front visibility

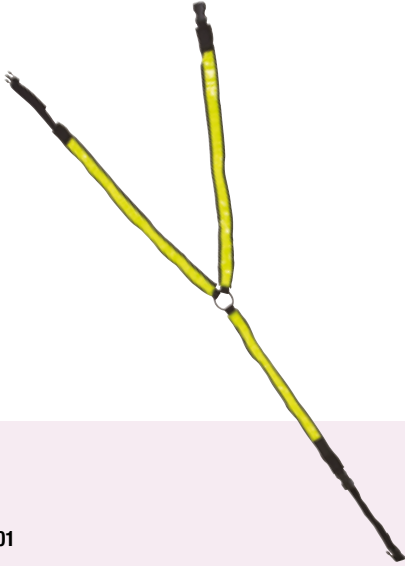

CODE
2100-401



HI-VIS GAITERS

- Highly reflective heavy duty
- Easily adjustable with Velcro fastener
- Additional snap-closure prevents losing the horse straps
- Sold as pairs



CODE	SIZE
2100-301	M
2100-302	L

REFLECTIVE ARMBANDS

- Highly reflective
- Designed to be fixed at the upper arm with Velcro fastening
- Complies with CE-EN 471



CODE
2100-001

patura



Electric Fencing



Patura Electric Fencing

...ONE OF THE BEST ELECTRIC FENCING SYSTEMS IN THE WORLD...

When you invest in electric fencing, you'll want to be sure you can depend on it, without question, without fail - whether it's to keep animals in or to keep them out!

Already the "system of choice" across Continental Europe, Patura is a respected brand with an enviable reputation for practical, efficient yet innovative products.

Combining the latest technologies and materials with guaranteed quality, reliability and durability, plus German attention to detail from the acknowledged experts in electric fencing.

Patura won't let you down, guaranteed.



GOLD STAMP OF QUALITY

Patura is a German manufacturer of a quality product with outstanding strength and durability.

*Terms and conditions apply, for more information please contact your supplier.



5-YEAR WARRANTY

All Patura products are manufactured to the highest industry standards and this is backed by a no-quibble guarantee policy. All energisers have a 3-year warranty* and some insulators have a 10-year warranty.

PATURA HAS A COMPLETE RANGE FOR EVERY NEED



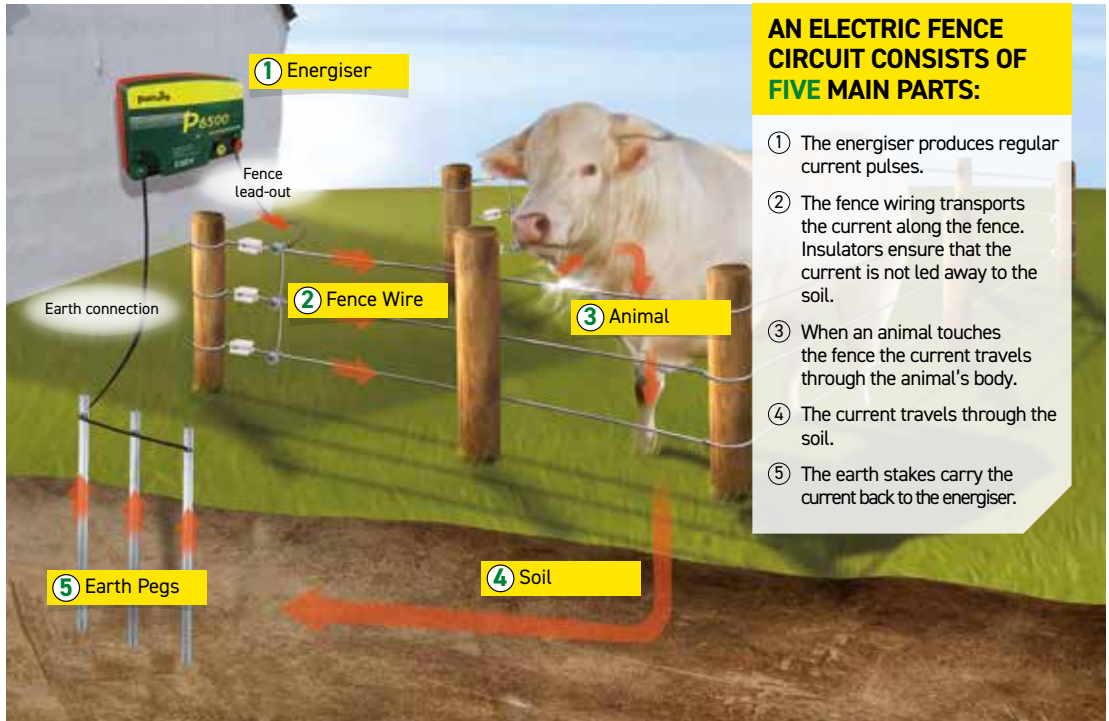

AN ELECTRIC FENCE CIRCUIT CONSISTS OF FIVE MAIN PARTS:

- ① The energiser produces regular current pulses.
- ② The fence wiring transports the current along the fence. Insulators ensure that the current is not led away to the soil.
- ③ When an animal touches the fence the current travels through the animal's body.
- ④ The current travels through the soil.
- ⑤ The earth stakes carry the current back to the energiser.

THE ENERGISER (POWER SOURCE)

An efficient energiser is the foundation of the basic power supply to your electric fence. The output power of an energiser is specified in joules.

Four factors play a crucial role when deciding which energiser to use:

- ① Vegetation load on the fence
- ② Fence length and conductivity of the wire used
- ③ Type of animal
- ④ Whether a permanent or temporary (moveable) system is required

You will find detailed advice regarding the selection of an energiser in the tables for the particular energisers.



ELECTRIC FENCING ENERGISERS & BATTERIES

Choosing the right energiser

In order to simplify the choice of an energiser in any particular circumstance, consider all the following factors.

VEGETATION (WEEDS ETC)

The decisive role in the selection of an energiser is determined by the effect of vegetation at the fence. The high output energy of the PATURA® energisers is used primarily to destroy heavy vegetation at the fence and, despite this vegetation, to maintain a high voltage level at the fence. These are the various vegetation conditions:



No vegetation - no contact between the vegetation and the fence wire



Normal vegetation - the vegetation is often touching the wire



Heavy vegetation - the wire runs completely in vegetation

FENCE LENGTH

After the vegetation, the length of the fence plays the next most important role in the selection of equipment. By fence length we mean not the total length of the individual wires added together, but simply the length of the actual fence itself. Multi-wire fences carry the current better than single strand ones, providing that the wires are connected to each other at regular intervals.

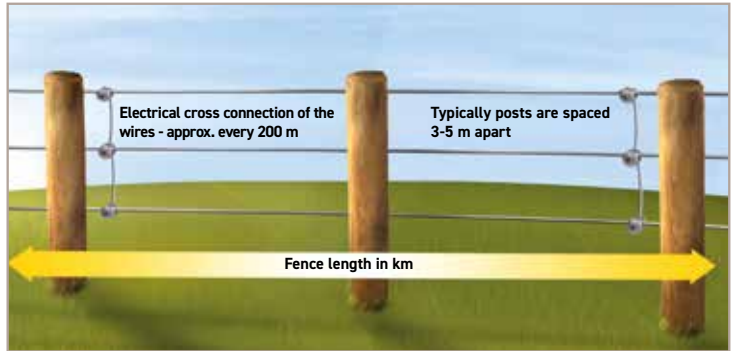

ANIMAL TYPE

The type of animal plays an important role in the selection. With animals that are difficult to contain, such as wild animals, sheep, goats and fowl, powerful equipment should be used. With more easily contained animals, such as cattle, horses, pigs and domestic animals, less powerful equipment is needed for the equivalent length of fencing.

For recommended maximum fence length please refer to the tables for the particular energisers.



Animals that are easy to contain



Animals that are difficult to contain

THE POWER SOURCE

Various power sources are available for powering energisers:

- 230 volts AC from the power outlet
- 12 volts DC from a rechargeable battery
- 12 volts DC from solar cells + battery
- 9 volts DC from non-rechargeable batteries

There are many reasons for choosing an energiser with a mains connection, should such a connection be available: the acquisition price of the energiser is relatively low, the energy costs are extremely low, and the ease of operation is very high. If there is no mains supply available, then the next best alternative is equipment with a 12 volt battery connection. The energy costs are still justifiable, but the maintenance requirement for the recharging of the batteries is nonetheless considerable. In

order to minimise this requirement - at least in the spring to autumn period - we recommend the use of solar panels, especially with the more powerful 12 volt energisers.

The most expensive alternative for powering energisers is the use of 9 volt non-rechargeable dry batteries, which also have to be disposed as special waste when exhausted. The advantage with these energisers is that they are easy to use, but their low power is a disadvantage.

9V Dry-Cell Battery Energisers

PATURA® 9V Dry-Cell Battery Energiser

Battery powered energisers for use with 9V non-rechargeable 'dry-cell' batteries or 12V rechargeable 'wet-cell' batteries. Ideal for use in areas where mains power is not easily available.

DESC	KEY FEATURES	ENERGY OUTPUT (JOULES)	MIN. ORDER Qty	OUTER CARTON Qty	CODE
P20	Great value amongst Patura 9V dry-cell battery energisers; ideal for small cattle and horse pastures. User friendly switch with a single indicator light.	0.17	1	2	P141220
P40	The all round Patura energiser for 9V dry-cell batteries; ideal for cattle and horse pastures with no or little vegetation. Includes battery test, slow pulse sequence, night save mode and half/full power indicator.	0.23	1	2	P141420
P60	Our most powerful energiser using 9V dry-cell batteries; high performance for effective animal control even under load conditions at the fence. Includes battery test, slow mode, night safe mode, and half/full power indicator.	0.33	1	2	P141620
Lead Adaptor Set for 9V Battery Energiser	Adaptor set for connecting all Patura 9V dry-cell battery energisers to 12V battery or mains adaptor.		1	10	P159101



**ALL ENERGISERS
HAVE A 3 YEAR
WARRANTY***

And many other products are covered up to 10 years.



Low Powered Battery Energisers

PATURA® 3V Battery Energiser

This handy little energiser is ideal for light duty work with horses and ponies. It is also suitable for pheasant release pens and for domestic work such as keeping cats out of gardens and herons from fish ponds.

DESC	SUITABLE FOR	ENERGY OUTPUT (JOULES)	MIN. ORDER Qty	OUTER CARTON Qty	CODE
P10	3V Battery	0.04	1	6	P140700

Powered by 2 x D-size 1.5V dry-cell batteries. Max fence length: 800m.



PATURA® 6 or 12V Battery Energiser

The ideal energiser for small horse paddocks, for trekking and for domestic animals.

DESC	SUITABLE FOR	ENERGY OUTPUT (JOULES)	MIN. ORDER Qty	OUTER CARTON Qty	CODE
P30	6 or 12V Battery	0.12	1	8	P140800
P30 + post*	6 or 12V Battery	0.12	1	6	P140900

Powered by 4 x 1.5V internal batteries, D-size or 12V battery.
*Addition of practical mounting post, which under good earth conditions doubles as an earth stake.



Only perfect earthing allows maximum power at the fence

CODE	Stored energy (joules)	Max. output energy (joules)	No-load voltage (volts)	Voltage at 500 ohms (volts)	Max. power consumption at 9V (mA)	Supply voltage (volts)	Max. fence length in km (multiple wires)				Single indicator	3-step fence and battery monitor	Connection to 9 and 12V (*with separate 12 V cable)	Switch for 2 speeds	Switch for 2 power levels	Night save mode	Deep discharge protection	Min. length of earth stake (m)	
							No vegetation	Little vegetation	No vegetation	Little vegetation									
P10	P140700	0.05	0.04	5800	1000	14	3	0.8	0.2	0.4	0.1	•	•	•	•	•	•	•	0.25
P20	P141220	0.22	0.17	8400	2600	24	9-12	1.4	0.5	0.7	0.25	•	•	•*	•	•	•	•	0.25
P30	P140800/900	0.16	0.12	8300	1400	15-27	6-12	1.2	0.4	0.6	0.2	•	•	•	•	•	•	•	0.25
P40	P141420	0.29	0.23	8700	2800	15-29	9-12	1.9	0.75	0.9	0.35	•	•	•*	•	•	•	•	0.25
P60	P141620	0.43	0.33	8700	2900	24-45	9-12	3	1.5	1.5	0.75	•	•	•*	•	•	•	•	0.25

PATURA® energisers comply with all obligatory standards

Particularly in dry subsoil conditions, we recommend the use of a supplementary earth stake (Ref.P161700) in addition to that provided with the energiser.

PATURA® 12V Battery Energiser

Greatest value for money amongst the 12V energisers; for short fences for cattle, horses and domestic animals. Features deep discharge protection for longest possible operating life of the battery.



DESC	SUITABLE FOR	ENERGY OUTPUT (JOULES)	MIN. ORDER Qty	OUTER CARTON Qty	CODE
P100	12V Battery	0.45	1	4	P146100
P200	12V Battery	1.10	1	4	P146200

12 Volt Battery Energisers		Stored energy (joules)	Max. output energy (joules)	No- load voltage (volts)	Voltage at 500 ohms (volts)	Max. power consumption at 12 V (mA)	Supply voltage (volts)	Max. fence length in km (multiple wires)						Fence indicator lights	Battery indicator lights	Day/night switch	Deep discharge protection	2 power levels	Recommended solar panel power output	Recommended battery (min Ah)	No. of 1 m earth stakes (min)
CODE								No vegetation	Normal vegetation	Heavy vegetation	No vegetation	Normal vegetation	Heavy vegetation								
P100	P146100	0.6	0.45	7900	4300	50-70	12	5	2	0	2.5	1	0	-	-	-	•	-	15	60	1
P200	P146200	1.5	1.1	9600	5400	110-155	12	10	3	1	5	1.5	0.5	-	-	-	•	-	15	60	1

Only perfect earthing allows maximum power at the fence

As part of our ongoing commitment to and investment in our stockists, we offer branded merchandisers free of charge with an initial order over £1,000. Call your Account Manager today!



Mains Operated Energisers

PATURA® 230V Mains Energisers

DESC	KEY FEATURES	ENERGY OUTPUT (JOULES)	MIN. ORDER Qty	OUTER CARTON Qty	CODE
P2000	The 230V energiser for short fences with light vegetation for cattle and horses. Includes energiser monitoring indicator.	1.10	1	4	P142000
P4000	Our most powerful 230V energiser for electric fences for cattle, horses and sheep; also for longer fences with heavier vegetation. Includes energiser monitoring indicator.	3.20	1	4	P144040



Only perfect earthing allows maximum power at the fence

230 Volt Mains Energiser		Stored energy (joules)		No-load voltage (volts)		Power consumption (watts)		Supply voltage (volts)			Signal indicator			Multiple fence voltage indicators			MaixPuls technology			Adaptive control			Reduced voltage terminal			Earth monitoring			Remote control option			No. of 1 m earth stakes (min)																				
CODE		Max. output energy (joules)		Voltage at 500 ohms (volts)		Power consumption (watts)		Supply voltage (volts)			No vegetation			Normal vegetation			Heavy vegetation			No vegetation			Normal vegetation			Heavy vegetation			Signal indicator			Multiple fence voltage indicators			MaixPuls technology			Adaptive control			Reduced voltage terminal			Earth monitoring			Remote control option			No. of 1 m earth stakes (min)		
P2000	P142000	1.5	1.1	9900	5400	2.5	230	10	3	1	5	1.5	0.5	•	-	-	-	-	-	-	-	-	-	-	-	-	-	-	-	-	-	-	-	-	1																	
P4000	P144040	5.8	3.2	9900	6100	7.0	230	23	8	3	12	4	1.5	•	-	-	-	-	-	-	-	-	-	-	-	-	-	-	-	-	-	-	-	-	2																	

PATURA® energisers comply with all obligatory standards

Multi-Voltage Energisers

PATURA® Multi-Voltage Energiser

Energisers for use with either mains power or batteries. Supplied with stainless steel connectors and all leadsets.



DESC	KEY FEATURES	ENERGY OUTPUT (JOULES)	MIN. ORDER Qty	OUTER CARTON Qty	CODE
P1	The PATURA® multi-voltage energiser for short fences with light vegetation and domestic animals.	0.50	1	5	P147110
P2	The PATURA® multi-voltage energiser for short fences with light vegetation for cattle and horses.	1.00	1	5	P147210
P3	The PATURA® multi-voltage energiser for electric fences with normal vegetation.	2.00	1	5	P147310
P4	The PATURA® multi-voltage energiser for longer fences with normal vegetation.	3.00	1	5	P147410
P5	The PATURA® multi-voltage energiser for electric fences for cattle, sheep and horses, also for longer fences with heavier vegetation. Includes 230V mains adaptor and 12V adaptor cable.	3.80	1	5	P147500

Energisers for 230 + 12 volts		Stored energy (joules)		Max. output energy (joules)		No- load voltage (volts)		Voltage at 500 ohms (volts)		Power input at 230 V (W)		Max. power consumption at 12 V (mA)		Max. fence length in km (multiple wires)								
CODE		0.7	0.5	8300	4400	1.0	55	No vegetation			Normal vegetation			Heavy vegetation			Operation with 12 V battery	Operation with 230 V mains adaptor	Energiser monitoring indicator	Battery deep discharge protection	Recommended battery (min Ah)	No. of 1 m earth stakes (min)
								5	2	0	2.5	1	0	•	•	•						
P1	P147110	0.7	0.5	8300	4400	1.0	55	5	2	0	2.5	1	0	•	•	•	•	•	•	60	1	
P2	P147210	1.4	1.0	9800	5300	2.0	105	10	3	1	5	1.5	0.5	•	•	•	•	•	•	60	1	
P3	P147310	2.7	2.0	11000	5900	3.2	195	15	5	1.5	7.5	2.5	0.75	•	•	•	•	•	•	80	2	
P4	P147410	4.5	3.0	11400	6200	4.8	320	20	7.5	2.5	10	3	1	•	•	•	•	•	•	80	2	
P5	P147500	6.4	3.8	11400	6300	6.8	450	25	8.5	3	12	3.5	1.2	•	•	•	•	•	•	100	3	

Only perfect earthing allows maximum power at the fence

PATURA® energisers comply with all obligatory standards

PATURA® Multi-Voltage Energisers (Multi-Function)

These PATURA® multi-function energisers have highly efficient energiser technology:

- 5 step fence and battery monitor
- 6 step switch
- Deep discharge protection
- Includes 240V mains adaptor, stainless steel 12V adaptor set and fence/earth lead set



DESC	KEY FEATURES	ENERGY OUTPUT (JOULES)	MIN. ORDER Qty	OUTER CARTON Qty	CODE
P1500	Multi-function energiser for short fences with little vegetation for cattle and horses.	1.00	1	5	P142100
P2500	Multi-function energiser for fences with normal vegetation for cattle and horses.	2.00	1	5	P142200

6-STEP SWITCH



Note: The battery test mode works with 12V batteries only.

- | | |
|-------------------------------|-------------------------------|
| A OFF | D Night slow, day fast |
| B Battery Test | E Half power |
| C Night fast, day slow | F Full power |

Energisers for 230 + 12 volts

Only perfect earthing allows maximum power at the fence

CODE	Stored energy (joules)	Max. output energy (joules)	No- load voltage (volts)	Voltage at 500 ohms (volts)	Power input at 230 V (W)	Max. power consumption at 12 V (mA)	Max. fence length in km (multiple wires)						Operation with 12 V battery	Operation with 230 V mains adaptor	Energiser monitoring indicator	Battery deep discharge protection	Recommended solar panel performance	Recommended battery (min Ah)	No. of 1 m earth stakes (min)	
							No vegetation	Normal vegetation	Heavy vegetation	No vegetation	Normal vegetation	Heavy vegetation								
P1500	P142100	1.4	1	9800	5300	2	60-105	10	3	1	5	1.5	0.5	•	•	•	•	15	60	1
P2500	P142200	2.7	2	11000	5900	3.2	105-195	15	5	1.5	7.5	2.5	0.75	•	•	•	•	25	80	2

PATURA® Multi-Voltage Energisers MaxiPuls (Multi-Function)



These PATURA® multi-function energisers have MaxiPuls technology for long fences for cattle, sheep, horses, and to exclude wild animals:

- 10 step fence and battery monitor
- 6 step switch
- Deep discharge protection
- Includes 230V mains adaptor, stainless steel 12V adaptor set and fence/earth lead set

DESC	KEY FEATURES	ENERGY OUTPUT (JOULES)	MIN. ORDER Qty	OUTER CARTON Qty	CODE
MaxiPuls P4600	Powerful, multi-function energiser for long fences with heavy vegetation; digital display to monitor the fence, the earth and the battery; earth monitoring via reference earth.	6.00	1	4	P145450
MaxiPuls P6000	Extremely powerful multi-function energiser for long fences with heavier vegetation; digital display to monitor the fence, the earth and the battery; earth monitoring via reference earth.	15.00	1	-	P145602

Special order only.

Energisers for 230 + 12 volts		Stored energy (joules)	Max. output energy (joules)	No- load voltage (volts)	Voltage at 500 ohms (volts)	Power input at 230 V (W)	Max. power consumption at 12 V (mA)	Max. fence length in km (multiple wires)						Operation with 12 V battery or 230 V mains adaptor	Time-delayed and loads alternation alarm	Two power levels / day/night switch	10-step fence and battery monitor	Digital display	Earth monitoring	Remote control option	Recommended solar panel power output (W)	Recommended battery (min Ah)	No. of 1 m earth stakes (min)
CODE								No vegetation	Normal vegetation	Heavy vegetation	No vegetation	Normal vegetation	Heavy vegetation										
P4600	P145450	9	6	9500	6800	10	330-650	30	10	5	15	5	2.5	•	•	•	•	•	•	•	65	130	3
P6000	P145602	20	15	9800	7500	18	630-1250	48	18	8	24	9	4	•	•	•	•	•	•	•	2x65	130	3

Only perfect earthing allows maximum power at the fence

PATURA® energisers comply with all obligatory standards

PATURA® Multi-Voltage Energiser Accessories



DESC	FINISH	MIN. ORDER Qty	OUTER CARTON Qty	CODE
Mains Adaptor (A)	N/A	1	-	P165030
Remote Control (B)*	Green	1	16	P151001

*Remote control for use with the P4600 and P6000 energisers; includes fence compass with digital voltmeter and ammeter. Ideal for use on wires, limited use on polywire, not suitable for polyrope or polytape.

Solar Powered Energisers & Panels

Suggestions of places to site your Solar Powered Energiser

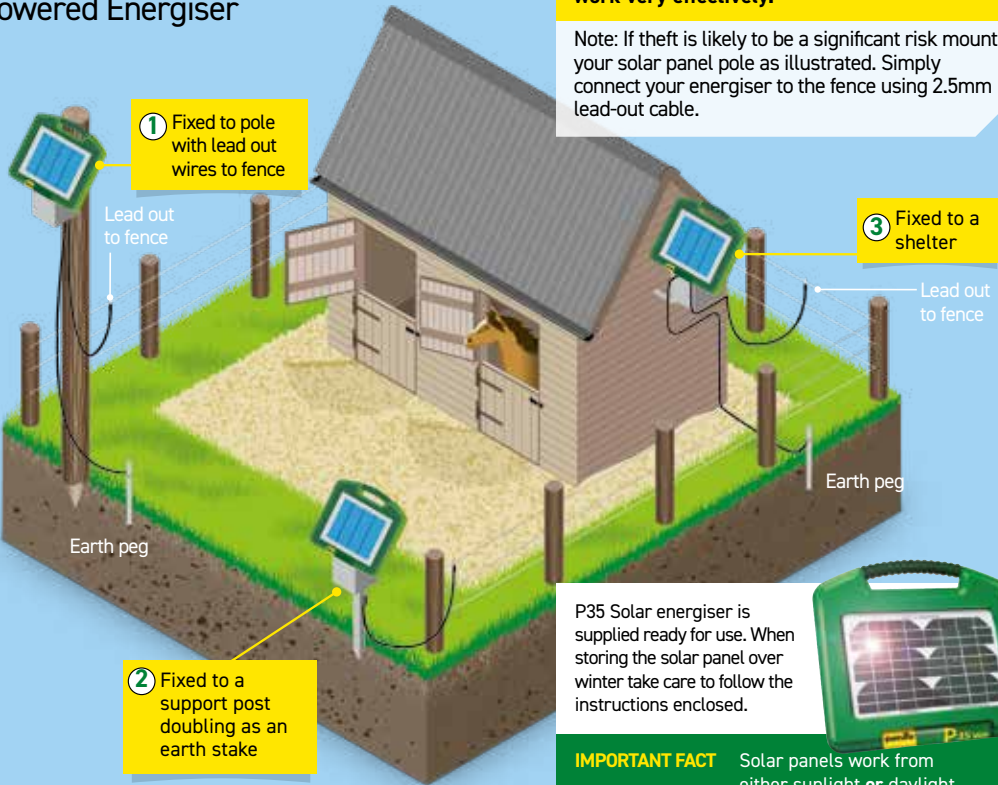

A solar panel can be mounted anywhere. So long as it is not in a shaded place it will work very effectively.

Note: If theft is likely to be a significant risk mount your solar panel pole as illustrated. Simply connect your energiser to the fence using 2.5mm lead-out cable.

P35 Solar energiser is supplied ready for use. When storing the solar panel over winter take care to follow the instructions enclosed.

IMPORTANT FACT Solar panels work from either sunlight or daylight

PATURA® Solar Panel with Universal Mounting Bracket

- Polycrystalline cells for highest energy efficiency
- 5 year efficiency warranty
- Integrated charge regulator
- Aluminium universal mounting bracket allow mounting onto posts and walls

SUITABLE FOR	ENERGY OUTPUT	MIN. ORDER Qty	CODE
P2500	25W	1	P148521



MORE SOLAR PANELS AVAILABLE TO ORDER ON REQUEST
PLEASE ENQUIRE



**SOCKET
COMPATIBLE
WITH T-ANGLE OF
PATURA® EARTH
STAKE**

PATURA® Solar Energisers & Batteries

Solar powered energisers with built in solar cells. A low-cost solution for powering fences in areas where mains power is not easily available.

DESC	KEY FEATURES	ENERGY OUTPUT (JOULES)	MIN. ORDER Qty	OUTER CARTON Qty	CODE
P25 (Low Power)	Energiser with integrated 3.0W solar panel and 6V/4Ah gel-cell battery; ideal for short fences. Max fence length (no vegetation): 800m. Max fence length (little vegetation): 300m	0.08	1	2	P140310
P35 (Medium Power)	Energiser with integrated 3W solar panel and 6V/4Ah gel-cell battery. Ideal for small cattle and horses. Max fence length (no vegetation) 1600m. Max fence length (little vegetation) 600m.	0.15	1	-	P140410
P70 (High Power)	Energiser with integrated 9.6W solar panel and 12V/7Ah gel-cell battery; ideal for cattle and horse pastures. Max fence length (no vegetation): 4000m. Max fence length (little vegetation): 2000m.	0.50	1	-	P140510

Solar Installations		Stored energy (joules)	Max. output energy (joules)	No-load voltage (volts)	Voltage at 500 ohms (volts)	Max. power consumption (mA)	Max. fence length in km (multiple wires)		No. of 1 m earth stakes (metres)
CODE						No vegetation	Little vegetation		
P25 Solar	P140310	0.11	0.08	7300	2100	16	1.0	0.3	0.60
P35 Solar	P140410	0.21	0.15	9300	2600	30	1.6	0.6	0.60
P70 Solar	P140510	0.65	0.50	9800	4800	40	5.0	3.0	0.60



PATURA® Earth Stake 2m with Stainless Steel Screw

- Galvanised T-angle-Iron for maximum surface area and effectiveness
- With Stainless steel screw for attaching the earth connection

LENGTH (M)	FINISH	MIN. ORDER Qty	OUTER ORDER Qty	CODE
1	Galvanised	1	10	P161800
2	Galvanised	1	10	P161802

Energiser Batteries

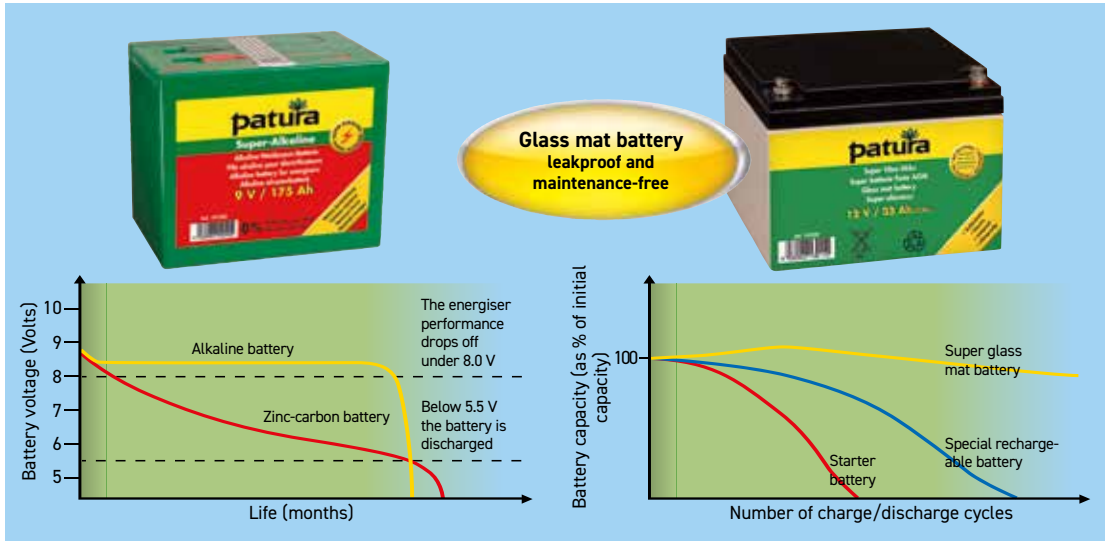

The constant voltage supply of PATURA® alkaline batteries provides full energiser performance until the very last day.

By the use of the glass mat battery you get longer use from them and thus make a contribution in preventing waste batteries.

PATURA® 9 V alkaline electric fence battery

PATURA® alkaline batteries have a high constant voltage supply throughout their life. Thus it can be assured that throughout this time the energiser will always provide a constant output to the fence. In comparison with a zinc-carbon battery of the same capacity there is more energy stored (see figure). PATURA® alkaline batteries contain neither mercury nor cadmium. Suitable for storage up to 3 years.

PATURA® 12 V glass mat batteries

Starter batteries for cars or trucks have decisive disadvantages if used to power energisers. They have a high self-discharge, and are only cycle proof to a small degree. i.e. they will stand for markedly fewer charge-discharge cycles. PATURA® glass mat batteries for 12 V energisers and solar installations are totally maintenance-free and function independent from locations. They have a low self-discharge and are especially cyclic proof.



PATURA® 9V Super Alkaline Battery for Energisers

- Our most powerful 9V battery
- The environmentally friendly electric fence battery with constant voltage level; for constant optimal energiser performance

ENERGY OUTPUT	MIN. ORDER Qty	OUTER CARTON Qty	CODE
9V/55Ah	1	4	P190500
9V/120Ah	1	4	P191200
9V/175Ah	1	4	P191500

PATURA® 12V Super Glass Mat Battery

- The ideal leak proof maintenance free battery, which will operate in any position; for all 9V energisers which will also operate on 12V
- No acid necessary - ready to use!

ENERGY OUTPUT	SIZE (MM)	WEIGHT (KG)	MIN. ORDER Qty	CODE
12V/32Ah	166 x 175 x 125	8.9	1	P133200

PATURA® 12V Standard Wet-Cell Battery

The cost effective wet-cell battery for use with 12V battery energisers.

ENERGY OUTPUT	MIN. ORDER Qty	PALLET Qty	CODE
12V/84Ah	4	45	P133500

Please note: this product is delivered without battery acid.

PATURA® 9V Special Battery for Energisers

Zinc-carbon battery for energisers.

ENERGY OUTPUT	MIN. ORDER Qty	OUTER CARTON Qty	CODE
9V/55Ah	1	4	P151200
9V/90Ah	1	4	P151300
9V/130Ah	1	4	P151400



THE ELECTRIC FENCE CIRCUIT EXPLAINED

How does the electric fence circuit work? What are the five main parts to consider? See page 75 for more information.



p75

ELECTRIC FENCING CONDUCTORS & ACCESSORIES

Recommended Wire Spacings

Fence animals in...

In principle, containing animals is easier than excluding them. Animals that are contained quickly get used to the fence and can be relied upon to respect it. In excluding animals, we have to consider that animals approaching the fence have no previous experience of it. In this case we need to ensure that initially the animal receives a strong and memorable electric shock, and adjusts itself to give the electric fence the necessary respect. Thus for exclusion fences, only especially powerful energisers should be used.

COWS

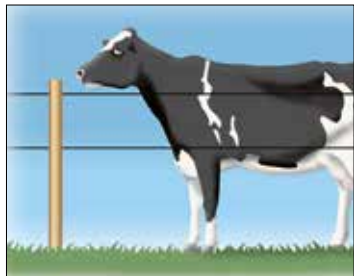

Electric fences for cows are 0.85 to 1.05 m high with 1 to 2 wires.

SHEEP

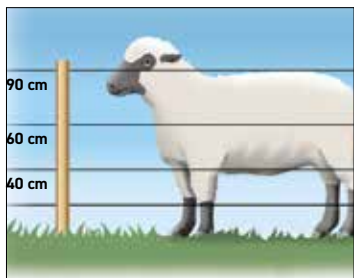

Electric fences for sheep require 3 or 4 highly conductive wires at the spaces shown. (The bottom wire is only necessary if lambs are being kept in)

...or keep wildlife out

EXCLUDING RED DEER

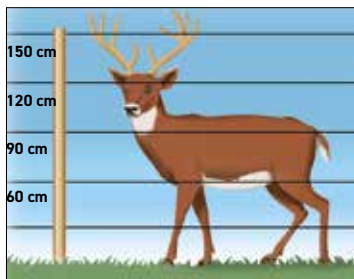

Electric fences for protecting against red deer are up to 1.50 m high with 5 wires.

ELECTRIC FENCES

Electric fences are suitable for containing or deterring just about all kinds of animal.

The fences differ only in their height, the number of wires and partly in the fence material.

Whether the fence is to be an outer fence or a subdivision also plays a role.

On these pages you will find the information on outer fence construction with respect to the quantity and height of wires for the most important types of animal.

For inner fences the heights can be selected as some 10 to 15 cm less, and one wire fewer can possibly be used.

We will be pleased to advise you on any electric fencing questions.

HORSES & PONIES



Electric fences for large horses are 1.30 to 1.60 m high with 2 to 3 conducting wires.

PIGS

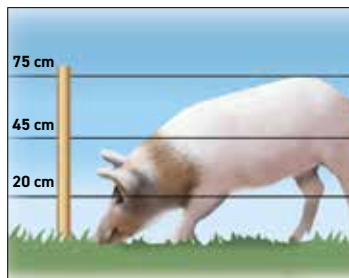

Electric fences for pigs are 0.55 to 0.75 m high with 2 to 3 wires. Outer fences for domestic pigs should have a second fence to protect against wild animals.

EXCLUDING RABBITS

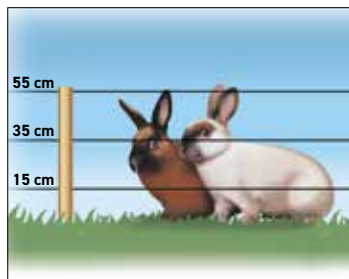

Electric fences for protecting against rabbits are approx. 0.55 m high with 3 wires. With rabbits, in order to prevent them digging under the fence, it may be necessary to lay an earthed wire directly on the ground. The fence should be slightly canted towards the animals.

THE ELECTRIC FENCE FOR EXCLUDING ANIMALS

As stated above, electric fences used for keeping animals out (excluding) require high power energisers. Also be sure to choose the right conductor as wires may be subject to extreme power loss (wires placed near to the ground or through woodland). The best product to use to withstand this requirement is aluminium wire featured on page 88.

Wire

PATURA® Plain Steel Wire

For permanent electric fencing systems.

FINISH	LENGTH (M)	WIRE Ø (MM)	MIN. ORDER Qty	OUTER CARTON Qty	CODE
Galvanised	approx. 250	1.8	1	5	P109100



PATURA® Tornado Steel Wire

Tornado Steel Wire has a special thick galvanised coating of 95% zinc and 5% aluminium, giving it a life that is 9 times that of normal thick galvanised wire. The retention of the zinc coating on the wire is markedly improved by combination with the aluminium.

LENGTH (M)	WIRE Ø (MM)	MIN. ORDER Qty	OUTER CARTON Qty	CODE
approx. 625	2.5	1	10	P190000

Ø 2.5mm = very high tensile strength.



PATURA® Hippo Wire with Conductive Plastic Coating

- The best visibility, optimum conductivity, minimal risk of injury and a long life - the PATURA® Hippowire meets all those demands with 2.5mm steel wire sheathed in conductive plastic
- The steel wire core ensures the best conductivity, the thick plastic sheathing offers good visibility and the lowest risk of injury, while the 4 black conducting portions ensure that the current is best passed to the animal

FINISH	LENGTH (M)	WIRE Ø (MM)	MIN. ORDER Qty	PALLET Qty	CODE
White	304	7	1	40	P190400

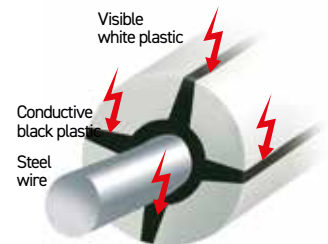

PATURA® Stranded Wire

Typically used with permanent outdoor pig and cattle fences. This product is particularly suitable for fences that are used to deter wildlife as wires can be installed close to the ground.

FINISH	LENGTH (M)	WIRE Ø (MM)	MIN. ORDER Qty	CODE
Galvanised	200	1.5	1	P108100
Galvanised	500	1.5	1	P108200





PATURA® Aluminum Wire

- Very high conductivity, 4 times lighter than normal plain steel wire
- Particularly suitable for fences used to deter wildlife as wires can be installed close to the ground

FINISH	LENGTH (M)	WIRE Ø (MM)	MIN. ORDER Qty	OUTER CARTON Qty	CODE
Aluminium	400	2.0	1	4	P191800

Tip: these wires only require a lightweight tension up to 20kg which can be easily reached by hand

Polywire

Conductivity of the fence wiring

Long lengths of electric fence can only function using fence wiring with good conductivity. When using 4 wires of 2.5mm steel, fences up to 120km can be considered when there is no vegetation. Using only one wire of the same, the maximum length drops to 30km.

If you go down to one compact-polywire that has 6 x Ø 0.20mm stainless steel strands, the maximum length of fence goes down to 250m. If there is vegetation at the fence, then these figures drop considerably. The fence wire must be carefully selected depending on the desired fence length and the anticipated vegetation growth.

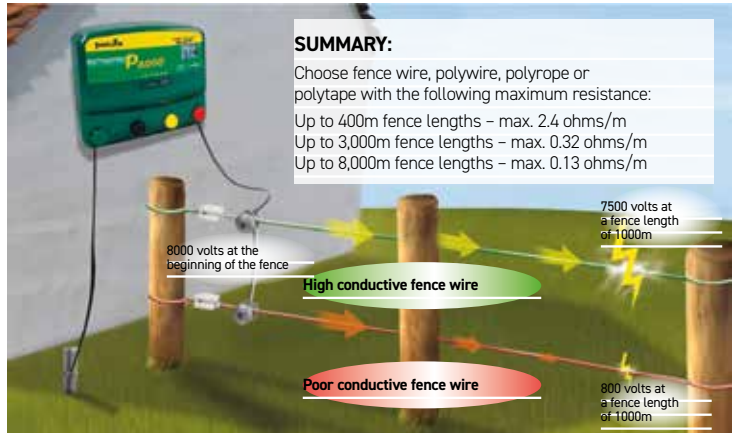

In longer fence lengths, only high conductivity fence wires ensure maximum performance to the end of the fence.

Fence Voltage	after 100 m	after 1 km	after 3 km
Standard Polywire 3 x 0.16	2100 V	300 V	100 V
Compact Polywire 6 x 0.20	4200 V	800 V	300 V
Tornado Polywire 1 x 0.30 + 5 x 0.20 Tornado Polywire	7700 V	5500 V	3400 V
Tornado XL Polywire 3 x 0.30 + 8 x 0.20	7900 V	6900 V	5500 V



PATURA® Tornado: MAXIMUM CONDUCTIVITY FOR THE HIGHEST SECURITY

Extremely strong and conductive, thanks to a combination of stainless steel and copper strands. Stainless steel strands are very durable and copper strands are very conductive, which results in a highly effective product - able to cope with long fences in the most challenging conditions!

PATURA® Standard 3 Strand Polywire

Our recommendation for fences up to 100m long.

FINISH	LENGTH (M)	MIN. ORDER Qty	OUTER CARTON Qty	CODE
Yellow-Orange	250	1	20	P180000



PATURA® Compact 6 Strand Polywire

Our recommendation for fences up to 250m long.

FINISH	LENGTH (M)	WIRE Ø (MM)	MIN. ORDER Qty	OUTER CARTON Qty	CODE
White-Green	200	0.3	1	12	P180100
White-Green	400	0.3	1	12	P180200



PATURA® Tornado 6 Strand Polywire

- 5 x stainless steel strands and 1 x copper strand for extra conductivity
- Recommended for fences up to 5000m long

FINISH	LENGTH (M)	COPPER STRANDS Ø (MM)	STAINLESS STEEL STRANDS Ø (MM)	MIN. ORDER Qty	OUTER CARTON Qty	CODE
White-Orange	200	0.3	0.2	1	12	P180501
White-Orange	400	0.3	0.2	1	12	P180601
White-Orange	1000	0.3	0.2	1	6	P180701



PATURA® Tornado XL 11 Strand Polywire

- Conductive wire and rope for use with temporary electric fencing systems
- 8 x stainless steel strands and 3 x copper strands for extra conductivity
- Our recommendation for fences up to 13000m long

FINISH	LENGTH (M)	COPPER STRANDS Ø (MM)	STAINLESS STEEL STRANDS Ø (MM)	MIN. ORDER Qty	OUTER CARTON Qty	CODE
White-Red	200	0.3	0.2	1	12	P181001
White-Red	400	0.3	0.2	1	12	P181101
White-Red	1000	0.3	0.2	1	5	P181201



Polyrope

Ideal for use with horses and good for use in exposed windy areas.

Fence Voltage	after 100 m	after 1 km	after 3 km
Compact Polyrope 6 x 0.20	4200 V	800 V	300 V
Super Polyrope 3 x 0.40	5500 V	1400 V	600 V
Tornado Polyrope 1 x 0.30 + 5 x 0.20	7700 V	5500 V	3400 V
Tornado XL Polyrope 3 x 0.30 + 8 x 0.20	7900 V	6900 V	5500 V
Tornado XXL Polyrope 3 x 0.30 + 6 x 0.20	7900 V	6900 V	5500 V



PATURA® Compact 6 Strand Polyrope



- 6 x stainless steel strands
- Our recommendation for fences up to 300m long

FINISH	LENGTH (M)	STAINLESS STEEL STRANDS Ø (MM)	MIN. ORDER Qty	OUTER CARTON Qty	CODE
White	200	0.3	1	6	P182000

PATURA® Super 3 Strand Polyrope



- 3 x stainless steel strands
- Our recommendation for fences up to 700m long

FINISH	LENGTH (M)	STAINLESS STEEL STRANDS Ø (MM)	MIN. ORDER Qty	OUTER CARTON Qty	CODE
White-Green	200	0.4	1	6	P182100

PATURA® Tornado 6 Strand Polyrope



- 5 x stainless steel strands and 1 x copper strand for extra conductivity
- Our recommendation for fences up to 5000m long

FINISH	LENGTH (M)	COPPER STRANDS Ø (MM)	STAINLESS STEEL STRANDS Ø (MM)	MIN. ORDER Qty	OUTER CARTON Qty	CODE
White-Orange	200	0.3	0.2	1	6	P182501
White-Orange	500	0.3	0.2	1	2	P182601

PATURA® Tornado XL 11 Strand Polyrope

- 8 x stainless steel strands and 3 x copper strands for extra conductivity
- Our recommendation for fences up to 13000m long

FINISH	LENGTH (M)	COPPER STRANDS Ø (MM)	STAINLESS STEEL STRANDS Ø (MM)	MIN. ORDER Qty	OUTER CARTON Qty	CODE
White-Red	200	0.3	0.2	1	6	P183001
White-Red	500	0.3	0.2	1	2	P183101



PATURA® Tornado XXL Braided Polyrope

- 6 x stainless steel strands and 3 x copper strands for extra conductivity
- Braided polyrope for ultimate durability
- Our recommendation for fences up to 13000m long

FINISH	LENGTH (M)	COPPER STRANDS Ø (MM)	STAINLESS STEEL STRANDS Ø (MM)	MIN. ORDER Qty	CODE
Red/White	200	0.3	0.2	1	P183500



Polytape

The most important criteria in the assessment of polytape is the conductivity, it's mechanical strength and particularly for use with horses, it's weight and higher flexibility.

PATURA® Standard 4 Strand Polytape

- 4 x stainless steel strands
- Our recommendation for fences up to 150m long

FINISH	LENGTH (M)	TAPE Ø (MM)	STAINLESS STEEL STRANDS Ø (MM)	MIN. ORDER Qty	OUTER CARTON Qty	CODE
White	200	10	0.16	1	16	P184400



PATURA® Compact 6 Strand Polytape

- 6 x stainless steel stands
- Our recommendation for fences up to 200m long

FINISH	LENGTH (M)	TAPE Ø (MM)	STAINLESS STEEL STRANDS Ø (MM)	MIN. ORDER Qty	OUTER CARTON Qty	CODE
White-Green	200	10	0.16	1	16	P184200
White-Green	200	20	0.16	1	8	P186100
White-Green	400	10	0.16	1	8	P184300





PATURA® Compact 8 Strand Polytape

- 8 x stainless steel strands
- Our recommendation for fences up to 300m long

FINISH	LENGTH (M)	TAPE Ø (MM)	STAINLESS STEEL STRANDS Ø (MM)	MIN. ORDER Qty	OUTER CARTON Qty	CODE
White-Green	200	40	0.16	1	2	P188500

PATURA® Compact Plus 8 Strand Polytape

- 8 x stainless steel strands
- Our recommendation for fences up to 400m long



FINISH	LENGTH (M)	TAPE Ø (MM)	STAINLESS STEEL STRANDS Ø (MM)	MIN. ORDER Qty	OUTER CARTON Qty	CODE
White	200	40	0.2	1	2	P188600

PATURA® Tornado Multi Strand Polytape

- Features cross connecting vertical stainless steel wires providing optimum current flow
- Mixture of stainless steel and copper strands for extra conductivity
- Clustered connectors, with reinforced edges, increase resistance to sparks and guarantees immediate re-electrification in the event of a power cut
- Our recommendation for fences up to 5000m long



COPPER STRANDS Ø (MM)	STAINLESS STEEL STRANDS Ø (MM)	FINISH	LENGTH (M)	TAPE Ø (MM)	MIN. ORDER Qty	OUTER CARTON Qty	CODE
1 x 0.3	4 x 0.2	White-Orange	200	12.5	1	12	P185001
1 x 0.3	5 x 0.2	White-Orange	200	20	1	6	P186501
1 x 0.3	5 x 0.2	White-Orange	400	20	1	2	P186601
1 x 0.3	11 x 0.16	White-Orange	200	38	1	2	P189001
1 x 0.3	12 x 0.16	Brown	200	38	1	2	P189101

PATURA® Tornado XL Multi Strand Polytape

- Features cross connecting vertical stainless steel wires providing optimum current flow
- Mixture of stainless steel and copper strands for extra conductivity
- Clustered connectors, with reinforced edges, increase resistance to sparks and guarantees immediate re-electrification in the event of a power cut
- Our recommendation for fences up to 9000m or 13000m long, when used with 12.5/20mm tape or 40mm tape respectively



COPPER STRANDS Ø (MM)	STAINLESS STEEL STRANDS Ø (MM)	FINISH	LENGTH (M)	TAPE Ø (MM)	MIN. ORDER Qty	OUTER CARTON Qty	CODE
3 x 0.3	11 x 0.16	White-Red	200	40	1	2	P189501

Reels

SHEEP SYSTEMS How to erect a 3-line temporary fence system for grazing sheep

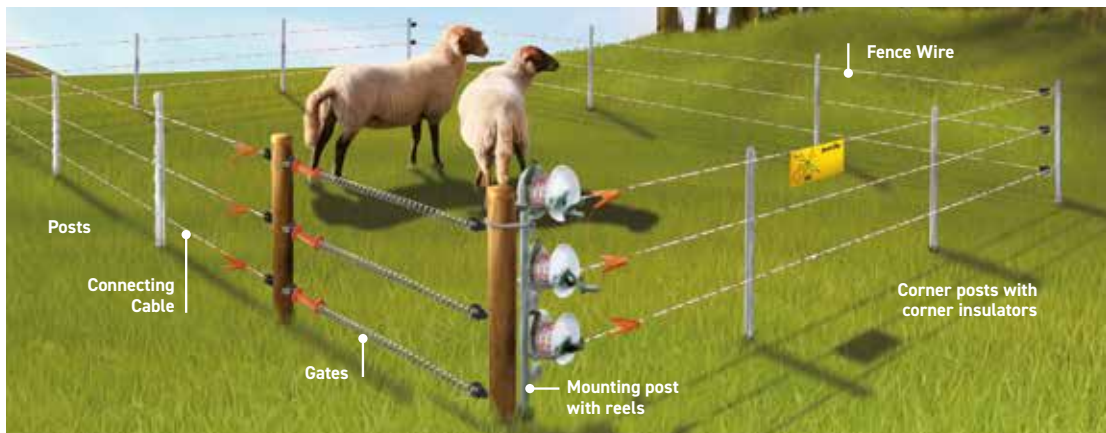

Rapid Fence construction – step by step

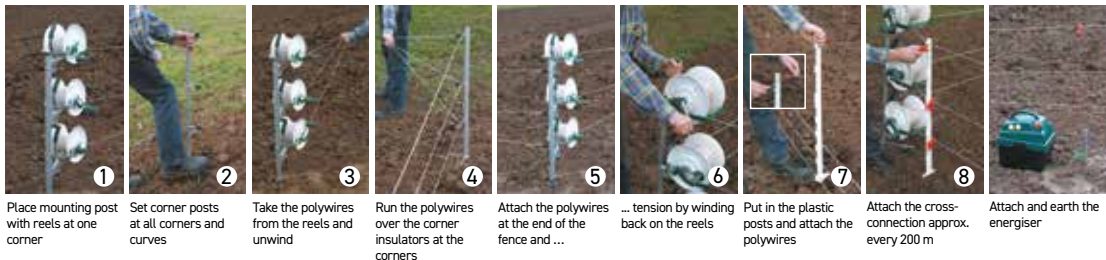

- Place mounting post with reels at one corner
- Set corner posts at all corners and curves
- Take the polywires from the reels and unwind
- Run the polywires over the corner insulators at the corners
- Attach the polywires at the end of the fence and ...
- ... tension by winding back on the reels
- Put in the plastic posts and attach the polywires
- Attach the cross-connection approx. every 200 m
- Attach and earth the energiser

PATURA® Reel Universal with Handle & Hanging Hook

Tensioning fixture with locking ratchet. Holds up to 800m polywire. Also suitable to fasten to the standard mounting post.



FINISH	SUITABLE FOR	MIN. ORDER Qty	OUTER CARTON Qty	CODE
Steel and Black/Red Plastic	Up to 800mm polywire	1	6	P161002



PATURA® Mini Hand Reel with Carry Handle & Hanging Hook

With lock pin, carry handle and hook to hang on fence wire. Holds up to 300m polywire.

FINISH	MIN. ORDER Qty	PALLET Qty	CODE
Black/Red Plastic	1	120	P105210



PATURA® Reel Standard with Handle & Mounting Hook

With carry handle, mounting hook and tensioning device.

FINISH	SUITABLE FOR	MIN. ORDER Qty	OUTER CARTON Qty	CODE
Steel and Black Plastic	up to 500m polywire	1	4	P161001



PATURA® Special Reel with Reduction Gearing

With carry handle, mounting hook and tensioning device.

FINISH	SUITABLE FOR	MIN. ORDER Qty	OUTER CARTON Qty	CODE
Steel and White Plastic	up to 600m polywire	1	4	P161301

PATURA® Metal Corner Post - Super

Made of sturdy, hot dip galvanised angle iron, with 3 points and predrilled holes for insulators such as corner insulators and ring insulators.

FINISH	LENGTH (MM)	MIN. ORDER Qty	OUTER CARTON Qty	CODE
Galvanised	850	1	10	P104500

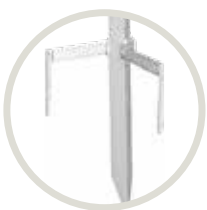

PATURA® Standard Mounting Post

Standard mounting post for short temporary fences with only a few corners. Reels are firmly bolted on.

DESC	FINISH	FENCE HEIGHT (M)	MIN. ORDER Qty	CODE
3 Reel	Galvanised	1	1	P635000



MORE POSTS ON PAGE P108

PATURA® Special Mounting Post

- Special mounting post for longer temporary fences, particularly those with many corners
- Hand-screw sockets allow quick and easy removal of reels
- No tools required!

DESC	FINISH	FENCE HEIGHT (M)	MIN. ORDER Qty	CODE
3 Reel	Galvanised	1	1	P633001



Strainers & Tensioners

PATURA® Rotating Wire Tensioner

- This rotating wire tensioner system enables you to easily tighten wires without cutting them
- The tensioner is inserted in the wire at any place on the fence
- The handle is attached and the tensioner is turned around its own axle until the correct fence tension is reached
- A cotter pin is then installed and the wire tensioner handle removed
- If necessary the wire can be retightened or relaxed at any time

DESC	FINISH	UNIT Qty	MIN. ORDER Qty	OUTER CARTON Qty	CODE
Rotating Wire Tensioner (A)	Aluminium	Pack of 3	1 Pack	12 Packs	P164303
Rotating Wire Tensioner (A)	Aluminium	Box of 25	1 Box	-	P164325
Wire Tensioner Handle (B)	Galvanised	Pack of 1	1 Pack	-	P644000

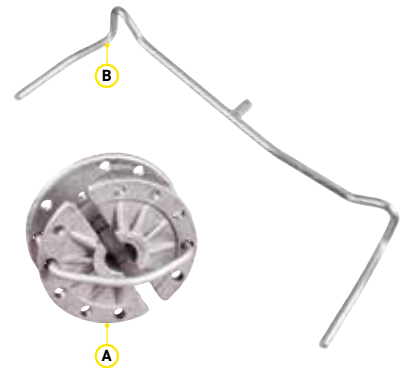

PATURA® Wire Strainer with Lock

Used to tighten wires.

FINISH	UNIT Qty	MIN. ORDER Qty	OUTER CARTON Qty	CODE
Galvanised/Plastic	Pack of 10	1 Pack	5 Packs	P164602



PATURA® Wire Strainer with Insulator



Used to tighten live wires easily and securely.

FINISH	UNIT Qty	MIN. ORDER Qty	OUTER CARTON Qty	CODE
Galvanised/Plastic	Box of 10	1 Box	5 Boxes	P164612

PATURA® Tension handle for wire strainer



For easy tensioning of wire strainers.

FINISH	UNIT Qty	MIN. ORDER Qty	OUTER CARTON Qty	CODE
Galvanised	1	1	10	P164630

Underground Cables & Connectors

PATURA® High Voltage Cable - Lead Out



- The PATURA® high voltage electric fence cable is double insulated and high voltage safe to over 10,000V. It can be used for over and underground lead outs, for the connection of earth stakes and for carrying current past gates.
- For fence and earth lead outs up to 50m, or for by-passing gates; resistance 0.1ohms/m.

FINISH	LENGTH (M)	GAUGE (MM)	MIN. ORDER Qty	CODE
Black	10	1.6	1	P160910
Black	25	1.6	1	P160925
Black	50	1.6	1	P160950
Black	100	1.6	1	P160960

PATURA® High Voltage Cable - Underground



High voltage, double insulated, single core cable with 2.5mm steel core; for fence and earth lead outs up to 200m; resistance 0.035ohms/m.

FINISH	LENGTH (M)	GAUGE (MM)	MIN. ORDER Qty	CODE
Black	50	2.5	1	P161050
Black	100	2.5	1	P161060

Cross-Connections

PATURA® Fence Connecting Cable

With insulated spring clamps and stainless steel contacts; for quick wire connection with multi-wire temporary fences.

DESC	FINISH	UNIT Qty	MIN. ORDER Qty	OUTER CARTON Qty	CODE
2 Wire	Red	Pack of 2	1 Pack	10 Packs	P101102



PATURA® Fence & Earth Lead Set with Eyelets

- Insulated spring clips (red=fence/green=earth) with stainless steel contacts and 8mm eyelets
- For PATURA® energisers P250 and P350

DESC	FINISH	EYELET (MM)	PACK TYPE	MIN. ORDER Qty	OUTER CARTON Qty	CODE
Fence & Earth	Red/ Green	8	Hanging Card	1	10	P100901
Fence	Red	8	Hanging Card	1	10	P100101



PATURA® Fence & Earth Lead Set with Probes

Insulated spring clips (red=fence/green=earth) with stainless steel contacts and 3mm probes.

DESC	FINISH	PROBE (MM)	PACK TYPE	MIN. ORDER Qty	OUTER CARTON Qty	CODE
Fence & Earth	Red/ Green	3	Hanging Card	1	10	P101001
	Green Lead					P100601
	Red Lead					P100301



PATURA® Spare Spring Clip

Spare spring clips suitable for PATURA® connecting cables.

FINISH	MIN. ORDER Qty	OUTER CARTON Qty	CODE
Red	1	10	P919001
Black	1	10	P919002
Green	1	10	P919003



PATURA® Fence Lead Connector

For connecting the energiser to polytape fences.

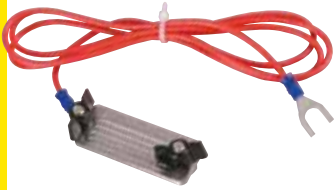

DESC	FINISH	PROBE (MM)	SUITABLE FOR	PACK TYPE	MIN. ORDER Qty	OUTER CARTON Qty	CODE
For Polytape	Stainless Steel	3	up to 40mm tape	Hanging Card	1	10	P170601

PATURA® Fence Connecting Cable

- For establishing cross-connections on polyrope fences
- With 2 stainless steel polyrope clamps for polyropes up to 6mm



KEY FEATURES	FINISH	SUITABLE FOR	PACK TYPE	MIN. ORDER Qty	OUTER CARTON Qty	CODE
With 2 stainless steel polyrope clamps; for establishing cross connections on polyrope fences (A)	Red	up to 6mm rope	Hanging Card	1	10	P101401
Rapid inter-connection for multi wire polytape fences (B)	Stainless Steel	up to 40mm tape	Hanging Card	1	10	P170401

PATURA® 12V Lead Set for Battery Energisers



MIN. ORDER Qty	CODE
1 Pair	P9187225

Electric Fence Netting

PATURA® Electric Fence Netting

PATURA® netting features three distinctive advantages; clips for optimum connection, double spikes for easy ground insertion and firmly welded joints. Each net also includes extra ground pegs and a repair kit.



DESC	FINISH	HEIGHT (MM)	LENGTH (M)	MIN. ORDER Qty	OUTER CARTON Qty	CODE
With Double Spike	Orange	900	50	1	77	P109250
With Single Spike	Orange	900	50	1	77	P108900

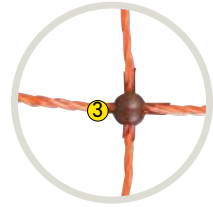
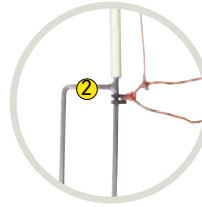
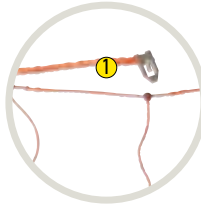

PATURA® Fowl Netting

Electric netting fence for fowl. Features small mesh aperture in the lower area.

DESC	FINISH	HEIGHT (MM)	LENGTH (M)	MIN. ORDER Qty	OUTER CARTON Qty	CODE
w/ Double Spike	Orange	1120	50	1	45	P111200



NOW AVAILABLE



Coloured Posts
See Page 109



Coloured Gate Handles
See Page 111

p109

p111

ELECTRIC FENCING INSULATORS & JOINERS

Insulators



PATURA® Permanent Fence Insulator for Rope & Hippo Wire

Solid, UV resistant plastic insulator, to be mounted using screws.

FINISH	UNIT Qty	MIN. ORDER Qty	OUTER CARTON Qty	CODE
Black Plastic	Pack of 25	1 Pack	10 Packs	P168425



PATURA® Permanent Fence Insulators for Wire

- For use with wire in permanent electric fencing systems
- Solid, UV resistant plastic insulator to be mounted using staples

FINISH	UNIT Qty	MIN. ORDER Qty	OUTER CARTON Qty	CODE
Black Plastic	Tub of 25	1 Tub	20 Tubs	P167325
Black Plastic	Tub of 150	1 Tub	-	P167365



PATURA® Porcelain High Tensile Corner Insulator

Corner insulator for high tensile wire and hippowire.



FINISH	UNIT Qty	MIN. ORDER Qty	OUTER CARTON Qty	CODE
White Porcelain	Tub of 3	1 Tub	40 Tubs	P167403



PATURA® Strain Insulator

Start and end insulator for wire, hippowire and rope.



FINISH	UNIT Qty	MIN. ORDER Qty	OUTER CARTON Qty	CODE
Black Plastic	Tub of 25	1 Tub	20 Tubs	P167725
Black Plastic	Tub of 100	1 Tub	-	P167760
Strain Insulator	Tub of 6	1 Tub	-	P167706

PATURA® Super Strain Insulator Fibreglass

- Start and end insulator for high tensile wire, hippowire and rope
- Fibreglass reinforced plastic

FINISH	UNIT Qty	MIN. ORDER Qty	OUTER CARTON Qty	CODE
White Fibreglass	Tub of 6	1 Tub	12 Tubs	P167806
White Fibreglass	Tub of 25	1 Tub	20 Tubs	P167825
White Fibreglass	Tub of 100	1 Tub	-	P167860



PATURA® Porcelain High Tensile Strain Insulator

Porcelain start and end insulator for high tensile wire.

FINISH	UNIT Qty	MIN. ORDER Qty	CODE
White Porcelain	Tub of 50	1 Tub	P169250



PATURA® Nail-On Insulator

- Traditional nail-on economy insulator method
- Generally used with polywire and standard wire
- Fix to wooden posts using integrated nail

FINISH	UNIT Qty	MIN. ORDER Qty	OUTER CARTON Qty	CODE
Black Plastic	Pack of 100	1 Pack	25 Packs	P101110



PATURA® Insultube

- Traditional tube insulating method
- Slide insulator onto wire prior to fixing to the posts
- Generally used with high tensile wire
- Fix to wooden posts using 40mm staples
Generally used for high tension wire or polyrope up to 6mm

FINISH	LENGTH (MM)	UNIT Qty	MIN. ORDER Qty	CODE
Black Plastic	100	Pack of 100	1 Pack	P161410
Insultube.	5m	Pack 1		P161405





PATURA® Ring Insulator

For use with polywire.

DESC	FINISH	SHAFT DIAMETER (MM)	UNIT Qty	MIN. ORDER Qty	OUTER CARTON Qty	CODE
Wood Screw Thread (A)	Black Plastic	6	Pack of 25	1 Pack	-	P101725
Wood Screw Thread (A)	Black Plastic	6	Tub of 100	1 Tub	-	P101760
Bolt On, Long Metric Thread (80mm) (B)	Black Plastic	6	Pack of 25	1 Pack	20 Packs	P102925
Bolt On, Metric Thread, High Quality* (C)	Black Plastic	6	Pack of 25	1 Pack	20 Packs	P102425
Screw Adaptor for Ring Insulators** (D)	Black Plastic	N/A	Pack of 1	1 Pack	10 Packs	P158901

*High quality plastic; solid shaft attachment; large leakage rings.

**For the easy screwing in of ring insulators in softwood posts using an electric screwdriver.

PATURA® Universal Rope and Tape Insulator

For rope and tapes up to 20mm.



DESC	FINISH	SHAFT DIAMETER (MM)	UNIT Qty	MIN. ORDER Qty	OUTER CARTON Qty	CODE
Wood Screw Thread	Black Plastic	6	Pack of 25	1 Pack	8 Packs	P127325

PATURA® Doughnut Type Corner Insulators



DESC	FINISH	SUITABLE FOR	UNIT Qty	MIN. ORDER Qty	OUTER CARTON Qty	CODE
Wood Screw Thread (A)	Black Plastic	Polytapes up to 40mm	Pack of 3	1 Pack	12 Packs	P104003
Wood Screw Thread (B)	Black Plastic	Redirection of polywires and rope at corners without chafing	Pack of 6	1 Pack	12 Packs	P102206

PATURA® Super Screw-on Rod Insulator

- UV resistant, solid plastic insulator
- Height adjustable
- For all posts without cap insulator up to 16mm
- Suitable for polywires and polytapes up to 12.5mm



FINISH	SUITABLE FOR	UNIT Qty	MIN. ORDER Qty	OUTER CARTON Qty	CODE
Black Plastic	up to 16mm posts	Pack of 25	1 Pack	10 Packs	P165625

PATURA® Polytape Line Insulator

- Economy nail-on polytape insulator
- Suitable for all sizes of tapes and ropes



FINISH	UNIT Qty	MIN. ORDER Qty	OUTER CARTON Qty	CODE
Black Plastic	Pack of 25	1 Pack	20 Packs	P166825
Polytape Line Insulator	Tub of 60	1 Pack		P166851

PATURA® Polytape & Rope Insulator

For tapes up to 40mm and ropes.



DESC	FINISH	UNIT Qty	MIN. ORDER Qty	OUTER CARTON Qty	CODE
Wood Screw Thread	Black plastic	Pack of 25	1 Pack	8 Packs	P127025

PATURA® Tornado Polytape Insulator

- Rugged line insulator for polytape tensioning
- Suitable for all polytapes up to 40mm
- Safe and protective clamping of the polytape due to offset rubber inserts



FINISH	SUITABLE FOR	UNIT Qty	MIN. ORDER Qty	OUTER CARTON Qty	CODE
Black Plastic	up to 40mm tape	Pack of 20	1 Pack	10 Packs	P166920

PATURA® Corner Insulator for Polytape

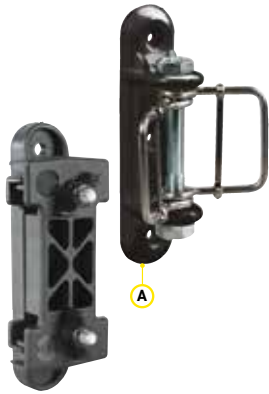

DESC	FINISH	SUITABLE FOR	UNIT Qty	MIN. ORDER Qty	OUTER CARTON Qty	CODE
Includes 2 stainless steel tape joiners (A)	Black Plastic/ Stainless Steel	up to 40mm tape	Pack of 3	1 Pack	12 Packs	P168003
Clamps the tape safely between 2 faces (B)	Black Plastic	up to 40mm tape	Pack of 3	1 Pack	12 Packs	P167003

PATURA® Strain and Corner Insulator for Polytape



- Sturdy insulator with stainless steel connector plate for polytape up to 40mm
- Multiple applications in polytape fences, eg. start insulator, 3-way insulator, gate insulator

FINISH	SUITABLE FOR	UNIT Qty	MIN. ORDER Qty	OUTER CARTON Qty	CODE
Black Plastic/ Stainless Steel	up to 40mm tape	Pack of 3	1 Pack	12 Packs	P167103

PATURA® Offset Ring insulator with Long Shaft

For polywires and polyropes.



DESC	SHAFT LENGTH (MM)	UNIT Qty	MIN. ORDER Qty	OUTER CARTON Qty	CODE
Wood Screw Thread	200	Pack of 10	1 Pack	8 Packs	P101610

PATURA® Offset Rope & Tape Insulator with Long Shaft



DESC	SHAFT LENGTH (MM)	SUITABLE FOR	UNIT Qty	MIN. ORDER Qty	OUTER CARTON Qty	CODE
w/ Long Shaft Wood Screw Thread (A)	180	up to 20mm tape + rope	Pack of 10	1 Pack	8 Packs	P127410
w/ Long Shaft Wood Screw Thread (B)	180	up to 40mm tape + rope	Pack of 10	1 Pack	8 Packs	P127910

PATURA® Offset Pigtail Bracket with Eyelet Insulator

- Offset insulator made of round bar steel with an insulated loop
- Designed for use with polywire and polyrope, but can also be used for polytape up to 40mm
- Nail directly onto wooden posts (secure additionally with 1 staple)
- Secure insulator with at least 2 staples when installed on top of post



LENGTH (MM)	UNIT Qty	MIN. ORDER Qty	OUTER CARTON Qty	CODE
250	Pack of 5	1 Pack	20 Packs	P166105
400	Pack of 5	1 Pack	20 Packs	P166205
800 (2 Sided)	Pack of 5	1 Pack	10 Packs	P166505

Joiners

PATURA® Polywire Joiner

- For secure connection of all electric fence polywires up to 2.5mm
- This product can also be used to join high voltage cable above ground



FINISH	SUITABLE FOR	UNIT Qty	MIN. ORDER Qty	OUTER CARTON Qty	CODE
Galvanised	up to 2.5mm polywire	Pack of 5	1 Pack	12 Packs	P160505

PATURA® Polyrope Joiner

- For secure connection of all electric fence polyrope up to 6mm
- This product can also be used to join high voltage cable above ground

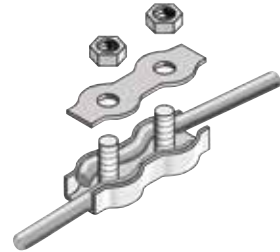

FINISH	SUITABLE FOR	UNIT Qty	MIN. ORDER Qty	OUTER CARTON Qty	CODE
Galvanised	up to 6mm rope	Pack of 5	1 Pack	10 Packs	P103205
Stainless Steel	up to 6mm rope	Pack of 3	1 Pack	12 Packs	P103903

PATURA® Tape Joiner

Good connection, no corrosion, optimum current flow, stainless steel.



FINISH	SIZE INS (MM)	UNIT Qty	MIN. ORDER Qty	OUTER CARTON Qty	CODE
Stainless Steel	12	Pack of 5	1 Pack	12 Packs	P103305
Stainless Steel	20	Pack of 5	1 Pack	12 Packs	P103405
Stainless Steel	40	Pack of 5	1 Pack	12 Packs	P103505



Rope Clamp

FINISH	SUITABLE FOR	DESC	MIN. ORDER Qty	OUTER CARTON Qty	CODE
					P160405



Gripples

FINISH	SUITABLE FOR	DESC	MIN. ORDER Qty	OUTER CARTON Qty	CODE
Galvanised	1.40-2.20mm steel wire	Small	20	200	2210011
Galvanised	2 - 3.25mm steel wire and hippo wire	Medium	20	200	2210021



PATURA® Joint Screw

Hot dip galvanised; for the electrical cross connection of several wires or for the connection of high voltage cable with the fence.

FINISH	UNIT Qty	MIN. ORDER Qty	OUTER CARTON Qty	CODE
Galvanised	Pack of 5	1 Pack	12 Packs	P169605
Galvanised	Pack of 25	1 Pack	10 Packs	P169625

ELECTRIC FENCING POSTS

Spring Steel Post with Pigtail Insulator

Round (7mmØ) galvanised, welded step with tread plate.

DESC	LENGTH MM	MIN. ORDER Qty	CODE
w/ Pigtail Insulator	1000	1	P164220

PATURA® Steel Step-In Pig Post

Round (10mmØ) galvanised metal post with welded double tread-in bracket. Use with round rod insulator.

FINISH	LENGTH (MM)	MIN. ORDER Qty	CODE
Galvanised	1100	1	P164211

PATURA® Polypost with Metal Spike & Double Step

- Robust, fully insulating plastic post with metal spike and double step
- 7 or 8 wire holders and 1-3 rope holders

FINISH	LENGTH (MM)	NO. WIRE HOLDERS	FENCE HEIGHT (MM)	UNIT Qty	MIN. ORDER Qty	PALLET Qty	CODE
White	1050	7	550	Pack of 10	1 Pack	100 Packs	P163710
Green	1050	7	850	Pack of 10	1 Pack	100 Packs	P163720
White	1550	8	1300	Pack of 10	1 Pack	100 Packs	P163810

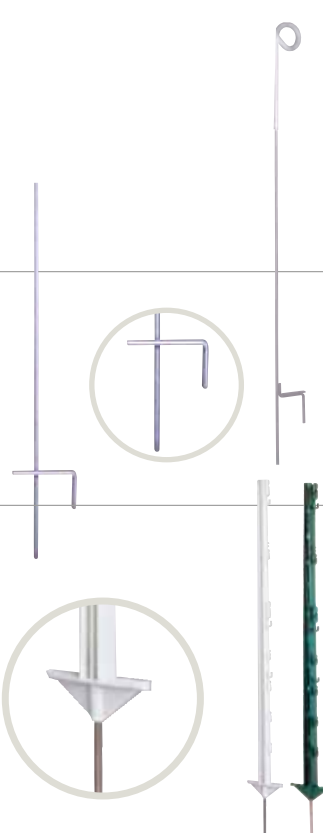

Heavy Duty Polypost

FINISH	LENGTH (MM)	NO. WIRE HOLDERS	FENCE HEIGHT (MM)	UNIT Qty	MIN. ORDER Qty	CODE
Green	1550	8	1300	Pack of 10	1 Pack	P163820
Pink	1550	8	1300	Pack of 10	1 Pack	163920
Petrol	1550	8	1300	Pack of 10	1 Pack	163910



PATURA® Plastic Stirrup Post

- Robust, fully insulating plastic post with metal spike and strong stirrup for easy ground insertion
- 6 or 8 holders for polywires
- Up to 40mm tape and cable

FINISH	LENGTH (MM)	NO. WIRE HOLDERS	FENCE HEIGHT (MM)	UNIT Qty	MIN. ORDER Qty	PALLET Qty	CODE
White	1500	6	1300	Pack of 10	1 Pack	60 Packs	P163610
Green	1500	8	900	Pack of 10	1 Pack	60 Packs	P163630



PATURA® Metal Corner Post - Super

Made of sturdy, hot dip galvanised angle iron, with 3 points and predrilled holes for insulators such as corner insulators and ring insulators.

FINISH	LENGTH (MM)	MIN. ORDER Qty	OUTER CARTON Qty	CODE
Galvanised	850	1	10	P104500

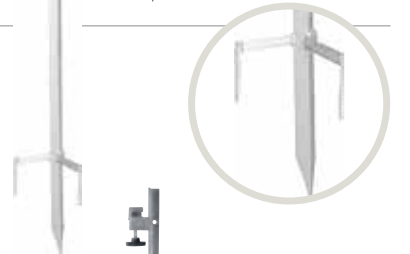

PATURA® Special Mounting Post

- Special mounting post for longer temporary fences, particularly those with many corners. Hand-screw sockets allow quick and easy removal of reels
- No tools required!

DESC	FINISH	FENCE HEIGHT (M)	MIN. ORDER Qty	CODE
3 Reel	Galvanised	1	1	P633001



ELECTRIC FENCING GATES

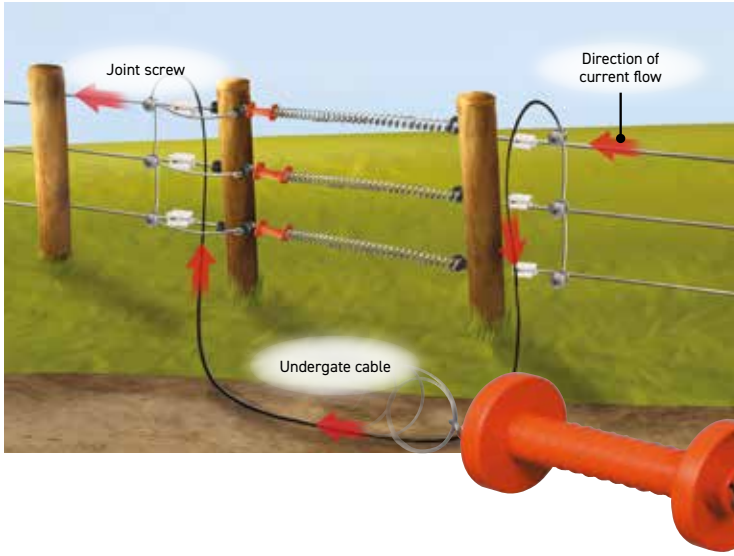

Gates in the Fence – 5 basic rules

1. Keep the number of gates to a minimum, as gates are always a weak point in the fence.
2. If possible, ensure that the gate is on level ground, as the gate area is always endangered by erosion.
3. You will simplify the fence construction by putting the gate in a corner area.
4. Never run the current through the gate itself from one side to the other, rather use high voltage cable to pass it under the gate.
5. Do not use spring gate sets in horse fences.

Spring gate set – the practical gate

A spring gate set consists of 4 parts: the gate handle, gate handle insulator, gate tensioning spring and the insulator for attaching the spring. Patura spring gate sets contain an especially large spring and are suitable for all gate widths from 3 to 5 metres. In the opened condition the spring carries no current, contracts to about 25cm and hangs down, with the handle from the gatepost. To shut the gate, the gate handle and spring are attached to the gate insulator on the other side of the gate. From here, the gate handle and spring obtain the current.

PATURA® Spring Gate Set

FINISH	MIN. ORDER Qty	CODE
Galvanised	1	P164001



PATURA® Elastic Rope Gate Set

Suitable for use with horses. Includes:

- Gate handle
- Insulators
- 3m elastic polyrope (extends to 6m)

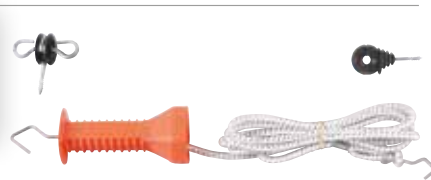

SUITABLE FOR	MIN. ORDER Qty	OUTER CARTON Qty	CODE
up to 6m gateways	1	8	P641201

PATURA® Polytape Gate Set

Complete polytape set. Includes:

- Gate handle
- Insulators
- 5m polytape
- Ideal for use with horses due to high visibility



SUITABLE FOR	MIN. ORDER Qty	OUTER CARTON Qty	CODE
up to 5m gateways	1	6	P641001

PATURA® Gate Handle with Galvanised Hook

With galvanised hook and tension spring.

FINISH	MIN. ORDER Qty	OUTER CARTON Qty	CODE
Black Plastic	1	20	P639100
Pack of 10	1	20	P639100PK10

PATURA® Special Gate Handle

DESC	FINISH	KEY FEATURES	MIN. ORDER Qty	OUTER CARTON Qty	CODE
w/ Tension Spring (B)	Orange Plastic	Stainless steel hook, stainless steel spring and wide protective shield.	1	50	P639400
for Tape (C)	Orange Plastic	Stainless steel connector plate for polytape up to 40mm.	1	50	P639500

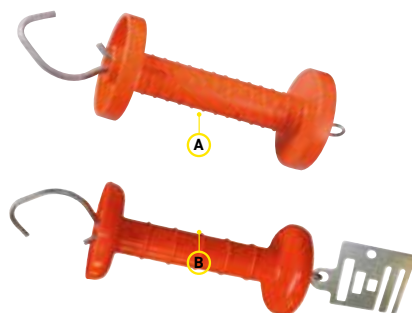

*The tension on the gate handle is converted to pressure on the spring inside, avoiding over extension of the spring gate

Gate Handle with Galvanised Hook & Spring

FINISH	MIN. ORDER Qty	OUTER CARTON Qty	CODE
Petrol	1	20	P639100PR
Petrol Pack of 10	1	20	P639100PRPK10
Pink	1	20	P639100PK
Pink Pack of 10	1	20	P639100PKPK10





PATURA® Retractable Roller Gate

- For fast installation of flexible gates and partitions on pastures, drive paths, passage ways and paddocks
- Tape retracts automatically and is protected inside the housing
- Mounting parts and gate handle are included

DESC	SUITABLE FOR	MIN. ORDER Qty	OUTER CARTON Qty	CODE
6m rope	up to 6m gateways	1	6	P641301
6m tape, 35mm	up to 6m gateways	1	6	P641302



PATURA® Gate Handle Connector Plate

FINISH	SUITABLE FOR	MIN. ORDER Qty	CODE
Stainless Steel	up to 40mm tape	1	P639800



PATURA® Gate Handle Insulator

DESC	FINISH	KEY FEATURES	UNIT Qty	MIN. ORDER Qty	OUTER CARTON Qty	CODE
2-Way (A)	Black Plastic	Wood Screw Thread w/ 2 eyelets	Pack of 4	1 Pack	6 Packs	P102504
3-Way (B)	Hot dipped galvanised plate	Attachment screw for high voltage cable and 2 woodscrews.	Pack of 4	1 Pack	6 Packs	P102604

PATURA® Elastic Rope

Spare elastic rope for PATURA® electric gate systems.



LENGTH (M)	DIAMETER (MM)	MIN. ORDER Qty	OUTER CARTON Qty	CODE
25	8	1	14	P162225

ELECTRIC FENCING INSTALLATION GUIDELINES

See page 115-118 for our handy installation guides

Tips and advice for installation of PATURA® products in a range of settings



PATURA® Fence Tester (8 levels)

- Essential for daily fence monitoring; shows the condition of your fence in 8 stages (1000 to 8000V). Complete with connecting cable and earth stake.

MIN. ORDER Qty
CODE

1

P150002
PATURA® Digital Voltmeter

The ideal measuring equipment with earth stake, fence contacts and digital display. Essential for the monitoring of electric fences, their earthing, for fault finding and for checking equipment. With integrated activatable load resistor to simulate animal contact

MIN. ORDER Qty
OUTER CARTON Qty
CODE

1

10

P150302
PATURA® Cutout Switch

For switching the current on and off independently of the energiser and for switching individual paddocks on or off.

MIN. ORDER Qty
OUTER CARTON Qty
CODE

1

12

P160701
PATURA® Lightning Diverter

MIN. ORDER Qty
OUTER CARTON Qty
CODE

1

10

P164801

PATURA® Warning Sign
DESC
MIN. ORDER Qty
CODE

Plastic printed both sides

1

P160001

Caution: Electric fence international standards require that warning signs be placed at clearly visible points 50m apart, at junctions with byways, as well as at points where the existence of an electric fence would not be expected.

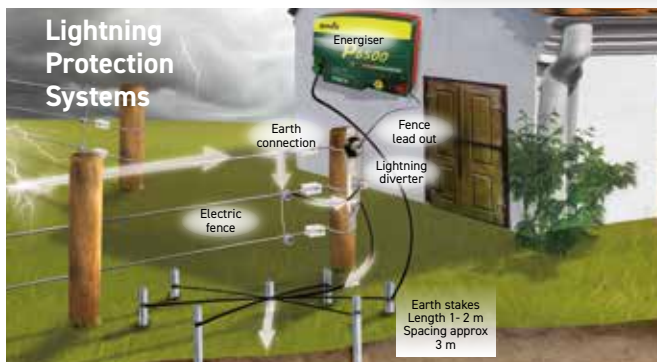
International standard requirements:

"Energisers for the operation of electric fence installations on pasture land may not be installed in buildings that are susceptible to fire such as barns, hay lofts and stables.

To protect against lightning damage, a lightning protection system (spark gap with earthing) must be built into the fence lead-out before the introduction of that lead out cable into the building".

SITEMATE® Spinning Jenny Wire Dispenser

- Galvanised adjustable wire dispenser including ground spike
- For the simple rolling up of steel wire, horse wire and plain steel wire; with base to allow direct insertion into the ground

FINISH	MIN. ORDER Qty	CODE
Galvanised	1	6600003



Tensioning Tool for Gripples

DESC	FINISH	MIN. ORDER Qty	CODE
For tensioning wire	Plastic	1	2210000



PATURA® Electric Fencing Pliers

DESC	FINISH	MIN. ORDER Qty	CODE
Traditional fencing pliers with hammer and wire cutter	Steel	1	P152201



PATURA® Professional Electric Fencing Pliers

- Rugged insulated pliers
- Heavy duty model with hammer, parallel clamping jaws and special wire cutter for steel wire

FINISH	MIN. ORDER Qty	CODE
Steel	1	P522001



INSTALLATION GUIDELINES

CATTLE FENCING

A Compact Reel can be hooked onto existing fencing if desired. Note: There is no electrical connection

EXISTING FENCE

3-4m APART

GATE BREAK INSULATOR P102504



P112

GATE HANDLE P639100



P111

REEL P161001



P95

COMPACT POLYWIRE P180200



P91

POLYPOST P163710



P108

WE RECOMMEND



P1 for fences up to 5km



P20 for fences up to 1.5km

TEMPORARY HORSE PADDOCK FENCING

The PATURA temporary fence system is ideal for fencing in areas for a short term or in changing locations.

All parts are designed for a quick and easy erection of the fence. It is possible for one person to fence in an area of one hectare, in less than half an hour.

POLYPOST P163810



P109

CONNECTORS



P100

4-6m APART

POLYTAPE P186501 OR P186100



P94

TAPE GATE SET P641001



P110

REEL POST SYSTEM

1 X P635000 STANDARD MOUNTING POST 2X REELS P161002



P96



P95

WE RECOMMEND



P2 for fences up to 10km



P20 for fences up to 1.5km

HORSE & PONY Post & Rail Protection

Optional extra line can be mounted lower down with ring insulators (P101760) if desired.

CONNECTOR P101401
P100

PULLEY INSULATORS P102206
P104

RING INSULATORS P101610
P104

ROPE JOINER P160405
P108

POLYROPE P183001
P92

ROTATING TENSIONERS P164325
P97

WE RECOMMEND
P2 for fences up to 10km

HORSE & PONY Permanent Fencing

2-3m Apart

120cm

75cm

CONNECTOR P170401
P100

POLYTAPE P189001
P91

IN-LINE TAPE INSULATOR P166920
P105

CORNER INSULATOR P168003
P106

WE RECOMMEND
P2 for fences up to 10km

RABBITS Crop Protection Systems

Posts lean towards the direction that the rabbits are coming from.

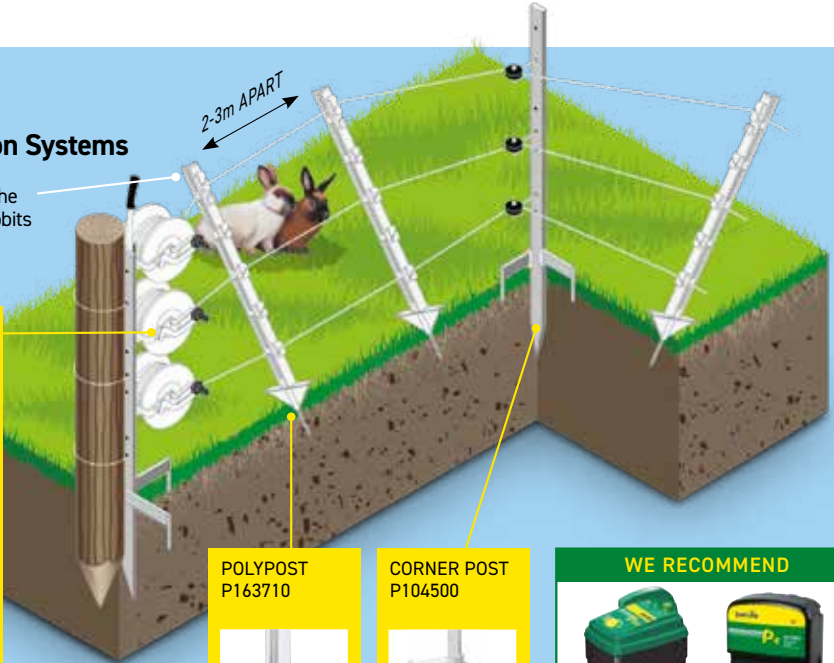

REEL POST SYSTEM

1x CORNER POST
P633001



P96

3x REELS
P161301



P96

POLYPOST
P163710



P108

CORNER POST
P104500



P96

WE RECOMMEND



P60 for fences up to 3km



P4 for fences up to 20km

SHEEP Strip Grazing Systems

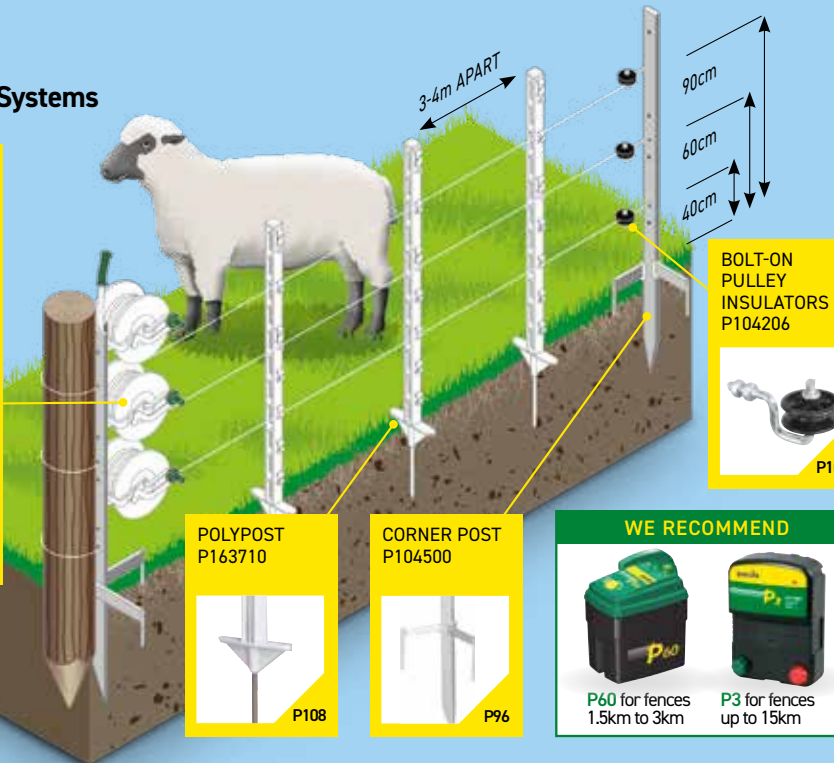

REEL POST SYSTEM

1x CORNER POST
P633001



P96

3x REELS
P161301



P96

POLYPOST
P163710



P108

CORNER POST
P104500



P96

BOLT-ON PULLEY INSULATORS
P104206



P104

WE RECOMMEND



P60 for fences 1.5km to 3km



P3 for fences up to 15km

PIG SYSTEMS

BOLT-ON PULLEY INSULATORS P104206



P104

ROUND ROD INSULATORS P165625



P105

CORNER POST P104500



P96

TORNADO XL POLYWIRE P181201



P91

PIG POST P164211



WE RECOMMEND



P4 for fences up to 20km

MULTI-STRAND PERMANENT SYSTEMS FOR WILDLIFE

Typically free range poultry can be contained with systems of up to 9 lines.

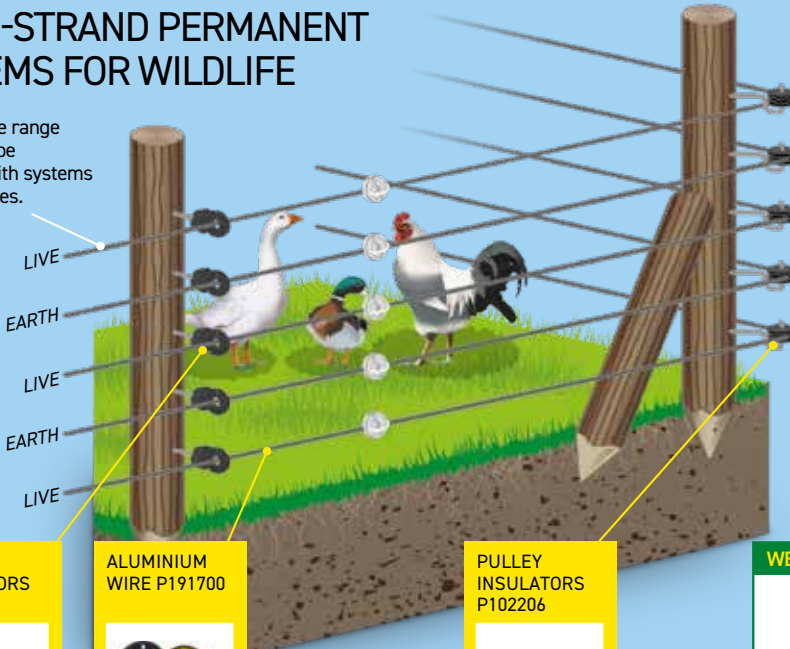

RING INSULATORS P101760



P104

ALUMINIUM WIRE P191700



P90

PULLEY INSULATORS P102206



P104

WE RECOMMEND



P3 for fences up to 15km



Pest Control

WOODEN TRAPS

Wooden mouse and rat traps supplied on display cards.



CODE	DESCRIPTION
7009-201	Wooden mouse trap – 2 mounted on card
7010-101	Wooden rat trap – mounted on card

SNAPPER TRAPS

Strong plastic traps, hygienic and easy to use. Supplied mounted on display cards.



CODE	DESCRIPTION
7009-209	Snapper Mousetrap – 2 mounted on card
7010-109	Snapper Rattrap – mounted on card

RATSTOP TRAP

Ready to use Rat Trap including special trigger. Used trigger is quickly and easily replaced. Guaranteed trapping efficiency. Replacement bait supplied in packs of 3.



CODE	DESCRIPTION
7010-209	Mounted on a display card
7010-210	Replacement Bait. 3 Pack

FLY PAPER ROLL

Glue trap for controlling flies and flying insects. Use in the stable or dairy. 7m long x 30cm wide with a metal hanging handle. Yellow paper has a greater attraction to flies and insects.



CODE	SIZE
7407-700	Size: 7m x 30cm

BAIT BOX

Lockable rat bait box station ideal for use with loose grain, block bait and pasta bait. Two pre-moulded reservoirs hold grain or pellets and a removable bar with hold block or pasta bait.



CODE
7107-100

HORSEFLY TRAP

This trap will reduce gadfly presence by up to 95% in the immediate vicinity. It has a maximum effective range of approximately 5000m².

- Completely non-toxic and environmentally friendly.
- Easy to assemble and hang using the supplied link chain.
- Umbrella diameter approximately 1.1m.



CODE
6013-004

WASP/FLY TRAP

- Very high capture rate for wasps and flies and other insects attracted by sugar.
- Complete protection for bees – the special entrance to the trap and the transparent cover prevent bees from falling into the trap
- Effective area up to 200m² per trap.
- Exceptionally easy to use.
- Can be stood on a flat surface or hung up
- Weather resistant plastic with UV protection.



CODE **DESCRIPTION**
6012-003
6012-003B Box of 13

WASP/FLY ATTRACTANT

- Highly effective ready to use natural attractant.
- The attractant remains effective for up to 6 weeks.
- Can be used indoors and out.
- Attracts wasps, fruit and house flies and midges thanks to its natural fruit juice concentrates.
- Eco friendly and 100% non-toxic.



CODE DESCRIPTION

6010-001
6010-001B Box of 12

FLYCAGE 2

- Very effective fly trap.
- Special attractants made from natural raw materials.
- Flies are attracted by the scent and drown in the trap.
- Removes approximately 70% of all flies and wasps in a radius of up to 1000m².
- Effective for 4-6 weeks.
- Non-toxic and ecological.



CODE DESCRIPTION

6011-002
6011-002B Box of 20

HORSEFLY BUCKET TRAP

Bucket trap complete with suspension cord and spring snap hook for hanging.



CODE DESCRIPTION

7408-200

HORSEFLY GLUE

High quality Horsefly glue that remains firmly adhered to the substrate even at high temperatures. Simply coat a surface and flies are immediately attracted and stuck fast. No insecticide and rain resistant.



CODE DESCRIPTION

7408-050 500g
7408-150 1.5Kg

GATEMATE®

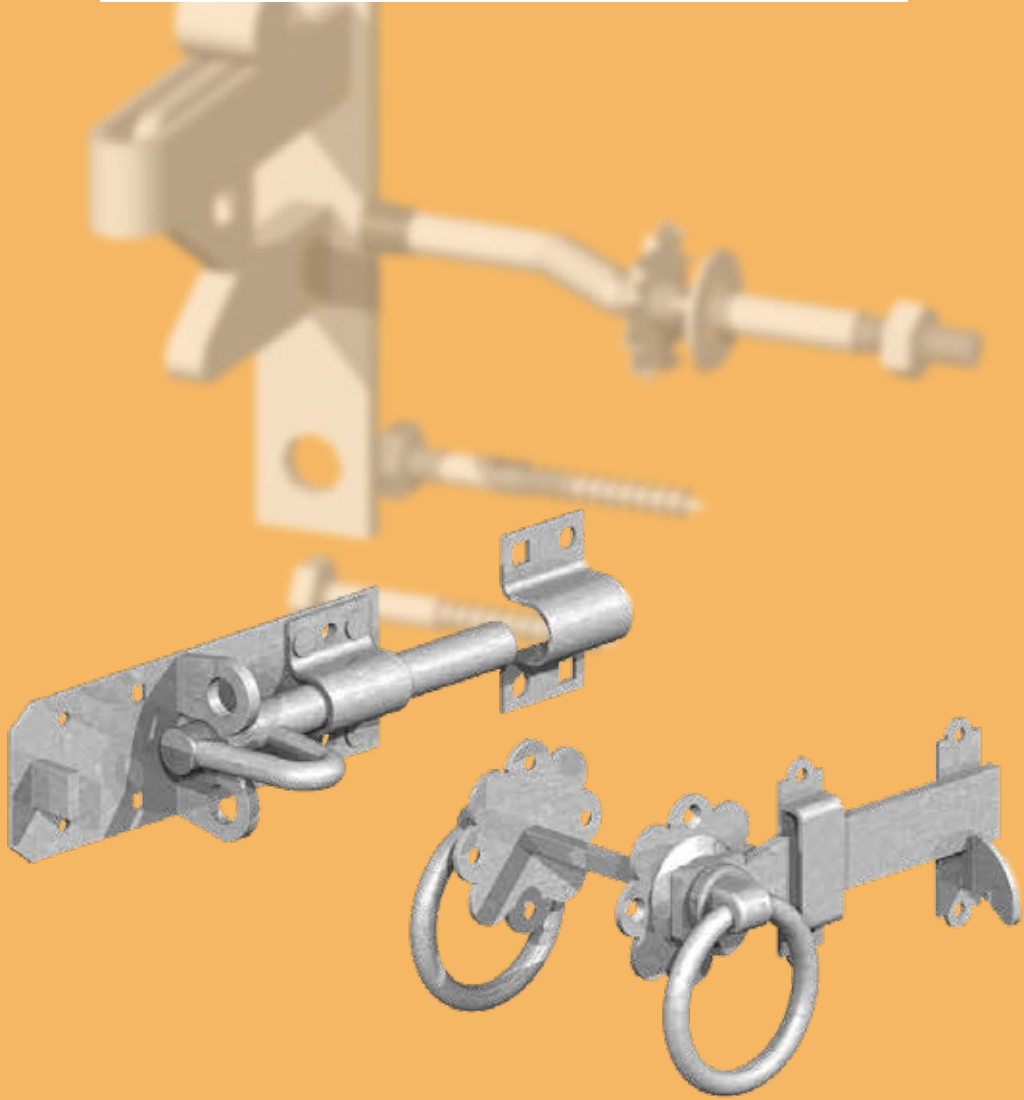

GateMate

GATEMATE MEDIUM TEE HINGES

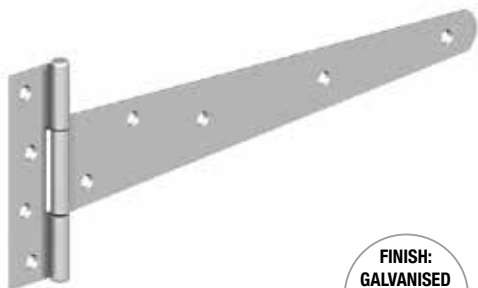

CODE	SIZE INS	FINISH	PAIRS P/BOX
502-3001	12	Galvanised	5
502-3501	14	Galvanised	5

GATEMATE STRONG TEE HINGES

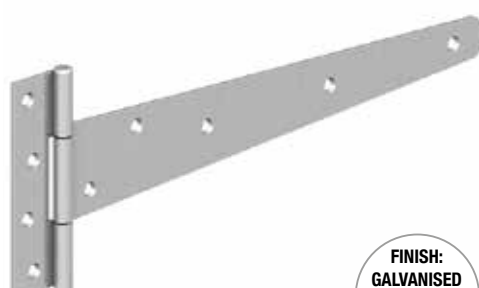

CODE	SIZE INS (MM)	FINISH	PAIRS P/BOX
503-3001	12	Galvanised	5
503-3501	14	Galvanised	5
503-4501	18	Galvanised	5

WEIGHTY SCOTCH TEE HINGES

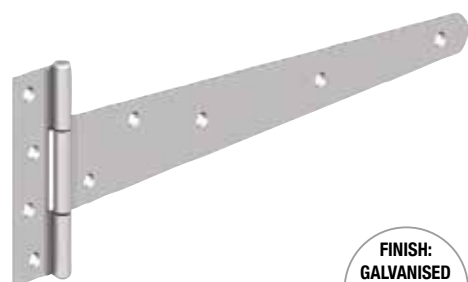

CODE	SIZE INS	FINISH	PAIRS PER BOX
505-4001	16"	Galvanised	5
505-4501	18"	Galvanised	5

GATEMATE STRAIGHT BANDS & HOOKS ON PLATES



CODE	SIZE INS	FINISH	PAIRS PER BOX
506-4501	18	Galvanised	5
506-5001	20	Galvanised	5
506-6001	24	Galvanised	5

GATEMATE HEAVY REVERSIBLE HINGES



CODE	SIZE INS	FINISH	PAIRS PER BOX
509-4501	18	Galvanised	5
509-5001	20	Galvanised	5
509-6001	24	Galvanised	5

ADJUSTABLE GATE EYES WITH 2 NUTS



CODE	SIZE INS	FINISH	PAIRS PER BOX
549-6202	6"x3/4"	Galvanised	5 2 Per Pack

GATEMATE BRENTON PADBOLTS 5/8" SHOOT

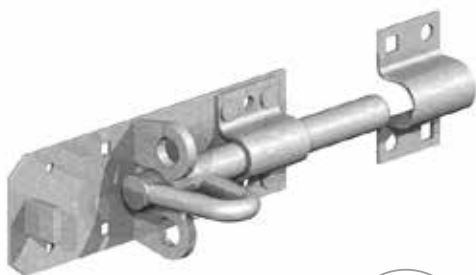

CODE	SIZE INS	FINISH	QTY PER BOX
513-1501	6	Galvanised	5
513-2001	8	Galvanised	5

GATEMATE AUTOLOCK ANIMAL BOLTS

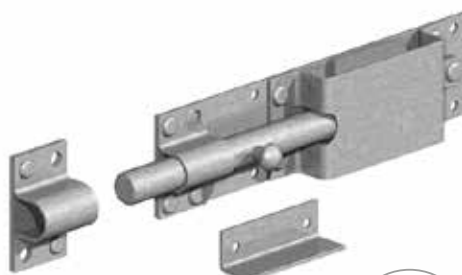

CODE	SIZE INS	FINISH	QTY PER BOX
515-2301	9	Galvanised	5

GATEMATE SPRING LOADED ANIMAL BOLT



CODE	SIZE INS	FINISH	QTY PER BOX
516-0122	1/2 dia	Galvanised	5

GATEMATE GARAGE DOOR BOLTS



CODE	SIZE INS	FINISH	QTY PER BOX
520-3001	12	Galvanised	5
520-4501	18	Galvanised	5

GATEMATE AUTO GATE CATCHES

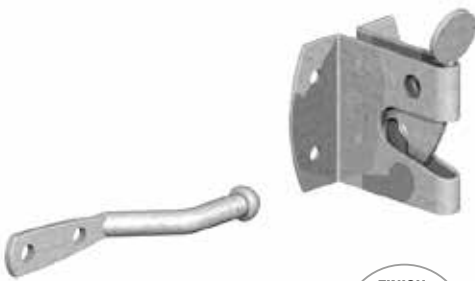

CODE	SIZE	FINISH	QTY P/BOX
521-0021	Large	Galvanised	5

GATEMATE RING GATE LATCHES

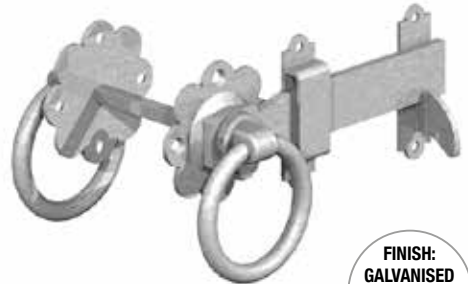

CODE	SIZE INS	FINISH	QTY PER BOX
525-1501	6	Galvanised	5

GATEMATE KICK OVER STABLE LATCHES



CODE	SIZE INS	FINISH	QTY PER BOX
530-2401	9½	Galvanised	5

GATEMATE SLIP RAIL BRACKETS



CODE	SIZE	FINISH	QTY PER BOX
529-0001	For rails up to 100 x 50 mm	Galvanised	5

GATEMATE SELF LOCKING GATE CATCH KIT



CODE	DESCRIPTION	FINISH	QTY PER BOX
563-0001	c/w striker fixings	Galvanised	5

HUNTING TYPE GATE CATCH KIT



CODE	DESCRIPTION	FINISH	QTY PER BOX
564-0001	c/w striker fixings	Galvanised	5

GATEMATE CABIN HOOKS CAST PATTERN



FINISH:
GALVANISED

CODE	SIZE INS	FINISH	PAIRS PER BOX
541-1501	6	Galvanised	5
541-2001	8	Galvanised	5
541-2501	10	Galvanised	5

GATEMATE CABIN HOOKS WIRE PATTERN



FINISH:
GALVANISED

CODE	SIZE INS	FINISH	PAIRS PER BOX
532-1501	6	Galvanised	5
532-2001	8	Galvanised	5
532-2501	10	Galvanised	5

GATEMATE HEAVY HASP & STAPLE

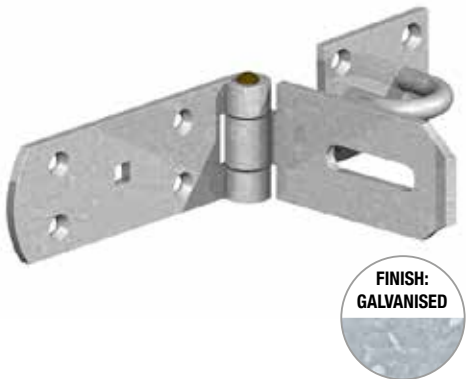

FINISH:
GALVANISED

CODE	SIZE INS	FINISH	QTY PER BOX
535-2501	10	Galvanised	5

GATEMATE DOOR-GATE HANDLES



FINISH:
GALVANISED

CODE	SIZE INS	FINISH	QTY PER BOX
537-1501	6	Galvanised	5

GATEMATE WIRE HASP & STAPLE

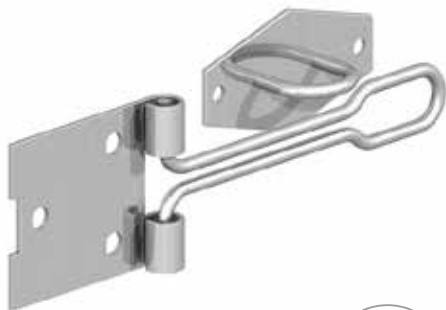

CODE	SIZE INS	FINISH	QTY PER BOX
536-1502	6	Galvanised	5

GATEMATE PADLOCK PROTECTORS



CODE	SIZE INS	FINISH	QTY PER BOX
538-1853	7½ x 2½	Galvanised	5

GATEMATE INTERMEDIATE FITTINGS FOR 4" POSTS.

Pack of 2.



CODE	SIZE INS	FINISH	QTY PER PACK
580-0101	¾	Galvanised	2

GATEMATE HOOKS ON PLATES

Pack of 2.

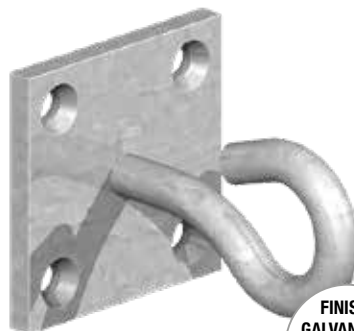

CODE	SIZE INS	FINISH	QTY PER PACK
582-0501	2 x 2	Galvanised	5

GATEMATE STAPLES ON PLATES

Pack of 2.



CODE	SIZE INS	FINISH	QTY PER PACK
583-0501	2 x 2	Galvanised	5

GATEMATE RINGS ON PLATES

Pack of 2.



CODE	SIZE INS	FINISH	QTY PER BOX
584-0501	2 x 2	Galvanised	5

BUCKET CLIP



CODE	SIZE INS	FINISH	QTY PER BOX
584-0001	2x2	Gaalvanised	5

GATEMATE RINGS ON EYEBOLT



CODE	SIZE INS	FINISH	QTY PER BOX
585-0752	3 x 8	BZP	5

GATEMATE CARBINE HOOKS

Pack of 2.

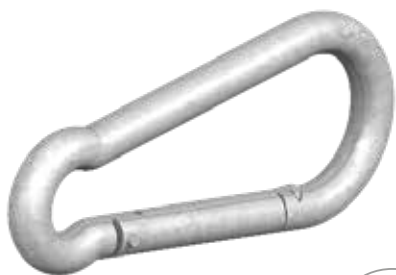

CODE	SIZE MM	FINISH	QTY PER PACK
587-8082	80 x 8	BZP	5
587-1002	10 x 100	BZP	5

GATEMATE SWIVEL HARNESS SNAP HOOKS



CODE	SIZE INS	FINISH	QTY PER BOX
588-0760	3 x 3/4	Galvanised	5

GATEMATE SWIVEL SPRING HOOKS

Pack of 2.



CODE	SIZE INS	FINISH	QTY PER PACK
589-0752	3"	Galvanised	5
589-1002	4"	Galvanised	5

SNAP HOOK

Heavy duty snap hook with swivel ring.



CODE	FINISH
910-1402	Galvanised

PANIC HOOK

Heavy duty 14mm eye panic hook for tie ropes.



CODE
910-1401

FINISH
Galvanised

GATEMATE QUICK REPAIR LINKS

Pack of 2.



FINISH:
GALVANISED

CODE	SIZE MM	FINISH	QTY PER PACK
591-0062	6	BZP	5
591-0082	8	BZP	5

GATEMATE MENDING LINKS FOR CHAIN



FINISH:
GALVANISED

CODE	SIZE INS (MM)	FINISH	QTY PER BOX
238-0062	1¼ x ¼ (30 x 6)	E-Galvanised	10

SPIKED CHAIN ALTERNATE LINKS



FINISH:
GALVANISED

CODE	SIZE INS	FINISH	QTY PER REEL
235-0061	¼	Galvanised	25 m

SPIKED CHAIN EVERY 4 LINKS



CODE	SIZE INS	FINISH	QTY PER REEL
236-0061	1/4	Galvanised	25 m

SPIKED CHAIN EVERY LINK



CODE	SIZE INS	FINISH	QTY PER REEL
237-0061	1/4	Galvanised	25 m

STRAIGHT LINK CHAIN



CODE	SIZE MM	FINISH	QTY PER REEL M
241-0031	3 x 21	Galvanised	30
241-0041	4 x 26	Galvanised	30
241-0051	5 x 28	Galvanised	25
241-0061	6 x 42	Galvanised	15
241-0081	8 x 42	Galvanised	30

BLUE POLYPROPYLENE ROPE



CODE	SIZE MM	FINISH	LENGTH P/COIL
223-3100	10	Blue	30m
223-3120	12	Blue	30m

ROUND WIRE NAILS (PRE-PACKED)



CODE (GALVANISED)	CODE (BRIGHT)	PACK SIZE	LENGTH MM	GAUGE MM
601-0191	601-0194	500 g	50	2.65
611-0191	611-0194	1 kg	50	5.65
601-0081	601-0084	500 g	75	3.35
611-0081	611-0084	1 kg	75	3.35
601-0041	601-0044	500 g	100	4.5
611-0041	611-0044	1 kg	100	4.5
601-0021	601-0024	500 g	125	5.6
611-0021	611-0024	1 kg	125	5.6
601-0111	601-0114	500 g	150	6
611-0011	611-0014	1 kg	150	6

ROUND WIRE NAILS (PLASTIC TUBS) GALVANISED



CODE	PACK SIZE	LENGTH MM	GAUGE MM
626-0041	10 kg	100	4.5
626-0081	10 kg	75	3.35
626-0131	10 kg	50	2.65
626-1131	5 kg	50	2.65
626-0811	5 kg	75	3.35
626-0511	5 kg	100	4.00

EXTRA LARGE HEAD CLOUT NAILS (PRE PACKED) GALVANISED



CODE	PACK SIZE	LENGTH MM	GAUGE MM
612-0031	1 kg	30	3
612-0021	1 kg	40	3
612-0011	1 kg	50	3
612-0051	1 kg	20	3

STAPLES (PRE-PACKED) GALVANISED



CODE	PACK SIZE	LENGTH MM	GAUGE MM
605-0201	500 g	20	2
615-0201	1 kg	20	2
605-0251	500 g	25	2.65
615-0251	1 kg	25	2.65
605-0401	500g	40	4
615-0401	1kg	40	4
605-0501	500 g	50	5
615-0501	1 kg	50	5

POWER PRO TIMBER SCREWS

Countersunk head Pro Screws



CODE	FINISH	SIZE MM	QTY / BOX
374-00302	BZP	4x30	200
374-00402	BZP	4x40	200
374-00502	BZP	4x50	200
375-00402	BZP	5x40	200
375-00502	BZP	5x50	200
375-00602	BZP	5x60	100
375-00702	BZP	5x70	100
375-00802	BZP	5x80	100
375-00902	BZP	5x90	100
375-01002	BZP	5x100	100
376-00802	Ruspert	5x80	100
376-01002	Ruspert	5x100	100

TIMBER HEX HEAD SCREWS

Hex Head Sure Drive Screws



CODE	FINISH	SIZE MM	QTY / BOX
441-0701	Ruspert	70mm	100
441-1001	Ruspert	100	100
441-1501	Ruspert	150	100

CUP SQUARE HEX BOLT & NUT



CODE	FINISH	SIZE MM	QTY / BOX
C101-002	BZP	M10x100	50
C101-402	BZP	M10x140	50
C101-502	BZP	M10x150	50
C101-602	BZP	M10x160	25
C101-802	BZP	M10x180	25

STEEL WASHERS

Mudguard Washers

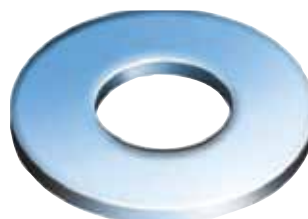

CODE	FINISH	SIZE MM	QTY / BOX
423-0122	BZP	M8x25	100
423-0152	BZP	M10x30	100
423-0162	BZP	M10x40	100

ROOFING BOLTS & NUTS



CODE	FINISH	SIZE MM	QTY / BOX
R08-0302	BZP	M8x30	100
R08-402	BZP	M8x40	100
R08-0502	BZP	M8x50	100
R08-0602	BZP	M8x60	100
R08-0702	BZP	M8x70	100
R08-0802	BZP	M8x80	100
R08-1002	BZP	M8x100	50

HEXAGON HEAD COACH SCREWS



CODE	FINISH	SIZE MM	QTY / BOX
H10-0702	ZINC PLATED	M10 X 70	100
H10-0802		M10 X 80	50
H10-1002		M10 X 100	50
H10-1502		M10 X 150	50
H10-2002		M10 X 200	50
H08-0702		M8 X 70	100
H08-0802		M8 X 80	100
H08-1002		M8 X 100	100

GATEMATE LINC H PINS



CODE	SIZE INS (MM)	FINISH	QTY PER BOX
842-0082	Medium 5/16" [8]	Galvanised	2
842-0112	Large 7/16" [11]	Galvanised	2

GENERAL PURPOSE WHEELBARROW

NEW PRODUCT

SEE P17 FOR DETAILS



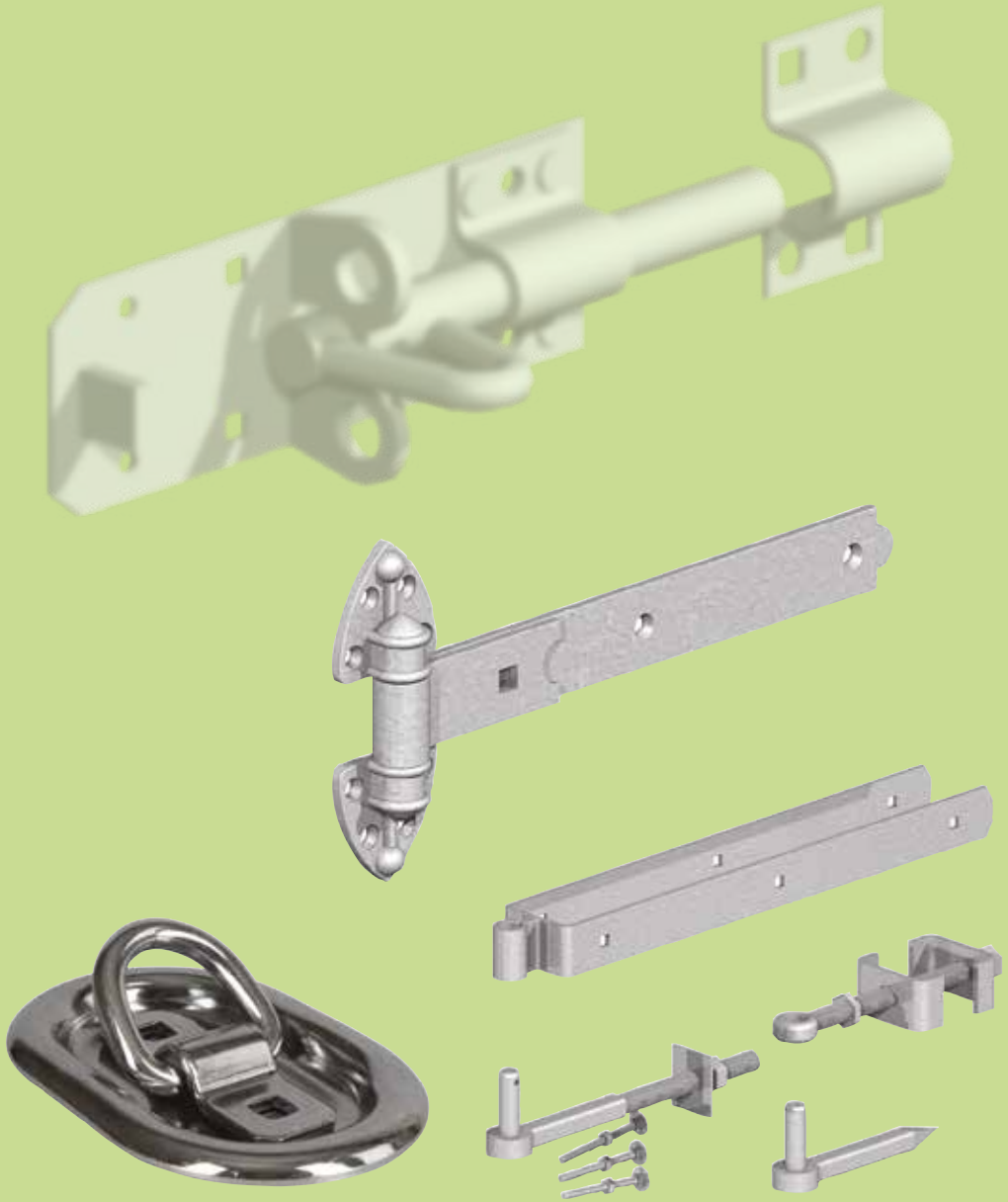

Hardware & Gate Fittings

FIELD GATE HINGE SET WITH HOOKS ON PLATES (PRE-PACKED)

For 3" Gates, 2" x 1/4" Top Band, 5" x 2" x 1/4" Bottom Band, 2 no. Hooks on 4" Square Plates and Fixings. This standard hinge set comes with hooks on plates to make installation easier.

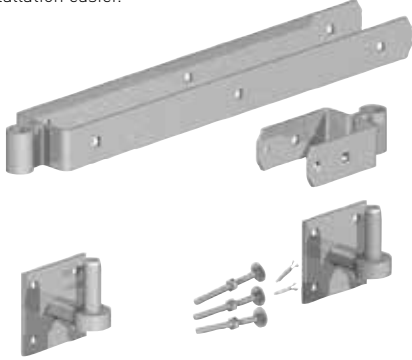

CODE	SIZE INS (MM)	FINISH
031-4501	18 (450)	Galvanised
031-6001	24 (600)	Galvanised

STANDARD FIELD GATE HINGE SET (PRE-PACKED)

For 3" Gates, 2" x 1/4" Top Band, 5" x 2" x 1/4" Bottom Band, Hook to Bolt, Hook to Drive and Fixings. A traditional hanging set for field gates complete with fixings.

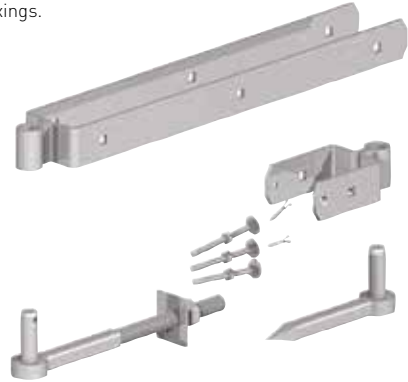

CODE	SIZE INS (MM)	FINISH
030-4501	18 (450)	Galvanised
030-6001	24 (600)	Galvanised

ADJUSTABLE HINGE SETS (PRE-PACKED)

For 3" Gates, 2" x 1/4" Top Band, Adjustable Gate Eye and Heel Clips, Hook to Bolt, Hook to Drive and Fixings. An alternative field gate hanging set. The bottom fitting allows the gate to be adjusted up or down after installation. Complete with fixings.

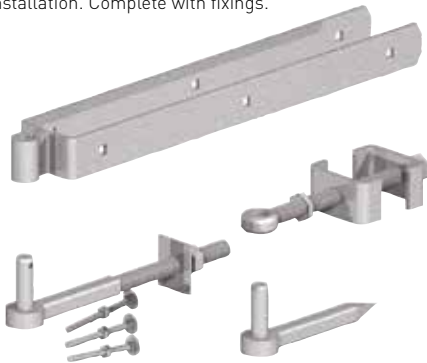

CODE	SIZE INS (MM)	FINISH
032-4501	18 (450)	Galvanised
032-6001	24 (600)	Galvanised

ADJUSTABLE HINGE SETS WITH HOOKS ON PLATES (PRE-PACKED)

For 3" Gates, 2" x 1/4" Top Band, Adjustable Gate Eye and Heel Clips, 2 No Hooks on 4" Square Plates and Fixings. As our standard hooks on plates hinge set but with an adjustable gate eye to allow adjustment of the gate after installation.



CODE	SIZE INS (MM)	FINISH
033-4501	18 (450)	Galvanised
033-6001	24 (600)	Galvanised

SPRING FASTENER SETS (PRE-PACKED)

For 3" Gates, Spring Fastener, Catch, Keep and Fixings. A spring latch, catch and keep to close a fieldgate. All fixings are included in this set.



CODE	DESCRIPTION	FINISH
036-0001	c/w staple catch	Galvanised

SELF LOCKING GATE CATCHES (PRE-PACKED)

An automatic catch complete with striker bar for closing gate. All fixings included.



CODE	FINISH
039-0001	Galvanised

ANIMAL SAFETY SELF LOCKING GATE CATCHES (PRE-PACKED)

An automatic gate catch complete with double leg striker and fixings. This catch is surrounded by a ring of steel to help protect livestock from damaging themselves on the catch.



CODE	FINISH
039-0041	Galvanised

DOUBLE GATE FASTENER SETS (PRE-PACKED)

A complete set of hardware to secure two gates together. Complete with fixings.

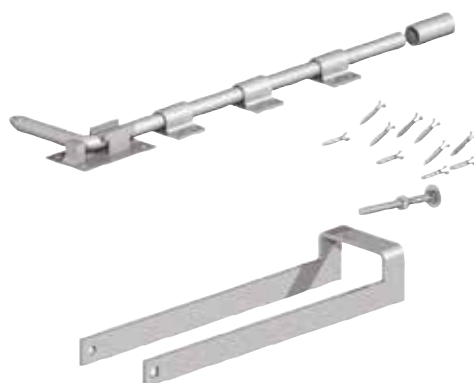

CODE	SIZE INS (MM)	FINISH
038-0001	For 3" gates	Galvanised

HOOKS AND CATCHES

HOOKS TO BOLT

A galvanised hook which is available separately. Fully threaded with a hole in the pin for added security.



CODE	SIZE INS (MM)	PIN Ø MM	FINISH
040-3251	13 (325)	19	Galvanised

HOOK TO DRIVE

A gate hook normally fitted at the bottom of the post. Fully galvanised and barbed to ensure a strong fixing.



CODE	SIZE INS (MM)	FINISH
041-8191	8½ (215)	Galvanised

HOOK ON PLATE

This hook is mounted on a square plate with fixing holes which enables a gate to be hung without having to drill through the post.



CODE	SIZE INS (MM)	FINISH
042-4191	4" sq (100)	Galvanised

HOOK ON NARROW PLATE

A narrow version of our standard hook on plate for hanging field gates.



CODE	SIZE INS (MM)	FINISH
045-0191	3/4 (19)	Galvanised

ADJUSTABLE HOOK ON NARROW PLATE

This hook on plate allows for adjusting the gate after installation.



CODE	SIZE INS (MM)	FINISH	PAIRS PER BOX
042-6191	3/4 (19)	Galvanised	10

ADJUSTABLE GATE EYES WITH 2 NUTS

Adjustable gate eyes supplied with two nuts.



CODE	SIZE INS (MM)	FINISH	BOX QTY
049-4201	4 x 3/4 (100 x 20)	Galvanised	25
049-6161	6 x 5/8 (150 x 16)	Galvanised	50
049-6201	6 x 3/4 (150 x 20)	Galvanised	25
049-8201	8 x 3/4 (200 x 20)	Galvanised	25
049-8241	8 x 7/8 (200 x 22)	Galvanised	25

SELF LOCKING GATE CATCH

An automatic catch.

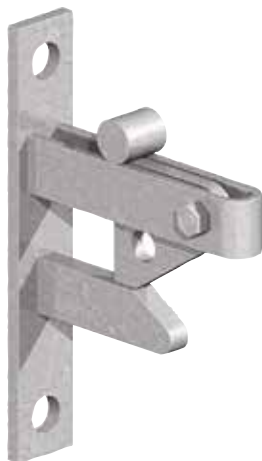

CODE	FINISH	BOX QTY
063-0001	Galvanised	25

SELF LOCKING GATE CATCHES HUNTING TYPE

An automatic catch with a long handle which can easily be reached on horseback.



CODE	FINISH
064-0001	Galvanised

STRIKERS FOR SELF LOCKING GATE CATCHES

A range of strikers available to complement our gate catches.

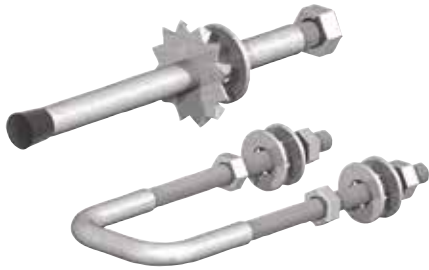

CODE	DESCRIPTION	FINISH
065-0041	Straight leg	Galvanised
065-0021	Double leg	Galvanised

GATE HOOK TO WELD

Hooks to weld with a flat base.



CODE	SIZE INS (MM)	FINISH	BOX QTY
046-0194	¾ (19)	Self colour	10

GATE EYE TO WELD

Eyes to weld with a flat base.



CODE	SIZE INS (MM)	FINISH	BOX QTY
047-0194	¾ (19)	Self colour	10

WEIGHTY SCOTCH TEE HINGE

Material thickness between 2.00 and 4.00mm

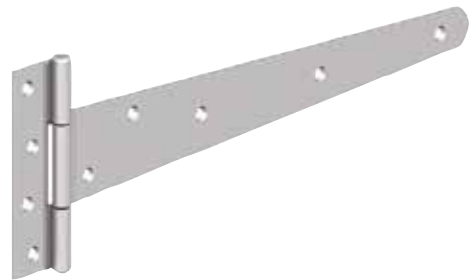

CODE	SIZE INS (MM)	FINISH	BOX QTY
004-4501	18 (450)	Galvanised	10
004-5001	20 (500)	Galvanised	10
004-6001	24 (600)	Galvanised	10

HINGES

STRONG TEE HINGES

A heavy duty tee hinge for all types of doors. Galvanised finish for extra durability. Also available in epoxy black.

CODE	SIZE INS (MM)	FINISH	PAIRS PER BOX
003-2501	10 (250)	Galvanised	10
003-3001	12 (300)	Galvanised	10
003-3003	12 (300)	Epoxy Black	10
003-3501	14 (350)	Galvanised	10
003-3503	14 (350)	Epoxy Black	10
003-4001	16 (400)	Galvanised	10
003-4003	16 (400)	Epoxy Black	10
003-4501	18 (450)	Galvanised	10
003-4503	18 (450)	Epoxy Black	10
003-5001	20 (500)	Galvanised	10
003-5003	20 (500)	Epoxy Black	10
003-6001	24 (600)	Galvanised	10
003-6003	24 (600)	Epoxy Black	10

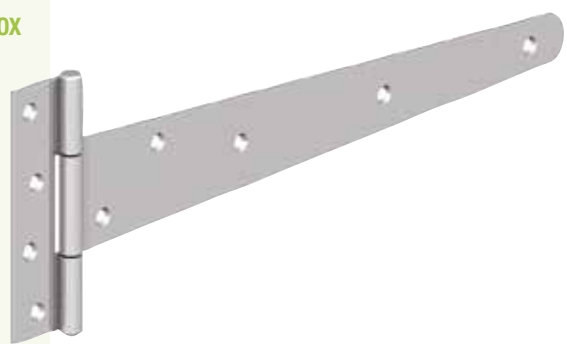

STRAIGHT BANDS AND HOOKS ON PLATES

A heavy duty band hinge ideal for stable doors.



CODE	SIZE INS (MM)	FINISH	PAIRS PER BOX
006-3501	14 (350)	Galvanised	5
006-4001	16 (400)	Galvanised	5
006-4501	18 (450)	Galvanised	5
006-5001	20 (500)	Galvanised	5
006-6001	24 (600)	Galvanised	2

CRANKED BANDS AND HOOKS ON PLATES

Another heavy duty band hinge which is cranked to allow the stable door to fit flush with the frame.



CODE	SIZE INS (MM)	FINISH	PAIRS PER BOX
007-3501	14 (350)	Galvanised	5
007-4001	16 (400)	Galvanised	5
007-4501	18 (450)	Galvanised	5
007-5001	20 (500)	Galvanised	5
007-6001	24 (600)	Galvanised	2

HEAVY REVERSIBLE HINGES

A decorative heavy band hinge for stable doors.



CODE	SIZE INS (MM)	FINISH	PAIRS PER BOX
017-3001	12 (300)	Galvanised	5
017-3501	14 (350)	Galvanised	5
017-4001	16 (400)	Galvanised	5
017-4501	18 (450)	Galvanised	5
017-5001	20 (500)	Galvanised	5
017-6001	24 (600)	Galvanised	2
017-7501	30 (750)	Galvanised	2
017-9001	36 (900)	Galvanised	2

MONKEY TAIL BOLT WITH 5/8" SQUARE SHOOT

CODE	SIZE INS (MM)	FINISH
113-3001	Size 12 (300)	Finish Galvanised
113-4501	Size 18 (450)	Finish Galvanised

NECKED TOWER BOLT

CODE	SIZE INS (MM)	FINISH
101-1501	6 (150)	Finish Galvanised
101-2001	8 (200)	Finish Galvanised
101-1003	4 (100)	Finish Epoxy Black
101-1503	6 (150)	Finish Epoxy Black

TOWER BOLT

A standard bolt for retaining any door.

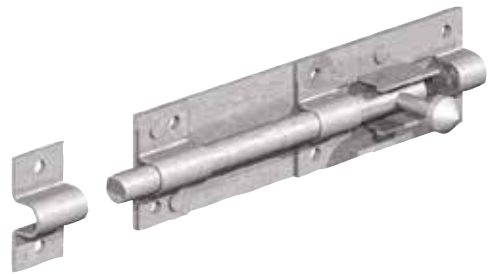

CODE	SIZE INS (MM)	FINISH	BOX QTY
100-1501	6 (150)	Galvanised	10
100-1503	6 (150)	Epoxy Black	10
100-2001	8 (200)	Galvanised	10
100-2003	8 (200)	Epoxy Black	10

SLIP RAIL BRACKETS

A galvanised set of brackets to ease the removal and retaining of a single rail within a fence.



CODE	DESCRIPTION	FINISH
072-0001	For rails up to 100 x 50 mm	Galvanised

BOLTS

BRENTON PADBOLTS

Our brenton padbolts are ideal for a stable door.

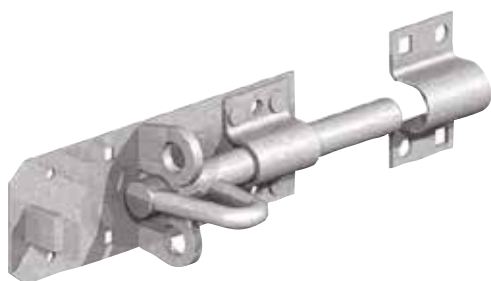

CODE	SIZE INS (MM)	FINISH	BOX QTY
104-1501	6 (150)	Galvanised	5
104-2011	8 (200)	Galvanised	5
	(with elongated keep)		
104-2501	10 (250)	Galvanised	5
104-3001	12 (300)	Galvanised	5

OVAL PADBOLT

A door bolt that requires a smaller fixing area.

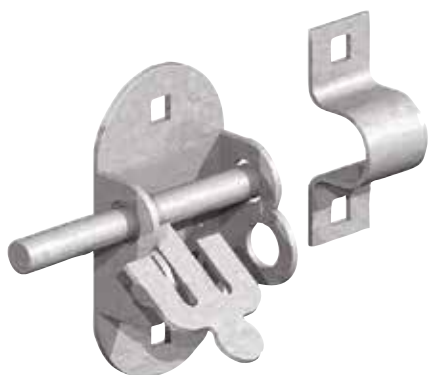

CODE	SIZE INS	FINISH	BOX QTY
102-1001	4	Galvanised	10

ELONGATED KEEPS

A wider keep to allow for plenty of clearance on a stable door.



CODE	FINISH	BOX QTY
106-0161	Galvanised	10

GATE RETURN SPRING

CODE	SIZE INS (MM)	FINISH
132-2002	8 (200)	Finish BZP
132-2502	10 (250)	Finish BZP

AUTOLOCK ANIMAL BOLTS

An ingeniously designed bolt. Cannot be opened unless the catch and the shoot are moved at the same time.

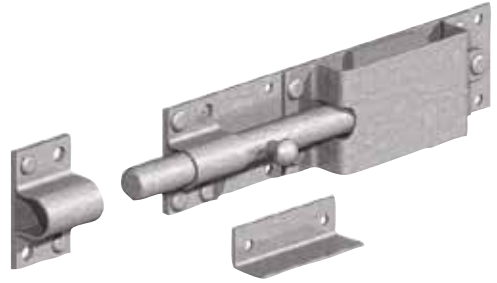

CODE	SIZE INS (MM)	FINISH	BOX QTY
108-2301	6 (150)	Galvanised	5

½" SPRING LOADED BOLT

A strong, spring loaded bolt complete with staple for securing a door or gate.

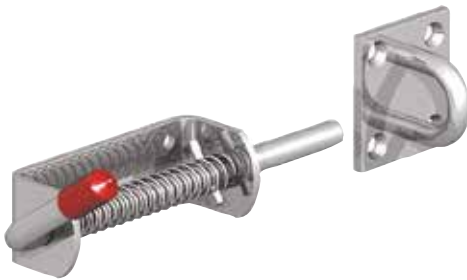

CODE	SIZE INS (MM)	FINISH	BOX QTY
109-0122	½ (12)	E-Galvanised	10

SPRING LOADED BOLT

Another spring loaded bolt for use on a door or gate, 450 mm (18") long.



CODE	SIZE INS (MM)	FINISH	BOX QTY
110-4501	½ (12)	Galvanised	10

18" DROP BOLT

A popular drop down bolt for securing a gate. Comes with ground sockets.



CODE	SIZE INS (MM)	FINISH
116-4501	18 (450)	Galvanised

HEAVY DUTY SPRING LOADED GATE WHEEL

Heavy duty spring loaded gate wheel for carrying the gate weight.

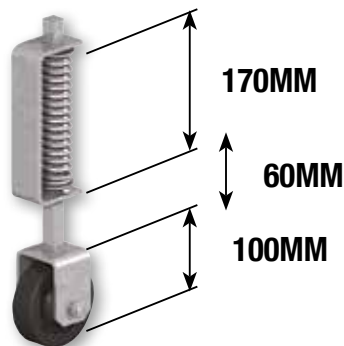

CODE	SIZE INS (MM)	FINISH
081-3681	14 1/2 (368)	Galvanised

LATCHES AND CATCHES

AUTO GATE CATCHES

Heavy duty auto gate catch which is popular for most types of gates.

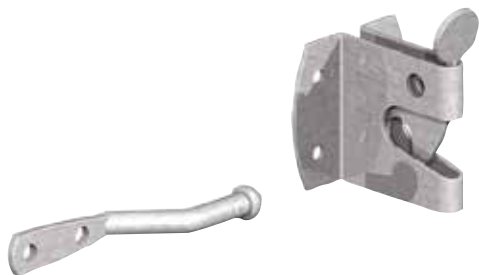

CODE	SIZE	FINISH	BOX QTY
120-0021	Large	Galvanised	10

6" RING GATE LATCH

A neat and easy to fix latch for any gate. Strong construction.



CODE	SIZE INS (MM)	FINISH	BOX QTY
124-1501	6 (150)	Galvanised	5

CABIN HOOKS

Our wire pattern cabin hook is all galvanised and ideal for holding back a door or gate.



CODE	SIZE INS (MM)	FINISH	BOX QTY
135-1501	6 (150)	Galvanised	20
135-2001	8 (200)	Galvanised	20
135-2501	10 (250)	Galvanised	10
135-3001	12 (300)	Galvanised	10

TURN BUTTON

Useful for holding a door closed.



CODE	SIZE INS (MM)	FINISH
133-0502	2 (50)	E-Galvanised

HEAVY HASP AND STAPLE

A very strong security product complete with hardened staple.

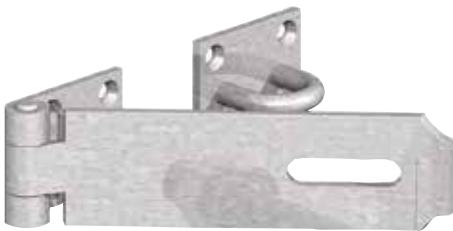

CODE	SIZE INS (MM)	FINISH	BOX QTY
139-2501	10 (250)	Galvanised	10

KICK OVER STABLE LATCHES

A must for every stable door. Heavy construction.

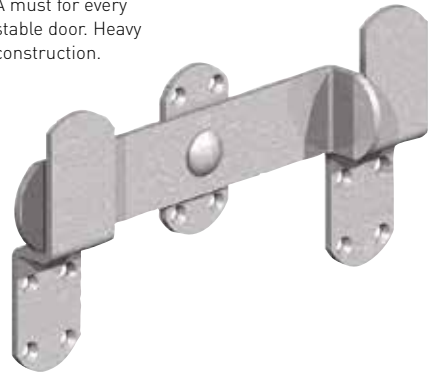

CODE	SIZE INS (MM)	FINISH	BOX QTY
131-2401	9½ (240)	Galvanised	5

RING ON PLATE

Our popular Ring on Plate can be screwed anywhere for tying up a horse. Heavy duty ring with welded staple, available in galvanised.

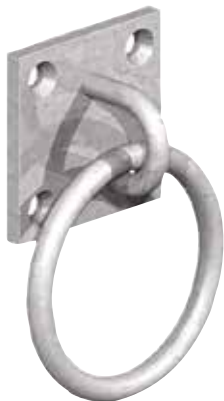

CODE
246-0501

FINISH
Galvanised

BUCKET CLIP

A galvanised spring clip for holding a bucket against a wall. The staple is welded for durability.



CODE
910-0001

FINISH
Galvanised

STAPLE ON PLATE

This product can be used for many applications. The welded staple is sufficient for use with a padlock. Galvanised finish.



CODE
245-0501

FINISH
Galvanised

HOOK ON PLATE

Our Hook on Plate will hold a rope or chain securely. Screw fixings and galvanised finish.



CODE
244-0501

FINISH
Galvanised

MANGER RING ON EYEBOLT

Fully threaded eyebolt with nut and washer.

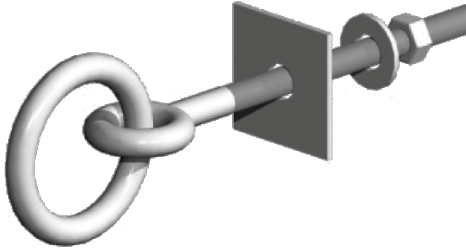

CODE	SIZE INS (MM)	FINISH	BOX QTY
247-0752	75x200		

LASHING RING

3 part lashing ring with 2 hole fixing – M10 hole. Breaking force 2270kg e.g. permitted tensile force max 1135kg.



CODE	FINISH
247-1501	145x100x15.5mm

**BRASS
PADLOCK**

CODE	SIZE INS (MM)	FINISH/ COLOUR	KEYED ALIKE	BOX/ PACK QTY
148-0500	2 (50)	Brass	No	5
148-0650	2 3/4 (70)	Brass	No	5

**LAMINATED
STEEL
PADLOCK**

CODE	SIZE INS (MM)	FINISH/ COLOUR	KEYED ALIKE	BOX/ PACK QTY
713-0500	2 (50)	Laminated Steel	No	5

LAMINATED STEEL PADLOCK W/ LONG SHACKLE



CODE	SIZE INS (MM)	FINISH/ COLOUR	KEYED ALIKE	BOX/ PACK QTY
713-0510	2 (50)	Laminated Steel	No	5
713-0600	2 (60)	Laminated Steel	No	5

ARMoured PADLOCK – HEAVY DUTY STAINLESS STEEL



CODE	SIZE INS (MM)	FINISH/ COLOUR	KEYED ALIKE	BOX/ PK QTY	OUTER BOX QTY
708-0900	3½ (90)	Stainless Steel	No	5	6

GATEMATE DISCUSS PADLOCK – STAINLESS STEEL



CODE	SIZE INS (MM)	FINISH/ COLOUR	KEYED ALIKE	BOX/ PACK QTY
771-0700	2¾ (70)	Stainless Steel	No	5

BRASS COMBINATION PADLOCK



CODE	SIZE INS (MM)	FINISH/ COLOUR	KEYED ALIKE	BOX/ PACK QTY
712-0500	2 (50)	Chrome Shackle	No	6

HEAVY DUTY SECURITY CHAIN

Fully hardened square steel links in a PVC sheath for weather resistance.



CODE	SIZE MM
149-1200	1200

SLEEVED SECURITY CHAIN

High specification links produced from 10mm hardened steel. Large link size for use with large shackles. Fabric covered.



CODE	SIZE (MM)
149-0060	600
149-0120	1200



Smallholder Range

DRINKERS

BASIC DRINKERS

Economical smaller basic drinkers. Translucent plastic allows you to see the fill level.



CODE	DESCRIPTION
5008-029	1.5L
5008-039	3.5L
5008-059	5L
5008-109	10L

COMBINATION DRINKER

Can be hanging or ground standing including the option of four push fit legs. Tube can be stood on end for ease of filling.



CODE	SIZE
5008-139	3 litre
5008-159	6 litre
5008-209	12 litre
5003-709	Legs for combination drinker

MINI CUP DRINKER

A unique self-filling multi use drinker that can be fitted to any water container.

It enables any container to be used as a flexible drinker.



CODE
5008-409

CAGE CUPS

Available in 5 colours. Suited to a wide range of purposes.



CODE	FINISH
5008-609	Blue, Green, Red, White, Yellow

FEEDERS

EMPEROR FEEDER

Designed for use in pens, open woodland and moorland. It has a capacity of 70 litres and includes a unique rain water capture system.



CODE
5003-609

NORTON FEEDER

12 kg capacity feeder with a feed flow adjuster and ergonomic carry handle that doubles as a hanger. Finned tube to minimise waste. Push fit legs can be purchased separately. Rain hat can be purchased separately.



CODE	DESCRIPTION
5003-409	12 kg feeder
5003-419	Rain hat for Norton feeder

CHENEY FEEDER

High quality popular size feeder. Comes with four push fit legs. Outdoor model has a rain hat.



CODE	DESCRIPTION
5003-309	6 kg (without rain hat)
5003-309C	6 kg outdoor c/w rain hat & legs

WESTON FEEDER

A smaller model of our Cheney Feeder. Available as indoor or outdoor version. The outdoor one has four push fit legs and a rain hat.



CODE	DESCRIPTION
5003-329	2.5 kg indoor with fins
5003-329C	2.5 kg outdoor c/w rain hat & legs

SUTTON FEEDER

Made of high-grade plastic. Two adjustable height settings regulates feed supply.



CODE	DESCRIPTION
5003-109	7 kg
5003-209	15 kg

BASIC FEEDER

Economical, translucent plastic feeder. Allows you to see feed level.



CODE	DESCRIPTION
5003-019	1.5 kg chick feeder
5003-039	3 kg hen feeder
5003-059	5kg hen feeder

RAIN HATS

The rain hat is designed to fit the Norton and Aston feeders enabling them to be used outside without feed becoming wet or contaminated.



CODE	DESCRIPTION
5003-419	Fits Norton Feeder
5003-519	Fits Aston Feeder

GALVANISED FEEDERS

Made of high quality galvanised sheet metal. For hanging or free standing.



CODE	DESCRIPTION
5001-051	5 kg chick/hen feeder
5001-052	5 kg chick/hen feeder c/w rain hat
5001-181	18 kg hen feeder
5001-401	40 kg hen/turkey feeder

GRIT / FEED STATION

Heavy duty and designed to provide easy access to feed and grit.



CODE
5009-309

SADDLERS

PLASTIC FEED SCOOP

Marked with graduations for accurate measuring.



COLOURS AVAILABLE:



CODE **FINISH**
919-0009 Black, Green, Red, Blue

PLASTIC ROUND BOWL SCOOP

Plastic scoop is very strong and marked with graduations.



COLOURS AVAILABLE:



CODE **FINISH**
954-0049 Black, Blue, Green, Pink, Purple, Red, Yellow

TROUGHS

STANDARD FEEDING TROUGH

Plastic economy trough



CODE

- 5006-059** 50 cm long x 7 cm wide
- 5006-509** 50 cm long
- 5006-759** 75 cm long

GALVANISED FEEDING TROUGH

Galvanised anti-perch feeding trough



CODE

- 5004-001** 50 cm long x 7.5 cm wide
- 5004-051** 50 cm long x 13 cm wide
- 5004-101** 100 cm long x 13 cm wide

FINISH:
GALVANISED

ANTI-PERCH FEEDING TROUGH

High quality polyethylene anti-perch feeding trough

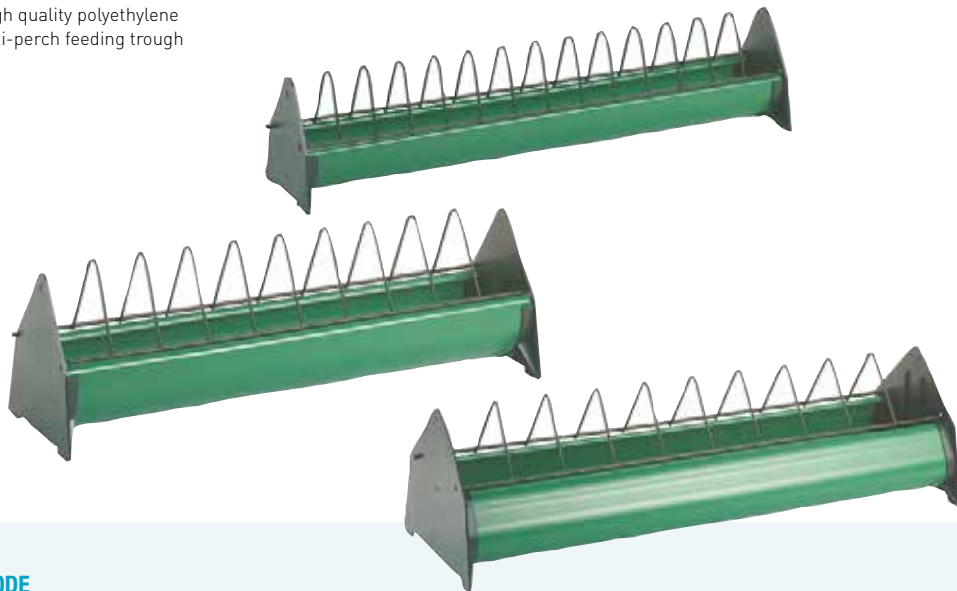

CODE

- 5005-059** 50 cm long x 7 cm wide
- 5005-509** 50 cm long x 10.5 cm wide
- 5005-759** 75 cm long x 20 cm wide

BARRIER HEALTHCARE

100% natural products suitable for organic systems

LIVESTOCK LOUSE POWDER

Fully HSE Approved. A 100% natural insect repellent for use against biting and blood sucking lice by direct application to horses, ponies, donkeys, cattle, goats, rabbits and other small pets. One application remains active for up to six weeks depending on weather conditions. Suitable for use in organic farming systems. Note: Efficacy will be affected if used in conjunction with chemical based products.



CODE **SIZE**
5010-705 500 g

RED MITE POWDER

This kind and gentle powder is designed to be applied to all poultry. Its slow release formulation will last for up to 6 weeks depending on weather.



CODE **DESCRIPTION**
5010-205 500 ml

SADDLERS

INFRARED LAMP

Aluminium shade with ventilation holes for air circulation complete with hanging chain. Lamp has an on / off switch and a dimmer facility.



CODE **DESCRIPTION**
5009-050 Infrared lamp
5009-100 Infrared Heat Bulb 100 Watt
5009-250 Infrared Heat Bulb 250 Watt
Durable, excellent heat transmission.

ANTI-FATIGUE AND ANTI-SLIP MATTING

Upgrade corporate entrance ways through our sister company
Work Well Mats UK



We also offer:
Custom Shapes and Sizes
On-site analysis and reports
Measuring and fitting service
Wide range of standard sizes available

E: sales@wwmuk.uk
Call: 01295 757157



Ergo-Tred



Euro-Mat



Comfy-Grip



Ulti-Mat



Opti-Mat



Dura-Tred



Soft-Step



Hygi-Mat



Slip-Safe



Agricultural Products

CODE	DESCRIPTION	SIZE	WEIGHT
4301-3001	AgriMat	1040 x 920 x 24 mm	23kg
4302-1007	PitZone	1000 x 1000 x 20 mm	2.5kg
4305-1807	ComfortBed	1800 x 1150 x 25 mm	35kg
4306-1807	DuraLay	1800 x 34 mm x cut to length	
4300-1807	SoftBed	1800 x 24400 x 40 mm available cut to length	
4094-0320	Rubberlite	1850 x 1200 x 20	
4308-1010	Tudor interlocking	1000 x 1000 x 17mm	



AGRIMAT

Premium solid rubber interlocking system manufactured in Canada. Stands on a stud to aid softness with high grip surface. Use anywhere cattle are slipping. Can be driven on when fixed with our stainless steel fixings.

4301-3001

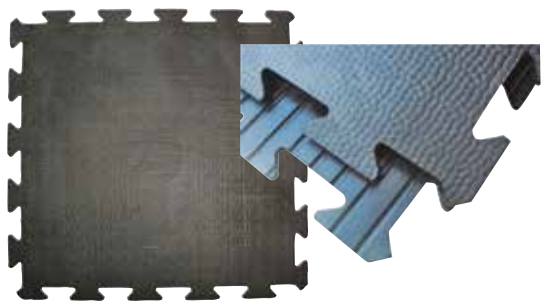

TUDOR INTERLOCKING MAT

Very high abrasion resistant interlocking mat for the most demanding of areas. Easy clean hammer top and mats will not separate due to interlocking system.

4308-1010



PITZONE

EVA foam matting designed to take pressure off the milker's feet, legs and back. Interlocking lightweight yet super tough matting tile.

4302-1007

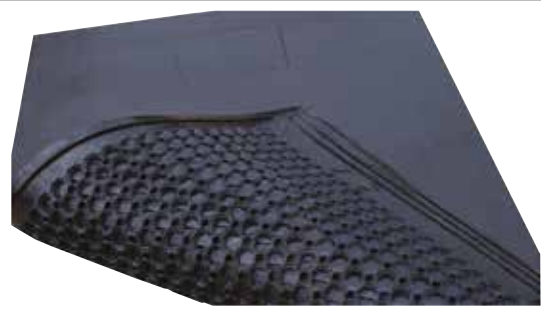

COMFORTBED

High quality 25mm thick cubicle rubber mat. Unique honeycomb base that provides softness and stability. Suitable for floor-mounted and suspender divider systems.

4305-1807



DURALAY

Dual mattress system with a 4mm thick linen textured rubber laid over 30mm thick polyurethane foam underlay. Superb bedding choice for a lower budget.

4306-1807



SOFTBED

Premium quality free stall barn matting system delivering outstanding warmth and comfort. Dual mat system renowned for its structural integrity and long life. Bevelled edge assists run-off of dirt and liquid. Top sheet has 22mm thick solid rubber at the edges with 10mm thick rubber through the centre, laid on 30mm polyurethane foam. Exceptional comfort and strength.

4300-1807

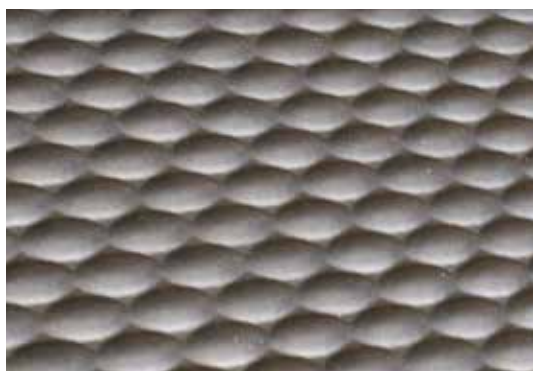

RUBBERLITE

20mm thick EVA & rubber mix cow bed mat with a tear drop surface. Excellent quality.

4094-0320

STAINLESS STEEL MAT FIXING

Drive in stainless steel concrete split fixing with recessed washer. Requires 7mm hole. Size: 2.5 inches x 7mm

CODE 4302-3807



STAINLESS STEEL MAT FIXING

Drive in stainless steel mat fixings with recessed washer and plug. Requires 8mm hole. Size 3 inches x 8mm

CODE 4302-3808



CATTLE BRUSHES

DUO COW BRUSH

Fully automatic rotating brushes alternating direction after each activation. Two brushes give complete and thorough cleaning. High quality polyamide brushes for long life.. Newly developed electronics for low maintenance fault free operation. Supplied assembled ready to mount and plug in.



CODE
5011-1002

HAPPY COW BRUSH

Fully automatic rotating brush. Encourages the cows natural behaviour. Easy to mount. Dense brush bristle for thorough cleaning. Supplied assembled ready to mount and plug in.



CODE
5011-3002

SWING BRUSH

Fully automatic rotating brush. Brush can pivot in every direction to allow thorough cleaning. New powerful motor for maximum loads. Electronic controls with informative display. Designed for long life with low maintenance.



CODE
5011-2002

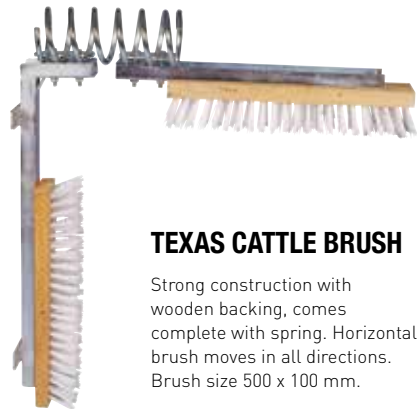

TEXAS CATTLE BRUSH

Strong construction with wooden backing, comes complete with spring. Horizontal brush moves in all directions. Brush size 500 x 100 mm.

CODE	DESCRIPTION	SIZE
5011-4002	Texas Cattle Brush	500 x 100 mm
5011-4012	Spare Brush	500 x 100 mm
5011-4022	Spare Spring for Texas Cattle Brush.	

LIFTING DEVICES

COW LIFTING FRAME

Lifting device for cows, used for standing up downer cows. Clamps are infinitely adjustable to the specific bowl width. Any animal can be raised with the help of a pulley or other lifting device.



CODE
9000-0001

COW SLING LIFTING DEVICE

Developed for short to medium-term support of weak cows. Large main sling resulting in no pressure points. Adjustable to different sizes. Supplied as complete kit in a carry bag. Recommended for animals up to 1000kg live weight.



CODE
9000-0002

DEHORNING PRODUCTS

GAS BUDDEX DEHORNER

For fast humane dehorning of calves. As pain free as possible with maximum time of 10 seconds dehorning process. Complete with 2 gas cartridges and replacement tips in metal carry box.



CODE	DESCRIPTION
1100-1001	Gas Buddex DeHornor
1101-1002	Gas Cartridge for Gas Buddex DeHornor
1101-1201	Spare 15mm Dehorning Tip for Gas Buddex DeHornor

TOOLS

MANURE SCRAPER HALF ROUND

Galvanised shaft. Bolted with interchangeable, ammonia-resistant rubber scraper. High quality blend with mesh insert ensuring maximum flexibility while preventing the occurrence of fractures and cracks. Sturdy design with reinforced back. Shaft holder with wing-nut. Complete with handle. Size: 73cm



CODE	DESCRIPTION
9001-0001	Manure Scraper Half Round
9001-0011	Replacement rubber blade for Manure Scraper Half Round.

TAILWELL2 POWER TAIL TRIMMER

Fits to most battery powered screwdrivers operating at 14 volt. Removes all tail hair in seconds, even completely matted with dung and dirt. Easy to sharpen with the supplied specially developed sharpening paste. Supplied in handy plastic case for safe storage. Included DVD and Handbook. Drill not included.



CODE	DESCRIPTION
9001-1002	

COLOSTROSTART SET

Colostrum bags with their aluminium lining are designed to cool and heat at maximum rate removing the risk of bacteria breeding. Bags are single use and by attaching the supplied teat or feeding tube, calves can be fed directly from the bag removing any risk of contamination during transfer between vessels.



CODE	DESCRIPTION
1200-1010	10 Colostrum Bags, 1 Teat, 1 Drencher Probe
1200-1050	50 Colostrum Bags, 3 Teats, 3 Drencher Probes

SADDLERS

INFRARED LAMP

Aluminium shade with ventilation holes for air circulation complete with hanging chain. Lamp has an on / off switch and a dimmer facility.



CODE	DESCRIPTION
5009-050	Infrared lamp
5009-100	Infrared Heat Bulb 100 Watt
5009-250	Infrared Heat Bulb 250 Watt

Durable, excellent heat transmission.

DIGITAL CALF MILK HEATER

Digital control with selectable temperatures. Stores the last target temperature set. Illuminated display. Visual and audible signal output. Safety cut-out in the event of dry operation.

Overall height 785 mm. Extremely light weight - 2.7 kg. PTFE coated element results in easy cleaning.

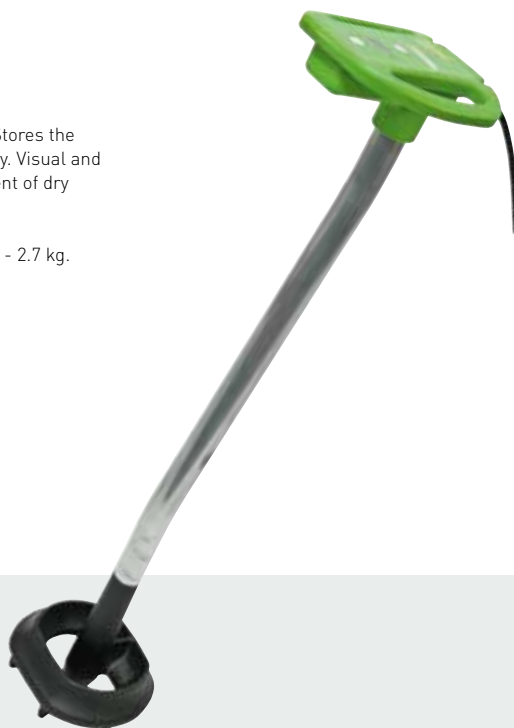

CODE
9020-1014

AGRICULTURAL ACCESSORIES

FEEDING BUCKET WITH FIXCLIP-VALVE AND VITAL TEAT

Complete with FixClip valve and teat.

- 8 Litres
- Metal handle
- Acid proof
- Food Safe
- Easy to clean
- Mounting bracket sold separately - Product Code 9020 -1021
- Spare FixClip Valve with Vital Teat 9020-1003
- Vital Teat for FixClip Valve 9020-1013



CODE	DESCRIPTION
9020-1001	Feeding Bucket
9020-1021	Mounting bracket for Feeding Bucket Suitable for 9020-1001 and 9020-1002

PLASTIC CALF FEEDING BUCKET

Transparent feeding bucket complete with red teat and valve. 8 Litre capacity with measuring scale on both sides.

- Metal handle
- Acid proof
- Food Safe
- Easy to clean
- Mounting bracket sold separately - Product Code 9020 -1021
- Spare valve 9020-1022
- Spare valve and teat 9020-1023
- Spare teat 9020-1033



CODE	DESCRIPTION
9020-1002	Plastic Calf Feeding Bucket
9020-1022	Complete Valve. Spare valve for Calf feeding bucket - Product code 9020 -1002

FIXCLIP VALVE WITH VITAL TEAT

Patented clip fastener making the removal, instillation and cleaning of the valve and teat easier and faster. Minimal bacterial load, minimal time required for valve replacement. FixClip consists of 3 parts, valve body (a) with straight intake supports making them easier to access for cleaning, Removable valve flap (b), Clip (c) for fixing the teat and valve body to the bracket. Suitable for all feeding buckets with a hole size 36-38mm but only usable with specially developed Vital and Super teats.

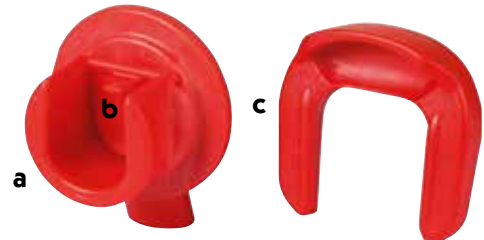

CODE
9020-1003

VITAL TEAT FOR FIXCLIP VALVE

The shape and materials of the Vital Teat promote natural suckling behaviour in calves. Slower and more challenging sucking, reducing the amount of mutual sucking. Increased saliva ensures better digestion. Box of 5.



CODE
9020-1013

SPARE VALVE WITH 100MM SUPER TEAT

Complete valve and Super Teat for the Plastic Calf Feeding Bucket. Display pack of 2.



CODE
9020-1024

SUPER TEAT FOR PLASTIC CALF FEEDING BUCKET

Spare 100mm Super Teat - X pierced and suitable for the Plastic Calf Feeding Bucket. Display pack of 3.



CODE
9020-1033

CALF FEEDING TROUGH

5 teat outlets for simultaneous feeding of 5 calves. 30 litre capacity. Rounded corners resulting in easy cleaning. Acid proof, food safe. No fixings or teats included.



CODE	DESCRIPTION
9020-1023	700 x 354 x 278 mm

SADDLERS

FORGED FORKS

High quality forged steel forks.
Well balanced and very strong.

COLOURS AVAILABLE:



CODE

DESCRIPTION

FINISH

- 679-6110** 4 prong muck fork, long handle with soft plastic grip
- 679-6120** 4 prong muck fork, tubular D handle
- 679-6150** 5 prong muck fork, long handle with soft plastic grip
- 679-6160** 5 prong muck fork, tubular D handle

- Grey, pink
- Grey, pink
- Grey
- Grey

SADDLERS

LARGE PLASTIC SHOVEL

Large strong plastic blade with a wooden D handle.



CODE

672-1009

SADDLERS

LARGE ALUMINIUM SHOVEL

Large aluminium blade with a fibreglass D handle.



CODE

672-6559



Hygiene Products

ULTRA-GRIME MULTI-USE XXL CLOTHWIPES

BIGGER: Over twice the size of regular wipes.

Huge absorbency capacity

WETTER: Stay wet & usable for over 1 hour.

Pack does not dry out, even when left open for days.



CODE

1000-5100

QTY

Pack of 100 XXL wipes

**FREE COUNTERTOP POS DISPLAY
STAND WHEN YOU BUY 18 PACKS**



ULTRA-GRIME PET WIPES

Ultra-Grime life pet clothwipes are purrfect for paws, claws and dirty floors.

- For Pets, pet equipment and household surfaces
- 80 sheets per pack

Features and benefits

- These XXL pet clothwipes have been especially designed to keep your pet and home clean. Tough on mess and kind to furry friends, the cloth-like fabric easily cleans up mess & mud on upholstery, tiles, leather and carpets.
- High moisture retention & absorption
- Huge wipes double the size of common wipes
- Leaves surfaces looking and smelling fresher
- Wipes stay wet even when the lid is left open
- Designed for pets with cosmetic grade ingredients.



CODE

1000-6100

QTY

Pack of 80 XXL wipes

CLINICAL MIDI DISINFECTANT SURFACE WIPES

Highly effective disinfectant cleaning wipes with outstanding microbiocidal performance. Clinical Midi-Wipes are active against bacteria, fungi & viruses. With dual action cleaning and disinfecting properties.



CODE 1000-4200
QTY Pack of 200 wipes

CENTRE FEED ROLL – 2 PLY

Ideal for surface wiping and hand drying. Allows you to tear as little or as much as you require. Hygienic, convenient and economical.



COLOURS AVAILABLE:



CODE 1000-1006
QTY Pack of 6, 150m per roll

INSTANT 70% ALCOHOL HAND SANITISER

Kills 99.99% of bacteria & germs
Child safe bottles
Long lasting protection
Fragrance free



CODE 1000-0050
SIZE 50ml

DISPOSABLE FACE MASKS



CODE 1000-3050
QTY Box of 50

LUXURY HAND SOAP – ANTI BACTERIAL

A luxury soft white antibacterial hand soap. Use on a regular basis to help reduce the risk of cross contamination.



CODE	SIZE
1000-2001	1L
1000-2005	5L

PINE DISINFECTANT SOLUTION

A strong green pine QAP 30 disinfectant designed to kill germs and bacteria.



CODE	SIZE
1000-2105	5L

PREMIUM TFR CONCENTRATE 350

Our premium traffic film remover is a super concentrate with a dilution rate of 350-1. This TFR is highly popular due to its effectiveness at the rapid removal of soiling, grease and general traffic film.

With high foaming action, it is ideal for power washing stables through hot or cold pressure washer systems.



CODE	SIZE
1000-2225	25L

INDUSTRIAL HAND CLEANING PASTE

The powerful cleaning paste has been manufactured to a grade paste consistency for extreme environments. Specially selected blend of natural citrus terpene, abrasive pumice compound and additional detergents to provide rapid removal of grease, oil and general dirt.



CODE	SIZE
1000-2315	5L

INDEX

CATEGORY	PAGE	CATEGORY	PAGE
A			
Aluminium Shovel	22,170	Calf Feeding Trough	169
All Purpose Broom	28	Centre Feed Roll	173
Anti-Weaver Grille	38		
Autolock Animal Bolts	125,146	D	
Auto Gate Catch	126,147	Dirt Buster Entrance Mat	14
Agrimat	162	Dual Wheel Wheelbarrow	17
		Dustpan & Brush	27
B		Dustbin 85L	35
Broad Rib Rubber	9	Dustbin 70L	35
Broughton Fitness Mat	12	Dustbin 50L	35
Briquettes	12	Dustbin 110L	36
Barrow Bag	21	Door Grille	38
Bass Broom	28	Dressage Markers	53
Bucket 3 Gallon	30	Drinking Bowl	55
Bucket Holder	30	Drop Bolt	147
Bucket 2 Gallon	30	Drinkers	154
Bucket 6 Gallon	32	Duralay	163
Blanket Hanger	42	Durafloor	8
Boot Jack	48	Disinfectant	174
Bungee Trailer Tie	52		
Beastie Brushes	59	E	
Bucket Brush	59	EVA Matting	10
Batteries	86-87	EVA Fixings	10
Brenton Padbolts	125,145	Ergo-Tred	13
Bands & Hooks on Plates	124,143	Economy Barrow	16
Bolts - Cup Square	135	Energisers 9V	77
Bucket Clip	130,149	Energisers 12V	78-79
Bulbs	159,167	Energisers D Battery	78
		Energisers Mains	80
C		Energisers Multi Voltage	81-82
Continuous Roll Rubber	7	Energisers Solar	85
Coco Broom	28	Earth Stake	85
Corn Broom	28	Eyebolt	130,150
Calf Bucket	31	Elongated Keep	145
Corner Manger	34		
Corner Manger Support Frame	34	F	
Corner Hayrack	39	Fine Rib Rubber	9
Corner Hayrack	40	Foot Bath Mat	13
Corner Haylage Rack	40	Forged Forks	21,170
Corner Feeding Station	41	Fynalite Rake	23-26
Clip on Saddle Rack	45	Fynalite Forks	26
Cleaning Hook	46	Feed Mixer Bucket	31
Cross Tie Chain	52	Flat Sided Bucket	31
Covaliero Grooming Brushes	60	Feeding Bowl	34
Combee T	70	Folding Saddle Rack	44
Cotton Wool	70	Folding Pole Saddle Rack	45
Conductive Wire	89	Feed Scoop	51,157
Cabin Hook	128,148	Fence Netting	101
Carbine Hooks	131	Fence Testers	113
Chain	132,133	Fly Paper Roll	120
Coach Screws	136	Flycage 2	122
Combination Drinkers	154	Field Gate Hinge Sets	138
Cage Cups	154	Feeders	155,156
Comfortbed	162	Feeding Trough	158
Cow Brushes	164	Feeding Bucket	168
Cow Lifting Frame	165	Fix Clip Valve	168
Cow Lifting Sling	165	Face Mask	173
Colostrostart Set	166		
Calf Milk Heater	167		

INDEX

CATEGORY	PAGE	CATEGORY	PAGE
G			
Granulistic Liquid Rubber	7	Hook on Plate-Adjustable	141
Grip Top Matting	8	Hasp and Staple	148
Ground Ring Mat	11	Hand Sanitiser	173
Gym Flooring	12	Hand Cleaning Paste	174
General Purpose Wheelbarrow	17		
General Purpose Broom	27	I	
Galvanised Bucket	31	Insertion Rubber	9
Galvanised Dustbin	36	Incinerator	36
Grille Sockets	38	Infil Panel	38
Grippee Brushes	58	Internal Stable Grille	39
Grooming Boxes	65-67	Insulators	102-106
Gate Handles	111-112	Insultube	103
Garage Door Bolt	126	Infrared Lamp	159,167
Gate Catch-Self Locking	139,141		
Gate Catch-Animal Safety	139	J	
Gate Eyes	141	Joint Sealant	11
Gate Catch-Hunting Type	141	Junior Wheelbarrow	16
Gate Hook to Weld	142	Junior Manure Collector Set	49
Gate Eye to Weld	142	Jump Cup Support Bars	52
Gate Return Spring	146	Jump Cups	53
Gate Wheel	147	Joiners	107-108
Grit Station	157		
Gas Buddex	165	K	
		KBF99 Grooming	63-64
		Kick Over Stable Latch	127,148
		Linch Pins	136
H		L	
H2go Bag	20	Lokmat	6
Harold Moore Standard Shovel	23	Logo Entrance Mat	14
Hand Shovel	23	Large Capacity Wheelbarrow	18
Hook Over Manger	33	Large Plastic Shovel	22,170
Hay Soaker	36	Luggage Rack	46
Heavy Duty Grille	39	Lead Rope	55
Hayrack Fixing Clips	41	Lilli Starlight Brushes	61
Hay-Graze Feeder	41	Lead Out Cable	98
Head Collar Hook	43	Lead Sets	99-100
Hook Set	43	Lashing Ring	150
Hook Over Saddle Rack	45	Louse Powder	159
Handy Hanger	46		
Helmet Hanger	46	M	
Hose Fittings	50	Mat Adhesive	11
Hose Pipe	50	Maxi Guard	13
Hose Holder	50	Muck Bucket	32
Himalayan Salt	54	Manure Collector & Rake	48
Hay Ball	54	Manure Shaker & Rake Set	49
Hay Nets	56	Multi Purpose Knife	49
Haylage Nets	56	Magic Brush Soft	62
Hoof Pick	59	Magic Brush	63
Hoof Oil Brush	60	Mounting Post	96
Hi-Viz	71-72	Mouse Traps	120
Horsefly Trap	121	Monkey Tail Bolt	144
Horsefly Glue	122	Manure Scraper	166
Horsefly Bucket Trap	122		
Heavy Reversible Hinges	125,144	N	
Hunting Type Latch	127	Nails Pre Packed	134
Heavy Hasp & Staple	128	Nails Tubs	134
Hook on Plate	129,149	Nails Clout Head	134
Hooks to Bolt	140		
Hook on Plate (Field Gate)	140	O	
Hooks to Drive	140	Oval Padbolt	145

CATEGORY	PAGE	CATEGORY	PAGE
P			
Premium Stable Mat	6	Spray Nozzle	50
PVC (Clear)	10	Stirrer	51
Platform Trolley	20	Stall Chain	52
PVC Brooms	27	Salt Lick Holder	53
Pet Feed container	35	Stud Card Holder	55
Play Ball	54	Sweat Scraper	59
Poldress	70	Sealing Tape	69
Patura Electric Fencing	73-118	Solar Panel	84
Polywire	91	Spring Gate Set	110
Polyrope	92-93	Spinning Jenny	114
Polytape	93-95	Spring Loaded Bolt	126,146
Pigtail Insulators	107	Slip Rail Bracket	127
Posts	108-109	Staple on Plate	130,149
Polytape Gate Set	111	Swivel Harness Snap Hook	131
Pliers	114	Snap Hook	131
Padlock Protector	129	Staples	134
Panic Hook	132	Screws Power Pro	135
Padlocks	150,151	Screws Hex Head	135
Pitzone	162	Spring Fastener Sets	139
Pet Wipes	172	Slip Rail Brackets	145
		Security Chain	152
R		Softbed	136
Rubberlite Mat	7,163	Stainless Steel Fixings	163
Ramp Mat	8	Sanitising Wipes	173
Ramp Carpet	8	Soap	174
Rubber Sheeting	9		
Rubber Adhesive	11	T	
Metal Pan Wheelbarrow	17	Tudor Interlocking mat	7,162
Rake	26	Twin Wheel Barrow	19
Rubber Feed Skip	32	Tyre Bowl	34
Rug Hanger	42	Tool Holders	47
Rug Rail	42	Tack Cabinet	55/68
Round Bowl Scoop	51,157	Tee Hinges	124,143
Reel	96	Tower Bolt	144
Rope Gate Set	111	Turn Button	148
Rat Traps	120	Tail Trimmer	166
Ring Gate Latch	126,147	Teats	169
Ring on Plate	130,149	TFR Concentrate	174
Repair Links	132		
Rope	133	U	
Roofing Bolts	136	Ulti-Mat	12
Rain Hats	156	Ultra-Grime Wipes	172
Red Mite Powder	159		
		W	
S		Wycombe Stable Mat	6
Stanbridge Stable Mat	6	Water Carrier	34
Spiked Roller	8	Wall Hayrack Heavy Duty	39
Scraper Mat	13	Wall Hayrack	40
Super Barrow	16	Wall Haylage Rack	40
Stable Barrow	18	Western Saddle Rack	44
Sack Truck	20	Wellington Rack	47
Shavings Fork	21	Wraptec	69
Shavings Fork (Economy)	22	Wire Strainer	97
Superbucket	30	Wasp Trap	121
Super Size Container	32	Weighty Scotch Tee Hinges	124,142
Supertub	33	Washers	135
Saddle Display Stand	43		
Saddle Rack	44	Y	
Spring Balance	49	Yard Scoop	22
		Yard Rake	26

TERMS & CONDITIONS

1. INTERPRETATION

1.1

Definitions. In these Conditions, the following definitions apply:

Business Day a day [other than a Saturday, Sunday or public holiday] when banks in London are open for business.

Conditions the terms and conditions set out in this document as amended from time to time in accordance with clause 11.6.

Contract the contract between the Supplier and the Customer for the sale and purchase of the Goods in accordance with these Conditions.

Customer Force Majeure Event Goods Order the person or firm who purchases the Goods from the Supplier. has the meaning given in clause 10. the goods (or any part of them) set out in the Order. the order for the Goods, as set out in the Customer's written acceptance of the Supplier's quotation, or overleaf, as the case may be.

Specification any specification for the Goods, including any related plans and drawings, that is agreed in writing by the Customer and the Supplier.

Supplier **Eartswood Supplies Limited** (registered in England and Wales with company number 8816584).

1.2 **Construction.** In these Conditions, the following rules apply:

- A person includes a natural person, corporate or unincorporated body (whether or not having separate legal personality).
- A reference to a party includes its personal representatives, successors or permitted assigns.
- A reference to a statute or statutory provision is a reference to such statute or provision as amended or re-enacted. A reference to a statute or statutory provision includes any subordinate legislation made under that statute or statutory provision, as amended or re-enacted.
- Any phrase introduced by the terms **including, include, in particular** or any similar expression shall be construed as illustrative and shall not limit the sense of the words preceding those terms.
- A reference to **writing** or **written** includes faxes and e-mails.

2. BASIS OF CONTRACT

2.1 These Conditions apply to the Contract to the exclusion of any other terms that the Customer seeks to impose or incorporate, or which are implied by trade, custom, practice or course of dealing.

2.2 The Order constitutes an offer by the Customer to purchase the Goods in accordance with these Conditions. The Customer is responsible for ensuring that the terms of the Order and any applicable Specification are complete and accurate.

2.3 The Order shall only be deemed to be accepted when the Supplier issues a written acceptance of the Order or commences performance of the Contract by delivering the Goods at which point the Contract shall come into existence.

2.4 The Contract constitutes the entire agreement between the parties. The Customer acknowledges that it has not relied on any statement, promise, representation, assurance or warranty made or given by or on behalf of the Supplier which is not set out in the Contract.

2.5 Any samples, drawings, descriptive matter, or advertising produced by the Supplier and any descriptions or illustrations contained in the Supplier's catalogues or brochures are produced for the sole purpose of giving an approximate idea of the Goods described in them. They shall not form part of the Contract or have any contractual force.

2.6 A quotation for the Goods given by the Supplier shall not constitute an offer. A quotation shall only be valid for a period of 30 Business Days from its date of issue.

3. GOODS

3.1 The Goods are described in the Supplier's catalogue as modified by any applicable Specification.

3.2 To the extent that the Goods are to be manufactured in accordance with a Specification supplied by the Customer, the Customer shall indemnify the Supplier against all liabilities, costs, expenses, damages and losses (including any direct, indirect or consequential losses, loss of profit, loss of reputation and all interest, penalties and legal and other professional costs and expenses) suffered or incurred by the Supplier in connection with any claim made against the Supplier for actual or alleged infringement of a third party's intellectual property rights arising out of or in connection with the Supplier's use of the Specification. This clause 3.2 shall survive termination of the Contract.

3.3 The Supplier reserves the right to amend the specification of the Goods if required by any applicable statutory or regulatory requirements.

4. DELIVERY

4.1 The Supplier shall ensure that:

- each delivery of the Goods is accompanied by a delivery note which shows the date of the Order, all relevant Customer and Supplier reference numbers, the type and quantity of the Goods (including the code number of the Goods, where applicable), special storage instructions (if any) and, if the Order is being delivered by instalments, the outstanding balance of Goods remaining to be delivered; and
- if the Supplier requires the Customer to return any packaging materials to the Supplier, that fact is clearly stated on the delivery note. The Customer shall make any such packaging materials available for collection at such times as the Supplier shall reasonably request.

Returns of packaging materials shall be at the Supplier's expense.

4.2 The Supplier shall deliver the Goods to the location set out in the Order or such other location as the parties may agree (Delivery Location) at any time after the Supplier notifies the Customer that the Goods are ready.

4.3 Delivery of the Goods shall be completed on the Goods' arrival at the Delivery Location.

4.4 Any dates quoted for delivery are approximate only, and the time of delivery is not of the essence. The Supplier shall not be liable for any delay in delivery of the Goods that is caused by a Force Majeure Event or the Customer's failure to provide the Supplier with adequate delivery instructions or any other instructions that are relevant to the supply of the Goods.

4.5 If the Supplier fails to deliver the Goods, its liability shall be limited to the costs and expenses incurred by the Customer in obtaining replacement goods of similar description and quality in the cheapest market available, less the price of the Goods. The Supplier shall have no liability for any failure to deliver the Goods to the extent that such failure is caused by a Force Majeure Event or the Customer's failure to provide the Supplier with adequate delivery instructions or any other instructions that are relevant to the supply of the Goods.

4.6 If the Customer fails to take delivery of the Goods within three Business Days of the Supplier notifying the Customer that the Goods

are ready, then, except where such failure or delay is caused by a Force Majeure Event or the Supplier's failure to comply with its obligations under the Contract:

- delivery of the Goods shall be deemed to have been completed at 9.00 am on the third Business Day after the day on which the Supplier notified the Customer that the Goods were ready; and
 - the Supplier shall store the Goods until delivery takes place, and charge the Customer for all related costs and expenses (including insurance).
- 4.7 If 10 Business Days after the day on which the Supplier notified the Customer that the Goods were ready for delivery the Customer has not accepted delivery of them, the Supplier may resell or otherwise dispose of part or all of the Goods and, after deducting reasonable storage and selling costs, account to the Customer for any excess over the price of the Goods or charge the Customer for any shortfall below the price of the Goods.
- 4.8 The Customer shall not be entitled to reject the Goods if the Supplier delivers up to and including 5% more or less than the quantity of Goods ordered.
- 4.9 The Supplier may deliver the Goods by instalments, which shall be invoiced and paid for separately. Each instalment shall constitute a separate Contract. Any delay in delivery or defect in an instalment shall not entitle the Customer to cancel any other instalment.

5. QUALITY

5.1 The Supplier warrants that on delivery the Goods shall:

(a) conform in all material respects with their description and any applicable Specification; and

(b) be free from material defects in design, material and workmanship.

5.2 Subject to clause 5.3, if:

- the Customer gives notice in writing to the Supplier within a reasonable time of discovery that some or all of the Goods do not comply with the warranty set out in clause 5.1;
- the Supplier is given a reasonable opportunity of examining such Goods;
- the Customer (if asked to do so by the Supplier) returns such Goods to the Supplier's place of business at the Customer's cost;
- the Supplier in its reasonable opinion having examined such Goods finds that such Goods do not comply with the warranty set out in clause 5.1, the Supplier shall, at its option, repair or replace the defective Goods, or refund the price of the defective Goods in full.

5.3 The Supplier shall not be liable for Goods' failure to comply with the warranty set out in clause 5.1 in any of the following events:

- the Customer makes any further use of such Goods after giving notice in accordance with clause 5.2;
- the defect arises because the Customer failed to follow the Supplier's oral or written instructions as to the storage, commissioning, installation, use and maintenance of the Goods or (if there are none) good trade practice regarding the same;
- the defect arises as a result of the Supplier following any drawing, design or Specification supplied by the Customer;
- the Customer alters or repairs such Goods without the written consent of the Supplier;
- the defect arises as a result of fair wear and tear, wilful damage, negligence, or abnormal storage or working conditions; or
- the Goods differ from their description as a result of changes made to ensure they comply with applicable statutory or regulatory requirements.

5.4 Except as provided in this clause 5, the Supplier shall have no liability to the Customer in respect of the Goods' failure to comply with the warranty set out in clause 5.1.

5.5 The terms implied by sections 13 to 15 of the Sale of Goods Act 1979 are, to the fullest extent permitted by law, excluded from the Contract.

5.6 These Conditions shall apply to any repaired or replacement Goods supplied by the Supplier.

6. TITLE AND RISK

6.1 The risk in the Goods shall pass to the Customer on completion of delivery.

6.2 Title to the Goods shall not pass to the Customer until the earlier of:

- the Supplier receives payment in full (in cash or cleared funds) for the Goods and any other goods that the Supplier has supplied to the Customer in respect of which payment has become due, in which case title to the Goods shall pass at the time of payment of all such sums; and
- the Customer resells the Goods, in which case title to the Goods shall pass to the Customer at the time specified in clause 6.4.

6.3 Until title to the Goods has passed to the Customer, the Customer shall:

- store the Goods separately from all other goods held by the Customer so that they remain readily identifiable as the Supplier's property;
- not remove, deface or obscure any identifying mark or packaging on or relating to the Goods;
- maintain the Goods in satisfactory condition and keep them insured against all risks for their full price from the date of delivery;
- notify the Supplier immediately if it becomes subject to any of the events listed in clause 8.2; and
- give the Supplier such information relating to the Goods as the Supplier may require from time to time.

6.4 Subject to clause 6.4, the Customer may resell or use the Goods in the ordinary course of its business (but not otherwise) before the Supplier receives payment for the Goods. However, if the Customer resells the Goods before that time:

- it does so as principal and not as the Suppliers' agent; and
- title to the Goods shall pass from the Supplier to the Customer immediately before the time at which resale by the Customer occurs.

6.5 If before title to the Goods passes to the Customer the Customer becomes subject to any of the events listed in clause 8.2, then, without limiting any other right or remedy the Supplier may have:

- the Customer's right to resell the Goods or use them in the ordinary course of its business ceases immediately; and
- the Supplier may at any time:
 - require the Customer to deliver up all Goods in its possession which have not been resold, or irrevocably incorporated into another product; and
 - if the Customer fails to do so promptly, enter any premises of the Customer or of any third party where the Goods are stored in order to recover them.

TERMS & CONDITIONS

7. PRICE and PAYMENT

- 7.1 The price of the Goods shall be the price set out in the Order, or, if no price is quoted, the price set out in the Supplier's published price list in force as at the date of delivery.
- 7.2 The Supplier may, by giving notice to the Customer at any time before delivery, increase the price of the Goods to reflect any increase in the cost of the Goods that is due to:
- any factor beyond the Supplier's control (including foreign exchange fluctuations, increases in taxes and duties, and increases in labour, materials and other manufacturing costs);
 - any request by the Customer to change the delivery date(s), quantities or types of Goods ordered, or the Specification; or
 - any delay caused by any instructions of the Customer or failure of the Customer to give the Supplier adequate or accurate information or instructions.
- 7.3 The price of the Goods is exclusive of the costs and charges of packaging, insurance and transport of the Goods, which shall be invoiced to the Customer.
- 7.4 The price of the Goods is exclusive of amounts in respect of value added tax (VAT). The Customer shall, on receipt of a valid VAT invoice from the Supplier, pay to the Supplier such additional amounts in respect of VAT as are chargeable on the supply of the Goods.
- 7.5 Unless otherwise agreed in writing by the Supplier (in which case clause 7.6 shall apply), payment for the Goods must be made in advance of delivery to the bank account nominated in writing by the Supplier.
- 7.6 Where the Supplier agrees to provide the Customer with extended payment terms, it shall do in writing and the Customer shall pay the invoice in full and in cleared funds by the end of the month following the date of the invoice. Payment shall be made to the bank account nominated in writing by the Supplier. Time of payment is of the essence.
- 7.7 If the Customer fails to make any payment due to the Supplier under the Contract by the due date for payment, then the Customer shall pay interest on the overdue amount at the rate of 4% per annum above Barclay Bank plc's base rate from time to time. Such interest shall accrue on a daily basis from the due date until actual payment of the overdue amount, whether before or after judgment. The Customer shall pay the interest together with the overdue amount.
- 7.8 The Customer shall pay all amounts due under the Contract in full without set-off, counterclaim, deduction or withholding (except for any deduction or withholding required by law). The Supplier may at any time, without limiting any other rights or remedies it may have, set off any amount owing to it by the Customer against any amount payable by the Supplier to the Customer.

8. TERMINATION and SUSPENSION

- 8.1 If the Customer becomes subject to any of the events listed in clause 8.2, the Supplier may terminate the Contract with immediate effect by giving written notice to the Customer.
- 8.2 For the purposes of clause 8.1, the relevant events are:
- the Customer suspends, or threatens to suspend, payment of its debts, or is unable to pay its debts as they fall due or admits inability to pay its debts, or (being a company or limited liability partnership) is deemed unable to pay its debts within the meaning of section 123 of the Insolvency Act 1986, or (being an individual) is deemed either unable to pay its debts or as having no reasonable prospect of so doing, in either case, within the meaning of section 268 of the Insolvency Act 1986, or (being a partnership) has any partner to whom any of the foregoing apply;
 - the Customer commences negotiations with all or any class of its creditors with a view to rescheduling any of its debts, or makes a proposal for or enters into any compromise or arrangement with its creditors other than (where the Customer is a company) where these events take place for the sole purpose of a scheme for a solvent amalgamation of the Customer with one or more other companies or the solvent reconstruction of the Customer;
 - (being a company) a petition is filed, a notice is given, a resolution is passed, or an order is made, for or in connection with the winding up of the Customer, other than for the sole purpose of a scheme for a solvent amalgamation of the Customer with one or more other companies or the solvent reconstruction of the Customer;
 - (being a company) an application is made to court, or an order is made, for the appointment of an administrator or if a notice of intention to appoint an administrator is given or if an administrator is appointed over the Customer;
 - (being a company) the holder of a qualifying floating charge over the Customer's assets has become entitled to appoint or has appointed an administrative receiver;
 - a person becomes entitled to appoint a receiver over the Customer's assets or a receiver is appointed over the Customer's assets;
 - (being an individual) the Customer is the subject of a bankruptcy petition or order;
 - a creditor or encumbrancer of the Customer attaches or takes possession of, or a distress, execution, sequestration or other such process is levied or enforced or sued against, the whole or any part of its assets and such attachment or process is not discharged within 14 days;
 - any event occurs, or proceeding is taken, with respect to the Customer in any jurisdiction to which it is subject that has an effect equivalent or similar to any of the events mentioned in clause 8.2(a) to clause 8.2(i) (inclusive);
 - the Customer suspends, threatens to suspend, ceases or threatens to cease to carry on all or a substantial part of its business;
 - the Customer's financial position deteriorates to such an extent that in the Supplier's opinion the Customer's capability to adequately fulfil its obligations under the Contract has been placed in jeopardy; and
 - (being an individual) the Customer dies or, by reason of illness or incapacity (whether mental or physical), is incapable of managing his or her own affairs or becomes a patient under any mental health legislation.
- 8.3 Without limiting its other rights or remedies, the Supplier may suspend provision of the Goods under the Contract or any other contract between the Customer and the Supplier if the Customer becomes subject to any of the events listed in clause 8.2(a) to clause 8.2(i), or the Supplier reasonably believes that the Customer is about to become subject to any of them, or if the Customer fails to pay any amount due under this Contract on the due date for payment.
- 8.4 On termination of the Contract for any reason the Customer shall immediately pay to the Supplier all of the Supplier's outstanding unpaid invoices and interest.
- 8.5 Termination of the Contract, however arising, shall not affect any of the parties' rights, remedies, obligations and liabilities that have accrued

- as at termination.
8.6 Clauses which expressly or by implication survive termination of the Contract shall continue in full force and effect.

9. LIMITATION OF LIABILITY

- 9.1 Nothing in these Conditions shall limit or exclude the Supplier's liability for:
- death or personal injury caused by its negligence, or the negligence of its employees, agents or subcontractors (as applicable);
 - fraud or fraudulent misrepresentation;
 - breach of the terms implied by section 12 of the Sale of Goods Act 1979; or
 - defective products under the Consumer Protection Act 1987.
- 9.2 Subject to clause 9.1:
- the Supplier shall under no circumstances whatever be liable to the Customer, whether in contract, tort (including negligence), breach of statutory duty, or otherwise, for any loss of profit, or any indirect or consequential loss arising under or in connection with the Contract; and
 - the Supplier's total liability to the Customer in respect of all other losses arising under or in connection with the Contract, whether in contract, tort (including negligence), breach of statutory duty, or otherwise, shall in no circumstance exceed the price of the Goods.
10. **FORCE MAJEURE**
Neither party shall be liable for any failure or delay in performing its obligations under the Contract to the extent that such failure or delay is caused by a Force Majeure Event. A Force Majeure Event means any event beyond a party's reasonable control, which by its nature could not have been foreseen, or, if it could have been foreseen, was unavoidable, including strikes, lock-outs or other industrial disputes (whether involving its own workforce or a third party's), failure of energy sources or transport network, acts of God, war, terrorism, riot, civil commotion, interference by civil or military authorities, national or international calamity, armed conflict, malicious damage, breakdown of plant or machinery, nuclear, chemical or biological contamination, sonic boom, explosions, collapse of building structures, fires, floods, storms, earthquakes, loss at sea, epidemics or similar events, natural disasters or extreme adverse weather conditions, or default of suppliers or subcontractors.

11. GENERAL

- 11.1 **Assignment and other dealings.**
- The Supplier may at any time assign, transfer, mortgage, charge, subcontract or deal in any other manner with all or any of its rights or obligations under the Contract.
 - The Customer may not assign, transfer, mortgage, charge, subcontract, declare a trust over or deal in any other manner with any or all of its rights or obligations under the Contract without the prior written consent of the Supplier.
- 11.2 **Notices.**
- Any notice or other communication given to a party under or in connection with the Contract shall be in writing, addressed to that party at its registered office (if it is a company) or its principal place of business (in any other case) or such other address as that party may have specified to the other party in writing in accordance with this clause, and shall be delivered personally, sent by pre-paid first class post or other next working day delivery service, commercial courier, fax or e-mail.
 - A notice or other communication shall be deemed to have been received: if delivered personally, when left at the address referred to in clause 11.2(a); if sent by pre-paid first class post or other next working day delivery service, at 9.00 am on the second Business Day after posting; if delivered by commercial courier, on the date and at the time that the courier's delivery receipt is signed; or, if sent by fax or e-mail, one Business Day after transmission.
 - The provisions of this clause shall not apply to the service of any proceedings or other documents in any legal action.
- 11.3 **Severance.**
- If any provision or part-provision of the Contract is or becomes invalid, illegal or unenforceable, it shall be deemed modified to the minimum extent necessary to make it valid, legal and enforceable. If such modification is not possible, the relevant provision or part-provision shall be deemed deleted. Any modification to or deletion of a provision or part-provision under this clause shall not affect the validity and enforceability of the rest of the Contract.
 - If any provision or part-provision of this Contract is invalid, illegal or unenforceable, the parties shall negotiate in good faith to amend such provision so that, as amended, it is legal, valid and enforceable, and, to the greatest extent possible, achieves the intended commercial result of the original provision.
- 11.4 **Waiver.**
A waiver of any right or remedy under the Contract or law is only effective if given in writing and shall not be deemed a waiver of any subsequent breach or default. No failure or delay by a party to exercise any right or remedy provided under the Contract or by law shall constitute a waiver of that or any other right or remedy, nor shall it prevent or restrict the further exercise of that or any other right or remedy. No single or partial exercise of such right or remedy shall prevent or restrict the further exercise of that or any other right or remedy.
- 11.5 **Third party rights.**
A person who is not a party to the Contract shall not have any rights to enforce its terms.
- 11.6 **Variation.**
Except as set out in these Conditions, no variation of the Contract, including the introduction of any additional terms and conditions, shall be effective unless it is in writing and signed by the Supplier.
- 11.7 **Governing law.**
The Contract, and any dispute or claim arising out of or in connection with it or its subject matter or formation (including non-contractual disputes or claims), shall be governed by, and construed in accordance with the law of England and Wales.
- 11.8 **Jurisdiction.**
Each party irrevocably agrees that the courts of England and Wales shall have exclusive jurisdiction to settle any dispute or claim arising out of or in connection with this Contract or its subject matter or formation (including non-contractual disputes or claims).

THE UK'S NO.1 STABLE MAT SUPPLIER

earlswood
SUPPLIES LTD

Thatchems Farm,
Williamscot,
Banbury
Oxfordshire
OX17 1AR

T: 01295 758734

E: sales@earlswoodsupplies.com

W: www.earlswoodsupplies.com

SADDLERS

carrimore

surefoot