

# Wheel-End Products CATALOG



*Click to continue...*

**Version  
2.03**

**Commercial Highway Group  
15300 Centennial Drive  
Northville, MI 48167  
800-521-0515**

**<http://ch.hayes-lemmerz.com>**



**SEARCH**

**Wheels & Rims**

**Brake Drums**

**Hub & Drum Assemblies**

**Fasteners**

**HLI Mexico**

**Customer Service**

Here's how to use this Catalog.

To the left is the navigation bar. Click on any topic to jump to that section. Section headings are always shown in RED.

You can jump from any section to any section at any time.

Opens search window



**IMPORTANT**

Avoid mixing wheels or hub and bolt assemblies of different mounting systems with common bolt patterns.

Examples:

1. CentruMount-8 hub piloted (22mm wheel bolts) with 8-hole 275mm ISO (20mm wheel bolts).
2. DCN stud piloted with CentruMount-10 / ISO hub piloted.

**Inner Cap Nuts**

Inner cap nuts for aluminum inner dual DCN wheels must be high-strength nuts made from material equivalent to SAE Grade 8 and should conform to industry part number 5988. These nuts are not available from Hayes Lemmerz.

**ABBREVIATIONS**

- DCN Double Cap Nut
- CLN Cone Lock Nut
- ABS Loc. ABS ring location. All rings have 100 teeth. If listed as "SAE", then the location is per SAE J1730.
- RH Right hand
- LH Left hand

**Wheel Usage**

The abbreviations in the Wheel Usage column are as follows:

- S For use with steel wheels
- A For use with aluminum wheels
- S, A For use with steel or aluminum wheels

**Footnotes**

The letters in the Footnotes column (Hub & Drum Assemblies sections) have the following meaning:

- F Ford Product
- L Lube fill: 1/4-18 NPTF – Iron Hubs, 9/16-18 O-ring Seal – Alum. Hubs
- M 5.19" offset
- Q 5.44" offset
- T For axles with 8.62" linings located at the 7" brake location
- U For axles with 8.62" linings located inboard of the 7" brake location
- V For industry axles except Meritor TN or TB
- W For Meritor TN or TB axles only
- Y Assembly includes an unbalanced drum



### SEARCH

#### Wheels & Rims

General Notes

Customer Service

Applications

CentruMount-8 Hub Piloted Tubeless

CentruMount-10 Hub Piloted Tubeless

Wide Base Hub & Stud Piloted

CentruSteel Stud Piloted Tubeless

Demountable Rims

Paint Finishes

Selection Procedures

Disc Wheel Mounting Types

Wide Base Wheel Warranty

Rim & Disc Wheel Warranty

Identification

Tire/Rim Size Selection

Dual Wheel/Rim Spacing

Demountable Rim

Comparisons

Dual Spacing on

Cast Spoke Wheels

Demountable Rim

Dimensions

Spacer Bands for

Cast Spoke Wheels

Brake Drums

Hub & Drum Assemblies

Fasteners

HLI Mexico

Customer Service

#### Wheel & Rim Products

Hayes Lemmerz Akron Operations  
428 Seiberling Street  
Akron, Ohio 44306-3282 USA

Toll free: 800•337•0457

800•337•0458

Fax: 800•736•8760





# Steel Wheels & Rims

## CentruMount-8™ Hub Piloted Disc Wheels

Money saving technology for maintenance savings and superior performance. Positive hub piloting and cone lock clamping leads to improved wheel life. There are no inner wheel nuts to freeze on or to complicate retorquing. Eight nuts per wheel, dual or single, all with right hand threads. Distinctive four hand hold design makes CentruMount-8 wheels easy to identify. Available in our standard Electro-Deposition Primer or optional white, gray, black, or custom color premium electrostatic powder topcoat for superior corrosion protection.

### SEARCH

#### Wheels & Rims

#### General Notes

#### Customer Service

#### Applications

#### CentruMount-8 Hub Piloted Tubeless

#### CentruMount-10 Hub Piloted Tubeless

#### Wide Base Hub & Stud Piloted

#### CentruSteel Stud Piloted Tubeless

#### Demountable Rims

#### Paint Finishes

#### Selection Procedures

#### Disc Wheel Mounting Types

#### Wide Base Wheel Warranty

#### Rim & Disc Wheel Warranty

#### Identification

#### Tire/Rim Size Selection

#### Dual Wheel/Rim Spacing

#### Demountable Rim

#### Comparisons

#### Dual Spacing on

#### Cast Spoke Wheels

#### Demountable Rim

#### Dimensions

#### Spacer Bands for

#### Cast Spoke Wheels

#### Brake Drums

#### Hub & Drum Assemblies

#### Fasteners

#### HLI Mexico

#### Customer Service

### CentruMount™ - 8

#### HUB PILOTED Mountings for CLN (Cone Lock Nut)

Part Number	Size	Wheel Offset	Disc Thickness	Approx. Weight	Hand Holes	Maximum Load Rating	Maximum Inflation	Recommended Valve
<b>8 bolt hole, 6.50" bolt circle, 4.77" center hole</b>								
10008EBK	17.5" x 6.75"	-0.50"	0.500"	65 lbs.	0	6,005 lbs.	125 psi	TR-500
91816EBK	17.5" x 6.75"	-0.31"	0.385"	49 lbs.	0	4,805 lbs.	125 psi	TR-500
91818EBK	17.5" x 6.75"	0.19"	0.385"	49 lbs.	0	4,805 lbs.	125 psi	TR-500
<b>8 bolt hole, 6.50" bolt circle, 4.89" center hole</b>								
91817EBK	17.5" x 6.75"	-0.31"	0.385"	49 lbs.	0	4,805 lbs.	125 psi	TR-500
<b>8 bolt hole, 275mm bolt circle, 221.1mm (8.701") center hole</b>								
91272E*	17.5" x 6.75"	5.60"	0.387"	60 lbs.	4	6,500 lbs.	125 psi	TR-574-K29
10013TW*	17.5" x 6.75"	5.60"	0.437"	65 lbs.	4	6,500 lbs.	125 psi	TR-574-L29
91831TW*	19.5" x 6.75"	5.60"	0.437"	58 lbs.	4	5,000 lbs.	115 psi	TR570-E14
90614E	22.5" x 7.50"	6.50"	0.430"	76 lbs.	4	6,610 lbs.	120 psi	TR-572
88884E	22.5" x 8.25"	6.62"	0.430"	80 lbs.	4	7,400 lbs.	120 psi	TR-573
89920E	22.5" x 8.25"	6.62"	0.500"	90 lbs.	4	7,800 lbs.	120 psi	TR-573
88790E	24.5" x 8.25"	6.62"	0.437"	89 lbs.	4	7,400 lbs.	120 psi	TR-573
89851E	24.5" x 8.25"	6.62"	0.500"	94 lbs.	4	7,800 lbs.	120 psi	TR-573

\* Fits on ISO hub backup diameter for 8 hole, 275mm systems. Do not use with CentruMount-8 brake drums.







# Steel Wheels & Rims

## CentruMount-10™ Hub Piloted Disc Wheels

Money saving technology for maintenance savings and superior performance. Positive hub piloting and cone lock clamping leads to improved wheel life. There are no inner wheel nuts to freeze on or to complicate retorquing. Ten nuts per wheel, dual or single, all with right hand threads. Built in compliance with ISO standards for universal OEM truck and trailer applications. Available in our standard Electro-Deposition Primer or optional white, gray, black, or custom color premium electrostatic powder topcoat for superior corrosion protection.

### SEARCH

#### Wheels & Rims

#### General Notes

#### Customer Service

#### Applications

#### CentruMount-8 Hub Piloted Tubeless

#### CentruMount-10 Hub Piloted Tubeless

#### Wide Base Hub & Stud Piloted

#### CentruSteel Stud Piloted Tubeless

#### Demountable Rims

#### Paint Finishes

#### Selection Procedures

#### Disc Wheel Mounting Types

#### Wide Base Wheel Warranty

#### Rim & Disc Wheel Warranty

#### Identification

#### Tire/Rim Size Selection

#### Dual Wheel/Rim Spacing

#### Demountable Rim

#### Comparisons

#### Dual Spacing on

#### Cast Spoke Wheels

#### Demountable Rim

#### Dimensions

#### Spacer Bands for

#### Cast Spoke Wheels

#### Brake Drums

#### Hub & Drum Assemblies

#### Fasteners

#### HLI Mexico

#### Customer Service

### CentruMount™ - 10

#### HUB PILOTED Mountings for CLN (Cone Lock Nut)

Part Number	Size	Wheel Offset	Disc Thickness	Approx. Weight	Hand Holes	Maximum Load Rating	Maximum Inflation	Recommended Valve
<b>10 bolt hole, 285.75mm (11.25") bolt circle, 220mm (8.661") center hole</b>								
91840TW	19.5" x 6.75"	6.40"	0.437"	65 lbs.	5	6,700 lbs.	120 psi	TR-546***
10038E	22.5" x 7.50"	6.50"	0.430"	76 lbs.	5	7,100 lbs.	120 psi	TR-573
90631E	22.5" x 7.50"	6.50"	0.430"	78 lbs.	2	7,100 lbs.	120 psi	TR-573
10049E	22.5" x 8.25"	6.62"	0.500"	82 lbs.	5	8,000 lbs.	120 psi	TR-573
90541E	22.5" x 8.25"	6.62"	0.430"	81 lbs.	2	7,400 lbs.	120 psi	TR-573
90273E	22.5" x 8.25"	6.62"	0.430"	82 lbs.	4	7,400 lbs.	120 psi	TR-573
90262E	22.5" x 8.25"	6.62"	0.430"	79 lbs.	5	7,400 lbs.	120 psi	TR-573
90260E	22.5" x 8.25"	6.62"	0.500"	90 lbs.	2	7,800 lbs.	120 psi	TR-573
10041E	22.5" x 9.00"	**5.25"	0.522"	94 lbs.	5	10,000 lbs.	130 psi	TR-573-E17
10047TW	22.5" x 9.00"	7.00"	0.581"	104 lbs.	5	10,000 lbs.	130 psi	TR-573-E17
90542E	24.5" x 8.25"	6.62"	0.437"	90 lbs.	2	7,400 lbs.	120 psi	TR-573
90275E	24.5" x 8.25"	6.62"	0.437"	89 lbs.	4	7,400 lbs.	120 psi	TR-573
90263E	24.5" x 8.25"	6.62"	0.437"	88 lbs.	5	7,400 lbs.	120 psi	TR-573
90261E	24.5" x 8.25"	6.62"	0.500"	97 lbs.	2	7,800 lbs.	120 psi	TR-573

\*\*Inset value shown  
\*\*\*Bend valve to fit.

#### Special Bus Mounting:

#### 10 bolt hole, 11.25" bolt circle, 8.665" center hole

87934E	22.5" x 8.25"	6.62"	0.430"	79 lbs.	5	7,400 lbs.	120 psi	TR-573
91720E	24.5" x 8.25"	6.62"	0.437"	88 lbs.	5	7,400 lbs.	120 psi	TR-573

#### 10 bolt hole, 335mm (13.19") bolt circle, 281mm (11.063") center hole

2920086TW	22.5" x 7.50"	6.49"	0.463"	78 lbs.	10	6,930 lbs.	120 psi	V3-20-4
2920072TW	22.5" x 8.25"	6.69"	0.502"	84 lbs.	10	7,810 lbs.	120 psi	V3-20-4





These quality 22.5" wheels are available in 9", 12.25", 13", and 14" widths, and offer weight savings resulting in better fuel economy or more payload. You can also expect to experience less tire wear for dual replacement applications because you get better road contact with the wider tire. And with higher load ratings, you can be sure these wheels will carry the load! All wide base wheels are topcoated white. Custom colors are available upon request.

### SEARCH

#### Wheels & Rims

#### General Notes

#### Customer Service

#### Applications

#### CentruMount-8 Hub Piloted Tubeless

#### CentruMount-10 Hub Piloted Tubeless

#### Wide Base Hub & Stud Piloted

#### CentruSteel Stud Piloted Tubeless

#### Demountable Rims

#### Paint Finishes

#### Selection Procedures

#### Disc Wheel Mounting Types

#### Wide Base Wheel Warranty

#### Rim & Disc Wheel Warranty

#### Identification

#### Tire/Rim Size Selection

#### Dual Wheel/Rim Spacing

#### Demountable Rim

#### Comparisons

#### Dual Spacing on Cast Spoke Wheels

#### Demountable Rim

#### Dimensions

#### Spacer Bands for Cast Spoke Wheels

#### Brake Drums

#### Hub & Drum Assemblies

#### Fasteners

#### HLI Mexico

#### Customer Service

### HUB PILOTED Mountings for CLN (Cone Lock Nut) 10 bolt hole, 285.75mm bolt circle, 220.0mm center hole

Part Number	Size	Outset* (pos.)	Inset* (neg.)	Approx. Weight	Hand Holes	Disc Position	Max. Load Rating	Max. Inflation	Recommended Valve**
10034TW	22.5" x 12.25"	4.54"	4.00"	111 lbs.	5	1	11,400 lbs.	125 psi	TR500
10035TW	22.5" x 12.25"	5.29"	4.75"	111 lbs.	5	1	11,400 lbs.	125 psi	TR574 - E26
10039TW	22.5" x 13.00"	0.51"	0"	119 lbs.	5	2	11,000 lbs.	110 psi	TR574 - E26
10043TW	22.5" x 13.00"	3.13"	2.62"	119 lbs.	5	2	11,000 lbs.	110 psi	TR500
10027TW	22.5" x 14.00"	2.00"	1.49"	136 lbs.	0	2	11,000 lbs.	125 psi	TR575
10031TW	22.5" x 14.00"	0.512"	0"	138 lbs.	0	2	12,300 lbs.	120 psi	TR575

### STUD PILOTED Mountings for Outer Cap Nut 10 bolt hole, 11.25" bolt circle, 8.72" center hole

Part Number	Size	Outset* (pos.)	Inset* (neg.)	Approx. Weight	Hand Holes	Disc Position	Max. Load Rating	Max. Inflation	Recommended Valve**
10032TW	22.5" x 12.25"	4.54"	4.00"	112 lbs.	2	1	11,400 lbs.	125 psi	TR500
10033TW	22.5" x 12.25"	5.29"	4.75"	112 lbs.	2	1	11,400 lbs.	125 psi	TR574 - E26
10042TW	22.5" x 13.00"	0.51"	0"	120 lbs.	2	2	11,000 lbs.	110 psi	TR574 - E26
10036TW	22.5" x 13.00"	3.13"	2.62"	120 lbs.	2	2	11,000 lbs.	110 psi	TR500

\* When the centerline of the rim is inboard of the mounting surface, the distance between the rim center-line and the mounting surface is defined as the inset. When the centerline of the rim is outboard of the mounting surface, the distance between the rim center-line and the mounting surface is defined as the outset.

\*\* The valves listed for the 12.25" and 13.00" rim sizes are for the inset position.



Disc Position 1

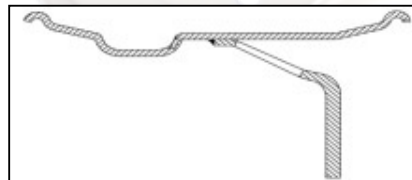

Disc Position 2

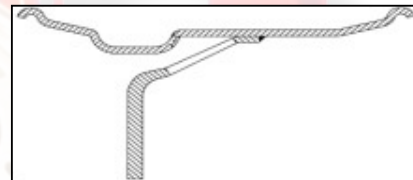





INTERNATIONAL, INC.



# Steel Wheels & Rims

## Wide Base Wheel Warranty

### SEARCH

**Wheels & Rims**

General Notes

Customer Service

Applications

CentruMount-8 Hub Piloted Tubeless

CentruMount-10 Hub Piloted Tubeless

Wide Base Hub & Stud Piloted

CentruSteel Stud Piloted Tubeless

Demountable Rims

Paint Finishes

Selection Procedures

Disc Wheel Mounting Types

**Wide Base Wheel Warranty**

Rim & Disc Wheel Warranty

Identification

Tire/Rim Size Selection

Dual Wheel/Rim Spacing

Demountable Rim

Comparisons

Dual Spacing on

Cast Spoke Wheels

Demountable Rim

Dimensions

Spacer Bands for

Cast Spoke Wheels

Brake Drums

Hub & Drum Assemblies

Fasteners

HLI Mexico

Customer Service

## Wide Base Wheels 5 Year Limited Warranty

FOR TRUCKS, TRAILERS, AND BUSES

Hayes Lemmerz warrants to the user to replace each on-highway wide base steel wheel which becomes unserviceable with 5 years of date of manufacture due to functional defects in workmanship and materials, excluding finish.

This warranty is void if these products are altered or modified, are not properly installed, or are not operated or maintained in accordance with instructions printed in catalogs current for the year of manufacture. Also, it will not cover defects caused by corrosion, other components, accident, overloading, improper tire size, improper tire inflation, excessive speeds, or other abnormal or severe operating conditions.

Hayes Lemmerz' obligation under this warranty is limited to replacing any product that proves, upon inspection of failed parts and, if deemed necessary, associated vehicles and their maintenance records, to be defective within the applicable provisions of this warranty. Replacement products will be shipped FOB our factory.

Parts on which a warranty is claimed must, upon request, be returned to place of manufacture or to our authorized representative with transportation charges prepaid.

THIS WARRANTY IS IN LIEU OF ALL OTHER WARRANTIES, EXPRESSED OR IMPLIED, INCLUDING THE WARRANTIES OF MERCHANTABILITY OR FITNESS FOR A PARTICULAR PURPOSE, APPLICATION OR USE. IN NO EVENT SHALL HAYES LEMMERZ' LIABILITY EXCEED THE ORIGINAL PRICE OF THE PRODUCT, NOR SHALL HAYES LEMMERZ BE LIABLE FOR SPECIAL INCIDENTAL OR CONSEQUENTIAL DAMAGES.



INTERNATIONAL, INC.

15300 Centennial Drive • Northville, Michigan 48167 USA  
<http://ch.hayes-lemmerz.com>

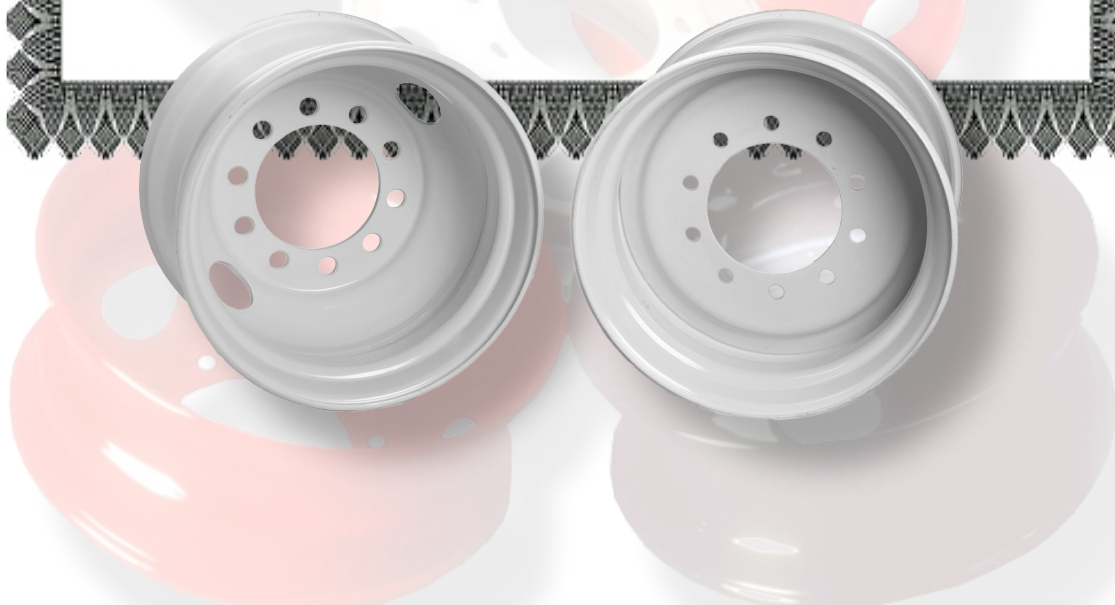



## CentruSteel® Stud Piloted Disc Wheels

Stud piloted dual wheels use inner and outer cap nuts, so that each wheel is tightened individually. For a front or single wheel, a single cap nut is used. Right and left hand fasteners are required. Wheels of this type have spherical countersinks on each stud hole. Available in our standard Electro-Deposition Primer or optional white, gray, black, or custom color premium electrostatic powder topcoat for superior corrosion protection.

### SEARCH

#### Wheels & Rims

#### General Notes

#### Customer Service

#### Applications

#### CentruMount-8 Hub Piloted Tubeless

#### CentruMount-10 Hub Piloted Tubeless

#### Wide Base Hub & Stud Piloted

#### CentruSteel Stud Piloted Tubeless

#### Demountable Rims

#### Paint Finishes

#### Selection Procedures

#### Disc Wheel Mounting Types

#### Wide Base Wheel Warranty

#### Rim & Disc Wheel Warranty

#### Identification

#### Tire/Rim Size Selection

#### Dual Wheel/Rim Spacing

#### Demountable Rim

#### Comparisons

#### Dual Spacing on

#### Cast Spoke Wheels

#### Demountable Rim

#### Dimensions

#### Spacer Bands for

#### Cast Spoke Wheels

#### Brake Drums

#### Hub & Drum Assemblies

#### Fasteners

#### HLI Mexico

#### Customer Service

### CentruSteel®

#### STUD PILOTED Mountings for DCN (Double Cap Nut)

Part Number	Size	Wheel Offset	Disc Thickness	Approx. Weight	Hand Holes	Maximum Load Rating	Maximum Inflation	Recommended Valve
<b>10 bolt hole, 11.25" bolt circle, 8.725" center hole</b>								
87892E	22.5" x 7.50"	6.50"	0.430"	76 lbs.	5	7,100 lbs.	120 psi	TR-572
87893E	22.5" x 7.50"	6.50"	0.430"	78 lbs.	2	7,100 lbs.	120 psi	TR-572
87904E	22.5" x 8.25"	6.62"	0.430"	79 lbs.	5	7,400 lbs.	120 psi	TR-573
87905E	22.5" x 8.25"	6.62"	0.430"	81 lbs.	2	7,400 lbs.	120 psi	TR-573
89921E	22.5" x 8.25"	6.62"	0.500"	90 lbs.	2	7,800 lbs.	120 psi	TR-573
87896E	24.5" x 8.25"	6.62"	0.437"	88 lbs.	5	7,400 lbs.	120 psi	TR-573
87897E	24.5" x 8.25"	6.62"	0.437"	90 lbs.	2	7,400 lbs.	120 psi	TR-573
89922E	24.5" x 8.25"	6.62"	0.500"	97 lbs.	2	7,800 lbs.	120 psi	TR-573
<b>10 bolt hole, 11.25" bolt circle, 8.738" center hole</b>								
10048TW	22.5" x 9.00"	7.00"	0.581"	105 lbs.	2	10,000 lbs.	130 psi	TR-573-E17
<b>6 bolt hole, 8.75" bolt circle, 6.50" center hole</b>								
91836TW	17.5" x 6.75"	6.12"	0.417"	63 lbs.	2	5,070 lbs.	125 psi	TR570-C14
<b>10 bolt hole, 8.75" bolt circle, 6.50" center hole</b>								
91834TW	17.5" x 6.75"	6.19"	0.417"	62 lbs.	2	6,500 lbs.	125 psi	TR570-C14
90714E	17.5" x 6.75"	6.19"	0.390"	61 lbs.	5	6,500 lbs.	125 psi	TR574-K29
<b>Special Japanese Mounting: (available in silver only)</b>								
<b>8 bolt hole, 285mm bolt circle, 221 mm center hole</b>								
91856	22.5" x 7.50"	6.38"	0.550"	86 lbs.	8	7,200 lbs.	128 psi	TR545D
91857	22.5" x 8.25"	6.50"	0.550"	90 lbs.	8	7,400 lbs.	128 psi	TR545D







Available in tubeless or tube-type designs. For features of tubeless or tube-type rims, please refer to "Demountable Rim Comparisons" under the Steel Wheels and Rims menu. Available in our standard Electro-Deposition Primer or optional white, gray, black, or custom color premium electrostatic powder topcoat for superior corrosion protection.

### SEARCH

#### Wheels & Rims

#### General Notes

#### Customer Service

#### Applications

#### CentruMount-8 Hub Piloted Tubeless

#### CentruMount-10 Hub Piloted Tubeless

#### Wide Base Hub & Stud Piloted

#### CentruSteel Stud Piloted Tubeless

#### Demountable Rims

#### Paint Finishes

#### Selection Procedures

#### Disc Wheel Mounting Types

#### Wide Base Wheel Warranty

#### Rim & Disc Wheel Warranty

#### Identification

#### Tire/Rim Size Selection

#### Dual Wheel/Rim Spacing

#### Demountable Rim

#### Comparisons

#### Dual Spacing on Cast Spoke Wheels

#### Demountable Rim

#### Dimensions

#### Spacer Bands for Cast Spoke Wheels

#### Brake Drums

#### Hub & Drum Assemblies

#### Fasteners

#### HLI Mexico

#### Customer Service

### Steel Demountable Rims For Cast Spoke Wheels

#### On-Highway Tubeless Rims

Part Number	Size	Offset	Approx. Weight	Maximum Load Rating	Maximum Inflation	Recommended Valve
675175ERSE	17.5" x 6.75"	3.90"	47 lbs.	4,805 lbs.	120 psi	TR-573
750225DVSE	22.5" x 7.50"	4.24"	64 lbs.	7,030 lbs.	120 psi	TR-572
825225DVSE	22.5" x 8.25"	4.40"	66 lbs.	7,300 lbs.	120 psi	TR-573
825225DVLE	22.5" x 8.25"	4.75"	68 lbs.	7,300 lbs.	120 psi	TR-573
825245DVSE	24.5" x 8.25"	4.40"	72 lbs.	7,300 lbs.	120 psi	TR-573
825245DVLE	24.5" x 8.25"	4.75"	74 lbs.	7,300 lbs.	120 psi	TR-573

"S" = short offset 17.5" diameter fits 15" cast spoke wheels  
 "D" = demountable 22.5" diameter fits 20" cast spoke wheels  
 "V" = new rim 24.5" diameter fits 22" cast spoke wheels  
 "L" = long offset  
 "E" = white primer (See Wheel & Rim Finishes page in this section for other available finishes.)

#### On-Highway Tube-Type Rims

Type	SIZE			ASSEMBLY		RIM BASE		SIDE RING		RATING	
	Width	Dia.	Offset	Part Number	Weight	Part Number	Weight	Part Number	Weight	Max Load Rating	Max Inflation
LW	6.50" T	15"	3.715"	6515LWDE	37 lbs.	B6515LWDE	27 lbs.	R6515LWE	10 lbs.	4,290 lbs.	105 psi
		20"	3.715"	6520LWDE	49 lbs.	B6520LWDE	36 lbs.	R6520LWE	13 lbs.	4,610 lbs.	105 psi
LW	7.50" V	15"	4.258"	7515LWDE	52 lbs.	B7515LWDE	40 lbs.	R8015LWE	12 lbs.	5,520 lbs.	105 psi
		20"	4.258"	7520LWDE	70 lbs.	B7520LWDE	54 lbs.	R8020LWE	16 lbs.	6,400 lbs.	105 psi
LW	8.00" V	20"	4.496"	8020LWDE	73 lbs.	B8020LWDE	57 lbs.	R8020LWE	16 lbs.	7,600 lbs.	105 psi
		24"	4.496"	8024LWDE	87 lbs.	B8024LWDE	68 lbs.	R8024LWE	19 lbs.	7,600 lbs.	105 psi
LW	9.00" V	20"	5.123"	9020LWDE	92 lbs.	B9020LWDE	76 lbs.	R8020LWE	16 lbs.	9,230 lbs.	120 psi
		24"	5.123"	9024LWDE	110 lbs.	B9024LWDE	91 lbs.	R8024LWE	19 lbs.	9,230 lbs.	120 psi
FL	7.5"	20"	4.750"	7520FLD2E	59 lbs.	B7520FLDE	46 lbs.	R7520FLE	14 lbs.	5,430 lbs.	100 psi

#### Heavy Duty On/Off Highway Type M Rims

Width	SIZE			ASSEMBLY		RIM BASE		FLANGE		LOCK RING		RATING	
	Dia.	Offset	Part Number	Weight	Part Number	Weight	Part Number	Weight	Part Number	Weight	Max Load Rating	Max Inflation	
7.50" VM	20"	4.750"	7520MDE	80 lbs.	B8020LWDE	57 lbs.	F7520ME	16 lbs.	LR20ME	7 lbs.	7,600 lbs.	120 psi	
7.50" VM	24"	4.750"	7524MDE	97 lbs.	B8024LWDE	68 lbs.	F7524ME	19 lbs.	LR24ME	9 lbs.	7,600 lbs.	120 psi	
8.50" VM	20"	5.375"	8520MDE	99 lbs.	B9020LWDE	76 lbs.	F7520ME	16 lbs.	LR20ME	7 lbs.	9,230 lbs.	120 psi	
8.50" VM	24"	5.375"	8524MDE	119 lbs.	B9024LWDE	91 lbs.	F7524ME	19 lbs.	LR24ME	9 lbs.	9,230 lbs.	120 psi	
10.00" W	20"	6.312"	I020MDE	116 lbs.	B1020MDE	87 lbs.	F1020ME	22 lbs.	LR20ME	7 lbs.	9,610 lbs.	120 psi	
											11,250 lbs.*	120 psi	
10.00" W	24"	6.312"	I024MDE	141 lbs.	B1024MDE	105 lbs.	F1024ME	27 lbs.	LR24ME	9 lbs.	9,740 lbs.	120 psi	
											11,500 lbs.*	120 psi	

\* For restricted highway speeds 50 MPH maximum

### SEARCH

#### Wheels & Rims

#### General Notes

#### Customer Service

#### Applications

CentruMount-8 Hub Piloted Tubeless

CentruMount-10 Hub Piloted Tubeless

Wide Base Hub & Stud Piloted

CentruSteel Stud Piloted Tubeless

Demountable Rims

Paint Finishes

Selection Procedures

Disc Wheel Mounting Types

Wide Base Wheel Warranty

Rim & Disc Wheel Warranty

Identification

Tire/Rim Size Selection

Dual Wheel/Rim Spacing

Demountable Rim

Comparisons

Dual Spacing on

Cast Spoke Wheels

Demountable Rim

Dimensions

Spacer Bands for

Cast Spoke Wheels

Brake Drums

Hub & Drum Assemblies

Fasteners

HLI Mexico

Customer Service

#### Standard Finish

Wheels and demountable rims – both tubeless and tube-type – are supplied with ElectroDeposition Primer (EDP). It is a glossy, uniform finish, which provides excellent basic corrosion protection. Primer-coated wheels are designated by suffix “E” applied to the wheel part number.

COLOR	SUFFIX
White primer *	E
Black primer **	EBK
Topcoat white ***	TW

\*Topcoating not required

\*\*Must be topcoated (by customer)

\*\*\*Do NOT re-topcoat

#### A Superior Finish Rewards You with Superior Value

Get spectacular appearance while saving money on cleaning and repainting with our **premium powder top-coated** wheels and rims. Colors available include dazzling white, gray, black, and custom colors.



Triple protected with a phosphate coating, EDP primer and powder paint, top-coated wheels and rims have a durable baked-on finish that provides superior corrosion protection. In salt spray tests (ASTM B117-85), our powder topcoat finish will provide 1,200 hours of corrosion protection – that’s over three times longer than the standard finish.

To order, specify **premium powder topcoat** by replacing part number “E” suffix with one of the following:

COLOR	SUFFIX
White	W
Gray	G
Black	BK
Custom *	Inquire

\* Also available with liquid enamel topcoat paint.

Contact your sales representative for additional information or a quotation.

#### Recommendations for Top-coating Standard Finish Truck Wheels and Rims

Hayes Lemmerz standard primed truck wheels and rims are coated with cathodic acrylic ElectroDeposition Primer (EDP). Though resistant to corrosion and sunlight – the EDP may be successfully top-coated to enhance protection and appearance, if you follow these practices:

1. Make sure that the topcoat is fully cured before mounting the wheel or rim on a vehicle. Uncured paint causes wheel or rim fasteners to lose torque – which causes wheels or rims to break, or even separate from the vehicle. Loose fasteners can also lead to damaged hubs and/or brake drums. Since paint curing times vary, see your paint supplier’s instructions for the proper curing time.
2. Hayes Lemmerz cannot assure success for every variation of paint applied over our primer, but lab testing shows excellent adhesion for:
  - Vinyl air-dry paints
  - Conventional alkyd/ acrylic with an isocyanate hardener
  - Nitrocellulose alkyd lacquers
3. Do not apply too much paint to wheel mounting areas. The maximum allowable thickness, primer and topcoat combined, is 3 mils. You can measure it with a paint gauge, available from paint and paint equipment suppliers. Thicker coatings compress under the fasteners, which causes lost torque, leading to broken or damaged components.
4. On tube-type rim assemblies, we recommend that the base and side ring be assembled before top-coating. This helps assure proper rim component seating, without paint interference.

**For the ultimate topcoat finish, specify our *premium powder coat***



### SEARCH

#### Wheels & Rims

#### General Notes

#### Customer Service

#### Applications

#### CentruMount-8 Hub Piloted Tubeless

#### CentruMount-10 Hub Piloted Tubeless

#### Wide Base Hub & Stud Piloted

#### CentruSteel Stud Piloted Tubeless

#### Demountable Rims

#### Paint Finishes

#### Selection Procedures

#### Disc Wheel Mounting Types

#### Wide Base Wheel Warranty

#### Rim & Disc Wheel Warranty

#### Identification

#### Tire/Rim Size Selection

#### Dual Wheel/Rim Spacing

#### Demountable Rim

#### Comparisons

#### Dual Spacing on

#### Cast Spoke Wheels

#### Demountable Rim

#### Dimensions

#### Spacer Bands for

#### Cast Spoke Wheels

#### Brake Drums

#### Hub & Drum Assemblies

#### Fasteners

#### HLI Mexico

#### Customer Service

#### Proper Procedures for Selecting Wheels/Rims

1. Determine operating conditions plus tire size, type, pressure and load.
2. Refer to Tire/Rim Size Selection chart in this section for tubeless and tube-type tires.
3. Select rim width and check dual spacing on Dual Wheel/Rim Spacing page and Dual Spacing for Demountable Rims on Cast Spoke Wheels page, both contained in this section.
4. Refer to rim/wheel specification pages. Select appropriate part number for load and pressure rating, type of mounting, offset, rim width, and tire diameter.
5. Select attaching hardware for disc wheels or demountable rims.
6. Determine spacer width for demountable rims and then select spacer.

#### Wheel and Rim Selection

When choosing the correct wheel or rim, it is important to determine the operating conditions to which the wheel or rim will be subjected. Conditions to consider are loads, speeds, road environment, tire pressure, tire sizes and tube-type or tubeless tires.

Consult wheel and rim application engineers at Hayes Lemmerz for wheel/rim load and inflation ratings and application recommendations for conditions such as high-center-of-gravity loads, Canadian highway operation, and on-off highway, restricted speed, or severe service operation.

#### Ratings

Maximum load rating and maximum inflation rating for highway service are listed with each wheel and rim part number on the application tables in this section.

#### Rim Width

Design rim width is the specific rim width used with a basic tire size. This rim width will give the best overall tire performance. Other approved rim widths may offer advantages or provide solutions to specific problems.



#### WARNING

Rim and tire servicing can be dangerous. To protect life and limb, be sure you understand and follow all mounting, demounting, maintenance, inspection, operational procedures, and safety instructions and practices.

**For complete information, call (800) 521-0515.**



### SEARCH

Wheels & Rims

General Notes

Customer Service

Applications

CentruMount-8 Hub Piloted Tubeless

CentruMount-10 Hub Piloted Tubeless

Wide Base Hub & Stud Piloted

CentruSteel Stud Piloted Tubeless

Demountable Rims

Paint Finishes

Selection Procedures

Disc Wheel Mounting Types

Wide Base Wheel Warranty

Rim & Disc Wheel Warranty

Identification

Tire/Rim Size Selection

Dual Wheel/Rim Spacing

Demountable Rim

Comparisons

Dual Spacing on

Cast Spoke Wheels

Demountable Rim

Dimensions

Spacer Bands for

Cast Spoke Wheels

Brake Drums

Hub & Drum Assemblies

Fasteners

HLI Mexico

Customer Service

Hayes Lemmerz is an industry leader in disc wheel technology. Advanced design, analysis, and manufacturing methods assure a precision product with optimum performance. Wheels are available with a standard EDP primer finish or a premium electrostatic powder topcoat. See Wheel & Rim Finishes page for more details.

#### CentruMount™ - Hub Piloted Wheels

A single cone lock nut is used on each bolt, for single or dual wheels, front or rear axles. Only right-hand threads are required. Wheels for this type of system have straight-through stud holes, *without* a spherical chamfer.

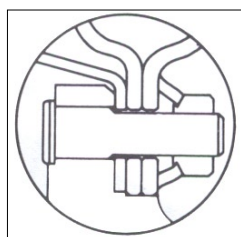

Cone Lock Nut (CLN)  
Hub Piloted

Hayes Lemmerz hub piloted technology comes in 8 and 10 bolt hole configurations:



CentruMount™ - 8

Money-saving technology for maintenance savings and superior performance. Positive hub piloting and cone lock clamping leads to improved wheel life. There are no inner wheel nuts to freeze on or to complicate retorquing. Eight nuts per wheel, dual or single, all with right hand threads. Distinctive four hand hole design makes CentruMount-8 wheels easy to identify.



CentruMount™ - 10

Hub-piloting technology also is available in a ten bolt hole version, offering similar advantages in simplified maintenance, longer wheel life, and reduced parts inventory. CentruMount-10 is built in compliance with ISO standards for universal OEM truck and trailer applications.

#### CentruSteel™ - Stud Piloted Wheels

Dual wheels use inner and outer cap nuts, so that each wheel is tightened individually. For a front or single wheel, a single cap nut is used. Right and left hand fasteners are required. Wheels of this type have spherical countersinks on each stud hole.

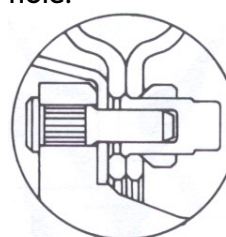

Double Cap Nut (DCN)  
Stud Piloted

Hayes Lemmerz **tubeless** disc wheels are designed to be lightweight to help lower fuel costs and increase payload. Low-point marking facilitates tire-to-wheel matching, for smoother ride and longer tire life.

Hayes Lemmerz **tube-type** disc wheels are based on time-tested designs, available in a variety of designs tough enough to handle heavy service applications with larger tire sizes. These wheels are supplied in standard or heavy duty mountings, depending on load capacity.





### SEARCH

**Wheels & Rims**

General Notes

Customer Service

Applications

CentruMount-8 Hub Piloted Tubeless

CentruMount-10 Hub Piloted Tubeless

Wide Base Hub & Stud Piloted

CentruSteel Stud Piloted Tubeless

Demountable Rims

Paint Finishes

Selection Procedures

Disc Wheel Mounting Types

Wide Base Wheel Warranty

**Rim & Disc Wheel Warranty**

Identification

Tire/Rim Size Selection

Dual Wheel/Rim Spacing

Demountable Rim

Comparisons

Dual Spacing on

Cast Spoke Wheels

Demountable Rim

Dimensions

Spacer Bands for

Cast Spoke Wheels

Brake Drums

Hub & Drum Assemblies

Fasteners

HLI Mexico

Customer Service

## Rim and Disc Wheel 5 Year Limited Warranty

### FOR TRUCKS, TRAILERS, AND BUSES

Hayes Lemmerz warrants to the user to replace each on-highway tubeless truck disc wheel or demountable rim, which becomes unserviceable within five years of date of manufacture due to functional defects in workmanship and materials, excluding finish.

All other wheel and rim products are warranted for one year from date of manufacture.

This warranty is void if these products are altered or modified, are not properly installed, or are not operated or maintained in accordance with instructions printed in catalogs current for the year of manufacture. Also, it will not cover defects caused by corrosion, other components, accident, improper tire size, improper tire inflation, excessive speeds, or other abnormal or severe operating conditions.

Hayes Lemmerz' obligation under this warranty is limited to replacing any product that proves, upon inspection of failed parts and, if deemed necessary, associated vehicles and their maintenance records, to be defective within the applicable provisions of this warranty. Replacement products will be shipped FOB our factory.

Parts on which a warranty is claimed must, upon request, be returned to place of manufacture or to our authorized representative with transportation charges prepaid.

THIS WARRANTY IS IN LIEU OF ALL OTHER WARRANTIES, EXPRESS OR IMPLIED, INCLUDING THE WARRANTIES OF MERCHANTABILITY OR FITNESS FOR A PARTICULAR PURPOSE, APPLICATION OR USE. IN NO EVENT SHALL HAYES LEMMERZ' LIABILITY EXCEED THE ORIGINAL PRICE OF THE PRODUCT, NOR SHALL HAYES LEMMERZ BE LIABLE FOR SPECIAL INCIDENTAL OR CONSEQUENTIAL DAMAGES.



15300 Centennial Drive • Northville, Michigan 48167 USA  
<http://ch.hayes-lemmerz.com>



### SEARCH

#### Wheels & Rims

#### General Notes

#### Customer Service

#### Applications

#### CentruMount-8 Hub Piloted Tubeless

#### CentruMount-10 Hub Piloted Tubeless

#### Wide Base Hub & Stud Piloted

#### CentruSteel Stud Piloted Tubeless

#### Demountable Rims

#### Paint Finishes

#### Selection Procedures

#### Disc Wheel Mounting Types

#### Wide Base Wheel Warranty

#### Rim & Disc Wheel Warranty

#### Identification

#### Tire/Rim Size Selection

#### Dual Wheel/Rim Spacing

#### Demountable Rim

#### Comparisons

#### Dual Spacing on

#### Cast Spoke Wheels

#### Demountable Rim

#### Dimensions

#### Spacer Bands for

#### Cast Spoke Wheels

#### Brake Drums

#### Hub & Drum Assemblies

#### Fasteners

#### HLI Mexico

#### Customer Service

### Identification Required by FMVSS120

Federal Motor Vehicle Safety Standard (FMVSS120) was issued in 1977 requiring that the rim size and type must be stamped on the rim and rim components (20" x 7.50" LW). Prior to this regulation, the part number was stamped on the rim or rim component (B7520LWD).

This FMVSS120 rim- stamping standard also requires the following: name of manufacturer, country where the rim or component was manufactured, date manufactured, the DOT symbol, and a designation that indicates the source of the rims dimensions (T=Tire and Rim Association).

### Tubeless Drop Center Rims

Drop center rims have the rim size and type stamped on the weather side of the rim base as shown:

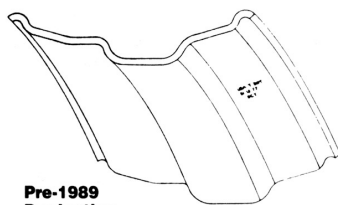

Pre-1989  
Production

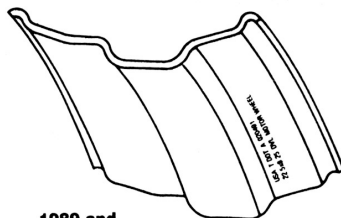

1989 and  
Newer

### Tubeless Disc Wheel

Beginning in January 1989, Hayes Lemmerz identification stamps are located on the weather side of the rim under the tire bead seat.

In addition to rim stamps, the following stamps are present:

- Wheel Part Number
- Shift and Date of Assembly
- Maximum Load (lbs.)
- Maximum Inflation (psi)

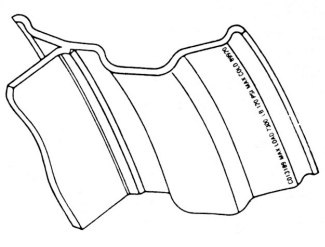

### Tube-Type Disc Wheel

Wheel part number, maximum load and inflation, and assembly date are stamped on the exposed side of the rim fixed flange.

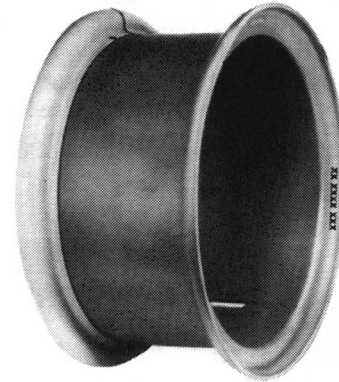

### Two-Piece Rims

Two-piece truck rims have the rim base size and type located as shown on inside diameter, or weather side, of rim base adjacent to the butt weld area of the rim base. Side ring size and type are stamped on the outside face 2" to 4" left of the split in the side ring.

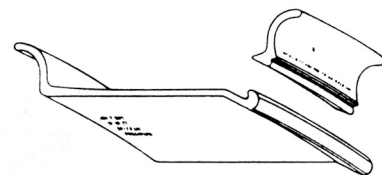

### Three-Piece Rims

Three-piece truck rims have rim base size and type stamped on the inside diameter, or weather side, of the rim base, as shown, adjacent to the butt weld area of the rim base. Side flange size and type is stamped on the outside face of side flange 2" to 4" to the left on the butt weld area of the flange. On some types, the split lock ring has the size and type stamped inside of the ring and cannot be seen when mounted. The stamping is located on the flat face as shown, adjacent to the pry bar notch, away from the split lock ring.

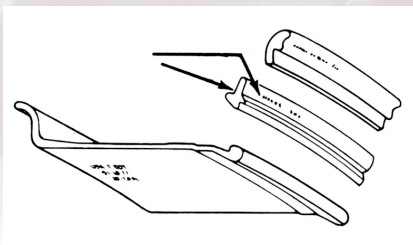



These tables give recommended rim and tire combinations for single or dual applications. **Design rim width shown in bold face.** Other approved rim widths are also shown.

### SEARCH

#### Wheels & Rims

#### General Notes

#### Customer Service

#### Applications

#### CentruMount-8 Hub Piloted Tubeless

#### CentruMount-10 Hub Piloted Tubeless

#### Wide Base Hub & Stud Piloted

#### CentruSteel Stud Piloted Tubeless

#### Demountable Rims

#### Paint Finishes

#### Selection Procedures

#### Disc Wheel Mounting Types

#### Wide Base Wheel Warranty

#### Rim & Disc Wheel Warranty

#### Identification

#### Tire/Rim Size Selection

#### Dual Wheel/Rim Spacing

#### Demountable Rim

#### Comparisons

#### Dual Spacing on

#### Cast Spoke Wheels

#### Demountable Rim

#### Dimensions

#### Spacer Bands for

#### Cast Spoke Wheels

#### Brake Drums

#### Hub & Drum Assemblies

#### Fasteners

#### HLI Mexico

#### Customer Service

### Tubeless Tire/Rim

Tire Size	Rim Width	Tire Section Width	Minimum Dual Spacing Without Chains
	(inch)	(inch)	(inch)
8	5.25	7.70	8.9
	<b>6.00</b>	8.00	9.2
9	6.50	8.30	9.5
	6.00	8.70	10.0
	<b>6.75</b>	9.00	10.3
10	7.50	9.30	10.6
	6.75	9.70	11.1
11	<b>7.50</b>	10.00	11.4
	7.50	10.70	12.3
12	<b>8.25</b>	11.00	12.6
	8.25	11.50	13.2
12.5	<b>9.00</b>	11.80	13.5
	8.25	11.60	13.3
12.75	<b>9.00</b>	11.90	13.6
	8.25	12.00	13.7
225/70	<b>9.00</b>	12.30	14.0
	6.00	8.60	9.7
235/80	<b>6.75</b>	8.90	10.0
	6.75	9.10	10.3
245/70	7.50	9.40	10.6
	6.75	9.50	10.7
245/75	<b>7.50</b>	9.80	11.0
	6.75	9.70	11.0
255/70	<b>7.50</b>	10.00	11.3
	8.25	10.30	11.6
265/70	<b>7.50</b>	10.30	11.6
	8.25	10.60	11.9
265/75	7.50	10.60	11.9
	<b>8.25</b>	10.90	12.2
275/80	7.50	10.84	12.2
	<b>8.25</b>	11.14	12.5
285/75	9.00	11.44	12.8
	8.25	11.43	12.9
295/75	<b>9.00</b>	11.73	13.2
	8.25	11.70	13.2
305/70	<b>9.00</b>	12.00	13.5
	8.25*	11.98	13.2
315/80	<b>9.00</b>	12.28	13.8
	9.75	12.58	14.2

\*Maximum Load 7,610 lbs.

### Tube-type Tire/Rim

Tire Size	Rim Width	Tire Section Width	Minimum Dual Spacing Without Chains
	(inch)	(inch)	(inch)
7.5	5.50	8.25	9.5
	<b>6.00</b>	8.45	9.7
8.25	6.50	8.65	9.9
	6.00	9.10	10.4
	<b>6.50</b>	9.30	10.6
9	7.00	9.50	10.8
	6.50	10.00	11.5
10	<b>7.00</b>	10.20	11.7
	7.50	10.40	11.9
11	7.00	10.75	12.3
	<b>7.50</b>	10.95	12.5
11.5	8.00	11.15	12.7
	7.50	11.35	12.8
12	<b>8.00</b>	11.55	13.0
	8.50	11.75	13.2
13	7.50	11.45	12.8
	<b>8.00</b>	11.65	13.0
14	8.50	11.85	13.2
	8.00	12.20	14.0
13/80	<b>8.50</b>	12.40	14.2
	9.00	12.60	14.4
14/80	<b>9.00</b>	13.40	16.2
	10.00	13.60	16.4
365/80	10.00	14.75	17.7
	8.00	12.45	13.5
13/80	8.50	12.65	13.8
	<b>9.00</b>	12.85	14.0
14/80	10.00	13.05	14.4
	9.00	13.40	15.1
365/80	<b>10.00</b>	13.80	15.5
	14.40		--

Note: 17.5HC tires require 17.5HC rims.

This data was obtained from the Tire and Rim Association, European Tire & Rim Technical Organization and tire manufacturers. It is believed to be correct. However, you should always check these sources, as well as wheel/vehicle manufacturers for current practices and recommendations.

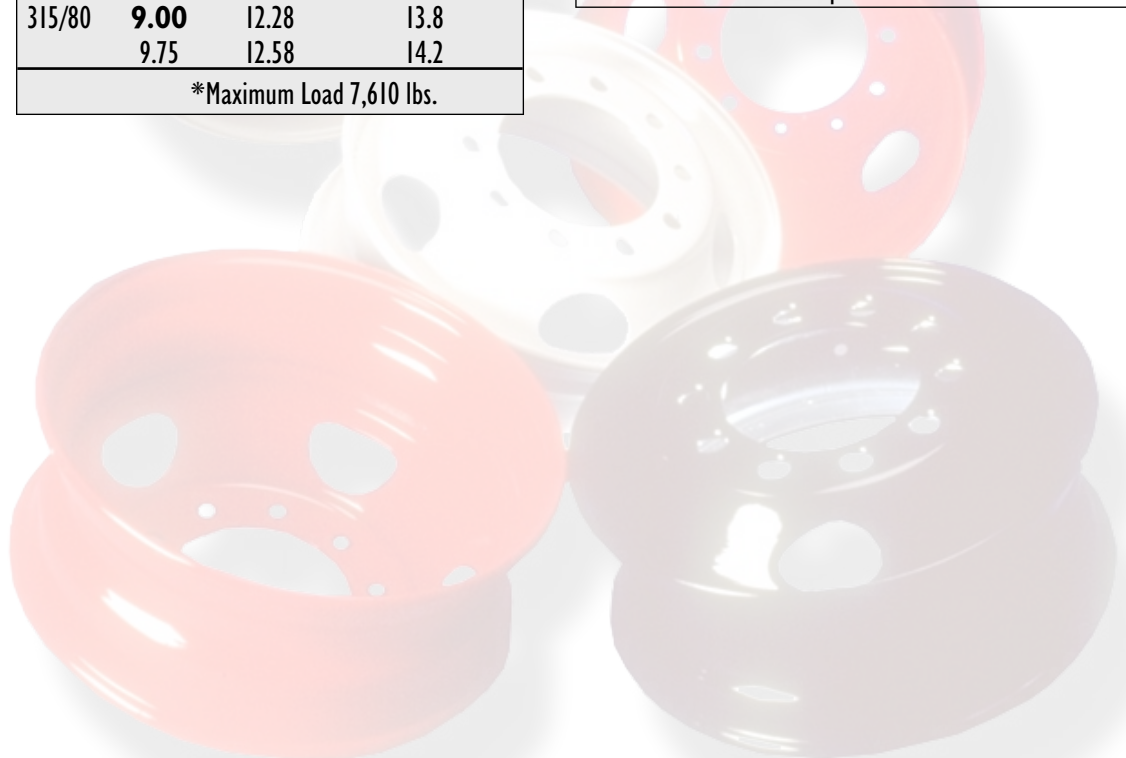

### SEARCH

**Wheels & Rims**

General Notes

Customer Service

Applications

CentruMount-8 Hub Piloted Tubeless

CentruMount-10 Hub Piloted Tubeless

Wide Base Hub & Stud Piloted

CentruSteel Stud Piloted Tubeless

Demountable Rims

Paint Finishes

Selection Procedures

Disc Wheel Mounting Types

Wide Base Wheel Warranty

Rim & Disc Wheel Warranty

Identification

Tire/Rim Size Selection

Dual Wheel/Rim Spacing

Demountable Rim

Comparisons

Dual Spacing on

Cast Spoke Wheels

Demountable Rim

Dimensions

Spacer Bands for

Cast Spoke Wheels

Brake Drums

Hub & Drum Assemblies

Fasteners

HLI Mexico

Customer Service

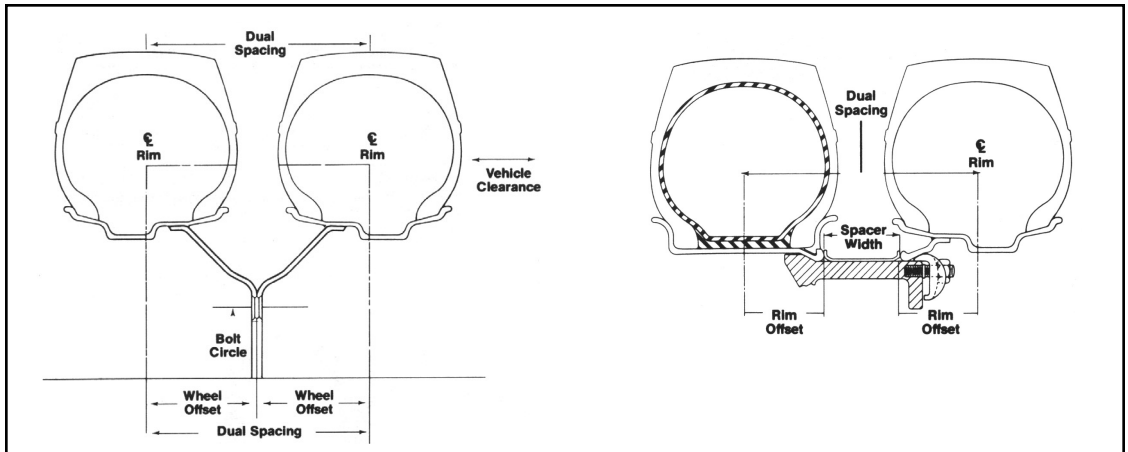

Tubeless		Tube-Type	
Rim Width	Offset	Rim Width	Offset
6.00	3.350	6.00	3.415
6.75	3.900	6.50	3.715
7.50	4.260	7.00	3.965
7.50	4.260	7.50	4.258
8.25S	4.400	7.50	4.750
8.25L	4.750		

**Caution is necessary in selecting wheel/rim offsets to insure proper tire spacing, body and chassis clearance, and overall width. If dualing is involved, minimum dual spacing must be provided as shown to give proper clearance between tires. Minimum dual spacing data is shown with approved rim and tire combinations.**

To determine the dual spacing dimension of two disc wheels or demountable rims, add their offsets; for rims, also add width (see diagrams). The clearance between tires may be calculated by subtracting the width of one tire section from the dual spacing dimension. The tire section width dimension may be obtained by referring to the tire manufacturer's data book. The wheel/rim offset dimension is given in the wheel/tire and rim application tables in this section.

It should be noted that the outside dual wheel's offset and rim width directly affects the overall width of the vehicle's running gear (one side to the other). Maximum overall width is set by state and federal law. Inboard clearance to vehicle is directly affected by the inner dual wheel rim width and offset. See Tire/Rim Size Selection page for tire section width and wheel offset information.

Tubeless and tube-type rims are interchangeable on the same cast spoke wheel. Inside rim diameters are identical for all rims listed.





### SEARCH

**Wheels & Rims**

General Notes

Customer Service

Applications

CentruMount-8 Hub Piloted Tubeless

CentruMount-10 Hub Piloted Tubeless

Wide Base Hub & Stud Piloted

CentruSteel Stud Piloted Tubeless

Demountable Rims

Paint Finishes

Selection Procedures

Disc Wheel Mounting Types

Wide Base Wheel Warranty

Rim & Disc Wheel Warranty

Identification

Tire/Rim Size Selection

Dual Wheel/Rim Spacing

Demountable Rim Comparisons

Dual Spacing on Cast Spoke Wheels

Demountable Rim Dimensions

Spacer Bands for Cast Spoke Wheels

Brake Drums

Hub & Drum Assemblies

Fasteners

HLI Mexico

Customer Service

### Tubeless 15° Drop Center Features

- For radial tires or bias-ply tires
- Contour minimizes stress for long life, while reducing rim weight
- Uniform 15° tapered bead seats provide compression fit
- Heavy-duty adapter benefits:
  - Interchange with tube-type rim
  - Increases rim life
  - Reduces adapter chording and distortion
  - Improves clamp/nut retention
  - Cuts wheel/rim slippage

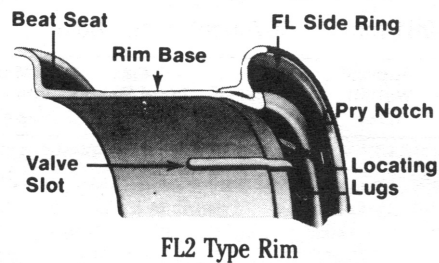

FL2 Type Rim

### Tube-Type Rim Features

- Rim bases – hot rolled contour for maximum weight to strength ratios
- Hayes Lemmerz two-piece rim assemblies are lighter than competitive rim assemblies
- LW and FL types are two-piece rims
  - LW recommended for heavy-duty operating conditions, accepts higher load-range tires; interchangeable with short (S) offset tubeless demountable rims

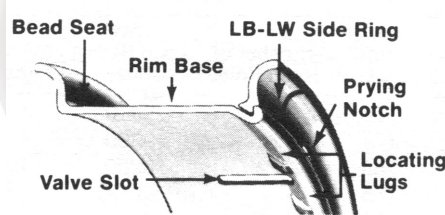

LW and LB Type Rims

- FL lightweight rims with wide rim offset for greater tire clearance between duals; interchangeable with long (L) offset tubeless demountable rims  
(NOTE: Check vehicle/tire clearance on dual applications when interchanging with LW or LB type rims)

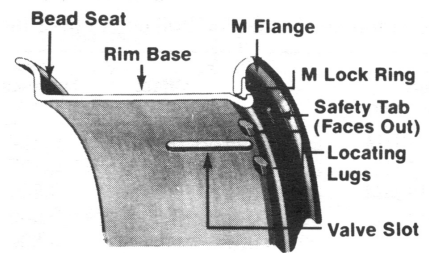

M Type Rim

- M type rims are three-piece rims:
  - Designed for heavier duty tires
  - For use in on/off highway and mixed service applications
  - CAUTION: Safety tab on lock ring must face outward when assembling the M rim. Otherwise, the parts will not fit tightly together and may separate under inflation with resulting danger to life and limb. If warning stamp "DANGER WRONG SIDE OUT - DO NOT INFLATE" can be read on rims manufactured after 1/1/91, lock ring is installed backward.

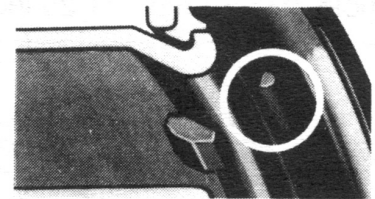

Safety Tab Assembly

- Side Rings:
  - 2-piece rims have a single split side ring for ease of tire mounting
  - 3-piece rims have a solid flange and a split lock ring which allow higher air pressure capability and continuous tire side wall support
- Pry Notch – always clearly visible
- Locating Lugs – provide an aid in positioning the air valve between cast wheel spokes. Can be omitted if to be used for disc wheel applications by eliminating "D" designation in part number.

### SEARCH

#### Wheels & Rims

General Notes

Customer Service

Applications

CentruMount-8 Hub Piloted Tubeless

CentruMount-10 Hub Piloted Tubeless

Wide Base Hub & Stud Piloted

CentruSteel Stud Piloted Tubeless

Demountable Rims

Paint Finishes

Selection Procedures

Disc Wheel Mounting Types

Wide Base Wheel Warranty

Rim & Disc Wheel Warranty

Identification

Tire/Rim Size Selection

Dual Wheel/Rim Spacing

Demountable Rim

Comparisons

Dual Spacing on  
Cast Spoke Wheels

Demountable Rim  
Dimensions

Spacer Bands for  
Cast Spoke Wheels

Brake Drums

Hub & Drum Assemblies

Fasteners

HLI Mexico

Customer Service

### Dual Spacing

Rim Width & Type	3.00	3.38	3.63	4.00	4.25	4.50	4.75	5.13	5.63
5.50 LW	9.33	9.71	9.96	10.33	10.58	10.83	11.08		
6.50 LW		10.81	11.06	11.43	11.68	11.93	12.18		
7.00 LW		11.31	11.56	11.93	12.18	12.43	12.68		
7.50 LW		11.90	12.15	12.52	12.77	13.02	13.27		
8.00 LW			12.62	12.99	13.24	13.49	13.74		15.87
9.00 LW						14.75	15.00	15.38	
7.5 FL	12.50	12.88	13.13	13.50	13.75	14.00	14.25		
7.5 LB	11.50	11.88	12.13	12.50	12.75	13.00	13.25		
7.50 M						14.00	14.25		
8.50 M						15.25		15.88	16.38
10.00 M						17.12		17.75	18.25
7.50 DVS	11.52	11.90	12.15	12.52	12.77	13.02	13.27		
8.25 DVS			12.43	12.80	13.05	13.30	13.55		
8.25 DVL	12.50	12.88	13.13	13.50	13.75	14.00	14.25		

Note: 8.50M, 9.00LW, and 10.00M wide rims have a smaller inside diameter. They may be used only on cast spoke wheels with corresponding smaller spoke wheel diameter. Use 'M' type spacers.

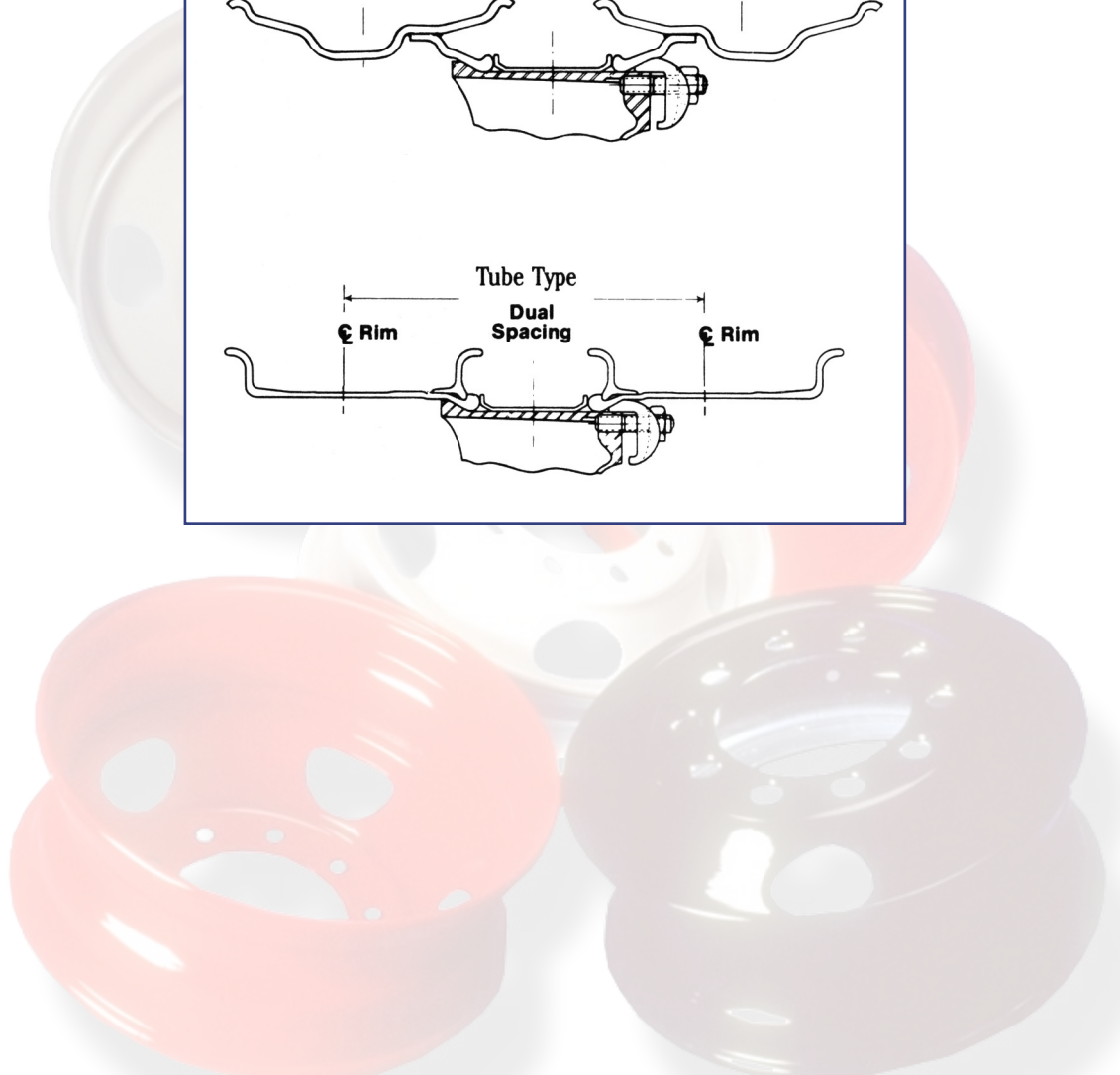
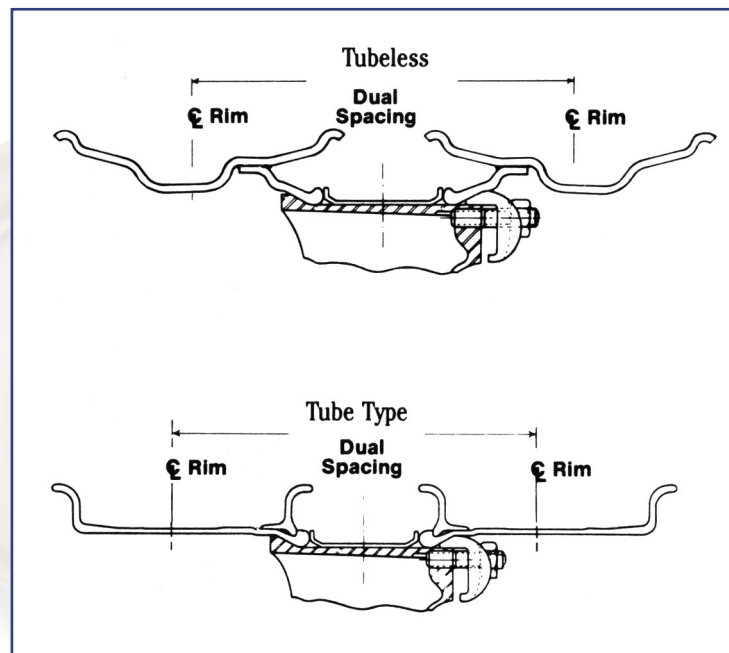



### SEARCH

#### Wheels & Rims

General Notes

Customer Service

Applications

CentruMount-8 Hub Piloted Tubeless

CentruMount-10 Hub Piloted Tubeless

Wide Base Hub & Stud Piloted

CentruSteel Stud Piloted Tubeless

Demountable Rims

Paint Finishes

Selection Procedures

Disc Wheel Mounting Types

Wide Base Wheel Warranty

Rim & Disc Wheel Warranty

Identification

Tire/Rim Size Selection

Dual Wheel/Rim Spacing

Demountable Rim

Comparisons

Dual Spacing on

Cast Spoke Wheels

Demountable Rim

Dimensions

Spacer Bands for

Cast Spoke Wheels

Brake Drums

Hub & Drum Assemblies

Fasteners

HLI Mexico

Customer Service

### Demountable Rim Dimensions for Tube-Type Rims

Part Number	Size		Rim Offset	Inside Diameter A	Hook Height B	Flange Height C	Hook Diameter D	Layout Line E	Locator Spacing F
	Dia.	Width							
6515LWDE	15"	6.50"	3.715"	14.626"	0.686"	1.500"	13.588"	1.742"	3.75"
6520LWDE	20"	6.50"	3.715"	19.626"	0.686"	1.500"	18.628"	1.742"	3.75"
7515LWDE	15"	7.50"	4.258"	14.500"	0.686"	1.750"	13.588"	1.742"	3.75"
7520LWDE	20"	7.50"	4.258"	19.500"	0.686"	1.750"	18.628"	1.742"	3.75"
8020LWDE	20"	8.00"	4.496"	19.500"	0.686"	1.781"	18.628"	1.781"	3.75"
8024LWDE	24"	8.00"	4.496"	23.500"	0.686"	1.781"	22.628"	1.781"	5.25"
9020LWDE	20"	9.00"	5.123"	19.392"	0.750"	1.750"	18.500"	2.000"	3.75"
9024LWDE	24"	9.00"	5.123"	23.392"	0.750"	1.750"	22.500"	2.000"	5.25"
7520FLDE	20"	7.50"	4.750"	19.592"	0.686"	1.600"	18.628"	1.782"	3.75"
7520MDE	20"	7.50"	4.750"	19.500"	0.686"	1.750"	18.628"	1.781"	3.75"
7524MDE	24"	7.50"	4.750"	23.500"	0.686"	1.750"	22.628"	1.781"	5.25"
8520MDE	20"	8.50"	5.375"	19.392"	0.750"	1.750"	18.500"	2.000"	3.75"
8524MDE	24"	8.50"	5.375"	23.392"	0.750"	1.750"	22.500"	2.000"	5.25"
1020MDE	20"	10.00"	6.312"	19.392"	0.696"	2.000"	18.500"	2.000"	3.75"
1024MDE	24"	10.00"	6.312"	23.392"	0.696"	2.000"	22.500"	2.000"	5.25"

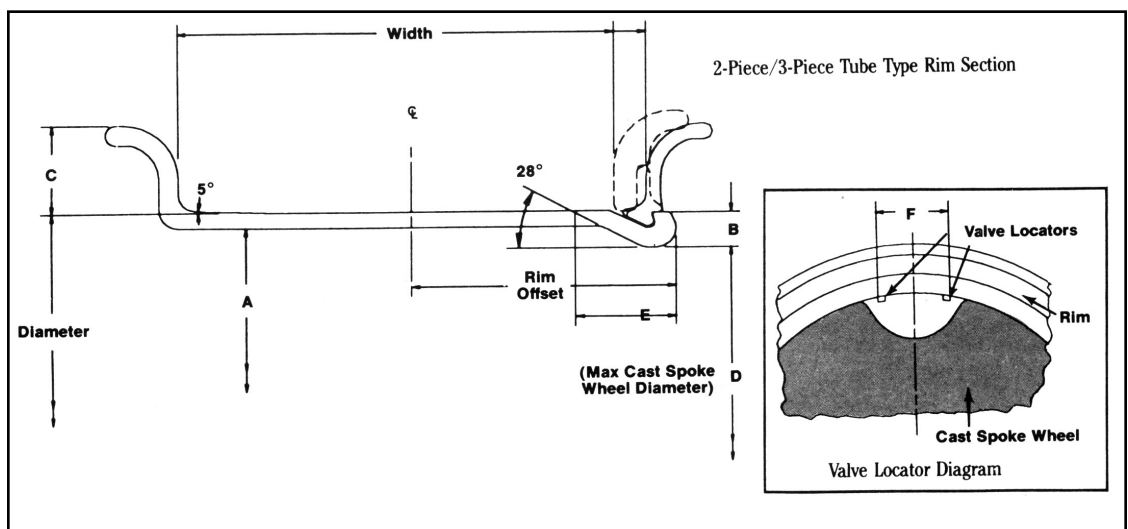

### Cast Spoke Wheel Dimensions - Source: SAE J851

Wheel Width	Rim Diameter	A	B	C
8.25" & Narrower	15"	14.365"	13.550"	12.500"
	17"	16.365"	15.550"	14.500"
	17.5"	14.365"	13.550"	12.500"
	18"	17.365"	16.550"	15.500"
	20"	19.365"	18.550"	17.500"
	22"	21.365"	20.550"	19.500"
	22.5"	19.365"	18.550"	17.500"
	24"	23.365"	22.550"	21.500"
8.50" & Wider	20"	19.281"	18.422"	17.375"
	24"	23.281"	22.422"	21.375"

### SEARCH

#### Wheels & Rims

#### General Notes

#### Customer Service

#### Applications

#### CentruMount-8 Hub Piloted Tubeless

#### CentruMount-10 Hub Piloted Tubeless

#### Wide Base Hub & Stud Piloted

#### CentruSteel Stud Piloted Tubeless

#### Demountable Rims

#### Paint Finishes

#### Selection Procedures

#### Disc Wheel Mounting Types

#### Wide Base Wheel Warranty

#### Rim & Disc Wheel Warranty

#### Identification

#### Tire/Rim Size Selection

#### Dual Wheel/Rim Spacing

#### Demountable Rim

#### Comparisons

#### Dual Spacing on Cast Spoke Wheels

#### Demountable Rim

#### Dimensions

#### Spacer Bands for Cast Spoke Wheels

#### Brake Drums

#### Hub & Drum Assemblies

#### Fasteners

#### HLI Mexico

#### Customer Service

### K Type Channel Spacer Bands for 5.00 through 8.00 Tube-Type Rims and All Tubeless Rims

Width Diameter	Nominal Diameter	Part Number	Stock Thickness	Weight	Inside Diameter
3.000"	15"	SB3015K *	0.156"	7 lbs.	13.578"
3.375"	15"	SB3315K	0.156"	7 lbs.	13.578"
	20"	SB3320K	0.109"	7 lbs.	18.578"
3.625"	20"	SB3520K	0.109"	7 lbs.	18.578"
4.000"	15"	SB4015K	0.156"	8 lbs.	13.578"
	20"	SB4020K	0.109"	8 lbs.	18.578"
	24"	SB4024K	0.109"	10 lbs.	22.578"
4.250"	20"	SB4220K	0.109"	8 lbs.	18.578"
	24"	SB4224K	0.109"	10 lbs.	22.578"
4.500"	20"	SB4420K	0.109"	9 lbs.	18.578"
	24"	SB4424K	0.109"	11 lbs.	22.578"
4.750"	20"	SB4620K	0.109"	9 lbs.	18.578"
	24"	SB4624K *	0.109"	11 lbs.	22.578"

\* Check availability

Tubeless Rims

17.5" diameter rims use 15" diameter spacer bands

22.5" diameter rims use 20" diameter spacer bands

24.5" diameter rims use 22" diameter spacer bands

### M Type Channel Spacer Bands for 8.50 and Wider Tube-Type Rims

Width Diameter	Nominal Diameter	Part Number	Stock Thickness	Weight	Inside Diameter
4.500"	20"	SB4420M	0.156"	13 lbs.	18.469"
	24"	SB4424M	0.156"	16 lbs.	22.469"
5.125"	20"	SB5120M	0.156"	15 lbs.	18.469"
	24"	SB5124M	0.156"	18 lbs.	22.469"

8.5" and wider tube-type rims require M type spacer band to fit smaller diameter cast spoke wheels.

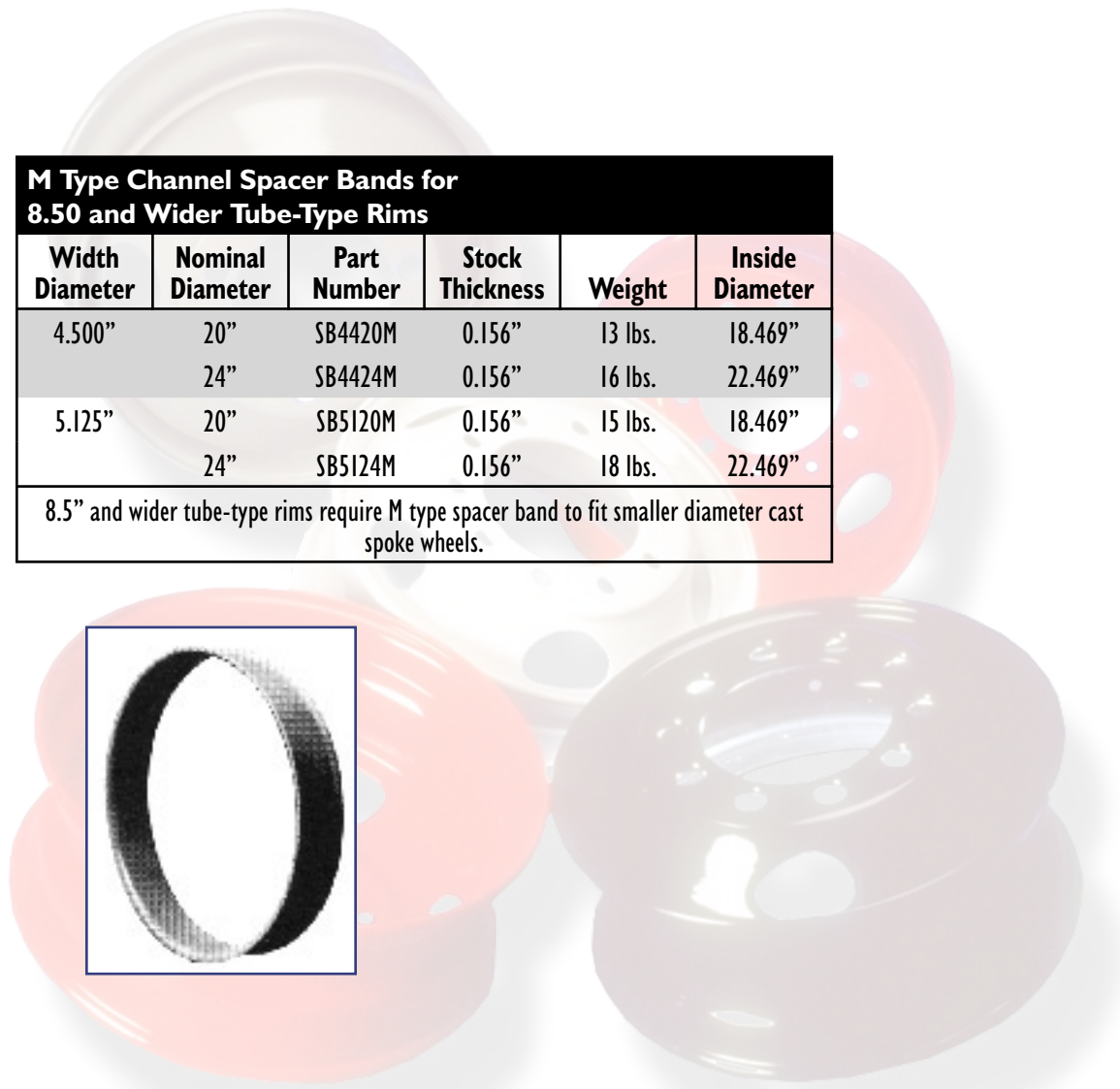
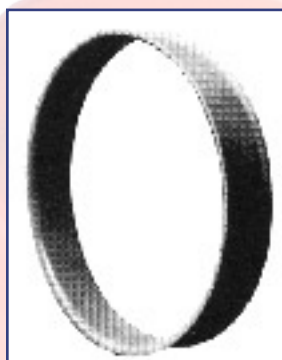



### SEARCH

[Steel Wheels & Rims](#)

[Brake Drums](#)

[Customer Service](#)

[Applications](#)

[CentriFuse Numerical Index](#)

[CentriFuse by Brake Size](#)

[CentruCast by Brake Size](#)

[CentriFuse Brake Drums](#)

[Cross Reference](#)

[CentruCast Brake Drums](#)

[Cross Reference](#)

[CentriFuse Drum Back/Band  
to Drum Number](#)

[CentriFuse Advantages](#)

[CentriFuse Lite Advantages](#)

[CentriFuse Warranty](#)

[CentruCast Warranty](#)

[Hub & Drum Assemblies](#)

[Fasteners](#)

[HLI Mexico](#)

[Customer Service](#)

#### Hub & Drum Products

Hayes Lemmerz Berea Operations  
159 Glades Road  
Berea, Kentucky 40403-1326 USA

**Toll free: 800•337•0455**

**800•337•0456**

**Fax: 800•669•8760**





Our most popular brake drum is the Genuine CentriFuse, the original lightweight steel-jacketed brake drum. Renowned for its light weight, superior safety, exceptional balance, low cost of operation, and proven performance, it is no wonder fleets have trusted Genuine CentriFuse for so many years! And with more than 50 different part numbers available, you can rely on CentriFuse for the application you require!

### SEARCH

Steel Wheels & Rims

Brake Drums

Customer Service

Applications

CentriFuse Numerical Index

CentriFuse by Brake Size

CentruCast by Brake Size

CentriFuse Brake Drums

Cross Reference

CentruCast Brake Drums

Cross Reference

CentriFuse Drum Back/Band  
to Drum Number

CentriFuse Advantages

CentriFuse Lite Advantages

CentriFuse Warranty

CentruCast Warranty

Hub & Drum Assemblies

Fasteners

HLI Mexico

Customer Service

### Numerical Index

Mtg. Type	CentriFuse Drum Part No.	Brake Size	Wt. Lb	Overall Depth	Brake Surf. Width	Hub Pilot Dia.	Bolt Circle Dia.	# of Bolt Holes	Bolt Hole Dia.	Drum Back No.	Drum Band No.	Special Information
O	600001	16.5 X 5	78	8.88	5.46	8.78	285.75	10	1.25	90599	87369	
O	600002	16.5x7	84	10.41	7.64	9.00	275	8	0.92	88798	610000	CentriFuse Lite
O	600084	16.5x7	84	10.41	7.64	8.78	285.75	10	0.96	91538	610000	CentriFuse Lite
O	87101B	16.5x7	90	10.41	7.64	8.53	11.25	10	0.81	91611	87105	Replaces 86879
O	87128B	15x7	90	10.22	7.42	8.53	11.25	10	0.81	91008	87132	Replaces 86935
O	87156B	16.5x7	90	10.41	7.64	9.00	11.25	10	0.81	87157	87105	Replaces 86232
O	87295B	16.5x7	89	10.04	7.27	8.53	11.25	10	0.81	91611	87298	
I	87397B	16.5x7	86	8.13	7.24	9.44	11.00	5	0.78	88253	87298	Replaces 85593 & 86141
I	87405B	16.5x7	84	8.50	7.64	11.25	12.75	5	0.77	87406	87105	CA, Replaces 85968B
I	87407B	16.5x7	85	9.66	7.58	9.44	11.25	10	0.81	88152	87105	Replaces 85369, 85831, 86140, 86909
I	87415B	16.5x7	85	8.66	7.64	9.50	11.25	10	0.81	87416	87105	Replaces 85130 & 86134
I	87417B	16.5x7	86	8.66	7.64	9.44	11.25	10	0.81	87418	87105	Replaces 85617
O	87615B	16.5x8.62	96	12.15	9.38	8.53	11.25	10	0.81	91611	87618	Replaces 86889
O	87707B	16.5x5	80	9.22	5.83	8.53	11.25	10	1.25	87709	87369	NA
O	87945BK	15x4	67	8.84	4.40	8.53	11.25	10	1.25	91024	91028	
O	88114B	15x4	66	8.53	4.49	9.00	11.25	10	1.25	88116	91028	Replaces 87439, 91068B
I	88115B	15x4	64	7.89	4.46	9.44	11.25	10	0.81	88117	91028	CA, Replaces 87357
O	88739B	16.5x5	77	8.59	5.87	8.53	11.25	10	1.25	88435	87369	
O	88797B	16.5x7	90	10.41	7.64	9.00	275	8	0.92	88798	87105	CentruMount-8
O	88814B	16.5x5	80	9.21	5.83	9.00	275	8	0.92	88810	87369	CentruMount-8
O	88870BK	15x4	66	8.84	4.40	9.00	275	8	0.92	91025	91028	CentruMount-8
O	89467B	16.5x8.62	96	11.87	9.08	8.53	11.25	10	0.81	91611	87618	
O	89571B	16.5x8.62	98	12.15	9.36	9.00	275	8	0.92	88798	87618	CentruMount-8
O	89651B	16.5x7	89	10.04	7.24	9.00	275	8	0.92	88798	87298	CentruMount-8
O	89855B	15x6	79	9.30	6.50	9.00	11.25	10	1.25	87438	89852	Replaces 89818
O	89870BK	15x4	67	8.84	4.52	8.78	285.75	10	1.25	91026	91028	CentruMount-10
O	89874B	16.5x5	80	9.53	5.81	8.78	285.75	10	1.25	89873	87369	CentruMount-10
O	89877B	16.5x7	91	10.04	7.27	8.78	285.75	10	0.96	91538	87298	CentruMount-10
O	89996B	16.5x7	90	10.41	7.64	8.78	285.75	10	0.96	91538	87105	CentruMount-10
O	90089BK	15x4	66	8.46	4.51	8.78	285.75	10	1.25	91294	91028	
O	90137B	16.5x5	77	8.59	5.87	8.78	285.75	10	1.25	91507	87369	
O	90148B	15x7	90	10.22	7.39	8.78	285.75	10	0.96	91293	87132	CA, CentruMount-10
O	90172B	15x7	89	9.80	7.43	8.78	285.75	10	0.96	90170	87132	CA, CentruMount-10
O	90174B	15x5	78	9.53	5.81	8.78	285.75	10	1.25	90173	87311	CentruMount-10
O	90176B	15x5	78	9.53	5.81	9.00	275	8	0.92	90175	87311	CentruMount-8
O	90358B	15x6	78	8.56	6.50	8.53	11.25	10	1.25	90357	89852	
O	90434B	16.5x8.62	96	11.87	9.08	8.78	285.75	10	0.96	91538	87618	CentruMount-10
O	90486B	16.5x8.62	98	12.15	9.38	8.78	285.75	10	0.96	91538	87618	CentruMount-10
O	90499B	16.5x7	89	10.41	7.64	8.78	285.75	10	1.25	91507	87105	NA
O	90600B	16.5x5	80	9.22	5.82	8.78	285.75	10	1.25	90599	87369	CentruMount-10
O	90660BK	15x4	66	8.84	4.52	8.78	285.75	10	0.96	91029	91028	CentruMount-10
O	91049B	16.5x6	88	9.62	6.68	8.78	285.75	10	0.96	91052	87298	Replaced with 91265B
O	91137BK	15x4	66	8.53	4.46	8.78	285.75	10	0.96	91136	91028	
O	91265B	16.5x6	88	9.62	6.68	8.78	285.75	10	1.25	91264	87298	CentruMount-10
O	91438B	15x8.62	90	11.19	9.11	9.00	275	8	0.92	91439	91480	For industry axles except Meritor TN
O	91482B	15x8.62	90	11.19	9.11	8.78	285.75	10	0.96	91481	91480	For industry axles except Meritor TN
O	91589B	15x6	80	9.30	6.50	8.78	285.75	10	1.25	91588	89852	
O	91655B	15x7	90	10.22	7.42	9.00	275	8	0.92	91654	87132	CentruMount-8
O	91723B	15x8.62	90	11.44	9.11	9.00	275	8	0.92	91722	91480	For Meritor TN axle only
O	91725B	15x8.62	90	11.44	9.11	8.78	285.75	10	0.96	91724	91480	For Meritor TN or TB axle only.
O	91792B	16.5x8	95	10.96	8.55	8.78	285.75	10	0.96	91793	91795	CentruMount-10
O	91812B	16.5x8.62	100	11.46	9.22	8.78	285.75	10	0.96	91813	87618	0.375 thick mtg. CentruMount-10

Notes: CentriFuse drum mounting face is 0.25" thick unless otherwise noted.  
I - Inboard Mounted Drums  
O - Outboard Mounted Drums  
All CentriFuse Drums are Balanced

Notes: CA - Check Availability  
NA - Not Available  
For general notes, see page 2



Our most popular brake drum is the Genuine CentriFuse, the original lightweight steel-jacketed brake drum. Renowned for its light weight, superior safety, exceptional balance, low cost of operation, and proven performance, it is no wonder fleets have trusted Genuine CentriFuse for so many years! And with more than 50 different part numbers available, you can rely on CentriFuse for the application you require!

### SEARCH

Steel Wheels & Rims

Brake Drums

Customer Service

Applications

CentriFuse Numerical Index

CentriFuse by Brake Size

CentruCast by Brake Size

CentriFuse Brake Drums

Cross Reference

CentruCast Brake Drums

Cross Reference

CentriFuse Drum Back/Band

to Drum Number

CentriFuse Advantages

CentriFuse Lite Advantages

CentriFuse Warranty

CentruCast Warranty

Hub & Drum Assemblies

Fasteners

HLI Mexico

Customer Service

### Brake Size Index

Mtg. Type	CentriFuse Drum Part No.	Brake Size	Wt. Lb	Over-All Depth	Brake Surf. Width	Hub Pilot Dia.	Bolt Circle Dia.	No. Bolt Holes	Bolt Hole Dia.	Drum Back No.	Drum Band No.	Special Information
<b>15 x 4 Brake Size</b>												
I	88115B	15x4	64	7.89	4.46	9.44	11.25	10	0.81	88117	91028	CA, Replaces 87357
O	90089BK	15x4	66	8.46	4.51	8.78	285.75	10	1.25	91294	91028	
O	91137BK	15x4	66	8.53	4.46	8.78	285.75	10	0.96	91136	91028	
O	88114B	15x4	66	8.53	4.49	9.00	11.25	10	1.25	88116	91028	Replaces 87439, 91068B
O	87945BK	15x4	67	8.84	4.40	8.53	11.25	10	1.25	91024	91028	
O	88870BK	15x4	66	8.84	4.40	9.00	275	8	0.92	91025	91028	CentruMount-8
O	89870BK	15x4	67	8.84	4.52	8.78	285.75	10	1.25	91026	91028	CentruMount-10
O	90660BK	15x4	66	8.84	4.52	8.78	285.75	10	0.96	91029	91028	CentruMount-10
<b>15 x 5 Brake Size</b>												
O	90174B	15x5	78	9.53	5.81	8.78	285.75	10	1.25	90173	87311	CentruMount-10
O	90176B	15x5	78	9.53	5.81	9.00	275	8	0.92	90175	87311	CentruMount-8
<b>15 x 6 Brake Size</b>												
O	90358B	15x6	78	8.56	6.50	8.53	11.25	10	1.25	90357	89852	
O	89855B	15x6	79	9.30	6.50	9.00	11.25	10	1.25	87438	89852	Replaces 89818
O	91589B	15x6	80	9.30	6.50	8.78	285.75	10	1.25	91588	89852	
<b>15 x 7 Brake Size</b>												
O	90172B	15x7	89	9.80	7.43	8.78	285.75	10	0.96	90170	87132	CA, CentruMount-10
O	90148B	15x7	90	10.22	7.39	8.78	285.75	10	0.96	91293	87132	CA, CentruMount-10
O	87128B	15x7	90	10.22	7.42	8.53	11.25	10	0.81	91008	87132	Replaces 86935
O	91655B	15x7	90	10.22	7.42	9.00	275	8	0.92	91654	87132	CentruMount-8
<b>15 x 8.62 Brake Size</b>												
O	91438B	15x8.62	90	11.19	9.11	9.00	275	8	0.92	91439	91480	For industry axles except Meritor TN
O	91482B	15x8.62	90	11.19	9.11	8.78	285.75	10	0.96	91481	91480	For industry axles except Meritor TN
O	91723B	15x8.62	90	11.44	9.11	9.00	275	8	0.92	91722	91480	For Meritor TN axle only
O	91725B	15x8.62	90	11.44	9.11	8.78	285.75	10	0.96	91724	91480	For Meritor TN or TB axle only.
<b>16.5 x 5 Brake Size</b>												
O	88739B	16.5x5	77	8.59	5.87	8.53	11.25	10	1.25	88435	87369	
O	90137B	16.5x5	77	8.59	5.87	8.78	285.75	10	1.25	91507	87369	
O	60000I	16.5 X 5	78	8.88	5.46	8.78	285.75	10	1.25	90599	87369	
O	88814B	16.5x5	80	9.21	5.83	9.00	275	8	0.92	88810	87369	CentruMount-8
O	90600B	16.5x5	80	9.22	5.82	8.78	285.75	10	1.25	90599	87369	CentruMount-10
O	87707B	16.5x5	80	9.22	5.83	8.53	11.25	10	1.25	87709	87369	NA
O	89874B	16.5x5	80	9.53	5.81	8.78	285.75	10	1.25	89873	87369	CentruMount-10
<b>16.5 x 6 Brake Size</b>												
O	91049B	16.5x6	88	9.62	6.68	8.78	285.75	10	0.96	91052	87298	Replaced with 91265B
O	91265B	16.5x6	88	9.62	6.68	8.78	285.75	10	1.25	91264	87298	CentruMount-10
<b>16.5 x 7 Brake Size</b>												
I	87397B	16.5x7	86	8.13	7.24	9.44	11.00	5	0.78	88253	87298	Replaces 85593 & 86141
								6	0.66			
I	87405B	16.5x7	84	8.50	7.64	11.25	12.75	5	0.77	87406	87105	CA, Replaces 85968B
								6	0.77			
I	87415B	16.5x7	85	8.66	7.64	9.50	11.25	10	0.81	87416	87105	Replaces 85130 & 86134
I	87417B	16.5x7	86	8.66	7.64	9.44	11.25	10	0.81	87418	87105	Replaces 85617
I	87407B	16.5x7	85	9.66	7.58	9.44	11.25	10	0.81	88152	87105	Replaces 85369, 85831, 86140, 86909
O	89651B	16.5x7	89	10.04	7.24	9.00	275	8	0.92	88798	87298	CentruMount-8
O	87295B	16.5x7	89	10.04	7.27	8.53	11.25	10	0.81	91611	87298	
O	89877B	16.5x7	91	10.04	7.27	8.78	285.75	10	0.96	91538	87298	CentruMount-10
O	87101B	16.5x7	90	10.41	7.64	8.53	11.25	10	0.81	91611	87105	Replaces 86879
O	87156B	16.5x7	90	10.41	7.64	9.00	11.25	10	0.81	87157	87105	Replaces 86232
O	88797B	16.5x7	90	10.41	7.64	9.00	275	8	0.92	88798	87105	CentruMount-8
O	89996B	16.5x7	90	10.41	7.64	8.78	285.75	10	0.96	91538	87105	CentruMount-10
O	90499B	16.5x7	89	10.41	7.64	8.78	285.75	10	1.25	91507	87105	NA
O	600002	16.5x7	84	10.41	7.64	9.00	275	8	0.92	88798	610000	CentriFuse Lite
O	600084	16.5x7	84	10.41	7.64	8.78	285.75	10	0.96	91538	610000	CentriFuse Lite
<b>16.5 x 8 Brake Size</b>												
O	91792B	16.5x8	95	10.96	8.55	8.78	285.75	10	0.96	91793	91795	CentruMount-10
<b>16.5 x 8.62 Brake Size</b>												
O	91812B	16.5x8.62	100	11.46	9.22	8.78	285.75	10	0.96	91813	87618	0.375 thick mtg. CentruMount-10
O	89467B	16.5x8.62	96	11.87	9.08	8.53	11.25	10	0.81	91611	87618	
O	90434B	16.5x8.62	96	11.87	9.08	8.78	285.75	10	0.96	91538	87618	CentruMount-10
O	89571B	16.5x8.62	98	12.15	9.36	9.00	275	8	0.92	88798	87618	CentruMount-8
O	87615B	16.5x8.62	96	12.15	9.38	8.53	11.25	10	0.81	91611	87618	Replaces 86889
O	90486B	16.5x8.62	98	12.15	9.38	8.78	285.75	10	0.96	91538	87618	CentruMount-10
Notes:	CentriFuse drum mounting face is 0.25" thick unless otherwise noted.										Notes:	CA - Check Availability
	I - Inboard Mounted Drums											NA - Not Available
	O - Outboard Mounted Drums											For general notes see page 2
	All CentriFuse Drums are Balanced											



**SEARCH**

**Steel Wheels & Rims**

**Brake Drums**

**Customer Service**

**Applications**

**CentriFuse Numerical Index**

**CentriFuse by Brake Size**

**CentruCast by Brake Size**

**CentriFuse Brake Drums**

**Cross Reference**

**CentruCast Brake Drums**

**Cross Reference**

**CentriFuse Drum Back/Band  
to Drum Number**

**CentriFuse Advantages**

**CentriFuse Lite Advantages**

**CentriFuse Warranty**

**CentruCast Warranty**

**Hub & Drum Assemblies**

**Fasteners**

**HLI Mexico**

**Customer Service**

## CentriFuse® Brake Drum 10 Year Warranty

Hayes Lemmerz warrants to the user that it will replace each CentriFuse 15" and 16 1/2" truck or trailer brake drum manufactured after January 1, 1994 which becomes unserviceable due to workmanship or material, breaks before ten years from date of manufacture, or before the 0.120" wear limit is reached – whichever occurs first. This warranty shall not apply if failure is due to other brake components, lack of required maintenance, misuse, damage by accident, improper installation, or adjustment of braking system.

Hayes Lemmerz' obligation under this warranty is limited to replacing any CentriFuse brake drum that proves, upon inspection of failed parts and, if deemed necessary, associated vehicles and their maintenance records, to be defective within the applicable provisions of this warranty. Replacement products will be shipped FOB our factory.

Parts on which a warranty is claimed must, upon request, be returned to place of manufacture or to our authorized representative with transportation charges prepaid.

THIS WARRANTY IS IN LIEU OF ALL OTHER WARRANTIES, EXPRESS OR IMPLIED, INCLUDING THE WARRANTIES OF MERCHANTABILITY OR FITNESS FOR A PARTICULAR PURPOSE, APPLICATION OR USE. IN NO EVENT SHALL HAYES LEMMERZ' LIABILITY EXCEED THE ORIGINAL PRICE OF THE PRODUCT, NOR SHALL HAYES LEMMERZ BE LIABLE FOR SPECIAL, INCIDENTAL OR CONSEQUENTIAL DAMAGES.



15300 Centennial Drive • Northville, Michigan 48167 USA  
<http://ch.hayes-lemmerz.com>





### SEARCH

Steel Wheels & Rims

Brake Drums

Customer Service

Applications

CentriFuse Numerical Index

CentriFuse by Brake Size

CentruCast by Brake Size

CentriFuse Brake Drums

Cross Reference

CentruCast Brake Drums

Cross Reference

CentriFuse Drum Back/Band

to Drum Number

CentriFuse Advantages

CentriFuse Lite Advantages

CentriFuse Warranty

CentruCast Warranty

Hub & Drum Assemblies

Fasteners

HLI Mexico

Customer Service

### Brake Size Index

Mtg. Type	Full Cast Drum Part No.	Brake Size	Wt. Lb	Overall Depth	Brake Surface Width	Hub Pilot Dia.	Bolt Circle Dia.	No. Bolt Holes	Bolt Hole Dia.	Special Information
<b>12.25 x 7.5 Brake Size</b>										
0	630002	12.25 x 7.5	92	11.15	8.16	9.00	275	8	0.92	Unbalanced
1	03-126631	12.25 x 7.5	86	10.50	8.24	7.13	8.75	10	0.84	Unbalanced
<b>15 x 4 Brake Size</b>										
0	630001	15 x 4	78	9.20	4.61	8.78	285.75	10	0.94	Balanced
0	630004	15 x 4	78	9.20	4.61	9.00	275	8	0.92	Balanced
0	630005	15 x 4	78	9.20	4.61	8.78	285.75	10	1.26	Balanced
0	2308401	15 x 4	78	8.82	4.58	8.78	11.25	10	0.94	Balanced
0	2308705	15 x 4	78	8.82	4.58	8.78	11.25	10	1.26	Balanced
<b>15 x 7 Brake Size</b>										
0	2308001	15 x 7	96	10.26	7.32	8.53	11.25	10	0.84	Balanced
0	2308400	15 x 7	97	10.55	7.38	8.78	11.25	10	0.94	Balanced
<b>16.5 x 5 Brake Size</b>										
0	2308406	16.5 x 5	95	9.22	5.83	8.78	11.25	10	0.94	Balanced
0	2308704	16.5 x 5	95	9.22	5.83	8.78	11.25	10	1.26	Balanced
<b>16.5 x 6 Brake Size</b>										
0	2308708	16.5 x 6	118	9.67	6.45	8.78	11.25	10	0.94	Balanced
0	2308804	16.5 x 6	118	9.67	6.45	8.78	11.25	10	1.26	Balanced
<b>16.5 x 7 Brake Size</b>										
0	2308002	16.5 x 7	106	10.38	7.51	8.53	11.25	10	0.84	Balanced
0	2308709	16.5 x 7	112	10.59	7.59	8.78	11.25	10	0.94	Balanced
0	2308712	16.5 x 7	112	10.59	7.59	8.78	11.25	10	0.94	Unbalanced
0	630003	16.5 x 7	113	10.59	7.59	9.00	275	8	0.92	Balanced
0	630003A	16.5 x 7	113	10.59	7.59	9.00	275	8	0.92	Unbalanced
<b>16.5 x 8 Brake Size</b>										
0	630007	16.5 x 8	118	11.23	8.7	8.78	11.25	10	0.94	Balanced
0	630007A	16.5 x 8	118	11.23	8.7	8.78	11.25	10	0.94	Unbalanced
<b>16.5 x 8.62 Brake Size</b>										
0	630000	16.5 x 8.62	125	11.54	9.18	8.78	11.25	10	0.94	Balanced
0	630000A	16.5 x 8.62	125	11.54	9.18	8.78	11.25	10	0.94	Unbalanced
0	630006	16.5 x 8.62	125	12.14	9.18	8.78	11.25	10	0.94	Balanced
0	630006A	16.5 x 8.62	125	12.14	9.18	8.78	11.25	10	0.94	Unbalanced

**Notes:**

1 - Inboard Mounted Drums

0 - Outboard Mounted Drums

Cast drum mounting face is 0.50" thick unless otherwise noted.

For general notes, see page 2

## SEARCH

[Steel Wheels & Rims](#)

[Brake Drums](#)

[Customer Service](#)

[Applications](#)

[CentriFuse Numerical Index](#)

[CentriFuse by Brake Size](#)

[CentruCast by Brake Size](#)

[CentriFuse Brake Drums](#)

[Cross Reference](#)

[CentruCast Brake Drums](#)

[Cross Reference](#)

[CentriFuse Drum Back/Band](#)

[to Drum Number](#)

[CentriFuse Advantages](#)

[CentriFuse Lite Advantages](#)

[CentriFuse Warranty](#)

[CentruCast Warranty](#)

[Hub & Drum Assemblies](#)

[Fasteners](#)

[HLI Mexico](#)

[Customer Service](#)

ArvinMeritor (Dayton / X30)	CentriFuse
012517	87397B
012677	87397B
120001	87397B
120017	87397B
120038	87397B
120075	87405B
120389	87397B
120643	87415B
122155	87397B
122194	87415B
122203	87415B
122287	87405B
122332	87156B
122333	87128B
122340	87415B
122453	87295B
122460	87615B
122505	88115BK
122506	87417B
122550	87156B
122607	87101B
122810	87615B
123022	89877B
123207	89996B
123312	88114BK
123315	87128B
123404	89996B
123423	89870BK
123448	89870BK
53-123512-002	90089BK
53-123519-002	87397B
53-123535-002	91792 B
53-123537-002	89996B
53-123542-002	89870BK
53-123544-002	91812 B
53-123564-002	87101B
53-123565-002	87156B
53-123566-002	88797B
53-123567-002	91137BK
53-123568-002	90660BK
53-123575-002	88870 BK
53-123579-002	89571B
53-123580-002	87615B

ArvinMeritor (X30)	CentriFuse
53-123581-002	90486 B
53-123588-002	88814B
53-123589-002	90600B
53-123590-002	87707B
53-123591-002	90148B
53-123592-002	87128B
53-123598-002	90174B
53-123599-002	90176B
53-123601-002	91725B
53-123602-002	91723B
53-123605-002	88739B
53-123606-002	90137B
53-123607-002	91265B
53-123608-002	91265B
53-123627-002	600001
Gunite	CentriFuse
2546B	87417B
2983C	87397B
3018A	87415B
3097A	90172B
3141	87156B
3141B	88797B
3166	87101B
3219	87128B
3219A	90148B
3295A	87405B
3402	89877B
3402A	89651B
3483	87101B
3574	87945BK
3596	90089BK
3598A	88814B
3600	90499B
3600A	89996B
3610	88115BK
3686	91589B
3687	91265B
3699	87295B
3721A	90089BK
3726X	89870BK
3782	91792 B
3800X	89870BK
3807A	91812 B

Webb	CentriFuse
60528	90089BK
60545	89870BK
60864 B	89996B
60875 B	88797B
60893 B	87101B
60895 B	87156B
61571	87128B
64483	88115BK
65157	89855B
65543	88870BK
65545	89870BK
65547	90089BK
65550	87945BK
65650	87707B
65739	88739B
66800	91792 B
66811	89467B
66814	90486 B
66815	87615B
66816	89571B
66873	89877B
66875	88797B
66878	89651B
66884	89996B
66892	87295B
66893	87101B
66895	87156B
67101B	87101B
67128B	87128B
67156B	87156B
67397B	87397B
67405B	87405B
67415B	87415B
67434B	90434B
67518	87397B
67615B	87615B
67707B	87707B
67945B	87945BK
68730	87415B
68797B	88797B
68814B	88114BK
68872B	88870BK
68921	87417B
68981	87405B
69571B	89571B
69870B	89870BK
69996B	89996B



## SEARCH

[Steel Wheels & Rims](#)

[Brake Drums](#)

[Customer Service](#)

[Applications](#)

[CentriFuse Numerical Index](#)

[CentriFuse by Brake Size](#)

[CentruCast by Brake Size](#)

[CentriFuse Brake Drums](#)

[Cross Reference](#)

[CentruCast Brake Drums](#)

[Cross Reference](#)

[CentriFuse Drum Back/Band to Drum Number](#)

[CentriFuse Advantages](#)

[CentriFuse Lite Advantages](#)

[CentriFuse Warranty](#)

[CentruCast Warranty](#)

[Hub & Drum Assemblies](#)

[Fasteners](#)

[HLI Mexico](#)

[Customer Service](#)

ArvinMeritor (Dayton)	CentruCast
I20586	I20568
I20743	I22600
I20877	I29230
I22126	I22126
I22453	2308002
I22490	I22683
I22518	I22126
I22562	I22562
I22600	I22600
I22607	I22607
I22683	I22683
I22898	630003
I22990	I20568
I23207	2308709
I23207	2308712
I23254	2308705
I23366	630001
I23367	2308401
I23370	2308406
I23371	2308406
I23383	2308704
I23386	2308705
I23388	2308704
I23406	630006
I23409	630003
I23520	630007
I23570	630000
I29297	630005

ConMet	CentruCast
I07150	2308709
I07150	2308712
I07164	630005
I07193	2308804
I07453	2308704
I07507	2308401
I07637	630007
I07638	630000
I07875	630003
I07902	630004
Gunite	CentruCast
2546C	I20568
2546C	I22126
3120	I29230
3141B	630003
3169A	I22562
3219A	2308400
3295A	I22683
3401A	630003
3402	I29088
3483	I22607
3557	I26631
3600A	2308712
3600AX	2308709
3687X	2308804
3699	2308002
3721AX	630001
3721X	2308401
3726X	630005
3741X	630004
3758	2308704
3782	630007
3800X	630005
8656	I22600

Webb	CentruCast
60876	I29230
61527	2308401
61528	2308705
61577	2308400
61591	2308001
62671	2308804
63631	I26631
63680	630002
64405	I22562
65162	2308708
65543B	630004
65545B	630001
65554	630005
65654	2308406
66800	630007
66814	630006
66852	2308002
66854	630000
66864	2308712
66864B	2308709
66873	I29088
66875	630003
66884	I23365
66892	2308002
66893	I22607
68730	I22126
68765	I20568
68897	I22600
68981B	I22683

### SEARCH

[Steel Wheels & Rims](#)

[Brake Drums](#)

[Customer Service](#)

[Applications](#)

[CentriFuse Numerical Index](#)

[CentriFuse by Brake Size](#)

[CentruCast by Brake Size](#)

[CentriFuse Brake Drums](#)

[Cross Reference](#)

[CentruCast Brake Drums](#)

[Cross Reference](#)

[CentriFuse Drum Back/Band to Drum Number](#)

[CentriFuse Advantages](#)

[CentriFuse Lite Advantages](#)

[CentriFuse Warranty](#)

[CentruCast Warranty](#)

[Hub & Drum Assemblies](#)

[Fasteners](#)

[HLI Mexico](#)

[Customer Service](#)

Drum Back Number	CentriFuse Drum Part Number
87157	87156B
87406	87405B
87416	87415B
87418	87417B
87438	89855B
87709	87707B
88116	88114B
88117	88115B
88152	87407B
88253	87397B
88435	88739B
88798	600002
88798	88797B
88798	89571B
88798	89651B
88810	88814B
89873	89874B
90170	90172B
90173	90174B
90175	90176B
90357	90358B
90599	600001
90599	90600B
91008	87128B
91024	87945BK
91025	88870BK
91026	89870BK
91029	90660BK
91052	91049B
91136	91137BK
91264	91265B
91293	90148B
91294	90089BK
91439	91438B
91481	91482B
91507	90137B
91507	90499B
91538	600084
91538	89877B
91538	89996B
91538	90434B
91538	90486B
91588	91589B
91611	87101B
91611	87295B
91611	87615B
91611	89467B
91654	91655B
91722	91723B
91724	91725B
91793	91792B
91813	91812B



Drum Band Number	CentriFuse Drum Part Number
610000	600002
610000	600084
87105	87101B
87105	87156B
87105	87405B
87105	87407B
87105	87415B
87105	87417B
87105	88797B
87105	89996B
87105	90499B
87132	87128B
87132	90148B
87132	90172B
87132	91655B
87298	87295B
87298	87397B
87298	89651B
87298	89877B
87298	91049B
87298	91265B
87311	90174B
87311	90176B
87369	600001
87369	87707B
87369	88739B
87369	88814B
87369	89874B
87369	90137B
87369	90600B
87618	87615B
87618	89467B
87618	89571B
87618	90434B
87618	90486B
87618	91812B
89852	89855B
89852	90358B
89852	91589B
91028	87945BK
91028	88114B
91028	88115B
91028	88870BK
91028	89870BK
91028	90089BK
91028	90660BK
91028	91137BK
91480	91438B
91480	91482B
91480	91723B
91480	91725B
91795	91792B

### SEARCH

Steel Wheels & Rims

**Brake Drums**

Customer Service

Applications

CentriFuse Numerical Index

CentriFuse by Brake Size

CentruCast by Brake Size

**CentriFuse Brake Drums**

Cross Reference

CentruCast Brake Drums

Cross Reference

CentriFuse Drum Back/Band  
to Drum Number

CentriFuse Advantages

CentriFuse Lite Advantages

CentriFuse Warranty

CentruCast Warranty

**Hub & Drum Assemblies**

Fasteners

HLI Mexico

Customer Service

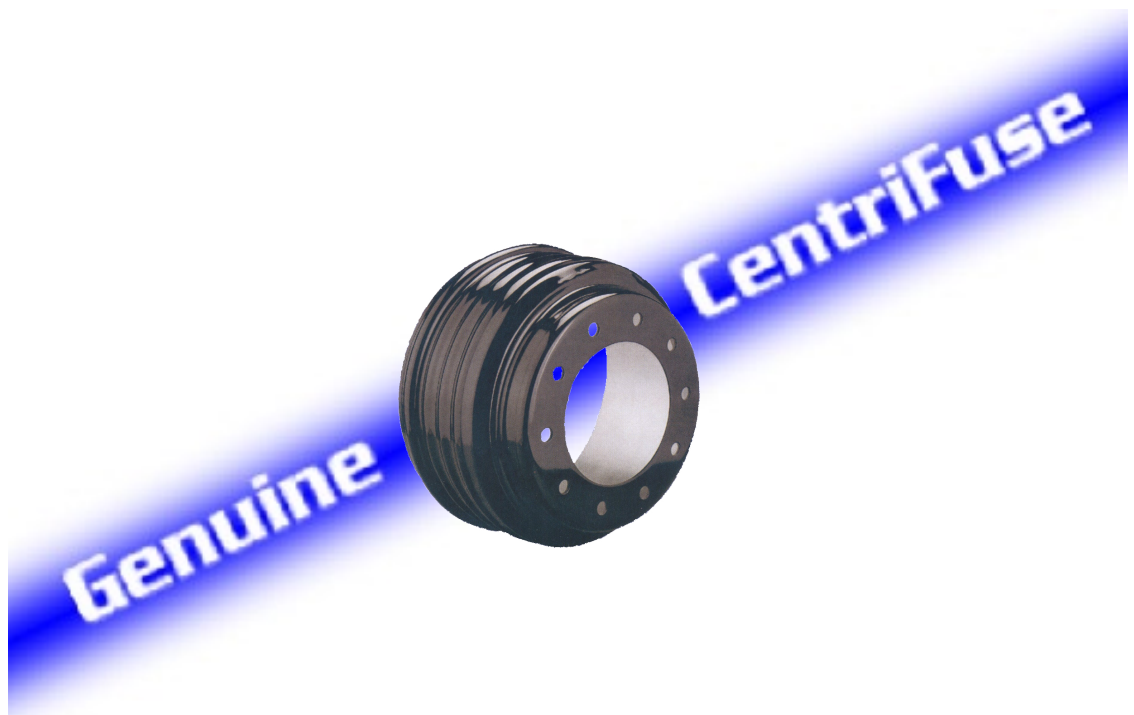

## BREAKAGE IS NOT AN OPTION

### SAFETY

CentriFuse brake drums do not break apart. And we back that claim with a 10 year written warranty. The reason lies in the superior quality drum construction, centrifugally-fused to a special steel jacket, resulting in superior drum strength. CentriFuse also offers better drum balance and uniformity over the competition. The result is safer operation in all conditions!

### LOW COST OF OPERATION

You can afford Genuine CentriFuse brake drums. Because of the lightweight design, you receive increased fuel efficiency and increased payload. And with 50% more drum life than the competitor's product combined with 40% better lining life, CentriFuse is more economical than ever!

### PROVEN PERFORMANCE

With over 70 years of reliable service to the trucking industry, you can count on CentriFuse drums. We have over 3.9 million drums placed in service since 1994. And with more than 50 different part numbers available, you can rely on CentriFuse for the application you require.

**Accept NO substitute!**  
**SPECIFY**

**Genuine CentriFuse<sup>®</sup>**

**Quality Lightweight Brake Drums**



### SEARCH

Steel Wheels & Rims

Brake Drums

Customer Service

Applications

CentriFuse Numerical Index

CentriFuse by Brake Size

CentruCast by Brake Size

CentriFuse Brake Drums

Cross Reference

CentruCast Brake Drums

Cross Reference

CentriFuse Drum Back/Band

to Drum Number

CentriFuse Advantages

CentriFuse Lite Advantages

CentriFuse Warranty

CentruCast Warranty

Hub & Drum Assemblies

Fasteners

HLI Mexico

Customer Service

## CentriFuse Lite

### Quality Lightweight Brake Drums



### Ideal Application

Ideal for weight sensitive applications such as:  
Refrigerated trailers, tank trailers, bulk haulers or  
fleets looking to increase their payload and fuel efficiency!

**Save up to 224 pounds per tractor/trailer  
when you choose CentriFuse Lite®!**

Compare to:	Published Weight of Comparable Part Number	Weight Savings per drum	Weight Savings Tandem Truck Axles	Weight Savings Tandem Trailer	Total Combined Weight Savings
CentriFuse Lite® Part #600084	84 lbs.	Weight Savings per drum	Weight Savings Tandem Truck Axles	Weight Savings Tandem Trailer	Total Combined Weight Savings
X30™	94 lbs.	10 lbs.	40 lbs.	40 lbs.	80 lbs.
Platinum	94 lbs.	10 lbs.	40 lbs.	40 lbs.	80 lbs.
Genuine CentriFuse® Part #89996B	90 lbs.	6 lbs.	24 lbs.	24 lbs.	48 lbs.
Full Cast	112 lbs.	28 lbs.	112 lbs.	112 lbs.	224 lbs.

- 20,000 lb. Axle Rating
- Same great safety, balance, and reliability as Genuine CentriFuse with less weight!
- Backed by a 10 year written warranty
- Developed with over 70 years of proven technology and experience
- Pair with other lightweight Motor Wheel components for even more weight savings



INTERNATIONAL, INC.



# Brake Drums CentruCast™ Warranty

## SEARCH

Steel Wheels & Rims

Brake Drums

Customer Service

Applications

CentriFuse Numerical Index

CentriFuse by Brake Size

CentruCast by Brake Size

CentriFuse Brake Drums

Cross Reference

CentruCast Brake Drums

Cross Reference

CentriFuse Drum Back/Band

to Drum Number

CentriFuse Advantages

CentriFuse Lite Advantages

CentriFuse Warranty

CentruCast Warranty

Hub & Drum Assemblies

Fasteners

HLI Mexico

Customer Service

## CentruCast™ Brake Drum 1 Year Limited Warranty

Hayes Lemmerz warrants to the user that it will replace each highway cast brake drum that becomes unserviceable within one year of date of manufacture due to functional defects in workmanship and materials, excluding finish.

This warranty shall not apply if failure is due to other brake components, lack of required maintenance, misuse, damage by accident, improper installation or adjustment, excessive speeds, or other abnormal or severe operating conditions.

Hayes Lemmerz' obligation under this warranty is limited, upon inspection of failed parts, associated vehicles and their maintenance records, to replace (FOB our factory) any part which our examination discloses to be defective.

Parts on which a warranty is claimed must, upon request, be returned to place of manufacture or to our authorized representative with transportation charges prepaid.

THIS WARRANTY IS IN LIEU OF ALL OTHER WARRANTIES, EXPRESS OR IMPLIED, INCLUDING THE WARRANTIES OF MERCHANTABILITY OR FITNESS FOR A PARTICULAR PURPOSE, APPLICATION OR USE. IN NO EVENT SHALL HAYES LEMMERZ' LIABILITY EXCEED THE ORIGINAL PRICE OF THE PRODUCT, NOR SHALL HAYES LEMMERZ BE LIABLE FOR SPECIAL, INCIDENTAL OR CONSEQUENTIAL DAMAGES.



INTERNATIONAL, INC.

15300 Centennial Drive • Northville, Michigan 48167 USA  
<http://ch.hayes-lemmerz.com>

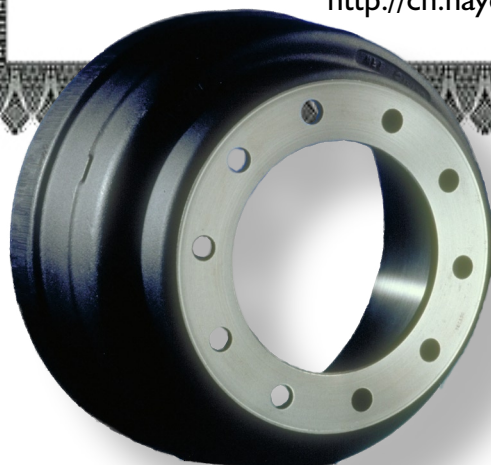





# Hub & Drum Assemblies

## Customer Service

### SEARCH

**Wheels & Rims**

**Brake Drums**

**Hub & Drum Assemblies**

**Customer Service**

**Hub & Drum Assembly  
Components**

**CentriFuse Hub & Drum  
Assemblies**

CentruMount-8 Front & Drive Axles

CentruMount-8 Trailer Axle

CentruMount-10 Front & Drive Axles

CentruMount-10 Drive Axle

CentruMount-10 Trailer Axle

DCN - Front & Drive Axles

DCN - Trailer Axle

**CentruCast Hub & Drum  
Assemblies**

Low Platform Trailer Assemblies

CentruMount-8  
Front, Drive & Trailer Axles

CentruMount-10 Front & Drive Axle

CentruMount-10 Trailer Axle

DCN - Front & Drive Axle

DCN - Trailer Axle

**Fasteners**

**HLI Mexico**

**Customer Service**

**Hub & Drum Products**  
**Hayes Lemmerz Berea Operations**  
159 Glades Road  
Berea, Kentucky 40403-1326 USA

**Toll free: 800•337•0455**  
**800•337•0456**  
**Fax: 800•669•8760**



### SEARCH

Wheels & Rims

Brake Drums

Hub & Drum Assemblies

Customer Service

Hub & Drum Assembly  
Components

CentriFuse Hub & Drum  
Assemblies

CentruMount-8 Front & Drive Axles

CentruMount-8 Trailer Axle

CentruMount-10 Front & Drive Axles

CentruMount-10 Drive Axle

CentruMount-10 Trailer Axle

DCN - Front & Drive Axles

DCN - Trailer Axle

CentruCast Hub & Drum  
Assemblies

Low Platform Trailer Assemblies

CentruMount-8  
Front, Drive & Trailer Axles

CentruMount-10 Front & Drive Axle

CentruMount-10 Trailer Axle

DCN - Front & Drive Axle

DCN - Trailer Axle

Fasteners

HLI Mexico

Customer Service

## Your COMPLETE source for Hub & Drum Assemblies

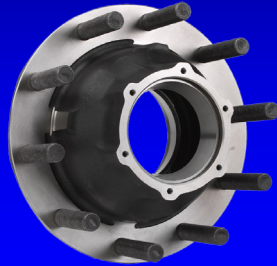

**CentruLite<sup>®</sup> ADI** hubs are light weight, high strength, extremely durable, and easy to mount. Currently available in N and P spindle applications, these hubs are comparable to the weight of aluminum, but less expensive! Pair with the CentriFuse Lite brake drum for ultimate weight savings!



**Ductile Iron** hubs are a versatile and economic choice, available for tractor or trailer applications. When weight is not a critical factor, these tough ductile iron hubs do the job!

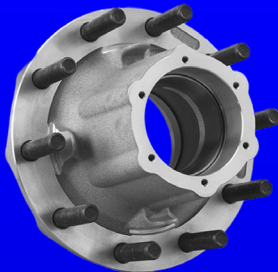

**Aluminum hubs** are available for tractor or trailer applications. These hubs offer excellent weight savings when paired with a CentriFuse Lite Brake Drum!



**CentriFuse Lite<sup>®</sup>** drums are weight optimized at 84 lbs., ideal for weight sensitive applications or for fleets looking to increase their fuel efficiency and payload. These incredibly light drums provide up to 224 pounds of weight savings compared to a typical full cast drum-equipped 18-wheel tractor/trailer!



**Genuine CentriFuse<sup>®</sup>** the *original* lightweight steel jacketed brake drum. Renowned for its light weight, superior safety, exceptional balance, low cost of operation, and proven performance, it is no wonder fleets have trusted Genuine CentriFuse<sup>®</sup> for so many years.

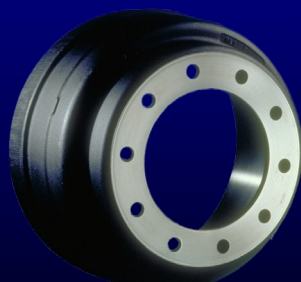

**CentruCast<sup>®</sup>** full cast brake drums are ideal for applications where weight is not a critical factor. CentruCast<sup>®</sup> drums are an excellent choice providing economical performance and uniformity.



# Hub & Drum Assemblies

## CentriFuse® Hub & Drum Assemblies

Our CentriFuse Hub & Drum Assemblies are available for CentruMount 8, 10, or DCN applications for front, drive, or trailer axles. Your choice of ductile iron, austempered ductile iron, or aluminum hubs give you flexibility to choose the right hub & drum assembly for your application.

### SEARCH

Wheels & Rims

Brake Drums

Hub & Drum Assemblies

Customer Service

Hub & Drum Assembly Components

CentriFuse Hub & Drum Assemblies

CentruMount-8 Front & Drive Axles

CentruMount-8 Trailer Axle

CentruMount-10 Front & Drive Axles

CentruMount-10 Drive Axle

CentruMount-10 Trailer Axle

DCN - Front & Drive Axles

DCN - Trailer Axle

CentruCast Hub & Drum Assemblies

Low Platform Trailer Assemblies

CentruMount-8 Front, Drive & Trailer Axles

CentruMount-10 Front & Drive Axle

CentruMount-10 Trailer Axle

DCN - Front & Drive Axle

DCN - Trailer Axle

Fasteners

HLI Mexico

Customer Service

### CentruMount-8 CentriFuse Outboard Hub & Drum Assemblies

#### CentruMount-8 System: 8 Hole, 275mm Hub-Piloted Mounting (CLN)

Item #	Hub & Drum Part Number	Brake Size	Hub Material	Wheel Usage	ABS Loc.	Foot Notes	Wt.	Drum Part #	Hub and Bolt	Wheel Bolt	Drive Studs
<b>FF - Front Axle</b>											
<b>BEARINGS:</b>		Inner/Outer Cups: HM212011/3720			Cones: HM212047 or 49/3782			Seal O.D.: 4.84			
<b>AXLE/ APPLICATION:</b>		Eaton - EFA-12F4, EFA-13FS			Meritor - FF941, FF942, FF943, FF961, FG941						
		Spicer - 1100S, 1120S, 1140S			Westport - F3W1200, F3W1400, F6W1200, F6W1400						
1	91420BK	15 x 4	Iron	S	1.53		122	88870BK	91419	91100	
2	90587BK	15 x 4	Iron	A	1.53		122	88870BK	90578	88836	
3	240008	15 x 4	Alum	S	1.53		103	88870BK	107578	107477	
4	240009	15 x 4	Alum	A	1.53		103	88870BK	107579	107479	
5	91421B	16.5 x 5	Iron	S	1.53		135	88814B	91419	91100	
6	90579B	16.5 x 5	Iron	A	1.53		135	88814B	90578	88836	
7	240010	16.5 x 5	Alum	S	1.53		116	88814B	107578	107477	
8	240011	16.5 x 5	Alum	A	1.53		116	88814B	107579	107479	
<b>R - Drive Axle</b>											
<b>BEARINGS:</b>		Inner/Outer Cups: 592A / 572			Cones: 598A or 594A / 580			Seal O.D.: 6.31			
<b>AXLE/ APPLICATION:</b>		Eaton - 21, 22, 23, 26, 402, 451, 461, 521			Spicer - 220, 230, 400, 460						
		Meritor - Q, R & S Series									
9	340005	15 x 8.62	Alum	A	2.33	V	131	91438B	104980	102292	(8) - 5/8
10	91116B	16.5 x 7	Iron	S		L	157	88797B	91115	88836	(8) - 5/8
11	91120B	16.5 x 7	Iron	S	2.33	L	158	88797B	91119	88836	(8) - 5/8
12	91310B	16.5 x 7	Iron	S			157	88797B	91121	88836	(8) - 5/8
13	91318B	16.5 x 7	Iron	S	2.33		158	88797B	91317	88836	(8) - 5/8
14	91311B	16.5 x 7	Iron	A			158	88797B	91122	88799	(8) - 5/8
15	91316B	16.5 x 7	Iron	A	2.33	L	159	88797B	91315	89620	(8) - 5/8
16	91320B	16.5 x 7	Iron	A	2.33		159	88797B	91319	89620	(8) - 5/8
17	91322B	16.5 x 7	Iron	A		L	158	88797B	91321	89620	(8) - 5/8
18	300012	16.5 x 7	Alum	A		L	133	88797B	105211	102292	(8) - 5/8
19	340012	16.5 x 7	Alum	A	2.33	L	133	88797B	105214	102292	(8) - 5/8
<b>R-Short - Drive Axle</b>											
<b>BEARINGS:</b>		Inner/Outer Cups: 592A / 572			Cones: 598A or 594A / 580			Seal O.D.: 6.31			
<b>AXLE/ APPLICATION:</b>		Eaton - 21, 22, 23, 26, 402, 451, 461, 521			Spicer - 220, 230, 400, 460						
		Meritor - Q, R & S Series									
20	90325B	16.5 X 7	Iron	A			170	88797B	90324	89620	(8) - 5/8
21	91644B	16.5 X 7	Iron	A	2.33		171	88797B	91643	89620	(8) - 5/8
<b>Notes:</b>											For general notes, see page 2.
L = Lube fill: 1/4-18 NPTF — Iron Hubs, 9/16-18 O-ring Seal — Alum. Hubs											
V = For industry axles except Meritor TN or TB											





# Hub & Drum Assemblies

## CentriFuse® Hub & Drum Assemblies

Our CentriFuse Hub & Drum Assemblies are available for CentruMount 8, 10, or DCN applications for front, drive, or trailer axles. Your choice of ductile iron, austempered ductile iron, or aluminum hubs give you flexibility to choose the right hub & drum assembly for your application.

### SEARCH

Wheels & Rims

Brake Drums

Hub & Drum Assemblies

Customer Service

Hub & Drum Assembly

Components

CentriFuse Hub & Drum Assemblies

CentruMount-8 Front & Drive Axles

CentruMount-8 Trailer Axle

CentruMount-10 Front & Drive Axles

CentruMount-10 Drive Axle

CentruMount-10 Trailer Axle

DCN - Front & Drive Axles

DCN - Trailer Axle

CentruCast Hub & Drum Assemblies

Low Platform Trailer Assemblies

CentruMount-8 Front, Drive & Trailer Axles

CentruMount-10 Front & Drive Axle

CentruMount-10 Trailer Axle

DCN - Front & Drive Axle

DCN - Trailer Axle

Fasteners

HLI Mexico

Customer Service

### CentruMount-8 CentriFuse Outboard Hub & Drum Assemblies

#### CentruMount-8 System: 8 Hole, 275mm Hub-Piloted Mounting (CLN)

Item #	Hub & Drum Part No.	Brake Size	Hub Material	Wheel Usage	ABS Loc.	Foot Notes	Weight	Drum Part #	Hub and Bolt	Wheel Bolt	Drive Studs
--------	---------------------	------------	--------------	-------------	----------	------------	--------	-------------	--------------	------------	-------------

#### N - Trailer Axle

**BEARINGS:** Inner/Outer Cups: HM218210/HM212011 Cones: HM218248/HM212049 Seal O.D.: 6.00  
**AXLE/** Dexter-D225K Ingersoll-A22,F22 Meritor-TN, RQ, TQ,TQD,TNC  
**APPLICATION:** Eaton-ETA225J, EST230J KB-KBW Spicer-D22,K22

1	89424B	16.5 x 7	Iron	S			136	88797B	89425	88836	
2	90895B	16.5 x 7	Iron	S	2.34		136	88797B	90894	88836	
3	90609B	16.5 x 7	Iron	A			137	88797B	90607	88799	
4	90893B	16.5 x 7	Iron	A	2.34		137	88797B	90892	88799	
5	91370B	16.5 x 7	Alum	S			120	88797B	91372	102188	
6	91376B	16.5 x 7	Alum	S	2.34		120	88797B	91378	102188	
7	91373B	16.5 x 7	Alum	A			121	88797B	91375	102189	
8	91379B	16.5 x 7	Alum	A	2.34		121	88797B	91381	102189	
9	89567B	16.5 x 8.62	Iron	S		U	152	89571B	89425	88836	
10	44003I	16.5 x 8.62	Iron	S	2.34	U	153	89571B	90894	88836	
11	90610B	16.5 x 8.62	Iron	A		U	153	89571B	90607	88799	
12	91371B	16.5 x 8.62	Alum	S		U	136	89571B	91372	102188	
13	91377B	16.5 x 8.62	Alum	S	2.34	U	136	89571B	91378	102188	
14	91374B	16.5 x 8.62	Alum	A		U	137	89571B	91375	102189	
15	91380B	16.5 x 8.62	Alum	A	2.34	U	137	89571B	91381	102189	

#### P - Trailer Axle

**BEARINGS:** Inner/Outer Cups: HM518410 / HM518410 Cones: HM518445 / HM518445 Seal O.D.: 6.00  
**AXLE/** Eaton - EST225P, EST230P Ingersoll-A24,F24 Spicer - P22  
**APPLICATION:** Fruehauf - PROPAR Meritor - TP

16	91806B	15 x 8.62	Alum	A		V	125	91438B	89850	102190	
17	91807B	15 x 8.62	Alum	A	2.20	V	125	91438B	91638	102190	
18	89404B	16.5 x 7	Iron	S			146	88797B	89403	88836	
19	91510B	16.5 x 7	Iron	S	2.20		147	88797B	91509	88836	
20	90611B	16.5 x 7	Iron	A			148	88797B	90608	88799	
21	91513B	16.5 x 7	Iron	A	2.20		147	88797B	91512	88799	
22	89985B	16.5 x 7	Alum	S			127	88797B	89984	102188	
23	91639B	16.5 x 7	Alum	S	2.20		125	88797B	91637	102188	
24	89867B	16.5 x 7	Alum	A			128	88797B	89850	102190	
25	91640B	16.5 x 7	Alum	A	2.20		126	88797B	91638	102190	
26	89632B	16.5 x 8.62	Iron	S		U	159	89571B	89403	88836	
27	91511B	16.5 x 8.62	Iron	S	2.20	U	160	89571B	91509	88836	
28	90612B	16.5 x 8.62	Iron	A		U	161	89571B	90608	88799	
29	91514B	16.5 x 8.62	Iron	A	2.20	U	163	89571B	91512	88799	
30	89868B	16.5 x 8.62	Alum	A		U	144	89571B	89850	102190	

Notes:

U = For axles with 8.62" linings located inboard of the 7" brake location

V = For industry axles except Meritor TN or TB

For general notes, see page 2.



# Hub & Drum Assemblies

## CentriFuse® Hub & Drum Assemblies

Our CentriFuse Hub & Drum Assemblies are available for CentruMount 8, 10, or DCN applications for front, drive, or trailer axles. Your choice of ductile iron, austempered ductile iron, or aluminum hubs give you flexibility to choose the right hub & drum assembly for your application.

### SEARCH

Wheels & Rims

Brake Drums

Hub & Drum Assemblies

Customer Service

Hub & Drum Assembly Components

CentriFuse Hub & Drum Assemblies

CentruMount-8 Front & Drive Axles

CentruMount-8 Trailer Axle

CentruMount-10 Front & Drive Axles

CentruMount-10 Drive Axle

CentruMount-10 Trailer Axle

DCN - Front & Drive Axles

DCN - Trailer Axle

CentruCast Hub & Drum Assemblies

Low Platform Trailer Assemblies

CentruMount-8 Front, Drive & Trailer Axles

CentruMount-10 Front & Drive Axle

CentruMount-10 Trailer Axle

DCN - Front & Drive Axle

DCN - Trailer Axle

Fasteners

HLI Mexico

Customer Service

### CentruMount-10 CentriFuse Outboard Hub & Drum Assemblies

CentruMount-10 System: 10 Hole, 285.75mm Hub-Piloted Mounting (CLN)

for use with ISO Wheels

Item #	Hub & Drum Part No.	Brake Size	Hub Material	Wheel Usage	ABS Loc.	Foot Notes	Weight	Drum Part #	Hub and Bolt	Wheel Bolt	Drive Studs
<b>FF - Front Axle</b>											
BEARINGS:		Inner/Outer Cups: HM212011/3720				Cones: HM212047 or 49/3782		Seal O.D.: 4.84			
AXLE/ APPLICATION:		Eaton - EFA-12F4, EFA-13FS				Meritor - FF941, FF942, FF943, FF961, FG941					
		Spicer - 1100S, 1120S, 1140S				Westport - F3W1200, F3W1400, F6W1200, F6W1400					
1	91130BK	15 x 4	Iron	A	1.53		117	89870BK	91129	90427	
2	91570BK	15 x 4	Alum	S	1.53		102	89870BK	91550	102033	
3	91572BK	15 x 4	Alum	A	1.53		103	89870BK	91551	102290	
4	91810B	15 x 5	Iron	A	1.53		127	90174B	91129	90427	
5	91811B	16.5 x 5	Iron	A	1.53		129	90600B	91129	90427	
6	91571B	16.5 x 5	Alum	S	1.53		115	90600B	91550	102033	
7	91573B	16.5 x 5	Alum	A	1.53		116	90600B	91551	102290	

### R - Drive Axle

BEARINGS:		Inner/Outer Cups: 592A / 572				Cones: 598A or 594A / 580		Seal O.D.: 6.31			
AXLE/ APPLICATION:		Eaton - 21, 22, 23, 26, 402, 451, 461, 521				Spicer - 220, 230, 400, 460					
		Meritor - Q, R & S Series									
8	340002	15 x 8.62	Iron	S	2.33	V	156	91482B	4219203	3018503	(8) - 5/8
9	340003	15 x 8.62	Iron	A	2.33	V	157	91482B	4218725	3018501	(8) - 5/8
10	340004	15 x 8.62	Alum	A	2.33	V	135	91482B	104970	102292	(8) - 5/8
11	90883B	16.5 x 7	Iron	S			154	89996B	2218724	3018503	(8) - 5/8
12	91407B	16.5 x 7	Iron	S	2.33		156	89996B	4219203	3018503	(8) - 5/8
13	90322B	16.5 x 7	Iron	A			155	89996B	2218725	3018501	(8) - 5/8
14	91400B	16.5 x 7	Iron	A	2.33		160	89996B	4218725	3018501	(8) - 5/8
15	91647B	16.5 x 7	Alum	S	2.33		132	89996B	91646	91165	(8) - 5/8
16	91649B	16.5 x 7	Alum	A	2.33		133	89996B	91648	91163	(8) - 5/8
17	90884B	16.5 x 8.62	Iron	S		U	171	90434B	2218724	3018503	(8) - 5/8
18	91408B	16.5 x 8.62	Iron	S	2.33	U	171	90434B	4219203	3018503	(8) - 5/8
19	90440B	16.5 x 8.62	Iron	A		U	173	90434B	2218725	3018501	(8) - 5/8
20	91399B	16.5 x 8.62	Iron	A	2.33	U	173	90434B	4218725	3018501	(8) - 5/8

### R-Short - Drive Axle

BEARINGS:		Inner/Outer Cups: 592A / 572				Cones: 598A or 594A / 580		Seal O.D.: 6.31			
AXLE/ APPLICATION:		Eaton - 21, 22, 23, 26, 402, 451, 461, 521				Spicer - 220, 230, 400, 460					
		Meritor - Q, R & S Series									
21	340006	15 x 8.62	Iron	S	2.33	V	154	91482B	4219204	3018503	(8) - 3/4
22	2209401	16.5 x 7	Iron	S			151	89996B	2218718	3018503	(8) - 5/8
23	91802B	16.5 x 7	Iron	S	2.33		156	89996B	4219201	3018503	(8) - 5/8
24	2209306	16.5 x 7	Iron	A			152	89996B	2218812	3018501	(8) - 5/8
25	4209305	16.5 x 7	Iron	A	2.33		153	89996B	4219301	3018501	(8) - 5/8

Notes:

U = For axles with 8.62" linings located inboard of the 7" brake location

V = For industry axles except Meritor TN or TB

For general notes, see page 2.



# Hub & Drum Assemblies

## CentriFuse® Hub & Drum Assemblies

Our CentriFuse Hub & Drum Assemblies are available for CentruMount 8, 10, or DCN applications for front, drive, or trailer axles. Your choice of ductile iron, austempered ductile iron, or aluminum hubs give you flexibility to choose the right hub & drum assembly for your application.

### SEARCH

Wheels & Rims

Brake Drums

Hub & Drum Assemblies

Customer Service

Hub & Drum Assembly Components

CentriFuse Hub & Drum Assemblies

CentruMount-8 Front & Drive Axles

CentruMount-8 Trailer Axle

CentruMount-10 Front & Drive Axles

CentruMount-10 Drive Axle

CentruMount-10 Trailer Axle

DCN - Front & Drive Axles

DCN - Trailer Axle

CentruCast Hub & Drum Assemblies

Low Platform Trailer Assemblies

CentruMount-8 Front, Drive & Trailer Axles

CentruMount-10 Front & Drive Axle

CentruMount-10 Trailer Axle

DCN - Front & Drive Axle

DCN - Trailer Axle

Fasteners

HLI Mexico

Customer Service

### CentruMount-10 CentriFuse Outboard Hub & Drum Assemblies

CentruMount-10 System: 10 Hole, 285.75mm Hub-Piloted Mounting (CLN) for use with ISO Wheels

Item #	Hub & Drum Part No.	Brake Size	Hub Material	Wheel Usage	ABS Loc.	Foot Notes	Wt.	Drum Part No.	Hub and Bolt	Wheel Bolt	Drive Studs
<b>N - Trailer Axle</b>											
<b>BEARINGS:</b>			Inner/Outer Cups: HM218210/HM212011			Cones: HM218248/HM212049			Seal O.D.: 6.00		
			Dexter-D225K			Ingersoll-A22,F22			Meritor-TN, RQ, TQ, TQD, TNC		
<b>AXLE/APPLICATION:</b>			Eaton-ETA225J, EST230J			KB-KBW			Spicer-D22,K22		
1	400071	15 X 8.62	Iron	S		V	136	91482B	2819001	3018503	
2	440071	15 X 8.62	Iron	S	2.34	V	137	91482B	4819001	3018503	
3	91687B	15 X 8.62	Alum	A		L, V	124	91482B	105774	102190	
4	91688B	15 X 8.62	Alum	A	2.34	L, V	124	91482B	105782	102190	
5	91756B	15 X 8.62	Alum	S		L, W	124	91725B	105773	102188	
6	91757B	15 X 8.62	Alum	S	2.34	L, W	124	91725B	105781	102188	
7	91758B	15 X 8.62	Alum	A		L, W	124	91725B	105774	102190	
8	91759B	15 X 8.62	Alum	A	2.34	L, W	124	91725B	105782	102190	
9	400082	16.5 X 7	Iron	S			130	600084	2819001	3018503	
10	440082	16.5 X 7	Iron	S	2.34		131	600084	4819001	3018503	
11	400083	16.5 X 7	Iron	A			131	600084	2819002	3018501	
12	440083	16.5 X 7	Iron	A	2.34		132	600084	4819002	3018501	
13	400021	16.5 X 7	Iron	S			137	89996B	2819001	3018503	
14	440021	16.5 X 7	Iron	S	2.34		137	89996B	4819001	3018503	
15	400022	16.5 X 7	Iron	A			138	89996B	2819002	3018501	
16	440022	16.5 X 7	Iron	A	2.34		138	89996B	4819002	3018501	
17	400093	16.5 X 7	ADI	S			125	89996B	410007	500006	
18	440093	16.5 X 7	ADI	S	2.34		124	89996B	450007	500007	
19	400094	16.5 X 7	ADI	A			125	89996B	410008	500006	
20	440094	16.5 X 7	ADI	A	2.34		126	89996B	450008	500007	
21	400095	16.5 X 7	ADI	S			117	600084	410007	500006	
22	440095	16.5 X 7	ADI	S	2.34		118	600084	450007	500007	
23	400096	16.5 X 7	ADI	A			119	600084	410008	500006	
24	440096	16.5 X 7	ADI	A	2.34		120	600084	450008	500007	
25	400084	16.5 X 7	Alum	S		L	117	600084	105773	102188	
26	440084	16.5 X 7	Alum	S	2.34	L	118	600084	105781	102188	
27	400085	16.5 X 7	Alum	A		L	118	600084	105774	102190	
28	440085	16.5 X 7	Alum	A	2.34	L	119	600084	105782	102190	
29	91179B	16.5 X 7	Alum	S		L	122	89996B	105773	102188	
30	91183B	16.5 X 7	Alum	S	2.34	L	123	89996B	105781	102188	
31	91177B	16.5 X 7	Alum	A		L	123	89996B	105774	102190	
32	91181B	16.5 X 7	Alum	A	2.34	L	123	89996B	105782	102190	
33	400000	16.5 X 8	Iron	S			142	91792B	2819001	3018503	
34	440000	16.5 X 8	Iron	S	2.34		142	91792B	4819001	3018503	
35	400001	16.5 X 8	Iron	A			143	91792B	2819002	3018501	
36	440001	16.5 X 8	Iron	A	2.34		143	91792B	4819002	3018501	
37	400002	16.5 X 8	Alum	S		L	128	91792B	105773	102188	
38	440002	16.5 X 8	Alum	S	2.34	L	128	91792B	105781	102188	
39	400003	16.5 X 8	Alum	A		L	129	91792B	105774	102190	
40	440003	16.5 X 8	Alum	A	2.34	L	129	91792B	105782	102190	
41	400045	16.5 X 8.62	Iron	S		U	144	90486B	2819001	3018503	
42	440045	16.5 X 8.62	Iron	S	2.34	U	145	90486B	4819001	3018503	
43	400046	16.5 X 8.62	Iron	A		U	145	90486B	2819002	3018501	
44	440046	16.5 X 8.62	Iron	A	2.34	U	146	90486B	4819002	3018501	
45	400023	16.5 X 8.62	Iron	S		T	147	91812B	2819001	3018503	
46	440023	16.5 X 8.62	Iron	S	2.34	T	147	91812B	4819001	3018503	
47	400024	16.5 X 8.62	Iron	A		T	148	91812B	2819002	3018503	
48	440024	16.5 X 8.62	Iron	A	2.34	T	148	91812B	4819002	3018501	
49	91257B	16.5 X 8.62	Alum	S		L, U	130	90486B	105773	102188	
50	91259B	16.5 X 8.62	Alum	S	2.34	L, U	131	90486B	105781	102188	
51	91256B	16.5 X 8.62	Alum	A		L, U	131	90486B	105774	102190	
52	91258B	16.5 X 8.62	Alum	A	2.34	L, U	132	90486B	105782	102190	
53	400025	16.5 X 8.62	Alum	S		L, T	132	91812B	105773	500001	
54	440025	16.5 X 8.62	Alum	S	2.34	L, T	132	91812B	105781	102188	
55	400026	16.5 X 8.62	Alum	A		L, T	134	91812B	105774	500001	
56	440026	16.5 X 8.62	Alum	A	2.34	L, T	134	91812B	105782	102190	

Notes:

L = Lube fill: 1/4-18 NPTF – Iron Hubs, 9/16-18 O-ring Seal – Alum. Hubs

V = For industry axles except Meritor TN or TB

W = For Meritor TN or TB axles only

For general notes, see





# Hub & Drum Assemblies

## CentriFuse® Hub & Drum Assemblies

Our CentriFuse Hub & Drum Assemblies are available for CentruMount 8, 10, or DCN applications for front, drive, or trailer axles. Your choice of ductile iron, austempered ductile iron, or aluminum hubs give you flexibility to choose the right hub & drum assembly for your application.

### SEARCH

Wheels & Rims

Brake Drums

Hub & Drum Assemblies

Customer Service

Hub & Drum Assembly

Components

CentriFuse Hub & Drum Assemblies

CentruMount-8 Front & Drive Axles

CentruMount-8 Trailer Axle

CentruMount-10 Front & Drive Axles

CentruMount-10 Drive Axle

CentruMount-10 Trailer Axle

DCN - Front & Drive Axles

DCN - Trailer Axle

CentruCast Hub & Drum Assemblies

Low Platform Trailer Assemblies

CentruMount-8 Front, Drive & Trailer Axles

CentruMount-10 Front & Drive Axle

CentruMount-10 Trailer Axle

DCN - Front & Drive Axle

DCN - Trailer Axle

Fasteners

HLI Mexico

Customer Service

### CentruMount-10 CentriFuse Outboard Hub & Drum Assemblies

**CentruMount-10 System: 10 Hole, 285.75mm Hub-Piloted Mounting (CLN) for use with ISO Wheels**

Item #	Hub & Drum Part No.	Brake Size	Hub Material	Wheel Usage	ABS Loc.	Foot Notes	Wt.	Drum Part No.	Hub and Bolt	Wheel Bolt	Drive Studs
<b>P - Trailer Axle</b>											
BEARINGS:		Inner/Outer Cups: HM518410 / HM518410 Eaton - EST225P, EST230P			Cones: HM518445 / HM518445 Ingersoll-A24,F24			Seal O.D.: 6.00 Spicer - P22			
AXLE/APPLICATION:		Fruehauf - PROPAP			Meritor - TP						
1	400019	16.5 X 7	Iron	S			143	89996B	2819301	3018503	
2	440019	16.5 X 7	Iron	S	2.20		143	89996B	4819301	3018503	
3	400020	16.5 X 7	Iron	A			144	89996B	2819302	3018501	
4	440020	16.5 X 7	Iron	A	2.20		144	89996B	4819302	3018501	
5	400099	16.5 X 7	ADI	S			124	89996B	410022	500006	
6	440099	16.5 X 7	ADI	S	2.20		124	89996B	450022	500007	
7	400100	16.5 X 7	ADI	A			125	89996B	410023	500006	
8	440100	16.5 X 7	ADI	A	2.20		126	89996B	450023	500007	
9	400101	16.5 X 7	ADI	S			117	600084	410022	500006	
10	440101	16.5 X 7	ADI	S	2.20		118	600084	450022	500007	
11	400102	16.5 X 7	ADI	A			119	600084	410023	500006	
12	440102	16.5 X 7	ADI	A	2.20		120	600084	450023	500007	
13	400012	16.5 X 7	Alum	S		L	129	89996B	106248	102290	
14	440012	16.5 X 7	Alum	S	2.20	L	129	89996B	106251	102290	
15	400013	16.5 X 7	Alum	A		L	130	89996B	106250	102292	
16	440013	16.5 X 7	Alum	A	2.20	L	130	89996B	106253	102292	
17	400004	16.5 X 8	Iron	S			148	91792B	2819301	3018503	
18	440004	16.5 X 8	Iron	S	2.20		148	91792B	4819301	3018503	
19	400005	16.5 X 8	Iron	A			149	91792B	2819302	3018501	
20	440005	16.5 X 8	Iron	A	2.20		149	91792B	4819302	3018501	
21	400006	16.5 X 8	Alum	S		L	134	91792B	106248	102290	
22	440006	16.5 X 8	Alum	S	2.20	L	134	91792B	106251	102290	
23	400007	16.5 X 8	Alum	A		L	135	91792B	106250	102292	
24	440007	16.5 X 8	Alum	A	2.20	L	135	91792B	106253	102292	
25	400032	16.5 X 8.62	Iron	S		U	151	90486B	2819301	3018503	
26	440032	16.5 X 8.62	Iron	S	2.20	U	151	90486B	4819301	3018503	
27	400033	16.5 X 8.62	Iron	A		U	152	90486B	2819302	3018501	
28	440033	16.5 X 8.62	Iron	A	2.20	U	152	90486B	4819302	3018501	
29	400027	16.5 X 8.62	Iron	S		T	155	91812B	2819301	3018503	
30	440027	16.5 X 8.62	Iron	S	2.20	T	155	91812B	4819301	3018503	
31	400028	16.5 X 8.62	Iron	A		T	156	91812B	2819302	3018501	
32	440028	16.5 X 8.62	Iron	A	2.20	T	156	91812B	4819302	3018501	
33	400029	16.5 X 8.62	Alum	S		L, T	141	91812B	106248	102290	
34	440029	16.5 X 8.62	Alum	S	2.20	L, T	141	91812B	106251	102290	
35	400030	16.5 X 8.62	Alum	A		L, T	142	91812B	106250	102292	
36	440030	16.5 X 8.62	Alum	A	2.20	L, T	142	91812B	106253	102292	

**Notes:**

L = Lube fill: 1/4-18 NPTF – Iron Hubs, 9/16-18 O-ring Seal – Alum. Hubs  
T = For axles with 8.62" linings located at the 7" brake location  
U = For axles with 8.62" linings located inboard of the 7" brake location

For general notes, see page 2.



# Hub & Drum Assemblies

## CentriFuse® Hub & Drum Assemblies

Our CentriFuse Hub & Drum Assemblies are available for CentruMount 8, 10, or DCN applications for front, drive, or trailer axles. Your choice of ductile iron, austempered ductile iron, or aluminum hubs give you flexibility to choose the right hub & drum assembly for your application.

### SEARCH

Wheels & Rims

Brake Drums

Hub & Drum Assemblies

Customer Service

Hub & Drum Assembly Components

CentriFuse Hub & Drum Assemblies

CentruMount-8 Front & Drive Axles

CentruMount-8 Trailer Axle

CentruMount-10 Front & Drive Axles

CentruMount-10 Drive Axle

CentruMount-10 Trailer Axle

DCN - Front & Drive Axles

DCN - Trailer Axle

CentruCast Hub & Drum Assemblies

Low Platform Trailer Assemblies

CentruMount-8 Front, Drive & Trailer Axles

CentruMount-10 Front & Drive Axle

CentruMount-10 Trailer Axle

DCN - Front & Drive Axle

DCN - Trailer Axle

Fasteners

HLI Mexico

Customer Service

### DCN CentriFuse Outboard Hub & Drum Assemblies

#### 10 Hole, 11 1/4", Stud Piloted Mounting

Item #	Hub & Drum Part No.	R or L Hand	Brake Size	Hub Material	Wheel Usage	ABS Loc.	Foot Notes	Wt.	Drum Part #	Hub and Bolt	Wheel Bolt	Drive Studs
--------	---------------------	-------------	------------	--------------	-------------	----------	------------	-----	-------------	--------------	------------	-------------

#### FF - Front Axle

BEARINGS: Inner/Outer Cups: HM212011/3720 Cones: HM212047 or 49/3782 Seal O.D.: 4.84  
 AXLE/ Eaton - EFA-12F4, EFA-13FS Meritor - FF941, FF942, FF943, FF961, FG941  
 APPLICATION: Spicer - 1100S, 1120S, 1140S Westport - F3W1200, F3W1400, F6W1200, F6W1400

1	90431BK	R	15 X 4	Iron	A, S			115	89870BK	90428	90575	
2	90432BK	L	15 X 4	Iron	A, S			115	89870BK	90429	90576	
3	90687BK	R	15 X 4	Iron	A, S	1.90	F	121	89870BK	90685	90575	
4	90688BK	L	15 X 4	Iron	A, S	1.90	F	121	89870BK	90686	90576	
5	240000	R	15 X 5	Iron	A, S	1.90	F	130	90174B	90685	90575	
6	240001	L	15 X 5	Iron	A, S	1.90	F	130	90174B	90686	90576	
7	240002	R	15 X 5	Iron	A, S	1.53		131	90174B	250000	90575	
8	240003	L	15 X 5	Iron	A, S	1.53		131	90174B	250001	90576	
9	90604B	R	16.5 X 5	Iron	A, S			132	90600B	90428	90575	
10	90605B	L	16.5 X 5	Iron	A, S			132	90600B	90429	90576	

#### R - Drive Axle

BEARINGS: Inner/Outer Cups: 592A / 572 Cones: 598A or 594A / 580 Seal O.D.: 6.31  
 AXLE/ Eaton - 21, 22, 23, 26, 402, 451, 461, 521 Spicer - 220, 230, 400, 460  
 APPLICATION: Meritor - Q, R & S Series

11	90320B	R	16.5 X 7	Iron	A, S			157	89996B	2218726	3008401	(8) - 5/8
12	90321B	L	16.5 X 7	Iron	A, S			157	89996B	2218727	3008402	(8) - 5/8
13	91397B	R	16.5 X 7	Iron	A, S	2.33		157	89996B	4218726	3008401	(8) - 5/8
14	91398B	L	16.5 X 7	Iron	A, S	2.33		157	89996B	4218727	3008402	(8) - 5/8
15	90438B	R	16.5 X 8.62	Iron	A, S		U	171	90434B	2218726	3008401	(8) - 5/8
16	90439B	L	16.5 X 8.62	Iron	A, S		U	171	90434B	2218727	3008402	(8) - 5/8
17	91403B	R	16.5 X 8.62	Iron	A, S	2.33	U	171	90434B	4218726	3008401	(8) - 5/8
18	91404B	L	16.5 X 8.62	Iron	A, S	2.33	U	171	90434B	4218727	3008402	(8) - 5/8

#### R - Short - Drive Axle

BEARINGS: Inner/Outer Cups: 592A / 572 Cones: 598A or 594A / 580 Seal O.D.: 6.31  
 AXLE/ Eaton - 21, 22, 23, 26, 402, 451, 461, 521 Spicer - 220, 230, 400, 460  
 APPLICATION: Meritor - Q, R & S Series

19	340000	R	16.5 X 8	Iron	A, S	2.33		154	91792B	4219307	3008401	(8) - 5/8
20	340001	L	16.5 X 8	Iron	A, S	2.33		154	91792B	4219308	3008402	(8) - 5/8

Notes:

For general notes, see page 2.

F = Ford Product

U = For axles with 8.62" linings located inboard of the 7" brake location



# Hub & Drum Assemblies

## CentriFuse® Hub & Drum Assemblies

Our CentriFuse Hub & Drum Assemblies are available for CentruMount 8, 10, or DCN applications for front, drive, or trailer axles. Your choice of ductile iron, austempered ductile iron, or aluminum hubs give you flexibility to choose the right hub & drum assembly for your application.

### SEARCH

Wheels & Rims

Brake Drums

Hub & Drum Assemblies

Customer Service

Hub & Drum Assembly Components

CentriFuse Hub & Drum Assemblies

CentruMount-8 Front & Drive Axles

CentruMount-8 Trailer Axle

CentruMount-10 Front & Drive Axles

CentruMount-10 Drive Axle

CentruMount-10 Trailer Axle

DCN - Front & Drive Axles

DCN - Trailer Axle

CentruCast Hub & Drum Assemblies

Low Platform Trailer Assemblies

CentruMount-8 Front, Drive & Trailer Axles

CentruMount-10 Front & Drive Axle

CentruMount-10 Trailer Axle

DCN - Front & Drive Axle

DCN - Trailer Axle

Fasteners

HLI Mexico

Customer Service

### DCN CentriFuse Outboard Hub & Drum Assemblies

#### 10 Hole, 1 1/4", Stud Piloted Mounting

Item #	Hub & Drum Part No.	R or L Hand	Brake Size	Hub Material	Wheel Usage	ABS Loc.	Foot Notes	Wt.	Drum Part #	Hub and Bolt	Wheel Bolt	Drive Studs
<b>N - Trailer Axle</b>												
BEARINGS:			Inner/Outer Cups: HM218210/HM212011			Cones: HM218248/HM212049			Seal O.D.: 6.00			
AXLE/			Dexter-D225K			Ingersoll-A22,F22			Meritor-TN, RQ, TQ,TQD,TNC			
APPLICATION:			Eaton-ETA225J, EST230J			KB-KBW			Spicer-D22,K22			
1	400051	R	16.5 X 7	Iron	A, S			135	89996B	2819003	3008401	
2	400052	L	16.5 X 7	Iron	A, S			135	89996B	2819004	3008402	
3	440051	R	16.5 X 7	Iron	A, S	2.34		136	89996B	4819003	3008401	
4	440052	L	16.5 X 7	Iron	A, S	2.34		136	89996B	4819004	3008402	
5	91749B	R	16.5 X 7	Duralite	A, S	2.34		122	89996B	91747	20-00031	
6	91750B	L	16.5 X 7	Duralite	A, S	2.34		122	89996B	91748	20-00032	
7	400063	R	16.5 X 7	Alum	A, S		L	123	89996B	105728	102192	
8	400064	L	16.5 X 7	Alum	A, S		L	123	89996B	105727	102191	
9	440063	R	16.5 X 7	Alum	A, S	2.34	L	123	89996B	105748	102192	
10	440064	L	16.5 X 7	Alum	A, S	2.34	L	123	89996B	105747	102191	
11	400039	L	16.5 X 8.62	Iron	A, S		T	147	91812B	2819003	3008401	
12	400040	R	16.5 X 8.62	Iron	A, S		T	147	91812B	2819004	3008402	
13	440039	R	16.5 X 8.62	Iron	A, S	2.34	T	147	91812B	4819003	3008401	
14	440040	L	16.5 X 8.62	Iron	A, S	2.34	T	147	91812B	4819004	3008402	
15	400065	R	16.5 X 8.62	Alum	A, S		L, U	131	90486B	105728	102192	
16	400066	L	16.5 X 8.62	Alum	A, S		L, U	131	90486B	105727	102191	
17	440065	R	16.5 X 8.62	Alum	A, S	2.34	L, U	131	90486B	105748	102192	
18	440066	L	16.5 X 8.62	Alum	A, S	2.34	L, U	131	90486B	105747	102191	

#### P - Trailer Axle

BEARINGS:			Inner/Outer Cups: HM518410 / HM518410			Cones: HM518445 / HM518445			Seal O.D.: 6.00			
AXLE/			Eaton - EST225P, EST230P			Ingersoll-A24,F24			Spicer - P22			
APPLICATION:			Fruehauf - PROPAR			Meritor - TP						
19	400034	R	16.5 X 7	Iron	A, S			142	89996B	2819303	3008401	
20	400035	L	16.5 X 7	Iron	A, S			142	89996B	2819304	3008402	
21	440034	R	16.5 X 7	Iron	A, S	2.20		142	89996B	4819303	3008401	
22	440035	L	16.5 X 7	Iron	A, S	2.20		142	89996B	4819304	3008402	
23	400036	R	16.5 X 8.62	Iron	A, S		U	150	90486B	2819303	3008401	
24	400037	L	16.5 X 8.62	Iron	A, S		U	150	90486B	2819304	3008402	
25	440036	R	16.5 X 8.62	Iron	A, S	2.20	U	150	90486B	4819303	3008401	
26	440037	L	16.5 X 8.62	Iron	A, S	2.20	U	150	90486B	4819304	3008402	

#### Notes:

L = Lube fill: 1/4-18 NPTF – Iron Hubs, 9/16-18 O-ring Seal – Alum. Hubs  
 T = For axles with 8.62" linings located at the 7" brake location  
 U = For axles with 8.62" linings located inboard of the 7" brake location

For general notes, see page 2.



### SEARCH

Wheels & Rims

Brake Drums

Hub & Drum Assemblies

Customer Service

Hub & Drum Assembly Components

CentriFuse Hub & Drum Assemblies

CentruMount-8 Front & Drive Axles

CentruMount-8 Trailer Axle

CentruMount-10 Front & Drive Axles

CentruMount-10 Drive Axle

CentruMount-10 Trailer Axle

DCN - Front & Drive Axles

DCN - Trailer Axle

CentruCast Hub & Drum Assemblies

Low Platform Trailer Assemblies

CentruMount-8 Front, Drive & Trailer Axles

CentruMount-10 Front & Drive Axle

CentruMount-10 Trailer Axle

DCN - Front & Drive Axle

DCN - Trailer Axle

Fasteners

HLI Mexico

Customer Service

### Low Platform Trailer Applications Ductile Iron Hub & Cast Drum Assemblies

Item #	Hub & Drum Part No.	Brake Size	Hub Mat.	Wheel Usage	ABS Loc.	Foot Notes	Wt.	Drum Part #	Hub and Bolt	Wheel Bolt	Drive Studs
<b>Hub Piloted Mountings</b>											
<b>8 Hole, 275mm Bolt Circle, Outboard Mounted Drum with M22 wheel bolts</b>											
BEARINGS: Inner/Outer Cups: HM218210 / HM212011 Seal O.D.: 6.00 Cones: HM218248 / HM212049											
AXLE/APPLICATION: * ABS versions have 80-tooth ABS rings for use with tire diameters 15" and 17.5". SAE Configuration N											
1	400038	12.25 x 7.5	Iron		S	Y	133	630002	410002	3018503	
2	440038	12.25 x 7.5	Iron	2.34	S	Y	134	630002	450002	3018503	
3	400067	12.25 x 7.5	Iron		A	Y	134	630002	410011	3018501	
4	440067	12.25 x 7.5	Iron	2.34	A	Y	135	630002	450011	3018501	
<b>Stud Piloted Mountings</b>											
<b>10 Hole, 8.75" Bolt Circle, Inboard Mounted Drum with 3/4-16 bolts</b>											
BEARINGS: Inner/Outer Cups: HM218210 / HM212011 Seal O.D.: 6.00 Cones: HM218248 / HM212049											
AXLE/APPLICATION: * ABS versions have 80-tooth ABS rings for use with tire diameters 15" and 17.5". SAE Configuration N											
5	403002 R	12.25 x 7.5	Iron		A, S	Y	128	03-126631	413001	09-661901	
6	403003 L	12.25 x 7.5	Iron		A, S	Y	128	03-126631	413001	09-661902	
7	443002 R	12.25 x 7.5	Iron	2.34	A, S	Y	129	03-126631	453001	09-661901	
8	443003 L	12.25 x 7.5	Iron	2.34	A, S	Y	129	03-126631	453001	09-661902	
Notes: For general notes, see page 2.											
Y = Assembly includes an unbalanced drum											



8 Hole, Hub Piloted Assembly

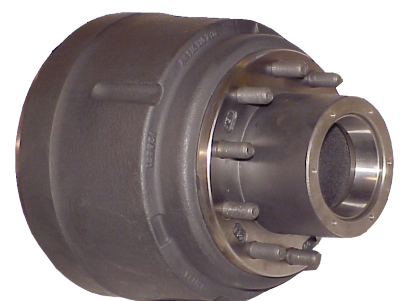

10 Hole, Stud Piloted Assembly



# Hub & Drum Assemblies

## CentruCast™ Hub & Drum Assemblies

Our CentruCast Hub & Drum Assemblies are available for CentruMount 8, 10, or DCN applications for front, drive, or trailer axles. Your choice of ductile iron, austempered ductile iron, or aluminum hubs give you flexibility to choose the right hub & drum assembly for your application. Low platform trailer applications are also available.

### SEARCH

Wheels & Rims

Brake Drums

Hub & Drum Assemblies

Customer Service

Hub & Drum Assembly Components

CentriFuse Hub & Drum Assemblies

CentruMount-8 Front & Drive Axles

CentruMount-8 Trailer Axle

CentruMount-10 Front & Drive Axles

CentruMount-10 Drive Axle

CentruMount-10 Trailer Axle

DCN - Front & Drive Axles

DCN - Trailer Axle

CentruCast Hub & Drum Assemblies

Low Platform Trailer Assemblies

CentruMount-8 Front, Drive & Trailer Axles

CentruMount-10 Front & Drive Axle

CentruMount-10 Trailer Axle

DCN - Front & Drive Axle

DCN - Trailer Axle

Fasteners

HLI Mexico

Customer Service

### CentruMount-8 Full Cast Outboard Hub & Drum Assemblies

#### CentruMount-8 System: 8 Hole, 275mm Hub-Piloted Mounting (CLN)

Item #	Hub & Drum Part No.	Brake Size	Hub Material	Wheel Usage	ABS Loc.	Foot Notes	Wt.	Drum Part #	Hub and Bolt	Wheel Bolt	Drive Studs
--------	---------------------	------------	--------------	-------------	----------	------------	-----	-------------	--------------	------------	-------------

#### FF - Front Axle

<b>BEARINGS:</b>	Inner/Outer Cups: HM212011/3720	Cones: HM212047 or 49/3782		Seal O.D.: 4.84						
<b>AXLE/ APPLICATION:</b>	Eaton - EFA-12F4, EFA-13FS	Meritor - FF941, FF942, FF943, FF961, FG941								
	Spicer - 1100S, 1120S, 1140S	Westport - F3W1200, F3W1400, F6W1200, F6W1400								
1	240014	15 X 4	Iron	S	1.53	133	630004	90578	88836	

#### R - Drive Axle

<b>BEARINGS:</b>	Inner/Outer Cups: 592A / 572	Cones: 598A or 594A / 580		Seal O.D.: 6.31						
<b>AXLE/ APPLICATION:</b>	Eaton - 21, 22, 23, 26, 402, 451, 461, 521	Spicer - 220, 230, 400, 460								
	Meritor - Q, R & S Series									
2	340014	16.5 x 7	Iron	S	2.33	L	181	630003	350004	88799 (8) - 5/8

#### N - Trailer Axle

<b>BEARINGS:</b>	Inner/Outer Cups: HM218210/HM212011	Cones: HM218248/HM212049		Seal O.D.: 6.00						
<b>AXLE/ APPLICATION:</b>	Dexter-D225K	Ingersoll-A22,F22		Meritor-TN, RQ, TQ,TQD,TNC						
	Eaton-ETA225J, EST230J	KB-KBW		Spicer-D22,K22						
3	400038	12.25 x 7.50	Iron	S		Y	128	640002	410002	3018503
4	440038	12.25 x 7.50	Iron	S	2.34	Y	129	640002	450002	3018503
5	400067	12.25 x 7.50	Iron	A		Y	134	640002	410011	3018501
6	440067	12.25 x 7.50	Iron	A	2.34	Y	135	640002	450011	3018501
7	400068	16.5 x 7	iron	S			162	630003	90607	88799
8	440068	16.5 x 7	iron	S	2.34		162	630003	90892	88799

Notes:

L = Lube fill: 1/4-18 NPTF – Iron Hubs, 9/16-18 O-ring Seal – Alum. Hubs  
Y = Assembly includes an unbalanced drum

For general notes, see page 2.



# Hub & Drum Assemblies

## CentruCast™ Hub & Drum Assemblies

Our CentruCast Hub & Drum Assemblies are available for CentruMount 8, 10, or DCN applications for front, drive, or trailer axles. Your choice of ductile iron, austempered ductile iron, or aluminum hubs give you flexibility to choose the right hub & drum assembly for your application. Low platform trailer applications are also available.

### SEARCH

Wheels & Rims

Brake Drums

Hub & Drum Assemblies

Customer Service

Hub & Drum Assembly Components

CentriFuse Hub & Drum Assemblies

CentruMount-8 Front & Drive Axles

CentruMount-8 Trailer Axle

CentruMount-10 Front & Drive Axles

CentruMount-10 Drive Axle

CentruMount-10 Trailer Axle

DCN - Front & Drive Axles

DCN - Trailer Axle

CentruCast Hub & Drum Assemblies

Low Platform Trailer Assemblies

CentruMount-8 Front, Drive & Trailer Axles

CentruMount-10 Front & Drive Axle

CentruMount-10 Trailer Axle

DCN - Front & Drive Axle

DCN - Trailer Axle

Fasteners

HLI Mexico

Customer Service

### CentruMount-10 Full Cast Outboard Hub & Drum Assemblies

CentruMount-10 System: 10 Hole, 285.75mm Hub-Piloted Mounting (CLN) for use with ISO Wheels

Item #	Hub & Drum Part No.	Brake Size	Hub Material	Wheel Usage	ABS Loc.	Foot Notes	Wt.	Drum Part #	Hub and Bolt	Wheel Bolt	Drive Studs	
<b>FD - Front Axle</b>												
<b>BEARINGS:</b>		Inner/Outer Cups: 39520/3525			Cones: 39581/3585			Seal O.D.: 4.54				
<b>AXLE/APPLICATION:</b>		Meritor - FD931										
1	240013	15 x 4	Iron	S	1.12		121	2308401	4019206	3018502		
2	4009305	15 x 4	Iron	A	1.12		122	2308401	4019310	3018503		
<b>FF - Front Axle</b>												
<b>BEARINGS:</b>		Inner/Outer Cups: HM212011/3720			Cones: HM212047 or 49/3782			Seal O.D.: 4.84				
<b>AXLE/</b>		Eaton - EFA-12F4, EFA-13FS			Meritor - FF941, FF942, FF943, FF961, FG941							
<b>APPLICATION:</b>		Spicer - 1100S, 1120S, 1140S			Westport - F3W1200, F3W1400, F6W1200, F6W1400							
3	240012	15 x 4	Iron	S	1.90	M	121	2308401	4019102	3018502		
4	4009208	15 x 4	Iron	A	1.90	M	122	2308401	4019301	3018503		
5	4008401	15 x 4	Iron	S	1.53	M	122	2308401	4018401	3018502		
6	4008402	15 x 4	Iron	A	1.53	M	123	2308401	4018402	3018503		
7	240015	15 x 4	Iron	S	1.53	Q	128	630001	250012	3018502		
8	240016	15 x 4	Iron	A	1.53	Q	129	630001	250013	3018503		
9	4008405	16.5 x 5	Iron	S	1.53	M	139	2308406	4018401	3018502		
10	4008406	16.5 x 5	Iron	A	1.53	M	140	2308406	4018402	3018503		
11	4009201	16.5 x 5	Iron	S	1.90	M	138	2308406	4019102	3018502		
12	4009209	16.5 x 5	Iron	A	1.90	M	139	2308406	4019301	3018503		
<b>FL - Front Axle</b>												
<b>BEARINGS:</b>		Inner/Outer Cups: 6420/552A			Cones: 6461A/555A			Seal O.D.: 5.90				
<b>AXLE/</b>		Eaton - EFA-18F3, EFA-22T2/T5, EFA-24T2/T5										
<b>APPLICATION:</b>		Meritor FL-941										
13	4008718	16.5 X 6	Iron	S	2.36		176	2308708	4019101	3018502		
14	4008719	16.5 X 6	Iron	A	2.36		177	2308708	4019202	3018503		
<b>R - Drive Axle</b>												
<b>BEARINGS:</b>		Inner/Outer Cups: 592A / 572			Cones: 598A or 594A / 580			Seal O.D.: 6.31				
<b>AXLE/</b>		Eaton - 21, 22, 23, 26, 402, 451, 461, 521			Spicer - 220, 230, 400, 460							
<b>APPLICATION:</b>		Meritor - Q, R & S Series										
15	2208754	16.5 x 7	Iron	A			177	2308709	2218725	3018501	(8) - 5/8	
16	4208754	16.5 x 7	Iron	A	2.33		179	2308709	4218725	3018501	(8) - 5/8	
17	2208753	16.5 x 7	Iron	S			176	2308709	2218724	3018503	(8) - 5/8	
18	4208753	16.5 x 7	Iron	S	2.33		178	2308709	4219203	3018503	(8) - 5/8	
<b>R-Short - Drive Axle</b>												
<b>BEARINGS:</b>		Inner/Outer Cups: 592A / 572			Cones: 598A or 594A / 580			Seal O.D.: 6.31				
<b>AXLE/</b>		Eaton - 21, 22, 23, 26, 402, 451, 461, 521			Spicer - 220, 230, 400, 460							
<b>APPLICATION:</b>		Meritor - Q, R & S Series										
19	2208739	15 x 7	Iron	S			158	2308400	2218718	3018503	(8) - 5/8	
20	2208738	16.5 x 7	Iron	S			173	2308709	2218718	3018503	(8) - 5/8	
21	4208738	16.5 x 7	Iron	S	2.33		174	2308709	4219201	3018503	(8) - 5/8	
22	2208813	16.5 x 7	Iron	A			174	2308709	2218812	3018501	(8) - 5/8	
23	4208813	16.5 x 7	Iron	A	2.33		175	2308709	4219301	3018501	(8) - 5/8	
24	2208752	16.5 x 7	Iron	S			175	2308709	2218805	3018503	(8) - 3/4	
25	4208752	16.5 x 7	Iron	S	2.33		176	2308709	4219204	3018503	(8) - 3/4	
26	2209302	16.5 x 7	Iron	A			176	2308709	2219302	3018501	(8) - 3/4	
27	4209302	16.5 x 7	Iron	A	2.33		177	2308709	4219302	3018501	(8) - 3/4	
<b>Notes:</b>											For general notes, see page 2.	
M = 5.14 offset												
Q = 5.44 offset												





# Hub & Drum Assemblies

## CentruCast™ Hub & Drum Assemblies

Our CentruCast Hub & Drum Assemblies are available for CentruMount 8, 10, or DCN applications for front, drive, or trailer axles. Your choice of ductile iron, austempered ductile iron, or aluminum hubs give you flexibility to choose the right hub & drum assembly for your application. Low platform trailer applications are also available.

### SEARCH

Wheels & Rims

Brake Drums

Hub & Drum Assemblies

Customer Service

Hub & Drum Assembly Components

CentriFuse Hub & Drum Assemblies

CentruMount-8 Front & Drive Axles

CentruMount-8 Trailer Axle

CentruMount-10 Front & Drive Axles

CentruMount-10 Drive Axle

CentruMount-10 Trailer Axle

DCN - Front & Drive Axles

DCN - Trailer Axle

CentruCast Hub & Drum Assemblies

Low Platform Trailer Assemblies

CentruMount-8 Front, Drive & Trailer Axles

CentruMount-10 Front & Drive Axle

CentruMount-10 Trailer Axle

DCN - Front & Drive Axle

DCN - Trailer Axle

Fasteners

HLI Mexico

Customer Service

### CentruMount-10 Full Cast Outboard Hub & Drum Assemblies

CentruMount-10 System: 10 Hole, 285.75mm Hub-Piloted Mounting (CLN) for use with ISO Wheels

Item #	Hub & Drum Part No.	Brake Size	Hub Material	Wheel Usage	ABS Loc.	Foot Notes	Wt.	Drum Part #	Hub and Bolt	Wheel Bolt	Drive Studs
<b>N - Trailer Axle</b>											
<b>BEARINGS:</b>		Inner/Outer Cups: HM218210/HM212011			Cones: HM218248/HM212049			Seal O.D.: 6.00			
<b>AXLE/APPLICATION:</b>		Dexter-D225K Eaton-ETA225J, EST230J			Ingersoll-KB-KBW			Meritor-TN, RQ, TQ, TQD, TNC Spicer-D22, K22			
1	2809001	16.5 x 7	Iron	S		Y	159	2308712	2819001	3018503	
2	4809001	16.5 x 7	Iron	S	2.34	Y	159	2308712	4819001	3018503	
3	2809002	16.5 x 7	Iron	A		Y	160	2308712	2819002	3018501	
4	4809002	16.5 x 7	Iron	A	2.34	Y	160	2308712	4819002	3018501	
5	400041	16.5 x 7	Iron	S		L, Y	159	2308712	410003	3018503	
6	440041	16.5 x 7	Iron	S	2.34	L, Y	159	2308712	450003	3018503	
7	400042	16.5 x 7	Iron	A		L, Y	160	2308712	410004	3018501	
8	440042	16.5 x 7	Iron	A	2.34	L, Y	160	2308712	450004	3018501	
9	400091	16.5 x 7	ADI	S		Y	146	2308712	410007	500006	
10	440091	16.5 x 7	ADI	S	2.34	Y	146	2308712	450007	500007	
11	400092	16.5 x 7	ADI	A		Y	147	2308712	410008	500006	
12	440092	16.5 x 7	ADI	A	2.34	Y	147	2308712	450008	500007	
13	400015	16.5 x 7	Alum	S		Y	145	2308712	105773	102188	
14	440015	16.5 x 7	Alum	S	2.34	Y	145	2308712	105781	102188	
15	400016	16.5 x 7	Alum	A		Y	146	2308712	105774	102190	
16	440016	16.5 x 7	Alum	A	2.34	Y	146	2308712	105782	102190	
17	400086	16.5 x 8.62	Iron	S		U, Y	172	630006A	2819001	3018503	
18	440086	16.5 x 8.62	Iron	S	2.34	U, Y	172	630006A	4819001	3018503	
19	400087	16.5 x 8.62	Iron	A		U, Y	173	630006A	2819002	3018501	
20	440087	16.5 x 8.62	Iron	A	2.34	U, Y	173	630006A	4819002	3018501	
21	400088	16.5 x 8.62	Iron	S		T, Y	172	630000A	2819001	3018503	
22	440088	16.5 x 8.62	Iron	S	2.34	T, Y	172	630000A	4819001	3018503	
23	400089	16.5 x 8.62	Iron	A		T, Y	173	630000A	2819002	3018501	
24	440089	16.5 x 8.62	Iron	A	2.34	T, Y	173	630000A	4819002	3018501	

### P - Trailer Axle

<b>BEARINGS:</b>		Inner/Outer Cups: HM518410 / HM518410			Cones: HM518445 / HM518445			Seal O.D.: 6.00			
<b>AXLE/APPLICATION:</b>		Eaton - EST225P, EST230P Fruehauf - PROPAR			Ingersoll-A24, F24 Meritor - TP			Spicer - P22			
1	2809301	16.5 X 7	Iron	S		Y	165	2308712	2819301	3018503	
2	4809301	16.5 X 7	Iron	S	2.20	Y	165	2308712	4819301	3018503	
3	2809302	16.5 X 7	Iron	A		Y	166	2308712	2819302	3018501	
4	4809302	16.5 X 7	Iron	A	2.20	Y	166	2308712	4819302	3018501	
5	400043	16.5 X 7	Iron	S		L, Y	165	2308712	410005	3018503	
6	440043	16.5 X 7	Iron	S	2.20	L, Y	165	2308712	450005	3018503	
7	400044	16.5 X 7	Iron	A		L, Y	166	2308712	410006	3018501	
8	440044	16.5 X 7	Iron	A	2.20	L, Y	166	2308712	450006	3018501	
9	400097	16.5 X 7	ADI	S		Y	148	2308712	410022	500006	
10	440097	16.5 X 7	ADI	S	2.20	Y	149	2308712	450022	500007	
11	400098	16.5 X 7	ADI	A		Y	150	2308712	410023	500006	
12	440098	16.5 X 7	ADI	A	2.20	Y	151	2308712	450023	500007	
13	400090	16.5 X 8.62	Iron	S		T, Y*	165	630000A	413007	3018503	
14	440090	16.5 X 8.62	Iron	S	2.20	T, Y*	165	630000A	453007	3018503	

### Notes:

- L = Lube fill: 1/4-18 NPTF – Iron Hubs, 9/16-18 O-ring Seal – Alum. Hubs
- T = For axles with 8.62" linings located at the 7" brake center
- U = For axles with 8.62" linings located inboard of the 7" brake location
- Y = Assembly includes an unbalanced drum
- \* = Uses Thread-On Hub Cap

For general notes, see page 2.



# Hub & Drum Assemblies

## CentruCast™ Hub & Drum Assemblies

Our CentruCast Hub & Drum Assemblies are available for CentruMount 8, 10, or DCN applications for front, drive, or trailer axles. Your choice of ductile iron, austempered ductile iron, or aluminum hubs give you flexibility to choose the right hub & drum assembly for your application. Low platform trailer applications are also available.

### SEARCH

Wheels & Rims

Brake Drums

Hub & Drum Assemblies

Customer Service

Hub & Drum Assembly Components

CentriFuse Hub & Drum Assemblies

CentruMount-8 Front & Drive Axles

CentruMount-8 Trailer Axle

CentruMount-10 Front & Drive Axles

CentruMount-10 Drive Axle

CentruMount-10 Trailer Axle

DCN - Front & Drive Axles

DCN - Trailer Axle

CentruCast Hub & Drum Assemblies

Low Platform Trailer Assemblies

CentruMount-8 Front, Drive & Trailer Axles

CentruMount-10 Front & Drive Axle

CentruMount-10 Trailer Axle

DCN - Front & Drive Axle

DCN - Trailer Axle

Fasteners

HLI Mexico

Customer Service

### DCN Full Cast Outboard Hub & Drum Assemblies 10 Hole, 1 1/4", Stud Piloted Mounting

Item #	Hub & Drum Part No.	R or L Hand	Brake Size	Hub Material	Wheel Usage	ABS Loc.	Foot Notes	Wt.	Drum Part #	Hub and Bolt	Wheel Bolt	Drive Studs
<b>FD - Front Axle</b>												
<b>BEARINGS:</b>			Inner/Outer Cups: 39520/3525				Cones: 39581/3585			Seal O.D.: 4.84		
<b>AXLE/ APPLICATION:</b>			Meritor - FD93I									
1	4009204	R	15 X 4	Iron	A, S	1.12		121	2308401	4019203	3008401	
2	4009205	L	15 X 4	Iron	A, S	1.12		121	2308401	4019204	3008402	
<b>FF - Front Axle</b>												
<b>BEARINGS:</b>			Inner/Outer Cups: HM212011/3720				Cones: HM212047 or 49/3782			Seal O.D.: 4.84		
<b>AXLE/ APPLICATION:</b>			Eaton - EFA-I2F4, EFA-I3FS				Meritor - FF941, FF942, FF943, FF961, FG941					
			Spicer - I100S, I120S, I140S				Westport - F3WI200, F3WI400, F6WI200, F6WI400					
3	4008509	R	15 X 4	Iron	A, S	1.53	M	120	2308401	4018505	3008401	
4	4008510	L	15 X 4	Iron	A, S	1.53	M	120	2308401	4018506	3008402	
5	4008737	R	15 X 4	Iron	A, S	1.53	M	124	2308401	4018803	3008709	
6	4008738	L	15 X 4	Iron	A, S	1.53	M	124	2308401	4018804	3008710	
7	4008802	R	16.5 X 5	Iron	A, S	1.90	M	141	2308704	4018808	3008709	
8	4008803	L	16.5 X 5	Iron	A, S	1.90	M	141	2308704	4018809	3008710	
9	4009114	R	15 X 4	Iron	A, S	1.90	M	124	2308705	4019203	3008709	
10	4009115	L	15 X 4	Iron	A, S	1.90	M	124	2308705	4019104	3008710	
11	240017	R	15 X 4	Iron	A, S	1.53	Q	129	630005	250014	3008709	
12	240018	L	15 X 4	Iron	A, S	1.53	Q	129	630005	250015	3008710	
<b>FL - Front Axle</b>												
<b>BEARINGS:</b>			Inner/Outer Cups: 6420/552A				Cones: 6461A/555A			Seal O.D.: 4.84		
<b>AXLE/ APPLICATION:</b>			Eaton - EFA-I8F3, EFA-22T2/T5, EFA-24T2/T5									
			Meritor FL-94I									
13	4009107	R	16.5 X 6	Iron	A, S	2.36		179	2308804	4018801	3008709	
14	4009108	L	16.5 X 6	Iron	A, S	2.36		179	2308804	4018802	3008710	
<b>R - Drive Axle</b>												
<b>BEARINGS:</b>			Inner/Outer Cups: 592A / 572				Cones: 598A or 594A / 580			Seal O.D.: 6.31		
<b>AXLE/ APPLICATION:</b>			Eaton - 21, 22, 23, 26, 402, 451, 461, 521 Spicer - 220, 230, 400, 460									
			Meritor - Q, R & S Series									
15	2208755	R	16.5 X 7	Iron	A, S			174	2308709	2218726	3008401	(8) - 5/8
16	2208756	L	16.5 X 7	Iron	A, S			174	2308709	2218727	3008402	(8) - 5/8
17	4208755	L	16.5 X 7	Iron	A, S	2.33		176	2308709	4218726	3008401	(8) - 5/8
18	4208756	L	16.5 X 7	Iron	A, S	2.33		176	2308709	4218727	3008402	(8) - 5/8
<b>R - Short - Drive Axle</b>												
<b>BEARINGS:</b>			Inner/Outer Cups: 592A / 572				Cones: 598A or 594A / 580			Seal O.D.: 6.31		
<b>AXLE/ APPLICATION:</b>			Eaton - 21, 22, 23, 26, 402, 451, 461, 521 Spicer - 220, 230, 400, 460									
			Meritor - Q, R & S Series									
19	2208801	R	16.5 X 7	Iron	A, S			171	2308709	2218722	3008401	(8) - 5/8
20	2208802	L	16.5 X 7	Iron	A, S			171	2308709	2218723	3008402	(8) - 5/8
21	4208801	R	16.5 X 7	Iron	A, S			173	2308709	4219307	3008401	(8) - 5/8
22	4208802	L	16.5 X 7	Iron	A, S			173	2308709	4219308	3008402	(8) - 5/8
Notes: For general notes, see page 2.												
M = 5.14 offset												
Q = 5.44 offset												



# Hub & Drum Assemblies

## CentruCast™ Hub & Drum Assemblies

Our CentruCast Hub & Drum Assemblies are available for CentruMount 8, 10, or DCN applications for front, drive, or trailer axles. Your choice of ductile iron, austempered ductile iron, or aluminum hubs give you flexibility to choose the right hub & drum assembly for your application. Low platform trailer applications are also available.

### SEARCH

Wheels & Rims

Brake Drums

Hub & Drum Assemblies

Customer Service

Hub & Drum Assembly Components

CentriFuse Hub & Drum Assemblies

CentruMount-8 Front & Drive Axles

CentruMount-8 Trailer Axle

CentruMount-10 Front & Drive Axles

CentruMount-10 Drive Axle

CentruMount-10 Trailer Axle

DCN - Front & Drive Axles

DCN - Trailer Axle

CentruCast Hub & Drum Assemblies

Low Platform Trailer Assemblies

CentruMount-8 Front, Drive & Trailer Axles

CentruMount-10 Front & Drive Axle

CentruMount-10 Trailer Axle

DCN - Front & Drive Axle

DCN - Trailer Axle

Fasteners

HLI Mexico

Customer Service

### DCN Full Cast Outboard Hub & Drum Assemblies 10 Hole, 1 1/4", Stud Piloted Mounting

Item #	Hub & Drum Part No.	R or L Hand	Brake Size	Hub Material	Wheel Usage	ABS Loc.	Foot Notes	Wt.	Drum Part #	Hub and Bolt	Wheel Bolt	Drive Studs
--------	---------------------	-------------	------------	--------------	-------------	----------	------------	-----	-------------	--------------	------------	-------------

#### N - Trailer Axle

<b>BEARINGS:</b>	Inner/Outer Cups: HM218210/HM212011	Cones: HM218248/HM212049		Seal O.D.: 6.00	
<b>AXLE/APPLICATION:</b>	Dexter-D225K Eaton-ETA225J, EST230J	Ingersoll-A22,F22 KB-KBW	Meritor-TN, RQ, TQ,TQD,TNC Spicer-D22,K22		

1	403002	R	12.25 X 7.50	Iron	A, S		10/8.75	119	126631	453001	861901	
2	403003	L	12.25 X 7.50	Iron	A, S		10/8.75	119	126631	453001	861902	
3	443002	R	12.25X7.50	Iron	A, S	2.34	10/8.75	119	126631	453001	861901	
4	443003	L	12.25X7.50	Iron	A, S	2.34	10/8.75	119	126631	453001	861902	
5	2809003	R	16.5 X 7	Iron	A, S			Y 159	2308712	2819003	3008401	
6	2809004	L	16.5 X 7	Iron	A, S			Y 159	2308712	2819004	3008402	
7	4809003	R	16.5 X 7	Iron	A, S	2.34		Y 159	2308712	4819003	3008401	
8	4809004	L	16.5 X 7	Iron	A, S	2.34		Y 159	2308712	4819004	3008402	

#### P - Trailer Axle

<b>BEARINGS:</b>	Inner/Outer Cups: HM518410 / HM518410	Cones: HM518445 / HM518445		Seal O.D.: 6.00	
<b>AXLE/APPLICATION:</b>	Eaton - EST225P, EST230P Fruehauf - PROPAR	Ingersoll-A24,F24	Meritor - TP		Spicer - P22

9	2809303	R	16.5 X 7	Iron	A, S			Y 166	2308712	2819303	3008401	
10	2809304	L	16.5 X 7	Iron	A, S			Y 166	2308712	2819304	3008402	
11	4809303	R	16.5 X 7	Iron	A, S	2.20		Y 166	2308712	4819303	3008401	
12	4809304	L	16.5 X 7	Iron	A, S	2.20		Y 166	2308712	4819304	3008402	

Notes:

For general notes, see page 2.

Y = Assembly includes an unbalanced drum



### SEARCH

Wheels & Rims

Brake Drums

Hub & Drum Assemblies

Fasteners

Rim Clamps & Fasteners

Wheel Bolts

Wheel Nuts

HLI Mexico

Customer Service

### 5/8 Clamps for 5/8 Bolts or Studs

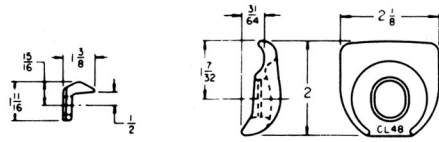

CL48

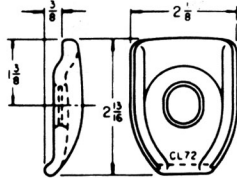

CL72\*\*

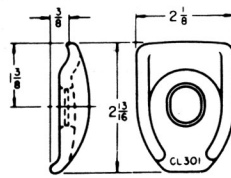

CL301

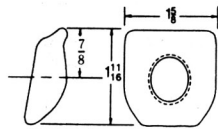

CL368\*\*

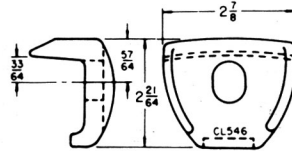

CL546\*\*

### 3/4 Clamps for 3/4 Bolts or Studs

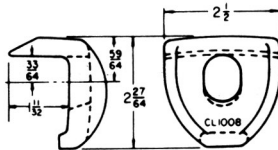

CL1008

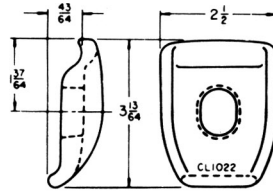

CL1022

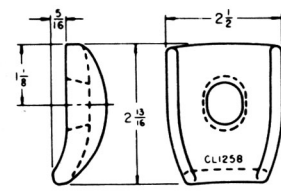

CL1258

\*\* No longer available when current inventory is depleted.

### Rim Nuts



Part #	Thread	Hex Diameter	Length	Type
NU35	1/2-13	7/8	1/2	Rounded Face
NU45	1/2-13	7/8	1/2	Flat Face Heavy Hex
NU65	5/8-11	1-1/16	5/8	Heavy Hex

### SEARCH

Wheels & Rims

Brake Drums

Hub & Drum Assemblies

Fasteners

Rim Clamps & Fasteners

Wheel Bolts

Wheel Nuts

HLI Mexico

Customer Service

### Wheel Bolts

#### Serrated

Part #		Thread	Finish Code	A Overall Length	B Thread Length	C Head Diameter	D Serration Diameter	E Shoulder Length	Head Marking
86797	RH	3/4-16	1	3.02	1.22	1.31	1.00	1.39	
86798	LH		1						
87142	RH	1-1/8-16	1	3.56	1.80	1.50	1.25	1.68	
87143	LH		1						
87319	RH	3/4-16	1	2.51	1.25	1.19	0.81	1.06	
87320	LH		1						
88108	RH	1-1/8-16	1	2.96	1.96	1.50	1.25	1.00	
88109	LH		1						
89085	RH	1-1/8-16	3	2.96	1.96	1.50	1.25	1.00	
89086	LH		3						
89087	RH	1-1/8-16	3	3.27	2.27	1.50	1.25	1.00	
89088	LH		3						
90092	RH	M22X1.5	1	4.13	2.13	1.50	1.25	1.87	092
500000	RH	M22X1.5	1	5.11	3.59	1.69	0.933	1.17	500000
500001	RH	M22X1.5	1	4.11	2.59	1.69	0.933	1.17	500001
3018501	RH	M22X1.5	1	4.59	3.35	1.26	0.94	0.91	WQ
3018502	RH	M22X1.5	1	3.17	1.93	1.26	0.94	0.91	WR
3018503	RH	M22X1.5	1	3.66	2.42	1.26	0.94	0.91	WK
3008401	RH	3/4-16	1	2.60	1.28	1.26	0.94	0.98	VK
3008402	LH	3/4-16	1	2.60	1.28	1.26	0.94	0.98	VK
3008709	RH	1-1/8-16	1	3.15	1.91	1.54	1.25	0.96	VH
3008710	LH	1-1/8-16	1	3.15	1.91	1.54	1.25	0.96	VH

### Wheel Bolts:

#### Non-Serrated, Clipped Head

Part #		Thread	Finish Code	A Overall Length	B Thread Length	C Head Diameter	D Serration Diameter	E Shoulder Length	Head Marking
88799	RH	M22X1.5	1	4.22	3.06	1.62	0.98	0.85	799
88836	RH	M22X1.5	1	3.58	2.51	1.62	0.98	0.85	836
89620	RH	M22X1.5	1	4.80	3.73	1.62	0.98	0.85	620
90427	RH	M22X1.5	1	3.46	2.17	1.70	1.23	0.94	427
90807	RH	M22X1.5	1	3.20	2.51	1.62	0.98	0.73	807
91100	RH	M22X1.5	1	3.20	2.13	1.62	0.98	0.73	100
90114	RH	3/4-16	1	2.51	1.32	1.62	0.98	0.85	114
90115	LH		1						115
90575	RH	1-1/8-16	1	2.88	1.96	1.70	1.23	0.85	575
90576	LH		1						576
500006	RH	M22X1.5	1	3.42	2.58	1.31	0.89	0.5	500006
500007	RH	M22X1.5	1	4.42	3.58	1.31	0.89	0.5	500007

FINISH CODES:  
 1-PHOSPHATE & OIL  
 2-ZINC SILVER CLEAR CHROMATE  
 3-ZINC GOLD DICHROMATE

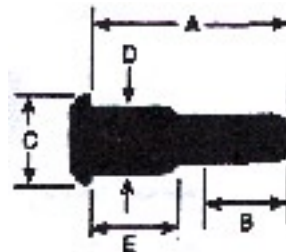

### SEARCH

Wheels & Rims

Brake Drums

Hub & Drum Assemblies

Fasteners

Rim Clamps & Fasteners

Wheel Bolts

Wheel Nuts

HLI Mexico

Customer Service

### Wheel Nuts (DCN Type) For Stud Piloted Wheels Single or Outer Cap Nuts

Type	Part Number	Thread	Nut Height	Wrench Size	Reference Part Number
A	84527 RH 84528 LH	1-1/8-16	0.88	1-1/2 Hex	3203801 (37891) 3203802 (37892)
B	84523 RH 84524 LH	3/4-16	0.88	1-1/2 Hex	3205101 (37888) 3205102 (37889)
A	3204501 RH 3204502 LH	1-5/16-12	1.38	1-3/4 Hex	49416 49417
B	3205701 RH 3205702 LH	15/16-12	1.38	1-3/4 Hex	76635 76636



### Inner Cap Nuts: For Steel Inner Wheels\*

Part Number	Overall Length	Inner Thread	Outer Thread	Head Square	Reference Part #
3203403 RH 3203404 LH	2.218	3/4-16	1-1/8-16	13/16	10708 10709
3203001 RH 3203002 LH	3.062	3/4-16	1-1/8-16	13/16	22621 22622
3203401 RH 3203402 LH	2.56	3/4-16	1-1/8-16	13/16	35336 35337
3204503 RH 3204504 LH	3.00	15/16-12	1-5/16-12	15/16	49414 49415

\* Aluminum wheels require special inner cap nuts. See your wheel supplier.



### Wheel Nuts (CLN Type) For Hub-Piloted Wheels

Type	Part Number	Thread	Overall Height	Hex Size	Flange Diameter	Reference Part #
C	07669S	7/8-14	1.38	1-1/2	2.00	
C	88881	M22x1.5	1.38	1-1/2	2.00	
C	90846	M22x1.5	1.19	33mm	1.80	3208401
D	08434S	3/4-16	1.13	1-3/16	1.75	
E	07652A	7/8-14	0.91	1-1/2	2.00	

### Recommended Nut Torque

Nut Type	Part Number	Stud or Bolt Size and Thread	Recommended Torque (ft/lb)	
Double Cap Nut (DCN)	84523-24	3/4-16	450-500	
	84527-28	1-1/8-16	450-500	
	3205701-2	15/16-12	750-900	
	3204501-2	1-5/16-12	750-900	
Cone Lock Nuts (CLN)	88881, 90846, 51000	M22x1.5	450-500	
	08434S	3/4-16	300-350	
	(Bus front)	07652A	7/8-14	350-400
	(Bus rear)	07669S	7/8-14	450-500
Rim Nuts	NU65	5/8-11	160-200	
	--	3/4-10	200-260	

**NOTE:** See wheel/vehicle manufacturer's recommendations for other mounting systems.

**CAUTION:** Low torque can cause the following problems: on disc-type wheels — broken studs, cracked disc, loss of wheel, enlarged bolt holes, excessive wear on wheel disc face and hub face. On cast spoke wheels — broken studs, rim spinout. Always re-torque wheel fasteners after 50-100 miles of vehicle operation to compensate for torque loss due to seating in of parts. This must be done every time wheels are re-installed. Excessive torque can cause the following problems: on disc-type wheels — broken bolts, broken nuts, disc damage (ball seat breakdown, burr on edge of counter-sunk hole), distorted brake drum/rotor. On cast spoke wheels — broken studs, chorded rim, clamp bending.

**CAUTION:** Most tire, rim and wheel problems result from care-less installation. Use only specified sizes and types of clamps, nuts, and studs.



### SEARCH

**Wheels & Rims**

**Brake Drums**

**Hub & Drum Assemblies**

**Fasteners**

**HLI Mexico**

**Customer Service**

**Brake Drums**

**Brake Rotors**

**Hub & Drum Assemblies**

CentruMount 8

CentruMount 10 Front Axle

CentruMount 10 Drive Axle

CentruMount 10 Trailer Axle

DCN - Front Axle

DCN - Drive Axle

DCN - Trailer Axle

**Spoke Wheel & Drum Assemblies**

15 inch applications

20 inch Front Axle applications

20 inch Drive Axle applications

20 inch Trailer Axle application

22 inch applications

**Customer Service**

### HLI Mexico

Hayes Lemmerz Mexico, S.A. de C.V.  
Prolongacion Av. Mexico #96  
Col. Tulpetlac, Ecatepec  
Edo. De Mexico C.P. 55400

Ezequiel Aguilar  
(English & Spanish speaking)

**Phone: 011-5255-5776-4956**

**Fax: 011-5255-5778-5467**





**SEARCH**

**Wheels & Rims**

**Brake Drums**

**Hub & Drum Assemblies**

**Fasteners**

**HLI Mexico**

**Customer Service**

**Brake Drums**

**Brake Rotors**

**Hub & Drum Assemblies**

**CentruMount 8**

**CentruMount 10 Front Axle**

**CentruMount 10 Drive Axle**

**CentruMount 10 Trailer Axle**

**DCN - Front Axle**

**DCN - Drive Axle**

**DCN - Trailer Axle**

**Spoke Wheel & Drum  
Assemblies**

**15 inch applications**

**20 inch Front Axle applications**

**20 inch Drive Axle applications**

**20 inch Trailer Axle application**

**22 inch applications**

**Customer Service**

**Brake Drums -Listed by Size**

Mexico										
Brake Size	Hayes L. México	Wt. (kg.)	Mounting System	Overall Depth	Brake Surf. Width	Pilot Diameter	Face	Bolt Circle	Bolt Hole No.	Size
12.00 X 3.00	03-122798	20.4	Hub Inboard	7.05	3.51	5.329/5.332	0.340	6.50000	8	0.656
12.00 X 4.20	03-129066	22.9	Hub Pilot	6.53	4.22	6.516/6.519	0.395	8.070	6	0.731
12.12 X 3.00	03-129104	18.7	Hub Pilot	6.89	4.11	4.998/5.001	0.320	6.500	8	1.00-1.08
12.25 X 7.00	03-120822	36.5	Spoke	8.81	8.00	8.500	0.500	10.000	6	0.656
12.25 X 7.50	640002	28.0	Hub Pilot	11.15	8.16	98.995/8.999	0.500	10.827	8	0.930-0.950
12.25 X 7.50	03-126631	40.8	Stud Piloted	10.50	8.12	7.125/7.128	0.500	8.750	10	0.812
13.00 X 3.00	03-129056	31.4	Hub Pilot	7.60	3.93	4.595/98	0.360	6.500	8	.619/.615
13.00 X 3.50	03-129075	27.2	Hub Pilot	8.86	4.03	4.846/4.843	0.310	6.500	8	0.656
13.00 X 3.50	03-129236	20.4	Hub Pilot	8.86	4.03	4.843/4.846	0.310	6.500	8	0.656
14.00 X 2.00	03-122597	17.8	Stud Piloted	4.03	2.94	4.600/3	0.360	6.00	6	0.531
14.00 X 2.50	03-120588	23.8	Stud Piloted	7.00	2.760	7.126/7.129	0.330	8.750	6	0.812
15.00 X 3.00	03-120705	20.4	Spoke	4.13	3.560	10.005/10.00	0.400	11.000	5	0.531
15.00 X 3.50	03-122120	22.9	Spoke	4.42	3.880	8.991/8.994	0.540	10.500	5	0.656
15.00 X 4.00	03-129080	28.0	Spoke	5.38	4.55	9.249/9.252	0.440	11.250	5	0.656
15.00 X 4.00	03-123431	30.6	Spoke	5.84	4.63	9.251/54	0.620	11.250	6	0.781
15.00 X 4.00	03-122104	34.0	Spoke	5.88	4.690	9.250/9.253	0.500	11.250	5/6.	0.781
15.00 X 4.00	03-129152	34.0	Hub Pilot	7.75	4.38	9.001/9.004	0.500	11.250	10	1.030
15.00 X 4.00	03-120440	38.2	Spoke	8.69	7.50	11.00/11.003	0.500	12.500	5/6.	0.656
15.00 X 4.00	03-129062	38.2	Hub Pilot	8.78	4.63	9.001/9.004	0.500	11.250	10	1.281
15.00 X 4.00	2318401	34.8	Hub Pilot	8.82	4.58	8.779/8.782	0.500	11.250	10	0.945
15.00 X 4.00	03-129070	44.2	Hub Pilot	8.90	4.625	8.776/8.779	0.500	11.250	10	0.938
15.00 X 4.00	03-129297	36.6	Hub Pilot	9.20	5.05	8.779/8.782	0.500	11.250	10	1.250
15.00 X 5.00	03-122562	34.8	Spoke	7.99	5.480	6.443/46	0.440	8.750	6	0.843
15.00 X 6.00	03-126256	30.6	Spoke	7.44	6.50	11.250/53	0.500	12.750	6	0.781
15.00 X 7.00	03-122011	45.9	Spoke	8.50	7.500	10.500/03	0.562	12.750	5/6.	0.812
15.00 X 7.00	03-122009	53.5	Spoke	8.65	7.530	10.501/04	0.600	12.750	5	0.781
15.00 X 7.00	03-129218	47.6	Hub Pilot	10.19	7.49	9.001/9.004	0.560	11.250	10	1.280
15.00 X 7.00	03-129254	49.3	Hub Pilot	10.19	7.49	9.001/9.004	0.560	11.250	10	1.280
15.00 X 7.00	03-129173	51.0	Hub Pilot	10.47	7.63	11.250/11.254	0.560	11.250	10	1.000
15.00 X 7.00	03-129240	51.0	Stud Piloted	10.47	7.63	9.001/9.004	0.560	11.250	10	1.280
15.00 X 7.00	03-129243	51.0	Hub Pilot	10.47	7.63	8.779/8.782	0.560	11.250	10	1.281
16.14 X 6.00	03-129138	51.8	Hub Pilot	9.38	8.58	14.532/36	0.630	13.189	10	0.905-0.910
16.25 X 7.00	03-129122	69.7	Hub Pilot	9.78	7.20	14.760/14.770	0.470	13.189	10	0.930
16.25 X 8.00	03-129123	71.4	Hub Pilot	10.85	8.43	14.760/14.770	0.470	13.189	10	0.930
16.40 X 8.00	03-129121	71.4	Ultra	12.05	8.25	14.532/36	0.630	13.189	10	0.905
16.50 X 5.00	03-129141	34.8	Spoke	6.19	5.50	8.991/8.994	0.440	10.500	5	0.531
16.50 X 5.00	03-129197	60.3	Spoke	6.19	5.50	8.991/8.994	0.440	10.500	6	0.531
16.50 X 5.00	03-129258	34.8	Spoke	6.19	5.50	8.991/8.994	0.440	10.500	5	0.531
16.50 X 5.00	03-122266	46.7	Spoke	6.50	5.380	10.00/003	0.562	12.750	5/6.	0.781
16.50 X 5.00	03-129051	45.0	Hub Pilot	9.157	5.44	9.001/04	0.625	11.250	10	1.281
16.50 X 5.00	03-129190	51.8	Hub Pilot	9.22	5.62	9.001/9.004	0.620	11.250	10	1.281
16.50 X 5.00	03-129082	47.6	Hub Pilot	9.25	5.49	8.776/8.779	0.630	11.250	10	1.030
16.50 X 6.00	03-129193	60.3	Hub Pilot	9.75	6.62	9.001/9.004	0.620	11.250	10	1.281

Continued Next Page



**SEARCH**

**Wheels & Rims**

**Brake Drums**

**Hub & Drum Assemblies**

**Fasteners**

**HLI Mexico**

**Customer Service**

**Brake Drums**

**Brake Rotors**

**Hub & Drum Assemblies**

**CentruMount 8**

**CentruMount 10 Front Axle**

**CentruMount 10 Drive Axle**

**CentruMount 10 Trailer Axle**

**DCN - Front Axle**

**DCN - Drive Axle**

**DCN - Trailer Axle**

**Spoke Wheel & Drum  
Assemblies**

**15 inch applications**

**20 inch Front Axle applications**

**20 inch Drive Axle applications**

**20 inch Trailer Axle application**

**22 inch applications**

**Customer Service**

**Brake Drums -Listed by Size - Continued**

Brake Size	Hayes L. México	Wt. (kg.)	Mounting System	Overall Depth	Brake Surf. Width	Pilot Diameter	Face	Bolt Circle	Bolt Hole No.	Size
16.50 X 7.00	03-122600	52.70	Spoke	7.94	7.19	10.998/11.001	0.630	12.70	5/6	0.656
16.50 X 7.00	03-122455	52.70	Spoke	8.03	7.320	14.250/54	0.590	12.750	5/6.	0.656
16.50 X 7.00	03-1200017	51.00	Spoke	8.15	7.19	9.438/41	0.500	11.000	5	0.781
16.50 X 7.00	03-122822	50.15	Spoke	8.18	7.31	9.438/9.441	0.500	11.000	5	0.781
16.50 X 7.00	03-129130	49.30	Spoke	8.41	7.59	11.000/11.003	0.500	12.500	5	0.656
16.50 X 7.00	03-129252	46.75	Spoke	8.41	7.59	11.000/11.003	0.500	12.500	5	0.856
16.50 X 7.00	03-122683	52.70	Spoke	8.45	7.27	11.251/54	0.560	12.750	5/6	0.781
16.50 X 7.00	03-123430	51.85	Spoke	8.65	7.53	10.501/504	0.600	13.500	5/6	0.781
16.50 X 7.00	03-129219	47.60	Spoke	8.65	7.75	10.501/10.504	0.593	12.750	6	0.781
16.50 X 7.00	03-120568	57.80	Spoke	8.75	7.380	9.499/9.502	0.670	11.250	5/6.	.781/.656
16.50 X 7.00	03-120586	57.80	Spoke	8.75	7.500	9.500	0.500	11.250	5/6.	.781/.656
16.50 X 7.00	03-122126	57.80	Spoke/Stud Pilot	8.75	7.380	9.499/502	0.670	11.250	10	0.840
16.50 X 7.00	03-120574	53.55	Spoke	9.00	7.500	11.250/11.253	0.500	12.750	5/6.	0.781
16.50 X 7.00	03-120442	55.25	Spoke	9.12	7.63	11.00/11.003	0.500	12.500	5/6.	0.656
16.50 X 7.00	03-129128	51.85	Stud Piloted	9.63	7.60	9.438/9.441	0.440	11.250	10	0.843
16.50 X 7.00	03-126886	68.00	Stud Piloted	10.25	7.62	9.438/9.441	0.500	11.250	10	0.812
16.50 X 7.00	03-129088	53.55	Hub Pilot	10.31	7.57	8.779/8.782	0.500	11.250	10	1.030
16.50 X 7.00	03-129244	51.85	Hub Pilot	10.31	7.57	8.779/8.782	0.500	11.250	10	1.030
16.50 X 7.00	03-129245	55.25	Stud Piloted	10.31	7.57	8.531/8.534	0.500	11.250	10	0.840
16.50 X 7.00	03-129249	53.55	Stud Piloted	10.31	7.57	8.779/8.782	0.500	11.250	10	0.840
16.50 X 7.00	03-129048	52.70	Stud Piloted	10.312	7.57	8.531/35	0.500	11.250	10	0.840
16.50 X 7.00	03-122453	56.95	Stud Piloted	10.38	7.440	8.531/8.534	0.500	11.250	10	0.812
16.50 X 7.00	03-126873	53.55	Hub Pilot	10.38	7.50	8.750/8.753	0.500	11.250	10	1.000
16.50 X 7.00	03-123207	51.85	Hub Pilot	10.54	7.58	8.780/83	0.500	11.250	10	0.937
16.50 X 7.00	03-129071	56.10	Hub Pilot	10.55	7.60	8.779/8.782	0.500	11.250	10	1.030
16.50 X 7.00	03-129115	55.25	Stud Piloted	10.55	7.81	8.531/8.535	0.500	11.250	10	0.840
16.50 X 7.00	03-122550	59.50	Stud Piloted	10.59	7.750	9.001/4	0.500	11.250	10	0.812
16.50 X 7.00	03-123365	59.50	Hub Pilot	10.59	7.63	8.779/82	0.500	11.250	10	0.937
16.50 X 7.00	03-129149	59.50	Hub Pilot	10.59	7.63	8.779/82	0.500	11.250	10	0.937
16.50 X 7.00	03-129306	62.05	Hub Pilot	10.59	7.75	11.249/11.252	0.500	13.189	10	0.937
16.50 X 7.00	2318709	58.65	Hub Pilot	10.59	7.59	8.779/8.782	0.500	11.250	10	0.945
16.50 X 7.00	03-122607	59.50	Stud Piloted	10.63	7.70	8.531/35	0.500	11.250	10	0.812
16.50 X 7.00	03-120877	57.80	Stud Piloted	10.69	7.410	9.438/9.441	0.560	11.250	10	0.843
16.50 X 7.00	03-126875	55.25	Hub Pilot	10.69	7.81	9.000/03	0.500	10.817	8	1.000
16.50 X 7.00	03-129230	54.40	Stud Piloted	10.69	7.73	9.438/9.441	0.500	11.250	10	0.840
16.50 X 7.00	03-129189	57.80	Hub Pilot	10.82	7.63	9.001/9.004	0.500	11.250	10	0.940
16.50 X 7.00	03-129053	64.60	Stud Piloted	10.94	5.44	8.531/34	0.500	11.250	10	0.843
16.50 X 8.00	03-129168	73.95	Hub Pilot	10.94	8.32	8.779/8.782	0.500	11.250	10	1.030
16.50 X 8.00	03-129177	68.00	Hub Pilot	11.41	8.45	8.776/8.779	0.500	13.189	10	0.937
16.50 X 8.63	03-129301	75.65	Stud Piloted	11.19	8.94	8.531/8.534	0.620	11.250	10	0.840
16.50 X 8.63	03-129300	76.50	Hub Pilot	11.39	8.94	8.779/8.782	0.620	11.250	10	1.030



**SEARCH**

**Wheels & Rims**

**Brake Drums**

**Hub & Drum Assemblies**

**Fasteners**

**HLI Mexico**

**Customer Service**

**Brake Drums**

**Brake Rotors**

**Hub & Drum Assemblies**

CentruMount 8

CentruMount 10 Front Axle

CentruMount 10 Drive Axle

CentruMount 10 Trailer Axle

DCN - Front Axle

DCN - Drive Axle

DCN - Trailer Axle

**Spoke Wheel & Drum Assemblies**

15 inch applications

20 inch Front Axle applications

20 inch Drive Axle applications

20 inch Trailer Axle application

22 inch applications

**Customer Service**

**Brake Rotors - Listed by Size**

Hayes L. México	Rotor Type	Weight (kg.)	Disc Outer Dia.	Disc Thickness	Rotor Depth	Pilot Diameter	Bolt Circle	Bolt Hole Number	Size
<b>12.50"</b>									
23-129106	RH		12.500	1.540	2.760	5.400	6.500	8	0.640
<b>12.90"</b>									
23-129099	RH	17.8	12.900	1.500	5.820	4.855	5.709	10	0.508
<b>14.75"</b>									
23-122687	RH	17.8	14.750	1.350	3.810	5.400	6.750	5	0.656
23-122700	RH	17.8	14.750	1.350	3.810	5.400	7.250	6	0.781
23-123296	RH	17.8	14.750	1.350	3.810	6.000	7.250	10	0.591
23-123439	RH	17.8	14.750	1.350	3.810	6.000	7.250	10	0.781
23-123443	RH	17.8	14.750	1.350	3.810	5.400	7.250	6	0.781
23-123460	RH	17.8	14.750	1.350	3.810	5.750	7.250	6	0.781
23-123468	RH	17.8	14.750	1.350	3.810	5.400	6.750	6	0.656
23-123480	RH	17.8	14.750	1.350	3.810	5.400	7.250	6	0.781
23-123486	RH	17.8	14.750	1.350	3.810	5.400	6.750	5	0.656
23-123494	RH	17.8	14.750	1.350	3.810	5.740	7.250	6	0.781
23-123495	RH	17.8	14.750	1.350	3.810	6.000	7.250	10	0.594
<b>15.00"</b>									
23-122897	RH	21.2	15.000	1.440	4.440	6.000	7.250	10	0.578
663000	RU	28.9	15.000	1.440	7.120	8.500	10.827	8	1.000
<b>15.38"</b>									
23-122729	RH	21.2	15.380	1.540	3.400	6.000	7.250	10	0.594
23-123458	RH	21.2	15.380	1.540	3.400	6.000	7.250	10	0.656
23-122691	RU	28.0	15.380	1.540	4.750	9.250	11.250	6	0.781

**SEARCH**

**Wheels & Rims**

**Brake Drums**

**Hub & Drum Assemblies**

**Fasteners**

**HLI Mexico**

**Customer Service**

**Brake Drums**

**Brake Rotors**

**Hub & Drum Assemblies**

CentruMount 8

CentruMount 10 Front Axle

CentruMount 10 Drive Axle

CentruMount 10 Trailer Axle

DCN - Front Axle

DCN - Drive Axle

DCN - Trailer Axle

**Spoke Wheel & Drum  
Assemblies**

15 inch applications

20 inch Front Axle applications

20 inch Drive Axle applications

20 inch Trailer Axle application

22 inch applications

**Customer Service**

**CentruMount-8  
Hub & Drum Assemblies**

**10.827" (275 mm) C.B., 8 HOLES, USING PILOT 9.00  
Trailer Axles**

Application / Axle	Brake Surface Code	Hub & Drum	Wt.	Drum	Hub & Bolt Hub Material	Serrated Bolt Wheel Usage	Nut	ABS Loc
<b>BEARINGS: Inner /Outer Cups: HM218210 / HM212011 Cones: HM218248 / HM212049</b> <b>Eaton - ETA225J, EST230J</b> <b>Meritor - TN, RQ, TQ, TQD, TNC</b> <b>Spicer - D22, K22</b>								<b>Seal OD: 6.00</b>
	12.25 x 7.50	400038	48.8 107.3	640002	410002 Iron	3018503 Steel	106931 2	Non ABS
	12.25 x 7.50	440038	49.2 108.2	640002	450002 Iron	3018503 Steel	106931 2	2.34
	12.25 x 7.50	400067	49.6 109.1	640002	410011 Iron	3018501 Aluminum	106931 2	Non ABS
	12.25 x 7.50	440067	50 110	640002	450011 Iron	3018501 Aluminum	106931 2	2.34

## CentruMount-10 Hub & Drum Assemblies Front Axles

### SEARCH

Wheels & Rims

Brake Drums

Hub & Drum Assemblies

Fasteners

HLI Mexico

Customer Service

Brake Drums

Brake Rotors

Hub & Drum Assemblies

CentruMount 8

CentruMount 10 Front Axle

CentruMount 10 Drive Axle

CentruMount 10 Trailer Axle

DCN - Front Axle

DCN - Drive Axle

DCN - Trailer Axle

Spoke Wheel & Drum  
Assemblies

15 inch applications

20 inch Front Axle applications

20 inch Drive Axle applications

20 inch Trailer Axle application

22 inch applications

Customer Service

### CentruMount-10 Hub & Drum Assemblies

#### 11.250" (285.75mm) C.B., 10 HOLES, USING PILOT 9.00

Application / Axle	Brake Surface Code	Hub & Drum	Wt.	Drum	Hub & Bolt Hub Material	Serrated Bolt Wheel Usage	Nut	ABS Loc
<b>Front Axles</b>								
BEARINGS: Inner /Outer Cups: JM207010 / 25820			Cones: JM207049 / 25880			Seal OD: 3.88		
Meritor - FC941								
B.C. FOR CAP								
3.625	15x4	15-18129-01	70.8 155.8	03-129152	05-18219-009 Iron	09-820051 Steel	08-205578 10	Non ABS
3.625	15x4	15-18281-01	71.3 156.9	03-129152	05-18281-048 Iron	09-820051 Steel	08-205578 10	SAE

#### 11.250" (285.75mm) C.B., 10 HOLES, USING PILOT 8.78

Application / Axle	Brake Surface Code	Hub & Drum	Wt.	Drum	Hub & Bolt Hub Material	Serrated Bolt Wheel Usage	Nut	ABS Loc
<b>Front Axles</b>								
BEARINGS: Inner /Outer Cups: 39520 / 3525			Cones: 39581 / 3585			Seal OD: 4.54		
Meritor - FC-931, FD-931, FD-933, FD-961, FC941								
Westport - F5W-0900								
B.C. FOR CAP								
4.500	15x4	2009311-F	59.4 130.7	2308401	2019205 Iron	3018502 Steel	3009305 2	Non ABS
4.500	15x4	240013	59.7 131.3	2308401	2019205 Iron	3018502 Steel	3009305 2	1.13

#### 11.250" (285.75mm) C.B., 10 HOLES, USING PILOT 8.78

Application / Axle	Brake Surface Code	Hub & Drum	Wt.	Drum	Hub & Bolt Hub Material	Serrated Bolt Wheel Usage	Nut	ABS Loc
<b>Front Axles</b>								
BEARINGS: Inner /Outer Cups: HM212011 / 3720			Cones: HM212047 or 49X / 3782			Seal OD: 4.84		
Eaton - EFA-12F4, EFA-13FS								
Meritor - FF941, FF942, FF943, FF961, FG941								
Spicer - 1100S, 1120S, 1140S								
B.C. FOR CAP								
5.500 B.C.	15x4	15-18061-02	72.0 158.4	03-129070	05-18061-006 Iron	09-820051 Steel	08-205578 10	Non ABS
5.500 B.C.	15x4	15-18219-100	72.4 159.3	03-129070	05-18061-030 Iron	09-820051 Steel	08-205578 10	SAE
5.500 B.C.	15x4	15-18061-03	70.4 154.9	03-129070	05-18061-006 Iron	09-820051 Steel	08-205734 2	Non ABS
5.500 B.C.	15x4	15-18219-101	70.8 155.8	03-129070	05-18061-030 Iron	09-820051 Steel	08-205734 2	SAE
5.500 B.C.	15x7	15-18061-200	74.0 162.8	03-129316	05-18061-006 Iron	09-820230 Aluminum	08-205734 2	Non ABS
5.500 B.C.	15x7	15-18219-150	74.4 163.7	03-129316	05-18061-030 Iron	09-820230 Aluminum	08-205734 2	SAE
5.500 B.C.	16.5x5	15-18061-050	75.4 165.9	03-129082	05-18061-006 Iron	09-820051 Steel	08-205578 10	Non ABS
5.500 B.C.	16.5x5	15-18219-01	75.8 166.8	03-129082	05-18219-030 Iron	09-820051 Steel	08-205578 10	1.41

Continued



## CentruMount-10 Hub & Drum Assemblies Front Axles - Continued

### SEARCH

Wheels & Rims

Brake Drums

Hub & Drum Assemblies

Fasteners

HLI Mexico

Customer Service

Brake Drums

Brake Rotors

Hub & Drum Assemblies

CentruMount 8

CentruMount 10 Front Axle

CentruMount 10 Drive Axle

CentruMount 10 Trailer Axle

DCN - Front Axle

DCN - Drive Axle

DCN - Trailer Axle

Spoke Wheel & Drum  
Assemblies

15 inch applications

20 inch Front Axle applications

20 inch Drive Axle applications

20 inch Trailer Axle application

22 inch applications

Customer Service

### 11.250" (285.75mm) C.B., 10 HOLES, USING PILOT 8.78 - Continued

Application / Axle	Brake Surface Code	Hub & Drum	Wt.	Drum	Hub & Bolt Hub Material	Serrated Bolt Wheel Usage	Nut	ABS Loc
<b>Front Axles</b>								
<b>BEARINGS: Inner /Outer Cups: HM212011 / 3720</b>			<b>Cones: HM212047 or 49X /3782</b>			<b>Seal OD: 4.84</b>		
Eaton - EFA-12F4, EFA-13FS								
Meritor - FF941, FF942, FF943, FF961, FG941								
Spicer - 1100S, 1120S, 1140S								
<b>B.C. FOR CAP</b>								
5.500 B.C.	16.5x5	15-18061-051	72.2 158.8	03-129082	05-18061-006 Iron	09-820051 Steel	08-205734 2	Non ABS
5.500 B.C.	16.5x5	15-18219-200	72.6 159.7	03-129082	05-18219-030 Iron	09-820051 Steel	08-205734 2	SAE
5.500 B.C.	16.5x6	15-18061-250	86.5 190.3	03-129322	05-18061-006 Iron	09-820051 Steel	08-205734 2	Non ABS
5.500 B.C.	16.5x6	15-18219-050	86.9 191.2	03-129322	05-18219-030 Iron	09-820051 Steel	08-205734 2	1.41
4.500 B.C.	15x4	15-18145-050	59.6 131.1	03-129317	05-18145-006 Iron	09-820051 Steel	08-205734 2	Non ABS
4.500 B.C.	15x4	15-18145-050	60.0 132.0	03-129317	05-18145-030 Iron	09-820051 Steel	08-205734 2	1.53
4.500 B.C.	15x4	15-18145-051	60.2 132.4	03-129317	05-18145-030A Iron	09-820230 Aluminum	08-205734 2	1.53
4.500 B.C.	15x4	2008401-F	61.0 134.2	2308401	2018401 Iron	2018502 Steel	3209305 2	Non ABS
4.500 B.C.	15x4	240012	61.3 134.8	2308401	2018401 Iron	2018502 Steel	3209305 2	1.89

## CentruMount-10 - Hub & Drum Assemblies Drive Axles

### SEARCH

Wheels & Rims

Brake Drums

Hub & Drum Assemblies

Fasteners

HLI Mexico

Customer Service

Brake Drums

Brake Rotors

Hub & Drum Assemblies

CentruMount 8

CentruMount 10 Front Axle

CentruMount 10 Drive Axle

CentruMount 10 Trailer Axle

DCN - Front Axle

DCN - Drive Axle

DCN - Trailer Axle

Spoke Wheel & Drum  
Assemblies

15 inch applications

20 inch Front Axle applications

20 inch Drive Axle applications

20 inch Trailer Axle application

22 inch applications

Customer Service

### CentruMount-10 - Hub & Drum Assemblies

Drive Axles

Mexico

11.250" (285.75mm) C.B., 10 HOLES, USING PILOT 8.78

Application / Axle	Brake Surface Code	Hub & Drum	Wt.	Drum	Hub & Bolt Hub Material	Serrated Bolt Wheel Usage	Nut	ABS Loc
--------------------	--------------------	------------	-----	------	-------------------------	---------------------------	-----	---------

Drive Axles

**BEARINGS: Inner /Outer Cups: 47620 /39520**      **Cones: 47686 / 39590**      **Seal OD: 5.69**

Eaton - 17 & 34 Series

Meritor - L Series

Spicer - 170, 175, 190, 210

8 drive stud	16.5X7	14-18073-100	85.0	03-129088	04-18073-024 Iron	09-820045 Steel	08-205578 10	Non ABS
8 drive stud	16.5X7	14-18273-01	85.4 187.9	03-129088	04-18073-011 Iron	09-820045 Steel	08-205578 10	SAE
12 drive stud	16.5X7	14-18093-100	85.0	03-129088	04-18073-024 Iron	09-820045 Steel	08-205578 10	Non ABS
12 drive stud	16.5X7	14-18282-050	85.4 187.9	03-129088	04-18073-011 Iron	09-820045 Steel	08-205578 10	SAE

11.250" (285.75mm) C.B., 10 HOLES, USING PILOT 8.78

Application / Axle	Brake Surface Code	Hub & Drum	Wt.	Drum	Hub & Bolt Hub Material	Serrated Bolt Wheel Usage	Nut	ABS Loc
--------------------	--------------------	------------	-----	------	-------------------------	---------------------------	-----	---------

Drive Axles

**BEARINGS: Inner /Outer Cups: 592A / 572**      **Cones: 598A or 594A / 580**      **Seal OD:6.31**

Eaton - 21, 22, 23, 26, 402, 451, 461, 521

Meritor - Q, R, & S Series

Spicer - 220, 230, 400, 460

Short barrel	16.5X7	14-18062-01	89.4 196.7	03-129071	04-18062-024 Iron	09-820045 Steel	08-205578 10	Non ABS
Short barrel	16.5X7	14-18062-02	88.4 194.5	03-129071	04-18062-024 Iron	09-820045 Steel	08-205734 2	Non ABS
Short barrel	16.5X7	14-18062-03	89.5 196.9	03-129071	04-18062-024A Iron	09-820231 Aluminum	08-205734 2	Non ABS
Short barrel	16.5X7	14-18221-01	90.18 198.4	03-129071	04-18221-011A Iron	09-820231 Aluminum	08-205578 10	SAE
Long barrel	16.5X7	14-18215-052	79.6 175.1	03-129088	04-18215-024 Iron	09-820045 Steel	08-205734 2	Non ABS
Long barrel	16.5X7	14-18215-050	80 176.0	03-129088	04-18215-024 Iron	09-820045 Steel	08-205734 2	2.33
Long barrel	16.5X7	14-18215-054	80.1 176.2	03-129088	04-18215-024A Iron	09-820228 Aluminum	08-205734 2	Non ABS
Long barrel	16.5X7	14-18215-051	80.5 177.1	03-129088	04-18215-024A Iron	09-820228 Aluminum	08-205734 2	2.33
Long barrel	16.5X7	14-18215-053	80.5 177.1	03-129088	04-18215-024A Iron	09-820231 Aluminum	08-205734 2	SAE
Short barrel	16.5X7	2208738-F	80.9 178.0	2308709	2218718 Iron	3018503 Steel	3209305 2	Non ABS
Short barrel	16.5X7	340013	81.6 179.5	2308709	2218718 Iron	3018503 Steel	3209305 2	2.33

## CentruMount-10 Hub & Drum Assemblies Trailer Axles

### SEARCH

Wheels & Rims

Brake Drums

Hub & Drum Assemblies

Fasteners

HLI Mexico

Customer Service

Brake Drums

Brake Rotors

Hub & Drum Assemblies

CentruMount 8

CentruMount 10 Front Axle

CentruMount 10 Drive Axle

CentruMount 10 Trailer Axle

DCN - Front Axle

DCN - Drive Axle

DCN - Trailer Axle

Spoke Wheel & Drum  
Assemblies

15 inch applications

20 inch Front Axle applications

20 inch Drive Axle applications

20 inch Trailer Axle application

22 inch applications

Customer Service

### CentruMount-10 Hub & Drum Assemblies

Mexico

#### 11.250" (285.75mm) C.B., 10 HOLES, USING PILOT 8.78

Application / Axle	Brake Surface Code	Hub & Drum	Wt.	Drum	Hub & Bolt Hub Material	Serrated Bolt Wheel Usage	Nut	ABS Loc
--------------------	--------------------	------------	-----	------	-------------------------	---------------------------	-----	---------

#### Trailer Axles

**BEARINGS:** Inner /Outer Cups: HM218210 / HM212011 Cones: HM218248 / HM212049 **Seal OD: 6.00**

Eaton - ETA225J, EST230J

Meritor - TN, RQ, TQ, TQD, TNC

Spicer - D22, K22

16.5X7	2809001	77.1 169.6	2308712	4819002	3018503	106932	Non ABS
16.5X7	4809001	77.6 170.7	2308712	4819001	3018503	106932	SAE
16.5X7	2809002	77.5 170.5	2308712	4819002	3018501	106932	Non ABS
16.5X7	4809002	77.9 171.3	2308712	4819001	3018501	106932	SAE

#### 11.250" (285.75mm) C.B., 10 HOLES, USING PILOT 8.78

Application / Axle	Brake Surface Code	Hub & Drum	Wt.	Drum	Hub & Bolt Hub Material	Serrated Bolt Wheel Usage	Nut	ABS Loc
--------------------	--------------------	------------	-----	------	-------------------------	---------------------------	-----	---------

#### Trailer Axles

**BEARINGS:** Inner /Outer Cups: HM518410/HM518410 Cones:HM518445 / HM518445 **Seal OD: 6.00**

Eaton - EST225P, EST230P

Fruehauf - PROPAR

Meritor - TP

Ingersoll - A24, F24

Spicer - P22

Hub cap thread	16.5X7	403007	78.1 171.8	2318709	413007	09-820230	08-205734	Non ABS
Hub cap thread	16.5X7	443007	79.2 174.2	2318709	453007	3018501	08-205734	SAE

#### 13.189" (335 mm) C.B., 10 HOLES, USING PILOT 11.250"

Application / Axle	Brake Surface Code	Hub & Drum	Wt.	Drum	Hub & Bolt Hub Material	Serrated Bolt Wheel Usage	Nut	ABS Loc
--------------------	--------------------	------------	-----	------	-------------------------	---------------------------	-----	---------

#### Trailer Axles

**BEARINGS:** Inner /Outer Cups: HM518410 HM518410 Cones:HM518445 / HM518445 **Seal OD: 6.00**

Eaton - EST225P, EST230P

Fruehauf - PROPAR

Meritor - TP

Ingersoll - A24, F24

Spicer - P22

16.5X8	14-15413-100	93.7 206.1	03-129177	04-15413-006	09-001740	08-205734	Non ABS
16.5X8	14-18297-01	94.1 207.0	03-129177	04-18297-030	09-001740	08-205734	SAE

## SEARCH

Wheels & Rims

Brake Drums

Hub & Drum Assemblies

Fasteners

HLI Mexico

Customer Service

Brake Drums

Brake Rotors

Hub & Drum Assemblies

CentruMount 8

CentruMount 10 Front Axle

CentruMount 10 Drive Axle

CentruMount 10 Trailer Axle

DCN - Front Axle

DCN - Drive Axle

DCN - Trailer Axle

Spoke Wheel & Drum Assemblies

15 inch applications

20 inch Front Axle applications

20 inch Drive Axle applications

20 inch Trailer Axle application

22 inch applications

Customer Service

### DCN Hub & Drum Assemblies

#### 10 HOLES, 1 1/4", Stud Piloted Mounting (DCN)

Application / Axle	Brake Surface Code	Hub & Drum	Wt.	Drum	Hub & Bolt Hub Material	Serrated Bolt Drive Stud	Nut	ABS Loc
<b>Front Axles</b>								
BEARINGS: Inner /Outer Cups: JM207010 / 25820			Cones: JM207049 / 25880			Seal OD: 3.88		
Meritor - FC941								
<b>B.C. FOR CAP</b>								
3.625	15x4	15-18128-01L/02R	70.8 155.8	03-129151	05-18128-006 Iron	09-861901/02 None	106677R/78L 2	Non ABS
3.625	15x4	15-18283-01R/02R	71.3 156.9	03-129151	05-18219-030 Iron	09-861901/02 None	106677R/78L 2	SAE

#### 10 HOLES, 1 1/4", Stud Piloted Mounting (DCN)

Application / Axle	Brake Surface Code	Hub & Drum	Wt.	Drum	Hub & Bolt Hub Material	Serrated Bolt Drive Stud	Nut	ABS Loc
<b>Front Axles</b>								
BEARINGS: Inner /Outer Cups: HM212011 / 3720			Cones: HM212047 or 49X /3782			Seal OD: 4.84		
Eaton - EFA-12F4, EFA-13FS								
Meritor - FF941, FF942, FF943, FF961, FG941								
Spicer - 1100S, 1120S, 1140S								
<b>B.C. FOR CAP</b>								
5.500 B.C.	15x4	15-18084-250/51	64.7 142.3	03-129098	15-18084-006 Iron	09-820043-A None	08-820058-A 2	Non ABS
5.500 B.C.	15x4	15-18284-01/02	65 143	03-129098	15-18284-030 Iron	09-820043-A None	08-820058-A 2	SAE
5.500 B.C.	15x7	15-18084-350-51	79.7 175.3	03-129217	05-180084-006 Iron	09-820043-A None	08-820058-A 10	Non ABS
5.500 B.C.	15x7	15-18284-050/51	80 176	03-129217	15-18284-030 Iron	09-820043-A None	08-820058-A 2	SAE
5.500 B.C.	16.5X5	15-18084-200-01	76.3 167.9	03-129100	05-180084-006 Iron	09-820043-A None	08-820058-A 10	Non ABS
5.500 B.C.	16.5X5	15-18284-100/001	76.6 168.52	03-129100	15-18284-030 Iron	09-820043-A None	08-820058-A 2	SAE
4.500 B.C.	15x4	15-18034-052-53	66.0 145.2	03-129062	15-18034-006 Iron	09-820043-A None	08-820058-A 2	Non ABS
4.500 B.C.	15x4	15-18034-050-51	66.3 145.9	03-129062	15-18034-030 Iron	09-820043-A None	08-820058-A	1.53
5.500 B.C.	16.5x5	15-18157-01-02	78.8 173.4	03-129190	05-18223-006 Iron	09-820113-14 None	08-820058-A 10	Non ABS
5.500 B.C.	16.5x5	15-18223-01-02	79.1 174.0	03-129190	05-18223-030 Iron	09-820113-14 None	08-820058-A 10	1.53
5.500 B.C.	16.5x6	15-18157-050-51	87.3 192.1	03-129193	05-18223-006 Iron	09-820113-14 None	08-820058-A 10	Non ABS
5.500 B.C.	16.5x6	15-18223-050-51	87.6 192.7	03-129193	05-18223-030 Iron	09-820113-14 None	08-820058-A 10	1.53



## SEARCH

Wheels & Rims

Brake Drums

Hub & Drum Assemblies

Fasteners

HLI Mexico

Customer Service

Brake Drums

Brake Rotors

Hub & Drum Assemblies

CentruMount 8

CentruMount 10 Front Axle

CentruMount 10 Drive Axle

CentruMount 10 Trailer Axle

DCN - Front Axle

DCN - Drive Axle

DCN - Trailer Axle

Spoke Wheel & Drum Assemblies

15 inch applications

20 inch Front Axle applications

20 inch Drive Axle applications

20 inch Trailer Axle application

22 inch applications

Customer Service

### DCN Hub & Drum Assemblies

#### 10 HOLES, 1 1/4", Stud Piloted Mounting (DCN)

Application / Axle	Brake Surface Code	Hub & Drum	Wt.	Drum	Hub & Bolt Hub Material	Serrated Bolt Drive Stud	Nut	ABS Loc
--------------------	--------------------	------------	-----	------	-------------------------	--------------------------	-----	---------

#### Drive Axles

BEARINGS: Inner /Outer Cups: 592A / 572 Cones: 598A or 594A / 580 Seal OD:6.31

Eaton - 21, 22, 23, 26, 402, 451, 461, 521

Meritor - Q, R, & S Series

Spicer - 220, 230, 400, 460

Long barrel	16.5X7	14-18085-052/53	88.3 194.3	03-129048	04-18085-024 Iron	09-861901-02 08-008551	08-820058-A 10	Non ABS
Long barrel	16.5X7	14-18286-01/02	89 195.8	03-129048	04-18286-011 Iron	09-861901-02 08-008551	08-820058-A 10	SAE
Long barrel	16.5X7	14-18077-052-53	82.9 182.4	03-129048	04-18085-024 Iron	09-861901-02 08-008551	08-820058-A 10	Non ABS
Long barrel	16.5X7	14-18077-050-51	83.6 183.9	03-129048	04-18085-011 Iron	09-861901-02 08-008551	08-820058-A 10	2.33

#### 10 HOLES, 1 1/4", Stud Piloted Mounting (DCN)

Application / Axle	Brake Surface Code	Hub & Drum	Wt.	Drum	Hub & Bolt Hub Material	Serrated Bolt Drive Stud	Nut	ABS Loc
--------------------	--------------------	------------	-----	------	-------------------------	--------------------------	-----	---------

#### Drive Axles

BEARINGS: Inner /Outer Cups: 47620 /39520 Cones: 47686 / 39590 Seal OD: 5.69

Eaton - 17 & 34 Series

Meritor - L Series

Spicer - 170, 175, 190, 210

	16.5X7	14-18105-01/02	83.9 184.6	03-129048	04-18105-024 Iron	09-861901-02 08-205534	08-820058-A 10	Non ABS
	16.5X7	14-18285-01/02	84.3 185.46	03-129048	04-18285-011 Iron	09-861901-02 08-205534	08-820058-A 10	SAE
	16.5X7	14-18156-01/02	88.1 193.8	03-129189	04-18156-024 Iron	09-820116-17 09-820115	08-820058-A 10	Non ABS
	16.5X7	14-18222-01/02	88.5 194.7	03-129189	04-18222-011 Iron	09-820116-17 09-820115	08-820058-A 10	2.33

## SEARCH

Wheels & Rims

Brake Drums

Hub & Drum Assemblies

Fasteners

HLI Mexico

Customer Service

Brake Drums

Brake Rotors

Hub & Drum Assemblies

CentruMount 8

CentruMount 10 Front Axle

CentruMount 10 Drive Axle

CentruMount 10 Trailer Axle

DCN - Front Axle

DCN - Drive Axle

DCN - Trailer Axle

Spoke Wheel & Drum Assemblies

15 inch applications

20 inch Front Axle applications

20 inch Drive Axle applications

20 inch Trailer Axle application

22 inch applications

Customer Service

### DCN Hub & Drum Assemblies

#### 10 HOLES, 8 3/4", Stud Piloted Mounting (DCN)

Application / Axle	Brake Surface Code	Hub & Drum	Wt.	Drum	Hub & Bolt Hub Material	Serrated Bolt Drive Stud	Nut	ABS Loc
--------------------	--------------------	------------	-----	------	-------------------------	--------------------------	-----	---------

#### Trailer Axles

BEARINGS: Inner /Outer Cups: HM218210 / HM212011 Cones: HM218248 / HM212049 Seal OD: 6.00  
 Eaton - ETA225J, EST230J  
 Meritor - TN, RQ, TQ, TQD, TNC  
 Spicer - D22, K22

INBOARD	12.25X7.50	403002/03	66.8 147.0	03-126631	413001 Iron	09-861901-02 None	None	Non ABS
INBOARD	12.25X7.50	443002/03	67.2 147.8	03-126631	453001 Iron	09-861901-02 None	None	2.34

#### 10 HOLES, 11 1/4", Stud Piloted Mounting (DCN)

Application / Axle	Brake Surface Code	Hub & Drum	Wt.	Drum	Hub & Bolt Hub Material	Serrated Bolt Drive Stud	Nut	ABS Loc
--------------------	--------------------	------------	-----	------	-------------------------	--------------------------	-----	---------

#### Trailer Axles

BEARINGS: Inner /Outer Cups: HM218210 / HM212011 Cones: HM218248 / HM212049 Seal OD: 6.00  
 Eaton - ETA225J, EST230J  
 Meritor - TN, RQ, TQ, TQD, TNC  
 Spicer - D22, K22

INBOARD	16.5X7	14-14059-150/51	73.9 162.6	03-129128	04-14059-006 Iron	09-861901-02 None	08-820058-A 10	Non ABS
INBOARD	16.5X7	14-18298-01/02	74.3 163.46	03-129128	04-18298-030 Iron	09-861901-02 None	08-820058-A 10	SAE
OUTBOARD	16.5X7	14-14344-056/57	79.8 175.6	03-120877	04-14344-006 Iron	09-861901-02 None	08-820058-A 10	Non ABS
OUTBOARD	16.5X7	14-18216-01/02	80.2 176.4	03-120877	04-18216-030 Iron	09-861901-02 None	08-820058-A 10	SAE

#### 10 HOLES, 11 1/4", Stud Piloted Mounting (DCN)

Application / Axle	Brake Surface Code	Hub & Drum	Wt.	Drum	Hub & Bolt Hub Material	Serrated Bolt Drive Stud	Nut	ABS Loc
--------------------	--------------------	------------	-----	------	-------------------------	--------------------------	-----	---------

#### Trailer Axles

BEARINGS: Inner /Outer Cups: HM518410 HM518410 Cones: HM518445 / HM518445 Seal OD: 6.00  
 Eaton - EST225P, EST230P Fruehauf - PROPAR  
 Meritor - TP Ingersoll - A24, F24  
 Spicer - P22

Outboard	16.5X7	14-18192-01/02	77.0 169.4	03-129230	04-18192-006 Iron	09-861901-02 None	08-820058-A 10	Non ABS
Outboard	16.5X7	14-18270-01/02	77.4 170.3	03-129230	04-18270-030 Iron	09-861901-02 None	08-820058-A 10	2.31
Inboard	16.5X7	14-09179-01/02	96.6 212.6	03-122126	04-09179-006 Iron	09-861901-02 None	08-820058-A 10	Non ABS
Inboard	16.5X7	14-18299-01/02	96.6 212.5	03-122126	04-18299-030 Iron	09-861901-02 None	08-820058-A 10	SAE

### SEARCH

Wheels & Rims

Brake Drums

Hub & Drum Assemblies

Fasteners

HLI Mexico

Customer Service

Brake Drums

Brake Rotors

Hub & Drum Assemblies

CentruMount 8

CentruMount 10 Front Axle

CentruMount 10 Drive Axle

CentruMount 10 Trailer Axle

DCN - Front Axle

DCN - Drive Axle

DCN - Trailer Axle

Spoke Wheel & Drum Assemblies

15 inch applications

20 inch Front Axle applications

20 inch Drive Axle applications

20 inch Trailer Axle application

22 inch applications

Customer Service

### 15" - Spoke Wheel & Drum Assemblies

#### Spoke Wheel , 15", 3 Spokes

#### Rear Trailer Axles

Application / Axle	Brake Surface Code	Wheel & Drum	Wt.	Drum	Wheel & Bolt Hub Material	Wheel Bolt Drive Stud	Bolt Assy Nut	ABS Loc
BEARINGS: Inner /Outer Cups: HM218210 / HM212011				Cones: HM218248 / HM212049				Seal OD: 6.00
Eaton - ETA225J, EST230J								
Meritor - TN, RQ, TQ, TQD, TNC								
Spicer - D22, K22								
	12.25X7.25	743000	63.6 139.9	643002	743000-048 Iron	08-205349 None	08-201140 08-201932	Non ABS

#### Spoke Wheel , 15", 3 Spoke

Application / Axle	Brake Surface Code	Wheel & Drum	Wt.	Drum	Wheel & Bolt Hub Material	Wheel Bolt Drive Stud	Bolt Assy Nut	ABS Loc
BEARINGS: Inner /Outer Cups: 653 / HM212011				Cones:				Seal OD: 5.75
Eaton - C2, C, CB, CD, CD2, CE, E, ED, 20L, 2								
Meritor - TL, TKL, RL, TKLD, TLD, TK								
Spicer - K2I								
	12.25x7.25	48-09763-01	66.6 146.5	03-120822	47-09763-009 Iron	08-205349 None	08-201500 08-201932	Non ABS
	12.25x7.25	48-18307-01	67.0 147.4	03-120822	47-18307-048 Iron	08-205349 None	08-201500 08-201932	SAE

#### Spoke Wheel , 15", 3 Spoke

Application / Axle	Brake Surface Code	Wheel & Drum	Wt.	Drum	Wheel & Bolt Hub Material	Wheel Bolt Drive Stud	Bolt Assy Nut	ABS Loc
BEARINGS: Inner /Outer Cups: HM518410 / HM518410				Cones: HM518445 /HM518445				Seal OD: 5.75
Eaton - EST225P, EST230P		Meritor- TP						
Fruhauf - PROPAR		Spicer -P22						
Ingersoll - A24, F24								
	12.25x7.25	48-15106-01	66.2 145.6	03-120822	47-15106-009 Iron	08-205349 None	08-201500 08-201932	Non ABS
	12.25x7.25	48-18308-01	66.6 146.5	03-120822	47-18308-048 Iron	08-205349 None	08-201500 08-201932	SAE

## 20" - Spoke Wheel & Drum Assemblies Front Axles

### SEARCH

Wheels & Rims

Brake Drums

Hub & Drum Assemblies

Fasteners

HLI Mexico

Customer Service

Brake Drums

Brake Rotors

Hub & Drum Assemblies

CentruMount 8

CentruMount 10 Front Axle

CentruMount 10 Drive Axle

CentruMount 10 Trailer Axle

DCN - Front Axle

DCN - Drive Axle

DCN - Trailer Axle

Spoke Wheel & Drum  
Assemblies

15 inch applications

20 inch Front Axle applications

20 inch Drive Axle applications

20 inch Trailer Axle application

22 inch applications

Customer Service

### 20" - Spoke Wheel & Drum Assemblies

#### Spoke Wheel , 20" , 6 Spokes Front Axles

Application / Axle	Brake Surface Code	Wheel & Drum	Wt.	Drum	Wheel & Bolt Hub Material	Wheel Bolt Drive Stud	Bolt Assy Nut	ABS Loc
<b>BEARINGS: Inner /Outer Cups: 39520 / 3525</b> <span style="float:right"><b>Cones: 39521 / 3585</b></span> <span style="float:right"><b>Seal OD: 3.88</b></span>								
<b>Meritor - FC-931, FD-931, FD-933, FD-961, FC941</b>								
<b>Westport - F5W-0900</b>								
	15x4	55-15695-200MTB	52.6 115.7	03-123431	55-15695-009 Iron	08-205349 None	08-201500 08-201932	Non ABS
	15x4	55-18287-01	53.1 116.8	03-123431	55-18287-048 Iron	08-205349 None	08-201500 08-201932	SAE

#### Spoke Wheel , 20" , 5 Spokes Front Axles

Application / Axle	Brake Surface Code	Wheel & Drum	Wt.	Drum	Wheel & Bolt Hub Material	Wheel Bolt Drive Stud	Bolt Assy Nut	ABS Loc
<b>BEARINGS: Inner /Outer Cups: JM207010 / 25820</b> <span style="float:right"><b>Cones: JM207049 / 25880</b></span> <span style="float:right"><b>Seal OD: 3.88</b></span>								
<b>Meritor - FC941</b>								
	15x4	12-18042-01	45.2 99.4	03-122120	02-18042-009 Iron	08-205349 None	08-201140 08-201931	Non ABS
	15x4	12-18042-02	45.7 100.54	03-122120	02-18042-048 Iron	08-205349 None	08-201140 08-201931	SAE
	15x4	12-18080-01	48.6 106.9	03-129080	02-18080-009 Iron	08-205349 None	08-201140 08-201931	Non ABS
	15x4	12-18080-02	49 107.8	03-129080	02-18080-048 Iron	08-205349 None	08-201140 08-201931	SAE

#### Spoke Wheel , 20" , 5 Spokes Front Axles

Application / Axle	Brake Surface Code	Wheel & Drum	Wt.	Drum	Wheel & Bolt Hub Material	Wheel Bolt Drive Stud	Bolt Assy Nut	ABS Loc
<b>BEARINGS: Inner /Outer Cups: HM212011 / 3720</b> <span style="float:right"><b>Cones: HM212047 or 49X /3782</b></span> <span style="float:right"><b>Seal OD: 4.84</b></span>								
<b>Eaton - EFA-12F4, EFA-13FS</b>								
<b>Meritor - FF941, FF942, FF943, FF961, FG941</b>								
<b>Spicer - I100S, I120S, I140S</b>								
	15x4	56-14231-200	53.7	03-129018	55-14231-009 Iron	08-205349 None	08-200052 08-201929	Non ABS
	15x4	55-18288-01	54.0	03-129018	55-18288-048 Iron	08-205349 None	08-200052 08-201929	SAE
	16.5x5	55-18121-01	58.8	03-129141	55-18121-009 Iron	08-205349 None	08-200052 08-201929	Non ABS
	16.5x5	55-18289-01	59.1	03-129141	55-18289-048 Iron	08-205349 None	08-200052 08-201929	SAE

#### Spoke Wheel , 20" , 6 Spokes Front Axles

Application / Axle	Brake Surface Code	Wheel & Drum	Wt.	Drum	Wheel & Bolt Hub Material	Wheel Bolt Drive Stud	Bolt Assy Nut	ABS Loc
<b>BEARINGS: Inner /Outer Cups: HM212011 / 3720</b> <span style="float:right"><b>Cones: HM212047 or 49X /3782</b></span> <span style="float:right"><b>Seal OD: 4.84</b></span>								
<b>Eaton - EFA-12F4, EFA-13FS</b>								
<b>Meritor - FF941, FF942, FF943, FF961, FG941</b>								
<b>Spicer - I100S, I120S, I140S</b>								
	16.5x5	56-18179-01	58.0 127.6	03-129197	55-18179-009 Iron	08-205349 None	08-200052 08-201929	Non ABS
	16.5x5	56-18228-01	58.3 128.3	03-129197	55-18228-048 Iron	08-205349 None	08-200052 08-201929	SAE



## 20" - Spoke Wheel & Drum Assemblies Drive Axles

### SEARCH

Wheels & Rims

Brake Drums

Hub & Drum Assemblies

Fasteners

HLI Mexico

Customer Service

Brake Drums

Brake Rotors

Hub & Drum Assemblies

CentruMount 8

CentruMount 10 Front Axle

CentruMount 10 Drive Axle

CentruMount 10 Trailer Axle

DCN - Front Axle

DCN - Drive Axle

DCN - Trailer Axle

Spoke Wheel & Drum  
Assemblies

15 inch applications

20 inch Front Axle applications

20 inch Drive Axle applications

20 inch Trailer Axle application

22 inch applications

Customer Service

### 20" - Spoke Wheel & Drum Assemblies - Drive Axles

#### Spoke Wheel , 20", 5 Spokes Drive Axles

Application / Axle	Brake Surface Code	Wheel & Drum	Wt.	Drum	Wheel & Bolt Hub Material	Wheel Bolt Drive Stud	Bolt Assy Nut	ABS Loc
BEARINGS: Inner /Outer Cups: 33462 / 3920			Cones: 33287 / 3982			Seal OD: 4.76		
Meritor - RS15210								
	16.5X5	48-14212-01	69.4 152.7	03-129026	47-14212-008 Iron	08-205349 08-201758	08-200052 08-201929	Non ABS
	16.5X5	48-18290-01	69.9 153.8	03-129026	47-18290-012 Iron	08-205349 08-201758	08-200052 08-201929	SAE

#### Spoke Wheel , 20", 5 Spokes Drive Axles

Application / Axle	Brake Surface Code	Wheel & Drum	Wt.	Drum	Wheel & Bolt Hub Material	Wheel Bolt Drive Stud	Bolt Assy Nut	ABS Loc
BEARINGS: Inner /Outer Cups: 592A / 572			Cones: 598A or 594A / 580			Seal OD: 6.31		
Eaton - 21, 22, 23, 26, 402, 451, 461, 521								
Meritor - Q, R, & S Series								
Spicer - 220, 230, 400, 460								
	16.5X7	48-18000-050	95.3 207.7	03-129001	47-18000-008 Iron	08-205349 08-007775	08-201500 08-201932	Non ABS
	16.5X7	48-18294-01	96.0 207.7	03-129001	47-18294-012 Iron	08-205349 08-007775	08-201500 08-201932	SAE

#### Spoke Wheel , 20", 6 Spokes Drive Axles

Application / Axle	Brake Surface Code	Wheel & Drum	Wt.	Drum	Wheel & Bolt Hub Material	Wheel Bolt Drive Stud	Bolt Assy Nut	ABS Loc
BEARINGS: Inner /Outer Cups: 592A / 572			Cones: 598A or 594A / 580			Seal OD: 6.31		
Eaton - 21, 22, 23, 26, 402, 451, 461, 521								
Meritor - Q, R, & S Series								
Spicer - 220, 230, 400, 460								
Long barrel	16.5X7	48-18183-01	102.9 226.4	03-123200	47-18183-008 Iron	08-205349 08-007775	08-201500 08-201932	Non ABS
Long barrel	16.5X7	48-18229-01	103.6 227.9	03-123200	47-18229-012 Iron	08-205349 08-007775	08-201500 08-201932	SAE
Short barrel	16.5X7	48-15311-058MTB	94.4 207.7	03-123200	47-15311-008 Iron	08-205349 08-007775	08-201500 08-201932	Non ABS
Short barrel	16.5X7	48-18295-01	95.1 209.2	03-123200	47-18295-012 Iron	08-205349 08-007775	08-201500 08-201932	SAE

#### Spoke Wheel , 20", 5 Spokes Drive Axles

Application / Axle	Brake Surface Code	Wheel & Drum	Wt.	Drum	Wheel & Bolt Hub Material	Wheel Bolt Drive Stud	Bolt Assy Nut	ABS Loc
BEARINGS: Inner /Outer Cups: 47620 / 39520			Cones: 47686 / 39590			Seal OD: 5.69		
Eaton - 17 & 34 Series								
Meritor - L Series								
Spicer - 170, 175, 190, 210								
	16.5X7	48-14189-200	85.1 187.2	03-129130	47-14189-008 Iron	08-205349 08-205435	08-201140 08-201931	Non ABS
	16.5X7	48-18291-01	85.5 188.1	03-129130	47-18291-012 Iron	08-205349 08-205435	08-201500 08-201932	SAE
	16.5X7	48-09962-112	90.1 198.2	03-122009	47-09962-008 Iron	08-205349 08-205435	08-201500 08-201932	Non ABS
	16.5X7	48-18292-01	90.5 199.1	03-122009	47-18292-012 Iron	08-205349 08-205435	08-201500 08-201932	SAE

#### Spoke Wheel , 20", 6 Spokes Drive Axles

Application / Axle	Brake Surface Code	Wheel & Drum	Wt.	Drum	Wheel & Bolt Hub Material	Wheel Bolt Drive Stud	Bolt Assy Nut	ABS Loc
BEARINGS: Inner /Outer Cups: 47620 / 39520			Cones: 47686 / 39590			Seal OD: 5.69		
Eaton - 17 & 34 Series								
Meritor - L Series								
Spicer - 170, 175, 190, 210								
	16.5X7	48-18185-01	85.9 189.0	03-129221	47-18285-008 Iron	08-205349 08-205435	08-201140 08-201931	Non ABS
	16.5X7	48-18293-01	86.6 190.5	03-129221	47-18293-012 Iron	08-205349 08-205435	08-201140 08-201931	SAE

## 20" - Spoke Wheel & Drum Assemblies Trailer Axles

### SEARCH

Wheels & Rims

Brake Drums

Hub & Drum Assemblies

Fasteners

HLI Mexico

Customer Service

Brake Drums

Brake Rotors

Hub & Drum Assemblies

CentruMount 8

CentruMount 10 Front Axle

CentruMount 10 Drive Axle

CentruMount 10 Trailer Axle

DCN - Front Axle

DCN - Drive Axle

DCN - Trailer Axle

Spoke Wheel & Drum  
Assemblies

15 inch applications

20 inch Front Axle applications

20 inch Drive Axle applications

20 inch Trailer Axle application

22 inch applications

Customer Service

### 20" - Spoke Wheel & Drum Assemblies - Trailer Axles

#### Spoke Wheel , 20", 5 Spokes

Application / Axle	Brake Surface Code	Wheel & Drum	Wt.	Drum	Wheel & Bolt Hub Material	Wheel Bolt Drive Stud	Bolt Assy Nut	ABS Loc
BEARINGS: Inner /Outer Cups: HM218210 / HM212011				Cones: HM218248 / HM212049				Seal OD: 6.00
Eaton - ETA225J, EST230J								
Meritor - TN, RQ, TQ, TQD, TNC								
Spicer - D22, K22								
	16.5X7	48-14018-01	85.6 188.3	03-120017	47-14018-009 Iron	08-205349 None	08-201500 08-201932	Non ABS
	16.5X7	48-18226-01	86.0 189.2	03-120017	47-18226-048 Iron	08-205349 None	08-201500 08-201932	SAE

#### Spoke Wheel , 20", 3 Spokes

Application / Axle	Brake Surface Code	Wheel & Drum	Wt.	Drum	Wheel & Bolt Hub Material	Wheel Bolt Drive Stud	Bolt Assy Nut	ABS Loc
BEARINGS: Inner /Outer Cups: HM218210 / HM212011				Cones: HM218248 / HM212049				Seal OD: 6.00
Eaton - ETA225J, EST230J								
Meritor - TN, RQ, TQ, TQD, TNC								
Spicer - D22, K22								
	16.5X7	743001	93.2 205.0	03-122222	743001-048 Iron	08-205349 None	08-201500 08-201932	Non ABS
	16.5X7	753001	93.6 205.9	03-122222	753001-048 Iron	08-205349 None	08-201500 08-201932	2.34

#### Spoke Wheel , 20", 5 Spoke

Application / Axle	Brake Surface Code	Wheel & Drum	Wt.	Drum	Wheel & Bolt Hub Material	Wheel Bolt Drive Stud	Bolt Assy Nut	ABS Loc
BEARINGS: Inner /Outer Cups: 653 / HM212011				Cones: 663 or665A/HM212069				Seal OD: 5.75
Eaton - J, JE, 23L, 23R, 25R,225J								
Meritor - TK, TKL, TKLD, TL, TLD								
	16.5x7	48-07791-01	84.9 186.8	03-120017	47-07791-009 Iron	08-205349 None	08-201500 08-201932	Non ABS
	16.5x7	48-18305-01	85.3 187.7	03-120017	47-18305-048 Iron	08-205349 None	08-201500 08-201932	SAE

## 22" - Spoke Wheel & Drum Assemblies Trailer Axles

### SEARCH

Wheels & Rims

Brake Drums

Hub & Drum Assemblies

Fasteners

HLI Mexico

Customer Service

Brake Drums

Brake Rotors

Hub & Drum Assemblies

CentruMount 8

CentruMount 10 Front Axle

CentruMount 10 Drive Axle

CentruMount 10 Trailer Axle

DCN - Front Axle

DCN - Drive Axle

DCN - Trailer Axle

Spoke Wheel & Drum  
Assemblies

15 inch applications

20 inch Front Axle applications

20 inch Drive Axle applications

20 inch Trailer Axle application

22 inch applications

Customer Service

### 22" - Spoke Wheel & Drum Assemblies

Spoke Wheel , 22", 5 Spoke

Trailer Axles

Application / Axle	Brake Surface Code	Wheel & Drum	Wt.	Drum	Wheel & Bolt Hub Material	Wheel Bolt Drive Stud	Bolt Assy Nut	ABS Loc
<b>BEARINGS: Inner /Outer Cups: HM218210 / HM212011</b> <b>Cones: HM218248 / HM212049</b> <b>Seal OD: 6.00</b>								
Eaton - ETA225J, EST230J								
Meritor - TN, RQ, TQ, TQD, TNC								
Spicer - D22, K22								
	16.5X7	48-14068-01	89.8 197.6	03-120017	47-14068-009 Iron	08-205349 None	08-201500 08-201932	Non ABS
	16.5X7	48-18303-01	90.3 198.7	03-120017	47-14303-009 Iron	08-205349 None	08-201500 08-201932	SAE

Spoke Wheel , 22", 5 Spoke

Trailer Axles

Application / Axle	Brake Surface Code	Wheel & Drum	Wt.	Drum	Wheel & Bolt Hub Material	Wheel Bolt Drive Stud	Bolt Assy Nut	ABS Loc
<b>BEARINGS: Inner /Outer Cups: 653 / HM212011</b> <b>Cones: 663 or665A/HM212069</b> <b>Seal OD: 5.75</b>								
Eaton - J, JE, 23L, 23R, 25R,225J								
Meritor - TK, TKL, TKLD, TL, TLD								
	16.5x7	48-07841-01	89.0 195.8	03-120017	47-07841-009 Iron	08-205349 None	08-201500 08-201932	Non ABS
	16.5x7	48-18306-01	90.3 198.7	03-120017	47-18306-048 Iron	08-205349 None	08-201500 08-201932	SAE

### SEARCH

Wheels & Rims

Brake Drums

Hub & Drum Assemblies

Fasteners

HLI Mexico

Customer Service

Commercial Highway  
Group Locations

#### Wheel & Rim Products

Hayes Lemmerz Akron Operations  
428 Seiberling Street  
Akron, Ohio 44306-3282 USA

**Toll free: 800•337•0457**  
**800•337•0458**  
**Fax: 800•736•8760**



#### Hub & Drum Products

Hayes Lemmerz Berea Operations  
159 Glades Road  
Berea, Kentucky 40403-1326 USA

**Toll free: 800•337•0455**  
**800•337•0456**  
**Fax: 800•669•8760**



#### World Headquarters

15300 Centennial Drive  
Northville, Michigan 48167 USA

Website: <http://ch.hayes-lemmerz.com>

**Toll free: 800•521•0515**  
**Fax: 734•737•2071**



#### HLI Mexico

Hayes Lemmerz Mexico, S.A. de C.V.  
Prolongacion Av. Mexico #96  
Col. Tulpetlac, Ecatepec  
Edo. De Mexico C.P. 55400

Ezequiel Aguilar  
(English & Spanish speaking)

**Phone: 011-5255-5776-4956**  
**Fax: 011-5255-5778-5467**

