

75BDL3000U
V2.00



www.philips.com/welcome

User Manual (English)

PHILIPS

SignageSolutions

Safety Instructions

Safety precautions and maintenance



WARNING: Use of controls, adjustments or procedures other than those specified in this documentation may result in exposure to shock, electrical hazards and/or mechanical hazards.

Read and follow these instructions when connecting and using your display:

Operation:

- Keep the display out of direct sunlight and away from stoves or any other heat sources.
- Remove any object that could fall into ventilation holes or prevent proper cooling of the display's electronics.
- Do not block the ventilation holes on the cabinet.
- When positioning the display, make sure the power plug and outlet are easily accessible.
- When turning off the display by detaching the power cord, wait 6 seconds before re-attaching the power cord for normal operation.
- Ensure the use of an approved power cord provided by Philips at all times. If your power cord is missing, please contact your local service center.
- Do not subject the display to severe vibration or high impact conditions during operation.
- Do not knock or drop the display during operation or transportation.
- The eye bolt is for usage in short-time maintenance and installation. We suggest not to use the eye bolt for more than 1 hour. Prolong usage is prohibited. Please keep a clear safety area under the display while using the eye bolt.

Maintenance:

- To protect your display from possible damage, do not put excessive pressure on the LCD panel. When moving your display, grasp the frame to lift; do not lift the display by placing your hand or fingers on the LCD panel.
- Unplug the display if you are not going to use it for an extensive period of time.
- Unplug the display if you need to clean it with a slightly damp cloth. The screen may be wiped with a dry cloth when the power is off. However, never use organic solvent, such as, alcohol, or ammonia-based liquids to clean your display.
- To avoid the risk of shock or permanent damage to the set, do not expose the display to dust, rain, water or an excessively moist environment.
- If your display becomes wet, wipe it with dry cloth as soon as possible.
- If a foreign substance or water gets in your display, turn the power off immediately and disconnect the power cord. Then remove the foreign substance or water, and send the unit to the maintenance center.
- Do not store or use the display in locations exposed to heat, direct sunlight or extreme cold.
- In order to maintain the best performance of your display and ensure a longer lifetime, we strongly recommend using the display in a location that falls within the following temperature and humidity ranges.
 - Temperature: 0-40°C 32-104°F
 - Humidity: 20-80% RH

IMPORTANT: Always activate a moving screen saver program when you leave your display unattended. Always activate a periodic screen refresh application if the unit will display unchanging static content. Uninterrupted display of still or static images over an extended period may cause "burn in", also known as "after-imaging" or "ghost imaging", on your screen. This is a well-known phenomenon in LCD panel technology. In most cases, the "burned in" or "after-imaging" or "ghost imaging" will disappear gradually over a period of time after the power has been switched off.

WARNING: Severe "burn-in" or "after-image" or "ghost image" symptoms will not disappear and cannot be repaired. This is also not covered under the terms of your warranty.

Service:

- The casing cover should be opened only by qualified service personnel.
- If there is any need for repair or integration, please contact your local service center.
- Do not leave your display under direct sunlight.



If your display does not operate normally, having followed the instructions set out in this document, please contact a technician or your local service center.

Read and follow these instructions when connecting and using your display:

- Unplug the display if you are not going to use it for an extensive period of time.
- Unplug the display if you need to clean it with a slightly damp cloth. The screen may be wiped with a dry cloth when the power is off. However, never use alcohol, solvents or ammonia-based liquids.
- Consult a service technician if the display does not operate normally when you have followed the instructions in this manual.
- The casing cover should be opened only by qualified service personnel.
- Keep the display out of direct sunlight and away from stoves or any other heat sources.
- Remove any object that could fall into the vents or prevent proper cooling of the display's electronics.
- Do not block the ventilation holes on the cabinet.
- Keep the display dry. To avoid electric shock, do not expose it to rain or excessive moisture.
- When turning off the display by detaching the power cable or DC power cord, wait for 6 seconds before re-attaching the power cable or DC power cord for normal operation.
- To avoid the risk of shock or permanent damage to the set do not expose the display to rain or excessive moisture.
- When positioning the display, make sure the power plug and outlet are easily accessible.
- **IMPORTANT:** Always activate a screen saver program during your application. If a still image in high contrast remains on the screen for an extended period of time, it may leave an 'after-image' or 'ghost image' on the front of the screen. This is a well-known phenomenon that is caused by the shortcomings inherent in LCD technology. In most cases the afterimage will disappear gradually over a period of time after the power has been switched off. Be aware that the after-image symptom cannot be repaired and is not covered under warranty.

CE Declaration of Conformity

This device complies with the requirements set out in the Council Directive on the Approximation of the Laws of the Member States relating to Electromagnetic Compatibility (2014/30/EU), Low-voltage Directive (2014/35/EU), RoHS directive (2011/65/EU).

This product has been tested and found to comply with the harmonized standards for Information Technology Equipment, these harmonized standards published under Directives of Official Journal of the European Union.

Warning:

This equipment is compliant with Class A of EN55032/CISPR 32. In a residential environment this equipment may cause radio interference.

Federal Communications Commission (FCC) Notice (U.S. Only)

NOTE: This equipment has been tested and found to comply with the limits for a Class A digital device, pursuant to part 15 of the FCC Rules. These limits are designed to provide reasonable protection against harmful interference when the equipment is operated in a commercial environment. This equipment generates, uses, and can radiate radio frequency energy and, if not installed and used in accordance with the instruction manual, may cause harmful interference to radio communications. Operation of this equipment in a residential area is likely to cause harmful interference in which case the user will be required to correct the interference at his own expense.



Changes or modifications not expressly approved by the party responsible for compliance could void the user's authority to operate the equipment.

Use only an RF shielded cable that was supplied with the display when connecting this display to a computer device.

To prevent damage which may result in fire or shock hazard, do not expose this appliance to rain or excessive moisture.

This device complies with Part 15 of the FCC Rules. Operation is subject to the following two conditions: (1) This device may not cause harmful interference, and (2) this device must accept any interference received, including interference that may cause undesired operation.

Polish Center for Testing and Certification Notice

The equipment should draw power from a socket with an attached protection circuit (a three-prong socket). All equipment that works together (computer, display, printer, and so on) should have the same power supply source.

The phasing conductor of the room's electrical installation should have a reserve short-circuit protection device in the form of a fuse with a nominal value no larger than 16 amperes (A).

To completely switch off the equipment, the power supply cable must be removed from the power supply socket, which should be located near the equipment and easily accessible.

A protection mark "B" confirms that the equipment is in compliance with the protection usage requirements of standards PN-93/T-42107 and PN-89/E-06251.

Wymagania Polskiego Centrum Badań i Certyfikacji

Urządzenie powinno być zasilane z gniazda z przyłączonym obwodem ochronnym (gniazdo z kolkiem). Współpracujące ze sobą urządzenia (komputer, monitor, drukarka) powinny być zasilane z tego samego źródła.

Instalacja elektryczna pomieszczenia powinna zawierać w przewodzie fazowym rezerwową ochronę przed zwarciami, w postaci bezpiecznika o wartości znamionowej nie większej niż 16A (amperów).

W celu całkowitego wyłączenia urządzenia z sieci zasilania, należy wyjąć wtyczkę kabla zasilającego z gniazda, które powinno znajdować się w pobliżu urządzenia i być łatwo dostępne.

Znak bezpieczeństwa "B" potwierdza zgodność urządzenia z wymaganiami bezpieczeństwa użytkowania zawartymi w PN-93/T-42107 i PN-89/E-06251.

Pozostałe instrukcje bezpieczeństwa

- Nie należy używać wtyczek adapterowych lub usuwać kolka obwodu ochronnego z wtyczki. Jeżeli konieczne jest użycie przedłużacza to należy użyć przedłużacza 3-żyłowego z prawidłowo połączonym przewodem ochronnym.
- System komputerowy należy zabezpieczyć przed nagłymi, chwilowymi wzrostami lub spadkami napięcia, używając eliminatora przepięć, urządzenia dopasowującego lub bezzakłóceniewego źródła zasilania.
- Należy upewnić się, aby nie leżało na kablach systemu komputerowego, oraz aby kable nie były umieszczone w miejscu, gdzie można byłoby na nie nadeptywać lub potykać się o nie.
- Nie należy rozlewać napojów ani innych płynów na system komputerowy.
- Nie należy wpychać żadnych przedmiotów do otworów systemu komputerowego, gdyż może to spowodować pożar lub porażenie prądem, poprzez zwarcie elementów wewnętrznych.
- System komputerowy powinien znajdować się z dala od grzejników i źródeł ciepła. Ponadto, nie należy blokować otworów wentylacyjnych. Należy unikać kładzenia luźnych papierów pod komputer oraz umieszczania komputera w ciasnym miejscu bez możliwości cyrkulacji powietrza wokół niego.

Electric, Magnetic and Electromagnetic Fields ("EMF")

1. We manufacture and sell many products targeted at consumers, which, like any electronic apparatus, in general have the ability to emit and receive electromagnetic signals.
2. One of our leading Business Principles is to take all necessary health and safety measures for our products, to comply with all applicable legal requirements and to stay well within the EMF standards applicable at the time of producing the products.
3. We are committed to develop, produce and market products that cause no adverse health effects.
4. We confirm that if its products are handled properly for their intended use, they are safe to use according to scientific evidence available today.
5. We play an active role in the development of international EMF and safety standards, enabling us to anticipate further developments in standardization for early integration in its products.

Information for U.K. only

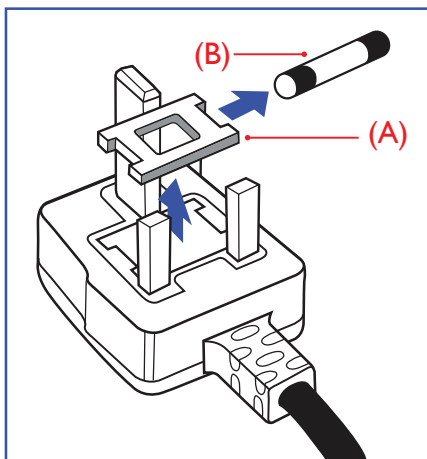

WARNING - THIS APPLIANCE MUST BE EARTHED.

Important:

This apparatus is supplied with an approved moulded 13A plug. To change a fuse in this type of plug proceed as follows:+

1. Remove fuse cover and fuse.
2. Fit new fuse which should be a BS 1362 5A, A.S.T.A. or BSI approved type.
3. Refit the fuse cover.

If the fitted plug is not suitable for your socket outlets, it should be cut off and an appropriate 3-pin plug fitted in its place.

If the mains plug contains a fuse, this should have a value of 5A. If a plug without a fuse is used, the fuse at the distribution board should not be greater than 5A.

NOTE: The severed plug must be destroyed to avoid a possible shock hazard should it be inserted into a 13A socket elsewhere.

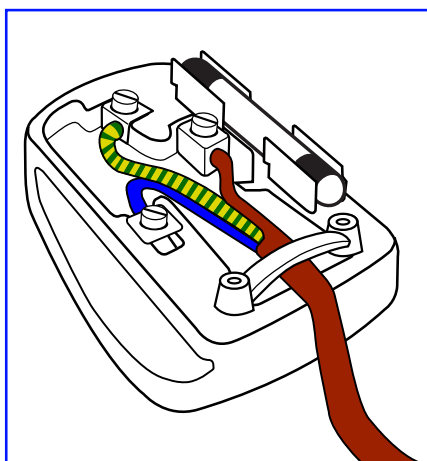

How to connect a plug

The wires in the mains lead are coloured in accordance with the following code:

- BLUE - "NEUTRAL" ("N")
- BROWN - "LIVE" ("L")
- GREEN & YELLOW - "EARTH" ("E")

1. The GREEN & YELLOW wire must be connected to the terminal in the plug which is marked with the letter "E" or by the Earth symbol or coloured GREEN or GREEN & YELLOW.
2. The BLUE wire must be connected to the terminal which is marked with the letter "N" or coloured BLACK.
3. The BROWN wire must be connected to the terminal which marked with the letter "L" or coloured RED.

Before replacing the plug cover, make certain that the cord grip is clamped over the sheath of the lead - not simply over the three wires.

North Europe (Nordic Countries) Information

Placering/Ventilation

VARNING:

FÖRSÄKRA DIG OM ATT HUVUDBRYTARE OCH UTTAG ÄR LÄTÅTKOMLIGA, NÄR DU STÄLLER DIN UTRUSTNING PÅPLATS.

Placering/Ventilation

ADVARSEL:

SØRG VED PLACERINGSFOR, AT NETLEDNINGENS STIK OG STIKKONTAKT ER NEMT TILGÆNGELIGE.

Paikka/Ilmankierto

VAROITUS:

SIIJOITA LAITE SITEN, ETTÄ VERKKOJOHTO VOIDAAN TARVITTAESSA HELPOSTI IRROTTAA PISTORASIESTA.

Plassering/Ventilasjon

ADVARSEL:

NÅR DETTE UTSTYRET PLASSERES, MÅ DU PASSE PÅ AT KONTAKTENE FOR STØMTILFØRSEL ER LETTE Å NÅ.

China RoHS

根据中国大陆《电子电气产品有害物质限制使用标识要求》，以下部分列出了本产品中可能包含的有害物质的名称和含量。

部件名称	有害物质					
	铅 (Pb)	汞 (Hg)	镉 (Cd)	六价铬 (Cr (VI))	多溴联苯 (PBB)	多溴二苯醚 (PBDE)
外壳	○	○	○	○	○	○
液晶显示屏/灯管	×	×	○	○	○	○
电路板组件*	×	○	○	○	○	○
电源适配器	×	○	○	○	○	○
电源线/连接线	×	○	○	○	○	○
遥控器	×	○	○	○	○	○

本表格依据SJ/T 11364 的规定编制。

*: 电路板组件包括印刷电路板及其构成的零部件，如电阻、电容、集成电路、连接器等。

○: 表示该有害物质在该部件所有均质材料中的含量均在 GB/T 26572规定的限量要求以下。

×: 表示该有害物质至少在该部件的某一均质材料中的含量超出GB/T 26572规定的限量要求。

上表中打“×”的部件，应功能需要，部分有害物质含量超出GB/T 26572规定的限量要求，但符合欧盟RoHS法规要求（属于豁免部分）。

备注：上表仅做为范例，实际标示时应依照各产品的实际部件及所含有害物质进行标示。



环保使用期限

此标识指期限(十年)，电子电气产品中含有的有害物质在正常使用的条件下不会发生外泄或突变，电子电气产品用户使用该电子电气产品不会对环境造成严重污染或对其人身、财产造成严重损害的期限。

《废弃电器电子产品回收处理管理条例》提示性说明

为了更好地关爱及保护地球，当用户不再需要此产品或产品寿命终止时，请遵守国家废弃电器电子产品回收处理相关法律法规，将其交给当地具有国家认可的回收处理资质的厂商进行回收处理。

警告

此为A级产品。在生活环境中，该产品可能会造成无线电干扰。在这种情况下，可能需要用户对干扰采取切实可行的措施。

單元	限用物質及其化學符號					
	鉛 (Pb)	汞 (Hg)	鎘 (Cd)	六價鉻 (Cr ⁶⁺)	多溴聯苯 (PBB)	多溴二苯醚 (PBDE)
塑料外框	○	○	○	○	○	○
後殼	○	○	○	○	○	○
液晶面板	—	○	○	○	○	○
電路板組件	—	○	○	○	○	○
底座	○	○	○	○	○	○
電源線	—	○	○	○	○	○
其他線材	—	○	○	○	○	○
遙控器	—	○	○	○	○	○
備考1. “○” 係指該項限用物質之百分比含量未超出百分比含量基準值。 備考2. “—” 係指該項限用物質為排除項目。						

警語：使用過度恐傷害視力。

注意事項：

- (1) 使用30分鐘請休息10分鐘。
- (2) 未滿2歲幼兒不看螢幕，2歲以上每天看螢幕不要超過1小時。

警告使用者：

此為甲類資訊技術設備，於居住環境中使用時，可能會造成射頻擾動，在此種情況下，使用者會被要求採取某些適當的對策。

End-of-Life Disposal

Your new Public Information Display contains materials that can be recycled and reused. Specialized companies can recycle your product to increase the amount of reusable materials and to minimize the amount to be disposed of.

Please find out about the local regulations on how to dispose of your old display from your local Philips dealer.

(For customers in Canada and U.S.A.)

This product may contain lead and/or mercury. Dispose of in accordance to local-state and federal regulations. For additional information on recycling contact www.eia.org (Consumer Education Initiative)

Waste Electrical and Electronic Equipment-WEEE

Attention users in European Union private households



This marking on the product or on its packaging illustrates that, under European Directive 2012/19/EU governing used electrical and electronic appliances, this product may not be disposed of with normal household waste. You are responsible for disposal of this equipment through a designated waste electrical and electronic equipment collection. To determine the locations for dropping off such waste electrical and electronic, contact your local government office, the waste disposal organization that serves your household or the store at which you purchased the product.

Attention users in United States:

Please dispose of according to all Local, State and Federal Laws. For the disposal or recycling information, contact: www.mygreenelectronics.com or www.eiae.org.

End of Life Directives-Recycling



Your new Public Information Display contains several materials that can be recycled for new users.

Please dispose of according to all Local, State, and Federal laws.

Restriction on Hazardous Substances statement (India)

This product complies with the "E-Waste (Management) Rules, 2016" CHAPTER V, rule 16, sub-rule (1) .Whereas New Electrical and Electronic Equipment and their components or consumables or parts or spares do not contain Lead, Mercury, Cadmium, Hexavalent Chromium, polybrominated biphenyls and polybrominated diphenyl ethers beyond a maximum concentration value of 0.1% by weight in homogenous materials for lead, mercury, hexavalent chromium, polybrominated biphenyls and polybrominated diphenyl ethers and of 0.01% by weight in homogenous materials for cadmium, except of exemptions set in Schedule 2 of the Rule.

E-Waste Declaration for India



This symbol on the product or on its packaging indicates that this product must not be disposed of with your other household waste. Instead it is your responsibility to dispose of your waste equipment by handing it over to a designated collection point for the recycling of waste electrical and electronic equipment .The separate collection and recycling of your waste equipment at the time of disposal will help to conserve natural resources and ensure that it is recycled in a manner that protects human health and the environment. For more information about E -waste please visit <http://www.india.philips.com/about/sustainability/recycling/index.page> and to know where you can drop off your waste equipment for recycling in India please contact on below given contact details.

Helpline number: 1800-425-6396 (Monday to Saturday, 9 a.m. to 5:30 pm)

Centralized E-waste collection center

Address:TPV Technology India Private Limited,

59, Maheswari Nagar, 1st Main Road, Mahadevapura Post, Whitefield Road

Bangalore, Karnataka, PIN: 560048, Tel: 080-3023-1000

E-mail: india.callcentre@tpv-tech.com

Batteries



For EU: The crossed-out wheeled bin implies that used batteries should not be put to the general household waste! There is a separate collection system for used batteries, to allow proper treatment and recycling in accordance with legislation.

Please contact your local authority for details on the collection and recycling schemes.

For Switzerland: The used battery is to be returned to the selling point.

For other non-EU countries: Please contact your local authority for correct method of disposal of the used battery.

According to EU directive 2006/66/EC, the battery can't be disposed improperly. The battery shall be separated to collect by local service.

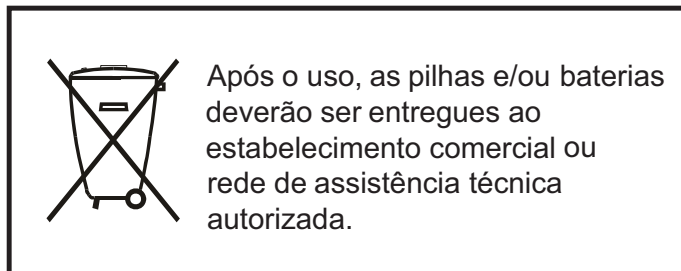

Turkey RoHS:

Türkiye Cumhuriyeti: EEE Yönetmeliğine Uygundur

Ukraine RoHS:

Обладнання відповідає вимогам Технічного регламенту щодо обмеження використання деяких небезпечних речовин в електричному та електронному обладнанні, затвердженого постановою Кабінету Міністрів України від 3 грудня 2008 № 1057

Information for EAC	
Month and year of manufacturing	please refer information in Rating label.
Name and location of manufacturer	ООО "Профтехника" Адрес: 3-й Проезд Марьиной роши, 40/1 офис 1. Москва, 127018, Россия
Importer and information	Наименование организации: ООО "Профтехника" Адрес: 3-й Проезд Марьиной роши, 40/1 офис 1. Москва, 127018, Россия Контактное лицо: Наталья Астафьева, +7 495 640 20 20 nat@profdisplays.ru

Table Of Contents

1. Unpacking and Installation	1
1.1. Unpacking.....	1
1.2. Package Contents.....	1
1.3. Installation Notes.....	1
1.4. Mounting on a Wall.....	2
1.4.1. VESA Grid.....	2
1.5. Using of Remote sensor and power indicator.....	3
2. Parts and Functions	4
2.1. Control Panel.....	4
2.2. Input/Output Terminals.....	5
2.3. Remote Control.....	6
2.3.1. General functions.....	6
2.3.2. ID Remote Control.....	7
2.3.3. Inserting the batteries in the remote control.....	8
2.3.4. Handling the remote control.....	8
2.3.5. Operating range of the remote control.....	8
3. Connecting External Equipment	9
3.1. Connecting External Equipment (DVD/VCR/VCD).....	9
3.1.1. Using COMPONENT video input.....	9
3.1.2. Using Video Source input.....	9
3.1.3. Using HDMI video input.....	10
3.2. Connecting a PC.....	10
3.2.1. Using VGA input.....	10
3.2.2. Using DVI input.....	11
3.2.3. Using HDMI input.....	11
3.2.4. Using DisplayPort input.....	11
3.3. Connecting Audio Equipment.....	12
3.3.1. Connecting external speakers.....	12
3.3.2. Connecting an external audio device.....	12
3.4. Connecting Multiple Displays in a Daisy-chain Configuration.....	12
3.4.1. Display control connection.....	12
3.4.2. Digital video connection.....	13
3.5. IR connection.....	13
3.6. IR Pass-through Connection.....	14
3.7. Wire-connecting to Network.....	14
4. Operation	15
4.1. Watch the Connected Video Source.....	15
4.2. Play multimedia files from USB device.....	15
4.3. Play options.....	15
4.3.1. Playing music files.....	15
4.3.2. Playing movie files.....	15
4.3.3. Playing photo files.....	15
4.4. How to use Opera browser (HTML5).....	16
5. OSD Menu	17
5.1. Navigating the OSD Menu.....	17
5.1.1. Navigating the OSD menu using the remote control.....	17
5.1.2. Navigating the OSD menu using the display's control buttons.....	17
5.2. OSD Menu Overview.....	17
5.2.1. Picture menu.....	17
5.2.2. Screen menu.....	18
5.2.3. Audio menu.....	19
5.2.4. PIP menu.....	19
5.2.5. Configuration1 menu.....	20
5.2.6. Configuration2 menu.....	21
5.2.7. Advanced option menu.....	22
5.2.8. Input menu.....	25
6. USB device compatibility	26
7. Input Mode	28
8. Pixel Defect Policy	29
8.1. Pixels and Sub-Pixels.....	29
8.2. Types of Pixel Defects + Dot Definition.....	29
8.3. Bright Dot Defects.....	29
8.4. Dark Dot Defects.....	30
8.5. Proximity of Pixel Defects.....	30
8.6. Pixel Defect Tolerances.....	30
8.7. MURA.....	30
9. Cleaning and Troubleshooting	31
9.1. Cleaning.....	31
9.2. Troubleshooting.....	32
10. Technical Specifications	33

1. Unpacking and Installation

1.1. Unpacking

- This product is packed in a carton, together with the standard accessories.
- Any other optional accessories will be packed separately.
- Due to the size and weight of this display it is recommended for two people to move it.
- After opening the carton, ensure that the contents are complete and in good condition.

1.2. Package Contents

Please verify that you received the following items with your package content:

- LCD display
- Quick start guide
- Remote control with AAA batteries
- Power cord
- HDMI cable
- RS232 cable
- RS232 daisy chain cable
- IR sensor cable
- Logo

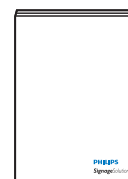
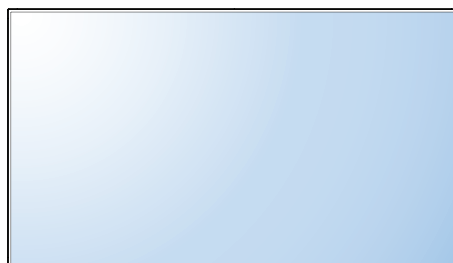

Quick start guide

* The supplied power cord varies depending on destination.



Power Cord



HDMI Cable



Logo

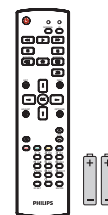

Remote Control and AAA Batteries

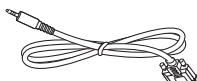

RS232 Cable

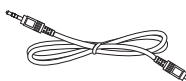

RS232 Daisy Chain Cable



IR Sensor Cable

* Differences according to regions.

Display design and accessories may differ from those illustrated above.

NOTES:

- For all other regions, apply a power cord that conforms to the AC voltage of the power socket and has been approved by and complies with the safety regulations of the particular country.
- You might like to save the package box and packing material for shipping the display.

1.3. Installation Notes

- Due to the high power consumption, always use the plug exclusively designed for this product. If an extended line is required, please consult your service agent.
- The product should be installed on a flat surface to avoid tipping. The distance between the back of the product and the wall should be maintained for proper ventilation. Avoid installing the product in the kitchen, bathroom or any other places with high humidity so as not to shorten the service life of the electronic components.
- The product can normally operate only under 3000m in altitude. In installations at altitudes above 3000m, some abnormalities may be experienced.

1.4. Mounting on a Wall

To mount this display to a wall, you will have to obtain a standard wall-mounting kit (commercially available). We recommend using a mounting interface that complies with TUV-GS and/or UL1678 standard.

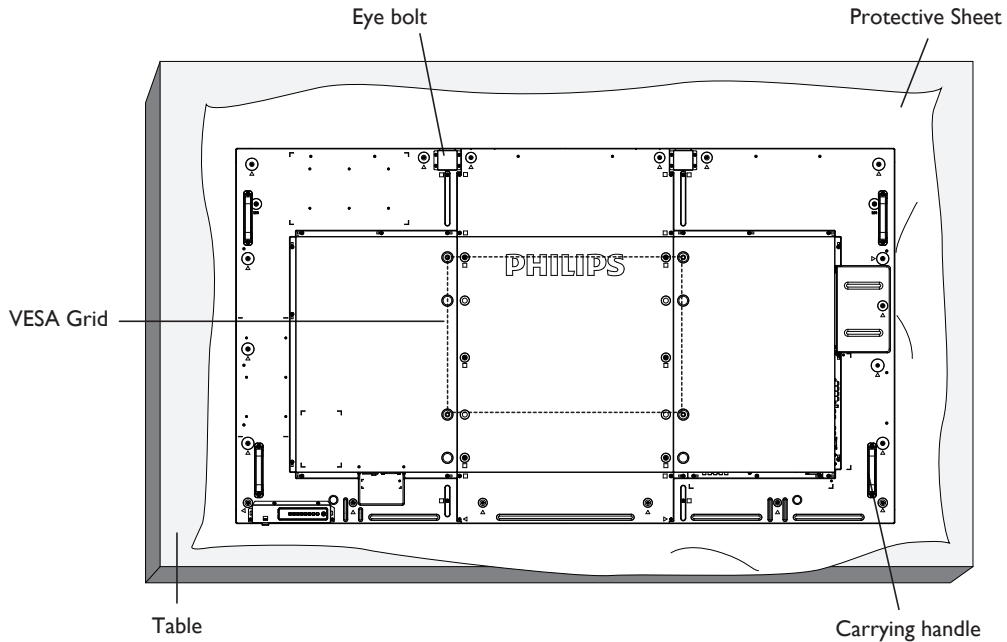

1. Lay a protective sheet on a table, which was wrapped around the display when it was packaged, beneath the screen surface so as not to scratch the screen face.
2. Ensure you have all accessories for mounting this display (wall mount, ceiling mount, table stand, etc).
3. Follow the instructions that come with the base mounting kit. Failure to follow correct mounting procedures could result in damage to the equipment or injury to the user or installer. Product warranty does not cover damage caused by improper installation.
4. For the wall-mounting kit, use M8 mounting screws (having a length 15 mm longer than the thickness of the mounting bracket) and tighten them securely.
5. The eye bolt is for usage in short-time maintenance and installation. We suggest not to use the eye bolt for more than 1 hour. Prolong usage is prohibited. Please keep a clear safety area under the display while using the eye bolt.
6. Portrait is not allowed.

1.4.1. VESA Grid

75BDL3000U	600(H) x 400(V) mm
-------------------	--------------------

Caution:

To prevent the display from falling:

- For wall or ceiling installation, we recommend installing the display with metal brackets which are commercially available. For detailed installation instructions, refer to the guide received with the respective bracket.
- To lessen the probability of injury and damage resulting from fall of the display in case of earthquake or other natural disaster, be sure to consult the bracket manufacturer for installation location.

Ventilation Requirements for enclosure locating

To allow heat to disperse, leave space between surrounding objects as shown in the diagram below.

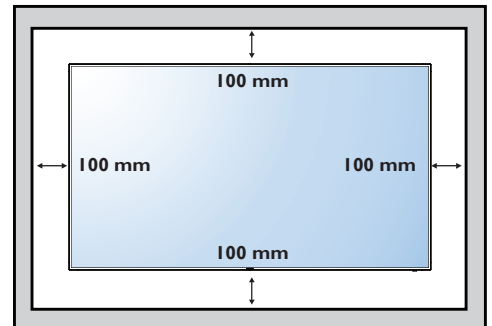

1.5. Using of Remote sensor and power indicator

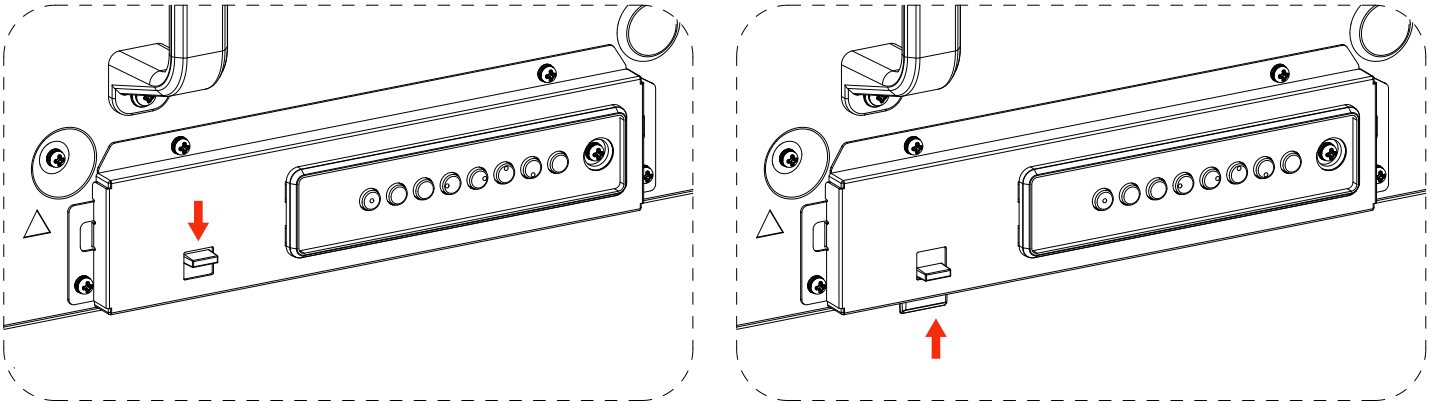

1. Pull down the lens to have better remote control performance and easy to observe the light information of power status.
2. Push up the lens before mounting the display for video wall application.
3. Pull/Push the lens until hearing the click sound

2. Parts and Functions

2.1. Control Panel

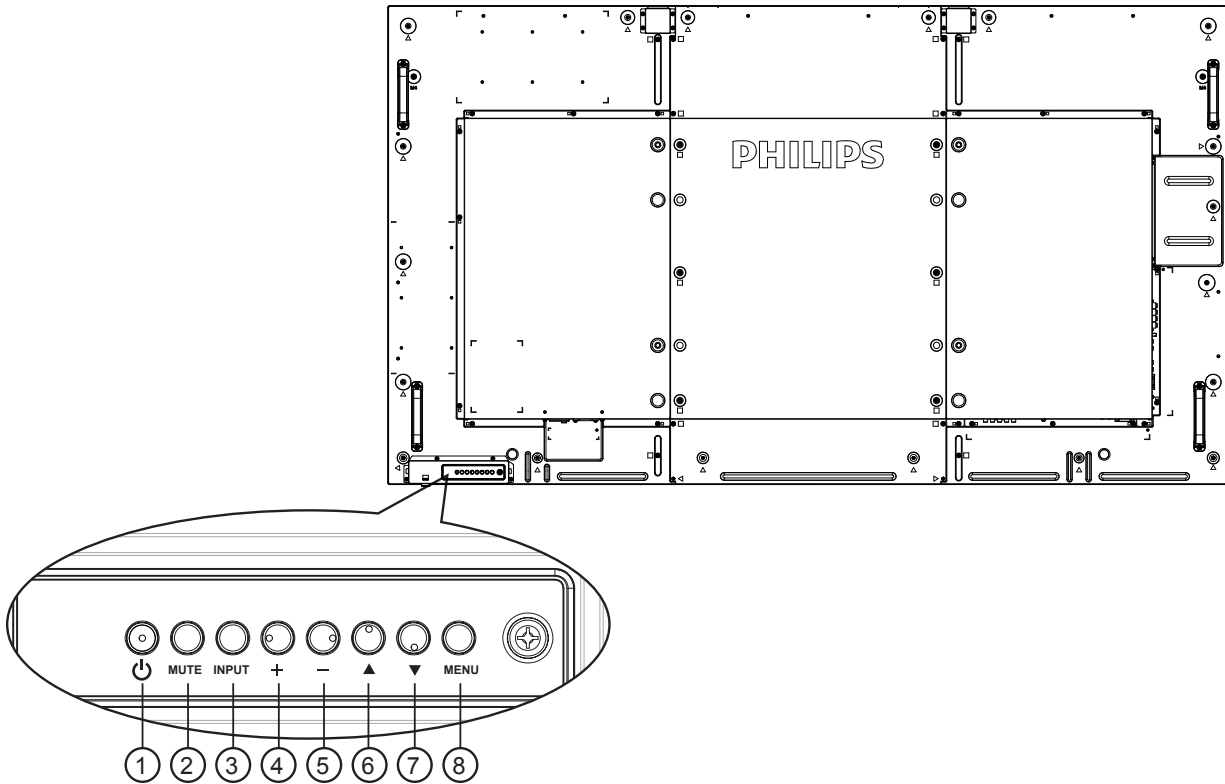

① [Power] button

Use this button to turn the display on or put the display to standby.

② [MUTE] button

Switch the audio mute ON/OFF.

③ [INPUT] button

Use this button to select the input source.

④ [+] button

Increase the adjustment while OSD menu is on, or increase the audio output level while OSD menu is off.

- Used as [OK] button in the On-Screen-Display menu.

⑤ [-] button

Decrease the adjustment while OSD menu is on, or decrease the audio output level while OSD menu is off.

⑥ [▲] button

Move the highlight bar up to adjust the selected item while OSD menu is on.

⑦ [▼] button

Move the highlight bar down to adjust the selected item while OSD menu is on.

⑧ [MENU] button

Return to previous menu while OSD menu is on, or to activate the OSD menu when OSD menu is off.

2.2. Input/Output Terminals

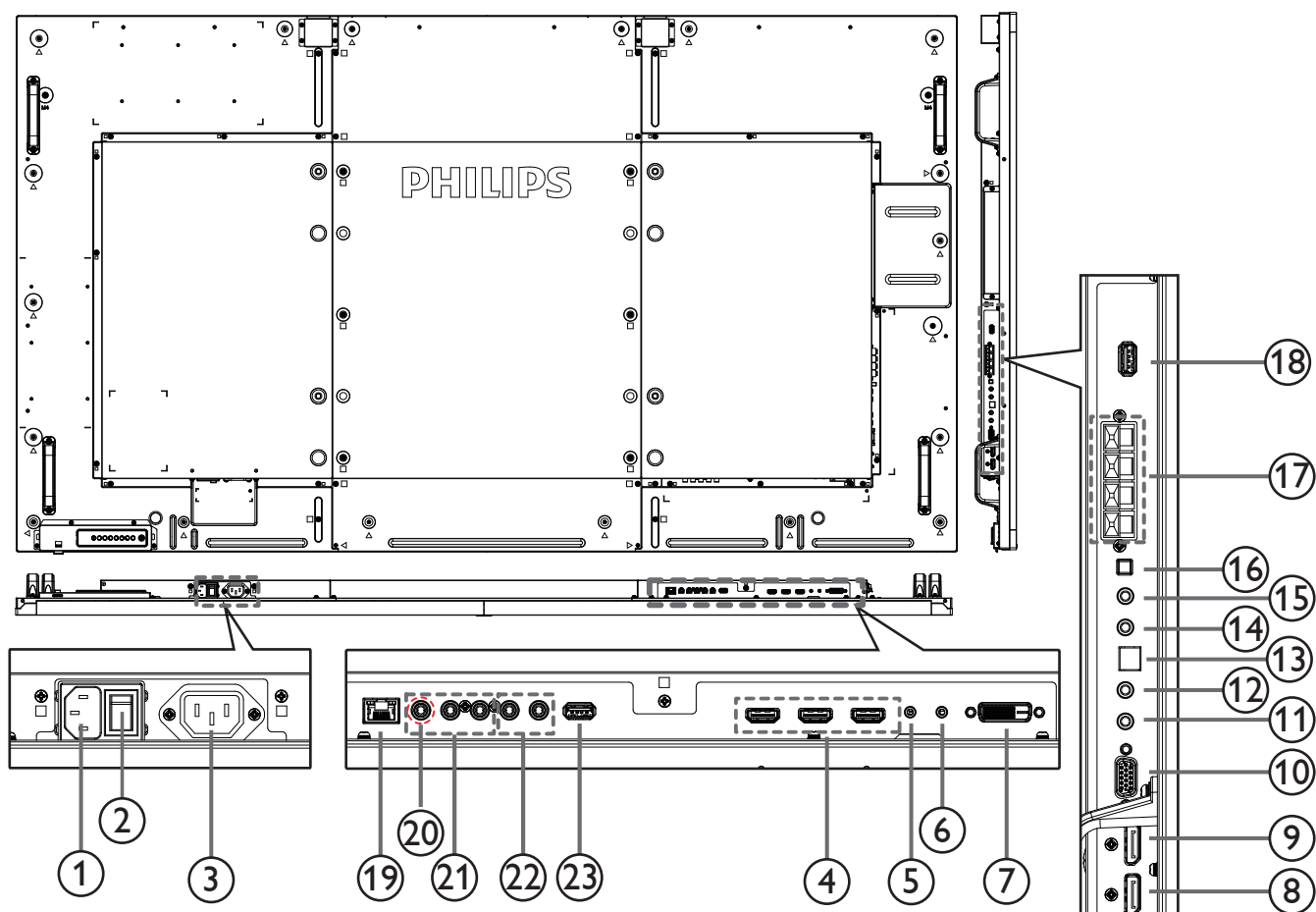

① AC IN

AC power input from the wall outlet.

② MAIN POWER SWITCH

Switch the main power on/off.

③ AC OUT

AC power supply to the AC IN jack of a media player.

④ HDMI1 IN / HDMI2 IN / HDMI3 IN

HDMI video/audio input.

⑤ RS232C IN / ⑥ RS232C OUT

RS232C network input / output for the loop-through function.

⑦ DVI IN

DVI-D video input.

⑧ DisplayPort IN / ⑨ DisplayPort OUT

DisplayPort video input / output.

⑩ VGA IN (D-Sub)

VGA video input.

⑪ IR IN / ⑫ IR OUT

IR signal input / output for the loop-through function.

NOTES:

- This display's remote control sensor will stop working if the jack [IR IN] is connected.
- To remotely control your A/V device via this display, refer to page 14 for IR Pass Through connection.

⑬ SPDIF OUT

Digital audio output

⑭ AUDIO IN

Audio input for VGA source (3.5mm stereo phone).

⑮ AUDIO OUT

Audio output to external AV device.

⑯ SPEAKER SWITCH

Internal speaker on/off switch.

⑰ SPEAKERS OUT

Audio output to external speakers.

⑱ USB SERVICE PORT

Connect to USB storage for main board Firmware update.

NOTE:

It's for updating firmware only.

Remove the plastic plug first before using.

⑲ RJ-45

LAN control function for the use of remote control signal from control center.

⑳ Y/CVBS

Video source input.

㉑ COMPONENT IN

Component YPbPr video source input.

22 AUDIO IN

Audio input from external AV device (RCA).

23 USB PORT

Connect your USB storage device.

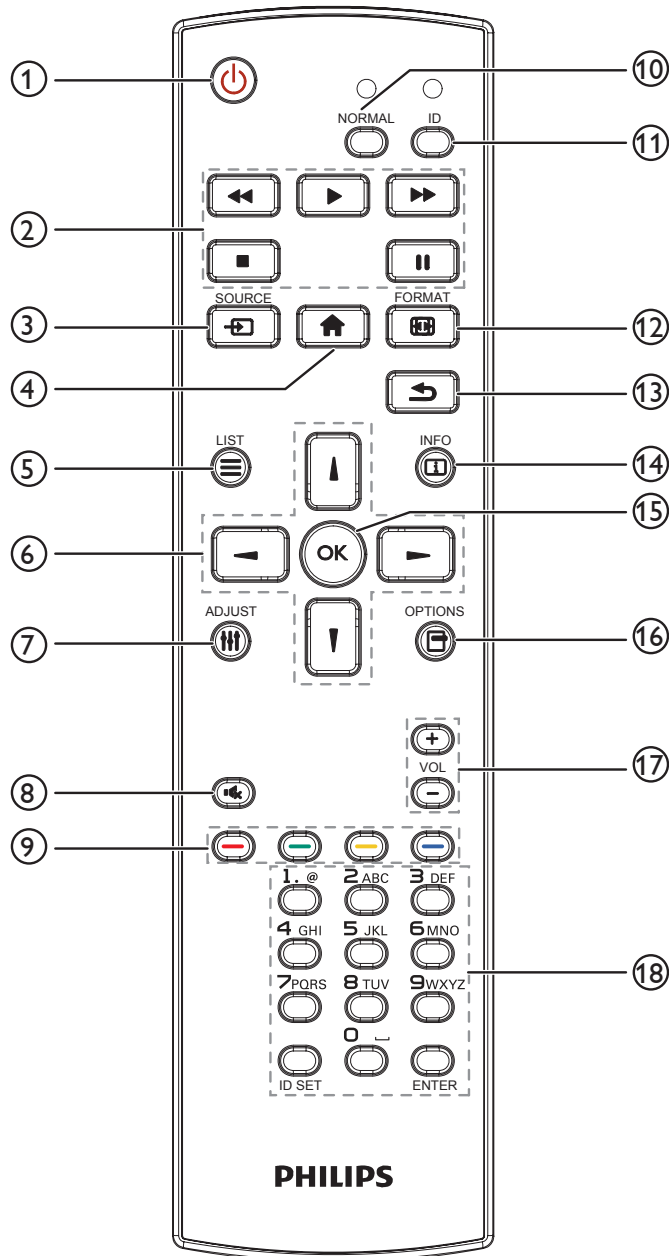
2.3. Remote Control**2.3.1. General functions****1 [POWER] button**

Turn the display on or put the display to standby.

2 [PLAY] buttons

Control playback of media files.

3 [SOURCE] button

Choose input source. Press [A] or [T] button to choose from **DisplayPort, DVI-D, VGA, HDMI 1, HDMI 2, HDMI 3, Component, Video, USB, BROWSER, SmartCMS, or Card OPS**. Press [OK] button to confirm and exit.

4 [HOME] button

Access the OSD menu.

5 [LIST] button

No function.

6 [A] [T] [←] [→] NAVIGATION buttons

Navigate through menus and choose items.

7 [ADJUST] button

To auto adjust for VGA input only.

8 [MUTE] button

Press to turn the mute function on/off.

9 [RED] [GREEN] [YELLOW] [BLUE] COLOR buttons

Choose tasks or options.

10 [NORMAL] buttons

Switch to normal mode.

11 [ID] buttons

Switch to ID mode.

12 [FORMAT] button

Change zoom mode.

13 [BACK] button

Return to the previous menu page or exit from the previous function.

14 [i] INFO button

Display information about current activity.

15 [OK] button

Confirm an entry or selection.

16 [OPTIONS] button

Access currently available options, picture and sound menus.

17 [−] [+] VOLUME button

Adjust volume.

18 [NUMERIC] buttons

Enter text for network setting, and set up ID for ID mode.

2.3.2. ID Remote Control

You can set the remote control ID when you want to use this remote control on one of several different displays.

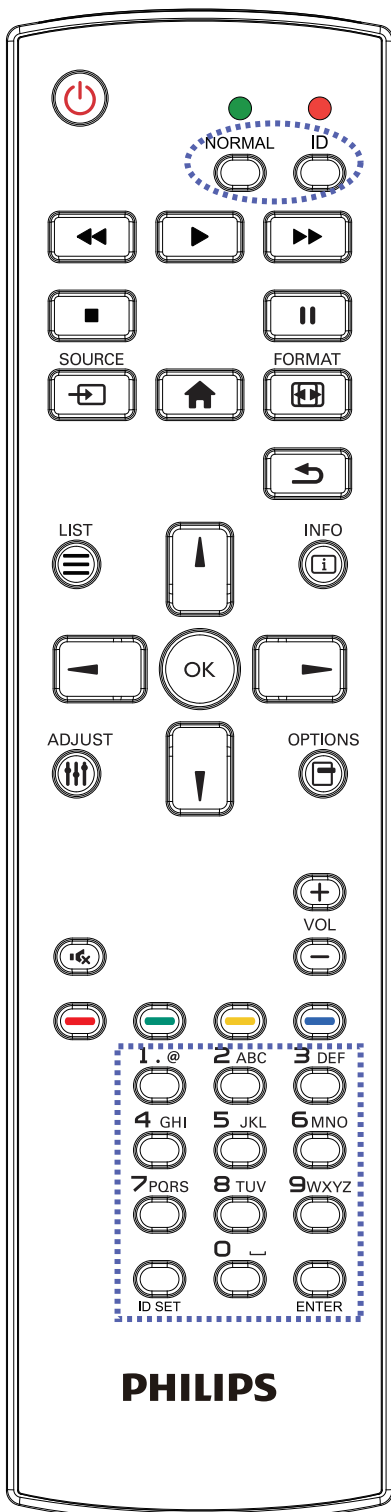

Press [ID] button. The red LED blinks twice.

1. Press [ID SET] button for more than 1 second to enter the ID Mode. The red LED lights up.
Press the [ID SET] button again will exit the ID Mode. The red LED lights off.

Press the digit numbers [0] ~ [9] to select the display you want to control.

For example: press [0] and [1] for display No.1, press [1] and [1] for display No.11.

The numbers available are from [01] ~ [255].

2. Not pressing any button within 10 seconds will exit the ID Mode.
3. If an error pressing of buttons other than the digits occurred, wait 1 second after the red LED lights off and then lights up again, then press the correct digits again.
4. Press [ENTER] button to confirm. The red LED blinks twice and then lights off.

NOTE:

- Press [NORMAL] button. The green LED blinks twice, indicating the display is in normal operation.
- It is necessary to set up the ID number for each display before selecting its ID number.
- Use "||" (pause) key on the remote controller to freeze the screen. Use "▶" (play) key on the remote controller to unfreeze the screen.
- The "freeze" feature only can be adopted on "real" video sources like VGA, AV, YPbPr, HDMI, DVI, DP.
- Any operation on the remote controller or video mode change will unfreeze the screen.

2.3.3. Inserting the batteries in the remote control

The remote control is powered by two 1.5V AAA batteries.

To install or replace batteries:

1. Press and then slide the cover to open it.
2. Align the batteries according to the (+) and (-) indications inside the battery compartment.
3. Replace the cover.

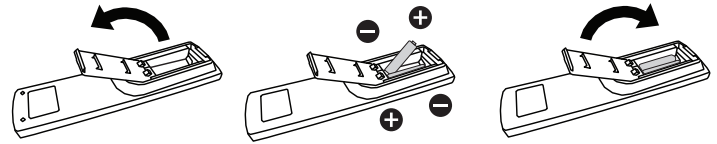

Caution:

The incorrect use of batteries can result in leaks or bursting. Be sure to follow these instructions:

- Place "AAA" batteries matching the (+) and (-) signs on each battery to the (+) and (-) signs of the battery compartment.
- Do not mix battery types.
- Do not combine new batteries with used ones. It causes shorter life or leakage of batteries.
- Remove the dead batteries immediately to prevent them from liquid leaking in the battery compartment. Don't touch exposed battery acid, as it can damage your skin.

NOTE: If you do not intend to use the remote control for a long period, remove the batteries.

2.3.4. Handling the remote control

- Do not subject to strong shock.
- Do not allow water or other liquid to splash the remote control. If the remote control gets wet, wipe it dry immediately.
- Avoid exposure to heat and steam.
- Other than to install the batteries, do not open the remote control.

2.3.5. Operating range of the remote control

Point the top of the remote control toward the display's remote control sensor when pressing a button.

Use the remote control within a distance of less than 5m (pull the lens down and use the remote control from the front) /16ft from the display's sensor; and a horizontal and vertical angle of less than 20 degrees.

NOTE:

- The remote control may not function properly when the remote control sensor on the display is under direct sunlight or strong illumination, or when there is an obstacle in the path of signal transmission.
- Using IR sensor cable for better remote control performance. (Please refer to the instructions of 3.5).

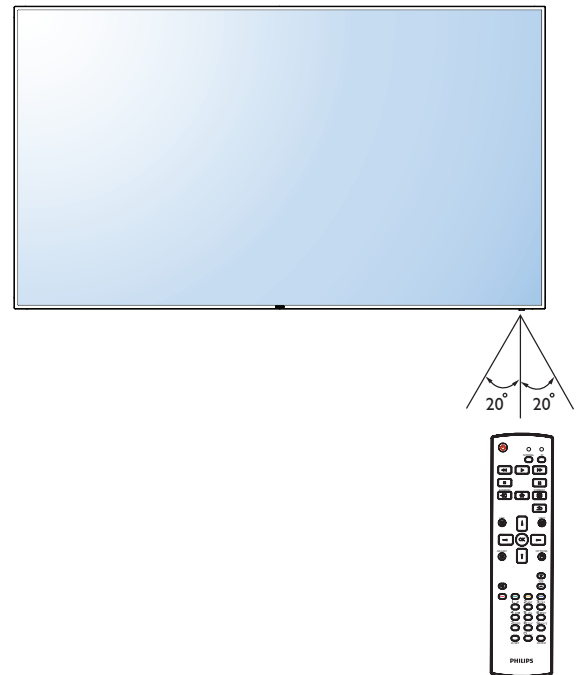

3. Connecting External Equipment

3.1. Connecting External Equipment (DVD/VCR/VCD)

3.1.1. Using COMPONENT video input

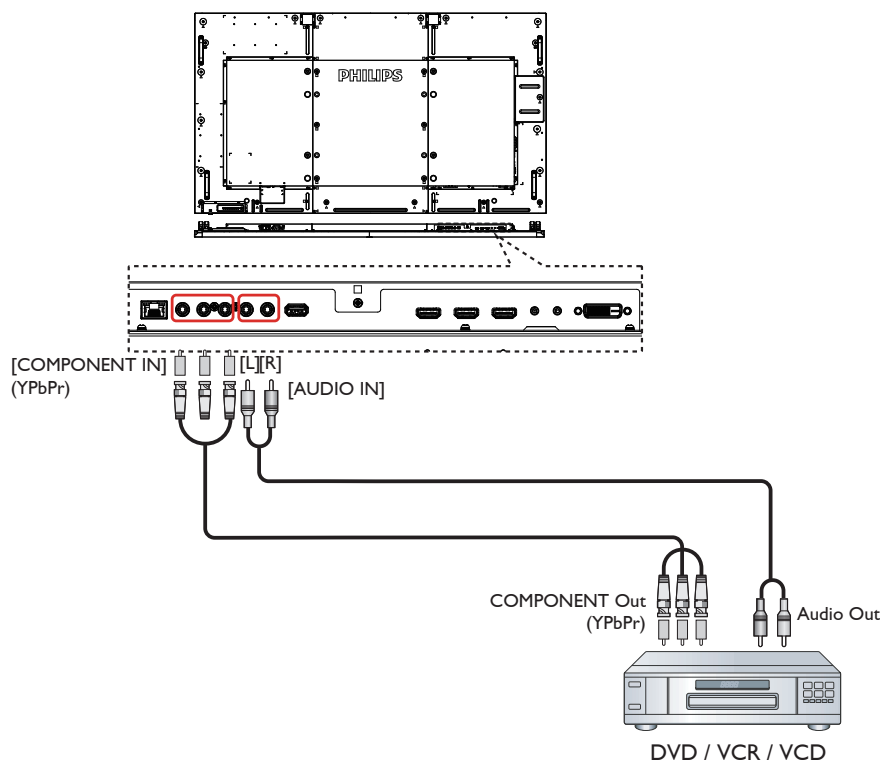

3.1.2. Using Video Source input

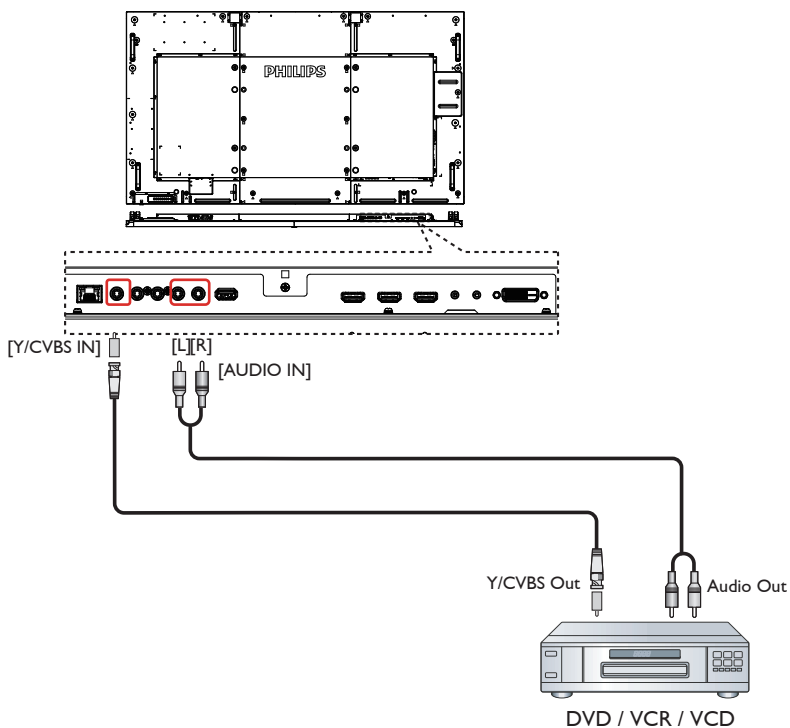

3.1.3. Using HDMI video input

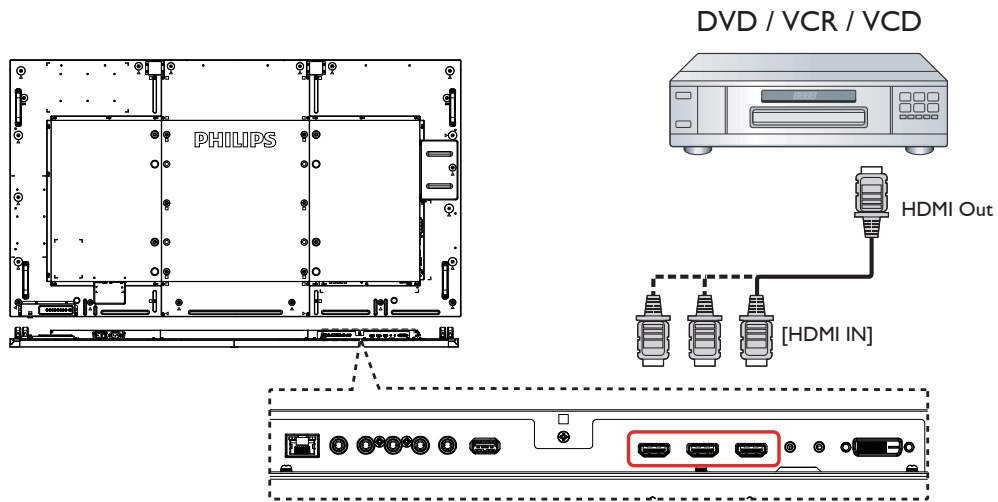

3.2. Connecting a PC

3.2.1. Using VGA input

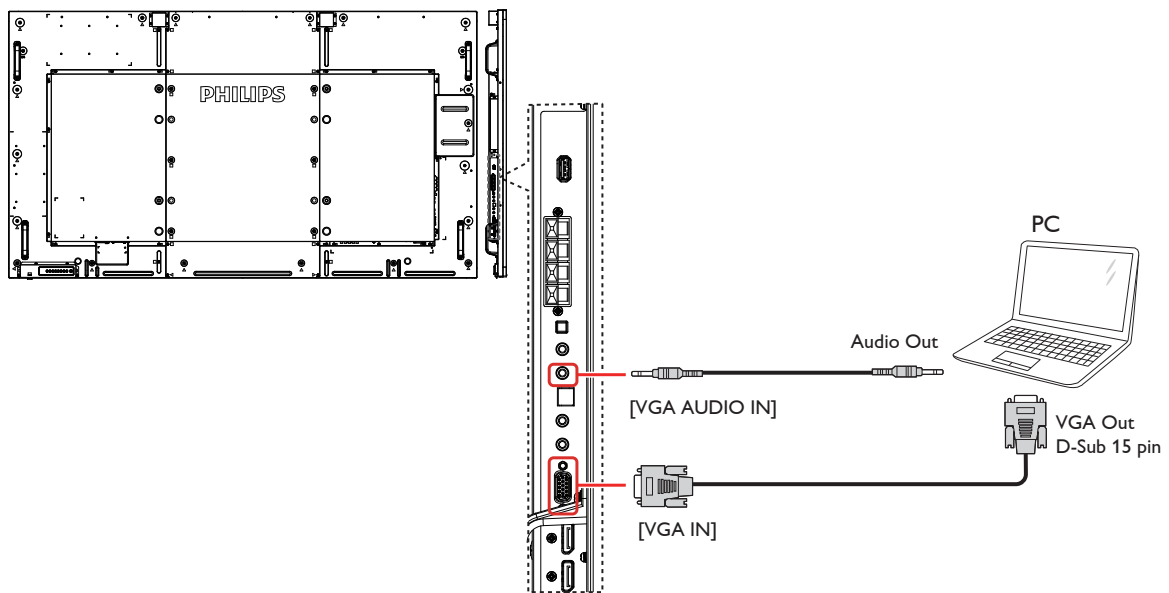

3.2.2. Using DVI input

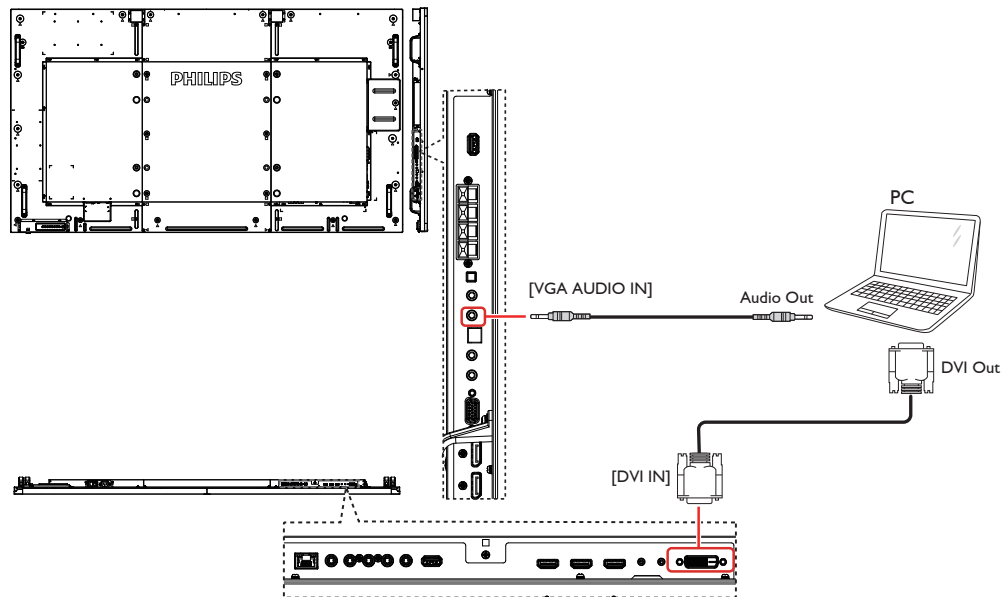

3.2.3. Using HDMI input

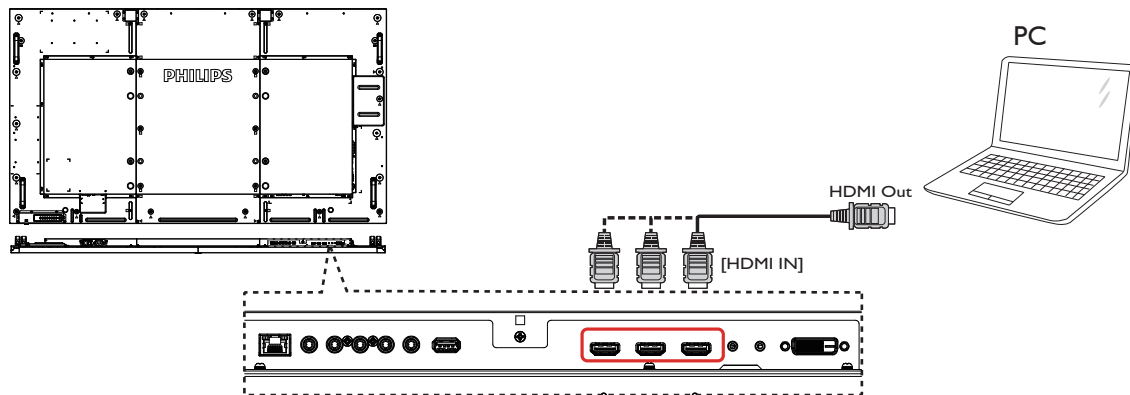

3.2.4. Using DisplayPort input

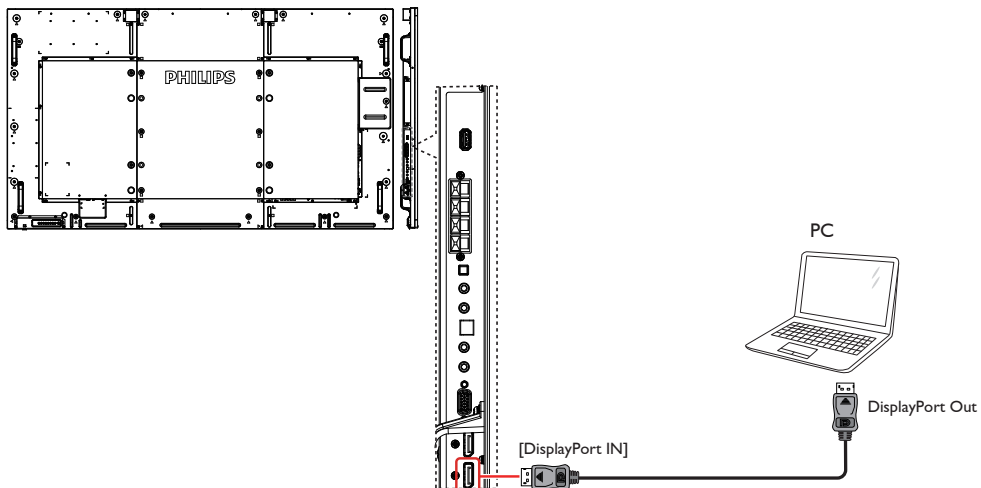

3.3. Connecting Audio Equipment

3.3.1. Connecting external speakers

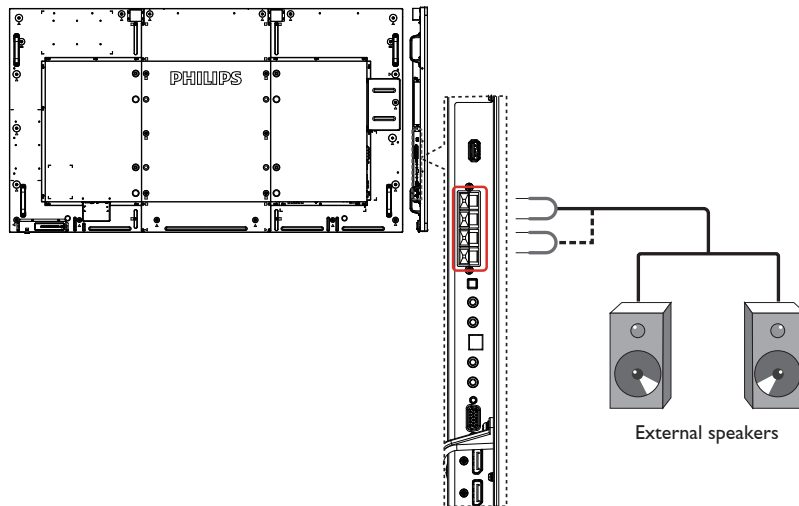

3.3.2. Connecting an external audio device

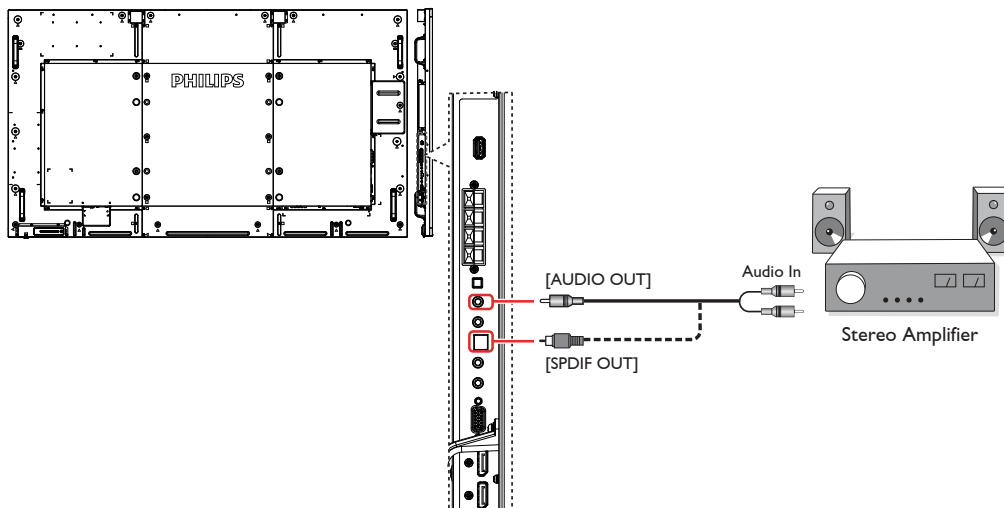

3.4. Connecting Multiple Displays in a Daisy-chain Configuration

You can interconnect multiple displays to create a daisy-chain configuration for applications such as a video wall.

NOTE: Maximum 25 displays (5x5) can be used in a daisy-chain configuration.

3.4.1. Display control connection

Connect the [RS232C OUT] connector of DISPLAY 1 to the [RS232C IN] connector of DISPLAY 2.

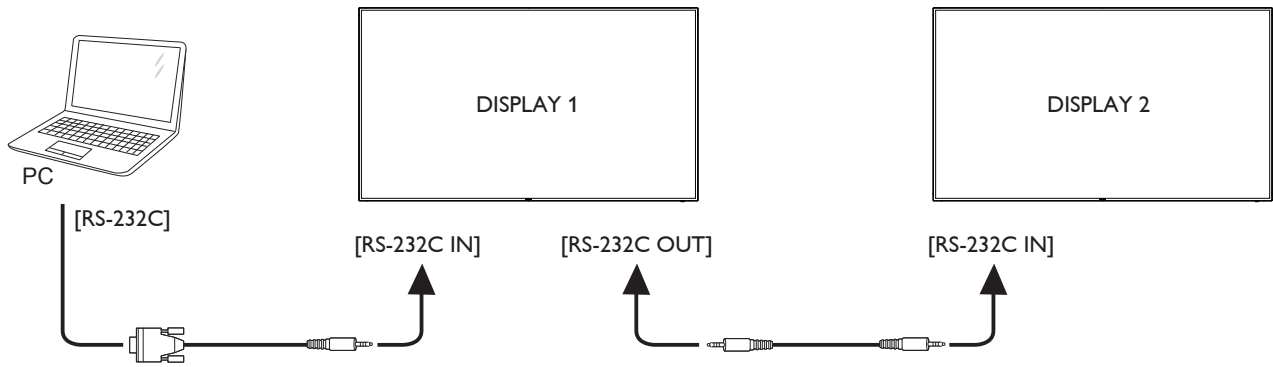

3.4.2. Digital video connection

Connect the [DP OUT] connector of DISPLAY 1 to the [DP IN] connector of DISPLAY 2.

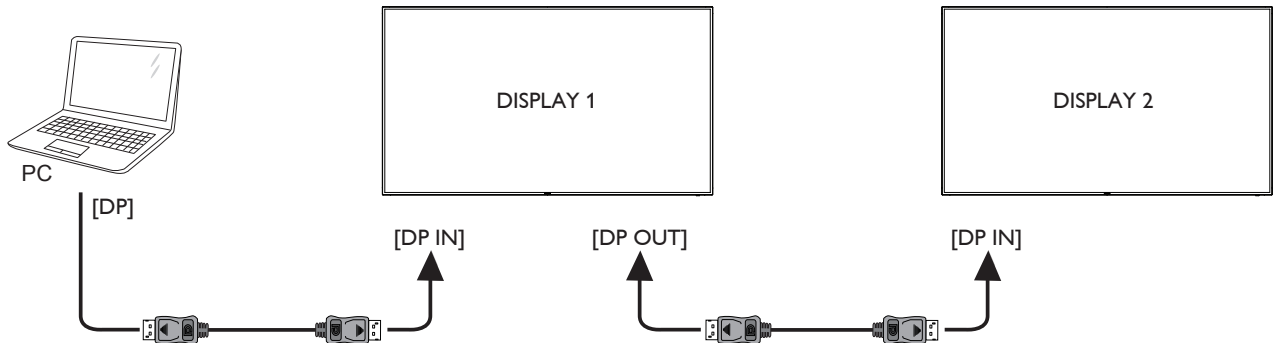

3.5. IR connection

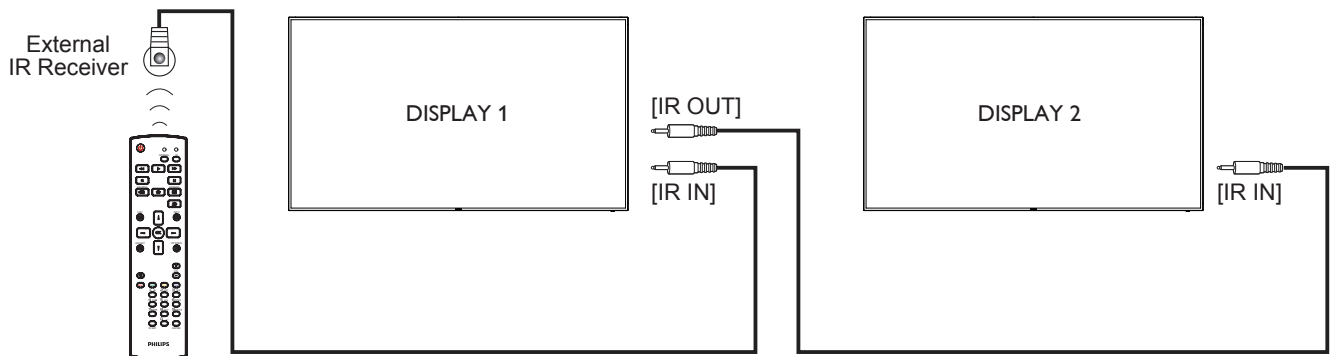

NOTE:

1. This display's remote control sensor will stop working if the [IR IN] is connected.
2. IR loop through connection can support up to 9 displays.

3.6. IR Pass-through Connection

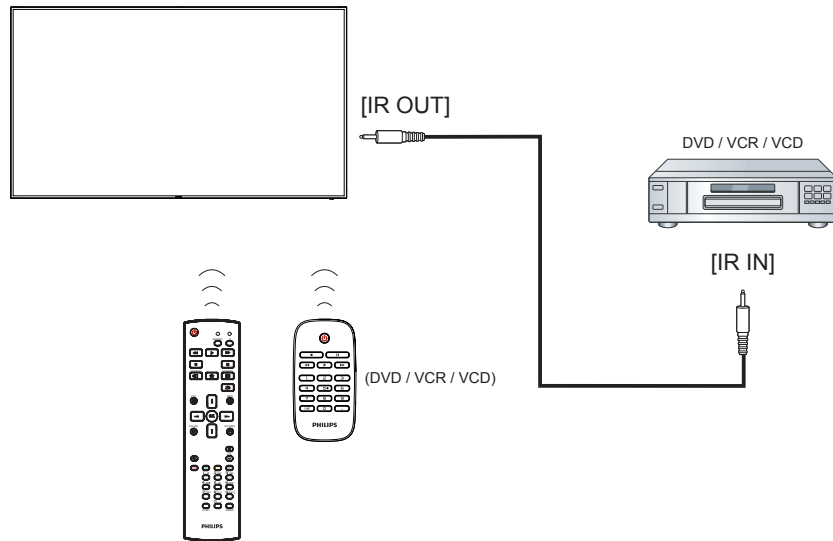

3.7. Wire-connecting to Network

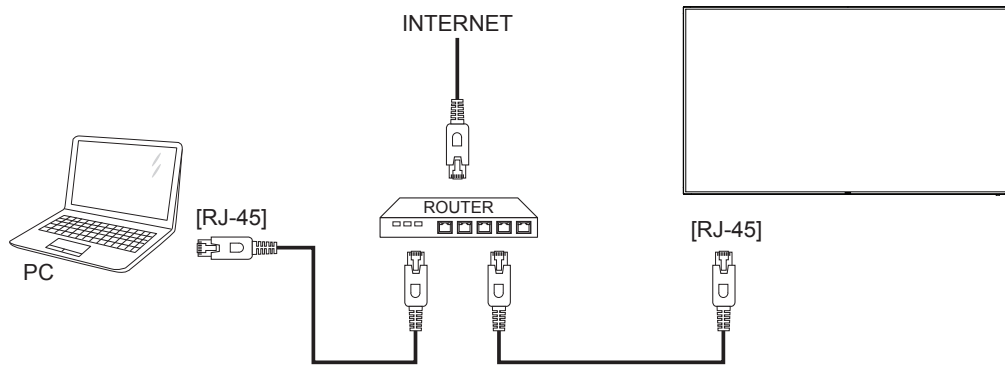

4. Operation

NOTE: The control button described in this section is mainly on the remote control unless specified otherwise.

4.1. Watch the Connected Video Source

See page 13 for external equipments connection.

1. Press **[SOURCE]** button.

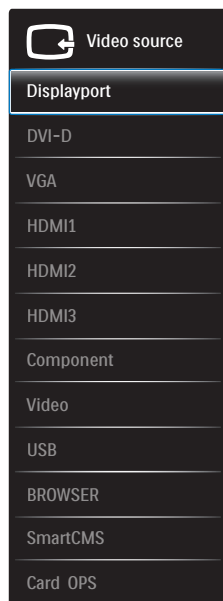

2. Press **[A]** or **[T]** button to choose a device, then press **[OK]** button.

4.2. Play multimedia files from USB device

1. Connect your USB device to the USB port on the display.

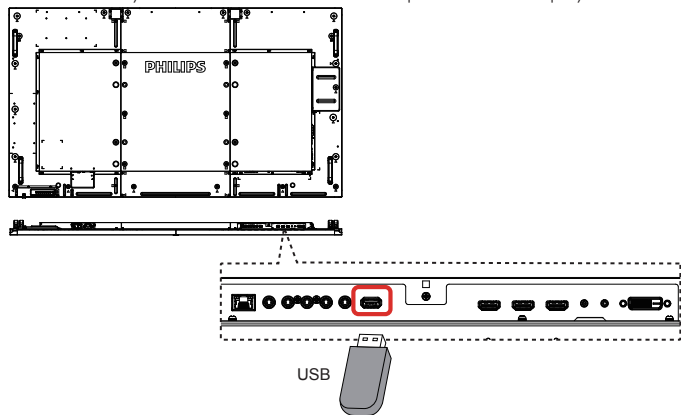

2. Press **[SOURCE]** button, choose **USB**, and press **[OK]** button.
3. The connected USB device is detected automatically for all its playable files, which will be automatically sorted into 3 types: **Music**, **Movie**, and **Photo**.
4. Press **[BACK]** button to go up to the top layer in the screen. Press **[←]** or **[→]** button to choose the file type. Press **[OK]** button to enter its play list.
5. Choose the file you want. Press **[OK]** button to start playing.
6. Follow the on-screen instruction to control the play option.

7. Press **[PLAY]** buttons (**■ || ◀▶ ▶▶**) to control playing.

4.3. Play options

4.3.1. Playing music files

1. Choose **Music** in the top bar.



2. Choose one music track, and press **[OK]** button.
 - To play all the tracks in a folder, choose one music file. Then, press **[▶▶▶]** to **Play All**.
 - To skip to the next or previous track, press **[A]** or **[T]** button.
 - To pause the track, press **[OK]** button. Press **[OK]** button again to resume playback.
 - To skip backward or forward 10 seconds, press **[←]** or **[→]** button.
 - To search backward or forward, press **[◀◀]** or **[▶▶]** button, press repeatedly to toggle between different speeds.
 - To stop the music, press **■** button.

4.3.2. Playing movie files

1. Choose **Movie** in the top bar.



2. Choose a video, and press **[OK]** button.
 - To play all the videos in a folder, choose one video file. Then, press **[▶▶▶]** to **Play All**.
 - To pause the video, press **[OK]** button. Press **[OK]** button again to resume playback.
 - To skip backward or forward 10 seconds, press **[←]** or **[→]** button.
 - To search backward or forward, press **[◀◀]** or **[▶▶]** button, press repeatedly to toggle between different speeds.
 - To stop the video, press **■** button.

4.3.3. Playing photo files

1. Choose **Photo** in the top bar.



2. Choose a photo thumbnail, then press **[OK]** button.

Start a slideshow

If there are multiple photos in a folder, choose a photo. Then, press **[▶▶▶]** to **Play All**.

- To skip to the previous or next photo, press **[←]** or **[→]** button, and then press **[OK]** button.
- To stop the slideshow, press **■** button.

4.4. How to use Opera browser (HTML5)

1. Press [**→**] **SOURCE** button, choose **BROWSER**, and press [**OK**] button.
2. Move the cursor to URL address bar. Press [**OK**] button and it will pop out the on-screen keyboard. You can move the cursor to enter the URL address. After finishing the URL address, choose **Done**.

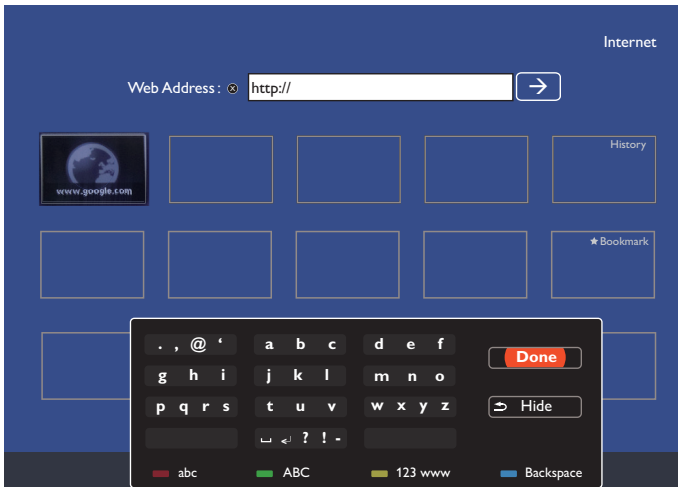

3. Move the cursor to "→" icon and press [**OK**] button.

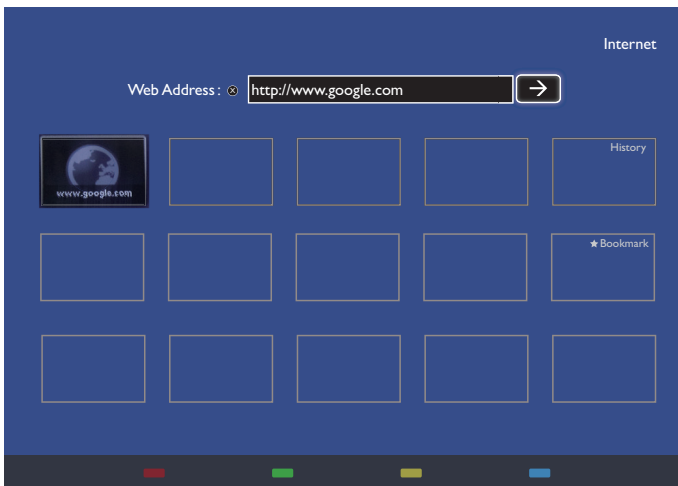

4. Now, you can see the web page.

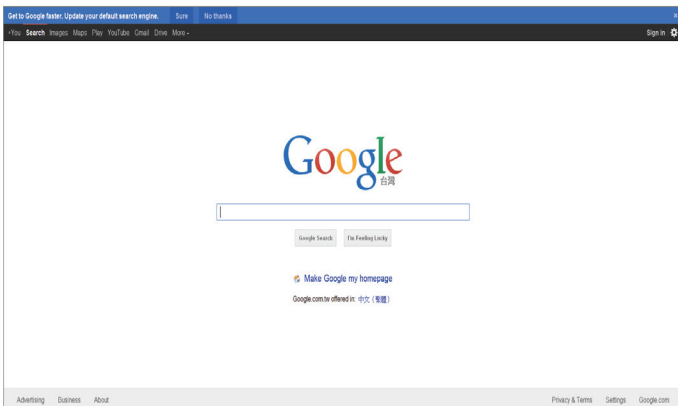

NOTES:

- The Opera browser does not support FLASH format.
- The browser is not a video source. It will not stay at the browser screen after you restart the display.

5. OSD Menu

An overall view of the On-Screen Display (OSD) structure is shown below. You can use it as a reference for further adjusting your display.

5.1. Navigating the OSD Menu

5.1.1. Navigating the OSD menu using the remote control

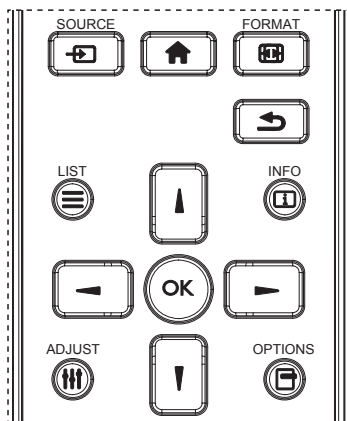

1. Press [HOME] button on the remote control to display the OSD menu.
2. Press [LIST] or [INFO] button to choose the item you want to adjust.
3. Press [OK] or [RIGHT] button to enter the submenu.
4. In the submenu, press [LIST] or [INFO] button to toggle among items, press [LEFT] or [RIGHT] button to adjust settings. If there is a submenu, press [OK] or [RIGHT] button to enter the submenu.
5. Press [RETURN] button to return to the previous menu, or press [HOME] button to exit the OSD menu.

NOTES:

- When there is no OSD menu on the screen, press [LIST] to display the menu of {Smart picture}.
- When there is no OSD menu on the screen, press [INFO] to display the menu of {Audio source}.

5.1.2. Navigating the OSD menu using the display's control buttons

1. Press [MENU] button to display the OSD menu.
2. Press [UP] or [DOWN] button to choose the item you want to adjust.
3. Press [UP] button to enter the submenu.
4. In the submenu, press [UP] or [DOWN] button to toggle among items, press [UP] or [DOWN] button to adjust settings. If there is a submenu, press [UP] button to enter the submenu.
5. Press [MENU] button to return to the previous menu, or press [MENU] button several times to exit the OSD menu.

5.2. OSD Menu Overview

5.2.1. Picture menu

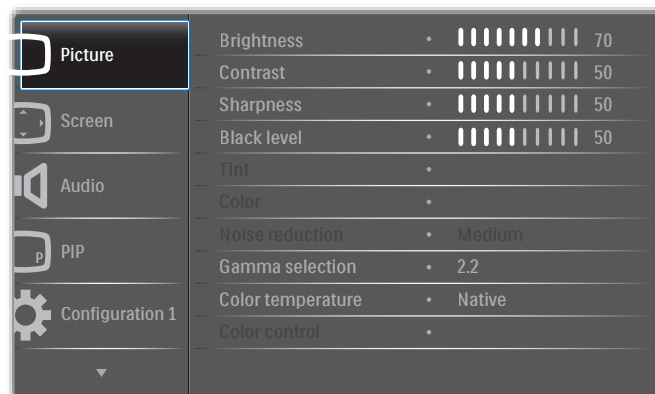

Brightness

Adjust the overall image brightness by changing the intensity of the LCD panel's backlight.

Contrast

Adjust to sharpen the picture quality. The black portions of the picture become richer in darkness and the white become brighter.

Sharpness

Adjust to improve the image detail.

Black level

Video black level is defined as the level of brightness at the darkest (black) part of a visual image. Adjust to change the image brightness.

Tint

Adjust to change the color tint of the image.

Use the [LEFT] or [RIGHT] button to adjust. Press the [RIGHT] button and the flesh tone color turns slightly green. Press the [LEFT] button and the flesh tone color turns slightly purple.

NOTE: This item functional for Video mode(YUV color space) only.

Color

Adjust to increase or decrease the intensity of colors in the image.

NOTE: This item functional for Video mode(YUV color space) only.

Noise reduction

Adjust to remove the noise in the image. You can select a suitable noise reduction level.

Choose from: {Off} / {Low} / {Medium} / {High}.

NOTE: This item functional for Video mode(YUV color space) only.

Gamma selection

Gamma is what controls the overall brightness of an image. Images which are not corrected properly can appear too white or too dark, so controlling the gamma properly can have a huge influence on the overall picture quality of your display.

The options are: {Native} / {2.2} / {2.4} / {S gamma} / {D-image}.

Color temperature

Select a color temperature for the image. A lower color temperature will have a reddish tint, whilst a higher color temperature gives off a more bluish tint.

Choose from: {3000K} / {4000K} / {5000K} / {6500K} / {7500K} / {9300K} / {10000K} / {Native} / {User 1} / {User 2}.

Color control

You can adjust the color tones of the image precisely by changing the **User-R** (Red), **User-G** (Green) and **User-B** (Blue) settings independently when the following condition:

{Picture} - {Color temperature} - {User} setting to [User 1]

Or, you can adjust the color tones per 100K in the range of 2000K to 10000K when the following condition:

{Picture} - {Color temperature} - {User} setting to [User 2]

Smart picture

The following smart picture modes are available for:

- PC mode: {Standard} / {Highbright} / {sRGB}.
- Video mode: {Standard} / {Highbright} / {Cinema}.

Smart contrast

Smart contrast function is to enhance image contrast on darker scenes when activated. The {Brightness} setting in the **Picture** menu will be disabled when Smart Contrast is activated.

Smart power

Set the display to reduce the power consumption automatically.

The options are: {Off} / {Medium} / {High}.

Light sensor

Light sensor function is to adjust brightness automatically when ambient light changed

Scan mode

Change the display area of the image.

- {Over scan} - Display about 95% of the original size of the image. The rest of the areas surrounding the image will be cut off.
- {Under scan} - Display the image in its original size.

Picture reset

Reset all settings in the **Picture** menu.

5.2.2. Screen menu

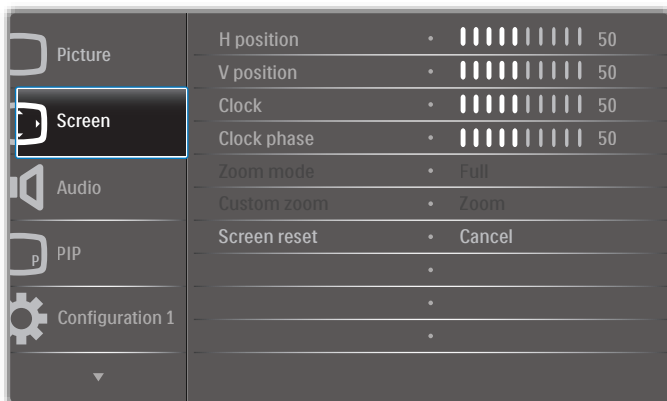

H position

Press the [→] button to move the image to the right, or [←] to move the image to the left.

NOTES:

- H position adjustment is functional for **VGA** input only.
- H position cannot be adjusted when {Pixel Shift} is activated.

V position

Press the [↑] button to move the image up, or [↓] to move the image down.

NOTES:

- V position adjustment is functional for **VGA** input only.
- V position cannot be adjusted when {Pixel Shift} is activated.

Clock

Adjust the width of the image.

NOTE: This item is functional for **VGA** input only.

Clock phase

Adjust to improve the focus, clarity and stability of the image.

NOTE: This item is functional for **VGA** input only.

Zoom mode

The pictures you receive may be transmitted in 16:9 format (wide screen) or 4:3 format (conventional screen). The 16:9 pictures sometimes have a black band at the top and bottom of the screen (letterbox format). Zoom Mode will be deactivated when {Pixel Shift} is activated or turned on, and when {Tiling} is enabled.

Choose from: {Full} / {Normal} / {Real} / {21:9} / {Custom}.

	<p>Full</p> <p>This mode restores the correct proportions of pictures transmitted in 16:9 using the full screen display.</p>
	<p>Normal</p> <p>The picture is reproduced in 4:3 format and a black band is displayed on either side of the picture.</p>
	<p>Real</p> <p>This mode displays the image pixel-by-pixel on screen without scaling the original image size.</p>
	<p>21:9</p> <p>The picture is enlarged to 21:9 format. This mode is recommended when displaying pictures that have black bands at the top and bottom (letterbox format).</p>
	<p>Custom</p> <p>Choose to apply the custom zoom settings in the Custom Zoom submenu.</p>

Custom zoom

You can use this function to further customize the zoom settings to suit the image you want to display.

NOTE: This item is functional only when the {Zoom mode} is set to {Custom}.

	<p>Zoom</p> <p>Expands the horizontal and vertical sizes of the image simultaneously.</p>
	<p>H zoom</p> <p>Expands the horizontal size of the image only.</p>
	<p>V zoom</p> <p>Expands the vertical size of the image only.</p>

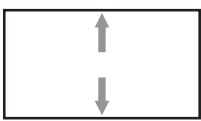
	H position Moves the horizontal position of the image left or right.
	V position Moves the vertical position of the image up or down.

Screen reset

Reset all settings in the **Screen** menu to factory preset values.

5.2.3. Audio menu

Picture	Balance	•		50
	Treble	•		50
Screen	Bass	•		50
	Volume	•		30
Audio	Maximum volume	•		100
	Minimum volume	•		0
	Mute	•	Off	
PIP	Audio reset	•	Cancel	
		•		
Configuration 1		•		

Balance

Adjust to emphasize left or right audio output balance.

Treble

Adjust to increase or decrease higher-pitched sounds.

Bass

Adjust to increase or decrease lower-pitched sounds.

Volume

Adjust to increase or decrease the audio output level.

Maximum volume

Adjust your own limitation for the maximum volume setting. This stops the volume from being playing at too loud a level.

Minimum volume

Adjust your own limitation for the minimum volume setting.

Mute

Turn the mute function on/off.

Audio reset

Reset all settings in the **Audio** menu to factory preset values.





5.2.4. PIP menu

Picture	Sub mode	•	Off
	PIP size	•	Small
Screen	PIP position	•	Bottom-Left
	PIP change	•	Cancel
Audio	PIP reset	•	Cancel
		•	
PIP		•	
		•	
Configuration 1		•	
		•	

Sub mode

Select the PIP (Picture-in-Picture) mode.

Choose from: {Off} / {PIP} / {POP} / {Quick swap} / {PBP 2Win} / {PBP 3Win} / {PBP 4Win}.

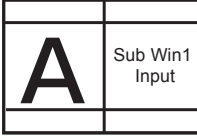
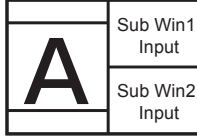
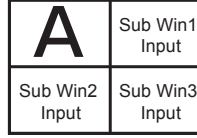
Off 	PIP 	POP 
Quick swap		
		Switch main on top or sub on top.
PBP 2Win 	PBP 3Win 	PBP 4Win 

PIP size

Select the size of the sub picture in the PIP (Picture-in-Picture) mode.

Choose from: {Small} / {Medium} / {Large}.

PIP position

Select the position of the sub picture in the PIP (Picture-in-Picture) mode.

Choose from: {Bottom-Right} / {Bottom -Left} / {Top-Right} / {Top-Left}.

PIP change

Exchange input signal of Main and Sub for **PIP** / **POP** / **Quick swap** mode.

PIP reset

Reset all settings in the **PIP** menu to factory preset values.

NOTES:

- The PIP function is available only for the following condition: {Advanced option} - {Tiling} - {Enable} setting to [No].

- The PIP function is available only for certain signal source combinations as shown in the table below.

Sub	Main												
	DP	OPS	HDMI1	VGA	HDMI2	HDMI3	COMP	VIDEO	USB	BROWSER	SmartCMS	DVI	
DP	○	○	○	○	○	○	○	○	○	○	○	○	
OPS	○	○	X	○	○	○	○	○	○	○	○	○	
HDMI1	○	X	○	○	○	○	○	○	○	○	○	○	
VGA	○	○	○	○	○	○	○	○	○	○	○	○	
HDMI2	○	○	○	○	○	X	○	○	○	○	○	○	
HDMI3	○	○	○	○	X	○	○	○	○	○	○	○	
COMP	○	○	○	○	○	○	○	X	X	X	X	○	
VIDEO	○	○	○	○	○	○	X	○	X	X	X	○	
USB	○	○	○	○	○	○	X	X	○	X	X	○	
BROWSER	○	○	○	○	○	○	X	X	X	○	X	○	
SmartCMS	○	○	○	○	○	○	X	X	X	○	○	○	
DVI	○	○	○	○	○	○	○	○	○	○	○	○	

(○: PIP function available, X: PIP function unavailable)

- The availability of the PIP function will also depend on the resolution of the input signal being used.

5.2.5. Configuration1 menu

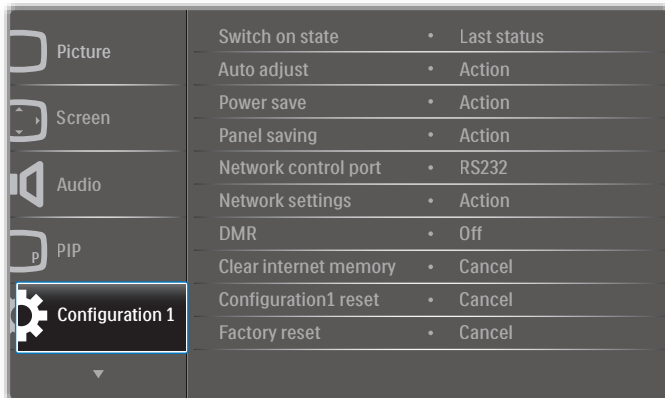

Switch on state

Select the display status used for the next time you connect the power cord.

- {Power off} - The display will remain off when the power cord is connected to a wall outlet.
- {Forced on} - The display will turn on when the power cord is connected to a wall outlet.
- {Last status} - The display will return to the previous power status (on/off/standby) when removing and replacing the power cord.

Auto adjust

Use this function to automatically optimize the display of VGA input image.

NOTE: This item is functional for **VGA** input only.

Power save

Use this setting to reduce the power automatically.

- {RGB} - Select {On} to let the display enter power saving mode when no signal is detected from the PC mode (RGB color space) inputs after 10 seconds.
- {Video} - Select {On} to enter power saving mode when no signal is detected from the VIDEO mode (YUV color space) inputs after 10 seconds.

Panel saving

Choose to enable the panel saving functions and thus reduce the risk of "image persistence" or "ghost-imaging".

- {Cooling Fan} - Choose to adjust the cooling fan's speed of rotation. Select {Auto} to turn on/off the cooling fan according to the display's temperature.

Choose from: {Auto} / {Off} / {Low} / {Medium} / {High}.

NOTES:

- The default {Auto} option will start running the cooling fan if the temperature of **55°C (130°F)** is reached, and stop running the cooling fan if the temperature of **53°C (127°F)**.
- A temperature-warning message will be shown on the screen if the temperature reaches **68°C (154°F)**. All key functions except [Power] key will then be disabled.
- Once the temperature reaches **70°C (158°F)**, the display power will be shut down automatically.
- {Brightness} - Select {On} and the image brightness will be reduced to an appropriate level. The Brightness setting in the Picture menu will be unavailable when selected.
- {Pixel shift} - Select the time interval ({Auto} / {10 ~ 900} Seconds / {Off}) for the display to slightly expand the image size and shift the position of pixels in four directions (up, down, left, or right). Activating Pixel Shift will disable H Position, V Position and Zoom Mode in the Screen Menu.

Network control port

Select the network control port.

Choose from: {RS232} / {Card OPS RS232} / {LAN ->RS232}.

NOTE: After connected to your OPS device, the option {Card OPS RS232} is functional.

Network settings

Assign {IP address}, {Subnet Mask}, and {Default gateway} for the display.

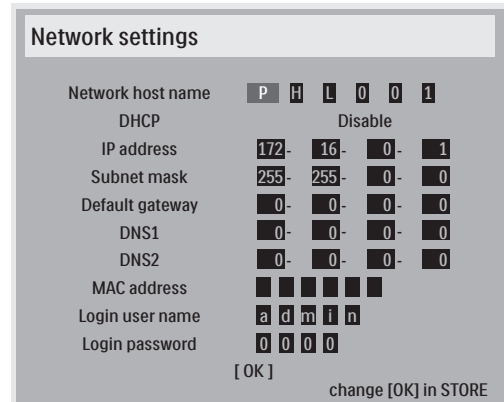

- Network host name
- DHCP - Choose to enable or disable the DHCP function. If enabled, the display will be assigned IP address, Subnet mask and Default gateway automatically. If disabled, you will be prompted to enter the following values manually. Press [OK] button to store and save the chosen values.
- IP address
- Subnet mask
- Default gateway
- DNS1
- DNS2
- MAC address
- Login user name (The default user name is {admin})
- Login password (The default password is {0000})

DMR

Receive multimedia files from the connected device by your network.

Clear internet memory

Clear all the cookies, bookmarks, history list and text used for filling automatically.

Configuration1 reset

Reset all settings in **Configuration1** menu to the factory preset values.

Factory reset

Reset all settings in the OSD menus of {Picture}, {Screen}, {Audio}, {PIP}, {Configuration1}, {Configuration2}, and {Advanced option} to the factory preset values.

Press [←] or [→] button to select {Reset}, and press [OK] button to do the reset.

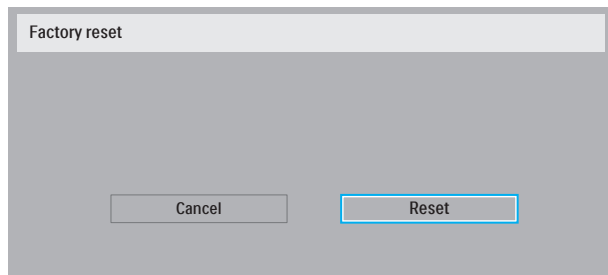

5.2.6. Configuration2 menu

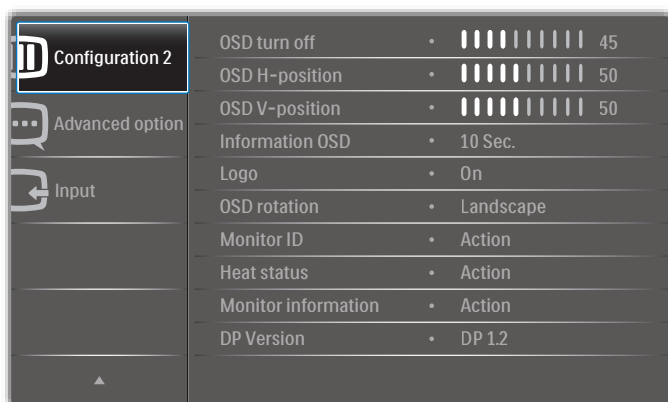

OSD turn off

Set the period of time the OSD (on-screen display) menu stays on the screen.

The options are: {0 ~ 120} seconds.

OSD H-position

Adjust the horizontal position of the OSD menu.

OSD V-position

Adjust the vertical position of the OSD menu.

Information OSD

Set the period of time the information OSD is displayed on the upper right corner of the screen. The information OSD will display when input signal is changed.

The information OSD will remain on the screen with {Off} selection.

The options are: {Off, 1 ~ 60} seconds.

Logo

Enable or disable to show the **PHILIPS** logo when you turn on the display.

OSD rotation

Rotate the OSD Menu.

The options are:

- {Landscape} (Default)
- {Portrait}

Monitor ID

Set the ID number for controlling the display via the RS232C connection. Each display must have a unique ID number when multiple sets of this display are connected. Monitor ID number range is between 1 to 255.

The option are: {Monitor group} / {Tiling matrix} / {Auto ID}

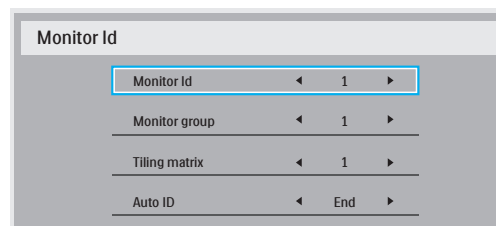

- {Monitor group}

The options are: {1-255}. The default setting is 1.

- {Tiling matrix}

Tiling matrix number range is between 1 to 15. 1 is default setting. The {Auto ID} setup function enables setting up {Monitor ID} of connected machine according to {Tiling matrix} settings.

Example: Tiling matrix sets as 4

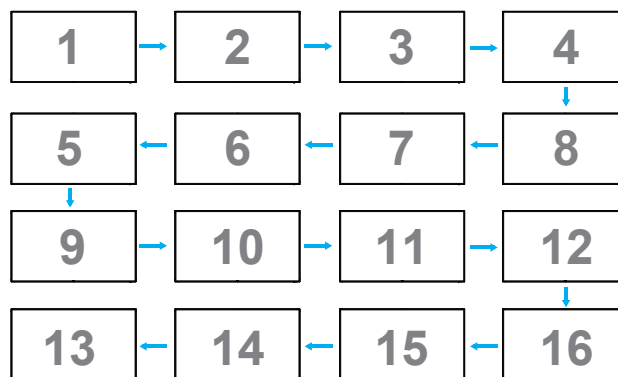

- {Auto ID}

The option are: {Start} / {End}. The default is {End}.

- Switch to Start option to set up IDs of machines backward from current one.
- Once the setup is completed, the option exits to End automatically.
- To use this function, serial connect all machines with RS-232 cable and set their Control ports to RS-232, too.

Heat status

This function allows you to check the thermal status of the display at any time.

Monitor information

Shows information about your display, including model number, serial number, operating hours and software version.

Monitor information	
Model name	75BDL3000U
Serial no	CNCA123456789
Operation hours	46H45M
SW Version	V0.300

DP Version

The option are: {DP 1.1} / {DP 1.2} / {DP 1.2 multi}. The default is {DP 1.1}.

Human sensor

Set the display to turn on backlight if it does sensor human and turn off backlight after an amount of time specified

The options are: {Off, 10 ~ 60} minutes.

HDMI edid

The option are: {HDMI 1.4} / {HDMI 2.0}. The default is {HDMI 1.4}.

NOTE: HDMI 2.0 option is to support HDMI 2.0 equipment use.

Image rotation

Set the picture of main Window to rotate 270 degrees.

The options are: {Off} (default) / {On}.

Power LED light

Choose to control the power LED.

The options are: {Off} / {On} (default).

Configuration2 reset

Reset all settings in Configuration2 menu to the factory preset values.

5.2.7. Advanced option menu

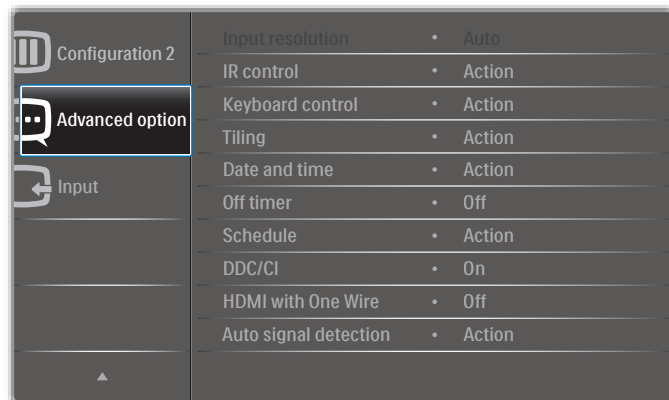

Input resolution

Set the resolution of the VGA input. This is only required when the display is unable to detect the VGA input resolution correctly.

NOTE: This item is functional for **VGA** input only.

The options are:

- {1024x768 / 1280x768 / 1360x768 / 1366x768}
- {1400x1050 / 1680x1050}
- {1600x1200 / 1920x1200}
- {Auto}: Determines the resolution automatically.

The selected settings will become effective after turning off the power and turning it on again.

IR control

Select the operation mode of the remote control when multiple displays are connected via an RS232C connection.

- {Normal} - All displays can be operated normally by the remote control unit.
- {Primary} - Designate this display as the primary display for remote control operation. Only this display can be operated by the remote control.
- {Secondary} - Designate this display as the secondary display. This display can not be operated by the remote control, and will only receive the control signal from the primary display via the RS232C connection.
- {Lock All} / {Lock all but Volume} / {Lock all but Power} - Lock the remote control function of this display. To unlock, press and hold the **[i]** INFO button on the remote control for 5 (five) seconds.

NOTE: After the main OSD menu vanished, the Primary / Secondary OSD will be displayed for 3 seconds. Or, press **[OK]** button to display the Primary / Secondary OSD when no other OSD.

1. During the Primary OSD, press **[←]** or **[→]** button to adjust the value of {Control Monitor ID}, and press **[A]** or **[T]** button to adjust the value of {Control Group ID}.

Keyboard control

Choose to enable or disable the display keyboard (control buttons) function.

- {Unlock} - Enable the keyboard function.
- {Lock All} / {Lock all but Volume} / {Lock all but Power} - Disable the keyboard function.

NOTE: To enable or disable the keyboard control lock, press both **[+]** and **[A]** buttons and hold down continuously for more than 3 seconds.

Tiling

With this function you can create a single large-screen matrix (video wall) that consists of up to 150 sets of this display (**up to 10-sets on the vertical and 15-sets on the horizontal sides**). This function requires a daisy-chain connection.

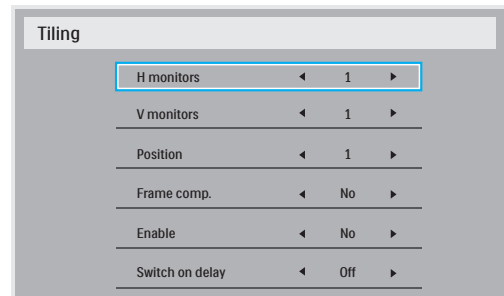

Example: 2 x 2 screen matrix (4 displays)

H monitors = 2 displays

V monitors = 2 displays

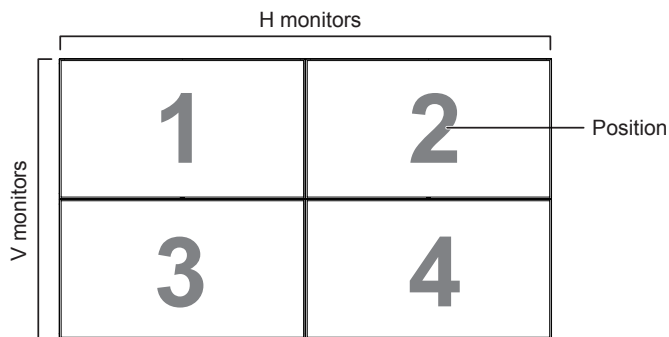

Frame comp. - No

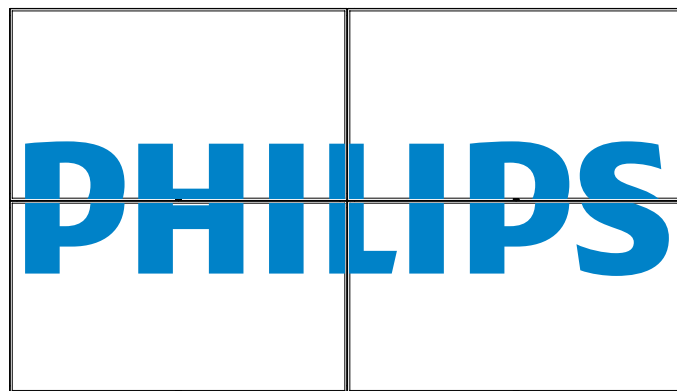

- **{Enable}** - Choose to enable or disable the Tiling function. If enabled, the display will apply the settings in **{H monitors}**, **{V monitors}**, **{Position}**, and **{Frame comp.}**.
- **{Switch on delay}** - Set the power-on delaying time (in seconds). The default option **{Auto}** allows a sequential powering-on for each display by their ID number when multiple displays are connected. The options are: **{Off / Auto / 2 ~ 255}**

NOTE: The Tiling function will be disabled during using PIP function.

Date and time

Adjust the current date and time for the display's internal clock.

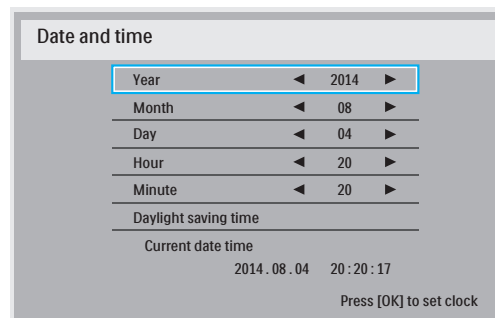

1. Press **[OK]** button to enter the submenu.
2. Press **[▲]** or **[▼]** button to toggle between **{Year}**, **{Month}**, **{Day}**, **{Hour}**, **{Minute}**, and **{Daylight saving time}**.
3. Press **[←]** or **[→]** button to adjust all settings except **{Daylight saving time}**.
4. Press **[OK]** button to enter the **{Daylight saving time}** submenu.

Example: 5 x 5 screen matrix (25 displays)

H monitors = 5 displays

V monitors = 5 displays

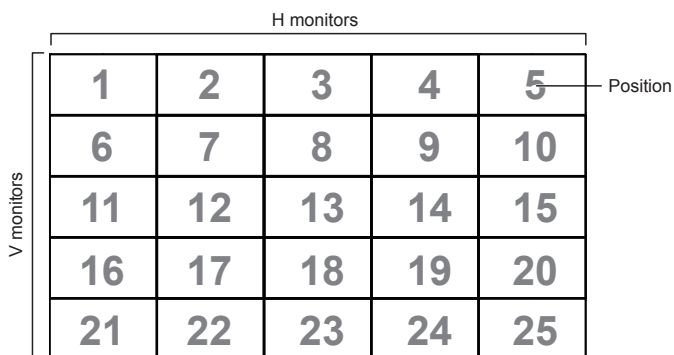

- **{H monitors}** - Select the number of displays on the horizontal side.
- **{V monitors}** - Select the number of displays on the vertical side.
- **{Position}** - Select the position of this display in the screen matrix.
- **{Frame comp.}** - Choose to turn the frame compensation function on or off. If selected **{Yes}**, the display will adjust the image to compensate for the width of the display bezels in order to accurately display the image.

Frame comp. - Yes

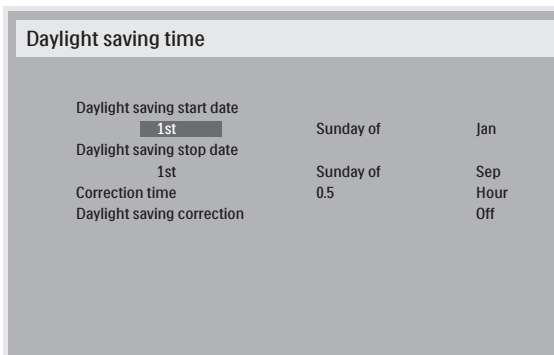
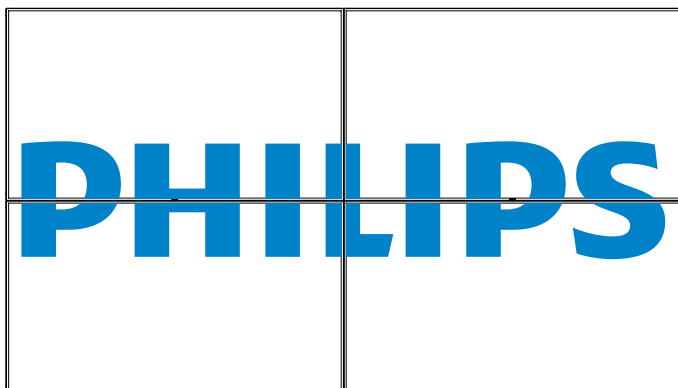

5. Press **[←]** or **[→]** button to select item, press **[▲]** or **[▼]** button to adjust.
- **{Daylight saving start date}** - Select **{1st / 2nd / 3rd / 4th / last}** Sunday of the month **{Jan ~ Dec}**.

- {Daylight saving stop date} - Select {1st / 2nd / 3rd / 4th / last} Sunday of the month {Jan ~ Dec}.
- {Correction time} - The options are: {0.5 / 1.0 / 1.5 / 2.0}
- {Daylight saving correction} Select {On} to enable this function.

OffTimer

Set the display to turn itself off to standby mode within an amount of time specified.

The options are: {Off, 1 ~ 24} hours from current time.

NOTE: When the "Off timer" is activated, the "Schedule" settings will be disabled.

Schedule

This function allows you to program up to 7 (seven) different scheduled time intervals for the display to activate.

You can select:

- The time for the display to turn on and turn off.
- The days in a week for the display to activate.
- Which input source the display will use for each scheduled activation period.

NOTE: We recommend you to set up current date and time in the {Date and time} menu before using this function.

1. Press [OK] or [Enter] button to enter the submenu.

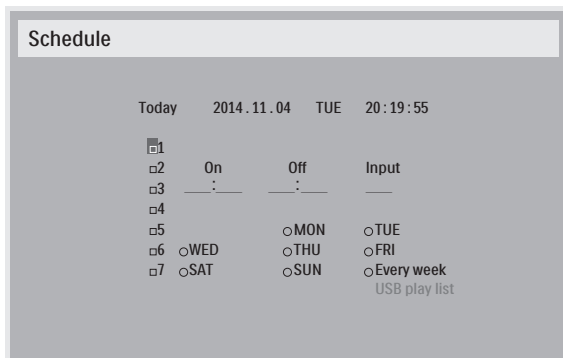

2. Press [Up] or [Down] button to select a schedule item (item number 1 ~ 7), and then press [OK] button to mark it the item number.

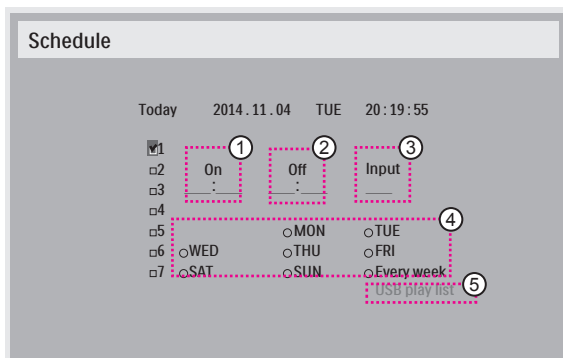

3. Press [Left] or [Right] button to select the schedule:
 - ① **Power-on** schedule: Press [Up] or [Down] button to set the hour and minute for the display to turn on.
 - ② **Power-off** schedule: Press [Up] or [Down] button to set the hour and minute for the display to turn off.

Select or leave an empty "___" for both the hour and minute slot if you do not want to use this power-on or power-off schedule.

- ③ **Input-source** selection: Press [Up] or [Down] button to select an input source. If no input source is selected, the input source will remain the same as last selected.

- ④ **Date** schedule: Press [Left] button to select which day in a week this schedule item will be take effect, and then press the [OK] button.
- ⑤ When **Input-source** select to **USB**, enable to access **USB play list** setting:

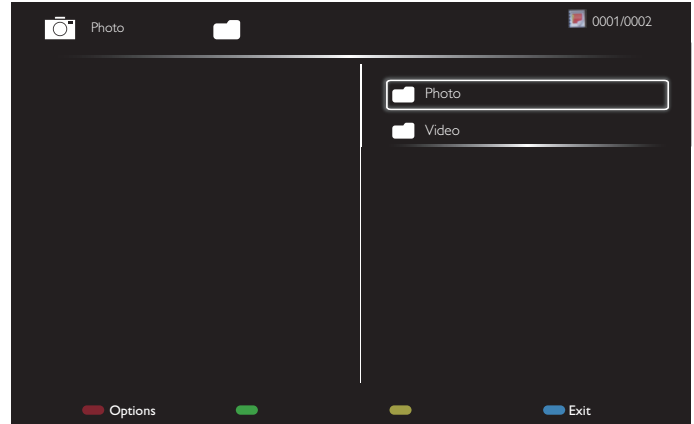

- Press [Left] [Right] buttons to choose files.
- Press [Left] [Right] buttons to switch Playlist and File Manager.
- Press [OK] button to set or clear the playlist.
- To save the playlist, press [Red] and choose **Save list**.

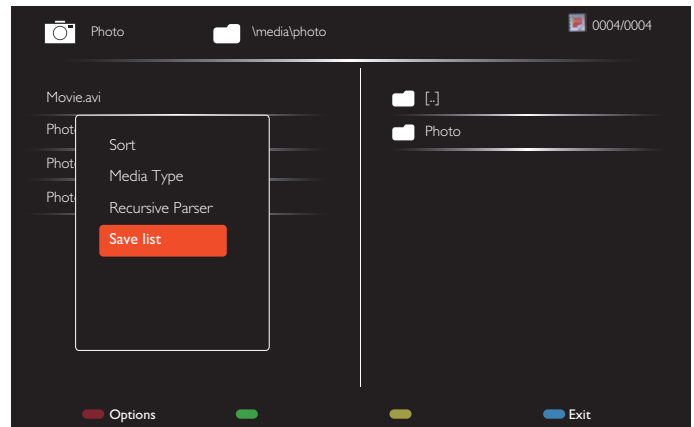

4. For additional schedule settings, press [Enter], then repeat the steps above. A check mark in the box next to the number of the schedule item indicates that the selected schedule is in effect.

NOTES:

- If the schedules overlap, the scheduled power-on time takes priority over scheduled power-off time.
- If there are two schedule items programmed for the same time, the highest numbered schedule takes priority. For example, if schedule items #1 and #2 both set the display to power on at 7:00 AM and off at 5:00 PM, then only schedule item # 1 will take effect.
- Each Playlist supports up to 30 files.
- Playlist will not be cleared after {Factory reset}. You have to manually remove the files or delete usb_schedulinglist.txt in the USB.

DDC/CI

Choose to turn on or off the DDC/CI communication function. Select {On} for normal use.

DDC/CI (Command Interface) specifies a means for a computer to send commands to the monitor, as well as receive sensor data from the monitor, over the bidirectional link such as DDC2Ab/Bi/B+.

Specific commands to control monitors are defined in a separate Monitor Control Command Set (MCCS) standard.

DDC/CI monitors are sometimes supplied with an external color sensor to allow automatic calibration of the monitor's color balance. Some tilting DDC/CI monitors support an auto pivot function, where a rotation sensor in the monitor enables the operating system to keep the display upright as the monitor is moved between its portrait and landscape positions.

The following DDC/CI commands should be supported via command line:

No.	Commands	No.	Commands
1	Set Brightness	6	Get Brightness
2	Set Contrast	7	Get Contrast
3	Set Red Gain	8	Get Red Gain
4	Set Green Gain	9	Get Green Gain
5	Set Blue Gain	10	Get Blue Gain

HDMI with One Wire

CEC control.

- {Off} - Disable CEC.(Default)
- {On} - Enable CEC.

Auto signal detection

Choose to let the display detect and display available signal sources automatically.

- {Off} - Once a signal is connected, it can only be selected manually.

If the selected input is no signal, set the display to display the image automatically according to the search order of each option.

The options are: {All} / {PC source only} / {Video source only} / {Failover}

- {All}: DP / HDMI1 / HDMI2 / HDMI3 / DVI / VGA / Component / OPS.
- {PC source only}: DP / DVI / VGA / Card OPS.
- {Video source only}: HDMI1 / HDMI2 / HDMI3 / Component.
- {Failover}
 - Failover 1-12: User-defined setting. Default: HDMI.

OPS settings

Set the OPS configuration under each power condition.

- {Auto} - After selecting {Card OPS} for video source input, the OPS will be set to off when the display power is set to off, or set to on when the display power is set to on. When set to other video source inputs, the OPS will always be set to on.
- {Always off} - The OPS will always be set to off.
- {Always on} - The OPS will always be set to on.

Language

Select the language used in the OSD menu.

The options are: {English} / {Deutsch} / {简体中文} / {Français} / {Italiano} / {Español} / {Русский} / {Polski} / {Türkçe} / {繁體中文} / {日本語} / {Português}.

Advanced option reset

Reset all settings except {Date and Time} in the **Advanced option** menu to factory preset values.

1. Press [OK] or [↵] button to enter the submenu.
2. Press [←] or [→] button to select {Reset} and press the [OK] button to restore settings to factory preset values.
3. Press the [↵] button or select {Cancel} and press the [OK] button to cancel and then return to the previous menu.

APM

Power save setting.

- **Off (TCP off/WOL off)** - not support WOL / not support wake up on TCP socket / not support wake up on web page.
- **Mode 1 (TCP off/WOL on)** - support WOL / not support wake up on TCP socket / not support wake up on web page.
- **Mode 2 (TCP on/WOL off)** - not support WOL / support wake up on TCP socket / support wake up on web page.

5.2.8. Input menu

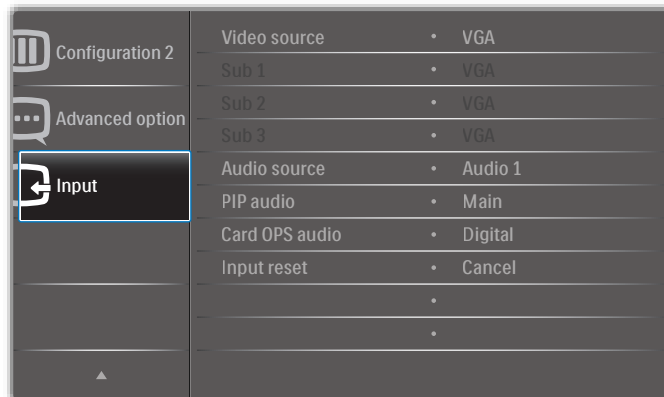

Video source

Select a video input source.

Choose from: {Displayport} / {DVI-D} / {VGA} / {HDMI1} / {HDMI2} / {HDMI3} / {Component} / {Video} / {USB} / {BROWSER} / {SmartCMS} / {Card OPS}.

Sub 1

Select the input signal for the sub Win1 picture.

Choose from: {Displayport} / {DVI-D} / {VGA} / {HDMI1} / {HDMI2} / {HDMI3} / {Component} / {Video} / {USB} / {BROWSER} / {SmartCMS} / {Card OPS}.

Sub 2

Select the input signal for the sub Win2 picture.

Choose from: {Displayport} / {DVI-D} / {VGA} / {HDMI1} / {HDMI2} / {HDMI3} / {Component} / {Video} / {USB} / {BROWSER} / {SmartCMS} / {Card OPS}.

Sub 3

Select the input signal for the sub Win3 picture.

Choose from: {Displayport} / {DVI-D} / {VGA} / {HDMI1} / {HDMI2} / {HDMI3} / {Component} / {Video} / {USB} / {BROWSER} / {SmartCMS} / {Card OPS}.

Audio source

Select the audio input source according to the audio signal source connected to the audio input and HDMI sockets on the display.

Choose from: {Analog} / {Displayport} / {Audio1} / {Audio2} / {Media}.

PIP audio

Select the audio source the PIP (Picture-in-Picture) mode.

- {Main} - Select audio from the main picture
- {Sub 1} - Select audio from the sub1 picture.
- {Sub 2} - Select audio from the sub2 picture.
- {Sub 3} - Select audio from the sub3 picture.

Card OPS audio

Select the analog or digital audio mode for card OPS.

Input reset

Reset all settings in the **Input** menu to factory preset values.

6. USB device compatibility**USB Video Subtitle Formats (for language subtitles, etc.)**

File Extensions	Container	Video codec	Maximum resolution	Max. Frame Rate (fps)	Max. Bit Rate (Mbps)	Audio codec
.mpg mpeg .vob	PS	MPEG-1	1920x1080	25p,30p,50i,60i	30	MPEG-1(L1&L2), MPEG-1,2,2.5 L3, AAC/HE-AAC(v1&v2), DVD-PCM,AC3
		MPEG-2	1920x1080	25p,30p,50i,60i	30	
		MPEG-4 ASP	1920x1080	25p,30p,50i,60i	30	
		H.264	1920x1080	25p,30p,50p,60p,60i	30	
.ts	TS	MPEG-2	1920x1080	25p,30p,50i,60i	30	MPEG-1(L1&L2), MPEG-1,2,2.5 L3, AAC/HE-AAC (v1&v2), AC3,E-AC3, Dolby Pulse
		MPEG-4 ASP	1920x1080	25p,30p,50i,60i	30	
		H.264	1920x1080	25p,30p,50p,60p,60i	30	
		MVC	1920x1080i@field rate=50, 60Hz 1920x1080p@frame rate=24, 25,30Hz 1280x720p@frame rate=50, 60Hz	-	30	
.ts .m2ts .mts .mt2	MaTS TTS	MPEG-2	1920x1080	25p,30p,50i,60i	30	MPEG-1(L1&L2), MPEG-1,2,2.5 L3, AAC/HE-AAC (v1&v2), AC3,E-AC3, Dolby Pulse
		MPEG-4 ASP	1920x1080	25p,30p,50i,60i	30	
		H.264	1920x1080	25p,30p,50p,60p,60i	30	
		MVC	1920x1080i @ field rate=50, 60Hz 1920x1080p @ frame rate=24, 25,30Hz 1280x720p @ frame rate=50, 60Hz	-	30	
.ts .m2ts .mts	AVCHD	MPEG-2	1920x1080	25p,30p,50i,60i	30	MPEG-1(L1&L2), MPEG-1,2,2.5 L3, AAC/HE-AAC (v1&v2), AC3,E-AC3, Dolby Pulse
		MPEG-4 ASP	1920x1080	25p,30p,50i,60i	30	
		H.264	1920x1080	25p,30p,50p,60p,60i	30	
.ts .m2ts .mts	AVCHD	MVC	1920x1080i@field rate=50, 60Hz 1920x1080p@frame rate=24, 25,30Hz 1280x720p @ frame rate=50, 60Hz	-	30	MPEG-1(L1&L2), MPEG-1,2,2.5 L3, AAC/HE-AAC (v1&v2), AC3,E-AC3, Dolby Pulse
.m4v	M4V	H.264	1920x1080	25p,30p,50p,60p,60i	30	AAC
.ism/Manifest .mpd	frag MP4	H.264	1920x1080	25p,30p,50p,60p,60i	30	AAC/HE-AAC(v1&v2), AC3,E-AC3,WMA, WMA-PRO
		MVC	1920x1080i@field rate=50, 60Hz 1920x1080p@frame rate=24, 25,30Hz 1280x720p @ frame rate=50, 60Hz	-	30	
.mp4	MP4	MPEG-4 ASP	1920x1080	25p,30p,50i,60i	30	AAC/HE-AAC(v1&v2), AC3,E-AC3,WMA, WMA-PRO
		H.264	1920x1080		30	
		MVC	1920x1080i@field rate=50, 60Hz 1920x1080p@frame rate=24, 25,30Hz 1280x720p @ frame rate=50, 60Hz	-	30	
		WMV9/VC1	1920x1080	30p,60i	30	
.mkv .mk3d	MKV	MPEG-4 ASP	1920x1080	25p,30p,50i,60i	30	MPEG-1(L1&L2), MPEG-1,2,2.5 L3, AAC/HE-AAC (v1&v2), AC3,E-AC3,WMA, WMA-PRO
		H.264	1920x1080		30	

USB Multimedia Formats

File Extensions	Container	Video codec	Maximum resolution	Frequency (kHz)	Max.Bit Rate (Mbps)	Audio codec
.mp3	MP3	-	-	48	384	MPEG-1,2,2.5 L3
.wma .asf	WMA (V2 up to V9.2)	-	-	48	192	WMA
.wma	WMA Pro	-	-	96	768	WMA,WMA Pro
.wav(PC)	LPCM	-	-	192	768	LPCM
.aif(mac) .aiff(mac)	LPCM	-	-	192	768	LPCM
.aac .mp4 .m4a	AAC	-	-	48	1024	AAC,HE-AAC(v1&v2)
.pls .m3u	Playlists	-	-	-	-	-
.m4a	M4A	-	-	48	1024	AAC,HE-AAC(v1&v2)

USB Photo file format type: JPEG, BMP, PNG, GIF

NOTES:

- Sound or video may not work if the contents have a standard bit rate/frame rate above the compatible Frame/sec listed in the table above.
- Video content with a Bit rate or Frame rate larger than the rate specified in the table above can cause choppy video during playback.

7. Input Mode

FHD Preset Mode (VGA/DVI timing support):

Item	Resolution	H.Freq. (KHz)	V.Freq. (Hz)	BW(MHz)
1	640x350	31.469	70.086	25.175
2	640x480	31.469	59.94	25.175
3	640x480	35	66.67	30.240
4	640x480	37.861	72.809	31.500
5	640x480	37.5	75	31.500
6	720x400	31.469	70.087	28.322
7	800x600	35.156	56.25	36.000
8	800x600	37.879	60.317	40.000
9	800x600	48.077	72.188	50.000
10	800x600	46.875	75.000	49.500
11	832x624	49.726	74.551	57.284
12	848x480	31	60.000	33.750
13	960x720	56.4	75.000	72.420
14	960x720	44.74	59.973	57.580
15	1024x768	48.363	60.004	65.000
16	1024x768	56.476	70.069	75.000
17	1024x768	60.023	75.029	78.750
18	1024x768	61.08	75.781	86.000
19	1024x768	35.5	43.000	44.900
20	1152x864	53.986	59.985	79.900
21	1152x864	53.783	59.959	81.750
22	1152x864	63.851	70.012	94.499
23	1152x864	67.5	75.000	108.000
24	1152x870	68.681	75.062	100.000
25	1152x900	61.846	66.004	94.500
26	1152x900	71.809	76.149	108.000
27	1280x720	44.772	60.000	74.500
28	1280x720	52.5	70.000	89.040
29	1280 x768	47.776	59.870	79.500
30	1280 x768	60.289	74.893	102.250
31	1280x800	49.7	59.810	83.500
32	1280x800	62.8	74.930	106.500
33	1280x960	60	60.000	108.000
34	1280x960	75.171	75.021	129.895
35	1280x1024	63.981	60.020	108.000
36	1280x1024	71.691	67.189	117.000
37	1280x1024	76.02	71.448	130.223
38	1280x1024	79.976	75.025	135.000
39	1280x1024	81.13	76.110	135.000
40	1360x768	47.712	60.015	85.500
41	1366x768	47.712	59.790	85.500
42	1440x900	55.469	59.901	88.750
43	1440x900	55.935	59.887	106.500
44	1440x900	70.635	74.984	136.750
45	1400x1050	64.744	59.948	101
46	1440x1050	65.3	60.000	121.750
47	1400x1050	82.278	74.867	156
48	1600x900	55.54	60.000	97.750
49	1600x1200	75	60	162
50	1680x1050	65.29	59.954	146.250
51	1680x1050	64.674	59.883	119.000
52	1920x1080	66.587	59.934	138.500
53	1920x1080	67.5	60.000	148.500
54	1920x1080	67.1584	59.963	173.000
55	1920x1080	67.08	60	172.798
56	1920x1200	74.038	59.950	154.000

UHD Preset Mode (DP/HDMI timing support):

Item	Resolution	H.Freq. (KHz)	V.Freq. (Hz)	BW(MHz)
1	3840x2160	53.946	23.900	296.703
2	3840x2160	54	24.000	297.000

Item	Resolution	H.Freq. (KHz)	V.Freq. (Hz)	BW(MHz)
3	3840x2160	56.25	25.000	297.000
4	3840x2160	67.432	29.900	296.703
5	3840x2160	67.5	30.000	297.000
6	4096x2160	54	24.000	297.000
7	3840x2160	135	60.000	594.000

Video timing support (HDMI/DVD HD/DVI):

480i, 480p, 576i, 576p, 720p, 1080i, 1080p, 4Kx2K (except DVI).

NOTES:

- The PC text quality is optimum in HD 1080 mode (1920 x 1080, 60Hz).
- Your PC display screen might appear different depending on the manufacturer (and your particular version of Windows).
- Check your PC instruction book for information about connecting your PC to a display.
- If a vertical and horizontal frequency-select mode exists, select 60Hz (vertical) and 31.5KHz (horizontal). In some cases, abnormal signals (such as stripes) might appear on the screen when the PC power is turned off (or if the PC is disconnected). If so, press the [INPUT] button to enter the video mode. Also, make sure that the PC is connected.
- When horizontal synchronous signals seem irregular in RGB mode, check PC power saving mode or cable connections.
- The display settings table complies to the IBM/VESA standards, and based on the analog input.
- The DVI support mode is regarded as same to the PC support mode.
- The best timing for the vertical frequency to each mode is 60Hz.
- When the input source is Component or Video, the Information OSD will be displayed slowly than other input sources.
- No matter the resolution of Component source or Video source input, the result of Zoom mode setting is the same as 1080P resolution.

8. Pixel Defect Policy

We strive to deliver the highest quality products and use some of the industry's most advanced manufacturing processes whilst practicing stringent quality control. However, pixel or sub-pixel defects on the PDP / TFT panels used in Plasma- & LCD- displays are sometimes unavoidable. No manufacturer can guarantee that all panels will be free from pixel defects, but Philips guarantees that any Plasma- & LCD- displays with an unacceptable number of defects will be repaired during the warranty period in line with your local guarantee conditions.

This notice explains the different types of pixel defects and defines the acceptable defect level for the LCD screen. In order to qualify for repair under warranty, the number of pixel defects must exceed a certain level as shown in the reference table. If the LCD screen is within specification a warranty exchange / claim back will be refused. Additionally, because some types or combinations of pixel defects are more noticeable than others, Philips sets even higher quality standards for those.

8.1. Pixels and Sub-Pixels

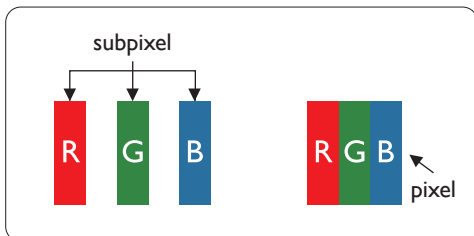

A pixel, or picture element, is composed of three sub-pixels in the primary colors of red, green and blue. Many pixels together form an image. When all sub-pixels of a pixel are lit, the three colored sub-pixels together appear as a single white pixel. When all are dark, the three colored sub-pixels together appear as a single black pixel. Other combinations of lit and dark sub-pixels appear as single pixels of other colors.

8.2. Types of Pixel Defects + Dot Definition

Pixel and sub-pixel defects appear on the screen in different ways. There are three categories of pixel defects and several types of sub-pixel defects within each category.

Dot definition = What is a defective "Dot"?

One or more defective, adjacent sub-pixel are defined as one "dot". The no. of defective sub-pixels are not relevant to define a defective dot. This means that a defective dot can consist of one, two or three defective sub-pixels which can be dark or lit.

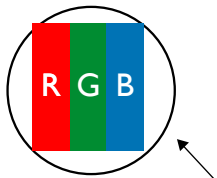

One dot = One Pixel; consists of three sub-pixels of Red, Green, and Blue.

8.3. Bright Dot Defects

Bright dot defects appear as pixels or sub-pixels that are always lit or "on". These are the examples of bright dot defects:

<p>One lit red, green or blue sub pixel</p>	<p>Two adjacent lit sub pixels: Red + Blue = Purple Red + Green = Yellow Green + Blue = Cyan (Light Blue)</p>	<p>Three adjacent lit sub pixels (one white pixel)</p>
---	---	--

8.4. Dark Dot Defects

Black dot defects appear as pixels or sub-pixels that are always dark or "off". These are the examples of black dot defects:

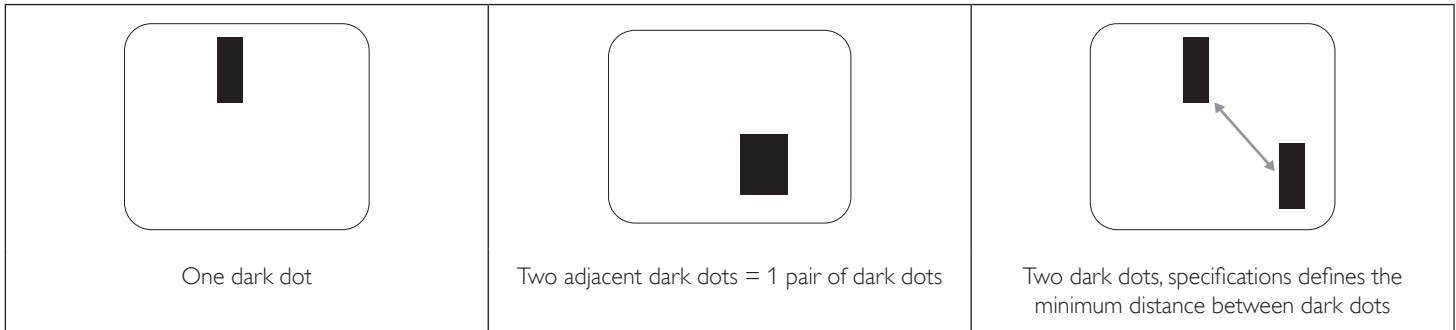

8.5. Proximity of Pixel Defects

Because pixel and sub-pixels defects of the same type that are nearby one another may be more noticeable, Philips also specifies tolerances for the proximity of pixel defects. In the table below you can find specifications about:

- Allowed amount of adjacent dark dots = (adjacent dark dots = 1 pair of dark dots)
- Minimum distance between dark dots
- Total no. of all defective dots

8.6. Pixel Defect Tolerances

In order to qualify for repair due to pixel defects during the warranty period, a PDP / TFT panel in a Philips Plasma / LCD- display must have pixel or sub-pixel defects exceeding the tolerances listed in the following table.

BRIGHT DOT EFFECT	ACCEPTABLE LEVEL
1 lit sub pixel	2
BLACK DOT EFFECT	ACCEPTABLE LEVEL
1 dark sub pixel	10
TOTAL DOT DEFECTS OF ALL TYPES	12

NOTE: * 1 or 2 adjacent sub pixel defects = 1 dot defect

8.7. MURA

Dark spots or patches may occasionally appear on some liquid crystal display (LCD) panels. This is known within the industry as Mura, which is a Japanese term for "unevenness." It is used to describe an irregular pattern or area in which uneven screen uniformity appears under certain conditions. Mura is a result of the deterioration of the liquid crystal alignment layer and is most commonly caused by long-term operation under high ambient temperatures. It is an industry- wide phenomenon and Mura is not repairable. It is also not covered by our warranty terms.

Mura has been around since the introduction of LCD technology and with screens getting bigger and in operation 24/7, many displays are running in low light conditions. This all adds to the possibility of Mura affecting displays.

HOW TO SPOT MURA

There are many symptoms of Mura and also multiple causes. Several of these are listed below:

- Impurities or foreign particles in the crystal matrix
- Uneven distribution of LCD matrix during manufacturing
- Non-uniform luminance distribution of the backlight
- Panel assembly induced stress
- Flaws within the LCD cells
- Thermal induced stress - high temperature operation over long periods of time

HOW TO AVOID MURA

Although we can not guarantee the complete eradication of Mura every time, in general the appearance of Mura can be minimized by these methods:

- Lower the backlight brightness
- Use a screen saver
- Reduce the ambient temperature around the unit

9. Cleaning and Troubleshooting

9.1. Cleaning

Caution When Using the Display

- Do not bring your hands, face or objects close to the ventilation holes of the display. The top of the display is usually very hot due to the high temperature of exhaust air being released through the ventilation holes. Burns or personal injuries may occur if any body parts are brought too close. Placing any object near the top of the display could also result in heat related damage to the object as well as the display itself.
- Be sure to disconnect all cables before moving the display. Moving the display with its cables attached may damage the cables and thus cause fire or electric shock.
- Disconnect the power plug from the wall outlet as a safety precaution before carrying out any type of cleaning or maintenance procedure.

Front Panel Cleaning Instructions

- The front of the display has been specially treated. Wipe the surface gently using only a cleaning cloth or a soft, lint-free cloth.
- If the surface becomes dirty, soak a soft, lint-free cloth in a mild detergent solution. Wring the cloth to remove excess liquid. Wipe the surface of the display to remove dirt. Then use a dry cloth of the same type to dry.
- Do not scratch or hit the surface of the panel with fingers or hard objects of any kind.
- Do not use volatile substances such as insect sprays, solvents and thinners.

Cabinet Cleaning Instructions

- If the cabinet becomes dirty, wipe the cabinet with a soft, dry cloth.
- If the cabinet is extremely dirty, soak a lint-free cloth in a mild detergent solution. Wring the cloth to remove as much moisture as possible. Wipe the cabinet. Use another dry cloth to wipe over until the surface is dry.
- Do not allow any water or detergent to come into contact with the surface of the display. If water or moisture gets inside the unit, operating problems, electrical and shock hazards may result.
- Do not scratch or hit the cabinet with fingers or hard objects of any kind.
- Do not use volatile substances such as insect sprays, solvents and thinners on the cabinet.
- Do not place anything made from rubber or PVC near the cabinet for any extended periods of time.

9.2. Troubleshooting

Symptom	Possible Cause	Remedy
No picture is displayed	<ol style="list-style-type: none"> 1. The power cord is disconnected. 2. The main power switch on the back of the display is not switched on. 3. The selected input has no connection. 4. The display is in standby mode. 	<ol style="list-style-type: none"> 1. Plug in the power cord. 2. Make sure the power switch is switched on. 3. Connect a signal connection to the display.
Interference displayed on the display or audible noise is heard	Caused by surrounding electrical appliances or fluorescent lights.	Move the display to another location to see if the interference is reduced.
Color is abnormal	The signal cable is not connected properly.	Make sure that the signal cable is attached firmly to the back of the display.
Picture is distorted with abnormal patterns	<ol style="list-style-type: none"> 1. The signal cable is not connected properly. 2. The input signal is beyond the capabilities of the display. 	<ol style="list-style-type: none"> 1. Make sure that the signal cable is attached firmly. 2. Check the video signal source to see if it is beyond the range of the display. Please verify its specifications with this display's specification section.
Display image doesn't fill up the full size of the screen	<ol style="list-style-type: none"> 1. The zoom mode is not set correctly. 2. Scan Mode may be set incorrectly to underscan. 3. If the image exceeds the screen size, Scan Mode may need to be set to Underscan. 	Use the Zoom mode or Custom zoom function in the Screen menu to fine tune display geometry and time frequency parameter.
Can hear sound, but no picture	Improperly connected source signal cable.	Make sure that both video inputs and sound inputs are correctly connected.
Can see picture but no sound is heard	<ol style="list-style-type: none"> 1. Improperly connected source signal cable. 2. Volume is turned all the way down. 3. {Mute} is turned on. 4. No external speaker connected. 	<ol style="list-style-type: none"> 1. Make sure that both video inputs and sound inputs are correctly connected. 2. Press [+] or [-] button to hear sound. 3. Switch MUTE off by using the [MUTE] button. 4. Connect external speakers and adjust the volume to a suitable level.
Some picture elements do not light up	Some pixels of the display may not turn on.	This display is manufactured using an extremely high level of precision technology; however, sometimes some pixels of the display may not display. This is not a malfunction.
After-Images can still be seen on the display after the display is powered off. (Examples of still pictures include logos, video games, computer images, and images displayed in 4:3 normal mode)	A still picture is displayed for an over extended period of time	Do not allow a still image to be displayed for an extended period of time as this can cause a permanent after-image to remain on the display.

10. Technical Specifications

Display:

Item	Specifications
Screen Size (Active Area)	74.52 inches (1892.73 mm)
Aspect Ratio	16:9
Number of pixels	3840 (H) × 2160 (V)
Pixel pitch	0.429 × 0.429 mm
Color depth	1073.7M colors
Brightness	410cd/m ²
Contrast ratio	1200:1
Viewing angle	89 degrees

In/Out Terminals:

Item	Specifications
Speaker Output	Internal Speakers External Speakers
	10W (L) + 10W (R) [RMS]/8Ω 1 Way 1 Speaker System 82 dB/W/M/160 Hz ~ 13 KHz
SPDIF Output	SPDIF Port
	Serial digital audio output when input is HDMI
Audio Output	3.5 mm Stereo × 1
	0.5V [rms] (Normal) / 2 Channel (L+R)
Audio Input	RCA Jack × 2 3.5 mm Stereo × 1
	0.5V [rms] (Normal) / 2 Channel (L+R)
RS232C	2.5mm Phone jack × 2
	RS232C in/RS232C out
RJ-45	RJ-45 Jack × 1 (8 pin)
	10/100 LAN Port
HDMI Input	HDMI Jack × 3 (Type A) (19 pin)
	Digital RGB:TMDS (Video + Audio) MAX: Video - 720p, 1080p, 1920 × 1080/60 Hz (WUXGA), 4K/2K 30/60Hz Audio - 48 KHz/ 2 Channel (L+R) Supports LPCM only
DVI-D Input	DVI-D jack
	Digital RGB:TMDS (Video)
VGA Input	D-Sub Jack × 1 (15 pin)
	Analog RGB: 0.7V [p-p] (75Ω), H/CS/V:TTL (2.2kΩ), SOG: 1V [p-p] (75Ω) MAX: 720p, 1080p, 1920 × 1080/60 Hz (WUXGA)
Component Input	RCA Jack × 3
	Y: 1V [p-p] (75Ω), Pb: 0.7V [p-p] (75Ω), Pr: 0.7V [p-p] (75Ω) MAX: 480i, 576i, 480p, 576p, 720p, 1080i, 1080p
Video Input	RCA × 1 (Share with Component_Y)
	Composite 1V [p-p] (75Ω)
Displayport in/out	Displayport Jack × 2 (20 pin)
	Digital RGB:TMDS (Video + Audio) MAX: Video - 3840×2160@60Hz Audio - 48 KHz/ 2 Channel (L+R) Supports LPCM only
IR Input/Output	3.5 mm × 2
	IR pass through or IR daisy chain
USB Input	USB × 1 (Type A)
	USB 2.0, Multimedia play only

General:

Item	Specifications
Power Supply	AC 100 - 240V, 50 - 60Hz
Power Consumption	600 W (max)
	400 W (typ)
	NA (EPA 6.0)
	<0.5W (standby mode)
Dimensions (Without Stand)	1676.6(W) × 955.0(H) × 73.8(D@Handle)/62.8(D@Wall Mount) mm
Weight (Without Stand)	53.3 Kg

Gross Weight (Without Stand)	65.5 Kg
------------------------------	---------

Product Fiche :

Item	Specifications
Energy Efficiency Class	A
Visible Screen Size	189.3 cm / 75 inch
On Mode Power Consumption (W)	197 W
Annual Energy Consumption (kWh)	288 kWh
Standby Power Consumption (W)	0.50 W
Off Mode Power Consumption (W)	0.50 W
Display Resolution (Pixels)	3840*2160
Network Standby (W)	4.05w

Environmental Condition:

Item		Specifications
Temperature	Operational	0 ~ 40°C
	Storage	-20 ~ 60°C
Humidity	Operational	20 ~ 80% (without condensation)
	Storage	5 ~ 95% (without condensation)
Altitude	Operational	0 ~ 3,000 m
	Storage / Shipment	0 ~ 9,000 m

Internal Speaker:

Item	Specifications
Type	1 Way 1 Speaker
Input	10 W (RMS)
Impedance	8Ω
Output Sound Pressure	82 dB/W/M
Frequency Response	160 Hz ~ 13 KHz



2016 © Koninklijke Philips N.V. All rights reserved.

Philips and the Philips Shield Emblem are registered trademarks of Koninklijke Philips N.V. and are used under license from Koninklijke Philips N.V.

Specifications are subject to change without notice.