

# Catalogue 24 | 25

Proven and innovative measuring technology  
for compressed air and gases



Chart recorder

Dew Point

Humidity

Flow

Compressed air quality

Leakage

Software

Pressure

Ambient air



# OVERVIEW CHART RECORDER



## DS 500

- Chart recorder for data logging of up to 4/8/12 sensors

Page 12-15



## DS 400

- Chart recorder for data logging of up to 2/4 sensors

Page 16-19



## DS 500 mobile

- Chart recorder for data logging of up to 4/8/12 sensors

Page 24-27



## DS 500 PM mobile

- For efficiency measurement of compressors

Page 28-31



## DS 400 mobile

- Chart recorder for data logging of up to 2/4 sensors

Page 32-35



## PI 500

- Portable handheld device

Page 36-37

## Sensors for DS 500 / DS 400

Pressure



Current



Temperature



Page 20-23

## Sensors for mobile devices

Pressure



Current



Temperature



Page 38-41



## DP 500/510

- Mobile dew point device

Page 46-47



## DP 400 mobile

- Mobile dew point device in a sturdy service case

Page 48-49



## FA 510/515

- Dew point sensor for residual moisture measurement in compressed air and gases

Page 50



## DS 52

- Plug-in dew point set

Page 51



## FA 515 EX

- Dew point sensor for residual moisture measurement in compressed air and gases in potentially explosive atmospheres

Page 52



## FA 550

- Dew point sensor with a sturdy die-cast aluminium housing

Page 54-55



## FA 500

- Dew point sensor with integrated display

Page 56-57



## DS 400

- Plug-in dew point set

Page 58-59

## Accessories for dew point measurement / calibration

Page 60-66



## FO 510

- Industrial oil moisture sensor

Page 72



## VA 570

- Inline flow meter with flange
- DN 15 to DN 80

Page 74-78



## VA 570

- Inline flow meter with thread
- 1/2" to 2"

Page 74-78



## VA 550

- Sturdy flow meter as an insertion version

Page 80-83



## VA 500

- Flow meter as an insertion version

Page 84-86



## VA 520

- Inline flow meter with flange
- DN 15 to DN 80

Page 88-92



## VA 520

- Inline flow meter with thread
- 1/4" to 2"

Page 86-90



## VA 521

- Compact Inline flow meter

Page 94-95



## VA 525

- Compact Inline flow meter for air and nitrogen

Page 96-97



## VD 500

- Flow sensor for wet compressed air

Page 98-99



## VU 570

- Vortex ultrasonic flow sensor

Page 100-102



## VX 570

- Vortex flow sensor

Page 104-105

**Accessories for Consumption Measurement / Calibration / Measuring ranges for different gases**

Page 108-123



## Oil-Check 400 / PC 400 / FA 510



- Measure compressed air quality according to ISO 8573

Page 128-129

## Oil-Check 400 / PC 400 / FA 510



- Measure compressed air quality according to ISO 8573

Page 129

## Oil-Check 400 - stationary solution



- Monitoring system for residual oil content measurement in compressed air

Page 130-131

## Oil-Check 400 - mobile solution



- Monitoring system for residual oil content measurement in compressed air

Page 131

## PC 400 / DS 400 - stationary solution



- Monitoring system for particle measurement in compressed air

Page 132-133

## PC 400 / DS 500 mobile solution



- Monitoring system for particle measurement in compressed air

Page 133

## UltraCam LD 500 / 510

- Leak detector with camera
- 30 MEMS microphones create the image of the leaks

Page 134-142



## LD 500 / 510

- Leak detector with camera



Page 136-142



## LD 450

- Low-price leak detector

Page 144-145

| Leakage Report                  | Start: 10/04/2019   | End: 10/06/2019   | Duration: 10 days       |
|---------------------------------|---|---|-------------------------|
| <b>Customer details:</b>        | <b>Customer:</b>  | <b>Address:</b>   |                         |
| Company:                        | Arcos   | John Sample   |                         |
| Address:                        | ---   | 1 Sample St., 12345 Sampletown  |                         |
| E-mail:                         | john@arcos.com  | j.sample@sample.com   |                         |
| Phone:                          | ---   | +49 1234 567890   |                         |
| Logo:                           |  |  |                         |
| <b>Project number details:</b>  |   |   |                         |
| Input date:                     |   | CO <sub>2</sub> emissions:  | 0.027 kg/kWh            |
| Cost calculation basis:         | Energy costs (70%)  | Specific output:  | 0.12 kWh/m <sup>3</sup> |
| Compressed air costs:           | 21.6 €/1000 m <sup>3</sup>  | Electricity price:  | 0.18 €/kWh              |
| Operating hours per year:       | 4300 h  |   |                         |
| <b>Results:</b>                 |   |   |                         |
| Number of leaks:                | 141   | Number remedied:  | 1                       |
| Total leakage amount:           | 710.120 l/min   | Leakage amount saved:   | 3.465 l/min             |
| Total costs per year:           | 4,840.49 €  | Costs saved per year:   | 18.93 €                 |
| Total CO <sub>2</sub> per year: | 11.91 tonnes  | CO <sub>2</sub> saved per year:   | 0.08 tonnes             |

| Leak tag:                       | 1                       |                                      |
|---------------------------------|-------------------------|--------------------------------------|
| Building - location:            | COMPRESSOR ROOM 1       | Repair under pressure possible? - No |
| Date and time:                  | 19/04/2019 12:08:03     | Error: Ball valve defective          |
| Leakage rate:                   | < 1.306 l/min           | Spare part: 1/2" ball valve          |
| Costs per year:                 | < 7.30 €                | Action: Replace                      |
| Total CO <sub>2</sub> per year: | 0.02 tonnes             | Mode: -                              |
| Priority:                       | Low                     | Status: Open                         |
| Comment:                        | Replace ball valve      | Remediated on: -                     |
|                                 |                         | Remediated by: -                     |
| Leak tag:                       | 2                       |                                      |
| Building - location:            |                         | Repair under pressure possible? - No |
| Date and time:                  | 19/04/2019 12:08:10     | Error: Flange leaking                |
| Leakage rate:                   | 2.919 l/min             | Spare part: DN 100 flange seal       |
| Costs per year:                 | 14.2 €                  | Action: Reestablish seal             |
| Total CO <sub>2</sub> per year: | 0.04 tonnes             | Mode: -                              |
| Priority:                       | High                    | Status: Done                         |
| Comment:                        | Reestablish flange seal | Remediated on: 19/04/2019            |
|                                 |                         | Remediated by: AM                    |

## CS Leak Reporter

- Creates detailed ISO 50001 reports

## CS Leak Reporter - Cloud solution

- Browser-based access to the CS Cloud



# OVERVIEW SOFTWARE



## CS Basic

- Data evaluation as a graph or in table form

Page 146-147



## CS Network

- Energy monitoring software with Client/Server solution

Page 148-1150



# OVERVIEW PRESSURE



## Differential pressure probe

- For testing on Compressed air systems

Page 152-153



## PTS 500

- 2 in 1 sensor: measures pressure and temperature in the process

Page 154



## DPS 16

- Digital temperature compensation and non-linearity correction



## CS 16

- Welded measuring system with no seals

Page 155



# OVERVIEW AMBIENT AIR



## IAC 500

- 3 in 1 sensor: Absolute pressure, temperature and humidity in the room

Page 156



# OVERVIEW CONVERSION UNITS

## Conversion table

| PSI  | Bar    |
|------|--------|
| 1    | 0.07   |
| 2    | 0.14   |
| 3    | 0.21   |
| 4    | 0.28   |
| 5    | 0.34   |
| 6    | 0.41   |
| 7    | 0.48   |
| 8    | 0.55   |
| 9    | 0.62   |
| 10   | 0.69   |
| 11   | 0.76   |
| 12   | 0.83   |
| 13   | 0.90   |
| 14   | 0.97   |
| 15   | 1.03   |
| 20   | 1.38   |
| 25   | 1.72   |
| 30   | 2.07   |
| 40   | 2.76   |
| 50   | 3.45   |
| 60   | 4.14   |
| 70   | 4.83   |
| 80   | 5.52   |
| 90   | 6.21   |
| 100  | 6.89   |
| 110  | 7.58   |
| 120  | 8.27   |
| 130  | 8.96   |
| 140  | 9.65   |
| 150  | 10.34  |
| 200  | 13.79  |
| 250  | 17.24  |
| 300  | 20.68  |
| 400  | 27.58  |
| 500  | 34.47  |
| 600  | 41.37  |
| 700  | 48.26  |
| 800  | 55.16  |
| 900  | 62.05  |
| 1000 | 68.95  |
| 1500 | 103.42 |
| 3000 | 206.84 |
| 5000 | 344.74 |

| F°   | C°   |
|------|------|
| -148 | -100 |
| -112 | -80  |
| -94  | -70  |
| -76  | -60  |
| -58  | -50  |
| -40  | -40  |
| -22  | -30  |
| -4   | -20  |
| 14   | -10  |
| 32   | 0    |
| 50   | 10   |
| 68   | 20   |
| 86   | 30   |
| 104  | 40   |
| 122  | 50   |
| 140  | 60   |
| 158  | 70   |
| 176  | 80   |
| 194  | 90   |
| 212  | 100  |
| 230  | 110  |
| 248  | 120  |
| 266  | 130  |
| 284  | 140  |
| 302  | 150  |
| 392  | 200  |
| 482  | 250  |
| 572  | 300  |
| 662  | 350  |
| 752  | 400  |
| 842  | 450  |
| 932  | 500  |

| mm  | Inch |
|-----|------|
| 1   | 0.04 |
| 2   | 0.08 |
| 3   | 0.12 |
| 4   | 0.16 |
| 5   | 0.20 |
| 6   | 0.24 |
| 7   | 0.28 |
| 8   | 0.31 |
| 9   | 0.35 |
| 10  | 0.39 |
| 11  | 0.43 |
| 12  | 0.47 |
| 13  | 0.51 |
| 14  | 0.55 |
| 15  | 0.59 |
| 16  | 0.63 |
| 17  | 0.67 |
| 18  | 0.71 |
| 19  | 0.75 |
| 20  | 0.79 |
| 25  | 0.98 |
| 30  | 1.18 |
| 35  | 1.38 |
| 40  | 1.57 |
| 45  | 1.77 |
| 50  | 1.97 |
| 55  | 2.17 |
| 60  | 2.36 |
| 65  | 2.56 |
| 70  | 2.76 |
| 75  | 2.95 |
| 80  | 3.15 |
| 85  | 3.35 |
| 90  | 3.54 |
| 95  | 3.74 |
| 100 | 3.94 |
| 105 | 4.13 |
| 110 | 4.33 |
| 115 | 4.53 |
| 120 | 4.72 |
| 125 | 4.92 |
| 130 | 5.12 |
| 135 | 5.31 |

| Inch  | mm  |
|-------|-----|
| 1/8   | 3   |
| 1/6   | 4   |
| 1/5   | 5   |
| 1/4   | 6   |
| 1/3   | 8   |
| 2/5   | 10  |
| 1/2   | 12  |
| 3/5   | 15  |
| 2/3   | 17  |
| 3/4   | 19  |
| 4/5   | 20  |
| 1     | 25  |
| 1 1/6 | 30  |
| 1 3/8 | 35  |
| 1 4/7 | 40  |
| 1 7/9 | 45  |
| 2     | 50  |
| 2 1/6 | 55  |
| 2 1/3 | 60  |
| 2 5/9 | 65  |
| 2 3/4 | 70  |
| 3     | 75  |
| 3 1/7 | 80  |
| 3 1/3 | 85  |
| 3 1/2 | 90  |
| 3 3/4 | 95  |
| 4     | 100 |
| 4 1/7 | 105 |
| 4 1/3 | 110 |
| 4 1/2 | 115 |
| 4 5/7 | 120 |
| 5     | 125 |
| 5 1/8 | 130 |
| 5 1/3 | 135 |

①

## Efficiency measurement + compressed air audits

- Electrical power measurement (page 23)
- Compressor capacity (page 100)
- Data logger / chart recorder (page 12-45)
- CS Basic Software (page 146-147)
- Compressor intake conditions (page 156)
- System pressure (page 154)

②

## Compressed air quality ISO 8573-1

- Dew point (page 50-59)
- Residual oil (page 128-133)
- Particles (page 128-133)

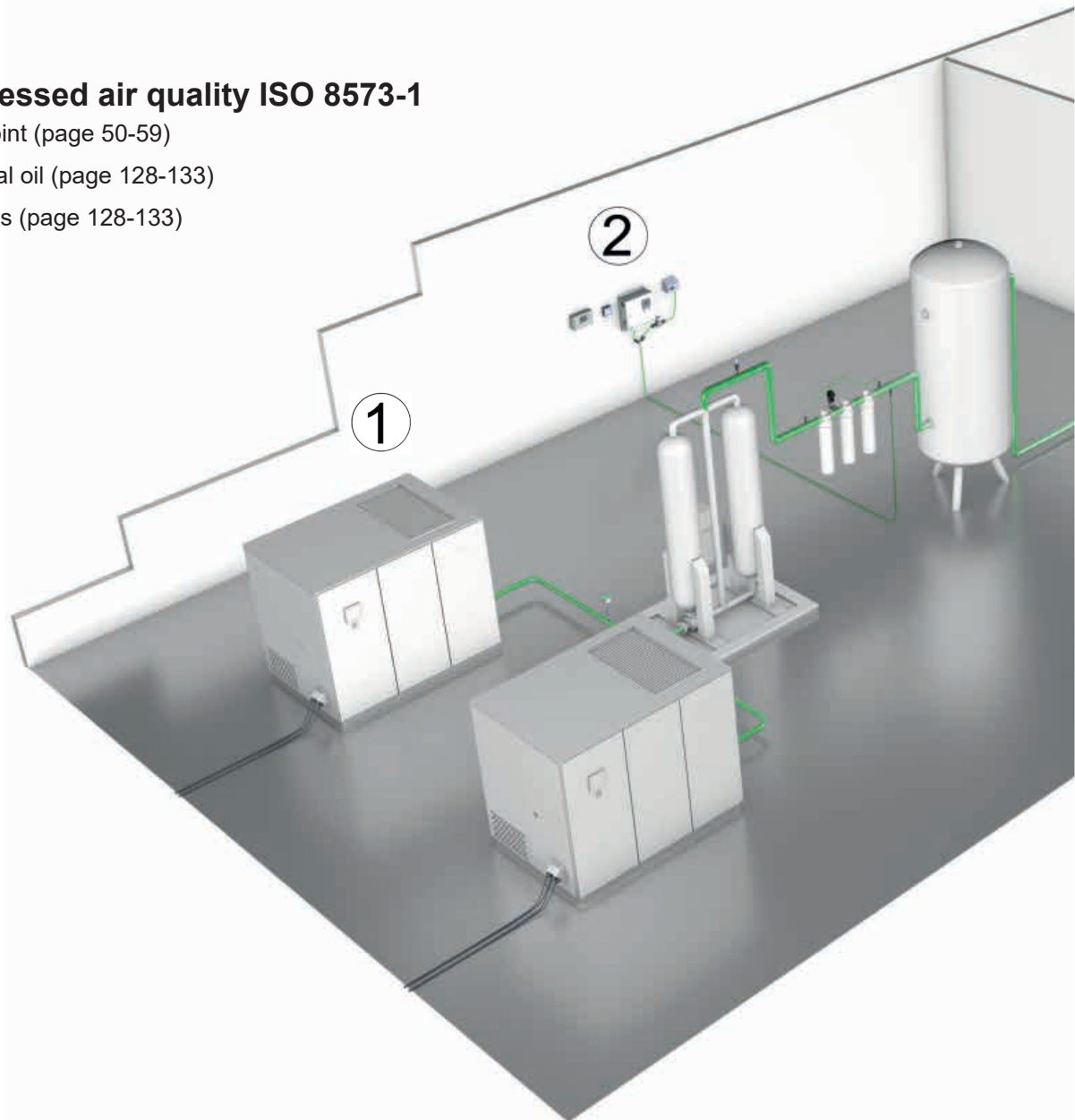

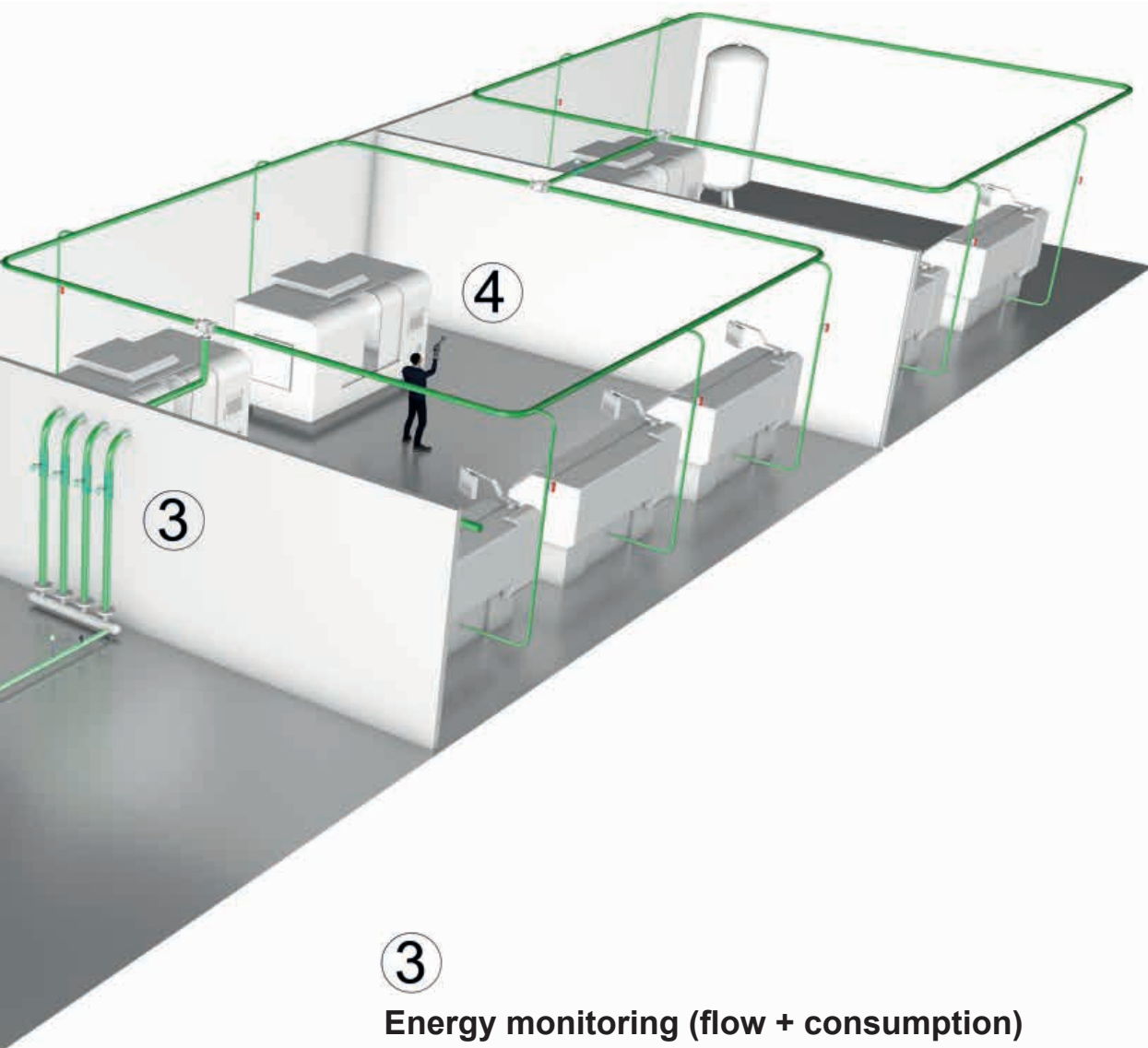

③

## Energy monitoring (flow + consumption)

- Insertion version (page 84-86)
- Inline version (page 88-92)
- Compact version (page 94-97)
- CS Network Software (page 148-150)

④

## Leak detection

- Leak detector with camera - shows leakage rate in l/min and costs in € (page 134-142)
- CS Leak Reporter Software - creates detailed ISO 50001 reports (page 139)



## DS 500 - Intelligent chart recorder for compressed air and gases

Measurement - control - indication - alarm - recording - evaluation

### Advantages at a glance:

- **Clear layout:** 7" colour screen with touch panel...
- **Versatile:** 4, 8 or 12 sensor inputs. Up to 12 analogue sensors or up to 40 digital sensors (Modbus RTU).
- **Suitable for industrial applications:** Metal housing IP 65 or panel mounting...
- **Data available through world wide web:** Network-compatible and remote transmission via web-server
- **Mathematical function:** for internal calculations
- **Totaliser function:** for analogue signals
- **...saves time and costs during installation**
- **Simple:** DS 500 provides the power supply for the sensors

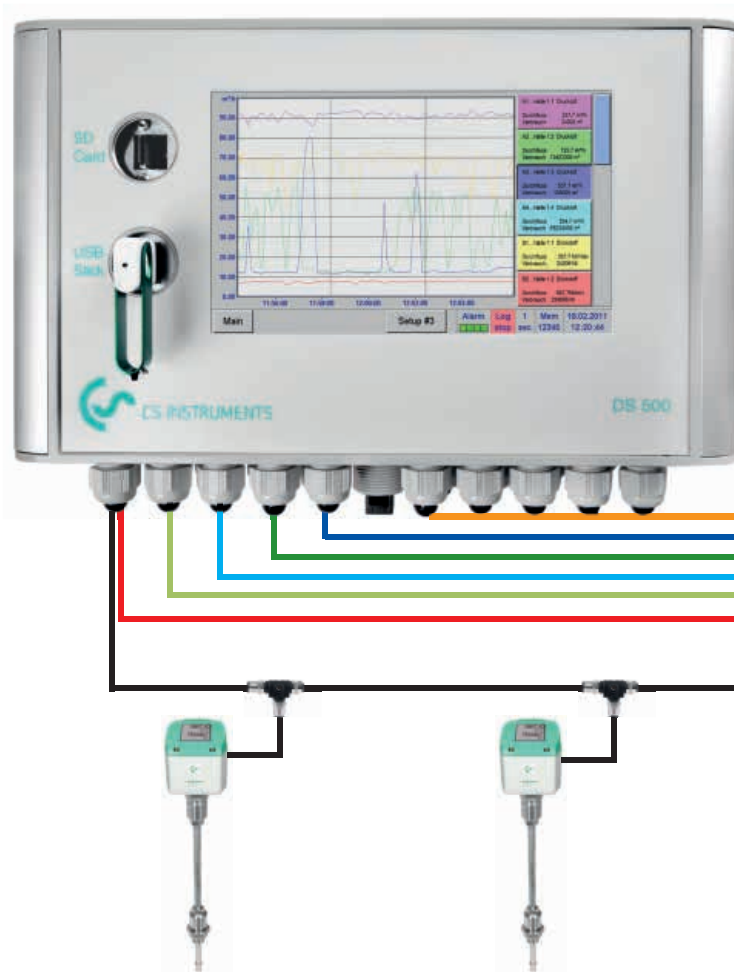

## DS 500 - The intelligent chart recorder of the next generation

Recording of the measured data, indication on a big colour screen, alerting, storage, not to mention remote read-out via webserver... this is all possible with DS 500.

All measured values, measurement curves and threshold value exceedances are indicated. The curve progressions from the beginning of the measurement can be viewed by an easy slide of the finger.

The big difference to ordinary paperless chart recorders reveals in the easy initiation and in the evaluation of the measured data. All sensors are identified directly and powered by DS 500. Everything is matched and tuned.

Mathematical function for internal calculations, e.g. the typical figures of a compressed air system:

- Costs in € per generated m<sup>3</sup> air
- kWh/m<sup>3</sup> generated air
- Consumption of single lines including summation

Totaliser function for analogue signals (e.g. 0/4...20 mA, 0...10 V). In case of third-party sensors which e.g. only give a 4...20 mA signal for the actual flow in m<sup>3</sup>/h, a total counter reading in m<sup>3</sup> can be generated by means of the totaliser function.

No time consuming studying of the instruction manual... this saves time. Internal voltage supply of all sensors, no wiring of external mains units ... this saves additional costs.



## Flow meters for compressed air and gases

- Installation and removal under pressure via standard 1/2" ball valve
- A safety ring prevents the uncontrolled ejection in case of installation/removal under pressure
- Usable for different gases: Compressed air, nitrogen, argon, CO<sub>2</sub>, oxygen...



## Dew point sensors

- Extremely stable in the long term
- Quick adaption time
- Large measuring range (-80° to +20 °Ctd)
- For all dryers: (Adsorption dryers, membrane dryers and refrigeration dryers)
- Easy installation under pressure via the measuring chamber with quick coupling



## Pressure sensors

- Large selection of pressure sensors with different measuring ranges for each measuring purpose
- Quick installation under pressure by quick coupling
- Pressure probe 0-10/16/40/100/250/400 bar overpressure
- Pressure probe -1 to +15 bar (underpressure/overpressure)
- Differential pressure 0...1.6 bar
- Absolute pressure 0 - 1.6 bar (abs)



- Large selection of temperature sensors e.g. for measurement of the ambient temperature or gas temperature
- Pt100 (2-wire or 3-wire)
- Pt1000 (2-wire or 3-wire)
- Temperature sensors with measuring transducer (4-20 mA output)



## Temperature sensors



- Monitoring of compressed air quality according to ISO 8573
- Residual oil, particles, residual moisture



## Compressed air quality measurement



- CS PM5110 current/effective power meters for panel mounting
- External current transformers for encompassing the phases (max. 2000 A)
- Measures kW, kWh, cos phi, kVar, kVA
- Data transfer DS 500 via Modbus



## Current/effective power meters

By means of the intelligent chart recorder **DS 500**, all measuring data of a compressor station can be recorded, indicated and evaluated.

At **12 freely assignable sensor inputs**, all our sensors can be connected as well as any optional **third-party sensors and meters with the following signal outputs:**

4-20 mA, 0-20 mA | 0-1 V / 0-10 V / 0-30 V | Pt 100 (2- or 3-wire), Pt 1000 (2- or 3-wire), pulse outputs (e.g. of gas meters) | Modbus protocol.



Measured values, statistics, curves with the 7" colour screen with touch panel

| A1 Compressed Air |                         | A2 Compressed Air |                           | A3 Compressed Air |                         | A4 Compressed Air |                         |
|-------------------|-------------------------|-------------------|---------------------------|-------------------|-------------------------|-------------------|-------------------------|
| A1a               | 237.7 m <sup>3</sup> /h | A2a               | 729.762 m <sup>3</sup> /h | A3a               | 537.0 m <sup>3</sup> /h | A4a               | 254.7 m <sup>3</sup> /h |
| --                | 34106 m <sup>3</sup>    | --                | 13423271 m <sup>3</sup>   | --                | 155132 m <sup>3</sup>   | --                | 55234063 m <sup>3</sup> |
| B1 Nitrogen       |                         | B2 Nitrogen       |                           | B3 Nitrogen       |                         | B4 Nitrogen       |                         |
| B1a               | 337.7 ltr/min           | B2a               | 657.7 ltr/min             | B3a               | 15.7 ltr/min            | B4a               | 237.7 ltr/min           |
| --                | 27734 ltr               | --                | 240041 ltr                | --                | 34131 ltr               | --                | 235322 ltr              |
| C1 Oxygen         |                         | C2 Oxygen         |                           | C3 Oxygen         |                         | C4 Oxygen         |                         |
| C1a               | 17.7 ltr/min            | C2a               | 37.7 ltr/min              | C3a               | 223.7 ltr/min           | C4a               | 75.8 ltr/min            |
| --                | 4080 ltr                | --                | 234108 ltr                | --                | 3749 ltr                | --                | 43584 ltr               |

Zurück Virtuelle Kanäle Alarm Lg. stop days, Int...: 24.03.2014 16:41:52

## Actual measured values

All measured values can be seen at a glance. Threshold value exceedances are indicated in red color. A „measuring site name“ can be allocated to each sensor.

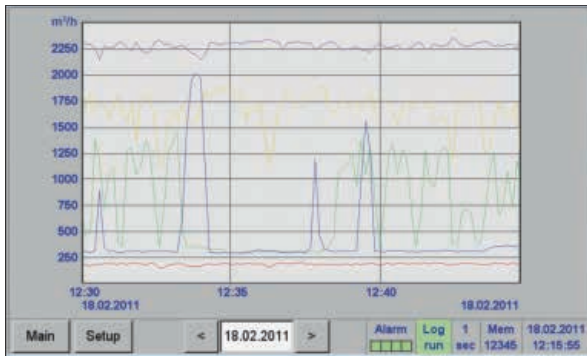

## Graphic display

This display replaces the former evaluation of ordinary paper chart recorders and offers lots of advantages. The time axis can be moved by a finger slide. The „zoom function by finger movement“ which enables an analysis of peak values is unique.



## Actual measured values and graphic

Additionally to the measurement curves, the current measured values are indicated as well.

### Alarm settings for channel A1 (DewPoint)

|   | Value °C/d | Hysteresis +/- | Relay 1 | Relay 2 | Relay 3 | Relay 4 |
|---|------------|----------------|---------|---------|---------|---------|
| <b>Upper limit</b>                          |            |                |         |         |         |         |
| <input checked="" type="checkbox"/> Alarm 1 | -40.000    | 0.500          | T0      |         |         |         |
| <input checked="" type="checkbox"/> Alarm 2 | -30.000    | 0.500          |         | T0      |         |         |
| <b>Lower limit</b>                          |            |                |         |         |         |         |
| <input type="checkbox"/> Alarm 1            |            |                |         |         |         |         |
| <input type="checkbox"/> Alarm 2            |            |                |         |         |         |         |

OK Cancel Setup Delay

## Adjustment of the alarm relays

Each one of the four alarm relays can be allocated individually to a connected sensor. The alarm thresholds and the hysteresis can be freely adjusted.

**New:** It is possible to set an alarm delay for each alarm relay so that the relay is only triggered after that period of time.



## Technical data of the DS 500

### TECHNICAL DATA DS 500

|                                   |   |
|-----------------------------------|---|
| <b>Dimensions of housing:</b>     | 280 x 170 x 90 mm, IP 65  |
| <b>Connections:</b>               | 18 x PG for sensors and supply  |
| <b>Version panel mounting:</b>    | Cutout panel 250 x 156 mm   |
| <b>Weight:</b>                    | 3,5 kg  |
| <b>Material:</b>                  | Die cast metal, front screen polyester  |
| <b>Sensor inputs:</b>             | <ul style="list-style-type: none"> <li>• 4/8/12 sensor inputs for analogue and digital sensors; freely allocatable. See options</li> <li>• Digital CS sensors for dew point and consumption with SDI interface FA/VA series,</li> <li>• Digital third-party sensors RS 485 / Modbus RTU, other bus systems realizable on request.</li> <li>• Analogue CS Sensors for pressure, temperature, clamp-on ammeters pre-configured.</li> <li>• Analogue third-party sensors 0/4...20 mA, 0...1/10/30 V, pulse, Pt 100 / Pt 1000, KTY</li> </ul> |
| <b>Voltage supply for sensor:</b> | 24 VDC, max. 130 mA per sensor, integrated mains unit max. 24 VDC, 25 W. In case of version 8/12 sensor inputs, 2 integrated mains units each max. 24 VDC, 25 W.  |
| <b>Interfaces:</b>                | USB stick, Ethernet / RS 485 Modbus-RTU / TCP, SDI other bus systems on request, webserver optional   |
| <b>Outputs:</b>                   | <ul style="list-style-type: none"> <li>• 4 relays (changeover contact 230 VAC, 6 A), alarm management, relays freely programmable, collective alarm</li> <li>• Analog output, pulse in case of sensors with own signal output looped, such as e.g. VA/FA series</li> </ul>  |
| <b>Memory card:</b>               | Memory size 16 GB Micro SD card   |
| <b>Power supply:</b>              | 100...240 VAC / 50-60 Hz, special version 24 VDC  |
| <b>Colour screen:</b>             | 7" touch panel TFT transmissive, graphics, curves, statistics   |
| <b>Accuracy:</b>                  | See sensor specifications   |
| <b>Operating temperature:</b>     | 0...50 °C   |
| <b>Storage temperature:</b>       | -20...70 °C   |
| <b>Optional:</b>                  | Web server  |

| DESCRIPTION  | ORDER NO. |
|--|-----------|
| DS 500 - intelligent chart recorder in basic version (4 sensor inputs)   | 0500 5000 |
| Option: 4 additional sensor inputs for DS 500 V2   | Z500 5501 |
| Option: 8 additional sensor inputs for DS 500 V2   | Z500 5502 |
| Option: Integrated webserver   | Z500 5003 |
| Option: version for panel mounting   | Z500 5006 |
| Option: Power supply 24 VDC (instead of 100...240 VAC)   | Z500 5007 |
| Option: "Mathematics calculation function" for 4 freely selectable channels, (virtual channels): addition, subtraction, division, multiplication | Z500 5008 |
| Option: "Totaliser function for analogue signals"  | Z500 5009 |
| External Gateway Profibus for connecting an integrated RS 485 interface  | Z500 3008 |
| CS Basic – data evaluation graphically and in tabular form - reading of the measured data via USB or Ethernet, license for 2 workstations        | 0554 8040 |
| CS Network – energy monitoring with client/server solution (max. 20 measured values of different sensors/devices)                                | 0554 8041 |
| CS Network – energy monitoring with client/server solution (max. 50 measured values of different sensors/devices)                                | 0554 8042 |
| CS Network – energy monitoring with client/server solution (max. 100 measured values of different sensors/devices)                               | 0554 8043 |
| CS Network - Energy Monitoring with Client / Server Solution (max. 200 measured values of different sensors / devices)                           | 0554 8044 |

Matching sensors can be found on pages 20 to 23

### INPUT SIGNALS

|                                   |   |
|-----------------------------------|---|
| <b>Current signals</b>            | (0...20 mA/ 4...20 mA)  |
| Internal or external power supply |   |
| Measuring range                   | 0...20 mA   |
| Resolution                        | 0.0001 mA   |
| Accuracy                          | ± 0.03 mA ± 0.05 %  |
| Input resistance                  | 50 Ω  |
| <b>Voltage signal</b>             | (0...1 V)   |
| Measuring range                   | 0...1 V   |
| Resolution                        | 0.05 mV   |
| Accuracy                          | ± 0.2 mV ± 0.05 %   |
| Input resistance                  | 100 kΩ  |
| <b>Voltage signal</b>             | (0...10 V / 30 V)   |
| Measuring range                   | 0...10 V  |
| Resolution                        | 0.5 mV  |
| Accuracy                          | ± 2 mV ± 0.05 %   |
| Input resistance                  | 1 MΩ  |
| <b>RTD Pt 100</b>                 |   |
| Measuring range                   | -200...850 °C   |
| Resolution                        | 0.1 °C  |
| Accuracy                          | ± 0.2 °C (-100...400 °C)<br>± 0.3 °C (further range)          |
| <b>RTD Pt 1000</b>                |   |
| Measuring range                   | -200...850 °C   |
| Resolution                        | 0.1 °C  |
| Accuracy                          | ± 0.2° (-100...400 °C)  |
| <b>Pulse</b>                      |   |
| Measuring range                   | Min pulse length 500 µs<br>frequency 0...1 kHz<br>max. 30 VDC |



## DS 400 - Chart recorder

for all relevant parameters of compressed air



### Standard equipment:

- USB interface
- 3.5" graphic display with touch screen
- Integrated mains unit for supply of the sensors
- 4...20 mA analogue output of all connected active sensors
- Pulse output (for total consumption) in case of flow sensors
- 2 alarm relays (pot.-free changeover contacts, max. 230 V, 3 A)







### Software options:

- Integrated webserver
- Mathematics calculation function
- Totaliser function

### Hardware options:

- Integrated data logger
- Ethernet / RS 485 interface
- Additional sensor inputs (digital or analogue) selectable

The sensor inputs 1 and 2 and 3 and 4 can be selected according to the required sensors (see table pages 20 to 21):

| Digital   | Digital   | Digital   | Digital   | Digital   | Analogue  | Analogue  | Analogue | Analogue                           |
|---|---|---|---|---|---|---|----------|------------------------------------|
| m <sup>3</sup> /h, m <sup>3</sup>   | °Ctd  | A, kWh  |   | bar   | A   | °C  |          | °C                                 |
|  |  |  |  |  |  |  |          |                                    |
| Flow sensor   | Dew point sensor  | Current/effective power meter   | Third-party sensors with RS 485   | Pressure sensor   | Clamp-on ammeter  | Temperature sensor  |          | Third party sensor analogue output |





Panel mounting



Back view

## TECHNICAL DS 400

|                                    |  |
|------------------------------------|--|
| <b>Dimensions:</b>                 | 118 x 115 x 98 mm<br>IP 54 (wall housing)<br>92 x 92 x 75 mm<br>(panel mounting)   |
| <b>Inputs:</b>                     | 2 digital inputs for FA 5xx<br>resp. VA 5xx  |
| <b>Interface:</b>                  | USB interface  |
| <b>Power supply:</b>               | 100...240 VAC, 50-60 Hz  |
| <b>Accuracy:</b>                   | See sensor specifications  |
| <b>Alarm outputs:</b>              | 2 relays, (pot.-free)  |
| <b>Options:</b>                    |  |
| <b>Data logger:</b>                | 100 million measured values start/stop time, measuring rate freely adjustable  |
| <b>2 additional sensor inputs:</b> | For connection of pressure sensors, temperature sensors, clamp-on ammeters, third-party sensors with 4...20 mA, 0 to 10 V, Pt 100, Pt 1000 |

| DESCRIPTION   | Sensor input 1+2     | Sensor input 3+4     | ORDER NO.    |
|---|----------------------|----------------------|--------------|
| DS 400 - Chart recorder with graphic display and touch screen | Digital (Z500 4003)  | -----                | 0500 4000 D  |
|   | Digital (Z500 4003)  | Digital (Z500 4003)  | 0500 4000 DD |
|   | Digital (Z500 4003)  | Analogue (Z500 4001) | 0500 4000 DA |
|   | Analogue (Z500 4001) | -----                | 0500 4000 A  |
|   | Analogue (Z500 4001) | Analogue (Z500 4001) | 0500 4000 AA |

### Options:

Option: Integrated data logger for 100 million measured values

Option: Integrated Ethernet and RS 485 interface

Option: Integrated webserver

Option: "Mathematics calculation function" for 4 freely selectable channels, (virtual channels): addition, subtraction, division, multiplication

Option: "Totaliser function for analogue signals"

External Gateway Profibus for RS 485 interface connection

|           |
|-----------|
| Z500 4002 |
| Z500 4004 |
| Z500 4005 |
| Z500 4007 |
| Z500 4006 |
| Z500 3008 |

### Further accessories:

CS Basic – data evaluation graphically and in tabular form - reading of the measured data via USB or Ethernet, license for 2 workstations

CS Network – energy monitoring with client/server solution (max. 20 measured values of different sensors/devices)

CS Network – energy monitoring with client/server solution (max. 50 measured values of different sensors/devices)

CS Network – energy monitoring with client/server solution (max. 100 measured values of different sensors/devices)

CS Network - Energy Monitoring with Client / Server Solution (max. 200 measured values of different sensors / devices)

|           |
|-----------|
| 0554 8040 |
| 0554 8041 |
| 0554 8042 |
| 0554 8043 |
| 0554 8044 |

## INPUT SIGNALS

|  |   |
|--|---|
| <b>Current signals</b><br>internal or external power supply<br>Measuring range<br>Resolution<br>Accuracy<br>Input resistance | (0...20 mA/4...20 mA)   |
| <b>Voltage signal:</b><br>Measuring range<br>Resolution<br>Accuracy<br>Input resistance                                      | (0...1 V)<br>0...1 V<br>0.05 mV<br>± 0.2 mV ± 0.05 %<br>100 kΩ                  |
| <b>Voltage signal</b><br>Measuring range<br>Resolution<br>Accuracy<br>Input resistance                                       | (0...10 V / 30 V)<br>0...10 V<br>0.5 mV<br>± 2 mV ± 0.05 %<br>1 MΩ              |
| <b>RTD Pt 100</b><br>Measuring range<br>Resolution<br>Accuracy   | -200...850 °C<br>0.1 °C<br>± 0.2 °C (-100...400 °C)<br>± 0.3 °C (further range) |
| <b>RTD Pt 1000</b><br>Measuring range<br>Resolution<br>Accuracy  | -200...850 °C<br>0.1 °C<br>± 0.2° (-100...400 °C)                               |
| <b>Pulse</b><br>Measuring range  | Min pulse length 500 µs<br>frequency 0...1 kHz<br>max. 30 VDC                   |



## DS 500 / DS 400

Easy operation via touchscreen:

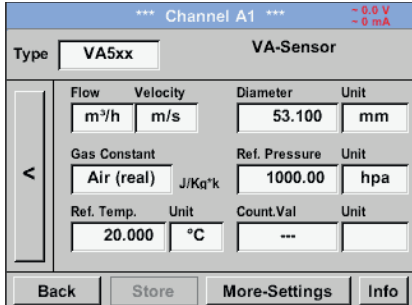

### Configuration of flow sensor

In the menu of the DS 500 / DS 400, the flow sensor VA 5xx can be set to the respective pipe inside diameter. Furthermore, the unit, the gas type and the reference condition can be set. The meter reading can be set to "zero" if necessary.

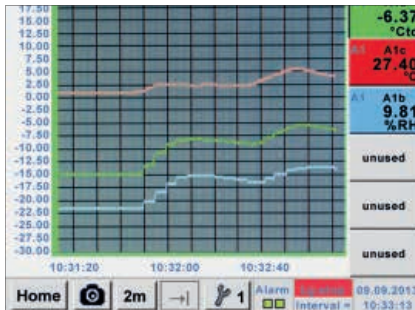

### Graphic view

In the graphic view all measured values are indicated as curves. It is possible to browse back on the time axis by a slide of the finger (without data logger maximum 24 h, with data logger back to the start of the measurement).

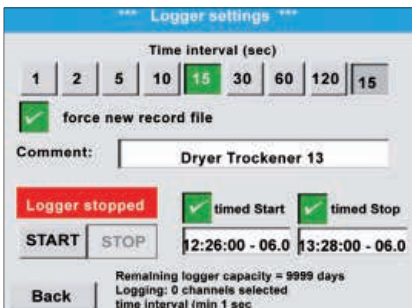

### Data logger

With the option „integrated data logger“ the measured values are stored in the DS 500 / DS 400. The time interval can be freely set. Furthermore there is the possibility to fix the starting time and the end time of the data recording. Read-out of the measured data via USB interface or via the optional Ethernet interface.

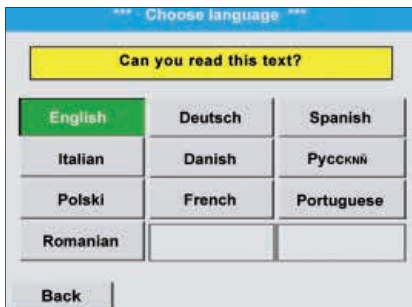

### Selection of the language

DS 500 / DS 400 "speaks" several languages. The desired language can be selected via the selection button.

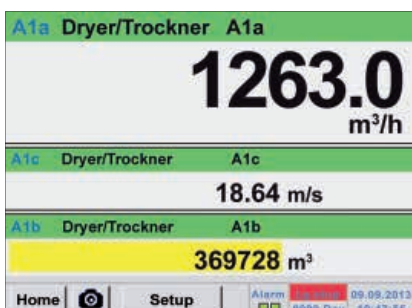

### All relevant parameters at a glance

In addition to the flow rate in m³ / h, the DS 500 / DS 400 also displays other parameters such as total consumption in m³ and speed in m/s.



## Web server

The new webserver with substantially extended features for the chart recorders DS 500 and DS 400 is available with immediate effect. Users can thereby get direct access to their measured data worldwide (current and historic ones) and display them on their smart phone, tablet or computer.

The new webserver can be ordered as an option with each stationary DS 500/400, but also for their mobile devices. For using the features of the webserver, the DS 500/400 must be set up with it's own IP address within the corporate network.

The web server in the DS 500/400 provides a website, which displays the measured values. This website can be accessed from smartphones, tablets and computers via the respectively installed browser. Advantage: This is all possible without the installation of any new or additional software.



### View of the real time measured values (graphic table view)

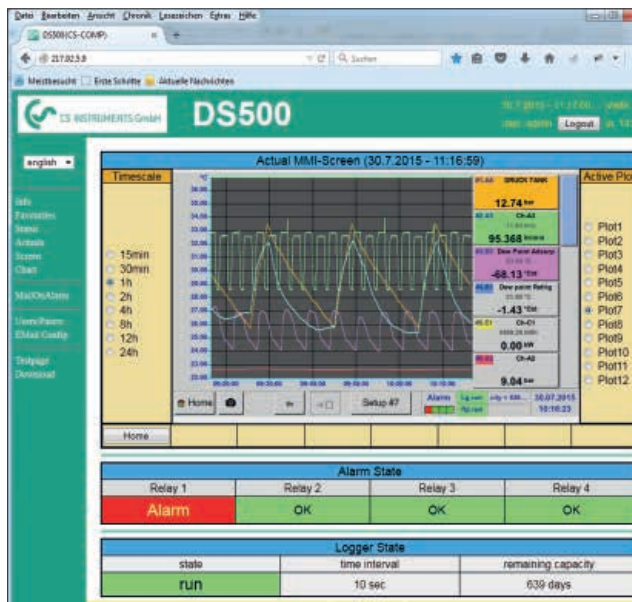

### View of the historic measured values as a single chart (time period freely selectable)

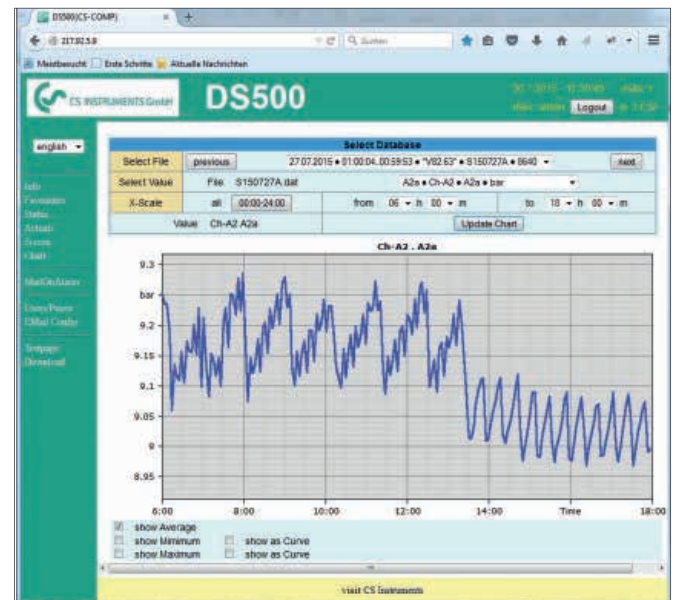

### Access authorization

Different groups with different users/passwords can be assigned to different access levels.

### Starting the data logger

In case of a stopped data logger the group operator or administrator can start the data logger remotely, via the web server.

**PS: The new webserver can be retrofitted to any DS 500/DS 400 already in use.**



## Suitable sensors for DS 500 / DS 400

### Flow meters for installation and removal under pressure (insertion type)

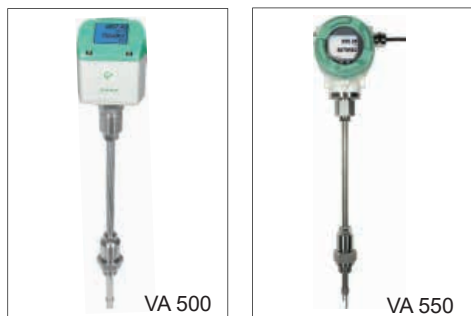

| FLOW METERS INSERTION-VERSION   | ORDER NO.                              |
|---|--|
| VA 500 meter in basic version:<br>Standard (92.7 m/s), probe length 220 mm, without display | 0695 5001                              |
| VA 550 Flow meter, measuring head in robust aluminium die casting housing                   | 0695 0550<br>+ order code<br>A...M..._ |

### Inline flow meter



| FLOW METERS IN-LINE VERSION   | ORDER NO. |
|---|-----------|
| Flow meter VA 520 with integrated measuring section, (R 1/4" DN 8)    | 0695 0520 |
| Flow meter VA 520 with integrated measuring section, (R 1/2" DN 15)   | 0695 0521 |
| Flow meter VA 520 with integrated measuring section, (R 3/4" DN 20)   | 0695 0522 |
| Flow meter VA 520 with integrated measuring section, (R 1" DN 25)     | 0695 0523 |
| Flow meter VA 520 with integrated measuring section, (R 1 1/4" DN 32) | 0695 0526 |
| Flow meter VA 520 with integrated measuring section, (R 1 1/2" DN 40) | 0695 0524 |
| Flow meter VA 520 with integrated measuring section, (R 2" DN 50)     | 0695 0525 |



|   |                                     |
|---|-------------------------------------|
| Inline Flow meter VA 570 with integrated 1/2" measuring section | 0695 0570<br>+ order code<br>A...K_ |
| Flow meter VA 570 with integrated 3/4" measuring section        | 0695 0571                           |
| Flow meter VA 570 with integrated 1" measuring section          | 0695 0572                           |
| Flow meter VA 570 with integrated 1 1/4" measuring section      | 0695 0573                           |
| Flow meter VA 570 with integrated 1 1/2" measuring section      | 0695 0574                           |
| Flow meter VA 570 with integrated 2" measuring section          | 0695 0575                           |



| DEW POINT SENSORS   | ORDER NO. |
|---|-----------|
| FA 510 dew point sensor, -80...+20 °Ctd incl. factory certificate | 0699 0510 |
| FA 510 dew point sensor, -20...+50 °Ctd incl. factory certificate | 0699 0512 |
| Standard measuring chamber for compressed air up to 16 bar        | 0699 3390 |



| CONNECTION CABLES FOR FLOW METERS/DEW POINT SENSORS<br>VA 500, 520 AND FA 510 | ORDER NO. |
|---|-----------|
| Connection cable for VA/FA series, 5 m  | 0553 0104 |
| Connection cable for VA/FA sensors, 10 m                                      | 0553 0105 |

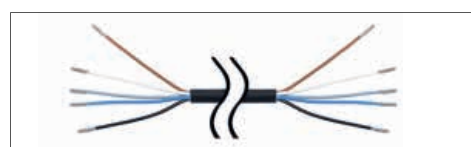

| CONNECTION CABLES FOR FLOW METERS VA 550/570: | ORDER NO. |
|---|-----------|
| Connection cable 5 m with open ends           | 0553 0108 |
| Connection cable 10 m with open ends          | 0553 0109 |



| PRESSURE PROBES WITH 4...20 mA ANALOGUE OUTPUT                                       | ± 1%      | ± 0,5%    |
|--|-----------|-----------|
|  | ACCURACY  | ACCURACY  |
| Standard pressure probe CS 16, 0...16 bar  | 0694 1886 | 0694 3555 |
| Standard pressure probe CS 40, 0...40 bar  | 0694 0356 | 0694 3930 |
| Standard pressure probe CS 1.6, 0...1.6 bar abs.                                     |           | 0694 3550 |
| Standard pressure probe CS 10, 0...10 bar  | 0694 3556 | 0694 3554 |
| Standard pressure probe CS 100, 0...100 bar  |           | 0694 3557 |
| Standard pressure probe CS 250, 0...250 bar  |           | 0694 3558 |
| Standard pressure probe CS 400, 0...400 bar  |           | 0694 3559 |
| Precision pressure probe CS -1...+15 bar, ± 0.5 % accuracy of. f.s.                  |           | 0694 3553 |
| Differential pressure probe 1.6 bar diff.  |           | 0694 3561 |
| Calibration certificate pressure, 5 calibration points for the whole measuring range |           | 3200 0004 |



| DIGITAL PRESSURE PROBES                                    | ± 1%      | ± 0,5%    |
|--|-----------|-----------|
|  | ACCURACY  | ACCURACY  |
| Digital pressure probe DPS 16, 0...16 bar RS 485, G1/2"    | 0694 2886 | 0694 4555 |
| Digital pressure probe DPS 16, 0...16 bar RS 485, NPT 1/2" | 0694 3886 | 0694 5555 |



0604 0201

0604 0208

| TEMPERATURE SENSORS   | ORDER NO. |
|---|-----------|
| Screw-in temperature sensor PT 100 class A, length 300 mm, d = 6 mm, with measuring transducer 4...20 mA = -50 °C...+ 550 °C (2-wire)             | 0604 0201 |
| Outdoor temperature sensor PT 100 class B (2-wire) in wall housing (82x55x33 mm), application range: -50 °C...+80 °C                              | 0604 0203 |
| Room/outdoor temperature sensor with measuring transducer, 4...20 mA (2-wire), measuring range switchable -20 °C...+80 °C / -50 °C...+50 °C       | 0604 0209 |
| Indoor temperature sensor PT 100 class B (2-wire) in wall housing with ventilation slots (82x55x33 mm), application range: -50 °C...+80 °C        | 0604 0204 |
| Cable temperature sensor PT 100 class A (4-wire), length: 300 mm, d = 6 mm, -70 ... +260 ° C, 5 m connection cable PFA with open ends             | 0604 0205 |
| Cable temperature sensor PT 100 class A (4-wire), length: 100 mm, d = 6 mm, -70...+260 ° C, 5 m connection cable PFA with open ends               | 0604 0206 |
| Cable temperature sensor PT 100 class A (4-wire), length: 200 mm, d = 6 mm, -70...+260 ° C, 5 m connection cable PFA with open ends               | 0604 0207 |
| Magnetic surface temperature sensor, holding magnet 39x26x25 mm, PT 100 class B (2-wire), -30...+180 ° C, 5 m connection cable PFA with open ends | 0604 0208 |
| Compression fittings: 6 mm; G 1/2" PTFE clamping ring pressure-tight up to 10 bar   | 0554 0200 |
| Material: stainless steel, application area: max. + 260 ° C   |           |
| Compression fitting; 6 mm; G 1/2" stainless steel clamping ring   | 0554 0201 |
| Pressure-tight up to 16 bar, material: stainless steel, application area: max. + 260 ° C  |           |
| Calibration certificate temperature, 2 calibration points   | 0520 0180 |



0604 0209



0604 0205



0554 0200

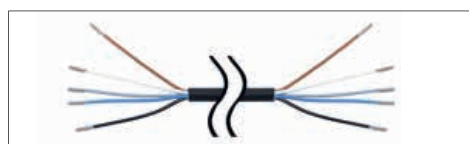

| CONNECTION CABLES FOR PRESSURE SENSORS / TEMPERATURE SENSORS | ORDER NO. |
|--|-----------|
| Connection cable for probes 5 m with open ends               | 0553 0108 |
| Connection cable for probes 10 m with open ends              | 0553 0109 |

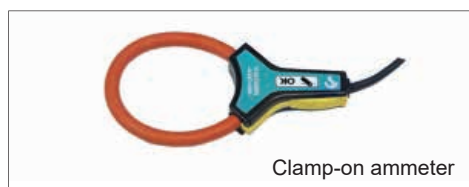

Clamp-on ammeter

| CLAMP-ON AMMETERS  | ORDER NO. |
|--|-----------|
| Clamp-on ammeter 0...1000 A TRMS incl. 3 m connection cable with open ends | 0554 0518 |
| Clamp-on ammeter 0...400 A TRMS incl. 3 m connection cable with open ends  | 0554 0510 |



## CS PM 5110 - Current/effective power meters for panel mounting

Measures voltage, current and calculates:

- Effective power [kW]
- Apparent power [kVA]
- Reactive power [kVar]
- Active energy [kWh]
- cos phi

All measured data are transmitted digitally (Modbus) to the DS 500 and can be recorded there.

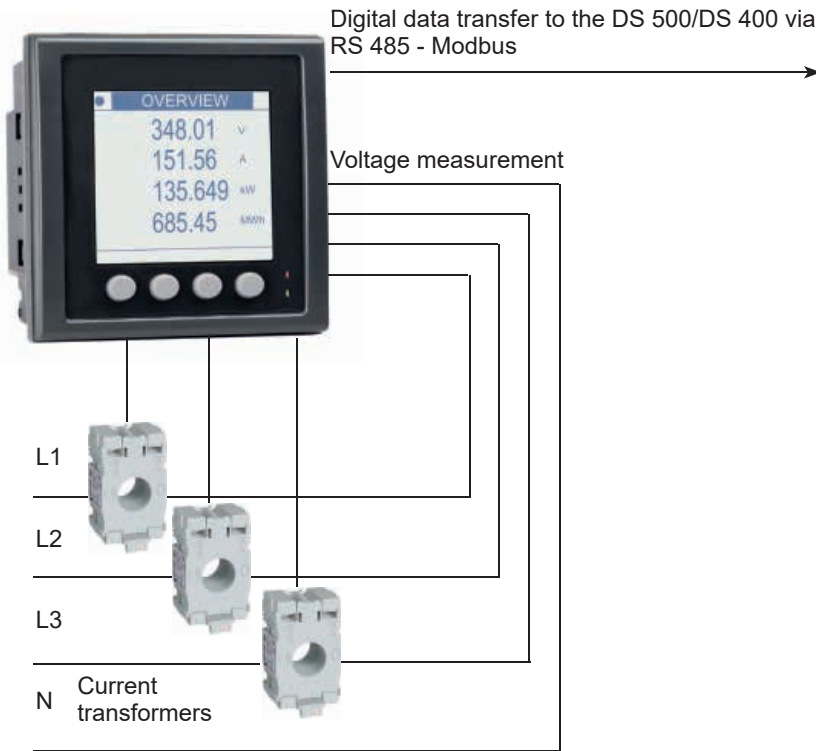

| DESCRIPTION  | ORDER NO. |
|--|-----------|
| CS PM5110 Current/effective power meters for panel mounting, with RS485 interface  | 0554 5357 |
| Install-construction for the CS PM5110, on top hat rail  | 0554 5356 |
| Current transformer 100/5 A connectable to current/effective power meter for panel mounting (for cables up to Ø 21 mm)           | 0554 5344 |
| Current transformer 200/5 A connectable to current/effective power meter for panel mounting (for cables up to Ø 21 mm)           | 0554 5345 |
| Current transformer 300/5 A connectable to current/effective power meter for panel mounting (for cables up to Ø 22 mm)           | 0554 5346 |
| Current transformer 500/5 A connectable to current/effective power meter for panel mounting (for cables up to Ø 22 mm)           | 0554 5347 |
| Current transformer 600/5 A connectable to current/effective power meter for panel mounting (for cables up to Ø 22 mm)           | 0554 5348 |
| Current transformer 1000/5 A connectable to current/effective power meter for panel mounting (for current bar up to 65 x 32 mm)  | 0554 5349 |
| Current transformer 2000/5 A connectable to current/effective power meter for panel mounting (for current bar up to 127 x 38 mm) | 0554 5350 |
| Connection cable for probes 5 m, with open ends  | 0553 0108 |
| Connection cable for probes 10 m, with open ends   | 0553 0109 |

### TECHNICAL DATA PM5110

|                                      |   |
|--------------------------------------|---|
| <b>Parameters:</b>                   | Voltage (Volt)<br>Current (Ampere)<br>Cos phi<br>Effective power (kW)<br>Apparent power (kVA)<br>Reactive power (kVar)<br>Active energy (kWh)<br>Power frequency (Hz)<br>All parameters are transferred digitally to DS 500/DS 400. |
| <b>Accuracy current measurement:</b> | ± 0.5% from 1 to 6 A  |
| <b>Accuracy voltage:</b>             | ± 0.5% from 50 V to 277 V   |
| <b>Accuracy active energy:</b>       | IEC 62053-21 Class 1  |
| <b>Interfaces:</b>                   | RS 485 (Modbus protocol)  |
| <b>Measuring range:</b>              | Voltage measurement max. 600 VAC  |
| <b>Dimensions:</b>                   | 96 x 96 x 78.5 mm (W x H x D)   |
| <b>Operating temperature:</b>        | -10...+55 °C  |



## CS PM Flex - Current/effective power meter with Rogowski Coils

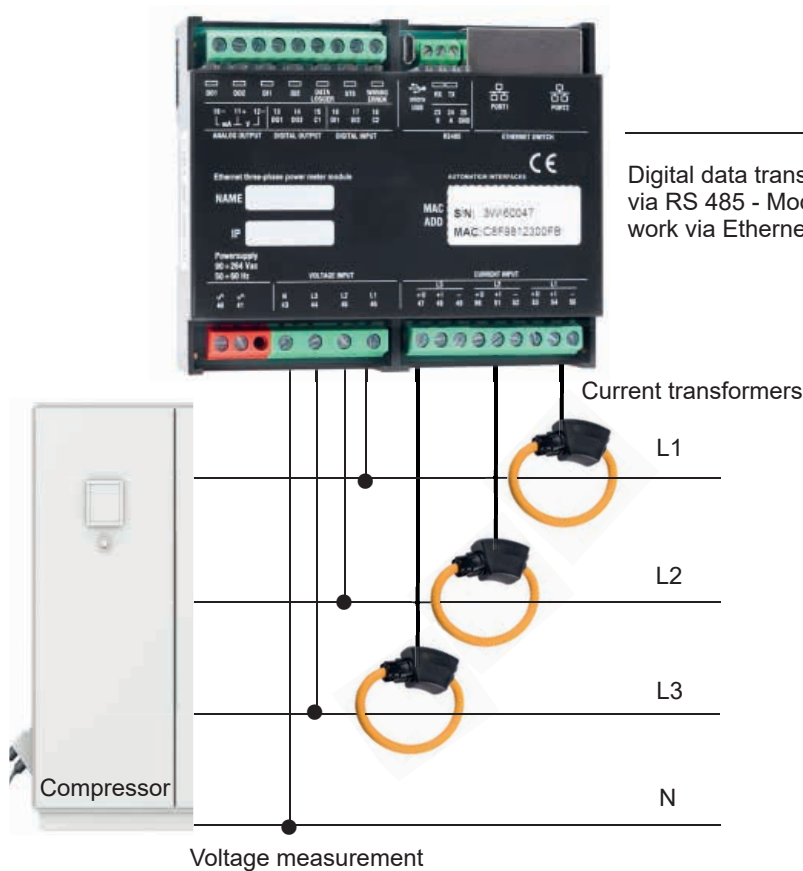

Measures voltage, current and calculates:

- Effective power [kW]
- Apparent power [kVA]
- Reactive power [kVar]
- Active energy [kWh]
- cos phi

### Rogowski Coil:

The split coil bobbin allows subsequent, quick and easy installation



### Accuracy range:

C: Conductor in centred position

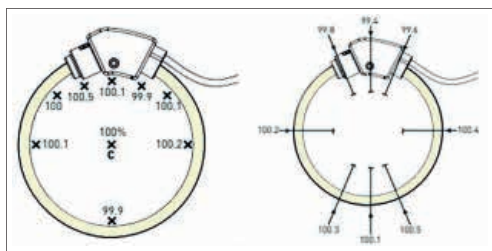

### TECNICAL DATA CS PM Flex

#### Parameters:

- Voltage (Volt)
- Current (Ampere)
- Cos phi
- Effective power (kW)
- Apparent power (kVA)
- Reactive power (kVar)
- Active energy (kWh)
- Power frequency (Hz)
- All parameters are transferred digitally to DS 500/ CS Network.

#### Measuring range:

**Voltage measurement:**  
max. 600 VAC, 45-65 Hz

**Current measurement:**  
10 - 3000 A @ 50 Hz  
10 - 2500 A @ 60 Hz

#### Accuracy

**Current measurement / active energy:**

± 0,5%

**Accuracy voltage measurement:**

± 0,2 %

#### Interfaces:

RS 485 and Ethernet

#### Dimensions:

90 x 107 x 32 mm  
(B x H x T)

#### Operating temperature:

-25...+55 °C

| DESCRIPTION  | ORDER NO. |
|--|-----------|
| CS PM Flex Current/effective power meters for top-hat rail mounting, with RS485 and Ethernet interface | 0554 5358 |
| Rogowski Coil (Ø 80 mm) connectable to CS PM Flex incl. 3 m connection cable with open ends            | 0554 5359 |



## DS 500 mobile - Intelligent mobile chart recorder

The intelligent chart recorder of the future - energy analysis according to DIN EN 50001  
Energy analysis - consumption measurement - leakage calculation at compressed air systems

### Advantages at a glance:

- Easy operation via 7" colour screen with touch panel

### Versatile:

- Up to 12 sensors / meters can be connected, including third-party sensors / counters incl. power supply

### Reliable:

- Reliably stores all measured values on a memory card. Easy reading out via USB stick possible

### Intelligent energy analysis:

- Costs in € per generated m<sup>3</sup> air
- kWh/m<sup>3</sup> generated air
- Consumption of single lines including summation







## Technical data of DS 500 mobile

| TECHNICAL DATA DS 500 MOBILE      |   | INPUT SIGNALS   |   |
|-----------------------------------|---|---|---|
| <b>Case dimensions</b>            | 384 x 264 x 164 mm  | <b>Current signal internal or external power supply</b> | (0...20 mA/4...20 mA)   |
| <b>Weight:</b>                    | 4.5 kg  | Measuring range   | 0...20 mA   |
| <b>Material:</b>                  | Diecast, front foil polyester, ABS  | Resolution  | 0.0001 mA   |
| <b>Sensor inputs:</b>             | 4/8/12 sensor inputs for analogue and digital sensors; freely allocatable. See options<br>Digital CS sensors for dew point and flow with SDI interface FA/VA series, digital third-party sensors RS485 / Modbus RTU.<br>Analogue CS Sensors for pressure, temperature, clamp-on ammeters preconfigured.<br>Analogue third-party sensors 0/4...20 mA, 0...1/10/30 V, pulse, Pt 100 / Pt 1000, KTY, counter | Accuracy  | $\pm 0.03 \text{ mA} \pm 0.05 \%$   |
| <b>Voltage supply for sensor:</b> | 24 VDC, max. 130 mA per sensor, integrated mains unit, max. 24 VDC, 25 W.<br>For version 8/12 sensor inputs 2 integrated mains units, each max. 24 VDC, 25 W  | Input resistance  | 50 $\Omega$   |
| <b>Interfaces:</b>                | USB stick, Ethernet / RS 485 Modbus RTU / TCP, SDI other bus systems on request, webserver optionally, GSM module   | <b>Voltage signal</b>                                   |   |
| <b>Memory card:</b>               | Memory size 16 GB Micro SD memory card  | Measuring range   | (0...1 V)   |
| <b>Power supply:</b>              | 100...240 VAC, 50-60 Hz   | Resolution  | 0...1 V   |
| <b>Colour screen:</b>             | 7" touch panel TFT transmissive, graphics, curves, statistics   | Accuracy  | 0.05 mV   |
| <b>Accuracy:</b>                  | Please see sensor specifications  | Input resistance  | $\pm 0.2 \text{ mV} \pm 0.05 \%$<br>100 k $\Omega$  |
| <b>Operating temperature:</b>     | 0...50 °C   | <b>Voltage signal</b>                                   |   |
| <b>Storage temperature:</b>       | -20...70 °C   | Measuring range   | (0...10 V / 30 V)   |
|                                   |   | Resolution  | 0...10 V  |
|                                   |   | Accuracy  | 0.5 mV  |
|                                   |   | Input resistance  | $\pm 2 \text{ mV} \pm 0.05 \%$<br>1 M $\Omega$  |
|                                   |   | <b>RTD Pt 100</b>                                       |   |
|                                   |   | Measuring range   | -200...850 °C   |
|                                   |   | Resolution  | 0.1 °C  |
|                                   |   | Accuracy  | $\pm 0.2 \text{ °C} (-100...400 \text{ °C})$<br>$\pm 0.3 \text{ °C} (\text{further range})$ |
|                                   |   | <b>RTD Pt 1000</b>                                      |   |
|                                   |   | Measuring range   | -200...850 °C   |
|                                   |   | Resolution  | 0.1 °C  |
|                                   |   | Accuracy  | $\pm 0.2 \text{ °C} (-100...400 \text{ °C})$  |
|                                   |   | <b>Pulse</b>  |   |
|                                   |   | Measuring range   | Min pulse length 100 $\mu\text{s}$ frequency<br>0...1 kHz max. 30 VDC                       |

| DESCRIPTION  | ORDER NO. |
|--|-----------|
| Intelligent chart recorder DS 500 mobile, 4 sensor inputs  | 0500 5012 |
| Intelligent chart recorder DS 500 mobile, 8 sensor inputs  | 0500 5013 |
| Intelligent chart recorder DS 500 mobile, 12 sensor inputs   | 0500 5014 |
| Option: "Integrated webserver"   | Z500 5003 |
| Option: "Mathematics calculation function" for 4 freely selectable channels, (virtual channels): addition, subtraction, division, multiplication | Z500 5008 |
| Option: "Totaliser function for analogue signals"  | Z500 5009 |
| CS Basic - data evaluation in graphic and table form - read-out of the measured data via USB or Ethernet.<br>License for 2 working places        | 0554 8040 |
| CS Soft Energy Analyzer for energy and leakage analysis of compressed air stations   | 0554 7050 |
| Connection cable for pressure, temperature and third-party sensors to mobile devices, ODU/open ends, 5 m   | 0553 0501 |
| Connection cable for pressure, temperature and third-party sensors to mobile devices, ODU/open ends, 10 m  | 0553 0502 |
| Connection cable for VA / FA sensors to mobile devices, ODU/M12, 5 m   | 0553 1503 |
| Extension cable for mobile devices, ODU/open ends, 10 m  | 0553 0504 |
| Case for all sensors (dimensions: 500 x 360 x 120 x mm)  | 0554 6006 |

Further sensors can be found on pages 38 to 41



## DS 500 mobile - Intelligent mobile chart recorder

The intelligent chart recorder of the future - energy analysis according to DIN EN 50001

If we talk about operating costs in compressed air systems, we are actually talking about the energy costs, because the electricity costs make up about 70-80% of the total cost of a compressed air system.

Depending on the size of the system, this means considerable operating costs. Even in smaller systems, this may quickly add up to €10,000 to 20,000 per year. This is an amount which can be considerably reduced - even in the case of well operated and maintained plants.

Does this also apply to your compressed air system? Which are your actual costs per generated m<sup>3</sup> air? Which energy is gained due to the waste heat recovery? What is the total performance balance of your plant? How high are the differential pressures of single filters, how high is the humidity (pressure dew point), how much compressed air is used?

By means of the new intelligent chart recorder DS 500 mobile and the suitable sensors and meters all these questions can be answered easily. For example by means of a long-term measurement over 7 days, data recording and evaluation on the PC.



Touch screen



12 sensor inputs

Including voltage supply for all sensors



USB stick



Ethernet connection





## Sensors for DS 500/DS 400 mobile

### Flow meters for compressed air and gases

- Installation and removal under pressure via standard 1/2" ball valve
- A safety ring prevents the uncontrolled ejection in case of installation/removal under pressure
- Usable for different gases: Compressed air, nitrogen, argon, CO<sub>2</sub>, oxygen



### Dew point sensors

- Extremely stable in the long term
- Quick adaption time
- Large measuring range (-80° to +20 °Ctd)
- For all dryers: (Adsorption dryers, membrane dryers and refrigeration dryers)
- Easy installation under pressure via the standard measuring chamber with quick coupling



### Pressure sensors

- large selection of pressure sensors with different measuring ranges for each measuring purpose
- Quick installation under pressure by quick coupling
- Pressure sensor 0-10/16/40/100/250/400 overpressure
- Pressure probe -1 to +15 bar (underpressure/overpressure)
- Differential pressure 0...1.6 bar
- Absolute pressure 0 - 1.6 bar (abs)



### Temperature sensors

- Large selection of temperature sensors e.g. for measurement of the ambient temperature or gas temperature
- Pt100 (2-wire or 3-wire)
- Pt1000 (2-wire or 3-wire)
- Temperature sensors with measuring transducer (4-20 mA output)



- Monitoring of compressed air quality according to ISO 8573
- Residual oil, particles, residual moisture



Compressed air quality measurement



- Particle counter PC 400 in a service case
- up to 0.1 µm or
- up to 0.3 µm



Compressed air quality measurement



- For the analysis of compressors (load and idle times, energy consumption, on/off cycles) the current consumption of up to 12 compressors is recorded by clamp-on ammeter
- Measuring range of the clamp-on ammeters:  
0 - 400 A  
0 - 1000 A



Clamp-on ammeters



- **CS PM 600** mobile current/effective power meter with external current transformers for large machines and systems
- External current transformers for encompassing the phases (100 A or 600 A)
- External magnetic measuring tip for measuring the voltage
- Measures KW, kWh, cos phi, kVar, kVA
- Data transmission **DS 500 mobile** via Modbus



Current/effective power meters

By means of the mobile chart recorder **DS 500 mobile**, all measuring data of a compressor station can be recorded, indicated and evaluated.

At **12 freely assignable sensor inputs**, all our sensors can be connected as well as any optional **third-party sensors and meters with the following signal outputs:**

4-20 mA, 0-20 mA I 0-1 V / 0-10 V / 0-30 V I Pt 100 (2- or 3-wire), Pt 1000 (2- or 3-wire), KTY I pulse outputs (e.g. of gas meters) I Modbus protocol



## DS 500 PM mobile – Efficiency measurement for compressors

All-in-one measurement: electrical energy, pressure, dew point, temperature and consumption

Besides common measurements such as compressed air consumption or humidity, even more complex measurement tasks can be tackled with this all-round mobile device. With the DS 500 PM mobile, conducting an energy analysis according to DIN ISO 50001 is child's play.

Its clear, simple operating method makes it possible, for example, to carry out an analysis of compressed air costs by simultaneously measuring energy consumption (kW/kWh) and compressor output (m<sup>3</sup>/m<sup>3</sup>/h). And the data logger with its integrated effective power meter is perfect for auditors or service technicians.

### Power consumption

|                 |        |
|-----------------|--------|
| Current rating  | [A]    |
| Voltage         | [V]    |
| Effective power | [kW]   |
| Active energy   | [kWh]  |
| Apparent power  | [kVA]  |
| Reactive power  | [kVar] |
| Cos phi         |        |

### Special features:

- Magnetic voltage measuring tips for picking off the voltage during operation.
- Hinged current transformers encompass the conductors of phases L1, L2, L3.  
Can also be used during operation.



### For universal use:

- Up to 11 devices can be connected, including third-party sensors incl. power supply

### Reliable:

- Reliably stores all measured values on a memory card. Easy readout possible via USB stick

### Energy analysis according to DIN ISO 50001:

- Costs in EUR per m<sup>3</sup> air generated
- Specific output in kWh/m<sup>3</sup>
- Consumption of single lines including summation



## Flow meters for compressed air and gases

- Can be installed and removed under pressure via standard 1/2" ball valve
- A safety ring prevents uncontrollable ejection during installation/removal under pressure
- Can be used with different gases: compressed air, nitrogen, argon, CO<sub>2</sub>, oxygen



Compressed air consumption

## Dew point sensors

- Extreme long-term stability
- Short adaption time
- Wide measuring range (-80° to +20° Ctd)
- For all dryers: (adsorption dryers, membrane dryers and refrigeration dryers)
- Easy to install under pressure using the standard measuring chamber with quick coupling



Pressure dew point

## Pressure sensors

- Large selection of pressure sensors with different measuring ranges for each measuring purpose
- Quick to install under pressure by quick coupling
- Pressure sensor 0-10/16/40/100/250/400 overpressure
- Pressure probe -1 to +15 bar (underpressure/overpressure)
- Differential pressure 0...1.6 bar
- Absolute pressure 0 - 1.6 bar (abs)



Pressure

## Temperature sensors

- Large selection of temperature sensors e.g. for measurement of the ambient temperature or gas temperature
- Pt 100 (2-wire or 3-wire)
- Pt 1000 (2-wire or 3-wire)
- Temperature sensors with measuring transducer (4-20 mA output)



Temperature

## Compressed air quality

- Monitoring of compressed air quality according to ISO 8573
- Residual oil, particles, residual moisture
- Particle counter PC 400 in service case up to 0.1 µm or up to 0.3 µm



Residual oil/particles



Mobile electricity/effective power meter  
CS PM 600

### Compressed air generated

- Compressed air flow [m<sup>3</sup>]
- Pressure dew point [° Ctd]
- Pressure [bar]
- Temperature [° C/°F]
- Residual oil content [mg/m<sup>3</sup>]
- Particle content [Cts/m<sup>3</sup>]

With one or more additional electricity/effective power meters, it is possible to carry out efficiency measurements of several compressors simultaneously.



## Analysis of specific power:

By measuring power consumption and delivery volume simultaneously, it is possible to calculate the specific power of the compressor. The specific power is calculated using the ratio of the required energy consumption in kWh to the volume of air in m<sup>3</sup> output during the same period.

$$\text{Specific power} = \frac{kWh}{m^3}$$

The specific performance indicator of the compressor supplies information about the compressor's characteristics. The 'traffic light' graphic below can be used as an aid to assessment:

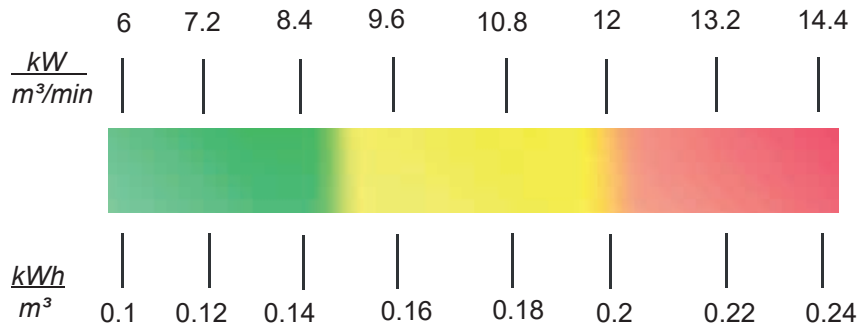

A typical specific power requirement for an oil-injected compressor might look something like this:

**Delivery volume:** 43.7 Nm<sup>3</sup>/min  
(according to ISO 1217 based on 20° C + 1 bar)

**Total power consumption:** 272.7 kW

**Specific power requirement = 272.7 kW/43.7 m<sup>3</sup>/min**  
**= 6.24 kWh/m<sup>3</sup>/min**  
**= 0.104 kW/m<sup>3</sup>**

## DS 500 PM MOBILE TECHNICAL DATA

|                                    |   |
|------------------------------------|---|
| <b>Case dimensions:</b>            | 360 x 270 x 150 mm  |
| <b>Weight:</b>                     | 4.5 kg  |
| <b>Material:</b>                   | Diecast, front foil polyester, ABS  |
| <b>Sensor inputs:</b>              | 3/7/11 sensor inputs for analogue and digital sensors; freely allocatable. See options<br>Digital CS sensors for dew point and consumption with FA/VA series SDI interface, RS 485/Modbus RTU digital third-party sensors.<br>Analogue CS Sensors for pressure, temperature, clamp-on ammeters preconfigured. Analogue third-party sensors 0/4...20 mA, 0...1/10/30 V, pulse, Pt 100/Pt 1000, KTY |
| <b>Voltage supply for sensors:</b> | 24 VDC, max. 130 mA per sensor, integrated mains unit, max. 24 VDC, 25 W.<br>For 8/12 sensor input version: 2 integrated mains units, each max. 24 VDC, 25 W  |
| <b>Interfaces:</b>                 | USB stick, Ethernet/RS 485 Modbus RTU/TCP, SDI (other bus systems on request), webserver optional   |
| <b>Memory card:</b>                | Micro SD memory card, memory size 16 GB   |
| <b>Power supply:</b>               | 100...240 VAC, 50-60 Hz   |
| <b>Colour display:</b>             | TFT transmissive 7" touch panel, graphics, curves, statistics   |
| <b>Accuracy:</b>                   | Please see sensor specifications  |
| <b>Operating temperature:</b>      | 0...50° C   |
| <b>Storage temperature:</b>        | -20...70° C   |



Example order code for DS 500 PM mobile:

0500 5340\_A1\_B1\_C1\_D1\_E1

| Number of additional sensor inputs |           |
|------------------------------------|-----------|
| A1                                 | 3 inputs  |
| A2                                 | 7 inputs  |
| A3                                 | 11 inputs |

| Current transformers – set consisting of 3 transformers (recommendation refers to 400 volt) |                         |
|---|-------------------------|
| B1  | 100A/1A – up to 55 kW   |
| B2  | 600A/1A – up to 340 kW  |
| B3  | 1000A/1A – up to 600 kW |

| Mathematics calculation function (4 virtual channels) |   |
|---|---|
| C1  | without mathematics calculation functions |
| C2  | with mathematics calculation functions    |

| Totaliser function for analogue signals |   |
|---|---|
| D1                                      | without totaliser function for analogue signals |
| D2                                      | with totaliser function for analogue signals    |

| Webserver |                       |
|-----------|-----------------------|
| E1        | without web server    |
| E2        | web server integrated |

| DESCRIPTION   | ORDER NO.                      |
|---|--------------------------------|
| DS 500 PM mobile chart recorder with integrated effective power meter for the analysis of compressors and other consumers     | 0500 5340 + Order code A_...E_ |
| CS Basic – data evaluation in graphic and table form. Readout of measured data via USB or Ethernet. Licensed for 2 work sites | 0554 8040                      |
| CS Soft Energy Analyzer for energy and leakage analysis of compressed air stations  | 0554 7050                      |
| Connection cable for pressure, temperature and third-party sensors to mobile devices, ODU/open ends, 5 m                      | 0553 0501                      |
| Connection cable for pressure, temperature and third-party sensors to mobile devices, ODU/open ends, 10 m                     | 0553 0502                      |
| Connection cable for VA/FA sensors to mobile devices, ODU/M12, 5 m  | 0553 1503                      |
| Extension cable for mobile devices, ODU/ODU, 10 m   | 0553 0504                      |
| Case for all sensors (dimensions: 500 x 360 x 120 x mm)   | 0554 6006                      |



## DS 400 mobile - Affordable mobile chart recorder

Energy analysis - consumption measurement - leakage calculation at compressed air systems

### Advantages at a glance:

- Easy operation via 3.5" colour screen with touch panel
- Internally rechargeable Li-Ion battery - about 8 hours continuous operation

### Versatile:

- Up to 4 sensors / meters can be connected, including third-party sensors / counters incl. power supply

### Reliable:

- Reliably stores all measured values on a memory card. Easy reading out via USB stick possible

### Intelligent energy analysis:

- Costs in € per generated m<sup>3</sup> air
- kWh/m<sup>3</sup> generated air
- Consumption of single lines including summation



Up to 4 sensors can be connected including power supply for all sensors

Easy & intuitive in its operation

Saves time & costs on installation





## Sensors for DS 500 / DS 400 mobile

| Digital  | Digital  | Digital / Analogue  | Analogue   |
|--|--|---|--|
| <p><b>Flow meters for compressed air and gases</b></p> <ul style="list-style-type: none"> <li>Installation and removal under pressure via standard 1/2" ball valve</li> <li>A safety ring avoids the uncontrolled ejection in case of installation/removal under pressure</li> <li>Usable for different gases: Compressed air, nitrogen, argon, CO<sub>2</sub>, oxygen</li> </ul>   | <p><b>Dew point sensors</b></p> <ul style="list-style-type: none"> <li>Extremely stable in the long term</li> <li>Quick adaption time</li> <li>Large measuring range (-80° to +20 °Ctd)</li> <li>For all dryers: (Adsorption dryers, membrane dryers and refrigeration dryers)</li> <li>Easy installation under pressure via the standard measuring chamber with quick coupling</li> </ul>   | <p><b>Pressure sensors</b></p> <ul style="list-style-type: none"> <li>Large selection of pressure sensors with different measuring ranges for each measuring purpose</li> <li>Quick installation under pressure by quick coupling</li> <li>Pressure probe 0-10/16/40/100/250/400 overpressure</li> <li>Pressure probe -1 to +15 bar (underpressure/overpressure)</li> <li>Differential pressure 0...1.6 bar</li> <li>Absolute pressure 0 - 1.6 bar (abs)</li> </ul>   | <p><b>Temperature sensors</b></p> <ul style="list-style-type: none"> <li>Large selection of temperature sensors e.g. for measurement of the ambient temperature or gas temperature</li> <li>Pt 100 (2- or 3-wire)</li> <li>Pt 1000 (2- or 3-wire)</li> <li>Temperature sensors with measuring transducer (4-20 mA output)</li> </ul>     |
|  <ul style="list-style-type: none"> <li>Monitoring of compressed air quality according to ISO 8573</li> <li>Residual oil, particles, residual moisture</li> </ul>    |  <ul style="list-style-type: none"> <li>Particle counter PC 400 in a service case</li> <li>up to 0.1 µm or</li> <li>up to 0.3 µm</li> </ul>    |  <ul style="list-style-type: none"> <li>For the analysis of compressors (load and idle times, energy consumption, on/off cycles) the current consumption of up to 12 compressors is recorded by clamp-on ammeter</li> <li>Measuring range of the clamp-on ammeters: <ul style="list-style-type: none"> <li>0 - 400 A</li> <li>0 - 1000 A</li> </ul> </li> </ul>   |  <ul style="list-style-type: none"> <li><b>CS PM 600</b> mobile current/effective power meter with external current transformers for large machines and plants</li> <li>External current transformers for encompassing the phases (100 A or 600 A)</li> <li>External magnetic measuring tip for measuring the voltage</li> <li>Measures KW, kWh, cos phi, kVar, kVA</li> <li>Data transmission <b>DS 400 mobile</b> via Modbus</li> </ul>  |
| <b>Compressed air quality measurement</b>  | <b>Compressed air quality measurement</b>  | <b>Clamp-on ammeters</b>  | <b>Current/effective power meters</b>  |
| Analogue   | Digital  | Analogue  | Digital  |

By means of the chart recorder **DS 400 mobile**, all measured data of a compressor station can be recorded, indicated and evaluated. All sensors of our product range can be connected to the **digital sensor inputs**, e.g.:

flow meters, dew point sensors, current/effective power meters and third-party sensors with Modbus (RS 485).

At **analogue sensor inputs** third party sensors and meters with the following signal output could be connected: 4-20 mA, 0-20 mA | 0-1 V / 0-10 V / 0-30 V | Pt 100 (2- or 3-wire), Pt 1000 (2- or 3-wire), pulse outputs (e.g. of gas meters), Modbus protocol

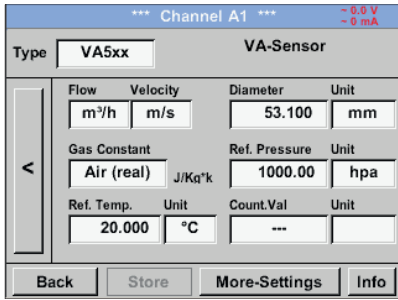

## Configuration of flow sensor

In the menu of the DS 500 mobile / DS 400 mobile, the flow meter VA 500 can be set to the respective pipe inside diameter. Furthermore, the unit, the gas type and the reference condition can be set. The meter reading can be set to "zero" if necessary.

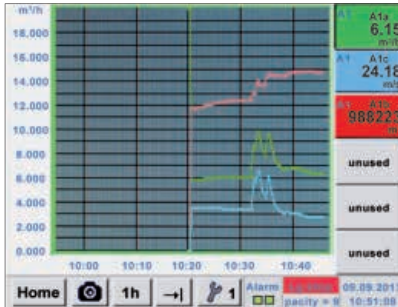

## Graphic view

In the graphic view all measured values are indicated as curves.

It is possible to browse back on the time axis by a slide of the finger (without data logger maximum 24 h, with data logger back to the start of the measurement).

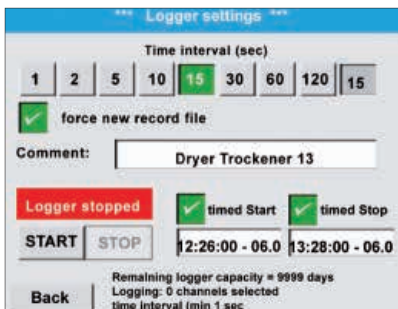

## Data logger

With the option "integrated data logger", the measured values are stored in the DS 500/DS 400. The time interval can be freely set. Furthermore there is the possibility to fix the starting time and the end time of the data recording. Read-out of the measured data via USB interface or via the optional Ethernet interface.

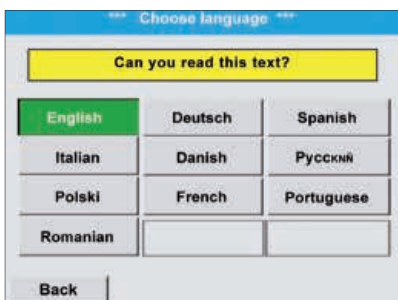

## Selection of the language

Many languages are already stored in every DS 500 mobile/ DS 400 mobile. The desired language can be selected via the selection button.

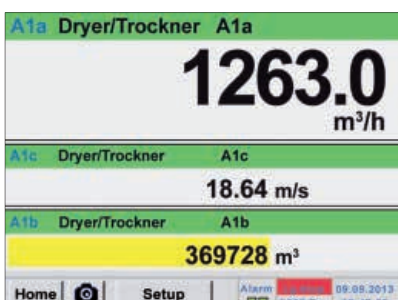

## All relevant parameters at a glance

In addition to the flow rate in m³/h, the DS 500 mobile/DS 400 mobile also displays other parameters such as total consumption in m³ and speed in m/s.





## PI 500 - Hand-held measuring device for the industry

The new **PI 500** is an all-purpose hand-held measuring device for many applications in the industry, like e. g.:

- **Flow measurement**
- **Pressure/vacuum measurement**
- **Temperature measurement**
- **Moisture/dew point measurement**

The graphic indication of colored measurement curves is inimitably.

Up to 100 million measured values can be stored with date and name of measuring site. The measured values can be transferred to the computer by means of a USB stick. The data can be conveniently evaluated with the CS Basic software.

Measured data and service reports can be issued easily and quickly. The following probes can optionally be connected to the freely configurable sensor input of PI 500:

- Pressure sensors (high and low pressure)
- Flow probes, VA 500/VA 520
- Temperature sensors Pt 100, Pt 1000/4...20 mA
- Dew point sensors FA 510
- Effective power meters
- Optional third-party sensors with the following signals: 0...1/10 V, 0/4...20 mA, Pt 100, Pt 1000, pulse, Modbus



### Special features:

- Universal sensor input for many common sensor signals
- Internal rechargeable Li-Ion batteries (approx. 12 h continuous operation)
- 3.5" graphic display / easy operation via touch screen
- Integrated data logger for storage of the measured values
- USB interface for reading out via USB stick
- International: International: Up to 8 languages selectable

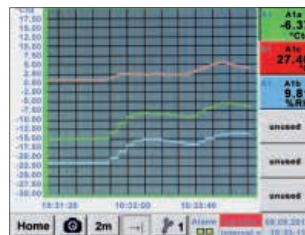

Measurement curves are displayed graphically, so the operator sees at a glance the behaviour of the dryer from the start of the measurement.

| DewPoint             |                         |
|----------------------|-------------------------|
| <b>-46.3</b><br>°Ctd |                         |
| A1f                  | A1d                     |
| 8.18 ppm             | 44.88 mg/m <sup>3</sup> |
| A1c                  | A1a Pressure C1a        |
| 25.01 °C             | 6.540 bar               |

All physical parameters of the humidity measurement are calculated automatically. The PI 500 also displays the measured values of the external sensor.

Up to 100 million measured values can be stored. Each measurement can be stored with a comment, e.g. measuring site name. The time interval can be freely set.



## PI 500 - Hand-held measuring instrument with large sensor selection

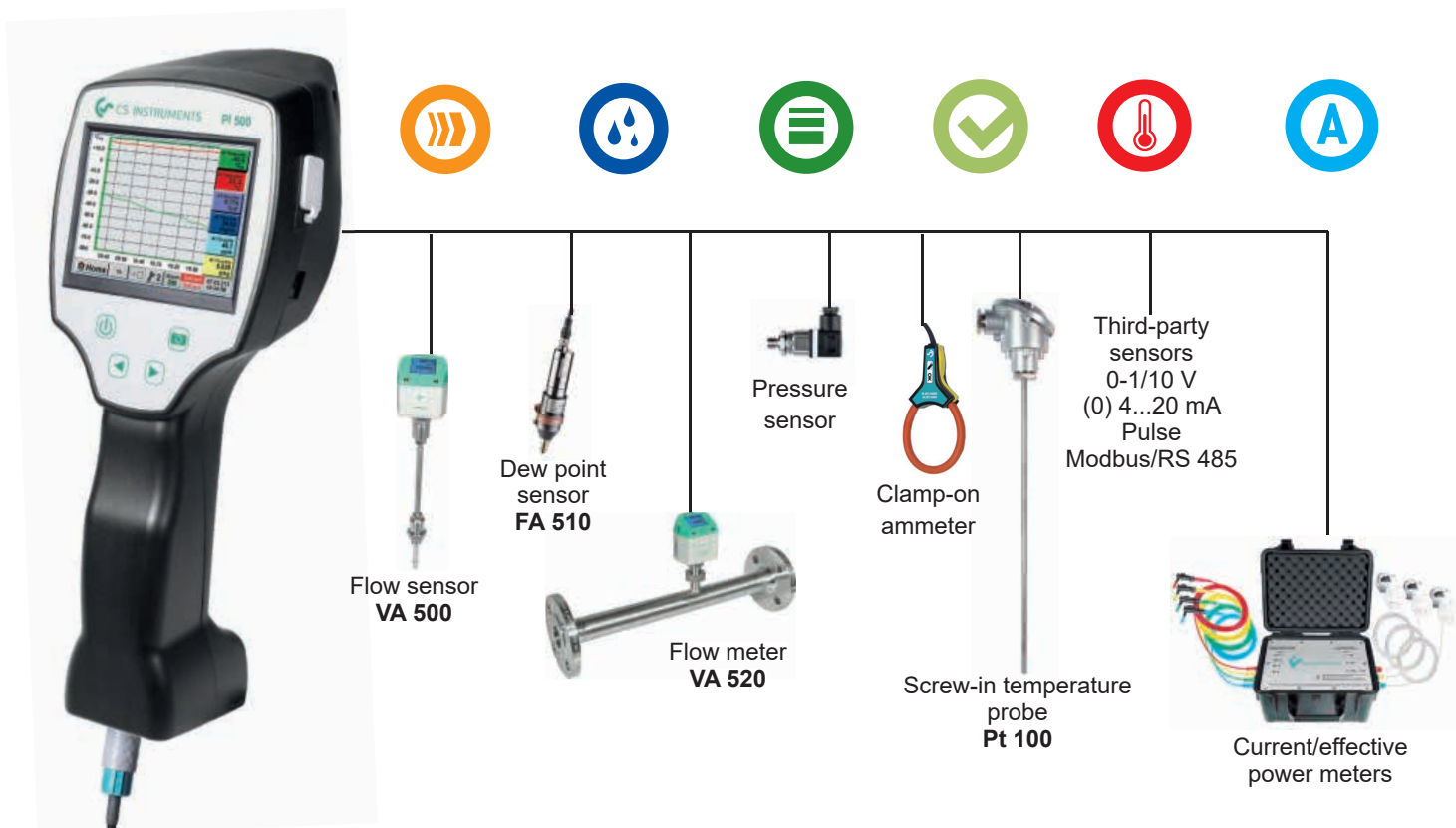

### INPUT SIGNALS

#### Current signals internal or external power supply

(0...20 mA/4...20 mA)  
 Measuring range 0...20 mA  
 Resolution 0.0001 mA  
 Accuracy  $\pm 0.03 \text{ mA} \pm 0.05 \%$   
 Input resistance 50  $\Omega$

#### Voltage signal:

(0...1 V)  
 Measuring range 0...1 V  
 Resolution 0.05 mV  
 Accuracy  $\pm 0.2 \text{ mV} \pm 0.05 \%$   
 Input resistance 100 k $\Omega$

#### Voltage signal

(0...10 V / 30 V)  
 Measuring range 0...10 V  
 Resolution 0.5 mV  
 Accuracy  $\pm 2 \text{ mV} \pm 0.05 \%$   
 Input resistance 1 M $\Omega$

#### RTD Pt 100

Measuring range -200...850  $^{\circ}\text{C}$   
 Resolution 0.1  $^{\circ}\text{C}$   
 Accuracy  $\pm 0.2 \text{ }^{\circ}\text{C}$  (-100...400  $^{\circ}\text{C}$ )  
 $\pm 0.3 \text{ }^{\circ}\text{C}$  (further range)

#### RTD Pt 1000

Measuring range -200...850  $^{\circ}\text{C}$   
 Resolution 0.1  $^{\circ}\text{C}$   
 Accuracy  $\pm 0.2 \text{ }^{\circ}\text{C}$  (-100...400  $^{\circ}\text{C}$ )

#### Pulse

Measuring range Min pulse length 500  $\mu\text{s}$   
 frequency 0...1 kHz  
 max. 30 VDC

### DESCRIPTION

PI 500 portable measuring instrument with integrated data logger  
 Option: "Mathematics calculation function" for 4 freely selectable channels, (virtual channels): addition, subtraction, division, multiplication  
 Option: „Totaliser function for analogue signals“  
 CS Basic – data evaluation graphically and in tabular form - reading of the measured data via USB or Ethernet, license for 2 workstations  
 Transport case

Further sensors can be found on pages 38 to 41

### ORDER NO.

0560 0511  
 Z500 5107  
 Z500 5106  
 0554 8040  
 0554 6510

### TECHNICAL DATA PI 500

|                                  |  |
|----------------------------------|--|
| <b>Display:</b>                  | 3.5" touch panel TFT transmissive, graphics, curves, statistics  |
| <b>Interfaces:</b>               | USB interface  |
| <b>Power supply for sensors:</b> | Output voltage: 24 VDC $\pm 10\%$<br>Output current: 120 mA in continuous operation  |
| <b>Power supply:</b>             | Internal rechargeable Li-Ion batteries, charging time approx. 4 h, PI 500 continuous operation > 4h depending on power consumption for ext. sensor |
| <b>Power adapter:</b>            | 100 - 240 VAC / 50 - 60 Hz, 12 VDC - 1A, safety class 2 only for use in dry rooms  |
| <b>Dimensions:</b>               | 82 x 96 x 245 mm   |
| <b>Housing material:</b>         | PC/ABS   |
| <b>Weight:</b>                   | 450 g  |
| <b>Operating temperature:</b>    | 0...50 $^{\circ}\text{C}$ ambient temperature  |
| <b>Storage temperature:</b>      | -20 to +70 $^{\circ}\text{C}$  |
| <b>EMC:</b>                      | DIN EN 61326   |
| <b>Sensor input:</b>             | For connection of pressure and temperature sensors, clamp-on ammeters, third-party sensors with 4 ... 20 mA, 0-10 V, Pt 100, Pt 1000, Modbus       |
| <b>Memory Size:</b>              | 16 GB memory card standard   |



## Suitable sensors for DS 500 mobile, DS 400 mobile, PI 500, DP 510, LD 510

### Flow meters for installation and removal under pressure (insertion type)

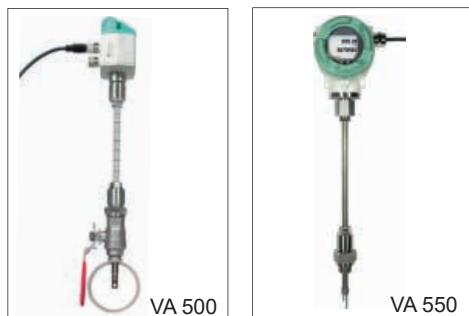

| FLOW METERS INSERTION-VERSION  | ORDER NO.                              |
|--|--|
| VA 500 flow meter, max. version (185 m/s), probe length 220 mm, incl. 5 m connection cable to mobile devices       | 0695 1124                              |
| VA 500 flow meter, high-speed version (224 m/s), probe length 220 mm, incl. 5 m connection cable to mobile devices | 0695 1125                              |
| VA 550 Flow meter, measuring head in robust aluminium die casting housing  | 0695 0550<br>+ order code<br>A...M..._ |

### Inline flow meter



| FLOW METERS INLINE VERSION  | ORDER NO.                           |
|---|-------------------------------------|
| Flow meter VA 520 with integrated measuring section, (R 1/4" DN 8)    | 0695 0520                           |
| Flow meter VA 520 with integrated measuring section, (R 1/2" DN 15)   | 0695 0521                           |
| Flow meter VA 520 with integrated measuring section, (R 3/4" DN 20)   | 0695 0522                           |
| Flow meter VA 520 with integrated measuring section, (R 1" DN 25)     | 0695 0523                           |
| Flow meter VA 520 with integrated measuring section, (R 1 1/4" DN 32) | 0695 0526                           |
| Flow meter VA 520 with integrated measuring section, (R 1 1/2" DN 40) | 0695 0524                           |
| Flow meter VA 520 with integrated measuring section, (R 2" DN 50)     | 0695 0525                           |
| Inline flow meter VA 570 with integrated 1/2" measuring section       | 0695 0570<br>+ order code<br>A...K_ |
| Inline Flow meter VA 570 with integrated 3/4" measuring section       | 0695 0571                           |
| Inline Flow meter VA 570 with integrated 1" measuring section         | 0695 0572                           |
| Inline Flow meter VA 570 with integrated 1 1/4" measuring section     | 0695 0573                           |
| Inline flow meter VA 570 with integrated 1 1/2" measuring section     | 0695 0574                           |
| Inline Flow meter VA 570 with integrated 2" measuring section         | 0695 0575                           |



| DEW POINT SENSORS   | ORDER NO. |
|---|-----------|
| FA 510 dew point sensor, -80...+20 °Ctd incl. measuring chamber mobile and 5 m connection cable to mobile devices | 0699 1510 |
| FA 510 dew point sensor, -20...+50 °Ctd incl. measuring chamber mobile and 5 m connection cable to mobile devices | 0699 1512 |

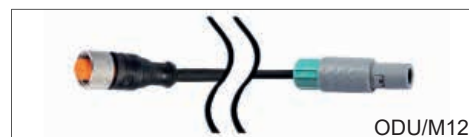

| CONNECTION CABLE FOR VA 500/520 AND FA 510 SENSORS                   | ORDER NO. |
|--|-----------|
| Connection cable for VA / FA sensors to mobile devices, ODU/M12, 5 m | 0553 1503 |
| Extension cable for mobile instruments, ODU / ODU, 10 m              | 0553 0504 |

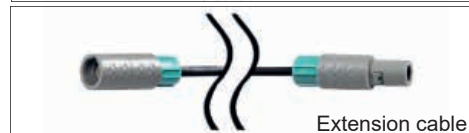

| CALIBRATION CERTIFICATES FOR FLOW METERS AND DEW POINT SENSORS       | ORDER NO. |
|--|-----------|
| 5 point precision calibration for flow sensors incl. ISO certificate | 3200 0001 |
| Precision calibration at -40 °Ctd with ISO certificate               | 0699 3396 |



## Suitable sensors for DS 500 mobile, DS 400 mobile, PI 500, DP 510, LD 510



| PRESSURE PROBE WITH 4...20 mA ANALOGUE OUTPUT  | ± 1%      | ± 0,5%    |
|--|-----------|-----------|
|  | ACCURACY  | ACCURACY  |
| Standard pressure probe CS 16, 0...16 bar  | 0694 1886 | 0694 3555 |
| Standard pressure probe CS 40, 0...40 bar  | 0694 0356 | 0694 3930 |
| Standard pressure probe CS 1.6, 0...1.6 bar abs.                                     |           | 0694 3550 |
| Standard pressure probe CS 10, 0...10 bar  | 0694 3556 | 0694 3554 |
| Standard pressure probe CS 100, 0...100 bar  |           | 0694 3557 |
| Standard pressure probe CS 250, 0...250 bar  |           | 0694 3558 |
| Standard pressure probe CS 400, 0...400 bar  |           | 0694 3559 |
| Precision pressure probe CS -1...+15 bar, ± 0.5 % accuracy of. f.s.                  |           | 0694 3553 |
| Differential pressure probe 1.6 bar diff.  |           | 0694 3561 |
| Calibration certificate pressure, 5 calibration points for the whole measuring range | 3200 0004 |           |



| DIGITAL PRESSURE SENSORS                                   | ± 1%      | ± 0,5%    |
|--|-----------|-----------|
|  | ACCURACY  | ACCURACY  |
| Digital pressure probe DPS 16, 0...16 bar RS 485, G1/2"    | 0694 2886 | 0694 4555 |
| Digital pressure probe DPS 16, 0...16 bar RS 485, NPT 1/2" | 0694 3886 | 0694 5555 |

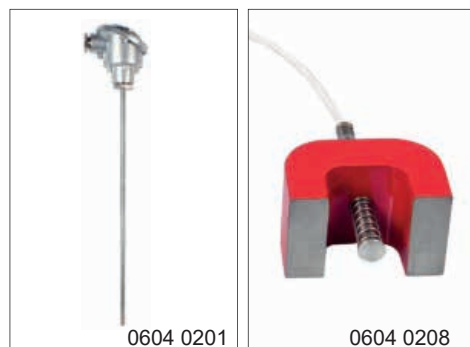

0604 0201

0604 0208

| TEMPERATURE SENSORS  | ORDER NO. |
|--|-----------|
| Bendable temperature sensor PT 100 (2-wire) class B, length: 300 mm, d=3 mm, -70...+550 °C, connection cable 2 m PFA with ODU plug (8-pin) to mobile devices | 0604 0200 |
| Screw-in temperature sensor PT 100 class A, length 300 mm, d = 6 mm, with measuring transducer 4...20 mA = -50 °C...+ 550 °C (2-wire)                        | 0604 0201 |
| Cross-band surface probe, thermocouple type K with measuring transducer 4...20 mA = 0°C...+180 °C, 2 m cable PVC with ODU plug (8-pole) to mobile devices    | 0604 0202 |
| Cable temperature sensor PT 100 class A (4-wire), length: 300 mm, d = 6 mm, -70 ... +260 °C, 5 m connection cable PFA with open ends                         | 0604 0205 |
| Cable temperature sensor PT 100 class A (4-wire), length: 100 mm, d = 6 mm, -70...+260 °C, 5 m connection cable PFA with open ends                           | 0604 0206 |
| Cable temperature sensor PT 100 class A (4-wire), length: 200 mm, d = 6 mm, -70...+260 °C, 5 m connection cable PFA with open ends                           | 0604 0207 |
| Magnetic surface temperature sensor, holding magnet 39x26x25 mm, PT 100 class B (2-wire), -30...+180 °C, 5 m connection cable PFA with open ends             | 0604 0208 |
| Compression fitting; 6 mm; G 1/2" PTFE clamping ring pressure-tight up to 10 bar. Material: stainless steel, application area: max. + 260 °C                 | 0554 0200 |
| Compression fitting; 6 mm; G 1/2" stainless steel clamping ring. Pressure-tight up to 16 bar, material: stainless steel, application area: max. + 260 °C     | 0554 0201 |
| Calibration certificate temperature, 2 calibration points  | 0520 0180 |



0604 0205



0554 0200

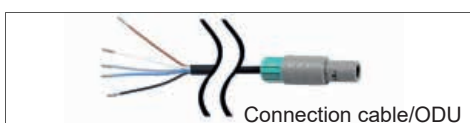

Connection cable/ODU

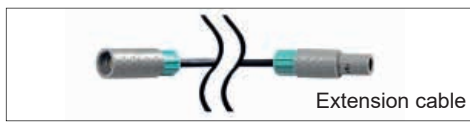

Extension cable



ODU connector

| CONNECTION CABLES FOR PRESSURE SENSORS / TEMPERATURE SENSORS   | ORDER NO. |
|--|-----------|
| Connection cable for pressure, temperature or third-party sensors on mobile devices, ODU/open ends, 5 m  | 0553 0501 |
| Connection cable for pressure, temperature or third-party sensors on mobile devices, ODU/open ends, 10 m | 0553 0502 |
| Extension cable for mobile instruments, ODU / ODU, 10 m  | 0553 0504 |
| ODU plug for connection to mobile devices  | Z604 0104 |



## Suitable sensors for DS 500 mobile, DS 400 mobile, PI 500, DP 510, LD 510

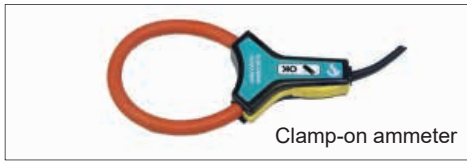

### CLAMP-ON AMMETERS

|   | ORDER NO. |
|---|-----------|
| Clamp-on ammeter 0...1000 A TRMS incl. 3 m connection cable | 0554 0519 |
| Clamp-on ammeter 0...400 A TRMS incl. 3 m connection cable  | 0554 0511 |

## Suitable sensors for DS 500 mobil, DS 400 mobil, PI 500



### CURRENT/EFFECTIVE POWER METER

|   | ORDER NO. |
|---|-----------|
| <b>CS PM 600 mobile current/effective power meter up to 100 A</b> | 0554 5341 |
| <b>CS PM 600 mobile current/effective power meter up to 600 A</b> | 0554 5342 |

- Mobile current/effective power meter with 3 external current transformers for big machines and systems
- External current transformers for encompassing the phases (100 A or 600 A)
- External magnetic measuring tip for picking off the voltage – measures kW, kWh, cos, phi, Var, kVA
- Data transfer to DS 500 mobile / DS 400 mobile via Modbus
- Incl. connection cable for mobile current/effective power meter, 5 m

Current transformer 100A/1A consisting of 3 transformers for mobile instruments Z554 0001

Current transformer 600A/1A consisting of 3 transformers for mobile instruments Z554 0002

Current transformer 1000A/1A consisting of 3 transformers for mobile instruments Z554 0003



### ANY THIRD-PARTY SENSOR CONNECTABLE

Additionally, any third-party sensors with the following signal outputs can be connected:

- 4-20 mA
- 0-20 mA
- 0-1 V/0-10 V/0-30 V
- Pt 100 (2- or 3-wire)
- Pt 1000 (2- or 3-wire)
- Pulse outputs (e. g. of gas meters)
- Frequency output
- Modbus protocol

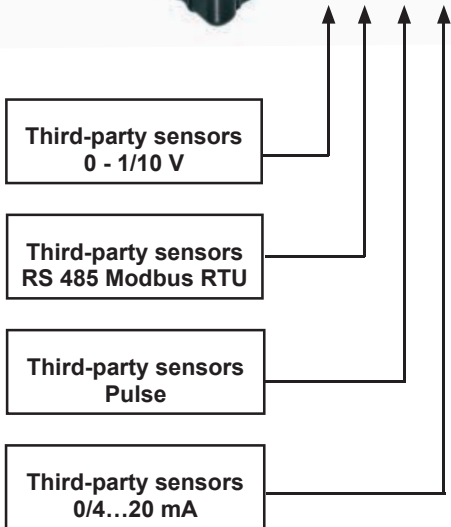





## CS PM 600 - Mobile current/effective power meter suitable for: DS 500 mobile / DS 400 mobile / PI 500

### Measures voltage, current and calculates:

Effective power [kW]  
 Apparent power [kVA]  
 Reactive power [kVar]  
 Active energy [kWh]  
 cos phi



Magnetic voltage measuring tips electrically isolated



### Special features:

- Magnetic voltage measuring tips for picking off the voltage during operation
- Hinged current transformers encompass the conductors of the phases L1, L2, L3. This can also be done during operation

All measured data are transferred digitally (Modbus) to DS 500 mobile/ DS 400 mobile and can be recorded there.



Example: Measurement on the compressor

### TECHNICAL DATA CS PM 600

|                                      |   |
|--------------------------------------|---|
| <b>Parameters:</b>                   | Voltage (Volt)<br>Current (Ampere)<br>Cos phi<br>Effective power (kW)<br>Apparent power (kVA)<br>Reactive power (kVar)<br>Active energy (kWh)<br>Power frequency (Hz)<br>All parameters are transferred digitally to DS 500 mobile /DS 400 mobile |
| <b>Accuracy current measurement:</b> | Threshold values for current deviation. Loss angle according to IEC 60044-1. Current deviation in % at rated current in<br>120% 1<br>100% 1<br>20% 1.5<br>5% 3  |
| <b>Accuracy active energy:</b>       | IEC 62053-21 Class 1  |
| <b>Sensor connections:</b>           | 3 x current transformers (L1,L2,L3,N)<br>4 x voltage measurement (L1,L2,L3)   |
| <b>Interfaces:</b>                   | RS 485 (Modbus protocol)  |
| <b>Measuring range:</b>              | Voltage measurement max. 400 Volt (in special version up to 480V)<br>Current measurement max. 100 A or 600 A  |
| <b>Size current transformers:</b>    | 100 A / 1 A (max. 24 mm wire),<br>600 A / 1 A (max. 36 mm wire)   |
| <b>Dimensions case:</b>              | 270 x 225 x 156 mm (B x H x T)  |
| <b>Operating temperature:</b>        | - 10...+40 °C   |

| DESCRIPTION  | ORDER NO. |
|--|-----------|
| CS PM 600 mobile current/effective power meter 100 A   | 0554 5341 |
| CS PM 600 mobile current/effective power meter 600 A   | 0554 5342 |
| <ul style="list-style-type: none"> <li>• Mobile current/effective power meter with 3 external current transformers for big machines and systems</li> <li>• External current transformers for encompassing the phases (100 A or 600 A)</li> <li>• External magnetic measuring tip for measuring the voltage</li> <li>• Measures kW, kWh, cos, phi, kVar, kVA</li> <li>• Data transfer via Modbus</li> <li>• Incl. connection cable for mobile current/effective power meter to mobile instruments, 5 m</li> </ul> |           |
| Current transformer 100A/1A consisting of 3 transformers for mobile instruments  | Z554 0001 |
| Current transformer 600A/1A consisting of 3 transformers for mobile instruments  | Z554 0002 |
| Current transformer 1000A/1A consisting of 3 transformers for mobile instruments   | Z554 0003 |



### Energy analysis - consumption measurement - leakage calculation

DS 500 mobile - Energy analysis according to DIN EN 50001

If we talk about operating costs in compressed air systems, we are actually talking about the energy costs, because the electricity costs make up about 70-80% of the total cost of a compressed air system. Depending on the size of the system, this means considerable operating costs.

Even in smaller systems, this may quickly add up to €10,000 to 20,000 per year. This is an amount which can be considerably reduced – even in case of well operated and maintained plants. This will also apply to your compressed air system without a doubt!

Which are your actual costs per generated m<sup>3</sup> air? Which energy is gained due to the waste heat recovery? What is the total performance balance of your plant?





What is the differential pressure of individual filters? What is the humidity (pressure dew point)? How much compressed air is consumed?

Although compressed air is one of the most expensive forms of energy, there are often enormous energy losses in factories, especially in this area.

They are mainly caused by the following factors:

- **Disuse of the waste heat**
- **Leakages of up to 50%**
- **Missing compressor control system**
- **Compressed air losses**

Lots of systems are not adapted to the actual demand or they are in need of repair. Leak curing programs could save about 1.7 million tons of carbon dioxide emissions per year. (Source: Fraunhofer Institut, Karlsruhe).

So there is a considerable amount of possible energy savings slumbering in the compressed air lines of lots of enterprises. To tap into this, the heat generated during compressed air generation should be used to heat the space or to heat water.

Furthermore, it is important to optimise the control of compressed air stations because this will lead to considerable energy savings in any case. Also the restoration of an ailing or no longer suitable compressed air supply will pay off after only a short period of time. Losses due to leakages within the pipe network incur high costs.

**This table shows the annual energy costs incurred by leaks:**

| Hole diameter<br>mm | Air loss at |              | Energy loss at |              | Cost at   |            |
|---------------------|-------------|--------------|----------------|--------------|-----------|------------|
|                     | 6 bar (1/s) | 12 bar (1/s) | 6 bar (kWh)    | 12 bar (kWh) | 6 bar (€) | 12 bar (€) |
| 1                   | 1.2         | 1.8          | 0.3            | 1.0          | 144.00    | 480.00     |
| 3                   | 11.1        | 20.8         | 3.1            | 12.7         | 1488.00   | 6096.00    |
| 5                   | 30.9        | 58.5         | 8.3            | 33.7         | 3984.00   | 16176.00   |
| 10                  | 123.8       | 235.2        | 33.0           | 132.0        | 15840.00  | 63360.00   |

(Source: compressed air efficiency, kW x €0.06 x 8000 working hours per year)

Energy resources like electricity, water and gas are usually monitored and therefore the costs are transparent.

Water consumption, for example, is precisely measured with consumption meters. Contrary to compressed air, a water leak is visible for all to see straight away and therefore fixed immediately. Leakages in the compressed air network „blow out“ unnoticed, even on weekends and during production stops.

The compressors continue to run during this time just to maintain a constant pressure in the network. For mature compressed air networks, the leak rate can be between 25 and 35 percent. They are the most industrious consumers working 365 days a year.

Not considered in these considerations are the costs of “producing clean and dry” compressed air. Refrigeration and adsorption dryers dry the air with significant operating costs, which then “blows out” uselessly.

With ever-increasing energy costs, these potential savings must be used more and more to stay competitive within the market. Savings potential can only be exploited if the consumption of individual machines or systems is known and made transparent for all.

When introducing an energy management system according to DIN EN 16001, all consumers have to be recorded in the first step. This gives the user an overview of what is being consumed. This transparency makes it possible to deliberately intervene and save energy. In compressed air systems this means, in the first step, to detect and eliminate leaks.

Especially for the complete monitoring and consumption analysis of compressor stations and compressed air lines we developed a portable measuring system, the DS 500 mobile. DS 500 mobile meets with all requirements for analyzing a compressed air system.

In addition to the evaluation of standard sensors such as for example:

- **Flow meters,**
- **Pressure dew point,**
- **Pressure,**
- **Differential pressure,**
- **Absolute pressure,**
- **Temperature sensors**

, the connection of all kinds of third-party sensors such as:

- **Pt 100**
- **Pt 1000**
- **0/4...20 mA**
- **0-1/10 V**
- **pulse**
- **RS 485 Modbus etc.**

is also possible. One of the main advantages of DS 500 mobile is the possibility to connect not only clamp-on ammeters but also external power meters, water meters or heat meters. As such, the current costs can be included very accurately in the analysis and typical figures of a compressed air plant can be determined.



DS 500 mobile enables an intelligent energy analysis in a quick and easy way. The data will be indicated immediately in the display.

For this purpose just the costs in € per kWh (please consider day and night tariff) have to be entered.

By means of a mathematical function typical calculations can be carried out like for example:

- **Costs in € per generated m<sup>3</sup> of compressed air**
- **Specific output in kWh/m<sup>3</sup>**
- **Consumption of single compressed air lines including summation**
- **Indication of Min-Max values, average value**

If the minimum values rise continuously over the years this is a clear signal that the leakage rate increases. This can easily be determined by carrying out the measurements in regular intervals.

### Consumption analysis including statistics at the touch of a button

Besides the compressed air also all other energy costs like current, water, vapor etc. can be recorded in this evaluation. This creates transparency.

So all energy and flow meters for compressed air, gas, water, vapor and so on can be recorded and evaluated. The customer gets the costs in Euro.

On the big 7" colour display with touch panel, all information is visible at a glance. By means of the evaluation software CS Soft Basic all data can be evaluated online at the PC via a USB stick or Ethernet.

Additionally to the consumption analysis as daily/weekly or monthly report an alarm can be sent by e-mail or SMS in case of threshold value exceedance.

The measured data can be retrieved all over the world via the webserver, GSM module.

How is this done in practice?

## Step 1: Measurement

It is a special advantage that up to 12 compressors can be measured with one DS 500 mobile at the same time.

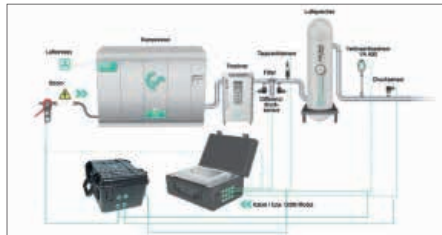

## Step 2: Analysis

### 2.1) Compressor analysis (current-/ power measurement)

The energy consumption of every single compressor is measured by means of a clamp-on ammeter. The produced compressed air quantity is calculated by the software on a basis of the performance data of the compressor which have to be entered.

- **The following parameters are calculated additionally:**
- **Energy consumption in (kWh),**
- **Load,**
- **Idle,**
- **Stop time,**
- **Compressor load in %,**
- **Number of load/unload cycles, specific output in kWh/m<sup>3</sup>,**
- **Costs in €/m<sup>3</sup>**

### 2.2) System analysis (current measurement and real consumption measurement)

The system analysis has the same function like the compressor analysis, however, it additionally offers the possibility to measure the actually produced resp. used quantity of compressed air by means of the flow sensor VA 500.

With the additional „real consumption measurement“ the leakages and therefore the cost share of the leakages in comparison to the total costs in € can be determined.

## 2.3) Leakage calculation

The leakage calculation is carried out during production-free time (shutdown, weekend, holidays). The flow meter VA 500 measures the actual supplied quantity. The compressor delivers compressed air during this down time, in order to maintain a constant pressure.

According to statistics, even if production is carried out day and night, there is at least one short period of time during which all load is switched off. By means of this data, the software defines a calculated leakage rate and calculates the incurred leakage costs in €.

## Step 3: Evaluation at the PC with graphics and statistics

### 3.1) Entry of necessary parameters

Specific data have to be entered before the analysis is carried out:

- **Selection of compressor type (load/ idle resp. variable speed drive controlled)**
- **As well as entry of the performance data according to data sheet**
- **Period of measurement**
- **Costs in € for 1 kWh**

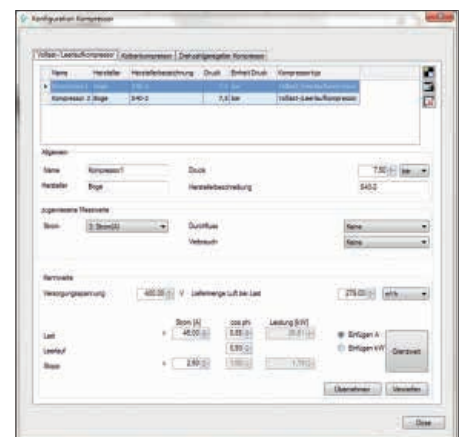



### 3.2) Graphic evaluation with day view and week view

Everything at a glance:

The user gets a day and week view of all stored measured data with his company logo (can be easily integrated) at the touch of a button. By means of the zoom and the cross lines function peak values can be determined.

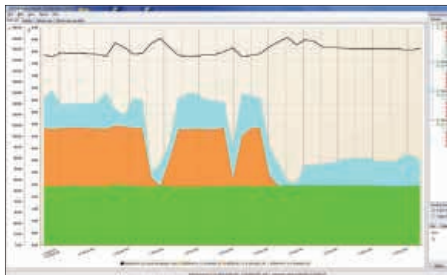

### 3.3) Compressed air costs in €

At the touch of a button the user gets all important data like e. g.:

- Electricity costs
- Compressed air costs
- Leakage costs in €
- Compressor data with load/ idle times
- Specific output in kWh/m<sup>3</sup>
- Costs per m<sup>3</sup> in €

| Energie- und Kostenauswertung |         |  |         |      |         |      |         |      |         |      |         |               |         |      |
|-------------------------------|---------|--|---------|------|---------|------|---------|------|---------|------|---------|---------------|---------|------|
| Anlagenname:                  |         | 22.02.2019 00:00 - 22.02.2019 00:00    |         |      |         |      |         |      |         |      |         | Takt A:       |         |      |
| Zustimmung (Stunde):          |         | 00:00 - 00:00                          |         |      |         |      |         |      |         |      |         | 5,14 Euro     |         |      |
| Zustimmung (Gesamt):          |         | Summe energieeffizienter Kompressoren: |         |      |         |      |         |      |         |      |         | Takt B:       |         |      |
| Leistungswert:                |         | 128,00                                 |         |      |         |      |         |      |         |      |         | 20:00 - 00:00 |         |      |
|                               |         |  |         |      |         |      |         |      |         |      |         | 5,14 Euro     |         |      |
| Parameter                     | Einheit | Wert                                   | Einheit | Wert | Einheit | Wert | Einheit | Wert | Einheit | Wert | Einheit | Wert          | Einheit | Wert |
| 1. Kompressor                 | kWh     | 1000                                   | €       | 100  | €/m³    | 0,1  | h       | 100  | h       | 100  | h       | 100           | h       | 100  |
| 2. Kompressor                 | kWh     | 2000                                   | €       | 200  | €/m³    | 0,2  | h       | 200  | h       | 200  | h       | 200           | h       | 200  |
| 3. Kompressor                 | kWh     | 3000                                   | €       | 300  | €/m³    | 0,3  | h       | 300  | h       | 300  | h       | 300           | h       | 300  |

### 4) Measures

Based on these analysis some measures should be carried out in order to optimize the compressed air system. These measures may differ from system to system, however, normally there are the following possibilities:

- **Please check whether there are leakages in the compressed air system and localize them. Usually they occur at weld seams and junctions. (50 holes with a diameter smaller than 1 mm may cause incur of € 11,000 per year).**
- **By means of the load/idle analysis and the pressure profile the compressor regulation and adjustment should be optimized. Modern compressor operation systems help to minimize the idle times. (During idle times, the compressor takes up about 30 % of the full load energy, however, it does not release any air)**
- **Reduce the input temperature (a temperature reduction by about 10 °C can save 3% of the energy).**
- **Optimize the pipe system by avoiding unnecessary pressure drops.**



## DP 500/510 - Mobile dew point meters with data logger

### Applications:

- Compressed air: Examination of refrigeration, membrane, adsorption dryers
- Technical gases: Residual moisture measurement in gases such as N<sub>2</sub>, O<sub>2</sub> etc.
- Plastics industry: Examination of granulate dryers

### Special features:

- Precise dew point measurement down to -80 °Ctd
- Quick response time
- 3.5" graphic display / easy operation via touch screen
- Integrated data logger for storage of the measured values
- USB interface for reading out via USB stick
- Calculates all necessary moisture parameters like g/m<sup>3</sup>, mg/m<sup>3</sup>, ppm V/V, g/kg, °Ctdatm
- 2nd freely assignable sensor input for third-party sensors (only DP 510)
- International: up to 8 languages selectable



Quick installation by means of measuring chamber and quick coupling



Ideal for service technicians - everything in one case



Dry container - for sensor protection and quick adaption time

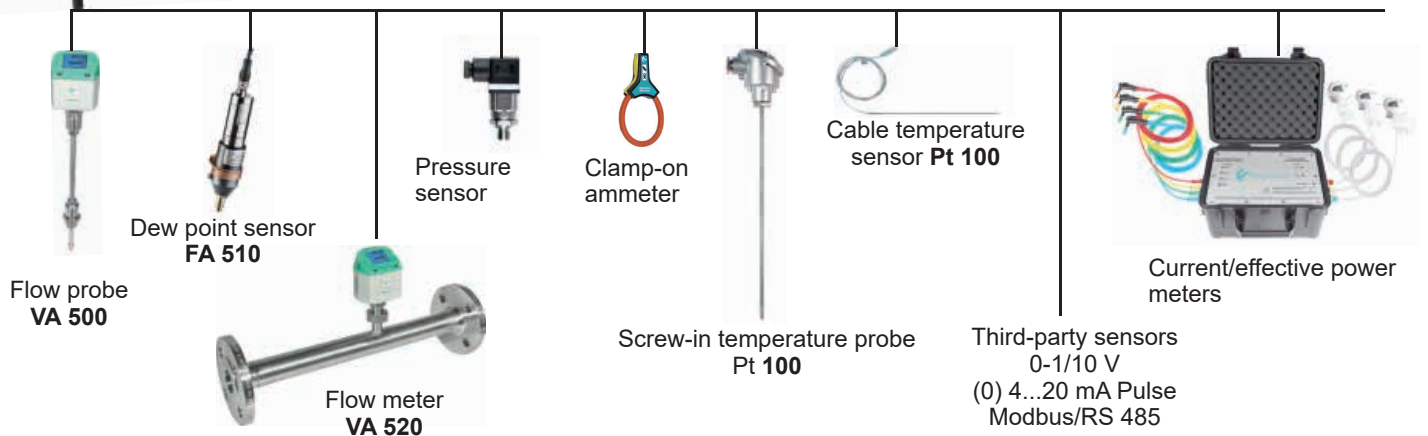

The whole range of suitable sensors can be found on pages 38 to 41

## Everything at a glance

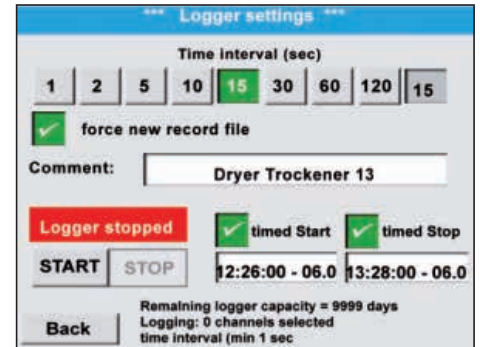
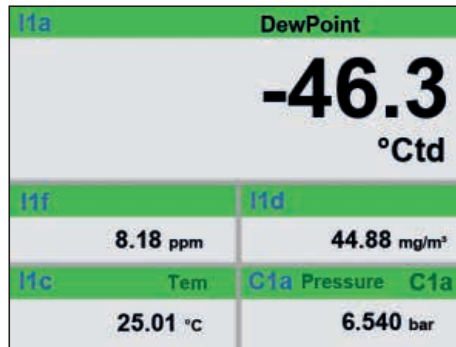
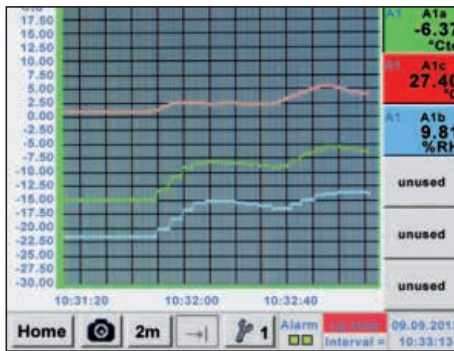

measurement curves are displayed graphically, so the operator sees at a glance the behavior of the dryer since the start of the measurement.

All physical parameters of the humidity measurement are calculated automatically. The DP 510 also displays the measured values of the external sensor.

Up to 100 million measured values can be stored. Each measurement can be stored with a comment, e.g. measuring site name. The time interval can be freely set.

| DESCRIPTION  | ORDER NO.        |
|--|------------------|
| <b>Set DP 500 in a case - consisting of:</b>   | <b>0600 0500</b> |
| - Portable dew point meter DP 500 for compressed air and gases   | 0560 0500        |
| - Mobile measuring chamber up to 16 bar  | 0699 4490        |
| - Diffusion-tight PTFE hose with quick coupling, length 1 m  | 0554 0003        |
| - Power supply for DP 500/DP 510   | 0554 0009        |
| - Control and calibration set 11.3% RH   | 0554 0002        |
| - Quick-lock coupling  | 0530 1101        |
| - Dry container for CS dew point sensors   | 0699 2500        |
| - Transportation case (small) for DP 500   | 0554 6500        |
| <b>Set DP 510 in a case - consisting of:</b>   | <b>0600 0510</b> |
| - Mobile dew point meter DP 510 with one additional input for external sensors   | 0560 0510        |
| - Mobile measuring chamber up to 16 bar  | 0699 4490        |
| - Diffusion-tight PTFE hose with quick coupling, length 1 m  | 0554 0003        |
| - Power supply for DP 500/DP 510   | 0554 0009        |
| - Control and calibration set 11.3% RH   | 0554 0002        |
| - Quick-lock coupling  | 0530 1101        |
| - Dry container for CS dew point sensors   | 0699 2500        |
| - Transportation case (large) for DP 510 as well as other sensors  | 0554 6510        |
| <b>Further options, not included in the set:</b>   |                  |
| Option: „Mathematics calculation function“ for 4 freely selectable channels, (virtual channels): addition, subtraction, division, multiplication | Z500 5107        |
| Option: „Totaliser function for analogue signals“  | Z500 5106        |
| CS Basic – data evaluation graphically and in table form - reading of the measured data via USB or Ethernet, licence for 2 workstations          | 0554 8040        |
| Precision calibration at -40 °Ctd or 3 °Ctd with ISO certificate   | 0699 3396        |
| Additional calibration point freely selectable in the range between -80...+20 °Ctd   | 0700 7710        |
| High pressure measuring chamber up to 350 bar  | 0699 3590        |
| Measuring chamber for atmospheric dew point  | 0699 3690        |
| Measuring chamber for granulate dryers with minimum overpressure   | 0699 3490        |
| Portable dew point meter DP 510 for compressed air and gases (high pressure version up to 350 bar)   | 0560 0512        |
| Portable dew point meter DP 500 for compressed air and gases (high pressure version up to 350 bar)   | 0560 0501        |



Photo key saves current screen as an image file. No additional software necessary.

| TECHNICAL DATA DP 500/510   |  |
|-----------------------------|--|
| <b>Display:</b>             | 3.5" touch screen  |
| <b>Measuring range:</b>     | -80...+50 °Ctd<br>-20...+70 °C<br>0...100% RH  |
| <b>Accuracy:</b>            | ± 0.5 °Ctd at<br>-10...+50 °Ctd<br>Typ. ± 2 °Ctd (further range)                             |
| <b>Moisture parameters:</b> | g/m³, mg/m³, ppm V/V, g/kg, °Ctdatm, % RH  |
| <b>Pressure range:</b>      | -1...50 bar standard<br>-1...350 bar special version   |
| <b>Interface:</b>           | USB interface  |
| <b>Data logger:</b>         | 16 GB SD memory card<br>(100 million values)   |
| <b>Power supply:</b>        | Output voltage: 24 VDC ± 10%<br>Output current: 120 mA in continuous operation               |
| <b>Power supply:</b>        | Internal rechargeable Li-Ion batteries, approx. 12 h continuous operation, 4 h charging time |
| <b>Screw-in thread:</b>     | G 1/2" stainless steel   |
| <b>Ambient temperature:</b> | 0...+50 °C   |
| <b>EMC:</b>                 | DIN EN 61326-1   |



## DP 400 mobile - With integrated dew point and pressure measurement

For measurement of all humidity parameters under pressure up to 16 bar

The DP 400 mobile with integrated, rechargeable battery has been developed especially for field use. In addition to a highly precise dew point sensor, a precise pressure sensor is also installed in the device up to 16 bar. So in addition to the pressure dew point in °Ctd, the temperature in °C and the line pressure in bar, further moisture parameters (% RH, mg/m<sup>3</sup>, g/m<sup>3</sup>) as well as pressure-dependent measured values (g/kg, ppm v/v, atm. dew point °C) can also be calculated.

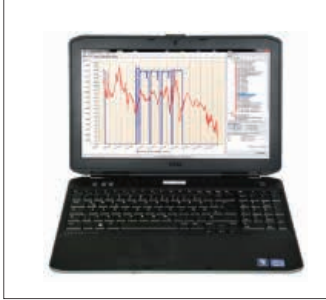

### SPECIAL FEATURES:

- Precise dew point measurement down to -80 °Ctd, ppm V/V, atmospheric dew point
- Robust service case for field use
- Integrated pressure measurement up to 16 bar
- Integrated measuring chamber with integrated dry container protects the dew point sensor during transport and guarantees quick adaption time
- Humidity sensor with long-term stability: precise, condensation-resistant, quick adaption time
- Optional: 2 further sensor inputs for external sensors
- Optional: Integrated data logger



6 mm plug connection for measuring gas/compressed air feed

**Option:** Two further sensor inputs for: (flow, pressure, dew point, 4...20 mA, Modbus-RTU...)



## Easy operation via touchscreen

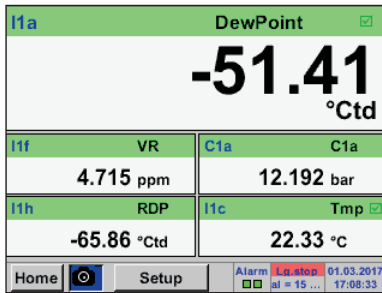

## Actual measured values

All measured values can be seen at a glance. Threshold value exceedances are indicated in red color. Thanks to the integrated pressure sensor, DP 400 mobile is able to calculate the atmospheric dew point.

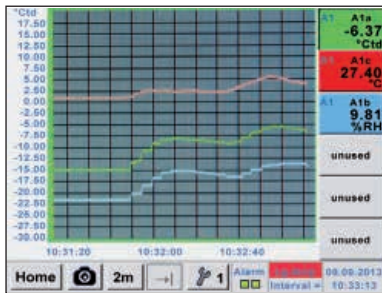

## Graphic view

In the graphic view all measured values are indicated as curves. It is possible to browse back on the time axis by a slide of the finger (without data logger maximum 24 h, with data logger back to the start of the measurement).



## Data logger

Measured values are stored in DP 400 by means of the option „integrated data logger“. The time interval can be freely set. Furthermore there is the possibility to fix the starting time and the end time of the data recording. Read-out of the measured data via USB interface or via the optional Ethernet interface.

| DESCRIPTION  | ORDER NO. | TECHNICAL DATA DP 400 MOBIL  |
|--|-----------|--|
| DP 400 mobile - Portable dew point meter with integrated pressure measurement, incl. transportation bag for PTFE hose and power supply           | 0500 4505 | <b>Display:</b> 3.5" touch screen  |
| Option: Integrated data logger for 100 million measured values   | Z500 4002 | <b>Measuring range:</b> -80...+50 °Ctd<br>-20...+70 °C   |
| Option: Integrated Ethernet and RS 485 interface   | Z500 4004 | 0...100% RH  |
| Option: Integrated webserver   | Z500 4005 | 0...16 bar ± 0.5 %   |
| Option: "Mathematics calculation function" for 4 freely selectable channels, (virtual channels): addition, subtraction, division, multiplication | Z500 4007 | <b>Accuracy:</b> ± 1 °C at 50...-20 °Ctd<br>± 2 °C at -20...-50 °Ctd<br>± 3 °C at -50...-80 °Ctd                         |
| Option: 2 additional sensor inputs for external sensors (1 x digital sensor Modbus, 1 x analogue sensor)   | Z500 4001 | <b>Moisture parameters:</b> g/m <sup>3</sup> , mg/m <sup>3</sup> , ppm V/V, g/kg, °Ctdatm, % RH                          |
| CS Basic – data evaluation graphically and in tabular form - reading of the measured data via USB or Ethernet, license for 2 workstations        | 0554 8040 | <b>Interface:</b> USB interface  |
| Connection cable for VA / FA sensors to mobile devices, ODU/M12, 5 m   | 0553 1503 | <b>Data logger option:</b> 16 GB SD memory card (100 million values)   |
| Connection cable for pressure, temperature or third-party sensors on mobile devices, ODU/open ends, 5 m  | 0553 0501 | <b>Power supply for external sensors:</b> Output voltage: 24 VDC ± 10%<br>Output current: 120 mA in continuous operation |
| Connection cable for pressure, temperature or third-party sensors on mobile devices, ODU/open ends, 10 m   | 0553 0502 | <b>Power supply:</b> Internal rechargeable Li-Ion batteries, approx. 12 h continuous operation, 4 h charging time        |
| Extension cable for mobile instruments ODU/ODU, 10m  | 0553 0504 | <b>Process connection:</b> 6 mm plug connections   |
|  |           | <b>Ambient temperature:</b> 0...+50 °C   |
|  |           | <b>EMC:</b> DIN EN 61326-1   |

The whole range of suitable sensors can be found on pages 38 to 41



## FA 510/515 - Dew point sensor

FA 510/515 for residual moisture measurement in compressed air and gases



### Typical applications:

- Dew point measurement in the compressed air after adsorption dryer, membrane dryer, refrigeration dryer
- Residual moisture/dew point measurement in gases such as oxygen, nitrogen, argon...
- Residual moisture/dew point measurement after granulate dryers in the plastics industry

### Recommendation:

Mounting with standard measuring chamber for compressed air up to 16 bar

**Advantage:** Easy installation via quick coupling

### Special features:

- Extremely stable in the long term
- Analog output 4...20 mA for dew point
- Condensation-resistant
- Quick adaption time
- Pressure-tight up to 350 bar (special version)
- **NEW:** Modbus-RTU interface
- **NEW:** Higher resolution of sensor signal due to the improved evaluation electronics
- **NEW:** Sensor diagnosis on site with a portable device or CS Service Software
- **Readable via Modbus:**
  - Pressure dew point [°Ctd.]
  - Temperature [°C]
  - rel. humidity [% RH]
  - abs. humidity [g/m³]
  - Degree of humidity [g/kg]
  - Moisture content V/V [ppmV/V]
  - Partial vapor pressure [hPa]
  - Atmospheric dew point [°Ctd.atm]

| DESCRIPTION   | ORDER NO. |
|---|-----------|
| FA 510 dew point sensor for adsorption dryers -80...20 °Ctd incl. factory certificate, 4...20 mA analogue output (3-wire connection) and Modbus-RTU interface   | 0699 0510 |
| FA 515 dew point sensor for adsorption dryers -80...20 °Ctd incl. factory certificate, 4...20 mA analogue output (2-wire connection) or Modbus-RTU interface    | 0699 0515 |
| FA 510 dew point sensor for refrigeration dryer -20...50 °Ctd incl. factory certificate, 4...20 mA analogue output (3-wire connection) and Modbus-RTU interface | 0699 0512 |
| FA 515 dew point sensor for refrigeration dryer -20...50 °Ctd incl. factory certificate, 4...20 mA analogue output (2-wire connection) or Modbus-RTU interface  | 0699 0517 |
| <b>Connection cables:</b>   |           |
| Connection cable for VA/FA series, 5 m  | 0553 0104 |
| Connection cable for VA/FA sensors, 10 m  | 0553 0105 |
| <b>Option for FA 510:</b>   |           |
| Option: analogue output FA 510, special version 2...10 volts  | Z699 0510 |
| <b>Options for FA 510/515:</b>  |           |
| Option: max. pressure FA5xx 350 bar   | Z699 0515 |
| Option: max. pressure FA5xx 500 bar   | Z699 0516 |
| Option: special scaling FA5xx 4...20 mA=___ ... ___ g/m³, ppm etc.  | Z699 0514 |
| Option: connection thread FA5xx, 5/8" UNF   | Z699 0511 |
| Option: surface condition FA 5xx, free of oil & grease  | Z699 0517 |
| <b>Further accessories:</b>   |           |
| Standard measuring chamber up to 16 bar   | 0699 3390 |
| High pressure measuring chamber up to 350 bar   | 0699 3590 |
| Stainless steel bypass measuring chamber for dew point measurement in gases under pressure  | 0699 3290 |
| CS Service Software for dew point sensors incl. PC connection set (Modbus to USB Interface).  | 0554 2007 |
| <b>Calibration and adjustment:</b>  |           |
| Precision calibration at -40 °Ctd or 3 °Ctd incl. ISO certificate   | 0699 3396 |
| Additional calibration point freely selectable  | 0700 7710 |

| TECHNICAL DATA FA 510/515          |  |
|------------------------------------|--|
| <b>Measuring range:</b>            | -80...20 °Ctd, -20...50 °Ctd   |
| <b>Accuracy:</b>                   | ± 1 °C at 50...-20 °Ctd<br>± 2 °C at -20...-50 °Ctd<br>± 3 °C at -50...-80 °Ctd                                    |
| <b>Pressure range:</b>             | -1...50 bar<br>Special version up to 500 bar   |
| <b>Power supply:</b>               | 24 VDC (10...36 VDC)   |
| <b>Protection class:</b>           | IP 66  |
| <b>EMC:</b>                        | In acc. with DIN EN 61326-1  |
| <b>Operating temperature:</b>      | -20...70 °C  |
| <b>Connection:</b>                 | M12, 5-pin   |
| <b>PC connection:</b>              | Modbus-RTU interface (RS 485)  |
| <b>Analogue output:</b>            | 4...20 mA = -80...20 °Ctd<br>4...20 mA = -20...50 °Ctd<br>FA 510: 4...20 mA (3-wire)<br>FA 515: 4...20 mA (2-wire) |
| <b>Burden for analogue output:</b> | < 500 Ω  |
| <b>Screw-in thread:</b>            | G 1/2" Stainless steel<br>Optional: UNF 5/8", NPT 1/2"   |
| <b>Dimensions:</b>                 | Ø 30 mm, length approx. 130 mm   |
| <b>Via service software:</b>       |  |
| Choose units                       | % RH, °Ctd, g/m³, mg/m³, ppm V/V   |
| Scaling                            | 4...20 mA change   |

## DS 52 - Dew point monitoring

The dew point set is wired ready to plug in at the factory. The alarm values can be set freely. The dew point sensor FA 510 is extremely long-term stable and can be quickly and easily installed and removed under pressure via the screw-on measuring chamber incl. Quick coupling.

**Option:**  
Alarm unit (Buzzer and continuous red light)

**Consisting of:**  
Digital process meter DS 52

**Special features:**

- Plug-in system: everything wired and ready
- No time-consuming studying of the instruction manual
- 2 alarm contacts (250 VAC, 3 A) pre- and main alarm freely adjustable
- 4...20 mA analogue output
- Option alarm unit: Buzzer and continuous red light



| DESCRIPTION   | ORDER NO.        | TECHNICAL DATA DISPLAY DS 52  |
|---|------------------|---|
| <b>Dew point monitoring DS 52 for adsorption dryer consisting of:</b>   | <b>0600 5100</b> | <b>Dimensions:</b> 118 x 92 x 93 mm   |
| DS 52 LED process display in the wall housing   | 0500 0009        | <b>Display:</b> LED red, 7-segment, height: 13 mm, 5-digit, 2 LED for alarm relay |
| FA 510 dew point sensor for adsorption dryers -80 °...20 °Ctd incl. factory certificate, 4...20 mA analogue output (3-wire connection) and Modbus-RTU interface | 0699 0510        | <b>Keypad:</b> 4 keys   |
| Standard measuring chamber up to 16 bar   | 0699 3390        | <b>Input:</b> 4...20 mA   |
| Connection cable for VA/FA series, 5 m  | 0553 0104        | <b>Power supply:</b> 230 VAC, 50/60 Hz; option: 24 VDC or 110 VAC 50/60 Hz        |
| <b>Dew point monitoring DS 52 for refrigeration dryers, consisting of:</b>  | <b>0600 5120</b> | <b>Alarm outputs:</b> 2 x relay output, changeover contact, 250 VAC, max. 3 A     |
| DS 52 LED process display in the wall housing   | 0500 0009        | <b>Operating temperature:</b> -10...+60 °C (storage temperature -20 °C...+80 °C)  |
| FA 510 dew point sensor for refrigeration dryer -20...50 °Ctd incl. factory certificate, 4...20 mA analogue output (3-wire connection) and Modbus-RTU interface | 0699 0512        | <b>Alarm thresholds:</b> Freely adjustable  |
| Standard measuring chamber up to 16 bar   | 0699 3390        | <b>Hysteresis:</b> 2 °Ctd   |
| Connection cable for VA/FA series, 5 m  | 0553 0104        | <b>Analogue output:</b> 4...20 mA = -80...20 Ctd or -20...50 Ctd.                 |
| <b>Options:</b>   | Z500 0001        |   |
| Power supply 24 VDC (instead of 230 VAC)  | Z500 0002        |   |
| Power supply 110 VAC (instead of 230 VAC)   | Z500 0003        |   |
| Alarm unit mounted to the wall housing  | Z500 0004        |   |
| Alarm unit for external mounting with 5 m cable   |                  |   |
| <b>Further accessories:</b>   |                  |   |
| Precision calibration at -40 °Ctd incl. ISO certificate   | 0699 3396        |   |
| Additional calibration point freely selectable  | 0700 7710        |   |



## FA 515 Ex Dew point sensor - For residual moisture measurement in potentially explosive atmospheres

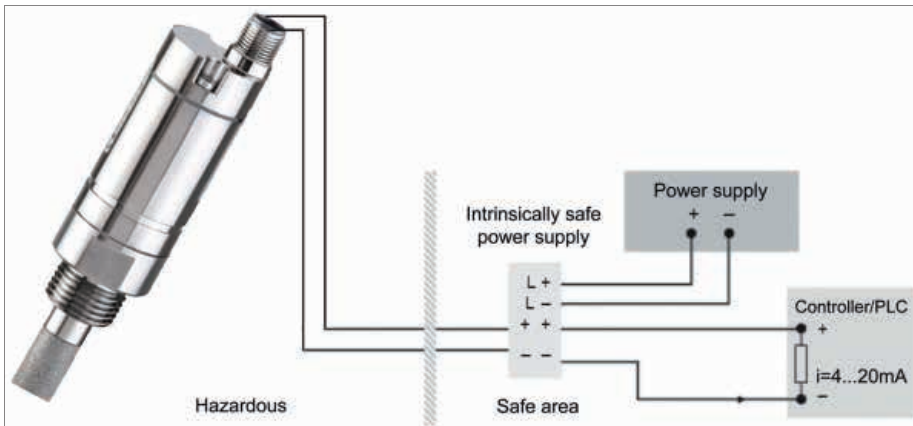

The FA 515 Ex measures dew point or pressure dew point in potentially explosive atmospheres and can be used in many nonaggressive gases.

### Typical applications:

- Air/Compressed air
- Argon
- Nitrogen
- Biogas
- Natural gas
- Hydrogen
- etc...

### Special features:

- Robust design
- Pressure-tight up to 500 bar
- Humidity sensor with long-term stability, tried-and-tested for years
- 4...20 mA analogue output in 2-wire technology
- **NEW:** Higher resolution of sensor signal due to the improved evaluation electronics

### Approvals:



II 2 G Ex ib IIC T4 Gb Zone 1, gas, intrinsically safe, temp. 135 °C



II 2 D Ex ib IIIC T80°C Db Zone 21, dust, intrinsically safe, temp. 80 °C

FA 515 Ex may only be used in connection with approved Ex-rated power supplies or safety barriers or galvanic separating elements with max.:

$U_i = 28 \text{ V max.}$   
 $I_i = 95 \text{ mA max.}$   
 $P_i = 0.65 \text{ W max.}$

### TECHNICAL DATA FA 515 EX

|                             |  |
|-----------------------------|--|
| Measuring range:            | -80...20 °Ctd = 4...20 mA  |
| Pressure range:             | -1...500 bar   |
| Power supply:               | 24 VDC (18...28 VDC)   |
| Accuracy:                   | ± 1 °C at -20...+20 °Ctd<br>± 2 °C at -50...-20 °Ctd<br>± 3 °C at -80...-50 °Ctd |
| Output:                     | 4...20 mA in 2-wire technology   |
| Protection class:           | IP 65  |
| EMC:                        | In acc. with DIN EN 61326-1  |
| Operating temperature:      | -20...+70 °C   |
| Storage temperature:        | -40...+80 °C   |
| Burden for analogue output: | < 500 Ω at 24 V  |
| Screw-in thread:            | G 1/2" stainless steel<br>optional 5/8" UNF                                      |
| Connection:                 | M12, 4-pin   |
| Sensor protection:          | Sinter filter 50 μm stainless steel  |

| DESCRIPTION  | ORDER NO. |
|--|-----------|
| FA 515 Ex pressure dew point meter   | 0699 5515 |
| High pressure measuring chamber for compressed air up to 350 bar   | 0699 3590 |
| Stainless steel bypass measuring chamber for dew point measurement in gases under pressure   | 0699 3290 |
| Special scaling, analogue output to other humidity parameters: % RH, g/m <sup>3</sup> , mg/m <sup>3</sup> , ppm V/V, g/kg  | Z699 0514 |
| Connection cable FA 515 EX, for laying in intrinsically safe circuits, ends open on both sides (cross-section 4x0.75 mm <sup>2</sup> ), cable length of free choice          | 0553 5126 |
| Shielded connection cable FA 515 EX, for laying in intrinsically safe circuits, ends open on both sides (cross-section 4x0.75 mm <sup>2</sup> ), cable length of free choice | 0553 5136 |
| Intrinsically safe power supply, safety barrier  | 0554 3071 |





## FA 550 dew point sensor - In robust die-cast aluminium housing

The FA 550 is ideal for outdoor dew point measurements or rougher industrial environment



### Special features:

- Robust, waterproof die-cast aluminium housing, IP 67
- Alarm relay - limit value adjustable via buttons (max 60 VDC, 0.5 A)
- 4...20 mA analogue output
- Optional: 2 pieces 4 ... 20 mA analogue output e.g. for dew point and temperature
- Extremely stable in the long term
- Quick adaption time
- Pressure-resistant up to 500 bar (optional)
- **NEW:** Modbus-RTU interface
- **NEW:** Ethernet interface (optional)
- **NEW:** Higher resolution of sensor signal due to the improved evaluation electronics
- **NEW:** Sensor diagnosis on site with a portable device or CS Service Software
- **Readable via Modbus:** pressure dew point [° Ctd.], temperature [° C], rel. humidity [% RH], abs. humidity [g/m<sup>3</sup>], degree of humidity [g/kg], moisture content V/V [ppmV/V], partial vapour pressure [hPa], atmospheric dew point [° Ctd.atm]

### APPLICATION:

- Dew point measurement in the compressed air after adsorption dryers/membrane dryers and refrigeration dryers
- Residual moisture measurement / dew point measurement in gases such as: oxygen, nitrogen, argon, hydrogen, natural gas, biogas ...

Easy operation via the keys on the display

The screenshots show the following display pages:

- Page 1 (R&D):** Large display of -47.8 °Ctd. Bottom status: HW: 1.02 SW:1.00 MBID:1 1/3
- Page 2 (R&D):** 22.10 °C, 0.1940 %rH, 0.0378 g/m<sup>3</sup>. Bottom status: HW: 1.02 SW:1.00 MBID:1 2/3
- Page 3 (R&D):** 0.0321 g/kg, 50.88 ppm, 0.0522 hPa, -47.80 °Ctd. Bottom status: HW: 1.02 SW:1.00 MBID:1 3/3
- Page 4 (Alarm):** Alarm status (checked), Unit: °Ctd, Value: -60.00, Hysterese: 2.00, overrun button, back button.
- Page 5 (4 - 20mA Channel 1):** State: on, Unit: °Ctd, Scale 4mA: -80.00°Ctd, Scale 20mA: 20.00°Ctd, back button.
- Page 6 (4 - 20mA Channel 1):** State: on, Unit: g/m<sup>3</sup>, Scale 4mA: 0g/m<sup>3</sup>, Scale 20mA: 10g/m<sup>3</sup>, Save, Cancel buttons.
- Page 7 (IP Adresse Einstellen):** DHCP: checked, IP Address: 192.168.172.010, Sub Netz: 255.255.255.000, Gateway: 192.168.172.001, Erweitert, Speicher, Abbruch buttons.
- Page 8 (Pressure Setting):** Ref.Pressure: 1013.00 hpa, Sys.Pressure: 7500.00 hpa, back button.

The integrated display shows the dew point in big figures as well as further humidity parameters on two more display pages. The arrow key can be used to scroll between the display pages.

The alarm threshold value for the integrated relay can be freely entered via the keys. In addition to the alarm threshold, the hysteresis can also be freely entered.

The 4...20 mA analogue output can be scaled freely or also allocated to one further parameter, e. g. g/m<sup>3</sup>.

After entering the system pressure of the compressed air system and the reference pressure (atmospheric pressure), the sensor can also calculate back to the atmospheric dew point from the measured pressure dew point if desired.

Example order code FA 550: [0699 0550\\_A1\\_B1\\_C1\\_D1\\_E1\\_F1\\_G1\\_H1\\_I1](#)

| Measuring range |   |
|-----------------|---|
| A1              | -80...+20 °Ctd. (-112 to 68 °F)   |
| A2              | -20...+50 °Ctd. (-4 to 122 °F)  |
| A3              | -40...+30 °Ctd. (-40 to 86 °F)  |
| A4              | -60...+30 °Ctd. (-76 to 86 °F)  |
| A5              | -80...+20 °Ctd. (-112 to 68 °F)<br>(scaling 4...20 mA = -100...+20 °Ctd.) |
| A6              | -80...+20 °Ctd. (-112 to 68 °F)<br>(scaling 4...20 mA = -110...+20 °Ctd.) |

| Display option |                         |
|----------------|-------------------------|
| B1             | with integrated display |
| B2             | without display         |

| Option Signal output / Bus connection |  |
|---------------------------------------|--|
| C1                                    | 2 x 4 ... 20 mA analogue output (electrically isolated), alarm relay, RS 485 (Modbus-RTU)  |
| C4                                    | 1 x 4 ... 20 mA analogue output (not electrically isolated), alarm relay, RS 485 (Modbus-RTU)  |
| C5                                    | Ethernet interface (Modbus / TCP), 1 x 4 ... 20 mA analogue output (not electrically isolated), alarm relay, RS 485 (Modbus-RTU)                         |
| C8                                    | M-Bus  |
| C9                                    | Ethernet interface PoE (Power over Ethernet) Modbus / TCP, 1 x 4 ... 20 mA analogue output (not electrically isolated), alarm relay, RS 485 (Modbus-RTU) |

| Special version analogue output |                          |
|---------------------------------|--------------------------|
| D1                              | No special version       |
| D2                              | Special version 2...10 V |

| Scaling analogue output |   |
|-------------------------|---|
| E1                      | Standard scaling  |
| E2                      | Special scaling 4...20 mA = 0...x g/m <sup>3</sup> , ppm, g/kg etc. |

| Sensor protection cap |  |
|-----------------------|--|
| F1                    | Stainless steel sintered cap (~ 50 µm) |
| F2                    | perforated stainless steel cap         |

| Connection thread |          |
|-------------------|----------|
| G1                | G 1/2"   |
| G2                | UNF 5/8" |
| G3                | 1/2" NPT |

| Maximum pressure |         |
|------------------|---------|
| H1               | 50 bar  |
| H2               | 350 bar |
| H3               | 500 bar |

| Surface condition |   |
|-------------------|---|
| I1                | standard version  |
| I2                | special cleaning - oil and grease free (e.g. for oxygen applications and so on) |
| I3                | Silicone-free version including special cleaning oil- and grease-free           |

| DESCRIPTION  | ORDER NO. | TECHNICAL DATA FA 550   |
|--|-----------|---|
| FA 550 Dew point sensor in robust die-cast aluminum housing  | 0699 0550 | <b>Measuring range:</b> -80...20 °Ctd, -60...30 °Ctd, -20...50 °Ctd, or 0...100% RH   |
| <b>Further accessories:</b>  |           | <b>Accuracy:</b> ± 1 °C at +50...-20 °Ctd<br>± 2 °C at -20...-50 °Ctd<br>± 3 °C at -50...-80 °Ctd   |
| Standard measuring chamber up to 16 bar  | 0699 3390 | <b>Pressure range:</b> -1...50 bar,<br>Special version up to 350 bar or 500 bar   |
| High pressure measuring chamber for compressed air up to 350 bar   | 0699 3590 | <b>Power supply:</b> 24 VDC (10...36 VDC)   |
| Stainless steel bypass measuring chamber for dew point measurement in gases under pressure                                     | 0699 3290 | <b>Protection class:</b> IP 67  |
| <b>Connection cables:</b>  |           | <b>EMC:</b> In acc. with DIN EN 61326-1   |
| Connection cable for probes 5 m with open ends   | 0553 0108 | <b>Operating temperature:</b> -20...50 °C   |
| Connection cable for probes 10 m with open ends  | 0553 0109 | <b>Outputs:</b> <b>Standard:</b> Modbus-RTU, 4...20 mA active (not electrically isolated), alarm relay (max. 48 VDC, 0.5 A)<br><b>Options:</b> See order code |
| Ethernet connection cable length 5 m, M12 plug x-coded (8 pin) to RJ 45 plug   | 0553 2503 | <b>Burden:</b> < 500 Ω  |
| Ethernet connection cable length 10 m, M12 plug x-coded (8 pin) to RJ 45 plug  | 0553 2504 | <b>Material:</b> Die-cast aluminum housing, sensor tube stainless steel 1.4571  |
| Power supply in wall housing for max. 2 sensors VA / FA series 5xx, 100-240 VAC, 23 VA, 50-60 Hz / 24 VDC, 0.35 A              | 0554 0110 | <b>Screw-in thread:</b> G 1/2", optional 5/8" UNF, NPT 1/2"   |
| CS Service Software VA 550 incl. interface cable to PC (USB) and power supply - for configuration / parametrisation VA 550/570 | 0554 2007 |   |
| PNG cable screwing - for FA 550, VA 550/570  | 0553 0552 |   |
| <b>Calibration and adjustment:</b>   |           |   |
| Precision calibration at -40 °Ctd or 3 °Ctd incl. ISO certificate  | 0699 3396 |   |
| Additional calibration point freely selectable   | 0700 7710 |   |



## FA 500 - Dew point sensor from -80 to 20 °Ctd

FA 500 is the ideal dew point measuring instrument with integrated display and alarm relay for refrigeration, membrane and adsorption dryers.



### Special features:

- Integrated display
- Threshold value adjustable via keypad, alarm relay (max. 60 VDC, 0.5 A)
- Pressure-tight up to 500 bar (special version)
- Extremely stable in the long term
- Quick adaption time
- 4...20 mA analogue output for dew point
- Different refrigeration and adsorption dryer versions
- **NEW:** Modbus-RTU interface
- **NEW:** Higher resolution of sensor signal due to the improved evaluation electronics
- **NEW:** Sensor diagnosis on site with a portable device or CS Service Software

### Readable via Modbus:

- Pressure dew point [°Ctd.]
- Temperature [°C]
- Rel. humidity [% RH]
- Abs. humidity [g/m<sup>3</sup>]
- Degree of humidity [g/m<sup>3</sup>]
- Moisture content V/V [ppmV/V]
- Water vapour particle pressure [hPa]
- Atmospheric dew point [°Ctd.atm]



The integrated keys enable simple, menu-controlled operation



### Upper connection:

Power supply, 4...20 mA output, Modbus-RTU output

### Lower connection:

Alarm relay



**Option:** Ethernet interface (PoE)



## Easy operation via the keys on the display



The integrated display shows the dew point in big figures as well as further humidity parameters on two more display pages. The arrow key can be used to scroll between the display pages.

The alarm threshold value for the integrated relay can be freely entered via the keys. In addition to the alarm threshold, the hysteresis can also be freely entered.

The 4...20 mA analogue output can be scaled freely or also allocated to one further parameter, e. g. g/m<sup>3</sup>.

After entering the system pressure of the compressed air system and the reference pressure (atmospheric pressure), the sensor can also calculate back to the atmospheric dew point from the measured pressure dew point if desired.

| DESCRIPTION   | ORDER NO. |
|---|-----------|
| FA 500 dew point sensor for refrigeration dryers, -20...50 °Ctd   | 0699 0501 |
| FA 500 dew point sensor for adsorption dryers, -80...20 °Ctd  | 0699 0502 |
| FA 500 dew point sensor for adsorption dryers, -60...30 °Ctd  | 0699 0503 |
| <b>Connection cables:</b>   |           |
| Connection cable for VA/FA series, 5 m  | 0553 0104 |
| Connection cable for VA/FA sensors, 10 m  | 0553 0105 |
| Cable for alarm/pulse output, with M12 plug, length 5 m   | 0553 0106 |
| Cable for alarm/pulse output, with M12 plug, length 10 m  | 0553 0107 |
| Ethernet connection cable length 5 m, M12 plug x-coded (8 pin) to RJ 45 plug  | 0553 2503 |
| Ethernet connection cable length 10 m, M12 plug x-coded (8 pin) to RJ 45 plug   | 0553 2504 |
| <b>Options for FA 500:</b>  |           |
| Option: Max. pressure FA5xx 350 bar   | Z699 0515 |
| Option: Max. pressure FA5xx 500 bar   | Z699 0516 |
| Option: Special scaling FA5xx 4...20 mA=... .. g/m <sup>3</sup> , ppm etc.  | Z699 0514 |
| Option: connection thread FA5xx, 5/8" UNF   | Z699 0511 |
| Option: surface condition FA 5xx, free of oil & grease  | Z699 0517 |
| Ethernet-Interface for VA 500/520 and FA 500  | Z695 5006 |
| Ethernet-Interface PoE for VA 500/520 and FA 500  | Z695 5007 |
| M-Bus board for VA 500/520 and FA 500   | Z695 5004 |
| <b>Further accessories:</b>   |           |
| Standard measuring chamber for compressed air up to 16 bar  | 0699 3390 |
| High pressure measuring chamber up to 350 bar   | 0699 3590 |
| CS Service Software for FA/VA sensors incl. PC connection set, USB connection and interface adapter to the sensor     | 0554 2007 |
| Mains unit in wall housing for maximum 2 sensors of the series VA/FA 5xx, 100-240 V, 23 VA, 50-60 Hz / 24 VDC, 0.35 A | 0554 0110 |
| AC adapter plug 100-240 VAC / 24 VDC for VA/FA 5xx  | 0554 0109 |
| <b>Calibration and adjustment:</b>  |           |
| Precision calibration at -40 °Ctd or +3 °Ctd incl. ISO certificate  | 0699 3396 |

| TECHNICAL DATA FA 500              |  |
|------------------------------------|--|
| <b>Measuring range:</b>            | -80...20 °Ctd, -60...30 °Ctd, -20...50 °Ctd, or 0...100% RH  |
| <b>Accuracy:</b>                   | ± 1 °C at +50...-20 °Ctd<br>± 2 °C at -20...-50 °Ctd<br>± 3 °C at -50...-80 °Ctd                               |
| <b>Pressure range:</b>             | -1...50 bar<br>Special version up to 500 bar   |
| <b>Power supply:</b>               | 24 VDC (10...36 VDC)   |
| <b>Protection class:</b>           | IP 65  |
| <b>EMC:</b>                        | In acc. with DIN EN 61326-1  |
| <b>Operating temperature:</b>      | -20...50 °C  |
| <b>Connection:</b>                 | 2 x M12, 5-pin for analogue output, Modbus-RTU and alarm output, M-Bus (optional)<br>Ethernet (PoE) (optional) |
| <b>PC connection:</b>              | Modbus-RTU interface (RS 485)  |
| <b>Output: (3-wire)</b>            | 4...20 mA = -80...20 °Ctd<br>4...20 mA = -60...30 °Ctd<br>4...20 mA = -20...50 °Ctd                            |
| <b>Burden for analogue output:</b> | < 500 Ω  |
| <b>Alarm relay:</b>                | NC, max. 60 VDC, 0.5 A   |
| <b>Screw-in thread:</b>            | G 1/2"   |
| <b>Dimensions housing:</b>         | 76.5 x 85 x 75 mm (Wx-HxD)   |



## DS 400 Dew point monitoring

For stationary dew point monitoring of refrigeration or adsorption dryers. The touch screen graphic display enables an intuitive operation and graphically shows the progress of the measured values. Two alarm relays are available for monitoring threshold values. Available interfaces are either a classic analogue output 4...20 mA or optionally digital interfaces such as Ethernet and RS 485 (Modbus protocol). As a stand-alone solution, the measured values stored in the optional data logger can be read-out via USB stick and evaluated on the computer by means of the software CS Basic.

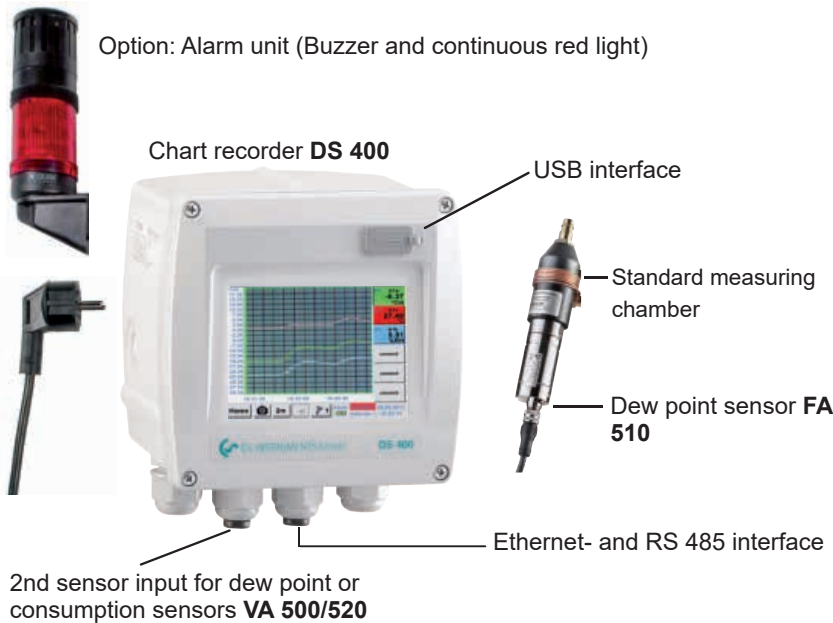

### SPECIAL FEATURES:

- 3.5" Graphic display – easy to use with touchscreen
- Plug-in system: everything wired and ready
- 2 alarm contacts (230 VAC, 3 A), pre-alarm and main alarm freely adjustable
- An alarm delay can be set for each alarm relay.
- 4...20 mA analogue output
- Option: Ethernet and RS 485 interface (Modbus protocols)
- Option: Web server

### Transfer of data to the PC via USB stick



- **Option:** Integrated data logger
- Record dew point curve up to 100 million measured values
- CS Basic for evaluation in graphs and tables. Read out data either via USB stick or Ethernet

| DESCRIPTION   | ORDER NO. |
|---|-----------|
| Dew point monitoring DS 400 for adsorption dryers (-80...+20 °Ctd)  | 0601 0510 |
| Dew point monitoring DS 400 for refrigeration dryers (-20...+50 °Ctd)   | 0601 0512 |
| <b>Options:</b>   |           |
| Option: Integrated data logger for 100 million measured values  | Z500 4002 |
| Option: Integrated Ethernet and RS 485 interface  | Z500 4004 |
| Option: Integrated webserver  | Z500 4005 |
| Option: 2 additional sensor inputs for analogue sensors (pressure sensors, temperature sensors etc.)                                    | Z500 4001 |
| <b>Further accessories</b>  |           |
| CS Basic – data evaluation graphically and in table form - reading of the measured data via USB or Ethernet, licence for 2 workstations | 0554 8040 |
| Alarm unit mounted to the wall housing  | Z500 0003 |
| Alarm unit for external mounting with 5 m cable   | Z500 0004 |
| <b>Calibration and adjustment</b>   |           |
| Precision calibration at -40 °Ctd or +3 °Ctd incl. ISO certificate  | 0699 3396 |

### TECHNICAL DS 400

|                                    |  |
|------------------------------------|--|
| <b>Dimensions:</b>                 | 118 x 115 x 98 mm<br>IP 54 (wall housing)<br>92 x 92 x 75 mm<br>(panel mounting)   |
| <b>Inputs:</b>                     | 2 digital inputs for FA 510 or VA 500/520  |
| <b>Interface:</b>                  | USB interface  |
| <b>Power supply:</b>               | 100...240 VAC, 50-60 Hz  |
| <b>Accuracy:</b>                   | See FA 510   |
| <b>Alarm outputs:</b>              | 2 relays, (pot.-free)  |
| <b>Options:</b>                    |  |
| <b>Data logger:</b>                | 100 million measured values start/stop time, measuring rate freely adjustable  |
| <b>2 additional sensor inputs:</b> | For connection of pressure sensors, temperature sensors, clamp-on ammeters, third-party sensors with 4...20 mA, 0 to 10 V, Pt 100, Pt 1000 |

### TECHNICAL DATA FA 510

|                         |   |
|-------------------------|---|
| <b>Measuring range:</b> | -80...-20 °Ctd or<br>-20...50 °Ctd  |
| <b>Accuracy:</b>        | ± 1 °C at 50...-20 °Ctd<br>± 2 °C at -20...-50 °Ctd<br>± 3 °C at -50...-80 °Ctd |
| <b>Pressure range:</b>  | -1...50 bar, special version<br>350 bar   |

## Easy operation via touchscreen

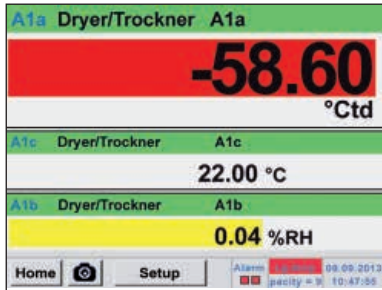

### Actual measured values

All measured values can be seen at a glance. Threshold value exceedances are indicated in red color. A „measuring site name“ can be allocated to each sensor.



### Graphic view

In the graphic view all measured values are indicated as curves. It is possible to browse back on the time axis by a slide of the finger (without data logger maximum 24 h, with data logger back to the start of the measurement).



### Data logger

Measured values are stored in DS 400 by means of the option „integrated data logger“. The time interval can be freely set. Furthermore there is the possibility to fix the starting time and the end time of the data recording. Read-out of the measured data via USB interface or via the optional Ethernet interface.



### Selection of the language

DS 400 „speaks“ several languages. The desired language can be selected via the selection button.

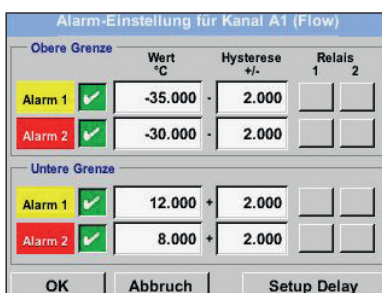

### Adjustment of the alarm relays

Each one of the two alarm relays can be allocated individually to a connected sensor. The alarm thresholds and the hysteresis can be freely adjusted.

**New:** It is possible to set an alarm delay for each alarm relay so that the relay is only triggered after that period of time.



## Accessories FA 500/510/515

**DESCRIPTION**

Diffusion-tight PTFE hose 6 mm with quick-lock coupling length 1 m  
 Diffusion-tight PTFE hose 6 mm, length 1 m

**ORDER NO.**

0554 0003  
 0554 0008

**DESCRIPTION**

Cooling section made of stainless steel

**ORDER NO.**

0699 3291

- 8 mm stainless steel tube wound as a spiral.
- With the cooling section, process gases from ovens etc. can be cooled from high temperatures to a sensor-compatible temperature of about 50°C. Falling below the dew point to be avoided.

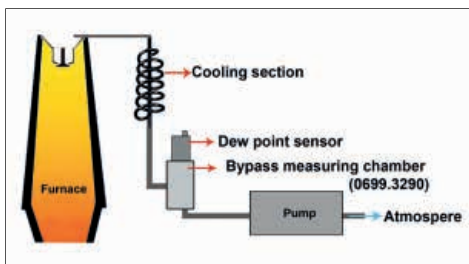
**DESCRIPTION**

Suction pump max. 0.9 l/min, 200 mbar for DP 510

**ORDER NO.**

0554 6520

**DESCRIPTION**

Quick-lock coupling NW 7,2 - G 1/2" male thread

**ORDER NO.**

0530 1101

**DESCRIPTION**

Control and calibration set 11.3% RH  
 Control and calibration set 33% RH  
 Control and calibration set 75.3% RH

**ORDER NO.**

0554 0002  
 0554 0004  
 0554 0005

- Control and calibration sets provide a defined humidity over a saturated saline solution
- The control and calibration set is screwed onto the dew point sensor and thus enables a simple and inexpensive control and calibration option down to -20 °Ctd dew point on site

## Accessories FA 500/510/515



| DESCRIPTION   | ORDER NO. |
|---|-----------|
| Dry container for CS dew point sensors  | 0699 2500 |
| <ul style="list-style-type: none"> <li>Guarantees sensor protection and quick adaption time. Recommended for storage of mobile sensors</li> </ul> |           |

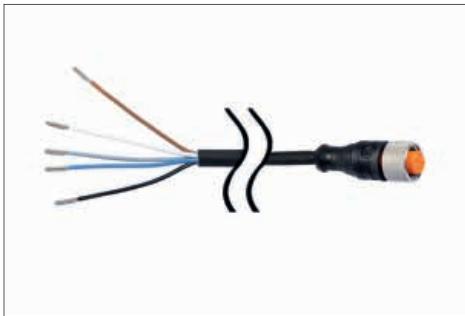

| DESCRIPTION                                       | ORDER NO. |
|---|-----------|
| Connection cable for VA/FA series, 5 m            | 0553 0104 |
| Connection cable for VA/FA sensors, 10 m          | 0553 0105 |
| Connection cable for VA/FA series, 20 m           | 0553 0120 |
| Connection cable for VA/FA series, 5 m shielded   | 0553 0129 |
| Connection cable for VA/FA series, 10 m shielded  | 0553 0130 |
| Cable for alarm/pulse output, with M12 plug, 5 m  | 0553 0106 |
| Cable for alarm/pulse output, with M12 plug, 10 m | 0553 0107 |



| DESCRIPTION                 | ORDER NO.   |
|-----------------------------|-------------|
| M12 plug for FA 500/510/515 | 0 2000 0082 |
| M12 plug 90° angled         | 0219 0060   |



| DESCRIPTION   | ORDER NO.   |
|---|-------------|
| Adapter plug FA 515/Michell easidew valve connector DIN 43650 form C 8 mm | 0 2000 1389 |



| DESCRIPTION   | ORDER NO. |
|---|-----------|
| Ethernet connection cable length 5 m, M12 plug x-coded (8 pin) to RJ 45 plug  | 0553 2503 |
| Ethernet connection cable length 10 m, M12 plug x-coded (8 pin) to RJ 45 plug | 0553 2504 |

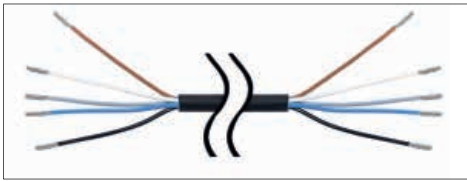

## Accessories FA 550

**DESCRIPTION**

Connection cable 5 m with open ends  
 Connection cable 10 m with open ends

**ORDER NO.**

0553 0108  
 0553 0109

**DESCRIPTION**

PNG cable screwing - for standard

**ORDER NO.**

0553 0552

## Accessories for all FA 5xx

**DESCRIPTION**

Mains unit in wall housing for maximum 2 sensors of the series VA/FA 5xx, 100-240 V, 23 VA, 50-60 Hz / 24 VDC, 0.35 A

**ORDER NO.**

0554 0110

**DESCRIPTION**

AC adapter plug 100-240 VAC / 24 VDC for VA/FA 5xx

**ORDER NO.**

0554 0109

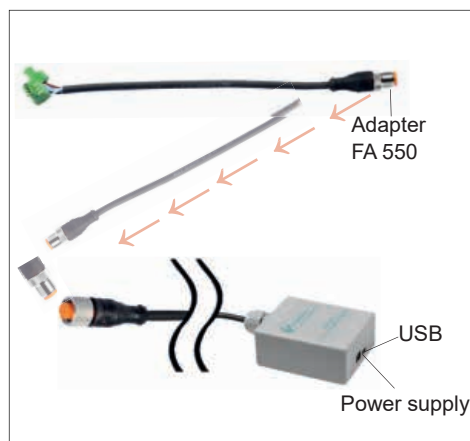
**DESCRIPTION**

CS Service Software incl. PC connection set, USB connection and interface adapter to the sensor

**ORDER NO.**

0554 2007

## Measuring chambers



| DESCRIPTION                                   | ORDER NO. |
|---|-----------|
| Standard measuring chamber for compressed air | 0699 3390 |

- Applicable for 2...16 bar
- Process connection: Plug nipple NW 7.2 (Parker series 26) or G 1/4" female thread when using without plug nipple
- Sensor connection: G 1/2" female thread
- Gives 2-3 liters / min of process air to the environment
- The copper capillary relaxes the compressed air and prevents the backflow of moisture from the ambient air into the measuring chamber



| DESCRIPTION   | ORDER NO. |
|---|-----------|
| Stainless steel measuring chamber for compressed air up to 50 bar | 0699 3292 |

- Applicable for 2...50 bar
- Process connection: G1/4" female thread
- Sensor connection: G 1/2" female thread
- Gives 2-3 liters / min of process air to the environment



| DESCRIPTION  | ORDER NO. |
|--|-----------|
| High pressure measuring chamber for compressed air up to 350 bar | 0699 3590 |

- Applicable for 30...350 bar
- Process connection: G 1/4" female thread
- Sensor connection: G 1/2" female thread
- Emits 2-3 litres/min of process air to the environment via a fine nozzle
- Via the high-pressure valve, the amount of air for sampling can be adjusted individually depending on the pressure level. The process air is released to the environment via the sinter filter



| DESCRIPTION  | ORDER NO. |
|--|-----------|
| Stainless steel bypass measuring chamber for dew point measurement in gases under pressure | 0699 3290 |

- Applicable for -1...500 bar
- Process connection: G 1/4" female thread gas inlet and G 1/4" female thread gas outlet
- Sensor connection: G 1/2" female thread
- The flow of at least 2 liters / min of gas must be ensured by the customer



| DESCRIPTION  | ORDER NO. |
|--|-----------|
| Standard measuring chamber for compressed air NPT 1/2" | 0699 3393 |

- Applicable for 2...16 bar
- Process connection: NPT 1/2" male thread, or NPT 1/4" female thread for use without adapter
- Sensor connection: NPT 1/2" female thread
- Gives 2-3 liters / min of process air to the environment
- The copper capillary relaxes the compressed air and prevents the backflow of moisture from the ambient air into the measuring chamber



## Measuring chambers

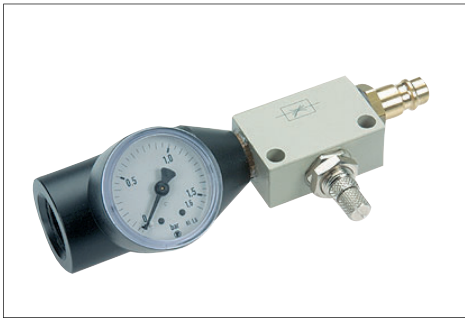

| DESCRIPTION  | ORDER NO. |
|--|-----------|
| Measuring chamber for atmospheric dew point  | 0699 3690 |
| <ul style="list-style-type: none"><li>• Applicable for 2...16 bar</li><li>• Process connection: Plug nipple NW 7.2 (Parker series 26) or G 1/4" female thread when using without plug nipple</li><li>• Sensor connection: G 1/2" female thread</li><li>• Gives 2-3 liters / min of process air to the environment</li><li>• The throttle valve in front of the measuring chamber relaxes the compressed air to atmospheric pressure in the measuring chamber. The manometer integrated in the measuring chamber indicates the overpressure to the atmosphere</li></ul> |           |



| DESCRIPTION   | ORDER NO. |
|---|-----------|
| Measuring chamber for granulate dryers and gases  | 0699 3490 |
| <ul style="list-style-type: none"><li>• Applicable for -1...16 bar</li><li>• Process connection: Plug connection for 6 mm hose at inlet and outlet or G 1/4" female thread when using without plug connections</li><li>• Sensor connection: G 1/2" female thread</li><li>• The flow of at least 2 liters / min of air / gas must be ensured by the customer</li></ul> |           |







## Calibration of dew point sensors

The calibration range for dew point sensors is from -80 °Ctd...20 °Ctd

Both dew point sensors from us and from other manufacturers can be calibrated. High precision reference measuring devices with DKD or BAM certificate guarantee an accuracy of up to 0.1 °C dew point.

### Special feature:

Due to the digital data transmission, only the dew point sensor has to be calibrated. The display devices remain wired on site.



**Calibration range:** from -80 to 20 °Ctd -  
**Accuracy of the DKD reference:** 0.1 °Ctd



## Control and calibration set

Control and calibration sets provide a defined humidity over a saturated saline solution.

The control and calibration set is screwed onto the dew point sensor and therefore enables an easy and low-priced possibility for on-site control and calibration down to -20 °C dew point.

| DESCRIPTION  | ORDER NO. |
|--|-----------|
| Recalibration and precision calibration at -40 °Ctd or 3 °Ctd incl. ISO certificate                    | 0699 3333 |
| Precision calibration in the range -80...20 °Ctd, °Ctd points freely selectable                        | 0700 7710 |
| Control and calibration set 11.3% RH   | 0554 0002 |
| Control and calibration set 33% RH   | 0554 0004 |
| Control and calibration set 75.3% RH   | 0554 0005 |
| Precision calibration at -40 °Ctd or 3 °Ctd incl. ISO certificate                                      | 0699 3396 |
| Replacement unit for the period of re-calibration  | 0699 3900 |
| Pressure dew point replacement sensor from our device pool including precision certificate at -40 °Ctd | 0699 3990 |

## CS Service Software

With the CS service software including the USB Modbus interface adapter, the FA 510 / FA 515 / FA 500 dew point sensors can be configured via laptop / PC. The following settings can be made via CS Service Software:



- Scaling of the 4...20 mA analogue output
- Assignment of the parameter to the analogue output (e.g. 4...20 mA = 0...10 g/m<sup>3</sup>)
- Available units: °Ctd, °Ftd, g/m<sup>3</sup>, mg/m<sup>3</sup>, ppmv/v, g/kg
- Reading out the firmware version, serial number, date of the last calibration
- One-point calibration (adjustment) of the sensors in the process. This requires a reference device
- Update of the sensor software (Firmware)
- Modbus settings as Modbus-ID, Baud rate, Stopbit, Parity

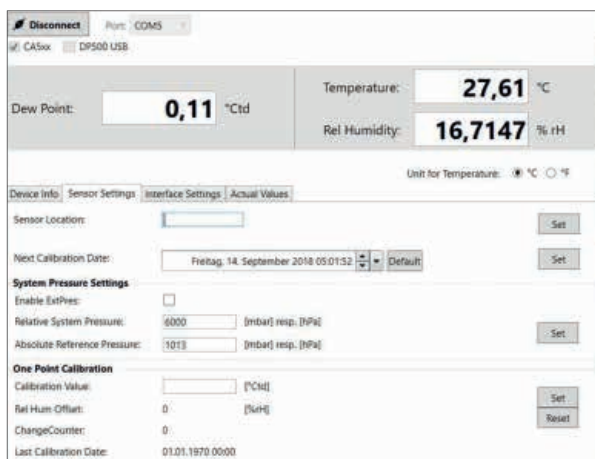
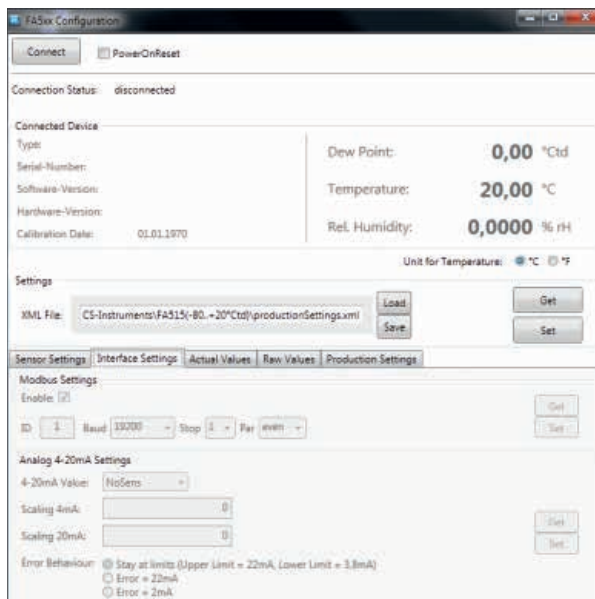

| DESCRIPTION   | ORDER NO. |
|---|-----------|
| CS Service Software incl. PC connection set, USB connection and interface adapter to the sensor | 0554 2007 |



## Dew point measurement in compressed air systems

Today, compressed air is an essential and reliable source of energy from modern production processes.

Depending on the particular application, different requirements are made on the compressed air. The compliance with a specific moisture content or dew point/pressure dew point is the basic prerequisite for a permanently trouble-free system operation for every process.

Especially for moisture measurement or dew point / pressure dew point measurement in compressed air and gases, we have developed the DS 400 measuring device with many new advantages.



Usually, compressed air is generated from ambient air which must be aspirated, compressed by using pistons or screw compressors and which must then be dried more or less strongly.

The aim is to produce dry and oil-free compressed air which is low in dust particles with the smallest possible effort. Residual oil and dust particles can be removed by means of complex filter systems.

However, moisture must be reduced by means of dryers (refrigeration dryers, membrane dryers, adsorption dryers and so on) which ideally work in a controlled manner independent of any load.

### How does water get into compressed air?

Air is able to bind more water vapour the higher the temperature and the larger the volume. Conversely, if the air is compressed, the capacity to bind water vapour is reduced.

A compressor compresses atmospheric ambient air into a fraction of its original volume. At a certain point of the compression process the water content of the air exceeds the decreasing ability of the air to bind water. The air is saturated and part of the water drops out as condensate.

By means of an additional decrease of the temperature even more water will condensate.

This means that the relative humidity on the output of a compressor will always be at 100 % and that there will be additional water drops in the outgoing air.

The amount of liquid which drops out under pressure can be large. For example, a 30 kW compressor thus releases approximately 20 litres into the compressed air line at a humidity level of 60 % and an ambient temperature of 20 °C in eight hours. In case of big compressors this value will be much higher.

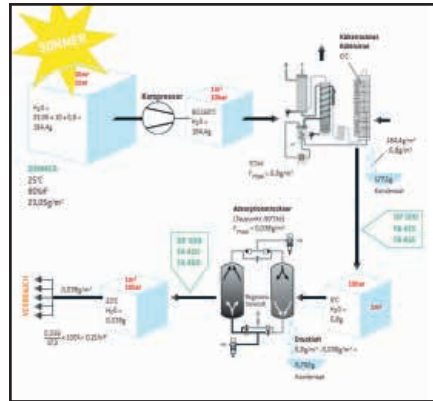

### Effects of the moisture content

Depending on the application different demands are made on the compressed air. For each process the observance of a certain moisture content is the condition for a durably failure-free functioning of the whole system.

Most of the compressed air lines are made from steel or non zinc-coated steel. Since the corrosion speed strongly increases from a relative humidity of 50 % this value should not be exceeded in any case.

In the course of time, high moisture will lead to a corrosion in case of non zinc-coated lines. The rust gradually chips off and moves to the sampling points. This leads e. g. to blocked nozzles, defective control elements and production stops.

Expensive repairs and short maintenance intervals are inevitable. In addition to problems with corrosion and the described results the moisture content has direct influence on the quality of the final products.

### Wich problems may arise in case of too high moisture?

In the following please find some of the most occurring samples:

- Hygroscopic products (spices, sugar etc.) get stuck together during transport by the pneumatic conveyor system
- Bubbles are formed during painting and coating processes
- Boreholes can clog up from dust being carried
- Control valves freeze over in winter in unheated halls 10610101

| Anwendung                                 | Empfohlene Druckluftqualitäten                  |     |            |            |
|---|---|-----|------------|------------|
|   | Druckluftqualitätsklassen nach DIN ISO 8573 - 1 |     |            |            |
|   | Partikel  |     | Restwasser |            |
| KL  | µm  | KL  | DTP        |            |
| Atemluft                                  | 1   | 0,1 | 1-3        | -70/+20 °C |
| Spritzpistolen                            | 1   | 0,1 | 2          | -40 °C     |
| Medizintechnik                            | 1   | 0,1 | 3-4        | -20/+3 °C  |
| Mess- und Regeltechnik                    | 1   | 0,1 | 4          | +3 °C      |
| Förderung von Lebensmitteln und Getränken | 2   | 1   | 3          | -20 °C     |
| Sandstrahlanlagen                         | —   | —   | 4-5        | +3/+10 °C  |
| Allgemeine Werksluft                      | 3   | 5   | 4          | +3 °C      |
| Aufbruchhammer                            | 4   | 15  | 5-4        | +7/+3 °C   |

### Tasks of dryers

Different types of dryers are used in practice in order to control the problems of moisture levels that are too high.

In compressed air technology, the pressure dew point is the parameter for indicating the dryness of compressed air. The pressure dew point is the temperature at which the moisture which is contained in the compressed air condenses to form liquid water (also saturation, 100% relative humidity).

The lower the pressure dew point temperature, the smaller the amount of water vapour contained in the compressed air.



## Refrigeration dryer for dew point parameters around +2 °Ctd.

There are different types of compressed air dryers; refrigeration dryers or adsorption dryers are the most commonly used ones.

Refrigeration dryers cool down the compressed air to approx. 2 to 5 °C. In this case, the pressure dew point is also 2 to 5 °C. The excess water vapour condenses and precipitates.

After that the air is again heated up to room temperature.

The refrigeration compressed air dryers are monitored in most cases only by a display of the cooling temperature. A stationary humidity monitor is hitherto only installed in large systems or in particularly important applications.

However, the display of the cooling temperature alone is not sufficient. Even if the cooling temperature seems to be OK, the following errors can cause an excessive pressure dew point:

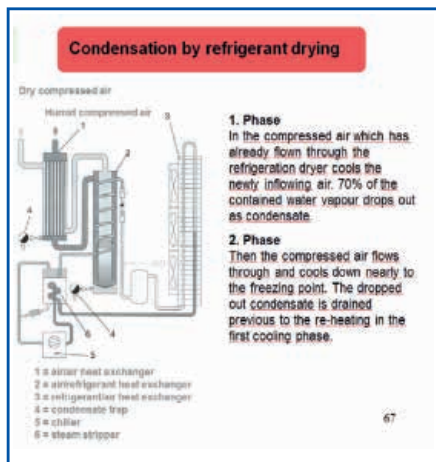

- Condensate in the refrigeration dryer is not drained off (condensate drain defective resp. soiled)
- Compressed air bypass in the refrigeration dryer (close and corrode heat exchanger pipes and so on); compressed air bypass in bypass lines
- A failure of the refrigeration dryer inevitably leads to considerable problems with condensate in the compressed air line

It is especially problematic (besides the already listed problems), if the condensate can concentrate in blind lines and does not drain off automatically. Condensate in blind lines can only be removed again by means of considerable efforts or dried and drained off by means of an extremely large amount of compressed air.

This often leads to increased dew point values at very low consumption rates, without the refrigeration dryer showing any obvious problems. In this case, it is quite difficult for the person who is responsible for compressed air to find out the reason for the increased dew point values or in extreme cases for the condensate in the long-term.

## Adsorption dryers for typical dew points -30...-40 °Ctd.

The functioning of the adsorption dryer is based on the principle of the attraction between the two masses. Water vapor is bound (absorbed) at the surface of a desiccant.

Effective adsorption dryers are able to dry compressed air down to a pressure dew point of -40 °C and lower.

Regenerative adsorption dryer exist of two tanks which are filled with desiccant. In different procedures there is one tank regenerated cold resp. warm while the other one dries the operation air.

Depending on the procedure and the operating conditions the desiccant has to be exchanged in cycles of three to five years.

**Certain operating conditions lead to a shortening of the life span of the desiccant:**

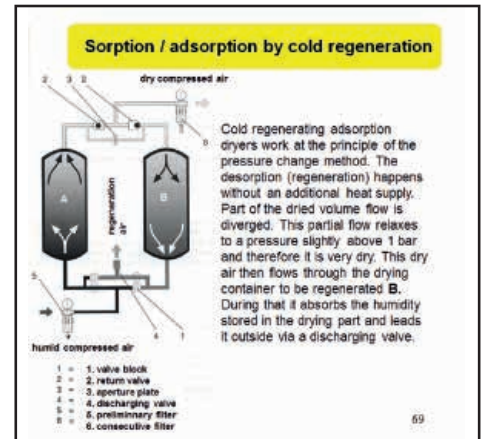

- Overload on compressed air side due to excessive compressed air consumption
- Poor pre-separation of condensate
- Oily air
- Regeneration times of the individual tanks too long

## New: DS 400 dew point measurement with alarm ensures process reliability

Unique worldwide with 3.5" graphic display with touch screen and print function.

An alarm delay can be set for each relay. This grants that only really long-term threshold value exceedances are indicated. Additionally every alarm can be reset.



The dew point set DS 400 consists of the chart recorder DS 400 and the dew point sensor FA 510 including measuring chamber for the pressure dew point measurement of compressed air and gases up to 16/50/350 bar.

For pressures of more than 16 bar, please use the high-pressure measuring chamber.

The heart of the dew point sensor is the worldwide proven humidity sensor. In order to get quick and accurate measurements it is necessary that the humidity sensor is continuously flown by the gas (compressed air) to be measured. For this purpose a defined volume flow is blown out at a certain pressure via a capillary line.

The measuring chamber can be connected to the sampling point without any large installation efforts by means of the standard plug nipple for compressed air lines.

The big difference to customary paperless chart recorders is reflected in the simplicity of DS 400 on initiation and evaluation of the measured data.

The intuitive operation with the 3.5" touch screen graphic display with zoom function and print key is the only one of its kind in the world in this price category. By means of the graphic display with zoom function the drying procedure resp. the dew point curve can be seen at a glance and stored in the data logger. So the user can take a look at the stored measuring curves also without any computer at any time on site. This grants a quick and easy analysis of the drying behavior.

By means of the print key the actual screen can be stored as an image file to the internal SD card or to a USB stick and printed out at the computer without any additional software.

Ideal for documentation of the measured values/measurement curves on site.

Colored measurement curves can be sent by e-mail as image files or integrated into a service report.

The internal data logger enables the storage of the measured data for several years. The measured data can be evaluated on a USB stick or via Ethernet by means of the comfortable software CS Soft Basic.

#### Special features:

- **3.5" graphic display, intuitive operation via touch screen**
- **Zoom function for accurate analysis of measured values**
- **Colored measurement curves with names**
- **Mathematical calculation function for calculation of the dew point distance (condensate switch)**
- **Print key: optional indications can be stored as image files directly on a USB stick and sent by e-mail without any software**
- **2 alarm contacts for threshold value exceedance**
- **Freely adjustable alarm delay for both alarm contacts with reset function**
- **Up to 4 sensor inputs for: additional dew point, pressure, temperature, flow meters, electrical effective power meters, optional third-party sensors can be connected: Pt 100/ 1000, 0/4...20 mA, 0-1/10 V, Modbus, pulse**
- **Integrated data logger 8 GB**
- **USB, Ethernet interface, RS 485 / Modbus**
- **Web server**



## FO 510 - Industrial oil moisture sensor

FO 510 for moisture measurement in technical oils



### Special advantages:

- Fast response time
- Highly accurate measurement of water activity ( $a_w$ ), as well as process temperature. Measurement is independent of the respective oil type or age
- Calculation of the absolute water content (PPM), possible for transformer oil
- Two configurable analogue outputs, as well as Modbus-RTU (RS 485) interface available

### Typical application, measurement of residual moisture in:

- Transformer oil
- Engine oil
- Lubricating oil
- Hydraulic oil
- Diesel fuels

Example order code FO 510:

0699 0100\_A1\_B1\_C1\_D1

| Process connection |          |
|--------------------|----------|
| A1                 | G 1/2"   |
| A2                 | 1/2" NPT |

| Scaling analogue output 1 |                               |
|---------------------------|-------------------------------|
| B1                        | Water activity [ ] (standard) |
| B2                        | Water content x [ppm]         |
| B3                        | Temperature T (°C)            |
| B4                        | Temperature T (°F)            |

| Scaling analogue output 2 |                               |
|---------------------------|-------------------------------|
| C1                        | Temperature T (°C) (standard) |
| C2                        | Temperature T (°F)            |
| C3                        | Water activity [ ]            |
| C4                        | Water content x [ppm]         |

| Oil type |                          |
|----------|--------------------------|
| D1       | Standard transformer oil |
| D2       | Customer specific oil    |

Order code Cable for FO 510:

0553 0145\_A1

| Cable 8-polig |                             |
|---------------|-----------------------------|
| A1            | 5 m                         |
| A2            | 10 m                        |
| A3            | Variable lengths on request |



**Recommendation:**  
Installation in a constantly flushed measuring point for best results

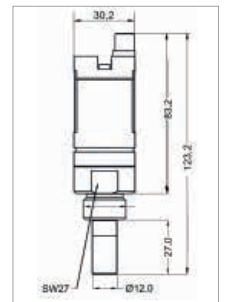

Dimensions FO 510

| ACCESSORIES   | ORDER NO. |
|---|-----------|
| CS Service Software FO 510 incl. interface cable to PC (USB) and power supply - for configuration / parametrisation of FO 510 | 0554 2010 |

| TECHNICAL DATA FO 510                         |  |
|---|--|
| <b>Measuring range humidity:</b>              | 0...1 $a_w$  |
| <b>Accuracy (0...0.9 <math>a_w</math>):</b>   | $\pm 0.02 a_w$ at +23 °C                                     |
| <b>Accuracy (0.9...1.0 <math>a_w</math>):</b> | typically $\pm 0.03 a_w$ at +23 °C                           |
| <b>Measuring range temperature:</b>           | 0...100 °C   |
| <b>Accuracy temperature:</b>                  | $\pm 0,3$ °C   |
| <b>Oil temperature:</b>                       | -20...+100°C   |
| <b>Ambient temperature:</b>                   | -20...+70°C  |
| <b>Pressure range:</b>                        | up to 300 bar  |
| <b>Interfaces:</b>                            | 2 x analogue output 04...20 mA (3-wire), Modbus RTU (RS 485) |
| <b>Supply voltage:</b>                        | 24 VDC (10...36 VDC)   |
| <b>Protection class:</b>                      | IP 66  |
| <b>EMV:</b>                                   | acc. to DIN EN 61326-1                                       |
| <b>Material thread:</b>                       | 1.4404   |
| <b>Material perforated cap</b>                | 1.4301   |
| <b>Connection:</b>                            | M12, 8-pin   |







## VA 570 - Inline flow meter



Flange version



Version with pipe thread R thread or NPT thread

VA 570 is supplied with an integrated measuring section. The measuring sections are available in flanged version or with R resp. NPT thread.

A special feature is the removable measuring head. So the measuring unit can be removed easily and quickly for calibration or cleaning purposes without having to dismount the measuring section intricately. During this period the measuring section is sealed by a closing cap (accessory).

The screwing with a centring device is designed such that the sensor is positioned accurately in the centre when screwing it into the measuring section; furthermore, it enables an exact positioning in the flow direction. This eliminates unnecessary measuring faults.

### Approvals:

 II 2 G Ex db IIC T4 Gb

 II 2 D Ex tb IIIC T90 °C Db

### Special measurement technology features:

- 4 values on the display: Flow, total consumption, velocity, temperature. Units freely adjustable
- All measured values, settings such as gas type, inner diameter, serial number and so on can be accessed via Modbus-RTU
- Comprehensive diagnostic functions readable on the display or remote access via Modbus such as calibration cycle, error codes, serial number
- Notification in case of exceeding the calibration cycle
- Standard version accuracy 1.5% of m.v. ± 0.3% of f.s.
- Precision version accuracy 1.0% of m.v. ± 0.3% of f.s.
- Measuring span of 1 : 1000 (0.1 up to 224 m/s)
- Configuration and diagnosis via display, hand-held device PI 500, PC service software on-site
- Gas type (air, nitrogen, oxygen, argon and so on) freely adjustable via PC service software or external device DS 400, DS 500, PI 500
- Reference conditions °C and mbar/hPa freely adjustable
- Zero-point adjustment, leak flow volume suppression
- Pressure loss negligible



The sensor can be removed and cleaned

### Special mechanical features:

- Robust impact-proof aluminium die cast housing for the outdoor area IP 67
- All wetted parts made from stainless steel 1.4404
- On request with DVGW approval for natural gas (up to 16 bar)
- Pressure range up to 16 bar, special version up to 40 bar
- Temperature range up to 180 °C
- No moveable parts, no wear
- Sensor tip very robust, easy to clean
- Housing rotatable, display rotatable by 180°



## Measuring range - Flow VA 570

|   |                      | 1/2"       | 3/4"       | 1"         | 1 1/4"     | 1 1/2"     | 2"          | 2 1/2"      | 3"          |
|---|----------------------|------------|------------|------------|------------|------------|-------------|-------------|-------------|
|   |                      | m³/h (cfm) | m³/h (cfm) | m³/h (cfm) | m³/h (cfm) | m³/h (cfm) | m³/h (cfm)  | m³/h (cfm)  | m³/h (cfm)  |
| <b>Reference conditions DIN 1945 / ISO 1217: 20 °C, 1000 mbar</b> |                      |            |            |            |            |            |             |             |             |
| <b>Air</b>  | Low-Speed (50 m/s)   | 20 (14)    | 45 (25)    | 75 (45)    | 140 (80)   | 195 (115)  | 320 (190)   | 550 (325)   | 765 (450)   |
|   | Standard (92.7 m/s)  | 45 (25)    | 85 (50)    | 145 (85)   | 265 (155)  | 365 (215)  | 600 (350)   | 1025 (600)  | 1420 (835)  |
|   | Max (185 m/s)        | 90 (50)    | 175 (100)  | 290 (170)  | 530 (310)  | 730 (430)  | 1195 (700)  | 2050 (1205) | 2840 (1670) |
|   | High-Speed (224 m/s) | 110(60)    | 215 (125)  | 355 (210)  | 640 (375)  | 885 (520)  | 1450 (850)  | 2480 (1460) | 3440 (2025) |
| <b>Setting to DIN 1343: 0 °C, 1013.25 mbar</b>                    |                      |            |            |            |            |            |             |             |             |
| <b>Argon (Ar)</b>   | Low-Speed (50 m/s)   | 35 (20)    | 75 (40)    | 120 (70)   | 220 (130)  | 305 (180)  | 505 (295)   | 865 (510)   | 1200 (705)  |
|   | Standard (92.7 m/s)  | 70 (40)    | 135 (80)   | 230 (135)  | 415 (245)  | 570 (335)  | 935 (550)   | 1605 (945)  | 2225 (1310) |
|   | Max (185 m/s)        | 140 (80)   | 275 (160)  | 460 (270)  | 830 (485)  | 1140 (670) | 1870 (1100) | 3205 (1885) | 4440 (2615) |
|   | High-Speed (224 m/s) | 170 (100)  | 335 (195)  | 555 (325)  | 1005 (590) | 1385 (815) | 2265 (1330) | 3880 (2285) | 5380 (3165) |
| <b>Carbondi-oxide (CO2)</b>                                       | Low-Speed (50 m/s)   | 20 (14)    | 45 (25)    | 75 (45)    | 140 (80)   | 195 (115)  | 320 (185)   | 545 (320)   | 760 (445)   |
|   | Standard (92.7 m/s)  | 45 (25)    | 85 (50)    | 145 (85)   | 260 (155)  | 360 (210)  | 590 (345)   | 1015 (595)  | 1405 (825)  |
|   | Max (185 m/s)        | 90 (50)    | 175 (100)  | 290 (170)  | 525 (305)  | 720 (425)  | 1185 (695)  | 2030 (1190) | 2810 (1655) |
|   | High-Speed (224 m/s) | 105 (60)   | 210 (125)  | 350 (205)  | 635 (370)  | 875 (515)  | 1430 (840)  | 2455 (1445) | 3405 (2000) |
| <b>Nitrogen (N2)</b>  | Low-Speed (50 m/s)   | 20 (13)    | 40 (25)    | 70 (40)    | 130 (75)   | 180 (105)  | 295 (175)   | 505 (300)   | 705 (415)   |
|   | Standard (92.7 m/s)  | 40 (20)    | 80 (45)    | 135 (75)   | 240 (140)  | 335 (195)  | 550 (320)   | 945 (555)   | 1305 (770)  |
|   | Max (185 m/s)        | 80 (45)    | 160 (95)   | 270 (155)  | 485 (285)  | 670 (395)  | 1100 (645)  | 1885 (1110) | 2610 (1535) |
|   | High-Speed (224 m/s) | 100 (55)   | 195 (115)  | 325 (190)  | 590 (345)  | 815 (475)  | 1330 (780)  | 2280 (1340) | 3165 (1860) |
| <b>Oxygen (O2)</b>  | Low-Speed (50 m/s)   | 20 (13)    | 45 (25)    | 75 (40)    | 135 (80)   | 185 (110)  | 305 (180)   | 525 (310)   | 730 (430)   |
|   | Standard (92.7 m/s)  | 40 (25)    | 80 (45)    | 140 (80)   | 250 (145)  | 345 (205)  | 570 (335)   | 980 (575)   | 1355 (795)  |
|   | Max (185 m/s)        | 85 (50)    | 165 (95)   | 280 (165)  | 505 (295)  | 695 (410)  | 1140 (670)  | 1955 (1150) | 2710 (1590) |
|   | High-Speed (224 m/s) | 105 (60)   | 205 (120)  | 340 (200)  | 610 (360)  | 845 (495)  | 1380 (810)  | 2365 (1390) | 3280 (1930) |
| <b>Nitrous oxide (N2O)</b>  | Low-Speed (50 m/s)   | 20 (14)    | 45 (25)    | 75 (45)    | 140 (80)   | 190 (110)  | 315 (185)   | 540 (320)   | 750 (440)   |
|   | Standard (92.7 m/s)  | 40 (25)    | 85 (50)    | 140 (85)   | 260 (150)  | 355 (210)  | 585 (345)   | 1005 (590)  | 1395 (820)  |
|   | Max (185 m/s)        | 85 (50)    | 170 (100)  | 285 (170)  | 520 (305)  | 715 (420)  | 1170 (690)  | 2010 (1180) | 2785 (1640) |
|   | High-Speed (224 m/s) | 105 (60)   | 210 (120)  | 345 (205)  | 630 (370)  | 865 (510)  | 1420 (835)  | 2435 (1430) | 3375 (1985) |
| <b>Natural gas (NG)</b>   | Low-Speed (50 m/s)   | 14,4 (8)   | 25 (15)    | 45 (25)    | 85 (50)    | 115 (65)   | 190 (110)   | 325 (190)   | 450 (265)   |
|   | Standard (92.7 m/s)  | 25 (15)    | 50 (30)    | 85 (50)    | 155 (90)   | 215 (125)  | 355 (205)   | 605 (355)   | 840 (495)   |
|   | Max (185 m/s)        | 50 (30)    | 105 (60)   | 170 (100)  | 310 (185)  | 430 (250)  | 705 (415)   | 1210 (710)  | 1680 (985)  |
|   | High-Speed (224 m/s) | 65 (35)    | 125 (70)   | 210 (120)  | 380 (220)  | 520 (305)  | 855 (500)   | 1465 (865)  | 2035 (1195) |



### Optional: Connection to different Bus systems

There are different options available for connection to modern Bus systems:

- Ethernet interface (Modbus-TCP) / PoE
- M-BUS
- Modbus-RTU
- Profibus DP interface (in process)
- Profinet interface (in process)
- HART (in process)



Ethernet Modbus TCP

M12 Ethernet port, x-coded



For further accessories refer to pages 108 to 112



## VA 570 - Inline flow meter

Example order code VA 570:

0695 0570\_A1\_B1\_C1\_D1\_E1\_F1\_G1\_H1\_I1\_J1\_K1\_L1\_M1\_R1

| Male thread measuring section |                                |
|-------------------------------|--------------------------------|
| A1                            | R male thread                  |
| A2                            | NPT male thread                |
| A3                            | Flange DIN EN 1092-1           |
| A4                            | Flange ANSI 16.5 Class 150 lbs |
| A5                            | Flange ANSI 16.5 Class 300 lbs |

| Display option |                         |
|----------------|-------------------------|
| B1             | with integrated display |
| B2             | without display         |

| Option signal outputs / bus connection |   |
|--|---|
| C1                                     | 2 units 4...20 mA analogue output (electrically isolated), pulse output, RS 485 (Modbus-RTU)  |
| C4                                     | 1 x 4...20 mA analogue output (not electrically isolated), pulse output, RS 485 (Modbus-RTU)  |
| C5                                     | Ethernet interface (Modbus / TCP), 1 x 4...20 mA analogue output (not electrically isolated), pulse output, RS 485 (Modbus-RTU)                         |
| C8                                     | M-Bus, 1 x 4...20 mA analogue output (not electrically isolated), pulse output, RS 485 (Modbus-RTU)   |
| C9                                     | Ethernet interface PoE (Power over Ethernet) (Modbus/TCP), 1 x 4...20 mA analogue output (not electrically isolated), pulse output, RS 485 (Modbus-RTU) |

| Adjustment/calibration |  |
|------------------------|--|
| D1                     | No real gas adjustment - gas type configuration per gas constant |
| D2                     | Real gas adjustment in the gas type selected below               |

| Gas type |  |
|----------|--|
| E1       | Compressed air   |
| E2       | Nitrogen (N2)  |
| E3       | Argon (Ar)   |
| E4       | Carbon dioxide (CO2)                                     |
| E5       | Oxygen (O2)  |
| E6       | Nitrous oxide (N2O)                                      |
| E7       | Natural gas (NG)   |
| E8       | Helium (He) (real gas adjustment <b>D2</b> required)     |
| E9       | Propane (C3H8) (real gas adjustment <b>D2</b> required)  |
| E10      | Methane (CH4)  |
| E11      | Biogas (methane 50% : CO2 50%)                           |
| E12      | Hydrogen (H2) (real gas adjustment <b>D2</b> required)   |
| E90      | Further gas / please indicate gas type (on request)      |
| E91      | Gas mixture / please indicate mixture ratio (on request) |

| Reference standard |                     |
|--------------------|---------------------|
| F1                 | 20 °C, 1000 mbar    |
| F2                 | 0 °C, 1013.25 mbar  |
| F3                 | 15 °C, 981 mbar     |
| F4                 | 15 °C, 1013.25 mbar |

| Maximum pressure |        |
|------------------|--------|
| G1               | 16 bar |
| G2               | 40 bar |

| Surface condition |  |
|-------------------|--|
| H1                | standard version   |
| H2                | Special cleaning - oil and grease free (e. g. for oxygen applications and so on) |
| H3                | Silicone-free version including special cleaning oil- and grease-free            |

| Accuracy class |   |
|----------------|---|
| I1             | ± 1.5% of the measured value ± 0.3% f.s. (standard) |
| I2             | ± 1% of the measured value ± 0.3% f.s. (precision)  |

| Maximum gas temperature on the sensor tip |  |
|---|--|
| J1  | up to 120 °C gas temperature (only for ATEX version) |
| J2  | up to 180 °C gas temperature (standard)              |

| Approvals |  |
|-----------|--|
| K1        | Non-explosive area - no approval                           |
| K2        | ATEX II 2G Ex d IIC T4<br>ATEX II 2D Ex tb IIIC T90 °C, Db |
| K3        | DVGW approval for natural gas (max. pressure 16 bar)       |

| Measuring range (see table) |                              |
|-----------------------------|------------------------------|
| M1                          | Max version (185 m/s)        |
| M2                          | Low-speed version (50 m/s)   |
| M3                          | Standard version (92,7 m/s)  |
| M4                          | High-speed version (224 m/s) |

| Special measuring range |   |
|-------------------------|---|
| R1                      | Special measuring range (please specify when placing order) |



## Order no. VA 570

| DESCRIPTION   | ORDER NO.                           | TECHNICAL DATA VA 570   |
|---|-------------------------------------|---|
| VA 570 flow meter with integrated 1/2" measuring section  | 0695 0570<br>+ order code<br>A...R_ | <p><b>Measuring range VA 570:</b> up to 50 Nm/s, low-speed version*<br/>up to 92.7 Nm/s, standard version*<br/>up to 185 Nm/s, max. version*<br/>up to 224 Nm/s, high-speed version*</p> <p>* Measuring range Nm<sup>3</sup>/h for different pipe diameters and gases, see table measuring ranges flow</p> <p>* All measured values related to DIN 1343 standard conditions 0° and 1013 mbar ex works</p> <p><b>Accuracy:</b> ± 1.5% of m.v. ± 0.3 % of f.s.<br/><b>Accuracy class</b><br/>(o. M. V. = of measured value)<br/>(o. F. S. = of full scale)<br/><b>Accuracy indications:</b> ± 1.0% of m.v. ± 0.3 % of f.s.</p> <p><b>Repeatability:</b> relative to ambient temperature 22 °C ± 2 °C, system pressure 6 bar</p> <p><b>Measuring principle:</b> 0.25% of m.v. in case of correct mounting (mounting aid, position, inlet section)<br/>Thermal mass flow sensor</p> <p><b>Response time:</b> t90 &lt; 3 s</p> <p><b>Operating temperature range sensor tube/display unit:</b> -40...180 °C standard version, sensor tube<br/>-20...70 °C display unit<br/>-20...120 °C for ATEX version</p> <p><b>Adjustment possibilities via display, external hand-held device PI 500, PC Service Software, remote diagnosis:</b> Nm<sup>3</sup>/h, Nm<sup>3</sup>/min, NI/min, l/s, ft/min, cfm, kg/h, kg/min, inner diameter, reference conditions ° C/° F, mbar/hPa, zero point correction, leak flow volume suppression, scaling analogue output 4...20 mA, pulse/alarm, error codes etc.</p> <p><b>Outputs:</b> Standard: 1 x 4...20 mA analogue output (not electrically isolated), pulse output, RS 485 (Modbus-RTU)<br/><b>Optional:</b> 2 x 4 ... 20 mA active, Modbus TCP, HART, Profibus DP, Profinet, M-Bus</p> <p><b>Burden:</b> &lt; 500 Ohm</p> <p><b>Additional average value calculation:</b> for all parameters freely adjustable from 1 minute up to 1 day, e. g. 1/2 hours average value, average day value</p> <p><b>Protection class:</b> IP 67</p> <p><b>Material:</b> Die-cast aluminum housing, sensor tube stainless steel 1.4404</p> <p><b>Operating pressure:</b> 16 bar, in special version 40 bar</p> <p><b>Power supply:</b> 18...36 VDC, 5 W</p> <p><b>Approval:</b> ATEX II 2G Ex db IIC T4 Gb, ATEX II 2D Ex tb IIC T90 °C, Db, DVGW</p> |
| VA 570 flow meter with integrated 3/4" measuring section  | 0695 0571                           |   |
| VA 570 flow meter with integrated 1" measuring section  | 0695 0572                           |   |
| VA 570 flow meter with integrated 1 1/4" measuring section  | 0695 0573                           |   |
| VA 570 flow meter with integrated 1 1/2" measuring section  | 0695 0574                           |   |
| VA 570 flow meter with integrated 2" measuring section  | 0695 0575                           |   |
| VA 570 flow meter with integrated DN 15 measuring section with flange   | 0695 2570                           |   |
| VA 570 flow meter with integrated DN 20 measuring section with flange   | 0695 2571                           |   |
| VA 570 flow meter with integrated DN 25 measuring section with flange   | 0695 2572                           |   |
| VA 570 flow meter with integrated DN 32 measuring section with flange   | 0695 2573                           |   |
| VA 570 flow meter with integrated DN 40 measuring section with flange   | 0695 2574                           |   |
| VA 570 flow meter with integrated DN 50 measuring section with flange   | 0695 2575                           |   |
| VA 570 flow meter with integrated DN 65 measuring section with flange   | 0695 2576                           |   |
| VA 570 flow meter with integrated DN 80 measuring section with flange   | 0695 2577                           |   |
| <b>Further accessories:</b>   |                                     |   |
| Closing cap for measuring section in aluminium  | 0190 0001                           |   |
| Closing cap for measuring section stainless steel 1.4404  | 0190 0002                           |   |
| Connection cable for probes 5 m with open ends  | 0553 0108                           |   |
| Connection cable for probes 10 m with open ends   | 0553 0109                           |   |
| Ethernet connection cable length 5 m, M12 plug x-coded (8 pin) to RJ 45 plug  | 0553 2503                           |   |
| Ethernet connection cable length 10 m, M12 plug x-coded (8 pin) to RJ 45 plug   | 0553 2504                           |   |
| Mains unit in wall housing for maximum 2 sensors of the series VA/FA 5xx, 100-240 V, 23 VA, 50-60 Hz / 24 VDC, 0.35 A         | 0554 0110                           |   |
| ISO calibration certificate at 5 measuring points for VA sensors  | 3200 0001                           |   |
| Additional calibration point (point freely selectable) Volume flow  | 0700 7720                           |   |
| CS Service Software VA 550 incl. interface cable to PC (USB) and power supply - for configuration / parametrisation of VA 550 | 0554 2007                           |   |
| PNG cable screwing - standard VA 550/570  | 0553 0552                           |   |
| PNG cable screwing - for ATEX version VA 550/570  | 0553 0551                           |   |

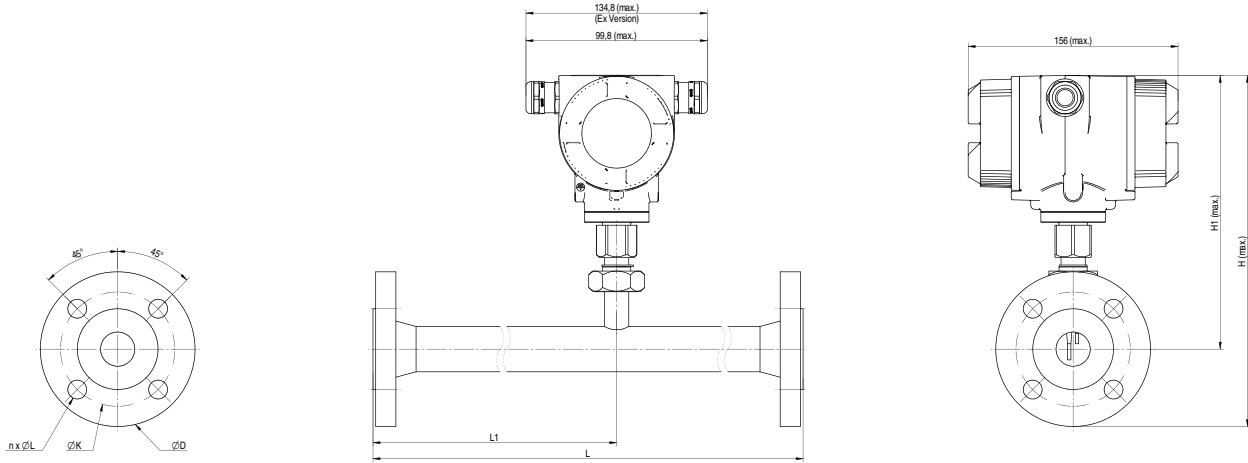

### VA 570 - with flange

| Pipe size | AD pipe - mm | ID pipe - mm | L - mm | L1 - mm | H - mm | H1 - mm | Flange DIN EN 1092-1 |     |         |
|-----------|--------------|--------------|--------|---------|--------|---------|----------------------|-----|---------|
|           |              |              |        |         |        |         | Ø D                  | Ø K | n x Ø L |
| DN 15     | 21.3         | 16.1         | 300*   | 210     | 267    | 218     | 95                   | 65  | 4 x 14  |
| DN 20     | 26.9         | 21.7         | 475*   | 275     | 270    | 218     | 105                  | 75  | 4 x 14  |
| DN 25     | 33.7         | 27.3         | 475*   | 275     | 275    | 218     | 115                  | 85  | 4 x 14  |
| DN 32     | 42.4         | 36.0         | 475*   | 275     | 288    | 218     | 140                  | 100 | 4 x 18  |
| DN 40     | 48.3         | 41.9         | 475*   | 275     | 293    | 218     | 150                  | 110 | 4 x 18  |
| DN 50     | 60.3         | 53.1         | 475*   | 275     | 300    | 218     | 165                  | 125 | 4 x 18  |
| DN 65     | 76.1         | 68.9         | 475*   | 275     | 320    | 228     | 185                  | 145 | 8 x 18  |
| DN 80     | 88.9         | 80.9         | 475*   | 275     | 328    | 228     | 200                  | 160 | 8 x 18  |

\*Attention: Shortened inlet section. Please observe the recommended minimum inlet section (length = 15 x inner diameter)!

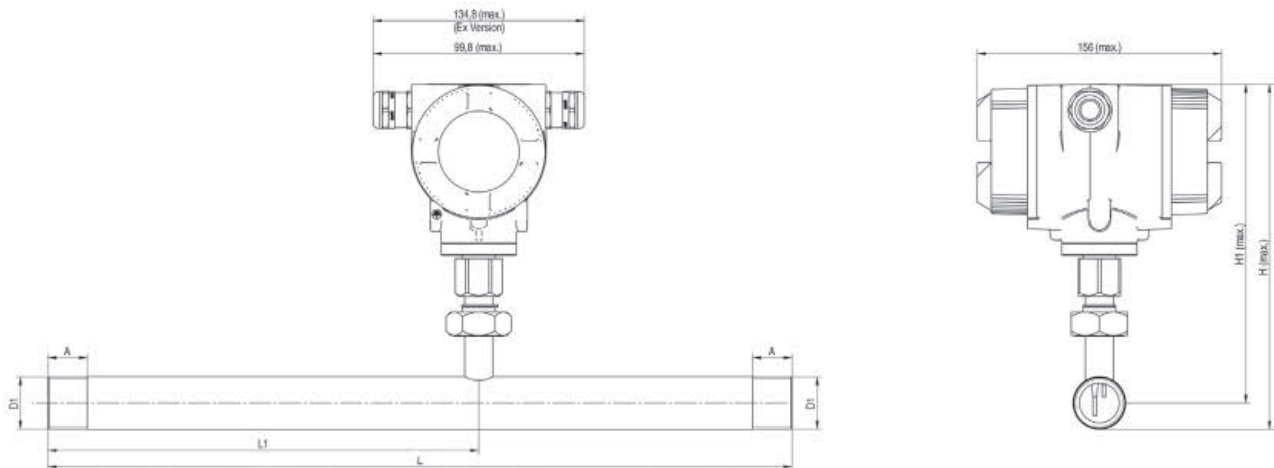

### VA 570 - Threaded version

| Connection thread | AD pipe - mm | ID pipe - mm | L - mm | L1 - mm | H - mm | H1 - mm | A - mm |
|-------------------|--------------|--------------|--------|---------|--------|---------|--------|
| R 1/2"            | 21.3         | 16.1         | 300*   | 210     | 228    | 218     | 20     |
| R 3/4"            | 26.9         | 21.7         | 475*   | 275     | 231    | 218     | 20     |
| R 1"              | 33.7         | 27.3         | 475*   | 275     | 235    | 218     | 25     |
| R 1 1/4"          | 42.4         | 36.0         | 475*   | 275     | 239    | 218     | 25     |
| R 1 1/2"          | 48.3         | 41.9         | 475*   | 275     | 242    | 218     | 25     |
| R 2"              | 60.3         | 53.1         | 475*   | 275     | 248    | 218     | 30     |

\*Attention: Shortened inlet section. Please observe the recommended minimum inlet section (length = 15 x inner diameter) on site!





## VA 550 - Flow meter insertion type

Flow sensor for installation in existing compressed air or gas line of 3/4" to DN 1000



Housing IP 67

Outputs:  
4...20 mA, pulse, Modbus,  
M-Bus, Profi Bus, Ethernet,  
HART

Housing rotatable, display  
180° rotatable (on the head).  
Settings can be modified via  
display, flow meter can be  
reset

All wetted parts made from stain-  
less steel 1.4571

### Approvals:



II 2 G Ex db IIC T4 Gb

II 2 D Ex tb IIIC T90 °C Db



### Advantages of optical keys:

The sensor can also be config-  
ured in the ATEX area, without  
the housing needing to be  
opened.



The sensor can  
be removed and  
cleaned

### Special measurement technology features:

- 4 values on the display: Flow, total consumption, velocity, temperature. Units freely adjustable
- All measured values, settings such as gas type, inner diameter, serial number and so on can be accessed via Modbus-RTU
- Comprehensive diagnostic functions readable on the display or remote access via Modbus such as calibration cycle, error codes, serial number
- Notification in case of exceeding the calibration cycle
- Standard version accuracy 1.5% of m.v. ± 0.3% of f.s.
- Precision version accuracy 1.0% of m.v. ± 0.3% of f.s
- Measuring span of 1 : 1000 (0.1 up to 224 m/s)
- Configuration and diagnosis via display, hand-held device PI 500, PC service software on-site
- Gas type (air, nitrogen, oxygen, argon and so on) freely adjustable via PC service software or external device DS 400, DS 500, PI 500
- Reference conditions °C and mbar/hPa freely adjustable
- Zero-point adjustment, leak flow volume suppression
- Pressure loss negligible

### Special mechanical features:

- Robust impact-proof aluminium die cast housing for the outdoor area IP 67
- All wetted parts made from stainless steel 1.4571
- Suitable as an insertion version for 3/4" to DN 1000
- On request with DVGW approval for natural gas (up to 16 bar)
- Pressure range up to 50 bar, special version up to 100 bar
- Temperature range up to 180 °C
- No moveable parts, no wear
- Sensor tip very robust, easy to clean
- Easy installation and removal under pressure via 1/2" ball valve
- Housing rotatable, display rotatable by 180°
- Safety ring for installation and removal under pressure
- Depth scale for precise installation





Easy mounting/dismounting of **VA 550** under pressure - without disconnection of the line - without emptying the line

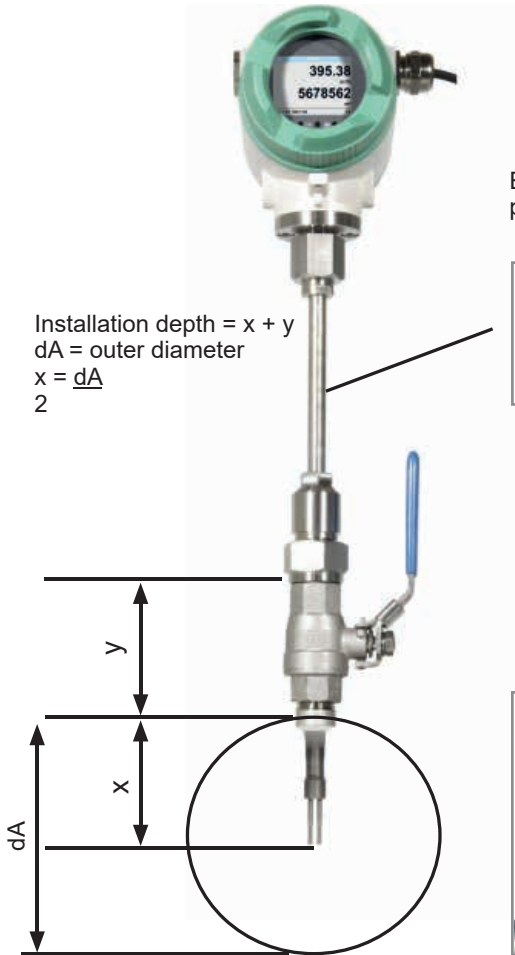

Installation depth =  $x + y$   
 $dA =$  outer diameter  
 $x = \frac{dA}{2}$

Engraved depth scale for precise installation

|  |  |  |     |
|--|--|--|-----|
|  |  |  | 180 |
|  |  |  | 170 |
|  |  |  | 160 |

If there is no suitable measuring site with 1/2" ball valve, there are two simple possibilities to set up a measuring site:

**A** Weld on a 1/2" screw neck and screw on a 1/2" ball valve

**B** Mount spot drilling collar including ball valve

By means of the drilling jig, it is possible to drill under pressure through the 1/2" ball valve into the existing pipe. The drilling chips are collected in a filter. Then the probe can be mounted.



**A** Screw neck

Order no.: 3300 0006



**B** Spot drilling collars

Order no.: see page 112



Drill under pressure with the CS drilling jig

Order no.: 0530 1108



**Optional: Connection to different Bus systems**

There are different options available for connection to modern Bus systems:

- Ethernet interface (Modbus-TCP) / PoE
- M-BUS
- Modbus-RTU
- Profibus DP interface (in process)
- Profinet interface (in process)
- HART (in process)



Ethernet Modbus TCP

M12 Ethernet port, x-coded

For further accessories refer to pages 108 to 112

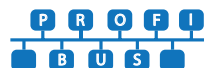



## VA 550 - Flow meter insertion meter

Example order code VA 550:

0695 0550\_A1\_B1\_C1\_D1\_E1\_F1\_G1\_H1\_I1\_J1\_K1\_L1\_M1\_R1

| Measuring range (see table page 116 to 119) |                              |
|---|------------------------------|
| A1  | Standard version (92,7 m/s)  |
| A2  | Max version (185 m/s)        |
| A3  | High-speed version (224 m/s) |
| A4  | Low-speed version (50 m/s)   |

| Screw-in thread |                      |
|-----------------|----------------------|
| B1              | G 1/2" male thread   |
| B2              | 1/2" NPT male thread |

| Installation length / shaft length |                         |
|------------------------------------|-------------------------|
| C1                                 | 220 mm                  |
| C2                                 | 300 mm                  |
| C3                                 | 400 mm                  |
| C4                                 | 500 mm                  |
| C5                                 | 600 mm                  |
| C6                                 | 700 mm (not with ATEX)  |
| C7                                 | 160 mm                  |
| C8                                 | 1000 mm (not with ATEX) |
| C9                                 | 1500 mm (not with ATEX) |

| Display option |                         |
|----------------|-------------------------|
| D1             | with integrated display |
| D2             | without display         |

| Signal outputs / bus connection option |   |
|--|---|
| E1                                     | 2 units 4...20 mA analogue output (electrically isolated), pulse output, RS 485 (Modbus-RTU)  |
| E4                                     | 1 x 4...20 mA analogue output (not electrically isolated), pulse output, RS 485 (Modbus-RTU)  |
| E5                                     | Ethernet interface (Modbus / TCP), 1 x 4...20 mA analogue output (not electrically isolated), pulse output, RS 485 (Modbus-RTU)                         |
| E8                                     | M-Bus, 1 x 4...20 mA analogue output (not electrically isolated), pulse output, RS 485 (Modbus-RTU)   |
| E9                                     | Ethernet interface PoE (Power over Ethernet) (Modbus/TCP), 1 x 4...20 mA analogue output (not electrically isolated), pulse output, RS 485 (Modbus-RTU) |

| Adjustment / calibration |  |
|--------------------------|--|
| F1                       | No real gas adjustment - gas type configuration per gas constant |
| F2                       | Real gas adjustment in the gas type selected below               |

| Gas type |  |
|----------|--|
| G1       | Compressed air   |
| G2       | Nitrogen (N2)  |
| G3       | Argon (Ar)   |
| G4       | Carbon dioxide (CO2)                                     |
| G5       | Oxygen (O2)  |
| G6       | Nitrous oxide (N2O)                                      |
| G7       | Natural gas (NG)   |
| G8       | Helium (He) (real gas adjustment <b>F2</b> required)     |
| G9       | Propane (C3H8) (real gas adjustment <b>F2</b> required)  |
| G10      | Methane (CH4)  |
| G11      | Biogas (methane 50% : CO2 50%)                           |
| G12      | Hydrogen (H2) (real gas adjustment <b>F2</b> required)   |
| G90      | Further gas / please indicate gas type (on request)      |
| G91      | Gas mixture / please indicate mixture ratio (on request) |

| Maximum pressure (more than 10 bar high-pressure protection required!) |         |
|--|---------|
| H1   | 50 bar  |
| H2   | 100 bar |
| H3   | 16 bar  |

| Surface condition |   |
|-------------------|---|
| I1                | standard version  |
| I2                | special cleaning - oil and grease free (e.g. for oxygen applications and so on) |
| I3                | Silicone-free version including special cleaning oil- and grease-free           |

| Accuracy class |   |
|----------------|---|
| J1             | ± 1.5% of the measured value ± 0.3% f.s. (standard) |
| J2             | ± 1% of the measured value ± 0.3% f.s. (precision)  |

| Maximum gas temperature on the sensor tip |  |
|---|--|
| K1  | up to 120 °C gas temperature (only for ATEX version) |
| K2  | up to 180 °C gas temperature (standard)              |

| Approvals |  |
|-----------|--|
| L1        | Non-explosive area - no approval                               |
| L2        | ATEX II 2G Ex db IIC T4 Gb<br>ATEX II 2D Ex tb IIIC T90 °C, Db |
| L3        | DVGW approval for natural gas (max. pressure 16 bar)           |

| Reference standard |                     |
|--------------------|---------------------|
| M1                 | 20 °C, 1000 mbar    |
| M2                 | 0 °C, 1013.25 mbar  |
| M3                 | 15 °C, 981 mbar     |
| M4                 | 15 °C, 1013.25 mbar |

| Special measuring range |   |
|-------------------------|---|
| R1                      | Special measuring range (please specify when placing order) |

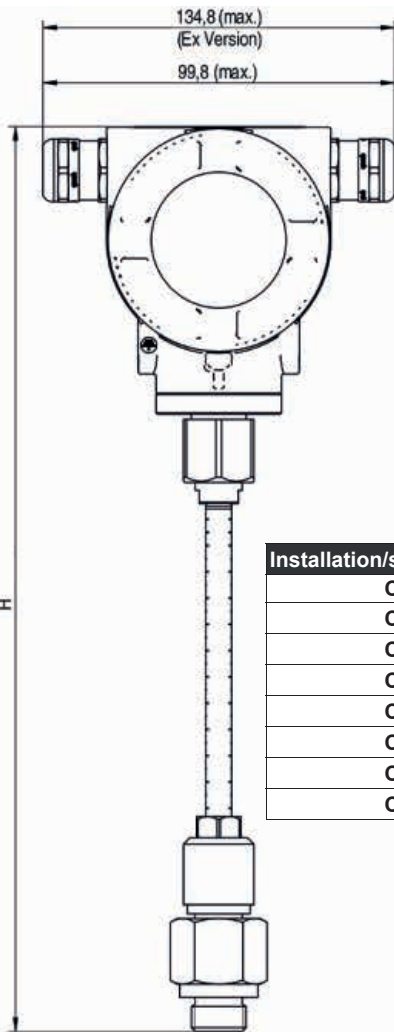

| Installation/shaft length | L (mm) | H (mm) |
|---------------------------|--------|--------|
| C1                        | 220    | 441    |
| C2                        | 300    | 521    |
| C3                        | 400    | 621    |
| C4                        | 500    | 721    |
| C5                        | 600    | 821    |
| C7                        | 160    | 381    |
| C8                        | 1000   | 1221   |
| C8                        | 1500   | 1721   |

#### Further accessories:

| DESCRIPTION   | ORDER NO. |
|---|-----------|
| Connection cable for probes 5 m with open ends  | 0553 0108 |
| Connection cable for probes 10 m with open ends   | 0553 0109 |
| Ethernet connection cable length 5 m, M12 plug x-coded (8 pin) to RJ 45 plug  | 0553 2503 |
| Ethernet connection cable length 10 m, M12 plug x-coded (8 pin) to RJ 45 plug   | 0553 2504 |
| Mains unit in wall housing for maximum 2 sensors of the series VA/FA 5xx, 100-240 V, 23 VA, 50-60 Hz / 24 VDC, 0.35 A         | 0554 0110 |
| ISO calibration certificate at 5 measuring points for VA 500/550  | 3200 0001 |
| Additional calibration point for volume flow (point freely selectable)  | 0700 7720 |
| CS Service Software VA 550 incl. interface cable to PC (USB) and power supply - for configuration / parametrization of VA 550 | 0554 2007 |
| High-pressure protection recommended for installation from 10 to 100 bar (for VA 550)   | 0530 1115 |
| High-pressure protection recommended for installation from 10 to 16 bar DVGW (for VA 550)                                     | 0530 1116 |
| PNG cable screwing - standard VA 550/570  | 0553 0552 |
| PNG cable screwing - for ATEX version VA 550/570  | 0553 0551 |

#### Order no. VA 550

| DESCRIPTION   | ORDER NO.                     |
|---|-------------------------------|
| VA 550 Flow meter, measuring head in robust aluminium die casting housing | 0695 0550 + Order code A...R_ |

#### TECHNICAL DATA VA 550

|   |   |
|---|---|
| <b>Measuring range VA 550:</b>  | up to 50 Nm/s, low-speed version*<br>up to 92.7 Nm/s, standard version*<br>up to 185 Nm/s, max. version*<br>up to 224 Nm/s, high-speed version*   |
|   | * Measuring range Nm <sup>3</sup> /h for different pipe diameters and gases, see table measuring ranges flow<br>* All measured values related to DIN 1343 standard conditions 0° and 1013 mbar ex works   |
| <b>Accuracy:</b><br>Accuracy class<br>(o. M. V. = of measured value)<br>(o. F. S. = of full scale)                    | ± 1.5 % of m.v. ± 0.3 % of f.s.<br>on request:<br>± 1.0 % of m.v. ± 0.3 % of f.s.   |
| <b>Accuracy indications:</b>  | relative to ambient temperature 22 °C ± 2 °C, system pressure 6 bar   |
| <b>Repeatability:</b>   | 0.25 % of m.v. in case of correct mounting (mounting aid, position, inlet section)  |
| <b>Measuring principle:</b>   | Thermal mass flow sensor  |
| <b>Response time:</b>   | t 90 < 3 s  |
| <b>Operating temperature range sensor tube/display unit:</b>  | -40...180 °C standard version, sensor tube<br>-20...70 °C display unit<br>-20...120 °C for ATEX version   |
| <b>Adjustment possibilities via display, external hand-held device PI 500, PC Service Software, remote diagnosis:</b> | Nm <sup>3</sup> /h, Nm <sup>3</sup> /min, Nl/min, l/s, ft/min, cfm, kg/h, kg/min, inner diameter, reference conditions ° C/° F, mbar/hPa, zero point correction, leak flow volume suppression, scaling analogue output 4...20 mA, pulse/alarm, error codes etc. |
| <b>Outputs:</b>   | <b>Standard:</b> 1 x 4...20 mA analogue output (electrically not isolated), pulse output, RS 485 (Modbus-RTU)<br><b>Optional:</b> 2 x 4...20 mA active, Modbus TCP, HART, Profibus DP, Profinet, M-Bus  |
| <b>Burden:</b>  | < 500 ohm   |
| <b>Additional average value calculation:</b>  | for all parameters freely adjustable from 1 minute up to 1 day, e. g. 1/2 hours average value, average day value  |
| <b>Protection class:</b>  | IP 67   |
| <b>Material:</b>  | Die-cast aluminum housing, sensor tube stainless steel 1.4571   |
| <b>Screw-in thread:</b>   | G 1/2" ISO 228, NPT 1/2", R 1/2", PT 1/2"   |
| <b>Operating pressure VA 550:</b>   | 50 bar, in special version 100 bar (with DVGW approval max. 16 bar)   |
| <b>Power supply:</b>  | 18...36 VDC, 5 W  |
| <b>Approval:</b>  | ATEX II 2G Ex db IIC T4 Gb,<br>ATEX II 2D Ex tb IIC T90 °C, Db,<br>DVGW   |



## VA 500 - Flow meter for compressed air and gases

**NEW:**  
As option, integrated pressure sensor

Bewegliches Montagegewinde G 1/2"

Sicherungsring Ø 11,7 mm



### Special features:

- Including temperature measurement, optional: pressure measurement
- RS 485 interface, Modbus-RTU as standard
- Integrated display for m<sup>3</sup>/h and m<sup>3</sup>
- Applicable from 1/2" to DN 1000
- Easy installation under pressure
- 4...20 mA analogue output for m<sup>3</sup>/h or m<sup>3</sup>/min
- Pulse output for m<sup>3</sup> or M-Bus (optional)
- Inner diameter adjustable by means of keys
- Flow meter can be reset
- Adjustable by means of keypad on the display: Reference conditions, °C and mbar, 4...20 mA scaling, pulse weight

### TECHNICAL DATA VA 500

|   |  |
|---|--|
| <b>Parameters:</b>  | m <sup>3</sup> /h, l/min (1000 mbar, 20 °C) in case of compressed air or Nm <sup>3</sup> /h, Nl/min (1013 mbar, 0 °C) in case of gases                         |
| <b>Units adjustable via keys at display:</b>                                | m <sup>3</sup> /h, m <sup>3</sup> /min, l/min, l/s, ft <sup>3</sup> /min, cfm, m/s, kg/h, kg/min, g/s, lb/min, lb/h  |
| <b>Adjustable via keypad:</b>   | Diameter for volume flow calculation, counter resettable   |
| <b>Sensor:</b>  | Thermal mass flow sensor   |
| <b>Measured medium:</b>   | Air, gases   |
| <b>Gas types are adjustable over CS service software or CS data logger:</b> | Air, nitrogen, argon, helium, CO <sub>2</sub> , oxygen, vacuum   |
| <b>Measuring range:</b>   | See table page 12  |
| <b>Accuracy: (m.v.: of meas. value) (f.s.: of full scale)</b>               | ± 1.5% of m.v. ± 0.3 % of f.s.<br>on request:<br>± 1% of m.v. ± 0.3% of f.s.   |
| <b>Operating temperature:</b>   | -30...110 °C sensor tube<br>-20...85 °C with pressure sensor<br>-20...+70 °C housing   |
| <b>Operating pressure:</b>  | -1...50 bar (for pressure > 10 bar - order additional high-pressure protection)  |
| <b>Digital output:</b>  | RS 485 interface, (Modbus-RTU), optional: Ethernet interface PoE, M-Bus  |
| <b>Analogue output:</b>   | 4...20 mA for m <sup>3</sup> /h or l/min   |
| <b>Pulse output:</b>  | 1 pulse per m <sup>3</sup> or per litre electrically isolated. Pulse weight can be set on the display. Alternatively, the pulse output can be used as an alarm |
| <b>Supply:</b>  | 18...36 VDC, 5 W   |
| <b>Burden:</b>  | < 500 Ω  |
| <b>Housing:</b>   | Polycarbonate (IP 65)  |
| <b>Sensor tube:</b>   | Stainless steel, 1.4301<br>Installation length 220 mm, Ø 10 mm   |
| <b>Mounting thread:</b>   | G 1/2", 1/2" NPT male thread   |
| <b>Ø housing:</b>   | 65 mm  |
| <b>Mounting position:</b>   | any  |



Inner diameter adjustable via keypad



**Option:**  
Bi-directional measurement. Blue or green arrows in the display indicate the direction of flow. A meter reading is available for each flow direction.



The sensor can be removed during operation and cleaned if necessary.



## VA 500- Flow meter

Example order code VA 500:

0695 5001\_B1\_C1\_D1\_E1\_F1\_H1\_J1\_K1\_L1\_M1\_N1\_O1\_P1\_R1\_Y1

| Measuring range (see table page 116 to 119) |   |
|---|---|
| B1  | Standard version (92,7 m/s)   |
| B2  | Max version (185 m/s)   |
| B3  | High-Speed version (224 m/s)  |
| B4  | Low-Speed version (50 m/s)  |
| Screw-in thread                             |   |
| C1  | G 1/2" male thread  |
| C2  | 1/2" NPT male thread  |
| C3  | PT 1/2" male thread   |
| Installation length / shaft length          |   |
| D1  | 220 mm  |
| D2  | 120 mm  |
| D3  | 160 mm  |
| D4  | 300 mm  |
| D5  | 400 mm  |
| D6  | 500 mm  |
| D7  | 600 mm  |
| D8  | 700 mm  |
| Display option                              |   |
| E1  | with integrated display   |
| E2  | without display   |
| Signal outputs / bus connection option      |   |
| F8  | M-Bus, 1 x 4...20 mA analogue output (not electrically isolated), RS 485 (Modbus-RTU)   |
| F9  | 1 x 4...20 mA analogue output (not electrically isolated), pulse output, RS 485 (Modbus-RTU)  |
| F10   | Ethernet interface (Modbus / TCP), 1 x 4...20 mA analogue output (not electrically isolated), RS 485 (Modbus-RTU)                         |
| F11   | Ethernet interface PoE (Power over Ethernet) (Modbus/TCP), 1 x 4...20 mA analogue output (not electrically isolated), RS 485 (Modbus-RTU) |
| Surface condition                           |   |
| H1  | standard version  |
| H2  | special cleaning - oil and grease free (e.g. for oxygen applications and so on)   |
| H3  | Silicone-free version including special cleaning oil- and grease-free   |
| Adjustment / calibration                    |   |
| J1  | No real gas adjustment - gas type configuration per gas constant  |
| J2  | Real gas adjustment in the gas type selected below  |
| Gas type                                    |   |
| K1  | Compressed air  |
| K2  | Nitrogen (N2)   |
| K3  | Argon (Ar)  |
| K4  | Carbon dioxide (CO2)  |
| K5  | Oxygen (O2)   |
| K6  | Nitrous oxide (N2O)   |
| K7  | Natural gas (NG)  |
| K8  | Helium (He) (real gas adjustment J2 required)   |
| K9  | Propane (C3H8) (real gas adjustment J2 required)  |
| K10   | Methane (CH4)   |
| K12   | Further gas / please indicate gas type (on request)   |
| K13   | Gas mixture / please indicate mixture ratio (on request)  |

| Reference standard  |  |
|---|--|
| L1  | 20 °C, 1000 mbar   |
| L2  | 0 °C, 1013,25 mbar   |
| L3  | 15 °C, 981 mbar  |
| L4  | 15 °C, 1013,25 mbar  |
| Accuracy class  |  |
| M1  | ± 1.5% of the measured value ± 0.3% f.s. (standard)  |
| M2  | ± 1% of the measured value ± 0.3% f.s. (precision)   |
| Approvals   |  |
| N1  | Non-explosive area - no approval   |
| Bi-directional measurement  |  |
| O1  | without  |
| O2  | with (includes 2 x 4...20 mA analog outputs and 2x pulse outputs. These are omitted for Ethernet (PoE) and M-Bus). |
| Maximum pressure (more than 10 bar high-pressure protection required!)  |  |
| P1  | 50 bar   |
| P2  | 16 bar   |
| Special measuring range   |  |
| R1  | Special measuring range (please specify when placing order)  |
| Option pressure measurement (only with: D1, D4, K1, K2, K3, H1, O1, P2) |  |
| Y1  | without pressure sensor  |
| Y2  | with integrated pressure sensor 0...16 bar(g) (Output only via digital interfaces)                                 |
| Y3  | with integrated pressure sensor 10...2000 mbar (abs), for vacuum applications (output only via digital interfaces) |

| DESCRIPTION  | ORDER NO.    |
|--|--------------|
| High-pressure protection recommended for installation from 10 to 50 bar (for VA 400/500) | See page 105 |
| ISO calibration certificate (5 calibration points) for VA sensors                        | 3200 0001    |
| Additional calibration curve stored in the sensor  | Z695 5011    |
| Certificate of origin  | Z695 5012    |

For further accessories refer to pages 108 to 112



## Simple installation and removal under pressure

1) Even under pressure, the flow probe VA 500 is mounted by means of a standard 1/2" ball valve.

During mounting and dismantling the safety ring avoids an uncontrolled ejection of the probe which may be caused by the operating pressure.

For the mounting into different pipe diameters, VA 500 is available in the following probe lengths: 120, 160, 220, 300, 400 mm.

The flow probes are therefore suitable for being mounted into existing pipes with diameters of 1/2" to DN 300 upwards.

The exact positioning of the sensor in the middle of the pipe is granted by means of the engraved depth scale.

The maximum mounting depth corresponds to the respective probe length. (Probe length 220 mm = 220 mm maximum mounting depth).

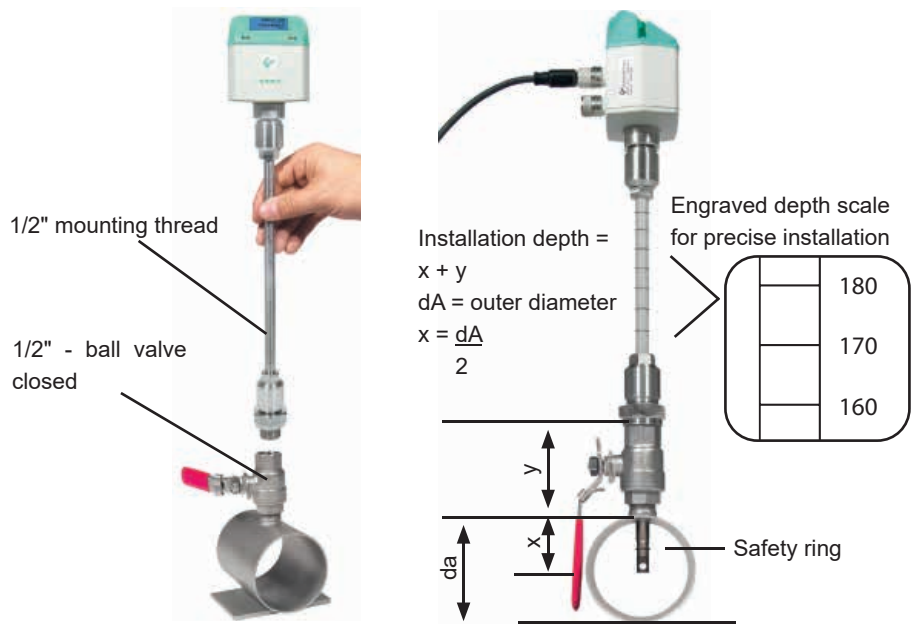

2) If there is no suitable measuring site with 1/2" ball valve, there are two easy ways to set up a measuring site:

**A** Weld on a 1/2" screw neck and screw on a 1/2" ball valve

**B** Mount spot drilling collar incl. ball valve (see accessories).

By means of the drilling jig, it is possible to drill under pressure through the 1/2" ball valve into the existing pipe. The drilling chips are collected in a filter. Then install the probe as described under 1).



**A** Screw neck



**B** Spot drilling collars



Drill under pressure with the CS drilling jig

3) Due to the large measuring range of the probe even extreme requirements to the consumption measurement (high volume flow in small pipe diameters) can be met.

The measuring range is depending on the pipe diameter - see table on the right hand side.

| Flow measuring ranges VA 500 for compressed air (ISO 1217: 1000 mbar, 20 °C)<br>Measuring ranges for other types of gas see pages 116 to 119 |       |        |                               |       |                            |       |                                  |       |
|--|-------|--------|-------------------------------|-------|----------------------------|-------|----------------------------------|-------|
| Inside diameter of pipe  |       |        | VA 500 Standard<br>(92.7 m/s) |       | VA 500 Max.<br>(185.0 m/s) |       | VA 500 High-Speed<br>(224.0 m/s) |       |
| Inch   | mm    | DN     | Measuring range full scale    |       | Measuring range full scale |       | Measuring range full scale       |       |
|  |       |        | m³/h                          | (cfm) | m³/h                       | (cfm) | m³/h                             | (cfm) |
| 1/2"   | 16.1  | DN 15  | 759 l/min                     | 26    | 1516 l/min                 | 53    | 1836 l/min                       | 64    |
| 3/4"   | 21.7  | DN 20  | 89 m³/h                       | 52    | 177 m³/h                   | 104   | 215 m³/h                         | 126   |
| 1"   | 27.3  | DN 25  | 148 m³/h                      | 86    | 294 m³/h                   | 173   | 356 m³/h                         | 210   |
| 1 1/4"   | 36.0  | DN 32  | 266 m³/h                      | 156   | 531 m³/h                   | 312   | 643 m³/h                         | 378   |
| 1 1/2"   | 41.9  | DN 40  | 366 m³/h                      | 215   | 732 m³/h                   | 430   | 886 m³/h                         | 521   |
| 2"   | 53.1  | DN 50  | 600 m³/h                      | 353   | 1197 m³/h                  | 704   | 1450 m³/h                        | 853   |
| 2 1/2"   | 68.9  | DN 65  | 1028 m³/h                     | 604   | 2051 m³/h                  | 1207  | 2484 m³/h                        | 1461  |
| 3"   | 80.9  | DN 80  | 1424 m³/h                     | 838   | 2842 m³/h                  | 1672  | 3441 m³/h                        | 2025  |
| 4"   | 110.0 | DN 100 | 2644 m³/h                     | 1556  | 5278 m³/h                  | 3106  | 6391 m³/h                        | 3761  |
| 5"   | 133.7 | DN 125 | 3912 m³/h                     | 2302  | 7808 m³/h                  | 4594  | 9453 m³/h                        | 5563  |
| 6"   | 159.3 | DN 150 | 5560 m³/h                     | 3272  | 11096 m³/h                 | 6530  | 13436 m³/h                       | 7907  |
| 8"   | 200.0 | DN 200 | 8785 m³/h                     | 5170  | 17533 m³/h                 | 10318 | 21229 m³/h                       | 12493 |
| 10"  | 250.0 | DN 250 | 13744 m³/h                    | 8088  | 27428 m³/h                 | 16141 | 33211 m³/h                       | 19544 |
| 12"  | 300.0 | DN 300 | 19814 m³/h                    | 11661 | 39544 m³/h                 | 23271 | 47880 m³/h                       | 28177 |





## VA 520 - Inline flow meter

Modbus-RTU output

4...20 mA output for present flow

Pulse output for total flow (counter reading), galvanically isolated or M-Bus (optionally)

**NEW:** As option, integrated pressure sensor

Measuring unit can be unscrewed: Removal of the entire measuring section not necessary, no by-pass necessary

Display head rotatable by 180 ° e.g. in case of reverse flow direction

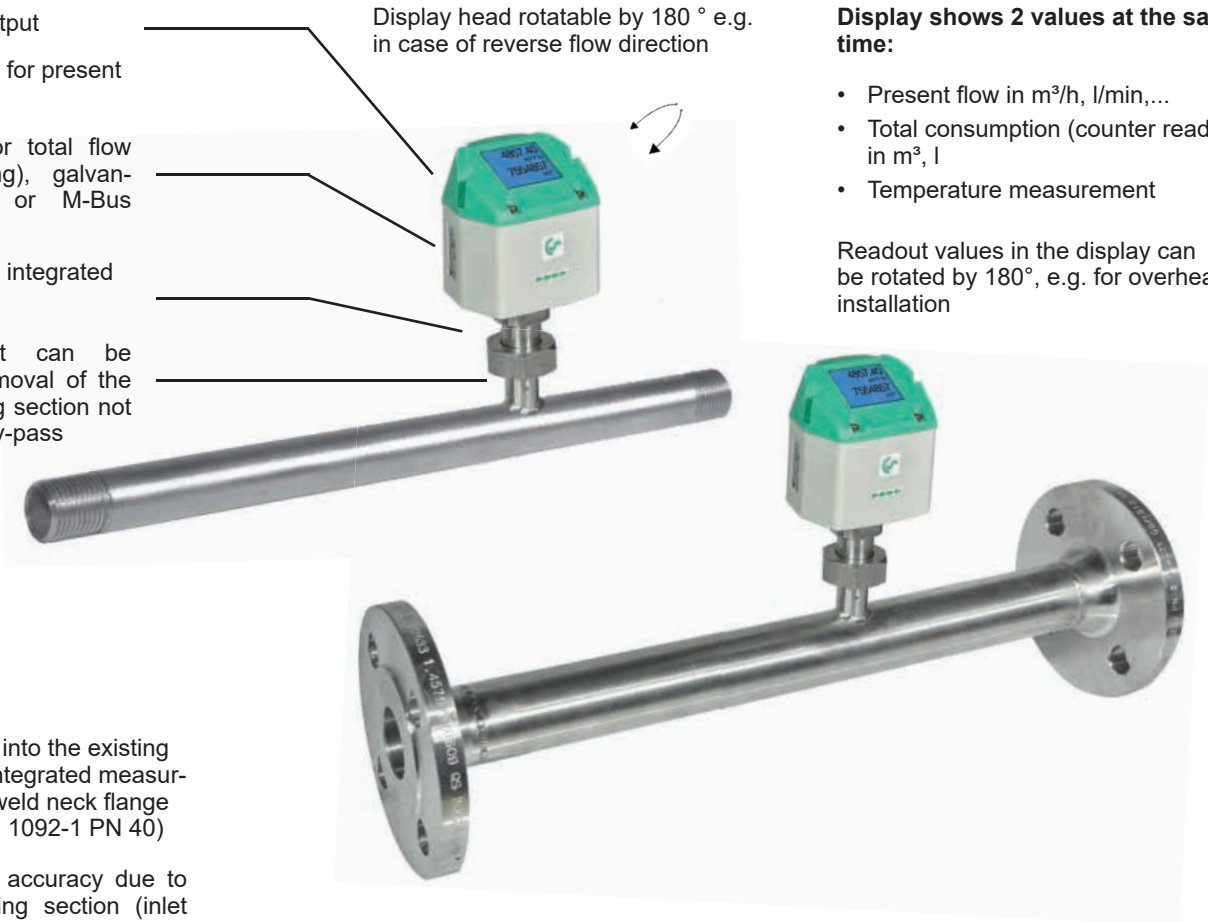

**Display shows 2 values at the same time:**

- Present flow in m³/h, l/min,...
- Total consumption (counter reading) in m³, l
- Temperature measurement

Readout values in the display can be rotated by 180°, e.g. for overhead installation

Easy installation into the existing pipeline due to integrated measuring section and weld neck flange (according to EN 1092-1 PN 40)

High measuring accuracy due to defined measuring section (inlet and outlet section)



The sensor can be removed and cleaned



**With a key stroke:**

- Reset counter reading
- Select units
- Zero-point adjustment, leak flow volume suppression



**Option:**

Bi-directional measurement. Blue or green arrows in the display indicate the direction of flow. A meter reading is available for each flow direction.



### Application-technological features of the flow meters VA 520:

- Digital interfaces such as Modbus-RTU, Ethernet (PoE) and M-Bus enable connection to higher-level systems such as energy management systems, building management systems, PLC,...
- Easy and affordable installation
- Units freely selectable via keys on the display m³/h, m³/min, l/min, l/s, kg/h, kg/min, kg/s, cfm
- Compressed air counter up to 1,999,999,999 m³ can be reset to "zero" via keypad
- Analog output 4...20 mA, pulse output (electrically isolated)
- High measuring accuracy even in the lower measuring range (ideal for leakage measurement)
- Negligibly small loss of pressure
- Calorimetric measuring principle, no additional pressure and temperature measurement necessary, no mechanically moved parts
- Comprehensive diagnostic functions can be read out on the display or remote access via Modbus-RTU such as exceeding max./min values °C, calibration cycle, error codes, serial number. All parameters can be read out and changed via Modbus





## Measuring range - Flow VA 520

|  |                      | 1/4"        | 3/8"              | 1/2"       | 3/4"       | 1"         | 1 1/4"     | 1 1/2"     | 2"          | 2 1/2"      | 3"          |
|--|----------------------|-------------|-------------------|------------|------------|------------|------------|------------|-------------|-------------|-------------|
|  |                      | l/min (cfm) | m³/h (cfm)        | m³/h (cfm) | m³/h (cfm) | m³/h (cfm) | m³/h (cfm) | m³/h (cfm) | m³/h (cfm)  | m³/h (cfm)  | m³/h (cfm)  |
| <b>Referenzbedingungen DIN 1945 / ISO 1217: 20 °C, 1000 mbar</b> |                      |             |                   |            |            |            |            |            |             |             |             |
| <b>Air</b>   | Low-Speed (50 m/s)   | 25 (0,9)    | 225 NI/min (8)    | 20 (14)    | 45 (25)    | 75 (45)    | 140 (80)   | 195 (115)  | 320 (190)   | 550 (325)   | 765 (450)   |
|  | Standard (92,7 m/s)  | 50 (1,8)    | 25 (14,7)         | 45 (25)    | 85 (50)    | 145 (85)   | 265 (155)  | 365 (215)  | 600 (350)   | 1025 (600)  | 1420 (835)  |
|  | Max (185 m/s)        | 105 (3,6)   | 50 (29,4)         | 90 (50)    | 175 (100)  | 290 (170)  | 530 (310)  | 730 (430)  | 1195 (700)  | 2050 (1205) | 2840 (1670) |
|  | High-Speed (224 m/s) | 130 (4,5)   | 60 (35,3)         | 110(60)    | 215 (125)  | 355 (210)  | 640 (375)  | 885 (520)  | 1450 (850)  | 2480 (1460) | 3440 (2025) |
| <b>Setting to DIN 1343: 0 °C, 1013.25 mbar</b>                   |                      |             |                   |            |            |            |            |            |             |             |             |
| <b>Argon (Ar)</b>  | Low-Speed (50 m/s)   | 45 (1,5)    | 330 NI/min (11,7) | 35 (20)    | 75 (40)    | 120 (70)   | 220 (130)  | 305 (180)  | 505 (295)   | 865 (510)   | 1200 (705)  |
|  | Standard (92,7 m/s)  | 85 (3)      | 35 (20,5)         | 70 (40)    | 135 (80)   | 230 (135)  | 415 (245)  | 570 (335)  | 935 (550)   | 1605 (945)  | 2225 (1310) |
|  | Max (185 m/s)        | 170 (6)     | 75 (44,1)         | 140 (80)   | 275 (160)  | 460 (270)  | 830 (485)  | 1140 (670) | 1870 (1100) | 3205 (1885) | 4440 (2615) |
|  | High-Speed (224 m/s) | 205 (7,2)   | 95 (55,9)         | 170 (100)  | 335 (195)  | 555 (325)  | 1005 (590) | 1385 (815) | 2265 (1330) | 3880 (2285) | 5380 (3165) |
| <b>Carbondi-oxide (CO2)</b>                                      | Low-Speed (50 m/s)   | 25 (0,9)    | 225 NI/min (7,9)  | 20 (14)    | 45 (25)    | 75 (45)    | 140 (80)   | 195 (115)  | 320 (185)   | 545 (320)   | 760 (445)   |
|  | Standard (92,7 m/s)  | 50 (1,8)    | 25 (14,7)         | 45 (25)    | 85 (50)    | 145 (85)   | 260 (155)  | 360 (210)  | 590 (345)   | 1015 (595)  | 1405 (825)  |
|  | Max (185 m/s)        | 105 (3,6)   | 50 (29,4)         | 90 (50)    | 175 (100)  | 290 (170)  | 525 (305)  | 720 (425)  | 1185 (695)  | 2030 (1190) | 2810 (1655) |
|  | High-Speed (224 m/s) | 130 (4,5)   | 60 (35,3)         | 105 (60)   | 210 (125)  | 350 (205)  | 635 (370)  | 875 (515)  | 1430 (840)  | 2455 (1445) | 3405 (2000) |
| <b>Nitrogen (N2)</b>   | Low-Speed (50 m/s)   | 25 (0,9)    | 205 NI/min (7,2)  | 20 (13)    | 40 (25)    | 70 (40)    | 130 (75)   | 180 (105)  | 295 (175)   | 505 (300)   | 705 (415)   |
|  | Standard (92,7 m/s)  | 50 (1,5)    | 20 (11,7)         | 40 (20)    | 80 (45)    | 135 (75)   | 240 (140)  | 335 (195)  | 550 (320)   | 945 (555)   | 1305 (770)  |
|  | Max (185 m/s)        | 100 (3,3)   | 45 (26,4)         | 80 (45)    | 160 (95)   | 270 (155)  | 485 (285)  | 670 (395)  | 1100 (645)  | 1885 (1110) | 2610 (1535) |
|  | High-Speed (224 m/s) | 120 (4,2)   | 55 (32,3)         | 100 (55)   | 195 (115)  | 325 (190)  | 590 (345)  | 815 (475)  | 1330 (780)  | 2280 (1340) | 3165 (1860) |
| <b>Oxygen (O2)</b>   | Low-Speed (50 m/s)   | 25 (0,9)    | 215 NI/min (7,5)  | 20 (13)    | 45 (25)    | 75 (40)    | 135 (80)   | 185 (110)  | 305 (180)   | 525 (310)   | 730 (430)   |
|  | Standard (92,7 m/s)  | 50 (1,8)    | 20 (11,7)         | 40 (25)    | 80 (45)    | 140 (80)   | 250 (145)  | 345 (205)  | 570 (335)   | 980 (575)   | 1355 (795)  |
|  | Max (185 m/s)        | 100 (3,6)   | 45 (26,4)         | 85 (50)    | 165 (95)   | 280 (165)  | 505 (295)  | 695 (410)  | 1140 (670)  | 1955 (1150) | 2710 (1590) |
|  | High-Speed (224 m/s) | 125 (4,2)   | 55 (32,3)         | 105 (60)   | 205 (120)  | 340 (200)  | 610 (360)  | 845 (495)  | 1380 (810)  | 2365 (1390) | 3280 (1930) |
| <b>Nitrous oxide (N2O)</b>                                       | Low-Speed (50 m/s)   | 25 (0,9)    | 220 NI/min (7,7)  | 20 (14)    | 45 (25)    | 75 (45)    | 140 (80)   | 190 (110)  | 315 (185)   | 540 (320)   | 750 (440)   |
|  | Standard (92,7 m/s)  | 50 (1,8)    | 20 (11,7)         | 40 (25)    | 85 (50)    | 140 (85)   | 260 (150)  | 355 (210)  | 585 (345)   | 1005 (590)  | 1395 (820)  |
|  | Max (185 m/s)        | 105 (3,6)   | 45 (26,4)         | 85 (50)    | 170 (100)  | 285 (170)  | 520 (305)  | 715 (420)  | 1170 (690)  | 2010 (1180) | 2785 (1640) |
|  | High-Speed (224 m/s) | 125 (4,5)   | 60 (35,3)         | 105 (60)   | 210 (120)  | 345 (205)  | 630 (370)  | 865 (510)  | 1420 (835)  | 2435 (1430) | 3375 (1985) |
| <b>Natural gas (NG)</b>  | Low-Speed (50 m/s)   | 15 (0,6)    | 130 NI/min (4,5)  | 14,4 (8)   | 25 (15)    | 45 (25)    | 85 (50)    | 115 (65)   | 190 (110)   | 325 (190)   | 450 (265)   |
|  | Standard (92,7 m/s)  | 30 (0,9)    | 14 (8,8)          | 25 (15)    | 50 (30)    | 85 (50)    | 155 (90)   | 215 (125)  | 355 (205)   | 605 (355)   | 840 (495)   |
|  | Max (185 m/s)        | 60 (2,1)    | 25 (14,7)         | 50 (30)    | 105 (60)   | 170 (100)  | 310 (185)  | 430 (250)  | 705 (415)   | 1210 (710)  | 1680 (985)  |
|  | High-Speed (224 m/s) | 75 (2,7)    | 35 (20,5)         | 65 (35)    | 125 (70)   | 210 (120)  | 380 (220)  | 520 (305)  | 855 (500)   | 1465 (865)  | 2035 (1195) |



### Optional: Connection to different Bus systems

There are different options available for connection to modern Bus systems:

- Ethernet interface (Modbus-TCP) / PoE
- M-BUS
- Modbus-RTU



Ethernet Modbus TCP

M12 Ethernet port, x-coded

For further accessories refer to pages 106-110



## VA 520 - Inline flow meter

Example order code VA 520:

0695 xxxx\_B1\_C1\_E1\_F1\_G1\_H1\_K1\_L1\_M1\_N1\_O1\_R1\_Y1

| Measuring range (see table 114-117) |                              |
|-------------------------------------|------------------------------|
| B1                                  | Max version (185 m/s)        |
| B2                                  | Low-speed version (50 m/s)   |
| B3                                  | Standard version (92,7 m/s)  |
| B4                                  | High-speed version (224 m/s) |

| Male thread measuring section |                                  |
|-------------------------------|----------------------------------|
| C1                            | R male thread                    |
| C2                            | NPT male thread (only in 1.4404) |
| C3                            | Flange DIN EN 1092-1             |
| C4                            | Flange ANSI 16.5 Class 150 lbs   |
| C5                            | Flange ANSI 16.5 Class 300 lbs   |

| Option signal outputs / bus connection |   |
|--|---|
| E1                                     | 1 x 4...20 mA analogue output (not electrically isolated), pulse output, RS 485 (Modbus-RTU)  |
| E2                                     | M-Bus, 1 x 4...20 mA analogue output (not electrically isolated), RS 485 (Modbus-RTU)   |
| E4                                     | Ethernet interface (Modbus / TCP), 1 x 4...20 mA analogue output (not electrically isolated), RS 485 (Modbus-RTU)                         |
| E5                                     | Ethernet interface PoE (Power over Ethernet) (Modbus/TCP), 1 x 4...20 mA analogue output (not electrically isolated), RS 485 (Modbus-RTU) |

| Adjustment/calibration |  |
|------------------------|--|
| F1                     | No real gas adjustment - gas type configuration per gas constant |
| F2                     | Real gas adjustment in the gas type selected below               |

| Gas type |  |
|----------|--|
| G1       | Compressed air   |
| G2       | Nitrogen (N2)  |
| G3       | Argon (Ar)   |
| G4       | Carbon dioxide (CO2)                                     |
| G5       | Oxygen (O2)  |
| G6       | Nitrous oxide (N2O)                                      |
| G7       | Natural gas (NG)   |
| G8       | Helium (He) (real gas adjustment <b>F2</b> required)     |
| G9       | Propane (C3H8) (real gas adjustment <b>F2</b> required)  |
| G10      | Methane (CH4)  |
| G12      | Further gas / please indicate gas type (on request)      |
| G13      | Gas mixture / please indicate mixture ratio (on request) |

| Reference standard |                     |
|--------------------|---------------------|
| H1                 | 20 °C, 1000 mbar    |
| H2                 | 0 °C, 1013.25 mbar  |
| H3                 | 15 °C, 981 mbar     |
| H4                 | 15 °C, 1013.25 mbar |

| Maximum pressure |        |
|------------------|--------|
| K1               | 16 bar |
| K2               | 40 bar |

| Surface condition |  |
|-------------------|--|
| L1                | standard version   |
| L2                | Special cleaning - oil and grease free (e. g. for oxygen applications and so on) |
| L3                | Silicone-free version including special cleaning oil- and grease-free            |

| Accuracy class |   |
|----------------|---|
| M1             | ± 1.5% of the measured value ± 0.3% f.s. (standard) |
| M2             | ± 1% of the measured value ± 0.3% f.s. (precision)  |

| Approvals |  |
|-----------|--|
| N1        | Non-explosive area - no approval                     |
| N3        | DVGW approval for natural gas (max. pressure 16 bar) |

| Bi-directional measurement |  |
|----------------------------|--|
| O1                         | without  |
| O2                         | with (2 units 4...20 mA analogue output, pulse output<br>These are omitted for Ethernet (PoE and M-Bus)) |

| Special measuring range |   |
|-------------------------|---|
| R1                      | Special measuring range (please specify when placing order) |

| Option pressure measurement<br>(only with: G1, G2, G3, K1, L1, N1, O1) |  |
|--|--|
| Y1   | without pressure sensor  |
| Y2   | with integrated pressure sensor 0...16 bar(g)<br>(Output only via digital interfaces)  |
| Y3   | with integrated pressure sensor 10...2000 mbar<br>(Output only via digital interfaces) |



Order no. VA 520

| DESCRIPTION (Flange version) / Stainless steel 1.4404                 | ORDER NO. |
|---|-----------|
| VA 520 flow meter with integrated DN 15 measuring section with flange | 0695 2521 |
| VA 520 flow meter with integrated DN 20 measuring section with flange | 0695 2522 |
| VA 520 flow meter with integrated DN 25 measuring section with flange | 0695 2523 |
| VA 520 flow meter with integrated DN 32 measuring section with flange | 0695 2526 |
| VA 520 flow meter with integrated DN 40 measuring section with flange | 0695 2524 |
| VA 520 flow meter with integrated DN 50 measuring section with flange | 0695 2525 |
| VA 520 flow meter with integrated DN 65 measuring section with flange | 0695 2527 |
| VA 520 flow meter with integrated DN 80 measuring section with flange | 0695 2528 |

| DESCRIPTION                                     | ORDER NO.                 | ORDER NO.                 |
|---|---------------------------|---------------------------|
|   | Stainless steel<br>1.4404 | Stainless steel<br>1.4301 |
| VA 520 flow meter with 1/4" measuring section   | 0695 1520                 | 0695 0520                 |
| VA 520 flow meter with 3/8" measuring section   | 0695 1527                 | 0695 0527                 |
| VA 520 flow meter with 1/2" measuring section   | 0695 1521                 | 0695 0521                 |
| VA 520 flow meter with 3/4" measuring section   | 0695 1522                 | 0695 0522                 |
| VA 520 flow meter with 1" measuring section     | 0695 1523                 | 0695 0523                 |
| VA 520 flow meter with 1 1/4" measuring section | 0695 1526                 | 0695 0526                 |
| VA 520 flow meter with 1 1/2" measuring section | 0695 1524                 | 0695 0524                 |
| VA 520 flow meter with 2" measuring section     | 0695 1525                 | 0695 0525                 |

| ACCESSORIES  | ORDER NO. |
|--|-----------|
| ISO calibration certificate (5 calibration points) for VA sensors                | 3200 0001 |
| Additional calibration curve stored in the sensor                                | Z695 5011 |
| Certificate of origin  | Z695 5012 |
| Closing cap for measuring section in aluminium                                   | 0190 0001 |
| Closing cap for measuring section stainless steel 1.4404                         | 0190 0002 |
| Connection cable for VA/FA series, 5 m   | 0553 0104 |
| Connection cable for VA/FA sensors, 10 m   | 0553 0105 |
| Ethernet connection cable length 5 m,<br>M12 plug x-coded (8 pin) to RJ 45 plug  | 0553 2503 |
| Ethernet connection cable length 10 m,<br>M12 plug x-coded (8 pin) to RJ 45 plug | 0553 2504 |

For further accessories refer to pages 106-110

| TECHNICAL DATA VA 520  |   |
|--|---|
| <b>Parameters:</b>   | m <sup>3</sup> /h, l/min (1000 mbar, 20 °C) in case of compressed air or Nm <sup>3</sup> /h, Nl/min (1013 mbar, 0 °C) in case of gases                                  |
| <b>Units adjustable via keys at display:</b>                                       | m <sup>3</sup> /h, m <sup>3</sup> /min, l/min, l/s, ft/min, cfm, m/s, kg/h, kg/min, g/s, lb/min, lb/h   |
| <b>Sensor:</b>   | Thermal mass flow sensor  |
| <b>Measured medium:</b>  | Air, gases  |
| <b>Gas types are adjustable over CS service software or CS data logger:</b>        | Air, nitrogen, argon, CO <sub>2</sub> , oxygen  |
| <b>Measuring range:</b>  | See table above   |
| <b>Accuracy:<br/>(o. M. V. = of measured value)<br/>(o. F. S. = of full scale)</b> | ± 1.5% of m.v. ± 0.3% of f.s. on request:<br>± 1% of m.v. ± 0.3% of f.s.  |
| <b>Operating temperature:</b>  | -30...80 °C<br>-20...80 °C with pressure sensor   |
| <b>Operating pressure:</b>   | -1 to 16 bar optionally up to PN 40   |
| <b>Digital output:</b>   | RS 485 interface, (Modbus-RTU), optional: Ethernet interface PoE), M-Bus  |
| <b>Analogue output:</b>  | 4...20 mA for m <sup>3</sup> /h or l/min  |
| <b>Pulse output:</b>   | 1 pulse per m <sup>3</sup> or per litre electrically isolated. Pulse weight can be set on the display.<br>Alternatively, the pulse output can be used as an alarm relay |
| <b>Supply:</b>   | 18...36 VDC, 5 W  |
| <b>Burden:</b>   | < 500 Ω   |
| <b>Housing:</b>  | Polycarbonate (IP 65)   |
| <b>Measuring section:</b>  | Stainless steel, 1.4404 or 1.4301   |
| <b>Mounting position:</b>  | any   |

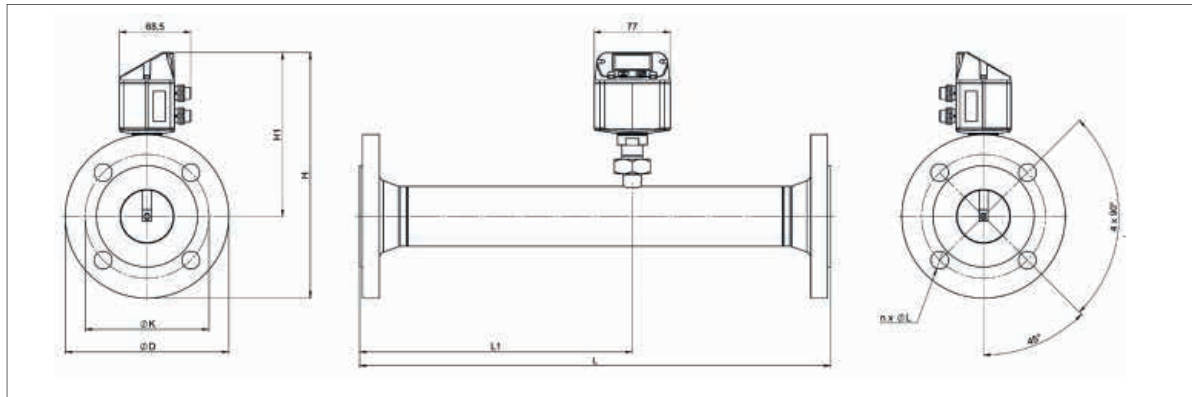

| VA 520 - Flange   |            |            |      |     |       |       | Flange DIN EN 1092-1 |     |        |
|-------------------|------------|------------|------|-----|-------|-------|----------------------|-----|--------|
| Measuring section | Outer pipe | Inner pipe | L    | L1  | H     | H1    | ØD                   | ØK  | n x ØL |
|                   | mm         | mm         | mm   | mm  | mm    | mm    | mm                   | mm  |        |
| DN 15             | 21.3       | 16.1       | 300  | 210 | 213.2 | 165.7 | 95                   | 65  | 4 x 14 |
| DN 20             | 26.9       | 21.7       | 475* | 275 | 218.2 | 165.7 | 105                  | 75  | 4 x 14 |
| DN 25             | 33.7       | 27.3       | 475* | 275 | 223.2 | 165.7 | 115                  | 85  | 4 x 14 |
| DN 32             | 42.4       | 36.0       | 475* | 275 | 235.7 | 165.7 | 140                  | 100 | 4 x 18 |
| DN 40             | 48.3       | 41.9       | 475* | 275 | 240.7 | 165.7 | 150                  | 110 | 4 x 18 |
| DN 50             | 60.3       | 53.1       | 475* | 275 | 248.2 | 165.7 | 165                  | 125 | 4 x 18 |
| DN 65             | 76.1       | 68.9       | 475* | 275 | 268.2 | 175.7 | 185                  | 145 | 8 x 18 |
| DN 80             | 88.9       | 80.9       | 475* | 275 | 275.7 | 175.7 | 200                  | 160 | 8 x 18 |

\*Attention: Shortened inlet section. Please observe the recommended minimum inlet section (length = 15 x inner diameter) on site.

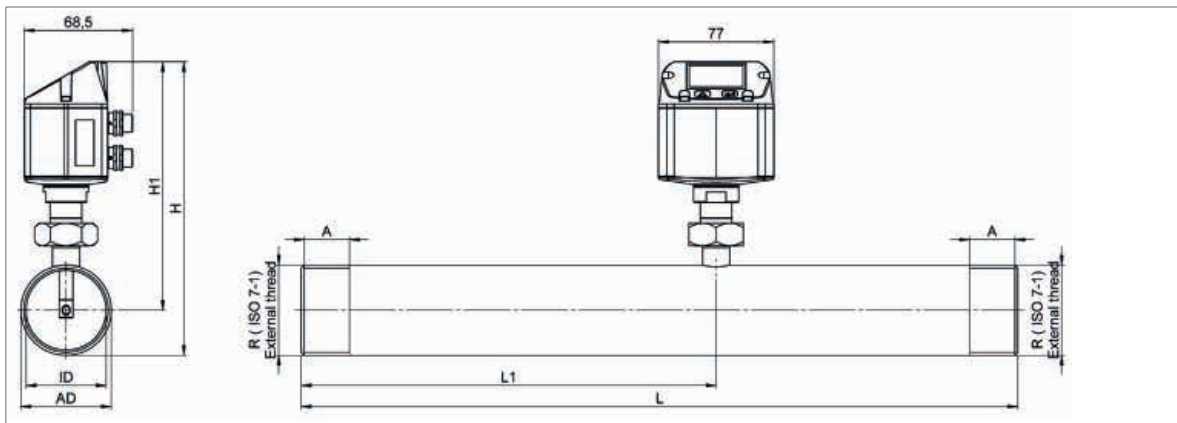

| VA 520 - Thread   |            |            |      |     |       |       |    |
|-------------------|------------|------------|------|-----|-------|-------|----|
| Connection thread | Outer pipe | Inner pipe | L    | L1  | H     | H1    | A  |
|                   | mm         | mm         | mm   | mm  | mm    | mm    | mm |
| R 1/4"            | 13.7       | 8.9        | 194  | 137 | 174.7 | 165.7 | 15 |
| R 3/8"            | 17.2       | 12.5       | 300  | 200 | 175   | 165.7 | 15 |
| R 1/2"            | 21.3       | 16.1       | 300* | 210 | 176.4 | 165.7 | 20 |
| R 3/4"            | 26.9       | 21.7       | 475* | 275 | 179.2 | 165.7 | 20 |
| R 1"              | 33.7       | 27.3       | 475* | 275 | 182.6 | 165.7 | 25 |
| R 1 1/4"          | 42.4       | 36.0       | 475* | 275 | 186.9 | 165.7 | 25 |
| R 1 1/2"          | 48.3       | 41.9       | 475* | 275 | 186.9 | 165.7 | 25 |
| R 2"              | 60.3       | 53.1       | 475* | 275 | 195.9 | 165.7 | 30 |

\*Attention: Shortened inlet section. Please observe the recommended minimum inlet section (length = 15 x inner diameter) on site!





## VA 521 - Compact inline flow sensor for compressed air and other types of gas

No inlet section necessary – integrated flow straightener – sensor unit removable

The newly developed VA 521 combines modern digital interfaces for connection to energy monitoring systems with a small, compact design. The VA 521 is always used when many machines (compressed air consumers) are to be integrated into an energy monitoring network.



Readout values in the display can be rotated by 180°, e.g. for overhead installation

### Display shows 2 values at the same time:

- Present flow in m<sup>3</sup>/h, l/min,...
- Total consumption (counter reading) in m<sup>3</sup>, l, kg
- Temperature measurement

### Screw-in thread:

Easy installation into the existing pipe due to integrated measuring section (suitable for 1/2", 3/4", 1", 1 1/4", 1 1/2" or 2" lines)

### Advantages at a glance:

- Compact, small design - for use in machines, behind maintenance unit on the end user
- All interfaces are freely programmable via the display
- Modbus-RTU output
- 4...20 mA analogue output for present flow
- Pulse output total flow (counter reading), electrically isolated. Optional: M-Bus, Ethernet interface or PoE
- **NEW:** As option, integrated pressure sensor

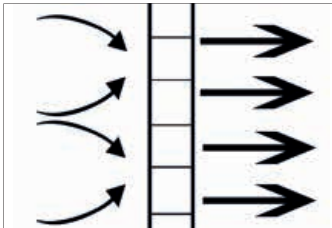

Integrated flow straightener - no inlet section necessary



### With a key stroke:

- Reset counter reading
- Select units
- Parameterise interfaces



The sensor can be removed from the measuring section and cleaned.

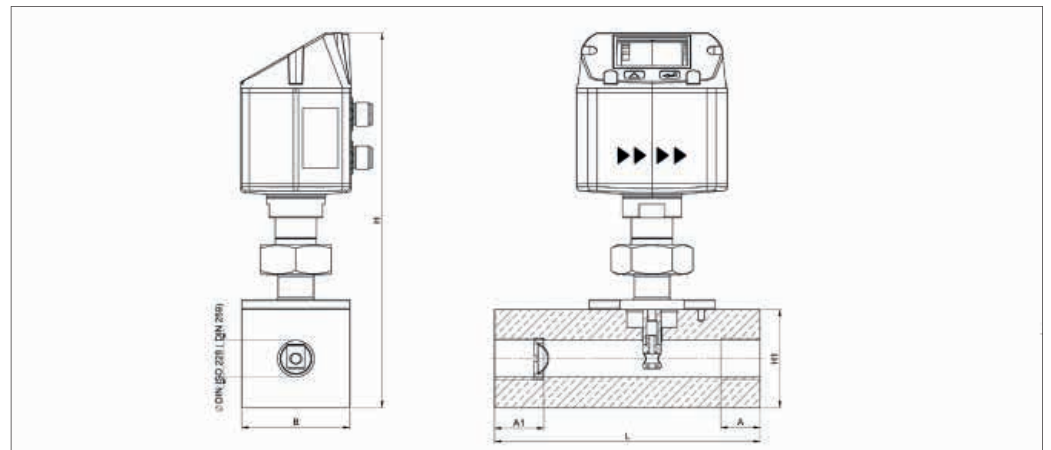

**Flow measuring ranges VA 521 (max version 185 m/s) for compressed air (ISO 1217: 1000 mbar, 20 °C)** Measuring ranges for other types of gas see pages 120 to 123

| Measuring section | Thread   | Measuring range full scales |     | L   | B  | H1 | H      | A1 | A  |
|-------------------|----------|-----------------------------|-----|-----|----|----|--------|----|----|
|                   |          | m <sup>3</sup> /h           | cfm |     |    |    |        |    |    |
| DN 15             | G 1/2"   | 90 m <sup>3</sup> /h        | 50  | 135 | 55 | 50 | 109.65 | 25 | 20 |
| DN 20             | G 3/4"   | 170 m <sup>3</sup> /h       | 100 | 135 | 55 | 50 | 109.65 | 26 | 20 |
| DN 25             | G 1"     | 290 m <sup>3</sup> /h       | 170 | 135 | 55 | 50 | 109.65 | 33 | 25 |
| DN 32             | G 1 1/4" | 530 m <sup>3</sup> /h       | 310 | 135 | 80 | 80 | 215.45 | 35 | 25 |
| DN 40             | G 1 1/2" | 730 m <sup>3</sup> /h       | 430 | 135 | 80 | 80 | 215.45 | 36 | 25 |
| DN 50             | G 2"     | 1195 m <sup>3</sup> /h      | 700 | 135 | 80 | 80 | 215.45 | 44 | 30 |



Example order code VA 521:

0696 0521\_A1\_B1\_C1\_D1\_E1\_F1\_G1\_H1\_I1\_J1\_K1\_L1\_M1\_R1

| Measuring section  |   |
|--|---|
| A2   | 1/2"  |
| A3   | 3/4"  |
| A4   | 1"  |
| A5   | 1 1/4"  |
| A6   | 1 1/2"  |
| A7   | 2"  |
| Threaded version   |   |
| B1   | G female thread   |
| B2   | NPT female thread   |
| Material type  |   |
| C1   | Aluminium   |
| C2   | Stainless steel 316L  |
| Adjustment/calibration   |   |
| D1   | No real gas adjustment - gas type configuration per gas constant  |
| D2   | Real gas adjustment in the gas type selected below  |
| Gas type   |   |
| E1   | Compressed air  |
| E2   | Nitrogen (N2)   |
| E3   | Argon (Ar)  |
| E4   | Carbon dioxide (CO2)  |
| E5   | Oxygen (O2)   |
| E6   | Nitrous oxide (N2O)   |
| E7   | Natural gas (NG)  |
| E90  | Further gas / please indicate gas type (on request)   |
| E91  | Gas mixture / please indicate mixture ratio (on request)  |
| Measuring range (see table)  |   |
| F1   | Low-speed version (50 m/s)  |
| F2   | Standard version (92,7 m/s)   |
| F3   | Max version (185 m/s)   |
| F4   | High-speed version (224 m/s)  |
| Reference standard   |   |
| G1   | 20 °C, 1000 mbar  |
| G2   | 0 °C, 1013.25 mbar  |
| G3   | 15 °C, 981 mbar   |
| G4   | 15 °C, 1013.25 mbar   |
| Display option   |   |
| H1   | With integrated display   |
| H2   | Without display   |
| Pressure measurement option<br>(only with: E1, E2, E3, M1, N1, P1) |   |
| I1   | Without pressure sensor   |
| I2   | with integrated pressure sensor 0...16 bar(g)<br>(Output only via digital interfaces)                                 |
| I3   | with integrated pressure sensor 10...2000 mbar<br>(Output only via digital interfaces)                                |
| Signal / bus connection option                                     |   |
| J1   | 1 x 4...20 mA analogue output (not electrically isolated), pulse output, RS 485 (Modbus-RTU)                          |
| J2   | Ethernet interface (Modbus / TCP), 1 x 4...20 mA analogue output (not electrically isolated, RS), 485 (Modbus-RTU)    |
| J3   | Ethernet interface PoE (Modbus / TCP), 1 x 4...20 mA analogue output (not electrically isolated), RS 485 (Modbus-RTU) |
| J4   | M-Bus, 1 x 4...20 mA analogue output (not electrically isolated), RS 485 (Modbus-RTU)                                 |
| Flow straightener  |   |
| K1   | With integrated flow straightener, no additional inlet section necessary (with measuring section 1/2" to 2")          |

| Accuracy class          |   |
|-------------------------|---|
| L1                      | ± 1.5% of m.v. ± 0.3% of f.s.   |
| L2                      | ± 1% of m.v. ± 0.3% of f.s.   |
| Maximum pressure        |   |
| M1                      | 16 bar  |
| M2                      | 40 bar (Not available with NPT thread >1")  |
| Surface condition       |   |
| N1                      | Standard version  |
| N2                      | Special cleaning oil and grease free<br>(e. g. for oxygen applications and so on) |
| N3                      | Silicone-free version including special cleaning oil and grease-free              |
| Approvals:              |   |
| O1                      | No approval   |
| O2                      | DVGW approval for natural gas (max. pressure 16 bar)                              |
| Special measuring range |   |
| R1                      | Special measuring range (please specify when placing order)                       |

Order no. VA 521

| DESCRIPTION               | ORDER NO.                     |
|---------------------------|-------------------------------|
| Compact inline flow meter | 0696 0521 + Order code A...R_ |

For further accessories refer to pages 108 to 112

| TECHNICAL DATA VA 521  |   |
|--|---|
| <b>Parameters:</b>   | m³/h, l/min (1000 mbar, 20 °C) in case of compressed air or Nm³/h, NI/min (1013 mbar, 0 °C) in case of gases  |
| <b>Units adjustable via keys at display:</b>                                       | m³/h, m³/min, l/min, l/s, ft/min, cfm, m/s, kg/h, kg/min, g/s, lb/min, lb/h   |
| <b>Sensor:</b>   | Thermal mass flow sensor  |
| <b>Measured medium:</b>  | Air, gases  |
| <b>Gas types are adjustable over CS service software or CS data logger:</b>        | Air, nitrogen, argon, CO2, oxygen   |
| <b>Measuring range:</b>  | See table   |
| <b>Accuracy:<br/>(o. M. V. = of measured value)<br/>(o. F. S. = of full scale)</b> | ± 1.5% of m.v. ± 0.3 % of f.s.<br>on request:<br>± 1% of m.v. ± 0.3% of f.s.  |
| <b>Operating temperature:</b>  | -30...80 °C, -20...80 °C with pressure sensor   |
| <b>Operating pressure:</b>   | Up to 16 bar, optionally 40 bar   |
| <b>Digital output:</b>   | RS 485 interface, (Modbus-RTU), optional M-Bus, Ethernet interface or PoE   |
| <b>Analogue output:</b>  | 4...20 mA for m³/h or l/min   |
| <b>Pulse output:</b>   | 1 pulse per m³ or per litre electrically isolated. Pulse weight can be set on the display. Alternatively, the pulse output can be used as an alarm relay. |
| <b>Supply:</b>   | 18...36 VDC, 5 W  |
| <b>Burden:</b>   | < 500 Ω   |
| <b>Housing:</b>  | Polycarbonate (IP 65)   |
| <b>Measuring section:</b>  | Aluminium, 316L   |
| <b>Connection thread of measuring sections:</b>                                    | G 1/2" to G 2" (BSP British Standard Piping) or 1/2" to 2" NPT thread   |
| <b>Mounting position:</b>  | any   |



## VA 525 - Compact inline flow sensor for air and nitrogen

No inlet section necessary – integrated flow straightener – optional pressure sensor

The newly developed VA 525 combines modern digital interfaces for connection to an energy monitoring system with a small, compact design. The VA 525 is always used when many machines (compressed air consumers) are to be integrated into an energy monitoring network.



Readout values in the display can be rotated by 180°, e.g. for overhead installation

### Display shows 2 values at the same time:

- Present flow in m<sup>3</sup>/h, l/min,...
- Total consumption (counter reading) in m<sup>3</sup>, l, kg
- Temperature measurement
- **Optional:** Pressure measurement

### Advantages at a glance:

- Compact, small design - for use in machines, behind maintenance unit on the end user
- Optionally with conventional analogue signals (4...20 mA and pulse) or digital interfaces such as Modbus-RTU, Ethernet (also PoE), M-Bus
- All interfaces are freely programmable via the display

### Screw-in thread:

Easy installation into the existing pipe due to integrated measuring section (suitable for 1/4", 1/2", 3/4", 1", 1 1/4", 1 1/2" or 2" lines)

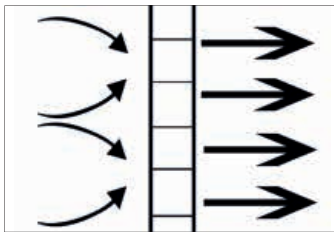

Integrated flow straightener - no inlet section necessary



### With a key stroke:

- Reset counter reading
- Select units
- Parameterise interfaces

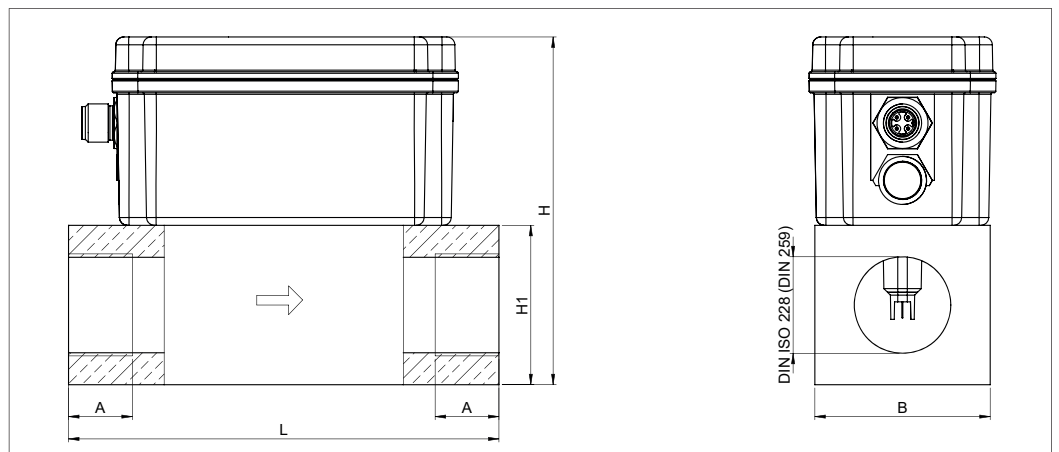

Flow measuring ranges VA 525 (max version 185 m/s) for compressed air (ISO 1217:1000 mbar, 20 °C) Measuring ranges for other types of gas see pages 120 to 123

| Measuring section | Thread   | Measuring range full scales |     | L   | B  | H1 | H     | A  |
|-------------------|----------|-----------------------------|-----|-----|----|----|-------|----|
|                   |          | m <sup>3</sup> /h           | cfm |     |    |    |       |    |
| DN 8              | G 1/4"   | 105 l/min                   | 3.6 | 135 | 55 | 50 | 109.1 | 15 |
| DN 15             | G 1/2"   | 90 m <sup>3</sup> /h        | 50  | 135 | 55 | 50 | 109.1 | 20 |
| DN 20             | G 3/4"   | 170 m <sup>3</sup> /h       | 100 | 135 | 55 | 50 | 109.1 | 20 |
| DN 25             | G 1"     | 290 m <sup>3</sup> /h       | 170 | 135 | 55 | 50 | 109.1 | 25 |
| DN 32             | G 1 1/4" | 530 m <sup>3</sup> /h       | 310 | 135 | 80 | 80 | 139.1 | 25 |
| DN 40             | G 1 1/2" | 730 m <sup>3</sup> /h       | 430 | 135 | 80 | 80 | 139.1 | 25 |
| DN 50             | G 2"     | 1195 m <sup>3</sup> /h      | 700 | 135 | 80 | 80 | 139.1 | 30 |





Example order code VA 525:

0695 5250\_A1\_B1\_C1\_D1\_E1\_F1\_G1\_H1\_I1\_J1\_K1\_L1\_M1\_R1

| Measuring section                     |  |
|---------------------------------------|--|
| A1                                    | 1/4"   |
| A2                                    | 1/2"   |
| A3                                    | 3/4"   |
| A4                                    | 1"   |
| A5                                    | 1 1/4"   |
| A6                                    | 1 1/2"   |
| A7                                    | 2"   |
| Threaded version                      |  |
| B1                                    | G female thread  |
| B2                                    | NPT female thread  |
| Material type                         |  |
| C1                                    | Aluminium  |
| Adjustment/calibration                |  |
| D1                                    | No real gas adjustment - gas type configuration per gas constant   |
| D2                                    | Real gas adjustment in the gas type selected below   |
| Gas type                              |  |
| E1                                    | Compressed air   |
| E2                                    | Nitrogen (N2)  |
| Measuring range (see table)           |  |
| F1                                    | Low-speed version (50 m/s)   |
| F2                                    | Standard version (92,7 m/s)  |
| F3                                    | Max version (185 m/s)  |
| F4                                    | High-speed version (224 m/s)   |
| Reference standard                    |  |
| G1                                    | 20 °C, 1000 mbar   |
| G2                                    | 0 °C, 1013.25 mbar   |
| G3                                    | 15 °C, 981 mbar  |
| G4                                    | 15 °C, 1013.25 mbar  |
| Display option                        |  |
| H1                                    | With integrated display  |
| H2                                    | Without display  |
| Pressure measurement option           |  |
| I1                                    | Without pressure sensor  |
| I2                                    | With integrated pressure sensor 0...16 bar (output only via digital interfaces)                                    |
| I3                                    | With integrated pressure sensor 10...2000 mbar (abs), for vacuum applications (output only via digital interfaces) |
| Signal output / bus connection option |  |
| J1                                    | 1x 4...20 mA analogue output for present flow and pulse output   |
| J2                                    | Modbus-RTU (RS485)   |
| J3                                    | Ethernet interface (Modbus/TCP)  |
| J4                                    | Ethernet interface Power over Ethernet (Modbus/TCP)  |
| J5                                    | M-Bus  |
| Rectifier                             |  |
| K1                                    | With integrated flow straightener, no additional inlet section necessary (with measuring section 1/2" to 2")       |
| K2                                    | Without rectifier (for measuring section 1/4")   |

| Accuracy class          |   |
|-------------------------|---|
| L1                      | ± 1.5% of m.v. ± 0.3% of f.s.                               |
| L2                      | ± 6% of m.v. ± 0.5% of f.s.                                 |
| L3                      | ± 1% of m.v. ± 0.3% of f.s.                                 |
| Maximum pressure        |   |
| M1                      | 16 bar  |
| Surface condition       |   |
| N1                      | Standard version  |
| Special measuring range |   |
| R1                      | Special measuring range (please specify when placing order) |

Order no. VA 525

| DESCRIPTION               | ORDER NO.                     |
|---------------------------|-------------------------------|
| Compact inline flow meter | 0695 5250 + Order code A...R_ |

#### TECHNICAL DATA VA 525

|  |   |
|--|---|
| <b>Parameters:</b>   | m <sup>3</sup> /h, l/min (1000 mbar, 20 °C) in case of compressed air or Nm <sup>3</sup> /h, NI/min (1013 mbar, 0 °C) in case of gases                                |
| <b>Units adjustable via keys at display:</b>                                     | m <sup>3</sup> /h, m <sup>3</sup> /min, l/min, l/s, ft/min, cfm, m/s, kg/h, kg/min, g/s, lb/min, lb/h   |
| <b>Sensor:</b>   | Thermal mass flow sensor  |
| <b>Measured medium:</b>  | Air   |
| <b>Measuring range:</b>  | See table above   |
| <b>Accuracy:</b><br>(o. M. V. = of measured value)<br>(o. F. S. = of full scale) | ± 1.5% of m.v. ± 0.3 % of f.s.<br>on request:<br>± 1% of m.v. ± 0.3% of f.s. or ± 6% of m.v. ± 0.5% of f.s.   |
| <b>Pressure measurement:</b>   | 0...16 bar, accuracy: 1%, or 10...2000 mbar (abs)   |
| <b>Operating temperature:</b>  | -20...60 °C   |
| <b>Operating pressure:</b>   | Up to 16 bar  |
| <b>Digital output:</b>   | RS 485 interface, (Modbus-RTU), M-Bus (optional) Ethernet interface or PoE  |
| <b>Analogue output:</b>  | 4...20 mA for m <sup>3</sup> /h or l/min  |
| <b>Pulse output:</b>   | 1 pulse per m <sup>3</sup> or per litre electrically isolated. Pulse weight can be set on the display. Alternatively, the pulse output can be used as an alarm relay. |
| <b>Supply:</b>   | 18...36 VDC, 5 W  |
| <b>Burden:</b>   | < 500 Ω   |
| <b>Housing:</b>  | Polycarbonate (IP 65)   |
| <b>Measuring section:</b>  | Aluminium   |
| <b>Connection thread of measuring sections:</b>                                  | G 1/4" to G 2" (BSP British Standard Piping) or 1/2" to 2" NPT thread   |
| <b>Mounting position:</b>  | any   |



## VD 500 - Flow sensor for wet compressed air

For measuring immediately downstream of the compressor in moist air up to +180 °C

### FIELD OF APPLICATION:

- Measurement immediately downstream of the compressor
- Measurement at high temperatures



### Benefits at a glance:

- **New:** Unique sensitivity in the lower measuring range: Measures from as little as 2 m/s and thus covers the complete operating range of variable speed drive (VSD) compressors
- Particularly suitable for extremely high flow rates
- Flow, total consumption, temperature and pressure
- Measurement at high temperatures, max. temperature 180 °C
- Can be used in pipes from DN 20 to DN 600
- Installation via 1/2" ball valve under pressure

### Typical applications:

- Measurement of the capacity of compressors
- Compressed air audits
- Efficiency measurement of compressed air systems

### Installation requirements:

- After functioning water separator
- In horizontal lines (recommended) or in risers

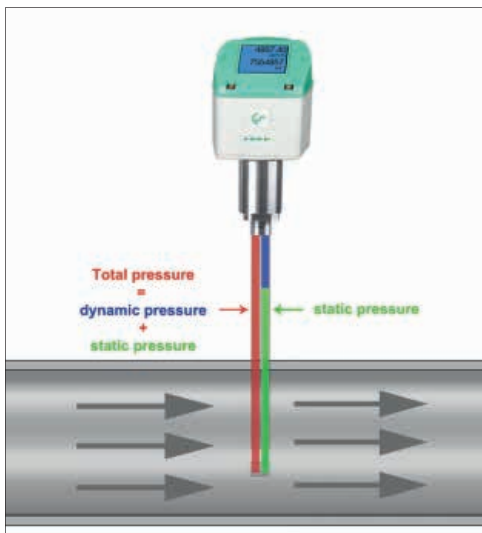

The integrated, precise differential pressure sensor measures the differential pressure/dynamic pressure at the sensor tip. The pressure depends on the respective gas velocity. The flow is therefore easy to determine by means of the pipe diameter.

The additional measurement of temperature and absolute pressure and calculation of the relevant density means that measuring can be carried out for various gases, a wide variety of temperatures and pressures.

### TECHNICAL DATA VD 500

|  |  |
|--|--|
| <b>Measuring range:</b>  | 2 up to 224 m/s / 600 m/s  |
| <b>Measured medium:</b>  | Air, non-aggressive gases  |
| <b>Accuracy:</b><br>(m.v.: of meas. value) (f.s.: of full scale) | ± 1.5% of m.v. ± 0.3% of f.s.<br>± 1.5% of m.v. (> 224 m/s)  |
| <b>Measuring principle:</b>                                      | Differential pressure  |
| <b>Measuring span:</b>   | 1:100  |
| <b>Response time:</b>  | t <sub>99</sub> : < 1 sec.   |
| <b>Temperature of the medium:</b>                                | -30 °...+180 °C  |
| <b>Operating pressure:</b>                                       | Max. 30 bar  |
| <b>Ambient temperature:</b>                                      | -30 °...+70 °C   |
| <b>Power supply:</b>   | 18...36 VDC, 5 W   |
| <b>Signal outputs:</b>   | As standard:<br>RS 485 (Modbus-RTU), 4...20 mA, pulse<br><b>Optional:</b><br>Ethernet Interface (PoE), M-Bus |



Example order code VD 500:

0690 5001\_A1\_B1\_C1\_D1\_E1\_G1\_K1

| Measuring range                        |   |
|--|---|
| A1                                     | 224 m/s   |
| A2                                     | 600 m/s   |
| Screw-in thread                        |   |
| B1                                     | G 1/2"  |
| B2                                     | 1/2" NPT male thread  |
| B3                                     | PT 1/2"   |
| Installation length / shaft length     |   |
| C1                                     | 220 mm  |
| C2                                     | 400 mm  |
| Display                                |   |
| D1                                     | with integrated display   |
| Signal outputs / bus connection option |   |
| E1                                     | 1x 4...20 mA analogue output (electrically not isolated), pulse output, RS 485 (Modbus-RTU)   |
| E2                                     | Ethernet interface (Modbus/TCP), 1 x 4...20 mA analogue output (not electrically isolated), RS 485 (Modbus-RTU)                           |
| E3                                     | Ethernet interface PoE (Power over Ethernet) (Modbus/TCP), 1 x 4...20 mA analogue output (not electrically isolated), RS 485 (Modbus-RTU) |
| E4                                     | M-Bus, 1 x 4...20 mA analogue output (not electrically isolated), RS 485 (Modbus-RTU)   |
| Reference standard                     |   |
| G1                                     | 20 °C, 1000 mbar  |
| G2                                     | 0 °C, 1013.25 mbar  |
| G3                                     | 15 °C, 981 mbar   |
| G4                                     | 15 °C, 1013.25 mbar   |
| Gas type                               |   |
| K1                                     | Compressed air  |
| K90                                    | Additional gas on request   |

## Simple installation and removal under pressure

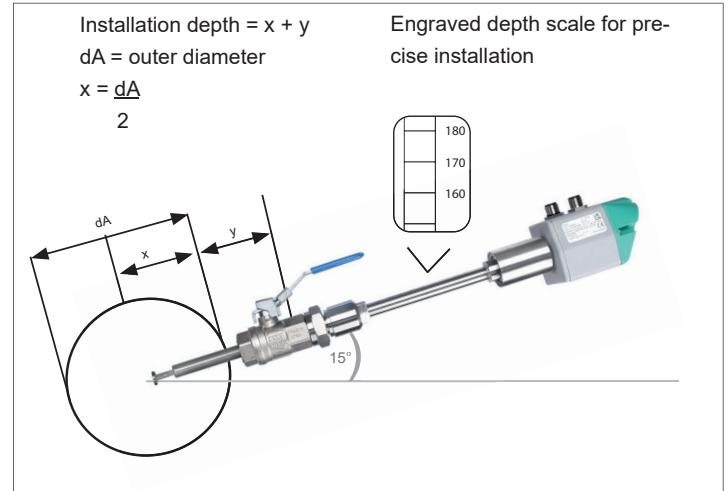

Recommended installation position

| DESCRIPTION                               | ORDER NO.                     |
|---|-------------------------------|
| VD 500 flow sensor for wet compressed air | 0690 5001 + Order code A...K_ |
| <b>Accessories:</b>                       |                               |
| ISO calibration certificate               | 3200 0001                     |
| High-pressure protection                  | 0530 2205                     |
| Configuration see page 103                |                               |

| Flow measuring ranges VD 500 for compressed air (ISO 1217:1000 mbar, 20 °C) |       |        |   |               |
|---|-------|--------|---|---------------|
| Inside diameter of pipe   |       |        | VD 500<br>2 ... 224 m/s                       |               |
|   |       |        | Measuring range initial values and full scale |               |
| Inch  | mm    | DN     | m³/h  | cfm           |
| 3/4"  | 21,7  | DN 20  | 2 ... 215                                     | 1.2 ... 127   |
| 1"  | 27,3  | DN 25  | 3,2 ... 357                                   | 1.9 ... 210   |
| 1 1/4"  | 36,0  | DN 32  | 5,7 ... 644                                   | 3.4 ... 379   |
| 1 1/2"  | 41,9  | DN 40  | 8 ... 886                                     | 4.7... 522    |
| 2"  | 53,1  | DN 50  | 13 ... 1450                                   | 8 ... 853     |
| 2 1/2"  | 68,9  | DN 65  | 23 ... 2484                                   | 13 ... 1462   |
| 3"  | 80,9  | DN 80  | 31 ... 3440                                   | 18 ... 2025   |
| 4"  | 110,0 | DN 100 | 57 ... 6391                                   | 34 ... 3762   |
| 5"  | 133,7 | DN 125 | 85 ... 9453                                   | 50 ... 5564   |
| 6"  | 159,3 | DN 150 | 120 ... 13436                                 | 71 ... 7908   |
| 8"  | 200,0 | DN 200 | 190 ... 21230                                 | 112 ... 12495 |
| 10"   | 250,0 | DN 250 | 296 ... 33211                                 | 175 ... 19547 |
| 12"   | 300,0 | DN 300 | 428 ... 47881                                 | 252 ... 28182 |



## VU 570 - Vortex ultrasonic flow sensor for technical gases and mixed gases

Independent from gas composition – integrated pressure and temperature compensation  
– larger measuring range than common Vortex sensors

### FIELD OF APPLICATION:

- Technical gases
- Mixed gases
- Compressed air in PET bottles production
- LPG
- Propane
- Crypton



### Function principle Vortex ultrasonic:

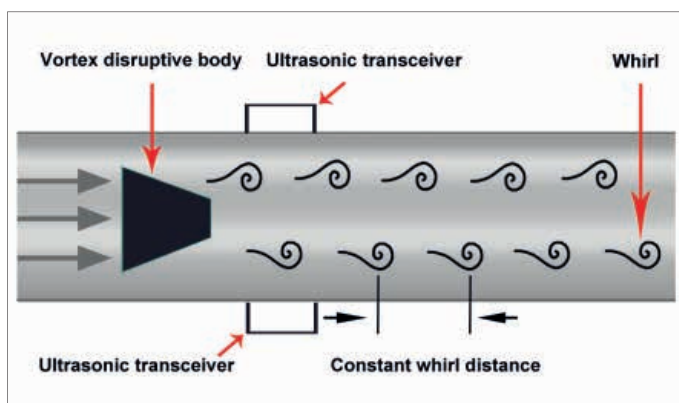

### Benefits at a glance:

- Measurement of standard volume flow, operating volume flow, mass flow
- Suitable for unknown/changing gas compositions and mixed gases
- The innovative measuring principle grant a precise flow measurement in different gases
- Suitable for quickly changing temperature and pressure changes as well as high mass flows

### Advantages towards common mechanic gas meters:

- No moving parts – no wearing

### Advantages towards common Vortex sensors:

- Precise measurement already from 0.3 m/s



Example order code VU 570:

0697 0570\_A1\_B1\_C1\_D1\_E1\_F1\_G1\_H1

| Measuring section |   |
|-------------------|---|
| A1                | 1/2" (DN 15)                              |
| A2                | 3/4" (DN 20)                              |
| A3                | 1" (DN 25)                                |
| A4                | 1 1/4" (DN 32)                            |
| A5                | 1 1/2" (DN 40)                            |
| A6                | 2" (DN 50)                                |
| A7                | 2 1/2" (DN 65), (only in flanged version) |
| A8                | 3" (DN 80), (only in flanged version)     |

| Process connection |                                |
|--------------------|--------------------------------|
| B1                 | R outer threads                |
| B2                 | NPT outer threads              |
| B3                 | Flange DIN 1092-1              |
| B4                 | Flange ANSI 16.5 Class 150 lbs |
| B5                 | Flange ANSI 16.5 Class 300 lbs |

| Option display |                         |
|----------------|-------------------------|
| C1             | With integrated display |
| C2             | Without display         |

| Pressure sensor |             |
|-----------------|-------------|
| D1              | 16 bar (g)  |
| D2              | 40 bar (g)  |
| D3              | 1.5 bar (g) |

| Signal outputs / bus connection option |  |
|--|--|
| E1                                     | 2 x 4...20 mA analogue output (galv. isolated), pulse output, RS 485 (Modbus-RTU)  |
| E4                                     | 1 x 4...20 mA analogue output (galv. not isolated), pulse output RS 485 (Modbus-RTU)   |
| E5                                     | Ethernet-Interface (Modbus/TCP), 1 x 4...20 mA analogue output (galv. not isolated), pulse output, RS 485 (Modbus-RTU)                         |
| E8                                     | M-Bus, 1 x 4...20 mA analogue output (galv. not isolated), pulse output RS 485 (Modbus-RTU)  |
| E9                                     | Ethernet-Interface PoE (Power over Ethernet) Modbus/TCP, 1 x 4...20 mA analogue output (galv. not isolated), pulse output, RS 485 (Modbus-RTU) |

| Calibration |   |
|-------------|---|
| F1          | No real gas calibration - Adjustment of gas type via gas constant |
| F2          | Real gas calibration in selected gas type                         |

| Reference conditions |                      |
|----------------------|----------------------|
| G1                   | 20 °C, 1000 mbar     |
| G2                   | 0 °C, 1013,25 mbar   |
| G3                   | 15 °C, 981 mbar      |
| G4                   | 15 °C, 1013,25 mbar  |
| G5                   | Operation conditions |

| Accuracy class |  |
|----------------|--|
| H1             | ± 1,5% of measured value (volume flow) |
| H2             | ± 1% of measured value (volume flow)   |

## TECHNICAL DATA VU 570

|  |  |
|--|--|
| <b>Measuring range:</b>                                    | See table  |
| <b>Measuring medium:</b>                                   | Air, non-aggressive gases and mixed gases (non-condensing)   |
| <b>Accuracy:</b>   | ± 1,5 % m. v., optional  |
| <b>Volume flow (m³/h)</b>                                  | ± 1 % m. v.  |
| <b>Mass flow (kg/h) resp. Standard volume flow (Nm³/h)</b> | ± 2 % m. v., optional<br>± 1,5 % m. v.   |
| <b>Meas. principle:</b>                                    | Vortex ultrasonic – Vortex frequency measurement   |
| <b>Process temp.:</b>                                      | -40° ... +100°C  |
| <b>Process pressure:</b>                                   | Up to 40 bar (ü)   |
| <b>Protection class:</b>                                   | IP67   |
| <b>Material meas. Section and medium-touching parts:</b>   | Stainless steel 316, Plastic   |
| <b>Material display unit:</b>                              | Aluminium - Die casting  |
| <b>Signal outputs:</b>                                     | As a standard:<br>RS 485 (Modbus-RTU), 1x 4...20 mA, puls<br>Optional:<br>Ethernet Interface                                   |
| <b>Power supply :</b>                                      | 18...36 VDC  |
| <b>Measuring span:</b>                                     | 1:50   |
| <b>Repeatability:</b>                                      | ± 0,3 % v. M.  |
| <b>Process connection:</b>                                 | Flange DIN EN1092-1 or<br>Flange ANSI 150 lbs - 300 lbs<br>R 1/2" - R 2" (BSP British Standard Piping)<br>1/2" - 2" NPT-thread |

| DESCRIPTION  | ORDER NO.                           |
|--|-------------------------------------|
| VU 570 - Vortex ultrasonic flow sensor for technical gases and mixed gases         | 0697 0570+<br>Order code<br>A_...H_ |
| <b>Further accessories:</b><br>ISO - calibration certificate at 5 measuring points | 3200 0001                           |

## Measuring ranges for gases VU 570 under operation conditions

| Inch   | mm   | DN | from | m/s | to | from | m³/h  | to  | from  | cfm  | to |
|--------|------|----|------|-----|----|------|-------|-----|-------|------|----|
| 1/2"   | 16,1 | 15 | 0,5  |     |    | 0,4  | 22,0  |     | 0,2   | 12,9 |    |
| 3/4"   | 21,7 | 20 |      |     |    | 0,7  | 39,9  | 0,4 | 23,5  |      |    |
| 1"     | 27,3 | 25 |      |     |    | 0,6  | 63,2  | 0,4 | 37,2  |      |    |
| 1 1/4" | 36   | 32 | 0,3  |     | 30 | 1,1  | 109,9 |     | 0,6   | 64,7 |    |
| 1 1/2" | 41,9 | 40 |      |     |    | 1,5  | 148,9 | 0,9 | 87,6  |      |    |
| 2"     | 53,1 | 50 |      |     |    | 2,4  | 239,2 | 1,4 | 140,8 |      |    |
| 2 1/2" | 68,9 | 65 |      |     |    | 4,0  | 402,7 | 2,4 | 237,0 |      |    |
| 3"     | 80,9 | 80 |      |     |    | 5,6  | 555,2 | 3,3 | 326,7 |      |    |

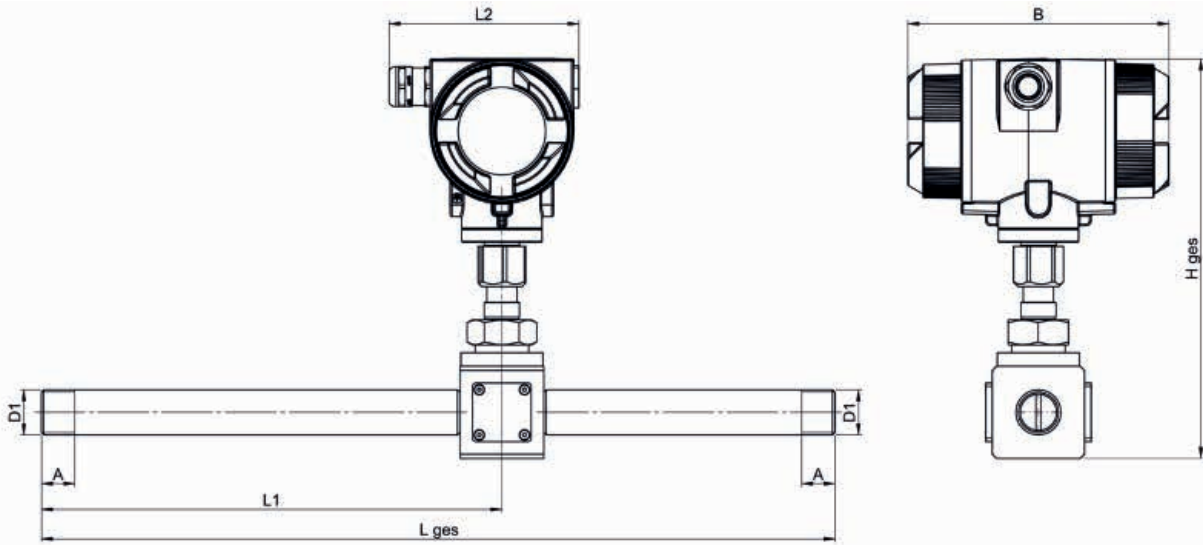

| VU 570 - with thread |              |              |            |         |         |            |        |        |
|----------------------|--------------|--------------|------------|---------|---------|------------|--------|--------|
| Connection thread    | AD pipe - mm | ID pipe - mm | L ges - mm | L1 - mm | L2 - mm | H ges - mm | B - mm | A - mm |
| R 1/2"               | 21,3         | 16,1         | 300        | 210     | 113,4   | 238        | 156    | 20     |
| R 3/4"               | 26,9         | 21,7         | 475        | 275     | 113,4   | 238        | 156    | 20     |
| R1"                  | 33,7         | 27,3         | 475        | 275     | 113,4   | 253        | 156    | 25     |
| R1 1/4"              | 42,4         | 36,0         | 475        | 275     | 113,4   | 253        | 156    | 25     |
| R1 1/2"              | 48,3         | 41,9         | 475        | 275     | 113,4   | 260        | 156    | 25     |
| R2"                  | 60,3         | 53,1         | 475        | 275     | 113,4   | 271        | 156    | 30     |

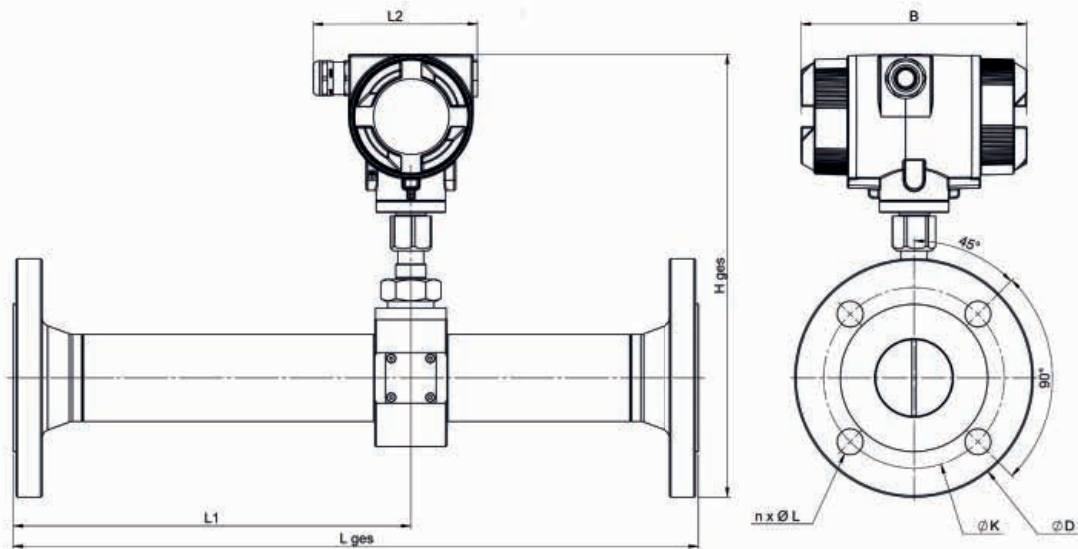

| VU 570 - with flanges |              |              |            |         |         |            |        |     |     |         |
|-----------------------|--------------|--------------|------------|---------|---------|------------|--------|-----|-----|---------|
| Pipe                  | AD pipe - mm | ID pipe - mm | L ges - mm | L1 - mm | L2 - mm | H ges - mm | B - mm | Ø D | Ø K | n x Ø L |
| DN 15                 | 21,3         | 16,1         | 300        | 210     | 113,4   | 258,5      | 156    | 95  | 65  | 4x14    |
| DN 20                 | 26,9         | 21,7         | 475        | 275     | 113,4   | 263,5      | 156    | 105 | 75  | 4x14    |
| DN 25                 | 33,7         | 27,3         | 475        | 275     | 113,4   | 276        | 156    | 115 | 85  | 4x14    |
| DN 32                 | 42,4         | 36,0         | 475        | 275     | 113,4   | 288,5      | 156    | 140 | 100 | 4x18    |
| DN 40                 | 48,3         | 41,9         | 475        | 275     | 113,4   | 293        | 156    | 150 | 110 | 4x18    |
| DN 50                 | 60,3         | 53,1         | 475        | 275     | 113,4   | 306,5      | 156    | 165 | 125 | 4x18    |
| DN 65                 | 76,1         | 68,9         | 475        | 275     | 113,4   | 325        | 156    | 185 | 145 | 8x18    |
| DN 80                 | 88,9         | 80,9         | 475        | 275     | 113,4   | 339        | 156    | 200 | 160 | 8x18    |





## VX 570 - Vortex Flow sensor for steam, gases and liquids

The high-precision all-rounder with integrated pressure and temperature compensation

### FIELD OF APPLICATION:

- Measurement of saturated steam or superheated steam
- Measurement of liquids
- Measurement of mixed gases
- Measurement of corrosive media

### Benefits at a glance:

- Measurement of standard volume flow, operating volume flow, mass flow
- Measurement at high temperatures of up to 350°C
- Measurement up to 63 bar(g)
- Suitable for unknown/changing gas compositions and mixed gases
- Aggression resistant – all parts in contact with media made of stainless steel
- Not sensitive to vibrations due to reference vibration measurement
- No moving parts



### Vortex operating principle, vortex frequency:

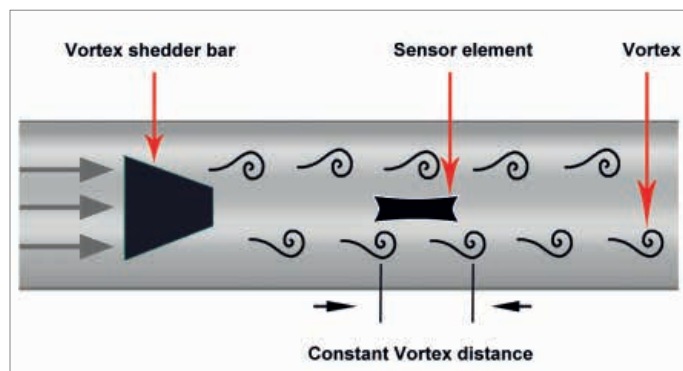





Example code for VX 570:

0698 0570\_A1\_B1\_C1\_D1\_E1\_F1\_G1\_H1\_I1

#### Basic model

|    |  |
|----|--|
| A1 | Vortex mass flow meter with integrated temperature and pressure sensor |
| A2 | Vortex flow meter without integrated temperature and pressure sensor   |

#### Measured medium:

|    |         |
|----|---------|
| B1 | Steam   |
| B2 | Liquids |
| B3 | Gas     |

#### Display option

|    |              |
|----|--------------|
| C1 | With display |
|----|--------------|

#### Measuring section

|     |                |
|-----|----------------|
| D1  | 1/2" (DN 15)   |
| D2  | 3/4" (DN 20)   |
| D3  | 1" (DN 25)     |
| D4  | 1 1/4" (DN 32) |
| D5  | 1 1/2" (DN 40) |
| D6  | 2" (DN 50)     |
| D7  | 2 1/2" (DN 65) |
| D8  | 3" (DN 80)     |
| D9  | 4" (DN 100)    |
| D10 | 5" (DN 125)    |
| D11 | 6" (DN 150)    |
| D12 | 8" (DN 200)    |
| D13 | 10" (DN 250)   |
| D14 | 12" (DN 300)   |

#### Process connection

|    |   |
|----|---|
| E1 | Wafer type up to 16 bar(g) / 232 psi(g) |
| E2 | Flange DIN PN 16                        |
| E3 | Flange DIN PN 25                        |
| E4 | Flange DIN PN 40                        |
| E5 | Flange DIN PN 63                        |
| E6 | Flange ANSI Class 150 lbs               |
| E7 | Flange ANSI Class 300 lbs               |
| E8 | Flange ANSI Class 400 lbs               |

#### Signal outputs / bus connection option

|    |  |
|----|--|
| F1 | 3 x 4...20 mA analogue output (not electrically isolated), RS 485 (Modbus-RTU) |
| F3 | RS 485 (Modbus-RTU)  |

#### Reference standard

|    |                      |
|----|----------------------|
| G1 | 20 °C, 1000 mbar     |
| G2 | 0 °C, 1013.25 mbar   |
| G3 | 15 °C, 981 mbar      |
| G4 | 15 °C, 1013.25 mbar  |
| G5 | Operating conditions |

#### Surface condition

|    |  |
|----|--|
| H1 | Standard version   |
| H2 | Special cleaning – oil and grease free (e.g. for oxygen application) |

#### Max. process temperature

|    |              |
|----|--------------|
| I1 | Up to 150 °C |
| I2 | Up to 250 °C |
| I3 | Up to 350 °C |

#### Measuring ranges of VX 570 (in m/s under operating conditions)

| Nominal width  | Gas   |        | Steam |        | Liquids |       |
|----------------|-------|--------|-------|--------|---------|-------|
|                | from  | to     | from  | to     | from    | to    |
| DN 15 - DN 20  | 6 m/s | 60 m/s | 6 m/s | 70 m/s | 0.3 m/s | 7 m/s |
| DN 25 - DN 32  | 4 m/s | 60 m/s | 4 m/s | 70 m/s |         |       |
| DN 40 - DN 300 | 2 m/s | 60 m/s | 2 m/s | 70 m/s |         |       |

#### TECHNICAL DATA VX 570

|   |  |
|---|--|
| <b>Measuring range:</b>   | See table  |
| <b>Measured medium:</b>   | Primary single-phase gases, mixed gases, saturated steam, superheated steam and liquids          |
| <b>Accuracy:</b>  | <b>Gas / Steam:</b><br>± 1 % of m.v., (Re > 20,000)<br>± 2 % of m.v., (10,000 < Re < 20,000)     |
| <b>Volume flow (m³/h)</b>   | <b>Liquids:</b><br>± 0.75 % of m.v., (Re > 20,000)<br>± 2 % of m.v., (10,000 < Re < 20,000)      |
| <b>Mass flow (kg/h) or standard volume flow (Nm³/h)</b>             | <b>Gas / Steam:</b><br>± 1.5 % of m.v., (Re > 20,000)<br>± 2.5 % of m.v., (10,000 < Re < 20,000) |
| <b>Measuring principle:</b>   | Vortex – vortex frequency measurement  |
| <b>Process temperature:</b>   | -40...+350°C   |
| <b>Process pressure:</b>  | Up to 63 bar(g)  |
| <b>Protection class</b>   | IP67   |
| <b>Material measuring section and parts in contact with medium:</b> | Stainless steel SS304 (SS316 on request)   |
| <b>Material display unit:</b>                                       | Aluminium – die casting  |
| <b>Signal outputs:</b>  | As standard:<br>RS 485 (Modbus-RTU), 3x 4...20 mA,<br><br><b>Optional:</b><br>Ethernet interface |
| <b>Power supply:</b>  | 18...36 VDC  |
| <b>Measuring span:</b>  | Gases: 1:30<br>Vapour: 1:35<br>Liquids 1:23  |
| <b>Viscosity</b>  | DN 15 ≤ 4 mPas<br>DN 25 ≤ 5 mPas<br>DN 40...DN 300 ≤ 7 mPas                                      |
| <b>Repeatability:</b>   | ± 0.3 % of m.v.  |
| <b>Process connection:</b>  | Flange DIN EN1092-1<br>Flange ANSI<br>Wafer type   |

| DESCRIPTION  | ORDER NO.                           |
|--|-------------------------------------|
| VX 570 – Vortex flow sensor for steam, gases and liquids                         | 0698 0570 +<br>Order code<br>A...I_ |
| <b>Further accessories:</b><br>ISO calibration certificate at 5 measuring points | 3200 0001                           |



| Measuring ranges for <b>gases and liquids</b> VX 570 under operating conditions |     |        |               |               |              |              |               |               |              |              |
|---|-----|--------|---------------|---------------|--------------|--------------|---------------|---------------|--------------|--------------|
| Inside diameter of pipe   |     |        | Gases         |               |              |              | Liquids       |               |              |              |
|   |     |        | Min flow m3/h | Max flow m3/h | Min flow cfm | Max flow cfm | Min flow m3/h | Max flow m3/h | Min flow GPM | Max flow GPM |
| Inch  | mm  | DN     |               |               |              |              |               |               |              |              |
| 1/2"  | 15  | DN 15  | 3.8           | 44.5          | 2.2          | 26.2         | 0.2           | 4.4           | 0.8          | 19.6         |
| 3/4"  | 20  | DN 20  | 6.8           | 79.1          | 4            | 46.6         | 0.3           | 7.9           | 1.5          | 34.8         |
| 1"  | 25  | DN 25  | 7.1           | 123.6         | 4.2          | 72.7         | 0.5           | 12.4          | 2.3          | 54.4         |
| 1 1/4"  | 32  | DN 32  | 11.6          | 202.5         | 6.8          | 119.2        | 0.9           | 20.2          | 3.8          | 89.2         |
| 1 1/2"  | 40  | DN 40  | 9             | 316.4         | 5.3          | 186.2        | 1.4           | 31.6          | 6.0          | 139.3        |
| 2"  | 50  | DN 50  | 14.1          | 494.4         | 8.3          | 291          | 2.1           | 49.4          | 9.3          | 217.7        |
| 2 1/2"  | 65  | DN 65  | 23.9          | 835.5         | 14           | 491.7        | 3.6           | 83.5          | 15.8         | 367.8        |
| 3"  | 80  | DN 80  | 36.2          | 1265.5        | 21.3         | 744.9        | 5.4           | 126.6         | 23.9         | 557.2        |
| 4"  | 100 | DN 100 | 56.5          | 1977.4        | 33.3         | 1163.9       | 8.5           | 197.7         | 37.3         | 870.6        |
| 5"  | 125 | DN 125 | 88.3          | 3089.7        | 52           | 1818.5       | 13.2          | 309.0         | 58.3         | 1360.4       |
| 6"  | 150 | DN 150 | 127.1         | 4449.2        | 74.8         | 2618.7       | 19.1          | 444.9         | 84.0         | 1958.9       |
| 8"  | 200 | DN 200 | 226           | 7909.6        | 133          | 4655.4       | 33.9          | 791.0         | 149.3        | 3482.5       |
| 10"   | 250 | DN 250 | 353.1         | 12358.8       | 207.8        | 7274.1       | 53.0          | 1235.9        | 233.2        | 5441.4       |
| 12"   | 300 | DN 300 | 508.5         | 17796.6       | 299.3        | 10474.7      | 76.3          | 1779.7        | 335.8        | 7835.6       |

| Measuring ranges for <b>steam</b> VX 570 under operating conditions in kg/h |     |        |                |         |               |         |               |         |               |         |               |         |               |         |               |         |
|---|-----|--------|----------------|---------|---------------|---------|---------------|---------|---------------|---------|---------------|---------|---------------|---------|---------------|---------|
| Inside diameter of pipe   |     |        | T=112 °C       |         | T=121 °C      |         | T=134 °C      |         | T=144 °C      |         | T=159 °C      |         | T=165 °C      |         | T=171 °C      |         |
|   |     |        | P=0.5 bar(g)   |         | P=1 bar(g)    |         | P=2 bar(g)    |         | P=3 bar(g)    |         | P=5 bar(g)    |         | P=6 bar(g)    |         | P=7 bar(g)    |         |
|   |     |        | D=0.8798 kg/m3 |         | D=1.155 kg/m3 |         | D=1.672 kg/m3 |         | D=2.185 kg/m3 |         | D=3.182 kg/m3 |         | D=3.671 kg/m3 |         | D=4.218 kg/m3 |         |
| Inch  | mm  | DN     | Min            | Max     | Min           | Max     | Min           | Max     | Min           | Max     | Min           | Max     | Min           | Max     | Min           | Max     |
| 1/2"  | 15  | DN 15  | 3.4            | 39.1    | 4.4           | 51.4    | 6.4           | 74.4    | 8.3           | 97.2    | 12.1          | 141.6   | 14.0          | 163.3   | 16.1          | 187.7   |
| 3/4"  | 20  | DN 20  | 6.0            | 69.6    | 7.8           | 91.4    | 11.3          | 132.2   | 14.8          | 172.8   | 21.6          | 251.7   | 24.9          | 290.4   | 28.6          | 333.6   |
| 1"  | 25  | DN 25  | 6.2            | 108.7   | 8.2           | 142.7   | 11.8          | 206.6   | 15.4          | 270.0   | 22.5          | 393.3   | 25.9          | 453.7   | 29.8          | 521.3   |
| 1 1/4"  | 32  | DN 32  | 10.2           | 178.1   | 13.4          | 233.9   | 19.3          | 338.6   | 25.3          | 442.4   | 36.8          | 644.3   | 42.5          | 743.3   | 48.8          | 854.1   |
| 1 1/2"  | 40  | DN 40  | 8.0            | 278.4   | 10.4          | 365.4   | 15.1          | 529.0   | 19.8          | 691.3   | 28.8          | 1006.7  | 33.2          | 1161.4  | 38.1          | 1334.5  |
| 2"  | 50  | DN 50  | 12.4           | 434.9   | 16.3          | 571.0   | 23.6          | 826.6   | 30.9          | 1080.2  | 44.9          | 1573.0  | 51.9          | 1814.8  | 59.6          | 2085.2  |
| 2 1/2"  | 65  | DN 65  | 21.0           | 735.0   | 27.6          | 964.9   | 39.9          | 1396.9  | 52.2          | 1825.5  | 76.0          | 2658.4  | 87.6          | 3066.9  | 100.7         | 3523.9  |
| 3"  | 80  | DN 80  | 31.8           | 1113.4  | 41.8          | 1461.7  | 60.5          | 2116.0  | 79.0          | 2765.2  | 115.1         | 4026.9  | 132.7         | 4645.8  | 152.5         | 5338.0  |
| 4"  | 100 | DN 100 | 49.7           | 1739.7  | 65.3          | 2283.9  | 94.5          | 3306.2  | 123.4         | 4320.6  | 179.8         | 6292.1  | 207.4         | 7259.0  | 238.3         | 8340.7  |
| 5"  | 125 | DN 125 | 77.7           | 2718.3  | 102.0         | 3568.6  | 147.6         | 5166.0  | 192.9         | 6751.0  | 280.9         | 9831.4  | 324.1         | 11342.2 | 372.4         | 13032.3 |
| 6"  | 150 | DN 150 | 111.8          | 3914.4  | 146.8         | 5138.8  | 212.5         | 7439.0  | 277.8         | 9721.4  | 404.5         | 14157.2 | 466.7         | 16332.8 | 536.2         | 18766.5 |
| 8"  | 200 | DN 200 | 198.8          | 6958.9  | 261.0         | 9135.6  | 377.9         | 13224.9 | 493.8         | 17282.5 | 719.1         | 25168.4 | 829.6         | 29036.2 | 953.2         | 33362.7 |
| 10"   | 250 | DN 250 | 310.7          | 10873.2 | 407.8         | 14274.4 | 590.4         | 20663.8 | 771.5         | 27003.9 | 1123.6        | 39325.6 | 1296.3        | 45369.0 | 1489.4        | 52129.2 |
| 12"   | 300 | DN 300 | 447.4          | 15657.5 | 587.3         | 20555.1 | 850.2         | 29755.9 | 1111.0        | 38885.6 | 1618.0        | 56628.8 | 1866.6        | 65331.4 | 2144.7        | 75066.1 |

| Measuring ranges for <b>steam</b> VX 570 under operating conditions kg/h |     |        |               |         |               |          |               |          |               |          |               |          |               |          |
|--|-----|--------|---------------|---------|---------------|----------|---------------|----------|---------------|----------|---------------|----------|---------------|----------|
| Inside diameter of pipe  |     |        | T=176 °C      |         | T=185 °C      |          | T=192 °C      |          | T=199 °C      |          | T=210 °C      |          | T=215 °C      |          |
|  |     |        | P=8 bar(g)    |         | P=10 bar(g)   |          | P=12 bar(g)   |          | P=14 bar(g)   |          | P=18 bar(g)   |          | P=20 bar(g)   |          |
|  |     |        | D=4.723 kg/m3 |         | D=5.752 kg/m3 |          | D=6.671 kg/m3 |          | D=7.706 kg/m3 |          | D=9.593 kg/m3 |          | D=10.57 kg/m3 |          |
| Inch   | mm  | DN     | Min           | Max     | Min           | Max      | Min           | Max      | Min           | Max      | Min           | Max      | Min           | Max      |
| 1/2"   | 15  | DN 15  | 18.0          | 210.1   | 21.9          | 255.9    | 25.4          | 296.8    | 29.4          | 342.9    | 36.6          | 426.8    | 40.3          | 470.3    |
| 3/4"   | 20  | DN 20  | 32.0          | 373.6   | 39.0          | 455.0    | 45.2          | 527.6    | 52.2          | 609.5    | 65.0          | 758.8    | 71.7          | 836.0    |
| 1"   | 25  | DN 25  | 33.4          | 583.7   | 40.6          | 710.9    | 47.1          | 824.5    | 54.4          | 952.4    | 67.7          | 1185.6   | 74.6          | 1306.3   |
| 1 1/4"   | 32  | DN 32  | 54.6          | 956.3   | 66.6          | 1164.7   | 77.2          | 1350.8   | 89.2          | 1560.4   | 111.0         | 1942.4   | 122.3         | 2140.3   |
| 1 1/2"   | 40  | DN 40  | 42.7          | 1494.3  | 52.0          | 1819.8   | 60.3          | 2110.6   | 69.7          | 2438.1   | 86.7          | 3035.1   | 95.5          | 3344.2   |
| 2"   | 50  | DN 50  | 66.7          | 2334.8  | 81.2          | 2843.5   | 94.2          | 3297.8   | 108.8         | 3809.5   | 135.5         | 4742.3   | 149.3         | 5225.3   |
| 2 1/2"   | 65  | DN 65  | 112.7         | 3945.8  | 137.3         | 4805.5   | 159.2         | 5573.3   | 183.9         | 6438.0   | 229.0         | 8014.5   | 252.3         | 8830.7   |
| 3"   | 80  | DN 80  | 170.8         | 5977.1  | 208.0         | 7279.4   | 241.2         | 8442.4   | 278.6         | 9752.2   | 346.9         | 12140.3  | 382.2         | 13376.7  |
| 4"   | 100 | DN 100 | 266.8         | 9339.3  | 325.0         | 11374.0  | 376.9         | 13191.2  | 435.4         | 15237.9  | 542.0         | 18969.2  | 597.2         | 20901.1  |
| 5"   | 125 | DN 125 | 416.9         | 14592.6 | 507.8         | 17771.9  | 588.9         | 20611.3  | 680.3         | 23809.1  | 846.8         | 29639.4  | 933.1         | 32658.0  |
| 6"   | 150 | DN 150 | 600.4         | 21013.3 | 731.2         | 25591.5  | 848.0         | 29680.3  | 979.6         | 34285.2  | 1219.4        | 42680.7  | 1343.6        | 47027.5  |
| 8"   | 200 | DN 200 | 1067.3        | 37357.1 | 1299.9        | 45496.0  | 1507.6        | 52765.0  | 1741.5        | 60951.4  | 2167.9        | 75876.8  | 2388.7        | 83604.5  |
| 10"  | 250 | DN 250 | 1667.7        | 58370.4 | 2031.1        | 71087.6  | 2355.6        | 82445.3  | 2721.0        | 95236.6  | 3387.4        | 118557.6 | 3732.3        | 130632.1 |
| 12"  | 300 | DN 300 | 2401.5        | 84053.4 | 2924.7        | 102366.1 | 3392.0        | 118721.2 | 3918.3        | 137140.7 | 4877.8        | 170722.9 | 5374.6        | 188110.2 |



| Measuring ranges for <b>steam</b> VX 570 under operating conditions in lb/h |     |        |                 |         |                 |         |                 |         |                 |         |                 |          |                 |          |                 |          |
|---|-----|--------|-----------------|---------|-----------------|---------|-----------------|---------|-----------------|---------|-----------------|----------|-----------------|----------|-----------------|----------|
| Inside diameter of pipe   |     |        | T=233.6 °F      |         | T=249.8 °F      |         | T=273.2 °F      |         | T=291.2 °F      |         | T=318.2 °F      |          | T=329 °F        |          | T=339.8 °F      |          |
|   |     |        | P=7.3 psi(g)    |         | P=14.5 psi(g)   |         | P=29 psi(g)     |         | P=43.5 psi(g)   |         | P=72.5 psi(g)   |          | P=87 psi(g)     |          | P=101.5 psi(g)  |          |
|   |     |        | D=0.0034 lb/ft3 |         | D=0.0721 lb/ft3 |         | D=0.1044 lb/ft3 |         | D=0.1364 lb/ft3 |         | D=0.1986 lb/ft3 |          | D=0.2292 lb/ft3 |          | D=0.2633 lb/ft3 |          |
| Inch  | mm  | DN     | Min             | Max     | Min             | Max     | Min             | Max     | Min             | Max     | Min             | Max      | Min             | Max      | Min             | Max      |
| 1/2"  | 15  | DN 15  | 7.4             | 86.3    | 9.7             | 113.3   | 14.1            | 164.0   | 18.4            | 214.3   | 26.8            | 312.1    | 30.9            | 360.1    | 35.5            | 413.7    |
| 3/4"  | 20  | DN 20  | 13.2            | 153.4   | 17.3            | 201.4   | 25.0            | 291.6   | 32.7            | 381.0   | 47.6            | 554.9    | 54.9            | 640.1    | 63.0            | 735.5    |
| 1"  | 25  | DN 25  | 13.7            | 239.7   | 18.0            | 314.7   | 26.0            | 455.6   | 34.0            | 595.3   | 49.5            | 867.0    | 57.2            | 1000.2   | 65.7            | 1149.3   |
| 1 1/4"  | 32  | DN 32  | 22.4            | 392.7   | 29.5            | 515.6   | 42.7            | 746.4   | 55.7            | 975.4   | 81.2            | 1420.5   | 93.6            | 1638.8   | 107.6           | 1882.9   |
| 1 1/2"  | 40  | DN 40  | 17.5            | 613.7   | 23.0            | 805.6   | 33.3            | 1166.2  | 43.5            | 1524.1  | 63.4            | 2219.5   | 73.2            | 2560.6   | 84.1            | 2942.1   |
| 2"  | 50  | DN 50  | 27.4            | 958.9   | 36.0            | 1258.8  | 52.1            | 1822.2  | 68.0            | 2381.3  | 99.1            | 3467.9   | 114.3           | 4000.9   | 131.3           | 4597.0   |
| 2 1/2"  | 65  | DN 65  | 46.3            | 1620.5  | 60.8            | 2127.3  | 88.0            | 3079.6  | 115.0           | 4024.5  | 167.5           | 5860.8   | 193.2           | 6761.5   | 222.0           | 7768.9   |
| 3"  | 80  | DN 80  | 70.1            | 2454.7  | 92.1            | 3222.5  | 133.3           | 4664.9  | 174.2           | 6096.2  | 253.7           | 8877.9   | 292.6           | 10242.2  | 336.2           | 11768.4  |
| 4"  | 100 | DN 100 | 109.6           | 3835.4  | 143.9           | 5035.1  | 208.3           | 7289.0  | 272.2           | 9525.3  | 396.3           | 13871.7  | 457.2           | 16003.4  | 525.4           | 18388.0  |
| 5"  | 125 | DN 125 | 171.2           | 5992.8  | 224.8           | 7867.4  | 325.4           | 11389.0 | 425.2           | 14883.3 | 619.3           | 21674.5  | 714.4           | 25005.4  | 820.9           | 28731.3  |
| 6"  | 150 | DN 150 | 246.6           | 8629.7  | 323.7           | 11329.1 | 468.6           | 16400.2 | 612.3           | 21432.0 | 891.8           | 31211.3  | 1028.8          | 36007.7  | 1182.1          | 41373.1  |
| 8"  | 200 | DN 200 | 438.3           | 15341.7 | 575.4           | 20140.5 | 833.0           | 29155.8 | 1088.6          | 38101.4 | 1585.3          | 55486.7  | 1829.0          | 64013.8  | 2101.5          | 73552.2  |
| 10"   | 250 | DN 250 | 684.9           | 23971.4 | 899.1           | 31469.6 | 1301.6          | 45556.0 | 1701.0          | 59533.4 | 2477.1          | 86698.0  | 2857.8          | 100021.5 | 3283.6          | 114925.3 |
| 12"   | 300 | DN 300 | 986.3           | 34518.8 | 1294.7          | 45316.2 | 1874.3          | 65600.6 | 2449.4          | 85728.1 | 3567.0          | 124845.2 | 4115.2          | 144031.0 | 4728.4          | 165492.4 |

| Measuring ranges for <b>steam</b> VX 570 under operating conditions in lb/h |     |        |                 |          |                 |          |                 |          |                 |          |                 |          |                 |          |  |  |
|---|-----|--------|-----------------|----------|-----------------|----------|-----------------|----------|-----------------|----------|-----------------|----------|-----------------|----------|--|--|
| Inside diameter of pipe   |     |        | T=348.8 °F      |          | T=365 °F        |          | T=377.6 °F      |          | T=390.2 °F      |          | T=410 °F        |          | T=419 °F        |          |  |  |
|   |     |        | P=116 psi(g)    |          | P=145 psi(g)    |          | P=174 psi(g)    |          | P=203 psi(g)    |          | P=261 psi(g)    |          | P=290 psi(g)    |          |  |  |
|   |     |        | D=0.2948 lb/ft3 |          | D=0.3591 lb/ft3 |          | D=0.4165 lb/ft3 |          | D=0.4811 lb/ft3 |          | D=0.5989 lb/ft3 |          | D=0.6599 lb/ft3 |          |  |  |
| Inch  | mm  | DN     | Min             | Max      | Min             | Max      | Min             | Max      | Min             | Max      | Min             | Max      | Min             | Max      |  |  |
| 1/2"  | 15  | DN 15  | 39.7            | 463.3    | 48.4            | 564.2    | 56.1            | 654.3    | 64.8            | 755.9    | 80.7            | 940.9    | 88.9            | 1036.8   |  |  |
| 3/4"  | 20  | DN 20  | 70.6            | 823.6    | 86.0            | 1003.0   | 99.7            | 1163.3   | 115.2           | 1343.7   | 143.4           | 1672.8   | 158.0           | 1843.2   |  |  |
| 1"  | 25  | DN 25  | 73.5            | 1286.8   | 89.6            | 1567.2   | 103.9           | 1817.6   | 120.0           | 2099.6   | 149.4           | 2613.7   | 164.6           | 2879.9   |  |  |
| 1 1/4"  | 32  | DN 32  | 120.5           | 2108.4   | 146.7           | 2567.7   | 170.2           | 2978.0   | 196.6           | 3440.0   | 244.7           | 4282.4   | 269.6           | 4718.5   |  |  |
| 1 1/2"  | 40  | DN 40  | 94.1            | 3294.3   | 114.6           | 4012.1   | 132.9           | 4653.1   | 153.6           | 5375.0   | 191.2           | 6691.2   | 210.6           | 7372.7   |  |  |
| 2"  | 50  | DN 50  | 147.1           | 5147.4   | 179.1           | 6268.9   | 207.7           | 7270.4   | 240.0           | 8398.4   | 298.7           | 10455.0  | 329.1           | 11519.8  |  |  |
| 2 1/2"  | 65  | DN 65  | 248.5           | 8699.1   | 302.7           | 10594.4  | 351.1           | 12287.0  | 405.5           | 14193.3  | 504.8           | 17668.9  | 556.2           | 19468.4  |  |  |
| 3"  | 80  | DN 80  | 376.5           | 13177.3  | 458.5           | 16048.3  | 531.8           | 18612.3  | 614.3           | 21500.0  | 764.7           | 26764.8  | 842.6           | 29490.6  |  |  |
| 4"  | 100 | DN 100 | 588.3           | 20589.6  | 716.4           | 25075.4  | 830.9           | 29081.7  | 959.8           | 33593.7  | 1194.9          | 41819.9  | 1316.5          | 46079.1  |  |  |
| 5"  | 125 | DN 125 | 919.2           | 32171.2  | 1119.4          | 39180.3  | 1298.3          | 45440.2  | 1499.7          | 52490.2  | 1867.0          | 65343.7  | 2057.1          | 71998.6  |  |  |
| 6"  | 150 | DN 150 | 1323.6          | 46326.5  | 1612.0          | 56419.7  | 1869.5          | 65433.9  | 2159.6          | 75585.9  | 2688.4          | 94094.9  | 2962.2          | 103678.0 |  |  |
| 8"  | 200 | DN 200 | 2353.1          | 82358.2  | 2865.8          | 100301.6 | 3323.6          | 116326.8 | 3839.3          | 134374.9 | 4779.4          | 167279.8 | 5266.2          | 184316.4 |  |  |
| 10"   | 250 | DN 250 | 3676.7          | 128684.7 | 4477.8          | 156721.3 | 5193.2          | 181760.7 | 5998.9          | 209960.7 | 7467.8          | 261374.7 | 8228.4          | 287994.4 |  |  |
| 12"   | 300 | DN 300 | 5294.5          | 185306.0 | 6448.0          | 225678.6 | 7478.2          | 261735.4 | 8638.4          | 302343.4 | 10753.7         | 376379.5 | 11848.9         | 414711.9 |  |  |



## Accessories VA 500/520/525



| DESCRIPTION                                       | ORDER NO. |
|---|-----------|
| Connection cable for VA/FA series, 5 m            | 0553 0104 |
| Connection cable for VA/FA sensors, 10 m          | 0553 0105 |
| Connection cable for VA/FA series, 20 m           | 0553 0120 |
| Cable for alarm/pulse output, with M12 plug, 5 m  | 0553 0106 |
| Cable for alarm/pulse output, with M12 plug, 10 m | 0553 0107 |
| Connection cable for VA/FA series, 5 m shielded   | 0553 0129 |
| Connection cable for VA/FA series, 10 m shielded  | 0553 0130 |

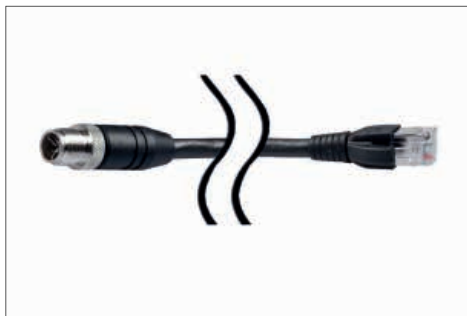

| DESCRIPTION  | ORDER NO. |
|--|-----------|
| Ethernet connection cable, length 5 m, M12 plug x-coded (8 pin) to RJ 45 plug  | 0553 2503 |
| Ethernet connection cable, length 10 m, M12 plug x-coded (8 pin) to RJ 45 plug | 0553 2504 |



| DESCRIPTION   | ORDER NO.   |
|---|-------------|
| M12 T-plug for VA 500/520 for connecting multiple sensors to an M-Bus or Modbus network | 0 2000 0823 |



| DESCRIPTION                 | ORDER NO.   |
|-----------------------------|-------------|
| M12 plug for VA 500/520/525 | 0 2000 0082 |
| M12 plug 90° angled         | 0219 0060   |

## Accessories VA 500/550



| DESCRIPTION                        | ORDER NO. |
|------------------------------------|-----------|
| Drilling jig incl. drill (Ø 13 mm) | 0530 1108 |



| DESCRIPTION  | ORDER NO. |
|--|-----------|
| Wall thickness measuring device CS 0495 incl. case and calibration block | 0560 0495 |



| DESCRIPTION   | ORDER NO. |
|---|-----------|
| Welding nipple, L = 35 mm, male thread, R 1/2" stainless steel 1.4301 | 3300 0006 |
| Welding nipple, L = 35 mm, male thread, R 1/2" stainless steel 1.4571 | 3300 0007 |



| DESCRIPTION                           | ORDER NO. |
|---------------------------------------|-----------|
| Ball valve 1/1 G 1/2" stainless steel | 3300 0002 |



| DESCRIPTION  | ORDER NO. |
|--|-----------|
| High-pressure safety device for the installation of insertion sensors > 10 bar, incl. ball valve | 0530 2205 |

Order code: **0530 2205 \_A1\_B1\_C1\_D1**

| Sensor Type |                        |
|-------------|------------------------|
| A1          | VA 500 (up to 50 bar)  |
| A2          | VA 550 (up to 100 bar) |
| A3          | VD 500 (up to 20 bar)  |

| Sensor length |        |
|---------------|--------|
| B1            | 160 mm |
| B2            | 220 mm |
| B3            | 300 mm |
| B4            | 400 mm |
| B5            | 500 mm |
| B6            | 600 mm |

| Connection thread |          |
|-------------------|----------|
| C1                | G 1/2"   |
| C2                | NPT 1/2" |

| Approval |                     |
|----------|---------------------|
| D1       | Without             |
| D2       | DVGW (up to 16 bar) |

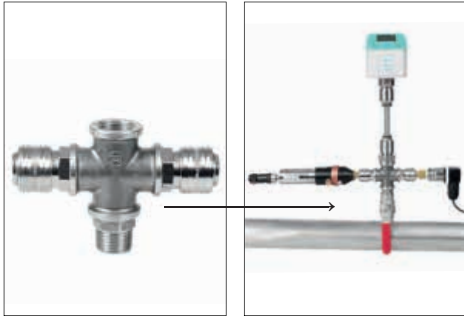

## Accessories VA 500/550

**DESCRIPTION**

X-connection for connection of pressure and dew point sensor at the same measuring point (incl. 2x quick-lock coupling)

**ORDER NO.**

0553 0133

**DESCRIPTION**

Thread adapter G 1/2" female thread to NPT 1/2" male thread

**ORDER NO.**

0553 0134

## Accessories VA 550/570

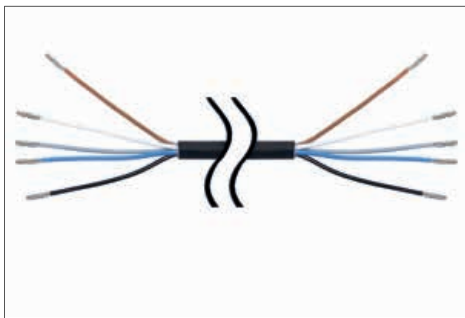
**DESCRIPTION**

Connection cable 5 m with open ends

**ORDER NO.**

0553 0108

Connection cable 10 m with open ends

0553 0109



Standard

ATEX

**DESCRIPTION**

PNG cable screwing M20 x 1,5- for standard

**ORDER NO.**

0553 0552

PNG cable screwing M20 x 1,5 - for ATEX

0553 0551

## Accessories VA 520/570



Aluminium

**DESCRIPTION**

Closing cap for measuring section VA 520/VA 570 (material: aluminium)

**ORDER NO.**

0190 0001

Closing cap for measuring section VA 520/VA 570 (material: stainless steel 1.4571)

0190 0002

## Accessories for all VA 5xx



| DESCRIPTION   | ORDER NO. |
|---|-----------|
| Mains unit in wall housing for maximum 2 sensors of the series VA/FA 5xx, 100-240 V, 23 VA, 50-60 Hz / 24 VDC, 0.35 A | 0554 0110 |
| Mains unit in wall housing for max. 4 sensors of the series VA500/520 100-240 V, 23 VA, 50-60 Hz / 24 VDC, 0,35 A     | 0554 0111 |



| DESCRIPTION  | ORDER NO. |
|--|-----------|
| AC adapter plug 100-240 VAC / 24 VDC for VA/FA 5xx | 0554 0109 |

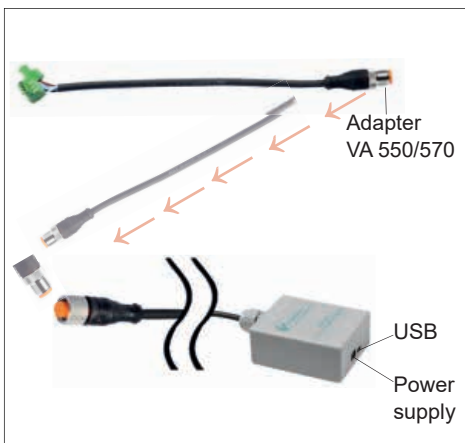

| DESCRIPTION   | ORDER NO. |
|---|-----------|
| CS Service Software incl. PC connection set, USB connection and interface adapter to the sensor | 0554 2007 |



| DESCRIPTION   | ORDER NO. |
|---|-----------|
| External Gateway PROFIBUS for connection to integrated RS 485 interface | Z500 3008 |
| External Gateway PROFINET for connection to integrated RS 485 interface | Z500 3009 |



| DESCRIPTION   | ORDER NO. |
|---|-----------|
| Case for all sensors (dimensions: 500 x 360 x 120 mm) | 0554 6006 |

## Practical measuring section accessories

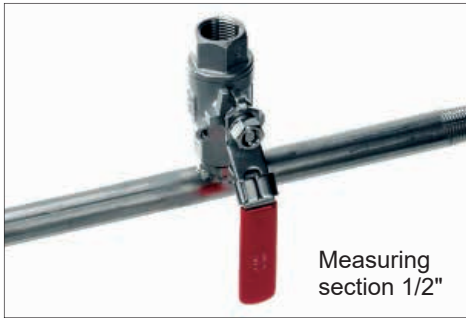

| MALE THREAD                            | PIPE (OUTER Ø X WALL THICKNESS) | TOTAL LENGTH | ORDER NO. |
|--|---------------------------------|--------------|-----------|
| R 1/2"                                 | 21.3 x 2.6 mm                   | 500 mm       | 4000 0015 |
| R 3/4"                                 | 26.9 x 2.6 mm                   | 600 mm       | 4000 0020 |
| R 1"                                   | 33.7 x 3.2 mm                   | 750 mm       | 4000 0025 |
| R 1 1/4"                               | 42.4 x 3.2 mm                   | 900 mm       | 4000 0032 |
| R 1 1/2"                               | 48.3 x 3.2 mm                   | 1000 mm      | 4000 0040 |
| R 2"                                   | 60.3 x 3.6 mm                   | 1250 mm      | 4000 0050 |
| R 2 1/2"                               | 76.1 x 3.6 mm                   | 1500 mm      | 4000 0065 |
| <b>From DN 80 with flange DIN 2633</b> |                                 |              |           |
| DN 80/88.9                             | 88.9 x 2.0 mm                   | 1850 mm      | 4000 0080 |
| DN 100/114.3                           | 114.3 x 2.0 mm                  | 2104 mm      | 4000 0100 |
| DN 125/139.7                           | 139.7 x 3.0 mm                  | 2860 mm      | 4000 0125 |
| DN 150/168.3                           | 168.3 x 3.0 mm                  | 3110 mm      | 4000 0150 |

### Measuring sections for precise measurements:

Measuring section in stainless steel 1.4301 incl. ball valve, up to DN 65 (R2 1/2") with R-male thread, from DN 80 with weld neck flange in acc. with DIN 2633.

## Practical spot drilling collar accessories for compressed air lines



If there is no measuring site with 1/2" ball valve present on existing pipes, it can be set up quickly and cost-effectively by means of spot drilling collars. The spot drilling collar is imposed onto the pipe and tightened via thread rods. The enveloping rubber gasket is pressure-tight up to 11 bar. By means of the drilling jig, it is possible to drill the spot drilling collar through the 1/2" ball valve into the existing pipe.

**Important:** Please indicate the exact outer diameter of the existing pipe when placing the order resp. please select the suitable spot drilling collar from the adjoining list.

| DESCRIPTION   | DN  | ORDER NO. |
|---|-----|-----------|
| Spot drilling collar for pipe Ø 032 - 036 mm, length: 100 mm* |     | 0500 0446 |
| Spot drilling collar for pipe Ø 036 - 040 mm, length: 100 mm* |     | 0500 0448 |
| Spot drilling collar for pipe Ø 040 - 044 mm, length: 150 mm* |     | 0500 0449 |
| Spot drilling collar for pipe Ø 044 - 051 mm, length: 200 mm* |     | 0500 0610 |
| Spot drilling collar for pipe Ø 048 - 055 mm, length: 200 mm* | 40  | 0500 0611 |
| Spot drilling collar for pipe Ø 052 - 059 mm, length: 200 mm* |     | 0500 0612 |
| Spot drilling collar for pipe Ø 057 - 064 mm, length: 200 mm* | 50  | 0500 0613 |
| Spot drilling collar for pipe Ø 063 - 070 mm, length: 200 mm* |     | 0500 0614 |
| Spot drilling collar for pipe Ø 070 - 077 mm, length: 200 mm* | 65  | 0500 0615 |
| Spot drilling collar for pipe Ø 075 - 083 mm, length: 200 mm* |     | 0500 0616 |
| Spot drilling collar for pipe Ø 082 - 090 mm, length: 200 mm* |     | 0500 0617 |
| Spot drilling collar for pipe Ø 087 - 097 mm, length: 200 mm* | 80  | 0500 0618 |
| Spot drilling collar for pipe Ø 095 - 104 mm, length: 200 mm* |     | 0500 0619 |
| Spot drilling collar for pipe Ø 102 - 112 mm, length: 200 mm* |     | 0500 0620 |
| Spot drilling collar for pipe Ø 108 - 118 mm, length: 200 mm* | 100 | 0500 0621 |
| Spot drilling collar for pipe Ø 118 - 128 mm, length: 200 mm* |     | 0500 0622 |
| Spot drilling collar for pipe Ø 125 - 135 mm, length: 200 mm* |     | 0500 0623 |
| Spot drilling collar for pipe Ø 133 - 144 mm, length: 200 mm* | 125 | 0500 0624 |
| Spot drilling collar for pipe Ø 145 - 155 mm, length: 250 mm* |     | 0500 0625 |
| Spot drilling collar for pipe Ø 151 - 161 mm, length: 250 mm* | 150 | 0500 0626 |
| Spot drilling collar for pipe Ø 159 - 170 mm, length: 250 mm* |     | 0500 0627 |
| Spot drilling collar for pipe Ø 168 - 180 mm, length: 250 mm* |     | 0500 0628 |
| Spot drilling collar for pipe Ø 180 - 191 mm, length: 250 mm* | 175 | 0500 0629 |
| Spot drilling collar for pipe Ø 193 - 203 mm, length: 300 mm* |     | 0500 0630 |
| Spot drilling collar for pipe Ø 200 - 210 mm, length: 300 mm* |     | 0500 0631 |
| Spot drilling collar for pipe Ø 209 - 220 mm, length: 300 mm* | 200 | 0500 0632 |

\*incl. 1/2" ball valve

\*not suitable for copper and plastic pipes

\*not suitable for aluminum



# VA 409 - Flow direction switch for compressed air systems



The thermal flow direction switch VA 409 with direction indication serves for determination of the flow direction of compressed air and gases especially in closed circular pipelines.

By means of VA 409 with flow direction indication the flow direction of the compressed air can be determined quickly and safely. Compared with the former mechanical paddle flow switches VA 409 is able to detect even the smallest changes in the flow direction quickly and without any mechanical movement.

The direction information in form of a potential-free contact (normally closed max. 60 VDC, 0.5 A) is transferred to the flow meters VA 5xx or to a separate building management system (BMS). Two LEDs show the flow direction.

In connection with 2 flow sensors VA 5xx incoming and out flowing compressed air in closed circular pipelines can be measured precisely.

### Special features:

- detects the smallest changes < 0.1 m/s relative to 20 °C and 1,000 mbar
- no mechanical wear parts
- easy installation under pressure



### TECHNICAL DATA VA 409

|  |   |
|--|---|
| <b>Response area detection of direction:</b> | < 0.1 m/s relative to 20 °C and 1000 mbar   |
| <b>Measuring principle:</b>                  | Calorimetric measurement  |
| <b>Sensor:</b>                               | Pt 30/ Pt 700/ Pt 330   |
| <b>Measured medium:</b>                      | Air, gases  |
| <b>Operating temperature:</b>                | 0...50 °C sensor tube<br>-20...70 °C housing  |
| <b>Operating pressure:</b>                   | Up to 16 bar  |
| <b>Power supply:</b>                         | 24 VDC, 40 mA   |
| <b>Current consumption:</b>                  | Max. 80 mA to 24 VDC  |
| <b>Protection class:</b>                     | IP 54   |
| <b>EMC:</b>                                  | in acc. with DIN EN 61326   |
| <b>Connection:</b>                           | 2 x M12, 5-pin, plug A and plug B   |
| <b>2 potential-free contacts:</b>            | 2 x U max. 60 VDC, I max 0.5 A (normally closed); on request: Normally open                       |
| <b>Housing:</b>                              | Polycarbonate   |
| <b>Sensor tube:</b>                          | Stainless steel, 1.4301, length 160 mm, Ø 10 mm, safety ring Ø 11.5 mm, longer sensors on request |
| <b>Mounting thread:</b>                      | G 1/2"  |
| <b>Housing diameter:</b>                     | 65 mm   |
| <b>Direction indication:</b>                 | 2 LED'S   |

| DESCRIPTION   | ORDER NO. |
|---|-----------|
| Direction switch VA 409   | 0695 0409 |
| Mains unit in wall housing for maximum 2 sensors of the series VA/FA 5xx, 100-240 V, 23 VA, 50-60 Hz / 24 VDC, 0,35 A | 0554 0110 |
| Connection cable for VA/FA series, 5 m  | 0553 0104 |
| Connection cable for VA/FA sensors, 10 m  | 0553 0105 |

## CS Service Software - for VA 5xx flow meters

... incl. PC connection set, USB connection and interface adapter to the sensor.



The flow meters VA 5xx can be connected to the PC, and the following settings can be made by means of the CS Service Software:

- Selection of gas type (air, CO<sub>2</sub>, N<sub>2</sub>O, N<sub>2</sub>, O<sub>2</sub>, NG, Ar, CH<sub>4</sub>)
- Selection of units for flow, speed, temperature, consumption
- Selection of units: m<sup>3</sup>/h, Nm<sup>3</sup>/h, m<sup>3</sup>/min, Nm<sup>3</sup>/min, ltr/h, Nltr/h, ltr/min, Nltr/min, ltr/s, Nltr/s, cfm, SCFM, kg/h, kg/min, kg/s
- Setting of the reference temperature, reference pressure
- Zero-point adjustment, leak flow volume suppression adjustable
- Modbus and M-Bus settings
- Scaling of the 4...20 mA analogue output
- Reading of: Version number, production date, series no., time of last calibration
- Setting of alarm limits
- Offset settings (flow offset, temperature offset)
- Reset factory settings
- Load updates onto the sensor (firmware update, language update)

| DESCRIPTION   | ORDER NO. |
|---|-----------|
| CS Service Software for FA/VA sensors incl. PC connection set, USB connection and interface adapter to the sensor | 0554 2007 |

# Calibration of flow meters

In the CS calibration laboratory for flow meters it is possible to calibrate our flow measuring instruments as well as of other manufacturers. High precision reference measuring devices guarantee an accuracy of up to 0.5% of the measured value.



### Special features:

- Due to the digital data transmission, only the flow meter must be calibrated. The display devices remain wired on site.

|                                   |  |
|-----------------------------------|--|
| <b>Calibration range:</b>         | from 0 to 4.000 m <sup>3</sup> /h under pressure |
| <b>Accuracy of the reference:</b> | between 0.5 and 1% of the measured value         |

| DESCRIPTION  | ORDER NO.  |
|--|------------|
| Recalibration and 5 point precision calibration of volume flow sensors VA 500/550 with ISO certificate | 0695 3333  |
| Recalibration and 5 point precision calibration of volume flow sensors VA 520/570 with ISO certificate | 0695 3332  |
| Volume flow, any measuring points  | on request |
| Real gas adjustment  | 3200 0015  |



# Measuring ranges VA 500 and VA 550

## Measuring ranges low-speed version

| Flow measuring ranges VA 500 / VA 550 - insertion meter |       |        |   |               |              |              |                      |                           |             |               |                |                      |                          |
|---|-------|--------|---|---------------|--------------|--------------|----------------------|---------------------------|-------------|---------------|----------------|----------------------|--------------------------|
| Inside diameter of pipe                                 |       |        | Low-speed version<br>(50 m/s)                               |               |              |              |                      |                           |             |               |                |                      | Recommended probe length |
|   |       |        | Measuring range full scales in Nm <sup>3</sup> /h * / [cfm] |               |              |              |                      |                           |             |               |                |                      |                          |
| Inch  | mm    | DN     | Air**   | Nitrogen (N2) | Argon (Ar)   | Oxygen (O2)  | Carbon dioxide (CO2) | Methane natural gas (CH4) | Helium (He) | Hydrogen (H2) | Propane (C3H8) |                      |                          |
| 1/2"  | 16.1  | DN 15  | 24 [14]   | 22 [13]       | 38 [22]      | 23 [13]      | 24 [14]              | 14 [8]                    | 10 [6]      | 7 [4]         | 11 [6]         | 160 mm - 6.299 inch  |                          |
| 3/4"  | 21.7  | DN 20  | 48 [28]   | 44 [26]       | 75 [44]      | 45 [26]      | 47 [27]              | 28 [16]                   | 20 [11]     | 14 [8]        | 22 [13]        |                      |                          |
| 1"  | 27.3  | DN 25  | 79 [46]   | 73 [43]       | 124 [73]     | 75 [44]      | 78 [46]              | 47 [27]                   | 33 [19]     | 23 [13]       | 36 [21]        |                      |                          |
| 1 1/4"  | 36.0  | DN 32  | 143 [84]  | 132 [77]      | 224 [132]    | 136 [80]     | 142 [83]             | 85 [50]                   | 60 [35]     | 42 [24]       | 66 [38]        |                      |                          |
| 1 1/2"  | 41.9  | DN 40  | 197 [116]   | 181 [107]     | 309 [182]    | 188 [111]    | 195 [115]            | 117 [68]                  | 82 [48]     | 58 [34]       | 90 [53]        |                      |                          |
| 2"  | 53.1  | DN 50  | 323 [190]   | 297 [175]     | 506 [297]    | 308 [181]    | 320 [188]            | 191 [112]                 | 135 [79]    | 95 [55]       | 148 [87]       |                      |                          |
| 2 1/2"  | 68.9  | DN 65  | 554 [326]   | 509 [300]     | 866 [510]    | 528 [311]    | 548 [322]            | 328 [193]                 | 231 [136]   | 162 [95]      | 254 [150]      | 220 mm - 8.661 inch  |                          |
| 3"  | 80.9  | DN 80  | 768 [452]   | 706 [415]     | 1201 [706]   | 732 [431]    | 760 [447]            | 454 [267]                 | 321 [188]   | 225 [132]     | 353 [207]      |                      |                          |
| 4"  | 110.0 | DN 100 | 1426 [839]  | 1311 [772]    | 2230 [1312]  | 1360 [800]   | 1411 [830]           | 844 [496]                 | 596 [350]   | 418 [246]     | 655 [386]      |                      |                          |
| 5"  | 133.7 | DN 125 | 2110 [1241]   | 1940 [1141]   | 3299 [1941]  | 2011 [1183]  | 2088 [1228]          | 1248 [734]                | 881 [519]   | 619 [364]     | 970 [570]      | 300 mm - 11.811 inch |                          |
| 6"  | 159.3 | DN 150 | 2999 [1765]   | 2758 [1623]   | 4689 [2759]  | 2859 [1682]  | 2967 [1746]          | 1774 [1044]               | 1253 [737]  | 880 [518]     | 1379 [811]     |                      |                          |
| 8"  | 200.0 | DN 200 | 4738 [2788]   | 4357 [2564]   | 7409 [4360]  | 4517 [2658]  | 4689 [2759]          | 2804 [1650]               | 1980 [1165] | 1391 [819]    | 2178 [1282]    |                      |                          |
| 10"   | 250.0 | DN 250 | 7413 [4362]   | 6817 [4011]   | 11590 [6820] | 7067 [4159]  | 7336 [4317]          | 4386 [2581]               | 3098 [1823] | 2177 [1281]   | 3408 [2005]    |                      |                          |
| 12"   | 300.0 | DN 300 | 10687 [6289]  | 9828 [5783]   | 16710 [9833] | 10189 [5996] | 10576 [6224]         | 6324 [3721]               | 4466 [2628] | 3138 [1847]   | 4914 [2891]    |                      |                          |

| Flow measuring ranges VA 500 / VA 550 - insertion meter |       |        |   |              |              |                             |                     |                          |                          |                          |                          |                     |                          |                      |
|---|-------|--------|---|--------------|--------------|-----------------------------|---------------------|--------------------------|--------------------------|--------------------------|--------------------------|---------------------|--------------------------|----------------------|
| Inside diameter of pipe                                 |       |        | Low-speed version<br>(50 m/s)                               |              |              |                             |                     |                          |                          |                          |                          |                     | Recommended probe length |                      |
|   |       |        | Measuring range full scales in Nm <sup>3</sup> /h * / [cfm] |              |              |                             |                     |                          |                          |                          |                          |                     |                          |                      |
| Inch  | mm    | DN     | Corgon @18  | Corgon @10   | Corgon @20   | Forming gas 90% N2 + 10% H2 | Natural gas L (CH4) | Biogas 50% CH4 + 50% CO2 | Biogas 60% CH4 + 40% CO2 | LPG 60% C3H8 + 40% C4H10 | LPG 50% C3H8 + 50% C4H10 | Nitrous oxide (N2O) | Ethyne/Acetylene (C2H2)  |                      |
| 1/2"  | 16.1  | DN 15  | 35 [21]   | 36 [21]      | 35 [20]      | 20 [12]                     | 15 [9]              | 17 [10]                  | 17 [10]                  | 13 [7]                   | 12 [7]                   | 24 [14]             | 13 [8]                   | 160 mm - 6.299 inch  |
| 3/4"  | 21.7  | DN 20  | 70 [41]   | 71 [42]      | 69 [40]      | 40 [23]                     | 30 [17]             | 34 [20]                  | 34 [20]                  | 25 [15]                  | 25 [14]                  | 47 [27]             | 26 [15]                  |                      |
| 1"  | 27.3  | DN 25  | 116 [68]  | 119 [70]     | 115 [67]     | 67 [39]                     | 50 [29]             | 57 [34]                  | 56 [33]                  | 42 [24]                  | 41 [24]                  | 78 [45]             | 44 [26]                  |                      |
| 1 1/4"  | 36.0  | DN 32  | 209 [123]   | 214 [126]    | 208 [122]    | 121 [71]                    | 91 [53]             | 104 [61]                 | 101 [59]                 | 76 [45]                  | 74 [44]                  | 140 [89]            | 80 [47]                  |                      |
| 1 1/2"  | 41.9  | DN 40  | 288 [170]   | 296 [174]    | 286 [168]    | 167 [98]                    | 125 [73]            | 143 [84]                 | 140 [82]                 | 105 [62]                 | 103 [60]                 | 194 [114]           | 110 [65]                 |                      |
| 2"  | 53.1  | DN 50  | 472 [278]   | 484 [284]    | 468 [275]    | 273 [161]                   | 205 [120]           | 235 [138]                | 229 [135]                | 172 [101]                | 168 [99]                 | 317 [186]           | 181 [106]                |                      |
| 2 1/2"  | 68.9  | DN 65  | 809 [476]   | 829 [488]    | 803 [472]    | 469 [276]                   | 351 [207]           | 403 [237]                | 393 [231]                | 295 [173]                | 288 [169]                | 543 [320]           | 311 [183]                | 220 mm - 8.661 inch  |
| 3"  | 80.9  | DN 80  | 1121 [660]  | 1149 [676]   | 1112 [654]   | 649 [382]                   | 487 [286]           | 558 [328]                | 544 [320]                | 409 [240]                | 400 [235]                | 753 [443]           | 430 [253]                |                      |
| 4"  | 110.0 | DN 100 | 2082 [1225]   | 2134 [1255]  | 2066 [1216]  | 1206 [710]                  | 905 [532]           | 1037 [610]               | 1011 [595]               | 759 [447]                | 742 [437]                | 1399 [823]          | 800 [470]                |                      |
| 5"  | 133.7 | DN 125 | 3080 [1813]   | 3156 [1857]  | 3056 [1798]  | 1785 [1050]                 | 1338 [787]          | 1534 [903]               | 1496 [880]               | 1123 [661]               | 1098 [646]               | 2069 [1217]         | 1183 [696]               | 300 mm - 11.811 inch |
| 6"  | 159.3 | DN 150 | 4378 [2576]   | 4486 [2640]  | 4344 [2556]  | 2537 [1493]                 | 1903 [1119]         | 2181 [1283]              | 2126 [1251]              | 1597 [939]               | 1561 [919]               | 2941 [1731]         | 1682 [990]               |                      |
| 8"  | 200.0 | DN 200 | 6918 [4071]   | 7089 [4171]  | 6864 [4039]  | 4009 [2359]                 | 3006 [1769]         | 3446 [2028]              | 3359 [1977]              | 2523 [1485]              | 2467 [1452]              | 4647 [2735]         | 2658 [1564]              |                      |
| 10"   | 250.0 | DN 250 | 10823 [6369]  | 11090 [6526] | 10738 [6319] | 6271 [3690]                 | 4703 [2768]         | 5392 [3173]              | 5255 [3093]              | 3947 [2323]              | 3860 [2271]              | 7270 [4278]         | 4158 [2447]              |                      |
| 12"   | 300.0 | DN 300 | 15604 [9183]  | 15988 [9409] | 15481 [9110] | 9042 [5321]                 | 6781 [3990]         | 7774 [4575]              | 7577 [4459]              | 5691 [3349]              | 5565 [3275]              | 10482 [6168]        | 5995 [3528]              |                      |

\* Nm<sup>3</sup>/h in acc. with DIN 1343: 0 °C, 1013.25 hPa for gases

\*\* ISO 1217: 20 °C, 1000 hPa for air

If you want to measure the consumption / flow rate of a specific gas mixture, ask us. We can offer a real gas adjustment under process conditions on request.



## Measuring ranges Standard version

| Flow measuring ranges VA 500 / VA 550 - insertion meter |       |        |  |               |               |               |                      |                           |             |               |                |                      |                          |
|---|-------|--------|--|---------------|---------------|---------------|----------------------|---------------------------|-------------|---------------|----------------|----------------------|--------------------------|
| Inside diameter of pipe                                 |       |        | Standard version<br>(92.7 m/s)               |               |               |               |                      |                           |             |               |                |                      | Recommended probe length |
|   |       |        | Measuring range Nm <sup>3</sup> /h * / [cfm] |               |               |               |                      |                           |             |               |                |                      |                          |
| Inch  | mm    | DN     | Air**  | Nitrogen (N2) | Argon (Ar)    | Oxygen (O2)   | Carbon dioxide (CO2) | Methane Natural gas (CH4) | Helium (He) | Hydrogen (H2) | Propane (C3H8) |                      |                          |
| 1/2"  | 16.1  | DN 15  | 45 [26]                                      | 41 [24]       | 71 [41]       | 43 [25]       | 45 [26]              | 26 [15]                   | 19 [11]     | 13 [7]        | 20 [12]        | 160 mm - 6.299 inch  |                          |
| 3/4"  | 21.7  | DN 20  | 89 [52]                                      | 81 [48]       | 139 [81]      | 84 [49]       | 88 [51]              | 52 [31]                   | 37 [21]     | 26 [15]       | 40 [24]        |                      |                          |
| 1"  | 27.3  | DN 25  | 147 [86]                                     | 135 [79]      | 230 [135]     | 140 [82]      | 146 [86]             | 87 [51]                   | 61 [36]     | 43 [25]       | 67 [39]        |                      |                          |
| 1 1/4"  | 36.0  | DN 32  | 266 [156]                                    | 244 [144]     | 416 [245]     | 253 [149]     | 263 [155]            | 157 [92]                  | 111 [65]    | 78 [46]       | 122 [72]       |                      |                          |
| 1 1/2"  | 41.9  | DN 40  | 366 [215]                                    | 337 [198]     | 573 [337]     | 349 [205]     | 363 [213]            | 217 [127]                 | 153 [90]    | 107 [63]      | 168 [99]       |                      |                          |
| 2"  | 53.1  | DN 50  | 600 [353]                                    | 551 [324]     | 938 [552]     | 572 [336]     | 593 [349]            | 355 [208]                 | 250 [147]   | 176 [103]     | 275 [162]      |                      |                          |
| 2 1/2"  | 68.9  | DN 65  | 1028 [604]                                   | 945 [556]     | 1607 [945]    | 980 [576]     | 1017 [598]           | 608 [358]                 | 429 [252]   | 301 [177]     | 472 [278]      | 220 mm - 8.661 inch  |                          |
| 3"  | 80.9  | DN 80  | 1424 [838]                                   | 1309 [770]    | 2227 [1310]   | 1358 [799]    | 1409 [829]           | 842 [496]                 | 595 [350]   | 418 [246]     | 654 [385]      |                      |                          |
| 4"  | 110.0 | DN 100 | 2644 [1556]                                  | 2432 [1431]   | 4135 [2433]   | 2521 [1484]   | 2617 [1540]          | 1565 [921]                | 1105 [650]  | 776 [457]     | 1216 [715]     |                      |                          |
| 5"  | 133.7 | DN 125 | 3912 [2302]                                  | 3597 [2117]   | 6116 [3599]   | 3729 [2195]   | 3871 [2278]          | 2315 [1362]               | 1635 [962]  | 1149 [676]    | 1798 [1058]    | 300 mm - 11.811 inch |                          |
| 6"  | 159.3 | DN 150 | 5560 [3272]                                  | 5113 [3009]   | 8693 [5116]   | 5301 [3119]   | 5502 [3238]          | 3290 [1936]               | 2324 [1367] | 1633 [961]    | 2556 [1504]    |                      |                          |
| 8"  | 200.0 | DN 200 | 8785 [5170]                                  | 8079 [4754]   | 13736 [8083]  | 8376 [4929]   | 8694 [5116]          | 5198 [3059]               | 3672 [2160] | 2580 [1518]   | 4039 [2377]    |                      |                          |
| 10"   | 250.0 | DN 250 | 13744 [8088]                                 | 12638 [7437]  | 21488 [12646] | 13103 [7711]  | 13601 [8004]         | 8133 [4786]               | 5744 [3380] | 4036 [2375]   | 6319 [3718]    |                      |                          |
| 12"   | 300.0 | DN 300 | 19814 [11661]                                | 18221 [10723] | 30980 [18232] | 18891 [11117] | 19609 [11539]        | 11725 [6900]              | 8281 [4873] | 5819 [3424]   | 9110 [5361]    |                      |                          |

| Flow measuring ranges VA 500 / VA 550 - insertion meter |       |        |   |               |               |                           |                     |                          |                          |                          |                          |                     |                         |                          |
|---|-------|--------|---|---------------|---------------|---------------------------|---------------------|--------------------------|--------------------------|--------------------------|--------------------------|---------------------|-------------------------|--------------------------|
| Inside diameter of pipe                                 |       |        | Standard version<br>(92.7 m/s)                              |               |               |                           |                     |                          |                          |                          |                          |                     |                         | Recommended probe length |
|   |       |        | Measuring range full scales in Nm <sup>3</sup> /h * / [cfm] |               |               |                           |                     |                          |                          |                          |                          |                     |                         |                          |
| Inch  | mm    | DN     | Corgon @18  | Corgon @10    | Corgon @20    | Forming gas 90% N2+10% H2 | Natural gas L (CH4) | Biogas 50% CH4 + 50% CO2 | Biogas 60% CH4 + 40% CO2 | LPG 60% C3H8 + 40% C4H10 | LPG 50% C3H8 + 50% C4H10 | Nitrous Oxide (N2O) | Ethyne/Acetylene (C2H2) |                          |
| 1/2"  | 16.1  | DN 15  | 66 [39]   | 68 [40]       | 66 [38]       | 38 [22]                   | 28 [17]             | 33 [19]                  | 32 [19]                  | 24 [14]                  | 23 [13]                  | 44 [26]             | 25 [15]                 | 160 mm - 6.299 inch      |
| 3/4"  | 21.7  | DN 20  | 130 [76]  | 133 [78]      | 129 [75]      | 75 [44]                   | 56 [33]             | 64 [38]                  | 63 [37]                  | 47 [27]                  | 46 [27]                  | 87 [51]             | 49 [29]                 |                          |
| 1"  | 27.3  | DN 25  | 215 [126]   | 220 [130]     | 213 [125]     | 124 [73]                  | 93 [55]             | 107 [63]                 | 104 [61]                 | 78 [46]                  | 76 [45]                  | 144 [85]            | 82 [48]                 |                          |
| 1 1/4"  | 36.0  | DN 32  | 388 [228]   | 398 [234]     | 385 [227]     | 225 [132]                 | 168 [99]            | 193 [114]                | 188 [111]                | 141 [83]                 | 138 [81]                 | 261 [153]           | 149 [87]                |                          |
| 1 1/2"  | 41.9  | DN 40  | 535 [315]   | 548 [322]     | 531 [312]     | 310 [182]                 | 232 [136]           | 266 [157]                | 260 [153]                | 195 [114]                | 191 [112]                | 359 [211]           | 205 [121]               |                          |
| 2"  | 53.1  | DN 50  | 876 [515]   | 897 [528]     | 869 [511]     | 507 [298]                 | 380 [224]           | 436 [256]                | 425 [250]                | 319 [188]                | 312 [183]                | 588 [346]           | 336 [198]               |                          |
| 2 1/2"  | 68.9  | DN 65  | 1500 [883]  | 1537 [905]    | 1489 [876]    | 869 [511]                 | 652 [383]           | 747 [440]                | 728 [428]                | 547 [322]                | 535 [315]                | 1008 [593]          | 576 [339]               | 220 mm - 8.661 inch      |
| 3"  | 80.9  | DN 80  | 2079 [1223]   | 2130 [1254]   | 2063 [1214]   | 1205 [709]                | 903 [531]           | 1036 [609]               | 1009 [594]               | 758 [446]                | 741 [436]                | 1397 [822]          | 799 [470]               |                          |
| 4"  | 110.0 | DN 100 | 3861 [2272]   | 3956 [2328]   | 3831 [2254]   | 2237 [1316]               | 1678 [987]          | 1923 [1132]              | 1875 [1103]              | 1408 [828]               | 1377 [810]               | 2594 [1526]         | 1483 [873]              |                          |
| 5"  | 133.7 | DN 125 | 5711 [3361]   | 5852 [3444]   | 5666 [3335]   | 3309 [1947]               | 2482 [1460]         | 2845 [1674]              | 2773 [1632]              | 2083 [1226]              | 2037 [1198]              | 3837 [2258]         | 2194 [1291]             | 300 mm - 11.811 inch     |
| 6"  | 159.3 | DN 150 | 8118 [4777]   | 8318 [4895]   | 8054 [4740]   | 4704 [2768]               | 3528 [2076]         | 4044 [2380]              | 3942 [2320]              | 2961 [1742]              | 2895 [1704]              | 5453 [3209]         | 3119 [1835]             |                          |
| 8"  | 200.0 | DN 200 | 12827 [7548]  | 13143 [7734]  | 12726 [7489]  | 7432 [4374]               | 5574 [3280]         | 6390 [3760]              | 6229 [3665]              | 4678 [2753]              | 4575 [2692]              | 8616 [5071]         | 4928 [2900]             |                          |
| 10"   | 250.0 | DN 250 | 20066 [11809]   | 20560 [12100] | 19908 [11716] | 11627 [6842]              | 8720 [5132]         | 9997 [5883]              | 9744 [5734]              | 7319 [4307]              | 7157 [4212]              | 13480 [7932]        | 7709 [4537]             |                          |
| 12"   | 300.0 | DN 300 | 28930 [17025]   | 29643 [17444] | 28702 [16891] | 16763 [9865]              | 12572 [7399]        | 14413 [8482]             | 14048 [8267]             | 10552 [6209]             | 10318 [6072]             | 19434 [11437]       | 11115 [6541]            |                          |

\* Nm<sup>3</sup>/h in acc. with DIN 1343: 0 °C, 1013.25 hPa for gases

\*\* ISO 1217: 20 °C, 1000 hPa for air

If you want to measure the consumption / flow rate of a specific gas mixture, ask us. We can offer a real gas adjustment under process conditions on request.



## Measuring ranges max version

| Flow measuring ranges VA 500 / VA 550 - insertion meter |       |        |  |               |               |               |                      |                           |              |               |                |                      |                          |
|---|-------|--------|--|---------------|---------------|---------------|----------------------|---------------------------|--------------|---------------|----------------|----------------------|--------------------------|
| Inside diameter of pipe                                 |       |        | Max version<br>(185.0 m/s)                   |               |               |               |                      |                           |              |               |                |                      | Recommended probe length |
|   |       |        | Measuring range Nm <sup>3</sup> /h * / [cfm] |               |               |               |                      |                           |              |               |                |                      |                          |
| Inch  | mm    | DN     | Air**  | Nitrogen (N2) | Argon (Ar)    | Oxygen (O2)   | Carbon dioxide (CO2) | Methane Natural gas (CH4) | Helium (He)  | Hydrogen (H2) | Propane (C3H8) |                      |                          |
| 1/2"  | 16.1  | DN 15  | 90 [53]                                      | 83 [49]       | 142 [83]      | 86 [51]       | 90 [52]              | 53 [31]                   | 38 [22]      | 26 [15]       | 41 [24]        | 160 mm - 6.299 inch  |                          |
| 3/4"  | 21.7  | DN 20  | 177 [104]                                    | 163 [96]      | 278 [163]     | 169 [99]      | 175 [103]            | 105 [61]                  | 74 [43]      | 52 [30]       | 81 [48]        |                      |                          |
| 1"  | 27.3  | DN 25  | 294 [173]                                    | 271 [159]     | 460 [271]     | 280 [165]     | 291 [171]            | 174 [102]                 | 123 [72]     | 86 [50]       | 135 [79]       |                      |                          |
| 1 1/4"  | 36.0  | DN 32  | 531 [312]                                    | 488 [287]     | 830 [489]     | 506 [298]     | 525 [309]            | 314 [185]                 | 222 [130]    | 156 [91]      | 244 [143]      |                      |                          |
| 1 1/2"  | 41.9  | DN 40  | 732 [430]                                    | 673 [396]     | 1144 [673]    | 697 [410]     | 724 [426]            | 433 [254]                 | 305 [180]    | 215 [126]     | 336 [198]      |                      |                          |
| 2"  | 53.1  | DN 50  | 1197 [704]                                   | 1101 [648]    | 1872 [1101]   | 1141 [671]    | 1185 [697]           | 708 [417]                 | 500 [294]    | 351 [206]     | 550 [324]      |                      |                          |
| 2 1/2"  | 68.9  | DN 65  | 2051 [1207]                                  | 1886 [1110]   | 3207 [1887]   | 1955 [1151]   | 2030 [1194]          | 1214 [714]                | 857 [504]    | 602 [354]     | 943 [555]      | 220 mm - 8.661 inch  |                          |
| 3"  | 80.9  | DN 80  | 2842 [1672]                                  | 2614 [1538]   | 4444 [2615]   | 2710 [1594]   | 2813 [1655]          | 1682 [989]                | 1188 [699]   | 834 [491]     | 1307 [769]     |                      |                          |
| 4"  | 110.0 | DN 100 | 5278 [3106]                                  | 4854 [2856]   | 8252 [4856]   | 5032 [2961]   | 5223 [3074]          | 3123 [1838]               | 2206 [1298]  | 1550 [912]    | 2427 [1428]    |                      |                          |
| 5"  | 133.7 | DN 125 | 7807 [4594]                                  | 7179 [4225]   | 12206 [7183]  | 7443 [4380]   | 7726 [4546]          | 4620 [2718]               | 3263 [1920]  | 2293 [1349]   | 3589 [2112]    |                      |                          |
| 6"  | 159.3 | DN 150 | 11096 [6530]                                 | 10204 [6005]  | 17349 [10210] | 10579 [6226]  | 10981 [6462]         | 6566 [3864]               | 4637 [2729]  | 3259 [1917]   | 5102 [3002]    | 300 mm - 11.811 inch |                          |
| 8"  | 200.0 | DN 200 | 17533 [10318]                                | 16123 [9488]  | 27413 [16132] | 16716 [9837]  | 17351 [10211]        | 10375 [6105]              | 7328 [4312]  | 5149 [3030]   | 8061 [4744]    |                      |                          |
| 10"   | 250.0 | DN 250 | 27428 [16141]                                | 25223 [14843] | 42884 [25237] | 26150 [15389] | 27143 [15974]        | 16231 [9552]              | 11463 [6746] | 8055 [4740]   | 12611 [7421]   |                      |                          |
| 12"   | 300.0 | DN 300 | 39544 [23271]                                | 36364 [21400] | 61827 [36385] | 37701 [22187] | 39133 [23030]        | 23400 [13771]             | 16527 [9726] | 11614 [6834]  | 18182 [10700]  |                      |                          |

| Flow measuring ranges VA 500 / VA 550 - insertion meter |       |        |  |               |               |                             |                     |                          |                          |                          |                          |                     |                         |                      |                          |
|---|-------|--------|--|---------------|---------------|-----------------------------|---------------------|--------------------------|--------------------------|--------------------------|--------------------------|---------------------|-------------------------|----------------------|--------------------------|
| Inside diameter of pipe                                 |       |        | Max version<br>(185.0 m/s)                   |               |               |                             |                     |                          |                          |                          |                          |                     |                         |                      | Recommended probe length |
|   |       |        | Measuring range Nm <sup>3</sup> /h * / [cfm] |               |               |                             |                     |                          |                          |                          |                          |                     |                         |                      |                          |
| Inch  | mm    | DN     | Corgon @18                                   | Corgon @10    | Corgon @20    | Forming gas 90% N2 + 10% H2 | Natural gas L (CH4) | Biogas 50% CH4 + 50% CO2 | Biogas 60% CH4 + 40% CO2 | LPG 60% C3H8 + 40% C4H10 | LPG 50% C3H8 + 50% C4H10 | Nitrous Oxide (N2O) | Ethyne/Acetylene (C2H2) |                      |                          |
| 1/2"  | 16.1  | DN 15  | 132 [78]                                     | 136 [80]      | 131 [77]      | 76 [45]                     | 57 [33]             | 66 [38]                  | 64 [37]                  | 48 [28]                  | 47 [27]                  | 89 [52]             | 51 [30]                 | 160 mm - 6.299 inch  |                          |
| 3/4"  | 21.7  | DN 20  | 259 [152]                                    | 266 [156]     | 257 [151]     | 150 [88]                    | 112 [66]            | 129 [76]                 | 126 [74]                 | 94 [55]                  | 92 [54]                  | 174 [102]           | 99 [58]                 |                      |                          |
| 1"  | 27.3  | DN 25  | 430 [253]                                    | 440 [259]     | 426 [251]     | 249 [146]                   | 187 [110]           | 214 [126]                | 208 [122]                | 156 [92]                 | 153 [90]                 | 289 [170]           | 165 [97]                |                      |                          |
| 1 1/4"  | 36.0  | DN 32  | 775 [456]                                    | 795 [467]     | 769 [453]     | 449 [264]                   | 337 [198]           | 386 [227]                | 376 [221]                | 283 [166]                | 276 [162]                | 521 [306]           | 298 [175]               |                      |                          |
| 1 1/2"  | 41.9  | DN 40  | 1068 [629]                                   | 1095 [644]    | 1060 [624]    | 619 [364]                   | 464 [273]           | 532 [313]                | 519 [305]                | 389 [229]                | 381 [224]                | 718 [422]           | 410 [241]               |                      |                          |
| 2"  | 53.1  | DN 50  | 1748 [1029]                                  | 1791 [1054]   | 1734 [1020]   | 1013 [596]                  | 759 [447]           | 871 [512]                | 849 [499]                | 637 [375]                | 623 [367]                | 1174 [691]          | 671 [395]               |                      |                          |
| 2 1/2"  | 68.9  | DN 65  | 2995 [1762]                                  | 3069 [1806]   | 2971 [1748]   | 1735 [1021]                 | 1301 [766]          | 1492 [878]               | 1454 [856]               | 1092 [642]               | 1068 [628]               | 2012 [1184]         | 1150 [677]              | 220 mm - 8.661 inch  |                          |
| 3"  | 80.9  | DN 80  | 4150 [2442]                                  | 4252 [2502]   | 4117 [2423]   | 2404 [1415]                 | 1803 [1061]         | 2067 [1216]              | 2015 [1186]              | 1513 [890]               | 1480 [871]               | 2788 [1640]         | 1594 [938]              |                      |                          |
| 4"  | 110.0 | DN 100 | 7706 [4535]                                  | 7896 [4647]   | 7646 [4499]   | 4465 [2628]                 | 3349 [1971]         | 3839 [2259]              | 3742 [2202]              | 2811 [1654]              | 2748 [1617]              | 5177 [3046]         | 2961 [1742]             |                      |                          |
| 5"  | 133.7 | DN 125 | 11399 [6708]                                 | 11679 [6873]  | 11309 [6655]  | 6605 [3887]                 | 4954 [2915]         | 5679 [3342]              | 5535 [3257]              | 4157 [2446]              | 4065 [2392]              | 7657 [4506]         | 4379 [2577]             |                      |                          |
| 6"  | 159.3 | DN 150 | 16201 [9534]                                 | 16600 [9769]  | 16074 [9459]  | 9388 [5524]                 | 7041 [4143]         | 8071 [4750]              | 7867 [4630]              | 5909 [3477]              | 5778 [3400]              | 10883 [6405]        | 6224 [3663]             | 300 mm - 11.811 inch |                          |
| 8"  | 200.0 | DN 200 | 25599 [15065]                                | 26229 [15436] | 25397 [14946] | 14833 [8729]                | 11125 [6547]        | 12753 [7505]             | 12431 [7315]             | 9337 [5494]              | 9130 [5373]              | 17196 [10120]       | 9835 [5788]             |                      |                          |
| 10"   | 250.0 | DN 250 | 40046 [23567]                                | 41033 [24148] | 39731 [23382] | 23205 [13656]               | 17404 [10242]       | 19951 [11741]            | 19447 [11444]            | 14606 [8596]             | 14283 [8406]             | 26901 [15831]       | 15386 [9054]            |                      |                          |
| 12"   | 300.0 | DN 300 | 57736 [33977]                                | 59158 [34814] | 57281 [33710] | 33455 [19688]               | 25091 [14766]       | 28764 [16927]            | 28037 [16499]            | 21058 [12393]            | 20593 [12119]            | 38784 [22824]       | 22182 [13054]           |                      |                          |

\* Nm<sup>3</sup>/h in acc. with DIN 1343: 0 °C, 1013.25 hPa for gases

\*\* ISO 1217: 20 °C, 1000 hPa for air

If you want to measure the consumption / flow rate of a specific gas mixture, ask us.  
We can offer a real gas adjustment under process conditions on request.



## Measuring ranges high-speed version

| Flow measuring ranges VA 500 / VA 550 - insertion meter |       |        |  |               |               |               |                      |                           |               |               |                |                      |                          |
|---|-------|--------|--|---------------|---------------|---------------|----------------------|---------------------------|---------------|---------------|----------------|----------------------|--------------------------|
| Inside diameter of pipe                                 |       |        | High-speed version<br>(224.0 m/s)            |               |               |               |                      |                           |               |               |                |                      | Recommended probe length |
|   |       |        | Measuring range Nm <sup>3</sup> /h * / [cfm] |               |               |               |                      |                           |               |               |                |                      |                          |
| Inch  | mm    | DN     | Air**  | Nitrogen (N2) | Argon (Ar)    | Oxygen (O2)   | Carbon dioxide (CO2) | Methane Natural gas (CH4) | Helium (He)   | Hydrogen (H2) | Propane (C3H8) |                      |                          |
| 1/2"  | 16.1  | DN 15  | 110 [64]                                     | 101 [59]      | 172 [101]     | 105 [61]      | 109 [64]             | 65 [38]                   | 46 [27]       | 32 [19]       | 50 [29]        | 160 mm - 6.299 inch  |                          |
| 3/4"  | 21.7  | DN 20  | 215 [126]                                    | 198 [116]     | 336 [198]     | 205 [120]     | 213 [125]            | 127 [74]                  | 89 [52]       | 63 [37]       | 99 [58]        |                      |                          |
| 1"  | 27.3  | DN 25  | 356 [210]                                    | 328 [193]     | 557 [328]     | 340 [200]     | 353 [207]            | 211 [124]                 | 149 [87]      | 104 [61]      | 164 [96]       |                      |                          |
| 1 1/4"  | 36.0  | DN 32  | 643 [378]                                    | 591 [348]     | 1006 [592]    | 613 [361]     | 636 [374]            | 380 [224]                 | 268 [158]     | 188 [111]     | 295 [174]      |                      |                          |
| 1 1/2"  | 41.9  | DN 40  | 886 [521]                                    | 815 [479]     | 1385 [815]    | 845 [497]     | 877 [516]            | 524 [308]                 | 370 [218]     | 260 [153]     | 407 [239]      |                      |                          |
| 2"  | 53.1  | DN 50  | 1450 [853]                                   | 1333 [784]    | 2267 [1334]   | 1382 [813]    | 1434 [844]           | 858 [504]                 | 606 [356]     | 425 [250]     | 666 [392]      |                      |                          |
| 2 1/2"  | 68.9  | DN 65  | 2484 [1461]                                  | 2284 [1344]   | 3883 [2285]   | 2368 [1393]   | 2458 [1446]          | 1469 [865]                | 1038 [611]    | 729 [429]     | 1142 [672]     | 220 mm - 8.661 inch  |                          |
| 3"  | 80.9  | DN 80  | 3441 [2025]                                  | 3165 [1862]   | 5381 [3166]   | 3281 [1931]   | 3406 [2004]          | 2036 [1198]               | 1438 [846]    | 1010 [594]    | 1582 [931]     |                      |                          |
| 4"  | 110.0 | DN 100 | 6391 [3761]                                  | 5877 [3458]   | 9992 [5880]   | 6093 [3586]   | 6324 [3722]          | 3782 [2225]               | 2671 [1572]   | 1877 [1104]   | 2938 [1729]    |                      |                          |
| 5"  | 133.7 | DN 125 | 9453 [5563]                                  | 8693 [5116]   | 14780 [8698]  | 9012 [5304]   | 9355 [5505]          | 5594 [3292]               | 3951 [2325]   | 2776 [1633]   | 4346 [2558]    |                      |                          |
| 6"  | 159.3 | DN 150 | 13436 [7907]                                 | 12355 [7271]  | 21007 [12362] | 12810 [7538]  | 13296 [7825]         | 7950 [4679]               | 5615 [3304]   | 3946 [2322]   | 6177 [3635]    |                      |                          |
| 8"  | 200.0 | DN 200 | 21229 [12493]                                | 19522 [11489] | 33192 [19533] | 20240 [11911] | 21009 [12363]        | 12562 [7393]              | 8873 [5221]   | 6235 [3669]   | 9761 [5744]    | 300 mm - 11.811 inch |                          |
| 10"   | 250.0 | DN 250 | 33211 [19544]                                | 30540 [17973] | 51925 [30557] | 31663 [18633] | 32865 [19341]        | 19652 [11565]             | 13880 [8168]  | 9753 [5740]   | 15270 [8986]   |                      |                          |
| 12"   | 300.0 | DN 300 | 47880 [28177]                                | 44030 [25912] | 74861 [44055] | 45649 [26864] | 47383 [27885]        | 28333 [16674]             | 20012 [11777] | 14062 [8275]  | 22015 [12956]  |                      |                          |

| Flow measuring ranges VA 500 / VA 550 - insertion meter |       |        |  |               |               |                           |                     |                        |                        |                        |                          |                     |                          |                      |  |
|---|-------|--------|--|---------------|---------------|---------------------------|---------------------|------------------------|------------------------|------------------------|--------------------------|---------------------|--------------------------|----------------------|--|
| Inside diameter of pipe                                 |       |        | High-speed version<br>(224.0 m/s)            |               |               |                           |                     |                        |                        |                        |                          |                     | Recommended probe length |                      |  |
|   |       |        | Measuring range Nm <sup>3</sup> /h * / [cfm] |               |               |                           |                     |                        |                        |                        |                          |                     |                          |                      |  |
| Inch  | mm    | DN     | Corgon @18                                   | Corgon @10    | Corgon @20    | Forming gas 90%N2 + 10%H2 | Natural gas L (CH4) | Biogas 50%CH4 + 50%CO2 | Biogas 60%CH4 + 40%CO2 | LPG 60%C3H8 + 40%C4H10 | LPG 50% C3H8 + 50% C4H10 | Nitrous Oxide (N2O) | Ethyne/Acetylene (C2H2)  |                      |  |
| 1/2"  | 16.1  | DN 15  | 160 [94]                                     | 164 [96]      | 159 [93]      | 93 [54]                   | 69 [41]             | 80 [47]                | 78 [45]                | 58 [34]                | 57 [33]                  | 108 [63]            | 61 [36]                  | 160 mm - 6.299 inch  |  |
| 3/4"  | 21.7  | DN 20  | 314 [185]                                    | 322 [189]     | 311 [183]     | 182 [107]                 | 136 [80]            | 156 [92]               | 152 [89]               | 114 [67]               | 112 [65]                 | 211 [124]           | 120 [71]                 |                      |  |
| 1"  | 27.3  | DN 25  | 521 [306]                                    | 533 [314]     | 516 [304]     | 301 [177]                 | 226 [133]           | 259 [152]              | 253 [148]              | 190 [111]              | 185 [109]                | 349 [205]           | 200 [117]                |                      |  |
| 1 1/4"  | 36.0  | DN 32  | 939 [552]                                    | 962 [566]     | 932 [548]     | 544 [320]                 | 408 [240]           | 468 [275]              | 456 [268]              | 342 [201]              | 335 [197]                | 631 [371]           | 360 [212]                |                      |  |
| 1 1/2"  | 41.9  | DN 40  | 1294 [761]                                   | 1326 [780]    | 1284 [755]    | 749 [441]                 | 562 [331]           | 644 [379]              | 628 [369]              | 472 [277]              | 461 [271]                | 869 [511]           | 497 [292]                |                      |  |
| 2"  | 53.1  | DN 50  | 2117 [1245]                                  | 2169 [1276]   | 2100 [1236]   | 1226 [721]                | 920 [541]           | 1054 [620]             | 1028 [605]             | 772 [454]              | 755 [444]                | 1422 [836]          | 813 [478]                |                      |  |
| 2 1/2"  | 68.9  | DN 65  | 3626 [2134]                                  | 3716 [2186]   | 3598 [2117]   | 2101 [1236]               | 1576 [927]          | 1806 [1063]            | 1761 [1036]            | 1322 [778]             | 1293 [761]               | 2436 [1433]         | 1393 [820]               | 220 mm - 8.661 inch  |  |
| 3"  | 80.9  | DN 80  | 5025 [2957]                                  | 5149 [3030]   | 4985 [2934]   | 2911 [1713]               | 2183 [1285]         | 2503 [1473]            | 2440 [1436]            | 1832 [1078]            | 1792 [1054]              | 3375 [1986]         | 1930 [1136]              |                      |  |
| 4"  | 110.0 | DN 100 | 9331 [5491]                                  | 9561 [5626]   | 9258 [5448]   | 5407 [3182]               | 4055 [2386]         | 4649 [2735]            | 4531 [2666]            | 3403 [2003]            | 3328 [1958]              | 6268 [3689]         | 3585 [2109]              |                      |  |
| 5"  | 133.7 | DN 125 | 13802 [8122]                                 | 14142 [8322]  | 13693 [8058]  | 7997 [4706]               | 5998 [3530]         | 6876 [4046]            | 6702 [3944]            | 5034 [2962]            | 4923 [2897]              | 9271 [5456]         | 5302 [3120]              |                      |  |
| 6"  | 159.3 | DN 150 | 19617 [11544]                                | 20100 [11829] | 19462 [11453] | 11367 [6689]              | 8525 [5017]         | 9773 [5751]            | 9526 [5606]            | 7155 [4210]            | 6997 [4117]              | 13178 [7755]        | 7537 [4435]              |                      |  |
| 8"  | 200.0 | DN 200 | 30996 [18241]                                | 31759 [18690] | 30752 [18097] | 17960 [10569]             | 13470 [7927]        | 15442 [9087]           | 15051 [8858]           | 11305 [6653]           | 11055 [6506]             | 20821 [12253]       | 11908 [7008]             | 300 mm - 11.811 inch |  |
| 10"   | 250.0 | DN 250 | 48489 [28535]                                | 49683 [29238] | 48107 [28311] | 28097 [16535]             | 21072 [12401]       | 24157 [14216]          | 23546 [13857]          | 17686 [10408]          | 17295 [10178]            | 32573 [19169]       | 18629 [10963]            |                      |  |
| 12"   | 300.0 | DN 300 | 69907 [41140]                                | 71629 [42153] | 69357 [40816] | 40508 [23839]             | 30381 [17879]       | 34828 [20496]          | 33947 [19978]          | 25498 [15005]          | 24934 [14674]            | 46961 [27636]       | 26858 [15806]            |                      |  |

\* Nm<sup>3</sup>/h in acc. with DIN 1343: 0 °C, 1013.25 hPa for gases

\*\* ISO 1217: 20 °C, 1000 hPa for air

If you want to measure the consumption / flow rate of a specific gas mixture, ask us.  
We can offer a real gas adjustment under process conditions on request.



## Measuring ranges VA 570/ VA 520/ VA 525/ VA 521

### Measuring ranges low-speed version

| Flow measuring ranges VA 570/ VA 520/ VA 525/ VA 521 |      |       |   |                  |                 |                  |                      |                           |                 |                  |                  |  |
|--|------|-------|---|------------------|-----------------|------------------|----------------------|---------------------------|-----------------|------------------|------------------|--|
| Inside diameter of pipe                              |      |       | Low-speed version (50 m/s)                                  |                  |                 |                  |                      |                           |                 |                  |                  |  |
|  |      |       | Measuring range full scales in Nm <sup>3</sup> /h * / [cfm] |                  |                 |                  |                      |                           |                 |                  |                  |  |
| Inch   | mm   | DN    | Air**   | Nitrogen (N2)    | Argon (Ar)      | Oxygen (O2)      | Carbon dioxide (CO2) | Methane Natural gas (CH4) | Helium (He)     | Hydrogen (H2)    | Propane (C3H8)   |  |
| 1/4"   | 8.9  | DN 8  | 25 NI/min [0.9]   | 25 NI/min [0.9]  | 45 NI/min [1.5] | 25 NI/min [0.9]  | 25 NI/min [0.9]      | 15 NI/min [0.6]           | 735 NI/h [0.3]  | 515 NI/h [0.3]   | 810 NI/h [0.3]   |  |
| 3/8" ***   | 12.5 | DN 10 | 225 NI/min [8]  | 205 NI/min [7.2] | 20 [11.7]       | 215 NI/min [7.5] | 225 NI/min [7.9]     | 130 NI/min [4.5]          | 95 NI/min [3.3] | 65 NI/min [2.3]  | 100 NI/min [3.5] |  |
| 1/2"   | 16.1 | DN 15 | 20 [14.4]   | 20 [13.2]        | 35 [20]         | 20 [13.5]        | 20 [14.1]            | 240 NI/min [8.4]          | 170 NI/min [6]  | 120 NI/min [4.2] | 185 NI/min [6.6] |  |
| 3/4"   | 21.7 | DN 20 | 45 [25]   | 40 [25]          | 75 [40]         | 45 [25]          | 45 [25]              | 25 [15]                   | 20 [11.7]       | 235 NI/min [8.1] | 20 [12.9]        |  |
| 1"   | 27.3 | DN 25 | 75 [45]   | 70 [40]          | 120 [70]        | 75 [40]          | 75 [45]              | 45 [25]                   | 30 [15]         | 20 [13.5]        | 35 [20]          |  |
| 1 1/4"   | 36.0 | DN 32 | 140 [80]  | 130 [75]         | 220 [130]       | 135 [80]         | 140 [80]             | 85 [50]                   | 60 [35]         | 40 [20]          | 65 [35]          |  |
| 1 1/2"   | 41.9 | DN 40 | 195 [115]   | 180 [105]        | 305 [180]       | 185 [110]        | 195 [115]            | 115 [65]                  | 80 [45]         | 55 [30]          | 90 [50]          |  |
| 2"   | 53.1 | DN 50 | 320 [190]   | 295 [175]        | 505 [295]       | 305 [180]        | 320 [185]            | 190 [110]                 | 135 [75]        | 95 [55]          | 145 [85]         |  |
| 2 1/2"   | 68.9 | DN 65 | 550 [325]   | 505 [300]        | 865 [510]       | 525 [310]        | 545 [320]            | 325 [190]                 | 230 [135]       | 160 [95]         | 250 [150]        |  |
| 3"   | 80.9 | DN 80 | 765 [450]   | 705 [415]        | 1200 [705]      | 730 [430]        | 760 [445]            | 450 [265]                 | 320 [185]       | 225 [130]        | 350 [205]        |  |

| Flow measuring ranges VA 570/ VA 520/ VA 525/ VA 521 |      |       |  |                 |                 |                             |                     |                          |                          |                          |                          |                     |                         |
|--|------|-------|--|-----------------|-----------------|-----------------------------|---------------------|--------------------------|--------------------------|--------------------------|--------------------------|---------------------|-------------------------|
| Inside diameter of pipe                              |      |       | Low-speed version (50 m/s)                   |                 |                 |                             |                     |                          |                          |                          |                          |                     |                         |
|  |      |       | Measuring range Nm <sup>3</sup> /h * / [cfm] |                 |                 |                             |                     |                          |                          |                          |                          |                     |                         |
| Inch   | mm   | DN    | Corgon ®18                                   | Corgon ®10      | Corgon ®20      | Forming gas 90% N2 + 10% H2 | Natural gas L (CH4) | Biogas 50% CH4 + 50% CO2 | Biogas 60% CH4 + 40% CO2 | LPG 60% C3H8 + 40% C4H10 | LPG 50% C3H8 + 50% C4H10 | Nitrous oxide (N2O) | Ethyne/Acetylene (C2H2) |
| 1/4"   | 8.9  | DN 8  | 40 NI/min [1.5]                              | 40 NI/min [1.5] | 40 NI/min [1.5] | 20 NI/min [0.6]             | 15 NI/min [0.6]     | 20 NI/min [0.6]          | 20 NI/min [0.6]          | 15 NI/min [0.3]          | 15 NI/min [0.3]          | 25 NI/min [0.9]     | 15 NI/min [0.3]         |
| 3/8" ***   | 12.5 | DN 10 | 15 [8,8]                                     | 20 [11,7]       | 15 [8,8]        | 190 NI/min [6,7]            | 140 NI/min [4,9]    | 10 [5,8]                 | 160 NI/min [5,6]         | 120 NI/min [4,2]         | 115 NI/min [4]           | 220 NI/min [7,7]    | 125 NI/min [4,4]        |
| 1/2"   | 16.1 | DN 15 | 35 [20]                                      | 35 [20]         | 35 [20]         | 20 [12]                     | 15 [9]              | 15 [10,5]                | 15 [10,2]                | 215 NI/min [7,5]         | 210 NI/min [7,5]         | 20 [14,1]           | 225 NI/min [8,1]        |
| 3/4"   | 21.7 | DN 20 | 70 [40]                                      | 70 [40]         | 65 [40]         | 40 [20]                     | 30 [15]             | 30 [20]                  | 30 [20]                  | 25 [15]                  | 25 [14,7]                | 45 [25]             | 25 [15]                 |
| 1"   | 27.3 | DN 25 | 115 [65]                                     | 115 [70]        | 115 [65]        | 65 [35]                     | 50 [25]             | 55 [30]                  | 55 [30]                  | 40 [20]                  | 40 [20]                  | 75 [45]             | 40 [25]                 |
| 1 1/4"   | 36.0 | DN 32 | 205 [120]                                    | 210 [125]       | 205 [120]       | 120 [70]                    | 90 [50]             | 100 [60]                 | 100 [55]                 | 75 [45]                  | 70 [40]                  | 140 [80]            | 80 [45]                 |
| 1 1/2"   | 41.9 | DN 40 | 285 [170]                                    | 295 [170]       | 285 [165]       | 165 [95]                    | 125 [70]            | 140 [80]                 | 140 [80]                 | 105 [60]                 | 100 [60]                 | 190 [110]           | 110 [65]                |
| 2"   | 53.1 | DN 50 | 470 [275]                                    | 480 [280]       | 465 [275]       | 270 [160]                   | 205 [120]           | 235 [135]                | 225 [135]                | 170 [100]                | 165 [95]                 | 315 [185]           | 180 [105]               |
| 2 1/2"   | 68.9 | DN 65 | 805 [475]                                    | 825 [485]       | 800 [470]       | 465 [275]                   | 350 [205]           | 400 [235]                | 390 [230]                | 295 [170]                | 285 [165]                | 540 [320]           | 310 [180]               |
| 3"   | 80.9 | DN 80 | 1120 [660]                                   | 1145 [675]      | 1110 [650]      | 645 [380]                   | 485 [285]           | 555 [325]                | 540 [320]                | 405 [240]                | 400 [235]                | 750 [440]           | 430 [250]               |

\* Nm<sup>3</sup>/h in acc. with DIN 1343: 0 °C, 1013.25 hPa for gases

\*\* ISO 1217: 20 °C, 1000 hPa for air

\*\*\* 3/8" only available with VA 520

If you want to measure the consumption / flow rate of a specific gas mixture, ask us. We can offer a real gas adjustment under process conditions on request.





## Measuring ranges Standard version

| Flow measuring ranges VA 570/ VA 520/ VA 525/ VA 521 |      |       |  |                            |               |                          |                                   |  |                  |                            |  |
|--|------|-------|--|----------------------------|---------------|--------------------------|-----------------------------------|--|------------------|----------------------------|--|
| Inside diameter of pipe                              |      |       | Standard version<br>(92.7 m/s)               |                            |               |                          |                                   |  |                  |                            |  |
|  |      |       | Measuring range Nm <sup>3</sup> /h * / [cfm] |                            |               |                          |                                   |  |                  |                            |  |
| Inch   | mm   | DN    | Air**  | Nitrogen (N <sub>2</sub> ) | Argon (Ar)    | Oxygen (O <sub>2</sub> ) | Carbon dioxide (CO <sub>2</sub> ) | Methane Natural gas (CH <sub>4</sub> ) | Helium (He)      | Hydrogen (H <sub>2</sub> ) | Propane (C <sub>3</sub> H <sub>8</sub> ) |
| 1/4"   | 8.9  | DN 8  | 50 NI/min [1.8]                              | 50 NI/min [1.5]            | 85 NI/min [3] | 50 NI/min [1.8]          | 50 NI/min [1.8]                   | 30 NI/min [0.9]                        | 20 NI/min [0.6]  | 15 NI/min [0.3]            | 25 NI/min [0.6]                          |
| 3/8" ***   | 12.5 | DN 10 | 25 [14,7]                                    | 20 [11,7]                  | 35 [20,5]     | 20 [11,7]                | 25 [14,7]                         | 245 NI/min [8,6]                       | 175 NI/min [6,1] | 120 NI/min [4,2]           | 190 NI/min [6,7]                         |
| 1/2"   | 16.1 | DN 15 | 45 [25]                                      | 40 [20]                    | 70 [40]       | 40 [25]                  | 45 [25]                           | 25 [15]                                | 15 [11.1]        | 220 NI/min [7.8]           | 20 [12.3]                                |
| 3/4"   | 21.7 | DN 20 | 85 [50]                                      | 80 [45]                    | 135 [80]      | 80 [45]                  | 85 [50]                           | 50 [30]                                | 35 [20]          | 25 [15]                    | 40 [20]                                  |
| 1"   | 27.3 | DN 25 | 145 [85]                                     | 135 [75]                   | 230 [135]     | 140 [80]                 | 145 [85]                          | 85 [50]                                | 60 [35]          | 40 [25]                    | 65 [35]                                  |
| 1 1/4"   | 36.0 | DN 32 | 265 [155]                                    | 240 [140]                  | 415 [245]     | 250 [145]                | 260 [155]                         | 155 [90]                               | 110 [65]         | 75 [45]                    | 120 [70]                                 |
| 1 1/2"   | 41.9 | DN 40 | 365 [215]                                    | 335 [195]                  | 570 [335]     | 345 [205]                | 360 [210]                         | 215 [125]                              | 150 [90]         | 105 [60]                   | 165 [95]                                 |
| 2"   | 53.1 | DN 50 | 600 [350]                                    | 550 [320]                  | 935 [550]     | 570 [335]                | 590 [345]                         | 355 [205]                              | 250 [145]        | 175 [100]                  | 275 [160]                                |
| 2 1/2"   | 68.9 | DN 65 | 1025 [600]                                   | 945 [555]                  | 1605 [945]    | 980 [575]                | 1015 [595]                        | 605 [355]                              | 425 [250]        | 300 [175]                  | 470 [275]                                |
| 3"   | 80.9 | DN 80 | 1420 [835]                                   | 1305 [770]                 | 2225 [1310]   | 1355 [795]               | 1405 [825]                        | 840 [495]                              | 595 [350]        | 415 [245]                  | 650 [385]                                |

| Flow measuring ranges VA 570/ VA 520/ VA 525/ VA 521 |      |       |  |                 |                 |   |                                  |  |  |  |  |                                  |   |
|--|------|-------|--|-----------------|-----------------|---|----------------------------------|--|--|--|--|----------------------------------|---|
| Inside diameter of pipe                              |      |       | Standard version<br>(92.7 m/s)               |                 |                 |   |                                  |  |  |  |  |                                  |   |
|  |      |       | Measuring range Nm <sup>3</sup> /h * / [cfm] |                 |                 |   |                                  |  |  |  |  |                                  |   |
| Inch   | mm   | DN    | Corgon ®18                                   | Corgon ®10      | Corgon ®20      | Forming gas 90% N <sub>2</sub> + 10% H <sub>2</sub> | Natural gas L (CH <sub>4</sub> ) | Biogas 50% CH <sub>4</sub> + 50% CO <sub>2</sub> | Biogas 60% CH <sub>4</sub> + 40% CO <sub>2</sub> | LPG 60% C <sub>3</sub> H <sub>8</sub> + 40% C <sub>4</sub> H <sub>10</sub> | LPG 50% C <sub>3</sub> H <sub>8</sub> + 50% C <sub>4</sub> H <sub>10</sub> | Nitrous oxide (N <sub>2</sub> O) | Ethyne/Acetylene (C <sub>2</sub> H <sub>2</sub> ) |
| 1/4"   | 8.9  | DN 8  | 75 NI/min [2.7]                              | 80 NI/min [2.7] | 75 NI/min [2.7] | 45 NI/min [1.5]                                     | 30 NI/min [1.2]                  | 35 NI/min [1.2]                                  | 35 NI/min [1.2]                                  | 25 NI/min [0.9]  | 25 NI/min [0.9]  | 50 NI/min [1.8]                  | 30 NI/min [0.9]                                   |
| 3/8" ***   | 12.5 | DN 10 | 35 [20,5]                                    | 35 [20,5]       | 35 [20,5]       | 20 [11,7]   | 15 [8,8]                         | 15 [8,8]   | 15 [8,8]   | 220 NI/min [7,7]   | 215 NI/min [7,5]   | 20 [11,7]                        | 235 NI/min [8,2]                                  |
| 1/2"   | 16.1 | DN 15 | 65 [35]                                      | 65 [40]         | 65 [35]         | 35 [20]   | 25 [15]                          | 30 [15]  | 30 [15]  | 20 [14.1]  | 20 [13.8]  | 40 [25]                          | 25 [15]   |
| 3/4"   | 21.7 | DN 20 | 130 [75]                                     | 130 [75]        | 125 [75]        | 75 [40]   | 55 [30]                          | 60 [35]  | 60 [35]  | 45 [25]  | 45 [25]  | 85 [50]                          | 45 [25]   |
| 1"   | 27.3 | DN 25 | 215 [125]                                    | 220 [130]       | 210 [125]       | 120 [70]  | 90 [55]                          | 105 [60]   | 100 [60]   | 75 [45]  | 75 [45]  | 140 [85]                         | 80 [45]   |
| 1 1/4"   | 36.0 | DN 32 | 385 [225]                                    | 395 [230]       | 385 [225]       | 225 [130]   | 165 [95]                         | 190 [110]  | 185 [110]  | 140 [80]   | 135 [80]   | 260 [150]                        | 145 [85]  |
| 1 1/2"   | 41.9 | DN 40 | 535 [315]                                    | 545 [320]       | 530 [310]       | 310 [180]   | 230 [135]                        | 265 [155]  | 260 [150]  | 195 [110]  | 190 [110]  | 355 [210]                        | 205 [120]   |
| 2"   | 53.1 | DN 50 | 875 [515]                                    | 895 [525]       | 865 [510]       | 505 [295]   | 380 [220]                        | 435 [255]  | 425 [250]  | 315 [185]  | 310 [180]  | 585 [345]                        | 335 [195]   |
| 2 1/2"   | 68.9 | DN 65 | 1500 [880]                                   | 1535 [905]      | 1485 [875]      | 865 [510]   | 650 [380]                        | 745 [440]  | 725 [425]  | 545 [320]  | 535 [315]  | 1005 [590]                       | 575 [335]   |
| 3"   | 80.9 | DN 80 | 2075 [1220]                                  | 2130 [1250]     | 2060 [1210]     | 1205 [705]  | 900 [530]                        | 1035 [605]                                       | 1005 [590]                                       | 755 [445]  | 740 [435]  | 1395 [820]                       | 795 [470]   |

\* Nm<sup>3</sup>/h in acc. with DIN 1343: 0 °C, 1013.25 hPa for gases

\*\* ISO 1217: 20 °C, 1000 hPa for air

\*\*\* 3/8 "only available with VA 520

If you want to measure the consumption / flow rate of a specific gas mixture, ask us.  
We can offer a real gas adjustment under process conditions on request.



## Measuring ranges max version

| Flow measuring ranges VA 570/ VA 520/ VA 525/ VA 521 |      |       |  |                            |                |                          |                                   |  |                 |                            |  |  |
|--|------|-------|--|----------------------------|----------------|--------------------------|-----------------------------------|--|-----------------|----------------------------|--|--|
| Inside diameter of pipe                              |      |       | Max version<br>(185.0 m/s)                   |                            |                |                          |                                   |  |                 |                            |  |  |
|  |      |       | Measuring range Nm <sup>3</sup> /h * / [cfm] |                            |                |                          |                                   |  |                 |                            |  |  |
| Inch   | mm   | DN    | Air**  | Nitrogen (N <sub>2</sub> ) | Argon (Ar)     | Oxygen (O <sub>2</sub> ) | Carbon dioxide (CO <sub>2</sub> ) | Methane Natural gas (CH <sub>4</sub> ) | Helium (He)     | Hydrogen (H <sub>2</sub> ) | Propane (C <sub>3</sub> H <sub>8</sub> ) |  |
| 1/4"   | 8.9  | DN 8  | 105 NI/min [3.6]                             | 100 NI/min [3.3]           | 170 NI/min [6] | 100 NI/min [3.6]         | 105 NI/min [3.6]                  | 60 NI/min [2.1]                        | 45 NI/min [1.5] | 30 NI/min [0.9]            | 50 NI/min [1.5]                          |  |
| 3/8" ***   | 12.5 | DN 10 | 50 [29,4]                                    | 45 [26,4]                  | 75 [44,1]      | 45 [26,4]                | 50 [29,4]                         | 25 [14,7]                              | 20 [11,7]       | 245 NI/min [8,6]           | 20 [11,7]                                |  |
| 1/2"   | 16.1 | DN 15 | 90 [50]                                      | 80 [45]                    | 140 [80]       | 85 [50]                  | 90 [50]                           | 50 [30]                                | 35 [20]         | 25 [15]                    | 40 [20]                                  |  |
| 3/4"   | 21.7 | DN 20 | 175 [100]                                    | 160 [95]                   | 275 [160]      | 165 [95]                 | 175 [100]                         | 105 [60]                               | 70 [40]         | 50 [30]                    | 80 [45]                                  |  |
| 1"   | 27.3 | DN 25 | 290 [170]                                    | 270 [155]                  | 460 [270]      | 280 [165]                | 290 [170]                         | 170 [100]                              | 120 [70]        | 85 [50]                    | 135 [75]                                 |  |
| 1 1/4"   | 36.0 | DN 32 | 530 [310]                                    | 485 [285]                  | 830 [485]      | 505 [295]                | 525 [305]                         | 310 [185]                              | 220 [130]       | 155 [90]                   | 240 [140]                                |  |
| 1 1/2"   | 41.9 | DN 40 | 730 [430]                                    | 670 [395]                  | 1140 [670]     | 695 [410]                | 720 [425]                         | 430 [250]                              | 305 [180]       | 215 [125]                  | 335 [195]                                |  |
| 2"   | 53.1 | DN 50 | 1195 [700]                                   | 1100 [645]                 | 1870 [1100]    | 1140 [670]               | 1185 [695]                        | 705 [415]                              | 500 [290]       | 350 [205]                  | 550 [320]                                |  |
| 2 1/2"   | 68.9 | DN 65 | 2050 [1205]                                  | 1885 [1110]                | 3205 [1885]    | 1955 [1150]              | 2030 [1190]                       | 1210 [710]                             | 855 [500]       | 600 [350]                  | 940 [555]                                |  |
| 3"   | 80.9 | DN 80 | 2840 [1670]                                  | 2610 [1535]                | 4440 [2615]    | 2710 [1590]              | 2810 [1655]                       | 1680 [985]                             | 1185 [695]      | 830 [490]                  | 1305 [765]                               |  |

| Flow measuring ranges VA 570/ VA 520/ VA 525/ VA 521 |      |       |  |                  |                  |   |                                  |  |  |  |  |                                  |  |
|--|------|-------|--|------------------|------------------|---|----------------------------------|--|--|--|--|----------------------------------|--|
| Inside diameter of pipe                              |      |       | Max version<br>(185.0 m/s)                   |                  |                  |   |                                  |  |  |  |  |                                  |  |
|  |      |       | Measuring range Nm <sup>3</sup> /h * / [cfm] |                  |                  |   |                                  |  |  |  |  |                                  |  |
| Inch   | mm   | DN    | Corgon @18                                   | Corgon @10       | Corgon @20       | Forming gas 90% N <sub>2</sub> + 10% H <sub>2</sub> | Natural gas L (CH <sub>4</sub> ) | Biogas 50% CH <sub>4</sub> + 50% CO <sub>2</sub> | Biogas 60% CH <sub>4</sub> + 40% CO <sub>2</sub> | LPG 60% C <sub>3</sub> H <sub>8</sub> + 40% C <sub>4</sub> H <sub>10</sub> | LPG 50% C <sub>3</sub> H <sub>8</sub> + 50% C <sub>4</sub> H <sub>10</sub> | Nitrous Oxide (N <sub>2</sub> O) | Ethyne/ Acetylene (C <sub>2</sub> H <sub>2</sub> ) |
| 1/4"   | 8.9  | DN 8  | 155 NI/min [5.4]                             | 160 NI/min [5.7] | 155 NI/min [5.4] | 90 NI/min [3]                                       | 65 NI/min [2.4]                  | 75 NI/min [2.7]                                  | 75 NI/min [2.7]                                  | 55 NI/min [1.8]  | 55 NI/min [1.8]  | 105 NI/min [3.6]                 | 60 NI/min [2.1]                                    |
| 3/8" ***   | 12.5 | DN 10 | 70 [41,1]                                    | 75 [44,1]        | 70 [41,1]        | 40 [23,5]   | 30 [17,6]                        | 35 [20,5]  | 35 [20,5]  | 25 [14,7]  | 25 [14,7]  | 45 [26,4]                        | 25 [14,7]  |
| 1/2"   | 16.1 | DN 15 | 130 [75]                                     | 135 [80]         | 130 [75]         | 75 [45]   | 55 [30]                          | 65 [35]  | 60 [35]  | 45 [25]  | 45 [25]  | 85 [50]                          | 50 [30]  |
| 3/4"   | 21.7 | DN 20 | 255 [150]                                    | 265 [155]        | 255 [150]        | 150 [85]  | 110 [65]                         | 125 [75]   | 125 [70]   | 90 [55]  | 90 [50]  | 170 [100]                        | 95 [55]  |
| 1"   | 27.3 | DN 25 | 430 [250]                                    | 440 [255]        | 425 [250]        | 245 [145]   | 185 [110]                        | 210 [125]  | 205 [120]  | 155 [90]   | 150 [90]   | 285 [170]                        | 165 [95]   |
| 1 1/4"   | 36.0 | DN 32 | 775 [455]                                    | 795 [465]        | 765 [450]        | 445 [260]   | 335 [195]                        | 385 [225]  | 375 [220]  | 280 [165]  | 275 [160]  | 520 [305]                        | 295 [175]  |
| 1 1/2"   | 41.9 | DN 40 | 1065 [625]                                   | 1095 [640]       | 1060 [620]       | 615 [360]   | 460 [270]                        | 530 [310]  | 515 [305]  | 385 [225]  | 380 [220]  | 715 [420]                        | 410 [240]  |
| 2"   | 53.1 | DN 50 | 1745 [1025]                                  | 1790 [1050]      | 1730 [1020]      | 1010 [595]  | 755 [445]                        | 870 [510]  | 845 [495]  | 635 [375]  | 620 [365]  | 1170 [690]                       | 670 [395]  |
| 2 1/2"   | 68.9 | DN 65 | 2995 [1760]                                  | 3065 [1805]      | 2970 [1745]      | 1735 [1020]   | 1300 [765]                       | 1490 [875]                                       | 1450 [855]                                       | 1090 [640]   | 1065 [625]   | 2010 [1180]                      | 1150 [675]   |
| 3"   | 80.9 | DN 80 | 4150 [2440]                                  | 4250 [2500]      | 4115 [2420]      | 2400 [1415]   | 1800 [1060]                      | 2065 [1215]                                      | 2015 [1185]                                      | 1510 [890]   | 1480 [870]   | 2785 [1640]                      | 1590 [935]   |

\* Nm<sup>3</sup>/h in acc. with DIN 1343: 0 °C, 1013.25 hPa for gases

\*\* ISO 1217: 20 °C, 1000 hPa for air

\*\*\* 3/8 "only available with VA 520

If you want to measure the consumption / flow rate of a specific gas mixture, ask us.  
We can offer a real gas adjustment under process conditions on request.



## Measuring ranges high-speed version

| Flow measuring ranges VA 570/ VA 520/ VA 525/ VA 521 |      |       |  |                            |                  |                          |                                   |  |                 |                            |  |  |
|--|------|-------|--|----------------------------|------------------|--------------------------|-----------------------------------|--|-----------------|----------------------------|--|--|
| Inside diameter of pipe                              |      |       | High-speed version<br>(224.0 m/s)            |                            |                  |                          |                                   |  |                 |                            |  |  |
|  |      |       | Measuring range Nm <sup>3</sup> /h * / [cfm] |                            |                  |                          |                                   |  |                 |                            |  |  |
| Inch   | mm   | DN    | Air**  | Nitrogen (N <sub>2</sub> ) | Argon (Ar)       | Oxygen (O <sub>2</sub> ) | Carbon dioxide (CO <sub>2</sub> ) | Methane Natural gas (CH <sub>4</sub> ) | Helium (He)     | Hydrogen (H <sub>2</sub> ) | Propane (C <sub>3</sub> H <sub>8</sub> ) |  |
| 1/4"   | 8.9  | DN 8  | 130 NI/min [4.5]                             | 120 NI/min [4.2]           | 205 NI/min [7.2] | 125 NI/min [4.2]         | 130 NI/min [4.5]                  | 75 NI/min [2.7]                        | 55 NI/min [1.8] | 35 NI/min [1.2]            | 60 NI/min [2.1]                          |  |
| 3/8" ***   | 12.5 | DN 10 | 60 [35,3]                                    | 55 [32,3]                  | 95 [55,9]        | 55 [32,3]                | 60 [35,3]                         | 35 [20,5]                              | 25 [14,7]       | 15 [8,8]                   | 25 [14,7]                                |  |
| 1/2"   | 16.1 | DN 15 | 110 [60]                                     | 100 [55]                   | 170 [100]        | 105 [60]                 | 105 [60]                          | 65 [35]                                | 45 [25]         | 30 [15]                    | 50 [25]                                  |  |
| 3/4"   | 21.7 | DN 20 | 215 [125]                                    | 195 [115]                  | 335 [195]        | 205 [120]                | 210 [125]                         | 125 [70]                               | 85 [50]         | 60 [35]                    | 95 [55]                                  |  |
| 1"   | 27.3 | DN 25 | 355 [210]                                    | 325 [190]                  | 555 [325]        | 340 [200]                | 350 [205]                         | 210 [120]                              | 145 [85]        | 100 [60]                   | 160 [95]                                 |  |
| 1 1/4"   | 36.0 | DN 32 | 640 [375]                                    | 590 [345]                  | 1005 [590]       | 610 [360]                | 635 [370]                         | 380 [220]                              | 265 [155]       | 185 [110]                  | 295 [170]                                |  |
| 1 1/2"   | 41.9 | DN 40 | 885 [520]                                    | 815 [475]                  | 1385 [815]       | 845 [495]                | 875 [515]                         | 520 [305]                              | 370 [215]       | 260 [150]                  | 405 [235]                                |  |
| 2"   | 53.1 | DN 50 | 1450 [850]                                   | 1330 [780]                 | 2265 [1330]      | 1380 [810]               | 1430 [840]                        | 855 [500]                              | 605 [355]       | 425 [250]                  | 665 [390]                                |  |
| 2 1/2"   | 68.9 | DN 65 | 2480 [1460]                                  | 2280 [1340]                | 3880 [2285]      | 2365 [1390]              | 2455 [1445]                       | 1465 [865]                             | 1035 [610]      | 725 [425]                  | 1140 [670]                               |  |
| 3"   | 80.9 | DN 80 | 3440 [2025]                                  | 3165 [1860]                | 5380 [3165]      | 3280 [1930]              | 3405 [2000]                       | 2035 [1195]                            | 1435 [845]      | 1010 [590]                 | 1580 [930]                               |  |

| Flow measuring ranges VA 570/ VA 520/ VA 525/ VA 521 |      |       |  |                  |                  |   |                                  |  |  |  |  |                                  |  |
|--|------|-------|--|------------------|------------------|---|----------------------------------|--|--|--|--|----------------------------------|--|
| Inside diameter of pipe                              |      |       | High-speed version<br>(224.0 m/s)            |                  |                  |   |                                  |  |  |  |  |                                  |  |
|  |      |       | Measuring range Nm <sup>3</sup> /h * / [cfm] |                  |                  |   |                                  |  |  |  |  |                                  |  |
| Inch   | mm   | DN    | Corgon @18                                   | Corgon @10       | Corgon @20       | Forming gas 90% N <sub>2</sub> + 10% H <sub>2</sub> | Natural gas L (CH <sub>4</sub> ) | Biogas 50% CH <sub>4</sub> + 50% CO <sub>2</sub> | Biogas 60% CH <sub>4</sub> + 40% CO <sub>2</sub> | LPG 60% C <sub>3</sub> H <sub>8</sub> + 40% C <sub>4</sub> H <sub>10</sub> | LPG 50% C <sub>3</sub> H <sub>8</sub> + 50% C <sub>4</sub> H <sub>10</sub> | Nitrous Oxide (N <sub>2</sub> O) | Ethyne/ Acetylene (C <sub>2</sub> H <sub>2</sub> ) |
| 1/4"   | 8.9  | DN 8  | 190 NI/min [6.6]                             | 195 NI/min [6.9] | 190 NI/min [6.6] | 110 NI/min [3.9]                                    | 80 NI/min [2.7]                  | 95 NI/min [3.3]                                  | 90 NI/min [3.3]                                  | 70 NI/min [2.4]  | 65 NI/min [2.4]  | 125 NI/min [4.5]                 | 70 NI/min [2.4]                                    |
| 3/8" ***   | 12.5 | DN 10 | 85 [50]                                      | 90 [52,9]        | 85 [50]          | 50 [29,4]   | 35 [20,5]                        | 40 [23,5]  | 40 [23,5]  | 30 [17,6]  | 30 [17,6]  | 60 [35,3]                        | 30 [17,6]  |
| 1/2"   | 16.1 | DN 15 | 160 [90]                                     | 160 [95]         | 155 [90]         | 90 [50]   | 65 [40]                          | 80 [45]  | 75 [45]  | 55 [30]  | 55 [30]  | 105 [60]                         | 60 [35]  |
| 3/4"   | 21.7 | DN 20 | 310 [185]                                    | 320 [185]        | 310 [180]        | 180 [105]   | 135 [80]                         | 155 [90]   | 150 [85]   | 110 [65]   | 110 [65]   | 210 [120]                        | 120 [70]   |
| 1"   | 27.3 | DN 25 | 520 [305]                                    | 530 [310]        | 515 [300]        | 300 [175]   | 225 [130]                        | 255 [150]  | 250 [145]  | 190 [110]  | 185 [105]  | 345 [205]                        | 200 [115]  |
| 1 1/4"   | 36.0 | DN 32 | 935 [550]                                    | 960 [565]        | 930 [545]        | 540 [320]   | 405 [240]                        | 465 [275]  | 455 [265]  | 340 [200]  | 335 [195]  | 630 [370]                        | 360 [210]  |
| 1 1/2"   | 41.9 | DN 40 | 1290 [760]                                   | 1325 [780]       | 1280 [755]       | 745 [440]   | 560 [330]                        | 640 [375]  | 625 [365]  | 470 [275]  | 460 [270]  | 865 [510]                        | 495 [290]  |
| 2"   | 53.1 | DN 50 | 2115 [1245]                                  | 2165 [1275]      | 2100 [1235]      | 1225 [720]  | 920 [540]                        | 1050 [620]                                       | 1025 [605]                                       | 770 [450]  | 755 [440]  | 1420 [835]                       | 810 [475]  |
| 2 1/2"   | 68.9 | DN 65 | 3625 [2130]                                  | 3715 [2185]      | 3595 [2115]      | 2100 [1235]   | 1575 [925]                       | 1805 [1060]                                      | 1760 [1035]                                      | 1320 [775]   | 1290 [760]   | 2435 [1430]                      | 1390 [820]   |
| 3"   | 80.9 | DN 80 | 5025 [2955]                                  | 5145 [3030]      | 4985 [2930]      | 2910 [1710]   | 2180 [1285]                      | 2500 [1470]                                      | 2440 [1435]                                      | 1830 [1075]  | 1790 [1050]  | 3375 [1985]                      | 1930 [1135]  |

\* Nm<sup>3</sup>/h in acc. with DIN 1343: 0 °C, 1013.25 hPa for gases

\*\* ISO 1217: 20 °C, 1000 hPa for air

\*\*\* 3/8 "only available with VA 520

If you want to measure the consumption / flow rate of a specific gas mixture, ask us.  
We can offer a real gas adjustment under process conditions on request.

## Measuring compressed air consumption and saving energy

Compressed air is one of the most expensive forms of energy at all. An intelligent use of compressed air holds enormous savings potential.

Therefore a consumption measurement that can measure and record the actual compressed air consumption and even the smallest leaks quickly and reliably is very helpful.



If we talk about operating costs in compressed air systems, we are actually talking about the energy costs. Because the electricity costs make up about 70-80% of the total cost of a compressed air system.

Depending on the size of the system, this means considerable operating costs. Even in smaller systems, this may quickly add up to €10,000 to 20,000 per year. This is an amount which can be considerably reduced – even in case of well operated and maintained plants.

In case of a three shift operation with 200 kW compressor performance a bad compressed air distribution can create redundant energy costs of more than 50,000 € per year.

This mainly relates to the detection of leaks and the correct design of the compressed air lines to minimize the pressure losses.

Energy resources like electricity, water or gas are usually monitored and therefore the costs are transparent.

Contrary to compressed air, a water leak is usually found quickly due to the visibility of the leak and therefore is fixed immediately. Leakages in the compressed air network „blow out“ unnoticed, even on weekends and during production stops.

The compressors continue to run during this time just to maintain a constant pressure in the network. For mature compressed air networks, the leak rate can be between 25 and 35 percent.

They are the most industrious consumers working 365 days a year.

Not considered in these considerations are the costs of producing clean and dry compressed air. Refrigeration and adsorption dryers dry the air with significant operating costs, which then „blow out“ useless through leaks.

With constantly rising energy costs, these energy savings have to be implemented in order to stay competitive within the market. Potential savings can only be exploited if the consumption of individual machines or systems is known and made transparent for all.

However, often there is no knowledge about the leak ratio. In the following we show you how leakage rate can be determined easily in your company.

Formerly the simple but inaccurate container method was applied very often. A simplified determination of the leakages is possible by means of the emptying of the tank. To carry out this measurement you just need a clock and a manometer.

Furthermore you should know the storage volume of the tank as well as of the compressed air system.

For measurement first the tank and the compressed air system are set to the upper cut-out pressure value. All compressed air consumers have to be switched off. Then the compressor is switched off and there will be no compressed air feeding into the system.

Now the time T which elapses until there is a pressure drop of 1 to 2 bar due to the leakages is measured. The pressure drop between which the measurement is taking place can be selected freely.

However, in practice the described method is very time-consuming, not adequate and inaccurate due to the following reasons:

- Storage volume, distribution pipelines cannot be determined exactly
- The accuracy of the differential pressure measurement and time measurement has to be observed
- During the pressure drop, the compressed air volume cools down and therefore changes the volume flow reference value.
- An online measurement with consumption report is not possible.

This method belongs to the so-called indirect measurements, like also the method of the load and unload measurement during which the current intake is measured by means of clamp-on ammeters and calculated back to the volume flow over the technical data of the compressor.

These indirect methods are antiquated and not suitable to detect leakages in the lower measuring range.

## Determination of compressed air leakages with modern flow meters

A modern compressed air consumption measurement resp. leakage measurement should be able to measure the real compressed air flow and also the smallest leakages quickly and reliably and record them.

### New: Flow measurement DS 400 for compressed air and gases

Worldwide unique with 3.5 inch, graphic display with touch screen and print function.

With the new "ready for plug-in" flow measurement DS 400 the current flow in m<sup>3</sup>/h, l/min etc. as well as the consumption in m<sup>3</sup> or l can be measured.

The new flow station works according to the approved calorimetric measuring principle.



The heart is the flow sensor which has been proven and tested for years.

It is characterized by a new thermally more efficient sensor structure which shows a higher chip temperature in case of same electrical connection values. Compared to other calorimetric measuring instruments the sensor has a considerably lower mass and therefore a faster response time.

An additional pressure and temperature compensation is not necessary. The advantage is that the user can use the flow meters in different pressures and temperatures without any further compensation.

In addition to compressed air, other gases such as

- nitrogen
- oxygen
- CO<sub>2</sub>
- argon
- natural gas
- helium

can also be measured.

| *** Channel A1 *** |                 |               |         | -0.0 V<br>-0 mA |  |
|--------------------|-----------------|---------------|---------|-----------------|--|
| Type               | VA5xx VA-Sensor |               |         |                 |  |
| Flow               | Velocity        | Diameter      | Unit    |                 |  |
| m <sup>3</sup> /h  | m/s             | 53.100        | mm      |                 |  |
| Gas Constant       |                 | Ref. Pressure | Unit    |                 |  |
| Air (real)         |                 | J/Kg*K        | 1000.00 | hpa             |  |
| Ref. Temp.         | Unit            | Count.Val     | Unit    |                 |  |
| 20.000             | °C              | ---           |         |                 |  |
| Back               | Store           | More-Settings | Info    |                 |  |

Threshold value exceedance can be reported optically and acoustically. 2 relays for pre- and main alarm are freely adjustable.

An alarm delay can be set for each relay. This grants that only really long-term threshold value exceedances are indicated.

Additionally every alarm can be reset.

The intuitive operation with the 3.5 inch touch screen graphic display with zoom function and print key is one of its kind in the world in this price class.

The graphic display with zoom function shows the actual flow, the peak values and the leakage at a glance, the values are stored in the data logger.

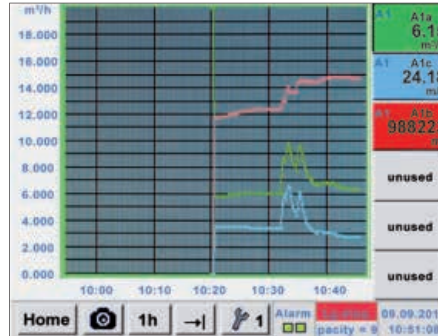

So the user can take a look at the stored measurement curves also without any computer at any time on site. This grants a quick and easy analysis of the compressed air or gas consumption.

With the print key, the current screen can be saved as an image file on the internal SD card or on a USB stick and can be printed out without additional software on a PC.

Ideal for documentation of the measured values/measurement curves on site. Colored measurement curves can be sent by e-mail as image files or integrated into a service report.

The internal data logger enables the storage of the measured data for several years.

The measured data can be evaluated via a USB stick or via Ethernet by means of the comfortable software CS Soft Basic.

Particularly comfortable is the consumption analysis at the touch of a button.

The CS Soft Basic automatically draws up daily, weekly and monthly reports.

## Special features:

- 3.5" graphic display – easy to use with touchscreen
- Zoom function for accurate analysis of measured values
- Consumption analysis with daily/weekly/monthly reports
- Colored measurement curves with names
- Mathematical calculation function, e.g. addition of several consumers to a total consumption or energy costs per kWh/m<sup>3</sup>
- Print key: optional indications can be stored as image files directly on a USB stick and sent by e-mail without any software
- 2 alarm contacts for threshold value exceedance
- Freely adjustable alarm delay for both alarm contacts with reset function
- Up to 4 sensor inputs for: additional flow meters, dew point, pressure, temperature sensors, electrical effective power meters, optional third-party sensors can be connected: Pt 100/1000, 0/4...20 mA, 0-1/10 V, Modbus, pulse
- Integrated data logger 8 GB
- USB, Ethernet interface, RS 485
- Web server

## Installation VA 500 under pressure



### VA 500 flow meter for compressed air and gases

Even under pressure, the flow probe VA 500 is mounted by means of a standard 1/2" ball valve.

During mounting and dismantling the safety ring avoids an uncontrolled ejection of the probe which may be caused by the operating pressure.

For the mounting into different pipe diameters, VA 500 is available in the following probe lengths: 120, 160, 220, 300, 400 mm.

The flow probes are thus suitable for being mounted into existing pipes with diameters of 1/2" to DN 1000 upwards.

The exact positioning of the sensor in the middle of the pipe is granted by means of the engraved depth scale. The maximum mounting depth corresponds to the respective probe length.

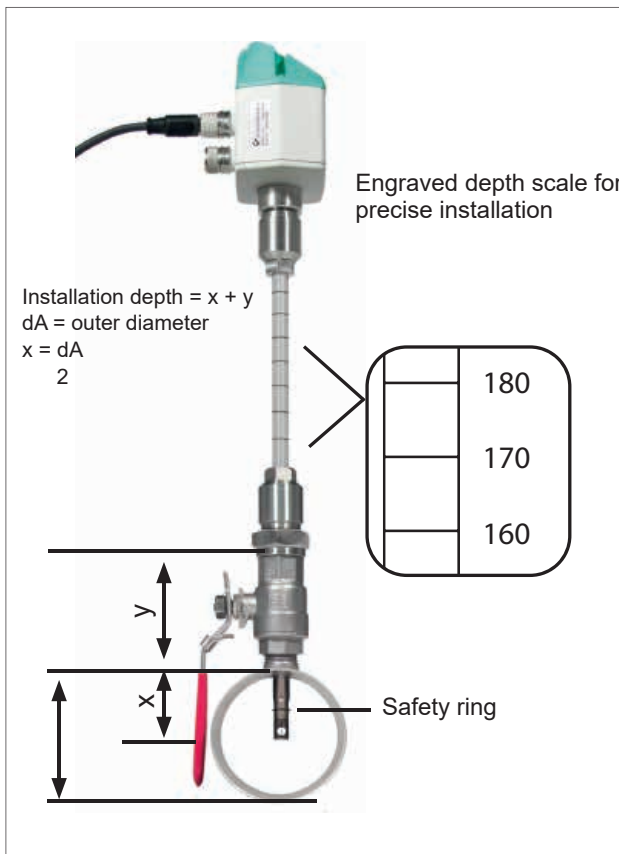

### Configuring the measuring site

If there is no suitable measuring site with 1/2" ball valve, there are two simple possibilities to set up a measuring site:

- A Weld on a 1/2" screw neck and screw on a 1/2" ball valve
- B Mount spot drilling collar incl. ball valve (see accessories)

By means of the drilling jig, it is possible to drill under pressure through the 1/2" ball valve into the existing pipe.

The drilling chips are collected in a filter. Then install the probe as described above.

Due to the large measuring range of the probes, even extreme requirements placed on the consumption measurement (high volume flow in small pipe diameters) can be met.

(The measuring range depends on the pipe diameter).



## Measure compressed air quality according to ISO 8573

### Residual oil - particles - residual moisture



#### Residual oil content measurement – OIL-Check 400

For permanent and highly precise measurement of the vaporous residual oil content from 0.001 mg/m<sup>3</sup> to 2.5 mg/m<sup>3</sup>. Due to the low detection limit of 0.001 mg/m<sup>3</sup>, the compressed air quality class 1 (ISO 8573) can be monitored.

#### Particle counter PC 400

The highly precise, optical particle counter PC 400 measures particles from a size of 0.1 µm and is therefore suitable for monitoring the compressed air quality class 1 (ISO 8573).

#### Moisture – dew point sensor FA 510

FA 510 measures the pressure dew point down to -80 °Ctd. Also in this case the continuous measurement takes care that alert is triggered immediately if the compressed air dryer breaks down.

#### DS 500 - the intelligent chart recorder of the next generation

The centerpiece of compressed air quality measurement is the chart recorder DS 500. It measures and documents the measured data of the sensors for residual oil content, particles and moisture. The measured values are indicated on a 7" colour screen. The curve progressions from the begin-

ning of the measurement can be viewed by an easy slide of the finger. The integrated data logger stores the measured values safely and reliably. The threshold value can be freely entered for each measured parameter. 4 alarm relays are available for automatic alarm in case of threshold value exceedance. Optionally DS 500 can be upgraded with up to 12 sensor inputs. For connection to a PLC DS 500 has an Ether-

net interface as well as a RS 485 interface. The communication is done via the Modbus protocol.

| ISO 8573-1:2010 Class | Solid particles   |            |           | Humidity           | Oil  |
|-----------------------|---|------------|-----------|--------------------|--|
|                       | Number of particles per m <sup>3</sup>  |            |           | Pressure dew point | Total share of oil (liquid aerosol and vaporous)<br>mg/ m <sup>3</sup> |
|                       | 0.1 - 0.5 µm  | 0.5 - 1 µm | 1 - 5 µm  |                    |  |
| 0                     | In accordance with specification by the device user, stricter requirements than class 1 |            |           |                    |  |
| 1                     | ≤ 20,000  | ≤ 400      | ≤ 10      | ≤ -70 °C           | ≤ 0.01   |
| 2                     | ≤ 400,000   | ≤ 6,000    | ≤ 100     | ≤ -40 °C           | ≤ 0.1  |
| 3                     | --  | ≤ 90,000   | ≤ 1,000   | ≤ -20 °C           | ≤ 1  |
| 4                     | --  | --         | ≤ 10,000  | ≤ +3 °C            | ≤ 5  |
| 5                     | --  | --         | ≤ 100,000 | ≤ +7 °C            | --   |
| 6                     | --  | --         | --        | ≤ +10 °C           | --   |
| 7                     | --  | --         | --        | --                 | --   |
| 8                     | --  | --         | --        | --                 | --   |
| 9                     | --  | --         | --        | --                 | --   |
| x                     | --  | --         | --        | --                 | --   |



## Stationary solution

| DESCRIPTION   | ORDER NO. |
|---|-----------|
| DS 500 – intelligent chart recorder in basic version (4 sensor inputs)  | 0500 5000 |
| CS Basic - data evaluation in graphic and table form - readout of the measured data via USB or Ethernet. License for 2 working places   | 0554 8040 |
| <b>Residual oil measurement:</b><br>OIL-Check 400 – residual oil measurement of the vaporous residual oil content from 0.001...2.5 mg/m <sup>3</sup> , 3...16 bar. Highly precise PID sensor, integrated mini catalyst for zero point calibration, without integrated display, with analogue output 0...10 volts for connection to external chart recorders | 0699 0070 |
| <b>Sampling system OIL-Check 400:</b><br>Sampling system consisting of ½" ball valve (oil- and grease-free), 1 m stainless steel tube 6x1 mm (oil- and grease-free), clamp screwing (oil- and grease-free)  | Z699 0075 |
| <b>Alternative:</b><br>Portable sampling system consisting of 2 m PTFE hose, quick coupling (oil- and grease-free)  | Z699 0074 |
| <b>Options for systems &gt; 16 bar:</b><br>Pressure reducer (oil- and grease-free), input pressure max. 300 bar, output pressure up to 10 bar   | Z699 0076 |
| Connection cable for probes 5 m with open ends  | 0553 0108 |
| <b>PC 400 particle counter</b> up to 0.1 µm for compressed air and gases, incl. pressure reducer/sampling hose, calibration certificate, Modbus-RTU interface   | 0699 0040 |
| Connection cable for probes 5 m with open ends  | 0553 0108 |
| <b>FA 510 dew point sensor</b> for adsorption dryers -80 °...+20 °Ctd incl. factory certificate, 4...20 mA analogue output (3-wire connection) and Modbus-RTU interface   | 0699 0510 |
| Standard measuring chamber up to 16 bar   | 0699 3390 |
| Connection cable for VA/FA series, 5 m  | 0553 0104 |

## Mobile solution with DS 500 mobile, OIL-Check 400, PC 400, FA 510



| DESCRIPTION   | ORDER NO. |
|---|-----------|
| DS 500 mobile - intelligent chart recorder with 4 sensor inputs   | 0500 5012 |
| CS Basic - data evaluation in graphic and table form - readout of the measured data via USB or Ethernet. License for 2 working places   | 0554 8040 |
| <b>Residual oil measurement:</b><br>OIL-Check 400 – residual oil measurement of the vaporous residual oil content from 0.001...2.5 mg/m <sup>3</sup> , 3...16 bar. Highly precise PID sensor, integrated mini catalyst for zero point calibration, without integrated display, with analogue output 0...10 volts for connection to external chart recorders | 0699 0070 |
| Mobile transport trolley including roles (outer dimensions: 0,68 x 1,06 x 0,41 m) (W x H x D) with firmly mounted components of OIL-Check 400, PC 400, FA 510   | 0554 6017 |
| Mobile sampling system consisting of 2 m PTFE hose, quick coupling (oil- and grease-free)   | Z699 0074 |
| Connection cable for pressure, temperature, third party sensors to portable devices, ODU/ open ends, 5 m  | 0553 0501 |
| PC 400 particle counter up to 0.1 µm for compressed air and gases, incl. pressure reducer/sampling hose, calibration certificate, Modbus-RTU interface  | 0699 0040 |
| Connection cable to portable devices, ODU/ M12, 5 m   | 0553 1503 |
| FA 510 dew point sensor, -80...+20 °Ctd incl. measuring chamber mobile and 5 m connection cable to mobile devices   | 0699 1510 |



## OIL-Check 400

The monitoring system for permanent highly precise measurement of the vaporous residual oil content in compressed air



### Advantages at a glance:

- Permanent, highly precise residual oil measurement (oil vapour) with PID sensor (photo-ionic-detector)
- Ideal for mobile measurement: The PID sensor is ready for measurement within about 30 minutes
- Measuring results with long-term stability due to automatic zero point calibration. The integrated mini catalyst reliably generates a defined reference gas for zero point calibration
- In contrast to measuring systems which generate the “zero air” or reference gas by means of active carbon filters and which are therefore dependent on the ageing and saturation of the active carbon filters, the mini catalyst generates the “zero air” without ageing or wear. There is no change of active carbon filters necessary
- Easy sampling via PTFE hose or stainless steel pipe

### Integrated chart recorder DS 400:

- Data logger for long-term monitoring
- Display shows trend curves (online and history curves available)
- Zoom function directly on the touch screen
- Integrated Ethernet interface (Modbus/TCP) and RS 485 interface (Modbus-RTU) for data transfer to superordinate controls
- 2 alarm relays (changeover contact 230 VAC, 3A) – threshold values freely adjustable
- Easy operation via 3.5" touchscreen

### TECHNICAL DATA OIL-CHECK 400

|  |  |
|--|--|
| <b>Measured medium:</b>                | Compressed air, free from aggressive, corrosive, acid, toxic, flammable and oxidising components.  |
| <b>Measuring unit:</b>                 | Residual oil content in mg oil/norm m <sup>3</sup> relative to 1.0 bar [abs], +20 °C, 0% relative humidity, in accordance with ISO 8573-1      |
| <b>Identifiable substances:</b>        | Hydrocarbons, functional hydrocarbons, aromatic hydrocarbons   |
| <b>Field of application:</b>           | After activated carbon filter, after activated carbon adsorber, after oil-free compressor, always with connected upstream filtration and dryer |
| <b>Ambient temperature:</b>            | +5 °C... +45 °C, rel. humidity ≤ 75% without condensation  |
| <b>Pressure dew point:</b>             | max. +10 °Ctd.   |
| <b>Compressed air temp.:</b>           | +5 °C... +50 °C  |
| <b>Operational overpressure:</b>       | 3...16 bar [ü] optional pressure reducer connected upstream for up to 300 bar [ü]  |
| <b>Setting operational pressure:</b>   | By means of integrated pressure reducer with display   |
| <b>Humidity of measured gas:</b>       | ≤ 40% rel. humidity, pressure dew point max. +10 °C, non-condensable humidity  |
| <b>Compressed air connection:</b>      | G 1/8" female thread according to ISO 228-1  |
| <b>Measured values:</b>                | mg/norm m <sup>3</sup> , pressure and temperature compensated residual oil vapour content  |
| <b>Measuring range:</b>                | 0.001 ... 2.5 mg/m <sup>3</sup>  |
| <b>Detection limit (residual oil):</b> | 0.001 mg/m <sup>3</sup>  |
| <b>Flow of measuring gas:</b>          | approx. 1.20 norm litres/minute, relative to 1.0 bar [abs] and + 20 °C, in a relaxed state   |
| <b>Reference gas generation:</b>       | By means of integrated mini catalyst   |
| <b>Power supply:</b>                   | 100...240 VAC / 1 Ph. / PE / 50...60 Hz / ± 10%  |
| <b>Outputs:</b>                        | Ethernet interface (Modbus/TCP), RS 485 interface (Modbus-RTU), 2 alarm relays (change 230 VAC 3A), 4...20 mA (on request)                     |
| <b>Operating hours counter:</b>        | integrated   |
| <b>Dimensions (mm):</b>                | 410 x 440 x 163 (W x H x D)  |
| <b>Weight:</b>                         | approx. 16.3 kg  |

## OIL-Check 400 - Stationary solution



| DESCRIPTION   | ORDER NO. |
|---|-----------|
| OIL-Check 400 – residual oil measurement of the vaporous residual oil content from 0.001...2.5 mg/m <sup>3</sup> , 3...16 bar. Highly precise PID sensor, integrated mini catalyst for zero point calibration, without integrated display, with analogue output 0...10 volts for connection to external chart recorders | 0699 0070 |
| <b>Option:</b> DS 400 chart recorder integrated into OIL-Check 400  | Z699 0071 |
| <b>Sampling system OIL-Check 400:</b><br>Sampling system consisting of ½" ball valve (oil- and grease-free), 1 m stainless steel tube 6x1 mm (oil- and grease-free), clamp screwing (oil- and grease-free)  | Z699 0075 |
| Portable sampling system consisting of 2 m PTFE hose, quick coupling (oil- and grease-free)   | Z699 0074 |
| For systems > 16 bar: Pressure reducer (oil- and grease-free), input pressure max. 300 bar, output pressure up to 10 bar  | Z699 0076 |
| <b>Options for the DS 400:</b><br>Integrated data logger for 100 million measured values  | Z500 4002 |
| Integrated Ethernet and RS 485 interface  | Z500 4004 |
| Integrated webserver  | Z500 4005 |
| 2 additional sensor inputs for analogue sensors (pressure sensors, temperature sensors etc.)  | Z500 4001 |
| CS Basic - data evaluation in graphic and table form - readout of the measured data via USB or Ethernet. License for 2 working places   | 0554 8040 |

## OIL-Check 400 - Portable solution with handle



Handle and stand



Flight case

| DESCRIPTION   | ORDER NO. |
|---|-----------|
| OIL-Check 400 – residual oil measurement of the vaporous residual oil content from 0.001...2.5 mg/m <sup>3</sup> , 3...16 bar. Highly precise PID sensor, integrated mini catalyst for zero point calibration, without integrated display, with analogue output 0...10 volts for connection to external chart recorders | 0699 0070 |
| <b>Option:</b><br>DS 400 chart recorder integrated into OIL-Check 400   | Z699 0071 |
| Handle and stand for mobile use of the OIL-Check 400  | Z699 0072 |
| Flight case for OIL-Check 400   | Z699 0073 |
| Portable sampling system consisting of 2 m PTFE hose, quick coupling (oil- and grease-free)   | Z699 0074 |
| <b>Options for the DS 400:</b><br>Integrated data logger for 100 million measured values  | Z500 4002 |
| Integrated Ethernet and RS 485 interface  | Z500 4004 |
| Integrated webserver  | Z500 4005 |
| 2 additional sensor inputs for analogue sensors (pressure sensors, temperature sensors etc.)  | Z500 4001 |
| CS Basic - data evaluation in graphic and table form - readout of the measured data via USB or Ethernet. License for 2 working places   | 0554 8040 |



| DESCRIPTION   | ORDER NO. |
|---|-----------|
| Replacement unit OIL-Check for the period of re-calibration   | 0699 3910 |
| Replacement unit OIL-Check incl. DS 400 for the period of re-calibration                              | 0699 3920 |
| Re-calibration OIL-Check 400 incl. certificate  | 0699 3401 |
| Re-calibration and maintenance OIL-Check 400 incl. certificate, rate 1 for up to 8760 operating hours | 0699 3402 |
| Re-calibration and maintenance OIL-Check 400 incl. certificate, rate 2 from 8760 operating hours      | 0699 3403 |



## Particle counter PC 400 and DS 400

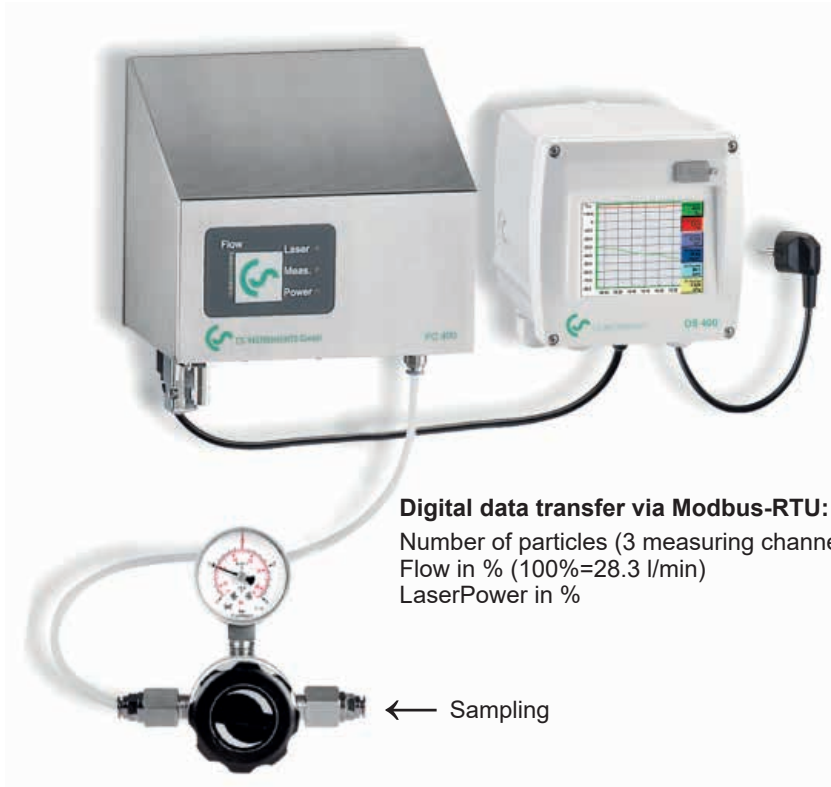

**Digital data transfer via Modbus-RTU:**  
 Number of particles (3 measuring channels)  
 Flow in % (100%=28.3 l/min)  
 LaserPower in %

**The DS 400 shows all 3 measuring channels according to ISO 8573-1**

Particle size 0.1...0.5 µm: Number of particles per m<sup>3</sup>

Particle size 0.5...1.0 µm: Number of particles per m<sup>3</sup>

Particle size 1.0...5.0 µm: Number of particles per m<sup>3</sup>

|      |        |          |  |
|------|--------|----------|--|
| A1a  | PC 400 | 0.1-0.5µ | 1458 cts/m <sup>3</sup>                          |
| A1b  | PC 400 | 0.5-1.0µ | 246 cts/m <sup>3</sup>                           |
| A1c  | PC 400 | 1.0-5.0µ | 8 cts/m <sup>3</sup>                             |
| Home |        | Setup    | Alarm Lg.stop 10.01.2012<br>1 days, ... 22:34:33 |

### TECHNICAL DATA PC 400

|  |  |
|--|--|
| <b>Measured medium:</b>                    | Compressed air (free from aggressive, corrosive, acid, toxic, flammable and oxidising components) as well as gas types like N <sub>2</sub> , O <sub>2</sub> , CO <sub>2</sub> .<br>Further gas types on request  |
| <b>Field of application:</b>               | In case of compressed air after filtration<br>In case of gases / pure gases also without filtration  |
| <b>Parameter:</b>                          | Number of particles per m <sup>3</sup> (relative to expanded air: 20 °C, 1000 hPa)<br><br>Size channels for the PC 400 0.1 µm:<br>Particle size 0.1...0.5 µm: Number of particles per m <sup>3</sup><br>Particle size 0.5...1.0 µm: Number of particles per m <sup>3</sup><br>Particle size 1.0...5.0 µm: Number of particles per m <sup>3</sup><br><br>Size channels for the PC 400 0.3 µm:<br>Particle size 0.3...0.5 µm: Number of particles per m <sup>3</sup><br>Particle size 0.5...1.0 µm: Number of particles per m <sup>3</sup><br>Particle size 1.0...5.0 µm: Number of particles per m <sup>3</sup> |
| <b>Operating pressure:</b>                 | Max. input pressure on the pressure reducer: 40 bar  |
| <b>Humidity of measured gas:</b>           | <= 90% rel. humidity, pressure dew point max. 10 °C, non-condensable humidity  |
| <b>Ambient temperature:</b>                | 5...40 °C  |
| <b>Temperature of the measured medium:</b> | 0...40 °C  |
| <b>Compressed air connection:</b>          | 6 mm PTFE-hose incl. quick coupling  |
| <b>Flow rate:</b>                          | 28.3 l/min (1 cfm)   |
| <b>Interface:</b>                          | RS 485 (Modbus-RTU)  |
| <b>Light source:</b>                       | Laser diode  |
| <b>Power supply:</b>                       | 24 VDC, 300 mA   |
| <b>Dimensions:</b>                         | 150 x 200 x 300 mm   |
| <b>Weight:</b>                             | 8 kg   |
| <b>Housing:</b>                            | Stainless steel  |

### Advantages at a glance:

- Highly precise, optical laser particle counter for use in compressed air and technical gases
- Highly precise optics for detecting the smallest particles up to 0.1 µm and therefore suitable for monitoring the compressed air class 1 according to ISO 8573-1
- The flow rate of 28.3 l/min (1 cfm) is 10 times higher than that of the particle counters generally available on the market (usually 2.83 l/min). Advantage: Counts the smallest particles with high counting accuracy at the same time
- Due to the digital data transfer (Modbus-RTU) to the chart recorders DS 400 or DS 500, 3 measuring channels can be transferred at the same time (without any faults due to check sum)
- The class 1 filter which is included in the scope of delivery can be used for on-site calibration at any time. Contaminations on the optics can therefore be quickly detected or eliminated.

### Advantages of the DS 400

- Data logger for long-term monitoring
- Display shows trend curves (online and history curves available)
- Zoom function directly on the touch screen
- Integrated Ethernet interface (Modbus/TCP) and RS 485 interface (Modbus-RTU) for data transfer to superordinate controls
- 2 alarm relays (changeover contact 230 VAC, 3A) – threshold values freely adjustable
- Easy operation via 3.5" touchscreen

## Stationary solution with particle counter PC 400 and DS 400



| DESCRIPTION   | ORDER NO.   |
|---|-------------|
| PC 400 particle counter up to 0.1 µm for compressed air and gases, incl. pressure reducer and calibration certificate                 | 0699 0040   |
| Connection cable for probes 5 m, with open ends   | 0553 0108   |
| DS 400 chart recorder with graphic display and touch screen operation   | 0500 4000 D |
| <b>Option:</b>  |             |
| Integrated data logger for 100 million measured values  | Z500 4002   |
| Integrated Ethernet and RS 485 interface  | Z500 4004   |
| CS Basic - data evaluation in graphic and table form - readout of the measured data via USB or Ethernet. License for 2 working places | 0554 8040   |
| <b>As an alternative to PC 400 up to 0.1 µm:</b>  | 0699 0041   |
| PC 400 particle counter up to 0.3 µm for compressed air and gases, incl. pressure reducer and calibration certificate                 |             |

## Mobile solution with particle counter PC 400 in a service case and DS 500 mobile



| DESCRIPTION  | ORDER NO. |
|--|-----------|
| PC 400 particle counter up to 0.1 µm for compressed air and gases incl. pressure reducer and calibration certificate in a service case | 0699 0042 |
| Connection cable to portable devices, ODU/ M12, 5 m  | 0553 1503 |
| Chart recorder DS 500 mobile, 4 sensor inputs  | 0500 5012 |
| CS Basic - data evaluation in graphic and table form - readout of the measured data via USB or Ethernet. License for 2 working places  | 0554 8040 |
| <b>As an alternative to PC 400 up to 0.1 µm:</b>   | 0699 0043 |
| PC 400 particle counter up to 0.3 µm for compressed air and gases incl. pressure reducer and calibration certificate in a service case |           |











## Re-calibration and accessories particle counter PC 400



| DESCRIPTION  | ORDER NO. |
|--|-----------|
| Re-calibration particle counter PC 400 incl. certificate | 0699 3304 |
| CS Service Software incl. PC connection set for PC 400   | 0554 2009 |

# UltraCam LD 500/510 – Visualises the leaks directly in the image



-  Enormous time saving compared to classic leak detectors
-  30 MEMS microphones create the image of the leaks
-  Brightness sensor activates LEDs in dark surroundings
-  Available as an upgrade for LD 500/510
-  **NEW:** Multi-user capable through cloud solution
-  **NEW:** Unique laser distance measurement for automatic cost determination
-  Find out your leakage rate (l/min or cfm) and potential savings (€ /year). Currency can be set as required
-  Photograph leaking parts
-  Paperless documentation. Enter everything into the device on site: Define the leakage location as well as the remedial measures and spare parts required
-  Create a report in accordance with ISO 50001
-  Fatigue-free work – ergonomic, one-hand operation – low weight

The LD 500 meets the requirements of class 1 instruments for the "Standard Test Method for Leaks Using Ultrasonic" (ASTM Int. - E1002-05)

## Display and function in detail



The UltraCam LD 500/510 uses 30 MEMS microphones to calculate and visualise the ultrasound image. In addition, the device makes inaudible ultrasound audible

Advantage over the **classic leak detectors**:

Visual representation of the leakage in the live image, even in noisy environments during production

To **determine the leakage rate**, the user aims the laser directly at the leakage. Leakage, laser and red circle must be on top of each other in the image. Then, the **leakage rate in l/min or cfm** and the **costs in €/year** are determined exactly. The distance is measured automatically.



| DESCRIPTION  | ORDER NO. |
|--|-----------|
| <b>Set UltraCam with leak detector LD 500:</b>   | 0601 0205 |
| LD 500 leak detector with UltraCam, integrated camera, 30 ultrasonic microphones for visualisation of the leakage on the screen, incl. 100 leak tags | 0560 0205 |
| Transport case   | 0554 0106 |
| Sound-proof headset  | 0554 0104 |
| Focus tube with focus tip  | 0530 0104 |
| AC adapter plug  | 0554 0009 |
| Spiral cable for connecting the ultrasonic sensor, length 2m (extended)  | 020001402 |
| Holster with shoulder strap for LD 500/510   | 020001795 |



| DESCRIPTION  | ORDER NO. |
|--|-----------|
| <b>Set UltraCam with leak detector LD 510:</b>   | 0601 0206 |
| LD 510 leak detector with UltraCam, integrated camera, 30 ultrasonic microphones for visualisation of the leakage on the screen, incl. 100 leak tags | 0560 0206 |
| Transport case   | 0554 0106 |
| Sound-proof headset  | 0554 0104 |
| Focus tube with focus tip  | 0530 0104 |
| AC adapter plug  | 0554 0009 |
| Spiral cable for connecting the ultrasonic sensor, length 2m (extended)  | 020001402 |
| Holster with shoulder strap for LD 500/510   | 020001795 |

Reporting software see page 137  
For further accessories, refer to pages 138-139

# LD 500/510 – Leak detector with camera - Shows leakage rate in l/min and cost in €



The LD 500 meets the requirements of class I instruments for the "Standard Test Method for Leaks Using Ultrasonic" (ASTM Int. – E1002-05)



**NEW:** Multi-user capable through cloud solution



**NEW:** Unique laser distance measurement for automatic cost determination



Find out your leakage rate (l/min or cfm) and potential savings (€ /year). Currency can be set as required



Find the smallest leaks at large distances



**NEW:** Automatic sensor detection



Auto level: Automatically adapts the sensitivity to the environment and reliably eliminates ambient noise



Photograph leaking parts



Paperless documentation. Enter everything into the device on site: Define the leakage location as well as the remedial measures and spare parts required



Transmit the leakage data via USB to your desktop software



Create a report in accordance with ISO 50001



9 hours of continuous operation possible



Fatigue-free work – ergonomic, one-hand operation – low weight

## FINDING LEAKS PAYS OFF:

### Sample calculation for a medium-sized company:

Approx. 25% of compressed air is lost due to leaks  
 Installed compressor capacity 150 kW(e) x 6000 OpHrs x € 0.24 /kWh  
 Annual electricity costs: **€ 216.000**

**25% leakage cost: 54.000 € per year!**





## Display and function in detail

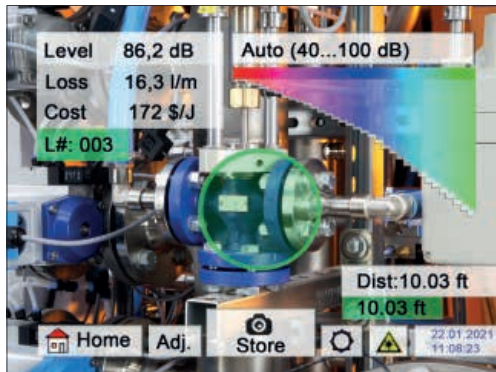

### Search for leaks

The ultrasound, which is inaudible to the human ear, is made audible via headphones. Loud ambient noises are faded out.

The device indicates the leakage rate in (l/min or cfm) and the savings potential in (€ /year) on the display. Currency can be set as required. This data is saved together with the photo.

With the LD 500/510, the smallest leaks, even over long distances (0.1 l/min corresponds to approx. 1 € p.a.) can also be tracked and documented.



| DESCRIPTION   | ORDER NO. |
|---|-----------|
| <b>LD 500 set consisting of:</b>  | 0601 0105 |
| LD 500 leak detector with acoustic trumpet and integrated camera, 100 leak tags for marking the leaks on site | 0560 0105 |
| <b>NEW:</b> Integrated laser distance measurement   | Z554 5000 |
| Transport case  | 0554 0106 |
| Sound-proof headset   | 0554 0104 |
| Focus tube with focus tip   | 0530 0104 |
| AC adapter plug   | 0554 0009 |
| Spiral cable for connecting the ultrasonic sensor, length 2m (extended)                                       | 020001402 |
| Holster with shoulder strap for LD 500/510  | 020001795 |

| DESCRIPTION  | ORDER NO. |
|--|-----------|
| <b>LD 510 set consisting of:</b>   | 0601 0106 |
| LD 510 leak detector incl. acoustic trumpet, with integrated camera and additional input for external sensors, 100 leak tags for marking the leaks on site | 0560 0106 |
| <b>NEW:</b> Integrated laser distance measurement  | Z554 5000 |
| Transport case   | 0554 0106 |
| Sound-proof headset  | 0554 0104 |
| Focus tube with focus tip  | 0530 0104 |
| AC adapter plug  | 0554 0009 |
| Spiral cable for connecting the ultrasonic sensor, length 2m (extended)  | 020001402 |
| Holster with shoulder strap for LD 500/510   | 020001795 |

## Easy documentation in the LD 500 / UltraCam LD 500 directly on site

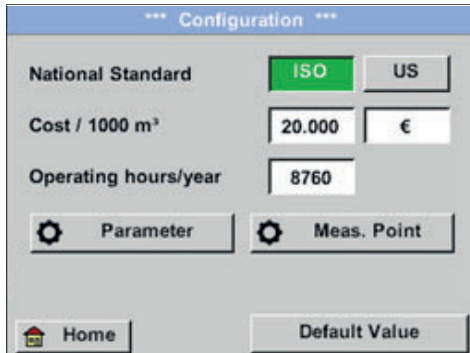

### Entering the compressed air costs in the unit

Depending on the electricity costs, the costs per 1000 m<sup>3</sup> (or per 1000 cf) can be freely entered in any currency

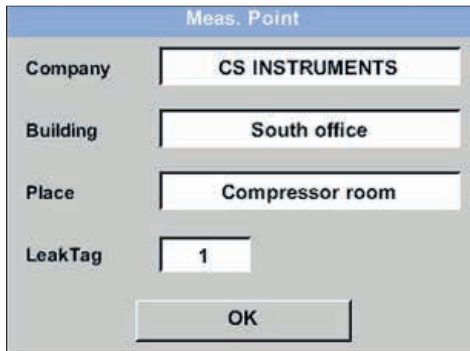

### Define the location

The location of each leak can be stored:  
Company / building / location

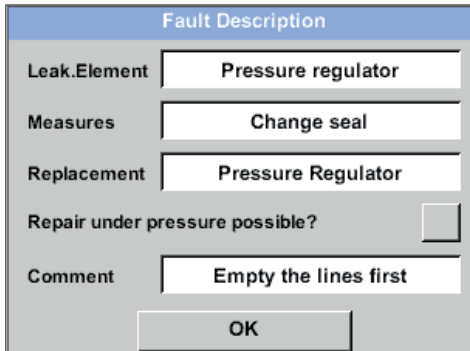

### Remedy the leak

Efficiency and clarity also for elimination of leaks. Definition of the necessary spare parts and maintenance work already on site.

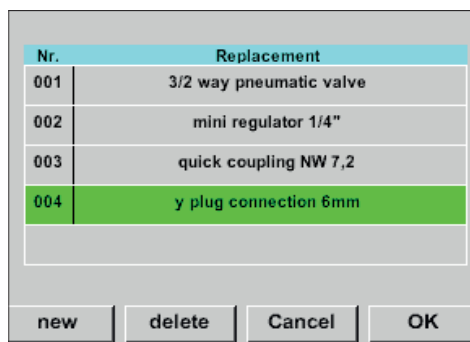

| Nr. | Replacement             |
|-----|-------------------------|
| 001 | 3/2 way pneumatic valve |
| 002 | mini regulator 1/4"     |
| 003 | quick coupling NW 7,2   |
| 004 | y plug connection 6mm   |

### Spare parts list in the device

The software can be used to transfer a custom spare parts list to the device. The device offers an intelligent search function with auto-complete feature. The list with the required spare parts can be exported from the CS Leak Reporter software.

## Use the reporting software to quickly and efficiently produce an ISO 50001 report



### CS Leak Reporter – cloud solution



Ideal for leak detection service providers and for companies/ major corporations with multiple locations.



- Each “user” in the leakage search team can be assigned a role (e.g. leakage search, leakage repair, monitoring, checking for success)
- Access rights to individual or all projects can be assigned individually to each user
- The browser-based software ensures a common database in real time and paperless documentation



### CS Leak Reporter – PC solution

Creates detailed ISO 50001 reports. Provides an illustrated overview of the leaks found and their savings potential. Measures for elimination, including status display, can be defined for every leak – license for two computers

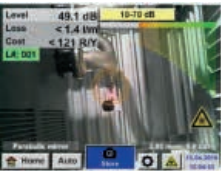
| Leakage Report                  | Start: 15/04/2019   | End: 25/04/2019   | Duration: 10 day(s)     |
|---------------------------------|---|---|-------------------------|
| <b>Contact details:</b>         | <b>Customer:</b>  | <b>Auditor:</b>   |                         |
| Company:                        | Acme  | John Sample   |                         |
| Address:                        | ...   | 1 Sample St., 12345 Sampletown  |                         |
| E-mail:                         | johnacme@sample.com   | j.sample@acme.com   |                         |
| Phone:                          | ...   | +49 1234 567890   |                         |
| Logo:                           |  |  |                         |
| <b>Project master data:</b>     |   |   |                         |
| Import date:                    |   | CO <sub>2</sub> emissions:  | 0.527 kg/kWh            |
| Cost calculation basis:         | Energy costs (70%)  | Specific output:  | 0.12 kWh/m <sup>3</sup> |
| Compressed air costs:           | 21.6 €/1000 m <sup>3</sup>  | Electricity price:  | 0.18 €/kWh              |
| Operating hours per year:       | 4350 h  |   |                         |
| <b>Results:</b>                 |   | <b>Improvements:</b>  |                         |
| Number of leaks:                | 141   | Number remedied:  | 1                       |
| Total leakage amount:           | 718.126 ltr/min   | Leakage amount saved:   | 3.468 ltr/min           |
| Total costs per year:           | 4,048.49 €  | Costs saved per year:   | 19.55 €                 |
| Total CO <sub>2</sub> per year: | 11.91 tonnes  | CO <sub>2</sub> saved per year:   | 0.06 tonnes             |

|  |                                       |                                       |   |
|--|---------------------------------------|---------------------------------------|---|
|  | <b>Leak tag:</b>                      | <b>1</b>                              |   |
|  | <b>Building – location</b>            | COMPRESSOR ROOM 1                     | <b>Repair under pressure possible?</b> - No |
|  | <b>Date and time:</b>                 | 15/04/2019 12:06:03                   | <b>Error:</b> Ball valve defective          |
|  | <b>Leakage rate:</b>                  | < 1.395 ltr/min                       | <b>Spare part:</b> 1/2" ball valve          |
|  | <b>Costs per year:</b>                | < 7.86 €                              | <b>Action:</b> Replace                      |
|  | <b>Total CO<sub>2</sub> per year:</b> | 0.02 tonnes                           | <b>Note:</b> -                              |
|  | <b>Priority:</b>                      | Low                                   | <b>Status:</b> Open                         |
|  | <b>Comment:</b>                       | Replace ball valve                    | <b>Remedied on:</b> -                       |
|  | <b>Remedied by:</b>                   |                                       | <b>Remedied by:</b> -                       |
|  | <b>Leak tag:</b>                      | <b>2</b>                              |   |
|  | <b>Building – location</b>            |                                       | <b>Repair under pressure possible?</b> - No |
|  | <b>Date and time:</b>                 | 15/04/2019 12:08:19                   | <b>Error:</b> Flange leaking                |
| <b>Leakage rate:</b>   | 2.519 ltr/min                         | <b>Spare part:</b> DN 100 flange seal |   |
| <b>Costs per year:</b>   | 14.2 €                                | <b>Action:</b> Reestablish seal       |   |
| <b>Total CO<sub>2</sub> per year:</b>  | 0.04 tonnes                           | <b>Note:</b> -                        |   |
| <b>Priority:</b>   | High                                  | <b>Status:</b> Done                   |   |
| <b>Comment:</b>  | Reestablish flange seal               | <b>Remedied on:</b> 16/04/2019        |   |
|  |                                       | <b>Remedied by:</b> AM                |   |

## Accessories included in the set:



### Headset

The noise-proof headset enables leak detection even in an extremely loud environment. The ambient noise is faded out, and the leakage (inaudible ultrasonic sound) is transformed into an audible signal



### Holster with shoulder strap

For the LD 500/510, enables ergonomic and safe work



### Focus tube with focus tip

For pinpoint detection of the smallest leaks in confined spaces

## Professional accessory – parabolic mirror

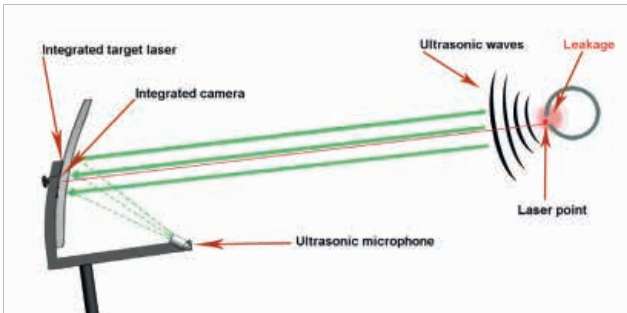

By focusing the ultrasonic waves in the parabolic mirror, even the smallest leaks of 0.8 l/min (approx. € 8 p.a.) can be located with pinpoint precision ( $\pm 15$  cm) at a distance of up to 10 to 15 m.

The shape of the parabolic mirror ensures that only ultrasonic waves of the targeted leak are evaluated. Background noise is reduced to a minimum.

## Accessories



### DESCRIPTION

Gooseneck for leak detection at sites which are difficult to access (length 600 mm)

### ORDER NO.

0530 0105

Gooseneck for leak detection at sites which are difficult to access (length 1500 mm)

0530 0108

Gooseneck High Sensitivity for leak detection on vacuum systems and for leak testing (length: 600 mm)

0530 0110



### DESCRIPTION

Parabolic mirror with laser distance measurement for leak detection in long distances, incl. transport case

### ORDER NO.

0530 0206

Parabolic mirror for leak detection at long distances, incl. transport case

0530 0106



### DESCRIPTION

Ultrasonic tone generator for leak testing. A handy ultrasonic tone generator is available for detecting leaks in systems that are not under pressure. The transmitter is positioned so that the sound can enter the pipe system. The ultrasonic signal penetrates the smallest openings, which can then be detected with the LD 500

### ORDER NO.

0554 0103



### DESCRIPTION

500 leak tags for marking the leaks on site

### ORDER NO.

0530 0107



### DESCRIPTION

UltraCam – funnel with integrated camera, 30 ultrasonic microphones for visualisation of leakages – for retrofitting to existing LD 500 / LD 510

### ORDER NO.

Z554 5500

## Software



| DESCRIPTION   | ORDER NO. |
|---|-----------|
| <b>CS Leak Reporter V2</b><br>Creates detailed ISO 50001 reports. Provides an illustrated overview of the leaks found and their savings potential. Measures for elimination, including status display, can be defined for every leak – license for two computers<br><br>New functions:<br>- Simple spare parts management<br>- Histogram functions for documenting continuous improvement in accordance with ISO 50001 on the company or building level | 0554 0205 |



| DESCRIPTION   | ORDER NO.   |
|---|-------------|
| CS Leak Reporter V2 – additional licence for one computer | Z554 0205CS |



| DESCRIPTION   | ORDER NO. |
|---|-----------|
| <b>CS Leak Reporter – cloud solution</b><br>Basic package:<br>Browser-based access to the CS Cloud.<br>Advantages:<br>- Common database of all users in real time.<br>- Cross-location work in a team<br>- Paperless documentation.<br>- Unlimited number of guest logins (read-only rights) can be set up.<br>Only available in combination with at least one CS Cloud (0554 0306) user licence. | 0554 0305 |

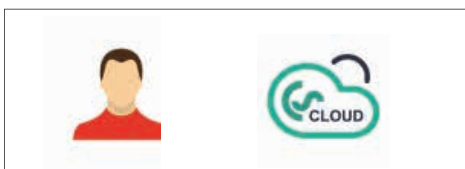

| DESCRIPTION   | ORDER NO.                  |
|---|----------------------------|
| <b>User licence – CS Cloud</b><br>1 user / 12 months for CS Leak Reporter Cloud solution use.<br><br>Term extension - 1 user / 12 months for CS Leak Reporter Cloud solution use. | 0554 0306<br><br>0554 0307 |

## LD 500/510 calibration



| DESCRIPTION  | ORDER NO. |
|--|-----------|
| LD 500/LD 510 re-calibration / UltraCam LD 500/510 | 0560 3333 |

## Additional sensors / accessories for connection to LD 510



| DESCRIPTION   | ORDER NO. |
|---|-----------|
| FA 510 dew point sensor for mobile devices, -80...+20 °Ctd incl. mobile measuring chamber, 5 m connection cable and perforated protection cap | 0699 1510 |
| VA 500 flow probe, max. version (185 m/s), probe length 220 mm, incl. 5 m connection cable  | 0695 1124 |
| Standard pressure probe CS 16, 0...16 bar, ± 1% accuracy of f.s.  | 0694 1886 |
| Differential pressure probe 1.6 bar diff.   | 0694 3561 |
| Connection cable for pressure, temperature or external sensors on mobile instruments, 5 m   | 0553 0501 |
| CS Basic – data evaluation in graphic and table form – readout of the measured data via USB or Ethernet. License for two workstations         | 0554 8040 |

## Calculation

| Costs per year |                              |        |         |         |         |         |
|----------------|------------------------------|--------|---------|---------|---------|---------|
| Pressure       | Size of leak – diameter (mm) |        |         |         |         |         |
|                | 0.5 mm                       | 1.0 mm | 1.5 mm  | 2.0 mm  | 2.5 mm  | 3.0 mm  |
| 3 bar          | € 90                         | € 361  | € 812   | € 1,444 | € 2,256 | € 3,248 |
| 4 bar          | € 113                        | € 451  | € 1,015 | € 1,805 | € 2,820 | € 4,061 |
| 5 bar          | € 135                        | € 541  | € 1,218 | € 2,166 | € 3,384 | € 4,873 |
| 6 bar          | € 158                        | € 632  | € 1,421 | € 2,527 | € 3,948 | € 5,685 |
| 7 bar          | € 180                        | € 722  | € 1,624 | € 2,888 | € 4,512 | € 6,497 |
| 8 bar          | € 203                        | € 812  | € 1,827 | € 3,248 | € 5,076 | € 7,309 |

Table: Leakage costs in one year with 24-hour operation 365 days per year calculated with compressed air costs of 1.9 ct/Nm<sup>3</sup>.

### TECHNICAL DATA OF THE LD 500 / LD 510

|                                |   |
|--------------------------------|---|
| <b>Operating frequency:</b>    | 40 kHz ± 2 kHz  |
| <b>Connections:</b>            | 3.5 mm stereo jack for headset, power supply socket for connecting an external charger        |
| <b>Laser:</b>                  | Wavelength: 630...660 nm<br>Output power: < 1 mW (laser class 2)                              |
| <b>Display:</b>                | 3.5" touch screen   |
| <b>Interface:</b>              | USB interface   |
| <b>Data logger:</b>            | 16 GB SD memory card<br>(100 million values)  |
| <b>Power supply:</b>           | Internal rechargeable Li-Ion batteries, approx. 9 h continuous operation, 4 h charging time   |
| <b>Operating temperature:</b>  | -5...+50 °C   |
| <b>EMC:</b>                    | DIN EN 61326  |
| <b>Auto level:</b>             | Automatically adapts the sensitivity to the environment and reliably eliminates ambient noise |
| <b>Sensitivity:</b>            | min: 0.1 l/min at 6 bar, 5 m distance, approx. € 1/year of compressed air costs               |
| <b>Weight without headset:</b> | 540 grams   |

### TECHNICAL DATA OF EXTERNAL SENSOR INPUT (LD 510 ONLY)

|                         |  |
|-------------------------|--|
| <b>Measuring range:</b> | See external CS sensors  |
| <b>Accuracy:</b>        | See external CS sensors  |
| <b>Power supply:</b>    | Output voltage: 24 VDC ± 10%<br>Output current: 120 mA in continuous operation |



# Leak detector LD 450

If gases escape through leaks in pressurized pipe systems (e.g. non-tight screwed connections, corruptions and so on), ultrasonic noises are generated. By means of LD 450, even the smallest leakages which cannot be heard by the human ear and which are not visible due to their size can be detected even from distances of

several meters. LD 450 transforms the inaudible signals into a frequency which can be identified by human beings. By means of the comfortable sound-proof headset, these noises can be detected even in extremely noisy environments. The LD 450 leak detector is the advancement of the proven LD 300 and LD 400 and it impresses with its

significantly refined sensor technology and its improved support in the tracing of leaks. By means of the integrated laser pointer, which serves for target heading, the leak can be localised more accurately.

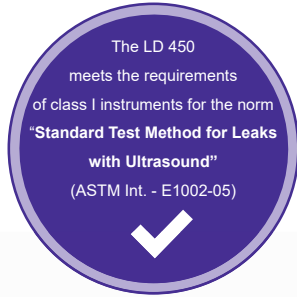

### Applications

Leak detection on:

- compressed air, gas and vacuum systems
- Door seals



↑  
Acoustic trumpet



### Sound-proof headset:

Enables leak detection in an extremely loud environment



LD 450 with straightening tube and straightening tip for accurate detection.

### Costs per year

| Pressure | Size of leakage - diameter (mm) |        |        |        |        |        |
|----------|---------------------------------|--------|--------|--------|--------|--------|
|          | 0.5 mm                          | 1.0 mm | 1.5 mm | 2.0 mm | 2.5 mm | 3.0 mm |
| 3 bar    | €90                             | €361   | €812   | €1,444 | €2,256 | €3,248 |
| 4 bar    | €113                            | €451   | €1,015 | €1,805 | €2,820 | €4,061 |
| 5 bar    | €135                            | €541   | €1,218 | €2,166 | €3,384 | €4,873 |
| 6 bar    | €158                            | €632   | €1,421 | €2,527 | €3,948 | €5,685 |
| 7 bar    | €180                            | €722   | €1,624 | €2,888 | €4,512 | €6,497 |
| 8 bar    | €203                            | €812   | €1,827 | €3,248 | €5,076 | €7,309 |

Table: Leakage costs within one year in case of operation 24 h/365 days, calculated with compressed air costs of 1.9 ct/Nm<sup>3</sup>.



Through the use of a specially designed acoustic trumpet, a better bundling of the sound waves is achieved. This trumpet acts like a directional microphone, which bundles ultrasonic waves and thus improves the acoustic behavior. Due to the special design of the acoustic

trumpet, the use of the laser pointer is not hindered.

**Leak test:**

A handy ultrasonic transmitter is available for detecting leaks in pressureless systems. The transmitter is positioned so that the sound can enter the pipe system. The ultrasonic signal penetrates the small-

est openings, which can then be detected with the LD 450.

**Special features**

- Robustness and low weight ensure fatigue-free use in industrial environments
- Improved detection of leakages with the acoustic trumpet
- Modern Li-Ion battery with high capacity, external charger
- Minimum operating time 10 h
- Easy operation via membrane keypad
- Adjustable sensitivity



**LD 450** is available either as standalone device or in a complete set. The set includes a robust impact-proof transportation case which contains all necessary components and accessories.

| DESCRIPTION                                     | ORDER NO. |
|---|-----------|
| <b>Set LD 450 consisting of:</b>                |           |
| LD 450 leak detector for compressed air systems | 0601 0204 |
| Transport case                                  | 0560 0204 |
| Sound-proof headset                             | 0554 0106 |
| Focus tube with focus tip                       | 0554 0104 |
| AC adapter plug                                 | 0530 0104 |
| Acoustic trumpet                                | 0554 0009 |
|   | 0530 0109 |
| <b>Accessories not included in the set:</b>     |           |
| Ultrasonic transmitter                          | 0554 0103 |

**TECHNICAL DATA LD 450**

|                               |   |
|-------------------------------|---|
| <b>Operating frequency:</b>   | 40 kHz ± 2 kHz  |
| <b>Connections:</b>           | 3.5 mm stereo jack for headset.<br>Power supply socket for connecting an external charger |
| <b>Laser:</b>                 | Wavelength: 630...660 nm<br>Output power: < 1 mW (laser class 2)                          |
| <b>Operating time:</b>        | >10 h   |
| <b>Charging time:</b>         | max. 4h   |
| <b>Operating temperature:</b> | -5 °C to 50 °C  |
| <b>Storage temperature:</b>   | -20 °C to +60 °C  |



## CS Basic

### Data evaluation during mobile measurement:

With the CS Basic, the chart recorder DS 500/400 and all mobile devices with data logger can be read out. Depending on the device, data transfer is performed either via USB stick or Ethernet connection.

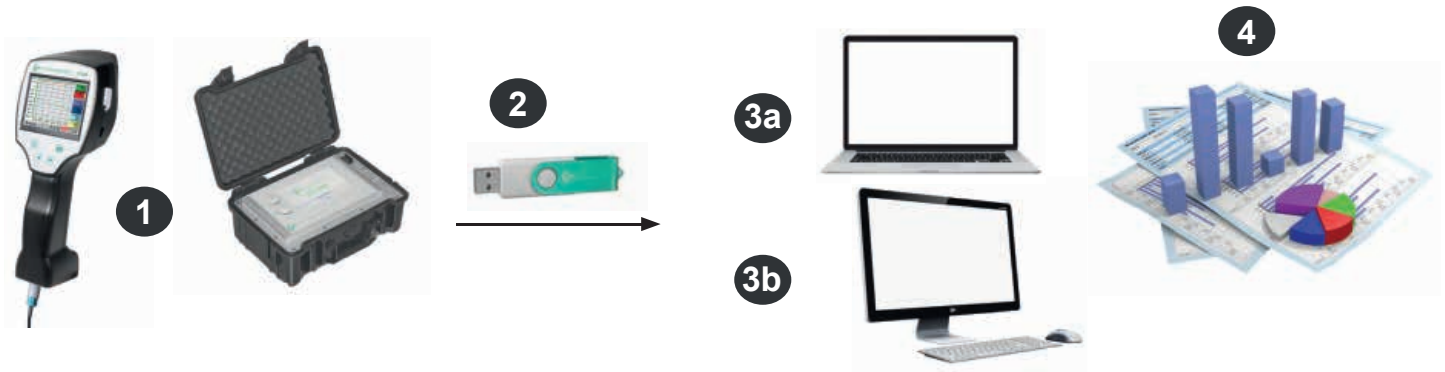

- 1** Mobile measurement at the customer. Measured data are saved in the data logger in the selected measuring cycle
- 2** Export of the data to USB stick
- 3a** Import of the measured data to the laptop directly on-site
- 3b** Import of the measured data to the computer in the office
- 4** Evaluation and print out of the measured data

### Data evaluation for firmly installed chart recorders in the company:

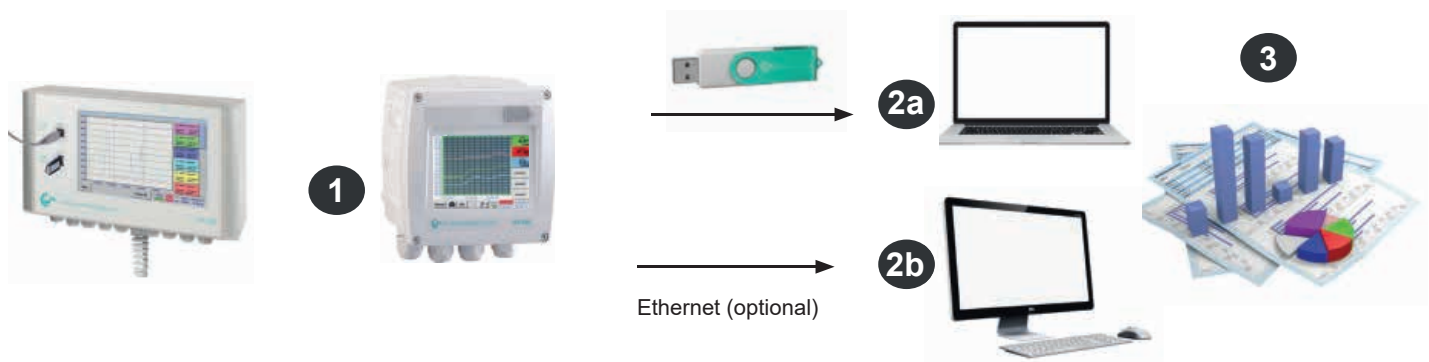

- 1** Chart recorder is firmly installed in the company. Measured data are saved in the data logger in the set measuring cycle.
- 2a** Transfer of the data via USB stick to the computer
- 2b** Readout of the logger data via the computer network (LAN) by means of CS Basic
- 3** Evaluation and print out of the measured data

| DESCRIPTION   | ORDER NO. |
|---|-----------|
| CS Basic – data evaluation graphically and in tabular form - reading of the measured data via USB or Ethernet, license for 2 workstations | 0554 8040 |
| Additional license for 1 further workplace  | Z554 8040 |
| Upgrade CS Soft Basic (0554 7040) to CS Basic (0554 8040). CAA module is no longer available. Please state old licence key when ordering  | Z554 8041 |

# CS Basic

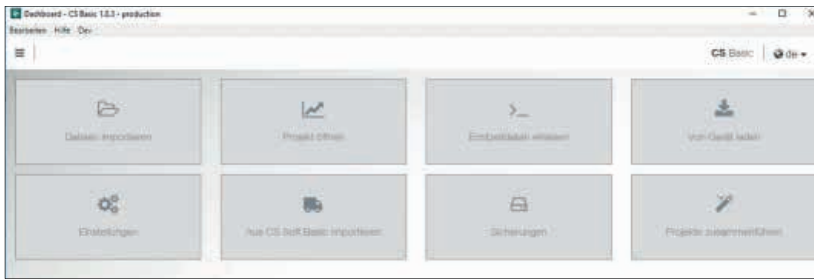

## Intuitive operation

- All important functions can be retrieved via the dashboard.
- Global settings: Adjust units and change decimal places, store company name and logo
- Import real-time data: Establish Ethernet connection to CS logger or sensor. Trace real-time measured values in graphic and in table form
- Import from CS Soft Basic: Data migration from the previous version of CS Soft Basic
- Data backup: Backup of the projects and the database
- csv. export



## Graphic evaluation

All measurement curves are indicated in colour. All necessary functions like free zoom, selection/deselection of single measurement curves, free selection of periods, scaling of the axes, selection of colours and so on are integrated:  
 This view can be saved as a PDF file and sent as an e-mail. Different data can be combined in a shared file.

| Datum                | Gerät | A2.1<br>Pressure<br>bar | B3.1<br>Dewpoint<br>°Ctd | B3.2<br>Rel.Humid.<br>% | B3.3<br>Temperatur<br>°C |
|----------------------|-------|-------------------------|--------------------------|-------------------------|--------------------------|
| 27.01.17<br>13:52:18 | 0     | 9,6749                  | -50,6462                 | 0,1534                  | 20,2556                  |
| 27.01.17<br>13:52:28 | 0     | 9,676                   | -51,4187                 | 0,1394                  | 20,2517                  |
| 27.01.17<br>13:52:38 | 0     | 9,6769                  | -52,0952                 | 0,128                   | 20,2499                  |
| 27.01.17<br>13:52:48 | 0     | 9,678                   | -52,791                  | 0,1173                  | 20,2479                  |

## Table view

All measuring points are listed with exact time interval. The desired measuring channels with the name of the measuring place can be selected via the diagram explorer.

| Kanal                           | Durchschnitt  | Minimum       | Datum von Minimum | Maximum       | Datum von Maximum |
|---------------------------------|---------------|---------------|-------------------|---------------|-------------------|
| B3.2 Dewpoint - Rel.Humid. (%)  | 0,1034 %      | 0,0548 %      | 15.02.17 13:50:38 | 0,4118 %      | 13.02.17 14:30:08 |
| B3.1 Dewpoint - DewPoint (°Ctd) | -53,2759 °Ctd | -57,9552 °Ctd | 27.01.17 13:54:36 | -41,8251 °Ctd | 13.02.17 14:38:08 |
| B3.3 Dewpoint - Temperatur (°C) | 22,072 °C     | 20,1182 °C    | 27.01.17 13:59:38 | 28,0402 °C    | 14.02.17 08:25:38 |

## Statistics

All required statistic data are visible at a glance. So the user can see very quickly which minimal or maximal measured values occurred when and for how long.

|                                      | Januar    | Februar   | März      | April     | Mai       | Juni      | Juli      | August    | September | Oktober   | November  | Dezember  | Summe      |
|--------------------------------------|-----------|-----------|-----------|-----------|-----------|-----------|-----------|-----------|-----------|-----------|-----------|-----------|------------|
| A1.2 Verbrauch<br>Halle 1 - A1b (m³) | 1.956.827 | 2.076.325 | 2.215.952 | 2.396.484 | 2.514.612 | 2.696.480 | 2.826.480 | 3.002.936 | 3.169.484 | 3.318.842 | 3.491.691 | 3.659.617 | 3.775.979  |
| Verbrauch (m³)                       | 117.456   | 136.737   | 153.402   | 146.148   | 151.868   | 160.003   | 178.455   | 166.546   | 149.156   | 173.019   | 167.956   | 110.356   | 1.817.148  |
| Kosten (€)                           | 2.230,46  | 2.698,00  | 2.914,94  | 2.778,61  | 2.895,49  | 3.040,06  | 3.352,65  | 3.184,37  | 2.834,00  | 3.287,36  | 3.191,18  | 2.210,76  | 34.925,774 |
| A1.1 Verbrauch<br>Halle 1 - A1a (m³) | 0         | 63        | 0         | 0         | 0         | 136       | 0         | 0         | 0         | 0         | 0         | 0         | 0          |
| Durchschnitt (m³/t)                  | 157,6     | 205,66    | 205,6     | 202,64    | 203,82    | 221,66    | 236,5     | 223,25    | 206,67    | 232,19    | 232,67    | 156,99    |            |
| Maximum (m³/t)                       | 1.000,36  | 527,02    | 736,39    | 1.154     | 862,43    | 616,27    | 617,8     | 838,36    | 931,66    | 642,96    | 666,77    | 2.410,71  |            |

## Flow evaluation

The software carries out flow analysis for all connected flow meters, optionally as a daily, weekly or monthly analysis.

# CS Network

## Energy monitoring for compressed air and gases in an enterprise

The CS Network is a client-server solution. The server software automatically collects the measured values of all chart recorders and sensors embedded in the company's computer network and stores them in a database. The evaluation/analysis of the measured data is carried out via the evaluation software (client) at any number of workstations.

- Display real-time data in individual dashboards
- Automatic reporting for consumption: Weekly, monthly, annually
- Automatic alarm by e-mail if limit value is exceeded or not reached
- Alarm history

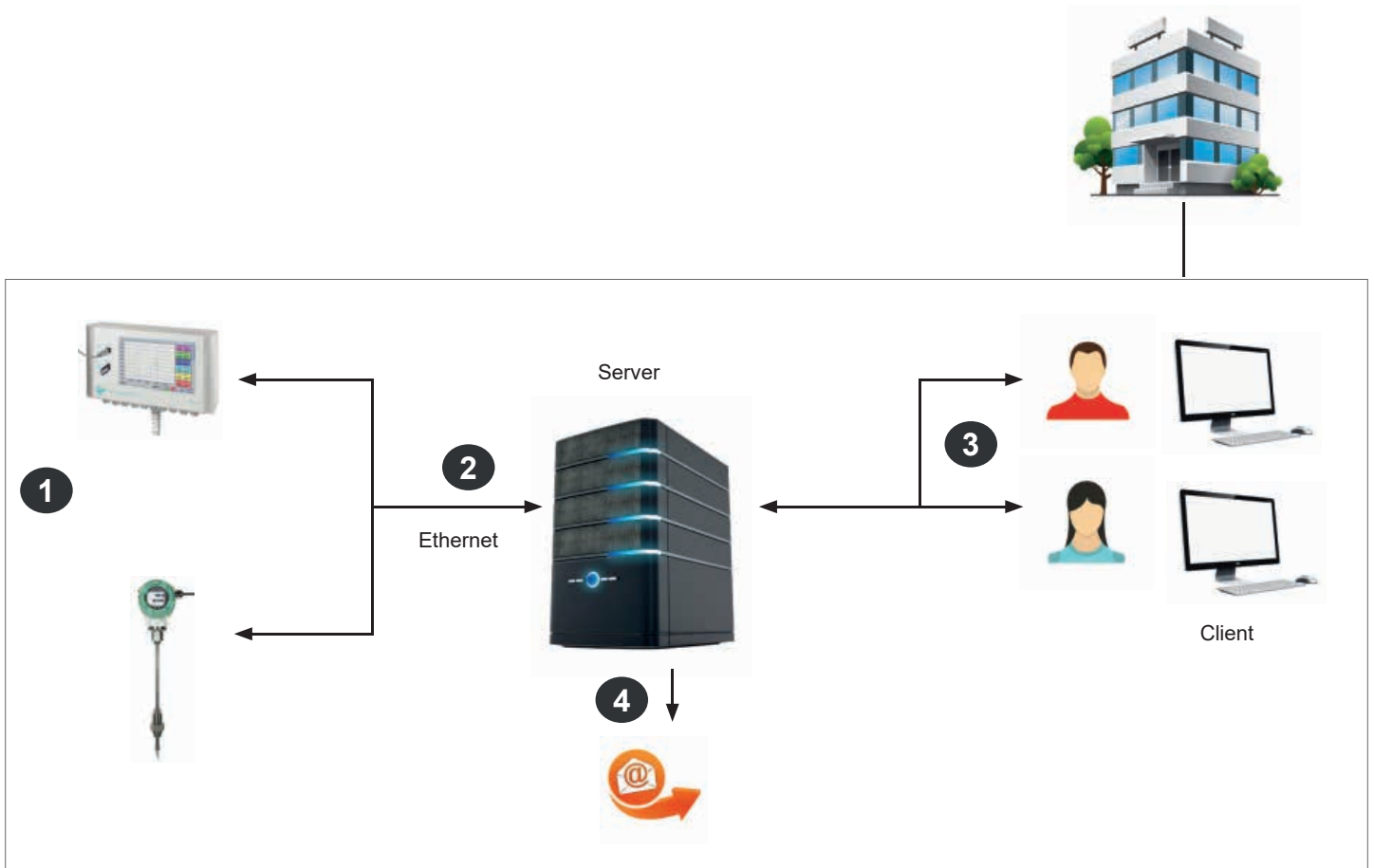

- 1** Single sensors with Ethernet connection or chart recorders with several sensors measure the compressed air and gas consumption of all departments/cost centres in an enterprise.
- 2** The CS Network (Server Installation) automatically collects the measured values of all CS chart recorders and CS sensors which are connected to the computer network in an enterprise and stores them in a database.
- 3** The evaluation/analysis of the measured data is carried out via the evaluation software (Client) at an unlimited number of workstations.
- 4** In case of an exceeding of the limit values (freely adjustable), there will be an automatic alarm via e-mail

# CS Network

## Example – Dashboards



### Energy monitoring

Monitoring of consumption and leakage of the entire site, individual departments or systems

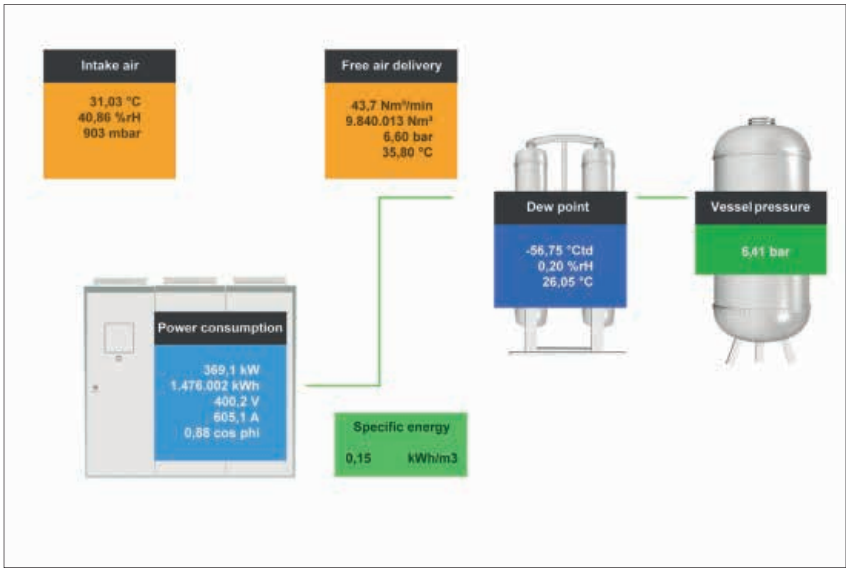

### Compressor efficiency

Monitoring of the intake controls, power consumption and free air delivery of the compressors

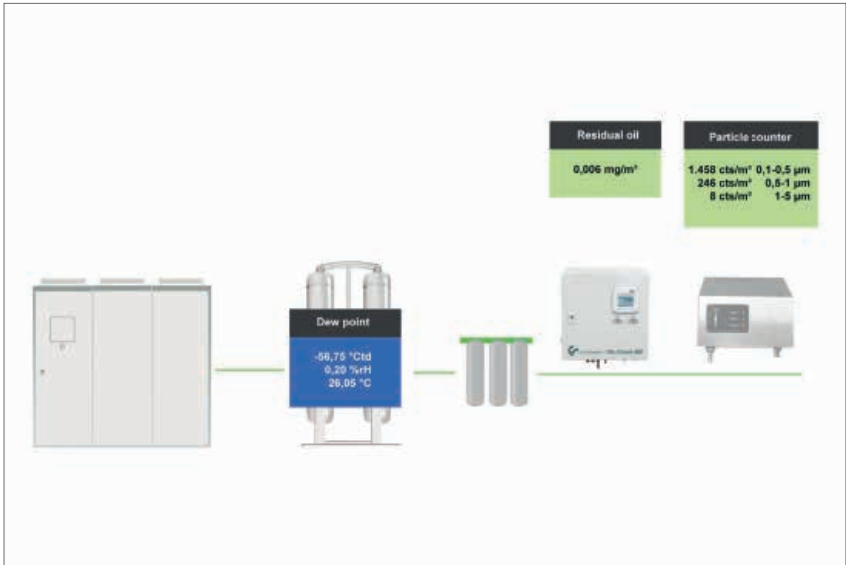

### Quality monitoring

Monitoring of compressed air treatment and required ISO 8573-1 quality classes – particles, residual oil and dew point

# CS Network

## Evaluations

| Channel   | Unit        | Description | Monday   | Tuesday  | Wednesday | Thursday | Friday   | Saturday | Sunday   | Total   |
|---|-------------|-------------|----------|----------|-----------|----------|----------|----------|----------|---------|
| <b>Demobereich Vertrieb</b>   |             |             |          |          |           |          |          |          |          |         |
| <b>Frühschicht (06:00:00-14:00:00)</b>  |             |             |          |          |           |          |          |          |          |         |
| Consumption compressed air Site 1 production - Tarif "Standardtarif" 00:00:00 - 23:59:59 : 5 € per m³ |             |             |          |          |           |          |          |          |          |         |
| m³  | start count |             | 7675.00  | 7865.00  | 8074.00   | 8271.00  | 8329.00  | 8329.00  | 8329.00  |         |
| m³  | end count   |             | 7729.00  | 7935.00  | 8147.00   | 8329.00  | 8329.00  | 8329.00  | 8329.00  |         |
| m³  | total       |             | 54.00    | 70.00    | 73.00     | 58.00    | 0.00     | 0.00     | 0.00     | 255.00  |
| m³/h  | average     |             | 8.5      | 8.7      | 9.1       | 7.3      | 0.0      | 0.0      | 0.0      | 5.6     |
| m³/h  | min         |             | 7.6      | 0.0      | 0.5       | 0.0      | 0.0      | 0.0      | 0.0      |         |
| m³/h  | max         |             | 9.0      | 9.3      | 13.4      | 8.2      | 0.0      | 0.0      | 0.0      |         |
| €   | costs       |             | 270.00   | 350.00   | 365.00    | 290.00   | 0.00     | 0.00     | 0.00     | 1275.00 |
| Consumption compressor station - Tarif "Standardtarif" 00:00:00 - 23:59:59 : 5 € per Nm³              |             |             |          |          |           |          |          |          |          |         |
| Nm³   | start count |             | 26659.00 | 26667.00 | 26676.00  | 26788.00 | 26841.00 | 26851.00 | 26851.00 |         |
| Nm³   | end count   |             | 26660.00 | 26676.00 | 26683.00  | 26835.00 | 26845.00 | 26854.00 | 26854.00 |         |
| Nm³   | total       |             | 1.00     | 3.00     | 7.00      | 47.00    | 4.00     | 3.00     | 3.00     | 65.00   |
| Nm³/h   | average     |             | 0.4      | 0.4      | 1.0       | 6.0      | 0.4      | 0.4      | 0.4      | 1.4     |
| Nm³/h   | min         |             | 0.4      | 0.4      | 0.4       | 0.4      | 0.4      | 0.4      | 0.4      |         |
| Nm³/h   | max         |             | 0.6      | 0.8      | 6.9       | 7.3      | 0.4      | 0.4      | 0.4      |         |
| €   | costs       |             | 5.00     | 15.00    | 35.00     | 235.00   | 20.00    | 15.00    | 15.00    | 325.00  |

## Weekly report

Have consumption reports created automatically and sent by e-mail. This way you always have an overview of your consumption and costs and have them under control. You can choose between monthly, weekly or annual reports. The comparison function allows you to compare different time periods so that you can recognise irregularities in your consumption, among other things..

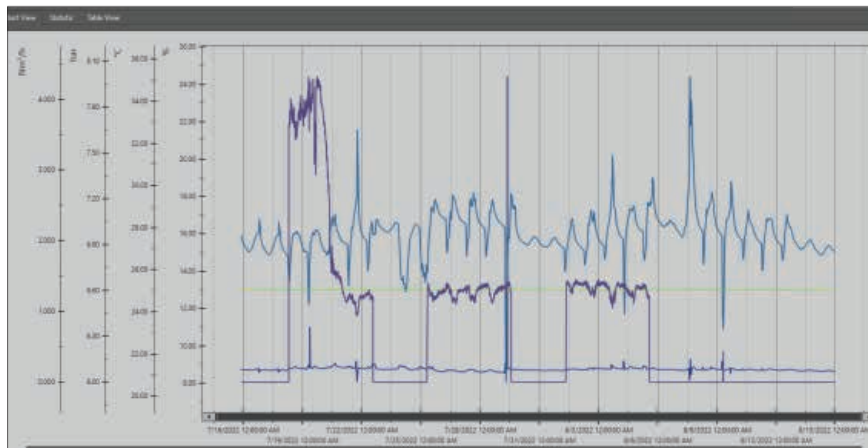

## Graphic evaluation

All measurement curves are indicated in colour. All necessary functions like free zoom, selection/deselection of single measurement curves, free selection of periods, scaling of the axes, selection of colours and so on are integrated: Different data can be merged into one common file. This view can be saved as a PDF file and sent as a mail.

| Time                 | Demobereich Vertrieb_DS 500 CS Network_A3b: ReLHumid. [%] | Demobereich Vertrieb_DS 500 CS Network_A3c: Temperatur. [°C] | Demobereich Vertrieb_DS 500 CS Network_B1a: Druck_[bar] | Demobereich Vertrieb_DS 500 CS Network_B2a: Flow_[Nm³/h] |
|----------------------|---|--|---|--|
| 7/19/2022 3:57:00 PM | 8.89  | 27.67  | 6.60  | 3.300  |
| 7/19/2022 4:06:00 PM | 8.89  | 27.84  | 6.60  | 2.933  |
| 7/19/2022 4:15:00 PM | 8.88  | 27.84  | 6.60  | 2.925  |
| 7/19/2022 4:24:00 PM | 8.88  | 27.84  | 6.60  | 3.125  |
| 7/19/2022 4:33:00 PM | 8.88  | 27.84  | 6.60  | 3.039  |
| 7/19/2022 4:42:00 PM | 8.88  | 27.84  | 6.60  | 3.232  |
| 7/19/2022 4:51:00 PM | 8.87  | 27.84  | 6.60  | 4.058  |
| 7/19/2022 5:00:00 PM | 8.85  | 27.86  | 6.60  | 4.144  |
| 7/19/2022 5:09:00 PM | 8.85  | 27.88  | 6.60  | 4.055  |
| 7/19/2022 5:18:00 PM | 8.86  | 27.86  | 6.60  | 4.190  |
| 7/19/2022 5:27:00 PM | 8.84  | 27.89  | 6.60  | 4.129  |

## Table view

All measuring points are listed with exact time interval. The desired measuring channels with the name of the measuring place can be selected via the diagram explorer.

| Area name: Demobereich Vertrieb |                 |       |       |       |                      |  |
|---------------------------------|-----------------|-------|-------|-------|----------------------|--|
| Part name: DS 500 CS Network    |                 |       |       |       |                      |  |
| 11                              | A3b: ReLHumid   | %     | 8.73  | 8.06  | 7/21/2022 7:06:00 PM |  |
| 12                              | A3c: Temperatur | °C    | 27.73 | 20.66 | 7/29/2022 7:42:00 AM |  |
| 13                              | B1a: Druck      | bar   | 6.6   | 6.59  | 7/29/2022 7:51:00 AM |  |
| 14                              | B2a: Flow       | Nm³/h | 0.719 | 0     | 7/15/2022 9:39:00 PM |  |

## Statistics

All required statistic data are visible at a glance. So the user can see very quickly which minimal or maximal measured values occurred when and for how long.

| DESCRIPTION  | ORDER NO. |
|--|-----------|
| CS Network – Energy monitoring with client/server solution (max. 20 measured values of different sensors/devices)  | 0554 8041 |
| CS Network – Energy monitoring with client/server solution (max. 50 measured values of different sensors/devices)  | 0554 8042 |
| CS Network – Energy monitoring with client/server solution (max. 100 measured values of different sensors/devices) | 0554 8043 |
| CS Network – Energy monitoring with client/server solution (max. 200 measured values of different sensors/devices) | 0554 8044 |





## Competitive differential pressure probe for testing on compressed air systems

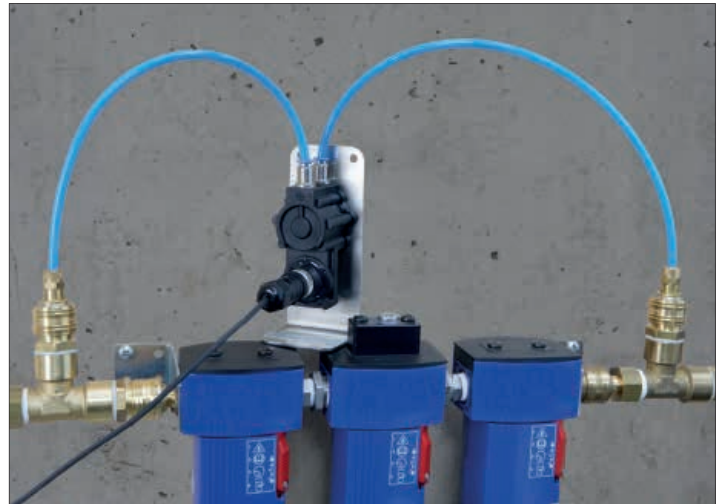

Typical application of the differential pressure sensor: connection with two PE hoses before and after the filter elements.

### Requirements in practice:

- Timely replacement of the filter elements
- At a differential pressure of >350 mbar at the latest, the filter elements should be replaced (active carbon filters are excluded from this)

| DESCRIPTION  | ORDER NO. |
|--|-----------|
| Differential pressure probe 1.6 bar diff.  | 0694 3561 |
| Connection cable for probes 5 m, with open ends  | 0553 0108 |
| Connection cable for probes 10 m, with open ends   | 0553 0109 |
| Connection cable for pressure, temperature or external sensors on mobile instruments, ODU / open ends, 5 m | 0553 0501 |
| Connection cable for pressure, temperature or external sensors on mobile instruments, 10 m                 | 0553 0502 |

### TECHNICAL DATA

|  |  |
|--|--|
| <b>Measuring range:</b>                    | 0 ... 1.6 bar difference                                     |
| <b>Max. system pressure:</b>               | 10 bar   |
| <b>Max. overload capability two-sided:</b> | 15 bar   |
| <b>Max. one-sided overload capability:</b> |  |
| + side                                     | 15 bar   |
| - side                                     | 10 bar   |
| <b>Bursting pressure:</b>                  | 60 bar   |
| <b>Total error:</b>                        | 2.0% of the full scale                                       |
| <b>Output:</b>                             | 4 ... 20 mA two-wire   |
| <b>Power supply:</b>                       | 10 ... 30 V<br>for output<br>4...20 mA                       |
| <b>Ambient operating temperature:</b>      | -20 ... +80 °C   |
| <b>Connections:</b>                        | 2× G 1/8" female thread incl. plug-in coupling for 6 mm hose |
| <b>Electrical connection:</b>              | Round plug M12 × 1   |



The longer a filter element is in use, the quicker the differential pressure is rising, and consequently the costs – see diagram below.

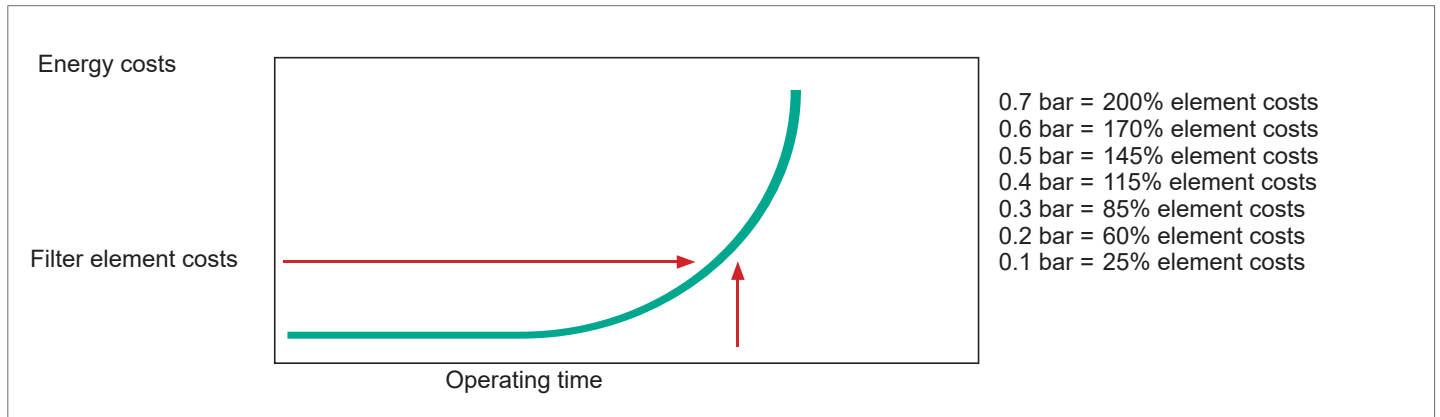

Fig.: Typical differential pressure process, energy costs in relation to filter element costs

### PI 500 set for mobile measurement



- |   |           |
|---|-----------|
| 1. PI 500 portable handheld device with integrated data logger  | 0560 0511 |
| 2. Differential pressure probe 1.6 bar diff.  | 0694 3561 |
| 3. Connection cable for pressure, temperature or external sensors to mobile devices, ODU / open ends, 5 m | 0553 0501 |

### DS 52 set for stationary measurement



- |  |           |
|--|-----------|
| 1. DS 52 LED process display in the wall housing   | 0500 0009 |
| 2. Differential pressure probe 1.6 bar diff.       | 0694 3561 |
| 3. Connection cable for probes 5 m, with open ends | 0553 0108 |

# PTS 500 – Measures pressure and temperature in the process

**Special features:**

- 2 in 1 sensor: Pressure and temperature
- Wetted parts made of stainless steel for universal use in gases and liquids
- Easy integration into control systems, process control technology and energy management systems via digital interfaces
- Modbus-RTU, Ethernet or M-Bus interface
- Alarm relay – limit value adjustable via buttons (max 60 VDC, 0.5 A)
- Optional: 2 x 4...20 mA analogue output, 2 x alarm relays for pressure and temperature

Example order code PTS 500:

0694 7000\_A1\_B1\_C1

| Signal output option |   |
|----------------------|---|
| A1                   | 1 x 4...20 mA analogue output (galvanically not isolated), alarm relay, RS 485 (Modbus-RTU)   |
| A2                   | 2 x 4...20 mA analogue output (galvanically not isolated), 2 x alarm relays, RS 485 (Modbus-RTU)  |
| A3                   | Ethernet interface (Modbus/TCP), 1 x 4...20 mA analogue output (galvanically not isolated), RS 485 (Modbus-RTU)                           |
| A4                   | Ethernet interface PoE (Power over Ethernet) (Modbus/TCP), 1 x 4...20 mA analogue output (galvanically not isolated), RS 485 (Modbus-RTU) |
| A5                   | M-Bus, 1 x 4...20 mA analogue output (galvanically not isolated), alarm relay, RS 485 (Modbus-RTU)  |

| Pressure measuring ranges |                             |
|---------------------------|-----------------------------|
| B1                        | -1... 0 bar (-14.5...0 psi) |
| B2                        | 0... 1.6 bar (0...23.2 psi) |
| B3                        | 0... 10 bar (0...145 psi)   |
| B4                        | 0... 16 bar (0...232 psi)   |
| B5                        | 0... 50 bar (0...725 psi)   |

| Process connections |          |
|---------------------|----------|
| C1                  | G1/2"    |
| C2                  | 1/2" NPT |

| DESCRIPTION   | ORDER NO. |
|---|-----------|
| PTS 500 sensor for measuring of pressure and temperature                      | 0694 7000 |
| <b>Further accessories:</b>   |           |
| Connection cable for probes 5 m with open ends                                | 0553 0104 |
| Connection cable for probes 10 m with open ends                               | 0553 0105 |
| Ethernet connection cable length 5 m, M12 plug x-coded (8 pin) to RJ 45 plug  | 0553 2503 |
| Ethernet connection cable length 10 m, M12 plug x-coded (8 pin) to RJ 45 plug | 0553 2504 |

**TECHNICAL DATA of PTS 500**

|                                     |  |
|-------------------------------------|--|
| <b>Temperature measuring range:</b> | -20...125°C  |
| <b>Accuracy:</b>                    | ± 1.0 °C (-10...+50°C)   |
| <b>Pressure measuring range:</b>    | See order code   |
| <b>Accuracy:</b>                    | ± 0.5% off f.s.(at 20°C)   |
| <b>Voltage supply:</b>              | 18...36 VDC via SELV supply, 5W<br>or Power over Ethernet (IEEE802.3af: Class 2 (3.84W - 6.49W)) |
| <b>Protection class of housing:</b> | IP 65  |
| <b>Operating temperature:</b>       | -20...+125°C for pressure sensor   |
| <b>Ambient temperature:</b>         | -20...+60°C  |
| <b>Storage temperature:</b>         | -40...+80°C  |
| <b>Readable via Modbus:</b>         | Pressure [hPa, mbar, bar, psi,...]<br>Temperature [°C, °F]                                       |
| <b>Signal output:</b>               | See order code   |

## DPS 16 - Digital Pressure probe



### Features:

- Digital temperature compensation and non-linearity correction
- RS 485 interface (Modbus-RTU)

| DIGITAL PRESSURE PROBE                                     | ± 1%<br>ACCURACY | ± 0,5%<br>ACCURACY |
|--|------------------|--------------------|
| Digital pressure probe DPS 16, 0...16 bar RS 485, G1/2"    | 0694 2886        | 0694 4555          |
| Digital pressure probe DPS 16, 0...16 bar RS 485, NPT 1/2" | 0694 3886        | 0694 5555          |

| TECHNICAL DATE DPS 16                    |                     |
|--|---------------------|
| <b>Measuring range:</b>                  | 0...16 bar          |
| <b>Accuracy:</b>                         | ± 0.5%<br>resp. ±1% |
| <b>Long-term Stability:</b>              | ±0.2% FS/year       |
| <b>Temperature:</b>                      | -30°C...80°C        |
| <b>Protecting Rating:</b>                | IP65                |
| <b>Power supply:</b>                     | 11...28 VDC         |
| <b>Components in contact with media:</b> | 316 L               |
| <b>Process connection:</b>               | G 1/2" or 1/2" NPT  |

## CS 16 - Pressure probe



### Features:

- Welded measuring system with no seals
- 4...20 mA analogue output, 2-wire

| PRESSURE PROBES WITH 4...20 mA<br>ANALOGUE OUTPUT                                    | ± 1%<br>ACCURACY | ± 0,5%<br>ACCURACY |
|--|------------------|--------------------|
| Standard pressure probe CS 16, 0...16 bar  | 0694 1886        | 0694 3555          |
| Standard pressure probe CS 40, 0...40 bar  | 0694 0356        | 0694 3930          |
| Standard pressure probe CS 1.6, 0...1.6 bar abs.                                     |                  | 0694 3550          |
| Standard pressure probe CS 10, 0...10 bar  | 0694 3556        | 0694 3554          |
| Standard pressure probe CS 100, 0...100 bar  |                  | 0694 3557          |
| Standard pressure probe CS 250, 0...250 bar  |                  | 0694 3558          |
| Standard pressure probe CS 400, 0...400 bar  |                  | 0694 3559          |
| Precision pressure probe CS -1...+15 bar, ± 0.5 % accuracy of. f.s.                  |                  | 0694 3553          |
| Calibration certificate pressure, 5 calibration points for the whole measuring range |                  | 3200 0004          |

| TECHNICAL DATE CS 16                     |                     |
|--|---------------------|
| <b>Measuring range:</b>                  | -1...400 bar        |
| <b>Accuracy:</b>                         | ± 0.5%<br>resp. ±1% |
| <b>Long-term Stability:</b>              | ±0.2% FS/year       |
| <b>Temperature:</b>                      | -40°C...125°C       |
| <b>Protecting Rating:</b>                | IP65                |
| <b>Power supply:</b>                     | 8...30 VDC          |
| <b>Components in contact with media:</b> | 316 L, 304          |
| <b>Process connection:</b>               | G 1/4"              |



## IAC 500– Measures ambient conditions in the room – Absolute pressure, room temperature, humidity



### Special features:

- 3 in 1 sensor: absolute pressure, temperature and humidity in the room
- Modbus-RTU, Ethernet or M-Bus interface
- Alarm relay – limit value adjustable via buttons (max 60 VDC, 0.5 A)
- Optional: 2 x 4...20 mA analogue outputs, 2 x alarm relays, e.g., for dew point and temperature

### Application:

- Monitoring the intake air of compressed air stations
- Monitoring of room air e.g. cold rooms, storage rooms or clean rooms

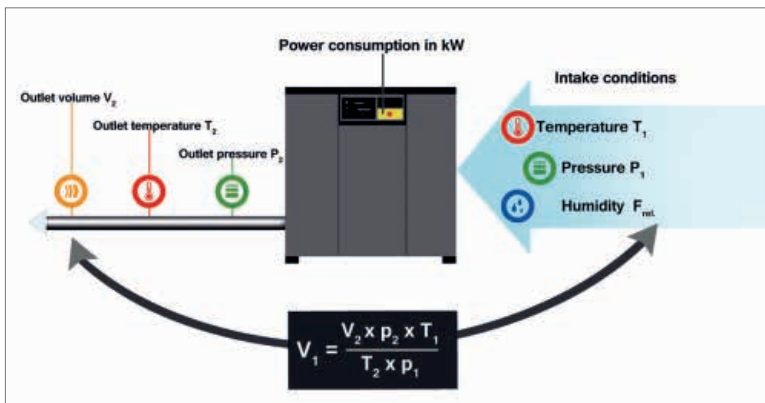

The delivery rate of compressors depends on the intake air.

The installation site and the climatic conditions must already be taken into account when designing compressed air stations.

Large temperature fluctuations, e.g. between day and night, lead to uneven compressed air flow.

### Example order code IAC 500:

0604 1000\_A1

| Signal output option |   |
|----------------------|---|
| A1                   | 1 x 4...20 mA analogue output (galvanically not isolated), alarm relay, RS 485 (Modbus-RTU)   |
| A2                   | 2 x 4...20 mA analogue output (galvanically not isolated), 2 x alarm relays, RS 485 (Modbus-RTU)  |
| A3                   | Ethernet interface (Modbus/TCP), 1 x 4...20 mA analogue output (galvanically not isolated), RS 485 (Modbus-RTU)                           |
| A4                   | Ethernet interface PoE (Power over Ethernet) (Modbus/TCP), 1 x 4...20 mA analogue output (galvanically not isolated), RS 485 (Modbus-RTU) |
| A5                   | M-Bus, 1 x 4...20 mA analogue output (galvanically not isolated), alarm relay, RS 485 (Modbus-RTU)  |

| DESCRIPTION   | ORDER NO. |
|---|-----------|
| IAC 500 sensor for measuring ambient conditions (absolute pressure, temperature, rel. humidity), incl. wall bracket | 0604 1000 |
| <b>Further accessories:</b>   |           |
| Connection cable for probes 5 m with open ends  | 0553 0104 |
| Connection cable for probes 10 m with open ends   | 0553 0105 |
| Ethernet connection cable length 5 m, M12 plug x-coded (8 pin) to RJ 45 plug  | 0553 2503 |
| Ethernet connection cable length 10 m, M12 plug x-coded (8 pin) to RJ 45 plug                                       | 0553 2504 |

### TECHNICAL DATA of IAC 500

|                                     |   |
|-------------------------------------|---|
| <b>Temperature</b>                  |   |
| <b>Measuring range:</b>             | -20...+60°C,  |
| <b>Accuracy:</b>                    | ± 1.0 K (0...60°C)<br>± 1.25 K (-20...0°C)  |
| <b>Rel. humidity</b>                |   |
| <b>Measuring range:</b>             | 5...95% rF  |
| <b>Accuracy:</b>                    | ± 3%  |
| <b>Absolute pressure</b>            |   |
| <b>measuring range:</b>             | 300...1100 hPa (abs)  |
| <b>Accuracy</b>                     | ±1.7 hPa  |
| <b>Voltage supply:</b>              | 24 VDC (18...30 VDC via SELV supply) or Power over Ethernet (IEEE802.3af: Class 2 (3.84W - 6.49W))  |
| <b>Protection class of housing:</b> | IP 65   |
| <b>Operating temperature:</b>       | -20...+60°C   |
| <b>Ambient temperature:</b>         | -20...+60°C   |
| <b>Storage temperature:</b>         | -40...+80°C   |
| <b>Readable via Modbus:</b>         | Absolute pressure [hPa, mbar, bar, psi,...],<br>dew point [°Ctd, °Ftd],<br>temperature [°C, °F],<br>rel. humidity [%RH],<br>abs. humidity [g/m³]. |





## DS 52 - LED process display

In wall housing for 0 (4)...20 mA standard signals



The DS 52 has 2 potential-free alarm contacts (changeover contacts) which can be charged with a maximum of 230 VAC, 3 A. The alarm thresholds are freely adjustable with the keys. The display is supplied with 230 VAC and has an internal mains unit which provides a voltage of 24 VDC/100 mA for the sensor. Free screwing clamps are available for forwarding the (0) 4...20 mA signal to superordinate controls.



### Special features:

- Integrated in a well-designed wall housing
- Suitable for all common sensors with 0 (4)...20 mA signal
- Easy operation
- 2 relay outputs (230 VAC, 3 A)

### Application example:

Pressure monitoring with optional alarm unit (buzzer + continuous light)

### Application example:

Temperature monitoring with alarm

| DESCRIPTION   | ORDER NO.: |
|---|------------|
| DS 52 LED process display in the wall housing   | 0500 0009  |
| <b>Options:</b>   |            |
| Power supply 24 VDC instead of 230 VAC  | Z500 0001  |
| Power supply 110 VAC instead of 230 VAC   | Z500 0002  |
| Alarm unit mounted to the wall housing  | Z500 0003  |
| Alarm unit for external mounting  | Z500 0004  |
| <b>Complete sets:</b>   |            |
| DS 52 - all-in-one set for pressure monitoring/alerting, consisting of DS 52 LED display and pressure sensor 0...16 bar                   | on request |
| DS 52 - all-in-one set for temperature monitoring/alerting, consisting of DS 52 LED display and screw-in temperature sensor -50...+500 °C | on request |

### TECHNICAL DATA DS 52

|                                |  |
|--------------------------------|--|
| <b>Dimensions:</b>             | 118 x 133 x 92 mm (WxHxD)  |
| <b>Display:</b>                | LED, 5-digit, height 13 mm, 2 LEDs for alarm                                       |
| <b>Keypad:</b>                 | 4 keys: Enter, Back, Up, Down  |
| <b>Sensor input:</b>           | For sensors with 0 (4)...20 mA signal. Can be connected in 2-/3-/4-wire technology |
| <b>Accuracy:</b>               | Max. +/- 20 µA, typically +/- 10 µA  |
| <b>Burden:</b>                 | 100 Ω  |
| <b>Sensor supply:</b>          | 24 VDC, max. 100 mA  |
| <b>Power supply: (option):</b> | 230 VAC, 50/60 Hz (24 VDC or 110 VAC)  |
| <b>Outputs:</b>                | 2 x relay output, changeover contact, 250 VAC, max. 3 A                            |
| <b>Alarm thresholds:</b>       | Freely adjustable via keypad   |
| <b>Hysteresis:</b>             | Freely adjustable via keypad   |
| <b>Operating temperature:</b>  | -10...+60 °C (Storage temp.: -20...+80 °C)   |
| <b>Control menu:</b>           | Can be locked via code for unauthorised access                                     |





## Headquarters Germany



### Sales / technology

#### SALES OFFICE SOUTH CS INSTRUMENTS GmbH & Co. KG

Zindelsteiner Straße 15  
78052 VS-Tannheim  
Germany

Tel.: +49 (0)7705 978 99-0  
Fax: +49 (0)7705 978 99-20  
E-mail: [info@cs-instruments.com](mailto:info@cs-instruments.com)  
Web.: [www.cs-instruments.com](http://www.cs-instruments.com)

### Order processing and recalibration

#### SALES OFFICE NORTH CS INSTRUMENTS GmbH & Co. KG

Gewerbehof 14  
24955 Harrislee  
Germany

Tel.: +49 (0)461 807 150-0  
Fax: +49 (0)461 807 150-15  
E-mail: [info@cs-instruments.com](mailto:info@cs-instruments.com)  
Web.: [www.cs-instruments.com](http://www.cs-instruments.com)

## Subsidiaries of CS INSTRUMENTS



**CHINA**  
**CS INSTRUMENTS (Shanghai) Co.,Ltd**  
Room 508, JT1166, No. 1080, Moyu South Road  
Anting Town, Jiading District  
200003, Shanghai, China  
P.: +86 13601694498  
E-Mail: [k.wu@cs-instruments.cn](mailto:k.wu@cs-instruments.cn)  
Web.: [www.cs-instruments.com/zh](http://www.cs-instruments.com/zh)



**FRANCE**  
**CS INSTRUMENTS**  
4, rue du docteur Heulin  
75017 Paris  
France  
Phone: +33 1 86 95 87 60  
E-mail: [info@cs-instruments.fr](mailto:info@cs-instruments.fr)  
Web.: [www.cs-instruments.com/fr](http://www.cs-instruments.com/fr)



**ITALY**  
**CS INSTRUMENTS Italia S.r.l.**  
Via Matteotti 66  
20092 - Cinisello Balsamo (Mi)  
Italy  
Phone: +39 0225061761  
E-mail: [info@cs-instruments.it](mailto:info@cs-instruments.it)  
Web.: [www.cs-instruments.com/it](http://www.cs-instruments.com/it)



**NETHERLANDS / BELGIUM**  
**CS INSTRUMENTS BENELUX B.V.**  
Volhardingstraat 27  
2020 Antwerpen  
Belgium  
Phone: +32 484 57 59 50  
E-mail: [info@cs-instruments.nl](mailto:info@cs-instruments.nl)  
Web.: [www.cs-instruments.com/nl](http://www.cs-instruments.com/nl)



**AUSTRIA**  
**CS INSTRUMENTS GmbH**  
Grazer Straße 8  
8605 Kapfenberg  
Austria  
Phone: +43 (0)664 181 3284  
E-mail: [a.sieberer@cs-instruments.at](mailto:a.sieberer@cs-instruments.at)  
Web.: [www.cs-instruments.com/at](http://www.cs-instruments.com/at)



**SWEDEN / NORWAY**  
**CS INSTRUMENTS Skandinavia AB**  
Hovlanda 30  
471 93 Kållekärr  
Sweden  
P.: +46304668450  
E-Mail: [a.ahs@cs-instruments.com](mailto:a.ahs@cs-instruments.com)  
Web.: [www.cs-instruments.com/se](http://www.cs-instruments.com/se)



**SWITZERLAND**  
**CS INSTRUMENTS (Switzerland) GmbH**  
Mühlegasse 8  
3237 Brüttelen  
Switzerland  
Phone: +41 32 355 4160  
E-mail: [info@cs-instruments.ch](mailto:info@cs-instruments.ch)  
Web.: [www.cs-instruments.com/ch](http://www.cs-instruments.com/ch)



**SPAIN**  
**CS INSTRUMENTS, S.L.**  
Avda. Cerro Milano 4, Local 1  
28051 Madrid  
Spain  
Phone: +34 91 33 15 758  
E-mail: [info@cs-instruments.es](mailto:info@cs-instruments.es)  
Web.: [www.cs-instruments.com/es](http://www.cs-instruments.com/es)



**SOUTH AFRICA**  
**CS INSTRUMENTS (Pty) Ltd.**  
142 Briza Road, Table View  
7441 Cape Town  
South Africa  
Phone: +27 (0)21 557 56 18  
E-Mail: [info@cs-instruments.co.za](mailto:info@cs-instruments.co.za)  
Web.: [www.cs-instruments.com/za](http://www.cs-instruments.com/za)



**TURKEY**  
**CS INSTRUMENTS Ölçüm Ekipmanları Tic. Ltd. Şti.**  
Yeşilbağlar Mah. D-100 Bulv.  
Pendik Pera Residence A Blok No: 20K  
34893 Pendik İstanbul, Turkey  
Phone: +90 216 755 10 20  
E-mail: [info@cs-instruments.com.tr](mailto:info@cs-instruments.com.tr)  
Web.: [www.cs-instruments.com/tr](http://www.cs-instruments.com/tr)



**USA**  
**CS INSTRUMENTS USA INC.**  
110 Traders Cross  
Bluffton, SC 29909  
USA  
P.: +1 843 599 6700  
E-Mail: [info-us@cs-instruments.com](mailto:info-us@cs-instruments.com)  
Web.: [www.cs-instruments.com/us](http://www.cs-instruments.com/us)