

Project		Catalog #		Type	
Prepared by		Notes		Date	



Metalux

Cruze SB 22CZ

2' x 2' LED Specification Grade Troffer

Typical Applications

Office • Education • Healthcare • Hospitality • Retail

Product Certification



Product Features



Interactive Menu

- Order Information [page 2](#)
- Photometric Data [page 3](#)
- Connected Systems [page 5](#)
- VividTune™ Color Tuning Solutions [page 5](#)
- Product Warranty

Top Product Features

- Matte white door provides access to drivers and LED from below
- Lens options - ribbed, smooth, round & square perforated
- High performance efficacy up to 157 lumens per watt
- Integrated sensor systems - occupancy, daylight and IoT connectivity
- VividTune CCT tuning options from 3000K–5000K or 2700K-6500K
- Options to meet Buy American and other domestic preference requirements

Dimensional and Mounting Details

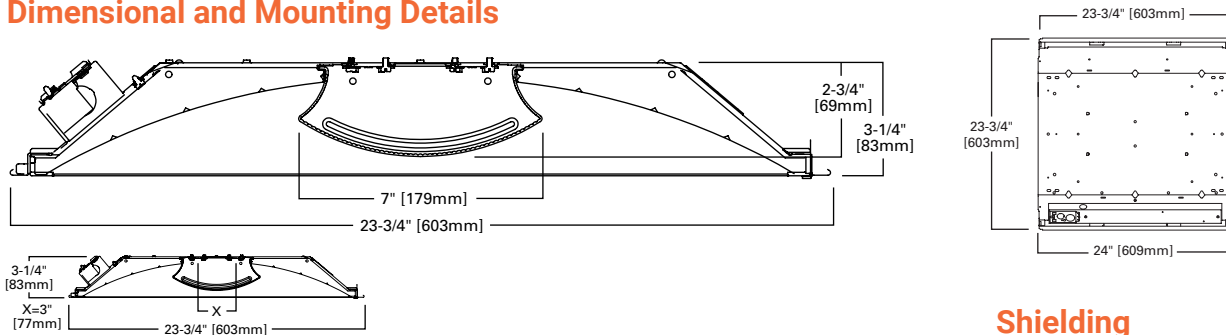

Ceiling Compatibility

G	G	G	Ceiling Type	Trim Type
Grid/Lay-in Standard	Concealed T	Slot Grid	Exposed Grid	Standard
			Concealed T	Standard
			Slot Grid	Standard
			Flange	*

Shielding

2' wide versions shown for detail.

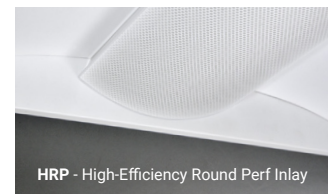

See ordering information for more shielding options.

Order Information

SAMPLE ORDER NUMBER: **22CZ-LD5-34-UNV-L835-CD1-U**

Domestic Preferences	Rating	Series	Door Frame	Lamp Type	Lumen Output	Shielding	Voltage	Options
Domestic Preferences ⁽¹⁾	Rating	Series ⁽²⁾	Door Frame	Lamp Type	Lumen Output	Shielding	Voltage ⁽⁵⁾	Options
[Blank]=Standard BAA=Buy American Act TAA=Trade Agreements Act	[Blank]=Standard ATW-SW4=Chicago Rated	22CZ=2x2 Cruze SB	[Blank]=Flat White Steel Door (standard)	LD5=LED 5.0	Cruze SB 20=2000 Lumens ⁽³⁾ 24=2400 Lumens ⁽³⁾ 29=2900 Lumens 34=3400 Lumens 39=3900 Lumens 44=4400 Lumens Standard Efficacy 20SE=2000 Lumens ^{(3),(4)} 24SE=2400 Lumens ^{(3),(4)} 32SE=3200 Lumens ⁽⁴⁾ 39SE=3900 Lumens ⁽⁴⁾ 44SE=4400 Lumens ⁽⁴⁾	[Blank]=Ribbed Frosted Acrylic Lens (standard) S=Smooth Frosted Acrylic Lens SQP=Smooth Lens with Square Pattern Insert HRP=High-Efficiency Round Perf Inlay	UNV=Universal Voltage 120-277 347V=347 Volt ⁽⁶⁾ 48V=48 Volt Low-voltage (Class 2) ⁽⁷⁾ 120V=120 Volt ⁽⁷⁾ 277V=277 Volt ⁽⁷⁾	GL=Single Element Fuse GM=Double Element Fuse
Notes ⁽¹⁾ Only product configurations with these designated prefixes are built to be compliant with the Buy American Act of 1933 (BAA) or Trade Agreements Act of 1979 (TAA), respectively. Please refer to DOMESTIC PREFERENCES website for more information. Components shipped separately may be separately analyzed under domestic preference requirements.		Notes ⁽²⁾ DesignLights Consortium® Qualified and classified for both DLC Standard and DLC Premium, refer to www.designlights.org for details.		Notes ⁽³⁾ With integral test switch/indicator/laser test. For approximate delivered lumens multiply the lumens per watt of the desired fixture by the wattage of the emergency battery pack (100 lm/W x 7=700 lumens). IES-format photometry for luminaire under emergency operation available. ⁽⁴⁾ White tuning not available with this model.			Notes ⁽⁵⁾ Products also available in non-US voltages and frequencies for international markets. ⁽⁶⁾ 347V versions are not available with emergency options. SD, SLTD, and SR drivers with 347V are available but not DLC qualified. ⁽⁷⁾ Must specify voltage as 120V or 277V when ordering GTR2 option. ^(C) Consult WaveLinx Low-Voltage or DLVP system pages for additional details and compatibility.	

Emergency Options	CRI/CCT	Flex
-------------------	---------	------

Emergency Options	CRI/CCT	Flex
[Blank]=No emergency EL7W=7-watt 120V-277V emergency battery pack ⁽⁸⁾ EL10W=10-watt 120V-277V emergency battery pack ⁽⁸⁾ EL14W=14-watt 120V-277V emergency battery pack ⁽⁸⁾ EL10WSD=10W emergency battery pack with self-diagnostic installed ^{(8),(21)} EL14WSD=14W emergency battery pack with self-diagnostic installed ^{(8),(21)} EL7W=Low-voltage system, 7-watt emergency battery pack ⁽⁹⁾ ELV14W=Low-voltage system, 14-watt emergency battery pack ⁽⁹⁾ GTR2=Bodine Generator Transfer Relay ^{(9),(10)} ETRD=Emergency Transfer Relay with dimming control ⁽⁹⁾	L830=80CRI, 3000K L835=80CRI, 3500K L840=80CRI, 4000K L850=80CRI, 5000K L930=90CRI, 3000K L935=90CRI, 3500K L940=90CRI, 4000K L950=90CRI, 5000K L83050=80CRI 3000K-5000K White Tuning ⁽¹¹⁾ L93050=90CRI 3000K-5000K White Tuning ⁽¹¹⁾ L82765=80CRI 2700K-6500K White Tuning ⁽¹¹⁾ L92765=90CRI 2700K-6500K White Tuning ⁽¹¹⁾	[Blank]=No Flex A3/8-4/18GDIM=3/8" Flex with 0-10V Dimming Leads A3/8-2/18G=3/8" Flex with line and common A3/8-5/18GDIM=Flex with 0-10V Dimming leads and Blue for alternate wiring. See below for details.
Notes ⁽⁸⁾ Factory installed with integral test switch/indicator/laser test. For approximate delivered lumens multiply the lumens per watt of the desired fixture by the wattage of the emergency battery pack (100 lm/W x 7=700 lumens). IES-format photometry for luminaire under emergency operation available. Battery option increases total height by 1 inch. ⁽⁹⁾ Used to bypass local control during outage. Must be used in conjunction with UL 1008 device (provided by others). GTR2 option includes 2 relays on fixtures with dimming drivers. ETRD option only requires one relay when used on a dimming fixture. ⁽¹⁰⁾ Must specify voltage as 120V or 277V when ordering GTR2 option. ⁽²¹⁾ EL10WSD and EL14WSD not available with 347V. ^(C) Consult WaveLinx Low-Voltage or DLVP system pages for additional details and compatibility.	Notes ⁽¹¹⁾ White tuning provides correlated color temperatures (CCT) between 3000K (warm) to 5000K (cool) or 2700K (warm) to 6500K (cool). Must be used in conjunction with W2A driver only. Must be used with two (2) 10V dimming control channels, 1 color, 1 intensity. May be combined with WaveLinx sensor control systems only.	Flexible Metal Conduit Options Flex options available for 0-10V dimming control, DALI dimming control, emergency and night light functions. 72-inch factory-installed and pre-wired to driver, fitted to luminaire housing access plate with 90° enclosed FMC connector. Not all options may be combined and installation ratings vary by type. See online configurator for all flex options. A3/8-4/18GDIM series notes: Factory installed dimming option 3/8" flexible metal conduit with 2-#18 power and ground wires and 2-#18 UL-listed jacketed 0-10V +/- control wires. Meets UL 66, 83, 1479, 1569, 1581, 2556. NEC® 250.118, 300.22(C), 392, 396, 501, 502, 503, 530, 504, 505, 518, 520, 530, 645, 72. Federal Specification A-A-59544 (formerly J-C-308); all applicable OSHA and HUD Requirements. UL Classified 1-, 2-, and 3-hour through penetration with applicable fire stop product (not included). May be surface mounted, fished and/or embedded in plaster. Cable tray and approved raceway rated, install per NEC®; Environmental Air-Handling Space Installation per NEC® 300.22(C).

Driver Type	No. of Drivers	Integrated Sensing Systems	Sensor Accessories	Packaging	Accessories
-------------	----------------	----------------------------	--------------------	-----------	-------------

Driver Type	No. of Drivers	Integrated Sensing Systems	Sensor Accessories	Packaging	Accessories (order separately) ⁽²⁰⁾
CD=0-10V Driver (1%-100% Dimming) SLTD=DALI Driver (5%-100% Dimming) SLTHD=DALI Driver (1%-100% Dimming) LV=Low-voltage System Driver (0%-100% Dimming) ⁽¹²⁾ SD=Step Dimming Driver (50%-100% Dimming) ⁽¹²⁾ LH=Lutron HiLume (LDE1 series) 1%-100% EcoSystem Driver with Soft-on Fade to Black dimming ^(F) W2A=White Tuning, 2 ch, Analog 0-10V Intensity and CCT Control ⁽¹³⁾ SR=Sensor-ready Driver (1%-100% Dimming)	1=1 Driver	WAA=WaveLinx PRO Wireless Integrated Sensor ^{(14),(A)} WPN=WaveLinx PRO Wireless Node without Sensor ^{(14),(A)} WAB=WaveLinx LITE Wireless Integrated Sensor ^{(15),(B)} WLA=Low-voltage Integrated Sensor ^{(16),(C)}	DV=Dual Band ⁽¹⁸⁾	U=Unit Pack PAL=Job Pack, out of carton PALC=Job Pack, in carton	EQ-CLIP-U=T-BAR Safety Earthquake Clips ⁽¹⁹⁾ DF-22W-U=2' x 2' Drywall Frame Kit SK-22-WS=2' x 2' Shallow Surface Mount Kit SK-22-WT=2' x 2' Tall Surface Mount Kit
Notes ⁽¹²⁾ Step dim (SD) driver option is not available with 2000, 2400, 2900 and 3400 lumen packages and 2000SE, 2400SE and 3200SE versions. ⁽¹³⁾ White tuning provides correlated color temperatures (CCT) between 3000K (warm) to 5000K (cool) or 2700K (warm) to 6500K (cool). Must be used in conjunction with W2A driver only. Must be used with two (2) 10V dimming control channels, 1 color, 1 intensity. May be combined with WaveLinx sensor control systems only. Integrated options must be used in conjunction with the associated system and may not be compatible with other options or accessories. Please refer to the following: ^(C) Consult WaveLinx Low-Voltage or DLVP system pages for additional details and compatibility. ^(F) Consult Marketplace Options - Lutron system pages for additional details and compatibility. Compatible only with driver series shown, and may require two or more drivers. Requires field commissioning to operate or dim. Contact Lutron at www.lutron.com .		Notes ⁽¹⁴⁾ WAA sensor and WPN node to be used with CD or W2A driver. Consult factory for WPN with tunable white W2A driver. ⁽¹⁵⁾ WAB sensor to be used with CD and HCD driver. ⁽¹⁶⁾ WLA sensor to be used with LV driver. Integrated options must be used in conjunction with the associated system and may not be compatible with other options or accessories. Please refer to the following: ^(A) Consult WaveLinx PRO system pages for additional details and compatibility. ^(B) WaveLinx LITE devices are not currently compatible with the WaveLinx Wireless Area Controller. Consult WaveLinx LITE system pages for additional details and compatibility. ^(C) Consult WaveLinx Low-Voltage or DLVP system pages for additional details and compatibility.	Notes ⁽¹⁸⁾ Provides blank band on opposite side from sensor band to provide symmetric appearance.		Notes ⁽¹⁹⁾ An EQ Grid Clip is recommended for all 9/16" ceiling systems. Four required per fixture. ⁽²⁰⁾ Accessories sold separately will be separately analyzed under domestic preference requirements. Consult factory for further information. Integrated options must be used in conjunction with the associated system and may not be compatible with other options or accessories.

Product Specifications

Construction

- Die formed of code gauge prime cold rolled steel with full length die-formed stiffeners
- Unibody endplates attached with interlocking tabs and screws
- Hemmed side flanges
- Four auxiliary fixture end suspension points provided
- Optional earthquake clips available

Integrated Controls

- 0-10V dimming to 1% standard
- WaveLinX wireless sensor compatible for standalone, controlled, connected, and IoT capability
- Low-voltage sensor and driver compatible for WaveLinX Low-Voltage and DLVP applications
- DALI 2.0, Lutron, and step-dimming available

LED and Light Engine

- Long-life LED systems coupled with electrical driver
- Color accuracy ≤ 3 -Step MacAdam ellipse (SDCM)
- Available in 3000K, 3500K, 4000K, or 5000K with a minimum CRI of 80
- L70 is more than 60,000 hours based on TM21 testing standards
- Available in 120-277V and 347V

Emergency Battery Options

- 120V-277V integral emergency battery pack comes in 7-watts, 10-watt, or 14-watts
- Self-diagnostic emergency battery available in 10 or 14-watts (NFPA 101® Life Safety Code®)
- Constant power to the LED system for controlled, predictable discharge
- Integrated test switch/indicator light visible from floor
- Min. 90-minute backup period for code compliance
- Integral emergency transfer relay available for generator equipped power systems

Hinging/Latching

- Positive cam action steel latches with baked white enamel finish
- Safety-lock T-hinges allow hinging and latching either side
- Door assembly hinges down for easy access from below

Frame/Shielding

- Die formed, heavy gauge flat steel door
- Mitered corners and painted after fabrication
- Baked matte white enamel finish
- Positive light seals
- Acrylic frosted lens
- Replacement lenses available, contact factory

Compliance

- IC rated for insulation contact
- cULus listed for damp locations
- RoHS compliant
- Tested to IESNA LM-79 and LM-80
- Stated life tested to TM21 standards
- Can be used for State of California Title 24 high efficacy luminaire
- Options to meet Buy American and other domestic preference requirements

Warranty

- Five-year warranty standard. Optional ten year warranty available.

Finish

- Multistage, iron phosphate pretreatment
- Housing finished with 90% white enamel

Photometric Data

[View IES files](#)

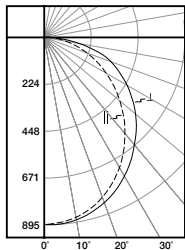

22CZ-LD5-24-UNV-L835-CD1-U

Electronic Driver
 Linear LED 3500K
 Spacing criterion: (II) 1.17 x mounting height,
 (⊥) 1.25 x mounting height
 Lumens: 2470
 Input Watts: 19.6W
 Efficacy: 126 LPW
 Test Report: 22CZ-LD5-24-UNV-L835-CD1-U.IES

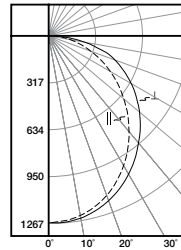

22CZ-LD5-34-UNV-L835-CD1-U

Electronic Driver
 Linear LED 3500K
 Spacing criterion: (II) 1.17 x mounting height,
 (⊥) 1.25 x mounting height
 Lumens: 3497
 Input Watts: 29.4W
 Efficacy: 118.9 LPW
 Test Report: 22CZ-LD5-34-UNV-L835-CD1-U.IES

Energy and Performance Data

Lumen Maintenance

Ambient Temperature	TM-21 Lumen Maintenance (60,000 hours) ⁽²⁾	Theoretical L70 (Hours) ⁽³⁾
25°C	> 85%	> 135,000

Notes: (2) Supported by IES TM-21 standards. (3) Theoretical values represent estimations commonly used; however, refer to the IES position on LED Product Lifetime Prediction, IES PS-10-18, that explains proper use of IES TM-21 and LM-80.

Shielding

Lumen Adjustment Factors		
S	SQP	HRP
1.05	0.670	0.883

Load Data (Stock Product)

Thd	6.78%
Power Factor	0.99
Weight (lbs.)	12.5
Low Temp. Start	-20°C

Shipping Data

Catalog No.	Wt.
22CZ-LD5-27	12.5 lbs.
22CZ-LD5-36	12.5 lbs.

90 CRI

Lumen Adjustment Factors 80->90 CRI	
3000K	0.88
3500K	0.861
4000K	0.865
5000K	0.87

Example of Lumen Adjustment Calculation

22CZ-LD5-34-UNV-L935-CD1-U
 at 90CRI at 3500K
 Lumen Adjustment Factor = 0.861
 Total Light Output =
 $3,497 \text{ lm} \times 0.861 = 3,010 \text{ lm}$
 Efficacy = $\frac{3,010 \text{ lm}}{29.4\text{W}} = 102.3 \text{ lm/W}$

Energy and Performance Data

Catalog Logic (Ribbed Lens)	Delivered Lumens	Watts	Efficacy (lm/W)
22CZ-LD5-20-UNV-L830-CD1-U	1865	15	124
22CZ-LD5-20-UNV-L835-CD1-U	1932.3	15	129
22CZ-LD5-20-UNV-L840-CD1-U	1968.2	15	131
22CZ-LD5-20-UNV-L850-CD1-U	1969.3	15	131
22CZ-LD5-24-UNV-L830-CD1-U	2273	18.1	126
22CZ-LD5-24-UNV-L835-CD1-U	2355	18.1	130
22CZ-LD5-24-UNV-L840-CD1-U	2398.7	18.1	133
22CZ-LD5-24-UNV-L850-CD1-U	2400.1	18.1	133
22CZ-LD5-29-UNV-L830-CD1-U	2739.2	20.9	131
22CZ-LD5-29-UNV-L835-CD1-U	2838	20.9	136
22CZ-LD5-29-UNV-L840-CD1-U	2890.8	20.9	138
22CZ-LD5-29-UNV-L850-CD1-U	2892.4	20.9	138
22CZ-LD5-34-UNV-L830-CD1-U	3147.2	24.3	130
22CZ-LD5-34-UNV-L835-CD1-U	3260.7	24.3	134
22CZ-LD5-34-UNV-L840-CD1-U	3321.3	24.3	137
22CZ-LD5-34-UNV-L850-CD1-U	3323.2	24.3	137
22CZ-LD5-39-UNV-L830-CD1-U	3671.7	28.5	129
22CZ-LD5-39-UNV-L835-CD1-U	3804.2	28.5	133
22CZ-LD5-39-UNV-L840-CD1-U	3874.9	28.5	136
22CZ-LD5-39-UNV-L850-CD1-U	3877.1	28.5	136
22CZ-LD5-44-UNV-L830-CD1-U	4196.2	32.8	128
22CZ-LD5-44-UNV-L835-CD1-U	4347.6	32.8	133
22CZ-LD5-44-UNV-L840-CD1-U	4428.4	32.8	135
22CZ-LD5-44-UNV-L850-CD1-U	4430.9	32.8	135

Standard Efficacy Versions

Catalog Logic (Ribbed Lens)	Delivered Lumens	Watts	Efficacy (lm/W)
22CZ-LD5-20SE-UNV-L830-CD1-U	1967.9	16.2	121
22CZ-LD5-20SE-UNV-L835-CD1-U	2038.8	16.2	126
22CZ-LD5-20SE-UNV-L840-CD1-U	2076.7	16.2	128
22CZ-LD5-20SE-UNV-L850-CD1-U	2077.9	16.2	128
22CZ-LD5-24SE-UNV-L830-CD1-U	2254.6	18.5	122
22CZ-LD5-24SE-UNV-L835-CD1-U	2335.9	18.5	126
22CZ-LD5-24SE-UNV-L840-CD1-U	2379.3	18.5	129
22CZ-LD5-24SE-UNV-L850-CD1-U	2380.7	18.5	129
22CZ-LD5-32SE-UNV-L830-CD1-U	3006.4	24.2	124
22CZ-LD5-32SE-UNV-L835-CD1-U	3114.9	24.2	129
22CZ-LD5-32SE-UNV-L840-CD1-U	3172.8	24.2	131
22CZ-LD5-32SE-UNV-L850-CD1-U	3174.6	24.2	131
22CZ-LD5-39SE-UNV-L830-CD1-U	3849.3	31.2	123
22CZ-LD5-39SE-UNV-L835-CD1-U	3988.1	31.2	128
22CZ-LD5-39SE-UNV-L840-CD1-U	4062.2	31.2	130
22CZ-LD5-39SE-UNV-L850-CD1-U	4064.5	31.2	130
22CZ-LD5-44SE-UNV-L830-CD1-U	4099.7	33.2	123
22CZ-LD5-44SE-UNV-L835-CD1-U	4247.6	33.2	128
22CZ-LD5-44SE-UNV-L840-CD1-U	4326.5	33.2	130
22CZ-LD5-44SE-UNV-L850-CD1-U	4329	33.2	130

Catalog Logic (Smooth Lens)	Delivered Lumens	Watts	Efficacy (lm/W)
22CZ-LD5-20-S-UNV-L830-CD1-U	1958	15.0	131
22CZ-LD5-20-S-UNV-L835-CD1-U	2029	15.0	135
22CZ-LD5-20-S-UNV-L840-CD1-U	2067	15.0	138
22CZ-LD5-20-S-UNV-L850-CD1-U	2068	15.0	138
22CZ-LD5-24-S-UNV-L830-CD1-U	2387	18.1	132
22CZ-LD5-24-S-UNV-L835-CD1-U	2473	18.1	137
22CZ-LD5-24-S-UNV-L840-CD1-U	2519	18.1	139
22CZ-LD5-24-S-UNV-L850-CD1-U	2520	18.1	139
22CZ-LD5-29-S-UNV-L830-CD1-U	2876	20.9	138
22CZ-LD5-29-S-UNV-L835-CD1-U	2980	20.9	143
22CZ-LD5-29-S-UNV-L840-CD1-U	3035	20.9	145
22CZ-LD5-29-S-UNV-L850-CD1-U	3037	20.9	145
22CZ-LD5-34-S-UNV-L830-CD1-U	3305	24.3	136
22CZ-LD5-34-S-UNV-L835-CD1-U	3424	24.3	141
22CZ-LD5-34-S-UNV-L840-CD1-U	3487	24.3	144
22CZ-LD5-34-S-UNV-L850-CD1-U	3489	24.3	144
22CZ-LD5-39-S-UNV-L830-CD1-U	3855	28.5	135
22CZ-LD5-39-S-UNV-L835-CD1-U	3994	28.5	140
22CZ-LD5-39-S-UNV-L840-CD1-U	4069	28.5	143
22CZ-LD5-39-S-UNV-L850-CD1-U	4071	28.5	143
22CZ-LD5-44-S-UNV-L830-CD1-U	4406	32.8	134
22CZ-LD5-44-S-UNV-L835-CD1-U	4565	32.8	139
22CZ-LD5-44-S-UNV-L840-CD1-U	4650	32.8	142
22CZ-LD5-44-S-UNV-L850-CD1-U	4653	32.8	142

Standard Efficacy Versions

Catalog Logic (Smooth Lens)	Delivered Lumens	Watts	Efficacy (lm/W)
22CZ-LD5-20SE-S-UNV-L830-CD1-U	2066	16.2	128
22CZ-LD5-20SE-S-UNV-L835-CD1-U	2141	16.2	132
22CZ-LD5-20SE-S-UNV-L840-CD1-U	2181	16.2	135
22CZ-LD5-20SE-S-UNV-L850-CD1-U	2182	16.2	135
22CZ-LD5-24SE-S-UNV-L830-CD1-U	2367	18.5	128
22CZ-LD5-24SE-S-UNV-L835-CD1-U	2453	18.5	133
22CZ-LD5-24SE-S-UNV-L840-CD1-U	2498	18.5	135
22CZ-LD5-24SE-S-UNV-L850-CD1-U	2500	18.5	135
22CZ-LD5-32SE-S-UNV-L830-CD1-U	3157	24.2	130
22CZ-LD5-32SE-S-UNV-L835-CD1-U	3271	24.2	135
22CZ-LD5-32SE-S-UNV-L840-CD1-U	3331	24.2	138
22CZ-LD5-32SE-S-UNV-L850-CD1-U	3333	24.2	138
22CZ-LD5-39SE-S-UNV-L830-CD1-U	4042	31.2	130
22CZ-LD5-39SE-S-UNV-L835-CD1-U	4188	31.2	134
22CZ-LD5-39SE-S-UNV-L840-CD1-U	4265	31.2	137
22CZ-LD5-39SE-S-UNV-L850-CD1-U	4268	31.2	137
22CZ-LD5-44SE-S-UNV-L830-CD1-U	4305	33.2	130
22CZ-LD5-44SE-S-UNV-L835-CD1-U	4460	33.2	134
22CZ-LD5-44SE-S-UNV-L840-CD1-U	4543	33.2	137
22CZ-LD5-44SE-S-UNV-L850-CD1-U	4545	33.2	137

Control Systems

- WaveLinX PRO Wireless
- WaveLinX LITE Wireless
- WaveLinX Wired

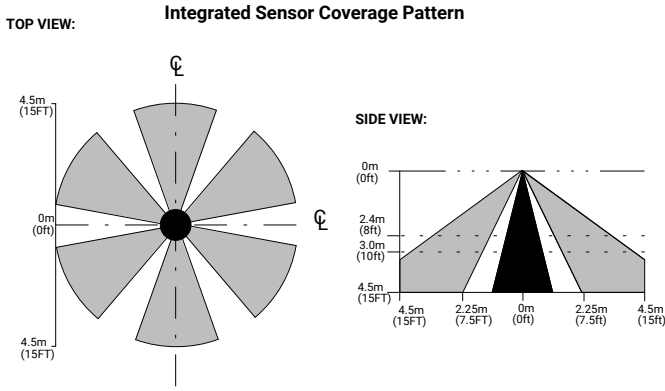

Note: Installation of integrated sensors within 3-ft (1m) of HVAC air vents is not recommended. The pattern shown is intended solely as a general guide and is not to scale.

The Cruze SB with WaveLinX offers no-hassle lighting control with multiple luminaire level control solutions.

WaveLinX PRO is used for applications where spaces need to be connected to a lighting or building management system and to help building owners improve their operations, building environment, and tenants' experience by leveraging the data generated by the sensors. The WaveLinX PRO devices communicate with each other via the WaveLinX Area Controller which coordinates the data traffic between the devices, lighting apps and CORE platform. The WaveLinX Area Controller also hosts the time clock required if spaces need to be turned on/off at a specific time.

The WaveLinX PRO Sensor offers built-in occupancy and daylighting controls as well as luminaire level control including white tuning while the WaveLinX PRO Node offers luminaire level control and white tuning. If opting for the WaveLinX PRO Node option, a PRO Ceiling Sensor will most likely be needed within the space to control the lights based on occupancy and daylight levels.

WaveLinX LITE is used for single spaces where there is no need to manage the spaces remotely or exchange the sensor data with other sub-systems within the building or smart applications.

The WaveLinX LITE Sensor offers built-in occupancy and daylighting controls as well as luminaire level control.

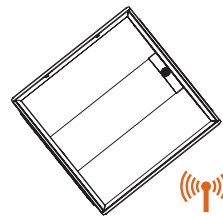

With Integrated WaveLinX Sensor

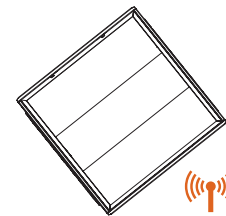

With Integrated WaveLinX Node

Systems comparison chart

Cooper Lighting Solutions provides many lighting system solutions designed to satisfy code requirements and meet the unique needs of any project.



Luminaire with standalone sensor



Standalone Spaces WaveLinX LITE



Networked Spaces WaveLinX PRO



Enterprise WaveLinX CORE

	Luminaire with standalone sensor	Standalone Spaces WaveLinX LITE	Networked Spaces WaveLinX PRO	Enterprise WaveLinX CORE
Occupancy	Yes	Yes	Yes	Yes
Daylighting	Yes	Yes	Yes	Yes
Wallstations	-	Yes	Yes	Yes
Gateways	-	-	1 WAC	300 WACs
Devices (MAX)	-	50 per Area (1400 per site)	200 per WAC2	32,500 per CORE Enterprise
Software	-	WaveLinX LITE Mobile App	WaveLinX Mobile App	CORE
Areas	-	28 per Site	50 per WAC2	up to 3,000
Zones	-	16 per Area	16 per Area	up to 9,000
Scheduling	-	-	Local	Global
VividTune™	-	-	Yes	Yes
Plug-Load Control	-	-	Yes	Yes
Low-Voltage Power	-	-	Yes	Yes
Integration	-	-	-	BACnet, API
Dashboards	-	-	-	Energy, Occupancy
Configuration	-	Installer	Technician	Technician / IT

SCALABILITY





22 Cruze SB LED with VividTune Tunable White

VividTune tunable white luminaires from Cooper Lighting Solutions deliver high-quality light in a broad range of continuously variable color temperatures and intensities. Create a dynamic environment by adjusting the ambient light warmer or cooler to influence mood, support the task at hand, or create a dramatic ambience. The ability to control correlated color temperature and intensity separately using simple controls is the next evolution of LED lighting for the commercial, educational, healthcare and hospitality space. The unparalleled flexibility and number of available lighting environments enable users to find the right light with tunable white.

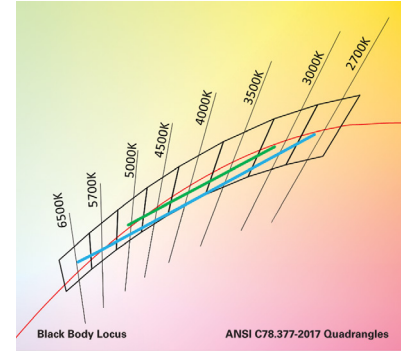

3000K - 5000K
2700K - 6500K

Performance Data*

Tunable White - Lumen Adjustment Factors				
CCT	3000K-5000K		2700K-6500K	
	80 CRI	90 CRI	80 CRI	90 CRI
2700K	-	-	0.902	0.771
3000K	0.929	0.765	0.928	0.801
3500K	0.983	0.836	0.960	0.841
4000K	1.032	0.902	0.981	0.868
4500K	1.042	0.918	0.999	0.891
5000K	1.042	0.918	1.012	0.908
6500K	-	-	1.027	0.933

2' x 2' Cruze SB LED - Example of Approximate Lumen Calculation			
	Standard Catalog #	VividTune 80 CRI Catalog #	VividTune 90 CRI Catalog #
CCT Setting	22CZ-LD5-34-UNV-L835-CD1-U	22CZ-LD5-34-UNV-L83050-W2A1-U	22CZ-LD5-34-UNV-L93050-W2A1-U
3000K	-	3247	2673
3500K	3497	3436	2921
4000K	-	3608	3154
4500K	-	3642	3209
5000K	-	3642	3209

Controlling VividTune Tunable White

VividTune luminaires make tunable white more accessible by using simple and familiar controls. From wall dimmers to wireless controls, VividTune tunable white luminaires are compatible with industry standard 0-10V dimming controls. A single 0-10V dimming input is used to control intensity (brightness) while a second 0-10V dimming input is used to adjust CCT. For suggested control configurations, go to www.cooperlighting.com for tunable white application guides.

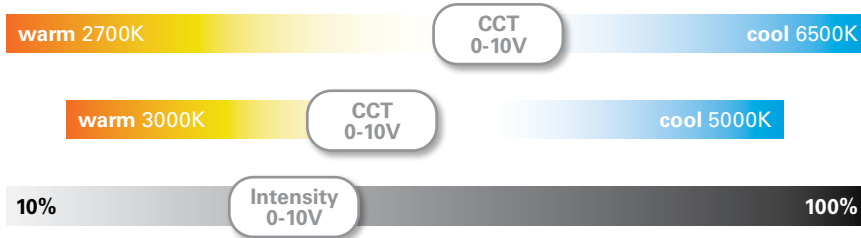

Example of Lumen Adjustment Calculation

22CZ-LD5-34-UNV-L83050-W2A1-U at 80 CRI tuned to 3500K

$$\text{Adjusted Lumen} = \text{published } lm \times \text{adjusted } lm \text{ factor}$$

$$\text{Adjusted Lumen} = 3497 \times 0.983$$

$$\text{Adjusted Lumen} = 3436 \text{ lm}$$

* Lumen adjustment factors are for reference and may be different for each product selected. Refer to IES files for actual performance data on each.