



Smart Business Communication Systems

Network condivisi.
Collaborazione efficace.



Workshop sulle soluzioni di business Cisco - Edizione 2008

Luca Bin

LBin@cisco.com

12-Feb-2009

Cisco Unified Communications

Endpoints



Applications

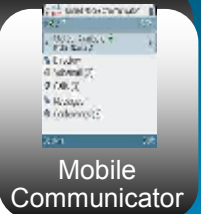
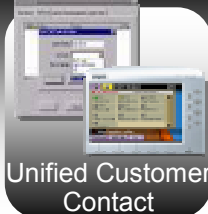

Services

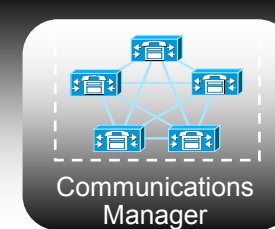



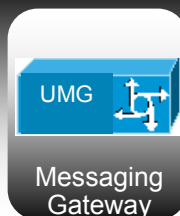
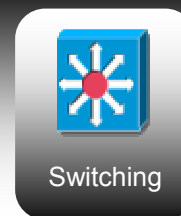



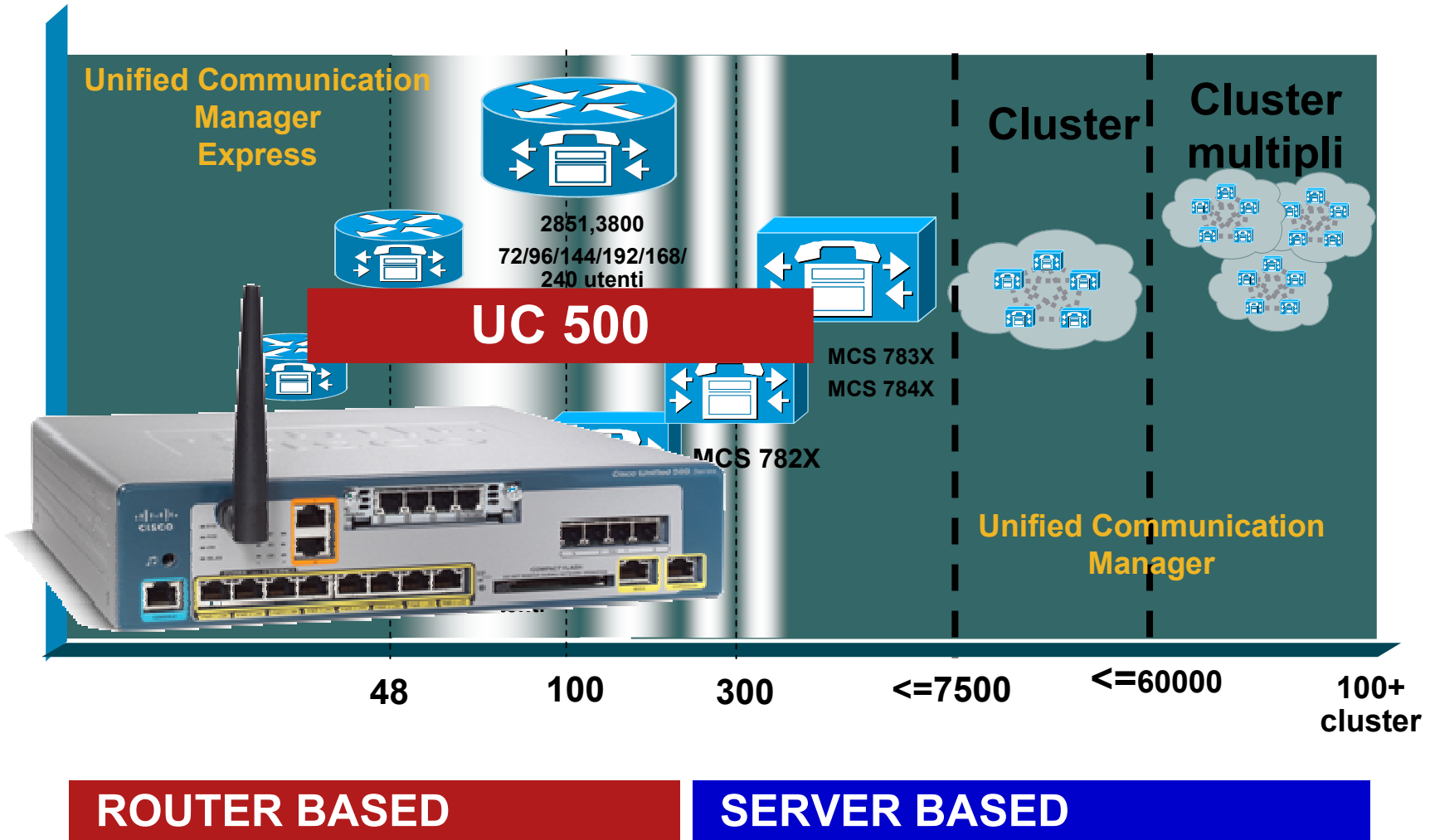









Infrastructure



Cisco Unified Call Control Portfolio

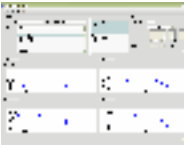

Cisco Smart Business Communications System

Unified Communications & Network Foundation	UC Applications	Cisco IP Phones	Switching	Wireless	Teleworker
<p>Unified 500 Series</p>  <p>8- and 16-User models</p> <p>Optional Integrated WLAN AP</p> <p>32- 64-User Rack-mount models</p> <p>No integrated WLAN AP</p> 	<p>Cisco Unified CallConnector for Microsoft Office</p> <p>Cisco Unified CallConnector for CRM</p> <p>Cisco IP Communicator</p> <p>Cisco Unified Video Advantage</p>	     <p>All IP Phones are supported</p>	<p>CE520</p>  <p>WS-CE520-8PC-UC</p> <p>Additional rack mount switching options</p>  <p>WS-CE520-24PC-UC</p>	<p>AP500 WLC 500</p>  <p>Unified 500 Series has Optional WLAN AP</p> <p>Autonomous APs or Unified Wireless Solution with WLAN Controller 500</p>	<p>C871W</p>   <p>VPN, Wired & Wireless Access, IP Phone ext.</p>
<div style="display: flex; justify-content: space-between; align-items: center;">   <div style="text-align: center;"> <p>Systems Management</p> <p>Cisco Smart Assist Features</p> <p>Cisco Configuration Assistant</p> <p>Cisco Monitor Manager / Cisco Monitor Director</p> </div>   </div>					

I telefoni

Funzionalità

Espansione
Cisco IP Phone 7914



Cisco IP Phone
7970G/7971/75G-GE



Cisco IP Phone
7985G



Cell./SP/Wi-Fi Dual Mode di 3e parti



Cisco Wireless IP Phone
7920/21



Cisco IP Phone 7960G/61/62/65G-GE



Cisco Unified Personal Comm.

Cisco IP Phone
7940G/41/42G-GE



Cisco Unified Video Advantage



Cisco IP Conference
Station 7936/7



Cisco IP Phone 7931G



Cisco IP Phone 7906G/11G



Cisco IP Comm.



Cisco VG224/248
Analog Phone
Gateway



Cisco ATA186



Tipologie

Cisco Smart Business Communications System

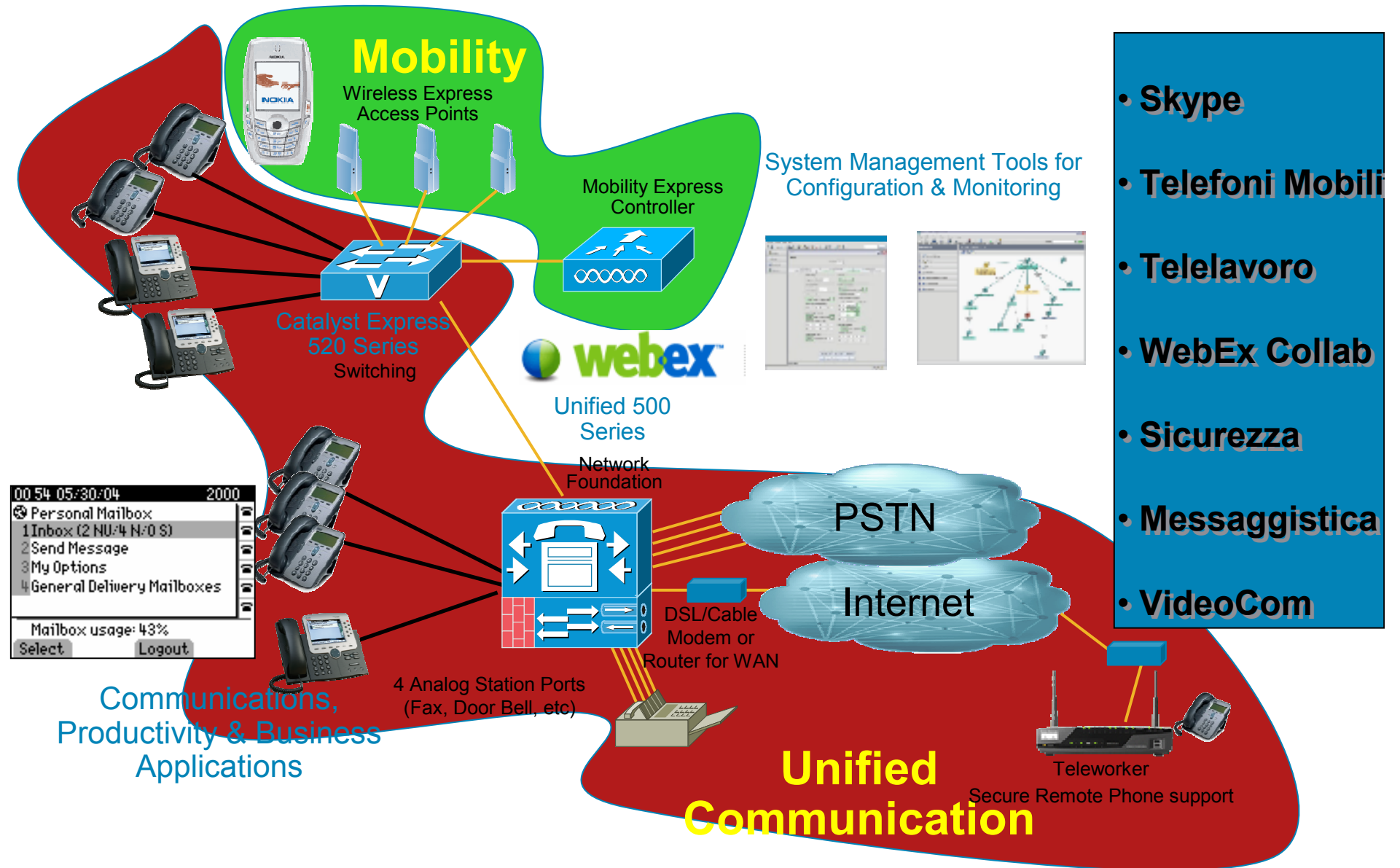

Cisco UC 500 series

- **Modularità**
 - da 8 a 64 utenti
 - opzioni da 8, 16, 24, 32, 48 e 64 utenti
 - espansione utenti via aggiunta Companion Switch
- **Communication Manager Express**
- **Cisco Unity Express – default**
- **Supporto per la gamma completa dei Telefoni IP Cisco**
- **Videoconferenza via CVTA o CP 7985**
- **FXS/DID – 4 porte**
- **4 FXO o 2 BRI per la connessione alla PSTN**
- **switch 8 porte POE per i telefoni IP**
- **DSPs opportunamente dimensionati**
- **slot VIC per aumentare la capacità delle porte voce**
- **Ethernet WAN uplink**
- **Fast Ethernet Expansion port**
- **AP WiFi integrato come opzione di fabbrica**

ROUTER BASED

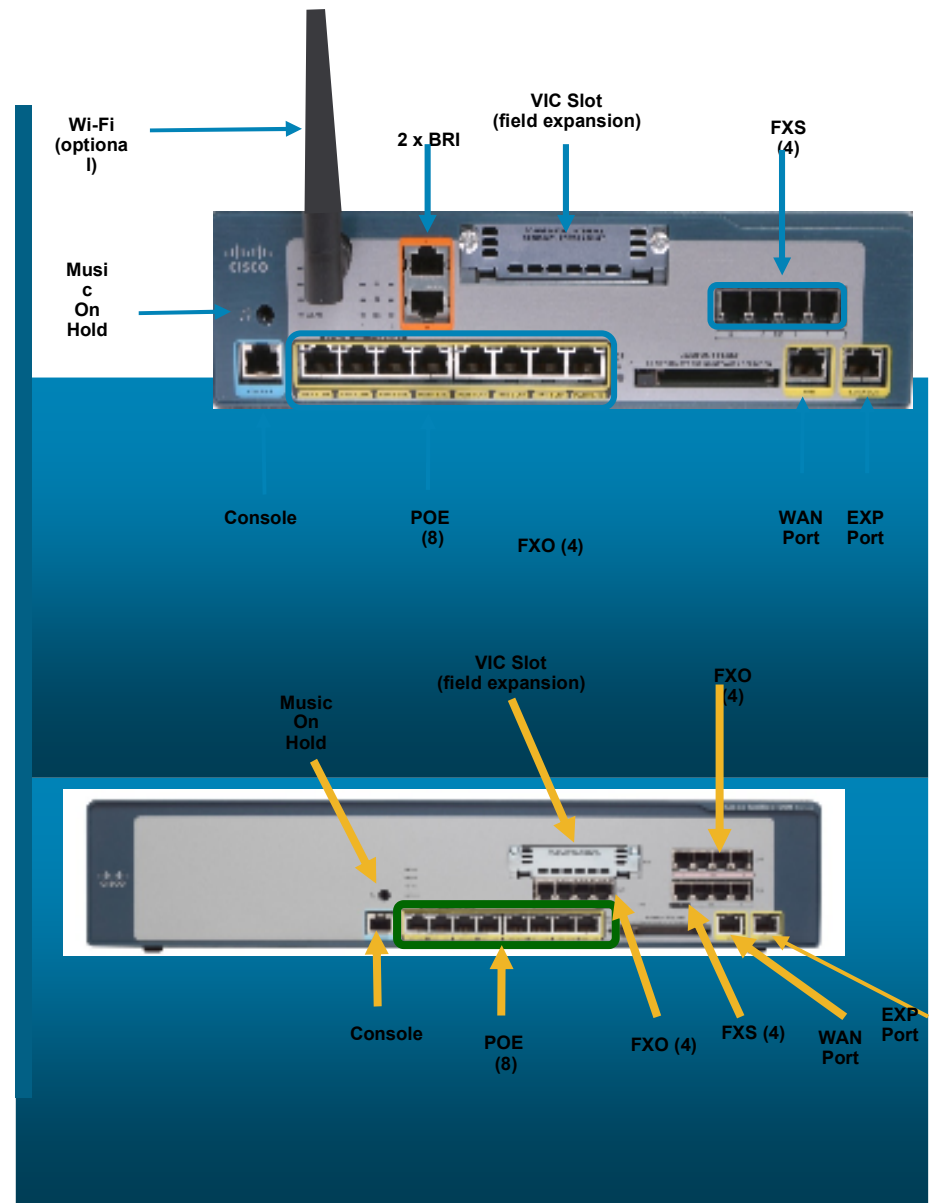

Caratteristiche

Feature Set IOS

- UC520 implementa una immagina IOS feature set derivata da Advanced IP Services feature set - rel. 12.4(15)T
- Il “feature set” supporta tutte le funzionalità voce, video, dati e sicurezza ad esso proprie ma con le seguenti eccezioni:
 - per la voce – MGCP / CCM / SRST
 - per i dati – WAN Protocols such as FR / ATM / X.25 / MPLS / Tag / LAPB
 - per la sicurezza – L2TP
 - per il routing – Routing Protocols
 - per il Network Management – SNMP Proxy
 - altre – GLBP (load balancing)

Sicurezza

- Cisco IOS Firewall e NAT.
- IPSec VPN con DES, 3DES e AES.
- UC520 ospita un server EZVPN per le configurazioni da remoto via CCA. Interlavora con i client Cisco VPN e Microsoft VPN .
- Ottimizzazione del carico di CPU via supporto in HW per la cifratura AES, DES e 3DES in caso di IPSec VPN .
- Supporto di SSL Web VPN e SSH 2.0

Wireless LAN

Il supporto per WLAN è opzionale

UC 520 integra opzionalmente un AP 802.11b/g che può essere utilizzato per fornire connettività wlan a client telefonici e dati (max 54 mbps)

Le connessioni WiFi realizzate con l'Ap integrato sono rese sicure tramite l'implementazione degli standard di sicurezza quali Wi-Fi Protected Access (WPA), con autenticazione via 802.1X e Cisco LEAP, Protected Extensible Authentication Protocol (PEAP), dynamic Wired Equivalent Privacy (WEP), o static WEP.

L'Access Point integrato in UC 500 può essere SOLO in versione stand-alone e NON può essere convertito nella versione controller-based

All'Access Point integrato possono essere aggiunti altri 2 AP esterni della serie AP 500 sempre in versione stand-alone



SBCS 1.3 Update



SBCS Update Overview

What's New in SBCS?

- **SBCS 1.3**
 - **64 User License Upgrade**
 - **Cisco 520 Series Secure Router**
 - **Cisco Unified IP Phones 500 Series – 521SG, 524SG**
 - **Support for Cisco Unified IP Conference Station 7937G on Unified Communications 500 Series**
 - **Support for Cisco Unified IP Phone Expansion Modules 7915 and 7916 on Unified Communications 500 Series**
 - **Cisco Configuration Assistant 1.8**

Smart Business Communication Systems 1.3

Simple, Complete, Secure Communications for Small Businesses

New Unified Communicatio	New IP Phones	Switching	Wireless	New Security
------------------------------------	-------------------------	-----------	----------	------------------------



Unified 500 Series

7900 & 500 Series

CE520 Series

AP500 WLC 500

SR520 Series

- 8 to 64 Voice Users
- Desktop & Rackmount Models
- Optional Integrated WLAN AP on desktop models

- All Cisco Unified IP Phones supported including *new* Cisco 500 Series phones – 521S/G, 524S/G

- 8 port desktop and 24 port rack mount models
- Companion Switch for Unified 500 Series

- Autonomous APs or Unified Wireless Solution with Mobility Express

- Secure VPN, Wired and Wireless Access

Business & Productivity Applications

Cisco Smart Assist Features
Cisco Configuration Assistant
Cisco Monitor Director

Cisco Unified Communications 500 Series Updates



New 64 user software upgrade available in September 2008

- License-based upgrades make growth easy
- Scales up from 48U solution using an additional Catalyst Express 520 Series 24-port switch
- 64U upgrade only works with 48U UC500 models
- No direct upgrade path for 24U => 64U and 32U => 64U
- Installed on UC520 48U model via CCA 1.8 and above
- Unified Communications 500 Series support for Cisco Unified IP Phone Conference Station 7937G and 7915, 7916 Expansion Modules

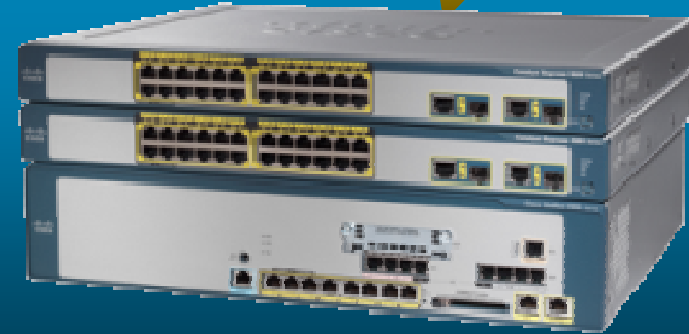

SW licensing upgrades to add users

Available in July 2008:

SL-UC520-32UPG= (from 24-32)

SL-UC520-24-48UPG= (from 24-48)

Available in September 2008:

SL-UC520-64UPG= (from 48-64)

- July software upgrades require (20)T IOS release on UC500 and Cisco Configuration Assistant 1.7

- September software upgrade requires XW9 IOS release on UC500 and Cisco Configuration Assistant 1.8

Scaling SBCS - Cisco UC500 Series Options for Various Business Sizes

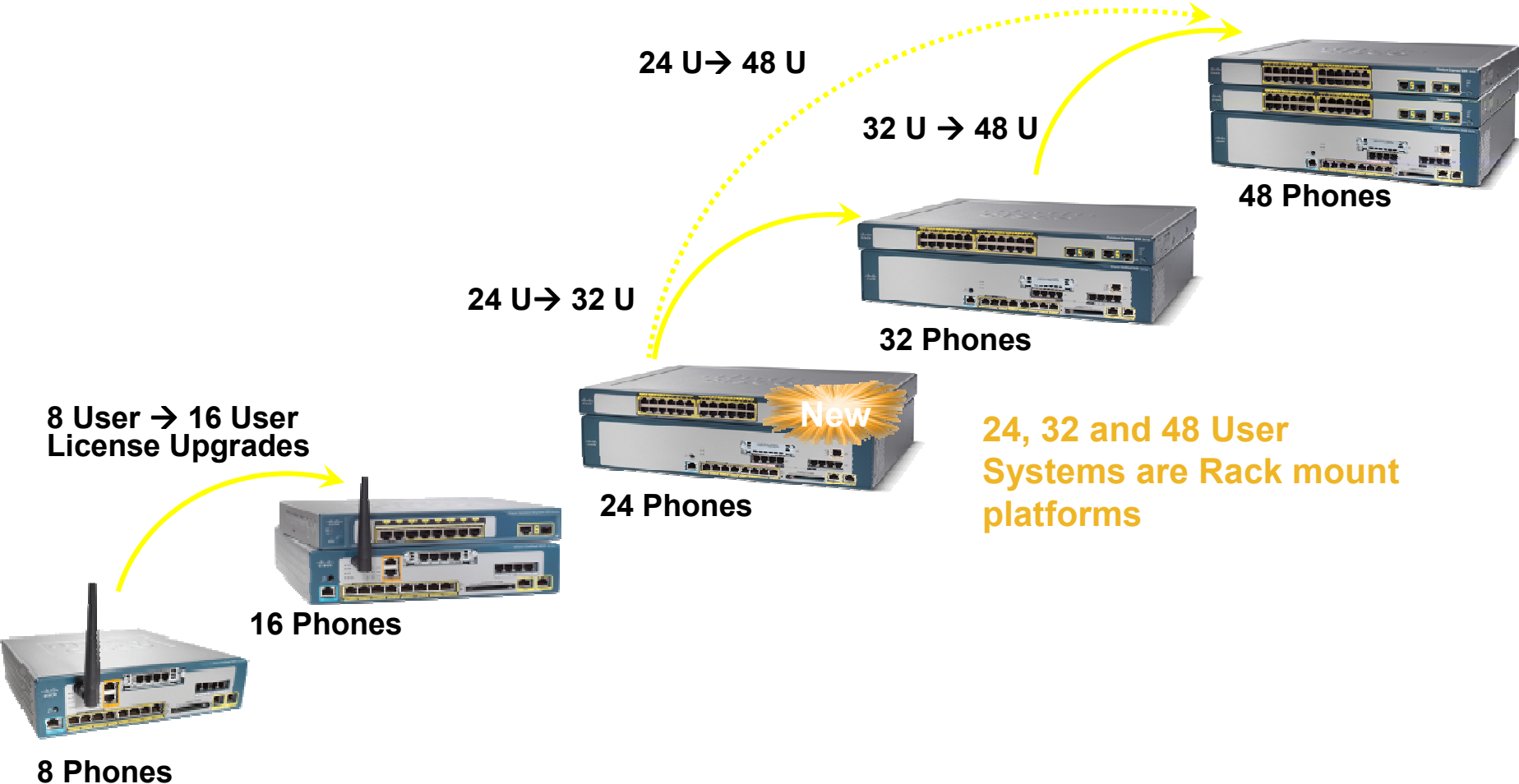

Cisco Unified IP Phone 500 Series



services

Two ***NEW** affordable, entry-level Cisco IP Phones for SBCS

Provide full feature functionality (such as shared line, intercom, speakerphone, paging, park). Purpose built for use with Cisco's UC500 Series platforms.

***Single 10/100 switch port for PCs**

Two models

CP-521SG= (1-line, with LCD),

CP-524SG= (4-line, with LCD)

G.711/G.729 only

Single 10/100 PoE port (802.3af)

Optional power supplies and wallmount kit

Supported only on SBCS/UC500 (via unique SPCP protocol)

Cisco Secure Router 520 Series Overview

August
2008



- **Complements & supports SBCS**
- **Security**
 - Stateful inspection firewall (SPI)
 - Intrusion prevention system (IPS)
 - Application Inspection and Control
- **Connectivity**
 - Support for static routing and dynamic routing protocols
 - Quality of service (QoS)
 - Secure connectivity with site to site VPN and Cisco Easy VPN
 - Offers optional Secure 802.11b/g wireless
 - Four-port 10/100 managed switch with VLAN support
- **Ease-of-Use**
 - Simple deployment, management and troubleshooting with Cisco Configuration Assistant

Cisco Configuration Assistant 1.8

Available
Sept 2008

System Level Feature Enhancements

- Support for SR520 secure router as gateway device or teleworker device
- 64 user license Unified 500 Series

Voice Feature Enhancements

- Support for 7915/16G expansion modules and 7937G conference phone
- Support for 521SG, 524SG phones

Wireless Feature Enhancements

- Support for 10 autonomous APs

Security (with SR520 only)

- Zone-based firewall
- SSL VPN

Simplifies the Task of Configuring, Deploying,
and Administering SBCS Solutions



***CCA 1.8 available 9/08 –
supports all prior CCA
features plus new Cisco
Unified IP Phones 521SG
and 524SG and Secure
Router 520**

www.cisco.com/go/configassist

Cisco Unified Call Control Portfolio

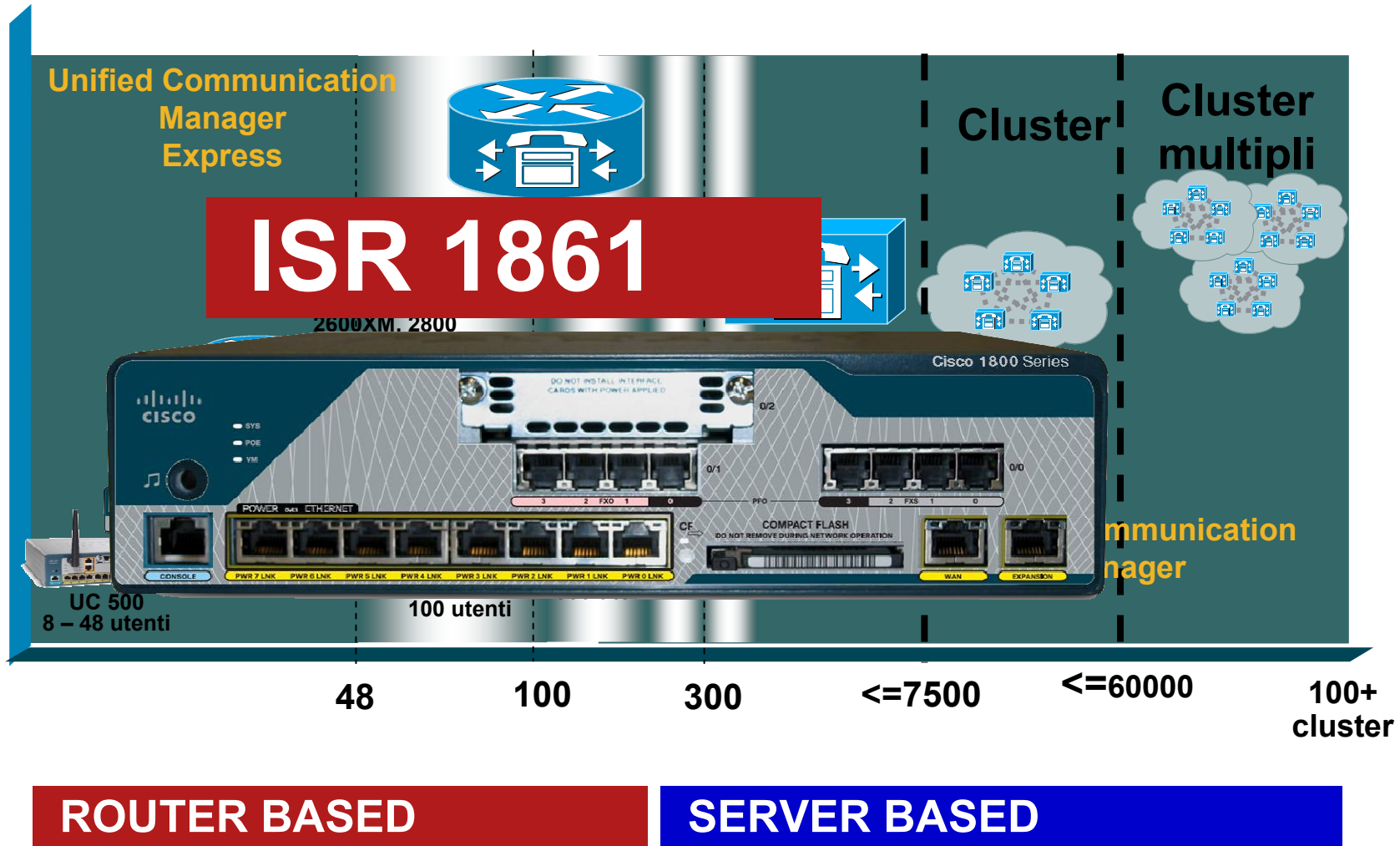

Cisco Integrated Services Router Portfolio

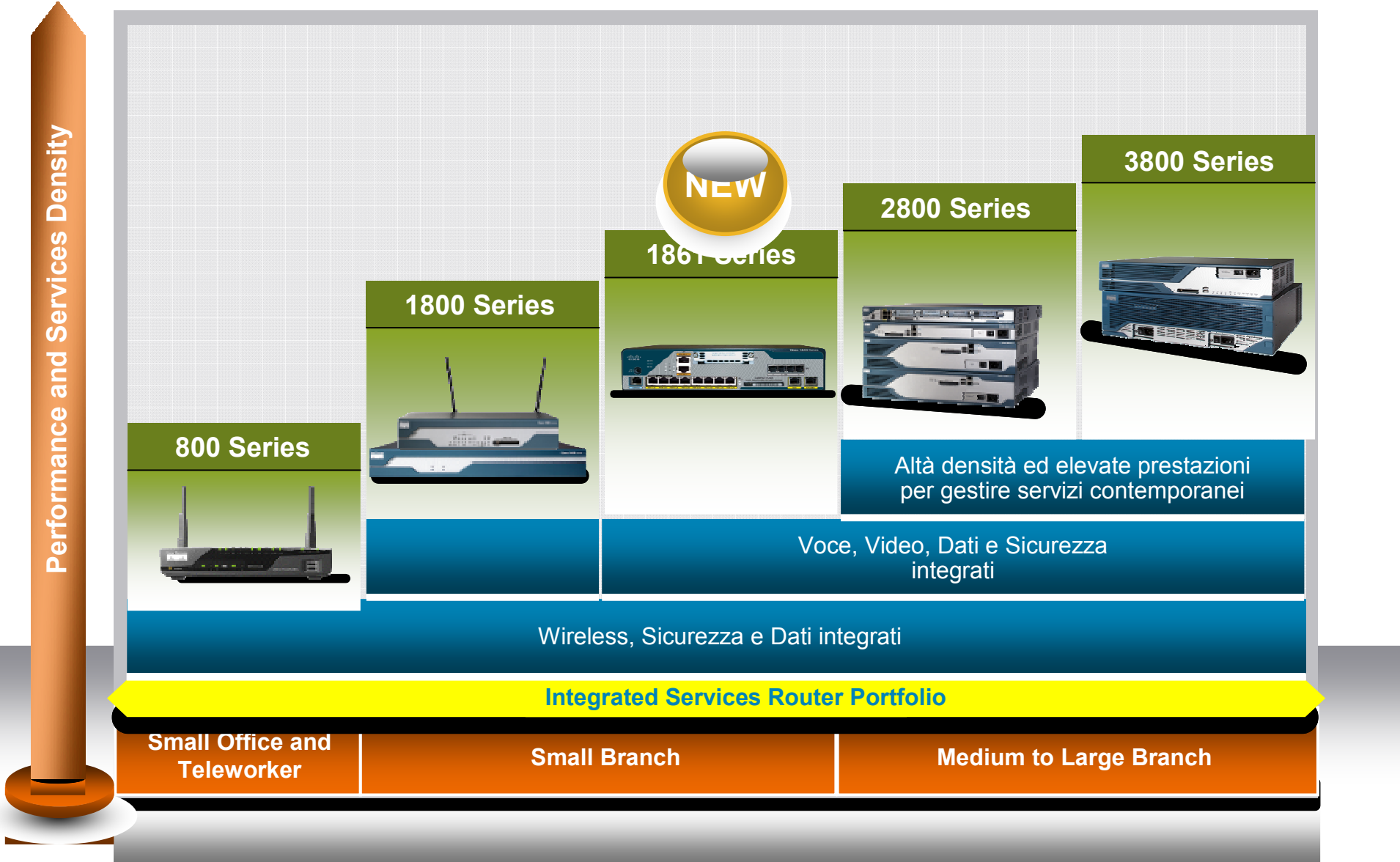

Cisco 1861 Integrated Services Router

- MAX 8 utenti – no espansione
- Unified Communications Features:
 - o Cisco Unified Communications Manager Express
 - o Survivable Remote Site Telephony
 - o Interlavoro con Unified Communication Manager
 - o IVR
 - o Fixed PVDM configuration (1 DSP)
 - o Cisco Unity Express opzionale
 - o 4 porte FXS
 - o 4 porte FXO o 2 porte BRI per la connessione con la PSTN
 - o porta per la Musica su attesa
 - o switch 8 porte 10/100 POE + 1 Expansion port
- Funzionalità complete di routing e security
- T1/E1 & Serial WAN
 - o 3G Wireless WAN
 - o DSL and Cable
 - o Cisco IOS® Firewall, IPS, and V3PN
- Cisco IOS® Security software images

ROUTER BASED

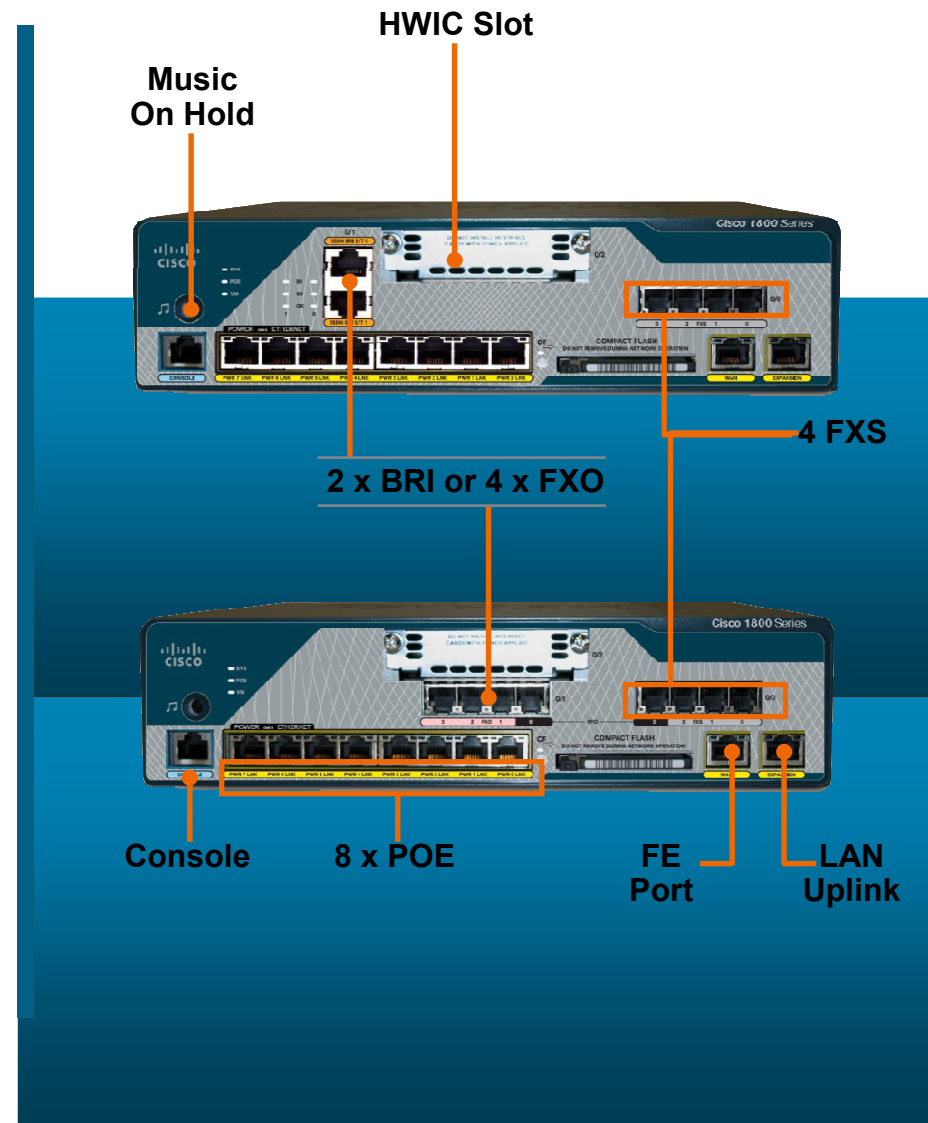

Scenario implementativo

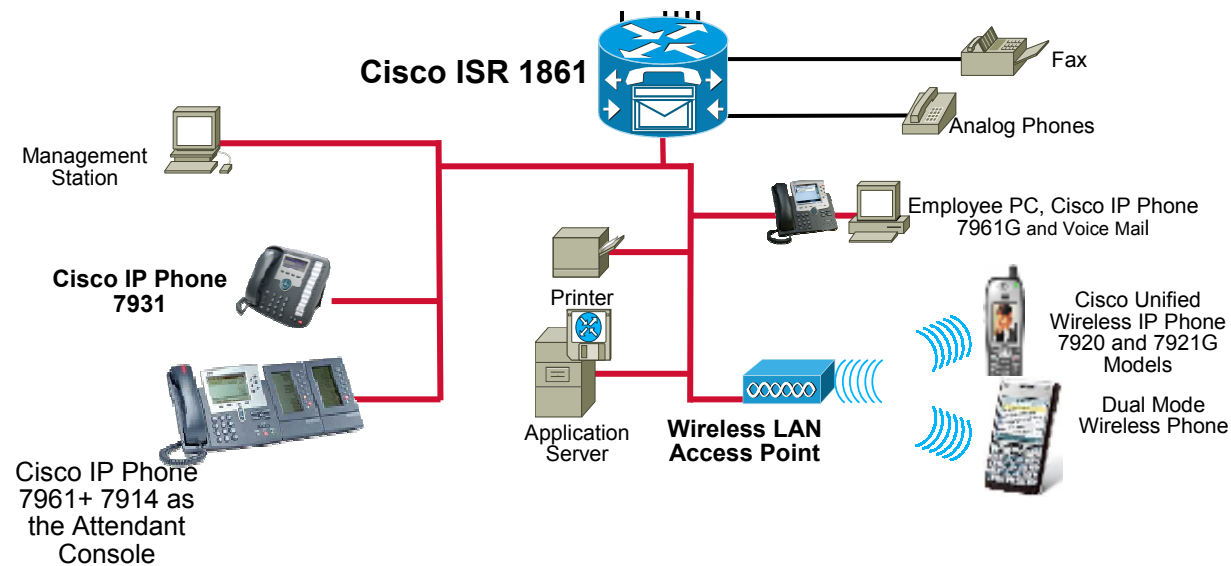

situazione
tipica di
utilizzo: sede
periferica

sede singola o
sede multipla

no limiti nel
numero di sedi
collegabili

interlavoro
con UCM e
UCME

WLAN
opzionale

flessibilità
nelle
connessioni
WAN

Cisco Unified Call Control Portfolio

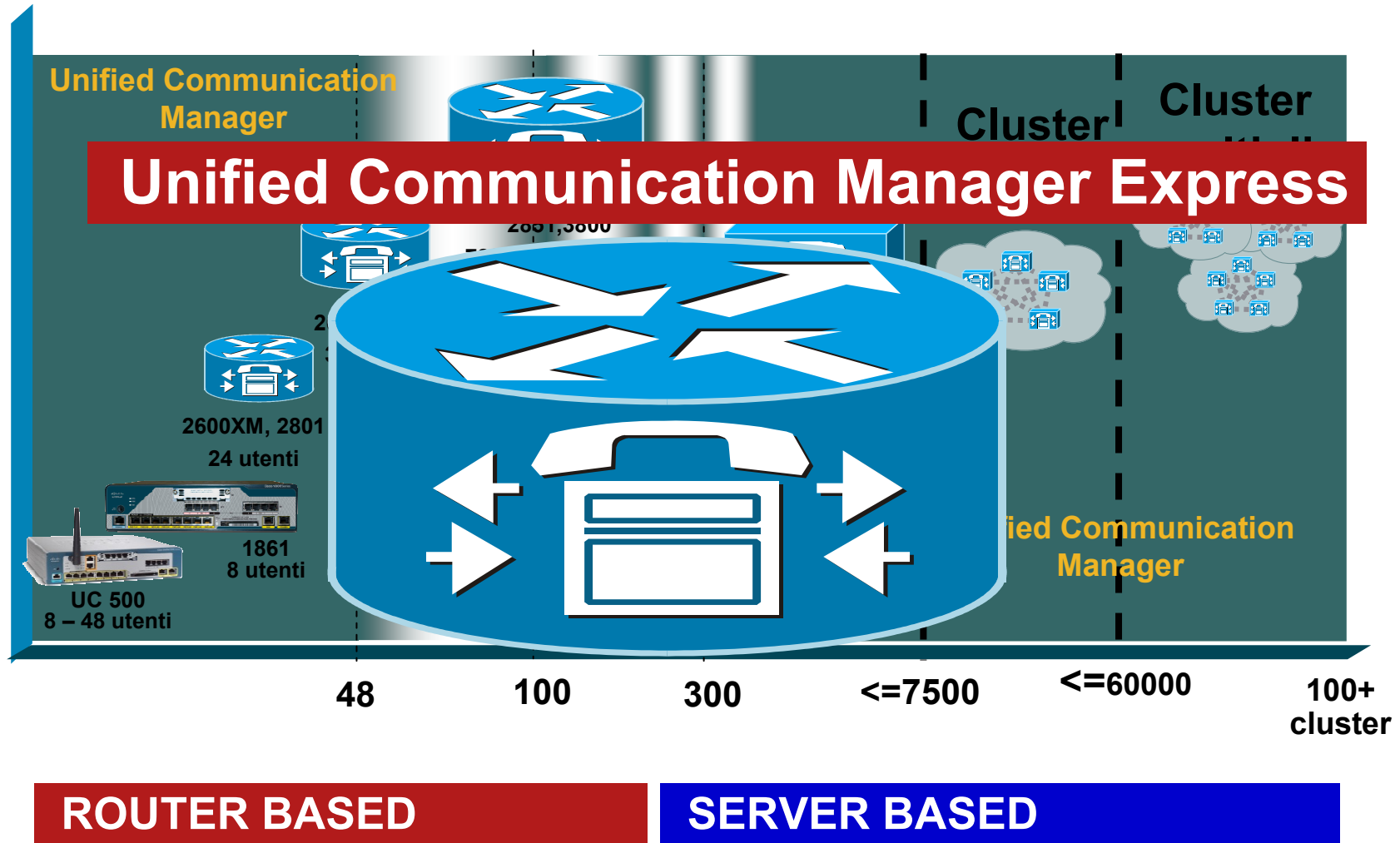

Unified Communication Express

Concurrent Services and Performance

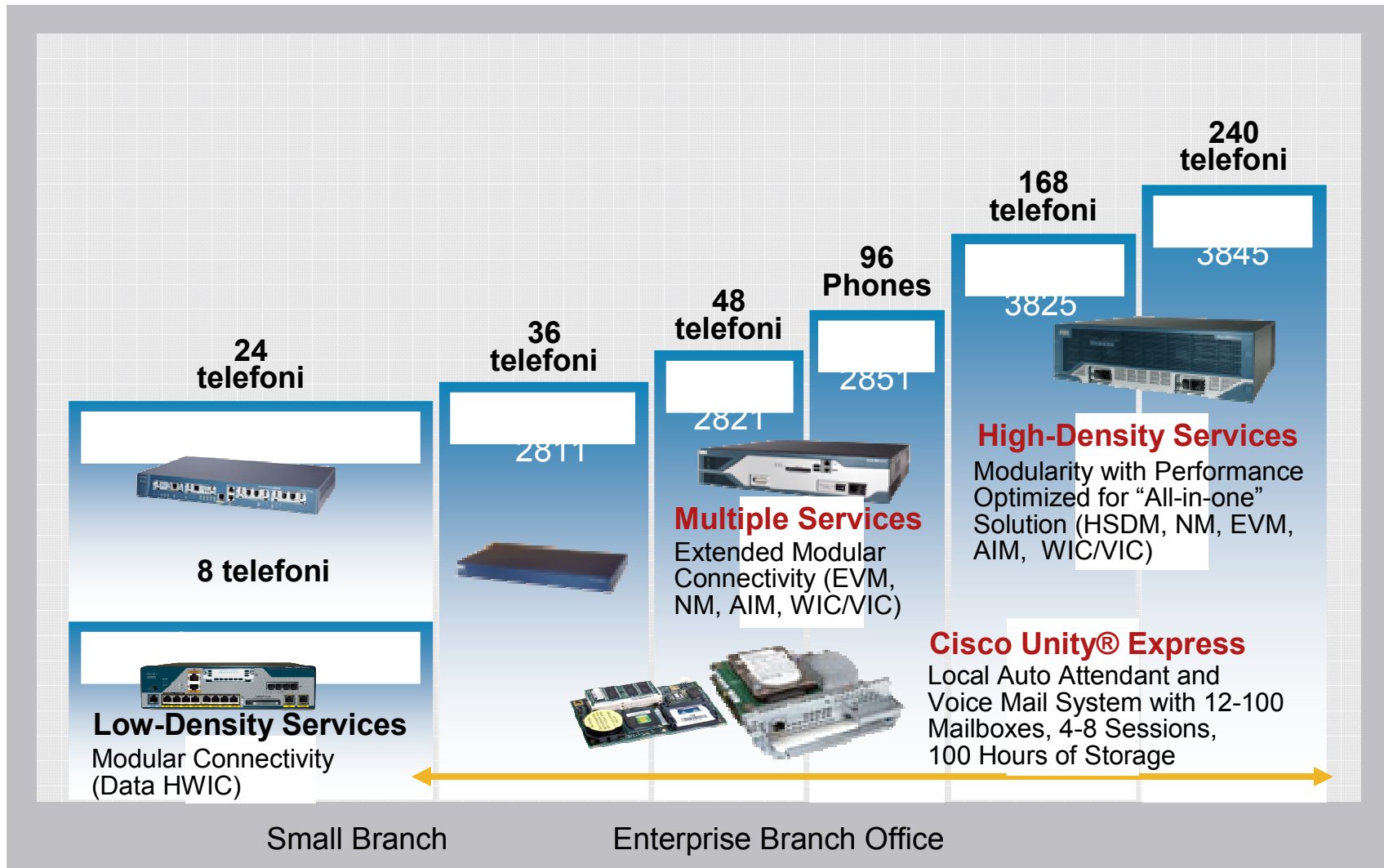

ROUTER BASED

Scenario implementativo singola sede

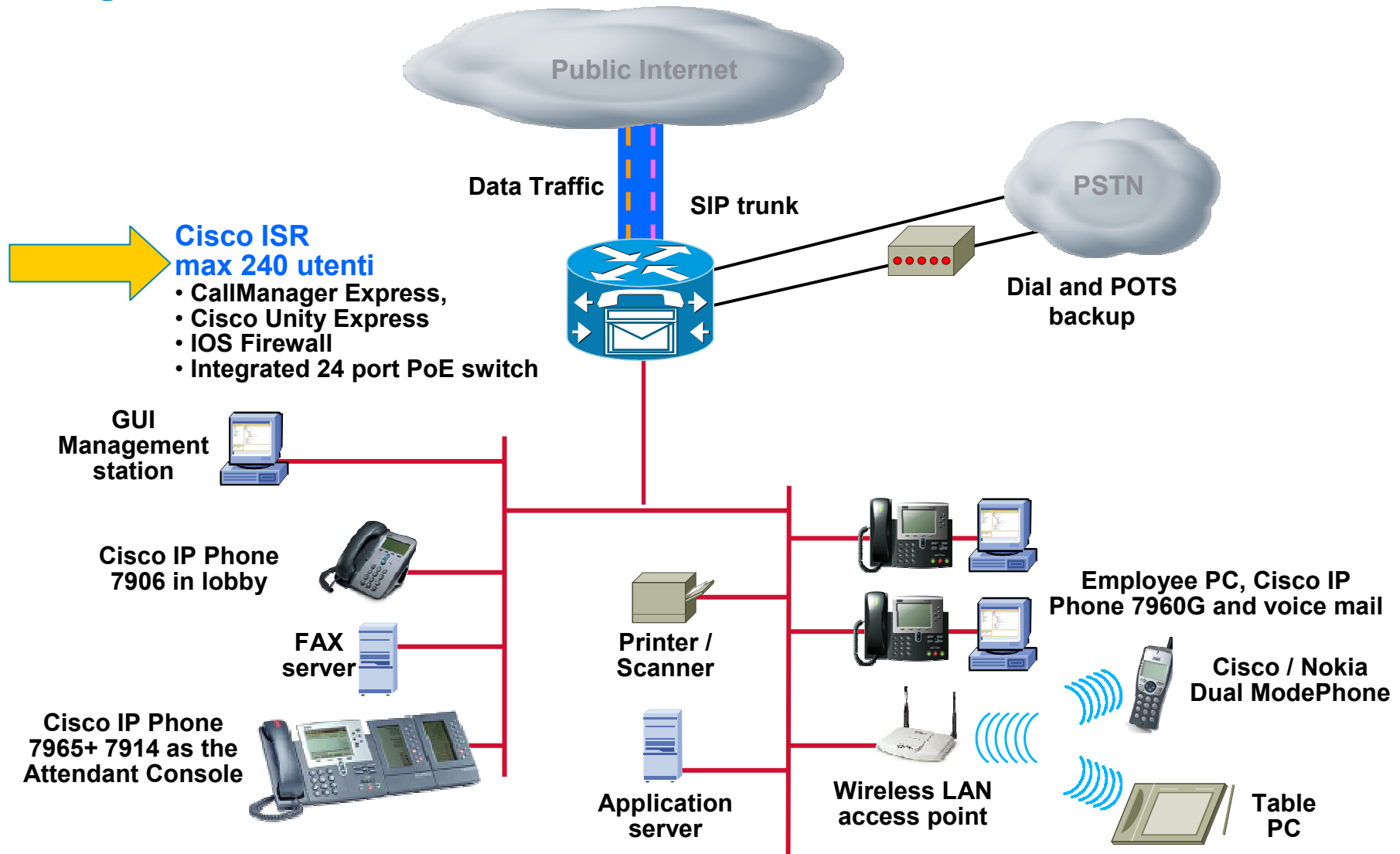

Scenario implementativo misto - sedi distribuite

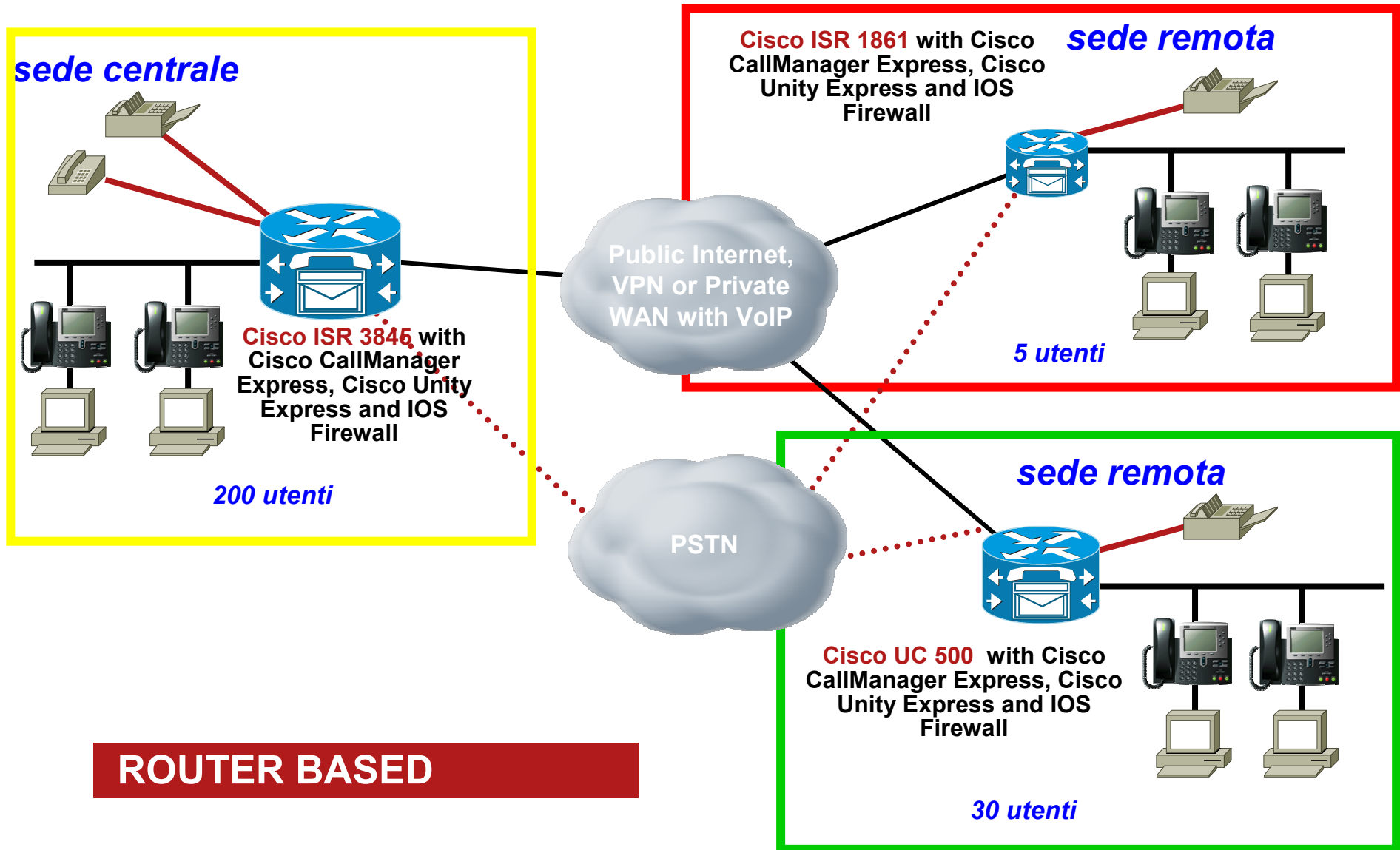

Confronto UC 500, ISR 1861, ISR

	ISR	UC500 Series	ISR1861
WAN Module	✓	Ethernet Uplink	✓
Call Manager Interoperability (SRST)	✓	NO	✓
Dynamic routing (RIP, BGP, OSPF, EIGRP, etc.)	✓	NO	✓
IP Phone Support	8-240	8-64	12
Voice Mail	Optional	✓	Factory Optional
Collaborative Security features	✓	Limited (opt. Secure route 520)	✓
Site-to-Site Voice Features	✓	✓	✓
Market Positioning	Commercial and Enterprise	Commercial	Commercial and Enterprise
Support – SmartNet or better	✓	✓	✓

Cisco Unified Call Control Portfolio

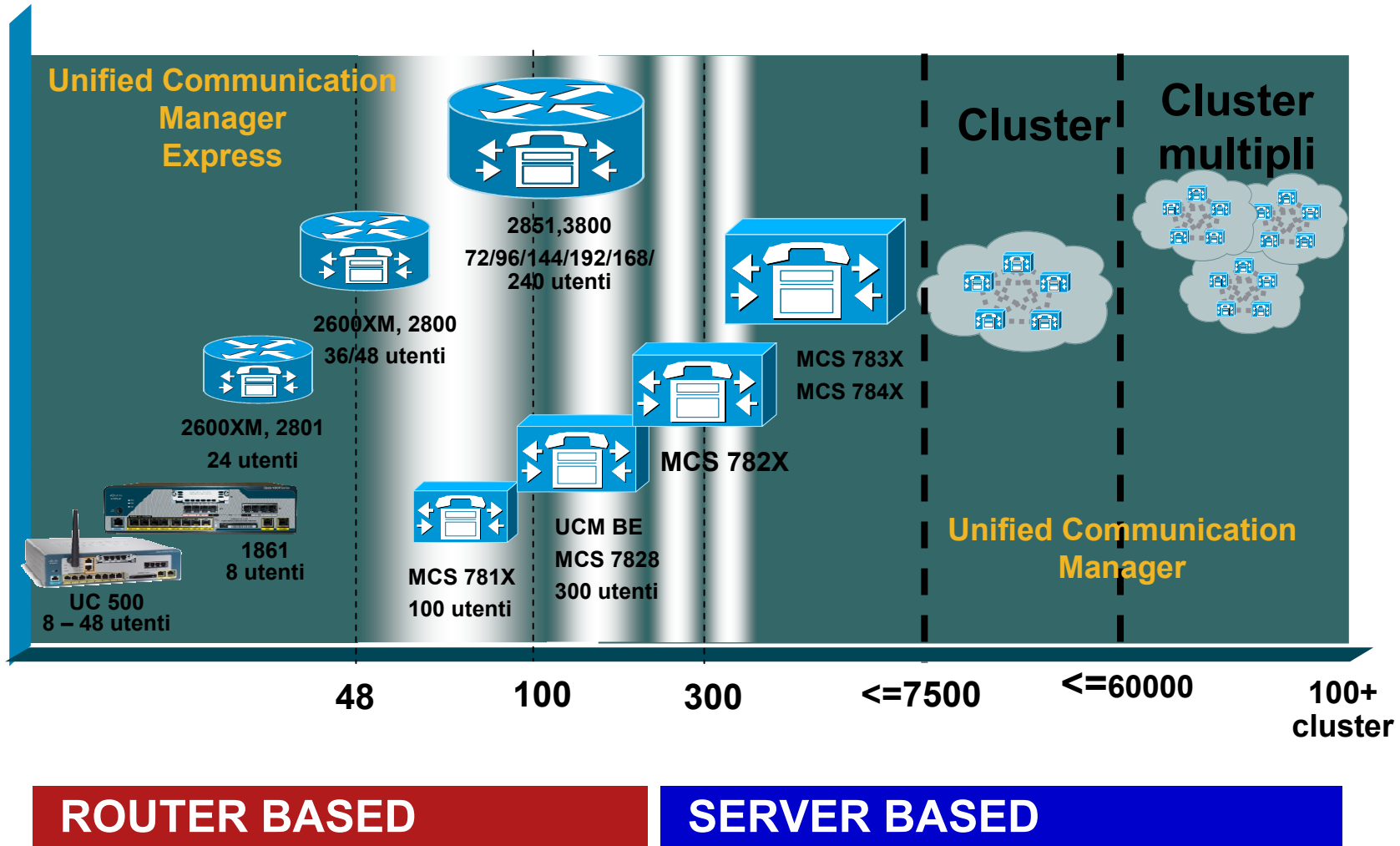



CISCO