



DESIGNING INNOVATIVE SOLUTIONS

United Technologies

PARTS AND COMMODITIES FOR HEATING AND AIR CONDITIONING

EMEA REPLACEMENT COMPONENTS DIVISION

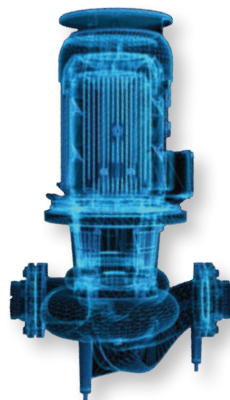
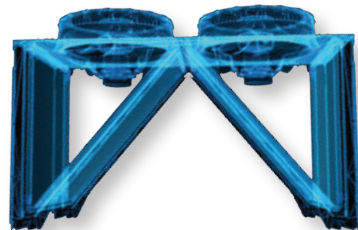
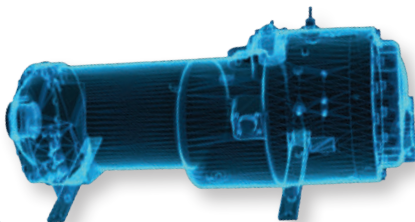
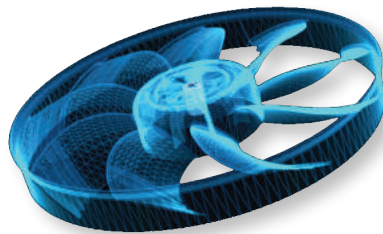

CATALOG
2019



CARRIER'S MISSION

At Carrier, our mission is to be the first choice for HVAC solutions worldwide. We work every day to make the world a better place to live, work and play. Our employees, products and services create comfortable, productive and healthy environments, regardless of climate. Our culture is rooted in our core values. They define who we are and guide every decision we make.

Expertise

Carrier delivers global solutions across the broadest range of air conditioning, ventilation and heating applications. With a proven track record of leadership and industry expertise, Carrier provides a portfolio of market-leading products and services.

Innovation

Carrier is a company of ideas, committed to research and development, whose founder still inspires the company to reach the next innovative, powerful and marketable idea. AdvanTEC, a global company Experts in Efficiency and Environment, supports customers around the world in developing strategic, energy-efficient and custom-engineered building solutions.

Performance

Carrier strives for continuous growth to reinforce its leadership position, continuously improving the productivity and quality of its assets and resources.

Quality

Carrier quality and reliability are incorporated and guaranteed in all products and systems. Products undergo extensive tests before delivery and are certified by internal organisations to ensure the highest levels of safety and quality.

Service Excellence

The Carrier Service delivery model maintains a reputation for high customer satisfaction and delivers service excellence with strong communication channels, the top technicians in the industry, continuous improvement of contracts and a highly experienced management team.

Sustainability

Carrier continuously works to improve the environmental performance of its products and services, operations and its culture to help lead the way to environmental sustainability. Sustainability is a growing concern to the building sector and a key factor for building owners and operators. A high efficiency air conditioning system with a low carbon footprint is a must to support green building design.



EUROPEAN PARTS CENTER : BUILDING SERVICE EXCELLENCE FOR CUSTOMER

ERCD (EMEA Replacement Components Division) team is able to deliver 250 orders daily and ship efficiently more than 1,600 shipments per week around the world.



A robust supply chain

• Dedicated team & expert advices

An experienced and attentive team will support you throughout the process of spare parts procurement: parts selection, management orders follow-up and logistics until delivery.

Our powerful purchasing negotiations ensures optimized pricing and lead-times. Thanks to our manufacturing expertise, we provide advice to help you find the best service solution to meet your specific needs.

- State-of-the art logistics with reliable next day delivery for Europe
- Storage permanently adjusted according to customer demand
- Accessible and reactive contacts
- Dedicated online shop to facilitate the selection of parts

A comprehensive parts offering

• High added value parts solutions

With more than 10,000 items in stock, we propose a comprehensive parts offering including compressors, universal parts and manufactured components.

- Factory Authorized & Proprietary and universal spare parts
- Parts kits solutions
- Consultancy services
- Dedicated solutions for railways, mining & marine business

• Quality & reliability

Quality and Reliability are integrated and guaranteed for all products & systems and extended to every spare part.



+80,000
Managed parts number*



99%
Deliveries on time*



5.9/7
Customer satisfaction*

*2017 Carrier data

A COMPRESSORS & CPR PARTS	11
B VALVES	63
C MOTORS	95
D HYDRAULIC	113
E OILS & TESTS	129
F TRANSMISSION	135
G FILTERS DRIERS AND SHELLS	151
H AIR FILTERS	161
I PRESSURE SWITCH	175
J ELECTRICAL PARTS	183
K USER INTERFACE	227
L CONTROL	235
M BRASS FITTINGS	251

A | COMPRESSORS & CPR PARTS

COMPRESSORS / DANFOSS TECHNICAL DATAS RANGE MT/ MTZ	12
COMPRESSORS / COMPRESSORS SCROLL DANFOSS RANGE MT	13
COMPRESSORS / COMPRESSORS SCROLL DANFOSS RANGE MTZ	14
COMPRESSORS / DANFOSS TECHNICAL DATAS RANGE SZ	16
COMPRESSORS / COMPRESSORS SCROLL DANFOSS RANGE SZ	17
COMPRESSORS / DANFOSS TECHNICAL DATAS RANGE SH	18
COMPRESSORS / COMPRESSORS SCROLL DANFOSS RANGE SH	19
COMPRESSORS / COMPRESSORS SCROLL DANFOSS RANGE VSH / WSH	20
COMPRESSORS / COMPRESSORS SCROLL DANFOSS RANGE SM	21
COMPRESSORS / DANFOSS TECHNICAL DATAS RANGE H	22
COMPRESSORS / COMPRESSORS SCROLL DANFOSS RANGE HLM/HRM/HCJ/HLH	23
COMPRESSORS / COMPRESSORS SCROLL COPELAND SEMI-HERMETIC	24
COMPRESSORS / COPELAND TECHNICAL DATAS	26
COMPRESSORS / COMPRESSORS SCROLL COPELAND RANGE ZH	27
COMPRESSORS / COMPRESSORS SCROLL COPELAND RANGE ZP	28
COMPRESSORS / COMPRESSORS SCROLL COPELAND RANGE ZR-ZF	29
COMPRESSORS / 06D SEMI-HERMETICS COMPRESSORS CARRIER	30
COMPRESSORS / 06E SEMI-HERMETICS COMPRESSORS CARRIER	35
COMPRESSORS / 06N SCREWS COMPRESSORS	40
COMPRESSORS / 06N SCREWS COMPRESSORS CARRIER	41
COMPRESSORS / 06N SCREWS COMPRESSORS SPARE PARTS CARRIER	42
COMPRESSORS / 06T COMPRESSORS CARRIER	43
COMPRESSORS / 06T COMPRESSORS SPARE PARTS CARRIER	44
COMPRESSORS / 5F & 5H COMPRESSORS CARRIER	50
COMPRESSORS / 5F & 5H COMPRESSORS SPARE PARTS CARRIER	51
COMPRESSORS / 06B COMPRESSORS SPARE PARTS CARRIER	58

B | VALVES

VALVES / ELECTRONIC EXPANSION VALVES	64
VALVES / R22 COMPLETE THERMOSTATIC EXPANSION VALVES	68
VALVES / R134A THERMOSTATIC EXPANSION VALVES	69
VALVES / R407C THERMOSTATIC EXPANSION VALVES	70
VALVES / R22 COMPLETE THERMOSTATIC EXPANSION VALVES	71
VALVES / R134A THERMOSTATIC EXPANSION VALVES	72
VALVES / R407C COMPLETE THERMOSTATIC EXPANSION VALVES	73
VALVES / R410A THERMOSTATIC EXPANSION VALVES	74
VALVES / BALL VALVES	75
VALVES / COOLING 2 WAYS WATER VALVES	77
VALVES / 2 WAYS VALVES	78
VALVES / COOLING 3 WAYS WATER VALVES	80
VALVES / 3 WAYS VALVES	82
VALVES / COOLING WATER VALVES ACTUATOR	85
VALVES / R22 REVERSING VALVE	86
VALVES / R22 SOLENOID VALVES	87
VALVES / SAFETY RELIEF VALVES	89
VALVES / FUSES PLUGS	90

VALVES / SCREW ANGLE VALVES	91
VALVES / ACCURATORS PISTONS	92
VALVES / ACCURATORS SPARE PARTS	93
C MOTORS	
MOTORS / ABB	96
MOTORS / LEROY SOMER	97
MOTORS / WEG	98
MOTORS / LEROY SOMER	99
MOTORS / REGAL MANUFACTURING & ZIEHL-ABEGG	100
MOTORS / GENERAL ELECTRIC	101
MOTORS / CARRIER	102
MOTORS / WELLING	103
MOTORS / SISME	104
FAN PROPELLER / CARRIER	106
FAN PROPELLER / FABRESSE	107
CAPS / CARRIER	108
FAN MOTORS	109
FAN ASSEMBLY	111
D HYDRAULIC	
HYDRAULIC / SINGLE PUMP & DOUBLE PUMP	114
HYDRAULIC / DOUBLE PUMP	118
HYDRAULIC / HYDRAULIC COLLARS	119
HYDRAULIC / FLOW SWITCH & HYDRAULIC VALVES	121
HYDRAULIC / BRASS TAP VALVES & EXPANSION TANK & WATER FILTERS	122
HYDRAULIC / FLEXIBLES	123
HYDRAULIC / PLATE EXCHANGERS	124
E OILS & TESTS	
OILS / COMPRESSORS OILS	130
OILS / BITZER	132
TESTS / OIL TEST	133
F TRANSMISSION	
TRANSMISSION / BELT	136
TRANSMISSION / PULLEY	143
TRANSMISSION / HUB	147
G FILTERS DRIERS AND SHELLS	
FILTERS DRIERS AND SHELLS	152
FILTERS DRIERS AND SHELLS / CARTRIDGES	157
FILTERS DRIERS AND SHELLS / INOX CARTRIDGES	158

H | AIR FILTERS

AIR FILTERS / G1 & G2	162
AIR FILTERS / G3	163
AIR FILTERS / G4	166
AIR FILTERS / F5	168
AIR FILTERS / F6	169
AIR FILTERS / F7	170
AIR FILTERS / F8 & F9	171
AIR FILTERS / M5 & M6	172

I | PRESSURE SWITCH

PRESSURE SWITCH / MINI PRESSURE SWITCH	176
PRESSURE SWITCH / HIGH PRESSURE SWITCH	177
PRESSURE SWITCH / LOW PRESSURE SWITCH	180

J | ELECTRICAL PARTS

ELECTRICAL PARTS / CONTACTORS	184
ELECTRICAL PARTS / CONTACTORS ACCESSORIES	186
ELECTRICAL PARTS / CONTACTORS	187
ELECTRICAL PARTS / AUXILIARY CONTACT RELAYS	190
ELECTRICAL PARTS / STARTERS	192
ELECTRICAL PARTS / BREAKERS	193
ELECTRICAL PARTS / FUSES	203
ELECTRICAL PARTS / FUSES SIEMENS	206
ELECTRICAL PARTS / FUSES SWITCH DISCONNECTOR	207
ELECTRICAL PARTS / SWITCH DISCONNECTORS WITHOUT FUSE	210
ELECTRICAL PARTS / TRANSFORMERS	211
ELECTRICAL PARTS / RELAYS	213
ELECTRICAL PARTS / CAPACITORS	216
ELECTRICAL PARTS / CRANKCASE HEATER	220
ELECTRICAL PARTS / ACTUATORS	221
ELECTRICAL PARTS / DAMPER ACTUATOR	223
ELECTRICAL PARTS / SPRING RETURN ACTUATOR	224

K | USER INTERFACE

USER INTERFACE	228
USER INTERFACE / REMOTE CONTROL	233

L | CONTROL

CONTROL / DISPLAY	236
CONTROL / FLOTRONIC 1 & 2 CONTROL	237
CONTROL / PRODIALOG	238

TABLE OF CONTENTS

CONTROL / PRODIALOG & PRODIALOG + (30H/30G) CONTROL	239
CONTROL / PRODIALOG AQUASNAP (30RB/RQ)	241
CONTROL / PRODIALOG + 4	242
CONTROL / CONTROL AQUAFORCE 30 XA / 30 XW PDS CONTROL	243
CONTROL / ELECTRONIC BOARD	244
CONTROL / TOUCH PILOT	246
CONTROL / KIT AQUASMART	248
CONTROL / AQUASMART SYSTEM MANAGER CARRIER	249

M | BRASS FITTINGS

BRASS FITTINGS / SAE FLARE NUTS	252
BRASS FITTINGS / COUPLING	253
BRASS FITTINGS / 90° ELBOWS, TEES, PLUGS	254
BRASS FITTINGS / COPPER SEAL CAPS & GASKETS	255





A | COMPRESSORS & CPR PARTS

COMPRESSORS / DANFOSS TECHNICAL DATAS RANGE MT/ MTZ	12
COMPRESSORS / COMPRESSORS SCROLL DANFOSS RANGE MT	13
COMPRESSORS / COMPRESSORS SCROLL DANFOSS RANGE MTZ	14
COMPRESSORS / DANFOSS TECHNICAL DATAS RANGE SZ	16
COMPRESSORS / COMPRESSORS SCROLL DANFOSS RANGE SZ	17
COMPRESSORS / DANFOSS TECHNICAL DATAS RANGE SH	18
COMPRESSORS / COMPRESSORS SCROLL DANFOSS RANGE SH	19
COMPRESSORS / COMPRESSORS SCROLL DANFOSS RANGE VSH / WSH	20
COMPRESSORS / COMPRESSORS SCROLL DANFOSS RANGE SM	21
COMPRESSORS / DANFOSS TECHNICAL DATAS RANGE H	22
COMPRESSORS / COMPRESSORS SCROLL DANFOSS RANGE HLM/HRM/HCJ/HLH	23
COMPRESSORS / COMPRESSORS SCROLL COPELAND SEMI-HERMETIC	24
COMPRESSORS / COPELAND TECHNICAL DATAS	26
COMPRESSORS / COMPRESSORS SCROLL COPELAND RANGE ZH	27
COMPRESSORS / COMPRESSORS SCROLL COPELAND RANGE ZP	28
COMPRESSORS / COMPRESSORS SCROLL COPELAND RANGE ZR-ZF	29
COMPRESSORS / 06D SEMI-HERMETICS COMPRESSORS CARRIER	30
COMPRESSORS / 06E SEMI-HERMETICS COMPRESSORS CARRIER	35
COMPRESSORS / 06N SCREWS COMPRESSORS	40
COMPRESSORS / 06N SCREWS COMPRESSORS CARRIER	41
COMPRESSORS / 06N SCREWS COMPRESSORS SPARE PARTS CARRIER	42
COMPRESSORS / 06T COMPRESSORS CARRIER	43
COMPRESSORS / 06T COMPRESSORS SPARE PARTS CARRIER	44
COMPRESSORS / 5F & 5H COMPRESSORS CARRIER	50
COMPRESSORS / 5F & 5H COMPRESSORS SPARE PARTS CARRIER	51
COMPRESSORS / 06B COMPRESSORS SPARE PARTS CARRIER	58

DANFOSS

Nomenclature/Model No. | MT/MTZ - Medium/High Temperature Reciprocating Compressors

Nomenclature / Model No.

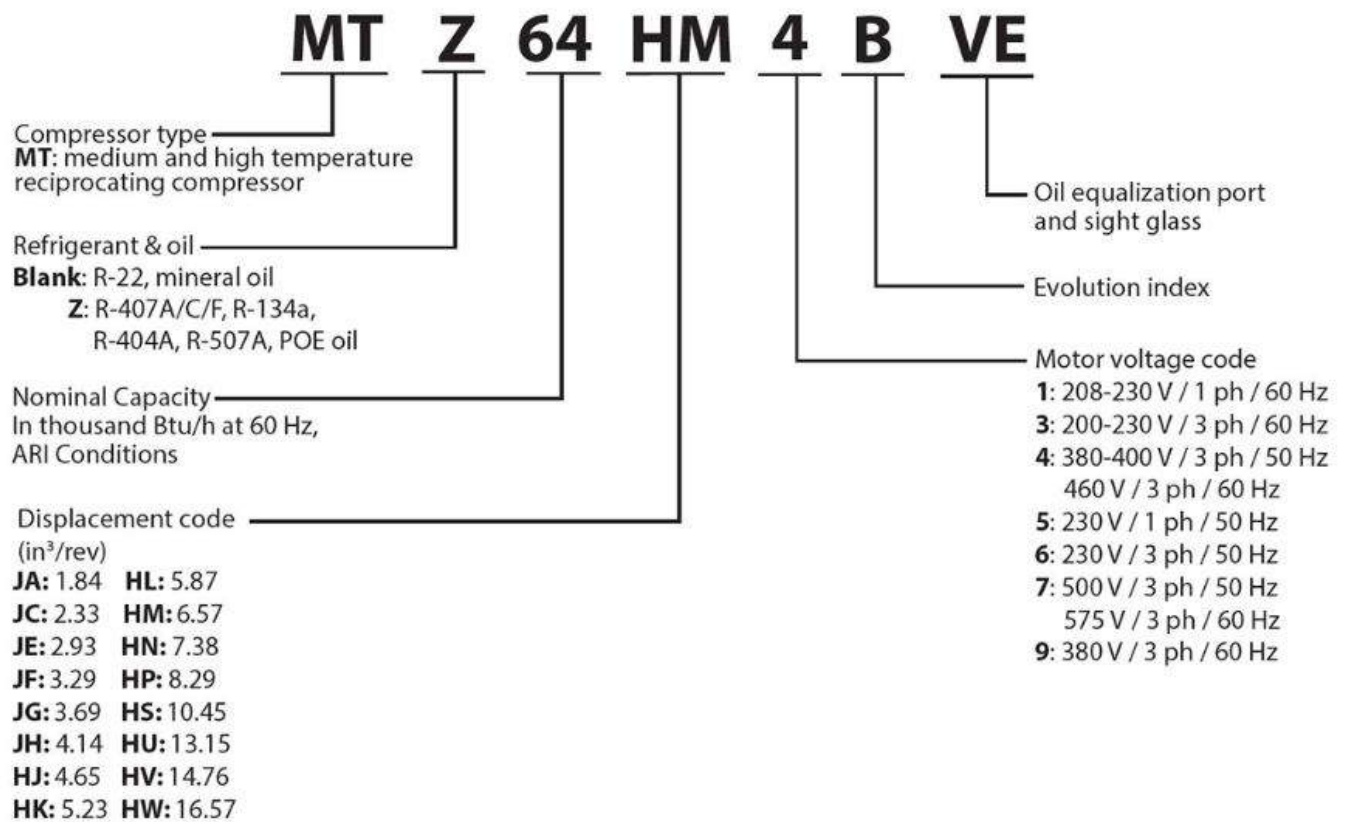



DANFOSS

Compressors shipped with oil and under nitrogen pressure
Refrigerant : R22

Ordering references	Product description	Suction sold connection size (inch)	Discharge sold connection size (inch)	Width (mm)	Length (mm)	Height (mm)	Weight (kg)	Voltage (V)	Connection type
--DQ--12BA-005EE1	MT80HP4AVE	1-1/8 ODF	3/4 ODF	295	295	403	44	400/3/50	ROTOLOCK
--DQ--12BA-014EE1	MT160HW4EVE	1-1/8 ODF	3/4 ODF	352	352	500	72	400/3/50	
--DQ--12BA-015EE1	MT100HS4DVE	1-1/8 ODF	3/4 ODF	353	352	500	69,5	400/3/50	ROTOLOCK
--DQ--12BA-016EE1	MT64HM4DVE	7/8 ODF	3/4 ODF	-			39,5	400/3/50	ROTOLOCK
--DQ--12BA-017EE1	MT32JF4DVE	5/8 ODF	1/2 ODF	-			26,5	400/3/50	ROTOLOCK
--DQ--12BA-018EE1	MT40JH4EVE	5/8 ODF	1/2 ODF	-			27,5	400/3/50	ROTOLOCK
--DQ--12BA-023EE1	MT56HL4BVE	7/8 ODF	3/4 ODF	-			39	400/3/50	ROTOLOCK
--DQ--12BA-024EE1	MT125HU4DVE	1-1/8 ODF	3/4 ODF	-			71	400/3/50	ROTOLOCK
3200108	MT50HK4CVE	7/8 ODF	3/4 ODF	-			39	400/3/50	ROTOLOCK
--DQ--12BA-028EE1	MT36JG4EVE	5/8 ODF	1/2 ODF	-			27	400/3/50	ROTOLOCK
--DQ--12BA-031EE1	MT28JE4AVE	1/2 ODF	3/8 ODF	-			25,5	400/3/50	ROTOLOCK



DANFOSS

Compressors shipped with oil and under nitrogen pressure
Refrigerant : R407C

Ordering references	Product description	Suction sold connection size (inch)	Discharge sold connection size (inch)	Width (mm)	Length (mm)	Height (mm)	Weight (kg)	Voltage (V)	Connection type
--DQ--12BA-070--EE	MTZ100HS4VE	1-1/8	3/4	446	446	500	69,5	400/3/50	ROTOLOCK
--DQ--12BA-074EE1	MTZ160HW4AVE	1-1/8	3/4	450	450	500	72	400/3/50	ROTOLOCK
--DQ--12AL-001EE1	MTZ125HU4VE							400/3/50	
--DQ--12AL-002EE1	MTZ144HV4VI	1-1/8 ODF	3/4 ODF	352	352	540	67	400/3/50	ROTOLOCK
--DQ--12AL-005EE1	MTZ80HP4AVE							400/3/50	ROTOLOCK
--DQ--12AL-007EE1	MTZ50HK4CVE							400/3/50	ROTOLOCK
--DQ--12AL-008EE1	MTZ40JH4AVE							400/3/50	ROTOLOCK
--DQ--12AL-009EE1	MTZ36JG4AVE							400/3/50	ROTOLOCK
--DQ--12AL-011EE1	MTZ28JE4AVE	1/2 ODF	3/8 ODF	224	224	333	23	400/3/50	ROTOLOCK
--DQ--12AL-012EE1	MTZ22JC4AVE							400/3/50	ROTOLOCK
3200222	MTZ64HM4CVE							400/3/50	ROTOLOCK
7003907	MTZ44-4-VI							400/3/50	ROTOLOCK
7006037	MTZ56HL4BVE							400/3/50	ROTOLOCK
7006754	MTZ72HN4AVE							400/3/50	ROTOLOCK
3200201	MTZ32JF4S							400/3/50	ROTOLOCK



COMPRESSORS / DANFOSS TECHNICAL DATAS RANGE SZ

DANFOSS

Family, lubricant & refrigerant SZ SY	Nominal capacity 185 300	-	Voltage 4 7	Version R CA	Evolution index C A	Single compressors Single compressors
---	--	---	---------------------------------	----------------------------------	---	--

<p>Family, lubricant & refrigerant SM: Scroll, Mineral oil, R22/R417A* SY: Scroll, POE lubricant, R22/R417A (and R407C for SY185-240-300) SZ: Scroll, POE lubricant, R407C - R134a (and R404A, R507A for SZ084 to SZ185)</p> <p>Nominal capacity In thousand Btu/h at 60 Hz, R22, ARI conditions</p> <p>Motor voltage code 3: 200-230V/3~/60 Hz 4: 380-400V/3~/50 - 460V/3~/60 Hz 6: 230V/3~/50 Hz 7: 500V/3~/50 Hz - 575V/3~/60 Hz 9: 380V/3~/60 Hz</p>	<table border="1" style="width: 100%; border-collapse: collapse;"> <thead> <tr> <th>Motor protection type</th> <th>Connection</th> <th>Module voltage</th> <th>Applies to</th> </tr> </thead> <tbody> <tr> <td rowspan="2">Internal overload protector</td> <td>V : brazed</td> <td></td> <td>S 084-090-100-110-120-148-161</td> </tr> <tr> <td>A : brazed</td> <td></td> <td>S 112-124-147</td> </tr> <tr> <td rowspan="2">Internal thermostat</td> <td>C : brazed</td> <td></td> <td rowspan="4">S 175-185</td> </tr> <tr> <td>R : rotolock</td> <td></td> </tr> <tr> <td rowspan="6">Electronic protection module</td> <td>P : brazed</td> <td>24 V AC</td> <td rowspan="6">S 240 - 300</td> </tr> <tr> <td>X : brazed</td> <td>230 V</td> </tr> <tr> <td>S : rotolock</td> <td>24 V AC</td> </tr> <tr> <td>Y : rotolock</td> <td>230 V</td> </tr> <tr> <td>CA</td> <td>C: brazed</td> <td>A: 24V AC</td> </tr> <tr> <td>CB</td> <td>P: rotolock</td> <td>B: 115/230V</td> </tr> <tr> <td>PA</td> <td></td> <td>A: 24V AC</td> </tr> <tr> <td>PB</td> <td></td> <td>B: 115/230V</td> </tr> <tr> <td>CA</td> <td>C: brazed</td> <td>A: 24V AC</td> <td rowspan="2">S 380</td> </tr> <tr> <td>CB</td> <td></td> <td>B: 115/230V</td> </tr> </tbody> </table>	Motor protection type	Connection	Module voltage	Applies to	Internal overload protector	V : brazed		S 084-090-100-110-120-148-161	A : brazed		S 112-124-147	Internal thermostat	C : brazed		S 175-185	R : rotolock		Electronic protection module	P : brazed	24 V AC	S 240 - 300	X : brazed	230 V	S : rotolock	24 V AC	Y : rotolock	230 V	CA	C: brazed	A: 24V AC	CB	P: rotolock	B: 115/230V	PA		A: 24V AC	PB		B: 115/230V	CA	C: brazed	A: 24V AC	S 380	CB		B: 115/230V
Motor protection type	Connection	Module voltage	Applies to																																												
Internal overload protector	V : brazed		S 084-090-100-110-120-148-161																																												
	A : brazed		S 112-124-147																																												
Internal thermostat	C : brazed		S 175-185																																												
	R : rotolock																																														
Electronic protection module	P : brazed	24 V AC		S 240 - 300																																											
	X : brazed	230 V																																													
	S : rotolock	24 V AC																																													
	Y : rotolock	230 V																																													
	CA	C: brazed	A: 24V AC																																												
	CB	P: rotolock	B: 115/230V																																												
PA		A: 24V AC																																													
PB		B: 115/230V																																													
CA	C: brazed	A: 24V AC	S 380																																												
CB		B: 115/230V																																													

*When SM compressors are used with R417A, the factory charged mineral oil 160P must be replaced by polyolester oil 160SZ



DANFOSS

Compressors shipped with oil and under nitrogen pressure
Refrigerant : R407C

Ordering references	Product description	Suction sold connection size (inch)	Discharge sold connection size (inch)	Width (mm)	Length (mm)	Height (mm)	Weight (kg)	Voltage (V)	Connection type
--DQ--12CA-001--EE	SZ110S4VC	1-3/8	7/8	284	284	558	80,5	400/3/50	BRAZING
--DQ--12CA-002--EE	SZ120S4VC	1-3/8	7/8	285	284	558	80,5	400/3/50	BRAZING
--DQ--12CA-003--E-	SZ115S4CC	1-3/8	7/8	284,2	369,1	581	80	400/3/50	BRAZING
--DQ--12CA-005--E-	SZ160T4CC	1-5/8	1-1/8	284,2	369,1	632	94	400/3/50	BRAZING
--DQ--12CA-006--E-	SZ185S4CC	1-5/8	1-1/8	345,4	370,8	678	103	400/3/50	BRAZING
--DQ--12CA-025--EE	SZ084S4VC	1-1/8	3/4	284	284	508	71,5	400/3/50	BRAZING
--DQ--12CA-027--EE	SZ240A4CAE	1-5/8	1-1/8	392	392	729	160	400/3/50	BRAZING
--DQ--12CA-028--EE	SZ300A4CAE	1-5/8	1-1/8	393	392	740	160	400/3/50	BRAZING
--DQ--12CA-031--EE	SZ161T4VC	1-3/8	7/8	284	284	590	86	400/3/50	BRAZING
--DQ--12CA-032--EE	SZ185U4CC	1-5/8	1-1/8	345,4	370,8	678	103	400/3/50	BRAZING
--DQ--12CA-034--EE	SZ115S4RC	1-3/4	1-1/4					400/3/50	ROTOLOCK
--DQ--12CA-035--EE	SZ160T4RC	2-1/4	1-3/4					400/3/50	ROTOLOCK
--DQ--12CA-036--EE	SZ185W4PD	1-3/8	1-1/8	345,4	370,8	641,3	103	400/3/50	BRAZING
7113795	SZ380A4CBE							400/3/50	BRAZING
3200300	SZ240A4CBE	1-5/8	1-1/8					400/3/50	BRAZING
3200192	SZ125S4RC	1-3/4	1-1/4					400/3/50	ROTOLOCK
1940800	SZ240A4PBE	2-1/4	1-3/4					400/3/50	ROTOLOCK
3200193	SZ 125 6R							400/3/50	BRAZING
3200196	SZ185S4RC	2-1/4	1-3/4					400/3/50	ROTOLOCK
3200301	SZ300A4CBM	2-1/4	1-3/4					400/3/50	BRAZING

DANFOSS

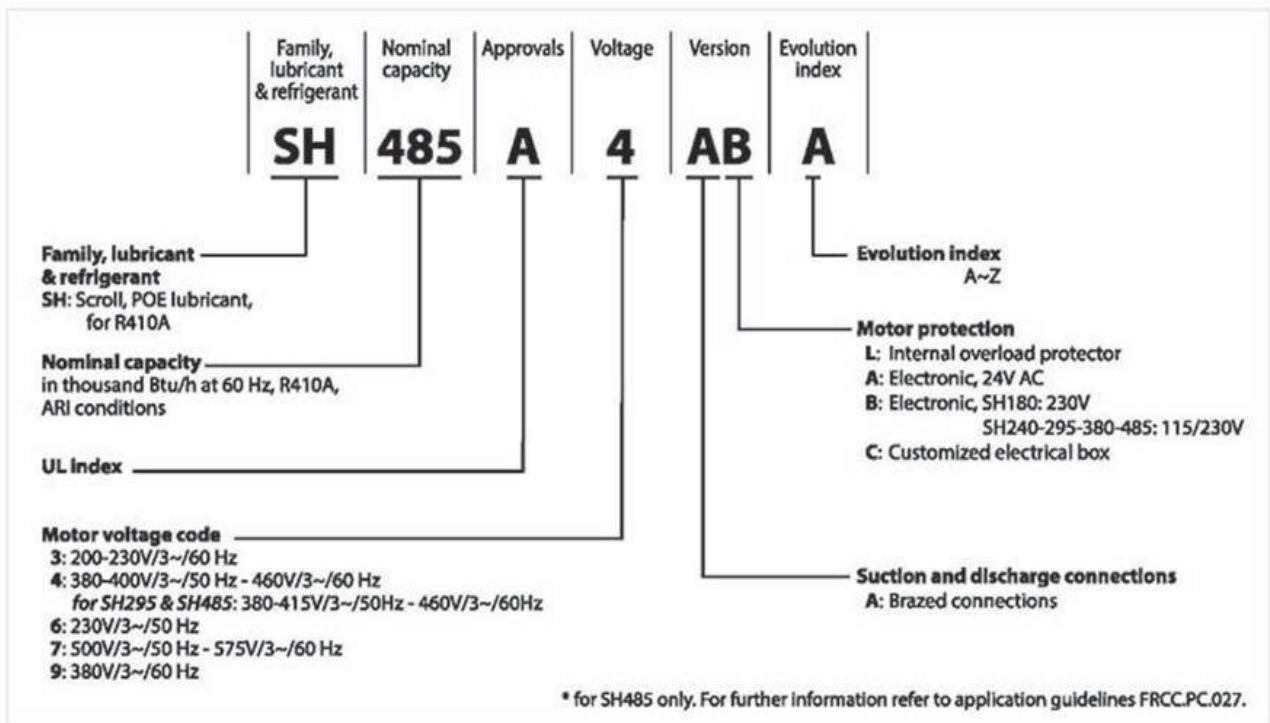



DANFOSS

Compressors shipped with oil and under nitrogen pressure R410A

Ordering references	Product description	Suction sold connection size (inch)	Discharge sold connection size (inch)	Width (mm)	Length (mm)	Height (mm)	Weight (kg)	Voltage (V)	Connection type
00PSG001482000A	SH090A4ACC	1-1/8 ODF	7/8 ODF	243	243	482	58	400/3/50	BRAZING
00PSG001482100A	SH105A4ACC	1-3/8 ODF	7/8 ODF	243	243	540	64	400/3/50	BRAZING
00PSG001482200A	SH120A4ACC	1-3/8 ODF	7/8 ODF	243	243	540	64	400/3/50	BRAZING
00PSG001482300A	SH140A4ACC	1-3/8 ODF	7/8 ODF	243	243	540	67	400/3/50	BRAZING
00PSG001482400A	SH161A4ACC	1-3/8 ODF	7/8 ODF	243	243	540	69	400/3/50	BRAZING
00PSG001482500A	SH184A4ACC	1-3/8 ODF	7/8 ODF	243	243	555	72	400/3/50	BRAZING
00PSG001748000A	SH295A4ACE	1-5/8 ODF	1-1/8 ODF					400/3/50	BRAZING
2059560	SH295A4ABE	1-5/8 ODF	1-1/8 ODF					400/3/50	BRAZING
2062690	SH090-A9ALC							400/3/50	BRAZING
7243957	SH380A4ABE	1-5/8 ODF	1-1/8 ODF					400/3/50	BRAZING
7243955	SH240A4ABE	1-5/8 ODF	1-1/8 ODF					400/3/50	BRAZING
7243847	SH180B4ABF	1-5/8 ODF	1-1/8 ODF					400/3/50	BRAZING
7388693	SH184A4ALC	1-3/8 ODF	7/8 ODF					400/3/50	BRAZING
7266997	SH120A4ALC	1-3/8 ODF	7/8 ODF					400/3/50	BRAZING
00PPG000471003A	SH300B4ACC	1-5/8 ODF	1-1/8 ODF					400/3/50	
7243956	SH300B4ABE	1-5/8 ODF	1-1/8 ODF					400/3/50	BRAZING
7266910	SH161A4ALC	1-3/8 ODF	7/8 ODF					400/3/50	BRAZING
00PSG001961100A	SH240A4ACA	1-5/8 ODF	1-1/8 ODF	345,4	370,8	650	107	400/3/50	BRAZING



DANFOSS

Compressors shipped with oil and under nitrogen pressure

Ordering references	Product description	Connection type
7300312	VSH088AGANB	BRAZING
7300315	VSH117AGANB	BRAZING

Ordering references	Product description	Connection type
00PSG001549200A	WSH105A4ACC	BRAZING
00PSG001549300A	WSH120A4ACC	BRAZING
00PSG001549400A	WSH140A4ACC	BRAZING
00PSG001549500A	WSH161A4ACC	BRAZING
00PSG001549100A	WSH090A4ACC	BRAZING
00PSG001549600A	WSH184A4ACC	BRAZING

DANFOSS

Compressors shipped with oil and under nitrogen pressure

Ordering references	Product description	Suction sold connection size (inch)	Discharge sold connection size (inch)	Width (mm)	Length (mm)	Height (mm)	Weight (kg)	Voltage (V)	Connection type
SM185S4RA	SM185S4RC								ROTOLOCK
--DQ--12CA-015--E-	SM115S4CC	1-3/8	7/8	284,2	369,1	581	80	400/3/50	BRAZING
--DQ--12CA-017--E-	SM160T4CC	1-5/8	1-1/8	284,2	369,1	632	94	400/3/50	BRAZING
--DQ--12CA-018--E-	SM185S4CC	1-5/8	1-1/8	345,4	370,8	678	103	400/3/50	BRAZING
--DQ--12CA-037--EE	SM161T4VC								BRAZING
--DQ--12CA-038--EE	SM185W4PD								BRAZING

DANFOSS

Type	Size	Motor	Features
HRH	036	U1L	P6

Application: _____
H: high temperature / air conditioning

Family: _____
C: light commercial scroll
R: residential scroll (new platform)
L: light commercial scroll (new platform)

Refrigerant & lubricant: _____
M: R22, alkylbenzene lubricant
P: R407C, PVE lubricant
H: R410A, PVE lubricant
J: R410A, PVE lubricant

Nominal capacity: _____
In thousand Btu/h at 60 Hz,
ARI conditions

Model variation _____
T: design optimized for 7.2/54.4°C
U: design optimized for 7.2/37.8°C

Other features

	Oil sight glass	Oil equalisation	Oil drain	LP gauge port	Gas equalisation port
6	None	None	None	None	None
7	Threaded	None	None	None	None
8	None	Brazed	None	None	Brazed

Tubing and electrical connections
P: brazed connections, spade terminals
C: brazed connections, screw terminals

Motor protection
L: internal motor protection

Motor voltage code
1: 208-230V/1~/60 Hz
2: 200-220V/3~/50Hz & 208-230V/3~/60 Hz
4: 380-400V/3~/50 Hz & 460V/3~/60 Hz
5: 220-240V/1~/50 Hz
7: 500V/3~/50 Hz & 575V/ 3~/60 Hz
9: 380V/3~/60 Hz

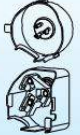

DANFOSS

Compressors shipped with oil and under nitrogen pressure



Ordering references	Product description
HLM075T4LP6	HLM075T4LP6

Ordering references	Product description	Connection type
HRM060T4LP6	HRM060T4LP6	BRAZING

Ordering references	Product description	Connection type
7406478	HCJ400VR410	BRAZING
7406475	HCJ091T4LO6	

Ordering references	Product description	Connection type
7406469	HLH068T4LO6	BRAZING



COPELAND

Compressors shipped with oil and under nitrogen pressure

Ordering references	Product description
3201235	8DJ6-600X-AWM/D
3201271	8DJ6-600X-EWM/D
3201233	D6DJ5-400X-AWM/D
7028578	D6SK2-500X-EWL
7028572	D6SK2-500X-AWM/D
3201245	D6DH5-350X-AWM/D
7028573	D6SJ1-400X-AWM/D
3201231	D4DJ5-300X-AWM/D
7104202	D8SJ2-600X-AWM/D
3201230	D4DH5-250X-AWM/D-1R
3201240	D6DJ5-400X-EWL-2R



COMPRESSORS / COPELAND TECHNICAL DATAS

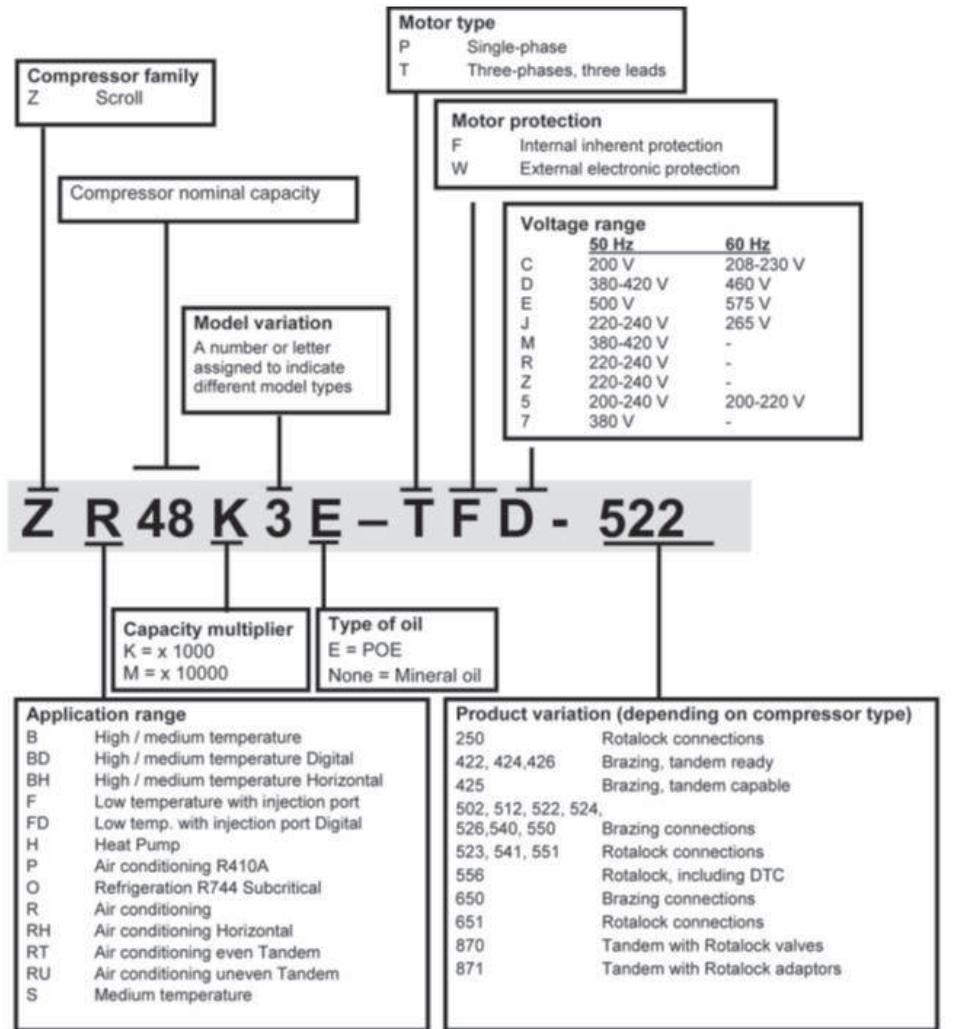

COPELAND

Compressors shipped with oil and under nitrogen pressure R407C



Ordering references	Product description	Suction sold connection size (inch)	Discharge sold connection size (inch)	Width (mm)	Length (mm)	Height (mm)	Voltage (V)	Connection type
7201746	ZH24KVE-TWD-526	1-3/8	7/8	366	321	525	380-420	BRAZING
00PPG000459500A	ZH40KVE-TWD-568	1-3/8	7/8	368	321	532	380-420	BRAZING
00PPG000459600A	ZH48KVE-TWD-568	1-5/8	1-1/8	368	323	579	380-420	BRAZING
7389286	ZH04K1P-PFZ-524							BRAZING
0370620H70	ZH18KVE-TFD-526	7/8	1/2	244	241	438	380-420	BRAZING
7336706	ZH09K1P-PFZ-524							BRAZING
7139083	ZH13KVE-TFD-526	7/8	1/2	244	241	438	380-420	BRAZING
7139084	ZH13KVE-PFJ-526	7/8	1/2	244	241	438	220-240	BRAZING
7201755	ZH48KVE-TWD-526	1-5/8	1-1/8	368	323	579	380-420	BRAZING
7201750	ZH33KVE-TWD-526	1-3/8	7/8	368	321	525	380-420	BRAZING
7414837	ZH12K1P							BRAZING

COMPRESSORS / COMPRESSORS SCROLL COPELAND RANGE ZP



COPELAND

Compressors shipped with oil and under nitrogen pressure
R410A

Ordering references	Product description	Suction sold connection size (inch)	Discharge sold connection size (inch)	Width (mm)	Length (mm)	Height (mm)	Voltage (V)	Connection type
7125800	ZP50K3E-PFJ-522							BRAZING
0370620H07	ZP23K3E-TFD-522	3/4	1/2	242	242	362	380-420	BRAZING
0370620H08	ZP26K3E-TFD-522	3/4	1/2	242	242	362	380-420	BRAZING
0370620H16	ZP26K3E-PFJ-522	3/4	1/2	242	242	362	220 - 240	BRAZING
0370620H25	ZP32K3E-TFD-522	3/4	1/2	242	242	384	400	BRAZING
0370620H26	ZP36K3E-TFD-522	7/8	1/2	242	242	421	380-420	BRAZING
0370620H27	ZP41K3E-TFD-522	3/4	1/2	242	242	397	380-420	BRAZING
0370620H28	ZP54K3E-TFD-522	7/8	1/2	242	242	440	380-420	BRAZING
0370620H29	ZP32K3E-PFJ-522	3/4	1/2	242	242	384	220 - 240	BRAZING
0370620H30	ZP41K3E-PFJ-522	3/4	1/2	242	242	397	220 - 240	BRAZING
0370620H63	ZP90KCE-TFD-455	1-3/8	7/8	264	284	476	400	BRAZING
0370620H64	ZP72KCE-TFD-522	7/8	1/2	245	249	440	400	BRAZING
7351587	ZP180KCE-TWD-922							ROTALOCK + BRAZING KIT
7002185	ZP23K3E-PFJ-522							BRAZING
7045159	ZP67KCE-TFD-522							BRAZING
7066321	ZP103KCE-TFD-455							BRAZING
7204645	ZP24KSE-PFZN-522							BRAZING
7204651	ZP54KSE-PFZN-522							BRAZING
7040884	ZP120KCE-TFD-455							BRAZING
7388340	ZP182KCE-TFD-477							BRAZING
7536522	ZP54K5-PJF-522							BRAZING
7040885	ZP137KCE-TFD-455							BRAZING
7532788	ZP90KCE-TF7455-60HZ							
0370620H71-	ZP91KCE-TFD-522							BRAZING
7117486	ZP120KCE-TF5							
7069802	ZP83KCE-TFD-522							BRAZING
7389519	ZP182KCE-TFD-455							BRAZING
7249993	ZP485KCE-TWD-522							BRAZING
7146360	ZP385KCE-TWD-522							BRAZING
00PPG000461400A	ZP90KQE-TFD-604	1-1/8	7/8	264	284	476	400	BRAZING
00PPG000461500A	ZP103KQE-TFD-604	1-3/8	7/8	264	284	533	380-420	BRAZING
00PPG000461600A	ZP120KQE-TFD-604	1-3/8	7/8	285	293	533	380-420	BRAZING
00PPG000461700A	ZP137KQE-TFD-604	1-3/8	7/8	264	284	533	380-420	BRAZING
00PPG000461800A	ZP154KQE-TFD-604	1-3/8	7/8	264	284	552	380-420	BRAZING
00PPG000461900A	ZP182KQE-TFD-604	1-3/8	7/8	264	284	552	380-420	BRAZING
7511597	ZP295KCE-TWD-522							BRAZING
7040888	ZP54K5E							BRAZING
7040887	ZP235KCE-TWD-522							BRAZING



COPELAND

Compressors shipped with oil and under nitrogen pressure

Ordering references	Product description	Suction sold connection size (inch)	Discharge sold connection size (inch)	Width (mm)	Length (mm)	Height (mm)	Voltage (V)	Connection type
ZRD94KCE-TFD-522	ZRD94KCE-TFD-522							BRAZING
0370620H20	ZR48K3E-PFJ-522	7/8	1/2	242 X 242 X 417	220-240			BRAZING
ZR19M3E-TWD-961	ZR19M3E-TWD-961	2-1/4	1-3/4	349 X 321 X 579	380-420/3/50			ROTALOCK + BRAZING KIT
--DQ--12EB-004--EE	ZR16M3E-TWD-961	1-3/4 ROTALOCK	1-1/4 ROTALOCK	319 X 357 X 550	400/3/50			ROTALOCK + BRAZING KIT
3200272	ZR61KCE-TFD-522							BRAZING
0370620X12	ZR34K3E-TFD-522							BRAZING
7014505	ZR250KCE-TWD-522							BRAZING
0370620H58	ZR72KCE-TFD-522	7/8	1/2	245	249	440	200-240	BRAZING
7350855	ZR11M3E-TWD-961							ROTALOCK + BRAZING KIT
ZR190KCE-TFD-455	ZR190KCE-TFD-455							BRAZING
7006810	ZR48K3E-TFD-522							BRAZING
3200231	ZR28K3E-TFD-522							BRAZING
3200266	ZR40K3E-TFD-522							BRAZING
AM031660	ZR90K3E-TWD-961							ROTALOCK + BRAZING KIT
3200265	ZR40K3E-PFJ-522							BRAZING
3200261	ZR28K3E-PFJ-522							BRAZING
ZR310KCE-TWD-523	ZR310KCE-TWD-523	1-5/8	1-3/8	448 X 392 X 715	380-420/3/50			ROTALOCK
ZR48K3E-TFD-422	ZR48K3E-TFD-422							BRAZING, TANDEM READY
7537733	ZR310KCE-TWD524							
3200271	ZR81KCE-TFD-522							BRAZING
ZF09-K4E-TFD-551	ZF09K4E-TFD-551							ROTALOCK

CARRIER



Compressors shipped without oil and under nitrogen pressure
Manufactured by Carlyle USA

All references published on the compressor model designation
are available.

Carlyle compressors technical datas are available on
www.carlylecompressor.com

Ordering references	Product description	Capacity (L)	Weight (kg)	Voltage (V)	Cylinder
06DA5372B1065A	NEWMAN	4,73	145	400/3/50 - 460/3/60	6
06DA8182A1365A	NEWMAN	3,31	123	400/3/50 - 460/3/60	4
06DA8252B13250	NEWMAN	3,79	143	208/230/3/60	6
06DA8252B13650	NEWMAN	3,79	143	400/460/3/50/60	6
06DM3160C1365A	NEWMAN	2,36	150	208/3/60 - 230/3/60	4
06DM3160C1365A	NEWMAN	2,13	150	400/460/3/50/60	4
06DM3370D13650	NEWMAN	3,79	147	400/460/3/50/60	6
06DM3370DD1757	NEWMAN	4,73	140	415/3/50	6
06DM8080G10650	NEWMAN	1,42	73	400/460/3/50/60	2
06DM8187A00650	NEWMAN	3,31	150	400/3/50 - 460/3/60	4
06DR0130C13650	NEWMAN	2,13	104	400/460/3/50/60	4
06DR1090G10650	NEWMAN	1,42	73	400/460/3/50/60	2
06DR2280D13650	NEWMAN	3,79	143	400/460/3/50/60	6
06DR2280D13650	NEWMAN	2,13	143	400/460/3/50/60	6
06DR3160C13650	NEWMAN	2,13	107	400/460/3/50/60	4
06DR3370D0325A	NEWMAN	3,79	147	208/230/3/60	6
06DR3370D1365A	NEWMAN	4,73	140	400/3/50 - 460/3/60	6
06DR3160C13650	NEWMAN	3,79	107	400/460/3/50/60	4
06DR5410D10650	NEWMAN	3,79	147	400/460/3/50/60	6
06DR7180D13250	NEWMAN	2,6	113	208/230/3/60	4
06DR7180D1365A	NEWMAN	2,6	113	400/460-3-50/60	4
06DR7250D1365A	NEWMAN	3,79	141	400/460-3-50/60	6

Please contact us for further information

CARRIER



Compressors shipped without oil and under nitrogen pressure
Manufactured by Carlyle USA

All references published on the compressor model designation are available.

Ordering references	Product description	Capacity (L)	Weight (kg)	Voltage (V)	Cylinder
06DS5376BC325ARP	REMAN	4,73	150	208/3/60 - 230/3/60	6
06DS5376BC365ARP	REMAN	4,7	150	400/3/50	6
06DS8246BC365ARP	REMAN	4,73	210	400/3/50 - 460/3/60	6
06DX3286BC065A	REMAN	4,73	150	400/3/50 - 460/3/60	6
06DM8186AC065A	REMAN	3,31	120	400/3/50 - 460/3/60	4
06DX3376BC065A	REMAN	4,73	140	400/3/50 - 460/3/60	6
06DX5376BC065A	REMAN	4,73	150	400/3/50 - 460/3/60	6
06DX5376BC125A	REMAN	4,73	150	208/3/60 - 230/3/60	6
06DX5376BD155A	REMAN	4,73	150	230/3/60	6
06DX7246AC065A	REMAN	4,73	136	400/3/50 - 460/3/60	6
06DX8246AC065A	REMAN	4,73	140	400/3/50 - 460/3/60	6
06DX8246BC065A	REMAN	4,73	140	400/3/50 - 460/3/60	6

Please contact us for further information

CARRIER

Ordering references	Product description
801013	FEMALE CONNECTOR / CONNECTEUR FEMELLE
06DA-401---782--S	CRANKSHAFT
06DA-401---842--EE	OIL PRESSURE REGULATOR
06DA-402---133--C	SUCTION FILTER
06DA-402---283--S	COVER
06DA-404---674P6S	VALVE PLATE ASSY
06DA-408---824-OEM	SOLENOID VALVE
06DA-502---322--C	CHECK VALVE
06DA-502---323--S	SPACER
06DA-502---333-OEM	SPACER
06DA-502---342--C	CHECK VALVE
06DA-502---343--S	SCREW
06DA-502---763--C	SCREW (MULT 6)
06DA-502---903-OEM	SUCTION CHECK VALVE
06DA-502---913-OEM	CHECK VALVE
06DA-502---923--S	GASKET
06DA-502---963--C	VALVE BODY
06DA-502---973-OEM	COVER
06DA-502---983-OEM	GASKET
06DA-503---033--S	CONNECTING ROD SCREW
06DA-503---073--C-	PISTON
06DA-503---083-OEM	GASKET
06DA-503---102--S	WASHER
06DA-503---262--C	NUT
06DA-503---633--C	PUMP SIDE BEARING
06DA-503---643--C	MOTOR SIDE BEARING
06DA-503---664C--B	TERMINAL BLOCK
06DA-503---674C--B	PHASE BARRIER
06DA-503---823--S	PUMP ROTOR
06DA-504---053--S	COUNTERWEIGHT
06DA-504---113--S	GASKET
06DA-504---123-OEM	TERMINAL PLATE GASKET
06DA-504---153--S	GASKET (METAL + PLASTIC)
06DA-504---163--S	GASKET
06DA-504---884--S	CRANKSHAFT
06DA-507---452-OEM	BUSHING TERMINAL
06DA-507---564--S	GASKET
06DA-507---674-OEM	TERMINAL PLATE
06DA-508---654--S	CRANKSHAFT
06DA-508---684--S	STRAP
06DA-605---614--S	MUFFLER
06DA-660---041--S	CONNECTING ROD
06DA-660---042--S	CONNECTING ROD
06DA-660---043--S	ADAPTER
06DA-660---047--S	CONNECTING ROD

Ordering references	Product description
06DA-660--055--S	THERMOSTAT
06DA-660--056--S	MOUNTING KIT
06DA-660--057--C	MOUNTING KIT
06DA-660--060--S	COMPRESSOR VALVE
06DA-660--061--S	SUCTION & DISCHARGE VALVE KIT
06DA-660--062--S	SUCTION & DISCHARGE VALVE KIT
06DA-660--063--S	COMPRESSOR VALVE
06DA-660--064--C	SUCTION & DISCHARGE VALVE KIT
06DA-660--065--C	SUCTION VALVE KIT
06DA-660--075--S	TERMINAL BOX PACKAGE
06DA-660--076--S	CRANKCASE HEATER
06DA-660--078--S	TERMINAL BOX PACKAGE
06DA-660--086--S	ROD
06DA-660--088--S	TERMINAL BOX + COVER
06DA-660--089--C	CYLINDER HEAD (ELECTRIC UNLOADER)
06DA-660--090--C	CYLINDER HEAD (PRESSURE UNLOADER)
06DA-660--091--S	HEATER
06DA-660--092--C	CRANKCASE HEATER
06DA-660--102--S	STATOR LOCKING KIT
06DA-660--105--S	BAFFLE PACKAGE
06DA-660--111--S	REWORK KIT
06DA-660--122--S	PISTON + PIN PACKAGE
06DA-660--123--S	PISTON
06DA-660--126--S	OIL PUMP
06DA-660--133--S	PISTON PACKAGE
06DA-660--134--S	TERMINAL PLATE
06DA-660--145--S	PISTON AND PIN ASSEMBLY
06DA-660--151--S	VALE PLATE PACKAGE
06DA-660--152--S	VALVE PLATE PACKAGE
06DA-680--070--S	CYLINDER HEAD FAN ASSEMBLY
06DA-900--072--S	INTER CONNECTING PACKAGE
06DR-660--026--S	PISTON
06DR-660--027--S	PISTON PACKAGE
06DR-660--028--S	PISTON
06DR-660--029--S	PISTON
06DR-660--030--S	PISTON
06DR-660--040--S	PISTON
06DR-660--047--S	PISTON
06DR-660--051--S	PISTON + PIN PACKAGE
06EA-660--090--S	SUCTION VALVE KIT
38AQ-680--001--S	CONTACT GREASE
-6-D--12--660041EE	CRANKSHAFT
-6-D--23--1421--C	GASKET (MULT 12)
-6-D--24--1094--S	CRANKSHAFT
-6-D--40--1012--C	BEARING

COMPRESSORS / 06D SEMI-HERMETICS

COMPRESSORS SPARE PARTS CARRIER

Ordering references	Product description
-6-D--40--1021--C	SPRING (MULT 12)
-6-D--40--1031--C	SPRING
-6-D--40---103-OEM	SCREEN
-6-D--40--1051--C	VANE
-6-D--40--1112--E	SPRING
-6-D--40--1131-OEM	VALVE GASKET (MULT 12)
-6-D--40--1171--S	OIL CHECK VALVE
-6-D--40--1181--C-	SPRING GUIDE (MULT 50)
-6-D--40---162--C	VALVE
-6-D--40--2163-E-W	CYLINDER HEAD
-6-D--43--1651--C	RING (MULT 12)
-6-D--43--1661-OEM	AXLE
-6-D--43---172--S	GASKET SET
-6-D--43---962--S	PISTON
-6-D--48--1072--C	CHECK VALVE (MULT 2)
-6-D--48---303--S	STRAINER
-6-D--48---403--S	CRANKSHAFT
-6-D--68--1024-E-W	COVER
-6-D--68--1442--S	CONNECTING ROD
-6-D--68--1491-OEM	COMP THRUST WASHER
-6-D--68--2153--S	TUBE
-6-D--73--2241-OEM	GROMMET
-6-D--75--1204--S	CYLINDER HEAD
-6-D--75---161---E	PISTON PACKAGE
-6-D--75--1722--EE	TERMINAL
-6-D--75--1941---E	SPACER
-6-D--75--2043-E-W	PISTON
-6-D--75--2081--C	SPRING
-6-D--75---293--S	CONNECTING ROD
-6-D--75---601--S	STRAINER
-6-D--75---722--S	CRANKSHAFT
--WM--12FA-018--EE	CRANKCASE HEATER 230V
--XL--12AA-001--EE	OIL CHANGE VALVE 1/4 NPT - 1/4 FLARE
--XM--12ZA-115--E-	115 VOLTS COIL / 10W

CARRIER



Compressors shipped without oil and under nitrogen pressure
 Manufactured by Carlyle USA
 All references published on the compressor model designation
 are available
 Please contact us for further information.

Ordering references	Product description	Weight (kg)	Voltage (V)	Cylinder
06ET-150---621DCEE	NEWMAN	193	400/460-3-50/60	4
06ET-175---621DCEE	NEWMAN	230	400/460-3-50/60	6
06ET-175-A-621DCEE	NEWMAN	230	400/460-3-50/60	6
06ET-199---621DCEE	NEWMAN	250	400/460-3-50/60	6
06ET-199-A-621DCEE	NEWMAN	250	400/460-3-50/60	6
06ET-250---621DCEE	NEWMAN	224	400/460-3-50/60	4
06ET-265---621DCEE	NEWMAN	233	400/460-3-50/60	6
06ET-275---621DCEE	NEWMAN	234	400/460-3-50/60	6
06ET-275-A-621DCEE	NEWMAN	234	400/460-3-50/60	6
06ET-299---621DCEE	NEWMAN	250	400/460-3-50/60	6
06ET-299-A-621DCEE	NEWMAN	250	400/460-3-50/60	6
06ET-150----66ERCD	REMAN	220	400/460-3-50/60	4
06ET-175----66ERCD	REMAN	247	400/460-3-50/60	6
06ET-250---66ARPS	REMAN	224	400/460-3-50/60	4
06ET-250----66ERCD	REMAN	221	400/460-3-50/60	4
06ET-265----66ERCD	REMAN	195	400/460-3-50/60	6
06ET-275----66ERCD	REMAN	264	400/460-3-50/60	6
06ET-299----66ERCD	REMAN	272	400/460-3-50/60	6

CARRIER

Ordering references	Product description
06DA-660---064--C	DISCHARGE VALVE KIT
06DA-660---065--C	DISCHARGE VALVE KIT
06EA-400---252--C	SUCTION SCREEN
06EA-400---982--C-	ORIFICE
06EA-401---993--S	CRANKSHAFT
06EA-402---003--S	CRANKSHAFT
06EA-402---013--S	CRANKSHAFT
06EA-402---403--S	LIQUID SIGHT GLASS
06EA-404---944--C-	VALVE PLATE
06EA-406---774--S	CRANKSHAFT
06EA-500---031--C-	SPRING
06EA-500---052--S	FOOT
06EA-500---073--C-	CHECK VALVE
06EA-500---094C--W	COVER
06EA-500---101-OEM	BUTEE ANTIFRICT
06EA-500---111--C	PISTON PIN
06EA-500---122EE-B	TERMINAL BOX GASKET
06EA-500---131--S	RING
06EA-500---132EE-A	TERMINAL BOX COVER GASKET
06EA-500---141--S	LOCK WASHER
06EA-500---153--C	CHECK VALVE (MULT 2)
06EA-500---181--S	GASKET
06EA-500---211--C	RING
06EA-500---233--C-	TUBE
06EA-500---233-OEM	TUBE
06EA-500---261EE-A	SUCTION FLANGE
06EA-500---302--C	MUFFLER
06EA-500---321-OEM	RING COMPRESSION (MULT 12)
06EA-500---321S2-S	O-RING (MULT 12)
06EA-500---331-OEM	RING OIL (MULT 12)
06EA-500---331S2-S	O-RING (MULT 12)
06EA-500---332--EE	CAP
06EA-500---342---E	SPACER NLA
06EA-500---351--C	ROTOR SCREW
06EA-500---352-OEM	CENTRAL BEARING (PUMP SIDE)
06EA-500---362C--A	CENTRAL BEARING (MOTOR SIDE)
06EA-500---371--S	BOLT
06EA-500---392-E-C	FLANGE
06EA-500---404--EE	TERMINAL BOX
06EA-500---661--S	STATOR KEY
06EA-500---672--C	INSULATION
06EA-500---682--C-	CHECK VALVE
06EA-500---702EE-A	MUFFLER
06EA-500---712EE-A	MUFFLER
06EA-500---742--EE	SPRING

Ordering references	Product description
06EA-500---752--EE	OIL SIGHT GLASS
06EA-500---832--S	COMPRESSOR SENSOR
06EA-501---012--C	DOWEL PIN (MULT 12)
06EA-501---302--S	COLLAR
06EA-501---363--C	CHECK VALVE
06EA-501---382--C-	GASKET
06EA-501---513--C	GASKET (MULT 10)
06EA-501---543--C	SCREW
06EA-501---563--C	CHECK VALVE (MULT 2)
06EA-501---563-OEM	CHECK VALVE (MULT 2)
06EA-501---853--S	GASKET
06EA-501---973--S	STUD (MULT 4)
06EA-502---023-OEM	GASKET
06EA-502---064--S	CYLINDER HEAD
06EA-502---074--S	CYLINDER HEAD
06EA-502---084--S	HEAD
06EA-502---223--S	SELF-LOCKING CAPSCREW
06EA-502---224--S	COVER
06EA-502---523--S	GASKET
06EA-502---553--S	GASKET
06EA-502---662--S	COVER
06EA-503---304--C	GASKET (MULT 10)
06EA-503---314--C	GASKET (MULT 12)
06EA-503---334--C	GASKET (MULT 12)
06EA-503---524C--A	CYLINDER HEAD
06EA-504---514--S	PISTON
06EA-504---524-OEM	PISTON
06EA-504---914--C	DISCHARGE CHECK VALVE (MULT 6)
06EA-506---324--S	STOP VALVE
06EA-506---334--S	STOP VALVE
06EA-506---344--S	VALVE
06EA-506---414--S	GASKET
06EA-506---684--S	MOTOR END COVER GASKET
06EA-601---052--C	CONDUIT PACKAGE
06EA-660---026--S	CONNECTING ROD
06EA-660---034--S	CONNECTING ROD
06EA-660---051--C	TERMINAL
06EA-660---071--S	GASKET SET
06EA-660---079--C-	UNLOADER KIT
06EA-660---085--S	ROD 010 PACKAGE
06EA-660---086--S	CONNECTING ROD

COMPRESSORS / 06E SEMI-HERMETICS

COMPRESSORS SPARE PARTS

Ordering references	Product description
06EA-660---087--S	TERMINAL PLATE
06EA-660---089--S	SUSPENSION KIT
06EA-660---090--S	SUCTION & DISCHARGE VALVE KIT
06EA-660---095--S	TERMINAL BOX PACKAGE
06EA-660---096--S	MOUNTING PLATE
06EA-660---104--S	CYLINDER HEAD GASKET SET
06EA-660---105--C	VALVE PLATE
06EA-660---107--S	HEATER
06EA-660---108--S	CRANKCASE HEATER
06EA-660---109--S	PISTON
06EA-660---110--S	PISTON
06EA-660---111--S	PISTON
06EA-660---112--S	PISTON 020 + PIN PACKAGE
06EA-660---125--C	TERMINAL PLATE
06EA-660---127--C-	SIGHT GLASS ADAPTER
06EA-660---137--S	VALVE PLATE PACKAGE
06EA-660---141--S	JUMPER BAR PACKAGE
06EA-660---143--S	VALVE PLATE
06EA-660---147--S	BLOCKING PACKAGE
06EA-660---151--S	SERVICE PARTS PACKAGE
06EA-660---157--S	OIL PUMP KIT
06EA-660---159--S	VALVE PLATE (LEFT SIDE)
06EA-660---164--S	VALVE KIT 2-1/8"
06EA-660---165--S	CRANKCASE HEATER
06EA-660---166--S	CRANKCASE HEATER
06EA-660---167--S	HEATER
06EA-660---168--S	CRANKCASE HEATER KIT
06EA-900---023--S	MOUNTING SPRING PKG
06EP-410---614--EE	MOTOR
06EP-412---614--EE	MOTOR
06EP-475---614--EE	MOTOR
06ER-660---009--S	GASKET PACKAGE
06ER-660---013--S	PISTON PACKAGE
38AQ-680---001--S	CONTACT GREASE
--HN--68GA-295--C	R22 DGT
--WG--12RA-001--EE	R134A DGT
--WM--12FA-006--EE	CRANKCASE HEATER 230V
--WM--12FA-017--EE	CRANKCASE HEATER 230V / 125 W
--WM--12FA-018--EE	CRANKCASE HEATER 230V
--WM--12FA-020--E-	CANCKASE HEATER 110V / 125W
--XL--12AA-001--EE	OIL CHANGE VALVE 1/4 NPT-1/4 FLARE
--XM--12ZA-115--E-	115 VOLTS COIL / 10 W



COMPRESSORS / 06N SCREWS COMPRESSORS

06N SCREW COMPRESSOR SIGNIFICANCE CHART

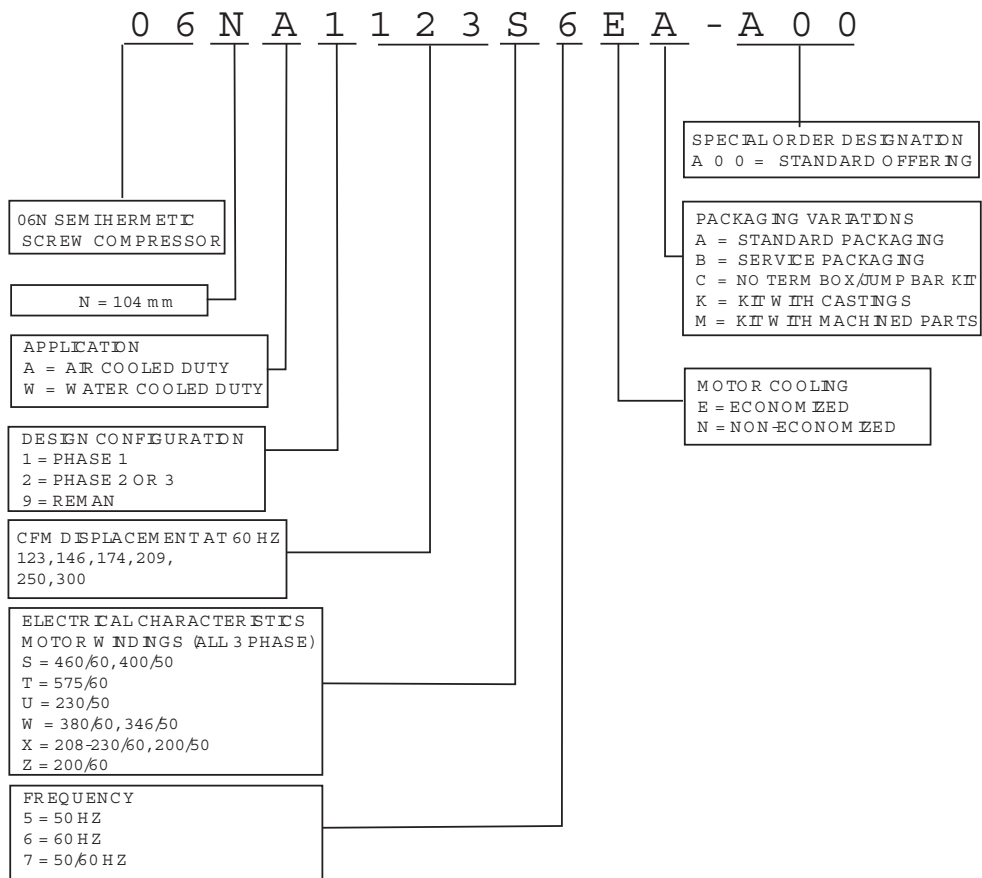

CARRIER



Screw compressors shipped without oil
Manufactured by Carlyle USA

Ordering references	Weight (kg)	Voltage (V)	Power (Tons)	Maximum Current (A)
06NA2146-S---7EAC	380	400/3/50 - 460/3/60	39	-
06NA2146-S---7NAC	380	400/3/50 - 460/3/60	39	90,2
06NA2174-S---7EAC	390	400/3/50 - 460/3/60	46	NC
06NA2174-S---7NAC	390	400/3/50 - 460/3/60	46	112,3
06NA2209-S---7EAC	400	400/3/50 - 460/3/60	56	-
06NA2209-S---7NAC-	400	400/3/50 - 460/3/60	56	134,1
06NA2250-S---7EAC	405	400/3/50 - 460/3/60	66	-
06NA2250-S---7NAS	405	400/3/50 - 460/3/60	66	161,2
06NA2300-S---5EAC-	415	400/3/50 - 460/3/60	80	234,7
06NA2300-S---5NAC-	415	400/3/50 - 460/3/60	80	188,5
06NW2146-S---7NAC	360	400/3/50 - 460/3/60	39	71,7
06NW2174-S---7NAC	365	400/3/50 - 460/3/60	46	88,5
06NW2209-S---7EAC-	375	400/3/50 - 460/3/60	56	NC
06NW2209-S---7NAC-	375	400/3/50 - 460/3/60	56	106,7
06NW2250-S---7EAC-	380	400/3/50 - 460/3/60	66	-
06NW2250-S---7NAC	380	400/3/50 - 460/3/60	66	128,8
06NW2300-S---5EAC	400	400/3/50 - 460/3/60	80	172,2
06NW2300-S---5NAC-	390	400/3/50 - 460/3/60	80	156,2

Note that 06NA compressors needs oil contained in the oil separator

Ordering reference : ---P-903SW220-5TTL : Totaline SW220, 5L drum,

---P-903SW220-20TL : Totaline SW220, 20L drum

EAC means compressor works with an economizer in frigorific system

NAC means compressor works without an economizer in frigorific system

Caution ! Always add installation kit code 06NA-660---013--S

1 Ton = 3,5 kW Frigo (SI)

CARRIER

Ordering references	Product description
06NA-660---001--S	24V AC OIL SOLENOID PACKAGE
06NA-660---005--S	COMPR SUCTION SCREEN PKG.
06NA-660---010--S	COMPR SUCTION SHIPPING PLATE PKG.
06NA-660---011--S	COMPR UNLOADER SOLENOID PKG. (24V AC):
06NA-660---012--S	SUCTION O-RING PKG.
06NA-660---017--S	LOAD/UNLOAD SOLENOID O-RING KIT
06NA-660---019--S	SCHRAEDER ACCESS FITTING KIT
06NA-660---020--S	1/8» SAE PLUG KIT
06NA-660---021--S	1/4» SAE PLUG KIT
06NA-660---022--S	3/8» SAE PLUG KIT
06NA-660---023--S	1-1/4» SAE PLUG KIT
06NA-660---024--S	2» SAE PLUG KIT(OIL FILTER)
06NA-660---025--S	OIL CONTROL SOLENOID O-RING KIT
06NA-660---038--S	UNLOADER CVR PLATE GSKT KIT
06NA-660---037--S	SQ. UNLOADER CVR O-RING KIT
06NA-660---028--S	COMPR OIL FILTER ELEMENT(INTERNAL)
06NA-660---007--S	COMPR ECONOMIZER SCREEN PKG.
06NA-660---009--S	COMPR ECON. SHIPPING PLATE PKG.
06NA-660---004--S	COMPR CHECK VALVE/MUFF. KIT
06NA-660---008--S	COMPR DISCH. SHIPPING PLATE PKG.
06NA-660---013--S	COMP. INSTALLATION PKT
06NA-660---018--S	MUFFLER O-RING KIT
06NA-660---015--S	COMPR SERVICE TOOL PKG.
06NA-660---027--S	COMPRESSION END SEAL
06NA-660---026--S	TERMINAL PIN SEAL REPLACEMENT KIT
06NA-660---032--S	GEAR KIT 146 CFM
06NA-660---034--S	GEAR KIT 209 CFM
06NA-660---036--S	GEAR KIT 300 CFM
06NA-660---039--S	ROTOR INJECTION LINE KIT(HIGH SCT OPERATION)
06NA-660---040--S	ROTOR INJECTION LINE KIT(LOW AMB OPERATION)
06NA-660---041--S	O-RING KIT, OIL INJECTION LINE
06NA-660---042--S	SENSOR PINS
06NA-660---003--S	COMPR TERM. BOX KIT
06NA-660---002--S	COMPR TERM. JUMPER BAR KIT
06NZJ23H09	06NW2123S // 06NW2146S NON ECONOMISED
06NZK23H09	06NW2146S ECONOMISED // 06NW2174S NON ECONOMISED
06NZM23H09	06NA2123S NON ECONOMISED // 06NW2174S ECONOMISED // 06NW2209S NON ECONOMISED
06NZP23H09	06NA2123S ECONOMISED // 06NA2146S NON ECONOMISED // 06NW2209S ECONOMISED // 06NW2250S NON ECONOMISED
06NZQ23H09	06NA2146S ECONOMISED // 06NA2174S NON ECONOMISED // 06NW2250S ECONOMISED //06NW2300S NON ECONOMISED
06NZR23H09	06NA2174S ECONOMISED // 06NA2209S NON ECONOMISED // 06NW2300S ECONOMISED
06NZS23H09	06NA2209S ECONOMISED // 06NA2250S NON ECONOMISED
06NZU23H09	06NA2250S ECONOMISED // 06NA2300S NON ECONOMISED
06NZW23H09	06NA2300S ECONOMISED

CARRIER

Compressor shipped without oil



Ordering references	Weight (kg)	Origin
06TSA155SJ1C-	1068	US
06TSA186SJ1C-	1068	US
06TTA266SP1C-	1068	US
06TTA301SS1C-	1068	US
06TTA356SS1C-	1068	US
06TT-----W266SM1D-	500	US
06TT-----W301SM1D-	500	US
06TT-----W356SP1D-	500	US
06TUA483SW1C-	1068	US
06TUA483TW1C	1068	US
06TUA483WW1C	1068	US
06TUA554SW1C-	1068	US
06TUW483ST1C	350	US
06TWW680SW1C-	1145	CN
06TWW753SW1C-	1154	CN
06TWW819SW1C-	1160	CN

Note that 06T compressors needs oil contained in the oil separator
 Ordering reference : ---P-903SW220-5TTL : Totaline SW220, 5L drum,
 ---P-903SW220-20TL : Totaline SW220, 20L drum

CARRIER

Ordering references	Product description	Description
06TT-660---038--S	06TSA137 // 06TSA155 // 06TSA186	MOTOR COVER GASKET KIT
06TT-660---001--S	06TSA137 // 06TSA155 // 06TSA186	TERMINAL PIN KIT
06TT-660---002--S	06TSA137 // 06TSA155 // 06TSA186	TERMINAL PIN SEAL KIT
06TT-660---050--S	06TSA137 // 06TSA155 // 06TSA186	TERMINAL PIN GREASE KIT
06TT-660---003--S	06TSA137 // 06TSA155 // 06TSA186	SENSOR PIN KIT
06TT-660---004--S	06TSA137 // 06TSA155 // 06TSA186	PLUG KIT (STATOR LOCKING DOWEL)
06TT-660---053--S	06TSA137 // 06TSA155 // 06TSA186	MOTOR ROTOR FASTENING KIT
06TT-660---005--S	06TSA137 // 06TSA155 // 06TSA186	PRESSURE RELIEF VALVE KIT
06NA-660---021--S	06TSA137 // 06TSA155 // 06TSA186	PLUG (1/4) (7/16-20) (MOTOR CASING)
06NA-660---022--S	06TSA137 // 06TSA155 // 06TSA186	PLUG (3/8) (9/16-18) (MOTOR/OUTLET CSG)
06NA-660---023--S	06TSA137 // 06TSA155 // 06TSA186	PLUG (1-1/4) (1-5/8-12) (MOTOR CASING)
06TT-660---006--S	06TSA137 // 06TSA155 // 06TSA186	RADIAL BEARING KIT
06TT-660---007--S	06TSA137 // 06TSA155 // 06TSA186	THRUST BEARING KIT
06TT-660---008--S	06TSA137 // 06TSA155 // 06TSA186	INLET SEAL KIT
06TT-660---074--S	06TSA137 // 06TSA155 // 06TSA186	DISCHARGE SEAL KIT
06TT-660---045--S	06TSA137 // 06TSA155 // 06TSA186	DISCH. CASE TO ROTOR HSG O-RING KIT
06NA-660---019--S	06TSA137 // 06TSA155 // 06TSA186	ACCESS VALVE KIT
06TT-660---011--S	06TSA137 // 06TSA155 // 06TSA186	SLIDE VALVE PISTON ASSEMBLY KIT
06TT-660---042--S	06TSA137 // 06TSA155 // 06TSA186	SLIDE VALVE HOUSING GASKET KIT
06TT-660---077--S	06TSA137 // 06TSA155 // 06TSA186	SLIDE VALVE SHELF REPLACEMENT KIT
06TT-660---032--S	06TSA137 // 06TSA155 // 06TSA186	DISCHARGE CHECK VALVE KIT
06NA-660---011--S	06TSA137 // 06TSA155 // 06TSA186	CAPACITY CONTROL SOLENOID KIT
06TT-660---013--S	06TSA137 // 06TSA155 // 06TSA186	MOUNTING FEET KIT
06TT-660---035--S	06TSA137 // 06TSA155 // 06TSA186	COMPRESSOR REPLACEMENT KIT
06TSGZ5H04	06TSA137 // 06TSA155 // 06TSA186	MOTOR KIT FOR COMPRESSOR DIGIT 9=S & DIGIT 10 =G
06TSJZ5H04	06TSA137 // 06TSA155 // 06TSA186	MOTOR KIT FOR COMPRESSOR DIGIT 9=S & DIGIT 10 =J
06TSJZ5T04	06TSA137 // 06TSA155 // 06TSA186	MOTOR KIT FOR COMPRESSOR DIGIT 9=W & DIGIT 10 =J
06TSGZ5T04	06TSA137 // 06TSA155 // 06TSA186	MOTOR KIT FOR COMPRESSOR DIGIT 9=W & DIGIT 10 =G
06TT-660---039--S	06TTW266 // 06TTW301 // 06TTW356	MOTOR COVER GASKET KIT 06TTW USED ON ALL S/N'S WITH THE EXCEPTION OF BETWEEN 4206UNNNNN & 1207UNNNNN
06TT-660---049--S	06TTW266 // 06TTW301 // 06TTW356	MOTOR COVER GASKET KIT 06TTW USED ONLY ON S/N'S BETWEEN 4206UNNNNN & 1207UNNNNN
06TT-660---001--S	06TTW266 // 06TTW301 // 06TTW356	TERMINAL PIN KIT
06TT-660---002--S	06TTW266 // 06TTW301 // 06TTW356	TERMINAL PIN SEAL KIT
06TT-660---050--S	06TTW266 // 06TTW301 // 06TTW356	TERMINAL PIN GREASE KIT
06TT-660---046--S	06TTW266 // 06TTW301 // 06TTW356	COMPRESSOR END SERVICE KIT
06TT-660---003--S	06TTW266 // 06TTW301 // 06TTW356	SENSOR PIN KIT
06TT-660---004--S	06TTW266 // 06TTW301 // 06TTW356	PLUG KIT (STATOR LOCKING DOWEL)
06TT-660---005--S	06TTW266 // 06TTW301 // 06TTW356	PRESSURE RELIEF VALVE KIT
06NA-660---021--S	06TTW266 // 06TTW301 // 06TTW356	PLUG (1/4) (7/16-20) (MOTOR CASING)
06NA-660---022--S	06TTW266 // 06TTW301 // 06TTW356	PLUG (3/8) (9/16-18) (MOTOR/OUTLET CSG)
06NA-660---023--S	06TTW266 // 06TTW301 // 06TTW356	PLUG (1-1/4) (1-5/8-12) (MOTOR CASING)
06TT-660---054--S	06TTW266 // 06TTW301 // 06TTW356	MOTOR FASTENER KIT
06TT-660---014--S	06TTW266 // 06TTW301 // 06TTW356	RADIAL BEARING KIT

Ordering references	Product description	Description
06TT-660---015--S	06TTW266 // 06TTW301 // 06TTW356	THRUST BEARING KIT
06TT-660---016--S	06TTW266 // 06TTW301 // 06TTW356	INLET SEAL KIT
06TT-660---075--S	06TTW266 // 06TTW301 // 06TTW356	DISCHARGE SEAL KIT//DISCHARGE LIP SEALS KIT
06NA-660---019--S	06TTW266 // 06TTW301 // 06TTW356	ACCESS VALVE KIT
06TT-660---019--S	06TTW266 // 06TTW301 // 06TTW356	SLIDE VALVE PISTON ASSEMBLY KIT
06TT-660---043--S	06TTW266 // 06TTW301 // 06TTW356	SLIDE VALVE HOUSING GASKET KIT
06TT-660---033--S	06TTW266 // 06TTW301 // 06TTW356	DISCHARGE CHECK VALVE KIT
06NA-660---011--S	06TTW266 // 06TTW301 // 06TTW356	CAPACITY CONTROL SOLENOID KIT
06TT-660---029--S	06TTW266 // 06TTW301 // 06TTW356	MOUNTING FEET KIT
06TT-660---078--S	06TTW266 // 06TTW301 // 06TTW356	SLIDE VALVE SHELF REPLACEMENT KIT
06TT-660---036--S	06TTW266 // 06TTW301 // 06TTW356	COMPRESSOR REPLACEMENT KIT
06TTMZ4H04	06TTW266 // 06TTW301 // 06TTW356	MOTOR KIT FOR COMPRESSOR DIGIT 9=S & DIGIT 10 =M
06TTPZ4H04	06TTW266 // 06TTW301 // 06TTW356	MOTOR KIT FOR COMPRESSOR DIGIT 9=S & DIGIT 10 =P
06TT-660---039--S	06TTA266 // 06TTA301 // 06TTA356	MOTOR KIT FOR COMPRESSOR DIGIT 9=S & DIGIT 10 =P
06TT-660---048--S	06TTA266 // 06TTA301 // 06TTA356	MOTOR COVER GASKET KIT 06TTA USED ON ALL S/N'S WITH THE EXCEPTION OF BETWEEN 4206UNNNN & 1207UNNNNN
06TT-660---001--S	06TTA266 // 06TTA301 // 06TTA356	MOTOR COVER GASKET KIT 06TTA USED ONLY ON S/N'S BETWEEN 4206UNNNN & 1207UNNNNN
06TT-660---002--S	06TTA266 // 06TTA301 // 06TTA356	TERMINAL PIN KIT
06TT-660---050--S	06TTA266 // 06TTA301 // 06TTA356	TERMINAL PIN SEAL KIT
06TT-660---046--S	06TTA266 // 06TTA301 // 06TTA356	TERMINAL PIN GREASE KIT
06TT-660---003--S	06TTA266 // 06TTA301 // 06TTA356	COMPRESSOR END SERVICE KIT
06TT-660---004--S	06TTA266 // 06TTA301 // 06TTA356	SENSOR PIN KIT
06TT-660---005--S	06TTA266 // 06TTA301 // 06TTA356	PLUG KIT (STATOR LOCKING DOWEL)
06NA-660---021--S	06TTA266 // 06TTA301 // 06TTA356	PRESSURE RELIEF VALVE KIT
06NA-660---022--S	06TTA266 // 06TTA301 // 06TTA356	PLUG (1/4) (7/16-20) (MOTOR CASING)
06NA-660---023--S	06TTA266 // 06TTA301 // 06TTA356	PLUG (3/8) (9/16-18) (MOTOR/OUTLET CSG)
06TT-660---054--S	06TTA266 // 06TTA301 // 06TTA356	PLUG (1-1/4) (1-5/8-12) (MOTOR CASING)
06TT-660---014--S	06TTA266 // 06TTA301 // 06TTA356	MOTOR FASTENER KIT
06TT-660---015--S	06TTA266 // 06TTA301 // 06TTA356	RADIAL BEARING KIT
06TT-660---016--S	06TTA266 // 06TTA301 // 06TTA356	THRUST BEARING KIT
06TT-660---075--S	06TTA266 // 06TTA301 // 06TTA356	INLET SEAL KIT
06NA-660---019--S	06TTA266 // 06TTA301 // 06TTA356	DISCHARGE SEAL KIT//DISCHARGE LIP SEALS KIT
06TT-660---019--S	06TTA266 // 06TTA301 // 06TTA356	ACCESS VALVE KIT
06TT-660---043--S	06TTA266 // 06TTA301 // 06TTA356	SLIDE VALVE PISTON ASSEMBLY KIT
06TT-660---033--S	06TTA266 // 06TTA301 // 06TTA356	SLIDE VALVE HOUSING GASKET KIT
06NA-660---011--S	06TTA266 // 06TTA301 // 06TTA356	DISCHARGE CHECK VALVE KIT
06TT-660---029--S	06TTA266 // 06TTA301 // 06TTA356	CAPACITY CONTROL SOLENOID KIT
06TT-660---078--S	06TTA266 // 06TTA301 // 06TTA356	MOUNTING FEET KIT
06TT-660---036--S	06TTA266 // 06TTA301 // 06TTA356	SLIDE VALVE SHELF REPLACEMENT KIT
06TTSZ4H04	06TTA266 // 06TTA301 // 06TTA356	COMPRESSOR REPLACEMENT KIT
06TTPZ4H04	06TTA266 // 06TTA301 // 06TTA356	MOTOR KIT FOR COMPRESSOR DIGIT 9=S & DIGIT 10 =S
06TTPZ4T04	06TTA266 // 06TTA301 // 06TTA356	MOTOR KIT FOR COMPRESSOR DIGIT 9=S & DIGIT 10 =P
06TTSZ4T04	06TTA266 // 06TTA301 // 06TTA356	MOTOR KIT FOR COMPRESSOR DIGIT 9=W & DIGIT 10 =P

COMPRESSORS / 06T COMPRESSORS

SPARE PARTS CARRIER

Ordering references	Product description	Description
06TT-660---040--S	06TUA483 // 06TUA554	MOTOR KIT FOR COMPRESSOR DIGIT 9=W & DIGIT 10 =S
06TT-660---001--S	06TUA483 // 06TUA554	TERMINAL PIN KIT
06TT-660---002--S	06TUA483 // 06TUA554	TERMINAL PIN SEAL KIT
06TT-660---050--S	06TUA483 // 06TUA554	TERMINAL PIN GREASE KIT
06TT-660---003--S	06TUA483 // 06TUA554	SENSOR PIN KIT
06TT-660---005--S	06TUA483 // 06TUA554	PRESSURE RELIEF VALVE KIT
06NA-660---021--S	06TUA483 // 06TUA554	PLUG (1/4) (7/16-20) (MOTOR CASING)
06NA-660---022--S	06TUA483 // 06TUA554	PLUG (3/8) (9/16-18) (MOTOR/OUTLET CSG)
06NA-660---023--S	06TUA483 // 06TUA554	PLUG (1-1/4) (1-5/8-12) (MOTOR CASING)
06TT-660---004--S	06TUA483 // 06TUA554	PLUG 3/4-16
06TT-660---086--S	06TUA483 // 06TUA554	COUNTER THRUST SHIM KIT (MALE ROTOR)
06TT-660---031--S	06TUA483 // 06TUA554	RADIAL BEARING KIT
06TT-660---023--S	06TUA483 // 06TUA554	THRUST BEARING KIT
06TT-660---089--S	06TUA483 // 06TUA554	INLET SEAL KIT
06TT-660---076--S	06TUA483 // 06TUA554	DISCHARGE SEAL KIT
06TT-660---047--S	06TUA483 // 06TUA554	DISCH. CASE TO ROTOR HSG O-RING KIT
06NA-660---019--S	06TUA483 // 06TUA554	ACCESS VALVE KIT
06TT-660---027--S	06TUA483 // 06TUA554	SLIDE VALVE PISTON ASSEMBLY KIT WARNING :USE ONLY FOR COMPRESSORS MANUF. PRIOR TO S/N 2007U01767 AND PRIOR TO S/N 3707L59994.
06TT-660---057--S	06TUA483 // 06TUA554	SLIDE VALVE PISTON ASSEMBLY KIT WARNING:USE ONLY FOR COMPRESSORS MANUF. AFTER S/N 2007U01767 AND AFTER S/N 3707L59994.
06TT-660---044--S	06TUA483 // 06TUA554	SLIDE VALVE HOUSING GASKET KIT
06TT-660---079--S	06TUA483 // 06TUA554	SLIDE VALVE SHELF KIT
06TT-660---034--S	06TUA483 // 06TUA554	DISCHARGE CHECK VALVE KIT
06NA-660---011--S	06TUA483 // 06TUA554	CAPACITY CONTROL SOLENOID KIT
06TT-660---029--S	06TUA483 // 06TUA554	MOUNTING FEET KIT
06TT-660---037--S	06TUA483 // 06TUA554	COMPRESSOR REPLACEMENT KIT
06T UWZ6H04	06TUA483 // 06TUA554	MOTOR KIT FOR COMPRESSOR DIGIT 9=S & DIGIT 10 =W
06T UWZ6T04	06TUA483 // 06TUA554	MOTOR KIT FOR COMPRESSOR DIGIT 9=W & DIGIT 10 =W
06T UWZ6J04	06TUA483 // 06TUA554	MOTOR KIT FOR COMPRESSOR DIGIT 9=T & DIGIT 10 =W
06TT-660---040--S	06TUW483 // 06TUW554	MOTOR COVER GASKET KIT
06TT-660---001--S	06TUW483 // 06TUW554	TERMINAL PIN KIT
06TT-660---002--S	06TUW483 // 06TUW554	TERMINAL PIN SEAL KIT
06TT-660---050--S	06TUW483 // 06TUW554	TERMINAL PIN GREASE KIT
06TT-660---003--S	06TUW483 // 06TUW554	SENSOR PIN KIT
06TT-660---005--S	06TUW483 // 06TUW554	PRESSURE RELIEF VALVE KIT
06NA-660---021--S	06TUW483 // 06TUW554	PLUG (1/4) (7/16-20) (MOTOR CASING)
06NA-660---022--S	06TUW483 // 06TUW554	PLUG (3/8) (9/16-18) (MOTOR/OUTLET CSG)
06NA-660---023--S	06TUW483 // 06TUW554	PLUG (1-1/4) (1-5/8-12) (MOTOR CASING)
06TT-660---004--S	06TUW483 // 06TUW554	PLUG (3/4-16)
06TT-660---086--S	06TUW483 // 06TUW554	COUNTER THRUST SHIM KIT (MALE ROTOR)
06TT-660---031--S	06TUW483 // 06TUW554	RADIAL BEARING KIT
06TT-660---023--S	06TUW483 // 06TUW554	THRUST BEARING KIT
06TT-660---089--S	06TUW483 // 06TUW554	INLET SEAL KIT

Ordering references	Product description	Description
06TT-660---076--S	06TUW483 // 06TUW554	DISCHARGE SEAL KIT
06TT-660---047--S	06TUW483 // 06TUW554	DISCH. CASE TO ROTOR HSG O-RING KIT
06NA-660---019--S	06TUW483 // 06TUW554	ACCESS VALVE KIT
06TT-660---027--S	06TUW483 // 06TUW554	SLIDE VALVE PISTON ASSEMBLY KIT WARNING :USE ONLY FOR COMPRESSORS MANUF. PRIOR TO S/N 2007U01767 AND PRIOR TO S/N 3707L59994.
06TT-660---057--S	06TUW483 // 06TUW554	SLIDE VALVE PISTON ASSEMBLY KIT WARNING:USE ONLY FOR COMPRESSORS MANUF. AFTER S/N 2007U01767 AND AFTER S/N 3707L59994.
06TT-660---044--S	06TUW483 // 06TUW554	SLIDE VALVE HOUSING GASKET KIT
06TT-660---079--S	06TUW483 // 06TUW554	SLIDE VALVE SHELF KIT
06TT-660---034--S	06TUW483 // 06TUW554	DISCHARGE CHECK VALVE KIT
06NA-660---011--S	06TUW483 // 06TUW554	CAPACITY CONTROL SOLENOID KIT
06TT-660---029--S	06TUW483 // 06TUW554	MOUNTING FEET KIT
06TT-660---037--S	06TUW483 // 06TUW554	COMPRESSOR REPLACEMENT KIT
06TUTZ6H04	06TUW483 // 06TUW554	MOTOR KIT FOR COMPRESSOR DIGIT 9=S & DIGIT 10 =T
06TT-660---059--S	06TWW680 // 06TWW753 // 06TWW819	MOTOR COVER GASKET KIT
06TT-660---001--S	06TWW680 // 06TWW753 // 06TWW819	TERMINAL PIN KIT
06TT-660---002--S	06TWW680 // 06TWW753 // 06TWW819	TERMINAL PIN SEAL KIT
06TT-660---050--S	06TWW680 // 06TWW753 // 06TWW819	TERMINAL PIN GREASE KIT
06TT-660---003--S	06TWW680 // 06TWW753 // 06TWW819	SENSOR PIN KIT
06TT-660---070--S	06TWW680 // 06TWW753 // 06TWW819	PRESSURE RELIEF VALVE KIT
06NA-660---021--S	06TWW680 // 06TWW753 // 06TWW819	PLUG (1/4) (7/16-20) (MOTOR CASING)
06NA-660---022--S	06TWW680 // 06TWW753 // 06TWW819	PLUG (3/8) (9/16-18) (MOTOR/OUTLET CSG)
06NA-660---023--S	06TWW680 // 06TWW753 // 06TWW819	PLUG (1-1/4) (1-5/8-12) (MOTOR CASING)
06TT-660---004--S	06TWW680 // 06TWW753 // 06TWW819	PLUG (3/4-16)
06TT-660---086--S	06TWW680 // 06TWW753 // 06TWW819	COUNTER THRUST SHIM KIT (MALE ROTOR)
06TT-660---087--S	06TWW680 // 06TWW753 // 06TWW819	COUNTER THRUST SHIM KIT (FEMALE ROTOR)
06TT-660---031--S	06TWW680 // 06TWW753 // 06TWW819	RADIAL BEARING KIT
06TT-660---071--S	06TWW680 // 06TWW753 // 06TWW819	THRUST BEARING KIT
06TT-660---089--S	06TWW680 // 06TWW753 // 06TWW819	INLET SEAL KIT
06TT-660---076--S	06TWW680 // 06TWW753 // 06TWW819	DISCHARGE SEAL KIT
06TT-660---063--S	06TWW680 // 06TWW753 // 06TWW819	DISCH. CASE TO ROTOR HSG O-RING KIT
06NA-660---019--S	06TWW680 // 06TWW753 // 06TWW819	ACCESS VALVE KIT
06TT-660---060--S	06TWW680 // 06TWW753 // 06TWW819	SLIDE VALVE PISTON ASSEMBLY KIT
06TT-660---062--S	06TWW680 // 06TWW753 // 06TWW819	SLIDE VALVE HOUSING GASKET KIT
06TT-660---080--S	06TWW680 // 06TWW753 // 06TWW819	SLIDE VALVE SHELF KIT
06TT-660---067--S	06TWW680 // 06TWW753 // 06TWW819	DISCHARGE CHECK VALVE KIT
06NA-660---011--S	06TWW680 // 06TWW753 // 06TWW819	CAPACITY CONTROL SOLENOID KIT
06TT-660---058--S	06TWW680 // 06TWW753 // 06TWW819	COMPRESSOR REPLACEMENT KIT
06TWWZ6H04	06TWW680 // 06TWW753 // 06TWW819	MOTOR KIT FOR COMPRESSOR DIGIT 9= S & DIGIT 10 = W
06TT-660---092--S	06TVA680 // 06TVA753	MOTOR COVER GASKET KIT
06TT-660---021--S	06TVA680 // 06TVA753	TERMINAL PIN KIT
06TT-660---022--S	06TVA680 // 06TVA753	TERMINAL PIN SEAL KIT

COMPRESSORS / 06T COMPRESSORS

SPARE PARTS CARRIER

Ordering references	Product description	Description
06TT-660---050--S	06TVA680 // 06TVA753	TERMINAL PIN GREASE KIT
06TT-660---003--S	06TVA680 // 06TVA753	SENSOR PIN KIT
06TT-660---005--S	06TVA680 // 06TVA753	PRESSURE RELIEF VALVE KIT
06NA-660---021--S	06TVA680 // 06TVA753	PLUG (1/4) (7/16-20) (MOTOR CASING)
06NA-660---022--S	06TVA680 // 06TVA753	PLUG (3/8) (9/16-18) (MOTOR/OUTLET CSG)
06NA-660---023--S	06TVA680 // 06TVA753	PLUG (1-1/4) (1-5/8-12) (MOTOR CASING)
06TT-660---004--S	06TVA680 // 06TVA753	PLUG (3/4-16)
06TT-660---086--S	06TVA680 // 06TVA753	COUNTER THRUST SHIM KIT (MALE ROTOR)
06TT-660---087--S	06TVA680 // 06TVA753	COUNTER THRUST SHIM KIT (FEMALE ROTOR)
06TT-660---085--S	06TVA680 // 06TVA753	RADIAL BEARING KIT
06TT-660---071--S	06TVA680 // 06TVA753	THRUST BEARING KIT
06TT-660---089--S	06TVA680 // 06TVA753	INLET SEAL KIT
06TT-660---076--S	06TVA680 // 06TVA753	DISCHARGE SEAL KIT
06TT-660---063--S	06TVA680 // 06TVA753	DISCH. CASE TO ROTOR HSG O-RING KIT
06NA-660---019--S	06TVA680 // 06TVA753	ACCESS VALVE KIT
06TT-660---060--S	06TVA680 // 06TVA753	SLIDE VALVE PISTON ASSEMBLY KIT
06TT-660---062--S	06TVA680 // 06TVA753	SLIDE VALVE HOUSING GASKET KIT
06TT-660---091--S	06TVA680 // 06TVA753	SLIDE VALVE SHELF KIT
06TT-660---067--S	06TVA680 // 06TVA753	DISCHARGE CHECK VALVE KIT
06NA-660---011--S	06TVA680 // 06TVA753	CAPACITY CONTROL SOLENOID KIT
06TT-660---058--S	06TVA680 // 06TVA753	COMPRESSOR REPLACEMENT KIT
06TVXZ7H04	06TVA680 // 06TVA753	MOTOR KIT FOR COMPRESSOR DIGIT 9= S & DIGIT 10 = X
06TT-660---092--S	06TVA819	MOTOR COVER GASKET KIT
06TT-660---021--S	06TVA819	TERMINAL PIN KIT
06TT-660---022--S	06TVA819	TERMINAL PIN SEAL KIT
06TT-660---050--S	06TVA819	TERMINAL PIN GREASE KIT
06TT-660---003--S	06TVA819	SENSOR PIN KIT
06TT-660---005--S	06TVA819	PRESSURE RELIEF VALVE KIT
06NA-660---021--S	06TVA819	PLUG (1/4) (7/16-20) (MOTOR CASING)
06NA-660---022--S	06TVA819	PLUG (3/8) (9/16-18) (MOTOR/OUTLET CSG)
06NA-660---023--S	06TVA819	PLUG (1-1/4) (1-5/8-12) (MOTOR CASING)
06TT-660---004--S	06TVA819	PLUG (3/4-16)
06TT-660---088--S	06TVA819	COUNTER THRUST SHIM KIT (MALE ROTOR) (SIZE 819 ONLY)
06TT-660---088--S	06TVA819	COUNTER THRUST SHIM KIT (FEMALE ROTOR)(SIZE 819 ONLY)
06TT-660---073--S	06TVA819	RADIAL BEARING KIT(SIZE 819 ONLY)
06TT-660---072--S	06TVA819	THRUST BEARING KIT (SIZE 819 ONLY)
06TT-660---090--S	06TVA819	INLET SEAL KIT (SIZE 819 ONLY)
06TT-660---076--S	06TVA819	DISCHARGE SEAL KIT
06TT-660---063--S	06TVA819	DISCH. CASE TO ROTOR HSG O-RING KIT
06NA-660---019--S	06TVA819	ACCESS VALVE KIT
06TT-660---060--S	06TVA819	SLIDE VALVE PISTON ASSEMBLY KIT
06TT-660---062--S	06TVA819	SLIDE VALVE HOUSING GASKET KIT
06TT-660---091--S	06TVA819	SLIDE VALVE SHELF KIT
06TT-660---067--S	06TVA819	DISCHARGE CHECK VALVE KIT
06NA-660---011--S	06TVA819	CAPACITY CONTROL SOLENOID KIT
06TT-660---058--S	06TVA819	COMPRESSOR REPLACEMENT KIT
06TVXZ7H04	06TVA819	MOTOR KIT FOR COMPRESSOR DIGIT 9= S & DIGIT 10 = X





CARRIER

Ordering references	Product description	Suction sold connection size (inch)	Discharge sold connection size (inch)	Cylinder	Power R22 (CV)	Power R134A (CV)
-5-F--20-C-654D-S	NEWMAN	1-1/8 ODF	7/8 ODF	2	5,7	10
-5-F--20-S-674--S	NEWMAN	1-1/8 ODF	7/8 ODF	2	5,7	10
-5-F--20-S-684--S	NEWMAN	1-1/8 ODF	7/8 ODF	2	5,7	10
-5-F--20-A-684--S	REMAN					
-5-F--30-C-664D-S	NEWMAN	1-5/8 ODF	1-3/8 ODF	3	8,5	15
-5-F--30-S-644--S	NEWMAN	1-5/8 ODF	1-3/8 ODF	3	8,5	15
-5-F--30-S-664--S	NEWMAN	1-5/8 ODF	1-3/8 ODF	3	8,5	15
-5-F--30-A-219--S	REMAN	1-5/8 ODF	1-3/8 ODF	3	8,5	15
-5-F--40---909--S	NEWMAN	1-5/8 ODF	1-3/8 ODF	4	11,4	20
-5-F--40-S-219--S	NEWMAN	1-5/8 ODF	1-3/8 ODF	4	11,4	20
-5-F--40-A-219--S	REMAN	1-5/8 ODF	1-3/8 ODF	4	11,4	20
-5-F--60---909--S	NEWMAN	2-1/8 ODF	1-5/8 ODF	6	17,1	25
-5-F--60-C-149--S	NEWMAN	2-1/8 ODF	1-5/8 ODF	6	17,1	25
-5-F--60-S-219--S	NEWMAN	2-1/8 ODF	1-5/8 ODF	6	17,1	25
-5-F--60-A-219--S	REMAN	2-1/8 ODF	1-5/8 ODF	6	17,1	25
-5-H--40---909--S	NEWMAN	2-5/8 ODF	2-1/8 ODF	4	25	40
-5-H--40-S-219--S	NEWMAN	2-5/8 ODF	2-1/8 ODF	4	25	40
-5-H--40-A-219--S	REMAN	2-5/8 ODF	2-1/8 ODF	4	25	40
-5-H--46---909--C	NEWMAN	2-5/8 ODF	2-1/8 ODF	4	40	60
-5-H--46-S-219--S	NEWMAN	2-5/8 ODF	2-1/8 ODF	4	40	60
-5-H--46-A-219--S	REMAN	2-5/8 ODF	2-1/8 ODF	4	40	60
-5-H--60-C-119--S	NEWMAN	3-1/8 ODF	3-1/8 ODF	6	40	60
-5-H--60-S-219--S	NEWMAN	3-1/8 ODF	3-1/8 ODF	6	40	60
-5-H--60-A-219--S	REMAN	3-1/8 ODF	3-1/8 ODF	6	40	60
-5-H--66---404--S	NEWMAN	3-1/8 ODF	3-1/8 ODF	6	50	75
-5-H--66-S-219--S	NEWMAN	3-1/8 ODF	3-1/8 ODF	6	50	75
-5-H--66-A-219--S	REMAN	3-1/8 ODF	3-1/8 ODF	6	50	75
-5-H--80-S-219--S	NEWMAN	3-1/8 ODF	3-1/8 ODF	8	50	75
-5-H--80-A-204--S	REMAN	3-1/8 ODF	3-1/8 ODF	8	50	75
-5-H--80-A-219--S	REMAN	3-1/8 ODF	3-1/8 ODF	8	50	75
-5-H--86---404--S	NEWMAN	3-1/8 ODF	3-1/8 ODF	8	75	100
-5-H--86-S-219--S	NEWMAN	3-1/8 ODF	3-1/8 ODF	8	75	100
-5-H--86-A-219--S	REMAN	3-1/8 ODF	3-1/8 ODF	8	75	100
-5-H-120-S-219--S	NEWMAN					
-5-H-120-A-204--S	REMAN	4-1/8 ODF	4-1/8 ODF	12	81,4	125
-5-H-120-A-219--S	REMAN					
-5-H-126---404--S	NEWMAN	4-1/8 ODF	4-1/8 ODF	12	100	150
-5-H-126-S-219--S	NEWMAN					
-5-H-126-A-219--S	REMAN	4-1/8 ODF	4-1/8 ODF	12	100	150

CARRIER

Ordering references	Product description
05GA-501---762--S	OIL PLUG
05GA-502---282--S	CARBON ROTOR
05HG-660---004--S	CRANKSHAFT
05HG-660---005--S	CRANKSHAFT
05HG-660---006--S	SEAL
05HG-660---020--S	OIL FILTER
05KA-404---093-OEM	OIL PUMP DRIVE
05KA-404---093--S	OIL PUMP DRIVE
-5-D--40--1372--S	CONNECTING ROD
-5-F--20--1002--S	BEARING (MULT 4)
-5-F--20--1011--S	GASKET (MULT 12)
-5-F--20--1012--S	BEARING
-5-F--20--1022--S	BEARING
-5-F--20--1031--S	PISTON (MULT 6)
-5-F--20--1032--S	GASKET
-5-F--20---103--C	CONNECTING ROD
-5-F--20--1083--S	GASKET (MULT 50)
-5-F--20--1093--S	GASKET (MULT 12)
-5-F--20--1113--S	GASKET
-5-F--20---112--S	GUIDE
-5-F--20--1132--S	DISC (MULT 2)
-5-F--20--1142--S	DISC
-5-F--20--1301--S	WASHER (MULT 12)
-5-F--20--1311--S	ADAPTER
-5-F--20--1322--S	GUIDE
-5-F--20---132--S	STRAINER
-5-F--20--1451--S	GASKET (MULT 50)
-5-F--20---152--C	SIGHT GLASS
-5-F--20---153--S	ELEMENT
-5-F--20--1631--S	SIGHT GLASS GASKET (MULT 12)
-5-F--20--1701--S	GASKET (MULT 12)
-5-F--20--1703--S	GASKET
-5-F--20--1741--S	WASHER (MULT 6)
-5-F--20--1752--S	SLEEVE
-5-F--20--1761--S	WASHER (MULT 6)
-5-F--20--1791--S	SPRING (MULT 12)
-5-F--20--1801--S	SPRING (MULT 12)
-5-F--20--1802--S	SPRING (MULT 6)
-5-F--20--1813--S	GASKET
-5-F--20--1822--S	SPRING (MULT 6)
-5-F--20---212--C	PRESSURE SWITCH

COMPRESSORS / 5F & 5H COMPRESSORS SPARE PARTS CARRIER

Ordering references	Product description
-5-F--20--2653--S	GRID
-5-F--20--2751--S	PIN (MULT 6)
-5-F--20--2843--S	WASHER (MULT 12)
-5-F--20--3422--S	HALF BEARING (MULT 4)
-5-F--20--3432--S	BEARING (MULT 4)
-5-F--20---394--C	PULLEY
-5-F--20---481--S	RING
-5-F--20---482--S	PISTON
-5-F--20--5232--S	KEY
-5-F--20--660001S	GASKET
-5-F--20---676--S	SEAL
-5-F--20---677--S	HEAD
-5-F--20---781--S	LIQUID SIGHT GLASS
-5-F--20---847--S	COUPLING
-5-F--20---861--S	PULLEY PACKAGE
-5-F--20---891--S	PULLEY PACKAGE
-5-F--20-A-272--C	PUMP
-5-F--20-A-563--S	POWER CONTROL KIT
-5-F--20-A-752--C	UNLOADER KIT
-5-F--30--1003--S	SLEEVE
-5-F--30--1012--S	BEARING
-5-F--30---132--S	STRAINER
-5-F--30--136101S	GASKET (MULT 12)
-5-F--30--1831--S	GASKET
-5-F--30--3452--S	BEARING
-5-F--30---394--C	FLYWHEEL
-5-F--30---677--S	BEARING
-5-F--30---847--S	COUPLING
-5-F--36--1032--S	GASKET
-5-F--40--1012--S	BEARING
-5-F--40--1022--S	BEARING
-5-F--40---102--S	COVER
-5-F--40--1042--C	GASKET
-5-F--40--1083--S	GASKET (MULT 12)
-5-F--40---114--S	CRANKSHAFT
-5-F--40---120--S	VALVE PLATE
-5-F--40--1211--S	GASKET (MULT 12)
-5-F--40---132--S	STRAINER
-5-F--40---172--C	COLLECTOR
-5-F--40--1751--S	WASHER (MULT 6)
-5-F--40--1761--S	BAG OF 6 WASHERS

Ordering references	Product description
-5-F--40---237--S	GRID
-5-F--40---276--S	SEAL
-5-F--40--2783--S	SPRING (MULT 6)
-5-F--40--3442--S	BEARING
-5-F--40--3452--S	BEARING
-5-F--40--3462--S	BEARING
-5-F--40--3472--S	BEARING
-5-F--40--3742--S	CASING
-5-F--40---394--S	PULLEY
-5-F--40--4512--S	GASKET
-5-F--40---603--C	COUPLING
-5-F--40---623--C	COUPLING
-5-F--40---677--S	CYLINDER HEAD
-5-F--40---881--S	PULLEY
-5-F--40-A-164--S	COVER
-5-F--40-A-352--S	SUCTION FILTER
-5-F--41--1703--S	GASKET
-5-F--60---114--S	CRANKSHAFT
-5-F--60---132--S	SUCTION STRAINER
-5-F--60--1681--S	GASKET
-5-F--60--1831--S	GASKET (MULT 12)
-5-F--60--3792--S	BAG FELT FILTER
-5-F--60---394--C	PULLEY
-5-F--60---613--S	COUPLING
-5-F--60---623--S	COUPLING
-5-F--60--660001S	GASKET
-5-H-120--1072--C	WASHER (MULT 6)
-5-H-120--1242--C	BEARING
-5-H-120--1354--S	IMPELLER
-5-H-120--1593--S	SPRING (MULT 6)
-5-H-120--1683--S	SPRING (MULT 6)
-5-H-120---204--S	BEARING
-5-H-120--2113--S	LINE
-5-H-120--2133--S	TUBE
-5-H-120--2191--S	AXLE
-5-H-120---252--S	GRID
-5-H-120--3301--S	STRAINER
-5-H-120--3341--S	GASKET
-5-H-120--3361--S	GASKET
-5-H-120--3401--S	SEAT
-5-H-120--3411--S	DISC

COMPRESSORS / 5F & 5H COMPRESSORS SPARE PARTS CARRIER

Ordering references	Product description
-5-H-120--3441--S	GROMMET
-5-H-120--351--S	OIL FILTER
-5-H-120--3672--S	BEARING
-5-H-120--3682--S	BEARING
-5-H-120--4492--S	GASKET
-5-H-120--4552--S	FILTER
-5-H-120--4612--S	TUBE
-5-H-120--502--S	GASKET
-5-H-120--507--S	CYLINDER HEAD WATER COULING
-5-H-120--524--S	TUBE
-5-H-120--562--S	CRANKSHAFT
-5-H-120--623--C	COUPLING
-5-H-120--732AS	SEAL REPLACEMENT PACKAGE
-5-H-120--732--C	SEAL
-5-H-120--782--S	OIL REGULATOR
-5-H-120--794--S	STRAINER
-5-H-120--813--S	TUBE
-5-H-120--821--S	PULLEY
-5-H-120--837--S	OIL PUMP KIT
-5-H-120-A-773--S	PUMP
-5-H-120-B-283--S	OIL COOLER
-5-H-121--1703--S	GASKET
-5-H-126--113--S	TUBE
-5-H-126--134--S	TUBE
-5-H-126--562--S	CRANKSHAFT
-5-H--40--1002--S	DEMI-COUSSINET (MULT 4)
-5-H--40--1002S3S	BEARING (MULT 4)
-5-H--40--1003--S	SLEEVE
-5-H--40--1012--S	BEARING
-5-H--40--1022--S	BEARING
-5-H--40--102--S	COVER
-5-H--40--1031--S	BEARING
-5-H--40--1032--S	GASKET
-5-H--40--103--S	CONNECTING ROD
-5-H--40--1042--S	GASKET (MULT 12)
-5-H--40--1051--S	AXLE (MULT 6)
-5-H--40--1052--S	COVER
-5-H--40--1062--S	WASHER (MULT 6)
-5-H--40--1071--S	RING (MULT 4)
-5-H--40--1072--S	WASHER (MULT 6)
-5-H--40--1082--S	WASHER (MULT 12)

Ordering references	Product description
-5-H-40-1083-S	GASKET (MULT 30)
-5-H-40-1091-S	RING
-5-H-40-1093-S	GASKET
-5-H-40-1103-S	VALVE PLATE
-5-H-40-1113-S	GASKET (MULT 12)
-5-H-40-1121-S	NUT
-5-H-40-1132-C	DISCHARGE CHECK VALVE.
-5-H-40-1141-C	CAP
-5-H-40-1142-C	SUCTION CHECK VALVE
-5-H-40-1171-S	GASKET (MULT 12)
-5-H-40-1191-S	GASKET
-5-H-40-1201-S	LOCK WASHER
-5-H-40-1304-S	COVER
-5-H-40-1361-S	GASKET (MULT 12)
-5-H-40-1371-S	GASKET (MULT 12)
-5-H-40-1401-S	WASHER (MULT 6)
-5-H-40-1411-S	GASKET (MULT 12)
-5-H-40-1423-S	GASKET (MULT 10)
-5-H-40-1451-S	GASKET (MULT 12)
-5-H-40-1531-S	FERRULE
-5-H-40-1541-S	FERRULE
-5-H-40-1553-S	GUIDE
-5-H-40-163-S	ELEMENT
-5-H-40-1701-S	GASKET (MULT 12)
-5-H-40-1711-S	GASKET (MULT 12)
-5-H-40-1731-S	ROD
-5-H-40-1752-S	SLEEVE
-5-H-40-1782-S	PISTON
-5-H-40-1791-C	SPRING (MULT 12)
-5-H-40-1802-S	SPRING (MULT 6)
-5-H-40-1811-S	WASHER (MULT 6)
-5-H-40-1814-S	FORK
-5-H-40-1822-S	SPRING (MULT 6)
-5-H-40-1971-S	GRID
-5-H-40-2001-S	GASKET (MULT 12)
-5-H-40-2221-S	RING
-5-H-40-2231-S	AXLE (MULT 6)
-5-H-40-2241-S	SPRING (MULT 12)
-5-H-40-237-S	INTERNAL FILTER
-5-H-40-242-S	PLATE
-5-H-40-2433-S	COVER GASKET

COMPRESSORS / 5F & 5H COMPRESSORS

SPARE PARTS CARRIER

Ordering references	Product description
-5-H-40---276A-S	SEAL REPLACEMENT PACKAGE
-5-H-40---276--S	SEAL
-5-H-40--2812--S	SPRING (MULT 6)
-5-H-40---323--S	STRAINER
-5-H-40--3363--S	WASHER (MULT 6)
-5-H-40--3612--S	BEARING (MULT 4)
-5-H-40--3622--S	HALF BEARING 020" (MULT 4)
-5-H-40--3632--S	BEARING
-5-H-40--3642--S	BEARING
-5-H-40--3652--S	BEARING
-5-H-40--3662--S	BEARING
-5-H-40--3692--C	GASKET
-5-H-40---394--C	PULLEY
-5-H-40--3982--S	VALVE CAP
-5-H-40---477--S	SEAL ASSEMBLY
-5-H-40---481--S	COMPRESSION & OIL RING KIT
-5-H-40---482--S	PISTON
-5-H-40---502--S	GASKET
-5-H-40---562--S	CRANKSHAFT
-5-H-40---613--C	COUPLING
-5-H-40---677--S	PUMP
-5-H-40---703--C	COVER
-5-H-40--7322--S	SPRING (MULT 12)
-5-H-40---772--S	TUBE
-5-H-40-A-274--C	OIL FILTER
-5-H-40-A-372--S	PUMP
-5-H-40-A-564--S	CYLINDER HEAD
-5-H-40-B-283--S	OIL COOLER
-5-H-40-B-303--S	CARBON WASHER
-5-H-40-B-343--S	PUMP
-5-H-41--1019--S	HEAD
-5-H-41--1703--S	GASKET
-5-H-46--1003--S	SLEEVE
-5-H-46--1071--S	RING
-5-H-46---114--S	CRANKSHAFT
-5-H-46---481--S	RING PACKAGE
-5-H-46---482--S	PISTON
-5-H-60--1004--S	HEAD
-5-H-60--1133--S	TUBE
-5-H-60--1143--S	TUBE
-5-H-60---114--S	CRANKSHAFT

Ordering references	Product description
-5-H-60--1153--S	TUBE
-5-H-60--1163--S	TUBE
-5-H-60---132--S	STRAINER
-5-H-60--1342--S	TUBE
-5-H-60--1632--S	GASKET (MULT 12)
-5-H-60--1681--S	GASKET (MULT 12)
-5-H-60--1831--S	GASKET
-5-H-60---394--C	PULLEY
-5-H-60---4032-S	SUCTION FILTER
-5-H-60---502--S	GASKET
-5-H-60---613--C	COUPLING
-5-H-60---623--S	COUPLING
-5-H-660--005--S	ADAPTER
-5-H-660--006--S	ADAPTER
-5-H-66---562--S	CRANKSHAFT
-5-H-80--1242--C	BEARING
-5-H-80--1242S3S	BEARING
-5-H-80--1632--S	GASKET
-5-H-80--1774--S	ADAPTER
-5-H-80--1892--S	COVER
-5-H-80---204--S	BEARING
-5-H-80---323--S	STRAINER
-5-H-80--3672--S	BEARING
-5-H-80---394--C	PULLEY
-5-H-80--4962--C	GASKET
-5-H-80---502--S	GASKET
-5-H-80---507--S	WATER COOLED CYLINDER HEAD PACKAGE
-5-H-80---562--S	CRANKSHAFT
-5-H-80---613--S	COUPLING
-5-H-80---663--S	COUPLING
-5-H-80---853--S	TUBE
-5-H-81--1551--S	FERRULE
-5-H-86---562--S	CRANKSHAFT

CARRIER

Ordering references	Product description
06BA-400---012--EE	OIL PUMP
06BA-400---013EE-A	CONNECTING ROD
06BA-400---023EE-A	CONNECTING ROD
06BA-400---032--EE	SAFETY VALVE
06BA-400---033EE-A	CONNECTING ROD
06BA-400---072EE-A	FILTER
06BA-400---082EE-A	FILTER
06BA-400---232EE-B	TERMINAL PLATE ASSEMBLY
06BA-400---762--EE	CRANKSHAFT
06BA-500---001--EE	SPRING
06BA-500---011--EE	DISCHARGE CHECK VALVE.
06BA-500---012EE-A	VALVE PLATE GUIDE
06BA-500---031--EE	SUCTION CHECK VALVE
06BA-500---032--EE	PLATE
06BA-500---033EE-A	PUMP BEARING
06BA-500---042EE-A	SEAT PLATE
06BA-500---052--EE	SEAT PLATE
06BA-500---053--EE	LATERAL CYLINDER HEAD
06BA-500---073--EE	CENTRAL CYLINDER HEAD
06BA-500---081EE-A	KEY
06BA-500---082--EE	COMPRESSOR FOOT
06BA-500---091--EE	ROTOR BRAKE
06BA-500---093EE-A	BOTTOM COVER PLATE
06BA-500---101--EE	ROTOR WASHER
06BA-500---102--EE	PUMP END COVER
06BA-500---113EE-B	MOTOR END COVER
06BA-500---132EE-A	GASKET
06BA-500---142EE-A	GASKET
06BA-500---152EE-A	GASKET
06BA-500---162EE-A	CENTRAL CYLINDER HEAD GASKET
06BA-500---172EE-A	GASKET
06BA-500---181--EE	PISTON AXLE
06BA-500---182EE-A	GASKET
06BA-500---192--EE	GASKET
06BA-500---201EE-A	ROTOR KEY
06BA-500---212--EE	CLOSING PLATE
06BA-500---231--EE	WASHER
06BA-500---232EE-A	PISTON
06BA-500---242--EE	RING
06BA-500---252--EE	RING
06BA-500---261--EE	PIN
06BA-500---271--EE	PIN
06BA-500---291--EE	PIN
06BA-500---301--EE	NUT

Ordering references	Product description
06BA-500---311--EE	SCREW
06BA-500---321--EE	PIN
06BA-500---331--EE	PIN
06BA-500---341--EE	CONNECTING ROD SCREW
06BA-500---351--EE	GASKET
06BA-500---361--EE	AXLE
06BA-500---412--EE	PISTON
06BA-500---431--EE	SCREW
06BA-500---451--EE	SCREW
06BA-500---512--EE	MODULE
06BA-500---571--EE	CAP
06BA-500---591--EE	ELASTIC RING
06BA-500---601--EE	SCREW
06BA-500---612--EE	SPACER
06BA-500---622--EE	SPACER
06BA-500---641--EE	SPRING
06BA-500---661EE-A	THERMISTOR
06BA-500---722--EE	COPPER WASHER
06BA-500---872--EE	ROTOR KEY
06BA-500---972EE-C	TERMINAL BOX
06BA-500---982EE-C	TERMINAL BOX COVER
06BA-500---992EE-B	TERMINAL BOX GASKET
06BA-501---212--EE	PUMP SPRING
06BA-501---232--EE	GASKET
06BA-501---272EE-A	FILLER PLATE
06BA-501---282EE-A	FILLER PLATE
06BA-501---292--EE	TERMINAL INSULATION
06BA-501---322EE-A	CLOSING PLATE GASKET
06BA-501---332EE-A	GASKET
06BA-501---352EE-A	GASKET
06BA-501---412--EE	SCREW
06BA-501---532--EE	GASKET
06BA-501---542--EE	GASKET
06BA-501---552--EE	O-RING
06BA-501---592--EE	GASKET
06BA-501---612--EE	CENTER BEARING
06BA-660---092--EE	VALVE PLATE
06BA-660---192--EE	DISCHARGE VALVE
06BA-660---352--EE	CRANKSHAFT
06BP-450---614--EE	MOTOR
06BP-460---012--S	ROTOR
06BP-460---613--S	STATOR
06BP-460---614--EE	MOTOR
06BP-470---624--EE	MOTOR
06DA-403---844-OEM	COUPLING
06EA-500---752--EE	OIL SIGHT GLASS
06EA-501---253-OEM	GASKET

COMPRESSORS / 06B COMPRESSORS

SPARE PARTS CARRIER

Ordering references	Product description
06QA-400---521--EE	CONNECTING ROD
-6-D--40---162--C	VALVE
--AA--12AW-202--EE	SCREW
--AA--12AW-237--EE	SCREW
--AA--12AW-268--E-	SCREW
--AA--12AW-299--E-	SCREW
--AA--12AW-309--E-	SCREW
--AA--12BC-233--E-	SCREW
--AA--12BC-266--EE	SCREW
--AE--12AA-016--EE	SCREW
--AH--12AA-003--EE	WASHER
--AI--12AA-003--EE	WASHER
--AS--12CB-012--EE	NUT
--CA--63AA-051--S	CAP
--CA--64AA-001--S	CAP
--CA--64AM-225--S	PLUG
--CA--64AT-051--S	CAP
--DD--19CA-061--S	PLUG
--EM--99GA-516--C	GASKET
--EM--99GA-520--C	GASKET
--KK--71GW-015--C	OIL SIGHT GLASS O-RING
--KK--71PR-010--S	O-RING
--UD--12AA-003--EE	PLUG
--UD--12AB-002--EE	CAP 3/8" MALE





B | VALVES

VALVES / ELECTRONIC EXPANSION VALVES	64
VALVES / ELECTRONIC EXPANSION VALVES	66
VALVES / ELECTRONIC EXPANSION VALVES	67
VALVES / R22 COMPLETE THERMOSTATIC EXPANSION VALVES	68
VALVES / R134A THERMOSTATIC EXPANSION VALVES	69
VALVES / R407C THERMOSTATIC EXPANSION VALVES	70
VALVES / R22 COMPLETE THERMOSTATIC EXPANSION VALVES	71
VALVES / R134A THERMOSTATIC EXPANSION VALVES	72
VALVES / R407C COMPLETE THERMOSTATIC EXPANSION VALVES	73
VALVES / R410A THERMOSTATIC EXPANSION VALVES	74
VALVES / BALL VALVES	75
VALVES / COOLING 2 WAYS WATER VALVES	77
VALVES / 2 WAYS VALVES	78
VALVES / COOLING 3 WAYS WATER VALVES	80
VALVES / 3 WAYS VALVES	82
VALVES / COOLING WATER VALVES ACTUATOR	85
VALVES / R22 REVERSING VALVE	86
VALVES / R22 SOLENOID VALVES	87
VALVES / SAFETY RELIEF VALVES	89
VALVES / FUSES PLUGS	90
VALVES / SCREW ANGLE VALVES	91
VALVES / ACCURATORS PISTONS	92
VALVES / ACCURATORS SPARE PARTS	93

CARRIER

EXV 2



Ordering references	Product range	Frigo connection (inch)	Rated power (kW)	Input (inch)	Output (inch)	Straight	Capacity (tons)	Step
32GB-403---094--S	EXV2	SOLDER / ODE / MALE	70,34	1½/8	7/8	ANGLE, LEFT / RIGHT	20	760
32GB-403---224--S	EXV2	SOLDER / ODE / MALE	70,34	1½/8	7/8	ANGLE, LEFT / RIGHT	20	760
32GB-403---104--S	EXV2	SOLDER / ODE / MALE	105,51	1½/8	7/8	ANGLE, LEFT / RIGHT	30	760
32GB-403---234--S	EXV2	SOLDER / ODE / MALE	105,51	1½/8	7/8	ANGLE, LEFT / RIGHT	30	760
32GB-403---114--S	EXV2	SOLDER / ODE / MALE	140,67	1½/8	7/8	ANGLE, LEFT / RIGHT	40	760
32GB-403---244--S	EXV2	SOLDER / ODE / MALE	140,67	1½/8	7/8	ANGLE, LEFT / RIGHT	40	760
32GB-403---124--S	EXV2	SOLDER / ODE / MALE	175,84	1½/8	7/8	ANGLE, LEFT / RIGHT	50	760
32GB-403---254--S	EXV2	SOLDER / ODE / MALE	175,84	1½/8	7/8	ANGLE, LEFT / RIGHT	50	760
32GB-403---134--S	EXV2	SOLDER / ODE / MALE	211,01	1½/8	7/8	ANGLE, LEFT / RIGHT	60	760
32GB-403---264--S	EXV2	SOLDER / ODE / MALE	211,01	1½/8	1½/8	ANGLE, LEFT / RIGHT	60	760
32GB-403---144--S	EXV2	SOLDER / ODE / MALE	263,76	1½/8	1½/8	ANGLE, LEFT / RIGHT	75	760
32GB-403---274--S	EXV2	SOLDER / ODE / MALE	246,18	1½/8	1½/8	ANGLE, LEFT / RIGHT	75	760
32GB-403---154--S	EXV2	SOLDER / ODE / MALE	316,52	1½/8	1½/8	ANGLE, LEFT / RIGHT	90	760
32GB-403---284--S	EXV2	SOLDER / ODE / MALE	316,52	1½/8	1½/8	ANGLE, LEFT / RIGHT	90	760
32GB-403---164--S	EXV2	SOLDER / ODE / MALE	386,85	1½/8	1½/8	ANGLE, LEFT / RIGHT	110	760
32GB-403---174--S	EXV2	SOLDER / ODE / MALE	386,85	1½/8	1½/8	ANGLE, LEFT / RIGHT	110	760
32GB-403---184--S	EXV2							760
32GB-403---204--S	EXV2	SOLDER / ODE / MALE	492,36	1½/8	1½/8	ANGLE, LEFT / RIGHT		760
32GB-402---534--C	EXV2	SOLDER / ODE / MALE	70,34	1½/8	7/8	ANGLE, LEFT / RIGHT	20	1500
32GB-402---544--C	EXV2	SOLDER / ODE / MALE	105,51	1½/8	7/8	ANGLE, LEFT / RIGHT	30	1500
32GB-402---554--C	EXV2	SOLDER / ODE / MALE	140,67	1½/8	7/8	ANGLE, LEFT / RIGHT	40	1500
32GB-402---564--C	EXV2	SOLDER / ODE / MALE	175,84	1½/8	7/8	ANGLE, LEFT / RIGHT	50	1500
32GB-402---574--C	EXV2	SOLDER / ODE / MALE	175,84	1½/8	1½/8	ANGLE, LEFT / RIGHT	50	1500
32GB-402---384--C	EXV2	SOLDER / ODE / MALE	193,43	1½/8	1½/8	ANGLE, LEFT / RIGHT	55	1500
32GB-402---424--C	EXV2	SOLDER / ODE / MALE	221,01	1½/8	1½/8	ANGLE, LEFT / RIGHT	60	1500
32GB-402---584--C	EXV2	SOLDER / ODE / MALE	211,01	1½/8	1½/8	ANGLE, LEFT / RIGHT	60	1500
32GB-402---414--C	EXV2	SOLDER / ODE / MALE	228,6	1½/8	1½/8	ANGLE, LEFT / RIGHT	65	1500
32GB-402---394--C	EXV2	SOLDER / ODE / MALE	263,76	1½/8	1½/8	ANGLE, LEFT / RIGHT	75	1500
32GB-402---594--C	EXV2	SOLDER / ODE / MALE	263,76	1½/8	1½/8	ANGLE, LEFT / RIGHT	75	1500
32GB-402---604--C	EXV2	SOLDER / ODE / MALE	316,52	1½/8	1½/8	ANGLE, LEFT / RIGHT	90	1500
32GB-402---404--C	EXV2	SOLDER / ODE / MALE	351,69	1½/8	1½/8	ANGLE, LEFT / RIGHT	100	1500
32GB-402---614--C	EXV2	SOLDER / ODE / MALE	386,85	1½/8	1½/8	ANGLE, LEFT / RIGHT	110	1500
32GB-402---704--C	EXV2	SOLDER / ODE / MALE	492,36	1½/8	1½/8	ANGLE, LEFT / RIGHT	80	-
32GB-402---434--S	EXV2						-	-
32GB-402---504--S	EXV2						-	-
32GB-402---674--S	EXV2							-
32GB-402---374--C	EXV2	SOLDER / ODE / MALE	175,84	1½/8	1½/8	ANGLE, LEFT / RIGHT		
32GB-402---624--C	EXV2	SOLDER / ODE / MALE	422,02	1½/8	1½/8	ANGLE, LEFT / RIGHT		

CARRIER

EXV 3



Ordering references	Product range	Frigo connection (inch)	Rated power (kW)	Input (inch)	Output (inch)	Straight	Capacity (tons)	Step
30HZ-402---302--EE	EXV3/SG	SOLDER / ODE / MALE	70,34	1x1/8	7/8	ANGLE, LEFT / RIGHT	20	14210
32GB-403---824--S	EXV3	SOLDER / ODE / MALE	70,34	1x1/8	7/8	ANGLE, LEFT / RIGHT	20	14210
30HZ-402---322--EF	EXV3/SG	SOLDER / ODE / MALE	140,67	1x1/8	7/8	ANGLE, LEFT / RIGHT	40	14210
32GB-403---844--S	EXV3	SOLDER / ODE / MALE	140,67	1x1/8	7/8	ANGLE, LEFT / RIGHT	40	14210
30HZ-402---332--EE	EXV3/SG	SOLDER / ODE / MALE	175,84	1x1/8	7/8	ANGLE, LEFT / RIGHT	50	14210
32GB-403---854--S	EXV3	SOLDER / ODE / MALE	175,84	1x1/8	7/8	ANGLE, LEFT / RIGHT	50	-
32GB-404---424--S	EXV3	SOLDER / ODE / MALE	175,84	1x1/8	1x1/8	ANGLE, LEFT / RIGHT	50	14210
32GB-404---474--C	EXV3	SOLDER / ODE / MALE	221,01	1x1/8	1x1/8	ANGLE, LEFT / RIGHT	60	14210
32GB-404---464--C	EXV3	SOLDER / ODE / MALE	228,6	1x1/8	1x1/8	ANGLE, LEFT / RIGHT	65	14210
32GB-403---884--S	EXV3	SOLDER / ODE / MALE	263,76	1x1/8	1x1/8	ANGLE, LEFT / RIGHT	75	14210
32GB-404---234--S	EXV3						80	14210
32GB-403---894--S	EXV3	SOLDER / ODE / MALE	316,52	1x1/8	1x1/8	ANGLE, LEFT / RIGHT	90	14210
32GB-404---454--C	EXV3	SOLDER / ODE / MALE	351,69	1x1/8	1x1/8	ANGLE, LEFT / RIGHT	100	14210
32GB-403---904--S	EXV3	SOLDER / ODE / MALE	386,85	1x1/8	1x1/8	ANGLE, LEFT / RIGHT	110	14210
32GB-404---154--C	LEXV3						110	14210
32GB-404---484--C	LEXV3	SOLDER / ODE / MALE	386,85	1x5/8	1x5/8	ANGLE, LEFT / RIGHT	110	14210
30GX-434---442--EF	EXV3/SG	SOLDER / ODE / MALE	404,44	1x1/8	1x1/8	ANGLE, LEFT / RIGHT	115	14210
32GB-404---264--S	EXV3						115	14210
32GB-403---914--S	EXV3	SOLDER / ODE / MALE	422,02	1x1/8	1x1/8	ANGLE, LEFT / RIGHT	120	14210
32GB-404---164--C	LEXV3						120	14210
32GB-404---544--C	LEXV3	SOLDER / ODE / MALE	492,36	1x5/8	1x5/8	ANGLE, LEFT / RIGHT	125	14210
32GB-404---174--C	LEXV3	SOLDER / ODE / MALE	457,19	1x5/8	1x5/8	ANGLE, LEFT / RIGHT	130	14210
30GX-434---402--EF	LEXV3/SG	SOLDER / ODE / MALE		1x5/8	1x5/8	ANGLE, LEFT / RIGHT	-	14210
30GX-434---412--EE	LEXV3/SG	SOLDER / ODE / MALE		1x5/8	1x5/8	ANGLE, LEFT / RIGHT	-	14210
30GX-434---452--EF	EXV3/SG	SOLDER / ODE / MALE	439,61	1x1/8	1x1/8	ANGLE, LEFT / RIGHT	-	14210
30GX-434---462--EF	EXV3/SG	SOLDER / ODE / MALE		1x1/8	1x1/8	ANGLE, LEFT / RIGHT	-	14210
30GX-434---472--EF	EXV3/SG	SOLDER / ODE / MALE	211,01	1x1/8	1x1/8	ANGLE, LEFT / RIGHT	-	14210
30HX-415---612--EF	EXV3						-	14210
30HX-415---622--EF	LEXV3/SG	SOLDER / ODE / MALE		1x5/8	1x5/8	ANGLE, LEFT / RIGHT	-	14210
30HX-415---632--EF	EXV3/SG	SOLDER / ODE / MALE		1x1/8	1x1/8	ANGLE, LEFT / RIGHT	-	14210
30HX-415---642--EF	EXV3/SG	SOLDER / ODE / MALE		1x1/8	1x1/8	ANGLE, LEFT / RIGHT	-	14210
30HZ-402---252--EF	LEXV3						-	14210
30HZ-402---262--EF	LEXV3						-	14210
30HZ-402---312--EF	EXV3/SG	SOLDER / ODE / MALE	105,51	1x1/8	7/8	ANGLE, LEFT / RIGHT	-	14210
30HZ-402---342--EE	EXV3/SG	SOLDER / ODE / MALE	175,84	1x1/8	1x1/8	ANGLE, LEFT / RIGHT	-	14210
32GB-404---034--S	EXV3						-	-
30HZ-402---352--EE	EXV3/SG	SOLDER / ODE / MALE	263,76	1x1/8	1x1/8	ANGLE, LEFT / RIGHT		
30HZ-402---372--E	EXV3/SG	SOLDER / ODE / MALE	386,85	1x1/8	1x1/8	ANGLE, LEFT / RIGHT		
30HZ-402---382--E	EXV3/SG	SOLDER / ODE / MALE	422,02	1x1/8	1x1/8	ANGLE, LEFT / RIGHT		
32GB-403---834--S	EXV3	SOLDER / ODE / MALE	105,51	1x1/8	7/8	ANGLE, LEFT / RIGHT		
32GB-403---974--S	EXV3	SOLDER / ODE / MALE		1x1/8	1x1/8	ANGLE, 90-DEGREE		
32GB-404---494--C	LEXV3	SOLDER / ODE / MALE	439,61	1x5/8	1x5/8	ANGLE, LEFT / RIGHT		



PARKER

Ordering references	Product range	Frigo connection (inch)	Rated power (kW)	Input (inch)	Output (inch)	Refrigerant	Straight
3250165	QJE16	ODF	56,27	7/8	1×3/8	R134A	STRAIGHT
3250162	SJE5	ODF	17,58	5/8	7/8	R134A	STRAIGHT
7081844	VJE		193,43	3/8	3/8	R134A	
7054488	WJE		281,35	3/8	3/8	R134A	
7084708	WJE		281,35	5/8	1/8	R134A	
2082350	EBSVE15	ODF	53	7/8	1×1/8	R22	STRAIGHT
00PPG000460300A	ESX18A		3,5	3/8	3/8	R22 / R407C / R134A / R410A	ANGLE
00PPG000460400A	EXV 24B	ODF		3/8	1/2	R22/R407C/R134A/R410A	ANGLE
00PPG000460200A	EXV14A	ODF		3/8	3/8	R22/R407C/R134A/R410A	ANGLE
7480981	ERVE		7,03			R22/R407C	STRAIGHT
7480982	ERVE		10,6	1/2	5/8	R22/R407C	STRAIGHT
2078710	ERVE	ODF		5/8	7/8	R22/R407C	STRAIGHT
2077170	ERVE10C	ODF	35,17	5/8	7/8	R22/R407C	STRAIGHT
2082340	ERVE12	ODF	42,2	5/8	7/8	R22/R407C	STRAIGHT
2078670	ERVE12C	ODF	42,2	5/8	7/8	R22/R407C	STRAIGHT
2082300	ERVE3C	ODF	10,55	1/2	5/8	R22/R407C	STRAIGHT
2082320	ERVE5	ODF	17,58	1/2	7/8	R22/R407C	STRAIGHT
2078690	ERVE6C	ODF	21,1	1/2	7/8	R22/R407C	STRAIGHT
3250024	OVE		140,67	1×1/8	1×3/8	R22/R407C	STRAIGHT
3250025	OVE		246,18	1×1/8	1×3/8	R22/R407C	STRAIGHT
3250201	WE		351,69	1×3/8	1×3/8	R22/R407C	STRAIGHT
7298139	BBINE		10,6			R407C	
7218244	BBINE		28,1	5/8	7/8	R407C	
2078680	EBSNE15C	ODF	53	7/8	1×1/8	R407C	STRAIGHT
7102601	BBIZE		5,28	1/2	1/2	R410A	
7093914	BBIZE		7,03	1/2	1/2	R410A	
0150408H64	BBIZE		7,03	1/4	3/8	R410A	STRAIGHT
7093915	BBIZE		10,6	1/2	5/8	R410A	
7093916	BBIZE		14,1	1/2	5/8	R410A	
0150408H65	BBIZE		14,1	3/8	3/8	R410A	STRAIGHT
7093918	BBIZE		17,6	1/2	5/8	R410A	
7093919	BBIZE		21,1	5/8	7/8	R410A	
00PPG000497400A	BBIZE		24,62	5/8	7/8	R410A	STRAIGHT
7093920	BBIZE		28,1	5/8	7/8	R410A	
0150408H63	BBIZE		28,1	5/8	7/8	R410A	STRAIGHT
7096241	BBIZE		52,75	7/8	7/8	R410A	
7096242	OZE		87,92	7/8	1×1/8	R410A	STRAIGHT
7100356	OZE		123,09	1×1/8	1×3/8	R410A	STRAIGHT
OZE35GA	OZE		123,09	1×1/8	1×3/8	R410A	STRAIGHT
7155329	OZE		175,84	1×1/8	1×3/8	R410A	STRAIGHT
7150199	OZEB		87,92	7/8	1×1/8	R410A	STRAIGHT
7150200	OZEB		123,09	7/8	1×1/8	R410A	STRAIGHT
3250340	IJ		1,76	3/8	3/8		
7026721	IJ		10,55	3/8	3/8		
7026723	IJ		17,58	3/8	3/8		

DANFOSS



Ordering references	Product range	Frigo connection (inch)	Rated power (kW)	Input (inch)	Output (inch)	Straight	Capacity ou Nominal Capacity (kW)
00PPG000479300A	ETS12.5	SOLDER / ODF / ODM	70	5/8	5/8		
7312510	ETS25B	SOLDER / ODF / COPPER	144	7/8	7/8	STRAIGHT	
00PPG000481400A	ETS50	SOLDER / ODF / BI-METAL	262	7/8	7/8	STRAIGHT	
00PPG000484200A	ETS50	SOLDER / ODF / BI-METAL	262	7/8	1 1/8	STRAIGHT	
00PPG000484400A	ETS100	SOLDER / ODF / BI-METAL	488	1 1/8	1 1/8	STRAIGHT	
--EF--05BD-333--EE	ETS250	SOLDER / ODF / COPPER	874	1 3/8	1 3/8	STRAIGHT	250
--EF--05BD-391--EE	ETS50	SOLDER / ODF / BI-METAL	262	1 1/8	1 1/8	STRAIGHT	50
--EF--05BD-451--EE	ETS250	SOLDER / ODF / COPPER	874	7/8	7/8	STRAIGHT	25
00PPG000446701A	ETS250	SOLDER / ODF / COPPER	874	1 1/8	1 1/8	STRAIGHT	
00PPG000484801A	ETS250	SOLDER / ODF / COPPER	874	1 1/8	1 1/8	STRAIGHT	
00PPG000484802A	ETS400	SOLDER / ODF / COPPER	1390	1 5/8	1 5/8	STRAIGHT	
00PPG000484803A	ETS400	SOLDER / ODF / COPPER	1390	2 1/8	2 1/8	STRAIGHT	
00PPG000479400A	ETS25			7/8		STRAIGHT	

ALCO-EMERSON



Complete thermostatic expansion valve (sold connections)
Capacity R22 at + 4°C evaporating temperature with + 38°C condensing temperature

Ordering references	Product range	Frigo connection (inch)	Rated power (kW)	Input (inch)	Output (inch)	Straight	Capacity ou Nominal Capacity (kW)
--XA--12AB-005--EE	TCLE 50HW						1,9
--XA--12AB-010--EE	TCLE 100HW						3,7
--XA--12AB-501--EE	TCLE 500HW	ODF	22,2	1/2	5/8	ANGLE	22,2
--XA--12AN-001--EE	TCLE 750HW						30,4
--XA--12AB1001--EE	TCLE 1000HW						41,1
--XA--12AN-003--EE	TCLE 1000HW	ODF	41,1	5/8	7/8	ANGLE	41,1
3250345	TCLE 1200HW	ODF	47,8	5/8	7/8	ANGLE	47,8
--XA--12AB-015--EE	TJRE 14HW	ODF	58	7/8	7/8	ANGLE	58
--XA--12AB-019--EE	TJRE 18HW	ODF	74	7/8	7/8	ANGLE	74
--XA--12AB-022--E-	TERE 22HW	ODF	91	7/8	7/8	ANGLE	91
--XA--12AB-026--EE	TERE 26HW	ODF	104	7/8	7/8	ANGLE	104
--EA--09KB-561--C	TERE 35HW						143
--XA--12AB-036--EE	TERE 35HW	ODF	143	7/8	7/8	ANGLE	143
--XA--12AB-035--EE	TERE35HW	ODF	143	7/8	7/8	ANGLE	143
--XA--12AB-044--EE	TERE 45HW	ODF	174	7/8	7/8	ANGLE	174
--EA--09KB-571--C	TERE 45HW						177
--EA--09KB-581--C	TIRE 55HW						216,3
--XA--12AB-056--EE	TIRE 55HW						223
--XA--12AB-057--EE	TIRE 55HW	ODF	223	7/8	7/8	ANGLE	223
--XA--12AB-076--EE	THRE 75HW	ODF	253	7/8	7/8	ANGLE	253
--EA--09KB-595--C	THRE 75HW						295
--XA--12AB-100--EE	THRE 100HW	ODF	302	7/8	7/8	ANGLE	302
--EA--09KB-598--C	THRE 100HW						393
--XA--12AB1400--EE	TJLE 1400HW						-
--XA--12AB1800--EE	TJLE 1800HW						-

ALCO-EMERSON



Thermostatic expansion valves shipped (without body flange assy) with screws, gaskets, cage, power element and bulbe collar
 Nominal capacity (kW) R134A to + 4°C (evaporating temperature) + 38°C (condensing temperature)

Ordering references	Product range	Frigo connection (inch)	Rated power (kW)	Input (inch)	Output (inch)	Straight
--XA--12HA-002--EE	TERE 16MW	ODF	71	7/8	7/8	ANGLE
--XA--12HA-007--EE	TERE 19MW	ODF	81	7/8	7/8	ANGLE
--XA--12HA-015--EE	TERE 31MW		135			
--XA--12HA-006--EE	THRE 55MW					
--XA--12HA-016--EE	THRE 55MW		197			
--XA--12HA-017--EE	THRE 68MW		236			
--XA--12HA-004--EE	TIRE 45MW		174			
--XA--12HA-005--EE	TJRE 13MW		57			
7506120	TX7M04	ODF	22,5	5/8	7/8	STRAIGHT
7506116	TX7M05	ODF	27,5	5/8	7/8	STRAIGHT
7506119	TX7M06	ODF	45,4	7/8	1 1/8	STRAIGHT
7170217	EXL	ODF	13,7	1/4	1/4	ANGLE
7291484	EXM	ODM	23	1/4	1/4	ANGLE

ALCO-EMERSON



Thermostatic expansion valves shipped (without body flange assy) with screws, gaskets, cage, power element and bulbe collar
Nominal capacity (kW) R407C to + 4°C (evaporating temperature) + 38°C (condensing temperature)

Ordering references	Product range	Frigo connection (inch)	Rated power (kW)	Input (inch)	Output (inch)	Straight	Capacity ou Nominal Capacity (kW)
00PSP000000241A	TX7N13	ODF	28,9	1/2	5/8	STRAIGHT	
00PSP000000242A	TX7N14	ODF	36	5/8	7/8	STRAIGHT	
00PSP000000243A	TX7N15	ODF	44,1	5/8	7/8	STRAIGHT	
00PSP000000244A	TX7N16	ODF	72,7	7/8	1 1/8	STRAIGHT	
00PSP000000247A	TX7N17	ODF	89,7	7/8	1 1/8	STRAIGHT	
7506121	TX7N05	ODF	44,1	5/8	7/8	STRAIGHT	
7173293	EX5 U31	ODF	16	5/8	7/8	STRAIGHT	
7142740	EX7 I21	ODF	131	1 1/8	1 3/8	STRAIGHT	
7192503	EX8 I21	ODF	399	1 3/8	1 3/8	STRAIGHT	
--XA--12BM-060--E-	TCLE 750NW	ODF	32,9	1/2	5/8	ANGLE	32,9
--XA--12BM-070--EE	TCLE 1000NW	ODF	44,4	5/8	7/8	ANGLE	44,4
--XA--12BM-111--EE	TERE 21NW	ODF	99	7/8	7/8	ANGLE	99
--XA--12BM-121--EE	TERE 25NW	ODF	112	7/8	7/8	ANGLE	112
--XA--12BM-131--EE	TERE 35NW	ODF	155	7/8	7/8	ANGLE	155
--XA--12BM-151--EE	TIRE 52NW	ODF	241	7/8	7/8	ANGLE	241
--XA--12BM-090--EE	TJRE 14NW	ODF	62	7/8	7/8	ANGLE	62
--XA--12BM-091--EE	TJRE 14NW	ODF	62	7/8	7/8	ANGLE	62
--XA--12BM-100--EE	TJRE 17NW	ODF	80	7/8	7/8	ANGLE	80
--XA--12BM-101--EE	TJRE 17NW						80
3250331	TX3 N36	ODF	11,6	3/8	1/2	STRAIGHT	
3250332	TX3 N37	ODF	14,2	1/2	5/8	STRAIGHT	
3250333	TX3 N38	ODF	16,9	1/2	5/8	STRAIGHT	
3250311	TX3 N64	ODF	5,6	3/8	1/2	STRAIGHT	
3250315	TX3 N65	ODF	8,4	3/8	1/2	STRAIGHT	
7216158	TX3N25	ODF	8,4	3/8	1/2	STRAIGHT	
7212428	TX3N26	ODF	11,6	3/8	1/2	STRAIGHT	
3250336	TX6 N14	ODF	35,7	5/8	7/8	STRAIGHT	
00PSP000000364A	TX7N04	ODF	36	5/8	7/8	STRAIGHT	
7092606	TERE 21NW	ODF	99	7/8	7/8	ANGLE	

DANFOSS



Complete thermostatic expansion valve (sold connections)
 Evaporating range -25°C / +10°C
 Maximum working pressure 30 bar 1/4 SAE external pressure equalization

Ordering references	Product range	Frigo connection (inch)	Rated power (kW)	Input (inch)	Output (inch)	Straight	Capacity (tons)	Outlet diameter size (inch)	Inlet diameter size (inch)
--XA--12DF-010--EE	TGEX7.5	SOLDER / ODF	27	5/8	7/8	STRAIGHT	7,5	7/8 ODF	5/8 ODF
--XA--12DF-009--EE	TGEX6	SOLDER / ODF	20	1/2	5/8	STRAIGHT	5	5/8 ODF	1/2 ODF
--XA--12DF-014--EE	TGEX12	SOLDER / ODF	43	5/8	1-1/8	STRAIGHT	12	1-1/8 ODF	5/8 ODF
--XA--12DF-015--EE	TGEX18	SOLDER / ODF	63	7/8	1-1/8	STRAIGHT	-	SOLD ODF	SOLD ODF
--XA--12DF-016--EE	TGEX26	SOLDER / ODF	92	7/8	1-3/8	STRAIGHT	25	1-3/8 ODF	7/8 ODF

SPORLAN



Complete thermostatic expansion valve (sold connections)

Ordering references	Product range	Capacity ou Nominal Capacity (kW)	Connection size (inch)	Capillary length (m)
--EA--02SC-362--S	SVE5GA	17,5	5/8 - 5/8 ODF	1,5
--EA--03PC-462--S	PVE11GA	38,5	5/8 - 1-3/8 ODF	1,5
--EA--03PC-503--S	PVE16GA	56	7/8 - 1-3/8 ODF	1,5
--EA--03PC-519--S	PVE20GA	70	7/8 - 1-3/8 ODF	1,5

DANFOSS



Ordering references	Product range	Frigo connection (inch)	Rated power (kW)	Input (inch)	Output (inch)	Straight
7210858	TGEN3.1	SCREW	8	3/8	1/2	STRAIGHT
2039200	TGEN8	SOLDER / ODF	29	5/8	7/8	STRAIGHT
2039210	TGEN10	SOLDER / ODF	37	7/8	1*1/8	STRAIGHT
2039220	TGEN12	SOLDER / ODF	44	7/8	1*1/8	STRAIGHT
2039350	TGEN17	SOLDER / ODF	61	7/8	1*3/8	STRAIGHT
2039230	TGEN20	SOLDER / ODF	70	5/8	1*3/8	STRAIGHT
068Z3348	TEN2	FLARE		3/8	1/2	ANGLE

DANFOSS



Ordering references	Product range	Frigo connection (inch)	Rated power (kW)	Input (inch)	Output (inch)	Straight
7509193	TGEX11	SOLDER / ODF	38	5/8	7/8	STRAIGHT
AM036103	TGEX12	SOLDER / ODF	43	5/8	7/8	STRAIGHT
7087569	TEX2	FLARE		3/8	1/2	ANGLE
068Z3284	TEX2	FLARE / SOLDER		3/8	1/2	ANGLE
68U2236	TUAE	SOLDER / ODF		1/4	1/2	STRAIGHT
068-3360	TX12	FLARE		3/8	1/2	ANGLE
23ZZ-500---641--EE	TE20	SOLDER / ODF / ODM		7/8	1 1/8	STRAIGHT
7021842	TUBE5	SOLDER / ODF	3,8	1/4	1/2	ANGLE
7305295	TGEZ2.5	SOLDER / ODF	9	3/8	5/8	STRAIGHT
7328120	TGEZ2.5	SOLDER / ODF	9	3/8	5/8	STRAIGHT
7239599	TGEZ3.5	SOLDER / ODF	13	1/2	7/8	STRAIGHT
7368302	TGEZ3.5	SOLDER / ODF	13	1/2	7/8	STRAIGHT
7303473	TGEZ5	SOLDER / ODF	19	1/2	5/8	STRAIGHT
0150408H53	TGEZ7	SOLDER / ODF	25	5/8	7/8	STRAIGHT
7239603	TGEZ7	SOLDER / ODF	25	5/8	7/8	STRAIGHT
7300602	TGEZ7	SOLDER / ODF	25	5/8	7/8	STRAIGHT
7239602	TGEZ10	SOLDER / ODF	36	5/8	1 1/8	STRAIGHT
7300603	TGEZ10	SOLDER / ODF	36	5/8	7/8	STRAIGHT
7305297	TGEZ10	SOLDER / ODF	36	5/8	1 1/8	STRAIGHT
0150408H54	TGEZ12	SOLDER / ODF	42	5/8	7/8	STRAIGHT
068H7171	TGEZ12	SOLDER / ODF	42	5/8	1 1/8	STRAIGHT
2043320	TGEZ12	SOLDER / ODF	42	5/8	7/8	STRAIGHT
7239604	TGEZ12	SOLDER / ODF	42	5/8	1 1/8	STRAIGHT
7318741	TGEZ12	SOLDER / ODF	42	5/8	1 1/8	STRAIGHT
0150408X55	TGEZ15	SOLDER / ODF	53	5/8	1 1/8	STRAIGHT
7300604	TGEZ15	SOLDER / ODF	53	5/8	1 1/8	STRAIGHT
7239605	TGEZ15	SOLDER / ODF	53	7/8	1 1/8	STRAIGHT
33160040012	TGEZ15	SOLDER / ODF	53	7/8	1 1/8	STRAIGHT
33160040017	TGEZ15	SOLDER / ODF	53	7/8	1 1/8	STRAIGHT
7239606	TGEZ18	SOLDER / ODF	62	7/8	1 1/8	STRAIGHT
7300605	TGEZ18	SOLDER / ODF	62	7/8	1 1/8	STRAIGHT
--XA--12CA-034--EE	TGEZ24	SOLDER / ODF	84	7/8	1 3/8	STRAIGHT
7239607	TGEZ24	SOLDER / ODF	84	5/8	7/8	STRAIGHT
7300606	TGEZ24	SOLDER / ODF	84	7/8	1 3/8	STRAIGHT
2042940	TGEZ27	SOLDER / ODF	95	7/8	1 3/8	STRAIGHT
7305299	TGEZ27	SOLDER / ODF	95	7/8	1 3/8	STRAIGHT
7239608	TGEZ34	SOLDER / ODF	121	1 1/8	1 3/8	STRAIGHT
068U232600	TUAE	SOLDER / ODF		1/4	1/2	STRAIGHT

DANFOSS



Ordering references	Product range	Frigo connection (inch)	Rated power (kW)	Input (inch)	Output (inch)	Straight
0150408H57	TUBE 6	SOLDER / ODF	9	1/4	1/2	ANGLE
7314311	TGEL9N	SOLDER / ODF	32	5/8	7/8	STRAIGHT
7314290	TGEL15	SOLDER / ODF	53	7/8	7/8	STRAIGHT
33160040020	TGEL15	SOLDER / ODF	54	5/8	1»1/8	STRAIGHT
7314321	TGEL19	SOLDER / ODF	68	7/8	1»1/8	STRAIGHT
7360504	TGEL19	SOLDER / ODF	68	7/8	7/8	STRAIGHT
33160040021	TGEL19	SOLDER / ODF	68	7/8	1»1/8	STRAIGHT
067N3012	TGEL19	SOLDER / ODF	68	7/8	1»1/8	STRAIGHT
7334348	TGEL23	SOLDER / ODF	79	5/8	1»1/8	STRAIGHT
7314328	TGEL23	SOLDER / ODF	79	7/8	1»1/8	STRAIGHT
7314329	TGEL31	SOLDER / ODF	110	7/8	1»3/8	STRAIGHT
2043480	TGEL46	SOLDER / ODF	161	1»1/8	1»3/8	STRAIGHT
7383133	TGEL5/3.5	SOLDER / ODF	18	1/2	5/8	STRAIGHT
2032750	TGEL7/4.5	SOLDER / ODF	24	1/2	7/8	STRAIGHT
7360495	TGEL10/6.5	SOLDER / ODF	35	1/2	5/8	STRAIGHT
7314317	TGEL19/13	SOLDER / ODF	68	5/8	7/8	STRAIGHT
7314320	TGEL23/15	SOLDER / ODF	81	5/8	7/8	STRAIGHT

CARRIER



Ball valves
 Sold connection
 Installed in 30XA units

Ordering references	Outlet diameter size (inch)	Inlet diameter size (inch)	Curved valve
00PPG000007000	2-1/8 FEMALE	2-5/8 MALE	X
00PPG000006800C	1-1/8 FEMALE	1-1/8 FEMALE	X
00PPG000006900	1-5/8 FEMALE	1-5/8 FEMALE	X
00PPG000007100	2-5/8 FEMALE	2-5/8 MALE	X
00PPG000030401A	2-1/8 FEMALE	2-1/8 FEMALE	-
00PPG000030402A	2-5/8 FEMALE	2-5/8 FEMALE	-
00PPG000030403A	1-1/8 FEMALE	1-1/8 FEMALE	-
00PPG000030404A	7/8 FEMALE	7/8 FEMALE	-
00PPG000030405A	3-1/8 FEMALE	3-1/8 FEMALE	-
00PPG000030406A	5/8 FEMALE	5/8 FEMALE	-
--EP--71BA-233--S	5/8 FEMALE	5/8 FEMALE	-
--EP--71BA-343--EE	1-1/8 FEMALE	1-1/8 FEMALE	-
--EP--71BA-393--EE	1-3/8 FEMALE	1-3/8 FEMALE	-
--EP--71BA-463--EE	1-5/8 FEMALE	1-5/8 FEMALE	-

CASTEL



Ball valves

Ordering references	Connection size (inch)	Straight valve	Maximum working pressure (bar)
--XL--12EJ-001--EE	3/8	X	45
--XL--12EJ-003--EE	5/8	X	45
--XL--12EJ-005--EE	7/8	X	45
--XL--12EJ-008--E-	1-5/8	X	45
--XL--12EJ-009--E-	2-1/8	X	45
--XL--12EJ-010--E-	2-5/8	X	45
--XL--12EJ-012--EE	1-5/8	X	45
--XL--12QA-003--EE	1	X	45

DANFOSS



Ball valves

Ordering references	Connection size (inch)	Working temperature range (°C)	Maximum working pressure (bar)
00PPG000023501A	1 1/8 IN	-40 - 150 °C	45
00PPG000023502A	1 3/8 IN	-40 - 150 °C	45
00PPG000023503A	1 5/8 IN	-40 - 150 °C	45
00PPG000452201A	3 1/8 IN	-40 - 150 °C	45
--XL--12AJ-001--EE	1/4 IN	-55 - 100 °C	45
--XL--12AJ-003--EE	1/2 IN	-55 - 100 °C	45
--XL--12AJ-004--EE	5/8 IN	-55 - 100 °C	45

DANFOSS



Actuated ball valves and actuator (installed in 30XA units)
 Actuated ball valves shipped without actuator is
 00PPG000030900A rotation angle 90°, 24V
 Sold connections

Ordering references	Connection size (inch)	Straight valve	Maximum working pressure (bar)
00PPG000012500B	2-5/8 FEMALE	X	48
00PPG000012600B	2-1/8 FEMALE	X	48



CARRIER / WATTS

Cooling 2 ways water valves

Ordering references	WAY	PIPE	DN	KV	PN	Frigo connection (inch)	Stroke (mm)	Type connexion	Medium temperature	ΔP MAX (kPa) A 90N	Actuator type	Connection size (inch)
0150404H60	2	2	15	1,7	16	1/2	2,5	EXTERN THREADED	4 TO 110	0.8 BAR	E20C - 22C-OU 2.5MM	1/2 MALE
0150404X61	2	2	20	2,8	16	3/4	2,5	EXTERN THREADED	4 TO 110	0.7 BAR	22C OU 2.5MM	3/4
0150425H07	2	2	15	1,7	16	1/2	2,5	EXTERN THREADED	4 TO 110	0.8 BAR	22C OU 2.5MM	1/2
0150425H08	2	2	20	2,8	16	3/4	2,5	EXTERN THREADED	4 TO 110	0.7 BAR	22C OU 2.5MM	3/4
0150425H09	2	2	25	4,5	16	1	2,5	EXTERN THREADED	4 TO 110	0.6 BAR	22C OU 2.5MM	1
00PPG000502100A	2	2	20	2,8	16	3/4	2,5	EXTERN THREADED	4 TO 110	0.7 BAR	22C OU 2.5MM	
0150419H04	2	3	20		16	3/4		EXTERN THREADED				
0150102H15-	2	3	10		16	3/8		EXTERN THREADED	1 TO 200			



HONEYWELL

Ordering references	Product range	WAY	PIPE	DN	KV	PN	Frigo connection (inch)	Stroke (mm)	Type connexion	Medium temperature	ΔP MAX (KPa) A 90N	Actuator type
7177245	V50F	2	2	15	1,6	16	1/2	2,5	EXTERN THREADED	2 TO 120	300	M6410C/L - M7410C/E/A - M5410C/L - MT8/4
7306375	V2000	2	2	10	1,45	10	3/8	2,5	INTERN THREADED	-2 TO 130	100	MT / HR
5200709	V2000	2	2	10	1,7	10	3/8	2,5	INTERN THREADED	-2 TO 130	100	MT / HR
V2000DUB15	V2000	2	2	15	1,85	10	1/2	2,5	INTERN THREADED	-2 TO 130	100	MT / HR
907553	V5832	2	2	15	1,6	16	1/2	6,5	EXTERN THREADED	2 TO 120	180	MT / ME7410 - M6410C/L - M7410C/E/A - M4450/M8450 - Z100
V5832A4008	V5832	2	2	15	1,6	16	1/2	2,5	EXTERN THREADED	2 TO 120	180	MT / ME7410 - M6410C/L - M7410C/E/A - M4450/M8450 - Z100
XL12FA027EE	V5832	2	2	15	1	16	1/2	6,5	EXTERN THREADED	2 TO 120	180	MT / ME7410 - M6410C/L - M7410C/E/A - M4450/M8450 - Z100
5202235	V5832	2	2	20	2,5	16	3/4	6,5	EXTERN THREADED	2 TO 120	50	MT / ME7410 - M6410C/L - M7410C/E/A - M4450/M8450 - Z100
907554	V5832	2	2	20	4	16	3/4	6,5	EXTERN THREADED	2 TO 120	50	MT / ME7410 - M6410C/L - M7410C/E/A - M4450/M8450 - Z100
907556	V5832	2	2	25	10	16	1 1/2	6,5	EXTERN THREADED	2 TO 130	1600 KPA - 300N	M7410C/E - M6410C/L - ML74/64
907555	V5832	2	2	25	6,3	16	1 1/2	6,5	EXTERN THREADED	2 TO 130	1600 KPA - 300N	M7410C/E - M6410C/L - ML74/64
907557	V5832	2	2	32	16	16	2	6,5	EXTERN THREADED	2 TO 130	1200 KPA - 300N	M7410C/E - M6410C/L - ML74/64



HONEYWELL

Ordering references	Product range	WAY	PIPE	DN	KV	PN	Frigo connection (inch)	Stroke (mm)	Type connexion	Medium temperature	ΔP MAX (kPa) A 90N	Actuator type
XM12AH019EE	VSOE	2	2	15	1	16	1/2	2,5	EXTERN THREADED	2 TO 120	600	M6410C/L - M7410C/E/A - M5410C/L -MT8/4
7177246	VSOE	2	2	20	2,5	16	3/4	2,5	EXTERN THREADED	2 TO 120	200	M6410C/L - M7410C/E/A - M5410C/L -MT8/4
7177247	VSOE	2	2	20	4	16	3/4	2,5	EXTERN THREADED	2 TO 120	100	M6410C/L - M7410C/E/A - M5410C/L -MT8/4
907558	V5832	2	2	40	25	16	2 1/4	6,5	EXTERN THREADED	2 TO 130	1000 KPA - 300N	M7410C/E - M6410C/L - ML74/64
7343808	V9071	2	2	15	1,6	16	1/2	6,5	EXTERN THREADED	2 TO 130	16 BAR	M4450/M8450 - M7410C/E
7343807	VSMF	2	2	15	1	16	1/2	6,5	EXTERN THREADED	2 TO 120	600	M6410C/L - M7410C/E - MT8 - M5410C/L
00PPG000504900-	VSMF	2	2	20	2,5	16	3/4	6,5	EXTERN THREADED	2 TO 120	250KPA -180N	M6410C/L - M7410C/E - MT8 - M5410C/L
00PPG000505000-	VSMF	2	2	20	4	16	3/4	6,5	EXTERN THREADED	2 TO 120	50	M6410C/L - M7410C/E - MT8 - M5410C/L
--XM-12BL-003--EE	V9071	2	2	15	1	16	1/2	6,5	EXTERN THREADED	2 TO 130	16 BAR	M4450/M8450 - M7410C/E
XM12BL010EE	V9071	2	2	20	2,5	16	3/4	6,5	EXTERN THREADED	2 TO 130	16 BAR	M4450/M8450 - M7410C/E

SIEMENS

Ordering references	WAY	PIPE	DN	KV	PN	Frigo connection (inch)	Stroke (mm)	Type connexion	Medium temperature	ΔP MAX (kPa) A 90N	Actuator type
907231	2	3	15	1,6	16	3/4	5,5	EXTERN THREADED	1 TO 120	400	SAS - SQS
907330	2/3	3	25	8	16	1	8	INTERN THREADED	2 TO 130	300	AC 24V / DC 4-20MA



CARRIER

Cooling 3 ways water valves

Ordering references	Connection size (inch)
00PPG000023600B	2-1/8
00PPG000023800B	2-5/8
0150404X33	3/4 FEMALE
--XL--12AF-002--EE	3/4
--XL--12FA-035--EE	1/2 NPT - 1/2 NPT
--XL--12FA-047--EE	3/4 NPT- 3/4 NPT
--XL--12FA-049--EE	3/8 NPT- 3/8 NPT



SIEMENS

3 ways valves

Ordering references	Product range	WAY	PIPE	DN	KV	PN	Frigo connection (inch)	Stroke (mm)	Type connexion	Medium temperature	ΔP MAX (KPa) A 90N	Actuator type
907292	VXF	3	3	65	63	10		20	BRIDE	-10 TO 150	150-200-400	SAX - SKD - SKB
--XL--12FA-044--EE	VXF	3	3	50	31,5	16	3/4	20	BRIDE	-10 TO 150	300-400-400	SAX-SKD-SKB
VXF22.50-40	VXF	3	3	50	40	6		40	BRIDE	-10 TO 130	300	SAX-SKC-SKD-SKB
907261	VXG	3	3	20	6,3	16	1»1/4	5,5	EXTERN THREADED	1 TO 120	400	SAS - SQS
907262	VXG	3	3	25	10	16	1»1/2	5,5	EXTERN THREADED	1 TO 120	300	SAS - SQS
907218	VXG	3	3	40	20	16		5,5	EXTERN THREADED	1 TO 120		SSY319 - SSC(61)
907264	VXG	3	3	40	25	16	2»1/4	5,5	EXTERN THREADED	1 TO 120	100	SAS - SQS
7385430	VXG	3	3	40	25	16	2»1/4	5,5		-25 TO 150	525	SAX-SKD-SKB
42BJ570543M002-	VXP	3	3	10	1	16	1/2	2,5	EXTERN THREADED	1 TO 110		STA-SFA-SUA-SSA
31020050010	VXP	3	3	32	16	16		5,5	EXTERN THREADED	1 TO 110		SSC-SSB



WATTS

Ordering references	WAY	PIPE	DN	KV	PN	Frigo connection (inch)	Stroke (mm)	Type connexion	Medium temperature	ΔP MAX (kPa) A 90N	Actuator type	Connection size (inch)
0150404H41	3	3	20	4	16	3/4	4	ODF	4 TO 110	1.5 BAR	ETE - ETM	3/4 FEMALE
0150404H42	3	3	25	6,5	16	1	4	ODF	4 TO 110	1.5 BAR	ETE - ETM	1 FEMALE
0150404H59	3	3	20	2,8	16	3/4	2,5	EXTERN THREADED	4 TO 110	0.7 BAR	E20C -22C	3/4 MALE
0150404H97	3	3	25	4,5	16	1	2,5	EXTERN THREADED	4 TO 110	0.6 BAR	22C	1
0150404X58	3	3	15	1,7	16	1/2	2,5	EXTERN THREADED	4 TO 110	0.8 BAR	22C	1/2 MALE
0150425H23	3	4	15	1,7	16	1/2	2,5	EXTERN THREADED	4 TO 110	0.8 BAR	22C	1/2
0150425H24	3	4	20	2,8	16	3/4	2,5	EXTERN THREADED	4 TO 110	0.7 BAR	22C	3/4



HONEYWELL

Cooling 3 ways water valves

Ordering references	WAY	PIPE	DN	KV	PN	Frigo connection (inch)	Stroke (mm)	Type connexion	Medium temperature	ΔP MAX (kPa) A 90N	Actuator type	Connection size (inch)
0150404X64	3	3	15	1,6	16	1/2	2,5	EXTERN THREADED	2 TO 120	150	M4450/ M8450 - M7410C/E/A - M100/ Z100/H200	1/2
7177249	3	4	15	1,6	16	1/2	2,5	EXTERN THREADED	2 TO 120	300/200	M6410C/L - M7410C/E/A - M5410C/L -MT8/4	1/2



HONEYWELL

Cooling 3 ways water valves

Ordering references	Product range	WAY	PIPE DN	KV	PN	Frigo connection (inch)	Stroke (mm)	Type connexion	Medium temperature	ΔP MAX (kPa) A 90N	Actuator type	Connection size (inch)
V5329A1038	V5329	3	3	25	10	16	1½/4	20	BRIDE	2 TO 170	1000 - 600N	ML6420/25 - ML7420/25 - M64/7421 - MP953
7339363	V5329	3	3	50	40	16		20	BRIDE	2 TO 170	260 - 600N	ML6420/25 - ML7420/25 - M64/7421 - MP953
7170784	V5329	3	3	65	63	16	2½/2	20	BRIDE	2 TO 170	160 - 600N	ML6420/25 - ML7420/25 - M64/7421 - MP953
V5823A4017	V5823	3	3	20	2,5	16	¾	2,5	EXTERN THREADED	2 TO 120	50	M4450/M8450 - M7410C/E/A - M100/Z100/ H200
XL12FA014EE	V135	3	3	15	2,8	16	½	2	EXTERN THREADED	2 TO 120		T100R/RS
XL12FA031EE	V5833	3	3	15	0,4	16	½	6,5	EXTERN THREADED	2 TO 120	500	
XL12FA023EE	V5833	3	3	15	0,63	16	½	6,5	EXTERN THREADED	2 TO 120	500	
XL12FA024EE	V5833	3	3	15	1,6	16	½	6,5	EXTERN THREADED	2 TO 120	150	
XL12FA032EE	V5833	3	3	15	1	16	½	6,5	EXTERN THREADED	2 TO 120	150	ME7410E2026
907551	V5833	3	3	20	2,5	16	¾	6,5	EXTERN THREADED	2 TO 120	240 KPA - 180N	M6410C.L - M7410C.E
XL12FA033EE	V5833	3	3	20	2,5	16	¾	6,5	EXTERN THREADED	2 TO 120	50	M6410C.L - M7410C.E - MT4/8
907552	V5833	3	3	20	4	16	¾	6,5	EXTERN THREADED	2 TO 120	240 KPA - 180N	M6410C.L - M7410C.E
907544	V5833	3	3	25	10	16	1½/2	6,5	EXTERN THREADED	2 TO 120	600 - 300N	M7410C/E - M6410C/L - ML74/64
907543	V5833	3	3	25	6,3	16	1½/2	6,5	EXTERN THREADED	2 TO 120	600 - 300N	M7410C/E - M6410C/L - ML74/64
907545	V5833	3	3	32	16	16	2	6,5	EXTERN THREADED	2 TO 120	300 - 300N	M7410C/E - M6410C/L - ML74/64



HONEYWELL

Cooling 3 ways water valves

Ordering references	Product range	WAY	PPE	DN	KV	PN	Frigo connection (inch)	Stroke (mm)	Type connexion	Medium temperature	ΔP MAX (KPa) A 90N	Actuator type	Connection size (inch)
907546	V5833	3	3	40	25	16	2»1/4	6,5	EXTERN THREADED	2 TO 120	1000 KPA - 400N	M7410C/E - M6410C/L - ML74/64	
000136-	VCZ	3	3	25	6,8	16	1	10	EXTERN THREADED	1 TO 95	414	VC	
0150404H89	V5823	3	4	15	1,6	16	1/2	2,5	EXTERN THREADED	2 TO 120	150	M4450/M8450 - M7410C/E/A - M100/Z100/H200	1/2 MALE
0150404H90	V5823	3	4	20	2,5	16	1»1/8	2,5	EXTERN THREADED	2 TO 120	50	M4450/M8450 - M7410C/E/A - M100/Z100/H200	3/4 MALE
--XL--12CA-014--EE	V5833	3	4	15	1	16	1/2	6,5	EXTERN THREADED	2 TO 120	150	ME7410E2026	
V5833C4011	V5833	3	4	20	2,5	16	3/4	2,5	EXTERN THREADED	2 TO 120	50	ME7410E2026	
7387318	V5833	3	4	20	4	16	3/4	6,5	EXTERN THREADED	2 TO 120	240 - 180N	ME7410E2026	
7343813	VSMF	3	4	15	1,6	16	1/2	6,5	EXTERN THREADED	2 TO 120	300	M6410C/L - M7410C/E - MT8 - M5410C/L	
7343812	VSMF	3	4	15	1	16	1/2	6,5	EXTERN THREADED	2 TO 120	600	M6410C/L - M7410C/E - MT8 - M5410C/L	
00PPG000505300-	VSMF	3	4	20	2,5	16	3/4	6,5	EXTERN THREADED	2 TO 120	150	M6410C/L - M7410C/E - MT8 - M5410C/L	
00PPG000505400-	VSMF	3	4	20	4	16	3/4	6,5	EXTERN THREADED	2 TO 120	50	M6410C/L - M7410C/E - MT8 - M5410C/L	
7177250	VSOE	3	4	20	2,5	16	3/4	2,5	EXTERN THREADED	2 TO 120	200	M6410C/L - M7410C/E/A - M5410C/L - MT8/4	

WATTS INDUSTRIES



Ordering references	Product range	WAY	PIPE	DN	KV	PN	Frigo connection (inch)	Stroke (mm)	Type connexion	Medium temperature	ΔP MAX (KPa) A 90N	Actuator type	Connection size (inch)
0150404H76		3	3	10	2,5	16	3/4		EXTERN THREADED				
0150404H75	3131	3	3	15	1,7	16	1/2	2,5	EXTERN THREADED	4 TO 110	0.8 BAR	E20C -22C	
0100104H28	V3BM	3	3		6	16	3/4	4		1 TO 110	1.5 BAR	M400 - M800 - ETE	
0100104H30	V3BM	3	3		6	16	3/4	4		1 TO 110	1.5 BAR	M400 - M800 - ETE	
0150425H25	3131	3	4	25		16	1	2,5	EXTERN THREADED	4 TO 110		22C	
0150404H93	4131	3	4	15	1,7	16	1/2	2,5	EXTERN THREADED	4 TO 110	0.8 BAR	22C	
00PPG000502200A	4131	3	4	20	2,8	16	3/4	2,5	EXTERN THREADED	4 TO 110	0.7 BAR	22C	
0150404H94	4131	3	4	20	2,8	16	3/4	2,5	EXTERN THREADED	4 TO 110	0.7 BAR	22C	
0150404H98	VU311	3	4	25		16	1	4	ODF	4 TO 110	1.5 BAR	ETE - ETM	
0150404H40	VU04	3	4	15		16	1/2	4	ODM	4 TO 110	2 BAR	ETE - ETM	1/2 MALE
0150404H91	4131	3	4	15	1,7	16	1/2	2,5	EXTERN THREADED	4 TO 110	0.8 BAR	22C	1/2 MALE
0150404H92	4131	3	4	20	2,8	16	3/4	2,5	EXTERN THREADED	4 TO 110	0.7 BAR	22C	3/4 MALE
0150404X32	VU04	3	4	15		16	1/2	4	ODM	4 TO 110	2 BAR	ETE - ETM	1/2 MALE

CARRIER



Cooling water valves actuator

Ordering references	Product range
0150404H62	-
0150404H43	ÉTÉ 220
0150404H63	M4450A



CARRIER

4 ways valves (installed in 30RQ) shipped without coil
24V, 50Hz coil code is 00PPG000018800A, model
VHV-01AB522AI, 7W

Ordering references	Product range
00PPG000017400B	VHV3003
7283149	VHV-4002
7283150	VHV-5002
00PPG000550800A	VHV-6001

RANCO & INVENSYS



4 ways valves shipped without coil
Please contact us for the coil references
R22 reversing valve

Ordering references	Product range	Capacity (tons)	Capacity ou Nominal Capacity (kW)	Suction sold connection size (mm)
7089566	V12-4220T0200	-	46,78	35,13
--EF--17BG-247--S	L30	5,5	19	3/4
--XL--12CA-003--EE	LB6	9,5	33	1-1/8
--XL--12CA-004--EE	V10-318140-100	20	70	1-3/8
--XL--12CA-010--EE	LB6	NC	180	2-5/8

SIEMENS

Ordering references	WAY	PIPE	DN	KV	PN	Frigo connection (inch)	Stroke (mm)	Type connexion	Medium temperature	Actuator type
42EL570082M-	4	3	10	1,6	16	1/2	2,5	EXTERN THREADED	1 TO 110	STA-SFA-SUA-SSA
42EL570042M	4	3	10	1	16	1/2	2,5	EXTERN THREADED	1 TO 110	STA-SFA-SUA-SSA

DANFOSS



Solenoid Valves

Shipped with 220V 50Hz coil (AMP connectors)

You can also adapt these 2 coils :

-XM-12YA-010-EE = 220V, 10W coil

-XM-12ZN-017-EE = 24V, 10W coil

Ordering references	Product range	Piping diameter size (inch)	Fluid working temperature (°C)
00PPG000008502A	EVRH25S	1/8	-40 / +105
00PPG000008504A	EVRH40	1-5/8	-40 / +105
00PPG000008507A	EVR6	3/8	- 40 / + 105
00PPG000008508A	EVRH10	1/2	- 40 / + 105
00PPG000018200A	EVR15	5/8	-
00PPG000445600A	EVRH25	1-1/8	-40 / +105
00PPG000467400A	EVR2	1/4	-40 / +105
00PPG000472701A	EVR10	5/8	-40 / +105
032F1172	EVR15	5/8	-
032F1188	EVR10	1/2	-
032F1189	EVR25	1 1/8	-
032F1190	EVR25	1 1/8	-
032F8072	EVR15	3/8	- 40 / + 105
032F8107	EVR3	1/4	- 40 / + 105
--XM--12AE-008--EE	S4A	1	-
--XM--12AE-009--EE	S4A	1 1/4	-
--XM--12BE-009--EE	EVR10	1/2	-40 / +105
--XM--12BE-010--EE	EVR15	5/8	-40 / +105
--XM--12BE-012--EE	EVR20	7/8	- 40 / + 105
--XM--12BE-016--E-	EVR25	1-1/8	-40 / +105
--XM--12BE-029--EE	EVR10	16 MM	- 40 / + 105
--XM--12BH-002--EE	EVR3	1/4	- 40 + 105
--XM--12BH-003--EE	EVR6	3/8	- 40 + 105
--XM--12BH-006--EE	EVR15	7/8	- 40 + 105
--XM--12BH-007--EE	EVR20	7/8	- 40 + 105
--XM--12BH-008--EE	EVR20	1-1/8	- 40 + 105
--XM--12BH-010--EE	EVR25	1-3/8	- 40 + 105
--XM--12FB-011--EE	EVR32	35 MM	- 40 / + 105
--XM--12FB-012--EE	EVR20	7/8 X 7/8	- 40 / + 105
--XM--12FB-013--E-	EVR40	1-5/8	- 40 / + 105

ALCO



Solenoid Valves

Shipped with 220V 50Hz coil and connector, IP65 protection

You can also adapt these 3 coils :

-XM-12CY-024-EE = 24V coil

-XM12ZA-115-EE = 115V coil

-XM-12ZA-230-EE / 801064 = 230V coil

Ordering references	Product range	Piping diameter size (inch)	Seating diameter (inch)
801162	240RA9T7T	7/8 ODF	1/2
801163	240RA12T7T	7/8 ODF	9/16
--XM--12AH-012--EE	200RB4T3	3/8 ODF	-
--XM--12EB-331--EE	240RA16T9T	7/8 ODF	3/4

CARRIER

Suction valves

R22, R134A, R407C and R410A applications (exceptions below)

Maximum working pressure = 20 bar

Maximum working temperature -40°C / 70°C

Ordering references	Refrigerant	Size (inch)
00PSG000472500A	R134A R22 R407C R410A	4
00PSG000870300A	R134A R22 R407C R410A R404A	5
00PSG001283400A	R134A R22 R407C R410A	6
00PSG001423100A	R134A R22 R407C R410A	4

CARRIER

Safety relief valves



Ordering references	Release pressure (bar)	Inlet/Outlet diameter (inch)
00PPG000030800A	23	3/8 NPT / 1/2 SAE
00PPG000030801A	34	3/8 NPT / 1/2 SAE
00PPG000030804A	21	3/8 NPT / 1/2 SAE
3030/44C/160	16	1/2 NPT / 3/4 G
3030/44C/210	21	1/2 NPT / 3/4 G
3030/44C/245	24,5	1/2 NPT / 3/4 G
3030/44C/340	34	1/2 NPT / 3/4 G
3030/66C/150	15	3/4 NPT / 3/4 G
3030/66C/170	17	3/4 NPT / 3/4 G
3030/66C/185	18,5	3/4 NPT / 3/4 G
3030/66C/245	24,5	3/4 NPT / 3/4 G
3030/66C/280	28	3/4 NPT / 3/4 G
3030/88C/245	24,5	1 NPT / 1,1/4 G
3060/34C/320	32	3/8 NPT / 1/2 SAE
3060/45C/165	16,5	1/2 NPT / 5/8 SAE
3060/45C/280	28	1/2 NPT / 5/8 SAE
3060/46C/245	24,5	1/2 NPT / 3/4 G
3060/46C/250	25	1/2 NPT / 3/4 G
3060/46C/300	30	1/2 NPT / 3/4 G
--UM--12AP-013--EE	12,5	1 NPT / 1,1/4 G
--UM--12AQ-014--E-	14	1/2 NPT / 5/8 SAE
--UM--12AQ-019--EE	19	1/2 NPT / 5/8 SAE
--UM--12AQ-020--EE	20	1/2 NPT / 5/8 SAE
--UM--12AQ-021--EE	21	1/2 NPT / 5/8 SAE
--UM--12AQ-023--EE	23	1/2 NPT / 5/8 SAE
--UM--12AQ-025--EE	25	1/2 NPT / 5/8 SAE
--UM--12AQ-030--EE	30	1/2 NPT / 5/8 SAE
--UM--12AQ-032--EE	32	1/2 NPT / 5/8 SAE
--UM--12AQ-045--EE	45	1/2 NPT / 5/8 SAE
--UM--12AQ-047--EE	47	1/2 NPT / 5/8 SAE
--UM--12AQ-185--EE	18,5	1/2 NPT / 5/8 SAE
--UM--12LA-040--E-	12,5	1/2 NPT
--UM--12LA-047--EE	12,2	1 MPT / 1 FPT



CARRIER

Fuses plugs

Ordering references	Connection size (inch)
--EK--02JA-203--C	1/16 NPT
--EK--02KK-105--C	1/4 NPT
--EK--41JK-101--C	1/4 -1/4 NPT/FLARE
00PPG000472200A	3/8 NPT
--EP--12BH-211--S	5/8
--XL--12AL-002--EE	7/8
--XL--12AL-003--EE	1-1/8
--XL--12AL-004--EE	1-3/8
--XL--12AL-005--EE	1-5/8
--XL--12AU-051--EE	1-1/4 ROTALOCK

CASTEL



Screw angle valves
 R22, R134A and R407C applications
 Maximum working pressure = 30 bar
 Internal working temperature -20°C to +100°C
 Ambient working temperature -20°C to +50°C

Ordering references	Connection size (inch)
--XL--12AA-001--EE	1/4 - 1/4
--XL--12AA-002--EE	1/4 - 3/8
--XL--12AA-003--EE	3/8 - 1/4
--XL--12AA-004--EE	3/8 - 3/8
--XL--12AA-007--EE	1/4 - 1/4
--XL--12AA-008--EE	1/2 - 1/2
--XL--12AA-009--EE	5/8 - 1/2

CARRIER



Sold and screw angle valves
 R22, R134A and R407C applications
 Maximum working pressure = 30 bar
 Internal working temperature -20°C to +100°C
 Ambient working temperature -20°C to +50°C

Ordering references	Connection size (inch)
--XL--12AU-045--EE	1-1/4 ROTALOCK
--XL--12AU-046--EE	1-1/4 ROTALOCK - 7/8 ODF
--XL--12AU-047--EE	1-3/4 ROTALOCK - 1-1/8 ODF
--XL--12AU-048--EE	1-3/4 ROTALOCK - 1-3/8 ODF
--XL--12AU-049--EE	1-3/4 ROTALOCK - 1-5/8 ODF
--XL--12AU-050--EE	1-1/4 ROTALOCK

CARRIER

Brass piston



Ordering references	Internal orifice diameter size (mm)
--EA--52PH-040--S	1.016
--EA--52PH-042--S	1.066
--EA--52PH-046--S	1.191
--EA--52PH-049--S	1.249
--EA--52PH-052--S	1.321
--EA--52PH-055--S	1.397
--EA--52PH-061--S	1.549
--EA--52PH-063--S	1.613
--EA--52PH-065--S	1.651
--EA--52PH-067--S	1.702
--EA--52PH-070--S	1.778
--EA--52PH-073--S	1.854
--EA--52PH-076--S	1.93
--EA--52PH-078--S	1.983
--EA--52PH-080--S	2.05
--EA--52PH-084--S	2.149
--EA--52PH-086--S	2.184
--EA--52PH-088--S	2.25
--EA--52PH-090--S	2.298
--EA--52PH-093--S	2.382

CARRIER



Accurators can replace capillary expansion organ
 Brass body, retainer and piston
 3/8 flare body connection

Ordering references	Description
99CC-501---052--S	PISTON ACCURATOR GASKET
99CC-502---363--S	SINGLE ACCURATOR BODY
99CC-502---443--S	DOUBLE ACCURATOR BODY
--AU--35QA-272--S	RETAINER
--KH--11HH-066--S	ACCURATOR SCREEN
--UA--12AA-002--EE	SHORT NUT 3/8 E036N

ALCO

Accurators pistons
 BRASS BODY FLANGES

Ordering references	Product range	Outlet diameter size (inch)	Inlet diameter size (inch)
--EA--09GB-005--C	-	7/8 ODF	1-1/8 ODM 7/8 ODF
--EA--09GB-008--C	-	7/8 ODF	1-1/8 ODM 7/8 ODF
--XA--12AI-001--EE	9152-PCN 803 286	7/8 ODF	1-1/8 ODM 7/8 ODF
--XA--12FA-002--EE	-	5/8 ODF	7/8 ODM
--XA--12FA-003--EE	I0332-PCN 803 324	7/8 ODF	1-1/8 ODM 7/8 ODF
--XA--12FA-004--EE	I0331-PCN 803 338	7/8 ODF	1-1/8 ODM 7/8 ODF



C | MOTORS

MOTORS / ABB	96
MOTORS / LEROY SOMER	97
MOTORS / WEG	98
MOTORS / LEROY SOMER	99
MOTORS / REGAL MANUFACTURING & ZIEHL-ABEGG	100
MOTORS / GENERAL ELECTRIC	101
MOTORS / CARRIER	102
MOTORS / WELLING	103
MOTORS / SISME	104
FAN PROPELLER / CARRIER	106
FAN PROPELLER / FABRESSE	107
CAPS / CARRIER	108
FAN MOTORS	109
FAN ASSEMBLY	111

ABB

Motors IE3



Ordering references	Number of poles	Speed (rpm)	Rated power (kW)	Voltage (V)	Axis height (mm)	Sensor type	Tropicalized	Speed (rpm)	Rated power (kW)	Frequency (Hz)
7404007	4	1500	3	230/400	100	PTO	NOT	1500/1800	3	50/60
7403965	4	1500	11	400/690	160	PTC	NOT	1500/1800	11	50/60
7404012	4	1500	15	400/690	160	PTO	NOT	1500/1800	15	50/60
7403969	4	1500	30	400/690	200	PTC	NOT	1500/1800	30	50/60
7206356	4/8	1500	0,75	400	80	B	PTO	1500/750	0,75	50/60

LEROY SOMER

Motors IE3



Ordering references	Number of poles	Speed (rpm)	Rated power (kW)	Voltage (V)	Axis height (mm)	Builder index	Sensor type	Tropicalized	Speed (rpm)	Rated power (kW)	Frequency (Hz)
99MT0150AC-550EIE3	2	3000	1,5	230/400	90	L	PTO		3000/3600	1,5	50
99MT0075AC-550DIE3	2	3000	0,75	230/400	80	L	PTO	NOT	3000/3600	0,75	50
99MT0220AC-550EIE3	2	3000	2,2	230/400	90	LU	PTO	NOT	3000/3614	2,2	50
99MT1500AD-540IE3	2	3000	15	230/400	160	M	PTO	NOT	3000/3636	15	50
7511267	2	3000	5,5	230/400	132	SM	PTO	YES	3000/3626	5,5	50
7521657	2	3000	1,5	230/400	90	L			3000/3610	1,5	50
552858	2	3000	2,2	230/400	90	L	PTO		3000/3616	2,2	50
99MT1850BD-550JIE3	4	1500	18,5	400/690	180	M	PTO		1500/1800	18,5	50
99MT0170BC-550FIE3	4	1500	1,5	230/400	90	LU	PTO	NOT	1500/1800	1,5	50
99MT0075BC-550DIE3	4	1500	0,75	230/400	80	LG	PTO	NOT	1500/1800	0,75	50
99MT0220BC-550FIE3	4	1500	2,2	230/400	100	LR	PTO	NOT	1500/1800	2,2	50
99MT0300BC-550-FEE	4	1500	3	230/400	100	LG	PTO	NOT	1500/1800	3	50
99MT0750BD-550HIE3	4	1500	7,5	230/400	132	MU	PTO	NOT	1500/1800	7,5	50
99MT1100BD-550IE3	4	1500	11	230/400	160	M	PTO	NOT	1500/1800	11	50
99MT1500BD-550IE3	4	1500	15	230/400	160	LUR	PTO	NOT	1500/1800	15	50
99MT3000BD-550KIE3	4	1500	30	230/400	200	LU	PTO	NOT	1500/1800	30	50
99MT3700BD-550-LEE	4	1500	37	400/690	225	SR	PTO	NOT	1500/1800	37	50
00PSP000000370A	4	1500	3	230/400	100	LG			1500/1800	3	50

WEG

Motors IE3



Ordering references	Number of poles	Speed (rpm)	Rated power (kW)	Voltage (V)	Axis height (mm)	Builder index	Tropicalized	Speed (rpm)	Rated power (kW)	Frequency (Hz)
2079740-IE3	4	1500	0,75	230/400	80		NOT	1500/1800	0,75	50
2091890	4	1500	1,1	230/400	90	S	YES	1500/1800	1,1	50
2079730-IE3	4	1500	1,1	230/400	90	S	YES	1500/1800	1,1	50
2092100	4	1500	1,5	230/400	90	SL	YES	1500/1800	1,5	50
2079720-IE3	4	1500	1,5	230/400	90	L	YES	1500/1800	1,5	50
2079710-IE3	4	1500	2,2	230/400	100	L	YES	1500/1800	2,2	50
2092120	4	1500	3	230/400	100	L	YES	1500/1800	3	50
2079700-IE3	4	1500	3	230/400	100	L	YES	1500/1800	3	50
2079690-IE3	4	1500	4	230/400	112	M	YES	1500/1800	4	50
2079680-IE3	4	1500	5,5	400/690	132	S	YES	1500/1800	5,5	50
2092140	4	1500	5,5	400/690	132	S	YES	1500/1800	5,5	50
7511931	4	1500	7,5	400/690	132	M	YES	1500/1800	7,5	50/60
2079550	4	1500	11	400/690	160	M	YES	1500/1800	11	50/60
2079520	4	1500	22	400/690	180	L	YES	1500/1800	22	50

LEROY SOMER



Ordering references	Number of poles	Speed (rpm)	Rated power (kW)	Voltage (V)	Axis height (mm)	Builder index	Tropicalized	Speed (rpm)	Rated power (kW)	Frequency (Hz)	Capacity (W)
00PPG000478400B	6	1000	1,4	400	57		NOT	1000/1200	1,4	50	
--DK--12AB-006--EE	6	1000	1,8	230/400	100		NOT	1000/1200	1,8	50	
--DK--12AB-021--EE	6	1000	1	380/400	100	T	NOT	1000/1200	1	50/60	
--DK--12AB-028--E-	6	1000	1,8	400	101	T	NOT	1000/1200	1,8	50	
--DK--12AB-055--EE	6	1000	1,8	400	100	T	NOT	1000/1200	1,8	50	
--DK--12AB-036--E-	6/12	1000	1,8	230	100		NOT	1000/500	1,8	50	
--DK--12AB-050--E-	6/12	1000	1,8	400	100	T	NOT	1000/500	1,8	50	
00PPG000478500B	8	750	0,58	400	57		NOT	750/900	0,58	50	
--DK--12AB-005EE-1	8	750	0,75	230/400	100		NOT	750/900	0,75	50	
--DK--12AB-009--EE	8	750	0,75	400	100		NOT	750/900	0,75	50	
--DK--12AB-010--EE	8	750	0,75	230	100		NOT	750/900	0,75	50	
--DK--12AB-033--E-	8/10/12	750	0,9	400	100	GT	NOT	750/600/300	0,9	50	
--DK--12AB-044--EE	8	750	0,75	400	100	T	NOT	750/900	0,75	50	
--DK--12AB-047--EE	8	750	0,75	400	101	T	NOT	750/900	0,75	50	
--DK--12AB-052--EE		820									400/3/50
--DK--12AB-056--EE	8	750	0,75	400	100	T	NOT	750/900	0,75	50	

Ordering references	Number of poles	Speed (rpm)	Rated power (kW)	Voltage (V)	Axis height (mm)	Builder index	Sensor type	Tropicalized	Speed (rpm)	Rated power (kW)	Frequency (Hz)
4917115	2	3000	1,1	230/400	80				3000/3606	1,1	50
1763686	2	3000	0,55	230/400	71	L	PTO		3000/3600	0,55	50
99MT0037BC-550-CEE	4	1500	0,37	230/400	71	M	PTO	NOT	1500/1800	0,37	50
99MT0055BC-550-CEE	4	1500	0,55	230/400	71	L	PTO	NOT	1500/1800	0,55	50
552081	4	1500	0,37	230/400	71	L	PTO		1500/1800	0,37	50
99MT0037MC-550-CEE	4/8	1500	0,55	230/400	71	M	PTO	NOT	1500/750	0,55	50
99MT0110MC-550-EEE	4/8	1500	1,1	230/400	90	S	PTO	NOT	1500/750	1,1	50
99MT0220MC-550-FEE	4/8	1500	2,2	230/400	100	L	PTO	NOT	1500/750	2,2	50
99MT0300MC-550-FEE	4/8	1500	3	400	100	L	PTO	NOT	1500/750	3	50
99MT0550MC-550-HEE	4/8	1500	5,5	230/400	132	SM	PTO	NOT	1500/750	5,5	50
00PPZ000004000A	6	1000	1,4	380	57			NOT	1000/1200	1,4	50
00PPG000494700B	6	1000	1,4	400	57			NOT	1000/1200	1,4	50
00PPG000480800B	6	1000	2,4	400	57			NOT	1000/1200	2,4	60

REGAL MANUFACTURING

Ordering references	Number of poles	Speed (rpm)	Rated power (kW)	Voltage (V)	Axis height (mm)	Builder index	Tropicalized	Speed (rpm)	Rated power (kW)	Frequency (Hz)
--DK--12AB-051--EE	6	1000	1,8	400	101	LR	NOT	1000/1200	1,8	50
--DK--12AB-053--EE	8	750	0,82	400	101	LH	NOT	750/900	0,82	50

Ordering references	Speed (rpm)	Voltage (V)	Capacity (W)
00PPG000464700A	1137	360-440	2300
00PPG000464600A	1000	400	
00PPG000464500A	750	400	

ZIEHL-ABEGG

Ordering references	Number of poles	Speed (rpm)	Rated power (kW)	Voltage (V)	Axis height (mm)	Tropicalized	Speed (rpm)	Rated power (kW)	Frequency (Hz)
--DK--12AB-024--EE	6	1000	0,47	230/400	58	NOT	1000/1200	0,47	50
00PSG002076000A C025664H01-R									

GENERAL ELECTRIC

Electric motors



Ordering references	Speed (rpm)	Voltage (V)	Motor power (W)	Rotation (facing air discharge)
--HF--27CA-033--S	-	120V /50-60HZ	26	-
--HC--41AE-192--S	950	208-230/1/50	-	CCW
--HC--39CA-228--S	1075	230/1/60	-	CCW
--HC--43AE-232--S	1100	230/1/60	NC	CW
--HC--43VL-232--S	925	230/1/60	-	CCW
--HC--37ME-720--S	1350/2	230/3/50	149	REVERSIBLE
--HC--37VE-651--S	900/2	230/3/50	124	CW
--HC--39ME-236--S	1350/2	230/3/50	186	CCW
--HC--39ML-704--S	1350/2	230/3/50	186	CCW
--HC--39ML-717--C	1350	230/3/50	186	CCW
--HC--42GL-208--S	960	230/3/50	248	CCW
--HC--42ME-232--C	900	230/3/50	248	CCW
--HC--42SE-232--C	900	230/3/50	248	CW
--HC--44ME-701--C	900	230/3/50	373	CCW
--HC--44VE-232--C	875	230/3/50	373	CCW
--HC--46VL-703--S	925	230/3/50	560	CCW
--HC--52TE-231--C	900	230/3/50	747	CCW
--HD--46VE-202--C	950	230/3/50	560	REVERSIBLE
--HC--45AE-195--S	925	400/1/50	NC	CCW
--HC--43TL-400--S	1100	400/3/50	373	CCW
--HD--46VE-206--C	950	400/3/50	560	REVERSIBLE
--HD--52AK-653--S	950	400/3/50	747	REVERSIBLE
--HD--52AK-652--S	1140	430-460-575/3/60	NC	REVERSIBLE
--HC--40GE-462--S	1100	460/1/50	-	CW
--HC--43VL-460--S	1075	460/1/60	-	CCW
HC42AR231				

CARRIER

Ordering references	Number of poles	Speed (rpm)	Rated power (kW)	Voltage (V)	Axis height (mm)	Tropicalized	Speed (rpm)	Rated power (kW)	Frequency (Hz)	Power (W)	Intensity (A)	AXE
00PPG000007202A	6	1000	2,3	460	57	NOT	1000/1200	2,3	60			
B034947H01	6	1000		140					50	43	0,53	1
B035774H01	6	1000		140					50	43	0,53	1
B036870H01	6	1050		280					50	97	0,77	1
B036428H02-	6	880		230					50	155	0,7	1
C024073H01	6	950		140					50	50	0,45	1
D021790H01-	6	1030		230					50	118	0,54	2
00PPG000007208A	8	750	0,98	460	57	NOT	750/900	0,98	60			
00PPG000007209A	8	750	0,98	575	57	NOT	750/900	0,98	60			
B031691H01	8	750		230					50/60	23	0,1	1
B033057H01	8	850		149					50	40	0,475	1
B035055H01	8	805		140					50	63	0,58	1
B035775H01	8	805		140					50	63	0,58	1
D021789H01-	8	830		230					50	55	0,25	2
C025838H02	10	630		230					50/60	58	0,85	1
C025820H05	12	470		230					50/60	88	0,47	1

WELLING

Ordering references	Number of poles	Speed (rpm)	Voltage (V)	Frequency (HZ)	Capacity (W)	Motor power (W)	Rotation (facing air discharge)	Power (W)	Intensity (A)	AXE
B034447H01	4	1370	230	50		450	OW	550	2,43	2
D021709H01	8	830	230	50	20			55	0,25	2
B034456H01	4	1000	230	50		115	OW	115	1,1	2
D021710H01	6	1030	230	50	53			118	0,54	2
B034508H01	4	895	230	50				80	0,85	2
B034510H01	4	1180	230	50		290	OW	290	2,1	2
D021563H02	4	1330	230	50/60				164	0,71	2
D021793H01-	4	1330	230	50				164	0,71	2
B035767H01	8	780	230	50				125	0,56	1
B032774H01	6	860	230	50	42			100	0,49	1
B036428H01	6	880	230	50				155	0,7	1
B03RCD08H01	6	895	230	50				170,89	0,743	2
D021561H01	6	910	230	50/60				56	0,27	1
D021562H01	6	920	230	50/60				68	0,31	2
C025820H03	6	930	230	50/60				98,9	0,43	1
B034RCD6H01	6	1000	230	50				223	0,988	2
D021563H01	6	1040	230	50/60				108	0,48	2
B032776H01	6	1050	230	50	84			185	0,82	1
B035865H01	6	1050	230	50				140,3	0,61	1
D021561H02	6	1070	230	50/60				68	0,31	1
D021791H01-	6	1070	230	50				68	0,31	1
D021562H02	6	1080	230	50/60				94,3	0,41	2
D021792H01-	6	1080	230	50				94,3	0,41	2
B03RCD10H01	6	1180	230	50				460	2,02	2
B033097H01	6	1200	230	50				245	1,1	1
B033098H01	6	1200	230	50				245	1,1	1
D021708H01	8	730	230	50				35	0,15	1
D021788H01-	8	730	230	50				35	0,15	1
C025820H02	8	770	230	50/60				57,5	0,25	1
C025820H07	10	570	230	50/60				123	0,62	1
C025820H06	10	630	230	50/60				190	0,85	1
C025820H01	10	670	230	50/60				58	0,27	1
C025820H04	12	380	230	50/60				66	0,31	1

SISME



Ordering references	Number of poles	Speed (rpm)	Voltage (V)	Frecuence (HZ)	Power (W)	Intensity (A)	AXE
C023215H02	4	1420	230	50	27	0,11	1
C023215H01	4	1280	230	50	35	0,17	1
C022977H02	4	1390	230	50/60	55	0,23	1
B033701H07	4	1290	230	50/60	74,5	0,324	1
C023379H02	6	880	230	50/60	85	0,35	1
C023379H04	6	900	230	50/60	120	0,6	1
B033701H04	6	910	230	50/60	34,4	0,153	1
B031251H04	6	930	230	50/60	33	0,15	1
C025838H01	6	930	230	50/60	34	0,44	1
C025143H01	6	990	230	60	120	0,55	1
B033701H02	6	1000	230	50/60	24,9	0,111	1
C024465H13	6	1020	230	60	91	0,4	1
C022853X01	6	1065	230	50/60	31	0,13	1
B036771H01	6	1070	230	50/60	27,6	0,12	1
B037519H01-	6	1070	230	50/60	27,6	0,12	1
B036772H01	6	1070	230	50	34,5	0,15	1
B037534H01	6	1070	230	50	34,5	0,15	1
C023703H02	6	1070	230	50	24,15	0,105	1
C023215H04	6	1100	230	50	14	0,073	1
B033701H05	6	1120	230	50/60	36,1	0,164	1
C022977H01	6	1110	230	50/60	45	0,19	1
C023703H01	6	1140	230	50	24,38	0,106	1
B031251H06	6	1160	230	50/60	63	0,28	1
B033701H06	6	1215	230	50/60	65,3	0,287	1
B031251H07	6	1250	230	50/60	72	0,31	1
C023215H03	6	1250	230	50	25	0,1	1
B031251H01	8	720	230	50/60	22	0,1	1
C023379H01	8	760	230	50/60	59,8	0,26	1
C024465H01	8	760	230	50	59,8	0,26	1
B031251H03	8	780	230	50/60	28	0,14	1
C024465H02	8	830	230	50	55,2	0,24	1
B033836H01	8	860	230	50	101	0,49	1

SISME



Ordering references	Number of poles	Speed (rpm)	Voltage (V)	Frequence (HZ)	Power (W)	Intensity (A)	AXE
C023449H10	8	700	230	60	223	1,05	1
C023449H09	8	800	230	50	242	1,08	1
C023449H11	8	780	230	60	254	1,2	1
D021711H01	8	730	230	50	15	0,15	1
D021794H01	8	730	230	50	15	0,15	1
D021712H01	8	830	230	50	30	0,27	2
C023617H07	10	550	230	50/60	125	0,48	1
C023449H08	10	670	230	50	170	0,78	1
C025144H03	10	670	230	60	210	0,95	1
B031251H02	12	540	230	50/60	27	0,12	1
C023449H06	12	440	230	50/60	93	0,42	1
C025144H01	12	450	230	60	110	0,5	1
C023449H07	12	510	230	50/60	112,7	0,49	1

SISME

CW: Clockwise
CCW: anticlockwise

Ordering references	Speed (rpm)	Voltage (V)	Rotation (facing air discharge)
0352015X29	620/720	220/240 - 50HZ/60HZ	CCW
0352015X43	-	220/240 - 50HZ/60HZ	-
0352015X58	620/720	220/240 - 50HZ/60HZ	CW
0352015X59	750	220/240 - 50HZ/60HZ	CW
0352015X69	1100	220/240 - 60HZ	CCW
0352015X74	-	220/240 - 50HZ/60HZ	-

CARRIER



Flying Bird fan propellers

CW : Clockwise

CCW : Anticlockwise

Ordering references	Rotation (facing air discharge)	Blades	Bore (mm)
30GH-426---892--EE1	CW	15	19
00PSG000000100A	CW	9	23
30GX-415---402--EE	CCW	11	19

CARRIER



Fan propellers

CW : Clockwise

CCW : Anticlockwise

Ordering references	Rotation (facing air discharge)	Blades	Bore (mm)
--LA--01LA-035--C	CW	3	12,7
--LA--04AA-330--S	CW	3	15,8
--LA--04PA-301--C	CW	3	15,8
--LA--01AB-200--S	CCW	4	12,7
--LA--01AB-201--S	CW	4	12,7
--LA--01AA-023--S	CW	4	12,7
--LA--01AA-025--S	CW	4	12,7
--LA--01AD-028--S	CW	4	15,8
--LA--01LA-024--C	CCW	3	12,7
--LA--01AD-032--S	CW	4	15,8
--LA--01AD-039--S	CW	4	12,7
--LA--01EW-032--C	CW	4	15,8
--LA--04AA-299--C	CW	4	15,8
--LA--01AB-026--S	CCW	4	12,7
--LA--01EA-030--C	CW	6	15,75

FABRESSE



Fan propellers
 CW : Clockwise
 CCW : Anticlockwise

Ordering references	Rotation (facing air discharge)	Blades	Bore (mm)
--LA--12AA-007--EE	CW	4	15,8
--LA--12AA-008--EE	CW	6	15,8
--LA--12LA-002--EE	CW	3	12,7
--LA--12LA-003--EE	CW	3	15,8
--LA--12LA-016--EE	CW	3	16
--LA--01LA-030--C	CW	3	15,8
--LA--12AA-001--EE	CW	3	15,8
--LA--12AA-004--EE	CW	3	12,7
--LA--12AA-006--EE	CW	6	15,8

CARRIER

Caps



Ordering references	Total ext diameter (mm)	Bore (inch)
30GH-522---152--EE	300	-
00PSG000000200B	309,4	-
---P-251--0058--S	89	1/2
---P-251--0051--S	160	1-2
---P-251--0056--S	190	1-2
---P-251--0059--S	89	1/8
---P-251--0052--S	185	1/8

NICOTRA

Fan motors



Ordering references	Motor power (W)	Working temperature (°C)
C024321H01	72	-20 / +40
C024318H01	36	-20 / +40

EBM

Fan motors

CW : Clockwise

CCW : Anticlockwise

Ordering references	Rotation (facing air discharge)	Working temperature on 50Hz (°C)
42BJ574045MA	CCW	60 MAX
--DB--12DB-001--EE	CCW	50 MAX
42EM504122MB	CW	60 MAX
42GR500134M	CW	55 MAX
42GR505152M	CW	60 MAX



EMI

Fan motors

Ordering references	Motor power (W)	Working temperature on 50Hz (°C)
42EM500252M	48	32
42EM500262M	47	32
42EM503192M-	47	32
42EL500022M	47	32
42EL500302M	35	32
42EL500532M	140	32
42EL500032M	113	32
42EM505159MA		
00PSP000000248A		
00PSP000000249A		
00PSP000000250A		
42EM505191M-		
42EM505192MA		
42EM505272M		
4137.1251		
4137.1284		

WELLING

Fan motors

CW : Clockwise

CCW : Anticlockwise

Ordering references	Number of poles	Voltage (V)	Frequency (HZ)	Speed	Motor power (W)	Rotation (facing air discharge)	Intensity (A)	AXE
B034447H01	4	230	50	4	450	CW	2,43	2
B034456H01	4	230	50	4	115	CW	1,1	2
B034510H01	4	230	50	4	290	CW	2,1	2

FLAKT WOODS

This parts include motor, attachment, fan housing and fan propeller

CW : Clockwise

CCW : Anticlockwise

Ambient working temperature -20°C to +60°C

Ordering references	Motor power (W)	Rotation (facing air discharge)	Working temperature on 50Hz (°C)
--NB--12DC-002--E-	900/120	CCW	-20°C / +60°C
--NB--12DC-003--E-	1580 / 23	CCW	-20°C / +60°C
--NB--12DC-004--E-	2730 / 340	CCW	-20°C / +60°C



SIEMENS

This parts include motor, attachment, fan housing and fan propeller

CW : Clockwise

CCW : Anticlockwise

Ambient working temperature -20°C to +60°C

Ordering references	Motor power (W)	Rotation (facing air discharge)	Working temperature (°C)
--NB--12DD-001--E-	150/700	CW	-20°C / +70°C
--NB--12DD-002--E-	220 / 1000	CW	-20°C / +70°C



D | HYDRAULIC

HYDRAULIC / SINGLE PUMP & DOUBLE PUMP	114
HYDRAULIC / DOUBLE PUMP	118
HYDRAULIC / HYDRAULIC COLLARS	119
HYDRAULIC / FLOW SWITCH & HYDRAULIC VALVES	121
HYDRAULIC / BRASS TAP VALVES & EXPANSION TANK & WATER FILTERS	122
HYDRAULIC / FLEXIBLES	123
HYDRAULIC / PLATE EXCHANGERS	124



WILO

Winding class F
IP54 protection
Tropicalization: HR90%
Wired by DIN plugs

Ordering Reference	Unit CARRIER (CARRIER ONLY)	Power (kW)	Motor Kit	Wheel kit	Kit garniture mécanique	Kit joint
30RA-506---572--EH	30 RA / RH / RY / RW / RWA	0,75				
30RA-506---582--EH	30 RA / RH / RY / RW / RWA	1,5				
30RA-506---602--EH	30 RA / RH / RY / RW / RWA	2,2				
30RA-507---142--EH	30 RA / RH / RY / RW / RWA	1,1				
30RA-507---152--EH	30 RA / RH / RY / RW / RWA	1,1				
30RA-511---552--EH	30 RA / RH / RY / RW / RWA	5,5	2188078	2178954	4064020	2143761
30RW-500---012--EH	30 RA / RH / RY / RW / RWA	2,2				
30RW-505---432--EH	30 RA / RH / RY / RW / RWA	15	2191180	2145372	4064020	2143761
30RA-500---612--EF	30 RA / RH / RY / RYH			2164069	4064020	2143761
30RW-500---032--EE						
30RW-500---022--EE						
30RY-500---002--EE						



WILO

Winding class F
IP54 protection
Tropicalization: HR90%
Wired by DIN plugs

Ordering Reference	Unit CARRIER (CARRIER ONLY)	Power (kW)	Motor Kit	Wheel kit	Kit garniture mécanique	Kit joint
30RA-506---712--EG	30 RA / RH / RY / RW / RWA	13	2192742	2164070	4064020	2143761
30RA-509---372--EB	30 RA / RH / RY / RW / RWA	14	2192717	2164063	4064020	2143761
30RA-511---562--EH	30 RA / RH / RY / RW / RWA	5,5	2188078	2178954	4064020	2143761
30RA-500---652--EF				2164069	4064020	2143761
30RW-500---052--EH	30 RA / RH / RY / RW / RWA	5,5	2191182	2143578	2138980	2132657
30RW-505---442--EH	30 RA / RH / RY / RW / RWA	2,2	2192742	2164070	4064020	2143761
30RW-505---452--EH	30 RA / RH / RY / RW / RWA	4	2191180	2145372	4064020	2143761



WILO

Pump repair kits references

Ordering Reference	Unit CARRIER (CARRIER ONLY)	Power (kW)	Motor Kit	Wheel kit	Kit garniture mécanique	Kit joint
00PPG000004000F	30 RB / RQ / XA / XAS	4	2191169	2143563	122097593	2046358
00PPG000031100F	30 RB / RQ / XA / XAS	2,2	2191165	2143564	122097593	2046358
00PPG000031200F	30 RB / RQ / XA / XAS	3	2191173	2196693	122097593	2046358
00PPG000031300F	30 RB / RQ / XA / XAS	4	2191169	2164056	122097593	2046358
00PPG000031400F	30 RB / RQ / XA / XAS	5,5	2191176	2037891	2026902	2037527
00PPG000031500F	30 RB / RQ / XA / XAS	4	2191174	2116680	2026901	2037527
00PPG000031600F	30 RB / RQ / XA / XAS	5,5	2191179	2037291	2026902	2043160
00PPG000031700F	30 RB / RQ / XA / XAS	7,5	2157978	2155752	2026902	2043160
00PPG000031800F	30 RB / RQ / XA / XAS	11	2157980	2155753	2026902	2043160
00PPG000529000A	30 RB / RQ / XA / XAS		2175897	2143897	122097593	2046358
00PPG000529100A	30 RB / RQ / XA / XAS		2175899	2175894	122097593	2046358
00PPG000529200A	30 RB / RQ / XA / XAS		2175899	2164054	122097593	2046358
00PSZ000280200B		3	2192717	2164063	4064020	2143761



WILO

Pump repair kits references

Ordering Reference	Unit CARRIER (CARRIER ONLY)	Power (kW)	Motor Kit	Wheel kit	Kit garniture mécanique	Kit joint
00PPG000005100F	30 RB / RQ / XA / XAS	2,2	2191165	2143564	122097593	2046358
00PPG000005200F	30 RB / RQ / XA / XAS	3	2191173	2196693	122097593	2046358
00PPG000005300F	30 RB / RQ / XA / XAS	4	2191169	2143563	122097593	2046358
00PPG000005600F	30 RB / RQ / XA / XAS	4	2191174	2116680	2026901	2037527
00PPG000005800F	30 RB / RQ / XA / XAS	5,5	2191179	2037291	2026902	2043160
00PPG000032000F	30 RB / RQ / XA / XAS	2,2	2191165	2143564	122097593	2046358
00PPG000032100F	30 RB / RQ / XA / XAS	3	2191173	2196693	122097593	2046358
00PPG000032200F	30 RB / RQ / XA / XAS	4	2191169	2164056	122097593	2046358
00PPG000032300F	30 RB / RQ / XA / XAS	5,5	2191176	2037891	2026902	2037527
00PPG000032400F	30 RB / RQ / XA / XAS	4	2191174	2116680	2026901	2037527
00PPG000032500F	30 RB / RQ / XA / XAS	5,5	2191179	2037291	2026902	2043160
00PPG000032600F	30 RB / RQ / XA / XAS	7,5	2157978	2155752	2026902	2043160
00PPG000032700F	30 RB / RQ / XA / XAS	11	2157980	2155753	2026902	2043160
00PPG000529300A	30 RB / RQ / XA / XAS		2175899	2175894	122097593	2046358
00PPG000529400A	30 RB / RQ / XA / XAS		2175901	2175895	122097593	2046358
00PSG002797900A	30 RB / RQ / XA / XAS	7,5	2158013	2037295	2026902	2037527
00PSG002828600A	30 RB / RQ / XA / XAS	5,5		2157912	2026902	2037527
00PSG002828700A	30 RB / RQ / XA / XAS	11		2193931	2026902	2043160
00PSG002828800A	30 RB / RQ / XA / XAS	11		2106156	2026903	2043160
00PSG002828900A	30 RB / RQ / XA / XAS	15	2139548	2196694	2026903	2043160
--DM--12CA-002--EE						
--DM--12CA-004--EE						
--DM--12CA-003-IE3		0,75				
--DM--12CA-005--EE						
--DM--12CA-006--EE						
--DM--12CA-007--EE						

XYLEM

Pump repair kits references



Ordering Reference	Motor Kit	Wheek kit	Mecanical seal	Seal disk
00PPG000494800A	00PSP000000104A	KL04ABG	KL01AF0	160150201
00PPG000494900A	00PSP000000171A	KL04ABK	KL01AF0	150150041
00PPG000495000A	00PSP000000172A	KL04ABU	KL01AF0	160150221
00PPG000495100A	00PSP000000173A	KL04ABV	KL01AF0	150150051
00PPG000495200A	00PSP000000170A	KL04ABS	KL01AF0	160150221
00PPG000495300A	00PSP000000166A	KL04AB4	KL01AF0	160150221
00PPG000495400A	00PSP000000171A	KL04AC8	KL01AF0	160150221
00PPG000495500A	00PSP000000172A	KL04AB2	KL01AF0	160150221
00PPG000495600A	00PSP000000173A	KL04AB3	KL01AF0	160150221
00PPG000507900A	00PSP000000170A	KL04AMR	KL01AF2	160150201
00PPG000508000A	00PSP000000171A	KL04AQQ	KL01AF2	160150201
00PPG000508100A	00PSP000000172A	KL04AQR	KL01AF2	160150201
00PPG000508200A	00PSP000000170A	KL04AQS	KL01AF2	160150221
00PPG000508300A	00PSP000000171A	KL04AQS	KL01AF2	160150221
00PPG000508400A	00PSP000000173A	KL04AQT	KL01AF2	160150221
00PPG000508500A	00PSP000000174A	KL04AQV	KL01AF2	150150051
00PPG000508600A	00PSP000000172A	KL04QW	KL01AF2	150150280
00PPG000508700A	00PSP000000175A	KL04AQX	KL01AF8	150150081
00PPG000508800A	00PSP000000166A	KL04AQY	KL01AF8	150150081



XYLEM

Pump repair kits references

Ordering references	Motior kit	Wheel kit	Mecanical seal	Seal disk
00PPG000495700A	00PSP000000171A	KL04ABK	KL01AF0	150150041
00PPG000495800A	00PSP000000170A	KL04ABH	KL01AF0	160150201
00PPG000495900A	00PSP000000104A	KL04ABG	KL01AF0	160150201
00PPG000496000A	00PSP000000170A	KL04ABS	KL01AF0	160150221
00PPG000496100A	00PSP000000171A	KL04ABT	KL01AF0	160150221
00PPG000496200A	00PSP000000172A	KL04ABU	KL01AF0	160150221
00PPG000496300A	00PSP000000173A	KL04ABV	KL01AF0	160150221
00PPG000496400A	00PSP000000171A	KL04AC8	KL01AF0	160150221
00PPG000496500A	00PSP000000172A	KL04AB2	KL01AF0	160150221
00PPG000494500A	00PSP000000166A	KL04AB4	KL01AF0	160150221
00PPG000537900A	00PSP000000104A	KL04AMQ	KL01AF2	160150201
00PPG000538000A	00PSP000000170A	KL04AMR	KL01AF2	160150201
00PPG000538200A	00PSP000000171A	KL04AMT	KL01AF2	160150201
00PPG000538300A	00PSP000000172A	KL04AQZ	KL01AF2	160150201
00PPG000509300A	00PSP000000170A		KL01AF2	160150221
00PPG000538100A	00PSP000000171A	KL04AMS	KL01AF2	160150201
00PPG000509400A	00PSP000000171A	KL04AM7	KL01AF2	160150221
00PPG000509500A	00PSP000000172A	KL04AM8	KL01AF2	160150221
00PPG000509600A	00PSP000000173A	KL04AM9	KL01AF2	160150221
00PPG000509700A	00PSP000000166A	KL04ANA	KL01AF2	160150221
00PPG000509800A	00PSP000000172A	KL04AQW	KL01AF2	150150280
00PPG000509900A	00PSP000000175A	KL04AQX	KL01AF8	150150280
00PPG000510000A	00PSP000000166A	KL04AQY	KL01AF8	150150081

VICTAULIC

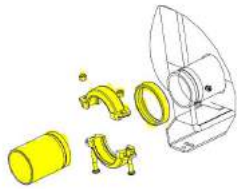

Victaulic Kit
 For Cooler or Condenser
 For dimensional drawing please contact us

Ordering references	Type	Size (mm)	Connection size (inch)
00PSG000119601A	VICTAULIC CONNECTING SLEEVE TO BE WELDED	150	4
00PSG000119602A	VICTAULIC CONNECTING SLEEVE TO BE WELDED	150	5
00PSG000119603A	VICTAULIC CONNECTING SLEEVE TO BE WELDED	150	6
00PSG000119604A	VICTAULIC CONNECTING SLEEVE TO BE WELDED	150	3
00PSG000596300A	VICTAULIC CONNECTING SLEEVE TO BE WELDED	150	6» + 8
00PSG001271800A	VICTAULIC CONNECTION SLEEVE	150	2»-1/2
00PSG001278900A	COOLER OR CONDENSER VICTAULIC TO FLANGE WATER CONNECTIONS	150	10
00PSG001279000A	VICTAULIC CONNECTING SLEEVE TO BE WELDED	150	10
30HX-900---032--E-	COOLER OR CONDENSER VICTAULIC TO FLANGE WATER CONNECTIONS	150	4
30HX-900---042--E-	COOLER OR CONDENSER VICTAULIC TO FLANGE WATER CONNECTIONS	150	5
30HX-900---052--E-	COOLER OR CONDENSER VICTAULIC TO FLANGE WATER CONNECTIONS	150	6
30HX-900---062--E-	COOLER OR CONDENSER VICTAULIC TO FLANGE WATER CONNECTIONS	150	8
30HX-900---102--E-	VICTAULIC CONNECTING SLEEVE TO BE WELDED	150	8
VICT150-1-1/2-SCR	VICTAULIC TO SCREWED CONNECTIONS	150	1»-1/2
VICT150-1-1/2-WEL	VICTAULIC CONNECTING SLEEVE TO BE WELDED	150	2
VICT150-2-----SCR	VICTAULIC TO SCREWED CONNECTIONS	150	2
VICT150-2-----WEL	VICTAULIC CONNECTING SLEEVE TO BE WELDED	150	2
VICT300-1-1/2-SCR	VICTAULIC TO SCREWED CONNECTIONS	300	1»-1/2
VICT300-1-1/2-WEL	VICTAULIC CONNECTING SLEEVE TO BE WELDED	300	1»-1/2
VICT300-1-1/4-SCR	VICTAULIC TO SCREWED CONNECTIONS	300	1»-1/4
VICT300-2-----SCR	VICTAULIC TO SCREWED CONNECTIONS	300	2
VICT300-2-----WEL	VICTAULIC CONNECTING SLEEVE TO BE WELDED	300	2

VICTAULIC



Hydraulic collars

ST75 Collars

Coating galvanized/painted

Bolting Geomet/Electrogalvanized

Standard EPDM gasket for water or FS-V (Neopren) Flusheal for use on application

For dimensional drawing please contact us

Ordering references	Total external diameter (mm)	Maximum working pressure (bar)	Connection size (inch)
00PPG000469501A	273	55	10
--BA--12LA-001--EE	48,3	34,5	1(1/2)
--BA--12LA-002--EE	60,3	34,5	2
--BA--12LA-003--EE	42,2	34,5	1(1/4)
--BA--12LA-004--EE	76,1	34,5	3
--BA--12LA-005--EE	88,9	34,5	3
--BA--12LA-006--EE	114,3	34,5	4
--BA--12LA-007--EE	141,3	31	5
--BA--12LA-008--EE	168,3	31	6
--BA--12LA-009--EE	219,1	31	8

FLOW SWITCH



Ordering references	Nominal pressure (bar)	Connection size (inch)	Piping diameter size (inch)	Adjustment margin with increasing flow (liters/hour)	Adjustment margin with decreasing flow (L/H)	Maximum working temperature (°C)	Opening point
00PPG000030500A	25	1/2 NPT		-	-	60	24V
00PPG000471400A	10		1-1/4 - 1-1/2	650-800 / 850-1200	600-900 / 850-1200	100	220V/1A - 26VA
00PPG000472900A	30	1/4 NPT MALE		-	-	80	24V
0170701H13	10	3/4 FEMALE LEFT	DN32	-	910	100	220V/1A - 26VA
0170701H14	10	3/4 FEMALE LEFT	DN20	-	420	100	220V/1A - 26VA
0170701H15	10	3/4 FEMALE LEFT	DN20	-	180	100	220V/1A - 26VA
--CY--12WA-001--EE	25	3/4 FEMALE LEFT	1	990-1280	950-1220	110	220V/1A - 26VA
--CY--12WA-003--E-	25	3/4 FEMALE LEFT	1	1590-2070	1530-1950	110	220V/1A - 26VA
--CY--12WA-005--EE	25	3/4 FEMALE LEFT	2	3500-4900	3300-4500	110	220V/1A - 26VA
--CY--12WA-007--EE	10	3/4 FEMALE LEFT	FROM 2 TO 3	1800-2500 / 3600-3450 / 3400-4500	1750-2400 / 2400-3100 / 3150-4050	100	220V/1A - 26VA
--HR--12AA-002--EE	10	1 NPT MALE		-	-	120	230V

HYDRAULIC VALVES



Ordering references	Inlet/Outlet diameter (inch)	Release pressure (bar)
00PPG000486900A	1/2 MALE GAZ/ 3/4 FEMELLE GAZ	3
0150106H01	1/2» M	3



BRASS TAP VALVES

Ordering references	Maximum working pressure (bar)	Connection size (inch)	Working temperature (°C)	Thread
--XL--12GE-001--EE	10	2 FEMALE	- 10 / + 100	GAZ
--XL--12GE-003--EE	10	3/258	- 10 / + 100	-
--XL--12GE-004--EE	10	3	- 10 / + 100	-



EXPANSION TANK

Ordering references	Total external diameter (mm)	Capacity (L)	Total high (mm)
00PPG000487700A	202	8	338
00PPG000487701A	302	25	448
00PPG000487702A	252	12	334
00PPG000487703A	404	35	392
00PPG000487704A	404	50	510
--XW--12PA-002--EE	302	18	350



WATER FILTERS

Water filters (integrated strainer)

Ordering references	Type	Maximum working pressure (bar)	Connection size (inch)	Thread
00PPG000487100A	Y-INOX	16	2	GAZ
30RA-411---312--EE	STRAIGHT INOX	-	2-1/2	-
30RA-411---382--EF	STRAIGHT INOX	-	2	-
--XH--12AB-012--EE	Y-INOX	16	2	GAZ
--XH--12AB-013--EE	Y-INOX	16	2-1/2	GAZ
--XH--12AB-015--E-	Y-INOX	16	1-1/4	GAZ



Stainless steel hydraulic flexibles

Ordering references	Maximum working pressure (bar)	Connection size (inch)	Maximum working temperature (°C)	Internal diameter (mm)	Length (mm)
--CF--12GY-120--EE	15	3/4 F/F	+100°C	10	1200
00PPG000003301A	15	F-3/4 M-1/2	+100°C	10	900
00PPG000003302A	15	F-3/4 M-1/2	+100°C	10	2000
00PPG000003303A	15	F-3/4 M-1/2	+100°C	10	1300
00PPG000007301A	15	1/2 F/M	+100°C	10	800
00PPG000007401A	15	1/2 F/M	+100°C	10	1300
00PPG000486400A	10	1/2 F/F	+100°C	10	800
00PPG000486600A	20	3/4 F/F	+100°C	12	300
00PPG000486601A	20	3/4 F/F	+100°C	12	500
CF12GS100EE	16	F1/2" - M1/2"		12	1000
CF12GT065EE	16	F 1/2" - F 1/2"		12	650
CF12GU100EE	16	F1/2" - M 1/2"		12	1000
CF12GV065EE	16	F1/2" - F 1/2"		12	650
CF12GV095EE	16	F1/2" - F 1/2"		12	950
--CF--12GY-100--EE	20	3/4 F/F	+100°C	12	1000

SWEP

Plate exchangers



Ordering references	Number of plates	Heat exchanger thickness (mm)	Refrigerant side volume (L)	Water side volume (L)	Max refrigerant side operating pressure (bar)	Min/Max refrigerant side temperature (°C)	Min/Max water side temperature (°C)
00PPG000460801A	14	35,7	0,252	0,294	31	-196/155	-196/155
00PPG000460802A	20	49,1	0,378	0,42	31	-196/155	-196/155
00PPG000461001A	20	48,8	0,738	0,82	31	-196/155	-196/155
00PPG000461002A	30	71,2	1,148	1,23	31	-196/155	-196/155
00PPG000461003A	40	93,6	1,558	1,64	31	-196/155	-196/155
00PPG000463401A	46	115	2,44	2,55	45	-196/155	-30/90
00PPG000463402A	54	133	2,89	3	45	-196/155	-30/90
00PPG000463403A	60	146,4	3,22	3,33	45	-196/155	-30/90
00PPG000463404A	72	173,3	3,89	4	45	-196/155	-30/90
00PPG000463405A	86	204,6	4,66	4,77	45	-196/155	-30/90
00PPG000463406A	100	236	5,44	5,55	45	-196/155	-30/90
00PPG000464201A	106	252,7	12,32	12,4	45	-196/135	-30/90
00PPG000464202A	126	298,5	14,69	14,74	45	-196/135	-30/90
00PPG000471901A	46	115	2,44	2,55	45	-196/135	-30/90
00PPG000471902A	54	133	2,89	3	45	-196/135	-30/90
00PPG000471903A	60	146,4	3,22	3,33	45	-196/135	-30/90
00PPG000471904A	72	173,3	3,89	4	45	-196/135	-30/90
00PPG000471905A	86	204,6	4,66	4,77	45	-196/135	-30/90
00PPG000471906A	100	236	5,44	5,55	45	-196/135	-30/90
00PPG000489901A	72	174,9	8,44	8,676	45	-196/135	-30/90
00PPG000489902A	82	197,8	9,64	9,981	45	-196/135	-30/90
00PPG000489903A	94	225,3	11,09	11,327	45	-196/135	-30/90
00PPG000491701A	88	201,1	4,773	4,884	32	-196/145	-30/145
00PPG000491702A	116	263,8	6,327	6,438	32	-196/145	-30/145
00PPG000491801A	68	165,7	7,95	8,19	32	-196/145	-30/145
00PPG000491802A	80	193,2	9,4	9,64	32	-196/145	-30/145
00PPG000491803A	100	239	11,81	12,05	32	-196/145	-30/145
00PPG000491804A	136	321,4	16,15	16,39	32	-196/145	-30/145
00PPG000491806A	202	472,6	24,1	24,34	32	-196/145	-30/145
--EU--12CA-040--EE	40	93,6	2,11	2,22	31	-196/155	-196/155
--EU--12CC-020--EE	20	55,8	2,2	2,4	31	-196/155	-196/155

SWEP

Plate exchangers



Ordering references	Number of plates	Heat exchanger thickness (mm)	Refrigerant side volume (L)	Water side volume (L)	Max refrigerant side operating pressure (bar)	Min/Max refrigerant side temperature (°C)	Min/Max water side temperature (°C)
--EU--12CC-040--EE	40	101,6	4,6	4,8	31	-196/155	-196/155
--EU--12CC-050--EE	50	124,5	5,8	6	31	-196/155	-196/155
--EU--12CC-080--EE	80	193,2	9,4	9,64	31	-196/155	-196/155
--EU--12CD-050--EE	50	125	4,3	4,5	31	-196/155	-196/155
--EU--12CD-060--EE	60	148,4	5,2	5,4	31	-196/155	-196/155
--EU--12CF-034--EE	34	88	3,9	4,1	31	-196/155	-196/155
--EU--12CF-050--EE	50	124,5	5,8	6	31	-196/155	-196/155
--EU--12CJ-040--EE	40	101,6	3,4	3,6	31	-196/155	-196/155
--EU--12CO-026--EE	26	62,2	1,33	1,44	31	-196/155	-196/155
--EU--12CO-040--EE	40	93,6	2,11	2,22	31	-196/155	-196/155
--EU--12CO-050--EE	50	116	2,67	2,78	31	-196/155	-196/155
--EU--12CO-060--EE	60	138,4	3,22	3,33	31	-196/155	-196/155
--EU--12CP-026--EE	26	62,2	1,33	1,44	31	-196/155	-196/155
--EU--12CP-030--EE	30	71,2	1,56	1,67	31	-196/155	-196/155
--EU--12CP-036--EE	36	84,6	1,89	2	31	-196/155	-196/155
--EU--12CP-050--EE	50	116	2,67	2,78	31	-196/155	-196/155
--EU--12CP-060--EE	60	138,4	3,22	3,33	31	-196/155	-196/155
--EU--12CR-060--EE	60	147,4	7	7,23	31	-196/155	-196/155
--EU--12CR-070--EE	70	170,3	8,2	8,4	31	-196/155	-196/155
--EU--12CR-090--EE	90	216,1	10,6	10,85	31	-196/155	-196/155
--EU--12CT-050--EE	50	124,5	5,8	6,02	31	-196/155	-196/155
--EU--12CT-060--EE	60	147,4	7	7,23	31	-196/155	-196/155
--EU--12CX-126--E-	126	323,4	26	26,4	32	-30/140	-30/60
--EU--12CX-166--EE	166	408,7	33,3	34,94	32	-30/140	-30/60
--EU--12CX-222--EE	222	558	46,2	46,8	32	-30/140	-30/60
--EU--12CX-222--EE	222	542,6	44,66	43,76	32	-30/140	-30/60
--LL--01SB-040--EE	34	80,2	1,78	1,89	31	-196/155	-196/155
--LL--01SB-048--EE	66	151,8	3,55	3,66	31	-196/155	-196/155
--LL--01SB-052--EE	84	192,2	4,55	4,66	31	-196/155	-196/155
--LL--01SB-054--EE	100	228	5,44	5,55	31	-196/155	-196/155

ALFA LAVAL

Plate exchangers



Ordering references	Number of plates	Heat exchanger thickness (mm)	Refrigerant side volume (L)	Water side volume (L)	Max refrigerant side operating pressure (bar)	Min/Max refrigerant side temperature (°C)	Min/Max water side temperature (°C)
00PPG000445501A	16	61	1,75	2	45	160/130	-30/90
00PPG000445504A	60	185	7,25	7,5	45	160/130	-30/90
00PPG000466503A	162	359,68	16	12,64	45	196/150	-30/90
00PPG000466504A	210	462,4	20,8	16,38	45	196/150	-30/90
00PPG000500202A	30	100	3,5	3,8	45	160/130	-30/90
00PPG000500203A	44	139	5,25	5,5	45	160/130	-30/90
00PSG002312600A	48	126	/	0,672	50	-196/+90	-196/+90
00PSG002312700A	72	162	/	1,008	50	-196/+90	-196/+90
0460106H12	48	130	/	0,672	50	-196/+90	-196/+90
0460106H18	72	166	/	1,008	50	-196/+90	-196/+90
0460106H25	72	45	/	1,008	50	-196/+90	-196/+90
0460106H26	10	48	/	0,14	50	-196/+90	-196/+90
0460106H27	60	191	/	2,85	45	-196/+150	-196/+150
0460106H28	68	230	/	3,23	45	-196/+150	-196/+150
B034016H03	46	49	/	2,185	30	-196/+120	-196/+120
B034016H04	60	191	/	2,85	32	-196/+150	-196/+150
B035447H01	38	52	/	1,805	48	-196/+100	-196/+100
B036087H01	30	122	/	1,425	45	-196/+150	-196/+150
B036087H02	26	113	/	1,235	32	-196/+150	-196/+150
B036087H05	14	85	/	0,665	32	-196/+150	-196/+150
B036087H07	20	100	/	0,95	32	-196/+150	-196/+150
B036087H09	18	94	/	0,855	32	-196/+150	-196/+150
B036087H10	38	140	-	1,805	45	-196/+150	-196/+150
CB60-60HF	60	-	-	3,09	40	-196/+90	-196/+90





E | OILS & TESTS

OILS / COMPRESSORS OILS	126
OILS / BITZER	128
TESTS / OIL TEST	129



COPELAND

Ordering references	VOLUME (L)	USE	Type	NATURE	REFRIGERANT
RL32-3MAF-1TTL	1	SCROLL	SYNTHETIC	ESTERS DE POLYOLS (POE)	R134A/R407C/R410A
RL32-3MAF-5TTL	5	SCROLL	SYNTHETIC	ESTERS DE POLYOLS (POE)	R134A/R407C/R410A



MANEUROP

Ordering references	VOLUME (L)	USE	Refrigerant	Product range	Type	Nature
7754001	2	SCROLL/RECIPROCATING LT MT SM	R22	160P	MINERAL	NAPHTENIQUE
120Z0573	2,5	RECIPROCATING MPZ MTZ NTZ VTZ	R407C / R134A	160PZ	SYNTHETIC	ESTERS DE POLYOLS (POE)
120Z0571	2,5	SCROLL				

TOTALINE



Totaline Mineral oils are offering the performance advantages :

- Long lubricant life
- Multi language packaging
- Good miscibility with HFC refrigerants

Ordering references	VOLUME (L)	USE	Refrigerant	Type
-----470EE-1	5	RECIPROCATING CARLYLE		MINERAL
-----477--EE	20	RECIPROCATING CARLYLE		MINERAL
---P-903MIN68-20TL	20	RECIPROCATING CARLYLE		MINERAL
-----150-5-TTL	5	RECIPROCATING CARLYLE		MINERAL
-----15020-TTL	20	RECIPROCATING CARLYLE		MINERAL
---P-903--2101--S	3,8		R22	MINERAL

TOTALINE



Totaline Ester Oils are offering the performance advantages :

- Long lubricant life
- Multi language packaging
- Good miscibility with HFC refrigerants

Ordering references	Product range	VOLUME (L)	USE	Type
---P-903EAL32-5EE	ICEMATIC SW	5	SCROLL	SYNTHETIC
---P-903EAL32-20EE	ICEMATIC SW	20	SCROLL	SYNTHETIC
---P-903EST68-5TL	68C	5	RECIPROCATING CARLYLE	SYNTHETIC
---P-903EST68-20TL	68C	20	RECIPROCATING CARLYLE	SYNTHETIC
---P-903SW68-5TTL	ICEMATIC SW	5	CENTRIFUGAL 19XL / XR	SYNTHETIC
---P-903SW68-20TTL	ICEMATIC SW	20	CENTRIFUGAL 19XL / XR	SYNTHETIC
---P-903SW-100-5EE	ICEMATIC SW	5		SYNTHETIC
---P-903SW-100-EE	ICEMATIC SW	20		SYNTHETIC
---P-903SW220-1TTL	ICEMATIC SW	1	33HU/HT 30HX/GX SCREW 06N	SYNTHETIC
---P-903SW220-5TTL	ICEMATIC SW	5	33HU/HT 30HX/GX SCREW 06N	SYNTHETIC
---P-903SW220-20TL	ICEMATIC SW	20	33HU/HT 30HX/GX SCREW 06N	SYNTHETIC
RL170H-5TTL	EMKARATE RL	5	SCREW	SYNTHETIC
P903-1501	E100	3,8		SYNTHETIC
---P-903--2305--S	EMKARATE	18,9		SYNTHETIC
---P-903--1701--S	POE68	3,8	06D/E 5F/H	SYNTHETIC
--PP--23BZ101005S	SOLEST170	18,9	05T/06T SCREW	SYNTHETIC

TOTALINE

Ordering references	VOLUME (L)	USE	NATURE
---P-903-HFO-18TTL	18	SCREW	ESTERS DE POLYOLS (POE)

BITZER

Ordering references	Product range	VOLUME (L)	USE	Type	NATURE	REFRIGERANT
7127237	B320SH	5	SCREW	SYNTHETIC	ESTERS DE POLYOLS (POE)	R22
7070610	BSE170	5	SCREW	SYNTHETIC	ESTERS DE POLYOLS (POE)	R407C / R134A
7072887	BSE170	10	SCREW	SYNTHETIC	ESTERS DE POLYOLS (POE)	R407C / R134A

VERNOLAB



Complete Kit :

Oil test are shipped with identification stickers, addressed envelopes and oil analysis reports

Analyse type : Spectrometry, TAN, viscosity and water content

Samples to be sent to laboratory and visualisation of the results on the laboratory website (5 days maximum delay)

Ordering references	Type
TEST-VERNOLAB-EXP	EXPORT
TESTVERNOLABMARINE	MARINE
TEST-VERNOLAB-FR	FRENCH
TESTVERNOLABIT	ITALIAN
TESTVERNOLABPL	POLISH
TESTVERNOLABUK	ENGLISH
TESTVERNOLABCH	SWISS
TESTVERNOLABSP	SPANISH
TESTVERNOLABPT	PORTUGUESE
TESTVERNOLABDE	GERMAN
TESTVERNOLABCZE	CZECH
TESTVERNOLABNL	DUTCH
TESTVERNOLABTUR	TURK



Ordering references	Type
TT1-002	TOTALTEST KIT
TT2-001	REFILL TUBE
TT2-002	TOTALTEST TUBES R410A
7011133	ACIDITY TEST



F | TRANSMISSION

TRANSMISSION / BELT	136
TRANSMISSION / PULLEY	143
TRANSMISSION / HUB	147

RANGE SPA

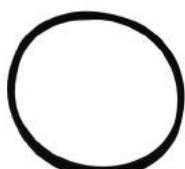

Ordering references	LENGTH (mm)
604153	832
604157	900
604160	950
604163	1000
604164	1032
604165	1060
604169	1120
604170	1132
604171	1157
604172	1180
604173	1207
604175	1232
604176	1250
604177	1282
604178	1307
604179	1320
604181	1357
57040020016	1382
604183	1400
604185	1457
604187	1500
604188	1557
604189	1582
604190	1600
7332355	1632
604192	1657
604194	1700
604196	1757
604197	1782
604198	1800
604199	1857

RANGE SPA



Ordering references	LENGTH (mm)
604201	1900
604202	1957
604203	2000
604205	2057
604206	2120
604207	2182
2061270	2207
604208	2240
604209	2300
604210	2360
604211	2432
604214	2500
604215	2532
604216	2582
604217	2650
7222275	2682
604218	2732
604219	2800
604220	2900
604221	2932
604222	3000
604223	3082
604224	3150
604225	3282
604226	3350
604227	3482
604228	3550
604229	3650
604230	3750
901620-12	12000



RANGE SPB

Ordering references	LENGTH (mm)
604311	1700
7416995	1850
604317	2000
604318	2060
604319	2120
604320	2180
604321	2240
604322	2300
604323	2360
604324	2430
604325	2500
604326	2580
604327	2650
604328	2720
604329	2800
604330	2900
7382667	2990
604331	3000
604332	3070
604333	3150
604334	3250
604335	3350
604336	3450
604337	3550
604338	3650
604339	3750
604340	3875
604341	4000
7394169	4120
604343	4250
604344	4370
604345	4500
604347	4750

RANGE SPC



Ordering references	LENGTH (mm)
605506	2650
604409	3150
604410	3350
604411	3550
7262039	5000
7257272	5300

RANGE SPZ

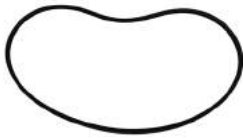

Ordering references	LENGTH (mm)
7262264	630
604005	670
2060500	687
7321625	737
604010	750
604011	762
604012	772
604013	787
604014	800
--KR--12AR-014--M	812
604017	837
604018	850
2061630	862
604020	875
7046985	887
604022	900
604023	912
604024	925
604025	937
604026	950
604027	962
604029	987
604030	1000
901625	1010
604031	1012
604032	1024
901226	1025
901627	1030
604033	1037
901227	1047
604035	1060
901228	1062
901229	1077
901630	1080
604036	1087
901230	1090
604037	1112

RANGE SPZ



Ordering references	LENGHT (mm)
604038	1120
604039	1137
901634	1140
901232	1150
604041	1162
604042	1180
7143837	1187
901234	1200
901637	1202
604043	1212
7210936	1220
604044	1237
604045	1250
2061580	1270
901640	1272
604047	1287
901237	1312
604049	1320
604050	1337
901643	1340
7515775	1347
604051	1362
2060890	1387
604053	1400
901646	1412
901647	1420
604054	1437
901648	1450
604055	1462
604057	1487
604058	1500
607059	1512
7343405	1520
7377616	1537
901244	1550
604061	1562
7383716	1587



RANGE SPZ

Ordering references	LENGTH (mm)
604064	1600
604065	1612
901654	1637
604066	1662
2060980	1687
604067	1700
901249	1737
901250	1750
604068	1762
2061440	1787
604069	1800
2061330	1812
901660	1837
901251	1850
604070	1862
7107834	1887
604071	1900
604072	1937
604073	2000
7343406	2037
604075	2087
604076	2120
604078	2240
604081	2360
604082	2437
604083	2500
7188516	2540
604085	2650
604086	2737
604087	2800
604089	3000
902154-6	6000
902154-12	12000
902154-15	15000
902154-25	25000



RANGE SPA

Ordering references	PRIMITIVE DIAMETER (mm)	TYPE OF HUB	NUMBER OF PULLEY RACES
607265	180	2012	1
607266	200	2012	1
607268	250	2012	1
607276	90	1610	2
607279	106	1610	2
607280	112	1610	2
607281	118	1610	2
607282	125	1610	2
607283	132	2012	2
607284	140	2012	2
607285	150	2012	2
607286	160	2012	2
607287	180	2012	2
601168	190	2012	2
607288	200	2517	2
607289	224	2517	2
607290	250	2517	2
607291	280	2517	2
607292	315	2517	2
607293	355	2517	2
607294	400	2517	2
607295	450	2517	2
607296	500	2517	2
607297	630	3020	2
607304	106	1610	3
607305	112	2012	3
607308	132	2012	3
607310	150	2517	3
607311	160	2517	3
607312	180	2517	3
607313	200	2517	3
607314	224	2517	3
607315	250	2517	3
607316	280	2517	3
607317	315	3020	3
607318	355	3020	3
607319	400	3020	3
607320	450	3020	3
607321	500	3020	3
607322	630	3020	3
7093933	180	2517	4
7247839	224	2517	4
7247840	250	2517	4
7148662	280	2517	4



RANGE SPB

Ordering references	PRIMITIVE DIAMETER (mm)	TYPE OF HUB	NUMBER OF PULLEY RACES
607508	160	2012	2
607509	170	2012	2
607510	180	2517	2
607511	190	2517	2
607512	200	2517	2
607513	212	2517	2
607514	224	2517	2
607515	236	2517	2
607516	250	2517	2
607517	280	2517	2
Z601056	300	2517	2
607518	315	2517	2
607519	355	3020	2
607520	400	3020	2
607521	450	3020	2
607522	500	3020	2
607523	630	3030	2
607529	140	2012	3
607530	150	2012	3
607531	160	2012	3
607532	170	2012	3
607533	180	2517	3
607534	190	2517	3
607535	200	2517	3
607536	212	2517	3
607537	224	2517	3
607538	236	2517	3
607539	250	2517	3
607540	280	2517	3
7300014	300	2517	3
607541	315	2517	3
607542	355	3020	3
607543	400	3020	3
607544	450	3020	3
607545	500	3020	3
607546	630	3535	3
607556	150	2517	4
607558	170	2517	4
607559	180	2517	4
607560	190	2517	4
607561	200	3020	4
607562	212	3020	4
607563	224	3020	4
607564	236	3020	4
607565	250	3020	4
607566	280	3020	4
607569	400	3535	4
607570	450	3535	4



RANGE SPC

Ordering references	PRIMITIVE DIAMETER (mm)	TYPE OF HUB	NUMBER OF PULLEY RACES
7012537	224	3020	3
7014126	236	3020	3
7005777	280	3535	3
7010453	300	3535	3
7010454	315	3535	3
7014127	335	3535	3
7227389	355	3535	3
7005775	400	3535	3
7257273	265	3535	4
7257274	800	5050	4
7024435	300	3535	6
7024436	355	3535	6

RANGE SPZ

Ordering references	PRIMITIVE DIAMETER (mm)	TYPE OF HUB	NUMBER OF PULLEY RACES
607001	63	1108	1
607002	67	1108	1
607003	71	1108	1
607004	75	1108	1
607005	80	1210	1
607006	85	1210	1
607007	90	1210	1
607008	95	1210	1
607009	100	1210	1
607010	106	1610	1
607011	112	1610	1
607012	118	1610	1
607013	125	1610	1
607014	132	1610	1
607015	140	1610	1
607016	150	1610	1
607017	160	1610	1
607018	180	1610	1
607019	200	2012	1
607020	224	2012	1
607021	250	2012	1
607022	280	2012	1
607023	315	2012	1

RANGE SPZ



Ordering references	PRIMITIVE DIAMETER (mm)	TYPE OF HUB	NUMBER OF PULLEY RACES
607026	71	1108	2
607027	75	1108	2
607028	80	1210	2
607029	85	1210	2
607030	90	1210	2
607031	95	1210	2
607032	100	1210	2
607033	106	1610	2
607034	112	1610	2
607035	118	1610	2
607036	125	1610	2
607037	132	1610	2
607038	140	1610	2
607039	150	1610	2
607040	160	1610	2
607041	180	1610	2
607042	200	2012	2
607043	224	2012	2
607044	250	2012	2
607045	280	2012	2
607046	315	2012	2
607047	355	2012	2
607048	400	2012	2
607054	80	1210	3
607055	85	1610	3
607056	90	1610	3
607057	95	1610	3
607058	100	1610	3
607060	112	2012	3
607062	125	2012	3
607059	106	1610	3
607066	160	2012	3
7255522	112	2012	5



HUB

Ordering references	Product range	PRIMITIVE DIAMETER (mm)
7081812	1008	14
7082566	1008	19
7081813	1008	20
7081814	1008	24
7081815	1008	25
602701	1108	14
602702	1108	19
602703	1108	20
602704	1108	24
602705	1108	25
602706	1108	28
602707	1210	14
602708	1210	19
602709	1210	20
602710	1210	24
602711	1210	25
602712	1210	28
602713	1210	30
7142548	1215	14
602715	1215	19
602716	1215	20
602717	1215	24
602718	1215	25
602719	1215	28
7081820	1215	30
602721	1610	14
602722	1610	19
602723	1610	20
602724	1610	24
602725	1610	25
602726	1610	28
602727	1610	30
602728	1610	35
602729	1610	38
7005608	1610	40
602730	1610	42
7142549	1615	19
7142550	1615	20
7142551	1615	24
7081887	1615	25
7081888	1615	28
7081890	1615	30
7081891	1615	35
7081892	1615	38
7081893	1615	42



HUB

Ordering references	Product range	PRIMITIVE DIAMETER (mm)
602731	2012	19
602732	2012	20
602733	2012	24
602734	2012	25
602735	2012	28
602736	2012	30
602737	2012	35
602738	2012	38
602739	2012	40
602740	2012	42
602742	2012	48
602743	2012	50
602746	2517	20
602748	2517	25
602749	2517	28
602750	2517	30
602751	2517	35
602752	2517	38
602753	2517	40
602754	2517	42
602755	2517	45
602756	2517	48
602757	2517	50
602758	2517	55
602759	2517	60
602766	3020	40
602768	3020	45
602769	3020	48
602770	3020	50
602771	3020	55
602772	3020	60
602773	3020	65
602774	3020	70
602775	3020	75
602778	3535	50
602780	3535	60
602781	3535	65





G | FILTERS DRIERS AND SHELLS

FILTERS DRIERS AND SHELLS	152
FILTERS DRIERS AND SHELLS / CARTRIDGES	157
FILTERS DRIERS AND SHELLS / INOX CARTRIDGES	158

KMP



Moisture liquid indicators to sold on tube
Hexagonal sight glass shipped with plastic protection cap

Ordering references	Application	Frigo connection (inch)
--XS--12AD-001--EE	R22-R134A-R407C	5/8
--XS--12AD-002--EE	R22-R134A-R407C	7/8
--XS--12AD-003--EE	R22-R134A-R407C	1-1/8
--XS--12AD-004--EE	R22-R134A-R407C	1-5/8
--XS--12AD-005--EE	R22-R134A-R407C	1-3/8

KMP



Copper tube moisture indicators
Copper tube with sight glass shipped with plastic protection cap

Ordering references	Application	Type	Lenght (mm)	Frigo connection (inch)
--XS--12CA-001--EE	R22-R134A-R407C	KSG5S	161	5/8
--XS--12CA-002--EE	R22-R134A-R407C	KSG7S	171	7/8
--XS--12CA-003--EE	R22-R134A-R407C	KSG9S	171	1-1/8

ALCO



Brass connection moisture indicators
 Brass connection sight glass shipped with plastic protection cap
CAUTION ! Remove sight glass head before brazing

Ordering references	Application	Frigo connection (inch)
--XS--12AB-001--EE	R22	1/4
--XS--12AB-002--EE	R22	3/8
--XS--12AB-003--EE	R22	1/2
--XS--12AB-004--EE	R22	5/8
--XS--12AB-005--EE	R22	7/8
--XS--12AB-006--EE	R22	1-1/8



CARLY

Filters driers shells for cartridges

Ordering references	Application	Type	Length (mm)	Frigo connection (inch)	Cartridge type	R404A	R507	R22	R134A	R407C	R410A	PWP (BAR)	ΔP (BAR)
--XW--12DA-006--EE		TOP COVER	672	1-5/8	OCY48	342	342	525	478	520	520	46	0.07
--XW--12DA-024--EE	R22-R134A- R407C- R410A		709	2-5/8									
--XW--12DA-027--EE		TOP COVER	400	2-1/8	OCY48N/48F							46	0.07
--XW--12DA-028--EE	R22-R134A- R407C- R410A		424	2-5/8									
--XW--12MA-002--EE	R22-R134A- R407C- R410A		525	1-1/8									
--XW--12MA-006--EE	R22-R134A- R407C- R410A	TOP COVER	900	2-1/8	OCY100	385	385	591	538	586	586	46	0.07



KMP / DANFOSS

Filters driers shells for cartridges

Ordering references	Application	Type	Lenght (mm)	Frigo connection (inch)	Cartridge type	R404A	R507	R22	R134A	R407C	R410A	PWP (BAR)	ΔP (BAR)
--XW--12GB-002--EE	R22 - R134A	TOP COVER	244	7/8	48			129	119	124	127	35	0.07
--KH--28ED-161--EE	R22-R134A- R407C-R410A	TOP COVER	260	7/8	100DM/ C/AF	92,5	89,6	132,6	128	132,6	136,8	46	0.07
--KH--28ED-200--S	R22-R134A- R407C-R410A		270,76	1-1/8									
--KH--28ED-202--EE	R22-R134A- R407C-R410A	TOP COVER	262	1-1/8	100DM/ C/AF	132,6	128,4	190,4	184,3	190,4	195,9	46	0.07
--KH--28ED-240--EE	R22-R134A- R407C-R410A	TOP COVER	264	1-3/8	100DM/ C/AF	180,5	174,8	285,5	249,3	285,5	266,8	46	0.07
--KH--28ED-242--C	R22-R134A- R407C-R410A	TOP COVER	403,3	1-3/8	100DM/ C/AF	187,2	181,4	268,6	259,7	268,6	276,7	46	0.07
--KH--28ED-280--S	R22-R134A- R407C-R410A		410	1-5/8									
00PPG000452501A	R22-R134A- R407C-R410A	TOP COVER	406,7	2/1-8	100DM/ C/AF	240,8	233,3	344,7	331,9	344,7	356,1	46	0.07
00PPG000452502A	R22-R134A- R407C-R410A	TOP COVER	408,5	2-5/8	100DA	11	11	14,1	13,6	14,1	14,1	46	0.04

PARKER



Filters driers shells for cartridges

Shell shipped with internal cartridge support and mechanical filtration
Steel sold connections

Ordering references	Application	Type	Lenght (mm)	Frigo connection (inch)	Cartridge type	R22	R134A	R407C	R410A	PWP (BAR)	ΔP (BAR)
--XW--12GB-003--EE	R22-R134A- R407C	TOP COVER	246	1-1/8	48	180	166	173	178	35	0.07
--XW--12GB-006--EE	R22-R134A- R407C		256	2-1/8							
--XW--12GB-008--EE	R22 - R134A	TOP COVER	385	1x1/8	48	224	206	215	221	35	0.07
--XW--12GB-010--EE	R22 - R134A	TOP COVER	387	1x5/8	48	255	234	245	252	35	0.07
--XW--12GB-016--EE	R22-R134A- R407C		675	1-3/8							
--XW--12GG-003--EE	R22-R134A- R407C	TOP COVER	248	1-5/8	48	244	224	234	241	35	0.07
--XW--12GG-004--EE	R22-R134A- R407C	TOP COVER	400	2-1/8	48	268	246	257	265	35	0.07
00PPG000499301A		SEALED	241	5/8		52,6	48,8	49,9	52,6	45	0.07
00PPG000499302A		SEALED	220,6	7/8		63,9	59,3	60,7	63,9	45	0.07
00PPG000499000A		SEALED	267,5	5/8		55,6	51,5	52,8	55,6	45	0.07



ALCO-EMERSON

Filters driers shells for cartridges

Ordering references	Application	Type	Length (mm)	Frigo connection (inch)	Cartridge type	R404A	R507	R22	R134A	R407C	R410A	PWP (BAR)	ΔP (BAR)
---P-505--819213S	R22-R134A-R407C-R410A	TOP COVER		1-5/8	100	258	258	395	362	377	390	45	0.07
---P-505--8485--S	R22-R134A-R407C-R410A			5/8									
---P-505--8489--S	R22-R134A-R407C-R410A			1-1/8									
P505-8967	R22-R134A-R407C-R410A			7/8									
---P-505--8969--S	R22-R134A-R407C-R410A			1-1/8									
--KH--49EA-040--C	R22-R134A-R407C-R410A			1-1/8									
--KH--49EA-200--C	R22-R134A-R407C-R410A			1-3/8									
420944	R22-R134A-R407C-R410A												
---P-502--8032--S	R22-R134A-R407C-R410A	HERMETIC	111	1/4 SAE	DC	7	7	6,7	7,3	4,8	7,2	45	0.07
---P-502--8082S-S	R22-R134A-R407C-R410A		112	1/4 ODF									
---P-502--8083S-S	R22-R134A-R407C-R410A	HERMETIC	137	3/8 ODF	DC	15,7	15,7	15	16,4	10,7	16,2	45	0.07
---P-502--8084S-S	R22-R134A-R407C-R410A		137	1/2 ODF									
---P-502--8165--S	R22-R134A-R407C-R410A	HERMETIC	192	5/8 SAE	DC	42,8	42,8	41,1	44,8	29,2	44,3	45	0.07
---P-502--8165S-S	R22-R134A-R407C-R410A		167	5/8 ODF									
---P-502--8305S-S	R22-R134A-R407C-R410A	HERMETIC	235	5/8 ODF	DC	50,4	50,4	48,4	52,8	34,4	52,1	45	0.07
---P-502--8305--S	R22-R134A-R407C-R410A		262	5/8 SAE									
---P-504--8164--S	R22-R134A-R407C-R410A		177	1/2 SAE									
---P-504--8083--S	R22-R134A-R407C-R410A		151	3/8 SAE									
---P-504--8084S-S	R22-R134A-R407C-R410A		137	1/2 ODF									
---P-502--8417S-S	R22-R134A-R407C-R410A		254	7/8 ODF									
3251697		HERMETIC		3/8	DC	15,6	15,6	15	16,4	10,7	16,1	45	0.07
3251698		HERMETIC		1/2	DC	25,6	25,6	24,5	26,8	17,5	26,4	45	0.07
909152		HERMETIC		1/2	DC	29,9	29,9	28,7	31,3	20,4	30,9	45	0.07
3251699		HERMETIC		1/2	DC	34,3	34,3	33	36	23,5	35,5	45	0.07
003628-		HERMETIC		7/8	DC	63,2	63,2	60,7	66,3	43,2	65,4	45	0.07
003632-		HERMETIC		5/8	DC	55,9	55,9	53,7	58,6	38,2	57,8	45	0.07
ADK757S		HERMETIC		7/8	DC	100,7	100,7	96,7	105,5	68,8	104,2	45	0.07
883552		TOP COVER		7/8		55	55		72			45	0.07
059328-		HERMETIC		7/8		43,1	43,1	66,1	60,5	63,1	65,2	45	0.07



DANFOSS

Filters driers

Ordering references	Application	Type	Length (mm)	Frigo connection (inch)	Cartridge type	R404A	R507	R22	R134A	R407C	R410A	PWP (BAR)	ΔP (BAR)
00PPG000462101A	R22-R134A-R407C-R410A	HERMETIC	158	5/8	42DM	36,59	35,59	51,82	44,64	50,16	54,83	46	0.07
00PPG000462102A	R22-R134A-R407C-R410A	HERMETIC	246	7/8	42DM	53,95	52,51	75,4	64,25	73,29	81,06	46	0.07
00PPG000462103A	R22-R134A-R407C-R410A	HERMETIC	247	7/8	48DM	56,32	54,89	78,5	66,74	76,37	84,67	46	0.07
00PPG000466201A	R22-R134A-R407C-R410A	HERMETIC	154	1/2	42DM	20	20	32	28	32	32	46	0.07
00PPG000466202A	R22-R134A-R407C-R410A	HERMETIC	162	5/8	42DM	29	29	40	37	40	40	46	0.07
00PPG000466203A	R22-R134A-R407C-R410A	HERMETIC	248	7/8	42DM	32	32	47	43	47	47	46	0.07
023Z0031	R22-R134A-R407C-R410A		NC	1/2								46	
023Z4589	R22-R134A-R407C-R410A	HERMETIC	246	3/4	42DM	39,89	38,95	53,22	43,73	52,49	60,57	46	0.07
00PPG000462001A	R410A		146	5/8									
00PPG000462002A	R410A		173	7/8									
00PPG000462003A	R22-R134A-R407C-R410A		146	1/2									
00PPG000462004A	R22-R134A-R407C-R410A		146	5/8									
00PPG000462005A	R22-R134A-R407C-R410A		173	7/8									
AM013540	R22-R134A-R407C-R410A	HERMETIC	160	5/8	42DC	29	29	40	37	40	40	46	0.07
023Z5008		HERMETIC	167	3/8	42DC	11,18	10,82	17,41	16,33	16,33	16,43	42	0.07
023Z8010		HERMETIC	184	5/8	42DC	36,59	35,6	51,82	44,64	50,16	54,83	42	0.07
AM013501		HERMETIC	160	5/8	42DC	36,59	35,59	51,82	44,64	50,16	54,83	42	0.07
00PPG000529602A		TOP COVER	264	1x3/8	100DM/C/AF	180,5	174,8	285,5	249,3	285,5	266,8	46	0.07
00PPG000452503A		TOP COVER	260	7/8	100DM/C/AF	92,5	89,6	132,6	128	132,6	136,8	46	0.07
00PPG000529601A		TOP COVER	262	1x1/8	100DM/C/AF	132,6	128,4	190,4	184,3	190,4	195,9	46	0.07
00PPG000529603A		TOP COVER	403	1x3/8	100DM/C/AF	187,2	181,4	268,6	259,7	268,6	276,7	46	0.07
00PPG000529604A		TOP COVER	404,5	1x5/8	100DM/C/AF	240,8	233,3	344,7	331,9	344,7	356,1	46	0.07
7224631		HERMETIC	150	3/8	42DM	13	13	20	18	20	20	46	0.07
7214590		HERMETIC	160	5/8	42DM	29	29	40	37	40	40	46	0.07
7254941		HERMETIC	160	5/8	42DM	28	28	42	38	42	42	46	0.07
7228643		HERMETIC	113	3/8	42DM	9,81	9,52	14,44	12,87	13,8	14,58	46	0.07
1911590		HERMETIC	139	3/8	42DM	10,98	10,66	16,03	14,19	15,37	16,35	46	0.07
7414848		HERMETIC	152	1/2	42DM	23,54	22,81	35,4	32,19	33,6	34,83	46	0.07
00PPG000480101A		HERMETIC	160	5/8	42DM	36,59	35,59	51,82	44,64	50,16	54,83	46	0.07
7254596		HERMETIC	234	5/8	42DM	36,96	35,93	52,72	45,71	50,91	50,29	46	0.07
00PPG000480102A		HERMETIC	246	7/8	42DM	53,95	52,51	75,4	64,25	73,29	81,06	46	0.07
7224642		HERMETIC	400	7/8	48DM	71,7	69,8	99,95	84,97	97,23	107,81	46	0.07

ALCO / DANFOSS / CARLY



Permanent or temporary application cartridges

42 type : volume 688 cm³

48 type : volume 787 cm³

100 type : volume 1639 cm³

Ordering references	Application	Type	LENGHT (mm)
--KH--29MD-048--EE	R134A - R407C- R410A	023U1396	138
--XW--12EA-015--EE	R134A, R22, R407C,R410A,R404A	11023	144
---P5068-H-100--S	R22	S100	165
---P5068-H--48--S	R22	H48	140
--XW--12EA-008--EE	R22 - R134A	CCY 42 HP	148
--XW--12EA-009--EE	R22 - R134A	CCY48HP	139,5
--XW--12EA-010--EE	R22 - R134A	CCY42N	148
--XW--12EA-011--EE	R22 - R134A	CCY48N	139,5
--XW--12EA-003--EE	R22-R134A-R407C	48DN	138
00PPG000445000A	R22-R134A-R407C-R410A	/	138
--XW--12EA-001--EE	R22-R134A-R407C-R410A	W48	
--XW--12EA-002--EE	R22-R134A-R407C-R410A	W100	
--XW--12EA-004--EE		CCY42F	
--XW--12EA-005--EE		CCY48F	
---P5068-F--48--S		F48	

INOX CARTRIDGES



Inox cartridges. Permanent application cartridges

42 type : volume 688cm³

48 type : volume 787cm³

100 type : volume 1 639cm³

Ordering references	Application	Type	Length (mm)	Total External diameter (mm)
--XW--12EA-006--EE	R22-R407C-R134A-R410A	CCY421	155	80
--XW--12EA-007--EE	R22-R407C-R134A-R410A	CCY481	140	95

CASTEL

Ordering references	Type	Frigo connection (inch)	CARTRIDGE TYPE	R404A	R507	R22	R134A	R407C	R410A	PWP (BAR)	ΔP (BAR)
7220460	TOP COVER	1½/8	4490/A/B/HA	176	176	270	250	268	271	45	0.07
7220455	TOP COVER	7/8	4490/A/B/HA	103	103	158	146	156	159	45	0.07
7219715	TOP COVER	1¼/8	4490/A/B/HA	141	141	216	200	214	217	45	0.07
7220454	TOP COVER	1¾/8	4490/A/B/HA	215	215	331	306	328	332	45	0.07
7219716	TOP COVER	1¾/8	4490/A/B/HA	230	230	354	327	351	355	45	0.07
7220459	TOP COVER	1½/8	4490/A/B/HA	300	300	460	426	456	462	35	0.07





H | AIR FILTERS

AIR FILTERS / G1 & G2	162
AIR FILTERS / G3	163
AIR FILTERS / G4	166
AIR FILTERS / F5	168
AIR FILTERS / F6	169
AIR FILTERS / F7	170
AIR FILTERS / F8 & F9	171
AIR FILTERS / M5 & M6	172

EFFICIENCY G1



Ordering references	Size (mm)
42NH500453-BOX-10	215 X 1000
42NH500450-BOX-10	215 X 430
42NH500454-BOX-10	265 X 995
42NH500455-BOX-10	265 X 1295
42NH500451-BOX-10	215 X 600
42NH500452-BOX-10	215 X 800

EFFICIENCY G2

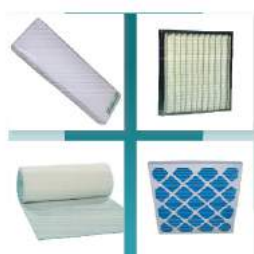

Ordering references	Size (mm)
0150711X82	413X203X12
0150711X83	483X257X12
0150711X84	633X352X12
0150722X03	422X215X12
0150722X04	642X215X12
0150722X05	862X215X12
502486BOX-10	1020X620



EFFICIENCY G3

Ordering references	Size (mm)
42BJ573132MD	255 X 570
42NH500079	995 X 265
42NH500080	1295 X 265
42ZZ501024M-	440 X 205
42NH500456-	215 X 430
42NH500457-	215 X 600
42NH500458-	215 X 800
42NH500459-	215 X 1000
42NH500460-	265 X 995
42NH500461-	265 X 1295
42CE500312M-	570X180
42BJ551012M-BOX-10	240 X 550
42EM505048MABOX-10	990 X 230
42EM500312M-BOX-10	208 X 578
42EM505046MABOX-10	420 X 230
36XB500027M-BOX-10	580 X 227
42EM505047MABOX-10	230 X 570
42BJ573132MDBOX-10	570 X 225
36XB500158M-BOX-10	893 X 277
42BJ551002M-BOX-10	240X400
42EL500082MBOX-10	218X984
42EM500322MBOX-10	978X208
42EM503522M-BOX-10	230X408
0150722X16	568X496X20
0150722X19	580X250X20
0150722X20	725X250X20
0150722X21	1015X250X20
35BD530542M	FRAME
41MC500222M	360X427
42BJ510022M	240X550X48
42CE500302M-	490X180
--KH--12AD-005--M	594X594X25
--KH--12AD-006--M	594X287X25
--KH--12AD-008--M	720X585X20
--KH--12AD-017--M	490X770X20
--KH--12AD-019--M	892X287X25
--KH--12AE-003--M	890X630X50
--KH--12AE-004--M	890X940X50
--KH--12AE-006--M	594X287X50
--KH--12AE-018--M	892X592X50
--KH--12AE-019--M	892X287X50
--KH--12AZ-027--M	620X935X25
--KH--12AZ-101--M	480X490X25
--XF--12DA-005--E-	594X594X50
42EM500312M	578X208

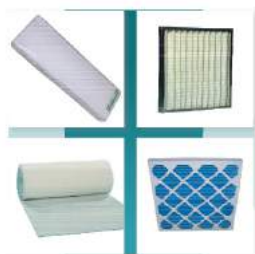

EFFICIENCY G3

Ordering references	Size (mm)
101059BOX-5	592X592
107759BOX-4	592X592
224566BOX-5	1190X210
231153BOX-10	800X180
FTR930BOX-10	507X230
FTR931BOX-10	1107X230
FTR941BOX-10	850X212
42EL500482MBOX-10	1100X310
5039374BOX-10	185X1194
5039459BOX-10	444X155
5039460BOX-10	794X155
509184BOX-10	640X620
510431BOX-10	1350X1000
510929BOX-10	1500X280
5204510BOX-10	225X660
5204511BOX-10	225X860
5204512BOX-10	225X1060
5204513BOX-10	225X1260
7000148BOX-10	245X1030
7049685BOX-10	385X200
7049686BOX-10	685X200
7049687BOX-10	985X200
7086601BOX-10	200X1135
7241971BOX-10	170X978
7323364BOX-10	928X260
7367866BOX-10	GRID 1200

EFFICIENCY G3

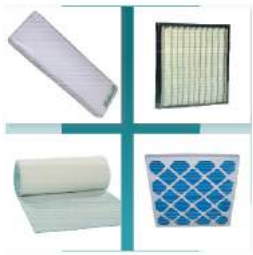

Ordering references	Size (mm)
42NH500456-BOX-10	215 X 430
42NH500457-BOX-10	215 X 600
42NH500458-BOX-10	215 X 800
42NH500459-BOX-10	215 X 1000
42NH500460-BOX-10	265 X 995
42NH500461-BOX-10	265 X 1295
5039373BOX-10	185X994
7241973BOX-10	1378X170
7376444BOX-10	1228X356
5201332BOX-10	174X1050
7241972BOX-10	170X1178
7323365BOX-10	1228X260
7323671BOX-10	550X550
7000142BOX-10	245X480
7323361BOX-10	628X195
5201330BOX-10	174X650
5039372BOX-10	185X794
5201334BOX-10	174X1450
5201333BOX-10	174X1250
5039371BOX-10	185X594
7241968BOX-10	170X418
7323363BOX-10	928X225
7000147BOX-10	245X730
7323362BOX-10	628X225
5201331BOX-10	174X850
7241970BOX-10	170X778
7241969BOX-10	170X578
5039370BOX-10	185X444
7301001BOX-10	410X410
5204509BOX-10	225X460

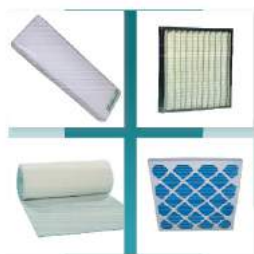

EFFICIENCY G4

Ordering references	Size (mm)
200002534BOX-10	596X596X48
-KH12AA05-MBOX-10	594X594X50
-KH12AA06-MBOX-10	594X287X50
-KH12AS07-MBOX-10	485X550X50
-KH12BA-3-MBOX-10	490X770X50
42BJ510012MBOX-10	240X400X48
101263BOX-8	592X592
101473BOX-10	287X592
101488BOX-5	490X592
101496BOX-5	592X592
101497BOX-10	592X287
101618BOX-5	592X592
101622BOX-8	592X287
107299BOX-10	287X592
108345BOX-10	287X592
108378BOX-5	490X592
108388BOX-5	592X490
108410BOX-5	592X592
200018744BOX-10	437X287
205889BOX-10	398X205
206093BOX-10	495X394
206452BOX-4	610X450
208234BOX-8	595X595
219319BOX-10	590X390
232021BOX-3	670X448
249301BOX-10	352X225
249302BOX-5	395X352
500076BOX-10	500X500
500152BOX-10	625X500
500958BOX-10	1000X635
503443BOX-10	1400X720
509217BOX-10	1300X390
509635BOX-10	900X390
510509BOX-10	750X385
51810113001BOX-10	287X287
57050012220BOX-7	595X495
57050012230BOX-7	595X495
900992BOX-10	292X292X49
903648BOX-13	566X350
903649BOX-13	706X430
903651BOX-7	512X510
903652BOX-7	592X592
903653BOX-13	670X448
903654BOX-13	750X502

EFFICIENCY G4

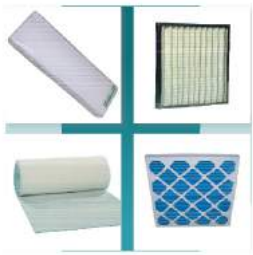

Ordering references	Size (mm)
--KH--12AA-003--M	890X630X50
--KH--12AC-001--M	594X594X25
--KH--12AC-002--M	594X287X25
--KH--12AC-003--M	892X592X25
--KH--12AC-008--M	890X940X25
--KH--12AC-021--M	490X538X23
--KH--12AC-023--M	720X592X23
--KH--12AF-001--M	575X630X75
--KH--12AF-002--M	575X940X75
--KH--12AF-003--M	890X630X75
--KH--12AF-004--M	890X940X75
--KH--12AR-001--M	575X630X75
--KH--12AZ-102--M	480X680X25
--KH--12BA-004--M	720X770X50
--KH--12BA-005--M	720X590X50
14742300	289X289X50
14742400	289X594X50
14743800	594X594X50
42BJ510002M	FRAME
42GR501622M	230X350X150
200002532	292X292X48

EFFICIENCY F5



Ordering references	Size (mm)
14720017	437X287X48
41PS-501---062--EE	780X690X100
41TB-500---442--EE	945X560X50
42BJ510032MBOX-10	240X550X48
42BJ510562M	470X240X54
42BJ513392MG	550X316X48
--KH--12AR-002--M	575X940X75
--KH--12AS-005--M	594X594X50
--KH--12AS-008--M	715X595X50
--KH--12AS-010--M	485X780X50
--KH--12AS-012--M	892X287X50
-KH12AS06-MBOX-10	594X287X50
MTA540023MBOX-10	225X352X48
MTA540752MBOX-10	395X352X48
200018749BOX-10	287X287
200018750BOX-10	437X287
200018751BOX-7	592X287
200018752BOX-8	437X592
200018753BOX-7	592X592

EFFICIENCY F6

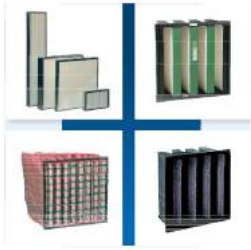

Ordering references	Size (mm)
7510113	305X305X48
2066710	305X610X48
2066510	610X610X48
42EM502072M	585X212X50
42EM502082M	985X212X50
--KH--12AJ-001--M	592X592X534
--KH--12AJ-002--M	287X592X534
--KH--12AJ-005--M	892X592X534
--KH--12AJ-006--M	892X287X534
--KH--12AJ-012--M	720X572X534
--KH--12AJ-013--M	720X768X534
--KH--12AJ-101--M	592X592X547
--KH--12BO-001--M	592X592X25

EFFICIENCY F7



Ordering references	Size (mm)
200032976	592X287X360
200032978	592X592X360
200046888	566X352X92
903210	866X432X92
903211	592X592X92
200046891	752X502X92
200046892	866X432X500
903214	592X592X500
200046894	502X752X500
903216	592X892X500
13875201	592X592X500
13879904	437X287X520
200004651	287X592X534
200004652	287X287X534
200013378	592X592X290
13879904-437592520	437X592X520
13879904-592287520	592X287X520
--KH--12AB-001--M	592X592X534
--KH--12AB-002--M	592X287X534
--KH--12AB-003--M	592X592X635
--KH--12AB-005--M	892X592X534
--KH--12AB-006--M	892X287X534
--KH--12AB-007--M	592X592X292
--KH--12AB-008--M	289X592X292
--KH--12AB-110--M	490X538X534
--KH--12AB-112--M	720X592X534
--KH--12AB-113--M	720X768X534
--KH--12BO-101--M	592X592X25
--KH--12BO-102--M	287X592X25
200032979BOX-8	287X287X360
200032977BOX-7	287X592X360
200029959BOX-7	287X592

EFFICIENCY F8



Ordering references	Size (mm)
200004585	592X592X290
200013379	592X292X290
B036874H01	485X715X50
--KH--12AI-001--M	592X592X534
--KH--12AI-006--M	592X287X292
7511209	610X610X48
7511210	305X610X48
7511211	305X305X48

EFFICIENCY F9



Ordering references	Size (mm)
7509786	305X305X48
7509730	305X610X48
7317855	610X610X48
39FZ-466---292--EE	595 X 592 X 290
39FZ-466---302--EE	595 X 287 X 290
B036874H02	350X1460/3X50
--KH--12AI-002--M	287X592X534
--KH--12AI-007--M	892X592X534

EFFICIENCY M5

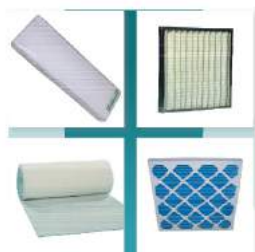

Ordering references	Size (mm)
102070BOX-13	287X592
102167BOX-10	287X592
102171BOX-10	287X287
102253BOX-10	287X592
102344BOX-10	287X592
102348BOX-8	287X287
105101BOX-10	287X592
207443BOX-10	495X495
210151BOX-10	495X495
210876BOX-10	495X394
224414BOX-6	550X307
243870BOX-10	595X290
502677BOX-10	530X290
509282BOX-10	860X650
943066BOX-4	437X592

EFFICIENCY M6



Ordering references	Size (mm)
102614BOX-7	287X592
103990BOX-7	287X592





I | PRESSURE SWITCH

PRESSURE SWITCH / MINI PRESSURE SWITCH	176
PRESSURE SWITCH / HIGH PRESSURE SWITCH	177
PRESSURE SWITCH / LOW PRESSURE SWITCH	180

PRESSURE SWITCH / MINI PRESSURE SWITCH



CARRIER

Mini high pressure switch

Ordering references	Product range	Utilisation type	Setting / Out-in point	Out-out point	Differential	Frigo connection (inch)	Electrical contact	Reset	Voltage (V)	Electrical connection	Refrigerant
00PPG000488900A	ACB 1UB	HP	15 ±2	21 ±0.5		1/4 SAE FLARE FEMALE	SPST/NC	MANUEL	250	WAGO	
00PPG000008201B	ACB 1UB	HP	34 ±2	44.2 ±0.7		1/4 SAE FLARE FEMALE	SPST/NC	AUTOMATIQUE	250	WAGO	
00PPG000008202B	ACB 1UB	HP	34 ±2	41.7 ±0.7		1/4 SAE FLARE FEMALE	SPST/NC	AUTOMATIQUE	250	WAGO	
--WB--12BG-016--EE	PSC	HP/DBK	16 -1/0		5 ±1.5	7/16 20UNF FEMALE	SPDT	MANUEL EXTERNAL	230	FASTON 6.35	R22/R134A/R407C
--WB--12BH-017--EE	PSC	HP/SDBK	17 -1/0		5 ±1.5	7/16 20UNF FEMALE	SPDT	MANUEL INTERNAL	230	CONNECTEURS 6.3MM	R22/R134A/R407C
--WB--12BG-022--EE	PSC	HP/DBK	21 -1/0		5.8 ±1.8	7/16 20UNF FEMALE	SPDT	MANUEL EXTERNAL	230	FASTON 6.35	R22/R134A/R407C
--WB--12BH-023--EE	PSC	HP/SDBK	22 -1/0		5.8 ±1.8	7/16 20UNF FEMALE	SPDT	MANUEL INTERNAL	230	CONNECTEURS 6.3MM	R22/R134A/R407C
--WB--12BG-027--EE	PSC	HP/DBK	27 -1/0		6.2 ±1.9	7/16 20UNF FEMALE	SPDT	MANUEL EXTERNAL	230	FASTON 6.35	R22/R134A/R407C
--WB--12BH-028--EE	PSC	HP/SDBK	28 -1/0		6.2 ±1.9	7/16 20UNF FEMALE	SPDT	MANUEL INTERNAL	230	CONNECTEURS 6.3MM	R22/R134A/R407C
--WB--12BG-029--EE	PSC	HP/DBK	29 -1/0		6.6 ±2	7/16 20UNF FEMALE	SPDT	MANUEL EXTERNAL	230	FASTON 6.35	R22/R134A/R407C
--WB--12BH-030--EE	PSC	HP/SDBK	30 -1/0		6.6 ±2	7/16 20UNF FEMALE	SPDT	MANUEL INTERNAL	230	CONNECTEURS 6.3MM	R22/R134A/R407C
--HK--02ZA-442--S					-	1/4 SAE FEMALE		-	-		R22
--HK--02ZA-395--C					-	1/4 SAE-FEMALE		-	-		R22



CARRIER

Mini low pressure switch

Ordering references	Product range	Utilisation type	Setting / Out-in point	Out-out point	Differential	Range setting	Frigo connection (inch)	Electrical contact	Reset	Voltage (V)	Electrical connection	Refrigerant
--WA--12MN-006--EE	FF31	BP	2.4 ±0.2	3.93 ±0.75	1.5	1/5	7/16 20UNF FEMALE	SPST/NC	AUTOMATIC	220	CONNECTEUR DIN43650	R22/R134A/R407C
--HK--02ZB-028--C							1/4 SAE FEMALE		AUTOMATIC	24 / 125 /230		R22
--HK--02ZB-038--S							1/4 SAE FEMALE		AUTOMATIC	24 / 125 /230		R22
--HK--02ZB-027--C							1/4 SAE-FEMALE		AUTOMATIC	24 / 125 /230		R22

CARRIER



Ordering references	Product range	Utilisation type	Setting / Cut-in point	Cut-out point	Differential	Range setting	Frigo connection (inch)	Electrical contact	Reset	Voltage (V)	Electrical connection	Refrigerant
--WA--12PH-001--EE							1/4 SAE FEMALE		AUTOMATIC 16,9	230		R22
--WA--12PH-002--EE	P20EA	HP	21 ±0.48	14 ±1.72	7 ±1.24	7/29	7/16 20UNF FLARE NUT	SPDT	AUTOMATIC	230	FASTON 6.35	R22
--WA--12PH-003--EE	P20EA	HP	23 ±0.48	16 ±1.72	7 ±1.24	7/29	7/16 20UNF FLARE NUT	SPDT	AUTOMATIC	230	FASTON 6.35	R22
--WA--12PH-004--EE							1/4 SAE FEMALE		AUTOMATIC 17,9	230		R22
--WA--12PH-005--EE							1/4 SAE FEMALE		AUTOMATIC 19,9	230		R22
--WA--12PJ-001--EE							1/4 SAE FEMALE		-	230		R22
--WA--12PJ-004--EE	P20GA	HP	19 ±0.48			7/29	7/16 20UNF FLARE NUT	SPDT	MANUEL HIGHT	230	FASTON 6.35	R22
--WA--12PJ-005--EE							1/4 SAE FEMALE		-	230		R22
--WA--12PJ-008--EE							1/4 SAE FEMALE		-	230		R22
--WA--12PJ-009--EE	P20GA	HP	28 ±0.55			7/29	7/16 20UNF FLARE NUT	SPDT	MANUEL HIGHT	230	FASTON 6.35	R22
--WA--12PJ-010--EE							1/4 SAE FEMALE		-	230		R22

JOHNSON



Ordering references	Product range	Utilisation type	Setting / Cut-in point	Cut-out point	Differential	Range setting	Frigo connection (inch)	Electrical contact	Reset	Voltage (V)	Electrical connection	Refrigerant
--WA--12BB-002--EE	P20EA	HP	1.3 ±0.2	2.8 ±0.75	1.5 ±0.55	7/29	7/16 20UNF FLARE NUT	SPDT	AUTOMATIC	230	FASTON 6.35	R22
--WA--12BB-003--EE	P20EA	HP	3 ±0.2	4.5 ±0.75	1.5 ±0.55	7/29	7/16 20UNF FLARE NUT	SPDT	AUTOMATIC	230	FASTON 6.35	R22
--VA--12BF-005--EE	P78	HP DBK/ SDBK	22 ±0.5	25 ±0.75		3/30	7/16 20UNF MALE NUT	SPST	MANUEL	400		R22/R134A/ R404A
--VA--12BF-006--EE	P78	HP DBK/ SDBK	20 ±0.5	22 ±0.75		3/30	7/16 20UNF MALE NUT	SPST	MANUEL	400		R22/R134A/ R404A
--VA--12BF-008--EE						3-30	7/16 MALE - 20UNF					R22 - R134A
--VA--12AA-002--EE	P78	HP DBK/ SDBK	11 ±0.5	12.5 ±0.75		3/30	7/16 20UNF MALE NUT	SPST	MANUEL	400		R22/R134A/ R404A
--VA--12AA-003--EE						0.2 - 4	R 3/8 MÅLE					
--WA--12KN-011--EE						10-31	-					

0352207X15 P35AC HP

For other codes, please consult us.

PRESSURE SWITCH / HIGH PRESSURE SWITCH

DANFOSS

Ordering references	Product range	Utilisation type	Setting / Out-in point	Out-out point	Differential	Frigo connection (inch)	Electrical contact	Reset	Voltage (V)	Electrical connection	Refrigerant
00PPG000513902A	ACB 1UB	HP	10 ±2	13.5 +0/-1		1/4 SAE FLARE FEMALE	SPST/NC	MANUEL	250	WAGO	
00PPG000453300B	ACB 1UB	HP	10 ±2	15 +0.5/-1		1/4 SAE FLARE FEMALE	SPST/NC	MANUEL	250	WAGO	
00PPG000514001A	ACB 1UB	HP	11 ±2	14.5 +0/-1		1/4 SAE FLARE FEMALE	SPST/NC	MANUEL	250	WAGO	
00PPG000513900-	ACB 1UB	HP	11 ±2	17 +0/-1		1/4 SAE FLARE FEMALE	SPST/NC	MANUEL	250	WAGO	
00PPG000513901A	ACB 1UB	HP	11 ±2	17 +0/-1		1/4 SAE FLARE FEMALE	SPST/NC	MANUEL	250	WAGO	
00PPG000469901A	ACB 1UB	HP	12 ±2	17 +0.5/-1		1/4 SAE FLARE FEMALE	SPST/NC	MANUEL	250	WAGO	
00PPG000514000-	ACB 1UB	HP	13 ±2	18 +0/-1		1/4 SAE FLARE FEMALE	SPST/NC	MANUEL	250	WAGO	
00PPG000513903A	ACB 1UB	HP	13 ±2	18.5 +0/-1		1/4 SAE FLARE FEMALE	SPST/NC	MANUEL	250	WAGO	
00PPG000514002A	ACB 1UB	HP	14 ±2	19.5 +0/-1		1/4 SAE FLARE FEMALE	SPST/NC	MANUEL	250	WAGO	
00PPG000469903A	ACB 1UB	HP	15 ±2	21 ±0.5		1/4 SAE FLARE FEMALE	SPST/NC	MANUEL	250	WAGO	
00PPG000541200A	ACB 1UB	HP	16 ±2	22.5		1/4 SAE FLARE FEMALE	SPST/NC	MANUEL	250	WAGO	
00PPG000469904A	ACB 1UB	HP	17 ±2	23.5 +0/-1		1/4 SAE FLARE FEMALE	SPST/NC	MANUEL	250	WAGO	
00PPG000513904A	ACB 1UB	HP	20 ±2	26 +0/-1		1/4 SAE FLARE FEMALE	SPST/NC	MANUEL	250	WAGO	
00PPG000514003A	ACB 1UB	HP	21 ±2	27 +0/-1		1/4 SAE FLARE FEMALE	SPST/NC	MANUEL	250	WAGO	
--WA--12LN-008--EE	MP54	HP			0.65/0.41	1/4 SAE FLARE MALE		MANUEL	120/240	4 VS M4	R22/R134A
00PPG000473400A		HP	15 ±2	21 +0.5/-1		1/4 SAE FLARE FEMALE	SPST/NC	MANUEL	250	WAGO	
--WA--12BA-003--EE		HP				1/4 SAE FLARE FEMALE					R22/R134A/ R407C
00PPG000008205B	ACB 1UB	HP	24 ±2	31.3 ±0.7		1/4 SAE FLARE FEMALE	SPST/NC	AUTOMATIC	250	WAGO	
00PPG000008206B	ACB 1UB	HP	24 ±2	31.3 ±0.7		1/4 SAE FLARE FEMALE	SPST/NC	AUTOMATIC	250	WAGO	
061F6491	ACB 1UB	HP	34 ±2	44 +0/- 1.5		1/4 SAE FLARE MALE	SPST/NC	AUTOMATIC	250		
00PPG000008204B	ACB 1UB	HP	34 ±2	44.2 ±0.7		1/4 SAE FLARE FEMALE	SPST/NC	AUTOMATIC	250	WAGO	
00PPG000480000C	ACB 1UB	HP	37 ±2	47 +0/- 1.4		1/4 SAE FLARE FEMALE	SPST/NC	AUTOMATIC	250	WAGO	
7248890	ACB 2UB	HP	33 ±2.1	42.54 ±1.2		1/4 SAE FLARE FEMALE	SPST/NC	AUTOMATIC	250	AWG18	R22/R407C/ R134A/R410A/ R1234ZE
7204500	ACB 2UC	HP	19 ±1.2	23 ±0.7		1/4 SAE FLARE FEMALE	SPDT	AUTOMATIC	250	CABLE	R22/R407C/ R134A/R410A/ R1234ZE
060-117966	KP5	HP	35		1.8/6	1/4 SOLDER ODF FEMALE	SPDT	AUTOMATIC	400		R22/R134A/ R407C/R404A

ALCO-EMERSON



Ordering references	Product range	Utilisation type	Setting / Cut-in point	Cut-out point	Differential	Range setting	Frigo connection (inch)	Electrical contact	Reset	Voltage (V)	Electrical connection	Refrigerant
FD113ZU	EBAL	HP	0,7	0,5	-0.8/12	0.3/4.5	1/4 SAE FLARE MALE	SPDT	MANUEL	230		R22/R134A/R407C
--WA--12KN-006-EE	FFW31	HP	19	12,7	6.3		7/16" 20UNF FEMALE	SPDT	AUTOMATIC	230	CONNECTEUR DIN43650	R22/R134A/R407C/R410A
4353300	PS1	HP	20			6/31	7/16" 20UNF MALE	SPDT	MANUEL EXTERNAL	230		R22/R134A/R407C/R410A
0715568-	PS3	HP	19,2	14,2			7/16" 20UNF FEMALE	SPDT	MANUEL EXTERNAL		CONNECTEUR DIN43650	R22/R134A/R407C
7245366	PS3	HP	21	16	1/5		7/16" 20UNF FEMALE	SPST/NC	AUTOMATIC	230	CONNECTEUR DIN43650	R22/R134A/R407C
30ZX-574---172-EE	PS3	HP	21 +0/-1		5.6 ±1.6			SPDT				
--WB--12KN-013-EE	PS3	HP	22 +0/-0.8		5.8 ±1.8		7/16" 20UNF FEMALE	SPDT	MANUEL INTERNAL	230	CONNECTEUR DIN43650	R134A
--WB--12KN-018-EE	PS3	HP	25 +0/-0.8		6.2 ±1.9		1/4 SAE FLARE FEMALE	SPDT	MANUEL INTERNAL	230	DIN PLUG 1/2 NPTF HUB	R22/R134A/R407C/R410A

JOHNSON CONTROL

Double High Pressure Switch



Ordering references	Utilisation type	Setting / Cut-in point	Cut-out point	Range setting	Frigo connection (inch)	Electrical contact	Reset	Voltage (V)	Refrigerant
--VA--12BF-001-EE	HP DBK/SDBK	19 ±0.5	20.5 ±0.75	3/30	7/16 20UNF MALE NUT	SPST	MANUEL	400	R22/R134A/R404A
--VA--12BF-003-EE	HP DBK/SDBK	25 ±0.5	26.5 ±0.75	3/30	7/16 20UNF MALE NUT	SPST	MANUEL	400	R22/R134A/R404A
--VA--12BF-007-EE	HP DBK/SDBK	27 ±0.5	28.5 ±0.75	3/30	7/16 20UNF MALE NUT	SPST	MANUEL	400	R22/R134A/R404A
--VA--12BF-004-EE	HP DBK/SDBK	29 ±0.5	30.5 ±0.75	3/30	7/16 20UNF MALE NUT	SPST	MANUEL	400	R22/R134A/R404A

PRESSURE SWITCH / LOW PRESSURE SWITCH

CARRIER



Ordering references	Product range	Utilisation type	Setting / Cut-in point	Out-out point	Differential	Range setting	Frigo connection (inch)	Electrical contact	Reset	Voltage (V)	Electrical connection	Refrigerant
--WA--12LN-002--EE	P20FA	BP	1.5 ±0.2	2.4 ±3%	0.9 ±3%	0.5/10	7/16 20UNF FLARE NUT	SPDT	AUTOMATIC	230	FASTON 6.35	R22
--WB--12LN-003--EE	P20FA	BP	3 ±0.2	3.9	0.9	0.5/10	7/16 20UNF FLARE NUT	SPDT	MANUEL LOW	230	FASTON 6.35	R22
--WB--12LN-001--EE							1/4 SAE FEMALE		AUTOMATIC	230		
--WA--12LN-005--EE	P20EA	BP	2 ±3%	2.9 ±3%	2.1 ±3%	0.5/10	7/16 20UNF FLARE NUT	SPDT	AUTOMATIC	230	FASTON 6.35	R22
--WA--12LN-006--EE							1/4 SAE FEMALE		AUTOMATIC	230		
--WA--12LN-011--EE	P20EA	BP	0.5 ±3%	1.4 ±3%	0.9 ±50%	0.5/10	7/16 20UNF FLARE NUT	SPDT	AUTOMATIC	230	FASTON 6.35	R22
--WB--12BB-003--EE							1/4 SAE FEMALE		AUTOMATIC	230		
--WB--12BB-004--EE	P20EA	BP	2 ±0.2	3.5 ±0.75	1.5 ±0.55	0.5/10	7/16 20UNF FLARE NUT	SPDT	AUTOMATIC	230	FASTON 6.35	R22
--WB--12BB-005--EE							1/4 SAE FEMALE		AUTOMATIC	230		

CARRIER

Oil differential pressure switch



Ordering references	Utilisation type	Setting / Cut-in point	Out-out point	Differential	Refrigerant
--HK--06UC-006--S	X	750 VA	0.27 - 0.41	0.62 - 0.82	
30GT-660---018--S					
--HK--06UC-007--C	X	750VA	0,27 - 0,41	0,62 - 0,82	





J | ELECTRICAL PARTS

ELECTRICAL PARTS / CONTACTORS	184
ELECTRICAL PARTS / CONTACTORS ACCESSORIES	186
ELECTRICAL PARTS / CONTACTORS	187
ELECTRICAL PARTS / AUXILIARY CONTACT RELAYS	190
ELECTRICAL PARTS / STARTERS	192
ELECTRICAL PARTS / BREAKERS	193
ELECTRICAL PARTS / FUSES	203
ELECTRICAL PARTS / FUSES SIEMENS	206
ELECTRICAL PARTS / FUSES SWITCH DISCONNECTOR	207
ELECTRICAL PARTS / SWITCH DISCONNECTORS WITHOUT FUSE	210
ELECTRICAL PARTS / TRANSFORMERS	211
ELECTRICAL PARTS / RELAYS	213
ELECTRICAL PARTS / CAPACITORS	216
ELECTRICAL PARTS / CRANKCASE HEATER	220
ELECTRICAL PARTS / ACTUATORS	221
ELECTRICAL PARTS / DAMPER ACTUATOR	223
ELECTRICAL PARTS / SPRING RETURN ACTUATOR	224

SIEMENS



3 Poles Contactors
 Previous range 3RT1 replaced by 3RT2
 NO : Normaly open
 NF : Normaly closed

Ordering reference	MAIN CONTACT	Auxiliary contact	Voltage (V)	FREQUENCE (HZ)	Power (W) 400 V
3RT2015-1AB01	3	1 NO	24	50/60	3
3RT2015-1AB02	3	1 NC	24	50/60	3
3RT2015-1AF01	3	1 NO	110	50/60	3
3RT2015-1AP01	3	1 NO	230	50/60	3
3RT2015-2AB01	3	1 NO	24	50/60	3
3RT2015-2AB02	3	1 NC	24	50/60	3
3RT2016-1AB01	3	1 NO	24	50/60	4
3RT2016-1AB02	3	1 NC	24	50/60	4
3RT2016-1AP01	3	1 NO	230	50/60	4
3RT2016-2AB01	3	1 NO	24	50/60	4
3RT2017-1AB01	3	1 NO	24	50/60	5,5
3RT2017-1AB02	3	1 NC	24	50/60	5,5
3RT2017-1AF01	3	1 NO	110	50/60	5,5
3RT2017-1AP01	3	1 NO	230	50/60	5,5
3RT2017-1AP02	3	1 NC	230	50/60	5,5
3RT2017-2AB01	3	1 NO	24	50/60	5,5
3RT2023-1AP00	3	-	230	50	4
3RT2023-2AB00	3	1 NO / 1NC	24	50	4
3RT2024-1AB00	3	-	24	50	5,5
3RT2024-1AF00	3	-	110	50	5,5
3RT2025-1AB00	3	-	24	50	7,5
3RT2025-1AB04	3	2 NO / 2NC	24	50	7,5
3RT2025-1AG20	3	-	110	50	7,5
3RT2025-1AP04	3	2 NO / 2NC	230	50	7,5
3RT2025-1BB40	3	-	24	50/60	7,5
3RT2026-1AB00	3	-	24	50	11
3RT2026-1AB04	3	-	24	50	11
3RT2026-1AC20	3	-	24	50/60	11
3RT2026-1AF00	3	-	110	50	11
3RT2026-1AG20	3	-	110	50/60	11
3RT2026-1AK60	3	-	110	50/60	11
3RT2026-1AP00	3	-	230	50	11
3RT2026-2AB00	3	1 NO / 1NC	24	50	11
3RT2027-1AB00	3	1 NO / 1NC	24	50	15
3RT2027-2AB00	3	1 NO / 1NC	24	50	15

SIEMENS



3 Poles Contactors
 Previous range 3RT1 replaced by 3RT2
 NO : Normaly open
 NF : Normaly closed

Ordering reference	MAIN CONTACT	Auxiliary contact	Voltage (V)	FREQUENCE (HZ)	Power (W) 400 V
3RT2028-1AB00	3	1 NO / 1NC	24	50	18,5
3RT2034-1AB00	3	-	24	50	15
3RT2034-3AB00	3	-	24	50	15
3RT2035-1AB00	3	-	24	50	18,5
3RT2035-1AB04	3	2 NO / 2NC	24	50	18,5
3RT2035-1AC20	3	-	24	50/60	18,5
3RT2035-1AF00	3	-	110	50	15
3RT2035-1AG20	3	-	110	50/60	15
3RT2035-1AP00	3	-	230	50	18,5
3RT2035-3AB00	3	-	24	50	18,5
3RT2035-3AF00	3	-	110	50	15
3RT2036-1AB00	3	-	24	50	22
3RT2036-1AB04	3	2 NO / 2NC	24	50	22
3RT2036-1AF00	3	-	110	50	22
3RT2036-1AF04	3	2 NO / 2NC	110	50	22
3RT2036-1AP00	3	-	230	50	18,5
3RT2036-1NF30	3	-	110	50/60	18,5
3RT2044-1AC20	3	-	24	50/60	30
3RT2044-1AF00	3	-	110	50	30
3RT2044-1AF04	3	2 NO / 2NC	110	50	LYON
3RT2044-1AG20	3	-	110	50/60	30
3RT2044-1AP00	3	-	230	50	30
3RT2044-3AB00	3	-	24	50	30
3RT2044-3AF00	3	-	110	50	30
3RT2045-1AF00	3	-	110	50	37
3RT2045-1AG20	3	-	110	50/60	37
3RT2045-1AP04	3	2 NO / 2NC	230	50	37
3RT2045-3AF00	3	-	110	50	37
3RT2046-1AB00	3	-	24	50	45
3RT2046-1AP04	3	2 NO / 2NC	230	50	45
3RT2046-3AF00	3	-	110	50	45
3RT2316-2AB00	4	-	24	50/60	4

SIEMENS

Contactors

NO : Normaly open

NF : Normaly closed

Ordering Reference	Description	Power category AC3 / 400V
3RT1954-6A	ACCESSORIE / MAIN CONTACTS COMPLET SET FOR 3RT1054	55
3RT1955-6A	ACCESSORIE / MAIN CONTACTS COMPLET SET FOR 3RT1055	75
3RT1956-6A	ACCESSORIE / MAIN CONTACTS COMPLET SET FOR 3RT1056	90
3RT1964-6A	ACCESSORIE / MAIN CONTACTS COMPLET SET FOR 3RT1064	110
3RT1965-6A	ACCESSORIE / MAIN CONTACTS COMPLET SET FOR 3RT1065	132

For more information about 3RT2 contactors accessories, please contact us



SCHNEIDER

Contactors

NO : Normaly open

NF : Normaly closed

Ordering Reference	MAIN CONTACT	Auxiliary contact	Voltage (V)	FREQUENCY (HZ)	Power (W) 400 V
LC1K0601B7	3	1 NC	24	50/60	2,2
LC1K0610B7	3	1 NO	24	50/60	2,2
LC1K09004B7	4	1NO / 1 NC	24	50/60	44
LC1K0901B7	3	1 NC	24	50/60	4
7262253	3	1 NO	24	50/60	4
LC1D12B7	3	1NO / 1 NC	24	50/60	5,5
LC1D18B7	3	1NO / 1 NC	24	50/60	7,5
LC1D25B7	3	1NO / 1 NC	24	50/60	11
LC1D32BD	3	1NO / 1 NC	24	50/60	15
--CT--12SA-099--EE		1NO / 1 NC			
3261545	3	1NO / 1 NC	115	50/60	37
3261546	3	1NO / 1 NC	230	50/60	5,5
7262655	3	1NO / 1 NC	230	50/60	7,5
3261548	3	1NO / 1 NC	230	50/60	11
7326798	3	1NO / 1 NC	230	50/60	18,5
7326739	3	1 NO	220	50/60	110
7326738	3	1NO / 1 NC	230	50/60	7,5
3261861	3	1NO / 1 NC	230	50/60	45
7015407	3	-	230	50/60	75
7318196	3	1 NC	230	50/60	4
7243892	3	1NO / 1 NC	230	50/60	15
7326784	3	1NO / 1 NC	230	50/60	30



TELEMECANIQUE

Contactors

NO : Normaly open

NF : Normaly closed

Ordering Reference	MAIN CONTACT	Auxiliary contact	Voltage (V)	FREQUENCE (HZ)	Power (W) 400 V
--CT--12DA-503--EE		1NO / 1 NC			22
--CT--12DA-803--EE	3	1NO / 1 NC	230	50/60	37
--CT--12SB-099--EE		1NO / 1 NC			4
--CT--12SB-403--EE		1NO / 1 NC			18,5
--CT--12SB-503--EE		1NO / 1 NC			22
--CT--12SB-603--EE		1NO / 1 NC			30
--CT--12SB-803--EE		1NO / 1 NC			37

ABB



Contactors
 NO : Normaly open
 NF : Normaly closed

Ordering Reference	MAIN CONTACT	Auxiliary contact	Voltage (V)	FREQUENCE (HZ)	Power (W) 400 V
0351802H98	3	1NO / 1 NC	230	50/60	4
0351804H30		1NO / 1 NC			
7239488	2	-	230/264	50/60	
--CW--12AL-619--EE	3	1 NO	24	50/60	4
7262876	3	1 NO	220	50/60	5,5
--CW--12AL-060--EE	3	1NO / 1 NC	220	50/60	18,5
--CW--00AL-279--EE		1NO / 1 NC			
--CW--00AL-725--EE		1NO / 1 NC			
--CW--12AL-019--EE	3	1 NO	220	50/60	2,2
--CW--12AL-025--EE	3	1 NO	220	50/60	7,5
--CW--12AL-034--EE	3	1NO / 1 NC	220	50/60	11
--CW--12AL-040--EE	3	1NO / 1 NC	220	50/60	15
--CW--12AL-064--EE	3	1NO / 1 NC	220	50/60	22
--CW--12AL-079--EE	3	1NO / 1 NC	220	50/60	30
--CW--12AL-090--EE		-			
--CW--12AL-622--EE	3	1 NO	24	50/60	5,5
--CW--12AL-625--EE		1 NO			
--CW--12AL-634--EE	3	1NO / 1 NC	24	50/60	11
--CW--12AL-660--EE	3	1NO / 1 NC	24	50/60	18,5
--CW--12AL-664--EE	3	1NO / 1 NC	24	50/60	22
--CW--12AL-679--EE	3	1NO / 1 NC	24	50/60	30
--CW--12BE-001--EE	3	3 NO / 0 NC MAIN CONTACT	220	50/60	45
--CW--12BE-002--EE	3	3 NO / 0 NC MAIN CONTACT	220	50/60	55
--CW--12BE-003--EE	3	1NO / 1 NC	220	50/60	75
--CW--12BE-005--EE	3	1NO / 1 NC	220	50/60	90
7513896	3		230	50/60	22
--CW--12BE-018--EE		0 NO / 0 NF			

ABB



Mini contactors
 NO : Normaly open
 NF : Normaly closed

Ordering Reference	MAIN CONTACT	Auxiliary contact	Voltage (V)	FREQUENCE (HZ)	Coil voltage/frequency
--CW--12AF-602--EA	3	1 NO	24	50/60	24 V AC / 40...450
--CW--12AF-002--EA	3	1 NC	230	50/60	230 V AC / 40...450
0351811H21		0 NO / 1 NF			24 V AC / 40...450

SIEMENS

AUXILIARY CONTACT RELAYS



Ordering Reference	MAIN CONTACT	Voltage (V)	Power (W) 400 V
3RH2122-1AB00	3	24	
3RH2122-1AF00	3	110	
3RH2122-1AP00	3	230	
3RH2131-1AB00	3	24	
3RH2131-2AF00	3	110	
3RH2140-1AB00	3	24	
3RH2140-2AP00	3	230	
3RH1911-2FA11	3		
3RH1911-2HA01	3		
3RH1921-1EA02	3		
3RH1921-1EA11	3		
3RH1921-1LA20	3		
3RH2131-2AB00	3	24	
3RH2140-2AB00	3	24	

TELEMECANIQUE



Contactors
 NO : Normaly open
 NF : Normaly closed

Ordering Reference
 --CT--12XA-040--EE

Auxiliary contact
 4 NO

SCHNEIDER



Contactors
 NO : Normaly open
 NF : Normaly closed

Ordering Reference

Auxiliary contact

7326734

3261604

LA1KN11

CA2SK20B7

1 NO / 4 NF

2 NO / 0 NF

ABB



Contactors
 NO : Normaly open
 NF : Normaly closed

Ordering Reference

Auxiliary contact

871200

--CW--12XA-031--EA

--CW--12XC-001--EE

--CW--12XC-002--EE

7262891

--CW--12XL-010--EE

--CW--12XL-901--EE

--CY--12AK-405--EE

1 NO / 1 NC

3 NO/ 1 NF

1 NO / 1 NC

1 NO / 1 NC

1 NO

1 NC

2 NO / 2 NC



SIEMENS

Starter

NO: Normaly open

NF: Normaly closed

Ordering references	PART DESIGNATION	starting / rated values for wiring type	Power 40°C/400V (kW)	Supply voltage (V)	Operational Voltage (V)	Rated current I _e /50°C (A)
57090020004	SOFT STARTER 3RW3014-1BB04					
57090020006	SOFT STARTER					
57090020007	SOFT STARTER 3RW3018-1BB04					
3RW3024-1AB04	ELECTRONIC SOFT STARTER					
3RW3026-1AB04	ELECTRONIC SOFT STARTER					
3RW3026-1BB04	ELECTRONIC SOFT STARTER 11kW 400V S0					
3RW3026-2BB04	ELECTRONIC SOFT STARTER					
3RW3027-1BB04	ELECTRONIC SOFT STARTER 15kW 400V S0	CLASS 10 / INLINE CIRCUIT	15	AC/DC 24 V	200-480 V	29
3RW3027-2BB04	SOFT STARTER					
3RW3028-2BB04	ELECTRONIC SOFT STARTER					
3RW3034-1AB04	ELECTRONIC SOFT STARTER 15kW 24V					
3RW3035-1AB04	ELECTRONIC SOFT STARTER					
3RW3036-1AB04	ELECTRONIC SOFT STARTER					
3RW3036-1BB04	ELECTRONIC SOFT STARTER 22kW 400V S2	CLASS 10 / INLINE CIRCUIT	22	AC/DC 24 V	200-480 V	42
3RW3037-1BB04	SOFT STARTER					
3RW3037-1BB14	SOFT STARTER					
3RW3038-1BB04	PROGRAMMABLE STARTER					
3RW3044-1AB04	ELECTRONIC SOFT STARTER					
3RW3346-0EC34	STARTER TO BE LOADED	CLASS 10 / INSIDE- DELTA CIRCUIT WITH EXTERNAL BYPASS	-	115 V AC	200-460 V AC	80
3RW4026-1BB04	ELECTRONIC SOFT STARTER 11kW 400V S0					
3RW4027-1BB04	ELECTRONIC SOFT STARTER 15kW 400V S0					
3RW4027-2BB04	SOFT STARTER	CLASS 10 / INLINE CIRCUIT	15	AC/DC 24 V	200-480 V	32
3RW4028-1BB04	ELECTRONIC SOFT STARTER 18,5kW 400V	CLASS 10 / INLINE CIRCUIT	18.5	AC/DC 24 V	200-480 V	34
3RW4028-2BB04	ELECTRONIC SOFT STARTER					
3RW4036-1BB04	SOFT STARTER 45A 22kW/400V					
3RW4037-1BB04	ELECTRONIC SOFT STARTER 30kW 400V S2					
3RW4037-2BB04	ELECTRONIC SOFT STARTER	CLASS 10 / INLINE CIRCUIT	30	AC/DC 24 V	200-480 V	58
3RW4075-6BB44	STARTER SIRISU 356A 200kW/400V					
3RW4445-6BC36	ELECTRONIC SOFT STARTER					
3RW4446-6BC34	SOFT STARTER					
3RW4446-6BC44	SOFT STARTER					
3RW4447-6BC34	SOFT STARTER					
3RW4454-6BC34	SOFT STARTER					
3RW4454-6BC36	SOFT STARTER					
3RW4928-8VB00	FAN STARTER					
KIT-DEMARREUR-30GX	30GX SOFT STARTER SIEMENS KIT					
KIT-DEMARREUR-30HX	30HX SOFT STARTER SIEMENS KIT					

EATON



Breakers
 Breaking capacity 4000A with 400V
 Reverser auxiliary contact placed on the rear

Ordering references	Terminal	Short circuit breaking capacity at 400V (kA)
--FL--12JA-060--EE	SCREW	5000A / 480VAC / UL508
--FL--12JA-077--EE	SCREW	5000A / 480VAC / UL508
--FL--12JA-080--EE	SCREW	5000A / 480VAC / UL508
--FL--12JA-088--EE	SCREW	5000A / 480VAC / UL508
--FL--12JA-015--EE	SCREW	5000A / 480VAC / UL508
--FL--12JA-050--EE	SCREW	5000A / 480VAC / UL508

ABB

1 Pole circuit Breakers

Ordering references	Number of poles	Operating current (A) 400V	Terminal	Voltage (V)	Frequency (HZ)
7212040	1	2	SCREW	230	50/60
7267141	1				50/60

SCHNEIDER

1 Pole circuit Breakers

Ordering references	Number of poles	Operating current (A) 400V	Terminal	Voltage (V)	Frequency (Hz)
7245852	1	8	1 OR 2 CABLE	250	50/60
7326724	1	3	1 OR 2 CABLE	250	50/60



SIEMENS

1 Pole circuit Breakers

Ordering references	Number of poles	Operating current (A) 400V	Terminal	Voltage (V)	Frequency (Hz)
5SY5101-7	1	1	QUICK	400	50/60
5SY6004-7	1	4	QUICK	230	50/60
5SY6101-7	1	1	QUICK	230	50/60
5SY6102-7	1	2		400	50/60
5SY6105-7	1	0,5		400	50/60
5SY6106-7	1	6		400	50/60
5SY6116-7	1	16		400	50/60
5SL3101-7	1			400	50/60
5SY4101-8	1	1	QUICK	400	50/60
5SY4105-7	1	0,5	QUICK	400	50/60
5SY4106-7	1	6	QUICK	400	50/60
5SY4110-7	1	10		400	50/60

ABB



2 Poles circuit Breakers

Ordering references	Number of poles	Operating current (A) 400V	Terminal	Voltage (V)	Frequency (HZ)
7212037	2	6	SCREW	230	50/60
7212041	2	4	SCREW	230	50/60
7227737	2	10	SCREW	230	50/60
7227738	2	16	SCREW	230	50/60
7381067	2	32		690	50/60
7267147N4	2	2	SCREW	230	50/60
ABB470227	2	1	SCREW	230	50/60
--FL--12EQ-003--EE	2	2	SCREW	440	50/60
2018470	2	4	SCREW	440	50/60
7096648	2	0,5	SCREW	440	50/60
7096650	2	1	SCREW	440	50/60
7096652	2	2	SCREW	440	50/60
7096654	2	3	SCREW	440	50/60
7096655	2	4	SCREW	440	50/60
7220090	2		SCREW	230	50/60
7220092	2	1	SCREW	440	50/60
7220379	2	10	SCREW	440	50/60
7227207	2	2	SCREW	440	50/60
7227730	2	20	SCREW	440	50/60
7369270	2	3	SCREW	440	50/60
7492665	2	2	SCREW	440	50/60
7526858	2	6	SCREW	440	50/60
0351406H47	2	50		415	50/60
0351406H49	2	16	SCREW	440	50/60
0351406X33	2	6	SCREW	440	50/60
--FL--12EP-001--EE	2		SCREW		50/60

SIEMENS



2 Poles circuit Breakers

Ordering references	Number of poles	Operating current (A) 400V	Terminal	Voltage (V)	Frequency (HZ)
7512192	2	32		690	50/60
7512193	2	32		690	50/60
5SY4208-7	2	8	QUICK	400	50/60
5SY4210-6	2	10	QUICK	400	50/60
5SY4210-8	2	10	QUICK	400	50/60
5SY4213-6	2	13	QUICK	400	50/60
5SY4220-6	2	20	QUICK	400	50/60
5SY4225-6	2	25	QUICK	400	50/60
5SY4225-7	2	25	QUICK	400	50/60
5SY4240-7	2	40	QUICK	400	50/60
5SY6202-7	2	2		400	50/60
5SY62106	2	10		400	50/60
5SY62206	2	20		400	50/60
5SY6232-7	2	32	QUICK	230	50/60
5SY7206-6	2	6	QUICK	400	50/60
5SM2322-6	2	1000		400	50/60
5SU1354-0KK06	2	6		230	50/60
5SV4311-OKL	2	16		230	50/60
5SY4201-8	2	1	SCREW	400	50/60
5SY4206-6	2	6	QUICK	400	50/60



SCHNEIDER

2 Poles circuit Breakers

Ordering references	Number of poles	Operating current (A) 400V	Terminal	Voltage (V)	Frequency (HZ)
25421	2	4	SCREW	500	50/60
7408419	2	6	SCREW	500	50/60
7409125	2	1	SCREW	500	50/60
7409126	2	10	SCREW	500	50/60
A9F95202	2	2	SCREW	500	50/60
A9F95203	2	3		440	50/60
GB2DB06	2	1	1 OR 2 CABLE	415	50/60

SIEMENS



3 Poles circuit Breakers
Without auxiliary contact bloc.
Previous range 3RV1 replaced by 3RV2

Ordering references	Number of poles	Operating current (A) 400V	Terminal	Power (KW) 400V	Voltage (V)	Frequency (Hz)	Thermal overload release setting current Ir (A)	Rated current Ie/50°C (A)	instantaneous overcurrent release Im (A)
3RV2011-0BA20	3	0,2	SPRING	0,06	690	50/60			
3RV2011-0CA10	3	0,25	SCREW	0,06	690	50/60	0,18 - 0,25	0,25	3,3
3RV2011-0DA10	3	0,32	SCREW	0,09	690	50/60	0,22 - 0,32	0,32	3,8
3RV2011-0DA20	3	0,32	SPRING	0,09	690	50/60	0,22 - 0,32	0,32	3,8
3RV2011-0FA10	3	0,5	SCREW	0,12	690	50/60	0,35 - 0,5	0,5	6
3RV2011-0GA10	3	0,63	SCREW	0,18	690	50/60	0,45 - 0,63	0,63	8,2
3RV2011-0GA20	3		CAGE CLAMP	0,18	690	50/60	0,45 - 0,63	0,63	7,6
3RV2011-0GA25	3	0,63	SPRING	0,18	690	50/60			
3RV2011-0HA20	3	0,8	SPRING	0,18	690	50/60	0,55 - 0,80	0,8	10
3RV2011-0JA10	3	1	SCREW	0,25	690	50/60	0,70 - 1,00	1	12
3RV2011-4AA10	3	16	SCREW	7,5	690	50/60			
3RV2011-4AA20	3	16	SPRING	7,5	690	50/60			
3RV2021-1KA20	3	12,5	SPRING	5,5	690	50/60			
3RV2011-0JA20	3	0,85	SPRING	0,25	690	50/60	0,70 - 1,00	1	12
3RV2011-0KA10	3	1,1	SCREW	0,37	690	50/60	0,9 - 1,25	1,25	16
3RV2011-0KA20	3	1,25	SPRING	0,37	690	50/60	0,9 - 1,25	1,25	15
3RV2011-1AA10	3	1,6	SCREW	0,55	690	50/60	1,1 - 1,6	1,6	21
3RV2011-1AA20	3	1,6	SPRING	0,55	690	50/60			
3RV2021-4AA10	3	16	SCREW	7,5	690	50/60	11-16	16	208
3RV2021-4AA15	3	16	SCREW	7,5	690	50/60	11-17	16	208
3RV2021-4AA20	3	16	SCREW	7,5	690	50/60	11 - 16	16	208
3RV2011-1BA10	3	2	SCREW	0,75	690	50/60	1,4 - 2	2	26
3RV2011-1BA15	3	2	SCREW	0,75	690	50/60	1,4-2	2	26
3RV2011-1BA20	3	1,9	SPRING	0,75	690	50/60			
3RV2021-4BA15	3	20	SCREW	7,5	690	50/60	14-20	20	260
3RV2021-4BA20	3	15,5	SPRING	7,5	690	50/60			
3RV2011-1CA10	3	2,5	SCREW	0,75	690	50/60			
3RV2011-1CA15	3	1,9	SCREW	0,75	690	50/60			
3RV2011-1DA10	3	3,2	SCREW	1,1	690	50/60	2,2 - 3,20	3,2	42
3RV2011-1EA10	3	4	SCREW	1,5	690	50/60	2,8-4	4	48
3RV2011-1EA20	3	3,6	SPRING	1,5	690	50/60			
3RV2011-1FA10	3	5	SCEW	2,2	690	50/60			
3RV2011-1FA20	3	5	SPRING	2,2	690	50/60	3,50 - 5,00	5	60
3RV2011-1GA10	3	6,3	SCREW	2,2	690	50/60	4,5-6,3	6,3	82
3RV2011-1GA20	3	6,3	SPRING	2,2	690	50/60	4,5 - 6,3	6,3	82
3RV2011-1HA10	3	8	SCREW	3	690	50/60	5,5-8	8	96
3RV2011-1HA20	3	8	SPRING	3	690	50/60	5,5 - 8	8	96
3RV2011-1HA25	3	8	SPRING	3	690	50/60			
3RV2011-1JA10	3	10	SCREW	4	690	50/60	7 - 10	10	120
3RV2011-1JA20	3	10	SPRING	4	690	50/60	7 - 10	10	130
3RV2011-1KA10	3	12	SCREW	5,5	690	50/60	9 - 12	12	156

SIEMENS



3 Poles circuit Breakers
Without auxiliary contact bloc.
Previous range 3RV1 replaced by 3RV2

Ordering references	Number of poles	Operating current (A) 400V	Terminal	Power (kW) 400V	Voltage (V)	Frequency (Hz)	Thermal overload release setting current I _r (A)	Rated current I _e /50°C (A)	instantaneous overcurrent release I _m (A)
3RV2021-4CA10	3	22	SCREW	11	690	50/60			
3RV2021-4CA20	3	22	SPRING	11	690	50/60	17 - 22	22	286
3RV2021-4DA10	3	25	SCREW	11	690	50/60	20-25	25	300
3RV2021-4EA10	3	32	SCREW	15	690	50/60			
3RV2021-4FA10	3	40	SCREW	18,5	690	50/60			
3RV2021-4NA10	3	22	SCREW	11	690	50/60			
3RV2021-4NA20	3	22	SPRING	11	690	50/60			
3RV2011-1AA25	3	1,6	SPRING	0,55	690	50/60			
3RV2031-4EA10	3	32	SCREW	15	690	50/60	22 - 32	32	416
3RV2031-4UA10	3	40	SCREW	18,5	690	50/60			
3RV2031-4VA10	3	45	SCREW	22	690	50/60			
3RV2031-4WA10	3	50	SCREW	22	690	50/60	40 - 50	50	650
3RV2011-1CA20	3	2,5	SPRING	0,75	690	50/60	1,8 - 2,5	2,5	30
3RV2041-4KA10	3	75	SCREW	37	690	50/60	57 - 75	75	975
3RV2041-4MA10	3	100	SCREW	45	690	50/60			
3RV2311-4AC20	3	16	SPRING	7,5	690	50/60			
3RV2321-4EC10	3	32	SCREW	15	690	50/60			
3RV2011-1DA20	3	2,7	SPRING	1,1	690	50/60	2,2 - 3,3	3,3	42
3RV2411-0BA10	3	0,2	SCREW		690	50/60			
3RV2411-0GA10	3	0,63	SCREW		690	50/60			
3RV2411-0JA10	3	1	SCREW		690	50/60			
3RV2411-1CA20	3	1,9	SPRING	0,75	690	50/60			
3RV2411-1GA10	3	6,3	SCREW		690	50/60			
3RV2411-1GA20	3	4,9	SPRING	2,2	690	50/60			
3RV2411-1HA10	3	8	SCREW	3	690	50/60			
3RV2411-1JA10	3	10	SCREW		690	50/60			
3RV2411-1KA10	3	12,5	SCREW		690	50/60			
3RV2411-4AA10	3	16	SCREW	7,5	690	50/60			
3RV2421-4DA10	3	22	SCREW	11	690	50/60			
3RV2421-4DA20	3	22	SPRING	11	690	50/60			
3RV2902-1AB4	3		SCREW		690	50/60			

SIEMENS



3 Poles circuit Breakers
Without auxiliary contact bloc.

Ordering references	Number of poles	Operating current (A) 400V	Terminal	Power (kW) 400V	Voltage (V)	Frequency (HZ)
7512194	3	32			690	50/60
7512195	3	5	SCREW	1,5	690	50/60
3LD2113-OTK51	3	25		7,5	690	50/60
3VL2716-1DK33-0AA0	3	160	BOX		690	50/60
3VL3725-2DC36-0AA0	3	250	SCREW		690	50/60
3VL4731-2DC36-0AA0	3	315	SCREW		690	50/60
3VL5750-3SP36-8RA0	3	500	SCREW	277,1	690	50/60
3VL5763-1DE36-8RE1	3	630	SCREW		690	50/60
3VL6780-2DE36-8RA0	3	800	SCREW		690	50/60
3VL7712-2DE36-8RA0	3	1,25	SCREW		690	50/60
3VL98001SR00	3					50/60
3WL1108-3BB32-1AF2	3	800			690	50/60
5SL4320-7	3	20			400	50/60
5SY4306-7	3	6	QUICK		400	50/60
5SY4310-7	3	10	QUICK		400	50/60
5SY4316-7	3	16	QUICK		400	50/60
5SY4320-7	3	20	QUICK		400	50/60
5SY4332-7	3	32	QUICK		400	50/60
5SY4332-8	3	32	QUICK		400	50/60
5SY6320-7	3	20	QUICK		230	50/60
5SY6340-7	3	40	QUICK		230	50/60
8US1051-5CM47	3	12,5	CABLE		400	50/60



ABB

3 Poles circuit Breakers

Ordering references	Number of poles	Operating current (A) 400V	Terminal	Power (KW) 400V	Voltage (V)	Frequency (HZ)
2075780	3	80	SCREW		440	50/60
3264522	3	50	SCREW	22	690	50/60
3264523	3	63	SCREW	30	690	50/60
7096657	3	32	SCREW		440	50/60
7096658	3	40	SCREW		440	50/60
7120636	3	80	SCREW		440	50/60
7211615	3	2,5	SCREW	0,75	690	50/60
7211617	3	4	SCREW	1,5	690	50/60
7211618	3	6,3	SCREW	2,2	690	50/60
7211620	3	12	SCREW	7,5	690	50/60
7213280	3	12,5	SCREW		690	50/60
7213281	3	16	SCREW		690	50/60
7220093	3	25	SCREW		440	50/60
7220410	3	16	SCREW		440	50/60
7220514	3	6	SCREW		440	50/60
7221655	3	0,63	SCREW	0,18	690	50/60
7227732	3	10	SCREW		440	50/60
7227733	3	20	SCREW		440	50/60
7262814	3	32	SCREW	15	690	50/60
7262820	3	25	SCREW	12,5	690	50/60
7262829	3	6,3	SCREW	2,2	690	50/60
7262830	3	10	SCREW	4	690	50/60
7262832	3	16	SCREW	7,5	690	50/60
7269565	3	1	SCREW		440	50/60
7269566	3	2	SCREW		440	50/60
7269567	3	3	SCREW		440	50/60
7269569	3	4	SCREW		440	50/60
7269570	3	6	SCREW		440	50/60
7326854	3	40	SCREW	18,5	690	50/60
7351349	3	2,5	SCREW		690	50/60
7351352	3	6,3	SCREW		690	50/60
7452110	3	65		30	690	50/60
7458256	3	54	SCREW	22	690	50/60
7512690	3	42	SCREW	22	690	50/60
1939760	3	40	SCREW		440	50/60
7096659	3	50	SCREW		440	50/60
7153045	3	16	SCREW		400	50/60
7220412	3	50	SCREW		440	50/60
7492666	3	10	SCREW		440	50/60
7492667	3	32	SCREW		440	50/60
0351406H39	3	50			415	50/60
0351406X37	3	32	SCREW		440	50/60
0351406X38	3	40	SCREW		440	50/60
ABB141104	3	1	SCREW	0,25	690	50/60
ABB141105	3	1,6	SCREW	0,55	690	50/60
ABB141109	3	10	SCREW	4	690	50/60
ABBH440013	3	20	SCREW	7,5	690	50/60
--FL--12LM-008--EE	3	4	SCREW	1,5	690	50/60

SCHNEIDER

3 Poles circuit Breakers



Ordering references	Number of poles	Operating current (A) 400V	Terminal	Power (KW) 400V	Voltage (V)	Frequency (Hz)
25508	3	40	SCREW		500	50/60
599167	3	18	SCREW	7,5	690	50/60
599168	3	23	SCREW	9	690	50/60
599173	3	100	SCREW	45	690	50/60
599174	3	32	SCREW	15	690	50/60
599718	3	2,5			250	50/60
3261898	3	100	TUNNEL RIGIDE FL		415	50/60
3264400	3	32	SCREW	15	690	50/60
7015396	3	2,5			250	50/60
7015398	3	150	SCREW	75	690	50/60
7152758	3	10	SCREW	4		50/60
7177184	3	38			690	50/60
7224719	3	50		22	690	50/60
7326731	3	220		110	690	50/60
7326797	3	40		18,5	690	50/60
7329211	3	25		11	690	50/60
7408397	3	10	SCREW		500	50/60
7409127	3	16	SCREW		500	50/60
A9F74301	3	1	SCREW		500	50/60
GV2G254	3	11			690	50/60
GV2G354	3	11			690	50/60
GV2ME08	3	4	SCREW	1,5	690	50/60
GV2ME10	3	6,3	SCREW	2,2	690	50/60
GV2RT07	3	1,6	SCREW	1,5	690	50/60
GV2RT08	3	2,5	SCREW	3	690	50/60
GV2RT10	3	4	SCREW	1,1	960	50/60
LV431830	3	250			690	50/60
LV431832	3	160			690	50/60
LV432693	3	400			690	50/60
LV432749	3	320			690	50/60
LV432893	3	630			690	50/60
LV432949	3	630	1 OR 2 CABLE		690	50/60
A9F95332	3	32	SCREW		500	50/60
A9F95350	3	50	SCREW		500	50/60

ABB



Breaker
 NO = Normaly Open
 NF = Normaly closed

Ordering references	Type	Number of poles
0351406H44	S803S-C80	3
--CW--12XC-002--EE	CAL16-11C	1 NO / 1 NC
7262891	CA5 01	1 NF
--CW--12XL-010--EE	CA5 10	1 NO

CARRIER

Fuses

Ordering references	Rated current (A)	Diameter x Height
--FA--12AA-001--EE		
--FA--12AA-002--EE	4	5X20
--FA--12AA-003--EE	8	5X20
--FA--12AA-004--EE		
--FA--12AA-005--EE	2	5 X 20
--FA--12AA-012--EE	0,1	5 X 20
--FA--12AA-015--EE	0,2	5 X 20
--FA--12AA-022--EE	1	5 X 20
--FA--12AA-024--EE		
--FA--12AA-025--EE	1,6	5 X 20
--FA--12AA-026--EE	2,5	5 X 20
--FA--12AA-028--EE	6,3	5 X 20
--FA--12AM-002--EE		
--FA--12AM-004--EE		
--FA--12AM-008--EE		
--FA--12BJ-080--EE		
--FA--12BJ-100--EE		
--FA--12BL-250--EE		
--FA--12DA-015--EE	2	/ X 18,54
6110282	5	6,3 X 32
A205643	12	14X51
--FB--12AM-020--EE	20	10X38
N205655/R214122J	50	22X58

SCHNEIDER

Box of 10



Ordering references	Rated current (A)	Diameter x Height
FUSE060	6	5X20
FUSE080	8	5X20
FUSE010	1	5X20
FUSE10A	10	5X20
FUSE6A-GG-6.3X32		

SIEMENS

Cylindrical fuses



Ordering references	Rated current (A)	Diameter x Height
3NW7013	32	10X38
3NW6117-1	40	14X51
3NW6120-1	50	14X51
3NW6110-1	25	14X51
3NW6112-1	32	14X51
3NW6003-1	10	
3NW6004-1		



SIEMENS

Link fuses

Ordering references	Size	Rated current (A)
3NA3136	T1	160
3NA3136-6		
3NA3140	T1	200
3NA3140-6		200
3NA3142	T1	224
3NA3144	T1	250
3NA3244	T2	250
3NA3252	T2	315
3NA3254	T2	355
3NA3260	T2	400
3NA3352	T3	315
3NA3365	T3	500
3NA3372	T3	630
3NA3810	T000	25
3NA3812	T000	32
3NA3814	T000	35
3NA3817	T000	40
3NA3820	T000	50
3NA3822	T000	63
3NA3824	T00	80
3NA3830	T000	100
3NA3832	T00	125
3NA3832-8	T000	125
3NA3836	T00	160
3NA6130	T1	100
3NA6824		80
3ND1836	T00	160
3ND2122	T1	63
3ND2130	T1	100
3ND2132	T1	125
3ND2252		315
3ND2254	T2	355
3NE3335	T2	560
3NE1803-0		35
3NE1813-0		

SIEMENS

Accessories

Ordering references	Description
3NW7131	FUSES HOLDER
3KX7131-2AA00	FUSES COVER
3KX7131-4AA00	FUSES COVER
3KX7132-1AA00	FUSES COVER
3KX7132-2AA00	FUSES COVER
3KX7132-3AA00	FUSE PROTECTION COVER
3KX7132-4AA00	FUSES COVER

SIEMENS

Fuses switch disconnecter



Ordering references	Number of poles	Operating current(A) 400V	Voltage (V)	Rated current (A)	NH fuse links	Mounting
3NP1123-1BB20	3	160	690	160A	T000	FOR 40MM BUSBAR SYSTEM
3NP1123-1BC20	3			160A	T000	FOR 60MM BUSBAR SYSTEM
3NP1123-1CA20	3		690	160A	T000	FLOOR MOUNTING



Switch disconnectors with fuse

Ordering references	Number of poles	Operating current(A) 400V	Power (W) 400V	Voltage (V)	Rated current (A)	NH fuse links	Switch Reference	Shaft Reference	Standard handle Reference	Unlocking handle Reference
3KL5530-1AB01	3	250	132	690	250A	-	/		8UC7313-1BB30	-
3KL7111-3AC00					32A	T000	3KL7111-3AA00	3KX7116-2AD00	3KX7112-2AA00	18234
3KL7112-3AA00	3	45	23	690						
3KL7112-3AC00					45A	T000	3KL7112-3AA00	3KX7116-2AD00	3KX7112-2AA00	18235
3KL7113-3AA00	3	63	33	690						
3KL7113-3AC00					63A	T000	3KL7113-3AA00	3KX7116-2AD00	3KX7112-2AA00	18236
3KL7114-3AA00	3	80	42	690						
3KL7114-3AC00					80A	T000	3KL7114-3AA00	3KX7116-2AD00	3KX7112-2AA00	18237
3KL7121-3AC00					100A	T00	3KL7121-3AA00	3KX7116-2AD00	3KX7112-2AA00	18238
3KL7122-3AC00					125A	T00/T0	3KL7122-3AA00	3KX7116-2AD00	3KX7112-2AA00	18239
3KL7123-3AC00					160A	T00/T0	3KL7123-3AA00	3KX7116-2AD00	3KX7112-2AA00	18240
3KL7131-3AC00					200A	T1	3KL7131-3AA00	3KX7116-5AD00	3KX7112-4AA00	18241
3KL7132-3AA00	3	250	130	690						
3KL7141-3AC00					315A	T2	3KL7141-3AA00	3KX7116-5AD00	3KX7112-4AA00	18236
3KL7142-3AA00	3	400	210	690						
3KL7142-3AC00					400A	T2	3KL7142-3AA00	3KX7116-5AD00	3KX7112-4AA00	18237
3KL7151-3AA00	3	630	330	690						
3KL7151-3AC00					630A	T3	3KL7151-3AA00	3KX7116-5AD00	3KX7112-5AA00	18238
3LD2714-0TK51	3	100	37	690						

ELECTRICAL PARTS / SWITCH DISCONNECTORS WITHOUT FUSE

SIEMENS



Switch disconnectors without fuse

Ordering references	Number of poles	Operating current(A) 400V	Power (W) 400V	Voltage (V)	Rated current (A)	Switch Reference	Shaft Reference	Standard handle Reference	Unlocking handle Reference	Width (m)	Height (m)	Depth (m)
28908	3			690	100					135	100	45
28910	3			690	125					135	100	45
28912	3			690	160					135	100	45
31102	3			690	200					14	136	86
3KA7112-3AA00	3	45	23	690								
3KA7113-3AC00					63A	3KA7113-3AA00	3KX7116-2AD00	3KX7112-2AA00	18234			
3KA7114-3AA00	3	80	42	690								
3KA7115-3AC00					100A	3KA7115-3AA00	3KX7116-2AD00	3KX7112-2AA00	18236			
3KA7116-3AA00	3	125	65	690								
3KA7116-3AC00					125A	3KA7116-3AA00	3KX7116-2AD00	3KX7112-2AA00	18237			
3KA7121-3AA00	3	160	85	690								
3KA7121-3AC00					160A	3KA7121-3AA00	3KX7116-2AD00	3KX7112-2AA00	18234			
3KA7122-3AA00	3	200	105	690								
3KA7123-3AA00	3	250	130	690								
3KA7123-3AC00					250A	3KA7123-3AA00	3KX7116-2AD00	3KX7112-2AA00	18236			
3KA7131-3AA00	3	315	165	690								
3KA7132-3AA00	3	400	210	690								
3KA7132-3AC00					400A	3KA7132-3AA00	3KX7116-5AD00	3KX7112-4AA00	18238			
3KA7141-3AA00	3	630	330	690								
3KA7141-3AC00					630A	3KA7141-3AA00	3KX7116-5AD00	3KX7112-4AA00	18236			
3KA7151-3AC00					800A	3KA7151-3AA00	3KX7116-5AD00	3KX7112-5AA00	18238			
3KA7152-3AC00					1000A	3KA7152-3AA00	3KX7116-5AD00	3KX7112-5AA00	18239			
3LD2213-0TK51	3	32	11,5	690	32	-	-	3LD9224-1B	-			
3LD2514-0TK51	3	63	22	690	63	-	-	3LD9284-1B	-			

Switch disconnectors accessories

Ordering references	Description
3KX7112-2AA00	DISCONNECTING SWITCH HANDLE
3KX7112-4AA00	DISCONNECTING SWITCH HANDLE T3/T4
3KX7116-2AD00	AXLE
3KX7116-5AD00	AXLE EXTENSION



SCHNEIDER

Ordering references	Product range
28941	PROLONGED FRONT CONTROL HANDLE
28962	ROTARY CONTROL HANDLE



ABB

Ordering references	Product range	Number of poles	Operating current(A) 400V	Power (W) 400V	Voltage (V)	Rated current (A)	Cable cross section	Section Type	Screw Diameter (for plate)
0351406H59	OT80F3					80	1.5...35 MM ²	CAGE	-
--CY--12AK-150--EE	OT125A3	3	105	55		125	10...70 MM ²	CAGE	-
--CY--12AK-152--EE	OT200E03P	3	200	110	1000	200	-	PLAGE	M8X25
7207773	OT250E03P	3	250	140	1000	250	-	PLAGE	M8X25
--CY--12AK-155--EE	OT400E03P					400	-	PLAGE	M10X30
--CY--12AK-156--EE	OT630E03P					630	-	PLAGE	M12X40
--CY--12AK-157--EE	OETL1600K3	3	800						
--CY--12AK-206--EE	OHB65J6								
--CY--12AK-280--EE	OXF6X210								
7242439	OT125F3	3	90	45	750				
7441022	OT125FT3	3	90	45	750				
7507528	OT160G03P	3	160	75	1000				
7227246	OT16F3	3	16	7,5	750				
7252803	OT25F3	3	20	9	750				
7378848	OT25FT3	3	20	9	750				
7396711	OT315E03	3	315	160	1000				
7388188	OT315E30P	3	315	160	1000				
7207791	OT400E03P	3	400	220	1000				
7252806	OT40F3	3	23	11	750				
7274185	OT40FT3	3	23	11	750				
7252808	OT63F3	3	63	22	750				
ABB939291	OT63F3	3	63	22	750				
7283235	OT63FT3	3	63	22	750				
0351406X30	OT63FT3	3	63	22	750				
0351406X31	OT63FT3	3	63	22	750				
7252809	OT80F3	3	75	37	750				
OT80F3	OT80F3	3	75	37	750				
7283240	OT80FT3	3	75	37	750				
7242440	OT125F4N2	4	90	45	750				
7335300	OT100F4N2	4	80	37	750				
7339125	OT16F4N2	4	16	7,5	750				
3264257	OT25F4N2	4	20	9	750				
3264258	OT40F4N2	4	23	11	750				
3264259	OT63F4N2	4	63	22	750				
7265200	OT80F4N2	4	75	37	750				

ELECTRICAL PARTS / SWITCH DISCONNECTORS WITHOUT FUSE

SOREEL

Ordering references	Product range	Number of poles	Operating current(A) 400V	Power (W) 400V	Voltage (V)
7404621	OHY125J12				
7390035	OT800E03	3	800	450	1000
7390038	OS630D03	3	630	355	690
7404634	OT200E30P	3	200	110	1000
7390033	OT250E03	3	250	140	1000
7404635	OT250E30P	3	250	140	1000
7404617	OT400E30P	3	400	220	1000
7390034	OT630E03	3	630	355	1000
7404618	OT630E30P	3	630	355	1000

SIEMENS

Voltage transformers



Ordering references	Power (VA)	Primary / secondary(ies) voltage
4AM4342-5AN00-OEA1	400	690/115V
TAM3496-0BR50-OEN1	100	400/24V
TAM3496-0BY00-OEN1	120	400/24V
TAM3496-0EL10-OEN1	120	400/24V
TAM3496-0FS30-OEN1	120	400/24V
TAM3896-0BQ60-OEN1	180	400/230-24V
TAM3896-0BQ70-OEN1	180	400/115-24V
TAM3896-0BS80-OEN1	180	460/230-24V
TAM3896-0EB40-OEN1	180	400/115-24V
TAM3896-0ED70-OEN1	150	400/24V
TAM4096-0EC10-OEN1	225	400/230-24V
TAM4096-0EV00-OEN1	180	400/115-24V
TAM4396-0EH20-OFN1	315	690/115-24V
TAM4396-0EM10-OEN1	230	400/230-24V
TAM4696-0EJ30-OFN1	380	400/115-24V
TAM4696-0EN30-OFN1	380	380-460/115-24V
TAM4696-0ER50-OEN1	325	400/115-24V
TAM8096-0BD00-OEN1	50	400/24V
TAM8196-0AX40-OEN1	315	400/115-24V
TAM8196-0BA30-OEN1	315	460/115-24V
TAM3896-0BT00-OEN1	180	380/230-24V
TAM3896-0BT10-OEN1	180	460/115-24V
TAM3896-0EQ40-OFN1	180	690/230-24V
TAM3896-0EQ50-OEN1	150	400/24V
TAM3896-0FN70-OEN1		
TAM3896-1AC40-OFA0		
TAM4396-0EL80-OFN1		
TAM4396-0EV20-OEN1	280	690/230-24V
TAM4396-1AB70-OFS1		
TAM4696-0EC50-OFN1		
TAM4696-0FC50-OEN1	325	690/115-24V
TAM5296-1AB30-OFS1	465	400/115-24V
TAM5296-1AB40-OFS1		
TAM5296-1AC20-OFA0		
TAM5296-1AC40-OFS1		
TAM5296-1AC70-OFS1		
TAM8096-0BE10-OEN1	50	460/24V
TAM8096-0BE20-OEN1	50	380-24V
TAM8196-0AY40-OEN1	240	400-24V
TAM8196-0BA10-OEN1	315	380/115-24V
TAM8196-0BA20-OEN1	240	460/24V
TAM8196-0BA40-OEN1	240	380/24V
TAM8196-1AA00-OFA0		
4AM3496-0EL70-OEN1		

ISME

Transformers

Ordering references	Power (VA)	Primary / secondary(ies) voltage
0351901H44	7	230V/12V
0351901H50	7	230V/12V
0351901X41	7	230V/12V
0351901X46	7	230V/12V
0351901X29	15	230V/24V



SCHNEIDER

Transformers

Ordering references	Power (VA)	Primary / secondary(ies) voltage
ABL6TS16B	160	230-400V / 24V
ABL6TS25B	250	230-400V / 24V
TSM30038	185	400VAC / 24VAC
TSM29146	215	400VAC / 24VAC
TSM29147	255	400 VAC / 24VAC
00PSG001283300D	630	6600V / 400V

SIEMENS



Thermal overload relays
Assembled with 3RT2.
Please contact ERCD for more information.

Ordering references	Part designation	Setting range (A)
3RU2116-0KB0	TIME DELAY RELAY	0,90 - 1,25
3RU2116-1CB0	TIME DELAY RELAY	1,80 - 2,50
3RU2116-1CC1	RELAY	1,80 - 2,50
3RU2116-1EB0	TIME DELAY RELAY	2,80 - 4
3RU2116-1FC1	TIME DELAY RELAY	3,50 - 5
3RU2116-1GB0	TIME DELAY RELAY	4,50 - 6,30
3RU2116-1GC1	RELAY	4,50 - 6,30
3RU2116-1HB0	RELAY	5,50 - 8
3RU2116-1JB0	TIME DELAY RELAY	7-10
3RU2136-4EB0	TIME DELAY RELAY	22 - 32

SIEMENS



Relays

Ordering references	Part designation	Type	Voltage (VAC)
3RP2525-1AW30	TIME DELAY RELAY	TIMING RELAY 1 CO	24/200-240 V AC
3RS1800-2AP00	RELAY	COUPLING RELAY 1 CO	24V AC/DC 220-240V AC
3RT1926-2CG11	TIME DELAY RELAY	TIMING RELAY BLOCK	24-66V AC/DC
3TX7005-1LB00	RELAY	COUPLING RELAY	24V
3UG4511-1AP20	RELAY	VOLTAGE CONTROL	320-500V
3UG4511-2AP20	PHASES DETECTOR	VOLTAGE CONTROL	320-500V



TELEMECANIQUE

Thermal overload relays
 Manual reset
 Maximum current on auxiliary contact = 10A

Ordering references	Part designation	Setting range (A)
--OL--12TV-018--EC	TIME DELAY RELAY	12 - 18
--OL--12TV-021--EC	TIME DELAY RELAY	16 - 24
--OL--12TV-031--EC	TIME DELAY RELAY	30 - 38
--OL--12TV-144--EC	THERMAL RELAY TL	37 - 50



ABB

Thermal overload relays
 Manual reset
 Maximum current on auxiliary contact = 10A

Ordering references	Part designation	Setting range (A)
--OL--12TY-025--EE	TIME DELAY RELAY	18 - 25
--OL--12TY-032--EE	TIME DELAY RELAY	24 - 32
--OL--12TY-042--EE	TIME DELAY RELAY	29 - 42



ABB

Relays

Ordering references	Part designation	Type	Auxiliary contact	Coil voltage/frequency
K31-E	AUXILIARY CONTACTOR	N31E	3 NO / 1 NC	48V / 50HZ
--OK--00TL-122--EE	RELAY	N22E	2 NO / 2 NC	220V / 50HZ
--OK--12TL-031--EE	RELAY	N31E	3 NO / 1 NC	220V / 50HZ
--OK--12TL-040--EE	RELAY	N40E	4 NO / 0 NC	230V / 50HZ
--OK--12TL-044--EE	RELAY	N44E	4 NO / 4 NC	220V / 50HZ
--OK--12TL-622--EE	RELAY	N22E	2 NO / 2 NC	24V / 50HZ

ABB

Mini relays

Ordering references	Part designation	Type	Auxiliary contact	Coil voltage/ frequency
--OK--12SW-103--EE	RELAY	K6-31Z-01	3 NO / 1 NC	24 V AC / 40...450
--OK--12SW-225--EA	RELAY	K6-22Z-80	2 NO / 2 NC	230 V AC / 40...450



SCHNEIDER

Thermal relays

Ordering references	Part designation	Thermal current	Auxiliary contact	Coil voltage/ frequency
RSB2A080B7	RELAIS	8 (A)	2NO / 2NF	24 V AC
--OK--12AC-044--EE	RELAY	10 (A)	2NO / 2NF	28 V DC



FINDER

Relays

Ordering references	Part designation	Nominal current/ Max current (A)	Nominal voltage/ Max voltage	Nominal load AC1 (VA)	Nominal load AC15 (230 V AC) (VA)	Power engine single phased (230 V AC) kW	Auxiliary contact
0351802H25	RELAY	20/40	250/400	5000	1000	1,1	1 NO / 1NC
0351802X47	CONTACTOR	16/30	250/400	4000	750	0,8/1,5	3 CONTACTS
0351804H56	RELAY 230V 2NO 2NF FINDER	10/20	250/400	2500	500	0,37	2 CONTACTS
0351804H58	RELAY	7/15	250/250	1750	350	0,125	4 CONTACTS

CARRIER

Plastic case capacitors



Ordering references	Part designation	Type	Capacity (µF)	Voltage (V)	Diameter size x length (mm)
0353101X63	CAPACITOR	4	20	450	40X92
0353101X12	CAPACITOR	1	25	450	45X91
0353101X65	CAPACITOR 25 µF	2	25	450	45X128
0353101X62	CAPACITOR	4	25	450	45X92
0353101X13	CAPACITOR	1	30	450	45X91
0353101X64	CAPACITOR 30 µF	2	30	450	45X128
0353101X76	CAPACITOR	4	30	450	45X92
0353101X14	CAPACITOR	1	35	450	55X128
0353101X80	CAPACITOR 35 µF	2	35	450	55X128
0353101X16	CAPACITOR	1	40	450	55X128
0353101X89	CAPACITOR 40 µF	2	40	450	55X128
0353101X50	CAPACITOR	1	45	450	55X128
0353101H86	CAPACITOR 45µF	2	45	450	55X128
0353103H03	CAPACITOR	3	1,5	450	25X51
0353103H04	CAPACITOR 2µF	3	2	450	25X51
0353103H05	CAPACITOR	3	2,5	450	25X51
0353103H17	CAPACITOR 3,5µF	2	3,5	450	30X51
0353103H26	CAPACITOR 3,5µF 450V	4	3,5	450	30X51
0353103H12	CAPACITOR 4µF	3	4	450	30X51
0353103X15	CAPACITOR NLA = 0353102X02	4	4	450	30X51
0353103H22	CAPACITOR 4 µF	2	4,5	450	30X56
0353103H25	CAPACITOR 5µF 450V	4	5	450	30X71
0353103H09	CAPACITOR	3	6,3	450	30X71
0353103X18	CAPACITOR 7 µF	4	7	400	32X55
0353103X19	CAPACITOR 8 µF	4	8	400	32X55
0353103H10	CAPACITOR 10 µF	3	10	450	35X71
0353103X20	CAPACITOR 10 µF	4	10	400	30X70

CARRIER

Plastic case capacitors



Ordering references	Part designation	Type	Capacity (µF)	Voltage (V)	Diameter size x length (mm)
0353101X68	CAPACITOR	1	1	450	25X51
0353101H59	CAPACITOR 1µF	2	1	450	28X55
0353101X30	CAPACITOR	1	1,5	450	25X51
0353101H20	CAPACITOR 1,5µF	2	1,5	450	28X55
0353101X31	CAPACITOR	1	2	450	25X51
0353101X44	CAPACITOR	1	2	500	30X63
0353101H25	CAPACITOR 2µF	2	2	450	28X55
0353101H72	CAPACITOR 2µF	4	2	450	28X55
0353101X32	CAPACITOR	1	2,5	450	25X51
0353101H21	CAPACITOR 2,5µF	2	2,5	450	28X55
0353101X73	CAPACITOR 2.5 µF	4	2,5	450	28X55
0353101X04	CAPACITOR	1	3	450	30X51
0353101H34	CAPACITOR 3 µF	2	3	450	28X55
0353101H93	CAPACITOR 3µF	3	3	450	30X51
0353101X87	CAPACITOR	4	3	450	28X55
0353101H05	CAPACITOR	1	4	450	30X51
0353101H19	CAPACITOR 4µF	2	4	450	28X55
0353101H07	CAPACITOR 5µF	1	5	450	30X71
0353101H53	CAPACITOR	2	5	450	30X71
0353101H94	CAPACITOR 5µF	3	5	450	30X71
0353101X51	CAPACITOR	1	6	450	30X71
0353101X52	CAPACITOR	1	9	450	35X71
0353101X56	CAPACITOR	2	10	280	30X71
0353101X78	CAPACITOR	4	10	450	35X71
0353101H17	CAPACITOR 16µF	1	16	450	40X71
0353101X11	CAPACITOR	1	20	450	45X71



CARRIER

Aluminium case capacitors

Ordering references	Part designation	Type	Capacity (µF)	Voltage (V)	Diameter size x length (mm)
0353102X08	CAPACITOR 1.5µF	2	1,5	450	30X63
0353102X14	CAPACITOR	2	2	450	30X63
0353102X09	CAPACITOR 2.5 µF	1	2,5	450	30X63
0353102X07	CAPACITOR 2.5 µF	2	2,5	450	30X63
0353102X02	CAPACITOR 4 µF	2	4	450	30X63
0353102H04	CAPACITOR 5µF	2	5	450	30X78
0353102H19	CAPACITOR	2	7,5	450	35X78
0353102H20	CAPACITOR	2	10	450	35X78
0353102X13	CAPACITOR 15 µF	2	15	450	35X103
0353102X06	CAPACITOR	2	16	450	40X103
0353102X03	CAPACITOR 50 µF	2	50	450	55X128
0353102X15	CAPACITOR 50 µF	2	50	450	55X128
0353102H21	CAPACITOR 55µF	2	55	450	35X78
0353102X18	CAPACITOR	2	60	450	55X122

CARRIER

Capacitors



Ordering references	Part designation	Type	Capacity (µF)	Voltage (V)	Diameter size x length (mm)
---P-291--3553--S	CAPACITOR	SINGLE	2	370	-
---P-291--0304--S	CAPACITOR	SINGLE	4	370	-
---P-291--2504--S	CAPACITOR	SINGLE	4	400	63 X 30
---P-291--0404--S	CAPACITOR	SINGLE	5	370	-
---P-291--0503R-S	CAPACITOR	SINGLE	5	370	-
PMF630ALVC0S635SM8	CAPACITOR	SINGLE	6	400	/ X 40
---P-291--0504--S	CAPACITOR	SINGLE	7,5	370	-
---P-291--0753--S	CAPACITOR	SINGLE	10	370	-
---P-291--0754--S	CAPACITOR	SINGLE	10	370	-
PMF1000ALVC0S6-35S	CAPACITOR	SINGLE	10	400	/ X 45
---P-291--1003--S	CAPACITOR	SINGLE	15	370	-
---P-291--1004--S	CAPACITOR	SINGLE	25	370	-
---P-291--1503--S	CAPACITOR	SINGLE	25	370	-
---P-291--2503--S	CAPACITOR	DUAL	25 + 5	370	-
---P-291--2553--S	CAPACITOR	DUAL	35 + 5	370	-

SEDES

Crankcase heater

Ordering references	Voltage (V)	Power (Watt)	Total length (mm)
0351501H31			
0351501X34			
0351501H44	240	25 (+/-10%)	2650
0351501H47			
0351501X48			
0351501X49			
0351501H50	240	25 (+/-10%)	4850
0351501H54	240	19 (-0+20%)	2565
0351501H59	240	19 (-0+20%)	2165
0351501H60	240	25 (+/-10%)	2450
0351501H61			
0351501H64			
0351501H65	240	28 (+/-10%)	2430
0351501H66	240	35 (+/-10%)	2950
0351501H67			



HONEYWELL

Ordering reference	Product range	Control signal	Voltage (V)	Stroke (mm)	Spring return	Open time (s)
--OP--12OB-002--EE	MT8	ON/OFF	AC 230	8	YES	210
OP12OB004EE	MT8	ON/OFF	AC 24	8	YES	360
7343817	GCA	ON/OFF	AC 24	ANG 90°	YES	150
7310084	M74	0/10V	AC 24	6,5	NO	90
--XM--12AH-022--EE	M64	3 PTS	AC 230	6,5	NO	150
--XM--12AH-023--EE	M64	3 PTS	AC 230	6,5	NO	150
7355637	M74	0/10V	AC 24	6,5	NO	150
00PPG000499500A	M74	0/10V	AC 24	6,5	NO	150
5202058	M74	3 PTS	AC 24	6,5	NO	150
7360302	M74	3 PTS	AC 24	6,5	NO	150
907530	M74	3 PTS	AC 24	6,5	NO	150
7245281	ML74	0/10V	AC 24	6,5	NO	15
7209697	ML74	0/10V	AC 24	6,5	YES	60
7170796	ML74	0/10V	AC 24	20	NO	60
7170795	ML74	0/10V	AC 24	20	NO	60
7367455	ML74	0/10V	AC 24	20	NO	30
7055331	ML74	0/10V	AC 24	20	NO	60
ML7421B3003	ML74	0/10V	AC 24	38	NO	210
MT4-230NC	MT4	ON/OFF	AC 230	4	YES	150
M100-B0	MT4	ON/OFF	AC 230	4	YES	150
7177256	MT4	ON/OFF	AC 230	4	NO	210
7177257	MT4	ON/OFF	AC 230	4	NO	210
M100-AG-L	MT4	ON/OFF	AC 24	4	YES	240
TSA6-11-GERSHWN	MT4	ON/OFF	AC 24	4	YES	240
7177253	MT4	ON/OFF	AC 24	4	NO	360
7177254	MT4	ON/OFF	AC 24	4	NO	360
--OP--12OB-005--E-	MT8	ON/OFF	AC 230	8	YES	210
OP12OB003EE	MT8	ON/OFF	AC 230	8	YES	210
7370865	S05	0/10V/3PTS	AC 24	ANG 90°	YES	90
7370867	S10	ON/OFF	AC 24	ANG 95°	YES	90
5202132	S55	ON/OFF	AC 24	8	YES	210
000135-	VC	3 PTS	AC 24	10		120

WATT INDUSTRIE



Ordering reference	Product range	Control signal	Voltage (V)	Stroke (mm)	Spring return	Open time (s)
0150404H62	22C	ON/OFF	AC/DC 230	3,5		75
0150425H41	22C	ON/OFF	AC 24	2,5		180
0150404H43	ETE	ON/OFF	AC 230	4		240
0150404H95	22C	ON/OFF	AC/DC 230	2,5		180
0150404X99	22C	ON/OFF	AC/DC 24	3,5		75
22XC230NC2	22X	0/10V	AC 230			
0150425H27	EMU	0/10V	AC 24	2,5	YES	15
0150425H37	EMU	0/10V	AC 24	6,3	YES	8
0150425H35	EMU	3 PTS	AC 230	6,3	YES	13
0150425H34	EMU	3 PTS	AC 230	6,3	YES	13
0150425H36	EMU	3 PTS	AC 24	6,3	YES	13
0150425H28	EMU	3 PTS	AC 24	8	YES	13
7370870		0/10V	DC	ANG 95°	NO	90
7423295	N10	ON/OFF	AC 230	ANG 95°	NO	140
7381137	N20	0/10V	AC 24	ANG 95°	NO	110
7388365	N34	3 PTS	AC 24	ANG 95°	NO	110

SIEMENS



Ordering reference	Product range	Control signal	Voltage (V)	Stroke (mm)	Spring return	Open time (s)
2010430	GEB	0/10V	AC 24	ANG 90°	NO	150
1888440	GEB	3 PTS	AC 230	ANG 90°	NO	150
7416411	S55	0/10V	AC/DC 24	20	NO	30
7347890	S55	ON/OFF	AC 230	3	YES	210
7347892	S55	ON/OFF 0/10V	AC/DC 24	3	YES	270
7469924	S55	ON/OFF 0/10V	AC/DC 24	3	YES	270
ACVATXSKC82	SKC	3 PTS	AC 24	40	YES	120
00PPG000512400A	SSA	0/10V	AC/DC 24	2,5		34
7353156	SSA	3 PTS	AC 24	2,5	NO	150
00PPG000512200A	SSA	3 PTS	AC 230	5,5		150
00PPG000512300A	SSA	3 PTS	AC 24	5,5		150
5202233	SSB	0/10V	AC/DC 24	5,5	NO	75
OP12NA025EE001	SSB	3 PTS	AC 24	5,5		150
54110015710	SSC	0/10V	AC 24	5,5	NO	30
00PSP000000277A	STA	ON/OFF	AC 230	3	YES	210
00PPG000511900A	STA	ON/OFF	AC 230	3	YES	210
42EL570022M-	STA	ON/OFF 0/10V	AC/DC 24	3	YES	270
00PPG000512000A	STA	ON/OFF 0/10V	AC/DC 24	3	YES	270

BELIMO



Ordering reference	Rotation angle	Torque (Nm)	Security function	Modulating 230V	Modulating 24V	Running time (Min)	Open-close 230V	Open-close 24V
GM230A	95°	40NM	NO			150 SEC.	YES	
GM24A	95°	40NM	NO			150 SEC.		YES
GM24A-SR	95°	40NM	NO		YES	150 SEC.		
LM230A	95°	5 NM	NO			150 SEC.	YES	
LM230ASR	95°	5 NM	NO	YES		150 SEC.		
LM24A	95°	5 NM	NO			150 SEC.		YES
LM24A-SR	95°	5 NM	NO		YES	150 SEC.		
NM230A	95°	10NM	NO			150 SEC.	YES	
NM24A	95°	10NM	NO			150 SEC.		YES
NM24A-SR	95°	10NM	NO		YES	150 SEC.		
SM230A	95°	20NM	NO			150 SEC.	YES	
SM230ASR	95°	20NM	NO	YES		150 SEC.		
SM24A	95°	20NM	NO			150 SEC.		YES
SM24A-SR	95°	20NM	NO		YES	150 SEC.		

BELIMO



Ordering reference	Rotation angle	Torque (Nm)	Security function	Modulating 24V	Running time (Min)	Open-close 230V	Open-close 24V
AF230	95°	15NM	YES		150 SEC.	YES	
AF230-S	95°	15NM	YES		150 SEC.	YES	
AF24	95°	15NM	YES		150 SEC.		YES
AF24-S	95°	15NM	YES		150 SEC.		YES
AF24-SR	95°	15NM	YES	YES	150 SEC.		
AF24-SR-S	95°	15NM	YES	YES	150 SEC.		
AFR230-S	95°	15NM	YES		150 SEC.	YES	
AFR24-S	95°	15NM	YES		150 SEC.		YES
LF230	95°	4NM	YES		40 - 75 SEC.	YES	
LF230-S	95°	4NM	YES		40 - 75 SEC.	YES	
LF24	95°	4NM	YES		40 - 75 SEC.		YES
LF24-S	95°	4NM	YES		40 - 75 SEC.		YES
LF24-SR	95°	4NM	YES	YES	150 SEC.		
TF230	95°	2NM	YES		<75 SEC.	YES	
TF230-S	95°	2NM	YES		<75 SEC.	YES	
TF24	95°	2NM	YES		<75 SEC.		YES
TF24-S	95°	2NM	YES		<75 SEC.		YES
TF24-SR	95°	2NM	YES	YES	<75 SEC.		









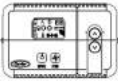

K | USER INTERFACE

USER INTERFACE	228
USER INTERFACE / REMOTE CONTROL	233









USER INTERFACE

Ordering references	Description	Regulation	Unit	SW Loading
 Z007209G32	2B4412 (CARRIER)		42E / 42Y	NO SOFTWARE
 Z007209G33	2B4412 (CARRIER)		42E / 42Y	NO SOFTWARE
 Z007209G34	2B4412 (CARRIER)		42E / 42Y	NO SOFTWARE
 O0PPG000489200A	AJUSTABLE TEMPERATURE SENSOR		38RBS	NO SOFTWARE
 30RAJ9002	AQUASNAP JUNIOR (CARRIER)		30RA/RH 005-013	NO SOFTWARE
 B036864G01	NUI (NO BRAND)		30AWH	NO SOFTWARE
 7428419	NUI (CIAT)		30AWH (EREBA)	NO SOFTWARE
 B036797H02	NUI (CARRIER)		30AWH	NO SOFTWARE
 33NT400022M	ZUI	NTC	42N / 42GW / 42DW / 42GM / 42GR / 42EM / 36XB / 42NH / 42NL	NO SOFTWARE
 001700-	CONEX - FRENCH LANGUAGE		NEXA	NO SOFTWARE
 D020366H01	CRC1			NO SOFTWARE
 C024509H01	CRC1		40KMC / 40KQV / 42VMC / 40SMC / 42HMC / 40DMC / 40SQV / 40DQV / 40PQV / XPD	NO SOFTWARE



Ordering references	Description	Regulation	Unit	SW Loading
 B037402H01-A	CRC2 (HDB)	HDB	42N / 42GW / 42DW / 42EM /	NO SOFTWARE
 33NTC-RC-A	CRC2 (NTC)	NTC	42N / 42GW / 42DW / 42GM / 42GR / 42EM / 36XB / 42NH / 42NL	NO SOFTWARE
 33NT900062M	SUI (WITHOUT SPEED SEL)	NTC / MAESTRO	42N / 42GW / 42DW / 42GM / 42GR / 42EM / 36XB / 42NH / 42NL	NO SOFTWARE
 33NT400072M	SUI (WITHOUT SPEED SEL)	NTC / MAESTRO	42N / 42GW / 42DW / 42GM / 42GR / 42EM / 36XB / 42NH / 42NL	NO SOFTWARE
 33NT400082M	SUI (WITH SPEED SEL)	NTC / MAESTRO	42N / 42GW / 42DW / 42GM / 42GR / 42EM / 36XB / 42NH / 42NL	NO SOFTWARE
 3121462	NETCON - ELCO			NO SOFTWARE
0170303H31		42GW9017 KLR E 7203	42GWC (10-20)	NO SOFTWARE
 0170303H23			42GWD-(10-20)	NO SOFTWARE
 0170303H30		KLR E 7012		NO SOFTWARE
 0170303H27			40JS	NO SOFTWARE
 33TB-AC01	33TB0001		42N / 42GW / 42DW / 42KW	NO SOFTWARE
 33TA-AC01	33TA0001		42N / 42GW / 42DW / 42KW	NO SOFTWARE

USER INTERFACE

Ordering references	Unit	SW Loading
	33TZ-AC01	NO SOFTWARE
	--OP--12CA-030--EE	42KW
	XK01J010N	50PZ / 38PZ / 40PZ / 50YZ / 38BZ / 40BZ / 50VZ / 38VZ / 50HZ / 50GZ / 38XTZ / 40ABZ
	D019959H02	NO SOFTWARE
	TC-PAC01-A	NO SOFTWARE
	TP-PHP01-A	NO SOFTWARE
	TP-NRH01-B	NO SOFTWARE
	TST-ENNC06320SCS00	NO SOFTWARE
	00PPG000520000A	30RBV / RQV
	33WT500037M-ERCD	42NH / 42NL
	33WT500048M-ERCD	42NH / 42NL

	Ordering references	Unit	SW Loading
	33WT500050M-ERCD	42NH / 42NL	NO SOFTWARE
	33WT500051M-ERCD	42NH / 42NL	NO SOFTWARE
	33WT500053M-ERCD	42NH / 42NL	NO SOFTWARE
	CA-BOF-TACT-N	42NH / 42NL	NO SOFTWARE
	7431969	50EH / 50EN	NO SOFTWARE
	57060049802	48/50 UA UZ	NO SOFTWARE
	B034307H01	30RA 17 - 50UZ - 48AZ	NO SOFTWARE
	7478394	50EH / 50EN / 50HF 30PA / PH CIATRTC / CARRIERRTC	NO SOFTWARE
	2079150	50EH / 50EN / 50HF 30PA / PH CIATRTC / CARRIERRTC	NO SOFTWARE
	7472887	50EH / 50EN / 38SF / 40SF / 40SZ / 38SZ CIAT AVANT/AVANT+ / CARRIERRTC BASIC & MEDIUM	NO SOFTWARE
	7431753	09PE / 09VE	NO SOFTWARE
	7431740	09PE / 09VE	NO SOFTWARE
	7499544	50CJ	LOADED

USER INTERFACE

Ordering references	Unit	SW Loading
 <p>7047141</p>	500J	
	17317100A00265	FMCC / 38VR UNITS
	--HK--50AA-031--S	

Ordering references	Unit	Additional information
	B034134H01 40GKX / 42HWS / 42HWX / 42VKX / 42VRX / 40JX	
	B033466H01 40KMC / 42VMC / 40SMC / 40SQV / DQV / XPD / PQV / 40DMC	REMOTE CONTROL NTC AQUASMART (B034703H01-) IR RECEIVER : 33NTC-HS
	00PPG000558300A NTC UNITS	NTC UNITS SAME THAN 33NTC-HR WITHOUT LOGO
	43T69707 42HQV	
	43T69741 42NQV	
	43T69649 42NQV - H	
	33WT500035M- ERCD WTC	ONLY COMPATIBLE WITH WTC-ISP AND WTC-ISPL
	33WT500224ME	REMOTE CONTROL RF
	33WT500223ME	RECEIVER RF
	33WT500222ME	ADAPTATOR RJA



L | CONTROL

CONTROL / DISPLAY	236
CONTROL / FLOTRONIC 1 & 2 CONTROL	237
CONTROL / PRODIALOG	238
CONTROL / PRODIALOG & PRODIALOG + (30H/30G) CONTROL	239
CONTROL / PRODIALOG AQUASNAP (30RB/RQ)	241
CONTROL / PRODIALOG + 4	242
CONTROL / CONTROL AQUAFORCE 30 XA / 30 XW PDS CONTROL	243
CONTROL / ELECTRONIC BOARD	244
CONTROL / TOUCH PILOT	246
CONTROL / KIT AQUASMART	248
CONTROL / AQUASMART SYSTEM MANAGER CARRIER	249

19XR

Ordering references	Description	Software Loaded	Soft. not loaded
32GB-500---462--EF	ICVC MODULE		X
19XR0403--1541--S	ICVC CONTROLER	X	
19XR0403--1531--S	ICVC CONTROLER	X	
19XR0403--1552--S	ICVC CONTROLER (SW V5)	X	
19XR-503---152--EF	ISM MODULE WITH PIC II (SAME THAN 19XR0401--2202--S)	X	
CEPL131092-03-R-	COMMUNICATION BOARD		
23XR04007521	ICVC CONTROLER (SW V4) Q&R COMPRESSORS	X	
23XR0401--7521--S	ICVC CONTROLER (SW V4) P COMPRESSORS	X	



CARRIER

Unloaded cards need Carrier Service intervention
Flotronic 1

Ordering references	Description
30GB-509---152--C	HEATER
32GB-500---034--C	RELAY BOARD
32GB-500---044--S	RELAY BOARD
32GB-500---254--S	CONTROLLER
32GB-500---734--C	BOARD EXV DRIVER
--DC--99RA-025--C	SENSOR COUPLING
--GB--12JC-016--EE	TRANSFORMER
--GB--12KM-001--EE	TRANSFORMER 230V/24V
--HH--79NZ-013--C	THERMISTOR
--HK--35AZ-001--C	ELECTRONIC BOARD
--HN--65KZ-027--C	ELECTRONIC BOARD
--HT--01BZ-230--S	TRANSFORMER



CARRIER

Unloaded cards need Carrier Service intervention
Flotronic 2

Ordering references	Description
CECO120803-02	HAZ PSIO MODULE BATTERY
--HK--35AA-002--C	TRANSDUCER POWER SUPPLY 5VDC
--HK--50AA-001--C	SENSOR MODULE
--HK--50AA-003--C-	DSIO LV MODULE 24V
--HK--50AA-004--C	DSIO MODULE EXV DRIVER
--HK--50AA-006--C	MODULE 8 IN
--HK--50AA-007--S	MODULE 8 OUT
--HK--50AA-008--C-	MODULE
--HK--50AA-021--S	UC203 FID PROCESSOR
--HK--50AA-029--S	MAIN BLANK BASE BOARD
--HK--50AA-031--S	DISPLAY BOARD
--HK--50AA-033--S	DISPLAY MODULE TO BE LOADED
--HK--50AA-035--S	ELECTRONIC BOARD
--HK--50AA-039--S	PREMIER LINK BOARD
--HK--50RL-004--S	LON CARD
--HN--65CT-011--C	COMPRESSOR SAFETY BOARD
--HR--53ZK-001--S	SWITCH ON-OFF-CCN
--OK--12AC-025--EE	RELAY 19-24V DC
--OP--12KA-009--EE	COMPRESSOR SAFETY BOARD
--GB--12JC-017--EE	4 IN X 4 OUT MODULE TRANSFORMER
30GX-660---006--S	HSIO II HUMAN SENSOR I/O
--FA--12AA-022--EE	FUSE
--WG--12KA-003--EE	THERMOSTAT

Black display

Ordering references	Description	No Software Required	Software Loaded	Configuration / Dipswitches
32GB500382L-XA-XW	PRODIALOG 5 BOARD LOADED FOR XA XW XAS		X	CONFIGURATION TO PARAMETER
32GB500382L-RB-RQ	PRODIALOG 5 BOARD LOADED FOR RB RQ		X	CONFIGURATION TO PARAMETER
30GH-900---862--EE	EPROM KIT		X	
30GX-900---68228EE	EPROM KIT		X	
30HT-900---93206EE	EPROM KIT		X	
30DQ-900---33202EE	EPROM KIT		X	
--OP--12AS-011--EA	SYNOPTIC 2 CKT AIR COOLED	X		
--OP--12AS-008--EA	SYNOPTIC	X		



CARRIER

PRODIALOLOG & PRODIALOG + (30H/30G) CONTROL Main Board

Ordering references	Description	No Soft. Required	Soft. Loaded	Soft. Not Loaded
CEPL130085-01	PRODIALOG 1&2 BOARD			X
CEPL13008501LOADED	PRODIALOG 1&2 BOARD LOADED		X	
--OP--12AS-015--EE	COMPRESSOR BOARD 4AI / 2AO SIO BUS	X		
--OP--12KA-010--EE	SAFETY CARD			
--OP--12KA-008--EE	COMPRESSOR SAFETY BOARD			
--HT--08DZ-026--S	TRANSFORMER			
--OP--12AS-004--E-	4 OUTPUT BOARD			
32GB-500---422--EE	EXV BOARD			
32GB500422L-EXVLEN	EXV BOARD LEN LOADED V1.01			
--HN--65CT-011--C	COMPRESSOR SAFETY BOARD			
--OP--12DA-039--EE	HIGH PRESSURE TRANSDUCER			
--OP--12DA-040--EE	LOW PRESSURE TRANSDUCER			
--HH--79NZ-059--C	THERMISTOR			

Displays

Ordering references	Description	No Soft. Required
--OP--12AS-008--EE	SYNOPTIC	
--OP--12AS-010--EA	DISPLAY FOR 30GX	X
--OP--12AS-011--EE	SYNOPTIC 2 CKT AIR COOLED	
--OP--12AS-012--EA	DISPLAY	
--OP--12AS-014--EA	DISPLAY	
--OP--12AS-018--EE	DISPLAY BOARD	
--OP--12AS-019--EA	DISPLAY FOR 30GX	X
--OP--12AS-020--EA	DISPLAY	X

CONTROL / PRODIALOG & PRODIALOG + (30H/30G) CONTROL

Accessories

Ordering references	Description	No Soft. Required
--OP--12AS-005--E-	4 IN/2OUT BOARD	X
32GB-500---432--EE	2LEN/8DO AUXILIARY BOARD	X
32GB-500---442--EE	8DO/4AI/2AO AUXILIARY BOARD	X
--OP--12AS-006--EE	BOARD INTERFACE 4DO/EXV	X
32GB-660--012--S	EXV CABLE 270V & GREASE	
--FA--12DA-015--EE	FUSE 2A PRODIALOG	
00PSGX01103800A	KIT ICM/SCPM	
3276073	WINDOW	
--CY--12RB-017--EE	SWTCH	
--CY--12RB-018--EE	SWTCH	
30GT-409---069--C	CONNECTOR ASSEMBLY	
99CM-403---222--EE	PRESURE SWITCH CABLE 2,5M	
99CM-403---232--EE	PRESURE SWITCH CABLE 5M	
99CM-403---242--EE	PRESURE SWITCH CABLE 6,5M	
99CM-403---252--EE	PRESURE SWITCH CABLE 12M	
99CM-403---632--EE	SENSOR CABLE 2500MM	
99CM-403---642--EE	SENSOR CABLE 5000 MM	
99CM-403---652--EE	SENSOR CABLE 6500 MM	
99CM-403---662--EE	SENSOR CABLE 8000 MM	
99CM-403---672--EE	SENSOR CABLE 12000 MM	
--OP--12DA-057--E-	TRANSDUCER	

CARRIER

Unloaded cards need Carrier Service intervention

Ordering references	Description	No Software Required	Soft. not loaded	Configuration / Dipswitches
00PPG000030700A	LOW PRESSURE TRANSDUCER			
32GB-500---362--EF	COMPRESSOR CONTROL BOARD (SPM)		X	DIPSWITCHES TO PARAMETER
32GB-500---372--EE	NRCP2 BOARD (NEED TO BE LOADED)		X	
00PPG000030600A	HP SENSOR			
00PSP000000159A	TEMPERATURE SENSOR KIT AKSF-AKSH-AANL-AA			
00PSG000072300A	PRODIALOG PLUS DISPLAY	X		
00PSG000072400A	DISPLAY BOARD			
00PSG000072500A	DISPLAY BOARD			
E353X05028AGYABMA	SUCTION A TRANSDUCER CABLE			
E353X05045BGYABMA	SUCTION B TRANSDUCER CABLE			
E353X05038BGYABMA	SUCTION C TRANSDUCER CABLE			
E353X05026ARDABMA	DISCHARGE A TRANSDUCER CABLE			
E353X05055BRDABMA	DISCHARGE B TRANSDUCER CABLE			
E353X05034CRDABMA	DISCHARGE C TRANSDUCER CABLE			



CARRIER

Ordering references	Description	No Software Required	Soft. loaded	Soft. not loaded	Configuration / Dipswitches
32GB-500---062--EF	CLOCK BOARD	X			
32GB-500---082--EF	DISPLAY BOARD 1CKT AIR	X			
32GB-500---092--EF	DISPLAY BOARD 2CKT AIR	X			
32GB-500---102--EF	DISPLAY BOARD 1CKT WATER	X			
32GB-500---112--EF	DISPLAY BOARD 2CKT WATER	X			
32GB-500---122--EE	DISPLAY BOARD	X			
32GB-500---132--EE	DISPLAY BOARD	X			
32GB-500---182--EF	PRODIALOG 4 BOARD TO BE LOADED			X	CONFIGURATION TO PARAMETER
32GB-500---192--EF	EXV BOARD TO BE LOADED			X	DIPSWITCHES TO PARAMETER
32GB-500---372--EE	NRCP2 BOARD (NEED TO BE LOADED)			X	
32GB-500---402--EE	COMPRESSOR CONTROL BOARD (SCPM)			X	DIPSWITCHES TO PARAMETER
32GB-500---472--EE	CONNECTOR KIT NRCP1 TO NRCP2				
32GB500372L-61AF70	BOARD NRCP2 LOADED 61AF SW7.0		X		
32GB500372L-RARHMA	LOADED BOARD NRCP2 RHRA MASTER		X		
32GB500372L-RARHR1	BOARD NRCP2 LOADED 30RA RH <15KW VLS		X		
32GB500372L-RARHSL	LOADED BOARD NRCP2 RHRA SLAVE		X		
32GB500372LRBSMA41	BOARD NRCP2 LOADED 30RB RBS MAST V4.1				
32GB500372L-RBSSL4	BOARD NRCP2 LOADED 30-38RBS SLAVE V4.00		X		
32GB500372L-RH1733	BOARD NRCP2 LOADED 30RA/RH 17-33 VLS		X		
32GB500372L-RW-MA3	LOADED BOARD NRCP2 30RW RWA V3		X		
32GB500372L-RW-MA5	LOADED BOARD NRCP2 30RW RWA V5		X		
32GB500372L-RW--SL	LOADED BOARD NRCP2 RHRA SLAVE		X		
32GB500372L-XWVEMM	BOARD NRCP2 LOADED 30XW-V EMM & RECLA		X		
32GB500402L-HXGX12	BOARD SCPM LOADED 30HXGX PH1-2 REPL ICM		X		
32GB500402L-HXGX3	COMPR. BOARD SCPM LOADED 30HXGX PH3		X		

CARRIER

Unloaded cards need Carrier Service intervention



Ordering references	Description	No Software Required	Software Loaded	Soft. not loaded	Configuration / Dipswitches
32GB-500---382--EE	PRODIALOG 5 BOARD			X	
00PPG000012000A	TRANSDUCER				
32GB-500---432--EE	THUNDERBOLT DISPLAY	X			
00PSG000281600A	PROGRAMMED TCPM BOARD			X	
00PSG000469000A	TRANSDUCER		X		DIPSWITCHES TO PARAMETER
00PPG000012100A	EXV BOARD				
00PPG000492500A	SIOB BOARD		X		DIPSWITCHES TO PARAMETER
32GB-500---422--EE	2LEN/8DO AUXILIARY BOARD			X	DIPSWITCHES TO PARAMETER

CARRIER

Unloaded cards need Carrier Service intervention

Ordering references	Description
CESO110021-00	ELECTRONIC BOARD
CESO110053-00-S	ELECTRONIC BOARD
CESO110059-00-S	ELECTRONIC BOARD
CESO110060-00	ELECTRONIC BOARD
CESO110063-02-S	ELECTRONIC BOARD
CESO121319-01	MODULE-STARTER MNGT
CESO110068-02	CONTROL MODULE
32GB-500---462--EF	ICVC BOARD
CESO110031-00	ELECTRONIC BOARD LOGIC
CESO110065-01	ELECTRONIC BOARD
CESO110031-00	LOGIC ELECTRONIC BOARD



CONTROL / TOUCH PILOT

Ordering references	Description	Software Loaded	Soft. not loaded	Configuration / Dipswitches
00PSG001652200A	TOUCH PILOT DISPLAY 5		X	CONFIGURATION TO PARAMETER
00PSG001652200LSF2	TOUCHPILOT 5" (CARRIER BRAND) LOADED FOR SFI	X		CONFIGURATION TO PARAMETER
00PSG001652200LXA	TOUCHPILOT 5" (CARRIER BRAND) LOADED FOR 30XA	X		CONFIGURATION TO PARAMETER
00PSG002314900A	CONNECT TOUCH 5" (CIAT BRAND)		X	CONFIGURATION TO PARAMETER
00PSG002314900-LD	CONNECT TOUCH 5" (CIAT BRAND) LOADED FOR LD	X		
00PSG002515100A	TOUCHPILOT 5" (NEUTRAL)			
00PSG002314600A	TOUCHPILOT 4.3" (CARRIER BRAND)		X	CONFIGURATION TO PARAMETER
00PSP000000253A	TOUCHPILOT 4.3" (CARRIER BRAND) BACNET RBS		X	CONFIGURATION TO PARAMETER
00PSP000000413A	TOUCHPILOT 4.3" (CARRIER BRAND) BACNET WG		X	CONFIGURATION TO PARAMETER
00PSG002314600LRBS	TOUCHPILOT 4.3" (CARRIER) LOADED FOR RBS	X		CONFIGURATION TO PARAMETER
00PSG00231460050UH	TOUCHPILOT 4.3" (CARRIER) LOADED FOR 50UH	X		
00PSG002314700A	TOUCHPILOT 4.3" (W/O BRAND)		X	CONFIGURATION TO PARAMETER
00PSG002314800A	CONNECT TOUCH 4.3" (CIAT BRAND)		X	CONFIGURATION TO PARAMETER
00PSG002314800-LD	CONNECT TOUCH 4.3" (CIAT BRAND) LOADED FOR LD	X		CONFIGURATION TO PARAMETER
00PSG002314800-LDB	CONNECT TOUCH 4.3" (CIAT BRAND) BACNET FOR LD	X		CONFIGURATION TO PARAMETER
00PSG001926000A	TOUCHPILOT 7" (CARRIER BRAND)		X	CONFIGURATION TO PARAMETER
00PSG002660700A	CONNECT TOUCH 7" (CIATBRAND)			
00PSG002660800A	CONNECT TOUCH 7" BACNET IP (CIATBRAND)			
00PSG001926100A	TOUCHPILOT 7" BACNET (CARRIER BRAND)		X	CONFIGURATION TO PARAMETER
00PSG001926200A	TOUCHPILOT 10" (CARRIER BRAND)		X	CONFIGURATION TO PARAMETER

EC MOTOR BOARD

Ordering references	Description	Software Loaded
B037156H02	EC FAN BOARD 42GW209	X
B037156H03	EC FAN BOARD 42GW309	X
B037156H04	EC FAN BOARD 42GW409	X
B037156H05	EC FAN BOARD 42GW509	X
B037156H06	EC FAN BOARD 42GW609	X
B037156H07	EC FAN BOARD 42GW709	X
B037156H16	EC FAN BOARD 42N E19	X
B037156H33	EC FAN BOARD 42N E29	X
B037156H50	EC FAN BOARD 42N E39	X
B037156H75	EC FAN BOARD 42N E49	X
B037156H75-E69	EC FAN BOARD 42N E69	X

COMMUNICATION BOARDS

Ordering references	Description	Software Loaded	Soft. not loaded
00PSG000119100B	BOARD COM BACNET JBUS 148B	X	
00PSG000119200A	ACC BACNET MODBUS 148C	X	
00PSG000119300A	LONTALK DATA PORT BOARD	X	
00PSG000119400A	EMM BOARD	X	
00PSG000120000A	ACC CONT. BOARD		
00PSG000456300B	ACC BASE JBUS		
00PSG000596400A	MASTER SLAVE SENSOR KIT		
00PSG001022800A	HMI DISPLAY + KIT (CARRIER BRAND)		X
00PSGX01103800A	KIT ICM/SCPM		
30RA-900---092--E-	CCN JBUS GATEWAY FOR PD4 (NRCP2 BASED)		X
30RA-900---102--E-	PD 4 AUX BOARD + 8DO ACC		
30RW-900---002--E-	KIT 8DO 4AI 2AO		
33CN-ETHER	CCN TO ETHERNET CONVERTER		
33CNTRAN485	CONTROL BOARD	X	
33CNTRANLON	ACC LEI LON + BASE	X	

CARRIER

KIT AQUASMART SYSTEM MANAGER V 3.0



Ordering references	Description
KIT33ASM-01-ONWALL	ON WALL ASM01 V.3 KIT
KIT33ASM-01-INWALL	IN WALL ASM01 V.3 KIT
00PSG001347700A	TOUCH PILOT
00PSG001347800A	ON WALL ELECTRICAL BOX
00PSG001347900A	IN WALL ELECTRICAL BOX
00PSG001350000A	POWER SUPPLY 230V/24DC

KIT AQUASMART SYSTEM MANAGER V 4.0 BACNET

Ordering references	Description
KITBACNET-ONWALL	KIT ASM BACNET ON WALL
KITBACNET-INWALL	KIT ASM BACNET IN WALL
00PSG001716900A	TOUCHPILOT DISPLAY ASM BACNET
00PSG001347800A	ON WALL ELECTRICAL BOX
00PSG001347900A	IN WALL ELECTRICAL BOX
00PSG001350000A	POWER SUPPLY 230V/24DC

AQUASMART SYSTEM MANAGER

Ordering references	Description
00PSG001717100A	V2 TO V3
00PSG001717200A	V3 TO V4

CARRIER



Ordering references	Description	LANGUAGE
99QM-803DE-050--EE	AQUASMART SM32	GERMAN
99QM-803DE-051--EE	AQUASMART SM64	GERMAN
99QM-803DE-052--EE	AQUASMART SM128	GERMAN
99QM-803GB-050--EE	AQUASMART SM32	ENGLISH
99QM-803GB-051--EE	AQUASMART SM64	ENGLISH
99QM-803GB-052--EE	AQUASMART SM128	ENGLISH
99QM-803SP-050--EE	AQUASMART SM32	SPANISH
99QM-803SP-051--EE	AQUASMART SM64	SPANISH
99QM-803SP-052--EE	AQUASMART SM128	SPANISH
99QM-803FI-050--EE	AQUASMART SM32	FINNISH
99QM-803FI-051--EE	AQUASMART SM64	FINNISH
99QM-803FI-052--EE	AQUASMART SM128	FINNISH
99QM-803FR-050--EE	AQUASMART SM32	FRENCH
99QM-803FR-051--EE	AQUASMART SM64	FRENCH
99QM-803FR-052--EE	AQUASMART SM128	FRENCH
99QM-803GR-050--EE	AQUASMART SM32	GREEK
99QM-803GR-051--EE	AQUASMART SM64	GREEK
99QM-803GR-052--EE	AQUASMART SM128	GREEK
99QM-803NL-050--EE	AQUASMART SM32	DUTCH
99QM-803NL-051--EE	AQUASMART SM64	DUTCH
99QM-803NL-052--EE	AQUASMART SM128	DUTCH
99QM-803IT-050--EE	AQUASMART SM32	ITALIAN
99QM-803IT-051--EE	AQUASMART SM64	ITALIAN
99QM-803IT-052--EE	AQUASMART SM128	ITALIAN
99QM-803PT-050--EE	AQUASMART SM32	PORTUGUESE
99QM-803PT-051--EE	AQUASMART SM64	PORTUGUESE
99QM-803PT-052--EE	AQUASMART SM128	PORTUGUESE
99QM-803SE-050--EE	AQUASMART SM32	SWEDISH
99QM-803SE-051--EE	AQUASMART SM64	SWEDISH
99QM-803SE-052--EE	AQUASMART SM128	SWEDISH



M | BRASS FITTINGS

BRASS FITTINGS / SAE FLARE NUTS	252
BRASS FITTINGS / COUPLING	253
BRASS FITTINGS / 90° ELBOWS, TEES, PLUGS	254
BRASS FITTINGS / COPPER SEAL CAPS & GASKETS	255

CARRIER

SAE Flare Nuts



Ordering references	Connection size (inch)	Copper tube diameter size (inch)
--UA--12AA-101--EE	1/4	1/4
--UA--12AA-102--EE	3/8	3/8
--UA--12AA-105--EE	1/2	1/2
--UA--12AA-106--EE	5/8	5/8

CARRIER

SAE Flare reducing nuts



Ordering references	Connection size (inch)	Piping diameter size (inch)
--UA--12AA-110--EE	3/8 SAE FLARE	1/4
--UA--12AA-111--EE	1/2 SAE FLARE	1/4
--UA--12AA-112--EE	1/2 SAE FLARE	3/8
--UA--12AA-113--EE	5/8 SAE FLARE	3/8
--UA--12AA-114--EE	5/8 SAE FLARE	1/2
--UA--12AA-115--EE	3/4 SAE FLARE	1/2
--UA--12AA-116--EE	3/4 SAE FLARE	5/8

CARRIER



Ordering references	Connection size (inch)	Type
--UA--12AB-002--EE	1/4 M-SAE FLARE / 1/4 F-NPT	MALE FLARE / FEMALE NPT
--UC--12AA-001--EE	1/4 NPT / 1/4 SAE FLARE	MALE NPT / MALE FLARE
--UC--12AA-002--EE	1/8 NPT / 1/4 SAE FLARE	MALE NPT / MALE FLARE
--UC--12AA-003--EE	1/8 NPT / 3/8 SAE FLARE	MALE NPT / MALE FLARE
--UC--12AA-004--EE	1/4 NPT / 3/8 SAE FLARE	MALE NPT / MALE FLARE
--UC--12AA-005--EE	1/4 NPT / 1/2 SAE FLARE	MALE NPT / MALE FLARE
--UC--12AA-007--EE	3/8 NPT / 1/4 SAE FLARE	MALE NPT / MALE FLARE
--UC--12AA-008--EE	3/8 NPT / 3/8 SAE FLARE	MALE NPT / MALE FLARE
--UC--12AA-009--EE	3/8 NPT / 1/2 SAE FLARE	MALE NPT / MALE FLARE
--UC--12AA-012--EE	1/2 NPT / 1/4 SAE FLARE	MALE NPT / MALE FLARE
--UC--12AA-013--EE	1/2 NPT / 3/8 SAE FLARE	MALE NPT / MALE FLARE
--UC--12AA-015--EE	1/2 NPT / 5/8 SAE FLARE	MALE NPT / MALE FLARE
--UC--12AA-019--EE	3/4 NPT / 5/8 SAE FLARE	MALE NPT / MALE FLARE
--UC--12AA-020--EE	3/4 NPT / 3/4 SAE FLARE	MALE NPT / MALE FLARE
--UC--12BB-001--EE	1/4	MALE FLARE / FEMALE TO SOLD
--UC--12BB-002--EE	3/8	MALE FLARE / FEMALE TO SOLD
--UC--12BB-003--EE	1/2	MALE FLARE / FEMALE TO SOLD
--UC--12BB-004--EE	5/8	MALE FLARE / FEMALE TO SOLD
--UC--12BB-005--EE	3/4	MALE FLARE / FEMALE TO SOLD
--UC--12BB-006--EE	1	MALE FLARE / FEMALE TO SOLD

CARRIER



90° ELBOWS

Ordering references	Connection size (inch)	Type
--UB--12AA-001--EE	1/8 NPT - 1/4 SAE FLARE	MALE NPT / MALE FLARE
--UB--12AA-002--EE	1/4 NPT - 1/4 SAE FLARE	MALE NPT / MALE FLARE
--UB--12AA-008--E-	3/8 NPT - 3/8 SAE FLARE	MALE NPT / MALE FLARE
--UB--12AA-009--EE	3/8 NPT - 1/2 SAE FLARE	MALE NPT / MALE FLARE

CARRIER



Tees

Ordering references	Connection size (inch)	Type
--UB--12BA-001--EE	1/4 M-FLARE / 1/8 M-NPT 1/4 M-FLARE	MALE FLARE / MALE NPT / MALE FLARE TEES
--UB--12BA-002--EE	1/4 M-FLARE / 1/4 M-NPT 1/4 M-FLARE	MALE FLARE / MALE NPT / MALE FLARE TEES
--UB--12BB-001--EE	1/4 M-FLARE	EQUAL TEES SAE FLARE
--UB--12BD-003--EE	1/4 M-SAE FLARE / 1/4 F-NPT / 1/4 M-SAE FLARE	MALE FLARE / FEMALE NPT / MALE FLARE TEES

CARRIER



Plugs

Ordering references	Connection size (inch)	Type
--UA--12BA-002--EE	3/8 M-FLARE	FEMALE SAE FLARE
--UA--12BA-001--EE	1/4 M-FLARE	FEMALE SAE FLARE
--UA--12BA-003--EE	1/2 M-FLARE	FEMALE SAE FLARE
--UA--12BA-004--EE	5/8 M-FLARE	FEMALE SAE FLARE
--UD--12AA-003--EE	1/8 M-NPT	MALE NPT

CARRIER

Copper seal caps



Ordering references	Connection size (inch)
--AH--12MB-002--EE	3/8
--AH--12MB-004--EE	5/8
--AH--12MB-005--EE	3/4

CARRIER

Copper gaskets



Ordering references	Connection size (inch)
--AH--12MA-002--EE	3/8
--AH--12MA-004--EE	5/8
--AH--12MA-005--EE	3/4



DESIGNING INNOVATIVE SOLUTIONS

United Technologies

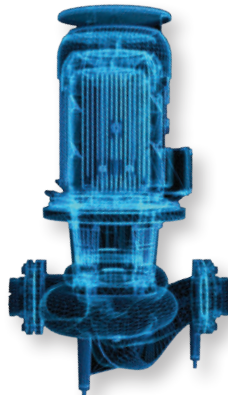
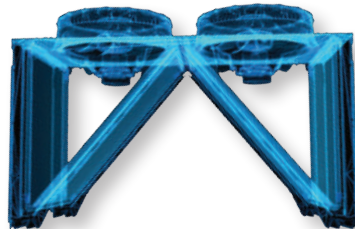
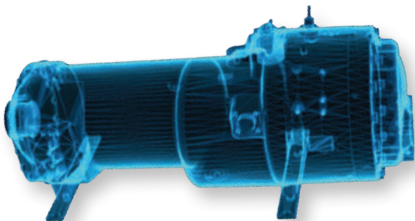
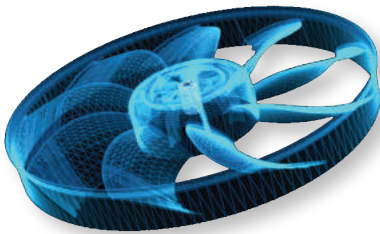

WWW.CARRIER-ERCD.COM