

# PRODUCT CATALOGUS 2023

LEVERING BINNEN 24 UUR

versie 02/2023

**FUTURE PROOF**

**CONNECTIONS**

## 1

**BEDRADINGSKOKER EN DIN-RAIL**

<b>Licatec bedradingskoker</b>	<b>8</b>
Serie F2000: PVC, intrinsiekveilig, halogeenvrij	8
Serie DIN: PVC, halogeenvrij	9
Losse deksels, accessoires	10
<b>GGK bedradingskoker</b>	<b>11</b>
Serie VK: PVC, accessoires	11
<b>Calpe DIN-EN montagerail</b>	<b>12</b>
TS35, TS32, TS15, accessoires	12

## 2

**DRAAD EN KABEL**

<b>Montagesnoer PVC</b>	<b>14</b>
Helukabel H05V2-K / H07V2-K (PVC 90°C)	14
Helukabel Fivenorm UL/CSA (PVC 105°C)	15
<b>Montagesnoer halogeenvrij</b>	<b>16</b>
Studer BETAtherm® 90 (105°C)	16
Studer BETAtherm® 145 (145°C)	17
<b>Montagesnoer halogeenvrij kortsluitvast</b>	<b>18</b>
Studer BETAtrans® (dubbel geïsoleerd)	18
<b>Datakabel</b>	<b>19</b>
Patchkabels	19
<b>Helukabel</b>	<b>20</b>
Helukabel stuurstroomkabel	20
Helukabel stuurstroomkabel afgeschermd	21
Helukabel datakabel	22
<b>Lapp kabel</b>	<b>23</b>
Lapp stuurstroomkabel	23
Lapp stuurstroomkabel afgeschermd	24
Lapp datakabel	25
Lapp montagesnoer LiY (PVC 70°)	26

## 3

**KABELVERBINDERS**

<b>GLW adereindhulzen</b>	<b>28</b>
Ongeïsoleerde adereindhulzen	28
Geïsoleerde adereindhulzen: diverse lengten	29
Geïsoleerde adereindhulzen: TWIN, cassettes, band, strip	30
Geïsoleerde adereindhulzen met grotere kraag	31
<b>Nichifu kabelschoenen</b>	<b>32</b>
Ring, vork, stift	32
Doorverbinders, vlak- en rondstekers, eind- en lijmverbindingen	33
<b>Mecatraction kabelschoenen</b>	<b>34</b>
Buiskabelschoenen 6-70mm <sup>2</sup>	34
Buiskabelschoenen 95-400mm <sup>2</sup> , haakse buiskabelschoenen 45°	35
Haakse buiskabelschoenen 90°, doorverbinders	36
DIN-buiskabelschoenen 6-240mm <sup>2</sup>	37
DIN-buiskabelschoenen 300-1000mm <sup>2</sup> , doorverbinders, ongeïsoleerde kabelschoenen (pen)	38
Ongeïsoleerde kabelschoenen (plaat), geïsoleerde buiskabelschoenen	39

## 4

**KABELDOORVOER**

<b>Jacob kabelwartels metrisch</b>	<b>44</b>
Kunststof: serie Perfect: wartels, zeskantmoeren, blindstoppen met schroefdraad	44
Kunststof: serie Perfect FIX, spiraalknikbescherming, blindstoppen, reduceer- en vergrootringen	45
Kunststof: adapters, verloopringen, meervoudige kabeldoorvoer	46
Messing: serie Perfect: wartels, zeskantmoeren, blindstoppen met schroefdraad	47
Messing: serie Perfect: wartels EMC, zeskantmoeren EMC	48
Messing: reduceer- en vergrootringen, adapters, verloopringen	49
Drukverschil condenspluggen en wartels	50
<b>Kabelwartels en doorvoer</b>	<b>51</b>

4

<b>Jacob kabelwartels PG</b>	<b>52</b>
Kunststof: serie Perfect: wartels, zeskantmoeren, blindstoppen met schroefdraad, spiraalknikbescherming	52
Kunststof: reduceer- en verloopringen, meervoudige kabeldoorvoer	53
Messing: serie Perfect: wartels (EMC), zeskantmoeren (EMC), blindstoppen met schroefdraad	54
Messing: reduceer- en verloopringen, adapters, verloopringen zeskantmoeren (EMC), blindstoppen schroefdraad	55
<b>Jacob kabelwartels explosieveilig</b>	<b>56</b>
Kunststof: serie GHG: wartels	56
Kunststof: serie GHG: blindstoppen met schroefdraad, reduceerringen	57
<b>TST kabeldoorvoer</b>	<b>58</b>
Kunststof: serie Rutaseal®	58
Kunststof: serie Klikseal®, serie TSS	59

5

## KABEL OMWIKKELINGEN

<b>Interflex bescherm slang</b>	<b>62</b>
Bescherm slang: serie AGT, serie STT	62
Toebehoren: slangwartels: recht, haaks, 90°	63
Toebehoren: slangwartels: 45°, wandbeugels, O-ringen	64
<b>Diverse omwikkeling</b>	<b>65</b>
Spiraal- en kabelmantel, beschermprofiel	65
Krimpkous: krimp 2:1	66
Krimpkous: met lijm, UL gecertificeerd	67
Elematic: isolatietape, gevlochten kous	68
Rubber tulen, gereedschap, krimpkous	69
Elematic: bundelbanden (halogeenvrij) + toebehoren	70
Elematic: 2-Lock™ en detecteerbare bundelbanden	71
Thomas&Betts: bundelbanden met inox clip (halogeenvrij)	72
Randclip (incl. bundelband), RVS (inox) bundelbanden	73

6

## AANSLUITEN EN VERBINDEN

<b>Cabur rijgklemmen</b>	<b>76</b>
Klemmen: serie CBC, TEO 2,5 - 35mm <sup>2</sup>	76
Accessoires CBC	77
Doorvoerklemmen, aardingsklemmen	78
Twee- en drie-etageklemmen	79
Mini doorvoerklemmen, doorvoerklemmen met zekeringhouders	80
Rijgklemmen push-in	81
Codering tbv Cabur klemmen	82
<b>Diverse verdeelbokken en aansluitklemmen</b>	<b>83</b>
Verdeelblokken: serie QBLOK, Aansluitklemmen: serie CK	83
<b>HoraEtec aansluit- en verdeelklemmen</b>	<b>84</b>
Serie RKA: enkel 50-300mm <sup>2</sup>	84
Serie RKA: dubbel 50-300mm <sup>2</sup>	85
Serie HLAk 25 A, HLAk 35 A	86
Serie HLAk 35 A, HLAk 70 A	87
Serie HLAk 25 C	88
<b>HoraEtec aansluit- en verdeelklemmen</b>	<b>89</b>
Serie HLAk C,D aftakingsklemmen voor koperen aders	89
Serie UVB100, UVB200, SSAK 16	90
Uitgelicht: HoraEtec serie overzicht	91
Serie PDB 100-125A	92
Serie PDB 160-400A	93
<b>Elkutec verbindingsrails</b>	<b>94</b>
Geïsoleerd: vork 17,8mm	94
Geïsoleerd: pen 17,8mm	95
Geïsoleerd: pen 1P+N, voedingsblokken	96
Geïsoleerd: vork tbv motorbeveiligingsschakelaars, voedingsblokken	97
<b>Aardrails</b>	<b>98</b>
diverse lengten en toebehoren	98
<b>SPS flexibel koper</b>	<b>99</b>
Uitgelicht: SPS serie Ultraflexx®	99
Geïsoleerd: serie Isoflexx® Classic 125-2500A	100
Geïsoleerd: serie Isoflexx® Premium 125-2500A (halogeenvrij)	101
Geïsoleerd: serie Ultraflexx® 25-100mm <sup>2</sup>	102
Geïsoleerd: serie Ultraflexx® 120-240mm <sup>2</sup>	103
Ongeïsoleerd: serie MBS vertind aardingsband	104

6	<b>Spanningsverdeelsysteem</b>	<b>105</b>
	Spanningsverdeelsysteem Busspeed	105
	<b>Diverse afstandsteunen</b>	<b>106</b>
	Kunststof: type S, serie 10-11	106
	Kunststof: type 6A, Metaal: ophoogbus en-steun, dopbout en -moeren	107
	Metaal: type DA, montageklemmen, deurbeugels	108
	<b>Eren isolatoren</b>	<b>109</b>
	Glasvezelversterkt: serie SK	109
	<b>DUURZAAM</b>	
	<b>EV laadpaal oplossingen</b>	<b>112</b>
Lovato: programma overzicht	113	
<b>Lovato DC lastschakelaars</b>	<b>114</b>	
Serie GD - GAZ...D..	114	
<b>Halogeenvrije Solar kabel</b>	<b>115</b>	
Studer BETAflam® Solar	115	
8	<b>COMPONENTEN</b>	
	<b>Katko lastschakelaars</b>	<b>118</b>
	Serie KU-N, KU	118
	Toebehoren serie KU-N, KU	119
	Kunststof: serie KEM 16-160A, serie KSM 16A met zijhefboom	120
	Aluminum: serie KEA 16-125A, RVS: serie KER 16-125A	121
	EMC: serie KEM-EMC (PC), serie KEA-EMC (Alu); ATEX: serie KEA-EX (Alu)	122
	Funcatiebehoud: serie KEA-FR, serie KEA-FR3	123
	<b>Kopp automaten, aardlek</b>	<b>124</b>
	Installatie automaten: B-, C-karakteristiek	124
	Installatie automaten: D-karakteristiek, aardlekautomaten, -schakelaars	125
	<b>Lovato Electric</b>	<b>126</b>
	Motorbeveiligingsschakelaars: serie SM1P (drukknop)	126
	Motorbeveiligingsschakelaars: serie SM1R (draaiknop)	127
	DOL-starters: serie M, Sterdriehoekschakelaars: serie BFA	128
	Mini-magneetschakelaars, thermorelais en toebehoren	129
	Magneetschakelaars 3- en 4-polig	130
	Thermorelais en toebehoren voor magneetschakelaars	131
	Insteekrelais	132
	Installatie automaten	134
	Installatie automaten, aardlek automaten, aardlek schakelaars	135
	Nokkenschakelaars, lastschakelaars	136
	Toebehoren lastschakelaars	137
	Lastschakelaars serie GL	138
	Softstarters serie ADXL	139
Modulaire tijdrelais	140	
Energiemanagement	141	
Eindschakelaars, veiligheidsschakelaars, voetschakelaars	142	
Niveauregeling, vlotterschakelaars	143	
<b>Alfa Electric</b>	<b>144</b>	
Verwarmingselementen, ventilatoren, thermostaten	144	
Schakelkastverlichting	145	
9	<b>CODEERMATERIAAL</b>	
	<b>Partex markeersysteem</b>	<b>148</b>
	Draad- en kabelcodering, serie PA, PC	148
	Draad- en kabelcodering, serie PO/POZ, PK, PKH	149
	RVS codering, RVS bundelbanden, printers	150
	<b>Märko markeersysteem</b>	<b>151</b>
	Draad- en kabelcoderingen	151
	Component codering, kabelcodering	152
	Kabelcodering op rol, op kaarten, printerlabels	153
	Printerlabels	154

10

## GEREEDSCHAP

<b>Voor verwerking van adereindhulzen</b>	<b>156</b>
geïsoleerde kabelschoenen	158
Enkel: 0,25-240mm <sup>2</sup> , Twin: 0,5-16mm <sup>2</sup>	159
<b>Voor knippen en strippen van draad en kabel</b>	<b>160</b>
Draad en kabel: 0,08-500mm <sup>2</sup>	160
Draad en kabel: 0,08-16mm <sup>2</sup>	161
<b>Voor verwerking van bundelbanden, tulen, diversen</b>	<b>162</b>
Knikschroefmachines, montagetangen, 3-puntstangen	162
<b>Voor verwerking van bedradingskoker en DIN-EN rail</b>	<b>163</b>
Kniptangen en -scharen, profielknippers	163
<b>Machines GLW</b>	<b>164</b>
Knippen, strippen, krimpen	164
Pneumatisch: strippen, krimpen	165
Krimpen van contacten	166
<b>Voor verwerking van buiskabelschoenen</b>	<b>167</b>
Krimptangen, hydraulische perstangen: 6-300mm <sup>2</sup>	167
<b>Schroevendraaiers en diverse tangen</b>	<b>168</b>
Witte: schroevendraaiers: serie Maxx Pro, Maxx VDE	168
Witte: boorbits, Knipex: tangen	169
<b>Krimptangen overig</b>	<b>170</b>
Krimptangen: set in koffer	170
Krimpmatrijzen: tbv adereindhulzen, coax stekers, RJ-connectoren	171

11

## BEDIENEN EN SIGNALEREN

<b>Lovato Electric serie Platinum kunststof</b>	<b>174</b>
Drukknoppen Ø22mm	174
Pilotlampjes, LED-monoblokken, dubbele drukknoepen, keuzeschakelaars Ø22mm	175
<b>Lovato Electric serie Platinum Metaal</b>	<b>176</b>
Drukknoppen, noodstoppen, keuzeschakelaars Ø22mm	176
Pilotlampjes, dubbele drukknoepen, joy-sticks Ø22mm	177
Drukknoppen, pilot lampjes, keuzeschakelaars, communicatie modules Ø30mm	178
Communicatie modules, potentiometers, buzzers, noodstop drukknoepen	179
<b>Lovato Electric serie Platinum</b>	<b>180</b>
Drukknopkastjes, (nood) slagknoppen	180
<b>Calpe Signaallampen</b>	<b>181</b>
Serie 3000, neon en LED uitvoering	181
Serie 3000: Ø20mm, Ø22,5mm: Rafi drukknoepen	182
<b>Signal Construct</b>	<b>183</b>
LED signaallampen: Ø5mm, Ø6mm, Ø8mm, Ø10mm, Ø14mm	183
LED signaallampen: Ø16mm, Ø22mm, Ø30mm	184
LED lampen: Ø5,6mm, Ø9,7mm, Ø18,5mm	185
<b>Contactdozen, alarmlampen</b>	<b>186</b>
Schuko (DIN-rail), Withled; serie 800	186
<b>Infrarood en piëzo schakelaars</b>	<b>187</b>
<b>Flitslampen, waarschuwingssignalen</b>	<b>188</b>
<b>Zekeringen</b>	<b>189</b>

12

## SCHAKELMATERIAAL

<b>Berker Business Solutions</b>	<b>193</b>
Afdekramen: enkelvoudig, 2- en 3-voudig	195
Afdekramen: met klapdeksel, opbouwdozen	196
Toebehoren, montagevoorschrift IP44	197
Basiselementen: wip- en drukschakelaars	198
Basiselementen: contactdozen	200
Basiselementen: TV/multimedia	201
Afschermdozen, draadloos laadstation	202
<b>Bulgin - Arcoelectric schakelaars</b>	<b>203</b>
Wipschakelaars diversen	203



NIEUW:



download of bekijk  
de catalogus nu ook  
digitaal in PDF op:

[calpe.nl](http://calpe.nl)



Calpe BV  
Anthonie Fokkerstraat 53  
3772 MP Barneveld (NL)

NL +31 (0)342 - 45 15 44  
BE +32 (0)475 - 94 44 29

KvK 32086233  
BTW NL8101.07.843.B01

IBAN NL80 ABNA 0553 0303 61  
BIC ABNA NL2A

info@calpe.nl  
www.calpe.nl

**calpe**  
INDUSTRIAL



# BEDRADINGSKOKER EN DIN-RAIL

---

1

# Licatec bedradingskoker

Serie F2000: PVC, intrinsiekveilig, halogeenvrij



## Serie F2000 | PVC

**Materiaal:** Hard PVC, lood-cadmiumvrij  
**Gatenpatroon:** Volgens DIN 50085-2-3  
**Temp.bereik:** -20°C tot +65°C piek +75°C  
**Volgens:** UL94-V0, zelfdovend  
**Kleur:** Grijs RAL7030



Bestelnr.	Afmetingen B H	VPE mtr.	Brutoprijs €/100mtr.
<b>30 hoog</b>			
33-7308-1	30 30	64	455,00
<b>40 hoog</b>			
33-7309-1	25 40	68	510,00
33-7310-1	30 40	60	535,00
33-7311-1	40 40	52	565,50
33-7312-1	60 40	40	700,00
<b>60 hoog</b>			
33-7319-1	25 60	60	535,00
33-7320-1	30 60	52	595,00
33-7321-1	40 60	48	640,00
33-7322-1	60 60	36	785,00
33-7323-1	80 60	32	1.080,00
33-7324-1	100 60	22	1.170,00
33-7325-1	120 60	20	1.455,00
<b>80 hoog</b>			
33-7329-1	25 80	56	755,00
33-7330-1	30 80	48	790,00
33-7331-1	40 80	40	805,00
33-7332-1	60 80	36	830,00
33-7333-1	80 80	24	1.160,00
33-7334-1	100 80	24	1.375,00
33-7335-1	120 80	16	1.515,00
<b>100 hoog</b>			
33-7340-1	30 100	32	1.220,00
33-7343-1	40 100	24	1.275,00
33-7341-1	60 100	32	1.415,00
33-7344-1	80 100	20	1.610,00
33-7342-1	100 100	16	1.750,00
33-7345-1	150 100	8	1.990,00
<b>120 hoog</b>			
33-7351-1	40 120	24	1.185,00
33-7352-1	60 120	24	1.645,00
33-7353-1	80 120	20	1.645,00

Genoemde prijzen zijn inclusief deksel

## Serie F2000 | Intrinsiek veilig

**Materiaal:** Hard PVC, lood-cadmiumvrij  
**Gatenpatroon:** Volgens DIN 50085-2-3  
**Temp.bereik:** -20°C tot +65°C piek +75°C  
**Volgens:** UL94-V0, zelfdovend  
**Kleur:** Blauw RAL5015



Bestelnr.	Afmetingen B H	VPE mtr.	Brutoprijs €/100mtr.
<b>30 hoog</b>			
-	-	-	-
<b>40 hoog</b>			
-	-	-	-
-	-	-	-
-	-	-	-
-	-	-	-
<b>60 hoog</b>			
-	-	-	-
-	-	-	-
33-7521-1	40 60	48	905,00
33-7522-1	60 60	36	905,00
33-7523-1	80 60	32	o.a.
-	-	-	-
-	-	-	-
<b>80 hoog</b>			
-	-	-	-
33-7530-1	30 80	48	880,00
33-7531-1	40 80	40	905,00
33-7532-1	60 80	36	965,00
33-7533-1	80 80	24	1.330,00
33-7534-1	100 80	24	1.510,00
-	-	-	-
<b>100 hoog</b>			
-	-	-	-
-	-	-	-
33-7541-1	60 100	32	1.565,00
-	-	-	-
33-7542-1	100 100	16	1.845,00
-	-	-	-
<b>120 hoog</b>			
-	-	-	-
-	-	-	-
-	-	-	-
-	-	-	-

Genoemde prijzen zijn inclusief deksel

## Serie F2000 | halogeenvrij

**Materiaal:** PC/ABS, lood-cadmiumvrij  
**Gatenpatroon:** Volgens DIN 50085-2-3  
**Temp.bereik:** -25°C tot +90°C piek 110°C  
**Volgens:** UL94-V0, zelfdovend  
**Kleur:** Grijs RAL7035



Bestelnr.	Afmetingen B H	VPE mtr.	Brutoprijs €/100mtr.
<b>30 hoog</b>			
33-7358-1	30 30	64	840,00
<b>40 hoog</b>			
33-7359-1	25 40	68	1.025,00
-	-	-	-
33-7361-1	40 40	52	1.255,00
33-7362-1	60 40	40	1.260,00
<b>60 hoog</b>			
33-7369-1	25 60	60	1.215,00
-	-	-	-
33-7371-1	40 60	48	1.505,00
33-7372-1	60 60	36	1.770,00
33-7373-1	80 60	32	2.170,00
-	-	-	-
-	-	-	-
<b>80 hoog</b>			
33-7379-1	25 80	56	1.740,00
-	-	-	-
33-7381-1	40 80	40	1.800,00
33-7382-1	60 80	36	2.025,00
33-7383-1	80 80	24	2.440,00
33-7384-1	100 80	24	2.650,00
33-7385-1	120 80	16	3.420,00
<b>100 hoog</b>			
33-7390-1	30 100	32	2.760,00
33-7393-1	40 100	24	2.850,00
33-7391-1	60 100	32	2.990,00
33-7394-1	80 100	20	3.105,00
33-7392-1	100 100	16	3.710,00
-	-	-	-
<b>120 hoog</b>			
-	-	-	-
-	-	-	-
-	-	-	-
-	-	-	-

Genoemde prijzen zijn inclusief deksel

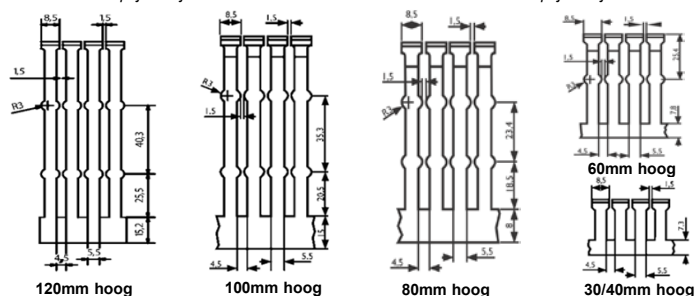
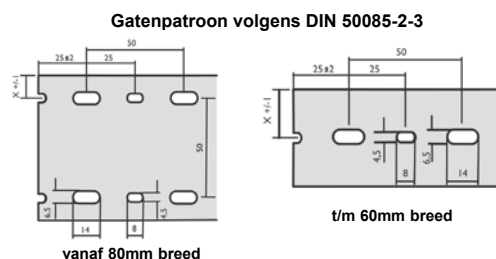



# Licatec bedradingskoker

Serie DIN: PVC, halogeenvrij



## Serie DIN | PVC

**Materiaal:** Hard PVC, lood-cadmiumvrij  
**Gatenpatroon:** Volgens DIN 50085-2-3  
**Temp.bereik:** -20°C tot +65°C piek 75°C  
**Volgens:** UL94-V0, zelfdovend  
**Kleur:** Grijs RAL7030



Bestelnr.	Afmetingen B H	VPE mtr.	Brutoprijs €/100mtr.
<b>25 hoog</b>			
33-7610-1	25 25	48	412,00
<b>37,5 hoog</b>			
33-7620-1	25 37,5	54	445,00
33-7621-1	37,5 37,5	40	515,00
33-7622-1	50 37,5	32	o.a.
<b>50 hoog</b>			
33-7630-1	25 50	44	515,00
33-7631-1	37,5 50	32	525,00
33-7632-1	50 50	42	675,00
33-7633-1	75 50	28	805,00
33-7634-1	100 50	20	990,00
<b>75 hoog</b>			
33-7640-1	25 75	36	675,00
33-7641-1	37,5 75	24	745,00
33-7642-1	50 75	28	810,00
33-7643-1	75 75	24	985,00
33-7644-1	100 75	16	1.220,00
33-7645-1	125 75	16	1.375,00

Standaard voorzien van dubbelzijdige plakstrip

Genoemde prijzen zijn inclusief deksel

## Serie DIN | halogeenvrij

**Materiaal:** PC/ABS, lood-cadmiumvrij  
**Gatenpatroon:** Volgens DIN 50085-2-3  
**Temp.bereik:** -25°C tot +90°C, piek 110°C  
**Volgens:** UL94-V0, zelfdovend  
**Kleur:** Grijs RAL7035



Bestelnr.	Afmetingen B H	VPE mtr.	Brutoprijs €/100mtr.
<b>25 hoog</b>			
33-7656-1	25 25	48	885,00
<b>37,5 hoog</b>			
33-7650-1	25 37,5	54	o.a.
33-7651-1	37,5 37,5	40	1.035,00
33-7652-1	50 37,5	32	o.a.
<b>50 hoog</b>			
33-7660-1	25 50	44	1.105,00
33-7661-1	37,5 50	32	1.215,00
33-7662-1	50 50	42	1.325,00
33-7663-1	75 50	28	1.740,00
33-7664-1	100 50	20	2.220,00
<b>75 hoog</b>			
33-7670-1	25 75	36	1.600,00
33-7671-1	37,5 75	24	1.745,00
33-7672-1	50 75	28	1.860,00
33-7673-1	75 75	24	2.340,00
33-7674-1	100 75	16	2.910,00
33-7675-1	125 75	16	2.905,00
<b>100 hoog</b>			
33-7677-1	50 100	32	2.505,00
33-7678-1	75 100	20	2.780,00
33-7679-1	100 100	16	3.305,00

Genoemde prijzen zijn inclusief deksel

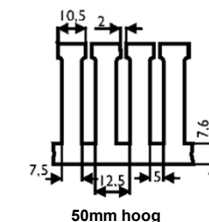
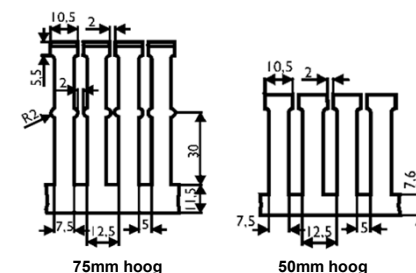
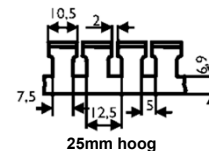
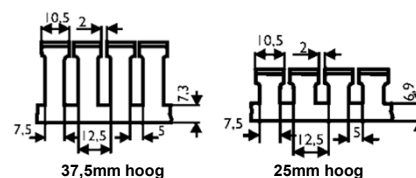
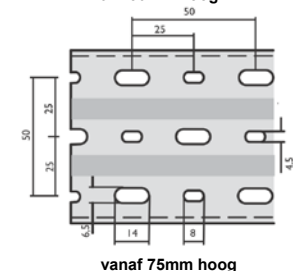
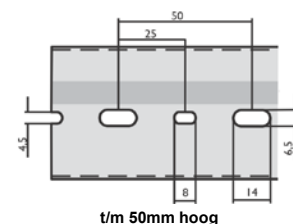

## Serie Flex | halogeenvrij

**Materiaal:** PP lood- en cadmiumvrij  
**Volgens:** UL94-V0, zelfdovend  
**Kleur:** Grijs RAL7030



Bestelnr.	ø mm	VPE stk.	Brutoprijs €/100stk.
<b>Lengten van 500mm</b>			
33-7860-1	10x10	100	420,00
33-7861-1	20	60	484,50
33-7862-1	30	36	505,00
33-7863-1	40	24	595,00

Standaard voorzien van dubbelzijdige plakstrip



Knipper voor bedradingskoker:  
zie hoofdstuk 10 Gereedschap



# Licatec bedradingskoker

Losse deksels, accessoires



## Deksels F2000 | PVC

Bestelnr.	Breed	VPE	Brutoprijs €/100mtr.
33-5509-1	25	10	124,50
33-5510-1	30	10	133,50
33-5511-1	40	10	142,00
33-5512-1	60	10	217,50
33-5513-1	80	10	298,50
33-5514-1	100	10	388,50
33-5515-1	120	10	520,00
33-5021-1	150	10	455,00

## Deksels F2000 | halogeen vrij

Bestelnr.	Breed	VPE	Brutoprijs €/100mtr.
33-5519-1	25	10	261,00
33-5520-1	30	10	267,00
33-5521-1	40	10	368,50
33-5522-1	60	10	445,00
33-5523-1	80	10	595,00
33-5524-1	100	10	1.045,00
33-5525-1	120	10	1.205,00

## Deksels DIN | PVC

Bestelnr.	Breed	VPE	Brutoprijs €/100mtr.
33-5015-1	25	10	194,50
33-5016-1	37,5	10	209,00
33-5017-1	50	10	238,00
33-5018-1	75	10	281,50
33-5019-1	100	10	388,50
33-5020-1	125	10	425,00

## Deksels DIN | halogeen vrij

Bestelnr.	Breed	VPE	Brutoprijs €/100mtr.
33-5030-1	25	10	450,00
33-5031-1	37,5	10	485,00
33-5032-1	50	10	590,00
33-5033-1	75	10	770,00
33-5034-1	100	10	1.000,00
33-5035-1	125	10	1.140,00

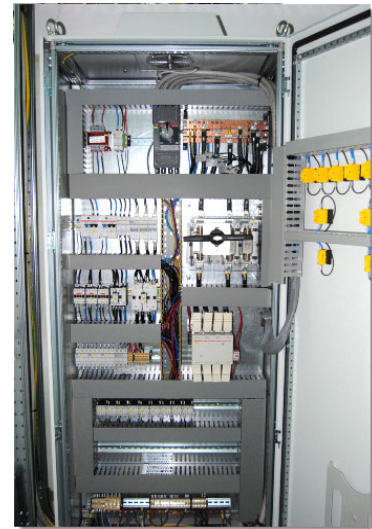

## Accessoires

### Draadhoudstrip

Bestelnr.	VPE	Brutoprijs €/100stk.
Lang 147,5mm / PP halogeen vrij		
33-7802	500	49,50

### Draadhouder | halogeen vrij

Bestelnr.	VPE	Brutoprijs €/100stk.
Lang 70mm, PS		
33-7803	400	29,00

### Scheidingswand

Bestelnr.	Breed	VPE	Brutoprijs €/100mtr.
PVC			
33-8830	80x100	80	415,00

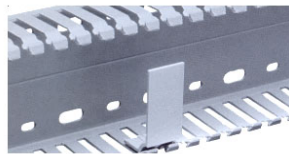

### Slaggereedschap

Bestelnr.	VPE t.b.v. spreidnieten stk.	Brutoprijs €/1stk.
toepasbaar voor Licatec en GGK		
33-7817-1	1	67,80

### Spreidnieten

Bestelnr.	Ø mm	VPE stk.	Brutoprijs €/100stk.
toepasbaar voor Licatec en GGK			
33-7814	3,5	4000	9,45
33-7815	5	4000	10,70
33-7816	6	4000	7,95

### Scheidingswandhouder | halogeen vrij

Bestelnr.	VPE	Brutoprijs €/100stk.
in combinatie met scheidingswand 33-8830		
33-7801	F2000 50	136,50
33-7804	DIN 50	180,00



### Uitsnij of kniptang 20mm

Bestelnr.	Nettoprijs €/1stk.
15-CAK20L	47,95



### Kniptang

Bestelnr.	Brutoprijs €/1stk.
65-05180920000	109,63

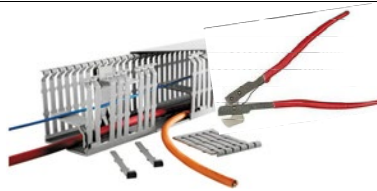

### Eindkap afbreekbaar 40,60,80mm

Bestelnr.	Brutoprijs €/1stk.
33-7399-1	2,70

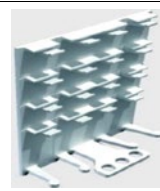

Gereedschap voor verwerking van bedradingskoker zie hoofdstuk 10 Gereedschap

# GGK bedradingskoker

Serie VK: PVC, accessoires

**GGK**<sup>®</sup>  
Smart Cable Coaching

## Bedradingskoker | Serie VK PVC

**Materiaal:** Hard PVC, UV gestabiliseerd  
**Gatenpatroon:** Volgens DIN 43659  
**Voorschriften:** CSA C22.2 en UL508, VDE  
**Volgens:** UL 94-V0, zelfdovend

### Karakteristieken

Speciale sleufstansing voor optimale draadordening.  
Braamvrij uitbrekbare kokerlippen.  
Solide deksel met stevige kliksluiting.

Bestelnummer	Afmetingen		VPE	Brutoprijs
Grijs - RAL7030	B	H	mtr.	€/100mtr.
<b>16 en 30 hoog</b>				
33-1682	16	16	100	650,00
33-1683	25	30	60	420,00
<b>40 hoog</b>				
33-1684	25	40	48	480,00
33-1685	40	40	48	590,00
33-1686	60	40	36	785,00
<b>60 hoog</b>				
33-N1687	25	60	32	675,00
33-N1696	30	60	32	770,00
33-N1688	40	60	32	830,00
33-N1689	60	60	32	910,00
33-N1690	80	60	32	1.185,00
33-N1691	100	60	24	1.330,00
33-N1692	120	60	16	1.615,00

Bestelnummer	Afmetingen		VPE	Brutoprijs
Grijs - RAL7030	B	H	mtr.	€/100mtr.
<b>80 hoog</b>				
33-N1675	25	80	40	940,00
33-N1676	30	80	36	985,00
33-N1677	40	80	28	920,00
33-N1678	60	80	20	1.055,00
33-N1679	80	80	20	1.485,00
33-N1680	100	80	16	1.645,00
33-N1681	120	80	16	1.908,90
<b>100 hoog</b>				
33-1697	25	100	48	880,00
33-1698	60	100	24	1.265,00
33-1699	100	100	8	1.640,00
<b>deksels</b>				
33-1656	25	-	40	285,00
33-1662	30	-	40	325,00
33-1657	40	-	40	363,60
33-1658	60	-	40	438,60
33-1659	80	-	40	623,15
33-1660	100	-	40	842,40
33-1661	120	-	40	1.055,25

Genoemde prijzen zijn inclusief deksel

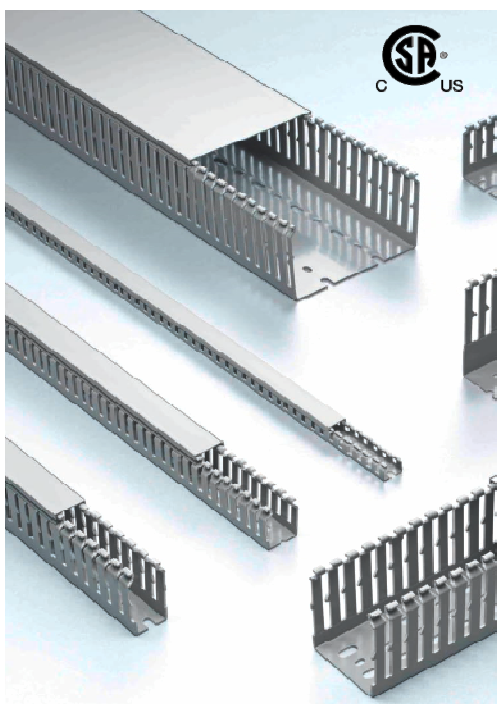
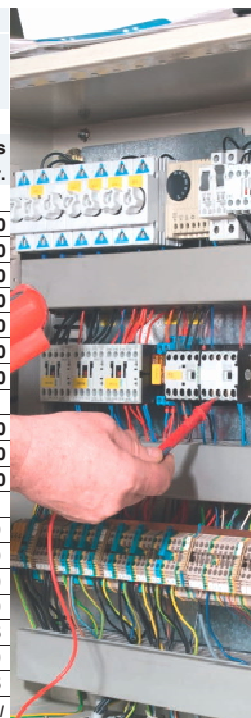

Gatenpatroon bodemprofiel volgens DIN 43659

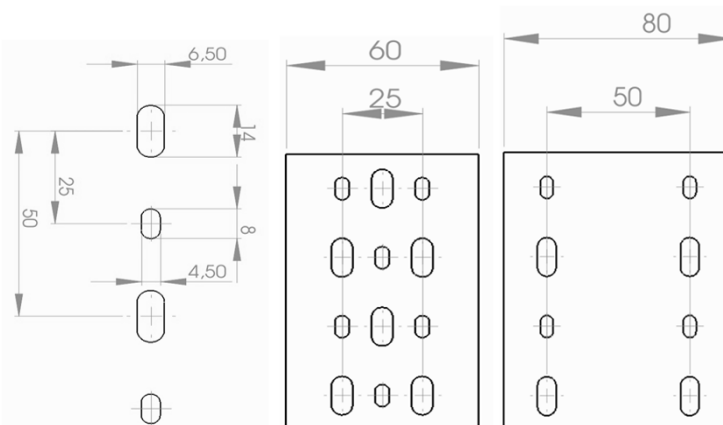

Afstand van gatenpatroon  
VK 25 t/m VK 40: Enkel, hart  
VK 60: Trippel, hart + 25mm  
VK 80 t/m 120: Dubbel 50

## Accessoires | Draadhouder

Bestelnummer	VPE	Brutoprijs
	stk.	€/100stk.
33-1632	50	225,00

Voorzien van breuklijnen en zodoende te gebruiken voor diverse kokerbreedten



## Accessoires | Draadtong

Bestelnummer	VPE	Brutoprijs
	stk.	€/100stk.
33-4127	50	235,00

Draadtong is af te breken op iedere gewenste lengte

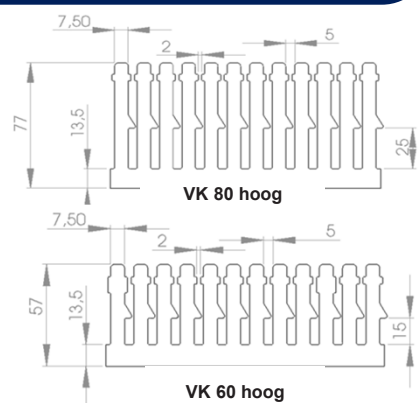

# Calpe DIN-EN montagerail

TS35, TS32, TS15, accessoires

## DIN-EN montagerail

**Materiaal:** Sendzimir verzinkt, wit gepassiveerd  
Aluminium of RVS (inox)

**Voorschriften:** EN 60715, ROHS

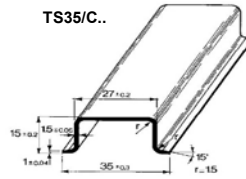

## TS | 35mm breed

Bestelnummer	Materiaal	Uitvoering	Sleufbreedte mm	Hoogte mm	VPE in meter	Bruto prijs €/1mtr
<b>Ongeperforeerd</b>						
34-TS35/ALU	Aluminium	laag	n.v.t.	7,5	40	<b>3,56</b>
34-TS35/INOX	RVS	laag	n.v.t.	7,5	40	<b>13,96</b>
34-TS35/SZ	Sendzimir verzinkt	laag	n.v.t.	7,5	40	<b>2,59</b>
34-TS35	Wit gepassiveerd	laag	n.v.t.	7,5	40	<b>3,01</b>
34-TS35/C	Wit gepassiveerd	hoog	n.v.t.	15	20	<b>5,55</b>
<b>Geperforeerd</b>						
34-TS35/FSZ-1	Sendzimir verzinkt	laag	6,3	7,5	40	<b>2,66</b>
34-TS35/F5SZ	Sendzimir verzinkt	laag	5,2	7,5	40	<b>2,66</b>
34-TS35/CF5SZ	Sendzimir verzinkt	hoog	5,2	15	20	<b>5,08</b>
34-TS35/F6	Wit gepassiveerd	laag	6,3	7,5	40	<b>3,08</b>
34-TS35/CF6	Wit gepassiveerd	hoog	6,3	15	20	<b>5,67</b>

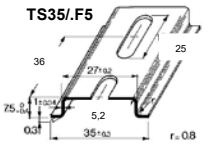
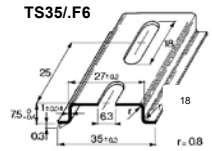

## TS | 32mm, 15mm breed

Bestelnummer	Materiaal	Perforatie	Sleufbreedte mm	Hoogte mm	VPE in meter	Bruto prijs €/1mtr
<b>32mm geperforeerd &amp; on-geperforeerd</b>						
34-TS32/SZ	Sendzimir verzinkt	nee	n.v.t.	15 mm	40	<b>5,48</b>
34-TS32/F6SZ	Sendzimir verzinkt	ja	6,3 mm	15 mm	40	<b>5,61</b>
<b>15mm geperforeerd</b>						
34-TS15/F	Wit gepassiveerd	ja	4,2 mm	5,5 mm	100	<b>2,21</b>

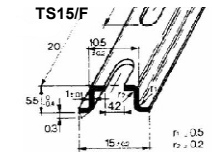
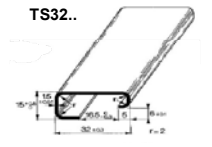

## Accessoires

Bestelnummer	Afmeting	VPE	Prijs per €/100stk	
<b>Eindkapjes</b>				
07-K0193	7,5 x 35 mm	10	Bruto	<b>13,00</b>
07-K0194	15 x 35 mm	10	Bruto	<b>15,00</b>
<b>Montagebeugels</b>				
34-TS-SM5	M5, schuin	10	Bruto	<b>70,50</b>
34-TS-SM6	M6, schuin	10	Bruto	<b>70,50</b>
34-TST20	M6, 20 mm	10	Bruto	<b>85,50</b>
34-TST40	M6, 40 mm	10	Bruto	<b>110,00</b>
34-TST50	M6, 50 mm	10	Bruto	<b>121,00</b>
34-TST70	M6, 70 mm	10	Bruto	<b>158,50</b>
<b>Zelfborende plaatschroeven</b>				
90-BD4,8x13	4,8x13	1000	Netto	<b>2,81</b>
90-BD4,8x16	4,8x16	1000	Netto	<b>2,97</b>
90-BD4,8x25	4,8x25	1000	Netto	<b>3,96</b>
90-BD4,8x32	4,8x32	1000	Netto	<b>4,62</b>
<b>Afschermdop</b>				
90-006205200201		500	Netto	<b>10,50</b>
<b>Boor bits</b>				
90-BD-S2-L075	75 mm	1	Netto	<b>180,00</b>
90-BD-S2-L100	100 mm	1	Netto	<b>180,00</b>
90-BD-S2-L150	150 mm	1	Netto	<b>180,00</b>

### Eindkapjes



### Montagebeugels

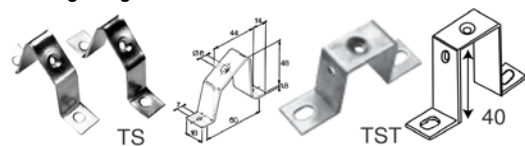

### Zelfborende plaatschroeven



### Afschermdoppen



### Boor bits



Zonder voorbereiden direct in de montageplaat



Profielknippers voor snel spaan- en braamvrije verwerking van DIN-EN montagerail, geschikt voor

TS15-5,5; TS35-7,5; TS35-15,1,5

zie hoofdstuk 10 Gereedschap voor meer informatie en prijzen.



**DRAAD EN KABEL**

---

**2**

# Montagesnoer PVC

Helukabel H05V2-K / H07V2-K (PVC 90°C)



## Montagesnoer | H05V2-K en H07V2-K 90°C

Voldoet aan NEN-EN-IEC 61439

### Technische eigenschappen

**Materiaal:** PVC isolatie  
**Testspanning:** 10 kV  
**Temp.bereik:** Flex: +5°C tot 90°C  
 Vast: -40°C tot 90°C  
**Litzen:** Klasse 5, DIN VDE 0295  
**Volgens:** DIN VDE 0281 VII, HD 21.7 S2

### Kleurcodes: cijfers toevoegen aan bestelnummer

● Zwart	01	● Grijs	07	● D.bl.	13
● Gn./ge	02	● Violet	08	● Oranje	14
● Blauw	03	● Geel	09	● Rd/w	21*
● Bruin	04	● Rose	10	● Bl/w	22*
● Rood	05	● Groen	11	● Br/w	23*
● Wit	06	○ Transp.	12	● D.bl/w	24*



mm <sup>2</sup>	Bestelnummer	Buiten Ø mm	VPE mtr.	Brutoprijs per 100mtr. [kopernotering*]		
				[850-875]	[875-900]	[900-925]
<b>In doos</b>						
0,50	30-3090005..	2,2	100	30,93	31,43	31,92
0,75	30-3090007..	2,3	100	41,67	42,41	43,15
1,00	30-3090010..	2,5	100	54,53	55,51	56,50
1,50	30-3090015..	3,0	100	74,85	76,34	77,82
2,50	30-3090025..	3,6	100	121,67	124,14	126,61
4,00	30-3090040..	4,3	100	194,18	198,09	202,01
6,00	30-3090060..	4,8	100	291,39	297,36	303,34
10,00	30-3090100..	6,3	100	491,84	501,73	511,62
16,00	30-3090160..	7,4	100	773,07	788,93	804,80
25,00	30-3090250..	9,1	100	1.228,69	1.253,42	1.278,14
35,00	30-3090350..	10,3	50	1.710,34	1.744,95	1.779,57
50,00	30-3090500..	12,7	50	2.452,16	2.501,61	2.551,06
70,00	30-3090700..	15,6	25	3.410,43	3.479,66	3.548,89
95,00	30-3090950..	16,7	25	4.605,10	4.699,05	4.793,00
120,00	30-3091200..	18,5	25	6.700,26	6.825,34	6.950,42
<b>Dubbelkleuren</b>						
				Dubbelkleuren: rood/wit, blauw/wit, bruin/wit en donkerblauw/wit		
0,75	30-3090007..	2,3	100	71,42	72,51	73,60
1,00	30-3090010..	2,5	100	91,58	93,04	94,49
<b>In vaten</b>						
0,50	30-3090005..V	2,2	3500	36,68	37,26	37,84
0,75	30-3090007..V	2,3	3000	50,65	51,53	52,40
1,00	30-3090010..V	2,5	2500	64,96	66,12	67,29
1,50	30-3090015..V	3,0	2000	89,21	90,96	92,70
2,50	30-3090025..V	3,6	1000	147,02	149,93	152,84



### BIJZONDERE EIGENSCHAPPEN H05V2-K / H07V2-K



Voldoet aan de NEN-EN-IEC 61439 laagspanningsschakel- en verdeelinrichtingen.  
 Goed (automatisch) stripbaar.  
 Isolatie volledig gekleurd en kleurvast.  
 Vanaf 16mm<sup>2</sup> koper litze gebundeld, voor betere flexibiliteit en krimpings.  
 Kosten- en ruimtebesparing t.o.v. 70°C montagesnoer.

# Montagesnoer PVC

Helukabel Fivenorm UL/CSA (PVC 105°C)



## Montagesnoer UL/CSA | FIVENORM (H05- H07V2-K) UL105°C

DIN VDE 0285-525-2-31 / DIN EN 50525-2-31, UL-Std. 1063, UL-Style 10269 en CSA-TEW en CSA-AWM i/A/B

### Technische eigenschappen

**Materiaal:** PVC isolatie  
**Testspanning:** 2kV  
**Temp.bereik:** Flex: +5°C tot +90°C  
 Vast: -40°C tot +90°C  
**UL (AWM):** -40°C tot +105°C / 1000V(AC)-1250(DC)  
**UL (MTW):** -40°C tot +90°C / 600V  
**CSA (TEW):** -40°C tot +105°C / 600V



mm <sup>2</sup>	AWG	Brutoprijs per 100mtr.															
		[kopernotering*]			●	●	●	●	●	●	●	●	●	●	●		
		[850-875]	[875-900]	[900-925]													
0,50	22	<b>57,53</b>	<b>58,01</b>	<b>58,50</b>	11019300	11019301	11019302	11019303	11019304	11019305	64081	11019311	64088				
0,75	20	<b>76,45</b>	<b>77,18</b>	<b>77,91</b>	11019335	11019336	11019337	11019338	11019339	11019340	11019341	11019346	11019347				
1,00	18	<b>89,90</b>	<b>90,86</b>	<b>91,84</b>	11019370	11019371	11019372	11019373	11019374	11019375	11019376	11019381	11019382				
1,50	16	<b>126,54</b>	<b>128,00</b>	<b>129,45</b>	11019405	11019406	11019407	11019408	11019409	11019410	64129	11019416	64136				
2,50	14	<b>190,92</b>	<b>193,34</b>	<b>195,77</b>	11019440	11019441	11019442	11019443	11019444	11019445	64145	11019451	11019452				
4,00	12	<b>289,01</b>	<b>292,85</b>	<b>296,69</b>	11019475	11019476	11019477	11019478	11019479	11019480	64161	11019486	64168				
6,00	10	<b>428,27</b>	<b>434,13</b>	<b>439,99</b>	11019510	11019511	11019512	64174	64175	64176	64177	64183	64184				
10,00	8	<b>668,04</b>	<b>677,74</b>	<b>687,43</b>	64187	64188	64189	64190	64191	64192	64193	64199	64200				
16,00	6	<b>1.244,63</b>	<b>1.260,18</b>	<b>1.275,74</b>	64203	64204	64205	64206	64207	64208	64209	64215	64216				
25,00	4	<b>1.709,76</b>	<b>1.734,00</b>	<b>1.758,24</b>	64219	64220	64221	64222	64223	64224	o.a.	64231	64232				
35,00	2	<b>2.555,40</b>	<b>2.589,34</b>	<b>2.623,27</b>	64235	64236	64237	64238	64239	64240	o.a.	64247	64248				
50,00	1	<b>3.818,52</b>	<b>3.867,00</b>	<b>3.915,48</b>	64251	64252	64253	o.a.	o.a.	o.a.	o.a.	o.a.	o.a.				
70,00	2/0	<b>4.654,32</b>	<b>4.722,19</b>	<b>4.790,06</b>	64267	64268	o.a.	o.a.	o.a.	o.a.	o.a.	o.a.	o.a.				
95,00	3/0	<b>5.545,24</b>	<b>5.637,35</b>	<b>5.729,46</b>	64283	64284	o.a.	o.a.	o.a.	o.a.	o.a.	o.a.	o.a.				

Ook verkrijgbaar in groen, violet en geel. Bestelcode = "30-+ artikelnummer"

# Montagesnoer halogeenvrij

Studer BETatherm® 90 (105°C)



## BETATHERM® 90

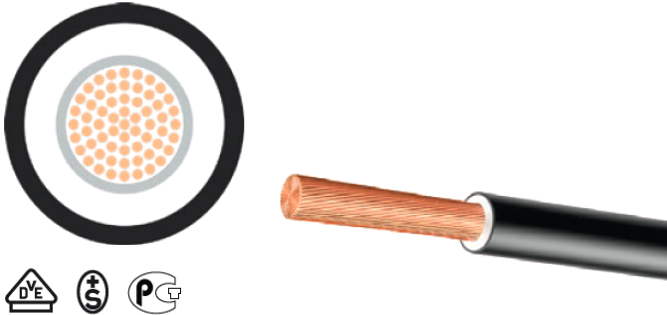

### Karakteristieken

<b>Materiaal:</b>	Polyolefin-copolymer
<b>Nominale spanning:</b>	≤1 mm Uo/U 300 / 500V ≥ 1,5 mm Uo/U 450 / 750V
<b>Testspanning:</b>	5 kV
<b>Temperatuurbereik:</b>	Flex: -25°C tot +90°C Vast: -40°C tot +105°C
<b>Litzen:</b>	Blank koper, fijndradig klasse 5 volgens VDE0295 / IEC60228
<b>Halogeenvrij:</b>	IEC 60754-1, EN 50267-2-1
<b>Geen bijtende gassen:</b>	IEC 60754-2, EN 50267-2-2
<b>Geen giftige gassen:</b>	NES 02-713, NF X 70-100
<b>Geen vlamverspreiding:</b>	IEC 60332-3, EN 50266-2
<b>Vlamvertragend:</b>	IEC 60332-1, EN 50265-2-1
<b>Beperkte rookontwikkeling:</b>	IEC 61034, EN 50268-2
<b>Lage vuurbelasting:</b>	DIN 51900

mm <sup>2</sup>	Buiten Ø mm	VPE m	Brutoprijs per 100mtr. [kopernotering*]		
			[851-900]	[901-950]	[951-1000]
0,50	2,2	200	40,30	41,34	42,38
0,75	2,4	100	52,87	54,43	55,99
1	2,5	100	64,38	66,46	68,55
1,5	3,0	100	83,79	86,92	90,04
2,5	3,7	100	133,88	139,10	144,31
4	4,2	100	213,97	222,31	230,65
6	4,8	100	325,65	338,16	350,67
10	6,9	100	505,92	526,76	547,61

mm <sup>2</sup>	Buiten Ø mm	VPE m	Brutoprijs per 100mtr. [kopernotering*]		
			[851-900]	[901-950]	[951-1000]
16	8,2	100	810,74	844,18	877,63
25	9,9	100	1245,51	1297,62	1349,74
35	11,4	50	1663,02	1735,98	1808,94
50	13,2	50	2449,31	2553,55	2657,78
70	15,1	25	3291,63	3437,55	3583,48
95	16,6	25	4537,66	4735,70	4933,74
120	18,6	25	6015,15	6265,30	6515,46

## BETatherm® 90 | Bestelnummers\*\*

mm <sup>2</sup>	●	●	●	●	●	○	●	●	●	●	●	●	●	●
0,50	22052202	22052102	22052302	220524S1	22052502	22052602	22135102	22154802	31582802	-	22134902	22092102	22135002	
0,75	22052801	22052701	22052901	22053001	22053101	21566701	22154401	22154901	31582901	31583601	22155601	22156001	22155301	
1	22053301	22053201	22053401	22053501	22053601	22053701	22154501	22155001	31583001	31583701	22155701	22044101	22044201	
1,5	21624501	22043701	22053801	22053901	22054001	22054101	22154601	22155101	31583101	31583801	22155801	22043801	22155401	
2,5	22054201	22044001	22054301	22090601	22054401	22054501	22154701	22155201	31583201	-	22155901	22156101	31583501	
4	22054701	22054601	22054801	22406401	22054901	22055001	22237601	31582701	22632401	-	31583401	22156201	22089201	
6	22055201	22055101	22055301	22406501	22131501	22131601	22406601	-	-	-	-	22156301	-	
10	22055901	22055401	22126001	22406801	22125901	22125801	22406701	-	-	-	-	-	-	
16	22056001	22055501	22126301	22407001	-	22126101	22406901	-	-	-	-	-	-	
25	22056101	22055601	21415001	316186	-	-	312312	-	-	-	-	-	-	
35	22056201	22055701	22154101	31261201	-	-	31260901	-	-	-	-	-	-	
50	22056301	22055801	22154201	-	-	-	-	-	-	-	-	-	-	
70	220564	221540	-	-	-	-	-	-	-	-	-	-	-	
95	220565	222033	-	-	-	-	-	-	-	-	-	-	-	
120	224891	-	-	-	-	-	-	-	-	-	-	-	-	

\*\* bestelnummers: voeg voor het nummer "30-" toe. Bestelcode voor 1 mm<sup>2</sup> zwart= 30-220553301

## BETatherm® 90 dubbelkleuren | Bestelnummers\*\*

mm <sup>2</sup>	Buiten Ø mm	VPE m	●	●	●	●	●	Brutoprijs per 100mtr. [kopernotering*]		
								[851-900]	[901-950]	[951-1000]
0,50	2,2	100	-	-	-	-	31706802	46,12	47,36	48,59
0,75	2,4	100	-	31584601	-	31584701	-	62,7	64,56	66,41
1	2,5	100	31583901	31584101	31584301	31584401	31706901	76,35	78,83	81,30
1,5	3	100	31584001	31584201	-	31584501	-	99,38	103,09	106,79
2,5	3,7	100	-	-	-	-	-	-	-	-



# Montagesnoer halogeenvrij

Studer BETatherm® 145 (145°C)



## BETATHERM® 145

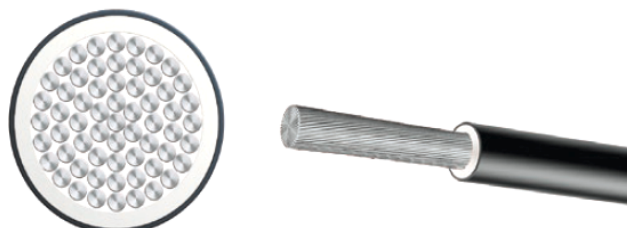

5 SCHEEPSKEUREN

Cross-linking via electronbeam



mm <sup>2</sup>	Buiten Ø mm	VPE m	Brutoprijs per 100mtr. [kopernotering*]		
			[851-900]	[901-950]	[951-1000]
0,50	1,9	100	82,32	83,36	84,40
0,75	2,2	100	97,89	99,45	101,02
1	2,4	100	118,62	120,71	122,79
1,5	3,0	100	155,79	158,91	162,04
2,5	3,7	100	215,50	220,71	225,92
4	4,2	100	363,10	371,35	379,60
6	4,7	100	548,33	560,84	573,34
10	6,1	100	903,28	924,12	944,97
16	7,5	100	1375,49	1408,85	1442,20
25	8,6	100	2037,46	2090,79	2144,12

### Karakteristieken

<b>Materiaal:</b>	Polyolefin-copolymer Electronbeam Cross-linked
<b>Nominale spanning:</b>	≤ 1mm <sup>2</sup> U0/U 300V/500V ≥ 1,5mm <sup>2</sup> U0/U 450V/750V
<b>Testspanning:</b>	5 kV
<b>Temperatuurbereik:</b>	Flex: -35°C tot +120°C Vast: -55°C tot +145°C
<b>Litzen:</b>	Vertind koper klasse 5 volgens VDE0295/IEC60228
<b>Halogeenvrij:</b>	IEC 60754-1, EN 50267-2-1
<b>Geen bijtende gassen:</b>	IEC 60754-2, EN 50267-2-2
<b>Geen giftige gassen:</b>	NF X 70-100
<b>Geen vlamverspreiding:</b>	IEC 60332-3, DIN EN 60332-3, EN50266-2
<b>Vlamvertragend:</b>	EN/IEC60332-1-2
<b>Bepaalde rookontwikkeling:</b>	IEC 61034, DIN EN 61034-2, EN 50268-2
<b>Lage vuurbelasting:</b>	DIN 51900

mm <sup>2</sup>	Buiten Ø mm	VPE m	Brutoprijs per 100mtr. [kopernotering*]		
			[851-900]	[901-950]	[951-1000]
35	10,1	50	2750,55	2825,20	2899,86
50	12,5	50	3901,13	4007,78	4114,44
70	14,0	25	5016,65	5165,97	5315,29
95	16,0	25	6927,84	7130,48	7333,13
120	17,8	25	8580,74	8836,71	9092,69
150	20,0	25	10456,86	10776,83	11096,80
185	21,9	25	12780,61	13175,24	13569,86
240	25,1	25	16334,72	16846,67	17358,62

Uit voorraad leverbaar in de kleuren: geel/groen, rood, wit, blauw, grijs, oranje, paars, donkerblauw, geel en bruin. Prijzen zijn gelijk aan zwart.

## BETatherm® 145 | Bestelnummers\*\*

mm <sup>2</sup>	●	●	●	●	●	○	●	●	●	●	●	●
0,50	190808	190815	190810	190813	190814	190809	211454	213414	190812	190811	191558	219356
0,75	190816	190823	190818	190821	190822	190817	211399	211663	190820	190819	191676	211662
1	190824	190831	190826	190829	190830	190825	191551	191550	190828	190827	191548	191549
1,5	190832	190839	190834	190837	190838	190833	191554	191552	190836	190835	191553	191555
2,5	190840	190847	190842	190845	190846	190841	211400	212277	190844	190843	211700	212276
4	190848	190855	190850	190853	190854	190849	211401	-	190852	190851	-	-
6	190856	190863	190858	190861	190862	190857	211864	-	190860	190859	216824	-
10	190864	191557	191556	218311	217184	218511	211865	-	-	-	-	-
16	190865	211335	211334	212169	211333	-	211866	-	-	-	-	-
25	190866	212373	213563	-	-	-	-	-	-	-	-	-
35	190867	211496	215266	-	-	-	-	-	-	-	-	-
50	190868	211574	215265	-	217185	-	-	-	-	-	-	-
70	190869	211984	-	-	-	-	-	-	-	-	-	-
95	190870	213697	-	-	-	-	-	-	-	-	-	-
120	210750	-	-	-	-	-	-	-	-	-	-	-
150	210751	219494	-	-	-	-	-	-	-	-	-	-
185	191675	-	-	-	-	-	-	-	-	-	-	-
240	210752	-	-	-	-	-	-	-	-	-	-	-

\*\* bestelnummers: voeg voor het nummer "30-" toe. Bestelcode voor 1 mm<sup>2</sup> zwart= 30-190824

KIJK VOOR ACTUELE KOPERNOTERINGEN OP CALPE.NL

# Montagesnoer halogeenvrij kortsluitvast

Studer BETAtrans® (dubbel geïsoleerd)



## BETAtrans® 4 GW-ENX R 1800V M

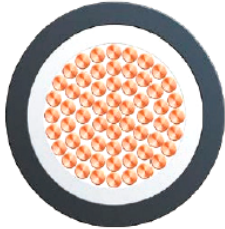

Karakteristieken	
<b>Materiaal aderisolatie:</b>	Polyolefin-copolymer
<b>Materiaal buitenmantel:</b>	Polyolefin-copolymer
<b>Nominale spanning:</b>	Uo/U 1,8/3kV AC
<b>Testspanning:</b>	6,5 kV AC (50Hz 5 min)
<b>Testspanning:</b>	5 kV
<b>Temperatuurbereik:</b>	Vast: -40°C tot + 120°C Kortsluiting: +280°C / 5 sec.
<b>Litzen:</b>	Blank koper, fijndradig klasse 5 volgens VDE0295/IEC60228
<b>Halogeenvrij:</b>	EN 50267-2-1; EN 60684-2
<b>Geen bijtende gassen:</b>	EN 50267-2-2
<b>Geen giftige gassen:</b>	EN 50305
<b>Beperkte rookontwikkeling:</b>	EN 61034-2
<b>Ozonbestendig:</b>	EN 50264-3-1
<b>Lage vuurbelasting:</b>	DIN 51900
<b>UV bestendig:</b>	EN 50618

mm <sup>2</sup>	Buiten Ø mm	VPE m	Bestelnummer	Brutoprijs per 100mtr. [kopernotering*]		
				[851-900]	[901-950]	[951-1000]
1	2,8	100	30-31247201	145,47	147,61	149,74
1,5	3,2	100	30-31247301	182,20	185,40	188,60
2,5	3,7	100	30-31247401	271,71	277,04	282,37
4	4,85	100	30-31247501	420,75	429,29	437,82
6	5,5	100	30-31247601	609,48	622,28	635,08
10	6,7	100	30-31247701	969,62	990,95	1012,28
16	7,8	100	30-31247801	1476,88	1511,01	1545,14

## BETAtrans® 4 GW-ENX EN 50264-3-1 1800 VM

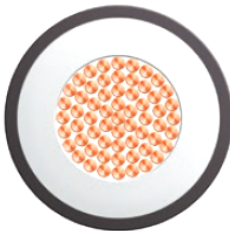

Karakteristieken	
<b>Materiaal aderisolatie:</b>	Polyolefin-copolymer
<b>Materiaal buitenmantel:</b>	Polyolefin-copolymer
<b>Nominale spanning:</b>	Uo/U 1,8/3kV AC
<b>Testspanning:</b>	6,5 kV AC (50Hz 5 min)
<b>Testspanning:</b>	5 kV
<b>Temperatuurbereik:</b>	Vast: -40°C tot + 120°C Kortsluiting: +280°C / 5 sec.
<b>Litzen:</b>	Blank koper, fijndradig klasse 5 volgens VDE0295/IEC60228
<b>Halogeenvrij:</b>	EN 50267-2-1; EN 60684-2
<b>Geen bijtende gassen:</b>	EN 50267-2-2
<b>Geen giftige gassen:</b>	EN 50305
<b>Beperkte rookontwikkeling:</b>	EN 61034-2
<b>Ozonbestendig:</b>	EN 50264-3-1
<b>Lage vuurbelasting:</b>	DIN 51900
<b>UV bestendig:</b>	EN 50618

mm <sup>2</sup>	Buiten Ø mm	VPE m	Bestelnummer	Brutoprijs per 100mtr. [kopernotering*]		
				[851-900]	[901-950]	[951-1000]
25	10,20	100	30-31290501	2175,36	2228,69	2282,02
35	11,70	50	30-31290601	2940,12	3014,77	3089,43
50	13,70	50	30-31290701	4105,09	4211,75	4318,41
70	15,20	25	30-31290801	5443,05	5592,36	5741,68
95	17,20	25	30-31290901	7317,24	7519,88	7722,53
120	19,00	25	30-31291001	9002,40	9258,37	9514,35
150	20,80	25	30-31291101	11003,94	11323,91	11643,88
185	22,70	o.a.	30-312912	13306,44	13701,07	14095,7
240	25,50	o.a.	30-312913	16927,26	17439,21	17951,16
300	28,10	o.a.	30-312914	20903,52	21543,46	22183,39
400	31,50	o.a.	30-312915	29056,26	29909,51	30762,76

### BIJZONDERE EIGENSCHAPPEN BETAtrans®

**Studer  
Cables**

- Uitstekende thermische eigenschappen van het isolatiemateriaal resulteert in langere levensduur.
- De kabel is zeer goed bestand tegen UV, olie en diesel alsmede bestand tegen hogere temperaturen.
- Hoge dielectrische sterkte, kortsluit- en aardfoutbestending
- Door de optimale buitendiameter ideaal voor toepassing in krappe ruimten.
- Ideaal voor het aansluiten van elektrische motoren, schakel- en verdeelinrichtingen, stroomomvormers

# Datakabel

## Patchkabels

### Patchkabels

#### Specificaties

<b>Materiaal mantel:</b>	PVC of LSZH (halogeenvrij)
<b>Normen:</b>	ANSI/TIA-568-C2, EN50288
<b>Vlamvertragend:</b>	IEC-60332-1 (LSZH), IEC-60332-1-2 (PVC)
<b>Connectoren:</b>	RJ45 met 50µm vergulde contacten
<b>Aansluiting:</b>	volgens EIA/TIA-568B
<b>Temperatuurbereik:</b>	-20°C tot +60°C



PVC uitvoeringen

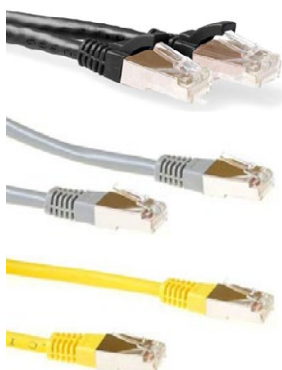

Zie hoofdstuk 4

#### Karakteristieken

Hoogwaardige patchkabel met 100% koperen geleiders. Geschikt voor PoE. Alle kabels zijn 100% getest. Geschikt voor zowel industriële als standaard PVC uitvoeringen zijn UL gecertificeerd.



U/UTP



F/UTP



S/FTP

Type	Afscherming aderpaar	Afscherming totaal	Afscherming	Toepassing
U/UTP	x	x	geen	Universeel
F/UTP	x	folie	basis	Kans op interferentie
S/FTP	folie	gevlochten koper	maximaal	Hoge kans op interferentie

Categorie	Bandbreedte	Snelheid 100m	Snelheid <100m	Toepassing
CAT5E	100Mhz	1000 Mbps	-	Universeel
CAT6	250Mhz	1000 Mbps	10 Gbps (55m)	Bij hogere snelheden
CAT6A	500Mhz	10 Gbps	-	Max snelheid, lange afstand

#### Bestellen? Gebruik onderstaande lengte-code

Lengte in meter	0,5m	1m	1,5m	2m	3m	5m	7m	10m
2 cijferige code	00	01	51	02	03	05	07	10

Bestelvoorbeeld: CAT5E U/UTP in rood 2 meter = 30-AC1-IB502

Bestelnummer	AWG	Mantel	Brutoprijs per stuk									
			0,5	1m	1,5m	2m	3m	5m	7m	10m		
30-AC1-IB64..	CAT5e	U/UTP	24	PVC	1,65	2,25	2,85	3,55	4,80	7,30	9,45	12,70
30-AC1-IB60..												
30-AC1-IB55..												
30-AC1-IB56..												
30-AC1-IB57..												
30-AC1-IB58..												
30-AC1-IB59..	CAT5e	F/UTP	26	PVC	2,25	2,80	3,35	4,00	5,05	7,15	8,90	12,30
30-AC1-IB72..												
30-AC1-IB71..												
30-AC1-FB20..												
30-AC1-IB75..												
30-AC1-IB76..												
30-AC1-IB77..	CAT5e	F/UTP	26	LSZH	2,35	2,95	3,55	4,30	5,50	8,00	9,95	13,65
30-AC1-IB78..												
30-AC1-IB79..												
30-AC1-IB84..												
30-AC1-IB85..												
30-AC1-IB86..												
30-AC1-IB87..	CAT6	U/UTP	24	PVC	2,60	3,10	3,70	4,20	5,35	7,70	10,00	13,40
30-AC1-IB88..												
30-AC1-IB89..												
30-AC1-FB90..												
30-AC1-FB95..												
30-AC1-FB96..												
30-AC1-FB97..	CAT6	S/FTP	26	LSZH	4,15	5,20	6,25	7,30	9,50	13,90	18,00	23,95
30-AC1-FB98..												
30-AC1-FB99..												
30-AC1-FB60..												
30-AC1-FB30..												
30-AC1-FB74..	CAT6a	S/FTP	26	PVC	5,20	6,10	6,95	7,85	9,65	13,15	16,50	21,20
30-AC1-FB70..												
30-AC1-FB75..												
30-AC1-FB76..												
30-AC1-FB77..												
30-AC1-FB78..	CAT6a	S/FTP	26	LSZH	5,60	6,45	7,35	8,35	10,25	14,35	18,20	24,00
30-AC1-FB79..												

# Helukabel

## Helukabel stuurstroomkabel



### JB-500 | Gekleurde aders

<b>Technische gegevens</b>	
Nominale spanning:	U0 / U: 300/500 V
Temperatuurbereik:	Incidentele buiging: -55°C tot + 80°C Vaste installatie: -40°C tot + 80°C
Testspanning:	4000V

<b>PVC zeldovend en vlamvertragend:</b>	
Volgens DIN VDE 0482-332-1, DIN EN 60332-1-2, IEC 60332-1 (gelijk aan DIN VDE 0472, deel 804 testmethode B)	
Kleurgecodeerd, PVC buitenmantel en gekleurde aders, incl. groen-geel	
Zonder groen-gele ader = serie OB-500	



HELUKABEL VDE-REG.-Nr. 7032 JB-500 5G1,5 QMM / 11082 300/500 V 001041518 C €



Bestelnummer	Aantal aders mm <sup>2</sup>	Buiten ø	Brutoprijs €/100mtr.	VPE mtr.	Bestelnummer	Aantal aders mm <sup>2</sup>	Buiten ø	Brutoprijs €/100mtr.	VPE mtr.
<b>Koperkoers [850-875]</b>									
30-11027	3 G 0,75	5,6	174,40	100	30-11078	3 G 1,5	6,8	284,80	100
30-11029	4 G 0,75	6,3	236,80	100	30-11080	4 G 1,5	7,4	385,60	100
30-11031	5 G 0,75	6,9	281,60	100	30-11083	5 G 1,5	8,3	-	100
30-11034	7 G 0,75	7,5	-	100	30-11085	7 G 1,5	9,2	-	100
<hr/>									
30-11051	3 G 1,0	5,9	227,20	100	30-11105	3 G 2,5	8,3	491,20	100
30-11053	4 G 1,0	6,6	273,60	100	30-11107	4 G 2,5	9,2	643,20	100
30-11055	5 G 1,0	7,3	385,60	100	30-11109	5 G 2,5	10,1	-	100
30-11059	7 G 1,0	8,1	-	100	30-11112	7 G 2,5	11,2	-	100

Lapp: Ölflex Classic® 100

### JZ-500 | Genummerde aders

<b>Technische gegevens</b>	
Nominale spanning:	U0 / U: 300/500 V
Temperatuurbereik:	Incidentele buiging: -15°C tot + 80°C Vaste installatie: -40°C tot + 80°C

<b>Test spanning:</b>		4000V
<b>Normreferentie:</b>		VDE-reg. 7032
		PVC buitenmantel en genummerde aders, incl. groen-geel
		Zonder groen-gele ader = serie OZ-500



HELUKABEL VDE-REG.-Nr. 7032 JZ-500 25G1,5 QMM / 10110 300/500 V 001041117 C €



Bestelnummer	Aantal aders mm <sup>2</sup>	Buiten ø	Brutoprijs €/100mtr.	VPE mtr.	Bestelnummer	Aantal aders mm <sup>2</sup>	Buiten ø	Brutoprijs €/100mtr.	VPE mtr.
<b>Koperkoers [850-875]</b>									
30-10031	3 G 0,75	5,6	135,28	100	30-10091	3 G 1,5	6,7	238,72	100
30-10033	4 G 0,75	6,3	182,16	100	30-10093	4 G 1,5	7,4	317,04	100
30-10035	5 G 0,75	6,9	220,16	100	30-10095	5 G 1,5	8,3	391,48	100
30-10038	7 G 0,75	6,5	315,52	100	30-10098	7 G 1,5	9,2	539,20	100
<hr/>									
30-10061	3 G 1,0	6,0	174,96	100	30-10122	3 G 2,5	8,3	456,00	100
30-10063	4 G 1,0	6,6	224,60	100	30-10123	4 G 2,5	9,2	503,40	100
30-10065	5 G 1,0	7,3	280,80	100	30-10125	5 G 2,5	10,1	633,96	100
30-10068	7 G 1,0	8,1	385,00	100	30-10127	7 G 2,5	11,2	-	100

Lapp: Ölflex Classic® 110

### JZ-603 | Genummerde aders UL/CSA

<b>Technische gegevens</b>	
Nominale spanning:	HAR U0 / U: 300/500V UL/CSA : 600V
Temperatuurbereik:	Incidentele buiging: -5°C tot + 70°C (UL +90°C) Vaste installatie: -40°C tot + 70°C (UL +90°C)
Testspanning:	3000V

<b>PVC zeldovend en vlamvertragend:</b>	
Volgens DIN VDE 0482-332-1-2, DIN EN 60332-1-2, IEC 60332-1 (gelijk aan DIN VDE 0472 deel 804 test methode 2) UL VW-1, CSA FT1	
<b>Oliefestendig:</b>	
DIN VDE 0473-811 -404/DIN EN 60811 -404, UL 1581 deel 50.182	
PVC buitenmantel en genummerde aders volgens VDE 0293, incl. groen-geel	
Zonder groen-gele ader = serie OZ-603	



HELUKABEL VDE-REG.-Nr. 7032 JZ-603 25G1,5 QMM / 10110 300/500 V 001041117 C €



Bestelnummer	Aantal aders mm <sup>2</sup>	Buiten ø	Brutoprijs €/100mtr.	VPE mtr.	Bestelnummer	Aantal aders mm <sup>2</sup>	Buiten ø	Brutoprijs €/100mtr.	VPE mtr.
<b>Koperkoers [850-875]</b>									
30-83661	3 G 0,75	6,5	302,40	100	30-83683	3 G 1,5	8,0	416,00	100
30-83662	4 G 0,75	7,1	353,60	100	30-83684	4 G 1,5	8,7	561,60	100
30-83663	5 G 0,75	7,9	465,60	100	30-83685	5 G 1,5	9,8	-	100
30-83664	7 G 0,75	9,5	700,80	100	30-83686	7 G 1,5	11,9	-	100
<hr/>									
30-83672	3 G 1,0	6,8	363,20	100	30-83694	3 G 2,5	9,9	683,20	100
30-83673	4 G 1,0	7,5	-	100	30-83695	4 G 2,5	11,0	-	100
30-83674	5 G 1,0	8,4	544,00	100	30-83696	5 G 2,5	12,0	1.201,60	100
30-83645	7 G 1,0	10,0	-	100	30-83697	7 G 2,5	14,6	-	100

Lapp: Ölflex® 150 Quatro

# Helukabel

## Helukabel stuurstroomkabel afgeschermd



### Y-CY-JB | Gekleurde aders

#### Technische gegevens

<b>Nominale spanning:</b>	tot max 1,5 mm <sup>2</sup> : U0 / U: 300/500 V vanaf 2,5 mm <sup>2</sup> : Uo/ U: 450/750
<b>Temperatuurbereik:</b>	Incidentele buiging: -15°C tot + 80°C Vaste installatie: -40°C tot + 80°C
<b>Testspanning:</b>	4000V
<b>Normreferentie:</b>	VDE-reg. 7032

#### PVC zelfdovend en vlamvertragend:

Volgens DIN VDE 0482-332-1-2, DIN EN 60332-1-2, IEC 60332-1 (gelijk aan DIN VDE 0472 deel 804 test methode 2)  
Gevlochten koperafscherming, Transparante PVC buitenmantel en gekleurde aders, incl. groen geel  
**Zonder groen-gele ader = serie Y-CY-OB**



Bestelnummer	Aantal aders mm <sup>2</sup>	Buiten Ø	Brutoprijs €/100mtr.	VPE mtr.
<b>Koperkoers [850-875]</b>				
30-16126	3 G 0,75	8,0	-	100
30-16127	4 G 0,75	8,5	-	100
30-16128	5 G 0,75	9,3	-	100
30-16130	3 G 1,0	8,3	-	100
30-16131	4 G 1,0	9,0	<b>662,40</b>	100
30-16132	5 G 1,0	9,7	-	100

Bestelnummer	Aantal aders mm <sup>2</sup>	Buiten Ø	Brutoprijs €/100mtr.	VPE mtr.
30-16134	3 G 1,5	9,2	-	100
30-16135	4 G 1,5	9,8	<b>742,40</b>	100
30-16136	5 G 1,5	10,8	-	100
30-16138	3 G 2,5	11,1	-	100
30-16139	4 G 2,5	12,7	-	100
30-16140	5 G 2,5	14,1	-	100

Lapp: Ölflex Classic® 100 CY

### F-CY-JZ | Genummerde aders

#### Technische gegevens

<b>Nominale spanning:</b>	U0 / U: 300/500 V
<b>Temperatuurbereik:</b>	Incidentele buiging: -10°C tot + 80°C Vaste installatie: -40°C tot + 80°C
<b>Testspanning:</b>	4000V
<b>Normreferentie:</b>	VDE-reg. nr. 7032

#### PVC zelfdovend en vlamvertragend:

Volgens DIN VDE 0482-332-1-2, DIN EN 60332-1-2, IEC 60332-1 (gelijk aan DIN VDE 0472 deel 804 test methode B)  
Afgeschermd PVC kabel met genummerde aders, incl. groen-geel  
**Zonder groen-gele ader = serie F-CY-JZ**

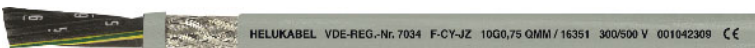

Bestelnummer	Aantal aders mm <sup>2</sup>	Buiten Ø	Brutoprijs €/100mtr.	VPE mtr.
<b>Koperkoers [850-875]</b>				
30-16345	3 G 0,75	6,3	<b>303,72</b>	100
30-16346	4 G 0,75	6,8	<b>355,40</b>	100
30-16347	5 G 0,75	7,4	<b>426,20</b>	100
30-16349	7 G 0,75	8,2	<b>538,60</b>	100
30-16371	3 G 1,0	6,7	<b>359,64</b>	100
30-16372	4 G 1,0	7,2	<b>434,00</b>	100
30-16373	5 G 1,0	8,0	<b>523,68</b>	100
30-16375	7 G 1,0	8,7	<b>641,60</b>	100

Bestelnummer	Aantal aders mm <sup>2</sup>	Buiten Ø	Brutoprijs €/100mtr.	VPE mtr.
30-16394	3 G 1,5	7,4	<b>461,72</b>	100
30-16395	4 G 1,5	8,1	<b>513,68</b>	100
30-16396	5 G 1,5	9,0	<b>679,32</b>	100
30-16397	7 G 1,5	9,8	<b>842,56</b>	100
30-16417	3 G 2,5	8,8	<b>744,40</b>	100
30-16418	4 G 2,5	9,8	<b>862,80</b>	100
30-16419	5 G 2,5	10,8	<b>1.013,88</b>	100
30-16420	7 G 2,5	11,9	-	100

Lapp: Ölflex Classic® 115 CY

### JZ-603-CY | Genummerde aders UL/CSA

#### Technische gegevens

<b>Nominale spanning:</b>	HAR U0 / U: 300/500V UL/CSA : 600V
<b>Temperatuurbereik:</b>	Incidentele buiging: -5°C tot + 70°C (UL +90°C) Vaste installatie: -40°C tot + 70°C (UL +90°C)
<b>Testspanning:</b>	3000V

#### PVC zelfdovend en vlamvertragend:

Volgens DIN VDE 0482-332-1-2, DIN EN 60332-1-2, IEC 60332-1 (gelijk aan DIN VDE 0472 deel 804 test methode 2) UL VW-1  
**Oliebestendig:**  
DIN EN 60811-2-4 UL 1581 deel 50.182  
PVC buitenmantel en genummerde aders volgens VDE 0293, incl. groen-geel  
**Zonder groen-gele ader = serie OZ-603**

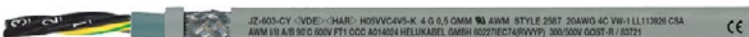

Bestelnummer	Aantal aders mm <sup>2</sup>	Buiten Ø	Brutoprijs €/100mtr.	VPE mtr.
<b>Koperkoers [850-875]</b>				
30-83731	3 G 0,75	8,6	<b>673,60</b>	100
30-83732	4 G 0,75	9,4	<b>849,60</b>	100
30-83733	5 G 0,75	10,1	-	100
30-83734	7 G 0,75	11,9	-	100
30-83742	3 G 1,0	9,2	-	100
30-83743	4 G 1,0	9,8	-	100
30-83744	5 G 1,0	10,7	-	100
30-83745	7 G 1,0	12,5	-	100

Bestelnummer	Aantal aders mm <sup>2</sup>	Buiten Ø	Brutoprijs €/100mtr.	VPE mtr.
30-83753	3 G 1,5	10,1	-	100
30-83754	4 G 1,5	11	<b>1.192,00</b>	100
30-83755	5 G 1,5	12,3	<b>1.408,00</b>	100
30-83756	7 G 1,5	14,2	-	100
30-83764	3 G 2,5	12	-	100
30-83765	4 G 2,5	13,4	-	100
30-83766	5 G 2,5	14,6	-	100
30-83767	7 G 2,5	17,2	-	100

Lapp: Ölflex® 150 Quatro

# Helukabel

## Helukabel datakabel



### Tronic LiYY | DIN 47100

#### Technische gegevens

**Max. bedr. spanning:** bij 0,14 mm<sup>2</sup> 350 V, > 0,25 mm<sup>2</sup> 500 V  
**Temperatuurbereik:** Incidentele buiging: -5°C tot + 80°C  
 Vaste installatie: -40°C tot + 80°C

#### Vlamvertragend:

Volgens IEC 60332-1-2

#### Test spanning:

Tot 0,25mm<sup>2</sup> 1.200 V, > 0,25 mm<sup>2</sup> 2.000 V

#### Normreferentie:

DIN VDE 0812

Datakabel met kleurcode volgens DIN 47100

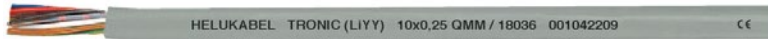

Bestelnummer	Aantal aders Ø mm <sup>2</sup>	Buiten Ø	Brutoprijs €/100mtr.	VPE mtr.
<b>Koperkoers [850-875]</b>				
30-18029	2 x 0,25	3,8	<b>63,44</b>	100
30-18030	3 x 0,25	3,9	<b>76,60</b>	100
30-18031	4 x 0,25	4,3	<b>92,24</b>	100
30-18032	5 x 0,25	4,7	<b>109,88</b>	100
30-18034	7 x 0,25	5,3	<b>151,04</b>	100
30-18057	2 x 0,34	4,2	<b>69,32</b>	100
30-18058	3 x 0,34	4,4	<b>95,00</b>	100
30-18059	4 x 0,34	4,8	<b>115,04</b>	100
30-18060	5 x 0,34	5,4	<b>134,64</b>	100
30-18062	7 x 0,34	5,9	<b>182,24</b>	100

Bestelnummer	Aantal aders mm <sup>2</sup>	Buiten Ø	Brutoprijs €/100mtr.	VPE mtr.
30-18085	2 x 0,50	4,6	<b>91,44</b>	100
30-18086	3 x 0,50	4,8	<b>118,16</b>	100
30-18087	4 x 0,50	5,4	<b>141,84</b>	100
30-18088	5 x 0,50	5,9	<b>178,00</b>	100
30-18090	7 x 0,50	6,4	<b>249,36</b>	100
30-18104	2 x 0,75	5,2	<b>128,96</b>	100
30-18097	3 x 0,75	5,4	<b>187,20</b>	100
30-18098	4 x 0,75	5,9	<b>240,00</b>	100
30-18099	5 x 0,75	6,7	-	100
30-18100	7 x 0,75	7,3	-	100

Lappkabel: Unitronic LiYY

### Tronic UL LiYY | DIN 47100 UL/CSA

#### Technische gegevens

**Max. bedr. spanning:** 300 V, UL/CSA 300 V  
**Temperatuurbereik:** Incidentele buiging: -10°C tot + 80°C  
 Vaste installatie: -20°C tot + 80°C

#### Vlamvertragend:

Volgens UL VW-1/CSA FT1

#### Test spanning:

1500 V

#### Normreferentie:

UL-style 246

Datakabel met kleurcode volgens DIN 47100



Bestelnummer	Aantal aders Ø mm <sup>2</sup>	Buiten Ø	Brutoprijs €/100mtr.	VPE mtr.
<b>Koperkoers [850-875]</b>				
30-83169	2 x 0,34 - 22	4,1	<b>o.a.</b>	100
30-83170	3 x 0,34 - 22	4,3	<b>o.a.</b>	100
30-83171	4 x 0,34 - 22	4,6	<b>259,20</b>	100
30-83172	6 x 0,34 - 22	5,4	<b>o.a.</b>	100
30-83173	10 x 0,34 - 22	6,6	<b>o.a.</b>	100

Bestelnummer	Aantal aders mm <sup>2</sup>	Buiten Ø	Brutoprijs €/100mtr.	VPE mtr.
30-83185	2 x 0,56 - 20	4,6	-	100
30-83186	3 x 0,56 - 20	4,8	<b>308,80</b>	100
30-83187	4 x 0,56 - 20	5,2	<b>432,00</b>	100
30-83202	3 x 0,82 - 18	6,4	-	100
30-83203	4 x 0,82 - 18	6,9	-	100

Lappkabel: Unitronic LiYY A

### Tronic-CY® LiYCY | DIN 47100 afgeschermd

#### Technische gegevens

**Max. bedr. spanning:** bij 0,14 mm<sup>2</sup> 350 V, > 0,25 mm<sup>2</sup> 500 V  
**Temperatuurbereik:** Incidentele buiging: -5°C tot + 70°C  
 Vaste installatie: -40°C tot + 80°C

#### Vlamvertragend:

Volgens IEC 60332-1-2

#### Test spanning:

Bij 0,14 mm<sup>2</sup> 1.200 V, > 0,25 mm<sup>2</sup> 1.500 V

#### Normreferentie:

VDE 0812

Afgeschermd datakabel met kleurcode volgens DIN 47100



Bestelnummer	Aantal aders Ø mm <sup>2</sup>	Buiten Ø	Brutoprijs €/100mtr.	VPE mtr.
<b>Koperkoers [850-875]</b>				
30-20029	2 x 0,25	4,2	<b>122,40</b>	100
30-20030	3 x 0,25	4,3	<b>147,60</b>	100
30-20031	4 x 0,25	4,7	<b>173,52</b>	100
30-20083	6 x 0,25	5,3	<b>238,24</b>	100
30-20033	7 x 0,25	5,7	<b>261,52</b>	100
30-20056	2 x 0,34	5,0	<b>144,04</b>	100
30-20057	3 x 0,34	5,2	<b>174,72</b>	100
30-20058	4 x 0,34	5,6	<b>201,36</b>	100
30-20085	6 x 0,34	6,7	<b>306,72</b>	100
30-20060	7 x 0,34	6,7	<b>323,60</b>	100

Bestelnummer	Aantal aders mm <sup>2</sup>	Buiten Ø	Brutoprijs €/100mtr.	VPE mtr.
30-16002	2 x 0,50	5,5	<b>186,40</b>	100
30-16003	3 x 0,50	5,7	<b>222,04</b>	100
30-16004	4 x 0,50	6,3	<b>272,88</b>	100
30-16006	6 x 0,50	7,3	<b>383,96</b>	100
30-16007	7 x 0,50	7,3	<b>413,68</b>	100
30-16026	2 x 0,75	5,8	<b>223,72</b>	100
30-16027	3 x 0,75	6,3	<b>284,56</b>	100
30-16028	4 x 0,75	6,8	<b>339,20</b>	100
30-16030	6 x 0,34	8,1	-	100
30-16031	7 x 0,75	8,2	<b>572,80</b>	100

Lappkabel: Unitronic LiYCY

# Lapp kabel

Lapp stuurstroomkabel



## Ölflex Classic® 100 | Gekleurde aders

### Technische gegevens

**Nominale spanning:** Tot max 1,5 mm<sup>2</sup>: Uo/U: 300/500 V  
Vanaf 2,5 mm<sup>2</sup>: Uo/U: 450/750 V  
Bij vaste en beschermde installaties vanaf 2,5 mm<sup>2</sup>: Uo/U: 600/1000 V

**Temperatuurbereik:** Incidentele buiging: -5°C tot + 70°C  
Vaste installatie: -40°C tot + 80°C

**Test spanning:** 4000V

**Normreferentie:** Gebaseerd op IEC 60227-5 en EN 50525-2-51

**Vlamvertragend:** Volgens IEC 60332-1-2

**Kleurgecodeerd:** PVC buitenmantel en gekleurde aders

LAPP KABEL STUFGART ÖLFLEX® CLASSIC 100 502,5 NCC



Bestelnummer	Aantal aders mm <sup>2</sup>	Buiten ø	Brutoprijs €/100mtr.	VPE mtr.
<b>Prijzen zijn koper gerelateerd</b>				
30-00100224	3 G 0,75	5,7	158,16	100
30-00100234	4 G 0,75	6,2	183,61	100
30-00100244	5 G 0,75	6,7	232,72	100
30-0010026	7 G 0,75	7,3	307,16	100
30-00100424	3 G 1,0	6,0	179,55	100
30-00100434	4 G 1,0	6,5	228,60	100
30-00100444	5 G 1,0	7,1	307,09	100
30-0010046	7 G 1,0	8,0	400,30	100

Bestelnummer	Aantal aders mm <sup>2</sup>	Buiten ø	Brutoprijs €/100mtr.	VPE mtr.
30-00100644	3 G 1,5	6,7	248,47	100
30-00100654	4 G 1,5	7,2	335,60	100
30-00100664	5 G 1,5	8,1	409,50	100
30-0010068	7 G 1,5	8,9	546,30	100
30-0010087	3 G 2,5	9,6	401,91	100
30-00100883	4 G 2,5	10,7	522,99	100
30-00100893	5 G 2,5	11,8	666,41	100
30-0010091	7 G 2,5	13,1	904,14	100

Helukabel: JB-500, OB-500/750

## Ölflex Classic® 110 | Genummerde aders

### Technische gegevens

**Nominale spanning:** Uo/U: 300/500 V

**Temperatuurbereik:** Incidentele buiging: -5°C tot + 70°C  
Vaste installatie: -40°C tot + 80°C

**Test spanning:** 4000V

**Normreferentie:** VDE-reg. nr. 8639

PVC buitenmantel en genummerde aders

LAPP KABEL STUFGART ÖLFLEX® CLASSIC 110 VDE Reg. Nr. 7030 CE

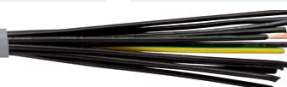

Bestelnummer	Aantal aders mm <sup>2</sup>	Buiten ø	Brutoprijs €/100mtr.	VPE mtr.
<b>Prijzen zijn koper gerelateerd</b>				
30-1119103	3 G 0,75	5,7	134,88	
30-1119104	4 G 0,75	6,2	174,57	
30-1119105	5 G 0,75	6,2	219,24	
30-1119107	7 G 0,75	6,7	293,30	
30-1119203	3 G 1,0	6,0	166,79	
30-1119204	4 G 1,0	6,5	214,83	
30-1119205	5 G 1,0	7,1	268,35	
30-1119207	7 G 1,0	8,0	371,86	

Bestelnummer	Aantal aders mm <sup>2</sup>	Buiten ø	Brutoprijs €/100mtr.	VPE mtr.
30-1119303	3 G 1,5	6,7	226,55	100
30-1119304	4 G 1,5	7,2	296,29	100
30-1119305	5 G 1,5	8,1	375,39	100
30-1119307	7 G 1,5	8,9	519,09	100
30-1119403	3 G 2,5	8,1	370,19	100
30-1119404	4 G 2,5	8,9	485,67	100
30-1119405	5 G 2,5	10	623,73	100
30-1119407	7 G 2,5	11,1	843,79	100

Helukabel: JZ-500, OZ-500 (VDE)

## Ölflex® 150 QUATRO | Genummerde aders UL/CSA

### Technische gegevens

**Nominale spanning:** HAR Uo/U: 300/500V  
UL/CSA: 600V

**Temperatuurbereik:** Incidentele buiging: -5°C tot + 70°C (UL + 90°C)  
Vaste installatie: -40°C tot + 80°C (UL + 90°C)

**Test spanning:** 3000V

**Normreferentie:** H05vv5-F (HD 21.13 S1), UL AWM style 21098 of 2587 CSA AWM I A/B II A/B

**Vlamvertragend:** Volgens IEC 60332-1-2

**Oliebestendig:** HD21.1:TM5 en UL1581 Class 43

PVC buitenmantel en genummerde aders volgens VDE 0293

LAPP KABEL STUFGART ÖLFLEX® 150 H05VV5-F ROHS CE  
UL AWM VW-1 CSA AWM I A/B II A/B 600 V FT1 90°C



Bestelnummer	Aantal aders mm <sup>2</sup>	Buiten ø	Brutoprijs €/100mtr.	VPE mtr.
<b>Prijzen zijn koper gerelateerd</b>				
30-0015103	3 G 0,75	7,9	219,65	
30-0015104	4 G 0,75	8,4	269,92	
30-0015105	5 G 0,75	8,9	336,92	
30-0015107	7 G 0,75	9,7	498,96	
30-0015203	3 G 1,0	8,2	250,33	
30-0015204	4 G 1,0	8,7	319,57	
30-0015205	5 G 1,0	9,5	397,12	
30-0015207	7 G 1,0	10,2	557,99	

Bestelnummer	Aantal aders mm <sup>2</sup>	Buiten ø	Brutoprijs €/100mtr.	VPE mtr.
30-0015303	3 G 1,5	10,3	333,96	100
30-0015304	4 G 1,5	11,3	432,78	100
30-0015305	5 G 1,5	12,6	528,85	100
30-0015307	7 G 1,5	13,9	778,81	100
30-0015403	3 G 2,5	11,8	521,26	100
30-0015404	4 G 2,5	13,5	661,50	100
30-0015405	5 G 2,5	14,6	827,06	100
30-0015407	7 G 2,5	15,9	1.188,43	100

Helukabel: JZ-603

# Lapp kabel

## Lapp stuurstroomkabel afgeschermd



### Ölflex Classic® 100 CY | Gekleurde aders

#### Technische gegevens

**Nominale spanning:** Tot max 1,0 mm<sup>2</sup>: Uo/U: 300/500 V  
Vanaf 1,5 mm<sup>2</sup>: Uo/U: 450/750 V  
Bij vaste en beschermde installaties  
Uo/U: 600/1000 V

**Temperatuurbereik:** Incidentele buiging: -5°C tot + 70°C  
Vaste installatie: -40°C tot + 80°C

**Test spanning:** 4000V

**Normreferentie:** Gebaseerd op IEC 60227-5 en EN 50525-2-51

**Vlamvertragend:** Volgens IEC 60332-1-2  
Kleurgecodeerd, PVC buitenmantel en 7 G 1,0 gekleurde aders  
Gevlochten koperafscherming



Bestelnummer	Aantal aders mm <sup>2</sup>	Buiten ø	Brutoprijs €/100mtr.
<b>Prijzen zijn koper gerelateerd</b>			
30-0035005	3 G 0,75	7,9	<b>352,08</b>
30-00350063	4 G 0,75	8,4	<b>398,00</b>
30-00350163	5 G 0,75	8,9	<b>470,48</b>
30-0035203	7 G 0,75	9,7	<b>581,05</b>
30-0035221	3 G 1,0	8,2	<b>392,62</b>
30-00352223	4 G 1,0	8,7	<b>457,19</b>
30-00352233	5 G 1,0	9,5	-
30-0035204	7 G 1,0	10,2	-

Bestelnummer	Aantal aders mm <sup>2</sup>	Buiten ø	Brutoprijs €/100mtr.	VPE mtr.
30-0035458	3 G 1,5	10,3	<b>523,06</b>	100
30-00354593	4 G 1,5	11,3	<b>621,18</b>	100
30-00354603	5 G 1,5	12,6	-	100
30-0035461	7 G 1,5	13,9	-	100
30-0035511	3 G 2,5	11,8	-	100
30-00350173	4 G 2,5	13,5	<b>963,14</b>	100
30-00350123	5 G 2,5	14,6	<b>1.160,43</b>	100
30-0035289	7 G 2,5	15,9	-	100

Helukabel: Y-CY-JB

### Ölflex Classic® 115 CY | Genummerde aders

#### Technische gegevens

**Nominale spanning:** Uo/U: 300/500 V

**Temperatuurbereik:** Incidentele buiging: -5°C tot + 70°C  
Vaste installatie: -40°C tot + 80°C

**Vlamvertragend:** Volgens IEC 60332-1-2

**Test spanning:** 4000V

**Normreferentie:** EN 50525-2-51

Afgeschermd PVC kabel met kleine buitendiameter en genummerde aders



Bestelnummer	Aantal aders mm <sup>2</sup>	Buiten ø	Brutoprijs €/100mtr.
<b>Prijzen zijn koper gerelateerd</b>			
30-1136103	3 G 0,75	6,5	<b>277,77</b>
30-1136104	4 G 0,75	7,0	<b>340,29</b>
30-1136105	5 G 0,75	7,7	<b>402,79</b>
30-1136107	7 G 0,75	8,3	<b>478,39</b>
30-1136203	3 G 1,0	6,8	<b>332,92</b>
30-1136204	4 G 1,0	7,3	<b>400,11</b>
30-1136205	5 G 1,0	8,1	<b>475,43</b>
30-1136207	7 G 1,0	8,8	<b>590,31</b>

Bestelnummer	Aantal aders mm <sup>2</sup>	Buiten ø	Brutoprijs €/100mtr.	VPE mtr.
30-1136303	3 G 1,5	7,7	<b>422,98</b>	100
30-1136304	4 G 1,5	8,2	<b>506,30</b>	100
30-1136305	5 G 1,5	8,9	<b>602,37</b>	100
30-1136307	7 G 1,5	9,9	<b>748,09</b>	100
30-1136403	3 G 2,5	8,9	<b>614,12</b>	100
30-1136404	4 G 2,5	9,9	<b>707,99</b>	100
30-1136405	5 G 2,5	11	<b>861,34</b>	100
30-1136407	7 G 2,5	11,9	<b>1.145,94</b>	100

Helukabel: F-CY-JZ (VDE)

### Ölflex® 150 CY QUATRO | Genummerde aders UL/CSA

#### Technische gegevens

**Nominale spanning:** HAR Uo/U: 300/500V  
UL/CSA: 600V

**Temperatuurbereik:** Incidentele buiging: -5°C tot + 70°C (UL + 90°C)  
Vaste installatie: -40°C tot + 80°C (UL + 90°C)

**Test spanning:** 3000V

**Normreferentie:** H05VV-C4V5-K (EN 50525-2-51)  
UL AWM style 21098 of 2587, CSA AWM I A/B II A/B

**Vlamvertragend:** Volgens IEC 60332-1-2 en UL 1581

**Oliebestendig:** Hoog  
PVC buitenmantel en genummerde aders volgens VDE 0293



Bestelnummer	Aantal aders mm <sup>2</sup>	Buiten ø	Brutoprijs €/100mtr.
<b>Prijzen zijn koper gerelateerd</b>			
30-0015603	3 G 0,75	8,9	<b>563,47</b>
30-0015604	4 G 0,75	9,6	<b>687,61</b>
30-0015605	5 G 0,75	10,3	<b>705,35</b>
30-0015607	7 G 0,75	12,3	-
30-0015703	3 G 1,0	9,4	-
30-0015704	4 G 1,0	10,0	<b>749,32</b>
30-0015705	5 G 1,0	11,0	<b>894,00</b>
30-0015707	7 G 1,0	13,0	-

Bestelnummer	Aantal aders mm <sup>2</sup>	Buiten ø	Brutoprijs €/100mtr.	VPE mtr.
30-0015803	3 G 1,5	10,5	-	100
30-0015804	4 G 1,5	11,4	<b>850,19</b>	100
30-0015805	5 G 1,5	12,7	-	100
30-0015807	7 G 1,5	15,1	-	100
30-0015903	3 G 2,5	11,9	-	100
30-0015904	4 G 2,5	13,2	<b>1.265,01</b>	100
30-0015905	5 G 2,5	14,7	-	100
30-0015907	7 G 2,5	17,5	-	100

Helukabel: JZ-603



# Lapp kabel

Lapp datakabel



## Unitronic® LiYY | DIN 47100

### Technische gegevens

**Max. bedr. spanning:** Bij 0,14 mm<sup>2</sup> 350 V, > 0,25 mm<sup>2</sup> 500 V  
**Temperatuurbereik:** Incidentele buiging: -5°C tot + 70°C  
 Vaste installatie: -40°C tot + 80°C

### Vlamvertragend:

Volgens IEC 60332-1-2

### Test spanning:

Bij 0,14 mm<sup>2</sup> 1.200 V, > 0,25 mm<sup>2</sup> 1.500 V

### Normreferentie:

VDE 0812

Datakabel met kleurcode volgens DIN 47100

LAPP KABEL STUIGART UNITRONIC® LIYY



Bestelnummer	Aantal aders Ø mm <sup>2</sup>	Buiten Ø	Brutoprijs €/100mtr.	VPE mtr.
<b>Prijzen zijn koper gerelateerd</b>				
30-0028302	2 x 0,25	3,8	59,13	100
30-0028303	3 x 0,25	4,0	66,84	100
30-0028304	4 x 0,25	4,3	86,97	100
30-0028305	5 x 0,25	4,7	104,83	100
30-0028307	7 x 0,25	5,1	143,33	100
30-0028402	2 x 0,34	4,2	68,51	100
30-0028403	3 x 0,34	4,4	87,10	100
30-0028404	4 x 0,34	4,8	105,12	100
30-0028405	5 x 0,34	5,5	138,54	100
30-0028407	7 x 0,34	6,9	179,24	100

Bestelnummer	Aantal aders mm <sup>2</sup>	Buiten Ø	Brutoprijs €/100mtr.	VPE mtr.
30-0028502	2 x 0,50	4,7	86,22	100
30-0028503	3 x 0,50	5,0	110,50	100
30-0028504	4 x 0,50	5,6	139,61	100
30-0028505	5 x 0,50	6,1	183,77	100
30-0028507	7 x 0,50	6,9	221,98	100
30-0028602	2 x 0,75	5,1	109,97	100
30-0028603	3 x 0,75	5,6	141,94	100
30-0028604	4 x 0,75	6,1	183,46	100
30-0028605	5 x 0,75	6,9	223,56	100
30-0028607	7 x 0,75	7,5	306,94	100

Helukabel: Tronic LiYY

## Unitronic® LiYY A | DIN 47100 UL/CSA

### Technische gegevens

**Max. bedr. spanning:** 300 V, UL/CSA 300 V  
**Temperatuurbereik:** Incidentele buiging: -5°C tot + 70°C  
 Vaste installatie: -40°C tot + 80°C

### Vlamvertragend:

Volgens IEC 60332-1-2, UL VW-1 &amp; CSA FT 1

### Test spanning:

1500 V

### Normreferentie:

UL AWM Style 2464/CSA AWM I/II A/UL File No. E63634  
Datakabel met kleurcode volgens DIN 47100  
UL/CSA keurmerk

LAPP KABEL STUIGART UNITRONIC® LIYY A



Bestelnummer	Aantal aders Ø mm <sup>2</sup>	Buiten Ø	Brutoprijs €/100mtr.	VPE mtr.
<b>Prijzen zijn koper gerelateerd</b>				
30-0022602	2 x 0,34 - 22/	4,8	117,18	100
30-0022603	3 x 0,34 - 22/	5,0	143,96	100
30-0022604	4 x 0,34 - 22/	5,4	157,53	100
30-0022605	5 x 0,34 - 22/	5,9	-	100
30-0022607	7 x 0,34 - 22/	6,4	250,74	100

Bestelnummer	Aantal aders mm <sup>2</sup>	Buiten Ø	Brutoprijs €/100mtr.	VPE mtr.
30-0022632	2 x 0,50 - 20/7	5,3	-	100
30-0022642	2 x 0,75 - 19/19	5,6	209,32	100

Helukabel: Tronic UL LiYY

## Unitronic® LiYCY | DIN 47100 afgeschermd

### Technische gegevens

**Max. bedr. spanning:** Bij 0,14 mm<sup>2</sup> 350 V, > 0,25 mm<sup>2</sup> 500 V  
**Temperatuurbereik:** Incidentele buiging: -5°C tot + 70°C  
 Vaste installatie: -40°C tot + 80°C

### Vlamvertragend:

Volgens IEC 60332-1-2

### Test spanning:

Bij 0,14 mm<sup>2</sup> 1.200 V, > 0,25 mm<sup>2</sup> 1.500 V

### Normreferentie:

VDE 0812

Afgeschermd datakabel met kleurcode volgens DIN 47100

LAPP KABEL STUIGART UNITRONIC® LIYCY



Bestelnummer	Aantal aders Ø mm <sup>2</sup>	Buiten Ø	Brutoprijs €/100mtr.	VPE mtr.
<b>Prijzen zijn koper gerelateerd</b>				
30-0034402	2 x 0,25	4,5	126,28	100
30-0034403	3 x 0,25	4,7	147,64	100
30-0034404	4 x 0,25	5,0	169,75	100
30-0034406	6 x 0,25	6,0	232,16	100
30-0034407	7 x 0,25	6,0	257,10	100
30-0034502	2 x 0,34	4,9	150,89	100
30-0034503	3 x 0,34	5,1	176,94	100
30-0034504	4 x 0,34	5,7	197,03	100
30-0034506	6 x 0,34	6,8	298,56	100
30-0034507	7 x 0,34	6,8	297,96	100

Bestelnummer	Aantal aders mm <sup>2</sup>	Buiten Ø	Brutoprijs €/100mtr.	VPE mtr.
30-0034602	2 x 0,50	5,6	178,67	100
30-0034603	3 x 0,50	5,9	221,22	100
30-0034604	4 x 0,50	6,3	258,62	100
30-0034606	6 x 0,50	7,6	365,24	100
30-0034607	7 x 0,50	7,6	369,50	100
30-0034702	2 x 0,75	6,0	220,37	100
30-0034703	3 x 0,75	6,3	266,49	100
30-0034704	4 x 0,75	7,0	315,79	100
30-0034707	7 x 0,75	8,2	505,92	100

Helukabel: Tronic-CY

# Lapp kabel

Lapp montagesnoer LiY (PVC 70°)



## Montagesnoer PVC | LiY op haspel 70°C

VDE 0812, vlamvertragend EC 60332.1.2

### Technische eigenschappen

**Materiaal:** PVC, YI2/TI 2 acc. VDE 0207-4  
**Testspanning:** 1,2kV (0,14mm<sup>2</sup>) 2,5kV (0,25mm<sup>2</sup>)  
**Nom. spanning:** <50 VAC  
**Temp. bereik:** -30°C tot +70°C

### RoHS

**B** 85mm  
**D1** 18mm  
**D2** 150mm

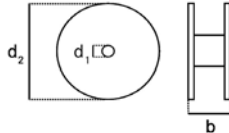

### Kleurcodes, cijfers toevoegen aan bestelnr.

● Zwart	001	● Grijs	106	● D.bl.	014
● Gn./ge	000	● Violet	007	● Oranje	009
● Blauw	002	● Geel	005	● Beige	004
● Bruin	003	● Rose	008		
● Rood	104	● Groen	006		
● Wit	105	○ Transp.	010		

mm <sup>2</sup>	Bestelnummer	Buiten Ø mm	Brutoprijzen per €/100mtr. [kopernotering*]
0,14	30-4125...S	1,1	prijslijst digitaal beschikbaar
0,25	30-4126...S	1,3	prijslijst digitaal beschikbaar



## Montagesnoer UL/CSA| Multi-Standard SC 2.1 (H05-H07V-K) UL90°C

H05- H07V-K DIN VDE 0281, UL (AWM) UL758 STYLE 1015, UL (MTW) UL 1063, CSA (TEW) C22.2 no 127

### Technische eigenschappen

**Materiaal:** PVC, vertinde litzen klasse 5  
**Testspanning:** 2,5KV  
**HAR:** -40°C tot +70°C | 450/700V  
**UL (AMW)(MTW)** -40°C tot +105°C/+90° | 600V  
**CSA (TEW):** -40°C tot +105°C | 600V  
**Volgens:** UL758, UL1063, C22.2 no. 127



### Kleurcodes, cijfers toevoegen aan bestelnr.

● Zwart	01	● Grijs	06	● D.bl.	14
● Gn./ge	00	● Violet	07	● Oranje	09
● Blauw	02	● Geel	10	● Rd/w	04
● Bruin	03	● Rose	08	● Bl/w	26
● Rood	04	● Groen	11	● W/bl	44
● Wit	05	○ Transp.	10		

RoHS **STYLE 1015**



mm <sup>2</sup>	AWG	Bestelnummer	Buiten Ø mm	VPE mtr.	Brutoprijzen per €/100mtr. [kopernotering*]
-----------------	-----	--------------	----------------	-------------	--

0,50	22	30-41601..R	2,7	100	Digitale prijslijst beschikbaar
0,75	20	30-41602..R	2,9	100	
1,00	18	30-41603..R	3,1	100	
1,50	16	30-41604..R	3,4	100	
2,50	14	30-41605..R	4,6	100	
4,00	12	30-41606..R	4,6	100	
6,00	10	30-41607..R	5,1	100	
10,00	8	30-41608..R	6,8	100	
16,00	6	30-41609..R	9,0	100	
25,00	4	30-41610..R	10,2	100	
35,00	2	30-41611..R	11,7	50	
50,00	1	30-41612..R	13,9	50	
70,00	2/0	30-41613..R	16,0	25	
95,00	3/0	30-41614..R	18,2	25	
120,00	4/0	30-41615..R	19,8	25	



# KABELVERBINDERS

---

3

# GLW adereindhulzen

Ongeïsoleerde adereindhulzen



## Adereindhulzen | Ongeïsoleerd

**Materiaal:** E-Cu,  
**Oppervlakte:** galvanisch vertind  
**Temp.bereik:** Max 105°C  
**Laagdikte:** 3 µm  
**UL-filenr.** E485383



Bestelnummer	mm <sup>2</sup>	Lengte mm	AWG	VPE	Brutoprijs € /1000 stk.
15-B00205*	0,25*	5	24	1000	10,20
15-B00207*	0,25*	7	24	1000	11,20
15-B00305*	0,34*	5	22	1000	10,40
15-B00307*	0,34*	7	22	1000	11,50
15-B00506	0,50	6	20	1000	9,40
15-B00508	0,50*	8	20	1000	10,70
15-B00510	0,50	10	20	1000	10,90
15-B00706	0,75	6	20	1000	9,60
15-B00708	0,75*	8	20	1000	10,90
15-B00710	0,75	10	20	1000	11,20
15-B00712	0,75*	12	20	1000	16,10
15-B01006	1,00	6	18	1000	9,90
15-B01008	1,00*	8	18	1000	11,10
15-B01010	1,00	10	18	1000	11,40
15-B01012	1,00*	12	18	1000	16,40
15-B01507	1,50	7	16	1000	10,40
15-B01508	1,50	8	16	1000	11,90
15-B01510	1,50	10	16	1000	12,40
15-B01512	1,50	12	16	1000	16,90
15-B01515	1,50*	15	16	1000	20,20
15-B01518	1,50	18	16	1000	23,40
15-B01520	1,50*	20	16	1000	25,40
15-B02507	2,50	7	14	1000	12,40
15-B02508	2,50	8	14	1000	14,70
15-B02510	2,50	10	14	1000	15,20
15-B02512	2,50	12	14	1000	17,30
15-B02515	2,50*	15	14	1000	23,70
15-B02518	2,50	18	14	1000	27,80
15-B02520	2,50*	20	14	1000	29,60
15-B04009	4,00	9	12	1000	17,70
15-B04010	4,00	10	12	1000	21,70
15-B04012	4,00	12	12	1000	23,30
15-B04015	4,00	15	12	1000	32,10
15-B04018	4,00	18	12	1000	36,90
15-B04020	4,00*	20	12	1000	41,10
15-B06010	6,00	10	10	1000	23,40
15-B06012	6,00	12	10	1000	25,80
15-B06015	6,00	15	10	1000	30,70

\* Niet conform DIN 46228T1 \* Niet conform UL

Bestelnummer	mm <sup>2</sup>	Lengte mm	AWG	VPE	Brutoprijs € /1000stk.
15-B06018	6,00	18	10	1000	45,00
15-B06020	6,00*	20	10	1000	52,10
15-B10012	10,00	12	8	500	34,70
15-B10015	10,00	15	8	500	41,00
15-B10018	10,00	18	8	500	49,20
15-B10020	10,00*	20	8	500	54,50
15-B10025	10,00*	25	8	500	65,10
15-B16012	16,00	12	6	250	38,50
15-B16015	16,00	15	6	250	50,50
15-B16018	16,00	18	6	250	59,70
15-B16020	16,00*	20	6	250	64,80
15-B16025	16,00	25	6	250	79,50
15-B16032	16,00	32	6	250	97,60
15-B25012	25,00*	12	4	100	59,70
15-B25015	25,00	15	4	100	74,80
15-B25018	25,00	18	4	100	88,70
15-B25025	25,00	25	4	100	118,80
15-B25032	25,00	32	4	100	146,20
15-B35018	35,00	18	2	100	101,70
15-B35020	35,00*	20	2	100	117,40
15-B35025	35,00	25	2	100	145,90
15-B35032	35,00	32	2	100	260,40
15-B50018	50,00	18	1	100	189,70
15-B50022	50,00*	22	1	100	238,20
15-B50025	50,00	25	1	100	290,60
15-B50032	50,00	32	1	100	432,10
15-B70025*	70,00*	25	2/0	100	415,20
15-B70032*	70,00*	32	2/0	100	528,90
15-B95025*	95,00*	25	3/0	50	539,70
15-B95030*	95,00*	30	3/0	50	666,60
15-B95032*	95,00*	32	3/0	50	716,20
15-B120032*	120,00*	32	4/0	50	752,10
15-B120040*	120,00*	40	4/0	50	954,60
15-B150032*	150,00*	32	300/MCM	50	851,20
15-B150038*	150,00*	38	300/MCM	50	985,30
15-B185032*	185,00*	32	350/MCM	25	1.089,10
15-B185040*	185,00*	40	350/MCM	25	1.395,00
15-B240040*	240,00*	40	400/MCM	25	2.765,40

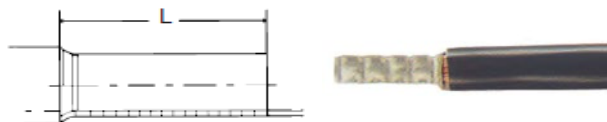

GLW is naast producent van adereindhulzen ook producent van diverse machines voor de automatische verwerking van adereindhulzen of knippen / strippen van bedrading.

Daarnaast is er een uitgebreid assortiment handgereedschap beschikbaar.

Details zijn terug te vinden in hoofdstuk 10 Gereedschap.

# GLW adereindhulzen

Geïsoleerde adereindhulzen: diverse lengten



**Materiaal:** E-Cu, polypropyleen  
**Oppervlakte:** galvanisch vertind  
**Temp.bereik:** Max 105°C  
**Laagdik:** 3 µm  
**UL-filenr.** E485383



mm <sup>2</sup>	Lengte mm	AWG	DIN-kleuren		T-kleuren		W-kleuren		VPE	Brutoprijs €/100 stk.
			Bestelnr.	Kleur	Bestelnr.	Kleur	Bestelnr.	Kleur		

## Kort

0,50	6	20	15-00535	○ wit	15-00532	○ wit	15-00537	● oranje	500	4,39
0,75	6	26	15-00735	● grijs	15-00732	● blauw	15-00737	○ wit	500	4,59
1,00	6	18	15-01035	● rood	15-01032	● rood	15-01037	● geel	500	4,64
1,50	6	16	15-01535	● zwart	15-05532*	● zwart	15-01537	● rood	500	4,65

## Standaard

0,14	6	26	15-00155*	● grijs	15-00152*	● bruin	15-00157*	● grijs	500	6,15
0,25	6	24	15-00255*	● geel	15-00252*	● violet	15-00257*	● blauw	500	4,74
0,34	6	22	15-00355*	● turq.	15-00352*	● rose	15-00357*	● turq.	500	4,74
0,50	8	20	15-00555	○ wit	15-00552	○ wit	15-00557	● oranje	500	2,60
0,75	8	20	15-00755	● grijs	15-00752	● blauw	15-00757	○ wit	500	2,63
1,00	8	18	15-01055	● rood	15-01052	● rood	15-01057	● geel	500	2,65
1,50	8	16	15-01555	● zwart	15-01552	● zwart	15-01557	● rood	500	2,68
2,50	8	14	15-02555	● blauw	15-02552	● grijs	15-02557	● blauw	500	2,99
4,00	10	12	15-04055	● grijs	15-04052	● oranje	15-04057	● grijs	500	6,17
6,00	12	10	15-06055	● geel	15-06052	● groen	15-06057	● zwart	100	7,15
10,00	12	8	15-10055	● rood	15-10052	● bruin	15-10057	● ivoor	100	9,63
16,00	12	6	15-16055	● blauw	15-16052	○ wit	15-16057	● groen	100	12,42
25,00	16	4	15-25055	● geel	15-25052	● zwart	15-25057	● bruin	50	29,59
35,00	16	2	15-35055	● rood	15-35052	● rood	15-35057	● beige	50	39,78
50,00	20	1/0	15-50055	● blauw	15-50052	● blauw	15-50057	● olijf	50	61,05
70,00	20	2/0	15-70055*	● geel	15-70052*	● geel	15-70057*	● geel	25	78,11
95,00	25	3/0	15-95055*	● rood	15-95052*	● rood	15-95057*	● rood	25	147,95
120,00	27	250/MCM	15-120055*	● blauw	15-120052*	● blauw	15-120057*	● blauw	25	157,22
150,00	32	300/MCM	15-150055*	● geel	15-150052*	● geel	15-150057*	● geel	25	184,21

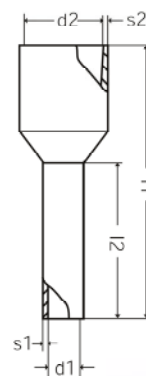

## Halflang

0,50	10	20	15-00575	○ wit	15-00572	○ wit	15-00577	● oranje	500	6,08
0,75	10	20	15-00775	● grijs	15-00772	● blauw	15-00777	○ wit	500	5,35
1,00	10	18	15-01075	● rood	15-01072	● rood	15-01077	● geel	500	5,41
1,50	10	16	15-01575	● zwart	15-01572	● zwart	15-01577	● rood	500	6,29
2,50	10	14	15-02565	● blauw					500	7,08
2,50	12	14	15-02575	● blauw	15-02572	● grijs	15-02577	● blauw	500	7,17
4,00	12	12	15-04075	● grijs	15-04072	● oranje	15-04077	● grijs	100	8,13
25,00	18	4	15-25075	● geel	15-25072	● zwart	15-25077	● bruin	50	36,42
35,00	18	2	15-35075	● rood	15-35072	● rood	15-35077	● beige	50	48,32

## Lang

0,14	8	26	15-00185*	● grijs	15-00182*	● bruin	15-00187*	● grijs	500	6,80
0,25	8	24	15-00285*	● geel	15-00282*	● violet	15-00287*	● blauw	500	6,80
0,34	8	22	15-00385*	● turq.	15-00382*	● rose	15-00387*	● turq.	500	6,80
0,50	12	20	15-00585	○ wit	15-00582	○ wit	15-00587	● oranje	500	5,78
0,75	12	20	15-00785	● grijs	15-00782	● blauw	15-00787	○ wit	500	5,74
1,00	12	18	15-01085	● rood	15-01082	● rood	15-01087	● geel	500	5,81
1,50	12	16	15-01565	● zwart	15-01562	● zwart	15-01567	● rood	500	5,89
1,50	18	16	15-01585	● zwart	15-01582	● zwart	15-01587	● rood	500	7,49
2,50	18	14	15-02585	● blauw	15-02582	● grijs	15-02587	● blauw	500	9,30
4,00	18	12	15-04085	● grijs	15-04082	● oranje	15-04087	● grijs	100	10,31
6,00	18	10	15-06085	● geel	15-06082	● groen	15-06087	● zwart	100	12,57
10,00	18	8	15-10085	● rood	15-10082	● bruin	15-10087	● ivoor	100	17,50
16,00	18	6	15-16085	● blauw	15-16082	○ wit	15-16087	● groen	100	22,26
25,00	22	4	15-25085	● geel	15-25082	● zwart	15-25087	● bruin	50	40,58
35,00	25	2	15-35085	● rood	15-35082	● rood	15-35087	● beige	50	56,79
50,00	25	1/0	15-50085	● blauw	15-50082	● blauw	15-50087	● olijf	25	80,46
70,00	27	2/0	15-70085*	● geel	15-70082*	● geel	15-70087*	● geel	25	126,02

\*Niet conform UL



# GLW adereindhulzen

Geïsoleerde adereindhulzen: TWIN, cassettes, band, strip



## Adereindhulzen | Twin

mm <sup>2</sup>	Lengte mm	AWG	DIN-kleuren		T-kleuren		W-kleuren		VPE	Brutoprijs €/100 stk.
			Bestelnr.	Kleur	Bestelnr.	Kleur	Bestelnr.	Kleur		
<b>Standaard</b>										
Let op! In de bestelcode TW vervangen door = TWIN										
2x0,50	8	2x20	15-00555TW	○ wit	15-00552TW	○ wit	15-00557TW	● oranje	500	4,62
2x0,75	8	2x20	15-00755TW	● grijs	15-00752TW	● blauw	15-00757TW	○ wit	500	4,68
2x1,00	8	2x18	15-01055TW	● rood	15-01052TW	● rood	15-01057TW	● geel	500	4,70
2x1,50	8	2x16	15-01555TW	● zwart	15-01552TW	● zwart	15-01557TW	● rood	500	4,76
2x2,50	10	2x14	15-02555TW	● blauw	15-02552TW	● grijs	15-02557TW	● blauw	250	5,36
2x4,00	12	2x12	15-04055TW	● grijs	15-04052TW	● oranje	15-04057TW	● grijs	100	14,10
2x6,00	14	2x10	15-06055TW	● geel	15-06052TW	● groen	15-06057TW	● zwart	100	15,60
2x10,0	14	2x8	15-10055TW	● rood	15-10052TW	● bruin	15-10057TW	● ivoor	100	19,57
2x16,0	16	2x6	15-16055TW	● blauw	15-16052TW	○ wit	15-16057TW	● groen	50	34,67
<b>Halflang</b>										
2x0,50	10	2x20	15-00575TW	○ wit	15-00575TW	○ wit	15-00577TW	● oranje	500	7,09
2x0,75	10	2x20	15-00775TW	● grijs	15-00772TW	● blauw	15-00777TW	○ wit	500	7,15
2x1,00	10	2x18	15-01075TW	● rood	15-01072TW	● rood	15-01077TW*	● geel	500	7,99
2x1,50	12	2x16	15-01575TW	● zwart	15-01572TW	● zwart	15-01577TW	● rood	500	7,90
2x2,50	13	2x14	15-02575TW	● blauw	15-02572TW	● grijs	15-02577TW*	● blauw	250	8,66
<b>Lang</b>										
2x0,75	12	2x20	15-00785TW	● grijs	15-00782TW	● blauw	15-00787TW	○ wit	500	7,08
2x1,00	12	2x18	15-01085TW	● rood	15-01082TW	● rood	15-01087TW	● geel	500	7,90
2x1,00	14	2x18	15-01065TW	● rood	15-01062TW	● rood	15-01067TW	● geel	500	7,96
2x1,50	18	2x16	15-01595TW	● zwart					100	21,02
2x2,50	18	2x14	15-02595TW	● blauw					100	12,50
2x4,00	18	2x12	15-04085TW	● grijs	15-04082TW	● oranje	15-04087TW	● grijs	100	18,20
2x6,00	18	2x10	15-06085TW	● geel	15-06082TW	● groen	15-06087TW	● zwart	100	22,92

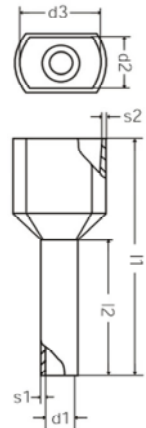

## Adereindhulzen | Cassettes t.b.v. MC 25

mm <sup>2</sup>	Lengte mm	AWG	DIN-kleuren		T-kleuren		W-kleuren		VPE	Brutoprijs Per VPE
			Bestelnr.	Kleur	Bestelnr.	Kleur	Bestelnr.	Kleur		
0,25	8	24	15-00255K*	● geel			15-00257K*	● blauw	1000	38,05
0,34	8	24	15-00355K*	● turq.			15-00357K*	● turq.	1000	38,05
0,50	8	20	15-00555K	○ wit	15-00552K	○ wit	15-00557K	● oranje	1000	29,75
0,75	8	20	15-00755K	● grijs	15-00752K	● blauw	15-00757K	○ wit	1000	37,27
1,00	8	18	15-01055K	● rood	15-01052K	● rood	15-01057K	● geel	1000	37,72
1,50	8	16	15-01555K	● zwart	15-01552K	● zwart	15-01557K	● rood	1000	38,12
2,50	8	14	15-02555K*	● blauw	15-02552K	● grijs	15-02557K	● blauw	500	24,51

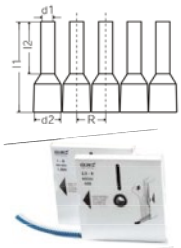

## Adereindhulzen | Aan band

mm <sup>2</sup>	Lengte mm	AWG	DIN-kleuren		T-kleuren		W-kleuren		VPE	Brutoprijs Per VPE
			Bestelnr.	Kleur	Bestelnr.	Kleur	Bestelnr.	Kleur		
0,50	8	20	15-00555B	○ wit	15-00552B	○ wit	15-00557B	● oranje	3000	111,13
0,75	8	20	15-00755B	● grijs	15-00752B	● blauw	15-00757B	○ wit	3000	112,49
1,00	8	18	15-01055B	● rood	15-01052B	● rood	15-01057B	● geel	3000	95,30
1,50	8	16	15-01555B	● zwart	15-01552B	● zwart	15-01557B	● rood	2500	95,30
2,50	8	14	15-02555B	● blauw	15-02552B	● grijs	15-02557B	● blauw	1500	73,52

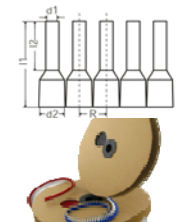

## Adereindhulzen | Aan strip

mm <sup>2</sup>	Lengte mm	AWG	DIN-kleuren		T-kleuren		W-kleuren		VPE	Brutoprijs Per VPE
			Bestelnr.	Kleur	Bestelnr.	Kleur	Bestelnr.	Kleur		
0,25	8	24	15-00255S	● geel			15-00257S*	● blauw	10x50	o.a.
0,34	8	24	15-00355S	● turq.			15-00357S*	● turq.	10x50	21,82
0,50	8	20	15-00555S	○ wit	15-00552S	○ wit	15-00557S	● oranje	10x50	19,17
0,75	8	20	15-00755S	● grijs	15-00752S	● blauw	15-00757S	○ wit	10x50	19,31
1,00	8	18	15-01055S	● rood	15-01052S	● rood	15-01057S	● geel	10x50	19,54
1,50	8	16	15-01555S	● zwart	15-01552S	● zwart	15-01557S	● rood	10x50	19,78
2,50	8	14	15-02555S	● blauw	15-02552S	● grijs	15-02557S	● blauw	10x50	21,82



## Adereindhulzen | Aan strip t.b.v. TC handcrimper

mm <sup>2</sup>	Lengte mm	AWG	DIN-kleuren		T-kleuren		W-kleuren		VPE	Brutoprijs Per VPE
			Bestelnr.	Kleur	Bestelnr.	Kleur	Bestelnr.	Kleur		
0,50	8	20	15-00555TC	○ wit	15-00552TC	○ wit	15-00557TC	● oranje	20x50	o.a.
0,75	8	20	15-00755TC	● grijs	15-00752TC	● blauw	15-00757TC	○ wit	20x50	37,50
1,00	8	18	15-01055TC	● rood	15-01052TC	● rood	15-01057TC	● geel	20x50	37,72
1,50	8	16	15-01555TC	● zwart	15-01552TC	● zwart	15-01557TC	● rood	20x50	38,12



# GLW adereindhulzen

Geïsoleerde adereindhulzen met grotere kraag



## Adereindhulzen | Geïsoleerde GB serie met grotere kraag

<b>Materiaal:</b>	E-Cu, polypropyleen
<b>Oppervlakte:</b>	Galvanisch vertind
<b>Temp. bereik:</b>	Max. 105°C
<b>Laagdikte:</b>	3µm
<b>UL-filenr.</b>	E485383

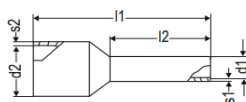

mm <sup>2</sup>	Lengte mm	AWG	DIN-kleuren		T-Kleuren		W-kleuren		VPE	Brutoprijs €/100stk.
			Bestelnummer	Kleur	Bestelnummer	Kleur	Bestelnummer	Kleur		
0,50	8	20	15-00555GB	○ wit	15-00552GB	○ wit	15-00557GB	● oranje	500	3,25
0,50	10	20	15-00575GB	○ wit	15-00572GB	○ wit	15-00577GB	● oranje	500	4,62
0,75	8	20	15-00755GB	● grijs	15-00772GB	● blauw	15-00757GB	○ wit	500	3,29
0,75	10	20	15-00775GB	● grijs	15-00782GB	● blauw	15-00777GB	○ wit	500	o.a.
0,75	12	20	15-00785GB	● grijs	15-01052GB	● blauw	15-00787GB	○ wit	500	o.a.
1,00	8	18	15-01055GB	● rood	15-01052GB	● rood	15-01057GB	● geel	500	3,31
1,00	10	18	15-01075GB	● rood	15-01072GB	● rood	15-01077GB	● geel	500	o.a.
1,00	12	18	15-01085GB	● rood	15-01082GB	● rood	15-01087GB	● geel	500	o.a.
1,50	6	16	15-01535GB	● zwart	15-01532GB	● zwart	15-01537GB	● rood	500	o.a.
1,50	8	16	15-01555GB	● zwart	15-01552GB	● zwart	15-01557GB	● rood	500	3,34
1,50	10	16	15-01575GB	● zwart	15-01572GB	● zwart	15-01577GB	● rood	500	o.a.
2,50	8	14	15-02555GB	● blauw	15-02552GB	● grijs	15-02557GB	● blauw	500	3,80
2,50	12	14	15-02575GB	● blauw	15-02572GB	● grijs	15-02577GB	● blauw	500	o.a.
4,00	10	12	15-04055GB	● grijs			15-04057GB	● grijs	500	7,22
4,00	12	12	15-04075GB	● grijs			15-04077GB	● grijs	500	o.a.
16,00	12	6	15-16055GB	● blauw	15-16052GB	○ wit	15-16057GB	● groen	100	14,08
16,00	18	6	15-16085GB	● blauw	15-16082GB	○ wit	15-16087GB	● groen	100	24,33

## Adereindhulzen | Geïsoleerde XL serie met grotere kraag (voor dubbel geïsoleerde kabel)

<b>Materiaal:</b>	E-Cu, polypropyleen
<b>Oppervlakte:</b>	Galvanisch vertind
<b>Temp. bereik:</b>	Max. 105°C
<b>Laagdikte:</b>	3µm
<b>UL-filenr.</b>	E485383

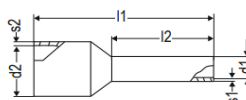

mm <sup>2</sup>	Lengte mm	AWG	DIN-kleuren		VPE	Brutoprijs €/100stk.
			Bestelnummer	Kleur		
1,50	8	16	15-01555XL	● zwart	100	11,74
1,50	10	16	15-01575XL	● zwart	100	14,41
2,50	8	14	15-02555XL	● blauw	100	12,60
2,50	12	14	15-02575XL	● blauw	100	15,21
4,00	10	12	15-04055XL	● grijs	100	14,18
6,00	12	10	15-06055XL	● geel	100	21,94
10,00	12	8	15-10055XL	● rood	100	24,01
16,00	12	6	15-16055XL	● blauw	100	32,90

## Assortimentsdozen | Leeg

Bestelnummer	Kleur	VPE	Brutoprijs €/1stk.
15-S20000AT	● zwart	10	10,89
15-S20000GY2	● donkergrijs	10	10,89
15-S20000GY	● grijs	10	10,89
15-S20000BU	● blauw	10	10,89
15-S20000GN	● groen	10	10,89
15-S20000RD	● rood	10	10,89
15-S20000OG	● oranje	10	10,89
15-S20000YE	● geel	10	10,89



Assortimentsdozen met inhoud:  
Op aanvraag leverbaar

# Nichifu kabelschoenen

Ring, vork, stift

**NTM** NICHIFU



**Materiaal:** X=Vinyl N=Nylon (artikelnr. TME(X) = Vinyl)  
**Temp.bereik:** -40°C tot +75°C Vinyl / +105°C Nylon  
**Brandverend:** UL94V0 -Vinyl / UL94V2 - Nylon

**EF:** Trechtersvormige ingang  
**CC:** Met extra koperlus  
**NC:** Met extra koperlus: Volledig nylon

## Ringkabelschoen | Geïsoleerd

Bereik mm	Bestelnummer	Type	Ø d2	B	L	VPE	Brutoprijs €/100 stk.
0,3 - 1,65	94-EF-15032	● TMEX1.25-3	3,2	5,5	17,5	100	9,35
	94-EF-15037	● TMEX1.25-3.5S	3,7	5,7	17,4	100	9,35
	94-EF-15043	● TMEX1.25-4M	4,3	6,8	19,4	100	9,35
	94-EF-15053	● TMEX1.25-5	5,3	8,0	21,1	100	9,70
	94-EF-15064	● TMEX1.25-6	6,4	12,0	25,7	100	11,65
	94-EF-15084	● TMEX1.25-8	8,4	12,0	25,7	100	11,65
1,04 - 2,63	94-EF-15105	● TMEX1.25-10	10,5	16,5	30,5	50	15,50
	94-EF-25032	● TMEX2-3	3,2	6,5	18,2	100	10,10
	94-EF-25037	● TMEX2-3.5S	3,7	6,6	19,9	100	10,00
	94-EF-25043	● TMEX2-4S	4,3	6,6	19,9	100	10,30
	94-EF-25053	● TMEX2-5M	5,3	8,0	21,5	100	10,30
	94-EF-25064	● TMEX2-6	6,4	12,0	27,0	100	12,40
2,63 - 6,64	94-EF-25084	● TMEX2-8	8,4	12,0	27,0	100	12,40
	94-EF-25105	● TMEX2-10	10,5	15,0	30,0	100	14,75
	94-EF-25130	● TMEX2-12	13,0	19,0	34,0	100	18,70
	94-EF-55032	● TMEX5.5-3S	3,2	9,0	25,7	50	16,55
	94-EF-55037	● TMEX5.5-3.5N	3,7	7,0	24,7	50	15,65
	94-EF-55043	● TMEX5.5-4S	4,3	9,0	25,7	50	15,65
2,63 - 6,64	94-EF-55053	● TMEX5.5-5S	5,3	9,0	25,7	50	15,65
	94-EF-55064	● TMEX5.5-6	6,4	12,0	30,5	50	17,30
	94-EF-55084	● TMEX5.5-8	8,4	15,0	35,5	50	19,80
	94-EF-55105	● TMEX5.5-10	10,5	15,0	35,5	50	19,80
	94-EF-55130	● TMEX5.5-12	13,0	19,2	40,0	50	19,80

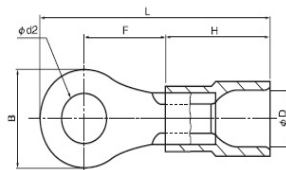

## Vorkkabelschoen | Geïsoleerd

Bereik mm	Bestelnummer	Type	Ø d2	B	L	VPE	Brutoprijs €/100 stk.
0,3 - 1,65	94-EF-15032-A	● TMEX1.25Y-3	3,2	5,8	20,5	100	10,10
	94-EF-15037-A	● TMEX1.25Y-3L	3,7	6,2	21,5	100	10,10
	94-EF-15043-A	● TMEX1.25Y-4N	4,3	6,4	21,9	100	9,35
	94-EF-15043-B	● TMEX1.25Y-4S	5,3	8,4	22,5	100	6,13
	94-EF-15053-A	● TMEX1.25Y-5	5,3	9,6	23,0	100	10,25
	94-EF-15064-A	● TMEX1.25Y-6	6,4	11,0	25,5	100	11,65
1,04 - 2,63	94-EF-15084-A	● TMEX1.25Y-8	8,4	14,0	25,7	100	6,33
	94-EF-25032-A	● TMEX2Y-3	3,2	5,9	21,3	100	11,05
	94-EF-25037-A	● TMEX2Y-3.5	3,7	6,4	21,3	100	11,05
	94-EF-25043-A	● TMEX2Y-4N	4,3	6,4	21,5	100	11,05
	94-EF-25043-1-A	● TMEX2Y-4S	4,3	7,0	21,5	100	12,20
	94-EF-25053-A	● TMEX2Y-5	5,3	8,0	21,5	100	11,05
2,63 - 6,64	94-EF-25064-A	● TMEX2Y-6	6,4	12,0	25,5	100	14,05
	94-EF-25084-A	● TMEX2Y-8	8,4	14,0	27,5	100	16,20
	94-EF-25105-A	● TMEX2Y-10	10,5	15,0	30,5	100	-
	94-EF-55037-A	● TMEX5.5Y-3.5N	3,7	9,0	25,7	100	16,20
	94-EF-55043-A	● TMEX5.5Y-4	4,3	9,0	25,7	50	16,20
	94-EF-55043-B	● TMEX5.5LY-4S	4,3	7,9	25,7	50	17,50
2,63 - 6,64	94-EF-55053-A	● TMEX5.5Y-5	5,2	9,0	25,7	50	16,20
	94-EF-55053-B	● TMEX5.5LY-5S	5,2	7,9	25,7	50	9,26
	94-EF-55064-A	● TMEX5.5Y-6	6,4	12,5	32,7	50	19,10
	94-EF-55084-A	● TMEX5.5Y-8	8,4	15,1	35,9	50	26,65
	94-EF-55105-A	● TMEX5.5Y-10	10,5	19,2	40,2	50	-

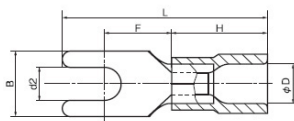

## Stiftkabelschoen | Geïsoleerd

Bereik mm	Bestelnummer	Type	Ø d2	B	L	VPE	Brutoprijs €/100 stk.
0,3 - 1,65	94-EF-15015	● TMEXTC1.25-11S	1,5	11,0	23,0	100	10,80
	94-EF-15019	● TMEXTC1.25-11	1,9	11,0	23,0	100	10,80
	94-EF-15019-1	● TMEXTC1.25-16	1,9	16,0	27,5	100	13,35
1,04 - 2,63	94-EF-25015	● TMEXTC2-11S	1,5	11,0	23,0	100	10,90
	94-EF-25019	● TMEXTC2-11	1,9	11,0	23,0	100	10,90
2,63 - 6,64	94-EF-25019-1	● TMEXTC2-16	1,9	16,0	27,5	100	13,35
	94-EF-55027	● TMEXTC5.5-11	2,7	11,0	28,5	50	17,30

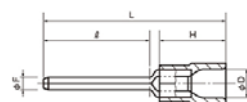



# Nichifu kabelschoenen

Doorverbinders, vlak- en rondstekers, eind- en lijmverbindingen



Bestelnummer	Type	VPE	Brutoprijs €/100 stk.
<b>Doorverbinder</b>			
94-EF-15017	● TMVB-1.25	100	12,60
94-EF-25023	● TMVB-2	100	13,95
94-EF-55034	● TMVB-5.5	100	18,10
<b>Vlakstekerhuls</b>			
94-CC-15028	● TMDV280509-F	100	10,05
94-CC-15028-1	● TMDV280809-F	100	10,05
94-CC-15048	● TMDV480509-F	100	10,80
94-CC-15048-1	● TMDV480809-F	100	10,80
94-CC-15063	● TMDV630809-F	100	12,65
94-CC-25048	● TMDV480520-F	100	10,80
94-CC-25048-1	● TMDV480820-F	100	10,80
94-CC-25063	● TMDV630820-F	100	12,65
94-CC-25079	● TMDV790820-F	100	16,10
94-CC-55063	● TMDV630855-F	100	15,25
94-CC-55095	● TMDV951255-F	100	19,35
<b>Vlaksteker</b>			
94-CC-15635	● TMDV630809-M	100	11,15
94-CC-25480	● TMDV480520-M	100	11,15
94-CC-25635	● TMDV530820-M	100	11,90
94-CC-55635	● TMDV630820-M	100	14,25
<b>Vlakstekerhuls vol geïsoleerd</b>			
94-NC-15028-2	● TMDEN280509-FA	100	18,15
94-NC-15028-2-1	● TMDEN280809-FA	100	18,15
94-NC-15048-2	● TMEDN480509-FA	100	17,10
94-NC-15048-2-1	● TMEDN480809-FA	100	17,10
94-NC-15063-2	● TMDN630809-FA	100	17,50
94-NC-25048-2	● TMEDN480520-FA	100	17,50
94-NC-25048-2-1	● TMEDN480820-FA	100	17,50
94-NC-25063-2	● TMDN630820-FA	100	17,85
94-NC-55063-2	● TMDN630855-FA	100	21,60
<b>Vlaksteker vol geïsoleerd</b>			
94-NC-15635-2	● TMEDN630809MA	100	13,75
94-NC-25635-2	● TMEDN630820-MA	100	13,75
<b>Rondstekerhuls vol geïsoleerd</b>			
94-NC-15039	● PC4009-F	100	19,35
94-NC-25039	● PC4020-F	100	19,85
<b>Rondsteker vol geïsoleerd</b>			
94-NC-15040	● PC4009-M	100	19,85
94-NC-25040	● PC4020-M	100	18,90
<b>Rondstekerhuls</b>			
94-NC-25039-1	● PCE4020-F	100	21,90
<b>Rondsteker</b>			
94-NC-15040-1	● PCE4009-M	100	17,50
94-NC-25040-1	● PCE4020-M	100	18,15
<b>Vlaksteker met tab</b>			
94-CC-15635-1	● TMEDV630809V	100	15,60
94-CC-25635-1	● TMEDV630820V	100	15,60
<b>Eindverbinding</b>			
94-NCE-1	● CE1 0,5 -1,75	100	8,40
94-NCE-2-1	● CE2 1,0 -3,00	100	9,60
94-NCE-5	● CE5 2,5 -6,00	100	11,35
<b>Lijmverbinding</b>			
94-EF-15017-L	● SB1816 0,75 -1,25	100	35,35
94-EF-25023-L	● SB1614 2,0	100	39,10
94-EF-55034-L	● SB1210 5,5	100	52,20

Gereedschap voor verwerking van geïsoleerde kabelschoenen zie hoofdstuk 10 Gereedschap

# Mecatraction kabelschoenen

Buiskabelschoenen 6-70mm<sup>2</sup>



Vereiste trekkrachten van kabels en verbindingen volgens VDE-0220-T2. /NEN-EN-IEC 61238-1:200

Aderdoorsnede mm <sup>2</sup>	Trekkraft(N) 10N = 1 kg.	Aantal verpersingen serie DE-SV	Aantal verpersingen serie YCA-TN
35	2.100	2 (5mm)	2 (5mm)
50	3.000	2 (5mm)	3 (5mm)
70	4.200	2 (5mm)	3 (5mm)
95	5.700	2 (5mm)	2 (5mm)
120	7.200	2 (5mm)	4 (5mm)
150	9.000	2 (5mm)	4 (5mm)
185	11.100	2 (5mm)	4 (5mm)
240	14.400	2 (5mm)	5 (5mm)

## Buiskabelschoenen | Serie DE-SV 6 - 70 mm<sup>2</sup>

**Materiaal:** Electrolytisch koper (EN 13600)

Galvanisch vertind

**Temp. Bereik:** tot +125 °C

**Voorschriften:** VDE-0220-2 NEN-EN-IEC 61238-1:2003

**Karakteristieken**

Afgeschuinde schachtingang

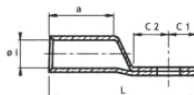

Kabel mm <sup>2</sup>	Bestelnummer	Bout	Afmetingen							Type matrijs	VPE in stk.	Brutoprijs €/100stk
			Øi	Øe	C1	C2	L	a	W			
6	23DE6-4 SV	M4	3,5	6,5	6,8	6,5	26,5	9	10	..R6	100	54,35
	23DE6-5 SV	M5	3,5	6,5	6,8	6,5	26,5	9	10	..R6	100	46,75
	23DE6-6 SV	M6	3,5	6,5	6,8	6,5	26,5	9	12	..R6	100	45,85
	23DE6-8 SV	M8	3,5	6,5	9,8	9,5	32,5	9	15	..R6	100	54,05
10	23DE10-5 SV	M5	4,5	7,0	6,8	6,5	28,0	10	12	..R10	100	55,05
	23DE10-6 SV	M6	4,5	7,0	6,8	6,5	28,0	10	12	..R10	100	50,20
	23DE10-8 SV	M8	4,5	7,0	9,8	9,5	34,0	10	15	..R10	100	57,95
	23DE10-10 SV	M10	4,5	7,0	11,8	11,5	38,0	10	17	..R10	100	58,70
16	23DE16-5 SV	M5	5,5	8,5	6,8	6,5	31,5	13	12	..R16	100	78,20
	23DE16-6 SV	M6	5,5	8,5	6,8	6,5	31,5	13	12	..R16	100	74,50
	23DE16-8 SV	M8	5,5	8,5	9,8	9,5	37,5	13	15	..R16	100	75,20
	23DE16-10 SV	M10	5,5	8,5	11,8	11,5	41,5	13	17	..R16	100	85,90
25	23DE 25-5 SV	M5	7,0	10,0	7,0	7,0	35,5	15	14	..R25	50	116,25
	23DE 25-6 SV	M6	7,0	10,0	7,0	7,0	35,5	15	14	..R25	50	115,85
	23DE 25-8 SV	M8	7,0	10,0	9,5	9,5	40,5	15	16	..R25	50	113,55
	23DE 25-10 SV	M10	7,0	10,0	11,5	11,5	44,5	15	18	..R25	50	122,70
35	23DE 25-12 SV	M12	7,0	10,0	13,0	13,5	48,0	15	19	..R25	50	130,75
	23DE 35-6 SV	M6	8,5	12,0	7,0	7,0	39,0	17	17	..R35	50	163,50
	23DE 35-8 SV	M8	8,5	12,0	9,5	9,5	44,0	17	17	..R35	50	159,20
	23DE 35-10 SV	M10	8,5	12,0	11,5	11,5	48,0	17	19	..R35	50	170,85
50	23DE 35-12 SV	M12	8,5	12,0	13,0	13,5	51,5	17	21	..R35	50	176,70
	23DE 35-14 SV	M14	8,5	12,0	14,0	14,5	53,5	17	21	..R35	50	190,50
	23DE 50-6 SV	M6	10,0	14,0	9,5	9,5	47,0	19	20	..R50	50	243,55
	23DE 50-8 SV	M8	10,0	14,0	9,5	9,5	47,0	19	20	..R50	50	225,65
70	23DE 50-10 SV	M10	10,0	14,0	11,5	11,5	51,0	19	23	..R50	50	227,70
	23DE 50-12 SV	M12	10,0	14,0	13,0	13,5	54,5	19	23	..R50	50	246,10
	23DE 50-14 SV	M14	10,0	14,0	14,0	14,5	56,5	19	23	..R50	50	272,45
	23DE 70-8 SV	M8	12,0	16,5	11,5	11,5	54,0	21	23	..R70	25	315,65
70	23DE 70-10 SV	M10	12,0	16,5	11,5	11,5	54,0	21	23	..R70	25	303,30
	23DE 70-12 SV	M12	12,0	16,5	13,0	13,5	57,5	21	23	..R70	25	320,90
	23DE 70-14 SV	M14	12,0	16,5	14,0	14,5	59,5	21	23	..R70	25	332,10
	23DE 70-16 SV	M16	12,0	16,5	15,5	16,0	62,5	21	28	..R70	25	337,65

# Mecatraction kabelschoenen

Buiskabelschoenen 95-400mm<sup>2</sup>, haakse buiskabelschoenen 45°



## Buiskabelschoenen | Serie DE-SV 95 - 400 mm<sup>2</sup>

Kabel mm <sup>2</sup>	Bestelnummer	Bout	Afmetingen							Type matrijs	VPE in stk.	Brutoprijs €/100stk
			Øi	Øe	C1	C2	L	a	W			
95	23DE 95-8 SV	M8	13,5	18,0	11,5	11,5	59,0	25	26	..R95	25	370,70
	23DE 95-10 SV	M10	13,5	18,0	11,5	11,5	59,5	25	26	..R95	25	370,15
	23DE 95-12 SV	M12	13,5	18,0	13,0	13,5	63,0	25	26	..R95	25	353,90
	23DE 95-14 SV	M14	13,5	18,0	14,0	14,5	65,0	25	26	..R95	25	441,00
	23DE 95-16 SV	M16	13,5	18,0	15,5	16,0	68,0	25	28	..R95	25	377,45
120	23DE 120-8 SV	M8	15,0	19,5	13,0	13,5	65,5	26	28	..R120	20	467,50
	23DE 120-10 SV	M10	15,0	19,5	13,0	13,5	65,5	26	28	..R120	20	466,00
	23DE 120-12 SV	M12	15,0	19,5	13,0	13,5	65,5	26	28	..R120	20	444,50
	23DE 120-14 SV	M14	15,0	19,5	14,0	14,5	67,5	26	28	..R120	20	502,00
	23DE 120-16 SV	M16	15,0	19,5	15,5	16,0	70,5	26	30	..R120	29	471,00
150	23DE 150-8 SV	M8	16,5	21,0	14,5	14,5	73,0	30	31	..R120	20	586,50
	23DE 150-10 SV	M10	16,5	21,0	14,5	14,5	73,0	30	31	..R150	20	599,00
	23DE 150-12 SV	M12	16,5	21,0	14,5	14,5	73,0	30	31	..R150	20	557,00
	23DE 150-14 SV	M14	16,5	21,0	14,5	14,5	73,0	30	31	..R150	20	625,00
	23DE 150-16 SV	M16	16,5	21,0	15,5	16,0	75,5	30	31	..R150	29	629,00
185	23DE 185-10 SV	M10	19,0	24,0	17,0	18,0	81,0	30	35	..R185	10	756,50
	23DE 185-12 SV	M12	19,0	24,0	17,0	18,0	81,0	30	35	..R185	10	753,00
	23DE 185-14 SV	M14	19,0	24,0	17,0	18,0	81,0	30	35	..R185	10	816,00
	23DE 185-16 SV	M16	19,0	24,0	17,0	18,0	81,0	30	35	..R185	10	737,50
	23DE 185-20 SV	M20	19,0	24,0	21,0	22,0	89,0	30	39	..R185	10	807,50
240	23DE 240-10 SV	M10	21,0	26,0	17,0	18,0	88,0	35	39	..R240	10	887,50
	23DE 240-12 SV	M12	21,0	26,0	17,0	18,0	88,0	35	39	..R240	10	923,50
	32DE 240-14 SV	M14	21,0	26,0	17,0	18,0	88,0	35	39	..R240	10	994,50
	23DE 240-16 SV	M16	21,0	26,0	17,0	18,0	88,0	35	39	..R240	10	898,00
	23DE 240-20 SV	M20	21,0	26,0	21,0	22,0	96,0	35	39	..R240	10	1011,50
300	23DE 300-12 SV	M12	23,5	29,5	17,0	18,0	99,0	44	43	..R300	5	1503,00
	23DE 300-14 SV	M14	23,5	29,5	17,0	18,0	99,0	44	43	..R300	5	1542,00
	23DE 300-16 SV	M16	23,5	29,5	17,0	18,0	99,0	44	43	..R300	5	1569,50
	23DE 300-20 SV	M20	23,5	29,5	21,0	22,0	107,0	44	43	..R300	5	1466,50
400	23DE 400-12 SV	M12	27,0	34,0	23,0	23,0	112,0	44	49	..R400	5	o.a.
	23DE 400-14 SV	M14	27,0	34,0	23,0	23,0	112,0	44	49	..R400	5	o.a.
	23DE 400-16 SV	M16	27,0	34,0	23,0	23,0	112,0	44	49	..R400	5	2605,00
	23DE 400-20 SV	M20	27,0	34,0	23,0	23,0	112,0	44	49	..R400	5	o.a.

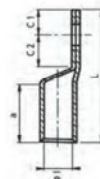

3

## Haakse buiskabelschoenen 45° | Serie DE-SV 45

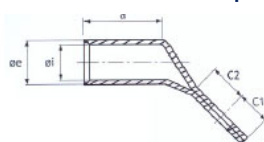

Kabel mm <sup>2</sup>	Bestelnummer	Bout	Afmetingen							Type matrijs	VPE in stk.	Brutoprijs €/100stk
			Øi	Øe	C1	C2	a	W				
6	23DE6-6SV45E	M6	3,5	6,5	7,5	7,5	9	12		100	158,70	
10	23DE10-8SV45E	M8	4,5	7,0	6,5	7,5	10	12		100	150,90	
16	23DE16-6SV45E	M6	5,5	8,5	6,5	7,5	13	12	...R16/...16DGE1T	100	176,85	
	23DE16-8SV45E	M8	5,5	8,5	8,5	9,5	13	15	...R16/...16DGE1T	100	176,85	
25	23DE25-8SV45E	M8	7,0	10,0	10,0	10,0	15	16			213,65	
	23DE25-10SV45E	M10	7,0	10,0	12,0	12,0	15	18			221,20	
35	23DE35-6SV45E	M6	8,5	12,0	7,5	7,5	17	17	...R35/...35DGE1T	50	259,25	
	23DE35-8SV45E	M8	8,5	12,0	10,0	10,0	17	17	...R35/...35DGE1T	50	301,20	
	23DE35-10SV45E	M10	8,5	12,0	12,0	12,0	17	19	...R35/...35DGE1T	50	300,05	
50	23DE50-8SV45E	M8	10,0	14,0	10,0	10,0	19	20	...R50/...50DGE1T	50	403,00	
	23DE50-10SV45E	M10	10,0	14,0	12,0	12,0	19	20	...R50/...50DGE1T	50	333,50	
	23DE70-8SV45E	M8	12,0	16,5	10,0	10,0	21	24	...R70/...70DGE1T	25	522,00	
70	23DE70-10SV45E	M10	12,0	16,5	12,0	12,0	21	24	...R70/...70DGE1T	25	511,50	
	23DE70-12SV45E	M12	12,0	16,5	13,0	13,0	21	24	...R70/...70DGE1T	25	554,00	
95	23DE95-8SV45E	M10	13,5	18,0	12,0	14,0	25	26	...R95/...95DGE1T	25	631,50	
	23DE95-10SV45E	M10	13,5	18,0	12,0	17,0	25	26	...R95/...95DGE1T	25	631,50	
	23DE95-12SV45E	M10	13,5	18,0	13,0	18,0	25	26	...R95/...95DGE1T	25	601,50	
120	23DE120-10SV45E	M10	15,0	19,5	14,0	17,0	26	28	...R120/...120DGE1T	25	734,50	
	23DE120-12SV45E	M12	15,0	19,5	14,0	18,0	26	28	...R120/...120DGE1T	25	649,50	
150	23DE150-10SV45E	M10	21,0	31,0	14,0	17,0	30	16,5	...R150/...150DGE1T	25	863,00	

# Mecatraction kabelschoenen

Haakse buiskabelschoenen 90°, doorverbinders



## Haakse buiskabelschoenen 90° | Serie DE 90

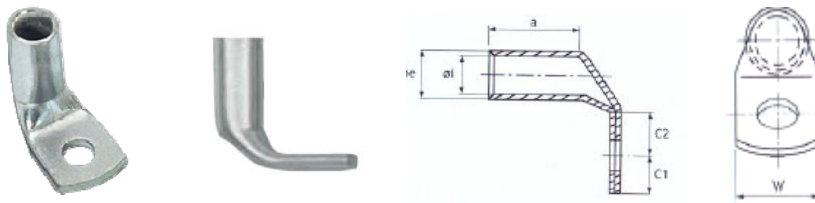

Kabel mm <sup>2</sup>	Bestelnummer	Bout	Ø		Afmetingen			Type matrijs	VPE in stk.	Brutoprijs €/100stk	
			Øi	Øe	C1	C2	a				W
10	23DE10-6SV90E	M6	4,5	7,0	6,5	7,5	10	12	...R10/...10DGE1T	100	<b>138,10</b>
	23DE10-8SV90E	M8	4,5	7,0	10,0	10,0	10	15	...R10/...10DGE1T	100	<b>164,10</b>
16	23DE16-6SV90E	M6	5,5	8,5	6,5	7,5	13	12	...R16/...16DGE1T	100	<b>181,40</b>
	23DE16-8SV90E	M8	5,5	8,5	6,5	9,5	13	15	...R16/...16DGE1T	100	<b>181,40</b>
	23DE16-10SV90E	M10	5,5	8,5	10,5	11,5	13	17	...R16/...16DGE1T	100	<b>187,25</b>
25	23DE25-6SV90E	M6	7,0	8,5	10,0	7,5	15	16	...R25/...25DGE1T	50	<b>213,10</b>
	23DE25-8SV90E	M8	7,0	8,5	10,0	10,5	15	18	...R25/...25DGE1T	50	<b>o.a.</b>
	23DE25-10SV90E	M10	7,0	8,5	10,5	12	15	17	...R25/...25DGE1T	50	<b>244,95</b>
35	23DE35-6SV90E	M6	8,5	12,0	7,5	7,5	17	17	...R35/...35DGE1T	50	<b>o.a.</b>
	23DE35-8SV90E	M8	8,5	12,0	10,0	10,0	17	17	...R35/...35DGE1T	50	<b>270,05</b>
	23DE35-10SV90E	M10	8,5	12,0	12,0	12,0	17	19	...R35/...35DGE1T	50	<b>300,05</b>
50	23DE50-6SV90E	M6	10,0	14,0	10,0	10,0	19	20	...R50/...50DGE1T	50	<b>343,30</b>
	23DE50-8SV90E	M8	10,0	14,0	10,0	10,0	19	20	...R50/...50DGE1T	50	<b>370,65</b>
	23DE50-10SV90E	M10	10,0	14,0	12,0	12,0	19	20	...R50/...50DGE1T	50	<b>360,10</b>
70	23DE70-8SV90E	M8	12,0	16,5	10,0	10,0	21	23	...R70/...70DGE1T	25	<b>465,00</b>
	23DE70-10SV90E	M10	12,0	16,5	12,0	12,0	21	23	...R70/...70DGE1T	25	<b>438,50</b>
	23DE70-12SV90E	M12	12,0	16,5	13,0	13,0	21	23	...R70/...70DGE1T	25	<b>493,00</b>
95	23DE95-8SV90E	M8	13,5	18,0	12,0	14,0	25	26	...R95/...95DGE1T	25	<b>459,00</b>
	23DE95-10SV90E	M10	13,5	18,0	12,0	17,0	25	26	...R95/...95DGE1T	25	<b>580,00</b>
	23DE95-12SV90E	M12	13,5	18,0	12,0	18,0	25	23	...R95/...95DGE1T	25	<b>580,00</b>
120	23DE120-10SV90E	M10	15,0	19,5	14,0	17,0	26	28	...R120/...120DGE1T	20	<b>691,50</b>

## Doorverbinders | Serie DEM

**Materiaal:** Electrolytisch koper (EN 13600)  
Galvanisch vertind

**Temp. Bereik:** tot +125 °C

**Voorschriften:** VDE-0220-2 NEN-EN-IEC 61238-1:2003

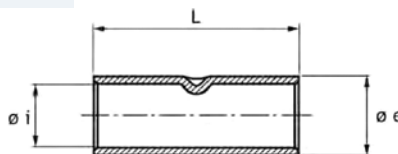

Kabel mm <sup>2</sup>	Bestelnummer	Afmetingen		L	Type matrijs	VPE in stk.	Brutoprijs €/100stk
		Øi	Øe				
6	23DEM 6	3,5	6,5	24	..R6	100	<b>42,05</b>
10	23DEM 10	4,5	7,0	28	..R10	100	<b>63,90</b>
16	23DEM 16	5,5	8,5	34	..R16	100	<b>90,30</b>
25	23DEM 25	7,0	10,0	38	..R25	100	<b>129,35</b>
35	23DEM 35	8,5	12,0	42	..R35	100	<b>151,05</b>
50	23DEM 50	10,0	14,0	48	..R50	50	<b>229,60</b>
70	23DEM 70	12,0	16,5	52	..R70	50	<b>290,30</b>
95	23DEM 95	13,5	18,0	59	..R95	50	<b>345,95</b>
120	23DEM 120	15,0	19,5	62	..R120	50	<b>414,50</b>
150	23DEM 150	16,5	21,0	72	..R150	50	<b>552,50</b>
185	23DEM 185	19,0	24,0	72	..R185	50	<b>703,00</b>
240	23DEM 240	21,0	26,0	82	..R240	50	<b>1011,00</b>
300	23DEM 300	23,5	29,5	102	..R300	25	<b>1149,50</b>
400	23DEM 400	27,0	34,0	102	..R400	25	<b>o.a.</b>

# Mecatraction kabelschoenen

DIN-buiskabelschoenen 6-240mm<sup>2</sup>



## Buiskabelschoenen | Serie YCA-TN 6 - 240 mm<sup>2</sup>

**Materiaal:** Electrolytisch koper (EN 13600)  
Galvanisch vertind

**Temp. Bereik:** tot +125 °C

**Voorschriften:** DIN 46235

**Karakteristieken**  
Afgeschuinde schachtingang

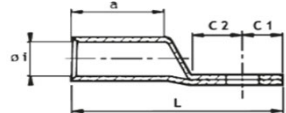
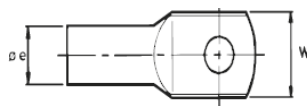

Kabel mm <sup>2</sup>	Bestelnummer	Bout	Afmetingen							Type matrijs	VPE in stk.	Brutoprijs €/100stk
			Øi	Øe	C1	C2	L	a	W			
6	23YCA06M5TN	M5	3,8	5,5	8	8	32	10	8,5	..K5	100	o.a.
	23YCA06M6TN	M6	3,8	5,5	8	8	32	10	8,5	..K5	100	o.a.
	23YCA06M8TN	M8	3,8	5,5	11	9	32	10	13	..K5	100	102,00
10	23YCA010M5TN	M5	4,5	6,0	8	8	35	10	12	..K6	100	165,00
	23YCA010M6TN	M6	4,5	6,0	8	8	35	10	15	..K6	100	170,00
	23YCA010M8TN	M8	4,5	6,0	10	10	39	10	17	..K6	100	190,00
16	23YCA016M6TN	M6	5,5	8,5	10	10	46	20	13	..K8	100	250,00
	23YCA016M8TN	M8	5,5	8,5	10	10	46	20	13	..K8	100	o.a.
	23YCA016M10TN	M10	5,5	8,5	13	13	49	20	17	..K8	100	245,00
	23YCA016M12TN	M12	5,5	8,5	12	12	48	20	18	..K8	100	o.a.
25	23YCA025M6TN	M6	7,0	10,0	10	10	48	20	14	..K10	100	310,00
	23YCA025M8TN	M8	7,0	10,0	10	10	48	20	16	..K10	100	290,00
	23YCA025M10TN	M10	7,0	10,0	13	13	51	20	17	..K10	100	275,00
	23YCA025M12TN	M12	7,0	10,0	13	13	51	20	19	..K10	100	320,00
35	23YCA035M6TN	M6	8,2	12,5	13	13	55	20	17	..K12	100	455,00
	23YCA035M8TN	M8	8,2	12,5	13	13	55	20	17	..K12	100	465,00
	23YCA035M10TN	M10	8,2	12,5	13	13	55	20	19	..K12	100	o.a.
	23YCA035M12TN	M12	8,2	12,5	13	13	55	20	21	..K12	100	o.a.
50	23YCA035M14TN	M14	8,2	12,5	13	13	55	20	21	..K12	100	o.a.
	23YCA050M8TN	M8	10,0	14,5	12	12	64	28	20	..K14	100	685,00
	23YCA050M10TN	M10	10,0	14,5	12	12	64	28	22	..K14	100	675,00
	23YCA050M12TN	M12	10,0	14,5	16	16	64	28	24	..K14	100	700,00
70	23YCA050M14TN	M14	10,0	14,5	16	16	68	28	24	..K14	100	o.a.
	23YCA050M16TN	M16	10,0	14,5	16	16	68	28	28	..K14	100	720,00
	23YCA070M8TN	M8	11,5	16,5	12	12	67	28	24	..K16	100	905,00
	23YCA070M10TN	M10	11,5	16,5	12	12	67	28	24	..K16	100	o.a.
95	23YCA070M12TN	M12	11,5	16,5	16	16	71	28	24	..K16	100	940,00
	23YCA070M14TN	M14	11,5	16,5	16	16	71	28	24	..K16	100	1050,00
	23YCA070M16TN	M16	11,5	16,5	16	16	71	28	30	..K16	100	720,00
	23YCA095M8TN	M8	13,5	19,0	14	13	79	35	28	..K18	50	o.a.
120	23YCA095M10TN	M10	13,5	19,0	14	13	79	35	28	..K18	50	1275,00
	23YCA095M12TN	M12	13,5	19,0	14	13	79	35	28	..K18	50	1225,00
	23YCA095M14TN	M14	13,5	19,0	16	16	81	35	28	..K18	50	o.a.
	23YCA095M16TN	M16	13,5	19,0	16	16	81	35	32	..K18	50	o.a.
150	23YCA095M20TN	M20	13,5	19,0	16	16	81	35	34	..K18	50	o.a.
	23YCA120M10TN	M10	15,5	21,0	13	13	83	35	32	..K20	50	1585,00
	23YCA120M12TN	M12	15,5	21,0	14	13	84	35	32	..K20	50	1565,00
	23YCA120M14TN	M14	15,5	21,0	14	13	84	35	32	..K20	50	o.a.
185	23YCA120M16TN	M16	15,5	21,0	17	16	90	35	32	..K20	50	o.a.
	23YCA120M20TN	M20	15,5	21,0	20	20	97	35	38	..K20	50	o.a.
	23YCA150M10TN	M10	17,0	23,5	13	13	91	35	34	..K22	50	2225,00
	23YCA150M12TN	M12	17,0	23,5	14	13	92	35	34	..K22	50	2020,00
240	23YCA150M14TN	M14	17,0	23,5	14	13	92	35	34	..K22	50	o.a.
	23YCA150M16TN	M16	17,0	23,5	17	16	98	35	34	..K22	50	o.a.
	23YCA150M20TN	M20	17,0	23,5	20	20	105	35	40	..K22	50	o.a.
	23YCA185M10TN	M10	19,0	25,5	13	13	95	40	37	..K25	50	2570,00
185	23YCA185M12TN	M12	19,0	25,5	14	13	96	40	37	..K25	50	2535,00
	23YCA185M14TN	M14	19,0	25,5	14	13	96	40	37	..K25	50	o.a.
	23YCA185M16TN	M16	19,0	25,5	17	16	102	40	37	..K25	50	o.a.
240	23YCAM185M20TN185	M20	19,0	25,5	20	20	109	40	40	..K25	50	o.a.
	23YCA240M12TN	M12	21,5	29,0	14	23	106	40	42	..K28	50	3265,00
	23YCA240M14TN	M14	21,5	29,0	14	23	106	40	42	..K28	50	o.a.
	23YCA240M16TN	M16	21,5	29,0	17	23	109	40	42	..K28	50	o.a.
23YCA240M20TN	M20	21,5	29,0	20	23	112	40	45	..K28	50	o.a.	

## Mecatraction kabelschoenen

DIN-buiskabelschoenen 300-1000mm<sup>2</sup>, doorverbinders, ongeïsoleerde kabelschoenen (pen)



### Buiskabelschoenen | Serie YCA-TN 300 - 1000 mm<sup>2</sup>

Kabel mm <sup>2</sup>	Bestelnummer	Bout	Afmetingen							Type matrijs	VPE in stk.	Brutoprijs €/100stk
			Øi	Øe	C1	C2	L	a	W			
300	23YCA300M14TN	M14	24,5	32,0	17	20	117	50	48	..K32	25	4725,00
	23YCA300M16YN	M16	24,5	32,0	17	20	117	50	48	..K32	25	o.a.
	23YCA300M20TN	M20	24,5	32,0	20	20	120	50	48	..K32	25	4790,00
400	23YCA400M14TN	M14	27,5	38,5	22	20	137	70	55	..K38	25	o.a.
	23YCA400M16TN	M16	27,5	38,5	22	20	137	70	55	..K38	25	-
	23YCA400M20TN	M20	27,5	38,5	22	20	137	70	55	..K38	25	-
500	23YCA500M16TN	M16	31,0	42,0	22	20	147	70	60	..K42	25	-
	23YCA500M20TN	M20	31,0	42,0	22	20	147	70	60	..K42	25	-
625/630	23YCA630M16TN	M16	34,5	44,0	22	20	157	80	60	..K44	10	-
	32YCA630M20TN	M20	34,5	44,0	22	20	157	80	60	..K44	10	-
800	23YCA800M20TN	M20	40,0	52,0	22	20	187	100	75	..K52	10	-
1000	23YCA1000M20TN1000	M20	44,0	58,0	22	20	187	100	85	..K58	10	-

### Doorverbinders | Serie YCS-TN

**Materiaal:** Electrolytisch koper (EN 13600)  
Galvanisch vertind  
**Temp. Bereik:** tot +125 °C  
**Voorschriften:** DIN 46267-1

**Karakteristieken**  
Afgeschuinde schachtingang

Kabel mm <sup>2</sup>	Bestelnummer	Afmetingen			Type matrijs	VPE in stk.	Brutoprijs €/100stk
		Øi	Øe	L			
6	23YCS06TN	3,8	5,5	30	..K5	100	o.a.
10	23YCS010TN	4,5	6,0	30	..K6	100	-
16	23YCS016TN	5,5	8,5	50	..K8	100	-
25	23YCS025TN	7,0	10,0	50	..K10	100	-
35	23YCS035TN	8,2	12,5	50	..K12	100	-
50	23YCS050TN	10,0	14,5	56	..K14	100	-
70	23YCS070TN	1,5	16,5	56	..K16	100	-
95	23YCS095TN	13,5	19,0	70	..K18	50	-
120	23YCS120TN	15,5	21,0	70	..K20	50	-
150	23YCS150TN	17,0	23,5	80	..K22	50	-
185	23YCS185TN	19,0	25,5	85	..K25	50	-
240	23YCS240TN	21,5	29,0	90	..K28	50	-
300	23YCS300TN	24,5	32,0	100	..K32	25	-
400	23YCS400TN	27,5	38,5	150	..K38	25	-
500	23YCS500TN	31,0	42,0	160	..K42	25	-
625/630	23YCS630TN	34,5	44,0	160	..K44	25	-
800	23YCS800TN	40,0	52,0	200	..K52	-	-
1000	23YCS1000TN	44,0	58,0	200	..K58	-	-

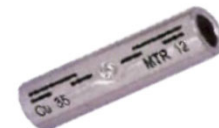
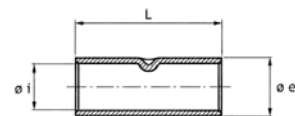

### Ongeïsoleerde kabelschoenen | Serie BYW-D

**Materiaal:** Electrolytisch koper  
Galvanisch vertind, pen gesoldeerd  
**Temp. Bereik:** tot +125 °C  
**Voorschriften:** DIN 46230

**Karakteristieken**  
Geschikt voor bedrading van 0,5 tot 95 mm<sup>2</sup>  
Uitvoering recht

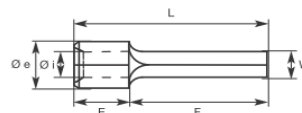

Kabel mm <sup>2</sup>	Bestelnummer	Afmetingen mm						Type Matrijs	VPE in stk.	Brutoprijs €/100stk
		Øi	Øe	F	E	L	W			
6-10	23BY10W13D	4,5	6,9	14,0	8,0	22,0	4,3	..DMB 10	100	71,60
10-16	23BY16W17D	5,8	8,4	16,0	10,0	26,0	5,5	..DMB 16	50	55,80
16-25	23BY25W17D	7,0	9,5	20,0	13,5	33,5	6,8	..DMB25	25	90,85
25-35	23BY35W23D	8,4	11,8	24,5	16,0	40,5	8,0	..DMB 35	25	206,65
35-50	23BY50W23D	9,6	13,6	26,0	19,0	45,0	9,5	..DMB50	25	357,50
50-70	23BY70W26D	11,4	15,8	31,0	24,0	55,0	11,0	..DMB 70	25	678,50
70-95	23BY95W26D	13,5	18,9	31,0	24,0	55,0	12,5	..DMB 95	25	987,50

# Mecatraction kabelschoenen

Ongeïsoleerde kabelschoenen (plaat), geïsoleerde buiskabelschoenen



## Ongeïsoleerde kabelschoenen | Serie MB

**Materiaal:** Elektrolytisch koper  
Galvanisch vertind

**Temp. Bereik:** tot +125 °C

**Voorschriften:** UL

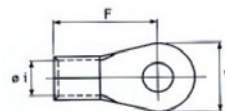

Koperader mm <sup>2</sup> massief - flexibel	Bestelnr.	Bout	Afmetingen mm			Type	VPE	Brutoprijs
			W	F	øi	matrijs	in stk.	€/stk
1,0 - 2,5	23MB2,5-4	M4	8,5	12,6	2,3	tang MB 524	100	13,95
	23MB2,5-5S	M5	8,5	12,6	2,3	tang MB 524	100	13,95
	23MB2,5-5	M5	9,5	12,1	2,3	tang MB 524	100	21,75
	23MB2,5-6	M6	12,0	15,8	2,3	tang MB 524	100	18,40
	23MB2,5-8	M8	12,0	15,9	2,3	tang MB 524	100	18,40
4,0 - 6,0	23MB6-4	M4	9,5	15,1	3,4	..MUJ6-8	100	34,65
	23MB6-5	M5	9,5	15,1	3,4	..MUJ6-8	100	22,15
	23MB6-6	M6	12,0	19,0	3,4	..MUJ6-8	100	29,95
	23MB6-8	M8	15,0	19,5	3,4	..MUJ6-8	100	29,95
	23MB6-10	M10	15,0	19,5	3,4	..MUJ6-8	100	46,00
6,0 - 10,0	23MB8-4	M4	12,0	17,8	4,5	..MUJ6-8	100	71,60
	23MB8-5	M5	12,0	17,8	4,5	..MUJ6-8	100	46,65
	23MB8-6	M6	12,0	17,8	4,5	..MUJ6-8	100	46,65
	23MB8-8	M8	15,0	22,3	4,5	..MUJ6-8	100	51,80
	23MB8-10	M10	15,0	22,3	4,5	..MUJ6-8	100	79,50
23MB8-12	M12	20,0	23,5	4,5	..MUJ6-8	100	o.a.	

## Geïsoleerde buiskabelschoenen | Serie PR-CU

**Materiaal:** Vertind koper

**Isolatiehuls :** Nylon

**Temp. Bereik:** tot +105 °C

**Karakteristieken**  
Uitvoering recht



Kabel mm <sup>2</sup>	Bestelnummer	Bout	Afmetingen					Isolatie max. ø	Type matrijs	VPE in stk.	Brutoprijs €/100stk
			øi	C1	C2	W	L				
10	23PR10-4CU	M4	4,6	5,3	3,8	11	34,5	8	MY70ME	100	105,95
	23PR10-5CU	M5	4,6	6,3	4,8	11	36,5	8	MY70ME	100	96,40
	23PR10-6CU	M6	4,6	7,3	5,8	11	38,5	8	MY70ME	100	96,40
	23PR10-8CU	M8	4,6	9,3	7,8	15	42,5	8	MY70ME	100	96,40
16	23PR10-10CU	M10	4,6	11,3	9,8	15	46,5	8	MY70ME	100	105,95
	23PR16-5CU	M5	5,8	6,3	4,8	12	40,0	9,4	MY70ME	100	o.a.
	23PR16-6CU	M6	5,8	7,3	5,8	12	42,0	9,4	MY70ME	100	102,50
	23PR16-8CU	M8	5,8	9,3	7,8	16	46,0	9,4	MY70ME	100	116,50
25	23PR16-10-CU	M10	5,8	11,3	9,8	16	50,0	9,4	MY70ME	100	o.a.
	23PR25-6CU	M6	7,0	7,3	5,8	14	45,5	11,5	MY70ME	100	162,00
	23PR25-8CU	M8	7,0	9,3	7,8	18	49,5	11,5	MY70ME	100	162,00
	23PR25-10CU	M10	7,0	11,3	9,8	18	53,5	11,5	MY70ME	100	162,00
35	23PR35-6CU	M6	8,9	7,3	5,8	17	50,5	14	MY70ME	50	168,50
	23PR35-8CU	M8	8,9	9,3	7,8	17	54,5	14	MY70ME	50	168,50
	23PR35-10CU	M10	8,9	11,3	9,8	19	58,5	14	MY70ME	50	168,50
50	23PR50-6CU	M6	10,0	7,3	5,8	19	57,0	15,5	MY70ME	50	193,80
	23PR50-8CU	M8	10,0	9,3	7,8	19	61,0	15,5	MY70ME	50	193,80
	23PR50-10CU	M10	10,0	11,3	9,8	19	65,0	15,5	MY70ME	50	193,80
70	23PR50-12CU	M12	10,0	13,8	11,3	22	69,0	15,5	MY70ME	50	o.a.
	23PR70-8CU	M8	11,3	9,3	7,8	22	67,0	18	MY70ME	25	291,00
	23PR70-10CU	M10	11,3	11,3	9,8	22	71,0	18	MY70ME	25	291,00
95	23PR70-12CU	M12	11,3	13,8	11,3	22	75,0	18	MY70ME	25	291,00
	23PR95-8CU	M8	13,5	9,3	7,8	26	71,5	20	MY286	25	856,00
	23PR95-10CU	M10	13,5	11,3	9,8	26	75,5	20	MY286	25	881,50
	23PR95-12CU	M12	13,5	13,8	11,3	26	79,5	20	MY286	25	856,00
120	23PR95-14CU	M14	13,5	15,3	13,8	26	83,5	20	MY286	25	o.a.
	23PR120-8F	M8	17,0	14,0	14,0	31	95,0	23	MY286	20	o.a.
	23PR120-10F	M10	17,0	14,0	14,0	31	95,0	23	MY286	20	o.a.
	23PR120-12F	M12	17,0	16,0	14,0	31	98,0	23	MY286	20	o.a.
23PR120-14F	M14	17,0	16,0	15,0	31	98,0	23	MY286	20	o.a.	
23PR120-16F	M16	17,0	16,0	15,0	31	98,0	23	MY286	20	o.a.	



# Mecatraction kabelschoenen



## Geïsoleerde penkabelschoenen | Serie EPR

**Materiaal:** Elektrolytisch koper, vertind  
**Isolatiekous:** Polyamide (halogeenvrij)  
**Voorschriften:** IEC 352-2

**Karakteristieken**  
 Gesoldeerd

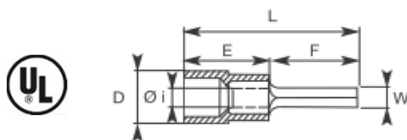

Kabel mm <sup>2</sup>	Bestelnummer	Afmetingen						VPE in stk.	Matrijs type	Kleur	Brutoprijs €/100stk
		W	F	L	E	Øi	D				
10	23EPR10-12	4,3	12	34,0	20,0	4,5	7,8	100	M470ME	●	98,85
16	23EPR16-13	5,5	13	40,7	24,7	5,8	10,8	100	M470ME	●	139,65
25	23EPR25-15	6,8	15	44,0	24,0	7,0	12,4	100	M470ME	●	185,15
35	23EPR35-20BK	8	20	52,5	28,0	8,4	14,0	100	M470ME	●	o.a.



## Messing verbindingselementen | 6,3 x 0,8 mm

Tek.	Bestelnummer	Afmetingen						Materiaal	Brutoprijs €/100stk
		D	L1	L2	L3	L4	A		
1	2301112V	4,2	10	8	8	9	45°	bl. koper	11,55
1	230113V	5,2	10	8	8	9	45°	bl. koper	11,55
2	2301122V	4,2	10	8	8	9	90°	bl. koper	11,55
2	2301122DV	4,2	10	8	8	9	90°	tinplated	11,55
3	2301212V	4,2	10	8	8	10	45°	bl. koper	11,15
3	2301213V	5,2	10	8	8	10	45°	bl. koper	11,15

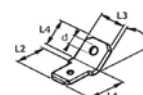

Tek. 1

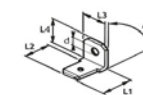

Tek. 2

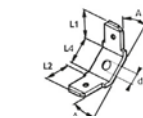

Tek. 3

### Koffer 23COFTN50HXDE

Inhoud	Buiskabelschoen	Aantal
DE6-6SV	6 mm <sup>2</sup> M6	25
DE6-8SV	6 mm <sup>2</sup> M8	25
DE10-6SV	10 mm <sup>2</sup> M6	25
DE10-8SV	10mm <sup>2</sup> M8	25
DE16-8SV	16 mm <sup>2</sup> M8	25
DE16-10SV	16 mm <sup>2</sup> M10	25
DE25-8SV	25 mm <sup>2</sup> M8	25
DE25-10SV	25 mm <sup>2</sup> M10	25
DE35-8SV	35 mm <sup>2</sup> M8	20
DE35-10SV	35 mm <sup>2</sup> M10	20
DE50-10SV	50 mm <sup>2</sup> M10	20
DE50-12SV	50 mm <sup>2</sup> M12	20
CK05 perstang	6 - 50 mm <sup>2</sup>	1



€ 296,45

Perstang voor ongeïsoleerde  
kabelschoenen met verstelbare  
persinzet 6 - 50 mm<sup>2</sup>



Bestelnr. 15-CK05    lengte 385mm

Perstang voor ongeïsoleerde  
kabelschoenen met verstelbare  
persinzet 10 - 120 mm<sup>2</sup>



Bestelnr. 15-CK06    lengte 650mm

Hydraulische perstang 60kN met  
ingebouwde elektromotor



Bestelnr. 90JB-APE6-22

Gereedschap voor de verwerking van kabelschoenen zie hoofdstuk 10 gereedschap









# KABELDOORVOER

---

4

# Jacob kabelwartels metrisch

Kunststof: serie Perfect: wartels, zeskantmoeren, blindstoppen met schroefdraad

## Wartels | Serie Perfect halogeenvrij

<b>Materiaal:</b>	Polyamide (PA6 V2)
<b>Temp.bereik:</b>	-20°C tot + 100°C, -40°C kortstondig
<b>Beschermklasse:</b>	IP68 (tot 5 bar)
<b>Voorschriften:</b>	EN 50262 / UL 514B
<b>UL/CSA-filenr.:</b>	E140310



### Karakteristieken

Wordt geleverd met neopreen binnenring.  
Geïntegreerde trekcontlasting met een ruim klembereik.  
Gemakkelijk te installeren.

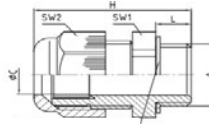

dichting vanaf M32

## Wartels | Serie Perfect (50.6xx PAzzzz)

Bestelnummer	Bestelnummer	Bestelnummer	Tapmaat	Klem- bereik ø	VPE	Brutoprijs €/100stk.	
Grijs - RAL7035	Grijs - RAL7001	Zwart - RAL9005	L				
25-50.612 PA7035	25-50.612 PA7001	25-50.612 PA/SW	M12x1,5	8	3-6	100	<b>32,15</b>
25-50.616 PA7035	25-50.616 PA7001	25-50.616 PA/SW	M16x1,5	8	5-10	100	<b>36,35</b>
25-50.620 PA7035	25-50.620 PA7001	25-50.620 PA/SW	M20x1,5	8	8-13	100	<b>45,05</b>
25-50.625 PA7035	25-50.625 PA7001	25-50.625 PA/SW	M25x1,5	8	11-17	50	<b>69,65</b>
25-50.632 PA7035	25-50.632 PA7001	25-50.632 PA/SW	M32x1,5	10	15-21	25	<b>126,60</b>
25-50.640 PA7035	25-50.640 PA7001	25-50.640 PA/SW	M40x1,5	10	19-28	10	<b>311,40</b>
25-50.650 PA7035	25-50.650 PA7001	25-50.650 PA/SW	M50x1,5	12	27-35	5	<b>387,45</b>
25-50.663 PA7035	25-50.663 PA7001	25-50.663 PA/SW	M63x1,5	12	32-42	5	<b>462,50</b>



## Wartels | Serie Perfect Lange tap (50.6xx PAzzzzL)

Bestelnummer	Bestelnummer	Bestelnummer	Tapmaat	Klem- bereik ø	VPE	Brutoprijs €/100stk.	
Grijs - RAL7035	Grijs - RAL7001	Zwart - RAL9005	L				
25-50.612 PA7035L	25-50.612 PA7001L	25-50.612 PA/SWL	M12x1,5	15	3-6	100	<b>62,25</b>
25-50.616 PA7035L	25-50.616 PA7001L	25-50.616 PA/SWL	M16x1,5	15	5-10	100	<b>64,85</b>
25-50.620 PA7035L	25-50.620 PA7001L	25-50.620 PA/SWL	M20x1,5	15	8-13	100	<b>79,80</b>
25-50.625 PA7035L	25-50.625 PA7001L	25-50.625 PA/SWL	M25x1,5	15	11-17	50	<b>116,60</b>
25-50.632 PA7035L	25-50.632 PA7001L	25-50.632 PA/SWL	M32x1,5	15	15-21	25	<b>178,35</b>
25-50.640 PA7035L	25-50.640 PA7001L	25-50.640 PA/SWL	M40x1,5	18	19-28	10	<b>672,00</b>
25-50.650 PA7035L	25-50.650 PA7001L	25-50.650 PA/SWL	M50x1,5	18	27-35	5	<b>1.284,55</b>
25-50.663 PA7035L	25-50.663 PA7001L	25-50.663 PA/SWL	M63x1,5	18	32-42	5	<b>1.430,00</b>



## Zeskantmoeren | (50.2xx PAzzzz)

Bestelnummer	Bestelnummer	Bestelnummer	Tapmaat	Sleutel- dikte	Sleutel- aanzet	VPE	Brutoprijs €/100stk.
Grijs - RAL7035	Grijs - RAL7001	Zwart - RAL9005					
25-50.212 PA7035	25-50.212 PA7001	25-50.212 PA/SW	M12x1,5	5	17	100	<b>11,05</b>
25-50.216 PA7035	25-50.216 PA7001	25-50.216 PA/SW	M16x1,5	5	22	100	<b>10,25</b>
25-50.220 PA7035	25-50.220 PA7001	25-50.220 PA/SW	M20x1,5	6	27	100	<b>11,45</b>
25-50.225 PA7035	25-50.225 PA7001	25-50.225 PA/SW	M25x1,5	6	32	100	<b>15,25</b>
25-50.232 PA7035	25-50.232 PA7001	25-50.232 PA/SW	M32x1,5	7	41	100	<b>29,00</b>
25-50.240 PA7035	25-50.240 PA7001	25-50.240 PA/SW	M40x1,5	7	50	50	<b>81,30</b>
25-50.250 PA7035	25-50.250 PA7001	25-50.250 PA/SW	M50x1,5	8	60	50	<b>113,75</b>
25-50.263 PA7035	25-50.263 PA7001	25-50.263 PA/SW	M63x1,5	8	75	50	<b>164,10</b>



## Blindstop met schroefdraad | IP54 (10.xx15 PAzzzz)

Bestelnummer	Bestelnummer	Bestelnummer	Tapmaat	VPE	Brutoprijs €/100stk.	
Grijs - RAL7035	Grijs - RAL7001	Zwart - RAL9005	L			
25-10.1215PA7035	25-10.1215 PA	25-10.1215PA/SW	M12x1,5	6	100	<b>16,20</b>
25-10.1615PA7035	25-10.1615 PA	25-10.1615PA/SW	M16x1,5	6	100	<b>18,15</b>
25-10.2015PA7035	25-10.2015 PA	25-10.2015PA/SW	M20x1,5	6	100	<b>18,40</b>
25-10.2515PA7035	25-10.2515 PA	25-10.2515PA/SW	M25x1,5	8	100	<b>25,60</b>
25-10.3215PA7035	25-10.3215 PA	25-10.3215PA/SW	M32x1,5	8	100	<b>44,95</b>
25-10.4015PA7035	25-10.4015 PA	25-10.4015PA/SW	M40x1,5	8	50	<b>104,00</b>
25-10.5015PA7035	25-10.5015 PA	25-10.5015PA/SW	M50x1,5	10	50	<b>137,00</b>
25-10.6315PA7035	25-10.6315 PA	25-10.6315PA/SW	M63x1,5	12	50	<b>170,40</b>

Kunststof: PA6 GF30 / Temperatuurbereik: -30°C tot + 100°C



# Jacob kabelwartels metrisch

Kunststof: serie Perfect FIX, spiraalknikbescherming, blindstoppen, reduceer- en vergrootringen

**Jacob**

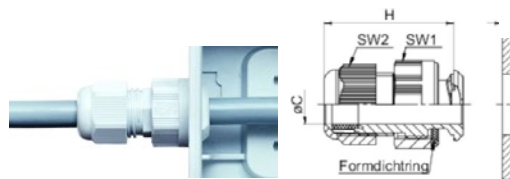

**Snelle montage zonder moer**

## Wartels | Serie Perfect FIX (K341-1xxx-zz)

Bestelnummer Grijs - RAL7035	Bestelnummer Grijs - RAL7001	Bestelnummer Zwart - RAL9005	Tapmaat	Klem- bereik ø mm	VPE	Brutoprijs €/100stk.
● 25-K341-1016-00	● 25-K341-1016-01	● 25-K341-1016-02	M16x1,5	5-10	100	<b>56,75</b>
● 25-K341-1020-00	● 25-K341-1020-01	● 25-K341-1020-02	M20x1,5	8-13	100	<b>66,10</b>
● 25-K341-1025-00	● 25-K341-1025-01	● 25-K341-1025-02	M25x1,5	11-17	50	<b>103,20</b>
● 25-K341-1032-00	● 25-K341-1032-01	● 25-K341-1032-02	M32x1,5	15-21	25	<b>189,25</b>

Kunststof: PA6 V2, temperatuurbereik: -20°C tot + 100°C



## Wartels | Perfect Spiraalknikbescherming (500xx PABSzzzz)

Bestelnummer Grijs - RAL7035	Bestelnummer Grijs - RAL7001	Bestelnummer Zwart - RAL9005	Tapmaat	L	Klem- bereik ø mm	VPE	Brutoprijs €/100stk.
● 25-50007M12BS7035	● 25-50007M12PABS	● 25-50007M12BSSW	M12x1,5	8	3-65	100	<b>110,70</b>
● 25-50011M16BS7035	● 25-50011M16PABS	● 25-50011M16BSSW	M16x1,5	15	5-10	100	<b>71,20</b>
● 25-50013M20BS7035	● 25-50013M20PABS	● 25-50013M20BSSW	M20x1,5	11	6-12	50	<b>112,65</b>
● 25-50016M20BS7035	● 25-50016M20PABS	● 25-50016M20BSSW	M20x1,5	15	10-14	25	<b>164,65</b>
● 25-50021M25BS7035	● 25-50021M25PABS	● 25-50021M25BSSW	M25x1,5	15	13-18	25	<b>o.a.</b>

Kunststof: PA6 V2, temperatuurbereik: -20°C tot + 100°C



## Blindstoppen | (WJ-DM xx-VPA)

Bestelnummer Grijs - RAL7035	Bestelnummer Zwart - RAL9005	Tapmaat	Diameter mm Da / Da1	H	VPE	Brutoprijs €/100stk.
● 25-WJ-DM 12-VPA	● 25-WJ-DM 12-VPA/SW	M12	10 / 5,5	9	50	<b>23,00</b>
● 25-WJ-DM 16-VPA	● 25-WJ-DM 16-VPA/SW	M16	13,5 / 9,5	12	50	<b>19,25</b>
● 25-WJ-DM 16-1-VPA		M16	13,5 / 9,0	14	50	<b>29,00</b>
● 25-WJ-DM 20-VPA	● 25-WJ-DM 20-VPA/SW	M20	16,5 / 12	12	50	<b>24,40</b>
● 25-WJ-DM 25-VPA	● 25-WJ-DM 25-VPA/SW	M25	20,5 / 16	15	50	<b>27,05</b>
● 25-WJ-DM 32-VPA		M32	24,5 / 20	17	25	<b>28,85</b>
● 25-WJ-DM 40-VPA		M40	32 / 27	20	10	<b>96,65</b>
● 25-WJ-DM 50-VPA		M50	39 / 35	25	5	<b>100,25</b>
● 25-WJ-DM 63-VPA		M63	52 / 42	25	5	<b>122,45</b>

Kunststof: PA6 GF30 / Temperatuurbereik: -30°C tot + 100°C



## Reduceer- en vergrootringen | (MxxMxx Pazzzz / MxxMxxPA)

Bestelnummer Grijs - RAL7035	Bestelnummer Zwart - RAL9005	Tapmaat		Lengte	VPE	Brutoprijs €/100stk.
Reduceerringen		Buiten	Binnen			
● 25-M16M12 PA	● 25-M16M12PA/SW	M16x1,5	M12x1,5	8	100	<b>48,10</b>
● 25-M20M12 PA	● 25-M20M12PA/SW	M20x1,5	M12x1,5	8	100	<b>50,90</b>
● 25-M20M16 PA	● 25-M20M16PA/SW	M20x1,5	M16x1,5	8	100	<b>50,90</b>
● 25-M25M12 PA	● 25-M25M12PA/SW	M25x1,5	M12x1,5	8	100	<b>59,05</b>
● 25-M25M16 PA	● 25-M25M16PA/SW	M25x1,5	M16x1,5	8	100	<b>59,05</b>
● 25-M25M20 PA	● 25-M25M20PA/SW	M25x1,5	M20x1,5	8	100	<b>58,70</b>
● 25-M32M12 PA	● 25-M32M12PA/SW	M32x1,5	M12x1,5	10	50	<b>88,00</b>
● 25-M32M16 PA	● 25-M32M16PA/SW	M32x1,5	M16x1,5	10	50	<b>88,00</b>
● 25-M32M20 PA	● 25-M32M20PA/SW	M32x1,5	M20x1,5	10	50	<b>88,00</b>
● 25-M32M25 PA	● 25-M32M25PA/SW	M32x1,5	M25x1,5	10	50	<b>88,00</b>
● 25-M40M16 PA	● 25-M40M16PA/SW	M40x1,5	M16x1,5	10	50	<b>184,60</b>
● 25-M40M20 PA	● 25-M40M20PA/SW	M40x1,5	M20x1,5	10	50	<b>184,60</b>
● 25-M40M25 PA	● 25-M40M25PA/SW	M40x1,5	M25x1,5	10	50	<b>184,60</b>
● 25-M40M32 PA	● 25-M40M32PA/SW	M40x1,5	M32x1,5	10	50	<b>184,60</b>
● 25-M50M20 PA	● 25-M50M20PA/SW	M50x1,5	M20x1,5	12	25	<b>325,10</b>
● 25-M50M25 PA	● 25-M50M25PA/SW	M50x1,5	M25x1,5	12	25	<b>325,10</b>
● 25-M50M32 PA	● 25-M50M32PA/SW	M50x1,5	M32x1,5	12	25	<b>325,10</b>
● 25-M50M40 PA	● 25-M50M40PA/SW	M50x1,5	M40x1,5	12	25	<b>325,10</b>
● 25-M63M25 PA	● 25-M63M25PA/SW	M63x1,5	M25x1,5	12	25	<b>562,55</b>
● 25-M63M32 PA	● 25-M63M32PA/SW	M63x1,5	M32x1,5	12	25	<b>562,55</b>
● 25-M63M40 PA	● 25-M63M40PA/SW	M63x1,5	M40x1,5	12	25	<b>646,90</b>
● 25-M63M50 PA	● 25-M63M50PA/SW	M63x1,5	M50x1,5	12	25	<b>562,55</b>
Vergrootringen						
● 25-M12M16PA		M12x1,5	M16x1,5	8	100	<b>60,20</b>
● 25-M16M20PA	● 25-M16M20PA/SW	M16x1,5	M20x1,5	8	100	<b>66,50</b>
● 25-M20M25PA	● 25-M20M25PA/SW	M20x1,5	M25x1,5	8	100	<b>80,20</b>
● 25-M25M32PA	● 25-M25M32PA/SW	M25x1,5	M32x1,5	8	50	<b>255,00</b>
● 25-M32M40PA		M32x1,5	M40x1,5	10	50	<b>397,45</b>

Kunststof: PA6 GF30 / Temperatuurbereik: -30°C tot + 100°C

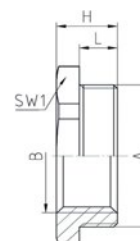

# Jacob kabelwartels metrisch

Kunststof: adapters, verloopingen, meervoudige kabeldoorvoer

**Jacob**

## Adapters en verloopingen | (PGxxMxxPA / 063xxMxxPAU)

Bestelnummer	Tapmaat		Sleutel- aanzet	VPE	Brutoprijs €/100stk.
	buiten	binnen			
<b>PG naar Metrisch</b>					
● 25-PG9M12PA	PG9	M12X1,5	19	100	71,50
● 25-PG9M16PA	PG9	M16X1,5	20	100	71,50
● 25-PG9M20PA	PG9	M20X1,5	24	100	71,50
● 25-PG11M16PA	PG11	M16X1,5	22	100	76,75
● 25-PG11M20PA	PG11	M20X1,5	24	100	76,75
● 25-PG13M16PA	PG13,5	M16X1,5	24	100	82,40
● 25-PG13M20PA	PG13,5	M20X1,5	24	100	82,40
● 25-PG13M25PA	PG13,5	M25X1,5	30	100	82,40
● 25-PG16M20PA	PG16	M20X1,5	27	100	92,00
● 25-PG16M25PA	PG16	M25X1,5	30	50	92,00
● 25-PG21M25PA	PG21	M25X1,5	33	50	105,65
● 25-PG21M32PA	PG21	M32X1,5	37	50	105,65
● 25-PG29M32PA	PG29	M32X1,5	42	50	144,30
● 25-PG29M40PA	PG29	M40X1,5	45	50	144,30
<b>Metrisch naar PG</b>					
● 25-06307M12PAU	M12X1,5	PG7	15	100	31,00
● 25-06309M12PAU	M12X1,5	PG9	19	100	34,85
● 25-06309M16PAU	M16X1,5	PG9	19	100	40,30
● 25-06311M20PAU	M20X1,5	PG11	22	100	44,45
● 25-06313M20PAU	M20X1,5	PG13,5	24	100	53,40
● 25-06316M20PAU	M20X1,5	PG16	27	100	66,90
● 25-06316M25PAU	M25X1,5	PG16	27	50	64,40
● 25-06321M25PAU	M25X1,5	PG21	32	50	68,45
● 25-06321M32PAU	M32X1,5	PG21	36	25	144,50
● 25-06329M32PAU	M32X1,5	PG29	42	25	136,80
● 25-06329M40PAU	M40X1,5	PG29	42	10	155,15
● 25-06336M50PAU	M50X1,5	PG36	53	10	320,30
● 25-06342M50PAU	M50X1,5	PG42	60	10	733,40
● 25-06348M63PAU	M63X1,5	PG48	65	10	815,93

Kunststof: PA6 GF30 / Temperatuurbereik: -30°C tot + 100°C

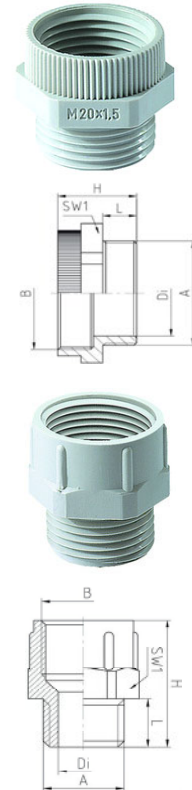

## Binnenring | Meervoudige kabeldoorvoer (WJ-DM xx/zXz)

Bestelnummer	n x Di	Maat wartel	H	Da	VPE	Brutoprijs €/100stk.
25-WJ-DM 12/2X1.6	2x1,6	M12	6,6	8,5	50	48,85
25-WJ-DM 12/4x2	4x2	M12	6,6	8,5	50	43,85
25-WJ-DM 16/2x4	2x4	M12	7,6	11,7	50	36,80
25-WJ-DM 16/2x4.5	2x4,5	M16	7,6	11,7	50	49,55
25-WJ-DM 16/4x3.5	4x3,5	M16	7,6	11,7	50	36,80
25-WJ-DM 20/2x4	2x4	M20	7,5	15,1	50	44,05
25-WJ-DM 20/2x6	2x6	M20	7,5	15,1	50	44,05
25-WJ-DM 20/4x5	4x5	M20	7,5	15,1	50	44,05
25-WJ-DM 25/2x6	2x6	M25	9,3	19,8	50	53,25
25-WJ-DM 25/2x8	2x8	M25	9,3	19,8	50	46,40
25-WJ-DM 25/3x4	3x4	M25	9,3	19,8	50	73,65
25-WJ-DM 25/3x6	3x6	M25	9,3	19,8	50	46,40
25-WJ-DM 25/3x7	3x7	M25	9,3	19,8	50	53,25
25-WJ-DM 25/4x5	4x5	M25	9,3	19,8	50	73,65
25-WJ-DM 25/4x6	4x6	M25	9,3	19,8	50	46,40
25-WJ-DM 25/4x6.5	4x6,5	M25	9,3	19,8	50	46,40
25-WJ-DM 25/5x4	5x4	M25	9,3	19,8	50	73,10
25-WJ-DM 25/6x4	6x4	M25	9,3	19,8	50	46,40
25-WJ-DM 32/2x8	2x8	M32	12,5	25,1	25	114,25
25-WJ-DM 32/3x8	3x8	M32	12,5	25,1	25	114,25
25-WJ-DM 32/4x7	4x7	M32	12,5	25,1	25	114,25
25-WJ-DM 32/4x8	4x8	M32	12,5	25,1	25	178,05
25-WJ-DM 32/4x8.5	4x8,5	M32	12,5	25,1	25	190,50
25-WJ-DM 32/6x4	6x4	M32	12,5	25,1	25	190,50
25-WJ-DM 32/6x6	6x6	M32	12,5	25,1	25	114,25
25-WJ-DM 40/4x10	4x10	M40	15,0	32,3	10	199,50
25-WJ-DM 40/5x8.5	6x6	M40	15,0	32,3	10	199,50
25-WJ-DM 40/8x6.5	4x10	M40	15,0	32,3	10	199,50

Kunststof: TPE TPS / Temperatuurbereik: -30°C tot + 100°C

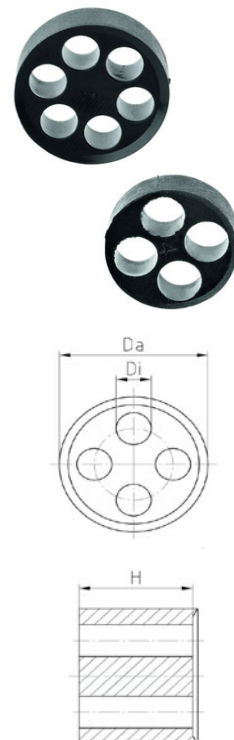

# Jacob kabelwartels metrisch

Messing: serie Perfect: wartels, zeskantmoeren, blindstoppen met schroefdraad

**Jacob**

## Wartels | Serie Perfect Messing

**Materiaal:** Messing vernikkeld (CuZn39Pb3)  
**Temp.bereik:** -20°C tot + 100°C  
**Beschermklasse:** IP68 (tot 5 bar) / IP69K\*  
**Voorschriften:** EN 50262 / UL 514B  
**UL/CSA-filenr:** E140310

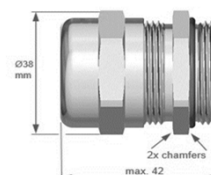
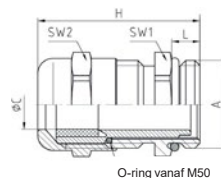
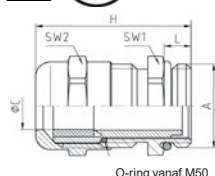

### Karakteristieken

Wordt geleverd met neopreen binnenring.  
 Geïntegreerde trekantasting met een ruim klembereik.  
 Gemakkelijk te installeren.

## Wartel | Serie Perfect (50.6xx M)

Bestelnummer	Taplengte L	VPE	Brutoprijs €/100stk.
<b>Normale Tap</b>			
25-50.612 M *	5	100	<b>327,30</b>
25-50.616 M *	5	100	<b>348,85</b>
25-50.620 M *	6	100	<b>353,70</b>
25-50.625 M *	7	50	<b>475,85</b>
25-50.632 M	8	25	<b>823,15</b>
25-50.640 M	8	10	<b>1.299,55</b>
25-50.650 M *	9	5	<b>2.504,25</b>
25-50.663 M *	10	5	<b>4.503,00</b>
25-50.663 M1	10	5	<b>4.503,00</b>

## Wartel | Serie Perfect lange tap (50.6xx M-L)

Bestelnummer	Taplengte L	VPE	Brutoprijs €/100stk.	Tapmaat	Klembereik ø mm
<b>Lange Tap</b>					
25-50.612 M-L	10	100	<b>344,30</b>	M12x1,5	3-6
25-50.616 M-L	10	100	<b>526,80</b>	M16x1,5	5-9
25-50.620 M-L	10	100	<b>509,55</b>	M20x1,5	9-13
25-50.625 M-L	11	50	<b>881,40</b>	M25x1,5	11-16
25-50.632 M-L	13	25	<b>1.438,15</b>	M32x1,5	14-21
25-50.640 M-L	13	10	<b>2.208,20</b>	M40x1,5	19-27
25-50.650 M-L	14	5	<b>3.547,65</b>	M50x1,5	24-35
25-50.663 M-L	14	5	<b>6.217,85</b>	M63x1,5	32-42
25-50.663 M1/L	14	5	<b>6.217,85</b>	M63x1,5	38-48

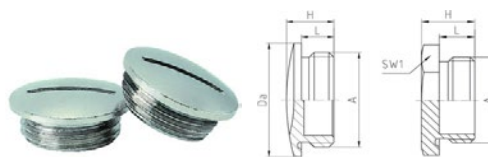

## Zeskantmoeren | (50.2xx M)

Temperatuurbereik: -60°C tot +200°C

Bestelnummer	Dikte H	Tapmaat	VPE	Brutoprijs €/100stk.
25-50.212 M	2,8	M12x1,5	100	<b>32,65</b>
25-50.216 M	2,8	M16x1,5	100	<b>40,30</b>
25-50.220 M	3	M20x1,5	100	<b>44,85</b>
25-50.225 M	3,5	M25x1,5	100	<b>69,15</b>
25-50.232 M	4	M32x1,5	100	<b>83,05</b>
25-50.240 M	5	M40x1,5	50	<b>142,35</b>
25-50.250 M	5	M50x1,5	50	<b>382,50</b>
25-50.263 M	6	M63x1,5	50	<b>499,40</b>

## Blindstop met schroefdraad | IP54 (10.xx15)

Temperatuurbereik: -60°C tot +200°C

Bestelnummer	Tapmaat	VPE	Brutoprijs €/100stk.
25-10.1215	M12x1,5	100	<b>80,65</b>
25-10.1615	M16x1,5	100	<b>90,90</b>
25-10.2015	M20x1,5	100	<b>102,10</b>
25-10.2515	M25x1,5	100	<b>179,85</b>
25-10.3215	M32x1,5	100	<b>309,00</b>
25-10.4015	M40x1,5	50	<b>480,25</b>
25-10.5015	M50x1,5	50	<b>718,90</b>
25-10.6315	M63x1,5	50	<b>1.371,90</b>

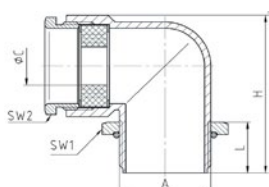

## Wartel | Haaks IP55 (21.7xxM)

Temperatuurbereik: -20°C tot +100°C

Bestelnummer	Taplengte L	VPE	Brutoprijs €/100stk.	Tapmaat	Klembereik ø mm
25-21.716M	16	100	<b>1.543,40</b>	M16x1,5	5-9
25-21.720M	16	50	<b>1.949,40</b>	M20x1,5	7-13
25-21.725M	16,5	50	<b>2.477,35</b>	M25x1,5	8,5-16
25-21.732M	18,5	25	<b>3.248,80</b>	M32x1,5	14-21

# Jacob kabelwartels metrisch

Messing: serie Perfect: wartels EMC, zeskantmoeren EMC

Jacob

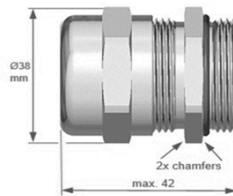
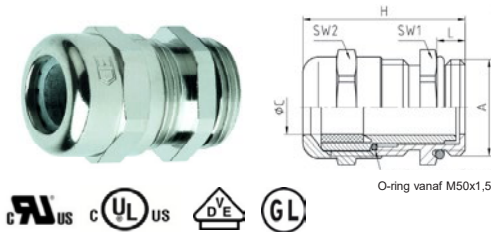

## Wartel | Serie Perfect EMC (50.6xx M/EMV)

Bestelnummer	Taplengte L	VPE	Brutoprijs €/100stk.
<b>Normale Tap</b>			
25-50.612 M/EMV	5	100	392,60
25-50.616 M/EMV	5	100	501,90
25-50.620 M/EMV	6	100	604,85
25-50.625 M/EMV	7	50	913,80
25-50.632 M/EMV	8	25	1.572,70
25-50.640 M/EMV	8	10	2.400,15
25-50.650 M/EMV	9	5	4.491,10
25-50.663 M/EMV	10	5	6.132,20
25-50.663 M1/EMV	10	5	7.213,70

## Wartel | Serie Perfect EMC lange tap (50.6xx M/EMV)

Bestelnummer	Taplengte L	VPE	Brutoprijs €/100stk.	Tapmaat	Klem- bereik ø mm
<b>Lange Tap</b>					
25-50.612M/EMV/L	10	100	513,30	M12x1,5	3-6
25-50.616M/EMV/L	10	100	543,00	M16x1,5	5-9
25-50.620M/EMV/L	10	100	623,90	M20x1,5	9-13
25-50.625M/EMV/L	11	50	1.013,95	M25x1,5	11-16
25-50.632M/EMV/L	13	25	1.770,40	M32x1,5	14-21
25-50.640M/EMV/L	13	10	2.828,25	M40x1,5	19-27
25-50.650M/EMV/L	14	5	5.985,00	M50x1,5	24-35
25-50.663M/EMV/L	14	5	7.550,50	M63x1,5	32-42
25-50.663M1/EMV/L	14	5	8.816,90	M63x1,5	38-48

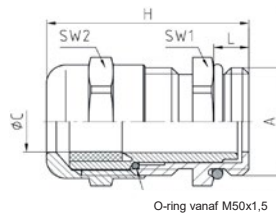

## Wartel | Serie Perfect EMC (50.6xx M/EMVD)

Bestelnummer	Taplengte L	VPE	Brutoprijs €/100stk.
<b>Normale Tap</b>			
25-50.616 M/EMVD	5	100	598,55
25-50.620 M/EMVD	6	100	722,95
25-50.625 M/EMVD	7	100	1.007,90
25-50.632 M/EMVD	8	50	1.689,70
25-50.640 M/EMVD	8	25	2.971,50
25-50.650 M/EMVD	9	10	5.525,50
25-50.663 M/EMVD	10	5	7.455,40

## Wartel | Serie Perfect EMC lange tap (50.6xx M/EMVDL)

Bestelnummer	Taplengte L	VPE	Brutoprijs €/100stk.	Tapmaat	Klem- bereik ø mm
<b>Lange Tap</b>					
25-50.616 M/EMVDL	10	100	783,95	M16x1,5	5-9
25-50.620 M/EMVDL	10	100	1.265,45	M20x1,5	9-13
25-50.625 M/EMVDL	11	50	1.670,45	M25x1,5	11-16
25-50.632 M/EMVDL	13	25	2.565,05	M32x1,5	14-21
25-50.640 M/EMVDL	13	10	4.284,75	M40x1,5	19-27
				M50x1,5	24-35
				M63x1,5	32-42

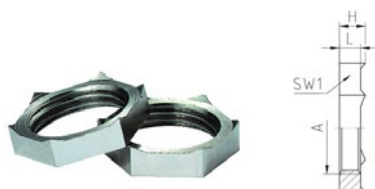

## Zeskantmoeren | EMC (50.2xx MPOT)

Temperatuurbereik: -60°C tot +200°C

Bestelnummer	Dikte H	VPE	Brutoprijs €/100stk.	Tapmaat
25-50.212 YPOT	5,5	100	196,30	M12x1,5
25-50.216 YPOT	5,5	100	159,38	M16x1,5
25-50.220 YPOT	5,5	100	280,00	M20x1,5
25-50.225 YPOT	5,5	100	289,55	M25x1,5
25-50.232 YPOT	5,5	100	426,55	M32x1,5
25-50.240 YPOT	6	50	683,50	M40x1,5
25-50.250 YPOT	6	50	1.530,60	M50x1,5
25-50.263 YPOT	7	50	1.674,60	M63x1,5



EMC serie EMVD voor snelle montage



# Jacob kabelwartels metrisch

Messing: reduceer- en vergrotringen, adapters, verloopringen

## Reduceer- en Vergrotringen | (MxxMxx / MxxMxx/FR)

Temperatuurbereik: -60°C tot +200°C

Bestelnummer	Tapmaat		Dikte H	VPE	Brutoprijs €/100stk.
	Buiten	Binnen			
<b>Reduceerringen</b>					
25-M16M12	M16x1,5	M12x1,5	8,5	100	108,50
25-M20M12	M20x1,5	M12x1,5	9	100	129,70
25-M20M16	M20x1,5	M16x1,5	9	100	113,00
25-M25M16	M25x1,5	M16x1,5	10	100	254,00
25-M25M20	M25x1,5	M20x1,5	10	100	212,75
25-M32M20	M32x1,5	M20x1,5	11,5	50	379,80
25-M32M25	M32x1,5	M25x1,5	11,5	50	305,95
25-M40M25	M40x1,5	M25x1,5	12,5	50	617,00
25-M40M32	M40x1,5	M32x1,5	12,5	50	506,50
25-M50M32	M50x1,5	M32x1,5	14	25	846,05
25-M50M40	M50x1,5	M40x1,5	14	25	686,75
25-M63M40	M63x1,5	M40x1,5	14	10	1.555,45
25-M63M50	M63x1,5	M50x1,5	14	10	1.402,55
<b>Vergrotringen</b>					
25-M12M16/FR	M12x1,5	M16x1,5	16	100	137,05
25-M16M20/FR	M16x1,5	M20x1,5	16,5	100	176,20
25-M20M25/FR	M20x1,5	M25x1,5	18,5	50	268,95
25-M25M32/FR	M25x1,5	M32x1,5	20,5	25	338,20
25-M32M40/FR	M32x1,5	M40x1,5	23,5	25	534,50
25-M40M50/FR	M40x1,5	M50x1,5	30	10	845,75
25-M50M63/FR	M50x1,5	M63x1,5	32,5	10	2.047,05

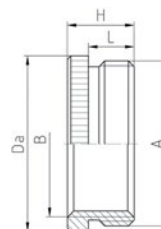

4

## Adapters en verloopringen | (PGxxMxx / MxxPGxx/OM)

Temperatuurbereik: -60°C tot +200°C

Bestelnummer	Tapmaat		Dikte H	VPE	Brutoprijs €/100stk.
	Buiten	Binnen			
<b>PG naar Metrisch</b>					
25-PG7M12	Pg 7	M12x1,5	15	100	192,55
25-PG9M16	Pg 9	M16x1,5	16	100	195,05
25-PG11M16	Pg 11	M16x1,5	16	100	195,70
25-PG13M20	Pg 13,5	M20x1,5	17,5	100	273,55
25-PG16M20	Pg 16	M20x1,5	17,5	100	239,85
25-PG16M25	Pg 16	M25x1,5	18,5	100	315,00
25-PG21M25	Pg 21	M25x1,5	19	100	508,75
25-PG21M32	Pg 21	M32x1,5	20	100	508,75
25-PG29M40	Pg 29	M40x1,5	21	50	1.221,55
25-PG36M50	Pg 36	M50x1,5	23	25	3.261,60
25-PG42M63	Pg 42	M63x1,5	25	10	3.766,20
<b>Metrisch naar PG, Temperatuurbereik: -60°C tot +200°C</b>					
25-M16PG7/OM	M16x1,5	Pg 7	8	100	165,25
25-M20PG9/OM	M20x1,5	Pg 9	9	100	133,70
25-M25PG9/OM	M25x1,5	Pg 9	10	100	342,70
25-M25PG11/OM	M25x1,5	Pg 11	10	100	327,45
25-M25PG13/OM	M25x1,5	Pg 13,5	10	100	317,95
25-M25PG16/OM*	M25x1,5	Pg16	18	100	565,25
25-M32PG13/OM	M32x1,5	Pg 13,5	11	50	462,05
25-M32PG16/OM	M32x1,5	Pg 16	11	50	420,15
25-M32PG21/OM	M32x1,5	Pg 21	11	50	345,60
25-M40PG16/OM	M40x1,5	Pg 16	12	25	774,55
25-M40PG21/OM	M40x1,5	Pg 21	12	25	576,75
25-M40PG29/OM	M40x1,5	Pg 29	12	25	514,25
25-M50PG21/OM	M50x1,5	Pg 21	13	25	1.009,70
25-M50PG29/OM	M50x1,5	Pg 29	13	10	990,45
25-M50PG36/OM	M50x1,5	Pg 36	13	10	712,70
25-M63PG29/OM	M63x1,5	Pg 29	14	10	1.932,50
25-M63PG36/OM	M63x1,5	Pg 36	14	10	2.018,60
25-M63PG42/OM	M63x1,5	Pg 42	14	10	1.886,50

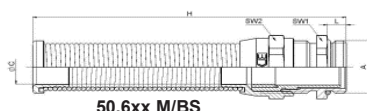
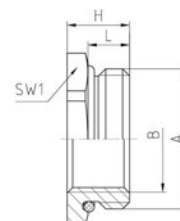
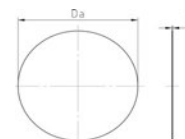

50.6xx M/BS



Voor permanente bescherming van flexibele kabels heeft Jacob nu de aan de serie PERFECT een kabelwartel toegevoegd met bescherming tegen buigen en knikken: vermindert de buigbelasting en het risico op kabelbreuk.

Overige eigenschappen:  
voorzien van een ruim klembereik  
geïntegreerde trekbelasting  
bescherming tegen draaien  
eenvoudige montage  
IP68 - 5 bar

# Jacob kabelwartels metrisch

Drukverschil condenspluggen en wartels

## Jacob

### Drukverschil condenspluggen | Serie JDAExxPAzzzz

<b>Materiaal:</b>	Messing vernikkeld (CuZn39Pb3)
<b>Lamelinzet:</b>	Polyamide PA6 V-2
<b>Dichtring:</b>	CR/NBR
<b>Membraan:</b>	PTFE
<b>Temperatuurbereik:</b>	-20°C tot +100°C
<b>Beschermklasse:</b>	IP66 / IP68
<b>Waterdruk:</b>	> 0,3 bar (voor het membraan)

#### Karakteristieken

Breed klembereik, bescherming tegen condensvorming bij hermetisch afgesloten elektro behuizingen in geval van schommelingen in druk en temperatuur.

Continue ventilatie en aanpassing van de binnendruk.

\*\*Dichtring bestaat uit 2 delen.



Bestelnummer	Kleur	Tap maat	L mm	SW1 mm	H mm	VPE	Brutoprijs 100st.
25-JDAE12PA7035	lichtgrijs	M12x1,5	10	17	17,8	100	340,60
25-JDAE12PA/SW	zwart	M12x1,5	10	17	17,8	100	340,60
25-JDAE20PA7035	lichtgrijs	M20x1,5	10	27	21,6	10	764,55
25-JDAE40PA7035	lichtgrijs	M40x1,5	18	50	35,6	5	1.593,25

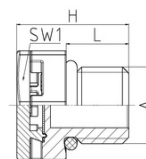

### Drukverschil condenspluggen | Serie JDAExxESzzzz

<b>Materiaal:</b>	RVS 1.4305
<b>Membraan:</b>	PES
<b>O-ring:</b>	NBR
<b>Temperatuurbereik:</b>	-40°C tot +100°C
<b>Beschermklasse:</b>	IP66/IP168 - 0,6 bar (60min.)/IP69



Bestelnummer	Materiaal	Tap maat	L mm	SW1 mm	H mm	VPE	Brutoprijs 100st.
25-JDAE12ES4305	RVS	M12x1,5	6	17	13,0	25	1.323,20
25-JDAE20ES4305	RVS	M20x1,5	6	24	13,0	10	2.268,35
25-JDAE40ES4305	RVS	M40x1,5	8	45	18,0	5	4.415,95

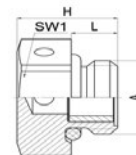

### Wartels | Serie Perfect AirVent

<b>Materiaal:</b>	Messing vernikkeld (CuZn39Pb3)
<b>Lamelinzet:</b>	Polyamide PA6 V-2
<b>Dichtring:</b>	CR/NBR
<b>Membraan:</b>	PTFE
<b>Temperatuurbereik:</b>	-20°C tot +100°C
<b>Beschermklasse:</b>	IP66 / IP68
<b>Waterdruk:</b>	> 0,3 bar (voor het membraan)

#### Karakteristieken

Breed klembereik, bescherming tegen condensvorming bij hermetisch afgesloten elektro behuizingen in geval van schommelingen in druk en temperatuur.

Continue ventilatie en aanpassing van de binnendruk.

\*\*Dichtring bestaat uit 2 delen.

RoHS  
COMPLIANT



Bestelnummer	ØC mm	L mm	SW1 mm	SW2 mm	H mm	VPE
25-50.620 M/R/AV**	5 - 13	6	22	22	33,5	5
25-50.620 M/AV	9 - 13	6	22	22	33,5	5
25-50.625 M/AV	11 - 16	7	27	27	33,5	5

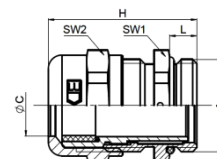

Vraag naar de mogelijkheden van de 100% LOODVRIJE kabelwartels:  
Serie Perfect 50.6xx Y  
Serie Perfect 50.6xx Y.EMV

Volgens de nieuwe ROHS richtlijnen ingang 21-7-2021.

# Kabelwartels en doorvoer



## Oplossingen voor vele toepassingsgebieden



**Wadi one AISI 316L**  
K252-1xxx-zz



**Wadi heat AISI 316L**  
K257-1xxx-zz



**Wadi rail**  
K160-1xxx-zz



### Heavy Duty kabelwartels

Messing vernikkeld, IP66-IP68  
Temperatuur bereik: -40°C tot +100°C  
Conform IEC 62444



**Wartel Favorit**  
22.6xxMxxPA



**Haaks tussenstuk**  
21.7xxPAzzzz



**Wurgnippels**  
1xx MG



**Wartel Perfect**  
50.0xxMxxPazzz



**Favorit drukmoer**  
05Mxx



**Vergrendelstop**  
Polyamide V361-9xxx-zz  
Atex GHG9601944R01zz

Bestelnummer	Tapmaat	Klembereik
25-C1513275	M75x1,5	48-65
25-C1514280	M80x2,0	55-74
25-C1515190	M90x2,0	65-83
25-C1516199	M100x2,0	74-93

### Kabeldoorvoersystemen Serie KADP

Geschikt voor standaard uitsparing maat 24 (Harting, Wieland).

Beschikbaar in 10 varianten met verschillende doorvoeren.

Polyamide PA66 GF25 V-0, halogeenvrij, IP66, temp.bereik -30°C tot +100°C

Conform UL 451B



### Kabeldoorvoersystemen Serie KADL

Geschikt voor voorgeconfectioneerde kabels. Losse frames en tulen apart te bestellen, beschikbaar in diverse maten.

Polyamide PA66 GF25 V-0, halogeenvrij, IP65, temp.bereik -30°C tot +100°C

Conform UL 451B

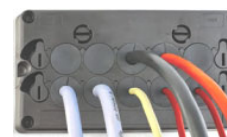

**Binnenring vlak kabel**  
WJ-DM xxFK1



**Uitpelbare binnenring**  
3xx UG



**Binnenring -20°C tot +200°C**  
WJ-DM xxV



**Binnenring vlak kabel**  
WJ-DM xx STO



**Uitpelbare binnenring**  
WJ-DM xx/ASI/z

# Jacob kabelwartels PG

Kunststof: serie Perfect: wartels, zeskantmoeren, blindstoppen met schroefdraad, spiraalknikbescherming

**Jacob**

## Wartels | Serie Perfect halogeen vrij

Materiaal:	Polyamide (PA6 V2)
Temp.bereik:	-20°C tot + 100°C
Beschermklasse:	IP68 (tot 5 bar)
Voorschriften:	UL 514B
UL/CSA-filenr.:	E140310



### Karakteristieken

Wordt geleverd met neopreen binnenring.  
Géïntegreerde trekantasting met een ruim klembereik.  
Gemakkelijk te installeren.

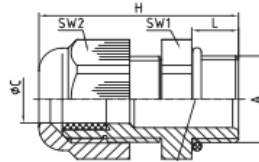

O-ring vanaf PG29

## Wartels | Serie Perfect (50.0xx PAzzzz)

Bestelnummer	L	VPE	Brutoprijs €/100stk.
<b>Normale Tap</b>			
25-50.007 PA7035	8	100	<b>45,25</b>
25-50.009 PA7035	8	100	<b>40,20</b>
25-50.011 PA7035	8	100	<b>48,20</b>
25-50.013 PA7035	9	100	<b>56,00</b>
25-50.016 PA7035	10	50	<b>56,30</b>
25-50.021 PA7035	11	50	<b>104,45</b>
25-50.029 PA7035	11	25	<b>225,40</b>
25-50.036 PA7035	13	10	<b>432,80</b>
25-50.042 PA7035	13	5	<b>922,10</b>
25-50.048 PA7035	14	5	<b>1.164,35</b>

## Wartels | Serie Perfect Lange Tap (50.0xx PAzzzz)

Bestelnummer	L	VPE	Brutoprijs €/100stk.	Tapmaat	Klem- bereik ø mm
<b>Lange Tap</b>					
25-50007/7035/15	15	100	<b>85,10</b>	PG7	3 - 6,5
25-50009/7035/15	15	100	<b>87,80</b>	PG9	4 - 8
25-50011/7035/15	15	100	<b>98,45</b>	PG11	5 - 10
25-50013/7035/15	15	100	<b>122,50</b>	PG13	6 - 12
25-50016/7035/15	15	50	<b>142,35</b>	PG16	10 - 14
25-50021/7035/15	15	50	<b>202,85</b>	PG21	13 - 18
25-50029/7035/15	15	25	<b>409,85</b>	PG29	18 - 25
25-50036/7035/18	18	10	<b>1.431,35</b>	PG36	22 - 32
				PG42	30-38
				PG48	34-44

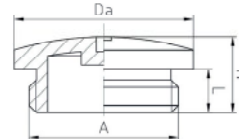
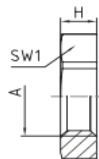

## Zeskantmoeren | (2xx PAzzzz)

Bestelnummer	H	Sleutel- aanzet	VPE	Brutoprijs €/100stk.
<b>Grijs RAL7035</b>				
● 25-207 PA	5	19	100	<b>10,85</b>
● 25-209 PA	5	22	100	<b>12,05</b>
● 25-211 PA	5	24	100	<b>12,40</b>
● 25-213 PA	6	27	100	<b>13,70</b>
● 25-216 PA	6	30	100	<b>14,85</b>
● 25-221 PA	7	36	100	<b>24,45</b>
● 25-229 PA	7	46	100	<b>47,00</b>
● 25-236 PA	8	60	50	<b>91,00</b>
● 25-242 PA	8	65	50	<b>120,10</b>
● 25-248 PA	8	70	50	<b>124,55</b>

Polyamide PA6 GF30

## Blindstoppen met schroefdraad | IP54 (10xx PAzzzz)

Bestelnummer	Tap L	VPE	Brutoprijs €/100stk.	Tapmaat
<b>Grijs RAL7035</b>				
● 25-1007 PA	6	100	<b>17,70</b>	PG7
● 25-1009 PA	6	100	<b>17,70</b>	PG9
● 25-1011 PA	6	100	<b>19,70</b>	PG11
● 25-1013 PA	6	100	<b>21,70</b>	PG13
● 25-1016 PA	6	100	<b>22,10</b>	PG16
● 25-1021 PA	8	100	<b>29,90</b>	PG21
● 25-1029 PA	8	100	<b>57,05</b>	PG29
● 25-1036 PA	10	50	<b>135,00</b>	PG36
● 25-1042 PA	10	50	<b>183,15</b>	PG42
● 25-1048 PA	12	50	<b>198,50</b>	PG48

Temperatuurbereik: -30°C tot +100°C

## Wartels | Perfect Spiraalknikbescherming (50.0xx PABSzzzz)

IP68 (tot 5 bar)

Bestelnummer	Tap L	VPE	Brutoprijs €/100stk.	Tap maat	Klem- bereik ø mm
<b>Grijs RAL 7035</b>					
● 25-50007PABS7035	8	100	<b>76,65</b>	PG7	3 - 6,5
● 25-50009PABS7035	8	100	<b>47,80</b>	PG9	4 - 8
● 25-50011PABS7035	8	100	<b>103,15</b>	PG11	5 - 10
● 25-50013PABS7035	9	50	<b>95,65</b>	PG13	6 - 12
● 25-50016PABS7035	10	25	<b>148,00</b>	PG16	10 - 14
● 25-50021PABS7035	11	25	<b>148,00</b>	PG21	13 - 18

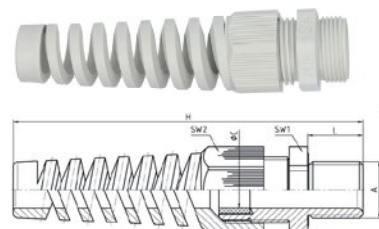

# Jacob kabelwartels PG

Kunststof: reduceer- en verloopingen, meervoudige kabeldoorvoer

**Jacob**

## Wartels | Serie Perfect halogeenvrij

Bestelnummer	Tapmaat		L	VPE	Brutoprijs €/100stk.
	Buiten	Binnen			
<b>Reduceerringen</b>					
25-907 PA	Pg 9	Pg 7	8	100	41,15
25-1107 PA	Pg 11	Pg 7	8	100	40,15
25-1109 PA	Pg 11	Pg 9	8	100	51,25
25-1307 PA	Pg 13,5	Pg 7	9	100	46,95
25-1309 PA	Pg 13,5	Pg 9	9	100	41,60
25-1311 PA	Pg 13,5	Pg 11	9	100	46,95
25-1609 PA	Pg 16	Pg 9	10	100	47,10
25-1611 PA	Pg 16	Pg 11	10	100	51,25
25-1613 PA	Pg 16	Pg 13,5	10	100	58,60
25-2111 PA	Pg 21	Pg 11	11	100	63,80
25-2113 PA	Pg 21	Pg 13,5	11	100	61,50
25-2116 PA	Pg 21	Pg 16	11	100	69,80
25-2913 PA	Pg 29	Pg 13,5	11	50	114,55
25-2916 PA	Pg 29	Pg 16	11	50	120,10
25-2921 PA	Pg 29	Pg 21	11	50	113,30
25-3621 PA	Pg 36	Pg 21	13	50	725,80
25-3629 PA	Pg 36	Pg 29	18	50	216,25
25-4221 PA	Pg 42	Pg 21	18	25	1.154,45
25-4229 PA	Pg 42	Pg 29	18	25	917,55
25-4236 PA	Pg 42	Pg 36	18	25	236,60
25-4829 PA	Pg 48	Pg 29	18	25	1.219,25
25-4836 PA	Pg 48	Pg 36	14	25	716,30
25-4842 PA	Pg 48	Pg 42	17	25	349,75
<b>Vergrootringen</b>					
25-709 PA	Pg 7	Pg 9	8	100	37,90
25-911 PA	Pg 9	Pg 11	8	100	43,90
25-1113 PA	Pg 11	Pg 13,5	8	100	47,10
25-1116 PA	Pg 11	Pg 16	8	100	125,30
25-1316 PA	Pg 13,5	Pg 16	9	100	53,65
25-1621 PA	Pg 16	Pg 21	9	100	68,90
25-2129 PA	Pg 21	Pg 29	10	50	123,25
25-2936 PA	Pg 29	Pg 36	11	25	229,05
25-3642 PA	Pg 36	Pg 42	13	10	304,10
25-4248 PA	Pg 42	Pg 48	13	10	362,70

Temperatuurbereik: -30°C tot +100°C

## Binnering | Meervoudige kabeldoorvoer (WJ-D xx/zXz)

Bestelnummer	Maat wartel	n x Di	H	VPE	Brutoprijs €/100stk.
25-WJ-D 9/4X3	Pg 9	4x3	7,5	50,0	54,30
25-WJ-D 11/2X4	Pg 11	2x4	8,5	50,0	53,90
25-WJ-D 11/3X3	Pg 11	3x3	8,5	50,0	56,60
25-WJ-D 13/3X4	Pg 13,5	3x4	8,5	50,0	38,15
25-WJ-D 13/3X5	Pg 13,5	3x5	8,5	50,0	27,90
25-WJ-D 16/2X4	Pg 16	2x4	9,0	50,0	71,70
25-WJ-D 16/2X6	Pg 16	2x6	9,0	50,0	64,45
25-WJ-D 16/3X4	Pg 16	3x4	9,0	50,0	68,35
25-WJ-D 16/3X5	Pg 16	3x5	9,0	50,0	71,70
25-WJ-D 16/3X6	Pg 16	3x6	9,0	50,0	71,70
25-WJ-D 16/4X4	Pg 16	4x4	9,0	50,0	71,70
25-WJ-D 16/4X5	Pg 16	4x5	9,0	50,0	68,35
25-WJ-D 16/4X6	Pg 16	4x6	9,0	50,0	71,70
25-WJ-D 16/5X4	Pg 16	5x4	9,0	50,0	71,70
25-WJ-D 21/2X7	Pg 21	2x7	11,0	50,0	52,25
25-WJ-D 21/2X8	Pg 21	2x8	11,0	50,0	84,50
25-WJ-D 21/3X7	Pg 21	3x7	11,0	50,0	84,50
25-WJ-D 21/3X8	Pg 21	3x8	11,0	25,0	52,25
25-WJ-D 21/4X5	Pg 21	4x5	11,0	25,0	88,70
25-WJ-D 21/4X6,5	Pg 21	4x6,5	11,0	25,0	52,25
25-WJ-D 21/4X7	Pg 21	4x7	11,0	25,0	50,95
25-WJ-D 21/4X7,5	Pg 21	4x7,5	11,0	25,0	88,70
25-WJ-D 21/5X5	Pg 21	5x5	11,0	25,0	88,70
25-WJ-D 29/6X5	Pg 29	6x5	13,0	10,0	234,30
25-WJ-D 29/6X7,5	Pg 29	6x7,5	13,0	10,0	135,60
25-WJ-D 29/8X5	Pg 29	8x5	13,0	10,0	135,60

Temperatuurbereik: -30°C tot +100°C

Zie programma metrisch voor adapters en verloopingen

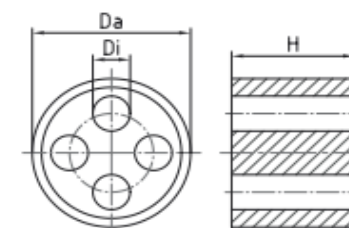
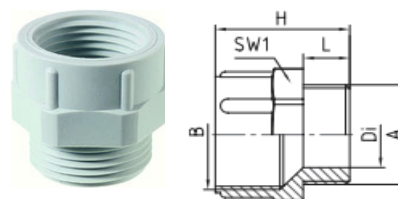
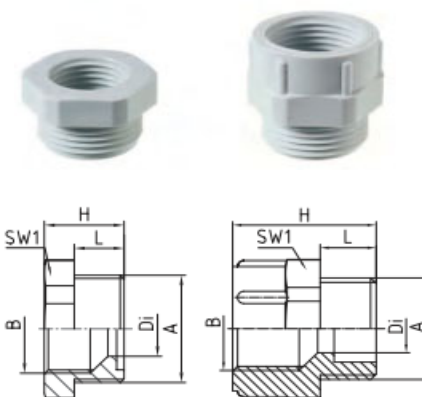

# Jacob kabelwartels PG

Messing: serie Perfect: wartels (EMC), zeskantmoeren (EMC), blindstoppen met schroefdraad

## Wartels | Serie Perfect halogeenvrij

**Materiaal:** Messing vernikkeld (CuZn39Pb3)  
**Temp.bereik:** -20°C tot + 100°C  
**Beschermklasse:** IP68 (tot 5 bar)  
**Voorschriften:** PG volgens DIN 40430

### Karakteristieken

Wordt geleverd met neopreen binnenring.  
 Geïntegreerde trekcontasting met een ruim klembereik.  
 Gemakkelijk te installeren.

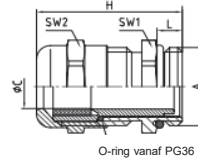
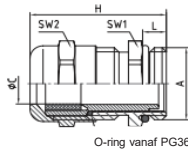

## Wartel | Serie Perfect (50.0xx PAzzzz)

Bestelnummer	Taplengte L	VPE	Brutoprijs €/100stk.
<b>Normale Tap</b>			
25-50.007	5	100	224,60
25-50.009	6	100	294,40
25-50.011	6	50	341,15
25-50.013	6,5	50	368,85
25-50.016	6,5	50	446,80
25-50.021	7	50	727,90
25-50.029	8	25	1.294,10
25-50.036	9	10	1.941,10
25-50.042	10	5	3.606,55
25-50.048	10	5	4.241,30

## Wartel | Serie Perfect lange tap (50.0xx 15Mm)

Bestelnummer	Taplengte L	VPE	Brutoprijs €/100stk.	Tapmaat	Klembereik ø
<b>Lange Tap</b>					
25-50.007-15MM	15	100	453,05	PG7	3 - 6,5
25-50.009-15MM	15	100	522,70	PG9	4 - 8
25-50.011-15MM	15	100	590,80	PG11	5 - 10
25-50.013-15MM	15	50	487,35	PG13	6 - 12
25-50.016-15MM	15	25	574,85	PG16	10 - 14
25-50.021-15MM	15	10	945,35	PG21	13 - 18
25-50.029-15MM	15	5	1.965,70	PG29	18 - 25
				PG36	22 - 32
				PG42	30 - 38
				PG48	34 - 44

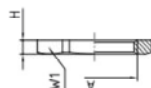

## Zeskantmoeren | (2xx PAzzzz)

Temperatuurbereik: -60°C tot +200°C

Bestelnummer	Dikte H	Tapmaat	VPE	Brutoprijs €/100stk.
25-207 M	2,8	PG7	100	20,50
25-209 M	2,8	PG9	100	20,95
25-211 M	3	PG11	100	20,50
25-213 M	3,5	PG13	100	28,80
25-216 M	4	PG16	100	33,95
25-221 M	5	PG21	100	49,80
25-229 M	5	PG29	100	79,65
25-236 M	6	PG36	50	134,20
25-242 M	7	PG42	50	275,90
25-248 M	8	PG48	50	315,45

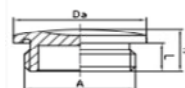

## Blindstoppen met schroefdraad | IP54 (10xx PAzzzz)

Temperatuurbereik: -60°C tot +200°C

Bestelnummer	Tapmaat	VPE	Brutoprijs €/100stk.
25-1007 M	PG7	100	42,35
25-1009 M	PG9	100	55,30
25-1011 M	PG11	100	64,35
25-1013 M	PG13	100	75,15
25-1016 M	PG16	100	83,40
25-1021 M	PG21	100	157,95
25-1029 M	PG29	100	303,90
25-1036 M	PG36	50	473,65
25-1042 M	PG42	50	731,20
25-1048 M	PG48	50	1.505,30

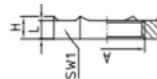
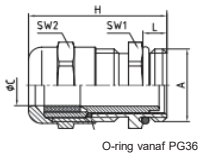

## Wartel | Serie Perfect EMC (50.0xx/EMV)

Ook verkrijgbaar in lange tap

Bestelnummer	Taplengte L	VPE	Brutoprijs €/100stk.
<b>Normale Tap</b>			
25-50.007/EMV	5	100	542,25
25-50.009/EMV	6	100	584,20
25-50.011/EMV	6	50	679,10
25-50.013/EMV	6,5	50	692,50
25-50.016/EMV	6,5	50	747,55
25-50.021/EMV	7	50	1.160,75
25-50.029/EMV	8	25	1.817,45
25-50.036/EMV	9	10	2.936,75
25-50.042/EMV	10	5	5.566,50
25-50.048/EMV	10	5	7.120,65

## Zeskantmoeren | EMC (2xx MPOT)

Temperatuurbereik: -60°C tot +200°C

Bestelnummer	Dikte H	VPE	Brutoprijs €/100stk.	Tapmaat	Klembereik ø
25-207 MPOT	4,7	100	172,15	PG7	3 - 6,5
25-209 MPOT	4,7	100	176,70	PG9	4 - 8
25-211 MPOT	4,7	100	161,10	PG11	5 - 10
25-213 MPOT	4,7	100	222,15	PG13	6 - 12
25-216 MPOT	4,7	100	204,55	PG16	10 - 14
25-221 MPOT	5,2	100	219,45	PG21	13 - 18
25-229 MPOT	5,7	100	359,05	PG29	18 - 25
25-236 MPOT	6	50	485,30	PG36	22 - 32
25-242 MPOT	6	50	1.523,05	PG42	30 - 38
25-248 MPOT	6,5	50	1.615,15	PG48	34 - 44

# Jacob kabelwartels PG

Messing: reduceer- en vergrootringen, adapters, verloopringen zeskantmoeren (EMC), blindstoppen met schroefdraad

## Reduceer- en Vergrootringen | (xxx RPg & 6xxxx/OM / xxxEPg)

Temperatuurbereik: -60°C tot +200°C (6xxxx/OM -30°C tot +100°C)

Bestelnummer	Tapmaat		Dikte H	VPE	Brutoprijs €/100stk.
	Buiten	Binnen			
<b>Reduceerringen (kleine trap)</b>					
25-907	Pg 9	Pg 7	8,5	100	52,95
25-1107	Pg 11	Pg 7	8,5	100	72,45
25-1109	Pg 11	Pg 9	8,5	100	61,10
25-1311	Pg 13,5	Pg 11	9	100	66,60
25-1613	Pg 16	Pg 13,5	9,5	100	69,10
25-2116	Pg 21	Pg 16	10	100	129,75
25-2921	Pg 29	Pg 21	11,5	50	269,25
25-3629	Pg 36	Pg 29	12,5	25	438,55
25-4236	Pg 42	Pg 36	14	10	510,05
25-4842	Pg 48	Pg 42	14	10	930,15
<b>Reduceerringen (grote trap)</b>					
25-61107/OM	Pg 11	Pg 7	8,5	100	196,10
25-61307/OM	Pg 13,5	Pg 7	9,5	100	267,35
25-61309/OM	Pg 13,5	Pg 9	9,5	100	210,80
25-61607/OM	Pg 16	Pg 7	9,5	100	263,30
25-61609/OM	Pg 16	Pg 9	9,5	100	263,30
25-61611/OM	Pg 16	Pg 11	9,5	100	229,35
25-62111/OM	Pg 21	Pg 11	10	100	392,60
25-62113/OM	Pg 21	Pg 13,5	10	100	282,60
25-62916/OM	Pg 29	Pg 16	11,5	50	860,45
25-63621/OM	Pg 36	Pg 21	12,5	25	1.116,50
25-63629/OM	Pg 36	Pg 29	12,5	25	871,95
25-64236/OM	Pg 42	Pg 36	14	25	1.939,15
<b>Vergrootringen</b>					
25-709	Pg 7	Pg 9	15	100	74,65
25-911	Pg 9	Pg 11	16,5	100	85,00
25-913	Pg 9	Pg 13,5	17,5	100	120,30
25-1113	Pg 11	Pg 13,5	17,5	100	100,50
25-1116	Pg 11	Pg 16	19	100	131,15
25-1121	Pg 11	Pg 21	21	100	442,45
25-1316	Pg 13,5	Pg 16	19	100	120,40
25-1321	Pg 13,5	Pg 21	21	100	258,50
25-1621	Pg 16	Pg 21	21	100	194,75
25-1629	Pg 16	Pg 29	22,5	50	677,40
25-2129	Pg 21	Pg 29	23	50	349,50
25-2936	Pg 29	Pg 36	27,5	25	596,90
25-3642	Pg 36	Pg 42	31	10	756,20
25-4248	Pg 42	Pg 48	33	10	1.273,10

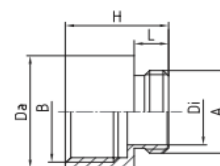
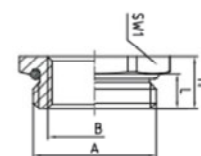
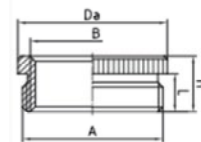

## Adapters en verloopringen | (PGxxMxx / MxxPGxx/OM)

Bestelnummer	Tapmaat		Dikte H	VPE	Brutoprijs €/100stk.
	Buiten	Binnen			
<b>PG naar Metrisch, Temperatuurbereik: -60°C tot +200°C</b>					
25-PG7M12	Pg 7	M12x1,5	15	100	192,55
25-PG9M16	Pg 9	M16x1,5	16	100	195,05
25-PG11M16	Pg 11	M16x1,5	16	100	195,70
25-PG13M20	Pg 13,5	M20x1,5	17,5	100	273,55
25-PG16M20	Pg 16	M20x1,5	17,5	100	239,85
25-PG16M25	Pg 16	M25x1,5	18,5	100	315,00
25-PG21M25	Pg 21	M25x1,5	19	100	508,75
25-PG21M32	Pg 21	M32x1,5	20	100	508,75
25-PG29M40	Pg 29	M40x1,5	21	50	1.221,55
25-PG36M50	Pg 36	M50x1,5	23	25	3.261,60
25-PG42M63	Pg 42	M63x1,5	25	10	3.766,20
<b>Metrisch naar PG, Temperatuurbereik: -60°C tot +200°C</b>					
25-M16PG7/OM	M16x1,5	Pg 7	8	100	165,25
25-M20PG9/OM	M20x1,5	Pg 9	9	100	133,70
25-M25PG9/OM	M25x1,5	Pg 9	10	100	342,70
25-M25PG11/OM	M25x1,5	Pg 11	10	100	327,45
25-M25PG13/OM	M25x1,5	Pg 13,5	10	100	317,95
25-M25PG16/OM*	M25x1,5	Pg16	18	100	565,25
25-M32PG13/OM	M32x1,5	Pg 13,5	11	50	462,05
25-M32PG16/OM	M32x1,5	Pg 16	11	50	420,15
25-M32PG21/OM	M32x1,5	Pg 21	11	50	345,60
25-M40PG16/OM	M40x1,5	Pg 16	12	25	774,55
25-M40PG21/OM	M40x1,5	Pg 21	12	25	576,75
25-M40PG29/OM	M40x1,5	Pg 29	12	25	514,25

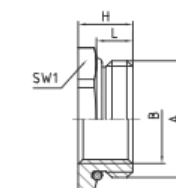
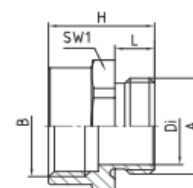

Zie programma metrisch voor overige maten

# Jacob kabelwartels explosie veilig

Kunststof: serie GHG: wartels

**Jacob**

## Wartels | Serie Explosie veilig

<b>Materiaal:</b>	Polyamide (PA6 )
<b>Temp.bereik:</b>	Zie tabel
<b>Beschermklasse:</b>	IP66
<b>Voorschriften</b>	EN 60079-0:2012, IEC 60079-0:2011 EN 60079-7:2007, IEC 60079-7:2006 EN 60079-31:2009, IEC 60079-31:2008
<b>EC-certificaten</b>	PTB 99 ATEX 3101 X (M12x1,5 - M16x1,5) PTB 99 ATEX 3128 X (M20x1,5 - M63x1,5) PTB14 ATEX 1015 X
<b>IECEX-certificaten</b>	IECEX PTB 05.0004X IECEX PTB 14.0027X

### Karakteristieken

Geschikt voor zone II 2 G (1,2) Ex e IIC Gb  
zone II 2 D (21,22) Ex tb IIIC Db  
Stofkap polyethyleen PE-LD,  
Dichtring silicoon, binnenzijde TPE TPS (vanaf M16)  
Ruim klembereik.  
Gemakkelijk te installeren.



## Wartels | Serie Explosie veilig (GHG9601955R00zzzz)

Bestelnummer	Bestelnummer	Tapmaat	L	Ø	Ø	Ø	VPE	Brutoprijs
Zwart - RAL9005	Zwart - RAL9005			C3	C2	C1		€/100stk.
-20°C tot +70°C	-55°C tot +70°C							
● 25-GHG9601955R0001		M12x1,5	8			5 - 7	20	235,15
● 25-GHG9601955R0002		M16x1,5	8		5,5 - 7	7 - 10	20	237,60
● 25-GHG9601955R0003		M20x1,5	8	5,5 - 7	7 - 9	9,5 - 13	20	242,95
● 25-GHG9601955R0004		M25x1,5	8	8 - 10	10 - 13	13,5 - 17,5	20	245,25
	● 25-GHG9601955R0009	M25x1,5	8	8 - 10	10 - 13	13,5 - 15	20	448,95
● 25-GHG9601955R0005	● op aanvraag	M32x1,5	10		14 - 17	17,5 - 21	20	401,10
	● 25-GHG9601955R0006	M40x1,5	10		19 - 22	22 - 28	10	936,30
	● 25-GHG9601955R0007	M50x1,5	12		24 - 28	28 - 35	10	2.787,40
	● 25-GHG9601955R0008	M63x1,5	12		29 - 35	36 - 48*	5	3.554,35

\* M63 met extra afdichting

## Wartels | Serie Explosie veilig lange tap (GHG9601955R00zzzz)

Bestelnummer	Bestelnummer	Tapmaat	L	Ø	Ø	Ø	VPE	Brutoprijs
Zwart - RAL9005	Zwart - RAL9005			C3	C2	C1		€/100stk.
-20°C tot +70°C	-55°C tot +70°C							
● 25-GHG9601955R0021		M12x1,5	12			5 - 7	20	297,10
● 25-GHG9601955R0022		M16x1,5	12		5,5 - 7	7 - 10	20	306,80
● 25-GHG9601955R0023		M20x1,5	13	5,5 - 7	7 - 9	9,5 - 13	20	221,30
● 25-GHG9601955R0024		M25x1,5	13	8 - 10	10 - 13	13,5 - 17,5	20	258,55
	● 25-GHG9601955R0030	M25x1,5	13	8 - 10	10 - 13	13,5 - 15	20	476,90
● 25-GHG9601955R0025	● op aanvraag	M32x1,5	15		14 - 17	17,5 - 21	20	415,75
	● 25-GHG9601955R0026	M40x1,5	15		19 - 22	22 - 28	10	960,40
	● 25-GHG9601955R0027	M50x1,5	16		24 - 28	28 - 35	10	6.845,40
	● 25-GHG9601955R0028	M63x1,5	16		29 - 35	36 - 48*	5	3.486,25

\* M63 met extra afdichting

## Ook verkrijgbaar



Serie GHG9601955R01zz  
EX-kabelwartels

Serie GHG9601955R005z  
EX-kabelwartels

Serie GHG9601956R00zz  
EX-kabelwartels

Serie GHG9601949R01zz  
EX-trompetkabelwartels

Serie GHG9601944R01zz  
EX-sluitingen



# Jacob kabelwartels explosie veilig

Kunststof: serie GHG: blindstoppen met schroefdraad, reduceerringen

## Jacob

### Blindstoppen met schroefdraad | Serie Explosie veilig (GHG9601952R01zz)

<b>Materiaal:</b>	Polyamide (PA6 6 GF25)
<b>Temp.bereik:</b>	-55°C tot +95°C (M16x1,5 - M50x1,5) -20°C tot +80°C (M63x1,5)
<b>Beschermklasse:</b>	IP66 (M16x1,5 - M50x1,5) IP65 (M63x1,5)
<b>Voorschriften</b>	EN 60079-0:2012, IEC 60079-0:2007 EN 60079-7:2007, IEC 60079-7:2006 EN 60079-31:2009, IEC 60079-31:2008
<b>EC-certificaten</b>	PTB 98 ATEX 3130
<b>IECEX-certificaten</b>	IECEX PTB 03.0000
<b>UL/CSA-file</b>	E254795 (M16x1,5 - M50x1,5)

<b>Karakteristieken</b>
Geschikt voor zone II 2 G (1,2) Ex e IIC Gb Zone II 2 D (21,22) Ex tb IIIC Db



Bestelnummer	A	L	SW1	H	Da	VPE	Brutoprijs €/100stk.
<b>Zwart RAL9005</b>							
● 25-GHG9601952R0111	M16x1,5	11	8	15	21	20	<b>419,25</b>
● 25-GHG9601952R0112	M20x1,5	12	8	16	25	20	<b>373,75</b>
● 25-GHG9601952R0113	M25x1,5	12	8	16	30	20	<b>419,25</b>
● 25-GHG9601952R0114	M32x1,5	14	8	19,5	37	10	<b>563,15</b>
● 25-GHG9601952R0115	M40x1,5	14	8	19,5	45	10	<b>1.006,15</b>
● 25-GHG9601952R0116	M50x1,5	15	8	20,5	55	5	<b>1.468,90</b>
● 25-GHG9601952R0117	M63x1,5	16	8	23	72	5	<b>6.828,65</b>



### Reduceerringen | Serie Explosie veilig (GHG9601946R00zz)

<b>Materiaal:</b>	Polyamide (PA6 )
<b>Temp.bereik:</b>	-55°C tot +70°C
<b>Beschermklasse:</b>	IP66
<b>Voorschriften</b>	EN 60079-0:2012, IEC 60079-0:2011 EN 60079-7:2007, IEC 60079-0:2006 EN 60079-31:2009, IEC 60079-31:2008
<b>EC-certificaten</b>	PTB 99 ATEX 3128 X, PTB 14 ATEX 1015X
<b>IECEX-certificaten</b>	IECEX PTB 05.0004X, IECEX PTB 14.0027X

<b>Karakteristieken</b>
Geschikt voor zone II 2 G (1,2) Ex e IIC Gb Zone II 2 D (21,22) Ex tb IIIC Db



Bestelnummer	A	B	L	SW1	H	VPE	Brutoprijs €/100stk.
<b>Zwart RAL9005</b>							
● 25-GHG9601946R0070	M16x1,5	M12x1,5	8	24	12	20	<b>699,55</b>
● 25-GHG9601946R0051	M20x1,5	M12x1,5	8	24	12	20	<b>794,35</b>
● 25-GHG9601946R0071	M20x1,5	M16x1,5	8	24	12	20	<b>1.096,95</b>
● 25-GHG9601946R0052	M25x1,5	M12x1,5	8	29	14	20	<b>426,00</b>
● 25-GHG9601946R0053	M25x1,5	M16x1,5	8	29	14	10	<b>801,60</b>
● 25-GHG9601946R0072	M25x1,5	M20x1,5	8	29	14	20	<b>809,30</b>
● 25-GHG9601946R0054	M32x1,5	M12x1,5	10	36	16	20	<b>570,05</b>
● 25-GHG9601946R0055	M32x1,5	M16x1,5	10	36	16	20	<b>570,05</b>
● 25-GHG9601946R0056	M32x1,5	M20x1,5	10	36	16	20	<b>1.457,55</b>
● 25-GHG9601946R0074	M32x1,5	M25x1,5	10	36	16	20	<b>849,80</b>
● 25-GHG9601946R0057	M40x1,5	M16x1,5	10	46	16	10	<b>880,30</b>
● 25-GHG9601946R0058	M40x1,5	M20x1,5	10	46	16	10	<b>1.359,85</b>
● 25-GHG9601946R0059	M40x1,5	M25x1,5	10	46	16	10	<b>2.108,05</b>
● 25-GHG9601946R0077	M40x1,5	M32x1,5	10	46	16	10	<b>1.558,30</b>
● 25-GHG9601946R0060	M50x1,5	M20x1,5	12	55	18	10	<b>2.374,15</b>
● 25-GHG9601946R0061	M50x1,5	M25x1,5	12	55	18	10	<b>2.322,70</b>
● 25-GHG9601946R0062	M50x1,5	M32x1,5	12	55	18	10	<b>2.722,10</b>
● 25-GHG9601946R0080	M50x1,5	M40x1,5	12	55	18	10	<b>2.738,15</b>
● 25-GHG9601946R0063	M63x1,5	M25x1,5	12	68	18	5	<b>2.435,55</b>
● 25-GHG9601946R0064	M63x1,5	M32x1,5	12	68	18	5	<b>2.435,55</b>
● 25-GHG9601946R0065	M63x1,5	M40x1,5	12	68	18	5	<b>5.716,10</b>
● 25-GHG9601946R0083	M63x1,5	M50x1,5	12	68	18	5	<b>5.716,10</b>



# TST kabeldoorvoer

Kunststof: serie Rutaseal®



## Doorvoeren | Serie Rutaseal® EPDM

**Materiaal:** EPDM Halogeenvrij  
**Temp.bereik:** -40°C tot + 110°C  
**Bescherming:** IP67 volgens EN60529  
**Keuren:** Semko  
**Karakteristiek:** Geschikt voor plaatdikte 0,5 - 4mm

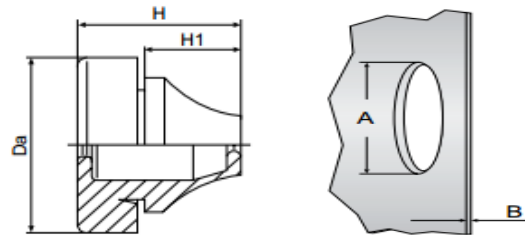

Bestelnummer	Bestelnummer	Bestelnummer	Schroef	Kabel	A	B	D	H	H1	VPE	Brutoprijs
Grijs - RAL7001	Grijs - RAL7035	Zwart - RAL9005	draad	ø mm	mm	mm	mm	mm	mm	In stk.	€/100stk.
<b>Metrisch</b>											
● 25-T1458233	● 25-T1458303	● 25-T1458293	M12	4-7	12,5	0,5-2	20	12,7	5,4	50	<b>28,50</b>
● 25-T1458234	● 25-T1458304	● 25-T1458294	M16	5-9	16,5	1-4	21	18	10,5	50	<b>38,00</b>
● 25-T1458235	● 25-T1458305	● 25-T1458295	M20	8-13	20,5	1-4	25,5	20	12,7	50	<b>52,00</b>
● 25-T1458236	● 25-T1458306	● 25-T1458296	M25	11-17	25,5	1-4	30,5	21,6	14,5	50	<b>70,00</b>
● 25-T1458237	● 25-T1458307	● 25-T1458297	M32	15-20	32,5	1-4	38,5	24,8	17,5	25	<b>113,50</b>
● 25-T1458238	● 25-T1458308	● 25-T1458298	M40	19-28	40,5	1-4	48,5	30	20,4	25	<b>200,50</b>
● 25-T1458239	● 25-T1458309	● 25-T1458299	M50	27-35	50,5	1-4	60,5	35	23,9	10	<b>360,50</b>
● 25-T1458240	● 25-T1458337	● 25-T1458300	M63	34-45	63,5	1-4	73,5	40	28,9	5	<b>1.463,50</b>
<b>PG</b>											
● 25-T1458220	● 25-T1458212	● 25-TRS-PG7S	PG7/12,5	3-5	13	0,5-2	20	12,7	5,4	50	<b>29,00</b>
● 25-T1458221	● 25-T1458213	● 25-TRS-PG9S	PG9/15,2	5-7	16	1-4	21	18	10,3	50	<b>41,50</b>
● 25-T1458222	● 25-T1458214	● 25-TRS-PG11S	PG11/18,6	7-10	19	1-4	24	20	12,7	50	<b>48,00</b>
● 25-T1458223	● 25-T1458215	● 25-TRS-PG16S	PG16/22,5	10-14	23	1-4	28	21,6	14,7	50	<b>70,00</b>
● 25-T1458224	● 25-T1458216	● 25-TRS-PG21S	PG21/28,3	14-20	29	1-4	35	24,8	17,6	25	<b>100,50</b>
● 25-T1458225	● 25-T1458217	● 25-TRS-PG29S	PG29/37	20-26	38	1-4	46	28,5	20,0	25	<b>187,00</b>
● 25-T1458226	● 25-T1458218	● 25-TRS-PG36S	PG36/47	26-35	48	1-4	58	35	23,9	10	<b>327,00</b>



Druk de doorvoer door het gatopening

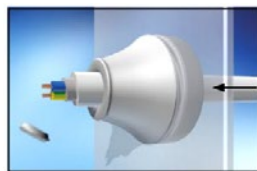

Duw de kabel door de sluiting

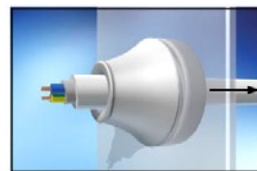

Trek de kabel terug om de doervoer te zekeren

**RUTASEAL®**

Snelle en eenvoudige montage zonder gebruik van gereedschappen

## Doorvoeren | Serie Rutaseal® Chloropreen

**Materiaal:** Chloropreen  
**Temp.bereik:** -30°C tot +100°C  
**Bescherming:** IP67 volgens EN60529  
**Keuren:** Semko, DNV E-12700  
**Karakteristiek:** Geschikt voor plaatdikte 0,5 - 4mm

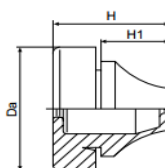

Bestelnummer	Schroef	Kabel	A	B	D	H	H1	VPE	Brutoprijs
Zwart - RAL9005	draad	ø mm	mm	mm	mm	mm	mm	In stk.	€/100stk.
<b>Metrisch</b>									
● 25-T1458253	M12	4-7	12,5	0,5-2	20	12,7	5,4	50	<b>56,00</b>
● 25-T1458254	M16	5-9	16,5	1-4	21	18	10,5	50	<b>79,00</b>
● 25-T1458255	M20	8-13	20,5	1-4	25,5	20	12,7	50	<b>112,50</b>
● 25-T1458256	M25	11-17	25,5	1-4	30,5	21,6	14,5	50	<b>164,00</b>
● 25-T1458257	M32	15-20	32,5	1-4	38,5	24,8	17,5	25	<b>256,50</b>
● 25-T1458258	M40	19-28	40,5	1-4	48,5	30	20,4	25	<b>465,00</b>
● 25-T1458259	M50	27-35	50,5	1-4	60,5	35	23,9	10	<b>705,00</b>
<b>PG</b>									
● 25-T1458242	PG7/12,5	3-5	13	0,5-2	20	12,7	5,4	50	<b>64,00</b>
● 25-T1458243	PG9/15,2	5-7	16	1-4	21	18	10,3	50	<b>80,50</b>
● 25-T1458244	PG11/18,6	7-10	19	1-4	24	20	12,7	50	<b>104,50</b>
● 25-T1458245	PG16/22,5	10-14	23	1-4	28	21,6	14,7	50	<b>136,50</b>
● 25-T1458246	PG21/28,3	14-20	29	1-4	35	24,8	17,6	25	<b>208,50</b>
● 25-T1458247	PG29/37	20-26	38	1-4	46	28,5	20,0	25	<b>401,00</b>
● 25-T1458248	PG36/47	26-35	48	1-4	58	35	23,9	10	<b>794,00</b>

# TST kabeldoorvoer

Kunststof: serie Klikseal®, serie TSS



## Doorvoeren | Serie KLIKSEAL®

**Materiaal:** TPE en Polyamide 66, halogeenvrij (UL approved materiaal)  
**Temp.bereik:** -20°C tot + 125°C  
**Bescherming:** IP67 / IP65  
**Volgens:** EN60529:1991+A1 / EN50262:1998

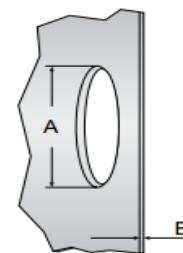
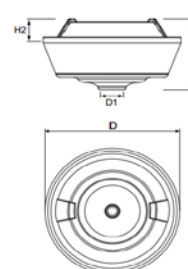

Bestelnummer WIT - RAL9010	Bestelnummer Grijs - RAL7035	Bestelnummer Zwart - RAL9005	Schroef- Draad	Kabel ø (IP67*)	Kabel ø (IP65)	A mm	B IP67/65 mm	H mm	H2 mm	D1 mm	D*** mm	VPE	Brutoprijs €/100stk.
○ 25-T1475823	● 25-T1475803	● 25-T1475813	M20	7-11	4-11	20,5	2-5	17-20	5,5	4	29,3-34,5	50	<b>66,50</b>
○ 25-T1475824	● 25-T1475804	● 25-T1475814	M25	7-13**	4-13	25,5	2-5	17-20	5,5	5	34,3-40,0	50	<b>80,00</b>
<b>Voor extra dunne plaatdikte</b>													
○ 25-T1475827	● 25-T1475807	● 25-T1475817	M20	7-11	4-11	20,5	0,5-3	17-20	5,5	4	34,2-37,2	50	<b>66,50</b>
○ 25-T1475828	● 25-T1475808	● 25-T1475818	M25	7-13**	4-13	25,5	0,9-3	17-20	5,5	5	39,2-42,2	50	<b>80,00</b>

\*Kabelverankering volgens type A, EN 50262

\*\* 8,1 - 8,9 mm alleen getest voor tension relief

\*\*\*Variabel, afhankelijk van de dikte van het materiaal



Plaats de KLIKSEAL voor de opening (vanuit de binnenkant), druk gelijkmatig tot dat het klikt.

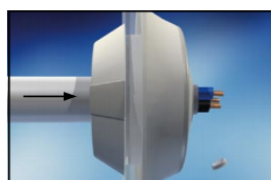

Voer de kabel door

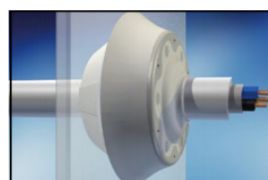

### Klikseal®

Ruimte besparend, snelle en eenvoudige montage zonder gereedschap met trekontlasting

## Doorvoeren | Serie TSS

**Materiaal:** TPE, halogeenvrij (UL approved materiaal)  
**Temp.bereik:** -50°C tot +125°C  
**Bescherming:** IP67  
**Volgens:** EN60529

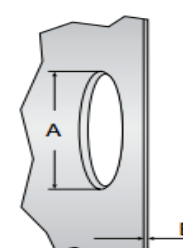
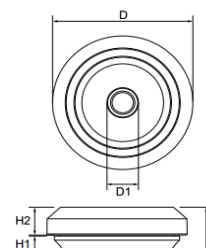

Bestelnummer WIT - RAL9010	Bestelnummer Grijs - RAL7035	Bestelnummer Zwart - RAL9005	Schroef- Draad	Kabel ø	A mm	B mm	D* mm	D1 mm	H mm	H1 mm	H2* mm	VPE	Brutoprijs €/100stk.
○ 25-T1475721	● 25-T1475711	● 25-T1475716	M16	5-10	16,5	0,5-3	23,5	4	11	4	6,75	50	<b>16,50</b>
○ 25-T1475722	● 25-T1475712	● 25-T1475717	M20	6-13	20,5	0,5-3	27,5	5	11	4	6,75	50	<b>20,00</b>
○ 25-T1475723	● 25-T1475713	● 25-T1475718	M25	8-17	25,5	0,5-3,5	32,5	7	11	4	6,75	50	<b>29,50</b>
○ 25-T1475724	● 25-T1475714	● 25-T1475719**	M32	12-24	32,5	0,5-4,5	39,5	11	11	4	6,75	25	<b>50,00</b>
○ 25-T1475725	● 25-T1475715	● 25-T1475720	M40	19-30	45,5	15-4,5	47,5	18	13,5	4,8	7,41	25	<b>98,00</b>

\*Variabel, afhankelijk van de dikte van het materiaal

\*\*Prijs op aanvraag



Druk de TSS door de opening

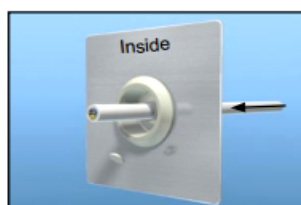

Voer de kabel door vanaf binnen

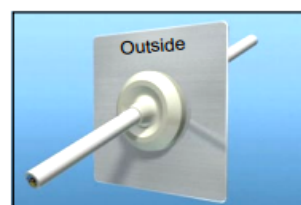

### TSS





# KABEL OMWIKKELINGEN

---

5

# Interflex beschermingslang

Beschermingslang: serie AGT, serie STT



## Slang | Series AGT, STT, MIR, NEC, NBC, LTC en YKD, halogeenvrij

**Materiaal:** Polyamide (PA6)  
**Temperatuurbereik:** -40°C tot 105°C (150°C in pieken)  
**UV-bestendig:** Kleur zwart  
**Voorschriften:** EN 60204  
**Beschermklasse:** IP66 tot IP68-69K

### Karakteristieken

Uniek en gepatenteerd montagesysteem, Easy-Click.  
 Standaard halogeenvrij, cadmiumvrij en zelfdovend (UL94 V2).  
 Montage met O-ring+pakking levert een bescherming van IP68-69K



## Slang | Serie AGT licht en hoog flexibel

Bestelnummer Grijs - RAL7001	Bestelnummer Zwart - RAL9005	Min.straal R	Nom. ø	Binnen ø	Buiten ø	VPE in mtr.	Brutoprijs €/100mtr
● 29-AGT-07G	● 29-AGT-07N	15	7	6.3	10.0	50	<b>123,50</b>
● 29-AGT-10G	● 29-AGT-10N	20	10	9.7	13.0	50	<b>123,00</b>
● 29-AGT-12G	● 29-AGT-12N	30	12	12.2	15.8	50	<b>172,00</b>
● 29-AGT-17G	● 29-AGT-17N	40	17	16.8	21.2	50	<b>243,50</b>
● 29-AGT-23G	● 29-AGT-23N	55	23	22.6	28.5	50	<b>376,00</b>
● 29-AGT-29G	● 29-AGT-29N	65	29	28.3	34.5	50	<b>504,00</b>
● 29-AGT-36G	● 29-AGT-36N	80	36	36.3	42.5	30	<b>657,50</b>
● 29-AGT-48G	● 29-AGT-48N	95	48	47.4	54.5	30	<b>970,50</b>
● 29-AGT-70G	● 29-AGT-70N	200	70	69.1	80.7	10	<b>3.362,50</b>
● 29-AGT-95G	● 29-AGT-95N	265	95	91.7	106.0	10	<b>4.540,00</b>

**NYLOFIX**  
plus



## Slang | Serie STT normaal en flexibel

Bestelnummer Grijs - RAL7001	Bestelnummer Zwart - RAL9005	Min.straal R	Nom. ø	Binnen ø	Buiten ø	VPE in mtr.	Brutoprijs €/100mtr
● 29-STT-07G	● 29-STT-07N	20	7	6,2	10,0	50	<b>162,50</b>
● 29-STT-10G	● 29-STT-10N	25	10	9,6	13,0	50	<b>172,50</b>
● 29-STT-12G	● 29-STT-12N	35	12	12,0	15,8	50	<b>220,50</b>
● 29-STT-17G	● 29-STT-17N	50	17	16,5	21,2	50	<b>348,50</b>
● 29-STT-23G	● 29-STT-23N	60	23	22,3	28,5	50	<b>546,00</b>
● 29-STT-29G	● 29-STT-29N	70	29	28,2	34,5	50	<b>682,50</b>
● 29-STT-36G	● 29-STT-36N	85	36	36,0	42,5	30	<b>973,00</b>
● 29-STT-48G	● 29-STT-48N	100	48	47,1	54,5	30	<b>1.444,00</b>

**Uit voorraad leverbaar**

## Easy-click slangwartels

Standaard IP66

IP68/IP69K met O-ring en pakking

IEC 61386 / UL 1696 / C22.2 No. 227.3

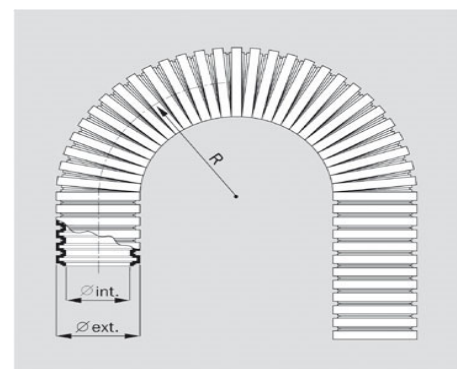
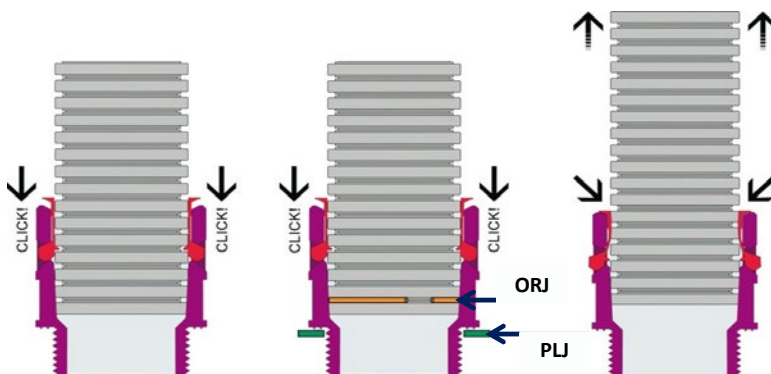

**Eenvoudige (de)montage zonder gereedschap**

# Interflex bescherm slang

Toebehoren: slangwartels: recht, haaks, 90°



## Wartels RECHT | Serie MIR

Bestelnummer Grijs - RAL7001	Bestelnummer Zwart - RAL9005	Schroef- draad	Slang nom. Ø	A Ø	C Ø	LR Ø	VPE in stk.	Brutoprijs €/100stk
<b>Metrisch</b>								
● 29-MIR-07M12G	● 29-MIR-07M12N	M12	7	35	19	11	100	137,50
● 29-MIR-10M16G	● 29-MIR-10M16N	M16	10	37	21	11	100	129,50
● 29-MIR-12M16G	● 29-MIR-12M16N	M16	12	37	26	11	100	128,50
● 29-MIR-12M20G	● 29-MIR-12M20N	M20	12	37	26	11	100	129,00
● 29-MIR-17M20G	● 29-MIR-17M20N	M20	17	44	31	11	100	141,50
● 29-MIR-17M25G	● 29-MIR-17M25N	M25	17	45	31	12	100	156,50
● 29-MIR-23M25G	● 29-MIR-23M25N	M25	23	48	37	12	50	246,50
● 29-MIR-23M32G	● 29-MIR-23M32N	M32	23	51	37	15	50	269,50
● 29-MIR-29M32G	● 29-MIR-29M32N	M32	29	52	46	15	30	294,00
● 29-MIR-29M40G	● 29-MIR-29M40N	M40	29	56	46	16	30	322,50
● 29-MIR-36M40G	● 29-MIR-36M40N	M40	36	60	54	19	20	455,50
● 29-MIR-36M50G	● 29-MIR-36M50N	M50	36	60	54	19	20	632,00
● 29-MIR-48M50G	● 29-MIR-48M50N	M50	48	61	69	19	10	669,50
● 29-MIR-48M63G	● 29-MIR-48M63N	M63	48	61	69	19	10	820,50
<b>PG</b>								
● 29-MIR-07P07G	● 29-MIR-07P07N	PG7	7	35	19	15	100	137,50
● 29-MIR-10P07G	● 29-MIR-10P07N	PG7	10	37	21	18	50	145,50
● 29-MIR-10P09G	● 29-MIR-10P09N	PG9	10	37	21	18	100	129,00
● 29-MIR-12P09G	● 29-MIR-12P09N	PG9	12	37	26	20	50	139,00
● 29-MIR-12P11G	● 29-MIR-12P11N	PG11	12	37	26	20	100	129,00
● 29-MIR-12P13G	● 29-MIR-12P13N	PG13	12	37	26	20	50	129,50
● 29-MIR-17P13G	● 29-MIR-17P13N	PG13	17	44	31	27	100	150,00
● 29-MIR-17P16G	● 29-MIR-17P16N	PG16	17	44	31	27	100	144,00
● 29-MIR-23P21G	● 29-MIR-23P21N	PG21	23	48	37	34	50	216,50
● 29-MIR-29P29G	● 29-MIR-29P29N	PG29	29	49	46	42	30	242,50
● 29-MIR-36P36G	● 29-MIR-36P36N	PG36	36	55	54	50	20	461,50
● 29-MIR-48P48G	● 29-MIR-48P48N	PG48	48	56	69	66	10	584,00

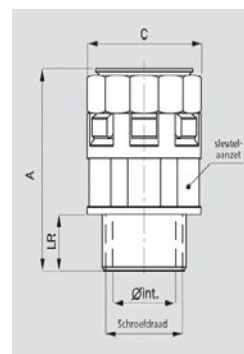

Vraag naar de EMC slangwartels.



Serie ECR

5

## Wartels HAAKS | Serie NEC

Bestelnummer Grijs - RAL7001	Bestelnummer Zwart - RAL9005	Schroef- draad	Slang nom. Ø	A Ø	C Ø	LR Ø	VPE in stk.	Brutoprijs €/100stk
<b>Metrisch</b>								
● 29-NEC-10M16G	● 29-NEC-10M16N	M16	10	35	21	11	50	228,50
● 29-NEC-12M16G	● 29-NEC-12M16N	M16	12	39	25	11	50	254,00
● 29-NEC-12M20G	● 29-NEC-12M20N	M20	12	39	25	11	50	255,00
● 29-NEC-17M20G	● 29-NEC-17M20N	M20	17	45	30	11	50	310,00
● 29-NEC-23M25G	● 29-NEC-23M25N	M25	23	53	36	12	30	390,00
● 29-NEC-29M32G	● 29-NEC-29M32N	M32	29	66	45	15	20	520,00
● 29-NEC-36M40G	● 29-NEC-36M40N	M40	36	79	54	19	10	905,00
● 29-NEC-48M50G	● 29-NEC-48M50N	M50	48	92	68	19	10	1.204,50
<b>PG</b>								
● 29-NEC-10P09G	● 29-NEC-10P09N	PG9	10	35	21	11,5	50	228,50
● 29-NEC-12P11G	● 29-NEC-12P11N	PG11	12	39	25	11,5	50	256,50
● 29-NEC-17P13G	● 29-NEC-17P13N	PG13	17	45	30	11,5	50	310,00
● 29-NEC-17P16G	● 29-NEC-17P16N	PG16	17	45	30	11,5	50	290,00
● 29-NEC-23P21G	● 29-NEC-23P21N	PG21	23	53	37	12,5	30	390,00
● 29-NEC-29P29G	● 29-NEC-29P29N	PG29	29	65	45	12,5	20	520,00
● 29-NEC-36P36G	● 29-NEC-36P36N	PG36	36	79	54	14,0	10	905,00
● 29-NEC-48P48G	● 29-NEC-48P48N	PG48	48	92	68	14,0	10	1.204,50

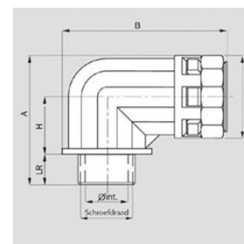

## Wartels 90° | Serie NBC

Bestelnummer Grijs - RAL7001	Bestelnummer Zwart - RAL9005	Schroef- draad	Slang nom. Ø	A	C	LR	VPE in stk.	Brutoprijs €/100stk
<b>Metrisch</b>								
● 29-NBC-17M25G	● 29-NBC-17M25N	M25	17	52	28	12	50	369,50
● 29-NBC-23M32G	● 29-NBC-23M32N	M32	23	69	36	15	30	506,50
● 29-NBC-29M40G	● 29-NBC-29M40N	M40	29	81	43	19	10	662,00
● 29-NBC-36M50G	● 29-NBC-36M50N	M50	36	98	51	19	10	919,50
● 29-NBC-48M63G	● 29-NBC-48M63N	M63	48	106	66	19	5	1.222,00
<b>PG</b>								
● 29-NBC-17P16G	● 29-NBC-17P16N	PG16	17	51	28	11,5	50	361,50
● 29-NBC-23P21G	● 29-NBC-23P21N	PG21	23	65	36	11,0	30	505,50
● 29-NBC-29P29G	● 29-NBC-29P29N	PG29	29	74	43	13,0	10	645,50
● 29-NBC-36P36G	● 29-NBC-36P36N	PG36	36	92	51	13,0	10	882,50
● 29-NBC-48P48G	● 29-NBC-48P48N	PG48	48	102	66	13,0	5	1.171,00

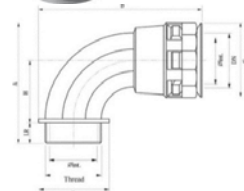

# Interflex beschermingslang

Toebehoren: slangwartels: 45°, wandbeugels, O-ringen



## Slangwartels 45° | Serie LTC

Bestelnummer Grijs - RAL7001	Bestelnummer Zwart - RAL9005	Schroef- draad	Slang nom. Ø	A Ø	C Ø	LR Ø	VPE in stk.	Brutoprijs €/100stk
<b>Metrisch</b>								
● 29-LTC-12M16G	● 29-LTC-12M16N	M16	12	50	24	11	50	267,00
● 29-LTC-17M20G	● 29-LTC-17M20N	M20	17	60	29	11	50	325,50
● 29-LTC-23M25G	● 29-LTC-23M25N	M25	23	70	37	12	30	409,50
● 29-LTC-29M32G	● 29-LTC-29M32N	M32	29	80	45	15	10	546,50
● 29-LTC-36M40G	● 29-LTC-36M40N	M40	36	96	53	19	10	950,50
● 29-LTC-48M50G	● 29-LTC-48M50N	M50	48	109	67	19	5	1.228,00
<b>PG</b>								
● 29-LTC-12P11G	● 29-LTC-12P11N	PG11	12	50	24	11	50	269,00
● 29-LTC-17P16G	● 29-LTC-17P16N	PG16	17	60	29	11	50	305,00
● 29-LTC-23P21G	● 29-LTC-23P21N	PG21	23	69	37	11	30	409,50
● 29-LTC-29P29G	● 29-LTC-29P29N	PG29	29	78	45	12	10	546,50
● 29-LTC-36P36G	● 29-LTC-36P36N	PG36	36	90	53	13	10	950,50
● 29-LTC-48P48G	● 29-LTC-48P48N	PG48	48	102	67	13	5	1.265,00

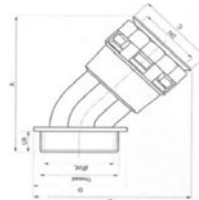

## Slangwartels Y-stuk | Serie YKD

Bestelnummer Grijs - RAL7001	Bestelnummer Zwart - RAL9005	Schroef- draad	Slang nom. Ø	A Ø	B Ø	C1 Ø	VPE in stk.	Brutoprijs €/100stk
● 29-YKD-171212G	● 29-YKD-171212N	M5	17	90	48	30	20	637,50
● 29-YKD-231717G	● 29-YKD-231717N	M6	23	108	59	38	20	701,00
● 29-YKD-292323G	● 29-YKD-292323N	M6	29	119	74	46	10	900,00
● 29-YKD-362929G	● 29-YKD-362929N	M6	36	142	89	54	5	1.215,00
● 29-YKD-483636G	● 29-YKD-483636N	M6	48	155	106	69	5	1.802,00

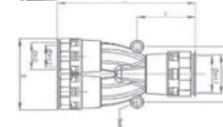

## NYLOFIX Toebehoren

Series SDN, SWL, ORJ en PLJ

### Wandbeugel | Serie SDN

Bestelnummer Grijs - RAL7001	Bestelnummer Zwart - RAL9005	Slang- maat	VPE in stk.	Brutoprijs €/100stk
● 29-SDN-07G	● 29-SDN-07N	7	100	75,50
● 29-SDN-10G	● 29-SDN-10N	10	100	75,50
● 29-SDN-12G	● 29-SDN-12N	12	100	76,00
● 29-SDN-17G	● 29-SDN-17N	17	100	91,50
● 29-SDN-23G	● 29-SDN-23N	23	50	161,00
● 29-SDN-29G	● 29-SDN-29N	29	30	194,50
● 29-SDN-36G	● 29-SDN-36N	36	20	332,00
● 29-SDN-48G	● 29-SDN-48N	48	10	400,00



SDN



SWL



ORJ

### Wandbeugel | Serie SWL

Bestelnummer Grijs - RAL7001	Bestelnummer Zwart - RAL9005	Slang- maat	VPE in stk.	Brutoprijs €/100stk
● 29-SWL-07G	● 29-SWL-07N	7	50	99,50
● 29-SWL-10G	● 29-SWL-10N	10	50	100,00
● 29-SWL-12G	● 29-SWL-12N	12	50	101,00
● 29-SWL-17G	● 29-SWL-17N	17	50	115,00
● 29-SWL-23G	● 29-SWL-23N	23	50	186,50
● 29-SWL-29G	● 29-SWL-29N	29	30	231,50
● 29-SWL-36G	● 29-SWL-36N	36	20	406,00
● 29-SWL-48G	● 29-SWL-48N	48	10	519,50

### O-Ring | Serie ORJ

Bestelnummer	Slang- maat	VPE in stk.	Brutoprijs €/100stk
29-ORJ-07	7	100	27,50
29-ORJ-10	10	100	20,00
29-ORJ-12	12	100	22,00
29-ORJ-17	17	100	25,50
29-ORJ-23	23	50	39,00
29-ORJ-29	29	30	62,00
29-ORJ-36	36	20	78,50
29-ORJ-48	48	10	78,50
29-ORJ-70	70	5	o.a.

### Pakking | Serie PLJ

Bestelnummer	Schroef- draad	VPE in stk.	Brutoprijs €/100stk
29-PLJ-M12	M12	100	34,50
29-PLJ-M16	M16	100	33,50
29-PLJ-M20	M20	100	40,50
29-PLJ-M25	M25	50	66,00
29-PLJ-M32	M32	30	100,50
29-PLJ-M40	M40	20	144,00
29-PLJ-M50	M50	10	208,00
29-PLJ-M63	M63	10	o.a.

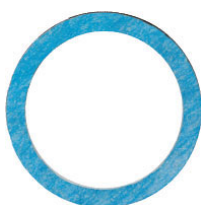

PLJ

Bestelnummer	Schroef- draad	VPE in stk.	Brutoprijs €/100stk
29-PLJ-P07	PG7	100	31,00
29-PLJ-P09	PG10	100	31,50
29-PLJ-P11	PG11	100	36,00
29-PLJ-P13	PG13	100	46,00
29-PLJ-P16	PG16	100	55,00
29-PLJ-P21	PG21	50	67,50
29-PLJ-P29	PG29	30	109,00
29-PLJ-P36	PG36	20	146,00



## Diverse omwikkeling

Spiraal- en kabelmantel, beschermprofiel

### Spiraalmantel | Serie SWHS85

<b>Materiaal:</b>	Polethyleen
<b>Temp. Bereik:</b>	-60°C tot +85°C
<b>Smeltpunt:</b>	112°C
<b>Trekvastheid:</b>	10 N/mm <sup>2</sup>
<b>Maximale rek:</b>	700%



Bestelnummer Zwart	Bestelnummer Transparant	Diam. inw.	Diam. uitw.	Bereik bundel mm	VPE per rol	Brutoprijs €/100mtr.
● 29-70040600Z	○ 29-70040610Z	4	6	5-20	25	43,05
● 29-70070900Z	○ 29-70070910Z	7	9	8-30	25	73,75
● 29-70091200Z	○ 29-70091210Z	9	12	10-40	25	103,95
● 29-70161900Z	○ 29-70161910Z	16	19	20-65	10	184,40

maten in mm

### Kabelmantel | Serie SHR Easycover halogeenvrij

<b>Materiaal:</b>	Polypropyleen
<b>Temp. Bereik:</b>	-30°C tot +110°C
<b>Kleuren:</b>	Zwart, lichtgrijs RAL7035, donkergrijs RAL7001
<b>Eigenschappen:</b>	Halogeenvrij, UL94

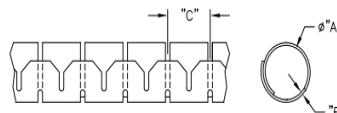
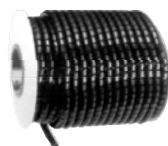

Bestelnummer Zwart	Bestelnummer Donker grijs	Bestelnummer Licht grijs	Diam. inw.	Bereik bundel mm	VPE per rol	Brutoprijs €/100mtr.
● 51-SHR-05-PPB	● 51-SHR-5-PPG	● 51-SHR-5-PPG/7035	5	6	100	<b>o.a.</b>
● 51-SHR-08-PPB	● 51-SHR-8-PPG	● 51-SHR-8-PPG/7035	8	10	100	<b>134,50</b>
● 51-SHR-15-PPB	● 51-SHR-15-PPG	● 51-SHR-15-PPG/7035	15	16	50	<b>160,00</b>
● 51-SHR-20-PPB	● 51-SHR-20-PPG	● 51-SHR-20-PPG/7035	20	23	30	<b>222,50</b>
● 51-SHR-25-PPB	● 51-SHR-25-PPG	● 51-SHR-25-PPG/7035	25	25	20	<b>224,50</b>
● 51-SHR-32-PPB	● 51-SHR-32-PPG	● 51-SHR-32-PPG/7035	32	32	20	<b>494,00</b>

Invoer tool wordt gratis meegeleverd

### Montage | Invoergereedschap

Bestelnummer	Gebruik voor max. ø	Brutoprijs 1stk.
51-CLIP08MM	8,0 mm	<b>3,00</b>
51-CLIP15MM	15,0 mm	<b>3,50</b>
51-CLIP20MM	20,0 mm	<b>4,00</b>
51-CLIP25MM	24,5 mm	<b>4,50</b>



Inclusief doorvoerclip



### Beschermprofiel | Carrosserieband

<b>Materiaal:</b>	Gevulkaniseerd rubber
-------------------	-----------------------

Bestelnummer Zwart	Klembereik	B mm	H mm	Bruto prijs €/100 mtr.
● 51-0780050	1,0 - 2,0 mm	6,5	9,5	<b>141,50</b>
● 51-07800120	1,0 - 4,0 mm	10,0	14,5	<b>205,50</b>

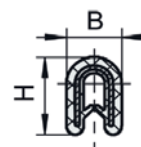
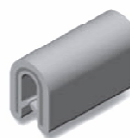

Voorzien van metalen klem.  
Ideaal om gaten in plaatstalen kasten  
mee af te screenen.

# Diverse omwikkeling

Krimpkou: krimp 2:1

## Serie STDB 102 | 2:1 in dispenser box

**Materiaal:** Polyolefin  
**Temp. bereik:** -55°C tot + 135°C  
**Krimptemp.:** >100°C  
**Volgens:** RoHS MIL-I-23053/5 klasse 3  
**Eigenschappen:** Vlamdovend

Om kleur te bestellen: 29-220 + "type" + "kleurcode" + G  
 Voorbeeld: 3/16 inch rood = 29-22004802G



Dispenser Box

Bestelnummer	Brutoprijs	Brutoprijs	Bestelnummer	Brutoprijs	Afmeting	Voor	Na	VPE
Zwart/transp./kleur	€/1stk.	€/1stk.	Groen/geel	€/1stk.	Inch	krimp	krimp	in mtr.
Zwart/transparant	Kleur	Groen/geel				mm	mm	
29-220012..G	20,80	23,80	29-25001254G	29,65	3/64	1,2	0,6	20
29-220016..G	20,80	23,80	29-25001654G	29,65	1/16	1,6	0,8	17
29-220024..G	20,80	23,80	29-25002454G	29,65	3/32	2,4	1,2	15
29-220032..G	20,80	23,80	29-25003254G	29,65	1/8	3,2	1,6	15
29-220048..G	20,80	23,80	29-25004854G	29,65	3/16	4,8	2,4	12
29-220064..G	20,80	23,80	29-25006454G	29,65	1/4	6,4	3,2	12
29-220095..G	20,80	23,80	29-25009554G	29,65	3/8	9,5	4,8	8
29-220127..G	20,80	23,80	29-25012754G	29,65	1/2	12,7	6,4	8
29-220191..G	20,80	23,80	29-25019154G	29,65	3/4	19,1	9,55	5
29-220254..G	20,80	23,80	29-25025454G	37,65	1	25,4	12,7	5

## Serie CGPT | 2:1

**Materiaal:** Polyolefin  
**Temp. bereik:** -55°C tot + 135°C  
**Krimptemp.:** >100°C  
**Volgens:** MIL-I-23053/5 klasse 3  
**Eigenschappen:** Vlamdovend



RoHS UL

Alleen in groen/geel  
 groen/geel

Voor andere kleuren zie: Serie HST

Bestelnummer	Afmeting	Voor	Na	VPE	Brutoprijs
Groen/geel	Inch	krimp	krimp	in mtr.	€/100mtr.
		mm	mm		
29-04001254U	3/64	1,2	0,6	150	o.a.
29-04001654U	1/16	1,6	0,8	150	o.a.
29-04002454U	3/32	2,4	1,2	150	o.a.
29-04003254U	1/8	3,2	1,6	200	o.a.
29-04004854U	3/16	4,8	2,4	200	o.a.
29-04006454U	1/4	6,4	3,2	150	o.a.
29-04009554U	3/8	9,5	4,8	150	o.a.
29-04012754U	1/2	12,7	6,4	100	o.a.
29-04019154U	3/4	19,1	9,6	50	o.a.
29-04025454U	1	25,4	12,7	50	o.a.
29-04038154U	1 1/2	38,1	19,1	25	o.a.
29-04050854U	2	50,8	25,4	25	o.a.

## Serie STHF112 | 2:1 halogeen vrij

**Materiaal:** Polyolefin  
**Temp. bereik:** -55°C tot + 105°C  
**Krimptemp.:** >100°C  
**Kleur:** Zwart, wit  
**Eigenschappen:** Vlamdovend



RoHS

00 09  
 zwart wit groen/geel op aanvraag

Bestelnummer	Afmeting	Voor	Na	VPE	Brutoprijs
Groen/geel	Inch	krimp	krimp	in mtr.	€/100mtr.
		mm	mm		
29-160012..A	3/64	1,2	0,6	150	147,80
29-160016..A	1/16	1,6	0,8	150	151,40
29-160024..A	3/32	2,4	1,2	150	162,20
29-160032..A	1/8	3,2	1,6	150	194,65
29-160048..A	3/16	4,8	2,4	75	201,90
29-160064..A	1/4	6,4	3,2	75	227,10
29-160095..A	3/8	9,5	4,8	75	259,55
29-160127..A	1/2	12,7	6,4	50	519,10
29-160160..A	5/8	15,9	8	50	562,40
29-160191..A	3/4	19,1	9,6	30	641,70
29-160254..A	1	25,4	12,7	30	778,70
29-160320..A	1 1/4	31,8	15,9	30	1.622,25
29-160381..A	1 1/2	38,1	19,1	30	2.206,25
29-160508..A	2	50,8	25,4	30	2.631,65

### Hittebestendig:

- Kynar, 2:1, transparant, -55°C tot + 175°C
- Viton, 2:1, zwart, -55°C tot + 200°C
- PTFE, 2:1, transparant, -55°C tot + 260°C

### Zwaardere toepassingen:

- HST 124, 4:1, zwart, -55°C tot + 125°C

## Diverse omwikkeling

Krimpkous: met lijm, UL gecertificeerd

### Serie STDB 113 | 3:1 met lijm in dispenser box

**Materiaal:** Polyolefin  
**Temp. bereik:** -55°C tot + 135°C  
**Krimptemp. :** >100°C  
**Volgens:** MIL-I-23053/5 klasse 3  
 FMVSS 302  
**Eigenschappen:** Vlamdovend / cross-linked



Bestelnummer	Afmeting	Voor	Na	VPE	Brutoprijs
Zwart/transparant		krimp	krimp	in mtr.	€/mtr.
	Inch	mm	mm		
29-240030..G	3/1	3	1	5	<b>25,80</b>
29-240048..G	4,8/1,6	4,8	1,6	4	<b>25,80</b>
29-240060..G	6/2	6	2	3,5	<b>25,80</b>
29-240090..G	9/3	9	3	3	<b>25,80</b>
29-240120..G	12/4	12	4	2,5	<b>25,80</b>
29-240180..G	18/6	18	6,3	2	<b>25,80</b>
29-240240..G	24/8	24	8	1,5	<b>25,80</b>

### Serie MST H-124 | 4:1 met lijm

**Materiaal:** Polyolefin  
**Temp.bereik:** -55°C tot + 125°C  
**Krimptemp.:** >120°C  
**Kleur:** Zwart  
**Eigenschappen:** Vlamdovend / cross-linked



Bestelnummer	Afmeting	Voor	Na	VPE	Brutoprijs
		krimp	krimp	in mtr.	€/lengte
	Inch	mm	mm		
29-520008AF	8/2	8	2	1,22	<b>9,10</b>
29-520012AF	12/3	12	3	1,22	<b>9,45</b>
29-520016AF	16/5	16	5	1,22	<b>11,10</b>
29-520022AF	22/6	22	6	1,22	<b>12,75</b>
29-520040AF	40/12	40	12	1,22	<b>16,95</b>
29-520055AF	55/16	55	16	1,22	<b>22,70</b>
29-520065AF	65/19	65	19	1,22	<b>25,30</b>
29-520075AF	75/22	75	22	1,22	<b>28,35</b>
29-520095AF	95/25	95	25	1,22	<b>44,70</b>
29-520115AF	115/34	115	34	1,22	<b>55,35</b>
29-520140AF	140/42	140	42	1,22	<b>58,75</b>
29-520180AF	180/58	180	58	1,22	<b>92,90</b>
29-520235AF	235/65	235	65	1,22	<b>o.a.</b>
29-520410AF	410/150	410	150	1,22	<b>o.a.</b>

### Serie HST | 2:1 met UL keurmerk op haspel

**Materiaal:** Polyolefin  
**Temp. bereik:** -55°C tot + 135°C  
**Krimptemp. :** >105°C  
**Volgens:** RoHS MIL-I-23053/5 klasse 3  
**Keuren:** UL (behalve transparant),  
 E 204071 incl. VW-1  
**Eigenschappen:** Vlamdovend



Beschikbaar in

00	02	04	05
zwart	rood	geel	groen
06	09	10	
blauw	wit	transparant (geen UL)	

Bestelnummer	Afmeting	Voor	Na	VPE	Brutoprijs
		krimp	krimp	in mtr.	€/100mtr.
	Inch	mm	mm		
29-020012..U	3/64	1,2	0,6	150	<b>74,50</b>
29-020016..U	1/16	1,6	0,8	150	<b>82,50</b>
29-020024..U	3/32	2,4	1,2	150	<b>87,00</b>
29-020032..U	1/8	3,2	1,6	150	<b>93,50</b>
29-020048..U	3/16	4,8	2,4	75	<b>104,50</b>
29-020064..U	1/4	6,4	3,2	75	<b>123,50</b>
29-020095..U	3/8	9,5	4,8	75	<b>141,00</b>
29-020127..U	1/2	12,7	6,4	50	<b>166,50</b>
29-020191..U	3/4	19,1	9,6	30	<b>253,50</b>
29-020254..U	1	25,4	12,7	30	<b>414,50</b>
29-020320..U	1 1/4	31,8	15,9	30	<b>522,50</b>
29-020381..U	1 1/2	38,1	19,1	30	<b>655,00</b>
29-020508..U	2	50,8	25,4	30	<b>945,00</b>
29-020762..U	3	76,2	38,1	15	<b>2.120,00</b>
29-021016..U	4	101,6	50,8	15	<b>2.770,00</b>



Ook leverbaar: enkel- en meervoudige afsluitdoppen

# Diverse omwikkeling

Elematic: isolatietape, gevlochten kous



## Tape | Isolatie

<b>Materiaal:</b>	PVC
<b>Temp. Bereik:</b>	-18°C tot + 90°C
<b>Eigenschappen:</b>	Vlamdovend
<b>Rekkracht:</b>	27 N/cm
<b>Lijmsterkte:</b>	2,2 N/cm
<b>Voorschriften:</b>	CEI EN 60454-3-1 en VDE 40039640"

### Karakteristieken

Geschikt voor toepassingen zowel industrie als woningbouw, ook bij lage temperaturen.  
Biedt goede elektrische isolatie.  
Zelfdovend en slijtvast.  
Beschikbaar in verschillende kleuren.



Bestelnummer	Kleur	Dikte mm	Breedte mm	Meters per rol	VPE in rollen	Rollen per karton	Brutoprijs €/100mtr.
95-NI 14N	● zwart	0,15	15	10	10	200	<b>o.a.</b>
95-NI 14BI	○ wit	0,15	15	10	10	200	
95-NI 14BL	● blauw	0,15	15	10	10	200	
95-NI 14GR	● grijs	0,15	15	10	10	200	
95-NI 14R	● rood	0,15	15	10	10	200	
95-NI 14T	● geel/groen	0,15	15	10	10	200	
95-NI 14M	● bruin	0,15	15	10	10	200	

## Gevlochten kous | Serie BSPA Grijs, halogeen vrij

<b>Materiaal:</b>	Polyamide 6.6
<b>Temp. Bereik:</b>	-40°C tot +125°C
<b>Voorschriften:</b>	DIN 5510-2 (S4SR2/ST2), FMVSS302, UL 94
<b>Ontvlambaarheid:</b>	UL94-V2

### Karakteristieken

Geschikt voor mechanische bescherming en bundeling van kabels.  
Bestand tegen chemicaliën.  
Slijtvast.

Bestelnummer	Nom.	Min.	Max.	VPE mtr.	Brutoprijs €/100mtr.
<b>Kleur grijs</b>					
95-BSPA-8G	● 8	4	13	50	<b>116,50</b>
95-BSPA-10G	● 10	7	15	50	<b>129,50</b>
95-BSPA-12G	● 12	9	18	50	<b>157,00</b>
95-BSPA-16G	● 16	11	21	25	<b>214,00</b>
95-BSPA-20G	● 20	14	25	25	<b>224,00</b>
95-BSPA-30G	● 30	22	37	25	<b>322,00</b>
95-BSPA-40G	● 40	30	48	25	<b>446,50</b>
95-BSPA-50G	● 50	40	65	50	<b>o.a.</b>
95-BSPA-70G	● 70	60	80	50	<b>o.a.</b>



# Diverse omwikkeling

Rubber tulen, gereedschap, krimpkous

## Tulen | Zwart, kleur en groen/geel

<b>Materiaal:</b>	Polychloroprene rubber
<b>Temp. bereik:</b>	-30°C tot 90°C (110°C in piek)
<b>Shore A hardheid:</b>	40 ±5
<b>Scheurvastheid:</b>	>6,5 MPa
<b>Max. rek voor breuk:</b>	>500 %
<b>Trekvastheid:</b>	>10 kN/m
<b>Dielektrische constante:</b>	>13 kV/mm
<b>Dwarsweerstand:</b>	4x10 Ω cm
<b>Brandbestendigheid:</b>	V0 UL94
<b>Tulen met smeermiddel:</b>	tot type A4

### Kleurcodes

Wit ○ 001	Oranje ● 005	Zwart ● 010
Blauw ● 002	Bruin ● 006	Grijs ● 013
Groen ● 003	Rood ● 007	Roze ● 015
Geel ● 004	Violet ● 008	Groen/geel ● 060



Bestelnummer Kleurcode ...	Artikel code	Voor draad Ø (mm)	lengte (mm)	binnen Ø (mm)	dikte (mm)	VPE stuks	Nettoprijs	Nettoprijs	Nettoprijs
							€/100stk.	€/100stk.	€/100stk.
							Zwart	Kleur	Geel/groen
65-020100 01...	A0	1,25 - 2,00	20	1,3	0,5	100	2,35	2,55	8,95
65-020100 02...	A1	1,75 - 3,50	20	1,8	0,5	100	2,45	2,70	9,20
65-020100 03...	A1 BIS	2,40 - 4,50	20	2,4	0,6	100	2,70	2,95	9,85
65-020100 04...	A2	3,00 - 6,00	25	3,0	0,6	100	3,85	4,15	12,00
65-020100 05...	A3	5,00 - 9,00	25	5,0	0,7	100	4,70	5,35	13,00
65-020100 06...	A4	7,50 - 12,00	30	7,5	0,8	100	7,75	9,15	17,75
65-020100 07...	A5	10,00 - 15,00	35	10,0	0,9	100	13,55	15,10	26,80
65-020100 08...	A8	12,00 - 20,00	50	12,0	1,2	100	26,70	29,30	47,70
65-020100 09...	A9	14,00 - 23,00	50	14,0	1,3	100	32,50	35,85	60,05
65-020100 10...	A10	17,00 - 28,00	50	17,0	1,3	100	40,35	44,55	68,65

## Gereedschap | 3-puntstangen

### 3-puntstang | KP-2

**Bestelnr. 65-04100134000**  
Voor tulen A1, A2, A3  
geschikt voor kabels tot Ø9mm

€ 80,66  
Netto per stuk



### 3-puntstang | KY-2

**Bestelnr. 65-04100137000**  
Voor tulen A1, A2, A3  
geschikt voor kabels tot Ø9mm

€ 64,49  
Netto per stuk



### 3-puntstang | KP-3

**Bestelnr. 65-04100135000**  
Voor tulen A2, A3, A4, A5  
geschikt voor kabels tot Ø15mm

€ 80,66  
Netto per stuk



### 3-puntstang | KY-3

**Bestelnr. 65-04100138000**  
Voor tulen A2, A3, A4, A5  
geschikt voor kabels tot Ø15mm

€ 64,49  
Netto per stuk



### 3-puntstang | KP-4

**Bestelnr. 65-04100145000**  
Voor tulen A5, A8, A9, A10  
geschikt voor kabels tot Ø28mm

€ 96,78  
Netto per stuk



### 3-puntstang | KY-4

**Bestelnr. 65-04100139000**  
Voor tulen A5, A8, A9, A10  
geschikt voor kabels tot Ø28mm

€ 69,92  
Netto per stuk



## Tulen | Smeermiddel 2,5 dl

Bestelnummer	Nettoprijs per stuk
65-07070001000	13,38



## Diverse omwikkeling

Elematic: bundelbanden (halogeenvrij) + toebehoren



### Bundelbanden | Naturel en zwart

**Materiaal:** Polyamide 6.6, halogeenvrij  
**Temp. Bereik:** -40°C tot 85°C  
**UV bestendig:** kleur zwart  
**Volgens norm:** CEI EN 62275  
**Brandbaarheid:** UL94 klasse V2

#### Karakteristieken

Halogeenvrij, Kleur: zwart en naturel



Bestelnummer Naturel	Bestelnummer Zwart	Afmeting (mm)		Bundeling Ø max (mm)	Kracht (kg)	Kracht (N)	VPE stks.	Karton stks.	Brutoprijs €/100stk.
		Lengte	Breedte						
○ 95-0098-025-0	● 95-0098-025-1	98	2,5	21	8,16	80	100	15000	1,80
○ 95-0135-025-0	● 95-0135-025-1	135	2,5	32	8,16	80	100	12000	4,10
○ 95-0200-026-0	● 95-0200-026-1	200	2,6	52	8,16	80	100	8000	5,60
○ 95-0140-036-0	● 95-0140-036-1	140	3,5	35	18,36	180	100	7000	4,80
○ 95-0200-036-0	● 95-0200-036-1	200	3,5	50	18,36	180	100	7000	7,40
○ 95-0290-036-0	● 95-0290-036-1	290	3,5	80	18,36	180	100	4500	10,20
○ 95-0178-048-0	● 95-0178-048-1	178	4,8	45	22,44	220	100	5000	8,10
○ 95-0200-048-0	● 95-0200-048-1	200	4,8	50	22,44	220	100	4500	8,20
○ 95-0290-048-0	● 95-0290-048-1	290	4,8	79	22,44	220	100	3500	13,20
○ 95-0360-048-0	● 95-0360-048-1	360	4,8	100	22,44	220	100	3000	16,05
○ 95-0430-048-0	● 95-0430-048-1	430	4,8	115	22,44	220	100	5000	15,80
○ 95-0300-078-0	● 95-0300-078-1	300	7,8	80	55,08	540	100	1500	26,15
○ 95-0365-078-0	● 95-0365-078-1	365	7,5	100	55,08	540	100	1500	28,30
○ 95-0450-078-0	● 95-0450-078-1	450	7,5	130	55,08	540	100	2500	51,70
○ 95-0540-078-0	● 95-0540-078-1	540	7,5	158	55,08	540	100	2500	69,30
○ 95-0750-078-0	● 95-0750-078-1	750	7,5	220	55,08	540	100	2000	87,50
○ -	● 95-0500-126-1	500	12,5	143	110,00	1080	50	1000	94,50

### Bundelbanden | Met label

**Materiaal:** Polyamide 6.6, halogeenvrij  
**Temp. Bereik:** -40°C tot 85°C  
**UV bestendig:** naturel  
**Brandbaarheid:** UL94 klasse V2



Bestelnummer Naturel	Bestelnummer Zwart	Afmeting (mm)		Bundeling Ø max (mm)	Kracht (kg)	Kracht (N)	VPE stks.	Karton stks.	Brutoprijs €/100stk.
		Lengte	Breedte						
○ 95-52100-ME	● o.a.	98	2,5	21	8,16	80	100	15000	6,45
○ 95-52200-ME	● o.a.	135	2,5	32	8,16	80	100	12000	45,90

### Plak- en schroefzadels | Naturel en zwart

Bestelnummer Naturel	Bestelnummer Zwart	afmeting (lxb mm)	Voor bundelband	Brutoprijs €/100stk.
<b>Plakzadels</b>				
○ 95-19x19wit	● 95-19x19zwart	19x19	tot 3,6 mm	21,75
○ 95-27x27wit	● 95-27x27zwart	27x27	tot 4,8 mm	34,15
<b>Schroefzadels</b>				
○ 95-15x10-M3,5-0	● 95-15x10-M3,5-ZW	15x10	tot 4,8 mm	22,35
○ 95-23x15-M5-0	● 95-23x15-M5-ZW	23x15	tot 9 mm	25,35

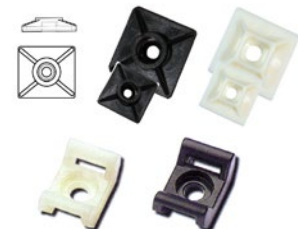

### Montage | Tang

**Bestelnummer 95-CT3010**  
 Afmeting (mm) 160x130



**40,00**

Netto per stuk

Gewicht 310 gr

**Ook leverbaar:** Gekleurde bundelbanden / detecteerbare bundelbanden / UV bestendige bundelbanden met 10 jaar garantie hittebestendige bundelbanden, (+125°C continue of +150°C max 5 uur) herbruikbare bundelbanden en nog veel meer ...

# Diverse omwikkeling

Elematic: 2-Lock™ en detecteerbare bundelbanden



## 2-LOCK™ KABELBINDERS

### DUBBELE VERTANDING

Door de symmetrische vorm van de dubbele vertanding wordt een treksterkte bereikt die tot 50% meer is in vergelijking met kabelbinders voorzien van een enkele stalen vertanding.



### PATENT

Om de exclusiviteit van de 2-LOCK™ kabelbinder te waarborgen en het eigen unieke productieproces te beschermen, is wereldwijd patent aangevraagd.

### UV BESTENDIG

Door toevoeging van koolstof aan de 2-LOCK™ kabelbinders zijn deze UV bestendig en geschikt voor buitengebruik.

### BEDRIJFSZEKERHEID

Altijd op de juiste spanning bij elke mogelijke klemdiameter dankzij de souplesse van de kabelbinder.



### INGEBOUWD STALEN FRAME

Het RVS frame met dubbele vertanding wordt al tijdens het spuitgieten in de kop verwerkt. Dit maakt de combinatie van staal en polyamide tot een extra stevig geheel.



### MAXIMALE BESCHERMING

De afgeronde vorm van de kop en uiteinde van de band zorgen ervoor dat er geen scherpe randen zijn die beschadigingen of verwondingen kunnen veroorzaken.

### VERWERKING BIJ LAGE TEMPERATUREN

Uitstekende prestaties bij lage temperaturen voor toepassingen tot -40°C.

### GERINGE INSTEELKRACHT

Omdat de band aan beide zijden geheel glad is, is de insteekkracht veel lager dan bij vergelijkbare producten.

## Bundelbanden | 2-Lock™

<b>Materiaal:</b>	Polyamide 6.6 (halogeenvrij), sluitingen RVS 316
<b>Temperatuurbereik:</b>	-40°C tot + 85°C
<b>UV bestendig:</b>	Kleur zwart
<b>Kleuren:</b>	Zwart of naturel
<b>Volgens norm:</b>	CEI EN 62275
<b>Vlamdovend</b>	UL94 klasse V2



Bestelnummer Naturel	Bestelnummer Zwart	Afmeting (mm)		Bundeling Ø max (mm)	Kracht (kg)	Kracht (N)	VPE stks.	Karton stks.	Brutoprijs	
		Lengte	Breedte						€/100stk.	€/100stk.
○ 95-0100-025-0-2LK	● 95-0100-025-1-2LK	100	2,5	21	18,34	180	100	15000	Naturel 12,15	Zwart 12,15
○ 95-0200-025-0-2LK	● 95-0200-025-1-2LK	200	2,5	50	18,34	180	100	8000	17,90	17,90
○ 95-0140-035-0-2LK	● 95-0140-035-1-2LK	140	3,5	35	25,51	250	100	7000	14,15	14,15
○ 95-0200-035-0-2LK	● 95-0200-035-1-2LK	200	3,5	50	25,51	250	100	7000	18,75	18,75
○ 95-0290-035-0-2LK	● 95-0290-035-1-2LK	290	3,5	80	25,51	250	100	4500	34,35	33,75
○ 95-0200-045-0-2LK	● 95-0200-045-1-2LK	200	4,5	50	36,70	360	100	4000	18,85	18,85
○ 95-0250-045-0-2LK	● 95-0250-045-1-2LK	250	4,5	68	36,70	360	100	4500	39,05	39,05
○ 95-0290-045-0-2LK	● 95-0290-045-1-2LK	290	4,5	80	36,70	360	100	3500	40,85	40,85
○ 95-0360-045-0-2LK	● 95-0360-045-1-2LK	360	4,5	101	36,70	360	100	3000	39,10	32,95
○ 95-0220-075-0-2LK	● 95-0220-075-1-2LK	220	7,5	56	79,51	780	100	2000	49,55	49,55
○ 95-0360-075-0-2LK	● 95-0360-075-1-2LK	360	7,5	101	79,51	780	100	1500	52,90	51,30

## Bundelbanden | Detecteerbaar

<b>Materiaal:</b>	Polyamide 6.6 (halogeenvrij), ijzeroxide
<b>Temperatuurbereik:</b>	-40°C tot + 85°C
<b>UV bestendig:</b>	Blauw
<b>Volgens norm:</b>	CEI EN 62275
<b>Vlamdovend</b>	UL94 klasse V2

### Karakteristieken

Detecteerbaar met behulp van röntgen of metaaldetectie, dankzij het toegevoegde ijzeroxide.  
Bestand tegen aromatische oplosmiddelen, oliën en vetten



Bestelnummer	Afmeting (mm)		Bundeling Ø max (mm)	Kracht (kg)	Kracht (N)	VPE stks.	Karton stks.	Brutoprijs €/100stk.
	Lengte	Breedte						
● 95-0098-025-DTE	98	2,5	21	8,16	80	100	15000	10,20
● 95-0140-036-DTE	140	3,6	35	18,34	180	100	7000	15,75
● 95-0200-036-DTE	200	3,6	50	18,34	180	100	7000	23,00
● 95-0200-048-DTE	200	4,8	50	22,44	220	100	4000	31,65
● 95-0290-048-DTE	290	4,5	79	22,44	220	100	3500	45,30
● 95-0360-048-DTE	360	4,5	100	22,44	220	100	3000	53,85
● 95-0365-078-DTE	365	7,5	100	55,08	540	100	15000	98,90

## Diverse omwikkeling

Thomas&Betts: bundelbanden met inox clip (halogeen vrij)

**Thomas&Betts**  
A Member of the ABB Group

### Bundelbanden inox | Naturel en zwart

<b>Materiaal:</b>	Polyamide 6.6, sluiting RVS316
<b>Temp.bereik:</b>	-60°C tot 85°C, zwart tot +105
<b>UV bestendig:</b>	Kleur zwart
<b>Brandbaarheid:</b>	UL94 V-2
<b>UL-filenr.:</b>	E49405



#### Karakteristieken

Geschikt voor vrijwel alle toepassingen binnen en buiten.  
RVS sluiting bestand tegen kou, hitte, vochtigheid, vibratie en andere externe invloeden.  
100 stuks verpakkingen op verzoek leverbaar.



Bestelnummer Naturel	Bestelnummer Zwart	Afmeting (mm)		Bundeling Ø max (mm)	Trek- kracht N	VPE stk.	Brutoprijs €/100stk.	
		Lengte	Breedte				Naturel	Zwart
○ 46-TYB-23M	● 46-TYB-23MX	92	2,3	22	80	1000	3,90	4,60
○ 46-TY-232M	● 46-TY-232MX	203	2,3	51	80	1000	7,40	9,10
○ 46-TY-234M	● 46-TY-234MX	356	2,3	102	80	1000	o.a.	o.a.
○ 46-TYB-24M	● 46-TYB-24MX	140	3,6	35	178	1000	5,50	6,35
○ 46-TY-242M	● 46-TY-242MX	208	3,6	51	180	1000	10,55	12,10
○ 46-TY-26M	● 46-TY-26MX	284	3,6	76	130	1000	12,65	15,10
○ 46-TY-244M	● 46-TY-244MX	368	3,6	102	134	1000	16,15	39,95
○ 46-TYB-25M	● 46-TYB-25MX	186	4,8	48	222	1000	8,15	9,95
○ 46-TY-253M	● 46-TY-253MX	295	4,8	78	222	1000	16,55	17,45
○ 46-TY-28M	● 46-TY-28MX	361	4,8	102	222	1000	16,55	19,50
○ 46-TY-272M	● 46-TY-272MX	222	7,6	51	534	500	39,10	29,00
○ 46-TY-27M	● 46-TY-27MX	340	6,9	102	540	500	23,15	25,55
○ 46-TY5-275M	● 46-TY5-275MX	457	6,9	127	540	50	63,60	80,73
○ 46-TY5-277M	● 46-TY5-277MX	617	6,9	177	540	50	o.a.	121,18
○ 46-TY5-29M	● 46-TY5-29MX	771	6,9	229	540	50	o.a.	o.a.

### Montagetang | voor kunststof banden

#### Montagetang | 90-ERG50

Bestelnummer 90-ERG50

Voor kunststof bundelbanden

2,4 - 4,8 mm

€ 188,88

netto per stuk

Gewicht: 240 gr

treksterkte van 80 tot 220N



#### Montagetang | 90-ERG120

Bestelnummer 90-ERG120

Voor kunststof bundelbanden

4,8 - 7,6 mm

€ 223,07

netto per stuk

Gewicht: 278 gr

treksterkte van 220 tot 540N





## Diverse omwikkeling

Randclip (incl. bundelband), RVS (inox) bundelbanden

### Randclip | Zwart

Temp. Bereik:	-10°C tot 85°C
UV bestendig:	kleur zwart
Volgens norm:	UL62275, EN62275
Brandbaarheid:	UL94 klasse V2



Bestelnummer	Afmeting (mm)		Bundeling max. (mm)	Trekkracht (kg)	VPE stks.	Brutoprijs €/100stk.
	Lengte	Breedte				
● 90-99990180	200	4,6	50	23	1000	o.a.

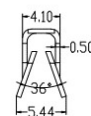
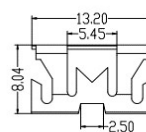
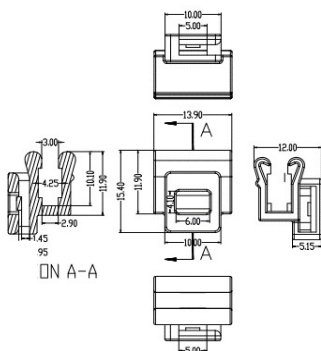
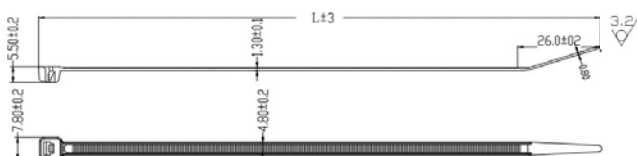

De randclip wordt standaard geleverd met kabelbundelbandje dat beschikbaar is in 3 verschillende maten. Ideaal voor toepassing in schakelkasten, machines of andere toepassingen waar het boren van gaten niet mogelijk is. Kabels en leidingen kunnen makkelijk gebundeld en zo netjes verwerkt worden. Bestand tegen olie, vetten, basen, oliederivaten, chlorideoplosmiddelen. Beperkt bestand tegen zuren. Niet bestand tegen fenolen.

De zwarte versie is UV bestendig en zeker ook geschikt voor toepassing in PV installaties.

Meer weten: vraag naar de mogelijkheden via 0342-454544 of mail naar [info@calpe.nl](mailto:info@calpe.nl)

### Kabelbanden RVS (inox) | Serie PKS



RVS 316 ongecoat



RVS 316 gecoat, zwart of rood



Bestelnummer	Maximale temperatuur (°C)	Afmeting (mm)		VPE	Uitvoering
		Lengte	Breedte		
46-PKS46150AN16	500	150	4,6	100	ongecoat
46-PKS46150AN16C	150	150	4,6	100	gecoat zwart
46-PKS46200AN16	500	200	4,6	100	ongecoat
46-PKS46200AN16C	150	200	4,6	100	gecoat zwart
46-PKS46360AN16	500	360	4,6	100	ongecoat
46-PKS46360AN16C	150	360	4,6	100	gecoat zwart



voor RVS codering zie hoofdstuk 9

Lined writing area for notes.



# AANSLUITEN EN VERBINDEN

---

6

# Cabur rijgklemmen

Klemmen: serie CBC, TEO 2,5 - 35mm<sup>2</sup>



## Serie CBC, TEO | 2,5 - 35 mm<sup>2</sup>

**Materiaal:** UL94V-0 polyamide  
**Temp.bereik:** -40°C tot +110°C  
**Kleuren:** Grijs, blauw, groen/geel

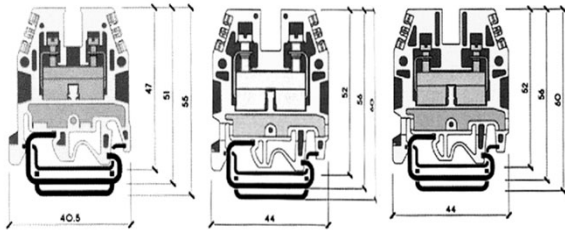

### Karakteristieken

Geschikt voor: 1000V - 60947-7-1  
600V - UL



Omschrijving	Bestelnummer	Type	VPE	Brutoprijs €/100st
<b>2,5 mm<sup>2</sup></b>				
Doorvoerklem grijs BOX	36-BCC02GR	BB/CBC.2GR	1400	<b>65,29</b>
Doorvoerklem grijs	36-CBC02GR	CBC.2/GR	120	<b>66,20</b>
Doorvoerklem blauw	36-CBI02	CBC.2 (EX)i	120	<b>69,25</b>
Aardklem groen/geel	36-TO910	TEO.2	75	<b>278,60</b>
Eindplaat grijs	36-CB061GR	CBC.2-10/PT/GR	50	<b>54,45</b>
Eindplaat blauw	36-CBI061	CBC.2-10/PT(Ex)i	50	<b>55,65</b>
Eindplaat groen/geel	36-TO911	TEO.2PT	25	<b>42,75</b>
Brugverbinding 2-polig	36-PTC0202	PTC/2/02	25	<b>55,60</b>
Brugverbinding 3-polig	36-PTC0203	PTC/2/03	25	<b>87,40</b>
Brugverbinding 5-polig	36-PTC0205	PTC/2/05	25	<b>150,75</b>
Brugverbinding 10-polig	36-PTC0210	PTC/2/10	10	<b>260,05</b>
Brugverbinding 250mm	36-PTC0200	PTC/2/00	8	<b>1319,90</b>
Eindsteun schroefbaar	36-BT003	BT/3	25	<b>78,45</b>
Eindsteun zelfklemmend	36-BT005	BTU	25	<b>120,50</b>

Bestelnummer	Type	VPE	Brutoprijs €/100st
<b>4 mm<sup>2</sup></b>			
36-BCC04GR	BB/CBC.4GR	1000	<b>69,72</b>
36-CBC04GR	CBC.4/GR	100	<b>71,65</b>
36-CBI04	CBC.4(Ex)i	100	<b>74,10</b>
36-TO430	TEO.4	50	<b>311,20</b>
36-CB061GR	CBC.2-10/PT/GR	50	<b>54,45</b>
36-CBI061	CBC.2-10/PT(Ex)i	50	<b>55,65</b>
36-TO431	TEO4.PT	25	<b>38,25</b>
36-PTC0402	PTC/4/02	25	<b>66,30</b>
36-PTC0403	PTC/4/03	25	<b>102,70</b>
36-PTC0405	PTC/4/05	25	<b>199,05</b>
36-PTC0410	PTC/4/10	10	<b>291,20</b>
36-PTC0400	PTC/4/00	8	<b>1520,00</b>
36-BT003	BT/3	25	<b>78,45</b>
36-BT005	BTU	25	<b>120,50</b>

Omschrijving	Bestelnummer	Type	VPE	Brutoprijs €/100st
<b>6 mm<sup>2</sup></b>				
Doorvoerklem grijs	36-CBC06GR	CBC.6/GR	100	<b>112,55</b>
Doorvoerklem blauw	36-CBI06	CBC.6(Ex)i	100	<b>115,30</b>
Aardklem groen/geel	36-TO110	TE.6/O	45	<b>384,05</b>
Eindplaat grijs	36-CB061GR	CBC.2-10/PT/GR	50	<b>54,45</b>
Eindplaat blauw	36-CBI061	CBC.2-10/PT(Ex)i	50	<b>55,65</b>
Brugverbinding 2-polig	36-PTC0602	PTC/6/02	25	<b>66,90</b>
Brugverbinding 3-polig	36-PTC0603	PTC/6/03	25	<b>123,15</b>
Brugverbinding 5-polig	36-PTC0605	PTC/6/05	25	<b>210,40</b>
Brugverbinding 10-polig	36-PTC0610	PTC/6/10	10	<b>306,25</b>
Brugverbinding 250mm	36-PTC0600	PTC/6/00	8	<b>1.550,00</b>
Eindsteun schroefbaar	36-BT003	BT/3	25	<b>78,45</b>
Eindsteun zelfklemmend	36-BT005	BTU	25	<b>120,50</b>

Bestelnummer	Type	VPE	Brutoprijs €/100st
<b>10 mm<sup>2</sup></b>			
36-CBC10GR	CBC.10/GR	100	<b>164,10</b>
36-CBI10	CBC.10(Ex)i	100	<b>162,45</b>
36-TO500	TE.10/O	35	<b>444,60</b>
36-CB061GR	CBC.2-10/PT/GR	50	<b>54,45</b>
36-CBI061	CBC.2-10/PT(Ex)i	50	<b>55,65</b>
36-PTC1002	PTC/10/02	25	<b>100,60</b>
36-PTC1003	PTC/10/03	25	<b>124,55</b>
36-PTC1005	PTC/10/05	25	<b>188,10</b>
36-PTC1010	PTC/10/10	10	<b>327,75</b>
36-PTC1000	PTC/10/00	8	<b>1640,00</b>
36-BT003	BT/3	25	<b>78,45</b>
36-BT005	BTU	25	<b>120,50</b>

Omschrijving	Bestelnummer	Type	VPE	Brutoprijs €/100st
<b>16 mm<sup>2</sup></b>				
Doorvoerklem grijs	36-CBC16GR	CBC.16/GR	50	<b>226,95</b>
Doorvoerklem blauw(ex)	36-CBI16	CBC.16 (Ex)i	50	<b>227,15</b>
Aardklem groen/geel	36-TO210	TE.16/O	30	<b>546,25</b>
Eindplaat grijs	36-CB161GR	CBC.16/PT/GR	25	<b>64,35</b>
Eindplaat blauw	36-CBI161	CBC.16/PT(Ex)i	25	<b>75,75</b>
Ontkoppelbare brugverb.	36-POS53	POS/53	25	<b>258,45</b>
Eindsteun schroefbaar	36-BT003	BT/3	25	<b>78,45</b>
Eindsteun zelfklemmend	36-BT005	BTU	25	<b>120,50</b>

Bestelnummer	Type	VPE	Brutoprijs €/100st
<b>35 mm<sup>2</sup></b>			
36-CBC35GR	CBC.35/GR	50	<b>465,90</b>
36-CBI35	CBC.35(Ex)i	50	<b>472,65</b>
36-CB351GR	CBC.35/PT/GR	25	<b>72,20</b>
36-CBI351	CBC.35/PT(Ex)i	25	<b>77,30</b>
36-BT003	BT/3	25	<b>78,45</b>
36-BT005	BTU	25	<b>120,50</b>

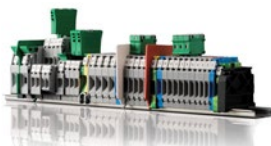

# Cabur rijgklemmen

Accessoires CBC

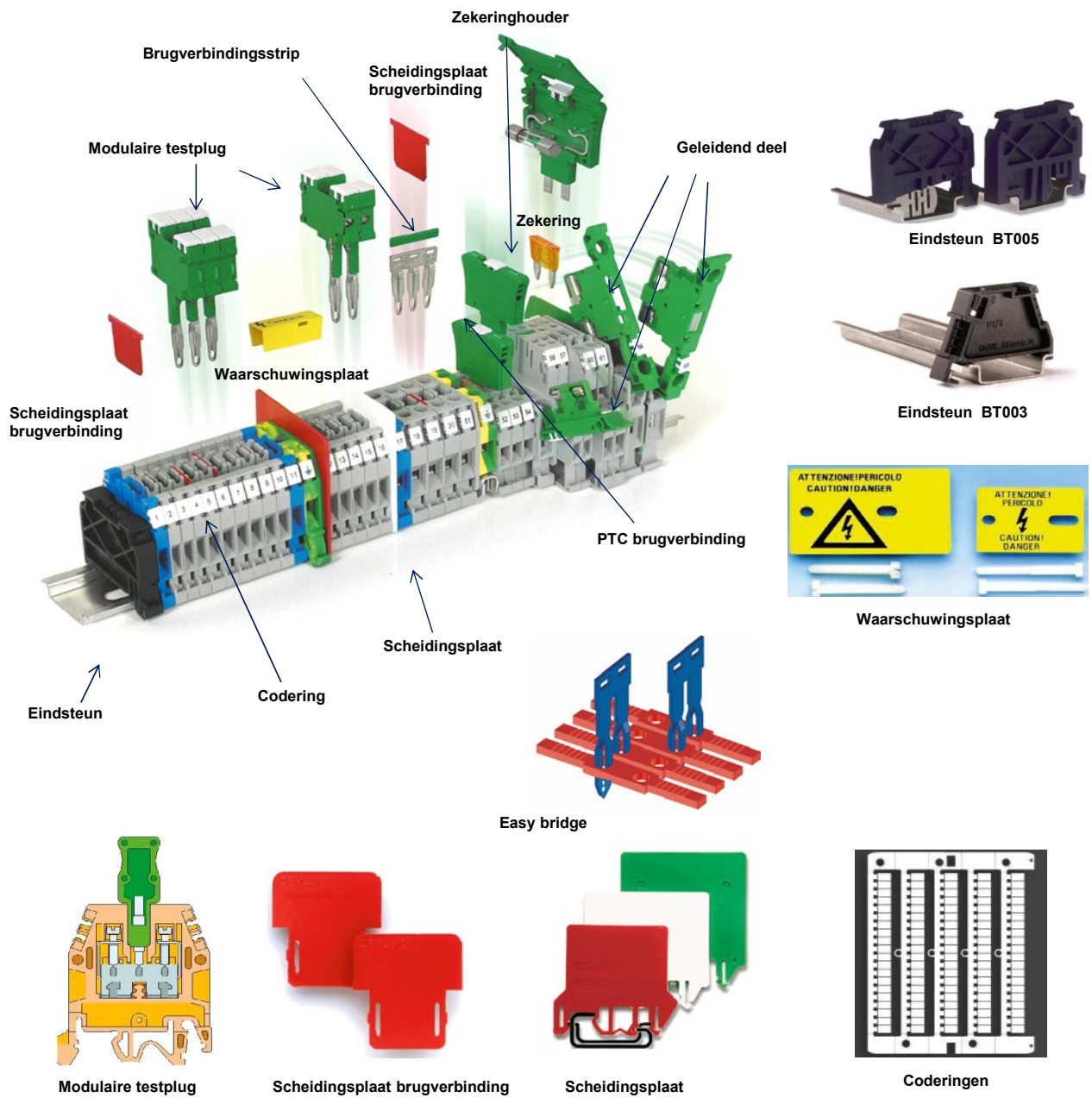

6

Omschrijving	2,5 mm <sup>2</sup>	4 mm <sup>2</sup>	6 mm <sup>2</sup>	10 mm <sup>2</sup>	16 mm <sup>2</sup>	35 mm <sup>2</sup>
Afscherming brugverbinding					36-PRP07	36-PPR08
Brugverbindingsstrip 250 mm					36-PMP05	36-PMP06
Schroef en bus					36-CPM53	36-CPM06
Scheidingsplaat wit	36-DU04B	36-DU04B	36-DU04B	36-DU04B	36-DU04B	36-DU05B
Scheidingsplaat rood	36-DU01R	36-DU04R	36-DU04R	36-DU04R	36-DU04R	36-DU05R
Scheidingsplaat groen	36-DU01V	36-DU04V	36-DU04V	36-DU04V	36-DU04V	36-DU05V
Scheidingsplaat brugverbinding	36-DF800	36-DF800	36-DF800	36-DF800	36-DF700	36-DF700
Scheidingsplaat brugverbinding	36-DF900	36-DF900	36-DF900	36-DF900	36-DF700	36-DF700
Testplug bus					36-PD002	36-PD002
Testplug	36-DC005	36-DC006			36-DC002	36-DC002
Testplug type 2	36-DC05P	36-DC06P				
Modulaire testplug	36-DCPOL	36-DCPOL				
Waarschuingsplaat	36-PRP/7/G	36-PRP/7/G	36-PRP/7/G	36-PRP/7/G	36-TUM16	36-TUM06
Coderingselement	36-NU0851S	36-NU0851S	36-NU0851S	36-NU0851S	36-NU0851S	36-NU0851S

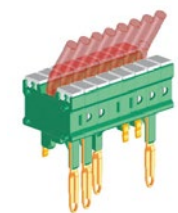

Modulaire testplug

# Cabur rijgklemmen

Doorvoerklemmen, aardingsklemmen



## Serie CBD, TE | 2,5 - 70 mm<sup>2</sup>

**Materiaal:** UL94V-0 polyamide  
**Temp.bereik:** -40°C tot +110°C  
**Kleuren:** Grijs, blauw, groen/geel



Omschrijving	Bestelnummer	Type	VPE	Brutoprijs €/100st	Bestelnummer	Type	VPE	Brutoprijs €/100st	
<b>2,5 mm<sup>2</sup></b>					<b>4 mm<sup>2</sup></b>				
Doorvoerklem Big box	36-BBC02	BB/CBD.2	1400	69,55	36-BBC04	BB/CBD.4	1000	81,04	
Doorvoerklem beige	36-CB110	CBD.2	120	76,60	36-CB240	CBD.4	120	89,10	
Doorvoerklem blauw	36-CBX12	CBD.2 (EX)i	120	101,85	36-CBX24	CBD.4 (EX)i	100	113,85	
Aardklem groen/geel	36-TO910	TEO.2	75	278,60	36-TO430	TEO.4	75	311,20	
Eindplaat groen	36-TO911	TEO.2PT	50	42,75	36-TO431	TEO.4PT	25	38,25	
Eindplaat beige	36-CB111	CB2/PT	50	38,40	36-CB241	CB4/6PT	25	60,70	
Eindplaat blauw	36-CBX13	CB2/PT (EX)i	50	52,20	36-CBX25	CB4/6PT (EX)i	25	58,35	
Brugverbinding 2-polig	36-PM202	PM20/2	25	114,40	36-PM402	PM40/2	25	166,30	
Brugverbinding 3-polig	36-PM203	PM20/3	25	189,70	36-PM403	PM40/3	25	283,25	
Brugverbinding 5-polig	36-PM205	PM205/5	25	285,35	36-PM405	PM40/5	25	330,30	
Brugverbinding 10-polig	36-PM210	PM20/10	10	399,35	36-PM400	PM40/10	10	611,95	
Ontkoppelbare brugverb.	36-POS11	POS/11	25	199,40	36-POS42	POS/42	25	199,40	
<b>6 mm<sup>2</sup></b>					<b>10 mm<sup>2</sup></b>				
Doorvoerklem Big box	36-BBC06	BB/CBD.6	900	112,91	36-BBC10	BB/CBD.4	600	148,68	
Doorvoerklem beige	36-CB340	CBD.6	100	126,00	36-CB440	CBD.10	100	158,85	
Doorvoerklem (EX)i	36-CBX34	CBD.6 (EX)i	100	154,60	36-CBX45	CBD.10 (EX)i	100	196,70	
Aardklem gr./geel	36-TO110	TE.6/O	45	384,05	36-TO500	TE.10/O	35	444,60	
Eindplaat beige	36-CB241	CB4/6/PT	25	60,70	36-CB431	CB10/PT	25	55,75	
Eindplaat blauw	36-CBX25	CB4/6/PT (EX)i	25	58,35	36-CBX44	CB10/PT (EX)i	25	64,50	
Brugverbinding 2-polig	36-PM602	PM20/2	25	179,50	36-PM102	PM10/2	25	187,50	
Brugverbinding 3-polig	36-PM603	PM20/3	25	314,40	36-PM103	PM10/3	25	326,70	
Brugverbinding 5-polig	36-PM605	PM205/5	25	417,25	36-PM105	PM10/5	25	379,00	
Brugverbinding 10-polig	36-PM610	PM20/10	10	682,60	36-PM100	PM10/10	10	839,00	
Ontkoppelbare brugverb.	36-POS93	POS/11	25	368,25	36-POS44	POS/44	25	365,10	
<b>16 mm<sup>2</sup></b>					<b>35 mm<sup>2</sup></b>				
Doorvoerklem beige	36-CB510	CBD.16	50	244,30	36-CB610	CBD.35	75	502,85	
Doorvoerklem (EX)i	36-CBX52	CBD.16 (EX)i	50	291,15	36-CBX62	CBD.35 (EX)i	75	555,00	
Aardklem gr./geel	36-TO210	TE.16/O	30	546,25	36-CB611	CB35/PT	25	64,05	
Eindplaat beige	36-CB511	CB16/PT	25	60,10	36-CBX63	CB35/PT (EX)i	25	74,65	
Eindplaat blauw	36-CBX53	CB16/PT (EX)i	25	69,60	36-POF06	POF/06	15	259,05	
Brugverbinding	36-POF44	POF/44	25	202,45	36-POS66	POS/66	15	0,00	
Ontkoppelbare brugverb.	36-POS44	POS/44	25	365,10					
<b>50 mm<sup>2</sup></b>					<b>70 mm<sup>2</sup></b>				
Doorvoerklem beige	36-CB710	CBD.50	50	603,90	36-CB810	CBD.70	40	1610,00	
Doorvoerklem grijs	36-CB710GR	CBD.50/GR	50	820,90	36-CB810GR	CBD.70/GR	40	1680,00	
Doorvoerklem (EX)i	36-CBX72	CBD.50 (EX)i	50	737,50	36-CBX82	CBD.10 (EX)i	40	1735,00	
Aardklem gr./geel	36-TO310	TE.50/O	15	837,45	36-TO810	TE.70/O	20	1430,00	
Eindplaat beige	36-CB711	CB50/PT	10	72,90	36-CB811	CB70/PT	10	121,80	
Eindplaat grijs	36-CB711GR	CB50/PT/GR	10	89,60	36-CB811GR	CB70/PT/GR	10	149,25	
Eindplaat blauw	36-CBX73	CB50/PT (EX)i	10	88,75	36-CBX83	CB70/PT (EX)i	10	129,75	
Brugverbinding	36-POF07	POF/07	15	277,75	36-POF08	POF/08	15	280,95	
Ontkoppelbare brugverb.	36-POS77	POS/77	25	425,50	36-POS08	POS/08	15	417,70	

# Cabur rijgklemmen

Twee- en drie-etageklemmen



## Twee- en drie-etageklemmen | Serie DAS.4 en TLD.2 | 2,5 - 4 mm<sup>2</sup>

**Materiaal:** UL94V-0 polyamide  
**Temperatuurbereik:** -40°C tot +110°C  
**Kleuren:** Grijs, beige, blauw

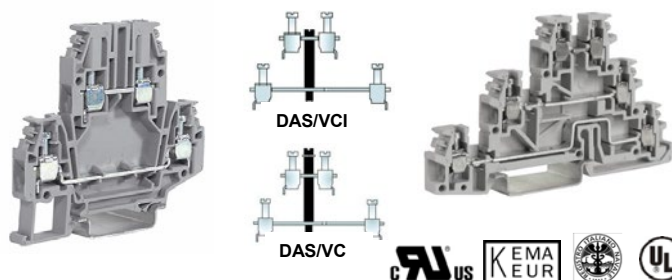

Omschrijving	Bestelnummer	Type	VPE	Brutoprijs €/100st	Bestelnummer	Type	VPE	Brutoprijs €/100st	
<b>2 etage 4 mm<sup>2</sup></b>					<b>3 etage 2,5 mm<sup>2</sup></b>				
Etageklem grijs BOX	36-BBD04GR	BB/DAS.4GR	700	<b>202,04</b>					
Etageklem grijs	36-DS100GR	DAS.4/GR	120	<b>225,10</b>	36-TL200GR	TLD.2/GR	125	<b>450,55</b>	
Etageklem beige BOX	36-BBD04	BB/DAS.4	700	<b>188,83</b>					
Etageklem beige	36-DS100	DAS.4	120	<b>215,30</b>	36-TL200	TLD.2	125	<b>442,95</b>	
Etageklem blauw	36-DS200	DAS.4(Ex)i	120	<b>227,45</b>	36-TL300	TLD.2 (Ex)i	125	<b>576,80</b>	
Eindplaat grijs	36-DS101GR	DAS/PT/GR	25	<b>59,50</b>	36-TL201GR	TLD/PT/GR	25	<b>70,35</b>	
Eindplaat beige	36-DS101	DAS/PT	25	<b>59,75</b>	36-TL201	TLD/PT	25	<b>70,35</b>	
Brugverbinding 2-polig	36-PM412	PM41/2	25	<b>163,95</b>	36-PM202	PM/20/2	15	<b>114,40</b>	
Brugverbinding 3-polig	36-PM513	PM51/3	25	<b>241,05</b>	36-PM303	PM/30/3	25	<b>275,30</b>	
Brugverbinding 5-polig	36-PM515	PM51/5	25	<b>326,75</b>	36-PM305	PM/30/5	25	<b>365,10</b>	
Brugverbinding 10-polig	36-PM510	PM51/10	10	<b>736,55</b>	36-PM310	PM/30/10	10	<b>724,40</b>	
Ontkoppelbare brugverb.	36-POS43	POS43	25	<b>276,55</b>	36-POS41	POS/41	25	<b>0,00</b>	

## Accessoires | DAS.4 en TLD.2

Omschrijving	2-etage	3-etage
	4 mm <sup>2</sup>	2,5 mm <sup>2</sup>
Afscherming brugverb.	36-PRP05	36-PRP05
Brugverb.strip 250 mm	36-PMP58	36-PMP02
Testplug bus	36-PD001	36-PD004
Testplug	36-DD001	36-DD001
DAS/VCi schroefverb.	36-DS107	
DAS/VCE schroefverb.	36-DS108	
Scheidingsplaat wit	36-DU07B	36-DU07B
Scheidingsplaat rood	36-DU07 R	36-DU07R
Scheidingsplaat groen	36-DU07V	36-DU07V
Coderingselement	36-NU1061S	36-NU0851S
Eindsteun schroefbaar	36-BT003	36-BT003
Eindsteun zelfklemmend	36-BT005	36-BT005

# Cabur rijgklemmen

Mini doorvoerklemmen, doorvoerklemmen met zekeringhouders



## Mini doorvoerklemmen | Serie RN, RP en TR | 1,5 - 4 mm<sup>2</sup>

**Materiaal:** UL94V-0 polyamide  
**Temp.bereik:** -40°C tot +110°C (vanaf 2,5mm<sup>2</sup>)  
**Kleuren:** Grijs, blauw, groen-geel

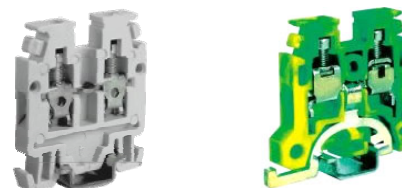

Omschrijving	Bestelnummer	Type	VPE	Brutoprijs €/100st	Bestelnummer	Type	VPE	Brutoprijs €/100st	
<b>Serie RN</b>					<b>Serie RN</b>				
					<b>1,5 mm<sup>2</sup></b>				
Mini doorvoerklem grijs	36-RN300GR	RN.1/GR	125	<b>104,95</b>	36-RN500GR	RN.2/GR	110	<b>104,95</b>	
Mini doorvoerklem blauw	36-RN400	RN.1(Ex)i	125	<b>116,20</b>	36-RN510	RN.2(Ex)i	110	<b>113,95</b>	
Mini aardklem groen/geel					36-TR110	TR.2	100	<b>337,80</b>	
Eindplaat grijs	36-RF101GR	RFN/PT/GR	25	<b>30,35</b>	36-RF101GR	RFN/PT/GR	25	<b>30,35</b>	
Eindplaat blauw	36-RF201	RFN/PT/(Ex)i	25	<b>34,20</b>	36-RF201	RFN/PT/(Ex)i	25	<b>34,20</b>	
Brugverbinding 2-polig	36-PM112	PM/11/2	25	<b>106,00</b>	36-PM122	PM/12/2	25	<b>106,00</b>	
Brugverbinding 3-polig	36-PM112	PM/11/3	25	<b>106,00</b>	36-PM123	PM/12/3	25	<b>140,10</b>	
Brugverbinding 5-polig	36-PM113	PM/11/5	25	<b>141,40</b>	36-PM125	PM/12/5	25	<b>209,10</b>	
Brugverbinding 10-polig	36-PM115	PM/11/10	10	<b>210,30</b>	36-PM120	PM/12/10	10	<b>416,30</b>	

Omschrijving	Bestelnummer	Type	VPE	Brutoprijs €/100st
<b>Serie RP</b>				
<b>4 mm<sup>2</sup></b>				
Mini doorvoerklem grijs	36-RP300GR	RP.4/GR	144	<b>125,80</b>
Mini doorvoerklem (Ex)i	36-RP400	RP.4(Ex)i	144	<b>129,65</b>
Mini aardklem groen/geel	36-TR200	TR.4	50	<b>331,90</b>
Eindplaat grijs	36-RP301GR	RP4/PT/GR	25	<b>28,80</b>
Eindplaat blauw blauw	36-RP401	RP4/PT/(Ex)i	25	<b>33,20</b>
Brugverbinding 2-polig	36-PM412	PM/41/2	25	<b>139,60</b>
Brugverbinding 3-polig	36-PM513	PM/51/3	25	<b>204,70</b>
Brugverbinding 5-polig	36-PM515	PM/51/5	25	<b>278,25</b>
Brugverbinding 10-polig	36-PM510	PM/51/10	10	<b>627,00</b>



## Accessoires | RN, RP en TR

Omschrijving	Serie RN		Serie RP	Serie TR
	1,5 mm <sup>2</sup>	2,5 mm <sup>2</sup>	4 mm <sup>2</sup>	2,5 mm <sup>2</sup>
Afscherming brugverb.	36-PRP05	36-PRP05	36-PRP05	
Brugverb.strip 250 mm	36-PMP16	36-PMP25	36-PMP58	
Testplug houder	36-PD011	36-PD001	36-PD001	
Testplug	36-DD001	36-DD001	36-DD001	
Scheidingsplaat wit	36-DFP2B	36-DFP2B	36-DFP2B	36-DFP2B
Scheidingsplaat rood	36-DFP2R	36-DFP2R	36-DFP2R	36-DFP2R
Scheidingsplaat groen	36-DFP2V	36-DFP2V	36-DFP2V	36-DFP2V
Coderingselement	36-NU1061S	36-NU0851S	36-NU1061S	36-NU0851S
Eindsteun schroefbaar	36-BT006	36-BT006	36-BT006	36-BT006



## Doorvoerklem met zekeringhouder | Serie SF voor 5x20 mm zekeringen

**Materiaal:** UL94V-0 polyamide  
**Temp.bereik:** -40°C tot +80°C  
**Kleuren:** Grijs, beige

Omschrijving	Bestelnummer	Type	VPE	Brutoprijs €/100st
Doorvoerklem grijs	36-SF900GR	SFR.4/GR	70	<b>368,90</b>
Doorvoerklem beige	36-SF900	SRF.4	70	<b>376,20</b>
Eindplaat grijs	36-SF701GR	SFR.4/PT/GR	25	<b>66,30</b>
Eindplaat beige	36-SF701	SFR.4/PT	25	<b>60,65</b>
Scheidingsplaat rood	36-DU03R	DFU/3/R	50	<b>100,70</b>
Eindsteun zelfklemmend	36-BT005	BTU	25	<b>102,55</b>
Eindsteun schroefbaar	36-BT003	BT/3	25	<b>66,80</b>





# Cabur rijgklemmen

## Rijgklemmen push-in



### Serie EFC.2 (4) - EFCE.2 (4) | 2,5 - 4 mm<sup>2</sup>

**Materiaal:** Polyamide UL94 V0  
**Temp.bereik:** -40°C tot +110°C  
**Kleuren:** Grijs, blauw, groen/geel  
**Kortsluitvastheid:** 8kV  
**Volgens:** IEC EN 60947-7-1

#### Karakteristieken

Snelle, betrouwbare en efficiënte montage.  
 Montage zonder gereedschap.  
 Schroevendraaier alleen nodig bij demontage:  
 drukken op de ontgrendelknop



Omschrijving	Bestelnr.	Type	VPE	Brutopr. €/100st	Bestelnr.	Type	VPE	Brutopr. €/100st	Bestelnr.	Type	VPE	Brutopr. €/100st	
<b>2,5 mm<sup>2</sup> 2 aansluitingen</b>					<b>2,5 mm<sup>2</sup> 3 aansluitingen</b>					<b>2,5 mm<sup>2</sup> 4 aansluitingen</b>			
Rijgklem Push-in grijs	36-EFC200GR	EFC.2/GR	160	66,60	36-EFC210GR	EFC.2/1+2GR	120	94,10	36-EFC220GR	EFC.2/2+2GR	90	111,35	
Rijgklem Push-in blauw	36-EFC200BL	EFC.2/BL	160	73,55	36-EFC210BL	EFC.2/1+2BL	120	103,85	36-EFC220BL	EFC.2/2+2BL	90	122,80	
Aardklem Push-in gr/gl	36-EFCE200	EFCE.2	80	261,40	36-EFCE210	EFCE.2/1+2	50	287,30	36-EFCE220	EFCE.2/2+2	60	311,70	
Eindplaat grijs	36-EFC201GR	EFC.2/PT/GR	25	37,50	36-EFC211GR	EFC.2/1+2/PT/GR	25	47,65	36-EFC221GR	EFC.2/2+2/PT/GR	25	51,15	
Eindplaat blauw	36-EFC201BL	EFC.2/PT/BL	25	40,30	36-EFC211BL	EFC.2/1+2/PT/BL	25	54,65	36-EFC221BL	EFC.2/2+2/PT/BL	25	58,65	
Brugverbinding 2-polig	36-EFB0202R	EFB.2/2/R	20	51,45	36-EFB0202R	EFB.2/2/R	20	51,45	36-EFB0202R	EFB.2/2/R	20	51,45	
Brugverbinding 3-polig	36-EFB0203R	EFB.2/3/R	20	67,55	36-EFB0203R	EFB.2/3/R	20	67,55	36-EFB0203R	EFB.2/3/R	20	67,55	
Brugverbinding 5-polig	36-EFB0205R	EFB.2/5/R	10	140,05	36-EFB0205R	EFB.2/5/R	10	140,05	36-EFB0205R	EFB.2/5/R	10	140,05	
Brugverbinding 10-polig	36-EFB0210R	EFB.2/10/R	5	289,45	36-EFB0210R	EFB.2/10/R	5	289,45	36-EFB0210R	EFB.2/10/R	5	289,45	
Eindsteun schroefbaar	36-BT003	BT/3	25	78,45	36-BT003	BT/3	25	78,45	36-BT003	BT/3	25	78,45	
Eindsteun zelfklemmend	36-BT007	BTO	25	73,70	36-BT007	BTO	25	73,70	36-BT007	BTO	25	73,70	
Coderingselement	36-NU1051S	CNU/10/51	100	6,90	36-NU1051S	CNU/10/51	100	6,90	36-NU1051S	CNU/10/51	100	6,90	

Omschrijving	Bestelnr.	Type	VPE	Brutopr. €/100st	Bestelnr.	Type	VPE	Brutopr. €/100st	Bestelnr.	Type	VPE	Brutopr. €/100st	
<b>4,0 mm<sup>2</sup> 2 aansluitingen</b>					<b>4,0 mm<sup>2</sup> 3 aansluitingen</b>					<b>4,0 mm<sup>2</sup> 4 aansluitingen</b>			
Rijgklem Push-in grijs	36-EFC400GR	EFC.4/GR	120	90,15	36-EFC410GR	EFC.4/1+2GR	110	141,60	36-EFC420GR	EFC.4/2+2GR	90	176,10	
Rijgklem Push-in blauw	36-EFC400BL	EFC.4/BL	120	99,55	36-EFC410BL	EFC.4/1+2BL	110	156,30	36-EFC420BL	EFC.4/2+2BL	90	194,45	
Aardklem Push-in gr/gl	36-EFCE400	EFCE.4	70	277,25	36-EFCE410	EFCE.4/1+2	60	338,30	36-EFCE420	EFCE.4/2+2	90	380,65	
Eindplaat grijs	36-EFC401GR	EFC.4/PT/GR	25	38,75	36-EFC411GR	EFC.4/1+2/PT/GR	25	49,65	36-EFC421GR	EFC.4/2+2/PT/GR	25	53,45	
Eindplaat blauw	36-EFC401BL	EFC.4/PT/BL	25	41,70	36-EFC411BL	EFC.4/1+2/PT/BL	25	56,90	36-EFC421BL	EFC.4/2+2/PT/BL	25	62,15	
Brugverbinding 2-polig	36-EFB0402R	EFB.4/2/R	20	55,15	36-EFB0402R	EFB.4/2/R	20	55,15	36-EFB0402R	EFB.4/2/R	20	55,15	
Brugverbinding 3-polig	36-EFB0403R	EFB.4/3/R	20	71,90	36-EFB0403R	EFB.4/3/R	20	71,90	36-EFB0403R	EFB.4/3/R	20	71,90	
Brugverbinding 5-polig	36-EFB0405R	EFB.4/5/R	10	194,20	36-EFB0405R	EFB.4/5/R	10	194,20	36-EFB0405R	EFB.4/5/R	10	194,20	
Brugverbinding 10-polig	36-EFB0410R	EFB.4/10/R	5	300,20	36-EFB0410R	EFB.4/10/R	5	300,20	36-EFB0410R	EFB.4/10/R	5	300,20	
Eindsteun schroefbaar	36-BT003	BT/3	25	78,45	36-BT003	BT/3	25	78,45	36-BT003	BT/3	25	78,45	
Eindsteun zelfklemmend	36-BT007	BTO	25	73,70	36-BT007	BTO	25	73,70	36-BT007	BTO	25	73,70	
Coderingselement	36-NU1051S	CNU/10/51	100	6,90	36-NU1051S	CNU/10/51	100	6,90	36-NU1051S	CNU/10/51	100	6,90	

### Serie EFD.2 (4) - EFDE.2 (4) | 2,5 - 4 mm<sup>2</sup> - 2-etage rijgklem Push-in

Omschrijving	Bestelnr.	Type	VPE	Brutopr. €/100st	Bestelnr.	Type	VPE	Brutopr. €/100st
<b>2,5 mm<sup>2</sup> 2 aansluitingen</b>					<b>4,0 mm<sup>2</sup> 2 aansluitingen</b>			
Rijgklem Push-in grijs	36-EFD200GR	EFD.2/GR	130	177,40	36-EFD400GR	EFD.4/GR	100	216,60
Rijgklem Push-in blauw	36-EFD200BL	EFD.2/BL	130	203,25	36-EFD400BL	EFD.4/BL	100	248,50
Aardklem Push-in gr/gl	36-EFDE200	EFDE.2	30	477,60	36-EFDE400	EFDE.4	40	553,75
Eindplaat grijs	36-EFD201GR	EFD.2/PT/GR	25	53,65	36-EFD401GR	EFD.4/PT/GR	25	76,10
Eindplaat blauw	36-EFD201BL	EFD.2/PT/BL	25	58,30	36-EFD401BL	EFD.4/PT/BL	25	82,10
Brugverbinding 2-polig	36-EFB0202R	EFB.2/2/R	20	51,45	36-EFB0402R	EFB.4/2/R	20	55,15
Brugverbinding 3-polig	36-EFB0203R	EFB.2/3/R	20	67,55	36-EFB0403R	EFB.4/3/R	20	71,90
Brugverbinding 5-polig	36-EFB0205R	EFB.2/5/R	10	140,05	36-EFB0405R	EFB.4/5/R	10	194,20
Brugverbinding 10-polig	36-EFB0210R	EFB.2/10/R	5	289,45	36-EFB0410R	EFB.4/10/R	5	300,20
Eindsteun schroefbaar	36-BT003	BT/3	25	78,45	36-BT003	BT/3	25	78,45
Eindsteun zelfklemmend	36-BT007	BTO	25	73,70	36-BT007	BTO	25	73,70
Coderingselement	36-NU1051S	CNU/10/51	100	6,90	36-NU1051S	CNU/10/51	100	6,90



**Binnenkort leverbaar:**  
 3-etage rijgklem Push-in  
 zekeringhouder Push-in

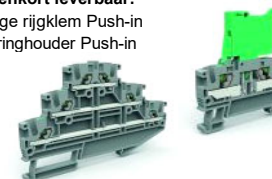

Eindsteun schroefbaar



Brugverbinding

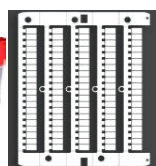

Coderingselement

# Cabur rijgklemmen

Codering tbv Cabur klemmen



## Coderingen voor alle Cabur klemmen

Calpe biedt u de mogelijkheid om coderingen volgens uw specificatie te bedrukken.

Wij gaan uit van een aantal basiskaarten, waarbij wij rekening hebben gehouden met het doornummeren op de klemmen.

Dit heeft te maken met de verschillende breedtes van de klemmen.

De tags passen op alle typen klemmen.

De printer, die wij hiervoor gebruiken is een inktjet printer, ontwikkeld door Cabur.

Buiten de klemcoderingen kan deze printer ook o.a. adercoderingen, componentcoderingen, stickers en typeplaatjes printen.

Hieronder volgen een aantal voorbeelden van de mogelijkheden.

### DAS.4

Een etageklem, waarbij het veel voorkomt dat de klem met een range van even en oneven nummers gecodeerd wordt.

Wij kunnen dan bijv. kaarten printen met even en oneven coderingen.

Omdat de printer werkt met True Type Windows letter typen kan er altijd voor een duidelijk resultaat worden gekozen.

Tevens kan de bedrukking gedraaid worden.

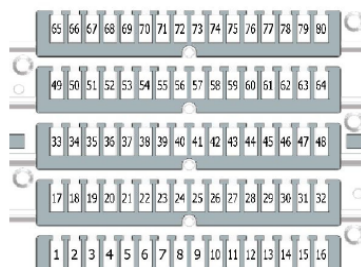

NU1061S DAS.4

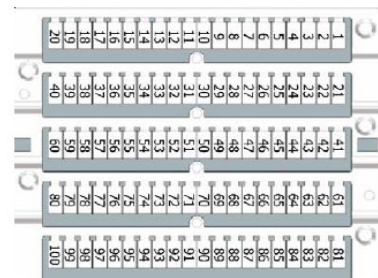

NU1051S CBC.2

Omschrijving	Bestelnummer	Brutoprijs €/ tag	Brutoprijs		Brutoprijs €/ VPE
			€/ kaart	VPE kaarten	
DAS.4 Blanco kaart 80 tags	36-NU1061S	0,0690	5,52	15	82,80
CBC.2 HMM blanco krt.100 tags	36-NU1051S	0,0690	6,90	15	103,50
CBC.4 HMM blanco krt. 80 tags	36-NU1061S	0,0690	5,52	15	82,80

Prijzen zijn exclusief instelkosten

## Voorbedrukte coderingen | Serie CSC

Passend op doorvoerklemmen CBD, DAS.4, TLD, RN, RP en SFR

Voorbeeld bestelnummer:

Losse cijfers 0 t/m 9	bijv. 1	<b>CS111</b>
Losse letters A t/m Z	bijv. A	<b>CSAAA</b>
Losse letters a t/m z	bijv. a	<b>CS00A</b>



Opdruk per 100 tags	Bestelnummer	VPE	Brutoprijs €/ kaart
Onbedrukt	36-CSC00	5	4,23
=	36-CS0G1	5	4,23
+	36-CS0G2	5	4,23
-	36-CS0G3	5	4,23
~	36-CS0G4	5	4,23
↓	36-CS0G5	5	4,23
⊕	36-CS0G5	5	4,23
÷	36-CS0G7	5	4,23
/	36-CS0G8	5	4,23
(	36-CS0G9	5	4,23
Losse cijfers 0, 1,2,3,4 etc.	36-CS...	5	4,23
Cijfers 0 t/m 9	36-CSC09	5	4,23
Losse letters A, B, C etc.	36-CS...	5	4,23
Losse letters a, b, c etc.	36-CS00.	5	4,23



Liever zelf bedrukken? Vraag naar de mogelijkheden!

# Diverse verdeelblokken en aansluitklemmen

Verdeelblokken: serie QBLOK, Aansluitklemmen: serie CK



## 2- en 4-polige verdeelblokken | Serie QBLOK

<b>Materiaal:</b>	Messing CW 614N
<b>Kunststof:</b>	PA 6.6 isolatie, polycarbonaat deksel
<b>Spanning:</b>	500V (overspanning 8 kV/3), 1000VDC (Qblok 2125)
<b>Aandraaimoment:</b>	2/2.5 Nm (bij gat 11mm 10/12,5 Nm)
<b>Voorschriften:</b>	EN 60947-7-1:2009
<b>Montage:</b>	Geschikt voor DIN-EN rail en bodemmontage



Max Belasting	Bestelnummer	Aantal polen	Gaten per pool	Gaten ø mm	Aansl. mm²	Lcw kA	Afmeting hxbxd	VPE	Brutoprijs €/st
125A 35mm²	36-QBLOK2125	2	11	2x9,0	10-35	4,2	52x49x109	2	16,55
				2x7,5	10-25				
				7x5,4	2,5-6				
100 A 25mm²	36-QBLOK4100	4	7	2x7,5	10-25	3,0	52x71x97	2	20,25
				5x5,4	2,5-6,0				
125 A 35mm²	36-QBLOK4125	4	11	2x9,0	10-35	4,2	52x108x97	1	28,25
				2x7,5	10-25				
				7x5,4	2,5-6				
125 A 35mm²	36-QBLOK4126	4	15	2x9,0	10-35	4,2	52x137x97	1	33,30
				2x7,5	10-25				
				11x5,4	2,5-6				
160 A 50mm²	36-QBLOK4160U	4	9	1x11	10-50	6,0	54x131x99	1	51,70
				2x8,5	10-35				
				6x6,5	2,5-16				
160 A 50mm²	36-QBLOK4161U	4	14	1x11	10-50	6,0	54x181x99	1	63,65
				4x8,5	10-35				
				9x6,5	2,5-16				

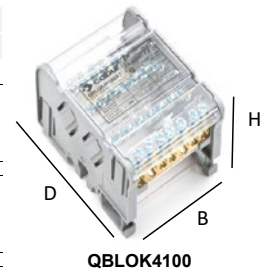

QBLOK4100



QBLOK416...

## Aansluitklemmen | Serie CK halogeenvrij

<b>Materiaal (body):</b>	Polyamide (PA6)
<b>Materiaal (blok):</b>	Aluminium
<b>Voorschriften:</b>	PA 6.6 isolatie, polycarbonaat deksel
<b>Bedrijfstemperatuur:</b>	Tot 80°C
<b>Montage:</b>	Geschikt voor DIN-EN rail en bodemmontage



Tot 240mm²

Bestelnummer	Kleur	Type	Aansluitbereik		I nom. (A)		Nominale spanning Ui (V)	Aandraaimoment Nm	Hexagon bout	Gewicht Kg	VPE	Brutoprijs €/1stk.
			Cu mm²	Al mm²	Cu	Al						
<b>Enkel</b>												
90-B2110100610		CK61	2,5 - 50	6 - 50	160	145	600	4 (2.5-4mm²) / 12 (6-50mm²)	5	0,030	10	5,00
90-B2110100612		CK61	2,5 - 50	6 - 50	160	145	600	4 (2.5-4mm²) / 12 (6-50mm²)	5	0,030	10	5,10
90-B2110100613		CK61	2,5 - 50	6 - 50	160	145	600	4 (2.5-4mm²) / 12 (6-50mm²)	5	0,030	10	5,10
90-B2110100620		CK62	16 - 95	16 - 95	245	220	600	20 (16-95mm²)	5	0,074	8	8,70
90-B2110100622		CK62	16 - 95	16 - 95	245	220	600	20 (16-95mm²)	5	0,074	8	8,90
90-B2110100623		CK62	16 - 95	16 - 95	245	220	600	20 (16-95mm²)	5	0,074	8	8,90
90-B2110100630		CK63	35 - 150	35 - 150	320	290	600	20 (35-95mm²) / 30 (120-150mm²)	8	0,120	5	12,70
90-B2110100632		CK63	35 - 150	35 - 150	320	290	600	20 (35-95mm²) / 30 (120-150mm²)	8	0,120	5	13,20
90-B2110100633		CK63	35 - 150	35 - 150	320	290	600	20 (35-95mm²) / 30 (120-150mm²)	8	0,120	5	13,20
90-B2110100640		CK64	35 - 240	35 - 240	425	380	600	12 (35-70mm²) / 45 (95-240mm²)	8	0,249	2	21,65
90-B2110100642		CK64	35 - 240	35 - 240	425	380	600	12 (35-70mm²) / 45 (95-240mm²)	8	0,249	2	22,85
90-B2110100643		CK64	35 - 240	35 - 240	425	380	600	12 (35-70mm²) / 45 (95-240mm²)	8	0,249	2	22,85
<b>Dubbel</b>												
90-B2110100660		CK66	2,5 - 50	6 - 50	160	145	600	4 (2.5-4mm²) / 12 (6-50mm²)	5	0,049	6	9,95
90-B2110100662		CK66	2,5 - 50	6 - 50	160	145	600	4 (2.5-4mm²) / 12 (6-50mm²)	5	0,049	6	10,15
90-B2110100663		CK66	2,5 - 50	6 - 50	160	145	600	4 (2.5-4mm²) / 12 (6-50mm²)	5	0,049	6	10,15
90-B2110100670		CK67	16 - 95	16 - 95	245	220	600	20 (16-95mm²)	5	0,128	3	15,85
90-B2110100672		CK67	16 - 95	16 - 95	245	220	600	20 (16-95mm²)	5	0,128	3	16,50
90-B2110100673		CK67	16 - 95	16 - 95	245	220	600	20 (16-95mm²)	5	0,128	3	16,50
90-B2110100680		CK68	35 - 150	35 - 150	320	290	600	20 (35-95mm²) / 30 (120-150mm²)	8	0,210	2	24,40
90-B2110100682		CK68	35 - 150	35 - 150	320	290	600	20 (35-95mm²) / 30 (120-150mm²)	8	0,210	2	24,40
90-B2110100683		CK68	35 - 150	35 - 150	320	290	600	20 (35-95mm²) / 30 (120-150mm²)	8	0,210	2	24,40
90-B2110100690		CK69	35 - 240	35 - 240	425	380	600	12 (35-70mm²) / 45 (95-240mm²)	8	0,438	1	44,25
90-B2110100692		CK69	35 - 240	35 - 240	425	380	600	12 (35-70mm²) / 45 (95-240mm²)	8	0,438	1	44,25
90-B2110100693		CK69	35 - 240	35 - 240	425	380	600	12 (35-70mm²) / 45 (95-240mm²)	8	0,438	1	44,25

# HoraEtec aansluit- en verdeelklemmen

Serie RKA: enkel 50-300mm<sup>2</sup>



## Doorvoerklemmen | Serie RKA

**Materiaal (body):** Polyamide (PA6) halogeenvrij  
**Materiaal (blok):** Aluminium vertind  
**Kleuren:** Grijs, blauw, groen, bruin, zwart  
**Voorschriften:** EN 60947-7-1, UL 1059 E344466

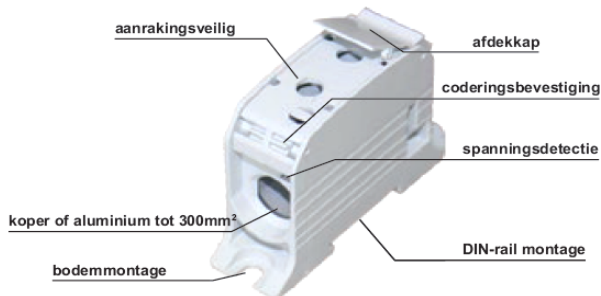

### Karakteristieken

Voor koper en aluminium kabel.  
 Nominale piekspanning 8kV, kruipstroomvastheid CTI1550.  
 Bij montage van onvertinde geleiders is een zuurvrije vaseline aanbevolen.

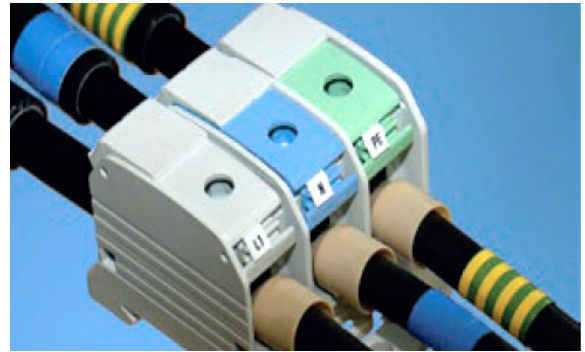

Al & Cu

### RKA 50 | 1000V AC/DC 150A Cu

Bestelnummer	Kleur	Aansluiting	Afmetingen	Aandraai-moment Nm	VPE	Bruto prijs €/1stk.
1-polig enkel						
In- en uitgangen						
49-087310-0-3				10 (EN) 14 (UL)	9	4,80
49-087310-1-3						
150A 49-087310-2-3		Cu 50mm <sup>2</sup> - 6mm <sup>2</sup>				
49-087310-3-3		Cu 35mm <sup>2</sup> - 4mm <sup>2</sup>				
49-087310-4-3		Al 50mm <sup>2</sup> - 16mm <sup>2</sup>				



### RKA 95 | 1000V AC/DC 232A Cu

Bestelnummer	Kleur	Aansluiting	Afmetingen	Aandraai-moment Nm	VPE	Bruto prijs €/1stk.
1-polig enkel						
In- en uitgangen						
49-087510-0-3				19 (EN) 2,3 (UL)	2	8,70
49-087510-1-3						
232A 49-087510-2-3		Cu 95mm <sup>2</sup> - 16mm <sup>2</sup>				
49-087510-3-3		Cu 70mm <sup>2</sup> - 10mm <sup>2</sup>				
49-087510-4-3		Al 95mm <sup>2</sup> - 16mm <sup>2</sup>				



### RKA 185 | 1000V AC/DC 353A Cu

Bestelnummer	Kleur	Aansluiting	Afmetingen	Aandraai-moment Nm	VPE	Bruto prijs €/1stk.
1-polig enkel						
In- en uitgangen						
49-087810-0-3				25 (EN) 28,2 (UL)	1	15,40
49-087810-1-3						
353A 49-087810-2-3		Cu 185mm <sup>2</sup> - 95mm <sup>2</sup>				
49-087810-3-3		Cu 150mm <sup>2</sup> - 70mm <sup>2</sup>				
49-087810-4-3						



### RKA 300 | 1000V AC/DC 520A Cu

Bestelnummer	Kleur	Aansluiting	Afmetingen	Aandraai-moment Nm	VPE	Bruto prijs €/1stk.
1-polig enkel						
In- en uitgangen						
49-087910-0-3				45 (EN) 33,9 (UL)	1	30,40
49-087910-1-3						
520A 49-087910-2-3		Cu 300mm <sup>2</sup> - 150mm <sup>2</sup>				
49-087910-3-3		Cu 240mm <sup>2</sup> - 120mm <sup>2</sup>				
49-087910-4-3						



# HoraEtec aansluit- en verdeelklemmen

Serie RKA: dubbel 50-300mm<sup>2</sup>



## RKA 50 D | 1000V AC/DC 150A Cu

Bestelnummer	Kleur	Aansluiting	Afmetingen	Aandraai-moment Nm	VPE	Bruto prijs €/1stk.
1-polig dubbel						
In- en uitgangen						
49-087320-0-3				10 (EN) 14 (UL)	5	9,55
49-087320-1-3					5	9,55
150A 49-087320-2-3		Cu 50mm <sup>2</sup> - 6mm <sup>2</sup>			5	9,55
49-087320-3-3		Cu 35mm <sup>2</sup> - 4mm <sup>2</sup>			5	9,55
49-087320-4-3		Al 50mm <sup>2</sup> - 16mm <sup>2</sup>			5	9,55



## RKA 95 D | 1000V AC/DC 232A Cu

Bestelnummer	Kleur	Aansluiting	Afmetingen	Aandraai-moment Nm	VPE	Bruto prijs €/1stk.
1-polig dubbel						
In- en uitgangen						
49-087520-0-3				19 (EN) 22,6 (UL)	1	16,50
49-087520-1-3					1	16,50
232A 49-087520-2-3		Cu 95mm <sup>2</sup> - 16mm <sup>2</sup>			1	16,50
49-087520-3-3		Cu 70mm <sup>2</sup> - 10mm <sup>2</sup>			1	16,50
49-087520-4-3		Al 95mm <sup>2</sup> - 16mm <sup>2</sup>			1	16,50



## RKA 185 D | 1000V AC/DC 353A Cu

Bestelnummer	Kleur	Aansluiting	Afmetingen	Aandraai-moment Nm	VPE	Bruto prijs €/1stk.
1-polig dubbel						
In- en uitgangen						
49-087820-0-3				25 (EN) 28,2 (UL)	1	29,20
49-087820-1-3					1	29,20
353A 49-087820-2-3		Cu 185mm <sup>2</sup> - 95mm <sup>2</sup>			1	29,20
49-087820-3-3		Cu 150mm <sup>2</sup> - 70mm <sup>2</sup>			1	29,20
49-087820-4-3					1	29,20



## RKA 300 D | 1000V AC/DC 520A Cu

Bestelnummer	Kleur	Aansluiting	Afmetingen	Aandraai-moment Nm	VPE	Bruto prijs €/1stk.
1-polig dubbel						
In- en uitgangen						
49-087920-0-3				45 (EN) 33,9 (UL)	1	49,25
49-087920-1-3					1	49,25
520A 49-087920-2-3		Cu 300mm <sup>2</sup> - 150mm <sup>2</sup>			1	49,25
49-087920-3-3		Cu 240mm <sup>2</sup> - 120mm <sup>2</sup>			1	49,25
49-087920-4-3					1	49,25



## RKA 50 | 1000V AC/DC 150A Cu

Bestelnummer	Kleur	Aansluiting	Afmetingen	Aandraai-moment Nm	VPE	Bruto prijs €/1stk.
3-polig						
In- en uitgangen						
49-087330-0-3				10 (EN) 14 (UL)	1	14,60
49-087330-1-3					1	14,60
150A 49-087330-2-3		Cu 50mm <sup>2</sup> - 6mm <sup>2</sup>			1	14,60
49-087330-3-3		Cu 35mm <sup>2</sup> - 4mm <sup>2</sup>			1	14,60
49-087330-5-3		Al 50mm <sup>2</sup> - 16mm <sup>2</sup>			1	14,60



## Accessoires

Beschrijving	VPE	Bruto prijs €/1stk.
50g zuurvrije vaseline	1	o.a.
600g zuurvrije vaseline	1	o.a.



Bestelnummer	Beschrijving	VPE	Bruto prijs €/1stk.
49-087500-0-0	Afdekkap voor RKA 50 (D, 3P)	1	0,85
49-087800-0-0	Afdekkap voor RKA 95 (D)	1	1,60
49-087900-0-0	Afdekkap voor RKA 185 (D)	1	2,55
49-087300-0-0	Afdekkap voor RKA 300 (D)	1	0,40



# HoraEtec aansluit- en verdeelklemmen

Serie HLAK 25 A, HLAK 35 A



## Aftakkingsklemmen | HLAK 25 Type A

<b>Materiaal (body):</b>	PVC, Ral 7035
<b>Materiaal (blok):</b>	Messing CuZn39Pb2
<b>Schroeven:</b>	Staal (kruiskop, PZ)
<b>Voorschriften:</b>	DIN VDE 0603-2, ROHS

Serie	Nominale spanning	Stroombelastbaarheid	Volgens
HLAK 25 A	500 V AC	80 A	DIN VDE 0603-2
HLAK 25/35 A	500 V AC	100 A	DIN VDE 0603-2
HLAK 35/35 A	500 V AC	100 A	DIN VDE 0603-2

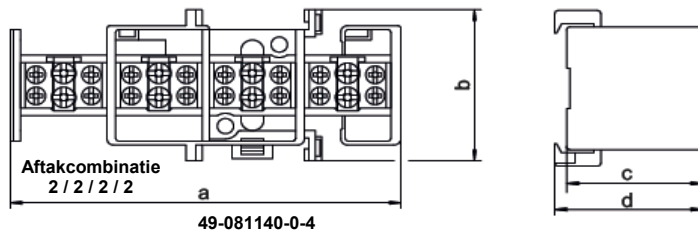

49-081110-0-4\*



49-081120-1-4\*



49-081140-3-4\*



49-081150-1-4\*

## HLAK 25 A | 25mm<sup>2</sup> in / 16mm<sup>2</sup> uit

Bestelnummer	Nominale Waarde	Ingang mm <sup>2</sup>	Uitgang mm <sup>2</sup>	Aftakcombinatie					Afmetingen LxBxH				VPE	Bruto prijs €/1stk.	
				P1	P2	P3	P4	P5	a	b	c	d			
<b>1-polig</b>															
Aftak per pool															
49-081110-0-4*	80 A	2 x 25	2 x 16	2	-	-	-	-	32,5	50	40	46	20	5,20	
49-081110-1-4	80 A	2 x 25	4 x 16	4	-	-	-	-	32,5	50	40	46	20	8,45	
49-081110-2-4	80 A	2 x 25	6 x 16	6	-	-	-	-	62	50	40	46	10	o.a.	
49-081110-3-4	80 A	2 x 25	12 x 16	12	-	-	-	-	62	50	40	46	10	o.a.	
<b>2-polig</b>															
49-081120-0-4	80 A	2 x 25	4 x 16	2	2	-	-	-	62	50	40	46	10	8,95	
49-081120-1-4*	80 A	2 x 25	8 x 16	4	4	-	-	-	62	50	40	46	10	o.a.	
<b>4-polig</b>															
49-081140-0-4	80 A	2 x 25	8 x 16	2	2	2	2	-	121	50	40	46	10	o.a.	
49-081140-1-4	80 A	2 x 25	10 x 16	2	2	2	4	-	121	50	40	46	10	19,35	
49-081140-2-4	80 A	2 x 25	16 x 16	4	4	4	4	-	121	50	40	46	10	31,30	
49-081140-3-4*	80 A	2 x 25	12 x 16	2	2	2	6	-	151	50	40	46	10	o.a.	
49-081140-4-4	80 A	2 x 25	18 x 16	4	4	4	6	-	151	50	40	46	10	o.a.	
49-081140-5-4	80 A	2 x 25	24 x 16	4	4	4	12	-	151	50	40	46	10	o.a.	
<b>5-polig</b>															
49-081150-0-4	80 A	2 x 25	10 x 16	2	2	2	2	2	151	50	40	46	10	o.a.	
49-081150-1-4 *	80 A	2 x 25	20 x 16	4	4	4	4	4	151	50	40	46	10	o.a.	

## HLAK 35 A | 35mm<sup>2</sup> in / 25mm<sup>2</sup> uit

Bestelnummer	Nominale Waarde	Ingang mm <sup>2</sup>	Uitgang mm <sup>2</sup>	Aftakcombinatie					Afmetingen LxBxH				VPE	Bruto prijs €/1stk.	
				P1	P2	P3	P4	P5	a	b	c	d			
<b>1-polig</b>															
49-081210-0-4	100 A	2x35	2 x 25	2	-	-	-	-	40	44	40	44	20	10,95	
49-081210-1-4	100 A	2x35	4 x 25	4	-	-	-	-	40	44	40	44	10	13,60	
<b>2-polig</b>															
49-081220-0-4	100 A	2x35	4 x 25	2	2	-	-	-	77	44	40	44	10	13,80	
49-081220-1-4	100 A	2x35	8 x 25	4	4	-	-	-	77	44	40	44	10	24,90	
<b>4-polig</b>															
49-081240-0-4	100 A	2x35	8 x 25	2	2	2	2	-	155	60	40	46	10	o.a.	
49-081240-4-4	100 A	2x35	16 x 25	4	4	4	4	-	155	50	40	46	10	o.a.	
49-081240-3-4	100 A	2x35	10 x 25	2	2	2	4	-	155	50	40	46	1	o.a.	
49-081240-1-4	100 A	2x35	12 x 25	2	2	2	6	-	192	50	40	46	1	o.a.	
49-081240-2-4	100 A	2x35	18 x 25	4	4	4	6	-	192	50	40	46	1	o.a.	
<b>5-polig</b>															
49-081250-0-4	100 A	2x35	10 x 25	2	2	2	2	2	192	60	40	46	1	36,70	
49-081250-1-4	100 A	2x35	20 x 25	4	4	4	4	4	192	60	40	46	1	o.a.	

# HoraEtec aansluit- en verdeelklemmen

Serie HLAK 35 A, HLAK 70 A



## HLAK 35 A | 35mm<sup>2</sup> in / 35mm<sup>2</sup> uit

Bestelnummer	Nominale spanning	Ingang mm <sup>2</sup>	Uitgang mm <sup>2</sup>	Aftakcombinatie					Afmetingen LxBxH				VPE	Bruto prijs €/1stk.
				P1	P2	P3	P4	P5	a	b	c	d		
<b>1-polig</b>														
49-081310-0-4	100 A	2x35	2 x 35	2	-	-	-	-	40	44	40	44	20	10,30
49-081310-1-4	100 A	2x35	4 x 35	4	-	-	-	-	40	44	40	44	20	o.a.
<b>2-polig</b>														
49-081320-1-4	100 A	2x35	4 x 35	2	2	-	-	-	77	44	40	44	10	o.a.
49-081320-0-4	100 A	2x35	8 x 35	4	4	-	-	-	77	44	40	44	10	24,40
<b>4-polig</b>														
49-081340-0-4	100 A	2x35	8 x 35	2	2	2	2	-	155	60	40	46	1	o.a.
49-081340-1-4	100 A	2x35	16 x 35	4	4	4	4	-	155	60	40	46	1	o.a.
<b>5-polig</b>														
49-081350-0-4	100 A	2x35	10 x 35	2	2	2	2	2	192	60	40	46	1	o.a.
49-081350-1-4	100 A	2x35	20 x 35	4	4	4	4	4	192	60	40	46	1	o.a.

## HLAK 70 A | 1-polig

500 V nominaal, volgens DIN VDE 0603-2

Bestelnummer	Nominale spanning	Ingang mm <sup>2</sup>	Uitgang mm <sup>2</sup>	Aftakcombinatie	VPE	Bruto prijs €/1stk.
<b>1-polig</b>						
49-081510-1-4	160 A	2x70	2x50	2 Klik-montage	20	o.a.
49-081510-3-4	160 A	2x70	2x50	4 Klik-montage	10	o.a.

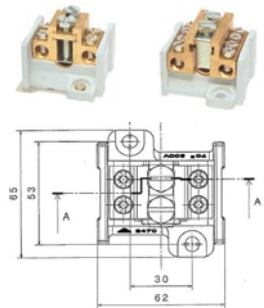

## Aansluitklemmen | 7 tot 15 polig (07-41xx/xxx)

Stroombelastbaarheid: 63A, Max. aandraaimoment: 1,5N, montage op DIN-rail 35mm

Bestelnummer	Afmetingen mm	Doorsnede mm <sup>2</sup>	Kleur P1	Bruto prijs €/1stk.
<b>7-polig</b>				
07-4116/7blauw	51x23	7x16mm <sup>2</sup>		1,82
07-4116/7groen	51x23	7x16mm <sup>2</sup>		1,82
07-4116/7zwart	51x23	7x16mm <sup>2</sup>		1,82
<b>12-polig</b>				
07-4117/12blauw	85x23	12x16mm <sup>2</sup>		3,67
07-4117/12bgroen	85x23	12x16mm <sup>2</sup>		o.a.
07-4117/12groen	85x23	12x16mm <sup>2</sup>		3,67
<b>15-polig</b>				
07-4127/15blauw	104x23	15x16mm <sup>2</sup>		4,52
07-4127/15bgroen	104x23	15x16mm <sup>2</sup>		o.a.
07-4127/15zwart	104x23	15x16mm <sup>2</sup>		4,52
<b>Afschermkapje + Klem</b>				
07-4116-2/Blauw	t.b.v. 7-polige aansluitklem			2,64
07-4116-2/Groen	t.b.v. 7-polige aansluitklem			2,64
07-4116-2/Zwart	t.b.v. 7-polige aansluitklem			2,64

Afschermkap los verkrijgbaar

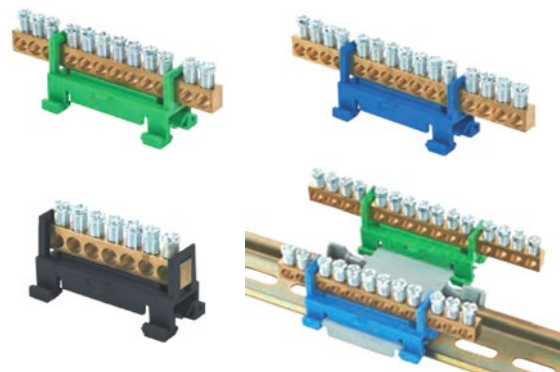

Voorzijde

Achterzijde

Met adapterplaat  
49-080000-0-0



# HoraEtec aansluit- en verdeelklemmen

Serie HLAK 25 C



## Aansluitklemmen | Serie HLAK25 HLAK35 Halogeenvrij

**Materiaal (body):** Polyamide (PA6)  
**Materiaal (blok):** Messing (schroeven staal)  
**Kleuren:** Lichtgrijs, lichtblauw, groen, bruin  
**Voorschriften:** DIN VDE 0603-2, ROHS



### Karakteristieken

Montage op DIN-rail TS35  
 Ook verticaal te monteren  
 (1-polige uitvoering met adapterplaat 49-080000-0-0)  
 Extreem smal  
 Zelfdovend en halogeenvrij  
 Klantspecifieke bedrukking mogelijk



HORA Etec klemmen, veilig en gebruiksvriendelijk!



HLAK 25 en 35 zijn te combineren

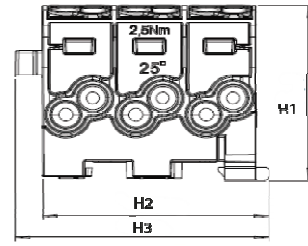
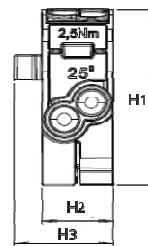
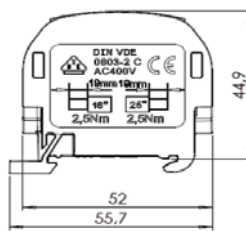

Nominale spanning	Stroombelastbaarheid	Volgens	
1000 V AC/DC	152 A	EN 60947-7-1	FI
690 V	100 A	DIN VDE 0603-2	VDE



### HLAK25 C 1-P



Bestelnummer	Kleur	Uitvoering	Afmetingen mm			Ingang mm <sup>2</sup>	Uitgang mm <sup>2</sup>	VPE	Brutoprijs €/1stk.
			H1	H2	H3				
49-080110-0-4		L	49,3	17,8	24,8	2x 25 - 2,5	2x 16 - 2,5	5/60	3,15
49-080110-1-4		N							
49-080110-2-4		PE							
49-080110-3-4		L							
49-080110-4-4		L							

\* Indien aangesloten met adereindhuls

### HLAK25 C 3-P



Bestelnummer	Kleur	Uitvoering	Afmetingen mm			Ingang mm <sup>2</sup>	Uitgang mm <sup>2</sup>	VPE	Brutoprijs €/1stk.
			H1	H2	H3				
49-080130-0-4		3L G	49,3	53,7	63,7	2x 25 - 2,5	2x 16 - 2,5	2/24	8,95
49-080130-1-4		L/N/PE							
49-080130-5-4		BSG							

\* Indien aangesloten met adereindhuls

### HLAK25 C 5-P



Bestelnummer	Kleur	Uitvoering	Afmetingen mm			Ingang mm <sup>2</sup>	Uitgang mm <sup>2</sup>	VPE	Brutoprijs €/1stk.
			H1	H2	H3				
49-080150-0-4		5L G	49,3		88	2x 25 - 2,5	2x 16 - 2,5	2/24	14,65
49-080150-3-4		PE/3L G/N							
49-080150-5-4		PE/3L BSG/N							

\* Indien aangesloten met adereindhuls



# HoraEtec aansluit- en verdeelklemmen

Serie HLAK C,D aftakkingsklemmen voor koperen aders



Nominale spanning	Stroombelastbaarheid	Volgens	
1000 V AC/DC	428 A	EN 60947-7-1	FI
690 V	125 A	DIN VDE 0603-2	VDE

## HLAK35 C 1-P



Bestelnummer	Kleur	Uit-voering	Afmetingen mm			Ingang mm <sup>2</sup>	Uitgang mm <sup>2</sup>	VPE	Brutoprijs €/1stk.
			H1	H2	H3				
49-080210-0-4		L G	49,3	22,2	29	2x 35 - 4,0	2x 25 - 2,5	5/60	5,05
49-080210-1-4		N							
49-080210-2-4		PE							
49-080210-3-4		L B							
49-080210-4-4		L S							

\* Indien aangesloten met adereindhuls

## HLAK35 C 1-P



Bestelnummer	Kleur	Uit-voering	Afmetingen mm			Ingang mm <sup>2</sup>	Uitgang mm <sup>2</sup>	VPE	Brutoprijs €/1stk.
			H1	H2	H3				
49-080220-0-4		D L G	49,3	43,2	49,9	4x 35 - 4,0	4x 25 - 2,5	2/24	10,30
49-080220-1-4		D N							
49-080220-2-4		D PE							
49-080220-3-4		D L B							
49-080220-4-4		D L S							

\* Indien aangesloten met adereindhuls

## HLAK35 C 3-P



Bestelnummer	Kleur	Uit-voering	Afmetingen mm			Ingang mm <sup>2</sup>	Uitgang mm <sup>2</sup>	VPE	Brutoprijs €/1stk.
			H1	H2	H3				
49-080230-0-4		3 L G	49,3	66,3	73,1	2x 35 - 4,0	2x 25 - 2,5	2/24	13,00
49-080230-1-4		L/N/PE							
49-080230-5-4		3L BSG							

\* Indien aangesloten met adereindhuls

## HLAK35 C 5-P



Bestelnummer	Kleur	Uit-voering	Afmetingen mm			Ingang mm <sup>2</sup>	Uitgang mm <sup>2</sup>	VPE	Brutoprijs €/1stk.
			H1	H2	H3				
49-080250-0-4		5 L G	49,3	110,9	117,6	2x 35 - 4,0	2x 25 - 2,5	1/12	24,80
49-080250-3-4		PE/3L G/N							
49-080250-5-4		PE/3L BSG/N							

\* Indien aangesloten met adereindhuls

## Aansluitklemmen | Serie HLAK70 Halogeenvrij

Nominale spanning	Stroombelastbaarheid	Volgens	
1000 V AC/DC	300 A	EN 60947-7-1	FI
690 V	160 A	DIN VDE 0603-2	VDE

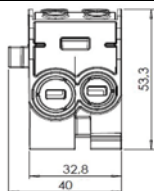
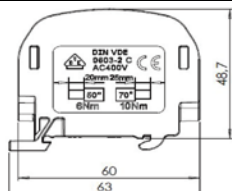

## HLAK70C 1-P



Bestelnummer	Kleur	Uit-voering	Afmetingen mm			Ingang mm <sup>2</sup>	Uitgang mm <sup>2</sup>	VPE	Brutoprijs €/1stk.
			H1	H2	H3				
49-080310-0-4		50 L G	53,3	32,8	40	2x 70 - 10,0	2x 50 - 6,0	3/36	16,70
49-080310-1-4		50 N							
49-080310-2-4		50 PE							
49-080310-3-4		50 L B							
49-080310-4-4		50 L S							

\* Indien aangesloten met adereindhuls

# HoraEtec aansluit- en verdeelklemmen

Serie UVB100, UVB200, SSAK 16



## Aftakkingsklemmen | Serie UVB 100, UVB 200 Halogeen vrij

**Materiaal (body):** Polyamide (PA6)  
**Materiaal (blok):** Messing (schroeven staal)  
**Kleuren:** Grijs, blauw, groen, bruin, zwart  
**Voorschriften:** IEC 60998-2-1(UVB 100)  
 IEC 60947-7-1(UVB 200)



### Karakteristieken

Montage op DIN-rail TS35 EN 60715  
 Zowel horizontaal als verticaal te gebruiken  
 Eenvoudig modulair uit te breiden  
 Extreem smal  
 Zelfdovend en halogeen vrij  
 Aanrakingsveilig

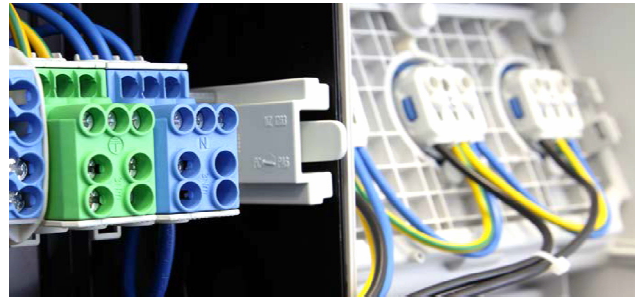

Halogeen vrij, horizontaal en verticaal te monteren

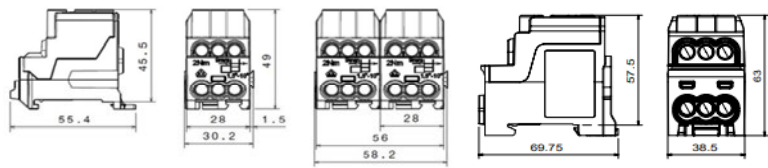

Serie UVB eenvoudig koppelbaar

Afmetingen UVB 100

Afmetingen UVB200

### UVB100



UVB 100

Bestelnummer	Kleur	Uitvoering	Afmetingen mm	Ingang mm <sup>2</sup>	Uitgang mm <sup>2</sup>	VPE	Brutoprijs €/1stk.
			H1 H2 H3				
<b>1000V AC - 101A</b>							
49-080010-0-4		L G	49 28 55,4	25 - 2,5	10 - 1,5	3	8,40
49-080010-1-4		N					
49-080010-2-4		PE					
49-080010-3-4		L B					
49-080010-4-4		L S					

\* Indien aangesloten met adereindhuls

### UVB200



UVB 200

Bestelnummer	Kleur	Uitvoering	Afmetingen mm	Ingang mm <sup>2</sup>	Uitgang mm <sup>2</sup>	VPE	Brutoprijs €/1stk.
			H1 H2 H3				
<b>1000V AC 1500V DC - 200A</b>							
49-080030-0-4		L G	63 38,5 69,75	70 - 10	1x 35 - 4	3	19,60
49-080030-1-4		N					
49-080030-2-4		PE					
49-080030-3-4		L B					
49-080030-4-4		L S					

\* Indien aangesloten met adereindhuls

## Railaftakklemmen | Serie SSAK

**Materiaal (body):** Polyamide (PA6)  
**Materiaal (blok):** Messing (schroeven staal)  
**Kleuren:** Grijs, blauw, groen, bruin, zwart  
**Voorschriften:** IEC60947-7-1

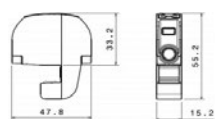

### Karakteristieken

Montage op DIN-rail TS35 EN 60715  
 Zelfdovend en halogeen vrij  
 Aanrakingsveilig  
 Geschikt voor koper



### SSAK 16



Bestelnummer	Uitvoering	Voltage	Amp.	Polen	Raildikte mm	Uitgang mm <sup>2</sup>	VPE	Brutoprijs €/1stk.
49-086105-0-4		690 V	114	1	3 - 10	2 x 16*	12	7,70
49-086105-1-4		690 V	114	1	3 - 10	2 x 16*	12	7,70
49-086105-2-4		690 V	114	1	3 - 10	2 x 16*	12	7,70
49-086105-3-4		690 V	114	1	3 - 10	2 x 16*	12	7,70
49-086105-4-4		690 V	114	1	3 - 10	2 x 16*	12	7,70

\* Uitgang 10mm<sup>2</sup> met adereindhuls

# HoraEtec aansluit- en verdeelklemmen

Uitgelicht: HoraEtec serie overzicht

**HORA**  
eTec

## HLAK

- Geschikt van 25 mm<sup>2</sup> – 70 mm<sup>2</sup>
- Compacte en robuuste constructie
- Aanrakingsveilig conform DIN EN 50274
- Geschikt voor spanning tot 1000 V AC/DC
- Modulair systeem, eenvoudig te koppelen
- Snellere installatie; vereenvoudigde schroefmontage
- Zowel horizontale- als verticale installatie mogelijk
- Smalle bouwvorm

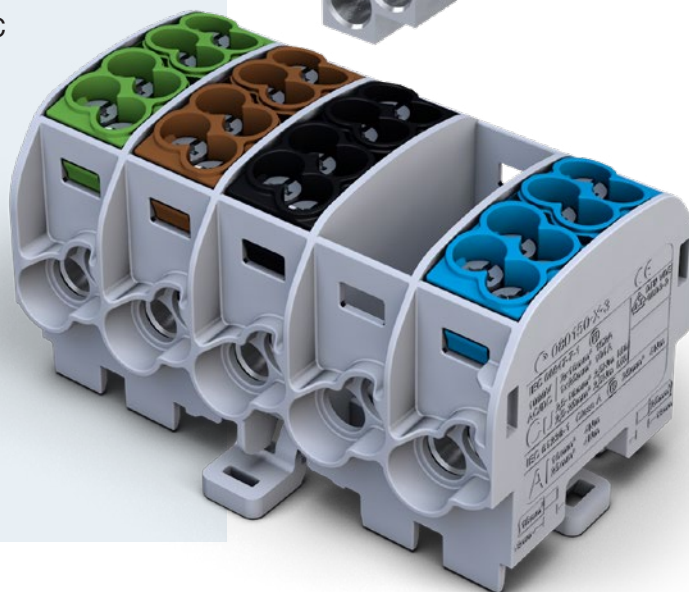

6

## UVB



## RKA



## PDB



**HORA**  
eTec

### HORA ETEC

Hora Etec, gevestigd in het Duitse Bunde, is al sinds 1919 gespecialiseerd in ontwikkeling en productie van een breed assortiment aansluit- en verdeelblokken.

### BIJZONDERE EIGENSCHAPPEN

Ruimtebesparend, veiligheid, besparing in tijd en kosten  
Geschikt voor zowel koperen- als aluminium geleiders.

**calpe**  
INDUSTRIAL

versie 02/2023

# HoraEtec aansluit- en verdeelklemmen

Serie PDB 100-125A



## Verdeelblokken | Serie PDB Halogeenvrij

**Materiaal (body):** Polyamide (PA6)  
**Materiaal (blok):** Messing (schroeven staal)  
**Voorschriften:** EN 60947-7-1, UL 1059



### Karakteristieken

PDB klemmen zijn eenvoudig koppelbaar  
 Eenvoudige schroefmontage  
 Schroeven zijn gezekeerd  
 Montage op 35mm DIN-en montagerail EN 60715  
 of rechtstreeks op montageplaat  
 Individuele bedrukking mogelijk (logo)  
 Zelfdovend en halogeenvrij  
 Aan te sluiten met koperrail (SPS)



Aansluiten met litze of verbinder

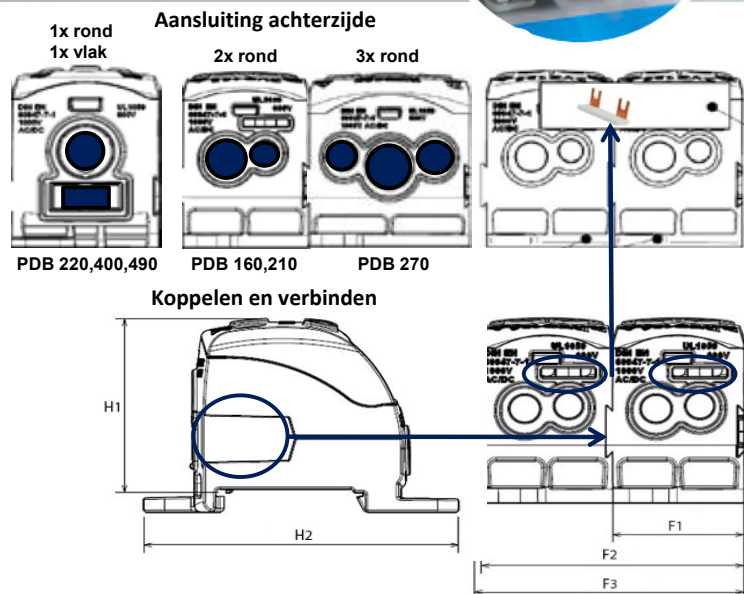

### PDB 160

Bestelnummer	Afmetingen (mm)					Ingang mm <sup>2</sup>	Uitgang mm <sup>2</sup>	VPE	Brutoprijs €/1stk.
	H1	H2	F1	F2	F3				
49-082040-0-3	44	68	31,5	63	64,5	1x 2,5 - 25 1,5 - 16	2x 1,5 - 16 1,5 - 10 3x 1,5 - 10 1,5 - 6	1	14,25
<b>doorverbinder 16mm2</b>									
49-082001-2-4	2 x M6 vork							1	2,90
49-082001-3-4	3 x M6 vork							1	3,70

Nominale spanning	Stroombelastbaarheid	Volgens
1000 V AC/DC	164 A Cu	IEC 60947-7-1 FI
1000 V AC/DC	101 A Cu	IEC 60947-7-1 VDE
600 V AC	85 A Cu / 65 A Al	UL-1059 UL



(Voorheen pvb100)

### PDB 210

Bestelnummer	Afmetingen (mm)					Ingang mm <sup>2</sup>	Uitgang mm <sup>2</sup>	VPE	Brutoprijs €/1stk.
	H1	H2	F1	F2	F3				
49-082050-0-3	48,7	70	35,6	71,2	72,7	1x 4,0 - 35 2,5 - 25	2x 2,5 - 25 1,5 - 16 3x 1,5 - 16 1,5 - 10	1	17,50
<b>doorverbinder 16mm2</b>									
49-082002-2-4	2 x M6 vork							1	3,25
49-082002-3-4	3 x M6 vork							1	4,00

Nominale spanning	Stroombelastbaarheid	Volgens
1000 V AC/DC	214 A Cu	IEC 60947-7-1 FI
1000 V AC/DC	125 A Cu	IEC 60947-7-1 VDE
600 V AC	115 A Cu / 90 A Al	UL-1059 UL



(Voorheen pvb125)

# HoraEtec aansluit- en verdeelklemmen

Serie PDB 160-400A



## Verdeelblokken | Serie PDB Halogeenvrij

### PDB 220

Bestelnummer	Afmetingen (mm)					Ingang		Uitgang		VPE	Brutoprijs €/1stk.
	H1	H2	F1	F2	F3	mm <sup>2</sup>		mm <sup>2</sup>			
49-082060-0-3	52,5	74,5	39,5	79	80,5	1x 10 - 70 6,0 - 50		2x 2,5 - 25 1,5 - 16		1	30,40
						1x 15,5 x 5mm		3x 1,5 - 16 1,5 - 10			
<b>Nominale spanning</b>		<b>Stroombelastbaarheid</b>			<b>Volgens</b>						
1000 V AC/DC		215 A Cu			IEC 60947-7-1		FI				
1000 V AC/DC		192 A Cu			IEC 60947-7-1		VDE				
600 V AC		160 A Cu / 135 A Al			UL-1059		UL				



### PDB 270

Bestelnummer	Afmetingen (mm)					Ingang		Uitgang		VPE	Brutoprijs €/1stk.
	H1	H2	F1	F2	F3	mm <sup>2</sup>		mm <sup>2</sup>			
49-082070-0-3	49,5	73	51	102	103,5	1x 16 - 95 10 - 70		2x 4,0 - 35 2,5 - 25		1	31,40
								8x 2,5 - 25 1,5 - 16			
<b>Nominale spanning</b>		<b>Stroombelastbaarheid</b>			<b>Volgens</b>						
1000 V AC/DC		270 A Cu			IEC 60947-7-1		FI				
1000 V AC/DC		232 A Cu			IEC 60947-7-1		VDE				
600 V AC		200 A Cu / 155 A Al			UL-1059		UL				



### PDB 400

Bestelnummer	Afmetingen (mm)					Ingang		Uitgang		VPE	Brutoprijs €/1stk.
	H1	H2	F1	F2	F3	mm <sup>2</sup>		mm <sup>2</sup>			
49-082080-0-3	72,5	95	51,1	102,2	103,8	1x 35 - 120 25 - 95		2x 4,0 - 35 2,5 - 25		1	40,65
						1x 24 x 10mm		3x 2,5 - 25 1,5 - 16			
								4x 1,5 - 16 1,5 - 10			
<b>Nominale spanning</b>		<b>Stroombelastbaarheid</b>			<b>Volgens</b>						
1000 V AC / 1500 V DC		400 A Cu			IEC 60947-7-1		FI				
1000 V AC / 1500 V DC		250 A Cu			IEC 60947-7-1		VDE				
600 V AC		250 A Cu / 205 A Al			UL-1059		UL				



(Voorheen pvb250)

### PDB 490

Bestelnummer	Afmetingen (mm)					Ingang		Uitgang		VPE	Brutoprijs €/1stk.
	H1	H2	F1	F2	F3	mm <sup>2</sup>		mm <sup>2</sup>			
49-082090-0-3	72,5	95	51,1	102,2	103,8	1x 95 - 185 70 - 150		2x 4,0 - 35 2,5 - 25		1	44,45
						1x 24 x 10mm		3x 2,5 - 25 1,5 - 16			
								4x 1,5 - 16 1,5 - 10			
<b>Nominale spanning</b>		<b>Stroombelastbaarheid</b>			<b>Volgens</b>						
1000 V AC / 1500 V DC		490 A Cu			IEC 60947-7-1		FI				
1000 V AC / 1500 V DC		353 A Cu			IEC 60947-7-1		VDE				
600 V AC		310 A Cu / 250 A Al			UL-1059		UL				



(Voorheen pvb400)

Ook leverbaar met blauw  
transparant deksel, of  
voorgemonteerd



De Power Distribution Blocks van HORA Etec zijn ook leverbaar in aluminium, informeer naar de mogelijkheden

# Elkotec verbindingsrails

Geïsoleerd: vork 17,8mm

**elkotec**

## Verbindingsrails | Vork 17,8mm

**Materiaal:** Polycarbonaat V2  
**Materiaal Cu.:** E-Cu-ETP  
**Kortsluitvast.:** 25 kA / 100A gl  
**Voorschriften:** DIN EN 61439  
**Isolatie:** VDE 0110 I  
**Halogeenvrij:** DIN EN 50267 2-2  
**Raillengte:** 1016 mm

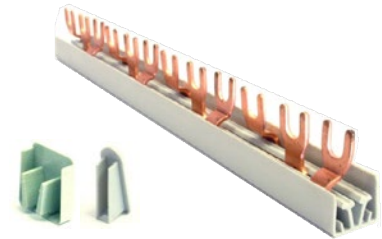
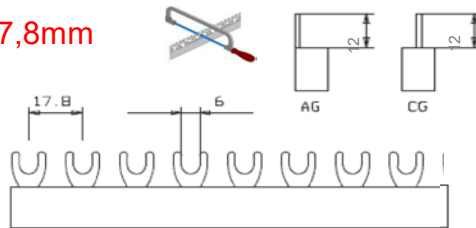

Fasen	Bestelnummer	Type	Max. belasting	Cu. mm <sup>2</sup>	Aantal vorken	Omschrijving	VPE	Brutoprijs €/stk	Bestelnr. Eindkapjes	Brutoprijs €/stk
1	<b>L1-L1</b>		<b>A</b>					<b>Cu. 950-1000*</b>		<b>Cu. 950-1000*</b>
	49-AG110.157.101	AG	63	10	57	L1-L1	1	13,53	49-EK002.100.100	0,32
2	<b>L1-L2</b>									
	49-AG110.256.101	AG	63	10	56	L1-L2	1	20,29	49-EK002.300.100	0,35
	49-CG112.256.101	CG	80	16	56	L1-L2	1	25,83	49-EK002.300.100	0,35
	<b>L1-L2-L3</b>									
3	49-CG110.357.101	CG	63	10	57	L1-L2-L3	1	30,63	49-EK000.300.100	0,34
	49-AG112.357.101	AG	80	16	57	L1-L2-L3	1	36,79	49-EK002.300.100	0,35
	49-CG112.357.101	CG	80	16	57	L1-L2-L3	1	36,99	49-EK002.300.100	0,35
	<b>L1-L2-L3-N</b>									
4	49-CG110.456.101	CG	63	10	56	L1-L2-L3-N	1	45,64	49-EK002.400.100	0,37
	49-CG112.456.101	CG	80	16	56	L1-L2-L3-N	1	56,37	49-EK002.400.100	0,37
	<b>L1-N-L2-N-L3-N</b>									
	49-CG112.454.54.101	CG	80	16	54	L1-N-L2-N-L3-N	1	54,50	49-EK002.400.100	0,37

\* bruto maandprijzen zijn volgens MK-kopernotering. Prijzen zijn inclusief koper, zie [www.calpe.nl](http://www.calpe.nl) voor de actuele koers

## Verbindingsrails | Vork 17,8mm Eurovario

**Diameter Cu.:** 10 mm<sup>2</sup>  
**Spanning:** 63A  
**Materiaal** Polyamide V2  
**Materiaal Cu.:** E-Cu-ETP

**Kortsluitvast.:** 25 kA / 100A gl  
**Voorschriften:** DIN EN 61439  
**Isolatie:** VDE 0110 I  
**Halogeenvrij:** DIN EN 50267 2-2

Fasen	Bestelnummer	Aantal vorken	Rail lengte mm	VPE in stk.	Brutoprijs €/stk
1	<b>L1-L1</b>				<b>Cu. 950-1000*</b>
	49-50M6.102.101	2	30	20	0,87
	49-50M6.103.101	3	44,5	20	1,15
	49-50M6.104.101	4	64	20	1,49
	49-50M6.105.101	5	104	20	o.a.
	49-50M6.106.101	6	104	20	1,99
2	<b>L1-L2</b>				
	49-50M6.204.101	4	65	10	1,94
	49-50M6.206.101	6	103	10	2,37
	49-50M6.208.101	8	138	10	3,19
	49-50M6.210.101	10	174	10	3,85
	49-50M6.212.101	12	210	10	4,52
3	<b>L1-L2-L3</b>				
	49-50M6.306.101	6	103	10	3,62
	49-50M6.308.101	8	138	10	4,46
	49-50M6.309.101	9	157	10	4,93
	49-50M6.310.101	10	174	10	5,44
	49-50M6.311.101	11	192	10	5,83
4	<b>L1-L2-L3+Hi (2x17,8-26,8mm)</b>				
	49-50M6.312.101	12	210	10	6,30
	49-50M6.314.101	14	250	10	o.a.
	<b>L1-L2-L3-N</b>				
	49-50M6.408.101	8	142	5	5,99
	49-50M6.412.101	12	210	5	8,16
	49-50M6.416.101	16	282	5	10,95
	49-50M6.418.101	18	322	5	12,21
	<b>L1-N-L2-N-L3-N</b>				
	49-57M6.412.101	12	210	5	8,16
	49-57M6.418.101	18	322	5	12,21

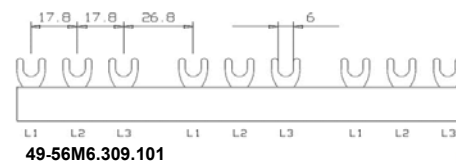
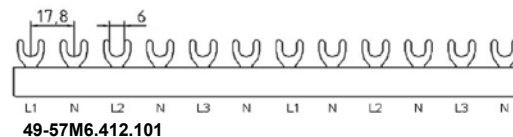
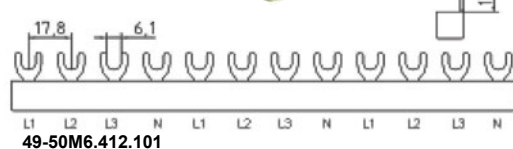
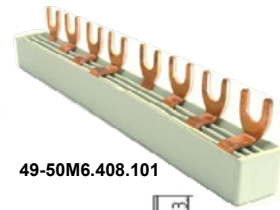
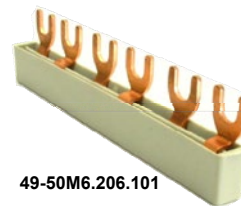

**Steekmaat 17,8mm:**  
 Geschikt voor o.a. Siemens, Eaton, Legrand, Schneider, GE, ETI, Kopp en meer.

**Op aanvraag:**  
 Andere steekmaten zoals, 17,6mm (ABB, Lovato), 18mm en 27mm. Kunststof in diverse kleuren leverbaar.

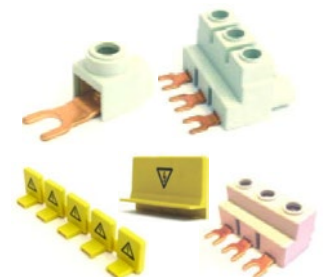

Vraag ook naar de diverse toebehoren

\* bruto maandprijzen zijn volgens MK-kopernotering. Prijzen zijn inclusief koper, zie [www.calpe.nl](http://www.calpe.nl) voor de actuele koers

# Elkotec verbindingsrails

Geïsoleerd: pen 17,8mm

**elkotec**

## Verbindingsrails | Pen 17,8mm

<b>Materiaal:</b>	Polycarbonaat V2
<b>Materiaal Cu.:</b>	E-Cu-ETP
<b>Kortsluitvast.:</b>	25 kA / 100A gl
<b>Voorschriften:</b>	DIN EN 61439
<b>Isolatie:</b>	VDE 0110 I
<b>Halogeenvrij:</b>	DIN EN 50267 2-2
<b>Raillengte:</b>	1016 mm

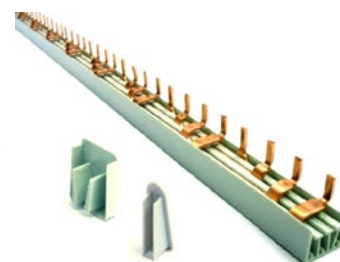
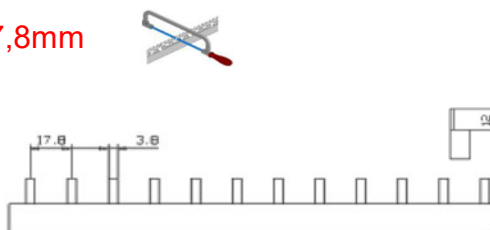

Fasen	Bestelnummer	Type	Max. belasting A	Cu. mm <sup>2</sup>	Aantal pennen	Omschrijving	VPE	Brutoprijs €/stk Cu. 950-1000*	Bestelnr. Eindkapjes	Brutoprijs €/stk Cu. 950-1000*
1	49-AS110.157.101	AS	63	10	57	L1-L1	1	14,41	49-EK002.100.100	0,32
	49-AS112.157.101	AS	80	16	57	L1-L1	1	16,83	49-EK002.100.100	0,32
2	49-AS110.256.101	AS	63	10	56	L1-L2	1	22,26	49-EK002.300.100	0,35
	49-AS112.256.101	AS	80	16	56	L1-L2	1	25,83	49-EK002.300.100	0,35
3	49-AS110.357.101	AS	63	10	57	L1-L2-L3	1	30,00	49-EK000.300.100	0,34
	49-AS112.357.101	AS	80	16	57	L1-L2-L3	1	36,36	49-EK002.300.100	0,35
4	<b>L1-L2-L3-N</b>									
	49-AS110.456.101	AS	63	10	56	L1-L2-L3-N	1	45,64	49-EK002.400.100	0,37
	49-AS112.456.101	AS	80	16	56	L1-L2-L3-N	1	56,21	49-EK002.400.100	0,37
	<b>L1-N-L2-N-L3-N</b>									
	49-AS110.454.54.101	AS	63	10	54	L1-N-L2-N-L3-N	1	51,32	49-EK002.400.100	0,37
	49-AS112.454.54.101	AS	80	16	54	L1-N-L2-N-L3-N	1	54,50	49-EK002.400.100	0,37

\* bruto maandprijzen zijn volgens MK-kopemotering. Prijzen zijn inclusief koper, zie [www.calpe.nl](http://www.calpe.nl) voor de actuele koers

## Verbindingsrails | Pen 17,8mm Eurovario

<b>Diameter Cu.:</b>	10 mm <sup>2</sup>
<b>Spanning:</b>	63A
<b>Materiaal:</b>	Polyamide V2
<b>Materiaal Cu.:</b>	E-Cu-ETP

<b>Kortsluitvast.:</b>	25 kA / 100A gl
<b>Voorschriften:</b>	DIN EN 61439
<b>Isolatie:</b>	VDE 0110 I
<b>Halogeenvrij:</b>	DIN EN 50267 2-2

Fasen	Bestelnummer	Aantal pennen	Rail Lengte mm	VPE in stk.	Brutoprijs €/stk Cu. 950-1000*
1	<b>L1-L1</b>				
	49-60.102.101	2	30	20	0,85
	49-60.103.101	3	44,5	20	1,12
	49-60.104.101	4	64	20	1,42
	49-60.105.101	5	104	20	1,74
	49-60.106.101	6	104	20	2,00
	49-60.108.101	8	158	20	2,57
2	<b>L1-L2</b>				
	49-60.112.101	12	210	20	3,16
	49-60.204.101	4	65	10	1,84
	49-60.206.101	6	103	10	2,41
	49-60.208.101	8	138	10	3,16
	49-60.210.101	10	174	10	3,80
	49-60.212.101	12	210	10	4,47
3	<b>L1-L2-L3</b>				
	49-60.214.101	14	250	10	5,28
	49-60.216.101	16	286	10	5,93
	49-60.306.101	6	105	10	3,58
	49-60.308.101	8	138	10	4,41
	49-60.309.101	9	157	10	4,89
	49-60.310.101	10	174	10	5,40
4	<b>L1-L2-L3-N</b>				
	49-60.311.101	11	192	10	5,78
	49-60.312.101	12	210	10	6,26
	49-60.316.101	16	286	10	8,40
	49-60.408.101	8	142	5	6,18
	49-60.412.101	12	210	5	8,49
	49-60.416.101	16	282	5	10,91
<b>L1-N-L2-N-L3-N</b>					
49-60.418.101	18	322	5	12,17	
	49-67.412.101	12	210	5	8,29
	49-67.418.101	18	322	5	12,17

\* bruto maandprijzen zijn volgens MK-kopemotering. Prijzen zijn inclusief koper, zie [www.calpe.nl](http://www.calpe.nl) voor de actuele koers



49-60.412.101



49-67.412.101

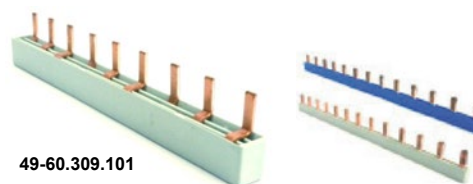

49-60.309.101

Eindeloze mogelijkheden

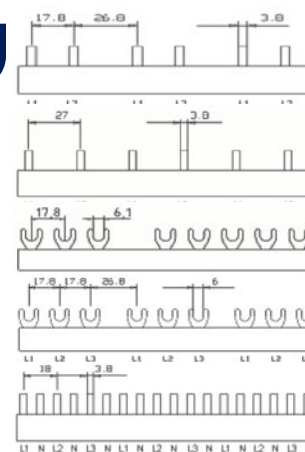

# Elkotec verbindingsrails

Geïsoleerd: pen 1P+N, voedingsblokken

elkotec

## Verbindingsrails | Pen L1+N (1 module) 4-fase 18mm

**Materiaal:** Polycarbonaat V2  
**Materiaal Cu.:** E-Cu-ETP  
**Kortsluitvast.:** 25 kA / 100A gl  
**Voorschriften:** DIN EN 61439  
**Isolatie:** VDE 0110 I  
**Halogeenvrij:** DIN EN 50267 2-2  
**Raillengte2-6-2021:** 1016 mm

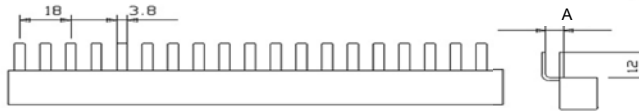

Fasen	Bestelnummer	Type	Max. belasting A	Breedte A mm	Aantal pennen	Omschrijving	VPE	Brutoprijs €/stk
4	49-AS192.407.108.101	AS	80	5,0	108	N-L1-N-L2-N-L3	1	<b>92,65</b>
	49-AS192.409.108.101	AS	80	6,0	108	L1-N-L2-N-L3-N	1	<b>o.a.</b>
	49-AS192.408.108.101	AS	80	6,0	108	N-L1-N-L2-N-L3	1	<b>o.a.</b>
	49-AS192.401.108.101	AS	80	6,5	108	N-L1-N-L2-N-L3	1	<b>o.a.</b>
	49-AS192.403.108.101	AS	80	10,0	108	L1-N-L2-N-L3-N	1	<b>92,65</b>
	49-EK002.400.100	Eindkap voor bovenstaande uitvoeringen					10	<b>0,37</b>

\* Bruto maandprijzen zijn volgens MK-kopernotering. Prijzen zijn inclusief koper, zie [www.calpe.nl](http://www.calpe.nl) voor de actuele koers  
 Bovenstaande series zijn beschikbaar van 8 t/m 108 pennen

## Verbindingsrails | Pen L1+N (1 module) 2-fase 18mm Eurovario

**Diameter Cu.:** 10 mm<sup>2</sup>  
**Spanning:** 63A  
**Materiaal:** Polyamide V2  
**Materiaal Cu.:** E-Cu-ETP  
**Kortsluitvast.:** 25 kA / 100A gl  
**Voorschriften:** DIN EN 61439  
**Isolatie:** VDE 0110 I  
**Halogeenvrij:** DIN EN 50267 2-2

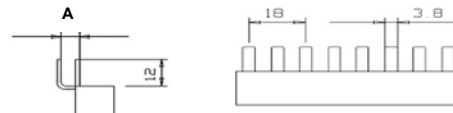

49-69.00X-8.101

Fasen	Aantal pennen	Rail Lengte	VPE in stk.	Bestelnummer	Brutoprijs €/stk	Bestelnummer	Brutoprijs €/stk
2	<b>A = 5,0mm</b>			<b>L1-N</b>	<b>Cu. 950-1000*</b>	<b>N-L1</b>	<b>Cu. 950-1000*</b>
	6	30,0	10	49-69.006.6.101	<b>o.a.</b>	49-69.007.6.101	<b>3,01</b>
	8	44,5	10	49-69.006.8.101	<b>o.a.</b>	49-69.007.8.101	<b>3,97</b>
	10	64,0	10	49-69.006.10.101	<b>o.a.</b>	49-69.007.10.101	<b>5,00</b>
	6	30,0	10	49-69.001.6.101	<b>2,68</b>	49-69.002.6.101	<b>2,68</b>
	8	44,5	10	49-69.001.8.101	<b>3,56</b>	49-69.002.8.101	<b>3,57</b>
	10	64,0	10	49-69.001.10.101	<b>4,10</b>	49-69.002.10.101	<b>4,10</b>
	<b>A = 9mm</b>			<b>L1-N</b>		<b>N-L1</b>	
	6	30,0	10	49-69.003.6.101	<b>2,68</b>	49-69.004.6.101	<b>o.a.</b>
	8	44,5	10	49-69.003.8.101	<b>o.a.</b>	49-69.004.8.101	<b>o.a.</b>
	10	64,0	10	49-69.003.10.101	<b>4,13</b>	49-69.004.10.101	<b>o.a.</b>

\* Bruto maandprijzen zijn volgens MK-kopernotering. Prijzen zijn inclusief koper, zie [www.calpe.nl](http://www.calpe.nl) voor de actuele koers

## Accessoires | Voedingsblokken

### Aftakblok Pen

Cu / mm <sup>2</sup>	10
Fase	1
VPE	10
Bestelnr.	49-60.005.101
<b>Brutoprijs stk.</b>	<b>1,68</b>

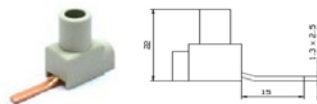

### Aftakblok Pen

Cu / mm <sup>2</sup>	6-25
Fase	1
VPE	10
Bestelnr.	49-60.001.101
<b>Brutoprijs stk.</b>	<b>1,76</b>

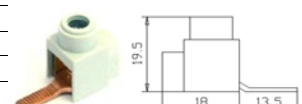

### Aftakblok Pen, boven

Cu / mm <sup>2</sup>	2x10
Fase	1
VPE	10
Bestelnr.	49-60.020.100
<b>Brutoprijs stk.</b>	<b>2,94</b>

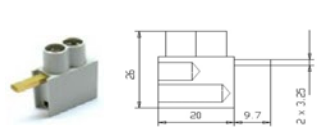

### Aftakblok Pen

Cu / mm <sup>2</sup>	6-25
Fase	1
VPE	10
Bestelnr.	49-60.003.101
<b>Brutoprijs stk.</b>	<b>2,06</b>

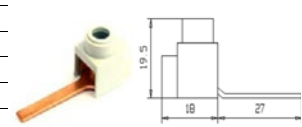

### Aftakblok Pen, beneden

Cu / mm <sup>2</sup>	2x10
Fase	1
VPE	10
Bestelnr.	49-60.021.100
<b>Brutoprijs stk.</b>	<b>2,94</b>

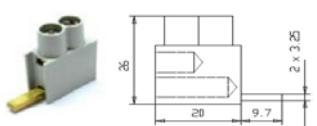

### Aftakblok Vork

Cu / mm <sup>2</sup>	6-25
Fase	1
VPE	10
Bestelnr.	49-50.002.100
<b>Brutoprijs stk.</b>	<b>1,77</b>

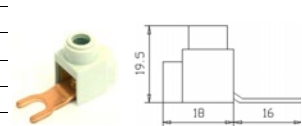

\* Bruto maandprijzen zijn volgens MK-kopernotering. Prijzen zijn inclusief koper, zie [www.calpe.nl](http://www.calpe.nl) voor de actuele koers



# Elkotec verbindingsrails

Geïsoleerd: vork tbv motorbeveiligingsschakelaars, voedingsblokken

**elkotec**

## Motorbeveiligingsrails | Vork M4, vorkbreedte 9mm

Diameter Cu.: 10 mm<sup>2</sup>  
Spanning: 63A  
Materiaal: Polyamide V2  
Materiaal Cu.: E-Cu-ETP



Toepasbaar voor o.a. Lovato, Eaton, Schneider.

Fasen	Bestelnummer	Rail Opbouw	Aantal Vorken	Rail Lengte mm	VPE in stk.	Brutoprijs €/stk
3	49-01.245.3128	2x14+17mm	6	91	10	6,18
	49-01.345.3128	2x14+17mm	9	139	10	7,82
	49-01.445.3128	2x14+17mm	12	181	10	9,08
	49-01.545.3128	2x14+17mm	15	229	10	10,36
3	49-01.254.3128	2x14+26mm	6	101	10	6,33
	49-01.354.3128	2x14+26mm	9	154	10	8,05
	49-01.454.3128	2x14+26mm	12	208	10	9,41
	49-01.554.3128	2x14+26mm	15	264	10	10,74
3	49-01.263.300	2x14+35mm	6	109	10	5,70
	49-01.463.300	2x14+35mm	12	235	10	o.a.
3	49-01.272.301	2x14+44mm	6	118	10	10,33
	49-01.472.301	2x14+44mm	12	265	10	13,75

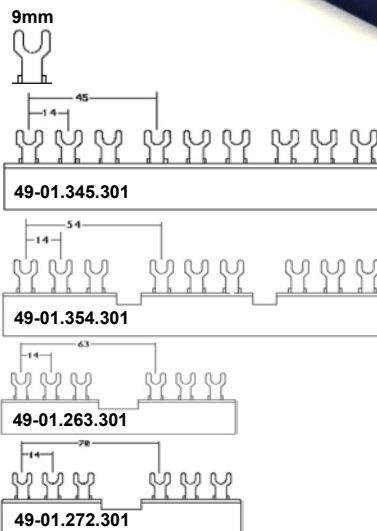

\* Bruto maandprijzen zijn volgens MK-kopemotoring. Prijzen zijn inclusief koper, zie [www.calpe.nl](http://www.calpe.nl) voor de actuele koers

## Motorbeveiligingsrails | Vork M4, vorkbreedte 7,5mm

Toepasbaar voor o.a. Siemens en ABB.

Fasen	Bestelnummer	Rail Opbouw	Aantal Vorken	Rail Lengte mm	VPE in stk.	Brutoprijs €/stk
3	49-04.245.3128	2x14+17mm	6	91	10	6,18
	49-04.345.3128	2x14+17mm	9	139	10	7,82
	49-04.445.3128	2x14+17mm	12	181	10	9,08
	49-04.545.3128	2x14+17mm	15	229	10	10,36
3	49-04.255.3128	2x14+26mm	6	101	10	6,45
	49-04.355.3128	2x14+26mm	9	154	10	8,19
	49-04.455.3128	2x14+26mm	12	208	10	9,57
	49-04.555.3128	2x14+26mm	15	264	10	10,92

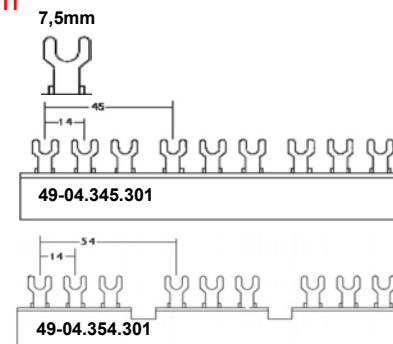

\* Bruto maandprijzen zijn volgens MK-kopemotoring. Prijzen zijn inclusief koper, zie [www.calpe.nl](http://www.calpe.nl) voor de actuele koers

## Accessoires | Voedingsblokken en beschermkapjes

Voedingsblok: Vork, breedte 9mm

Cu / mm <sup>2</sup>	3x 25
Fase	3
VPE	10
Bestelnr.	49-01.116.101
Brutoprijs stk.	6,48

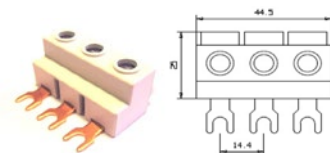

Beschermkap geel 5x Afbreekbaar

Cu / mm <sup>2</sup>	nvt
Fase	1-4
VPE	10
Bestelnr.	49-50.002.401
Brutoprijs stk.	1,42



Voedingsblok: Vork, breedte 7,5mm

Cu / mm <sup>2</sup>	3x 25
Fase	3
VPE	10
Bestelnr.	49-04.114.101
Brutoprijs stk.	6,13

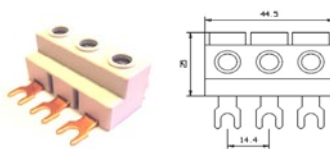

Beschermkap geel 3xvork

Cu / mm <sup>2</sup>	nvt
Fase	3
VPE	10
Bestelnr.	49-01.001.401
Brutoprijs stk.	0,93

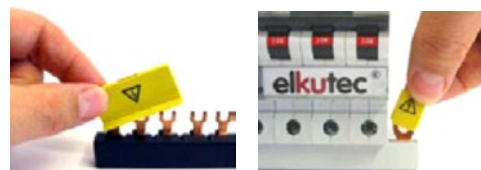
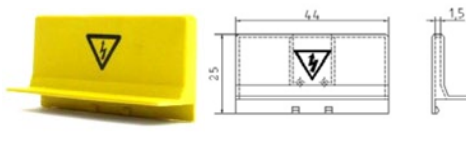

# Aardrails

diverse lengten en toebehoren



Serie NL/KLM/LKS1



Serie LKS2

A	Bestelnummer	Afmeting mm hxbxl	Schroef	mm <sup>2</sup>	Materiaal	Bruto prijs €/mtr.
40	51-NL-SL	8x8x1000	166 M4	10	vernikkeld	23,85
63	51-KLM-1000	10x8x1000	144 M5	16	vernikkeld	33,20
125	51-LKS1-25	10x15x1000	130 M5	25	vernikkeld	80,95
200	51-LKS2-16	15x15x1000	2x144 M5	16	vernikkeld	123,65
	51-LKS2-25	15x15x1000	2x130 M5	25	vernikkeld	122,25



MAXX PRO schroevendraaiers  
Zie hoofdstuk 10 Gereedschap

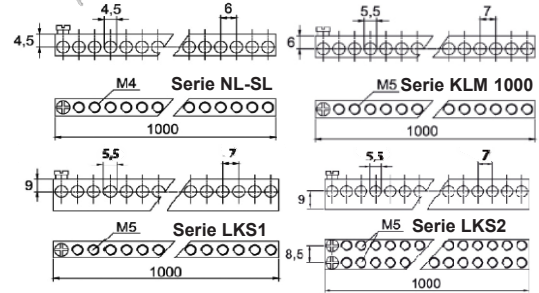

## Isolatiesteunen | Type IT en type IT-LKS

	Bestelnummer	Voor railtype	Materiaal	Brutoprijs €/stk.
IT	51-IT-1	NL-SL/KLM1000	noryl grijs	0,56
	51-IT-2	NL-SL/KLM1000	noryl grijs	1,00
IT-LKS	51-IT-LKS2	LKS1/LKS2	noryl grijs	3,10
	51-IT-LKS4	LKS1/LKS2	noryl grijs	7,00

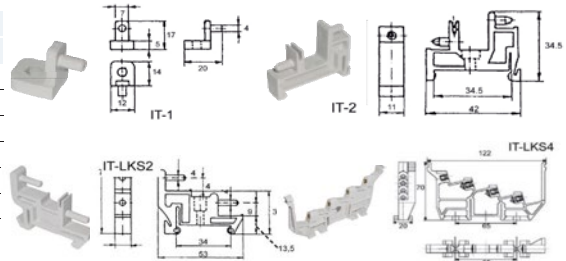

## Klembeugels | Type ZK

	Bestelnummer	Omschrijving	Brutoprijs €/stk.
ZK	51-02009	ZK-25 ST 6-25mm <sup>2</sup> tbv NL-SL	0,46
	51-02012	ZK-35 ST 6-35mm <sup>2</sup> tbv KLM1000/HK4565	0,56
	51-02013	ZK-70/1 6-70mm <sup>2</sup>	2,69
	51-02041	ZK-70/2 6-70mm <sup>2</sup> KLM/LKS25	o.a.



ZK-25/ZK-35



ZK-70

## Aardrail | Type HK

A	Bestelnummer	Materiaal	Afmeting mm hxbxl	Schroef	Brutoprijs €/stk.	
Lengte 1000mm	52-HK4114	blank	9x6,5x986	M5	140	
	52-HK4565	blank	9x6,5x1000	M5	16x6	
	25	52-HK4902	vernikkeld	10x2x1000	M5	60
	63	52-HK4908	vernikkeld	12x3x1000	M6	54
	100	52-HK100A	vernikkeld	15x4x1000	M8	40
	200	52-HK200A	vernikkeld	20x5x1000	M10	30
Korte lengten	52-HK4116	blank	9x6x51	M5	7	
	52-HK4329	vernikkeld	9x6,5x42	M5	4	
	HK	52-HK043D6012	blank	9x6,5x62	M5	6
		52-HK043D7012	blank	9x6,5x69	M5	7
		52-HK4333	blank	9x6,5x104	M5	12



HK4114



HK4565



HK49..



HK100A/200A



HK4116



HK4239



Niet de gewenste lengte gevonden?

Vraag naar de mogelijkheden voor de op maat  
gemaakte aardrails.

Bel 0342 - 45 15 44 of mail naar [info@calpe.nl](mailto:info@calpe.nl)

# SPS flexibel koper

Uitgelicht: SPS serie Ultraflexx®

DESIGNED  
VOLGENS  
IEC 61439-1

**ULTRAFLEXX®**

FLEXIBEL KOPER



ULTRAFlexx®: het beste alternatief voor kant- en klaar bedrading, zeker als er weinig ruimte beschikbaar is:

ULTRAFlexx® kan direct op de klemmen worden aangesloten.

ULTRAFlexx® is gemaakt van geweven elektrolytisch koper (plat) en daardoor zéér flexibel.

De uiteinden zijn samengeperst en onder druk gelast en kunnen als een massief eindstuk verwerkt kan worden. Standaard voorzien van een voorgeboord gat. De volledig gelaste verbindingen bieden de volgende voordelen: Geen extra overgangsweerstand, hierdoor minder spannings- en vermogensverlies en geen corrosie dus geen aantasting van de verbinding.



## ULTRAFLEXX®

- standaard verkrijgbaar in lengten van 100 tot 1000mm
- beschikbaar in een range van 25mm<sup>2</sup> - 240mm<sup>2</sup>
- temperatuurbereik: -55°C tot +125°C
- bedrijfsspanning: 1000 VAC – 1500 VDC
- diëlektrische sterkte: 20kV/mm
- vlam vertragend volgens UL224-VW1
- halogeenvrije isolatie
- UL gecertificeerd: E339288

**ZEER FLEXIBEL**

**MASSIEF CONTACTVLAK**

**REEDS GEPONST**



# SPS flexibel koper

Geïsoleerd: serie Isoflexx® Classic 125-2500A



## Flexibel stroomrail | Serie Isoflexx® classic

Materiaal geleider:	E-Cu 99,9/ E-Cu vertind
Materiaal isolatie:	Hoogwaardig PVC
Temp. Bereik:	-30°C tot +105°C
Spanning:	1000 VAC/ 1500 VDC
Kleuren:	Zwart , (blauw,bruin, groen/geel op aanvraag)
Brandbaarheid:	UL94 V0
Voorschriften:	DIN EN 50525

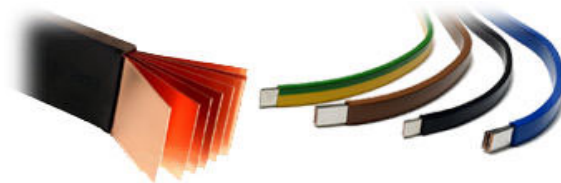

\* Leverbaar in zwart, blauw, groen/geel  
49-1131 X...  
X = 1 = Zwart  
3 = Blauw  
4 = Groen/Geel

1 stuk = twee meter

**ISO**  
**flexx**® **Classic**

Stroom- belasting A	Bestelnummer	Afmeting mm	Ø mm²	Stroombelasting (DIN 43671)			Thermische kortsluit- vastheid 1sec. kA	Cu-gewicht per 2 meter kg	Brutoprijs €/1stk
				ΔT=30 K bij 65°C A	ΔT=50 K bij 85°C A	ΔT=70 K bij 105°C A			
> 125 A	49-11311000*	3x9x0,8	21,6	98	130	152	3	0,38	21,33
	49-11311020*	6x9x0,8	43,2	147	196	228	7	0,77	37,24
	49-11311420*	9x9x0,8	64,8	179	238	277	10	1,15	o.a.
	49-11311030*	3x13x0,5	19,5	108	144	167	3	0,35	o.a.
	49-11311040*	6x13x0,5	39,0	162	215	251	6	0,69	o.a.
	-	2x16x0,8	24,8	110	148	195	4	0,44	o.a.
> 250 A	49-11311060*	4x16x0,8	49,6	201	267	312	8	0,88	43,77
	49-11311070*	6x16x0,8	74,4	252	335	391	11	1,32	61,87
	49-11311550*	2x20x1	40,0	188	250	291	6	0,71	37,73
	49-11311560*	3x20x1	60,0	237	315	367	9	1,07	51,46
	49-11311570	4x20x1	80,0	278	370	431	12	1,42	o.a.
	49-11311530	2x24x1	48,0	201	267	312	7	0,85	84,44
> 400 A	49-11311440	3x24x1	72,0	276	367	428	11	1,28	100,60
	49-11311360	2x32x1	64,0	289	384	448	10	1,14	92,64
	49-11311080*	10x16x0,8	124,0	330	439	512	19	2,21	98,07
	49-11311580*	5x20x1	100,0	319	424	494	15	1,78	79,19
	49-11311590	6x20x1	120,0	355	472	550	18	2,14	o.a.
	49-11311450*	4x24x1	96,0	322	428	499	15	1,71	76,93
> 500 A	49-11311460*	5x24x1	120,0	369	491	572	18	2,14	93,40
	49-11311370	3x32x1	96,0	359	477	556	15	1,71	113,69
	49-11311470	6x24x1	144,0	407	541	631	22	2,56	141,93
	49-11311500	4x32x1	128,0	418	556	648	20	2,28	134,30
	49-11311600	10x20x1	200,0	497	661	770	31	3,56	188,93
	-	11x21x1	231,0	563	749	873	36	o.a.	o.a.
> 630 A	49-11311480	8x24x1	192,0	483	642	749	30	3,42	143,10
	49-11311490*	10x24x1	240,0	559	743	866	37	4,27	176,56
	49-11311430*	5x32x1	160,0	477	634	739	25	2,85	125,11
	49-11311510	6x32x1	192,0	526	700	815	30	3,42	147,31
	49-11311130*	5x40x1	200,0	573	762	888	31	3,56	159,76
	49-11311520*	8x32x1	256,0	623	829	966	39	4,56	191,20
> 800 A	49-11311390*	10x32x1	320,0	721	959	1118	49	5,70	235,59
	49-11311140	8x40x1	320,0	739	983	1145	49	5,70	o.a.
	49-11311160*	5x50x1	250,0	697	927	1080	39	4,45	196,42
	-	10x35x1	350,0	757	1007	1173	54	o.a.	o.a.
	49-11311150*	10x40x1	400,0	850	1131	1318	62	7,12	297,74
	49-11311170	8x50x1	400,0	891	1185	1381	62	7,12	375,98
> 1000 A	49-11311190	5x63x1	315,0	826	1099	1280	49	5,61	332,24
	49-11311180	10x50x1	500,0	1020	1357	1581	77	8,90	367,63
	49-11311610	6x63x1	378,0	942	1253	1460	58	6,73	o.a.
	49-11311200	8x63x1	504,0	1038	1361	1609	78	8,97	o.a.
	49-11311210	10x63x1	630,0	1180	1569	2089	97	11,21	540,62
	49-11311650	4x80x1	320,0	954	1269	1689	49	5,70	o.a.
> 1250 A	49-11311220	5x80x1	400,0	1070	1423	1894	62	7,12	403,63
	49-11311660	6x80x1	480,0	1156	1537	2046	74	7,12	o.a.
	49-11311230	8x80x1	640,0	1328	1766	2351	99	11,39	555,06
	49-11311240	10x80x1	800,0	1500	1995	2655	123	14,24	655,70
	49-11311250	5x100x1	500,0	1300	1729	2301	77	8,90	o.a.
	49-11311260	8x100x1	800,0	1606	2136	2843	123	14,24	o.a.
> 2000 A	49-11311270	10x100x1	1000,0	1810	2407	3204	154	17,80	865,87
	> 2500 A	49-11311280	12x100x1	1200,0	1974	2625	3059	185	21,36

ⓘ Opwarming van de rail is afhankelijk van: stroomsterkte, omgevingstemperatuur, warmteafvoer, kabelinstallatie, inbouw en toepassing. Vermenigvuldigingsfactor 1.72 bij gebruik van 2 railen en factor 2.25 bij gebruik van 3 railen, parallel gemonteerd. Bij een omgevingstemperatuur van 35°C.  
Stroombelasting volgens DIN 43671 ⓘ, lamellen dikte 1mm

# SPS flexibel koper

Geïsoleerd: serie Isoflexx® Premium 125-2500A (halogeenvrij)



## Flexibel stroomrail geïsoleerd | Serie Isoflexx Premium

<b>Materiaal geleider:</b>	E-Cu 99,9/ E-Cu blank of vertind
<b>Materiaal isolatie:</b>	Hoogwaardig siliconen, grijs
<b>Temp. Bereik:</b>	-40°C tot +190°C
<b>Spanning:</b>	1000 VAC/1500 VDC
<b>Brandbaarheid:</b>	UL94 V0
<b>Voorschriften:</b>	DIN EN 50525



1 stuk = twee meter

ISOflexx® Premium

Stroom-belasting A	Bestelnummer	Afmeting mm	Ø mm²	Stroombelasting (DIN 43671)			Thermische kortsluit- vastheid 1sec. kA	Cu-gewicht per 2 meter kg	Brutoprijs €/1stk
				ΔT=30 K bij 65°C A	ΔT=50 K bij 85°C A	ΔT=70 K bij 105°C A			
> 400 A	49-12515000	5x20x1	100	319	424	565	26	1,78	o.a.
	49-12515010	5x24x1	120	369	491	653	31	2,14	
	49-12515240	10x20x1	200	497	661	880	52	3,56	
> 630 A	49-12515250	10x24x1	240	559	743	989	62	4,27	
	49-12515020	5x32x1	160	477	634	844	42	2,85	
	49-12515030	5x40x1	200	573	762	1014	52	3,56	
	-	10x32x1	320	721	959	1276	83	5,70	
> 800 A	49-12515090	8x40x1	320	729	983	1308	83	5,70	
	49-12515040	5x50x1	250	697	927	1234	65	4,45	
	-	10x40x1	400	850	1131	1505	100	7,12	
> 1000 A	49-12515100	8x50x1	400	850	1185	1577	100	7,12	
	49-12515050	5x63x1	315	826	1099	1462	82	5,61	
	49-12515170	10x50x1	500	1020	1357	1805	130	8,90	
> 1250 A	49-12515110	8x63x1	504	1038	136	1837	130	8,97	
	49-12515180	10x63x1	630	1180	1569	2089	160	11,21	
	49-12515060	5x80x1	400	1070	1423	1894	100	7,12	
	49-12515120	8x80x1	640	1328	1766	2351	170	11,39	
> 1600 A	49-12515190	10x80x1	800	1500	1995	2655	210	14,24	
	49-12515070	5x100x1	500	1300	1729	2301	130	8,90	
	49-12515130	8x100x1	800	1606	2136	2843	210	14,24	
> 2000 A	49-12515200	10x100x1	1000	1810	2407	3204	260	17,80	
	49-12515140	8x120x1	960	1794	2386	3175	250	17,09	
> 2500 A	49-12515230	12x100x1	1200	1974	2625	3494	310	21,36	
	49-12515210	10x120x1	1200	2110	2806	3735	310	21,36	

ⓘ Opwarming van de rail is afhankelijk van: stroomsterkte, omgevingstemperatuur, warmteafvoer, kabelinstallatie, inbouw en toepassing. Vermenigvuldigingsfactor 1.72 bij gebruik van 2 railen en factor 2.25 bij gebruik van 3 railen, parallel gemonteerd. Bij een omgevingstemperatuur van 35°C

## ISOFLEXX®

<p><b>+ Saves space</b></p>	<p>Isoflexx is uitermate flexibel, bij vergelijkbare belasting t.o.v. traditionele kabel kan op de diameter tot 40% bespaart worden en kan een kleinere buigradius gerealiseerd worden.</p>	<p><b>+ Material consumption</b></p>	<p>Door de kleine diameter vergeleken met kabels met dezelfde belastbaarheid bespaart u materiaal met ISOFLEXX. Simpel en efficiënt, tijd en kostenbesparend.</p>
<p><b>+ Reliability</b></p>	<p>Verhoogd de veiligheid in uw installatie.</p> <ul style="list-style-type: none"> <li>- Geen kabelschoenen</li> <li>- Versterkte randen</li> <li>- Extreem hittebestendig</li> <li>- Beproeft korstluitvastheid</li> <li>- Isolatie</li> </ul>	<p><b>+ Flexibility</b></p>	<p>Door de flexibiliteit van de Isoflexx kan t.o.v. massief koper het aantal worden vermindert. Buigen zoals bij massief koper is niet langer nodig hierdoor wordt de montagetijd veel korter.</p>

# SPS flexibel koper

Geïsoleerd: serie Ultraflexx® 25-100mm<sup>2</sup>



## Flexibel stroomrail | Serie Ultraflexx halogeenvrij

<b>Materiaal isolatie:</b>	Halogeenvrij, dikte: 0,8±0,3 mm
<b>Temp. Bereik:</b>	-55°C tot 125°C
<b>Voltage:</b>	1000 VAC/ 1500 VDC
<b>Kleuren:</b>	Zwart (andere kleuren op aanvraag)
<b>Brandbaarheid:</b>	UL224-VW1
<b>Voorschriften:</b>	DIN 43671



Geïsoleerd hoog flexibel



Stroombelasting volgens DIN 43671, bij een omgevingstemp. 35°C

$\Delta T=50$ K bij 85°C	Bestelnummer	$\varnothing$ mm <sup>2</sup>	Lengte tot gat mm	Gat maat	$\Delta T=30$ K bij 65°C	$\Delta T=70$ K bij 105°C	Cu-gewicht kg per stuk	Brutoprijs €/1stk Cu 850-900
160A	49-62150523	25	150	8/10	120	185	0,04	6,10
	49-62151023	25	200	8/10	120	185	0,05	7,22
	49-62151523	25	250	8/10	120	185	0,06	8,13
	49-62151923	25	300	8/10	120	185	0,08	9,06
	49-62152323	25	350	8/10	120	185	0,09	9,99
	49-62152823	25	400	8/10	120	185	0,10	10,92
	49-62153323	25	450	8/10	120	185	0,11	11,85
	49-62153523	25	500	8/10	120	185	0,12	12,78
	49-62153823	25	550	8/10	120	185	0,13	13,71
	49-62154023	25	600	8/10	120	185	0,15	14,64
	49-62154523	25	650	8/10	120	185	0,16	15,58
	49-62155023	25	700	8/10	120	185	0,17	16,51
	49-62155523	25	750	8/10	120	185	0,18	17,44
	49-62156023	25	800	8/10	120	185	0,19	18,37
	49-62156523	25	850	8/10	120	185	0,20	19,30
	49-62156823	25	900	8/10	120	185	0,22	20,23
49-62157523	25	950	8/10	120	185	0,23	21,16	
49-62158023	25	1000	8/10	120	185	0,24	22,09	
270A	49-62250523	50	150	8/10	200	315	0,08	8,31
	49-62251023	50	200	8/10	200	315	0,10	9,70
	49-62251523	50	250	8/10	200	315	0,13	11,08
	49-62251920	50	300	8/10	200	315	0,15	12,46
	49-62252323	50	350	8/10	200	315	0,17	13,84
	49-62252823	50	400	8/10	200	315	0,20	15,22
	49-62253323	50	450	8/10	200	315	0,22	16,60
	49-62253523	50	500	8/10	200	315	0,24	17,98
	49-62253823	50	550	8/10	200	315	0,27	19,36
	49-62254023	50	600	8/10	200	315	0,29	20,74
	49-62254523	50	650	8/10	200	315	0,31	22,12
	49-62255023	50	700	8/10	200	315	0,34	23,50
	49-62255523	50	750	8/10	200	315	0,36	24,88
	49-62256023	50	800	8/10	200	315	0,38	26,26
	49-62256523	50	850	8/10	200	315	0,40	27,64
	49-62256823	50	900	8/10	200	315	0,43	29,02
49-62257523	50	950	8/10	200	315	0,45	30,40	
49-62258023	50	1000	8/10	200	315	0,47	31,78	
425A	49-62550530	100	150	10	320	500	0,17	o.a.
	49-62551033	100	200	10	320	500	0,22	14,26
	49-62551533	100	250	10	320	500	0,26	16,54
	49-62551930	100	300	10	320	500	0,31	18,81
	49-62552333	100	350	10	320	500	0,36	21,08
	49-62552833	100	400	10	320	500	0,41	23,36
	49-62553333	100	450	10	320	500	0,46	25,63
	49-62553533	100	500	10	320	500	0,50	27,90
	49-62553833	100	550	10	320	500	0,55	30,18
	49-62554033	100	600	10	320	500	0,60	32,45
	49-62554533	100	650	10	320	500	0,65	34,73
	49-62555033	100	700	10	320	500	0,70	37,00
	49-62555533	100	750	10	320	500	0,74	39,27
	49-62556033	100	800	10	320	500	0,79	41,55
	49-62556533	100	850	10	320	500	0,84	43,82
	49-62556833	100	900	10	320	500	0,89	46,09
49-62557533	100	950	10	320	500	0,94	48,37	
49-62558033	100	1000	10	320	500	0,98	50,64	

# SPS flexibel koper

Geïsoleerd: serie Ultraflexx® 120-240mm<sup>2</sup>



## Flexibel stroomrail | Serie Ultraflexx halogeenvrij

$\Delta T=50$ K bij 85°C	Bestelnummer	$\varnothing$ mm <sup>2</sup>	Lengte tot gat mm	gat maat	$\Delta T=30$ K bij 65°C A	$\Delta T=70$ K bij 105°C A	Cu-gewicht kg per stuk	Brutoprijs €/1stk Cu 850-900
470A	49-62650533	120	150	10	355	555	0,21	15,34
	49-62651033	120	200	10	355	555	0,27	18,25
	49-62651533	120	250	10	355	555	0,33	21,16
	49-62651933	120	300	10	355	555	0,39	24,07
	49-62652333	120	350	10	355	555	0,44	26,99
	49-62652833	120	400	10	355	555	0,50	29,90
	49-62653333	120	450	10	355	555	0,56	32,81
	49-62653533	120	500	10	355	555	0,62	35,72
	49-62653833	120	550	10	355	555	0,68	38,63
	49-62654033	120	600	10	355	555	0,74	41,54
	49-62654533	120	650	10	355	555	0,80	44,45
	49-62655033	120	700	10	355	555	0,85	47,36
	49-62655533	120	750	10	355	555	0,91	50,28
	49-62656033	120	800	10	355	555	0,97	53,19
	49-62656533	120	850	10	355	555	1,03	56,10
	49-62656833	120	900	10	355	555	1,09	59,01
	49-62657533	120	950	10	355	555	1,15	61,92
	49-62658033	120	1000	10	355	555	1,21	64,83
745A	49-62850533	240	150	10	560	870	0,42	23,98
	49-62851033	240	200	10	560	870	0,54	29,02
	49-62851533	240	250	10	560	870	0,66	34,07
	49-62851933	240	300	10	560	870	0,77	39,11
	49-62852333	240	350	10	560	870	0,89	44,15
	49-62852833	240	400	10	560	870	1,01	49,20
	49-62853333	240	450	10	560	870	1,12	54,24
	49-62853533	240	500	10	560	870	1,24	59,29
	49-62853833	240	550	10	560	870	1,36	64,33
	49-62854033	240	600	10	560	870	1,47	69,37
	49-62854533	240	650	10	560	870	1,59	74,42
	49-62855033	240	700	10	560	870	1,71	79,46
	49-62855533	240	750	10	560	870	1,83	84,51
	49-62856033	240	800	10	560	870	1,94	89,55
	49-62856533	240	850	10	560	870	2,06	94,59
	49-62856833	240	900	10	560	870	2,18	99,64
	49-62857533	240	950	10	560	870	2,29	104,68
	49-62858033	240	1000	10	560	870	2,41	109,73



6

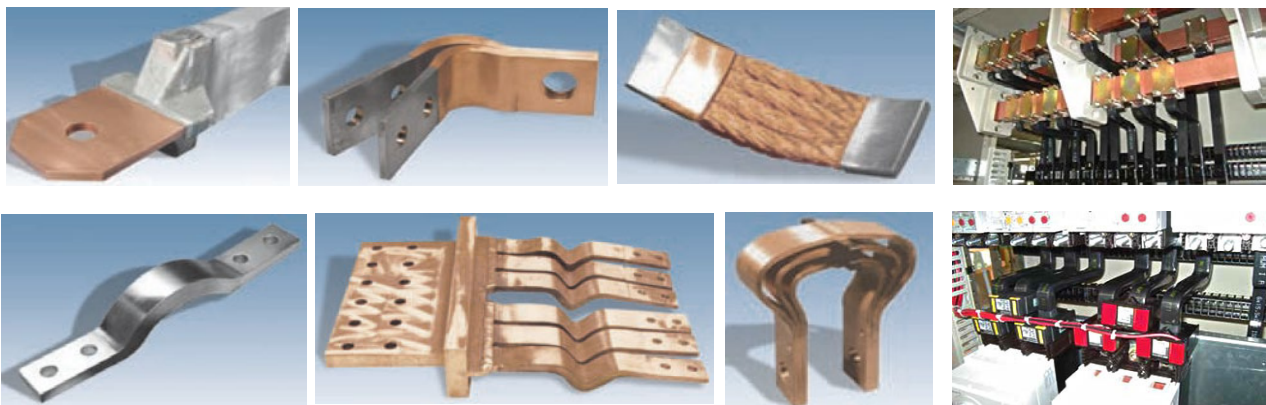

SPS biedt klantspecifieke mogelijkheden

# SPS flexibel koper

Ongeïsoleerd: serie MBS vertind aardingsband



## Aardingsband | Serie MBS vertind

### Karakteristieken

Vertind koper

Geringe opwarming in geval van kortsluiting

Stabiliteit op lange termijn

Hoge betrouwbaarheid

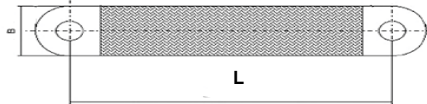

MBS - 25 - 250 - 10

X Z Y

X = doorsnede 35mm<sup>2</sup>

Z = lengte van gat tot gat

Y = gatmaat



Max. belasting	Bestelnummer	Type	ø	Lengte	Breedte	Gatmaat	Cu-gewicht per stuk	VPE	Brutoprijs €/1stk
<b>Cu 850-900</b>									
<b>50 A</b>	49-33010011	MBS 6-100-6	6	100	13	M6	0,005	10	2,43
	49-33015011	MBS 6-150-6	6	150	13	M6	0,008	10	2,58
	49-33020011	MBS 6-200-6	6	200	13	M6	0,011	10	2,75
	49-33025011	MBS 6-250-6	6	250	13	M6	0,014	10	2,91
	49-33030011	MBS 6-300-6	6	300	13	M6	0,016	10	3,08
	49-33050011	MBS 6-500-6	6	500	13	M6	0,027	10	3,72
<b>80 A</b>	49-33110011	MBS 10-100-6	10	100	13	M6	0,009	10	3,13
	49-33115011	MBS 10-150-6	10	150	13	M6	0,014	10	3,64
	49-33120011	MBS 10-200-6	10	200	13	M6	0,018	10	3,86
	49-33125011	MBS 10-250-6	10	250	13	M6	0,023	10	4,07
	49-33130011	MBS 10-300-6	10	300	13	M6	0,027	10	4,45
	49-33150011	MBS 10-500-6	10	500	13	M6	0,045	10	6,14
<b>120 A</b>	49-33210011	MBS 16-100-6	16	100	15	M6	0,014	10	3,37
	49-33215011	MBS 16-150-6	16	150	15	M6	0,022	10	4,00
	49-33220011	MBS 16-200-6	16	200	15	M6	0,029	10	4,52
	49-33225011	MBS 16-250-6	16	250	15	M6	0,036	10	5,02
	49-33230011	MBS 16-300-6	16	300	15	M6	0,043	10	5,41
	49-33250011	MBS 16-500-6	16	500	15	M6	0,072	10	7,79
	49-33210022	MBS 16-100-8	16	100	15	M8	0,014	10	3,37
	49-33215022	MBS 16-150-8	16	150	15	M8	0,022	10	4,00
	49-33220022	MBS 16-200-8	16	200	15	M8	0,029	10	4,52
	49-33225022	MBS 16-250-8	16	250	15	M8	0,036	10	5,02
<b>150 A</b>	49-33230022	MBS 16-300-8	16	300	15	M8	0,043	10	5,41
	49-33250022	MBS 16-500-8	16	500	15	M8	0,072	10	7,79
	49-33310033	MBS 25-100-10	25	100	23	M10	0,023	10	4,22
	49-33315033	MBS 25-150-10	25	150	23	M10	0,034	10	5,17
	49-33320033	MBS 25-200-10	25	200	23	M10	0,045	10	5,75
	49-33325033	MBS 25-250-10	25	250	23	M10	0,056	10	6,36
<b>180 A</b>	49-33330033	MBS 25-300-10	25	300	23	M10	0,068	10	7,03
	49-33350033	MBS 25-500-10	25	500	23	M10	0,113	10	10,27
	49-33410033	MBS 30-100-10	30	100	23	M10	0,027	10	4,41
	49-33415033	MBS 30-150-10	30	150	23	M10	0,041	10	5,19
	49-33420033	MBS 30-200-10	30	200	23	M10	0,054	10	5,98
	49-33425033	MBS 30-250-10	30	250	23	M10	0,068	10	6,89
<b>195 A</b>	49-33430033	MBS 30-300-10	30	300	23	M10	0,081	10	8,14
	49-33450033	MBS 30-500-10	30	500	23	M10	0,135	10	12,07
	49-33510033	MBS 35-100-10	35	100	23	M10	0,032	10	4,60
	49-33515033	MBS 35-150-10	35	150	23	M10	0,047	10	5,26
	49-33520033	MBS 35-200-10	35	200	23	M10	0,063	10	6,26
	49-33525033	MBS 35-250-10	35	250	23	M10	0,079	10	7,12
<b>250 A</b>	49-33530033	MBS 35-300-10	35	300	23	M10	0,095	10	8,90
	49-33550033	MBS 35-500-10	35	500	23	M10	0,158	10	11,77
	49-33610033	MBS 50-100-10	50	100	28	M10	0,045	10	6,09
	49-33615033	MBS 50-150-10	50	150	28	M10	0,068	10	7,79
	49-33620033	MBS 50-200-10	50	200	28	M10	0,090	10	9,34
	49-33625033	MBS 50-250-10	50	250	28	M10	0,113	10	11,02
	49-33630033	MBS 50-300-10	50	300	28	M10	0,135	10	12,51
	49-33650033	MBS 50-500-10	50	500	28	M10	0,225	10	18,63
	49-33610044	MBS 50-100-12	50	100	28	M12	0,045	10	6,09
	49-33615044	MBS 50-150-12	50	150	28	M12	0,068	10	7,79
<b>250 A</b>	49-33620044	MBS 50-200-12	50	200	28	M12	0,090	10	9,34
	49-33625044	MBS 50-250-12	50	250	28	M12	0,113	10	11,02
	49-33630044	MBS 50-300-12	50	300	28	M12	0,135	10	12,51
	49-33650044	MBS 50-500-12	50	500	28	M12	0,225	10	18,63

Op aanvraag: blank koper, geïsoleerde banden, uitvoeringen tot 95mm<sup>2</sup> mogelijk.



# Spanningsverdeelsysteem

## Spanningsverdeelsysteem Busspeed

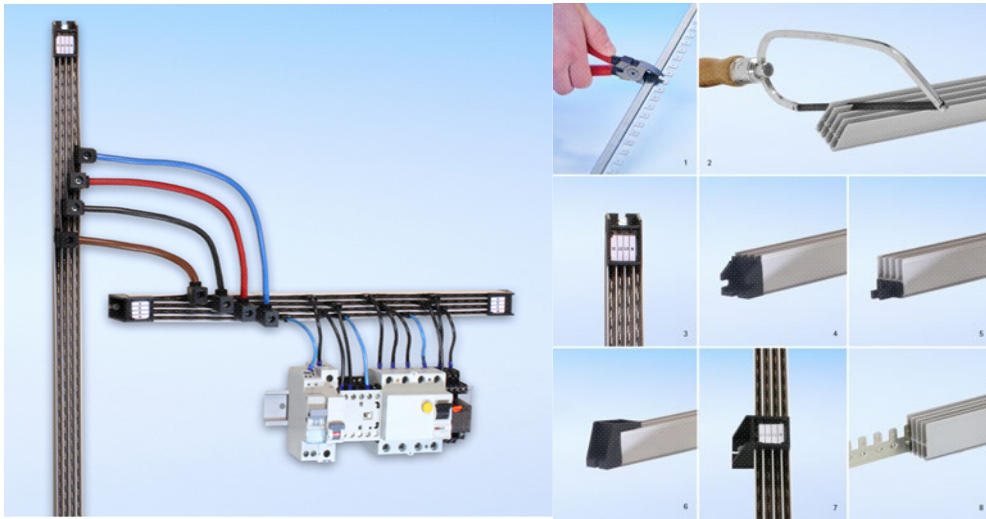

Voorkom "wilde" bedrading en kies voor maximale flexibiliteit in de schakelkast met het busSpeed systeem.

- . overzichtelijk
- . spaart montage tijd
- . verhoogd belastbaarheid
- . snelle herkenning fasen
- . bedrading wijzigen zonder gereedschap

Technische specificaties:  
 Nominale spanning: 660V/50Hz  
 Zelfdovend PVC UL94V0  
 Max. temperatuur +70°C

Geleider:  
 Vertind koper: 63A bij +40°C

1. vertind koperrails op maat te knippen, 2. kunststof profiel op maat zagen, 3. schroefbevestiging op montageplaat  
 4 - 6. diverse kunststof eindsteunen, 7. montagebeugels op elke 50-60 cm, 8. busbar in kunststof profiel

### Busbar | Met kunststof profiel lengte 1.855mm

Bestelnummer	Aantal geleiders	Materiaal	Fastons	Spanning	Brutoprijs €/stk
<b>A</b>					
66-B2CE6S	2	vertind koper	6,3 x 0,8	63	57,80
66-B3CE6S	3	vertind koper	6,3 x 0,8	63	74,55
66-B4CE2S	4	vertind koper	2,8 x 0,8	63	108,20
66-B4CE6S	4	vertind koper	6,3 x 0,8	63	91,30
66-BM4CE6S	4	vertind koper	6,3 x 0,8	125	259,39



Klantspecifieke lengten op aanvraag leverbaar

### Toebehoren

Bestelnummer	Omschrijving	Kleur	Spanning	Brutoprijs €/stk
<b>A</b>				
66-CCB	inkortschaar fastonstrip			56,53
66-CGB	inkortschaar profiel			147,26
66-40017V2	voedingsklem		63	13,40
66-DA4125S	voedingsklem		125	48,33
66-BLALV4	bevestigingsklem 4x10 schroef			0,50
66-SUSV4	bevestigingssteun zwart			1,56
66-SB4SV4	eindbevestiging kunststof			1,45
66-MCLRBC	kleurcodering	wit		0,23
66-MCLRBE	kleurcodering	blauw		0,23
66-MCLRBR	kleurcodering	bruin		0,23
66-MCLRGR	kleurcodering	grijs		0,23
66-MCLRJN	kleurcodering	geel		0,23
66-MCLRLL	kleurcodering	lila		0,23
66-MCLRNR	kleurcodering	zwart		0,23
66-MCLRROG	kleurcodering	oranje		0,23
66-MCLRROG	kleurcodering	rood		0,23
66-MCLRROG	kleurcodering	roze		0,23
66-MCLRVR	kleurcodering	groen		0,23



#### Keuze van geleiders voor het aansluiten van de busSpeed busbar

faston	diameter	I max. volgens IEC760 bij 40°C
2,8 x 0,8	0,5 mm <sup>2</sup>	6 A
	1,0 mm <sup>2</sup>	8 A
6,3 x 0,8	1,5 mm <sup>2</sup>	16 A
	2,5 mm <sup>2</sup>	20 A
	4,0 mm <sup>2</sup>	26 A
	6,0 mm <sup>2</sup>	34 A



## Diverse afstandsteunen

Kunststof: type S, serie 10-11

### Afstandsteunen | Type S met 7 mm breed zeskant gedeelte

**Materiaal:** Polystyreen  
**Draadeind:** Elektrolytisch verzinkt staal  
**Kleur:** RAL7035  
**Voorschriften:** IEC 947-1



Bestelnummer 10-serie	Bestelnummer 11-serie	Afmetingen			VPE	Brutoprijs €/100stk
		L	a	SW		
<b>M3</b>						
51-3S15-10	51-3S15-11	15	7	6	100	<b>63,00</b>
51-3S20-10	o.a.	20	7	6	100	<b>64,00</b>
51-3S25-10	51-3S25-11	25	7	6	100	<b>64,00</b>
51-3S30-10	51-3S30-11	30	7	6	100	<b>66,00</b>
51-3S40-10	51-3S40-11	40	7	6	100	<b>66,00</b>
51-3S55-10	51-3S55-11	55	7	6	100	<b>67,00</b>

#### Karakteristieken

Ook verkrijgbaar in PA6 (nylon)

10-serie draadeind/insert

11-serie draadeind/draadeind

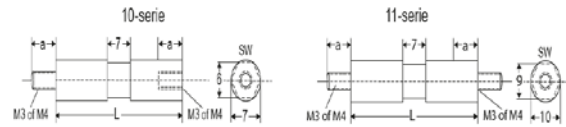

Bestelnummer 10-serie	Bestelnummer 11-serie	Afmetingen			VPE	Brutoprijs €/100stk
		L	a	SW		
<b>M4</b>						
51-4S10	51-4S10-11	10	7	9	100	<b>77,50</b>
51-4S15	51-4S15-11	15	7	9	100	<b>63,00</b>
51-4S20	51-4S20-11	20	7	9	100	<b>64,00</b>
51-4S25	51-4S25-11	25	7	9	100	<b>64,00</b>
51-4S30	o.a.	30	7	9	100	<b>66,00</b>
o.a.	51-4S35-11	35	7	9	100	<b>66,00</b>
51-4S40	o.a.	40	7	9	100	<b>66,00</b>
51-4S45	51-4S45-11	45	7	9	100	<b>80,50</b>
51-4S50	o.a.	50	7	9	100	<b>80,50</b>
51-4S55	51-4S55-11	55	7	9	100	<b>67,00</b>
51-4S60	51-4S60-11	60	7	9	100	<b>68,50</b>
51-4S90	o.a.	90	7	9	100	<b>90,00</b>

### Afstandsteunen | Type S geheel 6 kant

**Materiaal:** Polystyreen  
**Draadeind:** Elektrolytisch verzinkt staal  
**Kleur:** RAL7035  
**Voorschriften:** IEC 947-1

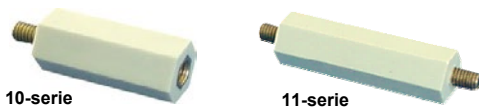

Bestelnummer 10-serie	Bestelnummer 11-serie	Afmetingen			VPE	Brutoprijs €/100stk
		L	a	SW		
<b>M5</b>						
51-5S15	o.a.	15	7	13	100	<b>90,50</b>
51-5S20	o.a.	20	7	13	100	<b>92,00</b>
51-5S30	o.a.	30	7	13	100	<b>102,50</b>
51-5S45	51-5S45-11	45	7	13	100	<b>114,00</b>
51-5S55	o.a.	55	7	13	100	<b>120,00</b>
51-5S70	o.a.	70	7	13	100	<b>122,50</b>
51-5S85	51-5S85-11	85	7	13	100	<b>125,50</b>
51-5S120	o.a.	120	7	13	100	<b>130,00</b>

#### Karakteristieken

Elke gewenste maat in stappen van 1mm tussen 10.. 120mm verkrijgbaar.

Draadeind is niet doorlopend.

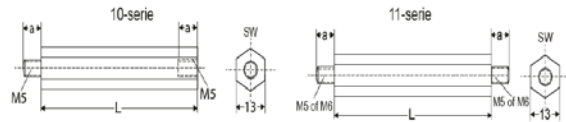

Bestelnummer 10-serie	Bestelnummer 11-serie	Afmetingen			VPE	Brutoprijs €/100stk
		L	a	SW		
<b>M6</b>						
51-6S15	51-6S15-11	15	7	13	100	<b>90,50</b>
51-6S20	o.a.	20	7	13	100	<b>92,00</b>
51-6S25		25	7	13	100	<b>117,50</b>
51-6S30	o.a.	30	7	13	100	<b>102,50</b>
51-6S35		35	7	13	100	<b>111,50</b>
51-6S40	51-6S40-11	40	7	13	100	<b>111,50</b>
51-6S45	o.a.	45	7	13	100	<b>114,00</b>
51-6S70	o.a.	70	7	13	100	<b>133,00</b>
51-6S100	51-6S100-11	100	7	13	100	<b>134,50</b>
51-6S120	o.a.	120	7	13	100	<b>148,50</b>

## Diverse afstandsteunen

Kunststof: type 6A, Metaal: ophoogbus en-steun, dopbout en -moeren

### Afstandsteunen | Type 6 A

**Materiaal:** Polystyrol  
**Draadeind:** Elektrolytisch verzinkt staal  
**Kleur:** RAL7035  
**Voorschriften:** IEC 947-1



#### Karakteristieken

Deze afstandsteun is een met kunststof omspotten draadstang en daardoor niet isoerend. Er zijn speciale koppelbussen verkrijgbaar voor deze steun: type 6K.

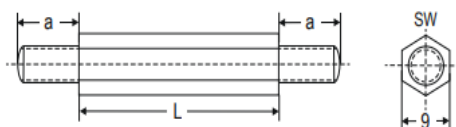

Bestelnr.	Afmetingen			VPE	Bruto prijs €/100stk
	L	a	SW		
<b>M6</b>					
51-6A45-65	45	10	9	100	<b>62,00</b>
51-6A50-70	50	10	9	100	<b>65,00</b>
51-6A60-80	60	10	9	100	<b>67,00</b>
51-6A70-90	70	10	9	100	<b>71,50</b>
51-6A85-105	85	10	9	100	<b>76,00</b>

Bestelnr.	Afmetingen			VPE	Bruto prijs €/100stk
	L	a	SW		
<b>M6</b>					
51-6A100-120	100	10	9	100	<b>77,50</b>
51-6A110-130	110	10	9	100	<b>83,50</b>
51-6A120-140	120	10	9	100	<b>87,50</b>
51-6A140-160	140	10	9	100	<b>93,00</b>
51-6A180-200	180	10	9	100	<b>112,50</b>

### Ophoogbus | Type V

**Materiaal:** Elektrolytisch verzinkt staal  
 Speciaal voor aardrail 25A en 63A

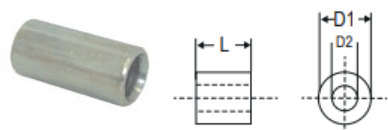

Bestelnr.	Afmetingen			VPE	Bruto prijs €/100stk
	L	D1	D2		
51-V5	5	10	7	100	<b>28,50</b>
51-V10	10	10	7	100	<b>38,00</b>
51-V15	15	10	7	100	<b>45,50</b>
51-V20	20	10	7	100	<b>80,00</b>
51-V25	25	10	7	100	<b>103,00</b>
51-V30	30	10	7	100	<b>114,00</b>

### Koppelbus | 6K

**Materiaal:** Elektrolytisch verzinkt staal  
 Om afstandsteunen type A te verbinden

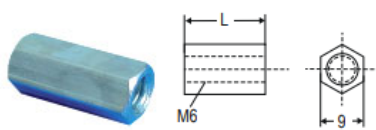

Bestelnr.	Insert L	VPE	Bruto prijs €/100stk
51-6K15	15	6	<b>42,50</b>
51-6K20	20	6	<b>47,50</b>

### Ophoogsteun | DI/DII

**Materiaal:** Elektrolytisch verzinkt Messing  
 Elektrolytisch verzinkt staal

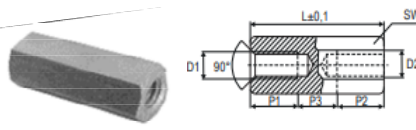

Bestelnr.	Afmetingen			VPE	Bruto prijs €/100stk
	L	P3	SW		
<b>Messing</b>					
51-DI5-M3x20	20	0	5	100	<b>37,00</b>
51-DI7-M4x12	12	0	7	100	<b>37,00</b>
51-DI7-M4x30	30	10	7	100	<b>57,00</b>
51-DI7-M4x50	50	10	7	100	<b>99,00</b>
51-DI7-M4x60	60	10	7	100	<b>124,00</b>
51-DI7-M4x70	70	10	7	100	<b>143,00</b>
51-DI8-M5x08	8	0	8	100	<b>43,50</b>
51-DI8-M5x15	15	0	8	100	<b>54,00</b>
<b>Staal</b>					
51-DI10-M6x12	12	0	10	100	<b>64,50</b>
51-DI10-M6x20	20	0	10	100	<b>77,00</b>
51-DI10-M6x25	25	10	10	100	<b>83,00</b>
51-DI10-M6x30	30	10	10	100	<b>91,00</b>

### Dopmoeren | Type D

**Materiaal:** Polystyreen



Bestelnr.	Insert (a)		VPE	Bruto prijs €/100stk
	L	A		
51-4D	11,5	8	M4	<b>22,00</b>
51-5D	11,5	8	M5	<b>22,00</b>
51-6D	11,5	8	M6	<b>22,00</b>

### Dopbouten | Type DB

**Materiaal:** Polyamide  
**Draadeind:** Elektrolytisch verzinkt

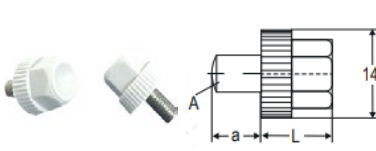

Bestelnr.	Afmetingen			VPE	Bruto prijs €/100stk
	L	a	A		
51-4DB	7	8	M4	100	<b>57,00</b>
51-5DB	9	8	M5	100	<b>57,00</b>
51-6DB	9	8	M6	100	<b>57,00</b>

### Dopbouten | Type OD

**Materiaal:** Polystyreen  
**Draadeind:** Elektrolytisch verzinkt  
**Veer:** Elektrolytisch verzinkt (onverliesbaar)

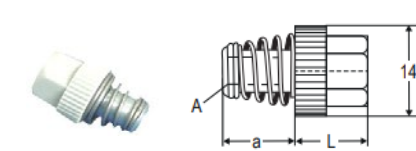

Bestelnr.	Afmetingen			VPE	Bruto prijs €/100stk
	L	a	A		
51-4OD	12	8	M4	100	<b>231,00</b>
51-5OD	12	8	M5	100	<b>231,00</b>
51-6OD	12	8	M6	100	<b>241,50</b>

# Diverse afstandsteunen

Metaal: type DA, montageklemmen, deurbeugels

## Afstandhouders | Type DA

**Materiaal:** Messing vernikkeld of elektrolytisch verzinkt staal

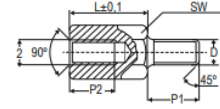

Bestelnummer	Afmetingen			VPE	Brutoprijs €/100stk
	L	P1	P2		
<b>Messing vernikkeld</b>					
51-DA5-M3x08	8	8	5	100	<b>34,00</b>
51-DA5-M3x10	10	8	5	100	<b>38,65</b>
51-DA5-M3x15	15	8	8	100	<b>41,90</b>
51-DA5-M3x18	18	8	8	100	<b>43,50</b>
51-DA5-M3x20	20	8	8	100	<b>48,80</b>
51-DA5-M3x30	30	10	10	100	<b>49,00</b>
51-DA5-M3x40	40	10	10	100	<b>64,60</b>
51-DA7-M4x10	10	8	5	100	<b>49,30</b>
51-DA7-M4x15	15	8	8	100	<b>54,35</b>
51-DA7-M4x20	20	8	8	100	<b>56,90</b>
51-DA7-M4x25	25	10	10	100	<b>57,65</b>
51-DA7-M4x30	30	10	10	100	<b>58,65</b>
51-DA7-M4x35	35	10	10	100	<b>67,45</b>
51-DA7-M4x40	40	10	10	100	<b>93,00</b>
51-DA7-M4x50	50	10	10	100	<b>78,20</b>
51-DA7-M4x60	60	10	10	100	<b>101,05</b>
51-DA7-M4x70	70	10	10	100	<b>168,50</b>
51-DA7-M4x80	80	10	10	100	<b>186,50</b>
68125-303100-00	34			100	<b>31,62</b>
68125-303101-00	35			100	<b>33,24</b>

Bestelnummer	Afmetingen			VPE	Brutoprijs €/100stk
	L	P1	P2		
<b>Verzinkt staal</b>					
51-DA8-M5x10	10	8	3	100	<b>40,80</b>
51-DA8-M5x15	15	10	8	100	<b>42,80</b>
51-DA8-M5x20	20	8	8	100	<b>53,20</b>
51-DA8-M5x25	25	10	10	100	<b>67,50</b>
51-DA8-M5x35	30	10	10	100	<b>80,00</b>
51-DA8-M5x40	40	10	10	100	<b>56,85</b>
51-DA8-M5x45	45	10	10	100	<b>79,15</b>
51-DA8-M5x50	50	10	10	100	<b>64,65</b>
51-DA8-M5x60	60	10	10	100	<b>75,10</b>
51-DA8-M5x70	70	10	10	100	<b>74,65</b>
51-DA8-M5x80	80	10	10	100	<b>91,60</b>
51-DA10-M6x10	10	8	5	100	<b>49,80</b>
51-DA10-M6x15	15	8	8	100	<b>52,00</b>
51-DA10-M6x20	20	8	8	100	<b>55,15</b>
51-DA10-M6x25	25	8	8	100	<b>54,45</b>
51-DA10-M6x30	30	10	10	100	<b>58,85</b>
51-DA10-M6x40	40	10	10	100	<b>67,40</b>
51-DA10-M6x45	45	10	10	100	<b>71,75</b>
51-DA10-M6x50	50	10	10	100	<b>76,10</b>
51-DA10-M6x60	60	10	10	100	<b>86,70</b>

Bestelnummer	Afmetingen			VPE	Brutoprijs €/100stk
	L	P1	P2		
<b>Verzinkt staal</b>					
51-DA10-M6x70	70	10	10	100	<b>94,90</b>
51-DA10-M6x80	80	10	10	100	<b>111,50</b>
51-DA10-M6x90	90	10	10	100	<b>127,95</b>
51-DA10-M6x100	100	10	10	100	<b>144,45</b>
51-DA13-M8x15	15	8	8	100	<b>129,50</b>
51-DA13-M8x18	18	8	8	100	<b>133,00</b>
51-DA13-M8x20	20	8	8	100	<b>137,50</b>
51-DA13-M8x25	25	8	8	100	<b>146,50</b>
51-DA13-M8x30	30	10	10	100	<b>156,50</b>
51-DA13-M8x35	35	10	10	100	<b>166,00</b>
51-DA13-M8x40	40	10	10	100	<b>176,00</b>
51-DA13-M8x45	45	10	10	100	<b>189,50</b>
51-DA13-M8x50	50	10	10	100	<b>202,50</b>
51-DA13-M8x55	55	10	10	100	<b>209,50</b>
51-DA13-M8x60	60	10	10	100	<b>222,00</b>
51-DA13-M8x70	70	10	10	100	<b>241,00</b>
51-DA13-M8x80	80	10	10	100	<b>265,00</b>
51-DA13-M8x90	90	10	10	100	<b>274,50</b>
51-DA13-M8x100	100	10	10	100	<b>298,50</b>

## Montageklemmen | Type KS

**Materiaal:** Polyamide / verzinkt staal  
Voor DIN-EN montagerail TS 35

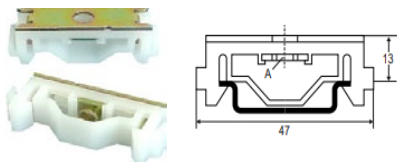

Bestelnummer	A	VPE	Brutoprijs €/10stk
51-KS5	M5	10	<b>27,75</b>
51-KS6	M6	10	<b>27,75</b>

## Deurbeugel | Type DEB

**Materiaal:** Verzinkt plaatstaal  
Aanrakingsbeveiliging  
binnenkant deur

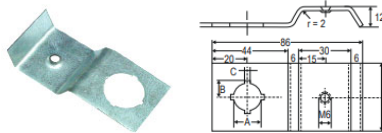

Bestelnummer	Afmetingen			VPE	Brutoprijs €/10stk
	A	B	C		
51-DEB161	16,1	9,2	2,6	1	<b>o.a.</b>
51-DEB225	22,5	14	2,8	1	<b>2,53</b>
51-DEB305	30,5	17	3,2	1	<b>o.a.</b>

## Ophoogbus | Type DR

**Materiaal:** Polystyrol

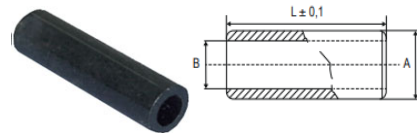

Bestelnummer	Afmetingen			VPE	Brutoprijs €/10stk
	L	A	B		
51-DR7/3,5X12	12	7	3,5	100	<b>6,00</b>
51-DR8/4,5X20	20	8	4,5	100	<b>8,00</b>
51-DR10/5,5X10	10	10	5,5	100	<b>9,50</b>
51-DR10/5,5X15	15	10	5,5	100	<b>11,80</b>
51-DR10/5,5X20	20	10	5,5	100	<b>13,00</b>
51-DR10/5,5X25	25	10	5,5	100	<b>17,50</b>
51-DR10/5,5X30	30	10	5,5	100	<b>17,00</b>
51-DR10/6,2X10	10	10	6,2	100	<b>10,00</b>
51-DR10/6,2X15	15	10	6,2	100	<b>11,10</b>
51-DR10/6,2X18	18	10	6,2	100	<b>13,50</b>
51-DR10/6,2X20	20	10	6,2	100	<b>13,10</b>
51-DR10/6,2X25	25	10	6,2	100	<b>15,50</b>
51-DR10/6,2X30	30	10	6,2	100	<b>18,00</b>
51-DR10/6,2X35	35	10	6,2	100	<b>19,00</b>

# Eren isolatoren

Glasvezelversterkt: serie SK



## Isolatoren | Serie SK

**Materiaal:** Glasvezelversterkt polyester (UP)  
Schroefdraad verzinkt staal

**Temp. bereik:** -40°C tot + 130°C

**Kleur:** Bruin (op bestelling rood)

**Karakteristieken**  
Zelfdovend, halogeenvrij, glasinhoud 18%

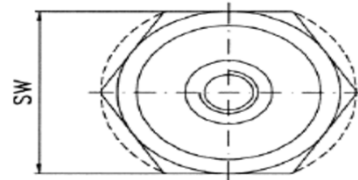
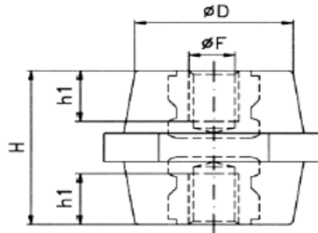

Halogeenvrij

Bestelnummer	Afmetingen					Service spanning	Test spanning	Zijwaartse belasting	Aandraai moment	Gewicht kg/100	VPE in stk.	Brutoprijs €/stk
	H	ØF	SW	ØD	h1							
50-SK-201705	20	M5	17	15	5	0,6	3	1	3	1,25	100	1,65
50-SK-201706	20	M6	17	15	5	0,6	3	1	3	1,25	100	1,65
50-SK-252205	25	M5	22	18	6	1,0	6	1	2,5	2,00	100	1,95
50-SK-252206	25	M6	22	18	6	1,0	6	1	4,5	2,00	100	1,95
50-SK-303006	30	M6	30	26	6	1,5	10	3	12	5,40	80	2,35
50-SK-303008	30	M8	30	26	8	1,5	10	3	20	5,30	80	2,35
50-SK-304008	30	M8	40	36	9	1,5	10	5	20	8,50	100	3,20
50-SK-353206	35	M6	32	28	8	1,5	12	4,5	12	7,00	100	2,10
50-SK-353208	35	M8	32	28	10	1,5	12	5	20	7,20	100	2,45
50-SK-403006	40	M6	30	26	8	2,0	15	2	12	6,90	100	2,65
50-SK-403008	40	M8	30	26	10	2,0	15	3	16	7,00	60	2,65
50-SK-403610	40	M10	36	32	12	2,0	15	6	40	10,80	100	2,80
50-SK-404006	40	M6	40	35	8	2,0	15	4,5	12	10,20	75	2,80
50-SK-404008	40	M8	40	35	10	2,0	15	5	20	10,70	75	2,70
50-SK-404010	40	M10	40	35	12	2,0	15	6	40	11,50	75	2,80
50-SK-404012	40	M12	40	35	11	2,0	15	7,5	40	11,80	75	3,15
50-SK-503608	50	M8	36	29	10	2,0	15	4,5	20	10,90	80	2,80
50-SK-503610	50	M10	36	29	14	2,0	15	4,5	20	12,20	80	3,00
50-SK-504012	50	M12	40	28	15	2,0	15	6	40	14,10	50	3,60
50-SK-505010	50	M10	50	42	14	2,0	15	7	40	19,00	50	3,70
50-SK-505012	50	M12	50	42	15	2,0	15	9	70	20,10	50	3,65
50-SK-604008	60	M8	40	35	10	3,0	20	3,5	20	15,00	50	3,70
50-SK-604010	60	M10	40	35	14	3,0	20	4,5	40	16,20	50	3,70
50-SK-605010	60	M10	50	42	14	3,0	15	7	40	25,40	32	4,20
50-SK-605010VA*	60	M10	50	42	14	2,0	15	7	40	19,00	20	o.a.
50-SK-605012	60	M12	50	42	18	3,0	15	8	70	26,00	32	0,00
50-SK-605512	60	M12	55	43	20	3,0	15	10	70	27,20	50	0,00
50-SK-606010	60	M10	60	43	14	3,0	15	6	40	38,00	24	5,80
50-SK-606012	60	M12	60	43	16	3,0	15	11	25	38,50	24	5,85
50-SK-606016	60	M16	60	43	20	3,0	15	14	28	36,50	24	6,25
50-SK-754612	75	M12	46	36	20	3,0	20	7	70	25,00	50	4,70
50-SR-806012**	80	M12	60	60	20	5,0	25	9	70	53,60	8	o.a.
50-SK-1006512	100	M12	65	52	18	5,0	26	9	70	64,80	9	12,80

\* VA = RVS inzet

\*\* rood

### Materiaalgegevens:

<b>Gewicht</b>	ASTM D-792, DIN 53479	1,75 g/cm <sup>3</sup>
<b>Martens degree</b>	DIN 53462	> 200° C
<b>Flexural strength</b>	DIN EN ISO 178	90 N/mm <sup>2</sup>
<b>Impact strength</b>	DIN EN ISO 179	25 - 30 kJ/m <sup>2</sup>
<b>Flammability</b>	UL 94	V0
<b>Glow-wire Flammability</b>	DIN EN 60695	960° C
<b>Surface resistivity</b>	DIN IEC 60093	10 Ωcm
<b>Volume resistivity</b>	DIN IEC 60093	10 Ωcm
<b>Dielectric strength</b>	DIN EN 60243-1	150 kV/cm
<b>Tracking resistance</b>	DIN IEC 60112	CTI 600
<b>Water absorption</b>	DIN EN ISO 62	<0,2% (<25 mg)







**DUURZAAM**

---

**7**

# EV LAADPAAL OPLOSSINGEN

MET CALPE MOBILITY

**Lovato**  
**electric**  
ENERGY AND AUTOMATION

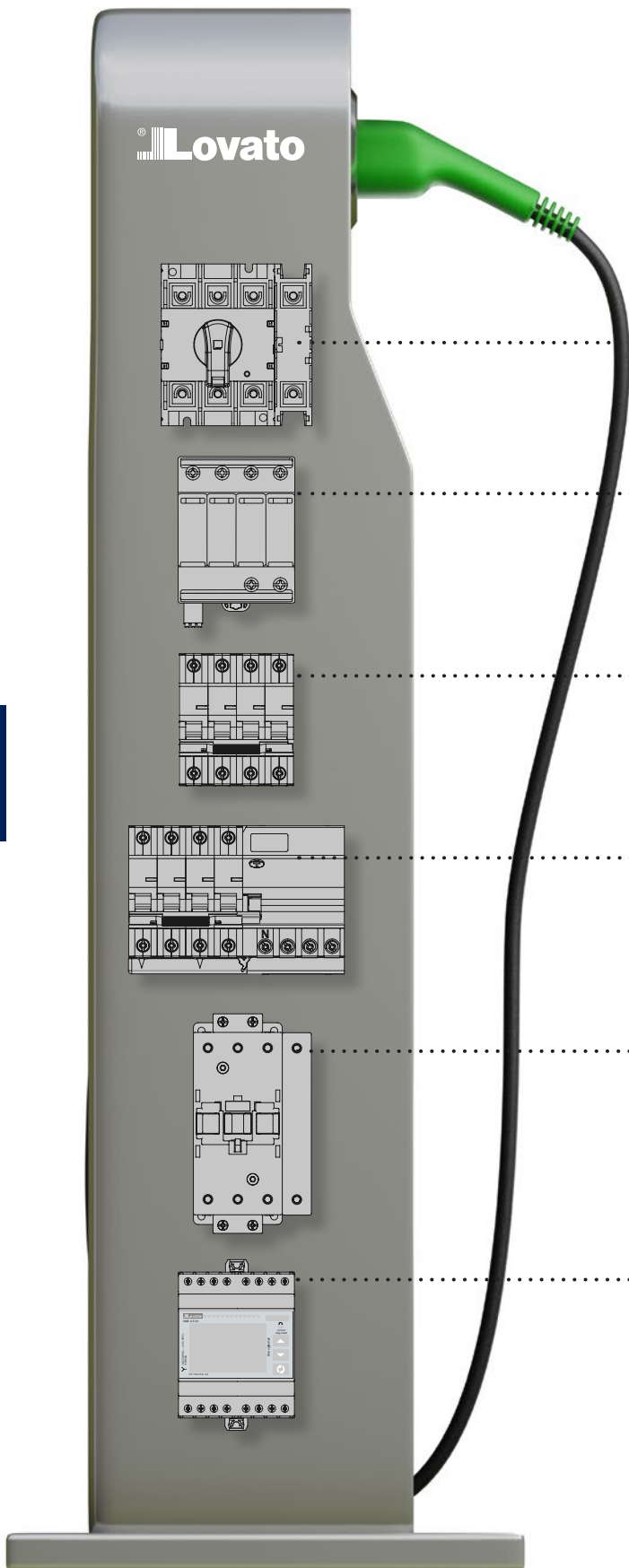

## LASTSCHAKELAARS

### SERIE GA, GL

Compacte lastschakelaars 7,5 tot 430kW  
Hangslot vergrendelbaar, ruim assortiment  
bedieningsknoppen

## OVERSPANNINGSBEVEILIGING

### SERIE SG

Bescherming tegen overspanning door directe of  
indirecte blikseminslag.  
Met visuele statusindicatie per module  
Voorzien van verwisselbare modules

## AUTOMATEN

### SERIE P1MB

C-karakteristiek tot 44kW  
Conform IEC/EN 60947-2, IEC/EN 60898-1,  
UL1077 CSA C22.2 n° 235  
Kortsluitvastheid 10kA (6kA voor 1P+N)

## AARDLEKCOMBINATIE

### SERIE P1RA

Type A, eenvoudig te combineren met  
serie P1MB automaten  
Voor bescherming tegen indirect contact en tegen  
brandgevaar door aanhoudende  
aardfout-/aardlekstroom.

## MAGNEETSCHAKELAARS

### SERIE B, BF, CN

Compacte bouwvorm,  
geschikt voor DIN rail montage  
Aanrakingsveilig IP20  
B serie tot 750kW AC1

## ENERGIEMETERS

### SERIE DMED

MID gecertificeerd, accurate meting  
(direct of indirect)  
Programmeerbare in- en outputs  
Modulaire behuizing, voorzijde IP40



**Lastschakelaars** | SERIE GA

3-polig 16A tot 160A (AC21A)

4<sup>de</sup> pool los te bestellen

DIN-rail montage of met deurkoppelingset

**Lastschakelaars** | SERIE GL

3-polig 160 – 630A (AC21A)

4<sup>de</sup> pool los te bestellen

Montage op DIN-rail of bodemmontage

Zichtbare contacten

**Overspanningsbeveiliging** | SERIE SG

Type 2

1P, 1P+N, 2P, 3P, 3P+N, 4P versies

Beschermingsniveau Up (1,5kV)

I<sub>max</sub> (8/20μs) 50kA of 15kA**Installatie automaten** | SERIE P1MB

1P, 1P+N, 2P, 3P, 4P versies

B-, C-, D-karakteristiek

Beschikbaar van 1A t/m 125A

Ruim assortiment toebehoren

**Aardlekcombinaties** | SERIE P1R

2P, 3P, 4P versies

40A, 63A

30mA, 300mA

Type A

**Modulaire magneetschakelaars** | SERIE CN

1P, 2P, 3P, 4P versies

20A, 25A, 32A, 40A, 63A (I<sub>th</sub> aC1 400V)

Ook beschikbaar met handbediening

**Aardlekschakelaars** | SERIE P1RC

2P, 4P versies

25A, 40A, 63A, 80A

30mA, 300mA

Type A, B

**Magneetschakelaars** | SERIE BF .. B

3P, 4P versies

I<sub>th</sub> 16 – 800A (AC1)I<sub>e</sub> 6 – 630A (AC3 440V)

Beschikbaar in AC of DC

Ruim assortiment toebehoren

**Energimeters** | SERIE DMED

1- en 3 fase

Met MID certificaat

Directe meting of via stroomtransformator

Ook beschikbaar met RS485 of M-bus interface



# Lovato DC lastschakelaars

Serie GD - GAZ...D..

**Lovato**  
**electric**

ENERGY AND AUTOMATION

## DC-Lastschakelaar | Serie GD

<b>Beschermingsklasse:</b>	IP20
<b>Voorschriften:</b>	IEC/EN/BS 60947-3, 60947-1, UL60947-4-1
<b>Temperatuurbereik:</b>	-25°C tot +55°C

**Karakteristieken**  
2-, 3- en 4-polig IN/UIT, compact, geschikt voor DIN-railmontage. Compleet met zwarte bedieningsknop, hangslotvergendelbaar.

**Ook voor PV: zekeringhouders, overspanningsbeveiliging, magneetschakelaars, installatie automaten, GSM-modem**

Spanning	Aantal polen	Schakelvermogen		Bestelnummer	Brutoprijs €/stk
		DC-21B			
25 A	2	1000VDC		60-GD025AT2	124,40
	3	1000VDC		60-GD025AT3	168,70
32 A	3	1200VDC		60-GD032AT3	226,80
	4	1200VDC		60-GD032AT4	278,85
40 A	3	1000VDC		60-GD040AT2	<b>o.a.</b>
	4	1000VDC		60-GD040AT4	316,00

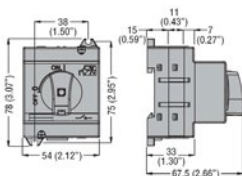

GD025AT2

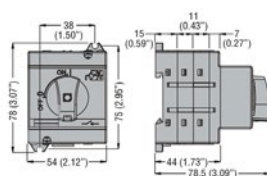

GD032AT4

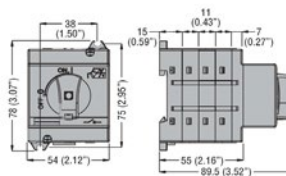

GD040AT4

## Zekeringen | Serie FE

Bestelnummer	Nominale stroom A	Brutoprijs €/stk
60-FE01D00200	2	24,05
60-FE01D00400	4	24,05
60-FE01D00600	6	24,05
60-FE01D00800	8	24,05
60-FE01D01000	10	24,05
60-FE01D01200	12	24,05
60-FE01D01600	16	24,05
60-FE01D02000	20	24,05

**Karakteristieken**  
10x38, volgens IEC 30kA, 1000VDC

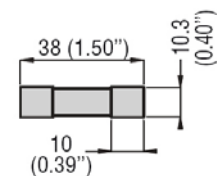

## DC-Lastschakelaar in behuizing | Serie GAZ...DT..

Spanning	Schakelvermogen		Bestelnr.	Brutoprijs €/stk
	polen	DC-21B		
<b>met rood/gele bedieningsknop</b>				
25 A	2	1000VDC	60-GAZ025DT2	175,25
32 A	3	1200VDC	60-GAZ032DT3	339,25
40 A	4	1000VDC	60-GAZ040DT4	443,60
<b>met zwarte bedieningsknop</b>				
25 A	2	1000VDC	60-GAZ025DT2B	175,25
32 A	3	1200VDC	60-GAZ032DT3B	301,90
40 A	4	1000VDC	60-GAZ040DT4B	394,80

**Karakteristieken**  
Materiaal: ABS  
Beschermingsklasse: IP65  
Voorschriften: IEC/EN/BS 60947-3, 60947-1



GAZ025DT2B



GAZ032DT3

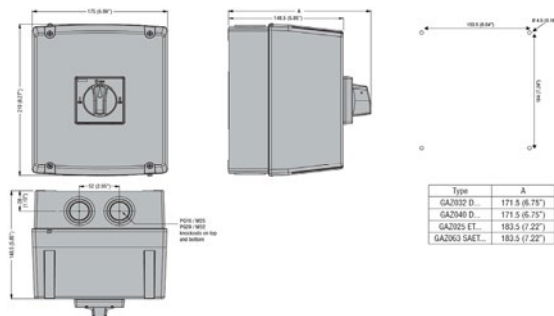

# Halogeenvrije Solar kabel

Studer BETAflam® Solar



## BETAflam® | Solar 125 RV flex 1500 V DC

### Standaarden en Eigenschappen

<b>Materiaal adersisolatie:</b>	XLPO, electron-beam cross-linked
<b>Materiaal buitenmantel:</b>	XLPO, electron-beam cross-linked
<b>Litzen:</b>	Vertind koper, fijndradig klasse 5 volgens VDE 0295/IEC 60228
<b>Temperatuur bereik:</b>	Vast: -50°C tot + 120°C Kortsluiting: +280°C / 5 sec.
<b>Nominale spanning:</b>	U0 = 1500 V DC
<b>Testspanning</b>	6,5 kV AC (50 Hz)

### Brandeigenschappen volgens CPR

<b>EN 50575, EN 13501-6:</b>	Dca-s2, d2, a2
<b>Brandprestaties:</b>	Dca: EN 50399
<b>Verbrandingsgassen:</b>	a2: EN 60754-2 (halogeenvrij)
<b>Rookdichtheid:</b>	s2: EN 50399
<b>Brandende druppels:</b>	d2: EN 50399
<b>Geen vlamverspreiding:</b>	EN 60332-1-2



### Karakteristieken

- EN50618 gecertificeerd
- UV, Ozon- en hydrolyse bestendig
- Bestand tegen hoge temperaturen
- Zéér flexibel ook bij lage temperaturen
- Levensduur: > 25 jaar bij 90°C

**BETAflam Solar 125 RV flex 1500 V DC is compatible met alle gangbare connectoren**

mm <sup>2</sup>	Bestelnummer	kleur streep	Buiten Ø
<b>Buitenmantel: zwart</b>			
2,5	30-313738	wit	5,00
4,0	30-313740	wit	5,50
6,0	30-313742	wit	6,10
10	30-313744	wit	7,20

mm <sup>2</sup>	Bestelnummer	kleur streep	Buiten Ø
<b>Buitenmantel: zwart</b>			
2,5	30-313739	rood	5,00
4,0	30-313741	rood	5,50
6,0	30-313743	rood	6,10
10	30-313745	rood	7,20

levering mogelijk op haspels van 500 of 1000 meter; afname uitsluitend per pallet







# COMPONENTEN



# Katko lastschakelaars

Serie KU-N, KU



## Lastschakelaar | Serie KU-N en KU

Beschermingsklasse: IP20  
 Voorschriften: IEC 60947-3 UL508 (16-150A)  
 Temperatuurbereik: -40°C tot +80°C



### Karakteristieken

3- en 4-polig IN/UIT, compact, geschikt voor DIN-EN rail.  
 De zilvercontacten zorgen voor een veilige en duurzame toepassing.  
 De 4-polige versie is ook leverbaar met voor- of na-ijlende contacten.  
 Serie KU modulair ontwerp.

Spanning AC22	Aantal polen	Schakelvermogen AC23/400V	Bestelnummer	Brutoprijs €/stuk
<b>KU-N</b>				
16 A	3-polig IN/UIT	7,5kW	62-KU 316N	16,80
	4-polig IN/UIT	7,5kW	62-KU 416N	22,20
25 A	3-polig IN/UIT	11kW	62-KU 325N	18,35
	4-polig IN/UIT	11kW	62-KU 425N	23,80
40 A	3-polig IN/UIT	15kW	62-KU 340N	19,95
	4-polig IN/UIT	15kW	62-KU 440N	25,35
63 A	3-polig IN/UIT	22kW	62-KU 363N	26,20
	4-polig IN/UIT	22kW	62-KU 463N	33,85
80 A	3-polig IN/UIT	30kW	62-KU 380N	30,80
	4-polig IN/UIT	30kW	62-KU 480N	40,00
125 A	3-polig IN/UIT	55kW	62-KU 3125N	39,35
	4-polig IN/UIT	55kW	62-KU 4125N	48,80
<b>KU</b>				
160 A	3-polig IN/UIT	90kW	62-KU 3160	<i>o.a.</i>
	4-polig IN/UIT	90kW	62-KU 4160	104,85

Bedieningsknop +  
verlengas los bestellen



KU-N



KU

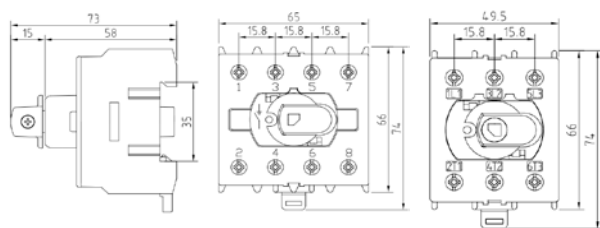

KU-N serie

4-polig

3-polig

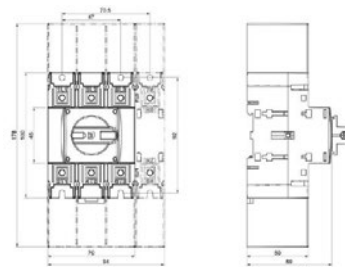

KU serie 3- en 4-polig

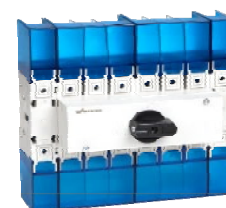

Losse afdekkappen leverbaar

## Lastschakelaar | Serie KU-N + Frontplaat KU-P

Spanning AC22	Aantal polen	Schakelvermogen AC23/400V	Bestelnummer	Brutoprijs €/stuk
16 A	3-polig IN/UIT	7,5kW	62-KU 316N+KKU3P	21,90
	4-polig IN/UIT	7,5kW	62-KU 416N+KKU4P	31,10
25 A	3-polig IN/UIT	11kW	62-KU 325N+KKU3P	23,45
	4-polig IN/UIT	11kW	62-KU 425N+KKU4P	32,65
40 A	3-polig IN/UIT	15kW	62-KU 340N+KKU3P	25,05
	4-polig IN/UIT	15kW	62-KU 440N+KKU4P	34,25
63 A	3-polig IN/UIT	22kW	62-KU 363N+KKU3P	31,30
	4-polig IN/UIT	22kW	62-KU 463N+KKU4P	42,75
80 A	3-polig IN/UIT	30kW	62-KU 380N+KKU3P	35,90
	4-polig IN/UIT	30kW	62-KU 480N+KKU4P	48,90

Paneelbouw  
uitvoering

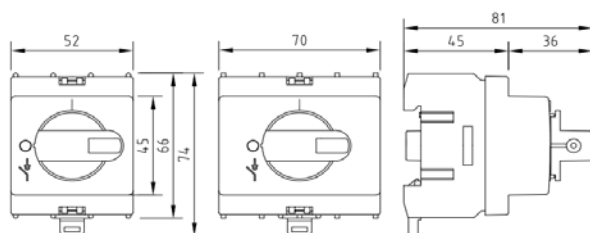

3-polig

4-polig

# Katko lastschakelaars

Toebehoren serie KU-N, KU



## Toebehoren | Serie KU-N en KU

### Bedieningsknoppen met deurekoppeling

Mogelijkheid voor een dubbele hangslotvergrendeling, IP65

Bestelnummer	Omschrijving	Brutoprijs €/stuk
62-LK3OK2	Draaiknop zwart/zwart	5,10
62-LK2OK2	Draaiknop rood/geel	5,10
62-LK10UL	Draaihendel zwart/zwart	11,15
62-LK10ULYR	Draaihendel rood/geel	11,15



LK 10 Y/R

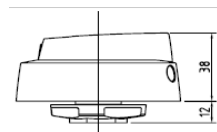

LK3/OK2



LK 10

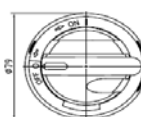

LK 2/OK2

### Deurmontageset

Set voor alle lastschakelaars t/m 80A. IP65 inbouwdiepte 72mm.

Bestelnummer	Omschrijving	Brutoprijs €/stuk
62-OKAKULK10	Draaiknop zwart/zwart	16,60
62-OKAKULK10YR	Draaiknop rood/geel	16,60
62-OKAKU4PLK10	Draaihendel zwart/zwart	19,05
62-OKAKU4PLK10YR	Draaihendel rood/geel	19,75

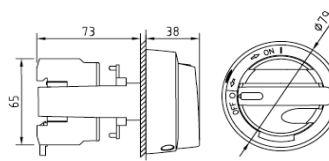

### Verlengassen

Op benodigde lengte te verzagen

Bestelnummer	Voor bedieningsknop	Lengte	Brutoprijs €/stuk
62-L200OK	LK3/OK2/LK2/OK2	Verlengas 200mm	1,95
62-L300OK	LK3/OK2/LK2/OK2	Verlengas 300mm	2,35
62-L200AD11	LK10, LK11	Verlengas 200mm	2,20
62-L300AD11	LK10, LK11	Verlengas 300mm	2,70



### Hulpcontacten

t.b.v. 3- en 4-polige schakelaars. 10A/250V Gemonteerd op de frontplaat die op de schakelaar wordt geklikt. Of zijmontage voor de KU serie.

Bestelnummer	Contactbezetting	Voor gebruik	A	Brutoprijs €/stuk
62-KU1V	Hulpcontact 1NO+1NC	KU-N 3P-4P	10-80	9,50
62-KU2V	Hulpcontact 2NO+2NC	KU-N 3P-4P	10-80	16,65
62-1V160KU	Hulpcontact 1NO+1NC	KU 3P-4P	100-160	17,85
62-2V160KU	Hulpcontact 2NO+2NC	KU 3P-4P	100-160	34,15



### Koppelsets

Voor twee gemonteerde KU-N of KU lastschakelaars.

Bestelnummer	Voor koppelen van	Schakeling	Brutoprijs €/stuk
62-KUVV	2xKU-N 16-125A	Omschakeling 1-0-2	41,85
62-VV102	2xKU 125-160A	Omschakeling 1-0-2	111,80
62-RV80	2xKU4P(8P) of 2xVKA3P(6P)	IN/UIT	17,40



VV.1-0-2



RV 80

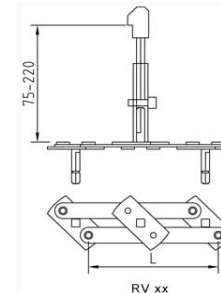
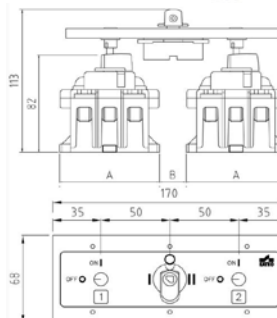

# Katko lastschakelaars

Kunststof: serie KEM 16-160A, serie KSM 16A met zijhefboom



## Lastschakelaar in kunststof behuizing | Serie KEM

**Materiaal:** Polycarbonaat of ABS, Grijs  
**Beschermingsklasse:** IP66 (MF11=IP65) (ABS IP65)  
**Voorschriften:** IEC 60947-3 UL508 (25-150A)  
**Temperatuurbereik:** -40°C tot +80°C

### Karakteristieken

Mogelijkheid voor drie hangslotvergrendelingen, bestand tegen chemicaliën. Polycarbonaat heeft een goede UV-bestendigheid en is zelfdovend.



Spanning	Aantal	Schakelvermogen	Behuizing	Bestelnummer	Bestelnummer	Brutoprijs
AC22	polen	AC23/400V				€/stuk
<b>Materiaal behuizing: Polycarbonaat</b>						
				<b>Knop zwart</b>	<b>Knop Geel/Rood</b>	
16 A	3-polig IN/UIT	7,5kW	M2	62-KEM 316 M2	62-KEM 316 YR M2	37,15
	4-polig IN/UIT	7,5kW	M2	62-KEM 416 M2	62-KEM 416 YR M2	48,65
	6-polig IN/UIT	7,5kW	M3	62-KEM 616 M3	62-KEM 616 YR M2	118,05
25 A	3-polig IN/UIT	11kW	M2	62-KEM 325 M2	62-KEM 325 YR M2	38,80
	4-polig IN/UIT	11kW	M2	62-KEM 425 M2	62-KEM 425 YR M2	51,85
	6-polig IN/UIT	11kW	M3	62-KEM 625 M3	62-KEM 625 YR M2	122,80
40 A	3-polig IN/UIT	15kW	M2	62-KEM 340 M2	62-KEM 340 YR M2	48,70
	4-polig IN/UIT	15kW	M2	62-KEM 440 M2	62-KEM 440 YR M2	60,70
	6-polig IN/UIT	15kW	M3	62-KEM 640 M3	62-KEM 640 YR M2	128,45
63 A	3-polig IN/UIT	22kW	M3	62-KEM 363 M3	62-KEM 363 YR M2	76,70
	4-polig IN/UIT	22kW	M3	62-KEM 463 M3	62-KEM 463 YR M2	82,70
	6-polig IN/UIT	22kW	M3	62-KEM 663 M3	62-KEM 663 YR M2	165,65
80 A	3-polig IN/UIT	30kW	M3	62-KEM 380 M3	62-KEM 380 YR M2	88,00
	4-polig IN/UIT	30kW	M3	62-KEM 480 M3	62-KEM 480 YR M2	100,55
	6-polig IN/UIT	30kW	M3	62-KEM 680 M3	62-KEM 680 YR M2	186,15
125 A	3-polig IN/UIT	55kW	M4	62-KEM 3125 M4	62-KEM 3125 YR M2	221,75
	4-polig IN/UIT	55kW	M4	62-KEM 4125 M4	62-KEM 4125 YR M2	262,75
	6-polig IN/UIT	55kW	MF11	62-KEM 6125 MF11	62-KEM 6125 YR MF11	344,35
160 A	3-polig IN/UIT	75kW	MF11	62-KEM 3160 MF11	62-KEM 3160 YR MF11	285,65
	4-polig IN/UIT	75kW	MF11	62-KEM 4160 MF11	62-KEM 4160 YR MF11	324,25
	6-polig IN/UIT	75kW	MF11	62-KEM 6160 MF11	62-KEM 6160 YR MF11	387,85
<b>Materiaal behuizing: ABS</b>						
16 A	3-polig IN/UIT	7,5kW	M2	62-KEM 316 M2ABS	62-KEM 316 M2ABS	o.a.
	4-polig IN/UIT	7,5kW	M2	62-KEM 416 M2ABS	62-KEM 416 M2ABS	o.a.
25 A	3-polig IN/UIT	11kW	M2	62-KEM 325 M2ABS	62-KEM 325 M2ABS	o.a.
	4-polig IN/UIT	11kW	M2	62-KEM 425 M2ABS	62-KEM 425 M2ABS	o.a.

Polycarbonaat is ook leverbaar met UL en in EMC uitvoering

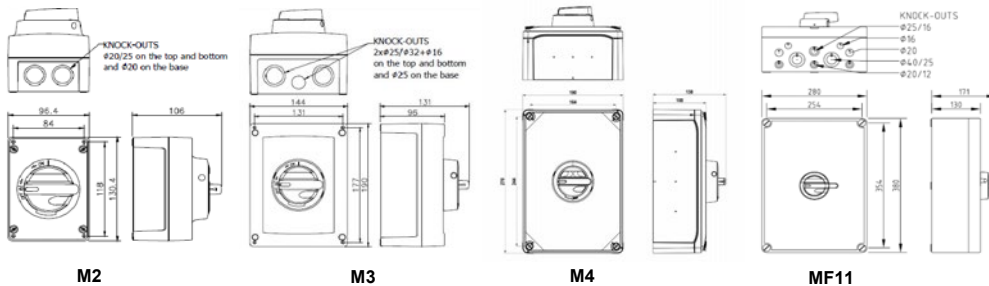

M2

M3

M4

MF11



Behuizing M2



Behuizing M2 (Y/R)



Behuizing M3



Behuizing M4



Behuizing MF11 (Y/R)

## Lastschakelaar in kunststof behuizing | Serie KSM

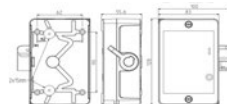

### Karakteristieken

Polycarbonaat IP65, goede UV-bestendigheid, voorzien van 2xM20 invoer aan boven en onderzijde, inclusief 2xM20 kabelwartel. Ook leverbaar in 2 polig.

Spanning	Aantal	Schakelvermogen	Behuizing	Bestelnummer	Bestelnummer	Brutoprijs
AC22	polen	AC23/400V				€/stuk
<b>Materiaal behuizing: Polycarbonaat</b>						
				<b>Knop Zwart</b>	<b>Knop Geel/Rood</b>	
16 A	3-polig IN/UIT	7,5kW	zijhefboom	62-KSM 316 M1	62-KSM 316 YR M1	33,55
	4-polig IN/UIT	7,5kW	zijhefboom	62-KSM 416 M1	62-KSM 416 YR M1	35,90



Katko is al meer dan 70 jaar gespecialiseerd in de productie van lastschakelaars. Het programma omvat een breed assortiment waarvan in deze documentatie slechts een beperkt deel is weergegeven.

Vraag naar de mogelijkheden voor brandweerschakelaars, ster-driehoek schakelaars, last-omschakelaars, tuimelschakelaars etc. Bel +31 (0) 342 - 45 15 44 of mail naar [info@calpe.nl](mailto:info@calpe.nl)





# Katko lastschakelaars

Aluminium: serie KEA 16-125A, RVS: serie KER 16-125A



## Lastschakelaar in aluminium behuizing | Serie KEA

**Materiaal:** Aluminium  
**Beschermingsklasse:** IP66 (A2, A3) IP65 (A4,A5)  
**Voorschriften:** IEC 60947-3 UL60947-4-1A  
**Temperatuurbereik:** -40°C tot +80°C

**Karakteristieken**  
 Goede UV-bestendigheid, geschikt voor toepassingen in extreme omstandigheden. Mogelijkheid voor 3 hangslotvergrendelingen. Ook leverbaar in ATEX uitvoering of met rode behuizing als brandweerschakelaar.



Spanning AC22	Aantal polen	Schakelvermogen AC23/400V	Behuizing	Bestelnummer		Brutoprijs €/stuk
				Knop Zwart	Knop Geel/Rood	
16 A	3-polig IN/UIT	7,5kW	A2	62-KEA 316 A2	62-KEA 316 YR A2	75,05
	4-polig IN/UIT	7,5kW	A2	62-KEA 416 A2	62-KEA 416 YR A2	91,15
25 A	3-polig IN/UIT	11kW	A2	62-KEA 325 A2	62-KEA 325 YR A2	80,80
	4-polig IN/UIT	11kW	A2	62-KEA 425 A2	62-KEA 425 YR A2	93,80
40 A	3-polig IN/UIT	15kW	A2	62-KEA 340 A2	62-KEA 340 YR A2	88,55
	4-polig IN/UIT	15kW	A2	62-KEA 440 A2	62-KEA 440 YR A2	98,70
63 A	3-polig IN/UIT	22kW	A4	62-KEA 363 A4	62-KEA 363 YR A4	238,75
	4-polig IN/UIT	22kW	A4	62-KEA 463 A4	62-KEA 463 YR A4	251,75
80 A	3-polig IN/UIT	30kW	A4	62-KEA 380 A4	62-KEA 380 YR A4	261,60
	4-polig IN/UIT	30kW	A4	62-KEA 480 A4	62-KEA 480 YR A4	277,15
125 A	3-polig IN/UIT	55kW	A4	62-KEA 3125 A4	62-KEA 3125 YR A4	298,60
	4-polig IN/UIT	55kW	A4	62-KEA 4125 A4	62-KEA 4125 YR A4	323,85

Ook leverbaar met UL

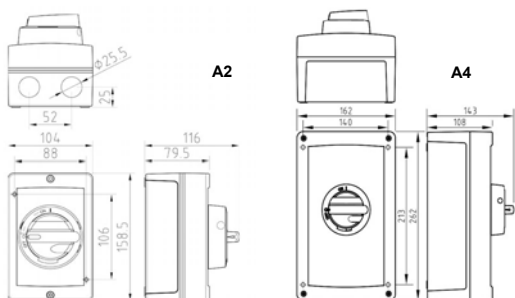

Behuizing A2



Behuizing A2 (Y/R)



Behuizing A4

## Lastschakelaar in RVS behuizing | Serie KER

**Materiaal:** RVS (Inox), AISI 316  
**Beschermingsklasse:** IP66 (H23,H32,H02)  
**Voorschriften:** IEC 60947-3 UL60947-4-1A  
**Temperatuurbereik:** -40°C tot +80°C

**Karakteristieken**  
 Mogelijkheid voor 3 hangslotvergrendelingen geschikt voor toepassingen in extreme omstandigheden of waar hygiëne en een goede bescherming tegen corrosie verplicht is. Ook leverbaar met UL



Spanning AC22	Aantal polen	Schakelvermogen AC23/400V	Behuizing	Bestelnummer		Brutoprijs €/stuk
				Knop Zwart	Knop Geel/Rood	
16 A	3-polig IN/UIT	7,5kW	RA2	62-KER 316 RA2-34300	62-KER 316 YR RA2-34305	324,70
	4-polig IN/UIT	7,5kW	RA2	62-KER 416 RA2-34310	62-KER 416 YR RA2-34315	334,05
25 A	3-polig IN/UIT	11kW	RA2	62-KER 325 RA2-34320	62-KER 325 YR RA2-34325	327,80
	4-polig IN/UIT	11kW	RA2	62-KER 425 RA2-34330	62-KER 425 YR RA2-34335	341,05
40 A	3-polig IN/UIT	15kW	RA2	62-KER 340 RA2-34340	62-KER 340 YR RA2-34345	339,50
	4-polig IN/UIT	15kW	RA2	62-KER 440 RA2-34350	62-KER 440 YR RA2-34355	359,15
63 A	3-polig IN/UIT	22kW	RA4	62-KER 363 RA4	62-KER 363 YR RA4	580,05
	4-polig IN/UIT	22kW	RA4	62-KER 463 RA4	62-KER 463 YR RA4	599,60
80 A	3-polig IN/UIT	30kW	RA4	62-KER 380 RA4	62-KER 380 YR RA4	582,65
	4-polig IN/UIT	30kW	RA4	62-KER 480 RA4	62-KER 480 YR RA4	602,50
125 A	3-polig IN/UIT	55kW	RA4	62-KER 3125 RA4	62-KER 3125 YR RA4	639,65
	4-polig IN/UIT	55kW	RA4	62-KER 4125 RA4	62-KER 4125 YR RA4	668,80

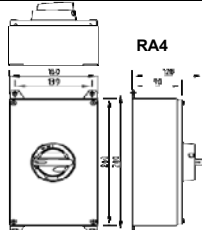
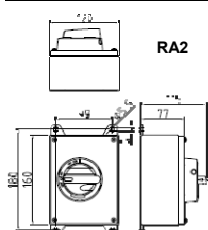

Ook leverbaar in IP69K of met RVS bedieningsknop

Behuizing RA4 (Y/R)



Behuizing RA4



# Katko lastschakelaars

EMC: serie KEM-EMC (PC), serie KEA-EMC (Alu); ATEX: serie KEA-EX (Alu)



## Lastschakelaar EMC in behuizing | Serie KEM-EMC, KEA-EMC

**Materiaal:** Polycarbonaat of Aluminium  
**Beschermingsklasse:** IP66  
**Voorschriften:** IEC 60947-3 UL508 (25-150A)  
**Temperatuurbereik:** -40°C tot +80°C

**Karakteristieken**  
 Mogelijkheid voor drie hangslotvergrendelingen, bestand tegen chemicaliën.  
 Levering inclusief EMC wartels.  
 6-polige versie of in plaatstalen behuizing op aanvraag.



Spanning AC22	Aantal polen	Schakelvermogen AC23/400V	Behuizing	Bestelnummer	Bestelnummer	Brutoprijs €/stuk
<b>Materiaal behuizing: Polycarbonaat</b>						
16 A	3-polig IN/UIT	7,5kW	M2	62-KEM 316 M2EMC-32920	62-KEM 316 YR M2EMC-32925	78,55
	4-polig IN/UIT	7,5kW	M2	62-KEM 416 M2EMC-20077	62-KEM 416 YR M2EMC-20109	87,90
25 A	3-polig IN/UIT	11kW	M2	62-KEM 325 M2EMC-32921	62-KEM 325 YR M2EMC-32926	79,45
	4-polig IN/UIT	11kW	M2	62-KEM 425 M2EMC-20080	62-KEM 425 YR M2EMC-20129	89,50
40 A	3-polig IN/UIT	15kW	M2	62-KEM 340 M2EMC-32922	62-KEM 340 YR M2EMC-32927	80,55
	4-polig IN/UIT	15kW	M2	62-KEM 440 M2EMC-20086	62-KEM 440 YR M2EMC-20130	90,30
63 A	3-polig IN/UIT	22kW	M3	62-KEM 363 M3EMC-32923	62-KEM 363 YR M3EMC-32928	108,70
	4-polig IN/UIT	22kW	M3	62-KEM 463 M3EMC-32233	62-KEM 463 YR M3EMC-32232	118,20
80 A	3-polig IN/UIT	30kW	M3	62-KEM 380 M3EMC-32924	62-KEM 380 YR M3EMC-32929	112,75
	4-polig IN/UIT	30kW	M3	62-KEM 480 M3EMC-20087	62-KEM 480 YR M3EMC-20131	122,45
125 A	3-polig IN/UIT	55kW	M4	62-KEM 3125 M4EMC-31549	62-KEM 3125 YR M4EMC-31553	261,60
	4-polig IN/UIT	55kW	M4	62-KEM 4125 M4EMC-20089	62-KEM 4125 YR M4EMC-32313	276,30
<b>Materiaal behuizing: Aluminium</b>						
16 A	3-polig IN/UIT	7,5kW	A2	62-KEA 316 A2EMC-48300	62-KEA 316 YR A2EMC-48303	134,95
	4-polig IN/UIT	7,5kW	A2	62-KEA 416 A2EMC-20095	62-KEA 416 YR A2EMC-20133	145,05
25 A	3-polig IN/UIT	11kW	A2	62-KEA 325 A2EMC-48301	62-KEA 325 YR A2EMC-48304	137,05
	4-polig IN/UIT	11kW	A2	62-KEA 425 A2EMC-33649	62-KEA 425 YR A2EMC-20134	147,95
40 A	3-polig IN/UIT	15kW	A2	62-KEA 340 A2EMC-48302	62-KEA 340 YR A2EMC-48305	139,15
	4-polig IN/UIT	15kW	A2	62-KEA 440 A2EMC-20096	62-KEA 440 YR A2EMC-20135	149,75
63 A	3-polig IN/UIT	22kW	A4	62-KEA 363 A4EMC-33660	62-KEA 363 YR A4EMC-33646	237,05
	4-polig IN/UIT	22kW	A4	62-KEA 463 A4EMC-20097	62-KEA 463 YR A4EMC-20136	247,30
80 A	3-polig IN/UIT	30kW	A4	62-KEA 380 A4EMC-33661	62-KEA 380 YR A4EMC-33647	244,65
	4-polig IN/UIT	30kW	A4	62-KEA 480 A4EMC-20098	62-KEA 480 YR A4EMC-20137	255,20
125 A	3-polig IN/UIT	55kW	A4	62-KEA 3125 A4EMC-33662	62-KEA 3125 YR A4EMC-33648	348,45
	4-polig IN/UIT	55kW	A4	62-KEA 4125 A4EMC-20101	62-KEA 4125 YR A4EMC-20139	364,45



Behuizing M2 (Y/R)



Behuizing M3



Behuizing A2



Behuizing A4

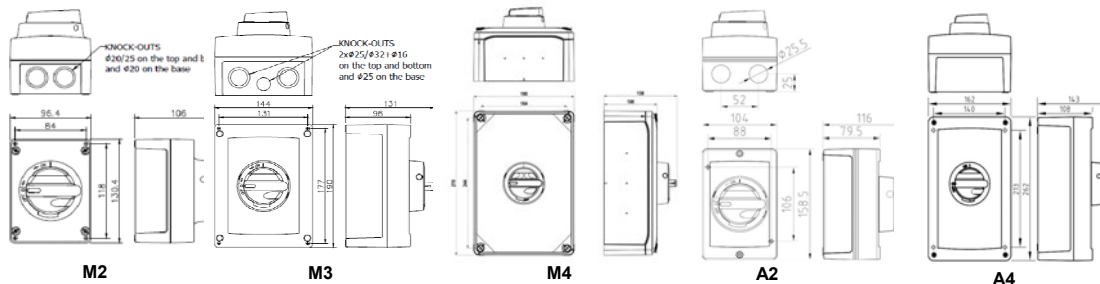

## Lastschakelaar ATEX in behuizing | Serie KEA-EX

**Materiaal:** Aluminium  
**Beschermingsklasse:** IP66  
**Voorschriften:** 2014/34/EU, EN 60079-0 (2012)  
 EN 60079-31 (2014)  
**Temperatuurbereik:** -40°C tot +80°C

**Karakteristieken**  
 Geschikt voor toepassing in Zone 22 (categorie 3D), Impacttest 7J, Hangslotvergrendelbaar. Levering inclusief ATEX wartels.  
 6-polige versie of in RVS behuizing op aanvraag.  
 Ook leverbaar met rood/gele bedieningsknop



Spanning AC22	Behuizing	Schakelvermogen AC23/400V	Brutoprijs €/stuk	Bestelnummer	Bestelnummer	Brutoprijs €/stuk
<b>Materiaal behuizing: Aluminium</b>						
16 A	A2EX	7,5kW	132,30	62-KEA 316 A2EX-30550	62-KEA 416 A2EX-30553	148,45
	A2EX	11kW	138,10	62-KEA 325 A2EX-30551	62-KEA 425 A2EX-30554	151,00
40 A	A2EX	22kW	145,70	62-KEA 340 A2EX-30552	62-KEA 440 A2EX-30555	155,80
	A3EX	22kW	323,60	62-KEA 363 A4EX-30556	62-KEA 463 A4EX-30560	336,70
80 A	A3EX	30kW	347,65	62-KEA 380 A4EX-30557	62-KEA 480 A4EX-30561	362,00
	A3EX	55kW	347,65	62-KEA 380 A4EX-30557	62-KEA 4125 A4EX-30562	456,60



Behuizing A2EX

# Katko lastschakelaars

Functiebehoud: serie KEA-FR, serie KEA-FR3



## Lastschakelaars met functiebehoud | Serie KEA-FR

<b>Materiaal:</b>	Aluminium
<b>Kleur behuizing:</b>	Rood
<b>Beschermingsklasse:</b>	IP66NW A2 behuizing IP66 A3, IP 65 A4
<b>Voorschriften:</b>	IEC 60947-3, EN 12101-3
<b>Temperatuurbereik:</b>	-40°C tot +200°C (max. 3 uur)

<b>Karakteristieken</b>
Functiebehoud gedurende 3 uur bij een temperatuur van 200°C voor type F200 3H.
Mogelijkheid voor hangslotvergrendeling, bestand tegen corrosie, UV-bestendig. Zeer geschikt voor extreme weersomstandigheden.

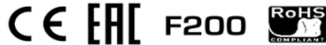

Spanning AC22	Aantal polen	Schakelvermogen AC23/400V	Behuizing	Bestelnummer	Brutoprijs €/stuk
<b>F200 3H</b>					
16 A	3-polig IN/UIT	7,5kW	A2	62-KEA 316 FR A2	102,10
	4-polig IN/UIT	7,5kW	A2	62-KEA 416 FR A2	119,65
25 A	3-polig IN/UIT	11kW	A2	62-KEA 325 FR A2	105,90
	4-polig IN/UIT	11kW	A2	62-KEA 425 FR A2	123,50
40 A	3-polig IN/UIT	22kW	A2	62-KEA 340 FR A2	109,75
	4-polig IN/UIT	22kW	A2	62-KEA 440 FR A2	127,30
63 A	3-polig IN/UIT	22kW	A4	62-KEA 363 FR A4	338,05
	4-polig IN/UIT	22kW	A4	62-KEA 463 FR A4	362,50
80 A	3-polig IN/UIT	30kW	A4	62-KEA 380 FR A4	344,95
	4-polig IN/UIT	30kW	A4	62-KEA 480 FR A4	444,05
125 A	3-polig IN/UIT	55kW	A5	62-KEA 3125 FR A5	903,55
	4-polig IN/UIT	55kW	A5	62-KEA 4125 FR A5	946,80
160 A	3-polig IN/UIT	75kW	A5	62-KEA 3160 FR A5	931,60
	4-polig IN/UIT	75kW	A5	62-KEA 4160 FR A5	965,85



## Lastschakelaars met functiebehoud | Serie KEA-FR3

<b>Materiaal:</b>	Aluminium
<b>Kleur behuizing:</b>	Rood
<b>Beschermingsklasse:</b>	IP66NW A2 behuizing IP66 A3, IP 65 A4
<b>Voorschriften:</b>	IEC 60947-3, EN 12101-3
<b>Temperatuurbereik:</b>	-40°C tot +300°C (max. 2 uur)

<b>Karakteristieken</b>
Functiebehoud gedurende 2 uur bij een temperatuur van 300°C voor type F300 2H.
Mogelijkheid voor hangslotvergrendeling, bestand tegen corrosie, UV-bestendig. Zeer geschikt voor extreme weersomstandigheden.

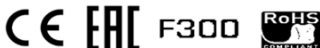

Spanning AC22	Aantal polen	Schakelvermogen AC23/400V	Behuizing	Bestelnummer	Brutoprijs €/stuk
<b>F300 2H</b>					
16 A	3-polig IN/UIT	7,5kW	A2	62-KEA 316 FR3 A2	267,10
	4-polig IN/UIT	7,5kW	A2	62-KEA 416 FR3 A2	302,90
25 A	3-polig IN/UIT	11kW	A2	62-KEA 325 FR3 A2	267,80
	4-polig IN/UIT	11kW	A2	62-KEA 425 FR3 A2	303,65
40 A	3-polig IN/UIT	15kW	A2	62-KEA 340 FR3 A2	268,50
	4-polig IN/UIT	15kW	A2	62-KEA 440 FR3 A2	304,30
63 A	3-polig IN/UIT	22kW	A4	62-KEA 363 FR3 A4	505,25
	4-polig IN/UIT	22kW	A4	62-KEA 463 FR3 A4	541,05
80 A	3-polig IN/UIT	30kW	A4	62-KEA 380 FR3 A4	512,15
	4-polig IN/UIT	30kW	A4	62-KEA 480 FR3 A4	620,95
125 A	3-polig IN/UIT	55kW	A5	62-KEA 3125 FR3 A5	1.071,85
	4-polig IN/UIT	55kW	A5	62-KEA 4125 FR3 A5	1.107,00
160 A	3-polig IN/UIT	75kW	A5	62-KEA 3160 FR3 A5	1.083,30
	4-polig IN/UIT	75kW	A5	62-KEA 4160 FR3 A5	1.126,75

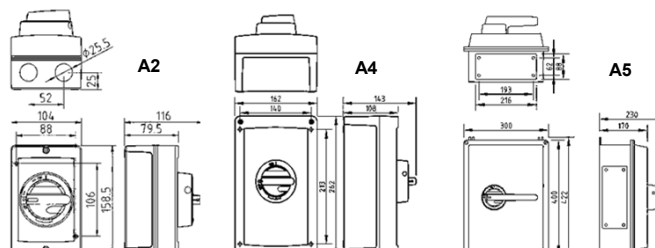

# Kopp automaten, aardlek

Installatie automaten: B-, C-karakteristiek

## Installatie automaten | MCB serie GE-2

<b>Materiaal:</b>	Thermoplast
<b>Beschermklasse:</b>	IP20 (aansluitklemmen)
<b>Temp.bereik:</b>	-25°C tot 55°C
<b>Voorschriften</b>	DIN VDE 0641 deel 1 DIN VDE 0660, IEC 60898 IEC 60947

**Karakteristieken**  
Voorzien van bi-metalen klikschijf.

**Afmetingen**

1-polig	1 Module	18mm
1-polig+N	2 Modules	36mm
2-polig	2 Modules	36mm
3-polig	3 Modules	54mm
3-polig+N	4 Modules	72mm

**Aanrakingsveilige aansluitklemmen!**

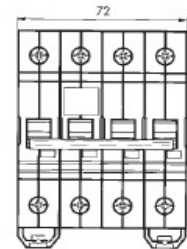
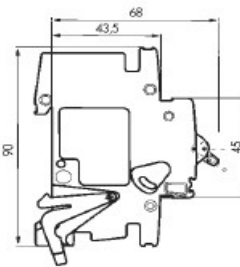
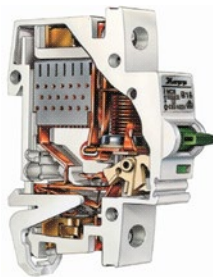
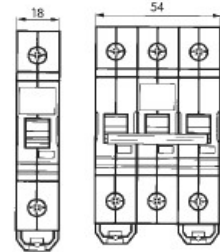

## B-Karakteristiek | 230/400 VAC, 60 VDC, 10kA

A	Bestelnummer	Bruto prijs €/stk	Bestelnummer	Bruto prijs €/stk	Bestelnummer	Bruto prijs €/stk	Bestelnummer	Bruto prijs €/stk	Bestelnummer	Bruto prijs €/stk
	<b>1-polig = 1 module</b>		<b>1-polig +N= 2 modules</b>		<b>2-polig = 2 modules</b>		<b>3-polig = 3 modules</b>		<b>3-polig +N = 4 modules</b>	
6	36-7206.0000.3	7,00	36-7206.1000.0	o.a.	36-7206.2000.7	16,70	36-7206.3000.4	26,85	36-7206.4000.1	40,85
10	36-7210.0000.6	5,85	36-7210.1000.3	13,20	36-7210.2000.0	14,50	36-7210.3000.7	26,35	36-7210.4000.4	32,25
16	36-7216.0000.4	5,85	36-7216.1000.1	13,20	36-7216.2000.8	14,50	36-7216.3000.5	26,35	36-7216.4000.2	32,25
20	36-7220.0000.7	5,85	36-7220.1000.4	13,20	36-7220.2000.1	14,50	36-7220.3000.8	26,35	36-7220.4000.5	32,25
25	36-7225.0000.2	5,85	36-7225.1000.9	13,20	36-7225.2000.6	14,50	36-7225.3000.3	26,35	36-7225.4000.0	32,25
32	36-7232.0000.4	7,00	36-7232.1000.1	o.a.	36-7232.2000.8	16,10	36-7232.3000.5	27,95	36-7232.4000.2	34,40
40	36-7240.0000.9	9,95	36-7240.1000.6	o.a.	36-7240.2000.3	o.a.	36-7240.3000.0	35,45	36-7240.4000.7	51,15
50	36-7250.0000.0	o.a.	36-7250.1000.7	23,40	36-7250.2000.4	29,00	36-7250.3000.1	44,05	36-7250.4000.8	53,75
63	36-7263.0000.0	o.a.	36-7263.1000.7	30,65	36-7263.2000.4	o.a.	36-7263.3000.1	o.a.	36-7263.4000.8	80,75

## C-Karakteristiek | 230/400 VAC, 60 VDC, 10kA

A	Bestelnummer	Bruto prijs €/stk	Bestelnummer	Bruto prijs €/stk	Bestelnummer	Bruto prijs €/stk	Bestelnummer	Bruto prijs €/stk	Bestelnummer	Bruto prijs €/stk
	<b>1-polig = 1 module</b>		<b>1-polig +N= 2 modules</b>		<b>2-polig = 2 modules</b>		<b>3-polig = 3 modules</b>		<b>3-polig +N = 4 modules</b>	
0,5	36-7205.0100.1	9,95			36-7205.2100.5	24,35				
1	36-7201.0100.9	9,95			36-7201.2100.3	22,55				
2	36-7202.0100.2	9,95	36-7202.1100.9	21,45	36-7202.2100.6	22,55	36-7202.3100.3	32,25	36-7202.4100.0	40,35
4	36-7204.0100.8	9,95	36-7204.1100.5	21,45	36-7204.2100.2	22,55	36-7204.3100.9	32,25	36-7204.4100.6	40,35
6	36-7206.0100.4	8,05	36-7206.1100.1	19,35	36-7206.2100.8	20,40	36-7206.3100.5	32,25	36-7206.4100.2	38,75
10	36-7210.0100.7	6,40	36-7210.1100.4	16,10	36-7210.2100.1	18,05	36-7210.3100.8	27,95	36-7210.4100.5	33,35
16	36-7216.0100.5	6,40	36-7216.1100.2	16,10	36-7216.2100.9	18,05	36-7216.3100.6	27,95	36-7216.4100.3	33,35
20	36-7220.0100.8	7,00	36-7220.1100.5	15,95	36-7220.2100.2	18,85	36-7220.3100.9	27,95	36-7220.4100.6	35,00
25	36-7225.0100.3	7,45	36-7225.1100.0	18,85	36-7225.2100.7	20,40	36-7225.3100.4	29,00	36-7225.4100.1	35,00
32	36-7232.0100.5	8,35	36-7232.1100.2	19,30	36-7232.2100.9	21,45	36-7232.3100.6	32,25	36-7232.4100.3	38,70
40	36-7240.0100.0	10,70	36-7240.1100.7	o.a.	36-7240.2100.4	31,15	36-7240.3100.1	43,00	36-7240.4100.8	52,20
50	36-7250.0100.1	13,95	36-7250.1100.8	26,85	36-7250.2100.5	36,55	36-7250.3100.2	53,75	36-7250.4100.9	62,40
63	36-7263.0100.1	16,10	36-7263.1100.8	o.a.	36-7263.2100.5	37,15	36-7263.3100.2	64,55	36-7263.4100.9	75,30

# Kopp automaten, aardlek

Installatie automaten: D-karakteristiek, aardlekautomaten, -schakelaars



## D-Karakteristiek | 230/400 VAC, 60 VDC, 10kA

Bestelnummer	Bruto prijs €/stk	Bestelnummer	Bruto prijs €/stk	Bestelnummer	Bruto prijs €/stk	Bestelnummer	Bruto prijs €/stk	
<b>A</b>		<b>1-polig = 1 module</b>		<b>2-polig = 2 modules</b>		<b>3-polig = 3 modules</b>		
2	36-7202.0200.3	14,85						
4	36-7204.0200.9	14,85						
6	36-7206.0200.5	14,85						
10	36-7210.0200.8	12,20	36-7210.2200.2	30,60	36-7206.3200.6	52,35		
16	36-7216.0200.6	11,50	36-7216.2200.0	29,50	36-7210.3200.9	45,85		
20	36-7220.0200.9	12,20			36-7216.3200.7	45,60		
25	36-7225.0200.4	14,50	36-7225.2200.8	34,90	36-7220.3200.0	47,75		
32	36-7232.0200.6	o.a.	36-7232.2200.0	o.a.	36-7225.3200.5	51,80		
					36-7232.3200.7	58,35		
							<b>Universeel hulpcontact 6A-AC 1A-DC</b>	
							36-7699.0000.9	7,95
							<b>Bestelnummer</b>	<b>Bruto prijs €/stk</b>
							<b>Plombeerkap 4-polig</b>	<b>o.a.</b>
							36-7652.40002	



## Aardlek automaten | Serie RCB

**Beschermklasse:** IP20 (aansluitklemmen)  
**Temp.bereik:** -25°C tot 40°C  
**Voorschriften** DIN VDE 0664 deel 2  
 EN 61009

### Karakteristieken

Voorzien van bi-metalen klikschijf.  
 Tot 250A stroomstootvast



## B-Karakteristiek | 30 mA

Bestelnummer	Bruto prijs €/stk	
<b>A</b>		
<b>2 polig = 2 modules</b>		
6	36-7406.1501.6	59,20
10	36-7410.1501.9	59,20
16	36-7416.1501.7	59,20
20	36-7420.1501.0	59,20

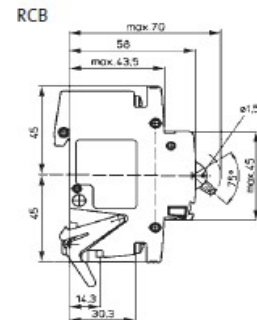
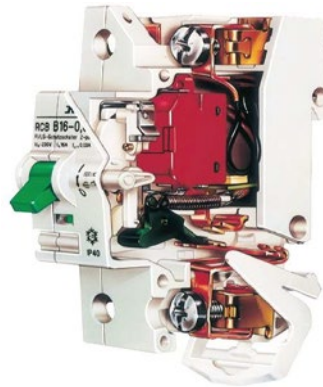

## C-Karakteristiek | 30 mA

Bestelnummer	Bruto prijs €/stk	
<b>A</b>		
<b>2 polig = 2 modules</b>		
10	36-7410.1601.0	59,20
16	36-7416.1601.8	59,20
20	36-7420.1601.1	59,20

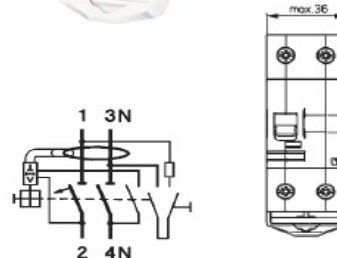

## Aardlek schakelaar | Serie RCD

**Beschermklasse:** IP20 (aansluitklemmen)  
**Temp.bereik:** -25°C tot 40°C  
**Voorschriften** DIN VDE 0664 deel 2  
 EN 61008

### Karakteristieken

Type A  
 Kortsluitvastheid 10kA



2 polig = 2 modules

Bestelnummer	Bruto prijs €/stk	Bestelnummer	Bruto prijs €/stk	
<b>A</b>				
<b>30 mA</b>				
16	36-7516.2802.1	53,30		
25	36-7525.2802.8	53,30	36-7525.2302.4	53,30
40	36-7540.2802.6	53,30	36-7540.2302.1	53,30
63	36-7563.2802.7	64,00	36-7563.2302.2	64,05

3 polig + N = 4 modules

Bestelnummer	Bruto prijs €/stk	Bestelnummer	Bruto prijs €/stk	Bestelnummer	Bruto prijs €/stk
<b>A</b>					
<b>30 mA</b>					
36-7525.4802.3	61,90	36-7525.4102.6	61,85	36-7525.4302.8	61,85
36-7540.4802.1	62,95	36-7540.4102.3	62,95	36-7540.4302.5	62,95
36-7563.4802.1	90,95	36-7563.4102.4	90,95	36-7563.4302.6	90,95

# Lovato Electric

Motorbeveiligingsschakelaars: serie SM1P (drukknop)

**Lovato**  
**electric**

ENERGY AND AUTOMATION

## Serie | SM1P

<b>Materiaal:</b>	Kunststof volgens EN45545(railway), IEC60335
<b>Temp.bereik:</b>	-25°C tot +60°C
<b>Voorschriften</b>	IEC/EN 60947 UL508, CSA C22.2°14
<b>Beschermklasse:</b>	IP20 (IP65 in behuizing SM1Z)



Bestelnummer	Instelbereik		Kortsluitvermogen bij Icu 400V	Brutoprijs €/stk
	A. min.	A. max.		
60-SM1P0016	0,1	0,16	100kA	50,25
60-SM1P0025	0,16	0,25	100kA	50,25
60-SM1P0040	0,25	0,4	100kA	50,25
60-SM1P0063	0,4	0,63	100kA	50,25
60-SM1P0100	0,63	1,0	100kA	50,25
60-SM1P0160	1,0	1,6	100kA	50,25
60-SM1P0250	1,6	2,5	100kA	50,25
60-SM1P0400	2,5	4,0	100kA	50,25
60-SM1P0650	4,0	6,5	100kA	50,25
60-SM1P1000	6,3	10	100kA	58,60
60-SM1P1400	9	14	25kA	58,60
60-SM1P1800	13	18	25kA	58,60
60-SM1P2300	17	23	15kA	66,95
60-SM1P2500	20	25	15kA	66,95
60-SM1P3200	24	32	10kA	92,10
60-SM1P4000	30	40	10kA	133,95

### Karakteristieken

De SM1P is geschikt voor de meest complexe installaties door het uitgebreide pakket van toebehoren. Tot 40A-690V (50-60Hz). Thermisch+elektromagnetisch met kortsluit-sneluitschakeling (13In). Geschikt voor DIN-rail montage. Genormaliseerde afmetingen. Hangslotvergrendelbaar in de OFF positie.

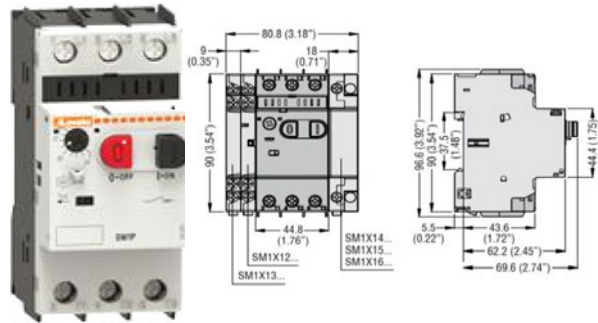

## Accessoires en toebehoren: serie SM1P

### Hulpcontacten | SM1X

Bestelnummer	Contact-bezetting	Montage	Brutoprijs €/stk
60-SM1X1202	2NC	zijkant	10,75
60-SM1X1211	1NO+1NC	zijkant	11,30
60-SM1X1220	2NO	zijkant	12,60
60-SM1X1111	1NO+1NC	front	11,30



60-SM1X11..



60-SM1X12..



60-SM1X14...

### Spanningsspoelen

Bestelnummer	Bedrijfsspanning V	Hz	Brutoprijs €/stk
<b>Serie SM1X14 minimumspanningsspoelen</b>			
60-SM1X14230	230	50/60	35,85
60-SM1X14400	400	50/60	35,85
<b>Serie SM1X16 uitschakelspoelen</b>			
60-SM1X16230	230	50/60	35,85
60-SM1X16400	400	50/60	35,85

## Accessoires

Bestelnummer	Brutoprijs €/stk
<b>Noodstop paddenstoel rood, IP65 voor behuizing SM1Z</b>	
60-SM1X1740P	25,15
<b>Hangslotvergrendeling, max 3 sloten voor behuizing SM1Z</b>	
60-SM1X1746P	12,35
<b>Reserve membraam voor behuizing SM1Z</b>	
60-SM1X1745P	6,20



60-SM1X1746P



60-SM1X1740P



60-SM1X1745P

### Kunststof kast IP65 (UL Type 4X) | SM1Z

Bestelnummer	Montage	(bxhxd)	Brutoprijs €/stk
60-SM1Z1701P	opbouw	80x135x101	18,95
60-SM1Z1705P	inbouw	87x132x18	17,00

### Karakteristieken

IP65-IPK07 met standaard aardingsklem, UV-bestendig. M25 wartelinvoer (2x boven 2x onder), UL gecertificeerd. Temperatuurbereik van -25°C tot +60°C

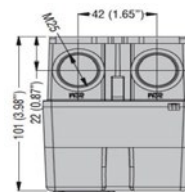

Maatschets  
60-SM1Z1701P met noodstop



60-SM1Z1701P

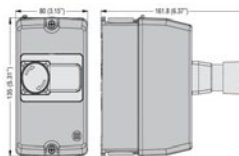

60-SM1Z1705P

Ook verkrijgbaar met draaiknop



SM1R

SM2R

SM3R



**calpe**  
INDUSTRIAL

# Lovato Electric

Motorbeveiligingsschakelaars: serie SM1R (draaiknop)



ENERGY AND AUTOMATION

## Serie | SM1R

<b>Materiaal:</b>	Kunststof volgens EN45545(railway), IEC60335
<b>Temp.bereik:</b>	-25°C tot +60°C
<b>Voorschriften:</b>	IEC/EN 60947-1 UL508, CSA C22.2 n°14
<b>Beschermklasse:</b>	IP20 (IP65 in behuizing SM1Z)



### Karakteristieken

De SM1R is geschikt voor de meest complexe installaties door het uitgebreide pakket van toebehoren. Tot 40A-690V (50-60Hz) compacte 45mm. Kortsluit-sneluitschakeling (13In). Geschikt voor DIN-rail montage. Hangslotvergrendelbaar in de OFF positie. Ook leverbaar in frame size 2 en 3 tot 100A.

Bestelnummer	Instelbereik		Kortsluit- vermogen	Brutoprijs €/stk
	A min.	A max.		
bij Icu 400V				
60-SM1R0016	0,1	0,16	100kA	55,25
60-SM1R0025	0,16	0,25	100kA	55,25
60-SM1R0040	0,25	0,4	100kA	55,25
60-SM1R0063	0,4	0,63	100kA	55,25
60-SM1R0100	0,63	1,0	100kA	55,25
60-SM1R0160	1,0	1,6	100kA	55,25
60-SM1R0250	1,6	2,5	100kA	55,25
60-SM1R0400	2,5	4,0	100kA	55,25
60-SM1R0650	4,0	6,5	100kA	55,25
60-SM1R1000	6,3	10	100kA	64,50
60-SM1R1400	9	14	100kA	64,50
60-SM1R1800	13	18	100kA	64,50
60-SM1R2300	17	23	50kA	73,65
60-SM1R2500	20	25	50kA	73,65
60-SM1R3200	24	32	50kA	101,30
60-SM1R4000	30	40	20kA	147,35

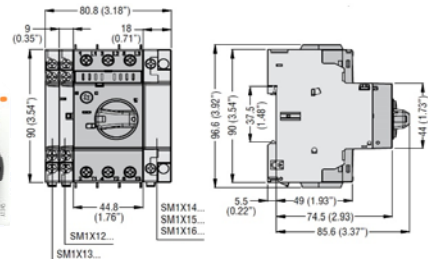

## Accessoires en toebehoren: serie SM1R

### Hulpcontacten | SM1X

Bestelnummer	Contact- bezetting	Montage	Brutoprijs €/stk
60-SM1X1202	2NC	zijkant	11,20
60-SM1X1211	1NO+1NC	zijkant	11,30
60-SM1X1220	2NO	zijkant	12,60
60-SM1X1111	1NO+1NC	front	11,30



60-SM1X12..



60-SM1X14..

### Spanningsspoelen

Bestelnummer	Bedrijfsspanning		Brutoprijs €/stk
	V	Hz	
<b>Serie SM1X14 minimumspanningsspoelen</b>			
60-SM1X14230	230	50/60	35,85
60-SM1X14400	400	50/60	35,85
<b>Serie SM1X16 uitschakelspoelen</b>			
60-SM1X16230	230	50/60	35,85
60-SM1X16400	400	50/60	35,85

## Accessoires

Bestelnummer		Brutoprijs €/stk
<b>Type E accessoires ivm UL</b>		
60-SM1X9000R	fase scheidervak	4,75
60-SM1X9050	aansluitblok	16,25
<b>Adapterplaat voor startercombinatie</b>		
60-11SMX9010	SM1 icm BG, BF09A..BF38A	13,10
60-11SMX9012	SM1 icm BF09A..BF38A (omkeer)	19,60



60-SM1X9000R 60-SM1X9050R 60-11SM1X9010 60-11SM1X9012

### Kunststof kast IP65 (UL Type 4X) | SM1Z

Bestelnummer	Montage	(bxhxd)	Brutoprijs €/stk
60-SM1Z1710R	opbouw	100x154x138	27,70
60-SM1Z1715R	opbouw	100x154x138	24,65
60-SM1Z1720R	inbouw	87x160x127	20,85
60-SM1Z1725R	inbouw	87x160x127	20,85

### Karakteristieken

IP65-1K07 met standaard aardingsklem, UV-bestendig. M25 wartelinvoer (2x boven 2x onder), UL gecertificeerd. Temperatuurbereik van -25°C tot +60°C

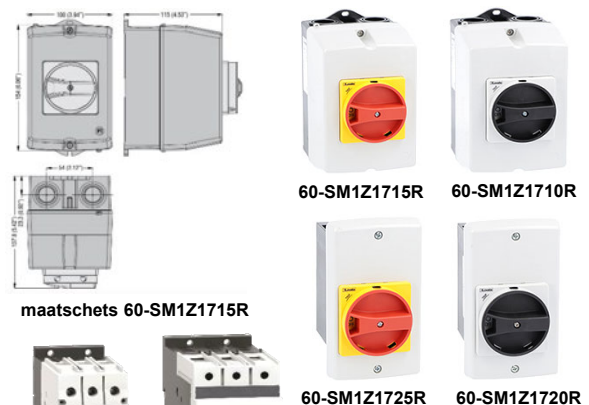

maatschets 60-SM1Z1715R



SM2R SM3R



# Lovato Electric

DOL-starters: serie M, Sterdriehoekschakelaars: serie BFA



ENERGY AND AUTOMATION

## Motor-directstarters | Serie M

<b>Materiaal:</b>	Polycarbonaat, IP65
<b>Temp.bereik:</b>	-25°C tot +60°C
<b>Kabeldoorvoer:</b>	4x M20
<b>Voorschriften:</b>	UL508, IEC/EN 60947-1, IEC/EN 60947-4-1, CSA C22.2 N°14

### Karakteristieken

Bestaat uit: magneetschakelaar (contactor) thermorelais start-stop knop.  
Op aanvraag typen met een instelbereik tot 95A.  
Ook leverbaar in uitvoering speciaal voor pluimveeteelt.



Instelbereik	Vermogen	Behuizing	Bestelnummer	Brutoprijs	Bestelnummer	Brutoprijs
Thermorelais	AC3-440V	Type		€/stk		€/stk
A	kW		Spoelspanning 230V-50/60Hz		Spoelspanning 400V-50/60Hz	
0,6 - 1,0	0,25	M0PA	60-M0P009122301	94,20	60-M0P009124001	94,20
0,9 - 1,5	0,37	M0PA	60-M0P009122301V5	94,20	60-M0P009124001V5	94,20
1,4 - 2,3	0,75	M0PA	60-M0P009122302V3	94,20	60-M0P009124002V3	94,20
2,0 - 3,3	1,10	M0PA	60-M0P0091223033	94,20	60-M0P0091240033	94,20
3,0 - 5,0	2,20	M0PA	60-M0P009122305	94,20	60-M0P009124005	94,20
4,5 - 7,5	3,00	M0PA	60-M0P0091223075	94,20	60-M0P0091240075	94,20
6,0 - 10,0	4,00	M0PA	60-M0P0091223010	94,20	60-M0P0091240010	94,20
9,0 - 15,0	5,50	M0PA	60-M0P0121223015	96,15	60-M0P0121240015	96,15
0,6 - 1,0	0,25	M1PA	60-M1P00912230A4	109,45	60-M1P00912400A4	109,45
1,0 - 1,6	0,55	M1PA	60-M1P00912230A5	109,45	60-M1P00912400A5	109,45
1,6 - 2,5	0,75	M1PA	60-M1P00912230A6	109,45	60-M1P00912400A6	109,45
2,5 - 4,0	1,50	M1PA	60-M1P00912230A7	109,45	60-M1P00912400A7	109,45
4,0 - 6,5	3,00	M1PA	60-M1P00912230A8	109,45	60-M1P00912400A8	109,45
6,3 - 10,0	4,00	M1PA	60-M1P00912230A9	109,45	60-M1P00912400A9	109,45
9,0 - 14,0	5,50	M1PA	60-M1P00912230B0	109,45	60-M1P00912400B0	109,45
13,0 - 18,0	7,50	M1PA	60-M1P01812230B1	132,15	60-M1P01812400B1	132,15
17,0 - 23,0	11,00	M2PA	60-M2P02512230B2	163,40	60-M2P02512400B2	163,40
20,0 - 25,0	11,00	M2PA	60-M2P02512230B3	163,40	60-M2P02512400B3	163,40
24,0 - 32,0	15,00	M2PA	60-M2P03212230B4	231,60	60-M2P03212400B4	231,60

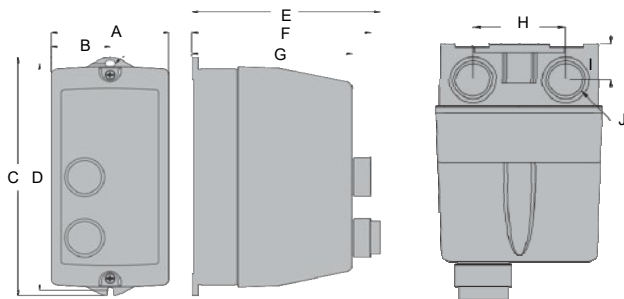

### Afmetingen behuizing (mm)

	M0PA	M1PA	M2PA
A	88,0	88,0	110,0
B	44,0	44,0	55,0
C	184,0	202,0	234,0
D	175,0	193,0	225,0
E	140,4	155,4	162,3
F	166,6	148,3	169,4
G	119,5	134,5	148,5
H	49,0	49,0	60,0
I	19,4	19,4	22,8
J	M20	M20	M20/25



Met ronde draaiknop speciaal voor toepassing in pluimveeteelt

## Ster-driehoekschakelaars | Serie BFA

<b>Materiaal:</b>	Polycarbonaat
<b>Temp.bereik:</b>	-25°C tot +60°C
<b>Voorschriften:</b>	IEC/EN 60947-1 IEC/EN 60947-4-9

### Karakteristieken

Bestaat uit: magneetschakelaar (contactor), multi- functioneel hulpcontact en compleet bedraad. Ook verkrijgbaar in behuizing.  
**Thermorelais apart te bestellen**



Schakelvermogen	Max	Thermorelais	Bestelnummer	Brutoprijs	Bestelnummer	Brutoprijs
230V	400V	belasting		€/stk	Ster-driehoekschakelaar	€/stk
kW	kW	A	A		Spoelspanning 230V 50/60Hz	
4,0 - 7,5	16	4,0 - 6,5	60-RF380650	46,60	60-BFA00970230	365,90
5,5 - 11,0	22	6,3 - 10	60-RF381000	46,60	60-BFA01270230	381,15
7,5 - 15,0	28	9,0 - 14	60-RF381400	46,60	60-BFA01870230	420,30
11,0 - 18,5	35	13 - 18	60-RF381800	53,30	60-BFA02570230	478,15
11,0 - 22,0	43	17 - 23	60-RF382300	53,30	60-BFA02670230	551,25
15,0 - 25,0	50	20 - 25	60-RF382500	53,30	60-BFA03270230	622,70
15,0 - 30,0	60	24 - 32	60-RF383200	82,40	60-BFA03870230	699,25

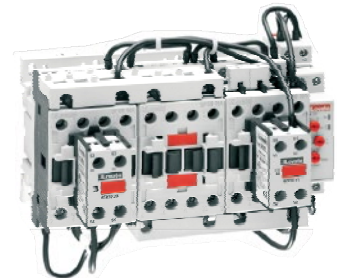



# Lovato Electric

Mini-magneetschakelaars, thermorelais en toebehoren



ENERGY AND AUTOMATION

## Mini-magneetschakelaars | Serie BG, 3-polig

<b>Materiaal:</b>	Polycarbonaat
<b>Temp.bereik:</b>	-40°C tot +60°C
<b>Voorschriften</b>	IEC60947
<b>Beschermklasse:</b>	IP20



### Karakteristieken

3-polig 6 tot 12A-IEC AC3, 4-polig 20A-IEC ACI, ook leverbaar met 2 NC+2 NO hoofdcontacten. Beschikbaar in zowel AC als DC, geschikt voor DIN-rail montage. Op aanvraag ook leverbaar met soldeerpin of fastonaansluiting.

Bestelnummer	Spoelspanning	Aantal Polen	Hulpcontacten	Schakelvermogen		Brutoprijs €/stk
				AC3-220/230V	AC3-380/400V	
60-11BG0910A024	24V - 50/60Hz	3-polig	1 NO	2,2 kW/ 9A	4 kW/ 9A	24,85
60-11BG0910A230	230V - 50/60Hz	3-polig	1 NO	2,2 kW/ 9A	4 kW/ 9A	24,85
60-11BG0910D024	24V/DC	3-polig	1 NO	2,2 kW/ 9A	4 kW/ 9A	46,40
60-11BG0901A024	24V - 50/60Hz	3-polig	1 NC	2,2 kW/ 9A	4 kW/ 9A	24,85
60-11BG0901A230	230V - 50/60Hz	3-polig	1 NC	2,2 kW/ 9A	4 kW/ 9A	24,85
60-11BG0901D024	24V/DC	3-polig	1 NC	2,2 kW/ 9A	4 kW/ 9A	46,40
60-11BG1210A024	24V - 50/60Hz	3-polig	1 NO	3,2 kW/12A	5,7 kW/12A	29,90
60-11BG1210A230	230V - 50/60Hz	3-polig	1 NO	3,2 kW/12A	5,7 kW/12A	29,90
60-11BG1210D024	24V/DC	3-polig	1 NO	3,2 kW/12A	5,7 kW/12A	49,75
60-11BG1201A024	24V - 50/60Hz	3-polig	1 NC	3,2 kW/12A	5,7 kW/12A	29,95
60-11BG1201A230	230V - 50/60Hz	3-polig	1 NC	3,2 kW/12A	5,7 kW/12A	29,95
60-11BG1201D024	24V/DC	3-polig	1 NC	3,2 kW/12A	5,7 kW/12A	49,75

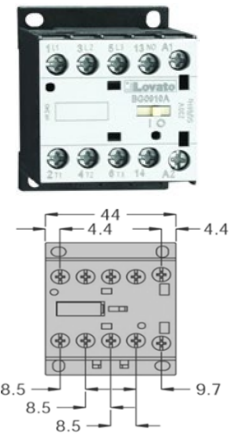

## Thermorelais voor mini-magneetschakelaars | Serie RF9

<b>Materiaal:</b>	Polycarbonaat
<b>Temp.bereik:</b>	-20°C tot +55°C
<b>Voorschriften</b>	IEC60947
<b>Beschermklasse:</b>	IP20



### Karakteristieken

Geschikt voor rechtstreekse montage op BG06, BG09, BG12 mini-magneetschakelaars. Uitschakelklasse 10A. Voorzien van handmatige resetknop, duidelijke schakelstandindicatie en testknop.

Bestelnummer	Instelbereik		Vóórzekering klasse gG	Brutoprijs €/stk
	Min	Max		
60-11RF9075	0,45	0,75	2A	38,10
60-11RF91	0,60	1,00	4A	38,10
60-11RF91V5	0,90	1,50	4A	38,10
60-11RF92V3	1,40	2,30	6A	38,10
60-11RF933	2,00	3,30	10A	38,10
60-11RF95	3,00	5,00	16A	38,10
60-11RF975	4,50	7,50	20A	38,10
60-11RF910	6,00	10,00	32A	38,10
60-11RF915	9,00	15,00	40A	38,10

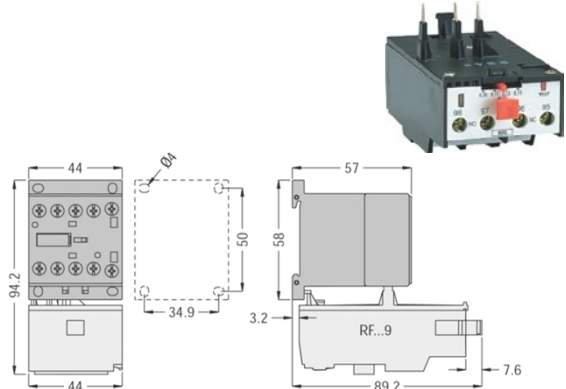

## Toebehoren mini-magneetschakelaars

### Hulpcontacten

Bestelnummer	Contactbezetting	Brutoprijs €/stk
60-11BGX1020	2 NO	16,10
60-11BGX1011	1 NO en 1 NC	16,10
60-11BGX1002	2 NC	16,10
60-11BGX1022	2 NO en 2 NC	28,10
60-11BGX1004	4 NC	28,10



### Blusfilters

Bestelnummer	Voor spoelspanning	Brutoprijs €/stk
60-11BGX77048	≤ 48VAC/DC varistor	16,00
60-11BGX77240	125-240VAC/DC varistor	16,00
60-11BGX78225	≤ 225VDC diode	16,00



### Mechanische vergrendeling

Bestelnummer	Brutoprijs €/stk
60-11BGX5000	13,90



# Lovato Electric

## Magneetschakelaars 3- en 4-polig



ENERGY AND AUTOMATION

### Magneetschakelaars | Serie BF 3-polig

**Materiaal:** Polycarbonaat  
**Temp.bereik:** -50°C tot +70°C  
**Voorschriften** IEC60947  
**Beschermklasse:** IP20

**Karakteristieken**  
 3-polig 9 tot 110A-IEC AC3, 4-polig 25 tot 125A in AC1 ook leverbaar met 2NO+2NC of 4NC hoofdcontacten.  
 Beschikbaar in zowel AC als DC, geschikt voor DIN-rail montage.



Bestelnummer	Spoelspanning	Aantal polen	Hulp-contact	Nominaal AC1	Schakelvermogen		Breedte	Brutoprijs €/1stk
					AC3-230V	AC3-400V		
<b>Uit tevoeren met afdekkap BFX80</b>								
60-BF0910A024	24V - 50/60Hz	3-polig	1 NO	25A-690V	2,2kW/9A	4,2kW/9A	45mm	29,65
60-BF0910A230	230V - 50/60Hz	3-polig	1 NO	25A-690V	2,2kW/9A	4,2kW/9A	45mm	29,65
60-BF0910A400	400V - 50/60Hz	3-polig	1 NO	25A-690V	2,2kW/9A	4,2kW/9A	45mm	29,65
60-BF1210A024	24V - 50/60Hz	3-polig	1 NO	28A-690V	3,2kW/12A	5,7kW/12A	45mm	35,65
60-BF1210A230	230V - 50/60Hz	3-polig	1 NO	28A-690V	3,2kW/12A	5,7kW/12A	45mm	35,65
60-BF1210A400	400V - 50/60Hz	3-polig	1 NO	28A-690V	3,2kW/12A	5,7kW/12A	45mm	35,65
60-BF1810A024	24V - 50/60Hz	3-polig	1 NO	32A-690V	4,0kW/18A	7,5kW/18A	45mm	48,55
60-BF1810A230	230V - 50/60Hz	3-polig	1 NO	32A-690V	4,0kW/18A	7,5kW/18A	45mm	48,55
60-BF1810A400	400V - 50/60Hz	3-polig	1 NO	32A-690V	4,0kW/18A	7,5kW/18A	45mm	48,55
60-BF2510A024	24V - 50/60Hz	3-polig	1 NO	45A-690V	7,0kW/26A	12,5kW/26A	45mm	63,45
60-BF2510A230	230V - 50/60Hz	3-polig	1 NO	45A-690V	7,0kW/26A	12,5kW/26A	45mm	63,45
60-BF2510A400	400V - 50/60Hz	3-polig	1 NO	45A-690V	7,0kW/26A	12,5kW/26A	45mm	63,45
60-BF3200A024	24V - 50/60Hz	3-polig	geen	56A-690V	8,8kW/32A	16,0kW/32A	45mm	94,90
60-BF3200A230	230V - 50/60Hz	3-polig	geen	56A-690V	8,8kW/32A	16,0kW/32A	45mm	94,90
60-BF3200A400	400V - 50/60Hz	3-polig	geen	56A-690V	8,8kW/32A	16,0kW/32A	45mm	94,90
60-BF3800A024	24V - 50/60Hz	3-polig	geen	60A-690V	11,0kW/38A	18,5kW/38A	45mm	115,25
60-BF3800A230	230V - 50/60Hz	3-polig	geen	60A-690V	11,0kW/38A	18,5kW/38A	45mm	115,25
60-BF3800A400	400V - 50/60Hz	3-polig	geen	60A-690V	11,0kW/38A	18,5kW/38A	45mm	115,25



Beschermkap BFX80 los te bestellen

BF serie 3-polig

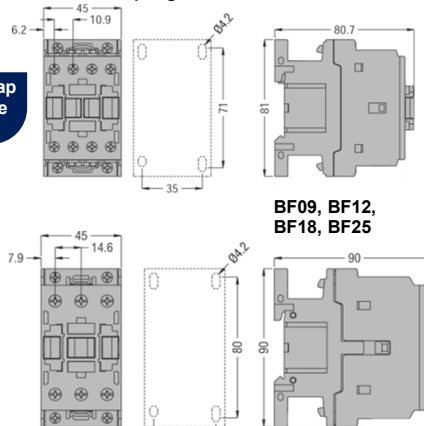

BF09, BF12, BF18, BF25

BF26, BF32, BF38

BF serie 4-polig

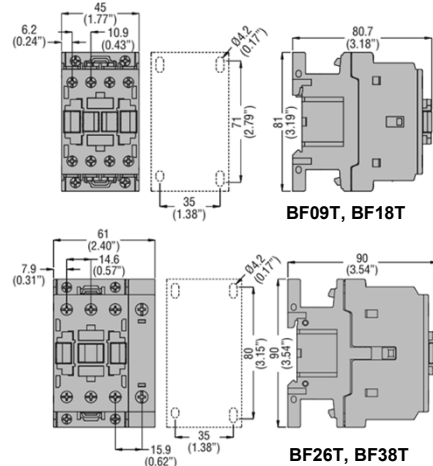

BF09T, BF18T

BF26T, BF38T

### Magneetschakelaars | Serie BF, 4-polig

Bestelnummer	Spoelspanning	Aantal polen	Hulp-contact	Nominaal AC1	Schakelvermogen		Breedte	Brutoprijs €/1stk
					AC1-230V	AC1-400V		
<b>Karakteristieken zijn gelijk aan aan 3-polige uitvoering</b>								
60-BF09T4A024	24V - 50/60Hz	4-polig	geen	25A-690V	9,5kW	16kW	45mm	51,10
60-BF09T4A230	230V - 50/60Hz	4-polig	geen	25A-690V	9,5kW	16kW	45mm	51,10
60-BF09T4A400	400V - 50/60Hz	4-polig	geen	25A-690V	9,5kW	16kW	45mm	51,10
60-BF18T4A024	24V - 50/60Hz	4-polig	geen	32A-690V	12kW	21kW	45mm	79,75
60-BF18T4A230	230V - 50/60Hz	4-polig	geen	32A-690V	12kW	21kW	45mm	79,75
60-BF18T4A400	400V - 50/60Hz	4-polig	geen	32A-690V	12kW	21kW	45mm	79,75
60-BF26T4A024	24V - 50/60Hz	4-polig	geen	45A-690V	17kW	30kW	61mm	113,30
60-BF26T4A230	230V - 50/60Hz	4-polig	geen	45A-690V	17kW	30kW	61mm	113,30
60-BF26T4A400	400V - 50/60Hz	4-polig	geen	45A-690V	17kW	30kW	61mm	113,30
60-BF38T4A024	24V - 50/60Hz	4-polig	geen	60A-690V	21kW	36kW	61mm	151,70
60-BF38T4A230	230V - 50/60Hz	4-polig	geen	60A-690V	21kW	36kW	61mm	151,70
60-BF38T4A400	400V - 50/60Hz	4-polig	geen	60A-690V	21kW	36kW	61mm	151,70

# Lovato Electric

Thermorelais en toebehoren voor magneetschakelaars



ENERGY AND AUTOMATION

## Thermorelais voor BF | Serie RF38

**Materiaal:** Polycarbonaat  
**Temp.bereik:** -25°C tot +60°C  
**Voorschriften** IEC 60947  
**Beschermklasse:** IP20



Bestelnummer	Instelbereik		Vóór-zekering	Brutoprijs €/stk
	Min	Max		
60-RF380063	0,40	0,63	2A	46,60
60-RF380100	1,63	1,00	4A	46,60
60-RF380160	1,00	1,60	4A	46,60
60-RF380250	1,60	2,50	6A	46,60
60-RF380400	2,50	4,00	6A	46,60
60-RF380650	4,00	6,50	16A	46,60
60-RF381000	6,30	10,00	20A	46,60
60-RF381400	9,00	14,00	32A	46,60
60-RF381800	13,00	18,00	40A	53,30
60-RF382300	17,00	23,00	50A	53,30
60-RF382500	20,00	25,00	50A	53,30
60-RF383200	24,00	32,00	63A	53,30
60-RF383800	32,00	38,00	63A	53,30

### Karakteristieken

Geschikt voor rechtstreekse montage op BF09-BF38 magneetschakelaars of dmv RFX3804 op DIN-rail. Uitschakelklasse 10A.

Voorzien van handmatige resetknop, automatische reset- en stopknop, duidelijke schakelstandindicatie en testknop

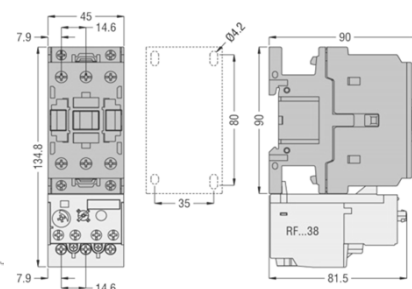
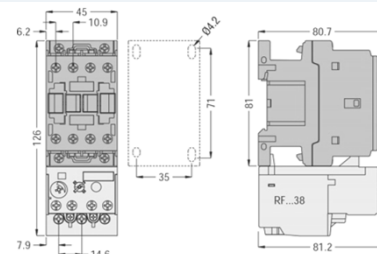
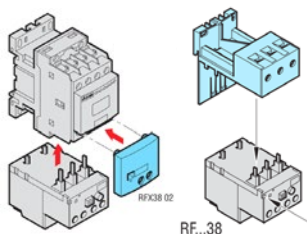

## Toebehoren magneetschakelaars, Serie BF09 tot BF38

### Hulpcontacten

Bestelnummer	Contact-bezetting	Montage	Brutoprijs €/stk
60-BFX1020	2 NO	front	9,00
60-BFX1002	2 NC	front	9,00
60-BFX1211	1 NO 1 NC	zijkant	15,25
60-BFX1022	2 NO 2 NC	zijkant	18,65

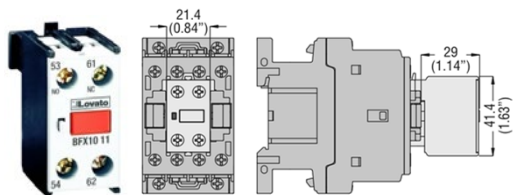

### Blusfilters

Bestelnummer	Voor spoelspanning	Brutoprijs €/stk
60-BFX79048	≤ 48VAC/DC (r/c)	16,95
60-BFX79240	125-240VAC/DC (r/c)	16,95
60-BFX79415	240-415VAC/DC (r/c)	16,95



### Mechanische vergrendeling

Bestelnummer		Brutoprijs €/stk
60-BFX5000	BF09-BF38	16,95
60-BFX5300	BF40-BF94	16,95
60-BFX5400	BF95-BF150	18,65



Meer Lovato

WHERE TECHNOLOGY MEETS TRADITION



Lovato Bergamo, Italië



Motor-directstarters



Nokkenschakelaars

# Lovato Electric

## Insteekrelais



ENERGY AND AUTOMATION

### Mini-insteekrelais | HR30

#### Karakteristieken

Miniatuur relais, geschikt voor 1 of 2 wisselcontacten.  
Max. 10A (16A op PCB), beschikbaar in AC of DC.  
Voet breedte 15,8mm.



Bestelnummer	Uitvoering	Brutoprijs	
		A	€/stk
60-HR301CA024	1 wisselcontact 12VAC	16	7,35
60-HR301CA110	1 wisselcontact 110VAC	16	8,45
60-HR301CA230	1 wisselcontact 230VAC	16	12,35
60-HR301CD012	1 wisselcontact 12VDC	16	5,25
60-HR301CD024	1 wisselcontact 24VDC	16	5,25
60-HR302CA024	2 wisselcontacten 24VAC	8	8,05
60-HR302CA110	2 wisselcontacten 110VAC	8	9,25
60-HR302CA230	2 wisselcontacten 230VAC	8	13,55
60-HR302CD012	2 wisselcontacten 12VDC	8	5,80
60-HR302CD024	2 wisselcontacten 24VDC	8	5,80

### Mini-insteekrelais met LED | HR50

#### Karakteristieken

Miniatuur relais, geschikt voor 1 of 2 wisselcontacten.  
Max. 10A, beschikbaar in AC of DC. Voet breedte 15,8mm.  
Mechanische testknop met vergrendelingsmogelijkheid.



Bestelnummer	Uitvoering	Brutoprijs	
		A	€/stk
60-HR501CA024	1 wisselcontact 24VAC	16	10,70
60-HR501CA110	1 wisselcontact 110VAC	16	12,10
60-HR501CA230	1 wisselcontact 230VAC	16	14,35
60-HR501CD012	1 wisselcontact 12VDC	16	9,35
60-HR501CD024	1 wisselcontact 24VDC	16	9,35
60-HR502CA024	2 wisselcontacten 24VAC	8	11,75
60-HR502CA110	2 wisselcontacten 110VAC	8	13,40
60-HR502CA230	2 wisselcontacten 230VAC	8	15,85
60-HR502CD012	2 wisselcontacten 12VDC	8	10,30
60-HR502CD024	2 wisselcontacten 24VDC	8	10,30

### Relais voet | HR5X (max 10A)



Bestelnummer	Uitvoering	Brutoprijs	
		A	€/stk
60-HR5XS21	relaisvoet schroefaansluiting (boven)		6,55
60-HR5XS22	relaisvoet schroefaansluiting		6,80
60-HR5XS21S	relaisvoet veerklem (max 10A)		7,85
60-HR3X88	bevestigingsclip tbv HR30		0,63
60-HR5X88	bevestigingsclip tbv HR50		0,69

### Toebehoren | HR5X



Bestelnummer	Uitvoering	Brutoprijs	
		A	€/stk
60-HR5X30	blanco codering tbv HR5X		0,30
60-HR5X9008	brugverbinding 8-polig (zwart)		5,60
60-HR6X78024	ontstoringfilter 6-24VDC met LED		4,55
60-HR6X77024	ontstoringfilter 6-24VAC/DC		4,55
60-HR6X77230	ontstoringfilter 110-230VAC/DC		3,55

### Industriële insteekrelais met LED | HR60

#### Karakteristieken

Industrieel insteekrelais, geschikt voor 2 of 4 wisselcontacten.  
Max. 7A of 5A, voorzien van LED en mechanische standindicatie.  
Beschikbaar in AC of DC. Voet breedte 27mm.

Bestelnummer	Uitvoering	Brutoprijs	
		A	€/stk
60-HR602CA012	2 wisselcontacten 12VAC	7	11,15
60-HR602CA024	2 wisselcontacten 24VAC	7	11,15
60-HR602CA110	2 wisselcontacten 110VAC	7	12,45
60-HR602CA230	2 wisselcontacten 230VAC	7	12,45
60-HR602CD012	2 wisselcontacten 12VDC	7	10,90
60-HR602CD024	2 wisselcontacten 24VDC	7	10,90
60-HR6XS21	relaisvoet schroefaansluiting (boven)		8,20
60-HR6XS22	relaisvoet schroefaansluiting		7,85



Push-in binnenkort leverbaar

Bestelnummer	Uitvoering	Brutoprijs	
		A	€/stk
60-HR604CA012	4 wisselcontacten 12VAC	5	11,85
60-HR604CA024	4 wisselcontacten 24VAC	5	11,85
60-HR604CA110	4 wisselcontacten 110VAC	5	13,30
60-HR604CA230	4 wisselcontacten 230VAC	5	13,30
60-HR604CD012	4 wisselcontacten 12VDC	5	11,60
60-HR604CD024	4 wisselcontacten 24VDC	5	11,60
60-HR6XS41	relaisvoet schroefaansluiting (boven)		9,05
60-HR6XS42	relaisvoet schroefaansluiting		8,65

voor ontstoringfilters zie toebehoren HR5X

# Lovato Electric

## Insteekrelais



ENERGY AND AUTOMATION

### Industriële insteekrelais met LED | HR70

#### Karakteristieken

Industrieel insteekrelais, geschikt voor 2 of 4 wisselcontacten.  
Max. 10A, voorzien van LED en mechanische standindicatie.  
Beschikbaar in AC of DC. Voet breedte 38mm.



Bestelnummer	Uitvoering	A	Brutoprijs €/stk
<b>8-pins</b>			
60-HR702CA024	2 wisselcontacten 24VAC	10	15,50
60-HR702CA110	2 wisselcontacten 110VAC	10	17,15
60-HR702CA230	2 wisselcontacten 230VAC	10	17,15
60-HR702CD024	2 wisselcontacten 24VDC	10	15,25
60-HR702CD110	2 wisselcontacten 110VDC	10	16,45
60-HR7XS1	relaisvoet 8-pins tbv HR702C		6,90
60-HR7X87	bevestigingsclip		0,45

Bestelnummer	Uitvoering	A	Brutoprijs €/stk
<b>11-pins</b>			
60-HR703CA024	3 wisselcontacten 24VAC	10	16,35
60-HR703CA110	3 wisselcontacten 110VAC	10	18,10
60-HR703CA230	3 wisselcontacten 230VAC	10	18,10
60-HR703CD024	3 wisselcontacten 24VDC	10	16,10
60-HR703CD110	3 wisselcontacten 110VDC	10	17,30
60-HR7XS2	relaisvoet 11pins tbv HR703C		7,95
60-HR7X87	bevestigingsclip		0,45

### Smalle insteekrelais | HR10

#### Karakteristieken

Smal insteekrelais breedte 6,2mm, 1 wisselcontact.  
Max. 6A. Relaisvoet met ingebouwd LED.  
Relaisvoet zowel in schroefversie als met veerklem leverbaar.

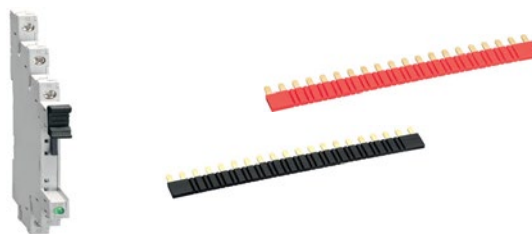

Bestelnummer	Uitvoering	A	Brutoprijs €/stk
60-HR101CE012	1 wisselcontact 12VDC	6	7,00
60-HR101CE024	1 wisselcontact 24VDC	6	7,00
60-HR201AS024	solid state relais 24VDC	2	29,45
60-HR201DS024	solid state relais 24VDC	4	31,35
60-HR1X9020	brugverbinding 20-polig (zwart)		3,85
60-HR1X9120	brugverbinding 20-polig (rood)		3,85
60-HR1X30	blanco codering los		0,25

Bestelnummer	Uitvoering	A	Brutoprijs €/stk
60-HR1XS024	relaisvoet 12-24V		schroef 10,30
60-HR1XS024S	relaisvoet 12-24V		veerklem 11,35
60-HR1XS110	relaisvoet 110-125V		schroef 12,20
60-HR1XS110S	relaisvoet 110-125V		veerklem 13,55
60-HR1XS230	relaisvoet 220-240V		schroef 12,20
60-HR1XS230S	relaisvoet 220-240V		veerklem 13,55
60-HR1X3016	blanco codering strip 16 stuks		3,45



Push-in binnenkort leverbaar

#### Karakteristieken

Relaisvoet met push-in  
Snelle en eenvoudige bedrading  
Eenvoudig te openen met de knop  
Transparante behuizing relais voor inspectie contact

# Lovato Electric

Installatie automaten



ENERGY AND AUTOMATION

## Installatie automaten | P1MB - P2MB

<b>Materiaal:</b>	Thermoplast
<b>Beschermklasse:</b>	IP20 (aansluitklemmen)
<b>Temp.bereik:</b>	-35°C tot +70°C
<b>Voorschriften:</b>	IEC/EN 60898-1 IEC/EN 60947-2 UL 1077, CSA C22.2 n°235 File E359585

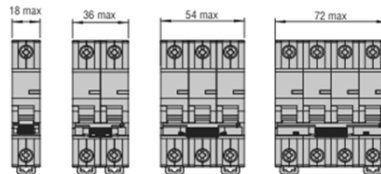

### B-Karakteristiek | 10kA

A	Bestelnummer	Brutoprijs €/stk	Bestelnummer	Brutoprijs €/stk	Bestelnummer	Brutoprijs €/stk	Bestelnummer	Brutoprijs €/stk	Bestelnummer	Brutoprijs €/stk
	<b>1-polig = 1 module</b>		<b>2-polig = 2 modules</b>		<b>3-polig = 3 modules</b>		<b>4-polig = 4 modules</b>		<b>1-polig+N = 1 module</b>	
6	60-P1MB1PB06	13,20	60-P1MB2PB06	26,40	60-P1MB3PB06	55,90	60-P1MB4PB06	92,50	60-P1MB1MB06	21,65
10	60-P1MB1PB10	11,60	60-P1MB2PB10	25,6	60-P1MB3PB10	48,45	60-P1MB4PB10	80,50	60-P1MB1MB10	21,65
16	60-P1MB1PB16	11,60	60-P1MB2PB16	25,6	60-P1MB3PB16	48,45	60-P1MB4PB16	80,50	60-P1MB1MB16	21,65
20	60-P1MB1PB20	11,60	60-P1MB2PB20	25,6	60-P1MB3PB20	48,45	60-P1MB4PB20	80,50	60-P1MB1MB20	21,65
25	60-P1MB1PB25	11,60	60-P1MB2PB25	25,6	60-P1MB3PB25	48,45	60-P1MB4PB25	80,50	60-P1MB1MB25	23,40
32	60-P1MB1PB32	11,60	60-P1MB2PB32	25,6	60-P1MB3PB32	47,15	60-P1MB4PB32	80,50	60-P1MB1MB32	23,85
40	60-P1MB1PB40	16,25	60-P1MB2PB40	30,95	60-P1MB3PB40	68,00	60-P1MB4PB40	112,65		
50	60-P1MB1PB50	16,25	60-P1MB2PB50	30,95	60-P1MB3PB50	68,00	60-P1MB4PB50	112,65		
63	60-P1MB1PB63	16,25	60-P1MB2PB63	30,95	60-P1MB3PB63	68,00	60-P1MB4PB63	112,65		

### B-Karakteristiek | 6kA

### C-Karakteristiek | 10kA

A	Bestelnummer	Brutoprijs €/stk	Bestelnummer	Brutoprijs €/stk	Bestelnummer	Brutoprijs €/stk	Bestelnummer	Brutoprijs €/stk	Bestelnummer	Brutoprijs €/stk
	<b>1-polig = 1 module</b>		<b>2-polig = 2 modules</b>		<b>3-polig = 3 modules</b>		<b>4-polig = 4 modules</b>		<b>1-polig+N = 1 module</b>	
1	60-P1MB1PC01	14,35	60-P1MB2PC01	27,70	60-P1MB3PC01	57,80	60-P1MB4PC01	91,40		
2	60-P1MB1PC02	14,35	60-P1MB2PC02	27,70	60-P1MB3PC02	57,80	60-P1MB4PC02	91,40	60-P1MB1MC02	23,40
4	60-P1MB1PC04	14,35	60-P1MB2PC04	27,70	60-P1MB3PC04	57,80	60-P1MB4PC04	91,40	60-P1MB1MC04	23,40
6	60-P1MB1PC06	13,15	60-P1MB2PC06	26,40	60-P1MB3PC06	53,15	60-P1MB4PC06	67,30	60-P1MB1MC06	19,95
8	60-P1MB1PC08	13,15	60-P1MB2PC08	26,40	60-P1MB3PC08	53,15				
10	60-P1MB1PC10	11,60	60-P1MB2PC10	24,95	60-P1MB3PC10	46,15	60-P1MB4PC10	58,95	60-P1MB1MC10	19,95
16	60-P1MB1PC16	11,60	60-P1MB2PC16	25,60	60-P1MB3PC16	46,15	60-P1MB4PC16	58,95	60-P1MB1MC16	19,95
20	60-P1MB1PC20	11,60	60-P1MB2PC20	25,60	60-P1MB3PC20	46,15	60-P1MB4PC20	58,95	60-P1MB1MC20	19,95
25	60-P1MB1PC25	11,60	60-P1MB2PC25	25,60	60-P1MB3PC25	46,15	60-P1MB4PC25	58,95	60-P1MB1MC25	21,55
32	60-P1MB1PC32	11,60	60-P1MB2PC32	25,60	60-P1MB3PC32	46,15	60-P1MB4PC32	58,95	60-P1MB1MC32	21,90
40	60-P1MB1PC40	16,25	60-P1MB2PC40	36,40	60-P1MB3PC40	64,60	60-P1MB4PC40	82,65	60-P1MB1MC40	24,00
50	60-P1MB1PC50	16,25	60-P1MB2PC50	36,40	60-P1MB3PC50	64,60	60-P1MB4PC50	82,65		
63	60-P1MB1PC63	16,25	60-P1MB2PC63	36,40	60-P1MB3PC63	64,60	60-P1MB4PC63	82,65		

### C-Karakteristiek | 6kA



### C-Karakteristiek | 10kA 80 - 125A

A	Bestelnummer	Brutoprijs €/stk	Bestelnummer	Brutoprijs €/stk	Bestelnummer	Brutoprijs €/stk	Bestelnummer	Brutoprijs €/stk
	<b>1-polig = 1 module</b>		<b>2-polig = 2 modules</b>		<b>3-polig = 3 modules</b>		<b>4-polig = 4 modules</b>	
80	60-P2MB1PC080	62,00	60-P2MB2PC080	VALUE!	60-P2MB3PC080	176,65	60-P2MB4PC080	238,35
100	60-P2MB1PC100	68,25	60-P2MB2PC100	129,55	60-P2MB3PC100	194,30	60-P2MB4PC100	262,15
125	60-P2MB1PC125	81,85	60-P2MB2PC125	155,50	60-P2MB3PC125	233,10	60-P2MB4PC125	314,60

Lovato biedt ook automaten volgens UL489 voor de Noord-Amerikaanse markt.

Meer weten, mail naar: [info@calpe.nl](mailto:info@calpe.nl)

# Lovato Electric

Installatie automaten, aardlek automaten, aardlek schakelaars



ENERGY AND AUTOMATION

## D-Karakteristiek | 10kA

A	Bestelnummer	Brutoprijs €/stk	Bestelnummer	Brutoprijs €/stk	Bestelnummer	Brutoprijs €/stk	Bestelnummer	Brutoprijs €/stk	Bestelnummer	Brutoprijs €/stk
	<b>1-polig = 1 module</b>		<b>2-polig = 2 modules</b>		<b>3-polig = 3 modules</b>		<b>4-polig = 4 modules</b>		<b>hulpcontact</b>	
2	60-P1MB1PD02	24,30	60-P1MB2PD02	50,30	60-P1MB3PD02	78,70	60-P1MB4PD02	100,50	60-P1X1011	19,45
4	60-P1MB1PD04	24,30	60-P1MB2PD04	50,30	60-P1MB3PD04	78,70	60-P1MB4PD04	100,50		
6	60-P1MB1PD06	22,40	60-P1MB2PD06	46,30	60-P1MB3PD06	72,45	60-P1MB4PD06	92,50		
10	60-P1MB1PD10	19,50	60-P1MB2PD10	40,30	60-P1MB3PD10	63,00	60-P1MB4PD10	80,50		
16	60-P1MB1PD16	19,50	60-P1MB2PD16	40,30	60-P1MB3PD16	63,00	60-P1MB4PD16	80,50		
20	60-P1MB1PD20	19,50	60-P1MB2PD20	40,30	60-P1MB3PD20	63,00	60-P1MB4PD20	80,50		
25	60-P1MB1PD25	19,50	60-P1MB2PD25	40,30	60-P1MB3PD25	63,00	60-P1MB4PD25	80,50		
32	60-P1MB1PD32	19,50	60-P1MB2PD32	40,30	60-P1MB3PD32	63,00	60-P1MB4PD32	80,50		
40	60-P1MB1PD40	27,25	60-P1MB2PD40	56,35	60-P1MB3PD40	88,10	60-P1MB4PD40	112,65		
50	60-P1MB1PD50	27,25	60-P1MB2PD50	56,35	60-P1MB3PD50	88,10	60-P1MB4PD50	112,65		
63	60-P1MB1PD63	27,25	60-P1MB2PD63	56,35	60-P1MB3PD63	88,10	60-P1MB4PD63	112,65		



## Aardlek automaten | P1RB

**Beschermklasse:** IP20 (aansluitklemmen)  
**Temp.bereik:** -25°C tot +40°C  
**Voorschriften:** IEC/EN 61009-1  
**Keur:** TÜV, EAC

### Karakteristieken

Geschikt voor detecteren en schakelen in geval van  
 Duidelijke statusindicatie.  
 Ook beschikbaar in 300mA.

## C-Karakteristiek | Type A 30 mA

A	Bestelnummer	Brutoprijs €/stk
	<b>1-polig+N = 2 modules</b>	
6	60-P1RB1NC06A030	128,75
10	60-P1RB1NC10A030	128,75
16	60-P1RB1NC16A030	128,75
20	60-P1RB1NC20A030	128,75
25	60-P1RB1NC25A030	128,75
32	60-P1RB1NC32A030	128,75
40	60-P1RB1NC40A030	128,75

## C-Karakteristiek | Type AC 30 mA

A	Bestelnummer	Brutoprijs €/stk
	<b>1-polig+N = 2 modules</b>	
6	60-P1RB1NC06AC030	103,30
10	60-P1RB1NC10AC030	103,30
16	60-P1RB1NC16AC030	103,30
20	60-P1RB1NC20AC030	103,30
25	60-P1RB1NC25AC030	103,30
32	60-P1RB1NC32AC030	103,30
40	60-P1RB1NC40AC030	103,30



### Karakteristieken

Eenvoudig uit te breiden met automaten serie P1MB

## Aardlek combinatie | P1RA

A	Bestelnummer	Brutoprijs €/stk
	<b>2-3-4-polig</b>	
40	60-P1RA2P40A030	141,65
63	60-P1RA2P63A030	148,70
40	60-P1RA3P40A030	225,80
63	60-P1RA3P63A030	237,10
40	60-P1RA4P40A030	239,70
63	60-P1RA4P63A030	251,65

A	Bestelnummer	Brutoprijs €/stk
	<b>2-3-4-polig</b>	
40	60-P1RA2P40A300	128,75
63	60-P1RA2P63A300	135,20
40	60-P1RA3P40A300	155,75
63	60-P1RA3P63A300	163,55
40	60-P1RA4P40A300	165,30
63	60-P1RA4P63A300	173,55



## Aardlek schakelaar | P1RC

**Beschermklasse:** IP20 (aansluitklemmen)  
**Temp.bereik:** -25°C tot +55°C  
**Voorschriften:** IEC/EN 61008-1  
**Keur:** TÜV, EAC

### Karakteristieken

Type A   
 Type AC   
 Type B    **Op aanvraag leverbaar**



2-polig = 2 modules



4-polig = 4 modules



A	Bestelnummer	Brutoprijs €/stk	Bestelnr	Brutoprijs €/stk	Bestelnummer	Brutoprijs €/stk	Bestelnummer	Brutoprijs €/stk
	<b>Type A*</b>		<b>Type AC*</b>		<b>Type A*</b>		<b>Type AC*</b>	
25	60-P1RC2P25A300	143,50	60-P1RC2P25AC300	102,70	60-P1RC4P25A300	134,25	60-P1RC4P25AC300	135,05
40	60-P1RC2P40A300	161,80	60-P1RC2P40AC300	123,85	60-P1RC4P40A300	212,70	60-P1RC4P40AC300	157,55
63	60-P1RC2P63A300	237,30	60-P1RC2P63AC300	179,60	60-P1RC4P63A300	256,30	60-P1RC4P63AC300	199,45

\* ook leverbaar in 30mA

# Lovato Electric

Nokkenschakelaars, lastschakelaars

**Lovato**  
**electric**

ENERGY AND AUTOMATION

## Nokkenschakelaars | Serie GX16U | 16A - 690 VAC

**Beschermklasse:** IP65  
**Temp.bereik:** -25°C tot +55°C  
**Kabeldoorvoer:** 0,5 - 2,5 mm  
**Voorschriften:** IEC/EN 60947-1, IEC/EN60947-3  
IEC/EN 60947-5-1, IEC/EN61058-1  
UL508, CSA C22.2 n°14

**Karakteristieken**  
Verzilverde dubbel onderbrekende contacten.  
Aansluitklemmen IP20.  
Ook verkrijgbaar in 32A of in behuizing.



Omschrijving	Aantal polen	Inbouw diepte mm	Stand aanduiding	Bestelnummer	Brutoprijs €/stk
<b>Grijs met zwarte knop (48 mm), 16 A</b>					
IN/UIT	2	42,5	0-1	60-GX1691U	15,50
IN/UIT	3	51,0	0-1	60-GX1610U	18,60
IN/UIT	4	51,0	0-1	60-GX1692U	20,65
LIJN/OM	3	59,5	1-0-2	60-GX1653U	26,50
DRAAI/OMKEER	3	59,5	1-0-2	60-GX1611U	24,70
POOL-OM(DHALANDER)	3	68,0	1-0-2	60-GX1613U	31,90
STER/DRIEHOEK	3	68,0	0-Y-Δ	60-GX1612U	32,40
AMPÈREMETER	1	59,5	0-L1-L2-L3	60-GX1698U	29,10
VOLTMETER	3	59,5	0-L1N-L2N-L3N L1L2-L2L3-L3L1	60-GX1666U	28,25
<b>Geel met rode knop geschikt voor hangslotvergrendeling (48 mm), 16A</b>					
3-polig IN/UIT	3	51,0	0-1	60-GX1610U25	25,60
4-polig IN/UIT	4	51,0	0-1	60-GX1692U25	28,10

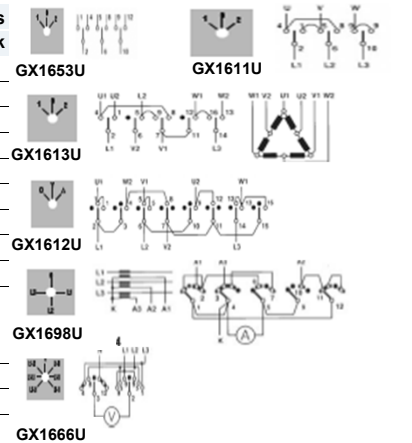

## Lastschakelaars inbouw | Serie GA | 3-polig

**Beschermklasse:** IP65  
**Temp.bereik:** -25°C tot +55°C  
**Voorschriften:** IEC/EN 60947-3, IEC/EN60947-1  
UL508, UL98A, CSA C22.2

**Karakteristieken**  
3-polig voor montage op DIN rail of deurkoppeling.  
Standaard geschikt voor hangslotvergrendeling.  
690 VAC in AC23. Ook beschikbaar met ABS behuizing.  
Op aanvraag verkrijgbaar in 1000V DC versie voor PV-installaties



Bestelnummer	70 mm		Brutoprijs €/stk
	AC21	AC22 AC23	
<b>Directe bediening</b>			
	<b>A</b>	<b>A</b>	
60-GA016 A	16	16	17,60
60-GA025 A	25	25	18,45
60-GA032 A	32	32	19,70
60-GA040 A	40	40	21,50
60-GA063 SA	63	45	30,10
60-GA063 A	63	63	40,80
60-GA080 A	80	80	46,75
60-GA100 A	100	100	57,95
60-GA125 A	125	125	66,55
60-GA160 A	160	125	69,10



Bestelnummer	70 mm		Brutoprijs €/stk
	AC21	AC22 AC23	
<b>Deurmontage</b>			
	<b>A</b>	<b>A</b>	
60-GA016 C	16	16	17,60
60-GA025 C	25	25	18,45
60-GA032 C	32	32	19,70
60-GA040 C	40	40	21,50
60-GA063 C	63	63	40,80
60-GA080 C	80	80	46,75
60-GA100 C	100	100	57,95
60-GA125 C	125	125	66,55

Op zoek naar Last-omschakelaars van Lovato?

Vraag naar de mogelijkheden van de nieuwe GLC serie.

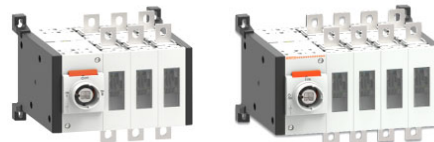



# Lovato Electric

Toebehoren lastschakelaars

**Lovato**  
**electric**

ENERGY AND AUTOMATION

## Toebehoren | Serie GAX

### 4e-Pool

Bestelnummer	AC21	AC22 AC23	Bruto prijs €/stk
<b>Voor GA.. A-versie</b>			
60-GAX42 040A <sup>1</sup>	40	40	11,10
60-GAX42 063SA <sup>2</sup>	63	45	14,50
60-GAX42 063A	63	63	17,10
60-GAX42 080A	80	80	22,40
60-GAX42 100A	100	100	27,70
60-GAX42 125A	125	125	33,05
60-GAX42 160A	160	125	34,75
<b>Voor GA.. C-versie</b>			
60-GAX42 040C <sup>3</sup>	40	40	11,10
60-GAX42 063C	63	45	17,10
60-GAX42 080C	80	80	22,40
60-GAX42 100C	100	100	27,70
60-GAX42 125C	125	125	33,05

### Add-on blokken

Bestelnummer	Omschrijving	Bruto prijs €/stk
<b>Hulpcontacten</b>		
60-GAX10 11A	1NO + INC voor GA...A	18,50
60-GAX10 11C	1NO + INC voor GA...C	18,50
<b>Mechanische vergrendeling (I-0-II)</b>		
60-GAX50 00	voor GA016A...GA040A GA063 SA	41,30
	GAX67 B □ 5 mm <sup>1</sup>	
60-GAX50 01	voor GA063A...GA160A	49,65
	GAX67 B □ 5 mm <sup>1</sup>	
<b>Mechanisch koppelsysteem voor 6-8 polige lastschakelaars</b>		
60-GAX60 00	voor GA016A...GA040A GA063 SA □ 5 mm <sup>1</sup>	24,85
60-GAX60 01	voor GA063A...GA125A □ 7 mm <sup>2 3</sup>	29,85

### Bedieningsknoppen IP65

Bestelnummer	Knop	Kleur	Brutoprijs €/stk
60-GAX61	Draaigreep	rood/geel	6,85
60-GAX62	Draaiknop	rood/geel	10,70
60-GAX63	Draaiknop	rood/geel	8,60
60-GAX63 2	Draaiknop	rood/geel	10,70
60-GAX64	Draaiknop	rood/geel	15,85
60-GAX66 N	Handgreep	rood/geel	30,85
60-GAX68	Draaiknop	rood/geel	9,65
60-GAX61 B	Draaigreep	zwart	6,85
60-GAX62 B	Draaiknop	zwart	10,70
60-GAX63 B	Draaiknop	zwart	8,60
60-GAX63 2B	Draaiknop	zwart	10,70
60-GAX64 B	Draaiknop	zwart	15,85
60-GAX66 NB	Handgreep	zwart	30,85
60-GAX67 B	Draaiknop	zwart	12,50
60-GAX68 B	Draaiknop	zwart	9,65

### Verlengassen

Voor bedieningsknop GAX61..., GAX64, GAX68, GAX61 B, GAX64 B, GAX67 B, en mechanische vergrendelingtype GAX50 00, GAX50 01 en GAX60 00

Bestelnummer	Lengte mm	□ mm	Brutoprijs €/stk
60-GAX7 055	55	5	3,65
60-GAX7 070	70	5	3,90
60-GAX7 090	90	5	4,05
60-GAX7 150	150	5	4,55
60-GAX7 200	200	5	5,10
60-GAX7 300	300	5	7,10
60-GAX7 400	400	5	9,95
60-GAX7 500	500	5	13,85

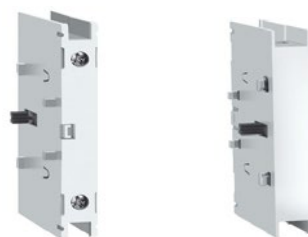

GAX42...A

GAX42...C

- <sup>1</sup> Alleen voor GA016A...GA040A
- <sup>2</sup> Alleen voor GA063 SA
- <sup>3</sup> Alleen voor GA016C...GA040C



GAX10 11A

GAX10 GAX50... en GAX60...

- <sup>1</sup> 1cm GAX7 verlengassen
- <sup>2</sup> 1cm GAX66 bedieningsknop en GAX7...A verlengassen
- <sup>3</sup> Niet geschikt voor GA..7

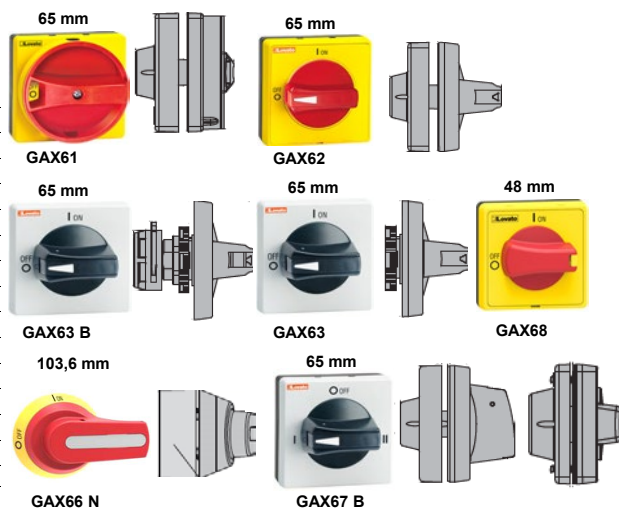

### Verlengassen en deurbekoppeling adapter

Voor bedieningsknop GAX66N, GAX66NB

Bestelnummer	Lengte mm	□ mm	Brutoprijs €/stk
60-GAX7 150AN	150	7	7,70
60-GAX7 200AN	200	7	8,30
60-GAX7 300AN	300	7	9,45
60-GAX60 B			3,40



# Lovato Electric

Lastschakelaars serie GL

**Lovato**  
**electric**

ENERGY AND AUTOMATION



- 160A tot 630A AC23
- 200A and 400A volgens UL98
- Schroef of DIN-rail montage tot 315A  
320A tot 630A bodemmontage
- 4de pool los te bestellen
- Zichtbare contacten
- Compacte afmetingen  
3P: 162mm tot 315A  
3P: 203mm 320A tot 500A  
3P: 231mm 630A

DIN-rail montage  
met antislip

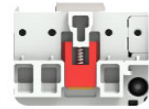

Bodemmontage richting  
aan te passen

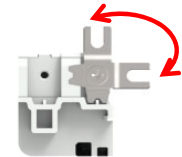

Nul (ongeschakeld)		Bruto €/stk
60-GLX300	GL160-315	51,40
60-GLX301	GL320-630	114,50
Aarde (ongeschakeld)		
60-GLX301	GL160-315	51,40
60-GLX303	GL320-630	114,50
Afdekkap 3-polig		
60-GLX800	GL160-315	29,20
60-GLX802	GL320-630	41,45

## Lastschakelaars | Serie GL

Temp.bereik: -25°C tot +55°C  
Voorschriften: IEC/EN 60947-3, IEC/EN60947-1



GL0160C1



GLX420315

Bestelnummer	AC21		AC23		Brutoprijs €/stk
	A	A	A	A	
60-GL0160C1	160	160	160	160	152,65
60-GL0200C1	200	200	200	200	198,45
60-GL0250C1	250	250	250	250	241,45
60-GL0315C1	315	250*	250*	250*	270,60
60-GL0320C1	320	320	320	320	297,85
60-GL0400C1	400	400	400	400	352,00
60-GL0500C1	500	500	500	500	414,25
60-GL0630C1	630	630*	630*	630*	496,85
60-GLX420315	4 <sup>de</sup> pool tot 315A				54,15
60-GLX420320	4 <sup>de</sup> pool tot 320A				86,65
60-GLX420400	4 <sup>de</sup> pool tot 400A				102,40
60-GLX420500	4 <sup>de</sup> pool tot 500A				120,55
60-GLX420630	4 <sup>de</sup> pool tot 630A				144,55

\*AC23 400V

## Toebehoren | Serie GL

Los te bestellen: Hulpcontacten, Nul, Aarde  
Bedieningsknoppen  
Verlengassen



GLX61



GLX62



GLX61



GLX62B

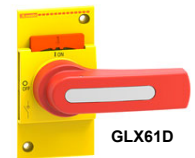

GLX61D



GLX61DB



GLX7150S10



Bestelnummer	Knop	Kleur	Brutoprijs €/stk
<b>deurkoppeling</b>			
60-GLX61	GL160-315	rood/geel	34,70
60-GLX61B	GL160-315	zwart	34,70
60-GLX62	GL320-630	rood/geel	46,05
60-GLX62B	GL320-630	zwart	46,05
60-GLX7150S10	verlengas	150mm	10,05
60-GLX7200S10	verlengas	200mm	10,70
60-GLX7300S10	verlengas	300mm	12,25
60-GLX7400S10	verlengas	400mm	16,85
60-GLX7500S10	verlengas	500mm	30,15
<b>directe bediening</b>			
60-GLX61D	GL160-315	rood/geel	26,45
60-GLX61DB	GL160-315	zwart	26,45
60-GLX62D	GL320-630	rood/geel	30,35
60-GLX62DB	GL320-630	zwart	30,35



# Lovato Electric

Softstarters serie ADXL

**Lovato**  
**electric**

ENERGY AND AUTOMATION



- Alles-in-één oplossing voor motoren
- Snelle eenvoudige configuratie via smartphone
- Programmeerbare in- en outputs
- Voorzien van NFC en ingebouwde optische poort
- Slimme functies als Torque control en Kick start
- Compatible met de volgende software:  
- Geïntegreerde bypass

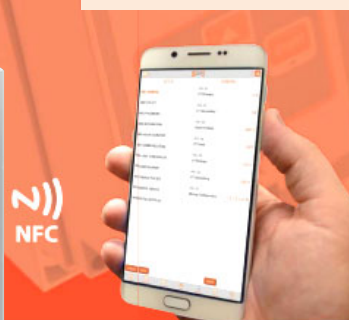

Opstarten in 4 stappen

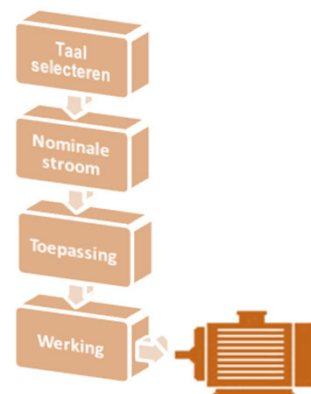

## Softstarters | Serie ADXL

Temp. bereik: -20°C tot +40°C  
In- en outputs: 3 in, 3 out  
Communicatie: NFC, optische poort voorzijde  
Optioneel: RS485



Bestelnummer	Nom. stroom	Motor vermogen	Brutoprijs €/stk
	A	kW	
60-ADXL0018600	18	7,5	955,70
60-ADXL0030600	30	15	1.100,60
60-ADXL0045600	45	22	1.455,55
60-ADXL0060600	60	30	1.583,05
60-ADXL0075600	75	37	1.757,45
60-ADXL0085600	85	45	2.037,95
60-ADXL0115600	115	55	2.260,30
60-ADXL0135600	135	75	3.014,10
60-ADXL0162600	162	90	3.504,70
60-ADXL0195600	195	110	4.029,00
60-ADXL0250600	250	132	4.310,50
60-ADXL0320600	320	160	5.499,85

## Toebehoren | Serie ADXL



Bestelnummer	Omschrijving	Brutoprijs €/stk
60-CX01	USB dongle	186,25
60-CX02	Wi-Fi dongle	465,50
60-EXCRDU1	Los LCD display	476,75
60-EXC1042	RS485 kaart	116,65
60-EXCCON01	RS485-ethernet omvormer	571,50
60-EXP8003	DIN-rail adapter	33,35
60-EXP8004	Ventilator	113,90



EXCRDU1



EXC1042



# Lovato Electric

Modulaire tijdrelais



ENERGY AND AUTOMATION

## Tijdrelais Elektronisch | Serie TM

**Beschermklasse:** IP40, aansluitklemmen IP20  
**Voorschriften:** IEC/EN 61812-1, UL508, CSA C22.2 n°14  
**Temp. Bereik:** -20°C tot +60°C



### Karakteristieken

Nauwkeurig, stabiel, ongevoelig voor industriële omgevingsgeluiden.  
 Geschikt voor bodemmontage of op DIN-rail.  
 Aansluitklemmen 0,2mm<sup>2</sup> tot 4mm<sup>2</sup>. Slechts één module inbouwbreedte.

Bestelnummer	Functie	Tijd instelbaar	Voedings- spanning	Brutoprijs €/stk
60-TMP	Opkom-vertraagd	0,1-1 sec.	24-48VDC 24-240VAC	49,70
		1-10 sec.		
		6-60 sec.		
		1-10 min		
		6-60 min		
		1-10 uur		
60-TMM1	Multifunctioneel* 1x uitgang	0,1-1 sec.	12-240VAC/DC	58,40
		1-10 sec.		
		6-60 sec.		
		1-10 min		
		1-10 uur		
		0,1-1 dag		
60-TMM1NFC	<b>NIEUW</b> Multifunctioneel* 1x uitgang 40 instelbare functies programmeren via NFC APP	0,1... sec.	12-240VAC/DC	58,40
		999 dgn		
		ON		
		OFF		
60-TMM2	Multifunctioneel* 2x uitgang	0,1-1 sec.	12-240VAC/DC	74,50
		1-10 sec.		
		6-60 sec.		
		1-10 min		
		6-60 min		
		1-10 uur		
60-TMST	Voor automatische ster-driehoek- starters	0,1-1 sec.	24/48VDC 24-240VAC	79,45
		1-10 sec.		
		6-60 sec.		
		1-10 min		
		6-60 min		
		1-10 uur		
60-TMD	Afval-vertraagd	1-10 dagen	24-240V AC/DC	163,55
		3-30 dagen		
		10-100 dagen		
		0,06-0,6 sec.		
60-TMLS	Trappenhuis	0,6-6 sec.	220-240V AC	83,30
		18-180 sec.		
		0,5-20 min		

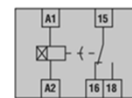

TMP

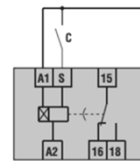

TMM1NFC

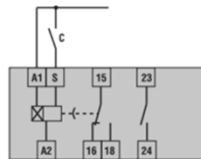
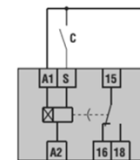

TMM2

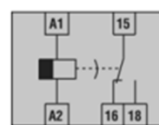
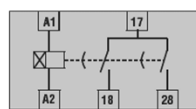

TMLS

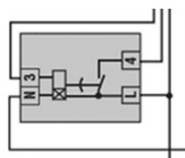

### \*Multifunctionele tijdrelais | Functies

- Opkom-vertraagd
- Opkom-vertraagd met startcommando dmv. hulpcontact.
- Afval-vertraagd met startcommando via een afzonderlijk potentiaalvrij contact.
- Opkom-impuls
- Opkom-impuls met startcommando via potentiaalvrij contact.
- Afval-impuls met startcommando via afzonderlijk potentiaalvrij contact.
- Opkom- en afval-impuls met startcommando via afzonderlijk potentiaalvrij contact.

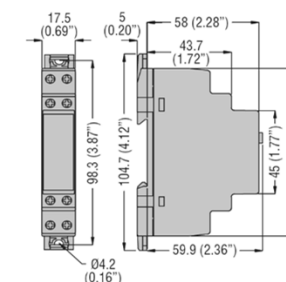

# Lovato Electric

Energiemanagement

**Lovato**  
**electric**

ENERGY AND AUTOMATION



Lovato Electric biedt een uitgebreid assortiment producten voor Energiemanagement:

- 1- en 3-fase energiemeters (met MID certificaat)
- Digitale Volt-, Ampère-, Watt- en frequentiemeters
- Digitale multimeters en vermogensanalyse
- Aansluiting op 1-, 2- en 3-fase systemen
- Ideaal voor distributiesystemen, elektrische warmtekoppeling en machine-installaties
- Hoge meetnauwkeurigheid
- Volledig programmeerbare digitale en analoge in- en uitgangen
- RS485, RS232, USB, Ethernet, Profibus, DP en M-bus communicatiepoorten
- Via de Gateway datalogger blijf je op afstand op de hoogte
- Met de beschikbare software Synergy uitgebreide rapportage mogelijk

# Lovato Electric

Eindschakelaars, veiligheidsschakelaars, voetschakelaars

**Lovato**  
**electric**

ENERGY AND AUTOMATION

Eindschakelaars  
Veiligheidsschakelaars (solenoid)  
Voetschakelaars



SIL3 : EN 62061  
PLe : EN ISO 13849-1

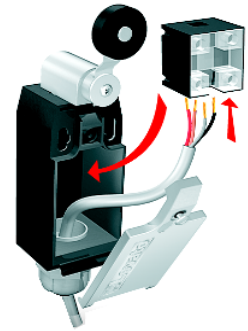

Eenvoudige bedrading



Onderzijde of zijkant



M20 kabel invoer  
overige op aanvraag

## Eindschakelaars | Kunststof, metaal

**Afmetingen:** Volgens EN 50047  
**Materiaal:** Polyamide, aluminium  
**Beschermklasse:** IP65  
**Temp.bereik:** tot +70°C

**Contactbezetting, ook leverbaar in:**  
2NC (snap action)  
1NO+1NC (slow break, make before break/overlapping)  
1NO+1NC (slow break action)  
2NC (slow break action)  
2NA (slow break action)



Eenvoudig  
verwisselbare  
contact  
elementen



Omschrijving	Type kop
<b>1xM20</b> <b>1NO+1NC snap action</b>	
metalen stootstang	1
kunststof rol-stootstang	2
kunststof rolhefboom midden	3
kunststof rolhefboom zijwaarts	4
dwarse rolhefboom kunststof rol	5
dwarse rolhefboom grote kunststof rol	6
verstelbare rolhefboom kunststof rol	7
keramische stootstang	8
staahefboom 3mm	9
antennehefboom	10
<b>2xM20</b> <b>1NO+1NC snap action</b>	
metalen stootstang	1
kunststof rol-stootstang	2
kunststof rolhefboom midden	3
kunststof rolhefboom zijwaarts	4
dwarse rolhefboom kunststof rol	5
dwarse rolhefboom grote kunststof rol	6
verstelbare rolhefboom kunststof rol	7
keramische stootstang	8
staahefboom 3mm	9
antennehefboom	10

Bestelnummer Kunststof	Brutoprijs €/stk	Bestelnummer Aluminium	Brutoprijs €/stk
<b>Serie KB</b>			
60-KBA1S11	26,45	60-KMA1S11	35,10
60-KBB1S11	30,10	60-KMB1S11	38,80
60-KBC1S11	30,70	60-KMC1S11	39,50
60-KBD1S11	30,70	60-KMD1S11	39,50
60-KBE1S11	32,10	60-KME1S11	40,90
60-KBE3S11	38,00	60-KME3S11	46,85
60-KBF1S11	33,65	60-KMF1S11	42,40
60-KBH1S11	51,15	60-KMH1S11	60,95
60-KBL1S11	35,35	60-KML1S11	44,10
60-KBM1S11	34,70	60-KMM1S11	43,45
<b>Serie KC</b>			
60-KCA1S11	22,95	60-KNA1S11	37,30
60-KCB1S11	25,85	60-KNB1S11	41,00
60-KCC1S11	26,35	60-KNC1S11	41,65
60-KCD1S11	26,35	60-KND1S11	41,65
60-KCE1S11	27,50	60-KNE1S11	43,20
60-KCE3S11	32,15	60-KNE3S11	49,15
60-KCF1S11	28,70	60-KNF1S11	44,65
60-KCH1S11	42,60	60-KNH1S11	63,30
60-KCL1S11	30,05	60-KNL1S11	46,35
60-KCM1S11	29,55	60-KNM1S11	45,80

# Lovato Electric

Niveauregeling, vlotterschakelaars



## Niveau controlerelais | Serie LVM20-40

<b>Afmetingen:</b>	Modulair
<b>Materiaal:</b>	Polyamide (zelfdovend)
<b>Temp.bereik:</b>	-20°C tot +60°C
<b>Werking:</b>	Elektrische geleiding van vloeistoffen



Bestelnummer	Spanning 50/60Hz	Type output	Brutoprijs €/stk
<b>Single-voltage</b>			
<b>V</b>			
60-LVM20A024	24	1 C/O	117,75
60-LVM20A127	110-127	1 C/O	117,75
60-LVM20A240	220-240	1 C/O	117,75
60-LVM20A415	380-415	1 C/O	117,75
<b>Multi-voltage</b>			
60-LVM25240	24-240	1 C/O	140,85
<b>Dual-voltage</b>			
60-LVM30A240	24/220-240	2 C/O	152,45
60-LVM30A415	110-127/380	2 C/O	152,45
<b>Single-voltage, multifunction</b>			
60-LVM40A024	24	1+1NO	288,95
60-LVM40A127	110/127	1+1NO	288,95
60-LVM40A240	220-240	1+1NO	288,95
60-LVM40A415	380-415	1+1NO	288,95

**Lovato**  
**electric**  
ENERGY AND AUTOMATION

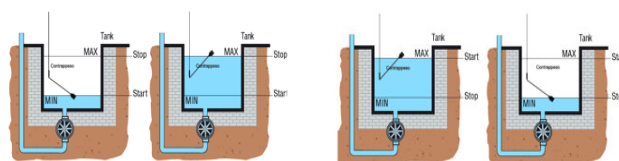

Met de vlotterschakelaars eenvoudig vullen en legen

## Vlotterschakelaars | Serie LVFSP, LVFSN

<b>Toepassing:</b>	Regenwater, rioolwater, drinkwater
<b>Materiaal:</b>	Polypropyleen
<b>Temp.bereik:</b>	-0°C tot +50°C
<b>Beschermklasse:</b>	IP68



Bestelnummer	Materiaal	Lengte kabel meter	Brutoprijs €/stk
<b>Regenwater</b>			
60-LVFSP1W03	PVC	3	31,40
60-LVFSP1W05	PVC	5	36,95
60-LVFSP1W10	PVC	10	49,90
60-LVFSP1W15	PVC	15	68,35
60-LVFSP1W20	PVC	20	90,50
<b>Afvalwater</b>			
60-LVFSN1B05	Neopreen	5	127,40
60-LVFSN1B10	Neopreen	10	156,85
60-LVFSN1B15	Neopreen	15	186,40
60-LVFSN1B20	Neopreen	20	215,95



Gepatenteerd

# Alfa Electric

Verwarmingselementen, ventilatoren, thermostaten

## Verwarmingselementen | Serie SHT, SHTW

**Materiaal :** Geëxtrudeerd aluminium profiel (geanodiseerd)  
**Beschermklasse:** IP20  
**Temp.bereik:** -45°C tot +70°C  
**Beveiliging:** Klasse II



Bestelnummer	Type	Verwarmings capaciteit W	Afmeting			Bruto €/stk
			h	b	d	
73-SHT25	klemmen	25	90	50	80	39,40
73-SHT50	klemmen	50	110	50	80	42,25
73-SHT75	klemmen	75	160	50	80	61,90
73-SHT100	klemmen	100	110	90	80	64,75
73-SHT125	klemmen	125	160	90	80	78,81
73-SHT150	klemmen	150	220	90	80	85,40

### Karakteristieken

Geschikt voor DIN-rail montage

**SHT:** voorzien van 2 klemmen voor 2,5mm<sup>2</sup>

**SHTW:** voorzien van 400mm 2x0,5mm<sup>2</sup> siliconenkenkabel



Bestelnummer	Type	Verwarmings capaciteit W	Afmeting			Bruto €/stk
			h	b	d	
73-SHT15W	kabel	15	50	50	80	32,37
73-SHT25W	kabel	25	60	50	80	33,80
73-SHT50W	kabel	50	80	50	80	38,00

## Ventilatoren | Serie ATV



### Karakteristieken

Snelle en eenvoudige installatie via de snap-in bevestiging.

Gemaakt van zelfdovend ABS, UL94-VO, IP54

Lange levensduur tot 30.000 uur bij 55°C omgevingstemperatuur.

Bestelnummer	Lucht- stroom m <sup>3</sup> /h	Stroom verbruik W	Afmeting			Bruto €/stk
			h	b	d	
<b>230V-50/60Hz</b>	<b>m<sup>3</sup>/h</b>	<b>W</b>				
73-ATV1100U	26	13	114	114	73	49,20
73-ATV2200U	58	22	150	150	86	53,45
73-ATV3200U	115	22	204	204	104	71,80
73-ATV4200U	125	22	250	250	107	76,00
73-ATV4300U	255	40	250	250	107	106,35
73-ATV4400U	410	70	250	250	136	191,40
73-ATV5400U	550	70	325	325	140	194,05
73-ATV5500U	700	130	325	325	140	240,55

## Ventilatie-roosters | Serie ATV



### Karakteristieken

De ventilatie-roosters zijn beschikbaar in 5 verschillende maten.

Zijn voorzien van hetzelfde design als de ventilatoren.

Standaard levering in kleur RAL 7035. UL versie op aanvraag.

Bestelnummer	Geschikt voor wanddikte mm	Afmeting			Bruto €/stk
		h	b	d	
73-ATV1000U	1,2 - 2,4	114	114	27	7,75
73-ATV2000U	1,2 - 2,4	150	150	37	9,00
73-ATV3000U	1,2 - 2,4	204	204	37	22,25
73-ATV4000U	1,2 - 2,4	250	250	38	23,70
73-ATV5000U	1,2 - 2,4	325	325	42	32,15

## Kastthermostaat | Serie THR, THV, THRV



### Karakteristieken

Compacte thermostaat, enkel of dubbel. Polyamide PA6

Geschikt voor DIN-rail montage. Thermostatisch bimetaal.

Voorzien van NO of NC contact, THRV heeft 1NO-1NC contact.

Bestelnummer	Omschrijving	Afmeting			Bruto €/stk
		h	b	d	
<b>220V</b>					
73-THR2	NC 0 tot +60°C verwarmen	61	34	35	16,20
73-THV2	NO 0 tot +60°C koelen	61	34	35	16,20
73-THRV13	NC -10/+50°C/NO +20/+80°C	61	53	35	33,25
73-THRV22	NC 0/+60°C/NO 0/+60°C	61	53	35	30,15

## Tekeninghouder | A4



### Karakteristieken

Geschikt voor documenten maximaal A4 formaat.

Ondergrond goed schoonmaken alvorens te bevestigen.

Kleur RAL 7035, andere kleuren op aanvraag.

Bestelnummer	Bevestiging	Afmeting			Bruto €/stk
		h	b	d	
73-ALFATASB	dubbelzijdig tape	264	235	35	5,45



# Alfa Electric

## Schakelkastverlichting

### Kastverlichting | Serie CP22

**Materiaal:** Aluminium profiel, ABS, UL94 V0  
**Beschermklasse:** IP20  
**Temp.bereik:** -20°C tot +50°C  
**Beveiliging:** Klasse I

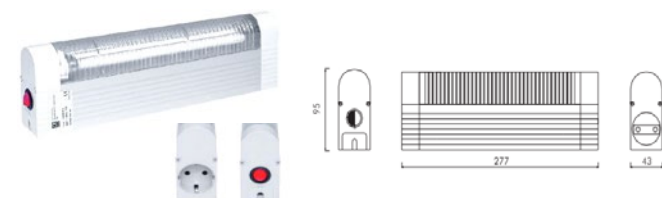

#### Karakteristieken

Diverse bevestigingsmogelijkheden: met clip, magneet, of beugel.  
 Voorzien van hoogrendement fluoriserende lamp.  
 Variabele installatie positie.



Bestelnummer	Voedings spanning	Afmeting			Bruto €/stk
		h	b	l	
<b>met Schuko 6A</b>		<b>50Hz</b>			
73-LAMPSP22+CLIP	220V	95	43	277	<b>78,80</b>
73-LAMPSP22+MAGN	220V	95	43	277	<b>86,00</b>
73-LAMPSP22+STAF	220V	95	43	277	<b>85,25</b>

Bestelnummer	Voedings spanning	Afmeting			Bruto €/stk
		h	b	l	
<b>zonder Schuko</b>		<b>50Hz</b>			
73-LAMPSP22+CLIP	220V	95	43	277	<b>68,80</b>
73-LAMPSP22+MAGN	220V	95	43	277	<b>75,95</b>
73-LAMPSP22+STAF	220V	95	43	277	<b>75,25</b>

### LED Kastverlichting | Serie LEDCP22

**Materiaal:** Aluminium profiel, ABS, UL94 V0  
**Beschermklasse:** IP20  
**Temp.bereik:** -20°C tot +60°C  
**Beveiliging:** Klasse I



#### Karakteristieken

Diverse bevestigingsmogelijkheden: met clip, magneet, of beugel.  
 Voorzien van LED lamp.  
 Variabele installatie positie.

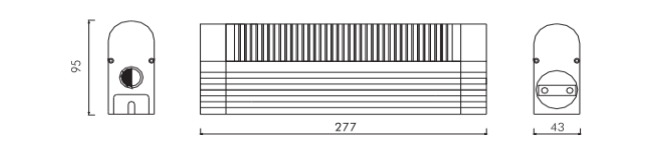

Bestelnummer	Voedings spanning	Afmeting			Bruto €/stk
		h	b	l	
<b>zonder bewegingssensor, met Schuko</b>					
73-LAMPLEDSP22+CLIP	100-240V	95	43	277	<b>111,26</b>
73-LAMPLEDSP22+MAGN	100-240V	95	43	277	<b>118,22</b>
73-LAMPLEDSP22+STAF	100-240V	95	43	277	<b>117,52</b>
<b>zonder bewegingssensor, zonder Schuko</b>					
73-LAMPLEDSP22+CLIP	100-240V	95	43	277	<b>101,52</b>
73-LAMPLEDSP22+MAGN	100-240V	95	43	277	<b>108,48</b>
73-LAMPLEDSP22+STAF	100-240V	95	43	277	<b>107,78</b>

Bestelnummer	Voedings spanning	Afmeting			Bruto €/stk
		h	b	l	
<b>met bewegingssensor, met Schuko</b>					
73-LAMPLEDSP22S+CLIP	100-240V	95	43	277	<b>145,99</b>
73-LAMPLEDSP22S+MAGN	100-240V	95	43	277	<b>152,95</b>
73-LAMPLEDSP22S+STAF	100-240V	95	43	277	<b>152,25</b>
<b>met bewegingssensor, zonder Schuko</b>					
73-LAMPLEDSP22S+CLIP	100-240V	95	43	277	<b>136,25</b>
73-LAMPLEDSP22S+MAGN	100-240V	95	43	277	<b>143,21</b>
73-LAMPLEDSP22S+STAF	100-240V	95	43	277	<b>142,52</b>

### Koppelbare verlichting | Serie LL4

**Materiaal:** Aluminium profiel, ABS, UL94 V0  
**Beschermklasse:** IP20  
**Temp.bereik:** -20°C tot +60°C  
**Beveiliging:** Klasse I



Bestelnummer	Stroom verbruik	Voedings spanning	Afmeting			Bruto €/stk
	W	50Hz	l	b	h	
73-LL44W100-230V	4	100-230V	227	22,8	36	<b>21,00</b>
73-LL49W100-230V	9	100-230V	538	22,8	36	<b>22,50</b>
73-LL413W100-230V	13	100-230V	838	22,8	36	<b>39,00</b>
73-LL418W100-230V	18	100-230V	1138	22,8	36	<b>47,50</b>

#### Binnenkort leverbaar



#### Deurschakelaars



Op zoek naar deurschakelaars?  
 Vraag naar de mogelijkheden van:

**Lovato**  
 electric





# CODEERMATERIAAL

---

9

# Partex markeersysteem

Draad- en kabelcodering, serie PA, PC



## Draadmarkeerders | Serie PA en PC

**Materiaal:** PVC  
**Temp.bereik:** -30°C tot +60°C  
**Kleur:** geel  
**Hittebestendig volgens:** UL94-V0

### Karakteristieken

Alfanumeriek en speciale karakters

## Draadmarkeerders gesloten | Serie PA

**Cijfers:** 0 t/m 9  
**Letters:** A t/m Z  
**Tekens:** + - . : = ↓

**Bestelvoorbeeld**  
 PA02/3 op ROL met codering A  
 46-PA 02/3-r-40/A

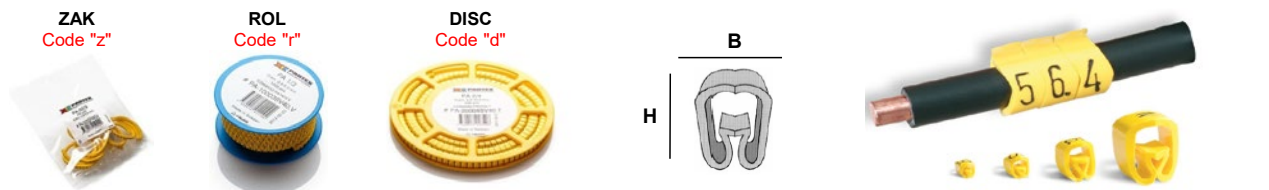

Ø mm	Draad mm <sup>2</sup>	H mm	B mm	Tekst H mm	Lengte mm	Bestelnummer	VPE zak	Brutoprijs €/1000	VPE rol	Brutoprijs €/1000	VPE disc	Brutoprijs €/1000
1,3 - 3,0	0,2 - 1,5	3,6	3,5	2,6	3	46-PA 02/3-* -40/*	5x200	18,40	1000	18,40	500	20,90
2,5 - 5,0	1,5 - 4,0	5,5	4,2	2,6	3	46-PA 1/3-* -40/*	5x200	18,40	1000	18,40	500	20,90
4,0 - 10	2,5 - 16	9,5	6,6	4,0	4	46-PA 2/4-* -40/*	5x100	26,70			250	26,80
8,0 - 16	16 - 70	16,5	11,0	4,0	6	46-PA 3/6-* -40/*	5x20	64,00				

## Teken | L1, L2, L3 per zak

Ø mm	Draad mm <sup>2</sup>	H mm	B mm	Tekst H mm	Lengte mm	Bestelnummer	VPE zak	Brutoprijs €/1000
1,3 - 3	0,2 - 1,5	3,6	3,5	2,6	6	46-PA 02/6-z-40/**	5x200	65,80
2,5 - 5	1,5 - 4,0	5,5	4,2	2,6	6	46-PA 1/6-z-40/**	5x200	31,60
4,0 - 10	2,5 - 16	9,5	6,6	4,0	4	46-PA 2/6-z-40/**	5x100	49,70
8,0 - 16	16 - 70	16,5	11,0	4,0	6	46-PA 3/6-z-40/**	5x20	86,50

### Bestelvoorbeeld

Serie PA 2,5-16mm<sup>2</sup> in ZAK met codering L1  
 46-PA2/6-z-40/L1

## Installatie gereedschap | Serie PAD

**Materiaal:** T = Teflon M = RVS

### Karakteristieken

Vergemakelijkt het coderen van dunne en gestripte draden. Verkort installatietijd.

	Draad mm <sup>2</sup>	L mm	Ø D1	Ø D2	Kleur	Bestelnummer	VPE	Brutoprijs €/stk.
<b>Ontworpen voor montage van</b>								
PA02	0,2-1,5	100	3,1	1,8	rood	46-PAD 3T	1	13,80
PA1	1,5-4,0	100	4,2	2,5	d. blauw	46-PAD 4T	1	13,80
PA02	0,2-1,5	100	3,1	1,8	metaal	46-PAD 3M	1	9,20
PA1	1,5-4,0	100	4,2	2,5	metaal	46-PAD 4M	1	9,20
PA1	1,5-4,0	100	5	2,5	metaal	46-PAD 5M	1	8,60

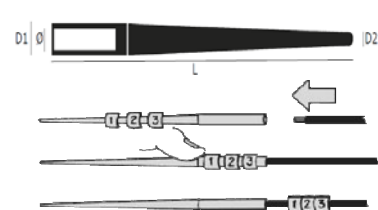

## Draadmarkeerders open | Serie PC

**Cijfers:** 0 t/m 9  
**Letters:** A t/m Z  
**Tekens:** = + - . : L1 L2 L3 ↓

**Bestelvoorbeeld**  
 Serie PC 4 - 5 mm<sup>2</sup> in ZAK met codering L1  
 46-PC40/3-z-L1

Ø mm	Draad mm <sup>2</sup>	H mm	B mm	Tekst H mm	Lengte mm	Bestelnummer zak	VPE zak	Brutoprijs €/1000	Bestelnummer strip	VPE strip	Brutoprijs €/1000
2,4 - 3,0	0,4 - 1,5	3,6	3,7	2,6	3	46-PC10/3-Z-*	5x200	32,50	46-PC10003PV40./.	1000	35,00
3,0 - 4,0	1,5 - 3,0	4,2	4,5	2,6	3	46-PC20/3-Z-*	5x200	34,30	46-PC20003PV40./.	1000	35,00
4,0 - 5,0	3,0 - 4,0	5,5	5,7	2,6	3	46-PC30/3-Z-*	5x200	-	46-PC30003PV40./.	1000	35,00
5,0 - 6,2	4,0 - 5,0	6,7	6,9	4,0	4	46-PC40/4-Z-*	5x200	-	46-PC40003PV40./.	1000	35,00

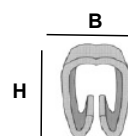

# Partex markeersysteem

Draad- en kabelcodering, serie PO/POZ, PK, PKH



## Draadcodering rondprofiel | Serie PO/POZ

<b>Materiaal:</b>	PO Cadmium en siliconenvrije PVC
	POZ <b>Halogeenvrij Zerex</b>
<b>Temp.bereik:</b>	PO -30°C tot +60°C
	POZ -30°C tot +90°C
<b>Kleuren:</b>	Geel, andere kleuren op aanvraag
<b>Hittebestendig volgens:</b>	UL94-V0

### Karakteristieken

Voor kabeldiameter van 1,3 mm tot 28 mm  
Geschikt voor bedrukking met Promark T-1000 of MK10 printer.  
Op aanvraag bedrukt leverbaar. Op disc geleverd.

Bestelnummer	Ø mm		Area mm <sup>2</sup>	VPE Disc	Brutoprijs PO disc	Brutoprijs POZ disc €/1000
	Min.	Max.				
<b>Voor halogeenvrij PO vervangen door POZ</b>						
46-PO-02000SN4	1,7	2,2	0,5	5 m.	13,75	22,07
46-PO-03000SN4	2,0	2,5	0,75	4,5 m.	13,75	22,07
46-PO-04000SN4	2,2	2,8	1,0	4,5 m.	13,75	22,07
46-PO-05000SN4	2,7	3,5	1,5	4 m.	13,75	22,07
46-PO-06000SN4	3,2	4,0	2,5	3,5 m.	17,20	22,07
46-PO-07000SN4	3,8	4,7	4,0	3,6 m.	17,20	22,07



## Kabelmarkeerders gesloten | Serie PK

<b>Materiaal:</b>	Cadmium en siliconenvrije PVC
<b>Temp.bereik:</b>	-30°C tot +60°C
<b>Kleur:</b>	Geel
<b>Hittebestendig volgens:</b>	UL94-V0

### Karakteristieken

Alfanumeriek en speciale karakters

<b>Cijfers</b>	0 t/m 9	<b>Bestelvoorbeeld</b> Serie PK2/4 in <b>zak</b> met codering A 46-PK2/4- <b>z</b> -40/A Op <b>disc</b> 46-PK2/4- <b>d</b> -40/A
<b>Letters</b>	A t/m Z	
<b>Tekens</b>	= + - . : ↓	



Bestelnummer	B1	B2	Tekst H mm	L mm	Brutoprijs €/1000	VPE zak	VPE disc
	mm	mm					
46-PK2/4- <b>z</b> -40/*	11,3	10,0	4,0	4	21,40	5x100	500

## Houders voor PK coderingen | Serie PKH | Serie POH

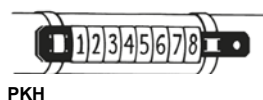

Met verhoogde clip voor snelle montage.

Bestelnummer	L	W	B	VPE	Brutoprijs €/100
	mm	mm	mm		
46-PKH070POL	70	12	9,0	100	26,43
46-PKH110POL	100	12	9,0	100	30,51
46-POH12082AA0	82	8,3	9,5	100	9,19
46-POH018118	110	8,3	9,5	100	o.a.

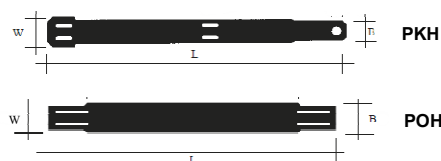

## Kabelcodering RVS | Serie PKS

<b>Materiaal:</b>	RVS AISI
-------------------	----------

**Bestelvoorbeeld**  
Serie PKS codering A  
46-PKS100006A



### Karakteristieken

Alfanumeriek en speciale karakters  
Bestendig tegen hitte, kou, corrosie, chemicaliën etc.

Bestelnummer	B	H	Max. aantal karakters	Omschrijving	VPE	Brutoprijs €/100
	mm	mm				
46-PKS-10/6-Z-*	10,9	5,5		teken	50	14,37
46-PKS-10040FQS	47	10,3	6	houder	50	49,53
46-PKS10060FQ	65	10,3	9	houder	50	o.a.
46-PKS10080FQ	87	10,3	13	houder	50	o.a.
46-PKS10100FQ	109	10,3	17	houder	50	o.a.
46-PKS10120FQ	128	10,3	20	houder	50	o.a.

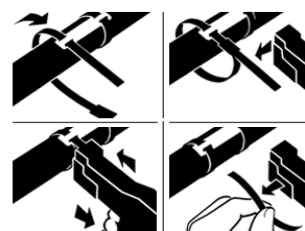

# Partex markeersysteem

RVS codering, RVS bundelbanden, printers



## Kabelcodering RVS | Serie PKS custom made

Materiaal: RVS AISI

Bestelnummer	L mm	W mm	Max. aantal karakters	Aantal regels
46-PKS-10040S	47	10,3	8	1
46-PKS-10060S	65	10,3	13	1
46-PKS-10080S	87	10,3	19	1
46-PKS-10100S	108	10,3	25	1
46-PKS-10120S	128	10,3	30	1
46-PKS-12040S	47	10,3	22	2
46-PKS-12060S	65	10,3	36	2
46-PKS-12080S	87	10,3	54	2
46-PKS-12100S	108	10,3	70	2
46-PKS-12120S	128	10,3	86	2

op aanvraag leverbaar

### Karakteristieken

Voorbedrukt volgens specificatie

1 of 2 regels, dikte 0,3 mm

Bestendig tegen hitte, kou, corrosie, chemicaliën etc.



## Kabelbanden RVS | Serie PKS

Bestelnummer	B mm	L mm	VPE
46-PKS46150AN16	4,6	150	100
46-PKS46150AN16C	4,6	150	100
46-PKS46200AN16	4,6	200	100
46-PKS46200AN16C	4,6	200	100
46-PKS46360AN16	4,6	360	100
46-PKS46360AN16C	4,6	360	100

op aanvraag leverbaar



C = gecoated staal



## Printers en accessoires | Mk 10, T1000, EOS1

Bestelnummer	Omschrijving	VPE
MK 10 thermo transferprinter		
46-MK10-KIT1	printer	1
46-MK10-CU	snij unit	1
46-MK10-RB*****	lint	300 m

op aanvraag leverbaar

Bestelnummer	Omschrijving	VPE
T1000 thermo transferprinter		
46-T100-KIT1	printer	1
46-T1000-CU	snij unit	1
46-T1000-RB-white	wit lint	85 m
46-T1000-RB-black	zwart lint	100 m

op aanvraag leverbaar

Bestelnummer	Omschrijving	VPE
EOS1 thermo transferprinter		
46-EOS1	printer	1
MK10-RB-*****	lint	300m

op aanvraag leverbaar



Kleine tafelprinter voor draad-, kabel- en componentencodering.



# Märko markeersysteem

Draad- en kabelcoderingen



## Component coderingen op kaarten | Cijfers, letters en speciale tekens

**Materiaal:** Acryl MT80  
Halogeenvrij

**Kleur:** Geel met zwart opschrift

**Karakteristieken**  
Labels op kaarten  
10 Kaarten per verpakking

### Bestelnummer aanvullen met afmetingen

- 45 6x 9 = 144 labels per kaart
- 47 9x13 = 72 labels per kaart
- 38 13x13 = 54 labels per kaart (geen letters & cijfers)
- 49 14x19 = 32 labels per kaart
- 51 19x38 = 12 labels per kaart
- 55 38x88 = 6 labels per kaart

### Bestelvoorbeeld

A afmeting 6x9  
35-45012

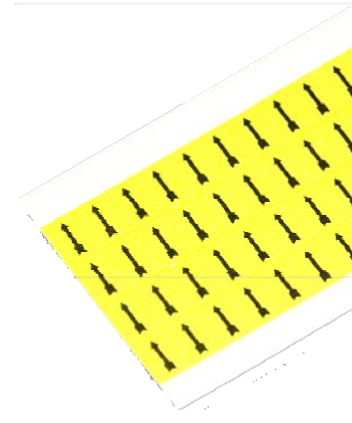
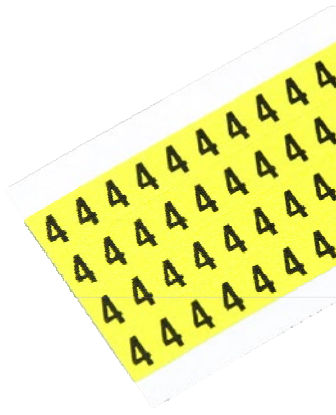

Symbol	Bestelnr.	Brutoprijs €/VPE	Symbol	Bestelnr.	Brutoprijs €/VPE	Symbol	Bestelnr.	Brutoprijs €/VPE	Symbol	Bestelnr.	Brutoprijs €/VPE
A	35-**012	16,50	N	35-**142	15,00	0	35-**402	16,50	-	35-**512	16,50
B	35-**022	16,50	O	35-**152	15,00	1	35-**412	16,50	+	35-**522	16,50
C	35-**032	16,50	P	35-**162	15,00	2	35-**422	16,50	aarde	35-**542	16,50
D	35-**042	16,50	Q	35-**172	15,00	3	35-**432	16,50	pijl	35-**532	16,50
E	35-**052	16,50	R	35-**182	15,00	4	35-**442	16,50	blanco	35-**552	16,50
F	35-**062	16,50	S	35-**192	15,00	5	35-**452	16,50			
G	35-**072	16,50	T	35-**202	15,00	6	35-**462	16,50			
H	35-**082	16,50	U	35-**212	15,00	7	35-**472	16,50			
I	35-**092	16,50	V	35-**222	15,00	8	35-**482	16,50			
J	35-**102	16,50	W	35-**232	15,00	9	35-**492	16,50			
K	35-**112	16,50	X	35-**242	15,00	0 t/m 9	35-**992	16,50			
L	35-**122	16,50	Y	35-**252	15,00						
M	35-**132	16,50	Z	35-**262	15,00						

Symbol	Bestelnr.	9x13	13x13	14x19	19x38	38x38	Brutoprijs €/VPE
Aarde omcirkeld			35-38372				16,50
Aarde			35-38392				16,50
Bliksem	35-47562			35-49562	35-51563	35-55562	16,50
L1	35-38012	35-38112	35-38172				16,50
L2	35-38022	35-38122	35-38182				16,50
L3	35-38032	35-38132	35-38192				16,50
PE		35-38272		35-38312			16,50
PEN		35-38292		35-38322			16,50

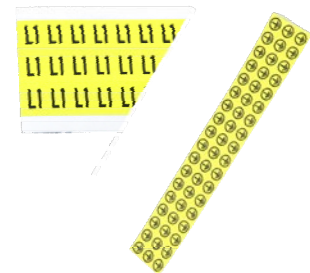

### Bliksem in driehoek

Formaat	Aantal per kaart	Bestelnr.	Brutoprijs €/VPE
13x13x13	54	35-38352	16,50
25x25x25	14	35-38872	19,25
50x50x50	7	35-38882	27,60
100x100x100	3	35-38902	36,40
200x200x200	1	35-38912	63,00



# Märko markeersysteem

Component codering, kabelcodering



## Component coderingen | In boekjes

**Materiaal:** Acryl MT70

Halogeenvrij

**Kleur:** Geel met zwart opschrift

Zilver met zwart opschrift

**Karakteristieken**

Labels in boekjes

10 Bladen per boekje. 1 Boekje per VPE



Symbol	Bestelnr.	6x9	9x13	9x19	14x14	14x19	Brutoprijs €/VPE
0-9		35-42517	35-42557			35-42597	16,50
A-Z			35-42537			35-42577	16,50
1-48					35-42617		16,50
49-96					35-42637		16,50
CE polyester					35-42307		16,50
CE polyester zilver					35-42295		16,50
Aarde cirkel					35-42857		16,50

## Kabel coderingen op kaarten | Zelfklevend

**Materiaal:** Acryl MT80

Halogeenvrij

**Kleur:** Wit met zwart opschrift

**Afmeting:** 6,5x38

**Karakteristieken**

Voor kabels Ø 4 - 14 mm

10 Kaarten per verpakking

36 Symbolen per kaart



Symbol	Bestelnr.	Brutoprijs €/VPE	Symbol	Bestelnr.	Brutoprijs €/VPE	Symbol	Bestelnr.	Brutoprijs €/VPE	Symbol	Bestelnr.	Brutoprijs €/VPE
A	35-33612	16,50	N	35-33742	16,50	0	35-33002	16,50	34/66	35-33922	16,50
B	35-33622	16,50	O	35-33752	16,50	1	35-33012	16,50	67/99	35-33932	16,50
C	35-33632	16,50	P	35-33762	16,50	2	35-33022	16,50	-	35-33512	16,50
D	35-33642	16,50	Q	35-33772	16,50	3	35-33032	16,50	+	35-33522	16,50
E	35-33652	16,50	R	35-33782	16,50	4	35-33042	16,50	aarde	35-33532	16,50
F	35-33662	16,50	S	35-33792	16,50	5	35-33052	16,50	blanco	35-33592	16,50
G	35-33672	16,50	T	35-33802	16,50	6	35-33062	16,50	L1	35-33542	16,50
H	35-33682	16,50	U	35-33812	16,50	7	35-33072	16,50	L2	35-33552	16,50
I	35-33692	16,50	V	35-33822	16,50	8	35-33082	16,50	L3	35-33562	16,50
J	35-33702	16,50	W	35-33832	16,50	9	35-33092	16,50	PE	35-33882	16,50
K	35-33712	16,50	X	35-33842	16,50	AZ, 0/9	35-33902	16,50	PEN	35-33892	16,50
L	35-33722	16,50	Y	35-33852	16,50	0/9	35-33992	16,50	/	35-33872	16,50
M	35-33732	16,50	Z	35-33862	16,50	1/33	35-33912	16,50			

## Kabel coderingen op rol | Dispenser



**Karakteristieken**

Geschikt voor alle diameters

1 Dispenser bevat 10 rollen van 5 mm. breed tape, lengte 2,4 mtr.

470 Symbolen per rol

Dispenser	Bestelnummer	Brutoprijs €/VPE
leeg	35-30859	17,70
0/9	35-30809	30,65



# Märko markeersysteem

Kabelcodering op rol, op kaarten, printerlabels



## Kabel codering op rol | Navulling

**Materiaal:** Vinyl MT101  
Halogeenvrij  
**Kleur:** Wit met zwart opschrift

**Karakteristieken**  
10 rollen per verpakking  
470 Symbolen per rol



Symbol	Bestelnr.	Brutoprijs €/VPE	Symbol	Bestelnr.	Brutoprijs €/VPE	Symbol	Bestelnr.	Brutoprijs €/VPE	Symbol	Bestelnr.	Brutoprijs €/VPE
A	35-30017	16,00	M	35-30137	16,00	Y	35-30257	16,00	0-9	35-30817	16,00
B	35-30027	16,00	N	35-30147	16,00	Z	35-30267	16,00	-	35-30527	16,00
C	35-30037	16,00	O	35-30157	16,00	0	35-30407	16,00	+	35-30507	16,00
D	35-30047	16,00	P	35-30167	16,00	1	35-30417	16,00	aarde	35-30547	16,00
E	35-30057	16,00	Q	35-30177	16,00	2	35-30427	16,00	blanco	35-30537	16,00
F	35-30067	16,00	R	35-30187	16,00	3	35-30437	16,00	L1	35-30567	16,00
G	35-30077	16,00	S	35-30197	16,00	4	35-30447	16,00	L2	35-30587	16,00
H	35-30087	16,00	T	35-30207	16,00	5	35-30457	16,00	L3	35-30607	16,00
I	35-30097	16,00	U	35-30217	16,00	6	35-30467	16,00	PE	35-30617	16,00
J	35-30107	16,00	V	35-30227	16,00	7	35-30477	16,00	PEN	35-30627	16,00
K	35-30117	16,00	W	35-30237	16,00	8	35-30487	16,00	/	35-30557	16,00
L	35-30127	16,00	X	35-30247	16,00	9	35-30497	16,00			

## Kabel coderingen op kaarten | Zelfklevend

**Materiaal:** Vinyl MT304

**Karakteristieken**

Voor markering met pen.  
Het transparante vinyl beschermt de tekst tegen  
vuil en olie.  
10 Bladen per boekje. 10 boekjes per VPE.



Maat	Kleur	Bestelnr.	Schrijfruimte	Aantal symbolen per boekje	Brutoprijs €/VPE
25x75	wit	35-42017	25x19 mm	60	90,00
25x75	geel	35-42037	25x19 mm	60	90,00
25x150	wit	35-42057	25x25 mm	30	90,00
25x150	geel	35-42077	25x25 mm	30	90,00

## Laserprint labels | Write on

**Materiaal:** Polyester MT 310

**Karakteristieken**

**Kleur:** Geel en wit

10 A4 vellen per verpakking

Maat b x h mm	Print ruimte	Bestelnr. geel	Bestelnr. wit	Aantal per labels vel	Brutoprijs €/VPE
15x55	15x13	35-24477	35-24487	65	44,50
15x70	15x17	35-24437	35-24537	52	44,50
15x84	15x36	35-24327	35-24527	39	44,50
15x125	15x34	35-24377	35-24577	26	44,50
15x140	15x7	35-24387	35-24587	26	44,50
15x230	15x64	35-24347	35-24547	13	44,50
15x280	15x82	35-24357	35-24557	13	44,50
17,8x34	17,8x13	35-24107	35-24507	88	44,50
22,8x55	22,8x13	35-24207	35-24607	40	44,50
24x93	24x25	35-24417	35-24817	24	44,50
25x37	25x13	35-24497	35-24897	56	44,50
25,4x57	25,4x18	35-24447	35-24847	35	44,50
25,4x68	25,4x18	35-24307	35-24707	28	44,50
25,4x95	25,4x25,4	35-24457	35-24857	21	44,50
25,4x139,7	25,4x25,4	35-24427	35-24827	16	44,50
35,5x93	35,5x25	35-24407	35-24807	12	44,50
47x34	47x13	35-24367	35-24567	32	44,50

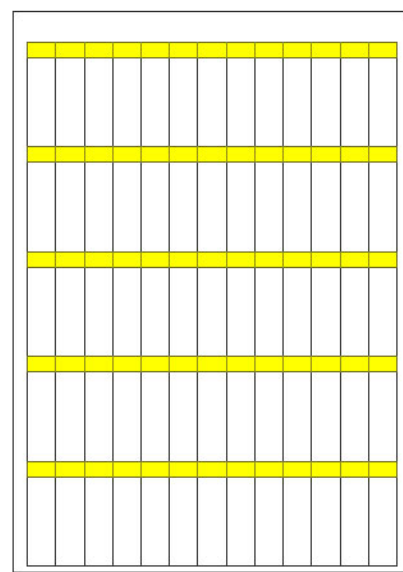

# Märko markeersysteem

## Printerlabels



### Laserprint labels

**Materiaal:** Polyester MT 300

**Kleur:** Geel, wit en zilver

**Karakteristieken**

10 A4 vellen per verpakking

geel = 20  
zilver = 21  
wit = 22

**Bestelvoorbeeld**  
geel 35-20167

Maat b x h mm	Bestelnr.	Aantal labels per vel	Brutoprijs €/VPE
15x4,63	35-**167	627	44,50
15x6	35-**037	484	44,50
17x6	35-**177	440	44,50
17x9	35-**047	290	44,50
18x6,5	35-**117	320	44,50
19x6,3	35-**207	256	44,50
20x8	35-**067	264	44,50
25,4x12,7	35-**187	147	44,50
26x10	35-**077	156	44,50
30x20	35-**087	78	44,50
40x6	35-**127	176	44,50
40x30	35-**217	36	44,50
56x22	35-**387	36	44,50
60x36	35-**437	21	44,50
105x148	35-**137	4	44,50
210x148	35-**157	2	44,50
210x297	35-**987	1	44,50

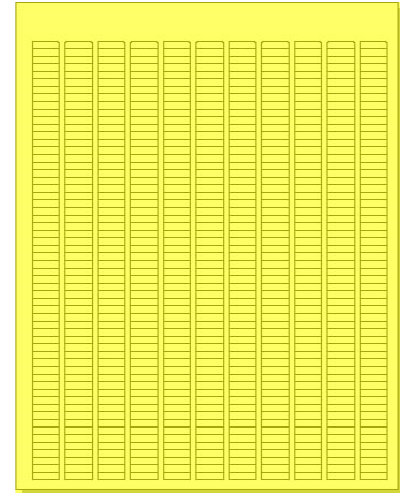



**GEREEDSCHAP**

---

**10**

# Voor verwerking van adereindhulzen

## Krimptang | CAE 0116

**Bestelnr. 15-CAE0116**

Voor adereindhulzen	enkel	0,14 - 16	mm <sup>2</sup>
	twin	nvt	

Krimpbreedte 13mm, trapezium  
Gewicht: 290 g

€ 60,80

netto per stuk



## Krimptang | CAE 0260 (met veiligheidskoppel)

**Bestelnr. 15-CAE0260**

Voor adereindhulzen	enkel	0,14 - 6,0	mm <sup>2</sup>
		26 - 10	AWG
	twin	2x0,5 - 2x2,5	mm <sup>2</sup>

Krimpbreedte 18mm, trapezium  
Gewicht: 485 g

€ 93,15

netto per stuk



## Krimptang | CAE 0210 (met veiligheidskoppel)

**Bestelnr. 15-CAE0210**

Voor adereindhulzen	enkel	0,06 - 10,0	mm <sup>2</sup>
	twin	2x0,5 - 2x4,0	mm <sup>2</sup>
		26 - 8	AWG

Krimpbreedte 13mm, vierkant  
Gewicht: 290 g

€ 116,85

netto per stuk



## Krimptang | CAE 1016 (met veiligheidskoppel)

**Bestelnr. 15-CAE1016**

Voor adereindhulzen	enkel	2,5 - 16	mm <sup>2</sup>
	twin	2x1,5 - 2x6	mm <sup>2</sup>
		8 - 6	AWG

Krimpbreedte 13mm, vierkant  
Gewicht: 290 g

€ 114,10

netto per stuk



## Krimptang | CRS 0110/6 (met veiligheidskoppel)

**Bestelnr. 15-CRS0110/6**

Voor adereindhulzen	enkel	0,08 - 10,0	mm <sup>2</sup>
	twin	2x0,5 - 2x2,5	mm <sup>2</sup>
		28 - 7	AWG

Krimpbreedte 13mm, zeskant  
Gewicht: 410 g

€ 117,90

netto per stuk



## Krimptang | CRS 0116 (met veiligheidskoppel)

**Bestelnr. 15-CRS0116**

Voor adereindhulzen	enkel	0,06 - 10,0	mm <sup>2</sup>
	twin	2x0,5 - 2x4,0	mm <sup>2</sup>
		28 - 5	AWG

Krimpbreedte 13mm, vierkant  
Gewicht: 410 g

€ 118,40

netto per stuk



## Krimptang | CPZ6-ROTO

**Bestelnr. 15-CPZ6-ROTO**

Voor adereindhulzen	enkel	0,14 - 6,0	mm <sup>2</sup>
	twin	2x0,5 - 2x2,5	mm <sup>2</sup>
		26 - 10	AWG

Krimpbreedte mm, trapezium  
Gewicht: 427 g

€ 200,65

netto per stuk

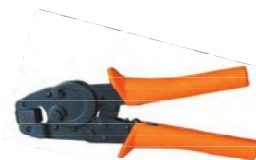

## Krimptang | CPZ16

**Bestelnr. 15-CPZ16**

Voor adereindhulzen	enkel	6,0 - 16,0	mm <sup>2</sup>
	twin	nvt	mm <sup>2</sup>
		10 - 6	AWG

Krimpbreedte mm, indent  
Gewicht: 418 g

€ 186,80

netto per stuk

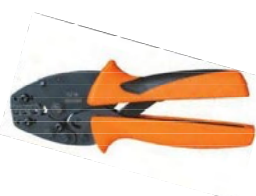

# Voor verwerking van adereindhulzen

## Krimptang | CEB 0560

### Bestelnr. 15-CEB0560

Voor adereindhulzen	enkel	0,5 - 6,0	mm <sup>2</sup>
		24 - 10	AWG
	twijn	2x0,5 - 2x2,5	mm <sup>2</sup>

Krimpbreedte 10mm, trapezium  
Gewicht: 360 g

€ 111,50  
netto per stuk



## Krimptang | CPZ 3 (met veiligheidskoppel)

### Bestelnr. 15-CPZ3

Voor adereindhulzen	enkel	0,50 - 6,0	mm <sup>2</sup>
		20 - 10	AWG
	twijn	2x0,5 - 2x2,5	mm <sup>2</sup>

Krimpbreedte 18mm, trapezium  
Gewicht: 485 g

€ 105,65  
netto per stuk



## Krimptang | CEB0160S (met veiligheidskoppel)

### Bestelnr. 15-CEB0160S

Voor adereindhulzen	enkel	0,14 - 6,0	mm <sup>2</sup>
	twijn	2x0,5 - 2x4	mm <sup>2</sup>
		26 - 10	AWG

Krimpbreedte 12mm, vierkant  
Gewicht: 368 g

€ 172,80  
netto per stuk



## Krimptang | CEB1025 (met veiligheidskoppel)

### Bestelnr. 15-CEB1025

Voor adereindhulzen	enkel	10 - 25	mm <sup>2</sup>
	enkel	8 - 4	AWG

Krimpbreedte 14mm, WM-krimp  
Gewicht: 515 g

€ 130,35  
netto per stuk



## Krimptang | CEB 3550 (met veiligheidskoppel)

### Bestelnr. 15-CEB3550

Voor adereindhulzen	enkel	35 - 50	mm <sup>2</sup>
	enkel	2 - 1	AWG

Krimpbreedte 18mm, WM-krimp  
Gewicht: 510 g

€ 132,05  
netto per stuk



## Krimptang | CEB 4010TWIN (met veiligheidskoppel)

### Bestelnr. 15-CEB4010TWIN

Voor adereindhulzen	twijn	2x4 - 2x10	mm <sup>2</sup>
	twijn	2x12 - 2x8	AWG

Krimpbreedte 14mm, trapezium  
Gewicht: 410 g

€ 155,65  
netto per stuk



## UL-Certificering

GLW Crimping Technology is gevestigd in het Duitse Kieslegg en is gespecialiseerd in ontwikkeling, productie en assemblage van adereindhulzen, gereedschap en machines.

DE CEBxxxx tangen zijn geschikt voor toepassing in combinatie met de adereindhulzen van GLW uit hoofdstuk 3. De hulzen zijn UL gecertificeerd en met verwerking van bovenstaand gereedschap UL certified conform E-file E485383



# Voor verwerking van adereindhulzen

## geïsoleerde kabelschoenen

### Strip- krimptang | CAP 2 (met veiligheidskoppel)

**Bestelnr. 15-CAP2**

Voor adereindhulzen(strips)	enkel	0,5 - 2,5	mm <sup>2</sup>
Voor strippen		0,5 - 2,5	mm <sup>2</sup>

Krimpbreedte 8mm, trapezium  
Gewicht: 250 g

€ 160,65  
netto per stuk



### Krimptang pneumatisch | AC25 - AC25 SQ

**Bestelnr. 15-AC25**

krimpvorm: trapezium

Voor adereindhulzen	enkel	0,14 - 2,5	mm <sup>2</sup>
		26 -14	AWG

**Bestelnr. 15-AC25SQ**

krimpvorm: vierkant

Voor adereindhulzen	enkel	0,14 - 2,5	mm <sup>2</sup>
---------------------	-------	------------	-----------------

Gewicht: 400 g

€ 254,80  
netto per stuk

o.a.  
netto per stuk



### Krimptang pneumatisch | AC25T

**Bestelnr. 15-AC25T**

Voor adereindhulzen	enkel	0,14 - 2,5	mm <sup>2</sup>
		26 -14	AWG
	twin	nvt	mm <sup>2</sup>

Krimpvorm: trapezium  
Gewicht: 1000 g

tafelmodel

€ 337,95  
netto per stuk



### Krimptang pneumatisch | AC100

**Bestelnr. 15-AC100**

Voor adereindhulzen	enkel	4,0 - 10	mm <sup>2</sup>
		12 - 8	AWG
	twin	nvt	mm <sup>2</sup>

Krimpvorm: trapezium  
Gewicht: 400 g

€ 357,48  
netto per stuk



### Krimptang pneumatisch | AC100T

**Bestelnr. 15-AC100T**

Voor adereindhulzen	enkel	4,0 - 10	mm <sup>2</sup>
		12 - 8	AWG
	twin	nvt	mm <sup>2</sup>

Krimpvorm: trapezium  
Gewicht: 1000 g

tafelmodel

€ 447,46  
netto per stuk



### Krimptang | CSA 0760 (met veiligheidskoppel)

**Bestelnr. 15-CSA0760**

Voor geïsoleerde kabelschoenen		0,5 - 6,0	mm <sup>2</sup>
--------------------------------	--	-----------	-----------------

Krimpvorm: symmetrisch  
Gewicht: 500 g

kalibreren met 15-CSASQ0760

€ 117,55



### Testkaliber | CSAQ 0760

**Bestelnr. 15-CSAQ0760**

Grip Ø8mm

Eenvoudig in gebruik

Voorzien van GO en NO GO positie

Levering in handige kunststof box

Gewicht: 240 g

o.a.  
netto per stuk



### Krimptang | CSA 0560 (met veiligheidskoppel)

**Bestelnr. 15-CSA0560**

Voor geïsoleerde kabelschoenen		0,5 - 6,0	mm <sup>2</sup>
--------------------------------	--	-----------	-----------------

Krimpvorm: symmetrisch  
Gewicht: 475 g

€ 72,20  
netto per stuk



# Voor verwerking van adereindhulzen

Enkel: 0,25-240mm<sup>2</sup>, Twin: 0,5-16mm<sup>2</sup>

## Krimptang | C 0225

### Bestelnr. 15-C0225

Voor adereindhulzen	enkel	0,25 - 2,5 24 - 14	mm <sup>2</sup> AWG
	twin	2x0,5 - 2x1,5	

Krimpbreedte 9mm, trapezium  
Gewicht: 160 g

€ 22,20  
netto per stuk



## Krimptang | C 0516

### Bestelnr. 15-C0516

Voor adereindhulzen	enkel	0,25 - 16 24 - 6	mm <sup>2</sup> AWG
	twin	2x0,5 - 2x6,0	mm <sup>2</sup>

Krimpbreedte 8mm, trapezium  
Gewicht: 315 g

€ 32,00  
netto per stuk



## Krimptang | CAE 0816

### Bestelnr. 15-CAE0816

Voor adereindhulzen	enkel	0,08 - 16 28 - 5	mm <sup>2</sup> AWG
---------------------	-------	---------------------	------------------------

Gewicht: 500 g

€ 95,65  
netto per stuk



## Krimptang | CK28 (met veiligheidskoppel)

### Bestelnr. 15-CK28

Voor adereindhulzen	enkel	10 - 50 8 - 1/0	mm <sup>2</sup> AWG
	twin	2x4 - 2x16	mm <sup>2</sup>

Krimpbreedte 12mm, trapezium  
Gewicht: 368 g

€ 193,35  
netto per stuk



## Krimptang | CK 29 (met veiligheidskoppel)

### Bestelnr. 15-CK29

Voor adereindhulzen	enkel	50 - 95 1/0 - 3/0	mm <sup>2</sup> AWG
---------------------	-------	----------------------	------------------------

Krimpbreedte 12mm, trapezium  
Gewicht: 870 g

€ 193,90  
netto per stuk



## Krimptang | CS70150

### Bestelnr. 15-CS70150

Voor adereindhulzen	enkel	70 - 150 2/0 - 300 MCM	mm <sup>2</sup> AWG
---------------------	-------	---------------------------	------------------------

Krimpbreedte 32mm, trapezium  
Gewicht: 2300 g

Te gebruiken in bankschroef

€ 358,45  
netto per stuk



## Krimptang | CE 240

### Bestelnr. 15-CE240

Voor adereindhulzen	enkel	25 - 240 4 - 500 MCM	mm <sup>2</sup> AWG
---------------------	-------	-------------------------	------------------------

Krimpbreedte 30mm, trapezium  
Gewicht: 3820 g

Krimpmatrijzen niet inbegrepen

€ 389,55  
netto per stuk



## Krimpmatrijzen | tbv CE 240

### Bestelnummer

15-CE E2535  
15-CE E50  
15-CE E70  
15-CE E95  
15-CE E120  
15-CE E150  
15-CE E185  
15-CE E240

netto per stuk  
68,45  
68,45  
68,45  
69,45  
69,45  
69,45  
68,45  
110,45

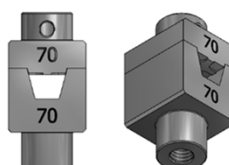

# Voor knippen en strippen van draad en kabel

Draad en kabel: 0,08-500mm<sup>2</sup>

## Kabelschaar | CKS 16

**Bestelnr. 15-CKS16**

Voor draad en kabel  
0,08 - 16 mm<sup>2</sup>  
28 - 6 AWG  
max. Ø 10 mm

Geschikt voor zowel aluminium als koper  
Gewicht: 120 g

€ 12,50  
netto per stuk



## Kabelschaar | CKS 50

**Bestelnr. 15-CKS50**

Voor draad en kabel  
0,08 - 50 mm<sup>2</sup>  
28 - 1/0 AWG  
max. Ø 15 mm

Geschikt voor zowel aluminium als koper  
Gewicht: 240 g

€ 36,75  
netto per stuk

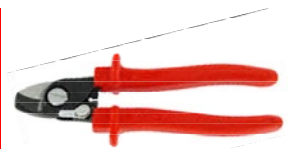

## Kabelschaar | CKS 70

**Bestelnr. 15-CKS70**

Voor draad en kabel  
0,08 - 70 mm<sup>2</sup>  
28 - 2/0 AWG  
max. Ø 20 mm

Geschikt voor zowel aluminium als koper  
Gewicht: 340 g

€ 43,05  
netto per stuk



## Kabelschaar | CKS 340

**Bestelnr. 15-CKS340**

Voor draad en kabel  
Meeraderige kabel  
0,08 - 300 mm<sup>2</sup>  
max. Ø 34 mm  
Enkel aderig koper  
max. Ø 25 mm  
Enkel aderig aluminiums  
max. Ø 15 mm

Gewicht: 660 g

€ 135,45  
netto per stuk



## Kabelschaar | CKS 620

**Bestelnr. 15-CKS620**

Voor draad en kabel  
0,08 - 500 mm<sup>2</sup>  
28 - 1000 MCM AWG

Gewicht: 660 g

€ 240,60  
netto per stuk



## Striptang | ODEN

**Bestelnr. 15-ODEN**

Voor verwijderen van isolatie  
Kerfdiepte instelbaar  
Ø 2,5 - 11 mm  
Striplengte niet instelbaar

Gewicht: 50 g

€ 22,60  
netto per stuk



## Striptang | CA 400

**Bestelnr. 15-CA400**

Instelbare messen voor isolatie  
Ontmantelen van kabel  
max. Ø 4,0 mm  
Ø 4,5 - 40 mm  
Stripfuncties: rond, langs, spiraal

Gewicht: 150 g

€ 51,52  
netto per stuk



## Hydraulische kabelschaar | ASEM40

**Bestelnr. 90JB-ASEM40**

Voor draad en kabel  
Knipkracht  
Accu laadtijd  
Gewicht: 2,8 kg  
max. Ø 40 mm  
30 kN  
30 minuten

€ 1.799,15  
netto per stuk





# Voor knippen en strippen van draad en kabel

Draad en kabel: 0,08-16mm<sup>2</sup>

## Striptang | CAT 6

### Bestelnr. 15-CAT6

Strippen PVC isolatie	0,08 - 6,0	mm <sup>2</sup>
Knippen draad soepel	max. 6,0	mm <sup>2</sup>
Knippen draad massief	max. 4,0	mm <sup>2</sup>
Stripmessen: recht parallel		
Gewicht: 200 g		

€ 56,10

netto per stuk



## Striptang | CAT 16

### Bestelnr. 15-CAT16

Voor draad en kabel	6 - 16	mm <sup>2</sup>
Voor kabeldiameter	2,9 4,2	mm
Striplengte	18	mm
Stripmessen: ovaal		
Gewicht: 240 g		

€ 80,20

netto per stuk



## Strip- en kniptang | CA 10

### Bestelnr. 15-CA10

PVC isolatie strippen	0,02 - 10	mm <sup>2</sup>
Knippen flexibele geleiders	max. 17	mm
Striplengte	17	mm
Stripmessen: recht parallel		
Gewicht: 184 g		

€ 61,35

netto per stuk



## Strip- en kniptang | CA 16

### Bestelnr. 15-CA16

Voor draad en kabel (PVC)	4 - 16	mm <sup>2</sup>
Knippen flexibele geleiders	tot 10	mm <sup>2</sup>
Strippen (instelbaar)	3 - 18	mm
Stripmessen: ovaal		
Gewicht: 135 g		

€ 102,55

netto per stuk



## Striptang | CA 4TS

### Bestelnr. 15-CA4TS

Voor stuggere, harde isolatie	0,1 - 4	mm <sup>2</sup>
	28 - 12	AWG
Messeninzet: kleur blauw		
Stripmessen: V-vorm		
Gewicht: 136 g		

€ 62,90

netto per stuk



## Striptang | CA 6

### Bestelnr. 15-CA6

Voor verwijderen van isolatie	0,08 - 6	mm <sup>2</sup>
	∅ 0,32 - 3,5	mm
Striplengte niet instelbaar	25	mm
Kerfdiepte instelbaar		
Gewicht: 225 g		

€ 96,50

netto per stuk



## Striptang | CAR 10

### Bestelnr. 15-CAR10

Instelbare messen voor isolatie	0,03 - 10	mm <sup>2</sup>
Ontmantelen van kabel		
Meswissel zonder gereedschap		
Gewicht: 245 g		

€ 94,30

netto per stuk



## Striptang | MULTISTRIP 16

### Bestelnr. 15-MULTISTRIP 16

Zelfinstellende messen voor isolatie	0,08 - 16	mm <sup>2</sup>
Ontmantelen van kabel		
Zonder beschadiging strippen door instelbare inkerfdiepte		
Gewicht: 200 g		

€ 81,46

netto per stuk



# Voor verwerking van bundelbanden, tulen, diversen

## Knikschroefmachines, montagetangen, 3-puntstangen

### Knikschroefmachine | EY7410LA2S

**Bestelnr. 54-EY7410LA2S**

Schroeven in metaal M5 x 8 mm  
 21 momentinstellingen  
 1/4"-zeskant-snelsluitkoppeling  
 Accu laadtijd (vol) 30 minuten  
 Gewicht: 500 g Incl. 2x accu en koffer

€ 215,00  
netto per stuk



### Schroef/boormachine | EY74A3 (18V)

**Bestelnr. 54-EY74A3X**

zonder accu en koffer  
 Snelspanboorkop Ø 1,5 - 13 mm  
 Koppelingskoppel 0,5 - 4,4 Nm

netto per stuk  
o.a.



**Bestelnr. 54-EY74A3PN2G**

3,0 Ah (PN type) incl. 2x accu, lader, koffer

o.a.

**Bestelnr. 54-EY74A3LJ2G**

5,0 Ah (LJ type) incl. 2x accu, lader, koffer

o.a.

### Aantrektang voor kunststof banden | CT3010

**Bestelnr. 95-CT3010**

Voor kunststof bundelbanden 2,2 - 4,8 mm

€ 40,00  
netto per stuk



Gewicht: 310 g

### Montagetang voor kunststof banden | ERG 50

**Bestelnr. 90-ERG50**

Voor kunststof bundelbanden 2,4 - 4,8 mm

€ 188,88  
netto per stuk



Gewicht: 240 g

treksterkte van 80 tot 220N

### Montagetang voor kunststof banden | ERG 120

**Bestelnr. 90-ERG120**

Voor kunststof bundelbanden 4,8 - 7,6 mm

€ 223,07  
netto per stuk



Gewicht: 278 g

treksterkte van 220 tot 540N

### 3-puntstang | KP-2

**Bestelnr. 65-04100134000**

Voor tulen A1, A2, A3

robuste constructie  
 ergonomische vorm  
 handige bedieningshendel  
 Gewicht: 120 g

geschikt voor kabels tot Ø9mm

€ 80,66  
netto per stuk



### 3-puntstang | KP-3

**Bestelnr. 65-04100135000**

Voor tulen A2, A3, A4, A5

robuste constructie  
 ergonomische vorm  
 handige bedieningshendel  
 Gewicht: 123 g

geschikt voor kabels tot Ø15mm

€ 80,66  
netto per stuk



### 3-puntstang | KP-4

**Bestelnr. 65-04100145000**

Voor tulen A5, A8, A9, A10

robuste constructie  
 ergonomische vorm  
 handige bedieningshendel  
 Gewicht: 149 g

geschikt voor kabels tot Ø28mm

€ 96,78  
netto per stuk



Overige Panasonic producten op aanvraag

# Voor verwerking van bedradingskoker en DIN-EN rail

## Kniptangen en -scharen, profielknippers

### Uitsnij- of kniptang | CAK20L

**Bestelnr. 15-CAK20L**

Voor bedradingskoker 20 mm  
Wegsnijden van lamellen

€ 47,95  
netto per stuk

Gewicht: 438 g

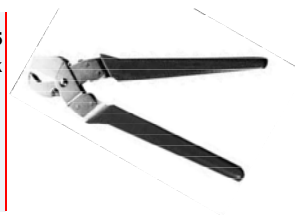

### Slaggereedschap | 7817-1

**Bestelnr. 33-7817-1**

Voor spreidnieten ∅ 3,5 - 5 - 6 mm

€ 67,80  
netto per stuk

Gewicht: 153 g



### Knipschaar | 3606/HU

**Bestelnr. 90-3606/HU**

Voor bedradingskoker max. 75 mm  
Rechthoekig knippen in hard plat kunststof

€ 111,90  
netto per stuk

Gewicht: 415 g



### Knipschaar | 5504

**Bestelnr. 90-5504**

Voor het knippen van kunststof slang max. 28 mm

€ 50,50  
netto per stuk

Gewicht: 270 g



### Knipapparaat | DC 125

**Bestelnr. 15-DC-125**

Voor bedradingskoker max. 125 mm  
Snijdt onder precieze hoek zonder bramen  
Gewicht: 10,5 kg

€ 717,75  
netto per stuk

**Bestelnr. 15-DC-10025** reserve mes

€ 128,55



### Profielknipper | RC 300

**Bestelnr. 15-RC-300**

Geschikt voor profiel EN 60715  
Voor afmetingen: TS 15-5,5; TS 35-7,5; TS 35-15x1,5  
Spaan- en braamvrije verwerking  
Verhoogd veiligheid in de werkplaats  
Gewicht: 8,3 kg

€ 963,30  
netto per stuk



### Profielknipper | RC 200

**Bestelnr. 15-RC-200**

Geschikt voor profiel EN 60715  
Voor afmetingen: TS 35-7,5; TS 35-15  
Spaan- en braamvrije verwerking  
Verhoogd veiligheid in de werkplaats  
Los verkrijgbaar meetlat en geleider: prijzen op aanvraag  
Gewicht: 4 kg

€ 565,40  
netto per stuk



# Machines GLW

## Knippen, strippen, krimpen



### Knipautomaat | LC 100

**Bestelnr. 15-LC100**

Voor het knippen van draad 0,08 - 10,0 mm<sup>2</sup>  
 Voor het knippen van kabel Ø 8,0 mm  
 Snel en eenvoudig knippen van 2mm tot 1000m  
 Netspanning 230V  
 Gewicht: 10 kg

€ 2.727,55  
 netto per stuk



### Strip automaat | CS 60

**Bestelnr. 15-CS60**

Voor het strippen van draad 0,08 - 6,0 mm<sup>2</sup>  
 Voor het strippen van kabel Ø 6,0 mm  
 Semi- of volledige strip met cyclustijd 0,3 seconde  
 Netspanning 230V  
 Gewicht: 9,5 kg

€ 2.642,60  
 netto per stuk



### Strip- en krimpautomaat | MC 25

**Bestelnr. 15-MC25**

Geschikt voor adereindhulzen 0,5 - 2,5 mm<sup>2</sup> (enkel)  
 Snel en eenvoudig strippen en krimpen (adereindhulzen lengte 8mm)  
 Cyclustijd: 1,5 seconde  
 Krimpvorm: trapezium  
 Netspanning 230V  
 Gewicht: 12 kg

€ 5.388,00  
 netto per stuk



### Uitbreidingskit | tbv MC 25

**Bestelnr. 15-MC2-0100E**

Geschikt voor adereindhulzen 0,25 - 0,34 mm<sup>2</sup> (enkel)  
 Krimpvorm: trapezium

€ 520,60  
 netto per stuk



### Bewerkingseenheid | tbv MC 25

**Bestelnr. 15-MC2SCH02E** 0,25 - 0,34 mm<sup>2</sup> (instelbaar) € 194,60  
**Bestelnr. 15-MC2SCH05** 0,5 mm<sup>2</sup> € 147,20  
**Bestelnr. 15-MC2SCH07** 0,75 mm<sup>2</sup> € 147,20  
**Bestelnr. 15-MC2SCH10** 1,0 mm<sup>2</sup> € 147,20  
**Bestelnr. 15-MC2SCH15** 1,5 mm<sup>2</sup> € 147,20  
**Bestelnr. 15-MC2SCH25** 2,5 mm<sup>2</sup> € 147,20

netto per stuk



### Stripmes | tbv MC 25

**Bestelnr. 15-MC2AM02E** 0,25 - 0,34 mm<sup>2</sup> € 119,55  
**Bestelnr. 15-MC2AM05** 0,5 mm<sup>2</sup> € 71,20  
**Bestelnr. 15-MC2AM07** 0,75 mm<sup>2</sup> € 71,20  
**Bestelnr. 15-MC2AM10** 1,0 mm<sup>2</sup> € 71,20  
**Bestelnr. 15-MC2AM15** 1,5 mm<sup>2</sup> € 71,20  
**Bestelnr. 15-MC2AM25** 2,5 mm<sup>2</sup> € 71,20

netto per stuk



### Locator | tbv MC 25

**Bestelnr. 15-MC2LOC02** 0,25 - 0,34 mm<sup>2</sup> € 10,45  
**Bestelnr. 15-MC2LOC05** 0,5 mm<sup>2</sup> € 5,65  
**Bestelnr. 15-MC2LOC07** 0,75 mm<sup>2</sup> € 5,65  
**Bestelnr. 15-MC2LOC10** 1 mm<sup>2</sup> € 5,65  
**Bestelnr. 15-MC2LOC15** 1,5 mm<sup>2</sup> € 5,65  
**Bestelnr. 15-MC2LOC25** 2,5 mm<sup>2</sup> € 5,65

netto per set



### Kabeldoorvoer | tbv MC 25

**Bestelnr. 15-MC2-0076** 0,25 - 0,34 mm<sup>2</sup> (set van 2) € 11,25  
**Bestelnr. 15-MC2-0071** 0,5 mm<sup>2</sup> (set van 2) € 11,25  
**Bestelnr. 15-MC2-0072** 0,75 mm<sup>2</sup> (set van 2) € 11,25  
**Bestelnr. 15-MC2-0073** 1 mm<sup>2</sup> (set van 2) € 11,25  
**Bestelnr. 15-MC2-0074** 1,5 mm<sup>2</sup> (set van 2) € 11,25  
**Bestelnr. 15-MC2-0075** 2,5 mm<sup>2</sup> (set van 2) € 11,25

netto per set



# Machines GLW

Pneumatisch: strippen, krimpen



## Elektro-pneumatische strip- en krimpautomaat | MC 40-1

### Bestelnr. 15-MC40.1

Geschikt voor adereindhulzen 0,5 - 1,5 mm<sup>2</sup> (enkel)

Snel en eenvoudig verwerken van adereindhulzen (lengte 6-12mm)

Cyclustijd: 0,8 seconde

Krimpvorm: vierkant

Perslucht 5 bar

Netspanning 230V

Gewicht: 27 kg

uitbreidingsset 0,25 - 4 - 6 mm leverbaar

€ 9.873,80

netto per stuk



## Uitbreidingskit | tbv MC 40.1

### Bestelnr. 15-MC4E0,25

Geschikt voor adereindhulzen 0,25 - 0,34 mm<sup>2</sup> (enkel)

Krimplengte 6 - 8 mm

€ 1.079,20

netto per stuk



Krimpvorm: vierkant

## Uitbreidingskit | tbv MC 40.1

### Bestelnr. 15-MC4E2,5

Geschikt voor adereindhulzen 2,5 mm<sup>2</sup> (enkel)

Krimplengte 8 - 12 mm

€ 797,85

netto per stuk



Krimpvorm: vierkant

## Uitbreidingskit | tbv MC 40.1

### Bestelnr. 15-MC4E4-10/12

Geschikt voor adereindhulzen 4,0 mm<sup>2</sup> (enkel)

Krimplengte 10 - 12 mm

€ 1.418,40

netto per stuk



Krimpvorm: vierkant

## Elektro-pneumatische strip- en krimpautomaat | MC 40-L

### Bestelnr. 15-MC40L

Geschikt voor adereindhulzen 4 - 10 mm<sup>2</sup> (enkel)

Snel en eenvoudig verwerken van adereindhulzen (lengte 6-12mm)

Cyclustijd: 1,5 seconde

Krimpvorm: vierkant

Perslucht 5,5 bar

Netspanning 230V

Gewicht: 29 kg

krimpmatrijzen niet inbegrepen

€ 8.540,20

netto per stuk



## Uitbreidingskit | tbv MC 40L

### Bestelnr. 15-MC4E4-10/12

Geschikt voor adereindhulzen 4,0 mm<sup>2</sup> (enkel)

Krimplengte 10 - 12 mm

€ 1.418,40

netto per stuk



Krimpvorm: vierkant

## Uitbreidingskit | tbv MC 40L

### Bestelnr. 15-MC4E6

Geschikt voor adereindhulzen 6,0 mm<sup>2</sup> (enkel)

Krimplengte 12 mm

€ 1.208,25

netto per stuk



Krimpvorm: vierkant

## Uitbreidingskit | tbv MC 40L

### Bestelnr. 15-MC4E10

Geschikt voor adereindhulzen 10 mm<sup>2</sup> (enkel)

Krimplengte 12 mm

€ 1.208,25

netto per stuk



Krimpvorm: vierkant

# Machines GLW

## Krimpen van contacten



### Elektrische krimpmachine | EC 65

**Bestelnr. 15-EC-65**

Geschikt voor het automatisch krimpen van diverse contacten

Cyclustijd: 1 seconde

Ruim assortiment krimpmatrijzen beschikbaar

Netspanning 230V

Gewicht: 10 kg krimpmatrijzen niet inbegrepen

€ 2.803,15  
netto per stuk



### Pneumatische krimpmachine | PC 65

**Bestelnr. 15-PC-65**

Geschikt voor het automatisch krimpen van diverse contacten

Cyclustijd: 1 seconde

Ruim assortiment krimpmatrijzen beschikbaar

Netspanning 230V

Gewicht: 10 kg krimpmatrijzen niet inbegrepen

€ 2.803,15  
netto per stuk



### Krimpmatrijzen | tbv EC 65 - PC 65

**Bestelnr. 15-EC-I0560**

Voor geïsoleerde kabelschoenen 0,5 - 6,0 mm<sup>2</sup>



Krimpvorm: symmetrisch afschermkap los bestellen

€ 83,55  
netto per stuk

**Bestelnr. 15-EC-I0560AS**

Voor geïsoleerde kabelschoenen 0,5 - 6,0 mm<sup>2</sup>



Krimpvorm: asymmetrisch afschermkap los bestellen

€ 142,35  
netto per stuk

**Bestelnr. 15-EC-E0160**

Voor geïsoleerde adereindhulzen (enkel) 0,14 - 6,0 mm<sup>2</sup>



Krimpvorm: trapezium afschermkap los bestellen

€ 102,70  
netto per stuk

**Bestelnr. 15-EC-E4099TWIN**

Voor geïsoleerde adereindhulzen (twin) 4,0 - 10 mm<sup>2</sup>



Krimpvorm: trapezium afschermkap los bestellen

€ 102,70  
netto per stuk

**Bestelnr. 15-EC-R0115**

Voor ongeïsoleerde vlakstekkers 0,1 - 1,5 mm<sup>2</sup>



afschermkap los bestellen

€ 102,70  
netto per stuk

**Bestelnr. 15-EC-R0560**

Voor ongeïsoleerde vlakstekkers 0,5 - 6,0 mm<sup>2</sup>



afschermkap los bestellen

€ 102,70  
netto per stuk

**Bestelnr. 15-EC-T0599Q**

Voor buiskabelschoenen (plaat) 0,5 - 10 mm<sup>2</sup>



afschermkap los bestellen

€ 83,55  
netto per stuk

**Bestelnr. 15-EC-T4099N**

Voor buiskabelschoenen 4 - 10 mm<sup>2</sup>



afschermkap los bestellen

€ 83,55  
netto per stuk

### Afschermkap | tbv EC 65

**Bestelnr. 15-EC-PC02**

voor krimpmatrijs

15-EC-R0115, 15-EC-R0560

netto per stuk

**Bestelnr. 15-EC-PC03**

15-EC-T0599Q, 15-EC-T4099N

€ 24,10

**Bestelnr. 15-EC-PC05**

15-EC-E0160

€ 24,10

**Bestelnr. 15-EC-PC06**

15-EC-I0560, 15-EC-I0560AS

€ 24,10

**Bestelnr. 15-EC-PC07**

15-EC-E4099TWIN

€ 24,10

afschermkap tbv PC 65 op aanvraag



..... en meer  
zoals positioneerhulp  
op aanvraag



# Voor verwerking van buiskabelschoenen

Krimptangen, hydraulische perstangen: 6-300mm<sup>2</sup>

## Krimptang | CK 05

### Bestelnr. 15-CK05

Voor ongeïsoleerde kabelschoenen 6,0 - 50 mm<sup>2</sup>  
Krimpvorm: zeskant  
Gewicht: 1478 g met verstelbare persinzet

€ 128,15  
netto per stuk



## Krimptang | CK 06

### Bestelnr. 15-CK06

Voor ongeïsoleerde kabelschoenen 10 - 120 mm<sup>2</sup>  
Krimpvorm: zeskant  
Gewicht: 4091 g met verstelbare persinzet

€ 153,70  
netto per stuk



## Hydraulische perstang | APEM 55

### Bestelnr. 90JB-APEM55

Voor buiskabelschoenen 6 - 240 mm<sup>2</sup>  
Perskracht 50 kN  
Accu laadtijd 30 minuten  
Levering in metalen koffer incl. snellader en batterij  
Gewicht: 2,3 kg krimpmatrizen niet inbegrepen

netto per stuk  
1.830,55



## Krimpmatrizen | tbv APEM 55

Bestelnummer	zeskant		netto per stuk
90JB-PE5-635	6 en 35	mm <sup>2</sup>	79,00
90JB-PE5-1050	10 en 50	mm <sup>2</sup>	79,00
90JB-PE5-1670	16 en 70	mm <sup>2</sup>	79,00
90JB-PE5-2595	25 en 95	mm <sup>2</sup>	79,00
90JB-PE5-120	120	mm <sup>2</sup>	79,00
90JB-PE5-150	150	mm <sup>2</sup>	79,00
90JB-PE5-185	185	mm <sup>2</sup>	79,00
90JB-PE5-240	240	mm <sup>2</sup>	79,00

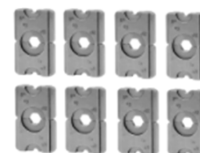

## Hydraulische perstang | APE 6-22

### Bestelnr. 90JB-APE6-22

Voor buiskabelschoenen 10 - 50 mm<sup>2</sup>  
Perskracht 60 kN  
Accu laadtijd 45 minuten  
Levering in metalen koffer incl. snellader en batterij  
Gewicht: 4,15 kg krimpmatrizen niet inbegrepen

netto per stuk  
1.830,55



## Krimpmatrizen | tbv APE 6-22

Bestelnummer	zeskant		netto per stuk
90JB-C6R6	6	mm <sup>2</sup>	70,45
90JB-C6R10	10	mm <sup>2</sup>	70,45
90JB-C6R16	16	mm <sup>2</sup>	70,45
90JB-C6R25	25	mm <sup>2</sup>	70,45
90JB-C6R35	35	mm <sup>2</sup>	70,45
90JB-C6R50	50	mm <sup>2</sup>	70,45
90JB-C6R70	70	mm <sup>2</sup>	70,45
90JB-C6R95	95	mm <sup>2</sup>	70,45
90JB-C6R120	120	mm <sup>2</sup>	70,45
90JB-C6R150	150	mm <sup>2</sup>	70,45
90JB-C6R185	185	mm <sup>2</sup>	70,45
90JB-C6R240	240	mm <sup>2</sup>	70,45
90JB-C6R300	300	mm <sup>2</sup>	70,45

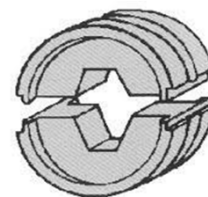

## Krimpmatrizen | tbv APE 6-22

Bestelnummer	B-crimp		netto per stuk
23C6BR6	6	mm <sup>2</sup>	o.a.
23C6BR10	10	mm <sup>2</sup>	71,90
23C6BR16	16	mm <sup>2</sup>	71,90
23C6BR25	25	mm <sup>2</sup>	73,35
23C6BR35	35	mm <sup>2</sup>	71,90
23C6BR50	50	mm <sup>2</sup>	73,35
23C6BR70	70	mm <sup>2</sup>	73,35
23C6BR95	95	mm <sup>2</sup>	73,35
23C6BR120	120	mm <sup>2</sup>	92,65
23C6BR150	150	mm <sup>2</sup>	92,65



APE 13-C Hydraulische perstang 130kN op aanvraag leverbaar

# Schroevendraaiers en diverse tangen

Witte: schroevendraaiers: serie Maxx Pro, Maxx VDE



## Schroevendraaiers | MAXX

## Schroevendraaiers | MAXX VDE

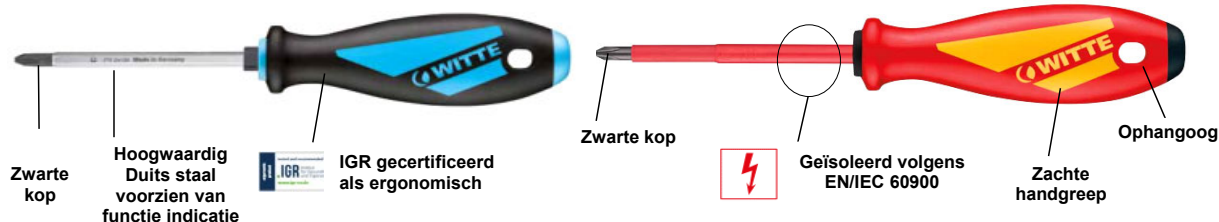

Bestelnummer	Artikelomschrijving	Ø mm	Handvat mm	Serie	Bruto prijs €/stk
53-53021	MAXX elek.sleuf 0,5x3,0x 75	3,0	103x23	Maxx	4,05
53-53022	MAXX elek.sleuf 0,6x3,5x100	3,5	103x23	Maxx	4,90
53-53024	MAXX elek.sleuf 0,8x4,0x125	4,0	103x23	Maxx	5,20
53-53025	MAXX elek.sleuf 1,0x5,5x150	5,5	107x32	Maxx	6,40
53-53031	MAXX Phillips 0x60	3,0	103x23	Maxx	4,25
53-53032	MAXX Phillips 1x80	4,5	107x32	Maxx	5,30
53-53035	MAXX Phillips 2x100	6,0	117x37	Maxx	7,10
53-53041	MAXX Pozidriv 0x60	3,0	103x23	Maxx	5,70
53-53042	MAXX Pozidriv 1x80	4,5	107x32	Maxx	7,50
53-53045	MAXX Pozidriv 2x100	6,0	117x37	Maxx	9,00
53-53051	MAXX kogelkop 3,0	3,0	103x23	Maxx	5,70
53-53052	MAXX kogelkop 4,0	4,0	103x23	Maxx	6,05
53-53055	MAXX kogelkop 8,0	8,0	127x39	Maxx	10,55
53-53204	MAXX TORX T 8	3,0	103x23	Maxx	6,00
53-53206	MAXX TORX T 10	3,5	103x23	Maxx	6,25
53-53207	MAXX TORX T 15	3,5	103x23	Maxx	6,25
53-53407	MAXX dopschroevendraaier 7,0	7,0	117x37	Maxx	9,85
53-53408	MAXX dopschroevendraaier 8,0	8,0	117x37	Maxx	10,05
53-53409	MAXX dopschroevendraaier 9,0	9,0	117x37	Maxx	o.a.
53-53410	MAXX dopschroevendraaier 10,0	10,0	117x37	Maxx	10,95
53-53413	MAXX dopschroevendraaier 13,0	13,0	127x39	Maxx	13,10
53-53086	MAXX flexibele dopschroevendraaier 1/4"	1/4"	117x37	Maxx	o.a.
53-53741	MAXX VDE Modul Phillips 1	4,5	107x32	Maxx VDE	6,80
53-53742	MAXX VDE Modul Phillips 2	6,0	117x37	Maxx VDE	8,65
53-53761	MAXX VDE Modul Pozidriv 1	4,5	107x32	Maxx VDE	8,55
53-53762	MAXX VDE Modul Pozidriv 2	6,0	117x37	Maxx VDE	10,35
53-53701	MAXX VDE sleuf 0,4x2,5x 75	2,5	103x23	Maxx VDE	5,05
53-53702	MAXX VDE sleuf 0,5x3,0x100	3,0	103x23	Maxx VDE	5,10
53-53703	MAXX VDE sleuf 0,6x3,5x100	3,5	103x23	Maxx VDE	5,30
53-53704	MAXX VDE sleuf 0,8x4,0x100	4,0	107x32	Maxx VDE	5,70
53-53705	MAXX VDE sleuf 1x5,5x125	5,5	107x32	Maxx VDE	7,10
53-53710	MAXX VDE Phillips 0	3,0	103x23	Maxx VDE	o.a.
53-53711	MAXX VDE Phillips 1x80	4,5	107x32	Maxx VDE	6,20
53-53712	MAXX VDE Phillips 2	6,0	117x37	Maxx VDE	7,85
53-53720	MAXX VDE Pozidriv 0	3,0	103x23	Maxx VDE	o.a.
53-53721	MAXX VDE Pozidriv 1	4,5	107x32	Maxx VDE	7,70
53-53722	MAXX VDE Pozidriv 2	6,0	117x37	Maxx VDE	9,35



# Schroevendraaiers en diverse tangen

Witte: boorbits, Knipex: tangen



## Boorbit | PRO Bit



Bestelnummer	Artikelomschrijving	Bruto prijs €/stk	
53-27450	Bit 1/4 -Phillips 1-70mm	2,80	
53-27455	Bit 1/4 Phillips 2-70mm	2,80	
+	53-27460	Bit 1/4 -Phillips 3-70mm	2,80
53-27451	Bit 1/4 Phillips 1-90mm	3,20	
53-27456	Bit 1/4 Phillips 2-90mm	3,20	
53-27461	Bit 1/4 -Phillips 3-90mm	3,20	
53-27510	Bit 1/4 -Sleuf 4x0,5-50mm	2,90	
53-27511	Bit 1/4 -Sleuf 4,5x0,6-50mm	2,90	
-	53-27512	Bit 1/4 -Sleuf 5,5x0,8-50mm	2,90
53-27513	Bit 1/4 -Sleuf 6x1-50mm	2,90	
53-27515	Bit 1/4 -Sleuf 8x1,6-50mm	3,25	
+	53-27020	Bit 1/4 Phillips 1-25 mm	0,40
53-27021	Bit 1/4 Phillips 2-25mm	0,40	
53-27022	Bit 1/4 Phillips 3-25 mm	0,40	
+	53-29593	Bit 1/4 -TORX met TIN T10-25mr	o.a.
53-29594	Bit 1/4 -TORX met TIN T15-25mr	-	
53-29595	Bit 1/4 -TORX met TIN T20-25mr	-	
53-29596	Bit 1/4 -TORX met TIN T25-25mr	-	

Bestelnummer	Artikelomschrijving	Bruto prijs €/stk	
53-27560	Bit 1/4 Pozidriv 1 - 70mm	2,80	
53-27565	Bit 1/4 -Pozidriv nr.2- 70mm	2,80	
+	53-27570	Bit 1/4 -Pozidriv nr.3- 70mm	2,80
53-27561	Bit 1/4 Pozidriv 1 - 90mm	3,20	
53-27566	Bit 1/4 Pozidriv 2 - 90mm	3,20	
53-27571	Bit 1/4 -Pozidriv nr.3- 90mm	3,20	
+	53-26461	Bit Modul 70 mm PH 1	3,45
53-26462	Bit Modul 70 mm PH 2	3,45	
+	53-26471	Bit Modul 70 mm PZ 1	3,45
53-26472	Bit Modul 70 mm PZ 2	3,45	
+	53-27045	Bit 1/4 Pozidriv 1-25 mm	o.a.
53-27046	Bit 1/4 Pozidriv 2-25 mm	0,40	
53-27047	Bit 1/4 Pozidriv 3-25 mm	0,40	
+	53-27120	Bit-Extrahard 1/4 Phillips 1-25mm	1,20
53-27121	Bit-Extrahard 1/4 Phillips 2-25mm	1,20	
53-27122	Bit-Extrahard 1/4 Phillips 3-25mm	1,20	

## Schroevendraaiers | Complete sets

Bestelnummer	Omschrijving	Bruto prijs €/stk
53-653741	<b>MAXX VDE SL-PH</b>	
	1x53701 0,4x2,5	34,20
	1x53704 0,8x40	
	1x53705 1,0x5,5	
	1x53721 PH1	
	1x53722 PH2	



Bestelnummer	Omschrijving	Bruto prijs €/stk
53-653744	<b>MAXX VDE SL-PZ</b>	
	1x53701 0,4x2,5	37,35
	1x53704 0,8x40	
	1x53705 1,0x5,5	
	1x53721 PZ1	
	1x53722 PZ2	

## Diverse tangen | Knipex



Bestelnummer	Artikelomschrijving	Type bekken	Lengte mm	Bruto prijs €/stk
53-0306180	Kombi-tang verchr./comfort	Grijpzone voor plat en rond materiaal	200	25,70
53-2616200	Telefoontang recht + zijsnijtang	Halfronde lange bekken, getand grijpvlak	200	32,50
53-2626200	Telefoontang 45gr. + zijsnijtang	Vlakronde, lange, spits toelopende bekken	180	36,60
53-7006160	Zijsnijtang verchr./comfort	Slanke kop voor moeilijk bereikbare plaatsen	160	27,98

# Krimptangen overig

Krimptangen: set in koffer

**TOOLOVA**  
Tools & Other Valuable Accessories

## Krimptang | TF PLUS

Bestelnummer	Omschrijving	Nettoprijs €/stk
16-4030100	TF PLUS tang	58,85

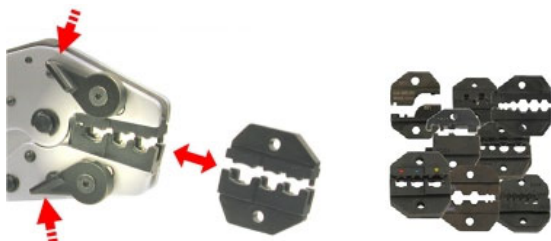

### Karakteristieken

Robuuste en betrouwbare krimptang. Zonder extra gereedschap geschikt voor het snel en eenvoudig verwisselen van krimpmatrijzen. De ingebouwde veiligheidsspal garandeert een correcte elektrische verbinding

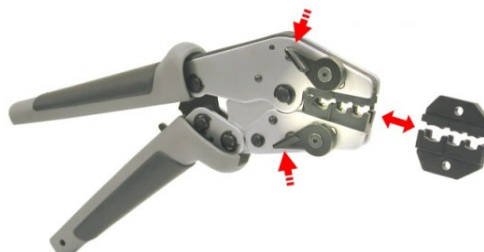

## Krimptangset | CT-5F EN PLUS

Bestelnummer	Omschrijving	Nettoprijs €/stk
16-4060141	TF	207,05



### Karakteristieken

De set "CT-5F EN PLUS" bestaat uit een koffer, TF PLUS tang en 5 verwisselbare krimpmatrijzen., te weten:

- Adereindhulzen 0,5 - 16,0 mm<sup>2</sup> EN 60947-1
- Adereindhulzen 25 - 50 mm<sup>2</sup> EN 60947-1
- Kabelschoenen geïsoleerd van 0,5 - 6,0 mm<sup>2</sup>
- Kabelschoenen (met lasnaad) ongeïsoleerd van 0,5 - 10,0 mm<sup>2</sup>
- Vlakstekkers 0,5 - 2,5 mm<sup>2</sup> (Breedte 6,3 en 4,8 mm)



## Krimptangset | CT-II F EN PLUS

Bestelnummer	Omschrijving	Nettoprijs €/stk
16-4060136F	TF	192,25



### Karakteristieken

De set "CT-II F EN PLUS" bestaat uit een koffer, TF PLUS tang en 5 verwisselbare krimpmatrijzen, te weten:

- Adereindhulzen 0,5 - 16,0 mm<sup>2</sup> EN 60947-1
- Kabelschoenen geïsoleerd van 0,5 - 6,0 mm<sup>2</sup>
- Kabelschoenen (met lasnaad) ongeïsoleerd van 0,5 - 10,0 mm<sup>2</sup>
- Vlakstekkers 0,5 - 2,5 mm<sup>2</sup> (breedte 6,3 en 4,8 mm)
- Voor BNC and TNC coax connectoren en voor RG58, RG59, RG62 en RG71 kabel



# Krimptangen overig

Krimpmatrijzen: tbv adereindhulzen, coax stekers, RJ-connectoren

**TOOLOVA**  
Tools & Other Valuable Accessories

## Krimpmatrijzen | TF PLUS tang

Bestelnummer	Type	Nettoprijs €/stk
<b>Voor adereindhulzen</b>		
16-4070006	WF6	20,30
Aansluiting:	0,5 - 6,0 mm <sup>2</sup>	
Kabel:	flexibel 0,5 - 6,0 mm <sup>2</sup>	
16-4070054	WF16 EN (volgens EN 60947-1)	32,75
Aansluiting:	0,25 - 16 mm <sup>2</sup>	
Kabel:	flexibel 0,25 - 16 mm <sup>2</sup>	
16-4070055	WF50 EN (volgens EN 60947-1)	32,75
Aansluiting:	25 - 50 mm <sup>2</sup>	
Kabel:	flexibel 25 - 50 mm <sup>2</sup>	
<b>Voor geïsoleerde kabelschoenen</b>		
16-4070014	IT6N	21,00
Aansluiting:	0,5 - 6,0 mm <sup>2</sup>	
Kabel:	flexibel 0,5 - 6,0 mm <sup>2</sup>	
<b>Voor ongeïsoleerde oogkabelschoenen</b>		
16-4070010	NIT10	18,00
Aansluiting:	0,5 - 10 mm <sup>2</sup>	
Kabel:	flexibel 0,5 - 10 mm <sup>2</sup>	
<b>Voor ongeïsoleerde kabelschoenen</b>		
16-4070052	OB2,5P	23,20
Aansluiting:	0,5 - 2,5 mm <sup>2</sup>	
Kabel:	flexibel 0,5 - 2,5 mm <sup>2</sup>	
<b>Voor SUB-D stekker</b>		
16-4070050	sub-D 075	25,10
Aansluiting:	AWG 24-30, AWG 18-22	
Kabel:	AWG 24-30, AWG 18-22 (0,05 - 0,75 mm <sup>2</sup> )	
16-4070051	sub-D 05	25,10
Aansluiting:	AWG 24-28, AWG 20-22	
Kabel:	AWG 24-28, AWG 20-22 (0,08 - 0,5 mm <sup>2</sup> )	
<b>Voor niet-afgeschermde RJ-connectoren (WE)</b>		
16-4070061	WE8-ST	23,80
Aansluiting:	RJ45 - 8P8K kort, Stewart connectoren	
Kabel:	Massief + flexibel, vlak en rond, 22-24 AWG	
16-4070062	WE6-ST	23,80
Aansluiting:	RJ11 en RJ12 - 6P6K, Stewart connectoren	
Kabel:	Massief + flexibel, vlak en rond, 22-24 AWG	
16-4070063	WE4-A/ST	23,80
Aansluiting:	Telefoon 4P4K, AMP + Stewart connectoren	
Kabel:	Massief + flexibel, vlak en rond, 22-24 AWG	
16-4070064	WE8-A	23,80
Aansluiting:	RJ45 - 8P8K, AMP	
Kabel:	Massief + flexibel, vlak en rond, 22-24 AWG	
16-4070065	WE6-A	23,80
Aansluiting:	RJ11 en RJ12 - 6P6K, AMP	
Kabel:	Massief + flexibel, vlak en rond, 22-24 AWG	
16-4070067	WE6-DEC	23,80
Aansluiting:	RJ11 DEC MMJ - 6P6K, AMP	
Kabel:	Massief + flexibel, vlak en rond, 22-24 AWG	
16-4070068	WE10-A	23,80
Aansluiting:	RJ11 50 - 10P10K, AMP	
Kabel:	Massief + flexibel, vlak en rond, 22-24 AWG	

Bestelnummer	Type	Nettoprijs €/stk
<b>Voor coax stekkers</b>		
16-4070007	C59	18,00
Aansluiting:	BNC/TNCB	
Kabel:	RG58, RG59, RG62 en RG71	
16-4070041	C174	19,00
Aansluiting:	Thinnet, Mini-UHF, BNC/TNC	
Kabel:	RG58, RG174	
16-4070042	C179	19,00
Aansluiting:	BNC/TNC	
Kabel:	RG174, RG179, kleine Coax stekkers	
16-4070044	CM59	19,00
Aansluiting:	SMA, SMB, Mini-59, Mini-UHF, BNC/TNC	
Kabel:	RG58, Mini-59, RG174	
16-4070043	C6	19,00
Aansluiting:	CATV type "F", BNC/TNC	
Kabel:	RG6 en RG6 Quad	
16-4070045	C11	19,00
Aansluiting:	type N	
Kabel:	RG8, RG11	
16-4070040	C213	19,00
Aansluiting:	type N	
Kabel:	RG58, RG11, RG213 en RG216	
<b>Voor Fibre Optic stekkers</b>		
16-4070046	F-SMA	20,63
Aansluiting:	Fibre Optic	
Kabel:	type SMA	
16-4070047	F-ST	20,63
Aansluiting:	Fibre Optic	
Kabel:	type SMA, SMB, SFR, ST, SC	



RJ11



RJ12



RJ45

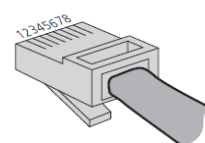

## Voor afgeschermde RJ-connectoren (WE)

16-4070070	WES8-ST	36,10
Aansluiting:	RJ45 - 8P8K kort, Stewart connectoren	
Kabel:	Massief + flexibel, STP 22-24 AWG	
16-4070071	WES8-HI	36,10
Aansluiting:	RJ45 - 8P8K lang, Hirose	
Kabel:	Massief + flexibel, STP 22-24 AWG	
16-4070072	WES8-HS	36,10
Aansluiting:	RJ45 - 8P8K kort, Hirose	
Kabel:	Massief + flexibel, STP 22-24 AWG	
16-4070074	WES8-M6/A	36,10
Aansluiting:	RJ45 - 8P8K, Molex, voor Ø 6,0 mm	
Kabel:	Massief + flexibel, STP 22-24 AWG	





# BEDIENEN EN SIGNALEREN

---

11

# Lovato Electric serie Platinum kunststof

Drukknoppen Ø22mm

**Lovato**  
**electric**

ENERGY AND AUTOMATION

## Drukknoppen

**Materiaal:** Polyamide  
**Temp.bereik:** -25°C tot +70°C  
**Beschermklasse:** IEC/EN IP66, IP67, IP69K  
UL/CSA type 1, 2, 3R, 4, 4X, 12, 12K

**Karakteristieken**  
Elegant en ergonomisch design  
Hoge mechanische levensduur  
Bestand tegen oliën en vetten



LPCB1..  
Vlak



LPCB2..  
Hoog



LPCB3..  
Verzonken

Bestelnummer	Brutoprijs €/1stk
● 60-LPCB102	5,55
● 60-LPCB103	5,55
● 60-LPCB104	5,55
● 60-LPCB105	5,55
● 60-LPCB106	5,55
○ 60-LPCB108	5,55

Bestelnummer	Brutoprijs €/1stk
60-LPCB202	7,00
60-LPCB203	7,00
60-LPCB204	7,00
60-LPCB205	7,00
60-LPCB206	7,00
60-LPCB208	7,00

Bestelnummer	Brutoprijs €/1stk
60-LPCB302	12,55
60-LPCB303	12,55
60-LPCB304	12,55
60-LPCB305	12,55
60-LPCB306	12,55
60-LPCB308	12,55

Op aanvraag met bedrukking leverbaar en/of als aan/uit schakelaar



Vlak



Hoog

## Verlichte drukknoppen

Bestelnummer	Brutoprijs €/1stk
● 60-LPCBL103	7,85
● 60-LPCBL104	7,85
● 60-LPCBL105	7,85
● 60-LPCBL106	7,85
○ 60-LPCBL107	7,85

Bestelnummer	Brutoprijs €/1stk
60-LPCBL203	12,75
60-LPCBL204	12,75
60-LPCBL205	12,75
60-LPCBL206	12,75
60-LPCBL207	12,75

Op aanvraag met bedrukking leverbaar en/of aan/uit schakelaar

## LED-elementen

Bestelnummer	Brutoprijs €/1stk
<b>12-30VAC/DC</b>	
60-LPXLBP3	11,00
60-LPXLBP4	11,00
60-LPXLBP5	11,00
60-LPXLBP6	11,00
60-LPXLBP8	11,00

Bestelnummer	Brutoprijs €/1stk
<b>185-265 VAC</b>	
60-LPXLPM3	16,50
60-LPXLPM4	16,50
60-LPXLPM5	16,50
60-LPXLPM6	16,50
60-LPXLPM8	16,50



## Montage adapter en contact-elementen

Omschrijving	Bestelnummer	Brutoprijs €/1stk
<b>Functie</b>		
Montage adapter Kunststof	60-LPXAU120	1,80
Montage adapter Metaal	60-LPXAU120M	4,25
Montage adapter Kunststof	60-LPXDIN	8,80
Contact-element NO	60-LPXC10	4,20
Contact-element NC	60-LPXC01	4,20

Push-in, op aanvraag leverbaar

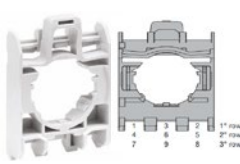

LPXAU120



LPXAU120M



LPXDIN

### Snelle en eenvoudige montage



### Contact-elementen



### Compacte afmetingen en hart afstand montage



LPXC10



LPXC01

Overige accessoires, zoals labelhouders en tekstplaatjes, op aanvraag leverbaar

# Lovato Electric serie Platinum kunststof

Pilotlampjes, LED-monoblokken, dubbele drukknoppen, keuzeschakelaars Ø22mm

**Lovato**  
**electric**

ENERGY AND AUTOMATION



Pilot



LED-monoblok

## Pilot lampjes en LED-monoblokken

Bestelnummer	Brutoprijs €/1stk	Bestelnummer	Brutoprijs €/1stk	Bestelnummer	Brutoprijs €/1stk
<b>Pilot lampjes</b>		<b>LED-monoblok</b>		<b>LED-monoblok</b>	
60-LPL3	5,90	60-LPMLB3	7,40	60-LPMLM3	8,90
60-LPL4	5,90	60-LPMLB4	7,40	60-LPMLM4	8,90
60-LPL5	5,90	60-LPMLB5	7,40	60-LPMLM5	8,90
60-LPL6	5,90	60-LPMLB6	7,40	60-LPMLM6	8,90
60-LPL7	5,90	60-LPMLB7	7,40	60-LPMLM7	8,90
60-LPL1187	7,70	60-LPMLB1	7,70	60-LPMLM1	8,90

Ook in 12VAC/DC, 28VAC/DC en 110-120VAC leverbaar

## Dubbel, triple en reset drukknoppen

Omschrijving	Bestelnummer	Brutoprijs €/1stk
Dubbele drukknop rood-groen	60-LPCB7113	10,75
Dubbele drukknop wit-zwart	60-LPCB7214	11,30
Triple drukknop rood-groen	60-LPCB7355	16,00
Mechanische reset drukknop	60-LPCR1196	12,50

In diverse uitvoeringen verkrijgbaar



## Keuzeschakelaars

**Materiaal:** Polyamide  
**Temp.bereik:** -25° tot +70°  
**Beschermklasse:** IEC/EN IP66, IP67, IP69K  
UL/CSA type 1, 2, 3R, 4, 4X, 12, 12K

### Karakteristieken

Mechanische levensduur: 1.000.000 schakelingen.  
Ook beschikbaar in verlichte uitvoering en diverse kleuren.  
**\*Standaard met sleutel nr. 455.**



Stand	Bestelnummer	Brutoprijs €/1stk	Bestelnummer	Brutoprijs €/1stk	Bestelnummer	Brutoprijs €/1stk	Bestelnummer	Brutoprijs €/1stk
	<b>Draaiknop</b>		<b>Hefboom</b>		<b>Sleutelschakelaar *</b>		<b>Ronde knop</b>	
		60-LPCS120	11,15	60-LPCS220	12,85		60-LPCS420	13,60
		60-LPCS121	13,45	60-LPCS221	14,00		60-LPCS421	14,80
						60-LPCS320	27,95	
						60-LPCS321	27,95	
						60-LPCS340	31,15	
		60-LPCS130	12,60	60-LPCS230	14,20		60-LPCS430	15,05
		60-LPCS131	14,95	60-LPCS231	15,55		60-LPCS431	16,45
		60-LPCS132	14,95	60-LPCS232	15,55		60-LPCS432	16,45
		60-LPCS133	14,95	60-LPCS233	15,55		60-LPCS433	16,45

# Lovato Electric serie Platinum Metaal

Drukknoppen, noodstoppen, keuzeschakelaars Ø22mm

**Lovato**  
**electric**

ENERGY AND AUTOMATION

## Drukknoppen

**Materiaal:** Zama (aluminium en zink)  
**Temp.bereik:** -25°C tot +70°C  
**Beschermklasse:** IEC/EN IP66, IP67, IP69K  
UL/CSA type 1, 2, 3R, 4, 4X, 12, 12K  
**Voorschriften** ISO 13850, IEC/EN 60947-1  
IEC/EN 60947-5-1, UL 508, CSA C22 n° 14

**Karakteristieken**  
Elegant en ergonomisch design  
Mechanische levensduur: 5.000.000 schakelingen  
Bestand tegen oliën en vetten



LPSB1..  
Vlak



LPSB2..  
Hoog



LPSB3..  
Verzonken



LPSBL1..  
Verlicht / Vlak\*

Bestelnummer	Brutoprijs €/1stk
● 60-LPSB102	6,80
● 60-LPSB103	6,80
● 60-LPSB104	6,80
● 60-LPSB105	6,80
● 60-LPSB106	6,80
○ 60-LPSB108	6,80

Bestelnummer	Brutoprijs €/1stk
60-LPSB202	8,55
60-LPSB203	8,55
60-LPSB204	8,55
60-LPSB205	8,55
60-LPSB206	8,55
60-LPSB208	8,55

Bestelnummer	Brutoprijs €/1stk
60-LPSB302	15,35
60-LPSB303	15,35
60-LPSB304	15,35
60-LPSB305	15,35
60-LPSB306	15,35
60-LPSB308	15,35

Bestelnummer	Brutoprijs €/1stk
60-LPSBL103	12,40
60-LPSBL104	12,40
60-LPSBL105	12,40
60-LPSBL106	12,40
60-LPSBL107	12,40

Op aanvraag met bedrukking leverbaar en/of als aan/uit schakelaar

\*Ook in hoog verkrijgbaar: 60-LPSBL2xx

## Noodstop drukknoppen

**Materiaal:** Zama (aluminium en zink)  
**Temp.bereik:** -25°C tot +70°C  
**Beschermklasse:** IEC/EN IP66, IP67, IP69K  
UL/CSA type 1, 2, 3R, 4, 4X, 12, 12K  
**Voorschriften** ISO 13850, IEC/EN 60947-1  
IEC/EN 60947-5-1, UL 508, CSA C22 n° 14



Ø 40 mm



Ø 40 mm



Ø 40 mm  
verlicht

Bestelnummer	Brutoprijs €/1stk
60-LPSB6634	30,10

Bestelnummer	Brutoprijs €/1stk
60-LPSB6644	28,70

Bestelnummer	Brutoprijs €/1stk
60-LPSB6844	57,35

Bestelnummer	Brutoprijs €/1stk
60-LPSBL6644	52,35

## Keuzeschakelaars

**Materiaal:** Zama (aluminium en zink)  
**Temp.bereik:** -25°C tot +70°C  
**Beschermklasse:** IEC/EN IP66, IP67, IP69K  
UL/CSA type 1, 2, 3R, 4, 4X, 12, 12K

**Karakteristieken**  
Mechanische levensduur: 1.000.000 schakelingen.  
Ook beschikbaar in verlichte uitvoering, diverse kleuren.  
\*Standaard met sleutel nr. 455.



Stand	Bestelnummer	Brutoprijs €/1stk
	<b>Draaiknop</b>	
	60-LPSS120	15,20
	60-LPSS121	16,55
	<b>Hefboom</b>	
	60-LPSS220	15,80
	60-LPSS221	17,15
	<b>Sleutelschakelaar *</b>	
	60-LPSS320	34,30
	60-LPSS321	34,30
	60-LPSS340	38,20
	<b>Ronde knop</b>	
	60-LPSS420	16,70
	60-LPSS421	18,15

Bestelnummer	Brutoprijs €/1stk
60-LPSS230	17,45
60-LPSS231	19,05
60-LPSS232	19,05
60-LPSS233	19,05

Bestelnummer	Brutoprijs €/1stk
60-LPSS430	18,50
60-LPSS431	20,15
60-LPSS432	20,15
60-LPSS433	20,15

Bestelnummer	Brutoprijs €/1stk
60-LPSS430	18,50
60-LPSS431	20,15
60-LPSS432	20,15
60-LPSS433	20,15



# Lovato Electric serie Platinum Metaal

Pilotlampjes, dubbele drukknoppen, joy-sticks Ø22mm



## Pilot lampjes

Bestelnummer	Brutoprijs €/1stk
● 60-LPSL3	7,25
● 60-LPSL4	7,25
● 60-LPSL5	7,25
● 60-LPSL6	7,25
○ 60-LPSL7	7,25
⚡ 60-LPSL1187	9,40



60-LPSL3



60-LPSL1187

## Dubbel, triple en reset drukknoppen

**Materiaal:** Zama (aluminium en zink)  
**Temp.bereik:** -25° tot +70°  
**Beschermklasse:** IEC/EN IP66, IP67, IP69K  
 UL/CSA type 4X

Bestelnummer	Omschrijving	Brutoprijs €/1stk
60-LPSB7113	Dubbele drukknop rood-groen	13,15
60-LPSBL7124	Dubbele drukknop wit-zwart	31,10
60-LPSB7355	Triple drukknop rood-groen	19,60
60-LPSR1196	Mechanische reset drukknop	15,35

*In diverse uitvoeringen verkrijgbaar*



## Joy-sticks

Stand	Bestelnummer	Brutoprijs €/1stk	Bestelnummer	Brutoprijs €/1stk
↓	60-LPSJ200	57,50	60-LPSJ210	69,00
	60-LPSJ201	57,50	60-LPSJ211	69,00
↔	60-LPSJ400	77,65	60-LPSJ410	93,20
	60-LPSJ401	77,65	60-LPSJ411	93,20

### Mechanische interlock



Met mechanische interlock

### Joystick positions and contact activation

↓ 2 instable    ↓ 2 stable  
 ↔ 4 instable    ↔ 4 stable

		↑ A	↓ B	← C	→ D	N
1	•					
2			•			
3					•	
4				•		

		↑ A	↓ B	N
1	•			
2			•	

## Nieuw in het assortiment van Lovato: Modulaire signaleringstorens



- Geluidssignaal module en bovendeksel
- Op te bouwen met verschillende LED licht modules
- Bekabelings modules
- Verschillende hoogtes
- Meerdere bevestigingsopties



Voor meer informatie: [info@calpe.nl](mailto:info@calpe.nl) of bel 0342 - 45 15 44

# Lovato Electric serie Platinum Metaal

Drukknoppen, pilot lampjes, keuzeschakelaars, communicatie modules Ø30mm

**Lovato**  
**electric**

ENERGY AND AUTOMATION

## Drukknoppen

**Materiaal:** Zama (aluminium en zink)  
**Temp.bereik:** -25°C tot +70°C  
**Beschermklasse:** IEC/EN IP66, IP67, IP69K  
UL/CSA type 1, 2, 3R, 4, 4X, 12, 12K

**Karakteristieken**  
Elegant en ergonomisch design  
Mechanische levensduur: 5.000.000  
Bestand tegen oliën en vetten



LPFB1..  
Vlak



LPFB2..  
Hoog



LPFBL1..  
Verlicht



LPFBL2..  
Verlicht

	Bestelnummer	Brutoprijs €/1stk
●	60-LPFB102	10,15
●	60-LPFB103	10,15
●	60-LPFB104	10,15
●	60-LPFB105	10,15
●	60-LPFB106	10,15
○	60-LPFB108	10,15

	Bestelnummer	Brutoprijs €/1stk
	60-LPFB202	12,80
	60-LPFB203	12,80
	60-LPFB204	12,80
	60-LPFB205	12,80
	60-LPFB206	12,80
	60-LPFB208	12,80

	Bestelnummer	Brutoprijs €/1stk
	60-LPFBL103	18,60
	60-LPFBL104	18,60
	60-LPFBL105	18,60
	60-LPFBL106	18,60
	60-LPFBL107	18,60

	Bestelnummer	Brutoprijs €/1stk
	60-LPFBL203	23,45
	60-LPFBL204	23,45
	60-LPFBL205	23,45
	60-LPFBL206	23,45
	60-LPFBL207	23,45

Op aanvraag met bedrukking leverbaar en/of als aan/uit schakelaar

## Pilot lampjes

	Bestelnummer	Brutoprijs €/1stk
●	60-LPFL3	10,90
●	60-LPFL4	10,90
●	60-LPFL5	10,90
●	60-LPFL6	10,90
○	60-LPFL7	10,90
⚡	60-LPFL1187	14,05



60-LPFL5



60-LPFL1187

## Keuzeschakelaars

**Materiaal:** Zama (aluminium en zink)  
**Temp.bereik:** -25°C tot +70°C  
**Beschermklasse:** IEC/EN IP66, IP67, IP69K  
UL/CSA type 1, 2, 3R, 4, 4X, 12, 12K

**Karakteristieken**  
Mechanische levensduur: 1.000.000 schakelingen.  
Ook beschikbaar in verlichte uitvoering en diverse kleuren.  
**\*Standaard met sleutel nr. 455.**



Stand	Bestelnummer	Brutoprijs €/1stk
	<b>Draaiknop</b>	
	60-LPFS120	15,20
	60-LPFS121	16,55
	60-LPFS130	16,75
	60-LPFS131	18,35
	60-LPFS132	18,35
	60-LPFS133	18,35

Bestelnummer	Brutoprijs €/1stk
<b>Hefboom</b>	
60-LPFS220	15,80
60-LPFS221	17,15
60-LPFS230	17,45
60-LPFS231	19,05
60-LPFS232	19,05
60-LPFS233	19,05

Bestelnummer	Brutoprijs €/1stk
<b>Sleutelschakelaar *</b>	
60-LPFS320	34,30
60-LPFS321	34,30
60-LPFS340	38,20

Bestelnummer	Brutoprijs €/1stk
<b>Ronde knop</b>	
60-LPFS420	16,70
60-LPFS421	18,15
60-LPFS430	18,50
60-LPFS431	20,15
60-LPFS432	20,15
60-LPFS433	20,15

## Communicatie module | USB en RJ45

Bestelnummer	Omschrijving	Brutoprijs €/1stk
60-LPFD01	USB 3.0 A-A	74,05
60-LPFD03	USB 3.0 A-B	74,05
60-LPFD05	USB 3.0 B-A	74,05
60-LPFD06	RJ45 cat. 6	82,15



# Lovato Electric serie Platinum Metaal

Communicatie modules, potentiometers, buzzers, noodstop drukknoppen

**Lovato**  
**electric**

ENERGY AND AUTOMATION

## Communicatie module | USB en RJ45

Bestelnummer	Omschrijving	Brutoprijs €/1stk
60-LPCD01	USB 3.0 A-A	40,25
60-LPCD03	USB 3.0 A-B	40,25
60-LPCD05	USB 3.0 B-A	40,25
60-LPCD06	RJ45 cat. 6	44,65



Communicatie module



Buzzer

## Monoblok potentiometer

Bestelnummer	Omschrijving	Brutoprijs €/1stk
60-LPCPA001	1 kΩ	74,90
60-LPCPA002	2,5 kΩ	74,90
60-LPCPA005	5 kΩ	74,90
60-LPCPA010	10 kΩ	74,90
60-LPCPA050	50 kΩ	74,90
60-LPCPA100	100 kΩ	74,90
60-LPCPA500	500 kΩ	74,90



Potentiometer

## Monoblok buzzer | Puls of continue

Bestelnummer	Omschrijving	DB	Brutoprijs €/1stk
60-LPCZSA	IP 40 9 - 15 VAC/DC	90	44,15
60-LPCZSB	IP 40 18 - 30 VAC/DC	90	44,15
60-LPCZSE	IP 40 85 - 140 VAC/DC	90	51,50
60-LPCZSM	IP 40 185 - 265 VAC/DC	90	51,50
60-LPCZSAIP	IP 69 9 - 15 VAC/DC	80	45,55
60-LPCZSBIP	IP 69 18 - 30 VAC/DC	80	45,55
60-LPCZSEIP	IP 69 85 - 140 VAC/DC	80	53,05
60-LPCZSMIP	IP 69 185 - 265 VAC/DC	80	53,05

## Noodstop drukknoppen

**Materiaal:** Polyamide  
**Temp.bereik:** -25°C tot +70°C  
**Beschermklasse:** IEC/EN IP66, IP67, IP69K  
 UL/CSA type 1, 2, 3R, 4, 4X, 12, 12K  
**Voorschriften** ISO 13850, IEC/EN 60947-1  
 IEC/EN 60947-5-1, UL 508, CSA C22 n° 14

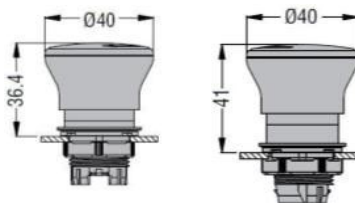

Ø 30 mm



Ø 40 mm



Ø 40 mm



Ø 40 mm verlicht

Bestelnummer	Brutoprijs €/1stk	Bestelnummer	Brutoprijs €/1stk	Bestelnummer	Brutoprijs €/1stk	Bestelnummer	Brutoprijs €/1stk
60-LPCB6634	24,55	60-LPCB6644	22,80	60-LPCB6844	46,75	60-LPCBL6644	42,70



LPXAU113



LPXAU124



LPXAU110



LPXAU158

## Accessoires

Bestelnummer	Ø mm	Brutoprijs €/1stk
60-LPXAU113	90	3,65
60-LPXAU115	60	3,55
60-LPXAU124	90	4,00
60-LPXAU123	60	3,70

Bestelnummer	Brutoprijs €/1stk	Bestelnummer	Brutoprijs €/1stk
60-LPXAU110	3,50	60-LPXAU158	14,05



Voordelen: snelle installatie, bestand tegen trillingen, één code voor compleet product

# Lovato Electric serie Platinum

Drukknopkastjes, (nood) slagknoppen



## Drukknopkastjes | Polyamide

<b>Materiaal:</b>	Polyamide
<b>Temp.bereik:</b>	-25°C tot +70°C
<b>Beschermklasse:</b>	IEC/EN: IP66, IP67, IP69K UL: Type 1, 2, 3R, 4, 4X, 12K

Bestelnummer	Gatmaat	Kleur deksel	Brutoprijs €/1stk
60-LPZP1A5	1 x 22 mm	geel	14,15
60-LPZP1A8	1 x 22 mm	grijs	14,15
60-LPZP2A8	2 x 22 mm	grijs	17,55
60-LPZP2A5	2 x 22 mm	geel	17,55
60-LPZP3A8	3 x 22 mm	grijs	20,95
60-LPZP4A8	4 x 22 mm	grijs	29,80
60-LPZP5A8	5 x 22 mm	grijs	39,50
60-LPZP6A8	6 x 22 mm	grijs	48,25
60-LPZP1B503	1 x 22 mm	geel	47,45

*ook compleet gemonteerd leverbaar*

### Karakteristieken

Compacte afmetingen, leverbaar met 1-6 gaten.  
Eenvoudige bedrading via de speciale contact elementen voor bodemmontage.  
Zowel in schroef- als push-in versie beschikbaar.  
cULus-file E93601

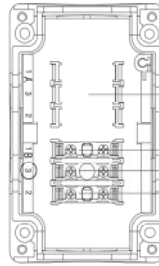

LPZP1B503



LPZP1A5



LPZP1B503

## Drukknopkastjes | Aluminium

<b>Materiaal:</b>	Aluminium
<b>Temp.bereik:</b>	-25°C tot +70°C
<b>Beschermklasse:</b>	IEC/EN: IP66, IP67 UL: NEMA 4X

Bestelnummer	Gatmaat	Kleur deksel	Brutoprijs €/1stk
60-LPZM1A5	1 x 22 mm	geel	31,80
60-LPZM1A5P	1 x 22 mm	geel	44,65
60-LPZM1A8	1 x 22 mm	grijs	33,70
60-LPZM2A8	2 x 22 mm	grijs	41,95
60-LPZM2A5	2 x 22 mm	geel	39,55
60-LPZM3A8	3 x 22 mm	grijs	50,05
60-LPZM4A8	4 x 22 mm	grijs	52,30
60-LPZM5A8	5 x 22 mm	grijs	68,90
60-LPZM6A8	6 x 22 mm	grijs	74,00
<b>Meervoudige versie:</b>			
60-LPZM4CA8	4 x 22 mm	grijs	47,20
60-LPZM6CA8	6 x 22 mm	grijs	73,00
60-LPZM8CA8	8 x 22 mm	grijs	90,60
60-LPZM12CA8	12x22 mm	grijs	93,75
60-LPZM16CA8	16x22 mm	grijs	111,60

*ook random gesloten leverbaar*

### Karakteristieken

Compacte afmetingen, leverbaar met 1-16 gaten.  
Voorzien van kabelinvoer Ø21mm (M20 of PG13,5).  
Maximaal 3 contact elementen per drukknop of keuzeschakelaar.  
cULus-file E93601

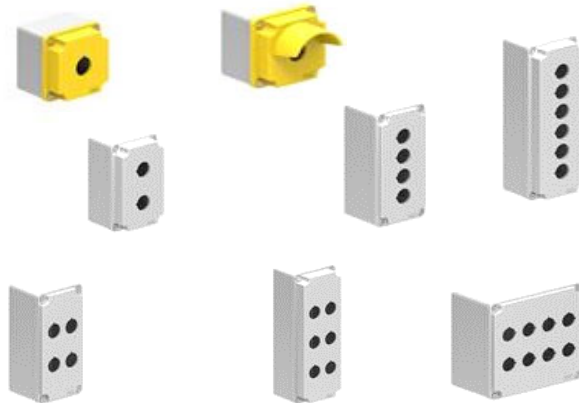

## Contact- en LED-elementen | Voor in behuizing



Bestelnummer	Brutoprijs €/1stk
<b>Maak contact NO</b>	
60-LPXCB10	5,80



Bestelnummer	Brutoprijs €/1stk
<b>Verbreek contact NC</b>	
60-LPXCB01	5,80



Bestelnummer	Brutoprijs €/1stk
<b>12-30VAC/DC</b>	
60-LPXL PBB8	11,50



Bestelnummer	Brutoprijs €/1stk
<b>185-265VAC</b>	
60-LPXL PBM8	17,35

## (Nood) Slagknop | Serie LP9

Bestelnummer	Contact Bezetting	Kleur deksel	Brutoprijs €/1stk
60-LP9S01R	1NC	rood	34,85
60-LP9S11R	1NO + 1 NC	rood	38,45
60-LP9S10B	1NO	zwart	34,85
60-LP9S11B	1NO + 1 NC	zwart	38,45
60-LP9P02R	2NC	geel/rood	49,30
60-LP9P11R	1NO + 1 NC	geel/rood	49,30

### Karakteristieken

Ergonomisch ontwerp, groot oppervlak voor eenvoudige bediening met de elleboog of voet.  
Speciaal voor onmiddellijke stop van machines en apparatuur, voldoet aan IEC/EN 60947-5-1, IP65.



**Noodstop:**  
Trekken voor vrijgave

# Calpe Signaallampen

Serie 3000, neon en LED uitvoering



## Serie 3000 | Inbouw Ø 13 - 22mm

<b>Materiaal:</b>	Lens, diffuser: polycarbonaat Body: PA6.6
<b>Kleur:</b>	rood, groen, oranje, wit, blauw
<b>Voorschriften:</b>	EN 60598-1 (NEON uitvoering)
<b>Beschermklasse:</b>	IP54 i.c.m. afdichting

### Karakteristieken

Neon/Fluor 230VAC, verbruik <1,5 mA met 25.000 branduren  
LED 230VAC, verbruik <2,5 mA, >50.000 branduren  
LED 28VAC/DC, verbruik <12 mA, >50.000 branduren  
Aanrakingsveilige schroefaansluiting

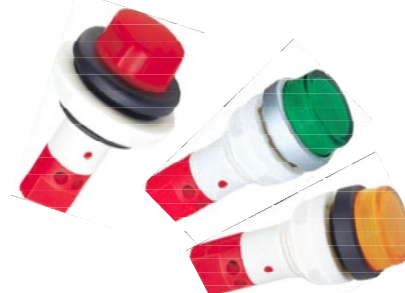
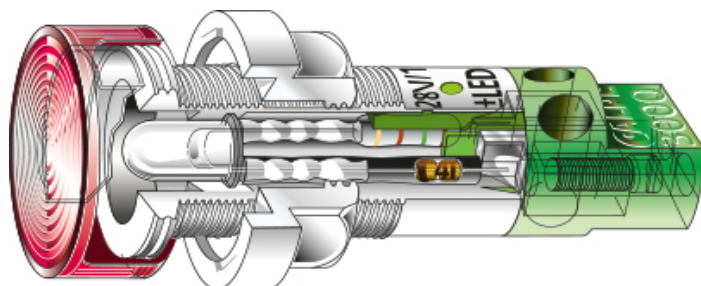

Onderzijde van de signaallamp is uitgevoerd in verschillende kleuren te weten:  
Rood: 230V Neon/Fluor | Groen, 28V LED | Oranje: 230V LED | Wit: LED 120V

## Serie 3000

### Type 3130 Ø 13 mm | Zonder ring

Bestelnummer	Brutoprijs €/ stk	Bestelnummer	Brutoprijs €/ stk	Bestelnummer	Brutoprijs €/ stk
<b>Neon/Fluor</b>		<b>LED 230VAC</b>		<b>LED 28VAC/DC</b>	
● 07-3130-1-230	n.l.	07-3130-L1-230	3,78	07-3130-L1-028Z	3,35
● 07-3130-3-230	n.l.	07-3130-L2-230	4,24	07-3130-L2-028Z	3,76
● 07-3130-4-230	n.l.	07-3130-L4-230	3,78	07-3130-L4-028Z	3,43
○ 07-3130-5-230	n.l.	07-3130-L6-230	4,24	07-3130-L6-028Z	3,76
● -	n.l.	07-3130-L7-230	4,24	07-3130-L7-028Z	3,76



### Type 3135 Ø 13 mm | Met chroom ring (reflector)

Bestelnummer	Brutoprijs €/ stk	Bestelnummer	Brutoprijs €/ stk	Bestelnummer	Brutoprijs €/ stk
<b>Neon/Fluor</b>		<b>LED 230VAC</b>		<b>LED 28VAC/DC</b>	
● 07-3135-1-230	n.l.	07-3135-L1-230	n.l.	07-3135-L1-028Z	n.l.
● 07-3135-3-230	n.l.	07-3135-L2-230	n.l.	07-3135-L2-028Z	n.l.
● 07-3135-4-230	n.l.	07-3135-L4-230	n.l.	07-3135-L4-028Z	n.l.
○ 07-3135-5-230	n.l.	07-3135-L6-230	n.l.	07-3135-L6-028Z	n.l.
● -	n.l.	07-3135-L7-230	n.l.	07-3135-L7-028Z	n.l.



### Type 3160 Ø 16 mm | Met zwarte ring

Bestelnummer	Brutoprijs €/ stk	Bestelnummer	Brutoprijs €/ stk	Bestelnummer	Brutoprijs €/ stk
<b>Neon/Fluor</b>		<b>LED 230VAC</b>		<b>LED 28VAC/DC</b>	
● 07-3160-1-230	n.l.	07-3160-L1-230	3,88	07-3160-L1-028Z	3,73
● 07-3160-3-230	n.l.	07-3160-L2-230	4,34	07-3160-L2-028Z	4,17
● 07-3160-4-230	n.l.	07-3160-L4-230	4,00	07-3160-L4-028Z	3,82
○ 07-3160-5-230	n.l.	07-3160-L6-230	4,34	07-3160-L6-028Z	4,17
● -	n.l.	07-3160-L7-230	4,34	07-3160-L7-028Z	4,17

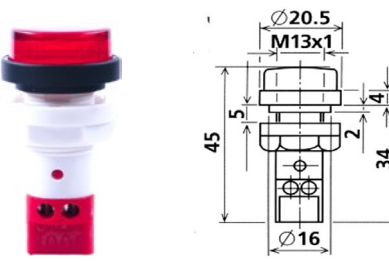

### Type 3161 Ø 16 mm | Met zilvergrijze ring

Bestelnummer	Brutoprijs €/ stk	Bestelnummer	Brutoprijs €/ stk	Bestelnummer	Brutoprijs €/ stk
<b>Neon/Fluor</b>		<b>LED 230VAC</b>		<b>LED 28VAC/DC</b>	
● 07-3161-1-230	n.l.	07-3161-L1-230	5,20	07-3161-L1-028Z	5,00
● 07-3161-3-230	n.l.	07-3161-L2-230	5,76	07-3161-L2-028Z	5,54
● 07-3161-4-230	n.l.	07-3161-L4-230	5,29	07-3161-L4-028Z	5,09
○ 07-3161-5-230	n.l.	07-3161-L6-230	5,76	07-3161-L6-028Z	5,54
● -	n.l.	07-3161-L7-230	5,76	07-3161-L7-028Z	5,54

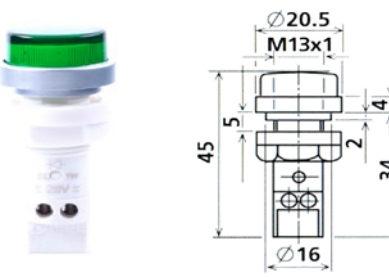

# Calpe Signaallampen

Serie 3000: Ø20mm, Ø22,5mm: Rafi drukknoppen

**calpe**  
INDUSTRIAL

## Type 3200 Ø 20 mm | Zwart, verzonken

Bestelnummer	Brutoprijs €/ stk	Bestelnummer	Brutoprijs €/ stk	Bestelnummer	Brutoprijs €/ stk
<b>Neon/Fluor</b>		<b>LED 230VAC</b>		<b>LED 28VAC/DC</b>	
● 07-3200-1-230	n.i.	07-3200-L1-230	4,93	07-3200-L1-028Z	4,78
● 07-3200-3-230	n.i.	07-3200-L2-230	5,26	07-3200-L2-028Z	5,07
● 07-3200-4-230	n.i.	07-3200-L4-230	5,07	07-3200-L4-028Z	4,88
○ 07-3200-5-230	n.i.	07-3200-L6-230	5,26	07-3200-L6-028Z	5,07
● -	n.i.	07-3200-L7-230	5,26	07-3200-L7-028Z	5,07

## Type 3201 Ø 20 mm | Mat chroom, verzonken

Bestelnummer	Brutoprijs €/ stk	Bestelnummer	Brutoprijs €/ stk	Bestelnummer	Brutoprijs €/ stk
<b>Neon/Fluor</b>		<b>LED 230VAC</b>		<b>LED 28VAC/DC</b>	
● 07-3201-1-230	n.i.	07-3201-L1-230	5,38	07-3201-L1-028Z	5,20
● 07-3201-3-230	n.i.	07-3201-L2-230	5,69	07-3201-L2-028Z	5,50
● 07-3201-4-230	n.i.	07-3201-L4-230	5,48	07-3201-L4-028Z	5,30
○ 07-3201-5-230	n.i.	07-3201-L6-230	5,69	07-3201-L6-028Z	5,50
● -	n.i.	07-3201-L7-230	5,69	07-3201-L7-028Z	5,50

## Type 3202 Ø 20 mm | Glanzend chroom, verzonken

Bestelnummer	Brutoprijs €/ stk	Bestelnummer	Brutoprijs €/ stk	Bestelnummer	Brutoprijs €/ stk
<b>Neon/Fluor</b>		<b>LED 230VAC</b>		<b>LED 28VAC/DC</b>	
● 07-3202-1-230	n.i.	07-3202-L1-230	5,38	07-3202-L1-028Z	5,20
● 07-3202-3-230	n.i.	07-3202-L2-230	5,69	07-3202-L2-028Z	5,50
● 07-3202-4-230	n.i.	07-3202-L4-230	5,48	07-3202-L4-028Z	5,30
○ 07-3202-5-230	n.i.	07-3202-L6-230	5,69	07-3202-L6-028Z	5,50
● -	n.i.	07-3202-L7-230	5,69	07-3202-L7-028Z	5,50

## Type 3220 Ø 22,5 mm | Met hoge zwarte ring

Bestelnummer	Brutoprijs €/ stk	Bestelnummer	Brutoprijs €/ stk	Bestelnummer	Brutoprijs €/ stk
<b>Neon/Fluor</b>		<b>LED 230VAC</b>		<b>LED 28VAC/DC</b>	
● 07-3220-1-230	n.i.	07-3220-L1-230	4,60	07-3220-L1-028Z	4,42
● 07-3220-3-230	n.i.	07-3220-L2-230	4,89	07-3220-L2-028Z	4,70
● 07-3220-4-230	n.i.	07-3220-L4-230	4,73	07-3220-L4-028Z	4,55
○ 07-3220-5-230	n.i.	07-3220-L6-230	4,89	07-3220-L6-028Z	4,70
● -	n.i.	07-3220-L7-230	4,89	07-3220-L7-028Z	4,70

## Type 3221 Ø 22,5 mm | Met lage zwarte ring

Bestelnummer	Brutoprijs €/ stk	Bestelnummer	Brutoprijs €/ stk	Bestelnummer	Brutoprijs €/ stk
<b>Neon/Fluor</b>		<b>LED 230VAC</b>		<b>LED 28VAC/DC</b>	
● 07-3221-1-230	n.i.	07-3221-L1-230	4,60	07-3221-L1-028Z	4,42
● 07-3221-3-230	n.i.	07-3221-L2-230	4,89	07-3221-L2-028Z	4,70
● 07-3221-4-230	n.i.	07-3221-L4-230	4,73	07-3221-L4-028Z	4,55
○ 07-3221-5-230	n.i.	07-3221-L6-230	4,89	07-3221-L6-028Z	4,70
● -	n.i.	07-3221-L7-230	4,89	07-3221-L7-028Z	4,70

## Accessoires | Spatwaterdichte afdichtring, blindstoppen

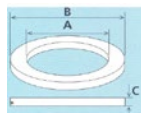

IP54 afdichtring  
Temperatuurbestendigheid tot 200°C

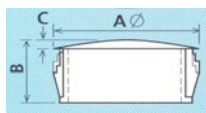

PA6.6 zwart, T105, UL 94V-2, CSA/UL  
Max. plaatdikte 3,2 mm  
NIET GESCHIKT VOOR TYPE 3135



## Drukknop RAFI | Ø15,2mm, IP40

Bestelnummer	Brutoprijs €/ stk	Bestelnummer	Brutoprijs €/ stk
<b>Maak-contact</b>		<b>Verbreek-contact</b>	
● 07-1001/0104	5,10	07-1151/0104	5,10
● 07-1001/0301	5,10	07-1151/0301	5,10
● 07-1001/0507	5,10	07-1151/0507	5,10

250V -  
700mA



**RAFI**

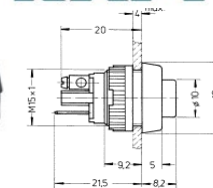

# Signal Construct

LED signaallampen: Ø5mm, Ø6mm, Ø8mm, Ø10mm, Ø14mm



## Serie SKG | Ø5mm, Ø10mm

<b>Materiaal:</b>	Polycarbonaat
<b>Beschermklasse:</b>	IP40
<b>Montage:</b>	Snap-in
<b>Aansluiting:</b>	Vlakstekker 2,8x0,8mm

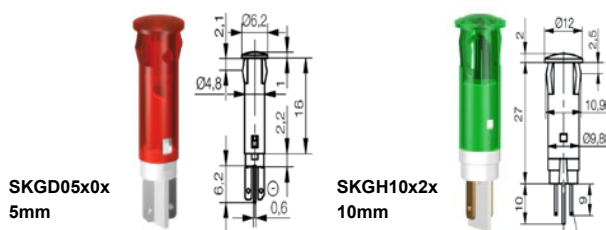

Bestelnummer	Brutoprijs €/stk	Bestelnummer	Brutoprijs €/stk
<b>24-28V</b>			
● 63SKGD-05004	2,90	63SKGH-10024	3,35
● 63SKGD-05204	2,90	63SKGH-10724A	3,35
● 63SKGD-05104	2,90	63SKGH-10124	3,35
○ 63SKGD-05604	3,70	63SKGH-10624	3,85
● 63SKGD-05404	3,70	63SKGH-10424	3,60

\*ook leverbaar in 230V

## Serie SMBD | Ø6mm, Ø8mm

<b>Materiaal behuizing:</b>	Metaal (isolatie polycarbonaat)
<b>Beschermklasse:</b>	IP50 (ook leverbaar in IP67)
<b>Montage:</b>	Schroefbevestiging
<b>Aansluiting SMBD06:</b>	Soldeerlip (tap 1,5x0,3mm)
<b>Aansluiting SMBD08:</b>	Vlakstekker 2,8x0,5

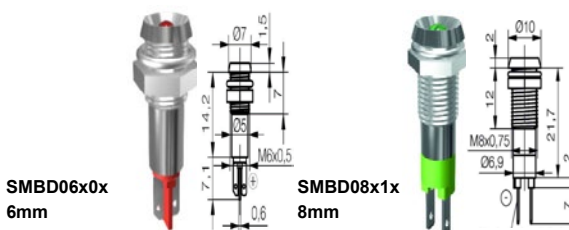

Bestelnummer	Brutoprijs €/stk	Bestelnummer	Brutoprijs €/stk
<b>24-28V</b>			
63SMBD-06004	3,80	63SMBD-08014	3,00
63SMBD-06204	3,80	63SMBD-08214	3,00
63SMBD-06104	3,80	63SMBD-08114	3,00
63SMBD-06604	4,35	63SMBD-08614	3,70
63SMBD-06404	4,35	63SMBD-08414	3,00

## Serie SMZD | Ø6mm, Ø8mm

<b>Materiaal behuizing:</b>	Metaal (isolatie polycarbonaat)
<b>Beschermklasse:</b>	IP50 (ook leverbaar in IP67)
<b>Montage:</b>	Schroefbevestiging (M8x0,75)
<b>Aansluiting:</b>	Vlakstekker 2,8x0,5 of 0,8mm

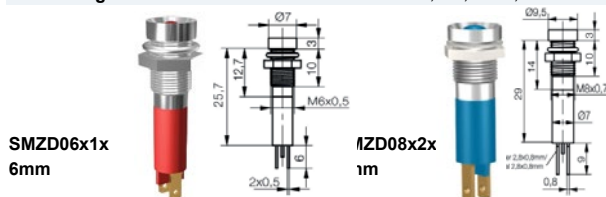

Bestelnummer	Brutoprijs €/stk	Bestelnummer	Brutoprijs €/stk
<b>24-28V</b>			
● 63SMZD-06014	3,30	63SMZD-08024	3,15
● 63SMZD-06214	3,30	63SMZD-08224	3,15
● 63SMZD-06114	3,30	63SMZD-08124	3,15
○ 63SMZD-06614	4,20	63SMZD-08624	3,80
● 63SMZD-06414	4,20	63SMZD-08424	3,80

## Serie SWBU | Ø14mm

<b>Materiaal behuizing:</b>	Metaal (isolatie polycarbonaat)
<b>Beschermklasse:</b>	IP67
<b>Montage:</b>	Schroefbevestiging (M14x1)
<b>Aansluiting:</b>	Vlakstekker 2,8x0,8mm

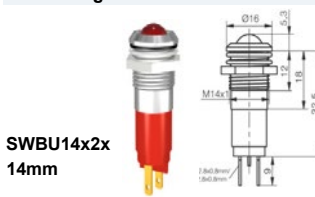

Bestelnummer	Brutoprijs €/stk	Bestelnummer	Brutoprijs €/stk
<b>24-28V</b>		<b>230V</b>	
63SWBU-14024A	6,35	63SWBU-14028A	6,85
63SWBU-14724A	6,70	63SWBU-14728A	7,90
63SWBU-14124A	6,35	63SWBU-14128A	6,85
63SWBU-14624A	6,70	63SWBU-14628A	7,90
63SWBU-14424A	6,70	63SWBU-14428A	7,90

## Serie SFEU | Ø8mm

<b>Materiaal behuizing:</b>	Metaal (isolatie polycarbonaat)
<b>Beschermklasse:</b>	IP67
<b>Montage:</b>	Schroefbevestiging (M8x0,75)
<b>Aansluiting:</b>	Vlakstekker 2,8x0,8mm

EXTRA VLAK

SFEU08x2x5  
8mm

Bestelnummer	Brutoprijs €/stk
<b>24-28V</b>	
● 63SFEU-080245	6,85
● 63SFEU-087245	7,05
● 63SFEU-081245	6,85
○ 63SFEU-086245	7,05
● 63SFEU-084245	7,05

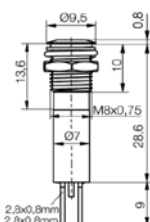

## Serie SML | Ø8mm

<b>Materiaal behuizing:</b>	Metaal (isolatie polycarbonaat)
<b>Beschermklasse:</b>	IP67
<b>Montage:</b>	Schroefbevestiging (M8x0,75)
<b>Aansluiting SMLU:</b>	Vlakstekker 2,8x0,5mm
<b>Aansluiting SMLE:</b>	Vlakstekker 2,0x0,5mm

SMLU08x1x / SMLE08x2x  
8mm

Bestelnummer	Brutoprijs €/stk
<b>24-28V</b>	
63SMLU-08014	o.a.
63SMLU-08714	o.a.
● 63SMLE-08224	6,60
63SMLU-08614	o.a.
63SMLU-08414	o.a.

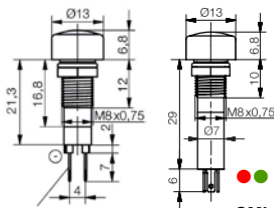

SMLE

# Calpe Signaallampen

LED signaallampen: Ø16mm, Ø22mm, Ø30mm



## Serie SMFL | Ø30mm

**Materiaal behuizing:** Metaal (cover polycarbonaat)  
**Beschermklasse:** IP67  
**Montage:** Schroefbevestiging (M30x1,5)  
**Aansluiting:** Vlakstekker 2,8x0,8mm

EXTRA VLAK

SMFL30x2x  
30mm

Bestelnummer	Brutoprijs €/stk
24-28V	
● 63SMFL-30024	21,65
● 63SMFL-30724	22,55
● 63SMFL-30124	21,65
○ 63SMFL-30624	22,55
● 63SMFL-30424	22,55

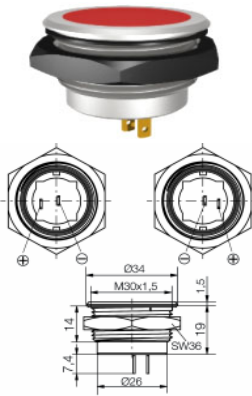

## Serie SMFL | Ø22mm

**Materiaal behuizing:** Metaal (cover polycarbonaat)  
**Beschermklasse:** IP67  
**Montage:** Schroefbevestiging (M22x1)  
**Aansluiting:** Vlakstekker 2,8x0,5mm

EXTRA VLAK

SMFL22x1x  
22mm

Bestelnummer	Brutoprijs €/stk
24-28V	
● 63SMFL-22014	17,40
● 63SMFL-22714	18,50
● 63SMFL-22114	18,50
○ 63SMFL-22614	18,50
● 63SMFL-22414	18,50

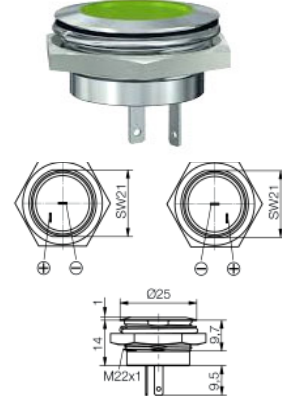

## Serie SMFE | Ø30mm

**Materiaal behuizing:** Metaal (cover polycarbonaat)  
**Beschermklasse:** IP67  
**Montage:** Schroefbevestiging (M30x1,5)  
**Aansluiting:** Vlakstekker 2,8x0,8mm

EXTRA VLAK

SMFE30x2x  
30mm

	A1	A2	A3
24V R+	G+	-	-
24V Y+	B+	-	-

Bestelnummer	Brutoprijs €/stk
24-28V	
● 63SMFE-30224	24,10
● 63SMFE-30BY24	o.a.

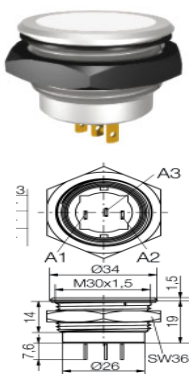

## Serie SMFE | Ø22mm

**Materiaal behuizing:** Metaal (cover polycarbonaat)  
**Beschermklasse:** IP67  
**Montage:** Schroefbevestiging (M22x1)  
**Aansluiting:** Vlakstekker 2,8x0,5mm

EXTRA VLAK

SMFE22x1x  
22mm

Bestelnummer	Brutoprijs €/stk
24-28V	
● 63SMFE22214	o.a.

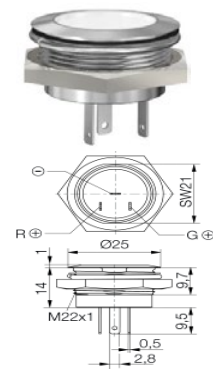

## Serie SKCE | Ø16mm

**Materiaal behuizing:** Kunststof (gemetalseerd)  
**Beschermklasse:** IP67  
**Montage:** Schroefbevestiging (M16x1)  
**Aansluiting:** Vlakstekker 2,8x0,5mm

SKCE1621x  
16mm

kleur	pin
rood+	1
groen+	2
mik kleur+	3
kathode-	4

Bestelnummer	Brutoprijs €/stk
12V	
● 63SKCE-16212	14,10
24V	
● 63SKCE-16214	14,10

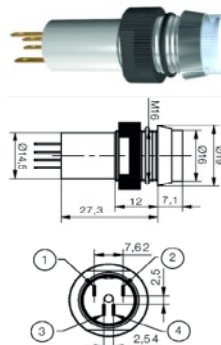

Andere varianten op aanvraag

Signal Construct is al meer dan 40 jaar gespecialiseerd in de ontwikkeling en productie van geavanceerde LED lampen en LED componenten "Made in Germany"

Van simpele LED lampjes tot oplossingen als in de toepassing hogere eisen worden gesteld, zoals robuust en/of hogere IP beschermklasse.

De nieuwe serie SKCH16x2x is nu beschikbaar met een groot signaaloppervlak voor homogene verlichting. Ø16mm IP67, super helder, voorzien van vlakstekker aansluiting 2,8x0,8. De lenskop is verkrijgbaar in bijbehorende lichtkleur of kleurloos diffuus.

De meeste producten uit het assortiment van Signal Construct zijn leverbaar in 12V, 24/28V, 230V. Vraag naar de mogelijkheden.



# Calpe Signaallampen

LED lampen: Ø5,6mm, Ø9,7mm, Ø18,5mm



## Serie MWCG57 | Ø5,6mm

**Algemeen:** Schok en tril bestendig  
**Aansluiting:** MG5,7  
**Lengte:** 15,8mm  
**Levensduur:** 60.000 uur (bij omgevingstemperatuur van 25°C)

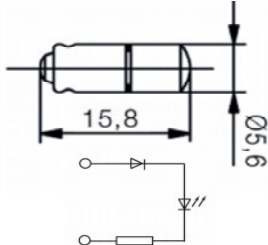

MWCG57xx  
Multi-Look®

Bestelnummer	Brutoprijs €/stk	Bestelnummer	Brutoprijs €/stk
<b>12-14V</b>			
● 63MWCG-5702	3,35	63MWCG-5704	3,35
● 63MWCG-5772	4,20	63MWCG-5774	4,20
● 63MWCG-5712	3,35	63MWCG-5714	3,35
○ 63MWCG-5762	4,20	63MWCG-5764	4,20
● 63MWCG-5742	4,30	63MWCG-5744	4,20

## Serie MWCB22 | Ø9,7mm

**Algemeen:** Grote zichthoek  
**Aansluiting:** BA9s  
**Lengte:** 22mm  
**Levensduur:** 60.000 uur (bij omgevingstemperatuur van 25°C)

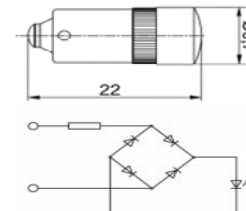

MWCB22xx9  
Multi-Look®

Bestelnummer	Brutoprijs €/stk	Bestelnummer	Brutoprijs €/stk
<b>12-14V</b>			
63MWCB-22029	5,80	63MWCB-22049	5,80
63MWCB-22729	6,00	63MWCB-22749	6,00
63MWCB-22129	5,80	63MWCB-22149	5,80
63MWCB-22629	6,00	63MWCB-22649	6,00
63MWCB-22429	6,00	63MWCB-22449	6,00

## Serie MBRD15 | Ø18,5mm

**Algemeen:** Schok en tril bestendig  
**Aansluiting:** BA15d  
**Lengte:** 45mm  
**Levensduur:** 60.000 uur (bij omgevingstemperatuur van 25°C)

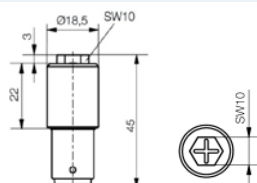

MBRD1508xx  
8 chip-led

Bestelnummer	Brutoprijs €/stk
<b>24-28V</b>	
● 63MBRD-150804A	22,00
● 63MBRD-150874A	24,20
● 63MBRD-150814A	22,00
○ 63MBRD-150864A	24,20
● 63MBRD-150844A	24,20

## Serie MWKB22 | Ø9,7mm

**Algemeen:** Met speciale lensdiffusor  
**Aansluiting:** BA9s  
**Lengte:** 22mm  
**Levensduur:** 60.000 uur (bij omgevingstemperatuur van 25°C)

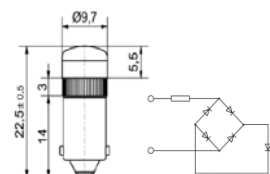

MWKB22x8  
Multi-Look®

Bestelnummer	Brutoprijs €/stk
<b>230V</b>	
63MWKB-2208	6,60
63MWKB-2278	6,60
63MWKB-2218	6,60
63MWKB-2258	6,60
63MWKB-2248	6,60

### Nieuwe serie MWKB22

De voordelen:  
 Lichtrendement sterk verbeterd  
 Hoge kleurstabiliteit  
 Gelijmatige helderheid door de speciale lensdiffusor  
 Bestand tegen schokken en trillingen

## Overzicht van de beschikbare LED lampen

### Soffittenlampen

Bi-PIN 4,2, 5,6  
 SX4S  
 MF6s/8  
 MG5,7  
 W2x4,6

W2, 1x9,5  
 BX8,4d  
 T4,5, T4,6  
 T5,5, T5,5k  
 T6,8

BA5s  
 E5,5  
 BA7s  
 BA9s  
 BA15d, BA15s



Signal Construct

Dé specialist voor LED fittingen

# Contactdozen, alarmlampen

Schuko (DIN-rail), Withled; serie 800

## Contactdoos | Schuko

**Materiaal:** Duroplast  
**Montage:** DIN-rail  
**Nom. stroom:** 16A  
**Voorschriften:** DIN 49440 deel 1



Bestelnummer	Aantal polen	Aarde	Afmeting breedte mm	Inbouw diepte mm	Brutoprijs €/stk
900571/GR	2	randaarde	45	55	10,85
900564/M/GR	2	penaarde	45	60	12,12
900569/GR	2	randaarde	45	60	16,58

## Alarmlampen | Serie 800 enkele kleur

**Beschermklasse:** IP67 (met zoemer IP30)  
**Temp.bereik:** -10°C tot +60°C  
**Levensduur:** 150.000 uur bij 60°C  
**Stroomverbruik:** < 3W

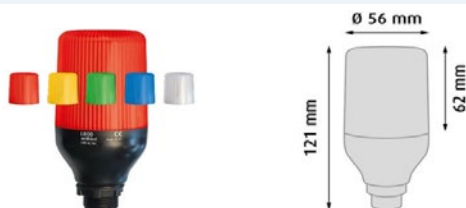

Bestelnummer	Spanning V	Lichtoptie	Brutoprijs €/stk
07-L810BL24F	24	continue	<b>o.a.</b>
07-L810R24F	24	continue	<b>27,50</b>
07-L810A24F	24	continue	<b>27,50</b>
07-L810V24F	24	continue	<b>o.a.</b>
07-L810AZ24F	24	continue	
07-L811BL24F	24	knipperend	
07-L811R24F	24	knipperend	
07-L811A24F	24	knipperend	
07-L811V24F	24	knipperend	
07-L811AZ24F	24	knipperend	

**withled**  
lighting experience

### Karakteristieken

Aansluiting: directe voeding met push-in stekker.  
 Lichtopties: continue, knipperend of continue / knipperend.  
 Diverse andere spanningen op aanvraag leverbaar.



Bestelnummer	Spanning V	Lichtoptie	Brutoprijs €/stk
07-L810BL230F	230	continue	<b>o.a.</b>
07-L810R230F	230	continue	<b>27,50</b>
07-L810A230F	230	continue	<b>27,50</b>
07-L810V230F	230	continue	<b>o.a.</b>
07-L810AZ230F	230	continue	
07-L811BL230F	230	knipperend	
07-L811R230F	230	knipperend	
07-L811A230F	230	knipperend	
07-L811V230F	230	knipperend	
07-L811AZ230F	230	knipperend	

## Alarmlampen | Serie 800 meerkleurig

Bestelnummer	Spanning V	Lichtoptie	Brutoprijs €/stk
07-L813RGB24	24	continue / knipperend	<b>55,00</b>
07-L813RGB230	230	continue / knipperend	<b>o.a.</b>



Voor alle versies geldt:  
ook leverbaar met zoemer

IP30 ((o))) 88db



## Accessoires | Serie 800

Bestelnummer	Omschrijving	Brutoprijs €/stk
07-80010	bevestigingsvoet 70mm	<b>3,91</b>
07-80015	wandbevestiging 90°	<b>26,10</b>
07-80020	verbindingsbuis alu zwart Ø25x70mm	<b>5,50</b>
07-80025	verbindingsbuis alu zwart Ø25x38mm	<b>o.a.</b>
07-80030	verbindingsbuis alu zilver Ø25x70mm	<b>5,50</b>



# Infrarood en piëzo schakelaars

Everswitch: infrarood en piëzo schakelaars



Everswitch is al jaren gespecialiseerd in piëzo-schakelaars en controlesystemen. Naast de bestaande producten is een nieuwe reeks ontwikkeld op infrarood gebaseerde schakeloplossingen. Zeker met het oog op de huidige ontwikkelingen en toenemende vraag naar oplossingen die verband houden met openbare hygiëne biedt dit goede mogelijkheden.

Bediening van de IR-schakelaars is mogelijk zonder enig daadwerkelijk contact - met infrarooddetectie van objecten zoals een vinger of hand op een afstand van ongeveer 5 cm. Deze functie maakt bediening van bijvoorbeeld deuropeners en vele andere apparaten die worden gebruikt in openbare voorzieningen, luchthavens en vele andere omgevingen mogelijk.

De infrarood contactloze schakelaars zijn eenvoudig in gebruik en makkelijk te installeren. Er is een ruime keuze aan materialen en schakel mogelijkheden beschikbaar. Ø 22mm op aanvraag.

## Contactloze metalen schakelaars | Serie IR

<b>Materiaal:</b>	RVS of Aluminum
<b>Beschermingsklasse:</b>	IP67
<b>Temperatuurbereik:</b>	-20°C tot +75°C
<b>Schakel vermogen:</b>	9V - 24V DC (AC optioneel)
<b>Detectiebereik:</b>	5 - 80 centimeter

<b>Karakteristieken</b>
Sensortype: Infrarood
Terugmelding via LED-punt in de sensorbehuizing
Instellingen remote programmeerbaar( type afhankelijk)
Mogelijkheid IOT-module te verbinden (Bluetooth)

Type	Afmeting mm	Schakel-vermogen V	Program-meerbaar	Toepassing	Bestelnummer	
					RVS	Aluminium
ES	28	12	nee	Exit switch	IR-ES-28-12V1A-INOX	IR-ES-28-12V1A-ALU
	28	24	nee	Exit switch	IR-ES-28-24V1A-INOX	IR-ES-28-24V1A-ALU
SS	28	12	ja	Smart switch	IR-SS-28-12V1A-INOX	IR-SS-28-12V1A-ALU
	28	24	ja	Smart switch	IR-SS-28-24V1A-INOX	IR-SS-28-24V1A-ALU
SA	28	12	ja	Sanitair switch	IR-SA-28-12V1A-INOX	IR-SA-28-12V1A-ALU
	28	24	ja	Sanitair switch	IR-SA-28-24V1A-INOX	IR-SA-28-24V1A-ALU

## Piëzo schakelaars | De technologie

### Voordelen:

Overall inzetbaar  
Gesloten metalen oppervlak  
Makkelijk schoon te maken  
Geen slijtage, lange levensduur  
Onderhoudsvrij  
Flexible ontwerp opties  
Absoluut stof- en waterdicht

De functie van de knop is gebaseerd op het natuurkundige principe van het piëzo-elektrisch effect. Door een externe kracht (toe of afname) wekt het piëzo-element een spanningspuls op die wordt gebruikt om een elektronische schakelaar aan te sturen.

### Toepassingsgebieden:

- parkeerautomaten, toegangscontrole, personenliften
- vuilniswagens, machines in buitenruimten
- voedselverwerkende (pharmaceutische) machines
- gevaar voor besmetting

### Een beknopt overzicht van het programma



# Flitslampen, waarschuwingssignalen

Deegee: xenon flitslampen



Deegee is sinds 1967 gespecialiseerd in het oplossen van contactloze detectie problemen. Het pakket omvat een uitgebreid assortiment visuele waarschuwingssignalen.

Immiddels behoort Deegee al meer dan 50 jaar tot de beste leveranciers van hoorbare en visuele signaleringsapparatuur van Europa.

Er zijn al vele awards gewonnen voor geavanceerd gebruik van informatie- en communicatie technologie.

Een team van R&D specialisten houdt zich actief bezig met de ontwikkeling van visuele gevarenwaarschuwingen en informatiedisplay.

Sinds 2008 is er fors geïnvesteerd in eigen EMC- en optische laboratorium apparatuur, hierdoor kunnen productprestaties rechtstreeks in het ontwikkelingsproces worden ingevoerd.

In aansluiting op de standaard range biedt Deegee ook mogelijkheden voor klantspecifieke oplossingen en is er een pakket explosieveilige visuele waarschuwingssignalen beschikbaar.

## Xenon flitslampen | Serie XFD

<b>Materiaal:</b>	ABS (lens polycarbonaat)
<b>Beschermingsklasse:</b>	IP65
<b>Temperatuurbereik:</b>	-20°C tot +55°C
<b>Voedingsspanning:</b>	12-24 VDC, 230V AC
<b>Kleur basis:</b>	wit (zwart op aanvraag)

### Karakteristieken

2,5 Joule flitsenergie, enkele flits.  
Montage op zowel vlakke ondergrond als aan de muur.  
Geschikt voor buismontage BESA-doos.  
Voorzien van basisinvoer.

Bestelnummer	Kleur	Voedings- spanning	Gemiddeld stroomverbruik mA	Afmeting (mm) hxø	Brutoprijs €/ stk
56XFD/AC/230/SH/2,5J/AMBER	oranje	230 VAC	34	102x79	89,35
56XFD/AC/230/SH/2,5J/GREEN	groen	230 VAC	34	102x79	89,35
56XFD/AC/230/SH/2,5J/RED	rood	230 VAC	34	102x79	89,35
56XFD/DC/12-24/SH/2,5J/AMBER	oranje	24 VDC	163	102x79	98,65
56XFD/DC/12-24/SH/2,5J/GREEN	groen	24 VDC	163	102x79	98,65
56XFD/DC/12-24/SH/2,5J/RED	rood	24 VDC	163	102x79	98,65

## Xenon flitslampen | Overige waarschuwingssignalen

### Voordelen:

Betrouwbaar  
Weinig onderhoud  
Lager stroomverbruik  
Lange levensduur

Voor veel paneelbouwers en installateurs is de XFD serie van Deegee het baken bij uitstek als een visueel waarschuwingsapparaat aan de installatie moet worden toegevoegd.

Xenon bakens staan voor betrouwbaar in vergelijking met traditionele gloeilampen. Daarnaast wordt het onderhoud tot een minimum beperkt.

Er is in toenemende mate vraag naar lagere stroom en langere levensduur. Dat is mede de reden dat het leveringsprogramma van de Xenon flitslampen steeds wordt doorontwikkeld.

### Een beknopt overzicht van het programma



RFE



XFB



PSD



SBB



RF



RF



STC



TPD



VXD



RFE/RMLED



DX/1520/2D



DX/2C

# Zekeringen

Glas, keramisch: 5,2x20



## Zekeringen 5,2x20 | Serie 50T, 50F (glas) en 50CT, 50CF (keramisch)

Spanning: 250V  
 Tempepratuurbereik: -55°C tot + 125°C  
 Voorschriften IEC 60127, GB9364

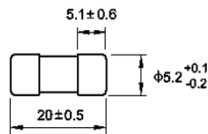

## Zekeringen Glas | 50T en 50F (5,2x20mm)

Laag afschakelvermogen 35A-250-VAC

Ampere (mA / A)	VPE	Bestelnummer Serie 50T	Bestelnummer (Oud)	Brutoprijs €/100stk.	Bestelnummer Serie 50F	Brutoprijs €/100stk.
		<b>Traag</b>			<b>Snel</b>	
100	mA	200 31-50T-0100H	WA5010	<b>34,05</b>	-	-
125	mA	200 31-50T-0125H	WA5012	<b>19,95</b>	31-50F-0125H	<b>30,80</b>
160	mA	200 31-50T-0160H	WA5016	<b>19,95</b>	31-50F-0160H	<b>30,80</b>
200	mA	200 31-50T-0200H	WA5020	<b>19,95</b>	31-50F-0200H	<b>19,30</b>
250	mA	200 31-50T-0250H	WA5025	<b>19,95</b>	31-50F-0250H	<b>19,30</b>
315	mA	200 31-50T-0315H	WA5031	<b>19,95</b>	31-50F-0315H	<b>17,25</b>
400	mA	200 31-50T-0400H	WA5040	<b>18,20</b>	31-50F-0400H	<b>17,25</b>
500	mA	200 31-50T-0500H	WA5050	<b>18,20</b>	31-50F-0500H	<b>17,25</b>
630	mA	200 31-50T-0630H	WA5063	<b>18,20</b>	31-50F-0630H	<b>17,25</b>
800	mA	200 31-50T-0800H	WA5080	<b>18,20</b>	31-50F-0800H	<b>17,25</b>
1,00	A	200 31-50T-010H	WA5100	<b>18,20</b>	31-50F-010H	<b>17,25</b>
1,25	A	200 31-50T-013H	WA5125	<b>18,20</b>	31-50F-013H	<b>17,25</b>
1,60	A	200 31-50T-016H	WA5160	<b>18,20</b>	31-50F-016H	<b>17,25</b>
2,00	A	200 31-50T-020H	WA5200	<b>18,20</b>	31-50F-020H	<b>17,25</b>
2,50	A	200 31-50T-025H	WA5250	<b>18,20</b>	31-50F-025H	<b>17,25</b>
3,15	A	200 31-50T-032H	WA5315	<b>18,20</b>	31-50F-032H	<b>17,25</b>
4,00	A	200 31-50T-040H	WA5400	<b>18,20</b>	31-50F-040H	<b>17,25</b>
5,00	A	200 31-50T-050H	WA5500	<b>18,20</b>	31-50F-050H	<b>17,25</b>
6,30	A	200 31-50T-063H	WA5630	<b>18,20</b>	31-50F-063H	<b>17,25</b>
8,00	A	200 31-50T-080H	WA5800	<b>19,50</b>	31-50F-080H	<b>20,15</b>
10,00	A	200 31-50T-100H	-	<b>19,50</b>	31-50F-100H	<b>20,15</b>
12,00	A	200 31-50T-120H	-	<b>19,50</b>	31-50F-120H	<b>20,15</b>
12,50	A	200 31-50T-125H	-	<b>19,50</b>	-	-
15,00	A	200 31-50T-150H	-	<b>19,50</b>	31-50F-150H	<b>20,15</b>
16,00	A	200 31-50T-160H	-	<b>19,50</b>	-	-

Minimale afname is 200 stuks

## Zekeringen Keramisch | 50CT en 50CF (5,2x20mm)

Hoog afschakelvermogen 1500A-250-VAC

Ampere (mA / A)	VPE	Bestelnummer Serie 50CT	Bestelnummer (Oud)	Brutoprijs €/100stk.	Bestelnummer Serie 50CF	Brutoprijs €/100stk.
		<b>Traag</b>			<b>Snel</b>	
200	mA	200 31-50CT-0200H	WA1020	<b>o.a.</b>	-	-
250	mA	200 31-50CT-0250H	WA1025	-	31-50CF-0250H	<b>o.a.</b>
315	mA	200 31-50CT-0315H	-	-	31-50CF-0315H	-
400	mA	200 31-50CT-0400H	WA1040	-	31-50CF-0400H	-
500	mA	200 31-50CT-0500H	WA1050	<b>24,85</b>	31-50CF-0500H	-
630	mA	200 31-50CT-0630H	WA1063	<b>24,85</b>	31-50CF-0630H	-
800	mA	200 31-50CT-0800H	WA1080	<b>24,85</b>	31-50CF-0800H	-
1,00	A	200 31-50CT-010H	WA1100	<b>24,85</b>	31-50CF-010H	-
1,25	A	200 31-50CT-013H	WA1125	<b>24,85</b>	31-50CF-013H	-
1,60	A	200 31-50CT-016H	WA1160	<b>24,85</b>	31-50CF-016H	-
2,00	A	200 31-50CT-020H	WA1200	<b>24,85</b>	31-50CF-020H	-
2,50	A	200 31-50CT-025H	WA1250	<b>24,85</b>	31-50CF-025H	-
3,15	A	200 31-50CT-032H	WA1315	<b>24,85</b>	31-50CF-032H	-
4,00	A	200 31-50CT-040H	WA1400	<b>24,85</b>	31-50CF-040H	-
5,00	A	200 31-50CT-050H	WA1500	<b>24,85</b>	31-50CF-050H	-
6,30	A	200 31-50CT-063H	WA1630	<b>24,85</b>	31-50CF-063H	-
8,00	A	200 31-50CT-080H	WA1800	<b>24,85</b>	31-50CF-080H	-
10,00	A	200 31-50CT-100H	-	<b>24,85</b>	31-50CF-100H	-
12,00	A	200 31-50CT-120H	-	<b>24,85</b>	31-50CF-120H	-
15,00	A	200 31-50CT-150H	-	<b>24,85</b>	31-50CF-150H	-

Minimale afname is 200 stuks

# Zekeringen

Glas, keramisch: 6,35x32



## Zekeringen Glas en Keramisch traag | 61S en 65TS (6,35x32mm)

Spanning: 250V  
 Temperatuurbereik: -55°C tot + 125°C  
 Voorschriften: UL248-1, UL248-14

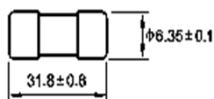

Ampere (mA / A)	VPE	Bestelnummer Serie 61S	Bestelnummer (Oud)	Brutoprijs €/100stk.	Bestelnummer Serie 65TS	Brutoprijs €/100stk.
		<b>Glas traag</b>			<b>Keramisch traag</b>	
200 mA	200	31-61S-0200H	-	<i>o.a.</i>	31-65TS-0200H	<i>o.a.</i>
250 mA	200	31-61S-0250H	-		31-65TS-0250H	
315 mA	200	31-61S-0315H	-		31-65TS-0315H	
400 mA	200	31-61S-0400H	-		31-65TS-0400H	
500 mA	200	31-61S-0500H	-		31-65TS-0500H	
630 mA	200	31-61S-0630H	-		31-65TS-0630H	
800 mA	200	31-61S-0800H	-		31-65TS-0800H	
1,00 A	200	31-61S-010H	WA3100		31-65TS-010H	
1,25 A	200	31-61S-013H	WA3125		31-65TS-013H	
1,60 A	200	31-61S-016H	WA3160		31-65TS-016H	
2,00 A	200	31-61S-020H	WA3200		31-65TS-020H	
2,50 A	200	31-61S-025H	WA3315		31-65TS-025H	
3,15 A	200	31-61S-032H	WA3400		31-65TS-032H	
4,00 A	200	31-61S-040H	WA3500		31-65TS-040H	
5,00 A	200	31-61S-050H	WA3630		31-65TS-050H	
6,30 A	200	31-61S-063H	WA3800		31-65TS-063H	
8,00 A	200	31-61S-080H	-		31-65TS-080H	
10,00 A	200	31-61S-100H	-		31-65TS-100H	
12,00 A	200	31-61S-120H	-		31-65TS-120H	
15,00 A	200	31-61S-150H	-		31-65TS-150H	
20,00 A	200	31-61S-200H	-		31-65TS-200H	
25,00 A	200	31-61S-250H	-		31-65TS-250H	
30,00 A	200	31-61S-300H	-		31-65TS-300H	

*Ook verkrijgbaar in "snel"*

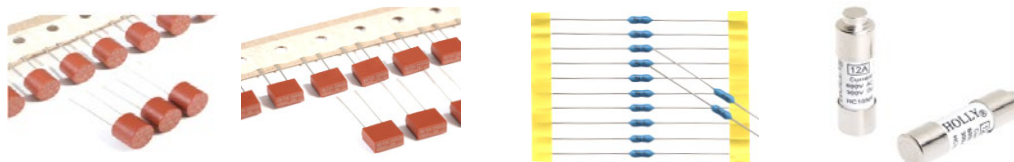

Voor zekeringhouders zie programma Arcoelectric.



Lined area for notes.





# SCHAKELMATERIAAL

---

12

# Berker Business Solutions

Uitgelicht: Berker design overzicht

**B.**  
Berker Business Solutions

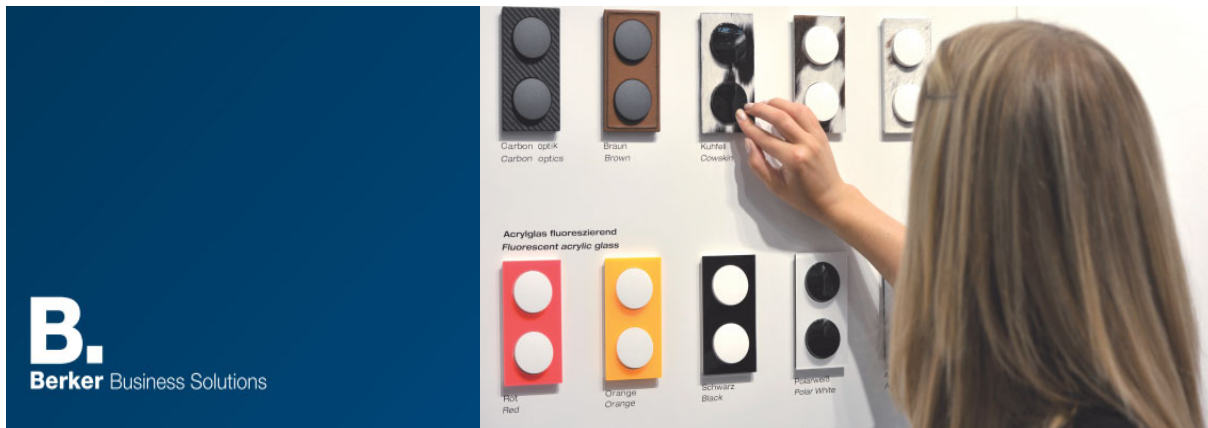

Sinds 1954 is Calpe de Nederlandse importeur van Berker Business Solutions. Berker is gevestigd in het Duitse Schalksmühle en is gespecialiseerd in de ontwikkeling en productie van hoogwaardig schakelmateriaal. Het Berker Integro concept is een modulair systeem dat door de compacte afmetingen met name wordt toegepast in meubelbouw en mobile living. (Luxe jachten, caravans, campers) Sinds 2010 maakt Berker Business Solutions onderdeel uit van de Hager Group.

## Designs | Serie Flow, Classic en Pure

### Design Flow



### Design Classic



### Design Pure



Bovenstaand overzicht is een weergave van de standaard producten. Berker biedt vele mogelijkheden voor afwijkende kleuren of individuele bedrukking. Daarnaast zijn er vele internationale uitvoeringen beschikbaar.

## Compacte afmetingen

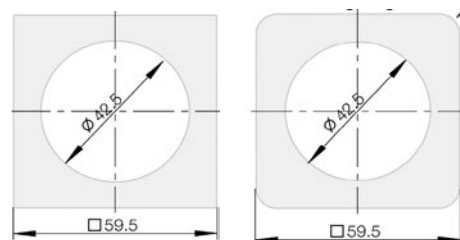

# Berker Business Solutions

Afdekramen: enkelvoudig, 2- en 3-voudig

**B.**  
Berker Business Solutions

## Enkelvoudig

Kleur	Bestelnummer	Brutoprijs €/stk	Bestelnummer	Brutoprijs €/stk	Bestelnummer	Brutoprijs €/stk
<b>Vpe 10</b>						
	<b>Flow</b>		<b>Classic</b>		<b>Pure</b>	
Bruin mat	09-18272501	0,70	09182701	0,70	-	
Antraciet/zwart	09-18272505	0,70	09182705	0,70	-	
Poolwit hg.	09-18272509	0,70	09182709	0,70	09-19752509	o.a.
Grijs hg.	09-18272507	0,70	09182707	0,70	-	
Zwart hg.	09-18272510	1,20	-	-	09-19752510	o.a.
Chroom hg.	09-18272518	6,85	09182718	6,85	09-19752518	o.a.
Chroom mat	09-18272528	6,85	09182728	6,85	09-19752528	7,70
Chroom mat gelakt	09-18272558	3,25	-	-	-	
RVS mat gelakt	09-18272524	2,90	-	-	09-19752524	o.a.



## Tweevoudig

Kleur	Bestelnummer	Brutoprijs €/stk	Bestelnummer	Brutoprijs €/stk	Bestelnummer	Brutoprijs €/stk
<b>Vpe 2</b>						
	<b>Flow</b>		<b>Classic</b>		<b>Pure</b>	
Bruin mat	09-18262511	2,00	09182611	1,90	-	
Antraciet/zwart	09-18262515	2,00	09182615	1,90	-	
Poolwit hg.	09-18262519	2,00	09182619	1,90	09-19762509	2,85
Grijs hg.	09-18262507	2,00	09182607	1,90	-	
Zwart hg.	09-18262510	o.a.	-	-	09-19762510	o.a.
Chroom hg.	09-18262518	11,45	09182618	10,70	09-19762518	
Chroom mat	09-18262528	11,45	09182628	10,70	09-19762528	12,15
Chroom mat gelakt	09-18262558	7,20	-	-	-	
RVS mat gelakt	09-18262524	4,95	09182614	o.a.	09-19762524	5,70

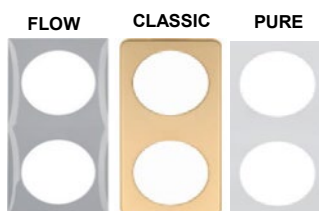

## Drievoudig

Kleur	Bestelnummer	Brutoprijs €/stk	Bestelnummer	Brutoprijs €/stk	Bestelnummer	Brutoprijs €/stk
<b>Vpe 2</b>						
	<b>Flow</b>		<b>Classic</b>		<b>Pure</b>	
Bruin mat	09-18192511	2,80	09181911	2,85	-	
Antraciet/zwart	09-18192515	2,80	09181915	2,80	-	
Poolwit hg.	09-18192519	2,80	09181919	2,85	09-19782509	o.a.
Grijs hg.	09-18192507	o.a.	09181907	2,85	-	
Zwart hg.	09-18192510	3,85	-	-	09-19782510	o.a.
Chroom hg.	09-18192518	42,45	-	-	09-19782518	o.a.
Chroom mat	09-18192528	o.a.	-	-	09-19782528	17,10
Chroom mat gelakt	09-18192568	42,45	-	-	-	
RVS mat gelakt	09-18192524	7,35	-	-	09-19782524	8,00

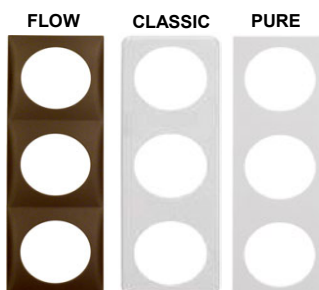

## Enkelvoudig | Met opdruk IP44

Kleur	Bestelnummer	Brutoprijs €/stk	Bestelnummer	Brutoprijs €/stk
<b>Vpe 10</b>				
	<b>Flow</b>		<b>Classic</b>	
Bruin mat	09-18272591	o.a.	09182791	0,85
Antraciet/zwart	09-18272595	0,85	09182795	0,85
Poolwit hg.	09-18272599	0,85	09182799	0,85
Grijs hg.	09-18272597	o.a.	09182797	0,85
Zwart hg.	-	-	-	-
Chroom hg.	-	-	-	-
Chroom mat	-	-	-	-
Chroom mat gelakt	09-18272568	o.a.	-	-
RVS mat gelakt	-	-	-	-



# Berker Business Solutions

Afdekramen: met klapdeksel, opbouwdozen

**B.**  
Berker Business Solutions

## Enkelvoudig | Met klapdeksel

Kleur	Bestelnummer	Brutoprijs	Bestelnummer	Brutoprijs
Vpe 10		€/stk		€/stk
	<b>Flow/Pure</b>		<b>Classic</b>	
Bruin mat	09-18282501	3,00	09182801	3,00
Antraciet/zwart	09-18282505	3,00	09182805	3,00
Poolwit hg.	09-18282509	3,00	09182809	3,00
Grijs hg.	09-18282507	3,00	09182807	3,00
Zwart hg.	09-18282510	4,10	-	-
Chroom hg.	09-18282518	15,65	09182818	15,65
Chroom mat	09-18282528	15,65	09182828	15,65
Chroom mat gelakt	09-18282578	7,20	-	-
RVS mat gelakt	09-18282524	7,20	-	-

FLOW



CLASSIC



## Enkelvoudig | Met klapdeksel + opdruk IP44

Kleur	Bestelnummer	Brutoprijs	Bestelnummer	Brutoprijs
Vpe 10		€/stk		€/stk
	<b>Flow/Pure</b>		<b>Classic</b>	
Bruin mat	09-18282591	3,60	09182891	3,60
Antraciet/zwart	09-18282595	3,60	09182895	3,60
Poolwit hg.	09-18282599	3,60	09182899	3,60
Grijs hg.	09-18282597	o.a.	09182897	3,60
Zwart hg.	-	-	-	-
Chroom hg.	-	-	-	-
Chroom mat	-	-	-	-
Chroom mat gelakt	09-18282568	o.a.	-	-
RVS mat gelakt	-	-	-	-

FLOW



CLASSIC



## Opbouwdoos | 41mm

Kleur	Bestelnummer	Brutoprijs	Bestelnummer	Brutoprijs	Bestelnummer	Brutoprijs
Vpe 10		€/stk		€/stk		€/stk
	<b>Flow/Pure</b>		<b>Classic</b>		<b>Pure</b>	
Bruin mat	09-11512501	7,00	09115101	7,00	-	-
Antraciet/zwart	09-11512505	7,00	09115105	7,20	-	-
Poolwit hg.	09-11512509	7,00	09115109	7,20	09-11512509	7,00
Grijs hg.	09-11512507	7,00	09115107	7,20	-	-
Zwart hg.	09-11512510	7,45	-	-	09-11512520	10,00
<b>Met trekcontlasting</b>						
Bruin mat	09-11512511	o.a.	-	-	-	-
Antraciet/zwart	09-11512515	9,15	-	-	-	-
Poolwit hg.	09-11512519	9,15	-	-	09-11512519	9,15
Grijs hg.	09-11512517	o.a.	-	-	-	-
Zwart hg.	09-11512520	10,00	-	-	09-11512520	10,00



09-11512507



09-11512509



09-11512515



09-11512519

## Opbouwdoos | 16mm

Kleur	Bestelnummer	Brutoprijs	Bestelnummer	Brutoprijs	Bestelnummer	Brutoprijs
Vpe 10		€/stk		€/stk		€/stk
	<b>Flow/Pure</b>		<b>Classic</b>		<b>Pure</b>	
Antraciet/zwart hg.	09-11522525	2,95	09115225	3,00	-	-
Poolwit hg.	09-11522529	2,95	09115229	3,00	09-11522529	2,95
<b>1x trekcontlasting</b>						
Antraciet/zwart hg.	09-11522555	4,00	09115255	4,10	-	-
Poolwit hg.	09-11522559	4,00	09115259	4,10	09-11522559	3,75



09-11522555



09-11522529

# Berker Business Solutions

Toebehoren, montagevoorschrift IP44

**B.**  
Berker Business Solutions

## Opvulring | Afmeting: 59,5x59x5x10mm

Kleur	Bestelnummer	Brutoprijs €/stk	Bestelnummer	Brutoprijs €/stk	Bestelnummer	Brutoprijs €/stk
<b>Vpe 10</b>						
	<b>Flow</b>		<b>Classic</b>		<b>Pure</b>	
Bruin mat	09-18252511	1,15	09182511	1,40	-	-
Antraciet/zwart	09-18252515	1,15	-	-	-	-
Poolwit hg.	09-18252512	1,15	09182512	1,40	09-18252512	1,15
Grijs hg.	09-18252506	-	09182506	1,40	-	-
Zwart hg.	09-18252510	o.a.	09182515	1,40	09-18252510	o.a.
Chroom mat gelakt	09-18252568	4,10	-	-	09-18252568	4,10
RVS mat gelakt	09-18252524	3,75	-	-	09-18252524	3,75

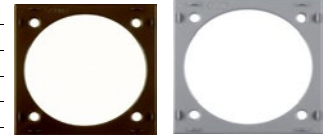

## Blindplaten

Kleur	Bestelnummer	Brutoprijs €/stk
<b>Vpe 10</b>		
Bruin mat	09-45162501	2,10
Antraciet/zwart	09-45162505	2,10
Poolwit hg.	09-45162509	2,10
Grijs hg.	09-45162507	2,10
Zwart hg.	09-45162510	2,45
RVS mat gelakt	09-45162524	3,00



## Montagevoorschrift voor afdichting IP44

Producten voorzien van  komen in aanmerking

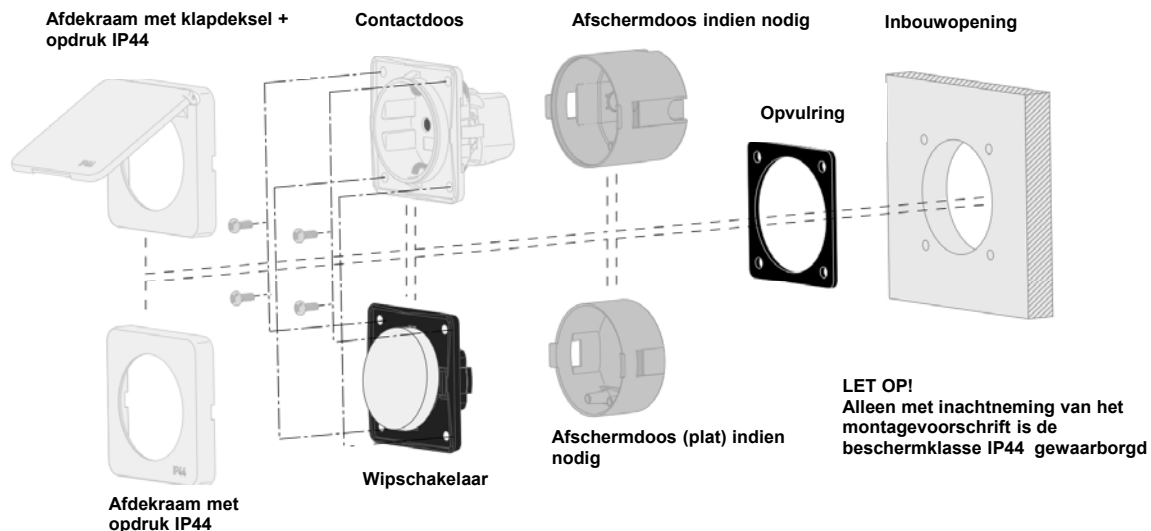

# Berker Business Solutions

Basiselementen: wip- en drukschakelaars

**B.**  
Berker Business Solutions



Wipschakelaar 10A/250V

## Serie 3651

Kleur	Bestelnummer	Brutoprijs €/stk
	<b>Flow/Pure</b>	
Bruin mat	09-36512501	6,75
Antraciet/zwart	09-36512505	6,75
Poolwit hg.	09-36512509	6,75
Grijs hg.	09-36512507	6,75
Zwart hg.	09-36512510	o.a.
Chroom hg.	09-36512518	11,20
Chroom mat	09-36512528	11,20
Chroom mat gelakt	09-36512568	o.a.
RVS mat gelakt	09-36512524	10,60

Bestelnummer	Brutoprijs €/stk
	<b>Classic</b>
09365105	6,75
09365109	6,75
09365107	6,75
-	-
09365118	11,20
09365128	11,20
-	-



Wisselschakelaar 10A/250V

## Serie 3656

Bestelnummer	Brutoprijs €/stk	Bestelnummer	Brutoprijs €/stk
	<b>Flow/Pure</b>		<b>Classic</b>
09-36562501	7,95	-	-
09-36562505	7,95	09365605	7,95
09-36562509	7,95	09365609	7,95
09-36562507	7,95	09365607	7,95
09-36562510	9,90	-	-
09-36562518	17,00	09365618	17,00
09-36562528	17,00	09365628	17,00
09-36562568	11,45	-	-
09-36562524	11,45	-	-

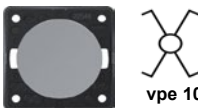

Kruisschakelaar 10A/250V

## Serie 3657

Kleur	Bestelnummer	Brutoprijs €/stk
	<b>Flow/Pure</b>	
Bruin mat	09-36572501	17,45
Antraciet/zwart	09-36572505	17,45
Poolwit hg.	09-36572509	17,45
Grijs hg.	09-36572507	o.a.
Zwart hg.	09-36572510	o.a.
Chroom hg.	-	-
Chroom mat	09-36572528	o.a.
Chroom mat gelakt	09-36572568	18,05
RVS mat gelakt	09-36572524	18,05

Bestelnummer	Brutoprijs €/stk
	<b>Classic</b>
09365709	17,45
-	-
-	-
-	-
-	-
-	-
-	-
-	-
-	-



Uitschakelaar 10A/250V, 2P

## Serie 3652 | Met opdruk "0"

Bestelnummer	Brutoprijs €/stk	Bestelnummer	Brutoprijs €/stk
	<b>Flow/Pure</b>		<b>Classic</b>
09-36522501	12,70	-	-
09-36522505	12,70	09365205	12,70
09-36522509	12,70	09365209	12,70
09-36522507	12,70	09365207	o.a.
09-36522510	13,20	-	-
09-36522518	o.a.	-	-
09-36522528	14,85	09365228	o.a.
09-36522568	o.a.	-	-
09-36522524	o.a.	-	-



Uitschakelaar 10A/250V, 2P

## Serie 3752 | Controlelicht + opdruk "0"

Kleur	Bestelnummer	Brutoprijs €/stk
	<b>Flow/Pure</b>	
Bruin mat	09-37522501	14,85
Antraciet/zwart	09-37522505	14,85
Poolwit hg.	09-37522509	14,85
Grijs hg.	09-37522507	14,85
Zwart hg.	09-37522510	o.a.
Chroom hg.	-	-
Chroom mat	-	-
Chroom mat gelakt	09-37522568	17,80
RVS mat gelakt	09-37522524	17,80

Bestelnummer	Brutoprijs €/stk
	<b>Classic</b>
09375205	14,85
09375209	14,85
09375207	14,85
-	-
-	-
-	-
-	-
-	-
-	-



Wipschakelaar 5A/12V, 2P

## Serie 3762 | Controlelicht + "0"

Bestelnummer	Brutoprijs €/stk
	<b>Flow/Pure</b>
09-37622531	13,80
09-37622535	13,80
09-37622539	13,80
-	-
09-37622510	26,05
09-37622518	o.a.
-	-
09-37622568	27,50
09-37622524	o.a.

# Berker Business Solutions

Basiselementen: wip- en drukschakelaars

**B.**  
Berker Business Solutions

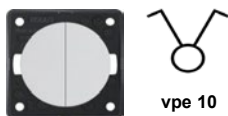

Serieschakelaar 10A/250V

## Serie 3655

Kleur	Bestelnummer	Brutoprijs €/stk
<b>Flow/Pure</b>		
Bruin mat	09-36552501	12,60
Antraciet/zwart	09-36552505	12,60
Poolwit hg.	09-36552509	12,60
Grijs hg.	09-36552507	12,60
Zwart hg.	09-36552510	o.a.
Chroom hg.	09-36552518	16,15
Chroom mat	09-36552528	16,15
Chroom mat gelakt	09-36552568	15,40
RVS mat gelakt	09-36552524	15,40

Bestelnummer	Brutoprijs €/stk
<b>Classic</b>	
-	-
09365505	12,60
09365509	12,60
09365507	12,60
-	-
09365518	o.a.
09365528	16,15
-	-
-	-

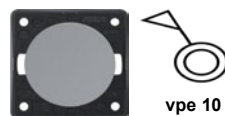

Impulsschakelaar 10A/250V

## Serie 3671 | NO contact

Bestelnummer	Brutoprijs €/stk	Bestelnummer	Brutoprijs €/stk
<b>Flow/Pure</b>		<b>Classic</b>	
09-36712501	8,10	-	-
09-36712505	8,10	09367105	8,10
09-36712509	8,10	09367109	8,10
09-36712507	o.a.	09367107	o.a.
09-36712510	9,05	-	-
09-36712518	14,70	09367118	o.a.
09-36712528	14,70	09367128	o.a.
09-36712568	11,10	-	-
09-36712524	11,10	-	-

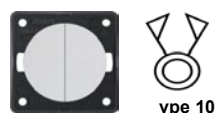

Impuls Serieschakelaar 10a/250V

## Serie 3675 | 2x NO contact

Kleur	Bestelnummer	Brutoprijs €/stk
<b>Flow/Pure</b>		
Bruin mat	09-36752501	14,35
Antraciet/zwart	09-36752505	14,35
Poolwit hg.	09-36752509	14,35
Grijs hg.	09-36752507	o.a.
Zwart hg.	09-36752510	o.a.
Chroom hg.	09-36752518	26,05
Chroom mat	09-36752508	26,05
Chroom mat gelakt	09-36752568	16,95
RVS mat gelakt	09-36752524	16,40

Bestelnummer	Brutoprijs €/stk
<b>Classic</b>	
-	-
09367505	14,35
09367509	14,35
09367507	14,35
-	-
-	-
-	-
-	-
-	-
-	-

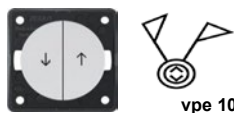

Jalouzie drukcontact 10A/250V

## Serie 3653

Bestelnummer	Brutoprijs €/stk	Bestelnummer	Brutoprijs €/stk
<b>Flow/Pure</b>		<b>Classic</b>	
09-36532501	14,65	-	-
09-36532505	14,65	09365305	14,65
09-36532509	14,65	09365309	14,65
09-36532507	14,65	09365307	o.a.
09-36532510	o.a.	-	-
09-36532518	o.a.	-	-
09-36532528	o.a.	-	-
09-36532568	22,35	-	-
09-36532524	o.a.	-	-



Poolomkeerschakelaars | 7,5A/24V - 15A/12V | 4 contacten

## Serie 3699 & 3696

Kleur	Bestelnummer	Brutoprijs €/stk
<b>Print "trap"</b>		
Bruin mat	09-36992501	o.a.
Antraciet/zwart	09-36992505	11,95
Poolwit hg.	09-36992509	o.a.
Grijs hg.	09-36992507	o.a.
Zwart hg.	09-36992510	o.a.
Chroom hg.	-	-
Chroom mat	09-36992528	14,40
Chroom mat gelakt	09-36992568	o.a.
RVS mat gelakt	-	-



Bestelnummer	Brutoprijs €/stk
<b>Print "bed"</b>	
-	-
09-36992575	15,10
-	-
-	-
-	-
09-36992578	o.a.
-	-
-	-



Bestelnummer	Brutoprijs €/stk
<b>Print "luifel"</b>	
09-36962505	17,85
-	-
-	-
09-36962518	o.a.
09-36962528	o.a.
09-36962568	o.a.
-	-



Potentiometer 1-10V

## Serie 2891

Bestelnummer	Brutoprijs €/stk
<b>Met afdekraam</b>	
<b>Flow</b>	
09-28912501	o.a.
09-28912505	40,75
09-28912509	o.a.
09-28912506	o.a.

Ook verkrijgbaar  
12v dc 50w LED-Dimmer

Meer contacten, andere opdruk, andere wensen? Vraag naar de mogelijkheden.

# Berker Business Solutions

Basiselementen: contactdozen

**B.**  
Berker Business Solutions

## Contactdozen Schuko

Kleur	Bestelnummer	Brutoprijs €/stk	VPE 10
-------	--------------	---------------------	-----------

### Serie 4185 | 16A, Schroefklem

Antraciet/zwart	09-41852505	4,45	
Poolwit	09-41852502	4,45	
Grijs	09-41852506	4,45	
Zwart	09418505	4,45	



### Serie 4185 | 16A, Schroefklem 45° gedraaid

Antraciet/zwart	09-41852525	4,45	
Poolwit	09-41852522	4,45	
Grijs	09-41852526	4,15	
Zwart	09451705	14,20	



Bestelnummer	Brutoprijs €/stk	VPE 10
--------------	---------------------	-----------

### Serie 4195 | 16A, Schroefklem

#### Kinderbeveiliging

09-41952505	6,35	
09-41952502	6,35	
09-41952506	6,35	
09419505	6,35	



Ter informatie:  
De kleur bruin is in de meeste gevallen standaard leverbaar wat ook geldt voor steekklem uitvoeringen.

## Contactdozen met Penaarde

### Serie 6185 | 2P+A, Schroefklem

#### 16A Met Penaarde

Antraciet/zwart	09-61852505	5,40	
Poolwit	09-61852502	5,40	
Grijs	09-61852506	5,40	
Zwart	09618505	5,40	



### Serie 6195 | 2P+A, Schroefklem

#### 16A, Penaarde + kinderbeveiliging

09-61952505	5,40	
09-61952502	5,40	
09-61952506	5,40	
09619505	5,40	



## Contactdozen Internationaal

### Serie 6262 | British Standard, schroefklem

#### 2P+A, 13A kinderbeveiliging

Antraciet/zwart	09-62622505	8,80	
Poolwit	09-62622502	8,80	
Grijs	09-62622506	10,50	
Zwart	09626205	8,80	



### Serie 6263 | USA/Canada, NEMA 5-15 R

#### 2P+A, 15A

-		
09-62632502	10,80	
-		
09-62632513	10,80	



Ook verkrijgbaar in NEMA 6-20 R, serie 6254

### Serie 6272 | Denemarken | Schroefklem

#### 2P+A, 13A, Kinderbeveiliging

Antraciet/zwart	09-62722505	11,05	
Poolwit	09-62722502	11,05	
Grijs	09-62722506	o.a.	
Zwart	09627205	11,05	



### Serie 6256 | Australië 15A, Schroefklem

#### 2P+A, 15A

09-62562505	31,65	
09-62562502	31,65	
09-62562506	o.a.	
09625605	31,65	



Ook verkrijgbaar in 10A, serie 6258

### Serie 6249 | Zwitserland Type 13, Schroefklem

#### 2P+A, 10A

Antraciet/zwart	09-62492505	15,55	
Poolwit	09-62492502	15,55	
Grijs	09-62492506	o.a.	
Zwart	09624905	15,55	



Ook verkrijgbaar in type 23, serie 6259 (16A)

Voor het volledige programma:  
[Berker-business-solutions.de](http://Berker-business-solutions.de)

## Contactdozen zonder Aarde

### Serie 6194 | Nederland, Schroefklem

#### Zonder Aarde, kinderbeveiliging

Antraciet/zwart	09-61942505	8,05	
Poolwit	09-61942502	8,05	
Grijs	09-61942506	o.a.	
Zwart	09-61942503	o.a.	



### Serie 6257 | EURO-Amerikaans stand., Schroefklem

#### Zonder aarde, 2P kinderbeveiliging

09-62572505	10,85	
09-62572502	10,85	
09-62572506	10,85	
09-62572503	o.a.	





# Berker Business Solutions

Basiselementen: TV/multimedia

**B.**  
Berker Business Solutions

## TV/multimedia

Kleur	Bestelnummer	Brutoprijs €/stk	VPE 10
-------	--------------	---------------------	-----------

### Serie 4517 | 12V, max 16A

Klein, vlakke aansluiting

Antraciet/zwart	09-45172505	14,20	
Poolwit hg	09-45172509	14,20	
Grijs mat	09-45172507	o.a.	
Zwart mat	09451705	14,20	



Bestelnummer	Brutoprijs €/stk	VPE 10
--------------	---------------------	-----------

### Serie 4571 | 12V, max 20A

Groot, vlakke aansluiting

09-45712505	12,65	
09-45712509	12,65	
09-45712507	o.a.	
09-45712503	o.a.	



### Serie 4570 | 12V, max 20A + klapdeksel

Opdruk "Max 20A"

Antraciet/zwart	09-45702505	19,60	
Poolwit hg	-		
Grijs mat	-		
Zwart mat	-		



Ook verkrijgbaar in 10A

### Serie 2610 | USB voeding, 2x

230V/3A, schroefklem

09-26102505	64,65	
09-26102509	64,65	
-		
-		



### Serie 2602 | USB voeding, 2x

12V/max 5A, schroefklem

Antraciet/zwart	09-26022505	60,90	
Poolwit hg	09-26022509	60,90	
Grijs mat	-		
Zwart mat	-		



### Serie 2603 | USB voeding, 1x

12V/Max 3A, schroefklem, type A

09-26032505	56,45	
09-26032509	56,45	
09-26032507	o.a.	
09-26032503	56,45	



### Serie 4511 | Antenne- TV

Zonder afscherming

Antraciet/zwart	09-45112515	5,20	
Poolwit hg	09-45112512	5,20	
Grijs mat	09-45112516	5,20	
Zwart mat	09-451115	o.a.	



### Serie 4581 | Antenne- TV, F-Techniek Aansluiting

Zonder afscherming

09-45812505	5,35	
09-45812502	5,35	
09-45812506	5,35	
09-45812503	o.a.	



### Serie 4519 | Antenne- SAT

Zonder afscherming

Antraciet/zwart	09-45192505	5,90	
Poolwit hg	09-45192502	o.a.	
Grijs mat	09-45192506	o.a.	
Zwart mat	09451905	5,90	



### Serie 4563 | Antenne- TV/SAT

Zonder afscherming

-		
-		
09-45632506	o.a.	
09-45632503	10,25	



### Draagplaat 2-voudig

Mini-com module

Antraciet/zwart	09-45592505	2,65	
Poolwit hg	09-45592509	2,65	
Grijs mat	09-45592507	2,65	
Zwart mat	09455905	2,65	



### Mini Jack

8-polig met Snijklem

RJ45, Cat.5e, shielded (AWG 24-22)		
091984	29,35	
RJ45, Cat.6, shielded (AWG 26)		
091985	26,65	



Geschikt voor mini-com module

### Draagplaat 1-voudig

AMP modular Jacks

Antraciet/zwart	09-45572505	2,05	
Poolwit hg	09-45572509	2,05	
Grijs mat	09-45572507	o.a.	
Zwart mat	09455705	2,05	



### Draagplaat 2-voudig

BTR-/E-DAT module

09-45582505	3,25	
09-45582509	3,25	
09-45582507	3,25	
09-45582510	3,60	



# Berker Business Solutions

Afschermdozen, draadloos laadstation

**B.**  
Berker Business Solutions

## Afschermdozen | Vlamvertragend volgens VDE 0606-1

Bestelnummer	Kabel Ø mm	Aantal invoeren	Diameter/ afmeting mm Ø	Inbouw Diepte mm	Trek- ontlasting	VPE	Brutoprijs €/stk	
<b>1-voudige afschermdoos, kleur grijs</b>								
09182003	10	1	45	22	nee	200	1,10	
09182001	10	1	45	22	enkel	200	1,30	
09182002	10	4	45	35,5	nee	200	1,05	
091820	10	4	45	35,5	enkel	200	1,35	
09188701	10	2	49	38	nee	200	o.a.	
091887	10	2	49	38	dubbel	200	2,10	
091883	10	2	49	45,5	dubbel	200	2,00	
<b>2-voudige afschermdoos, kleur grijs</b>								
			<b>afmeting</b>					
09191501	*	12	2	109x49	37	enkel	10	2,70
09191502	*	12	2	109x49	37	2xenkel	10	3,00
09191102	v	12	4	109x48	45,5	nee	100	o.a.
091911	v	12	4	109x48	45,5	1xdubbel	100	5,00
09191101	v	12	4	109x48	45,5	2xdubbel	100	o.a.
091912	h	12	4	48x109	45,5	1xdubbel	100	5,00
09191201	h	12	4	48x109	45,5	2xdubbel	100	o.a.
<i>*Kan horizontaal als verticaal gemonteerd worden, H = uitsluitend horizontaal, V= uitsluitend verticaal</i>								
<b>3-voudige afschermdoos, kleur grijs</b>								
091933	10	6	168x49	38	1xenkel	10	4,40	



09182001

091820



091833



091911

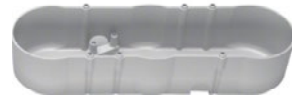

091933

## Montagesjabloon | Karton/Aluminium

Bestelnummer	Materiaal	Toepassing	VPE	Brutoprijs €/stk
091844	Karton	1- en 2-voudige combinaties	10	1,45
09184502	Aluminium	1- en 2-voudige combinaties	1	o.a.
09184503	Aluminium	1-, 2- en 3-voudige combinaties	1	o.a.



091844



## Afdichting | IP44

Bestelnummer	Type	Omschrijving	VPE	Brutoprijs €/stk
09-1853	Afdichting	tbv Berk Integro	10	1,45

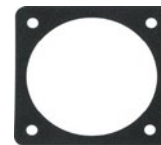

## Draadloos laadstation | Serie EB

Bestelnummer	Kleur cover	Inductie Ø	Spoel	Montage	Brutoprijs €/stk
09-261009	○ wit	80 mm	7	boven	177,05
09-261005	● zwart	80 mm	7	boven	177,05
09-261109	○ wit	80 mm	1	geïntegreerd	o.a.
09-261105	● zwart	80 mm	1	geïntegreerd	
09-261209	○ wit	62 mm	1	boven	
09-261205	● zwart	62 mm	1	boven	



# Bulgin - Arcoelectric schakelaars

Wipschakelaars diversen



## Serie 8500 | Wipschakelaars (miniatuur)

**Aantal polen:** 1- of 2-polig  
**Spanning:** tot 16A, 250VAC  
**Uitvoering:** Verlicht en onverlicht  
**Paneel uitsparing:** 19,3x12,9mm

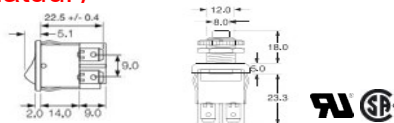

H8500VB



H8550VB



H8550HB



H8500PO



H8553VB



H8580AB

## Serie 8600 | Wipschakelaars (miniatuur)

**Aantal polen:** 1- of 2-polig  
**Spanning:** tot 16A, 250VAC  
**Uitvoering:** Verlicht en onverlicht  
**Paneel uitsparing:** 19,3x12,9mm (21,9 voor 2-polig)

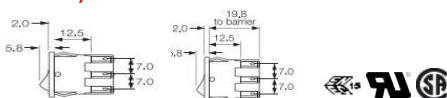

H8600VB



H8600VB



H8630FB



H8650VB



H8660VB



H8653VB

## Serie 6000 | Wipschakelaars (spatwaterdicht)

**Aantal polen:** 1- of 2-polig  
**Spanning:** tot 20A, 250VAC  
**Uitvoering:** Verlicht en onverlicht  
**Paneel uitsparing:** 30,1x11,1mm (22,2 voor 2-polig)



C6000AL



C6000AL



C6010AL



C6050AL



C6053AL



C6053PL

## Serie 1500 standaard, 1300 hoge inschakelstroom | Wipschakelaars

**Aantal polen:** 1- of 2-polig  
**Spanning:** tot 16A, 250VAC  
**Uitvoering:** Onverlicht  
**Paneel uitsparing:** 27,3x12,3 (22,3 voor 2-polig)

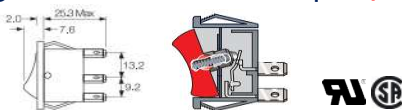

C1500AR



C1500AL



C1500XL



C1350AL



C1550XL



C1553PL

## Overige mogelijkheden



Bulgin/Arcoelectric biedt een ruim assortiment wipschakelaars, tuimel- en drukschakelaars.

Daarnaast is een pakket zekering-houders beschikbaar, geschikt voor 6,3x32mm zekeringen.

Het pakket van Bulgin is geschikt voor machine- en apparatenbouw. Vraag naar de mogelijkheden via [info@calpe.nl](mailto:info@calpe.nl) of bel 0342 - 45 15 44

#### ARTIKEL 1. TOEPASSELIJKHEID

- 1.1 Deze algemene voorwaarden zijn van toepassing op en maken deel uit van alle door Calpe aangegane opdrachten, offertes, aanbiedingen, overeenkomsten en verbintenissen hoe ook genaamd, tenzij door Calpe van deze voorwaarden uitdrukkelijk schriftelijk zal zijn afgeweken.
- 1.2 In het navolgende wordt verstaan onder Calpe: de besloten vennootschap Calpe B.V., gevestigd en zaakdoende te Barneveld en inschreven in het Handelsregister onder nummer 32086233. Afnemer: iedere rechtspersoon dan wel een natuurlijk persoon, dan wel een aantal gezamenlijk optredende personen al dan niet rechtspersonen die met Calpe een overeenkomst aangaat of wil aangaan of wie Calpe een aanbieding doet of een leverantie of prestatie verricht, alsmede diens rechtsopvolgers. Producten: de door Calpe geleverde of te leveren producten, in de ruimste zin van het woord. Overeenkomst: iedere overeenkomst die tussen Calpe en afnemer tot stand komt, elke wijziging daarvan of aanvulling daarop, alsmede alle (rechts)handelingen ter voorbereiding en ter uitvoering van die overeenkomst.
- 1.3 Van deze voorwaarden kan uitsluitend schriftelijk worden afgeweken, mits de directie van Calpe dit heeft ondertekend.
- 1.4 Wanneer de rechter één of meerdere bepalingen om welke reden dan ook niet van toepassing c.q. ongeldig verklaart, dan blijven deze voorwaarden voor het overige onverminderd gelden en gelden de afwijkende voorwaarden uitsluitend voor de betreffende overeenkomst met het oog waarop deze zijn overeengekomen.
- 1.5 Algemene voorwaarden van afnemer gelden niet, tenzij deze voorwaarden door Calpe schriftelijk zijn aanvaard.

#### Artikel 2. Aanbiedingen/offertes

- 2.1 Alle aanbiedingen door of vanwege Calpe, daaronder begrepen gegevens in eventuele toegevoegde bijlagen, prijzen en andere voorwaarden, zijn vrijblijvend en binden Calpe niet.
- 2.2 Een door Calpe gedane aanbieding, vervalt na een periode van twee weken, tenzij schriftelijk anders is overeengekomen, indien de aanbieding alsdan nog niet door afnemer is geaccepteerd.
- 2.3 Een door afnemer geplaatste order is onherroepelijk, tenzij afnemer bij het plaatsen van de order een voorbehoud heeft gemaakt.

#### Artikel 3. Overeenkomsten

- 3.1 Overeenkomsten worden eerst bindend door schriftelijke aanvaarding in een door Calpe ondertekende bevestiging van de overeenkomst of indien door Calpe uitvoering wordt gegeven aan de overeenkomst c.q. opdracht.
- 3.2 Als moment van de totstandkoming van de overeenkomst geldt de datum van de bevestiging van de overeenkomst door Calpe of het moment dat door Calpe uitvoering wordt gegeven aan de overeenkomst.
- 3.3 Eventuele latere wijzigingen in en aanvulling op de overeenkomst zijn slechts geldig indien Calpe deze schriftelijk heeft bevestigd of indien door Calpe hieraan uitvoering wordt gegeven.
- 3.4 Mondelinge bestellingen door een afnemer gedaan zijn pas bindend na schriftelijke bevestiging door afnemer en/of door aanvaarding c.q. uitvoering daarvan door Calpe.
- 3.5 Een samengestelde prijsopgave verplicht Calpe niet tot het verrichten van een gedeelte van de overeenkomst tegen een overeenkomstig deel van de opgegeven prijs.
- 3.6 De inhoud van folders, drukwerk, website etc. binden Calpe niet, tenzij daarnaar in de overeenkomst nadrukkelijk is verwezen.
- 3.7 Calpe behoudt zich het recht voor zonder opgave van redenen bestellingen of overeenkomsten niet te accepteren of uitsluitend te accepteren onder de voorwaarde dat vooraf de bestelling door afnemer schriftelijk wordt bevestigd en/of de verzending geschiedt onder rembours of na vooruitbetaling.

#### Artikel 4. Uitvoering

- 4.1. Calpe, dan wel de door haar ingeschakelde persoon of personen, zal (zullen) de overeenkomst met zorg uitvoeren, volgens de met afnemer overeengekomen procedures en daarbij de belangen van afnemer naar beste weten behartigen.
- 4.2 Mededelingen omtrent te verwachten prestaties van door Calpe te leveren producten zijn geheel vrijblijvend zonder enige verplichting en worden alleen gedaan bij wijze van niet-bindende informatie.
- 4.3 Afnemer zal zorgen voor het gebruik van de producten in overeenstemming met de bijgeleverde specificaties en instructies van Calpe danwel haar leverancier of fabrikant.
- 4.4 Calpe kan nimmer garanderen dat eerder door haar geleverde goederen op een later moment nog leverbaar zijn. Calpe kan dienaangaande nimmer aansprakelijk worden gehouden.

#### Artikel 5. Prijzen

- 5.1 De door Calpe genoemde prijzen zijn gebaseerd op per datum van aanbieding geldende omstandigheden, zoals kostprijzen en/of inkooprijzen en/of dealerprijzen, valutakoersen, vrachttarieven, lonen, salarissen, overheidslasten, sociale lasten, transportkosten, materiaalprijzen en dergelijke.
- 5.2 Indien, gedurende een tijdvak gelegen tussen de datum van de aanbieding en de datum van de aflevering, één of meer van de omstandigheden zoals in lid 1 genoemd, wijzigen, is Calpe gerechtigd tot verhoging van de prijs, tenzij enig wettelijk voorschrift zich hiertegen verzet. De eerder geoffeerde prijzen komen in dat geval direct te vervallen.
- 5.3 Alle door of vanwege Calpe genoemde prijzen zijn exclusief de daarover verschuldigde omzetbelasting.
- 5.4 De kosten van de verpakking, het transport en de afleveringskosten ter plaatse door afnemer aangewezen, vallen buiten de verkoopprijs en komen geheel of gedeeltelijk, zulks ter bepaling door Calpe, ten laste van afnemer, tenzij anders is overeengekomen.
- 5.5 Onverminderd hetgeen in lid 2 is bepaald, zal Calpe gerechtigd zijn om, indien overheidsmaatregelen worden afgekondigd die een hogere kostprijs voor Calpe ten gevolge heeft en welke niet als normaal handelsrisico zijn aan te merken, dienovereenkomstige toeslagen op prijzen van lopende order en/of bestellingen te berekenen.

#### Artikel 6. Betaling en zekerheidsstelling

- 6.1 Afnemer dient de aan Calpe verschuldigde bedragen binnen 30 dagen na factuurdatum, zonder opschorting, verrekening of aftrek van enig bedrag, te voldoen op de door Calpe aan te geven wijze.
- 6.2 Indien afnemer niet binnen de in het vorige lid genoemde termijn volledig betaalt, is

afnemer, zonder voorafgaande ingebrekestelling, in verzuim en is afnemer aan Calpe over het openstaande bedrag vanaf vervaldatum tot aan de dag der algehele voldoening een rente van 1,5% per maand verschuldigd.

- 6.3 Terzake van afnemers, niet zijnde natuurlijke personen die niet handelen in de uitoefening van een beroep of bedrijf, geldt in afwijking van artikel 6:96 lid 4 BW dat alle incassokosten voor rekening zijn van de afnemer, waarbij afnemer een bedrag aan buitengerechtelijke incassokosten verschuldigd is van 15% van het nog verschuldigde bedrag, met een minimum van € 350,-.
- 6.4 Door afnemer gedane betalingen strekken steeds ter afdoening in de eerste plaats van alle verschuldigde rente en kosten en vervolgens van de opeisbare facturen die het langst openstaan, zelfs al vermeldt afnemer dat de voldoening betrekking heeft op een latere factuur.
- 6.5 Onverminderd hetgeen hiervoor is bepaald, kan Calpe bij het aangaan van, dan wel tijdens de looptijd van een overeenkomst van afnemer verlangen, dat deze ten genoegen van Calpe voldoende zekerheid stelt (door middel van vooruitbetaling of anderszins) voor de nakoming van de verplichtingen die uit hoofde van de overeenkomst ten laste van afnemer zullen komen.
- 6.6 Het door afnemer, niet of onvoldoende verschaffen van de door Calpe verlangde zekerheid, als hiervoor bedoeld, geeft Calpe het recht om van de overeenkomst af te zien, danwel om deze al dan niet door een buitengerechtelijke verklaringen aan afnemer te ontbinden, onverminderd het recht van Calpe op schadevergoeding.
- 6.7 Reclames tegen facturen dienen binnen 14 dagen schriftelijk bij Calpe te worden ingediend. Reclames geven op zichzelf afnemer nog niet het recht haar betaling(en) geheel of gedeeltelijk op te schorten.

#### Artikel 7. Eigendomsvoorbehoud

- 7.1 Alle door Calpe geleverde producten blijven eigendom van Calpe totdat afnemer alle verplichtingen uit overeenkomst is nagekomen, met inbegrip van rente en kosten.
- 7.2 Afnemer is gehouden als een goed huisvader te zorgen voor de geleverde producten, totdat er volledige betaling heeft plaatsgevonden door afnemer en laatstgenoemde geen verdere verplichtingen meer heeft jegens Calpe terzake van de geleverde producten. Pas nadat de gehele koopsom en eventueel de daarbij komende kosten volledig zijn voldaan, heeft afnemer het recht de producten op welke wijze dan ook te bezwaren, te verkopen, verhuuren, te leveren dan wel aan derden af te staan.
- 7.3 Afnemer verbindt zich jegens derden, die de geleverde producten wil bezwaren, op eerste verlangen van Calpe te verklaren dat zij niet tot het bezwaren van de producten bevoegd is.
- 7.4 Afnemer geeft reeds nu onvoorwaardelijk en onherroepelijk toestemming aan Calpe danwel aan een door haar aan te wijzen derde om, in alle gevallen waarin Calpe haar eigendomsrechten wil uitoefenen, al die plaatsen te betreden waar de eigendommen van Calpe zich dan zullen bevinden en die producten aldaar mee te nemen.
- 7.5 Indien derden beslag leggen op de onder eigendomsvoorbehoud geleverde producten danwel rechten daarop willen vestigen of doen gelden, is afnemer verplicht Calpe zo snel als redelijkerwijs verwacht mag worden daarvan op de hoogte te stellen.
- 7.6 Bij beslag, (voorlopige) surséance van betaling of faillissement zal afnemer onmiddellijk de deurwaarder, de beslaglegger, de bewindvoerder en/of de curator wijzen op de (eigendoms)rechten van Calpe.

#### Artikel 8. Levering en risico

- 8.1 Levering van verkochte producten vindt plaats vanaf het magazijn of bedrijf van Calpe danwel vanaf het bedrijf van haar toeleverancier en vanaf dat moment gaat het risico over op afnemer, ongeacht de feitelijke plaats van aflevering en ongeacht de transporterende partij.
- 8.2 Afnemer is verplicht de gekochte producten af te nemen op het moment waarop deze hem worden bezorgd dan wel op het moment waarop deze volgens de overeenkomst aan hem ter beschikking worden gesteld. Indien afnemer de afname weigert of nalatig is met het verstrekken van informatie of instructies, noodzakelijk voor de levering, zullen de producten worden opgeslagen voor rekening en risico van afnemer. Afnemer zal in dat geval alle aanvullende kosten, waaronder in ieder geval begrepen de opslagkosten, verschuldigd zijn aan Calpe.
- 8.3 Afnemer is verplicht het geleverde onmiddellijk na ontvangst te controleren op juistheid van de aantallen en beschadigingen en eventuele andere tekortkomingen en deze op het vervoersdocument te vermelden.
- 8.4 Indien terzake van door Calpe verkochte producten keuring door afnemer is overeengekomen en afnemer binnen veertien dagen van deze uitnodiging geen gebruik heeft gemaakt, worden de verkochte producten na deze termijn geacht te zijn goedgekeurd en geaccepteerd door afnemer.
- 8.5 Indien bij gelegenheid van een keuring als hiervoor bedoeld door afnemer op- en/of aanmerkingen worden gegeven ten aanzien van, danwel bezwaren bestaan tegen de verkochte producten, heeft Calpe alsdan tenminste veertien dagen de tijd deze op en/of aanmerkingen c.q. bezwaren op te (doen) heffen, alvorens de verkochte producten door afnemer definitief kunnen worden afgekeurd of geweigerd.
- 8.6 Reeds bestelde en/of door Calpe geleverde goederen worden in beginsel niet retour genomen, tenzij er sprake is van een gebrek of anderszins onjuiste levering of indien Calpe anders beslist. Voorgenomen retourzendingen dienen vooraf bij Calpe te worden aangemeld en door Calpe te worden goedgekeurd alvorens afnemer tot verzending kan overgaan. Speciaal voor afnemer bestelde en/of gemaakte producten worden hoe dan ook niet retour genomen.

#### Artikel 9. Leveringstermijnen

- 9.1 Een door Calpe opgegeven afleveringstermijn is indicatief en informatief en bindt Calpe niet. Deze is gebaseerd op de ten tijde van het sluiten van de overeenkomst voor Calpe geldende omstandigheden en, voor zover afhankelijk van prestaties van toeleveranciers van Calpe, op de door die toeleveranciers aan Calpe verstrekte gegevens. Calpe kan niet verplicht worden binnen de afleveringstermijn de aflevering uit voeren, maar deze zal door Calpe zoveel mogelijk in acht worden genomen.
- 9.2 Bij overschrijding van de afleveringstermijn heeft afnemer geen recht op enige schadevergoeding. Afnemer heeft in dat geval evenmin recht op ontbinding van de overeenkomst, tenzij de overschrijding van de afleveringstermijn zodanig is dat van afnemer redelijkerwijs niet kan worden verlangd dat hij het betreffende gedeelte van de overeenkomst in stand laat. Afnemer is in dat geval gerechtigd, nadat er verzuim is ontstaan, de overeenkomst te ontbinden voor zover dat strikt noodzakelijk is en met inachtneming van hetgeen hiervoor is bepaald.
- 9.3 Calpe B.V. heeft te allen tijde het recht in gedeelten af te leveren.

## Artikel 10. Transport

- 10.1 Het transport van de verkochte producten geschiedt steeds af magazijn of bedrijf Calpe, tenzij schriftelijk uitdrukkelijk anderszins is overeengekomen.
- 10.2 Alle kosten van het transport komen voor rekening van afnemer, tenzij anders overeengekomen.
- 10.3 Alle risico's van welke aard ook, terzake van het transport van verkochte producten, komen volledig voor rekening en risico van afnemer, zodat Calpe derhalve op generlei wijze gehouden is om enige schade aan de verkochte producten tijdens het transport ontstaan aan afnemer te vergoeden.
- 10.4 Enkel indien dit expliciet schriftelijk tussen partijen is overeengekomen, zal Calpe voor rekening en ten behoeve van afnemer een transportverzekering voor de verkochte producten afsluiten.

## Artikel 11. Intellectueel eigendom

- 11.1 Calpe behoudt zich de rechten en bevoegdheden voor die haar toekomen op grond van de Auteurswet of overige wetten aangaande intellectuele eigendommen. Auteursrechten alsmede alle overige rechten van intellectuele eigendom op alle apparatuur, software, supplies, documentatie of andere materialen die door Calpe aan afnemer worden afgeleverd of op welke wijze dan ook ter beschikking worden gesteld, berusten uitsluitend bij Calpe of diens toeleveranciers, en afnemer verkrijgt daarvoor hoeguit de gebruiksrechten die bij deze voorwaarden uitdrukkelijk worden toegekend.
- 11.2 Afnemer is ermee bekend dat de producten en/of andere materialen als bedoeld in lid 1 vertrouwelijke informatie, unieke artikelnummers en bedrijfsgegevens van Calpe of diens toeleveranciers kunnen bevatten en afnemer verbindt zich alsdan deze gegevens, producten en/of andere materialen geheim te houden en niet aan enige derde bekend te maken of in gebruik te geven.
- 11.3 Het is afnemer niet toegestaan om op de producten of op de verpakking daarvan aangebrachte merkherkenningstekens of enige aanduiding omtrent auteursrechten, merken etc. daaronder begrepen enige aanduiding omtrent het vertrouwelijke karakter en geheimhouding van de software te verwijderen, te wijzigen of de producten op enig gedeelte daarvan te wijzigen of na te maken.
- 11.4 Het is Calpe toegestaan om technische maatregelen te nemen ter bescherming van eventueel toegepaste software.
- 11.5 Calpe verklaart dat naar beste weten de producten geen inbreuk maken op in Nederland geldende intellectuele eigendomsrechten van derden. In geval van aanspraak van derden ter zake van inbreuk op dergelijke rechten, kan Calpe zonnodig het desbetreffende product vervangen of wijzigen, dan wel de overeenkomst geheel of gedeeltelijk ontbinden. Afnemer heeft uitsluitend het recht de overeenkomst te ontbinden voor zover instandhouding van de overeenkomst in redelijkheid niet van haar kan worden verlangd.
- 11.6 Afnemer zal Calpe onmiddellijk in kennis stellen van enige aanspraak van derden ter zake van een inbreuk op intellectuele eigendomsrechten met betrekking tot de producten.

## Artikel 12. Reclames (klachten) en garantie

- 12.1 Calpe verstrekt nimmer meer garantie dan de garantie die zij heeft verkregen van haar eventuele fabrikant/toeleverancier. De door Calpe aan afnemer verstrekte garantie betreft in dat geval een fabrieksgarantie. De fabrikant/toeleverancier blijft in die situatie verantwoordelijk voor de afwikkeling van de klacht c.q. het verlenen van de garantie en in dit verband gelden de garantievooraanwaarden van de fabrikant/toeleverancier van Calpe.
- 12.2 De garantietermijn vangt aan op de factuurdatum.
- 12.3. Indien Calpe de garantieverplichting van de fabrikant/toeleverancier nakomt, is Calpe vrij in de keuze de betreffende gebreken op te heffen door reparatie dan wel door kosteloze vervanging van het product of onderdelen hiervan of door het retourneren van het product ofwel door de fabrikant/toeleverancier in staat te stellen de garantie te verlenen.
- 12.4 Afnemer dient klachten terzake van geleverde producten door Calpe schriftelijk aan Calpe mede te delen binnen acht dagen nadat hij het gebrek heeft ontdekt of had dienen te ontdekken. De klacht dient duidelijk en zo nauwkeurig mogelijk te worden omschreven.
- 12.5 Dergelijke klachten geven afnemer nog niet het recht zijn betaling(en) geheel of gedeeltelijk op te schorten.
- 12.6 Ieder vorderingsrecht vervalt indien:
- afnemer danwel een derde, zelf wijzigingen aan het geleverde verricht dan wel laat verrichten;
  - het geleverde niet nauwkeurig wordt of is gebruikt, behandeld of onderhouden volgens de (al dan niet) bijgeleverde of toepasselijke (fabrieks)voorschriften of de gebruiksaanwijzing; op andere wijze onoordeelkundig wordt of is gebruikt of behandeld;
  - het geleverde wordt of is gebruikt of toegepast voor andere doeleinden dan waarvoor het is bestemd;
  - het geleverde wordt of is gebruikt op een wijze welke voor Calpe redelijkerwijs niet was te verwachten;
  - afnemer geen of onvoldoende medewerking verleent binnen redelijke termijn terzake een onderzoek naar de grondigheid van klachten te doen;
  - de zaak niet door Calpe is verkocht;
  - de klachten voor het eerst worden geuit nadat de garantietermijn is verlopen ofwel (ingeval van niet waarneembare gebreken die voor het eerst bij de toepassing, verwerking of ingebruikname van de producten blijken) na drie maanden na aflevering;
  - hoe dan ook na verloop van 1 jaar nadat het product is verkocht of geleverd danwel indien de garantietermijn een andere termijn bedraagt, deze termijn.
- 12.7 Voldoening aan de garantierecht geldt als enige en volledige schadevergoeding. De garantie beperkt zich uitdrukkelijk tot het verkochte en strekt zich derhalve niet uit tot het vergoeden van schade aan personen en/of zaken, al dan niet van derden.
- 12.8 De vervangen onderdelen worden na een eventuele reparatie of vervanging eigendom van Calpe, zonder dat afnemer op vergoeding aanspraak kan maken.
- 12.9 Indien blijkt dat voor herstel of reparatie aangeboden goederen geen gebreken vertonen waarvoor Calpe verantwoordelijk is, zijn alle eventueel gemaakte kosten voor rekening van afnemer, ook tijdens de garantietermijn.

## Artikel 13. Tekortkoming, opschorting en ontbinding door Calpe

- 13.1 Een tekortkoming in de uitvoering van de overeenkomst kan Calpe niet worden toegerekend, indien zij niet te wijten is aan haar schuld, noch krachtens de wet, rechtshandeling of in het maatschappelijk verkeer geldende opvatting voor haar rekening komt.
- 13.2 Onder overmacht (danwel onvoorziene omstandigheden) wordt in deze algemene voorwaarden verstaan, naast hetgeen daaromtrent in de wet en jurisprudentie wordt begrepen, alle van buiten komende oorzaken, voorzien of niet-voorzien, waarop

Calpe geen directe invloed kan uitoefenen, doch waardoor Calpe niet in staat is haar verplichtingen geheel of gedeeltelijk (blijvend of tijdelijk) na te komen, waaronder (doch niet uitsluitend) in ieder geval is begrepen: oorlog, oorlogsgevaar, burgeroorlog, oproer, werkstaking, pandemie, uitbraak (voorbeelden: COVID-19, SARS, Vogelgriep, Q-koorts, Gekke koeziekte, of vergelijkbaar aan dezen), werklieden uitsluiting, transportmoeilijkheden, brand en andere ernstige storingen binnen het bedrijf van Calpe of diens leveranciers. Werkstakingen in het bedrijf van Calpe worden daaronder begrepen. In al deze gevallen komt Calpe het recht toe om zonder ingebrekestelling en zonder rechterlijke tussenkomst hetzij de overeenkomst voor ten hoogste 12 maanden op te schorten, hetzij geheel of gedeeltelijk te ontbinden, zulks zonder dat zij tot enige schadevergoeding of garantie gehouden zal zijn en onverminderd de haar verder toekomende rechten om alle andere met afnemer lopende overeenkomsten, voorzover nog niet uitgevoerd, onder gelijke voorwaarden, hetzij op te schorten, hetzij geheel of gedeeltelijk te ontbinden.

13.3 Naast de in het vorige lid genoemde mogelijkheden tot opschorten en (gedeeltelijk) ontbinden komt Calpe dit recht ook toe in het geval van faillissement, surséance van betaling, gehele of gedeeltelijke stillegging van zaken of bedrijf, liquidatie, overdracht, overlijden, bij curatele of indien op afnemer de Wettelijke Schuldsaneringsregeling voor Natuurlijke Personen van toepassing wordt of is verklaard en voorts in geval goederen van afnemer in conservatoir of executoriaal beslag worden genomen.

## Artikel 14. Ontbinding of beëindiging door afnemer

- 14.1 Indien afnemer de overeenkomst geheel of gedeeltelijk wenst te ontbinden, dient dit schriftelijk per aangetekende brief te geschieden.
- 14.2 Indien de overeenkomst wordt ontbonden, beëindigd of geannuleerd door afnemer, vanwege welke reden dan ook (overmacht of onvoorziene omstandigheden daaronder begrepen), heeft Calpe – in plaats van de vordering tot nakoming die haar rechtens toekomt – recht op compensatie vanwege het daardoor ontstane en aanmerkelijk te maken bezettingsverlies (waaronder in ieder geval de gemiste winst), zulks met een minimum van 35% van de overeengekomen prijs, tenzij er feiten en omstandigheden aan de beëindiging ten grondslag liggen die volledig aan Calpe zijn toe te rekenen. Voorts is afnemer alsdan gehouden tot betaling van de facturen voor tot dan toe geleverde diensten c.q. gedane leveringen.
- 14.3 Onverminderd hetgeen in lid 2 is bepaald, heeft Calpe het recht om, indien de daadwerkelijke schade groter is, vergoeding van deze schade te vorderen.

## Artikel 15. Aansprakelijkheid

- 15.1 Calpe is niet aansprakelijk voor door afnemer of derde(n) geleden directe of indirecte, materiële of immateriële schade die verband houdt met een tekortkoming door haar dan wel door haar ingeschakelde personen in de uitvoering van de overeenkomst, tenzij sprake is opzet of grove schuld van Calpe.
- 15.2 Indien Calpe onverminderd het vorige lid toch aansprakelijk kan worden gehouden, is deze aansprakelijkheid beperkt tot de directe schade en wel tot het bedrag dat de eventuele verzekeraar van Calpe uitkeert.
- 15.3 Indien de schade niet door een verzekering is of wordt gedekt of de verzekeraar in enig geval niet tot uitkering overgaat, is de aansprakelijkheid van Calpe beperkt tot de directe schade en wel voor maximaal het factuurbedrag (exclusief omzetbelasting).
- 15.4 De uit te keren schade zal hoe dan ook nooit hoger zijn dan € 10.000,--.
- 15.5 Afnemer heeft geen recht op vergoeding van enige schade die het gevolg is van overmacht, opschorting of ontbinding, zoals in deze algemene voorwaarden is bepaald.
- 15.6 Indien afnemer zijn schadevordering heeft gecedeerd aan een verzekeringsmaatschappij, dan blijft afnemer niettemin verplicht de BTW aan Calpe te voldoen, over het door de verzekeringsmaatschappij aan Calpe verschuldigde bedrag.
- 15.7 Afnemer vrijwaart Calpe voor alle schades en rechtsvorderingen van derden.
- 15.8 Afnemer vrijwaart Calpe bovendien onvoorwaardelijk terzake iedere aanspraak op grond van productaansprakelijkheid.

## Artikel 16. Geheimhouding

- 16.1 Afnemer is gehouden tot geheimhouding van alle beschreven en informatie die hij van Calpe ontvangt, zulks op verbeurte van een dwangsom ad € 50.000,-- (zegge: vijftigduizend euro) per overtreding, zulks onverminderd het recht van Calpe volledige schadevergoeding c.q. schadeloosstelling te vorderen.

## Artikel 17. Overdracht van rechten en verplichtingen

- 17.1 Het is Calpe toegestaan de in enige overeenkomst met afnemer omschreven rechten en verplichtingen aan derden over te dragen. In het geval verplichtingen van Calpe worden overgedragen zal Calpe afnemer voor zover mogelijk hiervan voorafgaand op de hoogte brengen. Calpe is in dat geval niet tot enige schadevergoeding ter zake gehouden.
- 17.2 Afnemer is niet gerechtigd zijn rechten en/of verplichtingen uit een overeenkomst aan enige derde over te dragen, zonder de voorafgaande schriftelijke toestemming van Calpe.

## Artikel 18. Vervaltermijn

- 18.1 Ieder vorderingsrecht en andere bevoegdheden van afnemer jegens Calpe, uit welke hoofde dan ook, vervallen in ieder geval na het verstrijken van één jaar vanaf het moment waarop zich een feit voordoet dat afnemer deze rechten en/of bevoegdheden jegens Calpe kan aanwenden en (binnen deze termijn) geen rechtsvordering is ingesteld.

## Artikel 19. Verwerking Persoonsgegevens

- 19.1 De persoonsgegevens van afnemer die worden vermeld op de overeenkomst worden door Calpe verwerkt overeenkomstig de Algemene Verordening Gegevensbescherming (AVG). Aan de hand van deze verwerking kan Calpe de overeenkomst uitvoeren. Calpe heeft adequate maatregelen genomen om persoonsgegevens te beschermen tegen verlies of onrechtmatige verwerking.

## Artikel 20. Toepasselijk recht en bevoegde rechter

- 20.1 Op alle verbintenissen hoe ook genaamd is, uitsluitend het Nederlandse recht van toepassing en is de Rechtbank Gelderland, locatie Arnhem bevoegd om van eventuele geschillen kennis te nemen, tenzij enige dwingendrechtelijke bepaling zich hier tegen verzet. Calpe heeft daarnaast het recht om een zaak aanhangig te maken bij de rechtbank die volgens de wet bevoegd is.
- 20.2 De toepasselijkheid van het Weens Koopverdrag is uitgesloten.

Versie juli 2020



**INDUSTRIAL  
MARINE  
RAILWAY**

Orders met een netto orderwaarde > € 150,- worden franco huis geleverd. Prijzen in euro excl. BTW.  
Drukfouten / prijswijzigingen voorbehouden. © copyright Calpe BV

**Calpe BV**

Anthonie Fokkerstraat 53  
3772 MP Barneveld (NL)



NL +31 (0)342 - 45 15 44  
BE +32 (0)475 - 94 44 29

KvK 32086233  
BTW NL8101.07.843.B01

IBAN NL80 ABNA 0553 0303 61  
BIC ABNA NL2A

✉ [info@calpe.nl](mailto:info@calpe.nl)

