

1972



ANNIVERSARY

 Briani

UTENSILI - TOOLS - WERKZEUGE - OUTILS

2022.b





50th

A TRADITIONAL FAMILY BUSINESS



STORIA DELL'AZIENDA

QUALITÀ E INNOVAZIONE DA 50 ANNI

Creata nel 1972 da Sergio Briani, l'Azienda è ormai alla terza generazione e, nell'anno in corso, festeggia il cinquantenario della propria nascita.

Fedele alla propria "corporate identity" di impresa ad impronta artigianale, ma con lo sguardo rivolta al futuro, la Briani ha sempre investito su macchinari e tecnologie di ultima generazione, sulla formazione del proprio personale e, da qualche anno, punta sulla sostenibilità ambientale con l'intento di ridurre sempre più il proprio impatto.

Tutto ciò le ha consentito di affermare la propria leadership negli utensili a fissaggio meccanico, settore che occupa il 60% del suo fatturato: era il suo principale obiettivo ed è stato raggiunto.

Le richieste dei consumatori e le modalità di vendita sono sempre oggetto di cambiamenti, ma la pandemia ne ha accelerato la corsa.

I nuovi obiettivi sono quindi ora quelli di soddisfare la sempre maggior richiesta da parte delle piattaforme di vendita on-line e nel perfezionamento dei processi produttivi per realizzare in tempi ancora più brevi utensili speciali.



HISTORY OF THE COMPANY

QUALITY AND INNOVATION FOR 50 YEARS

The company was founded in 1972 by Sergio Briani, It is now in its third generation and this year celebrates the fiftieth anniversary of its founding.

The Briani is faithful to its own "corporate identity" as an artisan business but with an eye towards the future. It has always invested in innovative machinery, in latest technologies and in its staff training. In recent years Briani company has been focusing on environmental sustainability with the purpose of reducing its environmental impact.

All that, allowed the company to confirm its leadership in routers with insert knives which is 60% of its turnover: this was its main goal and it has been achieved.

The consumer demand and the sales types are always evolving but the Pandemic has accelerated the change.

The new goals are therefore to satisfy the increasing demand for online-sales and to improve the production processes in order to produce special tools in even shorter times.



QUALITY TOOLS SINCE 1972



GESCHICHTE DES UNTERNEHMENS

QUALITÄT UND INNOVATION SEIT 50 JAHREN

Das Unternehmen wurde 1972 von Sergio Briani gegründet und in diesem Jahr feiert es den fünfzigsten Jahrestag. Heute führt die Familie in der dritten Generation das Unternehmen.

Die Firma Briani bleibt seiner eigenen Identität als Handwerksbetrieb treu, aber mit einem Blick in die Zukunft. Das Unternehmen investiert seit jeher in innovative Maschinen und Technologien der neusten Generation, sowie in die Ausbildung seiner Mitarbeiter.

Seit einigen Jahren konzentriert sich das Unternehmen auf ökologische Nachhaltigkeit mit dem Ziel, die Auswirkungen auf die Umwelt zu reduzieren.

Das alles hat es ihm ermöglicht seine Führungsrolle bei Wendepplatten-Werkzeuge zu behaupten. Dies macht 60% des Umsatzes aus: es war sein Hauptziel und es wurde erreicht.

Die Wunsch den Verbrauchern und die Verkaufstypologien ändern sich ständig, aber die Pandemie hat den Wandel beschleunigt.

Die neuen Ziele sind daher die steigende Nachfrage nach Online-Verkäufen zu befriedigen und die Produktionsprozesse zu perfektionieren um Spezialwerkzeuge in noch kürzerer Zeit herzustellen



HISTOIRE DE L'ENTREPRISE

QUALITÉ ET INNOVATION DEPUIS 50 ANS

L'entreprise a été fondée en 1972 par Sergio Briani, en est maintenant à sa troisième génération et célèbre cette année le cinquantième anniversaire de sa fondation.

L'entreprise Briani est fidèle à son identité d'entreprise artisanale, mais tournée vers l'avenir. L'entreprise a toujours investi dans des machines et des technologies de dernière génération et dans la formation du personnel et, depuis quelques années, s'est concentrée sur la durabilité environnementale pour réduire de plus en plus son impact sur l'environnement

Tout cela a permis à l'entreprise de confirmer son leadership dans les outils à bois professionnels à plaquettes réversibles, qui est le 60% de son chiffre d'affaires : c'était son objectif principal et il a été atteint. Les demandes des consommateurs et les ventes sont en constante évolution, mais la pandémie a accéléré le changement. Les nouveaux objectifs sont donc désormais de satisfaire la demande croissante de vente en ligne et de perfectionner les processus de production pour fabriquer des outils spéciaux dans des délais encore plus courts.

INDICE | INDEX

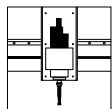
A
UTENSILI PER PANTOGRAFI E MACCHINE CNC

TOOLS FOR COPY ROUTERS AND CNC MACHINES
 WERKZEUGE FÜR KOPIERFRÄSE UND CNC
 OUTILS POUR PANTOGRAPHES ET CENTRES D'USINAGE CNC

B
UTENSILI NON SAGOMATI PER PANTOGRAFI PORTATILI

NOT PROFILED TOOLS FOR PORTABLE ROUTERS
 WERKZEUGE NICHT PROFILIERTEN FÜR HANDBERFRÄSER
 OUTILS PAS PROFILÉES POUR DÉFONCEUSES PORTATIVES

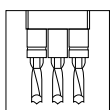
C
UTENSILI E MANDRINI PER FORATRICI MULTIMANDRINO

TOOLS AND CHUCKS FOR MULTI SPINDLE DRILLING MACHINES
 WERKZEUGE UND FUTTER FÜR BOHRAUTOMATEN
 MÈCHES ET MANDRINS POUR PERCEUSES MULTIBROCHES

D
UTENSILI PER TRAPANI E CAVETTATRICI

TOOLS FOR DRILLING MACHINES AND SLOTTING MACHINES
 WERKZEUGE FÜR BOHRMASCHINEN UND LANGLOCHBOHRMASCHINEN
 MÈCHES POUR PERCEUSES ET MORTAISEUSES

E
UTENSILI SAGOMATI PER PANTOGRAFI PORTATILI

PROFILED TOOLS FOR PORTABLE ROUTERS
 PROFILFRÄSER FÜR HANDBERFRÄSER
 FRAISES AVEC TRANCHANT PROFILÉ POUR DÉFONCEUSES PORTATIVES

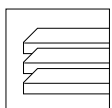
F
UTENSILI PER PLASTICA, ALLUMINIO E ALTRI MATERIALI

TOOLS FOR PLASTIC, ALUMINUM AND OTHER MATERIALS
 WERKZEUGE FÜR PLASTIK, ALUMINIUM UND ANDERE MATERIALIEN
 OUTILLAGE POUR PLASTIQUE, ALUMINIUM ET AUTRES MATÉRIAUX

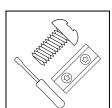
Z
RICAMBI

SPARE PARTS
 ERSATZTEILE
 PIÈCES DE RECHANGE



101	pag.	12	301	pag.	62	371	pag.	62	567	pag.	56
122	pag.	12	303	pag.	62	372	pag.	76	580	pag.	57
123	pag.	13	306	pag.	63	373	pag.	82	581	pag.	94
125	pag.	13	307	pag.	68	413	pag.	83	582	pag.	95
128	pag.	14	308	pag.	64	414	pag.	83	583	pag.	57
133	pag.	14	309	pag.	64	415	pag.	84	584	pag.	58
141	pag.	15	309 C	pag.	65	417	pag.	84	585	pag.	59
151	pag.	15	311	pag.	65	418	pag.	85	586	pag.	95
152	pag.	16	312	pag.	70	501	pag.	42	587	pag.	96
153	pag.	16	313	pag.	71	501 B	pag.	42	588	pag.	96
155	pag.	17	320	pag.	105	507	pag.	43	701	pag.	23
158	pag.	17	321	pag.	105	509	pag.	43	702	pag.	24
161	pag.	18	322	pag.	105	510	pag.	43	703	pag.	25
162	pag.	18	323	pag.	78	511	pag.	44	704	pag.	26
164	pag.	19	324	pag.	78	511 B	pag.	45	710	pag.	27
165	pag.	19	329	pag.	79	511 C	pag.	45	715	pag.	27
166	pag.	20	332	pag.	71	511 D	pag.	46	730	pag.	107
170	pag.	21	333	pag.	72	512	pag.	46	740	pag.	107
171	pag.	22	335	pag.	72	512 B	pag.	47	750	pag.	107
172	pag.	22	336	pag.	79	513	pag.	47	760	pag.	107
201	pag.	30	337	pag.	73	518	pag.	90	901	pag.	108
203	pag.	30	337 B	pag.	73	519	pag.	90	902	pag.	111
205	pag.	31	338	pag.	106	521	pag.	48	903	pag.	112
206	pag.	31	339	pag.	65	524	pag.	48	904	pag.	113
207	pag.	32	340	pag.	68	524 B	pag.	49	905	pag.	114
208	pag.	32	342	pag.	66	527	pag.	49	907	pag.	114
208 B	pag.	33	350	pag.	73	528	pag.	50	909	pag.	114
211	pag.	88	350 P	pag.	73	529	pag.	50	7050	pag.	98
212	pag.	88	350 AN	pag.	80	531	pag.	51	7060	pag.	98
213	pag.	89	351	pag.	106	532	pag.	51	7070	pag.	99
214	pag.	89	352	pag.	74	533	pag.	91	7071	pag.	99
219	pag.	104	353	pag.	74	533 B	pag.	91	7080	pag.	100
221	pag.	33	353 P	pag.	74	536	pag.	92	7083	pag.	100
230	pag.	34	354	pag.	80	536 B	pag.	92	7091	pag.	101
230 M10	pag.	34	355	pag.	66	542	pag.	93	7091 B	pag.	101
230 M12	pag.	35	356	pag.	67	543	pag.	52			
233	pag.	36	357	pag.	67	544	pag.	52			
235	pag.	36	360	pag.	69	546	pag.	53			
249	pag.	104	361	pag.	69	550	pag.	93			
250	pag.	104	370 T1	pag.	75	555	pag.	53			
259	pag.	37	370 T2	pag.	75	557	pag.	54			
262	pag.	38	370 T3	pag.	75	557 C	pag.	54			
270	pag.	40	370 T1	pag.	81	560	pag.	55			
270 M10	pag.	40	370 T2	pag.	81	564	pag.	55			
270 M12	pag.	41	370 T3	pag.	81	566	pag.	55			

LEGENDA



AVANZAMENTO MANUALE
MANUAL FEED
HAND-VORSCHUB
AVANCE MANUELLE



AVANZAMENTO MECCANICO
MECHANICAL FEED
MECHANISCHER VORSCHUB
AVANCE MÉCANIQUE



PER MACCHINE CNC
FOR CNC MACHINES
FÜR CNC-MASCHINEN
POUR CENTRES D'USINAGE CNC



METALLO DURO
TUNGSTEN CARBIDE
HARTMETALL
CARBURE



METALLO DURO INTEGRALE
SOLID CARBIDE
VOLLHARTMETALL
CARBURE MONOBLOC



ACCIAIO AD ALTA VELOCITA'
HIGH-SPEED STEEL
SCHNELLARBEITSSTAHL
ACIER RAPIDE



ROTAZIONE DESTRA
RIGHT ROTATION
RECHTSLAUF
ROTATION DROITE



ROTAZIONE SINISTRA
LEFT ROTATION
LINKSLAUF
ROTATION GAUCHE



ROTAZIONE DESTRA-SINISTRA
RIGHT-LEFT ROTATION
RECHTS-LINKSLAUF
ROTATION DROITE-GAUCHE



ALIMENTAZIONE LATERALE
HORIZONTAL FEEDING
HORIZONTALER VORSCHUB
USINAGE HORIZONTAL



ALIMENTAZIONE VERTICALE/ORIZZONTALE
VERTICAL/HORIZONTAL FEEDING
VERTIKALER/HORIZONTAL VORSCHUB
USINAGE VERTICAL ET HORIZONTAL



ALIMENTAZIONE CON DISCESA IN RAMPA
RAMP FEEDING
SCHRÄGEINTAUCHEN
USINAGE DE BIAIS



LAMA DI TESTA IN METALLO DURO
CARBIDE TIPPED
BOHRSCHEIDE AUS HARTMETALL
COUPE FRONTALE EN CARBURE



NUMERO DI TAGLIENTI
NUMBER OF CUTTING EDGES
ANZAHL VON SCHNEIDEN
NOMBRE D'ARÊTES DE COUPE



NUMERO DI TAGLIENTI + LAMA DI TESTA
NUMBER OF CUTTING EDGES + PLUNGING TIP
ANZAHL VON SCHNEIDEN + BOHRSCHEIDE
NOMBRE D'ARÊTES DE COUPE + COUPE FRONTALE



NUMERO DI INCISORI
NUMBER OF SPURS
ANZAHL VON VORSCHNEIDERN
NOMBRE DE TRAÇOIRS



NUMERO DI TAGLIENTI CON ROMPITRUCIOLO
NUMBER OF CUTTING EDGES WITH CHIPBREAKER
ANZAHL VON SCHNEIDEN MIT SPANBRECHER
NOMBRE D'ARÊTES DE COUPE AVEC BRISE-COPEAU



ROMPITRUCIOLO
CHIPBREAKER
SPANBRECHER
BRISE-COPEAU



CON CUSCINETTO
WITH BALL BEARING
MIT KUGELLAGER
AVEC ROULEMENT



CON CUSCINETTO Delrin®
WITH BALL BEARING Delrin®
MIT KUGELLAGER Delrin®
AVEC ROULEMENT Delrin®



ATTACCO CILINDRICO
CYLINDRICAL SHANK
ZYLINDRISCHER SCHAFT
QUEUE CYLINDRIQUE



ATTACCO CILINDRICO CON PIANO DI SERRAGGIO
CYLINDRICAL SHANK WITH FLAT
ZYLINDRISCHER SCHAFT MIT SPANNFLÄCHE
QUEUE CYLINDRIQUE AVEC MÉPLAT



ATTACCO CILINDRICO CON PIANO DI SERRAGGIO E VITE DI REGOLAZIONE
CYLINDRICAL SHANK WITH FLAT AND ADJUSTMENT SCREW
ZYLINDRISCHER SCHAFT MIT SPANNFLÄCHE UND EINSTELLSCHRAUBE
QUEUE CYLINDRIQUE AVEC MÉPLAT ET VIS DE RÉGLAGE



ELICA LAPPATA PER UNA MIGLIOR EVACUAZIONE DEL TRUCIOLO
 FLUTE INTERNAL POLISHED FOR A BETTER CHIP EVACUATION
 INNEN POLIERT FÜR EINE BESSERE SPANABWICKLUNG
 POLYGLAÇAGE INTÉRIEUR POUR UNE MEILLEURE ÉLIMINATION DES COPEAUX



PERFETTA PER SCRITTURA
 PERFECT FOR LETTERING
 PERFEKT FÜR BESCHRIFTUNG
 PARFAIT POUR LE LETTRAGE



UTENSILE PER PORTE
 TOOL FOR DOORS
 WERKZEUGE FÜR TÜREN
 OUTILS POUR PORTES

OPTIONAL



COLTELLI IN DIAMANTE
 DIAMOND KNIFE
 DIAMANT-WENDEMESSER
 PLACHETTE EN DIAMANT



ROMPITRUCIOLO
 CHIPBREAKER
 SPANBRECHER
 BRISE-COPEAU



ALTRE MISURE SU RICHIESTA
 OTHER DIMENSIONS ON REQUEST
 ANDERE ABMESSUNGEN AUF ANFRAGE
 AUTRES DIMENSIONS SUR DEMANDE



ROTAZIONE SINISTRA
 LEFT ROTATION
 LINKSLAUF
 ROTATION GAUCHE



FORNITA IN SET CON SCATOLA
 SUPPLIED IN SET WITH BOX
 LIEFERUNG IM SET MIT BOX
 SUR DOMANDE COMPOSITION EN COFFRET



COLTELLO REVERSIBILE PER FORO PASSANTE
 THROUGH-HOLE REVERSIBLE KNIFE
 DURCHGANGSLOCHBOHRER WENDEMESSER
 PLAQUETTES TROUS DÉBOUCHANTS



SET DI CUSCINETTI
 SET OF BALL BEARINGS
 KUGELLAGER-SET
 JEUX DE ROULEMENTS

CARATTERISTICHE UTENSILE / TOOL FEATURES



POSITIVO - UPCUT - POSITIVE - POSITIVES

Truciolo verso alto - Buona finitura sulla superficie inferiore del pezzo
 Pull the chips Upwards - Good finish on the lower surface
 Späneabführung nach oben - Gutes Finish auf der unteren Oberfläche des Stücks
 Tire les copeaux vers le haut - Bonne finition sur la surface inférieure de la pièce



NEGATIVO - DOWNCUT - NEGATIVE - NÉGATIVES

Truciolo verso basso - Buona finitura sulla superficie superiore del pezzo
 Push the chips Downwards - Good finish on the upper surface
 Späneabführung nach unten - Gutes Finish auf der oberen Oberfläche des Stücks
 Pousse les copeaux vers le bas - Bonne finition sur la surface supérieure de la pièce



COMPRESSIONE (UP-DOWN) - COMPRESSION - WECHSELSEITIGEM ACHSWINKEL - POSITIVE+NÉGATIV

Truciolo verso centro - Buona finitura sulla superficie superiore ed inferiore del pezzo
 Ejection of the chips in the centre - Good finish on the upper and lower surface
 Späneabführung im zentrum - Gutes Finish auf der oberen und unteren Oberfläche des Stücks
 Pousse les copeaux vers la matière - Bonne finition sur la surface supérieure et inférieure de la pièce

INDICE | INDEX

UTENSILI PER PANTOGRAFI E MACCHINE CNC

TOOLS FOR COPY ROUTERS AND CNC MACHINES

WERKZEUGE FÜR KOPIERFRÄSE UND CNC

OUTILS POUR PANTOGRAPHE ET CENTRES D'USINAGE CNC

A

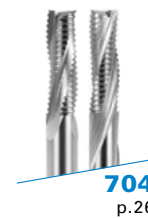
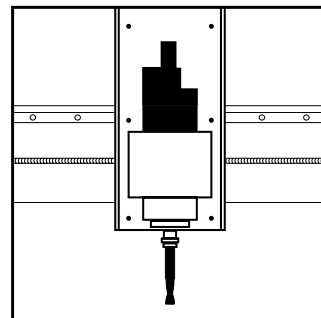

101

FRESA A TAGLIENTI DIRITTI CON LAMA DI TESTA

Carbide Tipped Straight Plunge
Nutfräser mit Bohrschneide
Mèche à rainier droite avec coupe frontale



Ø	LU	LT	S	CODE
8	25	55	12 x 25	101.080.25.28
10	25	55	12 x 25	101.100.25.28
12	25	55	12 x 25	101.120.25.28
14	25	55	12 x 25	101.140.25.28
10	40	70	12 x 25	101.100.40.28
12	40	70	12 x 25	101.120.40.28
13	40	70	12 x 25	101.130.40.28
14	40	70	12 x 25	101.140.40.28
15	40	70	12 x 25	101.150.40.28
16	40	70	12 x 25	101.160.40.28
17	40	70	12 x 25	101.170.40.28
18	40	70	12 x 25	101.180.40.28
19	40	70	12 x 25	101.190.40.28
20	40	70	12 x 25	101.200.40.28
22	40	70	12 x 25	101.220.40.28
24	40	70	12 x 25	101.240.40.28
25	40	70	12 x 25	101.250.40.28
26	40	70	12 x 25	101.260.40.28
28	40	70	12 x 25	101.280.40.28
30	40	70	12 x 25	101.300.40.28
35	40	70	12 x 25	101.350.40.28
12	45	75	12 x 25	101.120.45.28

€

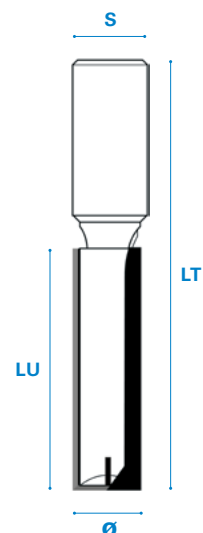
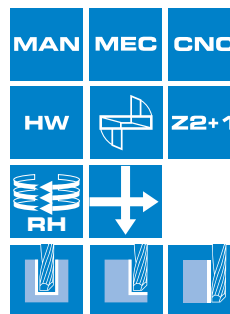

12

122

FRESA PER SGROSSATURA A COLTELLI REVERSIBILI E COLTELLO DI TESTA

Roughing Cutter with reversible knives and center tip knife
Schrupfräser mit Wendemesser und Wendeplatten Bohrschneide
Fraise d'ébauche à plaquettes réversibles



Ø	LU	LT	S	CODE
22	30	93	20 x 50	122.220.30.08
22	57	120	20 x 50	122.220.57.08
40	40	105	20 x 50	122.400.40.08

€

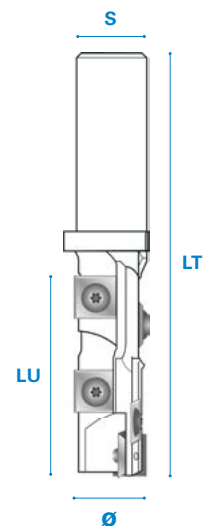
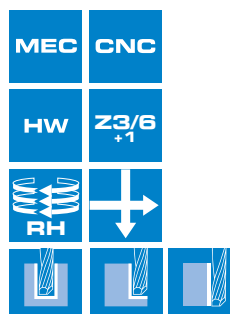

Ricambi - Spare parts - Ersatzteile - Pièces de rechange			CODE
x4	Z4	12x12x1,5	901.120.12.00
x2	Z2	Ø22	901.075.12.00
x2	Z2	Ø40	901.096.12.00
		TORX®15 M4x6 D9 L8	902.040.06.90
		TORX®15 M4x4 D5,6 L6,2	902.040.04.58
		TORX®15	903.002.15.00



123

FRESA A COLTELLO REVERSIBILE E COLTELLO DI TESTA

Straight router cutter with reversible knives and center tip knife
Nutfräser mit Wendemesser und Wendeplatten Bohrschneide
Fraise à rainer à plaquettes réversibles avec coupe en bout



Ø	LU	LT	S	CODE
16	29,5	82	12 x 35	123.160.12.08
18	29,5	82	12 x 35	123.180.12.08
20	29,5	82	12 x 35	123.200.12.08

€

Ricambi - Spare parts - Ersatzteile - Pièces de rechange				CODE
	Z4		29,5x12x1,5	901.295.12.13
	Z2	Ø16/18	7,5x12x1,5	901.075.12.00
	Z2	Ø20	9,6x12x1,5	901.096.12.00
		Ø16/18	TORX®15 M4x4 D9 L6	902.040.04.90
		Ø20	TORX®15 M4x6 D9 L8	902.040.06.90
			TORX®15 M4x6 D5,6 L7,8	902.040.06.58
			TORX®15	903.002.15.00

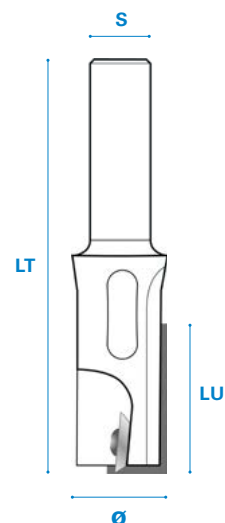
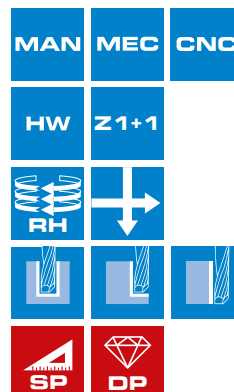

13

125

FRESA A COLTELLI REVERSIBILI E COLTELLO DI TESTA

Straight Router bit with reversible knives and center tip knife
Nutfräser mit Wendemesser und Wendeplatten Bohrschneide
Fraise à rainer à plaquettes réversibles avec coupe en bout



Ø	LU	LT	S	CODE
16	57	120	20 x 50	125.160.20.08
18	57	120	20 x 50	125.180.20.08
20	57	120	20 x 50	125.200.20.08

€

Ricambi - Spare parts - Ersatzteile - Pièces de rechange				CODE
	Z4		29,5x12x1,5	901.295.12.13
	Z2	Ø16/18	7,5x12x1,5	901.075.12.00
	Z2	Ø20	9,6x12x1,5	901.096.12.00
			TORX®15 M4x6 D9 L8	902.040.06.90
			TORX®15 M4x4 D9 L6	902.040.04.90
			TORX®15 M4x4 D5,6 L6,2	902.040.04.58
			TORX®15	903.002.15.00

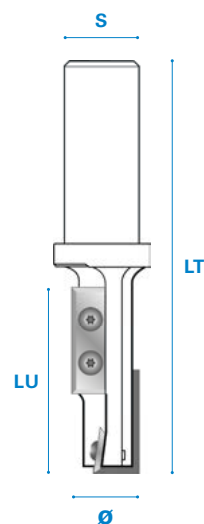
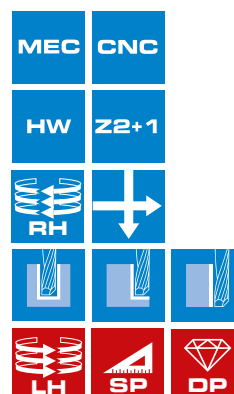

128

FRESA A COLTELLO REVERSIBILE E COLTELLO DI TESTA

Straight Router bit with reversible knives and center tip knife
Nutfräser mit Wendemesser und Wendeplatten Bohrschneide
Fraise à rainer à plaquettes réversibles avec coupe en bout



Ø	LU	LT	S	CODE
16	29,5	100	20 x 50	128.160.30.08
16	49,5	112	20 x 50	128.160.50.08
18	49,5	112	20 x 50	128.180.50.08
20	49,5	112	20 x 50	128.200.50.08

€

Ricambi - Spare parts - Ersatzteile - Pièces de rechange				CODE
	Z4	LU 29,5	29,5x12x1,5	901.295.12.13
	Z4	LU 49,5	49,5x12x1,5	901.495.12.13
	Z2	Ø16/18	7,5x12x1,5	901.075.12.00
	Z2	Ø20	9,6x12x1,5	901.096.12.00
		Ø16/18	TORX®15 M4x4 D9 L6	902.040.04.90
		Ø20	TORX®15 M4x6 D9 L8	902.040.06.90
			TORX®15 M4x6 D5,6 L6,2	902.040.06.58
			TORX®15	903.002.15.00

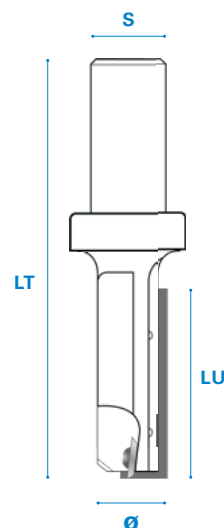
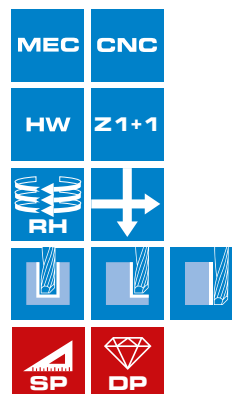

14

133

FRESA A COLTELLI PER SGROSSATURA-FINITURA CON ANGOLO ASSIALE POSITIVO E COLTELLO DI TESTA

Roughing/Finishing reversible knives router bit with up shear and center tip knife
Schrupp/Schlichtfräser mit positivem Schnittwinkel und Wendeplatten Bohrschneide
Fraise d'ébauche-finition à plaquettes avec angle d'axe positif et coupe en bout



Ø	LU	LT	S	CODE
30	29,5	85	12 x 40	133.300.30.12
40	29,5	85	12 x 40	133.400.30.12
40	29,5	95	20 x 50	133.400.30.08
30	49,5	115	20 x 50	133.300.50.08
40	49,5	115	20 x 50	133.400.50.08
50	49,5	115	20 x 50	133.500.50.08

€

Ricambi - Spare parts - Ersatzteile - Pièces de rechange				CODE
	Z4	LU 29,5	29,5x12x1,5	901.295.12.13
	Z4	LU 49,5	49,5x12x1,5	901.495.12.13
	Z4	Ø30/40	12x12x1,5	901.120.12.00
	Z2	Ø50	20x12x1,5	901.200.12.00
			TORX®15 M4x6 D9 L8	902.040.06.90
			TORX®15 M4x6 D5,6 L7,8	902.040.06.58
			TORX®15	903.002.15.00

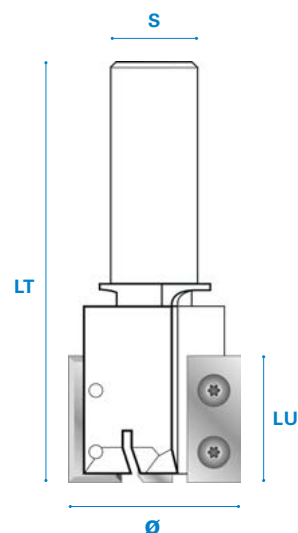
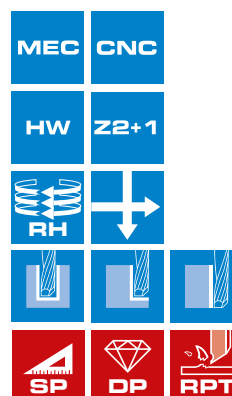

141





FRESA A COLTELLI CON ANGOLI ASSIALI ALTERNATI E COLTELLO DI TESTA

Compression router cutter with reversible knives and center tip knife
Wende-Shaftfräser mit wechselseitigem Achswinkel und Wendeplatten Bohrschneide
Fraise à plaquettes avec angle d'axe dessus et dessous et coupe en bout



Ø	LU	LT	S	CODE
30	75	140	20 x 50	141.300.75.08

€

Ricambi - Spare parts - Ersatzteile - Pièces de rechange			CODE
 Z4		39,5x9x1,5	901.395.09.02
 Z2		7,5x12x1,5	901.075.12.00
		TORX®15 M3,5x6 D6 L8	902.035.06.60
		TORX®15	903.002.15.00

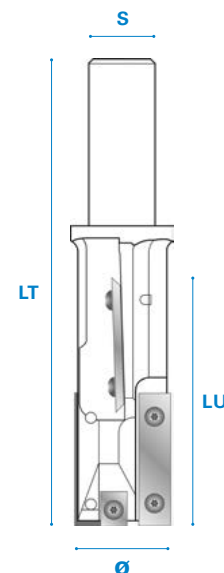
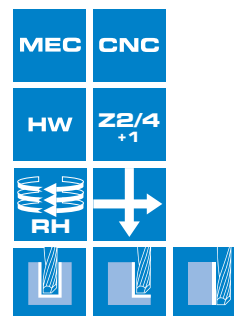

15

151





FRESA A COLTELLI CON ANGOLI ASSIALI ALTERNATI

Compression router cutter with reversible knives
Wende-Shaftfräser mit wechselseitigem Achswinkel
Fraise à plaquettes avec angle d'axe dessus et dessous



Ø	LU	LT	S	CODE
20	35	105	20 x 50	151.200.35.08
20	57	120	20 x 50	151.200.57.08
22	57	120	20 x 50	151.220.57.08

€

Ricambi - Spare parts - Ersatzteile - Pièces de rechange			CODE
 Z4	LU 35	19,5x12x1,5	901.195.12.13
 Z4	LU 57	29,5x12x1,5	901.295.12.13
		TORX®15 M4x6 D9 L8	902.040.06.90
		TORX®15	903.002.15.00

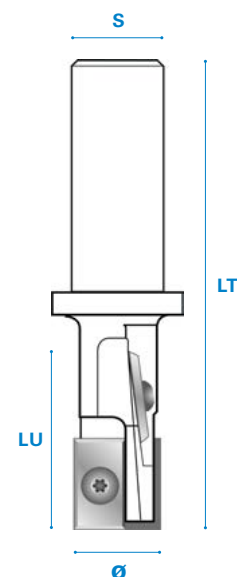
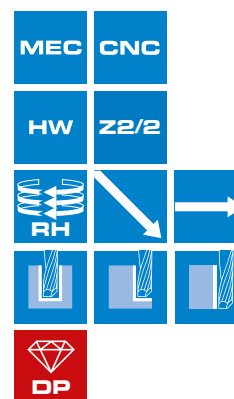

152

FRESA PILOTA CON ANGOLI DI TAGLIO POSITIVI/NEGATIVI, COLTELLI REVERSIBILI E COLTELLO IN TESTA

Panel Pilot Router Bit with Up & Down Shear, reversible knives and center tip knife
Wende-Kopierfreies mit wechelseitigem Achswinkel und Wendeplatten Bohrschneide
Fraise à oculus à plaquettes réversibles avec coupe en bout



Ø	LU	LT	S	CODE
20	73	165	20 x 50	152.200.73.08

€

Ricambi - Spare parts - Ersatzteile - Pièces de rechange			CODE
 xB	Z4	39,5x12x1,5	901.395.12.13
 x1	Z1	60°	901.200.12.60
	TORX®15 M4x6 D9 L8		902.040.06.90
	TORX®15 M4x6 D5,6 L7,8		902.040.06.58
	TORX® 15		903.002.15.00

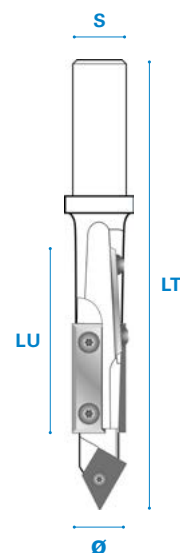
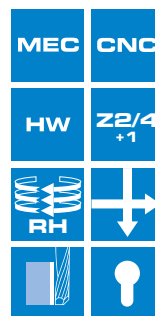

16

153

FRESA PER SERRATURE CON COLTELLI REVERSIBILI

Door lock router bit with reversible knives
Schlosskastenfräser mit Wendemesser
Mèche pour serrures à plaquettes réversibles



Ø	LU ¹ /LU ²	LT	S	CODE
16	29,5/85	135	20 x 50	153.160.30.08
20	29,5/85	135	20 x 50	153.200.30.08

€

Ricambi - Spare parts - Ersatzteile - Pièces de rechange			CODE
 xB	Z4	Ø16 29,5x9x1,5	901.295.09.00
 xB	Z4	Ø20 29,5x12x1,5	901.295.12.13
	Ø16 TORX®15 M4x6 D5,6 L7,8		902.040.06.58
	Ø20 TORX®15 M4x6 D9 L8		902.040.06.90
	TORX®15		903.002.15.00

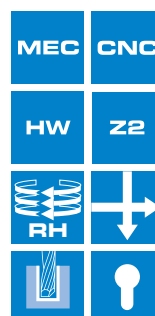

Optional			CODE
 xB	Z4	Ø20 29,5x12x1,5	901.295.12.RT

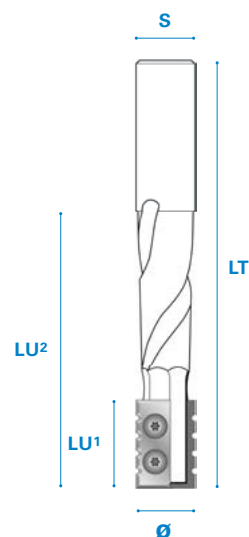

155

FRESA A TAGLIANTI DIRITTI CON COLTELLI REVERSIBILI

Straight Router bit with reversible knives
Wendeplatten Nutfräser
Fraise à affleurer à plaquettes réversibles



RH	Ø	LU	LT	S	CODE
	19	49,5	110	20 x 50	155.190.50.08

LH	Ø	LU	LT	S	CODE
	19	49,5	110	20 x 50	155.190.50.09

Ricambi - Spare parts - Ersatzteile - Pièces de rechange				CODE
	Z4		49,5x12x1,5	901.495.12.13
	Z4		49,5x12x1,5	901.495.12.09
	TORX®15 M4x6 D9 L8			902.040.06.90
	TORX® 15			903.002.15.00



MEC	CNC
HW	Z2

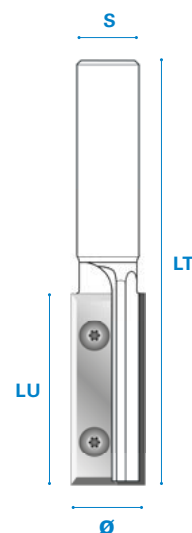

158

FRESA PER SCANALATURE A V, FOLDING E SCRITTURA CON COLTELLO REVERSIBILE

V-groove, Folding and lettering router bit with reversible knife
V-Nut, Folding and Schriftenfräser mit Wendemesser
Fraise à rainier en V, Folding et à graver à plaquette réversible



a	Ø	LU	LT	S	CODE
92°	17	8,3	73	12 x 40	158.450.12.08
92°	17	8,3	83	20 x 50	158.450.20.08

Ricambi - Spare parts - Ersatzteile - Pièces de rechange				CODE
	Z4		12x12x1,5	901.120.12.92
	TORX®15 M3,5x6 D6 L8			902.035.06.60
	TORX®15			903.002.15.00



MAN	MEC	CNC
HW	Z1	
SET		

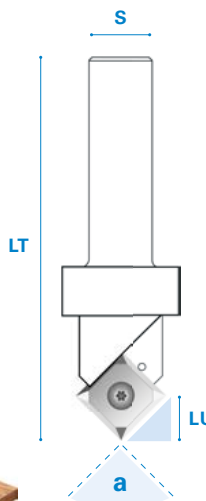

Optional



Optional



Optional









161

FRESA PER SCANALATURE A V, SMUSSI E FOLDING CON COLTELLO REVERSIBILE

V-groove, Chamfer and Folding router bit with reversible knife
V-Nut, Fase und Foldingfräser mit Wendemesser
Fraise à rainier en V, à chanfreiner et Folding à plaquette réversible



a	Ø	LU	LT	S	CODE	€
45°	35	42	118	20 x 50	161.450.20.08	
60°	40	35	118	20 x 50	161.600.20.08	
90°	38	19	77	12 x 40	161.900.12.08	
90°	50	25	100	20 x 50	161.910.20.08	

Ricambi - Spare parts - Ersatzteile - Pièces de rechange		CODE	€
 X2	Z2 45°	901.500.12.45	
 X2	Z2 60°	901.500.12.60	
 X2	Z2 90°/Ø38	901.300.12.90	
 X2	Z2 90°/Ø50	901.400.12.91	
	TORX®15 M4x6 D9 L8	902.040.06.90	
	TORX®15	903.002.15.00	

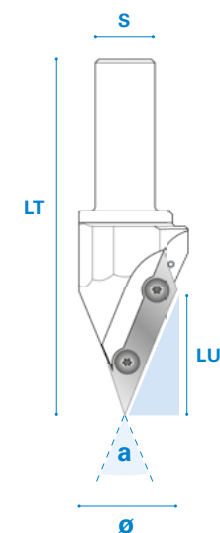
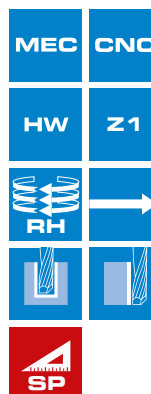
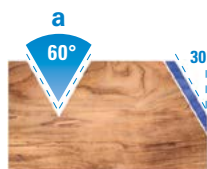
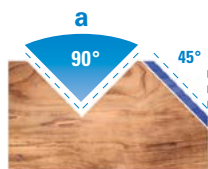
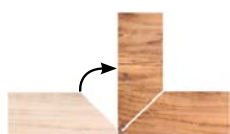

18





162

FRESA PER SMUSSI A COLTELLI REVERSIBILI

Chamfer router bit with reversible knives
Fasefräser mit Wendemesser
Fraise à chanfreiner à plaquettes réversibles



a	Ø	LU	LT	S	CODE	€
45°	55	21	75	12 x 40	162.450.12.08	
45°	80	35	105	20 x 50	162.450.20.08	

Ricambi - Spare parts - Ersatzteile - Pièces de rechange		CODE	€	
 X2	Z2 Ø55	30x12x1,5	901.300.12.00	
 X2	Z2 Ø80	50x12x1,5	901.500.12.00	
	TORX®15 M4x6 D9 L8	902.040.06.90		
	TORX®15	903.002.15.00		

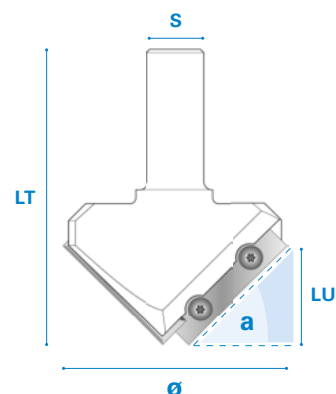
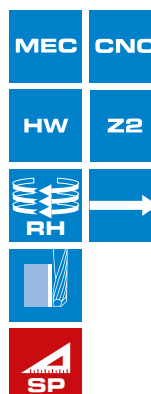

164

FRESA PER SPIANARE A COLTELLI REVERSIBILI





Spoilboard Surfacing router bit with reversible knives
Planfräser mit Wendemesser
Fraise à surfacer à plaquettes réversibles



Ø	LU	LT	S	CODE
28	12	60	8 x 35	164.280.08.08
28	12	60	12 x 35	164.280.12.08
39	12	60	8 x 35	164.390.08.08
39	12	60	12 x 35	164.390.12.08
59	12	70	12 x 40	164.590.12.08
80	12	90	20 x 50	164.800.20.08

€



Ricambi - Spare parts - Ersatzteile - Pièces de rechange	CODE
  Z4 12x12x1,5	901.120.12.00
 TORX®15 M4x6 D9 L8	902.040.06.90
 Ø28 TORX®15 M4x6 D5,6 L7,8	902.040.06.58
 TORX®15	903.002.15.00

x4

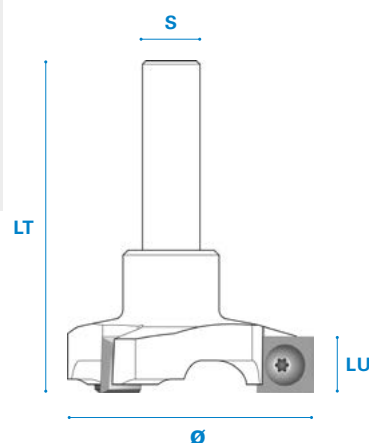
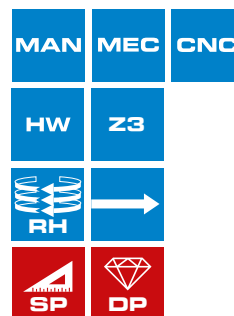

165

**FRESA PER SERRATURE Noha®
CON COLTELLI REVERSIBILI**

Router bit reversible knives for Door lock Noha®
Fräser für Noha® Schlösser mit Wendemesser
Fraise pour serrure Noha® à plaquettes réversibles







OFFICIAL SUPPLIER:

Noha
the invisible handle
www.no-ha.com

Ø	LU	LT	S	CODE
Z2 44	12	81,5	12 x 40	165.440.12.08
Z4 44	21	90,5	12 x 40	165.440.00.08

€



Ricambi - Spare parts - Ersatzteile - Pièces de rechange	CODE
  Z4 12x12x1,5	901.120.12.00
 TORX®15 M4x6 D9 L8	902.040.06.90
 TORX®15	903.002.15.00

x4

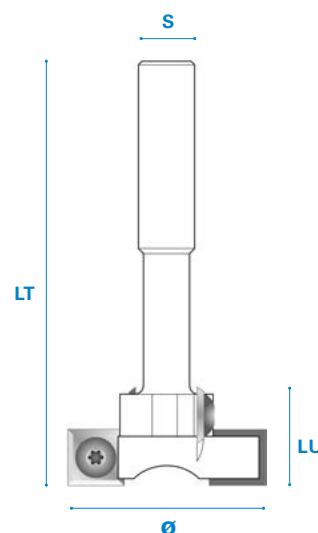
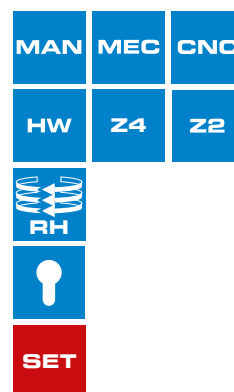
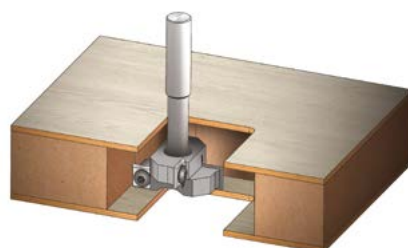

166

FRESA PER CERNIERE SIMONSWERK TECTUS® TE 300, 500, 600 CON COLTELLI REVERSIBILI





Router bit reversible knives for hinges Simonswerk TECTUS® TE 300, 500, 600
Wendeplatten-Nutfräser für Bandsystem Simonswerk TECTUS® TE 300, 500, 600
Fraise à rainier pour paumelle Simonswerk TECTUS TE 300, 500, 600 à plaquettes réversibles



COMPATIBILE CON
Compatible with
Passend für
Compatible avec

TECTUS®
by **SIMONSWERK**

Ø	LU	LT	S	CODE	€
24	29,5	120	12 x 40	166.240.30.08	

Ricambi - Spare parts - Ersatzteile - Pièces de rechange			CODE
	Z4	29,5x8x1,5	901.295.08.00
	Z2	9,6x12x1,5	901.096.12.00
		TORX®15 M4x6 D5,6 L7,8	902.040.06.58
		TORX®15	903.002.15.00

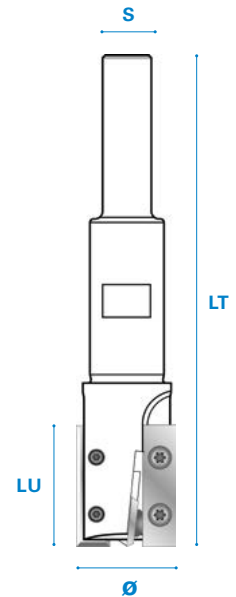
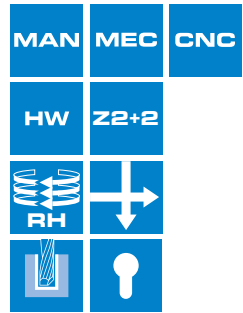

170





FRESA PER RAGGI E SMUSSI CON COLTELLI REVERSIBILI

Router bit reversible knives for Roundover/Chamfer
Fase/Viertelstabfräser mit wechsellatten
Mèche 1/4 de rond/à chanfreiner à plaquettes



Ø	LU	LT	S	CODE
41	15	90	12 x 40	170.410.01200
41	15	100	16 x 40	170.410.01600

€

	CODE
 R2	15x17x2 901.000.02.02
 R3	15x17x2 901.000.03.02
 R4	15x17x2 901.000.04.02
 R5	15x17x2 901.000.05.02
 45°	15x17x2 901.000.45.02



Ricambi - Spare parts - Ersatzteile - Pièces de rechange	CODE
 TORX®15 M4x6 D9 L8	902.040.60.90
 TORX®15	903.002.15.00

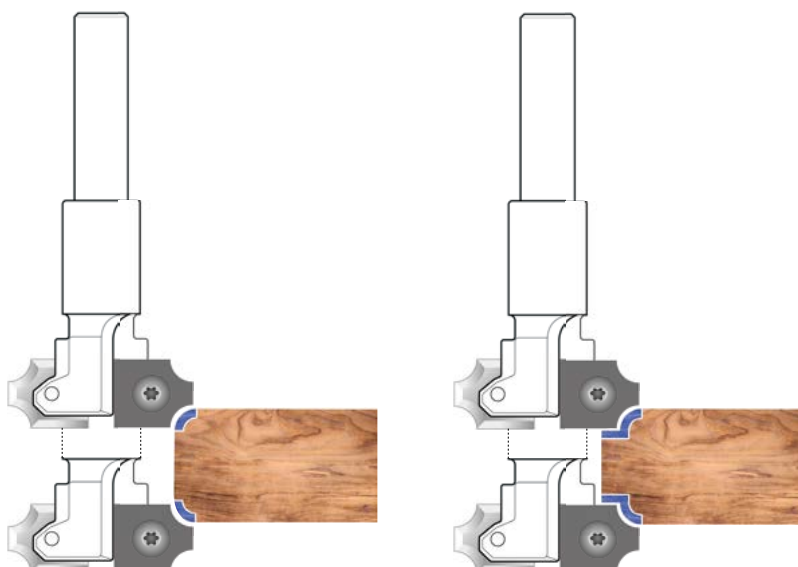
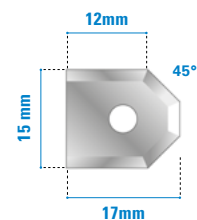
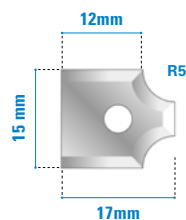
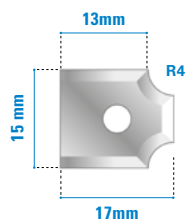
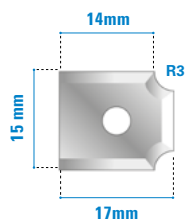
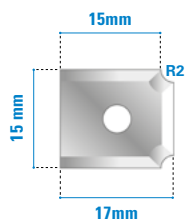
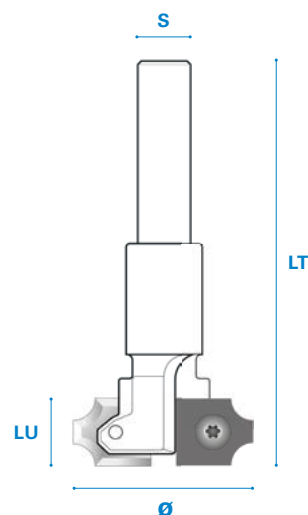
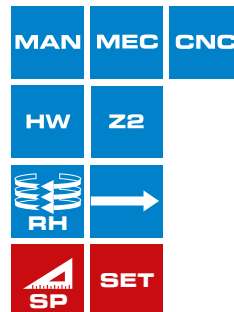

171

FRESA RAGGIO CONCAVO A COLTELLI

Roundover router bit with insert knives
Viertelstabfräser mit Wechselplatten
Mèche 1/4 de rond à plaquettes



R	Ø	LU	LT	S	CODE
8	32	18	80	20 x 50	171.080.02000
10	36	18	85	20 x 50	171.100.02000
12	40	18	85	20 x 50	171.120.02000
15	46	23	90	20 x 50	171.150.02000
20	60	30	100	20 x 50	171.200.02000

Ricambi - Spare parts - Ersatzteile - Pièces de rechange		CODE
x1	Z3 R8	901.171.08.CO
x1	Z3 R10	901.171.10.CO
x1	Z3 R12	901.171.12.CO
x1	Z3 R15	901.171.15.CO
x1	Z3 R20	901.171.20.CO
	TORX®15 M4x6 D9 L8	902.040.06.90
	TORX®15	903.002.15.00

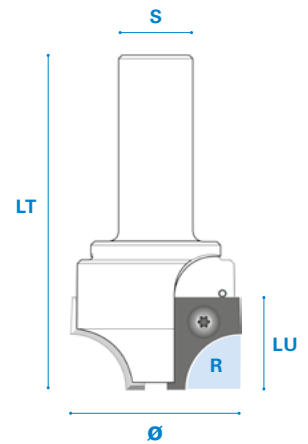
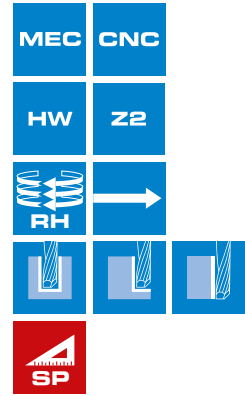

22

172

FRESA RAGGIO CONVESSO A COLTELLI

Core box router bit with insert knives
Hohlkehlfräser mit Wechselplatten
Mèche à gorge à plaquettes



R	Ø	LU	LT	S	CODE
12	24	18	85	20 x 50	172.120.02000
15	30	23	90	20 x 50	172.150.02000
20	40	23	90	20 x 50	172.200.02000

Ricambi - Spare parts - Ersatzteile - Pièces de rechange		CODE
x1	Z1 R12	901.172.12.CV
x1	Z1 R15	901.172.15.CV
x1	Z1 R20	901.172.20.CV
	R12 TORX®15 M4x6 D5,6 L7,8	902.040.06.58
	R15 - R20 TORX®15 M4x6 D9 L8	902.040.06.90
	TORX®15	903.002.15.00

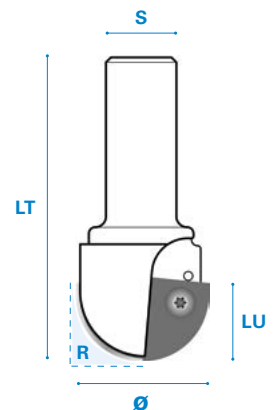
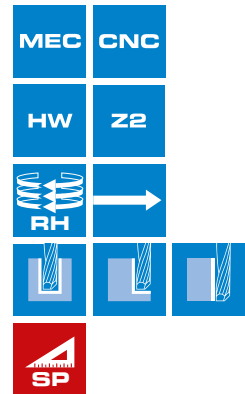

701

FRESA ELICOIDALE PER FINITURA

Finishing Spiral bit
Einzahn-Schlichtfräser
Fraise à coupe hélicoïdale



RH	Ø	LU	LT	S	CODE
DESTRA POSITIVA Right-hand / Up-cut Rechtslauf / Positive Droite / Positives	3	12	50	3	701.030.12.D8
	4	12	50	4	701.040.12.D8
	5	17	50	5	701.050.17.D8
	6	20	60	6	701.060.20.D8
	8	22	70	8	701.080.22.D8
	6	30	70	6	701.060.30.D8
	8	32	80	8	701.080.32.D8
	10	32	80	10	701.100.32.D8
	12	32	80	12	701.120.32.D8
	10	42	90	10	701.100.42.D8
	12	42	90	12	701.120.42.D8

LH	Ø	LU	LT	S	CODE
SINISTRA POSITIVA Left-hand / Up-cut Linkslauf / Positive Gauche / Positives	3	12	50	3	701.030.12.D9
	4	12	50	4	701.040.12.D9
	5	17	50	5	701.050.17.D9
	6	20	60	6	701.060.20.D9
	8	22	70	8	701.080.22.D9
	6	30	70	6	701.060.30.D9
	8	32	80	8	701.080.32.D9
	10	32	80	10	701.100.32.D9
	12	32	80	12	701.120.32.D9
	10	42	90	10	701.100.42.D9
	12	42	90	12	701.120.42.D9



€

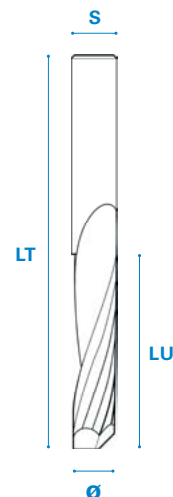
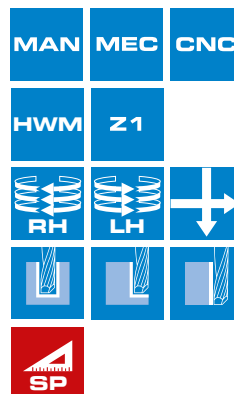

23



RH	Ø	LU	LT	S	CODE
DESTRA NEGATIVA Right-hand / Down-cut Rechtslauf / Negative Droite / Négatives	3	12	50	3	701.030.12.S8
	4	12	50	4	701.040.12.S8
	5	17	50	5	701.050.17.S8
	6	20	60	6	701.060.20.S8
	8	22	70	8	701.080.22.S8
	6	30	70	6	701.060.30.S8
	8	32	80	8	701.080.32.S8
	10	32	80	10	701.100.32.S8
	12	32	80	12	701.120.32.S8
	10	42	90	10	701.100.42.S8
	12	42	90	12	701.120.42.S8

LH	Ø	LU	LT	S	CODE
SINISTRA NEGATIVA Left-hand / Down-cut Linkslauf / Negative Gauche / Négatives	3	12	50	3	701.030.12.S9
	4	12	50	4	701.040.12.S9
	5	17	50	5	701.050.17.S9
	6	20	60	6	701.060.20.S9
	8	22	70	8	701.080.22.S9
	6	30	70	6	701.060.30.S9
	8	32	80	8	701.080.32.S9
	10	32	80	10	701.100.32.S9
	12	32	80	12	701.120.32.S9
	10	42	90	10	701.100.42.S9
	12	42	90	12	701.120.42.S9

€



702

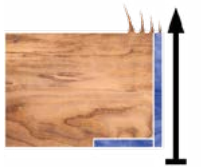

FRESA ELICOIDALE PER FINITURA

Finishing Spiral bit
Schlichtfräser
Fraise à coupes hélicoïdales

RH	Ø	LU	LT	S	CODE
DESTRA POSITIVA Right-hand / Up-cut Rechtslauf / Positive Droite / Positives	3	12	50	3	702.030.12.D8
	4	12	50	4	702.040.12.D8
	5	17	50	5	702.050.17.D8
	6	20	60	6	702.060.20.D8
	8	22	70	8	702.080.22.D8
	6	30	70	6	702.060.30.D8
	8	32	80	8	702.080.32.D8
	10	32	80	10	702.100.32.D8
	12	32	80	12	702.120.32.D8
	14	32	80	14	702.140.32.D8
	10	52	100	10	702.100.52.D8
	12	52	100	12	702.120.52.D8
	14	52	100	14	702.140.52.D8
	16	52	100	16	702.160.52.D8
	18	52	100	18	702.180.52.D8
	20	52	100	20	702.200.52.D8
	16	72	120	16	702.160.72.D8
	20	72	120	20	702.200.72.D8

LH	Ø	LU	LT	S	CODE
SINISTRA POSITIVA Left-hand / Up-cut Linkslauf / Positive Gauche / Positives	3	12	50	3	702.030.12.D9
	4	12	50	4	702.040.12.D9
	5	17	50	5	702.050.17.D9
	6	20	60	6	702.060.20.D9
	8	22	70	8	702.080.22.D9
	6	30	70	6	702.060.30.D9
	8	32	80	8	702.080.32.D9
	10	32	80	10	702.100.32.D9
	12	32	80	12	702.120.32.D9
	14	32	80	14	702.140.32.D9
	10	52	100	10	702.100.52.D9
	12	52	100	12	702.120.52.D9
	14	52	100	14	702.140.52.D9
	16	52	100	16	702.160.52.D9
	18	52	100	18	702.180.52.D9
	20	52	100	20	702.200.52.D9
	16	72	120	16	702.160.72.D9
	20	72	120	20	702.200.72.D9

RH	Ø	LU	LT	S	CODE
DESTRA NEGATIVA Right-hand / Down-cut Rechtslauf / Negative Droite / Négatives	3	12	50	3	702.030.12.S8
	4	12	50	4	702.040.12.S8
	5	17	50	5	702.050.17.S8
	6	20	60	6	702.060.20.S8
	8	22	70	8	702.080.22.S8
	6	30	70	6	702.060.30.S8
	8	32	80	8	702.080.32.S8
	10	32	80	10	702.100.32.S8
	12	32	80	12	702.120.32.S8
	14	32	80	14	702.140.32.S8
	10	52	100	10	702.100.52.S8
	12	52	100	12	702.120.52.S8
	14	52	100	14	702.140.52.S8
	16	52	100	16	702.160.52.S8
	18	52	100	18	702.180.52.S8
	20	52	100	20	702.200.52.S8
	16	72	120	16	702.160.72.S8
	20	72	120	20	702.200.72.S8

LH	Ø	LU	LT	S	CODE
SINISTRA NEGATIVA Left-hand / Down-cut Linkslauf / Negative Gauche / Négatives	3	12	50	3	702.030.12.S9
	4	12	50	4	702.040.12.S9
	5	17	50	5	702.050.17.S9
	6	20	60	6	702.060.20.S9
	8	22	70	8	702.080.22.S9
	6	30	70	6	702.060.30.S9
	8	32	80	8	702.080.32.S9
	10	32	80	10	702.100.32.S9
	12	32	80	12	702.120.32.S9
	14	32	80	14	702.140.32.S9
	10	52	100	10	702.100.52.S9
	12	52	100	12	702.120.52.S9
	14	52	100	14	702.140.52.S9
	16	52	100	16	702.160.52.S9
	18	52	100	18	702.180.52.S9
	20	52	100	20	702.200.52.S9
	16	72	120	16	702.160.72.S9
	20	72	120	20	702.200.72.S9



€

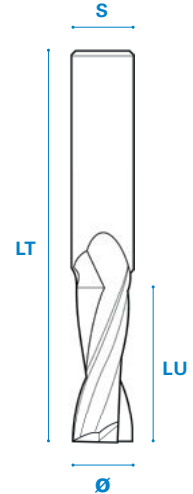
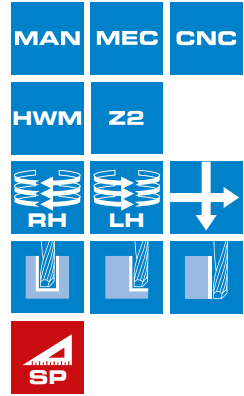

703

FRESA ELICOIDALE PER FINITURA

Finishing Spiral bit
Schlichtfräser
Fraise à coupes hélicoïdales



RH	Ø	LU	LT	S	CODE
DESTRA POSITIVA Right-hand / Up-cut Rechtslaut / Positive Droite / Positives	8	32	80	8	703.080.32.D8
	10	32	80	10	703.100.32.D8
	12	32	80	12	703.120.32.D8
	10	52	100	10	703.100.52.D8
	12	52	100	12	703.120.52.D8
	14	52	100	14	703.140.52.D8
	16	52	100	16	703.160.52.D8
	18	52	100	18	703.180.52.D8
	20	52	100	20	703.200.52.D8
	20	102	150	20	703.200.102.D8

€

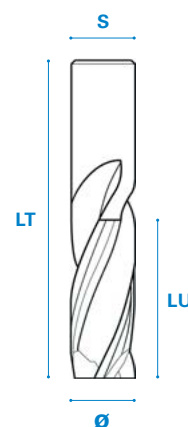
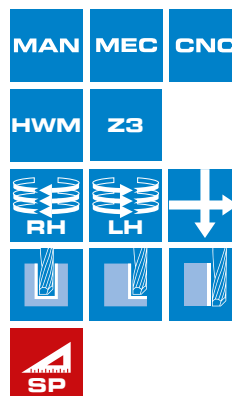

LH	Ø	LU	LT	S	CODE
SINISTRA POSITIVA Left-hand / Up-cut Linksaut / Positive Gauche / Positives	8	32	80	8	703.080.32.D9
	10	32	80	10	703.100.32.D9
	12	32	80	12	703.120.32.D9
	10	52	100	10	703.100.52.D9
	12	52	100	12	703.120.52.D9
	14	52	100	14	703.140.52.D9
	16	52	100	16	703.160.52.D9
	18	52	100	18	703.180.52.D9
	20	52	100	20	703.200.52.D9
	16	72	120	16	703.160.72.D9



RH	Ø	LU	LT	S	CODE
DESTRA NEGATIVA Right-hand / Down-cut Rechtslaut / Negative Droite / Négatives	8	32	80	8	703.080.32.S8
	10	32	80	10	703.100.32.S8
	12	32	80	12	703.120.32.S8
	10	52	100	10	703.100.52.S8
	12	52	100	12	703.120.52.S8
	14	52	100	14	703.140.52.S8
	16	52	100	16	703.160.52.S8
	18	52	100	18	703.180.52.S8
	20	52	100	20	703.200.52.S8
	20	102	150	20	703.200.102.S8

€



LH	Ø	LU	LT	S	CODE
SINISTRA NEGATIVA Left-hand / Down-cut Linksaut / Negative Gauche / Négatives	8	32	80	8	703.080.32.S9
	10	32	80	10	703.100.32.S9
	12	32	80	12	703.120.32.S9
	10	52	100	10	703.100.52.S9
	12	52	100	12	703.120.52.S9
	14	52	100	14	703.140.52.S9
	16	52	100	16	703.160.52.S9
	18	52	100	18	703.180.52.S9
	20	52	100	20	703.200.52.S9
	16	72	120	16	703.160.72.S9

704

FRESA ELICOIDALE PER SGROSSATURA CON ROMPITRUCIOLO

Roughing Spiral bit with Chipbreaker
 Schrappfräser mit Spanbrecher
 Fraise à coupes hélicoïdales avec brise-copeau



RH	Ø	LU	LT	S	CODE
	8	32	80	8	704.080.32.D8
	10	32	80	10	704.100.32.D8
	12	32	80	12	704.120.32.D8
	8	52	100	8	704.080.52.D8
	10	52	100	10	704.100.52.D8
	12	52	100	12	704.120.52.D8
	14	52	100	14	704.140.52.D8
	16	52	100	16	704.160.52.D8
	18	52	100	18	704.180.52.D8
	20	52	100	20	704.200.52.D8
	16	72	120	16	704.160.72.D8
	20	72	120	20	704.200.72.D8
	20	102	150	20	704.200.102.D8

LH	Ø	LU	LT	S	CODE
	8	32	80	8	704.080.32.D9
	10	32	80	10	704.100.32.D9
	12	32	80	12	704.120.32.D9
	8	52	100	8	704.080.52.D9
	10	52	100	10	704.100.52.D9
	12	52	100	12	704.120.52.D9
	14	52	100	14	704.140.52.D9
	16	52	100	16	704.160.52.D9
	18	52	100	18	704.180.52.D9
	20	52	100	20	704.200.52.D9
	16	72	120	16	704.160.72.D9

€

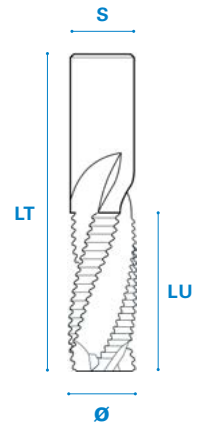
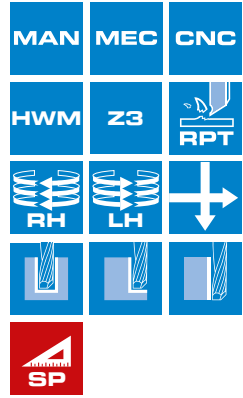

26



RH	Ø	LU	LT	S	CODE
	8	32	80	8	704.080.32.S8
	10	32	80	10	704.100.32.S8
	12	32	80	12	704.120.32.S8
	8	52	100	8	704.080.52.S8
	10	52	100	10	704.100.52.S8
	12	52	100	12	704.120.52.S8
	14	52	100	14	704.140.52.S8
	16	52	100	16	704.160.52.S8
	18	52	100	18	704.180.52.S8
	20	52	100	20	704.200.52.S8
	16	72	120	16	704.160.72.S8
	20	72	120	20	704.200.72.S8
	20	102	150	20	704.200.102.S8

€



LH	Ø	LU	LT	S	CODE
	8	32	80	8	704.080.32.S9
	10	32	80	10	704.100.32.S9
	12	32	80	12	704.120.32.S9
	8	52	100	8	704.080.52.S9
	10	52	100	10	704.100.52.S9
	12	52	100	12	704.120.52.S9
	14	52	100	14	704.140.52.S9
	16	52	100	16	704.160.52.S9
	18	52	100	18	704.180.52.S9
	20	52	100	20	704.200.52.S9
	16	72	120	16	704.160.72.S9

710

FRESA PER SERRATURE

Door Lock Mortise
Schlosskastenfräser
Mèche à coupes hélicoïdales pour serrures



DESTRA POSITIVA
Right-hand / Up-cut
Rechtslaut / Positive
Droite / Positives

Ø	LU ¹ /LU ²	LT	S	CODE
12	45/95	150	12	710.120.95.D8
14	45/95	150	14	710.140.95.D8
16	45/95	150	16	710.160.95.D8
18	45/95	150	18	710.180.95.D8

€

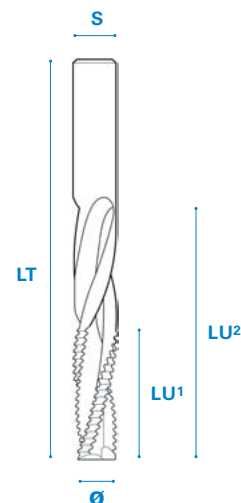
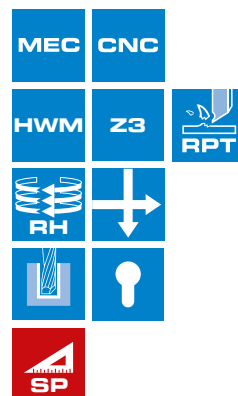

27

715

**FRESA PER FINITURA
CON ANGOLI ASSIALI ALTERNATI**

Compression Spiral Router Bit
Schlichtfräser mit wechselseitigem Achswinkel
Fraise à coupe alternée positive + négative



	Ø	LU	LT	S	CODE
Z1+1	4	15	50	4	715.040.15.D8
Z1+1	5	17	50	5	715.050.17.D8
Z1+1	6	22	70	6	715.060.22.D8
Z1+1	8	32	70	8	715.080.32.D8
Z2+2	10	32	80	10	715.100.32.D8
Z2+2	12	32	80	12	715.120.32.D8
Z2+2	12	42	90	12	715.120.42.D8

€

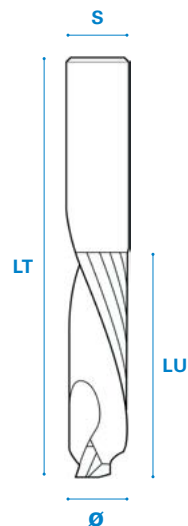
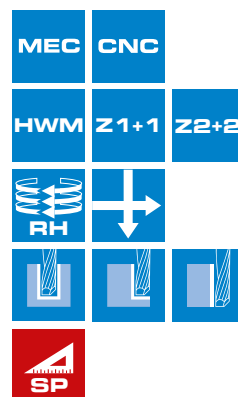

INDICE | INDEX

UTENSILI NON SAGOMATI PER PANTOGRAFI PORTATILI

NOT PROFILED TOOLS FOR PORTABLE ROUTERS

WERKZEUGE NICHT PROFILIERTEN FÜR HANDBERFRÄSER

OUTILS PAS PROFILÉES POUR DÉFONCEUSES PORTATIVES

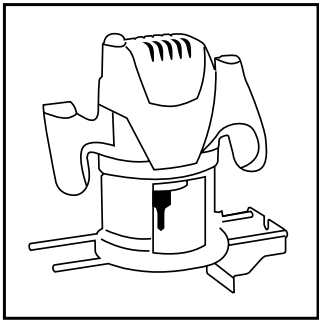

INDICE | INDEX

UTENSILI NON SAGOMATI PER PANTOGRAFI PORTATILI

NOT PROFILED TOOLS FOR PORTABLE ROUTERS

WERKZEUGE NICHT PROFILIERTEN FÜR HANDBERFRÄSER

OUTILS PAS PROFILÉES POUR DÉFONCEUSES PORTATIVES

B

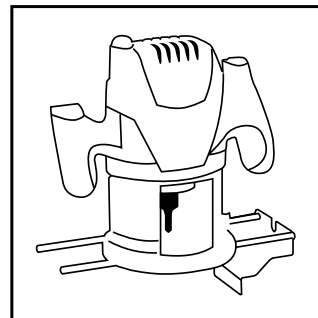

201

**FRESA A TAGLIANTI DIRITTI
CON LAMA DI TESTA - M12 Elu®**

Carbide Tipped Straight Plunge - M12 Elu®
Nutfräser mit Bohrschneide - M12 Elu®
Mèche à rainier avec coupe frontale - M12 Elu®

Ø	LU	LT	S	CODE
8	25	60	M12 x 1	201.080.25.28
10	25	60	M12 x 1	201.100.25.28
11	25	60	M12 x 1	201.110.25.28
12	25	60	M12 x 1	201.120.25.28
14	25	60	M12 x 1	201.140.25.28
15	25	60	M12 x 1	201.150.25.28
16	25	60	M12 x 1	201.160.25.28
18	25	60	M12 x 1	201.180.25.28
20	25	60	M12 x 1	201.200.25.28
22	25	60	M12 x 1	201.220.25.28
24	25	60	M12 x 1	201.240.25.28
25	25	60	M12 x 1	201.250.25.28
26	25	60	M12 x 1	201.260.25.28
28	25	60	M12 x 1	201.280.25.28
30	25	60	M12 x 1	201.300.25.28
35	25	60	M12 x 1	201.350.25.28
10	35	70	M12 x 1	201.100.35.28
12	40	75	M12 x 1	201.120.40.28
13	40	75	M12 x 1	201.130.40.28
14	40	75	M12 x 1	201.140.40.28
15	40	75	M12 x 1	201.150.40.28
16	40	75	M12 x 1	201.160.40.28
18	40	75	M12 x 1	201.180.40.28
20	40	75	M12 x 1	201.200.40.28
22	40	75	M12 x 1	201.220.40.28
16	45	80	M12 x 1	201.160.45.28
18	45	80	M12 x 1	201.180.45.28
12	50	85	M12 x 1	201.120.50.28
14	50	85	M12 x 1	201.140.50.28
16	50	85	M12 x 1	201.160.50.28
16	60	95	M12 x 1	201.160.60.28

€

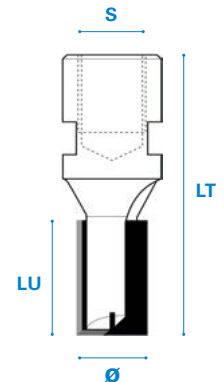
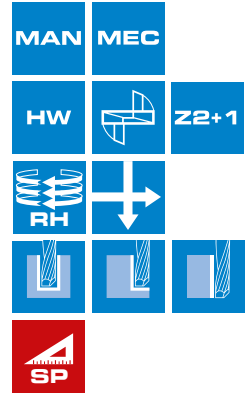

30

203

**FRESA A TAGLIANTI DIRITTI
CON LAMA DI TESTA - M10 Scheer®**

Carbide Tipped Straight Plunge - M10 Scheer®
Nutfräser mit Bohrschneide - M10 Scheer®
Mèche à rainier avec coupe frontal - M10 Scheer®

Ø	LU	LT	S	CODE
8	25	60	M10 x 1,5	203.080.25.28
10	25	60	M10 x 1,5	203.100.25.28
11	25	60	M10 x 1,5	203.110.25.28
12	25	60	M10 x 1,5	203.120.25.28
14	25	60	M10 x 1,5	203.140.25.28
15	25	60	M10 x 1,5	203.150.25.28
16	25	60	M10 x 1,5	203.160.25.28
18	25	60	M10 x 1,5	203.180.25.28
20	25	60	M10 x 1,5	203.200.25.28
22	25	60	M10 x 1,5	203.220.25.28
24	25	60	M10 x 1,5	203.240.25.28
25	25	60	M10 x 1,5	203.250.25.28
26	25	60	M10 x 1,5	203.260.25.28
28	25	60	M10 x 1,5	203.280.25.28
30	25	60	M10 x 1,5	203.300.25.28
35	25	60	M10 x 1,5	203.350.25.28
10	35	70	M10 x 1,5	203.100.35.28
12	40	75	M10 x 1,5	203.120.40.28
13	40	75	M10 x 1,5	203.130.40.28
14	40	75	M10 x 1,5	203.140.40.28
15	40	75	M10 x 1,5	203.150.40.28
16	40	75	M10 x 1,5	203.160.40.28
18	40	75	M10 x 1,5	203.180.40.28
20	40	75	M10 x 1,5	203.200.40.28
22	40	75	M10 x 1,5	203.220.40.28
16	45	80	M10 x 1,5	203.160.45.28
18	45	80	M10 x 1,5	203.180.45.28
20	45	80	M10 x 1,5	203.200.45.28
22	45	80	M10 x 1,5	203.220.45.28

€

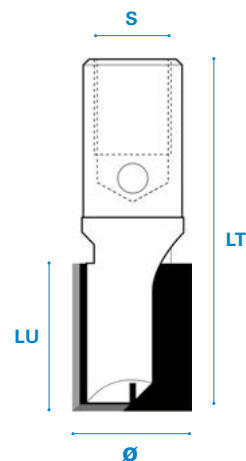
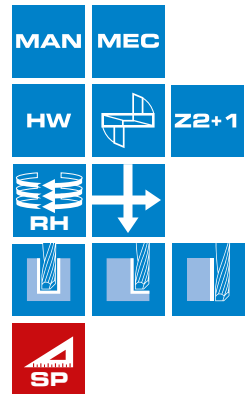

205

FRESA A TAGLIENTI DIRITTI CON LAMA DI TESTA

Carbide Tipped Straight Plunge
Nutfräser mit Bohrschneide
Mèche à rainer avec coupe frontale



Ø	LU	LT	S		CODE
28	5	60	8		205.280.05.28
30	5	60	8		205.300.05.28
4	10	60	8	HWM	205.040.10.28
22	10	70	8		205.220.10.28
23	10	60	8		205.230.10.28
24	10	60	8		205.240.10.28
26	10	60	8		205.260.10.28
5	12	60	8	HWM	205.050.12.28
14	12	60	8		205.140.12.28
15	12	50	8		205.150.12.28
16	12	70	8		205.160.12.28
18	12	70	8		205.180.12.28
20	12	70	8		205.200.12.28
12	15	60	8		205.120.15.28
13	15	60	8		205.130.15.28
6	16	60	8	HWM	205.060.16.28
7	16	60	8	HWM	205.070.16.28
8	20	60	8	HWM	205.080.20.28
9	20	60	8		205.090.20.28
10	20	60	8		205.100.20.28
11	20	60	8		205.110.20.28
14	20	70	8		205.140.20.28
16	20	80	8		205.160.20.28
18	20	80	8		205.180.20.28
20	20	80	8		205.200.20.28
22	20	80	8		205.220.20.28
8	30	90	8		205.080.30.28
10	30	90	8		205.100.30.28
12	30	90	8		205.120.30.28
14	30	90	8		205.140.30.28
16	30	90	8		205.160.30.28

€

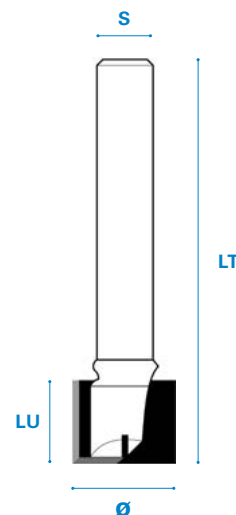
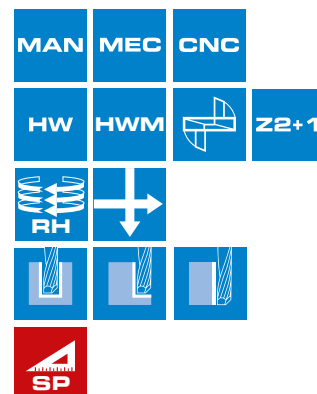

31

206

FRESA A TAGLIENTI DIRITTI CON LAMA DI TESTA

Carbide Tipped Straight Plunge
Nutfräser mit Bohrschneide
Mèche à rainer avec coupe frontale



Ø	LU	LT	S		CODE
10	25	70	10x38		206.100.25.28
11	25	70	10x38		206.110.25.28
12	25	70	10x38		206.120.25.28
14	25	70	10x38		206.140.25.28
15	25	70	10x38		206.150.25.28
16	25	70	10x38		206.160.25.28
18	25	70	10x38		206.180.25.28
20	25	70	10x38		206.200.25.28
22	25	70	10x38		206.220.25.28
24	25	70	10x38		206.240.25.28
26	25	70	10x38		206.260.25.28
30	25	70	10x38		206.300.25.28
10	35	87	10x38		206.100.35.28
12	35	87	10x38		206.120.35.28
14	35	87	10x38		206.140.35.28
16	35	87	10x38		206.160.35.28
18	35	87	10x38		206.180.35.28
20	35	87	10x38		206.200.35.28

€

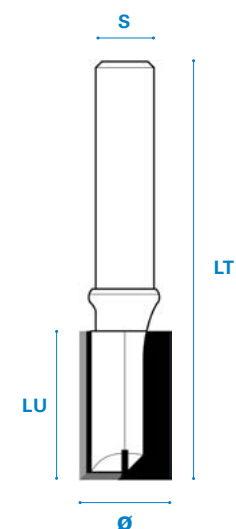
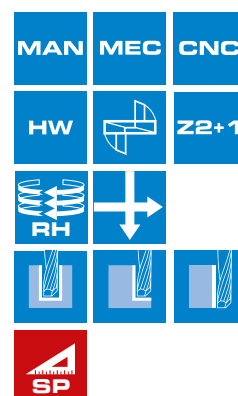

207

FRESA A TAGLIENTI DIRITTI CON LAMA DI TESTA

Carbide Tipped Straight Plunge
Nutfräser mit Bohrschneide
Mèche à rainier avec coupe frontale



Ø	LU	LT	S	CODE
10	35	90	12 x 50	207.100.35.28
12	35	90	12 x 50	207.120.35.28
14	35	90	12 x 50	207.140.35.28
16	35	90	12 x 50	207.160.35.28
18	35	90	12 x 50	207.180.35.28
20	35	90	12 x 50	207.200.35.28
22	35	90	12 x 50	207.220.35.28
24	35	90	12 x 50	207.240.35.28
30	35	90	12 x 50	207.300.35.28
35	35	90	12 x 50	207.350.35.28
12	45	90	12 x 50	207.120.45.28
14	50	100	12 x 50	207.140.50.28
16	60	105	12 x 50	207.160.60.28

€

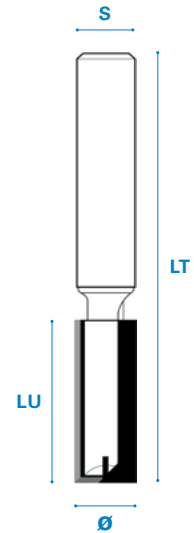
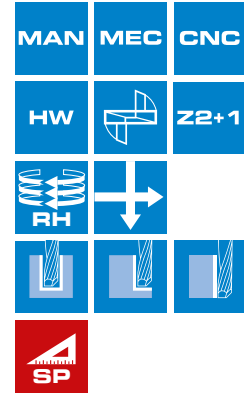

32

208

FRESA A TAGLIENTI DIRITTI CON CUSCINETTO - M12 Elu®

Flush trim bit with ball bearing - M12 Elu®
Bündigfräser mit Kugellager - M12 Elu®
Fraise à affleurer avec roulement - M12 Elu®



Ø	LU	LT	S	CODE
19	25	70	M12 x 1	208.190.25.28
19	40	85	M12 x 1	208.190.40.28
19	50	95	M12 x 1	208.190.50.28

€

Ricambi - Spare parts - Ersatzteile - Pièces de rechange	CODE
Ø19/6 H6	904.190.06.00
d4,3 D9 S0,8	905.040.09.08
⌀3 M4x8	902.040.08.00



Optional	CODE
⌀3	903.030.00.00

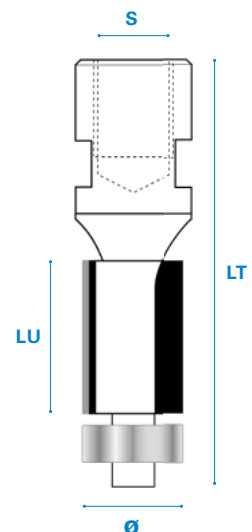
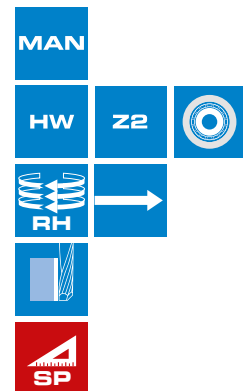

208 B









FRESA A TAGLIANTI DIRITTI CON CUSCINETTO E COLTELLI REVERSIBILI - M12 Elu®



Flush trim bit with ball bearing and reversible knives - M12 Elu®
 Bündigfräser mit Kugellager und Wendemesser - M12 Elu®
 Fraise à affleurer à plaquettes réversibles avec roulement - M12 Elu®



Ø	LU	LT	S	CODE
19	30	75	M12 x 1	208B.190.30.28
19	50	95	M12 x 1	208B.190.50.28

Ricambi - Spare parts - Ersatzteile - Pièces de rechange

	CODE
  Z2 LU 30 30x12x1,5	901.300.12.00
  Z2 LU 50 50x12x1,5	901.500.12.00
 TORX®15 M4x6 D9 L8	902.040.06.90
 Ø19/6 H6	904.190.06.00
 d4,3 D9 S0,8	905.040.09.08
 Ø 3 M4x8	902.040.08.00

Optional	CODE
 TORX®15	903.150.00.00
 Ø 3	903.030.00.00

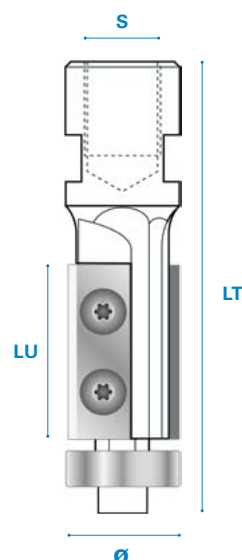
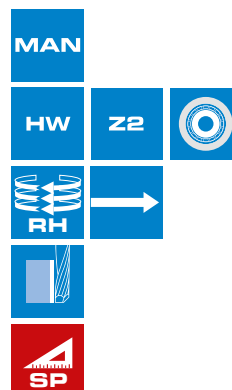

33

221



FRESA A TAGLIANTI DIRITTI CON LAMA DI TESTA E COLTELLI REVERSIBILI

Carbide Tipped Straight Plunge with reversible knives
 Wendeplatten Nutfräser mit Bohrschneide
 Mèche à rainer à plaquettes réversibles avec coupe frontale



Ø	LU	LT	S	CODE
15	20	70	8	221.150.00800
15	20	70	12	221.150.01200
16	20	70	8	221.160.00800
16	20	70	12	221.160.01200
18	20	70	8	221.180.00800
18	20	70	12	221.180.01200
20	20	70	8	221.200.00800
20	20	70	12	221.200.01200
22	20	70	8	221.220.00800
22	20	70	12	221.220.01200
25	20	70	8	221.250.00800

Ricambi - Spare parts - Ersatzteile - Pièces de rechange

	CODE
  Z4 12x12x1,5	901.120.12.00
 TORX®15 M4x6 D9 L8	902.040.06.90

Optional	CODE
 TORX®15	903.150.00.00

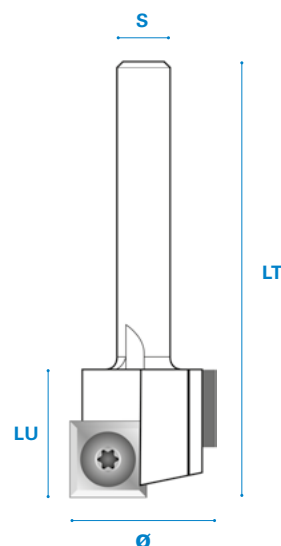
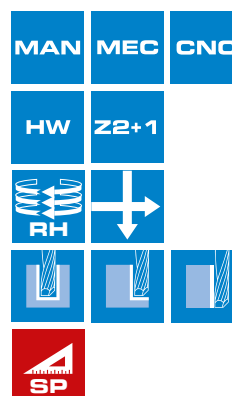

230

FRESA A TAGLIANTE DIRITTO CON COLTELLO REVERSIBILE

Straight Router bit with reversible knife
Nutfräser mit Wendemesser
Mèches à rainer à plaquette réversible



∅	LU	LT	S	CODE
8	20	65	8	230.080.20008
10	20	65	8	230.100.20008
12	20	65	8	230.120.20008
14	30	75	8	230.140.30008
15	30	75	8	230.150.30008
16	30	75	8	230.160.30008
18	30	75	8	230.180.30008
20	30	75	8	230.200.30008
22	30	75	8	230.220.30008
8	20	75	12	230.080.20012
10	20	75	12	230.100.20012
12	20	75	12	230.120.20012
14	30	85	12	230.140.30012
15	30	85	12	230.150.30012
16	30	85	12	230.160.30012
18	30	85	12	230.180.30012
20	30	85	12	230.200.30012
22	30	85	12	230.220.30012
14	50	105	12	230.140.50012
16	50	105	12	230.160.50012
18	50	105	12	230.180.50012
20	50	105	12	230.200.50012
22	50	105	12	230.220.50012

€

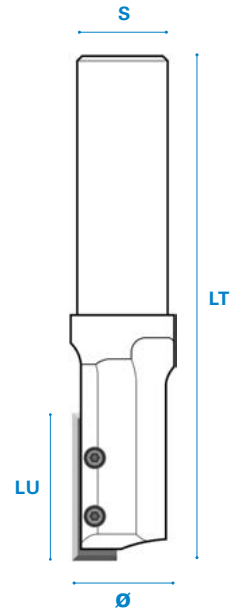
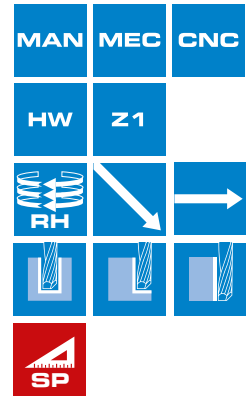

34

230 M10

FRESA A TAGLIANTE DIRITTO CON COLTELLO REVERSIBILE - M10 Scheer®

Straight Router bit with reversible knife - M10 Scheer®
Nutfräser mit Wendemesser - M10 Scheer®
Mèches à rainer à plaquette réversible - M10 Scheer®



∅	LU	LT	S	CODE
8	20	58	M10 x 1,5	230.080.20M10
10	20	58	M10 x 1,5	230.100.20M10
12	20	58	M10 x 1,5	230.120.20M10
14	30	65	M10 x 1,5	230.140.30M10
15	30	65	M10 x 1,5	230.150.30M10
16	30	65	M10 x 1,5	230.160.30M10
18	30	65	M10 x 1,5	230.180.30M10
20	30	65	M10 x 1,5	230.200.30M10
22	30	65	M10 x 1,5	230.220.30M10
14	50	85	M10 x 1,5	230.140.50M10
16	50	85	M10 x 1,5	230.160.50M10
18	50	85	M10 x 1,5	230.180.50M10
20	50	85	M10 x 1,5	230.200.50M10
22	50	85	M10 x 1,5	230.220.50M10

€

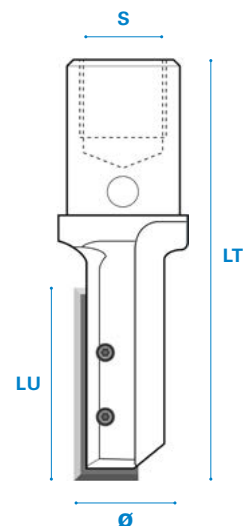
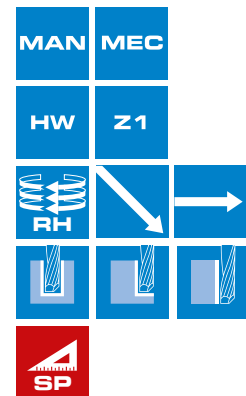

230 M12

FRESA A TAGLIANTE DIRITTO CON COLTELLO REVERSIBILE - M12 Elu®

Straight Router bit with reversible knife - M12 Elu®

Nutfräser mit Wendemesser - M12 Elu®

Mèches à rainer à plaquette réversible - M12 Elu®



Ø	LU	LT	S	CODE
8	20	58	M12 x 1	230.080.20M12
10	20	58	M12 x 1	230.100.20M12
12	20	58	M12 x 1	230.120.20M12
14	30	65	M12 x 1	230.140.30M12
15	30	65	M12 x 1	230.150.30M12
16	30	65	M12 x 1	230.160.30M12
18	30	65	M12 x 1	230.180.30M12
20	30	65	M12 x 1	230.200.30M12
22	30	65	M12 x 1	230.220.30M12
14	50	85	M12 x 1	230.140.50M12
16	50	85	M12 x 1	230.160.50M12
18	50	85	M12 x 1	230.180.50M12
20	50	85	M12 x 1	230.200.50M12
22	50	85	M12 x 1	230.220.50M12

€

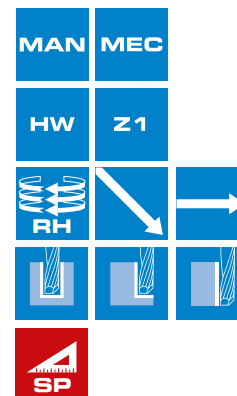

TiN

VENDUTA CON COLTELLO RIVESTITO TiN

TiN è da sempre un riferimento nel campo dell'asportazione truciolo, ma le sue proprietà suscitano molto interesse anche in tanti altri campi d'applicazione.

SOLD WITH KNIFE TiN COATED

TiN has always been a reference in the field of cutting tools, and its properties also spark much interest in many other fields of application.

VENDU AVEC PLAQUETTES REVÊTUE TiN

TiN a toujours été une référence dans le domaine de l'enlèvement de copeaux, mais ses caractéristiques suscitent beaucoup d'intérêt dans de nombreux autres domaines d'application.

WIRD MIT TiN-BESCHICHTUNG MESSER VERKAUFT

TiN wurde schon immer im Bereich der Zerspanung als Referenz betrachtet, obwohl seine Eigenschaften es auch für andere Bereiche interessant machen.

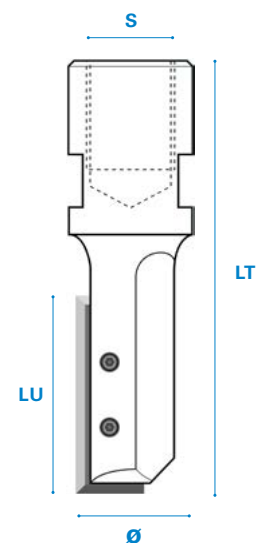

35

230

230 M10

230 M12

Ricambi - Spare parts - Ersatzteile - Pièces de rechange				CODE
	Z4 TiN	LU20	20x5,5x1,1	901.200.55.GT
	Z4	LU20	20x5,5x1,1	901.200.55.2G
	Z4 TiN	LU30	30x10x1,5	901.300.10.GT
	Z4	LU30	30x10x1,5	901.300.10.2G
	Z4 TiN	LU50	50x10x1,5	901.500.10.GT
		Ø8	∅ 1,3 M2,5x2	902.025.02.00
		Ø10-12	∅ 2 M2,5x3	902.025.03.00
		Ø14→18	∅ 2 M4x4	902.040.04.00
		Ø20→22	∅ 2 M4x5	902.040.05.00

€



Optional	CODE
	Ø8→12 ∅ 1,3 903.013.00.00
	Ø14→22 ∅ 2 903.020.00.00

233

FRESA A TAGLIANTE DIRITTO CON COLTELLO REVERSIBILE

Straight Router bit with reversible knife
Nutfräser mit Wendemesser
Mèches à défoncer à plaquette réversible



Ø	LU	LT	S	CODE
10	30	73	8 x 30	233.100.30098
12	30	80	8 x 30	233.120.30098
12	40	80	8 x 30	233.120.40098
12	30	85	12 x 40	233.120.30912
12	50	105	12 x 40	233.120.50912

€

Ricambi - Spare parts - Ersatzteile - Pièces de rechange				CODE
	Z4	Ø10	29,5x7x1,5	901.295.07.00
	Z4	Ø12 LU 30	29,5x9x1,5	901.295.09.00
	Z4	Ø12 LU 40	39,5x9x1,5	901.395.09.00
	Z4	Ø12 LU 50	49,5x9x1,5	901.495.09.00
	TORX®15 M3,5x4 D6 L6			902.035.04.60



Optional	CODE
	TORX®15 903.150.00.00

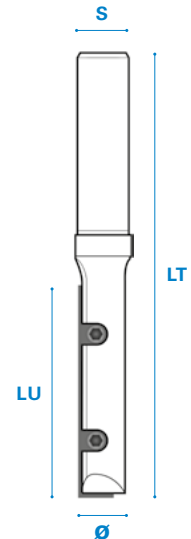
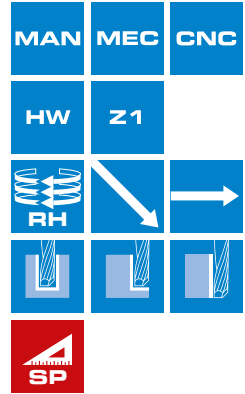

36

235

FRESA A CODA DI RONDINE 15° CON COLTELLI REVERSIBILI PER SISTEMA ARUNDA®

Dovetail router bit 15° with reversible knives for ARUNDA® System
Zinkenfräser 15° mit Wendemesser für ARUNDA® System
Mèche à queue d'aronde 15° à plaquettes réversibles pour Système ARUNDA®



COMPATIBILE CON
Compatible with
Passend für
Compatible avec



a	Ø	LU	LT	S	CODE
15°	39,5	31,5	65,5	M12 x 1	235.150.00.28

€

Ricambi - Spare parts - Ersatzteile - Pièces de rechange				CODE
	Z4	31,5x9x1,5		901.315.09.00
	TORX®15 M4x6 D5,6 L7,8			902.040.06.58



Optional	CODE
	TORX®15 903.150.00.00

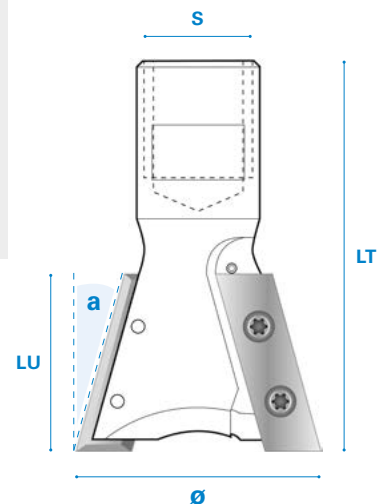
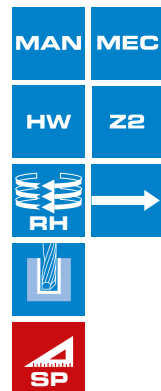

259

FRESA PER SISTEMA DOMINO®

Router bit for DOMINO® System
 Nutfräser für DOMINO® System
 Fraise pour Système DOMINO®

COMPATIBILE CON
 Compatible with
 Passend für
 Compatible avec

FESTOOL®

Ø	LU	LT	S		CODE	€
4	11	49	M6 x 0,75	HWM	259.040.00.28	
5	20	49	M6 x 0,75		259.050.00.28	
6	28	49	M6 x 0,75		259.060.00.28	
8	28	49	M6 x 0,75		259.080.00.28	
10	28	49	M6 x 0,75		259.100.00.28	
8	50	90	M8 x 1		259.080.50.28	
10	70	90	M8 x 1		259.100.70.28	
12	70	90	M8 x 1		259.120.00.28	
14	70	90	M8 x 1		259.140.00.28	

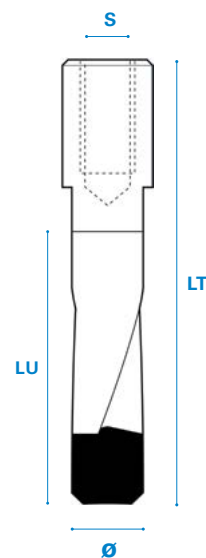
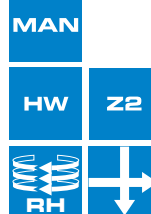
FESTOOL
DF500FESTOOL
DF700

262

P1



FRESA PER PROFILI IN ALLUMINIO

Router bit for ALU profiles
Fräser für ALU Einhängprofil
Fraise à rainer pour profilés ALU

COMPATIBILE CON
Compatible with
Passend für
Compatible avec

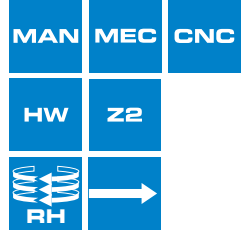

TYPE A (HW)

Ø	d	LU	LT	S	CODE
26	12	17,5	50	8 x 30	262.P1A26/12S8

TYPE B (A COLTELLI - WITH KNIVES - À PLAQUETTES - MIT WECHSELPLATTEN)

Ø	d	LU	LT	S	CODE
26	12	17,5	50	8 x 30	262.P1B26/12S8

Ricambi - Spare parts - Ersatzteile - Pièces de rechange

	CODE
TYPE B	901.000.00.P1
TYPE B	TORX®15 M3,5x6 D6 L8 902.035.06.60



Optional	CODE
TYPE B	TORX®15 903.150.00.00

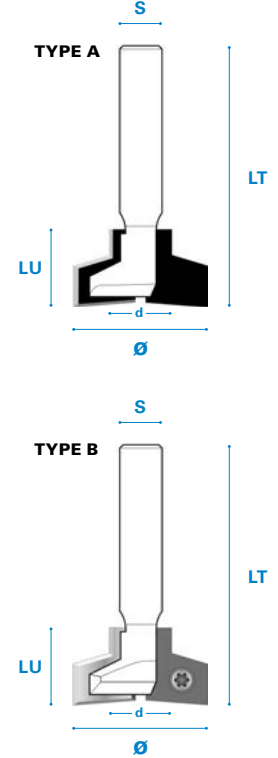

38

P2

COMPATIBILE CON
Compatible with
Passend für
Compatible avec



TYPE A (HW)

Ø	d	LU	LT	S	CODE
27	10,5	17,5	50	8 x 30	262.P2A27/8,3S8

TYPE B (A COLTELLI - WITH KNIVES - À PLAQUETTES - MIT WECHSELPLATTEN)

Ø	d	LU	LT	S	CODE
27	10,5	17,5	50	8 x 30	262.P2B27/8,3S8

Ricambi - Spare parts - Ersatzteile - Pièces de rechange

	CODE
TYPE B	901.000.00.P2
TYPE B	TORX®15 M3,5x6 D6 L8 902.035.06.60



Optional	CODE
TYPE B	TORX®15 903.150.00.00

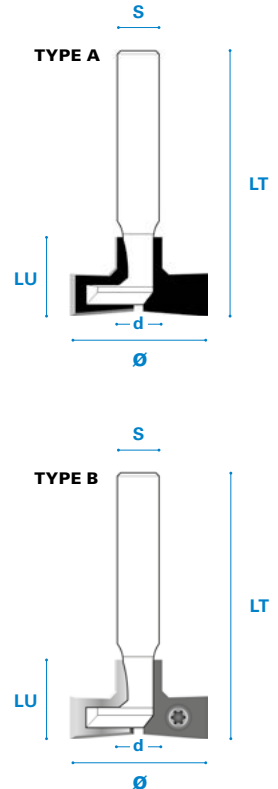

		\emptyset	d	LU	S	CODE
P3		20-40	8-12	on request	8-20	262.P3.000.00

€



		\emptyset	d	LU	S	CODE
P4		20-40	8-12	on request	8-20	262.P4.000.00



		\emptyset	d	LU	S	CODE
P5		20-40	8-12	on request	8-20	262.P5.000.00



		\emptyset	d	LU	S	CODE
P6		20-40	8-12	on request	8-20	262.P6.000.00



		\emptyset	d	LU	S	CODE
P7		20-40	8-12	on request	8-20	262.P7.000.00



		\emptyset	d	LU	S	CODE
P8		20-40	8-12	on request	8-20	262.P8.000.00



270

FRESA A TAGLIENTI DIRITTI CON COLTELLI REVERSIBILI

Straight Router bit with reversible knives
Nutfräser mit Wendemesser
Mèches à rainer à plaquettes réversibles



Ø	LU	LT	S	CODE
14	19,5	65	8 x 30	270.140.20008
15	19,5	65	8 x 30	270.150.20008
16	19,5	65	8 x 30	270.160.20008
18	19,5	65	8 x 30	270.180.20008
20	19,5	65	8 x 30	270.200.20008
22	19,5	65	8 x 30	270.220.20008
24	19,5	65	8 x 30	270.240.20008
14	29,5	75	8 x 30	270.140.30008
15	29,5	75	8 x 30	270.150.30008
16	29,5	75	8 x 30	270.160.30008
18	29,5	75	8 x 30	270.180.30008
20	29,5	75	8 x 30	270.200.30008
22	29,5	75	8 x 30	270.220.30008
14	29,5	80	12 x 40	270.140.30012
15	29,5	80	12 x 40	270.150.30012
16	29,5	80	12 x 40	270.160.30012
18	29,5	80	12 x 40	270.180.30012
20	29,5	80	12 x 40	270.200.30012
22	29,5	80	12 x 40	270.220.30012
24	29,5	80	12 x 40	270.240.30012
25	29,5	80	12 x 40	270.250.30012

€

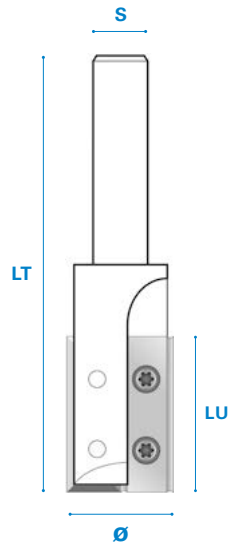
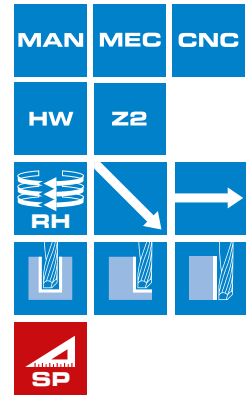

40

270 M10

FRESA A TAGLIENTI DIRITTI CON COLTELLI REVERSIBILI - M10 Scheer®

Straight Router bit with reversible knives - M10 Scheer®
Nutfräser mit Wendemesser - M10 Scheer®
Mèches à rainer à plaquettes réversibles - M10 Scheer®



Ø	LU	LT	S	CODE
14	29,5	70	M10 x 1,5	270.140.30M10
15	29,5	70	M10 x 1,5	270.150.30M10
16	29,5	70	M10 x 1,5	270.160.30M10
18	29,5	70	M10 x 1,5	270.180.30M10
20	29,5	70	M10 x 1,5	270.200.30M10
22	29,5	70	M10 x 1,5	270.220.30M10
24	29,5	70	M10 x 1,5	270.240.30M10
25	29,5	70	M10 x 1,5	270.250.30M10

€

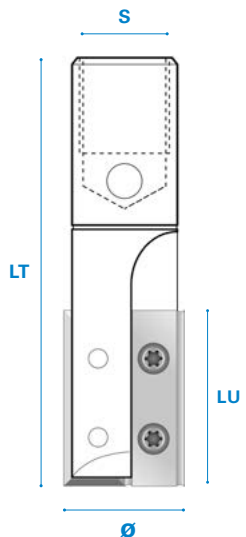
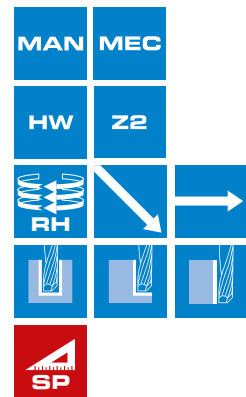

270 M12

FRESA A TAGLIENTI DIRITTI CON COLTELLI REVERSIBILI - M12 Elu®

Straight Router bit with reversible knives - M12 Elu®
Nutfräser mit Wendemesser - M12 Elu®
Mèches à rainer à plaquettes réversibles - M12 Elu®



Ø	LU	LT	S	CODE
14	29,5	70	M12 x 1	270.140.30M12
15	29,5	70	M12 x 1	270.150.30M12
16	29,5	70	M12 x 1	270.160.30M12
18	29,5	70	M12 x 1	270.180.30M12
20	29,5	70	M12 x 1	270.200.30M12
22	29,5	70	M12 x 1	270.220.30M12
24	29,5	70	M12 x 1	270.240.30M12
25	29,5	70	M12 x 1	270.250.30M12

€

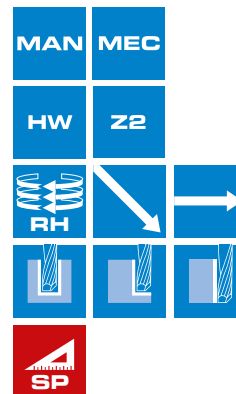

270

270 M10

270 M12

Ricambi - Spare parts - Ersatzteile - Pièces de rechange				CODE	
LU 19,5		Z4	Ø14	19,5x7x1,5	901.195.07.00
		Z4	Ø15	19,5x7,5x1,5	901.195.75.00
		Z4	Ø16	19,5x8x1,5	901.195.08.00
		Z4	Ø18	19,5x9x1,5	901.195.09.2G
		Z4	Ø20	19,5x10x1,5	901.195.10.2G
		Z4	Ø22	19,5x11x1,5	901.195.11.2G
		Z4	Ø24-25	19,5x12x1,5	901.195.12.2G
LU 29,5		Z4	Ø14	29,5x7x1,5	901.295.07.00
		Z4	Ø15	29,5x7,5x1,5	901.295.75.00
		Z4	Ø16	29,5x8x1,5	901.295.08.00
		Z4	Ø18	29,5x9x1,5	901.295.09.2G
		Z4	Ø20	29,5x10x1,5	901.295.10.2G
		Z4	Ø22	29,5x11x1,5	901.295.11.2G
		Z4	Ø24-25	29,5x12x1,5	901.295.12.2G
		Ø14-15	TORX®15 M3,5x4 D6 L6	902.035.04.60	
		Ø16→25	TORX®15 M4x6 D5,6 L7,8	902.040.06.58	

€



Optional	CODE
	TORX®15 903.150.00.00

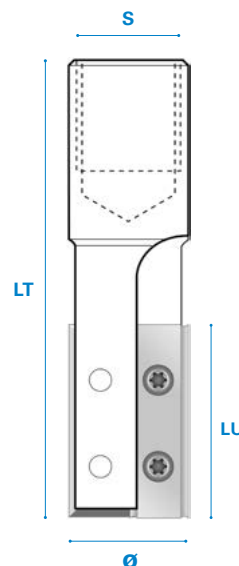

501

FRESA A TAGLIANTI DIRITTI

Straight Plunge
Nutfräser
Fraise à rainer à coupes droites



Ø	LU	LT	S	CODE
2	8	50	6	501.020.08600
2	8	50	8	501.020.08800
3	10	50	6	501.030.10600
3	10	50	8	501.030.10800
4	12	50	6	501.040.12600
4	12	50	8	501.040.12800
5	15	50	6	501.050.15600
5	15	50	8	501.050.15800
6	20	50	6	501.060.20600
6	20	50	8	501.060.20800

€

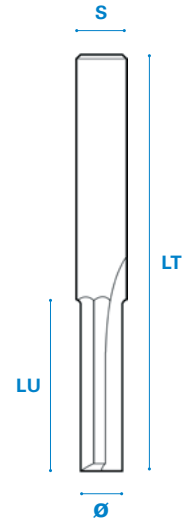
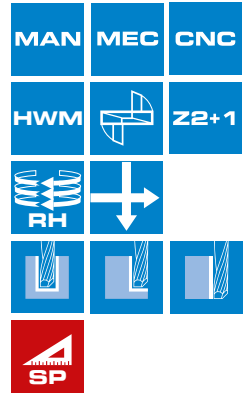

42

501 B

FRESA ELICOIDALE PER FINITURA

Finishing Spiral bit
Schlichtfräser
Fraise à rainer à coupes hélicoïdales



①

Ø	LU	LT	S	CODE
2	6	50	6	501B.020.6.D8
3	12	50	6	501B.030.6.D8
4	15	50	6	501B.040.6.D8
5	17	50	6	501B.050.6.D8
3	12	50	8	501B.030.8.D8
4	15	50	8	501B.040.8.D8
5	17	50	8	501B.050.8.D8
6	15	50	8	501B.060.8.D8

②

Ø	LU	LT	S	CODE
2	6	50	6	501B.020.6.S8
3	12	50	6	501B.030.6.S8
4	15	50	6	501B.040.6.S8
5	17	50	6	501B.050.6.S8
3	12	50	8	501B.030.8.S8
4	15	50	8	501B.040.8.S8
5	17	50	8	501B.050.8.S8
6	15	50	8	501B.060.8.S8

€

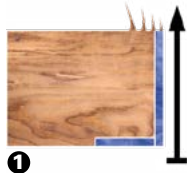
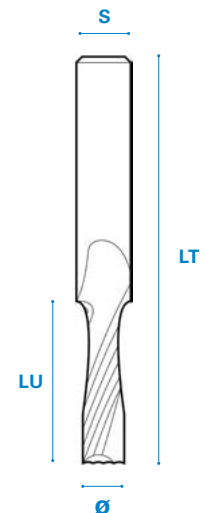
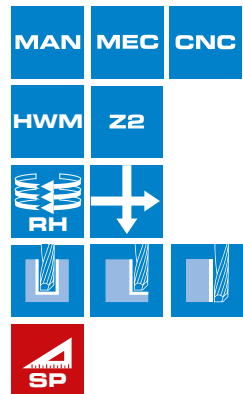

①

②

507

FRESA A DISCO PER INCASTRI

Grooving cutter
Scheibennutfräser
Disque à rainier

UTILIZZARE CON
To be used with
Benutzung mit
À utiliser avec

509

510



S	Ø	F	CODE
1,5	40	6	507.015.00600
1,8	40	6	507.018.00600
2,0	40	6	507.020.00600
2,2	40	6	507.022.00600
2,5	40	6	507.025.00600
2,8	40	6	507.028.00600
3,0	40	6	507.030.00600
3,5	40	6	507.035.00600
4,0	40	6	507.040.00600
5,0	40	6	507.050.00600
6,0	40	6	507.060.00600

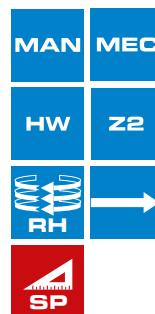
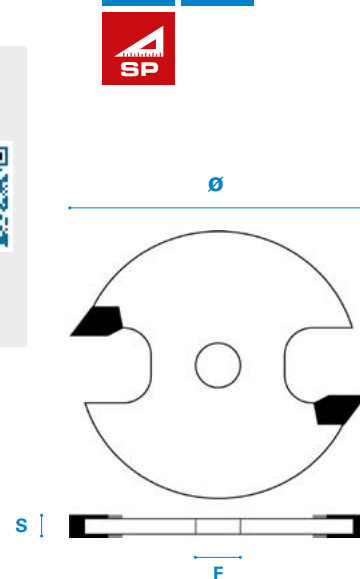

509

MANDRINO CON CUSCINETTO

Arbor with ball bearing
Aufnahmedorn mit Kugellager
Arbre avec roulement

UTILIZZARE CON
To be used with
Benutzung mit
À utiliser avec

507



Ø	d	LT	S	CODE
16	6	62	8 x 30	509.060.16800
19	6	62	6 x 30	509.060.00600
19	6	62	8 x 30	509.060.00800



Ricambi - Spare parts - Ersatzteile - Pièces de rechange	CODE
Ø16	904.160.06.00
Ø19	904.190.06.00
10x6x3	905.060.10.30
10x6x4	905.060.10.40
M6x6	902.060.00.DE

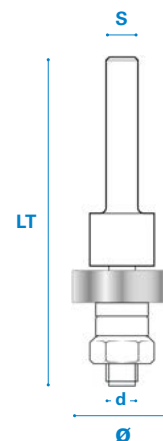

510

MANDRINO

Arbor
Aufnahmedorn
Arbre

UTILIZZARE CON
To be used with
Benutzung mit
À utiliser avec

507



Ø	LT	S	CODE
6	62	6 x 30	510.060.00600
6	62	8 x 30	510.060.00800



Ricambi - Spare parts - Ersatzteile - Pièces de rechange	CODE
d6,1 D12 S1	905.060.12.10
M6x6	902.060.00.DE

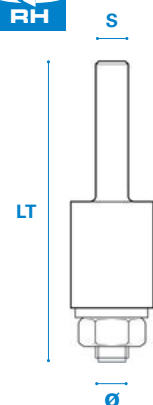

511

RIFILATORE CON CUSCINETTO E COLTELLI REVERSIBILI

Flush trim bit with ball bearing and reversible knives
Bündigfräser mit Kugellager und Wendemesser
Fraise à affleurer avec roulement à paquettes réversibles

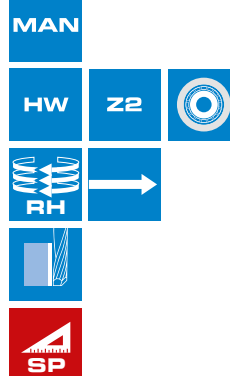

Ø	LU	LT	S	CODE
16	12	52	8 x 30	511.160.12800
19	12	55	6 x 30	511.190.12600
19	12	55	8 x 30	511.190.12800
22	12	55	8 x 30	511.220.12800
16	19,5	60	8 x 30	511.160.20800
16	29,5	70	8 x 30	511.160.30800
19	30	73	6 x 30	511.190.30600
19	30	73	8 x 30	511.190.30800
19	30	90	12 x 40	511.190.30120
22	30	73	8 x 30	511.220.30800
19	40	83	8 x 30	511.190.40800
19	50	110	12 x 40	511.190.50120

€

Ricambi - Spare parts - Ersatzteile - Pièces de rechange

				CODE	
Ø16		Z2	LU 12	12x9x1,5	901.120.09.00
		Z4	LU 19,5	19,5x9x1,5	901.195.09.00
		Z4	LU 29,5	29,5x9x1,5	901.295.09.00
Ø19-22		Z4	LU 12	12x12x1,5	901.120.12.00
		Z2	LU 30	30x12x1,5	901.300.12.00
		Z2	LU 40	40x12x1,5	901.400.12.00
		Z2	LU 50	50x12x1,5	901.500.12.00
			Ø16 TORX®15 M4x4 D5,6 L6,2	902.040.04.58	
			Ø19-22 TORX®15 M4x6 D9 L8	902.040.06.90	
			Ø16 Ø16/5 H5	904.160.05.00	
			Ø19 Ø19/6 H6	904.190.06.00	
			Ø22 Ø22/6 H7	904.220.06.00	
			Ø16 d3,2 D7 S0,5	905.030.07.05	
			Ø19-22 d4,3 D9 S0,8	905.040.09.08	
			Ø16 ○ 2,5 M3x6	902.030.06.00	
			Ø19-22 ○ 3 M4x8	902.040.08.00	



Optional		CODE
	TORX®15	903.150.00.00
	Ø16 ○ 2,5	903.025.00.00
	Ø19-22 ○ 3	903.030.00.00

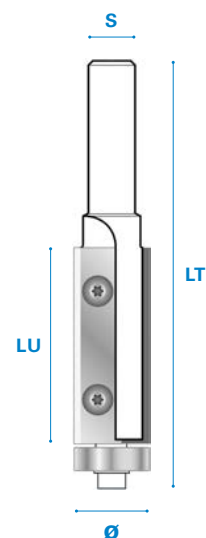

511 B







RIFILATORE CON CUSCINETTO
E COLTELLO REVERSIBILE

Flush trim bit with ball bearing and reversible knife
Bündigfräser mit Kugellager und Wendemesser
Fraise à affleurer avec roulement à palette réversible



Ø	LU	LT	S	CODICE
12	25	70	8	511B.120.0800

€

Ricambi - Spare parts - Ersatzteile - Pièces de rechange			CODE
 	Z4	25x5,5x1,1	901.250.55.00
			906.250.07.04
		TORX®9 M3x4,5 D4 L7	902.030.45.40
		Ø12/4 H4	904.120.04.00
		M4x4	902.040.00.DE



Optional		CODE
	TORX®9	903.003.09.00

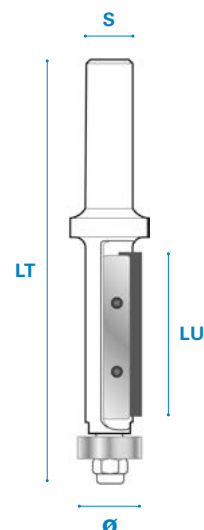
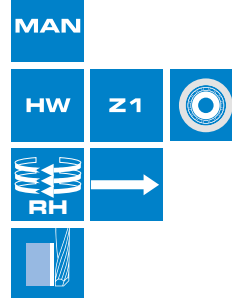

511 C







RIFILATORE CON DOPPIO CUSCINETTO
E COLTELLI REVERSIBILI

Flush trim bit with double ball bearing and reversible knives
Bündigfräser mit Doppelkugellager und Wendemesser
Fraise à affleurer avec double roulements à plaquettes réversibles





Ø	LU	LT	S	CODICE
19	50	115	12 x40	511C.190.5012

€

Ricambi - Spare parts - Ersatzteile - Pièces de rechange			CODE
 	Z2	50x12x1,5	901.500.12.00
		TORX®15 M4x6 D9 L8	902.040.06.90
		Ø19/6 H6	904.190.06.00
		d4,3 D9 S0,8	905.040.09.08
		∅3 M4x8	902.040.08.00



Optional		CODE
	TORX®15	903.150.00.00
	∅3	903.030.00.00

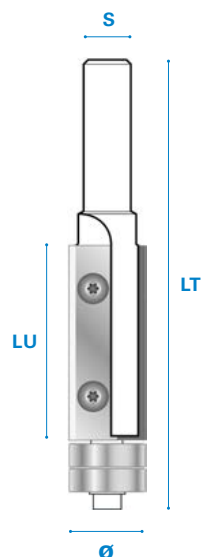
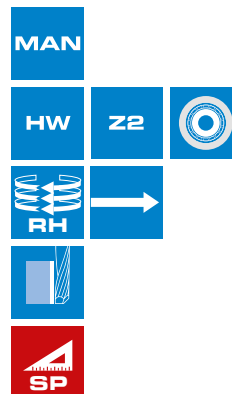

511 D







RIFILATORE CON ANGOLO ASSIALE NEGATIVO, CUSCINETTO E COLTELLI REVERSIBILI

Flush trim bit with negative shear angle, ball bearing and reversible knives
 Bündigfräser mit negativem Achswinkel, Kugellager und Wendemesser
 Fraise à affleurer avec angle d'axe négatif, roulement et plaquettes réversibles



Ø	LU	LT	a	S	CODE
19	29,5	72	5°	8 x 30	511D.190.30800

€

Ricambi - Spare parts - Ersatzteile - Pièces de rechange			CODE
  	Z4	29,5x9x1,5	901.295.09.00
		TORX®15 M4x4 D5,6 L6,2	902.040.04.58
		Ø19/6 H6	904.190.06.00
		d4,3 D9 S0,8	905.040.09.08
		Ø 3 M4x8	902.040.08.00



Optional		CODE
	TORX®15	903.150.00.00
	Ø 3	903.030.00.00

MAN

HW

Z2

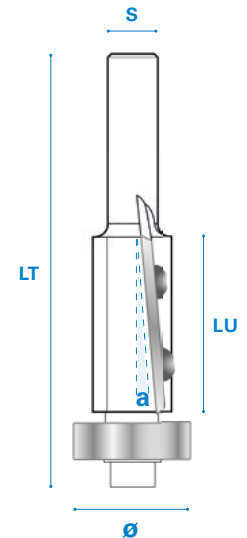

46

512









FRESA PER SMUSSI CON CUSCINETTO E COLTELLI REVERSIBILI

Chamfer router bit with ball bearing and reversible knife
 Fasefräser mit Kugellager und Wendemesser
 Fraise à chanfreiner avec roulement et plaquettes réversibles



a	Ø	LU	LT	S	CODE
10°	22	11,8	60	6 x 30	512.100.00600
10°	22	11,8	60	8 x 30	512.100.00800
22°	26	11	60	6 x 30	512.220.00600
22°	26	11	60	8 x 30	512.220.00800
30°	29	10	60	6 x 30	512.300.00600
30°	29	10	60	8 x 30	512.300.00800
45°	29	6,5	60	6 x 30	512.450.00600
45°	29	6,5	60	8 x 30	512.450.00800
45°	40	13	80	12 x 40	512.450.01240

€

Ricambi - Spare parts - Ersatzteile - Pièces de rechange			CODE	
  	Z4	12x12x1,5	901.120.12.00	
  	Z2	Ø40 45°	901.200.12.00	
		TORX®15 M4x6 D9 L8	902.040.06.90	
		45°	Ø16/5 H5	904.160.05.00
		Ø40 45°	Ø13/5 H4	904.130.05.00
		10°-22°-30°	Ø19/6 H6	904.190.06.00
		45°	M5	902.050.00.DA
		10°-22°-30°	M6	902.060.00.DA



Optional		CODE
	TORX®15	903.150.00.00

MAN

HW

Z2

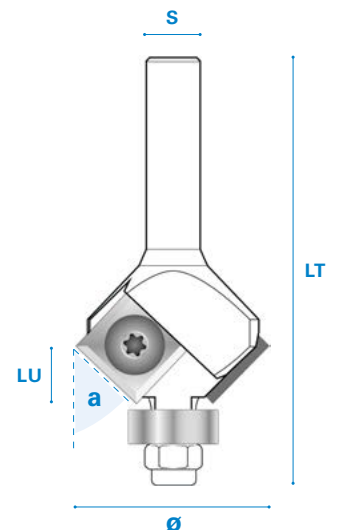

512 B



FRESA PER SMUSSI CON CUSCINETTO E COLTELLI REVERSIBILI

Chamfer router bit with ball bearing and reversible knives
 Fasefräser mit Kugellager und Wendemesser
 Fraise à chanfreiner avec roulement et plaquettes réversibles



a	∅	LU	LT	S	CODE
45°	29	7	60	8 x 30	512B.450.0800

Ricambi - Spare parts - Ersatzteile - Pièces de rechange				CODE
 x4	Z4		12x12x1,5	901.120.12.00
			TORX®15 M4x6 D9 L8	902.040.06.90
			∅16/5 H5	904.160.05.00
			d3,2 D7 S0,5	905.030.07.05
			∅ 2,5 M3x6	902.030.06.00

Optional		CODE	
	TORX®15	903.150.00.00	
	∅ 3	903.030.00.00	
	Delrin®	∅29/5	904.290.00.05

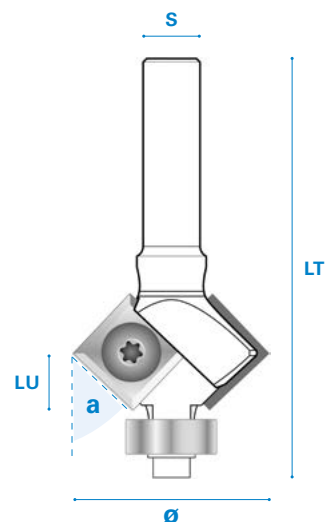
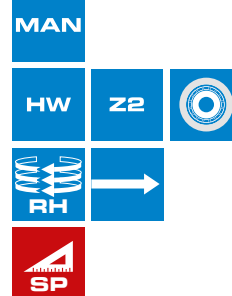





513

FRESA A CODA DI RONDINE CON COLTELLI REVERSIBILI

Dovetail router bit with reversible knives
 Zinkenfräser mit Wendemesser
 Mèche à queue d'aronde à plaquettes réversibles



a	∅	LU	LT	S	CODE
5°	22	27,5	60	8 x 30	513.050.00800
5°	22	27,5	70	12 x 40	513.050.01200
10°	25	26	60	8 x 30	513.100.00800
10°	25	26	70	12 x 40	513.100.01200
15°	28	24	60	8 x 30	513.150.00800
15°	28	24	70	12 x 40	513.150.01200

Ricambi - Spare parts - Ersatzteile - Pièces de rechange				CODE
 x2	Z4	5°		901.295.09.05
 x2	Z4	10°		901.295.09.10
 x2	Z4	15°		901.295.09.15
			TORX®15 M3,5x6 D6 L8	902.035.06.60

Optional		CODE
	TORX®15	903.150.00.00

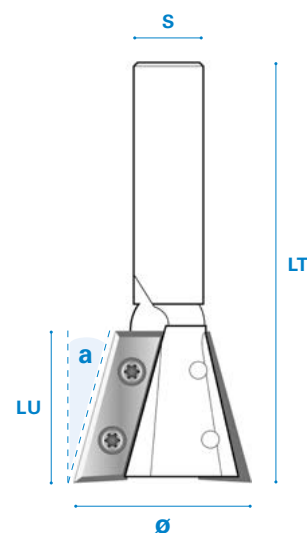
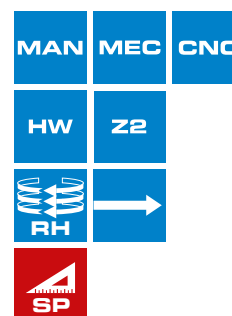

521

FRESA A TAGLIENTI DIRITTI CON LAMA DI TESTA

Carbide Tipped Straight Plunge
Nutfräser mit Bohrschneide
Mèche à rainier avec coupe frontale



Ø	LU	LT	S	CODE
8	20	55	6 x 30	521.080.20600
8	20	55	8 x 30	521.080.20800
10	20	55	6 x 30	521.100.20600
10	20	55	8 x 30	521.100.20800
11	20	55	6 x 30	521.110.20600
11	20	55	8 x 30	521.110.20800
12	20	55	6 x 30	521.120.20600
12	20	55	8 x 30	521.120.20800
14	20	55	6 x 30	521.140.20600
14	20	55	8 x 30	521.140.20800
15	20	55	6 x 30	521.150.20600
15	20	55	8 x 30	521.150.20800
16	20	55	6 x 30	521.160.20600
16	20	55	8 x 30	521.160.20800
18	20	55	6 x 30	521.180.20600
18	20	55	8 x 30	521.180.20800
20	20	55	6 x 30	521.200.20600
20	20	55	8 x 30	521.200.20800
22	20	55	6 x 30	521.220.20600
22	20	55	8 x 30	521.220.20800
24	20	55	6 x 30	521.240.20600
24	20	55	8 x 30	521.240.20800
25	20	55	6 x 30	521.250.20600
25	20	55	8 x 30	521.250.20800
8	30	65	6 x 30	521.080.30600
8	30	65	8 x 30	521.080.30800
10	30	65	6 x 30	521.100.30600
10	30	65	8 x 30	521.100.30800
12	30	65	6 x 30	521.120.30600
12	30	65	8 x 30	521.120.30800

€

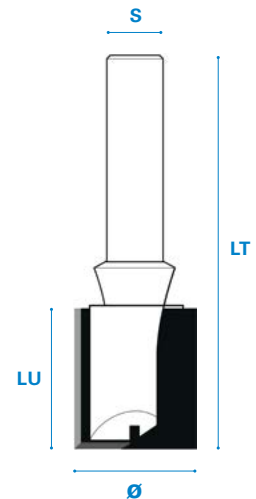
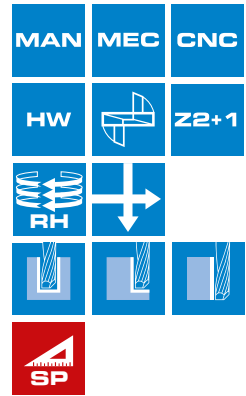

48

524

RIFILATORE CON CUSCINETTO

Flush trim bit with ball bearing
Bündigfräser mit Kugellager
Fraise à affleurer avec roulement



Ø	LU	LT	S	CODE
10	16	55	6 x 30	524.100.16600
10	16	55	8 x 30	524.100.16800
13	16	55	6 x 30	524.130.16600
13	16	55	8 x 30	524.130.16800
16	16	55	6 x 30	524.160.16600
16	16	55	8 x 30	524.160.16800
19	16	58	6 x 30	524.190.16600
19	16	58	8 x 30	524.190.16800
10	25	64	6 x 30	524.100.25600
10	25	64	8 x 30	524.100.25800
13	30	70	6 x 30	524.130.30600
13	30	70	8 x 30	524.130.30800
19	30	75	6 x 30	524.190.30600
19	30	75	8 x 30	524.190.30800
19	50	102	12 x 40	524.190.50120

Ricambi - Spare parts - Ersatzteile - Pièces de rechange	CODE
Ø10	Ø10/5 H4 904.100.05.00
Ø13	Ø13/5 H4 904.130.05.00
Ø16	Ø16/5 H5 904.160.05.00
Ø19	Ø19/6 H6 904.190.06.00
Ø10→16	d3,2 D7 S0,5 905.030.07.05
Ø19	d4,3 D9 S0,8 905.040.09.08
Ø10→16	○ 2,5 M3x6 902.030.06.00
Ø19	○ 3 M4x8 902.040.08.00

Optional	CODE
Ø10→16	○ 2,5 903.025.00.00
Ø19	○ 3 903.030.00.00

€

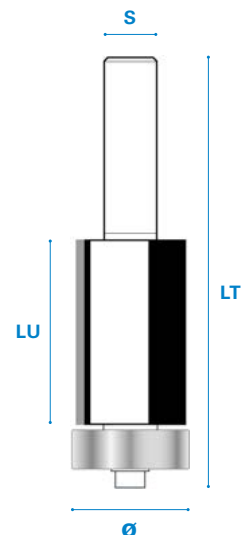
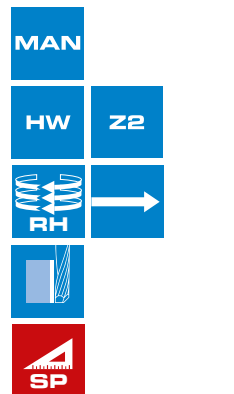

524 B

RIFILATORE CON ANGOLO ASSIALE NEGATIVO
E CUSCINETTO

Flush trim bit with negative shear angle and ball bearing
Bündigfräser mit negativen Achswinkel und Kugellager
Fraise à affleurer avec angle d'axe négatif et roulement



Ø	LU	LT	a	S	CODE
19	25	68	3°	8 x 30	524B.190.25.08
19	50	102	3°	12 x 40	524B.190.50.12

€

Ricambi - Spare parts - Ersatzteile - Pièces de rechange		CODE
	Ø19/6 H6	904.190.06.00
	d4,3 D9 S0,8	905.040.09.08
	Ø3 M4x8	902.040.08.00



Optional	CODE
	Ø3 903.030.00.00

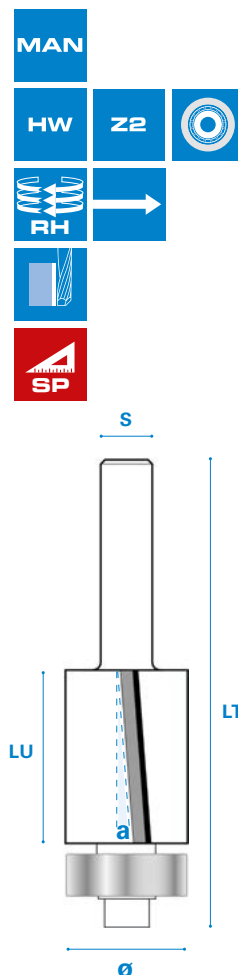

49

527

FRESE PER SMUSSI

Chamfer router bit
Fase Bündigfräser
Fraise à chanfreiner



a	Ø	LU	LT	S	CODE
22°	12	12	42	6 x 30	527.220.00600
22°	12	12	42	8 x 30	527.220.00800
30°	12	12	42	6 x 30	527.300.00600
30°	12	12	42	8 x 30	527.300.00800
45°	12	12	42	6 x 30	527.450.00600
45°	12	12	42	8 x 30	527.450.00800

€

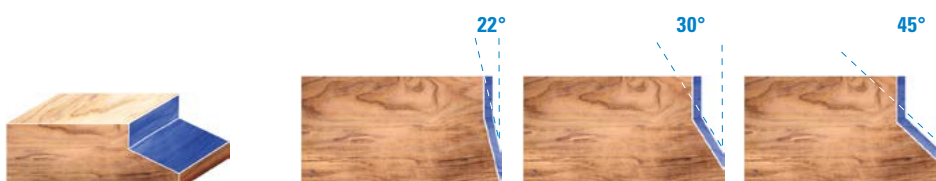
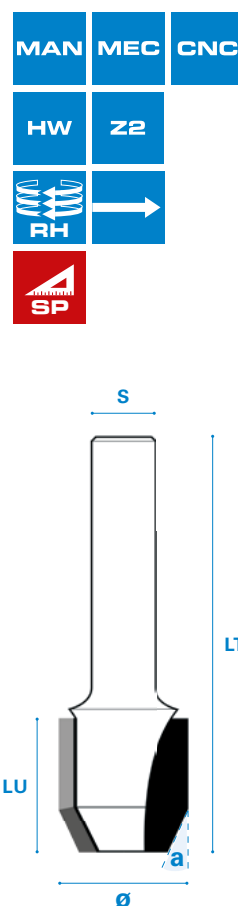

528

FRESA PER SMUSSI CON CUSCINETTO

Chamfer router bit with ball bearing
 Fasefräser mit Kugellager
 Fraise à chanfreiner avec roulement



a	∅	LU	LT	S	CODE
15°	19	12	51	6 x 30	528.150.00600
15°	19	12	51	8 x 30	528.150.00800
30°	23	12	51	6 x 30	528.300.00600
30°	23	12	51	8 x 30	528.300.00800
45°	29	12	51	6 x 30	528.450.00600
45°	29	12	51	8 x 30	528.450.00800
45°	48	20	70	12 x 40	528.450.01200

Ricambi - Spare parts - Ersatzteile - Pièces de rechange	CODE
∅13/5 H4	904.130.05.00
d3,2 D7 S0,5	905.030.07.05
∅ 2,5 M3x6	902.030.06.00
Optional	CODE
∅ 2,5	903.025.00.00

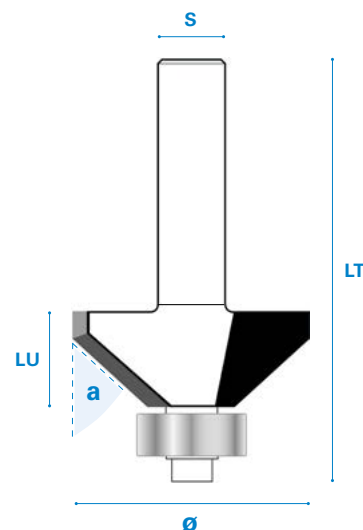
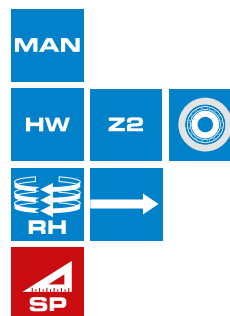

50

529

FRESA PER SMUSSI

Chamfer router bit
 Fasefräser
 Fraise à chanfreiner



a	∅	LU	LT	S	CODE
15°	24	14	45	6 x 30	529.150.00600
15°	24	12	45	8 x 30	529.150.00800
30°	24	12	45	6 x 30	529.300.00600
30°	24	12	45	8 x 30	529.300.00800
45°	24	9	40	6 x 30	529.450.00600
45°	24	9	40	8 x 30	529.450.00800

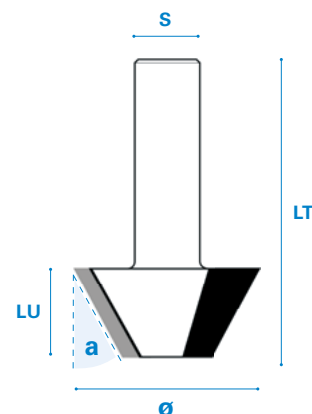
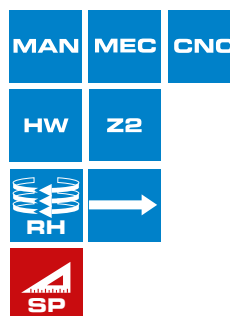

531

FRESA A CODA DI RONDINE

Dovetail router bit
Zinkenfräser
Mèche à queue d'aronde



a	∅	LU	LT	S	CODE
10°	11	13	45	6 x 30	531.110.00600
10°	11	13	45	8 x 30	531.110.00800
10°	14	16	48	6 x 30	531.140.00600
10°	14	16	48	8 x 30	531.140.00800
10°	16	18	50	8 x 30	531.160.00600
10°	16	18	50	8 x 30	531.160.00800

€

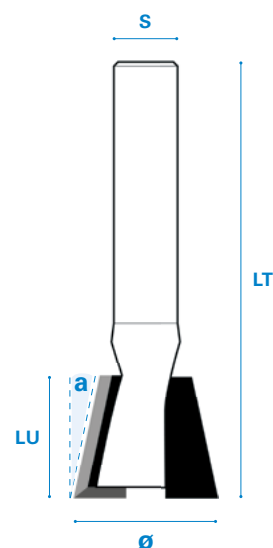
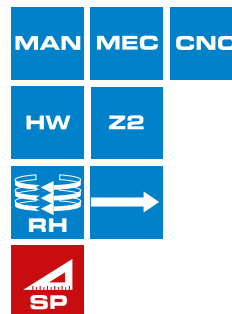

51

532

FRESA PER SCANALATURE A V, SCRITTURA, SMUSSI E FOLDING

V-groove, Lettering, Chamfer and Folding router bit
V-Nut, Schriftenfräser, Fase und Foldingfräser
Fraise à rainier en V, à graver, à chanfreiner



a	∅	LU	LT	S	CODE
30°	11	13	45	6 x 30	532.110.00600
30°	11	13	45	8 x 30	532.110.00800
45°	14	13	48	6 x 30	532.140.00600
45°	14	13	48	8 x 30	532.140.00800
45°	31,4	22	53	8 x 30	532.314.00800

€

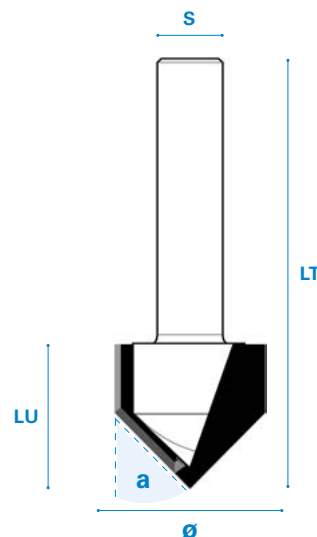
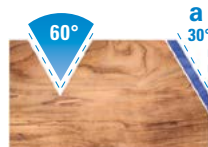
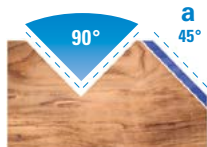
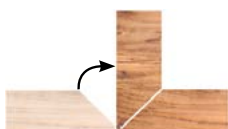
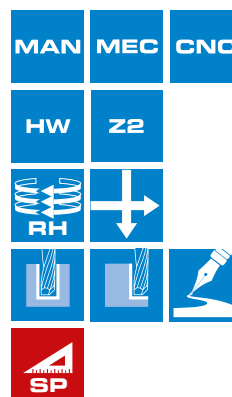

543

FRESA A TAGLIENTI DIRITTI CON COLTELLI REVERSIBILI

Straight Router bit with reversible knives
Wendeplatten Bündigfräser
Mèches à défoncer à plaquettes réversibles



Ø	LU	LT	S	CODE
19	12	43	6 x 30	543.190.00600
19	12	43	8 x 30	543.190.00800
19	29,5	62	8 x 30	543.190.30800
19	29,5	72	12 x 40	543.190.30120
19	49,5	100	12 x 40	543.190.50120

€

Ricambi - Spare parts - Ersatzteile - Pièces de rechange				CODE
x4	Z4	LU 12	12x12x1,5	901.120.12.00
x2	Z4	LU 29,5	29,5x12x1,5	901.295.12.00
x2	Z4	LU 49,5	49,5x12x1,5	901.495.12.00
		TORX®15 M4x6 D9 L8		902.040.06.90



Optional		CODE
	TORX®15	903.150.00.00

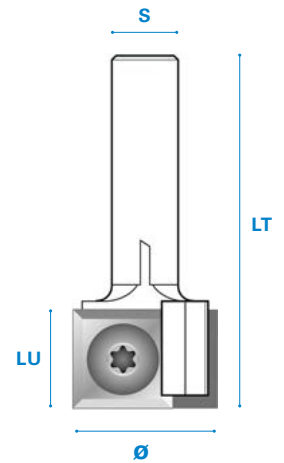
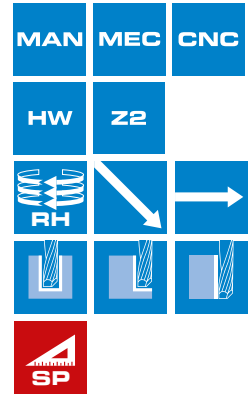

52

544

FRESA PER SMUSSI A COLTELLI REVERSIBILI

Chamfer router bit with reversible knife
Fasefräser mit Wendemesser
Fraise à chanfreiner avec plaquettes réversibles



a	Ø	LU	LT	S	CODE
10°	22	11,8	52	6 x 30	544.100.00600
10°	22	11,8	52	8 x 30	544.100.00800
22°	26	11,1	52	6 x 30	544.220.00600
22°	26	11,1	52	8 x 30	544.220.00800
30°	29	10,4	52	6 x 30	544.300.00600
30°	29	10,4	52	8 x 30	544.300.00800
45°	29	8,5	52	6 x 30	544.450.00600
45°	29	8,5	52	8 x 30	544.450.00800

€

Ricambi - Spare parts - Ersatzteile - Pièces de rechange				CODE
x4	Z4		12x12x1,5	901.120.12.00
		TORX®15 M4x6 D9 L8		902.040.06.90



Optional		CODE
	TORX®15	903.150.00.00

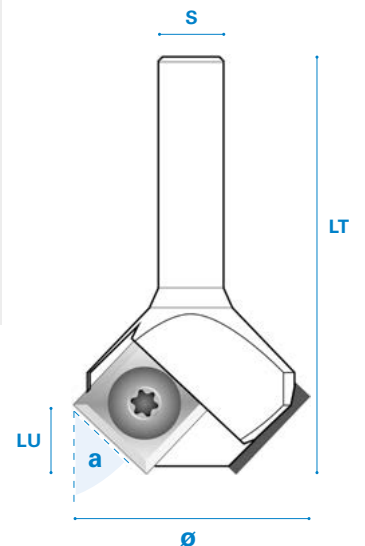
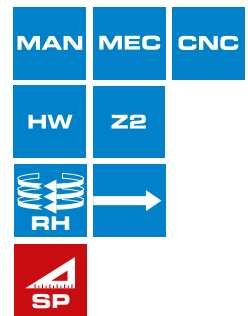

546

RIFILATORE CON ANGOLI ASSIALI ALTERNATI, CUSCINETTO E COLTELLI REVERSIBILI

Compression Flush trim bit with ball bearing and reversible knives
Wende-Bündigfräser mit wechselseitigem Achswinkel und Kugellager
Fraise à affleurer à plaquettes réversibles avec angle d'axe dessus et dessous et roulement



TYPE A

Ø	LU	LT	S	CODE	€
22	12/30	75	8 x 30	546.120.30800	

TYPE B

Ø	LU	LT	S	CODE	€
22	30/45	90	8 x 30	546.300.45800	

Ricambi - Spare parts - Ersatzteile - Pièces de rechange

	CODE	€
Z4	12x12x1,5	901.120.12.00
TORX®15 M4x4 D9 L6		902.040.04.90
TORX®15 M4x6 D9 L8		902.040.06.90
\varnothing 22/8 H7		904.220.08.00
TYPE B	11x8x7,5	905.080.11.75
M6		902.060.00.DA

Optional	CODE	€
TORX®15	903.150.00.00	

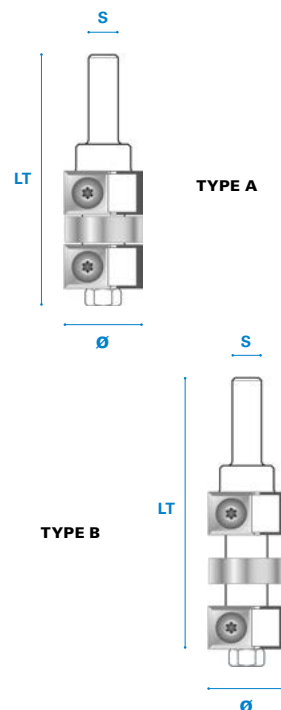
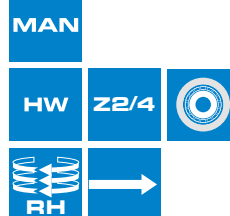
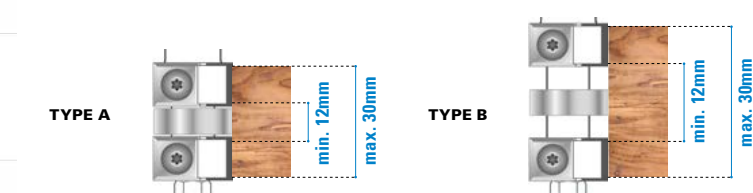

53

555

FRESA PER BATTUTE CON CUSCINETTO

Rabbet router bit with ball bearing
Falzfräser mit Kugellager
Fraise à feuillurer avec roulement



Ø	LU	LT	d	B	S	CODE	€
32	13	55	13-10	9,5-11	6 x 30	555.320.00600	
32	13	55	13-10	9,5-11	8 x 30	555.320.00800	

Ricambi - Spare parts - Ersatzteile - Pièces de rechange

	CODE	€
B 9,5	\varnothing 13/5 H4	904.130.05.00
B 11	\varnothing 10/5 H4	904.100.05.00
d3,2 D7 S0,5		905.030.07.05
\varnothing 2,5 M3x6		902.030.06.00

Optional	CODE	€
d8 B12 + d16 B8 + d19 B6,5	904.555.05.03	
\varnothing 2,5	903.025.00.00	

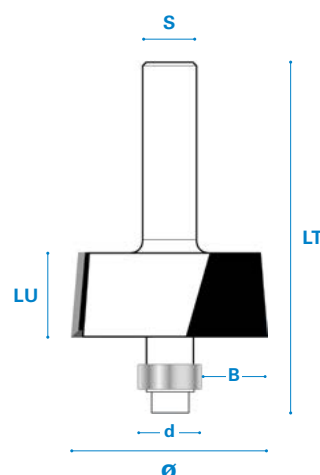
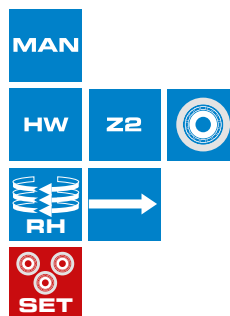
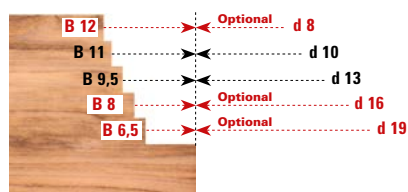
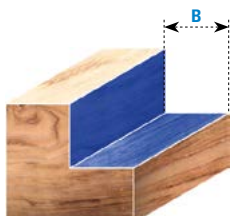

557

FRESA PER BATTUTE CON CUSCINETTO E COLTELLI REVERSIBILI

Rabbet router bit with ball bearing and reversible knives
 Falzfräser mit Kugellager und Wendemesser
 Fraise à feuillurer à plaquettes réversibles avec roulement



Ø	LU	LT	d	B	S	CODE
30	12	54	13	8,5	8 x 30	557.300.00800
38	12	54	13	12,5	8 x 30	557.380.00800

Ricambi - Spare parts - Ersatzteile - Pièces de rechange	CODE
Z4	12x12x1,5 901.120.12.00
TORX®15 M4x6 D9 L8	902.040.06.90
Ø13/5 H4	904.130.05.00
d3,2 D7 S0,5	905.030.07.05
Ø 2,5 M3x6	902.030.06.00

Optional	CODE
Ø30 d10 B10 + d16 B7 + d19 B5,5	904.557.05.30
Ø38 d10 B14 + d16 B11 + d19 B9,5	904.557.05.38
TORX®15	903.150.00.00
Ø 2,5	903.025.00.00



MAN

HW Z2

RH

SP SET SET

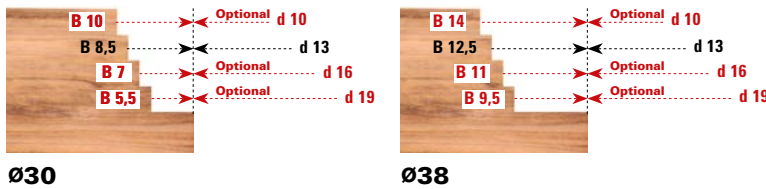
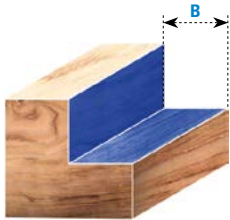
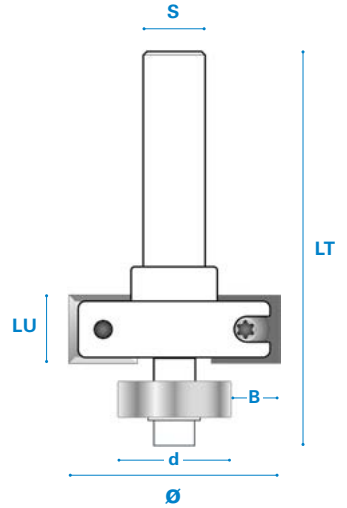

557 C

FRESA PER BATTUTE CON ANGOLO ASSIALE POSITIVO, CUSCINETTO E COLTELLI REVERSIBILI

Rabbet router bit with positive shear angle, ball bearing and reversible knives
 Falzfräser mit positiven Achswinkel, Kugellager und Wendemesser
 Fraise à feuillurer avec angle d'axe positif, roulement et plaquettes réversibles



Ø	LU	LT	d	B	S	CODE
50	29,5	95	16	17	12 x 40	557C.500.1200

Ricambi - Spare parts - Ersatzteile - Pièces de rechange	CODE
Z4	29,5x12x1,5 901.295.12.13
TORX®15 M4x6 D9 L8	902.040.06.90
B 17 (SET 2 plc)	Ø16/6 H5 904.160.06.02
d4,3 D9 S0,8	905.040.09.08
Ø 3 M4x8	902.040.08.00
TORX®15	903.002.15.00

Optional	CODE
d48 Delrin® B1	904.480.00.06
d46 Delrin® B2	904.460.00.06
d44 Delrin® B3	904.440.00.06
d42 Delrin® B4	904.420.00.06
d40 Delrin® B5	904.400.00.06
d38 Delrin® B6	904.380.00.06
d36 Delrin® B7	904.360.00.06
d34 Delrin® B8	904.340.00.06
d32 Delrin® B9	904.320.00.06
d30 Delrin® B10	904.300.00.06
d28 Delrin® B11	904.280.00.06
d26 Delrin® B12	904.260.00.06
d24 Delrin® B13	904.240.00.06
d22 Delrin® B14	904.220.00.06
d20 Delrin® B15	904.200.00.06
d19 B15,5 set 3 plc	904.190.06.03
d18 Delrin® B16	904.180.00.06
d13 B18,5 set 4 plc	904.130.06.04
d10 B20 set 4 plc	904.100.06.04
Ø 3	903.030.00.00



MAN

HW Z2

RH

SET SET

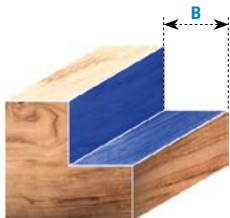
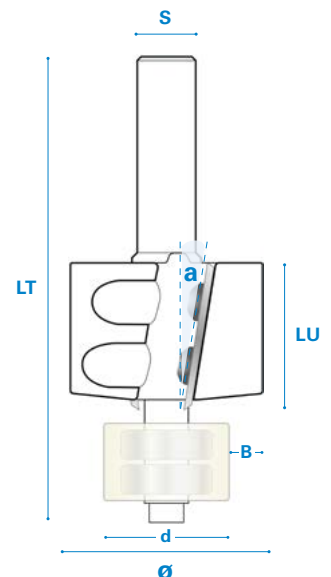

560

FRESA PER INCASTRO GUARNIZIONE A TAGLIENTI DIRITTI

Straight router bit for seal socket
Dichtungs-Nutfräser
Mèche à rainier à joints

Ø	LU	LT	S	CODE
3	8	60	6	560.030.00600
3,5	10	60	6	560.035.00600
4	10	60	6	560.040.00600

€

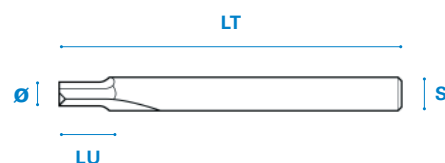
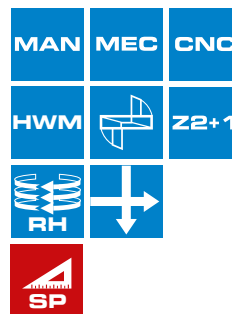

Optional

LT 70

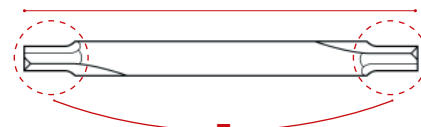

564

FRESA PER INCASTRO GUARNIZIONE A CODA DI RONDINE

Dovetail router bit for seal socket
Dichtungs- Zinkenfräser
Mèche à rainier à joints avec profil queue d'aronde

a	Ø	d	LU	LT	S	CODE
10°	4,3	2,9	5	60	6	564.043.00600

€

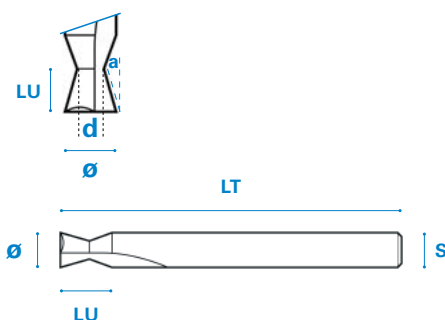
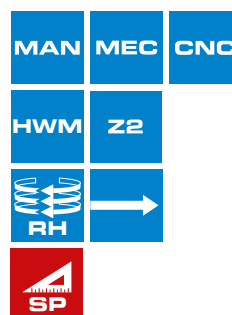

Optional

LT 70

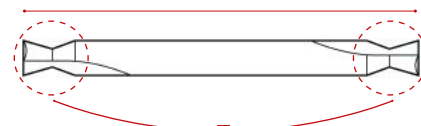

55

566

FRESA PER INCASTRO GUARNIZIONE A PUNTA D'ANCORA

Anchor router bit for seal socket
Dichtungs-Nutfräser mit Ankerprofil
Mèche à rainier à joints avec profil d'ancre

Ø	d	LU	LT	S	CODE
5,5	3,5	10	60	6	566.055.00600

€

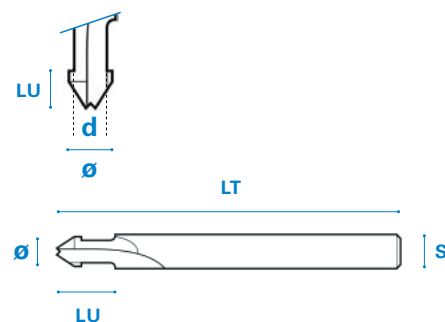
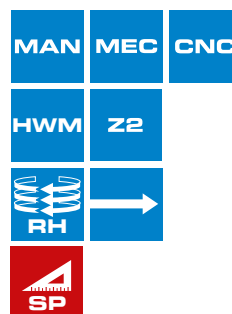

Optional

LT 70

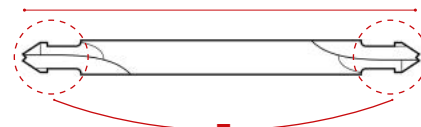

567

RIFILATORE CON DOPPIO CUSCINETTO E COLTELLI REVERSIBILI

Flush trim bit with double ball bearing and reversible knives
 Bündigfräser mit doppeltem Kugellager und Wendemesser
 Fraise à affleurer à plaquettes réversibles avec roulement dessus et roulement dessous



Ø	LU	LT	S	CODE
16	29,5	77	8 x 30	567.160.30800
19	30	80,5	8 x 30	567.190.30800
22	30	83	8 x 30	567.220.30800
16	49,5	98	8 x 30	567.160.50800
19	50	105	12 x 40	567.190.50120
22,2	50	116	12 x 40	567.222.50120

€

Ricambi - Spare parts - Ersatzteile - Pièces de rechange

				CODE		
Ø16	XB	Z4	LU 29,5	29,5x9x1,5	901.295.09.00	
		Z4	LU 49,5	49,5x9x1,5	901.495.09.00	
	XB	Z2	LU 30	30x12x1,5	901.300.12.00	
		Z4	LU 50	50x12x1,5	901.500.12.00	
Ø19-22,2	XB		Ø16	TORX®15 M4x4 D5,6 L6,2	902.040.04.58	
			Ø19-22,2	TORX®15 M4x6 D9 L8	902.040.06.90	
		HEAD		Ø16	Ø16/5 H5	904.160.05.00
				Ø19	Ø19/6 H6	904.190.06.00
SHANK	XB		Ø22	Ø22/6 H7	904.220.06.00	
			Ø22,2	Ø22,2/9,52 H7,1	904.222.95200	
		HEAD		Ø16	Ø16/8 H5	904.160.08.00
				Ø19 LU 30	Ø19/8 H6	904.190.08.00
	Ø19 LU 50		Ø19/12,7 H3,95	904.190.12700		
	Ø22		Ø22/8 H7	904.220.08.00		
SHANK	XB		Ø22,2	Ø22,2/12,7 H7	904.222.12700	
		HEAD		Ø16	d3,2 D7 S0,5	905.030.07.05
				Ø19-22	d4,3 D9 S0,8	905.040.09.08
				Ø22,2	d6,4 D12 S1,6	905.060.12.16
SHANK	XB		Ø16	○ 2,5 M3x6	902.030.06.00	
			Ø19-22	○ 3 M4x8	902.040.08.00	
			Ø22,2	○ 5 M6x8	902.060.08.00	
SHANK	XB		S8		907.080.00.ES	
			S12		907.120.00.ES	

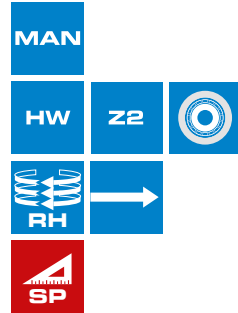

56

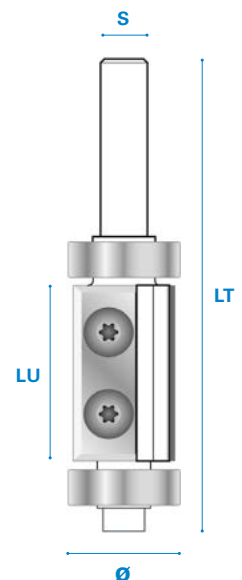

Optional		CODE
✓	TORX®15	903.150.00.00
✓	Ø16	○ 2,5 903.025.00.00
✓	Ø19-22	○ 3 903.030.00.00
✓	Ø22,2	○ 5 903.050.00.00

580

FRESA PER SCANALATURE A V, FOLDING E SCRITTURA CON COLTELLO REVERSIBILE

V-groove, Folding and lettering router bit with reversible knife
V-Nut, Folding und Schriftenfräser mit Wendemesser
Fraise à rainier en V, Folding et à graver à plaquette réversible



a	Ø	LU	LT	S	CODE
92°	17	8,3	63	8 x 30	580.450.00800
92°	17	8,3	73	12 x 40	580.450.01200

Ricambi - Spare parts - Ersatzteile - Pièces de rechange				CODE
	Z4		12x12x1,5	901.120.12.92
			TORX®15 M3,5x6 D6 L8	902.035.06.60

x4



Optional				CODE
	Z1	60° P2		901.120.12.60
	Z1	R3 P3		901.120.03.CO
	Z1	R4 P4		901.120.04.CV
	Z1	R5 P5		901.120.05.CO
			TORX®15	903.150.00.00

x1



x1



x1



x1

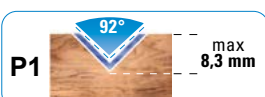
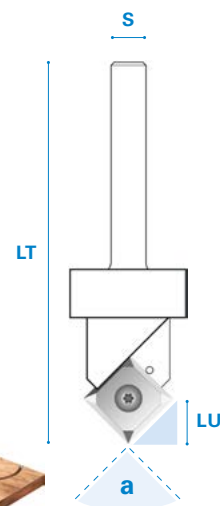
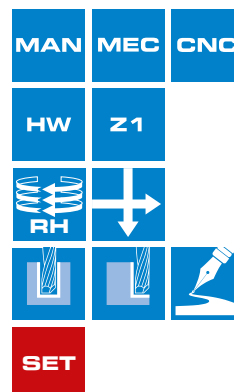

Optional



Optional



Optional



Optional



57

583

FRESA PER SMUSSI CON CUSCINETTO E COLTELLI REVERSIBILI

Chamfer router bit with ball bearing and reversible knives
Fasefräser mit Kugellager und Wendemesser
Fraise à chanfreiner avec roulement et plaquettes réversibles



a	Ø	LU	LT	d	S	CODE
45°	26	19,5	75	16	8 x 30	583.450.26800
45°	32	24,5	80	16	8 x 30	583.450.32800
45°	26	19,5	85	16	12 x 40	583.450.26120
45°	32	24,5	90	16	12 x 40	583.450.32120

Ricambi - Spare parts - Ersatzteile - Pièces de rechange				CODE
	Z4	Ø26	19,5x9x1,5	901.583.45.00
	Z4	Ø32	24,5x12x1,5	901.583.45.01
		Ø26	TORX®15 M4x6 D5,6 L8,2	902.040.06.58
		Ø32	TORX®15 M4x6 D9 L8	902.040.06.90
			Ø16/5 H5	904.160.05.00
			d3,2 D7 S0,5	905.030.07.05
			Ø 2,5 M3x6	902.030.06.00

x2



x2

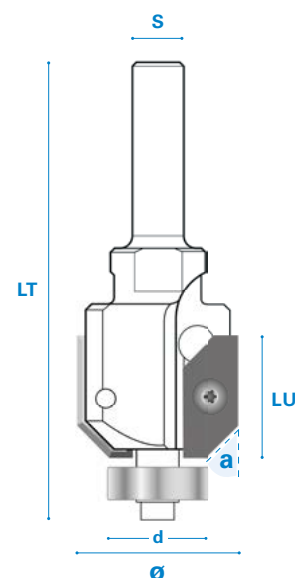
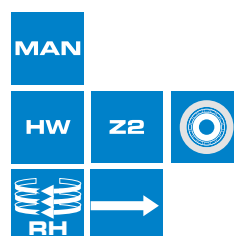

584

FRESA PER BATTUTE CON CUSCINETTO E COLTELLI REVERSIBILI

Rabbet router bit with ball bearing and reversible knives
 Falzfräser mit Kugellager und Wendemesser
 Fraise à feuillurer avec roulement et plaquettes réversibles



Ø	LU	LT	d	B	S	CODE
26	19,5	75	16-13-10	5-6,5-8	8 x 30	584.260.00800
32	24,5	80	16-13-10	8-9,5-11	8 x 30	584.320.00800
26	19,5	85	16-13-10	5-6,5-8	12 x 40	584.260.01200
32	24,5	90	16-13-10	8-9,5-11	12 x 40	584.320.01200

€

Ricambi - Spare parts - Ersatzteile - Pièces de rechange

	CODE
Z4 Ø32 24,5x12x1,5	901.245.12.00
Z4 Ø26 19,5x9x1,5	901.195.09.00
Ø26 TORX®15 M4x6 D5,6 L8,2	902.040.06.58
Ø32 TORX®15 M4x6 D9 L8	902.040.06.90
Ø16/5 H5	904.160.05.00
Ø13/5 H4	904.130.05.00
Ø10/5 H4	904.100.05.00
d3,2 D7 S0,5	905.030.07.05
Ø 2,5 M3x6	902.030.06.00



Optional

	CODE
TORX®15	903.150.00.00
Ø 2,5	903.025.00.00

MAN

HW Z2

RH →

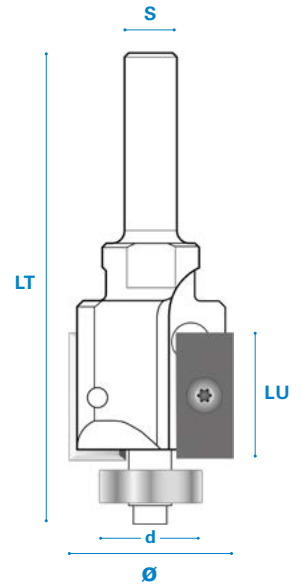

58

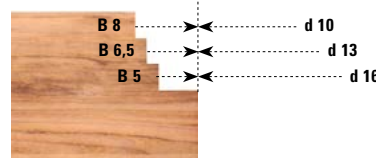
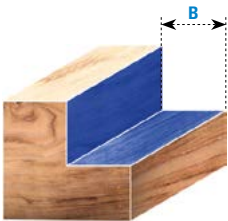

Ø26

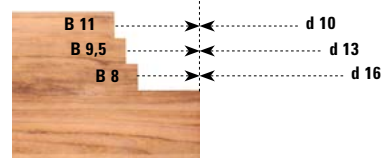

Ø32

585

RIFILATORE CON CUSCINETTO SULL'ATTACCO E COLTELLI REVERSIBILI

Flush trim bit with upper ball bearing and reversible knives
 Bündigfräser mit Kugellager am Schaft und Wendemesser
 Fraise à affleurer avec roulement dessus et paquettes réversibles

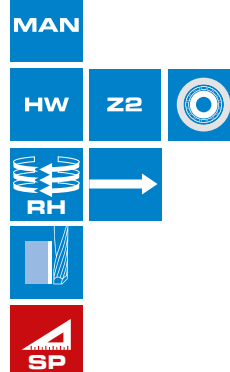

Ø	LU	LT	S	CODE
19	12	51,5	6 x 30	585.190.12600
19	12	51,5	8 x 30	585.190.12800
22	19,5	59,5	8 x 30	585.220.20800
16	29,5	68,5	8 x 30	585.160.30800
19	29,5	69,5	6 x 30	585.190.30600
19	29,5	69,5	8 x 30	585.190.30800
19	29,5	81,5	12 x 40	585.190.30120
22	29,5	69,5	8 x 30	585.220.30800
24	29,5	80,5	12 x 40	585.240.30120
16	49,5	88,5	8 x 30	585.160.50800
19	49,5	89,5	8 x 30	585.190.50800
19	49,5	101,5	12 x 40	585.190.50120
22,2	49,5	101,5	12 x 40	585.222.50120
24	49,5	101,5	12 x 40	585.240.50120

€

Ricambi - Spare parts - Ersatzteile - Pièces de rechange	CODE
LU 12	12x12x1,5 901.120.12.00
LU 19,5	19,5x12x1,5 901.195.12.00
LU 29,5	Ø16 29,5x9x1,5 901.295.09.00
	Ø19→24 29,5x12x1,5 901.295.12.00
LU 49,5	Ø16 49,5x9x1,5 901.495.09.00
	Ø19→24 49,5x12x1,5 901.495.12.00
	Ø16 TORX®15 M4x4 D5,6 L6,2 902.040.04.58
	Ø19→24 TORX®15 M4x6 D9 L8 902.040.06.90
S 6	Ø19 Ø19/6 H6 904.190.06.00
S 8	Ø16 Ø16/8 H5 904.160.08.00
	Ø19 Ø19/8 H6 904.190.08.00
	Ø22 Ø22/8 H7 904.220.08.00
S 12	Ø19 Ø19/12,7 H3,95 904.190.12700
	Ø22,2 Ø22,2/12,7 H7 904.222.12700
	Ø24 Ø24/12 H6 904.240.12.00
	S8 907.080.00.ES
	S12 907.120.00.ES



Optional	CODE
TORX®15	903.150.00.00

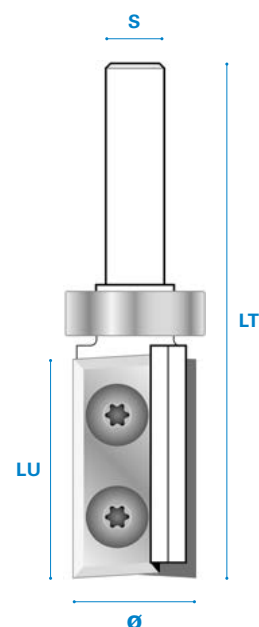

INDICE | INDEX

UTENSILI E MANDRINI PER FORATRICI MULTIMANDRINO

TOOLS AND CHUCKS FOR MULTI SPINDLE DRILLING MACHINES

WERKZEUGE UND FUTTER FÜR BOHRAUTOMATEN

MÈCHES ET MANDRINS POUR PERCEUSES MULTIBROCHES

C

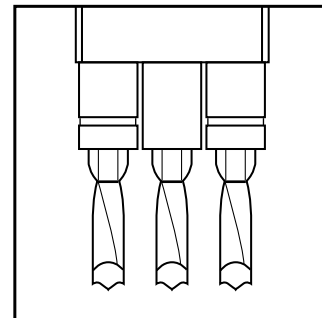

301
p.62



303
p.62



306
p.63



308
p.64



309
p.64



309C
p.65



311
p.65



339
p.65



342
p.66



355
p.66



356
p.67



357
p.67



307
p.68



340
p.68



360
p.69



361
p.69



312
p.70



313
p.71



332
p.71



333
p.72



335
p.72



337-337B
p.73



350-350P
p.73



352
p.74



353-353P
p.74



370
p.75



372
p.76

301

MANDRINO PER FORATRICI 30°

Drill adaptor 30°
Bohrer Spannfutter 30°
Mandrin de réduction 30°



Vitap BUSELLATO O.M.P.E.C. Alberti Balestrini SCHLEICHER



RH



LH

UTILIZZARE CON
To be used with
Benutzung mit
À utiliser avec

306 312 339
307 313 340

RH	F	LT	S	CODE
3	46	M10/30°	301.030.00.08	
4	46	M10/30°	301.040.00.08	
5	46	M10/30°	301.050.00.08	
8	46	M10/30°	301.080.00.08	
10	46	M10/30°	301.100.00.08	
8	46	M8/30°	301.080.M8.08	
10	46	M8/30°	301.100.M8.08	

LH	F	LT	S	CODE
3	46	M10/30°	301.030.00.09	
4	46	M10/30°	301.040.00.09	
5	46	M10/30°	301.050.00.09	
8	46	M10/30°	301.080.00.09	
10	46	M10/30°	301.100.00.09	
8	46	M8/30°	301.080.M8.09	
10	46	M8/30°	301.100.M8.09	

Ricambi - Spare parts - Ersatzteile - Pièces de rechange	CODE
⊙ 3 M6x5	902.060.05.00

€

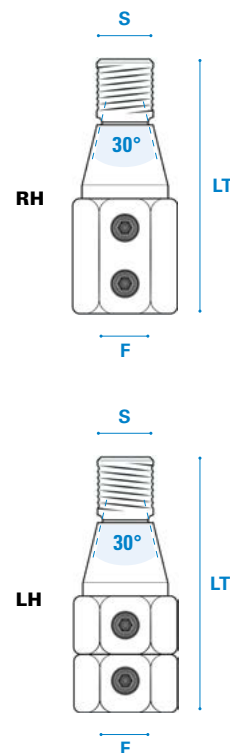

62

303

MANDRINO PER FORATRICI

Drill adaptor
Bohrer Spannfutter
Mandrin de réduction



Vitap BIESSE MORBIDELLI WEEKE TORWEGGE masterwood NOTTMEYER



RH



LH

UTILIZZARE CON
To be used with
Benutzung mit
À utiliser avec

306 312 339
307 313 340

RH	F	LT	S	CODE
3	40	M10/11	303.030.00.08	
4	40	M10/11	303.040.00.08	
5	40	M10/11	303.050.00.08	
8	40	M10/11	303.080.00.08	
10	40	M10/11	303.100.00.08	
8	40	M8/9	303.080.M8.08	
10	40	M8/9	303.100.M8.08	

LH	F	LT	S	CODE
3	40	M10/11	303.030.00.09	
4	40	M10/11	303.040.00.09	
5	40	M10/11	303.050.00.09	
8	40	M10/11	303.080.00.09	
10	40	M10/11	303.100.00.09	
8	40	M8/9	303.080.M8.09	
10	40	M8/9	303.100.M8.09	

Ricambi - Spare parts - Ersatzteile - Pièces de rechange	CODE
⊙ 3 M6x5	902.060.05.00

€

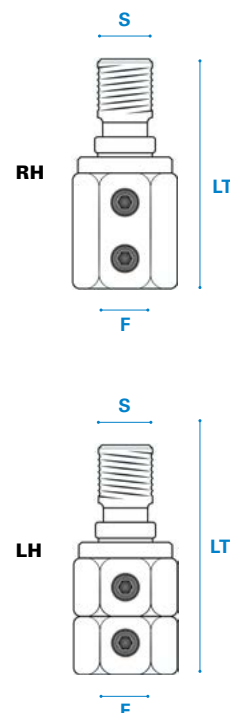

306

PUNTA PER FORI CIECHI

Blind holes dowel drill
 Dübellochbohrer
 Mèche à tourillonner pour trous borgne

UTILIZZARE CON
 To be used with
 Benutzung mit
 À utiliser avec

309

310



RH	Ø	LU	LT	S	CODE
5	30	57	10 x 20	306.050.30.28	
6	30	57	10 x 20	306.060.30.28	
7	30	57	10 x 20	306.070.30.28	
8	30	57	10 x 20	306.080.30.28	
9	30	57	10 x 20	306.090.30.28	
10	30	57	10 x 20	306.100.30.28	
11	30	57	10 x 20	306.110.30.28	
12	30	57	10 x 20	306.120.30.28	
13	30	57	10 x 20	306.130.30.28	
14	30	57	10 x 20	306.140.30.28	
15	30	57	10 x 20	306.150.30.28	
16	30	57	10 x 20	306.160.30.28	
5	43	70	10 x 20	306.050.43.28	
6	43	70	10 x 20	306.060.43.28	
7	43	70	10 x 20	306.070.43.28	
8	43	70	10 x 20	306.080.43.28	
9	43	70	10 x 20	306.090.43.28	
10	43	70	10 x 20	306.100.43.28	
11	43	70	10 x 20	306.110.43.28	
12	43	70	10 x 20	306.120.43.28	
13	43	70	10 x 20	306.130.43.28	
14	43	70	10 x 20	306.140.43.28	
15	43	70	10 x 20	306.150.43.28	
16	43	70	10 x 20	306.160.43.28	
5	65	85	10 x 20	306.050.65.28	
6	65	85	10 x 20	306.060.65.28	
8	65	85	10 x 20	306.080.65.28	
10	65	85	10 x 20	306.100.65.28	
12	65	85	10 x 20	306.120.65.28	
14	65	85	10 x 20	306.140.65.28	
5	85	105	10 x 20	306.050.85.28	
6	85	105	10 x 20	306.060.85.28	
8	85	105	10 x 20	306.080.85.28	
10	85	105	10 x 20	306.100.85.28	
12	85	105	10 x 20	306.120.85.28	
14	85	105	10 x 20	306.140.85.28	

LH	Ø	LU	LT	S	CODE
5	30	57	10 x 20	306.050.30.29	
6	30	57	10 x 20	306.060.30.29	
7	30	57	10 x 20	306.070.30.29	
8	30	57	10 x 20	306.080.30.29	
9	30	57	10 x 20	306.090.30.29	
10	30	57	10 x 20	306.100.30.29	
11	30	57	10 x 20	306.110.30.29	
12	30	57	10 x 20	306.120.30.29	
13	30	57	10 x 20	306.130.30.29	
14	30	57	10 x 20	306.140.30.29	
15	30	57	10 x 20	306.150.30.29	
16	30	57	10 x 20	306.160.30.29	
5	43	70	10 x 20	306.050.43.29	
6	43	70	10 x 20	306.060.43.29	
7	43	70	10 x 20	306.070.43.29	
8	43	70	10 x 20	306.080.43.29	
9	43	70	10 x 20	306.090.43.29	
10	43	70	10 x 20	306.100.43.29	
11	43	70	10 x 20	306.110.43.29	
12	43	70	10 x 20	306.120.43.29	
13	43	70	10 x 20	306.130.43.29	
14	43	70	10 x 20	306.140.43.29	
15	43	70	10 x 20	306.150.43.29	
16	43	70	10 x 20	306.160.43.29	
5	65	85	10 x 20	306.050.65.29	
6	65	85	10 x 20	306.060.65.29	
8	65	85	10 x 20	306.080.65.29	
10	65	85	10 x 20	306.100.65.29	
12	65	85	10 x 20	306.120.65.29	
14	65	85	10 x 20	306.140.65.29	
5	85	105	10 x 20	306.050.85.29	
6	85	105	10 x 20	306.060.85.29	
8	85	105	10 x 20	306.080.85.29	
10	85	105	10 x 20	306.100.85.29	
12	85	105	10 x 20	306.120.85.29	
14	85	105	10 x 20	306.140.85.29	

Ricambi - Spare parts - Ersatzteile - Pièces de rechange

CODE

M5x10

902.050.10.TA

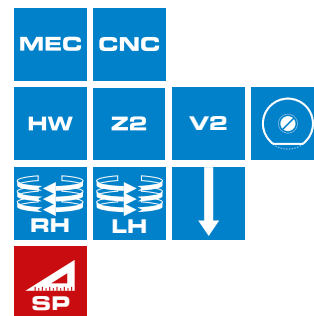

€

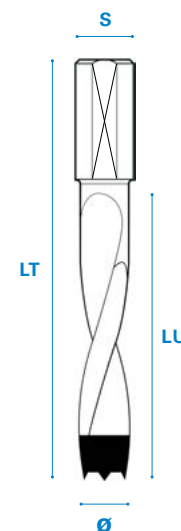
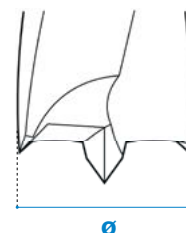

308

PUNTA PER SPINE COMPATIBILE CON SISTEMA Mafell®

Dowel drill compatible with Mafell® System
Dübellochbohrer passend für das Mafell® System
Mèche pour Système Mafell®

COMPATIBILE CON
Compatible with
Passend für
Compatible avec

DDF 40 DD40 P

Ø	LU	LT	S	CODE
5	30	58	8 x 20	308.050.00.28
6	30	58	8 x 20	308.060.00.28
8	30	58	8 x 20	308.080.00.28
10	30	58	8 x 20	308.100.00.28
12	30	58	8 x 20	308.120.00.28
14	30	58	8 x 20	308.140.00.28
16	30	58	8 x 20	308.160.00.28

€

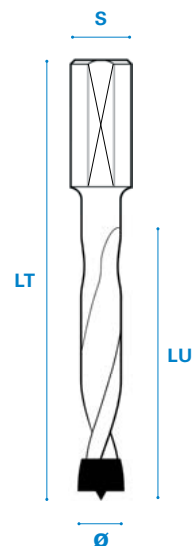
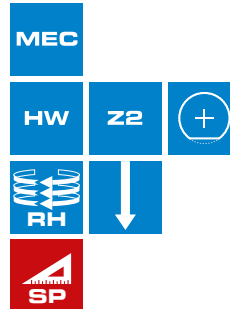
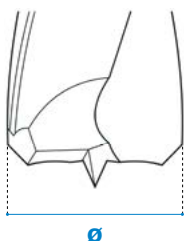

64

309

SVASATORE A 45°

Countersink 45°
Aufstecksenker 45°
Fraisoir à 45°

UTILIZZARE CON
To be used with
Benutzung mit
À utiliser avec

306

307

RH	Ø	d	LT	CODE
	4	17	16	309.040.00.28
	5	17	16	309.050.00.28
	6	17	16	309.060.00.28
	7	17	16	309.070.00.28
	8	17	16	309.080.00.28
	9	20	20	309.090.00.28
	10	20	20	309.100.00.28
	12	20	20	309.120.00.28

€

LH	Ø	d	LT	CODE
	4	17	16	309.040.00.29
	5	17	16	309.050.00.29
	6	17	16	309.060.00.29
	7	17	16	309.070.00.29
	8	17	16	309.080.00.29
	9	20	20	309.090.00.29
	10	20	20	309.100.00.29
	12	20	20	309.120.00.29



Ricambi - Spare parts - Ersatzteile - Pièces de rechange

CODE

⊙ 3 M5x6 902.050.06.PT

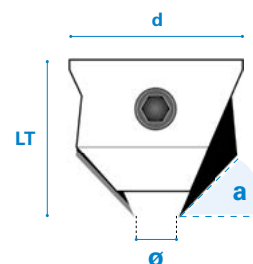
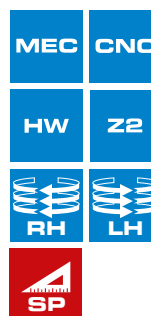

309 C

SVASATORE A 45°

Countersink 45°
Aufstecksenker 45°
Fraisoir à 45°

UTILIZZARE CON
To be used with
Benutzung mit
À utiliser avec

339

340



RH	Ø	d	LT	CODE
	20	10	16,5	309C.100.00.8
LH	Ø	d	LT	CODE
	20	10	16,5	309C.100.00.9
Ricambi - Spare parts - Ersatzteile - Pièces de rechange				CODE
○ 3 M6x5				902.060.05.PT

€

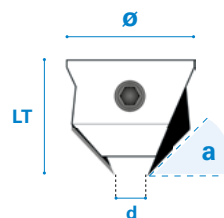
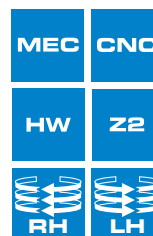

311

SVASATORE A 90°

Countersink 90°
Aufstecksenker 90°
Fraisoir à 90°

UTILIZZARE CON
To be used with
Benutzung mit
À utiliser avec

306

307



Ø	d	LT
on request		

€

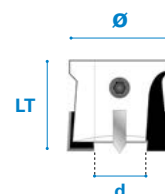
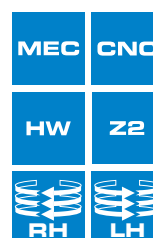

339

PUNTA PER FORI CIECHI

Blind holes dowel drill
Dübellochbohrer
Mèche à tourillonner pour trous borgne

UTILIZZARE CON
To be used with - Benutzung mit - À utiliser avec

309 C

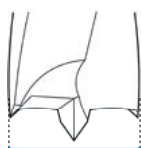

RH	Ø	LU	LT	S	CODE
	5	27	57,5	10 x 27	339.050.27.28
	6	27	57,5	10 x 27	339.060.27.28
	7	27	57,5	10 x 27	339.070.27.28
	8	27	57,5	10 x 27	339.080.27.28
	9	27	57,5	10 x 27	339.090.27.28
	10	27	57,5	10 x 27	339.100.27.28
	11	27	57,5	10 x 27	339.110.27.28
	12	27	57,5	10 x 27	339.120.27.28
	5	35	70	10 x 27	339.050.35.28
	6	35	70	10 x 27	339.060.35.28
	7	35	70	10 x 27	339.070.35.28
	8	35	70	10 x 27	339.080.35.28
	9	35	70	10 x 27	339.090.35.28
	10	35	70	10 x 27	339.100.35.28
	11	35	70	10 x 27	339.110.35.28
	12	35	70	10 x 27	339.120.35.28
LH	Ø	LU	LT	S	CODE
	5	27	57,5	10 x 27	339.050.27.29
	6	27	57,5	10 x 27	339.060.27.29
	7	27	57,5	10 x 27	339.070.27.29
	8	27	57,5	10 x 27	339.080.27.29
	9	27	57,5	10 x 27	339.090.27.29
	10	27	57,5	10 x 27	339.100.27.29
	11	27	57,5	10 x 27	339.110.27.29
	12	27	57,5	10 x 27	339.120.27.29
	5	35	70	10 x 27	339.050.35.29
	6	35	70	10 x 27	339.060.35.29
	7	35	70	10 x 27	339.070.35.29
	8	35	70	10 x 27	339.080.35.29
	9	35	70	10 x 27	339.090.35.29
	10	35	70	10 x 27	339.100.35.29
	11	35	70	10 x 27	339.110.35.29
	12	35	70	10 x 27	339.120.35.29

€

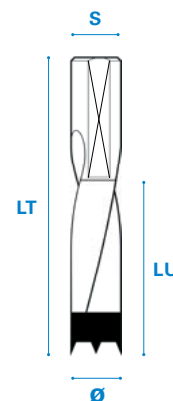
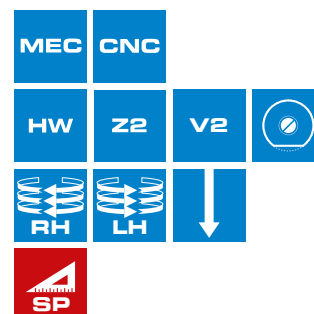

M5x10 902.050.10.TA

342

PUNTA AMBIDESTRA A 90° IN METALLO DURO INTEGRALE

Ambidextrous solid carbide dowel drill 90°
Rechts-Linkslauf Dübelbohrer 90° aus Vollhartmetall
Mèche à percer pour trous borgne carbure monobloc 90°

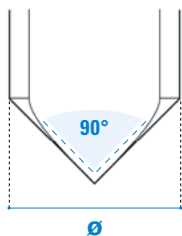

Ø	LU	LT	S	CODE
3	18	57,5	10 x 30	342.030.18.00
4	20	57,5	10 x 30	342.040.20.00
5	25	57,5	10 x 30	342.050.25.00
3	35	70	10 x 30	342.030.35.00
4	35	70	10 x 30	342.040.35.00
5	35	70	10 x 30	342.050.35.00

€



Ricambi - Spare parts - Ersatzteile - Pièces de rechange	CODE
M5x10	902.050.10.TA

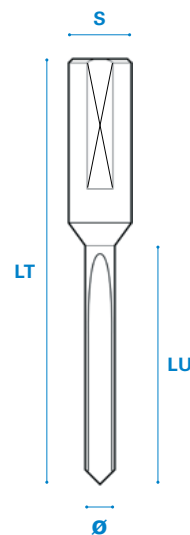
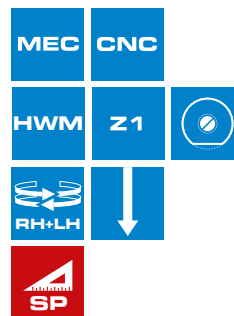

66

355

PUNTA PER FORI CIECHI IN METALLO DURO INTEGRALE

Solid carbide dowel drill for blind holes
Dübellochbohrer aus Vollhartmetall
Mèche à tourillonner pour trous borgne carbure monobloc

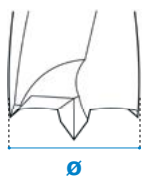

RH	Ø	LU	LT	S	CODE
3	25	57	10 x 30	355.030.25.28	
4	25	57	10 x 30	355.040.25.28	
5	25	57	10 x 30	355.050.25.28	
6	25	57	10 x 30	355.060.25.28	
8	25	57	10 x 30	355.080.25.28	
3	35	70	10 x 30	355.030.35.28	
4	35	70	10 x 30	355.040.35.28	
5	35	70	10 x 30	355.050.35.28	
6	35	70	10 x 30	355.060.35.28	
8	35	70	10 x 30	355.080.35.28	

€



LH	Ø	LU	LT	S	CODE
3	25	57	10 x 30	355.030.25.29	
4	25	57	10 x 30	355.040.25.29	
5	25	57	10 x 30	355.050.25.29	
6	25	57	10 x 30	355.060.25.29	
8	25	57	10 x 30	355.080.25.29	
3	35	70	10 x 30	355.030.35.29	
4	35	70	10 x 30	355.040.35.29	
5	35	70	10 x 30	355.050.35.29	
6	35	70	10 x 30	355.060.35.29	
8	35	70	10 x 30	355.080.35.29	

Ricambi - Spare parts - Ersatzteile - Pièces de rechange	CODE
M5x10	902.050.10.TA

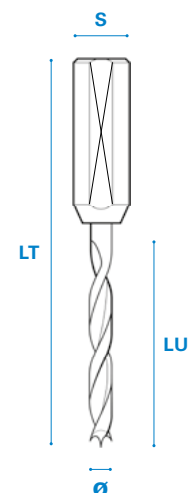
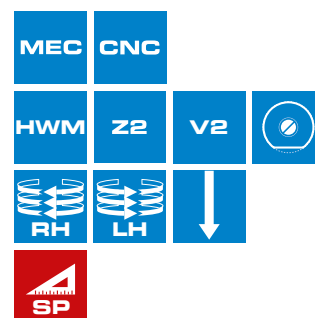

356

PUNTA PER FORI CIECHI CON INCISORI ARROTONDATI IN METALLO DURO INTEGRALE

Solid carbide dowel drill for blind holes with rounded spurs
 Dübellochbohrer mit gerundete Vorschneider aus Vollhartmetall
 Mèche à tourillonner pour trous borgne carbure monobloc avec inciseurs renforcés

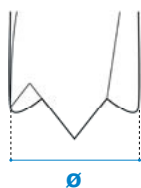

RH	Ø	LU	LT	S	CODE
	5	25	57	10 x 30	356.050.25.28
	6	25	57	10 x 30	356.060.25.28
	8	25	57	10 x 30	356.080.25.28
	5	35	70	10 x 30	356.050.35.28
	6	35	70	10 x 30	356.060.35.28
	8	35	70	10 x 30	356.080.35.28

LH	Ø	LU	LT	S	CODE
	5	25	57	10 x 30	356.050.25.29
	6	25	57	10 x 30	356.060.25.29
	8	25	57	10 x 30	356.080.25.29
	5	35	70	10 x 30	356.050.35.29
	6	35	70	10 x 30	356.060.35.29
	8	35	70	10 x 30	356.080.35.29

Ricambi - Spare parts - Ersatzteile - Pièces de rechange	CODE
M5x10	902.050.10.TA

€

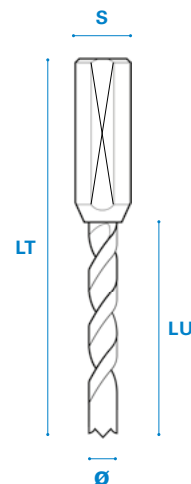
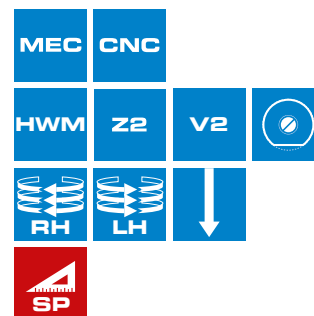

67

357

PUNTA PER FORI CIECHI CON INCISORI RINFORZATI

Dowel drill for blind holes with rounded spurs
 Dübellochbohrer mit gerundete Vorschneider
 Mèche à tourillonner pour trous borgne avec inciseurs renforcés

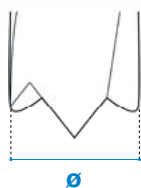

RH	Ø	LU	LT	S	CODE
	5	27	57,5	10 x 27	357.050.27.28
	6	27	57,5	10 x 27	357.060.27.28
	8	27	57,5	10 x 27	357.080.27.28
	10	27	57,5	10 x 27	357.100.27.28
	12	27	57,5	10 x 27	357.120.27.28
	5	35	70	10 x 27	357.050.35.28
	6	35	70	10 x 27	357.060.35.28
	8	35	70	10 x 27	357.080.35.28
	10	35	70	10 x 27	357.100.35.28
	12	35	70	10 x 27	357.120.35.28

LH	Ø	LU	LT	S	CODE
	5	27	57,5	10 x 27	357.050.27.29
	6	27	57,5	10 x 27	357.060.27.29
	8	27	57,5	10 x 27	357.080.27.29
	10	27	57,5	10 x 27	357.100.27.29
	12	27	57,5	10 x 27	357.120.27.29
	5	35	70	10 x 27	357.050.35.29
	6	35	70	10 x 27	357.060.35.29
	8	35	70	10 x 27	357.080.35.29
	10	35	70	10 x 27	357.100.35.29
	12	35	70	10 x 27	357.120.35.29

Ricambi - Spare parts - Ersatzteile - Pièces de rechange	CODE
M5x10	902.050.10.TA

€

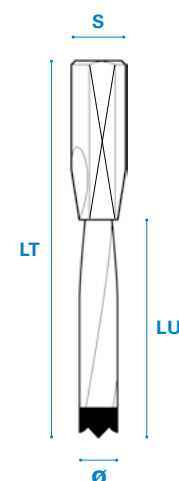
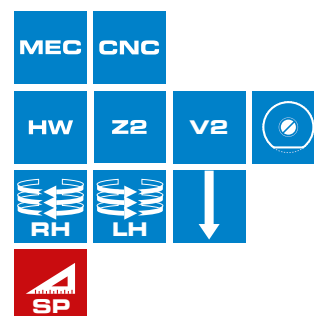

307

PUNTA PER FORI PASSANTI 60°

Through holes dowel drill 60°
Durchgangslochbohrer 60°
Mèche à tourillonner pour trous débouchants 60°

UTILIZZARE CON
To be used with
Benutzung mit
À utiliser avec

309

310



RH	Ø	LU	LT	S	CODE
	5	45	70	10 x 20	307.050.45.28
	6	45	70	10 x 20	307.060.45.28
	8	45	70	10 x 20	307.080.45.28
	10	45	70	10 x 20	307.100.45.28
	12	45	70	10 x 20	307.120.45.28

LH	Ø	LU	LT	S	CODE
	5	45	70	10 x 20	307.050.45.29
	6	45	70	10 x 20	307.060.45.29
	8	45	70	10 x 20	307.080.45.29
	10	45	70	10 x 20	307.100.45.29
	12	45	70	10 x 20	307.120.45.29

Ricambi - Spare parts - Ersatzteile - Pièces de rechange	CODE
M5x10	902.050.10.TA

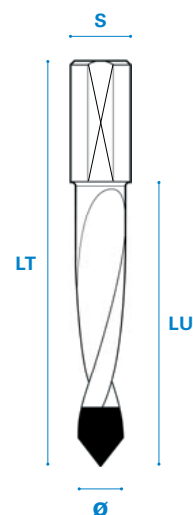
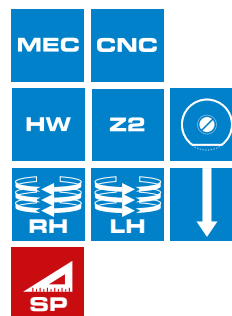
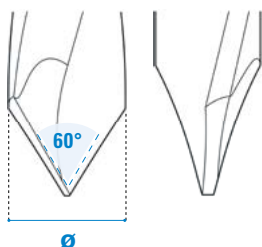

68

340

PUNTA PER FORI PASSANTI 60°

Through holes dowel drill 60°
Durchgangslochbohrer 60°
Mèche à tourillonner pour trous débouchants 60°

UTILIZZARE CON
To be used with - Benutzung mit - À utiliser avec

309 C



RH	Ø	LU	LT	S	CODE
	5	27	57,5	10 x 27	340.050.27.28
	6	27	57,5	10 x 27	340.060.27.28
	8	27	57,5	10 x 27	340.080.27.28
	10	27	57,5	10 x 27	340.100.27.28
	12	27	57,5	10 x 27	340.120.27.28

	5	35	70	10 x 27	340.050.35.28
	6	35	70	10 x 27	340.060.35.28
	8	35	70	10 x 27	340.080.35.28
	10	35	70	10 x 27	340.100.35.28
	12	35	70	10 x 27	340.120.35.28

LH	Ø	LU	LT	S	CODE
	5	27	57,5	10 x 27	340.050.27.29
	6	27	57,5	10 x 27	340.060.27.29
	8	27	57,5	10 x 27	340.080.27.29
	10	27	57,5	10 x 27	340.100.27.29
	12	27	57,5	10 x 27	340.120.27.29

	5	35	70	10 x 27	340.050.35.29
	6	35	70	10 x 27	340.060.35.29
	8	35	70	10 x 27	340.080.35.29
	10	35	70	10 x 27	340.100.35.29
	12	35	70	10 x 27	340.120.35.29

Ricambi - Spare parts - Ersatzteile - Pièces de rechange	CODE
M5x10	902.050.10.TA

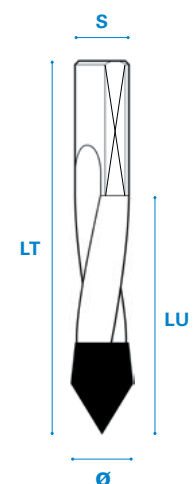
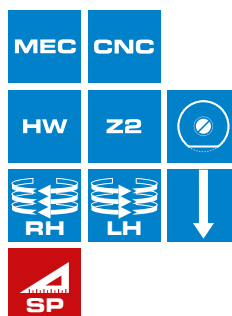
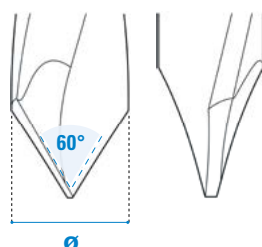

360

**PUNTA PER FORI PASSANTI 60°
IN METALLO DURO INTEGRALE**

Solid carbide dowel drill 60° for through hole
Durchgangslochbohrer 60° aus Vollhartmetall
Mèche à tourillonner pour trous débouchants 60°



RH	Ø	LU	LT	S	CODE
3	25	57	10 x 30		360.030.25.28
4	25	57	10 x 30		360.040.25.28
5	25	57	10 x 30		360.050.25.28
6	25	57	10 x 30		360.060.25.28
8	25	57	10 x 30		360.080.25.28
3	35	70	10 x 30		360.030.35.28
4	35	70	10 x 30		360.040.35.28
5	35	70	10 x 30		360.050.35.28
6	35	70	10 x 30		360.060.35.28
8	35	70	10 x 30		360.080.35.28

LH	Ø	LU	LT	S	CODE
3	25	57	10 x 30		360.030.25.29
4	25	57	10 x 30		360.040.25.29
5	25	57	10 x 30		360.050.25.29
6	25	57	10 x 30		360.060.25.29
8	25	57	10 x 30		360.080.25.29
3	35	70	10 x 30		360.030.35.29
4	35	70	10 x 30		360.040.35.29
5	35	70	10 x 30		360.050.35.29
6	35	70	10 x 30		360.060.35.29
8	35	70	10 x 30		360.080.35.29

Ricambi - Spare parts - Ersatzteile - Pièces de rechange	CODE
M5x10	902.050.10.TA

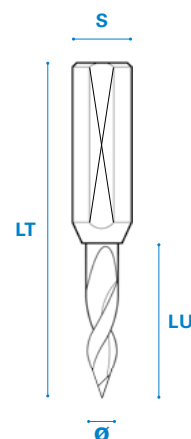
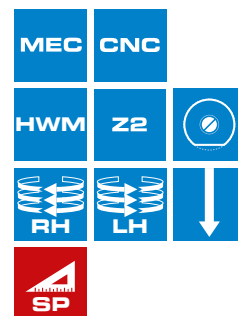
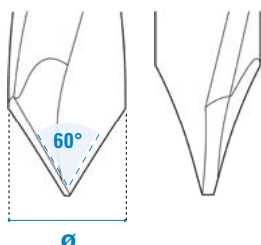

361

**PUNTA PER FORI PASSANTI
CON DOPPIA LANCIA IN METALLO DURO INTEGRALE**

Solid carbide dowel drill for through hole with double angle
Durchgangslochbohrer aus Vollhartmetall mit Doppelfase
Mèche à tourillonner pour trous débouchants carbure monobloc avec double angle



RH	Ø	LU	LT	S	CODE
5	27	57,5	10 x 30		361.050.27.28
6	27	57,5	10 x 30		361.060.27.28
8	27	57,5	10 x 30		361.080.27.28
5	35	70	10 x 30		361.050.35.28
6	35	70	10 x 30		361.060.35.28
8	35	70	10 x 30		361.080.35.28

LH	Ø	LU	LT	S	CODE
5	27	57,5	10 x 30		361.050.27.29
6	27	57,5	10 x 30		361.060.27.29
8	27	57,5	10 x 30		361.080.27.29
5	35	70	10 x 30		361.050.35.29
6	35	70	10 x 30		361.060.35.29
8	35	70	10 x 30		361.080.35.29

Ricambi - Spare parts - Ersatzteile - Pièces de rechange	CODE
M5x10	902.050.10.TA

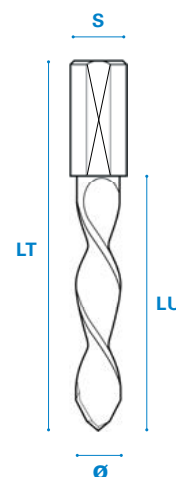
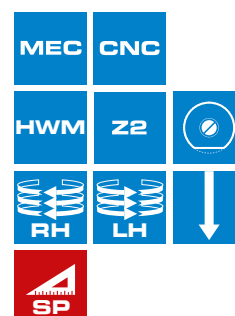
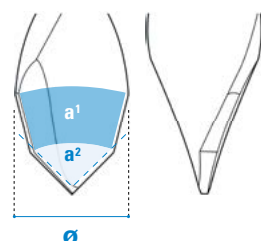

312

PUNTA PER CERNIERE

Hinge boring bit
Zylinderkopfböhrer
Mèche à façonner à fond plat

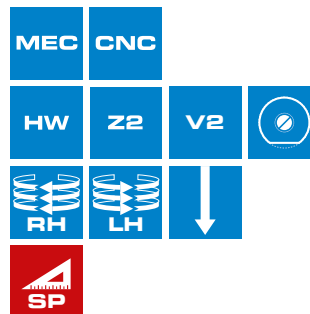

RH	Ø	LT	S	CODE
15	57	57	10 x 26	312.150.57.28
16	57	57	10 x 26	312.160.57.28
18	57	57	10 x 26	312.180.57.28
20	57	57	10 x 26	312.200.57.28
22	57	57	10 x 26	312.220.57.28
25	57	57	10 x 26	312.250.57.28
26	57	57	10 x 26	312.260.57.28
30	57	57	10 x 26	312.300.57.28
32	57	57	10 x 26	312.320.57.28
35	57	57	10 x 26	312.350.57.28
40	57	57	10 x 26	312.400.57.28
45	57	57	10 x 26	312.450.57.28
15	70	70	10 x 26	312.150.70.28
16	70	70	10 x 26	312.160.70.28
18	70	70	10 x 26	312.180.70.28
20	70	70	10 x 26	312.200.70.28
22	70	70	10 x 26	312.220.70.28
25	70	70	10 x 26	312.250.70.28
26	70	70	10 x 26	312.260.70.28
30	70	70	10 x 26	312.300.70.28
35	70	70	10 x 26	312.350.70.28
40	70	70	10 x 26	312.400.70.28



LH	Ø	LT	S	CODE
15	57	57	10 x 26	312.150.57.29
16	57	57	10 x 26	312.160.57.29
18	57	57	10 x 26	312.180.57.29
20	57	57	10 x 26	312.200.57.29
22	57	57	10 x 26	312.220.57.29
25	57	57	10 x 26	312.250.57.29
26	57	57	10 x 26	312.260.57.29
30	57	57	10 x 26	312.300.57.29
32	57	57	10 x 26	312.320.57.29
35	57	57	10 x 26	312.350.57.29
40	57	57	10 x 26	312.400.57.29
45	57	57	10 x 26	312.450.57.29
15	70	70	10 x 26	312.150.70.29
16	70	70	10 x 26	312.160.70.29
18	70	70	10 x 26	312.180.70.29
20	70	70	10 x 26	312.200.70.29
22	70	70	10 x 26	312.220.70.29
25	70	70	10 x 26	312.250.70.29
26	70	70	10 x 26	312.260.70.29
30	70	70	10 x 26	312.300.70.29
35	70	70	10 x 26	312.350.70.29
40	70	70	10 x 26	312.400.70.29

€



Ricambi - Spare parts - Ersatzteile - Pièces de rechange

CODE



M5x10

902.050.10.TA

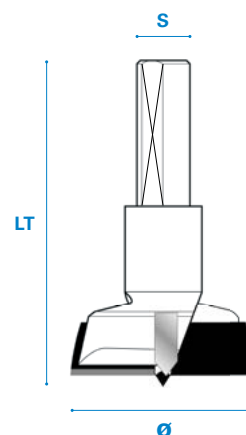

313

PUNTA PER CERNIERE

Hinge boring bit
Zylinderkopfbohrer
Mèche à façonner à fond plat



RH	Ø	LT	S	CODE
	25	57	10 x 26	313.250.00.28
	26	57	10 x 26	313.260.00.28
	30	57	10 x 26	313.300.00.28
	35	57	10 x 26	313.350.00.28
	38	57	10 x 26	313.380.00.28
	40	57	10 x 26	313.400.00.28

LH	Ø	LT	S	CODE
	25	57	10 x 26	313.250.00.29
	26	57	10 x 26	313.260.00.29
	30	57	10 x 26	313.300.00.29
	35	57	10 x 26	313.350.00.29
	38	57	10 x 26	313.380.00.29
	40	57	10 x 26	313.400.00.29

Ricambi - Spare parts - Ersatzteile - Pièces de rechange	CODE
M5x10	902.050.10.TA

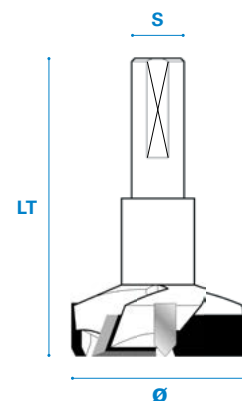
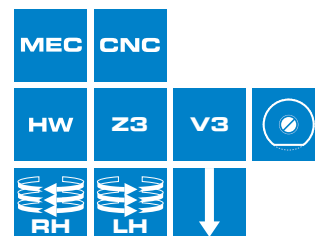
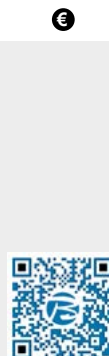

332

PUNTA PER FORI CIECHI CON ATTACCO FILETTATO

Blind holes dowel drill with threaded shank
Dübellochbohrer mit Gewindenschaft
Mèche à tourillonner avec filetage extérieur

Vitap BIESSE MORBIDELLI WEEKE TORWEGGE
masterwood NOTTMAYER

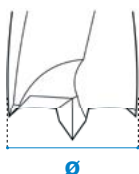

RH	Ø	LU	LT	S	CODE
	5	40	60	M10/11	332.050.40.28
	6	40	60	M10/11	332.060.40.28
	8	40	60	M10/11	332.080.40.28
	10	40	60	M10/11	332.100.40.28
	12	40	60	M10/11	332.120.40.28

LH	Ø	LU	LT	S	CODE
	5	40	60	M10/11	332.050.40.29
	6	40	60	M10/11	332.060.40.29
	8	40	60	M10/11	332.080.40.29
	10	40	60	M10/11	332.100.40.29
	12	40	60	M10/11	332.120.40.29

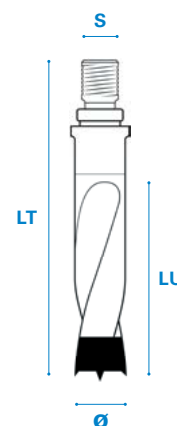
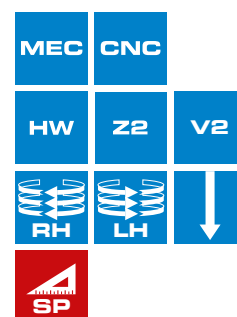

333

PUNTA PER FORI CIECHI CON ATTACCO FILETTATO CONICO 30°

Blind holes dowel drill with 30° threaded conical shank
Dübellochbohrer mit 30° konischen-Gewindeschaft
Mèche à tourillonner avec filetage extérieur cône 30°

Vitap

RH	Ø	LU	LT	S	CODE
	5	40	60	M10/30°	333.050.40.28
	6	40	60	M10/30°	333.060.40.28
	8	40	60	M10/30°	333.080.40.28
	10	40	60	M10/30°	333.100.40.28
	12	40	60	M10/30°	333.120.40.28

LH	Ø	LU	LT	S	CODE
	5	40	60	M10/30°	333.050.40.29
	6	40	60	M10/30°	333.060.40.29
	8	40	60	M10/30°	333.080.40.29
	10	40	60	M10/30°	333.100.40.29
	12	40	60	M10/30°	333.120.40.29

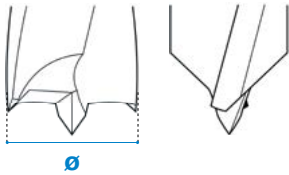
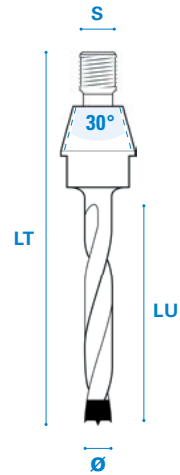
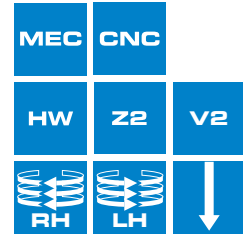

PUNTA PER CERNIERE A COLTELLI REVERSIBILI

Reversible knife hinge boring bit
Wendepplatten Zylinderkopfbohrer
Mèche à façonner à plaquettes réversibles

RH	Ø	LT	S	CODE
	25	57	10 x 26	335.250.00.08
	26	57	10 x 26	335.260.00.08
	30	57	10 x 26	335.300.00.08
	35	57	10 x 26	335.350.00.08
	40	57	10 x 26	335.400.00.08
	35	70	10 x 26	335.350.70.08

LH	Ø	LT	S	CODE
	25	57	10 x 26	335.250.00.09
	26	57	10 x 26	335.260.00.09
	30	57	10 x 26	335.300.00.09
	35	57	10 x 26	335.350.00.09
	40	57	10 x 26	335.400.00.09
	35	70	10 x 26	335.350.70.09

Ricambi - Spare parts - Ersatzteile - Pièces de rechange

Ricambi - Spare parts - Ersatzteile - Pièces de rechange		CODE
	Ø25	DX 901.240.13.08
		901.240.13.09
	Ø26	DX 901.250.13.08
		901.250.13.09
	Ø30	DX 901.290.13.08
		901.290.13.09
	Ø35	DX 901.340.13.08
		901.340.13.09
	Ø40	DX 901.390.13.08
		901.390.13.09
		901.180.08.00
	Ø25-26 TORX®15 M4x6 D5,6 L8	902.040.06.56
	Ø30-40 TORX®15 M4x8 D5,6 L10	902.040.08.56
	TORX®15 M4x6 D5,6 L8	902.040.06.56
	TORX®15	903.003.15.00
	M5x10	902.050.10.TA
Optional		CODE
	TORX®15	903.150.00.00

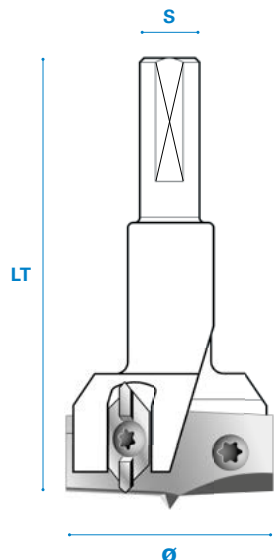
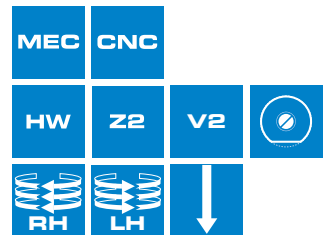

335

337 337B

PUNTA PER FORI PASSANTI 45° IN METALLO DURO INTEGRALE

Solid carbide dowel drill 45° for through hole
Durchgangslochbohrer 45° aus Vollhartmetall
Mèche à tourillonner pour trous débouchants carbure monobloc 45°

UTILIZZARE CON
To be used with
Benutzung mit
À utiliser avec

338

351

352



RH	Ø	LU	LT	S	CODE
2	14	50	2		337.020.14.28
2,5	16	50	2,5		337.025.16.28
3	18	50	3		337.030.18.28
3,2	18	50	3,2		337.032.18.28
3,5	20	50	3,5		337.035.20.28
4	20	50	4		337.040.20.28
5	25	50	5		337.050.25.28

LH	Ø	LU	LT	S	CODE
2	14	50	2		337.020.14.29
2,5	16	50	2,5		337.025.16.29
3	18	50	3		337.030.18.29
3,2	18	50	3,2		337.032.18.29
3,5	20	50	3,5		337.035.20.29
4	20	50	4		337.040.20.29
5	25	50	5		337.050.25.29

RH	Ø	LU	LT	S	CODE
3	30	60	3		337B.030.0HWM
3,5	30	60	3,5		337B.035.0HWM
4	30	60	4		337B.040.0HWM
4,5	30	60	4,5		337B.045.0HWM
5	30	60	5		337B.050.0HWM
5,5	30	60	5,5		337B.055.0HWM

€

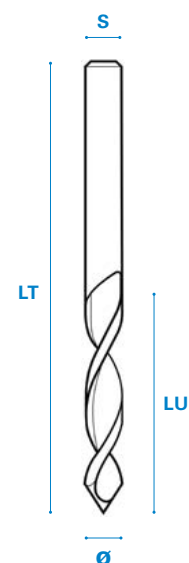
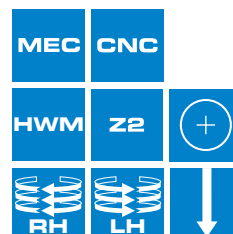

73

350 350P

PUNTA PER DOPPIO FORO PIANO

Step drill bit
Stufenbohrer
Mèche étagée



Ø	d	LU1	LU2	LT	CODE
on request					
Ricambi - Spare parts - Ersatzteile - Pièces de rechange					
M5x10					902.050.10.TA

€

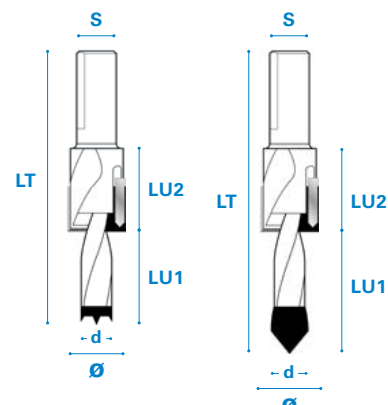
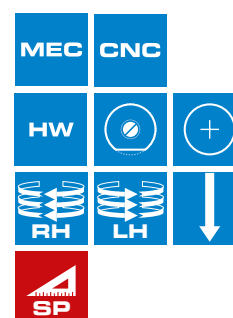

350



350P

352

SVASATORE PORTA PUNTE 45°

Countersink drill holder 45°

Aufsteckversenker für die Befestigung an Spiralbohrern 45°

Fraisoir porte-mèche à 45°

UTILIZZARE CON

To be used with
Benutzung mit
À utiliser avec

337

337 B



RH	a	∅	d	LT	S	CODE
45°	2	16	40	10		352.020.00.28
45°	2,5	16	40	10		352.025.00.28
45°	3	16	55	10		352.030.00.28
45°	3,2	16	55	10		352.032.00.28
45°	3,5	16	55	10		352.035.00.28
45°	4	16	55	10		352.040.00.28
45°	5	16	55	10		352.050.00.28

LH	a	∅	d	LT	S	CODE
45°	2	16	40	10		352.020.00.29
45°	2,5	16	40	10		352.025.00.29
45°	3	16	55	10		352.030.00.29
45°	3,2	16	55	10		352.032.00.29
45°	3,5	16	55	10		352.035.00.29
45°	4	16	55	10		352.040.00.29
45°	5	16	55	10		352.050.00.29



Ricambi - Spare parts - Ersatzteile - Pièces de rechange

∅2

∅ 2 M4x5

902.040.05.00



∅ 3 M5x5

902.050.05.00

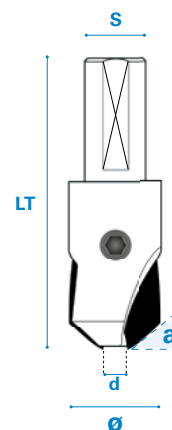
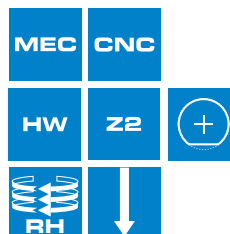

74

353
353P

PUNTA PER DOPPIO FORO SVASATO 45°

Countersink step drill bit 45°

Stufenbohrer mit Versenker 45°

Mèche étagée 45°



∅	d	LU1	LU2	LT
on request				



Ricambi - Spare parts - Ersatzteile - Pièces de rechange

M5x10

902.050.10.TA

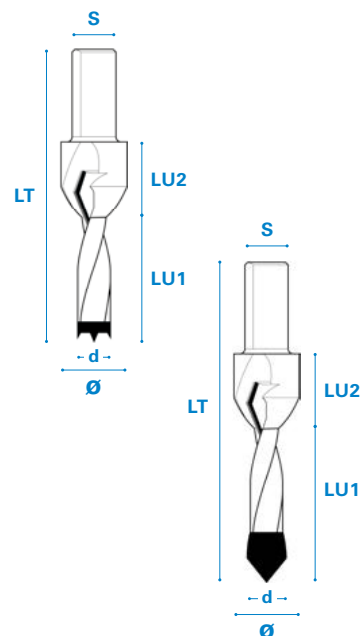
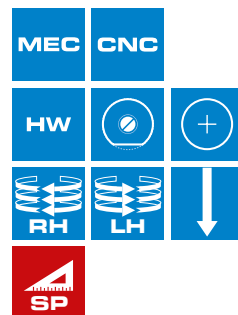

353



353P

370

SISTEMA DI FORATURA FLESSIBILE CON COLTELLO REVERSIBILE E ATTACCO INTERCAMBIABILE

Flexible drilling system with reversible knife and Interchangeable shank
Flexible Bohrsystem mit Wendemesser und Wechselschaft
Système de perçage flexible avec plaquette réversible et queue interchangeable

TYPE 1



Optional Art.901P



COLTELLO REVERSIBILE PER FORO PASSANTE
Through-hole reversible knife
Durchgangslöcherbohrer Wendemesser
Plaquettes trous débouchants

Ø	LT	S	CODE
15→22	27	M8	370.000.01.08
Ø	CODE		
15	901.150.01.08		
16	901.160.01.08		
17	901.170.01.08		
18	901.180.01.08		
19	901.190.01.08		
20	901.200.01.08		
21	901.210.01.08		
22	901.220.01.08		



€



Ricambi - Spare parts - Ersatzteile - Pièces de rechange	CODE
TORX®7 M2,5x3 D3 L4,5	902.025.45.30



Optional	CODE
TORX®7	903.003.07.00

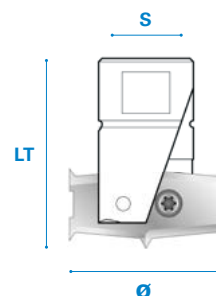
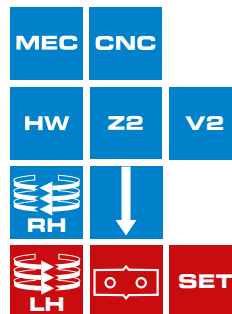

UTILIZZARE CON
To be used with
Benutzung mit
À utiliser avec

372

TYPE 2



Optional Art.901P



COLTELLO REVERSIBILE PER FORO PASSANTE
Through-hole reversible knife
Durchgangslöcherbohrer Wendemesser
Plaquettes trous débouchants

Ø	LT	S	CODE
23→30	27	M8	370.000.02.08
Ø	CODE		
23	901.230.02.08		
24	901.240.02.08		
25	901.250.02.08		
26	901.260.02.08		
27	901.270.02.08		
28	901.280.02.08		
29	901.290.02.08		
30	901.300.02.08		



€



Ricambi - Spare parts - Ersatzteile - Pièces de rechange	CODE
TORX®15 M4x6 D5,6 L8	902.040.06.56



Optional	CODE
TORX®15	903.003.15.00

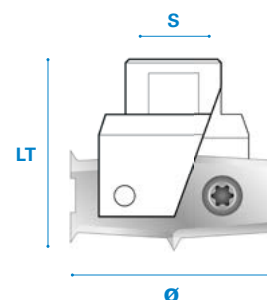

UTILIZZARE CON
To be used with
Benutzung mit
À utiliser avec

372

TYPE 3



Optional Art.901P



COLTELLO REVERSIBILE PER FORO PASSANTE
Through-hole reversible knife
Durchgangslöcherbohrer Wendemesser
Plaquettes trous débouchants

Ø	LT	S	CODE
32→40	27	M8	370.000.03.08
Ø	CODE		
32	901.320.03.08		
33	901.330.03.08		
34	901.340.03.08		
35	901.350.03.08		
36	901.360.03.08		
37	901.370.03.08		
38	901.380.03.08		
40	901.400.03.08		



€



Ricambi - Spare parts - Ersatzteile - Pièces de rechange	CODE
TORX®15 M4x8 D5,6 L10	902.040.08.56



Optional	CODE
TORX®15	903.003.15.00

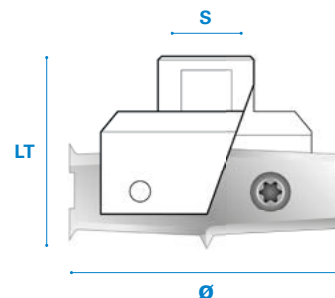

UTILIZZARE CON
To be used with
Benutzung mit
À utiliser avec

372

372

ATTACCO CILINDRICO CON PIANO DI SERRAGGIO*Cylindrical shank with flat**Zylindrischer schaft mit spanfläche**Pièce de réduction intermédiaire avec méplat sur la queue***UTILIZZARE CON***To be used with
Benutzung mit
À utiliser avec*

370



RH	LT	M	S	CODE
	57	8	10	372.100.57.08
	70	8	10	372.100.70.08
	77	8	10	372.100.77.08

LH	LT	M	S	CODE
	57	8	10	372.100.57.09
	70	8	10	372.100.70.09
	77	8	10	372.100.77.09

Ricambi - Spare parts - Ersatzteile - Pièces de rechange	CODE
M5x10	902.050.10.TA

€

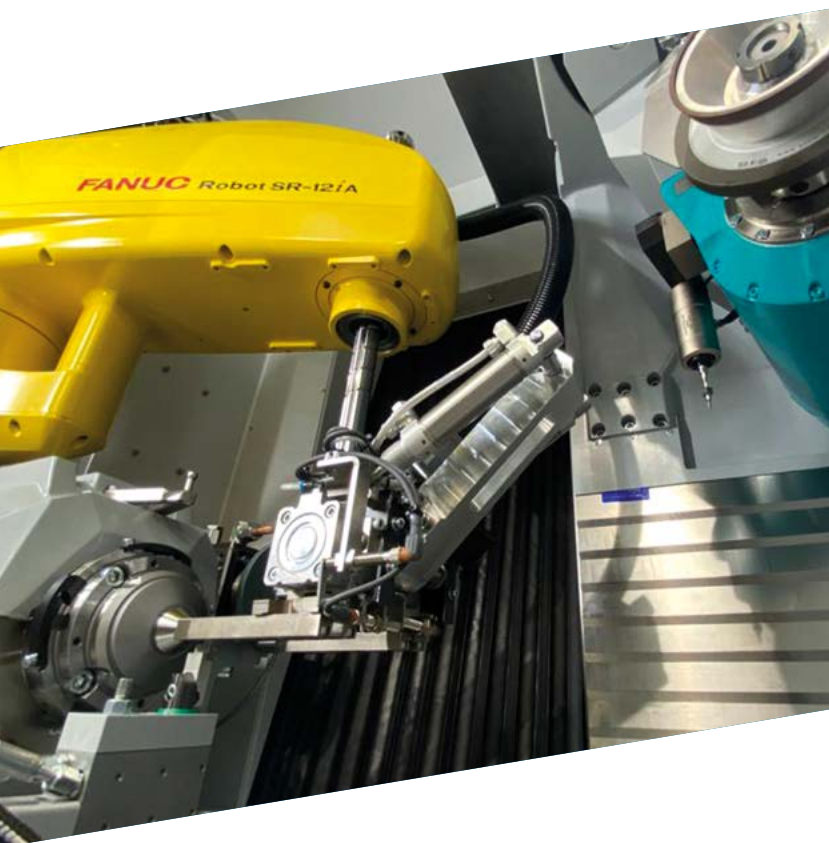
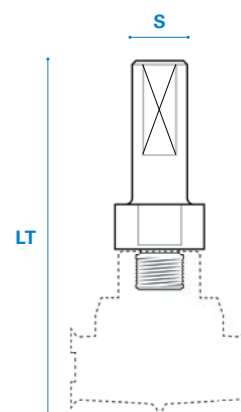

INDICE | INDEX

UTENSILI PER TRAPANI E CAVETTATRICI

TOOLS FOR DRILLING MACHINES AND SLOTTING MACHINES
 WERKZEUGE FÜR BOHRMASCHINEN UND LANGLOCHBOHRMASCHINEN
 MÊCHES POUR PERCEUSES ET MORTAISEUSES

D

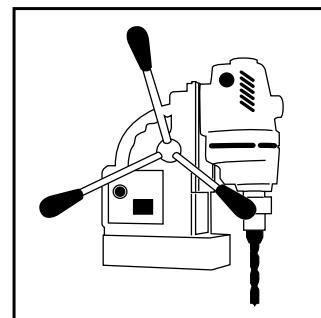

323
p.78



324
p.78



329
p.79



336
p.79



350AN
p.80



354
p.80



370
p.81



371
p.82



373
p.82



413
p.83



414
p.83



415
p.84



417
p.84



418
p.85

323

PUNTA INTERCAMBIABILE PER CERNIERE - M12 ELU®

Interchangeable hinge boring bit - M12 Elu®
Zylinderkopfbohrer wechselfach-ausführung - M12 Elu®
Tête à façonner interchangeables - M12 Elu®

UTILIZZARE CON **321**
To be used with
Benutzung mit **322**
A utiliser avec



Ø	LT	S	CODE
20	30	M12 x 1	323.200.00.28
22	30	M12 x 1	323.220.00.28
24	30	M12 x 1	323.240.00.28
25	30	M12 x 1	323.250.00.28
26	30	M12 x 1	323.260.00.28
28	30	M12 x 1	323.280.00.28
30	30	M12 x 1	323.300.00.28
32	30	M12 x 1	323.320.00.28
35	30	M12 x 1	323.350.00.28
38	30	M12 x 1	323.380.00.28
40	30	M12 x 1	323.400.00.28
45	30	M12 x 1	323.450.00.28
48	30	M12 x 1	323.480.00.28
50	30	M12 x 1	323.500.00.28
55	42	M12 x 1	323.550.00.28
60	42	M12 x 1	323.600.00.28

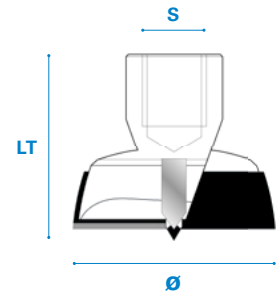
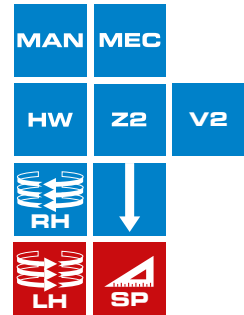

78

324

PUNTA PER CERNIERE CON ATTACCO CILINDRICO

Hinge boring bit with cylindrical shank
Zylinderkopfbohrer mit zylindrischem Schaft
Mèche à façonner à fond plat avec queue cylindrique



Ø	LT	S	CODE
8	90	10 x 60	324.080.00.28
10	90	10 x 60	324.100.00.28
12	90	10 x 60	324.120.00.28
14	90	10 x 60	324.140.00.28
15	90	10 x 60	324.150.00.28
16	90	10 x 60	324.160.00.28
17	90	10 x 60	324.170.00.28
18	90	10 x 60	324.180.00.28
19	90	10 x 60	324.190.00.28
20	90	10 x 60	324.200.00.28
22	90	10 x 60	324.220.00.28
24	90	10 x 60	324.240.00.28
25	90	10 x 60	324.250.00.28
26	90	10 x 60	324.260.00.28
28	90	10 x 60	324.280.00.28
30	90	10 x 60	324.300.00.28
32	90	10 x 60	324.320.00.28
34	90	10 x 60	324.340.00.28
35	90	10 x 60	324.350.00.28
36	90	10 x 60	324.360.00.28
38	90	10 x 60	324.380.00.28
40	90	10 x 60	324.400.00.28
45	90	10 x 60	324.450.00.28
48	90	10 x 60	324.480.00.28
50	90	10 x 60	324.500.00.28

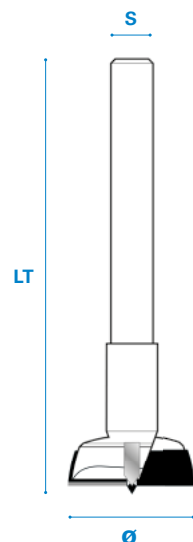
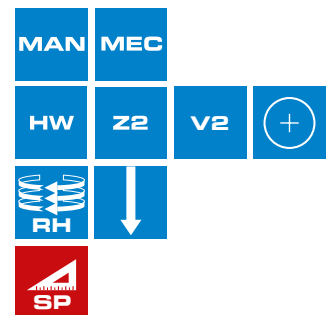
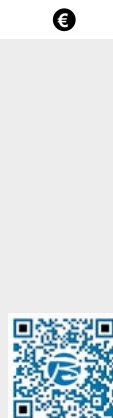

329

PUNTA ELICOIDALE PER FORI CIECHI

Spiral Bit for blind holes
Dübelbohrer
Mèche hélicoïdale à percer pour trous borgne



Ø	LU	LT	S	CODE
5	60	90	5	329.050.00.28
6	65	100	6	329.060.00.28
7	70	110	7	329.070.00.28
8	75	120	8	329.080.00.28
9	80	130	9	329.090.00.28
10	90	140	10	329.100.00.28
11	95	150	11	329.110.00.28
12	100	155	12	329.120.00.28
14	105	160	14	329.140.00.28
10	200	250	10	329.100.S1028
12	200	250	10	329.120.S1028
14	200	250	16	329.140.S1628
16	200	250	16	329.160.S1628

€

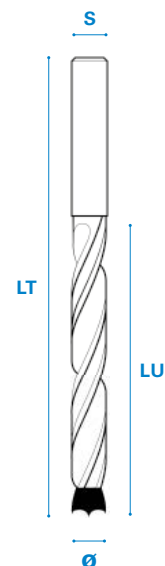
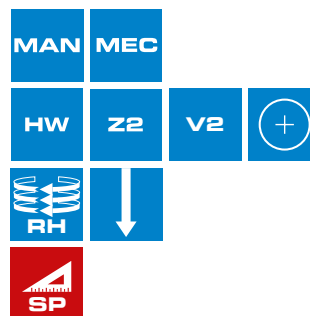

79

336

PUNTA PER CERNIERE A COLTELLI REVERSIBILI CON ATTACCO CILINDRICO

Reversible knife hinge boring bit with cylindrical shank
Wendeplatten Zylinderkopfbohrer mit zylindrischem Schaft
Mèche à façonné à plaquettes réversibles avec queue cylindrique



Ø	LT	S	CODE
25	90	10 x 60	336.250.00.08
26	90	10 x 60	336.260.00.08
30	90	10 x 60	336.300.00.08
35	90	10 x 60	336.350.00.08

€

Ricambi - Spare parts - Ersatzteile - Pièces de rechange	CODE
Z2 Ø25	901.240.13.08
Z2 Ø26	901.250.13.08
Z2 Ø30	901.290.13.08
Z2 Ø35	901.340.13.08
Ø25-26 TORX®15 M4x6 D5,6 L8	902.040.06.56
Ø30-35 TORX®15 M4x8 D5,6 L10	902.040.08.56
XE2	901.180.08.00
TORX®15 M4x6 D5,6 L8	902.040.06.56

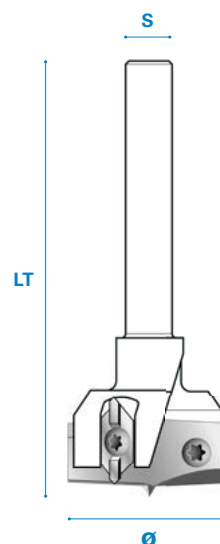
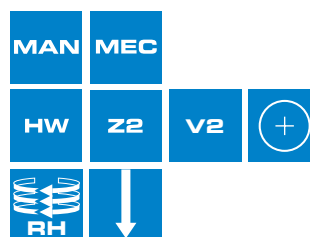

Optional	CODE
TORX®15	903.150.00.00

350AN

PUNTA PER CERNIERE ANUBA® CON ATTACCO CILINDRICO NOMINALE

Stepdrill for ANUBA® hinges with nominal cylindrical shank
Stufenbohrer für ANUBA® mit nominalen zylindrischem Schaft
Mèche pour charnières ANUBA® avec queue cylindrique nominal

COMPATIBILE CON
Compatible with
Passend für
Compatible avec

ANUBA

	Ø	d	LU1	LU2	LT	S	CODE
ANUBA® 1G	6,75	5,7	20	45	105	6,75	A13.350AN.675
ANUBA® 1S	7,25	6,25	20	45	105	7,25	A14.350AN.725
ANUBA® 1E	7,75	6,5	20	50	110	7,75	A16.350AN.775
ANUBA® 1B	8,5	6,7	25	45	110	8,5	A18.350AN.850

€

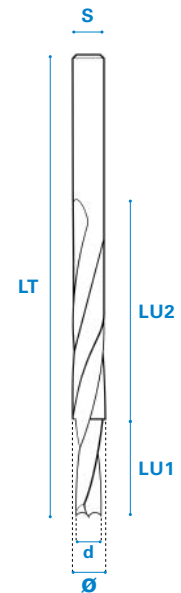
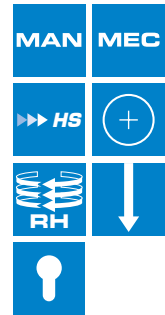

80

354

SVASATORE 90° IN METALLO DURO INTEGRALE

Coutersink 90° with cylindrical shank
Versenken 90° mit zylindrischem Schaft
Fraisoir 90° avec queue cylindrique

a	Ø	LU	LT	S	CODE
90°	19,5	9,5	73	10 x 50	354.090.10.00

€

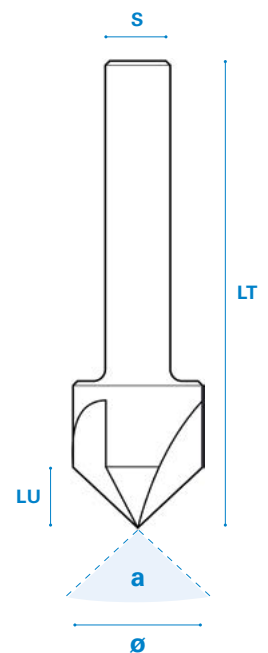
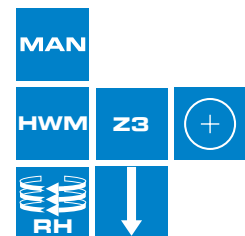

370

SISTEMA DI FORATURA FLESSIBILE CON COLTELLO REVERSIBILE E ATTACCO INTERCAMBIABILE

Flexible drilling system with reversible knife and Interchangeable shank
Flexible Bohrsystem mit Wendemesser und Wechselschaft
Système de perçage flexible avec plaquette réversible et queue interchangeable

TYPE 1



Optional Art.901P



COLTELLO REVERSIBILE PER FORO PASSANTE
Through-hole reversible knife
Durchgangslöcherbohrer Wendemesser
Plaquettes trous débouchants

Ø	LT	S	CODE
15→22	27	M8	370.000.01.08
Ø	CODE		
15	901.150.01.08		
16	901.160.01.08		
17	901.170.01.08		
18	901.180.01.08		
19	901.190.01.08		
20	901.200.01.08		
21	901.210.01.08		
22	901.220.01.08		

€

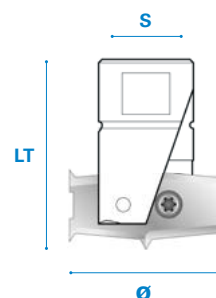
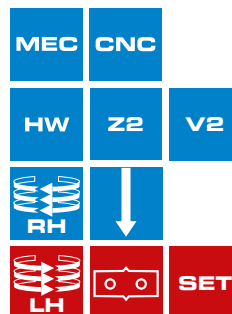

UTILIZZARE CON
To be used with
Benutzung mit
À utiliser avec

371

373

TYPE 2



Optional Art.901P



COLTELLO REVERSIBILE PER FORO PASSANTE
Through-hole reversible knife
Durchgangslöcherbohrer Wendemesser
Plaquettes trous débouchants

Ø	LT	S	CODE
23→30	27	M8	370.000.02.08
Ø	CODE		
23	901.230.02.08		
24	901.240.02.08		
25	901.250.02.08		
26	901.260.02.08		
27	901.270.02.08		
28	901.280.02.08		
29	901.290.02.08		
30	901.300.02.08		

€

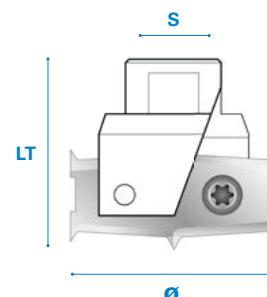

UTILIZZARE CON
To be used with
Benutzung mit
À utiliser avec

371

373

TYPE 3



Optional Art.901P



COLTELLO REVERSIBILE PER FORO PASSANTE
Through-hole reversible knife
Durchgangslöcherbohrer Wendemesser
Plaquettes trous débouchants

Ø	LT	S	CODE
32→40	27	M8	370.000.03.08
Ø	CODE		
32	901.320.03.08		
33	901.330.03.08		
34	901.340.03.08		
35	901.350.03.08		
36	901.360.03.08		
37	901.370.03.08		
38	901.380.03.08		
40	901.400.03.08		

€

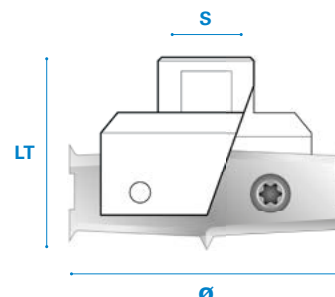

UTILIZZARE CON
To be used with
Benutzung mit
À utiliser avec

371

373

371

ATTACCO CILINDRICO

Cylindrical shank
Zylindrischer Schaft
Rallonge filetée a queue cylindrique

UTILIZZARE CON

To be used with
Benutzung mit
A utiliser avec

370

LT	S	CODE
60	8	371.080.60.08
60	10	371.100.60.08
60	12	371.120.60.08
90	10	371.100.90.08
140	13	371.130.00.08
126	16	371.160.00.08

€

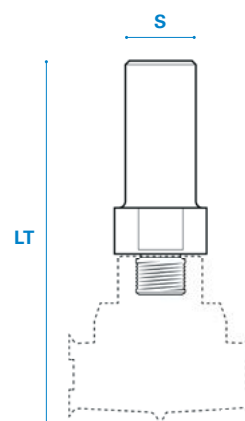

82

373

ADATTATORE M10 Scheer® - M12 Elu®

Adapter M10 Scheer® - M12 Elu®
Adapter M10 Scheer® - M12 Elu®
Adaptateur M10 Scheer® - M12 Elu®

UTILIZZARE CON

To be used with
Benutzung mit
A utiliser avec

370

LT	S		CODE
58	M10 x 1,5	Scheer®	373.M10.58.08
58	M12 x 1	Elu®	373.M12.58.08

€

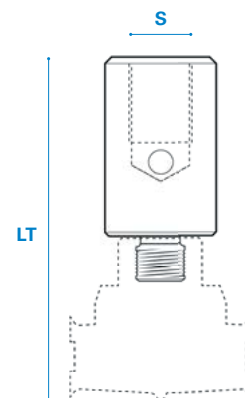

413

FRESA PER SEDE PIASTRINA SU PORTE - M12 Elu®*Straight bit for door look housing - M12 Elu®**Nutfräser für Schlüsselloch. - M12 Elu®**Mèche à rainier avec coupe frontale - M12 Elu®*

Ø	LU	LT	S	CODE
18	25	60	M12 x 1	413.180.00.28
20	25	60	M12 x 1	413.200.00.28
22	25	60	M12 x 1	413.220.00.28
24	25	60	M12 x 1	413.240.00.28

€

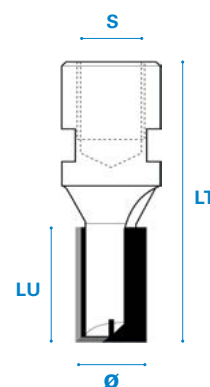

83

414

PUNTA PER SEDE SERRATURA - M12 Elu®*Door Lock Mortise bit - M12 Elu®**Fräser für Schlosskasten - M12 Elu®**Mèche pour serrures - M12 Elu®*

Ø	LT	S	CODE
10	100	M12 x 1	414.100.00.28
11	100	M12 x 1	414.110.00.28
12	100	M12 x 1	414.120.00.28
14	100	M12 x 1	414.140.00.28
14	125	M12 x 1	414.140.25.28
15	100	M12 x 1	414.150.00.28
15	125	M12 x 1	414.150.25.28
16	100	M12 x 1	414.160.00.28
16	125	M12 x 1	414.160.25.28

€

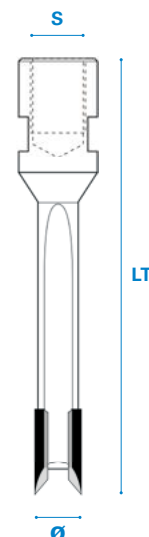
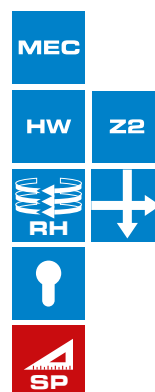

415

PUNTA PER FORO MANIGLIA - M12 Elu®*Door handle boring bit - M12 Elu®**Türgriff-Bohrer - M12 Elu®**Mèche à percer pour poignée - M12 Elu®*

Ø	LT	S	CODE
15	100	M12 x 1	415.150.00.28
18	100	M12 x 1	415.180.00.28
20	100	M12 x 1	415.200.00.28
22	100	M12 x 1	415.220.00.28
24	100	M12 x 1	415.240.00.28

€



MEC

HW

Z2

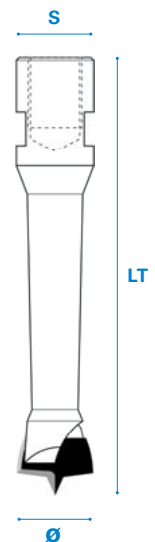

84

417

PUNTA PER ASOLA E FORO - M12 Elu®*Slot boring bit - M12 Elu®**Ausfräsen von Schlosskasten und Drückerlöchern - M12 Elu®**Mèche pour défonçage et perçage - M12 Elu®*

Ø	d	LU	LT	S	CODE
19	11	62	155	M12 x 1	417.190.11.28
19	12	70	173	M12 x 1	417.190.12173
19	12	62	155	M12 x 1	417.190.12.28
22	11	62	155	M12 x 1	417.220.11.28
24	12	62	155	M12 x 1	417.240.12.28

€



MEC

HW

Z2+2

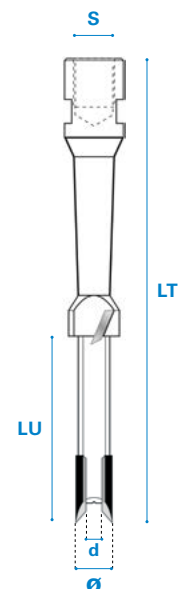

418

FRESA PER SEDE PIASTRINA SU PORTE - M12 Elu®*Straight bit for door lock housing - M12 Elu®**Nutfräser für Schlüsselloch. - M12 Elu®**Mèche à rainier avec coupe frontale - M12 Elu®*

Ø	LU	LT	S	CODE
18	15	48	M12 x 1	418.180.00.28
20	15	48	M12 x 1	418.200.00.28
22	15	48	M12 x 1	418.220.00.28
23	15	48	M12 x 1	418.230.00.28
24	15	48	M12 x 1	418.240.00.28
25	15	48	M12 x 1	418.250.00.28

€

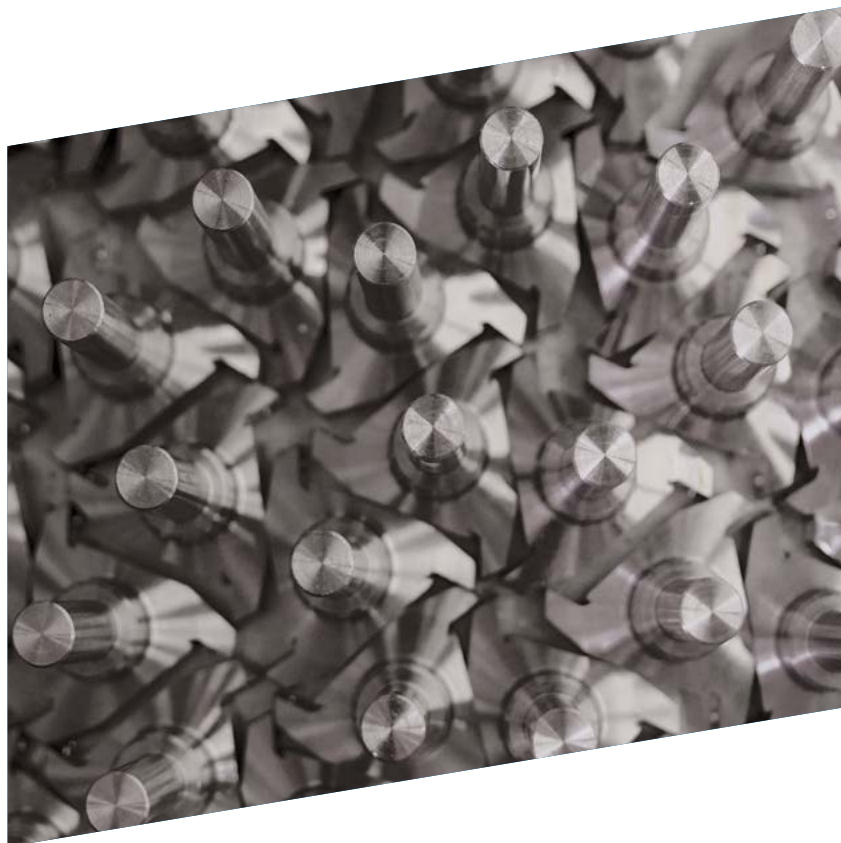
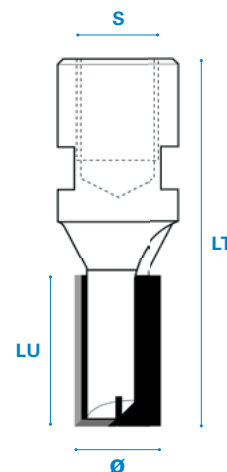

INDICE | INDEX

UTENSILI SAGOMATI PER PANTOGRAFI PORTATILI

PROFILED TOOLS FOR PORTABLE ROUTERS

PROFILFRÄSER FÜR HANDBERFRÄSER

FRAISES AVEC TRANCHANT PROFILÉ POUR DÉFONCEUSES PORTATIVES

E

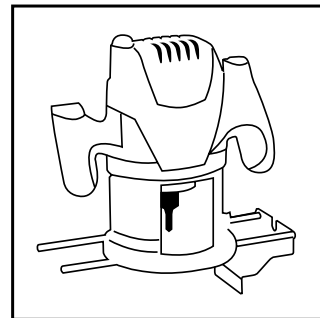

211

FRESA A RAGGIO CONCAVO - M12 Elu®

Roundover router bit - M12 Elu®

Viertelstabfräser - M12 Elu®

Mèche 1/4 de rond - M12 Elu®



R	Ø	LU	LT	S	CODE
4	20	10	60	M12 x 1	211.040.00.28
5	22	12	60	M12 x 1	211.050.00.28
6	24	13	60	M12 x 1	211.060.00.28
8	28	15	60	M12 x 1	211.080.00.28
10	32	17	60	M12 x 1	211.100.00.28
12,5	37	20	60	M12 x 1	211.125.00.28
15	42	23	60	M12 x 1	211.150.00.28
20	52	27	70	M12 x 1	211.200.00.28

€

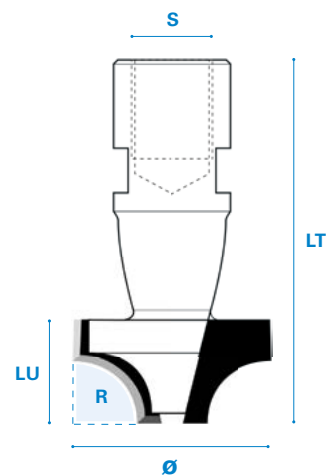
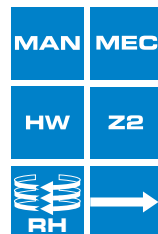

88

212

**FRESA A RAGGIO CONCAVO
CON CUSCINETTO - M12 Elu®**

Roundover router bit with ball bearing - M12 Elu®

Viertelstabfräser mit Kugellager - M12 Elu®

Mèche 1/4 de rond avec roulement - M12 Elu®



R	Ø	LU	LT	S	CODE
6	26	13	60	M12 x 1	212.060.00.28
7,5	29	15	60	M12 x 1	212.075.00.28
10	34	17	60	M12 x 1	212.100.00.28
15	44	19	60	M12 x 1	212.150.00.28
20	57	27	70	M12 x 1	212.200.00.28

€

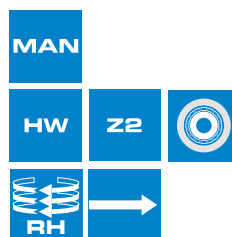

Ricambi - Spare parts - Ersatzteile - Pièces de rechange	CODE
Ø13/5 H4	904.130.05.00
R20 Ø16/6 H5	904.160.05.00
d3,2 D7 S0,5	905.030.07.05
R20 d4,3 D9 S0,8	905.040.09.08
Ø 2,5 M3x6	902.030.06.00
R20 Ø 3 M4x8	902.040.08.00

Optional	CODE
Ø 2,5	903.025.00.00
R20 Ø 3	903.030.00.00

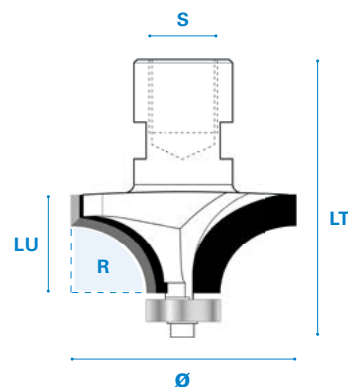

213

FRESA A RAGGIO CONVESSO - M12 Elu®

Core box router bit - M12 Elu®

Hohlkehlfräser - M12 Elu®

Mèche à gorge - M12 Elu®



R	Ø	LU	LT	S	CODE
8	16	18	60	M12 x 1	213.080.00.28
10	20	18	60	M12 x 1	213.100.00.28
12,5	25	18	60	M12 x 1	213.125.00.28
15	30	18	60	M12 x 1	213.150.00.28

€

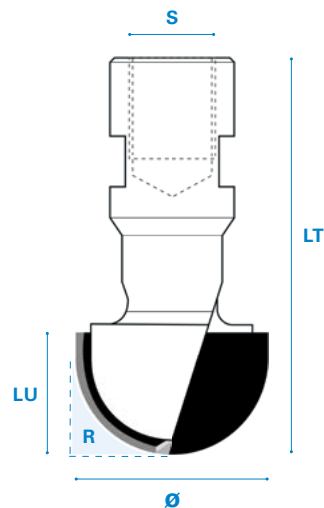
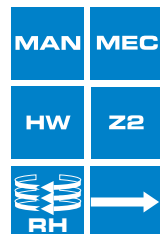

89

214

**FRESA A RAGGIO CONVESSO
CON CUSCINETTO - M12 Elu®**

Cove router bit with ball bearing - M12 Elu®



Hohlkehlfräser mit Kugellager - M12 Elu®

Mèche à gorge avec roulement - M12 Elu®



R	Ø	LU	LT	S	CODE
6	25	18	60	M12 x 1	214.060.00.28
7,5	28	18	60	M12 x 1	214.075.00.28
10	33	18	60	M12 x 1	214.100.00.28

€

Ricambi - Spare parts - Ersatzteile - Pièces de rechange	CODE
 Ø13/5 H4	904.130.05.00
 d3,2 D7 S0,5	905.030.07.05
 Ø 2,5 M3x6	902.030.06.00



Optional	CODE
 Ø 2,5	903.025.00.00

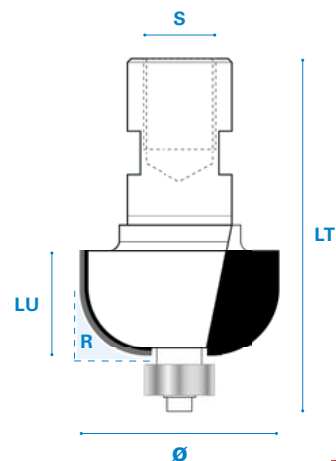
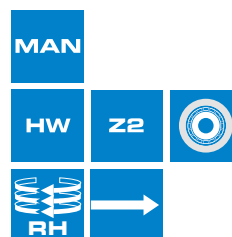

518

FRESA A RAGGIO CONVESSO CON CUSCINETTO

Cove router bit with ball bearing
Hohlkehlfräser mit Kugellager
Mèche à gorge avec roulement



R	Ø	LU	LT	S	CODE
5	20	12	50	6 x 30	518.050.00600
6	22	14	50	6 x 30	518.060.00600
8	26	16	60	6 x 30	518.080.00600
10	30	18	60	6 x 30	518.100.00600
5	20	12	50	8 x 30	518.050.00800
6	22	14	50	8 x 30	518.060.00800
8	26	16	60	8 x 30	518.080.00800
10	30	18	60	8 x 30	518.100.00800
12,7	30	18	60	8 x 30	518.127.00800



Ricambi - Spare parts - Ersatzteile - Pièces de rechange	CODE
Ø13/5 H4	904.130.05.00
d3,2 D7 S0,5	905.030.07.05
Ø 2,5 M3x6	902.030.06.00



Optional	CODE
Ø 2,5	903.025.00.00

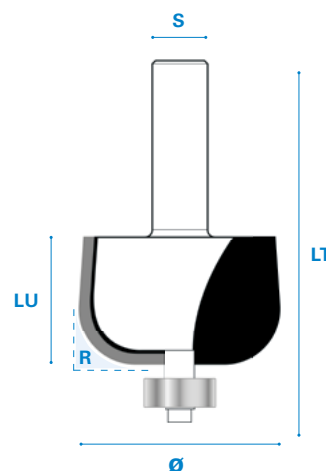
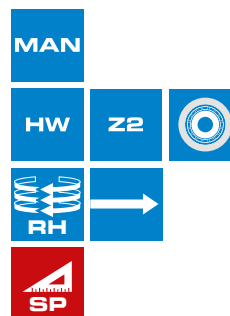

90

519

FRESA A RAGGIO CONCAVO CON CUSCINETTO

Roundover router bit with ball bearing
Viertelstabfräser mit Kugellager
Mèche 1/4 de rond avec roulement



R	Ø	LU	LT	S	CODE
2	15	9	45	6 x 30	519.020.00600
3	17	9	45	6 x 30	519.030.00600
4	19	10	50	6 x 30	519.040.00600
5	21	12	50	6 x 30	519.050.00600
6	23	13	50	6 x 30	519.060.00600
8	27	15	55	6 x 30	519.080.00600
10	31	17	55	6 x 30	519.100.00600
2	15	9	45	8 x 30	519.020.00800
3	17	9	45	8 x 30	519.030.00800
4	19	10	50	8 x 30	519.040.00800
5	21	12	50	8 x 30	519.050.00800
6	23	13	50	8 x 30	519.060.00800
8	27	15	55	8 x 30	519.080.00800
10	31	17	55	8 x 30	519.100.00800
12,7	36,4	19	60	8 x 30	519.127.00800
15	41	21	60	8 x 30	519.150.00800
20	54	26	70	8 x 30	519.200.00800
5	21	12	65	12 x 40	519.050.01200
6	23	13	65	12 x 40	519.060.01200
8	27	15	70	12 x 40	519.080.01200
10	31	17	70	12 x 40	519.100.01200
12,7	36,4	19	75	12 x 40	519.127.01200
15	41	21	75	12 x 40	519.150.01200
20	54	26	80	12 x 40	519.200.01200



Ricambi - Spare parts - Ersatzteile - Pièces de rechange	CODE	
R2→12,7	Ø10/5 H4	904.100.05.00
R15→20	Ø13/5 H4	904.130.05.00
	d3,2 D7 S0,5	905.030.07.05
	Ø 2,5 M3x6	902.030.06.00
	Ø 2,5	903.025.00.00

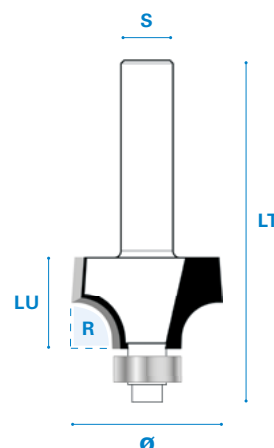
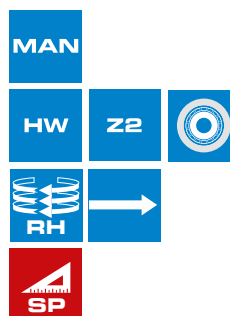

533

FRESA A RAGGIO CONVESSO

Core box router bit
Hohlkehlfräser
Mèche à gorge



	R	Ø	LU	LT	S	CODE
HWM	3	6	12	50	6 x 30	533.030.00600
HWM	4	8	13	50	6 x 30	533.040.00600
	5	10	15	50	6 x 30	533.050.00600
	6	12	15	50	6 x 30	533.060.00600
	8	16	16	50	6 x 30	533.080.00600
	10	20	18	50	6 x 30	533.100.00600
HWM	3	6	12	50	8 x 30	533.030.00800
HWM	4	8	13	50	8 x 30	533.040.00800
	5	10	15	50	8 x 30	533.050.00800
	6	12	15	50	8 x 30	533.060.00800
	8	16	16	50	8 x 30	533.080.00800
	10	20	18	50	8 x 30	533.100.00800
	5	10	15	60	12 x 40	533.050.01200
	6	12	15	60	12 x 40	533.060.01200
	8	16	16	60	12 x 40	533.080.01200
	10	20	18	60	12 x 40	533.100.01200
	15	30	18	60	12 x 40	533.150.01200

€

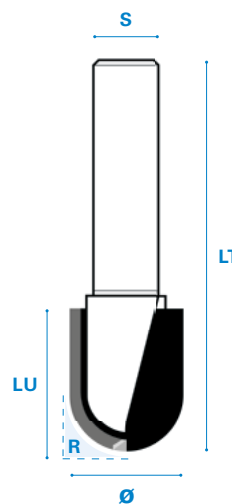
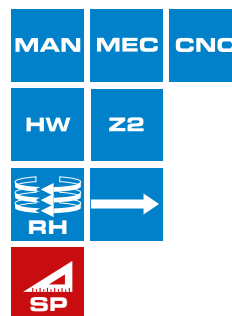

91

533 B

FRESA A RAGGIO CONVESSO
CON COLTELLI REVERSIBILI

Core box router bit with reversible knives
Hohlkehlfräser mit Wendemesser
Mèche à gorge à plaquettes réversibles



	R	Ø	LU	LT	S	CODE
	7	14	29	75	8 x 30	533B.070.00800
	7,5	15	29	75	8 x 30	533B.075.00800
	8	16	29	75	8 x 30	533B.080.00800
	9	18	29	75	8 x 30	533B.090.00800
	10	20	29	75	8 x 30	533B.100.00800
	11	22	29	75	8 x 30	533B.110.00800
	7	14	29	80	12 x 40	533B.070.01200
	7,5	15	29	80	12 x 40	533B.075.01200
	8	16	29	80	12 x 40	533B.080.01200
	9	18	29	80	12 x 40	533B.090.01200
	10	20	29	80	12 x 40	533B.100.01200
	11	22	29	80	12 x 40	533B.110.01200
	12	24	29	80	12 x 40	533B.120.01200

€

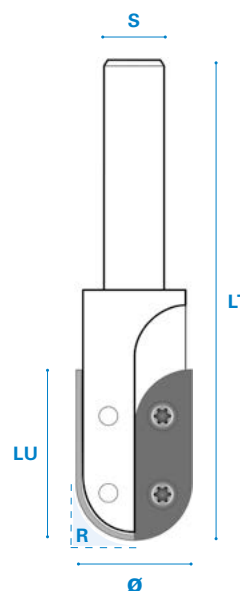
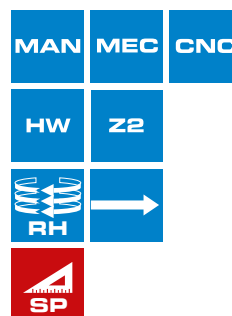

	Ricambi - Spare parts - Ersatzteile - Pièces de rechange	CODE
XCB	Z4 R7 29x7x1,5	901.533B.07.CV
XCB	Z4 R7,5 29x7,5x1,5	901.533B.75.CV
XCB	Z4 R8 29x8x1,5	901.533B.08.CV
XCB	Z4 R9 29x9x1,5	901.533B.09.CV
XCB	Z4 R10 29x10x1,5	901.533B.10.CV
XCB	Z4 R11 29x11x1,5	901.533B.11.CV
XCB	Z4 R12 29x12x1,5	901.533B.12.CV
	R7-R7,5 TORX®15 M3,5x4 D6 L6	902.035.04.60
	R8→12 TORX®15 M4x6 D5,6 L7,8	902.040.06.58
	Optional TORX®15	903.150.00.00



536

FRESA A RAGGIO CONCAVO

Roundover router bit
Viertelstabfräser
Mèche 1/4 de rond



R	Ø	LU	LT	S	CODE
3	15	8	40	6 x 30	536.030.00600
4	17	10	40	6 x 30	536.040.00600
5	19	11	40	6 x 30	536.050.00600
6	21	13	45	6 x 30	536.060.00600
8	25	15	45	6 x 30	536.080.00600
10	29	17	45	6 x 30	536.100.00600
3	15	8	40	8 x 30	536.030.00800
4	17	10	40	8 x 30	536.040.00800
5	19	11	40	8 x 30	536.050.00800
6	21	13	45	8 x 30	536.060.00800
8	25	15	45	8 x 30	536.080.00800
10	29	17	45	8 x 30	536.100.00800
15	42	19	50	8 x 30	536.150.00800
5	19	11	50	12 x 40	536.050.01200
6	21	13	50	12 x 40	536.060.01200
8	25	15	60	12 x 40	536.080.01200
10	29	17	60	12 x 40	536.100.01200
15	42	19	70	12 x 40	536.150.01200

€

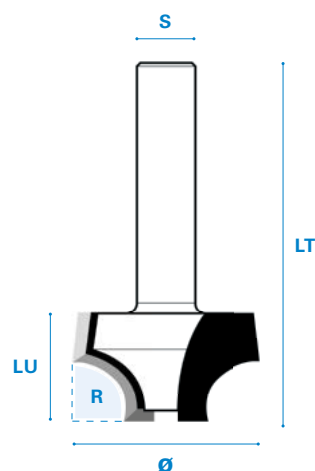
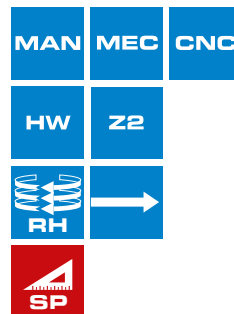

92

536 B

FRESA A RAGGIO CONCAVO
CON COLTELLI REVERSIBILI

Roundover router bit with reversible knives
Viertelstabfräser mit Wendemesser
Mèche 1/4 de rond à plaquettes réversibles



R	Ø	LU	LT	S	CODE
2	26	19,5	65	8 x 30	536B.020.0800
3	26	19,5	65	8 x 30	536B.030.0800
4	26	19,5	65	8 x 30	536B.040.0800
5	26	19,5	65	8 x 30	536B.050.0800
6	32	24,5	70	8 x 30	536B.060.0800
8	32	24,5	70	8 x 30	536B.080.0800
2	26	19,5	75	12 x 40	536B.020.0120
3	26	19,5	75	12 x 40	536B.030.0120
4	26	19,5	75	12 x 40	536B.040.0120
5	26	19,5	75	12 x 40	536B.050.0120
6	32	24,5	80	12 x 40	536B.060.0120
8	32	24,5	80	12 x 40	536B.080.0120

€

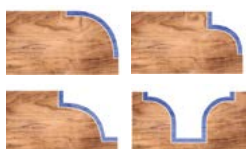
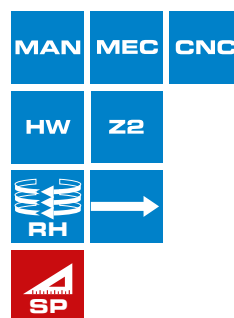

Ricambi - Spare parts - Ersatzteile - Pièces de rechange	CODE
XEB Z4 R2 19,5x9x1,5	901.536.02.CO
XEB Z4 R3 19,5x9x1,5	901.536.03.CO
XEB Z4 R4 19,5x9x1,5	901.536.04.CO
XEB Z4 R5 19,5x9x1,5	901.536.05.CO
XEB Z4 R6 24,5x12x1,5	901.536.06.CO
XEB Z4 R8 24,5x12x1,5	901.536.08.CO
R2→5 TORX®15 M4x6 D5,6 L7,8	902.040.06.58
R6→8 TORX®15 M4x6 D9 L8	902.040.06.90

Optional	CODE
TORX®15	903.150.00.00

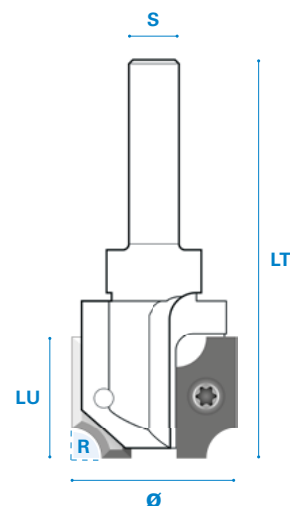

542

FRESA A MEZZO TONDO

Half round router bit
Halbstabfräser
Mèche ½ rond



R	∅	LU	LT	S	CODE
4	17	15	45	6 x 30	542.040.00600
5	21	18	50	6 x 30	542.050.00600
6	24	20	50	6 x 30	542.060.00600
8	30	24	55	6 x 30	542.080.00600
4	17	15	45	8 x 30	542.040.00800
5	21	18	50	8 x 30	542.050.00800
6	21	20	50	8 x 30	542.060.00800
8	30	24	55	8 x 30	542.080.00800

€

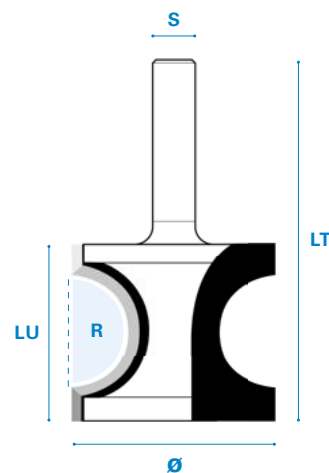
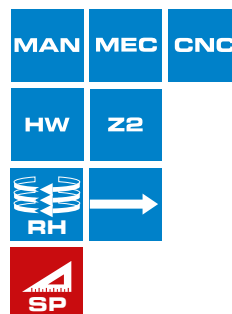

93

550

FRESA A RAGGIO CONCAVO/SMUSSO CON COLTELLI REVERSIBILI E CUSCINETTO

Roundover/chamfer router bit with reversible knives and ball bearing
Fase/Viertelstabfräser mit Wendemesser und Kugellager
Mèche 1/4 de rond/à chanfreiner à plaquettes réversibles avec roulement



R	a	∅	LU	LT	S	CODE
1,5	45°	28	7	60	8 x 30	550.150.00800
2	45°	28	7	60	8 x 30	550.200.00800
2,5	45°	28	7	60	8 x 30	550.250.00800
3	45°	28	7	60	8 x 30	550.300.00800

€

Ricambi - Spare parts - Ersatzteile - Pièces de rechange				CODE
		R1,5/45°	12x12x1,5	901.550.15.CO
		R2/45°	12x12x1,5	901.550.02.CO
		R2,5/45°	12x12x1,5	901.550.25.CO
		R3/45°	12x12x1,5	901.550.03.CO
		TORX®15 M4x6 D9 L8		902.040.06.90
		∅13/5 H4		904.130.05.00
		d3,2 D7 S0,5		905.030.07.05
		∅ 2,5 M3x6		902.030.06.00



Optional	CODE
	TORX®15 903.150.00.00
	∅ 2,5 903.025.00.00

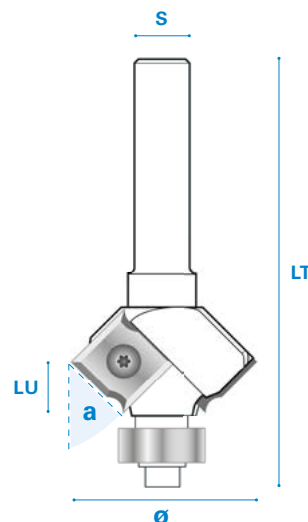
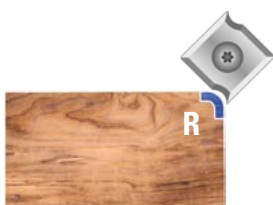
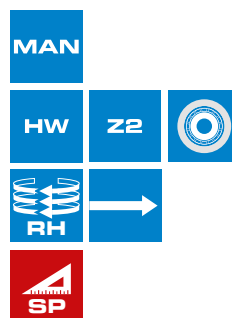

581

FRESA A RAGGIO CONCAVO CON COLTELLI REVERSIBILI E CUSCINETTO

Roundover router bit with reversible knives and ball bearing
Viertelstabfräser mit Wendemesser und Kugellager
Mèche 1/4 de rond à plaquettes réversibles avec roulement



R	Ø	d	LU	LT	B	S	CODE
2	26	22-16	19,5	75	0-3	8 x 30	581.020.00800
3	26	20-16	19,5	75	0-2	8 x 30	581.030.00800
4	26	18-13	19,5	75	0-2,5	8 x 30	581.040.00800
5	26	16-13	19,5	75	0-1,5	8 x 30	581.050.00800
6	32	20-10	24,5	80	0-5	8 x 30	581.060.00800
8	32	16-10	24,5	80	0-3	8 x 30	581.080.00800
2	26	22-16	19,5	85	0-3	12 x 40	581.020.01200
3	26	20-16	19,5	85	0-2	12 x 40	581.030.01200
4	26	18-13	19,5	85	0-2,5	12 x 40	581.040.01200
5	26	16-13	19,5	85	0-1,5	12 x 40	581.050.01200
6	32	20-10	24,5	90	0-5	12 x 40	581.060.01200
8	32	16-10	24,5	90	0-3	12 x 40	581.080.01200

€

Ricambi - Spare parts - Ersatzteile - Pièces de rechange				CODE
	Z4	R2	19,5x9x1,5	901.581.02.CO
	Z4	R3	19,5x9x1,5	901.581.03.CO
	Z4	R4	19,5x9x1,5	901.581.04.CO
	Z4	R5	19,5x9x1,5	901.581.05.CO
	Z4	R6	24,5x12x1,5	901.581.06.CO
	Z4	R8	24,5x12x1,5	901.581.08.CO
	R2→5	TORX®15 M4x4 D5,6 L6,2		902.040.04.58
	R6→8	TORX®15 M4x6 D9 L8		902.040.06.90
	d22	Delrin®		904.220.00.05
	d20	Delrin®		904.200.00.05
	d18	Delrin®		904.180.00.05
		Ø16/5 H5		904.160.05.00
		Ø13/5 H4		904.130.05.00
		Ø10/5 H4		904.100.05.00
		d3,2 D7 S0,5		905.030.07.05
		Ø 2,5 M3x6		902.030.06.00

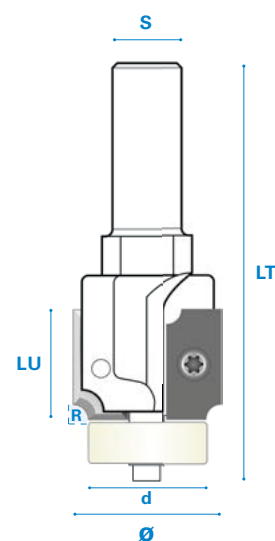
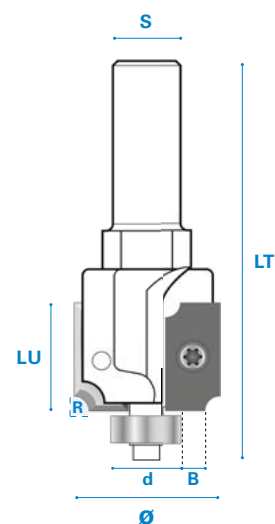
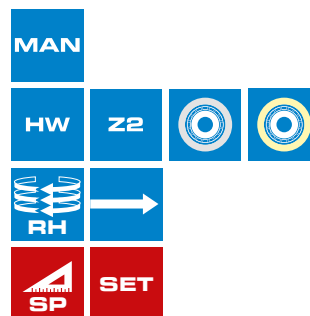

Optional	CODE
	TORX®15 903.150.00.00
	Ø 2,5 903.025.00.00



582

FRESA A RAGGIO CONVESSO A COLTELLI REVERSIBILI CON CUSCINETTO

Cove router bit with reversible knives and ball bearing
Hohlkehlfräser mit Wendemesser und Kugellager
Mèche à gorge à plaquettes réversibles avec roulement



R	Ø	d	LU	LT	S	CODE
5	26	16	19,5	75	8 x 30	582.050.00800
6	32	16	24,5	80	8 x 30	582.060.00800
8	32	16	24,5	80	8 x 30	582.080.00800
5	26	16	19,5	85	12 x 40	582.050.01200
6	32	16	24,5	90	12 x 40	582.060.01200
8	32	16	24,5	90	12 x 40	582.080.01200

Ricambi - Spare parts - Ersatzteile - Pièces de rechange						CODE
--	--	--	--	--	--	------

	Z4	R5	19,5x9x1,5	901.582.05.CV
	Z4	R6	24,5x12x1,5	901.582.06.CV
	Z4	R8	24,5x12x1,5	901.582.08.CV
			Ø16/5 H5	904.160.05.00
			d3,2 D7 S0,5	905.030.07.05
		R5	TORX®15 M4x6 D5,6 L7,8	902.040.06.58
		R6-8	TORX®15 M4x6 D9 L8	902.040.06.90
			Ø 2,5 M3x6	902.030.06.00

Optional		CODE
	TORX®15	903.150.00.00
	Ø 2,5	903.025.00.00

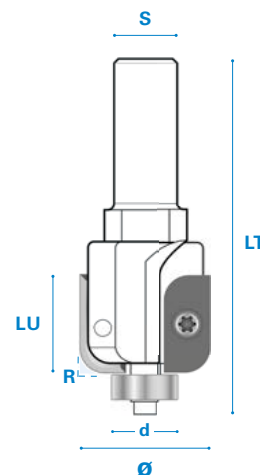
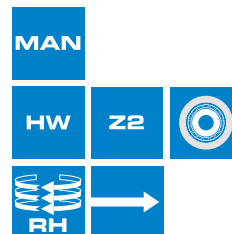

95

586

FRESA A RAGGIO CONCAVO A COLTELLI CON CUSCINETTO

Roundover router bit with knives and ball bearing
Viertelstabfräser mit Wechselplatten und Kugellager
Mèche 1/4 de rond à plaquettes avec roulement



R	Ø	LU	LT	S	CODE
10	39	20	70	8 x 30	586.100.00800
12	43	20	70	8 x 30	586.120.00800
10	39	20	80	12 x 40	586.100.01200
12	43	20	80	12 x 40	586.120.01200
15	49	25	85	12 x 40	586.150.01200

Ricambi - Spare parts - Ersatzteile - Pièces de rechange						CODE
--	--	--	--	--	--	------

	Z2	R10		901.586.10.CO
	Z2	R12		901.586.12.CO
	Z2	R15		901.586.15.CO
			Ø19/6 H6	904.190.06.00
		R10	TORX®15 M4x4 D5,6 L6,2	902.040.06.58
		R12→15	TORX®15 M4x6 D9 L8	902.040.06.90
			d4,3 D9 S0,8	905.040.09.08
			Ø 3 M4x8	902.040.08.00

Optional		CODE
	TORX®15	903.150.00.00
	Ø 3	903.030.00.00

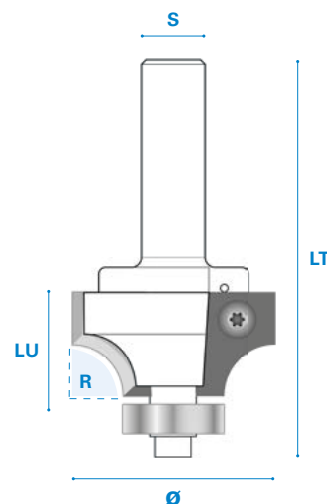
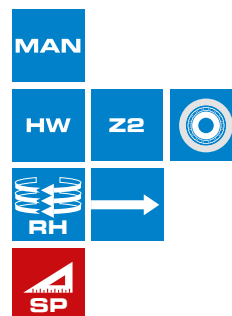

587

FRESA A RAGGIO CONVESSO A COLTELLI CON CUSCINETTO

Cove router bit with knives and ball bearing
Hohlkehlfräser mit Wechselplatten und Kugellager
Mèche à gorge à plaquettes avec roulement



R	Ø	LU	LT	S	CODE
10	39	18	53	8 x 30	587.100.00800
12	43	18	56	8 x 30	587.120.00800
10	39	18	63	12 x 40	587.100.01200
12	43	18	66	12 x 40	587.120.01200
15	49	23	71	12 x 40	587.150.01200

Ricambi - Spare parts - Ersatzteile - Pièces de rechange				CODE
	Z2	R10		901.587.10.CV
	Z2	R12		901.587.12.CV
	Z2	R15		901.587.15.CV
			Ø16/6 H6	904.190.06.00
		R10	TORX®15 M4x6 D5,6 L7,8	902.040.06.58
		R12→15	TORX®15 M4x6 D9 L8	902.040.06.90
			d4,3 D9 S0,8	905.040.09.08
			Ø 3 M4x8	902.040.08.00

Optional		CODE
	TORX®15	903.150.00.00
	Ø 3	903.030.00.00

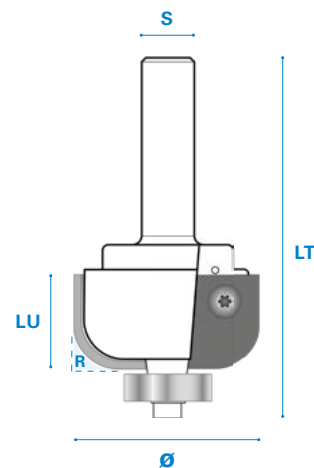
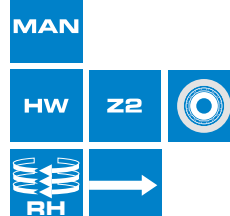

96

588

FRESA A RAGGIO CONCAVO A COLTELLI

Roundover router bit with knives
Viertelstabfräser mit Wechselplatten
Mèche 1/4 de rond à plaquettes



R	Ø	LU	LT	S	CODE
8	30	18	70	12 x 40	588.080.01200
10	30	18	70	12 x 40	588.100.01200
12	30	18	70	12 x 40	588.120.01200
15	40	23	75	12 x 40	588.150.01200

Ricambi - Spare parts - Ersatzteile - Pièces de rechange				CODE
	Z2	R8		901.588.08.CO
	Z2	R10		901.588.10.CO
	Z2	R12		901.588.12.CO
	Z2	R15		901.588.15.CO
			TORX®15 M4x6 D5,6 L7,8	902.040.06.58
			TORX®15	903.002.15.00
Optional		CODE		
	TORX®15	903.150.00.00		

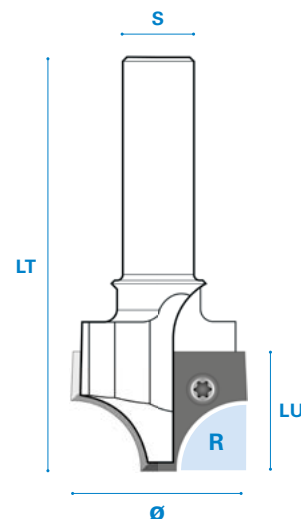
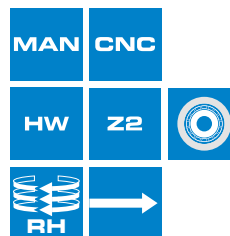

INDICE | INDEX

UTENSILI PER PLASTICA, ALLUMINIO E ALTRI MATERIALI

TOOLS FOR PLASTIC, ALUMINUM AND OTHER MATERIALS
WERKZEUGE FÜR PLASTIK, ALUMINIUM UND ANDERE MATERIALIEN
OUTILLAGE POUR PLASTIQUE, ALUMINIUM ET AUTRES MATÉRIAUX

F

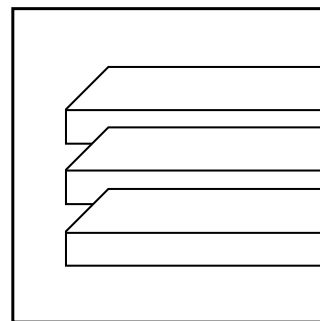

7050

**FRESA ELICOIDALE LAPPATA
PER PLASTICA E PLEXIGLASS**

Polished spiral bit for plastic and plexiglass
Polierte einzahn-Fräser für plastik und plexiglas
Fraise Hélicoidale rodée à copier pour plastique et plexiglass



DESTRA POSITIVA
 Right-hand / Up-cut
 Rechtslauf / Positive
 Droite / Positives

Ø	LU	LT	S	CODE	€
2	8	40	2	7050.020.08D8	
3	12	50	3	7050.030.12D8	
4	12	50	4	7050.040.12D8	
4	30	70	4	7050.040.30D8	
5	16	50	5	7050.050.16D8	
5	30	70	5	7050.050.30D8	
6	20	60	6	7050.060.20D8	
6	30	70	6	7050.060.30D8	
8	22	70	8	7050.080.22D8	
8	32	80	8	7050.080.32D8	
10	22	70	10	7050.100.22D8	
10	32	80	10	7050.100.32D8	
12	32	80	12	7050.120.32D8	

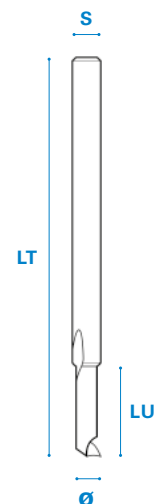
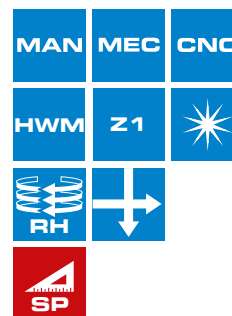

98

7060

**FRESA ELICOIDALE LAPPATA
PER ALLUMINIO**

Polished spiral bit for ALU
Polierte einzahn-Fräser für ALU
Fraise Hélicoidale rodée à copier pour ALU



DESTRA POSITIVA
 Right-hand / Up-cut
 Rechtslauf / Positive
 Droite / Positives

Ø	LU	LT	S	CODE	€
2	8	40	2	7060.020.08D8	
3	12	50	3	7060.030.12D8	
4	12	50	4	7060.040.12D8	
4	30	70	4	7060.040.30D8	
5	16	50	5	7060.050.16D8	
5	30	70	5	7060.050.30D8	
6	20	60	6	7060.060.20D8	
6	30	70	6	7060.060.30D8	
8	22	70	8	7060.080.22D8	
8	32	80	8	7060.080.32D8	
10	22	70	10	7060.100.22D8	
10	32	80	10	7060.100.32D8	
12	32	80	12	7060.120.32D8	

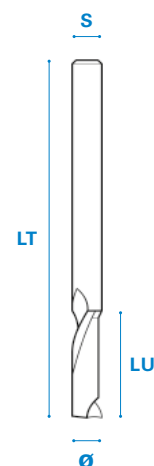
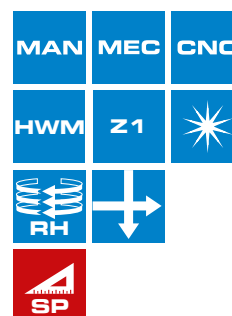

7070

**FRESA ELICOIDALE LAPPATA
PER METALLI NON FERROSI**

Polished spiral bit for non-ferrous metals
Polierte einzahn-Fräser für Nichteisenmetall
Fraise Hélicoidale rodée à copier pour métal non ferreux



DESTRA POSITIVA
Right-hand / Up-cut
Rechtslauf / Positive
Droite / Positives

Ø	LU	LT	S	CODE
2	8	40	2	7070.020.08D8
3	12	50	3	7070.030.12D8
4	12	50	4	7070.040.12D8
4	30	70	4	7070.040.30D8
5	16	50	5	7070.050.16D8
5	30	70	5	7070.050.30D8
6	20	60	6	7070.060.20D8
6	30	70	6	7070.060.30D8
8	22	70	8	7070.080.22D8
8	32	80	8	7070.080.32D8
10	22	70	10	7070.100.22D8
10	32	80	10	7070.100.32D8
12	32	80	12	7070.120.32D8

€

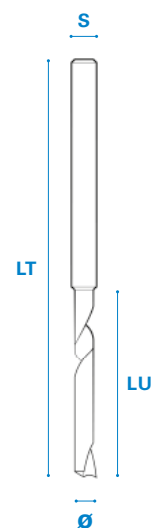
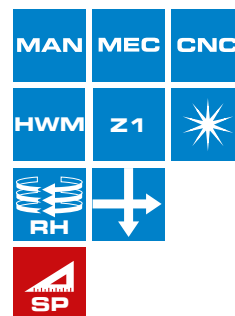

99

7071

**FRESA ELICOIDALE LAPPATA
PER METALLI NON FERROSI**

Polished spiral bit for non-ferrous metals
Polierte einzahn-Fräser für Nichteisenmetall
Fraise Hélicoidale rodée à copier pour métal non ferreux



DESTRA POSITIVA
Right-hand / Up-cut
Rechtslauf / Positive
Droite / Positives

Ø	LU	LT	S	CODE
3	10/20	60	3	7071.030.10D8
4	10/30	60	4	7071.040.10D8
5	15/40	70	5	7071.050.15D8
6	15/45	80	6	7071.060.15D8
8	15/45	80	8	7071.080.15D8
10	20/45	80	10	7071.100.20D8
12	20/45	80	12	7071.120.20D8

€

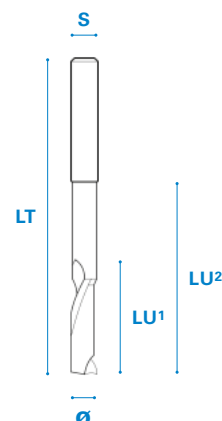
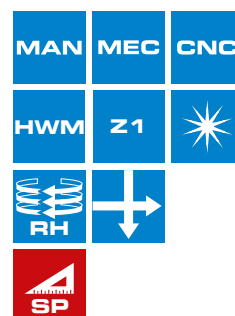

7080

FRESA PER SCANALATURE A V E FOLDING PER PANNELLI COMPOSITI ALU

V-groove and Folding router bit for ALU sandwich panels
V-Nut und Foldingfräser für ALU-Verbundplatten
Fraise à rainier en V et Folding pour ALU panneaux composites

Alucobond® - Alucore® - Alupanel LITE® - Dibond®
Etalbond® - Forex® - Imagebond® - Naturalbond® - Redbond®

a	Ø	d	LU	LT	S	CODE
90°	20	3	8,8	8 x 35		7080.090.0800
135°	20	2	4,1	8 x 35		7080.135.0800

€

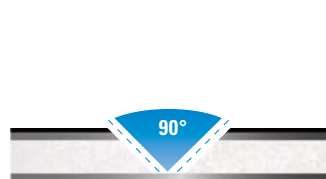

3 mm



2 mm

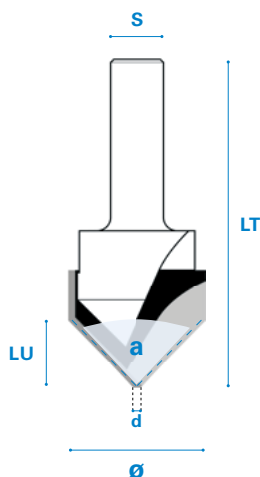
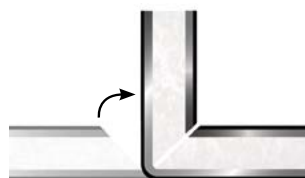

LU

LT

Ø

100

7083

FRESA PER SCANALATURE A V E FOLDING PER CARTONGESSO

V-groove and Folding router bit for PLASTERBOARD
V-Nut und Foldingfräser für TROCKENWAND
Fraise à rainier en V et Folding pour CLOISON SÈCHE

a	Ø	LU	LT	S	CODE
90°	32	18	50	8 x 30	7083.090.0800

€

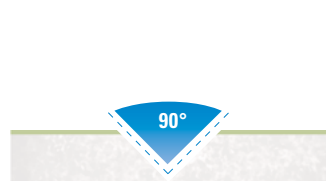

90°

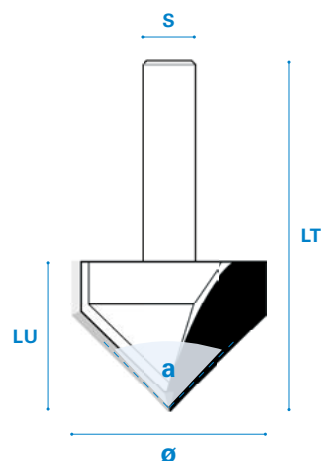
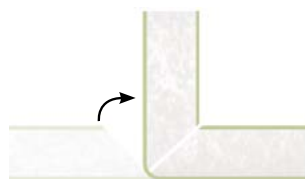

LU

LT

Ø

MAN MEC CNC

HW Z2



7091

**FRESA PER SCANALATURE A V
E SCRITTURA IN METALLO DURO INTEGRALE**

Solid carbide V-groove and lettering router bit
V-Nut und Schriftenfräser aus Vollhartmetall
Fraise à rainier en V, à graver carbure monobloc



Z2

Z3

a	Ø	LU	LT	Z	S	CODE
60°	8	7	60	2	8	7091.060.0800
60°	8	7	45	3	8	7091.060.08Z3
90°	8	4	60	2	8	7091.090.0800

€

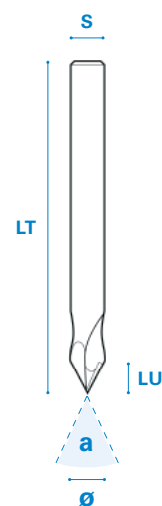
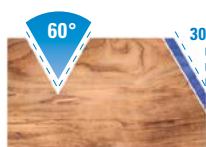
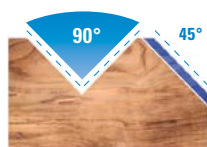
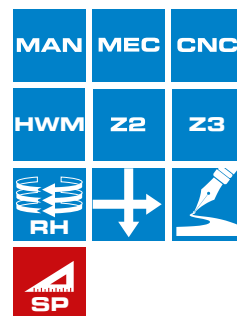

101

7091B

FRESA PER SCANALATURE A V E SCRITTURA

V-groove and lettering router bit
V-Nut und Schriftenfräser
Fraise à rainier en V, à graver



a	LU	LT	S	CODE
60	9,5	55	8 x 30	7091B.060.080

€

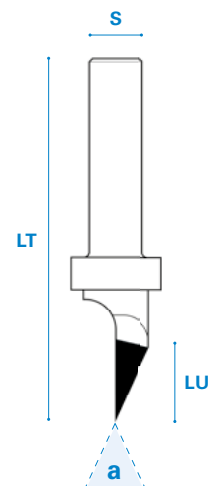
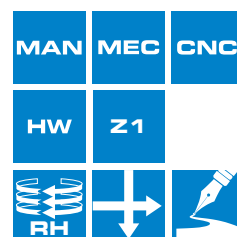

INDICE | INDEX

RICAMBI

SPARE PARTS

ERSATZTEILE

PIÈCES DE RECHANGE

Z

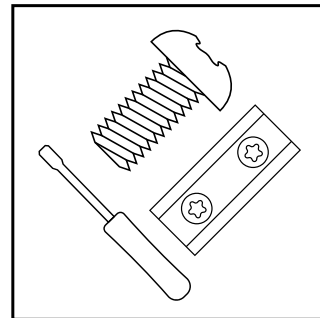

219
p.104



249
p.104



250
p.104



320
p.105



321
p.105



322
p.105



338
p.106



351
p.106



730
p.107



740
p.107



750
p.107



760
p.107

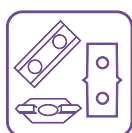

901
p.108



902
p.111



903
p.112



904
p.113



905
p.114



907
p.114



909
p.114

219

ATTACCO PER PUNTE

Arbor
Aufnahmedorn
Rallonge filetée

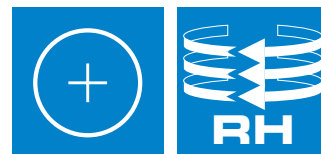

M	LT	S	CODE
M12 x 1	40	12 x 25	219.000.00.00

€

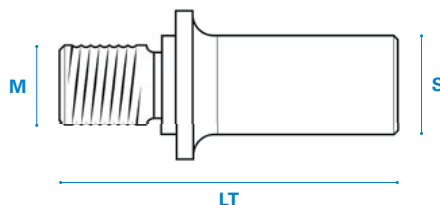

249

ADATTATORE

Adapter
Adapter
Pièce de réduction intermédiaire



M	LT	S	CODE
M12 x 1	25	M12 x 1	249.012.12.00
M12 x 1	25	M10 x 1,5	249.012.10.00
M10 x 1,5	25	M10 x 1,5	249.010.10.00
M10 x 1,5	25	M12 x 1	249.010.12.00

€

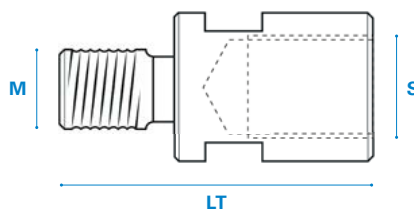

104

250

MANDRINO PER ELETTROFRESATRICI

Chuck for routers
Aufnahmedorn
Mandrin porte-mèche



Ø	LT	S	CODE
6	45	M10 x 1,5	250.006.10.00
8	45	M10 x 1,5	250.008.10.00
10	45	M10 x 1,5	250.010.10.00
6	45	M12 x 1	250.006.12.00
8	45	M12 x 1	250.008.12.00
10	45	M12 x 1	250.010.12.00

€

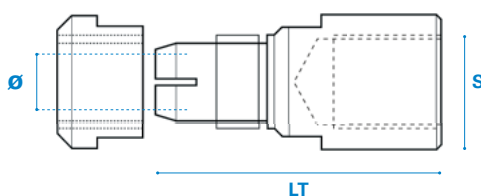

320

ATTACCO CILINDRICO CON PIANO DI SERRAGGIO

Cylindrical shank with flat
 Zylindrischer schaft mit spanfläche
 Pièce de réduction intermédiaire droite avec méplat sur la queue



RH	M	LT	S	CODE
	M12 x 1	27	10	320.000.27.08
	M12 x 1	40	10	320.000.40.08

LH	M	LT	S	CODE
	M12 x 1	27	10	320.000.27.09
	M12 x 1	40	10	320.000.40.09

Ricambi - Spare parts - Ersatzteile - Pièces de rechange			CODE
	M5x10		902.050.10.TA

€

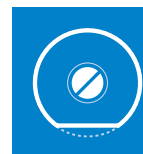

UTILIZZARE CON
 To be used with
 Benutzung mit
 À utiliser avec

323

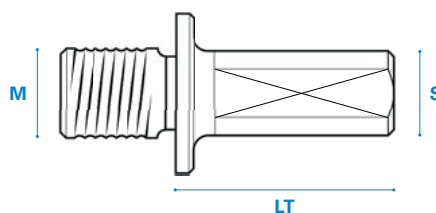

321

ATTACCO CILINDRICO

Cylindrical shank
 Zylindrischer schaft
 pièce de réduction intermédiaire à queue cylindrique



M	LT	S	CODE
M12 x 1	50	8	321.080.00.08
M12 x 1	50	9,5	321.095.00.08
M12 x 1	50	10	321.100.00.08
M12 x 1	50	12	321.120.00.08
M12 x 1	50	13	321.130.00.08
M12 x 1	50	16	321.160.00.08

€



UTILIZZARE CON
 To be used with
 Benutzung mit
 À utiliser avec

323

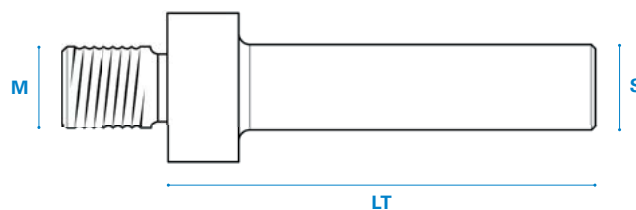

322

ATTACCO CILINDRICO

Cylindrical shank
 Zylindrischer schaft
 pièce de réduction intermédiaire à queue cylindrique



M	LT	S	CODE
M12 x 1	100	10 x 50	322.100.00.08
M12 x 1	100	13 x 50	322.130.00.08
M12 x 1	100	16 x 50	322.160.00.08

€



UTILIZZARE CON
 To be used with
 Benutzung mit
 À utiliser avec

323

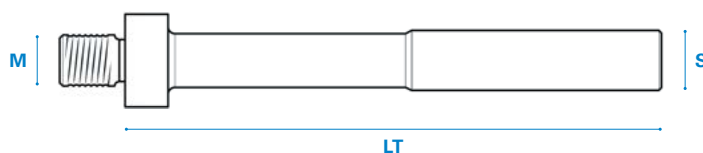

338

BUSSOLA PORTA PUNTE

Bushing for drills
Geschlitzte spannhülse
Douille fendue avec méplat

UTILIZZARE CON **337**
To be used with
Benutzung mit **337 B**
À utiliser avec



Ø	d	LT	CODE
2,5	10	23	338.025.00.08
3	10	23	338.030.00.08
3,2	10	23	338.032.00.08
3,5	10	23	338.035.00.08
4	10	23	338.040.00.08
5	10	23	338.050.00.08
6	10	23	338.060.00.08

€

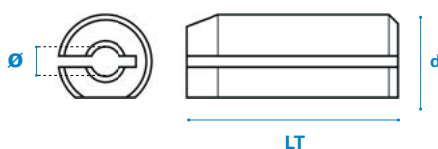

351

MANDRINO PORTA PUNTE CON PIANETTO

Drill holder with flat
Aufnahme mit zylinderschaft
Mandrin porte-mèche avec méplat



UTILIZZARE CON **337**
To be used with
Benutzung mit **337 B**
À utiliser avec



Ø	S	LT	CODE
2	10	35	351.020.00.08
2,5	10	35	351.025.00.08
3	10	35	351.030.00.08
3,2	10	35	351.032.00.08
3,5	10	35	351.035.00.08
4	10	35	351.040.00.08
5	10	35	351.050.00.08

€



Ricambi - Spare parts - Ersatzteile - Pièces de rechange	CODE
 Ø2	○ 2 M4x5 902.040.05.00
	○ 3 M5x5 902.050.05.00

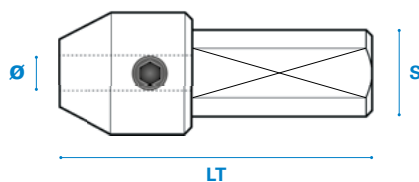

730

PINZA DI SERRAGGIO ER32 – DIN 6499/B

Precision collet ER32 – DIN 6499/B
 Präzisionsspannzangen ER32 – DIN 6499/B
 Pincés de serrage ER32 – DIN 6499/B



ER32	A	B	L	CODE
3-4	33	40	730.040.32.00	
5-6	33	40	730.060.32.00	
7-8	33	40	730.080.32.00	
9-10	33	40	730.100.32.00	
11-12	33	40	730.120.32.00	
13-14	33	40	730.140.32.00	
15-16	33	40	730.160.32.00	
17-18	33	40	730.180.32.00	
19-20	33	40	730.200.32.00	

€

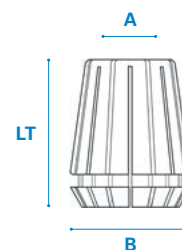
**PINZA DI SERRAGGIO ER40 – DIN 6499/B**

Precision collet ER40 – DIN 6499/B
 Präzisionsspannzangen ER40 – DIN 6499/B
 Pincés de serrage ER40 – DIN 6499/B

740



ER40	A	B	L	CODE
3-4	41	46	740.040.40.00	
5-6	41	46	740.060.40.00	
7-8	41	46	740.080.40.00	
9-10	41	46	740.100.40.00	
11-12	41	46	740.120.40.00	
13-14	41	46	740.140.40.00	
15-16	41	46	740.160.40.00	
17-18	41	46	740.180.40.00	
19-20	41	46	740.200.40.00	
24-25	41	46	740.250.40.00	

€

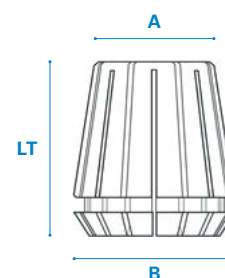
**PINZA DI SERRAGGIO ER25 – DIN 6499/B**

Precision collet ER25 – DIN 6499/B
 Präzisionsspannzangen ER25 – DIN 6499/B
 Pincés de serrage ER25 – DIN 6499/B

750



ER25	A	B	L	CODE
3-4	26	35	750.040.25.00	
5-6	26	35	750.060.25.00	
7-8	26	35	750.080.25.00	
9-10	26	35	750.100.25.00	
11-12	26	35	750.120.25.00	
13-14	26	35	750.140.25.00	
15-16	26	35	750.160.25.00	

€

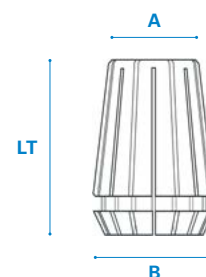
**PINZA DI SERRAGGIO ER20 – DIN 6499/B**

Precision collet ER20 – DIN 6499/B
 Präzisionsspannzangen ER20 – DIN 6499/B
 Pincés de serrage ER20 – DIN 6499/B

760



ER20	A	B	L	CODE
3-4	21	31	760.040.20.00	
5-6	21	31	760.060.20.00	
7-8	21	31	760.080.20.00	
9-10	21	31	760.100.20.00	
11-12	21	31	760.120.20.00	

€

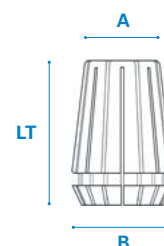

901

COLTELLI

Knives
Wendemeser
Plaquettes

TYPE 1

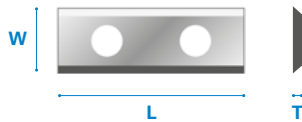

L x W x T	CODE
7,5 x 12 x 1,5	901.075.12.00
9,6 x 12 x 1,5	901.096.12.00
12 x 9 x 1,5	901.120.09.00
20 x 12 x 1,5	901.200.12.00
30 x 12 x 1,5	901.300.12.00
40 x 12 x 1,5	901.400.12.00
50 x 12 x 1,5	901.500.12.00

€

Z2

BOX
10_{pcs}

TYPE 2

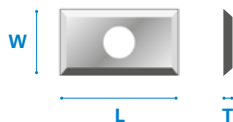

L x W x T	CODE
12 x 12 x 1,5	901.120.12.00
19,5 x 7 x 1,5	901.195.07.00
19,5 x 7,5 x 1,5	901.195.75.00
19,5 x 8 x 1,5	901.195.08.00
19,5 x 9 x 1,5	901.195.09.00
19,5 x 9 x 1,5	2 GROOVES 901.195.09.2G
19,5 x 10 x 1,5	2 GROOVES 901.195.10.2G
19,5 x 11 x 1,5	2 GROOVES 901.195.11.2G
19,5 x 12 x 1,5	901.195.12.00
19,5 x 12 x 1,5	2 GROOVES 901.195.12.2G
24,5 x 12 x 1,5	901.245.12.00
29,5 x 7 x 1,5	901.295.07.00
29,5 x 7,5 x 1,5	901.295.75.00
29,5 x 8 x 1,5	901.295.08.00
29,5 x 9 x 1,5	901.295.09.00
29,5 x 9 x 1,5	2 GROOVES 901.295.09.2G
29,5 x 10 x 1,5	2 GROOVES 901.295.10.2G
29,5 x 11 x 1,5	2 GROOVES 901.295.11.2G
29,5 x 12 x 1,5	2 GROOVES 901.295.12.2G
39,5 x 9 x 1,5	901.395.09.00
39,5 x 12 x 1,5	901.395.12.00
49,5 x 9 x 1,5	901.495.09.00
49,5 x 12 x 1,5	901.495.12.00



Z4

BOX
10_{pcs}

108

TYPE 3



LH

L x W x T	per / for / für / pour	CODE
12 x 12 x 1,5	ART. 158/580 92°	901.120.12.92
19,5 x 12 x 1,5		901.195.12.13
20 x 12 x 1,5	ART. 152	901.200.12.60
29,5 x 9 x 1,5	ART. 513 5°	901.295.09.05
29,5 x 9 x 1,5	ART. 513 10°	901.295.09.10
29,5 x 9 x 1,5	ART. 513 15°	901.295.09.15
29,5 x 12 x 1,5		901.295.12.13
30 x 12 x 1,5	ART. 161 90°	901.300.12.90
31,5 x 9 x 1,5	ART. 235	901.315.09.00
39,5 x 9 x 1,5	ART. 141	901.395.09.02
40 x 12 x 1,5	ART. 161 91°	901.400.12.91
49,5 x 12 x 1,5		901.495.12.09
49,5 x 12 x 1,5		901.495.12.13
50 x 12 x 1,5	ART. 161 45°	901.500.12.45
50 x 12 x 1,5	ART. 161 60°	901.500.12.60

Z4

BOX
10_{pcs}

TYPE 4

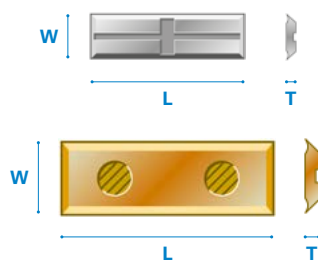

L x W x T	per / for / für / pour	CODE
20 x 5,5 x 1,1	ART. 230	901.200.55.2G
20 x 5,5 x 1,1	ART. 230 TIN	901.200.55.GT
25 x 5,5 x 1,1	ART. 511B	901.250.55.00
30 x 10 x 1,5	ART. 230	901.300.10.2G
30 x 10 x 1,5	ART. 230 TIN	901.300.10.GT
50 x 10 x 1,5	ART. 230 TIN	901.500.10.GT

€



TYPE 5

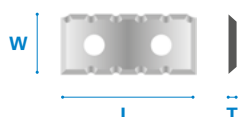

L x W x T	per / for / für / pour	CODE
29,5 x 12 x 1,5		901.295.12.RT
49,5 x 12 x 1,5		901.495.12.RT

TYPE 6



RH	Ø	per / for / für / pour	CODE
	Ø25	ART. 335/336	901.240.13.08
	Ø26	ART. 335/336	901.250.13.08
	Ø30	ART. 335/336	901.290.13.08
	Ø35	ART. 335/336	901.340.13.08

LH	Ø	per / for / für / pour	CODE
	Ø25	ART. 335	901.240.13.09
	Ø26	ART. 335	901.250.13.09
	Ø30	ART. 335	901.290.13.09
	Ø35	ART. 335	901.340.13.09
	Ø40	ART. 335	901.390.13.09

	per / for / für / pour	CODE
	ART. 335/336	901.180.08.00



INCISORI
SPURS
VORSCHNEIDERN
TRAÇOIRS

TYPE 7

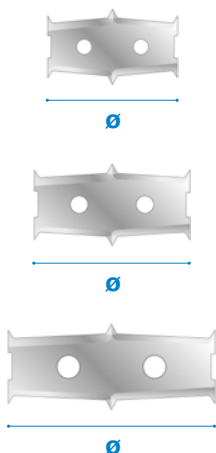

RH	Ø	per / for / für / pour	CODE
	Ø15	ART. 370-1	901.150.01.08
	Ø16	ART. 370-1	901.160.01.08
	Ø17	ART. 370-1	901.170.01.08
	Ø18	ART. 370-1	901.180.01.08
	Ø19	ART. 370-1	901.190.01.08
	Ø20	ART. 370-1	901.200.01.08
	Ø21	ART. 370-1	901.210.01.08
	Ø22	ART. 370-1	901.220.01.08
	Ø23	ART. 370-2	901.230.02.08
	Ø24	ART. 370-2	901.240.02.08
	Ø25	ART. 370-2	901.250.02.08
	Ø26	ART. 370-2	901.260.02.08
	Ø27	ART. 370-2	901.270.02.08
	Ø28	ART. 370-2	901.280.02.08
	Ø29	ART. 370-2	901.290.02.08
	Ø30	ART. 370-2	901.300.02.08
	Ø32	ART. 370-2	901.320.03.08
	Ø33	ART. 370-3	901.330.03.08
	Ø34	ART. 370-3	901.340.03.08
	Ø35	ART. 370-3	901.350.03.08
	Ø36	ART. 370-3	901.360.03.08
	Ø37	ART. 370-3	901.370.03.08
	Ø38	ART. 370-3	901.380.03.08
	Ø40	ART. 370-3	901.400.03.08



TYPE 8

		L x W x T	per / for / für / pour	CODE	€
	60°		ART. 158/580 60°	901.120.12.60	
	R3		ART. 158/580 R3	901.120.03.CO	
	R4		ART. 158/580 R4	901.120.04.CV	
	R5		ART. 158/580 R5	901.120.05.CO	
SET 10x			ART. 170	901.000.00.10	
SET 2x	R2		ART. 170 R2	901.000.02.02	
SET 2x	R3		ART. 170 R3	901.000.03.02	
SET 2x	R4		ART. 170 R4	901.000.04.02	
SET 2x	R5		ART. 170 R5	901.000.05.02	
SET 2x	45°		ART. 170 45°	901.000.45.02	
	R8		ART. 171 R8	901.171.08.CO	
	R10		ART. 171 R10	901.171.10.CO	
	R12		ART. 171 R12	901.171.12.CO	
	R15		ART. 171 R15	901.171.15.CO	
	R20		ART. 171 R20	901.171.20.CO	
	R12		ART. 172 R12	901.172.12.CV	
	R15		ART. 172 R15	901.172.15.CV	
	R20		ART. 172 R20	901.172.20.CV	
	R7	29 x 9 x 1,5	ART. 533B R7	901.533B.07.CV	
	R7,5	29 x 9 x 1,5	ART. 533B R7,5	901.533B.75.CV	
	R8	29 x 9 x 1,5	ART. 533B R8	901.533B.08.CV	
	R9	29 x 9 x 1,5	ART. 533B R9	901.533B.09.CV	
	R10	29 x 9 x 1,5	ART. 533B R10	901.533B.10.CV	
	R11	29 x 9 x 1,5	ART. 533B R11	901.533B.11.CV	
	R12	29 x 9 x 1,5	ART. 533B R12	901.533B.12.CV	
	R2	19,5 x 9 x 1,5	ART. 536 R2	901.536.02.CO	
	R3	19,5 x 9 x 1,5	ART. 536 R3	901.536.03.CO	
	R4	19,5 x 9 x 1,5	ART. 536 R4	901.536.04.CO	
	R5	19,5 x 9 x 1,5	ART. 536 R5	901.536.05.CO	
	R6	24,5 x 12 x 1,5	ART. 536 R6	901.536.06.CO	
	R8	24,5 x 12 x 1,5	ART. 536 R8	901.536.08.CO	
	R1,5	12 x 12 x 1,5	ART. 550 R1,5	901.550.15.CO	
	R2	12 x 12 x 1,5	ART. 550 R2	901.550.02.CO	
	R2,5	12 x 12 x 1,5	ART. 550 R2,5	901.550.25.CO	
	R3	12 x 12 x 1,5	ART. 550 R3	901.550.03.CO	
	R2	19,5 x 9 x 1,5	ART. 581 R2	901.581.02.CO	
	R3	19,5 x 9 x 1,5	ART. 581 R3	901.581.03.CO	
	R4	19,5 x 9 x 1,5	ART. 581 R4	901.581.04.CO	
	R5	19,5 x 9 x 1,5	ART. 581 R5	901.581.05.CO	
	R6	24,5 x 12 x 1,5	ART. 581 R6	901.581.06.CO	
	R8	24,5 x 12 x 1,5	ART. 581 R8	901.581.08.CO	
	R5	19,5 x 9 x 1,5	ART. 582 R5	901.582.05.CV	
	R6	24,5 x 12 x 1,5	ART. 582 R6	901.582.06.CV	
	R8	24,5 x 12 x 1,5	ART. 582 R8	901.582.08.CV	
	45°	19,5 x 9 x 1,5	ART. 583 45°	901.583.45.00	
	45°	24,5 x 12 x 1,5	ART. 583 45°	901.583.45.01	
	R10		ART. 586 R10	901.586.10.CO	
	R12		ART. 586 R12	901.586.12.CO	
	R15		ART. 586 R15	901.586.15.CO	
	R10		ART. 587 R10	901.587.10.CV	
	R12		ART. 587 R12	901.587.12.CV	
	R15		ART. 587 R15	901.587.15.CV	
	R8		ART. 588 R8	901.588.08.CO	
	R10		ART. 588 R10	901.588.10.CO	
	R12		ART. 588 R12	901.588.12.CO	
	R15		ART. 588 R15	901.588.15.CO	



902

VITI GRANI E DADI

Screws, point and nuts
Schraube, Gewindestifte, Sechskantmutter
Vis, vis sans tête, écrou hexagonal

TYPE 1

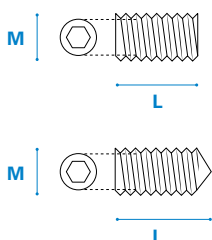

TYPE 2

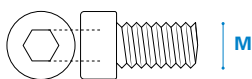

TYPE 3

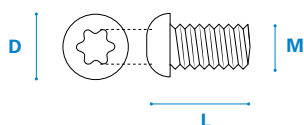

TYPE 4

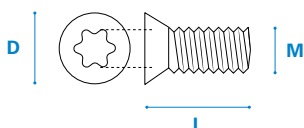

TYPE 5

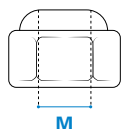

TYPE 6

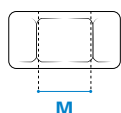

per / for / für / pour			CODE
○ 1,3	M2,5x2,0	ART. 230	902.025.02.00
○ 1,3	M2,5x3,0	ART. 230	902.025.03.00
○ 2	M4x4	ART. 230	902.040.04.00
○ 2	M4x5	ART. 230	902.040.05.00
○ 3	M5x5	ART. 352	902.050.05.00
○ 3	M5x6	ART. 309	902.050.10.PT
⊙	M5x10		902.050.10.TA
○ 3	M6x5	ART. 301/303/309C	902.060.05.00

	CODE
○ 2,5 M3x6	902.030.06.00
○ 3 M4x8	902.040.08.00
○ 5 M6x8	902.060.08.00

	CODE
TORX®15 M3,5x4 D6 L6	902.035.04.60
TORX®15 M3,5x6 D6 L8	902.035.06.60
TORX®15 M4x4 D5,6 L6,2	902.040.04.58
TORX®15 M4x4 D9 L6	902.040.04.90
TORX®15 M4x6 D5,6 L7,8	902.040.06.58
TORX®15 M4x6 D9 L8	902.040.06.90

	CODE
TORX®7 M2,5x3 D3 L4,5 ART.370-1	902.025.45.30
TORX®9 M3x4 D4 L7 ART.511B	902.030.45.40
TORX®15 M4x6 D5,6 L8 ART.370-2	902.040.06.56
TORX®15 M4x6 D5,6 L10 ART.370-3	902.040.08.56

	CODE
M5	902.050.00.DA
M6	902.060.00.DA

	CODE
M4x4	902.040.00.DE
M6x6	902.060.00.DE

€

BOX
10_{pcs}BOX
10_{pcs}BOX
10_{pcs}BOX
10_{pcs}BOX
10_{pcs}BOX
10_{pcs}

903

CHIAVI E CACCIAVITI

Key and screwdriver
Schlüssel und Schraubendreher
Clés et tournevis

TYPE 1

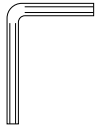

	CODE
⊖ 1,3	903.013.00.00
⊖ 2	903.020.00.00
⊖ 2,5	903.025.00.00
⊖ 3	903.030.00.00
⊖ 5	903.050.00.00
TORX®15	903.150.00.00

TYPE 2

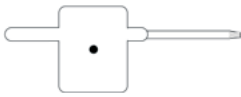

	CODE
TORX®15	903.002.15.00



TYPE 3



	CODE
TORX®7 ART. 370-1	903.003.07.00
TORX®9 ART. 511B	903.003.09.00
TORX®15	903.003.15.00



904

CUSCINETTI

Ball bearings
Kugellager
Roulements

TYPE 1

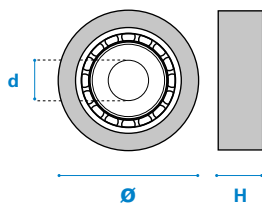

Ø	H	CODE
Ø10 d5	H4	904.100.05.00
Ø12 d4	H4	904.120.04.00
Ø13 d5	H4	904.130.05.00
Ø16 d5	H5	904.160.05.00
Ø16 d6	H5	904.160.06.00
Ø16 d8	H5	904.160.08.00
Ø19 d6	H6	904.190.06.00
Ø19 d8	H6	904.190.08.00
Ø19 d12,7	H3,95	904.190.12700
Ø22 d6	H7	904.220.06.00
Ø22 d8	H7	904.220.08.00
Ø22,2 d12,7	H7	904.222.12700
Ø22,2 d9,52	H7,1	904.222.95200
Ø24 d12	H6	904.240.12.00

TYPE 2

Delrin®

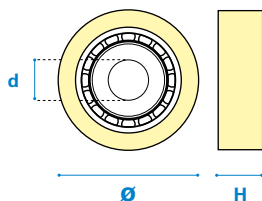

Ø		CODE
Ø18 d5	Delrin®	904.180.00.05
Ø18 d6	Delrin® ART.557C	904.180.00.06
Ø20 d5	Delrin®	904.200.00.05
Ø20 d6	Delrin® ART.557C	904.200.00.06
Ø22 d5	Delrin®	904.220.00.05
Ø22 d6	Delrin® ART.557C	904.220.00.06
Ø24 d6	Delrin® ART.557C	904.240.00.06
Ø26 d6	Delrin® ART.557C	904.260.00.06
Ø28 d6	Delrin® ART.557C	904.280.00.06
Ø29 d5	Delrin® ART.557C	904.290.00.05
Ø30 d6	Delrin® ART.557C	904.300.00.06
Ø32 d6	Delrin® ART.557C	904.320.00.06
Ø34 d6	Delrin® ART.557C	904.340.00.06
Ø36 d6	Delrin® ART.557C	904.360.00.06
Ø38 d6	Delrin® ART.557C	904.380.00.06
Ø40 d6	Delrin® ART.557C	904.400.00.06
Ø42 d6	Delrin® ART.557C	904.420.00.06
Ø44 d6	Delrin® ART.557C	904.440.00.06
Ø46 d6	Delrin® ART.557C	904.460.00.06
Ø48 d6	Delrin® ART.557C	904.480.00.06

	Ø		CODE
SET 4x	Ø10	ART.557C	904.100.06.04
SET 4x	Ø13	ART.557C	904.130.06.04
SET 2x	Ø16	ART.557C	904.160.06.02
SET 3x	Ø19	ART.557C	904.190.06.03
SET 3x	Ø 8-16-19	ART.555	904.555.05.03
SET 3x	Ø10-16-19	ART.557 Ø30	904.557.05.30
SET 3x	Ø10-16-19	ART.557 Ø38	904.557.05.38

€

BOX
10 pcs

905

RONDELLE E DISTANZIALI

Washer and spacer
Distanzring und Unterlegscheibe
Rondelle et enteretoise

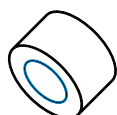

				CODE
	d3,2	D7	S0,5	905.030.07.05
	d4,3	D9	S0,8	905.040.09.08
	d5,3	D10	S1	905.050.10.10
	d6,1	D12	S1	905.060.12.10
	d6,4	D12	S1,6	905.060.12.16
	d8,4	D16	S1,6	905.080.16.16
	d6	D10	S3 ART. 509	905.060.10.30
	d6	D10	S4 ART. 509	905.060.10.40
	d8	D11	S7,5 ART. 546	905.080.11.75

€

BOX
10_{pcs}



907

SEEGER

Seeger
Seeger
Seeger



	Ø	CODE
	6	907.060.00.ES
	8	907.080.00.ES
	12	907.120.00.ES

€

BOX
10_{pcs}



114

BUSSOLE DI RIDUZIONE

Reduction bushing
Reduzierhülse Geschlitzt
Douille fendue

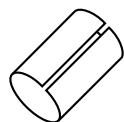

	Ø	d	CODE
	6	8	909.060.08.00
	6	10	909.060.10.00
	6	12	909.060.12.00
	8	10	909.080.10.00
	8	12	909.080.12.00
	10	12	909.100.12.00

€





Briani s.n.c.
Via Caravaggio 4
20831 Seregno (MB)
Italy

☎ +39 0362 238233
✉ info@briani.it

briani.it

