

# Bosch Commercial Vehicle Filters

Bodyguard of the engine  
2023



## Contents

1	90 years of Bosch Fuel Filters	4
2	History of Filtration	5
3	Bosch - A Strong Partner in the Filtration Business	6
4	Rely on Bosch Filters	8
5	Bosch Fuel Filters - Diesel	9
6	Bosch Fuel Filters - Gasoline (Petrol)	11
7	Bosch Fuel Filters in Comparison	12
8	Bosch Oil Filters	13
9	Bosch Oil Filters in Comparison	15
10	Bosch Air Filters	16
11	Bosch Air Filters in Comparison	18
12	Bosch Cabin Filters	19
13	Bosch Cabin Filters in Comparison	20
14	Application Chart	21

# 90 years of Bosch Fuel Filters: To be continued!

Since 1930, Bosch Fuel Filters have been protecting the injection systems of motor vehicles. They reliably separate particles and water from fuel and contribute to optimum engine performance.

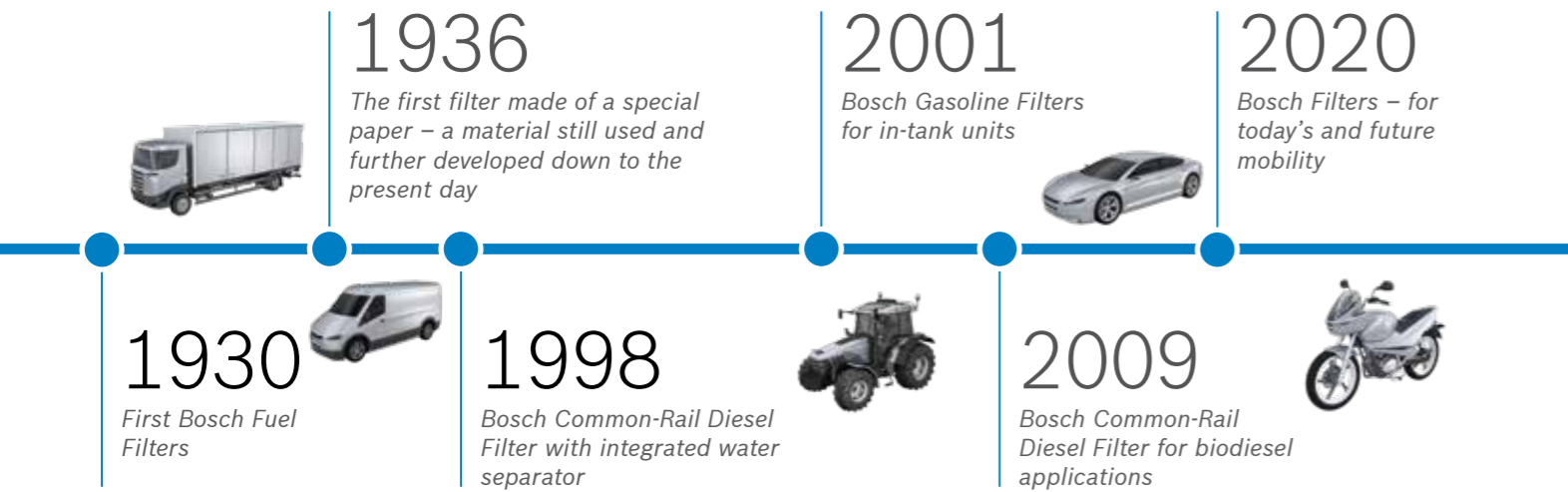

## For tomorrow's mobility, filters will continue being important!

In future, Bosch will continue to provide accurately fitting and matching filters – no matter which fuels or drive systems will then prevail in the markets. Whether electric drive, fuel cell, or hybrid drive, all of these powertrain systems need clean water, oil, or air for battery and / or engine cooling. And cabin filters will also continue to ensure clean air inside the cabin!



## History of Filtration

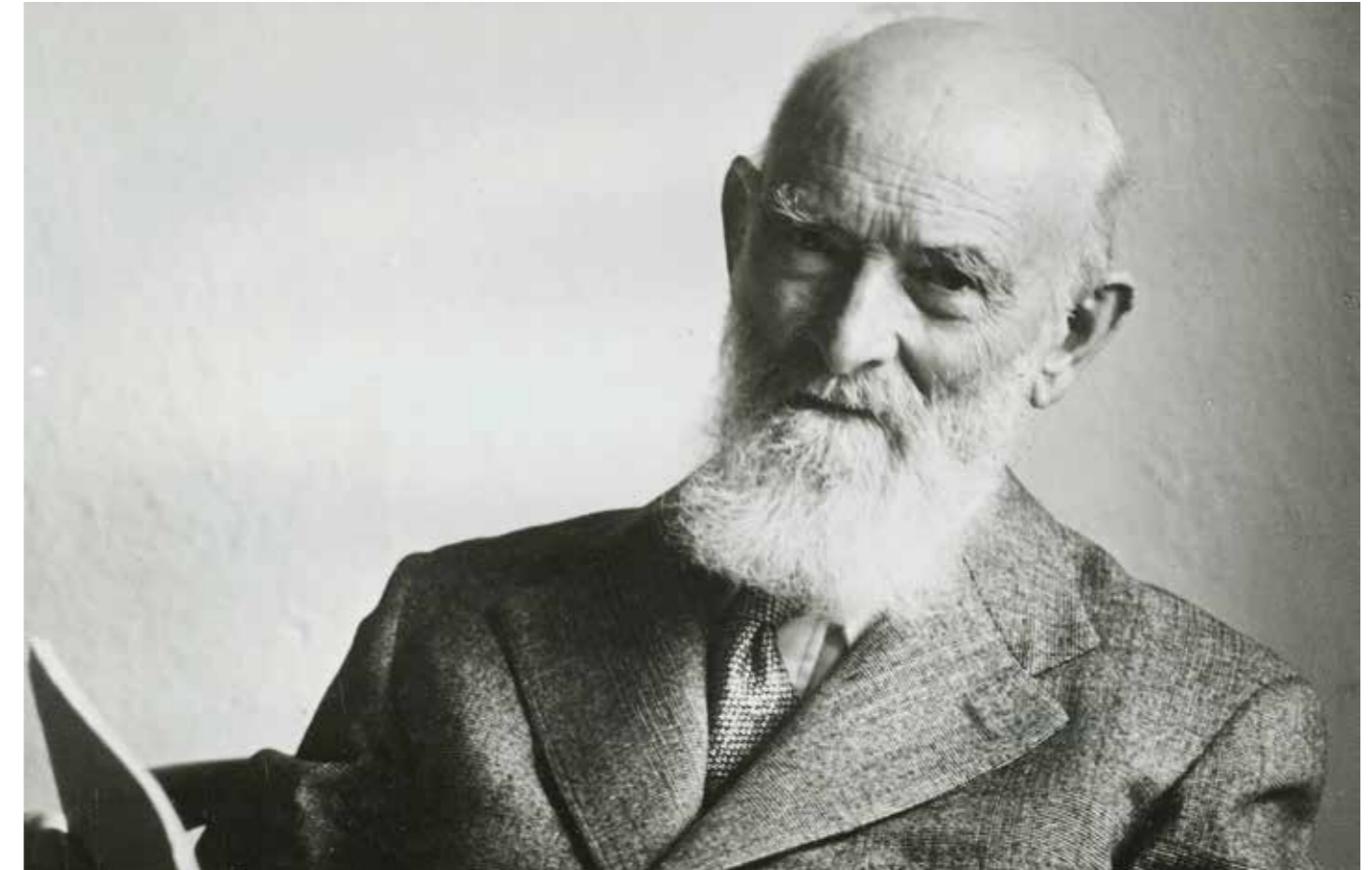

### Understanding Filtration

Bosch filters protect all the important and expensive components in vehicles, especially vehicles with modern gasoline and diesel injection systems which have lower tolerance levels. State-of-the-art technology is used to develop Bosch filters. As a result they are highly reliable in protecting the engine components from the smallest of dirt particles, abrasive particles, and water.

### Why filtration?

- ▶ Engine protection
- ▶ Reduced wear
- ▶ Increased fuel efficiency
- ▶ Environmental protection

### Consequences of inefficient filtration

- ▶ High fuel consumption
- ▶ Expensive damage to fuel injection parts
- ▶ Smoke, poor starting, and rough idling

### Filtration competence for over 80 years

In the beginning of motorised travel, blocked carburettor jets due to contaminated fuel was one of the most common causes for breakdowns.

### Bosch fuel filters solved this problem more than 80 years ago

In 1936, Bosch broke new ground and used a special paper in its filters – a material that has been constantly developed and remains in use to this day.

Ever since the first fuel filters were manufactured back in 1930, they had to meet increasingly strict performance requirements in line with advancements in engine technology. Nowadays, filters play a significant role in a vehicle's performance, economy, and emission values.

Drawing on this exemplary experience and ingenuity, Bosch is currently advancing filter technology and will continue to do so in the future.

# Bosch – A Strong Partner in the Filtration Business

**Satisfied customers, little effort required for warehousing and ordering, consistent use of the latest technologies – numerous USPs signify Bosch filters:**

- ▶ Safety, thanks to first-class product quality
- ▶ Complete range consisting of more than 2,000 filters from a single source
- ▶ Market coverage of 95 %
- ▶ Updated product range with more than 200 new additions each year
- ▶ High availability of goods, in more than 100 countries across the globe
- ▶ Strategic partner for the future through training courses and seminars
- ▶ Strong brand that is trusted by its customers

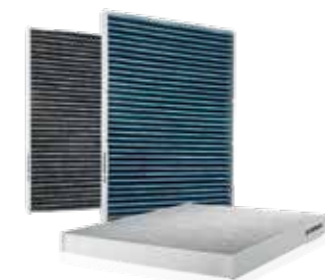

Bosch Oil Filters	Bosch Fuel Filters	Bosch Air Filters	Bosch Cabin Filters
<p>Task: To protect the engine from foreign particles, such as rust or minute pieces of metal in the oil.</p>	<p>Task: To protect the injection system and the engine from foreign particles, water, and other residue in fuel.</p>	<p>Task: To protect the engine against dirt particles in the intake air.</p>	<p>Information: Harmful pollutants like dust, pollen, fungus, and foul-smelling gases fill the air in the car leading to health-related issues. Cabin filters from Bosch absorb up to 100% of all pollen, dust particles, foul-smelling gases, and other harmful pollutants entering the vehicle's interior through its heating, ventilating, and air-conditioning systems, assuring a healthy and hygienic ambience inside the car</p>

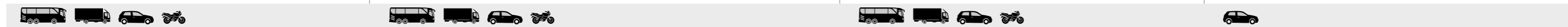

## Rely on Bosch Filters for assured quality and protection

Bosch Filters protect all the crucial components of your vehicle. Our technical expertise and top-of-the-line manufacturing processes and technologies enable us to supply superior and long-lasting products. Manufactured using high-quality materials and designed as per OE specifications, Bosch filters offer uncompromising quality and uninterrupted performance.

## Five steps of quality assurance

### Development

When it comes to development of new filters, our engineering team sticks to precisely defined milestones and follows a well-defined procedure.

### Production

High-quality materials, neat and accurate processing, and well-defined quality checks ensure that we deliver consistently high-quality filters.

### Release

Every Bosch filter is released to the market only after it passes a stringent final round of technical tests.

### Checks

Bosch filters are subjected to random sample tests before being stocked.

### Field observation / monitoring

If a fault is detected, it is taken as a basis to learn and prevent the errors from recurring. In case of a complaint, the cause of the reported problem is analysed and the results are passed on to the engineering team.



## Bosch Fuel Filters – Diesel

### From the specialists for injection systems

#### Task of Bosch Fuel Filters

- To protect the injection system and engine components from any foreign matter, such as dust and other residues in the fuel
- To safeguard against water in the fuel



### Bosch Diesel Filters

#### For conventional systems:

##### Technology from the specialists for diesel systems

Diesel filters are used to eliminate foreign matter and separate the water contained in diesel fuel. Bosch filters combine these two functions in an ideal manner.

#### For common rail systems:

**Designed to satisfy the highest standards** Bosch can supply innovative, economical concepts for common rail technologies. Bosch filters are ideally suited to the high injection pressures and tight tolerances encountered in common rail precision technology.

#### Change the diesel filter regularly according to the manufacturer's specifications.

##### Consequences of a clogged filter:

- Power loss of the engine, even to the extent of an engine standstill
- Impairment or interruption of the fuel supply
- Increased rate of wear on the engine
- Internal corrosion of engine components

#### The advantages of Bosch Fuel Filters

- Protection of the injection system through high particle separation rate
- Full engine performance thanks to large filter surface and low flow resistance
- Robust housing
- Long, reliable service life through a special filter medium coating

# Bosch Fuel Filters – Gasoline (Petrol)

## Shield your engine from dust, dirt, and grit

Bosch Fuel Filters – Gasoline (Petrol) protect the engine system by removing impurities from the fuel. Filtered fuel helps improve engine performance and increases service life. Bosch manufactures petrol filters for both carburetted vehicles and MPFI vehicles. The filter prevents impurities in the fuel from obstructing the openings of the carburettor / MPFI system, which would in turn cause difficulties in starting the engine and hamper the vehicle's performance.

Petrol Filters from Bosch ensure maximum engine protection, improved mileage, and effective prevention of power loss even under extreme conditions.

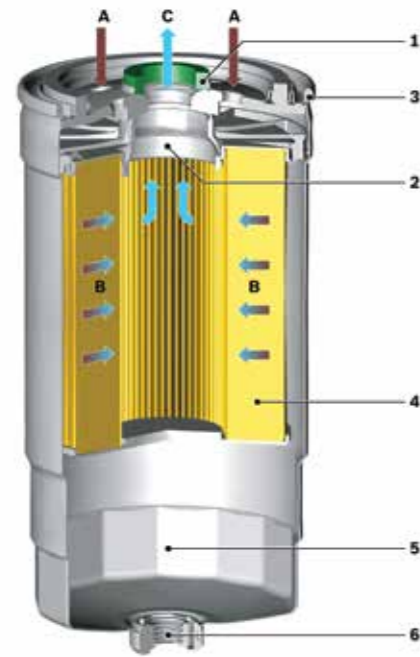

### Explanation

- 1 Sealing
  - 2 Fitting flange
  - 3 Double beading
  - 4 Multilayer filter medium
  - 5 Water chamber
  - 6 Water drain screw
- A Inflow of contaminated diesel  
 B Filtration of the diesel  
 C Cleaned diesel is conveyed to the engine

Features	Advantages	Benefits
Microporous, multilayered filter medium	High particle separation rate	Protection of the expensive injection system
Filter medium with special resin coating	Protection of the filter medium against water and aggressive components in the fuel	Long filter service life
Large filter surface	Excellent dirt collection capacity, low flow resistance	Long filter service life, full engine output
Precise, fuel-resistant connections	No throughput of unfiltered fuel (internal integrity)	Protection of the expensive injection system
Robust finish of the housing	Withstands high pressures (external integrity)	Long filter service life



**Crucial for commercial vehicles:**  
**Bosch Diesel Filters with water separators**  
 Due to the high flow rate, water separators are often built into commercial vehicles to pre-filter water and coarse particles. The actual diesel filter then performs the task of finely filtering the fuel.



### The advantages of Bosch Fuel Filters – Gasoline (Petrol)

- Protection of the injection system
- Longer service life
- Optimum engine performance

### Features:

- Application-specific media designed to meet the needs of all kinds of engines
- Long service life and extended service intervals
- Materials, design, and construction of Bosch Petrol Filters contribute to excellent performance in all kinds of operating conditions
- Unmatched fuel-cleansing performance

# Bosch Fuel Filters in Comparison

Quality pays off

## On the safe side with Bosch Fuel Filters

## Cheap filters – expensive consequences!

High particle separation rate, thanks to micro-porous multilayer filter medium

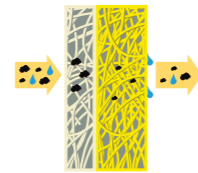
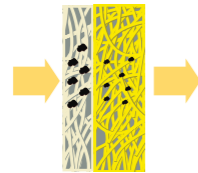

Low-quality filter medium:  
 ▶ Increased engine wear  
 ▶ Injector clogging  
 ▶ Corrosion

Large dust-holding capacity through high number of pleats

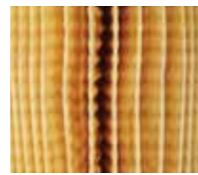

Lower number of pleats:  
 ▶ Increased engine wear due to particles  
 ▶ Reduced service life

Reliable filtration, thanks to stable pleat geometry



Unstable pleat geometry:  
 ▶ Insufficient fuel filtration  
 ▶ Increased engine wear

Corrosion-resistant housing prevents fuel leakages



Corrosion caused by spray water:  
 ▶ Hazards caused by leaking fuel  
 ▶ Environmental pollution  
 ▶ Increased engine wear

Robust connection of the end pleats

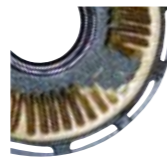

Bypass of unfiltered fuel caused by missing connection of end pleats:  
 ▶ Increased engine wear

High-quality seal made out of a special rubber prevents any fuel leakage



Damaged, porous seal:  
 ▶ Hazards caused by leaking fuel  
 ▶ Environmental pollution

Protection cap on the clean side (outlet) of the filter to prevent any soiling during transport and storage



Missing protection cap facilitates filter soiling:  
 ▶ Increased engine wear caused by dirt particles  
 ▶ Reduced filter service life

# Bosch Oil Filters

## For optimum engine performance

### Purpose of the oil

- Minimisation of wear and friction
- Heat dissipation

### Task of the Bosch Oil Filter

- To protect the engine against impurities in the oil such as dust, metal particles, combustion residue, or soot particles

## Change the oil filters regularly according to the vehicle manufacturer's specifications!

### Consequences of a clogged filter:

#### Urban traffic means stress for the oil

On short-distance trips and in stop-and-go traffic, the oil and the oil filters should be changed more often than the replacement intervals specified by the vehicle manufacturer because frequent cold starts lead to more condensation and excess fuel in the combustion mixture. This means that:

- Unburnt hydrocarbons and condensation enter the oil which leads to premature aging of the oil
- At high engine temperatures, these components evaporate in the oil circuit, which further reduces the lubrication quality

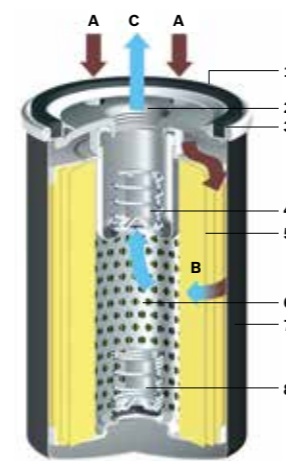

### Bosch Oil Filters – Design and operation

- 1 Sealing
- 2 Threaded connection
- 3 Double beading
- 4 Non-return valve
- 5 Filter medium
- 6 Support jacket
- 7 Pressure-resistant filter housing
- 8 Bypass valve

### The advantages of Bosch Oil Filters

- Protection of the engine and retaining engine oil functionality in the long term thanks to high particle separation rate, moisture resistance
- Long service life due to large filter surface  
Protection of the environment and engine as oil losses are prevented
- Immediate engine lubrication during cold starts because of non-return valve

- A Inflow of contaminated oil
- B Filtration of the oil
- C Clean oil is conveyed to the engine

## Bosch Oil Filter designs

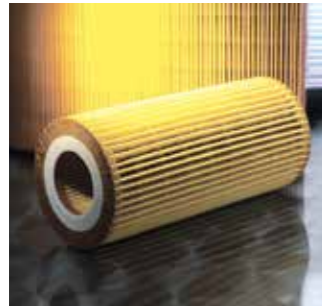

### Oil filter insert

The oil filter housing is connected permanently to the engine block. When changing the filter, only the filter insert and the seals are replaced.



### Oil filter exchange box

When changing the filter, the entire oil filter is replaced and bolted directly to the engine block using a connecting flange.

Features	Advantages	Benefits
Microporous, multilayered, specially impregnated filter medium	High particle separation rate, moisture resistance, tensile strength	Protection of the engine, long service life of the engine oil
Large filter surface	Excellent dirt collection capacity, low flow resistance	Long filter service life
Seals made of special rubber	Prevention of oil loss	Protection of the environment and of the engine
Bypass valve	Reliable engine lubrication even in cold conditions (viscous oil) or with silted-up filter	Protection of the engine
Non-return valve	Immediate engine lubrication after a cold start	Protection of the engine
Corrosion-resistant housing materials	No rusting due to spray water, no oil loss	Protection of the environment and of the engine

## Oil Bypass Filtration

### Specially for commercial vehicles

In commercial vehicles, a large amount of particles get collected in the oil over time, above all soot particles. This causes premature aging of the oil and engine wear. In addition to the main flow filter, which filters the entire quantity of oil with each cycle, commercial vehicles usually also have a bypass filter. This cleans 5 to 10% of the oil in a separate circuit.

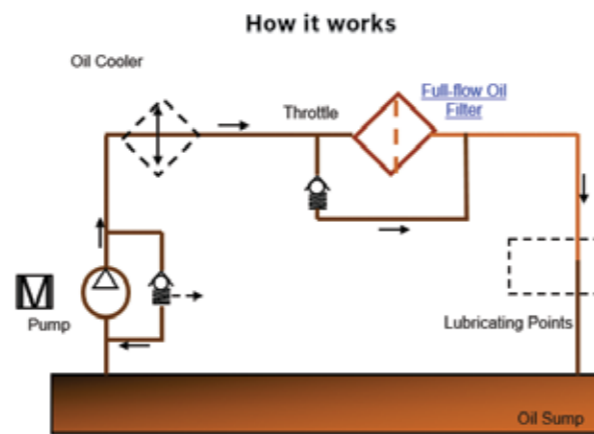

Bypass Circuit Diagram



Fresh engine oil  
Good lubrication properties



Aged engine oil  
With soot contamination, poor lubrication properties

## Bosch Oil Filters in Comparison

### Quality pays off

#### On the safe side with Bosch Oil Filters

#### Cheap filters – expensive consequences!

High particle separation rate, thanks to microporous filter medium with special impregnation

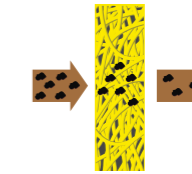
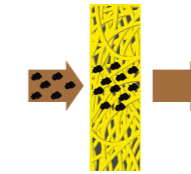

Low-quality filter medium:  
▶ Increased engine wear  
▶ Possible increase in fuel consumption

Large dust-holding capacity through large number of pleats

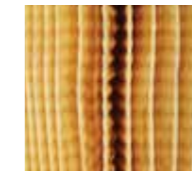

Low number of pleats:  
▶ Poor filtration  
▶ Increased wear or even engine damage  
▶ Reduced service life

Reliable filtration thanks to meticulous processing and stable pleat geometry



Unstable pleat geometry, excess of adhesives:  
▶ Increased engine wear  
▶ Possible increase in fuel consumption

Corrosion-resistant housing prevents oil leakages



Corrosion caused by spray water:  
▶ Increased wear or even engine damage  
▶ Environmental pollution caused by leaking oil

Robust felt ring prevents oil leakages



Poorly fitting felt ring:  
▶ Loss of internal integrity, poor filtration of oils  
▶ Increased wear leading to engine damage

High-quality seal made of a special rubber prevents oil leakages



Damaged, porous seal:  
▶ Increased wear or even engine damage  
▶ Environmental pollution caused by leaking oil

Accurately set valve-opening pressure ensures reliable engine lubrication – even under cold conditions and in case of a clogged filter



Poor functioning of the bypass valve:  
▶ Increased wear or even engine damage  
▶ Bursting of the oil filter



# Bosch Air Filters

## Top quality engine protection



### Why air filters must not be cleaned

To burn one litre of fuel, you need 10,000 litres of air. That makes it all the more important that air filters work perfectly and are changed regularly. If you try to extend the service life of an air filter by cleaning the filter medium with compressed air, it would not serve the purpose.

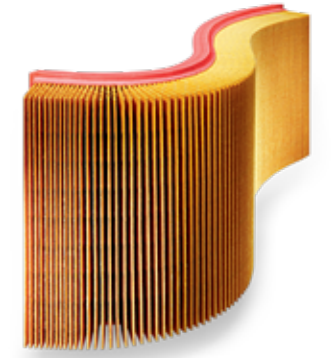

The risks are as follows:

- ▶ Compressed air destroys the folds in the filter medium and so impairs the operation of the air filter
- ▶ Impurities enclosed in the filter medium are released again
- ▶ Dirt and particles penetrate into the engine, leading to loss of power and, in the worst-case scenario, damage to the engine

Features	Advantages	Benefits
Microporous, specially impregnated filter medium	High particle separation rate, moisture resistance, tensile strength, chemical and thermal stability	Long filter service life, protection of the engine
Filter medium with special embossing	Robust fold geometry	Full efficiency during the entire filter service life
Large filter surface	Excellent dirt collection capacity, low flow resistance	Long filter service life, low fuel consumption
Precise fit, high-quality sealing material made of polyurethane	Compensation for unevenness in the housing, prevention of unfiltered, unmetred air (bypass)	Optimal mixture preparation, protection against wear

### Tasks of the Bosch Air Filter

- Protect the engine against dirt particles in the intake air
- Protect the engine against wear
- Safeguard the air supply for the mixture preparation
- Reduce the noise level

### Tight fit

The seal in air filters must remain soft, supple, and fit exactly during the entire service life, in order to prevent unfiltered air from reaching the engine. This is why Bosch Air Filters come with a 'high quality' seal and are manufactured in strict compliance with the requirements for each vehicle.

### Change the air filters regularly according to the vehicle manufacturer's specifications

#### Consequences of a clogged filter:

- Poor air-fuel mixture preparation, resulting in reduced engine power and increased pollutant emissions
- More fuel consumption
- Increased wear in the engine due to particles
- Problems when starting the engines

### The advantages of Bosch Air Filters

- High efficiency and reliability during the entire filter service life thanks to robust pleat geometry
- Long service life and thus protection of the engine thanks to high particle separation rate, moisture resistance, and tensile strength, as well as chemical and thermal stability
- Lower fuel consumption thanks to excellent dirt collection capacity and low flow resistance

### Design and operation of the Bosch Air Filter

Microfibre filter medium with artificial resin impregnation

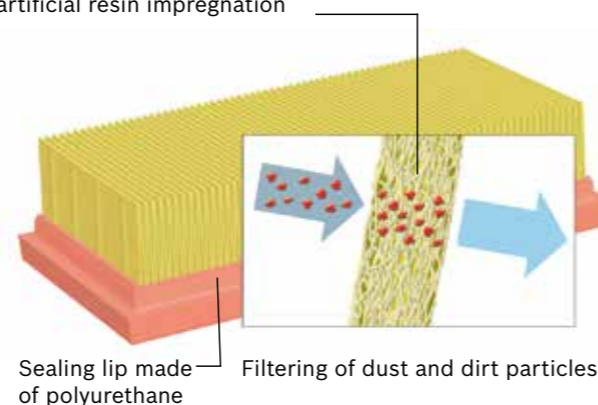

# Bosch Air Filters in Comparison

Quality pays off

On the safe side with Bosch Air Filters			Cheap filters – expensive consequences!
High particle separation rate, thanks to microporous filter medium			Low-quality filter medium: <ul style="list-style-type: none"> <li>▶ Increased engine wear</li> <li>▶ Accumulation of dirt on the air-mass meter</li> </ul>
Large dust-holding capacity thanks to high number of pleats			Low number of pleats: <ul style="list-style-type: none"> <li>▶ Reduced service life</li> </ul>
Moisture resistance thanks to impregnation with special resin			Conglomeration of pleats due to moisture: <ul style="list-style-type: none"> <li>▶ Decreased engine performance</li> <li>▶ Increased fuel consumption</li> </ul>
Inflammation protection thanks to special coating			Fire hazard caused by aspirated cigarette stubs or backfire: <ul style="list-style-type: none"> <li>▶ Vehicle fire</li> </ul>
Permanently stable pleat geometry thanks to sufficiently dimensioned glue beads			Unstable pleat geometry: <ul style="list-style-type: none"> <li>▶ Reduced service life</li> <li>▶ Reduced engine performance</li> <li>▶ Increased fuel consumption</li> </ul>
No bypass of unfiltered air thanks to high-quality polyurethane seal			Poor processing, low-quality sealing material: <ul style="list-style-type: none"> <li>▶ Increased engine wear</li> <li>▶ Accumulation of dirt on the air-mass meter</li> </ul>
No loss of filter surface thanks to careful processing of the sealing material			Excessive use of sealing material: <ul style="list-style-type: none"> <li>▶ Short service life</li> <li>▶ Reduced engine performance</li> <li>▶ Increased fuel consumption</li> </ul>

# Bosch Cabin Filters

For improved air quality and refreshing interiors

The air inside the vehicle cabin is often polluted due to pollen, dust particles, or emissions. Pollution levels inside the vehicle are often up to six times higher than the levels outside of it, since the emissions from the vehicle ahead are routed directly into the vehicle interior. Cabin filters from Bosch absorb up to 100% of pollen, dust particles, foul-smelling gases, and other pollutants, thus preventing them from entering the interior through its heating, ventilating, or air conditioning systems, assuring a healthy and hygienic ambience inside the car.



### The advantages of Bosch Cabin Filters:

- Filters up to 100% of dust and dirt particles, pollen, bacteria, and spores
- Consistent functionality during the entire filter service life, thanks to its excellent stability
- Filters even the smallest particle, down to the size of 0.0025 mm, offering enhanced protection
- Enhanced fresh air in the cabin, thanks to its considerable air flow

### Features and benefits:

- Multilayered filter medium with a large surface to ensure filtering of both large particles and small pollen spores & bacteria
- Electrostatically charged microfibre fleece filters out even the smallest, respirable particles down to the size of 0.0025 mm
- Allows only fresh air into the cabin, improving driver comfort, and eliminating misted windows
- Protects the passengers from allergies, bacteria, and foul smell

**Important: Cabin filters should be replaced every 15,000 km, or in accordance with manufacturers' recommendations. But you will know it's time to change the filter, when you notice the following occurrences: The windows will fog up faster, dust particles will accumulate inside the vehicle, and the air will smell less pleasant.**

### Bosch Cabin Filters are available in two variants:

#### Standard Cabin Filter







- Captures up to 100% of dust and dirt particles, pollen, and bacteria
- Ensures optimum filtration due to the several layers of different polymer fibres

#### Activated Carbon Cabin Filter

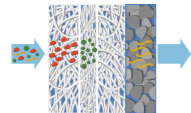
- Captures up to 100% of all dust & dirt particles, pollen, and bacteria
- Guarantees flow of fresh air, even in a tunnel or traffic jam
- Filtration of foul-smelling, harmful gases
- Improved level of comfort and concentration
- Improved view of the road due to minimum deposits on the windshield

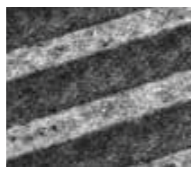
# Bosch Cabin Filters in Comparison

## Quality pays off

On the safe side with Bosch Cabin Filters		Cheap filters – unpleasant consequences!
Pure air through several well-coordinated filter layers		Too thin and badly coordinated filter layers: ▶ Particles and pollen get into the vehicle
Reliable filtration thanks to high-quality fibres		Insufficient fibres and low fibre quality: ▶ Low filtration performance
Stability and increased filter surface through special embossing of the filter medium		Low-quality filter medium without embossing: ▶ Reduced service life
Reliable adsorption of harmful gases and odours with: ▶ Sufficient activated carbon ▶ High quality		Insufficient and badly distributed low-quality activated carbon: ▶ Harmful gases get into the vehicle
Stable pleat geometry – even when exposed to humidity		Unstable pleat geometry: ▶ Unreliable filtration
Shape is perfectly geared to the installation space – and is still highly flexible in order to ease the installation under difficult circumstances		Incorrect fit and bad workmanship: ▶ Bypass of unfiltered air and accumulation of dirt on the air conditioning
Practice-approved installation instructions ease the filter replacement		Missing installation instructions: ▶ Loss of time during filter replacement

### Brand wise Filter Application Chart

Model Description	Air Filter	Cabin Filter	Fuel Filter	Oil Filter
<b>ASHOK LEYLAND</b>				
12M (D) 130 Kw (2005.04 -2010.10)	F 002 H21 219		F 002 H20 115	F 002 H60 022
12M (D) 130 Kw (2005.04 -2010.10)	F 002 H23 589		F 002 H20 115	F 002 H60 022
12M (D) 130 Kw (2005.04 -2010.10)	F 002 H60 010		F 002 H20 115	F 002 H60 022
12M (D) 165 Kw (2014.01-->), U 3723, Viking 160HP IL FIP BS3 (D) 118 Kw (2014.02-->), Viking 180HP ROTARY FIP EDC BS3 (D) 135 Kw (2014.02-->), RE SLF BS III (D) 135 Kw (2011.12-->), 12M FESLF, 1616 BS III (D) 119 Kw (2013.12-->), 12M FE BS IV (D) 132 Kw (2016.12-->), Viking BS III (D) 119 Kw (2011.12-->), 12M FE BS IV (D) 165 Kw (2016.12-->), 2523			F 002 H23 590	F 002 H23 572
12M (D) 165 Kw (2014.01-->), ULE Diesel BS 4, FE SLF			F 002 H24 920	F 002 H23 572
12M FE BS IV (D) 165 Kw (2016.12-->)			F 002 H26 311	F 002 H23 572
12M FE BS IV (D) 165 Kw (2016.12-->)			F 002 H26 311	F 002 H60 022
12M FESLF BS IV	F 002 H21 219			F 002 H23 572
1612 H, eComet 912 (D) 88 Kw (2008.11-->), Cheetah (D) 97 Kw (2005.04 -2010.10), Cargo 1613H, Viking (D) 84 Kw (2004.02 -2010.10), Viking BS IV (D) 97 Kw (2017.06-->), Ecomet 1012 Smart (D) 88 Kw (2010.11-->), Cheetah (D) 84 Kw (1995.04 -2010.10), eComet 1112 (D) 88 Kw (2008.11 -2010.10), Viking (D) 97 Kw (2004.02 -2010.10), Stag (D) 88 Kw (2010.10-->), Lynx (D) 88 Kw (2010.10-->), Comet 1613H, 12M (D) 84 Kw (2014.10-->)	F 002 H24 415		F 002 H21 298	F 002 H60 022
1613 H	F 002 H60 010		F 002 H23 536	
1614 BS III	F 002 H21 219			F 002 H60 022
1616 H (D) 121 Kw (2006.04 -2010.10), 3516 (D) 121 Kw (2002.02 -2010.10), 1616 XP (D) 124 Kw (2010.08-->), 1616 H (D) 123 Kw (2006.04 -2010.10), U 1618 (D) 97 Kw (2010.11-->), 1616 XL (D) 124 Kw (2010.08-->), Stag (D) 58 Kw (2003.03-->)				F 002 H60 022
1616 XL BS III (D) 119 Kw (2015.05-->), 1616 BS III, 1618 BS IV (D) 134 Kw (2015.12-->)	F 002 H24 415			
1616 XL BS III (D) 119 Kw (2015.05-->), 3014 BS II, 4019 (D) 130 Kw (2008.11 -2010.10), RE SLF BS III, Taurus 2516 6x2, 12M FE BS IV, 3116, 1618 BS IV (D) 134 Kw (2015.12-->), 4023 (D) 165 Kw (2011.03-->)	F 002 H21 219			
1616 XL BS III (D) 119 Kw (2015.05-->), 3014 BS II, U 3518, 4019 (D) 130 Kw (2008.11 -2010.10), RE SLF BS III, 12M FE BS IV, Viking BS IV, 3116, 4023 (D) 165 Kw (2011.03-->)	F 002 H23 589			
1616 XL, 1616 H	F 002 H21 219		F 002 H23 536	

### Brand wise Filter Application Chart

Model Description	Air Filter	Cabin Filter	Fuel Filter	Oil Filter
1616 XL, 1616 XP, 3516 Super, Tusker 3516, Viking BS IV (D) 116 Kw (2008.12-->), 3118 BS IV (D) 134 Kw (2015.12-->), U-2518 IL T HD BS IV (D) 134 Kw (2015.12-->), 2518 BS IV (D) 134 Kw (2018.12-->), 3718 iL (D) 132 Kw (2014.01-->), 2516, 3118 (D) 135 Kw (2010.08-->), 1616 iL (D) 118 Kw (2010.08-->), 3718 BS IV (D) 134 Kw (2015.12-->), 1616 H	F 002 H21 219		F 002 H21 298	
1616 XL, 1616 XP, 4019 5.6, Tusker 3516, 3118 BS IV (D) 134 Kw (2015.12-->), U 3718 BS IV (D) 132 Kw (2014.12-->), U-2518 IL T HD BS IV (D) 134 Kw (2015.12-->), 2518 BS IV (D) 134 Kw (2018.12-->), 3718 iL (D) 132 Kw (2014.01-->), 3118 (D) 135 Kw (2010.08-->), 1616 iL (D) 118 Kw (2010.08-->), 3518 BS IV (D) 134 Kw (2015.12-->), 3718 BS IV (D) 134 Kw (2015.12-->), 1616 H	F 002 H23 589		F 002 H21 298	
1616 XL, 2518, 1616 H	F 002 H23 589		F 002 H23 536	
1616 iL 5.7, U 2518, 2516 il, 3118, 3518, 4019il	F 002 H23 589		F 002 H23 536	F 002 H23 572
1616 iL, Cheetah (D) 118 Kw (2014.01-->), 3718 iL BS III, U-2518-IL-T HD BS III (D) 134 Kw (2016.08-->), 2518 (D) 132 Kw (2014.01-->), U 1616, 12M (D) 118 Kw (2010.10-->), 3518 BS III (D) 134 Kw (2015.12-->), U 4019 il, 3118, 3518, 4019il	F 002 H23 589		F 002 H24 921	F 002 H23 572
1618, eComet 1212			F 002 H23 536	
2214 6x2 (H)	F 002 H23 564		F 002 H21 298	F 002 H60 022
2214 6x2 (H)	F 002 H23 564		F 002 H23 536	F 002 H60 022
2214 6x2 (H) (D) 84 Kw (2005.07 -2009.07)	F 002 H23 564		F 002 H21 298	
2214 6x2 (H) (D) 84 Kw (2005.07 -2009.07)	F 002 H23 564		F 002 H23 590	
2214 6x2 (H) (D) 84 Kw (2005.07 -2009.07)	F 002 H23 567		F 002 H21 298	
2214 6x2 (H) (D) 84 Kw (2005.07 -2009.07)	F 002 H23 567		F 002 H23 590	
2214 6x2 (H) (D) 84 Kw (2005.07 -2009.07), Lynx (D) 88 Kw (2005.05 -2010.10)	F 002 H60 010		F 002 H21 298	
2214 6x2 (H) (D) 84 Kw (2005.07 -2009.07), Lynx (D) 88 Kw (2005.05 -2010.10)	F 002 H60 010		F 002 H23 590	
2214 Super	F 002 H60 010			
2514, 2513	F 002 H60 010		F 002 H23 536	F 002 H60 022
2514, 2513, 1612 H, Ecomet 1012 Smart	F 002 H24 415		F 002 H23 536	F 002 H60 022
2516 6x2 (H), 3121, 2516 6x4 (H) 4x4, 4018, 3516, 4921, 2516 S	F 002 H21 219		F 002 H23 536	F 002 H60 022
2516 6x2 (H), 4018, 3516	F 002 H23 561		F 002 H23 536	F 002 H60 022
2516 6x2 (H), 4018, 3516, Artik 3516	F 002 H23 561		F 002 H21 298	F 002 H60 022
2516 BS II, 2518T BS II, 3718 iL (D) 132 Kw (2014.01-->), 2521 BS II, 3118 (D) 135 Kw (2010.08-->), Viking 180HP ROTARY FIP EDC BS3, 1616 iL (D) 118 Kw (2010.08-->), 2517 BS II, 4018H BS III, Viking 160HP IL FIP BS3, U-2518 IL T HD BS IV (D) 134 Kw (2015.12-->)	F 002 H23 589		F 002 H24 921	

### Brand wise Filter Application Chart

Model Description	Air Filter	Cabin Filter	Fuel Filter	Oil Filter
2516 BS II, 2518T BS II, 3718 iL (D) 132 Kw (2014.01-->), 2521 BS II, 3118 (D) 135 Kw (2010.08-->), Viking 180HP ROTARY FIP EDC BS3, 1616 iL (D) 118 Kw (2010.08-->), 2517 BS II, Viking 160HP IL FIP BS3, U-2518 IL T HD BS IV (D) 134 Kw (2015.12-->)	F 002 H21 219		F 002 H24 921	
2516 il	F 002 H21 219		F 002 H23 536	F 002 H23 572
2516 il	F 002 H23 561		F 002 H21 298	F 002 H23 572
2516 il	F 002 H23 561		F 002 H23 536	F 002 H23 572
2516 il BS III (D) 119 Kw (2012.12-->), 1614 BS III	F 002 H23 589			F 002 H60 022
2516 il BS III, 3718 iL (D) 132 Kw (2014.01-->), 3015 BS II, U-2518 IL T HD BS IV (D) 134 Kw (2015.12-->)	F 002 H24 415		F 002 H24 921	
2516, 3516 Super, Tusker 3516	F 002 H23 561		F 002 H21 298	
2518 (D) 135 Kw (2010.10-->), Cheetah (D) 118 Kw (2014.01-->), 2518 (D) 132 Kw (2014.01-->), Cheetah (D) 135 Kw (2014.01-->), 12M (D) 118 Kw (2010.10-->), Cheetah (D) 88 Kw (2000.11 -2005.03), 1618 BS IV, U 2518, 2516 il	F 002 H23 589		F 002 H21 298	F 002 H23 572
2518 (D) 135 Kw (2010.10-->), Cheetah (D) 118 Kw (2014.01-->), Viking BS IV (D) 123 Kw (2016.12-->), Cheetah (D) 135 Kw (2014.01-->), 12M (D) 118 Kw (2010.10-->), Cheetah (D) 88 Kw (2000.11 -2005.03), 2516 il	F 002 H21 219		F 002 H21 298	F 002 H23 572
2518 BS II, Viking (D) 123 Kw (2005.05-->), Cheetah (D) 118 Kw (2014.01-->)	F 002 H21 219		F 002 H24 921	F 002 H60 022
2518 BS II, Viking (D) 123 Kw (2005.05-->), Cheetah (D) 118 Kw (2014.01-->), U-2518-IL-T HD BS III (D) 134 Kw (2016.08-->), 2518 (D) 132 Kw (2014.01-->), 3518 BS III (D) 134 Kw (2015.12-->), 3118-T BS III	F 002 H23 589		F 002 H24 921	F 002 H60 022
2518 BS IV (D) 134 Kw (2018.12-->), 3718 iL (D) 132 Kw (2014.01-->), 3518 BS IV (D) 134 Kw (2015.12-->), 3718 BS IV (D) 134 Kw (2015.12-->), 3118 BS IV (D) 134 Kw (2015.12-->), U 3718 BS IV (D) 132 Kw (2014.12-->), U-2518 IL T HD BS IV (D) 134 Kw (2015.12-->)	F 002 H24 415		F 002 H21 298	
2518 BS IV (D) 134 Kw (2018.12-->), 3718 iL (D) 132 Kw (2014.01-->), 3518 BS IV (D) 134 Kw (2015.12-->), 3718 BS IV (D) 134 Kw (2015.12-->), Viking BS III, 3118 BS IV (D) 134 Kw (2015.12-->), U 3718 BS IV (D) 132 Kw (2014.12-->)	F 002 H23 589		F 002 H22 095	
2518 BS IV (D) 134 Kw (2018.12-->), 3718 iL (D) 132 Kw (2014.01-->), 3718 BS IV (D) 134 Kw (2015.12-->), Viking BS IV (D) 116 Kw (2008.12-->), Viking BS III, 3518 BS IV, 3118 BS IV (D) 134 Kw (2015.12-->)	F 002 H21 219		F 002 H22 095	
3014	F 002 H60 010			F 002 H60 022
3118 (D) 135 Kw (2010.08-->), U 3723 (D) 165 Kw (2012.01-->), 3518 BS IV (D) 134 Kw (2015.12-->), Tusker 3516, U 3718 BS IV (D) 132 Kw (2014.12-->), 2523 (D) 165 Kw (2014.01-->)	F 002 H23 589		F 002 H23 590	

### Brand wise Filter Application Chart

Model Description	Air Filter	Cabin Filter	Fuel Filter	Oil Filter
3118 (D) 135 Kw (2010.08-->), U 3723 (D) 165 Kw (2012.01-->), Tusker 3516, Taurus 2516 6x4, 2523 (D) 165 Kw (2014.01-->)	F 002 H21 219		F 002 H23 590	
3121, 2516 6x4 (H) 4x4, 4018, 3516, 4921, 2516 S	F 002 H23 589		F 002 H23 536	F 002 H60 022
3123 BS III	F 002 H24 415		F 002 H26 311	F 002 H23 572
3516 (D) 118 Kw (2002.02 -2007.08)				F 002 H20 031
3718 BSIV, 4019 BS IV, 2516 il BS III (D) 119 Kw (2012.12-->), Captain 2518 BS IV, U 4923 BS IV	F 002 H24 415			F 002 H23 572
4123 BS IV, 4023, 2518 (D) 135 Kw (2010.10-->), 12M FE BS III, Cheetah (D) 118 Kw (2014.01-->), U-2518-IL-T HD BS III (D) 134 Kw (2016.08-->), 2518 (D) 132 Kw (2014.01-->), Cheetah (D) 88 Kw (2000.11 -2005.03), U-3118, 3120 il, 3123, Cheetah (D) 135 Kw (2014.01-->), 3518 BS III (D) 134 Kw (2015.12-->), Captain 3723 BS IV	F 002 H23 589		F 002 H23 590	F 002 H23 572
4921 (D) 151 Kw (2014.01-->), 3121 (D) 151 Kw (2008.04 -2010.10), U 4923 BS IV (D) 168 Kw (2018.12-->), U 4923 (D) 165 Kw (2010.09-->), 11M FESLF BS IV (D) 123 Kw (2018.12-->), 4019il (D) 132 Kw (2012.12-->), 2516 il (D) 118 Kw (2010.05-->), U 4023 (D) 165 Kw (2010.09-->), 3123 (D) 165 Kw (2010.08-->), 2214 Super (D) 97 Kw (2009.07 -2010.10), U-3118 (D) (2015.06-->), eComet 1214 (D) 88 Kw (2014.01-->), Boss 1412 LE BS III, 2514 (D) 97 Kw (2008.02 -2009.07), Viking (D) 123 Kw (2005.11 -2009.12), 4921 (D) 151 Kw (2007.05 -2010.10), 4923 (D) 165 Kw (2011.03-->), Captain 40 (D) 165 Kw (2016.02-->), Stag (D) 88 Kw (2005.04 -2010.10), 12MIFESLF BS IV (D) 123 Kw (2014.12-->), Ecomet 1012 BS III (D) 88 Kw (2013.12-->), 1614 BS III (D) (2015.06-->), Boss 1212 LE (D) 88 Kw (2014.01-->), Boss 912 LE 3.8 (D) 88 Kw (2014.01-->), U 2516 (D) 118 Kw (2010.09-->), Captain 49IT BS III (D) 165 Kw (2011.12-->), 4018 (D) 130 Kw (2004.08 -2009.09), Captain 4923 BS III (D) 123 Kw (2014.10-->), 11M FESLF BS IV (D) 123 Kw (2018.11-->), U 3123 (D) 165 Kw (2010.10-->), Boss 1112 LE (D) 88 Kw (2014.01-->), ULE Diesel BS 4 (D) 165 Kw (2014.01-->), U 4019 il (D) 132 Kw (2014.01-->), 2513 (D) 97 Kw (2005.08 -2008.01), 3123 BS III (D) 168 Kw (2013.12-->), JanBus BS4 (D) 165 Kw (2016.02-->), 1616 iL 5.7 (D) 118 Kw (2014.01-->), U 2518 (D) 132 Kw (2010.09-->), 1613 H (D) 97 Kw (2005.11 -2010.10), 3518 (D) 132 Kw (2010.10-->), Comet 1616H (D) 123 Kw (2009.11 -2010.10)			F 002 H23 590	
4923 (D) 165 Kw (2011.03-->), 3123 (D) 165 Kw (2010.08-->), RE SLF (D) 165 Kw (2014.01-->), U 3123 (D) 165 Kw (2010.10-->), ULE Diesel BS 4 (D) 165 Kw (2014.01-->), U 4923 (D) 165 Kw (2010.09-->)			F 002 H24 920	
Artik 3014			0 450 226 028	9 451 037 424
Artik 3014			1 457 431 003	9 451 037 424
Artik 3014			F 002 H24 406	9 451 037 424
Boss 1112 LE, Boss 1213 LE, 3718 iL			F 002 H23 536	F 002 H23 572

### Brand wise Filter Application Chart

Model Description	Air Filter	Cabin Filter	Fuel Filter	Oil Filter
Boss 1113 LX (D) 96 Kw (2014.01-->), 1618T BS IV (D) 134 Kw (2018.12-->), Boss 913 LX (D) 96 Kw (2014.01-->), U-2518 T BS IV (D) 134 Kw (2015.12-->), U 3118 LA BS IV (D) 134 Kw (2015.12-->), Lynx BS IV, Boss 1113 BS III, U 4923 BS IV (D) 168 Kw (2018.12-->), U 4923 (D) 165 Kw (2010.09-->), U 3518 BS IV (D) 134 Kw (2010.12 -2012.12), N 2523 BS IV (D) 172 Kw (2018.12-->), U 4023 (D) 165 Kw (2010.09-->), Boss 913 BS III (D) 95 Kw (2013.10-->), eComet 1212 BSIV (D) 97 Kw (2016.01-->), Captain 40IT BS III (D) 134 Kw (2016.02-->), eComet 1212 BSIV, U 4019 BS III (D) 134 Kw (2014.12-->), U-3118 (D) (2015.06-->), 4923 (D) 165 Kw (2011.03-->), 12MIFESLF BS IV (D) 123 Kw (2014.12-->), Ecomet 1012 BS IV (D) 97 Kw (2016.01-->), Captain 3123 BSIV (D) 134 Kw (2016.01-->), Ecomet 1012 BS IV, Captain 49IT BS III (D) 165 Kw (2011.12-->), Boss 913 BS III, 11M FESLF BS IV (D) 123 Kw (2018.11-->), Captain 4923 BS III (D) 123 Kw (2014.10-->), Captain 3123 BS IV (D) 170 Kw (2014.12-->), 2518 T BS IV (D) 134 Kw (2016.12-->), ULE Diesel BS 4 (D) 165 Kw (2014.01-->), 3123 BS III (D) 168 Kw (2013.12-->), 4019 BS IV (D) 134 Kw (2016.12-->), 1618, Captain 2518 BS IV (D) 134 Kw (2014.12-->), Boss 1213 LE (D) 96 Kw (2014.01-->), Captain 2518 BS IV (D) 134 Kw (2018.12-->), Captain 3123 BS IV (D) 172 Kw (2018.12-->), JanBus BS4 (D) 165 Kw (2016.02-->), N 2523 BS III (D) 166 Kw (2015.12-->), Boss 1113 BS III (D) 95 Kw (2012.12-->), JanBus Midi BS4 (D) 95 Kw (2016.02-->), 3118-T BS IV (D) 134 Kw (2019.06-->), 4019 BSIV (D) 134 Kw (2016.01-->), 3718 BSIV (D) 134 Kw (2016.01-->), 1612 BS IV (D) 97 Kw (2019.11-->), 1612 BS IV			F 002 H22 095	
Boss 1212 LE, U 2516	F 002 H24 415		F 002 H23 536	F 002 H23 572
Bus IV				9 451 037 424
Captain 2518 BS IV (D) 134 Kw (2014.12-->)			F 002 H26 310	
Captain 3723 BS IV, 2518 (D) 135 Kw (2010.10-->), 12M FE BS III, Cheetah (D) 118 Kw (2014.01-->), Viking BS IV (D) 123 Kw (2016.12-->), 3123, Cheetah (D) 135 Kw (2014.01-->), Cheetah (D) 88 Kw (2000.11 -2005.03), 4123 BS IV	F 002 H21 219		F 002 H23 590	F 002 H23 572
Captain 40 (D) 165 Kw (2016.02-->), 12MIFESLF BS IV (D) 123 Kw (2014.12-->), ULE Diesel BS 4 (D) 165 Kw (2014.01-->), U 4923 (D) 165 Kw (2010.09-->)			F 002 H26 311	
Captain 4923 BS III, 3120 il, N 3123 BS III, U-2518-IL-T HD BS III (D) 134 Kw (2016.08-->), Captain 49IT BS III, U 2523, 3518 BS III (D) 134 Kw (2015.12-->)	F 002 H24 415		F 002 H23 590	F 002 H23 572
Cheetah	F 002 H23 561		F 002 H24 406	F 002 H21 222
Cheetah (D) 118 Kw (2014.01-->)	F 002 H21 219		F 002 H26 311	F 002 H60 022
Cheetah (D) 118 Kw (2014.01-->)	F 002 H23 589		F 002 H26 311	F 002 H60 022

### Brand wise Filter Application Chart

Model Description	Air Filter	Cabin Filter	Fuel Filter	Oil Filter
Cheetah (D) 118 Kw (2014.01-->), 2516 6x2 (H), Cheetah (D) 122.8 Kw (2005.11-->), 3121, Double Decker BS III, 12M (D) 130 Kw (2005.04 -2010.10), 4018, 12M (D) 130 Kw (2006.11 -2010.10), 2516 S, Viking BS IV (D) 97 Kw (2017.06-->), Viking (D) 123 Kw (2005.05-->), Viking (D) 123 Kw (2011.01-->), Cheetah (D) 135 Kw (2014.01-->), 2516 6x4 (H) 4x4, 2518 (D) 132 Kw (2008.01 -2010.10), 3516, Artik 3516	F 002 H21 219		F 002 H21 298	F 002 H60 022
Cheetah (D) 118 Kw (2014.01-->), 2518 (D) 132 Kw (2014.01-->)	F 002 H23 589		F 002 H22 095	F 002 H60 022
Cheetah (D) 118 Kw (2014.01-->), 2518 (D) 132 Kw (2014.01-->), 1618 BS IV, U 3518 5.7	F 002 H23 589		F 002 H22 095	F 002 H23 572
Cheetah (D) 118 Kw (2014.01-->), 3718 iL BS III, 12M (D) 118 Kw (2010.10-->)	F 002 H21 219		F 002 H24 921	F 002 H23 572
Cheetah (D) 118 Kw (2014.01-->), Cheetah (D) 122.8 Kw (2005.11-->), 3121, 2518 (D) 132 Kw (2014.01-->), Double Decker BS III, 12M (D) 130 Kw (2005.04 -2010.10), 4018, 12M (D) 130 Kw (2006.11 -2010.10), 2516 S, 4019, Viking (D) 123 Kw (2005.05-->), Viking (D) 123 Kw (2011.01-->), Cheetah (D) 135 Kw (2014.01-->), 2516 6x4 (H) 4x4, 2518 (D) 132 Kw (2008.01 -2010.10), 3516	F 002 H23 589		F 002 H21 298	F 002 H60 022
Cheetah (D) 118 Kw (2014.01-->), U 3123, Captain 40, 11M FESLF BS IV	F 002 H23 589		F 002 H26 311	F 002 H23 572
Cheetah (D) 118 Kw (2014.01-->), Viking BS IV (D) 123 Kw (2016.12-->)	F 002 H21 219		F 002 H22 095	F 002 H23 572
Cheetah (D) 118 Kw (2014.01-->), Viking BS IV (D) 123 Kw (2016.12-->), 11M FESLF BS IV	F 002 H21 219		F 002 H26 311	F 002 H23 572
Cheetah (D) 118 Kw (2014.01-->), Viking BS IV (D) 97 Kw (2017.06-->)	F 002 H21 219		F 002 H22 095	F 002 H60 022
Cheetah (D) 74 Kw (1991.02 -2000.10)			9 450 030 100	
Cheetah (D) 74 Kw (1991.02 -2000.10)			9 451 037 404	
Cheetah (D) 74 Kw (1991.02 -2000.10)			9 451 037 405	
Cheetah (D) 84 Kw (1995.04 -2010.10)	F 002 H24 415		0 450 226 028	F 002 H60 022
Cheetah (D) 84 Kw (1995.04 -2010.10)	F 002 H24 415		1 457 431 003	F 002 H60 022
Cheetah (D) 84 Kw (1995.04 -2010.10)	F 002 H24 415		9 451 037 406	F 002 H60 022
Cheetah (D) 84 Kw (1995.04 -2010.10)	F 002 H24 415		F 002 H24 406	F 002 H60 022
Cheetah (D) 84 Kw (1995.04 -2010.10)	F 002 H60 010		0 450 226 028	F 002 H60 022
Cheetah (D) 84 Kw (1995.04 -2010.10)	F 002 H60 010		1 457 431 003	F 002 H60 022
Cheetah (D) 84 Kw (1995.04 -2010.10)	F 002 H60 010		9 451 037 406	F 002 H60 022
Cheetah (D) 84 Kw (1995.04 -2010.10)	F 002 H60 010		F 002 H24 406	F 002 H60 022
Cheetah (D) 84 Kw (1995.04 -2010.10), Cheetah (D) 97 Kw (2005.04 -2010.10)	F 002 H24 415		9 451 037 409	F 002 H60 022
Cheetah (D) 84 Kw (1995.04 -2010.10), Cheetah (D) 97 Kw (2005.04 -2010.10)	F 002 H60 010		9 451 037 409	F 002 H60 022
Cheetah (D) 84 Kw (1995.04 -2010.10), Viking (D) 84 Kw (2004.02 -2010.10)	F 002 H60 010		F 002 H24 921	F 002 H60 022
Cheetah (D) 88 Kw (2000.11 -2005.03)	F 002 H21 219		0 450 226 028	F 002 H23 572

### Brand wise Filter Application Chart

Model Description	Air Filter	Cabin Filter	Fuel Filter	Oil Filter
Cheetah (D) 88 Kw (2000.11 -2005.03)	F 002 H21 219		1 457 431 003	F 002 H23 572
Cheetah (D) 88 Kw (2000.11 -2005.03)	F 002 H21 219		9 451 037 406	F 002 H23 572
Cheetah (D) 88 Kw (2000.11 -2005.03)	F 002 H21 219		9 451 037 409	F 002 H23 572
Cheetah (D) 88 Kw (2000.11 -2005.03)	F 002 H21 219		F 002 H24 406	F 002 H23 572
Cheetah (D) 88 Kw (2000.11 -2005.03)	F 002 H23 589		0 450 226 028	F 002 H23 572
Cheetah (D) 88 Kw (2000.11 -2005.03)	F 002 H23 589		1 457 431 003	F 002 H23 572
Cheetah (D) 88 Kw (2000.11 -2005.03)	F 002 H23 589		9 451 037 406	F 002 H23 572
Cheetah (D) 88 Kw (2000.11 -2005.03)	F 002 H23 589		9 451 037 409	F 002 H23 572
Cheetah (D) 88 Kw (2000.11 -2005.03)	F 002 H23 589		F 002 H24 406	F 002 H23 572
Comet 1611	F 002 H60 010		9 451 037 404	F 002 H20 255
Comet 1611	F 002 H60 010		9 451 037 405	F 002 H20 255
Comet 1611	F 002 H60 010		F 002 H23 536	F 002 H20 255
Comet 1611 (D) 63 Kw (1961.05 -1980.01), Comet 1611 (D) 74 Kw (1980.02 -2001.02)			F 002 H21 298	9 451 037 424
Comet 1611 (D) 63 Kw (1961.05 -1980.01), Comet 1611 (D) 74 Kw (1980.02 -2001.02), Comet 1613, Comet Junior			9 450 030 100	9 451 037 424
Comet 1611 (D) 88.2 Kw (2004.09 -2010.10), Stag (D) 88 Kw (2013.10-->), Lynx BS IV (D) 95 Kw (2015.12-->), Viking 160HP IL FIP BS3 (D) 118 Kw (2014.02-->), Viking 180HP ROTARY FIP EDC BS3 (D) 135 Kw (2014.02-->), 1618 XP BS III (D) 134 Kw (2015.12-->), Captain 4923 BS IV (D) 172 Kw (2018.10-->), eComet 1212 (D) 88 Kw (2010.10-->), 3116 (D) 118 Kw (2010.10-->), Viking BS III (D) 119 Kw (2011.12-->), 3116 (D) 118 Kw (2009.07 -2010.10)			F 002 H21 298	F 002 H60 022
Comet 1611 (D) 88.2 Kw (2004.09 -2010.10), Viking 160HP IL FIP BS3 (D) 118 Kw (2014.02-->), Viking 180HP ROTARY FIP EDC BS3 (D) 135 Kw (2014.02-->), Lynx BS III, 1616 BS III (D) 119 Kw (2013.12-->), Viking BS III (D) 119 Kw (2014.12-->), eComet 1212 (D) 88 Kw (2010.10-->), Viking BS III (D) 119 Kw (2011.12-->), 12M FE BS IV (D) 165 Kw (2016.12-->), 3116 (D) 118 Kw (2009.07 -2010.10), Viking BS III (D) 124 Kw (2012.12-->)			F 002 H23 590	F 002 H60 022
Comet 1613, Comet Junior			9 450 030 100	F 002 H20 255
Comet 1613, Comet Junior			9 451 037 404	9 451 037 424
Comet 1613, Comet Junior			9 451 037 404	F 002 H20 255
Comet 1613, Comet Junior			9 451 037 405	9 451 037 424
Comet 1613, Comet Junior			9 451 037 405	F 002 H20 255
Comet 1616 BS II, SFC 1613 BS II, SFC 1613 BS III, U-2518-IL-T HD BS III (D) 134 Kw (2016.08-->), 2514 BS II, 1613 5.7, 2214 6x2 BS II, Captain 2518 HD BS III, Viking (D) 84 Kw (2004.02 -2010.10), 1611 BS II, Cheetah (D) 84 Kw (1995.04 -2010.10), 3518 BS III (D) 134 Kw (2015.12-->), Stag (D) 88 Kw (2010.10-->), 2518 T BS III, Lynx (D) 88 Kw (2010.10-->)	F 002 H24 415		F 002 H24 921	F 002 H60 022

### Brand wise Filter Application Chart

Model Description	Air Filter	Cabin Filter	Fuel Filter	Oil Filter
Comet 1616H			1 457 431 003	F 002 H20 241
Comet 1616H			1 457 431 003	F 002 H21 222
Comet 1616H			F 002 H23 536	F 002 H20 241
Comet 1616H			F 002 H23 536	F 002 H21 222
Comet 1616H			F 002 H24 406	F 002 H20 241
Comet 1616H			F 002 H24 406	F 002 H21 222
Comet 1616H (D) 123 Kw (2009.11 -2010.10)			0 450 226 028	
Comet 1616H (D) 123 Kw (2009.11 -2010.10), Artik 3014 (D) 99 Kw (2000.05 -2005.04)			9 451 037 406	
Comet 1616H (D) 123 Kw (2009.11 -2010.10), Artik 3014 (D) 99 Kw (2000.05 -2005.04)			9 451 037 409	
Comet 1616H (D) 123 Kw (2009.11 -2010.10), Artik 3014 (D) 99 Kw (2000.05 -2005.04)			F 002 H24 406	
Dost 1.5 CNG, Dost 1.5TD Plus, Dost 1.5TD Strong	F 002 H24 999			
Dost 1.5D, Dost 1.5TD Xpress	F 002 H24 999		F 002 H24 496	
Dost 1.5TD Strong (D) 43 Kw (2017.09-->), Dost 1.5TD Plus (D) 45 Kw (2017.09-->)			F 002 H22 471	
Ecomet 1012 BS III, 3014, 2516 il BS III (D) 119 Kw (2012.12-->), Viking BS II, Lynx (GAS) 106 Kw (2014.01-->)	F 002 H24 415			F 002 H60 022
Ecomet 1012 Smart (D) 88 Kw (2010.11-->), Cheetah (D) 84 Kw (1995.04 -2010.10), SFC 1613 BS II, eComet 1112 (D) 88 Kw (2008.11 -2010.10), U-2518-IL-T HD BS III (D) 134 Kw (2016.08-->), eComet 912 (D) 88 Kw (2008.11-->), 3518 BS III (D) 134 Kw (2015.12-->), Cheetah (D) 97 Kw (2005.04 -2010.10), Stag (D) 88 Kw (2010.10-->), Lynx (D) 88 Kw (2010.10-->), Viking (D) 84 Kw (2004.02 -2010.10)	F 002 H24 415		F 002 H23 590	F 002 H60 022
Ecomet 1012 Smart (D) 88 Kw (2010.11-->), Cheetah (D) 84 Kw (1995.04 -2010.10), eComet 1112 (D) 88 Kw (2008.11 -2010.10), Viking (D) 97 Kw (2004.02 -2010.10), eComet 912 (D) 88 Kw (2008.11-->), 12M (D) 130 Kw (2005.04 -2010.10), Cheetah (D) 97 Kw (2005.04 -2010.10), Viking (D) 84 Kw (2004.02 -2010.10)	F 002 H60 010		F 002 H21 298	F 002 H60 022
Ecomet 1012 Smart (D) 88 Kw (2010.11-->), Cheetah (D) 84 Kw (1995.04 -2010.10), eComet 1112 (D) 88 Kw (2008.11-->), 3015, 12M (D) 130 Kw (2005.04 -2010.10), Cheetah (D) 97 Kw (2005.04 -2010.10), Viking (D) 84 Kw (2004.02 -2010.10)	F 002 H60 010		F 002 H23 590	F 002 H60 022
Ecomet 1012 Smart (D) 88 Kw (2010.11-->), eComet 1112 (D) 88 Kw (2005.08 -2010.10), Viking (GAS) (2006.01-->), eComet 912 (D) 88 Kw (2005.08 -2010.10)	F 002 H24 415		F 002 H21 298	F 002 H20 241
Ecomet 1012 Smart (D) 88 Kw (2010.11-->), eComet 1112 (D) 88 Kw (2005.08 -2010.10), Viking (GAS) (2006.01-->), eComet 912 (D) 88 Kw (2005.08 -2010.10)	F 002 H60 010		F 002 H21 298	F 002 H20 241

### Brand wise Filter Application Chart

Model Description	Air Filter	Cabin Filter	Fuel Filter	Oil Filter
Ecomet 1012 Smart (D) 88 Kw (2010.11-->), eComet 1112 (D) 88 Kw (2005.08 -2010.10), eComet 912 (D) 88 Kw (2005.08 -2010.10)	F 002 H24 415		F 002 H23 590	F 002 H20 241
Ecomet 1012 Smart (D) 88 Kw (2010.11-->), eComet 1112 (D) 88 Kw (2005.08 -2010.10), eComet 912 (D) 88 Kw (2005.08 -2010.10)	F 002 H60 010		F 002 H23 590	F 002 H20 241
JanBus Midi BS4, 2518 BS IV (D) 134 Kw (2018.12-->), 3718 iL (D) 132 Kw (2014.01-->), Captain 4923 BS IV, Lynx, 3518 BS IV (D) 134 Kw (2015.12-->), 3718 BS IV (D) 134 Kw (2015.12-->), 3118 BS IV (D) 134 Kw (2015.12-->), U 3718 BS IV (D) 132 Kw (2014.12-->), 1618 XP BS III	F 002 H24 415		F 002 H22 095	
N 2523 BS III, Captain 3123 BSIV, N 2523 BS IV, Captain 3123 BS IV, Viking BS IV (D) 97 Kw (2017.06-->)	F 002 H24 415		F 002 H22 095	F 002 H60 022
Stag (D) 88 Kw (2002.01 -2005.03)	F 002 H23 564		F 002 H21 298	F 002 H20 241
Stag (D) 88 Kw (2002.01 -2005.03)	F 002 H23 567		F 002 H21 298	F 002 H20 241
Stag (D) 88 Kw (2013.10-->), 12M (D) 165 Kw (2014.01-->), Lynx BS IV (D) 95 Kw (2015.12-->), Viking 160HP IL FIP BS3 (D) 118 Kw (2014.02-->), Viking 180HP ROTARY FIP EDC BS3 (D) 135 Kw (2014.02-->), 1618 XP BS III (D) 134 Kw (2015.12-->), Captain 4923 BS IV (D) 172 Kw (2018.10-->), 3116 (D) 118 Kw (2010.10-->), Viking BS III (D) 119 Kw (2011.12-->)			F 002 H21 298	F 002 H23 572
Stag (D) 88 Kw (2013.10-->), Lynx BS IV (D) 95 Kw (2015.12-->), 1618 XP BS III (D) 134 Kw (2015.12-->), 12M FE BS IV (D) 132 Kw (2016.12-->), Viking BS III (D) 119 Kw (2011.12-->), 12M FE BS IV (D) 165 Kw (2016.12-->), 2518 BS IV, U 3718 BS IV, 3718 BS IV, 3118 BS IV, Boss 1213 LE, Boss 1113 LX, Boss 913 LX, Captain 4923 BS IV (D) 172 Kw (2018.10-->)			F 002 H22 095	F 002 H23 572
Stag (D) 88 Kw (2013.10-->), Lynx BS IV (D) 95 Kw (2015.12-->), 1618 XP BS III (D) 134 Kw (2015.12-->), Captain 4923 BS IV (D) 172 Kw (2018.10-->), Viking BS III (D) 119 Kw (2011.12-->), 12M FE BS IV (D) 165 Kw (2016.12-->)			F 002 H22 095	F 002 H60 022
Stag, 1612 IL BS-III, eComet 1214			F 002 H23 536	F 002 H60 022
Stile 1.5, Dost 1.5TD Strong (D) 43 Kw (2017.09-->), Dost 1.5TD Plus (D) 45 Kw (2017.09-->)			F 002 H24 496	
Sunshine				F 002 H26 313
Taurus 2516 6x2	F 002 H23 561			
Tusker 3516, Taurus 2516 6x4	F 002 H23 561		F 002 H23 590	

### Brand wise Filter Application Chart

Model Description	Air Filter	Cabin Filter	Fuel Filter	Oil Filter
U 1616 (D) 84 Kw (2010.11-->), Boss 1113 LX (D) 96 Kw (2014.01-->), 4921 (D) 151 Kw (2014.01-->), 1618T BS IV (D) 134 Kw (2018.12-->), Viking, Boss 913 LX (D) 96 Kw (2014.01-->), 3518 (D) 130 Kw (2008.07 -2010.10), U 4923 BS IV (D) 168 Kw (2018.12-->), 3121 (D) 151 Kw (2014.01-->), 2214 Super (D) 97 Kw (2009.07 -2010.10), U 4019 BS III (D) 134 Kw (2014.12-->), SG 1613 H, eComet 1214 (D) 88 Kw (2014.01-->), Viking (D) 123 Kw (2005.11 -2009.12), 12M (D) 135 Kw (2010.10-->), Comet 1611 (D) 89.7 Kw (2001.03 -2005.03), Stag (D) 64 Kw (2003.04 -2010.10), Stag (D) 88 Kw (2005.04 -2010.10), Captain 3123 BSIV (D) 134 Kw (2016.01-->), 4018 (D) 130 Kw (2004.08 -2009.09), 2518 T BS IV (D) 134 Kw (2016.12-->), Boss 913 LX BS IV, Captain 2518 BS IV (D) 134 Kw (2014.12-->), Captain 3123 BS IV (D) 172 Kw (2018.12-->), N 2523 BS III (D) 166 Kw (2015.12-->), U 2518 (D) 132 Kw (2010.09-->), 3518 (D) 132 Kw (2010.10-->), 4019 BSIV (D) 134 Kw (2016.01-->), Stag (D) 64 Kw (2005.04 -2010.10), 1612 BS IV (D) 97 Kw (2019.11-->), Viking (D) 90 Kw (2014.01-->), S 1613 H, RE SLF (D) 165 Kw (2014.01-->), U-2518 T BS IV (D) 134 Kw (2015.12-->), U 3118 LA BS IV (D) 134 Kw (2015.12-->), 3121 (D) 151 Kw (2008.04 -2010.10), Cheetah (D) 88.2 Kw (2007.03 -2010.10), U 3518 BS IV (D) 134 Kw (2010.12 -2012.12), N 2523 BS IV (D) 172 Kw (2018.12-->), 4019il (D) 132 Kw (2012.12-->), 2516 il (D) 118 Kw (2010.05-->), Viking BS II (D) 98 Kw (2004.02 -2010.10), Boss 913 BS III (D) 95 Kw (2013.10-->), eComet 1212 BSIV (D) 97 Kw (2016.01-->), Captain 40IT BS III (D) 134 Kw (2016.02-->), U-3118 (D) (2015.06-->), 2514 (D) 97 Kw (2008.02 -2009.07), 4921 (D) 151 Kw (2007.05 -2010.10), Tusker Super 1616, Viking (D) 88 Kw (2001.05 -2005.03), Boss 1413 BS IV, Boss 912 LE 3.8 (D) 88 Kw (2014.01-->), Ecomet 1012 BS IV (D) 97 Kw (2016.01-->), Boss 1213 LE BS IV, U 2516 (D) 118 Kw (2010.09-->), 1612 IL BS-III (D) 88 Kw (2014.01-->), Captain 3123 BS IV (D) 170 Kw (2014.12-->), 12M (D) 128 Kw (2009.03-->), JanBus Midi BS III, 2513 (D) 97 Kw (2005.08 -2008.01), Bison 1611, 4019 BS IV (D) 134 Kw (2016.12-->), Boss 1213 LE (D) 96 Kw (2014.01-->), Captain 2518 BS IV (D) 134 Kw (2018.12-->), 1616 iL 5.7 (D) 118 Kw (2014.01-->), Boss 1113 BS III (D) 95 Kw (2012.12-->), Lynx (D) 88 Kw (2014.01-->), JanBus Midi BS4 (D) 95 Kw (2016.02-->), 1613 H (D) 97 Kw (2005.11 -2010.10), 3118-T BS IV (D) 134 Kw (2019.06-->), 4018 (D) 130 Kw (2014.01-->), 3718 BSIV (D) 134 Kw (2016.01-->), Comet 1616H (D) 123 Kw (2009.11 -2010.10)			F 002 H21 298	

### Brand wise Filter Application Chart

Model Description	Air Filter	Cabin Filter	Fuel Filter	Oil Filter
U 1616 (D) 84 Kw (2010.11-->), Boss 1212 LE (D) 88 Kw (2014.01-->), 1614 BS III (D) (2015.06-->), Ecomet 1012 BS III (D) 88 Kw (2013.12-->), Boss 912 LE 3.8 (D) 88 Kw (2014.01-->), U 2516 (D) 118 Kw (2010.09-->), RE SLF (D) 165 Kw (2014.01-->), 1612 IL BS-III (D) 88 Kw (2014.01-->), Boss 1112 LE (D) 88 Kw (2014.01-->), U 4019 il (D) 132 Kw (2014.01-->), 3123 BS III (D) 168 Kw (2013.12-->), 11M FESLF BS IV (D) 123 Kw (2018.12-->), 4019il (D) 132 Kw (2012.12-->), Boss 1213 LE (D) 96 Kw (2014.01-->), 3123 (D) 165 Kw (2010.08-->), Viking BS II (D) 98 Kw (2004.02 -2010.10), 3518 (D) 132 Kw (2010.10-->)			F 002 H24 921	
U 1618, U 3723 (D) 165 Kw (2012.01-->), 3518 BS IV (D) 134 Kw (2015.12-->), eComet 1112, Lynx BS II, U 3718 BS IV (D) 132 Kw (2014.12-->), eComet 912, 2523 (D) 165 Kw (2014.01-->)	F 002 H24 415		F 002 H23 590	
U 1618, eComet 1112, eComet 912	F 002 H24 415		F 002 H23 536	
U 1619			F 002 H22 001	
U 2523	F 002 H24 415		F 002 H24 920	F 002 H23 572
U 3123, 4923	F 002 H23 589		F 002 H24 920	F 002 H23 572
U 3518 (D) 132 Kw (2010.10-->)			F 002 H22 001	F 002 H23 572
U 3518 (D) 132 Kw (2010.10-->)			F 002 H22 001	F 002 H60 022
U 3518 (D) 132 Kw (2010.10-->)			F 002 H22 004	F 002 H60 022
U 3518 (D) 132 Kw (2010.10-->), 12M (D) 165 Kw (2014.01-->)			F 002 H22 004	F 002 H23 572
U 3518 (D) 132 Kw (2010.10-->), 12M (D) 165 Kw (2014.01-->), Boss 912 LE 3.8, Viking 160HP IL FIP BS3 (D) 118 Kw (2014.02-->), Viking 180HP ROTARY FIP EDC BS3 (D) 135 Kw (2014.02-->), 1618 XP BS III (D) 134 Kw (2015.12-->), Boss 1112 LE, 1616 BS III (D) 119 Kw (2013.12-->), 3718 iL, 12M FE BS IV (D) 165 Kw (2016.12-->), 12M FESLF BS III			F 002 H24 921	F 002 H23 572
U 3518 (D) 132 Kw (2010.10-->), Viking 160HP IL FIP BS3 (D) 118 Kw (2014.02-->), Viking 180HP ROTARY FIP EDC BS3 (D) 135 Kw (2014.02-->), 1618 XP BS III (D) 134 Kw (2015.12-->), Viking BS III (D) 135 Kw (2012.12-->), 1616 XL BS III, 1616 BS III (D) 119 Kw (2013.12-->), RE SLF BS III (D) 168 Kw (2012.12-->), 1612 IL BS-III, 12M FE BS IV (D) 165 Kw (2016.12-->), Viking BS III (D) 124 Kw (2012.12-->)			F 002 H24 921	F 002 H60 022
U 3723 (D) 165 Kw (2012.01-->), 2523 (D) 165 Kw (2014.01-->)	F 002 H21 219		F 002 H24 920	
U 3723 (D) 165 Kw (2012.01-->), 2523 (D) 165 Kw (2014.01-->)	F 002 H23 589		F 002 H24 920	
U 3723 (D) 165 Kw (2012.01-->), 2523 (D) 165 Kw (2014.01-->)	F 002 H24 415		F 002 H24 920	
U 4019 BS III, U 3118 LA BS IV, Captain 40IT BS III, JanBus BS4, 3118-T BS IV, U-2518 T BS IV, 4019 BSIV, 2518 T BS IV, 1618T BS IV, Lynx (D) 96 Kw (2014.01-->), U 3518 BS IV	F 002 H24 415		F 002 H22 095	F 002 H23 572



### Brand wise Filter Application Chart

Model Description	Air Filter	Cabin Filter	Fuel Filter	Oil Filter
U 4019 BS IV, Lynx (D) 96 Kw (2014.01-->)	F 002 H24 415		F 002 H21 298	F 002 H23 572
U 4023	F 002 H23 589		F 002 H22 001	F 002 H23 572
U 4023 (D) 165 Kw (2010.09-->), U 1619			F 002 H22 004	
U 4923, 2516 il BS III (D) 119 Kw (2012.12-->), 12MIFESLF BS IV	F 002 H23 589			F 002 H23 572
U-2518 IL T HD BS IV, Captain 3718 BS IV, 1616 XP (D) 124 Kw (2010.08-->), 12M FESLF CNG BS IV, 1616 H (D) 123 Kw (2006.04 -2010.10), RE SLF, U 1618 (D) 97 Kw (2010.11-->), 1616 XL (D) 124 Kw (2010.08-->)				F 002 H23 572
U-2518-IL-T HD BS III (D) 134 Kw (2016.08-->), 3518 BS III (D) 134 Kw (2015.12-->), Boss 1212 LE, U 2516	F 002 H24 415		F 002 H24 921	F 002 H23 572
Viking (D) 123 Kw (2005.05-->), Cheetah (D) 118 Kw (2014.01-->), Cheetah (D) 135 Kw (2014.01-->), 12M (D) 130 Kw (2005.04 -2010.10), VESTIBULE BS III, 12M (D) 130 Kw (2006.11 -2010.10), 2518 (D) 132 Kw (2008.01 -2010.10), 4921	F 002 H21 219		F 002 H23 590	F 002 H60 022
Viking (D) 123 Kw (2005.05-->), Cheetah (D) 118 Kw (2014.01-->), U-2518-IL-T HD BS III (D) 134 Kw (2016.08-->), 2518 (D) 132 Kw (2014.01-->), Cheetah (D) 135 Kw (2014.01-->), 12M (D) 130 Kw (2005.04 -2010.10), 3518 BS III (D) 134 Kw (2015.12-->), VESTIBULE BS III, 12M (D) 130 Kw (2006.11 -2010.10), 2518 (D) 132 Kw (2008.01 -2010.10), 4921	F 002 H23 589		F 002 H23 590	F 002 H60 022
eComet 1109 3.8, 2214 Super	F 002 H23 564			
eComet 1109 3.8, 2214 Super	F 002 H23 567			
eComet 1212 (D) 88 Kw (2010.10-->)			F 002 H21 298	F 002 H20 241
eComet 1212 (D) 88 Kw (2010.10-->)			F 002 H23 590	F 002 H20 241
<b>EICHER</b>				
10.59 XP, 10.75, Pro 1090, Pro 1110, 10.80 E2 Plus (D) 70 Kw (2010.10-->), Pro 1095 XP, Pro 1080, 10.80 E2 Plus	F 002 H23 594			
10.80 E2 Plus (D) 70 Kw (2009.05 -2010.10), 10.90 E2 Plus, 10.80 E2 Plus, 11.10 E2 Plus	F 002 H23 592			
10.90 L 40	F 002 H21 218			
10.90 L 40	F 002 H23 563			
11.10	F 002 H23 562			
11.10	F 002 H23 567			
11.10 / XP				9 951 030 141
11.10, 10.95	F 002 H60 006			
Galaxy 33.25 (D) 130 Kw (2004.08 -2009.03), Galaxy 30.25 XP (D) 108 Kw (2010.08-->), Galaxy 30.25 XP (D) 108 Kw (2009.03 -2010.10)	F 002 H60 010			
Galaxy 33.25 (D) 130 Kw (2004.08 -2009.03), Galaxy 30.25 XP (D) 108 Kw (2010.08-->), Galaxy 30.25 XP (D) 108 Kw (2009.03 -2010.10)	F 002 H60 011			
Pro 1075	F 002 H23 594			F 002 H27 505

### Brand wise Filter Application Chart

Model Description	Air Filter	Cabin Filter	Fuel Filter	Oil Filter
Pro 1110 XP	F 002 H23 594		F 002 H23 582	
Pro 3012 TCI BS IV	F 002 H23 594		F 002 H24 918	F 002 H26 361
Pro 3013	F 002 H23 594		F 002 H24 919	
Pro 3013 (D) 89 Kw (2014.01-->), Pro 3015 TCI BS IV (D) 101 Kw (2016.02-->)			F 002 H24 919	
Pro 3013 (D) 89 Kw (2014.01-->), Pro 3015 TCI BS IV (D) 121 Kw (2016.02-->), 10.90, Pro 3015 TCI BS IV (D) 101 Kw (2016.02-->), Mega 40.40			F 002 H24 918	
Pro 3015 TCI BS IV, Pro 3012 TCI BS IV	F 002 H23 594		F 002 H24 919	F 002 H26 361
Skyline Pro 3008	F 002 H23 594		F 002 H23 582	F 002 H26 361
<b>EICHER MOTORS LIMITED</b>				
10.50 3.3 Diesel BS2	F 002 H23 594		F 002 H26 307	9 951 030 141
10.50 3.3 Diesel BS3, 10.50 3.3 Diesel			F 002 H26 307	9 951 030 141
10.50 3.3 Diesel Turbo	F 002 H21 218			
10.59 3.3 Diesel, 10.70				9 951 030 141
20.15 H BS III			F 002 H24 919	
20.15 H BS III, JUMBO 20.16			F 002 H24 918	
Galaxy 30.25 (D) 108 Kw (2005.08-->), Galaxy 30.25 (D) 108 Kw (2003.04-->)	F 002 H60 010			
Galaxy 30.25 (D) 108 Kw (2005.08-->), Galaxy 30.25 (D) 108 Kw (2003.04-->)	F 002 H60 011			
JUMBO 20.16, Galaxy 30.25			9 450 030 116	
Pro 1090 BS IV, Pro 1095XP BS IV, Pro 1080XPT BS IV	F 002 H23 594			F 002 H27 505
Pro 1110XP BS IV, Pro 1110 BS IV	F 002 H23 594			F 002 H26 361
Pro 2110XP Plus CNG BS-VI, Pro 2110XP Plus BS-VI, Skyline Pro 3009H CNG BS-VI, Pro 2110XPT BS-VI			F 002 H25 926	
Pro 2110XP Plus CNG BS-VI, Pro 2110XP Plus BS-VI, Skyline Pro 3009H CNG BS-VI, Pro 2110XPT BS-VI			F 002 H25 949	
Pro 3014 BS6, Pro 3012 BS-III, Pro 3014 BS-IV CNG, Pro 1080XP BS-IV, Pro 3015 BS6, Pro 1049, 10.60 3.3 Diesel, Pro 3012 BS6, Pro 1055 BS-IV, Pro 1110XPT BS-IV, Pro 1075 BS IV, Pro 1095 BS-IV, Pro 3015 BS-III, Pro 3016 BS-IV, 10.50 3.3 Diesel Turbo, Pro 2114XP BS-IV, Pro 3014 BS IV, Skyline Pro 3008 H BS-IV School Bus, Pro 1059 BS IV, Pro 1059XP BS IV, Pro 1080 DSD, Skyline Pro 3009L BS-IV School Bus, Pro 1050, Pro 1114XP BS-IV, Pro 1055K	F 002 H23 594			
STARLINE 12.12K BS IV				F 002 H26 361
Skyline Pro 3011L BS-VI, Pro 2114XP BS-VI, Pro 2110XP BS-VI, Skyline Pro 3010L BS-VI, 2112M Skyline BS-VI, Pro 3019 BS-VI, Skyline Pro 3009H BS-VI, Pro 2114XP CNG BS-VI, Pro 2110 BS-VI	F 002 H23 594		F 002 H25 926	
Skyline Pro 3011L BS-VI, Pro 2114XP BS-VI, Pro 2110XP BS-VI, Skyline Pro 3010L BS-VI, 2112M Skyline BS-VI, Pro 3019 BS-VI, Skyline Pro 3009H BS-VI, Pro 2114XP CNG BS-VI, Pro 2110 BS-VI	F 002 H23 594		F 002 H25 949	

## Brand wise Filter Application Chart

Model Description	Air Filter	Cabin Filter	Fuel Filter	Oil Filter
<b>FORCE MOTORS</b>				
Commuter 2.6 Diesel			9 450 030 116	
Tempo Traveller Ambulance 2.4 Diesel, Excel-4 2.6 Diesel, Excel-4 3.2 Diesel, Matador 2.4 Diesel, Excel-2 2.4 Diesel, Pick Up Trax Dual Cab 2.4 Diesel, Pick Up Trax Kargo 2.6 Diesel, Excel-3 2.4 Diesel, Citiline 2.6 Diesel, Tempo Traveller Ambulance LWB 2.6 Diesel			F 002 H26 307	
Tempo Traveller Minibus 2.4 Diesel, Trax 2.6D Kargo	F 002 H60 012		F 002 H26 307	
Traveller 2.6 Diesel Force				F 002 H23 437
Traveller 3350/3700 mm WB 2.6 Diesel			F 002 H26 307	F 002 H23 437
Traveller Smart DV 3050/3350mm WB 2.6 Diesel	F 002 H60 012			
<b>MAHINDRA</b>				
Blazo 31, Blazo 25 Tipper, Blazo X 28 BS6, Blazo X 40 BS6, Blazo X 42 BS6, Blazo 49, Blazo X 55 BS6, Blazo 37, Blazo 40 Tip trailer, Blazo X 35 BS6, Blazo X 46 BS IV, Blazo X 49 BS6, Blazo 31 Tipper, Blazo 25, Blazo X 35 BS IV, Blazo 35, Blazo X 55 BS IV, Blazo X 40 BS IV, Blazo X 49 BS IV, Blazo X 28 BS IV, Blazo 40, Blazo X 42 BS IV, Blazo X 46 BS6				F 002 H26 363
Bolero Camper	F 002 H60 012		F 002 H26 625	F 002 H23 439
Bolero Camper 2.5 Diesel	F 002 H60 012		F 002 H21 299	
Bolero Camper 2.5 Diesel 2880, Maxx Pickup 2.5 Diesel 4WD	F 002 H60 012		9 451 037 404	
Bolero Camper 2.5 Diesel 2880, Maxx Pickup 2.5 Diesel 4WD	F 002 H60 012		9 451 037 405	
Bolero Camper 2.5 Diesel 4x4, FJ 2.5 Diesel Chassis 4WD, Maxx Pickup 2.5 Diesel 4WD	F 002 H60 012		F 002 H24 496	
Bolero Camper 2.5, Maxx 2.5 Diesel Pickup Lite, Bolero Camper 2.5 Diesel 2450	F 002 H60 012			
Bolero Camper 2510 2.5 D, Bolero Camper 2750 2.5 D	F 002 H60 012			F 002 H23 439
Bolero Camper BS6, Bolero Pik up BS6 4WD, Bolero Pik up ExtraStrong BS6			F 002 H26 537	F 002 H26 539
Bolero Maxi Truck Plus, Bolero Pik up				F 002 H23 439
Bolero Maxi Truck Plus, Bolero Pik up ExtraLong BS6, Bolero Pik up, Bolero Maxi Truck Plus BS6				F 002 H26 539
Cabstar 2.5 Diesel, DI 3200 2.5 Diesel, Pik up 2.5 Diesel 4WD, Pik up 2.5 Diesel CBC, Utility 2.5 Diesel, Pik up 2.5 Diesel, Utility 2.5 Diesel 4WD, Maxx 2.5 Diesel Pickup			9 451 037 404	
Cabstar 2.5 Diesel, DI 3200 2.5 Diesel, Pik up 2.5 Diesel 4WD, Pik up 2.5 Diesel CBC, Utility 2.5 Diesel, Pik up 2.5 Diesel, Utility 2.5 Diesel 4WD, Maxx 2.5 Diesel Pickup			9 451 037 405	
Cosmo 32 BS IV, Cosmo 40 BS IV			F 002 H24 863	
Cosmo 32 BS IV, Cosmo 40 BS IV			F 002 H25 924	

## Brand wise Filter Application Chart

Model Description	Air Filter	Cabin Filter	Fuel Filter	Oil Filter
DI 3200 2.5 Diesel, DI 3200 2.5 Diesel Turbo, Tourister DX, Pik up 2.5 Diesel 4x4, King Cab 2.5 Diesel, King Cab 2.5 D 4x4, Vikrant 2.5 Diesel			F 002 H24 496	
FJ 2.1 Diesel Van				F 002 H20 247
FJ 3.3 Diesel Chassis, FJ 3.3 Diesel Truck, FJ 3.3 Diesel Truck 4WD			9 451 037 404	F 002 H20 247
FJ 3.3 Diesel Chassis, FJ 3.3 Diesel Truck, FJ 3.3 Diesel Truck 4WD			9 451 037 405	F 002 H20 247
FJ 3.3 Diesel Delivery Van, FJ 2.1 Diesel Truck 4WD, FJ 2.1 Diesel Ambulance, FJ 3.3 Diesel Chassis 4WD, FJ 3.3D Hi-Roof Mini-Bus 4WD			F 002 H21 299	
Genio 2.5D (D) 56 Kw (2011.02 -2017.03)			1 457 434 314	
Genio 2.5D (D) 56 Kw (2011.02 -2017.03)			F 002 H26 307	
Imperio 2.5	F 002 H23 585		F 002 H26 625	F 002 H26 539
Imperio 2.5, Genio 2.5D	F 002 H23 585		F 002 H26 625	F 002 H23 439
LoadKing Pride 2.6 CRDe, LoadKing Super 2.6 Diesel, LoadKing CRX Tipper, LoadKing Pride, LoadKing 2.5 Diesel 576 DI, LoadKing Zoom, LoadKing CRX 2.6 Diesel, LoadKing Pride 2.6 Diesel (D) 54 Kw (2005.03 -2009.12), LoadKing CRX			F 002 H24 742	
LoadKing Pride 2.6 Diesel (D) 54 Kw (2005.03 -2009.12)			F 002 H26 625	
LoadKing Pride 2.6 Diesel, LoadKing 2.5 Diesel DI			F 002 H24 742	F 002 H23 439
Maxx Pickup 2.5 Diesel	F 002 H60 012			9 451 037 446
Maxximo 0.9D MiniVan			F 002 H22 283	F 002 H23 439
Maxximo 0.9D, Maxximo Mini VX	F 002 H24 998		F 002 H22 283	F 002 H24 322
NC 640 DP 2.1 Diesel Pick up, NC 640 DP Pick up 2.1 Diesel 4WD, NC 640 DP Pickup 2.1D 4WD				9 451 037 446
SUPRO MAXITRUCK	F 002 H26 531			F 002 H23 439
Supro Maxitruck T2/T4/T6	F 002 H24 998			F 002 H24 322
Supro Maxitruck T2/T4/T6	F 002 H26 531			F 002 H24 322
Supro Minitruck BS6	F 002 H26 531			
Tourister 2.5 Diesel			9 451 037 404	9 451 037 446
Tourister 2.5 Diesel			9 451 037 405	9 451 037 446
Tourister 2.6 Diesel, LoadKing 2.5 Diesel DI			9 451 037 404	F 002 H23 439
Tourister 3.3, Tourister T36			F 002 H26 625	F 002 H23 439
Tourister T15 2.5TD, Tourister Excelo 2.5TD T, Tourister 2.5, DI 3200 Jayo, DI 3200 Optimo			F 002 H20 152	
Tourister T25 2.6TD			F 002 H20 152	F 002 H23 439
<b>MAN</b>				
CLA 15 t, CLA 20 t, CLA 26 t		1 987 431 162		
<b>MERCEDES-BENZ</b>				
O 500 (D) 224 Kw (2008.09 -2012.02), O 500 (D) 188 Kw (2012.03-->)			1 457 431 707	
O 500 (D) 265 Kw (2010.01 -2012.02)			1 457 429 655	



### Brand wise Filter Application Chart

Model Description	Air Filter	Cabin Filter	Fuel Filter	Oil Filter
T3500 Prestige WT49LWB, Prestige WT-48	F 002 H60 006		9 450 030 200	
T3500 Prestige, Prestige WT49TC, T3500 Bus WT-48, Premium T3500 WT 49 ESA, 4WD-BT 3.5D, T3500 3.5 Diesel 4WD, T3500 Truck/Dumper WT, T3500 Prestige WT49STD	F 002 H60 006			
<b>TATA MOTORS</b>				
1109 LP (D) 66 Kw (2007.05-->), 1109 LPT (D) 66 Kw (2001.12-->), 1109 LP (D) 66 Kw (2004.01 -2007.04), 1109 LPT (D) 66 Kw (2000.11-->)			9 450 030 116	
1210E				F 002 H20 032
1210E				F 002 H20 254
1510 LP (D) 77 Kw (2000.09-->), 1510 LP (D) 81 Kw (1988.04 -2000.01), 1516 LPT (D) 118 Kw (1984.02 -1999.12)			9 451 037 406	
1510 LP (D) 77 Kw (2000.09-->), 1510 LP (D) 81 Kw (1988.04 -2000.01), 1516 LPT (D) 118 Kw (1984.02 -1999.12)			9 451 037 409	
1510 LP (D) 77 Kw (2000.09-->), 1510 LP (D) 81 Kw (1988.04 -2000.01), 1516 LPT (D) 118 Kw (1984.02 -1999.12), 1510 LP			F 002 H24 406	
1510 LP/LPO BS-II, LP 1613 SuperMilo			F 002 H27 515	9 451 037 438
1512 LP 497 BS-III	F 002 H23 563		F 002 H23 536	F 002 H23 571
1512 LP/LPO TC BS-III	F 002 H21 218		F 002 H23 535	F 002 H26 360
1512 LP/LPO TC BS-III	F 002 H21 218		F 002 H24 500	F 002 H26 360
1512 LP/LPO TC BS-III (D) 114 Kw (2005.02-->)	F 002 H21 219		F 002 H20 239	0 451 203 228
1512 LP/LPO TC BS-III (D) 114 Kw (2005.02-->)	F 002 H21 219		F 002 H20 239	F 002 H20 240
1512 LP/LPO TC BS-III (D) 114 Kw (2005.02-->)	F 002 H21 219		F 002 H24 501	0 451 203 228
1512 LP/LPO TC BS-III (D) 114 Kw (2005.02-->)	F 002 H21 219		F 002 H24 501	F 002 H20 240
1512 LP/LPO TC BS-III (D) 114 Kw (2005.02-->)	F 002 H23 561		F 002 H20 239	0 451 203 228
1512 LP/LPO TC BS-III (D) 114 Kw (2005.02-->)	F 002 H23 561		F 002 H20 239	F 002 H20 240
1512 LP/LPO TC BS-III (D) 114 Kw (2005.02-->)	F 002 H23 561		F 002 H24 501	0 451 203 228
1512 LP/LPO TC BS-III (D) 114 Kw (2005.02-->)	F 002 H23 561		F 002 H24 501	F 002 H20 240
1512 LP/LPO TC BS-III, LPO 1615 BS III, LPO 1515 BS III	F 002 H23 563		F 002 H24 500	F 002 H26 360
1512 LP/LPO TC BS-III, LPO 1512 TC	F 002 H23 563		F 002 H23 535	F 002 H26 360
1512 TC LP	F 002 H23 563		F 002 H23 536	F 002 H20 240
1512 TC LP	F 002 H23 563		F 002 H23 536	F 002 H26 360
1512 TC LP	F 002 H23 563		F 002 H24 501	F 002 H20 240
1512 TC LP (D) 92 Kw (2000.01 -2001.08), 1510 TC LP, 2516 TC LPT (D) 118 Kw (1996.06-->)			F 002 H20 239	
1516 LPT, 1510 LP			0 450 226 029	
1516 LPT, 1510 LP			1 457 431 003	
1615 TC LPT, 1615 TC LPK, 3516 TC LPS (D) 118 Kw (1999.06-->), 1615 TC SK, 2516 TC LPK			F 002 H20 239	F 002 H20 240
206 1.9 D				9 951 030 134

### Brand wise Filter Application Chart

Model Description	Air Filter	Cabin Filter	Fuel Filter	Oil Filter
207 1.9 D	F 002 H24 419			9 451 037 456
2515 TC LPT	F 002 H21 218		F 002 H20 239	
2515 TC LPT	F 002 H21 219		F 002 H20 239	
2515 TC LPT	F 002 H23 563		F 002 H20 239	
2515 TC LPT (D) 118 Kw (1998.06-->)				0 451 203 228
2515 TC LPT (D) 118 Kw (1998.06-->), 2516 TC LPT				F 002 H20 240
3516 TC LPS (D) 118 Kw (1999.06-->)			F 002 H20 239	0 451 203 228
407 3.0 Diesel LP Turbo Bus (D) 55 Kw (2006.01-->)	F 002 H24 418			3 397 005 295
407 3.0 Diesel LP Turbo Bus (D) 55 Kw (2006.01-->)	F 002 H60 006			3 397 005 295
407 3.0 Diesel LP Turbo Bus (D) 55 Kw (2006.01-->)	F 002 H60 006			F 002 H26 360
407 3.0 Diesel LP Turbo Bus (D) 55 Kw (2006.01-->), 407 3.0 Diesel LPT (D) 53 Kw (2001.10 -2005.02)	F 002 H60 006			F 002 H23 571
407 3.0 Diesel LP Turbo Bus (D) 55 Kw (2006.01-->), 407 3.0 Diesel LPT (D) 53 Kw (2001.10 -2005.02), 407 3.0 4WD, 407 Citiride 3.0, 407 3.0D SFC EX Turbo (D) 55 Kw (2005.05 -2017.03)	F 002 H60 006			9 451 037 456
407 3.0 Diesel LP Turbo Bus (D) 55 Kw (2006.01-->), 407 3.0 Diesel LPT (D) 53 Kw (2001.10 -2005.02), 407 3.0D SFC EX Turbo (D) 55 Kw (2005.03 -2010.10)	F 002 H24 418			9 451 037 456
407 3.0 Diesel LP Turbo Bus (D) 55 Kw (2006.01-->), LPT 407 EX BS-IV, LPT 407 EX2 BS-IV, 407 3.0D SFC EX Turbo (D) 55 Kw (2003.11 -2005.04), LPT 909 EX (D) 66 Kw (2005.03 -2010.10), LP 708 BS III	F 002 H24 418			F 002 H26 360
407 3.0 Diesel LP Turbo Bus, 407 3.0 Diesel LPT, 407 3.0D SFC EX Turbo	F 002 H24 418		F 002 H26 307	
407 3.0 Diesel LPT Turbo, 407 3.0D Cityride NA	F 002 H60 006		9 451 037 404	9 451 037 456
407 3.0 Diesel LPT Turbo, 407 3.0D Cityride NA, 407 3.0 Diesel LP, 407 LP Turbo Bus 3.0, LP 609 Turbo Bus	F 002 H60 006		9 451 037 405	9 451 037 456
407 3.0 Diesel LPT Turbo, Cityride 407, 407 3.0D Cityride NA, 407 LP Turbo Bus 3.0, 407 TurboBus SWB 3.0 D, 407 3.0 Diesel	F 002 H60 006		F 002 H26 307	9 451 037 456
407 3.0 Diesel SFC Turbo Bus, 407 3.0 Diesel LP	F 002 H60 006		F 002 H23 535	9 451 037 456
407 3.0, Starbus 3.0	F 002 H60 006			F 002 H23 566
407 3.0D SFC Pickup (D) 55 Kw (2010.03-->), LPO 1515 BS IV (D) 119 Kw (2017.05-->), LPT 2518/62 TC BS3 (D) 135 Kw (2014.01-->), 1623 Globus LP, LP 1515 BS IV (D) 119 Kw (2017.05-->), Ultra 1012 BS III, SFC 407 EX BS III (D) 55 Kw (2013.05-->), Signa 3118 T (D) 167 Kw (2016.02-->), LPO 1618 BS-III (D) 135 Kw (2010.08-->), LPT 2513 (D) 102 Kw (2011.05-->), 407 3.0 Diesel SFC Turbo (D) 52 Kw (2003.11 -2005.05), LPT 810 Ex2 BS III (D) 91 Kw (2015.12-->), 407 SFC 3.0 (D) 43 Kw (2007.01 -2012.01), LPT 407 (D) 55 Kw (2005.03-->), Prima LX 2523 K / T (D) 171 Kw (2014.01-->)				F 002 H23 571

### Brand wise Filter Application Chart

Model Description	Air Filter	Cabin Filter	Fuel Filter	Oil Filter
407 3.0D SFC Pickup, 407 3.0 Diesel SFC Turbo	F 002 H24 418		9 450 030 116	F 002 H23 566
407 3.0D SFC Pickup, 407 SFC 3.0, 407 3.0 Diesel SFC Turbo, 410 Turbo SFC 3.0 Diesel	F 002 H24 418		F 002 H26 307	F 002 H23 566
407 Citiride 3.0 (D) 55 Kw (2007.12 -2011.09)			F 002 H26 307	
407 LP Turbo Bus 3.0	F 002 H60 006		9 451 037 405	F 002 H23 566
407 LP Turbo Bus 3.0	F 002 H60 006		F 002 H26 307	F 002 H23 566
407 SFC 3.0	F 002 H24 418		F 002 H24 366	F 002 H23 566
407 SFC 3.0, 407 3.0 Diesel SFC Turbo	F 002 H24 418		9 451 037 404	F 002 H23 566
407 SFC 3.0, 407 3.0 Diesel SFC Turbo	F 002 H24 418		9 451 037 405	F 002 H23 566
410 Turbo SFC 3.0 Diesel	F 002 H24 418		F 002 H26 307	F 002 H26 360
410 Turbo SFC 3.0 Diesel (D) 74 Kw (2006.05 -2017.03), Xenon 2.2 CRDI 2WD, Xenon 2.2 CRDI 4WD			F 002 H26 625	
609 3.8 Diesel LP	F 002 H60 006		F 002 H23 535	
609 SFC 3.8 Diesel	F 002 H60 006		9 450 030 106	
609 SFC 3.8 Diesel	F 002 H60 006		9 451 037 404	
609 SFC 3.8 Diesel, 609 3.8 Diesel LP	F 002 H60 006		9 451 037 405	
709 LP Bus (D) 66 Kw (1995.05 -1997.09)	F 002 H60 006		9 450 030 118	9 451 037 456
709 LP Bus (D) 66 Kw (2005.04-->)	F 002 H23 564		9 450 030 116	9 451 037 456
709 LP Bus (D) 66 Kw (2005.04-->)	F 002 H23 564		9 450 030 116	F 002 H23 571
709 LP Bus (D) 66 Kw (2005.04-->)	F 002 H24 418		9 450 030 116	9 451 037 456
709 LP Bus (D) 66 Kw (2005.04-->)	F 002 H60 006		9 450 030 116	9 451 037 456
709 LP Bus (D) 66 Kw (2005.04-->)	F 002 H60 006		9 450 030 116	F 002 H23 571
709 LP Bus, 407 3.0 Diesel LP Turbo Bus, 407 3.0D SFC EX Turbo	F 002 H24 418		9 450 030 116	
709 LP Bus, 407 3.0 Diesel LP Turbo Bus, 709 SFC EX	F 002 H24 418		9 451 037 405	
709 LP Bus, 709 SFC EX	F 002 H24 418		9 451 037 404	
709 LPT EX Turbo (D) 66 Kw (2003.01 -2004.12), 709 LP Bus (D) 66 Kw (2005.04-->)	F 002 H24 418		9 450 030 116	F 002 H23 571
709 LPT EX Turbo (D) 66 Kw (2005.01-->), 909	F 002 H23 564		F 002 H24 366	F 002 H23 571
709 LPT EX Turbo (D) 66 Kw (2005.01-->), 909	F 002 H23 564		F 002 H24 366	F 002 H26 360
709 LPT EX Turbo (D) 66 Kw (2005.01-->), 909	F 002 H24 418		F 002 H24 366	F 002 H26 360
709 LPT EX Turbo (D) 66 Kw (2005.01-->), LPT 1109 HEx2 CR (D) 92 Kw (2014.01-->), 909	F 002 H23 564		F 002 H23 536	F 002 H23 571
709 LPT EX Turbo (D) 66 Kw (2005.01-->), LPT 1109 HEx2 CR (D) 92 Kw (2014.01-->), 909	F 002 H23 564		F 002 H23 536	F 002 H26 360
709 LPT HEx2 (D) 92 Kw (2014.01-->), LPT 1109 HEx2 (D) 92 Kw (2014.01-->)	F 002 H23 564		F 002 H23 582	F 002 H26 360
709 LPT HEx2 (D) 92 Kw (2014.01-->), LPT 1109 HEx2 (D) 92 Kw (2014.01-->)	F 002 H24 418		F 002 H23 582	F 002 H26 360
709 LPT HEx2 (D) 92 Kw (2014.01-->), LPT 1109 HEx2 (D) 92 Kw (2014.01-->), 709 LPT EX Turbo (D) 66 Kw (2005.01-->), LPT 1109 HEx2 CR (D) 92 Kw (2014.01-->)	F 002 H23 564		F 002 H27 515	F 002 H26 360

### Brand wise Filter Application Chart

Model Description	Air Filter	Cabin Filter	Fuel Filter	Oil Filter
709 LPT HEx2 (D) 92 Kw (2014.01-->), LPT 1109 HEx2 (D) 92 Kw (2014.01-->), LPT 909 EX (D) 92 Kw (2010.10-->)	F 002 H23 564		F 002 H23 582	F 002 H23 571
709 LPT HEx2 (D) 92 Kw (2014.01-->), LPT 1109 HEx2 (D) 92 Kw (2014.01-->), LPT 909 EX (D) 92 Kw (2010.10-->)	F 002 H24 418		F 002 H23 582	F 002 H23 571
709 LPT HEx2 (D) 92 Kw (2014.01-->), LPT 1109 HEx2 (D) 92 Kw (2014.01-->), LPT 909 EX (D) 92 Kw (2010.10-->), 709 LPT EX Turbo (D) 66 Kw (2005.01-->), LPT 1109 HEx2 CR (D) 92 Kw (2014.01-->), LPT 1109 (D) 66 Kw (2003.09 -2007.04)	F 002 H23 564		F 002 H27 515	F 002 H23 571
709 LPT HEx2 (D) 92 Kw (2014.01-->), SFC 909 EX, LPT 1109 HEx2 (D) 92 Kw (2014.01-->), LPT 909 EX (D) 92 Kw (2010.10-->), 709 LPT EX Turbo (D) 66 Kw (2005.01-->), LPT 1109 HEx2 CR (D) 92 Kw (2014.01-->), LPT 1109 (D) 66 Kw (2003.09 -2007.04)	F 002 H24 418		F 002 H27 515	F 002 H23 571
709 SFC EX	F 002 H24 418		9 450 030 118	
709 SFC EX (D) 66 Kw (2003.11 -2005.03)			9 451 037 404	9 451 037 456
709 SFC EX (D) 66 Kw (2005.04-->), 709 SFC EX (D) 66 Kw (2003.11 -2005.03)			9 451 037 404	F 002 H23 571
709 SFC EX (D) 66 Kw (2005.04-->), LPO 8.5, LPO 7.5 3.8TD FBV BS3 Ultra (D) 92 Kw (2011.01-->), LPO 10.2 Starbus Ultra BS III, LPO 8.5 (D) 92 Kw (2014.02-->), LPO 7.5 3.8TD FBV BS3 Ultra, LPO 9.6			F 002 H27 515	F 002 H23 571
709 SFC EX (D) 66 Kw (2005.04-->), Ultra 812 BS III, LPO 10.2 Starbus Ultra BS III, Ultra 912, LPO 9.6			F 002 H24 366	F 002 H23 571
712 LP Bus (D) 92 Kw (2005.04-->), LP 912 (D) 92 Kw (2010.10-->)	F 002 H23 564		F 002 H24 366	
712 LP Bus (D) 92 Kw (2005.04-->), LP 912 (D) 92 Kw (2010.10-->)	F 002 H23 564		F 002 H27 515	
712 LP Bus (D) 92 Kw (2005.04-->), LP 912 (D) 92 Kw (2010.10-->), 709 LPT EX Turbo	F 002 H24 418		F 002 H24 366	
712 LPT EX, LP 410, LPK 407 BS II, 407 3.0 Diesel LP Turbo Bus (D) 55 Kw (2006.01-->), LPT 912, LPT 809 EX, 407 3.0 Diesel LPT (D) 53 Kw (2001.10 -2005.02), LPT 1112, LPT 909 EX (D) 66 Kw (2005.03 -2010.10), 712 LP Bus	F 002 H24 418			F 002 H23 571
ACE MAGIC	F 002 H26 532		F 002 H21 299	F 002 H23 434
ACE MAGIC	F 002 H26 532		F 002 H24 509	F 002 H23 434
ACE Magic CNG BS-IV	F 002 H26 532			F 002 H23 434
ACE Mega XL BS III	F 002 H26 532		F 002 H21 299	
Ace (BS III) 0.7			F 002 H24 509	F 002 H20 264
Ace (BS III) 0.7			F 002 H24 509	F 002 H21 221
Ace Gold	F 002 H26 532		F 002 H24 509	F 002 H20 264
Ace Gold BS6	F 002 H26 532		F 002 H25 993	
Ace Gold Petrol BS6, ACE Magic CNG BS III, Ace Gold CNG BS6	F 002 H26 532			

### Brand wise Filter Application Chart

Model Description	Air Filter	Cabin Filter	Fuel Filter	Oil Filter
Ace Mega XL 0.8D D	F 002 H26 532		F 002 H22 025	F 002 H21 221
Ace Super Mint 1.4, Intra V20 BS-IV				F 002 H23 432
Ace SuperAce 1.4	F 002 H24 902		F 002 H21 299	F 002 H21 221
Ace SuperAce 1.4 (D) 52 Kw (2009.12 -2012.10)				F 002 H20 264
Ace XL 0.7D (D) 11 Kw (2017.07-->)			F 002 H24 509	
Ace XL 0.7D (D) 11 Kw (2017.07-->), Magic Mantra BS-IV, Magic Express BS-IV, Magic Iris, ACE DICOR BS-III, ACE DICOR BS-IV			F 002 H21 299	
Ace XL 0.7D, ACE MAGIC 0.7, Ace (BS IV) 0.8	F 002 H26 532		F 002 H21 299	F 002 H21 221
Ace XL 0.7D, Ace Gold, ACE MAGIC 0.7, Ace (BS IV) 0.8	F 002 H26 532		F 002 H21 299	F 002 H20 264
Ace Zip 0.6			F 002 H22 283	F 002 H21 221
Ace Zip 0.6, Ace Zip XL 0.6			F 002 H21 299	F 002 H21 221
Ace Zip XL 0.6			F 002 H22 025	F 002 H21 221
LP 1109 3.7, LPT 1109 EX (D) 92 Kw (2010.10-->), LP 407 CNG BS III, LPT 912 (D) 92 Kw (2005.05-->), LPT 809 EX (D) 66 Kw (2008.02-->), SFC 909 EX (D) 66 Kw (2008.05 -2010.10), LPT 1109 EX (D) 66 Kw (2007.05 -2010.10), LP 410 (D) 75 Kw (2004.07 -2010.10)	F 002 H24 418			
LP 1109 3.7, LPT 1109 EX (D) 92 Kw (2010.10-->), LPT 912 (D) 92 Kw (2005.05-->), LPT 809 EX (D) 66 Kw (2008.02-->), SFC 909 EX (D) 66 Kw (2008.05 -2010.10), LPT 1109 EX (D) 66 Kw (2007.05 -2010.10)	F 002 H23 564			
LP 1112 BS IV	F 002 H23 561		F 002 H23 536	F 002 H26 360
LP 1112 BS IV	F 002 H23 561		F 002 H27 515	F 002 H26 360
LP 1512 BS III (D) 93 Kw (2008.03-->)	F 002 H23 563		F 002 H24 500	
LP 1512 BS III (D) 93 Kw (2008.03-->), LPO 1612 TC BS-II	F 002 H23 561		F 002 H24 500	
LP 1512 BS III (D) 93 Kw (2008.03-->), LPO 1612 TC BS-II, LPK 1618	F 002 H23 561		F 002 H24 501	
LP 1512 BS III (D) 93 Kw (2008.03-->), LPT 1613 EX	F 002 H23 563		F 002 H24 501	
LP 1613 SuperMilo (D) 96 Kw (2008.07 -2010.10), LPT 1613 (D) 96 Kw (1997.05 -2001.12), 1510 LP/LPO BS-II (D) 96 Kw (2005.03 -2010.10), LPT 2515 Turbo EX 6x2 (D) 104 Kw (2005.02 -2010.10)	F 002 H21 295			
LP 1613 SuperMilo (D) 96 Kw (2008.07 -2010.10), LPT 1613 (D) 96 Kw (1997.05 -2001.12), 1510 LP/LPO BS-II (D) 96 Kw (2005.03 -2010.10), LPT 2515 Turbo EX 6x2 (D) 104 Kw (2005.02 -2010.10)	F 002 H21 296			
LP 410 (D) 75 Kw (2004.07 -2010.10)	F 002 H60 006			
LP 410, LPT 407 EX2 CNG BS-IV, 407 3.0D SFC EX Turbo (D) 55 Kw (2003.11 -2005.04), LP 909 49 BS III CNG	F 002 H24 418			F 002 H23 566
LP 9.6T BS III, LP 9.6T BS IV, LPO 7.5 3.8TD FBV BS3 Ultra (D) 92 Kw (2011.01-->), LPO 8.5 (D) 92 Kw (2014.02-->)			F 002 H27 515	F 002 H26 360

### Brand wise Filter Application Chart

Model Description	Air Filter	Cabin Filter	Fuel Filter	Oil Filter
LP 9.6T BS III, LP 9.6T BS IV, LPS 4018 (D) 130 Kw (2004.01 -2006.12)			F 002 H23 536	F 002 H26 360
LP 912 (D) 92 Kw (2010.10-->)	F 002 H23 564		F 002 H23 535	
LP 912 (D) 92 Kw (2010.10-->)	F 002 H23 564		F 002 H23 582	
LP 912 (D) 92 Kw (2010.10-->)	F 002 H24 418		F 002 H23 535	
LP 912 (D) 92 Kw (2010.10-->), SFC 909 EX (D) 92 Kw (2010.10 -2017.04)	F 002 H24 418		F 002 H23 582	
LPK 1613	F 002 H23 563		F 002 H23 582	9 451 037 438
LPK 1613, LPT 2516 Super Turbo	F 002 H23 563		F 002 H23 536	9 451 037 438
LPK 1615 BS IV, LPK 2518 BS IV, LPK 3118 BS IV, Signa 2823.TK BS IV	F 002 H23 561			F 002 H20 360
LPK 1618 (D) 130 Kw (2007.12 -2010.10)			F 002 H24 500	F 002 H24 502
LPK 1618 (D) 130 Kw (2007.12 -2010.10), SK 1613 TC BS-II, LPT 1613 EX (D) 88 Kw (2002.08 -2010.10)			F 002 H23 535	F 002 H24 502
LPK 1618 BS IV	F 002 H23 561		F 002 H23 535	F 002 H20 360
LPK 1618 BS IV, LPO 1512 BS II, LPT 1613 (D) 100 Kw (2014.01-->), LPT 2515 EX 6x2	F 002 H23 561		F 002 H23 535	F 002 H26 360
LPK 1618 BS-III, LPT 3723 TC	F 002 H23 561		F 002 H24 500	F 002 H23 571
LPK 1923 BS-IV, Signa 1923.K BS-IV, Signa 2518.TK BS IV, Marcopolo 1625 LF	F 002 H23 561			F 002 H23 571
LPK 2516 6x2	F 002 H23 561		F 002 H21 252	F 002 H20 740
LPK 2516 6x2	F 002 H23 561		F 002 H21 252	F 002 H23 571
LPK 2516 6x2	F 002 H60 011		F 002 H21 252	F 002 H20 740
LPK 2516 6x2	F 002 H60 011		F 002 H21 252	F 002 H23 571
LPK 2516 6x2	F 002 H60 011		F 002 H21 252	F 002 H26 360
LPK 2516 TC 6x4 BS-II	F 002 H23 563		F 002 H21 252	F 002 H20 740
LPK 2516 TC 6x4 BS-II	F 002 H23 563		F 002 H24 374	F 002 H20 740
LPK 2516 TC 6x4 BS-II, LPK 2518 6x4 (D) 129 Kw (2007.12 -2010.10), LPT 2518 BS II, LPS 3516	F 002 H23 563		F 002 H21 252	F 002 H26 360
LPK 2516 TC 6x4 BS-II, LPTK 3118 BS-IV, Signa 3518.S BS IV, LPS 3518 BS IV, LPTK 3118 BS III, LPK 2518 BS III, LPT 1615 TC BS IV, LPT 2518 BS IV, Signa 3118.TK BS IV, LPS 3516, SIGNA 3718.T BS IV, LPT 3118 BS IV, LPK 2518 6x4 (D) 129 Kw (2007.12 -2010.10), LPT 3518 BS-IV, LPT 2518 BS II	F 002 H23 563		F 002 H24 374	F 002 H26 360
LPK 2518 6x4			F 002 H24 374	F 002 H24 502
LPK 2518 6x4 (D) 129 Kw (2007.12 -2010.10)	F 002 H23 561		F 002 H21 252	F 002 H24 502
LPK 2518 6x4 (D) 129 Kw (2007.12 -2010.10)	F 002 H23 561		F 002 H24 374	F 002 H24 502
LPK 2518 6x4 (D) 129 Kw (2007.12 -2010.10)	F 002 H23 561		F 002 H24 501	F 002 H24 502
LPK 2518 6x4 (D) 129 Kw (2007.12 -2010.10), LPK 3118 BS III, LPO 1616 TC BS-II, LPT 3718, LPT 1613 (D) 100 Kw (2014.01-->)	F 002 H23 561		F 002 H24 501	F 002 H26 360
LPK 2518 6x4 (D) 129 Kw (2007.12 -2010.10), LPT 2515 EX 6x2, LPK 2516 6x2	F 002 H23 561		F 002 H21 252	F 002 H26 360

### Brand wise Filter Application Chart

Model Description	Air Filter	Cabin Filter	Fuel Filter	Oil Filter
LPK 2518 6x4 (D) 129 Kw (2007.12 -2010.10), LPTK 3118 BS III, LPK 2518 BS III, LP 1512 BS-IV, LPT 1615 TC BS IV, LP 1515 BS IV, 1512 TC LP, LPO 1512 BS-IV	F 002 H23 563		F 002 H24 501	F 002 H26 360
LPK 2518 HD, LPO 1618, LPT 2518/62 TC BS3	F 002 H23 561		F 002 H23 535	
LPK 2518 HD, LPO 1618, LPT 2518/62 TC BS3	F 002 H23 561		F 002 H24 374	
LPK 2523 BS IV Tipper, LPK 2818 BS IV	F 002 H23 561		F 002 H24 374	F 002 H20 360
LPK 2523, LPS 4018 (D) 130 Kw (2004.01 -2006.12), LPT 3118 (D) 135 Kw (2010.09-->), LPS 3518 (D) 131 Kw (2012.01-->), LPT 2516 TC 6x2 (D) 115 Kw (1998.03 -2000.12), LPS 4018 (D) 135 Kw (2010.10-->), LPO 1612 TC BS-III (D) 98 Kw (2005.02 -2015.09), LP 1512 BS III, LPO 1618 (D) 135 Kw (2010.10-->), LPT 3723 TC (D) 155 Kw (2014.01-->), LPK 2518 HD (D) 135 Kw (2010.08-->), LPT 2518 (D) 135 Kw (2010.08-->), LPO 1512 TC SLF (D) 96 Kw (2009.07-->), LPO 1610 TC, LPK 1618 (D) 130 Kw (2007.12 -2010.10), LPT 3118 (D) 132 Kw (2007.12-->), LPT 1613 EX (D) 88 Kw (2002.08 -2010.10)			F 002 H23 535	F 002 H26 360
LPK 909, SK 407	F 002 H24 418		F 002 H23 536	9 451 037 456
LPO 1512 BS II	F 002 H23 561		F 002 H24 500	F 002 H26 360
LPO 1512 TC (D) 94 Kw (2005.10 -2010.10), LPK 2523 (D) 173 Kw (2009.07 -2010.10)			F 002 H24 374	
LPO 1512 TC SLF, LPT 2513	F 002 H23 563		F 002 H23 535	F 002 H23 571
LPO 1612 TC BS-II (D) 94 Kw (2002.08 -2010.10)				F 002 H24 502
LPO 1612 TC BS-III	F 002 H23 561		F 002 H23 536	F 002 H23 571
LPO 1616 BS-IV, Prima LX 2523 K / T (D) 171 Kw (2014.01-->)				F 002 H24 519
LPO 1618 (D) 135 Kw (2010.10-->), LPK 2518 HD (D) 135 Kw (2010.08-->), LPT 2518 (D) 135 Kw (2010.08-->), LPO 1512 TC SLF (D) 96 Kw (2009.07-->), LPK 2523 BS III, Signa 4223 BS IV, LPS 4923 TC 6x4 (D) 159 Kw (2014.01-->), LPT 3118 (D) 135 Kw (2010.09-->), LPS 3518 (D) 131 Kw (2012.01-->), LPT 2516 TC 6x2 (D) 115 Kw (1998.03 -2000.12), LPS 4018 (D) 135 Kw (2010.10-->), LPO 1612 TC BS-III (D) 98 Kw (2005.02 -2015.09)			F 002 H24 374	F 002 H26 360
LPO 1618 (D) 135 Kw (2010.10-->), LPK 2518 HD (D) 135 Kw (2010.08-->), LPT 2518 (D) 135 Kw (2010.08-->), LPO 1512 TC SLF (D) 96 Kw (2009.07-->), LPS 4923 TC 6x4 (D) 159 Kw (2014.01-->), LPT 3118 (D) 135 Kw (2010.09-->), LPS 3518 (D) 131 Kw (2012.01-->), LPT 2516 TC 6x2 (D) 115 Kw (1998.03 -2000.12), LPS 4018 (D) 135 Kw (2010.10-->), LPO 1612 TC BS-III (D) 98 Kw (2005.02 -2015.09)			F 002 H24 374	F 002 H23 571
LPO 1618 (D) 135 Kw (2010.10-->), LPO 1512 TC SLF (D) 96 Kw (2009.07-->), LPO 1610 TC, LPK 1618 (D) 130 Kw (2007.12 -2010.10), LPS 4923 TC 6x4 (D) 159 Kw (2014.01-->), LPO 1612 TC BS-III (D) 98 Kw (2005.02 -2015.09), LPS 4923 TC 6x4 (D) 170 Kw (2007.12 -2010.10)			F 002 H24 500	F 002 H26 360

### Brand wise Filter Application Chart

Model Description	Air Filter	Cabin Filter	Fuel Filter	Oil Filter
LPO 1618 (D) 135 Kw (2010.10-->), LPO 1512 TC SLF (D) 96 Kw (2009.07-->), LPS 4923 TC 6x4 (D) 159 Kw (2014.01-->), LPO 1612 TC BS-III (D) 98 Kw (2005.02 -2015.09)			F 002 H24 500	F 002 H23 571
LPO 1618 (D) 135 Kw (2010.10-->), LPT 3723 TC (D) 155 Kw (2014.01-->), LPK 2518 HD (D) 135 Kw (2010.08-->), LPT 2518 (D) 135 Kw (2010.08-->), LPO 1512 TC SLF (D) 96 Kw (2009.07-->), LPT 3118 (D) 135 Kw (2010.09-->), LPS 3518 (D) 131 Kw (2012.01-->), LPT 2516 TC 6x2 (D) 115 Kw (1998.03 -2000.12), LPS 4018 (D) 135 Kw (2010.10-->), LPS 4923 TC 6x4, LPO 1612 TC BS-III (D) 98 Kw (2005.02 -2015.09)			F 002 H23 535	F 002 H23 571
LPO 1618 BS III, LPS 4018 (D) 130 Kw (2004.01 -2006.12), LPT 3118 (D) 135 Kw (2010.09-->), LPS 3518 (D) 131 Kw (2012.01-->), LPT 2516 TC 6x2 (D) 115 Kw (1998.03 -2000.12), LPO 1612 TC BS-III (D) 98 Kw (2005.02 -2015.09), LPS 4923 TC 6x4 (D) 170 Kw (2007.12 -2010.10), LPT 3723 TC (D) 155 Kw (2014.01-->), LPK 2518 HD (D) 135 Kw (2010.08-->), LPT 2518 (D) 135 Kw (2010.08-->), LPO 1512 TC SLF (D) 96 Kw (2009.07-->), LPO 1610 TC, LPO 1618 BS-IV, LPK 2523 BS III, LPT 3118 (D) 132 Kw (2007.12-->), LPT 1613 EX (D) 88 Kw (2002.08 -2010.10)			F 002 H24 501	F 002 H26 360
LPO 7.5 3.8TD FBV BS3 Ultra (D) 92 Kw (2011.01-->), LPO 8.5 (D) 92 Kw (2014.02-->)			F 002 H23 582	F 002 H23 571
LPO 7.5 3.8TD FBV BS3 Ultra (D) 92 Kw (2011.01-->), LPO 8.5 (D) 92 Kw (2014.02-->)			F 002 H23 582	F 002 H26 360
LPO 8.5 BS-IV, LPO 10.2 Starbus Ultra BS-IV, Ultra 814 BS IV, LPO 9.6T BS IV			F 002 H26 388	
LPO 8.5, Ultra 812 BS III, Ultra 912, LPO 7.5 3.8TD FBV BS3 Ultra			F 002 H23 536	F 002 H23 571
LPS 3516	F 002 H23 563		F 002 H21 252	F 002 H23 516
LPS 3516	F 002 H23 563		F 002 H24 374	F 002 H23 516
LPS 3516 EX (D) 115 Kw (2004.01 -2005.09), 2516 TC LPT (D) 118 Kw (2001.03-->), LPO 1512 TC (D) 94 Kw (2005.10 -2010.10), LPK 2523 (D) 173 Kw (2009.07 -2010.10), Novus LPS 4930 6x4 (D) 221 Kw (2007.12 -2010.10), 1109 LP (D) 66 Kw (2004.01 -2007.04), LPT 1613 /62 TC (D) 92 Kw (2007.12 -2010.10), 407 Citiride 3.0 (D) 55 Kw (2007.12 -2011.09), LPT 2515 EX 6x2 (D) 101 Kw (2003.08 -2005.12), Starbus 1612, Novus LPK 2530 6x4, LPO 1610 TC (D) 74 Kw (2001.09 -2008.09), 1512 TC LP (D) 92 Kw (2001.03 -2010.10), LPO 1616 TC BS-II (D) 119 Kw (2007.08 -2010.10), LPO 1618 SLF, 3516 TC LPS (D) 118 Kw (2001.03-->)			F 002 H23 535	

### Brand wise Filter Application Chart

Model Description	Air Filter	Cabin Filter	Fuel Filter	Oil Filter
LPS 3516 EX (D) 115 Kw (2004.01 -2005.09), LPO 1512 TC (D) 94 Kw (2005.10 -2010.10), LPO 1616 BS IV, LPK 2523 (D) 173 Kw (2009.07 -2010.10), Novus LPS 4930 6x4, Novus LPS 4930 6x4 (D) 221 Kw (2007.12 -2010.10), LPT 1613 /62 TC (D) 92 Kw (2007.12 -2010.10), LPT 2515 EX 6x2 (D) 101 Kw (2003.08 -2005.12), SE 1613 TC, Starbus 1612, Novus LPK 2530 6x4, 1512 TC LP (D) 92 Kw (2001.03 -2010.10), LPO 1618 SLF, LPT 2521 TC (D) 150 Kw (2014.01-->)			F 002 H24 501	
LPS 3516 EX, LPO 1612 TC BS-II, LPT 1613 Turbo EX	F 002 H23 561		F 002 H23 536	
LPT 1109 (D) 66 Kw (2003.09 -2007.04)	F 002 H23 564		9 451 037 405	9 451 037 456
LPT 1109 (D) 66 Kw (2003.09 -2007.04)	F 002 H23 564		9 451 037 405	F 002 H23 571
LPT 1109 (D) 66 Kw (2003.09 -2007.04)	F 002 H23 564		F 002 H27 515	9 451 037 456
LPT 1109 (D) 66 Kw (2003.09 -2007.04)	F 002 H24 418		9 451 037 405	9 451 037 456
LPT 1109 (D) 66 Kw (2003.09 -2007.04)	F 002 H24 418		9 451 037 405	F 002 H23 571
LPT 1109 (D) 66 Kw (2003.09 -2007.04), LPK 909, SK 407	F 002 H24 418		F 002 H27 515	9 451 037 456
LPT 1109 EX, LPT 1109 HEx2 CR, SFC 909 EX, 709 LPT EX Turbo (D) 66 Kw (2005.01-->), LP 912, LPT 1109 HEx2 CR (D) 92 Kw (2014.01-->), 909	F 002 H24 418		F 002 H23 536	F 002 H23 571
LPT 1109 EX, LPT 407, 709 LPT EX Turbo (D) 66 Kw (2005.01-->), 909	F 002 H24 418		F 002 H24 366	F 002 H23 571
LPT 1613	F 002 H23 561		9 451 037 409	F 002 H23 554
LPT 1613	F 002 H23 561		9 451 037 409	F 002 H23 571
LPT 1613	F 002 H23 561		F 002 H23 535	F 002 H23 554
LPT 1613	F 002 H23 561		F 002 H24 374	F 002 H23 554
LPT 1613	F 002 H23 561		F 002 H24 501	F 002 H23 554
LPT 1613 /62 TC	F 002 H23 563		F 002 H23 535	F 002 H24 502
LPT 1613 /62 TC, LPK 2518 6x4 (D) 129 Kw (2007.12 -2010.10)	F 002 H23 563		F 002 H24 501	F 002 H24 502
LPT 1613 BS III			F 002 H23 536	
LPT 1613 BS III (D) 102 Kw (2016.06-->), LP/LPO 1615 697 BS-III, LP 913 BS IV CNG	F 002 H23 561			9 451 037 438
LPT 1613 BS III (D) 102 Kw (2016.06-->), LPK 1615 BS IV, LPK 2518 BS IV, LPK 1923 BS-IV, LPK 3118 BS IV, Signa 1923.K BS-IV, Signa 2518.TK BS IV, Signa 2823.TK BS IV, Marcopolo 1625 LF	F 002 H23 561			F 002 H26 360
LPT 1613 BS III (D) 102 Kw (2016.06-->), LPO 1613 CNG	F 002 H23 563			9 451 037 438
LPT 1613 BS III (D) 102 Kw (2016.06-->), LPS 4018 BS IV, Signa 4018.S BS IV, LPT 1918 BS IV, LPT 3718 BS IV, LPT 4223 BS IV, Signa 2818.T BS-IV, LPO 1515 BS IV, LPO 1623 BS III CNG, Signa 1615 BS IV, LPO 1623 BS IV CNG, LPT 2818 BS IV	F 002 H23 563			F 002 H26 360
LPT 1613 EX	F 002 H23 563		F 002 H23 535	
LPT 1613 TC, SE 1613 (D) 102 Kw (2015.01-->)	F 002 H23 563		F 002 H23 582	
LPT 1613 Turbo EX	F 002 H23 561		F 002 H27 515	

### Brand wise Filter Application Chart

Model Description	Air Filter	Cabin Filter	Fuel Filter	Oil Filter
LPT 1613 Turbo EX (D) 95 Kw (2003.12 -2010.10)				9 451 037 438
LPT 1613, LPK 1618 BS-III, LPT 2516 TC 6x2, LPO 1612 TC BS-III, Signa 3118 T, LPT 1613 (D) 100 Kw (2014.01-->), LPS 3518, LPS 4018	F 002 H23 561		F 002 H24 501	F 002 H23 571
LPT 1613, LPT 2518, LPT 3723 TC, LPT 2516 TC 6x2, LPT 1613 (D) 100 Kw (2014.01-->), LPS 3518, LPT 3118	F 002 H23 561		F 002 H23 535	F 002 H23 571
LPT 1613, LPTK 2518 BS III, LPT 2518, LPK 3518 TC BS-IV, LPK 1918 BS IV, LPK 2823 BS IV, LPS 4018, Signa 2523.K BS IV, LPT 3118	F 002 H23 561		F 002 H24 374	F 002 H23 571
LPT 1616 BS-III (D) 114 Kw (2010.08-->), LPK 1616 BS-III (D) 114 Kw (2010.08-->), LPT 1616 697 Super Turbo BS-II (D) 118 Kw (2009.09 -2010.10), LPT 2516 Super Turbo (D) 118 Kw (2007.12 -2010.10), SK 1616 (D) 114 Kw (2010.10-->), LPK 1613 5.7 BS-III (D) 100 Kw (2015.01-->), 1512 LP 497 BS-III (D) 92 Kw (2005.02-->), LPT 1613 BS III, SK 407 (D) 75 Kw (2014.07-->), Ultra 1012 BS III (D) 124 Kw (2016.01 -2017.12), LPK 909 (D) 92 Kw (2010.10-->)				F 002 H27 515
LPT 1616 BS-III (D) 114 Kw (2010.08-->), LPK 1616 BS-III (D) 114 Kw (2010.08-->), LPT 1616 697 Super Turbo BS-II (D) 118 Kw (2009.09 -2010.10), LPT 2516 Super Turbo (D) 118 Kw (2007.12 -2010.10), SK 1616 (D) 114 Kw (2010.10-->), LPK 1613 5.7 BS-III (D) 100 Kw (2015.01-->), 1512 LP 497 BS-III (D) 92 Kw (2005.02-->), SK 407 (D) 75 Kw (2014.07-->), LPK 909 (D) 92 Kw (2010.10-->)				F 002 H23 582
LPT 1618 BS IV, Signa 2518.TK BS IV (D) 134 Kw (2017.12-->), LP 1613 SuperMilo (D) 96 Kw (2008.07 -2010.10), LPT 2515 Turbo EX 6x2 (D) 104 Kw (2005.02 -2010.10), LPK 1615 BS IV (D) 118 Kw (2017.05-->), LPK 3118 BS III (D) 134 Kw (2017.12-->)	F 002 H23 563			
LPT 1618 BS-III, LPK 2518 6x4 (D) 129 Kw (2007.12 -2010.10)	F 002 H23 563		F 002 H21 252	F 002 H24 502
LPT 1618 BS-III, LPK 2518 6x4 (D) 129 Kw (2007.12 -2010.10)	F 002 H23 563		F 002 H24 374	F 002 H24 502
LPT 1913 BS-IV, LPT 1613 TC, LPK 1613 BS IV, LPT 1613 BS IV, LPO 1613 BS IV	F 002 H23 563		F 002 H23 536	
LPT 2515 Turbo EX 6x2, 1510 LP/LPO BS-II, LP 1613 SuperMilo			F 002 H20 306	9 451 037 438
LPT 2515 Turbo EX 6x2, 1510 LP/LPO BS-II, LP 1613 SuperMilo, SK 1613 Turbo BS-II, SE 1613 Turbo BS-II			F 002 H23 536	9 451 037 438
LPT 2518 BS III	F 002 H23 563		F 002 H27 515	9 451 037 438



### Brand wise Filter Application Chart

Model Description	Air Filter	Cabin Filter	Fuel Filter	Oil Filter
LPT 2518 BS IV (D) 132 Kw (2018.12-->), 407 3.0D SFC Pickup (D) 55 Kw (2010.03-->), LPO 1515 BS IV (D) 119 Kw (2017.05-->), LPT 1615 TC BS IV (D) 119 Kw (2008.01 -2010.12), LPT 2518/62 TC BS3 (D) 135 Kw (2014.01-->), 609 3.8 Diesel LP (D) 66 Kw (1993.09 -1997.07), 1623 Globus LP, LP 1515 BS IV (D) 119 Kw (2017.05-->), SFC 407 EX BS III (D) 55 Kw (2013.05-->), 609 SFC 3.8 Diesel (D) 66 Kw (1993.06 -1994.06), SFC 407, Signa 3118 T (D) 167 Kw (2016.02-->), LPO 1612 TC BS-II (D) 94 Kw (2002.08 -2010.10), LPK 1618 BS-III (D) 135 Kw (2010.08-->), LPT 2513 (D) 102 Kw (2011.05-->), LPT 810 Ex2 BS III (D) 91 Kw (2015.12-->), LPT 1613 Turbo EX (D) 95 Kw (2003.12 -2010.10), LPT 407 (D) 55 Kw (2005.03-->), Ultra T.7, 1109 LP, SFC 709 EX BS IV, SK 407 BS IV, Prima LX 2523 K / T (D) 171 Kw (2014.01-->)				F 002 H26 360
LPT 2518 BS IV (D) 132 Kw (2018.12-->), LPT 1615 TC BS IV (D) 119 Kw (2008.01 -2010.12), LPT 2518/62 TC BS3 (D) 135 Kw (2014.01-->), LPT 2518 BS IV (D) 134 Kw (2008.12-->)				F 002 H20 360
LPT 3723 TC (D) 155 Kw (2014.01-->), LPK 2518 HD (D) 135 Kw (2010.08-->), LPT 2518 (D) 135 Kw (2010.08-->), LPO 1512 TC SLF (D) 96 Kw (2009.07-->), LPT 3118 (D) 135 Kw (2010.09-->), LPS 3518 (D) 131 Kw (2012.01-->), LPT 2516 TC 6x2 (D) 115 Kw (1998.03 -2000.12), LPS 4923 TC 6x4, LPO 1612 TC BS-III (D) 98 Kw (2005.02 -2015.09)			F 002 H24 501	F 002 H23 571
LPT 909 BS IV, 709 LPT HEX2 (D) 92 Kw (2014.01-->), LP 709 BS III, LPT 1109 HEX2 (D) 92 Kw (2014.01-->), LPT 709 BS IV, LP 909, 709 LPT EX Turbo (D) 66 Kw (2005.01-->), LPT 1109 HEX2 CR (D) 92 Kw (2014.01-->), LPT 810 Ex2 BS IV, LP 912 TCIC BS IV	F 002 H24 418		F 002 H27 515	F 002 H26 360
LPT 909 BS IV, LPT 709 BS IV, 709 LPT EX Turbo (D) 66 Kw (2005.01-->), LPT 1109 HEX2 CR (D) 92 Kw (2014.01-->), 909, LPT 810 Ex2 BS IV	F 002 H24 418		F 002 H23 536	F 002 H26 360
LPT 909 EX (D) 66 Kw (2005.03 -2010.10)	F 002 H23 564			9 451 037 456
LPT 909 EX (D) 66 Kw (2005.03 -2010.10)	F 002 H23 564			F 002 H23 571
LPT 909 EX (D) 66 Kw (2005.03 -2010.10)	F 002 H23 564			F 002 H26 360
LPT 909 EX, 709 LPT HEX2, LPT 1109, LPT 1109 HEX2, 709 LPT EX Turbo	F 002 H24 418		F 002 H23 536	
LPT 909 EX, 712 LP Bus (D) 92 Kw (2005.04-->), LPT 810 Ex2 BS III, 709 LPT HEX2, LP 912 (D) 92 Kw (2010.10-->), LPT 1109 HEX2, SFC 909 EX (D) 92 Kw (2010.10 -2017.04)	F 002 H24 418		F 002 H27 515	
LPTK 2518 BS III, LPK 2518 6x4 (D) 129 Kw (2007.12 -2010.10), LPK 2523 BS IV Tipper, LPK 3118 BS III, LPK 2818 BS IV, LPT 3718, LPK 3518 TC BS-IV, LPK 1918 BS IV, LPK 2823 BS IV, Signa 2523.K BS IV, LPT 2515 EX 6x2	F 002 H23 561		F 002 H24 374	F 002 H26 360
LPTK 3118 BS-IV, LPT 3518 BS-IV, LPT 2513, Signa 3118.TK BS IV	F 002 H23 563		F 002 H24 374	F 002 H23 571
Magic Iris			F 002 H22 025	

### Brand wise Filter Application Chart

Model Description	Air Filter	Cabin Filter	Fuel Filter	Oil Filter
Magic Iris			F 002 H25 993	
Prima 2528 K 6x4	F 002 H23 561		F 002 H24 518	F 002 H24 519
Prima 2528 K 6x4	F 002 H23 561		F 002 H26 314	F 002 H24 519
Prima LX 3123.TTS BS III			F 002 H24 518	F 002 H26 360
Prima LX 3125.K BS IV, Prima LX 2823.TK BS-IV, Prima LX 2523 K / T, Prima LX 2523.K BS-III, Prima LX 2525.K BS IV, Prima LX 3123.K BS III, Prima LX 2825.K HRT BS IV	F 002 H23 561		F 002 H24 518	
Prima LX 4023 S, LPT 2521 TC			F 002 H26 314	F 002 H24 519
Prima LX 4028 S, Prima LX 4928 S, Prima 4928 S, Prima 3128 K 8x4, Marcopolo 1628 Divo, Prima LX 4023 S, LPT 2521 TC			F 002 H24 518	F 002 H24 519
Prima LX 4923 S			F 002 H26 314	
Prima LX 4923 S, 709 LP E Bus, Prima LX 2830.K BS-IV, Prima 4028, 1109 LPT (D) 66 Kw (2000.11-->), Prima LX 2530.K BS IV, Prima LX 4930.S BS IV, Prima LX 3130.K BS IV Tipper, Prima 2528 K 6x2, Prima LX 3123.K BS-III, Prima LX 4025.S BS IV, LPT 2521 TC (D) 150 Kw (2014.01-->)			F 002 H24 518	
SE 1613	F 002 H21 296		F 002 H23 536	9 451 037 438
SE 1613	F 002 H21 296		F 002 H27 515	9 451 037 438
SE 1613 (D) 102 Kw (2015.01-->)	F 002 H21 295		F 002 H23 582	
SE 1613 (D) 102 Kw (2015.01-->)	F 002 H21 295		F 002 H27 515	
SE 1613 BS IV, LP 1613 BS IV, LPT 1913 BS-IV, LPK 1613 BS IV, SE 1613 (D) 102 Kw (2015.01-->), LPT 1613 BS IV, LPO 1613 BS IV	F 002 H23 563		F 002 H27 515	
SE 1613 TC, Starbus 1612, LPO 1610 TC (D) 74 Kw (2001.09 -2008.09), 1512 TC LP (D) 92 Kw (2001.03 -2010.10), LPO 1616 TC BS-II (D) 119 Kw (2007.08 -2010.10), LPO 1618 SLF			F 002 H24 500	
SFC 407 EX BS III, 410 Turbo SFC 3.0 Diesel (D) 74 Kw (2006.05 -2017.03), LPT 2516 Super Turbo (D) 118 Kw (2007.12 -2010.10), 1512 LP 497 BS-III (D) 92 Kw (2005.02-->), Ultra 1012 BS III (D) 124 Kw (2016.01 -2017.12)			F 002 H24 366	
SIGNA 3718.T BS IV, Signa 3518.S BS IV, LPS 3518 BS IV, LPT 3118 BS IV	F 002 H23 563		F 002 H24 374	F 002 H20 360
SK 1613 TC			F 002 H21 252	F 002 H24 502
SK 1613 TC BS-II, SE 1613 TC BS-II, LPT 1613 EX (D) 88 Kw (2002.08 -2010.10)			F 002 H24 501	F 002 H24 502
SK 1613 TC, LP 1510 CGS, LPS 3015 TC, 1510 LP CGS BS-III, LPT 2515 TC 6x2, LPS 4018 TC EX, LPT 2515 6x2, LPO 1613, LPT 2515 60WB TC 6x2, LPK 2516 6x4			F 002 H21 252	F 002 H20 740
SK 1613 Turbo BS-II, SE 1613 Turbo BS-II			F 002 H23 582	9 451 037 438
SK 1616, LPK 1613 5.7 BS-III, LPK 1616 BS-III, LPT 1616 697 Super Turbo BS-II, LPT 1616 BS-III	F 002 H23 561		F 002 H23 536	9 451 037 438
SK 1616, LPK 1613 5.7 BS-III, LPK 1616 BS-III, LPT 1616 BS-III	F 002 H23 561		F 002 H27 515	9 451 037 438
SK 407	F 002 H24 418		F 002 H23 536	F 002 H23 566

### Brand wise Filter Application Chart

Model Description	Air Filter	Cabin Filter	Fuel Filter	Oil Filter
SK 407	F 002 H24 418		F 002 H27 515	F 002 H23 566
SK 407 BS II			9 450 030 116	9 451 037 456
SK 407 BS II			9 450 030 116	F 002 H23 566
Signa 2518.TK BS IV (D) 134 Kw (2017.12-->), LP 1613 SuperMilo (D) 96 Kw (2008.07 -2010.10), 1510 LP/LPO BS-II (D) 96 Kw (2005.03 -2010.10), LPK 1615 BS IV (D) 118 Kw (2017.05-->), LPK 3118 BS III (D) 134 Kw (2017.12-->)	F 002 H23 561			
Signa 2818.T BS-IV, LPT 2818 BS IV	F 002 H23 563			F 002 H23 571
Signa 4018.S BS IV, LPS 4018 BS IV, LPT 1918 BS IV, LPT 3718 BS IV, LPT 4223 BS IV, Signa 1615 BS IV	F 002 H23 563			F 002 H20 360
Signa 4223 BS IV			F 002 H24 374	F 002 H20 360
Super Ace Mint				F 002 H21 221
Ultra 3021.S BS6, Ultra 1918.T BS6, Starbus Ultra SKL LPO 7.5 BS6, T.16 ULTRA BS6, T.9 ULTRA BS6, ULTRA 2821.T BS6, T.12 ULTRA BS6, T.14 Ultra BS6, Starbus Ultra SKL LPO 10.2 BS6 Non-AC, Starbus Ultra SKL LPO 10.2 BS6 AC, T.10 Ultra BS6, T7 Ultra BS6, T.11 Ultra BS6			F 002 H25 960	
Ultra 3021.S BS6, Ultra 1918.T BS6, Starbus Ultra SKL LPO 7.5 BS6, T.16 ULTRA BS6, T.9 ULTRA BS6, ULTRA 2821.T BS6, T.12 ULTRA BS6, T.14 Ultra BS6, Starbus Ultra SKL LPO 10.2 BS6 Non-AC, Starbus Ultra SKL LPO 10.2 BS6 AC, T.10 Ultra BS6, T7 Ultra BS6, T.11 Ultra BS6			F 002 H25 964	
Venture 1.4D			F 002 H21 299	F 002 H23 434
Venture 1.4D (D) 37 Kw (2011.01 -2016.01), Ace SuperAce 1.4 (D) 52 Kw (2009.12 -2012.10)				F 002 H60 001
Venture 1.4D (D) 51 Kw (2011.01 -2016.01), ACE CNG BS III, Super Ace Mint, Xenon 1tonne Pickup BS-IV CNG, Winger CNG, ACE CNG BS-IV				F 002 H23 434
Venture 1.4D, ACE HT BS-IV			F 002 H24 509	F 002 H23 434
Winger BS III, TL Pickup 2.0			F 002 H24 509	F 002 H23 566
Xenon 2.2 CRDi Diesel				F 002 H20 236
Xenon Utility 3.0TD 4x2, 407 3.0D SFC Pickup (D) 55 Kw (2010.03-->), 407 3.0 Diesel SFC Turbo (D) 52 Kw (2003.11 -2005.05), 709 SFC E 3.8 Diesel, 407 SFC 3.0 (D) 43 Kw (2007.01 -2012.01), 609 3.8 Diesel LP (D) 66 Kw (1993.09 -1997.07), SFC 909, 1109 LPT, 609 SFC 3.8 Diesel (D) 66 Kw (1993.06 -1994.06)				9 451 037 456
Xenon Utility 3.0TD 4x2, SFC 407 CNG, Starbus SFC 407, SFC 407 TT, SFC 407, TL Pickup 2.0 Diesel 4WD				F 002 H23 566
<b>VOLKSWAGEN</b>				
Multivan T4 [70, 7D]		1 987 432 056	0 450 906 267	
<b>VOLVO</b>				
B 7 R			F 026 402 025	F 026 407 118
FH	F 026 400 644	1 987 431 167		F 026 407 043

### Brand wise Filter Application Chart

Model Description	Air Filter	Cabin Filter	Fuel Filter	Oil Filter
FH	F 026 400 644	1 987 431 451		F 026 407 043
FH (D) 382 Kw (2006.09 -2011.12)	F 026 400 034		F 026 402 132	F 026 404 003
FH (D) 382 Kw (2006.09 -2011.12)	F 026 400 034		F 026 402 132	F 026 404 004
FH (D) 382 Kw (2006.09 -2011.12)	F 026 400 034		F 026 402 135	F 026 404 003
FH (D) 382 Kw (2006.09 -2011.12)	F 026 400 034		F 026 402 135	F 026 404 004
FH (D) 382 Kw (2006.09 -2011.12)	F 026 400 034		F 026 402 865	F 026 404 003
FH (D) 382 Kw (2006.09 -2011.12)	F 026 400 034		F 026 402 865	F 026 404 004
FH (D) 382 Kw (2006.09 -2011.12)	F 026 400 535		F 026 402 017	F 026 404 003
FH (D) 382 Kw (2006.09 -2011.12)	F 026 400 535		F 026 402 017	F 026 404 004
FH (D) 382 Kw (2006.09 -2011.12)	F 026 400 535		F 026 402 118	F 026 404 003
FH (D) 382 Kw (2006.09 -2011.12)	F 026 400 535		F 026 402 118	F 026 404 004
FH (D) 382 Kw (2006.09 -2011.12)	F 026 400 535		F 026 402 132	F 026 404 003
FH (D) 382 Kw (2006.09 -2011.12)	F 026 400 535		F 026 402 135	F 026 404 003
FH (D) 382 Kw (2006.09 -2011.12)	F 026 400 535		F 026 402 135	F 026 404 004
FH (D) 382 Kw (2006.09 -2011.12)	F 026 400 535		F 026 402 865	F 026 404 003
FH (D) 382 Kw (2006.09 -2011.12)	F 026 400 535		F 026 402 865	F 026 404 004
FH (D) 382 Kw (2006.09 -2011.12), FM 12 (D) 280 Kw (2003.09 -2005.09)	F 026 400 034		F 026 402 017	F 026 404 003
FH (D) 382 Kw (2006.09 -2011.12), FM 12 (D) 280 Kw (2003.09 -2005.09)	F 026 400 034		F 026 402 017	F 026 404 004
FH (D) 382 Kw (2006.09 -2011.12), FM 12 (D) 280 Kw (2003.09 -2005.09)	F 026 400 034		F 026 402 118	F 026 404 003
FH (D) 382 Kw (2006.09 -2011.12), FM 12 (D) 280 Kw (2003.09 -2005.09)	F 026 400 034		F 026 402 118	F 026 404 004
FH 12	F 026 400 034	1 987 431 167	1 457 434 294	F 026 404 004
FH 12	F 026 400 034	1 987 431 167	F 026 402 025	F 026 404 004
FH 12	F 026 400 034	1 987 431 451	1 457 434 294	F 026 404 004
FH 12	F 026 400 034	1 987 431 451	F 026 402 025	F 026 404 004
FH 12 (D) 338 Kw (1998.08 -2001.11)				0 451 103 219
FH 12 (D) 338 Kw (1998.08 -2001.11)				0 451 300 003
FH 12 (D) 338 Kw (1998.08 -2001.11)				F 026 407 043
FM	F 026 400 364	1 987 431 167		
FM	F 026 400 364	1 987 431 451		
FM (D) 250 Kw (2006.05 -2009.07)	F 026 400 117		F 026 402 794	0 451 403 077
FM (D) 294 Kw (2006.09 -2012.02)			F 026 402 132	F 026 407 043
FM (D) 294 Kw (2006.09 -2012.02)			F 026 402 141	F 026 407 043
FM (D) 338 Kw (2013.04-->), FM (D) 309 Kw (2013.04-->)	F 026 400 717		F 026 402 311	0 451 300 003
FM (D) 338 Kw (2013.04-->), FM (D) 309 Kw (2013.04-->)	F 026 400 717		F 026 402 311	F 026 404 019
FM (D) 338 Kw (2013.04-->), FM (D) 309 Kw (2013.04-->)	F 026 400 717		F 026 402 311	F 026 407 043





### Brand wise Filter Application Chart

Model Description	Air Filter	Cabin Filter	Fuel Filter	Oil Filter
FM 9 (D) 221 Kw (2002.12 -2005.08)			F 026 402 017	0 451 300 003
FM 9 (D) 221 Kw (2002.12 -2005.08)			F 026 402 017	0 451 403 077
FM 9 (D) 221 Kw (2002.12 -2005.08)			F 026 402 017	F 026 404 003
FM 9 (D) 221 Kw (2002.12 -2005.08)			F 026 402 017	F 026 404 004
FM 9 (D) 221 Kw (2002.12 -2005.08)			F 026 402 017	F 026 407 043
FM 9 (D) 221 Kw (2002.12 -2005.08)			F 026 402 118	0 451 300 003
FM 9 (D) 221 Kw (2002.12 -2005.08)			F 026 402 118	0 451 403 077
FM 9 (D) 221 Kw (2002.12 -2005.08)			F 026 402 118	F 026 404 003
FM 9 (D) 221 Kw (2002.12 -2005.08)			F 026 402 118	F 026 404 004
FM 9 (D) 221 Kw (2002.12 -2005.08)			F 026 402 118	F 026 407 043



### Filter Application Chart

Part Number	Product Description	Image	Model Description 	Potential OE Part No	Potential Comp. Part No	MRP (₹)
F 002 H21 218	Air Filter Element Primary, Engine		EICHER- 10.90 L 40	ID202372		1,600.00
F 002 H21 218	Air Filter Element Primary, Engine		EICHER MOTORS LIMITED- 10.50 3.3 Diesel Turbo			1,600.00
F 002 H21 295	Air Filter Element Primary, Engine		TATA MOTORS- LP 1613 SuperMilo (D) 96 Kw (2008.07 -2010.10), LPT 1613 (D) 96 Kw (1997.05 -2001.12), 1510 LP/LPO BS-II (D) 96 Kw (2005.03 -2010.10), LPT 2515 Turbo EX 6x2 (D) 104 Kw (2005.02 -2010.10), SE 1613 (D) 102 Kw (2015.01-->)	252509140134		1,480.00



### Filter Application Chart

Part Number	Product Description	Image	Model Description 	Potential OE Part No	Potential Comp. Part No	MRP (₹)
F 002 H23 561	Air Filter Element Primary, Engine		TATA MOTORS- LPTK 2518 BS III, LPK 2523 BS IV Tipper, LP 1512 BS III (D) 93 Kw (2008.03-->), 1510 LP/LPO BS-II (D) 96 Kw (2005.03 -2010.10), Prima LX 2525.K BS IV, LPT 1613 (D) 100 Kw (2014.01-->), LPK 1918 BS IV, LPS 3518, Signa 2823.TK BS IV, LPK 1615 BS IV (D) 118 Kw (2017.05-->), LPT 3118, Marcopolo 1625 LF, LP 913 BS IV CNG, LPK 2518 6x4 (D) 129 Kw (2007.12 -2010.10), Prima 2528 K 6x4, LPK 2818 BS IV, LPO 1618, LPT 1616 BS-III, LPT 2518/62 TC BS3, LPT 2516 TC 6x2, LPS 4018, Prima LX 2823.TK BS-IV, LPK 3118 BS IV, Signa 3118 T, LPT 1613 Turbo EX, LPK 2518 BS IV, LPO 1612 TC BS-II, Signa 1923.K BS-IV, LPK 2823 BS IV, LPT 2515 EX 6x2, Prima LX 2825.K HRT BS IV, LPT 2518, LPO 1616 TC BS-II, LPK 1923 BS-IV, LPT 1616 697 Super Turbo BS-II, LPO 1612 TC BS-III, LPK 2516 6x2, LPK 1618 BS IV, SK 1616, LP/LPO 1615 697 BS-III, Signa 2518.TK BS IV (D) 134 Kw (2017.12-->), LPS 3516 EX, LPT 3718, LPK 2518 HD, Signa 2523.K BS IV, Prima LX 3125.K BS IV, LPK 1613 5.7 BS-III, Prima LX 2523 K / T, LPK 3518 TC BS-IV, Prima LX 3123.K BS III, LPK 1618 BS-III, LPT 1613 BS III (D) 102 Kw (2016.06-->), LP 1613 SuperMilo (D) 96 Kw (2008.07 -2010.10), LPT 3723 TC, LPO 1512 BS II, LPK 1616 BS-III, Prima LX 2523.K BS-III, LP 1112 BS IV, LPK 1618, LPK 3118 BS III (D) 134 Kw (2017.12-->)	409024000216, 278609139910, 278609139909, 885409052516, 278609139911, 278609139912, 278609139936, 278609139935, 278609139908	FLG -8200068, AF4669	2,158.00



### Filter Application Chart

Part Number	Product Description	Image	Model Description 	Potential OE Part No	Potential Comp. Part No	MRP (₹)
F 002 H23 563	Air Filter Element Primary, Engine		TATA MOTORS- Signa 4018.S BS IV, LPT 1913 BS-IV, LP 1512 BS III (D) 93 Kw (2008.03-->), LPTK 3118 BS III, LPK 2518 BS III, 1512 TC LP, LPK 1615 BS IV (D) 118 Kw (2017.05-->), LPS 3516, LPK 2518 6x4 (D) 129 Kw (2007.12 -2010.10), LPT 1613 TC, LPT 4223 BS IV, LPT 3518 BS-IV, LP 1512 BS-IV, LPK 1615 BS III, 1512 LP 497 BS-III, LPT 2818 BS IV, LPS 4018 BS IV, Signa 3518.S BS IV, 2515 TC LPT, LPT 1918 BS IV, Signa 1615 BS IV, Signa 3118.TK BS IV, LPT 1618 BS IV, LPO 1613 CNG, LPT 1613 EX, LPT 1613 BS IV, LPO 1623 BS IV CNG, LPO 1512 BS-IV, LPK 2516 TC 6x4 BS-II, 1512 LP/LPO TC BS-III, LPK 1613, LPT 2516 Super Turbo, LPS 3518 BS IV, LPT 3718 BS IV, LPK 1613 BS IV, Signa 2818.T BS-IV, LPT 1615 TC BS IV, LPT 2513, LPT 2518 BS IV, LP 1515 BS IV, Signa 2518.TK BS IV (D) 134 Kw (2017.12-->), LPT 1613 /62 TC, SE 1613 (D) 102 Kw (2015.01-->), LPO 1512 TC SLF, LPO 1515 BS IV, LPO 1613 BS IV, LPO 1512 TC, LPT 2518 BS III, LPT 1618 BS-III, LPTK 3118 BS-IV, SE 1613 BS IV, LP 1613 BS IV, LPT 2515 Turbo EX 6x2 (D) 104 Kw (2005.02 -2010.10), LPO 1515 BS III, SIGNA 3718.T BS IV, LPT 3118 BS IV, LPT 1613 BS III (D) 102 Kw (2016.06-->), LP 1613 SuperMilo (D) 96 Kw (2008.07 -2010.10), LPO 1623 BS III CNG, LPT 2518 BS II, LPK 3118 BS III (D) 134 Kw (2017.12-->)	278609139910, 278609139909, 278609139911, 885409041613, 278609139908	FLG -8200069	1,950.00

**Filter Application Chart**

Part Number	Product Description	Image	Model Description 	Potential OE Part No	Potential Comp. Part No	MRP (₹)
F 002 H23 564	Air Filter Element Primary, Engine		TATA MOTORS- LP 1109 3.7, 709 LPT EX Turbo (D) 66 Kw (2005.01-->), LP 912 (D) 92 Kw (2010.10-->), LPT 1109 HEx2 CR (D) 92 Kw (2014.01-->), SFC 909 EX (D) 66 Kw (2008.05 -2010.10), LPT 909 EX (D) 66 Kw (2005.03 -2010.10), 909, LPT 1109 (D) 66 Kw (2003.09 -2007.04), LPT 1109 EX (D) 66 Kw (2007.05 -2010.10), 712 LP Bus (D) 92 Kw (2005.04-->), 709 LPT HEx2 (D) 92 Kw (2014.01-->), LPT 1109 HEx2 (D) 92 Kw (2014.01-->), LPT 909 EX (D) 92 Kw (2010.10-->), LPT 1109 EX (D) 92 Kw (2010.10-->), 709 LP Bus (D) 66 Kw (2005.04-->), LPT 912 (D) 92 Kw (2005.05-->), LPT 809 EX (D) 66 Kw (2008.02-->)	253409130306	FLG -AF26074	1,408.00
F 002 H23 564	Air Filter Element Primary, Engine		ASHOK LEYLAND- 2214 6x2 (H) (D) 84 Kw (2005.07 -2009.07), Stag (D) 88 Kw (2002.01 -2005.03)	F8221300, F8221200, F8845900, F8845800, X7423500	FLG -AF26074	1,408.00



**Filter Application Chart**

Part Number	Product Description	Image	Model Description 	Potential OE Part No	Potential Comp. Part No	MRP (₹)
F 002 H23 589	Air Filter Element Primary, Engine		ASHOK LEYLAND- 2518 BS II, U 4923, 1616 iL, Cheetah (D) 118 Kw (2014.01-->), Cheetah (D) 122.8 Kw (2005.11-->), U 3123, RE SLF BS III, U 3723 (D) 165 Kw (2012.01-->), U-3118, Cheetah (D) 88 Kw (2000.11 -2005.03), 2517 BS II, U 2518, 4018, 12M (D) 130 Kw (2006.11 -2010.10), 3118 BS IV (D) 134 Kw (2015.12-->), U 3718 BS IV (D) 132 Kw (2014.12-->), 3118, Viking BS III, 3518, 4019, Viking (D) 123 Kw (2005.05-->), 1614 BS III, 3518 BS IV (D) 134 Kw (2015.12-->), U 4019 iL, VESTIBULE BS III, 4923, 1616 iL 5.7, 12M FE BS III, 2521 BS II, U 1616, Double Decker BS III, 1618 BS IV, Tusker 3516, 2516 iL, 2516 S, 4019iL, 3014 BS II, 2518T BS II, Cheetah (D) 135 Kw (2014.01-->), 3123, 12M (D) 118 Kw (2010.10-->), Viking BS IV, Viking 160HP IL FIP BS3, Captain 3723 BS IV, 1616 H, 1616 XL, U 3518, 1616 XP, 12M (D) 130 Kw (2005.04 -2010.10), Captain 40, 12M FESLF BS IV, 2523 (D) 165 Kw (2014.01-->), 2516 BS II, 2518 BS IV (D) 134 Kw (2018.12-->), 3718 iL (D) 132 Kw (2014.01-->), Viking (D) 123 Kw (2011.01-->), 3118-T BS III, 4123 BS IV, 4023, 1616 XL BS III (D) 119 Kw (2015.05-->), U 4023, U-2518-IL-T HD BS III (D) 134 Kw (2016.08-->), 4019 5.6, Viking 180HP ROTARY FIP EDC BS3, 3121, 12M FE BS IV, 11M FESLF BS IV, 3116, 4018H BS III, U 3518 5.7, U-2518 IL T HD BS IV (D) 134 Kw (2015.12-->), 3718 iL BS III, 2516 iL BS III (D) 119 Kw (2012.12-->), 3718 BS IV (D) 134 Kw (2015.12-->), 3518 BS III (D) 134 Kw (2015.12-->), 2516 6x4 (H) 4x4, 2518, 4921	F8365800, F7B01200, F8211200, F7B01300, F7B01400, F7B02100, X8830400, F7B01100, F7B02000, F8211300		3,443.00
F 002 H23 594	Air Filter Element Primary, Engine		EICHER- 10.59 XP, Pro 1110, Pro 3015 TCI BS IV, Pro 3012 TCI BS IV, Pro 3013	ID332218, ID370776, ID370777, ID303249, ID303248, ID332219		2,031.00

### Filter Application Chart

Part Number	Product Description	Image	Model Description 	Potential OE Part No	Potential Comp. Part No	MRP (₹)
F 002 H23 594	Air Filter Element Primary, Engine		EICHER MOTORS LIMITED- Pro 1110 BS IV, Pro 3012 BS-III, Pro 3014 BS-IV CNG, Pro 1055 BS-IV, Pro 1110XPT BS-IV, Pro 1095XP BS IV, Pro 1075 BS IV, Pro 1095 BS-IV, Pro 3015 BS-III, Pro 3016 BS-IV, Pro 3014 BS IV, Skyline Pro 3008 H BS-IV School Bus, Pro 1059 BS IV, Pro 1110XP BS IV, Pro 1090 BS IV, Pro 1059XP BS IV, Pro 1080XPT BS IV, Pro 1080 DSD, Skyline Pro 3009L BS-IV School Bus, Pro 1114XP BS-IV, Pro 1080XP BS-IV	ID370776, ID370777, ID303249, ID303248, ID332219		2,031.00
F 002 H23 594	Air Filter Element Primary, Engine		EICHER MOTORS LIMITED- 10.50 3.3 Diesel BS2, 10.60 3.3 Diesel, Pro 1049, Pro 1050	ID370776, ID370777, ID303249, ID303248, ID332219		2,031.00
F 002 H24 415	Air Filter Element Primary, Engine		ASHOK LEYLAND- Captain 40IT BS III, JanBus BS4, 3015 BS II, U 1618, U 3723 (D) 165 Kw (2012.01-->), Cheetah (D) 97 Kw (2005.04 -2010.10), Cargo 1613H, Captain 2518 BS IV, Lynx (D) 96 Kw (2014.01-->), Lynx (GAS) 106 Kw (2014.01-->), 3118 BS IV (D) 134 Kw (2015.12-->), U 3718 BS IV (D) 132 Kw (2014.12-->), 1618 XP BS III, 3123 BS III, Ecomet 1012 Smart (D) 88 Kw (2010.11-->), Captain 4923 BS III, N 2523 BS III, eComet 1112 (D) 88 Kw (2005.08 -2010.10), Captain 4923 BS IV, Viking (D) 97 Kw (2004.02 -2010.10), N 3123 BS III, 4019 BS IV, 3518 BS IV (D) 134 Kw (2015.12-->), Stag (D) 88 Kw (2010.10-->), N 2523 BS IV, Comet 1616 BS II, U 4019 BS III, 1613 5.7, 1618T BS IV, 1611 BS II, Cheetah (D) 84 Kw (1995.04 -2010.10), 3118-T BS IV, 2518 T BS IV, 2518 T BS III, Boss 1212 LE, Lynx BS II, U 2516, U 3518 BS IV	F8221300, F8221200, F7B01200, F8348900, F7B01100, F8845900, F8348800, F8845800		2,540.00

### Filter Application Chart

Part Number	Product Description	Image	Model Description 	Potential OE Part No	Potential Comp. Part No	MRP (₹)
F 002 H24 415	Air Filter Element Primary, Engine		, JanBus Midi BS4, 3718 BSIV, SFC 1613 BS II, Viking (GAS) (2006.01-->), Captain 49IT BS III, 1616 BS III, eComet 912 (D) 88 Kw (2008.11-->), U 2523, 2214 6x2 BS II, 2523 (D) 165 Kw (2014.01-->), eComet 912 (D) 88 Kw (2005.08 -2010.10), 2518 BS IV (D) 134 Kw (2018.12-->), 3718 iL (D) 132 Kw (2014.01-->), 3120 iL, eComet 1112 (D) 88 Kw (2008.11 -2010.10), U 3118 LA BS IV, Comet 1613H, Captain 3123 BS IV, 1616 XL BS III (D) 119 Kw (2015.05-->), U-2518-IL-T HD BS III (D) 134 Kw (2016.08-->), 2514 BS II, Captain 2518 HD BS III, U-2518 IL T HD BS IV (D) 134 Kw (2015.12-->), U 4019 BS IV, 2516 iL BS III (D) 119 Kw (2012.12-->), U-2518 T BS IV, Viking BS II, 4019 BSIV, 3718 BS IV (D) 134 Kw (2015.12-->), 3518 BS III (D) 134 Kw (2015.12-->), Lynx (D) 88 Kw (2010.10-->), U 4923 BS IV, 12M (D) 84 Kw (2014.10-->)	F8221300, F8221200, F7B01200, F8348900, F7B01100, F8845900, F8348800, F8845800		2,540.00

### Filter Application Chart

Part Number	Product Description	Image	Model Description 	Potential OE Part No	Potential Comp. Part No	MRP (₹)
F 002 H24 418	Air Filter Element Primary, Engine		TATA MOTORS- LPK 407 BS II, 712 LPT EX, LPT 909 BS IV, 709 LPT EX Turbo (D) 66 Kw (2003.01-2004.12), LPT 1109 HEx2 CR (D) 92 Kw (2014.01-->), SFC 909 EX (D) 66 Kw (2008.05 -2010.10), LPT 909 EX (D) 66 Kw (2005.03 -2010.10), LPT 1109 EX (D) 66 Kw (2007.05 -2010.10), 709 SFC EX, LPT 810 Ex2 BS III, 709 LPT HEx2 (D) 92 Kw (2014.01-->), LPT 1109 HEx2 (D) 92 Kw (2014.01-->), LPT 909 EX (D) 92 Kw (2010.10-->), LPT 1109 EX (D) 92 Kw (2010.10-->), LPT 407 EX BS-IV, LPT 407, LPT 912 (D) 92 Kw (2005.05-->), 709 LP Bus (D) 66 Kw (2005.04-->), LPT 407 EX2 BS-IV, LPT 809 EX (D) 66 Kw (2008.02-->), SFC 909 EX (D) 92 Kw (2010.10 -2017.04), LPT 1112, LP 909 49 BS III CNG, LPT 407 EX2 CNG BS-IV, 709 LPT EX Turbo (D) 66 Kw (2005.01-->), LP 912 (D) 92 Kw (2010.10-->), LP 708 BS III, LPT 1109 (D) 66 Kw (2003.09 -2007.04), LPT 810 Ex2 BS IV, 712 LP Bus (D) 92 Kw (2005.04-->), LP 709 BS III, LPT 709 BS IV, LP 909, LP 407 CNG BS III, LPK 909, LP 912 TCIC BS IV	252709130329, 253409130306, 253409140132, 885409010410, 253409140133, 253409130305, 252709130330, 278618999994	FLG -5005192	2,755.00
F 002 H24 418	Air Filter Element Primary, Engine		TATA MOTORS- 407 3.0 Diesel LP Turbo Bus (D) 55 Kw (2006.01-->), 407 3.0D SFC Pickup, 407 SFC 3.0, 407 3.0 Diesel SFC Turbo, 407 3.0 Diesel LPT (D) 53 Kw (2001.10 -2005.02), 407 3.0D SFC EX Turbo (D) 55 Kw (2003.11 -2005.04), 410 Turbo SFC 3.0 Diesel, LP 410 (D) 75 Kw (2004.07 -2010.10)	252709130329, 253409130306, 253409140132, 885409010410, 253409140133, 253409130305, 252709130330, 278618999994	FLG -5005192	2,755.00
F 002 H24 419	Air Filter Element Primary, Engine		TATA MOTORS- 207 1.9 D	254709130241, 253409130258, 253409130241, 253409130262, 253409130368		835.00
F 002 H24 902	Air Filter Element Primary, Engine		TATA MOTORS- Ace SuperAce 1.4	286409139904		520.00

### Filter Application Chart

Part Number	Product Description	Image	Model Description 	Potential OE Part No	Potential Comp. Part No	MRP (₹)
F 002 H24 998	Air Filter Element Primary, Engine		MAHINDRA- Maxximo 0.9D, Supro Maxitruck T2/T4/T6, Maxximo Mini VX	0313AAU00960N		283.00
F 002 H24 999	Air Filter Element Primary, Engine		ASHOK LEYLAND- Dost 1.5 CNG, Dost 1.5TD Plus, Dost 1.5D, Dost 1.5TD Xpress, Dost 1.5TD Strong	165462VA1A		770.00
F 002 H60 006	Air Filter Element Primary, Engine		EICHER- 11.10, 10.95; SWARAJ MAZDA- T3500 Prestige, T3500 Prestige WT49LWB, Prestige WT49TC, T3500 Bus WT-48, Prestige WT-48, Premium T3500 WT 49 ESA, 4WD-BT 3.5D, T3500 3.5 Diesel 4WD, T3500 Truck/Dumper WT, T3500 Prestige WT49STD			950.00
F 002 H60 006	Air Filter Element Primary, Engine		TATA MOTORS- 609 SFC 3.8 Diesel, 709 LP Bus (D) 66 Kw (2005.04-->), 709 LP Bus (D) 66 Kw (1995.05 -1997.09), LP 609 Turbo Bus	252709130248		950.00
F 002 H60 006	Air Filter Element Primary, Engine		TATA MOTORS- 407 3.0D SFC EX Turbo (D) 55 Kw (2005.05 -2017.03), 407 3.0 Diesel LPT Turbo, 407 3.0 Diesel LP Turbo Bus (D) 55 Kw (2006.01-->), 407 3.0 Diesel SFC Turbo Bus, 407 3.0 Diesel LPT (D) 53 Kw (2001.10 -2005.02), 407 3.0D Cityride NA, 407 3.0 Diesel LP, 407 3.0, 407 LP Turbo Bus 3.0, 407 3.0 4WD, 407 Citiride 3.0, Cityride 407, 609 3.8 Diesel LP, 407 TurboBus SWB 3.0 D, 407 3.0 Diesel, Starbus 3.0, LP 410 (D) 75 Kw (2004.07 -2010.10)	252709130248		950.00



### Filter Application Chart

Part Number	Product Description	Image	Model Description 	Potential OE Part No	Potential Comp. Part No	MRP (₹)
F 002 H60 010	Air Filter Element Primary, Engine		ASHOK LEYLAND- Comet 1611, Viking (GAS) (2006.01-->), 2214 6x2 (H) (D) 84 Kw (2005.07-2009.07), Lynx (D) 88 Kw (2005.05-2010.10), eComet 912 (D) 88 Kw (2008.11-->), 3015, 12M (D) 130 Kw (2005.04-2010.10), Cheetah (D) 97 Kw (2005.04-2010.10), 1613 H, Viking (D) 84 Kw (2004.02-2010.10), eComet 912 (D) 88 Kw (2005.08-2010.10), 2514, 2214 Super, Ecomet 1012 Smart (D) 88 Kw (2010.11-->), eComet 1112 (D) 88 Kw (2005.08-2010.10), Cheetah (D) 84 Kw (1995.04-2010.10), 3014, 2513, eComet 1112 (D) 88 Kw (2008.11-2010.10), Viking (D) 97 Kw (2004.02-2010.10)	F8221300	FLG -AF4670	548.00
F 002 H60 010	Air Filter Element Primary, Engine		EICHER- Galaxy 33.25 (D) 130 Kw (2004.08-2009.03), Galaxy 30.25 XP (D) 108 Kw (2010.08-->), Galaxy 30.25 XP (D) 108 Kw (2009.03-2010.10); EICHER MOTORS LIMITED- Galaxy 30.25 (D) 108 Kw (2005.08-->), Galaxy 30.25 (D) 108 Kw (2003.04-->)	ID202371	FLG -AF4670	548.00
F 002 H60 011	Air Filter Element Primary, Engine		EICHER- Galaxy 33.25 (D) 130 Kw (2004.08-2009.03), Galaxy 30.25 XP (D) 108 Kw (2010.08-->), Galaxy 30.25 XP (D) 108 Kw (2009.03-2010.10); EICHER MOTORS LIMITED- Galaxy 30.25 (D) 108 Kw (2005.08-->), Galaxy 30.25 (D) 108 Kw (2003.04-->)	ID202370		1,655.00
F 002 H60 012	Air Filter Element Primary, Engine		FORCE MOTORS- Traveller Smart DV 3050/3350mm WB 2.6 Diesel, Tempo Traveller Minibus 2.4 Diesel, Trax 2.6D Kargo			360.00
F 002 H60 012	Air Filter Element Primary, Engine		MAHINDRA- Bolero Camper 2.5, Bolero Camper 2510 2.5 D, Bolero Camper 2.5 Diesel 4x4, Bolero Camper 2750 2.5 D, Bolero Camper 2.5 Diesel 2880, Bolero Camper 2.5 Diesel, FJ 2.5 Diesel Chassis 4WD, Bolero Camper 2.5 Diesel 2450, Maxx Pickup 2.5 Diesel 4WD, Maxx Pickup 2.5 Diesel	0313AAM02031N, 0313AC0280N, 71817, 0313AC2261N, 70632		360.00

### Filter Application Chart

Part Number	Product Description	Image	Model Description 	Potential OE Part No	Potential Comp. Part No	MRP (₹)
F 002 H21 218	Air Filter Element, Engine		TATA MOTORS- 1512 LP/LPO TC BS-III, 2515 TC LPT	278609139910		1,600.00
F 002 H23 561	Air Filter Element, Engine		ASHOK LEYLAND- Cheetah, 2516, 2516 6x2 (H), Taurus 2516 6x2, 3516 Super, Tusker 3516, Taurus 2516 6x4, 4018, 3516, 2516 il, Artik 3516	F8211300	FLG -8200068, AF4669	2,158.00
F 002 H23 567	Air Filter Element, Engine		EICHER- 11.10		FLG -AF26058	1,491.00
F 002 H23 585	Air Filter Element, Engine		MAHINDRA- Imperio 2.5, Genio 2.5D	0313AAC04390N		977.00
F 002 H23 592	Air Filter Element, Engine		EICHER- 10.90 E2 Plus, 10.80 E2 Plus, 11.10 E2 Plus			1,600.00
F 002 H26 531	Air Filter Element, Engine		MAHINDRA- SUPRO MAXITRUCK, Supro Minitruck BS6, Supro Maxitruck T2/T4/T6			490.00
F 002 H26 532	Air Filter Element, Engine		TATA MOTORS- Ace XL 0.7D, Ace Gold, ACE MAGIC 0.7, ACE Magic CNG BS-IV, Ace Gold Petrol BS6, ACE Mega XL BS III, ACE MAGIC, ACE Magic CNG BS III, Ace Gold CNG BS6, Ace (BS IV) 0.8, Ace Mega XL 0.8D D, Ace Gold BS6			340.00
F 002 H60 011	Air Filter Element, Engine		TATA MOTORS- LPK 2516 6x2	278609139908		1,655.00
F 002 H60 012	Air Filter Element, Engine		FORCE MOTORS- Traveller Smart DV 3050/3350mm WB 2.6 Diesel, Tempo Traveller Minibus 2.4 Diesel, Trax 2.6D Kargo			360.00

### Filter Application Chart

Part Number	Product Description	Image	Model Description 	Potential OE Part No	Potential Comp. Part No	MRP (₹)
F 002 H60 012	Air Filter Element, Engine		MAHINDRA- Bolero Camper 2.5, Bolero Camper 2510 2.5 D, Maxx 2.5 Diesel Pickup Lite, Bolero Camper 2.5 Diesel 4x4, Bolero Camper 2750 2.5 D, Bolero Camper 2.5 Diesel 2880, Bolero Camper 2.5 Diesel, FJ 2.5 Diesel Chassis 4WD, Bolero Camper 2.5 Diesel 2450, Bolero Camper, Maxx Pickup 2.5 Diesel 4WD, Maxx Pickup 2.5 Diesel	0313AAM02031N, 0313AC0280N, 71817, 0313AC2261N, 70632		360.00
F 026 400 034	Air Filter Element, Engine		VOLVO- FH (D) 382 Kw (2006.09 -2011.12), FM 12 (D) 280 Kw (2003.09 -2005.09), FH 12			On Request
F 026 400 047	Air Filter Element, Engine		NISSAN- Evalia [M20M]	2232400Q2M		On Request
F 026 400 117	Air Filter Element, Engine		VOLVO- FM (D) 339 Kw (2009.05-->), FM 9, FM 7 290, FM 12 (D) 280 Kw (2003.09 -2005.09), FM (D) 250 Kw (2006.05 -2009.07)			On Request
F 026 400 526	Air Filter Element, Engine		SCANIA- P-Serie (D) 280 Kw (2007.09 -2018.12)	1421022		On Request
F 026 400 528	Air Filter Element, Engine		SCANIA- P-Serie (D) 280 Kw (2007.09 -2018.12)	1869988		On Request
F 026 400 529	Air Filter Element, Engine		SCANIA- P-Serie (D) 280 Kw (2007.09 -2018.12)	1421021		On Request
F 026 400 532	Air Filter Element, Engine		SCANIA- P-Serie (D) 280 Kw (2007.09 -2018.12)	1485592		On Request

### Filter Application Chart

Part Number	Product Description	Image	Model Description 	Potential OE Part No	Potential Comp. Part No	MRP (₹)
F 026 400 535	Air Filter Element, Engine		VOLVO- FH (D) 382 Kw (2006.09 -2011.12)			On Request
F 026 400 538	Air Filter Element, Engine		SCANIA- P-Serie (D) 280 Kw (2007.09 -2018.12)	1869987		On Request
F 026 400 554	Air Filter Element, Engine		SCANIA- P-Serie (D) 280 Kw (2007.09 -2018.12)	1869995		On Request
F 026 400 620	Air Filter Element, Engine		SCANIA- P-Serie (D) 280 Kw (2007.09 -2018.12)	1869993		On Request
F 026 400 637	Air Filter Element, Engine		SCANIA- P-Serie (D) 280 Kw (2007.09 -2018.12)	1869989		On Request
F 026 400 717	Air Filter Element, Engine		VOLVO- FM (D) 338 Kw (2013.04-->), FM (D) 309 Kw (2013.04-->)			On Request
F 002 H23 561	Air Filter Set, Engine		TATA MOTORS- LPT 1613, LPK 1613 5.7 BS-III, LPT 2518, LPO 1616 TC BS-II, LPT 1616 697 Super Turbo BS-II, Signa 3118 T, LPO 1612 TC BS-III, LPS 3518, LPT 3118, LPK 2516 6x2, Marcopolo 1625 LF, SK 1616, LPK 1618 BS-III, LP/LPO 1615 697 BS-III, LPS 3516 EX, LPT 3723 TC, LPT 3718, LPO 1612 TC BS-II, LPO 1618, LPK 1616 BS-III, LPK 2518 HD, LPT 2516 TC 6x2, LPT 2518/62 TC BS3, LPT 1616 BS-III, LPS 4018, LPK 1618, LPT 2515 EX 6x2	409024000216, 278609139910, 278609139909, 885409052516, 278609139911, 278609139912, 278609139936, 278609139935, 278609139908	FLG -8200068, AF4669	2,158.00







### Filter Application Chart

Part Number	Product Description	Image	Model Description 	Potential OE Part No	Potential Comp. Part No	MRP (₹)
F 002 H23 562	Air Filter Set, Engine		EICHER- 11.10			1,128.00
F 002 H23 563	Air Filter Set, Engine		TATA MOTORS- LPK 1613, LPT 1613 /62 TC, LPT 1613 TC, LPO 1613 CNG, LPO 1512 TC SLF, LPT 1613 EX, LPT 2513, 1512 LP 497 BS-III, 1512 TC LP	278609139910, 278609139909, 278609139911, 885409041613, 278609139908	FLG -8200069	1,950.00
F 002 H23 563	Air Filter Set, Engine		EICHER- 10.90 L 40	ID202373	FLG -8200069	1,950.00
F 002 H23 564	Air Filter Set, Engine		ASHOK LEYLAND- eComet 1109 3.8, 2214 6x2 (H), Stag (D) 88 Kw (2002.01 -2005.03), 2214 Super	F8221300, F8221200, F8845900, F8845800, X7423500	FLG -AF26074	1,408.00
F 002 H23 589	Air Filter Set, Engine		ASHOK LEYLAND- 1616 iL 5.7, U 4923, 1616 iL, 4023, U 3518, U 4023, 4019 5.6, U 3123, U 1616, Captain 40, U-3118, U 2518, 3118, 3518, U 3518 5.7, 4019iL, 4019, 3123, U 4019 iL, 2518, 4923, 3516	F8365800, F7B01200, F8211200, F7B01300, F7B01400, F7B02100, X8830400, F7B01100, F7B02000, F8211300		3,443.00
F 002 H23 594	Air Filter Set, Engine		EICHER- Skyline Pro 3008, Pro 1075, Pro 1110 XP, 10.75, Pro 1090, Pro 1110, 10.59 XP, Pro 3015 TCI BS IV, Pro 1095 XP, Pro 1080, 10.80 E2 Plus, Pro 3012 TCI BS IV, Pro 3013	ID332218, ID370776, ID370777, ID303249, ID303248, ID332219		2,031.00
F 002 H23 594	Air Filter Set, Engine		EICHER MOTORS LIMITED- 10.50 3.3 Diesel Turbo, Pro 1050, Pro 1049, Pro 1055K	ID370776, ID370777, ID303249, ID303248, ID332219		2,031.00
F 002 H24 415	Air Filter Set, Engine		ASHOK LEYLAND- JanBus Midi BS4, Lynx, JanBus BS4, Stag (D) 88 Kw (2010.10-->)	F8221300, F8221200, F7B01200, F8348900, F7B01100, F8845900, F8348800, F8845800		2,540.00

### Filter Application Chart

Part Number	Product Description	Image	Model Description 	Potential OE Part No	Potential Comp. Part No	MRP (₹)
F 002 H24 418	Air Filter Set, Engine		TATA MOTORS- LPT 1109 Hex2 CR, LP 1109 3.7, 709 LPT Hex2, 709 LP Bus, LPT 1109 Hex2, LP 912, 909, 712 LP Bus, 709 LPT EX Turbo, LPT 909 EX, SFC 909 EX, LPT 1109 EX, LPT 407, LPT 912, LPT 809 EX, LPT 1109	252709130329, 253409130306, 253409140132, 885409010410, 253409140133, 253409130305, 252709130330, 278618999994	FLG -5005192	2,755.00
F 002 H24 418	Air Filter Set, Engine		TATA MOTORS- 407 3.0D SFC Pickup, 407 SFC 3.0, 407 3.0 Diesel SFC Turbo, 410 Turbo SFC 3.0 Diesel, 407 3.0D SFC EX Turbo, SK 407	252709130329, 253409130306, 253409140132, 885409010410, 253409140133, 253409130305, 252709130330, 278618999994	FLG -5005192	2,755.00
1 987 431 162	Cabin Filter		MAN- CLA 15 t, CLA 20 t, CLA 26 t	85619500025		On Request
1 987 431 167	Cabin Filter		VOLVO- FH, FH 12, FM			On Request
1 987 431 172	Cabin Filter		SCANIA- P-Serie (D) 280 Kw (2007.09 -2018.12)	1913500		On Request
1 987 432 056	Cabin Filter		VOLKSWAGEN- Multivan T4 [70, 7D]	7D0819989		On Request
1 987 432 153	Cabin Filter		SCANIA- P-Serie (D) 280 Kw (2007.09 -2018.12)	1913503		On Request
1 987 435 125	Cabin Filter		SCANIA- Citywide	2283473		On Request

### Filter Application Chart

Part Number	Product Description	Image	Model Description 	Potential OE Part No	Potential Comp. Part No	MRP (₹)
1 987 431 451	Cabin Filter, Activated Carbon		VOLVO- FH, FH 12, FM			On Request
F 002 H24 367	Coolant Filter		ASHOK LEYLAND- U 4923, eComet 1212, U 4023, 3121, U 3123, U 1618, Captain 40, U 2523, U 2518, 4921, Ecomet 1012 Smart, eComet 1214	X4000700	FLG -WF2152	373.00
F 026 404 011	Coolant Filter		VOLVO- FM 9, FH 12, FM, FM 12			On Request
9 450 030 116	Diesel Filter Kit (preliminary And Main Filter)		TATA MOTORS- Xenon Yodha BS-III, 709 LP Bus, LPT 809 EX, 709 LPT EX Turbo	254709110106, 252709110104		2,605.00
9 450 030 116	Diesel Filter Kit (preliminary And Main Filter)		TATA MOTORS- 407 3.0D SFC Pickup (D) 55 Kw (2010.03-->), 407 3.0 Diesel SFC Turbo (D) 52 Kw (2003.11 -2005.05), 407 3.0 Diesel LP Turbo Bus (D) 55 Kw (2006.01-->), Winger BS III, TL Pickup 2.0, TL Pickup 2.0 Diesel 4WD	254709110106, 252709110104		2,605.00
F 002 H21 298	Diesel Filter Kit (preliminary And Main Filter)		ASHOK LEYLAND- 2518 (D) 135 Kw (2010.10-->), 1616 XL, 2516 6x2 (H), 1616 XP, 1612 H, 2214 6x2 (H), Cargo 1613H, 12M (D) 130 Kw (2006.11 -2010.10), Ecomet 1012 Smart, 2514, 2513, 3116 (D) 118 Kw (2010.10-->), Comet 1613H, Artik 3516, 1616 H	PD600344, FHN00400, P1300640, P1301340, FHJ00700, P1300640, FHN00100, F8835100, FJ124500, P1301540, P7B00022, FHJ01000, P2602040, F4003400, P1301640, F8332300, FHJ00400, P1301240, P1301440	FLG -FS19636	1,301.00











### Filter Application Chart

Part Number	Product Description	Image	Model Description 	Potential OE Part No	Potential Comp. Part No	MRP (₹)	
F 002 H23 555	Diesel Filter Kit (preliminary And Main Filter)		ASHOK LEYLAND- Cheetah, Artik 3014, Comet 1616H; TATA MOTORS- 1510 LP		FLG -FF5526F F5526	260.00	
F 002 H23 590	Diesel Filter Kit (preliminary And Main Filter)		ASHOK LEYLAND- U 3723, 3123, 12M (D) 130 Kw (2005.04 -2010.10), 2518 (D) 132 Kw (2008.01 -2010.10), 3116 (D) 118 Kw (2009.07 -2010.10)		FHN00400, F7A04700, FHJ00700, X8820800, P1302140, F8835100, X7471500, F7B02900, P7B00022, FHJ01000, P1301640, F4003400, P1302040, P1301240	FLG -FS19636	1,315.00
F 002 H24 918	Diesel Filter Kit (preliminary And Main Filter)		EICHER MOTORS LIMITED- JUMBO 20.16		ID320704	1,063.00	
F 002 H24 920	Diesel Filter Kit (preliminary And Main Filter)		ASHOK LEYLAND- 4923		X8820800, P1302040, F7B02900	FLG -FF5532	1,340.00
F 002 H24 921	Diesel Filter Kit (preliminary And Main Filter)		ASHOK LEYLAND- 12M (D) 118 Kw (2010.10-->), 3118		FHN00400, P1301340, FHJ00700, X8820800, P1302140, P1301640, F4003400, P1302040, F8835100, P1301240, P1301540, P7B00022, FHJ01000		685.00



### Filter Application Chart

Part Number	Product Description	Image	Model Description 	Potential OE Part No	Potential Comp. Part No	MRP (₹)
F 002 H26 625	Diesel Filter Kit (preliminary And Main Filter)		EICHER MOTORS LIMITED- 10.50 3.3 Diesel BS3, 10.50 3.3 Diesel BS2, 10.50 3.3 Diesel; FORCE MOTORS- Tempo Traveller Ambulance 2.4 Diesel, Excel-4 2.6 Diesel, Excel-4 3.2 Diesel, Matador 2.4 Diesel, Tempo Traveller Minibus 2.4 Diesel, Excel-2 2.4 Diesel, Pick Up Trax Dual Cab 2.4 Diesel, Pick Up Trax Kargo 2.6 Diesel, Excel-3 2.4 Diesel, Trax 2.6D Kargo, Citiline 2.6 Diesel, Tempo Traveller Ambulance LWB 2.6 Diesel, Traveller 3350/3700 mm WB 2.6 Diesel			280.00
F 002 H26 625	Diesel Filter Kit (preliminary And Main Filter)		MAHINDRA- Genio 2.5D	0305DC0081N, 1001CA0800N, 1001CAA14881N, 100000A0370N, 7902000096, 0305DC0161N, 1001CAA10240N		280.00
F 002 H26 625	Diesel Filter Kit (preliminary And Main Filter)		TATA MOTORS- 407 3.0 Diesel LPT Turbo, 407 3.0D SFC Pickup (D) 55 Kw (2010.03-->), 407 3.0 Diesel LP Turbo Bus (D) 55 Kw (2006.01-->), 407 3.0 Diesel SFC Turbo Bus, 407 3.0D Cityride NA, 410 Turbo SFC 3.0 Diesel, 407 3.0 Diesel LP, 407 LP Turbo Bus 3.0, 407 3.0 Diesel LPT, 407 3.0 4WD, 407 Citiride 3.0, 407 3.0D SFC EX Turbo, 407 3.0 Diesel SFC Turbo (D) 52 Kw (2003.11 -2005.05), Cityride 407, 407 SFC 3.0, 609 3.8 Diesel LP, 206 1.9 D, 407 TurboBus SWB 3.0 D, 407 3.0 Diesel	252709110105, 253409110117, 254709110118, G9450030116, 254709110106, 253409110120		280.00
F 002 H20 254	Filter Kit (oil And Diesel Filter)		TATA MOTORS- 1210E			623.00
F 002 H20 255	Filter Kit (oil And Diesel Filter)		ASHOK LEYLAND- Comet 1611, Comet 1613, Comet Junior			427.00

### Filter Application Chart

Part Number	Product Description	Image	Model Description 	Potential OE Part No	Potential Comp. Part No	MRP (₹)
F 002 H20 740	Filter Kit (oil And Diesel Filter)		TATA MOTORS- LPK 2516 TC 6x4 BS-II, SK 1613 TC, LP 1510 CGS, LPS 3015 TC, LPT 2515 TC 6x2, 1510 LP CGS BS-III, LPT 2515 6x2, LPS 4018 TC EX, LPO 1613, LPT 2515 60WB TC 6x2, LPK 2516 6x4, LPK 2516 6x2			1,118.00
F 002 H21 221	Filter Kit (oil And Diesel Filter)		TATA MOTORS- Super Ace Mint, Ace XL 0.7D, Ace (BS III) 0.7, ACE MAGIC 0.7, Ace Zip 0.6, Ace SuperAce 1.4, Ace Mega XL 0.8D D, Ace (BS IV) 0.8, Ace Zip XL 0.6			438.00
F 002 H21 222	Filter Kit (oil And Diesel Filter)		ASHOK LEYLAND- Cheetah, Comet 1616H			574.00
F 002 H23 554	Filter Kit (oil And Diesel Filter)		TATA MOTORS- LPT 1613			305.00
F 002 H20 364	Fuel Box Filter, Complete		PIAGGIO- Apetruk, Ape Mini, Apetruk 87D			373.00
F 002 H26 311	Fuel Box Filter, Complete		ASHOK LEYLAND- Captain 40	P1302040, F7B02900	FLG -FS19654	2,208.00
1 457 429 655	Fuel Filter Element		MERCEDES-BENZ- O 500 (D) 265 Kw (2010.01 -2012.02)	5410900151		On Request
1 457 431 003	Fuel Filter Element		SWARAJ MAZDA- T3500 Prestige WT49LWB, Premium WT 49 ESA, Prestige WT-48, Sartaj WV26S, Super ZT54 BS I	WT4923570		156.00
1 457 431 707	Fuel Filter Element		MERCEDES-BENZ- O 500 (D) 224 Kw (2008.09 -2012.02), O 500 (D) 188 Kw (2012.03-->)	0000901551		On Request









### Filter Application Chart

Part Number	Product Description	Image	Model Description 	Potential OE Part No	Potential Comp. Part No	MRP (₹)
9 451 037 405	Fuel Filter Element		TATA MOTORS- 609 3.8 Diesel LP, 407 3.0 Diesel LP, 407 3.0 Diesel LP Turbo Bus, 407 LP Turbo Bus 3.0	252709110105		150.00
F 002 H20 152	Fuel Filter Element		MAHINDRA- Tourister T15 2.5TD, Tourister T25 2.6TD, Tourister Excelo 2.5TD T, Tourister 2.5, DI 3200 Jayo, DI 3200 Optimo	1001CAA14881N, 0305DAB00581N		6,153.00
F 002 H21 299	Fuel Filter Element		TATA MOTORS- Ace XL 0.7D, Ace Gold, ACE MAGIC 0.7, Venture 1.4D, ACE MAGIC, Ace (BS IV) 0.8	279009110104, 571009119903, 254709110119, 279009110110, 279709110106, 278909110112, 886309000119, 253409110117, 279009110111		136.00
F 002 H22 283	Fuel Filter Element		TATA MOTORS- Ace Zip 0.6			352.00
F 002 H22 283	Fuel Filter Element		MAHINDRA- Maxximo 0.9D, Maxximo 0.9D MiniVan, Maxximo Mini VX	1001CAA08951N		352.00
F 002 H22 471	Fuel Filter Element		ASHOK LEYLAND- Dost 1.5TD Strong (D) 43 Kw (2017.09-->), Dost 1.5TD Plus (D) 45 Kw (2017.09-->)			591.00
F 002 H24 406	Fuel Filter Element		TATA MOTORS- 1510 LP			142.00
F 002 H24 406	Fuel Filter Element		ASHOK LEYLAND- Cheetah, Artik 3014, Comet 1616H	P1301440		142.00











### Filter Application Chart

Part Number	Product Description	Image	Model Description 	Potential OE Part No	Potential Comp. Part No	MRP (₹)
F 002 H24 496	Fuel Filter Element		MAHINDRA- DI 3200 2.5 Diesel, Bolero Camper 2.5 Diesel 4x4, DI 3200 2.5 Diesel Turbo, Tourister DX, FJ 2.5 Diesel Chassis 4WD, Pik up 2.5 Diesel 4x4, Maxx Pickup 2.5 Diesel 4WD, King Cab 2.5 Diesel, King Cab 2.5 D 4x4, Vikrant 2.5 Diesel	9420000319, 10000A0370N, 0305DAB00581N		227.00
F 002 H24 496	Fuel Filter Element		ASHOK LEYLAND- Stile 1.5, Dost 1.5TD Strong (D) 43 Kw (2017.09-->), Dost 1.5D, Dost 1.5TD Plus (D) 45 Kw (2017.09-->), Dost 1.5TD Xpress	F7B01700		227.00
F 002 H24 742	Fuel Filter Element		MAHINDRA- LoadKing Pride 2.6 CRDe, LoadKing Pride 2.6 Diesel (D) 54 Kw (2005.03 -2009.12)	7312AAA00021N, 1001CZ0070N		1,100.00
F 002 H25 924	Fuel Filter Element		MAHINDRA- Cosmo 32 BS IV, Cosmo 40 BS IV			545.00
F 002 H25 926	Fuel Filter Element		EICHER MOTORS LIMITED- Skyline Pro 3011L BS-VI, Pro 2110XP Plus CNG BS-VI, Pro 2110XP Plus BS-VI, Pro 2114XP BS-VI, Skyline Pro 3010L BS-VI, Pro 2110XP BS-VI, 2112M Skyline BS-VI, Pro 3019 BS-VI, Skyline Pro 3009H BS-VI, Pro 2114XP CNG BS-VI, Pro 2110XPT BS-VI, Skyline Pro 3009H CNG BS-VI, Pro 2110 BS-VI			515.00
F 002 H25 993	Fuel Filter Element		TATA MOTORS- Magic Iris, Ace Gold BS6			1,065.00
F 002 H26 537	Fuel Filter Element		MAHINDRA- Bolero Camper BS6, Bolero Pik up BS6 4WD, Bolero Pik up ExtraStrong BS6	S0305D020021N	MHL -KX653	590.00

### Filter Application Chart

Part Number	Product Description	Image	Model Description 	Potential OE Part No	Potential Comp. Part No	MRP (₹)
F 002 H26 625	Fuel Filter Element		MAHINDRA- Tourister T36	0305DC0081N, 1001CA0800N, 1001CAA14881N, 100000A0370N, 7902000096, 0305DC0161N, 1001CAA10240N		280.00
F 002 H26 625	Fuel Filter Element		MAHINDRA- Imperio 2.5, Tourister 3.3, LoadKing Pride 2.6 Diesel (D) 54 Kw (2005.03 -2009.12), Bolero Camper, Genio 2.5D	0305DC0081N, 1001CA0800N, 1001CAA14881N, 100000A0370N, 7902000096, 0305DC0161N, 1001CAA10240N		280.00
F 002 H26 625	Fuel Filter Element		TATA MOTORS- Xenon 2.2 CRDI 2WD, Xenon 2.2 CRDI 4WD	252709110105, 253409110117, 254709110118, G9450030116, 254709110106, 253409110120		280.00
F 026 402 100	Fuel Filter Element		SCANIA- P-Serie (D) 280 Kw (2007.09 -2018.12)	1873016		On Request
F 026 402 107	Fuel Filter Element		SCANIA- P-Serie (D) 280 Kw (2007.09 -2018.12)	1873018		On Request
0 450 226 028	Fuel Filter Spin-on		ASHOK LEYLAND- Cheetah (D) 84 Kw (1995.04 -2010.10), Cheetah (D) 88 Kw (2000.11 -2005.03), Artik 3014, Comet 1616H (D) 123 Kw (2009.11 -2010.10)	F3968400, P1302040, F7B02900		2,002.00
0 450 226 029	Fuel Filter Spin-on		TATA MOTORS- 1516 LPT, 1510 LP			1,983.00
1 457 434 294	Fuel Filter Spin-on		VOLVO- FM 7 290 (D) 210 Kw (1999.03 -2001.05), FM 12 (D) 280 Kw (2003.09 -2005.09), FH 12			780.00



### Filter Application Chart

Part Number	Product Description	Image	Model Description 	Potential OE Part No	Potential Comp. Part No	MRP (₹)
1 457 434 314	Fuel Filter Spin-on		MAHINDRA- Genio 2.5D (D) 56 Kw (2011.02 -2017.03)			1,385.00
9 450 030 100	Fuel Filter Spin-on		ASHOK LEYLAND- Comet 1611 (D) 63 Kw (1961.05 -1980.01), Comet 1611 (D) 74 Kw (1980.02 -2001.02), Comet 1613, Cheetah (D) 74 Kw (1991.02 -2000.10), Comet Junior	F3952100		1,720.00
9 450 030 106	Fuel Filter Spin-on		TATA MOTORS- 609 SFC 3.8 Diesel			1,720.00
9 450 030 116	Fuel Filter Spin-on		FORCE MOTORS- Commuter 2.6 Diesel			2,605.00
9 450 030 116	Fuel Filter Spin-on		TATA MOTORS- 1109 LP (D) 66 Kw (2007.05-->), 709 LP Bus (D) 66 Kw (2005.04-->), 1109 LPT (D) 66 Kw (2001.12-->), 1109 LP (D) 66 Kw (2004.01 -2007.04), 1109 LPT (D) 66 Kw (2000.11-->)	254709110106, 252709110104		2,605.00
9 450 030 116	Fuel Filter Spin-on		EICHER MOTORS LIMITED- JUMBO 20.16, Galaxy 30.25	ID201331		2,605.00
9 450 030 116	Fuel Filter Spin-on		SWARAJ MAZDA- Sartaj WV26STC A, Premium WT 49 ESA, Prestige WT-48, T3500 3.5 Diesel, Super ZT54 TC BS II	LP2413850		2,605.00
9 450 030 118	Fuel Filter Spin-on		TATA MOTORS- 709 SFC EX, 709 LP Bus (D) 66 Kw (1995.05 -1997.09)			1,690.00
F 002 H20 115	Fuel Filter Spin-on		ASHOK LEYLAND- 12M (D) 130 Kw (2005.04 -2010.10)			1,830.00

### Filter Application Chart



Part Number	Product Description	Image	Model Description 	Potential OE Part No	Potential Comp. Part No	MRP (₹)
F 002 H20 239	Fuel Filter Spin-on		TATA MOTORS- 1615 TC LPT, 2515 TC LPT, 1512 TC LP (D) 92 Kw (2000.01 -2001.08), 1615 TC LPK, 3516 TC LPS (D) 118 Kw (1999.06-->), 1510 TC LP, 2516 TC LPT (D) 118 Kw (1996.06-->), 1615 TC SK, 2516 TC LPK, 1512 LP/LPO TC BS-III (D) 114 Kw (2005.02-->)			283.00
F 002 H20 306	Fuel Filter Spin-on		TATA MOTORS- LPT 2515 Turbo EX 6x2, 1510 LP/LPO BS-II, LP 1613 SuperMilo			388.00
F 002 H21 252	Fuel Filter Spin-on		TATA MOTORS- LPK 2516 TC 6x4 BS-II, SK 1613 TC, LP 1510 CGS, LPS 3015 TC, LPT 2515 TC 6x2, 1510 LP CGS BS-III, LPT 2515 6x2, LPS 4018 TC EX, LPO 1613, LPT 2515 60WB TC 6x2, LPK 2516 6x4, LPK 2516 6x2	278607989916		441.00

### Filter Application Chart

Part Number	Product Description	Image	Model Description 	Potential OE Part No	Potential Comp. Part No	MRP (₹)	
F 002 H21 298	Fuel Filter Spin-on		ASHOK LEYLAND- U 1616 (D) 84 Kw (2010.11-->), Stag (D) 88 Kw (2013.10-->), 4921 (D) 151 Kw (2014.01-->), 3518 (D) 130 Kw (2008.07 -2010.10), 2214 6x2 (H) (D) 84 Kw (2005.07 -2009.07), Cheetah (D) 118 Kw (2014.01-->), Cheetah (D) 122.8 Kw (2005.11-->), Cheetah (D) 88 Kw (2000.11 -2005.03), Cheetah (D) 97 Kw (2005.04 -2010.10), Cargo 1613H, 12M (D) 130 Kw (2006.11 -2010.10), Lynx (D) 96 Kw (2014.01-->), 3121 (D) 151 Kw (2014.01-->), 4019, eComet 1112 (D) 88 Kw (2005.08 -2010.10), Viking (D) 123 Kw (2005.05-->), Ecomet 1012 Smart (D) 88 Kw (2010.11-->), 2516, Viking (D) 97 Kw (2004.02 -2010.10), 2214 Super (D) 97 Kw (2009.07 -2010.10), SG 1613 H, eComet 1214 (D) 88 Kw (2014.01-->), Stag (D) 88 Kw (2010.10-->), 2518 (D) 132 Kw (2008.01 -2010.10), Viking (D) 123 Kw (2005.11 -2009.12), 12M (D) 135 Kw (2010.10-->), Comet 1611 (D) 89.7 Kw (2001.03 -2005.03), Stag (D) 64 Kw (2003.04 -2010.10), 2518 (D) 135 Kw (2010.10-->), Lynx (D) 88 Kw (2005.05 -2010.10), 4018 (D) 130 Kw (2004.08 -2009.09), 2518 (D) 132 Kw (2014.01-->), Stag (D) 88 Kw (2002.01 -2005.03), Tusker 3516, 2516 S, Cheetah (D) 84 Kw (1995.04 -2010.10), 3118 (D) 135 Kw (2010.08-->), U 2518 (D) 132 Kw (2010.09-->), 3518 (D) 132 Kw (2010.10-->), Cheetah (D) 135 Kw (2014.01-->), 12M (D) 118 Kw (2010.10-->), Stag (D) 64 Kw (2005.04 -2010.10), 1616 H, Comet 1611 (D) 63 Kw (1961.05 -1980.01), 1616 XL, Viking (GAS) (2006.01-->), Viking (D) 90 Kw (2014.01-->), 1616		PD600344, FHN00400, P1300640, P1301340, FHJ00700, P13000640, FHN00100, F8835100, FJ124500, P1301540, P7B00022, FHJ01000, P2602040, F4003400, P1301640, F8332300, FHJ00400, P1301240, P1301440	FLG -FS19636	1,301.00







**Filter Application Chart**

Part Number	Product Description	Image	Model Description 	Potential OE Part No	Potential Comp. Part No	MRP (₹)
F 002 H21 298	Fuel Filter Spin-on		XP, S 1613 H, RE SLF (D) 165 Kw (2014.01-->), Viking 160HP IL FIP BS3 (D) 118 Kw (2014.02-->), eComet 912 (D) 88 Kw (2008.11-->), 3121 (D) 151 Kw (2008.04 -2010.10), 3516 Super, 12M (D) 130 Kw (2005.04 -2010.10), Cheetah (D) 88.2 Kw (2007.03 -2010.10), eComet 912 (D) 88 Kw (2005.08 -2010.10), Comet 1611 (D) 88.2 Kw (2004.09 -2010.10), 2516 il (D) 118 Kw (2010.05-->), 4019il (D) 132 Kw (2012.12-->), 3718 iL (D) 132 Kw (2014.01-->), eComet 1112 (D) 88 Kw (2008.11 -2010.10), Viking (D) 123 Kw (2011.01-->), 1616 iL (D) 118 Kw (2010.08-->), eComet 1212 (D) 88 Kw (2010.10-->), 2514 (D) 97 Kw (2008.02 -2009.07), 3516, Comet 1613H, 4921 (D) 151 Kw (2007.05 -2010.10), Artik 3516, Viking (D) 88 Kw (2001.05 -2005.03), Tusker Super 1616, 12M (D) 165 Kw (2014.01-->), Boss 912 LE 3.8 (D) 88 Kw (2014.01-->), 2516 6x2 (H), Viking 180HP ROTARY FIP EDC BS3 (D) 135 Kw (2014.02-->), 4019 5.6, 1612 H, U 2516 (D) 118 Kw (2010.09-->), 1612 IL BS-III (D) 88 Kw (2014.01-->), 12M (D) 128 Kw (2009.03-->), Comet 1611 (D) 74 Kw (1980.02 -2001.02), 2513 (D) 97 Kw (2005.08 -2008.01), Viking (D) 84 Kw (2004.02 -2010.10), Bison 1611, 1616 iL 5.7 (D) 118 Kw (2014.01-->), Lynx (D) 88 Kw (2014.01-->), 1613 H (D) 97 Kw (2005.11 -2010.10), 4018 (D) 130 Kw (2014.01-->), 2516 6x4 (H) 4x4, Lynx (D) 88 Kw (2010.10-->), 3116 (D) 118 Kw (2010.10-->), 3116 (D) 118 Kw (2009.07 -2010.10), Comet 1616H (D) 123 Kw (2009.11 -2010.10), 12M (D) 84 Kw (2014.10-->)	PD600344, FHN00400, P1300640, P1301340, FHJ00700, P13000640, FHN00100, F8835100, FJ124500, P1301540, P7B00022, FHJ01000, P2602040, F4003400, P1301640, F8332300, FHJ00400, P1301240, P1301440	FLG -FS19636	1,301.00



**Filter Application Chart**

Part Number	Product Description	Image	Model Description 	Potential OE Part No	Potential Comp. Part No	MRP (₹)
F 002 H21 298	Fuel Filter Spin-on		ASHOK LEYLAND- Stag (D) 88 Kw (2005.04 -2010.10)	PD600344, FHN00400, P1300640, P1301340, FHJ00700, P13000640, FHN00100, F8835100, FJ124500, P1301540, P7B00022, FHJ01000, P2602040, F4003400, P1301640, F8332300, FHJ00400, P1301240, P1301440	FLG -FS19636	1,301.00
F 002 H21 299	Fuel Filter Spin-on		MAHINDRA- FJ 3.3 Diesel Delivery Van, FJ 2.1 Diesel Truck 4WD, Bolero Camper 2.5 Diesel, FJ 2.1 Diesel Ambulance, FJ 3.3 Diesel Chassis 4WD, FJ 3.3D Hi-Roof Mini-Bus 4WD			136.00
F 002 H21 299	Fuel Filter Spin-on		TATA MOTORS- Ace XL 0.7D (D) 11 Kw (2017.07-->), Ace Zip 0.6, Magic Iris, Ace SuperAce 1.4, Ace Zip XL 0.6	279009110104, 571009119903, 254709110119, 279009110110, 279709110106, 278909110112, 886309000119, 253409110117, 279009110111		136.00
F 002 H22 001	Fuel Filter Spin-on		ASHOK LEYLAND- U 3518 (D) 132 Kw (2010.10-->), U 4023, U 1619	P1302040		3,657.00
F 002 H22 025	Fuel Filter Spin-on		TATA MOTORS- Ace Mega XL 0.8D D	571009119903, 571009110105		1,385.00
F 002 H22 095	Fuel Filter Spin-on		ASHOK LEYLAND- 4923 (D) 165 Kw (2011.03-->), 1618, JanBus Midi BS4, 3718 iL (D) 132 Kw (2014.01-->), JanBus BS4, Boss 1213 LE, Boss 913 LX, Boss 1113 LX, U 4923 (D) 165 Kw (2010.09-->), Lynx (D) 96 Kw (2014.01-->), U 3518 5.7	FHN00400, X8820800, P1301640, F7B02900, P7B00022, FHJ01000		1,766.00



### Filter Application Chart

Part Number	Product Description	Image	Model Description 	Potential OE Part No	Potential Comp. Part No	MRP (₹)
F 002 H23 535	Fuel Filter Spin-on		TATA MOTORS- LPS 3516 EX (D) 115 Kw (2004.01 -2005.09), LPO 1512 TC (D) 94 Kw (2005.10 -2010.10), 2516 TC LPT (D) 118 Kw (2001.03-->), LP 912 (D) 92 Kw (2010.10-->), Novus LPS 4930 6x4 (D) 221 Kw (2007.12 -2010.10), LPK 2523 (D) 173 Kw (2009.07 -2010.10), 1109 LP (D) 66 Kw (2004.01 -2007.04), LPT 1613 (D) 100 Kw (2014.01-->), LPT 1613 /62 TC (D) 92 Kw (2007.12 -2010.10), LPS 3518 (D) 131 Kw (2012.01-->), LPT 2516 TC 6x2 (D) 115 Kw (1998.03 -2000.12), LPT 3118 (D) 135 Kw (2010.09-->), LPT 2515 EX 6x2 (D) 101 Kw (2003.08 -2005.12), LPT 3723 TC (D) 155 Kw (2014.01-->), LPK 2518 HD (D) 135 Kw (2010.08-->), LPT 2518 (D) 135 Kw (2010.08-->), Novus LPK 2530 6x4, 3516 TC LPS (D) 118 Kw (2001.03-->), LPT 3118 (D) 132 Kw (2007.12-->), LPT 1613 EX (D) 88 Kw (2002.08 -2010.10)	278609119904, 278609999920, 278609999822, 278607989916	FLG -FF5522, FS1275	143.00
F 002 H23 535	Fuel Filter Spin-on		TATA MOTORS- 407 3.0 Diesel SFC Turbo Bus, 609 3.8 Diesel LP, 407 3.0 Diesel LP, 407 Citiride 3.0 (D) 55 Kw (2007.12 -2011.09)	278609119904, 278609999920, 278609999822, 278607989916	FLG -FF5522, FS1275	143.00
F 002 H23 582	Fuel Filter Spin-on		EICHER- Skyline Pro 3008, Pro 1110 XP		FLG -FS19644V, FS19644	1,319.00





### Filter Application Chart

Part Number	Product Description	Image	Model Description 	Potential OE Part No	Potential Comp. Part No	MRP (₹)
F 002 H23 582	Fuel Filter Spin-on		TATA MOTORS- LPK 1613, LPT 1616 BS-III (D) 114 Kw (2010.08-->), LP 912 (D) 92 Kw (2010.10-->), LPK 1613 5.7 BS-III (D) 100 Kw (2015.01-->), LPK 909 (D) 92 Kw (2010.10-->), 709 LPT HEx2 (D) 92 Kw (2014.01-->), LPT 1109 HEx2 (D) 92 Kw (2014.01-->), LPT 909 EX (D) 92 Kw (2010.10-->), LPK 1616 BS-III (D) 114 Kw (2010.08-->), LPT 1616 697 Super Turbo BS-II (D) 118 Kw (2009.09 -2010.10), LPO 7.5 3.8TD FBV BS3 Ultra (D) 92 Kw (2011.01-->), LPT 1613 TC, SK 1613 Turbo BS-II, LPT 2516 Super Turbo (D) 118 Kw (2007.12 -2010.10), SE 1613 (D) 102 Kw (2015.01-->), SFC 909 EX (D) 92 Kw (2010.10 -2017.04), LPO 8.5 (D) 92 Kw (2014.02-->), SK 1616 (D) 114 Kw (2010.10-->), 1512 LP 497 BS-III (D) 92 Kw (2005.02-->)	252509120239, 252509120264, 252709119913	FLG -FS19644V, FS19644	1,319.00
F 002 H23 582	Fuel Filter Spin-on		TATA MOTORS- SK 407 (D) 75 Kw (2014.07-->)	252509120239, 252509120264, 252709119913	FLG -FS19644V, FS19644	1,319.00





### Filter Application Chart

Part Number	Product Description	Image	Model Description 	Potential OE Part No	Potential Comp. Part No	MRP (₹)
F 002 H23 590	Fuel Filter Spin-on		ASHOK LEYLAND- 4921 (D) 151 Kw (2014.01-->), 2214 6x2 (H) (D) 84 Kw (2005.07 -2009.07), Cheetah (D) 118 Kw (2014.01-->), Viking 160HP IL FIP BS3 (D) 118 Kw (2014.02-->), eComet 912 (D) 88 Kw (2008.11-->), 3121 (D) 151 Kw (2008.04 -2010.10), U 3723 (D) 165 Kw (2012.01-->), U 1618, U-3118, 12M (D) 130 Kw (2005.04 -2010.10), Cheetah (D) 97 Kw (2005.04 -2010.10), 12M (D) 130 Kw (2006.11 -2010.10), 2523 (D) 165 Kw (2014.01-->), eComet 912 (D) 88 Kw (2005.08 -2010.10), Comet 1611 (D) 88.2 Kw (2004.09 -2010.10), 4019il (D) 132 Kw (2012.12-->), Ecomet 1012 Smart (D) 88 Kw (2010.11-->), eComet 1112 (D) 88 Kw (2005.08 -2010.10), 3123 (D) 165 Kw (2010.08-->), 2516 il (D) 118 Kw (2010.05-->), 3120 il, Viking (D) 123 Kw (2005.05-->), eComet 1112 (D) 88 Kw (2008.11 -2010.10), 2214 Super (D) 97 Kw (2009.07 -2010.10), eComet 1214 (D) 88 Kw (2014.01-->), Stag (D) 88 Kw (2010.10-->), eComet 1212 (D) 88 Kw (2010.10-->), 2518 (D) 132 Kw (2	FHN00400, F7A04700, FHJ00700, X8820800, P1302140, F8835100, X7471500, F7B02900, P7B00022, FHJ01000, P1301640, F4003400, P1302040, P1301240	FLG -FS19636	1,315.00







### Filter Application Chart

Part Number	Product Description	Image	Model Description 	Potential OE Part No	Potential Comp. Part No	MRP (₹)
F 002 H23 590	Fuel Filter Spin-on		008.01 -2010.10), Viking (D) 123 Kw (2005.11 -2009.12), 2514 (D) 97 Kw (2008.02 -2009.07), 4921 (D) 151 Kw (2007.05 -2010.10), 2518 (D) 135 Kw (2010.10-->), Boss 1212 LE (D) 88 Kw (2014.01-->), Boss 912 LE 3.8 (D) 88 Kw (2014.01-->), Viking 180HP ROTARY FIP EDC BS3 (D) 135 Kw (2014.02-->), U 2516 (D) 118 Kw (2010.09-->), 4018 (D) 130 Kw (2004.08 -2009.09), Lynx (D) 88 Kw (2005.05 -2010.10), 2518 (D) 132 Kw (2014.01-->), 3015, Boss 1112 LE (D) 88 Kw (2014.01-->), Taurus 2516 6x4, U 4019 il (D) 132 Kw (2014.01-->), 2513 (D) 97 Kw (2005.08 -2008.01), Viking (D) 84 Kw (2004.02 -2010.10), Cheetah (D) 84 Kw (1995.04 -2010.10), 1616 il 5.7 (D) 118 Kw (2014.01-->), U 2518 (D) 132 Kw (2010.09-->), 3118 (D) 135 Kw (2010.08-->), 3518 (D) 132 Kw (2010.10-->), Cheetah (D) 135 Kw (2014.01-->), 1613 H (D) 97 Kw (2005.11 -2010.10), Lynx (D) 88 Kw (2010.10-->), Comet 1616H (D) 123 Kw (2009.11 -2010.10), 3116 (D) 118 Kw (2009.07 -2010.10)	FHN00400, F7A04700, FHJ00700, X8820800, P1302140, F8835100, X7471500, F7B02900, P7B00022, FHJ01000, P1301640, F4003400, P1302040, P1301240	FLG -FS19636	1,315.00
F 002 H24 366	Fuel Filter Spin-on		TATA MOTORS- LPT 1109 EX, Ultra 812 BS III, Ultra 912, 909, 709 LPT EX Turbo	252709120254, 252509120264, 252709120259	FLG -FS19660	1,600.00
F 002 H24 374	Fuel Filter Spin-on		TATA MOTORS- LPK 2518 HD (D) 135 Kw (2010.08-->), LPO 1512 TC SLF (D) 96 Kw (2009.07-->), LPO 1618, LPT 2518/62 TC BS3	278607989967, 278609119904, 278607989965, 278609119909, 278609999822, 220747700109	FLG -FF5544	1,437.00

### Filter Application Chart

Part Number	Product Description	Image	Model Description 	Potential OE Part No	Potential Comp. Part No	MRP (₹)
F 002 H24 501	Fuel Filter Spin-on		TATA MOTORS- LPS 3516 EX (D) 115 Kw (2004.01 -2005.09), LPO 1512 TC (D) 94 Kw (2005.10 -2010.10), LPO 1616 TC BS-II, LPO 1612 TC BS-III, LPT 1613 /62 TC (D) 92 Kw (2007.12 -2010.10), LPT 1613 (D) 100 Kw (2014.01-->), LPT 3118 (D) 135 Kw (2010.09-->), LPS 3518 (D) 131 Kw (2012.01-->), LPT 2516 TC 6x2 (D) 115 Kw (1998.03 -2000.12), SE 1613 TC, LPT 3723 TC (D) 155 Kw (2014.01-->), LPT 2518 (D) 135 Kw (2010.08-->), Starbus 1612, LPO 1610 TC, LPS 4018, LPO 1618 SLF, SE 1613 TC BS-II, LPS 4923 TC 6x4, LPT 3118 (D) 132 Kw (2007.12-->), LPT 2521 TC (D) 150 Kw (2014.01-->), Novus LPS 4930 6x4 (D) 221 Kw (2007.12 -2010.10), LPK 2523 (D) 173 Kw (2009.07 -2010.10), LPT 2515 EX 6x2 (D) 101 Kw (2003.08 -2005.12), LPK 1618 BS-III, LPO 1512 TC SLF (D) 96 Kw (2009.07-->), LPO 1612 TC BS-II, SK 1613 TC BS-II, 1512 TC LP (D) 92 Kw (2001.03 -2010.10), 1512 LP/LPO TC BS-III (D) 114 Kw (2005.02-->), LPK 1618, LPT 1613 EX (D) 88 Kw (2002.08 -2010.10)	278609119904, 278607999845, 278607989915, 278609110106, 220747700103, 220009119901, 220747700108, 278607989956, 278609119909, 278607989953, 278607989916	FLG -FF5052, 5000549	471.00
F 002 H24 509	Fuel Filter Spin-on		TATA MOTORS- Ace XL 0.7D (D) 11 Kw (2017.07-->), Ace Gold, Ace (BS III) 0.7, ACE MAGIC	282947100184, 886309000119, 278809110104		274.00
F 002 H24 518	Fuel Filter Spin-on		TATA MOTORS- Prima LX 4028 S, Prima 4928 S, Prima LX 2523 K / T, Prima LX 4023 S, Prima LX 4928 S, Prima 2528 K 6x4, Prima 3128 K 8x4, Prima LX 4923 S, Marcopolo 1628 Divo, 709 LP E Bus, Prima 4028, 1109 LPT (D) 66 Kw (2000.11-->), Prima 2528 K 6x2, LPT 2521 TC (D) 150 Kw (2014.01-->)	278607999845, 279109110101, 279109110102, 570107999901, 288547704905	FLG -5010516	1,055.00
F 002 H24 742	Fuel Filter Spin-on		MAHINDRA- LoadKing CRX Tipper, LoadKing Pride, LoadKing CRX	7312AAA00021N, 1001CZ0070N		1,100.00







### Filter Application Chart

Part Number	Product Description	Image	Model Description 	Potential OE Part No	Potential Comp. Part No	MRP (₹)
F 002 H24 742	Fuel Filter Spin-on		MAHINDRA- LoadKing Pride 2.6 CRDe, LoadKing Pride 2.6 Diesel, LoadKing Super 2.6 Diesel, LoadKing 2.5 Diesel 576 DI, LoadKing Zoom, LoadKing 2.5 Diesel DI, LoadKing CRX 2.6 Diesel	7312AAA00021N, 1001CZ0070N		1,100.00
F 002 H24 863	Fuel Filter Spin-on		MAHINDRA- Cosmo 32 BS IV, Cosmo 40 BS IV			1,685.00
F 002 H24 919	Fuel Filter Spin-on		EICHER- Pro 3015 TCI BS IV, Pro 3012 TCI BS IV, Pro 3013	ID320477, ID320867, ID328310		930.00
F 002 H24 919	Fuel Filter Spin-on		EICHER MOTORS LIMITED- 20.15 H BS III	ID320867		930.00
F 002 H24 920	Fuel Filter Spin-on		ASHOK LEYLAND- 4923 (D) 165 Kw (2011.03-->), 12M (D) 165 Kw (2014.01-->), 3123 (D) 165 Kw (2010.08-->), ULE Diesel BS 4, RE SLF (D) 165 Kw (2014.01-->), U 3123, U 3723 (D) 165 Kw (2012.01-->), FE SLF, U 2523, U 4923 (D) 165 Kw (2010.09-->), 2523 (D) 165 Kw (2014.01-->)	X8820800, P1302040, F7B02900	FLG -FF5532	1,340.00





**Filter Application Chart**

Part Number	Product Description	Image	Model Description 	Potential OE Part No	Potential Comp. Part No	MRP (₹)
F 002 H24 921	Fuel Filter Spin-on		ASHOK LEYLAND- U 1616 (D) 84 Kw (2010.11-->), 12M (D) 165 Kw (2014.01-->), Boss 912 LE 3.8 (D) 88 Kw (2014.01-->), Boss 1212 LE (D) 88 Kw (2014.01-->), Viking 180HP ROTARY FIP EDC BS3 (D) 135 Kw (2014.02-->), U 2516 (D) 118 Kw (2010.09-->), RE SLF (D) 165 Kw (2014.01-->), Viking 160HP IL FIP BS3 (D) 118 Kw (2014.02-->), 2518 (D) 132 Kw (2014.01-->), 1612 IL BS-III (D) 88 Kw (2014.01-->), Boss 1112 LE (D) 88 Kw (2014.01-->), U 4019 il (D) 132 Kw (2014.01-->), 4019il (D) 132 Kw (2012.12-->), U 3518 (D) 132 Kw (2010.10-->), Cheetah (D) 84 Kw (1995.04 -2010.10), Viking (D) 123 Kw (2005.05-->), 3718 iL (D) 132 Kw (2014.01-->), 3118 (D) 135 Kw (2010.08-->), 3518 (D) 132 Kw (2010.10-->), 1616 iL (D) 118 Kw (2010.08-->), 12M (D) 118 Kw (2010.10-->), Stag (D) 88 Kw (2010.10-->), Lynx (D) 88 Kw (2010.10-->)	FHN00400, P1301340, FHJ00700, X8820800, P1302140, P1301640, F4003400, P1302040, F8835100, P1301240, P1301540, P7B00022, FHJ01000		685.00
F 002 H25 949	Fuel Filter Spin-on		EICHER MOTORS LIMITED- Skyline Pro 3011L BS-VI, Pro 2110XP Plus CNG BS-VI, Pro 2114XP BS-VI, Pro 2110XP Plus BS-VI, Pro 2110XP BS-VI, Skyline Pro 3010L BS-VI, 2112M Skyline BS-VI, Pro 3019 BS-VI, Skyline Pro 3009H CNG BS-VI, Pro 2110XPT BS-VI, Pro 2114XP CNG BS-VI, Skyline Pro 3009H BS-VI, Pro 2110 BS-VI			1,033.00
F 002 H25 964	Fuel Filter Spin-on		TATA MOTORS- Ultra 3021.S BS6, Ultra 1918.T BS6, T.16 ULTRA BS6, Starbus Ultra SKL LPO 7.5 BS6, T.9 ULTRA BS6, ULTRA 2821.T BS6, T.14 Ultra BS6, T.12 ULTRA BS6, Starbus Ultra SKL LPO 10.2 BS6 Non-AC, Starbus Ultra SKL LPO 10.2 BS6 AC, T7 Ultra BS6, T.10 Ultra BS6, T.11 Ultra BS6			1,980.00

**Filter Application Chart**

Part Number	Product Description	Image	Model Description 	Potential OE Part No	Potential Comp. Part No	MRP (₹)
F 002 H27 515	Fuel Filter Spin-on		TATA MOTORS- LPT 1616 BS-III (D) 114 Kw (2010.08-->), LP 912 (D) 92 Kw (2010.10-->), LPK 1613 5.7 BS-III (D) 100 Kw (2015.01-->), LPK 909 (D) 92 Kw (2010.10-->), 709 LPT HEx2 (D) 92 Kw (2014.01-->), LPT 1109 HEx2 (D) 92 Kw (2014.01-->), LPT 909 EX (D) 92 Kw (2010.10-->), LPK 1616 BS-III (D) 114 Kw (2010.08-->), LPT 1616 697 Super Turbo BS-II (D) 118 Kw (2009.09 -2010.10), LPO 7.5 3.8TD FBV BS3 Ultra (D) 92 Kw (2011.01-->), LPT 2516 Super Turbo (D) 118 Kw (2007.12 -2010.10), SE 1613 (D) 102 Kw (2015.01-->), SFC 909 EX (D) 92 Kw (2010.10 -2017.04), LPO 8.5 (D) 92 Kw (2014.02-->), SK 1616 (D) 114 Kw (2010.10-->), 1512 LP 497 BS-III (D) 92 Kw (2005.02-->)	252509120239, 252709120254, 252509120264, 252709120259, 252709119902		1,342.00
F 002 H27 515	Fuel Filter Spin-on		TATA MOTORS- SK 407 (D) 75 Kw (2014.07-->)	252509120239, 252709120254, 252509120264, 252709120259, 252709119902		1,342.00
F 026 402 017	Fuel Filter Spin-on		VOLVO- FM (D) 339 Kw (2009.05-->), FH (D) 382 Kw (2006.09 -2011.12), FM 9 (D) 221 Kw (2002.12 -2005.08), FM 12 (D) 280 Kw (2003.09 -2005.09), FM (D) 250 Kw (2006.05 -2009.07)			On Request
F 026 402 025	Fuel Filter Spin-on		VOLVO- FM 7 290 (D) 210 Kw (1999.03 -2001.05), FM 12 (D) 280 Kw (2003.09 -2005.09), B 7 R			On Request
F 026 402 118	Fuel Filter Spin-on		VOLVO- FH (D) 382 Kw (2006.09 -2011.12), FM 9 (D) 221 Kw (2002.12 -2005.08), FM 12 (D) 280 Kw (2003.09 -2005.09)			On Request
F 026 402 132	Fuel Filter Spin-on		VOLVO- FH (D) 382 Kw (2006.09 -2011.12), FM (D) 339 Kw (2009.05-->), FM (D) 294 Kw (2006.09 -2012.02)			On Request

### Filter Application Chart

Part Number	Product Description	Image	Model Description 	Potential OE Part No	Potential Comp. Part No	MRP (₹)
F 002 H26 307	Fuel Filter Spin-on		TATA MOTORS- 407 3.0 Diesel LPT Turbo, 407 3.0D SFC Pickup, 407 3.0D Cityride NA, 410 Turbo SFC 3.0 Diesel, 407 LP Turbo Bus 3.0, 407 Citiride 3.0 (D) 55 Kw (2007.12 -2011.09), 407 3.0 Diesel LPT, 407 3.0D SFC EX Turbo, Cityride 407, 407 SFC 3.0, 407 3.0 Diesel SFC Turbo, 407 3.0 Diesel LP Turbo Bus, 407 TurboBus SWB 3.0 D, 407 3.0 Diesel; FORCE MOTORS- Tempo Traveller Ambulance 2.4 Diesel, Excel-4 2.6 Diesel, Excel-4 3.2 Diesel, Tempo Traveller Minibus 2.4 Diesel, Matador 2.4 Diesel, Excel-2 2.4 Diesel, Pick Up Trax Kargo 2.6 Diesel, Pick Up Trax Dual Cab 2.4 Diesel, Excel-3 2.4 Diesel, Trax 2.6D Kargo, Traveller 3350/3700 mm WB 2.6 Diesel, Tempo Traveller Ambulance LWB 2.6 Diesel, Citiline 2.6 Diesel; EICHER MOTORS LIMITED- 10.50 3.3 Diesel BS3, 10.50 3.3 Diesel BS2, 10.50 3.3 Diesel			653.00
F 002 H26 307	Fuel Filter Spin-on		MAHINDRA- Genio 2.5D (D) 56 Kw (2011.02 -2017.03)	0305DC0161N		653.00
F 002 H26 388	Fuel Filter Spin-on		TATA MOTORS- Ultra 814 BS IV		570609110106, 570609110101, 570609110108	1,580.00





### Filter Application Chart

Part Number	Product Description	Image	Model Description 	Potential OE Part No	Potential Comp. Part No	MRP (₹)
F 026 402 135	Fuel Filter Spin-on		VOLVO- FH (D) 382 Kw (2006.09 -2011.12)			On Request
F 026 402 141	Fuel Filter Spin-on		VOLVO- FM (D) 339 Kw (2009.05-->), FM (D) 294 Kw (2006.09 -2012.02)			On Request
F 026 402 311	Fuel Filter Spin-on		VOLVO- FM (D) 338 Kw (2013.04-->), FM (D) 309 Kw (2013.04-->)			On Request
F 026 402 794	Fuel Filter Spin-on		VOLVO- FM (D) 339 Kw (2009.05-->), FM (D) 250 Kw (2006.05 -2009.07)			On Request
F 026 402 859	Fuel Filter Spin-on		VOLVO- FM (D) 338 Kw (2013.04-->), FM (D) 309 Kw (2013.04-->)			On Request
F 026 402 865	Fuel Filter Spin-on		VOLVO- FH (D) 382 Kw (2006.09 -2011.12)			On Request
0 450 226 028	Fuel Filter Spin-on, Fine Filter		ASHOK LEYLAND- Cheetah (D) 88 Kw (2000.11 -2005.03)	F3968400, P1302040, F7B02900		2,002.00
9 450 030 116	Fuel Filter Spin-on, Fine Filter		TATA MOTORS- 709 LPT EX Turbo (D) 66 Kw (2003.01 -2004.12), 709 LP Bus	254709110106, 252709110104		2,605.00
9 450 030 116	Fuel Filter Spin-on, Fine Filter		TATA MOTORS- 407 3.0D SFC Pickup, 407 3.0 Diesel SFC Turbo, 407 3.0 Diesel LP Turbo Bus, 407 3.0D SFC EX Turbo, SK 407 BS II	254709110106, 252709110104		2,605.00

### Filter Application Chart

Part Number	Product Description	Image	Model Description 	Potential OE Part No	Potential Comp. Part No	MRP (₹)
F 002 H21 298	Fuel Filter Spin-on, Fine Filter		ASHOK LEYLAND- Stag (D) 88 Kw (2013.10-->), Viking, 2518 (D) 132 Kw (2014.01-->), 12M (D) 130 Kw (2006.11 -2010.10), 3516, Comet 1613H, Artik 3516, 12M (D) 84 Kw (2014.10-->)	PD600344, FHN00400, P1300640, P1301340, FHJ00700, P13000640, FHN00100, F8835100, FJ124500, P1301540, P7B00022, FHJ01000, P2602040, F4003400, P1301640, F8332300, FHJ00400, P1301240, P1301440	FLG -FS19636	1,301.00
F 002 H21 299	Fuel Filter Spin-on, Fine Filter		TATA MOTORS- Ace XL 0.7D, ACE MAGIC 0.7, Magic Iris, ACE MAGIC, Ace (BS IV) 0.8, Ace SuperAce 1.4, Ace Zip XL 0.6	279009110104, 571009119903, 254709110119, 279009110110, 279709110106, 278909110112, 886309000119, 253409110117, 279009110111		136.00
F 002 H22 001	Fuel Filter Spin-on, Fine Filter		ASHOK LEYLAND- U 4023	P1302040		3,657.00







### Filter Application Chart

Part Number	Product Description	Image	Model Description 	Potential OE Part No	Potential Comp. Part No	MRP (₹)
F 002 H22 095	Fuel Filter Spin-on, Fine Filter		ASHOK LEYLAND- U 3518 BS IV, JanBus Midi BS4, Cheetah (D) 118 Kw (2014.01-->), Viking BS IV (D) 123 Kw (2016.12-->), Captain 40IT BS III, Lynx BS IV, Boss 1113 BS III, U 4923 BS IV (D) 168 Kw (2018.12-->), 3518 BS IV, Viking BS III, 1618 XP BS III, 2518 BS IV, Viking BS IV (D) 97 Kw (2017.06-->), U 3718 BS IV, N 2523 BS III, U 3118 LA BS IV, Captain 4923 BS IV, eComet 1212 BSIV, 3118 BS IV, U-3118 (D) (2015.06-->), Boss 1213 LE, Boss 1113 LX, N 2523 BS IV, Captain 3123 BS IV, Captain 3123 BSIV, U 4019 BS III, Ecomet 1012 BS IV, 2518 (D) 132 Kw (2014.01-->), Boss 913 BS III, 1618 BS IV, Viking BS IV (D) 116 Kw (2008.12-->), 1618T BS IV, Captain 2518 BS IV (D) 134 Kw (2018.12-->), JanBus BS4 (D) 165 Kw (2016.02-->), Lynx, 3718 BS IV, 3118-T BS IV, U-2518 T BS IV, 4019 BSIV, 2518 T BS IV, 1612 BS IV	FHN00400, X8820800, P1301640, F7B02900, P7B00022, FHJ01000		1,766.00
F 002 H23 536	Fuel Filter Spin-on, Fine Filter		TATA MOTORS- LPT 909 BS IV, LP 9.6T BS III, LPT 1109 HEx2 CR, 709 LPT HEx2, LPT 1913 BS-IV, 709 LPT EX Turbo (D) 66 Kw (2005.01-->), LPT 1109 HEx2, LPK 1613 BS IV, LPT 1616 697 Super Turbo BS-II, LPT 1613 Turbo EX, LPT 810 Ex2 BS IV, LPT 1613 BS III, SE 1613 Turbo BS-II, LP 9.6T BS IV, LPT 709 BS IV, SK 1613 Turbo BS-II, LP 1112 BS IV, LPT 1613 BS IV, LPO 1613 BS IV	252509120239, 252709110136, 252709119913, 278609999951	FLG -FF5479	143.00
F 002 H23 590	Fuel Filter Spin-on, Fine Filter		ASHOK LEYLAND- 12M (D) 165 Kw (2014.01-->), 12M FESLF BS IV (D) 123 Kw (2014.12-->), Cheetah (D) 118 Kw (2014.01-->), Viking BS IV (D) 123 Kw (2016.12-->), SFC 1613 BS II, Captain 49IT BS III, 12M FESLF, eComet 1112, Tusker 3516, U 4923 BS IV (D) 168 Kw (2018.12-->), 12M FE BS IV (D) 165 Kw (2016.12-->), eComet 912, Captain 4923 BS III, U 3723, JanBus BS4 (D) 165 Kw (2016.02-->), 3123, U-3118 (D) (2015.06-->), Lynx BS II, 2523, Captain 3723 BS IV	FHN00400, F7A04700, FHJ00700, X8820800, P1302140, F8835100, X7471500, F7B02900, P7B00022, FHJ01000, P1301640, F4003400, P1302040, P1301240	FLG -FS19636	1,315.00

### Filter Application Chart









Part Number	Product Description	Image	Model Description 	Potential OE Part No	Potential Comp. Part No	MRP (₹)
F 002 H23 590	Fuel Filter Spin-on, Fine Filter		ASHOK LEYLAND- Stag (D) 88 Kw (2005.04 -2010.10)	FHN00400, F7A04700, FHJ00700, X8820800, P1302140, F8835100, X7471500, F7B02900, P7B00022, FHJ01000, P1301640, F4003400, P1302040, P1301240	FLG -FS19636	1,315.00
F 002 H24 366	Fuel Filter Spin-on, Fine Filter		TATA MOTORS- 709 LPT EX Turbo (D) 66 Kw (2005.01-->)	252709120254, 252509120264, 252709120259	FLG -FS19660	1,600.00
F 002 H24 374	Fuel Filter Spin-on, Fine Filter		TATA MOTORS- LPK 2516 TC 6x4 BS-II, LPTK 2518 BS III, LPO 1512 TC (D) 94 Kw (2005.10 -2010.10), LPT 2518, LPS 3518 BS IV, LPK 2523 BS IV Tipper, LPTK 3118 BS III, Signa 4223 BS IV, LPK 2518 6x4, LPK 2518 BS III, LPT 1615 TC BS IV, LPT 2513, LPK 1918 BS IV, LPT 2518 BS IV, LPS 3518 (D) 131 Kw (2012.01-->), LPT 2516 TC 6x2 (D) 115 Kw (1998.03 -2000.12), LPT 3118, LPS 3516, LPK 3118 BS III, LPK 2818 BS IV, LPT 3718, LPT 2518/62 TC BS3, Signa 2523.K BS IV, LPS 4018, LPT 1618 BS-III, LPT 1613, LPTK 3118 BS-IV, Signa 3518.S BS IV, LPK 3518 TC BS-IV, LPS 4923 TC 6x4 (D) 159 Kw (2014.01-->), LPK 2523 (D) 173 Kw (2009.07 -2010.10), Signa 3118.TK BS IV, SIGNA 3718.T BS IV, LPT 3118 BS IV, LPO 1618 (D) 135 Kw (2010.10-->), LPO 1512 TC SLF (D) 96 Kw (2009.07-->), LPK 2523 BS III, LPK 2823 BS IV, LPT 2515 EX 6x2, LPT 2518 BS II	278607989967, 278609119904, 278607989965, 278609119909, 278609999822, 220747700109	FLG -FF5544	1,437.00

### Filter Application Chart

Part Number	Product Description	Image	Model Description 	Potential OE Part No	Potential Comp. Part No	MRP (₹)
F 002 H24 500	Fuel Filter Spin-on, Fine Filter		TATA MOTORS- 1512 LP/LPO TC BS-III, LPO 1618 (D) 135 Kw (2010.10-->), LPK 1618 BS-III, LP 1512 BS III (D) 93 Kw (2008.03-->), LPO 1512 TC SLF (D) 96 Kw (2009.07-->), LPT 3723 TC, LPO 1610 TC, LPO 1612 TC BS-II, LPO 1512 BS II, LPS 4923 TC 6x4 (D) 159 Kw (2014.01-->), LPO 1612 TC BS-III (D) 98 Kw (2005.02 -2015.09)	278607989967, 278609119904, 278607989965, 278607989914, 278607989916		290.00
F 002 H24 501	Fuel Filter Spin-on, Fine Filter		TATA MOTORS- LPT 1613 /62 TC, LPO 1512 TC (D) 94 Kw (2005.10 -2010.10), LP 1512 BS III (D) 93 Kw (2008.03-->), LPO 1512 TC SLF (D) 96 Kw (2009.07-->), LPK 2523 (D) 173 Kw (2009.07 -2010.10), LPT 1613 EX, LPS 3518 (D) 131 Kw (2012.01-->), LPT 2516 TC 6x2 (D) 115 Kw (1998.03 -2000.12), LPK 1618, SE 1613 TC BS-II, 1512 TC LP, LPO 1612 TC BS-III (D) 98 Kw (2005.02 -2015.09), LPS 4923 TC 6x4 (D) 170 Kw (2007.12 -2010.10)	278609119904, 278607999845, 278607989915, 278609110106, 220747700103, 220009119901, 220747700108, 278607989956, 278609119909, 278607989953, 278607989916	FLG -FF5052, 5000549	471.00
F 002 H24 509	Fuel Filter Spin-on, Fine Filter		TATA MOTORS- ACE HT BS-IV	282947100184, 886309000119, 278809110104		274.00
F 002 H24 509	Fuel Filter Spin-on, Fine Filter		TATA MOTORS- Ace (BS III) 0.7, Winger BS III, Venture 1.4D, TL Pickup 2.0	282947100184, 886309000119, 278809110104		274.00
F 002 H24 518	Fuel Filter Spin-on, Fine Filter		TATA MOTORS- Prima LX 4028 S, Prima LX 3125.K BS IV, Prima LX 3123.TTS BS III, Prima LX 2523 K / T, Prima LX 2525.K BS IV, LPT 2521 TC, Prima LX 3130.K BS IV Tipper, Prima LX 4928 S, Prima 2528 K 6x4, Prima 3128 K 8x4, Prima LX 2830.K BS-IV, Prima LX 2530.K BS IV, Prima LX 4930.S BS IV, Prima LX 4025.S BS IV, Prima LX 2825.K HRT BS IV	278607999845, 279109110101, 279109110102, 570107999901, 288547704905	FLG -5010516	1,055.00





### Filter Application Chart

Part Number	Product Description	Image	Model Description 	Potential OE Part No	Potential Comp. Part No	MRP (₹)
F 002 H24 918	Fuel Filter Spin-on, Fine Filter		EICHER- Pro 3012 TCI BS IV	ID320704, ID320867, ID328310		1,063.00
F 002 H24 919	Fuel Filter Spin-on, Fine Filter		EICHER- Pro 3015 TCI BS IV	ID320477, ID320867, ID328310		930.00
F 002 H24 920	Fuel Filter Spin-on, Fine Filter		ASHOK LEYLAND- U 2523, ULE Diesel BS 4 (D) 165 Kw (2014.01-->), 4923, U 4923 (D) 165 Kw (2010.09-->)	X8820800, P1302040, F7B02900	FLG -FF5532	1,340.00
F 002 H24 921	Fuel Filter Spin-on, Fine Filter		ASHOK LEYLAND- 12M (D) 165 Kw (2014.01-->), 2518 (D) 132 Kw (2014.01-->), 3118	FHN00400, P1301340, FHJ00700, X8820800, P1302140, P1301640, F4003400, P1302040, F8835100, P1301240, P1301540, P7B00022, FHJ01000		685.00
F 002 H26 310	Fuel Filter Spin-on, Fine Filter		ASHOK LEYLAND- Captain 2518 BS IV (D) 134 Kw (2014.12-->)	FHN00400		998.00
F 002 H26 311	Fuel Filter Spin-on, Fine Filter		ASHOK LEYLAND- 3123 BS III, 12M FESLF BS IV (D) 123 Kw (2014.12-->), Cheetah (D) 118 Kw (2014.01-->), Viking BS IV (D) 123 Kw (2016.12-->), U 3123, Captain 40, 11M FESLF BS IV, ULE Diesel BS 4 (D) 165 Kw (2014.01-->), U 4923 (D) 165 Kw (2010.09-->), 12M FE BS IV (D) 165 Kw (2016.12-->)	P1302040, F7B02900	FLG -FS19654	2,208.00
F 002 H26 388	Fuel Filter Spin-on, Fine Filter		TATA MOTORS- LPO 8.5 BS-IV, LPO 10.2 Starbus Ultra BS-IV, Ultra 814 BS IV, LPO 9.6T BS IV	570609110106, 570609110101, 570609110108		1,580.00



### Filter Application Chart

Part Number	Product Description	Image	Model Description 	Potential OE Part No	Potential Comp. Part No	MRP (₹)
F 002 H27 515	Fuel Filter Spin-on, Fine Filter		TATA MOTORS- LPO 8.5, LPO 10.2 Starbus Ultra BS III, LPO 7.5 3.8TD FBV BS3 Ultra, LPO 9.6	252509120239, 252709120254, 252509120264, 252709120259, 252709119902		1,342.00
0 450 226 028	Fuel Filter Spin-on, Pre-filter		ASHOK LEYLAND- Cheetah (D) 88 Kw (2000.11 -2005.03)	F3968400, P1302040, F7B02900		2,002.00
9 451 037 404	Fuel Filter Spin-on, Pre-filter		TATA MOTORS- 709 SFC EX (D) 66 Kw (2005.04-->), 709 LP Bus, 709 SFC EX (D) 66 Kw (2003.11 -2005.03)			124.00
9 451 037 405	Fuel Filter Spin-on, Pre-filter		TATA MOTORS- LPT 1109 (D) 66 Kw (2003.09 -2007.04)	252709110105		150.00
F 002 H21 252	Fuel Filter Spin-on, Pre-filter		TATA MOTORS- LPT 1618 BS-III, LPK 2516 TC 6x4 BS-II, LPK 2518 6x4 (D) 129 Kw (2007.12 -2010.10), LPT 2515 EX 6x2, LPT 2518 BS II, LPS 3516	278607989916		441.00

### Filter Application Chart

Part Number	Product Description	Image	Model Description 	Potential OE Part No	Potential Comp. Part No	MRP (₹)	
F 002 H21 298	Fuel Filter Spin-on, Pre-filter		ASHOK LEYLAND- Boss 1113 LX (D) 96 Kw (2014.01-->), Stag (D) 88 Kw (2013.10-->), Boss 913 LX (D) 96 Kw (2014.01-->), 1618T BS IV (D) 134 Kw (2018.12-->), Cheetah (D) 118 Kw (2014.01-->), Viking BS IV (D) 123 Kw (2016.12-->), Cheetah (D) 122.8 Kw (2005.11-->), U 2518, Cargo 1613H, U 4923 BS IV (D) 168 Kw (2018.12-->), Lynx (D) 96 Kw (2014.01-->), 3118 BS IV (D) 134 Kw (2015.12-->), U 3718 BS IV (D) 132 Kw (2014.12-->), 12M (D) 130 Kw (2006.11 -2010.10), 4018, Viking (D) 97 Kw (2004.02 -2010.10), U 4019 BS III (D) 134 Kw (2014.12-->), 3518 BS IV (D) 134 Kw (2015.12-->), Captain 3123 BSIV (D) 134 Kw (2016.01-->), Lynx BS IV (D) 95 Kw (2015.12-->), 2518 (D) 132 Kw (2014.01-->), Stag (D) 88 Kw (2002.01 -2005.03), Double Decker BS III, 1618 BS IV, Viking BS IV (D) 116 Kw (2008.12-->), 2518 T BS IV (D) 134 Kw (2016.12-->), 2516 il, Boss 913 LX BS IV, 2516 S, Captain 2518 BS IV (D) 134 Kw (2014.12-->), Captain 3123 BS IV (D) 172 Kw (2018.12-->), N 2523 BS III (D) 166 Kw (2015.12-->), 3118 (D) 135 Kw (2010.08-->), 4019 BSIV (D) 134 Kw (2016.01-->), Captain 4923 BS IV (D) 172 Kw (2018.10-->), 1612 BS IV (D) 97 Kw (2019.11-->), 1616 H, 1616 XL, Viking (GAS) (2006.01-->), 1616 XP, 1		PD600344, FHN00400, P1300640, P1301340, FHJ00700, P13000640, FHN00100, F8835100, FJ124500, P1301540, P7B00022, FHJ01000, P2602040, F4003400, P1301640, F8332300, FHJ00400, P1301240, P1301440	FLG -FS19636	1,301.00



### Filter Application Chart

Part Number	Product Description	Image	Model Description 	Potential OE Part No	Potential Comp. Part No	MRP (₹)	
F 002 H21 298	Fuel Filter Spin-on, Pre-filter		618 XP BS III (D) 134 Kw (2015.12-->), U-2518 T BS IV (D) 134 Kw (2015.12-->), U 3118 LA BS IV (D) 134 Kw (2015.12-->), 2214 6x2 (H), U 3518 BS IV (D) 134 Kw (2010.12 -2012.12), N 2523 BS IV (D) 172 Kw (2018.12-->), Viking BS IV (D) 97 Kw (2017.06-->), 2518 BS IV (D) 134 Kw (2018.12-->), Viking BS II (D) 98 Kw (2004.02 -2010.10), Boss 913 BS III (D) 95 Kw (2013.10-->), eComet 1212 BSIV (D) 97 Kw (2016.01-->), Captain 40IT BS III (D) 134 Kw (2016.02-->), U-3118 (D) (2015.06-->), eComet 1212 (D) 88 Kw (2010.10-->), Comet 1613H, Boss 1413 BS IV, Ecomet 1012 BS IV (D) 97 Kw (2016.01-->), Boss 1213 LE BS IV, 2516 6x2 (H), 1612 H, 3121, Captain 3123 BS IV (D) 170 Kw (2014.12-->), JanBus Midi BS III, Viking BS III (D) 119 Kw (2011.12-->), U-2518 IL T HD BS IV (D) 134 Kw (2015.12-->), Viking (D) 84 Kw (2004.02 -2010.10), 4019 BS IV (D) 134 Kw (2016.12-->), Boss 1213 LE (D) 96 Kw (2014.01-->), Captain 2518 BS IV (D) 134 Kw (2018.12-->), U 4019 BS IV, Boss 1113 BS III (D) 95 Kw (2012.12-->), 3118-T BS IV (D) 134 Kw (2019.06-->), JanBus Midi BS4 (D) 95 Kw (2016.02-->), 3718 BS IV (D) 134 Kw (2015.12-->), 2516 6x4 (H) 4x4, 3718 BSIV (D) 134 Kw (2016.01-->), 12M (D) 84 Kw (2014.10-->)		PD600344, FHN00400, P1300640, P1301340, FHJ00700, P13000640, FHN00100, F8835100, FJ124500, P1301540, P7B00022, FHJ01000, P2602040, F4003400, P1301640, F8332300, FHJ00400, P1301240, P1301440	FLG -FS19636	1,301.00
F 002 H21 299	Fuel Filter Spin-on, Pre-filter		TATA MOTORS- Magic Mantra BS-IV, Magic Express BS-IV, ACE DICOR BS-III, ACE DICOR BS-IV			279009110104, 571009119903, 254709110119, 279009110110, 279709110106, 278909110112, 886309000119, 253409110117, 279009110111	136.00

### Filter Application Chart

Part Number	Product Description	Image	Model Description 	Potential OE Part No	Potential Comp. Part No	MRP (₹)
F 002 H21 299	Fuel Filter Spin-on, Pre-filter		TATA MOTORS- Ace XL 0.7D, ACE MAGIC 0.7, ACE Mega XL BS III, ACE MAGIC, Ace SuperAce 1.4, Ace (BS IV) 0.8	279009110104, 571009119903, 254709110119, 279009110110, 279709110106, 278909110112, 886309000119, 253409110117, 279009110111		136.00
F 002 H22 004	Fuel Filter Spin-on, Pre-filter		ASHOK LEYLAND- U 3518 (D) 132 Kw (2010.10-->), 12M (D) 165 Kw (2014.01-->), U 4023 (D) 165 Kw (2010.09-->), U 1619	P1302140		3,533.00
F 002 H22 025	Fuel Filter Spin-on, Pre-filter		TATA MOTORS- Magic Iris, Ace Mega XL 0.8D D, Ace Zip XL 0.6	571009119903, 571009110105		1,385.00



### Filter Application Chart

Part Number	Product Description	Image	Model Description 	Potential OE Part No	Potential Comp. Part No	MRP (₹)
F 002 H22 095	Fuel Filter Spin-on, Pre-filter		ASHOK LEYLAND- Boss 1113 LX (D) 96 Kw (2014.01-->), Stag (D) 88 Kw (2013.10-->), 1618T BS IV (D) 134 Kw (2018.12-->), Boss 913 LX (D) 96 Kw (2014.01-->), Cheetah (D) 118 Kw (2014.01-->), Viking BS IV (D) 123 Kw (2016.12-->), 1618 XP BS III (D) 134 Kw (2015.12-->), U-2518 T BS IV (D) 134 Kw (2015.12-->), U 3118 LA BS IV (D) 134 Kw (2015.12-->), 12M FE BS IV (D) 132 Kw (2016.12-->), U 4923 BS IV (D) 168 Kw (2018.12-->), Lynx (D) 96 Kw (2014.01-->), 3118 BS IV (D) 134 Kw (2015.12-->), 12M FE BS IV (D) 165 Kw (2016.12-->), U 3718 BS IV (D) 132 Kw (2014.12-->), U 3518 BS IV (D) 134 Kw (2010.12 -2012.12), N 2523 BS IV (D) 172 Kw (2018.12-->), Viking BS IV (D) 97 Kw (2017.06-->), U 4923 (D) 165 Kw (2010.09-->), 2518 BS IV (D) 134 Kw (2018.12-->), U 4023 (D) 165 Kw (2010.09-->), Boss 913 BS III (D) 95 Kw (2013.10-->), eComet 1212 BSIV (D) 97 Kw (2016.01-->), Captain 40IT BS III (D) 134 Kw (2016.02-->), U 4019 BS III (D) 134 Kw (2014.12-->), 3518 BS IV (D) 134 Kw (2015.12-->), U-3118 (D) (2015.06-->), 12MIFESLF BS IV (D) 123 Kw (2014.12-->), Ecomet 1012 BS IV (D) 97		FHN00400, X8820800, P1301640, F7B02900, P7B00022, FHJ01000	1,766.00



### Filter Application Chart

Part Number	Product Description	Image	Model Description 	Potential OE Part No	Potential Comp. Part No	MRP (₹)
F 002 H22 095	Fuel Filter Spin-on, Pre-filter		Kw (2016.01-->), Captain 3123 BSIV (D) 134 Kw (2016.01-->), Lynx BS IV (D) 95 Kw (2015.12-->), Captain 49IT BS III (D) 165 Kw (2011.12-->), Captain 4923 BS III (D) 123 Kw (2014.10-->), 11M FESLF BS IV (D) 123 Kw (2018.11-->), 2518 (D) 132 Kw (2014.01-->), Captain 3123 BS IV (D) 170 Kw (2014.12-->), Viking BS IV (D) 116 Kw (2008.12-->), 2518 T BS IV (D) 134 Kw (2016.12-->), ULE Diesel BS 4 (D) 165 Kw (2014.01-->), Viking BS III (D) 119 Kw (2011.12-->), 3123 BS III (D) 168 Kw (2013.12-->), Captain 2518 BS IV (D) 134 Kw (2014.12-->), Captain 3123 BS IV (D) 172 Kw (2018.12-->), 4019 BS IV (D) 134 Kw (2016.12-->), Captain 2518 BS IV (D) 134 Kw (2018.12-->), Boss 1213 LE (D) 96 Kw (2014.01-->), JanBus BS4 (D) 165 Kw (2016.02-->), N 2523 BS III (D) 166 Kw (2015.12-->), Boss 1113 BS III (D) 95 Kw (2012.12-->), 3118-T BS IV (D) 134 Kw (2019.06-->), JanBus Midi BS4 (D) 95 Kw (2016.02-->), 4019 BSIV (D) 134 Kw (2016.01-->), 3718 BS IV (D) 134 Kw (2015.12-->), 3718 BSIV (D) 134 Kw (2016.01-->), Captain 4923 BS IV (D) 172 Kw (2018.10-->), 1612 BS IV (D) 97 Kw (2019.11-->)	FHN00400, X8820800, P1301640, F7B02900, P7B00022, FHJ01000		1,766.00
F 002 H23 535	Fuel Filter Spin-on, Pre-filter		TATA MOTORS- 1512 LP/LPO TC BS-III, LPO 1512 TC (D) 94 Kw (2005.10 -2010.10), LPS 4018 (D) 130 Kw (2004.01 -2006.12), LPS 4018 (D) 135 Kw (2010.10-->), LPO 1612 TC BS-III (D) 98 Kw (2005.02 -2015.09), LPK 1618 BS IV, LPO 1618 (D) 135 Kw (2010.10-->), LP 1512 BS III, LPO 1512 TC SLF (D) 96 Kw (2009.07-->), LPK 1618 (D) 130 Kw (2007.12 -2010.10), LPO 1512 BS II, LPO 1610 TC (D) 74 Kw (2001.09 -2008.09), 1512 TC LP (D) 92 Kw (2001.03 -2010.10), LPO 1616 TC BS-II (D) 119 Kw (2007.08 -2010.10)	278609119904, 278609999920, 278609999822, 278607989916	FLG -FF5522, FS1275	143.00





### Filter Application Chart

Part Number	Product Description	Image	Model Description 	Potential OE Part No	Potential Comp. Part No	MRP (₹)
F 002 H23 536	Fuel Filter Spin-on, Pre-filter		TATA MOTORS- LPT 1109 HEx2 CR (D) 92 Kw (2014.01-->)	252509120239, 252709110136, 252709119913, 278609999951	FLG -FF5479	143.00
F 002 H23 582	Fuel Filter Spin-on, Pre-filter		TATA MOTORS- LPT 1616 697 Super Turbo BS-II (D) 118 Kw (2009.09 -2010.10), SK 1613 Turbo BS-II, SE 1613 Turbo BS-II	252509120239, 252509120264, 252709119913	FLG -FS19644V, FS19644	1,319.00

### Filter Application Chart

Part Number	Product Description	Image	Model Description 	Potential OE Part No	Potential Comp. Part No	MRP (₹)
F 002 H23 590	Fuel Filter Spin-on, Pre-filter		ASHOK LEYLAND- Captain 3723 BS IV, Cheetah (D) 118 Kw (2014.01-->), Viking BS IV (D) 123 Kw (2016.12-->), U 1618, Cheetah (D) 88 Kw (2000.11 -2005.03), Cheetah (D) 97 Kw (2005.04 -2010.10), U 2523, 12M FE BS IV (D) 132 Kw (2016.12-->), U 4923 BS IV (D) 168 Kw (2018.12-->), U 4923 (D) 165 Kw (2010.09-->), U 3718 BS IV (D) 132 Kw (2014.12-->), 12M FE BS IV (D) 165 Kw (2016.12-->), eComet 912, 11M FESLF BS IV (D) 123 Kw (2018.12-->), U 4023 (D) 165 Kw (2010.09-->), 3123 (D) 165 Kw (2010.08-->), 3120 iL, N 3123 BS III, 3518 BS IV (D) 134 Kw (2015.12-->), U-3118 (D) (2015.06-->), 1616 BS III (D) 119 Kw (2013.12-->), Boss 1412 LE BS III, VESTIBULE BS III, eComet 1212 (D) 88 Kw (2010.10-->), 2523, 4123 BS IV, Captain 40 (D) 165 Kw (2016.02-->), 4923 (D) 165 Kw (2011.03-->), 12M FESLF BS IV (D) 123 Kw (2014.12-->), 1614 BS III (D) (2015.06-->), Ecomet 1012 BS III (D) 88 Kw (2013.12-->), 12M FE BS III, 4023, U-2518-IL-T HD BS III (D) 134 Kw (2016.08-->), Captain 49IT BS III (D) 165 Kw (2011.12-->), Captain 4923 BS III (D) 123 Kw (2014.10-->), 11M FESLF BS IV (D) 123 Kw (2018.11-->), U 3123 (D) 165 Kw (2010.10-->), eComet 1112, Viking BS III (D) 119 Kw (2014.12-->), ULE Diesel BS 4 (D) 165 Kw (2014.01-->), Viking BS III (D) 119 Kw (2011.12-->), 3123 BS III (D) 168 Kw (2013.12-->), U 3723, JanBus BS4 (D) 165 Kw (2016.02-->), Cheetah (D) 135 Kw (2014.01-->), RE SLF BS III (D) 135 Kw (2011.12-->), Lynx BS III, 3518 BS III (D) 134 Kw (2015.12-->), Lynx BS II, 4921, Viking BS III (D) 124 Kw (2012.12-->)	FHN00400, F7A04700, FHJ00700, X8820800, P1302140, F8835100, X7471500, F7B02900, P7B00022, FHJ01000, P1301640, F4003400, P1302040, P1301240	FLG -FS19636	1,315.00







### Filter Application Chart

Part Number	Product Description	Image	Model Description 	Potential OE Part No	Potential Comp. Part No	MRP (₹)
F 002 H23 590	Fuel Filter Spin-on, Pre-filter		ASHOK LEYLAND- Stag (D) 88 Kw (2005.04 -2010.10)	FHN00400, F7A04700, FHJ00700, X8820800, P1302140, F8835100, X7471500, F7B02900, P7B00022, FHJ01000, P1301640, F4003400, P1302040, P1301240	FLG -FS19636	1,315.00
F 002 H24 366	Fuel Filter Spin-on, Pre-filter		TATA MOTORS- 709 SFC EX (D) 66 Kw (2005.04-->), 712 LP Bus (D) 92 Kw (2005.04-->), LPT 1109 EX, Ultra 812 BS III, LPO 10.2 Starbus Ultra BS III, LPT 407, 709 LPT EX Turbo (D) 66 Kw (2005.01-->), LP 912 (D) 92 Kw (2010.10-->), LPT 2516 Super Turbo (D) 118 Kw (2007.12 -2010.10), Ultra 912, 1512 LP 497 BS-III (D) 92 Kw (2005.02-->), Ultra 1012 BS III (D) 124 Kw (2016.01 -2017.12), LPO 9.6	252709120254, 252509120264, 252709120259	FLG -FS19660	1,600.00
F 002 H24 366	Fuel Filter Spin-on, Pre-filter		TATA MOTORS- SFC 407 EX BS III, 410 Turbo SFC 3.0 Diesel (D) 74 Kw (2006.05 -2017.03), 407 SFC 3.0	252709120254, 252509120264, 252709120259	FLG -FS19660	1,600.00
F 002 H24 374	Fuel Filter Spin-on, Pre-filter		TATA MOTORS- LPTK 2518 BS III, LPK 2523 BS IV Tipper, LPK 3518 TC BS-IV, LPK 2523 (D) 173 Kw (2009.07 -2010.10), LPS 4923 TC 6x4 (D) 159 Kw (2014.01-->), LPT 3118 (D) 135 Kw (2010.09-->), LPK 1918 BS IV, LPT 2518 BS IV, LPS 4018 (D) 135 Kw (2010.10-->), LPO 1612 TC BS-III (D) 98 Kw (2005.02 -2015.09), LPT 3118 BS IV, LPO 1618 (D) 135 Kw (2010.10-->), LPK 2518 HD (D) 135 Kw (2010.08-->), LPT 2518 (D) 135 Kw (2010.08-->), LPK 2518 6x4 (D) 129 Kw (2007.12 -2010.10), LPK 2818 BS IV, LPT 3518 BS-IV, LPT 2518/62 TC BS3, Signa 2523.K BS IV, LPK 2823 BS IV	278607989967, 278609119904, 278607989965, 278609119909, 278609999822, 220747700109	FLG -FF5544	1,437.00



### Filter Application Chart

Part Number	Product Description	Image	Model Description 	Potential OE Part No	Potential Comp. Part No	MRP (₹)
F 002 H24 500	Fuel Filter Spin-on, Pre-filter		TATA MOTORS- LPS 4923 TC 6x4 (D) 159 Kw (2014.01-->), LPO 1515 BS III, LPO 1612 TC BS-III (D) 98 Kw (2005.02 -2015.09), LPS 4923 TC 6x4 (D) 170 Kw (2007.12 -2010.10), LPO 1618 (D) 135 Kw (2010.10-->), SE 1613 TC, LPK 1618 BS-III, Starbus 1612, LPO 1512 TC SLF (D) 96 Kw (2009.07-->), LPK 1618 (D) 130 Kw (2007.12 -2010.10), LPO 1612 TC BS-II, LPO 1610 TC (D) 74 Kw (2001.09 -2008.09), 1512 TC LP (D) 92 Kw (2001.03 -2010.10), LPK 1615 BS III, LPO 1618 SLF, LPO 1616 TC BS-II (D) 119 Kw (2007.08 -2010.10)	278607989967, 278609119904, 278607989965, 278607989914, 278607989916		290.00
F 002 H24 501	Fuel Filter Spin-on, Pre-filter		TATA MOTORS- LPO 1618 BS III, LPO 1512 TC (D) 94 Kw (2005.10 -2010.10), LPS 4018 (D) 130 Kw (2004.01 -2006.12), LPTK 3118 BS III, LPK 2518 BS III, Novus LPS 4930 6x4, LPT 1615 TC BS IV, LPT 3118 (D) 135 Kw (2010.09-->), LPS 3518, LP 1515 BS IV, LPT 1613 /62 TC, LPT 2518 (D) 135 Kw (2010.08-->), LPK 2518 6x4 (D) 129 Kw (2007.12 -2010.10), LPO 1618 BS-IV, LPK 3118 BS III, LPT 3718, LP 1512 BS-IV, LPT 2516 TC 6x2, SE 1613 TC BS-II, LPT 3118 (D) 132 Kw (2007.12-->), LPT 1613, LPO 1616 BS IV, LPK 2523 (D) 173 Kw (2009.07 -2010.10), Signa 3118 T, LPK 2518 HD (D) 135 Kw (2010.08-->), Novus LPK 2530 6x4, LPK 2523 BS III, SK 1613 TC BS-II, LPT 1613 EX, 1512 TC LP (D) 92 Kw (2001.03 -2010.10), LPO 1512 BS-IV	278609119904, 278607999845, 278607989915, 278609110106, 220747700103, 220009119901, 220747700108, 278607989956, 278609119909, 278607989953, 278607989916	FLG -FF5052, 5000549	471.00
F 002 H24 509	Fuel Filter Spin-on, Pre-filter		TATA MOTORS- ACE HT BS-IV	282947100184, 886309000119, 278809110104		274.00
F 002 H24 509	Fuel Filter Spin-on, Pre-filter		TATA MOTORS- Ace (BS III) 0.7, Winger BS III, Venture 1.4D	282947100184, 886309000119, 278809110104		274.00







### Filter Application Chart

Part Number	Product Description	Image	Model Description 	Potential OE Part No	Potential Comp. Part No	MRP (₹)
F 002 H24 518	Fuel Filter Spin-on, Pre-filter		TATA MOTORS- Prima LX 4028 S, Prima LX 3125.K BS IV, Prima 4928 S, Prima LX 2823.TK BS-IV, Prima LX 3123.TTS BS III, Prima LX 2523 K / T, Prima LX 2525.K BS IV, Prima LX 3123.K BS III, Prima LX 3130.K BS IV Tipper, Prima LX 3123.K BS-III, Prima LX 4928 S, Prima 3128 K 8x4, Prima LX 2523.K BS-III, Prima LX 2830.K BS-IV, Prima 4028, Prima LX 2530.K BS IV, Prima LX 4930.S BS IV, Prima LX 4025.S BS IV, Prima 2528 K 6x2, Prima LX 2825.K HRT BS IV	278607999845, 279109110101, 279109110102, 570107999901, 288547704905	FLG -5010516	1,055.00
F 002 H24 918	Fuel Filter Spin-on, Pre-filter		EICHER MOTORS LIMITED- 20.15 H BS III, JUMBO 20.16	ID320704		1,063.00
F 002 H24 918	Fuel Filter Spin-on, Pre-filter		EICHER- Pro 3013 (D) 89 Kw (2014.01-->), Pro 3015 TCI BS IV (D) 121 Kw (2016.02-->), 10.90, Pro 3015 TCI BS IV (D) 101 Kw (2016.02-->), Mega 40.40, Pro 3012 TCI BS IV	ID320704, ID320867, ID328310		1,063.00
F 002 H24 919	Fuel Filter Spin-on, Pre-filter		EICHER- Pro 3013 (D) 89 Kw (2014.01-->), Pro 3015 TCI BS IV (D) 101 Kw (2016.02-->)	ID320477, ID320867, ID328310		930.00
F 002 H24 920	Fuel Filter Spin-on, Pre-filter		ASHOK LEYLAND- 4923 (D) 165 Kw (2011.03-->), U 3123 (D) 165 Kw (2010.10-->), ULE Diesel BS 4 (D) 165 Kw (2014.01-->), U 4923 (D) 165 Kw (2010.09-->)	X8820800, P1302040, F7B02900	FLG -FF5532	1,340.00

### Filter Application Chart

Part Number	Product Description	Image	Model Description 	Potential OE Part No	Potential Comp. Part No	MRP (₹)
F 002 H24 921	Fuel Filter Spin-on, Pre-filter		ASHOK LEYLAND- 2518 BS II, 1616 iL, Cheetah (D) 118 Kw (2014.01-->), Boss 912 LE 3.8, 3015 BS II, 2517 BS II, 3518, 11M FESLF BS IV (D) 123 Kw (2018.12-->), Viking (D) 123 Kw (2005.05-->), 3123 (D) 165 Kw (2010.08-->), 1616 XL BS III, U 4019 iL, Stag (D) 88 Kw (2010.10-->), 12M FESLF BS III, Ecomet 1012 BS III (D) 88 Kw (2013.12-->), 2521 BS II, Comet 1616 BS II, SFC 1613 BS III, Viking BS III (D) 135 Kw (2012.12-->), 2518 (D) 132 Kw (2014.01-->), U 1616, 1613 5.7, 3123 BS III (D) 168 Kw (2013.12-->), 4019iL, 1611 BS II, Cheetah (D) 84 Kw (1995.04 -2010.10), 2518T BS II, 3118 (D) 135 Kw (2010.08-->), 12M (D) 118 Kw (2010.10-->), 2518 T BS III, Boss 1212 LE, Viking 160HP IL FIP BS3, U 2516, SFC 1613 BS II, 1618 XP BS III (D) 134 Kw (2015.12-->), 2214 6x2 BS II, 12M FE BS IV (D) 165 Kw (2016.12-->), U 3518 (D) 132 Kw (2010.10-->), 2516 BS II, Viking BS II (D) 98 Kw (2004.02 -2010.10), 1616 BS III (D) 119 Kw (2013.12-->), 3718 iL, 3118-T BS III, 12M (D) 165 Kw (2014.01-->), 1614 BS III (D) (2015.06-->), U-2518-IL-T HD BS III (D) 134 Kw (2016.08-->), Viking 180HP ROTARY FIP EDC BS3, 2514 BS II, Boss 1112 LE, 1612 IL BS-III, Captain 2518 HD BS III, 4018H BS III, U-2518 IL T HD BS IV (D) 134 Kw (2015.12-->), Viking (D) 84 Kw (2004.02 -2010.10), Boss 1213 LE (D) 96 Kw (2014.01-->), 2516 iL BS III, 3718 iL BS III, RE SLF BS III (D) 168 Kw (2012.12-->), 3518 BS III (D) 134 Kw (2015.12-->), Lynx (D) 88 Kw (2010.10-->), Viking BS III (D) 124 Kw (2012.12-->)	FHN00400, P1301340, FHJ00700, X8820800, P1302140, P1301640, F4003400, P1302040, F8835100, P1301240, P1301540, P7B00022, FHJ01000		685.00

### Filter Application Chart

Part Number	Product Description	Image	Model Description 	Potential OE Part No	Potential Comp. Part No	MRP (₹)
F 002 H25 960	Fuel Filter Spin-on, Pre-filter		TATA MOTORS- Ultra 3021.S BS6, Ultra 1918.T BS6, Starbus Ultra SKL LPO 7.5 BS6, T.16 ULTRA BS6, T.9 ULTRA BS6, ULTRA 2821.T BS6, T.12 ULTRA BS6, T.14 Ultra BS6, Starbus Ultra SKL LPO 10.2 BS6 Non-AC, Starbus Ultra SKL LPO 10.2 BS6 AC, T.10 Ultra BS6, T7 Ultra BS6, T.11 Ultra BS6			1,670.00
F 002 H26 311	Fuel Filter Spin-on, Pre-filter		ASHOK LEYLAND- Captain 40 (D) 165 Kw (2016.02-->)	P1302040, F7B02900	FLG -FS19654	2,208.00
F 002 H26 314	Fuel Filter Spin-on, Pre-filter		TATA MOTORS- Prima 2528 K 6x4, Prima LX 4923 S, Prima LX 4023 S, LPT 2521 TC	288547704905		2,270.00
F 002 H26 388	Fuel Filter Spin-on, Pre-filter		TATA MOTORS- Ultra 814 BS IV	570609110106, 570609110101, 570609110108		1,580.00
F 002 H26 625	Fuel Filter Spin-on, Pre-filter		TATA MOTORS- 410 Turbo SFC 3.0 Diesel (D) 74 Kw (2006.05 -2017.03)	252709110105, 253409110117, 254709110118, G9450030116, 254709110106, 253409110120		280.00

### Filter Application Chart

Part Number	Product Description	Image	Model Description 	Potential OE Part No	Potential Comp. Part No	MRP (₹)
F 002 H27 515	Fuel Filter Spin-on, Pre-filter		TATA MOTORS- LP 9.6T BS III, LPT 909 BS IV, 709 LPT HEX2, LPT 1913 BS-IV, LPK 1613 BS IV, LPT 1109 HEX2 CR (D) 92 Kw (2014.01-->), LPO 7.5 3.8TD FBV BS3 Ultra, Ultra 1012 BS III (D) 124 Kw (2016.01 -2017.12), 709 SFC EX (D) 66 Kw (2005.04-->), LPT 810 Ex2 BS III, SK 1616, LP 9.6T BS IV, SE 1613, 1510 LP/LPO BS-II, LPT 2516 Super Turbo (D) 118 Kw (2007.12 -2010.10), LPT 1616 BS-III, LPO 1613 BS IV, LPT 2518 BS III, SE 1613 BS IV, LPO 8.5, LP 1613 BS IV, LPK 1613 5.7 BS-III, 709 LPT EX Turbo (D) 66 Kw (2005.01-->), LP 912 (D) 92 Kw (2010.10-->), LPT 1109 HEX2, LPT 1613 Turbo EX, LPT 1109 (D) 66 Kw (2003.09 -2007.04), LPT 810 Ex2 BS IV, LPT 1613 BS III, LPT 909 EX, 712 LP Bus (D) 92 Kw (2005.04-->), LP 709 BS III, LPT 709 BS IV, SFC 909 EX, LP 909, LP 1613 SuperMilo, LPT 1616 697 Super Turbo BS-II (D) 118 Kw (2009.09 -2010.10), LPK 1616 BS-III, LP 1112 BS IV, LPT 1613 BS IV, 1512 LP 497 BS-III (D) 92 Kw (2005.02-->), LPK 909, LP 912 TCIC BS IV	252509120239, 252709120254, 252509120264, 252709120259, 252709119902		1,342.00
F 002 H27 515	Fuel Filter Spin-on, Pre-filter		TATA MOTORS- SK 407	252509120239, 252709120254, 252509120264, 252709120259, 252709119902		1,342.00
F 026 402 025	Fuel Filter Spin-on, Pre-filter		VOLVO- FM 7 290, FH 12, FM 12			On Request
F 026 402 025	Fuel Filter Spin-on, Pre-filter		SCANIA- P-Serie (D) 280 Kw (2007.09 -2018.12)	1393640		On Request

### Filter Application Chart







Part Number	Product Description	Image	Model Description 	Potential OE Part No	Potential Comp. Part No	MRP (₹)
F 026 402 138	Fuel Filter Spin-on, Pre-filter		SCANIA- P-Serie (D) 280 Kw (2007.09 -2018.12)	1780730		On Request
9 450 030 200	Fuel Filter, Complete		SWARAJ MAZDA- T3500 Prestige WT49LWB, Premium WT 49 ESA, Prestige WT-48, Sartaj WV26S, Super ZT54 BS I			1,611.00
9 451 037 405	Fuel Fine Filter Element		TATA MOTORS- 609 SFC 3.8 Diesel, 709 LP Bus, 709 SFC EX, LP 609 Turbo Bus	252709110105		150.00
9 451 037 405	Fuel Fine Filter Element		ASHOK LEYLAND- Comet 1611, Comet 1613, Cheetah (D) 74 Kw (1991.02 -2000.10), Comet Junior	P1301340		150.00
9 451 037 405	Fuel Fine Filter Element		MAHINDRA- FJ 3.3 Diesel Chassis, FJ 3.3 Diesel Truck, Tourister 2.5 Diesel, Pik up 2.5 Diesel, Maxx Pickup 2.5 Diesel 4WD, Utility 2.5 Diesel 4WD, Maxx 2.5 Diesel Pickup, Cabstar 2.5 Diesel, DI 3200 2.5 Diesel, Pik up 2.5 Diesel 4WD, Bolero Camper 2.5 Diesel 2880, Pik up 2.5 Diesel CBC, Utility 2.5 Diesel, FJ 3.3 Diesel Truck 4WD			150.00
9 451 037 405	Fuel Fine Filter Element		TATA MOTORS- 407 3.0 Diesel LPT Turbo, 407 SFC 3.0, 407 3.0 Diesel SFC Turbo, 407 3.0D Cityride NA	252709110105		150.00
9 451 037 406	Fuel Fine Filter Element		TATA MOTORS- 1510 LP (D) 77 Kw (2000.09-->), 1510 LP (D) 81 Kw (1988.04 -2000.01), 1516 LPT (D) 118 Kw (1984.02 -1999.12)			144.00
9 451 037 406	Fuel Fine Filter Element		ASHOK LEYLAND- Cheetah (D) 84 Kw (1995.04 -2010.10), Cheetah (D) 88 Kw (2000.11 -2005.03), Comet 1616H (D) 123 Kw (2009.11 -2010.10), Artik 3014 (D) 99 Kw (2000.05 -2005.04)	P1301440		144.00



### Filter Application Chart

Part Number	Product Description	Image	Model Description 	Potential OE Part No	Potential Comp. Part No	MRP (₹)
9 451 037 409	Fuel Fine Filter Element		TATA MOTORS- LPT 1613, 1510 LP (D) 77 Kw (2000.09-->), 1510 LP (D) 81 Kw (1988.04 -2000.01), 1516 LPT (D) 118 Kw (1984.02 -1999.12)		FLG -FF5534	155.00
9 451 037 409	Fuel Fine Filter Element		ASHOK LEYLAND- Cheetah (D) 84 Kw (1995.04 -2010.10), Cheetah (D) 88 Kw (2000.11 -2005.03), Cheetah (D) 97 Kw (2005.04 -2010.10), Comet 1616H (D) 123 Kw (2009.11 -2010.10), Artik 3014 (D) 99 Kw (2000.05 -2005.04)	P1301640	FLG -FF5534	155.00
F 002 H24 406	Fuel Fine Filter Element		TATA MOTORS- 1510 LP (D) 77 Kw (2000.09-->), 1510 LP (D) 81 Kw (1988.04 -2000.01), 1516 LPT (D) 118 Kw (1984.02 -1999.12)			142.00
F 002 H24 406	Fuel Fine Filter Element		ASHOK LEYLAND- Cheetah (D) 84 Kw (1995.04 -2010.10), Cheetah (D) 88 Kw (2000.11 -2005.03), Comet 1616H (D) 123 Kw (2009.11 -2010.10), Artik 3014 (D) 99 Kw (2000.05 -2005.04)	P1301440		142.00
0 450 906 267	Fuel Pipe Filter		VOLKSWAGEN- Multivan T4 [70, 7D]	1H0127401C		1,190.00
F 002 H23 535	Fuel Pipe Filter		TATA MOTORS- LPT 1613, LPK 2523, LPT 2518, LPT 2513, LPS 3518, LPS 4018 (D) 135 Kw (2010.10-->), LPT 3118, LPT 1613 /62 TC, Starbus 1612, Novus LPK 2530 6x4, LPT 3723 TC, LPO 1610 TC, LPO 1618, LPK 2518 HD, LPO 1512 TC SLF, LPT 2518/62 TC BS3, LPT 2516 TC 6x2, LPT 1613 EX, SK 1613 TC BS-II, LPO 1512 TC, LPO 1618 SLF, LPS 4923 TC 6x4, LPT 2515 EX 6x2	278609119904, 278609999920, 278609999822, 278607989916	FLG -FF5522, FS1275	143.00

### Filter Application Chart

Part Number	Product Description	Image	Model Description 	Potential OE Part No	Potential Comp. Part No	MRP (₹)
F 002 H23 536	Fuel Pipe Filter		TATA MOTORS- LPK 1613, LPT 1109 HEx2 CR, LPT 2516 Super Turbo, 709 LPT HEx2, LPS 4018 (D) 130 Kw (2004.01 -2006.12), Ultra 812 BS III, LPT 1616 697 Super Turbo BS-II, LP 912, LPO 1612 TC BS-III, LPO 7.5 3.8TD FBV BS3 Ultra, 909, 1512 TC LP, SE 1613, SK 1616, 1510 LP/LPO BS-II, LPS 3516 EX, LPT 1613 TC, LPT 1109, LPT 1616 BS-III, 1512 LP 497 BS-III, LPO 8.5, LPK 1613 5.7 BS-III, LPT 1109 HEx2, SE 1613 Turbo BS-II, 709 LPT EX Turbo, LPT 909 EX, SFC 909 EX, LPT 1109 EX, LPT 2515 Turbo EX 6x2, LP 1613 SuperMilo, Ultra 912, LPO 1612 TC BS-II, LPK 1616 BS-III, LPK 909	252509120239, 252709110136, 252709119913, 278609999951	FLG -FF5479	143.00
F 002 H23 536	Fuel Pipe Filter		ASHOK LEYLAND- 1616 XL, U 1618, 2214 6x2 (H), U 2518, 4018, 3118, 3518, Comet 1616H, eComet 912, eComet 1212, 2513, Boss 1213 LE, 3718 iL, 3516, eComet 1214, 1616 iL 5.7, Comet 1611, 2516 6x2 (H), 1612 H, 3121, Boss 1112 LE, eComet 1112, 1612 IL BS-III, 1613 H, 2516 il, Ecomet 1012 Smart, 4019il, 2514, 1618, 2516 S, 2516 6x4 (H) 4x4, 2518, Boss 1212 LE, 4921, U 2516, 1616 H	F8824500, FHN00400, P1301640, F8835100, P7B00022, FHJ01000	FLG -FF5479	143.00
F 002 H23 536	Fuel Pipe Filter		TATA MOTORS- SK 407	252509120239, 252709110136, 252709119913, 278609999951	FLG -FF5479	143.00
F 002 H23 536	Fuel Pipe Filter		ASHOK LEYLAND- Stag	F8824500, FHN00400, P1301640, F8835100, P7B00022, FHJ01000	FLG -FF5479	143.00
1 457 431 003	Fuel Pre-filter Element		TATA MOTORS- 1516 LPT, 1510 LP			156.00
1 457 431 003	Fuel Pre-filter Element		ASHOK LEYLAND- Cheetah (D) 84 Kw (1995.04 -2010.10), Cheetah (D) 88 Kw (2000.11 -2005.03), Artik 3014, Comet 1616H	P1300640		156.00

### Filter Application Chart

Part Number	Product Description	Image	Model Description 	Potential OE Part No	Potential Comp. Part No	MRP (₹)
9 451 037 404	Fuel Pre-filter Element		TATA MOTORS- 609 SFC 3.8 Diesel, 709 LP Bus, 709 SFC EX			124.00
9 451 037 404	Fuel Pre-filter Element		ASHOK LEYLAND- Comet 1611, Comet 1613, Cheetah (D) 74 Kw (1991.02 -2000.10), Comet Junior	P1301240		124.00
9 451 037 404	Fuel Pre-filter Element		TATA MOTORS- 407 3.0 Diesel LPT Turbo, 407 SFC 3.0, 407 3.0 Diesel SFC Turbo, 407 3.0D Cityride NA			124.00
9 451 037 404	Fuel Pre-filter Element		MAHINDRA- Tourister 2.6 Diesel, FJ 3.3 Diesel Chassis, FJ 3.3 Diesel Truck, Tourister 2.5 Diesel, Pik up 2.5 Diesel, Maxx Pickup 2.5 Diesel 4WD, Utility 2.5 Diesel 4WD, Maxx 2.5 Diesel Pickup, Cabstar 2.5 Diesel, DI 3200 2.5 Diesel, Pik up 2.5 Diesel 4WD, Bolero Camper 2.5 Diesel 2880, Pik up 2.5 Diesel CBC, Utility 2.5 Diesel, LoadKing 2.5 Diesel DI, FJ 3.3 Diesel Truck 4WD	9420000388		124.00
9 451 037 409	Fuel Pre-filter Element		ASHOK LEYLAND- Cheetah (D) 97 Kw (2005.04 -2010.10)	P1301640	FLG -FF5534	155.00
1 457 429 820	Hydraulic Filter, Steering System		VOLVO- FM (D) 339 Kw (2009.05-->), FM (D) 338 Kw (2013.04-->), FM 7 290, FH, FM (D) 294 Kw (2006.09 -2012.02), FH 12, B 7 R, FM (D) 250 Kw (2006.05 -2009.07), FM 12, FM (D) 309 Kw (2013.04-->)			275.00
1 457 429 820	Hydraulic Filter, Steering System		SCANIA- P-Serie, Citywide	153468, 1953094		275.00





### Filter Application Chart

Part Number	Product Description	Image	Model Description 	Potential OE Part No	Potential Comp. Part No	MRP (₹)
1 457 429 820	Hydraulic Filter, Steering System		MAN- CLA 16.220, CLA 31.280, CLA 15 t, CLA 20 t, CLA 26 t	81473016005		275.00
F 002 H24 336	Hydraulic Filter, Steering System		TATA MOTORS- LPO 1613 CNG (GAS) 92 Kw (2009.10-->), LPK 1613 5.7 BS-III, LPO 1613 CNG (GAS) 96 Kw (2010.10-->), LPO 1610 TC, LPO 1612 TC BS-II, LPT 1616 BS-III, LPO 1512 TC SLF, LPK 1616 BS-III, LPO 1612 TC BS-III, LPT 1613 (D) 100 Kw (2014.01-->), 1512 TC LP, LPS 4923 TC 6x4	257344500107	RAN -41200006	124.00
F 002 H24 336	Hydraulic Filter, Steering System		ASHOK LEYLAND- Cheetah (D) 84 Kw (1995.04 -2010.10), Viking (D) 97 Kw (2004.02 -2010.10), Guru 1111 BS IV	P2405339	RAN -41200006	124.00
F 002 H24 336	Hydraulic Filter, Steering System		ASHOK LEYLAND- Sunshine, Sunshine BS6	P2405339	RAN -41200006	124.00
F 002 H24 337	Hydraulic Filter, Steering System		TATA MOTORS- SE 1613, LPT 1618 BS-III, LPO 1613 CNG (GAS) 96 Kw (2010.10-->), LPK 2518 HD, LPK 2518 6x4, LPT 1616 697 Super Turbo BS-II, LPT 2516 TC 6x2, LPT 1613 (D) 100 Kw (2014.01-->)	277046609901	RAN -42200007	139.00

### Filter Application Chart

Part Number	Product Description	Image	Model Description 	Potential OE Part No	Potential Comp. Part No	MRP (₹)
F 002 H24 337	Hydraulic Filter, Steering System		ASHOK LEYLAND- U 4923, 1616 iL, 1616 XL, Viking (GAS) (2006.01-->), Cargo 1614, U 3518, 1616 XP, JanBus BS4, U 3123, U 1618, 2214 6x2 (H), Captain 40, U 2523, U-3118, U 2518, 3518, eComet 912, Viking (D) 123 Kw (2005.05-->), 3718 iL (D) 132 Kw (2014.01-->), eComet 1212, 2513, 2516, Viking (D) 123 Kw (2011.01-->), FE SLF, U 4019 iL, 2523, 1612 H, 4019 5.6, 3121, Viking 180HP ROTARY FIP EDC BS3, Cruiser, U 1616, 3015, 1613 5.7, eComet 1112, 1613 H, 3116, 2516 iL, U 3518 5.7, Viking (D) 84 Kw (2004.02 -2010.10), Ecomet 1012 Smart, Cheetah (D) 84 Kw (1995.04 -2010.10), Lynx, Cheetah (D) 135 Kw (2014.01-->), 12M, 2518, Viking 160HP IL FIP BS3, 1616 H	P4200340	RAN -42200007	139.00
F 002 H24 338	Hydraulic Filter, Steering System		ASHOK LEYLAND- 3718 iL (D) 132 Kw (2014.01-->), 3118, 4123 BS IV	PD600391		139.00
F 026 404 001	Hydraulic Filter, Steering System		VOLVO- FM (D) 339 Kw (2009.05-->), FM (D) 338 Kw (2013.04-->), FM (D) 250 Kw (2006.05 -2009.07), FM (D) 309 Kw (2013.04-->)			On Request
3 397 005 295	Oil Filter Element		TATA MOTORS- 407 3.0 Diesel LP Turbo Bus (D) 55 Kw (2006.01-->)	284582409902, G269982409908, 278918130101, 284582400103		437.00
9 451 037 424	Oil Filter Element		ASHOK LEYLAND- Comet 1611 (D) 63 Kw (1961.05 -1980.01), Bus IV, Comet 1611 (D) 74 Kw (1980.02 -2001.02), Comet 1613, Artik 3014, Comet Junior			201.00

### Filter Application Chart

Part Number	Product Description	Image	Model Description 	Potential OE Part No	Potential Comp. Part No	MRP (₹)
9 451 037 438	Oil Filter Element		TATA MOTORS- LPK 1613, LPT 2516 Super Turbo, LPK 1613 5.7 BS-III, LPT 1616 697 Super Turbo BS-II, SE 1613 Turbo BS-II, SE 1613, SK 1616, LPT 1613 BS III (D) 102 Kw (2016.06-->), LP/LPO 1615 697 BS-III, LPT 2515 Turbo EX 6x2, LP 913 BS IV CNG, 1510 LP/LPO BS-II, LP 1613 SuperMilo, SK 1613 Turbo BS-II, LPT 1613 Turbo EX (D) 95 Kw (2003.12 -2010.10), LPT 1616 BS-III, LPK 1616 BS-III, LPO 1613 CNG, LPT 2518 BS III	252518130139, 252518130175, 252518130124		389.00
9 451 037 456	Oil Filter Element		TATA MOTORS- LP 609 Turbo Bus, 709 SFC E 3.8 Diesel, SFC 909, 1109 LPT, 709 LP Bus (D) 66 Kw (2005.04-->), LPT 909 EX (D) 66 Kw (2005.03 -2010.10), LPT 1109 (D) 66 Kw (2003.09 -2007.04), LPK 909, 609 SFC 3.8 Diesel (D) 66 Kw (1993.06 -1994.06), 709 LP Bus (D) 66 Kw (1995.05 -1997.09), 709 SFC EX (D) 66 Kw (2003.11 -2005.03)	252718130105, 253418130169	FLG -LF16059	345.00
9 451 037 456	Oil Filter Element		TATA MOTORS- SK 407, 407 3.0 Diesel LPT Turbo, 407 3.0D SFC Pickup (D) 55 Kw (2010.03-->), Xenon Utility 3.0TD 4x2, 407 3.0 Diesel LP Turbo Bus (D) 55 Kw (2006.01-->), 609 3.8 Diesel LP (D) 66 Kw (1993.09 -1997.07), 407 3.0 Diesel SFC Turbo Bus, 407 3.0 Diesel LPT (D) 53 Kw (2001.10 -2005.02), 407 3.0D Cityride NA, 407 3.0 Diesel LP, 407 LP Turbo Bus 3.0, 407 Citiride 3.0, 207 1.9 D, 407 3.0 Diesel SFC Turbo (D) 52 Kw (2003.11 -2005.05), Cityride 407, 407 SFC 3.0 (D) 43 Kw (2007.01 -2012.01), 407 3.0D SFC EX Turbo (D) 55 Kw (2003.11 -2005.04), 407 TurboBus SWB 3.0 D, 407 3.0 Diesel, SK 407 BS II	252718130105, 253418130169	FLG -LF16059	345.00
9 951 030 141	Oil Filter Element		EICHER MOTORS LIMITED- 10.59 3.3 Diesel, 10.70			202.00

### Filter Application Chart

Part Number	Product Description	Image	Model Description 	Potential OE Part No	Potential Comp. Part No	MRP (₹)
9 951 030 141	Oil Filter Element		EICHER- 11.10 / XP	ID002922		202.00
9 951 030 141	Oil Filter Element		EICHER MOTORS LIMITED- 10.59 3.3 Diesel, 10.50 3.3 Diesel BS2, 10.50 3.3 Diesel BS3, 10.50 3.3 Diesel			202.00
F 002 H20 031	Oil Filter Element		ASHOK LEYLAND- 3516 (D) 118 Kw (2002.02 -2007.08)	F4034600	FLG -LF16052	237.00
F 002 H20 032	Oil Filter Element		TATA MOTORS- 1210E			402.00
F 002 H20 241	Oil Filter Element		ASHOK LEYLAND- Ecomet 1012 Smart (D) 88 Kw (2010.11-->), eComet 1112 (D) 88 Kw (2005.08 -2010.10), Viking (GAS) (2006.01-->), Stag (D) 88 Kw (2002.01 -2005.03), eComet 1212 (D) 88 Kw (2010.10-->), Comet 1616H, eComet 912 (D) 88 Kw (2005.08 -2010.10)	X4000600, F4034200, P3101540, F4034500		232.00
F 002 H20 264	Oil Filter Element		TATA MOTORS- ACE MAGIC 0.7	279018130104, 279018130101, 279018130102, G279018130103, 279018130105		220.00



### Filter Application Chart

Part Number	Product Description	Image	Model Description 	Potential OE Part No	Potential Comp. Part No	MRP (₹)
F 002 H20 360	Oil Filter Element		TATA MOTORS- Signa 4018.S BS IV, LPS 4018 BS IV, Signa 3518.S BS IV, LPT 2518 BS IV (D) 132 Kw (2018.12-->), LPK 2523 BS IV Tipper, LPT 1615 TC BS IV (D) 119 Kw (2008.01 -2010.12), LPT 2518/62 TC BS3 (D) 135 Kw (2014.01-->), LPS 3518 BS IV, LPT 1918 BS IV, LPT 3718 BS IV, Signa 4223 BS IV, LPK 3118 BS IV, LPT 2518 BS IV (D) 134 Kw (2008.12-->), Signa 1615 BS IV, Signa 2823.TK BS IV, LPT 3118 BS IV, LPK 1618 BS IV, SIGNA 3718.T BS IV, LPK 1615 BS IV, LPK 2518 BS IV, LPK 2818 BS IV, LPT 4223 BS IV	278618999994		278.00
F 002 H23 432	Oil Filter Element		TATA MOTORS- Intra V20 BS-IV	59063972, 279018130106, 570318109924		268.00
F 002 H23 432	Oil Filter Element		TATA MOTORS- Ace Super Mint 1.4	59063972, 279018130106, 570318109924		268.00
F 002 H23 434	Oil Filter Element		TATA MOTORS- ACE HT BS-IV	279018130104, 59063972, 279018130101, 279018130102, 279018130106, 570318139905, 570318139923, 279818130101, 55197218, 279018130105		358.00
F 002 H23 434	Oil Filter Element		TATA MOTORS- Super Ace Mint, ACE CNG BS III, Xenon 1tonne Pickup BS-IV CNG, Venture 1.4D, ACE Magic CNG BS-IV, ACE MAGIC, Winger CNG, ACE CNG BS-IV	279018130104, 59063972, 279018130101, 279018130102, 279018130106, 570318139905, 570318139923, 279818130101, 55197218, 279018130105		358.00



### Filter Application Chart

Part Number	Product Description	Image	Model Description 	Potential OE Part No	Potential Comp. Part No	MRP (₹)
F 002 H23 439	Oil Filter Element		MAHINDRA- Tourister T36	9420000073, 9420000074, 0303BAM00350N, 0303BC0071N, 0303BC0010N, 71817, 24772, 0303BC0073N, 0303BAU00110N		219.00
F 002 H23 439	Oil Filter Element		MAHINDRA- Bolero Maxi Truck Plus, Tourister 2.6 Diesel, LoadKing Pride 2.6 Diesel, SUPRO MAXITRUCK, Maxximo 0.9D MiniVan, Imperio 2.5, Tourister T25 2.6TD, Tourister 3.3, LoadKing 2.5 Diesel DI, Bolero Pik up, Bolero Camper, Genio 2.5D	9420000073, 9420000074, 0303BAM00350N, 0303BC0071N, 0303BC0010N, 71817, 24772, 0303BC0073N, 0303BAU00110N		219.00
F 002 H23 571	Oil Filter Element		TATA MOTORS- 712 LPT EX, LPTK 2518 BS III, 709 LPT EX Turbo (D) 66 Kw (2003.01 -2004.12), LPT 3118 (D) 135 Kw (2010.09-->), LPT 909 EX (D) 66 Kw (2005.03 -2010.10), LPT 1613 (D) 100 Kw (2014.01-->), LPT 1918 BS IV, LPT 2516 TC 6x2 (D) 115 Kw (1998.03 -2000.12), 709 SFC EX (D) 66 Kw (2005.04-->), LPT 1618 BS-III (D) 135 Kw (2010.08-->), LPT 1109 HEx2 (D) 92 Kw (2014.01-->), LPT 909 EX (D) 92 Kw (2010.10-->), 709 LP Bus (D) 66 Kw (2005.04-->), LPT 809 EX, LPT 407 (D) 55 Kw (2005.03-->), LPT 3518 BS-IV, LPT 1112, Signa 2518.TK BS IV, 1512 LP 497 BS-III, LPT 2818 BS IV, LPS 4923 TC 6x4 (D) 159 Kw (2014.01-->), LPT 1109 (D) 66 Kw (2003.09 -2007.04), Signa 3118.TK BS IV, 712 LP Bus, LPO 9.6, 709 SFC EX (D) 66 Kw (2003.11 -2005.03), LPT 1109 EX, LPT 2513 (D) 102 Kw (2011.05-->), LPT 2518 HD (D) 135 Kw (2010.08-->), LPT 810 Ex2 BS III (D) 91 K	252718130132, 253418130174, 252718130142, 252718130145, 278618999994	FLG -LF9028	1,262.00





### Filter Application Chart

Part Number	Product Description	Image	Model Description 	Potential OE Part No	Potential Comp. Part No	MRP (₹)
F 002 H23 571	Oil Filter Element		w (2015.12-->), LPO 7.5 3.8TD FBV BS3 Ultra (D) 92 Kw (2011.01-->), Ultra 912, Signa 1923.K BS-IV, LPO 8.5 (D) 92 Kw (2014.02-->), LPT 2823 BS IV, LPT 407 BS II, LPO 1515 BS IV (D) 119 Kw (2017.05-->), Ultra 812 BS III, LPT 1923 BS-IV, LPT 1109 HEx2 CR (D) 92 Kw (2014.01-->), LP 912, LP 1515 BS IV (D) 119 Kw (2017.05-->), Ultra 1012 BS III, Signa 2818.T BS-IV, LPS 3518 (D) 131 Kw (2012.01-->), LPS 4018 (D) 135 Kw (2010.10-->), 709 LPT HEx2 (D) 92 Kw (2014.01-->), LPT 3723 TC (D) 155 Kw (2014.01-->), LPT 2518 (D) 135 Kw (2010.08-->), Signa 2523.K BS IV, LPTK 3118 BS-IV, LPO 10.2 Starbus Ultra BS III, 709 LPT EX Turbo (D) 66 Kw (2005.01-->), LPT 3518 TC BS-IV, LPO 1612 TC BS-III (D) 98 Kw (2005.02 -2015.09), Signa 3118 T (D) 167 Kw (2016.02-->), LPO 1618 (D) 135 Kw (2010.10-->), SFC 909 EX, LPO 1512 TC SLF (D) 96 Kw (2009.07-->), LPT 912	252718130132, 253418130174, 252718130142, 252718130145, 278618999994	FLG -LF9028	1,262.00
F 002 H23 571	Oil Filter Element		TATA MOTORS- LP 410, 407 3.0D SFC Pickup (D) 55 Kw (2010.03-->), 407 3.0 Diesel SFC Turbo (D) 52 Kw (2003.11 -2005.05), 407 3.0 Diesel LP Turbo Bus (D) 55 Kw (2006.01-->), 407 SFC 3.0 (D) 43 Kw (2007.01 -2012.01), 407 3.0 Diesel LPT (D) 53 Kw (2001.10 -2005.02), SFC 407 EX BS III (D) 55 Kw (2013.05-->)	252718130132, 253418130174, 252718130142, 252718130145, 278618999994	FLG -LF9028	1,262.00



### Filter Application Chart

Part Number	Product Description	Image	Model Description 	Potential OE Part No	Potential Comp. Part No	MRP (₹)
F 002 H23 572	Oil Filter Element		ASHOK LEYLAND- Stag (D) 88 Kw (2013.10-->), U 4923, 1616 iL, Cheetah (D) 118 Kw (2014.01-->), Viking BS IV (D) 123 Kw (2016.12-->), Captain 40IT BS III, Boss 912 LE 3.8, JanBus BS4, U 3123, Cheetah (D) 88 Kw (2000.11 -2005.03), U-3118, 12M FE BS IV (D) 132 Kw (2016.12-->), Captain 2518 BS IV, U 2518, Lynx (D) 96 Kw (2014.01-->), 3118, 3518, 3123 BS III, Captain 4923 BS III, N 3123 BS III, 4019 BS IV, Boss 913 LX, U 4019 iL, 4923, 1616 XL (D) 124 Kw (2010.08-->), 2523, 12M FESLF BS III, 2518 (D) 135 Kw (2010.10-->), 12M FE BS III, U 4019 BS III, Lynx BS IV (D) 95 Kw (2015.12-->), 2518 (D) 132 Kw (2014.01-->), U 1616, 1618 BS IV, 1618T BS IV, 2516 iL, 4019iL, U-2518 IL T HD BS IV, Captain 3718 BS IV, 1616 XP (D) 124 Kw (2010.08-->), 3118-T BS IV, RE SLF BS III (D) 135 Kw (2011.12-->), 3123, 12M FESLF CNG BS IV, Cheetah (D) 135 Kw (2014.01-->), 12M (D) 118 Kw (2010.10-->), 2518 T BS IV, Captain 4923 BS IV (D) 172 Kw (2018.10-->), B	F7A05000, F7AO5000, F7A01500	FLG -LF16238	1,577.00





### Filter Application Chart

Part Number	Product Description	Image	Model Description 	Potential OE Part No	Potential Comp. Part No	MRP (₹)
F 002 H23 572	Oil Filter Element		oss 1212 LE, U 2516, Captain 3723 BS IV, U 3518 BS IV, 3718 BSIV, Viking 160HP IL FIP BS3 (D) 118 Kw (2014.02-->), 1618 XP BS III (D) 134 Kw (2015.12-->), Captain 49IT BS III, Captain 40, U 2523, 12M FE BS IV (D) 165 Kw (2016.12-->), 12M FESLF BS IV, 2518 BS IV, U 3518 (D) 132 Kw (2010.10-->), U 3718 BS IV, 3120 iL, U 3118 LA BS IV, 3118 BS IV, 1616 BS III (D) 119 Kw (2013.12-->), Boss 1213 LE, Boss 1113 LX, 3718 iL, 4123 BS IV, 12M (D) 165 Kw (2014.01-->), 4023, U 4023, Viking 180HP ROTARY FIP EDC BS3 (D) 135 Kw (2014.02-->), U-2518-IL-T HD BS III (D) 134 Kw (2016.08-->), Boss 1112 LE, 12M FESLF, 11M FESLF BS IV, U 1618 (D) 97 Kw (2010.11-->), Viking BS III (D) 119 Kw (2011.12-->), U 3723, 3718 iL BS III, U 4019 BS IV, ULE Diesel BS 4, 3718 BS IV, 2516 iL BS III (D) 119 Kw (2012.12-->), U-2518 T BS IV, 1616 H (D) 123 Kw (2006.04 -2010.10), 4019 BSIV, 3518 BS III (D) 134 Kw (2015.12-->), 3116 (D) 118 Kw (2010.10-->), U 4923 BS IV	F7A05000, F7AO5000, F7A01500	FLG -LF16238	1,577.00
F 002 H24 322	Oil Filter Element		MAHINDRA- Maxximo 0.9D, Supro Maxitruck T2/T4/T6	0303BAU00110N		193.00
F 002 H24 502	Oil Filter Element		TATA MOTORS- LPT 1618 BS-III, LPO 1612 TC BS-II (D) 94 Kw (2002.08 -2010.10), SK 1613 TC, LPT 1613 /62 TC, LPK 2518 6x4 (D) 129 Kw (2007.12 -2010.10), LPK 1618 (D) 130 Kw (2007.12 -2010.10), SK 1613 TC BS-II, SE 1613 TC BS-II, LPT 1613 EX (D) 88 Kw (2002.08 -2010.10)	278618139902, 278618999976		395.00
F 002 H24 519	Oil Filter Element		TATA MOTORS- Prima LX 4028 S, Prima LX 4928 S, Prima 2528 K 6x4, Prima 4928 S, Prima 3128 K 8x4, Prima LX 4023 S, LPT 2521 TC, Prima LX 2523 K / T (D) 171 Kw (2014.01-->)	570118999901	FLG -LF1601500	1,167.00

### Filter Application Chart

Part Number	Product Description	Image	Model Description 	Potential OE Part No	Potential Comp. Part No	MRP (₹)
F 002 H26 360	Oil Filter Element		TATA MOTORS- LP 9.6T BS III, LPO 1618 BS III, LPS 4018 (D) 130 Kw (2004.01 -2006.12), LPTK 3118 BS III, LPK 2518 BS III, 1623 Globus LP, LPT 3118 (D) 135 Kw (2010.09-->), LPT 909 EX (D) 66 Kw (2005.03 -2010.10), LPT 1613 (D) 100 Kw (2014.01-->), LPT 2516 TC 6x2 (D) 115 Kw (1998.03 -2000.12), 1512 TC LP, LPS 3516, Marcopolo 1625 LF, LP 9.6T BS IV, LPK 1618 BS-III (D) 135 Kw (2010.08-->), LPT 1109 HEx2 (D) 92 Kw (2014.01-->), LPK 2518 6x4 (D) 129 Kw (2007.12 -2010.10), LPT 407 EX BS-IV, LPO 1618 BS-IV, LPK 3118 BS III, LPO 1610 TC, LPT 1613 Turbo EX (D) 95 Kw (2003.12 -2010.10), LPT 407 (D) 55 Kw (2005.03-->), LPT 407 EX2 BS-IV, LP 1512 BS-IV, LPK 1615 BS III, Prima LX 2523 K / T (D) 171 Kw (2014.01-->), LPT 1615 TC BS IV (D) 119 Kw (2008.01 -2010.12), Prima LX 3123.TTS BS III, LPS 4923 TC 6x4 (D) 159 Kw (2014.01-->), LPT 2513 (D) 102 Kw (2011.05-->), LPK 2518 HD (D) 135 Kw (2010.08-->), LPT 810 Ex2 BS III (D) 91 Kw (2015.12-->), LPO 7.5 3.8TD FBV BS3 Ultra (D) 92 Kw (2011.01-->), LPK 1618 (D) 130 Kw (2007.12 -2010.10), LPO 8.5 (D) 92 Kw (2014.02-->), LPO 1623 BS IV CNG, LPT 2515 EX 6x2, LP 912 TCIC BS IV, LPO 1512 BS-IV, LPT 909 BS IV, LPK 251	278618139902, 252718990139, 252718130145, 278618999994		1,430.00





### Filter Application Chart

Part Number	Product Description	Image	Model Description 	Potential OE Part No	Potential Comp. Part No	MRP (₹)
F 002 H26 360	Oil Filter Element		6 TC 6x4 BS-II, 1512 LP/LPO TC BS-III, LPT 1613 EX (D) 88 Kw (2002.08 -2010.10), LPO 1515 BS IV (D) 119 Kw (2017.05-->), LPK 2523, LPO 1616 TC BS-II, LPT 1109 HEx2 CR (D) 92 Kw (2014.01-->), LP 1515 BS IV (D) 119 Kw (2017.05-->), 909, LPS 3518 (D) 131 Kw (2012.01-->), LPS 4018 (D) 135 Kw (2010.10-->), LPK 2516 6x2, LPS 4923 TC 6x4 (D) 170 Kw (2007.12 -2010.10), LP 1512 BS III, 709 LPT HEx2 (D) 92 Kw (2014.01-->), LPT 3723 TC (D) 155 Kw (2014.01-->), LPT 2518 (D) 135 Kw (2010.08-->), LPT 3718, LPO 1512 TC, LPT 3118 (D) 132 Kw (2007.12-->), LPT 2518 BS IV (D) 132 Kw (2018.12-->), LPT 2518/62 TC BS3 (D) 135 Kw (2014.01-->), 709 LPT EX Turbo (D) 66 Kw (2005.01-->), LP 708 BS III, LPO 1515 BS III, LPT 810 Ex2 BS IV, 609 SFC 3.8 Diesel (D) 66 Kw (1993.06 -1994.06), LPO 1612 TC BS-III (D) 98 Kw (2005.02 -2015.09), Signa 3118 T (D) 167 Kw (2016.02-->), LPO 1618 (D) 135 Kw (2010.10-->), LPT 1613 BS III (D) 102 Kw (2016.06-->), LPO 1612 TC BS-II (D) 94 Kw (2002.08 -2010.10), LP 709 BS III, LPT 709 BS IV, LP 909, LPO 1512 TC SLF (D) 96 Kw (2009.07-->), LPK 2523 BS III, LPO 1512 BS II, Ultra T.7, LP 1112 BS IV, 1109 LP, LPO 1623 BS III CNG, LPT 2518 BS II	278618139902, 252718990139, 252718130145, 278618999994		1,430.00
F 002 H26 360	Oil Filter Element		TATA MOTORS- 407 3.0D SFC Pickup (D) 55 Kw (2010.03-->), 407 3.0 Diesel LP Turbo Bus (D) 55 Kw (2006.01-->), 609 3.8 Diesel LP (D) 66 Kw (1993.09 -1997.07), 407 3.0D SFC EX Turbo (D) 55 Kw (2003.11 -2005.04), 410 Turbo SFC 3.0 Diesel, SFC 709 EX BS IV, SK 407 BS IV, SFC 407 EX BS III (D) 55 Kw (2013.05-->), SFC 407	278618139902, 252718990139, 252718130145, 278618999994		1,430.00
F 002 H26 361	Oil Filter Element		EICHER MOTORS LIMITED- Pro 1110XP BS IV, STARLINE 12.12K BS IV	ID321716		1,995.00

### Filter Application Chart









Part Number	Product Description	Image	Model Description 	Potential OE Part No	Potential Comp. Part No	MRP (₹)
F 002 H26 363	Oil Filter Element		MAHINDRA- Blazo X 42 BS IV	0303BAV00510N		815.00
F 002 H27 505	Oil Filter Element		EICHER MOTORS LIMITED- Pro 1090 BS IV, Pro 1095XP BS IV, Pro 1080XPT BS IV	ID337989		1,366.00
F 002 H60 022	Oil Filter Element		ASHOK LEYLAND- Viking BS III (D) 124 Kw (2012.12-->), Stag (D) 88 Kw (2013.10-->), 2518 BS II, Cheetah (D) 118 Kw (2014.01-->), Cheetah (D) 122.8 Kw (2005.11-->), Cargo 1613H, 4018, 12M (D) 130 Kw (2006.11-2010.10), Lynx (GAS) 106 Kw (2014.01-->), Ecomet 1012 Smart (D) 88 Kw (2010.11-->), Viking (D) 123 Kw (2005.05-->), N 2523 BS III, Viking (D) 97 Kw (2004.02-2010.10), 3516 (D) 121 Kw (2002.02-2010.10), 1616 XL BS III, 1614 BS III, Stag (D) 88 Kw (2010.10-->), VESTIBULE BS III, N 2523 BS IV, 2518 (D) 132 Kw (2008.01-2010.10), 1616 XL (D) 124 Kw (2010.08-->), Captain 3123 BSIV, Comet 1616 BS II, SFC 1613 BS III, Lynx BS IV (D) 95 Kw (2015.12-->), Viking BS III (D) 135 Kw (2012.12-->), 2518 (D) 132 Kw (2014.01-->), Double Decker BS III, 1613 5.7, 2516 S, 1611 BS II, Cheetah (D) 84 Kw (1995.04-2010.10), 1616 XP (D) 124 Kw (2010.08-->), Cheetah (D) 135 Kw (2014.01-->), Lynx BS III, 2518 T BS III, Captain 4923 BS IV (D) 172 Kw (2018.10-->), SFC 1613 BS II, Viking 160HP IL FIP BS3 (D) 118 Kw (2014.02-->), 1618 XP BS III (D) 134 Kw (2015.12-->), eComet 912 (D) 88 K	X4000600, F4034200, F7A05000, B8774802, F7A01500, X4001000, F4034500	FLG -LF16079	304.00

### Filter Application Chart

Part Number	Product Description	Image	Model Description 	Potential OE Part No	Potential Comp. Part No	MRP (₹)
F 002 H60 022	Oil Filter Element		w (2008.11-->), 2214 6x2 (H), 2214 6x2 BS II, 12M FE BS IV (D) 165 Kw (2016.12-->), Viking BS IV (D) 97 Kw (2017.06-->), Comet 1611 (D) 88.2 Kw (2004.09-2010.10), U 3518 (D) 132 Kw (2010.10-->), eComet 1112 (D) 88 Kw (2008.11-2010.10), Viking (D) 123 Kw (2011.01-->), 1616 BS III (D) 119 Kw (2013.12-->), eComet 1212 (D) 88 Kw (2010.10-->), Comet 1613H, Captain 3123 BS IV, Artik 3516, 3118-T BS III, Stag (D) 58 Kw (2003.03-->), eComet 1214, Viking 180HP ROTARY FIP EDC BS3 (D) 135 Kw (2014.02-->), U-2518-IL-T HD BS III (D) 134 Kw (2016.08-->), 3121, 2514 BS II, 1616 H (D) 121 Kw (2006.04-2010.10), 3015, Captain 2518 HD BS III, 1612 IL BS-III, U 1618 (D) 97 Kw (2010.11-->), Viking BS III (D) 119 Kw (2014.12-->), Viking BS III (D) 119 Kw (2011.12-->), Viking (D) 84 Kw (2004.02-2010.10), Ecomet 1012 BS III, 3014, 2516 il BS III (D) 119 Kw (2012.12-->), Viking BS II, 3518 BS III (D) 134 Kw (2015.12-->), RE SLF BS III (D) 168 Kw (2012.12-->), Lynx (D) 88 Kw (2010.10-->), 3116 (D) 118 Kw (2010.10-->), 3116 (D) 118 Kw (2009.07-2010.10), 4921, 12M (D) 84 Kw (2014.10-->)	X4000600, F4034200, F7A05000, B8774802, F7A01500, X4001000, F4034500	FLG -LF16079	304.00
0 451 103 219	Oil Filter Spin-on		VOLVO- FM 7 290 (D) 210 Kw (1999.03-2001.05), FH 12 (D) 338 Kw (1998.08-2001.11), B 7 R			On Request
0 451 103 343	Oil Filter Spin-on		SCANIA- P-Serie	2059778		1,733.00
0 451 203 228	Oil Filter Spin-on		TATA MOTORS- 3516 TC LPS (D) 118 Kw (1999.06-->), 2515 TC LPT (D) 118 Kw (1998.06-->), 1512 LP/LPO TC BS-III (D) 114 Kw (2005.02-->)			On Request



### Filter Application Chart

Part Number	Product Description	Image	Model Description 	Potential OE Part No	Potential Comp. Part No	MRP (₹)
0 451 300 003	Oil Filter Spin-on		VOLVO- FM 7 290 (D) 210 Kw (1999.03 -2001.05), FM (D) 339 Kw (2009.05-->), FM (D) 338 Kw (2013.04-->), FM 9 (D) 221 Kw (2002.12 -2005.08), FH 12 (D) 338 Kw (1998.08 -2001.11), FM 12 (D) 280 Kw (2003.09 -2005.09), FM (D) 250 Kw (2006.05 -2009.07), FM (D) 309 Kw (2013.04-->)			1,402.00
0 451 403 077	Oil Filter Spin-on		VOLVO- FM 7 290 (D) 210 Kw (1999.03 -2001.05), FM 9 (D) 221 Kw (2002.12 -2005.08), FM 12 (D) 280 Kw (2003.09 -2005.09), FM (D) 250 Kw (2006.05 -2009.07)			655.00
9 451 037 446	Oil Filter Spin-on		MAHINDRA- NC 640 DP 2.1 Diesel Pick up, Tourister 2.5 Diesel, NC 640 DP Pick up 2.1 Diesel 4WD, Maxx Pickup 2.5 Diesel, NC 640 DP Pickup 2.1D 4WD			301.00
9 451 037 456	Oil Filter Spin-on		TATA MOTORS- 407 3.0 4WD, 407 3.0D SFC EX Turbo (D) 55 Kw (2005.05 -2017.03)	252718130105, 253418130169	FLG -LF16059	345.00
9 951 030 134	Oil Filter Spin-on		TATA MOTORS- 206 1.9 D	254718130117		301.00
F 002 H20 236	Oil Filter Spin-on		TATA MOTORS- Xenon 2.2 CRDi Diesel	254718130115	FLG -LF16070	286.00
F 002 H20 240	Oil Filter Spin-on		TATA MOTORS- 1615 TC LPT, 1615 TC LPK, 3516 TC LPS (D) 118 Kw (1999.06-->), 2515 TC LPT (D) 118 Kw (1998.06-->), 2516 TC LPT, 1615 TC SK, 2516 TC LPK, 1512 LP/LPO TC BS-III (D) 114 Kw (2005.02-->), 1512 TC LP			395.00
F 002 H20 241	Oil Filter Spin-on		ASHOK LEYLAND- Viking (GAS) (2006.01-->)	X4000600, F4034200, P3101540, F4034500		232.00

### Filter Application Chart

Part Number	Product Description	Image	Model Description 	Potential OE Part No	Potential Comp. Part No	MRP (₹)
F 002 H20 247	Oil Filter Spin-on		MAHINDRA- FJ 3.3 Diesel Chassis, FJ 3.3 Diesel Truck, FJ 2.1 Diesel Van, FJ 3.3 Diesel Truck 4WD			245.00
F 002 H20 264	Oil Filter Spin-on		TATA MOTORS- Ace XL 0.7D, Ace Gold, Ace (BS III) 0.7, ACE MAGIC 0.7, Ace (BS IV) 0.8, Ace SuperAce 1.4 (D) 52 Kw (2009.12 -2012.10)	279018130104, 279018130101, 279018130102, G279018130103, 279018130105		220.00
F 002 H23 434	Oil Filter Spin-on		TATA MOTORS- Venture 1.4D (D) 51 Kw (2011.01 -2016.01), Super Ace Mint	279018130104, 59063972, 279018130101, 279018130102, 279018130106, 570318139905, 570318139923, 279818130101, 55197218, 279018130105		358.00
F 002 H23 437	Oil Filter Spin-on		FORCE MOTORS- Traveller 2.6 Diesel Force, Traveller 3350/3700 mm WB 2.6 Diesel			400.00
F 002 H23 439	Oil Filter Spin-on		MAHINDRA- Bolero Camper 2510 2.5 D, Bolero Camper 2750 2.5 D, Bolero Camper, Genio 2.5D	9420000073, 9420000074, 0303BAM00350N, 0303BC0071N, 0303BC0010N, 71817, 24772, 0303BC0073N, 0303BAU00110N		219.00
F 002 H23 516	Oil Filter Spin-on		TATA MOTORS- LPS 3516			647.00
F 002 H23 566	Oil Filter Spin-on		TATA MOTORS- LPT 407 EX2 CNG BS-IV, LP 909 49 BS III CNG	253418130129, 254718130106, 252718130127, 253418130169, 253418130141, 254718130117, 253418130187	FLG -LF16056	425.00

### Filter Application Chart

Part Number	Product Description	Image	Model Description 	Potential OE Part No	Potential Comp. Part No	MRP (₹)
F 002 H23 566	Oil Filter Spin-on		TATA MOTORS- Starbus 3.0, SK 407 BS II, Xenon Utility 3.0TD 4x2, 407 3.0D SFC Pickup, 410 Turbo SFC 3.0 Diesel, 407 3.0, 407 LP Turbo Bus 3.0, Starbus SFC 407, SFC 407, LP 410, 407 SFC 3.0, Winger BS III, 407 3.0 Diesel SFC Turbo, 407 3.0D SFC EX Turbo (D) 55 Kw (2003.11-2005.04), TL Pickup 2.0, SFC 407 CNG, SFC 407 TT, TL Pickup 2.0 Diesel 4WD, SK 407	253418130129, 254718130106, 252718130127, 253418130169, 253418130141, 254718130117, 253418130187	FLG -LF16056	425.00
F 002 H23 571	Oil Filter Spin-on		TATA MOTORS- LPT 1613, LPT 1109 HEx2 CR, LPO 8.5, LPT 2518, LPT 2518/62 TC BS3 (D) 135 Kw (2014.01-->), Signa 3118 T, 1623 Globus LP, LPT 2513, LPO 1612 TC BS-III, LPO 7.5 3.8TD FBV BS3 Ultra, LPS 3518, 909, LPT 3118, LPK 2516 6x2, Marcopolo 1625 LF, LPK 1618 BS-III, LPK 2518 HD (D) 135 Kw (2010.08-->), LPT 407, LPT 3723 TC, LPO 1512 TC SLF, LPT 2516 TC 6x2, LPS 4018, LPS 4923 TC 6x4, Prima LX 2523 K / T (D) 171 Kw (2014.01-->)	252718130132, 253418130174, 252718130142, 252718130145, 278618999994	FLG -LF9028	1,262.00
F 002 H23 572	Oil Filter Spin-on		ASHOK LEYLAND- U 4923, 1616 iL, U 3123, Captain 40, Cheetah (D) 88 Kw (2000.11-2005.03), U 2523, RE SLF, U 2518, 3118, 3518, 3120 iL, FE SLF, U 4019 iL, 4923, 1616 XL (D) 124 Kw (2010.08-->), 2523, 4023, 2518 (D) 135 Kw (2010.10-->), 1616 iL 5.7, 12M (D) 165 Kw (2014.01-->), U 4023, 2518 (D) 132 Kw (2014.01-->), U 3518 5.7, 4019iL, U 3723, 1616 XP (D) 124 Kw (2010.08-->), 3123, 1616 H (D) 123 Kw (2006.04-2010.10), 12M (D) 118 Kw (2010.10-->), 3116 (D) 118 Kw (2010.10-->), U 2516	F7A05000, F7A05000, F7A01500	FLG -LF16238	1,577.00
F 002 H24 250	Oil Filter Spin-on		PIAGGIO- Ape Mini			176.00
F 002 H24 322	Oil Filter Spin-on		MAHINDRA- Maxximo 0.9D, Supro Maxitruck T2/T4/T6, Maxximo Mini VX	0303BAU00110N		193.00





### Filter Application Chart

Part Number	Product Description	Image	Model Description 	Potential OE Part No	Potential Comp. Part No	MRP (₹)
F 002 H24 502	Oil Filter Spin-on		TATA MOTORS- LPK 2518 6x4	278618139902, 278618999976		395.00
F 002 H24 519	Oil Filter Spin-on		TATA MOTORS- Prima LX 4928 S, Prima LX 4028 S, Prima 2528 K 6x4, Prima 4928 S, Prima 3128 K 8x4, Marcopolo 1628 Divo, LPO 1616 BS-IV, Prima LX 4023 S, LPT 2521 TC, Prima LX 2523 K / T (D) 171 Kw (2014.01-->)	570118999901	FLG -LF1601500	1,167.00
F 002 H26 313	Oil Filter Spin-on		ASHOK LEYLAND- Sunshine	FPA00300	FLG -LF16309	710.00
F 002 H26 360	Oil Filter Spin-on		TATA MOTORS- Signa 4018.S BS IV, LPTK 2518 BS III, LPK 2523 BS IV Tipper, LPS 3518 BS IV, LPT 3718 BS IV, LPK 1923 BS-IV, Signa 4223 BS IV, Signa 2818.T BS-IV, LPT 1615 TC BS IV, LPK 1918 BS IV, LPT 2518 BS IV, LP 1515 BS IV, Signa 2823.TK BS IV, LPK 1618 BS IV, LPK 2818 BS IV, LPT 4223 BS IV, LPT 3518 BS-IV, LPO 1515 BS IV, Signa 2523.K BS IV, Signa 2518.TK BS IV, LPT 2818 BS IV, LPTK 3118 BS-IV, LPS 4018 BS IV, Signa 3518.S BS IV, LPT 1918 BS IV, LPT 2518/62 TC BS3 (D) 135 Kw (2014.01-->), LPK 3518 TC BS-IV, LPK 3118 BS IV, Signa 1615 BS IV, Signa 3118.TK BS IV, LPT 3118 BS IV, SIGNA 3718.T BS IV, LPK 2518 HD (D) 135 Kw (2010.08-->), LPK 1615 BS IV, LPK 2518 BS IV, Signa 1923.K BS-IV, LPK 2823 BS IV	278618139902, 252718990139, 252718130145, 278618999994		1,430.00
F 002 H26 361	Oil Filter Spin-on		EICHER- Skyline Pro 3008, Pro 3015 TCI BS IV, Pro 3012 TCI BS IV; EICHER MOTORS LIMITED- Pro 1110XP BS IV, STARLINE 12.12K BS IV, Pro 1110 BS IV	ID321716		1,995.00



### Filter Application Chart

Part Number	Product Description	Image	Model Description 	Potential OE Part No	Potential Comp. Part No	MRP (₹)
F 002 H26 363	Oil Filter Spin-on		MAHINDRA- Blazo X 28 BS6, Blazo 25 Tipper, Blazo 31, Blazo X 40 BS6, Blazo X 42 BS6, Blazo 49, Blazo X 55 BS6, Blazo 40 Tip trailer, Blazo X 35 BS6, Blazo 37, Blazo X 46 BS IV, Blazo 25, Blazo 31 Tipper, Blazo X 49 BS6, Blazo X 35 BS IV, Blazo 35, Blazo X 55 BS IV, Blazo X 40 BS IV, Blazo X 49 BS IV, Blazo X 28 BS IV, Blazo 40, Blazo X 42 BS IV, Blazo X 46 BS6	0303BAV00510N		815.00
F 002 H26 539	Oil Filter Spin-on		MAHINDRA- Bolero Maxi Truck Plus, Bolero Camper BS6, Imperio 2.5, Bolero Pik up BS6 4WD, Bolero Pik up ExtraLong BS6, Bolero Pik up, Bolero Pik up ExtraStrong BS6, Bolero Maxi Truck Plus BS6	0303BAM00350N	MHL -OC1692	268.00
F 002 H27 505	Oil Filter Spin-on		EICHER MOTORS LIMITED- Pro 1090 BS IV, Pro 1095XP BS IV, Pro 1080XPT BS IV; EICHER- Pro 1075	ID337989		1,366.00
F 002 H60 001	Oil Filter Spin-on		TATA MOTORS- Venture 1.4D (D) 37 Kw (2011.01 -2016.01), Ace SuperAce 1.4 (D) 52 Kw (2009.12 -2012.10)	279018130104, 279018130106, G279018130103, 279018130105		505.00
F 002 H60 022	Oil Filter Spin-on		ASHOK LEYLAND- Stag, Cheetah (D) 122.8 Kw (2005.11-->), 2214 6x2 (H), 12M (D) 130 Kw (2005.04 -2010.10), Cheetah (D) 97 Kw (2005.04 -2010.10), Cargo 1613H, 12M (D) 130 Kw (2006.11 -2010.10), 4019, 2513, Viking (D) 123 Kw (2011.01-->), 2518 (D) 132 Kw (2008.01 -2010.10), 3516, Comet 1613H, Artik 3516, 1616 XL (D) 124 Kw (2010.08-->), 2516 6x2 (H), 1612 H, 1616 H (D) 121 Kw (2006.04 -2010.10), Ecomet 1012 Smart, 2514, Cheetah (D) 84 Kw (1995.04 -2010.10), 3014, 1616 XP (D) 124 Kw (2010.08-->), 1616 H (D) 123 Kw (2006.04 -2010.10), 2516 6x4 (H) 4x4, 3116 (D) 118 Kw (2010.10-->), 3116 (D) 118 Kw (2009.07 -2010.10), 4921	X4000600, F4034200, F7A05000, B8774802, F7A01500, X4001000, F4034500	FLG -LF16079	304.00



### Filter Application Chart

Part Number	Product Description	Image	Model Description 	Potential OE Part No	Potential Comp. Part No	MRP (₹)
F 026 407 022	Oil Filter Spin-on		NISSAN- Evalia [M20M] (D) 63 Kw (2012.09-->)	1520800Q0D		517.00
F 026 407 043	Oil Filter Spin-on		VOLVO- FM (D) 339 Kw (2009.05-->), FM 7 290 (D) 210 Kw (1999.03 -2001.05), FM (D) 338 Kw (2013.04-->), FM 9 (D) 221 Kw (2002.12 -2005.08), FH, FH 12 (D) 338 Kw (1998.08 -2001.11), FM (D) 294 Kw (2006.09 -2012.02), FM 12 (D) 280 Kw (2003.09 -2005.09), FM (D) 250 Kw (2006.05 -2009.07), FM (D) 309 Kw (2013.04-->)			On Request
F 026 407 176	Oil Filter Spin-on		NISSAN- Evalia [M20M] (D) 63 Kw (2012.09-->)	1520800Q1D		On Request
F 002 H21 219	Safety Element Air Filter, Engine		TATA MOTORS- 2515 TC LPT, 1512 LP/LPO TC BS-III (D) 114 Kw (2005.02-->)	278609139911		541.00

### Filter Application Chart

Part Number	Product Description	Image	Model Description 	Potential OE Part No	Potential Comp. Part No	MRP (₹)
F 002 H21 219	Safety Element Air Filter, Engine		ASHOK LEYLAND- 2518 BS II, Cheetah (D) 118 Kw (2014.01-->), Viking BS IV (D) 123 Kw (2016.12-->), Cheetah (D) 122.8 Kw (2005.11-->), RE SLF BS III, U 3723 (D) 165 Kw (2012.01-->), Cheetah (D) 88 Kw (2000.11 -2005.03), 2517 BS II, 4018, 12M (D) 130 Kw (2006.11 -2010.10), 3118 BS IV (D) 134 Kw (2015.12-->), Viking BS III, Viking (D) 123 Kw (2005.05-->), 2516, 4019 (D) 130 Kw (2008.11 -2010.10), Taurus 2516 6x2, 1614 BS III, VESTIBULE BS III, 2518 (D) 132 Kw (2008.01 -2010.10), 2518 (D) 135 Kw (2010.10-->), 12M FE BS III, 2521 BS II, Double Decker BS III, Tusker 3516, Viking BS IV (D) 116 Kw (2008.12-->), 2516 il, 4023 (D) 165 Kw (2011.03-->), 2516 S, 3014 BS II, 2518T BS II, 3118 (D) 135 Kw (2010.08-->), Cheetah (D) 135 Kw (2014.01-->), 3123, 12M (D) 118 Kw (2010.10-->), 1618 BS IV (D) 134 Kw (2015.12-->), Viking 160HP IL FIP BS3, 1616 H, Captain 3723 BS IV, 1616 XL, 1616 XP, 3516 Super, 12M (D) 130 Kw (2005.04 -2010.10), 3518 BS IV, 12M FESLF BS IV, 2523 (D) 165 Kw (2014.01-->), Viking BS IV (D) 97 Kw (2017.06-->), 2516 BS II, 2518 BS IV (D) 134 Kw (2018.12-->), 3718 iL (D) 132 Kw (2014.01-->), Viking (D) 123 Kw (2011.01-->), 1616 iL (D) 118 Kw (2010.08-->), 3516, Artik 3516, 4123 BS IV, 1616 XL BS III (D) 119 Kw (2015.05-->), 2516 6x2 (H), 3121, Viking 180HP ROTARY FIP EDC BS3, 12M FE BS IV, 11M FESLF BS IV, Taurus 2516 6x4, 3116, U-2518 IL T HD BS IV (D) 134 Kw (2015.12-->), 3718 iL BS III, 3718 BS IV (D) 134 Kw (2015.12-->), 2516 6x4 (H) 4x4, 4921	F8221300, F8221200, F8211200, F8211300		541.00

### Filter Application Chart

Part Number	Product Description	Image	Model Description 	Potential OE Part No	Potential Comp. Part No	MRP (₹)
F 002 H21 296	Safety Element Air Filter, Engine		TATA MOTORS- SE 1613, LP 1613 SuperMilo (D) 96 Kw (2008.07 -2010.10), LPT 1613 (D) 96 Kw (1997.05 -2001.12), 1510 LP/LPO BS-II (D) 96 Kw (2005.03 -2010.10), LPT 2515 Turbo EX 6x2 (D) 104 Kw (2005.02 -2010.10)	252509140133		565.00
F 002 H23 561	Safety Element Air Filter, Engine		TATA MOTORS- LPTK 2518 BS III, LPK 2523 BS IV Tipper, LPT 2518, LP 1512 BS III (D) 93 Kw (2008.03-->), 1510 LP/LPO BS-II (D) 96 Kw (2005.03 -2010.10), LPO 1616 TC BS-II, LPK 1923 BS-IV, Prima LX 2525.K BS IV, LPT 1616 697 Super Turbo BS-II, LPO 1612 TC BS-III, LPT 1613 (D) 100 Kw (2014.01-->), LPK 1918 BS IV, LPS 3518, Signa 2823.TK BS IV, LPT 3118, LPK 1618 BS IV, SK 1616, LP/LPO 1615 697 BS-III, LP 913 BS IV CNG, LPK 2518 6x4 (D) 129 Kw (2007.12 -2010.10), Prima 2528 K 6x4, LPK 3118 BS III, LPK 2818 BS IV, LPT 3718, LPO 1618, LPT 1616 BS-III, LPK 2518 HD, LPT 2518/62 TC BS3, LPT 2516 TC 6x2, Signa 2523.K BS IV, LPS 4018, Signa 2518.TK BS IV, Prima LX 3125.K BS IV, LPK 1613 5.7 BS-III, Prima LX 2823.TK BS-IV, LPK 3518 TC BS-IV, LPK 3118 BS IV, LPT 1613 Turbo EX, Prima LX 3123.K BS III, LPK 1618 BS-III, LPT 1613 BS III (D) 102 Kw (2016.06-->), LPK 1615 BS IV, LP 1613 SuperMilo (D) 96 Kw (2008.07 -2010.10), LPK 2518 BS IV, LPT 3723 TC, LPO 1512 BS II, Signa 1923.K BS-IV, LPK 1616 BS-III, Prima LX 2523.K BS-III, LP 1112 BS IV, LPO 1612 TC BS-II, LPK 2823 BS IV, 1512 LP/LPO TC BS-III (D) 114 Kw (2005.02-->), LPK 1618, LPT 2515 EX 6x2, Prima LX 2825.K HRT BS IV	409024000216, 278609139910, 278609139909, 885409052516, 278609139911, 278609139912, 278609139936, 278609139935, 278609139908	FLG -8200068, AF4669	2,158.00



### Filter Application Chart

Part Number	Product Description	Image	Model Description 	Potential OE Part No	Potential Comp. Part No	MRP (₹)
F 002 H23 563	Safety Element Air Filter, Engine		TATA MOTORS- LPK 2516 TC 6x4 BS-II, LPK 1613, Signa 4018.S BS IV, LPT 2516 Super Turbo, LPS 3518 BS IV, LPT 1913 BS-IV, LP 1512 BS III (D) 93 Kw (2008.03-->), LPTK 3118 BS III, LPT 3718 BS IV, LPK 2518 BS III, LPK 1613 BS IV, Signa 2818.T BS-IV, LPT 1615 TC BS IV, LPT 2513, LPT 2518 BS IV, LP 1515 BS IV, 1512 TC LP, LPS 3516, LPT 1613 /62 TC, LPK 2518 6x4 (D) 129 Kw (2007.12 -2010.10), LPT 4223 BS IV, LPT 3518 BS-IV, LP 1512 BS-IV, LPO 1512 TC SLF, LPO 1515 BS IV, LPO 1613 BS IV, LPO 1512 TC, LPK 1615 BS III, LPT 2518 BS III, 1512 LP 497 BS-III, LPT 2818 BS IV, LPT 1618 BS-III, LPTK 3118 BS-IV, SE 1613 BS IV, Signa 3518.S BS IV, LPS 4018 BS IV, LP 1613 BS IV, LPT 1918 BS IV, LPT 2515 Turbo EX 6x2 (D) 104 Kw (2005.02 -2010.10), Signa 1615 BS IV, LPO 1515 BS III, Signa 3118.TK BS IV, SIGNA 3718.T BS IV, LPT 3118 BS IV, LPT 1613 BS III (D) 102 Kw (2016.06-->), LPT 1618 BS IV, LP 1613 SuperMilo (D) 96 Kw (2008.07 -2010.10), LPO 1613 CNG, LPT 1613 EX, LPT 1613 BS IV, LPT 2518 BS II, LPO 1512 BS-IV	278609139910, 278609139909, 278609139911, 885409041613, 278609139908	FLG -8200069	1,950.00
F 002 H23 564	Safety Element Air Filter, Engine		ASHOK LEYLAND- 2214 6x2 (H) (D) 84 Kw (2005.07 -2009.07), Stag (D) 88 Kw (2002.01 -2005.03)	F8221300, F8221200, F8845900, F8845800, X7423500	FLG -AF26074	1,408.00
F 002 H23 567	Safety Element Air Filter, Engine		ASHOK LEYLAND- 2214 6x2 (H) (D) 84 Kw (2005.07 -2009.07), eComet 1109 3.8, Stag (D) 88 Kw (2002.01 -2005.03), 2214 Super	X3962700	FLG -AF26058	1,491.00

### Filter Application Chart

Part Number	Product Description	Image	Model Description 	Potential OE Part No	Potential Comp. Part No	MRP (₹)
F 002 H23 589	Safety Element Air Filter, Engine		ASHOK LEYLAND- 2518 (D) 135 Kw (2010.10-->), U 4923, U 3518, U-2518-IL-T HD BS III (D) 134 Kw (2016.08-->), U 4023, U 3123, 2518 (D) 132 Kw (2014.01-->), U 1616, Captain 40, U-3118, U 2518, U 3718 BS IV (D) 132 Kw (2014.12-->), 3518, 4023 (D) 165 Kw (2011.03-->), 4019il, 3120 il, 3118 (D) 135 Kw (2010.08-->), 4019 (D) 130 Kw (2008.11 -2010.10), 1616 il (D) 118 Kw (2010.08-->), 3518 BS III (D) 134 Kw (2015.12-->), U 4019 il, 2518 (D) 132 Kw (2008.01 -2010.10), 4923, 3118-T BS III	F8365800, F7B01200, F8211200, F7B01300, F7B01400, F7B02100, X8830400, F7B01100, F7B02000, F8211300		3,443.00
F 002 H23 592	Safety Element Air Filter, Engine		EICHER- 10.80 E2 Plus (D) 70 Kw (2009.05 -2010.10), 10.90 E2 Plus, 11.10 E2 Plus			1,600.00
F 002 H23 594	Safety Element Air Filter, Engine		EICHER- Skyline Pro 3008, Pro 1075, 10.59 XP, 10.75, Pro 1110 XP, Pro 1090, 10.80 E2 Plus (D) 70 Kw (2010.10-->), Pro 1110, Pro 3015 TCI BS IV, Pro 1095 XP, Pro 1080, Pro 3012 TCI BS IV, Pro 3013	ID332218, ID370776, ID370777, ID303249, ID303248, ID332219		2,031.00
F 002 H23 594	Safety Element Air Filter, Engine		EICHER MOTORS LIMITED- Pro 3014 BS6, Pro 1080XP BS-IV, Skyline Pro 3011L BS-VI, Pro 3015 BS6, Pro 1055 BS-IV, Pro 2110XP BS-VI, Pro 1075 BS IV, Pro 1095 BS-IV, Pro 2114XP BS-IV, Pro 3014 BS IV, Pro 1059 BS IV, Pro 1110XP BS IV, 2112M Skyline BS-VI, Pro 1059XP BS IV, Skyline Pro 3009H BS-VI, Pro 1110 BS IV, Pro 2110 BS-VI, Pro 3012 BS-III, Pro 3014 BS-IV CNG, Pro 1110XPT BS-IV, Pro 1095XP BS IV, Pro 3019 BS-VI, Pro 2114XP CNG BS-VI, Pro 3015 BS-III, Pro 3016 BS-IV, Skyline Pro 3008 H BS-IV School Bus, Pro 2114XP BS-VI, Skyline Pro 3010L BS-VI, Pro 1090 BS IV, Pro 1080XPT BS IV, Pro 1080 DSD, Skyline Pro 3009L BS-IV School Bus, Pro 1114XP BS-IV, Pro 3012 BS6	ID370776, ID370777, ID303249, ID303248, ID332219		2,031.00

### Filter Application Chart

Part Number	Product Description	Image	Model Description 	Potential OE Part No	Potential Comp. Part No	MRP (₹)
F 002 H23 594	Safety Element Air Filter, Engine		EICHER MOTORS LIMITED- Pro 1049, Pro 1050	ID370776, ID370777, ID303249, ID303248, ID332219		2,031.00
F 002 H24 415	Safety Element Air Filter, Engine		ASHOK LEYLAND- JanBus BS4, 3015 BS II, U 1618, U 3723 (D) 165 Kw (2012.01-->), Cheetah (D) 97 Kw (2005.04 -2010.10), Captain 2518 BS IV, Cargo 1613H, 3118 BS IV (D) 134 Kw (2015.12-->), U 3718 BS IV (D) 132 Kw (2014.12-->), 1618 XP BS III, 3123 BS III, Captain 4923 BS III, N 2523 BS III, Captain 4923 BS IV, Viking (D) 97 Kw (2004.02 -2010.10), N 3123 BS III, 4019 BS IV, Stag (D) 88 Kw (2010.10-->), N 2523 BS IV, Captain 3123 BSIV, U 4019 BS III, SFC 1613 BS III, Comet 1616 BS II, 1618T BS IV, Ecomet 1012 Smart, 1611 BS II, Cheetah (D) 84 Kw (1995.04 -2010.10), Lynx, 3118-T BS IV, 2518 T BS IV, 2518 T BS III, 1618 BS IV (D) 134 Kw (2015.12-->), Lynx BS II, U 2516, U 3518 BS IV, JanBus Midi BS4, Viking (GAS) (2006.01-->), 3718 BSIV, SFC 1613 BS II, Captain 491T BS III, 1616 BS III, 2214 6x2 BS II, U 2523, eComet 912, 2523 (D) 165 Kw (2014.01-->), Viking BS IV (D) 97 Kw (2017.06-->), 2518 BS IV (D) 134 Kw (2018.12-->), 3718 iL (D) 132 Kw (2014.01-->), 2513, U 3118 LA BS IV, Comet 1613H, Captain 3123 BS IV, 1616 XL BS III (D) 119 Kw (2015.05-->), U-2518-IL-T HD BS III (D) 134 Kw (2016.08-->), 1612 H, 2514 BS II, eComet 1112, Captain 2518 HD BS III, U-2518 IL T HD BS IV (D) 134 Kw (2015.12-->), Viking (D) 84 Kw (2004.02 -2010.10), 2514, Ecomet 1012 BS III, 2516 il BS III, U 4019 BS IV, 3014, U-2518 T BS IV, Viking BS II, 4019 BSIV, 3718 BS IV (D) 134 Kw (2015.12-->), 3518 BS III (D) 134 Kw (2015.12-->), U 4923 BS IV, 12M (D) 84 Kw (2014.10-->)	F8221300, F8221200, F7B01200, F8348900, F7B01100, F8845900, F8348800, F8845800		2,540.00

### Filter Application Chart

Part Number	Product Description	Image	Model Description 	Potential OE Part No	Potential Comp. Part No	MRP (₹)
F 002 H24 418	Safety Element Air Filter, Engine		TATA MOTORS- LPK 407 BS II, 712 LPT EX, LPT 1109 HEX2 CR, 709 LPT HEX2, LP 912, 709 SFC EX, LPT 810 Ex2 BS III, LPT 407 EX BS-IV, LPT 407, LPT 809 EX, LPT 1109, LPT 407 EX2 BS-IV, LPT 1112, LP 909 49 BS III CNG, LPT 407 EX2 CNG BS-IV, 709 LP Bus, LPT 1109 HEX2, LP 708 BS III, LPT 810 Ex2 BS IV, 712 LP Bus, 709 LPT EX Turbo, LPT 909 EX, LP 709 BS III, LPT 709 BS IV, LPT 1109 EX, SFC 909 EX, LP 909, LP 407 CNG BS III, LPT 912, LPK 909, LP 912 TCIC BS IV	252709130329, 253409130306, 253409140132, 885409010410, 253409140133, 253409130305, 252709130330, 278618999994	FLG -5005192	2,755.00
F 002 H24 418	Safety Element Air Filter, Engine		TATA MOTORS- LP 410, 407 3.0D SFC Pickup, 407 SFC 3.0, 407 3.0 Diesel SFC Turbo, 410 Turbo SFC 3.0 Diesel, 407 3.0 Diesel LP Turbo Bus, 407 3.0 Diesel LPT, 407 3.0D SFC EX Turbo	252709130329, 253409130306, 253409140132, 885409010410, 253409140133, 253409130305, 252709130330, 278618999994	FLG -5005192	2,755.00
F 026 400 364	Safety Element Air Filter, Engine		VOLVO- FM 9, FM 7 290, FM			On Request
F 026 400 601	Safety Element Air Filter, Engine		SCANIA- P-Serie	1869991		On Request
F 026 400 644	Safety Element Air Filter, Engine		VOLVO- FH			On Request
F 026 404 003	Transmission Oil Filter		VOLVO- FM (D) 339 Kw (2009.05-->), FH (D) 382 Kw (2006.09 -2011.12), FM 9 (D) 221 Kw (2002.12 -2005.08), FM 12 (D) 280 Kw (2003.09 -2005.09), FM (D) 250 Kw (2006.05 -2009.07)			On Request
F 026 404 004	Transmission Oil Filter		VOLVO- FM (D) 339 Kw (2009.05-->), FH (D) 382 Kw (2006.09 -2011.12), FM 9 (D) 221 Kw (2002.12 -2005.08), FM 7 290, FM 12 (D) 280 Kw (2003.09 -2005.09), FH 12, FM (D) 250 Kw (2006.05 -2009.07)			On Request



### Filter Application Chart

Part Number	Product Description	Image	Model Description 	Potential OE Part No	Potential Comp. Part No	MRP (₹)
F 026 404 019	Transmission Oil Filter		VOLVO- FM (D) 338 Kw (2013.04-->), FM (D) 309 Kw (2013.04-->)			On Request
F 026 407 118	Transmission Oil Filter		VOLVO- B 7 R			On Request
F 026 407 284	Transmission Oil Filter		VOLVO- FM (D) 339 Kw (2009.05-->), FM (D) 338 Kw (2013.04-->), FM (D) 309 Kw (2013.04-->)			On Request



### NPI Filter Application Chart

Part Number	Product Description	Image	Model Description 	Potential OE Part No	Potential Comp. Part No	MRP (₹)
F 002 H21 295	Air Filter Element Primary, Engine		TATA MOTORS- LP 1613 SuperMilo (D) 96 Kw (2008.07 -2010.10), LPT 1613 (D) 96 Kw (1997.05 -2001.12), 1510 LP/LPO BS-II (D) 96 Kw (2005.03 -2010.10), LPT 2515 Turbo EX 6x2 (D) 104 Kw (2005.02 -2010.10), SE 1613 (D) 102 Kw (2015.01-->)	252509140134		1,480.00
F 002 H23 561	Air Filter Element Primary, Engine		TATA MOTORS- LPTK 2518 BS III, LPK 2523 BS IV Tipper, LP 1512 BS III (D) 93 Kw (2008.03-->), 1510 LP/LPO BS-II (D) 96 Kw (2005.03 -2010.10), Prima LX 2525.K BS IV, LPT 1613 (D) 100 Kw (2014.01-->), LPK 1918 BS IV, LPS 3518, Signa 2823.TK BS IV, LPK 1615 BS IV (D) 118 Kw (2017.05-->), LPT 3118, Marcopolo 1625 LF, LP 913 BS IV CNG, LPK 2518 6x4 (D) 129 Kw (2007.12 -2010.10), Prima 2528 K 6x4, LPK 2818 BS IV, LPO 1618, LPT 1616 BS-III, LPT 2518/62 TC BS3, LPT 2516 TC 6x2, LPS 4018, Prima LX 2823.TK BS-IV, LPK 3118 BS IV, Signa 3118 T, LPT 1613 Turbo EX, LPK 2518 BS IV, LPO 1612 TC BS-II, Signa 1923.K BS-IV, LPK 2823 BS IV, LPT 2515 EX 6x2, Prima LX 2825.K HRT BS IV, LPT 2518, LPO 1616 TC BS-II, LPK 1923 BS-IV, LPT 1616 697 Super Turbo BS-II, LPO 1612 TC BS-III, LPK 2516 6x2, LPK 1618 BS IV, SK 1616, LP/LPO 1615 697 BS-III, Signa 2518.TK BS IV (D) 134 Kw (2017.12-->), LPS 3516 EX, LPT 3718, LPK 2518 HD, Signa 2523.K BS IV, Prima LX 3125.K BS IV, LPK 1613 5.7 BS-III, Prima LX 2523 K / T, LPK 3518 TC BS-IV, Prima LX 3123.K BS III, LPK 1618 BS-III, LPT 1613 BS III (D) 102 Kw (2016.06-->), LP 1613 SuperMilo (D) 96 Kw (2008.07 -2010.10), LPT 3723 TC, LPO 1512 BS II, LPK 1616 BS-III, Prima LX 2523.K BS-III, LP 1112 BS IV, LPK 1618, LPK 3118 BS III (D) 134 Kw (2017.12-->)	409024000216, 278609139910, 278609139909, 885409052516, 278609139911, 278609139912, 278609139936, 278609139935, 278609139908	FLG -8200068, AF4669	2,158.00

### NPI Filter Application Chart

Part Number	Product Description	Image	Model Description 	Potential OE Part No	Potential Comp. Part No	MRP (₹)
F 002 H23 563	Air Filter Element Primary, Engine		TATA MOTORS- Signa 4018.S BS IV, LPT 1913 BS-IV, LP 1512 BS III (D) 93 Kw (2008.03-->), LPTK 3118 BS III, LPK 2518 BS III, 1512 TC LP, LPK 1615 BS IV (D) 118 Kw (2017.05-->), LPS 3516, LPK 2518 6x4 (D) 129 Kw (2007.12 -2010.10), LPT 1613 TC, LPT 4223 BS IV, LPT 3518 BS-IV, LP 1512 BS-IV, LPK 1615 BS III, 1512 LP 497 BS-III, LPT 2818 BS IV, LPS 4018 BS IV, Signa 3518.S BS IV, 2515 TC LPT, LPT 1918 BS IV, Signa 1615 BS IV, Signa 3118.TK BS IV, LPT 1618 BS IV, LPO 1613 CNG, LPT 1613 EX, LPT 1613 BS IV, LPO 1623 BS IV CNG, LPO 1512 BS-IV, LPK 2516 TC 6x4 BS-II, 1512 LP/LPO TC BS-III, LPK 1613, LPT 2516 Super Turbo, LPS 3518 BS IV, LPT 3718 BS IV, LPK 1613 BS IV, Signa 2818.T BS-IV, LPT 1615 TC BS IV, LPT 2513, LPT 2518 BS IV, LP 1515 BS IV, Signa 2518.TK BS IV (D) 134 Kw (2017.12-->), LPT 1613 /62 TC, SE 1613 (D) 102 Kw (2015.01-->), LPO 1512 TC SLF, LPO 1515 BS IV, LPO 1613 BS IV, LPO 1512 TC, LPT 2518 BS III, LPT 1618 BS-III, LPTK 3118 BS-IV, SE 1613 BS IV, LP 1613 BS IV, LPT 2515 Turbo EX 6x2 (D) 104 Kw (2005.02 -2010.10), LPO 1515 BS III, SIGNA 3718.T BS IV, LPT 3118 BS IV, LPT 1613 BS III (D) 102 Kw (2016.06-->), LP 1613 SuperMilo (D) 96 Kw (2008.07 -2010.10), LPO 1623 BS III CNG, LPT 2518 BS II, LPK 3118 BS III (D) 134 Kw (2017.12-->)	278609139910, 278609139909, 278609139911, 885409041613, 278609139908	FLG -8200069	1,950.00

### NPI Filter Application Chart

Part Number	Product Description	Image	Model Description 	Potential OE Part No	Potential Comp. Part No	MRP (₹)
F 002 H23 564	Air Filter Element Primary, Engine		TATA MOTORS- LP 1109 3.7, 709 LPT EX Turbo (D) 66 Kw (2005.01-->), LP 912 (D) 92 Kw (2010.10-->), LPT 1109 HEx2 CR (D) 92 Kw (2014.01-->), SFC 909 EX (D) 66 Kw (2008.05 -2010.10), LPT 909 EX (D) 66 Kw (2005.03 -2010.10), 909, LPT 1109 (D) 66 Kw (2003.09 -2007.04), LPT 1109 EX (D) 66 Kw (2007.05 -2010.10), 712 LP Bus (D) 92 Kw (2005.04-->), 709 LPT HEx2 (D) 92 Kw (2014.01-->), LPT 1109 HEx2 (D) 92 Kw (2014.01-->), LPT 909 EX (D) 92 Kw (2010.10-->), LPT 1109 EX (D) 92 Kw (2010.10-->), 709 LP Bus (D) 66 Kw (2005.04-->), LPT 912 (D) 92 Kw (2005.05-->), LPT 809 EX (D) 66 Kw (2008.02-->)	253409130306	FLG -AF26074	1,408.00
F 002 H23 564	Air Filter Element Primary, Engine		ASHOK LEYLAND- 2214 6x2 (H) (D) 84 Kw (2005.07 -2009.07), Stag (D) 88 Kw (2002.01 -2005.03)	F8221300, F8221200, F8845900, F8845800, X7423500	FLG -AF26074	1,408.00



### NPI Filter Application Chart

Part Number	Product Description	Image	Model Description 	Potential OE Part No	Potential Comp. Part No	MRP (₹)
F 002 H23 589	Air Filter Element Primary, Engine		ASHOK LEYLAND- 2518 BS II, U 4923, 1616 iL, Cheetah (D) 118 Kw (2014.01-->), Cheetah (D) 122.8 Kw (2005.11-->), U 3123, RE SLF BS III, U 3723 (D) 165 Kw (2012.01-->), U-3118, Cheetah (D) 88 Kw (2000.11 -2005.03), 2517 BS II, U 2518, 4018, 12M (D) 130 Kw (2006.11 -2010.10), 3118 BS IV (D) 134 Kw (2015.12-->), U 3718 BS IV (D) 132 Kw (2014.12-->), 3118, Viking BS III, 3518, 4019, Viking (D) 123 Kw (2005.05-->), 1614 BS III, 3518 BS IV (D) 134 Kw (2015.12-->), U 4019 iL, VESTIBULE BS III, 4923, 1616 iL 5.7, 12M FE BS III, 2521 BS II, U 1616, Double Decker BS III, 1618 BS IV, Tusker 3516, 2516 iL, 2516 S, 4019iL, 3014 BS II, 2518T BS II, Cheetah (D) 135 Kw (2014.01-->), 3123, 12M (D) 118 Kw (2010.10-->), Viking BS IV, Viking 160HP IL FIP BS3, Captain 3723 BS IV, 1616 H, 1616 XL, U 3518, 1616 XP, 12M (D) 130 Kw (2005.04 -2010.10), Captain 40, 12MIFESLF BS IV, 2523 (D) 165 Kw (2014.01-->), 2516 BS II, 2518 BS IV (D) 134 Kw (2018.12-->), 3718 iL (D) 132 Kw (2014.01-->), Viking (D) 123 Kw (2011.01-->), 3118-T BS III, 4123 BS IV, 4023, 1616 XL BS III (D) 119 Kw (2015.05-->), U 4023, U-2518-IL-T HD BS III (D) 134 Kw (2016.08-->), 4019 5.6, Viking 180HP ROTARY FIP EDC BS3, 3121, 12M FE BS IV, 11M FESLF BS IV, 3116, 4018H BS III, U 3518 5.7, U-2518 IL T HD BS IV (D) 134 Kw (2015.12-->), 3718 iL BS III, 2516 iL BS III (D) 119 Kw (2012.12-->), 3718 BS IV (D) 134 Kw (2015.12-->), 3518 BS III (D) 134 Kw (2015.12-->), 2516 6x4 (H) 4x4, 2518, 4921	F8365800, F7B01200, F8211200, F7B01300, F7B01400, F7B02100, X8830400, F7B01100, F7B02000, F8211300	3,443.00	
F 002 H24 902	Air Filter Element Primary, Engine		TATA MOTORS- Ace SuperAce 1.4	286409139904		520.00

### NPI Filter Application Chart

Part Number	Product Description	Image	Model Description 	Potential OE Part No	Potential Comp. Part No	MRP (₹)
F 002 H60 006	Air Filter Element Primary, Engine		EICHER- 11.10, 10.95; SWARAJ MAZDA- T3500 Prestige, T3500 Prestige WT49LWB, Prestige WT49TC, T3500 Bus WT-48, Prestige WT-48, Premium T3500 WT 49 ESA, 4WD-BT 3.5D, T3500 3.5 Diesel 4WD, T3500 Truck/Dumper WT, T3500 Prestige WT49STD			950.00
F 002 H60 006	Air Filter Element Primary, Engine		TATA MOTORS- 609 SFC 3.8 Diesel, 709 LP Bus (D) 66 Kw (2005.04-->), 709 LP Bus (D) 66 Kw (1995.05 -1997.09), LP 609 Turbo Bus	252709130248		950.00
F 002 H60 006	Air Filter Element Primary, Engine		TATA MOTORS- 407 3.0D SFC EX Turbo (D) 55 Kw (2005.05 -2017.03), 407 3.0 Diesel LPT Turbo, 407 3.0 Diesel LP Turbo Bus (D) 55 Kw (2006.01-->), 407 3.0 Diesel SFC Turbo Bus, 407 3.0 Diesel LPT (D) 53 Kw (2001.10 -2005.02), 407 3.0D Cityride NA, 407 3.0 Diesel LP, 407 3.0, 407 LP Turbo Bus 3.0, 407 3.0 4WD, 407 Citiride 3.0, Cityride 407, 609 3.8 Diesel LP, 407 TurboBus SWB 3.0 D, 407 3.0 Diesel, Starbus 3.0, LP 410 (D) 75 Kw (2004.07 -2010.10)	252709130248		950.00
F 002 H23 561	Air Filter Element, Engine		ASHOK LEYLAND- Cheetah, 2516, 2516 6x2 (H), Taurus 2516 6x2, 3516 Super, Tusker 3516, Taurus 2516 6x4, 4018, 3516, 2516 iL, Artik 3516	F8211300	FLG -8200068, AF4669	2,158.00
F 002 H23 567	Air Filter Element, Engine		EICHER- 11.10		FLG -AF26058	1,491.00
F 002 H23 585	Air Filter Element, Engine		MAHINDRA- Imperio 2.5, Genio 2.5D	0313AAC04390N		977.00
F 002 H23 592	Air Filter Element, Engine		EICHER- 10.90 E2 Plus, 10.80 E2 Plus, 11.10 E2 Plus			1,600.00







### NPI Filter Application Chart

Part Number	Product Description	Image	Model Description 	Potential OE Part No	Potential Comp. Part No	MRP (₹)
F 002 H26 531	Air Filter Element, Engine		MAHINDRA- SUPRO MAXITRUCK, Supro Minitruck BS6, Supro Maxitruck T2/T4/T6			490.00
F 002 H26 532	Air Filter Element, Engine		TATA MOTORS- Ace XL 0.7D, Ace Gold, ACE MAGIC 0.7, ACE Magic CNG BS-IV, Ace Gold Petrol BS6, ACE Mega XL BS III, ACE MAGIC, ACE Magic CNG BS III, Ace Gold CNG BS6, Ace (BS IV) 0.8, Ace Mega XL 0.8D D, Ace Gold BS6			340.00
F 002 H23 561	Air Filter Set, Engine		TATA MOTORS- LPT 1613, LPK 1613 5.7 BS-III, LPT 2518, LPO 1616 TC BS-II, LPT 1616 697 Super Turbo BS-II, Signa 3118 T, LPO 1612 TC BS-III, LPS 3518, LPT 3118, LPK 2516 6x2, Marcopolo 1625 LF, SK 1616, LPK 1618 BS-III, LP/LPO 1615 697 BS-III, LPS 3516 EX, LPT 3723 TC, LPT 3718, LPO 1612 TC BS-II, LPO 1618, LPK 1616 BS-III, LPK 2518 HD, LPT 2516 TC 6x2, LPT 2518/62 TC BS3, LPT 1616 BS-III, LPS 4018, LPK 1618, LPT 2515 EX 6x2	409024000216, 278609139910, 278609139909, 885409052516, 278609139911, 278609139912, 278609139936, 278609139935, 278609139908	FLG -8200068, AF4669	2,158.00
F 002 H23 562	Air Filter Set, Engine		EICHER- 11.10			1,128.00
F 002 H23 563	Air Filter Set, Engine		TATA MOTORS- LPK 1613, LPT 1613 /62 TC, LPT 1613 TC, LPO 1613 CNG, LPO 1512 TC SLF, LPT 1613 EX, LPT 2513, 1512 LP 497 BS-III, 1512 TC LP	278609139910, 278609139909, 278609139911, 885409041613, 278609139908	FLG -8200069	1,950.00
F 002 H23 563	Air Filter Set, Engine		EICHER- 10.90 L 40	ID202373	FLG -8200069	1,950.00
F 002 H23 564	Air Filter Set, Engine		ASHOK LEYLAND- eComet 1109 3.8, 2214 6x2 (H), Stag (D) 88 Kw (2002.01 -2005.03), 2214 Super	F8221300, F8221200, F8845900, F8845800, X7423500	FLG -AF26074	1,408.00





### NPI Filter Application Chart

Part Number	Product Description	Image	Model Description 	Potential OE Part No	Potential Comp. Part No	MRP (₹)
F 002 H23 589	Air Filter Set, Engine		ASHOK LEYLAND- 1616 iL 5.7, U 4923, 1616 iL, 4023, U 3518, U 4023, 4019 5.6, U 3123, U 1616, Captain 40, U-3118, U 2518, 3118, 3518, U 3518 5.7, 4019iL, 4019, 3123, U 4019 iL, 2518, 4923, 3516	F8365800, F7B01200, F8211200, F7B01300, F7B01400, F7B02100, X8830400, F7B01100, F7B02000, F8211300		3,443.00
F 002 H23 590	Diesel Filter Kit (preliminary And Main Filter)		ASHOK LEYLAND- U 3723, 3123, 12M (D) 130 Kw (2005.04 -2010.10), 2518 (D) 132 Kw (2008.01 -2010.10), 3116 (D) 118 Kw (2009.07 -2010.10)		FLG -FS19636	1,315.00
F 002 H26 311	Fuel Box Filter, Complete		ASHOK LEYLAND- Captain 40	P1302040, F7B02900	FLG -FS19654	2,208.00
F 002 H22 283	Fuel Filter Element		TATA MOTORS- Ace Zip 0.6			352.00
F 002 H22 283	Fuel Filter Element		MAHINDRA- Maxximo 0.9D, Maxximo 0.9D MiniVan, Maxximo Mini VX	1001CAA08951N		352.00
F 002 H22 471	Fuel Filter Element		ASHOK LEYLAND- Dost 1.5TD Strong (D) 43 Kw (2017.09-->), Dost 1.5TD Plus (D) 45 Kw (2017.09-->)			591.00



### NPI Filter Application Chart

Part Number	Product Description	Image	Model Description 	Potential OE Part No	Potential Comp. Part No	MRP (₹)
F 002 H24 496	Fuel Filter Element		MAHINDRA- DI 3200 2.5 Diesel, Bolero Camper 2.5 Diesel 4x4, DI 3200 2.5 Diesel Turbo, Tourister DX, FJ 2.5 Diesel Chassis 4WD, Pik up 2.5 Diesel 4x4, Maxx Pickup 2.5 Diesel 4WD, King Cab 2.5 Diesel, King Cab 2.5 D 4x4, Vikrant 2.5 Diesel	9420000319, 10000A0370N, 0305DAB00581N		227.00
F 002 H24 496	Fuel Filter Element		ASHOK LEYLAND- Stile 1.5, Dost 1.5TD Strong (D) 43 Kw (2017.09-->), Dost 1.5D, Dost 1.5TD Plus (D) 45 Kw (2017.09-->), Dost 1.5TD Xpress	F7B01700		227.00
F 002 H25 924	Fuel Filter Element		MAHINDRA- Cosmo 32 BS IV, Cosmo 40 BS IV			545.00
F 002 H25 926	Fuel Filter Element		EICHER MOTORS LIMITED- Skyline Pro 3011L BS-VI, Pro 2110XP Plus CNG BS-VI, Pro 2110XP Plus BS-VI, Pro 2114XP BS-VI, Skyline Pro 3010L BS-VI, Pro 2110XP BS-VI, 2112M Skyline BS-VI, Pro 3019 BS-VI, Skyline Pro 3009H BS-VI, Pro 2114XP CNG BS-VI, Pro 2110XPT BS-VI, Skyline Pro 3009H CNG BS-VI, Pro 2110 BS-VI			515.00
F 002 H25 993	Fuel Filter Element		TATA MOTORS- Magic Iris, Ace Gold BS6			1,065.00
F 002 H22 001	Fuel Filter Spin-on		ASHOK LEYLAND- U 3518 (D) 132 Kw (2010.10-->), U 4023, U 1619	P1302040		3,657.00



### NPI Filter Application Chart

Part Number	Product Description	Image	Model Description 	Potential OE Part No	Potential Comp. Part No	MRP (₹)
F 002 H23 535	Fuel Filter Spin-on		TATA MOTORS- LPS 3516 EX (D) 115 Kw (2004.01 -2005.09), LPO 1512 TC (D) 94 Kw (2005.10 -2010.10), 2516 TC LPT (D) 118 Kw (2001.03-->), LP 912 (D) 92 Kw (2010.10-->), Novus LPS 4930 6x4 (D) 221 Kw (2007.12 -2010.10), LPK 2523 (D) 173 Kw (2009.07 -2010.10), 1109 LP (D) 66 Kw (2004.01 -2007.04), LPT 1613 (D) 100 Kw (2014.01-->), LPT 1613 /62 TC (D) 92 Kw (2007.12 -2010.10), LPS 3518 (D) 131 Kw (2012.01-->), LPT 2516 TC 6x2 (D) 115 Kw (1998.03 -2000.12), LPT 3118 (D) 135 Kw (2010.09-->), LPT 2515 EX 6x2 (D) 101 Kw (2003.08 -2005.12), LPT 3723 TC (D) 155 Kw (2014.01-->), LPK 2518 HD (D) 135 Kw (2010.08-->), LPT 2518 (D) 135 Kw (2010.08-->), Novus LPK 2530 6x4, 3516 TC LPS (D) 118 Kw (2001.03-->), LPT 3118 (D) 132 Kw (2007.12-->), LPT 1613 EX (D) 88 Kw (2002.08 -2010.10)	278609119904, 278609999920, 278609999822, 278607989916	FLG -FF5522, FS1275	143.00
F 002 H23 535	Fuel Filter Spin-on		TATA MOTORS- 407 3.0 Diesel SFC Turbo Bus, 609 3.8 Diesel LP, 407 3.0 Diesel LP, 407 Citiride 3.0 (D) 55 Kw (2007.12 -2011.09)	278609119904, 278609999920, 278609999822, 278607989916	FLG -FF5522, FS1275	143.00
F 002 H23 582	Fuel Filter Spin-on		EICHER- Skyline Pro 3008, Pro 1110 XP		FLG -FS19644V, FS19644	1,319.00





### NPI Filter Application Chart

Part Number	Product Description	Image	Model Description 	Potential OE Part No	Potential Comp. Part No	MRP (₹)
F 002 H23 582	Fuel Filter Spin-on		TATA MOTORS- LPK 1613, LPT 1616 BS-III (D) 114 Kw (2010.08-->), LP 912 (D) 92 Kw (2010.10-->), LPK 1613 5.7 BS-III (D) 100 Kw (2015.01-->), LPK 909 (D) 92 Kw (2010.10-->), 709 LPT HEX2 (D) 92 Kw (2014.01-->), LPT 1109 HEX2 (D) 92 Kw (2014.01-->), LPT 909 EX (D) 92 Kw (2010.10-->), LPK 1616 BS-III (D) 114 Kw (2010.08-->), LPT 1616 697 Super Turbo BS-II (D) 118 Kw (2009.09 -2010.10), LPO 7.5 3.8TD FBV BS3 Ultra (D) 92 Kw (2011.01-->), LPT 1613 TC, SK 1613 Turbo BS-II, LPT 2516 Super Turbo (D) 118 Kw (2007.12 -2010.10), SE 1613 (D) 102 Kw (2015.01-->), SFC 909 EX (D) 92 Kw (2010.10 -2017.04), LPO 8.5 (D) 92 Kw (2014.02-->), SK 1616 (D) 114 Kw (2010.10-->), 1512 LP 497 BS-III (D) 92 Kw (2005.02-->)	252509120239, 252509120264, 252709119913	FLG -FS19644V, FS19644	1,319.00
F 002 H23 582	Fuel Filter Spin-on		TATA MOTORS- SK 407 (D) 75 Kw (2014.07-->)	252509120239, 252509120264, 252709119913	FLG -FS19644V, FS19644	1,319.00

### NPI Filter Application Chart

Part Number	Product Description	Image	Model Description 	Potential OE Part No	Potential Comp. Part No	MRP (₹)
F 002 H23 590	Fuel Filter Spin-on		ASHOK LEYLAND- 4921 (D) 151 Kw (2014.01-->), 2214 6x2 (H) (D) 84 Kw (2005.07 -2009.07), Cheetah (D) 118 Kw (2014.01-->), Viking 160HP IL FIP BS3 (D) 118 Kw (2014.02-->), eComet 912 (D) 88 Kw (2008.11-->), 3121 (D) 151 Kw (2008.04 -2010.10), U 3723 (D) 165 Kw (2012.01-->), U 1618, U-3118, 12M (D) 130 Kw (2005.04 -2010.10), Cheetah (D) 97 Kw (2005.04 -2010.10), 12M (D) 130 Kw (2006.11 -2010.10), 2523 (D) 165 Kw (2014.01-->), eComet 912 (D) 88 Kw (2005.08 -2010.10), Comet 1611 (D) 88.2 Kw (2004.09 -2010.10), 4019il (D) 132 Kw (2012.12-->), Ecomet 1012 Smart (D) 88 Kw (2010.11-->), eComet 1112 (D) 88 Kw (2005.08 -2010.10), 3123 (D) 165 Kw (2010.08-->), 2516 il (D) 118 Kw (2010.05-->), 3120 il, Viking (D) 123 Kw (2005.05-->), eComet 1112 (D) 88 Kw (2008.11 -2010.10), 2214 Super (D) 97 Kw (2009.07 -2010.10), eComet 1214 (D) 88 Kw (2014.01-->), Stag (D) 88 Kw (2010.10-->), eComet 1212 (D) 88 Kw (2010.10-->), 2518 (D) 132 Kw (2		FLG -FS19636	1,315.00

### NPI Filter Application Chart

Part Number	Product Description	Image	Model Description 	Potential OE Part No	Potential Comp. Part No	MRP (₹)
F 002 H23 590	Fuel Filter Spin-on		008.01 -2010.10), Viking (D) 123 Kw (2005.11 -2009.12), 2514 (D) 97 Kw (2008.02 -2009.07), 4921 (D) 151 Kw (2007.05 -2010.10), 2518 (D) 135 Kw (2010.10-->), Boss 1212 LE (D) 88 Kw (2014.01-->), Boss 912 LE 3.8 (D) 88 Kw (2014.01-->), Viking 180HP ROTARY FIP EDC BS3 (D) 135 Kw (2014.02-->), U 2516 (D) 118 Kw (2010.09-->), 4018 (D) 130 Kw (2004.08 -2009.09), Lynx (D) 88 Kw (2005.05 -2010.10), 2518 (D) 132 Kw (2014.01-->), 3015, Boss 1112 LE (D) 88 Kw (2014.01-->), Taurus 2516 6x4, U 4019 il (D) 132 Kw (2014.01-->), 2513 (D) 97 Kw (2005.08 -2008.01), Viking (D) 84 Kw (2004.02 -2010.10), Cheetah (D) 84 Kw (1995.04 -2010.10), 1616 iL 5.7 (D) 118 Kw (2014.01-->), U 2518 (D) 132 Kw (2010.09-->), 3118 (D) 135 Kw (2010.08-->), 3518 (D) 132 Kw (2010.10-->), Cheetah (D) 135 Kw (2014.01-->), 1613 H (D) 97 Kw (2005.11 -2010.10), Lynx (D) 88 Kw (2010.10-->), Comet 1616H (D) 123 Kw (2009.11 -2010.10), 3116 (D) 118 Kw (2009.07 -2010.10)	FHN00400, F7A04700, FHJ00700, X8820800, P1302140, F8835100, X7471500, F7B02900, P7B00022, FHJ01000, P1301640, F4003400, P1302040, P1301240	FLG -FS19636	1,315.00
F 002 H24 366	Fuel Filter Spin-on		TATA MOTORS- LPT 1109 EX, Ultra 812 BS III, Ultra 912, 909, 709 LPT EX Turbo	252709120254, 252509120264, 252709120259	FLG -FS19660	1,600.00
F 002 H24 518	Fuel Filter Spin-on		TATA MOTORS- Prima LX 4028 S, Prima 4928 S, Prima LX 2523 K / T, Prima LX 4023 S, Prima LX 4928 S, Prima 2528 K 6x4, Prima 3128 K 8x4, Prima LX 4923 S, Marcopolo 1628 Divo, 709 LP E Bus, Prima 4028, 1109 LPT (D) 66 Kw (2000.11-->), Prima 2528 K 6x2, LPT 2521 TC (D) 150 Kw (2014.01-->)	278607999845, 279109110101, 279109110102, 570107999901, 288547704905	FLG -5010516	1,055.00
F 002 H24 863	Fuel Filter Spin-on		MAHINDRA- Cosmo 32 BS IV, Cosmo 40 BS IV			1,685.00



### NPI Filter Application Chart

Part Number	Product Description	Image	Model Description 	Potential OE Part No	Potential Comp. Part No	MRP (₹)
F 002 H25 949	Fuel Filter Spin-on		EICHER MOTORS LIMITED- Skyline Pro 3011L BS-VI, Pro 2110XP Plus CNG BS-VI, Pro 2114XP BS-VI, Pro 2110XP Plus BS-VI, Pro 2110XP BS-VI, Skyline Pro 3010L BS-VI, 2112M Skyline BS-VI, Pro 3019 BS-VI, Skyline Pro 3009H CNG BS-VI, Pro 2110XPT BS-VI, Pro 2114XP CNG BS-VI, Skyline Pro 3009H BS-VI, Pro 2110 BS-VI			1,033.00
F 002 H25 964	Fuel Filter Spin-on		TATA MOTORS- Ultra 3021.S BS6, Ultra 1918.T BS6, T.16 ULTRA BS6, Starbus Ultra SKL LPO 7.5 BS6, T.9 ULTRA BS6, ULTRA 2821.T BS6, T.14 Ultra BS6, T.12 ULTRA BS6, Starbus Ultra SKL LPO 10.2 BS6 Non-AC, Starbus Ultra SKL LPO 10.2 BS6 AC, T7 Ultra BS6, T.10 Ultra BS6, T.11 Ultra BS6			1,980.00
F 002 H22 001	Fuel Filter Spin-on, Fine Filter		ASHOK LEYLAND- U 4023	P1302040		3,657.00
F 002 H23 536	Fuel Filter Spin-on, Fine Filter		TATA MOTORS- LPT 909 BS IV, LP 9.6T BS III, LPT 1109 Hex2 CR, 709 LPT Hex2, LPT 1913 BS-IV, 709 LPT EX Turbo (D) 66 Kw (2005.01-->), LPT 1109 Hex2, LPK 1613 BS IV, LPT 1616 697 Super Turbo BS-II, LPT 1613 Turbo EX, LPT 810 Ex2 BS IV, LPT 1613 BS III, SE 1613 Turbo BS-II, LP 9.6T BS IV, LPT 709 BS IV, SK 1613 Turbo BS-II, LP 1112 BS IV, LPT 1613 BS IV, LPO 1613 BS IV	252509120239, 252709110136, 252709119913, 278609999951	FLG -FF5479	143.00
F 002 H23 590	Fuel Filter Spin-on, Fine Filter		ASHOK LEYLAND- 12M (D) 165 Kw (2014.01-->), 12M FESLF BS IV (D) 123 Kw (2014.12-->), Cheetah (D) 118 Kw (2014.01-->), Viking BS IV (D) 123 Kw (2016.12-->), SFC 1613 BS II, Captain 49IT BS III, 12M FESLF, eComet 1112, Tusker 3516, U 4923 BS IV (D) 168 Kw (2018.12-->), 12M FE BS IV (D) 165 Kw (2016.12-->), eComet 912, Captain 4923 BS III, U 3723, JanBus BS4 (D) 165 Kw (2016.02-->), 3123, U-3118 (D) (2015.06-->), Lynx BS II, 2523, Captain 3723 BS IV	FHN00400, F7A04700, FHJ00700, X8820800, P1302140, F8835100, X7471500, F7B02900, P7B00022, FHJ01000, P1301640, F4003400, P1302040, P1301240	FLG -FS19636	1,315.00

### NPI Filter Application Chart

Part Number	Product Description	Image	Model Description 	Potential OE Part No	Potential Comp. Part No	MRP (₹)
F 002 H23 590	Fuel Filter Spin-on, Fine Filter		ASHOK LEYLAND- Stag (D) 88 Kw (2005.04 -2010.10)	FHN00400, F7A04700, FHJ00700, X8820800, P1302140, F8835100, X7471500, F7B02900, P7B00022, FHJ01000, P1301640, F4003400, P1302040, P1301240	FLG -FS19636	1,315.00
F 002 H24 366	Fuel Filter Spin-on, Fine Filter		TATA MOTORS- 709 LPT EX Turbo (D) 66 Kw (2005.01-->)	252709120254, 252509120264, 252709120259	FLG -FS19660	1,600.00
F 002 H24 518	Fuel Filter Spin-on, Fine Filter		TATA MOTORS- Prima LX 4028 S, Prima LX 3125.K BS IV, Prima LX 3123.TTS BS III, Prima LX 2523 K / T, Prima LX 2525.K BS IV, LPT 2521 TC, Prima LX 3130.K BS IV Tipper, Prima LX 4928 S, Prima 2528 K 6x4, Prima 3128 K 8x4, Prima LX 2830.K BS-IV, Prima LX 2530.K BS IV, Prima LX 4930.S BS IV, Prima LX 4025.S BS IV, Prima LX 2825.K HRT BS IV	278607999845, 279109110101, 279109110102, 570107999901, 288547704905	FLG -5010516	1,055.00
F 002 H26 310	Fuel Filter Spin-on, Fine Filter		ASHOK LEYLAND- Captain 2518 BS IV (D) 134 Kw (2014.12-->)	FHN00400		998.00
F 002 H26 311	Fuel Filter Spin-on, Fine Filter		ASHOK LEYLAND- 3123 BS III, 12M FESLF BS IV (D) 123 Kw (2014.12-->), Cheetah (D) 118 Kw (2014.01-->), Viking BS IV (D) 123 Kw (2016.12-->), U 3123, Captain 40, 11M FESLF BS IV, ULE Diesel BS 4 (D) 165 Kw (2014.01-->), U 4923 (D) 165 Kw (2010.09-->), 12M FE BS IV (D) 165 Kw (2016.12-->)	P1302040, F7B02900	FLG -FS19654	2,208.00
F 002 H22 004	Fuel Filter Spin-on, Pre-filter		ASHOK LEYLAND- U 3518 (D) 132 Kw (2010.10-->), 12M (D) 165 Kw (2014.01-->), U 4023 (D) 165 Kw (2010.09-->), U 1619	P1302140		3,533.00





### NPI Filter Application Chart

Part Number	Product Description	Image	Model Description 	Potential OE Part No	Potential Comp. Part No	MRP (₹)
F 002 H23 535	Fuel Filter Spin-on, Pre-filter		TATA MOTORS- 1512 LP/LPO TC BS-III, LPO 1512 TC (D) 94 Kw (2005.10 -2010.10), LPS 4018 (D) 130 Kw (2004.01 -2006.12), LPS 4018 (D) 135 Kw (2010.10-->), LPO 1612 TC BS-III (D) 98 Kw (2005.02 -2015.09), LPK 1618 BS IV, LPO 1618 (D) 135 Kw (2010.10-->), LP 1512 BS III, LPO 1512 TC SLF (D) 96 Kw (2009.07-->), LPK 1618 (D) 130 Kw (2007.12 -2010.10), LPO 1512 BS II, LPO 1610 TC (D) 74 Kw (2001.09 -2008.09), 1512 TC LP (D) 92 Kw (2001.03 -2010.10), LPO 1616 TC BS-II (D) 119 Kw (2007.08 -2010.10)	278609119904, 278609999920, 278609999822, 278607989916	FLG -FF5522, FS1275	143.00
F 002 H23 536	Fuel Filter Spin-on, Pre-filter		TATA MOTORS- LPT 1109 HEx2 CR (D) 92 Kw (2014.01-->)	252509120239, 252709110136, 252709119913, 278609999951	FLG -FF5479	143.00
F 002 H23 582	Fuel Filter Spin-on, Pre-filter		TATA MOTORS- LPT 1616 697 Super Turbo BS-II (D) 118 Kw (2009.09 -2010.10), SK 1613 Turbo BS-II, SE 1613 Turbo BS-II	252509120239, 252509120264, 252709119913	FLG -FS19644V, FS19644	1,319.00

### NPI Filter Application Chart

Part Number	Product Description	Image	Model Description 	Potential OE Part No	Potential Comp. Part No	MRP (₹)
F 002 H23 590	Fuel Filter Spin-on, Pre-filter		ASHOK LEYLAND- Captain 3723 BS IV, Cheetah (D) 118 Kw (2014.01-->), Viking BS IV (D) 123 Kw (2016.12-->), U 1618, Cheetah (D) 88 Kw (2000.11-2005.03), Cheetah (D) 97 Kw (2005.04-2010.10), U 2523, 12M FE BS IV (D) 132 Kw (2016.12-->), U 4923 BS IV (D) 168 Kw (2018.12-->), U 4923 (D) 165 Kw (2010.09-->), U 3718 BS IV (D) 132 Kw (2014.12-->), 12M FE BS IV (D) 165 Kw (2016.12-->), eComet 912, 11M FESLF BS IV (D) 123 Kw (2018.12-->), U 4023 (D) 165 Kw (2010.09-->), 3123 (D) 165 Kw (2010.08-->), 3120 il, N 3123 BS III, 3518 BS IV (D) 134 Kw (2015.12-->), U-3118 (D) (2015.06-->), 1616 BS III (D) 119 Kw (2013.12-->), Boss 1412 LE BS III, VESTIBULE BS III, eComet 1212 (D) 88 Kw (2010.10-->), 2523, 4123 BS IV, Captain 40 (D) 165 Kw (2016.02-->), 4923 (D) 165 Kw (2011.03-->), 12MIFESLF BS IV (D) 123 Kw (2014.12-->), 1614 BS III (D) (2015.06-->), Ecomet 1012 BS III (D) 88 Kw (2013.12-->), 12M FE BS III, 4023, U-2518-IL-T HD BS III (D) 134 Kw (2016.08-->), Captain 49IT BS III (D) 165 Kw (2011.12-->), Captain 4923 BS III (D) 123 Kw (2014.10-->), 11M FESLF BS IV (D) 123 Kw (2018.11-->), U 3123 (D) 165 Kw (2010.10-->), eComet 1112, Viking BS III (D) 119 Kw (2014.12-->), ULE Diesel BS 4 (D) 165 Kw (2014.01-->), Viking BS III (D) 119 Kw (2011.12-->), 3123 BS III (D) 168 Kw (2013.12-->), U 3723, JanBus BS4 (D) 165 Kw (2016.02-->), Cheetah (D) 135 Kw (2014.01-->), RE SLF BS III (D) 135 Kw (2011.12-->), Lynx BS III, 3518 BS III (D) 134 Kw (2015.12-->), Lynx BS II, 4921, Viking BS III (D) 124 Kw (2012.12-->)	FHN00400, F7A04700, FHJ00700, X8820800, P1302140, F8835100, X7471500, F7B02900, P7B00022, FHJ01000, P1301640, F4003400, P1302040, P1301240	FLG -FS19636	1,315.00







### NPI Filter Application Chart

Part Number	Product Description	Image	Model Description 	Potential OE Part No	Potential Comp. Part No	MRP (₹)
F 002 H23 590	Fuel Filter Spin-on, Pre-filter		ASHOK LEYLAND- Stag (D) 88 Kw (2005.04-2010.10)	FHN00400, F7A04700, FHJ00700, X8820800, P1302140, F8835100, X7471500, F7B02900, P7B00022, FHJ01000, P1301640, F4003400, P1302040, P1301240	FLG -FS19636	1,315.00
F 002 H24 366	Fuel Filter Spin-on, Pre-filter		TATA MOTORS- 709 SFC EX (D) 66 Kw (2005.04-->), 712 LP Bus (D) 92 Kw (2005.04-->), LPT 1109 EX, Ultra 812 BS III, LPO 10.2 Starbus Ultra BS III, LPT 407, 709 LPT EX Turbo (D) 66 Kw (2005.01-->), LP 912 (D) 92 Kw (2010.10-->), LPT 2516 Super Turbo (D) 118 Kw (2007.12-2010.10), Ultra 912, 1512 LP 497 BS-III (D) 92 Kw (2005.02-->), Ultra 1012 BS III (D) 124 Kw (2016.01-2017.12), LPO 9.6	252709120254, 252509120264, 252709120259	FLG -FS19660	1,600.00
F 002 H24 366	Fuel Filter Spin-on, Pre-filter		TATA MOTORS- SFC 407 EX BS III, 410 Turbo SFC 3.0 Diesel (D) 74 Kw (2006.05-2017.03), 407 SFC 3.0	252709120254, 252509120264, 252709120259	FLG -FS19660	1,600.00
F 002 H24 518	Fuel Filter Spin-on, Pre-filter		TATA MOTORS- Prima LX 4028 S, Prima LX 3125.K BS IV, Prima 4928 S, Prima LX 2823.TK BS-IV, Prima LX 3123.TTS BS III, Prima LX 2523 K / T, Prima LX 2525.K BS IV, Prima LX 3123.K BS III, Prima LX 3130.K BS IV Tipper, Prima LX 3123.K BS-III, Prima LX 4928 S, Prima 3128 K 8x4, Prima LX 2523.K BS-III, Prima LX 2830.K BS-IV, Prima 4028, Prima LX 2530.K BS IV, Prima LX 4930.S BS IV, Prima LX 4025.S BS IV, Prima 2528 K 6x2, Prima LX 2825.K HRT BS IV	278607999845, 279109110101, 279109110102, 570107999901, 288547704905	FLG -5010516	1,055.00

### NPI Filter Application Chart







Part Number	Product Description	Image	Model Description 	Potential OE Part No	Potential Comp. Part No	MRP (₹)
F 002 H25 960	Fuel Filter Spin-on, Pre-filter		TATA MOTORS- Ultra 3021.S BS6, Ultra 1918.T BS6, Starbus Ultra SKL LPO 7.5 BS6, T.16 ULTRA BS6, T.9 ULTRA BS6, ULTRA 2821.T BS6, T.12 ULTRA BS6, T.14 Ultra BS6, Starbus Ultra SKL LPO 10.2 BS6 Non-AC, Starbus Ultra SKL LPO 10.2 BS6 AC, T.10 Ultra BS6, T7 Ultra BS6, T.11 Ultra BS6			1,670.00
F 002 H26 311	Fuel Filter Spin-on, Pre-filter		ASHOK LEYLAND- Captain 40 (D) 165 Kw (2016.02-->)	P1302040, F7B02900	FLG -FS19654	2,208.00
F 002 H26 314	Fuel Filter Spin-on, Pre-filter		TATA MOTORS- Prima 2528 K 6x4, Prima LX 4923 S, Prima LX 4023 S, LPT 2521 TC	288547704905		2,270.00
F 002 H23 535	Fuel Pipe Filter		TATA MOTORS- LPT 1613, LPK 2523, LPT 2518, LPT 2513, LPS 3518, LPS 4018 (D) 135 Kw (2010.10-->), LPT 3118, LPT 1613 /62 TC, Starbus 1612, Novus LPK 2530 6x4, LPT 3723 TC, LPO 1610 TC, LPO 1618, LPK 2518 HD, LPO 1512 TC SLF, LPT 2518/62 TC BS3, LPT 2516 TC 6x2, LPT 1613 EX, SK 1613 TC BS-II, LPO 1512 TC, LPO 1618 SLF, LPS 4923 TC 6x4, LPT 2515 EX 6x2	278609119904, 278609999920, 278609999822, 278607989916	FLG -FF5522, FS1275	143.00
F 002 H23 536	Fuel Pipe Filter		TATA MOTORS- LPK 1613, LPT 1109 Hex2 CR, LPT 2516 Super Turbo, 709 LPT Hex2, LPS 4018 (D) 130 Kw (2004.01 -2006.12), Ultra 812 BS III, LPT 1616 697 Super Turbo BS-II, LP 912, LPO 1612 TC BS-III, LPO 7.5 3.8TD FBV BS3 Ultra, 909, 1512 TC LP, SE 1613, SK 1616, 1510 LP/LPO BS-II, LPS 3516 EX, LPT 1613 TC, LPT 1109, LPT 1616 BS-III, 1512 LP 497 BS-III, LPO 8.5, LPK 1613 5.7 BS-III, LPT 1109 Hex2, SE 1613 Turbo BS-II, 709 LPT EX Turbo, LPT 909 EX, SFC 909 EX, LPT 1109 EX, LPT 2515 Turbo EX 6x2, LP 1613 SuperMilo, Ultra 912, LPO 1612 TC BS-II, LPK 1616 BS-III, LPK 909	252509120239, 252709110136, 252709119913, 278609999951	FLG -FF5479	143.00

### NPI Filter Application Chart





Part Number	Product Description	Image	Model Description 	Potential OE Part No	Potential Comp. Part No	MRP (₹)
F 002 H23 536	Fuel Pipe Filter		ASHOK LEYLAND- 1616 XL, U 1618, 2214 6x2 (H), U 2518, 4018, 3118, 3518, Comet 1616H, eComet 912, eComet 1212, 2513, Boss 1213 LE, 3718 iL, 3516, eComet 1214, 1616 iL 5.7, Comet 1611, 2516 6x2 (H), 1612 H, 3121, Boss 1112 LE, eComet 1112, 1612 IL BS-III, 1613 H, 2516 il, Ecomet 1012 Smart, 4019il, 2514, 1618, 2516 S, 2516 6x4 (H) 4x4, 2518, Boss 1212 LE, 4921, U 2516, 1616 H		F8824500, FHN00400, P1301640, F8835100, P7B00022, FHJ01000	FLG -FF5479 143.00
F 002 H23 536	Fuel Pipe Filter		TATA MOTORS- SK 407		252509120239, 252709110136, 252709119913, 278609999951	FLG -FF5479 143.00
F 002 H23 536	Fuel Pipe Filter		ASHOK LEYLAND- Stag		F8824500, FHN00400, P1301640, F8835100, P7B00022, FHJ01000	FLG -FF5479 143.00
F 002 H24 337	Hydraulic Filter, Steering System		TATA MOTORS- SE 1613, LPT 1618 BS-III, LPO 1613 CNG (GAS) 96 Kw (2010.10-->), LPK 2518 HD, LPK 2518 6x4, LPT 1616 697 Super Turbo BS-II, LPT 2516 TC 6x2, LPT 1613 (D) 100 Kw (2014.01-->)		277046609901	RAN -42200007 139.00
F 002 H24 337	Hydraulic Filter, Steering System		ASHOK LEYLAND- U 4923, 1616 iL, 1616 XL, Viking (GAS) (2006.01-->), Cargo 1614, U 3518, 1616 XP, JanBus BS4, U 3123, U 1618, 2214 6x2 (H), Captain 40, U 2523, U-3118, U 2518, 3518, eComet 912, Viking (D) 123 Kw (2005.05-->), 3718 iL (D) 132 Kw (2014.01-->), eComet 1212, 2513, 2516, Viking (D) 123 Kw (2011.01-->), FE SLF, U 4019 il, 2523, 1612 H, 4019 5.6, 3121, Viking 180HP ROTARY FIP EDC BS3, Cruiser, U 1616, 3015, 1613 5.7, eComet 1112, 1613 H, 3116, 2516 il, U 3518 5.7, Viking (D) 84 Kw (2004.02 -2010.10), Ecomet 1012 Smart, Cheetah (D) 84 Kw (1995.04 -2010.10), Lynx, Cheetah (D) 135 Kw (2014.01-->), 12M, 2518, Viking 160HP IL FIP BS3, 1616 H		P4200340	RAN -42200007 139.00





### NPI Filter Application Chart

Part Number	Product Description	Image	Model Description 	Potential OE Part No	Potential Comp. Part No	MRP (₹)
9 451 037 456	Oil Filter Element		TATA MOTORS- LP 609 Turbo Bus, 709 SFC E 3.8 Diesel, SFC 909, 1109 LPT, 709 LP Bus (D) 66 Kw (2005.04-->), LPT 909 EX (D) 66 Kw (2005.03 -2010.10), LPT 1109 (D) 66 Kw (2003.09 -2007.04), LPK 909, 609 SFC 3.8 Diesel (D) 66 Kw (1993.06 -1994.06), 709 LP Bus (D) 66 Kw (1995.05 -1997.09), 709 SFC EX (D) 66 Kw (2003.11 -2005.03)	252718130105, 253418130169	FLG -LF16059	345.00
9 451 037 456	Oil Filter Element		TATA MOTORS- SK 407, 407 3.0 Diesel LPT Turbo, 407 3.0D SFC Pickup (D) 55 Kw (2010.03-->), Xenon Utility 3.0TD 4x2, 407 3.0 Diesel LP Turbo Bus (D) 55 Kw (2006.01-->), 609 3.8 Diesel LP (D) 66 Kw (1993.09 -1997.07), 407 3.0 Diesel SFC Turbo Bus, 407 3.0 Diesel LPT (D) 53 Kw (2001.10 -2005.02), 407 3.0D Cityride NA, 407 3.0 Diesel LP, 407 LP Turbo Bus 3.0, 407 Citiride 3.0, 207 1.9 D, 407 3.0 Diesel SFC Turbo (D) 52 Kw (2003.11 -2005.05), Cityride 407, 407 SFC 3.0 (D) 43 Kw (2007.01 -2012.01), 407 3.0D SFC EX Turbo (D) 55 Kw (2003.11 -2005.04), 407 TurboBus SWB 3.0 D, 407 3.0 Diesel, SK 407 BS II	252718130105, 253418130169	FLG -LF16059	345.00
9 951 030 141	Oil Filter Element		EICHER MOTORS LIMITED- 10.59 3.3 Diesel, 10.70			202.00
9 951 030 141	Oil Filter Element		EICHER- 11.10 / XP	ID002922		202.00
9 951 030 141	Oil Filter Element		EICHER MOTORS LIMITED- 10.59 3.3 Diesel, 10.50 3.3 Diesel BS2, 10.50 3.3 Diesel BS3, 10.50 3.3 Diesel			202.00

### NPI Filter Application Chart

Part Number	Product Description	Image	Model Description 	Potential OE Part No	Potential Comp. Part No	MRP (₹)
F 002 H23 434	Oil Filter Element		TATA MOTORS- ACE HT BS-IV	279018130104, 59063972, 279018130101, 279018130102, 279018130106, 570318139905, 570318139923, 279818130101, 55197218, 279018130105		358.00
F 002 H23 434	Oil Filter Element		TATA MOTORS- Super Ace Mint, ACE CNG BS III, Xenon 1tonne Pickup BS-IV CNG, Venture 1.4D, ACE Magic CNG BS-IV, ACE MAGIC, Winger CNG, ACE CNG BS-IV	279018130104, 59063972, 279018130101, 279018130102, 279018130106, 570318139905, 570318139923, 279818130101, 55197218, 279018130105		358.00
F 002 H23 439	Oil Filter Element		MAHINDRA- Tourister T36	9420000073, 9420000074, 0303BAM00350N, 0303BC0071N, 0303BC0010N, 71817, 24772, 0303BC0073N, 0303BAU00110N		219.00
F 002 H23 439	Oil Filter Element		MAHINDRA- Bolero Maxi Truck Plus, Tourister 2.6 Diesel, LoadKing Pride 2.6 Diesel, SUPRO MAXITRUCK, Maxximo 0.9D MiniVan, Imperio 2.5, Tourister T25 2.6TD, Tourister 3.3, LoadKing 2.5 Diesel DI, Bolero Pik up, Bolero Camper, Genio 2.5D	9420000073, 9420000074, 0303BAM00350N, 0303BC0071N, 0303BC0010N, 71817, 24772, 0303BC0073N, 0303BAU00110N		219.00

### NPI Filter Application Chart

Part Number	Product Description	Image	Model Description 	Potential OE Part No	Potential Comp. Part No	MRP (₹)
F 002 H23 572	Oil Filter Element		ASHOK LEYLAND- Stag (D) 88 Kw (2013.10-->), U 4923, 1616 iL, Cheetah (D) 118 Kw (2014.01-->), Viking BS IV (D) 123 Kw (2016.12-->), Captain 40IT BS III, Boss 912 LE 3.8, JanBus BS4, U 3123, Cheetah (D) 88 Kw (2000.11 -2005.03), U-3118, 12M FE BS IV (D) 132 Kw (2016.12-->), Captain 2518 BS IV, U 2518, Lynx (D) 96 Kw (2014.01-->), 3118, 3518, 3123 BS III, Captain 4923 BS III, N 3123 BS III, 4019 BS IV, Boss 913 LX, U 4019 iL, 4923, 1616 XL (D) 124 Kw (2010.08-->), 2523, 12M FESLF BS III, 2518 (D) 135 Kw (2010.10-->), 12M FE BS III, U 4019 BS III, Lynx BS IV (D) 95 Kw (2015.12-->), 2518 (D) 132 Kw (2014.01-->), U 1616, 1618 BS IV, 1618T BS IV, 2516 iL, 4019iL, U-2518 IL T HD BS IV, Captain 3718 BS IV, 1616 XP (D) 124 Kw (2010.08-->), 3118-T BS IV, RE SLF BS III (D) 135 Kw (2011.12-->), 3123, 12M FESLF CNG BS IV, Cheetah (D) 135 Kw (2014.01-->), 12M (D) 118 Kw (2010.10-->), 2518 T BS IV, Captain 4923 BS IV (D) 172 Kw (2018.10-->), B	F7A05000, F7A05000, F7A01500	FLG -LF16238	1,577.00

### NPI Filter Application Chart

Part Number	Product Description	Image	Model Description 	Potential OE Part No	Potential Comp. Part No	MRP (₹)
F 002 H23 572	Oil Filter Element		oss 1212 LE, U 2516, Captain 3723 BS IV, U 3518 BS IV, 3718 BSIV, Viking 160HP IL FIP BS3 (D) 118 Kw (2014.02-->), 1618 XP BS III (D) 134 Kw (2015.12-->), Captain 49IT BS III, Captain 40, U 2523, 12M FE BS IV (D) 165 Kw (2016.12-->), 12M FESLF BS IV, 2518 BS IV, U 3518 (D) 132 Kw (2010.10-->), U 3718 BS IV, 3120 iL, U 3118 LA BS IV, 3118 BS IV, 1616 BS III (D) 119 Kw (2013.12-->), Boss 1213 LE, Boss 1113 LX, 3718 iL, 4123 BS IV, 12M (D) 165 Kw (2014.01-->), 4023, U 4023, Viking 180HP ROTARY FIP EDC BS3 (D) 135 Kw (2014.02-->), U-2518-IL-T HD BS III (D) 134 Kw (2016.08-->), Boss 1112 LE, 12M FESLF, 11M FESLF BS IV, U 1618 (D) 97 Kw (2010.11-->), Viking BS III (D) 119 Kw (2011.12-->), U 3723, 3718 iL BS III, U 4019 BS IV, ULE Diesel BS 4, 3718 BS IV, 2516 iL BS III (D) 119 Kw (2012.12-->), U-2518 T BS IV, 1616 H (D) 123 Kw (2006.04 -2010.10), 4019 BSIV, 3518 BS III (D) 134 Kw (2015.12-->), 3116 (D) 118 Kw (2010.10-->), U 4923 BS IV	F7A05000, F7A05000, F7A01500	FLG -LF16238	1,577.00
F 002 H24 322	Oil Filter Element		MAHINDRA- Maxximo 0.9D, Supro Maxitruck T2/T4/T6	0303BAU00110N		193.00
F 002 H26 361	Oil Filter Element		EICHER MOTORS LIMITED- Pro 1110XP BS IV, STARLINE 12.12K BS IV	ID321716		1,995.00
F 002 H27 505	Oil Filter Element		EICHER MOTORS LIMITED- Pro 1090 BS IV, Pro 1095XP BS IV, Pro 1080XPT BS IV	ID337989		1,366.00

### NPI Filter Application Chart

Part Number	Product Description	Image	Model Description 	Potential OE Part No	Potential Comp. Part No	MRP (₹)
F 002 H60 022	Oil Filter Element		ASHOK LEYLAND- Viking BS III (D) 124 Kw (2012.12-->), Stag (D) 88 Kw (2013.10-->), 2518 BS II, Cheetah (D) 118 Kw (2014.01-->), Cheetah (D) 122.8 Kw (2005.11-->), Cargo 1613H, 4018, 12M (D) 130 Kw (2006.11 -2010.10), Lynx (GAS) 106 Kw (2014.01-->), Ecomet 1012 Smart (D) 88 Kw (2010.11-->), Viking (D) 123 Kw (2005.05-->), N 2523 BS III, Viking (D) 97 Kw (2004.02 -2010.10), 3516 (D) 121 Kw (2002.02 -2010.10), 1616 XL BS III, 1614 BS III, Stag (D) 88 Kw (2010.10-->), VESTIBULE BS III, N 2523 BS IV, 2518 (D) 132 Kw (2008.01 -2010.10), 1616 XL (D) 124 Kw (2010.08-->), Captain 3123 BSIV, Comet 1616 BS II, SFC 1613 BS III, Lynx BS IV (D) 95 Kw (2015.12-->), Viking BS III (D) 135 Kw (2012.12-->), 2518 (D) 132 Kw (2014.01-->), Double Decker BS III, 1613 5.7, 2516 S, 1611 BS II, Cheetah (D) 84 Kw (1995.04 -2010.10), 1616 XP (D) 124 Kw (2010.08-->), Cheetah (D) 135 Kw (2014.01-->), Lynx BS III, 2518 T BS III, Captain 4923 BS IV (D) 172 Kw (2018.10-->), SFC 1613 BS II, Viking 160HP IL FIP BS3 (D) 118 Kw (2014.02-->), 1618 XP BS III (D) 134 Kw (2015.12-->), eComet 912 (D) 88 K	X4000600, F4034200, F7A05000, B8774802, F7A01500, X4001000, F4034500	FLG -LF16079	304.00

### NPI Filter Application Chart

Part Number	Product Description	Image	Model Description 	Potential OE Part No	Potential Comp. Part No	MRP (₹)
F 002 H60 022	Oil Filter Element		w (2008.11-->), 2214 6x2 (H), 2214 6x2 BS II, 12M FE BS IV (D) 165 Kw (2016.12-->), Viking BS IV (D) 97 Kw (2017.06-->), Comet 1611 (D) 88.2 Kw (2004.09 -2010.10), U 3518 (D) 132 Kw (2010.10-->), eComet 1112 (D) 88 Kw (2008.11 -2010.10), Viking (D) 123 Kw (2011.01-->), 1616 BS III (D) 119 Kw (2013.12-->), eComet 1212 (D) 88 Kw (2010.10-->), Comet 1613H, Captain 3123 BS IV, Artik 3516, 3118-T BS III, Stag (D) 58 Kw (2003.03-->), eComet 1214, Viking 180HP ROTARY FIP EDC BS3 (D) 135 Kw (2014.02-->), U-2518-IL-T HD BS III (D) 134 Kw (2016.08-->), 3121, 2514 BS II, 1616 H (D) 121 Kw (2006.04 -2010.10), 3015, Captain 2518 HD BS III, 1612 IL BS-III, U 1618 (D) 97 Kw (2010.11-->), Viking BS III (D) 119 Kw (2014.12-->), Viking BS III (D) 119 Kw (2011.12-->), Viking (D) 84 Kw (2004.02 -2010.10), Ecomet 1012 BS III, 3014, 2516 il BS III (D) 119 Kw (2012.12-->), Viking BS II, 3518 BS III (D) 134 Kw (2015.12-->), RE SLF BS III (D) 168 Kw (2012.12-->), Lynx (D) 88 Kw (2010.10-->), 3116 (D) 118 Kw (2010.10-->), 3116 (D) 118 Kw (2009.07 -2010.10), 4921, 12M (D) 84 Kw (2014.10-->)	X4000600, F4034200, F7A05000, B8774802, F7A01500, X4001000, F4034500	FLG -LF16079	304.00
9 451 037 456	Oil Filter Spin-on		TATA MOTORS- 407 3.0 4WD, 407 3.0D SFC EX Turbo (D) 55 Kw (2005.05 -2017.03)	252718130105, 253418130169	FLG -LF16059	345.00
F 002 H23 434	Oil Filter Spin-on		TATA MOTORS- Venture 1.4D (D) 51 Kw (2011.01 -2016.01), Super Ace Mint	279018130104, 59063972, 279018130101, 279018130102, 279018130106, 570318139905, 570318139923, 279818130101, 55197218, 279018130105		358.00

### NPI Filter Application Chart

Part Number	Product Description	Image	Model Description 	Potential OE Part No	Potential Comp. Part No	MRP (₹)
F 002 H23 439	Oil Filter Spin-on		MAHINDRA- Bolero Camper 2510 2.5 D, Bolero Camper 2750 2.5 D, Bolero Camper, Genio 2.5D	9420000073, 9420000074, 0303BAM00350N, 0303BC0071N, 0303BC0010N, 71817, 24772, 0303BC0073N, 0303BAU00110N		219.00
F 002 H23 516	Oil Filter Spin-on		TATA MOTORS- LPS 3516			647.00
F 002 H23 566	Oil Filter Spin-on		TATA MOTORS- LPT 407 EX2 CNG BS-IV, LP 909 49 BS III CNG	253418130129, 254718130106, 252718130127, 253418130169, 253418130141, 254718130117, 253418130187	FLG -LF16056	425.00
F 002 H23 566	Oil Filter Spin-on		TATA MOTORS- Starbus 3.0, SK 407 BS II, Xenon Utility 3.0TD 4x2, 407 3.0D SFC Pickup, 410 Turbo SFC 3.0 Diesel, 407 3.0, 407 LP Turbo Bus 3.0, Starbus SFC 407, SFC 407, LP 410, 407 SFC 3.0, Winger BS III, 407 3.0 Diesel SFC Turbo, 407 3.0D SFC EX Turbo (D) 55 Kw (2003.11 -2005.04), TL Pickup 2.0, SFC 407 CNG, SFC 407 TT, TL Pickup 2.0 Diesel 4WD, SK 407	253418130129, 254718130106, 252718130127, 253418130169, 253418130141, 254718130117, 253418130187	FLG -LF16056	425.00
F 002 H23 572	Oil Filter Spin-on		ASHOK LEYLAND- U 4923, 1616 iL, U 3123, Captain 40, Cheetah (D) 88 Kw (2000.11 -2005.03), U 2523, RE SLF, U 2518, 3118, 3518, 3120 iL, FE SLF, U 4019 iL, 4923, 1616 XL (D) 124 Kw (2010.08-->), 2523, 4023, 2518 (D) 135 Kw (2010.10-->), 1616 iL 5.7, 12M (D) 165 Kw (2014.01-->), U 4023, 2518 (D) 132 Kw (2014.01-->), U 3518 5.7, 4019iL, U 3723, 1616 XP (D) 124 Kw (2010.08-->), 3123, 1616 H (D) 123 Kw (2006.04 -2010.10), 12M (D) 118 Kw (2010.10-->), 3116 (D) 118 Kw (2010.10-->), U 2516	F7A05000, F7A05000, F7A01500	FLG -LF16238	1,577.00





### NPI Filter Application Chart

Part Number	Product Description	Image	Model Description 	Potential OE Part No	Potential Comp. Part No	MRP (₹)
F 002 H24 250	Oil Filter Spin-on		PIAGGIO- Ape Mini			176.00
F 002 H24 322	Oil Filter Spin-on		MAHINDRA- Maxximo 0.9D, Supro Maxitruck T2/T4/T6, Maxximo Mini VX	0303BAU00110N		193.00
F 002 H26 313	Oil Filter Spin-on		ASHOK LEYLAND- Sunshine	FPA00300	FLG -LF16309	710.00
F 002 H26 361	Oil Filter Spin-on		EICHER- Skyline Pro 3008, Pro 3015 TCI BS IV, Pro 3012 TCI BS IV; EICHER MOTORS LIMITED- Pro 1110XP BS IV, STARLINE 12.12K BS IV, Pro 1110 BS IV	ID321716		1,995.00
F 002 H27 505	Oil Filter Spin-on		EICHER MOTORS LIMITED- Pro 1090 BS IV, Pro 1095XP BS IV, Pro 1080XPT BS IV; EICHER- Pro 1075	ID337989		1,366.00
F 002 H60 022	Oil Filter Spin-on		ASHOK LEYLAND- Stag, Cheetah (D) 122.8 Kw (2005.11-->), 2214 6x2 (H), 12M (D) 130 Kw (2005.04 -2010.10), Cheetah (D) 97 Kw (2005.04 -2010.10), Cargo 1613H, 12M (D) 130 Kw (2006.11 -2010.10), 4019, 2513, Viking (D) 123 Kw (2011.01-->), 2518 (D) 132 Kw (2008.01 -2010.10), 3516, Comet 1613H, Artik 3516, 1616 XL (D) 124 Kw (2010.08-->), 2516 6x2 (H), 1612 H, 1616 H (D) 121 Kw (2006.04 -2010.10), Ecomet 1012 Smart, 2514, Cheetah (D) 84 Kw (1995.04 -2010.10), 3014, 1616 XP (D) 124 Kw (2010.08-->), 1616 H (D) 123 Kw (2006.04 -2010.10), 2516 6x4 (H) 4x4, 3116 (D) 118 Kw (2010.10-->), 3116 (D) 118 Kw (2009.07 -2010.10), 4921	X4000600, F4034200, F7A05000, B8774802, F7A01500, X4001000, F4034500	FLG -LF16079	304.00



### NPI Filter Application Chart

Part Number	Product Description	Image	Model Description 	Potential OE Part No	Potential Comp. Part No	MRP (₹)
F 002 H21 296	Safety Element Air Filter, Engine		TATA MOTORS- SE 1613, LP 1613 SuperMilo (D) 96 Kw (2008.07 -2010.10), LPT 1613 (D) 96 Kw (1997.05 -2001.12), 1510 LP/LPO BS-II (D) 96 Kw (2005.03 -2010.10), LPT 2515 Turbo EX 6x2 (D) 104 Kw (2005.02 -2010.10)	252509140133		565.00
F 002 H23 561	Safety Element Air Filter, Engine		TATA MOTORS- LPTK 2518 BS III, LPK 2523 BS IV Tipper, LPT 2518, LP 1512 BS III (D) 93 Kw (2008.03-->), 1510 LP/LPO BS-II (D) 96 Kw (2005.03 -2010.10), LPO 1616 TC BS-II, LPK 1923 BS-IV, Prima LX 2525.K BS IV, LPT 1616 697 Super Turbo BS-II, LPO 1612 TC BS-III, LPT 1613 (D) 100 Kw (2014.01-->), LPK 1918 BS IV, LPS 3518, Signa 2823.TK BS IV, LPT 3118, LPK 1618 BS IV, SK 1616, LP/LPO 1615 697 BS-III, LP 913 BS IV CNG, LPK 2518 6x4 (D) 129 Kw (2007.12 -2010.10), Prima 2528 K 6x4, LPK 3118 BS III, LPK 2818 BS IV, LPT 3718, LPO 1618, LPT 1616 BS-III, LPK 2518 HD, LPT 2518/62 TC BS3, LPT 2516 TC 6x2, Signa 2523.K BS IV, LPS 4018, Signa 2518.TK BS IV, Prima LX 3125.K BS IV, LPK 1613 5.7 BS-III, Prima LX 2823.TK BS-IV, LPK 3518 TC BS-IV, LPK 3118 BS IV, LPT 1613 Turbo EX, Prima LX 3123.K BS III, LPK 1618 BS-III, LPT 1613 BS III (D) 102 Kw (2016.06-->), LPK 1615 BS IV, LP 1613 SuperMilo (D) 96 Kw (2008.07 -2010.10), LPK 2518 BS IV, LPT 3723 TC, LPO 1512 BS II, Signa 1923.K BS-IV, LPK 1616 BS-III, Prima LX 2523.K BS-III, LP 1112 BS IV, LPO 1612 TC BS-II, LPK 2823 BS IV, 1512 LP/LPO TC BS-III (D) 114 Kw (2005.02-->), LPK 1618, LPT 2515 EX 6x2, Prima LX 2825.K HRT BS IV	409024000216, 278609139910, 278609139909, 885409052516, 278609139911, 278609139912, 278609139936, 278609139935, 278609139908	FLG -8200068, AF4669	2,158.00

### NPI Filter Application Chart

Part Number	Product Description	Image	Model Description 	Potential OE Part No	Potential Comp. Part No	MRP (₹)
F 002 H23 563	Safety Element Air Filter, Engine		TATA MOTORS- LPK 2516 TC 6x4 BS-II, LPK 1613, Signa 4018.S BS IV, LPT 2516 Super Turbo, LPS 3518 BS IV, LPT 1913 BS-IV, LP 1512 BS III (D) 93 Kw (2008.03-->), LPTK 3118 BS III, LPT 3718 BS IV, LPK 2518 BS III, LPK 1613 BS IV, Signa 2818.T BS-IV, LPT 1615 TC BS IV, LPT 2513, LPT 2518 BS IV, LP 1515 BS IV, 1512 TC LP, LPS 3516, LPT 1613 /62 TC, LPK 2518 6x4 (D) 129 Kw (2007.12 -2010.10), LPT 4223 BS IV, LPT 3518 BS-IV, LP 1512 BS-IV, LPO 1512 TC SLF, LPO 1515 BS IV, LPO 1613 BS IV, LPO 1512 TC, LPK 1615 BS III, LPT 2518 BS III, 1512 LP 497 BS-III, LPT 2818 BS IV, LPT 1618 BS-III, LPTK 3118 BS-IV, SE 1613 BS IV, Signa 3518.S BS IV, LPS 4018 BS IV, LP 1613 BS IV, LPT 1918 BS IV, LPT 2515 Turbo EX 6x2 (D) 104 Kw (2005.02 -2010.10), Signa 1615 BS IV, LPO 1515 BS III, Signa 3118.TK BS IV, SIGNA 3718.T BS IV, LPT 3118 BS IV, LPT 1613 BS III (D) 102 Kw (2016.06-->), LPT 1618 BS IV, LP 1613 SuperMilo (D) 96 Kw (2008.07 -2010.10), LPO 1613 CNG, LPT 1613 EX, LPT 1613 BS IV, LPT 2518 BS II, LPO 1512 BS-IV	278609139910, 278609139909, 278609139911, 885409041613, 278609139908	FLG -8200069	1,950.00
F 002 H23 564	Safety Element Air Filter, Engine		ASHOK LEYLAND- 2214 6x2 (H) (D) 84 Kw (2005.07 -2009.07), Stag (D) 88 Kw (2002.01 -2005.03)	F8221300, F8221200, F8845900, F8845800, X7423500	FLG -AF26074	1,408.00
F 002 H23 567	Safety Element Air Filter, Engine		ASHOK LEYLAND- 2214 6x2 (H) (D) 84 Kw (2005.07 -2009.07), eComet 1109 3.8, Stag (D) 88 Kw (2002.01 -2005.03), 2214 Super	X3962700	FLG -AF26058	1,491.00

### NPI Filter Application Chart

Part Number	Product Description	Image	Model Description 	Potential OE Part No	Potential Comp. Part No	MRP (₹)
F 002 H23 589	Safety Element Air Filter, Engine		ASHOK LEYLAND- 2518 (D) 135 Kw (2010.10-->), U 4923, U 3518, U-2518-IL-T HD BS III (D) 134 Kw (2016.08-->), U 4023, U 3123, 2518 (D) 132 Kw (2014.01-->), U 1616, Captain 40, U-3118, U 2518, U 3718 BS IV (D) 132 Kw (2014.12-->), 3518, 4023 (D) 165 Kw (2011.03-->), 4019il, 3120 il, 3118 (D) 135 Kw (2010.08-->), 4019 (D) 130 Kw (2008.11 -2010.10), 1616 iL (D) 118 Kw (2010.08-->), 3518 BS III (D) 134 Kw (2015.12-->), U 4019 il, 2518 (D) 132 Kw (2008.01 -2010.10), 4923, 3118-T BS III	F8365800, F7B01200, F8211200, F7B01300, F7B01400, F7B02100, X8830400, F7B01100, F7B02000, F8211300		3,443.00
F 002 H23 592	Safety Element Air Filter, Engine		EICHER- 10.80 E2 Plus (D) 70 Kw (2009.05 -2010.10), 10.90 E2 Plus, 11.10 E2 Plus			1,600.00

### Filters Cross Reference Chart

Part Number	Product Description	Potential OE Part Number	Potential Comp. Part Number
F002H21295	Air Filter Element Primary, Engine	TAE-252509140134	FLG -AF25884; DON -P500917
F002H23564	Air Filter Element Primary, Engine	ASL-X3962800, X3962700	FLG -AF26058, AF26006, AF26059, AF26002, 5005191; DON -P500955, P500956
F002H24999	Air Filter Element Primary, Engine	ASL-165462VA1A	
F002H23594	Air Filter Element Primary, Engine	EII-ID303249, ID303248	DON -P500968, P500967; FLG -5003795, 5003796, 5010377U
F002H60011	Air Filter Element Primary, Engine		FLG -AF04669, AF26004
F002H21218	Air Filter Element Primary, Engine	EII-ID202372	FLG -AF00947, AF25921, AF25922
F002H60006	Air Filter Element Primary, Engine		DON -P500929; FLG -AF04058
F002H23563	Air Filter Element Primary, Engine	TAE-278609139910, 278609139911, 885409041613	FLG -AF00947, AF25931, AF25921, 8200069U, AF24930, 8200069, AF25922, AF00963
F002H23594	Air Filter Element Primary, Engine		DON -P500968, P500967; FLG -5003795, 5003796, 5010377U
F002H23561	Air Filter Element Primary, Engine	TAE-278609139909, 885409052516, 278609139908	FLG -AF25948, AF26008, AF04669, 8200068U, 8200068, AF26004, AF04670, AF25939
F002H24419	Air Filter Element Primary, Engine	TAE-253409130241	FLG -AF26046M
F002H23564	Air Filter Element Primary, Engine	TAE-252709130329, 885409020712, 252709130330	FLG -AF26058, AF26006, AF26059, AF26002, 5005191; DON -P500955, P500956
F002H60012	Air Filter Element Primary, Engine	MHI-0313AAM02031N, 0313AC0280N	
F002H60006	Air Filter Element Primary, Engine	TAE-253409140132, 252709130256, 252709130248	DON -P500929; FLG -AF04058
F002H21218	Air Filter Element Primary, Engine		FLG -AF00947, AF25921, AF25922
F002H24418	Air Filter Element Primary, Engine	TAE-253409130306, 885409010410, 253409130305	FLG -5005192, AF26074, AF26075
F002H60011	Air Filter Element Primary, Engine	EII-ID300068, ID202370	FLG -AF04669, AF26004
F002H24415	Air Filter Element Primary, Engine	ASL-F8845900, F8845800, X8800214, X8800114	FLG -AF26070, 502622200, AF26069
F002H24902	Air Filter Element Primary, Engine	TAE-286409139904	PUR -2820ELI99
F002H23589	Air Filter Element Primary, Engine	ASL-F7B01200, P5104005, F7B01100	DON -P617643, P617644; FLG -AF26125, 5005194U, AF26125U0, AF26485, AF26485U0
F002H24998	Air Filter Element Primary, Engine	MHI-0313AAU00960N	PUR -2955ELI99

**Filters Cross Reference Chart**

Part Number	Product Description	Potential OE Part Number	Potential Comp. Part Number
F026400620	Air Filter Element, Engine	SCA-1869993	MHL -LX2839; UFI -27B3600; HEG -E1013L; BBF -RS30142; KNE -LX2839; ASF -HF803; SOG -FLI6961; DON -P953211; FLT -AM4168; MN -C31014; FLG -AF27940
F002H23585	Air Filter Element, Engine	MHI-0313AAC04390N	
F026400538	Air Filter Element, Engine	SCA-1801774, 1869987, 1526086, 1387548	MHL -LX605, LX6051; HEG -E450L, E540L; FRA -CA9434; KSS -4630AR; FLG -AF25627; KNE -LX605, LX6051; SFM -S7615A; ALC -MD7662; MSF -R603; CPF -FLI9027; MFR -FA3357; THO -2601; WIX -93182E; MYL -8123210007; COO -AEM2834; FIM -FLI9027; ACD -PC2693E; GUD -ADG1219R; FIP -HP2584A; FLT -AM4165; DON -P781741, P787150, P781495, P787155, P782848; MFI -MAU60015; ASF -HF5077; MN -C311495; SOG -FLI9027; FBI -35491; CLF -MA1455; UFI -2761500
F002H60011	Air Filter Element, Engine	TAE-278609139908	FLG -AF04669, AF26004
F002H60012	Air Filter Element, Engine	MHI-0313AAM02031N, 0313AC0280N	
F026400526	Air Filter Element, Engine	SCA-1421022, 1335679	MFI -MAU60007; FLG -AF25314; MN -C301240; THO -2569; SFM -S7286A; SOG -FLI6932; WIX -93091E, 49724; GUD -ADG1638R; PUR -A67842; FBI -35015; MFR -FA3202; ALC -MD7572; CLF -MA747; BBF -RS3724; FIP -HP2513; CPF -FLI6932; TEF -ARS1187; DIG -DGML3724; FRA -CA5759; KNE -LX714; HEG -E451L, E1013L; PBR -AI3466; DON -P778335, P781242; MHL -LX714; UFI -2728600; MSF -R286; COO -AEM2710; LUB -LAF8088; KSS -50013522, 522AR; FLT -AM4161
F026400529	Air Filter Element, Engine	SCA-1421021, 1335678	DON -P778336, P781180; CPF -FLI6931; GUD -ADG1218R; MYL -8123210003; KNE -LX712; FLG -AF25313; DIG -DGML25313; TEF -ARS1188; FIP -HP2511; MN -C301500; SOG -FLI6931; ALC -MD7118; FBI -35424; BBF -RS3726; CLF -MA794; THO -2568; FLT -AM4162; TTP -1534512; UFI -2735800; COO -AEM2712; MFR -FA3203; WIX -93092E; FRA -CA5760; MHL -LX712; CRO -9159; HEG -E290L, E1033L; MSF -R358; MFI -MAU60006; SFM -S7358A; PBR -AI3465
F026400637	Air Filter Element, Engine	SCA-1538006, 1854214, 1869989	DON -P951825; MHL -LX6044; ASF -HF5699; KNE -LX6044
F026400717	Air Filter Element, Engine		DON -P958225; SPQ -036474; HEG -E528L; MFR -FA3659; AUE -95714; FBI -106289; MSF -R1221; ALC -MD7726; SFM -S7B39A; UFI -27B3900

**Filters Cross Reference Chart**

Part Number	Product Description	Potential OE Part Number	Potential Comp. Part Number
F026400554	Air Filter Element, Engine	SCA-1728667	UFI -27A2500; MFR -FA3576; MSF -R727; FLG -AF27708; KNE -LX714; HEG -E451L, E1013L; FLT -AM4167; TEF -ARS11841; MN -C3012401; DON -P785518; MHL -LX714; SOG -FLI9324
F026400535	Air Filter Element, Engine		BBF -RS5730; MN -C3314601; MFR -FA3475; MSF -R544; SKR -A71400; UFI -27A0300; SOG -FLI9326; FLT -AM4429; DON -P951102; GUD -ADG1893R; FLG -AF27970, AF27834; MHL -LX3141; TEF -ARS5574; WIX -93372E; HEG -E1024L, E1024L01
F026400528	Air Filter Element, Engine	SCA-1801775, 1869988, 1387549, 1526087	THO -2617; MFR -FA3216; KSS -50013624, 624AR; WIX -93181E; SOG -FLI9028; CLF -MA1418; MN -C311254; ALC -MD7570; FLT -AM4163; GUD -ADG1220R; CPF -FLI9028; FBI -23395; TEF -ARS1182; DON -P781740; COO -AEM2832; FIP -HP2610; MHL -LX6041; MFI -MAU60014; MSF -R344; SFM -S7970A; TEN -A2105; FRA -CA9433; UFI -2738800; ACD -PC2687E; CRO -8333; FLG -AF25614; HEG -E424L
F026400034	Air Filter Element, Engine		MFR -FA3217; MN -C341500, C3415001; FRA -CA9560; FLT -AM4424; CPF -FLI9043; SCT -SB3230; PBR -AI3514; CLF -MA1420; SOG -FLI9043; ALC -MD7592; DON -P782396; KNE -LX1281; FLG -AF25632; BAC -RS4967; GUD -ADG1599; WIX -93150E; MSF -R345; UFI -2734500; THO -ILM670, 2670; HEG -E420, E420L; CRO -8267; SFM -S7345A; MHL -LX1281; TEN -A2054; FIM -FLI9043; BBF -RS4967
F026400532	Air Filter Element, Engine	SCA-1485592	MSF -R1018; TEF -ARS9840; FLT -AM4554; FLG -AF27857; UFI -27A5000; GUD -ADG1595R; HEG -E1016L; RCO -PFA5627; MN -C271340; FBI -35598; MHL -LX3030
F002H21218	Air Filter Element, Engine	TAE-278609139910	FLG -AF00947, AF25921, AF25922
F026400117	Air Filter Element, Engine		TEN -A2053; ALC -MD7618; FLT -AM4425; MHL -LX1587; FIM -FLI9041; UFI -2734700; DON -P782857; KSS -50014104, 4104AR; MFR -FA3218; CRO -8266; RCO -PFA5624; MSF -R347; MFI -MAT60073; LUB -LAF8838; SFM -S7347A; THO -2754; SOG -FLI9041; FIP -HP2601; MN -C311345, C3113451; KNE -LX1587; FLG -AF25631; WIX -93151E; CLF -MA1419; GUD -ADG1106; BBF -RS4966; COO -AEM2846; FBI -38615; HEG -E496L, E496L01; FRA -CA9581

**Filters Cross Reference Chart**

Part Number	Product Description	Potential OE Part Number	Potential Comp. Part Number
F026400047	Air Filter Element, Engine	NIS-16546BC40A, 16546BN701, 16546BN70A, 1654600QAR, 2232400Q2M, 2232400QAB	GUD -AG1416, AG1417; MSF -P319, P448; SWA -60934407; CLF -MA1393, MA1374, MA1375; FRA -CA9932, CA10077, CA1007; LAT -ELP9078; MFR -ELP9078, ELP9151; COO -AG1668, AG1625; AHK -2001128; ALC -MD8120, MD8334; VAO -585079, 585071; PRF -A1222, A1184; SFM -S0412A; WIX -WA9469; MYL -16123210009; MQP -VFA1103; CPF -PA7503, PA7478; BLP -ADN12248; KNE -LX9332, LX9333, LX933; JPP -JFA128, FA128S, FA128; UNP -GFE4027; ACD -PC3184E; CHA -CAF100820P, U821606, CAF100821P, U820, U821, U820606; HEB -J1321059; FBI -34407; PBR -AI5405; MHL -LX9332, LX9333, LX933; MED -18273; FIM -PA7503, PA7478; NIP -J1321059; AMK -NA2608; FLT -AP1347; CMI -EAF557, EAF706; UFI -3031900; HEG -E769L, E888L; CRO -8372; MAR -71761676, 71758691; MPC -60559; TNO -AR10077PM, AR9932PM; KSS -50014265, 4265AP, PA7478; MN -C24852, C2485, C24851; FIP -HP2235; TEN -A2182, A2140; ASF -HF8274, HF8294, HF8284
F002H23561	Air Filter Element, Engine	ASL-F8211200, F8211300	FLG -AF25948, AF26008, AF04669, 8200068U, 8200068, AF26004, AF04670, AF25939
F002H23561	Air Filter Set, Engine	TAE-278609139909, 885409052516, 278609139908	FLG -AF25948, AF26008, AF04669, 8200068U, 8200068, AF26004, AF04670, AF25939
F002H24415	Air Filter Set, Engine	ASL-F8845900, F8845800, X8800214, X8800114	FLG -AF26070, 502622200, AF26069
F002H23564	Air Filter Set, Engine	ASL-X3962800, X3962700	FLG -AF26058, AF26006, AF26059, AF26002, 5005191; DON -P500955, P500956
F002H23589	Air Filter Set, Engine	ASL-F7B01200, P5104005, F7B01100	DON -P617643, P617644; FLG -AF26125, 5005194U, AF26125U0, AF26485, AF26485U0
F002H24418	Air Filter Set, Engine	TAE-253409130306, 885409010410, 253409130305	FLG -5005192, AF26074, AF26075
F002H23562	Air Filter Set, Engine		DON -X009682; FLG -5005190, AF04058, AF01842
F002H23594	Air Filter Set, Engine		DON -P500968, P500967; FLG -5003795, 5003796, 5010377U
F002H23563	Air Filter Set, Engine		FLG -AF00947, AF25931, AF25921, 8200069U, AF24930, 8200069, AF25922, AF00963
F002H23594	Air Filter Set, Engine	EII-ID303249, ID303248	DON -P500968, P500967; FLG -5003795, 5003796, 5010377U
F002H23563	Air Filter Set, Engine	TAE-278609139910, 278609139911, 885409041613	FLG -AF00947, AF25931, AF25921, 8200069U, AF24930, 8200069, AF25922, AF00963

**Filters Cross Reference Chart**

Part Number	Product Description	Potential OE Part Number	Potential Comp. Part Number
1987431162	Cabin Filter	MAN-85619500025	FIM -PC8106; FRA -CF9576; HEG -E949LI; MCA -MP155; WIX -93211E; GUD -AC68; FLT -K1049; KNE -LA279; COR -21653016; MN -CU37230
1987435125	Cabin Filter	SCA-2283474, 2283473	TTP -1535101; FLG -AF55818; MN -NPF193, CU50001; FLT -K1402; SOG -PC8423; DAF -1535101; KNE -LA1122; MHL -LA1122; COR -CP1490, 80005208; HEG -E4963LI
1987431167	Cabin Filter		KNE -LA148; FLT -K1029; UFI -5308900; FRA -CF5892; HEG -E947LI; BBF -PA669, PA3839; WIX -93135E; MCA -MP242; KSS -50013961, 961AC; COO -ACE143; COR -MP242, 21653139, CP1142; HFR -8300235, 8300249; DON -P782811; MN -CU2184; ALC -MS6211; FIM -PC8029; TEF -ACP007; RCO -PFA5639; TIV -0359001; HLA -NPF057; SOG -PC8029; CRO -E504; MAR -154064159960; MFR -ELR7501; TEN -E504; VAO -716041; VEO -95301215, V95301215; MED -17249, 17235; FLG -AF25305; PBR -AH7075; CLF -NC2160; FBI -10152, 103712; WGA -AKX4007; SFM -S3089C; MHL -LA148, LA656; THO -21142; CPF -PC8029
1987432056	Cabin Filter	VWW-7D0819989, 703819989, 703819990A	KNE -LA65; FLT -K1037; HEG -E922LI; UFI -5306700; TEN -E385; MHL -LA65; DEP -TSP0325151; ALC -MS6133; FRA -CF9579; HLA -NPF029; MFR -ELR7044; COO -ACE100; COR -21651987; MN -CU1738; CMI -EKF182, EKF182A; PUR -C28233; FIM -PF8107, PC8107; CLF -MC1270, NC2085; WIX -WP6874; FDB -MP024; WGA -AKX1037; THO -29046; PRF -AH182; MCA -MP024
1987432153	Cabin Filter	SCA-1913503, 1420197, 1379952	FLG -AF25829; WGA -AKX4002; MN -CU1722; UFI -5306600; MHL -LA432; COR -80000362; HEG -E956LI01, E956LI; FDB -MP171; HLA -NPF044; FRA -CF9655; FLT -K1094
1987431172	Cabin Filter	SCA-1770813, 1913500	UFI -5328900; COR -80001732; MN -CU37001; HEG -E2960LI; FLG -AF27692; FLT -K1294; KNE -LA502; WIX -93513E; MHL -LA502
1987431451	Cabin Filter, Activated Carbon		MHL -LAK148; HEG -E947LC; UFI -5426000; MN -CUK2184; COO -ACE181; FLT -K1029A
F002H24367	Coolant Filter	ASL-X4000700, X400700	FLG -WF02152, WF2153, WF2152
F026404011	Coolant Filter		FLT -CW750; DON -P552096; COO -CSM6506; HEG -H28WF, E490L; MHL -WFC17; MN -WA9409; KNE -WFC17; UFI -2900600



### Filters Cross Reference Chart

Part Number	Product Description	Potential OE Part Number	Potential Comp. Part Number
F002H24920	Diesel Filter Kit (preliminary And Main Filter)	ASL-X8820800	FLG -FF05532
9450030116	Diesel Filter Kit (preliminary And Main Filter)	TAE-254709110106	
F002H21298	Diesel Filter Kit (preliminary And Main Filter)	ASL-F8835100	FLG -FS19636
F002H24918	Diesel Filter Kit (preliminary And Main Filter)	EII-ID351932, ID320704	FLG -FS19634
F002H26625	Diesel Filter Kit (preliminary And Main Filter)	TAE-252709110105, G9450030116, 254709110106	
F002H24921	Diesel Filter Kit (preliminary And Main Filter)	ASL-FHJ00700	FLG -FS19669
F002H23590	Diesel Filter Kit (preliminary And Main Filter)	ASL-F8835100	FLG -FS19636
F002H20254	Filter Kit (oil And Diesel Filter)	TAE-885409011210	FLG -8260272
F002H20255	Filter Kit (oil And Diesel Filter)	ASL-P0936051	FLG -8260271
F002H26311	Fuel Box Filter, Complete	ASL-F7B02900	FLG -FS01003, FS19654
F002H22283	Fuel Filter Element	MHI-1001CAA10311N	
1457431707	Fuel Filter Element	MB-9060920305, 4570900325, A0000901551, 0000901551, 9060920205, A9060920205, 9060920505, A0000901251, 0000901251, A9060920105, 9060920105, A9060920305, A9060900051, A4570900325, A9060920505, 9060900051	TEN -N471; COO -FEM4149; MHL -KX672D, KX671, KX671D, KX672DECO, KX67; FIM -FA5554; UFI -2601700; MFR -ELG5528; DON -P550632; CMI -EFF105; LUB -L8701F; MN -PU10461, PU10461X; FRA -C8976; FLT -PE9351; LAT -ELG5528; CRO -4027; HEG -E52KPD36; ALC -MD447; MFI -MP4409; SFM -S6017NE; GUD -M22; FLG -FF5380; WIX -95021E; THO -7502; KNE -KX672DECO
F002H26625	Fuel Filter Element	TAE-252709110105, G9450030116, 254709110106	
F002H22283	Fuel Filter Element	TAE-571009117701	
F026402107	Fuel Filter Element	SCA-1873018, 1446432, 1429059	MN -PU941X; AL -ALG7532; UFI -2600800; HEG -E57KPD73; FLT -PE983; TEF -PEC3024; FLG -FF5683; KNE -KX1821D; MHL -KX1821D; GUD -M65; DON -P550628

### Filters Cross Reference Chart

Part Number	Product Description	Potential OE Part Number	Potential Comp. Part Number
F002H22471	Fuel Filter Element	ASL-P7A00024	
F002H24496	Fuel Filter Element	MHI-0305DAB00581N	
F026402100	Fuel Filter Element	SCA-1459762, 1873016	MAH -KX182D, KX182DECO; MHL -KX182D; FLG -FF5684, FF5463; TEF -PEC3015; SFM -S6010NE; WIX -95044E; MN -PU9411X; FLT -PE9831; HEG -E68KP01D73, E68KPD73; FRA -C9799; KNE -KX182D; COO -FEM4264; FIL -PE9831; GUD -M91; SOG -FA5820ECO; UFI -2601000
F002H24406	Fuel Filter Element		FLG -FF05526
F002H24496	Fuel Filter Element	ASL-F7B01700	
F002H21299	Fuel Filter Element	TAE-886309000012, 886309000119, 253409110117, 254709110118, 279009110111	
1457431003	Fuel Filter Element	SWJ-WT4923570	FLG -FF05525
1457429655	Fuel Filter Element	MB-A4570900051, 5410920405, 5410901152, 5410900051, A5410920305, A5410901152, A5410920505, A5410920905, A5410920405, A5410900151, 5410920905, 5410920305, 5410920805, A5410920805, A5410900051, 5410920605, 4570900051, 5410920505, 5410900151, A5410920605	MHL -KX80D, KX801D, KX80DECO, KX80; GUD -M21; THO -7500; FRA -C5932; WGA -FCD0769; TEN -N600; UFI -2600100, 092600100; TEF -PEC3021; AL -ALG7500; MFI -MP446; COO -FEM4126; LAT -ELG5517; SFM -S6001NE; FLG -FF5405; DON -P550762; MFR -ELG5517; ALC -MD383; FLT -PE935; LUB -L8994F; CRO -4026; WIX -95022E; MN -P999X, PU9991X; KNE -KX80DECO; KSS -627FX; HEG -E500KPD36, E500KP, E500KP02D36, D36E500KP, D36500KP
F002H24742	Fuel Filter Element	MHI-7312AAA00021N	
9450030100	Fuel Filter Spin-on	ASL-F3952100	
F026402135	Fuel Filter Spin-on		SKR -SFC24030, SFC710930; RCO -R60PDMAX; DEP -HDF305; DON -P551033; FLG -FS19895; AL -ALG2219; ALC -SP1404; GUD -Z629; SOG -FP6060; , -700,950,158.00""; KNE -KC384D; HEG -H7062WK30; WIX -WF10010; UFI -2415800; MN -WK10401X; MHL -KC384D; SFM -S4158NR
F002H23590	Fuel Filter Spin-on	ASL-F8835100	FLG -FS19636

**Filters Cross Reference Chart**

Part Number	Product Description	Potential OE Part Number	Potential Comp. Part Number
F026402025	Fuel Filter Spin-on		RAC -490R, R9030M, R90P; STC -ST6007; MN -WK10603X; AL -ALG2172; ALC -SP1314; WIX -33411; GUD -Z634, Z368; RCO -490R, R90DAF, R90R, R9030M, R90P; FLT -PP967; KNE -KC249D; MFI -MP4076; COO -FSM4208; DON -P551856, P551767, P551067; HEG -H7090WK30; LUB -LFF3290; BAC -BF1329; MHL -KC249D; FLG -FS19932, FS19532
1457434294	Fuel Filter Spin-on		FLG -FF5272; KSS -481FS; PBR -BG1576; PUR -F67838; GUD -Z317; SFM -S5020NR; TEN -RN205; FRA -P5694; WYT -PD125; BAC -BF7653, BF7539; WIX -33690, 33690E; CLF -DN997; MFR -ELG5522; DON -P550372; CRO -5042; MHL -KC75; HEG -H18WK03; FLT -PP964; LUB -LFP8964, LFF3584, LFF5874; MFI -MP4015; PRF -CS453; ALC -SP870; COO -FSM4111; MN -WK9627; UFI -2433600; FIM -FT5317; KNE -KC75
F002H23582	Fuel Filter Spin-on		FLG -5006821, FS19644
9450030116	Fuel Filter Spin-on	EII-ID201331	
F026402311	Fuel Filter Spin-on		HEG -H421WK; MSF -M719; MN -WK11051; FLG -FF5987
F002H24366	Fuel Filter Spin-on	TAE-252709120254, 252709120259	FLG -FS19660, 8050134
9450030116	Fuel Filter Spin-on	TAE-254709110106	
F002H22095	Fuel Filter Spin-on	ASL-P7B00022	FLG -FS19674
F002H24921	Fuel Filter Spin-on	ASL-FHJ00700	FLG -FS19669
F026402118	Fuel Filter Spin-on		GUD -Z630; UFI -2446100; DON -P551843, P559628; FLG -FS19735; ALC -SP1315; HEG -H700WK; FLT -PP9713; MN -WK94033X; FBI -30069; MHL -KC362D; RCO -R260P
F026402132	Fuel Filter Spin-on		GUD -Z613; HEG -H328WK, H7091WK30D199; KNE -KC429D; MHL -KC429D; MFR -ELG5561; FLG -FS19920; DEP -HDF304; ALC -SP1357; MN -WK11001X; CLF -DNW2512
F002H26388	Fuel Filter Spin-on	TAE-570609119901, 570609110108	FLG -FS19665, 5014094
F026402141	Fuel Filter Spin-on		HEG -H200WWDK01; FLG -FF254; DON -P550529; KNE -KC300; BBF -BF7943; UFI -2412000; GUD -Z584; MHL -KC300; FLT -PP9642; SOG -FT5658; MSF -M342; KSS -4113FS, 50014113; VIC -FC242; MN -WDK1110224, WDK1110211
F002H24920	Fuel Filter Spin-on	ASL-X8820800	FLG -FF05532
F002H23535	Fuel Filter Spin-on	TAE-278609999920	FLG -FF05522

**Filters Cross Reference Chart**

Part Number	Product Description	Potential OE Part Number	Potential Comp. Part Number
F026402017	Fuel Filter Spin-on		MFI -MP4088; FLT -PP9641; MHL -KC251; CRO -5103; DON -P550529; TEF -PSC80; GUD -Z398; SFM -S9320NR; COO -FSM4261; WIX -95037E, 9641N; UFI -2334200, 2434200; WGA -FCD2207; AL -ALG2075; FLG -FF5507; HEG -H200WWDK; KSS -650FS; MN -WDK1110224, WDK1110228, WDK111029, WDK1110223; FRA -P9626; LUB -LFF8059; ALC -SP1270
F002H24742	Fuel Filter Spin-on	MHI-7312AAA00021N	
F002H26307	Fuel Filter Spin-on	MHI-942000319, 0305DC0161N	
F002H22001	Fuel Filter Spin-on	ASL-P1302040	
1457434314	Fuel Filter Spin-on		MN -WK8546; TEC -RN216; CMI -EFF078, EFF128; WGA -FCD2076; DEP -6260950; CRO -5072; UFI -24H2000; GUD -Z550; FLT -PP968; NIP -J1330320; SOF -S0H20NR; MNC -WK8546; WIX -WF8277; PRF -CS490; MFR -ELG5324; HEG -H159WK; FRA -PS9420WST; KNE -KC140; PBR -WS1001
F002H20306	Fuel Filter Spin-on		FLG -FS19641
F026402794	Fuel Filter Spin-on		MHL -KC491D; MN -WK10006Z; FLG -FS19966; DON -P551838; TEF -PSD261
9450030116	Fuel Filter Spin-on	SWJ-LP2413850	
F002H24518	Fuel Filter Spin-on	TAE-570107999901	FLG -FF05485
F002H24509	Fuel Filter Spin-on	TAE-254709110119	
0450226028	Fuel Filter Spin-on	ASL-F3968400	
F002H21299	Fuel Filter Spin-on	TAE-886309000012, 886309000119, 253409110117, 254709110118, 279009110111	
F002H27515	Fuel Filter Spin-on	TAE-252509120239, 252509120264, 252509120235	FLG -FS19644V, FS19644
F002H24919	Fuel Filter Spin-on		FLG -FF05539
F002H24919	Fuel Filter Spin-on	EII-ID351931, ID320867, ID320481	FLG -FF05539
F002H24501	Fuel Filter Spin-on	TAE-278607989916	FLG -FS19630, FS01275; DON -P502913
F026402859	Fuel Filter Spin-on		RCO -R60RDRCR01; HEG -H392WK; BBF -BF1386O; MN -WK11019Z; AL -ALG2466; ALC -SP1448; DST -63321; FLG -FS20082
F002H21298	Fuel Filter Spin-on	ASL-F8835100	FLG -FS19636
F002H22025	Fuel Filter Spin-on	TAE-571009119903, 571009119903N, 252509119902	

### Filters Cross Reference Chart

Part Number	Product Description	Potential OE Part Number	Potential Comp. Part Number
F026402865	Fuel Filter Spin-on		MN -WK11003Z; GUD -Z621; MHL -KC583D; AL -ALG2342; HEG -H460WK; FLG -FS20053; KNE -KC583D
F002H24374	Fuel Filter Spin-on	TAE-278609110106, 278609113002, 278609119909	FLG -FS19662, 5000549
F002H24509	Fuel Filter Spin-on, Fine Filter	TAE-254709110119	
F002H24500	Fuel Filter Spin-on, Fine Filter	TAE-278609119904	DON -P502905; FLG -FF5052
F002H24921	Fuel Filter Spin-on, Fine Filter	ASL-FHJ00700	FLG -FS19669
0450226028	Fuel Filter Spin-on, Fine Filter	ASL-F3968400	
F002H26311	Fuel Filter Spin-on, Fine Filter	ASL-F7B02900	FLG -FS01003, FS19654
F002H24374	Fuel Filter Spin-on, Fine Filter	TAE-278609110106, 278609113002, 278609119909	FLG -FS19662, 5000549
F002H24920	Fuel Filter Spin-on, Fine Filter	ASL-X8820800	FLG -FF05532
F002H26388	Fuel Filter Spin-on, Fine Filter	TAE-570609119901, 570609110108	FLG -FS19665, 5014094
F002H21299	Fuel Filter Spin-on, Fine Filter	TAE-886309000012, 886309000119, 253409110117, 254709110118, 279009110111	
F002H21298	Fuel Filter Spin-on, Fine Filter	ASL-F8835100	FLG -FS19636
F002H27515	Fuel Filter Spin-on, Fine Filter	TAE-252509120239, 252509120264, 252509120235	FLG -FS19644V, FS19644
F002H23590	Fuel Filter Spin-on, Fine Filter	ASL-F8835100	FLG -FS19636
F002H24919	Fuel Filter Spin-on, Fine Filter		FLG -FF05539
F002H22095	Fuel Filter Spin-on, Fine Filter	ASL-P7B00022	FLG -FS19674
F002H26310	Fuel Filter Spin-on, Fine Filter	ASL-FHN00400	FLG -FS19671
F002H24518	Fuel Filter Spin-on, Fine Filter	TAE-570107999901	FLG -FF05485
F002H24918	Fuel Filter Spin-on, Fine Filter		FLG -FS19634
F002H24501	Fuel Filter Spin-on, Fine Filter	TAE-278607989916	FLG -FS19630, FS01275; DON -P502913

### Filters Cross Reference Chart

Part Number	Product Description	Potential OE Part Number	Potential Comp. Part Number
F002H23536	Fuel Filter Spin-on, Fine Filter	TAE-278609999951	FLG -FF05479
F002H24366	Fuel Filter Spin-on, Fine Filter	TAE-252709120254, 252709120259	FLG -FS19660, 8050134
F002H22001	Fuel Filter Spin-on, Fine Filter	ASL-P1302040	
9450030116	Fuel Filter Spin-on, Fine Filter	TAE-254709110106	
F002H26311	Fuel Filter Spin-on, Pre-filter	ASL-F7B02900	FLG -FS01003, FS19654
F002H24374	Fuel Filter Spin-on, Pre-filter	TAE-278609110106, 278609113002, 278609119909	FLG -FS19662, 5000549
F002H24919	Fuel Filter Spin-on, Pre-filter		FLG -FF05539
F002H24518	Fuel Filter Spin-on, Pre-filter	TAE-570107999901	FLG -FF05485
F002H23590	Fuel Filter Spin-on, Pre-filter	ASL-F8835100	FLG -FS19636
F026402025	Fuel Filter Spin-on, Pre-filter	SCA-1393640	RAC -490R, R9030M, R90P; STC -ST6007; MN -WK10603X; AL -ALG2172; ALC -SP1314; WIX -33411; GUD -Z634, Z368; RCO -490R, R90DAF, R90R, R9030M, R90P; FLT -PP967; KNE -KC249D; MFI -MP4076; COO -FSM4208; DON -P551856, P551767, P551067; HEG -H7090WK30; LUB -LFF3290; BAC -BF1329; MHL -KC249D; FLG -FS19932, FS19532
F002H21299	Fuel Filter Spin-on, Pre-filter	TAE-886309000012, 886309000119, 253409110117, 254709110118, 279009110111	
9451037404	Fuel Filter Spin-on, Pre-filter	TAE-9451037404, 252709110104	
F002H24918	Fuel Filter Spin-on, Pre-filter	EII-ID351932, ID320704	FLG -FS19634
F002H23536	Fuel Filter Spin-on, Pre-filter	TAE-278609999951	FLG -FF05479
F002H24918	Fuel Filter Spin-on, Pre-filter		FLG -FS19634
F002H27515	Fuel Filter Spin-on, Pre-filter	TAE-252509120239, 252509120264, 252509120235	FLG -FS19644V, FS19644
F002H26314	Fuel Filter Spin-on, Pre-filter	TAE-288547704905, 288047704904	FLG -FS19732, FS19641
F002H24509	Fuel Filter Spin-on, Pre-filter	TAE-254709110119	

**Filters Cross Reference Chart**

Part Number	Product Description	Potential OE Part Number	Potential Comp. Part Number
F002H23535	Fuel Filter Spin-on, Pre-filter	TAE-278609999920	FLG -FF05522
F002H22095	Fuel Filter Spin-on, Pre-filter	ASL-P7B00022	FLG -FS19674
F002H24501	Fuel Filter Spin-on, Pre-filter	TAE-278607989916	FLG -FS19630, FS01275; DON -P502913
F002H22025	Fuel Filter Spin-on, Pre-filter	TAE-571009119903, 571009119903N, 252509119902	
F026402025	Fuel Filter Spin-on, Pre-filter		RAC -490R, R9030M, R90P; STC -ST6007; MN -WK10603X; AL -ALG2172; ALC -SP1314; WIX -33411; GUD -Z634, Z368; RCO -490R, R90DAF, R90R, R9030M, R90P; FLT -PP967; KNE -KC249D; MFI -MP4076; COO -FSM4208; DON -P551856, P551767, P551067; HEG -H7090WK30; LUB -LFF3290; BAC -BF1329; MHL -KC249D; FLG -FS19932, FS19532
F002H24920	Fuel Filter Spin-on, Pre-filter	ASL-X8820800	FLG -FF05532
0450226028	Fuel Filter Spin-on, Pre-filter	ASL-F3968400	
F002H23582	Fuel Filter Spin-on, Pre-filter		FLG -5006821, FS19644
F026402138	Fuel Filter Spin-on, Pre-filter	SCA-1780730	HEG -H7160WK30; FLT -PP9676; SKR -SFC530230; MHL -KC375D, KC375; SOG -FP6061; MN -WK10806X; FBI -30006; FLG -FS19737, FS19949; DIG -DGMK30651; RCO -R160P, R90DMER03, PFF5603, R160PDMAX; KNE -KC375D, KC375; WIX -95151E
F002H21298	Fuel Filter Spin-on, Pre-filter	ASL-F8835100	FLG -FS19636
F002H24366	Fuel Filter Spin-on, Pre-filter	TAE-252709120254, 252709120259	FLG -FS19660, 8050134
F002H26625	Fuel Filter Spin-on, Pre-filter	TAE-252709110105, G9450030116, 254709110106	
F002H24500	Fuel Filter Spin-on, Pre-filter	TAE-278609119904	DON -P502905; FLG -FF5052
F002H24921	Fuel Filter Spin-on, Pre-filter	ASL-FHJ00700	FLG -FS19669
F002H22004	Fuel Filter Spin-on, Pre-filter	ASL-P1302140	
F002H26388	Fuel Filter Spin-on, Pre-filter	TAE-570609119901, 570609110108	FLG -FS19665, 5014094
9451037409	Fuel Fine Filter Element	ASL-P1301640, F4003400	FLG -FF05534
9451037409	Fuel Fine Filter Element	TAE-252709119913	FLG -FF05534

**Filters Cross Reference Chart**

Part Number	Product Description	Potential OE Part Number	Potential Comp. Part Number
9451037405	Fuel Fine Filter Element	ASL-P1301340	
9451037406	Fuel Fine Filter Element	ASL-P1301440	
F002H24406	Fuel Fine Filter Element		FLG -FF05526
F002H23536	Fuel Pipe Filter	TAE-278609999951	FLG -FF05479
0450906267	Fuel Pipe Filter	VWW-191127401M, 191127401J, 191127401A, 1H0127401C, 1H0127401G, 191127401B, 191127401N, 2TA127401, 191127401L, 191127401E	MFR -ELG5210; RYC -Z580; FIM -FT5385, FP5219; MHL -KL180; KNE -KL75, KL180; FLT -PP839; CLF -DN829; UFI -2436501; ALC -SP972; WIX -WF8045; MN -WK8424, WK851; HSS -GF204; HEG -H70WK05; CHA -L114; KAY -AK14DB; AL -ALG20552, ALG2055; HIT -1930010; CMI -EFF018; MOT -EFG301, EFG321; COO -Z1141; KSS -182FP; PRF -FCS412BV, FCS412B; FRA -P5328, PS7149; UNP -GFE5308; CRO -5034K, 5034; PUR -PFC4807; THO -6202; PBR -AG6015; LUB -LFF8813F, FN13; DEP -HDF507
F002H23535	Fuel Pipe Filter	TAE-278609999920	FLG -FF05522
F002H23536	Fuel Pipe Filter	ASL-F8824500	FLG -FF05479
9451037404	Fuel Pre-filter Element	TAE-9451037404, 252709110104	
9451037404	Fuel Pre-filter Element	ASL-P1301240	
9451037409	Fuel Pre-filter Element	ASL-P1301640, F4003400	FLG -FF05534
1457431003	Fuel Pre-filter Element		FLG -FF05525
1457431003	Fuel Pre-filter Element	ASL-P1300640, F4000700	FLG -FF05525
F002H24336	Hydraulic Filter, Steering System	ASL-P2405339	RAN -41200006; FLG -5007109, 500710900
1457429820	Hydraulic Filter, Steering System		PRF -L121; UFI -2540601; KNE -AF121, HX15, EH2681; CPF -FA4018A; LUB -LH8504; WYT -WO1013; WIX -57131E, WL7026; RYC -R2008P; RCO -RP352; MHL -AF121, HX15, EH2681; SFM -S3081PO; FIP -ML138; SOP -CAP72; FLG -HF6162, LF4143, H6014; CLF -ML26, ML476; FRA -CH803APL, CH5576; DON -P779624, P779625, P550309; TEN -OP803; LAT -ELH4199; ALC -MD215; TTP -1500663, 1534372; DIG -DGMH601; KSS -50013044, 0440H; CRO -697; MFI -MO1113; PUR -H27122, PM5122, L27122; SOG -FA8401A; HEU -4045601; HEG -E10H02, E1018H; THO -5050, D50; FIM -FA4018A; MYL -0340460000; MOK -30784604; MFR -ELH4199; COO -HEM6176, AZL015, AZH001, HEM6516, RG976; SVA -SO051, 92005117; FBI -15761; MN -H6014; GUD -G976; TEC -FP9580; ACD -AC165; ZF -7632141102, 76316011456801, 7632141111, 763160114568; APD -LK3394; FLT -OM512; PBR -AC3300

### Filters Cross Reference Chart

Part Number	Product Description	Potential OE Part Number	Potential Comp. Part Number
1457429820	Hydraulic Filter, Steering System	MAN-81473016005	PRF -L121; UFI -2540601; KNE -AF121, HX15, EH2681; CPF -FA4018A; LUB -LH8504; WYT -WO1013; WIX -57131E, WL7026; RYC -R2008P; RCO -RP352; MHL -AF121, HX15, EH2681; SFM -S3081PO; FIP -ML138; SOP -CAP72; FLG -HF6162, LF4143, H6014; CLF -ML26, ML476; FRA -CH803APL, CH5576; DON -P779624, P779625, P550309; TEN -OP803; LAT -ELH4199; ALC -MD215; TTP -1500663, 1534372; DIG -DGMH601; KSS -50013044, 044OH; CRO -697; MFI -MO1113; PUR -H27122, PM5122, L27122; SOG -FA8401A; HEU -4045601; HEG -E10H02, E1018H; THO -5050, D50; FIM -FA4018A; MYL -0340460000; MOK -30784604; MFR -ELH4199; COO -HEM6176, AZL015, AZH001, HEM6516, RG976; SVA -SO051, 92005117; FBI -15761; MN -H6014; GUD -G976; TEC -FP9580; ACD -AC165; ZF -7632141102, 76316011456801, 7632141111, 763160114568; APD -LK3394; FLT -OM512; PBR -AC3300
F026404001	Hydraulic Filter, Steering System		MHL -HX108; COO -HEM6216; CRO -7066; ZF -7632141110, 76316011453401, 763160114534; FLT -OM5122; MN -H623; KNE -HX108; HEG -E70H; WIX -92125E
F002H24337	Hydraulic Filter, Steering System	ASL-P4200340	RAN -42200007; FLG -5006457, 500645700
F002H24336	Hydraulic Filter, Steering System	TAE-257344500107	RAN -41200006; FLG -5007109, 500710900
1457429820	Hydraulic Filter, Steering System	SCA-153468, 1953094	PRF -L121; UFI -2540601; KNE -AF121, HX15, EH2681; CPF -FA4018A; LUB -LH8504; WYT -WO1013; WIX -57131E, WL7026; RYC -R2008P; RCO -RP352; MHL -AF121, HX15, EH2681; SFM -S3081PO; FIP -ML138; SOP -CAP72; FLG -HF6162, LF4143, H6014; CLF -ML26, ML476; FRA -CH803APL, CH5576; DON -P779624, P779625, P550309; TEN -OP803; LAT -ELH4199; ALC -MD215; TTP -1500663, 1534372; DIG -DGMH601; KSS -50013044, 044OH; CRO -697; MFI -MO1113; PUR -H27122, PM5122, L27122; SOG -FA8401A; HEU -4045601; HEG -E10H02, E1018H; THO -5050, D50; FIM -FA4018A; MYL -0340460000; MOK -30784604; MFR -ELH4199; COO -HEM6176, AZL015, AZH001, HEM6516, RG976; SVA -SO051, 92005117; FBI -15761; MN -H6014; GUD -G976; TEC -FP9580; ACD -AC165; ZF -7632141102, 76316011456801, 7632141111, 763160114568; APD -LK3394; FLT -OM512; PBR -AC3300
F002H24338	Hydraulic Filter, Steering System	ASL-PD600391	RAN -19105200

### Filters Cross Reference Chart

Part Number	Product Description	Potential OE Part Number	Potential Comp. Part Number
F002H24337	Hydraulic Filter, Steering System	TAE-277046609901	RAN -42200007; FLG -5006457, 500645700
F002H26361	Oil Filter Element	EII-ID321716	FLG -LF09667
F002H20031	Oil Filter Element	ASL-F4034600	FLG -LF16052
F002H23434	Oil Filter Element	TAE-279018130104, 279018130106, 279018130105, G279018130106	
F002H20360	Oil Filter Element	TAE-278618999994	FLG -LF16306
F002H26363	Oil Filter Element	MHI-0303BAV00510N	FLG -LF16340
F002H20264	Oil Filter Element	TAE-279018130101, 279018130102, G279018130103	FLG -LF16080
F002H23571	Oil Filter Element	TAE-252718130145	FLG -LF09028
F002H20241	Oil Filter Element	ASL-F4034200, P3101540, F4034500	FLG -LF16057
F002H24519	Oil Filter Element	TAE-570118999901	FLG -LF16015
F002H23572	Oil Filter Element	ASL-F7A01500	FLG -LF16238
F002H27505	Oil Filter Element	EII-ID337989	FLG -LF09053
9951030141	Oil Filter Element	EII-ID002922	FLG -LF16069
F002H23439	Oil Filter Element	MHI-9420000074, 9420000073, 0303BAM00350N, 0303BC0071N, 0303BC0010N, 0024772	
9451037438	Oil Filter Element	TAE-252318130110, 252518130124	FLG -LF16073
F002H23432	Oil Filter Element	TAE-59063972	
F002H24322	Oil Filter Element	MHI-0303BAU00110N	PUR -534000199
F002H24502	Oil Filter Element	TAE-278618139902	FLG -LF03959
9451037424	Oil Filter Element	ASL-F4000100	FLG -LF16074
F002H60022	Oil Filter Element	ASL-B8774802, X4001000	FLG -LF16079
9451037456	Oil Filter Element	TAE-253418130129, 252718130105	FLG -LF16059
F002H20032	Oil Filter Element	TAE-252518130124	FLG -LF16051
9951030141	Oil Filter Element		FLG -LF16069
F002H27505	Oil Filter Spin-on	EII-ID337989	FLG -LF09053
F002H26313	Oil Filter Spin-on	ASL-FPA00300	FLG -LF16309

**Filters Cross Reference Chart**

Part Number	Product Description	Potential OE Part Number	Potential Comp. Part Number
0451403077	Oil Filter Spin-on		FIM -FLI6943, FT4878; DON -P554004, ELF7739, LFP554004, P779143; FRA -PH5394, PH49A, PH5349; PRF -LS778, LS841; SVA -SO180, 92818017; TEC -FB5442, FB5443; WIX -51791; PUR -PER67, L50068, PER68; RYC -HDZ211; PBR -BC1083, BC1344; COO -LSF5106, AZL083, LSF5140; ACD -PF857; FLT -OP584; GUD -Z182, Z605; ALC -SP1010; MFI -MH3301, MH3300; THO -4094, OK94; CRO -9309, 9361, 2103; UFI -2314400; BAC -B76B, B76; MHL -OC121; MFR -ELH4707; LUB -LFP2216, LFP3191; APD -LK97403; CLF -DO300; WYT -PP201; MN -W1110236, W1110214; KSS -055OS; MOK -30758077; HEG -H200W10; STB -SH8148; TEN -R90; KNE -AW92, OC121; FLG -LF3321, LF3476, LF17505, LF667, LF3477; SOP -CV513; MOT -EFL170, FL307; SFM -S0900R
F002H60001	Oil Filter Spin-on	TAE-279018130104, 279018130106, 279018130105	
0451103219	Oil Filter Spin-on		SOP -CV325; FLG -LF3758, LF3736, LF4015, LF3400, LF3376, LF764; MRO -8671002059; LAT -ELH4171, ELH4092; AL -AL16; KSS -395OS; RYC -Z89A, R4P; KNE -FO3732, OC204; LUB -LS390, PH2904, LFP2215, PH2820A; BAC -B1434; TEN -R18, R62, R60; WYT -PP523; PBR -BC1345, BC1048, BC1053; HEG -H13W, H112WK, H131W, H10W06, H10W22; CMI -EOF028; LUC -EDL206; MOT -BFL041, EFL056; WEE -02; UFI -2312700, 2325700, 2313401; MFR -ELH4171, ELH4092, GL249; KRA -L65A; FRA -PH2800, PH2861B, PH28001, PH7328, PH2861A, PH2857A; MHL -OC204; WIX -WL7124; PRF -LS149; MN -W917; MFI -MH330, MH315; MNC -W917; CRO -5291, 2131, 661; UNP -GFE121, GFE207; PUR -PC265, PC26, L17019, PER18; FLT -OP568; ACD -X7, SR, ST, X19, SK; DON -P550882, LFP550882; POW -PMFL71; GKN -MOF3X, MOF11X, MOF68X; SFM -S3257R; SVA -264230, SO256, SO6031, 92800711; TEC -FB2070, FB5457; ALC -SP829; THO -4335, 4032, OK32; FIM -FT4828, FT4828A; DEP -FX0147, FX0013; MPC -61083; GUO -GH2800; CHA -C164, C102; HAF -HOF241; COO -Z27, Z69, Z1097, Z91, Z80; GUD -Z28; CLF -DO886, DO223
F002H26361	Oil Filter Spin-on	EII-ID321716	FLG -LF09667

**Filters Cross Reference Chart**

Part Number	Product Description	Potential OE Part Number	Potential Comp. Part Number
F026407022	Oil Filter Spin-on	NIS-15208AW300, 1520800QAF, 1520800Q0D, 1520800Q0G	UFI -2348100; CMI -EOF216; TEN -R283; JPP -FO122S; MFR -ELH4392, ELH4333; SFM -S3820R; UNP -GFE584; WIX -WL7427; FIM -FT5901, FT5688; BLP -ADN12121; MHL -OC727, OC1290; FLT -OP6434; PRF -LS933, LS926; CPF -FT5901; FRA -PH9739; MN -W7069, W79; GUD -Z559; HEG -H221W; KNE -OC1290, OC471
F002H24502	Oil Filter Spin-on	TAE-278618139902	FLG -LF03959
F002H24519	Oil Filter Spin-on	TAE-570118999901	FLG -LF16015
F002H23434	Oil Filter Spin-on	TAE-279018130104, 279018130106, 279018130105, G279018130106	
F002H26363	Oil Filter Spin-on	MHI-0303BAV00510N	FLG -LF16340
F002H23571	Oil Filter Spin-on	TAE-252718130145	FLG -LF09028
F002H23572	Oil Filter Spin-on	ASL-F7A01500	FLG -LF16238
F002H23566	Oil Filter Spin-on	TAE-253418130169, 254718130117	FLG -LF16056
F026407176	Oil Filter Spin-on	NIS-1520800Q1J, 1520800Q1D	MSF -Z642; PRF -LS946; MHL -OC978; CPF -FT6088; TEN -R998; WIX -WL7513; GUD -Z614; CLF -DO5515; HEG -H14W42; UFI -2362800; FLT -OP6435; FRA -PH11440; CMI -EOF285; MN -W7032; MQP -LVFL803; BLP -ADN12133
F002H23516	Oil Filter Spin-on	TAE-252518130139	FLG -LF16060
F002H26361	Oil Filter Spin-on		FLG -LF09667
F002H20264	Oil Filter Spin-on	TAE-279018130101, 279018130102, G279018130103	FLG -LF16080
0451203228	Oil Filter Spin-on	TAE-3908615, 278618139902	MN -W95018; AC -PF1070; HEG -H19W08; CRO -2069; WIX -51607; MOT -FL896; MFR -ELH4745; GUD -Z345; FLG -LF3349, LF3959, LF3552, LF3935, LF3921; MHL -OC320; FLT -OP5922; KNE -OC320; FRA -PH3976; DON -P558615, LFP558615; PBR -BC1042; COO -AZL799; FIM -FT5218
0451103343	Oil Filter Spin-on	SCA-1117295, 1117285, 2077885, 2059778, 1347726, 562810	SOP -OC246; MFI -MH3409; TEN -R108; LUB -LFP8591, LFP9591; PRF -LS260; PBR -BC1083, BC1344; PUR -L59068; MHL -OC246; KNE -OC370, OC246; BAC -B7600; MN -W1110220, W1110214, W1110237; FLT -OP584; FLG -LF8667, LF9667, LF3730, LF17513, LF3675; HEG -H200W20, H200W02; LAT -ELH4749; UFI -2314402; GUD -Z182, Z598; DON -ELF7404, P167404, P550490, P560369, P550369; CRO -2003
F002H24322	Oil Filter Spin-on	MHI-0303BAU00110N	PUR -534000199
9451037446	Oil Filter Spin-on		MN -W9005

**Filters Cross Reference Chart**

Part Number	Product Description	Potential OE Part Number	Potential Comp. Part Number
F026407043	Oil Filter Spin-on		DON -ELF7404, P554004, P167404, P550490, P550369, P553191, R010059, P550519; MFI -MH3409; FIP -ZP3226, ZP3203; TEN -R108; GUD -Z583, Z619; HEG -H200W04, H200W03, H200W40, H200W41; FRA -PH8842; WIX -51791MP, 51791XD, 51791; MYL -16343220002; TEF -PSL417; KSS -660OS, 50013660, 666OS; RCO -PFL5620; VIC -C228; WYT -PP201, PB201, PP2014; BAC -B7600; ALC -SP1058; FLT -OP584; KNO -K118000N50, K118000; MN -W1110234, W1110227, W11025; MHL -OC370; FLG -LF16013, LF16329, LF17503, LF16175, LF9667, LF16107, LF3675; CRL -2003; FRL -ABPN10GLF3675; THO -4331, 4341; TTP -1501002, 1536454, 1533831, 1534373; MED -15375; HEN -H200W23, H200W24; BBF -B7460, B7600; SKR -C55221; PRF -LS260; SOG -FT5715; KBJ -K118000N50, K118000; LUB -LFP8591, LFP3191; FBI -35425, 39215; MFR -ELH4749; LAT -ELH4749; UFI -2314402; SFM -S4402R; KNE -OC370; CRO -2003
9951030134	Oil Filter Spin-on	TAE-254718130117	
9451037456	Oil Filter Spin-on	TAE-253418130129, 252718130105	FLG -LF16059
F002H60022	Oil Filter Spin-on	ASL-B8774802, X4001000	FLG -LF16079
F002H20236	Oil Filter Spin-on	TAE-254718130115	FLG -LF16070
F002H27505	Oil Filter Spin-on		FLG -LF09053
F002H23439	Oil Filter Spin-on	MHI-9420000074, 9420000073, 0303BAM00350N, 0303BC0071N, 0303BC0010N, 0024772	
0451300003	Oil Filter Spin-on		SFM -S3410R, S4120R; HEG -H200WN01, H240W01, H200WN; MHL -OC282; PBR -BC1178; MFI -MH3344; FIM -FT5596, FT5460; LUB -LFP8642; FRA -P5786, P9407, P5465, P3555A; CRO -2020, 2023; WIX -51660, 51749; MN -WP111023; KNE -OC282; BAC -B7577, B7685, B7575; WYT -PB281; COO -AZL419, LSB5164, LSB5145; ACD -P940; FLT -OP631; DON -P550425, P550777; PUR -L50250; KRA -L275; GUD -Z374, Z238; KSS -261OS; TEN -R214; ALC -SP1011; RYC -HDZ233; MFR -FH502V; PRF -LS842; LAT -ELH4741; UFI -2344600; FLG -LF777, LF3410, LF3654, LF3635, LF17502; THO -4305
F002H20241	Oil Filter Spin-on	ASL-F4034200, P3101540, F4034500	FLG -LF16057

**Filters Cross Reference Chart**

Part Number	Product Description	Potential OE Part Number	Potential Comp. Part Number
F002H24418	Safety Element Air Filter, Engine	TAE-253409130306, 885409010410, 253409130305	FLG -5005192, AF26074, AF26075
F002H23564	Safety Element Air Filter, Engine	ASL-X3962800, X3962700	FLG -AF26058, AF26006, AF26059, AF26002, 5005191; DON -P500955, P500956
F026400644	Safety Element Air Filter, Engine		FBI -105983; MN -CF1940; MSF -R545; DON -P954476; FLG -AF4187; ALC -MD7880S; GUD -ADG1896R; KNE -LXS300; SFM -S7A04A; FIP -HP2699; TIV -314037; SOG -FLI6967; MFR -FA3505; AUE -80178; UFI -27A0400; KSS -50014659, 4659AP; HEG -E1024LS; WIX -93373E; MYL -MIX0334, 5343210013; FLT -AM4429W; MHL -LXS300; SPQ -34037
F026400364	Safety Element Air Filter, Engine		SOG -FLI9309; ALC -MD7618S; MN -CF15101; HEG -E496LS; FLG -AF26162; GUD -ADG1208; LUB -LAF8839; BBF -RS5408; MSF -R585; MFR -FA3401
F026400601	Safety Element Air Filter, Engine	SCA-1869991, 1335681	GUD -ADG1705R; KNE -LXS372; HEG -E1013LS; MHL -LXS372; FLT -AM4167W; UFI -27D4100; FLG -AF27995; DON -P953215; MSF -R1143; MN -CF17007
F002H23589	Safety Element Air Filter, Engine	ASL-F7B01200, P5104005, F7B01100	DON -P617643, P617644; FLG -AF26125, 5005194U, AF26125U0, AF26485, AF26485U0
F002H21296	Safety Element Air Filter, Engine	TAE-252509140133	DON -P500957; FLG -AF25885
F002H21219	Safety Element Air Filter, Engine	ASL-F8221300	FLG -AF25931, AF24930, AF00963
F002H23561	Safety Element Air Filter, Engine	TAE-278609139909, 885409052516, 278609139908	FLG -AF25948, AF26008, AF04669, 8200068U, 8200068, AF26004, AF04670, AF25939
F002H23594	Safety Element Air Filter, Engine	EII-ID303249, ID303248	DON -P500968, P500967; FLG -5003795, 5003796, 5010377U
F002H24415	Safety Element Air Filter, Engine	ASL-F8845900, F8845800, X8800214, X8800114	FLG -AF26070, 502622200, AF26069
F002H21219	Safety Element Air Filter, Engine	TAE-278609139911	FLG -AF25931, AF24930, AF00963
F002H23594	Safety Element Air Filter, Engine		DON -P500968, P500967; FLG -5003795, 5003796, 5010377U
F002H23563	Safety Element Air Filter, Engine	TAE-278609139910, 278609139911, 885409041613	FLG -AF00947, AF25931, AF25921, 8200069U, AF24930, 8200069, AF25922, AF00963
F026404019	Transmission Oil Filter		MN -HU721Y; FLT -OE6811; MHL -HX77, HX77ECO; KNE -HX77, HX77ECO; HEG -E28HD203

### Filters Cross Reference Chart

Part Number	Product Description	Potential OE Part Number	Potential Comp. Part Number
F026407118	Transmission Oil Filter		SFM -S2234Z; ZF -4139298038, 4139298936, 0750131003, 0501203018; HEG -E39H, E39HD119; UFI -2203400; MHL -HX40; TEN -Z604; LUB -LH8640; MN -H7101X; DON -P762756; KNE -S6013; SCT -SH4010; ALC -MD4069; FRA -P4596, C8884; FLG -HF7999
F026404003	Transmission Oil Filter		THO -5541; MHL -HX77ECO, HX77; MFI -MU1213; FRA -CH9535ECO; KNE -HX77ECO, HX77; FLT -OE681, 681N; COO -HEM6196; HEG -E28H, E28HD174; MN -HU721XKIT; FIM -FA5639ECO; FLG -HF35361, HF35074; CLF -ML079, ML079A; TEN -OP231; CRO -2247
F026407284	Transmission Oil Filter		MSF -L226; HEG -E28HD289; MN -HU721WKIT; AUE -77837; DON -P954921; FLG -HF29040; SPQ -033215
F026404004	Transmission Oil Filter		THO -5541; MFI -MU1213; FIM -FA5639ECO; FLG -HF35361, HF35358, HF35074; FRA -CH9535ECO; KNE -HX77ECO; CLF -ML079, ML079A; COO -HEM6196; MN -HU721ZKIT; MHL -HX77ECO; CRO -2247; HEG -E28HD175, E28H; TEN -OP231



# What drives you, drives us

Bosch technologies are used in most vehicles worldwide.  
People, and assuring their mobility, is what we are focused on.

Therefore, we have dedicated over 130 years of pioneering spirit  
and expertise in research and manufacturing to achieving this.

We provide the aftermarket and workshops worldwide with modern diagnostic  
and workshop equipment and a wide range of spare parts for passenger cars and  
commercial vehicles:

- Solutions for efficient vehicle repairs
- Innovative workshop equipment and software
- One of the world's most comprehensive ranges of new and exchange parts
- Large network of wholesale customers, for quick and reliable parts supply
- Competent hotline support
- Comprehensive educational and training offers
- Targeted sales and marketing support

Scan the below QR code to place your  
orders on the Bosch Infocomm App



Please contact your nearest Bosch Main Distributor to enroll in the  
Bosch Rewards Programme / register in the Bosch Infocomm App



**Bosch Limited**  
**Automotive Aftermarket**  
P. B. No: 3000, Hosur Road, Adugodi  
Bengaluru – 560 030