MiniOpticon™ System

Instruction Manual

For MiniOpticon real-time PCR detection system with CFX Manager™ software

Catalog #CFB-3120



BIO-RAD

©2012 Bio-Rad Laboratories, Inc. Reproduction in any form, either print or electronic, is prohibited without written permission of Bio-Rad Laboratories, Inc.

Adobe, Acrobat, and Reader are trademarks of Adobe Systems Incorporated. Excel, Microsoft, Windows, and Windows Vista are trademarks of Microsoft Corporation. EvaGreen is a trademark of Biotium, Inc. Bio-Rad Laboratories, Inc., is licensed by Biotium, Inc., to sell reagents containing EvaGreen dye for use in real-time PCR, for research purposes only. FAM, HEX, VIC, and ROX are trademarks of Applied Biosystems Corporation. SYBR[®] is a trademark of Life Technologies Corporation. Bio-Rad Laboratories, Inc. is licensed by Life Technologies Corporation to sell reagents containing SYBR[®] Green for use in real-time PCR, for research purposes only.

LICENSE NOTICE TO PURCHASER

Purchase of this instrument conveys a limited non-transferable immunity from suit for the purchaser's own internal research and development and for use in human in vitro diagnostics and all other applied fields under one or more of U.S. Patents Nos. 5,656,493, 5,333,675, 5,475,610 (claims 1, 44, 158, 160-163 and 167 only), and 6,703,236 (claims 1-7 only), or corresponding claims in their non-U.S. counterparts, owned by Applied Biosystems Corporation. No right is conveyed expressly, by implication or by estoppel under any other patent claim, such as claims to apparatus, reagents, kits, or methods such as 5' nuclease methods. Further information on purchasing licenses may be obtained by contacting the Director of Licensing, Applied Biosystems, 850 Lincoln Centre Drive, Foster City, California 94404, USA.

Bio-Rad's real-time thermal cyclers are licensed real-time thermal cyclers under Applied Biosystems' United States Patent No. 6,814,934 B1 for use in research, human in vitro diagnostics, and all other fields except veterinary diagnostics.

This product is covered by one or more of the following U.S. patents, their foreign counterparts, or their foreign counterparts owned by Eppendorf AG: U.S. Patent Nos. 6,767, 512 and 7,074,367.

Bio-Rad Resources

Table 1 lists Bio-Rad resources and how to locate what you need.

Table 1. Bio-Rad resources

Resource	How to Contact
Local Bio-Rad Laboratories representatives	Find local information and contacts on the Bio-Rad website by selecting your country on the home page (www.bio-rad.com). Find the nearest international office listed on the back of this manual.
Technical notes and literature	Go to the Bio-Rad website (www.bio-rad.com). Type a search term in the Search box and select Documents tab to find links to technical notes, manuals, and other literature.
Technical specialists	Bio-Rad's Technical Support department is staffed with experienced scientists to provide customers with practical and expert solutions. To find local technical support on the phone, contact your nearest Bio-Rad office. For technical support in the United States and Canada, call 1-800-424-6723 (toll-free phone), and select the technical support option.

Writing Conventions Used in this Manual

This manual uses the writing conventions listed in Table 2.

Table 2. Conventions used in this manual

Convention	Meaning
TIP:	Provides helpful information and instructions, including information explained in further detail elsewhere in this manual.
NOTE:	Provides important information, including information explained in further detail elsewhere in this manual.
WARNING!	Explains very important information about something that might damage the researcher, damage an instrument, or cause data loss.
X > Y	Select X and then select Y from a toolbar, menu or software window.

For information about safety labels used in this manual and on the MiniOpticon system, see, "Safety and Regulatory Compliance" on page iii.



Safety and Regulatory Compliance

For safe operation of the MiniOpticon system, we strongly recommend that you follow the safety specifications listed in this section and throughout this manual.

Safety Warning Labels

Warning labels posted on the instrument and in this manual warn you about sources of injury or harm. Refer to Table 3 to review the meaning of each safety warning label.





Table 3. Meaning of safety warning labels

	CAUTION: Biohazard! This symbol identifies components that may become contaminated with biohazardous material.
	CAUTION: Risk of danger! This symbol identifies components that pose a risk of personal injury or damage to the instrument if improperly handled. Wherever this symbol appears, consult the manual for further information before proceeding.
	CAUTION: Hot surface! This symbol identifies components that pose a risk of personal injury due to excessive heat if improperly handled.

Instrument Safety Warnings

The warning labels shown in Table 4 also display on the instrument, and refer directly to the safe use of the MiniOpticon real-time PCR detection system.

Table 4. Instrument Safety Warning Labels

Icon	Meaning
	Warning about risk of harm to body or equipment. Operating the MiniOpticon real-time PCR detection system before reading this manual can constitute a personal injury hazard. For safe use, do not operate this instrument in any manner unspecified in this manual. Only qualified laboratory personnel trained in the safe use of electrical equipment should operate this instrument. Always handle all components of the system with care, and with clean, dry hands.
	CAUTION: Biohazard! This symbol identifies components that may become contaminated with biohazardous material.
	Warning about risk of burning. A thermal cycler generates enough heat to cause serious burns. Wear safety goggles or other eye protection at all times during operation. Always allow the sample block to return to idle temperature before opening the lid and removing samples. Always allow maximum clearance to avoid accidental skin burns.
	Warning about risk of explosion. The sample blocks can become hot enough during the course of normal operation to cause liquids to boil and explode.

Safe Use Specifications and Compliance

Table 5 lists the safe use specifications for the MiniOpticon system. Shielded cables (supplied) must be used with this unit to ensure compliance with the Class A FCC limits.

Table 5. Safe Use Specifications

Safe Use Requirements	Specifications
Temperature	Indoor use. The system will operate safely when the ambient temperature is 5 – 40°C and will meet performance specifications when the ambient temperature is 15–31°C with a maximum relative humidity of 80% for temperatures up to 31°C, decreasing linearly to 50% relative humidity at 40°C
Altitude	Up to 2,000 meters above sea level
Electrical supply	100–240 VAC, 50–60 Hz, 400W. Main supply voltage fluctuations not to exceed +/- 10% of nominal voltage
Installation categories (Overvoltage Categories) II	
Pollution degree 2	

REGULATORY COMPLIANCE

This device complies with Part 15 of the FCC Rules. Operation is subject to the following two conditions: (1) this device may not cause harmful interference, and (2) this device must accept any interference received, including interference that may cause undesirable operation.

This device has been tested and found to comply with the EMC standards for emissions and susceptibility established by the European Union at time of manufacture.

This digital apparatus does not exceed the Class A limits for radio noise emissions from digital apparatus set out in the Radio Interference Regulations of the Canadian Department of Communications.

LE PRESENT APPAREIL NUMERIQUE N'EMET PAS DE BRUITS RADIOELEC-TRIQUES DEPASSANT LES LIMITES APPLICABLES AUX APPAREILS NUMERIQUES DE CLASS A PRESCRITES DANS LE REGLEMENT SUR LE BROUILLAGE RADIOELECTRIQUE EDICTE PAR LE MINISTERE DES COMMUNICATIONS DU CANADA.

This equipment generates, uses, and can radiate radio frequency energy and, if not installed and used in accordance with the instruction manual, may cause harmful interference to radio communications. Operation of this equipment in a residential area is likely to cause harmful interference in which case the user will be required to correct the interference at his own expense.

FCC WARNING

NOTE: Changes or modifications to this unit not expressly approved by the party responsible for compliance could void the user's authority to operate the equipment.

This equipment has been tested and found to comply with the limits for a Class A digital device, pursuant to Part 15 of the FCC Rules. These limits are designed to provide reasonable protection against harmful interference when the equipment is operated in a commercial environment. This equipment generates, uses, and can radiate radio frequency energy and, if not installed and used in accordance with the instruction manual, may cause harmful interference to radio communications. Operation of this equipment in a residential area is likely to cause harmful interference in which case the user will be required to correct the interference at his own expense.

Although this design of instrument has been tested and found to comply with Part 15, Subpart B of the FCC Rules for a Class A digital device, please note that this compliance is voluntary, for the instrument qualifies as an “Exempted device” under 47 CFR § 15.103(c), in regard to the cited FCC regulations in effect at the time of manufacture.

Hazards

The MiniOpticon real-time PCR detection system is designed to operate safely when used in the manner prescribed by the manufacturer. If the MiniOpticon system or any of its associated components are used in a manner not specified by the manufacturer, the inherent protection provided by the instrument may be impaired. Bio-Rad Laboratories, Inc. is not liable for any injury or damage caused by the use of this equipment in any unspecified manner, or by modifications to the instrument not performed by Bio-Rad or authorized agent. Service of the MiniOpticon system should be performed only by Bio-Rad personnel.

Biohazards

The MiniOpticon system is a laboratory product. However, if biohazardous samples are present, adhere to the following guidelines and comply with any local guidelines specific to your laboratory and location.

PRECAUTIONS

- Always wear laboratory gloves, coats, and safety glasses with side shields or goggles
- Keep your hands away from your mouth, nose and eyes
- Completely protect any cut or abrasion before working with potentially infectious materials
- Wash your hands thoroughly with soap and water after working with any potentially infectious material before leaving the laboratory
- Remove wristwatches and jewelry before working at the bench
- Store all infectious or potentially infectious material in unbreakable, leak-proof containers
- Before leaving the laboratory, remove protective clothing
- Do not use a gloved hand to write, answer the telephone, turn on a light switch, or touch anything that other people may touch without gloves
- Change gloves frequently. Remove gloves immediately when they are visibly contaminated
- Do not expose materials that cannot be properly decontaminated to potentially infectious material
- Upon completion of the operation involving biohazardous material, decontaminate the work area with an appropriate disinfectant (for example, a 1:10 dilution of household bleach)
- No biohazardous substances are exhausted during normal operations of this instrument

SURFACE DECONTAMINATION

WARNING! To prevent electrical shock, always turn off and unplug the instrument prior to performing decontamination procedures.

The following areas can be cleaned with any hospital-grade bactericide, virucide, or fungicide disinfectant:

- Outer lid and chassis
- Inner reaction block surface and reaction block wells
- Control panel and display

To prepare and apply the disinfectant, refer to the instructions provided by the product manufacturer. Always rinse the reaction block and reaction block wells several times with water after applying a disinfectant. Thoroughly dry the reaction block and reaction block wells after rinsing with water.

WARNING! Do not use abrasive or corrosive detergents or strong alkaline solutions. These agents can scratch surfaces and damage the reaction block, resulting in loss of precise thermal control.

DISPOSAL OF BIOHAZARDOUS MATERIAL

The MiniOpticon system contains no potentially hazardous chemical materials. Dispose of the following potentially contaminated materials in accordance with laboratory local, regional and national regulations:

- Clinical samples
- Reagents
- Used reaction vessels or other consumables that may be contaminated

Chemical Hazards

The MiniOpticon system contains no potentially hazardous chemical materials.

Explosive or Flammability Hazards

The MiniOpticon system poses no uncommon hazard related to flammability or explosion when used in a proper manner as specified by Bio-Rad Laboratories.

Electrical Hazards

The MiniOpticon system poses no uncommon electrical hazard to operators if installed and operated properly without physical modification and connected to a power source of proper specification.

Transport

Before moving or shipping the MiniOpticon system, decontamination procedures must be performed. Always move or ship the MiniOpticon system with the supplied packaging materials that will protect the instrument from damage. If appropriate containers cannot be found, contact your local Bio-Rad office.

Storage

The MiniOpticon system can be stored under the following conditions:

- Temperature range: -20 to 60°C
- Relative humidity: maximum 80%

Disposal

The MiniOpticon real-time PCR detection system contains electrical or electrical materials; it should be disposed of as unsorted waste and must be collected separately according to the European Union Directive 2002/96/CE on waste and electronic equipment —WEEE Directive. Before disposal, contact your local Bio-Rad representative for country-specific instructions.

Table of Contents

Bio-Rad Resources	ii
Writing Conventions Used in this Manual	ii
Safety and Regulatory Compliance	iii
Hazards	v
Chapter 1. System Installation	1
System Overview	1
System Requirements	3
Setting Up the system	4
Running Experiments	8
Chapter 2. CFX Manager™ Software	9
Main Software Window	9
Startup Wizard	12
Detected Instruments Pane	13
Status Bar	13
Instrument Properties Window	14
Master Mix Calculator	15
Scheduler	16
Chapter 3. Performing Runs	21
Run Setup Window	21
PrimePCR Runs	22
Protocol Tab	23
Plate Tab	23
Start Run Tab	24
Run Details Window	25
Instrument Summary Window	28
Chapter 4. Protocols	31
Protocol Editor Window	31
Protocol Editor Controls	33
Temperature Control Mode	36
Protocol AutoWriter	37

Chapter 5. Plates	39
Plate Editor Window	39
Setup Wizard	42
Select Fluorophores Window	44
Well Loading Controls	45
Experiment Settings Window	48
Well Selector Right-Click Menu Items	49
Well Groups Manager Window	50
Plate Spreadsheet View/Importer Window	51
Chapter 6. Data Analysis Overview	53
Data Analysis Window	53
Quantification Tab	56
Data Analysis Settings	58
Well Selectors	61
Charts	63
Spreadsheets	64
Export	65
Chapter 7. Data Analysis Windows	67
Quantification Tab	67
Quantification Data Tab	71
Melt Curve Tab	74
Melt Curve Data Tab	75
End Point Tab	77
Allelic Discrimination Tab	79
Custom Data View Tab	81
QC Tab	82
Run Information Tab	83
Data File Reports	84
Well Group Reports	87
Chapter 8. Gene Expression Analysis	89
Gene Expression	89
Plate Setup for Gene Expression Analysis	90
Guided Plate Setup	90
Bar Chart	91
Experiment Settings Window	95
Clustergram	97
Scatter Plot	98
Volcano Plot	99
Heat Map	100
Results	101
Gene Study	101
Gene Study Report Window	104
Gene Expression Calculations	106

Chapter 9. Users and Preferences	113
Log in or Select User	113
User Preferences Window	114
Files Tab	116
Protocol Tab	116
Plate Tab	117
Data Analysis Tab	118
Gene Expression Tab	119
QC Tab	120
Custom Export Tab	121
User Administration	122
Chapter 10. Resources	125
LIMS Integration	125
Calibration Wizard	126
Instrument Maintenance	127
Application Log	128
Troubleshooting	129
References	130
Index	131

Table of Contents

1 System Installation

Read this chapter for information about setting up the MiniOpticon™ real-time PCR detection system:

- System overview (page 1)
- System requirements (page 3)
- Setting up the system (page 4)
- Installing CFX Manager™ software (page 4)
- Running experiments (page 8)

System Overview

The MiniOpticon system uses an array of 48 light-emitting diodes (LEDs) to sequentially illuminate each of the 48 wells in the cycler block. The LEDs efficiently excite fluorescent dyes with absorption spectra in the 470–505 nm range. The MiniOpticon system uses two filtered photodiodes for fluorescence detection. The first channel is optimized to detect dyes with emission spectra in the 523–543 nm range, such as SYBR® Green I and FAM. The second channel is optimized for dyes with emission spectra of 540–700 nm. The MiniOpticon detector is calibrated at the factory and requires no further calibration before use.

The MiniOpticon system (Figure 1) includes:

- **Optical tower.** This tower includes an optical system to collect fluorescent data
NOTE: The serial number of the MiniOpticon system is located on a sticker on the back of the optical tower.

- **MJ Mini™ thermal cycler base.** The MiniOpticon system includes a thermal cycler block that rapidly heats and cools samples.

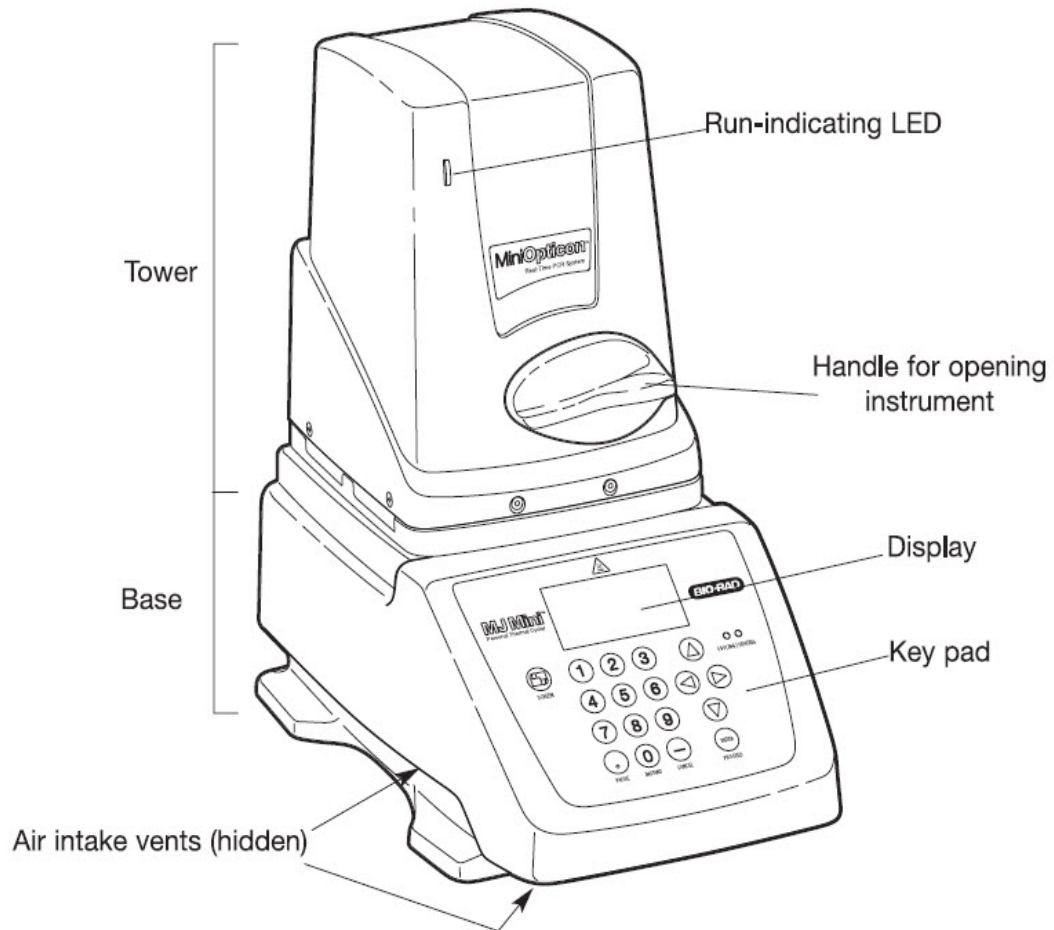

Figure 1. Front view of the MiniOpticon system.

When open, the MiniOpticon system includes these features:

- **Inner lid with heater plate.** The heater lid maintains temperature on the top of the reaction vessel to prevent sample evaporation. Avoid touching or otherwise contaminating the heater plate. Never poke anything through the holes, the apical system can be damaged.
- **Block.** Load samples in this block before the run
WARNING! Prevent contamination of the instrument by spills, and never run a reaction with an open or leaking sample lid. For information about general cleaning and maintenance of the instrument, see “Instrument Maintenance” (page 127).
WARNING! Avoid touching the inner lid or block: These surfaces can be hot.

The back panel of the MiniOpticon system includes these features (Figure 2):

- **Power switch.** Press the power switch to turn the power on
- **Power input.** Plug in the power cord here

- **USB connections.** Use these ports to connect the MiniOpticon system to a computer

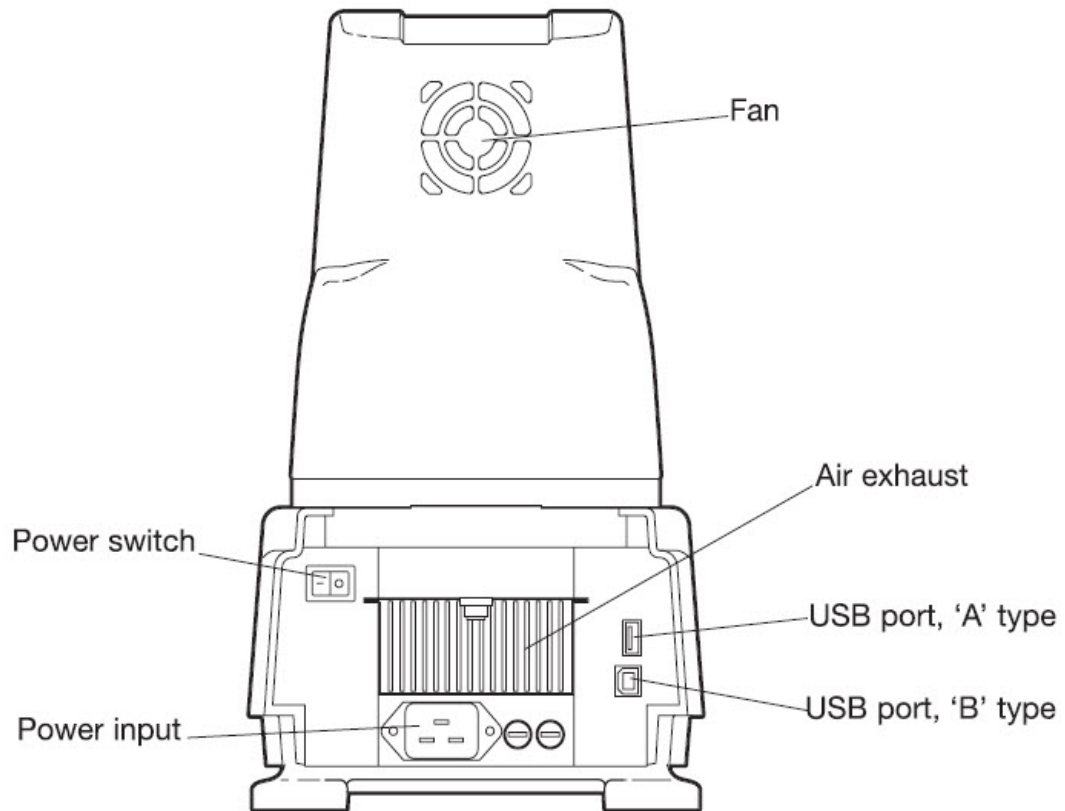

Figure 2. Back panel of MiniOpticon System.



WARNING! Avoid contact with the back panel during operation.

System Requirements

To operate the MiniOpticon system, use the following power sources and cables:

- **Input power.** 100–240 VAC, 50–60 Hz
- **Indoor use.** Ambient temperature of 15–31°C. Relative humidity maximum of 80% (non-condensing)
- **Air Supply.** The MiniOpticon system requires a constant supply of air that is 31°C or cooler in order to remove heat from the heat sink. Air is taken in from the lower vents located on the sides and front of the instrument and exhausted from the fan in the back. If the air supply is inadequate or too hot, the instrument can overheat, causing performance problems and even automatic shutdowns

WARNING! Do not place the MiniOpticon system on a lab bench covered by bench paper. The bench paper can prohibit sufficient air circulation.

- **USB cable.** Control the MiniOpticon system using only the USB cable provided from Bio-Rad. This cable is sufficiently shielded to help prevent data loss

Setting Up the system

The MiniOpticon system should be installed on a clean, dry, level surface with sufficient cool airflow to provide adequate air supply to run properly. The MiniOpticon system requires a location with power outlets to accommodate the MiniOpticon system and the computer.

NOTE: Only one MiniOpticon system should be connected to a computer at one time.

Installing the MiniOpticon System

To install the MiniOpticon system:

1. Your MiniOpticon system shipment includes the components listed below. Remove all packing materials and store them for future use. If any items are missing or damaged, contact your local Bio-Rad office.
 - MiniOpticon system
 - USB cable
 - CFX Manager™ software installation CD
 - Instruction manual
 - CFX Manager software quick guides for protocol, plate, data analysis, and gene expression analysis
2. Firmly grasp the instrument from beneath to support the weight of the cyclor and the optical tower. Carefully lift the instrument out of the shipping box.

WARNING! Do not lift the instrument by the green handle.

3. Insert the power cord plug into its jack at the back of the instrument.
4. Plug the power cord into a standard 110 V or 220 V electrical outlet. The MiniOpticon system will accept 220 V automatically. Avoid plugging the MiniOpticon system into a power outlet that is already being used for other laboratory equipment

NOTE: Turn the system on only after installing CFX Manager software. The power switch is on the back right-hand side of the MiniOpticon system.

Installing CFX Manager Software

CFX Manager software is run on a personal computer (PC) with either the Windows XP, Windows Vista, or Windows 7 operating system and is required to run and analyze real-time PCR data from the MiniOpticon system. Table 6 lists the computer system requirements for the software.

Table 6. Computer requirements for CFX Manager software.

System	Minimum	Recommended
Operating system	Windows XP Professional SP2 and above, Windows Vista, or Windows 7 Home Premium and above.	Windows XP Professional SP3 or Windows 7.
Drive	CD-ROM drive	CD-RW drive
Hard drive	10 GB	20 GB
Processor speed	2.0 GHz	2.0 GHz
RAM	1 GB RAM (2 GB for Windows Vista)	2 GB RAM
Screen resolution	1024 x 768 with true-color mode	1280 x 1024 with true-color mode

Table 6. Computer requirements for CFX Manager software. (continued)

System	Minimum	Recommended
USB	USB 2.0 Hi-Speed port	USB 2.0 Hi-Speed port

WARNING! Running a MiniOpticon system with CFX Manager software on a PC computer with a Windows 64-bit operating system is not supported due to incompatible USB drivers. A PC computer with a 64-bit processor (like Intel) on a 32-bit Windows operating system is supported.

WARNING! CFX Manager software can be installed on the same computer that already has Opticon Monitor™ version 3.1 installed. There may be conflicts controlling the instrument if both software packages are opened at the same time with the MiniOpticon turned on.

WARNING! If the computer with the CFX Manager software is running a virus scan program, make sure scans are performed when the MiniOpticon system is idle.

To install the CFX Manager software:

1. Log in to the computer with administrative privileges, the software must be installed on the computer by a user with administrative privileges.
2. Place the CFX Manager software CD in the computer's CD drive.
3. The software launch page should appear automatically. Double-click **Install Software** on the software launch page (Figure 3).

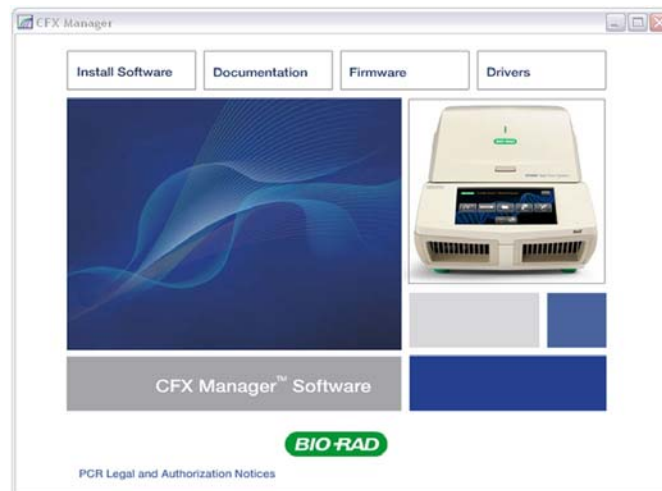

Figure 3. Software installation screen.

TIP: Click the **Documentation** button to find searchable PDF copies of instrument manuals and other documentation.

4. Accept the terms in the license agreement to continue.
5. Follow the instructions on the screen to complete the installation. When completed, the Bio-Rad CFX manager software icon will appear on the desktop of the computer.

6. If the launch page does not appear automatically, double-click on **(CD drive):\Bio-Rad CFX**, then open and follow instructions in the **Readme.txt** file.

NOTE: For Windows Vista operating system, you will be prompted to install device software for **Jungo** during the CFX Manager software installation. Click **Install** to proceed. If prompted with the warning “Windows can’t verify the publisher of this driver software,” Click **Install this driver software anyway** to proceed.

Installing MiniOpticon System Drivers

The MiniOpticon system drivers must be installed on the computer in order to properly communicate with the device and perform real-time PCR experiments. The drivers are installed automatically during CFX Manager software installation for computers running Windows Vista operating system. Drivers must be installed manually for computers running Windows XP operating system.

NOTE: For Windows XP operating system, three drivers must be installed: Bio-Rad Thermal Cycler (EEPROM Empty), Bio-Rad Mini Optical Module and Bio-Rad Mini Cycler. The driver installation package provides instructions on how to install the drivers correctly.

To install the system drivers for Windows XP:

1. Connect the MiniOpticon system to the computer by plugging a USB cable (square end) into the USB 2.0 port located on the back of the MiniOpticon system, and then connecting the cable (flat end) into the USB 2.0 port located on the computer.
2. Turn the MiniOpticon system on by pressing the switch on the back of the system so that the side marked “I” is depressed.
3. Follow the instructions in the **Found New Hardware Wizard** that launches after the instrument is first detected by the computer.
4. On the first screen, select **Yes, this time only** to instruct the Windows operating system to connect to Windows Update to search for software (Figure 4). Click **Next**.



Figure 4. Found New Hardware Wizard.

5. Select **Install the software automatically** to install the Bio-Rad Thermal Cyclers (EEPROM Empty) driver. Click **Next** (Figure 5).

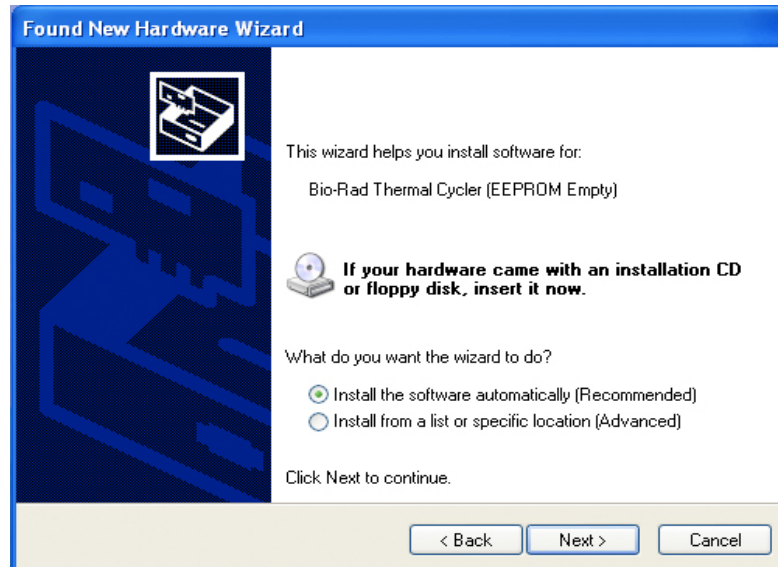

Figure 5. Software (Driver) installation screen.

6. A window will appear indicating the driver being installed has not passed Windows Logo testing to verify its compatibility with Windows XP. Click **Continue Anyway** to proceed.
7. Click **Finish** (Figure 6) at the software installation completion screen when the driver is installed.

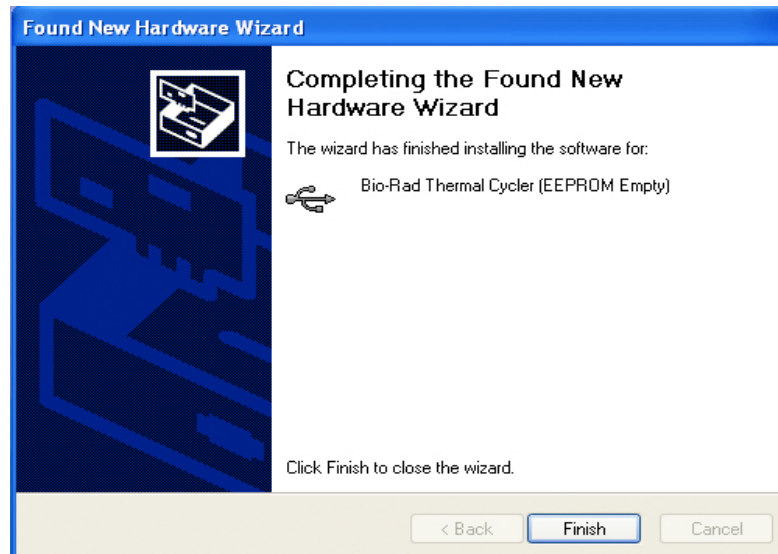

Figure 6. Finished Driver installation screen.

8. Repeat the driver installation for the Bio-Rad Mini Optical Module and the Bio-Rad MiniCycler drivers.

Running Experiments

Be sure that the MiniOpticon system is connected to the computer and turned on before launching the CFX Manager software. The green protocol-indicator light on the front of the MiniOpticon detector is illuminated only during a protocol run.

WARNING! Remove the shipping plate from the thermal cycler block to operate.

Loading the Block

1. To access the MiniOpticon system's block, turn the front green handle counter-clockwise until it snaps into the open position. Rotate the entire tower outward, to the left.
2. Place the 48-well, 0.2 ml microplate, or tube strips with sealed lids in the block. Check that the tubes are completely sealed to prevent leakage. For optimal results, load sample volumes of 15–30 μ l.
3. To ensure uniform heating and cooling of samples, sample vessels must be in complete contact with the sample holder. Adequate contact is ensured by:
 - Verifying the sample holder is clean before loading samples
 - Firmly pressing tubes, or a 48-well microplate into the sample holder

TIP: Spin down reactions in tubes or microplates before loading into the thermal cycler block. Air bubbles in samples, or liquid on the plate deck, can affect results.

- Bio-Rad strongly recommends that oil not be used to thermally couple sample vessels to the block

NOTE: Do not open the MiniOpticon detector while the green protocol-indicator light is illuminated. Opening the door, particularly during a scan of the plate, may interrupt the software's control of the protocol.

4. To close the instrument, rotate the tower back into the closed position and then turn the green handle clockwise (Figure 1). Both the tower and the handle have spring mechanisms that facilitate closure.

NOTE: For accurate data analysis, check that the orientation of reactions in the block is exactly the same as the orientation of the well contents in the software Plate tab (see "Plate Tab" on page 23). If needed, edit the well contents before, during, or after the run.

WARNING! When running the MiniOpticon system, always balance the tube strips or cut microplates in the wells. For example, if you run one tube strip on the left side of the block, run an empty tube strip (with caps) on the right side of the block to balance the pressure applied by the heated lid.

WARNING! Be sure that nothing is blocking the lid when it closes. Although there is a safety mechanism to prevent the lid from closing if it senses an obstruction, do not place anything in the way of the closing lid.

Recommended Plastic Consumables

Run only white-welled 48-well plates or white-welled strip tubes in the MiniOpticon system. For optimal results, Bio-Rad provides the following consumables for the MiniOpticon system (catalog numbers are provided in bold):

- **MLL-4851.** Multiplate low-profile 48-well unskirted PCR plates, white color wells
- **TLS-0851.** Low-profile 8-tube strips, 0.2 ml, without caps, white color wells
- **TCS-0803.** Optical flat 8-cap strips, for 0.2 ml tubes and plates, ultraclear

2 CFX Manager™ Software

Read this chapter for information about getting started with CFX Manager software.

- Main software window (page 9)
- Startup Wizard (page 12)
- Detected Instruments Pane (page 13)
- Status Bar (page 13)
- Instrument Properties window (page 14)
- Master Mix Calculator (page 15)
- Scheduler (page 16)

Main Software Window

Features available in the main software window are provided in Figure 7.

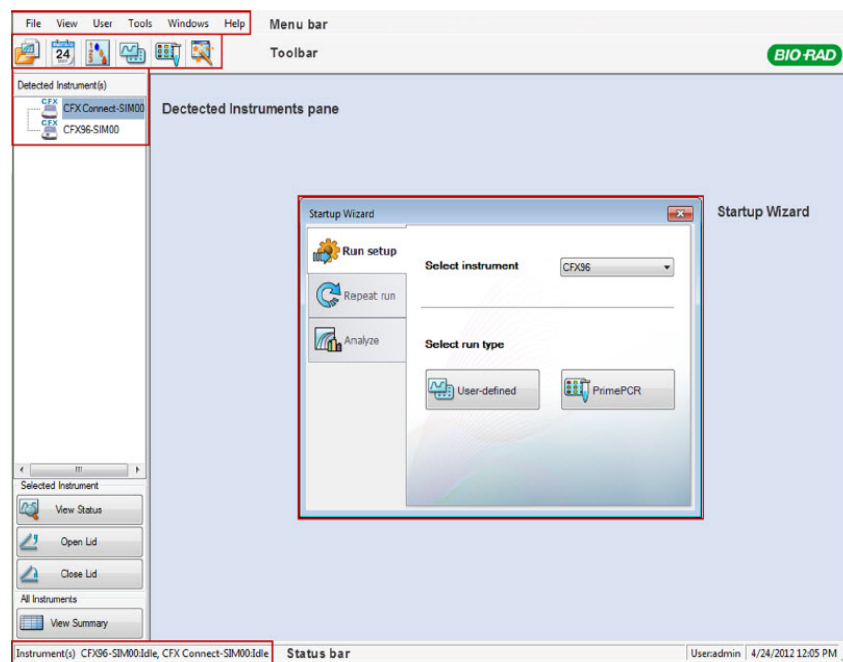

Figure 7. The main software window.

Menu Bar

The menu bar of the main software window provides the items listed in Table 7.

Table 7. Menu bar items in the main software window

Menu Item	Command	Function
File	New	Create a new protocol, plate, run, or Gene Study.
	Open	Open existing files, including protocol (.prcl), plate (.pltd), data (.pcrd), Gene Study (.mgxd), and stand-alone run files (.zpcr).
	Recent Data Files	View a list of the ten most recently viewed data files, and select one to open in Data Analysis.
	Repeat a run	Open the Run Setup window with the protocol and plate from a completed run to quickly repeat the run.
	Exit	Exit the software program.
View	Application Log	Display the application log for the software.
	Run Reports	Select a run report to review from a list.
	Startup Wizard	Open the Startup Wizard.
	Run Setup	Open the Run Setup window.
	Instrument Summary	Open the Instrument Summary window.
	Detected Instruments	Show or hide the Detected Instruments pane.
	Toolbar	Show or hide the main software window toolbar.
	Status Bar	Show or hide the main software window status bar.
User	Show	Open the Block Status window, application data folder, user data folder, LIMS file folder, PrimePCR folder, run history, or a window displaying the properties of all connected instruments.
	Select User	Open the Select User window to change software users.
	Change Password	Change your user password.
	User Preferences	Open the User Preferences window.
	User Administration	Manage users in the User Administration window.

Table 7. Menu bar items in the main software window (continued)

Menu Item	Command	Function
Tools	Scheduler	Open the Scheduler to make reservations for instrument use.
	Master Mix Calculator	Open the Master Mix Preparation calculator.
	Protocol AutoWriter	Open the Protocol AutoWriter window to create a new protocol.
	Ta Calculator	Open the Ta Calculator window to calculate the annealing temperature of primers.
	Dye Calibration Wizard	Open the Dye Calibration window to calibrate an instrument for a new fluorophore.
	Reinstall Instrument Drivers	Reinstall the drivers that control communication with Bio-Rad real-time PCR systems
	Zip Data and Log Files	Choose and condense selected files in a zipped file for storage or to email.
	Options	Configure software email settings.
Windows	Cascade	Arrange software windows on top of each other.
	Tile Vertical	Arrange software windows from top to bottom.
	Tile Horizontal	Arrange software windows from right to left.
	Close All	Close all open software windows.
Help	Contents	Open the software Help for more information about running PCR and real-time PCR.
	Index	View the index in the software Help.
	Search	Search the software Help.
	qPCR Applications & Technologies Web Site	Open a website to find information about real-time PCR.
	PCR Reagents Web Site	View a website that lists Bio-Rad PCR and real-time PCR reagents.
	PCR Plastic Consumables Web Site	View a website that lists Bio-Rad consumables for PCR and real-time PCR runs.
	Software Web Site	View a website that lists Bio-Rad PCR and real-time PCR amplification software.
	Check For Updates	Check for software or instrument updates.
	About	Open a window to see the software version.

Toolbar Buttons

Click a button in the toolbar of the main software window (Table 8) for quick access to common software commands.

Table 8. Toolbar buttons in the main software window.







Button	Button Name	Function
	Open a Data File or Gene Study	Open a browser window to locate a data file (*.pcrd extension) and open it in the Data Analysis window or a gene study file (.mgxd extension) open it in the Gene Study window.

Table 8. Toolbar buttons in the main software window. (continued)

Button	Button Name	Function
	Scheduler	Open the Scheduler to reserve a PCR instrument.
	Master Mix Calculator	Open the Master Mix Calculator window to set up reaction mixes.
	User-defined Run Setup	Open the Run Setup window to set up a run (page 21).
	PrimePCR Run Setup	Open the Run Setup window with the default PrimePCR™ protocol and plate layout loaded based on the instrument selected.
	Startup Wizard	Open the Startup Wizard that links you to common software functions (page 12).

Startup Wizard

The Startup Wizard automatically appears when CFX Manager software is first opened. If it is not shown, click the **Startup Wizard** button on the main software window toolbar.

Options in the Startup Wizard include the following:

- **Run setup.** Select the appropriate instrument in the pull-down list to ensure the default plate settings match the instrument to be used
- **User-defined.** Set up the protocol and plate to begin a new run in the **Run Setup** window (page 21)
- **PrimePCR.** Open the **Run Setup** window with the default PrimePCR protocol and plate layout (for the selected instrument) loaded. PrimePCR plate layouts are available only for 96- and 384-well plates.
- **Repeat Run.** Set up a run with the protocol and plate layout from a completed run. If needed, you can edit the run before starting
- **Analyze.** Open a data file to analyze results from a single run (page 53) or a gene study file for results from multiple gene expression runs (page 97)

Detected Instruments Pane

The connected instrument appears in the **Detected Instruments** pane (Figure 8). This list shows each instrument as an icon named with the serial number (default). Right-click on the instrument in the Detected Instruments pane to open the Instrument Properties window and rename the instrument.

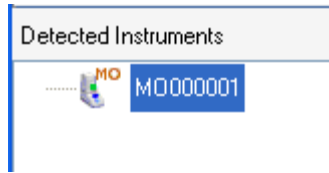

Figure 8. Instruments listed in the Detected Instruments pane.

Right-click on the instrument icon to select one of these options:

- **View Status.** Open the Run Details window to check the status of the selected instrument block
- **Flash Block Indicator.** Flash the indicator LED on the instrument
- **Rename.** Change the name of the instrument
- **Properties.** Open the Instrument Properties window
- **Collapse All.** Collapse the list of instruments in the Detected Instruments pane
- **Expand All.** Expand the list of instruments in the Detected Instruments pane

You can also control a block by clicking an instrument block icon in the Detected Instrument pane and then clicking a button in the Selected Instrument pane (Figure 9).

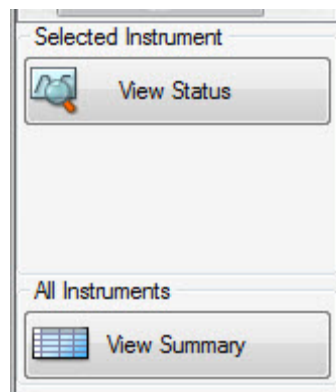

Figure 9. Buttons at the bottom of the Detected Instrument pane.

- Click **View Status** to open the Run Details window to check the status of the selected instrument block
- Click **View Summary** to open the Instrument Summary window

Status Bar

The left side of the status bar at the bottom of the main software window shows the current status of the instruments. View the right side of the status bar to see the current user name, date, and time. Click and drag the right corner of the status bar to resize the main window.

Instrument Properties Window

To open the Instrument Properties window to view information about an instrument, right-click on the instrument icon in the Detected Instruments pane (Figure 8). The window includes two tabs (Figure 10):

- **Properties.** View serial numbers of the MiniOpticon system
- **Calibrated Dyes.** View the list of calibrated fluorophores

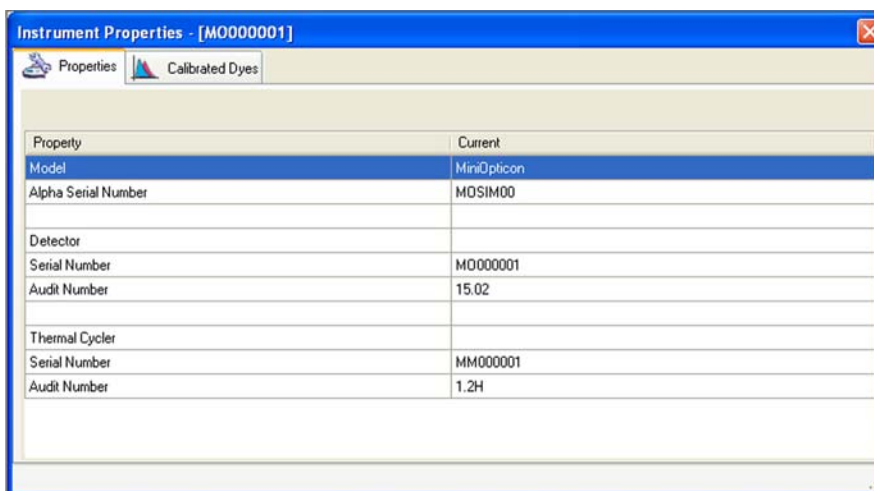

Figure 10. Instrument Properties window.

Properties Tab

The Properties tab displays important serial numbers for the connected instrument. The firmware versions are also displayed. The default name for an instrument is the MiniOpticon serial number, which appears in many locations in the software.

Calibrated Dyes Tab

Open the Calibrated Dyes tab (Figure 11) to view the list of calibrated fluorophores and plates for the selected instrument. Click an **Info** button to see detailed information about a calibration.

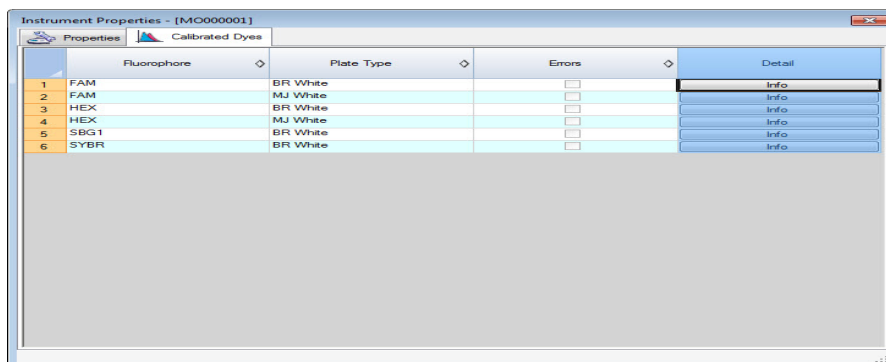

Figure 11. Calibrated Dyes tab in the Instrument Properties window.

Master Mix Calculator

To open the Master Mix Calculator, click the Master Mix Calculator button in the toolbar (Figure 12) or select **Tools > Master Mix Calculator** from the main window.

Component	Volume Per Reaction (μl)	Total Volume for 96 Reactions + (5)%
Supermix (2 x)	10.000	1008.0
10 μM Forward Primer (SYBR_targ...	0.400	40.3
10 μM Reverse Primer (SYBR_targ...	0.400	40.3
Template	(1.00)	(100.8)
Water	8.200	826.6
Total Volume (Excluding Template)	19.000	1915.2

Figure 12. Master Mix Calculator window.

To set up a reaction master mix:

1. Select either SYBR[®] Green/EvaGreen or Probes detection method.
2. Edit the default target name by highlighting the target name in the dropdown target list, entering a new target name in the **Target** box and pressing Enter on the keyboard.
3. Enter the starting and final concentrations for your forward and reverse primers and any probes.
4. Additional targets can be added by clicking the **New** button. To delete targets, select the target using the dropdown target list and click **Remove**.

WARNING! Removing a target from the target list also removes it from any master mixes calculations it is used in.

- Adjust the Supermix concentration, reaction volume per well, excess reaction volume, the volume of template that will be added to each well, and the number of reactions that will be run.
- Check the checkbox next to the target (only one can be chosen per SYBR® Green/ EvaGreen master mix) or targets (for probe multiplex reactions). The calculated volumes of the components required for the master mix are listed.
- To print a master mix calculations table click **Print**.
- Click the **Set as Default** button to set the quantities inputted in the Target and Master Mix Setup sections as new defaults.
- To save the contents of the Master Mix Calculator window, click **OK**.

Scheduler

Use the Scheduler to reserve access to an instrument(s). To access the Scheduler click the Scheduler button in the toolbar (Figure 13) or select **Tools > Scheduler** from the main window.

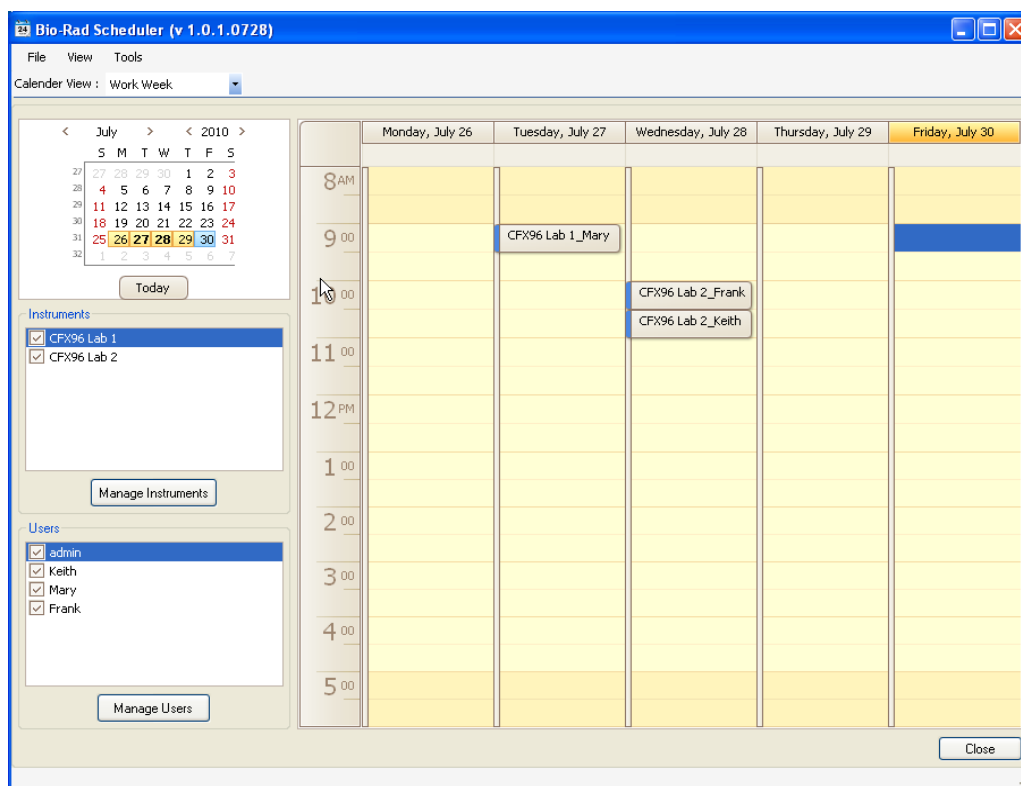

Figure 13. Scheduler Main Window.

To Set up the Scheduler

1. The first time Scheduler is opened, any User, Instrument, and SMTP email settings will be imported from CFX Manager software.
2. To add a new instrument, select **View > Instrument Details** or click the **Manage Instruments** button below the Instruments list (Figure 13) in the scheduler main window. In the Instrument Details window, enter the instrument name in the Name column. Choose a model from the drop down menu or leave it blank to schedule instrument types not listed. Entering base and optical head serial numbers is optional.
3. To add a new user, select **View > User Details** or click the **Manage Users** button below the Users list. In the User Details window (Figure 14), enter the new user name in the Name column. An e-mail address can be entered so that optional electronic notifications can be sent.
NOTE: The SMTP server needs to be set up in order for electronic notifications to be enabled.

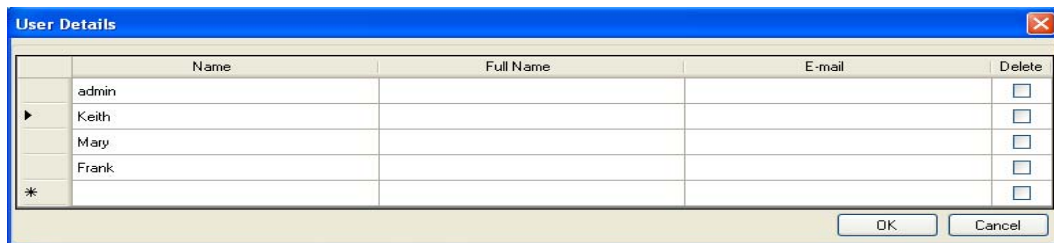

Figure 14. Scheduler User Details Window.

4. To remove an instrument or user, open the appropriate details window and check the corresponding box in the Delete column.
WARNING! All events associated with this instrument or user will be removed from the calendar.

Scheduler Menu Bar

The Scheduler menu bar contents are listed in Table 9.

Table 9. Menu bar items in the Scheduler

Menu Item	Command	Function
File	Print Preview	Open the print preview window to adjust print settings.
	Print	Print the calendar as it appears on the screen.
	Exit	Exit the scheduler.
View	Instrument Details	Open the instrument details window to view, edit, add, or delete the name, model, base or optical head serial numbers.
	User Details	Open the user details window to view, edit, add, or delete scheduler users.
	Log File	View the scheduler activity log.
Tools	Import from CFX Manager	Imports the instruments, users or SMTP e-mail settings from CFX Manager software.
	Cleanup Events	Delete events from the calendar older than the period of time specified in the options window.
	Options	Open a window to specify default calendar settings, create a desktop icon, choose to run the scheduler at start up or define cleanup parameters.

Entering Scheduler Events

To schedule an event:

1. Double click in the appropriate cell in the calendar or right click and choose **New Event**.
2. Select the instrument and user from the drop down list (Figure 15).
3. Adjust the start and end times. Once an event appears in the calendar view it can be moved to another time period by clicking and dragging the entry to a new position in the calendar.
4. Assign a color to this event (optional).
5. To include an e-mail or a popup reminder that will appear at a specified time prior to the start of an event, check the **Reminder** check box and choose an advance notification time period for the drop down list.

WARNING! The Scheduler must be running for reminders to be activated. Minimizing the Scheduler window will enable pop-up and e-mail reminders to occur at the scheduled time. Selecting **Close** will quit the Scheduler.

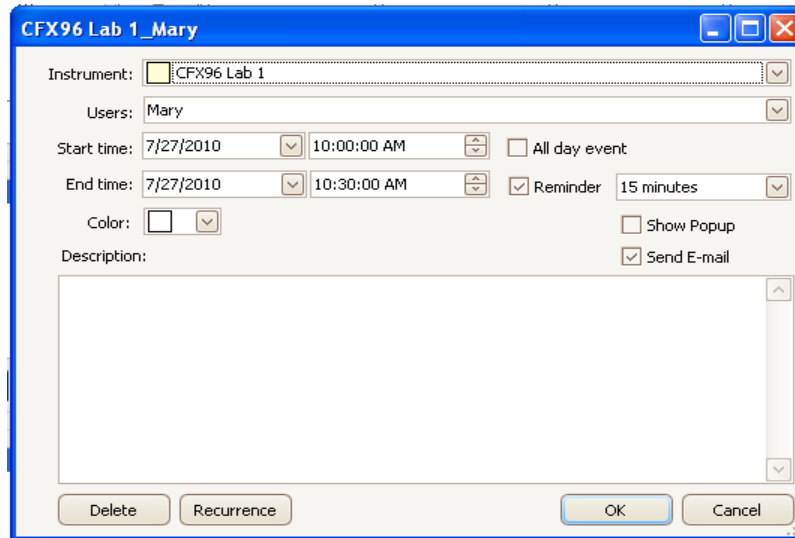

Figure 15. Scheduler New Event window.

Cleanup events

Select **Tools > Cleanup Events** to delete events from the calendar older than the period of time specified in the scheduler options window (Figure 16).

WARNING! All events older than the specified date will be deleted.

Scheduler Options

Select **Tools > Options** to define Scheduler display, cleanup and launch settings. Click **Restore Defaults** to restore the Scheduler default settings.

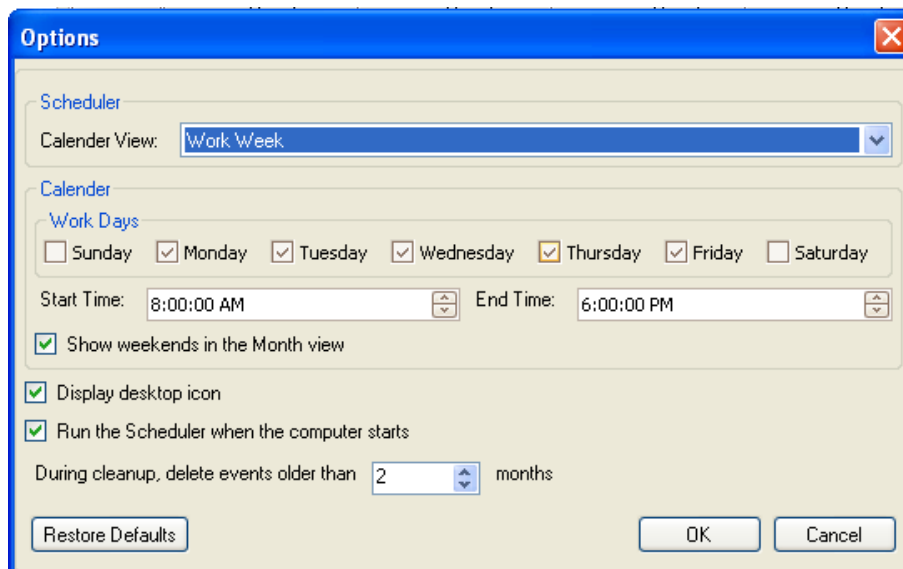

Figure 16. Scheduler Options window.

3 Performing Runs

Read this chapter for information about performing runs using CFX Manager™ software:

- Run Setup window (page 21)
- Prime PCR™ runs (page 22)
- Protocol tab (page 23)
- End point only runs (page 23)
- Plate tab (page 23)
- Start Run tab (page 24)
- Run Details window (page 25)
- Instrument Summary window (page 28)

Run Setup Window

The Run Setup window provides quick access to the files and settings needed to set up and start a run. To open the Run Setup window, perform one of these options:

- Click the **User-defined** or the **PrimePCR** button in the **Run Setup** tab of the Startup Wizard (page 12)
- Click the **User-defined Run Setup** or **PrimePCR Run Setup** button in the main software toolbar (page 9)
- Select **File > New > User-defined Run** or **PrimePCR Run** in the main software menu bar (page 10)

The Run Setup window includes three tabs:

- **Protocol.** Click the Protocol tab to select an existing protocol to run or edit, or to create a new protocol in the Protocol Editor window (page 31)
- **Plate.** Click the Plate tab to select an existing plate to run or edit, or to create a new plate in the Plate Editor window (page 39)

- **Start Run.** Click the Start Run tab (page 24) to check the run settings, select one or more instrument blocks, and begin the run

NOTE: If the protocol currently selected in the Protocol tab does not include a step with a plate read for real-time PCR analysis, then the Plate tab is hidden. To view the Plate tab, add a “Plate Read” (page 33) in at least one step in the protocol.

NOTE: Start a new run from a previous run by selecting **File > Repeat a Run** in the main software menu bar or **Repeat Run** in the Startup Wizard. Select the data file (.pcrd) for the run you want to repeat.

The Run Setup window opens with the Protocol tab in front (Figure 17). To open another tab, click that tab or click the **Prev** or **Next** button at the bottom of the window.

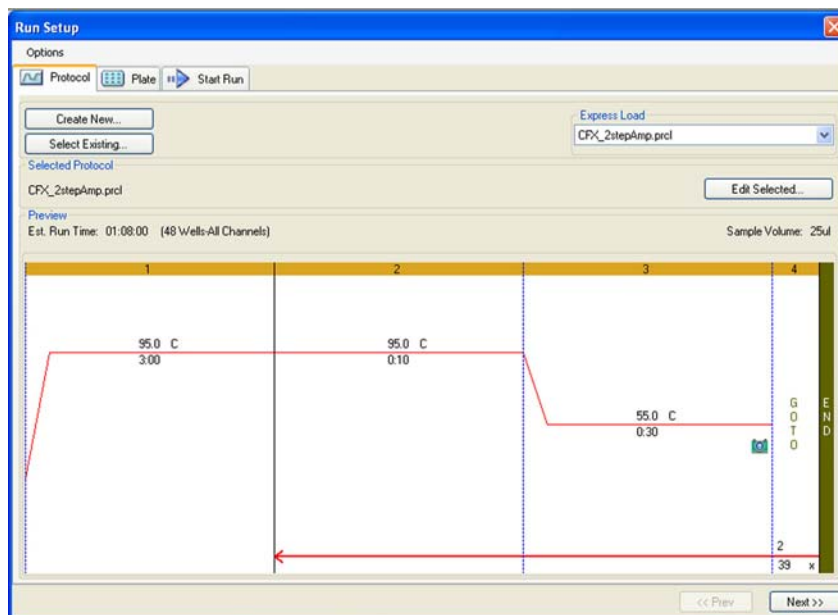

Figure 17. Run Setup window, including the Protocol, Plate, and Start Run tabs.

PrimePCR Runs

PrimePCR runs use pathway or disease-specific assays that have been wet-lab validated and optimized and are available from Bio-Rad in the following formats:

- **Pre-plated panels.** Plates contain assays that are specific for a biological pathway or disease. This option is available only in a 96- or 384-well format
- **Custom configured plates.** Plates can be set up in a user-defined layout with the option to choose assays for targets of interest, controls, and references. This option is available only in a 96- or 384-well format
- **Individual assays.** Tubes contain individual primer sets that can be used to manually set up reactions

Select one of the following options to start a PrimePCR run:

- **PrimePCR** from the **Run setup** tab on the Startup Wizard
- A PrimePCR run from the Recent Runs list of the **Repeat run** tab on the Startup Wizard
- **File > New > PrimePCR run** from the main window

- **File > Open > PrimePCR Run File...** from the main window

Once a PrimePCR run has been selected, the **Run Setup** window will open on the **Start Run** tab with the default PrimePCR protocol and plate layout loaded based on the instrument selected.

To reduce the overall run time, the melt step can be removed by unchecking the box adjacent to **Include Melt Step** on the **Protocol** tab. Any other modifications to a PrimePCR run protocol are not recommended since the default protocol was used for assay validation and any deviation from this may affect the results. Changes that are made will be noted in the **Run Information** tab of the resultant data file and in any reports that are created.

To import target information for PrimePCR plates into a run's plate layout, select **Plate Setup > Apply PrimePCR File** from the **Real-time Status** tab (page 27) or from the **Data Analysis** window (page 53) and choose the appropriate file (.csv). Select this file by searching in the PrimePCR folder using part of the file name or by browsing to the location on the computer where the file was downloaded from the Bio-Rad website when the plate was ordered.

Protocol Tab

The Protocol tab shows a preview of the selected protocol file loaded in the Run Setup (Figure 17). A protocol file contains the instructions for the instrument temperature steps, as well as instrument options that control the ramp rate and lid temperature.

Select one of the following options to select an existing protocol, create a new protocol, or edit the currently selected protocol:

- **Create New button.** Open the Protocol Editor to create a new protocol
- **Select Existing button.** Open a browser window to select and load an existing protocol file (.prcl extension) into the Protocol tab
- **Express Load pull-down menu.** Quickly select a protocol to load it into the Protocol tab
TIP: To add or delete protocols in the **Express Load** menu, add or delete files (.prcl extension) in the **ExpressLoad** folder. To locate this folder, select **Tools > User Data Folder** in the menu bar of the main software window
- **Edit Selected button.** Open the currently selected protocol in the Protocol Editor

End Point Only Runs

To run a protocol that contains only an end point data acquisition step, select **Options > End Point Only Run** from Options in the menu bar of the Run Setup window. The default end point protocol, which includes two cycles of 60.0°C for 30 seconds, is loaded into the Protocol tab.

To change the step temperature or sample volume for the end point only run, click the **Start Run** tab and edit the **Step Temperature** or **Sample Volume**.

Plate Tab

The Plate tab shows a preview of the selected plate file loaded in the Run Setup (Figure 18). In a real-time PCR run, the plate file contains a description of the contents of each well, the scan mode, and the plate type. CFX Manager software uses these descriptions for data collection and analysis.

Select one of the following options to select an existing plate, create a new plate, or edit the currently selected plate:

- **Create New button.** Open the Plate Editor to create a new plate
- **Select Existing button.** Open a browser window to select and load an existing plate file (.pltd extension) into the Plate tab
- **Express Load pull-down menu.** Quickly select a plate to load it into the Plate tab
TIP: To add or delete plates in the **Express Load** menu, add or delete files (.pltd extension) in the **ExpressLoad** folder. To locate this folder, select **Tools > User Data Folder** in the menu bar of the main software window.
- **Edit Selected button.** Open the currently selected plate in the Plate Editor

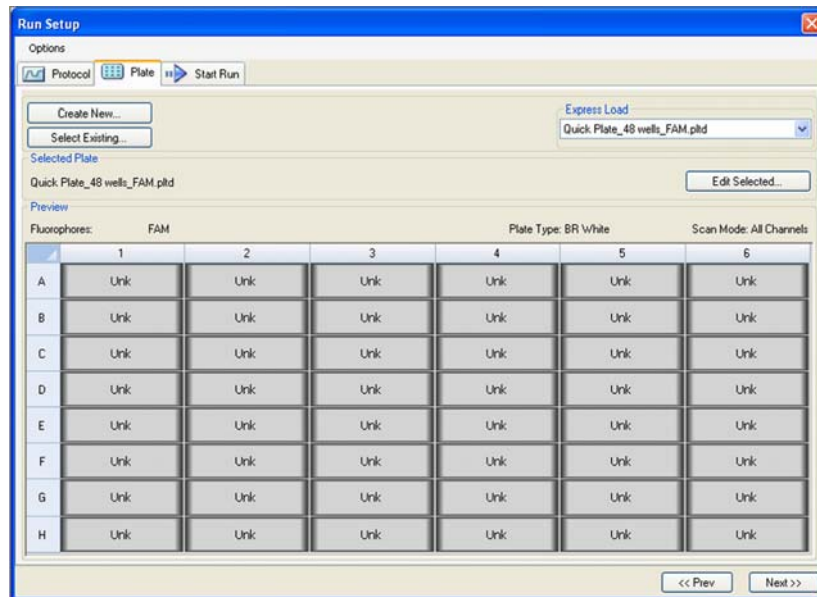

Figure 18. Plate tab window.

Start Run Tab

The Start Run tab (Figure 19) includes a section for checking information about the run that is going to be started and a section for selecting the instrument block.

- **Run Information pane.** View the selected Protocol file, Plate file, and data acquisition Scan Mode setting. Enter optional notes about the run in the **Notes** box.
- **Start Run on Selected Block(s) pane.** Select one or more blocks, edit run parameters (if necessary), and then click the **Start Run** button to begin the run

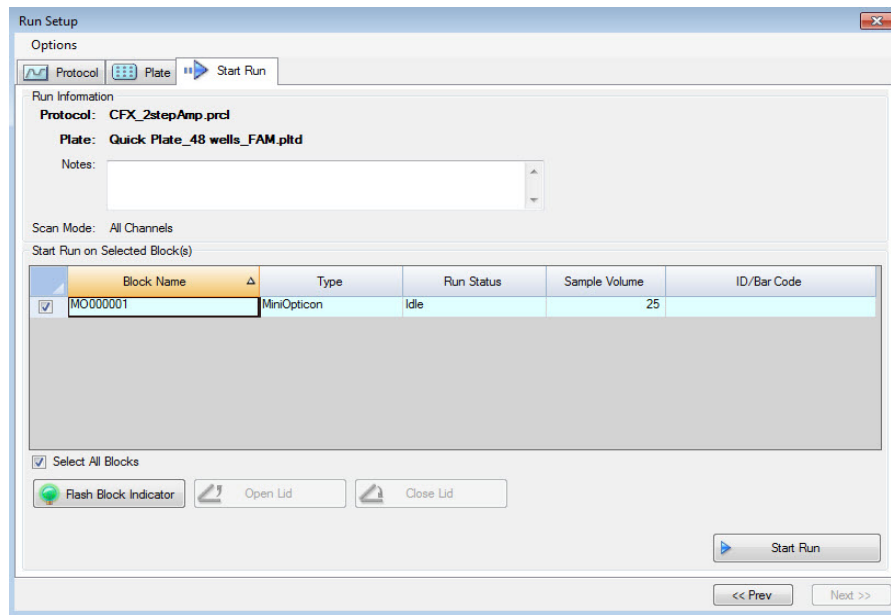

Figure 19. Start Run tab.

NOTE: You can override the Sample Volume loaded in the Protocol file by selecting the volume in the spreadsheet cell and typing a new volume.

NOTE: A run ID can be entered for each block by selecting the cell and typing an ID or by selecting the cell and scanning with a bar code reader.

To add or remove run parameters from the spreadsheet in the **Start Run on Selected Block(s)** pane, right-click on the list and select an option in the menu to display. Choose the value to change by clicking the text inside the cell to select it and then typing in the cell, or by selecting a new parameter from the pull-down menu. Editable parameters include:

- **Lid Temperature.** View the temperature of the lid. Override the lid temperature by selecting the text and typing a new temperature

Run Details Window

When you click the **Start Run** button, CFX Manager software prompts you to save the name of the data file and then opens the Run Details window. Review the information in this window to monitor the progress of a run.

- **Run Status tab.** Check the current status of the protocol, open the lid, pause a run, add repeats, skip steps, or stop the run
- **Real-time Status tab.** View the real-time PCR fluorescence data as they are collected
- **Time Status tab.** View a full-screen countdown timer for the protocol

Figure 20 shows the features of the Run Details window.

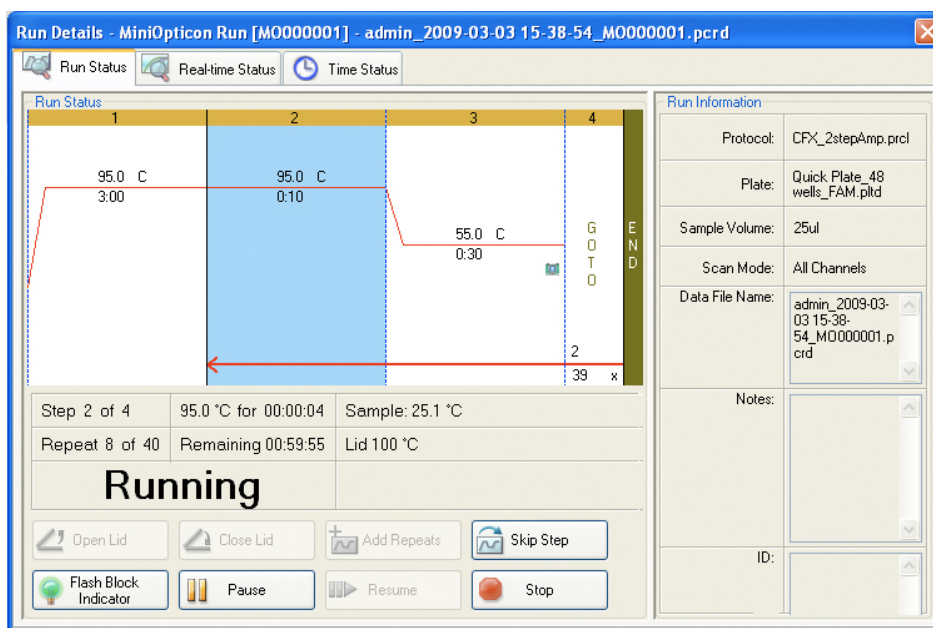

Figure 20. Run Details window showing the Run Status tab.

Run Status Tab

The Run Status tab (Figure 20) shows the current status of a run in progress in the Run Details window and provides buttons (see below) to control the lid and change the run in progress.

- **Run Status pane.** Displays the current progress of the protocol.
- **Run Status buttons.** Click one of the buttons to remotely operate the instrument or to interrupt the current protocol
- **Run Information pane.** Displays run details

Run Status Tab Buttons

Click one of the buttons listed in Table 10 to operate the instrument from the software or to change the run that is in progress.

NOTE: Changing the protocol during the run, such as adding repeats, does not change the protocol file associated with the run. These actions are recorded in the Run Log.

Table 10. Run Status buttons and their functions







Button	Function
 Open Lid	This button is disabled for the MiniOpticon™ system.
 Close Lid	This button is disabled for the MiniOpticon system.
 Add Repeats	Add more repeats to the current GOTO step in the protocol. This button is only available when a GOTO step is running.

Table 10. Run Status buttons and their functions (continued)

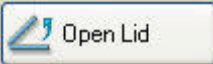
Button	Function
 Skip Step	Skip the current step in the protocol. If you skip a GOTO step, the software verifies that you want to skip the entire GOTO loop and proceed to the next step in the protocol.
 Flash Block Indicator	Flash the run indicating LED on the MiniOpticon system.
 Pause	Pause the protocol. NOTE: This action is recorded in the Run Log.
 Resume	Resume a protocol that was paused.
 Stop	Stop the run before the protocols ends, which may alter your data.

Real-time Status Tab

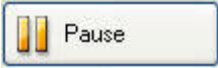
The Real-time Status tab (Figure 21) shows real-time PCR data collected at each cycle during the protocol after the first two plate reads.

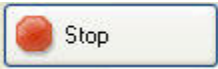
TIP: Click the **View/Edit Plate** button to open the Plate Editor window. During the run, you can enter more information about the contents of each well in the plate.

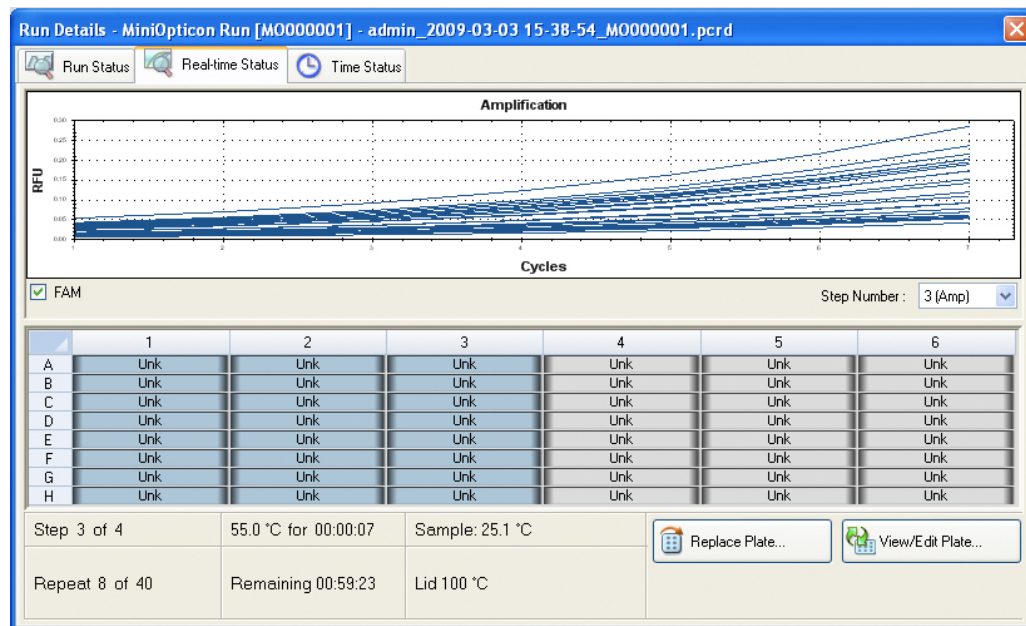

Figure 21. The Real-time Status tab displays the data during a run.

Editing a Plate Setup

The plate setup can be viewed and edited while a run is in progress by selecting the **View/Edit Plate** button in the Real-Time Status tab. The Plate Editor window will then be presented and edits can be made as outlined in Chapter 5 (Plates).

The trace styles can also be edited from the Plate Editor window and any changes made will be visible in the amplification trace plot in the Real-Time Status tab.

Replacing a Plate File

During a run, replace the plate file by selecting **Replace Plate file** from the **Plate Setup** dropdown in the **Real-time Status** tab. The Apply PrimePCR file selection is only applicable to a 96 or 384-well plate.

NOTE: CFX Manager software checks the scan mode and plate size for the plate file; these must match the run settings that were started during the run.

TIP: Replacing a plate file is especially useful if you start a run with a Quick Plate file in the Express Load folder.

NOTE:

Time Status Tab

The Time Status tab shows a countdown timer for the current run.

Instrument Summary Window

The Instrument Summary window (Figure 22) shows a list of the detected instruments and their status. Open the Instrument Summary by clicking the **View Summary** button (Figure 9 on page 13) in the Detected Instrument pane. Right-click in the Instrument Summary window to change the list of options that appear.

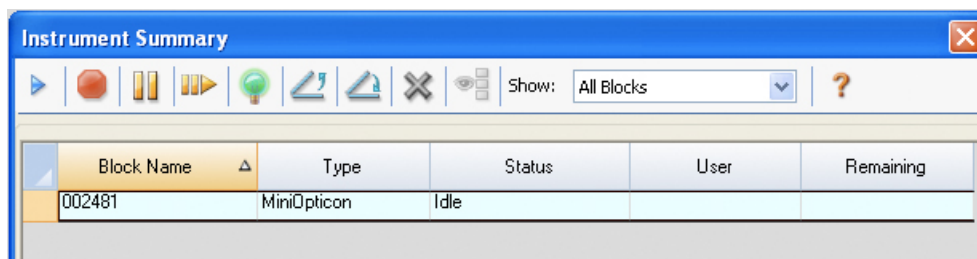











Figure 22. Instrument Summary window.

Instrument Summary Toolbar

The Instrument Summary toolbar includes buttons and functions listed in Table 11.

Table 11. Toolbar buttons in the Instrument Summary window

Button	Button Name	Function
	Set Up Experiment	Set up an experiment on the selected block by opening the Experiment Setup window.
	Stop	Stop the current run on selected blocks.
	Pause	Pause the current run on selected blocks.
	Resume	Resume the run on selected blocks.
	Flash Block Indicator	Flash the run indicating LED on the MiniOpticon system.
	Open Lid	This button is disabled for the MiniOpticon system.
	Close Lid	This button is disabled for the MiniOpticon system.
	Hide Selected Blocks	Hide the selected blocks in the Instrument Summary list.
	Show All Blocks	Show the selected blocks in the Instrument Summary list.
	Show	Select which blocks to show in the list. Select one of the options to show all detected blocks, all idle blocks, all the blocks that are running with the current user, or all running blocks.

Performing Runs

4 Protocols

Read the following chapter for information about creating and editing protocol files:

- Protocol Editor window (page 31)
- Protocol Editor controls (page 33)
- Temperature control mode (page 36)
- Protocol AutoWriter (page 37)

Protocol Editor Window

A protocol instructs the instrument to control the temperature steps, lid temperature, and other instrument options. Open the Protocol Editor window to create a new protocol or to edit the protocol currently selected in the Protocol tab. Once a Protocol is created or edited in the Protocol Editor, click **OK** to load the protocol file into the Run Setup window and run it.

Opening the Protocol Editor

To open the Protocol Editor, follow one of these options:

- To create a new protocol, select **File > New > Protocol** or click the **Create New** button in the Protocol tab (page 22)
- To open an existing protocol, select **File > Open > Protocol**, or click the **Open Existing** button in the Protocol tab (page 22)
- To edit the current protocol in the Protocol tab, click the **Edit Selected** button in the Protocol tab (page 22)

TIP: To change the default settings in the Protocol Editor window, enter the changes in the Protocol tab in the User Preferences window (page 114)

Protocol Editor Window

The Protocol Editor window (Figure 23) includes the following features:

- **Menu bar.** Select settings for the protocol
- **Toolbar.** Select options for editing the protocol
- **Protocol.** View the selected protocol in a graphic (top) and text (bottom) view. Click the temperature or dwell time in the graphic or text view of any step to enter a new value

- **Protocol Editor buttons.** Edit the protocol by clicking one of the buttons to the left of the text view

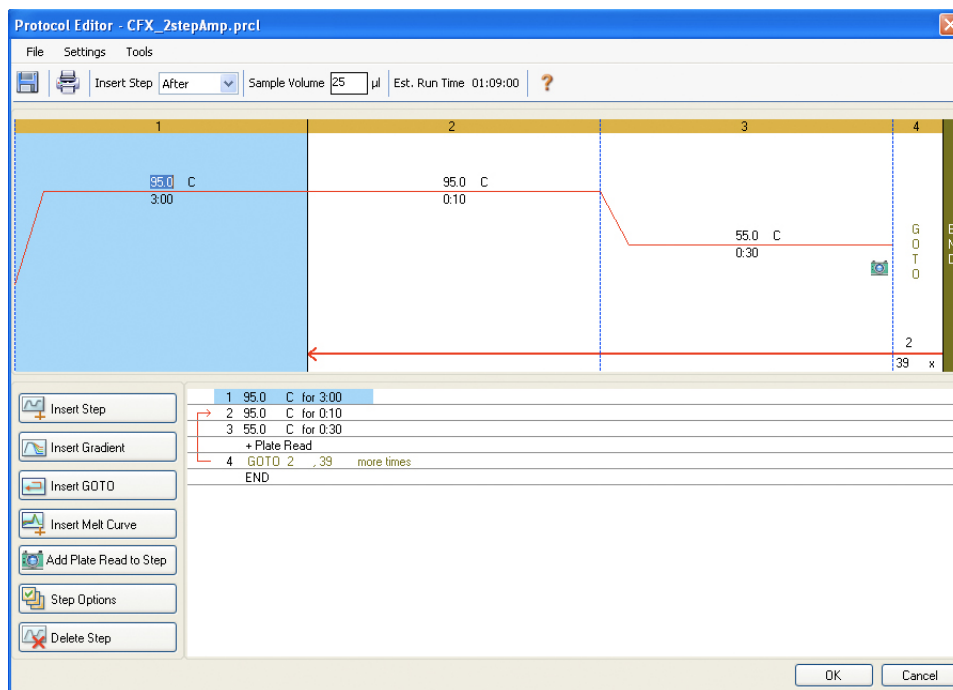

Figure 23. Protocol Editor window with buttons for editing protocols.

Protocol Editor Menu Bar







The menu bar in the Protocol Editor window provides the menu items listed in Table 12

Table 12. Protocol Editor menu bar

Menu Item	Command	Function
File	Save	Save the current protocol.
	Save As	Save the current protocol with a new name or in a new location.
	Close	Close the Protocol Editor.
Settings	Lid Settings	Open the Lid Settings window to change or set the Lid Temperature.
Tools	Gradient Calculator	Select the block type for a gradient step. Choose 48 wells for the MiniOpticon system.
	Run time Calculator	Select the instrument and scan mode to be used for calculating the estimated run time in the Experiment Setup window.

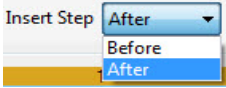
Table 13 lists the function of the Protocol Editor toolbar buttons:

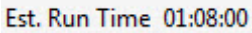
Table 13. Protocol Editor toolbar buttons

Toolbar Button and Menus	Name	Function
	Save	Save the current protocol file.
	Print	Print the selected window.
	Insert Step	Select After or Before to insert steps in a position relative to the currently highlighted step.
	Sample Volume	Enter a sample volume in μl between 0 and 50. If you are using higher than 50 μl reactions, select 50 μl . Sample volume determines the Temperature Control mode. Enter zero (0) to select Block mode.
	Est. Run Time	View an estimated run time based on the protocol steps and ramp rate.
	Help	Open the software Help for more information about protocols.

Protocol Editor Controls

The Protocol Editor window includes buttons for editing the protocol. First, select and highlight a step in the protocol by left clicking it with the mouse. Then click one of the Protocol Editor buttons at the bottom left side of the Protocol Editor window to change the protocol. The location for inserting a new step, “Before” or “After” the currently selected step is determined by the status of the Insert Step box located in the toolbar.

Insert Step Button

To insert a temperature step before or after the currently selected step:

1. Click the **Insert Step** button.
2. Edit the temperature or hold time by clicking the default value in the graphic or text view, and entering a new value.
3. (Optional) Click the **Step Options** button to enter an increment or extend option to the step (page 36).

Add or Remove a Plate Read

To add a plate read to a step or to remove a plate read from a step:

1. Select the step by clicking the step in either the graphical or text view.

2. Click the **Add Plate Read to Step** button to add a plate read to the selected step. If the step already contains a plate read, the text on the button changes, so now the same button reads **Remove Plate Read**. Click to remove a plate read from the selected step.

Insert Gradient Button

To insert a gradient step before or after the currently selected step:

1. Insert a temperature gradient step by clicking the **Insert Gradient** button.
2. Make sure the plate size for the gradient matches the block type of the instrument. Select the plate size for the gradient by selecting **Tools > Gradient Calculator** in the Protocol Editor menu bar.
3. Edit the gradient temperature range by clicking the default temperature in the graphic or text view, and entering a new temperature. Alternatively, click the **Step Options** button to enter the gradient range in the Step Options window (page 36)
4. Edit the hold time by clicking the default time in the graphic or text view, and entering a new time.

Figure 24 shows the inserted gradient step. The temperatures of each row in the gradient are charted on the right side of the window.

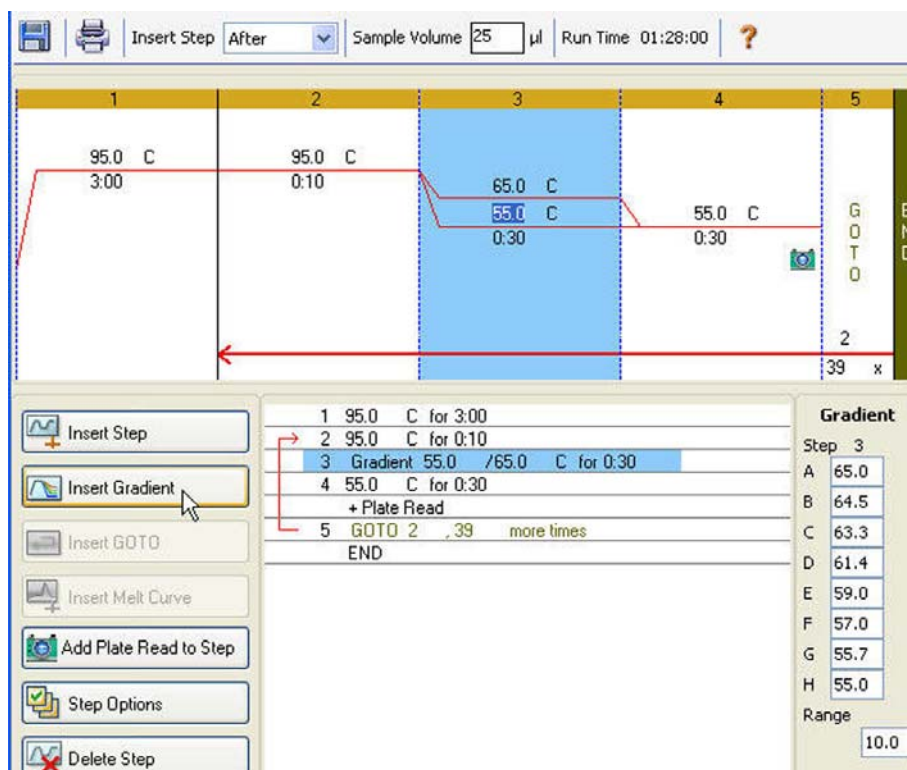

Figure 24. Protocol with inserted gradient step.

Insert GOTO Button

To insert a GOTO step before or after the selected step:

1. Click the **Insert GOTO** button.

2. Edit the GOTO step number or number of GOTO repeats by clicking the default number in the graphic or text view, and entering a new value.

Figure 24 shows an inserted GOTO step at the end of the protocol. Notice that the GOTO loop includes steps 2 through 4.

Insert Melt Curve Button

To insert a melt curve step before or after the selected step:

1. Click the **Insert Melt Curve** button.
2. Edit the melt temperature range or increment time by clicking the default number in the graphic or text view, and entering a new value. Alternatively, click the **Step Options** button to enter the gradient range in the Step Options window (page 36).

NOTE: You cannot insert a melt curve step inside a GOTO loop.

NOTE: The melt curve step includes a 30 second hold at the beginning of the step that is not shown in the protocol.

Figure 25 shows a melt curve step added after step 6:

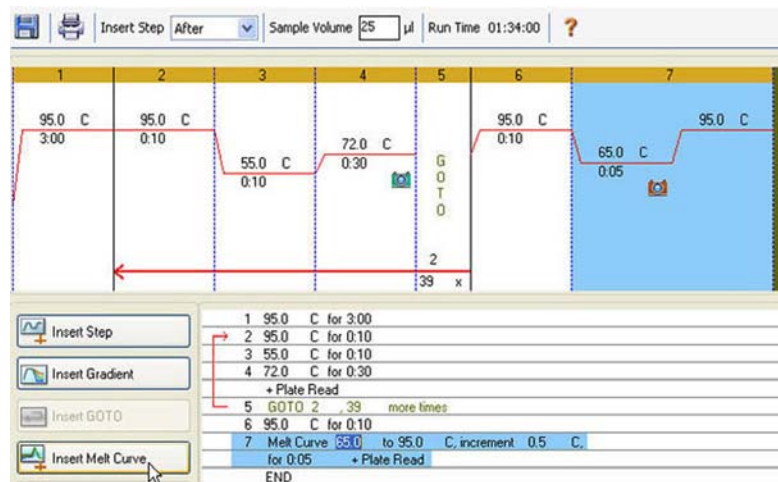

Figure 25. Protocol with inserted melt curve step.

Step Options

To change a step option for the selected step:

1. Select a step by clicking on the step in the graphic or text view.
2. Click the **Step Options** button to open the Step Options window.
3. Add or remove options by entering a number, editing a number, or clicking a check box.
TIP: To hold a step forever (an infinite hold), enter zero (0.00) for the time.

Figure 26 shows the selected step with a gradient of 10°C. Notice that some options are not available in a gradient step. A gradient step cannot include an increment or ramp rate change.

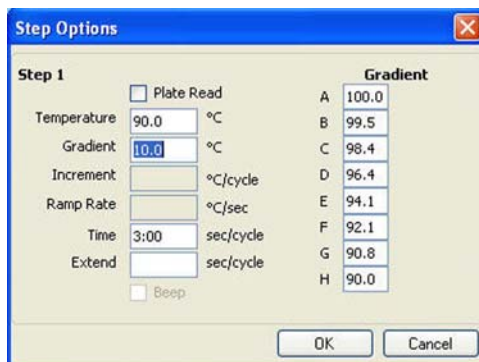

Figure 26. Step option for a gradient.

NOTE: A gradient runs with the lowest temperature in the front of the block (row H) and the highest temperature in the back of the block (row A).

The **Step Options** window lists the following options you can add or remove from steps:

- **Plate Read.** Check the box to include a plate read
- **Temperature.** Enter a target temperature for the selected step
- **Gradient.** Enter a gradient range for the step
- **Increment.** Enter a temperature to increment the selected step; the increment amount is added to the target temperature with each cycle
- **Ramp Rate.** Enter a rate for the selected step; the range depends on the block size
- **Time.** Enter a hold time for the selected step
- **Extend.** Enter a time to extend the selected step. The extend amount is added to the hold time with each cycle
- **Beep.** Check the box to include a beep at the end of the step

TIP: When you enter a number that is outside the option range, the software changes the number to the closest entry within the range.

Delete Step Button

To delete a step in the protocol:

1. Select a step in the graphic or text view.
2. Click the **Delete Step** button to delete the selected step.

WARNING! You cannot undo this function.

Temperature Control Mode

The instrument uses one of two temperature control modes to determine when the sample reaches the target temperature in a protocol.

TIP: The sample volume can be changed before a run by editing the Sample Volume parameter in the Start Run tab (see “Start Run Tab” on page 24).

Enter a sample volume in the protocol editor to select a temperature control mode:

- **Calculated mode.** When you enter a sample volume between 1 and 50 μl the thermal cycler calculates the sample temperature based on the sample volume. This is the standard mode
- **Block mode.** When you enter a sample volume of zero (0) μl , the thermal cycler records the sample temperature as the same as the measured block temperature

Protocol AutoWriter

Open the Protocol AutoWriter to quickly write protocols for PCR and real-time PCR runs. To open the Protocol AutoWriter, select one of these options:

- Click the **Protocol AutoWriter** button in the main software window toolbar
- Select **Tools > Protocol AutoWriter** from the menu bar in the main software window

Figure 27 shows a protocol (bottom of window) written by the Protocol AutoWriter.

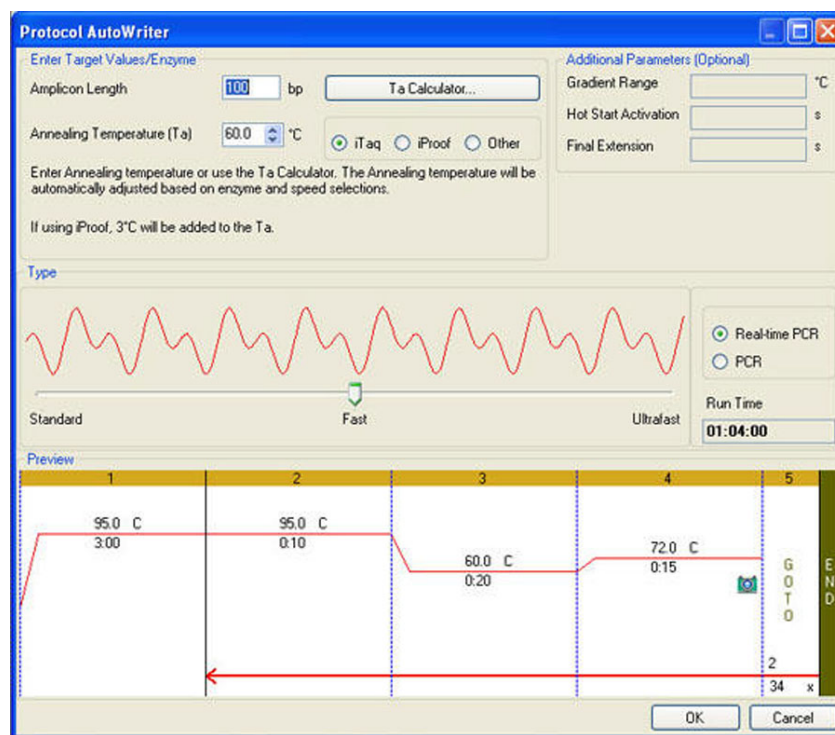

Figure 27. Protocol AutoWriter window with a new protocol.

Creating a Protocol with the Protocol AutoWriter

Follow these steps to use the Protocol AutoWriter to create a new protocol:

1. Click the **Protocol AutoWriter** button on the toolbar to open the Protocol AutoWriter window.
2. Enter the **Annealing Temperature (Ta)** and **Amplicon Length** in the boxes within the **Enter Target Values/Enzymes** pane. If you do not know the annealing temperature for primers, click the **Ta Calculator** button to enter the primer sequences and calculate the annealing temperature. For information about the calculations used in the Ta Calculator see Breslauer et al. 1986.

3. Select an enzyme type from the list of options (iTaQ™, iProof™, or Other).
4. Add parameters in the **Additional Parameters (Optional)** pane if you want to add a Gradient Range, Hot Start Activation temperature, or Final Extension time in the protocol.
5. Select a protocol speed (Standard, Fast, or Ultrafast) by moving the sliding bar in the Type pane. When you move the sliding bar, the software adjusts the total run time. Select **Real-time PCR** to tell the software to collect fluorescence data.
6. Review the protocol in the Preview pane and total run time. Make changes as needed.
TIP: Enter the lid temperature and sample volume before each run by editing the parameters in the Start Run tab (see “Start Run Tab” on page 24).
7. Click **OK** to save the new protocol, or click **Cancel** to close the window without saving the protocol.
TIP: To edit a protocol written with the Protocol AutoWriter, open the protocol file (.prcl extension) in the Protocol Editor window (page 31).
NOTE: Bio-Rad Laboratories does not guarantee that running a protocol written in the Protocol AutoWriter window will always result in a PCR product.

5 Plates

Read this chapter for information about creating and editing plate files:

- Plate Editor window (page 39)
- Plate size and type (page 42)
- Select Fluorophores window (page 44)
- Well loading controls (page 45)
- Experiment Settings window (page 48)
- Well selector right-click menu items (page 49)
- Well Groups Manager window (page 50)
- Plate Spreadsheet View/Importer window (page 51)

Plate Editor Window

A plate file contains run parameters, such as scan mode and fluorophores, and well contents and instructs the instrument about how to analyze the data. Open the Plate Editor window to create a new plate or to edit the plate currently selected in the Plate tab. Once a plate file is created or edited in the Plate Editor, click **OK** to load the plate file into the Run Setup window and run it.

To perform a real-time PCR run, you must load the minimal required information in the Plate Editor: at least one well must contain a loaded sample type and fluorophore.

TIP: Change the well contents before, during, and after completion of the run. However, the scan mode and plate size cannot be changed during or after the run.

Opening the Plate Editor

To open the Plate Editor window (Figure 28), follow one of these options:

- To create a new plate, select **File > New > Plate** or click the **Create New** button in the Plate tab (page 23)
- To open an existing plate, select **File > Open > Plate**, or click the **Open Existing** button in the Plate tab (page 23)
- To edit the current plate in the Plate tab, click the **Edit Selected** button in the Plate tab (page 23)
- To open the plate associated with a data file, in the Data Analysis window (page 53), click **View/Edit Plate** on the toolbar

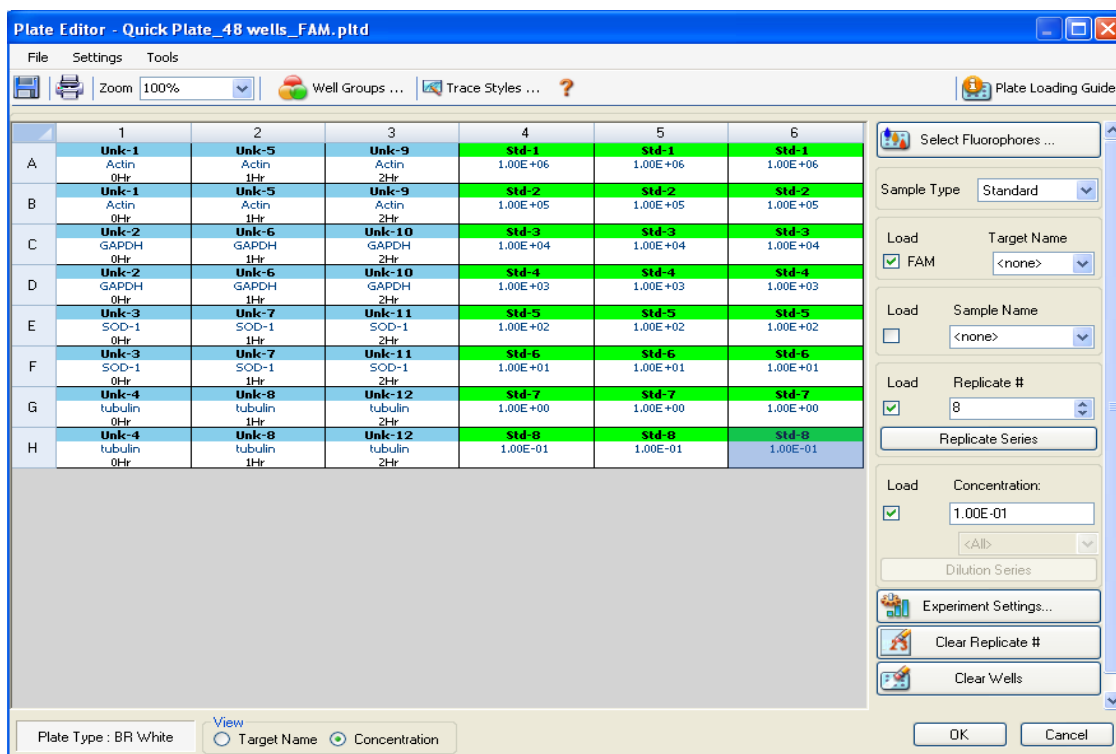

Figure 28. Plate Editor window.

Plate Editor Menu Bar

The menu bar in the Plate Editor window provides the menu items shown in Table 14.

Table 14. Menu bar items in the Plate Editor.

Menu Item	Command	Function
File	Save	Save the plate files.
	Save As	Save the plate file with a new file name.
	Exit	Exit the Plate Editor.
View	Show Well Notes	Select to show this pane in the well loading controls. Enter notes about one or more wells.
	Show Biological Set Name	Select to show this pane in the well loading controls. Select to enter Biological Set names for one or more wells.
	Plate Loading Guide	Show a guide about how to set up a plate and load the wells.
Settings	Plate Size	Select a plate size that reflects the number of wells in the instrument block. Choose 48 Wells for the MiniOpticon system.

Table 14. Menu bar items in the Plate Editor. (continued)

Menu Item	Command	Function
	Plate Type	Choose the type of wells in the plate that holds your samples. The MiniOpticon system is only factory calibrated for BR White plates. For accurate data analysis, the plate type must be the same as the plate well type used in the experiment. NOTE: You must calibrate new plate types.
	Number Convention	Select or cancel the selection for Scientific Notation.
	Units	Select the units to show in the spreadsheets when performing quantitation of unknowns versus a standard curve.
Editing Tools	Setup Wizard	Define plate layout and analysis parameters for gene expression.
	Spreadsheet View/Importer	View layout or import target/sample information using spreadsheet.
	Flip Plate	Flip the plate contents 180 degrees.

Plate Editor Toolbar

The toolbar in the Plate Editor provides quick access to important plate loading functions.

Table 15 lists the functions available in the Plate Editor toolbar.

Table 15. Plate Editor toolbar buttons.







Toolbar Item	Name	Function
	Save	Save the current plate file.
	Print	Print the selected window.
	Zoom	Increase or decrease magnification in plate view.
 Well Groups ...	Well Groups	Open the Well Groups Manager window and set up well groups for the current plate.
 Trace Styles...	Trace Styles	Select the colors and symbol used for the amplification traces.
	Help	Open the software Help for information about plates.

Table 15. Plate Editor toolbar buttons. (continued)

Toolbar Item	Name	Function
 Plate Loading Guide	Plate Loading Guide	Show a quick guide about how to set up a plate and load the wells.

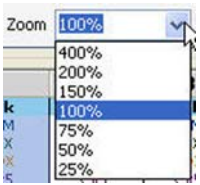
Plate Size and Type

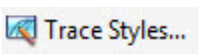
The software applies these plate settings to all the wells during the experiment:

- **Plate Size.** Select a plate size that represents the size of the reaction module block of your instrument. Choose **MiniOpticon** from the pull-down menu option on the Startup Wizard to change the default plate size loaded in the Plate tab of the Experiment Settings window. In the Plate Editor, select the plate size from the Settings menu (see Table 14). Plate size cannot be changed during or after the experiment

- **Plate Type.** For the MiniOpticon system, select the appropriate white wells designation from the Settings menu. For older systems, the plate type **MJ White** may need to be selected. For new systems, select the plate type **BR White**. Make sure the fluorophore being used in the experiment is calibrated for the selected plate type

NOTE: The MiniOpticon system is factory calibrated for plates with white wells. Calibration is specific to the instrument, dye, and plate type. To calibrate a new combination of dye and plate type on an instrument, select **Tools > Calibration Wizard** (see “Calibration Wizard” on page 126).

Trace Styles

During the plate setup and while a run is in progress, the color of the amplification traces can be modified. These colors will be displayed as the data is being collected, which can be viewed in the Real-time Status window. For more information on Trace Styles, see page 68.

Setup Wizard

The Setup Wizard can be used to enter plate layout information needed for normalized gene expression analysis either before, during or after a run has been completed. Target and sample name and location on plate, reference gene(s), and control sample can all be entered from this window.

The Wizard (Figure 29) can be opened by selecting **Editing Tools > Setup Wizard** from the Plate Editor window menu bar.

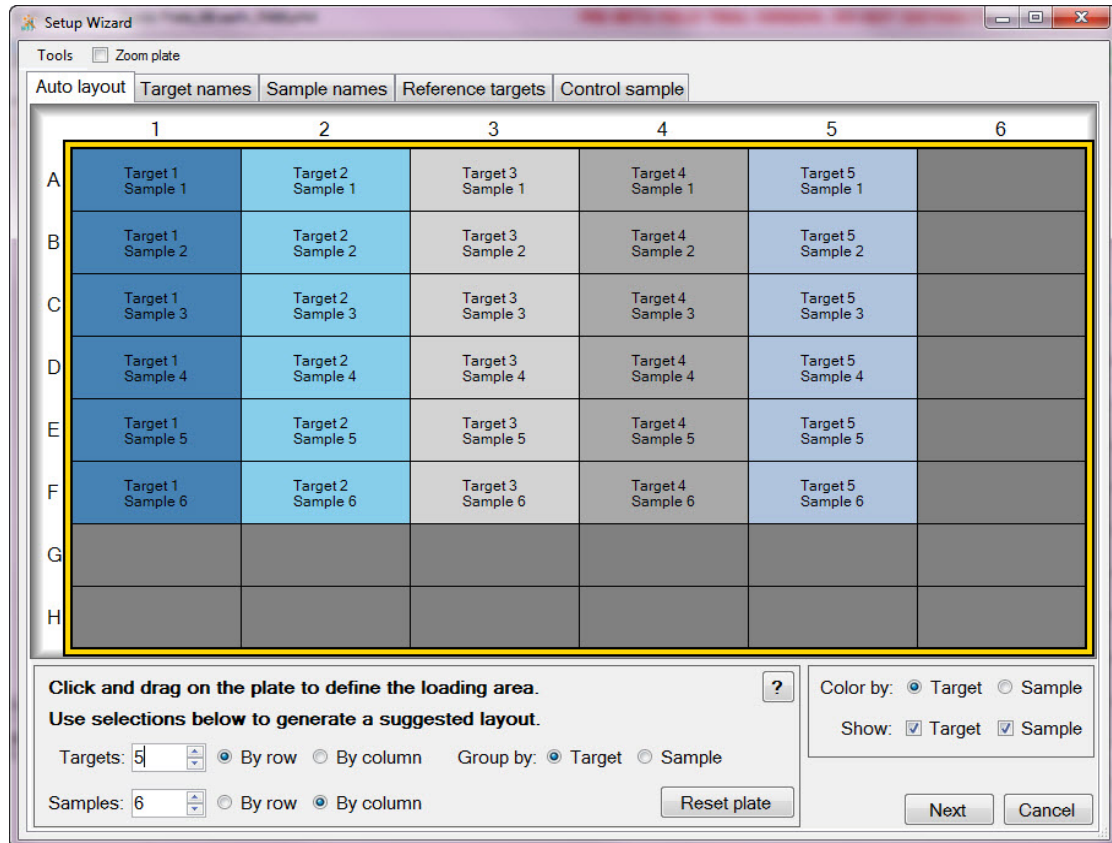

Figure 29. Auto layout tab of Setup Wizard.

Create a plate layout by following these steps:

- 1. Auto layout tab.** Select the area in which samples will be located on the plate by clicking on a well at one edge and then dragging to encompass the area required. Enter the number of targets and samples to be loaded. If the numbers entered do not fit in the area selected, you will need to reduce the numbers or increase the plate area. The orientation of items on the plate and their grouping can be specified.

NOTE: If your plate layout does not have a regular pattern, use the **Target names** tab to manually position your targets anywhere on the plate. Click and drag to select multiple wells.
- 2. Target names tab.** Click a target grouping and then enter its name in the box provided. Multiple target groups can be selected by clicking and dragging.

TIP: After entering a name, press **Tab** to advance to the next grouping on the right or **Enter** to move to the next group below.
- 3. Sample names tab.** Click a sample grouping and then enter its name in the box provided. Multiple sample groups can be selected by clicking and dragging.

TIP: When entering target or sample names, click and hold the control key to select groups of wells that are not adjacent.
- 4. Reference targets tab.** Click on one or more targets to use as references for normalized gene expression.
- 5. Control sample tab.** Click on one sample to use as a control for relative gene expression calculations.

- Click **OK** to apply the information entered to your plate. Any additional edits can be made using the **Plate Editor**.

NOTE: Returning to the **Auto layout** tab will reset the plate layout. The layout can also be reset by selecting **Tools > Clear Plate**.

TIP: To read text within wells of the plate layout more easily, click the **Zoom plate** box for a magnified view.

Select Fluorophores Window

The Select Fluorophores window lists fluorophores that can be selected to load into the Plate Editor well loading controls. To open the Select Fluorophores window, click the **Select Fluorophores** button on the right side of the Plate Editor.

NOTE: You cannot add or remove fluorophores in this list; you must calibrate the new fluorophores on an instrument in the Calibration Wizard (page 126). After calibration, the new fluorophore is added to the Select Fluorophore window.

NOTE: The MiniOpticon system is factory calibrated only for FAM, SYBR[®] and HEX. If you intend to use another dye, you must perform a dye calibration. To calibrate a new combination of dye and plate type on an instrument, select **Tools > Dye Calibration Wizard** (see “Calibration Wizard” on page 126).

Click the **Selected** check box next to the fluorophore name to add or remove the fluorophores to the list on the right side of the Plate Editor window.

In this example, SYBR[®] is selected from the list of available fluorophores (Figure 30).

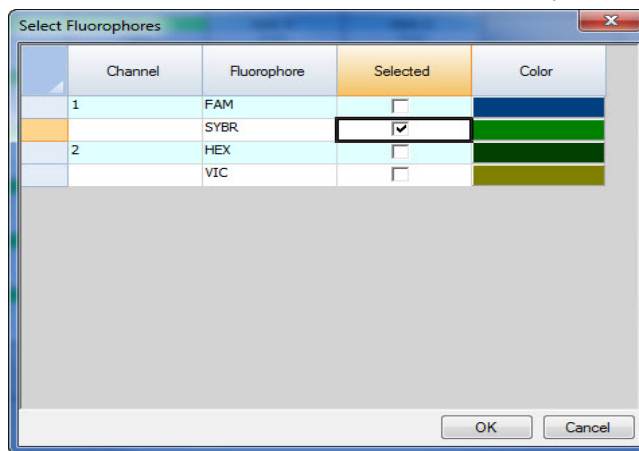

Figure 30. Select Fluorophores window.

- Click the **Color** box next to the fluorophore name and select a new color to represent each fluorophore in the Plate Editor window and Data Analysis charts

NOTE: Before beginning the run, the software verifies that the fluorophores you specified in the plate are calibrated on that instrument. You cannot run a plate if it includes fluorophores that have not been calibrated on that instrument.

Well Loading Controls

A plate file contains information about the contents of each well loaded with sample for a run. After the run, the software links the well contents to the fluorescence data collected during the protocol and applies the appropriate analysis in the Data Analysis window. For example, wells loaded with standard sample type are used to generate a standard curve.

When setting up a gene expression run, consider the following guidelines for well contents:

- **Target Name.** One or more targets of interest (genes or sequences) in each loaded well. Each target is assigned to one fluorophore
- **Sample Name.** One identifier or condition that corresponds to the sample in each loaded well, such as “0 hr”, “1 hr”, or “2 hr”

TIP: Target names and sample names must match between wells to compare data in the Gene Expression tab in the Data Analysis window. Each name must contain the same punctuation and spacing. For example, “Actin” is not the same as “actin”, and “2hr” is not the same as “2 hr”. To facilitate consistency in names, enter them in the Target and Sample Names Libraries in the Plate tab in the User Preferences window (page 117).

- **Biological Set Name.** Select **View > Show Biological Set Name** to show this pane in the well loading controls and then enter Biological Set names for one or more wells.

Select a well to load contents into by left-clicking in the plate view. Hold down the mouse button and drag to select multiple wells. The buttons and lists on the right side of the plate view include all the options needed to load the wells (Table 16).

Table 16. Options for loading the plate and wells in the Plate Editor.

Option	Function
	<p>After selecting wells, the Sample Type must be loaded first. Select a Sample Type from the pull-down menu to load it in the selected wells, including Unknown, Standard, NTC (no template control), Positive Control, Negative Control, and NRT (no reverse transcriptase).</p>
	<p>Click a Load box to add a fluorophore to the selected wells; each fluorophore corresponds to a target name. To add fluorophores to the Load list, select them in the Select Fluorophores window.</p> <p>For gene expression analysis or to distinguish among multiple targets, select a name in the Target Name pull-down menu and press the Enter key to load the target name in the well. To delete a target name, select it, press the Delete key, and then press the Enter key.</p> <p>TIP: To add a new target name to the pull-down menu in the current plate only, type a name in the pull-down box and press the Enter key.</p>

Table 16. Options for loading the plate and wells in the Plate Editor. (continued)



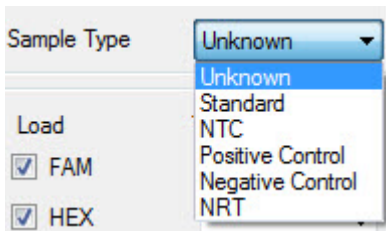
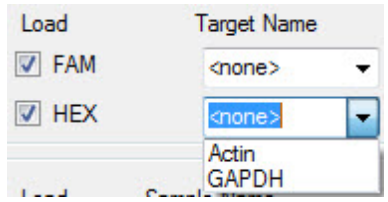

Option	Function
	<p>For gene expression analysis or to distinguish among multiple samples, select a Sample Name from the pull-down menu to load that sample name in the selected wells. To delete a sample name, select it in the menu, press the Delete key on your keyboard, and then press Enter.</p> <p>TIP: To add a new sample name to the pull-down menu in the current plate, type a new name in the pull-down box and press the Enter key.</p>
	<p>To load replicate numbers, selected wells must contain identical well contents. If they do not, the software disables this loading control. Click the Load box to add a Replicate # to the selected wells. Click the Clear Replicate # button to clear the replicate number from selected cells.</p> <p>TIP: To load multiple replicate numbers across a series of wells, click the Replicate Series button.</p>
	<p>In the Replicate Series pane you can apply a replicate series to a set of selected wells. Enter the Replicate Group Size by selecting a number that represents the number of samples (wells) in each group of replicates. Select a Starting Replicate # to add replicates.</p> <p>NOTE: You can load replicate groups with replicate numbers progressing from left to right (Horizontal), or progressing from top to bottom (Vertical).</p>
	<p>Enter a concentration to the selected wells with standard sample type by editing or typing a number in the Concentration box. To apply the concentration to one fluorophore in the well, select a single fluorophore from the pull-down menu (<All>) under the concentration box. To delete a concentration, select it, press the Back Space key on your keyboard and then press Enter.</p> <p>Select multiple wells with a Standard sample type to activate the Dilution Series button.</p>

Table 16. Options for loading the plate and wells in the Plate Editor. (continued)

Option	Function
	<p>Click the Dilution Series button to enter a dilution series for the concentration of Standard samples, and load a standard curve.</p> <p>Enter the Starting Concentration for the dilution series, the Replicates from (starting replicate number) and to (ending replicate number), and the Dilution Factor (amount to change the concentration with each replicate group). Select Increasing for a dilution series that increases, or select Decreasing for a dilution series that decreases. Finally, select the fluorophore used for the dilution series from the pull-down menu and click Apply.</p>
	<p>Select View > Show Well Notes to show this pane. Enter notes about one or more wells by selecting the wells and typing the notes in the pull-down menu. Any notes you add appear in the spreadsheet on the Quantification Data tab.</p>
	<p>Select View > Show Biological Set Name to show this pane. Enter biological set information about one or more wells by selecting the wells and typing a biological set name in the pull-down menu. Entering Biological Set Name information enables sample analysis in one of four configurations defined by the Biological Set Analysis Options. Refer to the Biological Set Analysis Options section for further details.</p>
	<p>Click the Experiment Settings button to open the Experiment Settings window to manage the lists of Targets and Samples, and to set up a gene expression run.</p>
	<p>Click the Clear Replicate # button to clear the replicates numbers in the selected wells.</p>
	<p>Click the Clear Wells button to permanently remove all content in the selected wells.</p>

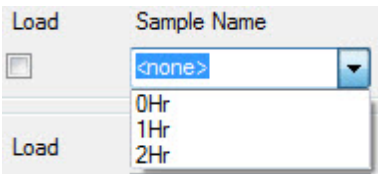
NOTE: Well contents can also be copied and pasted into other wells. To do this, highlight the well that is to be copied (only one well can be copied at a time), right-click and select **Copy Well**. Highlight the wells into which content is to be pasted and select **Paste Well**. Depress and hold the control key to select non-contiguous wells to paste to.

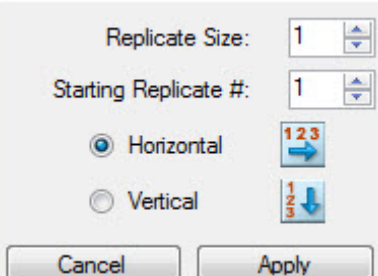
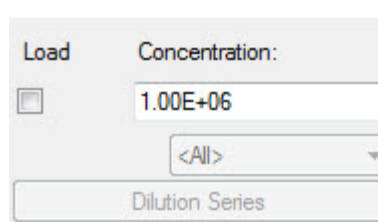
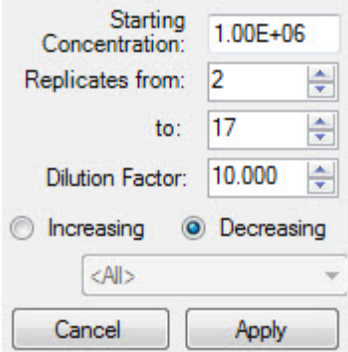
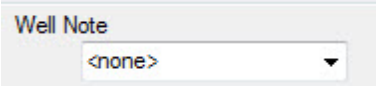
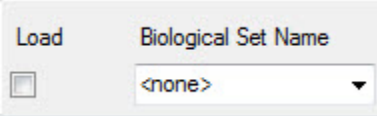
Experiment Settings Window

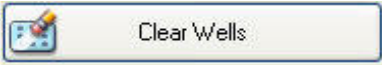
To open the Experiment Settings window, perform one of these options:

- In the Plate Editor, click the **Experiment Settings** button
- While analyzing data in the Data Analysis window, click the **Experiment Settings** button in the **Gene Expression** tab

Open the Experiment Settings window to view or change the list of Targets and Samples (Figure 31) or to set the gene expression analysis sample group to be analyzed if **Biological Set Names** have been added to the wells.

- **Targets.** A list of target names for each PCR reaction, such as a genes or sequences of interest. Click the Reference column to assign reference genes in a run
- **Samples.** A list of sample names that indicate the source of the target, such as a sample taken at 1 hour (1 hr), or taken from a specific individual (“mouse1”). Click the **Control** column to assign the control condition for a run

Figure 31 shows the Targets tab with the analysis settings shown.

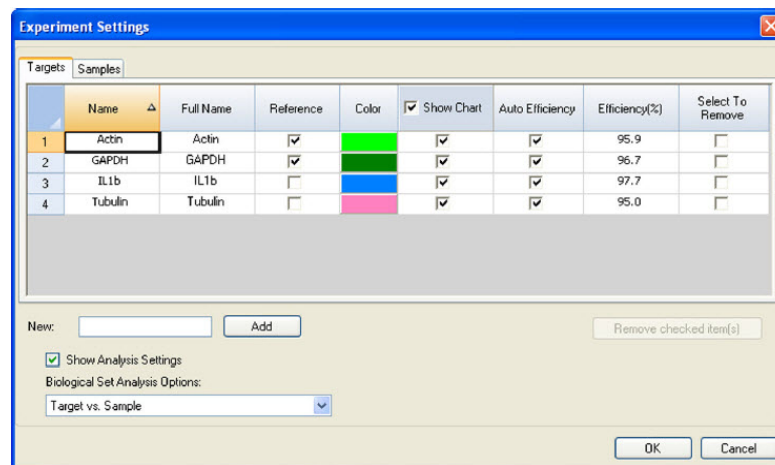

Figure 31. Targets tab in Experiment Settings window.

Figure 32 shows the Samples Tab with the Analysis Settings shown.

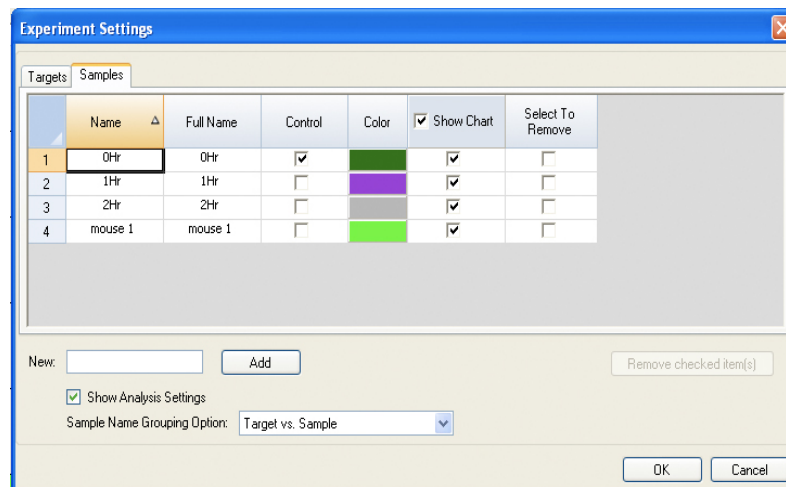

Figure 32. Samples tab in Experiment Settings window.

To adjust the lists in these tabs, use the following functions:

- Add a target or sample name by typing a name in the **New** box, and clicking **Add**
- Remove a target or sample name from the list by clicking the **Select to Remove** box for that row, and then clicking the **Remove checked item(s)** button
- Select the target as a reference for gene expression data analysis by clicking the box in the **Reference** column next to the name for that target
- Select the sample as a control sample for gene expression data analysis by clicking the box in the **Control** column next to the name for that sample

Click the **Show Analysis Settings** box in the Experiment Settings window to view or change analysis parameters applied in the Gene Expression tab.

To adjust target parameters:

- Click a cell in the **Color** column to change the color of the targets graphed in the Gene Expression chart
- Enter a number for the efficiency of a target. The software will calculate the relative efficiency for a target using **Auto Efficiency** if the data for a target includes a standard curve. Alternatively, type a previously determined efficiency

To adjust the settings for a sample in the Samples tab:

- Click a color in the **Color** column to change the color of the samples graphed in the Gene Expression chart
- Click a box in the **Show Graph** column to show the sample in the Gene Expression chart using a color selected in the **Color** column

Well Selector Right-Click Menu Items

Right-click any well to select the items listed in the table below.

Table 17. Right-click menu items in the Plate Editor Well Selector window

Item	Function
Copy Well	Copy the well contents, which can then be pasted into another well or wells.
Paste Well	Paste the contents from a copied well into another well or wells.
Copy to Clipboard	Copy the text from a well to a clipboard that can then be pasted into a document.
Copy as Image	Copy the well selector view as an image.
Print...	Print the well selector view.
Print Selection...	Print the current selection.
Export to Excel...	Export the data to an Excel spreadsheet.
Export to Text...	Export the data as a text document.
Export to Xml...	Export the data as a .xml document.
Export to Html...	Export the data as a .html document.
Find	Search for specific text.
Export Well Info to Excel	Export the well text information as a .xml document.

Well Groups Manager Window

Well groups divide a single plate into subsets of wells that can be analyzed independently in the Data Analysis window. Once well groups are set up, select one in the Data Analysis window to analyze the data as an independent group. For example, set up well groups to analyze multiple experiments run in one plate, or to analyze each well group with a different standard curve.

NOTE: The default well group is **All Wells**.

Create Well Groups

To create well groups in the Well Groups Manager window, follow these instructions:

1. Click the **Well Groups** button in the Plate Editor toolbar or click the **Manage Well Groups** button in the Data Analysis window toolbar.
2. Click **Add** to create a new group. The pull-down menu shows the group name as **Group 1** for the first group.
3. Select the wells that will compose the well group in the plate view by clicking and dragging across the group of wells. Selected wells turn blue in color (Figure 33).
4. (Optional) Change the name of the group by selecting the group name in the pull-down menu and typing a new name.
5. (Optional) Create more well groups by repeating steps 1 and 2.
6. (Optional) Delete well groups by selecting the group name in the pull-down list, and clicking the **Delete** button.
7. Click **OK** to finish and close the window, or click **Cancel** to close the window without making changes.

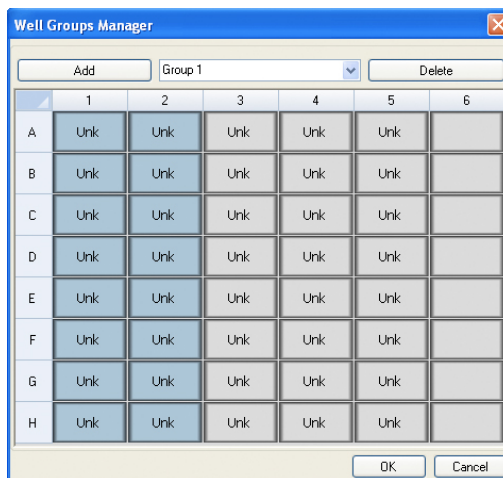

Figure 33. Color of wells in the Well Group Manager window.

Plate Spreadsheet View/Importer Window

The Plate Spreadsheet View window shows the contents of a plate in the Plate Editor. Open the Plate Spreadsheet View window (Figure 34) by selecting **Editing Tools > Spreadsheet View/Importer** in the Plate Editor menu bar.

Row	Column	Sample Type	Replicate #	*Target Name	*Sample Name	Quantity	Units
B	4	Unknown		Tubulin	0Hr	N/A	copy number
B	5	Unknown		Tubulin	1Hr	N/A	copy number
B	6	Unknown		Tubulin	2Hr	N/A	copy number
C	4	Unknown		Tubulin	0Hr	N/A	copy number
C	5	Unknown		Tubulin	1Hr	N/A	copy number
C	6	Unknown		Tubulin	2Hr	N/A	copy number
D	4	Unknown		Tubulin	0Hr	N/A	copy number
D	5	Unknown		Tubulin	1Hr	N/A	copy number
D	6	Unknown		Tubulin	2Hr	N/A	copy number
F	3	Standard	1			10000000.00	copy number
F	4	Standard	2			1000000.00	copy number
F	5	Standard	3			100000.00	copy number
F	6	Standard	4			10000.00	copy number
F	7	Standard	5			1000.00	copy number
F	8	Standard	6			100.00	copy number
F	9	Standard	7			10.00	copy number
G	3	Standard	1			10000000.00	copy number

Figure 34. Plate Spreadsheet View window.

Open the spreadsheet view to import or export the well contents to Excel or to another tab-delimited format:

- Click **Export Template** to export a plate spreadsheet template to an Excel file (.csv format). This template may be edited and used for import of well content information.
- Click **Import** to import well contents from a comma delimited file
- Sort or edit a column by selecting it and using these methods:
 - Sort the spreadsheet according to the data in one column by clicking the diamond next to a column name
 - Edit the contents of a column that has an asterisk (*) at top by clicking and typing in each well

NOTE: Select the units for the standard curve data in the Quantity column by opening the Plate Editor and selecting **Settings > Units** in the menu bar. After the plate runs, the data from these standards appear in the Standard Curve chart of the Quantification tab (Data Analysis window) with the units you select.

Right-click on the spreadsheet to select one of these options from the right-click menu:

- **Copy.** Copy the entire spreadsheet
- **Copy as Image.** Copy the spreadsheet as an image file
- **Print.** Print the spreadsheet
- **Print Selection.** Print only the selected cells
- **Export to Excel.** Export the file as an Excel- formatted file
- **Export to Text.** Export the file as a text file
- **Export to Xml.** Export the file as a .xml file.
- **Export to Html.** Export the file as a .html file.
- **Find.** Find text in the spreadsheet
- **Sort.** Sort the spreadsheet by selecting up to three columns of data in the Sort window.

6 Data Analysis Overview

Read this chapter for information about data analysis:

- Data Analysis window (page 53)
- Quantification tab (page 56)
- Well groups (page 57)
- Data analysis settings (page 58)
- Well selectors (page 61)
- Charts (page 63)
- Spreadsheets (page 64)
- Export (page 65)

Data Analysis Window

During data analysis, changing the way the data are displayed by changing the contents of the wells in the Plate Editor never changes the fluorescence data that were collected from each well during the run. Once the module collects fluorescence data, you cannot delete those data but you can choose to remove data from view and analysis.

To change the content of wells after a run, select one of the following options from the **Plate Setup** button at the top of the Data Analysis window:

- **Edit/View Plate.** Open the Plate Editor to make manual changes to the layout
- **Replace Plate file.** Select a previously saved plate file to replace the current plate layout
- **Apply PrimePCR file.** PrimePCR™ files are not be available for 48-well plates

CFX Manager™ software processes real-time PCR data automatically at the end of each run, and opens the Data Analysis window to display these data. Choose one of these methods to open existing data files in the Data Analysis window:

- Drag a data file (.pcrd extension) over the main software window and release it
- Select **Analyze** tab in the Startup Wizard window and either select from Recent Files or click the **Browse** button to find
- Select **File > Open > Data File** in the main software window to select a file in the Windows browser
- Click the **Data Analysis** button in the main software window toolbar to select a file in the Windows browser

- Select **File > Recent Data Files** to select from a list of the ten most recently opened data files

The Data Analysis window displays multiple tabs (Figure 35), each tab showing the analyzed data for a specific analysis method or run-specific information. Tabs will only be displayed if the data collected in the run are available for that type of analysis.

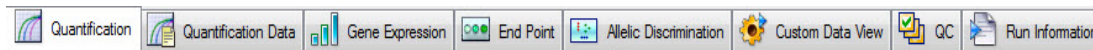

Figure 35. Data Analysis window tabs.

TIP: To choose the tabs displayed, select **View** in the main window. To return to the original tab layout, select **Settings > Restore Default Window Layout**.

Data Analysis Toolbar

The toolbar in the Data Analysis window (Figure 36) provides quick access to important data analysis functions.

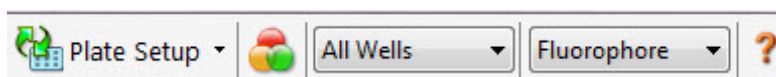





Figure 36. Toolbar in the Data Analysis window.

Table 18 lists the functions of buttons in the toolbar.

Table 18. Toolbar in the Data Analysis window.

Toolbar Button	Name	Function
 Plate Setup ▾	Plate Setup	View/Edit plate: Open the Plate Editor to view and edit the contents of the wells. Replace Plate file: Select a plate file to replace the plate layout. Apply PrimePCR file: Select a run file to replace the plate layout for a PrimePCR run.
	Manage Well Groups	Open the Well Groups Manager window to create, edit and delete well groups.
All Wells ▾	Well Group	Select an existing well group name from the pull-down menu. The default selection is All Wells. This will only be displayed if well groups have been created.
Fluorophore ▾	Analysis Mode	Select to analyze the data in either Fluorophore or Target mode.
	Help	Open the software Help for more information about data analysis.

Data Analysis Menu Bar

The menu bar in the Data Analysis window provides these menu items.

Table 19 lists the functions of items in the menu bar.

Table 19. Right-click menu items for spreadsheets.

Menu Item	Command	Function
File	Save	Save the file.
	Save As	Save the file with a new name.
	Repeat Run	Extract the protocol and plate file from the current run to rerun it.
	Exit	Exit the Data Analysis window.
View	Run Log	Open a Run Log window to view the run log of those data file.
	Quantification, Melt Curve, Gene Expression, End Point, Custom Data View, QC, Run Information	Select the tabs displayed in the Data Analysis window. At least one tab must be selected.
Settings	Cq Determination Mode	Select Regression or Single Threshold mode to determine how Cq values are calculated for each trace.
	Baseline Setting	Select Baseline Subtraction method for the selected well groups.
	Analysis Mode	Select to analyze data by Fluorophore or by Target.
	Cycles to Analyze	Select the cycles that are to be analyzed.
	Baseline Thresholds	Open the Baseline Thresholds window to adjust the baseline or the threshold.
	Trace Styles	Open the Trace Styles window.
	Plate Setup	Open the Plate Editor to view and edit the plate; replace the current plate with one from a user-defined plate file or a PrimePCR run file.
	Include All Excluded Wells	All excluded wells are included in the analysis.
	Mouse Highlighting	Turn on or off the simultaneous highlighting of data with the mouse pointer. TIP: If the Mouse Highlighting is turned off, then hold down the Control key to temporarily turn on the highlighting.
	Restore Default Window Layout	Restores the arrangement of windows to the default setting.
Export	Export All Data Sheets to Excel	Export all the spreadsheet views from every tab to a separate Excel formatted file.
	Export RDML File	Open a Save As window to specify an RDML file name and location.

Table 19. Right-click menu items for spreadsheets. (continued)

Menu Item	Command	Function
	Custom Export...	Open the Custom Export window in which the fields to be exported and the file format can be specified.
	Export to LIMS Folder...	Open a window to save data in a pre-determined format to the LIMS folder.
Tools	Reports...	Open the Report for this data file.
	Well Group Reports...	Open the Well Group Report window to generate reports for specified well groups.
	Import Fluorophore Calibration...	Select a calibration file to apply to the current data file.

Quantification Tab

Each tab in the Data Analysis window displays data in charts and spreadsheets for a specific analysis method and includes a well selector to select the data you want to show. The Data Analysis window opens with the Quantification tab (Figure 37) in front. The **Amplification** chart data in this tab should be used to determine the appropriate analysis settings for the run.

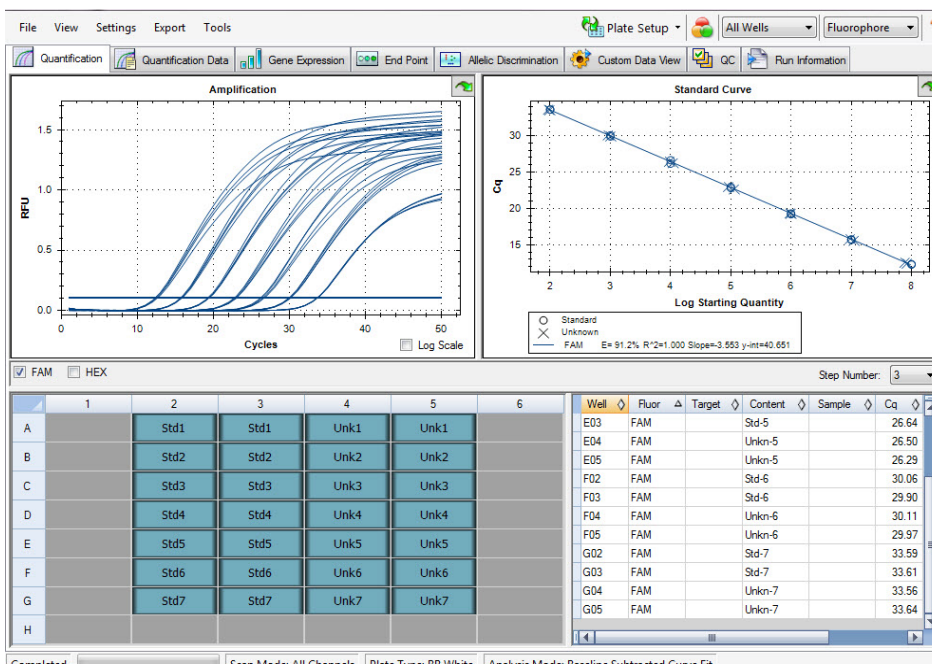

Figure 37. Layout for the Quantification tab in the Data Analysis window.

NOTE: The software links the data in the panes of each Data Analysis tab. For example, highlighting a well by placing the mouse pointer over the well in the well selector view highlights the data in all the other panes.

Step Number Selector

The MiniOpticon™ system can acquire fluorescence data at multiple protocol steps; the software maintains the data acquired at each step independently. The software displays the **Step Number** selector below the Standard Curve chart on the Quantification tab whenever a protocol contains more than one data collection step. When you select a step, the software applies that selection to all the data that are shown in the Data Analysis window. Figure 38 shows the data collection step number is **3** for all the data.



Figure 38. Step Number selection in the Data Analysis window.

Viewing Well Groups in Data Analysis

Wells in the plate can be grouped into subsets for independent analysis using well groups. When you create well groups in the **Well Groups Manager** window (page 50), group names appear in the Data Analysis window Well Groups drop-down list on the toolbar.

TIP: To edit, create and delete well groups, click the **Manage Well Groups** button in the toolbar.

By default, the well group **All Wells** is selected when the Data Analysis Window is first opened, with the data in all wells with content shown in the charts and spreadsheets.

Figure 39 shows Group 2 selected in the Well Groups menu. Only the wells in that well group appear loaded with content in the well selector and data only for these wells are included in the data analysis calculations.

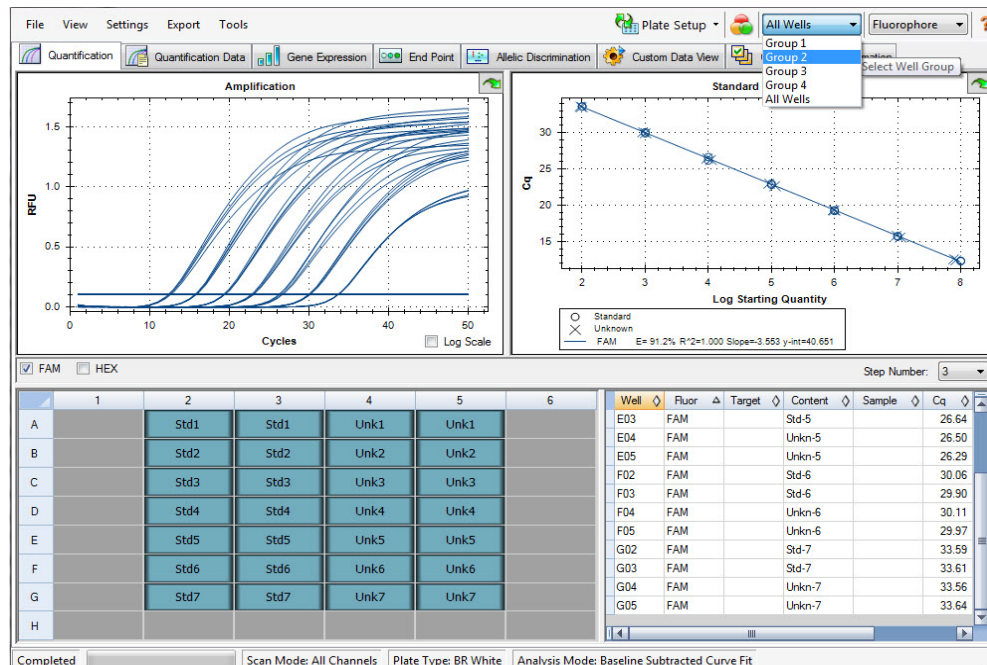

Figure 39. Data Analysis window with Group 2 selected.

Data Analysis Settings

The **Amplification** chart data in the Quantification tab shows the relative fluorescence (RFU) for each well at every cycle. Each trace in the chart represents data from a single fluorophore in one well. These data are used to determine C_q values for each well on a per fluorophore basis. The software uses one of two modes to determine C_q values:

- **Regression.** This mode applies a multivariable, nonlinear regression model to individual well traces and then uses this model to compute an optimal C_q value
- **Single Threshold.** This mode uses a single threshold value to calculate the C_q value based on the threshold crossing point of individual fluorescence traces

Select **Settings > C_q Determination Mode** to choose the C_q determination mode.

Adjusting the Threshold

In Single-Threshold mode, adjust the threshold for a fluorophore by clicking on the threshold line in the Amplification chart and moving the mouse pointer vertically. Alternatively, specify an exact crossing threshold for the selected fluorophore by following these instructions:

1. Select one fluorophore in the fluorophore selector in the **Quantification** tab (Figure 37) by clicking the boxes next to the fluorophore name located under the Amplification chart.
2. Select **Settings > Baseline Thresholds** in the menu bar to open the Baseline Thresholds window.
3. Adjust the crossing threshold (Figure 40) for the fluorophore by clicking **User Defined** and entering a threshold number.

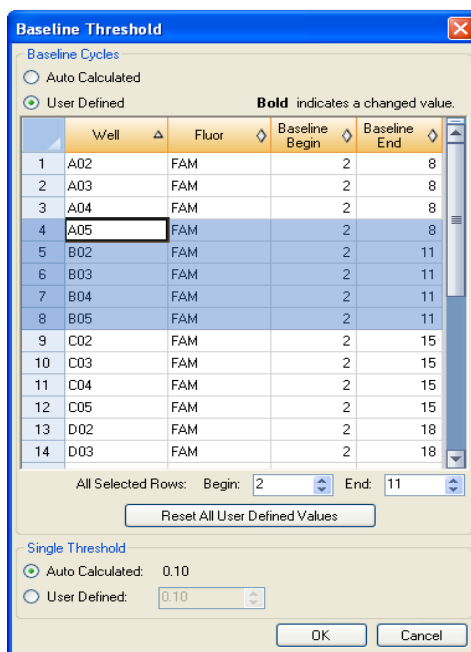

Figure 40. Baseline Thresholds window.

4. Click **OK** to confirm the change and close the window.

TIP: To have the same threshold value used for all of your data files define this in the **Data Analysis** tab of the **User Preferences** window. This value will be applied to all subsequently created data files.

Baseline Settings

The software automatically sets the baseline individually for each well. Select the Baseline Setting to determine the method of baseline subtraction for all fluorescence traces. Select **Settings > Baseline Setting** to choose one of these three options:

- **No Baseline Subtraction.** The software displays the data as relative fluorescence traces. Some analysis is not possible in this analysis mode, and therefore the software does not display the Gene Expression, End Point, and Allelic Discrimination tabs
- **Baseline Subtracted.** The software displays the data as baseline subtracted traces for each fluorophore in a well. The software must baseline subtract the data to determine quantification cycles, construct standard curves, and determine the concentration of unknown samples. To generate a baseline subtracted trace, the software fits the best straight line through the recorded fluorescence of each well during the baseline cycles, and then subtracts the best fit data from the background subtracted data at each cycle
- **Baseline Subtracted Curve Fit.** The software displays the data as baseline subtracted traces, and the software smoothes the baseline subtracted curve using a centered mean filter. This process is performed so that each C_q is left invariant

Along with the options above, the following can also be selected:

- **Apply Fluorescent Drift Correction.** For wells that have abnormally drifting RFU values during the initial few cycles of a run the software derives an estimated baseline from adjacent wells for which a horizontal baseline was successfully generated

Adjusting the Baseline

Once wells for analysis have been selected, check the baseline settings in these wells. Open the Baseline Thresholds window (Figure 40) to change the default baseline for selected wells. To open this window:

1. Select a single fluorophore in the Quantification tab (Figure 37) by clicking the boxes next to the fluorophore name located under the Amplification chart.
2. Select **Settings > Baseline Threshold** to open the Baseline Threshold window.

To adjust the begin and end baseline cycle for each well:

1. In the Baseline Cycles pane, select one or more wells by clicking the row number, clicking the top left corner to select all wells, holding down the Control key to select multiple individual wells, or holding down the shift key to select multiple wells in a row.
2. Adjust the **Baseline Begin** cycle and **Baseline End** cycle for all selected wells or change the **Begin** and **End** cycle number at the bottom of the spreadsheet (Figure 40).
3. To revert the settings back to the last saved values, click **Reset All User Defined Values**.
4. Click **OK** to confirm any changes and close the window.

Analysis Mode

Data can be analyzed and displayed grouped by either fluorophore or target name. To choose the data analysis mode, select **Settings > Analysis Mode** or make a selection from the **Analysis Mode** drop down menu in the toolbar.

When **Fluorophore** is chosen data traces are displayed by fluorophore as indicated in the plate setup for that run. Individual fluorophore data is displayed in the amplification and standard curve chart (if available) by checking the appropriate fluorophore selector check boxes located below the amplification chart (Figure 41).

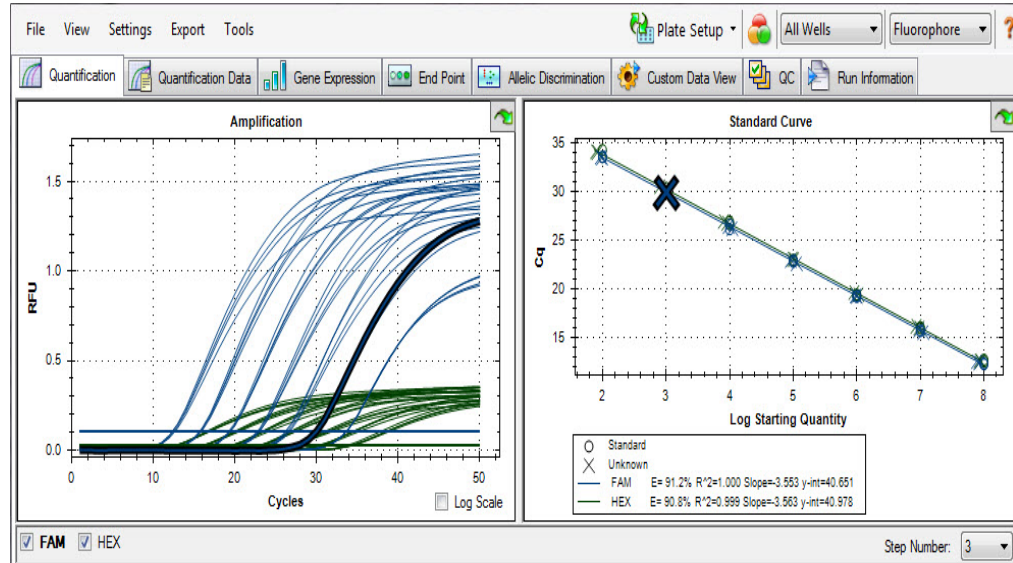

Figure 41. Fluorophore analysis mode selected.

When **Target** is selected data traces are displayed by target name as entered in the plate setup.

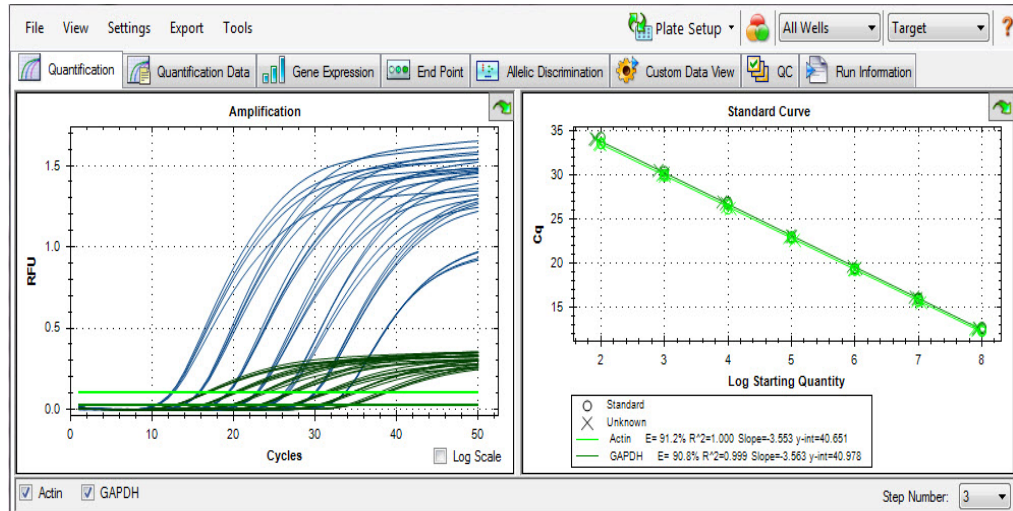

Figure 42. Target analysis mode selected.

Cycles to Analyze

To restrict data analysis to a specified range of cycles, select **Settings > Cycles to Analyze**. Select the starting cycle and the ending cycle using the arrow buttons or by typing in the desired values and pressing Enter. Click the **Restore Defaults** button to return to the cycles originally used for analysis.

NOTE: Removing cycles from the beginning of a run can have a significant impact on baselining.

Well Selectors

Click the wells in the well selector to show or to hide the data in the charts or spreadsheets throughout the Data Analysis window:

- To hide one well, highlight and click the individual well. To show that well, highlight and click the well again
- To hide multiple wells, click and drag across the wells you want to select. To show those wells, click and drag across the wells again
- Click the top left corner of the plate to hide all the wells. Click the top left corner again to show all wells
- Click the start of a column or row to hide those wells. Click the column or row again to show the wells

Only wells loaded with content (entered in the Plate Editor) can be selected in the well selector, and their color shows if they are selected. As shown in Figure 43, the well selector shows these three types of wells:

- **Selected, loaded wells (blue)**. These wells contain a loaded **Unk** (unknown) sample type. The data from these wells appear in the Data Analysis window
- **Unselected, loaded wells (light gray)**. These wells contain loaded **Std** and **Pos** sample types. The data from unselected wells do not appear in the Data Analysis window
- **Empty wells (dark gray)**. These wells were not loaded in the Plate Editor window

	1	2	3	4	5	6
A						
B			Std	Std		
C			Std	Std		
D			Std	Std		
E			Unk	Std		
F			Unk	Std		
G			Unk	Std		
H						

Figure 43. Three well colors appear in a well selector.

Well Selector Right-Click Menu Items

Right-click on well(s) in the well selector view to select the items listed in Table 20.

Table 20. Right-click menu items in the well selectors

Item	Function
Well XX	View only this well, remove this well from view, set color for this well, or exclude this well from analysis.
Selected Wells (right-click and drag)	View only these wells, remove these wells from view, set color for these wells, or exclude these wells from analysis.
Copy	Copy the content of the well to a clipboard, including Sample Type and optional Replicate #.
Copy as Image	Copy the well selector view as an image.
Print...	Print the well selector view.
Print Selection...	Print the current selection.
Export to Excel...	Export the data to an Excel spreadsheet.
Export to Text...	Export the data as a text document.
Export to Xml...	Export the data as a .xml document.
Well Labels	Change the well labels to Sample Type, Target Name or Sample Name.

Temporarily Exclude Wells from Analysis

USING RIGHT-CLICK

1. To exclude a single well, right-click on the well in the well selector, on a fluorescence trace, or on a point plotted on the standard curve, select **Well XX > Exclude from Analysis** (Figure 44).
2. To exclude multiple wells, right click and drag to highlight multiple wells, traces or points, click on **Selected Wells > Exclude from Analysis**.

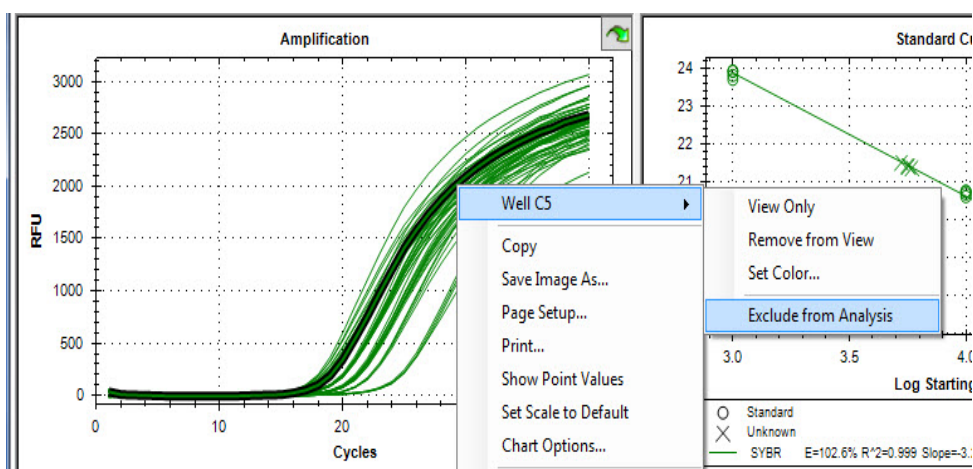

Figure 44. Right-click to exclude a well from analysis.

NOTE: To re-include an excluded well, click on the appropriate well in the well selector, right click and select **Include Well XX in Analysis**.

USING THE PLATE EDITOR

1. Click the **Plate Setup** button on the toolbar in the Data Analysis window.
2. Clicks **View/Edit Plate...**
3. Select one or more wells in the well selector view.
4. Click **Exclude Wells in Analysis** (Figure 45) to exclude the selected wells. This checkbox is at the bottom of the Plate Editor controls on the right side of the window.

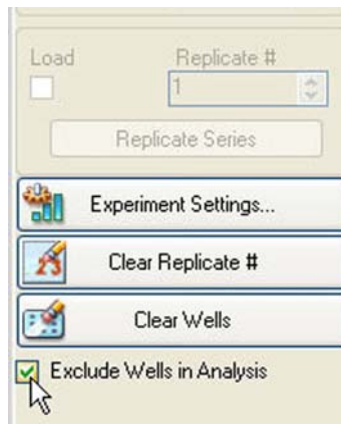

Figure 45. Exclude Wells in Analysis Checkbox at bottom of the pane.

5. The excluded well(s) are marked with an asterisk (*) in the Plate Editor window.

Alternatively, to permanently remove wells from analysis, clear the contents from wells in the Plate Editor by clicking the **Clear Wells** button.

WARNING! You will have to reenter any well content that is cleared.

Charts

Each chart in the Data Analysis window displays the data in a different graph and includes options for adjusting the data. To magnify an area of the chart, select an area by clicking and dragging the mouse. The software resizes the chart and centers it on the selected area.

TIP: Return the chart to a full view by right-clicking on the chart and selecting **Set Scale to Default** from the right-click menu.

Common Right-Click Menu Items for Charts

Right-click menu items are available on all charts. Some of the available items are present for all charts, and these items can be used to change how the data are displayed or to easily export the data from a chart (Table 21)

Table 21. Right-click menu items for charts

Item	Function
Copy	Copy the chart into the clipboard.
Save Image As...	Save the chart image in the selected image file type. Select from these formats: PNG (default), GIF, JPG, TIF, or BMP.

Table 21. Right-click menu items for charts (continued)

Item	Function
Page Setup...	Preview and select page setup for printing.
Print...	Print the chart.
Show Point Values	Show the point values when the mouse moves over a point on the chart.
Set Scale to Default	Return to the default chart view after magnifying the chart.
Chart Options...	Open the Chart Options window to change the chart, including changing the title, selecting limits for the x and y axes, showing grid lines, and showing minor ticks in the axes.

Charts can be copied into Microsoft Word or PowerPoint documents by clicking on the icon in the upper right corner of the pane, dragging, and then releasing at the required location. The image resolution will correspond to that of the screen from which the image was obtained.

NOTE: Menu items that apply to specific charts are described in the next chapter “Data Analysis Overview” (page 53).

Spreadsheets

The spreadsheets shown in Data Analysis include options for sorting and transferring the data. Sort the columns by one of these methods:

- Click and drag a column to a new location in the selected table
- Click the column header to sort the data in Ascending or Descending order

To sort up to three columns of data in the Sort window, follow these steps:

1. Right-click on the spreadsheet to open the menu and select **Sort**.
2. In the Sort window, select the first column title to sort. Sort the data in Ascending or Descending order.
3. Select more than one column title by selecting the title in the pull-down menu. Select **Ascending** or **Descending** to sort the column in that order.
4. Click **OK** to sort the data, or click **Cancel** to stop sorting.

Highlight the data on the associated charts and well selector by holding the mouse pointer over a cell. If you click in the cell, you can copy the contents to paste into another software program.

Common Right-Click Menu Items for Spreadsheets

Right-click any spreadsheet view to select the items shown in Table 22.

Table 22. Right-click menu items for spreadsheets.

Item	Function
Copy	Copy the contents of the selected wells to a clipboard, then, paste the contents into a spreadsheet such as Excel.
Copy as Image	Copy the spreadsheet view as an image file and paste it into a file that accepts an image file such as text, image, or spreadsheet files.

Table 22. Right-click menu items for spreadsheets. (continued)

Item	Function
Print...	Print the current view.
Print Selection...	Print the current selection.
Export to Excel...	Export the data to an Excel spreadsheet.
Export to Text...	Export the data to a text editor.
Export to Xml...	Export the data to an Xml file.
Export to Html...	Export the data to an Html file.
Find...	Search for text.
Sort...	Sort the data in up to three columns.
Select Columns...	Select the columns that will be displayed in the spreadsheet.

Export

Four export options are accessible from the **Export** drop-down menu.

Export All Data Sheets to Excel

Select **Export > Export All Data Sheets to Excel** to export all the spreadsheet views from every tab of the CFX Manager software into individual Excel formatted files.

Export RDML Files

Select **Export > Export RDML Files** and choose either version 1.1 or 1.0 to open a Save As window and specify the file name and location for the Real-Time PCR Data Markup Language (RDML)-formatted file. RDML is a structured and universal data standard for exchanging quantitative PCR (qPCR) data. The data standard is a text file in Extensible Markup Language (.xml) format. Refer to the International RDML Consortium website (www.rdml.org) for additional information about the RDML data exchange format.

NOTE: Save the RDML file as version 1.1 if you are using version 2.3 or higher of qbase^{PLUS} software.

Custom Export

Select **Export > Custom Export** to open a window in which the fields to be exported and the file format can be customized (Figure 46).

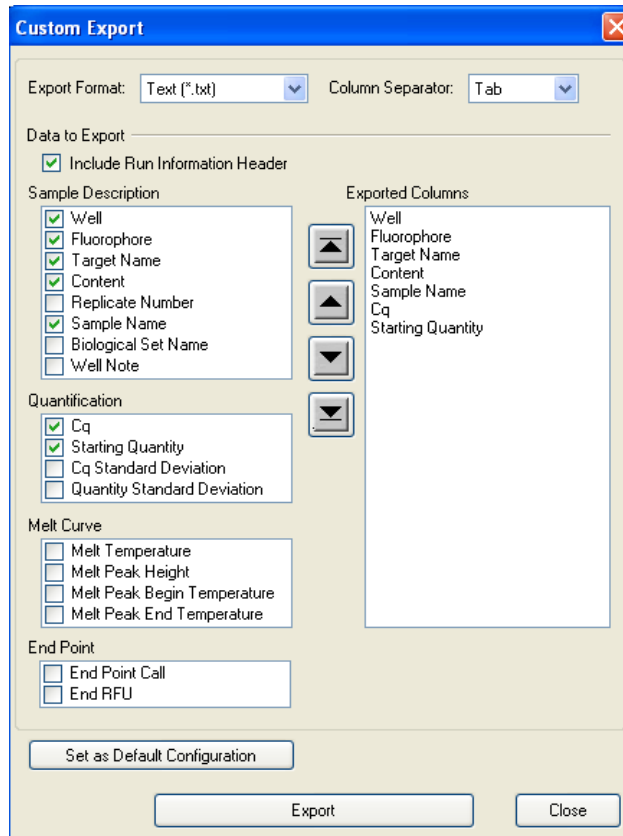

Figure 46. Custom Export window.

1. Select the export format from the following file export formats (Text *.txt, CSV *.csv, Excel 2007 *.xlsx, Excel 2003 *.xls, XML *.xml, and HTML *.html).
2. Select the items to be exported by checking the appropriate check boxes.
3. Click the Export button to open a Save As window to specify the file name and location for the exported file.

Export to LIMS Folder

LIMS compatibility is not currently available for the MiniOpticon™ system.

7 Data Analysis Windows

Read this chapter for more information about the tabs in the Data Analysis window:

- Quantification tab (page 67)
- Quantification Data tab (page 71)
- Melt Curve tab (page 74)
- Melt Curve Data tab (page 75)
- End Point tab (page 77)
- Allelic Discrimination tab (page 79)
- Custom Data View tab (page 81)
- QC tab (page 82)
- Run Information tab (page 83)
- Data file reports (page 84)
- Well Groups Reports (page 87)

NOTE: The tabs displayed in the data analysis window can be customized by selecting them in the **View** menu. This layout will be saved with the file.

Quantification Tab

Use the data in the Quantification tab (Figure 47) to set the data analysis conditions, including the baseline settings for individual wells and the threshold settings. The Quantification tab shows data in these four views:

- **Amplification chart.** Shows the relative fluorescence units (RFUs) for each well at every cycle. Each trace in the chart represents data from a single fluorophore in one well
- **Standard curve.** This graph is only shown if the run includes wells designated as Sample Type Standard. It shows a standard curve with the threshold cycle plotted against the log of the starting quantity. The legend shows the Reaction Efficiency (E) for each fluorophore in the wells with a standard sample type
- **Well selector.** Selects the wells with the fluorescence data you want to show

- **Spreadsheet.** Shows a spreadsheet of the data collected in the selected wells

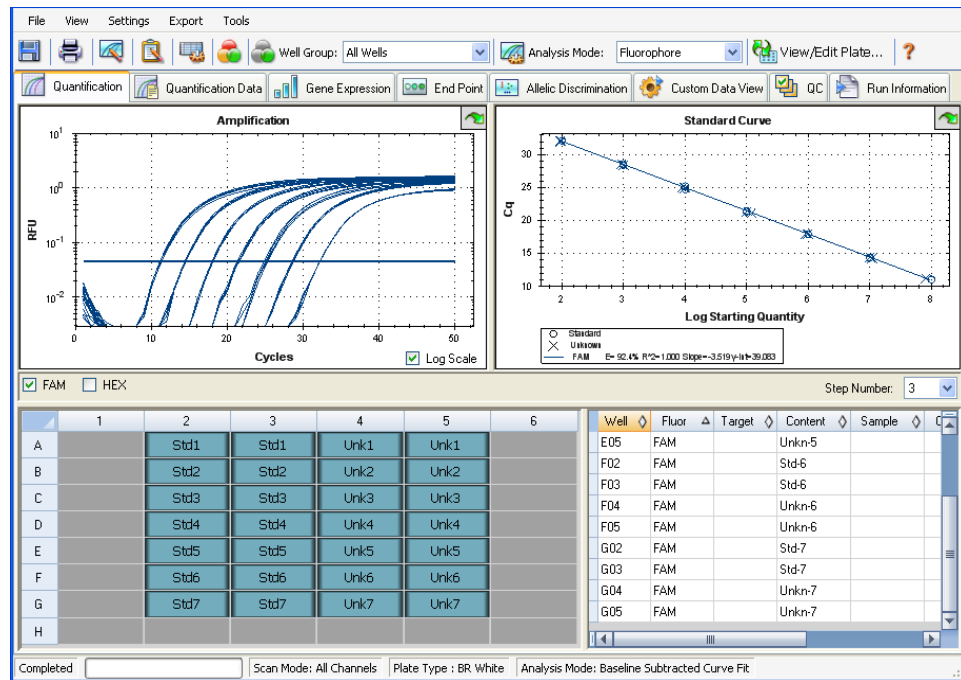

Figure 47. Layout for the Quantification tab in Data Analysis window.

Fluorophore Selector

To select the fluorophore data to display in the Quantification tab charts and spreadsheets, click the fluorophore selector below the Amplification chart. Click the box next to the fluorophore name to show or hide the fluorophore data throughout the data analysis window.

Trace Styles Window

Open the Trace Styles window (Figure 48) to adjust the appearance of traces in the amplification and melt curve charts in the Quantification and Melt Curve tabs.

To open this window, follow these steps:

1. Select only one fluorophore in the fluorophore selection boxes (Figure 41) under the Amplification chart.
2. Click **Settings > Trace Styles** in the Data Analysis menu bar, or right-click on a trace and select **Trace Styles**.

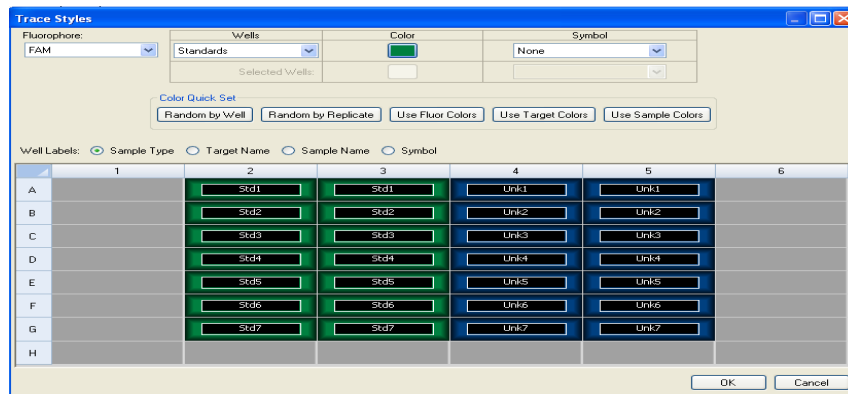

Figure 48. Trace Styles window.

Use the tools in the Trace Styles window to adjust the appearance of traces and preview the changes in the well selector at the bottom of the window.

- Select a specific set of wells by using the well selector. Alternatively, select wells that contain one sample type in the pull-down menu in the **Wells** column
- Click the box in the Color column to select a color for the wells
- Select a symbol from the dropdown menu in the Symbol column
- A **Color Quick Set** can be chosen to color the wells in the manner indicated by the button label: Random by Well, Random by Replicate, Use Fluor Colors, Use Target Colors, or Use Sample Colors
- Select the **Well Labels** by clicking either Sample Type, Target Name, Sample Name, or Symbol

Log Scale Option

Click the **Log Scale** box at the bottom of the Amplification chart to view the fluorescence traces in a semi-log scale, as shown in Figure 49.

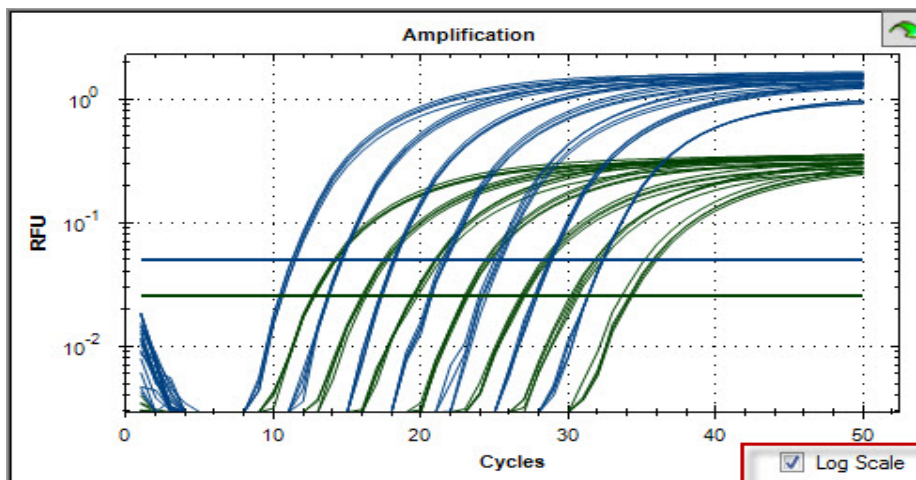

Figure 49. Log Scale option selected in the Amplification chart.

TIP: To magnify any area of the chart, click and drag the mouse across an area. To return to a full view, right-click and select **Set Scale to Default** from the menu.

Standard Curve Chart

The software creates a Standard Curve chart (Figure 50) in the Quantification tab if the data include sample types defined as standard (Std) for one fluorophore in the run.

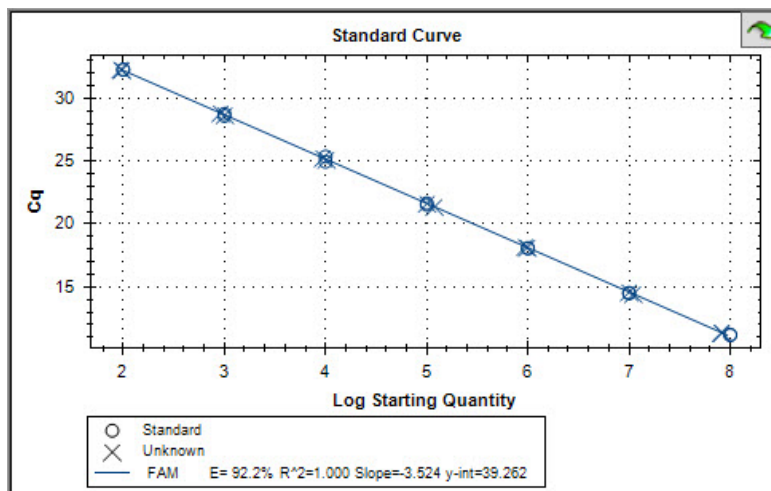

Figure 50. Standard Curve chart.

The Standard Curve chart displays the following information:

- Name for each curve (the fluorophore or target)
- Color of each fluorophore or target
- Reaction efficiency (E). Use this statistic to optimize a multiplex reaction and to equalize the data for a standard curve

NOTE: The reaction efficiency describes how much of your target is being produced with each cycle in the protocol. An efficiency of 100% means that you are doubling your target with each cycle.

- Coefficient of determination, R^2 (written as $R^{\wedge}2$). Use this statistic to determine how correctly the line describes the data (goodness of fit)
- Slope
- y-intercept

Chart Right-Click Menu Options

In addition to the common right-click menu options to copy, print and export charts, Table lists the menu options available only on the Amplification chart.

Table 23. Right-click menu items for spreadsheets.

Menu Option	Function
Well XX, Fluor/Target	View only this well, remove this well from view, set color for this trace, or exclude this well from analysis.
Selected Traces	View only these wells, remove these wells from view, set color for these traces, or exclude these wells from analysis.
Show Threshold Values	Display the threshold value for each amplification curve on the chart.
Trace Styles...	Open the Trace Styles window to change trace styles that appear on the Quantification and Melt Curve tabs.

Table 23. Right-click menu items for spreadsheets. (continued)

Menu Option	Function
Baseline Thresholds...	Open the Baseline Thresholds window to change baseline or thresholds of each fluorophore (changes appear in Amplification chart in Quantification tab).

Quantification Tab Spreadsheet

Table 24 shows the type of data shown in the spreadsheet at the bottom right side of the Quantification tab:

Table 24. Quantification tab spreadsheet content

Information	Description
Well	Well position in the plate.
Fluor	Fluorophore detected.
Target	Target Name loaded in the Plate Editor wells.
Content	A combination of the Sample Type (required) and Replicate # (optional) loaded in the Plate Editor.
Sample	Sample Name loaded in the Plate Editor wells.
C _q	Quantification cycle for each trace.

TIP: To make changes to the Content, Target, and Sample, open the Plate Editor by clicking the **Plate Setup** button and selecting **View/Edit Plate**.

Quantification Data Tab

The Quantification Data tab shows spreadsheets that describe the quantification data collected in each well. Select one of the four options to show the data in different formats:

- **Results.** Displays a spreadsheet view of the data
- **Standard Curve Results.** Displays a spreadsheet view of the standard curve data
- **Plate.** Displays a view of the data in each well as a plate map
- **RFU.** Choose this spreadsheet to show the RFU quantities in each well for each cycle

TIP: Right-click any spreadsheet for options, including the sort option.

Results Spreadsheet

Select a **Results** spreadsheet (Figure 51) to see data for each well in the plate.

Well	Fluor	Target	Content	Sample	Cq	Cq Mean	Cq Std. Dev	Starting Quantity (SQ)	Log Starting Quantity	SQ Mean
A02	FAM	Actin	Std-1		12.36	12.32	0.046	1.000E+08	8.000	1.00E+08
A03	FAM	Actin	Std-1		12.29	12.32	0.046	1.000E+08	8.000	1.00E+08
A04	FAM	Actin	Unkn-1		12.61	12.54	0.095	7.793E+07	7.892	8.15E+07
A05	FAM	Actin	Unkn-1		12.47	12.54	0.095	8.503E+07	7.930	8.15E+07
B02	FAM	Actin	Std-2		15.76	15.72	0.058	1.000E+07	7.000	1.00E+07
B03	FAM	Actin	Std-2		15.68	15.72	0.058	1.000E+07	7.000	1.00E+07
B04	FAM	Actin	Unkn-2		15.84	15.77	0.167	9.685E+06	6.982	1.04E+07

Figure 51. Quantification Data tab with Results spreadsheet selected.

NOTE: All Std. Dev (standard deviation) calculations apply to the replicate groups assigned in the wells in the Plate Editor window. The calculations average the C_q value for each well in the replicate group.

The Results spreadsheet includes the type of information listed in Table 25.

Table 25. Results spreadsheet content

Information	Description
Well	Well position in the plate.
Fluor	Fluorophore detected.
Target	Amplification target name (gene).
Content	Sample type and Replicate number.
Sample	Sample description.
Biological Set Name	Name of the biological set.
C_q	Quantification cycle.
C_q Mean	Mean of the quantification cycle for the replicate group.
C_q Std. Dev	Standard deviation of the quantification cycle for the replicate group.
Starting Quantity (SQ)	Estimate of the starting quantity of the target.
Log Starting Quantity	Log of the starting quantity.
SQ Mean	Mean of the starting quantity.
SQ Std. Dev	Standard deviation of the starting quantity.
Set Point	Temperature of sample in the well for a gradient step.
Sample Note	One round of denaturation, annealing, and extension, or one round of annealing and extension steps in a protocol.

Standard Curve Results Spreadsheet

Select the Standard Curve Results Spreadsheet (Figure 52) to see the calculated standard curve parameters.

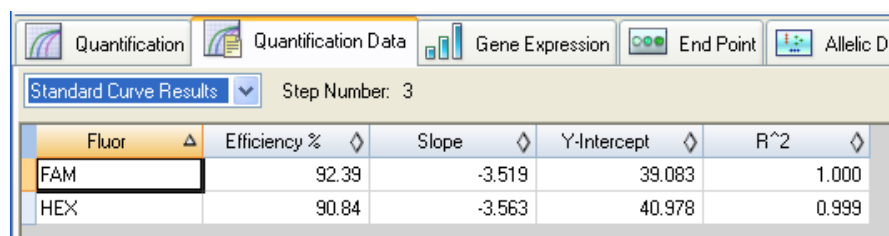

Fluor	Efficiency %	Slope	Y-Intercept	R ²
FAM	92.39	-3.519	39.083	1.000
HEX	90.84	-3.563	40.978	0.999

Figure 52. Standard Curve Results spreadsheet in the Quantification Data tab

These values can be copied and pasted into a document by right clicking and selecting **Copy** or a file can be created by choosing one of the **Export** options.

Table 26. Standard Curve Results spreadsheet contents

Information	Description
Fluor (or Target)	Fluorophore (or Target) detected.
Efficiency %	Reaction efficiency.
Slope	Slope of the standard curve.
Y-intercept	Point at which the curve intercepts the y-axis.
R ²	Coefficient of determination.

Plate Spreadsheet

Select the **Plate** spreadsheet to see a plate map of the data for one fluorophore at a time. Select each fluorophore by clicking a tab at the bottom of the spreadsheet. Figure 53 shows the Plate spreadsheet as a plate map.

Quantification Quantification Data Gene Expression End Point All

Plate Step Number: 3

Output: Content Sample Cq Starting Quantity

		1	2	3	4	5	6
A	Content		Std-1	Std-1	Unkn-1	Unkn-1	
	Sample						
	Cq		11.09	11.05	11.24	11.23	
	copy number		1.00e+08	1.00e+08	8.16e+07	8.21e+07	
B	Content		Std-2	Std-2	Unkn-2	Unkn-2	
	Sample						
	Cq		14.40	14.34	14.44	14.30	
	copy number		1.00e+07	1.00e+07	1.01e+07	1.10e+07	
C	Content		Std-3	Std-3	Unkn-3	Unkn-3	
	Sample						
	Cq		17.96	17.91	18.01	18.08	
	copy number		1.00e+06	1.00e+06	9.73e+05	9.30e+05	
	Content		Std-4	Std-4	Unkn-4	Unkn-4	

FAM HEX

Figure 53. Plate spreadsheet in the Quantification Data tab.

RFU Spreadsheet

Select the **RFU** spreadsheet to see the relative fluorescence units (RFU) readings for each well acquired at each cycle of the run. Select individual fluorophores by clicking a tab at the bottom of the spreadsheet. The well number appears at the top of each column, and the cycle number appears to the left of each row (Figure 54).

Cycle	A2	A3	A4	A5	B2	B3	B4	B5	C2
1	0.0115	0.0127	0.00926	0.0116	0.0185	0.0182	0.0185	0.0178	0.0134
2	0.00500	0.00558	0.00530	0.00568	0.00809	0.00830	0.00715	0.00728	0.00575
3	0.00384	0.00329	0.00262	0.00360	0.00315	0.00323	0.00433	0.00409	0.00312
4	0.00155	0.000997	0.00142	0.00205	0.00182	0.00202	0.00107	0.00269	0.00254
5	0.000660	0.000262	0.000469	0.000538	0.000849	0.000171	0.000544	0.000393	0.000623
6	-0.00318	-0.00138	-0.00175	-0.00273	0.000469	-0.00111	0.000704	-0.00159	0.000907

Figure 54. RFU spreadsheet in the Quantification Data tab.

Melt Curve Tab

For DNA-binding dyes and noncleavable hybridization probes, the fluorescence is brightest when the two strands of DNA anneal. Therefore, as the temperature rises toward the melting temperature (T_m), fluorescence decreases at a constant rate (constant slope). At the T_m , there is a dramatic reduction in the fluorescence with a noticeable change in slope. The rate of this change is determined by plotting the negative first Regression of fluorescence versus temperature ($-d(\text{RFU})/dT$). The greatest rate of change in fluorescence results in visible peaks and represents the T_m of the double-stranded DNA complexes.

The software plots the RFU data collected during a melt curve as a function of temperature. To analyze melt peak data, the software assigns a beginning and ending temperature to each peak by moving the threshold bar. The floor of the peak area is specified by the position of the melt threshold bar. A valid peak must have a minimum height relative to the distance between the threshold bar and the height of the highest peak.

Open the Melt Curve tab (Figure 55) to determine the melting temperature (T_m) of amplified PCR products. This tab shows the melt curve data in these four views:

- **Melt Curve.** View the real-time data for each fluorophore as RFUs per temperature for each well
 - **Melt Peak.** View the negative regression of the RFU data per temperature for each well
 - **Well selector.** Select wells to show or hide the data
 - **Peak spreadsheet.** View a spreadsheet of the data collected in the selected well
- NOTE: This spreadsheet shows only as many as two peaks for each trace. To see more peaks, click the **Melt Curve Data** tab (page 75).

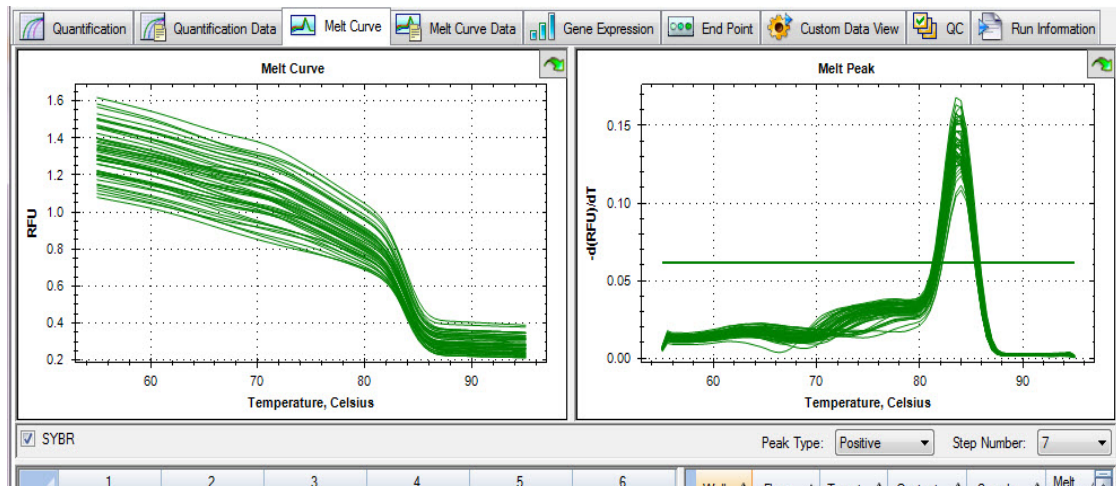

Figure 55. Layout of the Melt Curve tab in the Data Analysis window.

Adjust the Melt Curve data by any of these methods:

- Click and drag the threshold bars in the Melt Peak chart to include or exclude peaks in data analysis
- Select **Positive** in the Peaks pull-down menu to show the spreadsheet data for the peaks above the Melt Threshold line, or select **Negative** to view the spreadsheet data for the peaks below the Melt Threshold line
- Open the Trace Styles window to change the color of the traces in the Melt Curve and Melt Peak charts.
- Select a number in the Step Number selector (page 57) to view the Melt Curve data at another step in the protocol. The list shows more than one step if the protocol includes plate read (camera icon) in two or more melt curve steps
- Select wells in the well selector to focus on subsets of the data
- Select a well group (page 57) to view and analyze a subset of the wells in the plate. Select each well group by name in the Well Group pull-down menu in the toolbar

Melt Curve Data Tab

The Melt Curve Data tab shows the data from the Melt Curve tab in multiple spreadsheets that include all the melt peaks for each trace. Select one of these four options from the drop down list at the top of the tab to show the melt curve data in different spreadsheets:

- **Melt Peaks.** List all the data, including all the melt peaks, for each trace
- **Plate.** List a view of the data and contents of each well in the plate
- **RFU.** List the RFU quantities at each temperature for each well
- **-d(RFU)/dT.** List the negative rate of change in RFU as the temperature (T) changes. This is a first regression plot for each well in the plate

Melt Peaks Spreadsheet

Select the **Melt Peaks** spreadsheet (Figure 56) to view melt curve data.

Well	Fluor	Content	Target	Sample	Melt Temperature	Peak Height	Begin Temperature	End Temperature
A01	SYBR	Std-1			86.00	1502.14	82.00	88.00
A02	SYBR	Std-2			86.00	1496.90	81.50	88.00
A03	SYBR	Std-3			86.00	1496.51	82.00	88.00
A04	SYBR	Std-4			86.00	1523.68	81.50	88.00
A05	SYBR	Std-5			86.00	1369.55	82.00	88.00
A06	SYBR	Std-6			86.00	1379.17	82.00	88.00
A07	SYBR	Std-7			86.00	1282.97	82.00	88.00

Figure 56. Melt Peaks spreadsheet in the Melt Curve Data tab.

The Melt Peaks spreadsheet (Figure 56) includes the type of information shown in Table 27.

Table 27. Melt Peaks spreadsheet content

Information	Description
Well	Well position in the plate.
Fluor	Fluorophore detected.
Content	Sample Type listed in the Plate Editor window.
Target	Amplification target (gene).
Sample	Sample Name listed in the Plate Editor window.
Melt Temperature	The melting temperature of each product, listed as one peak (highest) per row in the spreadsheet.
Peak Height	Height of the peak.
Begin Temperature	Temperature at the beginning of the peak.
End Temperature	Temperature at the end of the peak.

Plate Spreadsheet

Select the **Plate** spreadsheet to view melt curve data in a plate format.

NOTE: To adjust the peak that the software calls, adjust the threshold line in the Melt Peak chart on the Melt Curve tab.

The Plate spreadsheet includes the types of information shown in Table 28.

Table 28. Plate spreadsheet content

Information	Description
Content	A combination of Sample Type (required) and Replicate # (optional).
Sample	Sample description.
Peak 1	First melt peak (highest).
Peak 2	Second (lower) melt peak.

RFU Spreadsheet

Select the **RFU** spreadsheet to view the fluorescence for each well at each cycle acquired during the melt curve.

Table 29 lists the types of information shown in the RFU spreadsheet.

Table 29. RFU spreadsheet content

Information	Description
Well number (A1, A2, A3, A4, A5...)	Well position in the plate for the loaded wells.
Temperature	Melting temperature of the amplified target. Plotted as one well per row, and multiple wells for multiple products in the same well.

-d(RFU)/dT Spreadsheet

Select the -d(RFU)/dT spreadsheet to view the types of data shown in.

Table 30 lists the types of information shown in the -d(RFU)/dT spreadsheet.

Table 30. -d(RFU)/dT spreadsheet content

Information	Description
Well number (A1, A2, A3, A4, A5...)	Well position in the plate for the loaded wells.
-d(RFU)/dT	Negative rate of change in RFU as temperature (T) changes.

End Point Tab

Open the End Point tab to analyze final relative fluorescence units (RFUs) for the sample wells (Figure 57). The software compares the RFU levels for wells with unknown samples to the RFU levels for wells with negative controls, and “calls” the unknown as a Positive or Negative. Positive samples have an RFU value that is greater than the average RFU value of the negative controls plus the Cut Off Value.

To analyze the end point data, the plate must contain negative controls, or the software cannot make the call. Run one of these two types of protocols:

- **Run a quantification protocol.** Set up a standard protocol. After completion of the run, open the Data Analysis window, adjust the data analysis settings in the Quantification tab, and then click the End Point tab to pick an end point cycle
- **Run an End Point Only protocol.** Load the End Point Only protocol in the Plate tab of the Run Setup window, select or create a plate, and start the run

The End Point tab shows the average RFU values to determine whether or not the target was amplified by the last (end) cycle. Use these data to determine if a specific target sequence is present (positive) in a sample. Positive targets have higher RFU values than the Cut Off value you define.

TIP: To create an end point protocol, open the Protocol tab (Run Setup window) and select **Options > End Point Only Run**.

The software displays these data in the End Point tab:

- **Settings.** Adjust data analysis settings

- **Results.** Shows the results immediately after you adjust the Settings
- **Well selector.** Select the wells with the end point data you want to show
- **Well spreadsheet.** Shows a spreadsheet of the end RFU collected in the selected wells

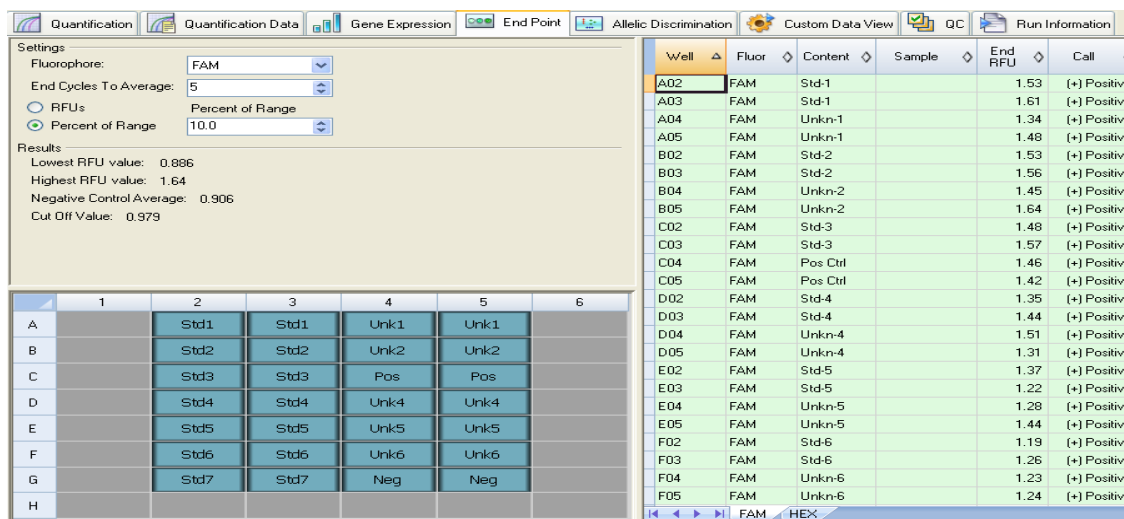

Figure 57. Layout of the End Point analysis tab.

The Results list includes this information:

- **Lowest RFU value.** Lowest RFU value in the data
- **Highest RFU value.** Highest RFU value in the data
- **Negative Control Average.** Average RFU for the wells that contain negative controls
- **Cut Off Value.** Calculated by adding the tolerance (RFU or Percentage of Range listed in the Settings) and the average of the negative controls. Samples with RFUs that are greater than the Cut Off Value will be called “Positive”. To adjust the Cut Off Value, change the RFU or Percentage of Range

The Cut Off Value is calculated using this formula:

$$\text{Cut Off Value} = \text{Negative Control Average} + \text{Tolerance}$$

Select a tolerance using one of these methods:

- **RFUs (default).** Select this method to use an absolute RFU value for the tolerance. The minimum RFU tolerance value is 2. The maximum is the absolute value of the highest RFU value minus the absolute value of the lowest RFU value. The default RFU tolerance value is 10% of the total RFU range
- **Percent of Range.** Select this method to use a percentage of the RFU range for the tolerance. The minimum percent of range is 1 percent. The maximum percent of range is 99 percent. The default percent of range is 10 percent

Adjusting the End Point Data Analysis

Adjust the information shown in the End Point tab by using these methods:

- Choose a **Fluorophore** from the pull-down list to view the data
- Choose an **End Cycle to Average** value to set the number of cycles that the software uses to calculate the average end point RFU
- Select **RFUs** to view the data in relative fluorescence units

- Select **Percentage of Range** to view the data as a percentage of the RFU range
- Select wells in the well selector to focus on subsets of the data
- Select a well group (page 57) to view and analyze a subset of the wells in the plate. Select each well group by name in the Well Group pull-down menu in the toolbar

Data Description for End Point Analysis

Table 31 lists the types of information shown in the spreadsheet in the End Point tab.

Table 31. End Point spreadsheet contents

Information	Description
Well	Well position in the plate.
Fluor	Fluorophore detected.
Content	A combination of the Sample type and Replicate #.
End RFU	RFU at the end point cycle.
Call	Positive or Negative, where positive samples have an RFU value greater than the average RFU of the negative controls plus the Cut Off Value.
Sample	Sample Name loaded in the Plate Editor.

Allelic Discrimination Tab

The Allelic Discrimination tab assigns the genotypes to wells with unknown samples using the RFU or C_q of positive control samples (Figure 58). Use this data to identify samples with different genotypes, including Allele 1, Allele 2, Heterozygote, Unknown, Control 1, or Control 2.

NOTE: The data for allelic discrimination must come from multiplex runs with at least two fluorophores. Each fluorophore identifies one allele in all samples.

Allelic discrimination analysis requires the following minimal well contents:

- Two fluorophores in each well, except the wells that contain positive controls can contain only one fluorophore
- One fluorophore that is common to all wells in the well group
- NTC (no template control) samples if you want to normalize the data

The software displays allelic discrimination data in these layouts:

- **RFU or C_q chart.** View the data in a graph of RFU or C_q for Allele 1/Allele 2. Each point in the graph represents data from a single fluorophore in one well
- **Well spreadsheet.** Shows a spreadsheet listing the allelic discrimination data collected in each well of the plate
- **Well selector.** Select the wells with the end point data you want to show

- **Well spreadsheet.** Shows a spreadsheet listing the allelic discrimination data collected in the selected wells

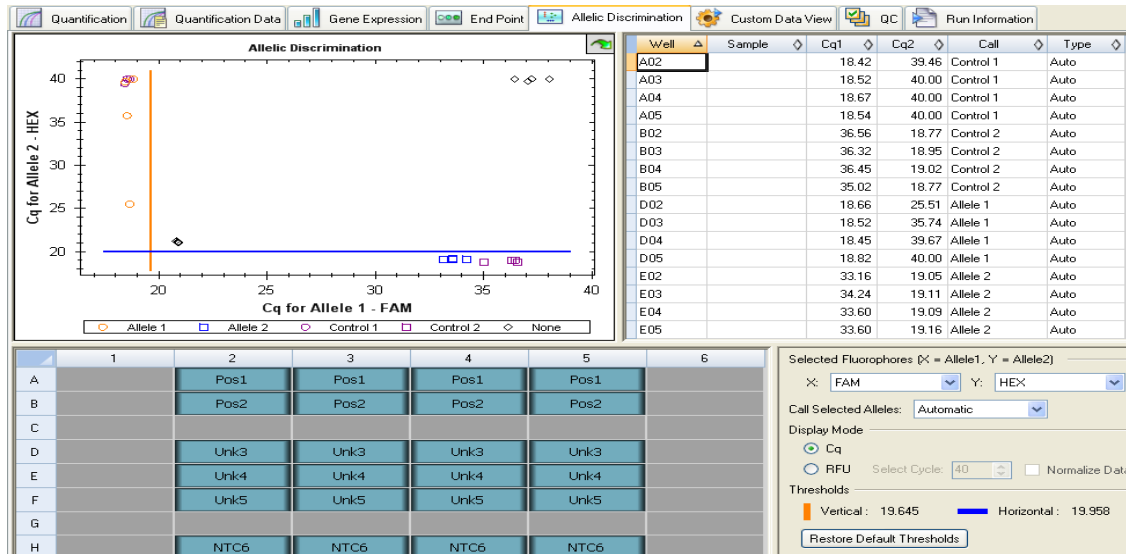

Figure 58. Layout of the Allelic Discrimination tab in the Data Analysis window.

Adjusting Data for Allelic Discrimination

The software automatically assigns a genotype to wells with unknown samples based on the positions of the vertical and horizontal threshold bars, and then lists genotype calls in the spreadsheet view. To automatically call genotypes, the software uses positive controls (when available), or estimates the thresholds. The software takes an average C_q or RFU for the positive controls to automatically set the threshold lines for discriminating the alleles.

Adjust the position of the threshold bars by clicking and dragging them; the software automatically adjusts the calculations to make new genotype assignments:

- If the run contains three controls in the plate, then the position of the threshold bars is based on the mean and standard deviation of the RFU or C_q of the controls
- If the number of controls is less than three, then the position of the threshold bars is determined by the range of RFU or threshold cycle values in the selected fluorophore

Adjust allelic discrimination data by following any of these methods:

- Click and drag the threshold bars in the Allelic Discrimination chart to adjust the calls in the spreadsheet
- Select a fluorophore for each axis in the chart (**X:** and **Y:**) in the settings options on the bottom right of the window
- Change a call manually by highlighting a row in the spreadsheet, and then selecting an option in the Call Selected Alleles list (including Allele 1, Allele 2, Heterozygote, None, Unknown, Control 1, or Control 2)
- Click the **Restore Default Thresholds** button to restore the vertical and horizontal bars to their original position, which are indicated by the numbers next to the bars
- Select the **C_q Display Mode** to view the data as threshold levels. Select **RFU Display Mode** to view the data in relative fluorescence units at the selected cycle

- Select **Normalize Data** to normalize the RFU data shown in the chart and spreadsheet

Normalization changes the data on the chart to a range from 0 to 1 on both axes. To normalize the data, the plate must contain wells with “no template control” (NTC) sample types for both Allele 1 and Allele 2. For this plot, the RFU data are normalized to the NTC values as a linear combination of Allele 1- and Allele 2-specific RFUs. This plot is an effective way to present RFU data.

The calculation for normalized RFU follows the formulas presented in Livak et al. (1995).

$$\text{Normalized } A_1 = \frac{A_1}{A_1 + A_2 + \bar{x}(\text{NTC}_{A_1 + A_2})}$$

Where:

- A_1 represents RFU for Allele 1
- A_2 represents RFU for Allele 2
- \bar{x} represents the mean RFU

$\text{NTC}_{A_1 + A_2}$ represents the sum of RFUs for the NTC sample of Allele 1 and Allele 2

Allelic Discrimination Spreadsheet

The Allelic Discrimination spreadsheet at the top right side of the Allelic Discrimination tab shows the information shown in Table 32.

Table 32. Allelic Discrimination spreadsheet contents

Information	Description
Well	Well position in the plate.
RFU1 or C_q1	RFU or C_q for Allele1.
RFU2 or C_q2	RFU or C_q for Allele2.
Call	Identity of the allele, including automatic Allele 1, Allele 2, Heterozygote, None, Unknown, Control 1, Control 2.
Type	Auto (Automatic) or Manual. Describes the way the call was made. Automatic means the software selected the call. Manual means the call was chosen by the user.

Custom Data View Tab

The Custom Data View tab simultaneously displays multiple panes in a customizable format (Figure 59).

The **Load a Preset View** dropdown list offers a selection of display format templates. The default view displayed is dependent on the file being analyzed. For example, if Melt Curve data are present, the Amp+Melt default view is displayed.

The data view can be further customized by:

- Selecting an alternate preset view from the dropdown list
- Using the dropdown menu located at the top of an individual pane
- Using the Rows and Columns dropdown selection options

- Changing individual pane dimensions by clicking and dragging the bars at the periphery of each pane.

Customized views can be saved as new preset templates by clicking **Save as Preset**. Existing presets can be deleted, renamed, or the default preset views restored using **Manage Presets**.

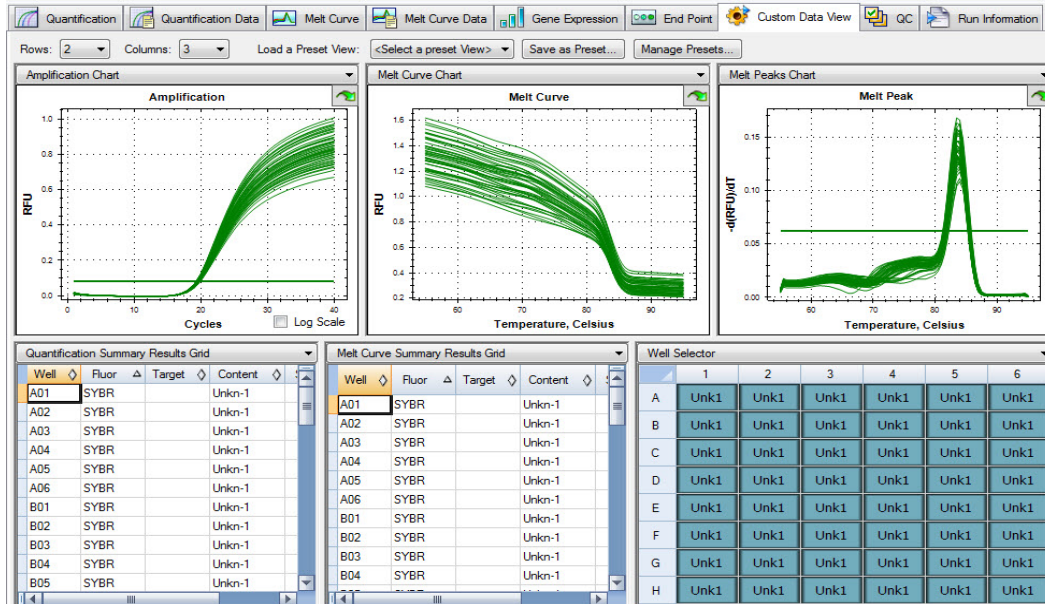

Figure 59. Custom Data View window.

QC Tab

Open the **QC tab** to quickly assess the quality of the run data based on the rules defined in the QC tab in the User Preferences window (see “QC Tab” on page 120).

The QC tab is divided into four areas (Figure 60):

- **Amplification chart.** Shows the RFU for each well at every cycle. Each trace in the chart represents data from a single fluorophore in one well
- **QC rules table.** Shows the available QC rules and the settings that define each rule. Applied QC rules are indicated by a checkmark. A QC rule can be removed by unchecking the Use box
- **Well selector.** Selects the wells with the fluorescence data you want to show
- **QC Rule Summary.** shows the selected QC rule and highlights wells that fail the rule

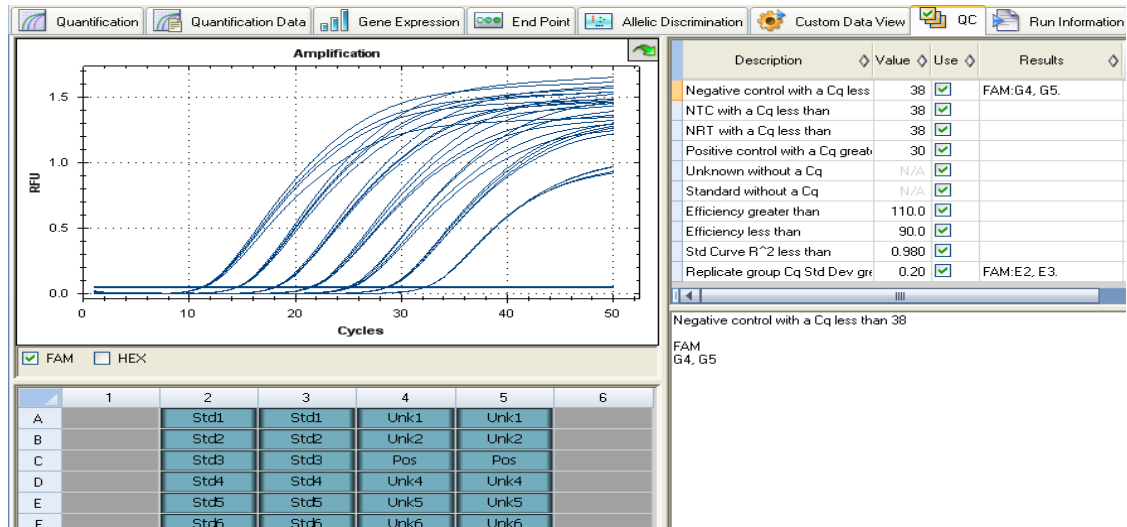

Figure 60. QC tab layout.

Excluding Wells that Fail QC

Wells failing QC criteria are listed in the results column of the QC rules table and in the summary pane. These wells can be excluded, or included, in analysis by checking or unchecking the appropriate Exclude Wells checkbox.

Run Information Tab

The Run Information tab (Figure 61) shows the protocol and other information about each run. Open this tab for the following options:

- View the protocol
- Enter and edit the Notes. Enter or edit notes about the run by typing in the Notes box
- Enter and edit the data ID for the run by typing in the ID box
- View the **Other** section to see events, such as error messages, that might have occurred during the run. View these messages to help troubleshoot a run

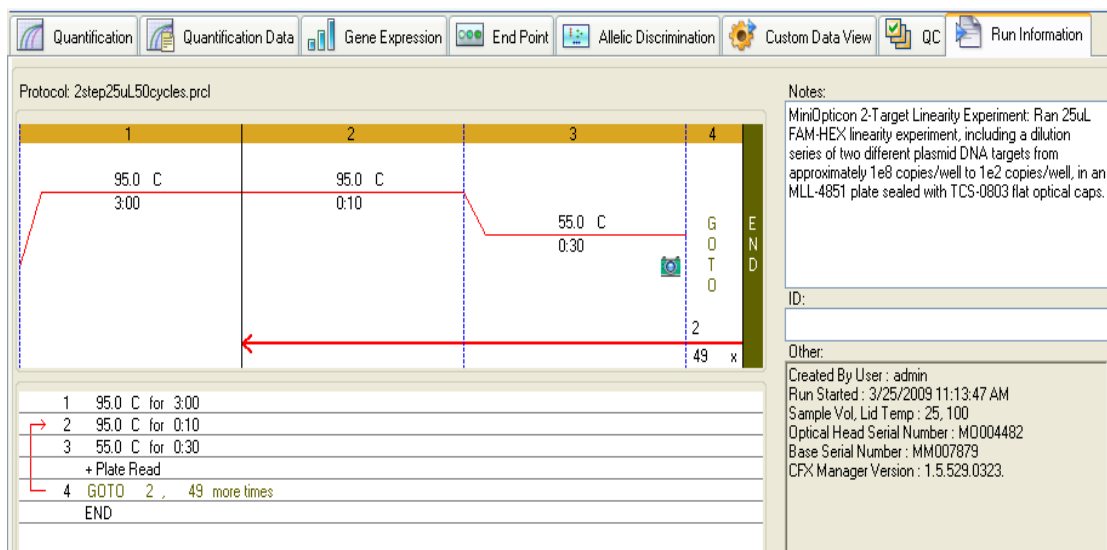

Figure 61. Layout of the Run Information tab in the Data Analysis window.

TIP: Right-click the Protocol to copy, export, or print it. Right-click the Notes, ID, or Other pane to undo, cut, copy, paste, delete, or select the text.

Data File Reports

The Report window (Figure 62) shows information about the current data file in the Data Analysis window. To open a report, select **Tools > Reports**, or click the **Reports** button on the toolbar in the Data Analysis window.

The Report window shows these three sections:

- **Menu and toolbar.** Select options to format, save and print the report or template
- **Options list (top, left side of window).** Select options to show in the report
- **Options pane (bottom, left side of window).** Enter information about a selected option
- **Preview pane (right side of window).** View the current report in a preview

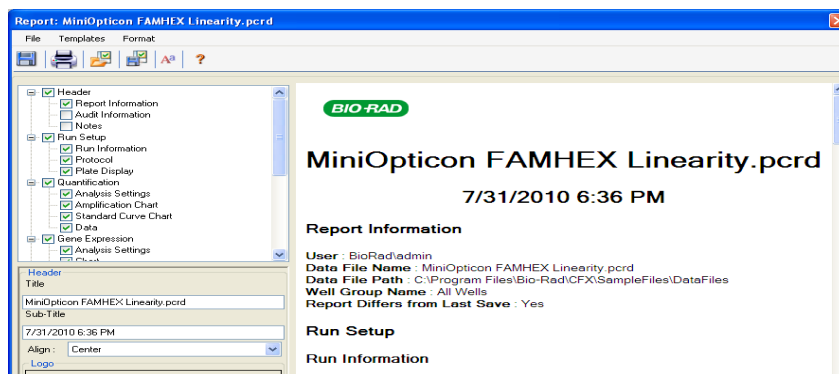

Figure 62. Example of a Report window for a data file.

TIP: The layout of a report can define the type of information that appears in any report if you save the report as a template. Select **Template > Save** or **Save As** to save the layout of the current report as a template.

Create a Data Analysis Report

To create a report in the Data Analysis window, follow these steps:

1. Make final adjustments to the well contents, selected wells, charts, and spreadsheets in the Data Analysis window before creating the report.
2. Click the **Report** button in the Data Analysis toolbar to open the Report window.
3. Change the options you want to include in the report. The report opens with default options selected. Click the check boxes in the report options list to change whole categories or individual options within a category.
NOTE: The data that appear in the report are dependent on the current selections within the tabs of the Data Analysis window. For example, a quantification run might not contain a standard curve, and therefore those data do not appear in the Data Analysis window or in the data report.
4. The ordering of categories and items within a report can be changed by clicking and dragging these to the desired relative position. Items can only be reordered within the categories to which they belong.
5. Click the **Update Report** button to update the Report Preview with any changes.
6. Print or save the report. Click the **Print Report** button in the toolbar to print the current report. Select **File > Save** to save the report as a PDF (Adobe Acrobat Reader file), MHT (Microsoft document), or MHTML (Microsoft document) file and select a location to store the file. Select **File > Save As** to save the report with a new name or in a new location.
7. (Optional) Create a report template with the information you want. To save the current report settings in a template, select **Template > Save** or **Save As**. Then load the report template the next time you want to make a new report.

Data Analysis Report Categories

A report can include any of the options in each category described in Table 33, depending on the type of data in Data Analysis window.

Table 33. Data analysis report categories in the options list.

Category	Option	Description
Header		
	Report Information	Run date, user name, data file name, data file path, and selected well group
	Audit Information	Supplementary information required for auditing, including signatures
	Notes	Notes about the data report
Run Setup		
	Run Information	Includes the run date, user, data file name, data file path, and the selected well group
	Protocol	Text view of the protocol steps and options
	Plate Display	Show a plate view of the information in each well of the plate
Quantification		

Table 33. Data analysis report categories in the options list. (continued)

Category	Option	Description
	Analysis Settings	Includes the step number when data were collected, the analysis mode, and the baseline subtraction method
	Amplification Chart	Copy of the amplification chart for runs that include quantification data
	Standard Curve Chart	Copy of the standard curve chart
	Data	Spreadsheet listing the data in each well
Gene Expression – Bar Chart		
	Analysis Settings	Includes the analysis mode, chart data, scaling option, and chart error
	Chart	Copy of the bar chart
	Target Names	Chart of the names
	Sample Names	Chart of the names
	Data	Spreadsheet listing the data in each well
	Target Stability	Chart of the target stability values
Gene Expression – Clustergram, Scatter Plot, Volcano Plot, Heat Map		
	Analysis Settings	Includes the settings for each chart type
	Chart	Copy of the chart
	Data	Spreadsheet listing the data in each target
Melt Curve		
	Analysis Settings	Includes the melt step number and threshold bar setting
	Melt Curve Chart	Copy of the melt curve chart
	Melt Peak Chart	Copy of the melt peak chart
	Data	Spreadsheet listing the data in each well
Allelic Discrimination		
	Analysis Settings	Includes display mode, fluorophores, cycle, thresholds, and normalized data
	Allelic Discrimination Chart	Copy of the allelic discrimination chart
	Data	Spreadsheet listing the data in each well
End Point		
	Analysis Settings	Includes fluorophore, end cycles to average, mode, lowest RFU value, highest RFU value, and cut off value
	Data	Spreadsheet listing the data in each well
QC Parameters		
	Data	Spreadsheet listing the parameters for each QC rule

Well Group Reports

To create reports for specific well groups:

1. Select **Tools > Well Group Reports** in the Data Analysis window.

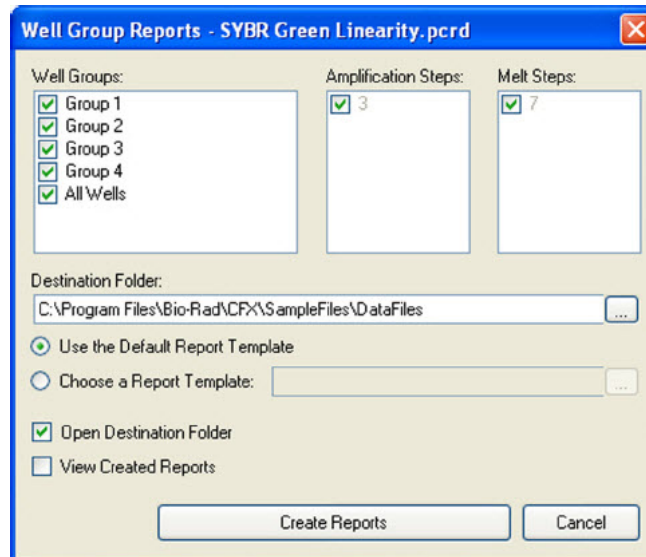

Figure 63. Well Group Reports window.

2. From the **Well Groups Reports** window (Figure 63) the Well Groups, Amplification Steps, and Melt Steps to be included in the reports can be specified by checking the appropriate box.
3. The destination folder can be changed to another location by clicking the ... button.
4. Select **Choose a Report Template** to choose a template other the default. Click the ... button to browse for the template file.
5. Once the reports have been generated, the destination folder can be opened and the reports viewed by checking the appropriate box.

Click **Create Reports** to create the reports as specified.

8 Gene Expression Analysis

Read this chapter for information about performing Gene Expression Analysis:

- Gene Expression (page 89)
- Plate setup for gene expression analysis (page 90)
- Guided plate setup (page 90)
- Bar Chart (page 91)
- Clustergram (page 97)
- Scatter Plot (page 98)
- Volcano Plot (page 99)
- Heat Map (page 100)
- Results (page 101)
- Gene Study (page 101)
- Gene Study Report window (page 104)
- Gene expression calculations (page 106)

Gene Expression

With the use of stringently qualified controls in your reactions, you can perform a gene expression run to normalize the relative differences in a target concentration among samples. Typically, message levels for one or more reference genes are used to normalize the expression levels of a gene of interest. Reference genes take into account loading differences or other variations represented in each sample, and they should not be regulated in the biological system being studied.

Open the Gene Expression tab (Figure 66) to evaluate relative differences between PCR reactions in two or more wells. For example, you can evaluate relative numbers of viral genomes, or relative number of transfected sequences in a PCR reaction. The most common application for gene expression study is the comparison of cDNA concentration in more than one reaction to estimate the levels of steady state messenger RNA.

The software calculates the relative expression level of a target with one of these scenarios:

- Relative expression level of a target sequence (Target 1) relative to another target (Target 2). For example, the amount of one gene relative to another gene under the same sample treatment

- Relative expression level of one target sequence in one sample compared to the same target under different sample treatments. For example, the relative amount of one gene relative to itself under different temporal, geographical, or developmental conditions

Plate Setup for Gene Expression Analysis

To perform gene expression analysis, the contents of the wells must include the following:

- **Two or more targets.** The two targets that represent different amplified genes or sequences in your samples
- **One or more reference targets.** At least one target must be a reference target for normalized expression. Assign all reference targets in the Experiment Settings window (page 48) to analyze the data in Normalized Expression mode ($\Delta\Delta C_q$). Runs that do not contain a reference must be analyzed using Relative Expression mode (ΔC_q)
- **Common samples.** Your reactions must include common samples (minimum of two required) to view your data plotted in the Gene Expression tab. These samples represent different treatments or conditions for each of your target sequences. Assign a control sample (optional) in the Experiment Settings window (page 48)

The requirements for Gene Expression setup in the Plate Editor depend on whether reaction contents are **singleplex PCR** with one fluorophore in the reactions, or **multiplex PCR** with more than one fluorophore in the reactions.

Figure 64 shows an example of the minimum contents of the wells for a singleplex gene expression run.

Unk	Unk
Target1	Target1
Sample1	Sample2
Unk	Unk
Target2	Target2
Sample1	Sample2

Figure 64. Example of well contents in a singleplex gene expression run.

Figure 65 shows an example of the minimum contents of the wells for a multiplex gene expression run.

Unk	Unk
Target1	Target1
Target2	Target2
Sample1	Sample2

Figure 65. Example of well contents in a multiplex gene expression run.

Guided Plate Setup

If the plate setup of a data file does not contain the required information for analysis and the Gene Expression tab is selected, the space normally occupied by the bar chart will contain instructions for entering this information. For normalized gene expression, the following steps must be completed:

1. Define Target and Sample names using
 - **Plate Setup.** This will open the Plate Editor window
 - **Replace Plate File.** Select a plate layout file that was previously created

- **Replace PrimePCR File.** Select a PrimePCR™ run file from which to apply the plate layout information

2. Select Reference Targets and Control Sample using

- **Experiment Settings...** This will open the Experiment Settings window so that one or more reference targets and a control sample can be selected

If the plate layout already contains target and sample information, only the second step is required and will be highlighted in orange. This step must be completed before normalized gene expression analysis can occur.

NOTE: Data for the clustergram, scatter plot, volcano plot, and heat map are only displayed if all of the requirements for normalized gene expression listed above have been met.

Bar Chart

The relative expression of targets is presented in these two views:

- **Gene Expression chart.** Shows the real-time PCR data as normalized expression ($\Delta\Delta C_q$) or relative quantity (ΔC_q)
- **Spreadsheet.** Shows a spreadsheet of the gene expression data

TIP: Right-click any chart or spreadsheet for options. Select **View/Edit Plate** from the **Plate Setup** button to open the Plate Editor and change well contents in the plate.

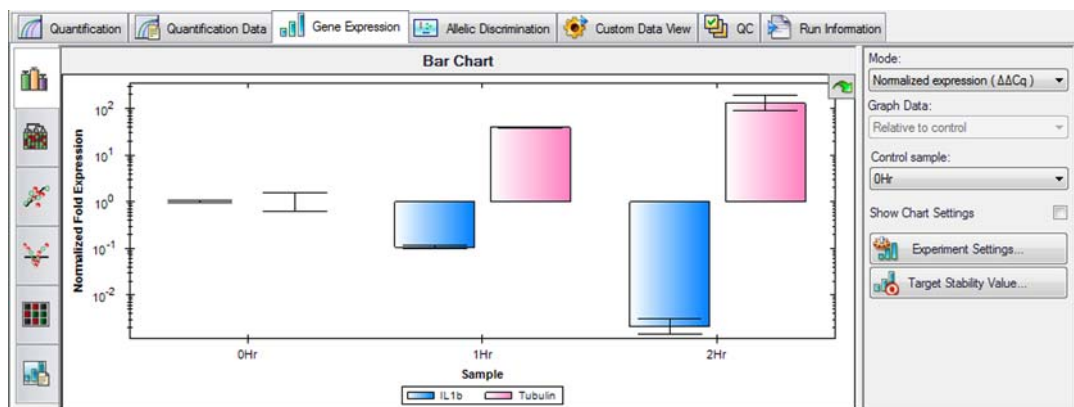

Figure 66. Layout of the Gene Expression tab in the Data Analysis window.

TIP: Select **Sort** from the right-click menu to rearrange the order of the Target and Sample names in the chart.

TIP: From experiment settings, quickly set up data for bar chart display by selecting in the following order: 1) Mode, 2) Control Sample, and 3) Reference target(s).

NORMALIZED GENE EXPRESSION

To normalize data, use the measured expression level of one or more reference genes (targets) as a normalization factor. Reference genes are targets that are not regulated in the biological system being studied, such as actin, GAPDH, or Histone H3.

To set up normalized gene expression ($\Delta\Delta C_q$) analysis, follow these steps:

1. Open a data file (.pcrd extension).
2. Review the data in the **Quantification tab** of the Data Analysis window. Make adjustments to the data, such as changing the threshold and the Analysis Mode.
3. Click the **Gene Expression** tab.
4. Choose a control in the **Samples** tab of the Experiment Settings window. If a control is assigned, the software normalizes the relative quantities for all genes to the control quantity, which is set to 1.
5. Select reference genes for this run in the **Target** tab of the Experiment Settings window. Gene expression analysis requires one reference among the targets in your samples.
6. Select **Normalized Expression ($\Delta\Delta C_q$)** if it is not already selected and then view the expression levels in the **Gene Expression** tab.

Relative Quantity

By definition, relative quantity (ΔC_q) data are not normalized. This method is used to quantitate samples that do not include any reference genes (targets). Typically, researchers are confident in one of the following considerations when they set up their run:

- Each sample represents the same amount of template in each biological sample, possibly the same mass of RNA or cDNA in each well
- Any variance in the amount of biological sample loaded will be normalized after the run by some method in the data analysis outside of the software. For example, a researcher might choose to simply divide the relative quantity value by the normalizing factor, possibly the mass of nucleic acid loaded for each sample, or the number of cells from which the nucleic acid was isolated.

Select **Relative Quantity (ΔC_q)** from the dropdown menu in the chart controls of the Gene Expression tab to run a Relative Quantity (ΔC_q) analysis.

TIP: To compare results to data from other gene expression runs, open a new Gene Study (page 101), or add a data file to an existing Gene Study.

Adjusting Gene Expression Data

After selecting your analysis method, adjust the data you view in the Gene Expression tab by changing the settings options to the right of the chart.

GRAPH DATA

Graph data options allow you to present the data in the graph with one of these two options:

- **Relative to control.** Graph the data with the axis scaled from 0 to 1. If you assign a control in your run, select this option to quickly visualize upregulation and downregulation of the target
- **Relative to zero.** Graph the data with the origin at zero

X-AXIS OPTIONS

The X-axis option allows you to select the x-axis data of the Gene Expression graph:

- **Target.** Select this option to graph the target names on the x-axis

- **Sample.** Select this option to graph the sample names on the x-axis

Y-AXIS OPTIONS

The Y-axis option allows you to show the Gene Expression graph in one of these three scales:

- **Linear.** Select this option to show a linear scale
- **Log 2.** Select this option to evaluate samples across a large dynamic range
- **Log 10.** Select this option to evaluate samples across a very large dynamic range

SCALING OPTIONS

Select **Normalized Gene Expression ($\Delta\Delta C_q$)** to activate the scaling options in the Gene Expression graph. Select one of these scaling options to calculate and present your data in a manner that best suits your run design:

- **Unscaled expression.** This option presents the unscaled normalized gene expression
- **Highest expression.** Scale the normalized gene expression to the highest for each target by dividing the expression level of each sample by the highest level of expression in all the samples. This scaling option uses the scaled to highest formula
- **Lowest expression.** Recalculate the normalized gene expression for each target by dividing the expression level of each sample by the lowest level of expression in all the samples. This scaling options uses the scaled to lowest formula

ERROR TYPE

Select an option for the type of error calculations (error bars) in the Gene Expression graph:

- Standard Error of the Mean (default, SEMs)
- Standard Deviation (Std Devs)

CHART ERROR BAR MULTIPLIER

Select a multiplier for the error bars in the Gene Expression graph. Select one of these integers: +/- 1 (default), 2, or 3. The type of multiplier changes when you select the Error Type:

- SEMs for Standard Error of the Mean
- Std Devs for Standard Deviations

TARGET STABILITY VALUE

Target stability values can be calculated whenever more than one reference gene is used. The software calculates two quality parameters for the reference genes:

- **Coefficient of Variation (CV)** of normalized reference gene relative quantities. A lower CV value denotes higher stability
- **M-value.** A measure of the reference gene expression stability:

Table 34. Acceptable values for stably expressed reference genes
(Hellemans *et al.* 2007)

Samples	CV	M
Homogeneous	< 0.25	< 0.5
Heterogeneous	< 0.5	< 1

Right-Click Menu Options

Right-click on the Gene Expression graph to select the items shown in Table 35.

Table 35. Right-click menu items

Item	Function
Copy	Copy the chart to a clipboard
Save as Image	Save the graph in the chart view as an image file. The default image type is PNG. The other selections for image file types include GIF, JPG, TIF, and BMP
Page Setup...	Select a page setup for printing
Print...	Print the chart view
Show Point Values	Display the relative quantity of each point on the graph when you place the cursor over that point
Set Scale to Default	Set the chart view back to the default settings after magnifying it
Chart Options...	Open the Chart Options window to adjust the graph
Sort	Sort the order that samples or targets appear on the chart X-axis
User Corrected Std Devs	Calculate the error bars using the corrected standard deviation formula
Use Solid Bar Colors	Display solid bars in the graph
X-axis labels	Choose to display x-axis labels horizontally or angled

Data Spreadsheet

Table 36 describes the information shown in the Gene Expression spreadsheet.

Table 36. Description of information in the spreadsheet on the Gene Expression tab.

Information	Description
Target	Target Name (amplified gene) selected in the Experiment Settings window
Sample	Sample Name selected in the Experiment Settings window
Ctrl	Control sample, when the Sample Name is selected as a control in the Experiment Settings window
Expression	Normalized Gene Expression ($\Delta\Delta C_q$) or Relative quantity (ΔC_q) depending on the selected mode
Expression SEM (or SD)	Standard Error of the Mean or Standard Deviation, depending on the selected option
Corrected Expression SEM (or SD)	Corrected value calculation for Standard Error of the Mean (SEM) or Standard Deviation (SD) of the relative expression, depending on the selected option
Mean C_q	Mean of the quantification cycle
C_q SEM (or SD)	Standard Error of the Mean or Standard Deviation of the quantification cycle, depending on the selected option

Show Details Option

When Show Details is selected from the right-click menu of the Gene Expression spreadsheet, the spreadsheet shows the information listed in Table 37.

Table 37. Information in the Gene Expression spreadsheet with Show Details selected.

Information	Description
Data Set	Fluorescence data from one fluorophore in the data file
Relative Quantity	Calculated relative quantity of samples
Relative Quantity SD	Standard deviation of the relative quantity calculation
Corrected Relative Quantity SD	Calculated standard deviation of the corrected relative quantity
Relative Quantity SEM	Standard error of the mean of the relative quantity calculation
Corrected Relative Quantity SEM	Calculated standard error of the mean of the corrected relative quantity
Unscaled Expression	Calculated unscaled expression
Unscaled Expression SD	Calculated Standard Deviation unscaled expression
Corrected Unscaled Expression SD	Calculated Standard Deviation of the unscaled expression
Unscaled Expression SEM	Calculated Standard Error of the Mean unscaled expression
Corrected Unscaled Expression SEM	Calculated Standard Error of the Mean of the unscaled expression
Expression	Relative expression level
Wells	Well number in the plate

Experiment Settings Window

Open the Experiment Settings window by clicking the **Experiment Settings** button in the Gene Expression tab. In this window, view or change the list of Targets and Samples, select reference genes, select control samples or set the Gene Expression Analysis sample group to be analyzed if Biological Set Names have been added to the wells (Figure 67).

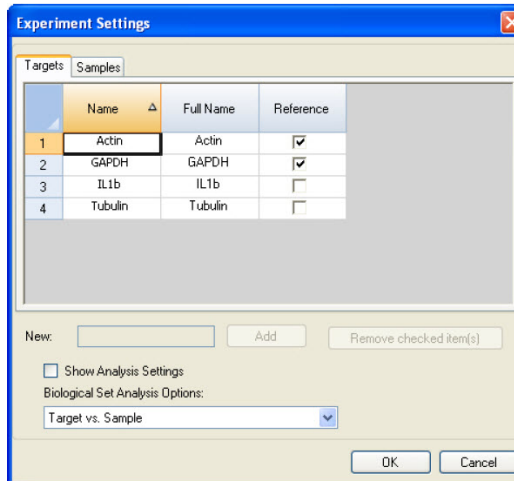

Figure 67. Experiment Settings window with Targets tab selected.

To adjust the lists in these tabs, use the following functions:

- Add a target or sample name by typing a name in the **New** box, and clicking **Add**
- Remove a target or sample name from the list by clicking the **Remove Name** box for that row, and then clicking the **Remove checked item(s)** button
- Select the target as a reference for gene expression data analysis by clicking the box in the **Reference** column next to the Name for that target
- Select the sample as a control sample for gene expression data analysis by clicking the box in the **Control** column next to the name for that sample

NOTE: Only one control can be selected per well group. If more than one control is selected, the bar chart data will be plotted with "None" as the control sample. To change this setting for the bar chart, select a control sample from the drop-down menu in the settings pane.

Biological Set Analysis Options

Loading **Biological Set Name** in the wells enables samples to be analyzed in one of four configurations. To access these options from the Gene Expression tab, click the **Experiments Settings** button and select an analysis configuration from the drop-down list of Biological Set Analysis Options.

- **Target vs. Sample.** Only the well sample name is used in the gene expression calculations
- **Target vs. Biological Set.** Only the biological set name is used in the calculations
- **Target vs. Sample_Biological Set.** The sample name and biological set name are combined to make a single name used in the calculations
- **Target vs. Biological Set_Sample.** The biological set name and sample name are combined to make a single name used in the calculations

Show Analysis Settings in Experiment Settings

Click the **Show Analysis Settings** box in the Experiment Settings window to view or change analysis parameters applied in the Gene Expression tab:

- Click a cell in the **Color** column to change the color of the targets graphed in the Gene Expression chart
- Enter a number for the efficiency of a target. The software will calculate the relative efficiency for a target using **Auto Efficiency** if the data for a target include a standard curve. Alternatively, type a previously determined efficiency

Figure 68 shows the efficiency of all the targets, which appear if **Auto Efficiency** is selected.

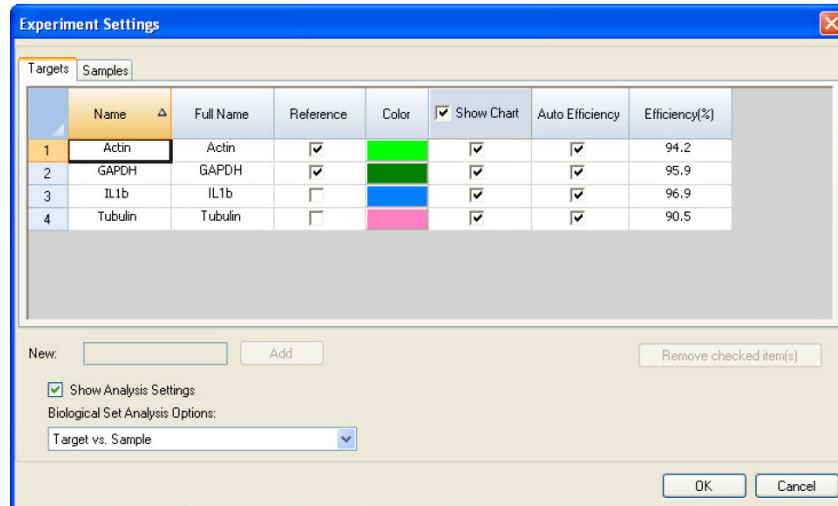

Figure 68. Targets tab in the Experiment Settings window with Analysis Settings selected.

To adjust the settings for a sample in the Samples tab:

- Click a color in the **Color** column to change the color of the samples graphed in the Gene Expression chart
- Click a box in the **Show Chart** column to show the sample in the Gene Expression chart using a color that is selected in the Color column

Figure 69 shows the samples with the **Show Chart** option selected.

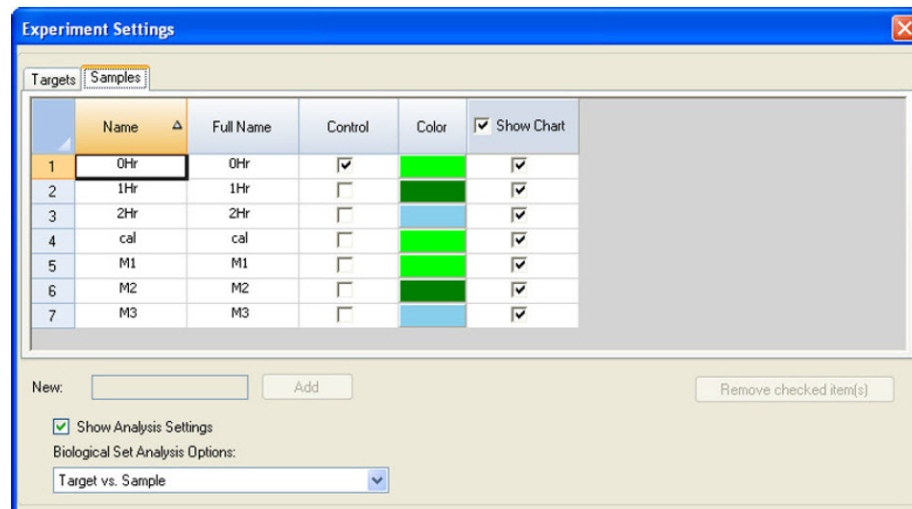

Figure 69. Samples tab in Experiment Settings window with Analysis Settings selected.

Clustergram

A clustergram shows the data in a hierarchy based on the degree of similarity of expression for different targets and samples.

NOTE: A reference target needs to be selected to display any of the data plots other than relative expression for bar charts.

The clustergram image depicts relative expression of a sample or target as follows:

- **Upregulation (red).** Relatively higher expression
- **Downregulation (green).** Relatively lower expression
- **No regulation (black)**
- **No value calculated (black with a white X)**

The lighter the shade of color, the greater the relative expression difference. If no normalized Cq value can be calculated the square will be black with a white X.

On the outer edges of the data plot is a dendrogram, which indicates the clustering hierarchy. Targets or samples that have similar expression patterns will have adjacent branches while those with dissimilar patterns will be more distant.

Settings

The following can be set:

- **Cluster by.** Targets, Samples, Both, or None can be selected
- **Size.** Image size can be adjusted using the slider to alter the degree of chart magnification for easier visualization
- **Split out replicates.** This option shows values for the individual replicates
TIP: The color scheme for clustergram, scatter plot, volcano plot, and heat map can be changed from the default Red/Green to Red/Blue by selecting this option from the right-click menu on any of these charts.

Right-Click Menu Options

Right-click on the clustergram to select the items shown in Table 38.

Table 38. Right-click menu items.

Item	Function
Copy	Copy the chart to a clipboard
Save Image As...	Save the graph in the chart view as an image file. The file type options are PNG, GIF, JPG, TIF, or BMP. The image resolution will be the same as the computer display
Print...	Print the chart view
Color Scheme	Choose Red/Green or Red/Blue for the chart colors

Data Spreadsheet

The spreadsheet lists the target, sample, and normalized expression. Click the check box adjacent to a target to include or exclude it from the clustergram. Select chart options by right-clicking.

Scatter Plot

The scatter plot shows the normalized expression of targets for a control versus an experimental sample.

The plot image shows the following changes in target expression based on the threshold set:

- **Upregulation (red circle).** Relatively higher expression
- **Downregulation (green circle).** Relatively lower expression
- **No change (black circle)**

Click and drag either threshold line to adjust the regulation threshold value.

TIP: To change the symbol used for a scatter or volcano plot, choose **Symbol** from the right-click menu and select one from the options presented.

Settings

The following can be set:

- **Control sample**
- **Experimental sample**
- **Regulation threshold.** As this value is altered, the threshold lines in the plot will be moved appropriately

Right-Click Menu Options

Right-click on the scatter plot to select the items shown in Table 39.

Table 39. Right-click menu items.

Item	Function
Copy	Copy the chart to a clipboard
Save Image As...	Save the graph in the chart view as an image file. Set the resolution and dimensions of the image and then select the file type (PNG, GIF, JPG, TIF, or BMP)
Page Setup...	Select a page setup for printing
Print...	Print the chart view
Set Scale to Default	Set the chart view back to the default settings after magnifying it
Chart Options...	Open the Chart Options window to adjust the graph
Symbol	Select the symbol to use for data points
Color Scheme	Choose Red/Green or Red/Blue for the chart colors

Data Spreadsheet

The spreadsheet lists the target, normalized expression for control sample and experimental samples, and whether targets are up or down regulated compared to the threshold setting. Click the check box adjacent to a target to include or exclude it from the plot. Select chart options by right-clicking.

Volcano Plot

The volcano plot shows the change in expression (regulation) of a target for an experimental sample compared to a control and indicates the degree of significance based on p-value.

The plot image shows the following changes in regulation based on the threshold setting:

- **Upregulation (red circle).** Relatively higher expression

- **Downregulation (green circle).** Relatively lower expression
- **No change (black circle)**

Click and drag either vertical threshold line to adjust the regulation threshold value.

Settings

The following can be set:

- **Control sample**
- **Experimental sample**
- **Regulation or P-Value threshold.** Enter or adjust the value using arrows and the plot threshold lines will be moved appropriately

Right-Click Menu Options

Right-click on the volcano plot to select the items shown in Table 39.

Data Spreadsheet

The spreadsheet lists the target, sample, regulation, p-value, whether the p-value exceeds the threshold, and indicates up- or downregulation compared to the threshold setting. Click the check box adjacent to a target to include or exclude it from the plot. Select chart options by right-clicking.

Heat Map

The heat map presents a visual depiction of the regulation of targets for an experimental sample compared to a control sample based on relative normalized expression and its location on a plate.

A legend below the heat map shows the range of normalized expression, which corresponds to the following:

- **Upregulation (red).** Relatively higher expression
- **Downregulation (green).** Relatively lower expression
- **No change (black)**

The lighter the shade of color, the greater the relative normalized expression difference. If no normalized expression value can be calculated the square will be black with a white X.

Settings

The following can be set:

- **Control sample**
- **Experimental sample**
- **Size.** Image size can be adjusted using the slider to alter the degree of chart magnification for easier visualization
- **Split out replicates.** Show values for the individual replicates

Right-Click Menu Options

Right-click on the heat map to select the items shown in Table 38.

Data Spreadsheet

The spreadsheet lists the target, sample, and regulation. Select chart options by right-clicking.

Results

The Results spreadsheet summarizes the data from all of the charts. The contents of the Results spreadsheet are listed in Table 40.

Table 40. Information in the Results tab.

Information	Description
Target	Target Name (amplified gene)
Sample	Sample Name
Mean Cq	Mean of the quantification cycle
Mean Efficiency Corrected Cq	Mean of the quantification cycle after adjusting for the reaction efficiency
Normalized Expression	Target expression normalized to a reference target ($\Delta\Delta C_q$)
Relative Normalized Expression	Normalized expression relative to a control sample. Also called Fold Change
Regulation	Change in expression relative to a control sample
Compared to Regulation Threshold	Up- or downregulation of an experimental sample based on the threshold setting
P-Value	The probability that a difference in expression is significant
Exceeds P-Value Threshold	Indication of whether or not the p-value for a target exceeds a threshold

NOTE: Data for replicates are found only in the spreadsheets of data analysis tabs in which Split Out Replicates has been selected (i.e. Clustergram and Heat Map).

Gene Study

Create a Gene Study to compare gene expression data from one or more real-time PCR experiments using an inter-run calibrator to normalize between the experiments. Create a Gene Study by adding data from one or more data files (.pcrd extension) to the Gene Study, the software groups them into a single file (.mgxd extension).

NOTE: The maximum number of samples you can analyze in a Gene Study is limited by the size of the computer's RAM and virtual memory.

Gene Study Inter-Run Calibration

Inter-run calibration is automatically attempted in every gene study for each target to normalize inter-run variations between targets assayed in separate real-time PCR runs (i.e. different .pcrd files).

For the software to recognize a sample as an inter-plate calibrator, it must share matching target name, sample name, and if used, collection name, across every plate being compared.

NOTE: At least one inter-run calibrator sample must be present in the Gene Study for inter-run calibration to occur. Targets without appropriate inter-run calibrator samples will be processed without correction in the Gene Study (not recommended).

During inter-run calibration an algorithm is used to calculate the pair-wise differences between the C_q values (ΔC_q) for all samples that qualify as inter-run calibrators. All data within the Gene Study are normalized by inter-run calibrator to calculate the smallest average ΔC_q value. When the data files within the Gene Study include more than one inter-run calibrator, then the calibrator with the smallest average ΔC_q value becomes the dominant inter-run calibrator. The dominant calibrator is used to adjust all C_q values in the Gene Study.

To find the dominant inter-run calibrator, the software calculates the average of the ΔC_q values for all inter-run calibrators of a given target, and then uses a multitiered algorithm to determine the dominant inter-run calibrator within all the data. The algorithm for finding the dominant inter-run calibrator includes the following hierarchy:

1. Set the dominant calibrator to the target with the highest number of common replicate groups in a given pair-wise comparison.
2. If any target has the same number of common replicate groups, then set the dominant calibrator to the target with the smallest range of ΔC_q values in pair-wise comparisons. The range is examined by comparing the absolute value of the difference between the maximum and minimum ΔC_q for the inter-run calibrators of a given target.
3. If any target has an identical range as the ΔC_q values, then set the dominant calibrator to the target with the smallest absolute value of average ΔC_q for eligible inter-run calibrator samples.
4. If any target has identical average ΔC_q absolute values, then set the dominant calibrator to the replicate group with the smallest ΔC_q .

NOTE: The first data file imported into the Gene Study will always serve as the “hub” file for pairwise data comparison during inter-run calibration.

Gene Study Window

The Gene Study window includes two tabs:

- **Study Setup tab.** Click this tab to manage the runs in the Gene Study. Adding or removing data files in a Gene Study does not change the original data in that file
- **Study Analysis tab.** Click this tab to view the gene expression data for the combined runs

Figure 70 shows the Gene Study window, including the Study Setup and Study Analysis tabs.

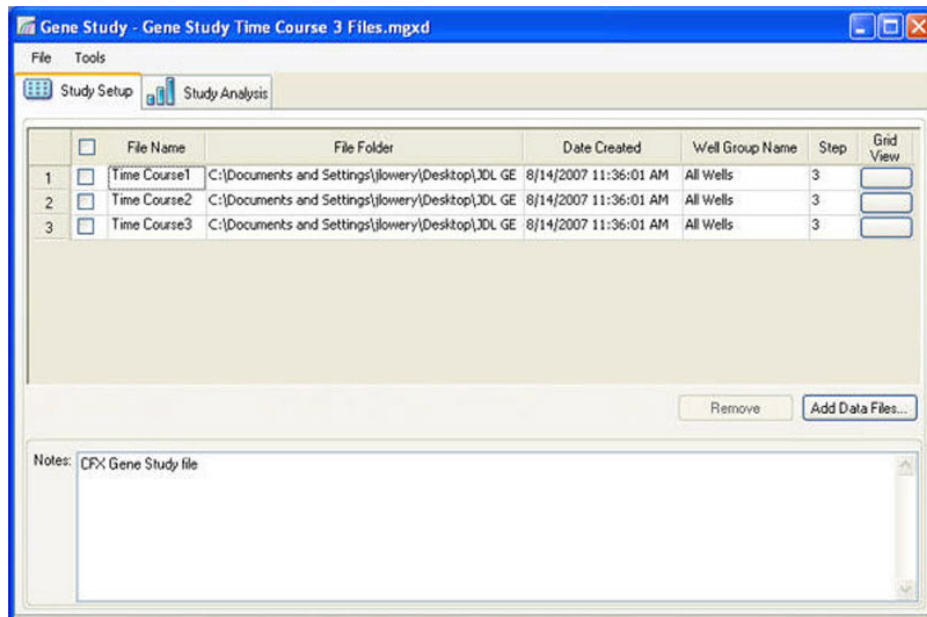

Figure 70. Study Setup tab in the Gene Study window.

Study Setup Tab

Before importing data into a Gene Study, do the following in the Data Analysis window:

- Check that samples containing the same content are named with the same name. In a Gene Study, the software assumes that wells with the same Target or Sample name contain the same samples
- Adjust the baseline and threshold (C_q) in the Quantification tab to optimize the data in each run before you add them to a Gene Study
- Select the well group you want to include in the Gene Study

The Study Setup tab (Figure 70) shows a list of all the runs in the Gene Study.

- **Add runs.** Click the **Add Data Files** button to select a file from a browser window. To quickly add runs to a Gene Study, drag the data files (.pcrd extension) to the Gene Study window
TIP: In order to show data from one well group in the Gene Study, that group must be selected before importing the Data file
- **Remove runs from this Gene Study.** Select one or more files in the list and click **Remove**
- **Add notes about the Gene Study.** Type in the Notes box to add comments about the files and analysis in this Gene Study

The Study Setup tab lists the data files in the Gene Study, as described in Table 41.

Table 41. Study Setup tab in the Gene Study window.

Column Title	Description
File Name	Name of the run data file (.pcrd extension)

Table 41. Study Setup tab in the Gene Study window. (continued)

Column Title	Description
File Folder	Directory that stores the data file for each run in the Gene Study
Date Created	Date the run data were collected
Well Group Name	Name of the well group that was selected when the file was added to the Gene Study TIP: In order to analyze one well group in the Gene Study, that well group must be selected in the Data Analysis window before importing the data file into the Gene Study
Step	Protocol step that included the plate read to collect real-time PCR data
Plate View	Open a plate map of the plate with the data in each of the runs included in the Gene Study

Study Analysis Tab

The Study Analysis tab shows the data from all runs that are added to the Gene Study. The gene expression data analysis options available are the same as those for a single data file with the following exceptions:

- For bar charts, inter-run calibration values, if calculated, will be displayed by clicking the **Inter-run Calibration** button
- For heat maps, if the same targets are in the same location on multiple plates, but with different samples, use the drop-down menu to select a particular plate for analysis

Gene Study Report Window

Open the Gene Study Report window to arrange the Gene Study data into a report. To create a gene study report, follow these steps:

1. Adjust the Gene Study report data and charts as needed before creating a report.
2. Select **Tools > Reports** to open the Gene Study report window.
3. Click the check boxes in the report options list to select and remove options to choose the data to display. Select the options shown in Table 42.

Table 42. Categories for a Gene Study report.

Category	Option	Description
Header		Title, subtitle, and logo for the report
	Report Information	Date, user name, data file name, data file path, and the selected well group
	Gene Study File List	List of all the data files in the Gene Study
	Notes	Notes about the data report
Study Analysis- Bar Chart	Analysis Settings	A list of the selected analysis parameters

Category	Option	Description
	Chart	Gene Expression chart showing the data
	Target Names	List of targets in the Gene Study
	Sample Names	List of samples in the Gene Study
	Data	Spreadsheet that shows the data
	Target Stability	Target stability data
	Inter-run Calibration	Inter-run calibration data
Study Analysis-Clustergram, Scatter Plot, Volcano Plot, and Heat Map	Analysis Settings	A list of the selected analysis parameters
	Chart	Gene Expression chart showing the data
	Data	Spreadsheet that shows the data

- Fill in the text for the report by entering text and images in option pane (Figure 71).

Figure 71. Example of Header and Logo options in a Gene Study report.

- Click the **Update Report** button to update the report preview pane. The report preview pane shows a view of the Report.
- Print or save the report. Click the **Print** button in the toolbar to print the current report. Select **File > Save** to save the report as a PDF- (Adobe Acrobat Reader file), MHT- (Microsoft document), or MHTML- (Microsoft document) formatted file and select a location to store the file. Select **File > Save As** to save the report with a new name or in a new location.
- Create a report template once you create a report with the content you want to include in all reports. To create a template, select **Template > Save** or **Save As** and save the current report as a template.

Gene Expression Calculations

CFX Manager™ software calculates formulas automatically and displays the resulting information in the Data Analysis tabs.

Reaction Efficiency

Evidence suggests that using accurate measure of efficiencies for each primer and probe sets will give you more accurate results when analyzing gene expression data. The default value of efficiency used in the gene expression calculations is 100%. To evaluate the reaction efficiency, generate a standard curve using serial dilutions of a representative sample across a relevant dynamic range, and then record the efficiency for subsequent gene expression analysis. If your run includes a standard curve, then the software automatically calculates the efficiency and displays it under the Standard Curve on the Quantification tab when Auto Efficiency is checked in the Targets tab of the Experiment Settings window.

The efficiency (E) in the efficiency formulas refers to the “efficiencies” as described by Pfaffl (2001) and Vandesompele et al. (2002). In these publications, an efficiency of 2 (perfect doubling with every cycle) is equivalent to 100% efficiency in this software. You have the option to convert your efficiency calculations to those used in the software by using the following mathematical relationships:

- $E = (\% \text{ Efficiency} * 0.01) + 1$
- $\% \text{ Efficiency} = (E - 1) * 100$

Relative Quantity

The relative quantity (ΔC_q) for any sample (GOI) is calculated with this formula:

$$\text{Relative Quantity}_{\text{sample (GOI)}} = E_{\text{GOI}}^{(C_{q(\text{MIN})} - C_{q(\text{sample})})}$$

Where:

- E = Efficiency of primer and probe set. This efficiency is calculated with the formula $(\% \text{ Efficiency} * 0.01) + 1$, where 100% efficiency = 2
- $C_{q(\text{MIN})}$ = Average C_q for the Sample with the lowest average C_q for GOI
- $C_{q(\text{sample})}$ = Average C_q for the Sample
- GOI = Gene of interest (one target)

Relative Quantity When a Control Is Selected

When a control sample (control) is assigned, then the relative quantity (RQ) for any sample (GOI) with a gene of interest is calculated with this formula:

$$\text{Relative Quantity}_{\text{sample (GOI)}} = E_{\text{GOI}}^{(C_{q(\text{control})} - C_{q(\text{sample})})}$$

Where:

- E = Efficiency of primer and probe set. This efficiency is calculated with the formula $(\% \text{ Efficiency} * 0.01) + 1$, where 100% efficiency = 2
- $C_{q(\text{control})}$ = Average C_q for the control sample
- $C_{q(\text{sample})}$ = Average C_q for any samples with a GOI
- GOI = Gene of interest (one target)

Standard Deviation of Relative Quantity

The standard deviation of the relative quantity is calculated with the following formula:

$$\text{SD Relative Quantity} = \text{SD } C_{q_{\text{GOI}}} \times \text{Relative Quantity}_{\text{Sample X}} \times \text{Ln}(E_{\text{GOI}})$$

Where:

- SD Relative Quantity = standard deviation of the relative quantity
- SD $C_{q_{\text{sample}}}$ = Standard deviation of the $C_{q_{\text{GOI}}}$ for the sample (GOI)
- Relative Quantity = Relative quantity of the sample
- E = Efficiency of primer and probe set. This efficiency is calculated with the formula (% Efficiency * 0.01) + 1, where 100% efficiency = 2
- GOI = Gene of interest (one target)

Normalization Factor

The denominator of the normalized expression equation is referred to as the normalization factor. The normalization factor is the geometric mean of the relative quantities of all the reference targets (genes) for a given sample, as described in this formula:

$$\text{Normalization Factor}_{\text{sample (GOI)}} = (\text{RQ}_{\text{sample (Ref 1)}} \times \text{RQ}_{\text{sample (Ref 2)}} \times \dots \times \text{RQ}_{\text{sample (Ref n)}})^{\frac{1}{n}}$$

Where:

- RQ = Relative quantity
- n = Number of reference targets
- GOI = Gene of interest (one target)

Efficiency Corrected Cq (C_{q_E})

The efficiency corrected Cq is calculated by the following formula:

$$C_{q_E} = C_q \times (\log(E)/\log(2))$$

Where:

- E = efficiency

Mean Efficiency Corrected Cq (MC_{q_E})

The mean efficiency corrected Cq is calculated with the following formula:

$$MC_{q_E} = \frac{C_{q_E(\text{Rep 1})} + C_{q_E(\text{Rep 2})} + \dots + C_{q_E(\text{Rep n})}}{n}$$

Where:

- C_{q_E} = Efficiency corrected Cq
- n = number fo replicates

Normalization Factor

The denominator of the normalized expression equation is referred to as the normalization factor. The normalization factor is the geometric mean of the relative quantities of all the reference targets (genes) for a given sample, as described in this formula:

$$\text{Normalization Factor}_{\text{sample (GOI)}} = (\text{RQ}_{\text{sample (Ref 1)}} \times \text{RQ}_{\text{sample (Ref 2)}} \times \dots \times \text{RQ}_{\text{sample (Ref n)}})^{\frac{1}{n}}$$

Where:

- RQ = Relative quantity
- n = Number of reference targets
- GOI = Gene of interest (one target)

Normalized Expression

Normalized expression ($\Delta\Delta C_q$) is the relative quantity of your target (gene) normalized to the quantities of the reference targets (genes or sequences) in your biological system. To select reference targets, open the Experiment Settings window and click the reference column for each target that serves as a reference gene.

The calculation for normalized expression is described in the following formula, which uses the calculated Relative Quantity (RQ) calculation:

$$\text{Normalized Expression}_{\text{sample (GOI)}} = \frac{\text{RQ}_{\text{sample (GOI)}}}{(\text{RQ}_{\text{sample (Ref 1)}} \times \text{RQ}_{\text{sample (Ref 2)}} \times \dots \times \text{RQ}_{\text{sample (Ref n)}})^{\frac{1}{n}}}$$

Where:

- RQ = Relative Quantity of a sample
- Ref = Reference target in a run that includes one or more reference targets in each sample
- GOI = Gene of interest (one target)

Provided that reference targets do not change their expression level in your biological system, the calculation of normalized expression will account for loading differences or variations in cell number that are represented in each of your samples.

Normalized Expression When a Control Is Selected

When you select a control sample in the Experiment Settings window, the software sets the expression level of the control sample to 1. In this situation, the software normalizes the relative quantities of all target (gene) expression to the control quantity (a value of 1). This normalized expression is equivalent to the unscaled normalized expression analysis when a control is chosen.

Standard Deviation for the Normalized Expression

Re-scaling the normalized expression value is accomplished by dividing the standard deviation of the normalized expression by the normalized expression value for the highest or lowest individual expression levels, depending on the Scaling Option you choose. The standard deviation (SD) of the normalization factor is calculated with this formula:

$$SD NF_n = NF_n \times \sqrt{\left(\frac{SD RQ_{\text{sample (Ref 1)}}}{n \times RQ_{\text{sample (Ref 1)}}}\right)^2 + \left(\frac{SD RQ_{\text{sample (Ref 2)}}}{n \times RQ_{\text{sample (Ref 2)}}}\right)^2 + \dots + \left(\frac{SD RQ_{\text{sample (Ref n)}}}{n \times RQ_{\text{sample (Ref n)}}}\right)^2}$$

Where:

- RQ = Relative quantity of a sample
- SD = Standard deviation
- NF = Normalization factor
- Ref = Reference target
- n = Number of reference targets

When a control sample is assigned, you do not need to perform this re-scaling function on the standard deviation, as shown in the following formula:

$$SD NE_{\text{sample (GOI)}} = NE_{\text{sample (GOI)}} \times \sqrt{\left(\frac{SD NF_{\text{sample}}}{NF_{\text{sample}}}\right)^2 + \left(\frac{SD RQ_{\text{sample (GOI)}}}{RQ_{\text{sample (GOI)}}}\right)^2}$$

Where:

- NE = Normalized expression
- RQ = Relative quantity of a sample
- SD = Standard deviation
- GOI = Gene of interest (one target)

Normalized Expression Scaled to Highest Expression Level

When the run does not include controls, scale the normalized expression (NE) for each target (gene) by dividing the expression level of each sample by the highest level of expression in all the samples. The software sets the highest level of expression to a value of 1, and re-scales all the sample expression levels. The highest scaling is calculated by this formula:

$$\text{Scaled Normalized Expression}_{\text{sample (GOI)}} = \frac{\text{Normalized Expression}_{\text{sample (GOI)}}}{\text{Normalized Expression}_{\text{Highest sample (GOI)}}}$$

Where:

- GOI = Gene of interest (target).

Normalized Expression Scaled to Lowest Expression Level

When the run does not include controls, scale the normalized expression (NE) for each target (gene) by dividing the expression level of each sample by the lowest level of expression in all the samples. The software sets the lowest level of expression to a value of 1 and re-scales all the sample expression levels. The lowest scaling is calculated by this formula:

$$\text{Scaled Normalized Expression}_{\text{sample (GOI)}} = \frac{\text{Normalized Expression}_{\text{sample (GOI)}}}{\text{Normalized Expression}_{\text{Lowest sample (GOI)}}}$$

Where:

- GOI = Gene of interest (target)

Normalized Expression Scaled to Average Expression Level

When the run does not include controls, scale the normalized expression (NE) for each target (gene) by dividing the expression level of each sample by the geometric mean level of expression of all the samples. The software sets the average level of expression to a value of 1 and rescales all the sample expression levels. The average scaling is calculated by this formula:

$$\text{Scaled Normalized Expression}_{\text{sample (GOI)}} = \frac{\text{Normalized Expression}_{\text{sample (GOI)}}}{\text{Normalized Expression}_{\text{GM (GOI)}}}$$

Where:

- GOI = Gene of interest (target)
- GM = Geometric mean of normalized expression for all samples

Standard Deviation for the Scaled Normalized Expression

Re-scaling the scaled normalized expression (NE) value is accomplished by dividing the standard deviation (SD) of the normalized expression by the normalized expression value for the highest (MAX) or lowest (MIN) expression level, depending on which scaling option you choose.

NOTE: When a control sample is assigned, you do not need to perform this rescaling function on the standard deviation.

The formula for this calculation is shown here:

$$\text{SD Scaled NE}_{\text{sample (GOI)}} = \frac{\text{SD NE}_{\text{sample (GOI)}}}{\text{NE}_{\text{MAX or MIN (GOI)}}}$$

Where:

- NE = Normalized expression
- SD = Standard deviation
- GOI = Gene of interest (target)
- MAX = Highest expression level
- MIN = Lowest expression level

Regulation

Regulation is a measure of the increase or decrease in the expression of a target for an experimental versus a control sample and is determined as follows:

$$\text{For RNE} \geq 1, \text{ Regulation} = \text{RNE}$$

$$\text{For RNE} < 1, \text{ Regulation} = (-1)/\text{RNE}$$

Where:

- RNE = Relative normalized expression; this is the same as normalized expression when a control is selected

P-Value

The p-value is a measure of the statistical significance of an experimental sample data point compared to a control.

NOTE: At least two replicates are required for both control and experimental samples for a p-value to be determined. The more replicates that are present, the greater the accuracy.

The p-value is calculated as follows:

Where:

-

$$A = \int_{x=-t}^t = \frac{\Gamma\left(\frac{v+1}{2}\right)}{\sqrt{v\pi}\Gamma\left(\frac{v}{2}\right)} \left(1 + \frac{x^2}{v}\right)^{-\frac{v+1}{2}}$$

Where:

$$v = \text{Count}(\text{NE}_{\text{sample (Experimental)}}) + \text{Count}(\text{NE}_{\text{sample (Control)}}) - 2$$

- Γ = gamma function
- t = t-statistic

$$t = \frac{\left| \text{Mean}(\text{NE}_{\text{sample(expt)}}) - \text{Mean}(\text{NE}_{\text{sample(control)}}) \right|}{\sqrt{\frac{\left(\text{Count}(\text{NE}_{\text{sample(expt)}}) - 1 \right) * \text{SD}(\text{NE}_{\text{sample(expt)}})^2 + \left(\text{Count}(\text{NE}_{\text{sample(control)}}) - 1 \right) * \text{SD}(\text{NE}_{\text{sample(control)}})^2}{\text{Count}(\text{NE}_{\text{sample(expt)}}) + \text{Count}(\text{NE}_{\text{sample(control)}}) - 2}} * \left(\frac{1}{\text{Count}(\text{NE}_{\text{sample(expt)}})} + \frac{1}{\text{Count}(\text{NE}_{\text{sample(control)}})} \right)}}$$

Where:

- Mean = Arithmetic mean
- NE = Normalized expression
- Count(x) = Size of list x
- SD = Sample standard deviation

Corrected Values Formulas

A difference between corrected values and noncorrected values is seen only if a standard curve is created as part of the real-time PCR run. The software uses three equations in determining the error propagation:

- Standard Error
- Standard Error for Normalized Expression
- Standard Error for the Normalized Gene of Interest (target)

The formula for standard error is shown here:

$$\text{Standard Error} = \frac{\text{SD}}{\sqrt{n}}$$

Where

- n = Number of reference targets (genes)
- SD = Standard deviation

The standard error for the normalization factor in the normalized expression formula is shown here:

$$SE NF_n = NF_n \times \sqrt{\left(\frac{SE RQ_{\text{sample (Ref 1)}}}{n \times SE RQ_{\text{sample (Ref 1)}}}\right)^2 + \left(\frac{SE RQ_{\text{sample (Ref 2)}}}{n \times SE RQ_{\text{sample (Ref 2)}}}\right)^2 + \dots + \left(\frac{SE RQ_{\text{sample (Ref n)}}}{n \times SE RQ_{\text{sample (Ref n)}}}\right)^2}$$

Where:

- n = Number of reference targets
- SE = Standard error
- NF = Normalized expression
- RQ = Relative quantity

The standard error for normalized gene of interest (GOI) formula is shown here:

$$SE GOI_n = GOI_n \times \sqrt{\left(\frac{SE NF_n}{NF_n}\right)^2 + \left(\frac{SE GOI}{GOI}\right)^2}$$

Where:

- SE = Standard error
- GOI = Gene of interest (one target)
- NF = Normalization factor
- n = Number of reference targets

9 Users and Preferences

Read this chapter to learn more about managing software users and their preferences:

- Log in or Select User (page 113)
- User Preferences window (page 114)
- Configuring email notification (page 115)
- User Administration (page 122)

Log in or Select User

CFX Manager™ software manages multiple users and their preferences. The current, logged in software user is displayed at the top of the main software window.

CFX Manager software manages who logs in to the software through the Login dialog box (Figure 72). When you start the software, the Login dialog box opens automatically if there are two or more users listed in the User Administration window.



Figure 72. Login dialog box.

Log in to the software or switch users by following these steps:

1. Open the Login dialog box, if it is not already open, by clicking the **Select User** button in the toolbar or selecting **User > Select User** in the menu bar.
2. Select a name from the **User Name** pull-down list. The default is “Admin” (administrator).
3. Type a password in the **Password** box.
4. Click **OK** to close the Login dialog box and open the software.
5. To add a new user name and password, contact your software administrator.

Change a Password

Change a password by following these steps:

1. Select **User > Change Password** from the main software window menu to open the Change Password dialog box (Figure 73).
2. Enter the old password in the Old Password box.
3. Enter the new password in the New Password and the Confirm New Password boxes.
4. Click **OK** to confirm the change.



Figure 73. Change Password dialog box.

User Preferences Window

CFX Manager software tracks the preferences of each user that logs in to the software. To change user preferences, open the User Preferences window using one of these methods:

- Click the **User Preferences** button in the main software window toolbar
- Select **User > User Preferences** in the main software window menu bar
- Click one of the tabs (Figure 74) to view or change preferences

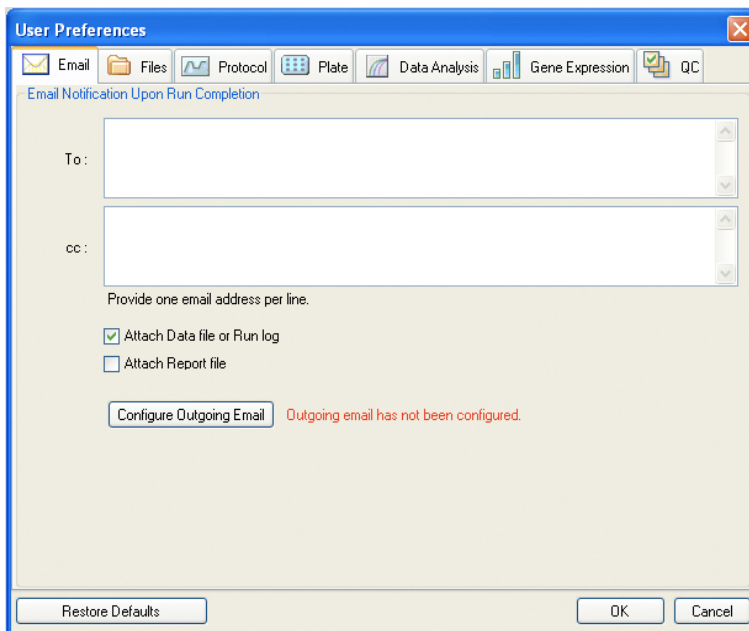

Figure 74. User Preferences window with tabs.

TIP: Click the **Restore Defaults** button to restore all settings to the default settings shown in this image. Then click **OK** to save the settings, and close the window.

Email Tab

Select the **Email** tab (Figure 74) to enter the email addresses where you want to receive confirmation of the completion of runs. The software can send an attached data file or report file with the email when the checkboxes next to these options are checked.

To set up email notification, click the **Configure Outgoing Email** button to open the Options window (Figure 75) to configure the SMTP server and send a test email from the computer. Input the following:

- **SMTP Server Name.** The name of the SMTP server as provided by your ISP
- **Port.** The port number of your SMTP server, as provided by your ISP; this is usually 25
- **Use SSL.** Whether to use Secure Sockets Layer. Some SMTP servers require this to be used; others require that it not be used
- **Use Default "From" Address.** This can usually be left in the default checked state. However, some SMTP servers require all sent email to have a "from" address that is from a certain domain, for example, <name>@YourCompany.com. If that is the case, this checkbox must be unchecked and a valid "from" email address must be supplied in the box labeled "From" Address:
- **Authentication Required.** Many SMTP servers require authentication. If so, this checkbox must be checked and a User Name and Password must be supplied
- **Test email.** To test the email settings, enter one or more email addresses in the **Test Email Address** text box. Multiple email addresses can be separated by a comma. Then click the **Test Email** button

The screenshot shows the 'Options' dialog box with the 'Email' tab selected. The 'SMTP Server Name' field contains 'smtp.gmail.com'. The 'Port' is set to '25'. 'Use SSL' and 'Use Default "From" Address' are both checked. The 'Authentication Required' checkbox is also checked. The 'User Name' field contains '<your account name>@gmail.com'. The 'Test Email Address' field is empty. The 'Test Attachment' checkbox is unchecked, and the 'Attachment Size in MB' is set to '0.5'. A 'Test Email' button is located to the right of the 'Test Attachment' field. 'OK' and 'Cancel' buttons are at the bottom of the dialog.

Figure 75. Options to configure email.

NOTE: Some SMTP servers do not allow attachments, and others allow attachments only up to certain sizes. If you will use CFX Manager software to email Data Files and/or Reports, you may want to test your server's ability to email

attachments by checking the Test Attachment box, and setting the Attachment Size in MB with up to 5 megabytes (MB) or more.

Files Tab

Select the **Files** tab to list the default locations for opening and saving files.

- **Default Folder for File Creation.** Select a default folder where you want to save new files. Select a location for each file type (Protocol, Plate, Data, or Gene Study file)
- **File Selection for Run Setup.** Select the default protocol and plate files that appear when you open the Experiment Setup window
- **Data File Prefix.** Define the beginning text of the file name for data files. The default setting instructs the software to create a file name that starts with the User (user name of the user who is currently logged on to software), Date (file creation date), and Instrument Name (instrument serial number or name)

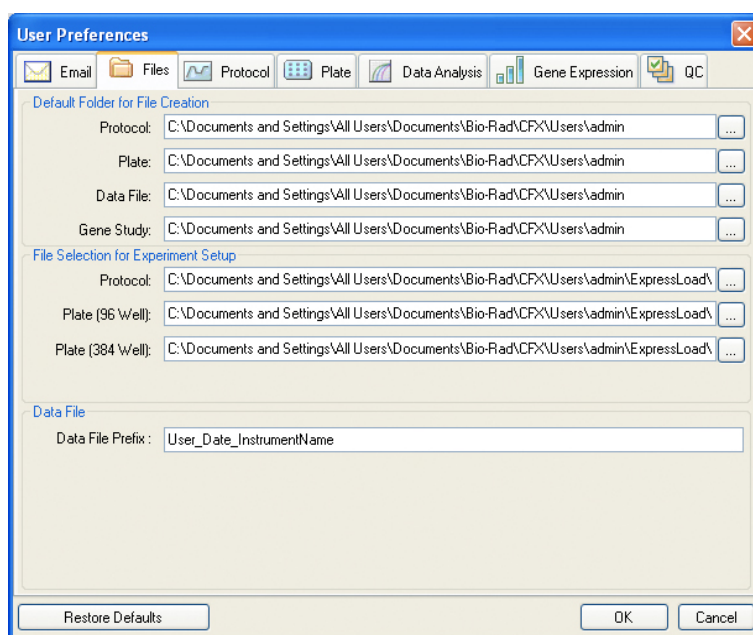

Figure 76. Files tab in the User Preferences window.

TIP: Click the “...” button to the right of each box to open a browser window and locate a folder.

Protocol Tab

Select the **Protocol** tab in the User Preferences window to specify the default settings for a new protocol file in the Protocol Editor window:

- **Protocol Editor.** Set the default settings that appear in the Protocol Editor. Select a default Sample Volume to describe the volume of each sample in the wells (in μl), and select a Lid Shutoff Temperature at which the lid heater turns off during a run

- **Protocol AutoWriter.** Selects default settings that appear in the Protocol AutoWriter, including default Annealing Temperature for experiments that use iProof™, iTaq™, or other polymerases and the default amplicon length

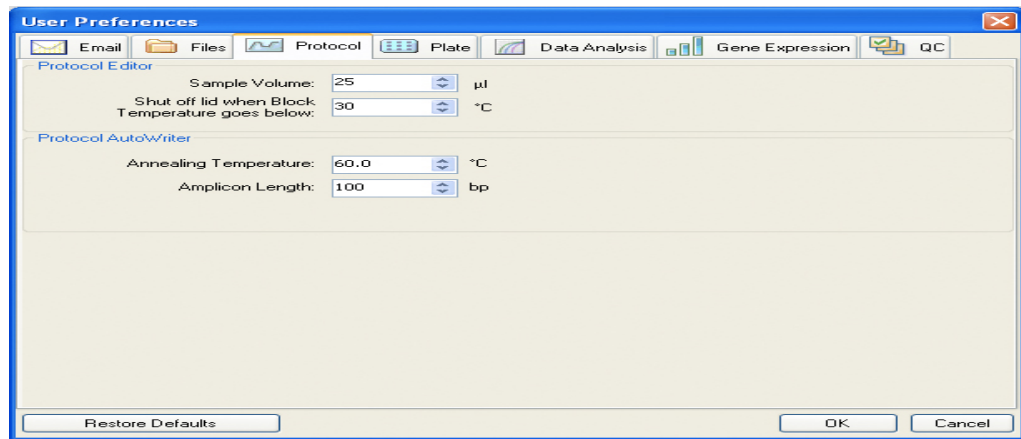

Figure 77. Protocol tab in the User Preferences window.

Plate Tab

Select the **Plate** tab in the User Preferences window (Figure 78) to specify the following default settings for a new Plate file in the Plate Editor window:

- **Plate Type.** Select the default plate well type from the list
- **Plate Size.** Select the default plate size from the list
- **Units.** Select the units used to describe the concentration of the starting template for wells that contain standards. The software uses these units to create a standard curve in the Data Analysis Quantification tab
- **Scientific Notation.** Select scientific notation to view concentration units in that notation
- **Scan Mode.** Select a default scan mode to set the number of channels to scan during a run
- **Fluorophores.** Click check boxes to select the default fluorophores that appear in the Plate Editor well loading controls
- **Libraries.** Enter the target and sample names that you typically use in your experiments. Enter target names to list genes and sequences, and enter sample names to list conditions for experiment samples. These names appear in the lists of in the Targets tab and Samples tab in the Experiment Settings window

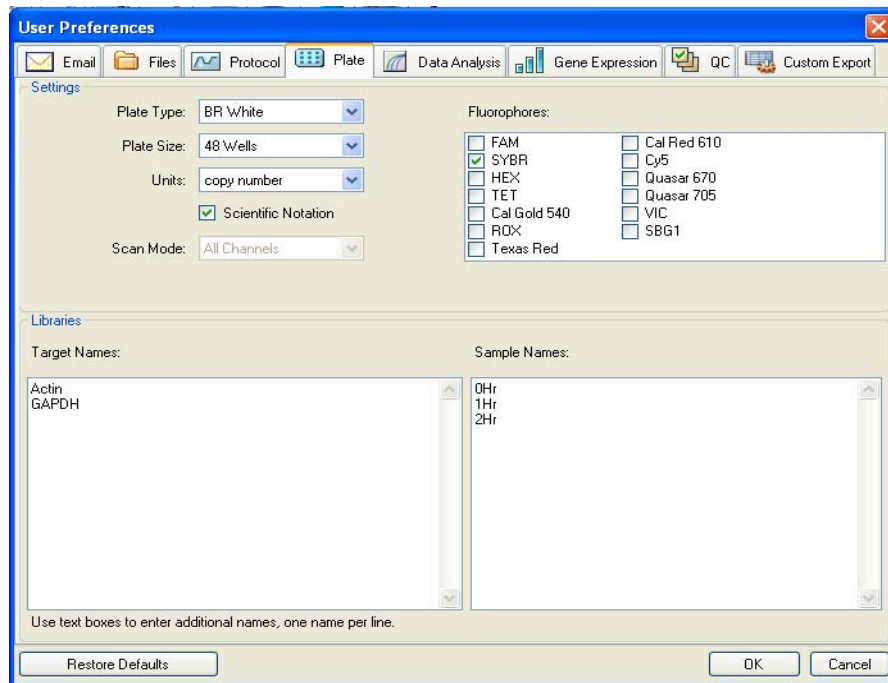

Figure 78. Plate tab in the User Preferences window.

Data Analysis Tab

Select the **Data Analysis** tab in the User Preferences window to change the default settings for data that appear in the Data Analysis window.

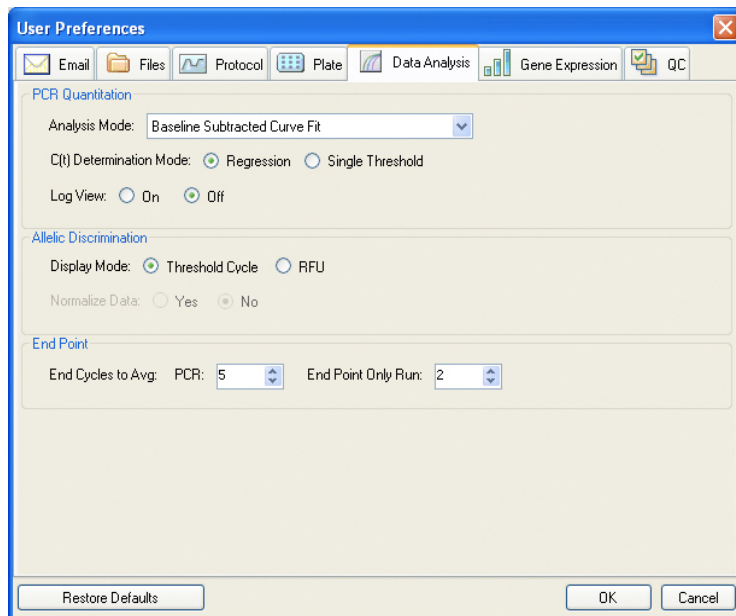

Figure 79. Data Analysis tab in the User Preferences window.

For analysis mode, select to analyze the data by either Fluorophore or Target.

For quantification data, select the following settings:

- **Baseline Setting.** Select the default base lining method for Analysis mode. Choose Baseline Subtracted Curve Fit, No Baseline Subtraction, or Baseline Subtracted
- **C_q Determination Mode.** Select between Regression mode or Single Threshold mode to determine how C_q values are calculated for each fluorescence trace
- **Log View.** Select **On** to show a semi-logarithmic graph of the amplification data. Select **Off** to show a linear graph

For the allelic discrimination data, select the following settings:

- **Display Mode.** Select **RFU** to show the data as a graph of the RFU, or select **C_q** to show a graph of quantification cycles
- **Normalize Data.** This selection is available only when RFU is selected. Select **No** to show unnormalized data. Select **Yes** to normalize the data to the control sample

For end point data, select the following settings. Select the number of end cycles to average when calculating the end point calculations:

- **PCR.** Enter a number of cycles for PCR to average the end cycles for quantification data (default is 5)
- **End Point Only Run.** Enter a number of cycles for End Point Only Run to average the end cycles for end point data (default is 2)

For melt curve data, select to detect either positive or negative peaks.

For well selector panes, select to label wells with sample type, target name, or sample name.

Gene Expression Tab

Select the **Gene Expression** tab in the User Preferences window to specify the default settings for a new Gene Expression data file.

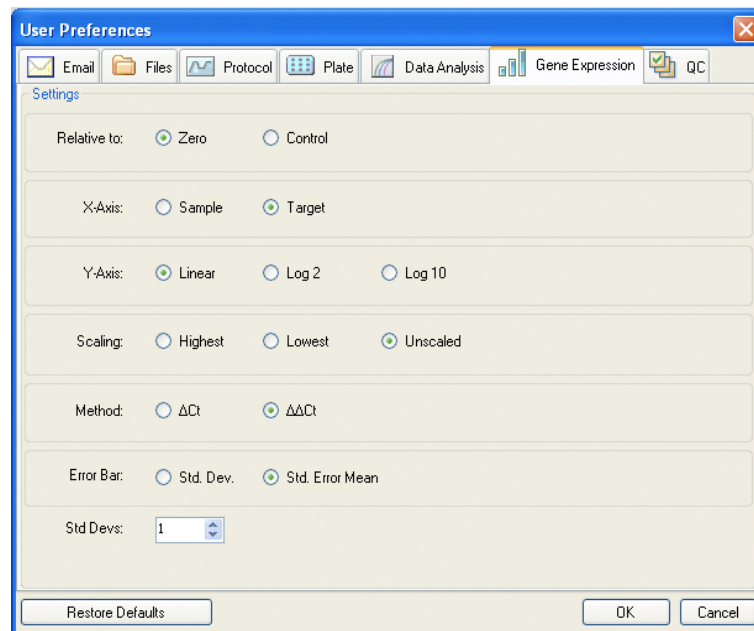

Figure 80. Gene Expression tab in the User Preferences window.

Specify the default settings for a new Gene Expression data file:

- **Relative to.** Select a control or zero. To graph the gene expression data originating at 1 (relative to a control), select **Control**. When you assign a control sample in the Experiment Setup window, the software automatically defaults to calculate the data relative to that control. Select **Relative to zero** to instruct the software to ignore the control, which is the default selection when no control sample is assigned in the Experiment Settings window
- **X-Axis.** Graph the Target or the Sample on the x-axis
- **Y-Axis.** Graph Linear, Log 2, or Log 10 scale on the y-axis
- **Scaling.** Select a scaling option for the graph. Leave the graph unscaled. Alternatively, choose a scaling option to scale to the highest value or to the lowest value
- **Method.** Set the default analysis mode, including normalized expression ($\Delta\Delta C_q$) or relative expression (ΔC_q)
- **Error Bar.** Select Std Dev. for standard deviation, or Std. Error Mean for the standard error of the mean
- **Error Bar Multiplier.** Select the standard deviation multiplier to graph the error bars. The default is 1. Change the multiplier to either 2 or 3

QC Tab

Select the **QC** tab in the User Preferences window to specify QC rules to apply to data in Data Analysis module. The software validates the data against the enabled tests and the assigned values.

NOTE: Wells that fail a QC parameter can easily be excluded from analysis in the QC module of the Data Analysis Window using the right-click menu option.

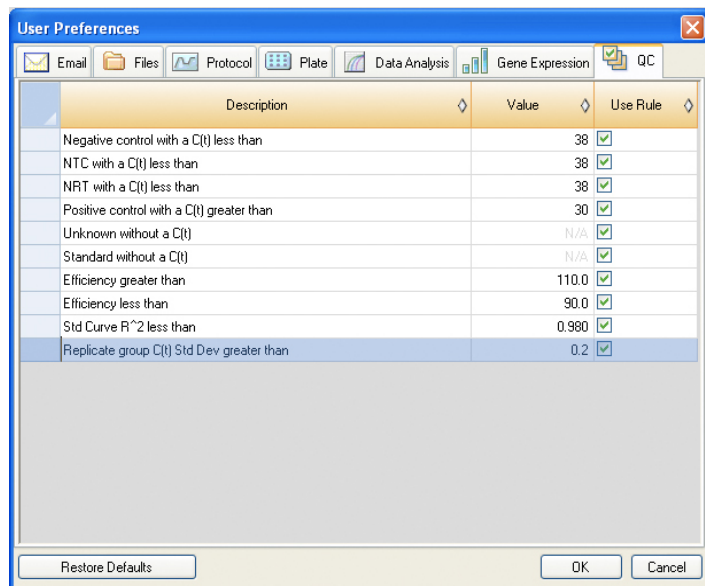

Figure 81. QC tab in the User Preferences window.

Specify to add cut off values and to enable the following QC rules:

- Negative control with a C_q less than XX. Input a C_q Cut-off Value
- NTC (no template control) with a C_q less than XX. Input a C_q Cut-off Value

- NRT (no reverse transcriptase control) with a C_q less than XX. Input a C_q Cut-off Value
- Positive control with a C_q greater than XX. Input a C_q Cut-off Value
- Unknown without a C_q
- Standard without a C_q
- Efficiency greater than XX. Input a reaction efficiency Cut-off Value that is calculated for the standard curve
- Efficiency less than XX. Input a reaction efficiency Cut-off Value that is calculated for the standard curve
- Std Curve R^2 less than XX. Input a Cut-off R^2 value for the standard curve
- Replicate group C_q Std Dev greater than XX. Input a Cut-off standard deviation that is calculated for each replicate group

Custom Export Tab

Select the **Custom Export** tab (Figure 82) to define the default settings for the fields that will be exported and their export format when the Custom Export option is chosen.

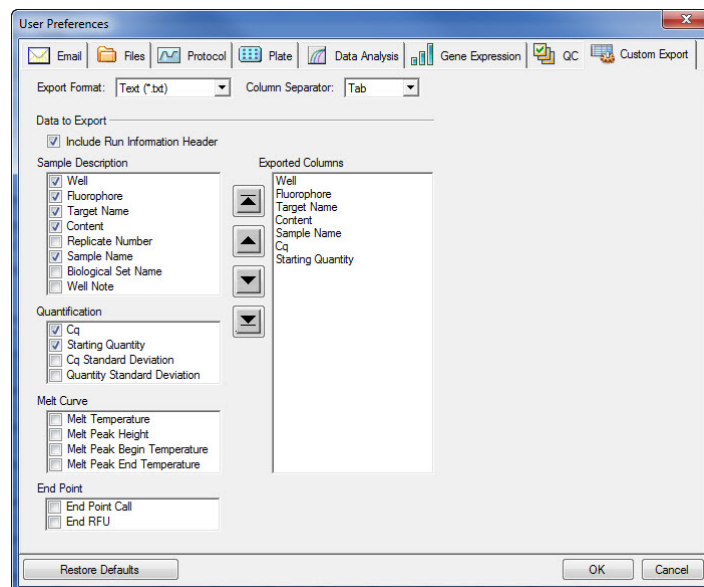

Figure 82. Custom Export tab in the User Preferences window.

The File export formats include text (*.txt), CSV (*.csv), Excel 2007 (*.xlsx), Excel 2003 (*.xls), XML (*.xml), and HTML (*.html).

The following items can be chosen for export:

- **Sample Description.** Well, Fluorophore, Target Name, Content, Replicate Number, Sample Name, Biological Set Name, and Well Note
- **Quantification.** C_q , Starting Quantity, C_q Standard Deviation, and Quantity Standard Deviation
- **Melt Curve.** Melt Temperature, Peak Height, Melt Peak Begin Temperature, and End Temperature
- **End Point.** End Point Call and End RFU

The ordering of the items selected can be changed by highlighting the item and then using the arrow buttons to the left of the Exported Columns list to move them up or down.

NOTE: Selecting Restore Defaults from any of the User Preferences tabs restores the default factory settings for all user preferences options.

User Administration

Open the User Administration window in the main software window:

- Select **Users > User Administration**
- Click the **User Administration** button in the menu bar

If you log in as an Administrator, open the User Administration window to manage users and user rights:

- **Manage Users.** Add or remove Users, and assign each user a Role
- **Manage Rights.** Change rights for user roles (Principal, Operator, or Guest)

NOTE: Only users who are Administrators can edit this window. Other users can only view it.

To assign a role to each user, select from the list of roles in the User Administration window (Figure 83). In this example, the Guest user is given the added right to save files.

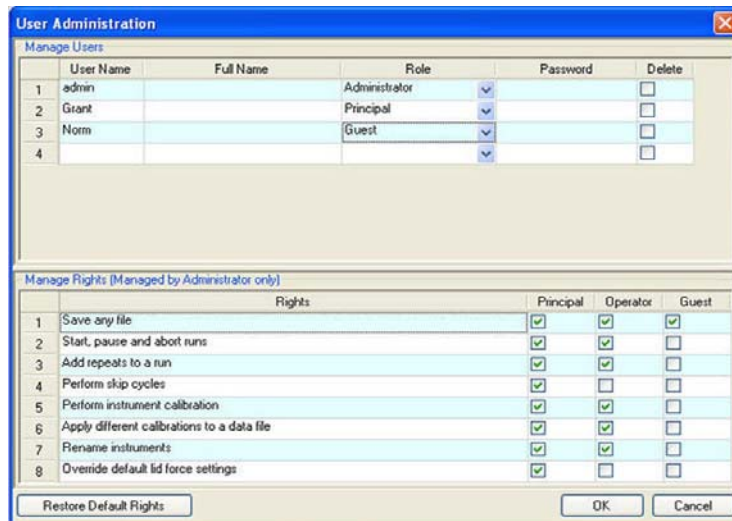

Figure 83. User Administration window with three users.

Adding and Removing Software Users

Only a software Administrator can add and remove users. To add software users in the Manage Users pane, follow these steps:

1. Enter a User Name for the new software user.
2. Select a user Role. These roles restrict the rights of each user. The default is Principal.
3. (Optional) Enter a Full Name and Password for the new software user.

4. Click **OK** to open a dialog box and confirm that you want to close the window.
5. Click **Yes** to close the dialog box and window.

To remove a software user, follow these steps:

1. In the Manage Users pane, click the box in the Delete list for each software user you want to remove.
2. Click **OK** to open a dialog box and confirm that you want to close the window.
3. Click **Yes** to close the dialog box and window.

NOTE: The list of software users must always include one Administrator.

Assign Rights for User Roles

The User Administration window provides access to user roles and rights. The software includes these four roles:

- **Administrator (required).** Each Administrator has all rights, and you cannot change those rights. The Administrator can also add and remove software users, and change the rights for each role
- **Principal.** By default each Principal has all rights
- **Operator.** By default each Operator has all rights except skipping cycles and creating a Gene Study
- **Guest.** By default each Guest has no additional rights, and can only read files

To specify the rights for each role, follow these steps. Only a software Administrator can change the rights for any role:

1. In the Manage Rights pane, click a box under the name of the role to add or remove that right. Click one or more rights in the list. To change all the rights for all the roles to the default list, click **Restore Default Rights**.
2. Click **OK** to open a dialog box and confirm that you want to close the window.
3. Click **Yes** to close the dialog box and window.

To view your current user role and rights, select **User > User Administration**. Contact a software administrator to modify the user settings, rights, and roles listed in the User Administration window. A Principal, Operator, or Guest user can view only their user settings, rights, and roles.

10 Resources

Read this chapter to learn more about resources for the MiniOpticon™ system:

- LIMS integration (page 125)
- Calibration Wizard (page 126)
- Instrument maintenance (page 127)
- Application Log (page 128)
- Troubleshooting (page 129)
- References (page 130)

LIMS Integration

CFX Manager™ software can be configured for use with a Laboratory Information Management System (LIMS) when running a CFX96™ or CFX384™ real-time PCR detection system. This functionality is not available for the MiniOpticon system.

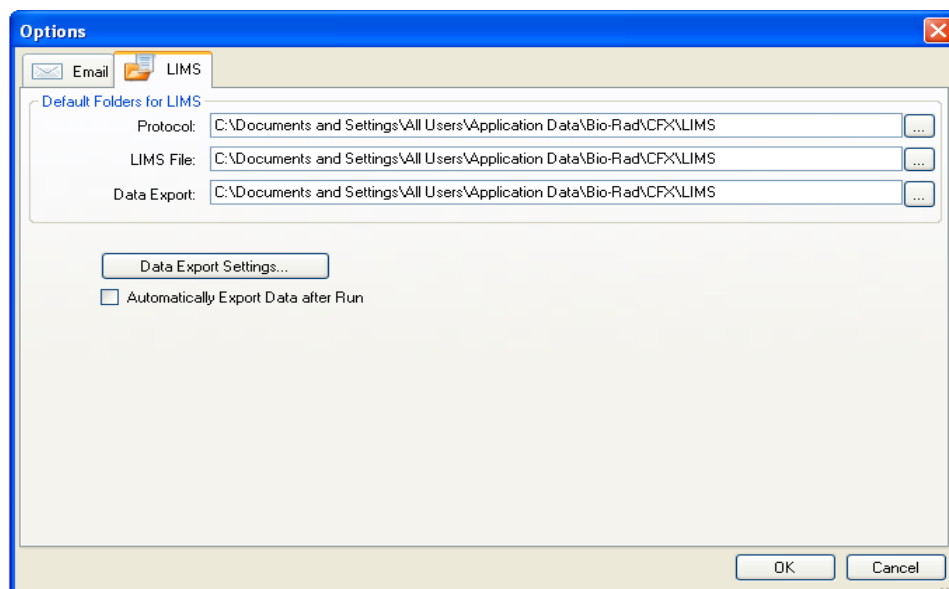

Figure 84. Options window displaying the LIMS settings for use with the CFX96 or CFX384 system.

Calibration Wizard

The MiniOpticon system is factory calibrated for commonly used fluorophores in Bio-Rad white-welled plates (Table 43).

Table 43. Factory calibrated fluorophores, channels, and instruments.

Fluorophores	Channel
FAM, SYBR [®] Green I	1
HEX	2

To open the Calibration Wizard to calibrate the MiniOpticon system:

1. Select an instrument in the Detected Instruments pane.
2. Select **Tools > Dye Calibration Wizard** to open the Dye Calibration window and calibrate new dye and plate combinations (Figure 85).

Figure 85 shows an example of the Dye Calibration window.

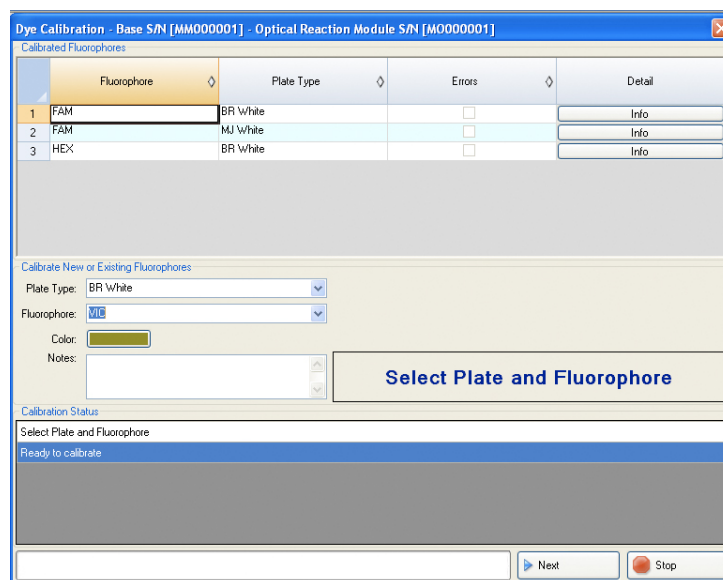

Figure 85. Dye Calibration window.

Calibrating the MiniOpticon System

To calibrate the MiniOpticon system in the Dye Calibration window:

1. Select the Plate Type in the Calibrate New or Existing Fluorophores pane. If the plate type is not included in the list, type the name in the box to add it to the list.
2. Select the fluorophore you want to calibrate from the pull-down list. If the fluorophore name is not included in the list, type the name in the box to add it to the list.
3. Begin preparing a 48-well plate for dye calibration by pipetting dye solution into each well. For each fluorophore, fill each well with 50 μ l of 300 nM dye solution.
4. Seal the plate using the sealing method you will use in your experiment.
5. Click **Next** and follow the on-screen instructions. First, place an empty plate in the MiniOpticon system for the first procedure of the calibration. Next, place the calibration

plate in the block and close the lid for the second procedure of the calibration. Click **OK** to confirm that the plate is in the block.

6. When CFX Manager software completes the calibration run, a dialog box appears. Click **Yes** to finish calibration and open the Dye Calibration Viewer.
7. Click **OK** to close the window.

Instrument Maintenance

The MiniOpticon system includes a sensitive optical detector system and a sample block that must heat and cool very fast. Contamination of these components can interfere with thermal cycling and data collection.

WARNING! Never allow a reaction to run with an open or leaking sample lid. The reagents could escape and coat the block, inner lid, or optical detection system. Excessive dirt can dim the signal, and fluorescence contamination can create excessive background signal.

Avoid contaminating the MiniOpticon system by following these suggestions:

- Always clean the outside of any containers before placing them in the block
- Never run a reaction with a seal that is open, loose, punctured, or otherwise damaged because you could contaminate the block, inner lid, and optical system
- Never run a PCR or real-time PCR reaction with volatile reagents that could explode and contaminate the block, inner lid, and optical system
- Never clean or otherwise touch the optical system behind the heater plate holes in the inner lid

Cleaning the Sample Block

The thermal block of the MiniOpticon system should be cleaned on a regular schedule to remove any debris or dirt that might interfere with proper function. Clean as soon as you discover debris and spilled liquids with a soft, lint-free cloth that is dampened with water. Cleaning the instrument allows precise instrument function.

WARNING! Never use cleaning solutions that are corrosive to aluminum. Avoid scratching the surface of the thermal block. Scratches and damage to this surface interfere with precise thermal control.

WARNING! Never pour water or other solutions into the reaction module bay. Wet components can cause electrical shock when the thermal cycler is plugged in.

Clean the MiniOpticon system as soon as you discover debris, dirt, or contamination in the block or on the inner lid. Any dirt can interfere with the ability of the block to change temperature quickly and collect accurate fluorescent data. To clean the reaction module, follow the guidelines on page 124.

WARNING! To prevent electrical shock, always unplug the base before cleaning the instrument.

WARNING! Never touch or allow solutions to touch the optical system that is located behind the heated plate holes in the inner lid.

TIP: For instructions on handling and cleaning radioactive or biohazardous materials, consult the guidelines for radiation safety and biosafety provided by your institution. These guidelines include cleaning, monitoring, and disposal methods for hazardous materials.

- **Clean the outer surface.** Use a damp cloth or tissue to clean spills off the outside case. If needed, use a mild soap solution, and then rinse the surface with a damp cloth. Cleaning the cover will prevent corrosion
NOTE: Never use cleaning solutions that are corrosive to aluminum, such as bleach or abrasive cleansers.
- **Use of oil in the wells is not recommended.** If oil is used, the wells must be cleaned thoroughly and often. Remove the oil when it is discolored or contains dirt. Use a solution of 95% ethanol to clean oil. Do not allow oil to build up in the block
- **Clean the wells in the block.** Clean spills immediately to prevent them from drying. Use disposable plastic pipets with water (recommended), 95% ethanol, or a 1:100 dilution of bleach in water. Also use a soft, lint-free cloth or paper towel and water to clean the block. Always rinse the wells with water several times to remove all traces of cleaning reagents
WARNING! Never clean the block with strong alkaline solutions (strong soap, ammonia, or high-concentration bleach). Never use corrosive or abrasive cleaning solutions. These cleaning agents can damage the block and prevent precise thermal control.
WARNING! Bleach, ethanol, or soap that is left in the block could corrode the block and destroy plastics during a run. After cleaning, always rinse the wells thoroughly with water to remove all traces of cleaning reagents.
WARNING! Never heat the block after adding a cleaning solution. Heating the block with cleaning solution will damage the block, reaction module, and thermal cycler base.
- **Clean the inner lid.** Use a soft, lint-free cloth and water to remove debris and solutions from the inner lid surface. Never use abrasive detergents or rough material that will scratch the surface. Cleaning the inner lid improves precise sample heating and cooling

Application Log

Before starting a new run, the instrument initiates a self-diagnostic test to verify that it is running within specifications. The software records results of this test in the Run log and Application log file. If you notice a problem in one or more experiments, open the run and application logs to find out when the problem started.

CFX Manager software tracks information about the state of an instrument during a run in the **Application Log** (Figure 86). Use these logs to track events that occur on instruments and in the software and for troubleshooting.

To open the Application Log in the main software window, select **View > Application Log**.

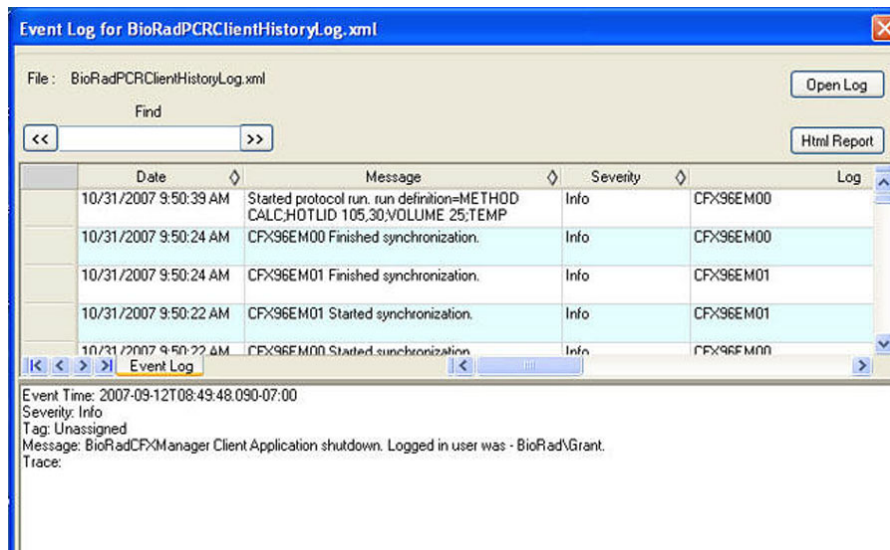

Figure 86. Example of an Event Log file.

Troubleshooting

Typically, software and instrument communication problems can be resolved by restarting your computer and the system. Be sure to save any work in progress before restarting.

NOTE: Check that your computer has sufficient RAM and free hard drive space. The minimum RAM is 2 GB and the minimum hard drive space is 20 GB.

Installing the Software Manually

If needed, install the software manually by following these instructions:

1. Insert the software CD.
2. Right-click the software CD icon, and select **Explore** to open the CD window.
3. Double-click the **CFX_Manager** folder to open the folder, and then double-click **setup.exe** to start the software installation wizard.
4. Follow the instructions on the wizard to install the software, and then click **Finish**.

Power Failure Options

In a power failure, the instrument and computer will shut down. If the power failure is short, the instrument will resume running a protocol, but the Application Log will note the power failure. Depending on the computer settings and the length of time the power is off, the instrument and software attempt to continue running the experiment when they are restarted.

References

- Breslauer KJ, et al. (1986). Predicting DNA duplex stability from the base sequence. *Proc Nat Acad Sci* 83, 3746–50.
- Livak JL, et al. (1995). Towards fully automated genome-wide polymorphism screening. *Nature Genetics* 9, 341–342.
- Pfaffl MW. (2001). A new mathematical model for relative quantification in real-time RT-PCR. *Nucleic Acids Research* 29(9), 2002–2007.
- Vandesompele J, et al. (2002). Accurate normalization of real-time quantitative RT-PCR data by geometric averaging of multiple internal control genes. *Genome Biology* 3(7), 1–12.

Minpack Copyright Notice (1999) University of Chicago. All rights reserved

Redistribution and use in source and binary forms, with or without modification, are permitted provided that the following conditions are met:

1. Redistributions of source code must retain the above copyright notice, this list of conditions and the following disclaimer.
2. Redistributions in binary form must reproduce the above copyright notice, this list of conditions and the following disclaimer in the documentation and/or other materials provided with the distribution.
3. The end-user documentation included with the redistribution, if any, must include the following acknowledgment:

“This product includes software developed by the University of Chicago, as Operator of Argonne National Laboratory.”

Index

A

- Add Repeats, 26
- Adding
 - Beep, 36
 - Extend, 36
 - Increment, 36
 - Ramp rate, 36
 - Repeats in run, 26
- Adjusting
 - Allelic Discrimination data, 80
 - Data analysis charts, 63
 - End point data, 78
 - Gene expression data, 92
 - Melt Curve Data, 75
 - Threshold, 58
 - Trace color, 68
 - Trace style, 68
- Adjusting the Threshold, 61
- Allelic Discrimination, 79
 - Adjusting data, 80
 - RFU, 79, 82
 - Spreadsheet, 81
- Amplicon length, 37
- Analysis Mode, 59
- Annealing temperature
 - Protocol AutoWriter, 37
- Apply Fluorescent Drift Correction, 59
- Auto Efficiency, 49, 96

B

- Back panel, 2
- Balance
 - Cut microplates, 8

- How to, 8
- Tube strips, 8
- Baseline
 - Window, 59
- Baseline Settings, 59
- Baseline Subtracted
 - Curve Fit mode, 59
- Baseline Subtracted mode, 59
- Baseline Threshold window, 59
- Beep, 36
- Block, 2
 - Mode, 37
- Button, 26
 - Clear Replicate #, 47
 - Clear Wells, 47
 - Close lid, 2, 26
 - Delete step, 36
 - Experiment Settings, 47, 48
 - Flash Block Indicator, 27
 - Open lid, 26
 - Pause, 27
 - Protocol AutoWriter, 37
 - Protocol Editor, 33
 - Resume, 27
 - Show Analysis Settings, 49, 96
 - Skip Step, 27

C

- Calculated mode, 37
- Calibration
 - Inter-run in a Gene Study, 101
- Cancelling a run, 27
- Changing
 - Baseline, 59

- Sample volume, 23, 33
- Thresholds, 59
- Chart
 - Data analysis, 63
- Cleanup events, 19
- Clear Replicate #, 47
- Clear Wells button, 47
- Clearing wells in Plate Editor, 63
- Close button for lid, 2
- Close Lid button, 26
- Closing the lid, 26
- Coefficient of Variation, 93
- Color, 44, 49, 97
- Concentration, 45, 46
- Control
 - Relative quantity with, 106
- Creating
 - Data report, 85
 - Protocol, 37
 - Well groups, 50
- Custom Data View, 81
- Custom Export, 65
- Cycles to Analyze, 60, 61

D

- d(RFU)/dT
 - Spreadsheet, 77
- Data analysis
 - About, 53
 - Adjusting, 53
 - Charts, adjusting, 63
 - Clearing wells, 63
 - Data analysis, 79
 - End Point, 77
 - Formula, 106
 - Gene Expression, 89
 - Melt Curve, 74
 - Menu bar, 55
 - Plate content, 53
 - Toolbar, 54
 - Well contents, 53
 - Well groups, 50
 - Well selector, 61
- Data file
 - Report, 84
- Data report
 - Creating, 85
- Delete Step button, 36
- Deleting a step, 36
- Detected Instruments, 9
- Dilution Series, 47

E

- Email Setup in CFX Manager, 115
- Email Tab, 115
- End Point
 - Adjusting data, 78
 - Changing sample volume in protocol, 23
 - RFU data analysis, 77
 - Spreadsheet, 79
 - Tab, 77
- End Point Only Run protocol, 23
- Enzyme type, 38
- Experiment Settings, 47
 - Auto Efficiency, 49, 96
 - Button, 48
 - Color, 49, 97
 - Show Analysis Settings button, 49, 96
 - Show Graph, 49, 97
 - Targets tab, 48, 95
- Export All Data Sheets to Excel, 55, 65
- Export RDML Files, 65
- Export Template, 51
- Export to LIMS Folder, 66
- Express Load
 - Protocol, 23, 24
- Extend, 36

F

- Flash Block Indicator button, 27
- Fluorophore Analysis Mode, 60
- Fluorophores, 45
- Formula, 107
 - Data analysis, 106
 - E (see reaction efficiency), 70
 - Normalized expression, 108, 109, 110
 - Normalized expression, scaled, 109
 - Reaction Efficiency (E), 70
 - Relative quantity, 106
 - SD normalized expression, 110
 - Standard error, 111
 - Standard error normalized expression, 111
- Front view, 2

G

- Gene expression
 - Adjusting data, 92
 - Data analysis, 89
 - Graph data, 92
 - Normalizing data, 91
 - Relative quantity, 92

- Right-click for graph, 94
- Scaling options, 93
- Spreadsheet, 94
- Gene Study, 101
 - Inter-run calibration, 101
 - Preparing data, 103
 - Report, 104
 - Show Details, 104
 - Study Analysis tab, 102, 104
 - Study Setup tab, 103
- GOI
 - Normalization factor, 107, 108
 - Normalized expression, 108, 109, 110
 - Relative quantity, 106, 107
 - SD Normalized expression, 110
- GOTO
 - Adding repeats, 26
 - Inserting, 34
- Gradient
 - Inserting, 34
 - Step, 34
- Gradient Calculator, 32

H

- Heated plate, 2

I

- Import Template, 51
- Increment, 36
- Inner lid, 2
- Instruments
 - Safety, iii
 - Warning labels, iii
- Inter-run calibration, 101

L

- Layout
 - Quantitation tab, 56, 68
- LED on lid, 2
- Library, 45
- Lid
 - Green LED, 2
 - Opening, 26

M

- Magnification in Plate Editor, 41
- Master Mix Calculator, 15
- Melt Curve
 - Adjusting data, 75
 - Data analysis, 74
 - Inserting, 35
 - Opening tab, 74
 - RFU data, 74
- Melt Curve Data, 76
 - Amplification Data (RFU), 77
 - Plate, 76
 - Tab, 75
- Melt Peaks
 - Spreadsheet, 76
- Melt Peaks Spreadsheet, 76
- Menu bar
 - Data analysis, 55
 - Main software, 10
 - Plate Editor, 40
 - Protocol Editor, 32
- Mode
 - Baseline Subtracted, 59
 - Baseline Subtracted Curve Fit, 59
 - Not Baseline Subtracted, 59
 - Temperature control, 36
- Multiple instruments
 - Viewing, 14
- M-value, 93

N

- Normalization factor
 - Relative quantity, 107, 108
- Normalized expression
 - Formula, 108
 - Formula for GOI, 111
 - Scaled to highest, 109
 - Scaled to lowest, 109, 110
 - Standard deviation (SD), 110
 - Standard deviation formula, 109
- Normalized GOI formula, 111
- Normalizing
 - Gene expression, 91
- Not Baseline Subtracted mode, 59
- Notes
 - Well, 45

O

- Open Lid button, 26

Index

Opening

- Lid, 26
- Melt Curve tab, 74
- Protocol AutoWriter, 37
- Protocol Editor, 31

Operation requirements, 3

P

Pause

- Button, 27
- Run, 27

Plastic Consumables, 8

Plate

- Contents of wells, 45
- Melt Curve Data, 76
- Size, in Plate Editor, 40
- Spreadsheet, 51, 76
- Type, 41
- Well contents, 45

Plate Editor

- Clear Replicate #, 47
- Clear Wells button, 47
- Clearing wells, 63
- Concentration, 46
- Dilution Series, 47
- Experiment Settings, 47
- Export plate spreadsheet, 51
- Import plate spreadsheet, 51
- Magnification, 41
- Menu bar, 40
- Plate size, 40
- Plate Type, 41
- Replicate #, 46
- Replicate Group, 46
- Replicate series, 46
- Sample Name, 46
- Sample Type, 45
- Scientific notation, 41
- Selecting fluorophores, 44
- Spreadsheet, 51
- Target Name, 45
- Toolbar, 41
- Units, 41
- Well Groups Manager, 41
- Well Notes, 47

Power

- Input, 2
- Switch, 2

Protocol

- Block mode, 37
- Calculated mode, 37
- End point, 23

- Express load, 23, 24
- Steps, temperature, 31

Protocol AutoWriter, 37

- Amplicon length, 37, 38
- Annealing temperature, 37
- Button, 37
- Creating a protocol, 37

Protocol Editor

- Buttons, 33
- Delete step, 36
- Inserting GOTO, 34
- Inserting gradient, 34
- Inserting melt curve, 35
- Menu bar, 32
- Window, 31

Q

QC Tab, 82

Quantitation

- Description, 56
- Tab, 56
- Tab layout, 56, 68

R

Ramp rate, 36

Reaction efficiency (E)

- Formula, 70
- Targets, 70

Real-Time Status, 27

Regression Mode, 58

Relative quantity

- Control sample selected, 106
- Described, 92
- Formula, 106
- GOI, 106
- Normalization factor, 107, 108
- Normalized expression, 109
- Standard deviation formula, 107

Replace Plate File, 28

Replicate #, 46

Replicate Group, 46

Replicate Series, 46

Report

- Data file, 84
- Gene Study, 104

Requirements

- Operation, 3

Resume button, 27

Resuming a run, 27

RFU

- Allelic Discrimination, 79, 82
- End Point tab, 77
- Melt Curve tab, 74
- Right-click
 - Gene expression graph, 94
- Run
 - Adding repeats, 26
 - Cancelling, 27
 - Flash block, 27
 - Pausing, 27
 - Skipping a step, 27
 - Stopping, 27
- Run Details
 - Real-Time Status tab, 27
 - Run Status, 26
 - Time Status tab, 28
 - Window, 25
- Run Information
 - Tab, 83
- Run Status
 - Tab, 26

S

- Safe use specifications, iv
- Safety
 - Instruments, iii
 - Warning labels, iii
 - Warnings, ii, iii, v, vi
- Sample
 - Name, 45, 46
 - Type, 45
- Sample Volume
 - Changing in end point, 23
- Sample volume
 - Changing, 33
- Scaling option in gene expression, 93
- Scheduler, 16
- Scientific notation, 41
- Select Fluorophores
 - Color, 44
 - Selected check box, 44
- Selecting
 - Fluorophores in plate, 44
- Show Analysis Settings, 49, 96
- Show Details
 - Gene Study, 104
- Show Graph, 49, 97
- Single Threshold Mode, 58
- Skip Step button, 27
- Skipping a step, 27
- Specifications
 - Safe use, iv

- Spreadsheet
 - Allelic Discrimination, 81
 - Amplification Data for Melt Curve, 77
 - d(RFU)/dT for Melt Curve, 77
 - End Point, 79
 - Gene expression, 94
 - Melt Peaks, 76
 - Plate in Melt Curve Data, 76
 - RFU for Melt Curve, 77
- Standard Curve
 - Well groups, 50
- Standard deviation
 - Formula for normalized expression, 110
 - Normalized expression, 109, 110
 - Relative quantity, 107
- Standard error, 111
 - Formula, 111
 - Normalized expression formula, 111
- Startup Wizard, 12
- Step
 - Temperature, 33
- Stop button, 27
- Stopping a run, 27
- Study Analysis tab, 102, 104
- Study Setup tab, 102, 103
- Support
 - Bio-Rad representatives, ii
 - Technical, ii
 - Technical Notes, ii

T

- Tab
 - End Point, 77
 - Melt Curve Data, 75
 - Quantitation, 54, 56
 - Real-Time Status, 27
 - Run Information, 83
 - Study Analysis in Gene Study, 102, 104
 - Study Setup in Gene Study, 103
 - Time Status, 28
- Target Analysis Mode, 60
- Target Name, 45
- Targets
 - Experiment Settings, 48, 95
 - Reaction efficiency (E), 70
- Technical
 - Notes, ii
 - Specialists, ii
- Temperature
 - Step, 33
- Temperature Control
 - Mode, 37

Index

- Temperature control
 - Block mode, 37
 - Mode, 36
- Threshold
 - Adjusting, 58
- Thresholds
 - Window, 59
- Time Status tab, 28
- Toolbar
 - Data analysis, 54
 - Main software, 11
 - Plate Editor, 41
- Trace
 - Adjusting, 68
 - Color, 68
 - Style, 68

U

- Units, 41
- USB
 - Connections, 3

W

- Warning
 - Instruments, iii
 - Labels, iii
 - Labels, safety, iii
 - List in manual, ii, v, vi
 - Risk of burning, iii
 - Risk of explosion, iii
 - Risk of harm, iii
 - Safety, iii
- Well
 - Concentration, 45
 - Contents, 45
 - Fluorophores, 45
 - Groups, 41
 - Notes, 45, 47
 - Sample Name, 45
 - Sample Type, 45
 - Target Name, 45
- Well Group Reports, 87
- Well groups, 50
 - Creating, 50
 - Data analysis, 50
 - Standard Curve, 50
- Well Groups Manager, 41
- Well Notes, 47
- Well selector
 - Data analysis, 61

Window

- Baseline, 59
- Gene Study, 101
- Protocol AutoWriter, 37
- Protocol Editor, 31
- Run Details, 25
- Threshold, 59
- Well Groups Manager, 41



**Bio-Rad
Laboratories, Inc.**

Life Science
Group

Web site www.bio-rad.com **USA** 800 424 6723 **Australia** 61 2 9914 2800 **Austria** 01 877 89 01 **Belgium** 09 385 55 11 **Brazil** 55 11 5044 5699
Canada 905 364 3435 **China** 86 21 6169 8500 **Czech Republic** 420 241 430 532 **Denmark** 44 52 10 00 **Finland** 09 804 22 00
France 01 47 95 69 65 **Germany** 089 31 884 0 **Greece** 30 210 9532 220 **Hong Kong** 852 2789 3300 **Hungary** 36 1 459 6100 **India** 91 124 4029300
Israel 03 963 6050 **Italy** 39 02 216091 **Japan** 03 6361 7000 **Korea** 82 2 3473 4460 **Mexico** 52 555 488 7670 **The Netherlands** 0318 540666
New Zealand 64 9 415 2280 **Norway** 23 38 41 30 **Poland** 48 22 331 99 99 **Portugal** 351 21 472 7700 **Russia** 7 495 721 14 04
Singapore 65 6415 3188 **South Africa** 27 861 246 723 **Spain** 34 91 590 5200 **Sweden** 08 555 12700 **Switzerland** 061 717 95 55
Taiwan 886 2 2578 7189 **Thailand** 800 88 22 88 **United Kingdom** 020 8328 2000
