

CALL US TODAY AT:
1 (888) 224-3446



BAI

ELECTRONIC SYSTEMS DISTRIBUTORS ®

2017-2018
PRODUCT GUIDE

WWW.BAIONLINE.COM

AUDIO • VIDEO • LIGHTING • INTERCOM • CCTV

BAI DISTRIBUTORS , INC.

SINCE 1983

**WHOLESALE DISTRIBUTION OF ELECTRONIC
SYSTEMS EQUIPMENT**

NO END USER SALES

**FACTORY PRICING / LARGE INVENTORY
SAME DAY SHIPPING FOR IN-STOCK PRODUCTS**

**MAIN OFFICE
2312 NE 29 AVENUE
OCALA, FL 34470
TOLL FREE 1-888-224-3446
LOCAL: 352-732-7009
FAX: 352-732-1616**

WEB SITE: WWW.BAIONLINE.COM

E-MAIL: sales@baionline.com

Notes:

This Product Guide the property of: _____

Serving the Systems Contractor Since 1983 ...

Welcome to BAI Distributors!

Our goal is to offer electronic system integrators a world of value-added solutions. Our extensive array of products from industry leading manufacturers will help to make your procurement efforts effortless. Our company has been evolving for over 30 years and we continually add new lines to provide solutions for every systems design requirement. In today's environment where dealing with FEWER vendors means MORE productivity for your sales and purchasing staff, BAI can offer you excellent integrated procurement solutions.

BAI has access to thousands of additional manufacturers - if you don't see it here - call us!

Table of Contents

	Page		Page
Accessories Cables, Wall Plates, Connectors	2	KLIK Wireless Presentation Controller	70
Adaptive Technologies Group A/V Mount Products	3	Liberty AV Solutions A/V Solution Based Products.....	71-72
ADJ - American DJ DJ Products	4	Lightronics Architectural & Performance Lighting.....	73-75
Airwave Technologies Wired/Wireless Mics & Misc	5	Listen Technologies Assistive Listening & More	76
AKG Mics, Broadcast & Studio Equipment	6	Louroe Audio Surveillance	77
Alesis Professional Audio Products	7	Lowell Manufacturing Professional A/V Equipment	78-81
Allen & Heath Mixing Consoles	8-9	Martin Lighting Full Line Lighting Equipment	82
Anchor Audio Portable Sound	10	Milestone Chief, Da-Lite, Raxxess & Vaddio	83
Astatic - See CAD		Numark Pro Audio & DJ Products	84
ASCO Power Technologies Surge Products	11	Omnimount A/V Racks & Mounts & Accessories	85-87
Ashly Amplifiers & DSP	12-13	On-Stage Audio Video Stands & Mounts	88
Atlas Sound Commercial Sound Products	14-21	Optoma Full Line Digital and Laser Projectors	89
Audimute Acoustical Soundproofing	22	Peerless-AV A/V Mounting Systems & Solutions	90-92
Audio-Technica Microphones & Electronics	23	Philips Commercial Flat Panel Displays	93
Audix Microphones & Speakers	24-25	PreSonus Digital Mixers, Signal Processors, EQ's	94
AV Armour Audio/Video Mounting Products	26	Projectors Assorted Manufacturers	95
Aviom Personal Monitor Mixing	27	Quam Commercial Audio Products - Made in the USA	96
Beyerdynamic Microphones & Headsets	28-29	Rane Professional Audio Products	97
Bogen Speakers, Amps & Audio Products	30	RF Venue Wireless Mic Antennas & Distribution	98
Bolide Full Line CCTV Products	31	RHC Audio Cables, Connectors, Snakes & Accessories	99
Bosch Communications Full Line PA & Intercom	32	Rolls Commercial Audio Products	100
BSS Professional Audio Signal Processing Equipment	33	RTS Conference Line Intercommunications	101-103
C2G Cables, Connectors & Accessories	34	Samson Professional Sound Equipment	104
CAD/Astatic Professional Mics	35-36	Sennheiser Professional Audio Products	105-108
CE Labs A/V Distribution & Digital Signage Solutions	37	Shure Professional Audio Mics & Mixers	109-112
Chauvet Lighting, Effects, Trusses Etc.	38-39	Sony Consumer & Pro Products	113
Clear-Com Wired & Wireless Intercom	40	Soundbarrier Professional Audio Equipment	114
Cleerline SSF Easy Termination Fiber & Accessories	41	Soundcraft Professional Audio Mixing Consoles.....	115
Countryman Associates Headset Mics & Pro Audio Products ..	42	SoundSphere Speakers	116
Crown Professional Amplifiers & Microphones	43-44	Soundtube Commercial Speaker Products	117
dbx Processors, Noise Reduction, EQ's	45	Special Projects Prof. Headsets, Wireless Mics	118
Denon Pro Pro Audio Products	46	Speco Commercial Audio & CCTV Products	119
Digital Projection Professional DLP Projectors	47	Switchcraft Full Line Components & Connectors.....	120
Ditek Surge Protection & UPS's	48-49	TAF Full Line Trussing Products	121
Draper A/V & Sports Equipment, Screens & Shades	50	Tascam Professional Audio Products	122-123
ElectroVoice Commercial Audio Products	51-57	TC Electronic Lab Gruppen & Tannoy	124
Fender Pro Audio Portable Sound	58	TechLogix Networkx Audio Video Solutions	125
Furman Sound Power Conditioners	59	Telex Wireless Mics & SoundMate™ Listening System	126
Galaxy Audio Personal Monitors/Speakers	60-61	TOA Electronics Commercial Audio Products	127-131
Gator Cases Cases, Racks, Bags & FrameWorks Stands	62	Tripp-Lite Power Conditioners, Distribution & UPS's	132
Hosa Audio Video Connectivity Products	63	Vaddio PTZ Camera Technology Products	133
IC Realtime Full Line CCTV	64	VocoPro Professional Vocal & Karaoke Systems.....	134-135
JBL Professional Audio Products	65-67	West Penn Wire Wire & Cable	136
Jensen Transformers Transformers & Problem Solvers.....	68	Williams Sound Wireless & Sound Enhancement.....	137
Key Digital Pro Distributed Video & Control Systems	69	Xantech Signal Processing & Control	138

BAI Distributors also distributes for the following:

- **ADC** - Motors & Tracks for Screens & Curtains
- **Alto Professional** - Professional Loudspeakers & Mixers
- **Ansr Audio** - Wired & Wireless Mics
- **Bolide** - Full Line CCTV
- **Cloud** - Professional Audio Equipment
- **Edco** - See Asco Power Technologies
- **Gemini** - DJ & Audio Products
- **Juice Goose** - Power Distribution, Conditioning & Control
- **Lexicon** - Pro Processing Equipment
- **Marantz** - Pro A/V Products
- **Midas** - Professional Mixing Products
- **Nord** - Keyboards & Accessiores
- **PureLink** - Digital Connectivity Solutions
- **Time Square Lighting** - Professional Lighting Solutions
- **URC** - **Universal Remote Controls**

- **Aiphone** - Communication & Security Intercom
- **American Audio** - Pro Audio Products
- **ATM Flyware** - See Adaptive Technologies page
- **BroadcastVision** - FM Rebroadcasters & Fitness Products
- **Da-Lite** - Video Screens, Carts, Stands & Lecterns
- **FSR** - Switching & Control Products
- **Intelix** - See Liberty A/V
- **Kramer** - Audio/Video Signal Processing Products
- **LG Electronics** - **Projectors**
- **Microboards** - **Duplicators/Printers**
- **Neutrik** - **Connectors**
- **Powersoft** **Professional Amplifiers**
- **TechFlex** - Braided Sleeving & Wire Protection Products
- **TV One** - Intelligent Video Processing Solutions
- **Whirlwind** - Audio Interfaces, Cables, Snakes & Custom

We also have access to over 1800 additional manufacturers through our cooperative buying ventures.

BAI ACCESSORIES

BAI carries a full line of audio accessories such as connectors, wall plates, cables, etc. The below is a list of the products that we try to maintain in our warehouses. BAI can also quote you on your Snake and custom requirements. Our prices are very competitive.

AUDIO CABLES

MIC
 SJ3'
 SJ6'
 SJ10'
 SJ20'
 SJ25'
 SJ50'
 SJ100'



SPEAKER
 SPKR16-6'
 SPKR16-25'
 SPKR16-50'
 SPKR16-100'
 SPKR16-25N4N4
 SPKR16-50N4N4
 SPKR16-100N4N4



INSTRUMENT
 INST-3'
 INST-6'
 INST-10'
 INST-20'
 INST-50'



VIDEO CABLES

BAI stocks a huge variety of important audio and video cables in various lengths. Call for other lengths and configurations! We sell standard 1080p & 4K HDMI cables!

HDMI
 1.5' 3' 6'
 10' 15' 20'
 25' 30' 35'
 40' 45' 50'
 60' 75' 100'



SVGA
 3' 6'
 10' 15'
 25' 50'
 75'



CAT5/5E/6
 6" 1' 3'
 6' 10' 15'
 20' 25' 50'
 75'



WALL PLATES

BAI Carries a full line of pre-connectorized Wall Plates in numerous configurations & offer custom plates as well. Call us with your requirements!

SP-1D3F SINGLE GANG W/F-XLR-3
 SP-1DMS SINGLE GANG W/M-XLR-3
 SP-1D5F SINGLE GANG W/5 PIN F-XLR
 SP-2DFS SINGLE GANG W/2 F-XLR-3
 DP-2DFS DOUBLE GANG W/2 F-XLR-3
 DP-4DFS DOUBLE GANG W/4 F-XLR-3
 SP13501FR SINGLE GANG WITH RCA



SP-111 SINGLE GANG W/1/4" JACK
 SP-211 SINGLE GANG W/2-1/4" JACKS
 SP-1NL4MP SINGLE GANG W/NL4MP
 SP-2N34MP SINGLE GANG W/2-NL4MP
 SP-13.5 SINGLE GANG WITH 1/8"
 SP-13.51C SINGLE GANG W/1/8" & RCA
 SP-13.52C SINGLE GANG W/1/8" & 2-RCA

CONNECTORS

1/4" MONO JACK
 1/4" MONO PLUG
 1/4" STEREO JACK
 1/4" STEREO PLUG



XLR-3F F-XLR
 XLR-3M M-XLR
 A3F A3M A4F
 B3F C3F R3F R3M



NL4FC SPEAKON
 NL4MC SPEAKON
 NL4MM NL4MPR
 RCA JACK & PLUG

BAI now offers a full line of fiber optic cable, connectors, transmitters, receivers and extenders. Our fiber product does NOT require certification or expensive connector kits. Call for details and pricing.

BAI is able to find and supply hard to find connectors and parts. Give us a call!



ADAPTIVE
TECHNOLOGIES GROUP

Time Saving AV Mounting & Rigging Solutions

MultiMount™ PAN AND TILT SPEAKER MOUNT

Pan & Tilt Speaker Mounts

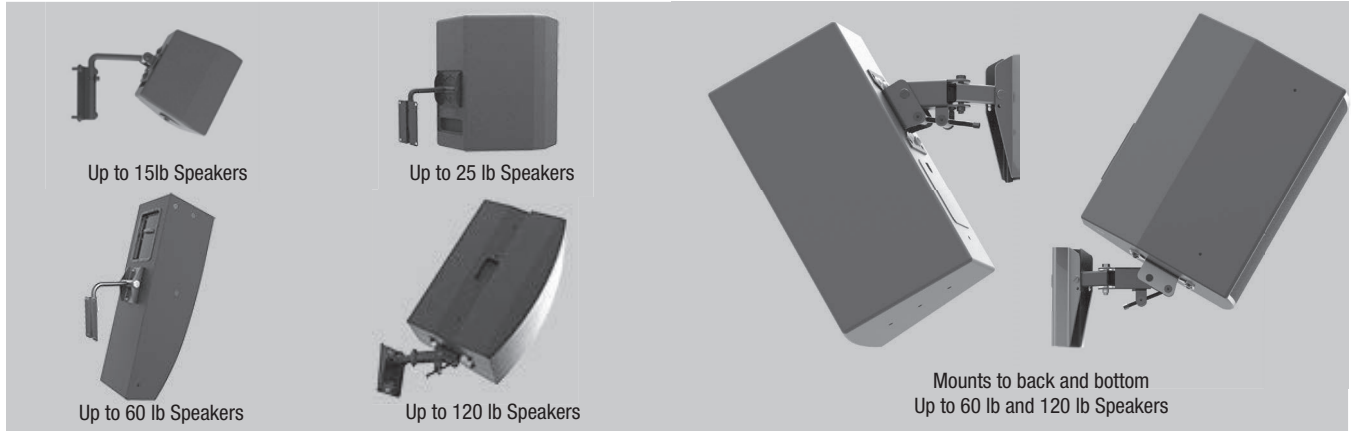

Steerables™ LOUDSPEAKER MOUNTING AND AIMING SYSTEM

Pan & Tilt Rigging Solutions

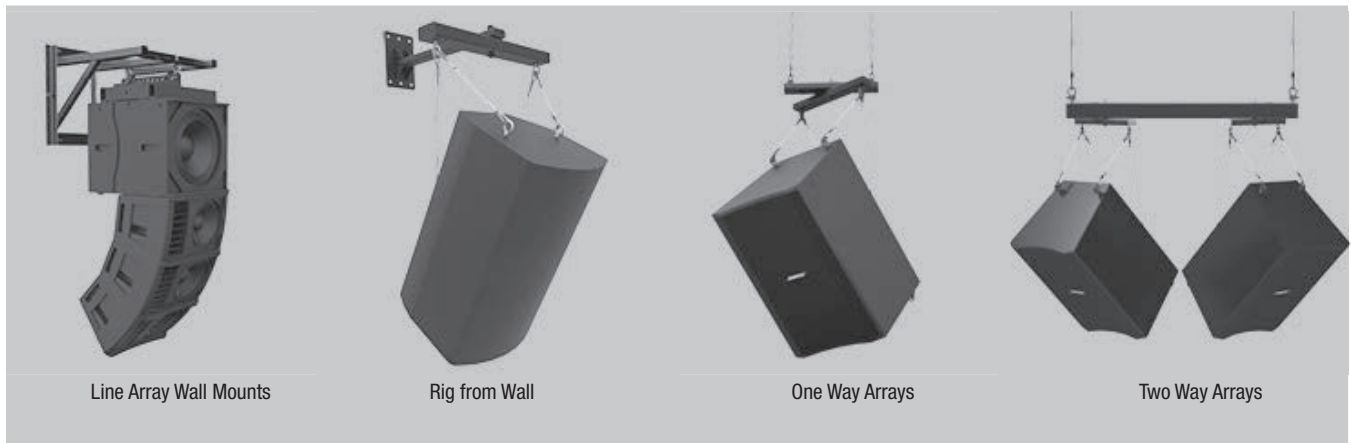

PoleStar™ POLE ADAPTER FOR SPEAKER MOUNTS

Outdoor Speaker Mounting Solutions

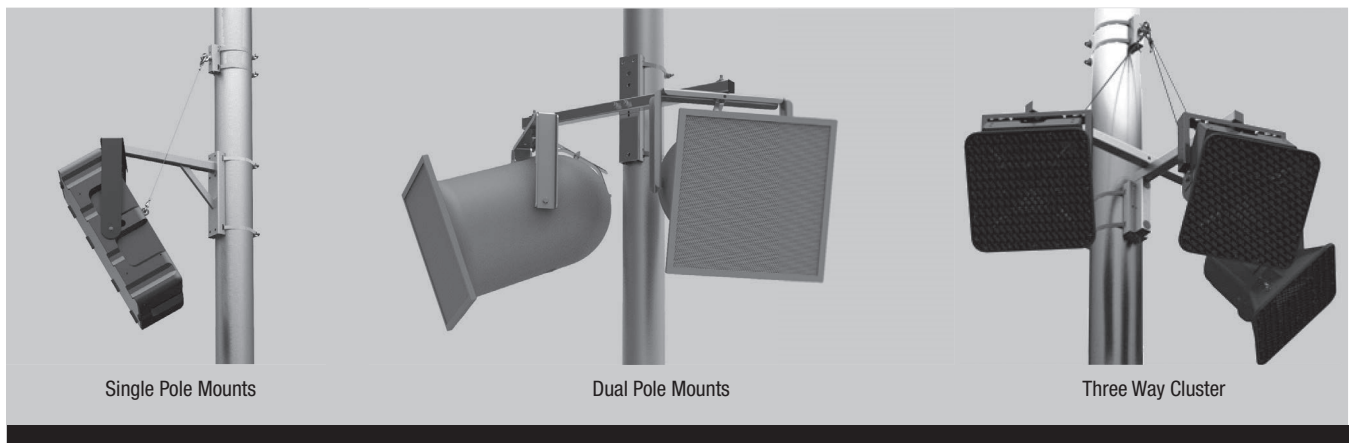



18P HEX
All metal Par with eighteen 12-Watt Hex (6-IN-1) LEDs, 30 Degree Beam angle, 63 Built in Color Macros, powerCON in and out connections. Gel Frame included.

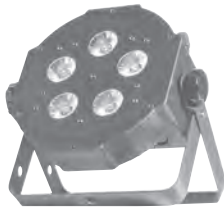

MEGA TRIPAR PROFILE PLUS
Compact, low profile LED Par with 5 x 4W 4-IN-1 RGB+UV LEDs. Intelligent design - great for up lighting. DMX-512.



MEGA QA GO
Battery powered, compact LED Par with five 4W (Quad 4-IN-1) RGBA LEDs. Intelligent design - great for up lighting. DMX-512. Quick set-up and take down. Set the color and go!



ENCORE PROFILE 1000 COLOR
120W RGBW LED Ellipsoidal with manual zoom and a 12-30-degree beam angle. 3 & 5-pin DMX. Accepts type M GOBOS.



ENCORE PROFILE 1000 WW
120W Warm White LED Ellipsoidal with manual zoom and a 12-30-degree beam angle. 3 & 5-pin DMX. Accepts type M GOBOS included.



IKON PROFILE
32W LED GOBO Projector that comes with 1 glass GOBO and 4 metal GOBOS. 15-30-degree beam angle, manual framing shutters, manual focus. DMX-512. High quality optics.



VIZI BEAM 5RX
Moving Head beam fixture with Philips® Platinum 5R lamp, motorized focus, PowerCon In/Out, frost filter, 8-facet prism and stepper motors for speed and accuracy.



FOCUS SPOT THREE Z
100W LED Moving Head with motorized focus and motorized zoom (12 ~ 18-degrees). Two 6-facet prisms, 2 GOBO wheels (1 wheel replaceable). GOBO indexing, DMX-512, powerCON.



FOCUS SPOT TWO
7W LED Moving Head with motorized focus. EZ GOBO replacement lid with hinge, GOBO indexing, DMX-512, powerCON. Built-in 3W UV LED. 4 built-in lightshows.



STINGER SPOT
Compact mini moving head with punch! 10W LED, with advanced optics, 7 colors, 7 GOBOS, DMX-512. Designed for small venues with low ceilings. DMX-512 and built-in lightshows.



ENTOURAGE
1500W Pro Faze Machine with durable flight case with powerCON & 3 & 5-pin DMX. Creates thin mist of atmospheric. Uses water based fog fluid. LED display with timer, continuous fog and manual fog options.



FOG FURY JETT
High velocity vertical Fog Machine that mixes color into the fog from 12x 3-Watt RGBA LEDs. Use vertically or horizontally. Uses water based fog fluid.



VF1300
1300W Fog Machine. Electronic Thermo Sensing (ETS) for optimum heating levels, and a low fog fluid shut off sensor to protect the pump. Includes remote.



BUBBLETRON
Small, lightweight bubble machine that features a bubble production rate comparable to larger machines. It's EZ-Access front fluid tank makes the Bubbletron easy to use and easy to clean.



STINGER STAR
Cover the room in light from the unique party effect! Includes 3-FX-IN-1: LED Moonflower, Color Wash and a red/green Laser.



STINGER
Great party effect! (3-FX-In-1) Moonflower, Strobe, & Laser Effect. 10 DMX Channels. 3 Operational Modes. Built-in Programs. Electronic Dimming & Strobe Effect.



DMX OPERATOR
DMX controller with 8 channel faders, 12 individual fixture buttons (16 DMX ch. per fixture) and 192 total channels. Midi capable.



myDMX 3.0
DMX control software for MAC or PC. Design and control lightshows faster with all the great features.



AIRSTREAM WIFI PACK
Switch pack that control eight outlets (ON/OFF) wirelessly from your iPhone or iPad. 2.4 GHz wireless frequency. Programmable timer and built-in memory.



WU-419W
4-channel UHF wireless microphone system that includes four wireless microphones, four different color coded rings, and a wireless receive with volume & audio input for each mic.



Airwave Technologies specializes in making quality microphone & pro-audio products at affordable prices. An amazing warranty, extra features & attractive price points are what separates Airwave from the rest of the pack.

HEADSETS

HSD-SLIMLINE+SE - ultra lightweight professional Single Ear microphone that uses a European made omni-directional microphone capsule with clarity and high quality sound output. Excellent for speech and vocal use in a variety of applications. Available in Black or Tan.

- Bendable Boom for Comfortable use
- Flexible to Fit over the Ear of any User
- Excellent Voice / Sound Pickup
- Detachable Cable -Universal Connector use



HSD-SLIMLINE+DE - similar to above but features thumbscrews to fully adjust the width of the headset to give the user a custom perfect fit while the boom can be adjusted by panning up and down and telescoping in and out. Available in Black or Tan.



Both headsets are available with the following connectors:

- T3** - Airwave, AKG®, Audix®, Gemini®, Samson® **T4** - Shure® Compatible
S8 - Sennheiser® Compatible **AT** - Audio Technica® Compatible **EV** - Electro-Voice® Compatible

AT-CHOIR MICROPHONE

AT-CHOIR - is a 50" Professional Carbon-Fiber Boom Choir Condenser Microphone that comes with a detachable cable and 3 interchangeable microphone elements including an Omni, Cardioid and Hypercardioid versions. The AT-CHOIR also comes with built-in power circuitry and also includes an 8' XLR Cable, windscreens and clutch. (Mic stand not included) Phantom Power Required.

Uses include recording acoustic instruments, ambient room miking & choir & group overhead miking



IN-EAR MONITORING

AT-EAR-1001 - is a wireless in-ear monitoring system with outstanding sound characteristics. A corrected frequency response ensures optimal adaptation to auditory requirements. The AT-EAR-1001 features 100 possible frequencies, permitting 10 systems to be operated in parallel without intermodulation. Both mono and stereo operation are possible, making the system very flexible and suitable for many applications such as live acts, theater and voice.

- 100 digitally selectable UHF channels
- Up to 10 transmitters may be used in the same space
- Stereo or Mono switch on the rear of the transmitter
- External antenna can be front mounted
- Single or Dual Mix Capability
- Blue Back-lit LCD display
- XLR & 1/4" combo input connectors
- Built-in automatic limiter



AT-EAR-1001-Pro - has all the features of the AT-EAR-1001 with the addition of professional grade, US made piston driven ear buds.

AT-EAR-PAK-4 - is a Professional In-Ear-Monitor System with 4 Body Packs and 4 Sets of Earbuds designed to provide 4 users with the same excellent quality signal. A corrected frequency response ensures optimal adaptation to auditory requirements.



8 PACK SYSTEM 1 PRO

This is the perfect portable or stationary solution for wireless microphones. Also available in multiple configurations. System includes:

- 4 AT-4200 Dual Channel Wireless Systems
- 4 AT-4000 Series U42 Wireless Bodypacks
- Power Distribution Panel with Side-out LED's
- 4 AT-4000 Series U41 Handheld Microphones
- 4 HSD-SLIMLINE+SE Single Ear Mic Headsets
- Antenna Distribution System



WIRELESS SYSTEMS

Perception Wireless is a high-performance analog wireless mic system, which delivers brilliant sound and is easy to use. It is the optimum plug and play wireless solution for small stages, clubs, places of worship, hotels, and gyms. The preset frequency sets allow easy setup from single-channel applications to multichannel systems. Auto Setup Mode - plug and play solution for easy setup.

- 30MHz selection bandwidth
- Eight hours of operation from a single AA



WMS4500 Wireless is a reference multichannel wireless mic system providing high channel quantity, maximum reliability and easy setup. HiQnet network remote control and monitoring from PC via Harman System Architect™ software, Apple iPhone/iPad/iPod® or Soundcraft Vi consoles. Available in a handheld version as the **WMS4500 D7 Set**; or in an instrumental set as the **WMS4500 Instrumental Set**.

- Up to 70 simultaneous channels
- Auto Setup, Environment Scan, and Rehearsal functions



WMS470 Wireless is a professional analog mic system is cost-efficient, high-performance multichannel system. Up to 16 channels can be used simultaneously within the same frequency band. The pilot tone prevents the user from unexpected startup noise and it continuously sends transmitter data including low battery information to the receiver. Up to 48 simultaneous channels.

- Compatible w/WMS4000 accessories
- Up to 14 hours use with one AA Lithium battery



WMS420 Professional Wireless Microphone System provides a highly flexible as well as easy to use solution. The ultra high frequency system is set up within seconds and is equally suitable on stage as well as in locations where a single or multi channel solution is needed. The WMS420 wireless system consists of the SR420 stationary receiver, HT420 handheld transmitter and the PT420 pocket transmitter. The HT420 handheld transmitter is available with the patented D5 dynamic mic acoustic. This capsule guarantees maximum rejection against feedback, reduced handling noise and the famous AKG sound. Both transmitters are shipped with charging contacts that enable the use of rechargeable batteries. Moreover the transmitters offers eight hours of operation time from a single AA size battery, which dramatically reduces the operating costs in day-to-day use. The WMS420 is available in a handheld version (mentioned above) and also as a beltpack system as the 'Presenter Set' and as a headworn set as the 'Headworn Set'.



GOOSENECK MICROPHONES

99ers Series - come with only one flexible section, a rigid connection between gooseneck & capsule, and a XLR3 connector for joining the gooseneck to the cable. Choose between 12" or 20" goosenecks w/either cardioid or hypercardioid polar pattern, and a cardioid hanging module.

CGN 99 C/S (C/L) Cardioid Short/Cardioid Long

- Cardioid polar pattern
- 125° pickup angle
- 30 or 50 cm (12 or 20 in.) long
- Especially suited for inexperienced talkers

CGN 99 H/S (H/L) Hypercardioid Short/Hypercardioid Long

- Hypercardioid polar pattern
- 95° pickup angle
- 30 or 50 cm (12 or 20 in.) long
- For acoustically difficult environments

DGN 99/DGN 99 E PA mic with rugged, all-metal body

- Long life even in day-to-day usage
- Frequency response optimized for intelligibility



HANGING MICROPHONES

CHM 99 Condenser Hanging Microphone is a hanging microphone module with cardioid polar pattern, used to record music or speech in houses of worship, conference rooms or on theater stages. The CHM99 is available in black or white. A 10m (33ft) special cable that is treated specially to reduce twisting to a minimum and a spring steel hanging clamp for precise microphone alignment keeps the microphone securely in its position. The attached phantom power adapter connects to any standard mixer input with 9V to 52V power supply.

- Cardioid polar pattern
- 10 m (33 ft.) cable
- 125° pickup angle

Especially suited for choir recordings



For Crown branded microphones manufactured by AKG; see Crown pages!

ALESIS

Established in 1980, Alesis was founded on award winning industrial designs that allowed entry level musicians and recording artists to afford excellent professional studio recording products that were never affordable before. Alesis is committed to delivering the most innovative and inspiring professional audio gear for musicians, producers and engineers of all levels.

MIXERS & AUDIO INTERFACES



MultiMix 4 USB FX

- 4-channel mixer w/ stereo 1/4" inputs & stereo 1/4" outputs
- 1/4" line-level inputs for instruments
- 2-XLR mic ins with gains, high-pass filters & phantom power
- Built-in DSP effects
- **Dual-band EQ on XLR inputs**



MultiMix 8 USB FX

- Mic/Line/Guitar (XLR & 1/4" balanced) inputs
- DSP effects with footswitch bypass
- 3-band EQ per channel (2-band on 5-8)
- Plug-and-Play USB for Mac and PC



CORE 1

- 24-Bit USB Audio Interface
- 1 XLR+1/4" TRS combo input with gain knob
- Record up to 24-bit, 48 kHz audio into any software
- Guitar & Bass / Line level switch
- **Stereo headphone out with level control**



MultiMix 10 Wireless

- Rack-Mountable
- Bluetooth streaming with simple single-button pairing
- 4 high-gain mic/line preamps with inserts
- 2-band high and low shelving EQ on every channel
- Pre-fader and post-fader aux sends; stereo aux return



MultiMix 12R

- 2RU Ultra-affordable 12-channel mixer
- 8 mic/line (XLR and 1/4" balanced) inputs
- 2 stereo balanced 1/4" line inputs
- 2 aux sends, stereo aux return
- Pan control & peak indicator each channel



Control Hub

- MIDI interface with audio playback
- MIDI In & Out jacks connect to any MIDI gear
- Headphone output with dedicated volume control
- Assignable footswitch/pedal input
- USB-powered; no power supply required

MONITORS



M1Active 320 USB

- USB 1.1 audio interface
- 16-Bit / 44.1-48 kHz recording and playback
- Two 1/4" phone jacks inputs & 1/8" TRS input
- Two-way 3", Active, Magnetically shielded
- Available in White



Elevate 3

- Separate high- and low-frequency drivers
- High-fidelity amplification with 60-watt peak power
- Custom wooden cabinets
- Flexible I/O and worldwide power options
- Dedicated subwoofer output



Elevate 4

- Separate high- and low-frequency drivers
- 25W per channel output power; 50W total
- Elliptical tweeter waveguide optimizes dispersion
- 1" silk dome tweeter provides smooth, clear highs
- Dedicated subwoofer output

MISCELLANEOUS



iO Dock II

- Pro Audio Dock For iPad™, iPad 2™, iPad3™ & iPad4™
- Connect mics, instruments, speakers, headphones & controllers
- Works with Core Audio or Core MIDI apps
- Professional 24-bit converters built in
- 30-pin and Lightning connectors included
- Input channel gain controls and switchable phantom power



TransActive Wireless

- Powerful, portable, self-contained PA system
- Stream sound wirelessly from any Bluetooth device
- Works with iPad, iPhone, iPod™, Android devices, Mac & PC
- Up to 50-hour rechargeable battery or plug-in power
- Rugged construction, built-in wheels & a retractable handle
- Pole cup for standard 1-3/8" speaker stand



Q49

- 49-key keyboard controller
- Velocity-sensitive keys w/modulation & pitch-bend wheels
- Backlit Octave Up and Down buttons
- Bus powered via USB
- USB-MIDI and traditional MIDI
- Includes Ableton Live Lite Alesis & Xpand!2

All Alesis Products are available through BAI including all Percussion, Synth and Keyboard Products

ALLEN&HEATH



Qu-32

38in / 28out Digital Mixer

33 Motor Faders
7" Color Touchscreen
Qu-Drive Direct Multitrack Recording / Playback on USB drives

Qu-24

30in / 24out Digital Mixer

25 Motor Faders
5" Color Touchscreen
Qu-Drive Direct Multitrack Recording / Playback on USB drives

Qu-16

22in / 12out Digital mixer

19" Rack Mountable
5" Color Touchscreen
Qu-Drive Direct Multitrack Recording / Playback on USB drives

Qu-Pac

Portable 22in / 12out Digital Mixer

5" Color Touchscreen
Automatic Mic Mixer
Expandable up to 38 inputs via dSNAKE™

Qu-SB

Portable 18in / 14out Digital Mixer

Qu-Pad iPad App for all live mixing controls
Up to 11 Monitor Mixes (4 mono + 7 stereo)
Qu-Drive direct Multitrack Recording to USB



ZED

ZED-6 - Compact 6 Input Analog Mixer

ZED-6FX - Compact 6 Input Analog Mixer with FX

ZEDi-8 - Hybrid Compact Mixer / USB Interface

ZEDi-10 - Hybrid Compact Mixer / USB Interface

ZEDi-10FX - Hybrid Compact Mixer / 4x4 USB Interface with FX

ZED-10 - Compact analog mixer with 4 mic/line and 2 stereo inputs

ZED-10FX - Compact analog mixer with 4 mic/line and 2 stereo inputs, with FX

ZED60-10FX - Compact analog mixer with 4 mic/line and 2 stereo inputs, with 60mm faders

ZED60-14FX - Compact analog mixer with 8 mic/line and 2 stereo inputs, with 60mm faders

ZED-12FX - Analog mixer with 6 mic/line and 3 stereo inputs, with FX

ZED-14 - Analog mixer with 6 mic/line and 3 stereo inputs

ZED-16FX - Analog mixer with 10 mic/line and 3 stereo inputs, with FX

ZED-18 - Analog mixer with 10 mic/line and 4 stereo inputs



Xone:PX5

DJ Performance Mixer

4+1 Channels
USB Soundcard
Internal Xone:FX



Xone:92

Professional 6 Channel Club / DJ Mixer

2 independent stereo mix outputs
2 aux sends for external FX.
VCF system – 2 independent filters



Xone:DB4

Professional Digital DJ FX Mixer

Four Stereo Channels
Quad FX Core
Trimodal EQ System



Xone:DB2

Professional Digital DJ FX Mixer

Four Stereo Channels
Twin Chainable FX Engines
Trimodal EQ System



Xone:43C

4+1 Channel DJ Mixer with Soundcard

16 channel 96kHz 24bit soundcard
Serato DJ and DVS Upgrade Ready
X:LINK for connection to Xone:K series controllers



Xone:43

4+1 Channel Analogue DJ Mixer

VCF Filter System
3-band EQ
External FX Loop



Xone:23C

2+2 Channel DJ Mixer + Internal Soundcard

VCF Filter system
4 Stereo Channel USB Soundcard
MixVibes Cross LE Software Included



Xone:23

2+2 Channel DJ Mixer

VCF Filter system
3-band true total kill EQ
External FX loop



Xone:K2

DJ MIDI Controller

Universal Controller for any DJ Software
52 Hardware Controls
171 MIDI Commands
Across 3 Layers





Anchor Audio has a portable sound system for just about any application - small crowds, large ones, music and speech, indoor and out. Anchor systems are easy to use, simple to setup and simple to pack up and GO!

Below are some of the most popular systems. Please call BAI Distribution for a complete listing.

Bigfoot



The Bigfoot Line Array is the newest, loudest, and most powerful portable sound system on the market. Designed to cover a football field, this thunderous battery powered system is up to any challenge. With a line array consisting of five 8" neodymium speakers and one high efficiency neodymium compression driver, the Bigfoot is ideal for large events and easily sets up in seconds.

Beacon



The Beacon is a battery-powered, portable line array sound system like no other on the market! The line array tower unfolds in less than a minute and contains eight 4 inch neodymium speakers with an additional three 8 inch neodymium subwoofers in the base. It stands about 6 feet tall and has a clean, full range of sound that spreads evenly over any large crowd.

Liberty



Anchor Audio introduced the world to professional portable sound systems, and its flagship speaker, the "Liberty," became the product to define the industry. This speaker provides crystal clear voice amplification and is also great for music. It is ideal for school functions, outdoor sporting events, political rallies, ceremonies and military events.

Go Getter



The Go Getter features 109 dB of crystal clear sound and is ideal for both voice and background music. It can be used indoors or outdoors and can reach crowds of up to 500+ people. Weighing in at just 20 pounds, the Go Getter is easy to transport and set up on a speaker stand. It's not just a speaker - it's a complete sound system. Simply connect a media player or microphone, and the system is ready to go.

MegaVox Pro



Just grab it and go! With the MegaVox Pro, you're ready for any situation. It's lightweight, loud and easy to carry. Thousands report that it's the most reliable PA system on the market. Emergency responders like its signal alert siren, wired microphone and convenient shoulder strap. Coaches, band directors and auctioneers appreciate the flexibility of the AC/DC operation and the range of the wireless microphones.

MiniVox Lite



The MiniVox Lite speaker monitor is the smallest, most powerful system on the market. The MiniVox Lite is battery-powered, so you can take it anywhere. Just switch it on, and you are ready for any indoor or outdoor assemblies. You can also connect your iPod, MP3 player, or CD Player to the MiniVox-Lite. It is perfect for any school event, special event, classroom, or cheer squad.

AN-1000X+



The AN-1000X+ is the most versatile powered speaker monitor on the market. You can add it to an A/V rack setup, use it as a studio monitor, install it in a trade show booth, or place it in the Captain's quarters on a US Navy warship to monitor activities in the intelligence room.

ProLink



Use the ProLink for houses of worship, high school theater, event coordination and production, broadcast studios, small theaters, and more! The ProLink 500 is a digital wireless intercom system that allows full duplex communication among four users simultaneously with the option of an unlimited number of listen-only beltacks.

Mission-Critical Equipment...Today's advanced commercial/residential fire, alarm, security and telecommunication systems are more sophisticated than ever before. In a nanosecond, transients can disrupt, disable and ruin your mission-critical equipment. It's why companies turn to ASCO Power Technologies Surge Protection for their line of surge suppression and filtering products to protect sensitive equipment from excessive maintenance costs, damage and costly downtime.

ASCO Model 175/Edco PC642 Series (Zone/Loop/Data)

The Edco PC642 surge suppressor is a two-pair (four-wire) module implementing three-stage hybrid technology. This module addresses over-voltage transients with gas tubes and silicon avalanche components. In addition, sneak and fault currents are mitigated with resettable fuses (PTCs). The PTCs increase resistance in several orders of magnitude when over-currents exceed safe levels and resume a normal state when over-currents are removed. The ability to self-restore in this manner significantly increases suppressor performance and survivability.



ASCO Model 172/Edco PHC Series (Two-Pair Signaling Circuit Protector)

The Edco PHC Series is designed to protect two pairs of wires specifically for alarm and security systems where operating currents can be as high as 5 Amps. Electrically, the Edco PHC Series is a rugged series hybrid implementing a staged complement of MOVs, copper wound inductors and Silicon Avalanche Diodes. This design reduces series resistance to 0.2 Ohms per pair. These products are intended to mate with an Edco PCB1B gold-plated female terminal connector.



ASCO Model 252/Edco HSP121BT-1RU Series (Advanced Three-Stage Hybrid Protector)

The Edco HSP121BT-1RU is an advanced three-stage hybrid, solid-state power line protector. Features such as noise filtering, common mode and normal mode suppression, nanosecond reaction time, power line tracking, and compression screw terminations make the Edco HSP121BT-1RU an excellent choice in commercial and industrial applications. The Edco HSP121BT-1RU offers a replaceable fuse designed to remove the load (protected equipment) from the line if the unit is either overloaded or the internal protection fails. This feature prevents surges from entering the equipment through a failed protector.



ASCO Model 237/PowerSure FAS-120AC (Medium Duty 120VAC - Single Phase)

The PowerSure FAS-120AC surge suppressor is designed to protect AC distribution panel circuits or 120V power supplies feeding sensitive electronic equipment. Electrically the unit incorporates MOV and thermal fusing technology. This device is designed to be installed in parallel on standard single phase 120VAC (L,N,G) circuits. Installation can be close-nipple up to a distribution panel/circuit or hardwired in parallel up to power supply input terminal screws. Be sure to dress leads as short as possible.



ASCO Model 151/Edco FAS-1 and Edco FAS-2 (Multi-Stage, Single-Pair/Two-Pair Suppressors for High Exposure Applications)

The Edco FAS-1 and Edco FAS-2 are multi-stage single-pair or two-pair surge suppressors designed for high exposure applications. These products were specifically designed to meet multiple low voltage protection applications in the fire and security industries.



ASCO Model 130/Edco PB Series (Advanced Technology Intercom/Speaker Punch Block Protection)

The Edco PB modules are solid-state protectors for Intercom Extension Pairs. As a new alternative to the "OPX", the standard Edco intercom protector, the PB adds fusing and a new component layout. These hybrid protectors are intended to be used in conjunction with the **MGB ground rail** and a standard **MI-50 punch down block**. The PB modules feature solid-state resettable fuses (PTCs) between the protected equipment and the over-voltage clamping components. This unique design prevents problems with "All-Call" in the event of catastrophic protector failure.



ASCO Model 131/132/Edco OPX Series (Intercom/Speaker Punch Block)

The Edco OPX surge protectors are specifically designed for medium exposure applications. The protectors can be used on pairs inside a building or outside the building in conduit up to 500 feet. These protections are intended to be used in conjunction with the Edco MGB Ground Rail and a standard MI-50 Punch Down Block.





Ashly digiMIX
Free Remote Control App
for iPad®



All Products Backed by
5-Year Warranty

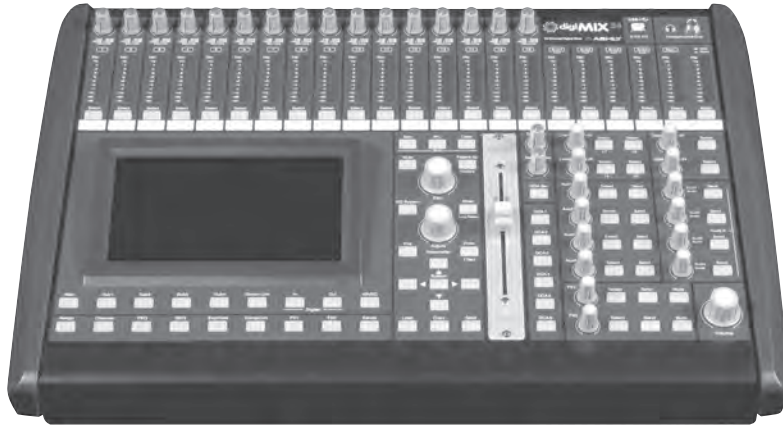

24 Channel Digital Mixer, Live Control Surface, 7" Touchscreen, Motorized Fader, Intelligent Meters Bridge, iPad Remote Control, EZ-Mode



Take complete control over your performance space. Whether you're mixing live bands, a high school musical, a worship service, or recording in a project studio, there are many applications where digiMIX24 feels right at home.

With its traditional feel, the Live Control Surface allows optimum control with real knobs and a live fader when selecting important functions, while offering conveniences of a responsive touchscreen, USB interfacing, and companion Apple iPad® App.

With two performance modes: 24x8 AUX channels or 24 x 4 AUX x 4 SUB-group channels and 6x DCA fader groups, you have the flexibility to accommodate instruments, voices and signals from various sources. Also equipped with Class-A mic pre's designed exclusively by Ashly, so you know great sound is always a standard feature!

Use digiMIX24 as a command center to integrate live performance through an entire venue using the optional Dante™ module. Choose the optional 32-channel USB I/O for home studio or recording of live events. Non-technical operators will appreciate the E-Z Mode feature!

- 24 Total Inputs x 14 Mix Buses
- 16 Discrete Ashly Class-A Mic/Line Combo Inputs
- 24 x 8 Aux Channels or 24 x 4 Aux/4 Sub
- Stereo Solo any Channels or Mix Buses
- 8 Separate Aux Outputs, 8 Separate Channel Inserts
- 33 Channels of DSP Processing: Expander/Gate, Comp/Limiter, PEQ, GEQ
- 2 Stereo FX Processors: 12 Digital FX: Reverb, Delay, Chorus & more
- Scene/Preset FX/GEQ: Save, Load, Copy
- Individual channel delays in 0.2ms increments, up to 300ms for easy sync of video and audio playback



4-Ch. / 2-Ch. Configurations, 3000 to 75 Watts per Ch., Network-Ready, Ashly EMS™ (Energy Management System)



Ashly's line of power multi-mode amplifiers are available in three product families (nX, nXe, nXp).

NX's are designed to meet the needs of the most demanding fixed installation and live sound applications. Available in 2 or 4-channel models,

output ratings are 3,000W/channel, 1,500W, 800W, 400W, 150W (1U) or 75W (1U). Rear panel dip switches allow you to choose Low-Z (2/4/8 Ohm) or 70V output on each channel. The nX is the base-level power amplifier. The nXe series adds Ethernet control, event scheduling, preset recall, AUX outputs and the ability to add a Dante™ or CobraNet™ network audio card.

The nXp amplifiers have all of the features of the nXe amps plus built-in Protea™ DSP and precision impedance monitoring. The NX amplifier family features energy-efficient Class-D design and switch mode power supplies. NX also features our exclusive Ashly EMS™ (Energy Management System).



ASHLY

Design a Customized Remote Control with any Network-Ready Amplifier with **Ashly Remote for iPad®**

All Products Backed by our Industry-Leading **5-Year Warranty**



8-Ch. / 4-Ch. / 2-Ch. Configurations, 250 to 125 Watts per Ch., Network-Ready, 70V Version Available, 8x8 Matrix Processing, On-board Protea™ DSP



Pema™ (Protea-Equipped Media Amplifier) has a feature set that allows Systems Integrators to replace a rack of amplifiers and signal processing equipment with a single 2U unit in many scenarios. The combination of a 4 or 8-channel amplifier and 8-in x 8-out sophisticated matrix mixing brings a new level of technology and innovation to your installation.

Dante® and CobraNet® digital I/Os are fully supported. Systems designers can select either 125W or 250W output units that are a perfect fit for your install based on ceiling height, loudspeaker sensitivity and ceiling speaker density. Pema is a restaurant or retail store-in-a-box with ambient noise control, automatic feedback suppression, event scheduling, a dedicated TEL/PBX input, dual RCA inputs and paging microphone inputs.

It's a liturgical church-in-a-box with gain sharing automatic microphone mixing, auto feedback suppression and a maximum of 8 wired or wireless microphone inputs. For courtroom projects, a single Pema offers amplification, an auto mixer, auto feedback suppression, AUX outputs for recording and a built-in pink noise generator for masking sidebar discussions. *One Pema™ Really Can Do It All.*



8-Ch. / 4-Ch. Configurations, 1200 to 250 Watts per Ch., Network-Ready, 70V Version Available, Protea™ DSP Optional



The NE (Network-Enabled) Series Amplifiers are designed around an energy efficient Class-D platform with a switching power supply. This complete line offers ease of use, setup and control using standard 10/100 Ethernet protocol and Protea™ NE Software.

No special outboard control units are needed. NE Series Amplifiers are offered in separate platforms: the standard network amplifier or a network amplifier with an on-board Protea™ DSP Processor. Each can be customized for any installation by adding your choice of AES3 inputs, mic pre inputs (models with Protea only) Dante® or CobraNet®. All models include balanced analog

inputs, bridge mono mode, selectable 8Hz 12dB/oct or 400Hz 6dB/oct hi-pass filter, input sensitivity switch, full Ethernet control using Protea™ ne Software, remote standby for power up, and DC remote level control using an Ashly WR-1 or equivalent. NE Amplifiers are a great value for any install. *Simplify Integration with NE.*



2-Ch. Configurations, 5000 to 2000 Watts per Ch., 2 Ohms Stable

The popular KLR Series are high-performance amplifiers that are the ideal choice for high-output speaker systems, line arrays, dual 18" subwoofers and much more. If you think you need to use an expensive, European amplifier to get a clean, stable, quiet amplifier—think again.

Lightweight for their class, all KLRs are designed in standard 2RU enclosures. KLRs are quiet with signal-to-noise ratio ratings from >108 dB to >110 dB across all models. The KLR amplifiers are rock solid down to 2 Ohms. The KLR-5000 is rated at 2,500W/channel @ 2 Ohms, while

the KLR-4000 delivers 2,000W. The KLR-3200 is rated at 1,600W @ 2 Ohms. The KLR-2000 comes in at 1,000W. Check out the KLR-3200 which will deliver 800W into a 70V line—a great choice when you need to value engineer a distributed sound system.



24 Channels of Matrix Processing, Protea™ DSP

The ne24.24M uses modular expansion cards to provide up to 24-channels of audio matrixing and processing. When your install requires input/output matrixing with signal processing it doesn't get much easier than programming your channels using Protea™ ne Software

on your PC. The base unit offers a 4-input/4-output configuration. Each input and output expansion card has an individual DSP processor allowing you to expand the total input or output 4 channels of DSP processing at a time. These cards are easily installed in the field without

the need to reprogram the device. Matrixing allows you to route any input to any output and control individual levels once they have been assigned. Fixed path architecture and extensive processing power per channel will reduce set up time of your system.

Strategy Series® AAPHD Mixer Amplifiers

The AtlasIED Strategy Series® AAPHD Mixer Amplifiers were designed to meet today's demanding requirements for commercial and industrial paging and BGM applications. The AAPHD features a unique, patent-pending automatic system test using the front panel "Push Here Diagnostic" button. This internal circuitry is designed to check the connected loudspeaker lines for wiring and impedance errors.

AA30PHD / AA50PHD - A 3 input, 35 Watt / 50 Watt mixer amplifier with Automatic System Test (PHD) designed for distributed business paging and background music (BGM) systems, small to medium speech privacy systems, and in applications where music on hold (MOH) plus paging is required.



AA100PHD - A 4 input, 100 Watt mixer amplifier with Automatic System Test (PHD) designed for distributed business paging and background music (BGM) systems, small to medium speech privacy systems, and in applications where music on hold (MOH) plus paging is required.



AA200PHD / AA400PHD - A 6 input, 200 Watt / 400 Watt mixer amplifier with Automatic System Test (PHD) designed for distributed business paging and background music (BGM) systems, medium to large speech privacy systems, and in applications where music on hold (MOH) plus paging is required.



The WPD-RISRL is a decora style wall plate that is designed for use with the AA50PHD, AA100PHD, AA200PHD, or AA400PHD mixer amplifiers to use the remote input selection (RIS) feature. The WPD-RISRL features an audio source slide selector as well as a source volume control. The unit includes an LED indicator to indicate which source is selected and if it is active. The unit fits in a single gang electrical outlet and uses an 8-conductor interface connection that includes a single 4 position removable Phoenix connector and dual 2 position Phoenix style connectors.



DPA Series Amplifiers

AtlasIED designed the DPA Series to be an "everyday use" amplifier. Units can be dynamically configured in three different amplification arrangements to meet the design requirements of any installation. The unit is factory preconfigured in 70V / 100V mode. If the design requires four channels of low impedance amplification, the amplifier can be configured as 4-channel model with either 4Ω or 8Ω load impedances. Many system designs require both low and high impedance amplification. This unit can be configured to deliver 70V / 100V for a paging / background system on a single channel plus two additional 4/8-Ohm amplifier channels for a foreground stereo application.

Each DPA Series amplifier provides network setup and control making it an affordable "game changer" in the commercial audio amplification world. Each DPA Series amplifier can be connected to a local area network (LAN) and be controlled remotely. Access to the GUI (Graphical User Interface) is accomplished via any computer, tablet or mobile device using a web browser. It does not require a dedicated software application to program and operate the amplifier. Each channel has an assortment of DSP tools including level controls, EQ's, limiters, high & low pass filters, and delay to provide flexibility for a range of applications.

- DPA2402 - 2 x 1200-Watts @ 70.7V; 4 x 500-Watts @ 4Ω
- DPA1202 - 2 x 600-Watts @ 70.7V; 4 x 300-Watts @ 4Ω
- DPA602 - 2 x 300-Watts @ 70.7V; 4 x 150-Watts @ 4Ω
- DPA404 - 4 x 100-Watts @ 70.7V; 4 x 50-Watts @ 4Ω (Available Q2 2017)
- DPA804 - 4 x 200-Watts @ 70.7V; 4 x 100-Watts @ 4Ω (Available Q2 2017)



DPA102PM - A 100 Watt X 2 @ 8Ω dual output amplifier that includes a patent pending through hole chassis design that makes it convenient to use with ceiling mounted video projectors.

DPA-DAC4 - An accessory card designed to work in conjunction with DPA Series 4-channel amplifiers. The DPA-DAC4 is a 4-input Dante™ receiver that features digital audio transportation over standard IP networks. The DPA Series 4-channel amplifiers come standard with four balanced line inputs and an accessory card slot to add an additional 4-inputs, giving the amplifier a total of 8-inputs. For use with DPA2402, DPA1202, DPA602, DPA404, or DPA804.



DPA102-PM

DPA-AMIX - Accessory card that provides four additional analog input channels expanding to eight total input channels. Each input channel can be mixed, processed, and routed to any amplifier's output channels. For use with DPA2402, DPA1202, DPA602, DPA404, or DPA804.



DPA-DAC4



DPA-AMIX

HPA Series Amplifiers

The HPA Series is AtlasIED's line of high-output power amplifiers. These workhorse amplifiers provide worry-free 24/7 operation for any application type or load condition. Each model has two-channels of output that can be configured in 70V, 8Ω, 4Ω, or 2Ω operation. HPA Series models meet Energy Star with less than 1W of power consumption in standby mode. Features include remote turn-on, fault reporting, and a universal power supply that auto senses AC current at both 120VAC and 220VAC enabling global use. An optional Dante™ Card is available for audio systems requiring digital audio networking.

Models Available

HPA4202 - 2 x 2100-Watts @ 70.7V

HPA2602 - 2 x 1300-Watts @ 70.7V



HPA4202

Global Commercial Mixer and Power Amplifiers

Small, compact, and engineered for reliability, the AtlasIED MA & PA amplifiers are the perfect choice for distributed business paging and background music (BGM) systems as well as small to medium speech privacy systems. They provide 40W (PA40G / MA40G) or 60W (PA60G / MA60G) into a 70.7V/100V line. The PA Series have balanced line level inputs via phoenix connector and a summing unbalanced RCA input. The MA Series have three total inputs including a balanced mic/line input featuring phantom power and variable mute sensitivity control as well as two unbalanced, summing line level inputs. Additional features include Removable Level Controls with "set it and forget it" security covers, contact closure mute terminals, and a global (100VAC-240VAC) power supply. These amplifiers are part of a new line from AtlasIED that are designed from the ground up and include the important features professional installation personnel require to meet or exceed their customer's expectations.



PA40G / PA60G



MA40G / MA60G

BlueBridge® DSP

The BlueBridge® family of products feature Digital Signal Processors with open architecture, drag and drop software that makes them incredibly easy to use. Each model utilizes high quality THAT® microphone preamps and 24 Bit D to A converters to deliver ultra-low noise floor while still maintaining a smooth sound that satisfies the needs of demanding clients, with the flexibility and control a system designer requires. BlueBridge® models use a 40 Bit Floating Point DSP engine to prevent digital clipping that commonly occurs in other DSP products and to obtain maximum speed and power to process advanced algorithms in complex system designs. BlueBridge® DSP units can operate on any network while the optional control accessories require a PoE Network. When connected to a network, each BlueBridge® processor on the network will be auto recognized and controllable.



The BlueBridge® DSP wall controllers can be both rack and wall mounted. These accessories extend the features of the BlueBridge® platform allowing for even greater installation flexibility and integration.

- TSD-BB22 - 2 Input, 2 Output Digital Signal Processor
- TSD-BB44 - 4 Input, 4 Output Digital Signal Processor
- BB-88 - 8 Input, 8 Output Digital Signal Processor
- BB-816 - 8 Input, 16 Output Digital Signal Processor
- BB-168 - 16 Input, 8 Output Digital Signal Processor
- BB-1616 - 16 Input, 16 Output Digital Signal Processor
- BB-88DT - 8 Input, 8 Output Digital Signal Processor w/ Dante™
- BB-816DT - 8 Input, 16 Output Digital Signal Processor w/ Dante™
- BB-168DT - 16 Input, 8 Output Digital Signal Processor w/ Dante™
- BB-1616DT - 16 Input, 16 Output Digital Signal Processor w/ Dante™
- BB-168AEDT - 16 Input, 8 Output Digital Signal Processor w/ AEC and Dante™
- BB-EB1616DT - 16 Input, 16 Output Expansion w/ Dante™
- BB-SM1 - BlueBridge® System Manager

- BBWP-S4W(B) - Wall Plate, 4 Buttons
- BBWP-S8W(B) - Wall Plate, 8 Buttons
- BBWP-K1W(B) - Wall Plate, 1 Knob
- BBWP-K4W(B) - Wall Plate, 4 Knobs, White
- BBWP-S4K1W(B) - Wall Plate, 4 Buttons & 1 Knob, White
- BBWP-TOUCH7W(B) - Wall Touch Panel, 7" White



Strategy Series® Ceiling Loudspeakers

Strategy III Series® coaxial in-ceiling loudspeaker packages provide a new innovative mounting system, easy installation, high performance, and UL Plenum rating. Three years of development and hundreds of prototypes has produced the next generation in-ceiling loudspeaker mounting solution. Our patent-pending Safety First Mounting System (SFMS) ensures the loudspeaker stays secured to the ceiling and does not require a tool to tighten the dog leg style mounting tabs. No more over-torqued mounts cracked by tools. No more rusted drywall screws. Eliminate both of these primary contributors that lead to falling loudspeakers. All models include the popular AtlasIED “C-Ring / V-Rail” mounting system for quick installation into drop tile acoustic ceilings and existing construction drywall.

Sonically, the Strategy III Series improves on the already high fidelity sound of the Strategy II Series loudspeakers. The 6.5” and 4.5” models utilize a tweeter bridge rather than a pole piece mounted tweeter. This improves the waveguide and results in greater dispersion allowing each loudspeaker to cover more area. Additionally, all models are safety listed to UL2043 and UL1480 for BOTH general signaling as well as fire protective signaling when used with impedance monitoring control equipment.

FAP33T-W 3” 16-Watt @ 70.7V / 100V
 Power Rating: 25-Watts @ 8Ω
 Power Taps: 2, 4, 8, & 16 Watts
 Frequency Response: 85Hz – 12kHz
 Sensitivity (1W/1m): 89.7dB
 Dispersion: 135°



FAP43T-W 4.5” 32-Watt @ 70.7V / 100V
 Power Rating: 50-Watts @ 8Ω
 Power Taps: 4, 8, 16, & 32 Watts
 Frequency Response: 60Hz – 20kHz
 Sensitivity (1W/1m): 90dB
 Dispersion: 110°



FAP63T-W 6.5” 32-Watt @ 70.7V / 100V
 Power Rating: 75-Watts @ 8Ω
 Power Taps: 4, 8, 16, & 32 Watts
 Frequency Response: 50Hz – 20kHz
 Sensitivity (1W/1m): 90dB
 Dispersion: 110°

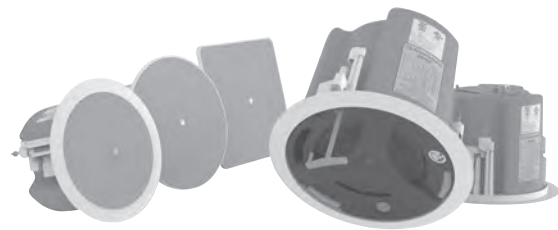

Edgeless Grille Options

AtlasIED offers edgeless grille options in both round and square shape with both black and white color options available for installations requiring a cleaner aesthetic.

Edgeless Grille Packaged Parts

FAP33T-WEGR	FAP43T-WEGR	FAP63T-WEGR
FAP33T-BEGR	FAP43T-BEGR	FAP63T-BEGR
FAP33T-WEGS	FAP43T-WEGS	FAP63T-WEGS
FAP33T-BEGS	FAP43T-BEGS	FAP63T-BEGS

The Strategy Series II premium 70.7/100V tuned & ported coaxial ceiling systems deliver full range high-fidelity sound reproduction in an easy-to-install system. Compact profile enclosures and wide dispersion make the FAP42T and FAP62T a perfect choice for low to medium ceilings and the FAP82T for higher ceilings. The FAP40T features a tile bridge and all other FAP series speakers feature the exclusive AtlasIED C Ring/V Rail mounting system for easy installation in drop tile or sheetrock ceilings. Common features of all FAP series loudspeakers include extended low-frequency response tuned and ported cabinets, front tap selector switch, unique “trap door” input section for rigid or flex through conduit runs and 4-pole Phoenix connector for easy daisy chaining between loudspeakers. FAP series feature an 8Ω transformer bypass setting. **Note:** The FAP40T does not have all of the standard features as the rest of the FAP models.

FAP40T(-B) - 4” 16-Watt @ 70.7V / 100V
 Power Rating: 16-Watts @ 8Ω
 Power Taps: 1, 2, 4, 8, & 16 Watts
 Frequency Response: 100Hz – 12kHz (±3dB)
 Sensitivity (1W/1m): 87dB
 Dispersion: 110°
 Available in Black or White Finish



FAP62T - 6” 32-Watt @ 70.7V / 100V
 Power Rating: 32 Watts @ 8Ω
 Power Taps: 2, 4, 8, 16, & 32 Watts
 Frequency Response: 63Hz – 20kHz (±7dB)
 Sensitivity (1W/1m): 88dB
 Dispersion: 110°

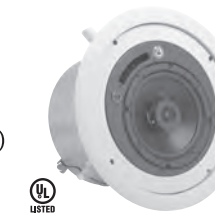

FAP6260T - 6” 60-Watt @ 70.7V / 100V
 Power Rating: 60 Watts @ 8Ω
 Power Taps: 1.9, 3.8, 7.5, 15, 30, & 60 Watts
 Frequency Response: 63Hz – 15kHz (±7dB)
 Sensitivity (1W/1m): 88dB
 Dispersion: 60°

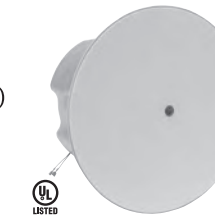

FAP42T / FAP42TC - 4” 16-Watt @ 70.7V / 100V
 Power Rating: 16-Watts @ 8Ω
 Power Taps: 1, 2, 4, 8, & 16 Watts
 Frequency Response: 75Hz – 20kHz (±3dB)
 Sensitivity (1W/1m): 88dB
 Dispersion: 130°
 “TC” Version is shallow-depth (4”)
 UL2043 Certified Model Also Available
 FAP42T Available in Black or White



FAP82T - 8” 60-Watt @ 70.7V / 100V
 Power Rating: 60-Watts @ 8Ω
 Power Taps: 1.9, 3.8, 7.5, 15, 30, & 60 Watts
 Frequency Response: 55Hz – 20kHz (±3dB)
 Sensitivity (1W/1M): 90dB
 Dispersion: 100°



FAPSUB - 8” 60-Watt @ 70.7V / 100V
 Power Rating: 60 Watts @ 8Ω
 Power Taps: 1.9, 3.8, 7.5, 15, 30, & 60 Watts
 Frequency Response: 45Hz – 120Hz (±10dB)
 Sensitivity (1W/1m): 89dB



Surface Mount Loudspeaker Systems

The Atlas SM Series expands on the industry standard Strategy Series® loudspeaker line with weather-resistant, surface-mount loudspeaker models. Models include the Strategy Series SM42T (25/70.7/100V) 4", two-way loudspeaker system, Strategy Series SM52T (25/70.7/100V) 5 1/4", two-way loudspeaker system and the Strategy Series SM82T (25/70.7/100V) 8" two-way loudspeaker system. System components consist of highly-efficient woofer sections and titanium dome high frequency devices. The Strategy Series surface mount weather resistant loudspeakers, models SM42T, SM52T, and SM82T, are constructed of weather-resistant materials: UV-resistant talc impregnated, polypropylene injection molded cabinets, Hycone® treated woofer cones, powder coated aluminum grill and all brass hardware. Strategy Series surface mount compression driver loudspeakers, models SM8XCT (8") and SM12CXT (12"), are coaxial type cabinets featuring high-efficiency and pattern control in a new, highly versatile enclosure system designed to fit a wide variety of applications. The multi-angle enclosure features multiple 1/4"-20 inserts providing fly points for a variety of mounting configurations; it can also be used as a dual angle floor monitor or stand mounted. Available in White (-WH) or Black (-B). All models also include an 8Ω bypass.



Model	Power Rating 8Ω	Sensitivity	70.7V Taps
SM42T	16W (Transformer Limited)	88dB	2, 4, 8, & 16
SM52T	30W (Transformer Limited)	90dB	.94, 1.9, 3.7, 7.5, 15, & 30
SM82T	60W (Transformer Limited)	92dB	1.9, 3.8, 7.5, 15, 30, & 60
SM8CXT	60W (Transformer Limited)	92dB	7.5, 15, 30, & 60
SM12CXT	60W (Transformer Limited)	99dB	7.5, 15, 30, & 60

The PM Series consists of pendant mount downfiring loudspeaker systems that provide natural sounding, accurate coverage while retaining impressive full range frequency response for both music and paging applications. Available in 4" 2-way model as PM4FA-B and PM4FA-W (Black/White) or as an 8" 2-way models PM8FA-B or PM8FA-W, high-efficiency models PM8GD-B or PM8GD-W, or high-performance models PM8CX-B or PM8CX-W.

Model	Power Rating 8Ω	Sensitivity	70.7V Taps
PM4FA-B(-WH)	25-Watts	88dB	1, 2, 4, 8, & 16
PM8FA-B(-WH)	70-Watts	90dB	1.9, 3.8, 7.5, 15, 30, & 60
PM8GD-B(-WH)	15-Watts	105dB	1, 2, 4, & 8
PM8CX-B(-WH)	150-Watts	92dB	7.5, 15, 30, & 60
PM8SUB-B(-WH)	150-Watts	92dB	7.5, 15, 30, & 60

Line Column Loudspeakers

The ALA line array loudspeaker system delivers exceptional performance and contemporary styling for applications requiring excellent speech intelligibility and minimal acoustical impact. These loudspeakers are constructed with an extruded aluminum housing that makes them lightweight and easy to install with contemporary aesthetics. ALA's new transducer configuration accurately reproduces sound to the listener. It incorporates tightly-packed, high-frequency transducers and full-range drivers for full sound spectrum coverage. A dual-purpose integrated pole mount bracket enables the array to be wall mounted for fixed installations or used in portable applications coupled with an A-Line subwoofer. Models are available in either a black or neutral metallic finish.

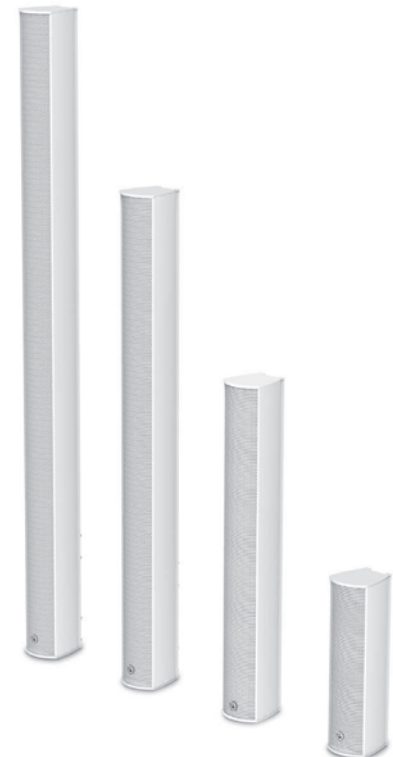

Model	ALA20T(-B)	ALA15T(-B)	ALA10T(-B)	ALA5T(-B)
70.7V Taps	7.5, 15, 30, & 60	7.5, 15, 30, & 60	7.5, 15, 30, & 60	7.5, 15, 30, & 60
8Ω Power	500-Watts	250-Watts	200-Watts	125-Watts
Sensitivity (1W/1m)	97dB	96dB	96dB	92dB
Dispersion	135 x 40	135 x 40	135 x 40	135 x 45
Frequency Response	90Hz - 20kHz	90Hz - 20kHz	125Hz - 20kHz	125Hz - 20kHz

Pole mount and wall mount brackets and accessories are available, call for more information.

Can also be used in portable applications in conjunction with AtlasIED subwoofers. Active subwoofers include integrated amplifier capable of powering itself and a full range ALA loudspeaker. Powered subwoofer can also be used with passive subwoofer and second ALA loudspeaker for use in stereo applications. AtlasIED subwoofers are available in 12", 15", and 18" sizes with integrated amplification and DSP technology.

8" Loudspeaker / Transformer / Baffle Packages

8" Loudspeaker Packages - Affordable, Attractive, Convenient

AtlasIED offers several cost-effective, 8" speaker packages. The SD72W package includes a 10 oz. magnet, dual cone loudspeaker with a 5-watt dual voltage transformer fully assembled onto an attractive CRS white powder coated grille. This grille includes welded speaker mounting studs making for a more discrete installed appearance. The SD72WV includes a 50Ω baffle mounted potentiometer for applications requiring volume controls. The GD87W package offers the contractor an upscale package featuring a GD87 coaxial 8" loudspeaker. The GD87 offers similar sonic qualities to the Atlas C803A speaker. The package is matched with a 8 watt 70.7V transformer with primary taps at 1,2,4 & 8 watts. Each SD and GD speaker package is individually packaged for stock and delivery convenience.

Model	Size	Description
GD87W	8"	Highest quality package featuring GD87 coaxial with 8W 70.7V transformer and 62-8 grille.
SD72W	8"	Dual cone speaker with 5W 70.7V transformer and white baffle.
SD72WV	8"	Dual cone speaker with 5W 70.7V transformer, white baffle, and baffle mounted volume control.

Complete kit packages are also available for ordering convenience (masterpack quantities may apply).

Model	Contents
SD72W-KIT	(1) SD72W, (1) CS95-8 enclosure, and (1) 81-8R tile bridge
SD72W-KIT4	(4) SD72W, (4) CS95-8 enclosures, (4) 81-8R tile bridges, (1) 100' spool of 18-2 speaker wire
SD72WV-KIT	(1) SD72WV, (1) CS95-8 enclosure, and (1) 81-8R tile bridge

Packages include everything necessary to install a loudspeaker in a UL Plenum listed environment.

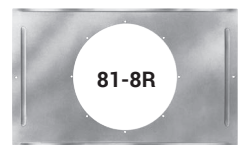
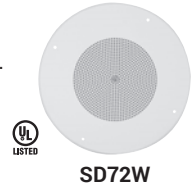

Tile Bridge Ceiling Loudspeakers

AtlasIED is pleased to offer drop tile ceiling loudspeaker packages that offer simplified installation and aesthetics that allow them to blend perfectly into most drop tile ceilings. These models incorporate high efficiency drivers with factory mounted transformers and an enclosure attached to a metal tile bridge in varying sizes offering flexibility for placement in retail, healthcare, transportation, hospitality, and other facilities using drop tile ceilings.

Model	Panel Size	Speaker
DT22	2' x 2'	8" Dual Cone
DT21	1' x 2'	8" Dual Cone
DT6	6" x 2'	3" Cone Type

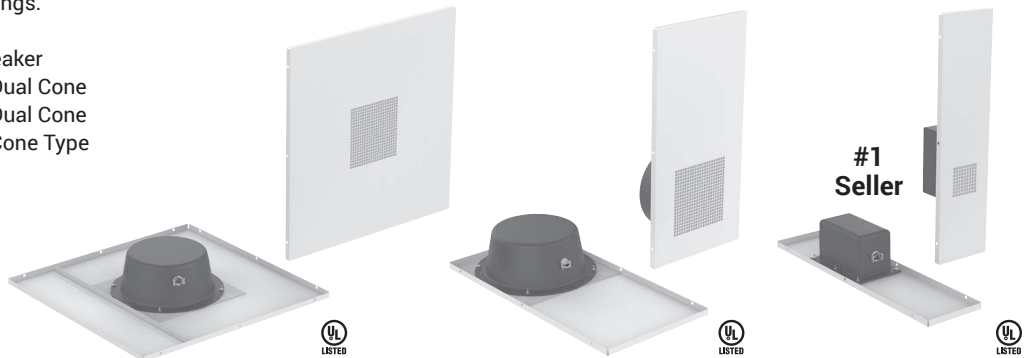

High Performance Cone Loudspeakers

AtlasIED is a world leader in the manufacture of cone loudspeakers for professional sound reinforcement and music systems in offices and retail establishments, auditoriums, meeting rooms, houses of worship, restaurants, clubs, transportation terminals, and recreation and sports centers throughout the world. Choices include standard cone and coaxial style loudspeakers in 4", 8" and 12" sizes. All models can be ordered with optional factory-installed, constant-voltage transformers for distributed sound system requirements.

Model	Size	Type	Watts/Taps	Response	Sensitivity
FC104	4"	High Compliance	10	105Hz – 17kHz	93dB
C10A	8"	Dual Cone	25	65Hz – 19kHz	97dB
C803A	8"	Coaxial	16	70Hz – 15.5kHz	98dB
12CX	12"	Coaxial Compression	250	45Hz – 18kHz	99dB

Speakers with Transformer Installed

SD72	8"	Dual Cone	.25, .5, 1, 2, 5	65Hz – 20kHz	97dB
GD87	8"	Coaxial	1, 2, 4, 8	60Hz – 20kHz	98dB
8CXT60	8"	Coaxial Compression	7.5, 15, 30, 60	48Hz – 18kHz	92dB
12CXT60	12"	Coaxial Compression	7.5, 15, 30, 60	45Hz – 18kHz	99dB
C12BT60	12"	Coaxial	7.5, 15, 30, 60	40Hz – 20kHz	95dB

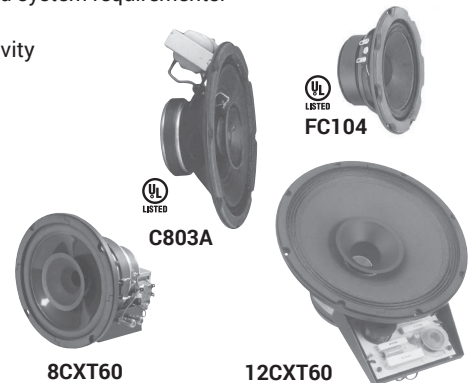

AtlasIED offers a wide variety of baffles, enclosures, and tile bridges to simplify installation. More info is available from BAI.

Garden Loudspeakers

AtlasIED Strategy garden and landscape loudspeaker systems are perfect for any commercial / residential application where rich sound and high durability is required including outdoor malls, theme parks, or hotels. For surface mount (patio / walkway) applications use model GSS-G. For burial applications specify model GST-G. Both versions are available with 32 watt, 70.7V line transformer with 8Ω bypass.

The loudspeaker utilized in the GS series is the FA138 strategy series 8" coax. This driver features a polypropylene cone with rubber surround for weather resistance, 3/4" Mylar dome tweeter for good high frequency reproduction and a 1 1/2" voice coil with powerful 21 oz. magnet for 70 watts of power handling. Modular design allows for a two-phase installation:

ROCKFA62T-BR: Nature inspired aesthetics in a compact, simulated rock enclosure. ROCKFA62T-BR brings Strategy Series® sound quality to the great outdoors with a specially designed, natural looking brown weather resistant enclosure designed to mimic the look of brown granite. System components consist of a highly efficient 6" woofer section and 3/4" PEI (Polyetherimide) dome high frequency tweeter. An internal 32-watt 70.7V / 100V transformer is terminated to a 24" direct burial rated pigtail that includes conductors for all transformer taps including a 1:1 connection for 8Ω operation.

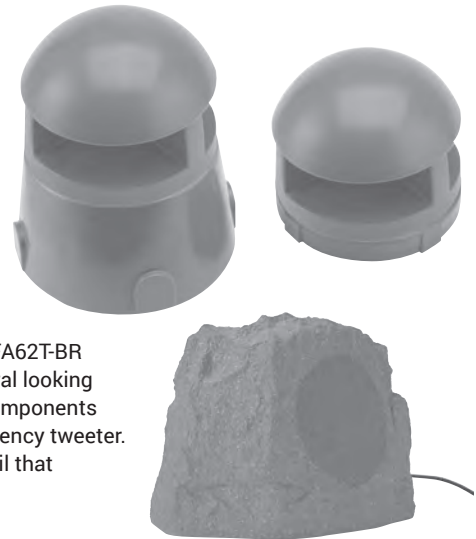

FS Series Arena Horn Loudspeakers

The FS Series is designed to deliver exceptional coverage and quality sound in a lightweight and compact all-weather enclosure that can be used in multiple outdoor and indoor installation applications including arenas, gymnasiums, civic centers, and other large venues. The FS Series is available in five models, each designed to provide optimum sound reinforcement. FS Series loudspeakers are constructed using molded linear low-density polyethylene (LLDPE) to create an incredibly strong yet lightweight enclosure. Each model includes a stainless steel U-bracket and fly-points allowing for easy mounting and incorporates an integrated 70.7V transformer with low insertion loss and full frequency response. The transformer is discretely mounted under the rear cover for weather protection. Each long throw model and the subwoofer has power taps up to 200-watts. The cabinet is UV resistant and has a neutral battleship gray finish.

Models:

FS12T-99	2-Way 12" LF 90° x 90° Horn
FS12T-94	2-Way 12" LF 90° x 40° Horn
FS12T-66	2-Way 12" LF 65° x 65° Horn
FS12T-BT60	2-Way 12" 90° Conical
FS12T-SUB	12" Omni-Directional Subwoofer

The #1 name in horns designed to last for years in the harshest environments.



Professional Omni-Purpose Loudspeakers

AP Series Environment-Resistant loudspeakers are the world standard for voice, music, and signal transmission in indoor & outdoor public address, intercom, security, and industrial signal system applications. Cost-effective, all-purpose units incorporate high-efficiency compression drivers to project through high ambient sound levels and to cover long distances at a minimum installed cost. AP series transformer equipped models include a 3-way 25 / 70.7 / 100V transformer except AP-30T-25 which is 25V only.

- AP-15 / AP-30 Series are 15 watt and 30 watt double re-entrant loudspeakers. Models come in 8Ω
 - AP-15T / AP-30T are 25 / 70.7 / 100V version Standard color is gray or (C) beige.
- Also available: GA-15T and GA-30T economical utility horns.

APX40TN Wide Frequency & Consistent Beamwidth Control loudspeakers are 40-watt, constant directivity paging loudspeakers for use in public address and paging applications. Includes a multi-tap 25 / 70.7 / 100V transformer with screwdriver adjustable power selection. The rotating bell pivots in precise 15° increments for exact on-site positioning of projection angle.

APF-15 / APF-15T Recessed Flange-Mounting loudspeakers are high-efficiency loudspeakers designed for recessed installation in sound and alarm system applications. Flange mounting may be installed flush or recessed. Model APF-15 installs inside a 4" deep opening and the APF-15T fits inside a 5 1/2" deep minimum opening and includes a multi-tap 25 / 70.7 / 100V transformer. Finished in Gray baked epoxy.



Sound Masking

AtlasIED offers a full array of sound masking solutions including white / pink noise generators, speakers, and self contained systems that can be deployed in any installation where speech privacy is critical. AtlasIED is an industry leader in sound masking system design and offers several helpful software programs to aid system designers in layout and planning.

Sound Masking Speakers

Model	Description
M1000	8" Dual Cone Sound Masking Speaker with 70.7V-4W Transformer and Enclosure
M1000-USA	8" Dual Cone Sound Masking Speaker with 70.7V-4W Transformer and Enclosure (Meets Buy America Act Standard)
M1000-W	8" Dual Cone Sound Masking Speaker with 70.7V-4W Transformer and Enclosure (White)
M1000-RW	8" Sound Masking Speaker with 70.7V-4W Transformer and Round Enclosure (White)
M812-S2T7-BX-RS	8" Sound Masking Speaker with 70.7V-5W Transformer and Channel Rail Enclosure



M1000

The M1000 is the #1 sound masking loudspeaker in the market and can be used firing up or down and can also be used for BGM or paging in addition to sound masking.

Sound Masking Generators

ASP-MG24	2 Input x 4 Masking Generators x 4 Output DSP Configurable Sound Masking Generator
ASP-MG24TDB	2 Input x 4 Masking Generators x 4 Output DSP Configurable Sound Masking Generator with Scheduler Card
TSD-GPN1200	Small Footprint Sound Masking Generator with Integrated 4W Output
GPN1200K	Kit Including TSD-GPN1200, TSD-PS24V250MA Power Supply, and TSD-RMK Rack Mount Kit

ASP-MG24



Stands and Booms

Microphone Floor Stands

MS-10C / MS-10CE Cost-efficient assemblies are the most frequently purchased stand throughout the world for dependable performance in music, entertainment, education, and other functions. Overall height span of 35" to 63" in Chrome or Ebony finish.

MS-12C / MS-12CE All-purpose stands feature wearproof clutch for quick height adjustment and a high-stability, low profile cast base. Overall height span of 34" to 62" in Chrome or Ebony finish.

MS20 / MS20E Heavy-duty stands for studio, recording, church, and school applications include an extra-height tube assembly and high-stability cast iron base. Overall height span of 37" to 66" in Chrome or Ebony finish.

SMS5B Stackable mic stand saves stage and storage space with its ability to stack as many as six units in a single 10" footprint. Wide mouth opening in the cast iron base and floating pole design allow for easy stacking. Height can be adjusted from 33" to 60.5" and it features a reflective black finish.

MS25 / MS25E Heavy-duty studio recording stand features tube assembly with integral air suspension system and triangular cast base. Overall height span of 38" to 67". Chrome or Ebony finish.

QR-2 Quick-release tube adapter is designed to save set-up and break-down time. A 'quick' step on the base and the tube is released.



Platinum Design Series Tripod & Tripod/Boom Stands

T3664 All-purpose tripod. The full height adjusts from 36" to 64" and includes a three-piece clutch design. Non-reflective ebony finish.

T1930 All-purpose tripod. The full height adjusts from 19" to 30" and includes a three-piece clutch design. Non-reflective ebony finish.

B2237 Adjustable boom. The full extension adjusts from 22" to 37" and includes a 0.5 lb. counterweight. Non-reflective ebony finish.

TB3664 Kit including T3664 and B2237.

TB1930 Kit including T1930 and B2237.



Standard Series 19" Equipment Cabinets

AtlasIED has been a leading manufacturer of cabinets, racks, and accessories for over 30 years and all racks are manufactured "Texas Tough" in our facility in Ennis, TX USA. Selection includes UL Listed 19" wide vertical floor cabinets and racks in 18 1/2", 25 1/2", 30", & 36" depths, sectional wall cabinets, desktop and security enclosures, modular consoles, desks and electronic, cooling, and convenience accessories. All cabinets are finished in black.

FMA (Folded Metal Assembly) Cabinets

Model	Rack Units	Panel Opening	Height
FMA35-25SA	35 RU	61 3/8"	68 7/8"
FMA44-25SA	44 RU	77 1/8"	84 1/2"

100 Series Cabinets With Fixed Rails And Rear Door

Model	Rack Units	Panel Opening	Height
121-18	21 RU	36 7/8"	41"
124-18	24 RU	42 1/8"	46 1/4"
135-18	35 RU	61 3/8"	65 1/2"
140-18	40 RU	70 1/8"	74 1/4"
144-18	44 RU	77 1/8"	81 1/4"

200 Series Cabinets With Adjustable Rails And Rear Door

Model	Rack Units	Panel Opening	Height
221-18	21 RU	36 7/8"	41"
224-18	24 RU	42 1/8"	46 1/4"
235-18	35 RU	61 3/8"	65 1/2"
240-18	40 RU	70 1/8"	74 1/4"
244-18	44 RU	77 1/8"	81 1/4"



UL LISTED FMA44-25SA



UL LISTED 144-18



UL LISTED 244-25

Sectional Wall Cabinets for 19" Equipment

Note: All 300 Series cabinets are 20 5/8" wide and rear section depth is 4 1/2". 300-12 Series have a center section depth of 12". 300-15 Series have a center section depth of 15". All models include deep front door.

300 Series

Model	Rack Units	Panel Opening	Height
307-12	7 RU	12 1/4"	15 1/4"
310-12	10 RU	17 5/8"	20 1/2"
312-12	12 RU	21 1/8"	24"
316-12	16 RU	28 1/8"	31"
324-12	24 RU	42 1/8"	45"
310-15	10 RU	17 5/8"	20 1/2"
312-15	12 RU	21 1/8"	24"
316-15	16 RU	28 1/8"	31"
324-15	24 RU	42 1/8"	45"
335-15	35 RU	61 3/8"	64 1/4"

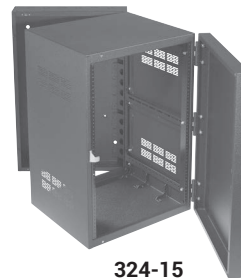

324-15



UL LISTED WMA24-23
(Door Sold Separately)

WMA Series

Wall Cabinets feature 1 person installation, mirror image back and separately boxed rear section. Optional solid, perforated, deep perforated or plexi front doors sold separately.

Model	Rack Units	Panel Opening	Height
WMA10-23	10 RU	17"	23 1/8"
WMA12-23	12 RU	21"	26 5/8"
WMA16-23	16 RU	28 1/8"	33 3/4"
WMA24-23	24 RU	42 1/8"	47 3/4"
WMA35-23	35 RU	61 3/8"	67"

Easy To Assemble, Stackable Utility Frames

Model	Rack Units	Panel Opening	Height
912-18	12 RU	19 1/4"	23 3/16"
916-18	16 RU	26 1/4"	30"

Cabinets With Casters, Solid Front Door & Side Handles For Mobile Use

Model	Rack Units	Panel Opening	Height
RX14-25SFD	14 RU	24 5/8"	28 13/16" / 33 9/16"*
RX21-25SFD	21 RU	36 7/8"	41 1/16" / 45 13/16"*

* w/casters

Wall-Mount Shelf/Enclosure System

WME150 is a versatile six-piece Wall-Mount Shelf/Enclosure System with locking front door. (Assembly required.)

AS120 / AS140 are sturdy shelves for wall-mounting electronic equipment.



916-18



RX21-25SFD



WME150



Audimute is a family owned sound company known for superior soundproofing materials & unmatched customer service - when you buy from us, experience & integrity are included!

Since 1993, we have been experimenting and crafting the highest quality soundproofing materials to create innovated and intuitive soundproofing panels and other products for perfect for every application. From the home to the office, theater to nursery, café to conference room, customers rely on Audimute’s acoustic solutions for soundproofing walls and ceilings to improve not only the quality of their sound but the quality of life within their space.

Eco-C-Tex® & AcoustiColor® Acoustic Material Tiles

Natural & AcoustiColor® Eco-C-Tex® Acoustic Material Sound Panels Offer:

- Solution to a variety of Sound Issues: loudness, echo, reverberation, poor sound quality and much more.
- Great Sound Absorption at a Low Price: Equally as effective as our more decorative fabric-covered acoustic panels (NRC .95!), but omitting the frame and fabric covering means you save money.
- Neutral Appearance or Custom Color Choice: The Natural eco-C-tex offers a no-frills functional look for industrial and other large spaces. Our coated eco-C-tex panels are a affordable customizable option that is aesthetically pleasing.
- Safety: Completely fiberglass-free. (Fiberglass acoustic material can irritate lungs, eyes, skin, and throat.)
- Eco-Friendliness: Made of a blend of cotton and cellulose (most of which comes from recycled newspapers!). Making Eco-C-Tex takes 1/10th the energy of making fiberglass and 1/40th of making foam acoustic material.
- Class-A Fire Rating: Suitable for use in commercial spaces, conforms to most building regulations.
- Standard stock 2X2 & 2X4 tiles as well as custom sizes.



Acoustic Panels - Ready to elevate the sound experience in your home, office, or business? Audimute acoustic panels are the perfect solution for a variety of noise problems. Reflected sound is reduced, echoes are dampened, and reverberation is significantly diminished in a room or space that’s properly treated with acoustic panels. The outcome is an impressive, acoustically pleasing environment everyone will enjoy.



Audimute Sound Absorption Sheets – also referred to as ‘Soundproofing Blankets’ – are 100% made in the U.S.A. from high-quality, eco-friendly materials that absorb sound. Audimute Sound Absorption Sheets are not soundproofing blankets, but may indeed reduce volume levels if the space is properly treated. When hung throughout the room, these sound blankets absorb echoes, reverberation and noise reflection. Audimute Sound Absorption Sheets have been tested in an acoustic laboratory and have an impressive NRC rating of .65.



Sound Baffles, or Acoustic Baffles, are your solution to reduce echo and help control unwanted noise in churches, gymnasiums, workout rooms, conference halls, office spaces and other large areas with high ceilings. Just like our wall panels, Audimute’s sound baffles hang in your space to control the noise while blending in as a décor piece. These ceiling sound baffles are both functional and fashionable, quieting busy spaces while making an impressive visual statement.

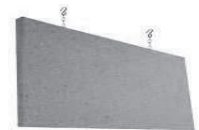

Our **Acoustic Bass Traps** capture low frequency sound to acoustically tune a room. An acoustic bass trap is useful in the acoustic treatment of recording studios, home theaters and other settings built to provide a better listening environment. Place in room corners for best absorption. Many acoustic tube traps and bass traps are made of fiberglass, mineral wool, and other harmful, unnatural materials. Audimute’s bass traps are made of only natural, eco-friendly sound absorbing materials. Compare to acoustic tube traps, Audimute Acoustic Bass Traps are a cost-effective acoustic bass trap for low frequency sound. Audimute acoustic bass traps can be **customized** to fit your space with options unavailable for acoustic tube traps. Get an acoustic panel samples today or choose from acoustical color coatings and fabric wraps above to create a professional style or brand in your practice or studio space!



Audimute’s **Isolé ‘soundproofing blanket’** is an eco-friendly alternative to foam, fiberglass and other sound absorbers. Its insides feature 3.2mm Peacemaker® and eco-C-tex® - one of the GREENEST acoustic materials in today’s marketplace made with natural cotton and renewable cellulose. Make a sound decision - choose Audimute’s Isolé® ‘sound proof blanket’ to control sound in your space!



BAI Distributors carries the entire line of Audimute Soundproofing products too numerous to mention here. Please call for a complete listing.



audio-technica

Audio-Technica designs and manufactures a wide range of products, including high-performance microphones, headphones, noise-cancelling headphones, wireless systems, mixers and electronic products for home and professional

WIRELESS MICROPHONES

System 9 4-Channel Frequency-agile VHF Wireless System - designed to provide rock-solid performance along with easy setup and clear, natural sound quality. Featuring sleek, stackable, contemporary styling, System 9 is available in handheld, headworn, guitar, lavalier and body-pack configurations. Available in 4 compatible user-switchable VHF channels (169.505, 170.245, 171.045, and 171.905 MHz).

- ATW-901 - ATW-R900 receiver and ATW-T901 UniPak transmitter
ATW-901/L - ATW-R900 receiver and ATW-T901 UniPak transmitter & lavalier microphone
ATW-902 - ATW-R900 receiver and ATW-T902 handheld dynamic unidirectional microphone/transmitter



System 10 Digital Wireless System - This high-fidelity digital wireless system (2.4 GHz range) offers advanced 24-bit operation, easy setup and clear, natural sound quality for musicians and presenters. Provides three levels of diversity assurance: frequency, time, and space. Up to eight channels may be used together without any frequency coordination problems or group selection issues. System 10 receivers and transmitters offer an easy-to-read digital ID display.

- ATW-1101 - ATW-R1100 receiver and ATW-T1001 UniPak transmitter
ATW-1101/L - ATW-R1100 receiver and ATW-T1001 UniPak transmitter & MT830cW lavalier microphone
ATW-1102 - ATW-R1100 receiver and ATW-T1002 UniPak transmitter & unidirectional microphone/transmitter



System 10 PRO Rack-Mount digital wireless system - Rack-Mount high-fidelity digital wireless system operates in the 2.4 GHz range (outside of TV bands). Half-rack chassis houses two receiver units, allowing four channels to fit in a single rack space. Receiver units can also be released from chassis and mounted remotely. Up to five chassis (10 receiver units) can be linked and used simultaneously. Some of the most popular versions:

- ATW-1301 - ATW-RC13 rack-mount receiver chassis, ATW-RU13 receiver unit & ATW-T1001 UniPak transmitter
ATW-1301/L - Same as ATW-1301 but also includes a MT830cW lavalier mic
ATW-1302 - ATW-RC13 rack-mount receiver chassis, ATW-RU13 receiver unit & ATW-T1002 Handheld transmitter
ATW-1311 - ATW-RC13 rack-mount chassis, ATW-RU13x2 receiver unit & ATW-T1001 UniPak transmitter x2
ATW-1311/L - Same as ATW-1311 but with 2 MT830cW lapel mics
ATW-1312 - ATW-RC13 chassis, 2-ATW-RU13 receivers, ATW-T1002 H/H transmitter & ATW-T1001 transmitter



2000 Series - 10-channel frequency-agile UHF wireless system designed to suit a variety of applications, including MI/live performance, fixed installation, public address, A/V rental houses and places of worship. It offers all the advantages of a high-quality, professional wireless system at an extremely affordable price. Features include two available frequency bands and switchable antenna power.

- ATW-2110b - ATW-2100b receiver & ATW-T210a UniPak transmitter
ATW-2120b - ATW-2100b receiver & ATW-T220a H/H cardioid transmitter
ATW-2129b - ATW-2100b receiver & ATW-T210a UniPak transmitter & AT829cW lavalier mic
ATW-2192b - ATW-2100b receiver & ATW-210a UniPak transmitter & BP892cW MicroSet headworn transmitter



HEADPHONES

ATH-M20x Professional Monitor Headphones - deliver accurate audio & outstanding comfort, perfect for long studio sessions and on the go. Contoured earcups seal tight for excellent sound isolation, with minimal bleed.

ATH-M30x Professional Monitor Headphones - 40mm drivers w/ rare earth magnets & copper-clad aluminum wire voice coils - tuned for enhanced detail, with excellent mid-range definition. Collapsible design for easy storage.

ATH-M40x Professional Monitor headphones - Same features as above with isolating earcups swivel 90°.

ATH-M50x Professional Monitor headphones - Same features as above but with 45mm drivers. Also available in White (ATH-M50xWH) and limited edition blue (ATH-M50xBL).



ATH-M30x ATH-M50x

WIRED MICROPHONES

AT829cW - Terminated w/locking 4-pin connector for A-T UniPak body-pack wireless transmitters. 55" cable.

AT831cW - Terminated w/locking 4-pin connector for A-T UniPak body-pack wireless transmitters. 55" cable. Includes windscreen and clothing clip.

MT830cW - Terminated w/locking 4-pin connector for A-T UniPak body-pack wireless transmitters. 55" cable. Includes windscreen and clothing clip. (Not shown)

BP893cW Omnidirectional Condenser Headworn Microphone - Same features and accessories as above but doesn't include AT8464 Mic mount. Does not include power module. Also available in beige as BP893cW-TH.

BP894cW Subminiature Cardioid Condenser Headworn Microphone - Same features and accessories as BP892cW. Does not include power module. Also available in beige as BP894cW-TH. (Not shown)

PRO 8HEcW - Hypercardioid Dynamic Headworn Microphone - terminated with locking 4-pin connector for A-T UniPak body-pack wireless transmitters. 55" (1.4 m) cable. Includes windscreen



AT819cW AT831cW



PRO8HEcW



BP893cW

If you don't see it here - Call for a complete Listing!

AUDIX MICROPHONES

DYNAMIC VOCAL MICROPHONES

Dynamic vocal microphones are the most popular type of vocal microphone for live performances because of their durability, flexibility, pattern control and cost. Between 1986 and 1989, Audix broke new ground with the OM Series of vocal microphones with patented diaphragms using VLM™ (Very Low Mass) technology. These microphones receive critical acclaim and set new performance records for clarity, SPL (Sound Pressure Level) handling and gain before feedback, particularly on stages with very high noise environments.

OM2 - Warm, full sound optimized for small to mid-sized PA systems.

OM3 - Clear, natural and accurate - for PA systems and venues of all sizes.

OM5 - Vocals, lead & backing - tight pattern control and tailored response enables vocals to cut through the mix.

OM6 - Vocals, lead & backing - extremely wide & flat frequency response for premium PA systems and broadcast.

OM7 - Designed for concert level and touring PA system - low output gain stage provides unprecedented gain before feedback in monitors.

OM11 - Lead vocal with mid-range presence; excellent for rock, metal and loud volumes.

F50 - Vocal microphone designed to sound clear and full bodied on small to mid-sized PA's.



OM2 OM3 OM5 OM6



OM7 OM11 f50

CONDENSER VOCAL MICROPHONES

As opposed to a dynamic microphone with a moving coil, a thin diaphragm is located alongside a stationary plate with an electrical current running through them. When the diaphragm is moved by sound vibrations, a change in the distance between the plates occurs. Condenser microphones also require a power source, provided via phantom power or from a small battery. Power is necessary for establishing the capacitor plate voltage and is also needed to power the microphone electronics.

VX5 - High performance electret condenser for vocals & acoustic instruments

VX10 - Elite vocal condenser microphone for live sound, recording & broadcast.

SCX25A - Large diaphragm condenser microphone for live stage or studio.

CX112B - Large diaphragm condenser microphone for recording, broadcast & live sound

CX212B - Large diaphragm, multi-pattern studio condenser microphone.



VX5 VX10 SCX25A CX112B CX212B

INSTRUMENT MICROPHONES

D2 - Ideal for rack toms, floor tom, congas and horns. Slight mid-bass boost.

D4 - Hypercardioid dynamic drum and instrument mic for instruments requiring additional bass response. Used for large rack toms, floor toms, tympani, leslie bottom, bass flute, saxophone & baritone sax, trombone, acoustic bass, bass cabinets and small kick drums.

D6 - Provides huge kick drum sound. Ground shaking low end combined with exceptional clarity and attack. Used for kick drums, large toms and bass cabinets.

i-5 - Multi-purpose dynamic microphone with clear accurate sound. Recommended for wide variety of musical instruments, guitars and bass cabinets as well as vocals and speech.

ADX20iP - miniature, high performance professional condenser microphone with integral gooseneck clip. The high tension, spring clamp keeps the microphone in place making it ideally suited for saxophone, trombone, trumpet and other brass instruments. With a smooth uniform response over a frequency range of 40-20kHz, the ADX-20iP offers a warm, rich sound not typical of microphones this size.

MicroD - primarily a drum and percussion instrument microphone for professional stage & studio applications; having a uniformly controlled hypercardioid polar pattern and a smooth, accurate response in its frequency range.

MicroHP - uniformly controlled cardioid polar pattern and provides excellent isolation and feedback control on stage. Used for professional stage and studio applications, the MicroHP is designed with clarity, excellent transient response, resistance to feedback and high SPL capabilities.





INSTALLED MICROPHONES

M3 - innovative, tri-element hanging microphone system designed for applications where aesthetics, sound quality, and ease of installation are critical. The M3 is an ideal audio capture solution for video conferencing, distance learning, courtroom activities, and surgical procedures. It can also be used for ambient room miking and surveillance. M3 incorporates three phase coherent hypercardioid capsules with tailored frequency response optimized for speech intelligibility; accomplished by minimizing frequencies caused by noise, vibration, paper shuffling, keyboard strokes, fans, and heating /air conditioning.



M70 - innovative flush mount condenser microphone designed for distance miking. Featuring a fully integrated preamp, extremely high sensitivity rating of 37 millivolts, and a small footprint of only 3" in diameter. The M70 applications include ceiling mount for video conferencing, distance learning, hospital rooms, surveillance, and ambient room miking. The M70W was designed for easy installation and allows the microphone to completely disappear from view without sacrificing sound quality.



ADX12/ADX18 - are professional miniature gooseneck condenser microphones designed for applications such as podium, presentation, meetings and teleconferencing. With a uniformly controlled cardioid polar pattern, the ADX12 helps isolate the speaker from ambient noise. The ADX12/ADX18 is available in a hypercardioid version for tighter pick-up control (Models ADX12HC/ADX18HC). The ADX18 is designed with an integrated preamp circuitry built into the base of the XLR. They can be mounted permanently via the supplied flange mount or with an optional base with an internal shock mount (see model ATS10, ATS1, ATS1L). The mic may also be used on a standard mic stand using the DCLIP snap to fit mic holder. Operates on phantom power of 18 - 52 V.



ADX60 - is a professional pre-polarized condenser boundary microphone designed for stage, studio and broadcast applications. The ADX60 is known for its high sensitivity and ability to handle distance and area miking for a wide variety of applications.



ADX40 - is a miniaturized condenser microphone designed to hang from an overhead position for applications such as group vocals, choir, theatrical production and room ambience. Known for its clarity, resistance to feedback, and ease of operation, the ADX40 has the ability to accurately capture and reproduce sound from a distance.



ADX10 - is a miniaturized condenser microphone designed for lavalier applications such as speech, presentation and theatrical production. Known for its clarity, resistance to feedback and ease of operation, the ADX10 has the ability to accurately capture and reproduce vocals from a comfortable distance of 4-8 inches. The ADX10 can be used in wired or wireless applications.



MICRO SERIES

MicroBoom™ - is produced in three lengths: **24", 50" and 84"**. The boom is a carbon fiber rod compatible with any of The Micros™ series providing a broad selection of pick-up patterns, output levels and frequency responses.. Excellent for many hard-to-reach miking applications including choir, live theater and orchestra. A high quality shielded cable is used internally to insure the cleanest audio signal path between the microphone and the bottom of the boom. The stand adapter offers total control over the angle, rotation and position of the carbon fiber rod by way of a flexible metal gooseneck.

- MICROBOOM24 - 24" carbon fiber boom arm with clutch assembly
- MICROBOOM50 - 50" carbon fiber boom arm with clutch assembly
- MICROBOOM84 - 84" carbon fiber boom arm with clutch assembly



- M1250B** capsule -for 'standard' output level as in miking podiums, conferences and instruments.
 - M1255B** capsule - 'high' output level-long-distance miking such as ceiling, overhead, audience & instrument.
 - M1280B** capsule - for extended frequency responses.
- Suffixes include 'B' – Black; 'BW' – White; 'BHC' – Hyper Cardioid; 'BWHC' – Hyper Cardioid white; 'BO' – Omni-directional; 'BOW' – Omni white; And 'BS' – Supercardioid Shotgun style.



MicroPod™ - a modular system consisting of a **M1250B** miniature condenser microphone combined with either a 6", 12" or 18" gooseneck shaft. Designed for presentations, meetings and teleconferencing, this mic series is immune to RF interference and is excellent in sound quality. The 6" gooseneck has recently been made available with the high output model M1255 with shotgun capsule for boardroom applications requiring additional reach & sensitivity. (MicroPod™ shown with the ATS10 Base - Sold separately)





OVER BUILT, OVER HEAD

SPEAKER POLE MOUNTS, SPEAKER CAGES,
SPEAKER ARRAY MOUNTS AND CUSTOM BRACKETS

AV Armour is focused on catering to your AVL mounting and rigging needs. Our robust, industrial design provides a high level of safety and peace of mind. All AV Armour solutions are manufactured for ease of installation and to shield against the harshest weather environments. In addition, AV Armour's reasonable prices are certain to fit any budget. We offer mounting & rigging solutions for most commonly used manufacturers in the audio, video and lighting industry. Custom design and manufacturing is our backbone. Our custom solutions are available in almost any configuration and color. From floor to ceiling and beyond, AV Armour is your resource for limitless mounting solutions.

Pole Mounts - Pole mounting solutions that adapt to fit almost any installation requirement.

The AV Armour Pole Mounting Solutions are designed for ease of installation. PM-Series pole mounts are overbuilt to shield against harsh weather conditions and insure a safe environment. AV Armour's family of pole mounts will adapt to almost every installation. All mounts are available in galvanized, stainless steel or custom color powder coating.



SC Series Speaker Cages - Robust speaker protection solutions for most commercial and professional speakers.

The AV Armour steel speaker cage solutions are designed for speaker protection in gymnasiums and where security is needed. SC-Series speaker cages are custom sized to fit the dimensions of most common speakers in the commercial & professional audio industry. AV Armour's family of speaker cages will adapt to almost every installation. Cages come in standard Black and White color and are available in custom color powder coating colors and custom sizes.

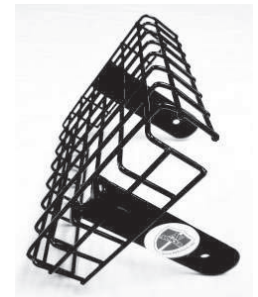

AF Series Array Mounts - Heavy-Duty speaker array mounting solutions for most applications.

Available in almost any configuration, size and color.



Custom Mounts - AV Armour offers superior custom solutions for permanent and portable applications.

Av Armour is equipped to develop and manufacture custom rigging solutions for almost every permanent installation and portable application. Custom orders are manufactured and delivered promptly to ensure customers do not experience installation delays.



OEM Solutions - AV Armour offers OEM design and manufacturing of brackets, mounting hardware and rigging solutions for almost any application.

AVIOM®

With more than 100,000 personal mixers on stages and in studios around the world, Aviom has helped more musicians fix their monitors than any other brand. Aviom personal mixers are designed with the performing and recording musician in mind, with streamlined user interfaces and powerful, practical features. All Aviom products are designed, manufactured, and supported in the USA.

Personal Mixers

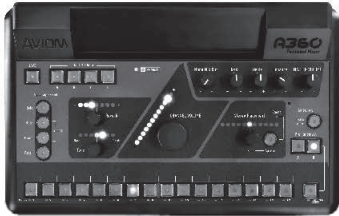

A360 Personal Mixer

- 36-channel mix engine for up to 18 mono or stereo mix sources, including One-Touch Ambience™
- Per-channel volume, Stereo Placement™ with independent pan and spread, reverb, and tone
- Customizable channel configurations



A320 Personal Mixer

- 32-channel mix engine for 16 mono or stereo mix sources
- Per-channel volume and Stereo Placement
- Simplest user interface

Network Devices



D800 A-Net Distributor

- Distributes power and audio to 8 personal mixers
- A-Net Bridge In
- Network Mix Back™ for wireless in-ears with A360
- Ethernet port for use with WiFi router and A360 Display™ for iOS®



D800-Dante A-Net Distributor

- All of the features of the D800, plus a 64x64 Dante™ interface



SB4 System Bridge

- Combines up to four Pro16® A-Net streams onto a single Cat-5e cable

Analog Output



AN-16/o v.4 Output Module

- 16 analog outputs, ideal for use with Network Mix Back for wireless in-ears

Console Card



Aviom16/o-Y1 A-Net® Card

- 16-channel digital output card for Yamaha® digital consoles

Accessories

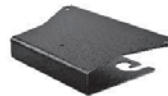

MT-1a Mic Stand Mount

- Compatible with A360 and A320 Personal Mixers



EB-1 Extension Bracket

- Use with MT-1a to mount an Aviom Personal Mixer to a mic stand shaft

Analog Input



AN-16/i v.2 Input Module

- 16 TRS balanced line-level inputs



AN-16/i-M Mic Input Module

- 16 mic or line-level inputs

BOUNDARY MICROPHONES

BM 34B condenser boundary microphone has been designed for flush mounting into tabletops or ceilings. Designed for applications such as tele/videoconferencing, recording or amplification of round table discussions and wherever the microphone needs to be as unobtrusive as possible. The high sensitivity guarantees a constant output level even from long distance sources. Elastic bearing rings achieve mechanical isolation from the mounting surface and therefore offer effective sound isolation of the microphone. The BM 34 is also available in white and silver.

- Half-cardioid polar pattern
- High-quality reproduction of speech
- Flat, wide range frequency response
- Ceiling or tabletop mounting



GOOSENECK MICROPHONES

The **Classis OM 302 US** gooseneck microphone is designed for ceiling mounting with a short flexible gooseneck and is ideal for installations with a low ceiling. The microphone terminate in a single gang plate for easy installation into a standard electrical box. The short, flexible gooseneck allows optimal positioning. The Classis OM 302 is suited for applications such as tele/video conferencing, choir miking, distance learning and wherever high quality speech or music reproduction/recording is required. All microphones feature the innovative Scudio™ technology, making the microphones absolutely insensitive to wireless communication devices such as mobile phones.

- RFI-proof due to Scudio™ technology
- High gain-before-feedback
- High-quality reproduction of speech and music
- Unobtrusive design
- Supercardioid polar pattern
- Flat, wide range frequency response
- Flexible gooseneck for optimum positioning
- For fixed ceiling mounting



GM 304 gooseneck microphones of the Classis series have an extremely small microphone head along with a 6mm ultra thin gooseneck with a matte black, non-glare surface. This microphone can be discretely integrated into any installation. The improved cardioid polar pattern of the microphone ensures maximum volume due to a high gain before feedback with excellent intelligibility of speech. The versatile series allows many kinds of application: the use with speaker's desks or altars, the use in conference systems, in studio and sound systems for mixing consoles or as a stationary microphone in paging systems.

- RFI-proof due to Scudio™ technology
- High gain before feedback
- Non-glare surface
- High sensitivity
- Unobtrusive due to small dimensions
- Phantom power 8 - 52 volts



DESKTOP MICROPHONE WITH REVOLUTO TECHNOLOGY

The **MPR 211** is a desktop microphone with many different functions. Depending on the application, the operating mode ON/OFF, Push-To-Talk (PTT) or Push-To-Mute (PTM) can be selected at the bottom of the microphone unit. The different functions are controlled by a micro-controller. The Revoluto technology with integrated microphone capsules provides a so-called corridor characteristic which ensures a wide range of good voice quality. Within this range the speaker can move freely, i.e. can stand up or sit down, move his/her head and move towards or away from the microphone. The MPR 211 is turned on/off with a silent microphone button. The illuminated LED on the microphone button and the LED on the left hand side indicate that the microphone is ready to speak into. The MPR 211 is ideal as desktop microphone for discussions, tele/video conferencing and announcements.

- "Intelligent", microprocessor-controlled microphone unit
- ON/OFF, Push-To-Talk and Push-To-Mute functions



The **Classis RM 30/ RM 30W (White)** is a desktop microphone for round table discussions, podiums, tele/video conferencing and lecterns. The vertical microphone array results in a horizontal corridor characteristic (horizontal cardioid, vertical lobe). This allows the speaker or conference participant maximum freedom of movement at a consistent intelligibility of speech. It is possible for two people to share one microphone. The vertical lobe polar pattern also optimises the gain before feedback. utilizes a 3-pin XLR connector.



BAI carries the entire line of beyerdynamic products. Call for more info.

HEADPHONES & HEADSETS

DT 100 Series is used throughout the world for audio recording and monitoring in studios, news gathering, film and TV production and live events. The headphones are exceptionally comfortable with a soft headband and ear pads. A high level of ambient noise attenuation is achieved with the closed design of the ear cups. Rugged construction ensures reliability for many years of use.

- **All models are available in black or grey.**
- Closed headphone
- Excellent ambient noise attenuation
- Single-sided, detachable cable
- Legendary, classic design
- Capable of handling very high SPL
- Single-Ear version: DT 102



DT 108/109 Series are used throughout the world for news gathering, film, TV production and live events. The headphones are exceptionally comfortable with a soft headband and ear pads. A high level of ambient noise attenuation is achieved with the closed design of the ear cups. Rugged construction ensures reliability for many years of use. The DT108/109 series are available in grey or black, **DT108 single-ear** or **DT109 double-ear** styles and with either 50Ω or 400Ω impedance.

- 50Ω - for mobile applications like intercom systems
- 400Ω - for fixed installations
- Capable of handling very high SPL
- Easy serviceable -all parts are replaceable
- Highly sensitive headphone and microphone transducers



The **DT 250(double-ear)** and **DT 252(single-ear)** are a lightweight, low profile design, closed dynamic headphone offering good ambient noise isolation. It's suitable for various applications in broadcast and recording studios. The powerful neodymium magnet systems provide high-fidelity reproduction and a balanced sound. The headband and circum-aural earphone cushioning system have been carefully designed for maximum comfort and unobtrusive style.

- Single-sided, detachable cable
- Balanced sound impression
- Powerful neodymium headphone system for excellent reproduction accuracy
- NEW - Limiter (Optional)
- Easy serviceable -all parts are replaceable



HANDHELD WIRED MICROPHONES

TG V35ds is a dynamic vocal microphone that is perfect for beginners. Its natural sound and super-cardoid polar pattern with high feedback rejection are valued by vocalists, DJs & speakers in rehearsal rooms and on the stage. Thanks to the high output level, the TG V35d s only needs a simple pre-amplifier in order to deliver impressive results. It features a noiseless on/off switch and includes an XLR cable, clamp and storage bag.



TG V50d with a combination of sleek design and rugged construction that is perfect for the stage, this exceptional sound makes the TG V50d a reliable companion that you will never want to be without. That is the definition of the new standard for the stage. **Also available with an on/off switch as the TG V50ds.**



WIRELESS MICROPHONE SYSTEMS

The **TG 500** wireless microphone system is a perfect all-around system, whether for performances on smaller stages, theater productions or speeches, the various sets always ensure perfect performance. While the vocal set with the dynamic The **TG 550 Vocal Set** with a **TG V50 handheld transmitter** is ideally suited for singing. The **TG 556 Vocal Set** with the **TG V56 condenser handheld transmitter** offers an ideal solution for presentations. An unobtrusive positioning of the microphone in lectures makes the **TG 5558 Presenter Set** with the **TG L58 lavalier microphone** is perfect for discrete presentations. The perfect companion for theater productions is the headworn set with the **TG 534 Headworn Set** and the included **TG H34 headset microphone**. The **TG 510 Instrument Set** with included **WA-CGI instrument cable** is ideal for professional miking of guitar and bass. With the included rack mount kit, the 9.5" single receiver can be easily installed in a rack and also offers the possibility to mount 2 receivers in one rack unit. For users requiring multiple channels, a dual receiver with integrated antenna splitter is available. All sets come with antennas and rack mount kit.



For the installation that requires a top of the line digital wireless system, beyerdynamic offers the **TG 1000 2-channel 24-bit digital wireless system**. Available in a handheld version with the TG 1000 transmitter which features interchangeable capsules with 6 different options to cover any application. It is also available with a beltpack transmitter as well as a neckworn mic.



BOGEN[®]

COMMUNICATIONS, INC.

Bogen Communications International is a leading provider of sound systems and telephone peripherals for commercial, industrial, and institutional applications the world over.

AMPLIFIERS & MIXER AMPLIFIERS

V35, V60, V100, V150, V250 Power Vector Series

- 35W, 60W, 100W, 150W, & 250W models; each with a large power reserve
- 8 module input bays, accepts up to 2 signal-processing output modules or up to 8 input modules
- Four priority levels
 - 4Ω/8Ω/25V/70V outputs
 - Rack mountable w/ kit (sold separately)



WV100, WV150, WV250 Wall-Mount Power Vectors

- 100W, 150W, & 250W models; each with a large power reserve
- 8 module input bays, accepts up to 2 signal-processing output modules or up to 8 input modules
- Input/Output modules sold separately
 - Four priority levels
- Wall-mountable with Back Box and Door (sold separately)
 - 4Ω, 8Ω, 25V/70V outputs



GS35, GS60, GS100, GS150, GS250 Gold Seal Series

- 35W, 60W, 100W, 150W, & 250W models
- 7 inputs; 4 MIC (Lo-Z), 1 AUX (Hi-Z), 1 MIC/TEL, 1MIC/AUX
 - 4Ω, 8Ω, 25V/70V outputs
- Dual-function, 10-band graphic equalizer (acoustic EQ/feedback control)



C10, C20, C35, C60, C100 Classic Series

- 10W, 20W, 35W, 60W, & 100W models
- 4 inputs (C35/60/100 models): 1 MIC (Lo-Z), 1 AUX (Hi-Z), 1 TEL, plus 1 selectable MIC or AUX
- 3 inputs (all C10/C20 models): 1 MIC (Lo-Z), 1 TEL, plus 1 selectable MIC or AUX



CC4021, CC4041, CC4052, CC4052m 40 Watt Mixer Amps

- Compatible w/70V, 25V, 4&8Ω systems
 - Rack mountable with RPK93 rack kit - sold separately
- **CC4021** - 2 Inputs - 1 balanced MIC/LINE 1 unbalanced AUX
- **CC4041** - 4 Inputs - 3 balanced MIC/LINE 1 unbalanced AUX
- **CC4052** - 5 Inputs - 3 balanced MIC/LINE 1 unbalanced AUX, 1 TEL
- **CC4052m** - 6 Inputs - 3 balanced MIC/LINE 1 unbalanced AUX, 1 TEL, 1 Media Player & MOH Output



CC4052m

MIC/LINE MIXERS

VMIX Power Vector Mixer/Pre-Amplifier

- 8 module input bays, accepts up to 2 signal-processing output modules or up to 8 input modules
- 11-segment LED output level meter monitors the output level of the mixer
 - Four priority levels



CAM8PRO Mic/Line Mixer

- 8 independently assignable inputs
 - Balanced inputs and outputs
 - MIC/Line switch for each input
- Dual-bus design w/Main/AUX output selector each input
 - Compressor/limiter, LED meter & headphone out



Also available - CAM2 w/4 Mic inputs

SURFACE/CEILING SPEAKERS

A-Series All-Weather Loudspeakers

Models:

- A2, A2T** - 6" woofer/1/2" tweeter w/max power handling of 100W@Ω (A2) & 16W@70V (A2T)
- A6, A6T** - 6" woofer/1-1/8" tweeter w/max power handling of 150W@8Ω (A6) & 32W at 70V (A6T)
- A8, A8T** - 8" woofer/1-1/8" tweeter w/max power handling of 175W@8Ω (A8) & 64W at 70V (A8T)
- A12** - Two 6.5" woofers/1" horn loaded HF driver w/max handling of 225W@16Ω & 128W@70V



A8T

CSD2X2/U Drop-In Ceiling Speaker with back can

- Easy assembly saves installation time, effort, and cost
 - Tile support rail for 2'x4' ceilings included
- 2' x 2' perforated grille over entire front
 - Off-white or bright white finish
- 8" speaker w/10 oz. magnet & tweeter & 25/70V transformer
 - 5 power taps (4W/2W/1W/1/2W/1/4W)
- Also available in a 1'X2' version as the CSD1X2/U CSD2X2VR/U & CSD1X2VR/U have recessed V/C



ASWG1, ASUG1, ASUG1/DK, ASWG1/DK Amplified 8" Ceiling Speaker Assemblies

- Front-mounted volume control knob (detachable on DK model)
 - Self-contained 1W amplifier



Bogen is a Full Line manufacturer of Speakers, Paging Systems, Amplifiers, Intercoms, Mixers, Telephone Products and Microphones. This is just a brief overview of what Bogen has to offer.



Bolide® Technology Group, Inc. is a worldwide manufacturer and ISO 9001:2008 certified distributor of CCTV surveillance products and accessories based in Southern California. Over the years, the company has grown and expanded its reach through our partners around the globe. With a rich history of offering cutting-edge products and a growing distribution network in United States and Latin America, Bolide has become one of the fastest growing companies and most sought-after suppliers in the industry.

Bolide® Technology Group develops the most distinct and innovative products in the security industry. Bolide's extensive product portfolio boasts a complete line of analog and network camera solutions, along with advanced digital video recorders, network video recorders, and accessories such as cables, connectors, and power supplies. Aside from existing lines, new products are constantly being developed in an effort to come out with only the latest and mostly technologically advanced products in the market.

Network Cameras

- iPacMeg
- iPacWD
- iPacPlus
- PTZ Cameras
- iCube Cameras
- 360° Panoramic View Cameras



Analog Cameras

- PTZ Cameras
- Effio™ Cameras
- Tiger-i PlusNew
- WDR Cameras
- Multipurpose Cameras
- Advanced 600TVL Cameras
- Raphael Series
- Tiger-i
- RED-i
- EAGLE-i
- Hidden Cameras



Video Recording

- VMS Software
- Network Video Recorders
- Digital Video Recorders
- Mobile DVR



Matrix

- DR-3208 Matrix Video Switcher/Controller
- BE8000 Advanced Network Matrix Video Switcher / System Controller
- DR-8000 Network Matrix Video Switching System



Monitors

- BE8019-7M TFT LCD Monitor with removable Sun visor
- BE8019LCD 19" Security LCD Monitor
- BE8043 14" High Resolution Color Monitor
- Video Wall - Customized per Application



Hidden Cameras

- BM3366 Self-Recording Computer Speaker
- BR1223 Portable Mini-Speaker
- BM3028 SD Card Picture Frame
- SD Card Digital Alarm Clock
- SD Card PIR
- Many other types of Hidden & Nanny Cameras



Bolide also carries an full range of cables, connectors and accessories and a full line of Mobile Solutions.



BOSCH

Bosch Security Systems is one of the world's leading manufacturers and suppliers of professional audio, wireless, life safety and communication equipment. Bosch Security Systems offers complete system solutions for the world's most critical, high-profile installations and events.

PLENA PUBLIC ADDRESS SYSTEM

Plena Public Address Solutions can be used to tailor the public address system to the precise needs of small-to-mid-sized locations. Plena offers facilities for background music, paging and playing pre-recorded commercials and additional power for applications such as hotels, offices and shopping malls.

PLM-8M8 PLENA Matrix 8 Channel DSP Matrix Mixer - Complete DSP zone matrix mixer & loudspeaker processor.

- 4 microphone/line, 3 music source, call station and emergency inputs
- 8 independent output zones, and "Amp Link" outputs
- RS485 connection for call stations and wall control panels
- Ethernet control and Windows PC GUI, and an iOS app for zone control via iPhone and iPad

PLM-4P125/PLM-4p220 PLENA matrix DSP Amplifiers - 4-channel, Class D power amplifier w/100V/70V/8Ω/4Ω outputs; 125 Watt and 220 Watt respectively. Complete loudspeaker processing DSP with input mixing; controlled by PC GUI and iOS app.

- Connects easily with PLM-8M8
- Environmentally friendly auto standby mode

Power Amplifiers - Compact power amps with pilot tone supervision are available in 120 W & 240 W versions. Highly dependable and solidly built, these amplifiers are protected against overload, short circuits and overheating. With 100 V - 8 ohm (70 V - 4 ohm) main power and a 24 V backup power connection, providing required power for any application.

- Temperature-controlled fan
- 3 inputs with priority switching
- PLE-1P120-US - 120 Watt Amplifier
- PLE-1P240-US - 240 Watt Amplifier

The **Plena Mixer/Mixer Amp** are high performance, professional public address mixers with modern state of the art features. Combined with the PLE-1P120-US or PLE-1P240-US amplifiers, you can build an easy-to-operate yet powerful and flexible public address system. All this without sacrificing features such as ducking, priority, and flexibility. The mixer fulfills a wide variety of public address requirements yet is surprisingly affordable.

- **PLE-1MA030-US - 30 Watt Mixer Amplifier**
- **PLE-1MA120-US - 120 Watt Mixer Amplifier**
- **PLE-2MA240-US - 2-Channel 240 Watt Mixer Amp**
- **PLE-1ME060-US - 60 Watt Economy Mixer Amp**
- **PLE-1ME240-US - 240 Watt Economy Mixer Amp**
- **PLE-1MA060-US - 60 Watt Mixer Amplifier**
- **PLE-2MA120-US - 2-Channel 120 Watt Mixer Amp**
- **PLE-10M2-US - 2-Channel Unpowered Mixer**
- **PLE-1ME120-US - 120 Watt Economy Mixer Amp**



CEILING & SURFACE LOUDSPEAKERS

LC5-WC06E4 Ceiling Loudspeaker is an extreme compact ceiling loudspeaker, suitable for speech & background music reproduction.

- Compact yet powerful
- Suitable for use in humid, chlorine and salty environments
- Selectable 70V, 100V and 80Ohm input



LS1-OC100E Hemi-directional Loudspeaker

- is an easy to install & innovative which projects consistent and high quality sound that will cover approximately 2000SF.
- For large area, high-ceiling applications
- Complies with EVAC
- High speech intelligibility for paging/emergency.



LBC 3481/12-US is a circular horn loudspeaker, 10 W, and made from ABS.

- Excellent speech reproduction
- Simple power setting
- IP65 Water and dust protected
- Versatile mounting bracket



LBC 3951/11-US is a compact 6W loudspeaker with a perforated metal grille. Px4 water protected for use in harsh environments.

- Modern unobtrusive styling
- Waterproof cone
- Very wide coverage angle



LHM 0606/00-US is a general-purpose 6 W, cost effective ceiling loudspeaker.

- Suitable for speech and music
- Simple power setting
- Flush mounting
- Unobtrusive in all interiors



LBC 3491/12-US is a rectangular horn loudspeaker, 10W, and made from ABS.

- Excellent speech reproduction
- Simple power setting
- IP65 Water and dust protected
- Versatile mounting bracket



BAI Carries the Entire Bosch Public Address Line of Products. Call for Complete Listing.



BSS Audio is world renowned for outstanding sound quality and reliable equipment that satisfies the real demands of professional musicians and high-profile installations. Products from BSS Audio are used on major tours, in recording and broadcast studios, churches, casinos, arenas, and nightclubs on every continent.

SOUNDWEB® LONDON

Fixed I/O Devices

BLU-100 - 12x8 Signal Processor with Digital Audio Bus. Offers a fixed configuration of 12 inputs and 8 outputs, configurable signal processing and a high bandwidth, fault tolerant digital audio bus.



BLU-101 - 12 inputs and 8 outputs, provides for up to 12 independent AEC algorithms.



BLU-102 - 10 analog inputs and 8 analog outputs, an analog telephone interface, configurable signal processing, AEC processing, and a high bandwidth, fault tolerant digital audio bus.



BLU-103 - 8 analog inputs & 8 analog outputs, a Voice over IP (VoIP) interface, configurable signal processing, AEC processing, and a high bandwidth, fault tolerant digital audio bus.



BLU-50 - Half-rack width processor that offers a fixed configuration of four inputs and four outputs, configurable signal processing, logic processing and BLU link. Powered w/included 12VDC PS but can accept 12-48VDC via a terminal block connector or with PoE+ via the Ethernet port



Chassis (requires up to four input/output cards)

BLU-120 - I/O Expander with Digital Audio Bus. Offers configurable I/O and a high bandwidth, fault tolerant digital audio bus.



BLU-160 - configurable I/O, configurable signal processing & a high bandwidth, fault tolerant digital audio bus.



BLU-320 - configurable I/O, CobraNet audio & a high bandwidth, fault tolerant digital audio bus.



BLU-325 - configurable I/O, Ethernet AVB audio & a high bandwidth, fault tolerant digital audio bus.



BLU-326 - configurable I/O, Dante audio, and a high bandwidth, fault tolerant digital audio bus.



BLU-800 - Signal Processor with Digital Audio Bus and CobraNet™. Features low latency, fault tolerant digital audio bus of 256 channels which uses standard Category 5e cabling giving a distance of 100m between compatible devices.



BLU-805 - Signal Processor with configurable I/O, configurable signal processing, Ethernet AVB audio and a high bandwidth, fault tolerant digital audio bus.



BLU-806 - Signal Processor with configurable I/O, configurable signal processing, Dante audio and a high bandwidth, fault tolerant digital audio bus.



Input/Output Cards

BLUAEC-IN - Soundweb™ London devices to cancel acoustic echo arising from feedback.

BLUHYBRID - Soundweb™ London devices to interface with a standard POTS.

BLUCARD-IN - enable Soundweb™ London devices to receive microphone / line level signals.

BLUCARD-OUT - enable Soundweb™ London devices to send line level signals.

BLUDIGITAL-IN - enable Soundweb™ London devices to receive AES/EBU and S/PDIF audio signals.

BLUDIGITAL-OUT - enable Soundweb™ London devices to send AES/EBU and S/PDIF audio signals.

BLUAEC-IN

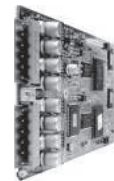

Break-In/Break-Out Boxes

BLU-BIB - Break-in Box; offers 8 channels of analog audio input expansion via the Soundweb London high bandwidth, fault tolerant digital audio bus.



BLU-BOB1 - Break-out Box; offers 8 channels of analog audio output expansion via the Soundweb London high bandwidth, fault tolerant digital audio bus.



BLU-BOB2 - Break-out Box; offers 8 channels of analog audio output expansion via the Soundweb London high bandwidth, fault tolerant digital audio bus.



Controllers

BLU-10-BLK - up to 100 control 'pages' of virtually any Soundweb™ London DSP parameter can be constructed, with the ability to create 'folders' for nested pages. Also available in White-WHT & Blue-BLU

BLU-8-V2-BLK - programmable zone controller capable of controlling a single zone, four zones or eight zones in different modes of operation. Also available in White - WHT

9012-US - provides an instant solution for volume and source select functions - 5 position. Also available in an 8 position version - 9015-US

BLU-3 - wall panel controller allowing designer to provide level control and source selection or preset recall in a simple wall-mounted panel. The BLU-3 offers a 5-way switch and the **BLU-6** offers an 8-way switch.

9012-US





Digital Extension that Spans Your Application

4K HDMI® + USB HDBaseT Extender

Deliver HDMI® and USB signals from a computer or media player to an interactive whiteboard, touch screen, digital signage, or other interactive displays or connect a conference camera system. Fully compliant with HDBaseT 2.0, this solution will support 4K 3840 x 2160 at 60Hz with 4:2:0 color sampling and USB 2.0 signals up to 100m or 328 feet using a solid conductor, shielded cat6 cable.

- Fully compliant with HDBaseT 2.0
- HDBaseT Certified
- Supports EDID pass-through and HDCP 2.2
- Extends IR signal and serial control communication and features



29510

HDMI® Active Optical Cables

Active Optical HDMI® Cables can be used in plenum applications where standard Active HDMI® cables can't go. The cable diameter is smaller than copper and more flexible which makes it easier to install in tight spaces.

- 110 lb. pull strength specification—far surpassing the 20 lb. pull rating of other cables on the market
- 6mm bend radius
- Supports up to a 4k resolution at 30Hz
- No external power required
- Plenum rated jacket



41370

Complete the AV System with Control & Sound

AV Controller

Control in-room devices without breaking the budget. The AV Controller provides the features you need without the cost and complexity of “higher end” solutions.

- Dual serial and Infrared (IR) control as well as a 12V DC trigger for electromechanical devices
- Multiple programming modes through software interface (GUI), front USB port or infrared (IR) port
- On-board, real-time clock for easy time and date programming



40348

Amplifiers and Speakers

Complete your sound reinforcement system with Plenum Rated Amplifiers that include PA sensors, remote control, and standby mode for energy savings, a simple Wall Plate Amplifier or Controller, and/or 8 Ohm & 70 Volt Speakers in Drop-In, Ceiling, and Wall Mount form factors.

- 50W, 25/70V or 8 Ohm options
- Plenum-rated amplifiers and speakers available
- Multiple form factors in both amplifiers & speakers



40348



41108



CAD Audio has been in the microphone manufacturing business for over 75 years. Over the past few decades, the CAD name has become synonymous with innovative products, great value and superior sonic accuracy. CAD continues to be a highly regarded name for value and quality.

Variable Polar Pattern Microphones

1600VP Continuously-variable Pattern Condenser Hanging Microphone System with Remote Polar Control and Exclusive Anti-rotational Positioning Mount

- Remote box is rack mountable up to six units per shelf
- RF (radio frequency) Resistant Architecture
- Selectable recessed high-pass filter
- Includes 30' cable, wall plate, hanger & accessories



1700VP Continuously-variable Pattern Condenser Overhead Microphone System with Remote Polar Control and Miniature Carbon Fiber Boom

- Same features as 1600VP



1800VP Continuously-variable Pattern Condenser 18" Gooseneck Mic System w/Remote polar Control

- Includes 18" gooseneck with XLRM-type quick connector
- Other features as stated for above models



2220VP-DSP/2220VPW-DSP - Continuously-variable Pattern Condenser Boundary "Button" DSP Microphone System with Remote Polar Control

- Continuously-variable polar pattern controllable from within a DSP
- Includes adapter cable (XLR-F to Phoenix-type) for use with Biamp® Digital Signal Platform



2600VP-DSP - Continuously-variable Pattern Condenser Overhead Microphone System with Remote Polar Control through Digital Signal Processor

- Same features as 2220VP-DSP/2220VPW-DSP



2700VP-DSP - Continuously-variable Pattern Condenser 56" Boom Microphone System with Remote Polar Control through Digital Signal Processor

- Same feature as 2600VP-DSP
- Attaches to any standard mic tripod or base stand



930VPL - Continuously-variable Pattern Condenser Boundary Microphone with Programmable Switch, LED and Logic Interface

- Continuously-variable polar pattern control
- Soft-touch programmable membrane switch
- Securable controls (polar pattern and mode)
- Logic I/O for external muting and/or remote control



220VP/220VPW - RF Resistant Continuously-variable Pattern Condenser Mini-Boundary Microphones

- Securable polar-pattern controls
- All-metal housing/Mounting hardware included



901VP - Continuously-variable Polar Pattern Control Boundry Microphone

- Remote Variable Pattern compatible when used with Variable Pattern Control box (VPC-1)
- Remote Variable Pattern through compatible digital signal platforms when used with 40-360 cable



Miniature Gooseneck Microphones

905R - Line-cardioid Condenser Mini-gooseneck Microphone

- RF (radio frequency) resistant architecture
- Quick-mount XLR format
- 8mm flex pipe w/position memory & silent operation
- Balanced, transformerless output circuitry



915B, 920B - Cardioid Condenser Mini-gooseneck Microphone

- Available in two lengths (15" & 20")
- 8mm flex pipe w/position memory & silent operation



827A-13, 827A-17 - Condenser Gooseneck Cardioid Condenser Mics 827A-13 (13"), 827A-17 (17")

- For: lectern, dais, courtrooms, conference/meeting rooms, paging, telecommunications, intercom systems
- Speech optimized frequency response



Dynamic Paging Microphones & Overhead Condenser Mics

878HL-2 - Omni-directional, Dynamic Tabletop Paging Mic for Fixed or Temporary Paging Applications

- Wide smooth frequency response speech intelligibility
- Momentary or latching Push-To-Talk switch bar



AMC105SNO-19 - Heavy Duty Omni-directional Paging Microphone (one DPDT switch)

- Heavy-duty gooseneck and mounting flange
- High impact resistant Cyclocac housing



WM-625/WM-625S - Indoor Omni-directional Wall Mount Microphones on Single Gang SS Plates

- Push-To-Talk option with 'S' suffix (DPDT switch)
- For intercom and P.A. applications



900B, 900W - Hanging Unidirectional Overhead Choir or Conference Mics 900 (black), 900W (white)

- Places of Worship, courtrooms, conference/meeting rooms
- Natural extended fidelity frequency response
- 7" flexpipe at mic end for precision aiming
- 30' twist resistant cable terminating in 3-pin XLR



BAI Carries the Entire CAD & Astatic Product Range - Don't see it? Call BAI!



CADLive Wired Microphones

D32X3 - supercardioid dynamic handheld microphone with on/off switch and neodymium capsule. Set of three.

D38X3- supercardioid dynamic handheld with a neodymium capsule. Durable and articulate the D38 overachieves in most any live sound application from lead vocals to spoken word announcements. Set of three.

D89 - supercardioid dynamic instrument mic is outfitted with a Trueflex™ diaphragm and PowerGap™ high gauss neodymium magnets creating a hot and articulate live performance instrument microphone.

D90 - supercardioid dynamic handheld mic is outfitted with a Trueflex™ diaphragm and PowerGap™ high gauss neodymium magnets creating a hot and articulate live performance vocal microphone.



Earworn Microphones

E19 Equitek Broadcast and Production Miniature Earworn - delivers industry leading performance with upgraded features - Its miniature ergonomic profile and behind the ear design along with replaceable cable have been updated for ease of use, comfort and stability to meet the markets changing needs. E19 provides maximum intelligibility with natural, accurate reproduction for the most demanding broadcaster, house of worship user, presenter or theater performer. Currently available for CAD Audio Wireless with TA4F type connector – subsequent replacement cables are planned for TA3F,HRS and locking mini type connectors.



Wireless Microphone Systems

WX1600 Series Wireless Systems - 100 channel frequency agile diversity reception for outstanding connectivity and minimizing multipath interference. Scan-Link™ technology provides instantaneous and automatic channel configuration (First, the receiver conducts an environmental frequency evaluation then selects a channel. Second, the receiver links to the transmitter and sets the transmit frequency automatically). CADLock™ automatic code encoded squelch helps to eliminate unauthorized interference. AA batteries supply >15hrs of battery life. Includes: • 1 - WX1600 Receiver • 1 - Cardioid Dynamic Handheld Transmitter



WX1610 Series Wireless Systems - Same feature as above. Includes:

- 1 - WX1610 Receiver
- 1 - E19 Equitek miniature earworn mic
- 1 - WXLAV lav mic & WXGTR guitar cable

Wireless InEar Systems

StageSelectIEM System - UHF In Ear Monitor Wireless System - Single Pack with Ear Buds. This is a high-performance wireless In Ear Monitor System that will deliver superior audio performance while supplying advanced frequency agility, capable enough to cope with today's dynamic RF environment – making it both easy to use and exciting to operate. Features 16-channel performance for outstanding connectivity. CADLock™ Automatic Tone Code Squelch and stereo operation - send discrete signals to the left or right channel. The MEB2 TruPitch™ Dual Armature Earbuds provide accurate audio reproduction while the EasyFit™ silicon earmolds provide a custom fit.



Headphones

MH110 - circumaural, precision-built monitor headphone equipped with 50mm neodymium drivers offering extended frequency response while delivering exceptional detail and clarity. Designed with an easyfold, comfort-fit headband allowing for convenient storage and hours of fatigue-free listening.

MH210 - studio monitor equipped with 40mm neodymium drivers offering extended frequency response while delivering powerful sound. Ultra-soft leather earpads outfitted with high density memory foam provide hours of fatigue free listening comfort. **Available in White as model # MH210W.**

MH320 - closed back, circumaural studio monitor headphones precision built and equipped with high output 45mm neodymium drivers, featuring an extended frequency response with an exceptionally clear and detailed sound. Crafted from high-grade stainless steel, manganese and aluminum, the headphones are built with the durability and solid construction to ensure years of use.



USB Microphones

With CAD USB Mics, you can •Record directly to your computer •Create your own audio for video
•Podcast over the internet •Simply plug in & start recording •Windows & Macintosh compatible

GXL2600USB - Large Diaphragm Studio Condenser Microphone features the Aoedin™ 1" large diaphragm capsule that delivers full range studio fidelity & outstanding transient response. Supplied w/shock mount, desk stand & cable.

U1 - USB Recording Microphone

U7 - USB Omnidirectional Condenser Tabletop Recording Microphone

U9 - USB MicroMic is a great high quality, compact solution for recording on the go

U37 - USB Cardioid Condenser Studio Recording Microphone for warm, rich recordings

U39 - USB Microphone outfitted with TrakMix™ headphone monitoring & a pro all metal construction

U2 - USB Stereo Headphones with Microphone - VoIP compatible!

ZOE - USB Condenser Recording Microphone with TrakMix™ Headphone Output





Started in 1989, CE labs®/Cable Electronics is the one stop source for your high quality audio/video needs. With over 25 years of experience, CE labs®, offers an array of products and services custom engineered to meet your business's needs. CE labs® is one of the top manufacturers of high-end audio and video products. With a wide range of products and services, CE labs is the one stop shop for all of your turn key operations. CE labs now manufactures a full line of professional grade AV distribution amplifiers including the latest HDMI technology, matrix switchers, digital media players and digital signage products. The digital signage package offers digital media players, content management software and electronic merchandising systems.

A/V PRODUCTS

CE labs® **HDMI™ A/V Distribution Amplifiers** are manufactured with the latest state-of-the-art Silicon Image™ chipset that supports up to 1080p resolution at 60Hz, 36-bit color depth, Dolby® True HD and DTS-HD high bit-rate audio formats to deliver a rich digital video and audio experience. (Also supports: Deep Color, High Bit-Rate HD Audio, DVD audio with 7.1-surround at 192kHz, SACD audio standards, and stereo audio at 192kHz).

CE labs® **Component Distribution Amplifiers** set a new level of performance for broadband dual current-feedback on amplifiers. Distribute HDTV and analog television signals from any single A/V source to multiple television receivers with minimal voltage headroom and crossover distortion. Compatible with all HDTV component video signals, CE labs® Component Amplifiers are capable of daisy chaining for larger displays, saving you the expense of additional A/V receivers.

CE labs® **Composite A/V Distribution Amplifiers** accept a baseband composite A/V signal via RCA type cable from any source and distribute it at a true one to one signal ratio to multiple displays without any signal loss. CE labs® composite amplifiers can be looped and cascaded.

CE labs® **VGA Distribution Amplifiers** - Easy installation and a 1U high rack design make CE labs® VGA Video Splitter ideal for all applications that require high performance distribution of computer-video signals. This Video Distribution Amplifier, sends 1 VGA source to multiple locations and supports DDC, DDC2, DDC2B (for video part 1).

The **HSC16** is a VGA to HDMI™ format converter that converts a PC VGA and Audio to HDMI™, with the benefit of connecting the PC to a 1080P HDTV. The converter will support multiple resolutions up to 1920×1080 @ 60Hz.

The **QMPPro 1200i** is part of CE labs® technology series of encoders/modulators that converts Digital Video Broadcasting (DVB) Standard and High definition video and audio signals to a QAM RF output. Perfect for multi-video distribution solutions in the commercial and institutional markets. Also available as **QMPPro 1100i** to send one 1080p channel over existing coax or IP infrastructure.



DIGITAL SIGNAGE PLAYERS

Network-Ready Digital Signage Players - Developed and built specifically for networked digital signage applications, CE labs solid-state network-ready digital signage players focus on exceeding the demands of low-cost, high performance standards in mid-to-large scale digital signage systems. Completely network enabled for updates over any network and an open API for writing unique applications for special control display functions, CE labs network-ready digital signage players are an essential piece for any economical and flexible digital signage campaign.

MP70 - simple, yet powerful, network digital signage appliance that provides the flexibility and reach needed for intricate digital signage systems, while keeping cost minimal.

MP80 - ultra-reliable, fan-less, solid-state, commercial 4K 60Hz player that supports all of the new technology standards of the 4K ecosystem for TRUE 4K playback.

MP700 - focuses on exceeding the demands of low-cost, high performance standards in mid-to-large scale digital signage systems.

MP800 - an ultra-reliable, fan-less, solid-state, commercial 4K 60Hz player that supports all of the new technology standards of the 4K ecosystem for TRUE 4K playback.

Stand-alone Digital Signage Players

MP60 - 1080p high definition stand-alone digital signage players that offers an easy and cost-effective advertising solution for simple stand-alone digital signage applications.

MP62 - 1080p high definition stand-alone digital signage players that allows the user to play an array of 1080p video and audio content.



CE Labs produces a wide-range of products other than what is shown here - Call for a more info.



CHAUVET DJ is a premier line of entertainment lighting, controllers and accessories for the mobile performer, DJs, clubs, corporate events and more — offering the most value in the industry.

FIXTURES

FXarray Q5 is an exciting and versatile quad-color LED wash light. Featuring an array of RGB+UV LEDs to spread light evenly across the dance floor with brilliant effects. Control the wash LEDs and the RGB SMDs separately for dynamic light shows and generate eye-catching effects with sound-activated and automated programs.



Helicopter Q6 is a multi-effect effect light designed to dazzle and energize the dance floor. It features adjustable RGBW beams, a round SMD strobe and a red/green pattern laser on a rotating base with continuous pan rotation creating unique and amazing effects. Its narrow, razor-sharp beams of RGBW light create astonishing aerial effects and the rotating red and green laser produces thousands of razor sharp beams that cover a large area.



COLORband PiX-M USB, a moving LED strip light, is a versatile wall-wash light that can create dynamic sweeping, chase, animation and blinder effects thanks to its rotating base, pixel-mapping capabilities, and the ability to control each of its 10 LEDs separately. Its motors allow you to angle the light where it's needed.



FXpar 3 is a compact effect par with multiple technologies in a single fixture. It includes three 8W Quad-color (RGB+UV) center LEDs, RGB SMD LED lights and SMD strobes. Separate control of these features makes creating breathtaking effects easy.



Geyser T6 brings a burst of lighting energy to your events with a pyrotechnic-like effect. Geyser T6 illuminates bursts of water-based fog with 6 tri-color (RGB) LEDs. Its advanced fluid sensor with automatic shut off protects the pump from overheating. Compact and lightweight, Geyser T6 is perfect for mobile applications.



Intimidator Spot 375Z IRC is an exceptionally bright, 150 W LED moving head spot designed for large events. It features motorized zoom for short-throw or long-throw applications and dual rotating prisms splits the beam for great effects and to cover a larger area. The motorized focus ensures crisp projections at almost any distance and the built-in Totem mode keeps the beams exactly where you want them. Intimidator Spot 375Z IRC includes built-in, automated and sound-activated programs or it can be controlled in DMX or Master/Slave mode.



4BAR Flex T USB is one of the most versatile and convenient pack-n-go lighting systems anywhere. The unit features unmatched flexibility with the addition of D-Fi™ USB compatibility for wireless master/slave or DMX control. You can maximize setup possibilities and configurations with 2 included L-brackets and the unit mounts to most tripods or speaker stands, without the need for additional clamps, using the pass-through hole.

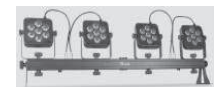

SlimPAR Q12 USB is a low-profile, high-output quad-color (RGBA) LED wash light with D-Fi USB for instant wireless connectivity. It is controllable via master/slave, DMX, standalone modes or the point-and-shoot IRC-6 remote (sold separately). It also features multiple user-configurable settings. SlimPAR Q12 USB creates natural-looking color temperatures thanks to punchy amber LEDs. Available in 6 LED version as **SlimPAR Q6 USB**.



Gobo Zoom USB is a super compact gobo projector with a manual zoom, and wireless connectivity in master/slave and DMX mode, thanks to its embedded D-Fi USB compatibility. Gobo Zoom USB includes 10 wedding-ready gobos.



SlimPAR 64 houses 180 red, green and blue LEDs in a slim casing that fits almost anywhere. This efficient wash light is controllable in 3- or 7-channel of DMX mode. Or for use on the fly, activate pulse effects at variable speed or built-in automated and sound-activated programs. Available with red, green, blue & amber as SlimPAR 64 RGBA.



COLORrail IRC is a linear wash and effect light fitted with 320 LEDs (128 red, 96 green, 96 blue) and featuring built-in, infrared technology. Create your own looks with eight sections of DMX control, or generate eye-catching chase and runway effects with built-in, automated and sound-activated programs.



LED Pinspot 3 is a palm-sized pinspot that can be turned on/off and dimmed from a distance via the optional IRC-6 remote. A pack of 5 gels is included to let you easily change colors.



DMX DIMMING CONTROLLER

The **Stage Designer 50** takes the size of a 24-channel dimming console and the functionality of a 48-channel console and combines the two into one powerful dimming unit. The Stage Designer 50 has up to 8 pages with 12 scenes each and 96,000 programmable steps. The console allows the user to re-assign channels as needed and allows for MIDI input.



BAI distributes the entire Chauvet DJ line including fixtures, lasers, effects, foggers & hazers & accessories.



Lighting • Control • Special Effects

CHAUVET is a major innovator, developer and manufacturer, leading the lighting entertainment market in terms of design, flexibility and options. Our formula is simple: the right products at the right price.

Wash & Spot Lights

COLORado 2 Solo uses three 40 W RGBW engines to project a beautiful and fully homogenized beam through fast and smooth zooming optics. IP rated power and data connectors, and full convection cooling ensure a reliable and silent performance indoors and out, in a wide range of applications, from theatrical to outdoor festival productions.



COLORado 1-Quad Zoom VW is a bright indoor/outdoor PAR-style variable white wash light featuring seven 15 W Osram quad-LEDs with tunable color temperature, from 2800 K to 9010 K, to match tungsten sources up to and beyond daylight.



COLORado 2-Quad Zoom is a solid indoor/outdoor wash light featuring 14 bright quad-colored Osram (RGBW) LEDs and a 14° to 44° zoom. Selectable dimming curves facilitate its integration into an existing rig.



COLORado 1-Quad Zoom is an excellent indoor/outdoor wash light with seven Osram RGBW LEDs delivering big time power from a compact, yet solid housing. It maintains its IP65 rating with IP rated DMX cables, but standard 5-pin XLR DMX cables work perfectly for indoor use.



COLORado 3 Solo uses advanced zooming optics and three 60 W RGBW engines to project an intense and fully homogenized beam. IP rated power and data connectors, and full convection cooling ensure a reliable and silent performance indoors and out, in a wide range of applications, from theatrical to outdoor festival productions.



COLORado 1 Solo builds on the pedigree of our COLORado line of fixtures with advanced optics and superb performance in any environment, from indoor stages to outdoor festivals. This powerful RGBW LED wash projects an even, fully homogenized beam through fast and smooth zooming optics.



COLORado 1-Tri Tour mirrors the Colorado 1-Tri IP's architecture but is built just for indoor use, which allows the incorporation of Neutrik® powerCON® connectors for a speedier and easier setup. Specially designed optics make the light from the LEDs converge before leaving the fixture, ensuring even better color mixing.



COLORado 1-Tri IP is an IP66-rated LED wash with 14 intense, calibrated tri-colored LEDs. This outdoor-rated workhorse is an ideal front light as high-efficiency optics and tri-colored LEDs eliminate multicolored shadows while selectable dimming curves ensure compatibility with an older non-LED rig.



COLORado Batten 72 Tour is a class leading batten-style wash light powered by 72 calibrated red, green, blue, white & amber LEDs. The incorporation of white and amber LEDs affords superb color rendering and a vast palette from soft pastels to saturated hues. Its 16-bit dimming capability as well as five selectable dimming curves provide.

COLORdash Par-Q12IP delivers an intense and beautiful RGBA LED wash in any weather condition. An OLED full text display is easy to navigate and direct IP rated connections for power and DMX make setup a breeze.



Maverick MK2 Spot is a stunningly bright moving yoke spot featuring a 440 W LED engine, precision engineered optics, CMY + CTO color mixing, two 6-position rotating slot and lock gobo wheels, a 7-position + white color wheel, variable frost, 3-facet prism and 13° – 37° zoom range. Control it with DMX, sACN, Art-Net, or W-DMX.



Maverick MK2 Wash rewrites the rules on wash fixtures with its flawlessly even output, custom designed optics, full pixel mapping, virtual gobo wheel with background colors, pre-programmed colors and 7°-49° zoom range. Powered by 12 (40 W) Osram RGBW LEDs, it has the muscle to handle any application, even aerial washing, with ease. Take control with DMX, sACN, Art-Net, Kling-Net or W-DMX.



Rogue R1 FX-B shakes things up, five times over. It orchestrates an infinite rotation of both pan and tilt for its 5 individually controlled heads, powered by 5 pixel mappable 15 W RGBW LEDs. Crisp beams, a sizzling output and rocket quick movements create amazing aerial effects. Control is achieved with DMX, Art-Net, sACN, or Kling-Net.



Rogue R3 Wash is an ideal moving wash workhorse for rental and production inventories. Durable and dependable, it outputs a bright, evenly dispersed light and offers nine zones of LED control to pixel map its 37 (15 W) RGBW quad-LEDs. A quick moving zoom range of 12° – 49° gives it the spread to cover even the largest areas.



BAI distributes the entire Chauvet Professional line of products. Call for a complete guide.



Clear-Com, an HME company, is a trusted global provider of professional real-time communications solutions and services since 1968. We innovate market proven technologies that link people together through wired and wireless systems.

Clear-Com was first to market portable wired and wireless intercom systems for live performances. Since then, our history of technological advancements and innovations has delivered significant improvements to the way people collaborate in professional settings where real-time communication matters. For the markets we serve -- broadcast, live performance, live events, sports, military, aerospace and government-- our communication products have consistently met the demands for high quality audio, reliability, scalability and low latency, while addressing communication requirements of varying size and complexity. Clear-Com offers hundreds of options in numerous configurations. We are showing some of the top selling items here - but for a complete listing, please contact BAI Distributors.

ANALOG PARTYLINE INTERCOM

Main Stations

CS-702 - 2-Channel Portable Headset Main Station with built-in 1-amp power supply

- Supports up to 40 beltpacks or 10 speaker stations on 2 channels. Accepts mic or line-level audio.

MS-702 - 2-Channel Headset/Speaker Main Station with built-in 2-amp power supply

- Rack Mount
- Supports up to 40 RS-701 beltpacks, 10 speaker stations or 12 headset stations on two channels.

MS-704 - 4-Channel Headset/Speaker Main Station with Built-in 2-amp Power Supply

- Supports up to 40 RS-701 beltpacks, 10 speaker stations or 12 headset stations; 3 IFB channels.
- Announce button/relay, Channel-linking button and Remote Mic Kill switch. • Rack Mount

Power Supplies

PS-702 - 2-Channel 1-Amp (2-Amp Peak) Rack Mount (1RU) Universal Power Supply

PS-704 - 4-Channel 2-Amp Rack Mount (1RU) System Power Supply

Belt Packs

RS-701 - Single-channel beltpack w/XLR-3 line connector & XLR-4M headset connector

RS-702 - 2-channel beltpack w/XLR-6 line connector and XLR-4M headset connector

Wall Stations

HB-702 - Selectable two-channel wall or console-mounted headset station

HB-704 - Selectable four-channel wall or console-mounted headset station

KB-701 - Remote speaker station connects to a single channel of party-line intercom and operates in half-duplex mode

KB-702 - Remote speaker station/select between 2 channels of party-line communications with the ability to talk and/or listen on the selected channel



DIGITAL WIRELESS INTERCOM

The easy-to-use HME DX200 System comes complete with synthesized voice prompts, rechargeable batteries, battery charger and rugged, lightweight COMMUNICATOR®s for reliable and cost-effective operation. With digital encryption and frequency-hopping technologies, you'll never have to worry about unauthorized users hearing your conversation.

BS200 Base Station - 2.4 GHz license-free operation

- Secure Communication - Digital Frequency Hopping Spread Spectrum with encrypted signals
- Flexible Battery-Powered Operation
- Triple Diversity
- Expandable

BP200 Beltpack - Super Compact Design - 7.4 ounces

- Rechargeable Lithium-Ion Batteries
- Internal Antennas
- Voice Prompts

WH220 Wireless Two-channel Headset

- 2.4GHz frequency range
- 12 hours of battery life
- 3.5 kHz wide band audio
- Up to 15 beltpacks and/or all-in-one headsets on a single system



HEADSETS

CC-300 single-ear headset - high ambient-noise attenuation w/hyper-cardioid dynamic mic

- Flexible design w/soft-ear pad
- Able to rotate 300 degrees
- Mic boom acts as an On/Off switch

CC-400 double-ear headset - high ambient-noise attenuation w/hyper-cardioid dynamic mic

- Same features as CC-300 but in a dual cup design

HS16 single-muff headset w/noise cancelling microphone for DX Series wireless



BAI is a full-line distributor for Clear-Com intercoms. Please call us for any requirement that you might have and our sales staff will be happy to assist you!



CLEERLINE SSF™

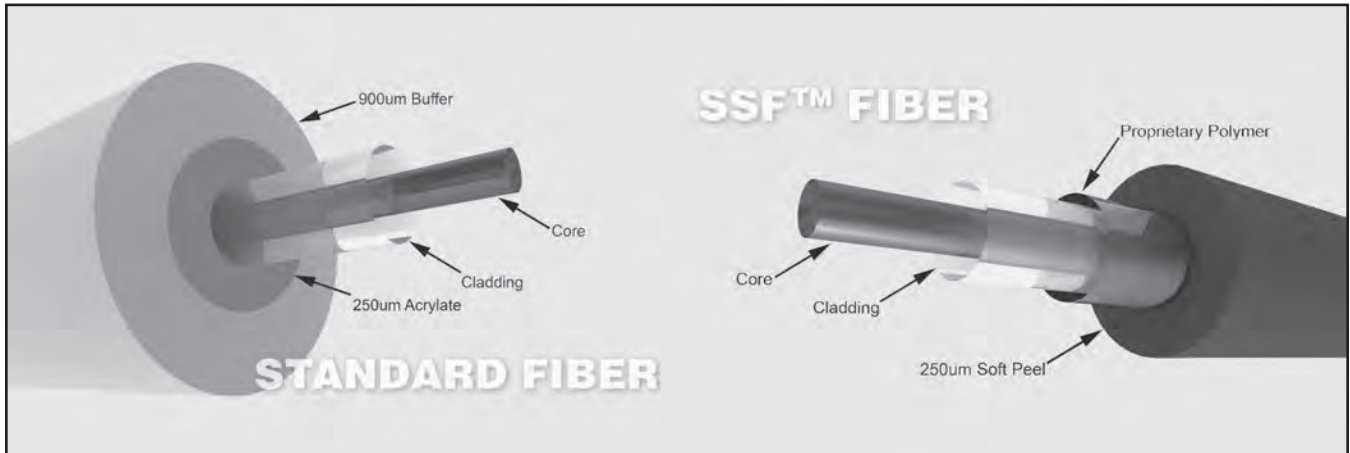

FIBER OPTICS, REDEFINED



STRONGER

- 10,000x the bend longevity of standard fiber
- 200x the durability of standard fiber
- 225 lb. pull strength rating



SAFER

- No protective gear required
- Won't puncture skin or other soft tissues
- Forget delicate handling



FASTER

- Terminate an LC or SC connector in under 1 minute
- Connectors are reusable
- Complete termination kits starting under \$500



Simplex, Duplex, Micro Distribution, & Breakout Fiber

Armored, Direct Burial, Plenum-Rated & Tactical Fiber

Fiber Optic Patch Cords

Connectors

Termination Kits

Testing Equipment

Custom Cables and Constructions Available

www.cleerlinefiber.com

COUNTRYMAN ASSOCIATES

For over 40 years, Countryman Associates has designed and manufactured legendary direct boxes and industry leading miniature microphones at our factory in California, USA.

Earset and Headset Microphones



H6 Headset

- Lowest-profile headset microphone in the world
- Exceptional comfort and performance
- Unidirectional or omnidirectional
- Quick-change water-resistant cables



E6 Earset

- Original and most popular earset
- Lightweight and positionable
- Unidirectional or omnidirectional
- Quick-change cables for wireless or XLR



E2 Earset

- Lowest-profile earset microphone in the world
- Unique design tuned for maximum performance with minimum visibility
- Quick-change cables for wireless or XLR



ISOMAX Headset

- Incredible isolation and full, warm sound
- Rugged, secure design perfect for active performances
- Unidirectional or omnidirectional options for wireless and XLR



EM2/EM6 Earset

- Low-profile, comfortable integration of the E2 or E6 Earsets and Shure Earphones
- Unidirectional or omnidirectional
- All earset and cable connection options

Lavalier and Instrument Microphones



B6 Lavalier

- Smallest lavalier in the world (2.5mm diameter) hides anywhere
- Full, natural frequency response for any application
- Water resistant with Kevlar reinforced cable
- Optional detachable connectors



B3 Lavalier

- Small (5mm diameter) workhorse lav for vocals or instruments
- Full, natural frequency response for any application
- Water resistant with 2mm Kevlar reinforced cable for challenging environments



EMW Lavalier

- Designed for extreme conditions with water sealing
- Ideal for sports/outdoors
- Fabric-noise-reducing polymer shell and 2mm Kevlar cable
- Frequency response available for use under clothing



B2D Lavalier

- Smallest directional lavalier in the world (2.5mm diameter)
- Precision directional patterns for maximum isolation
- Vibration-damping clips
- Optional detachable connectors



I2 Instrument

- Smooth frequency response, low noise, and precise polar patterns with deep nulls
- Perfectly captures the full character of instruments
- Available with full range of vibration damping mounts

Installed Microphones and Direct Boxes



ISOMAX 4RF

- Active vibration isolation detects and subtracts vibration from the signal
- Controlled pickup pattern ensures voice quality and reduces feedback
- Multiple lengths and patterns available



A3 Podium

- Multi-capsule precision gooseneck microphone
- Dramatically reduces vibration and wind noise
- Optional switchable pattern version for maximum versatility



ISOMAX 2-H

- Extremely small hanging microphone allows ideal placement with minimal hardware
- Tightly-controlled patterns provide full response and maximum rejection of ambient noise and feedback



Type 85 and Type 10 Direct Boxes

- Single-channel and stereo direct boxes connect instruments to balanced (XLR type) inputs, providing a strong, clean signal without compromising sonic character
- The legendary Type 85 is hand-built for extreme performance, low noise, and low distortion
- Delivers your sound with the lowest distortion, lowest noise, and highest accuracy of any direct box. The result is a clean, precise signal that is completely faithful to the original sound



From its humble beginnings in 1947, Crown International has grown to become one of the world's largest and most respected manufacturers of power amplifiers and microphones for professional audio markets.

AMPLIFIERS

DriveCore™ Install series amplifiers are a complete line of high performance installation amplifiers based on the proprietary DriveCore technology. DCi Series amplifiers are designed, engineered and manufactured to the industry's highest quality standards, and provide system integrators with the advanced features and flexibility required for challenging 21st century installed sound applications. Versatile, compact and highly energy-efficient, DCi Series amplifiers continue the unbroken Crown tradition of leadership in professional and commercial power amplifier technology.

- Direct Drive Constant Voltage - use smaller gauge wiring to drive the speakers using 70V/100V outputs.
- Channel Independent Hi-Z/Low-Z Selection – Drive either one or two speakers in low-Z mode, or literally hundreds of speakers in high-Z mode (70V/100V).
 - Remote On/Off Interface
- Bridgeable Channel Pairs -DCi Series channels are bridgeable – even in 100V mode.
- **DCi 2 | 300 - 2X300W @4/8Ω/70/100V** • **DCi 2 | 600 - 2X600W @4/8Ω/70/100V**
- **DCi 4 | 300 - 4X300W @4/8Ω/70/100V** • **DCi 4 | 600 - 4X600W @4/8Ω/70/100V**
- **DCi 8 | 300 - 8X300W @4/8Ω/70/100V** • **DCi 8 | 600 - 8X600W @4/8Ω/70/100V**
- **DCi 2 | 1250 - 2X1250W @4/8Ω/70/100V** • **DCi 4 | 1250 - 4X1250W @4/8Ω/70/100V**

All above amps are available in a network version - suffix 'N' and include Blu Link. The network series also includes the DCi 2 | 2400N - 2X2400W @4Ω and the DCi 4 | 2400N - 4X2400W @4Ω.



CDi Series amplifiers are professional tools designed and built for installed sound applications. The series includes four models which are identical except for output power:CDi 1000, CDi 2000, CDi 4000 & CDi 6000. All are rugged and light-weight, and offer unmatched value in their class.

- **CDi1000 - 2X500W@70V** • **CDi2000 - 2X800W@70V**
- **CDi4000 - 2X1000W@70V** • **CDi6000 - 2X2500W@70V**
- Rated for 2/4/8Ω loads & 70/140V
- Intuitive front-panel LCD screen
- Signal to Noise Ratio - 100dB
- Switch-mode universal power supply
- Onboard digital signal processing w/20 user defined presets
- Frequency Response (at 1 watt into 4 ohms, 20Hz - 20 kHz)



ComTech DriveCore™ is ideal for installations that require premium sound quality, multi-channel configurations, compact dimensions, and quite often zero ambient fan noise. Applications include boardrooms, video & teleconferencing, VIP suites in stadiums & arenas, and upscale restaurants & retail outlets to name just a few. Representing next generation technology available today, the ComTech DriveCore™ proves without a doubt that big things really do come in small packages.

- **CT475 - 4x75W@4/8Ω** • **CT4150 - 4X125W@4/8Ω**
- **CT875 - 8X75W@4/8Ω** • **CT8150 - 8X125W@4/8Ω**
- Amplifier is Stable for 2-16Ω Loads
- Universal Power Supply
- Optional XFMR4/8 for 70V Application
- Flexible Input Routing
- Up to 8X125W in 1RU with No Fan
- Patented Feedback & Protection Circuits



XLS Drivecore™ amplifiers define the standard for portable PA systems with unmatched performance, technology and affordability. Its advantageous flexibility includes multiple inputs so you can plug in anything and play anywhere, along with several system setup configurations. The integrated crossovers and switch-mode power supply produce superior sound, and Peakx™ limiters protect your speakers. Weighing less than 12 pounds, compared to 40 pounds for its competitors, it's much easier to set up and move from show to show. Simply put, the XLS is most reliable, versatile, efficient amp available today.

- **XLS 1002 - 2X350W@4Ω** • **XLS 1502 - 2X525W@4Ω**
- **XLS 2002 - 2X650W@4Ω** • **XLS 2502 - 2X775W@4Ω**
- High Performance Class D amp weighs less than 11 lbs
- Integrated PureBand™ Crossover System for better performance and control
- Peakx™ Limiters provide maximum output while protecting your speakers
- XLR, 1/4", RCA inputs provide outstanding flexibility



XT1 2 Series amplifiers defines the standard for portable PA systems with unmatched performance, technology and power-to-the-people affordability that delivers the goods night after night without even breaking a sweat.

- **XTi 1002 - 2X500W@4Ω** • **XTi 2002 - 2X800W@4Ω**
- **XTi 4002 - 2X1200W@4Ω** • **XTi 6002 - 2X2100W@4Ω**
- Enhanced Subharmonic Synth section
- Peakx Plus™ Limiters
- New system monitoring provides software visibility of AC line voltage and power supply temperature
- Integrated speaker presets with LCD front panel display
- 3 User-defined fan mode controls



DSi Series of power amplifiers offers four models of 500W, 800W, 1,200W, and 2,100W per channel at 4Ω

- **DSi1000 - 2X475W@4Ω** • **DSi2000 - 2X800W@4Ω**
- **DSi4000 - 2X1200W@4Ω** • **DSi6000 - 2X2100W@4Ω**
- Intuitive front-panel LCD
- Rear-panel HD-15 connector
- Onboard digital signal processing includes crossovers, EQ filters, delay, and output limiting
- Computer connectivity via USB
- Barrier strip outputs, removable Phoenix-style input



Macro-Tech i Series continues the Crown Macro-Tech legacy of unparalleled sonic accuracy and detail, putting sound quality above all else. With patented, cutting-edge Class-I circuitry users get more power out of an amp with less waste.

- **MA 5000i - 2X2500W @4Ω** • **MA 9000i - 2X3500W @4Ω** • **MA 12000i - 2X4500W @4Ω**





AMPLIFIERS (Cont.)

XLI Series of power amps represents a new era in affordable, quality power amplification. All four models in the series are powerful, rugged and reliable; suited for musicians, DJs, and entertainers as well as houses of worship, discos, and pubs.

- **XLi 800 - 2X300W @4Ω**
- **XLi 1500 - 2X450W @4Ω**
- **XLi 2500 - 2x750W @4Ω**
- **XLi 3500 - 2X1350W @4Ω**

- Stereo/parallel/bridge-mono mode
- Electronically balanced RCA & XLR inputs; binding post and Speakon® outputs
- Two level controls, power switch, power LED, and six LEDs which indicate signal presence, clip and fault for each channel
- Protection against shorts, no-load, on/off thumps and radio-frequency interference
- User selectable input sensitivity - 0.775V and 1.4V



COMMERCIAL AUDIO SERIES

Crown **135MA** and **160MA** are high value mixer-amplifiers that provide 8-ohm and constant-voltage outputs (70V and 100V).

135MA provides 3 inputs (each with a volume control) and 35W power.

160MA provides 4 inputs (each with a volume control) and 60W power.

Other features include:

- Priority muting, voice activated muting
- Phantom power
- Bass and Treble controls.
- Balanced Phoenix-type mic/line Input Telephone Output, Dual RCA Stereo Music Inputs
- Screw-Terminal Speaker Outputs
- Priority muting by VOX or external switch



TOURING SOUND

The **I-TECH HD** is one of the most technologically advanced professional touring amplifiers on the market today. Building on the decades of innovation, invention, and insight Crown is known for, the I-TECH HD features five new patents – three on the power supply alone – giving you an amp that goes well beyond the expected. At the heart of the new I-TECH HD is the BSS OMNIDRIVEHD processing engine. Four times faster than its predecessor and featuring Linear Phase FIR filters and LevelMAX™ limiters, OMNIDRIVEHD provides unmatched clarity and sonically pure signal processing.

- **I-T5000HD** - 2500X2@4Ω
- **I-T9000HD** - 3500X2@4Ω
- **I-T12000HD** - 4500WX2@4Ω
- **I-T4X3500HD** - 2400X4@4Ω
- The only Tour Sound Amplifier that provides inputs routable to any output (analog, AES, or CobraNet)
- Color Touch Screen LCD provides users with diagnostics and presets to ensure easy setup
- Includes SLM (Sweep Load Monitoring) with system-level diagnostics
- High common-mode rejection eliminates hum and RFI on input cables
- **VRACK Complete Amplification System** - customized, turnkey amplification package, complete with full safety approvals. "Go Anywhere" capability U.S. & European shipping configuration.
- Run 120VAC or 208VAC (US) or 220VAC to 240VAC (international) with the flip of a switch
- Allows multiple configurations
- Captive suspension provides lifting and hoisting options



MICROPHONES

PZM®-10/PZM®-10LL

The PZM®-10 and PZM®-10LL, part of the Pressure Zone Microphone® line, are designed for security, surveillance, and conference-table use. Since they do not look like microphones, they are inconspicuous. The mics easily mount into tables, walls or ceilings.



PZM®-11

The PZM®-11 present a low-cost solution for security and surveillance applications. Mounted on a standard wall plate; the PZM®-11 doesn't look like a microphone but rather an ordinary light switch. Also available as the PXM-11LL (Line Level) and PZM-11LL WR (Weather Resistant)



PCC®-160

The PCC®-160 is a surface-mounted supercardioid microphone and an industry-standard for lecterns, conference tables, and news desks – wherever improved gain-before-feedback and articulation are important.



PCC®-170

The Crown PCC®-170 is a surface-mounted supercardioid microphone of professional quality. This handsomely styled unit is appropriate for use on the most elegant boardroom table or lectern. The PCC®-170 minimizes background noise and feedback. Available with on/off membrane switch as **PCC®-170SW**





PROFESSIONAL PRODUCTS

The Professional's Choice in Signal Processing

DriveRack® PA2 provides the latest advancements in dbx's proprietary AutoEQ™ and AFS™ algorithms, a new input delay module for delaying the FOH system to the backline, Ethernet control via an Android®, iOS®, Mac®, or Windows® device, and updated Wizards.

- dbx Compression & Limiting
- AFS™ (Advanced Feedback Suppression)
- Graphic EQ
- Crossover
- Subharmonic Synthesis
- 8-Band Parametric EQ



DriveRack® VENU360 - all the processing & flexibility you need between your mixer and amplifiers to optimize and protect your loudspeakers. With the latest advancements in dbx's proprietary AutoEQ™ and AFS™ algorithms, additional input channels, ethernet control via Android®, iOS®, Mac®, or Windows® device, and updated wizards.

- AFS™ (Advanced Feedback Suppression)
- Subharmonic Synthesis
- 31-Band Graphic EQ
- Backline Delay
- 12-Band Parametric EQ
- Noise Gate



Also available - DriveRack VENU360-B with BLU Link and DriveRack VENU360-D with Dante™

DriveRack® 4820 Loudspeaker Management System includes a powerful 96 kHz DSP engine and standard analog and digital I/O and tamper-proof front panel, the 4820 provides all the processing, flexibility and control necessary for permanent installations.

- 4 analog and AES/EBU ins & 8 analog and AES/EBU outputs
- 31-Band Graphic and 9-band Parametric EQ on every input
- 6-band Parametric EQ -each output
- Loudspeaker Cluster & Driver Alignment Delays



DriveRack® 220i is the perfect tool for any fixed-install application. With a full complement of processing features and Mic/Line inputs the DriveRack 220i can provide both system and microphone processing.

- Advanced Feedback Suppression (AFS)
- Wall Panel Control & Security Lockout
- Bandpass Filters
- RS-232 PC GUI control
- Graphic and Parametric EQ
- De-Esser
- 2x2 Matrix Mixer
- Mic/Line Inputs
- Compressor/Limiter/Gate
- Ducker
- 1.3 Seconds of Delay
- Auto Gain Control



DriveRack 260 Loudspeaker Management System was designed with the purpose and vision of providing state-of-the-art signal processing, while utilizing a simple and intuitive user interface.

- Feedback Elimination
- Classic dbx Compression and Limiting
- Pink Noise Generator and fulltime RTA
- Setup Wizard with JBL speaker and Crown Power Amplifier Tunings
- RS-232 PC GUI control
- Graphic and Parametric EQ
- Full Bandpass, Crossover, and Routing Configurations
- Auto-EQ Function
- Auto Gain Control
- 2.7 Seconds of Alignment and Zone Delay



ZonePRO® 641 6x4 Digital Zone Processor provides flexible signal routing, powerful DSP processing and multiple control interfaces for Commercial Audio applications.

- 6 Inputs & 4 Outputs
- Advanced Feedback Suppression (AFS™)
- AGC, Compression & Limiting
- Bandpass & Crossover Filters
- Autowarmth®
- Parametric EQ



Zone Controllers - dbx offers a full range of zone controllers for use with the SC, DriveRack®, and ZonePRO families. They include:

- **ZC-1** - Programmable Volume Control Zone Controller
- **ZC-3** - Program Selector Zone Controller
- **ZC-6** - Push Button Up/Down Controller
- **ZC-8** - Up/Down Volume w/Source Select
- **ZC-BOB** - Break Out Box for Home Run Cabling
- **ZC-2** - Programmable Volume&Mute Zone Controller
- **ZC-4** - Contact Closure Input Zone Controller
- **ZC-7** - Mic Page Assignment Controller
- **ZC-9** - 8 Position Zone Controller
- **ZC-FIRE** - Fire System Interface



ZC-1

ZC-9

ZC-BOB

166xs Compressor/Limiter/Gate gives you more dynamic control to help create a more polished, professional sound. Error proof operation to smooth uneven levels, add sustain to guitars, fatten drums or tighten up mixes.

- New gate timing algorithms
- Separate precision LED displays for gain reduction, compression threshold and gate threshold
- Stereo/dual-mono operation
- Balanced inputs and outputs



231s Dual Channel 31-Band Equalizer meets the needs of the most demanding sound reinforcement environments, while offering the simplicity of straightforward controls.

- Dual 31-band, 1/3-octave Constant Q frequency
- XLR and TRS Inpts and Outputs
- Switchable boost/cut ranges of ±6 or ±12 dB
- Front panel bypass switch



215s Dual Channel 15-Band Equalizer includes two 15-band channels of 2/3-octave equalization, ±12 dB input gain, switchable ±6 dB or ±12 dB boost/cut range, 20mm nonconductive sliders, an intuitive user interface, and output level metering. • Same features as the 231s but in a Dual 15-band, 1/3-octave Constant Q frequency band.



131s Single Channel 31-Band Graphic Equalizer includes the same features as the 215s but in a single 31-band channel of 1/3-octave equalization configuration.



All dbx products are available through BAI Distributors. Call for an entire list.

DENON

PROFESSIONAL

CD/MEDIA PLAYERS

DN-F350 Solid-State Media Player with Bluetooth/USB/SD/Aux Inputs

- Pair up to (8) Bluetooth devices for playback
- Balanced XLR and unbalanced RCA outputs
- Control via front panel or included IR remote



DN-300C CD/Media Player with USB and Aux Inputs

- Plays CD and MP3 files
- Super-fast loading, slot-in CD mechanism
- 3.5mm AUX input
- 10-key direct track access buttons



DN-300Z Media Player with Bluetooth Receiver and AM/FM Tuner

- Supports USB & HDDs, SD/SDHC cards
- 100 Foot wireless Bluetooth range
- Plays CD-DA, MP3, WAV, and AAC files
- Wireless playback from tablets & smartphones



DN-500CB CD/Media Player with Bluetooth/USB/Aux Inputs and RS-232c

- Bluetooth 3.0 pairing to (8) devices
- 10-button direct track access
- 3.5mm AUX input
- Balanced (XLR) and unbalanced (RCA) outputs



DN-500DC Dual CD/Media Player with USB/SD Inputs and RS-232c

- Independent slot-in transport control
- Balanced XLR and unbalanced RCA outputs
- Supports CD, CD-R, CD-R/W, MP3, and USB/SD WAV/MP3



DN-501C CD/Media Player

- Direct digital playback of iPod/iPhone
- RS-232c serial controllable
- Supports CDDA/WAV/MP3/AAC/AIFF audio file formats



DN-700C Network CD/USB/Media Player with RS-232

- Large, bright OLED display
- Streams audio over the network (DLNA)
- Playback-CD-DA,WAV,AIFF,MP3&AAC files
- Balanced XLR audio output



DVD & BLU-RAY DVD PLAYERS

DN-333XAB 6-Channel Line Mixer 120W Amplifier with Bluetooth ®

- Euroblock connections for Common, 4Ω, 70V, 100V, Alarm, Chime and Mic 1 Priority Ports
- Independent volume controls for mic, line and Bluetooth inputs



DN-508MX 8-Zone Mixer with RS-232c and IP Control

- 6 mic/line inputs & 4 stereo inputs
- 8 zone outputs
- 3-band EQ for all inputs/ 5-band EQ for all outputs

Available in an 8-Zone Mixer with 4-Zone Amplified outputs 4X60W @ 4/8Ω 2X120W @70/100V



DVD & BLU-RAY DVD PLAYERS

DN-500BD Blu-Ray, DVD and CD Player

- Power-on Play button
- OSD (On Screen Display)
- RS-232C and IP control capability
- XLR balanced audio output
- Discrete 7.1ch analog audio output
- Repeat mode for uninterrupted playback loop
- Supports BD-Video, BD-R, BD-RE, DVD-Video, DVD-Audio, DVD+R, DVD+RW



A/V RECEIVERS

DN-AVR3300 7.2ch AV Surround Receiver with Wi-Fi, Bluetooth and Ethernet

- 105W per channel
- 8 HDMI inputs (incl. 1 front) with full HDCP 2.2
- Advanced Multi-Room options
- Dolby Atmos® (up to 5.1.2) and DTS:X™
- AirPlay®, Bluetooth®, Internet Radio, Spotify Connect®, Pandora® & SiriusXM™ Streaming



DN-700AV Professional 7.1 AV Receiver

- 6 - HDMI 2.0 inputs and one output
- XLR balanced 7.1 preamp outputs
- FM tuner with 20-channel memory
- Euroblock 7.1 amplified outputs (75W channel)



BAI carries the entire line of Denon Pro & DJ and Marantz products. Call for more info!

DIGITAL PROJECTION

Today, DPI manufactures and distributes an extensive line of ultra high-performance 3-chip and single-chip DLP™ and DLP Cinema™ based projection systems. DPI's projectors continue to be the reference standard for demanding applications such as scientific visualization, prestigious awards shows, command and control, film festivals, post-production, digital cinema, commercial entertainment, home cinema and houses of worship. DPI will continue to be driven by its pioneering spirit. DPI's legendary pursuit of innovative technology, unmatched customer service and unwavering promise to anticipate the needs of the industry assure it will remain the leader in projection system development and customer fulfillment.

E-Vision Series - delivers an unprecedented high brightness, high value projector option for installations looking for high visual impact on a sensitive budget. Remarkably affordable yet equipped to deliver astoundingly bright imagery, E-Vision projectors utilize the imaging fidelity of Texas Instruments' DLP technology. Fixed and zoom lens options give the E-Vision series a throw ratio range of .77:1 – 8.3:1. Easy to change color wheels allow the integrator or in-house technical team to customize the E-Vision's performance to produce the best balance of lumens and color saturation for their message. Available in WXGA, 1080p and WUXGA resolutions.



M-Vision Series - single-chip DLP projector is the most flexible, as the M-Vision series is available with either lamp-based illumination or with LED based Lifetime Illumination. Both affordable and efficient, lamp-based M-Vision projectors produce high lumens, deep contrast and accurate color. The LED illuminated M-Vision displays offer tens of thousands of hours of LED illumination life, while producing the lush color saturation and color gamut previously achievable only from DP's 3-chip DLP displays. High-brightness, 3D-capable M-Vision projectors are also available. Available in a variety of lens options and includes extensive vertical and horizontal lens shift, making them versatile, powerful choices for any small to medium install.



HIGHlite Series - the newest 3-chip DLP projector platform for installations. Economically priced, compact and quiet solutions for medium to large screen applications, HIGHlite Cine displays produce remarkable color depth, dark area detail and razor sharp imagery at budget-sensitive price points. High-quality optics, including fixed and zoom lenses, accommodate throw ratios from .7: 1 up to 6.76:1, providing tremendous installation flexibility. Further accenting this flexibility is the HIGHlite's impressive vertical and horizontal lens shift range. For churches needing advanced imaging capabilities, dual lamp HIGHlite models include Warp and Blend as a standard feature. Connectivity includes a diversity of digital and analog inputs with a variety of control options.



TITAN Quad 2000 /TITAN 930 3D /TITAN LED 3D - Digital Projection presents a revolution in advanced 3-chip DLP displays with the new **TITAN Quad 2000** product line. Incredibly compact and efficient for its lumen performance, the TITAN Quad 2000 series incorporates DP's active 3D connectivity, Intelligent Lens Mount, ColorMax calibration technology, and a host of vital professional features to suit almost any commercial installation or staging application imaginable.

TITAN 930 series projectors employ two high intensity discharge lamps to produce powerfully bright imagery, making them suitable for a wide variety of demanding medium and large venue applications. DP's ColorMax™ technology presents the most flexible color management system available today, and serves as a powerful color calibration tool, whether the installation calls for a single projector or an array of projectors in tiled / blended applications. A remarkable range of lens shift allows for extensive installation flexibility, further augmented by a suite of fixed and zoom lenses with throw ratios ranging from .73 to over 10.36:1. Additionally, all TITAN 930 displays are equipped with 3D capability and include DP's exclusive 3D advances that further extend the remarkable flexibility engineered within each TITAN projector



TITAN 1080p LED 3D merges the long-recognized precision and power of the TITAN product line with the stunning color space and black levels of LED illumination. The TITAN LED's 2,000 lumen specification separates it from all other purely LED driven displays, yet understates the perceived image brightness and clarity delivered. In addition to the higher brightness, the TITAN LED enlists DPI's Lifetime Illumination® platform, providing a virtually maintenance-free imaging solution that never requires a lamp replacement.

Insight Series - includes 5 models including **Dual Laser 4K, 4K Quad, 4K Dual-LED, 4K Laser & 4K LED**. Each of these 5 models offer full 4K resolution, 3-chip DLP and a range of lumens ranging from 2,000 up to 27,000. Naturally the laser and LED models require no periodic lamp replacement. The elimination of lamp replacements creates immediate value for any venue. By bypassing regular lamp replacement cycles, nearly all lifetime costs for the DP's LASER Projectors are incurred at time of purchase. This key characteristic allows a much lower cost of ownership over the lifespan of the system. Venues looking to produce a dazzling visual experience will realize true cost-saving benefits through the advanced illumination technology of DP's LASER displays.





Your First Line of Defense



DTK-120SRD: 120V AC Power Protection

Protects 120VAC power circuits that feed fire alarm panels, control panels and other critical equipment. It features EMI/RFI noise filtering, and dry contact terminals for remote monitoring.



DTK-120HW: 120V AC Power Protection

Provides surge protection for 120VAC equipment panels and dedicated branch circuits. The compact, parallel-wired design allows for installation in a variety of locations.

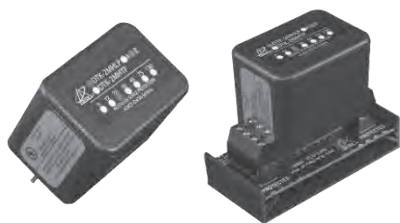

DTK-2MHL Series:

Protects two pairs of low voltage wires

Provides surge protection for low voltage fire alarm circuits. The 2MHL-F Series is designed to open the circuit if it is compromised, whereas the 2MHL-B Series will short the circuit to ground. Each model combines convenient field-replaceable modules with a Snap-Track base system, allowing the installer to protect multiple circuits while utilizing a common grounding point.



DTK-TSS Series: Total Surge Solutions

DITEK's TSS Series is a family of products that provide total surge protection for addressable and conventional fire alarm systems as well as control panels. Protects 120V system power and up to ten pairs of low voltage signaling and communication circuits.

Complete system protection, simple installation, and high quality field-replaceable modules make the TSS family a perfect fit for fire alarms and control panels.



DTK-iBNC28: Protects the video input to the camera

Designed to protect the video feed to externally-mounted fixed or PTZ analog cameras where a dedicated ground connection is unavailable



DTK-PVP27B: Protects camera power & video

Provides surge protection for fixed analog and HDcctv cameras running over coax cabling. Each device protects the 12/24V power wires and the coax video cable.

DTK-DP4P: Protects camera power, data & video

Provides surge protection for PTZ analog and HDcctv cameras running over coax cabling. Each device protects 12/24V power, 5V RS-422/485 data pairs, and the coax video cable.



Your First Line of Defense

Rack Mount / Head End

Networking

Intercom



DTK-RM12POES: 12-Channel PoE Surge Protection

Features shielded RJ45 connections, and is compatible with CAT5e, CAT6 and CAT6A cabling infrastructure. This 1U rack mount surge protector passes Gigabit Ethernet data speed, and is PoE Plus and High PoE ready for high wattage applications.



DTK-RM16NM: 16-Channel Coax Video Surge Protection

Protects up to 16 BCN video feeds utilizing a single point ground. SAD technology provides optimal circuit protection for analog, HD-CVI, AHS and HD-TVI signals.



DITEK's Versa-Module Series:

Completely Customizable Module Surge Protection

Designed to protect analog, digital, high speed data and communication circuits. Installing any combination of up to 6 or 12 protection modules in one of our rack mount or wall mount face plates allows you to utilize a single ground point, and simplifies cable management where space is limited.



DTK-UPS Series: On-Line Tower/Rack Mount UPS

Combines robust surge protection with uninterruptible power supplies for cost-effective and reliable performance. Rack/Tower models are available in 1kVA, 2kVA and 3kVA; and are equipped with an intuitive LCD display. Online double conversion technology provides superior protection for network servers, back office computers or other mission critical equipment.



Single Channel PoE Surge Protection:

DITEK's Power over Ethernet surge protectors are compatible with CAT5e, CAT6 and CAT6A cabling infrastructure. These devices are PoE Plus and High PoE ready for high wattage applications.

The DTK-MR-JPOE with RJ45 connections supports Gigabit Ethernet data speed with a robust surge current rating.

The NEW DTK-MR-JPOES with shielded RJ45 connections supports a maximum data rate of 1000Mbps with a surge current rating of 20kA per pair.

The NEW DTK-MR-JPOEX features a NEMA 4X enclosure for use in outdoor applications. Additional features include shielded RJ45 connections, a maximum data rate of 1000Mbps and boasts a surge current rating of 20kA per pair.



DTK-S Series: Protection for Speaker/Call-In Circuits

DITEK's "Snap-It" Series quick-connect 66 block surge protectors provide both overvoltage and overcurrent protection. Models are available for speakers, call-in circuits, current-limited standard lines and low capacitance digital lines.

DRAPER®

- Draper offers innovative projection solutions for every need. Motorized, fixed, manual and portable screens, with projection surfaces for every setting and system.



Product: Ultimate Folding Screen.

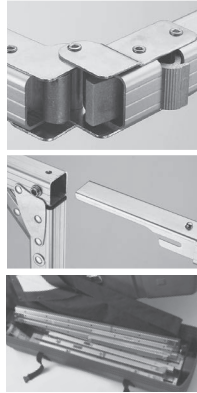

Product: Targa Screen, White Case

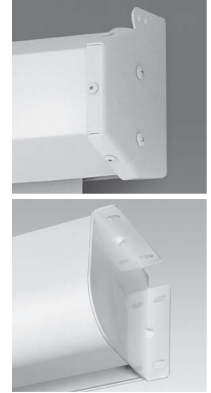

ULTIMATE FOLDING SCREEN (UFS) The first screen manufactured with 100% CNC (Computer Numerical Controlled) components and assembled with CNC technology. The lock and load latch is designed for ease of operation, maximum life and makes the frame extremely rigid. User friendly and incredibly durable. Built for repeated use and to handle the rigors of shipping and rental applications. Sizes available up to 16' wide.

TARGA Motorized projection screens will mount on the wall or ceiling. It is ideal for auditoriums, lecture halls, hospitals, hotels, churches, boardrooms or conference rooms. The motor is mounted inside the roller, for a clean low-profile appearance. Steel case is scratch-resistant, white polyester finish with matching endcaps. Sizes available up to 16' wide.

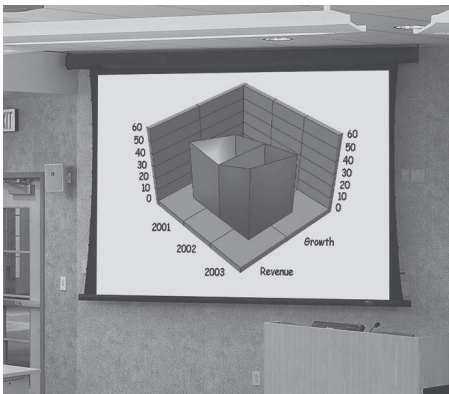

Product: Premier, Wall Mount

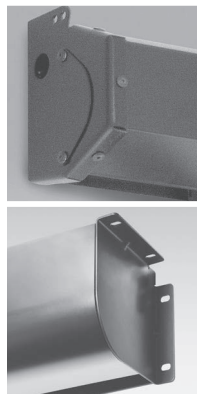

Product: Access V

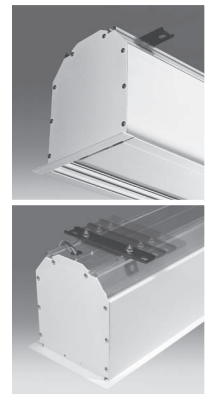

PREMIER Screen comes with a black finished, metal case designed for surface mounting on wall or ceiling. The tab tensioning system holds the surface taut. Motor-in-roller is mounted on special vibration insulators for smooth and quiet operation. Rear Projection surfaces available for this model. Sizes available up to 16' wide.

ACCESS Series The Access concept is a ceiling recessed, folded steel headbox designed to install during construction and screen later. Access door makes installation and service easy. Motorized, ceiling-recessed projection screen with a steel white case, can include door and vary in case dimensions. A trim flange finishes the ceiling opening for a clean appearance.

V is tab-tensioned, **E** version is free hanging. Sizes available up to 24' wide.

CALL ABOUT SCREEN SURFACES: Surface technologies include TecVision™, Rear Projection and Acoustically Transparent.

Draper Inc.

For more than 90 years, Electro-Voice has designed and engineered leading-edge sound reinforcement solutions – products that empower the performer, exceed the expectations of the audio professional and elevate the audience experience.

EVID 3.2/3.2T

- Dual 3" Two-way Full Range
- Vented LF Enclosure
- .75" Voice Coil
- Overload Protection
- Mount Included
- 'T' 70 V/100 V Transformer
- 75 W Power/300 W Peak

EVID 4.2/4.2T

- Dual 4" Two-way Full Range
- Vented LF Enclosure
- 1" Voice Coil
- Overload Protection
- Mount Included
- 'T' 70 V/100 V Transformer
- 100 W Power/400 W Peak

EVID 6.2/6.2T

- Dual 6" Two-way Full Range
- Vented LF Enclosure
- 1" Voice Coil
- Overload Protection
- Mount Included
- 'T' 70 V/100 V Transformer
- 150 W Power/600 W Peak

EVID12.1/12.1P

- Subwoofer
- Dual Voice Coil
- Built-in Crossover
- Trapezoidal
- Mount Included
- 'P' = Powered

EVID C4.2

- 4" LF Polypropylene Driver
- 65 Hz - 20 kHz
- 80 W Power Handling
- 86 dB Sensitivity
- 8 ohm/70 V/100 V

EVID C8.2

- 8" Polypropylene Driver
- 50 Hz - 20 kHz
- 100 W Power Handling
- 91 dB Sensitivity
- 8 ohm/70 V/100 V

EVID C8.2LP

- 8" Polypropylene Driver
- 50 Hz - 20 kHz
- 100 W Power Handling
- 91 dB Sensitivity
- 8 ohm/70 V/100 V

EVID C8.2HC

- 8" Polypropylene Driver
- 50 Hz - 20 kHz
- 100 W Power Handling
- 93 dB Sensitivity
- 8 ohm/70 V/100 V

EVID C10.1

- 10" Subwoofer
- 45 Hz - 180 Hz
- 150 W Power
- 94 dB Sensitivity
- 8 ohm/70 V/100 V

EVID C12.2

- 12" 2-Way Full Range
- 65 Hz - 20 kHz
- 100 W Power Handling
- 100 dB Sensitivity
- 70 V/100 V 64 W Xfmr

Sx300PIX

- 2-Way Full Range
- Weather Resistant
- 300 W/1200 W Peak
- 65° x 65° Varipath™ horn
- 70/100V Multi-tap xfmr

Sx600

- 2-Way Dual 12" All Weather
- 70 Hz - 16 kHz
- 600 W Power/2400 W
- 105 dB Sensitivity
- SuperSAM Mount

EVID PC6.2

- 6" 2-Way Ceiling Mount
- Ultra High Performance
- Concentric Compression Driver

EVID C44

- Ceiling BGM System
- Ceiling Mount Subwoofer w/8" driver
- 4-Ceiling Satellite Speaker w/2" drivers
- 4/8Ω 70/100V

- **EVID C2.1** - Ceiling Mount Satellites
- **EVID 40C** - Ceiling Mount Sub - Wht

EVID S44

- Wallmount 100 Watt BGM System
- Surface Mount Subwoofer
- 4-Surface Satellite Speakers
- Available in Black or White
- 4/8Ω 70/100V Selectable

EVID 2.1

- Surface Mount Satellites **w/2" drivers**

EVID 2.1W

- Same as above in White

EVID 40S Black

- Surface Mount Sub w/8" driver

EVID 40SW

- Same as above in White

EVID PC8.2

- 8" 2-Way Ceiling Mount
- Ultra High Performance
- Concentric Compression Driver



The **ETX** Series of loudspeakers is a versatile high-end choice for live entertainment venues, rental companies, pro musicians and DJs, and installed sound, the ETX Powered Loudspeakers family features three two-way models (10-inch, 12-inch and 15-inch, all with a precision HF titanium compression driver), a three-way model (15-inch with a 6.5-inch MF driver and a precision HF titanium compression driver) and two subs (15-inch and 18-inch drivers).

ETX-10P

- 10-inch LF SMX woofer
- 1.25-inch HF titanium driver
- 2000 W Class-D power amp
- Integrated FIR-Drive DSP
- 134 dB peak SPL

ETX-12P

- 12-inch LF SMX woofer
- 1.25-inch HF titanium driver
- 2000 W Class-D power amp
- Integrated FIR-Drive DSP
- 135 dB peak SPL

ETX-15P

- 15-inch LF SMX woofer
- 1.25-inch HF titanium driver
- 2000 W Class-D power amp
- Integrated FIR-Drive DSP
- 135 dB peak SPL

ETX-18SP

- 18-inch DVX woofer
- 1800 W Class-D power amp
- Integrated FIR-Drive DSP
- 135 dB peak SPL
- Removable casters

ETX-15SP

- 15-inch DVX woofer
- 1800 W Class-D power amp
- Integrated FIR-Drive DSP
- 134 dB peak SPL
- Removable casters

ETX-35P

- 15-inch LF SMX woofer
- 6.5-inch MF driver
- 1.25-inch HF titanium driver
- 2000 W Class-D power amp
- Integrated FIR-Drive DSP
- 136 dB peak SPL

The **EKX** series is the newest member of the Electro Voice portable loudspeaker family, and combines legendary EV sound quality and reliability with the latest technology — all in a compact package suitable for a wide range of sound reinforcement scenarios, including musicians/DJs and live/club/installed sound applications. The EKX series features eight models (four powered and four passive), including 12" and 15" two-way models and 15" and 18" subwoofers. EKX is positioned above the ZLX and ELX series and below the ETX series.

EKX-12

- 12" 2-Way Passive Loudspeaker
- 1400W (peak) 131dB peak SPL
- 90° x 60° Pattern
- 8 - M10 threaded mount points
- Aluminum pole mounts

EKX-12P

- 12" 2-Way Powered Loudspeaker
- 1500W (peak) 132 dB peak SPL
- Intelligent thermal management
- 8 - M10 threaded mount points
- Aluminum pole mounts

EKX-15

- 15" 2-Way Passive Loudspeaker
- 1600W (peak) 132 dB peak SPL
- 90° x 60° Pattern
- 8 - M10 threaded mount points
- Aluminum pole mounts

EKX-15S

- 15" Passive Subwoofer
- 1600W (peak) 133 dB peak SPL
- M20 threaded pole mount plate
- Lightweight, Compact 15-mm wood enclosure

EKX-18S

- 18" Passive Subwoofer
- 1600W (peak) 134 dB peak SPL
- M20 threaded pole mount plate
- Lightweight, Compact 15-mm wood enclosure

EKX-15P

- 15" 2-Way Powered Loudspeaker
- 1500W (peak) 132 dB peak SPL
- Intelligent thermal management
- Eight M10 threaded mount points
- Aluminum pole mounts

EKX-15SP

- 15" Powered Subwoofer
- Single-knob user interface
- 1300W (peak) 133 dB peak SPL
- Two XLR outputs
- Intelligent thermal management
- M20 threaded pole mount plate

EKX-18SP

- 18" Powered Subwoofer
- Single-knob user interface
- 1300W (peak) 134 dB peak SPL
- Two XLR outputs
- Intelligent thermal management
- M20 threaded pole mount plate

Clear, powerful, and musical, the ELX series was created to command the stage. The series includes three versatile powered wood cabinets — two loudspeakers and a matching subwoofer. Each self-contained system features EV-engineered components optimized for use with integrated high-efficiency amplifiers. These are housed in hardy stackable enclosures of solid wood, making ELX models lighter than comparable-quality composite or plastic boxes and therefore easier to load, transport, and set up.

ELX112

- 2-Way 12" Loudspeaker
- 250W/1000 W Max
- 132 dB max SPL

ELX115

- 2-Way 15" Loudspeaker
- 400 W/1600W Max
- 134 dB max SPL

ELX215

- Dual 15" 2-Way
- 600 W/2400W max
- 137 dB max SPL

ELX118

- 18" Subwoofer
- 400W/1600W Max
- 134 dB max SPL

ELX112P

- 2-Way 12" Powered Speaker
- 1000 W Class D Amplifier
- 132 dB max SPL
- 2-XLR/TRS&Stereo RCA/XLR Out

ELX115P

- 2-Way 15" Powered Speaker
- 1000 W Class D Amplifier
- 134 dB max SPL
- Same I/O as ELX112P

ELX118P

- 18" Powered Subwoofer
- 700 W Class D Amplifier
- 134 dB max SPL
- 1-XLR/TRS In/XLR Out

The **EVA series (Expandable Vertical Array)** is an elegantly simple solution for installed sound applications. EVA offers true line-array performance from the patented Hydra plane wave generator. The sophisticated internal crossover allows up to eight EVA boxes to be powered by a single amplifier channel with no additional DSP required. Available in 3 finishes - Indoor, PI and Fiberglass.

EVA-2082S 1220

- 120° horizontal coverage
- 20° vertical coverage
- 350W Power handling
- Suspension Hardware Included

EVA-2082S 126

- 120° horizontal coverage
- 6° vertical coverage
- 350W Power handling
- Suspension Hardware Included

EVA-2082S 906

- 90° horizontal coverage
- 6° vertical coverage
- 350W Power handling
- Suspension Hardware Incl.

EVA-2082S 920

- 90° horizontal coverage
- 2° vertical coverage
- 350W Power handling
- Suspension Hardware Incl.

Every loudspeaker and subwoofer in the **EVF Series** can be used for a wide variety of fixed-install applications where high-quality sound reinforcement is required in a compact, lightweight, and simple-to-use package. Part of the EV-Innovation loudspeaker family, the EVF Series of two-way, front-loaded, full-range systems is available with 12" or 15" woofers, a wide range of coverage patterns, and includes low-frequency systems. Very high maximum SPL output capability with extremely low distortion level.

Coverage patterns include 60° x 40°, 60° x 60°, 90° x 40°, 90° x 60°, 90° x 90°, 120° x 60° Constant Directivity.

EVF-S 12

- 12" 2-way full-range
- 500W Continuous/2000W Peak
- 98dB Sensitivity/131dB Max SPL

EVF-S 15

- 15" 2-way full-range
- 500W Continuous/2000W Peak
- 101dB Sensitivity/134dB Max SPL

EVF-1181S

- 18" Front-loaded sub
- 400W cont./1600W peak
- 99dB sensitivity/131dB max

EVF-2151D

- Dual 15" front-loaded sub
- 1000W cont./4000W peak
- 101dB sens./137 dB max

The **EVH Series** two-way, 15", full-range loudspeaker model is designated EVH-1152. Six different rotatable waveguides are available, ranging from 40° x 30° to 90° by 90°: EVH Series loudspeakers each use ND2B high-output, 2" pure titanium compression driver for EVH-S versions and DH7N 3" pure titanium compression driver for EVH-D series. Call for models.

Call BAI Distributors for Complete Parts Listing for both EVF & EVH Series.

ZLX-12P

- 12" 2-Way Powered
- 65 Hz - 18 kHz
- 90° x 60° Coverage
- 126 dB max SPL
- 1000 W Class D Amplifier

ZLX-12

- 12" 2-Way Passive
- 250 W/1000 W Max
- 82 Hz - 18 kHz
- 90° x 60° Coverage
- 125 dB Sensitivity

ZLX-15P

- 15" 2-Way Powered
- 55 Hz - 18 kHz
- 90° x 60° Coverage
- 127 dB max SPL
- 1000 W Class D Amplifier

ZLX-15

- 15" 2-Way Passive
- 250 W/1000 W Max
- 56 Hz - 18 kHz
- 90° x 60° Coverage
- 126 dB Sensitivity

ZX1

- 8" 2-way full-range
- 1.25" titanium HF driver
- Rotatable 90° x 50° horn
- 200W continuous/800W peak
- 123 dB maximum SPL

ZX1-Sub

- 12" Passive Subwoofer
- 400W Cont./1600W Peak
- 127 dB maximum SPL

ZX1i

- 8" 2-way full-range
- Indoor/outdoor
- Rotatable horn
- 200W Cont./800W Peak
- 123 dB max SPL

ZXA1

- 800W power amplifier
- 90° x 50° coverage
- Rotatable horn
- 126 dB maximum SPL
- Bi-amplified design

ZX3

- 12" 2-way full-range
- 2" ND2 titanium HF driver
- Coverage-90°x50°/60° x 60°
- 600W Cont./2400W Peak
- 131 dB maximum SPL

ZX5

- 15" 2-way full-range
- 2" ND2 titanium HF driver
- Coverage-90°x50°/60° x 60°
- 600W Cont./2400W Peak
- 132 dB maximum SPL

ZXA5

- Powered 15" 2-way full-range
- 2-Channel amp
- 1000W LF, 250W HF
- 90° x 50° coverage horn
- Switchable high-pass filter
- M8 mounting inserts (10)

ZXA1-Sub

- 12" Powered Subwoofer
- Dual XLR Ins and Outs
- Switchable EQ Modes
- 700 Watts Cont./Peak
- 126 dB Half Space max SPL

TX1122

- 12" 2-way full-range
- 500W Cont./2000W Peak
- 90° H x 50° V horn
- 97dB sens./130dB max SPL
- 6 - 3/8" suspension points

TX1152

- 15" 2-way full-range
- 500W Cont./2000W Peak
- 60° H x 40° Rotatable horn
- 100dB sens./133dB max SPL
- 6 - 3/8" suspension points

TX2181

- Dual 18" subwoofer
- 1000W Cont./4000W Peak
- 103dB sens./138dB max SPL
- Braced plywood/MDF
- Optional Wheel Kit

TX2152

- Dual 15" 2-way full-range
- 1000W Cont./4000W Peak
- 103dB/139dB max SPL
- Braced plywood/MDF
- 6 - 3/8" suspension points



The **R300 Wireless Microphone System** includes features like One-Touch ClearScan™ and EZsync allowing quicker and easier set up and use than any other similarly priced wireless system, while its rack-mountable metal receiver, sturdy metal bodypack and handheld transmitters & remote-mountable antennas are of a performance quality usually reserved for the highest-end professional products. Other great features include 14 hour battery life from two AA alkaline batteries and 32 preset channels, with compatible groups of 8 channels for simultaneous use.

Models include:

- R300-L Uni-directional Lapel Wireless System**
- R300-HD Handheld Wireless System with PL22 Dynamic Mic**
- R300-E Omni-directional Headworn Wireless**



The **RE-2 Series Wireless Microphone System** brings sophisticated professional features to an affordable price point. The RE-2 is a completely programmable 1,112 frequency, UHF frequency agile system with auto ClearScan™, XLR Mic or Line level output and more.

WIRED MICROPHONES



RE20
Dynamic Cardioid
45 Hz - 18 kHz
Broadcast



RE27N/D
Dynamic Cardioid
45 Hz - 20 kHz
Studio/Recording



RE320
Cardioid
30 Hz - 18 kHz
Live Sound



RE410
Cardioid Condenser
50 Hz - 20 kHz
Vocal/Instruments



RE510
Supercardioid Condenser
50 Hz - 20 kHz
Live & Studio Use



RE50B
Dynamic Omni
80 Hz - 13 kHz
Interview Mic



635A/B
Dynamic Omni
80 Hz - 13 kHz
"The Hammer"



ND76
Dynamic Cardioid
70 Hz - 17,000 Hz



ND76S
Dynamic Cardioid
70 Hz - 17,000 Hz



ND86
Dynamic Supercardioid
70 Hz - 17,000 Hz



ND96
Dynamic Supercardioid
140 Hz - 15,000 Hz



ND44
Dynamic Tight Cardioid
80 Hz - 16,500 Hz



ND46
Dynamic Supercardioid
70 Hz - 17,000 Hz



ND66
Condenser Cardioid
50 Hz - 20,000 Hz



ND68
Dynamic Supercardioid
20 Hz - 11,000 Hz



PL33
Kick Drum & Instrument
Supercardioid dynamic
Tight-mesh Memraflex™ grille



PL35
Tom, Snare & Instrument
Supercardioid dynamic
DRC-1 drum-rim clamp (Incl)
Excellent isolation



PL37
Overhead & Instrument
Tight Cardioid condenser
Detailed response
Crisp detail



PL80C
Live performance Vocal
Supercardioid dynamic
Superior off-axis rejection
Ultra-low handling noise



PL80A
Vocal microphone
Supercardioid dynamic
EQ friendly



US602FL
PTT Handheld Mic
For High Noise Areas
Noise Cancelling



US690
12" Gooseneck Mic
XLR Type Connector
6dB More Sensitivity



UW30
30W Underwater Speaker
3 Conductor 50" Cable
Up to 30' X 30' Pool

INSTALLATION MICROPHONES



PC-18/XLR
18" Multi-Pattern Gooseneck
Switchable HP Filter
PC-12 - 12" Version



PC PLUS-18
18" Multi-Pattern Gooseneck
Switchable HP Filter
PC Plus 12 - 12" Version



RE90P-18
18" Podium Gooseneck
Vocals/Instruments
RE90P-12 - 12" Version



PC Satellite
Mute switch with LED
4 polar patterns
5", 12", or 18" goosenecks



PC Boundary
Multi-pattern layer mic
Omni, Cardioid,
S-cardioid & Figure 8
XLR Connection



PC Boundary Satellite
Multi-pattern layer mic
Integrate with wireless
Telex & EV compatible
Mute-switch function



RE90B Boundary Mic
Half-cardioid Pattern
Built-in equalization
Black or White



RE90H Hanging Mic
Cardioid pattern
25' braided & shielded cable
Built in preamp
Available-white (RE90HW)

Much of EV's reputation in the audio community stems from EV's reliability and performance through time-tested rigors of the road, fixed-installation environments, studio use, and numerous other applications. EV amplifier products from this standpoint: high-quality products should be dependable, rugged and acoustically exceptional.



CPS2 Series Amplifiers

CPS Series are high-performance amplifiers with unmatched dynamic range capability ensuring the most reliable operation. Designed for the contractor, the CPS Series feature 2-RU chassis, Phoenix connectors for pre-programmable power-on delay, easy power-on via remote contact closures and other great features.

- **CPS 2.12 MK II** - 1200WX2 @ 4 Ohms
- **CPS 2.4 MK II** - 450WX2 @ 4 Ohms
- **CPS 2.6 MK II** - 600WX2 @ 4 Ohms
- **CPS 2.9 MK II** - 900WX2 @ 4 Ohms
- **CPS 4.5** - 500WX4 @ 70/100V
- **CPS 4.10** - 1000WX4 @ 70/100V
- **CPS 8.5** - 500WX8 @ 70/100V



PA Series Amplifiers

EV Commercial Power amplifiers are designed to operate under a variety of adverse conditions without fail. Several configurations, power levels, and features are available to suit nearly any commercial application. Features include many of the same comprehensive protection circuits typical of EV amplifiers.

- **PA1250T** - 1X270W @70.7V
- **PA2250T** - 2X270W @70.7V
- **PA2400T** - 2X400W @70.7V
- **PA4150L** - 4X150W @4 Ohms
- **PA2450L** - 2X400W @8 Ohms



Q-Series Amplifiers

As direct descendants of the legendary P3000 amplifiers Q Series amplifiers take Electro-Voice's unique amplifier design to a new level. With Q Series efficient Class 'H' design, the permanent voltage inputs and outputs, rail is designed to cover the average music signal rather than supplying the voltage for maximum output power.

- **Q44** - 450WX2 @ 4 Ohms
- **Q66** - 600WX2 @ 4 Ohms
- **Q99** - 900WX2 @ 4 Ohms
- **Q1212** - 1200WX2 @ 4 Ohms



RCM-810

For supervision and remote control of power amps.

- Power ON/OFF/Power On Delay
- Control Inputs/Outputs
- Load supervision/Output VU/Protect/Limit
- Pilot tone/Temperature/Gain/Sensitivity
- Up to 250 Amp total/ 100 Amp per CAN bus



Compact Precision Amps

- **CP4000S** - 2X1200W @ 4 Ohms



Tour Grade Amplifiers

- Grounded Bridge Class-H design
- Switch-mode power supply
- **TG5** - 2X1450W @ 4 Ohms
- **TG7** - 2X2500W @ 4 Ohms
- Optional **RCM-28 DSP module**
- OMNEO Network Interface
- Six recallable DSP presets



DC-One Digital Signal Processor

- 2 In/ 6 Out Speaker Processor
- 24-Bit Sigma Delta AD/DA Converter
- 111dB Dynamic Range
- USB Interface



Dx46 Speaker Processor

- 2x6 FIR-Drive Processor
- Analog and AES/EBU Inputs
- Full IRIS-Net Control
- 4 Separate Delay Sections



UCC-1

- USB-CAN converter
- For IRIS-Net enabled devices
- Supports up to 100 CAN devices
- USB Powered

HORNS AND COMPRESSION DRIVERS

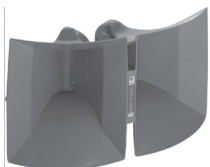

Cobraflex IIB Horn

A Folded Sectoral Horn featuring a patented design that eliminates high frequency phase cancellation and improves intelligibility. Provides a 80X60 dispersion. Includes bracket.



ID30CT Driver

A 30 Watt heavy-duty driver for reentrant horns. Designed for high-level public address areas. Indoor/Outdoor design.



ID60CT Driver

A 60 Watt heavy-duty driver with all the same features as the ID30CT.



PA60 - Paging Horn

The PA60 weather-resistant projector is ideal for any indoor or outdoor public address or paging application where reliability & durability are important.



FENDER™ PASSPORT® SERIES PORTABLE AUDIO SYSTEMS

Passport® Venue portable sound system full-range speakers, versatile features, friendly front-panel controls and 600 watts of uncompromising sonic power provide powerful, clear and reliable Fender sound reinforcement ideal for larger venues and occasions, including band and DJ gigs; education, sporting & worship events; meetings, presentations and more.

- **All-in-one PA system with 10-channel powered mixer and full-range speakers**
- **600 watts** • **Sub output with automatic high-pass filter**
- **13 inputs (4-XLR mic/line, 2-1/4" instrument/line, 2 each stereo 1/4" & 1/8", 1-USB stereo)**
- **USB record/playback system records WAV files and plays WAV/MP3 files**



Passport® Event portable audio system is perfect for amplifying your voice, instrument and background music anytime and anywhere. Its full-range speakers, versatile features, friendly front-panel controls and 375 watts of sonic power provide powerful, clear and reliable Fender sound ideal for gigs at parties, small clubs, education, sporting & worship events; meetings, seminars, presentations and more.

- **All-in-one PA system with seven-channel powered mixer and full-range speakers**
- **375 watts** • **Sub output w/automatic high-pass filter** • **Bluetooth® connectivity**
- **8-inputs (4-XLR mic/line, 1/4" instrument/line, 1/4" stereo, 1/8" stereo, stereo Bluetooth®)**



Passport® Conference audio system is ideal for small to medium-size audiences.

Its full-range speakers, versatile features, friendly front-panel controls and 175 watts of power provide clear and reliable Fender sound ideal for education, sporting & worship events; meetings, seminars and presentations; and gigs at parties, small clubs, coffeehouses and much more.

- **All-in-one PA system with five-channel powered mixer and full-range speaker**
- **175 watts** • **Nine inputs (three - XLR, five - 1/4", one 1/8" stereo)**
- **International voltage operation (100- 120-volt/220- 240-volt)**



Passport® Mini offers convenient amplification for instruments & microphones. It's ideal for grab-and-go performances by street musicians & students, and is the perfect small public address system for events and presentations. Weighing less than 8 pounds and powered via AC or batteries, the 7 Watt Passport Mini can go anywhere and is also a great media playback system and computer recording interface.

- **1/4" input instrument channel with 8 electric and acoustic models and 24 presets**
- **XLR and 1/4" input vocal channel with anti-feedback, volume, tone and reverb controls**
- **12 onboard effects with Tap Tempo** • **Dual channel with aux input**



FENDER™ POWERED SPEAKERS

Fortis™ F-12BT 12" Powered Speaker - Experience revolutionary Fender® sound in a easily portable package that's ideal for DJs, schools, houses of worship, solo performers, businesses or small-to-medium sized venues with the Fortis F-12BT 12" active two-way powered speaker. Combining the power of streaming technology and versatile design with user-friendly features, the F-12BT is 1,300W of Fender's musical "art and science" engineering packed into a lightweight package.

- 3 Input Channels
- Stereo Bluetooth
- M10 Rigging Points
- 9-ply Voidless Plywood
- 35mm Pole Socket w/2 angles



Fortis™ F-15BT 15" Powered Speaker - Same features as the F-12BT but with a 15" speaker

Fortis™ F-10BT 10" Powered Speaker - Same features as the F-12BT but with a 10" speaker



Fortis™ F-18SUB 18" Powered Subwoofer - adds 1,000W of audiophile-quality bass enhancement to a Fortis powered speaker system. Engineered for serious low end punch, the 18" woofer and Class 'D' power amp combine to kick out up to 134dB of thumping bass from 30Hz-200Hz.

FENDER™ IN-EAR MONITORS

Patented technology and an immersive listening experience for serious players & audiophiles.

There are 5 different models to suit any level of listening requirement. All Fender™ In-ear monitors are hand-assembled in Nashville, Tennessee and include custom drivers and 3D printed precision housings. DXA1 - Slimline shell, delivering cushion-like comfort and premium sound isolation, with a finely tuned custom driver—ideal for performances and smartphone-friendly listening.

FXA2 - Balanced precision, premium sound isolation and minimal distortion for serious players and music connoisseurs who appreciate definition on stage and off.

FXA5 - Breakthrough dual balanced armature array technology reproduces your mix with detailed, full-range response.

FXA6 - Hybrid driver technology pairs a balanced armature tweeter with a custom rare-earth driver to reproduce any mix with stunning clarity, full-range response and ample bass.

FXA7 - Articulate performance, luxurious comfort and precision clarity dance in perfect harmony in these in-ear monitors.



FURMAN

120V PRO AUDIO/VIDEO

CLASSIC SERIES - brings together superior protection & outstanding performance in a sturdy, rack-mountable design. The Classic Series features Series Multi-Stage Protection(SMP),Linear Filtering Technology(LiFT) & Extreme Voltage Shutdown(EVS)

- PL-8C** • 8 rear panel outlets & 1 front panel outlet • 15 amp rating
• BNC Lamp Connector • 3 'spaced' outlets for wall wart use



- PL-PLUS C** • LED Voltmeter & Pull out lights • 15 amp rating
• 8 rear panel outlets and one front panel outlet • 3 'spaced' outlets for wall wart use



- PL-PLUS DMC** • Same features as PL-PLUS C but with Digital Ammeter/Voltmeter



- P-8 PRO C** • Same features as PL-8C except no pullout lights
• 8 rear panel outlets & 1 front panel outlet • 20 amp rating



- PL-PRO C** • Same features as PL-PLUS C but with 20 amp rating



- PL-PRO DMC** • Same features as PL-PLUS DMC but with 20 amp rating



MERIT X SERIES - Low cost AC Power Solutions

- M-8X2** • Noise Filtration and Surge Protection • 8 rear panel & 1 front panel outlet
• 3 Wall wart spaced outlets • 15 amp rating



- M-8Dx** • Same as M-8Lx but with digital voltmeter



- M-8Lx** • Same as M-8X2 but with pull out lamps



- M-8S** • Sequencing - Six sequenced rear panel outlets (in 3 groups), two unswitched rear panel outlets, and one front panel unswitched outlet



- M-8x AR** Voltage Regulator • 9 regulated, conditioned AC outlets-8 rear panel & 1 front



- AC-215A** Compact Power Conditioner with Auto-Resetting Voltage Protection
• SMP Technology provides the highest level of surge & spike protection
• LiFT filtering to ensure clean power for unequaled audio & video clarity



- SS-6B** Pro Surge Suppressor • 6 outlet block • Heavy duty metal construction • 15' cord



CONTRACTOR SERIES - Intelligent Power Management Solutions

CN-1800S 15 Amp SmartSequencer

- SmartSequencing™ Technology allows large or complex A/V systems to be safely powered on and off with the simple press of a button or key turn.
- Series Multi-Stage Protection (SMP) ensures zero downtime for mission critical installations by safely eliminating dangerous surges & spikes. • Supports RS-232 Communication
- Extreme Voltage Shutdown (EVS) safeguards from catastrophic under & over voltage conditions.
- Linear Filtering Technology (LiFT) ensures maximum equipment performance by reducing AC noise in a linear fashion across a wide-bandwidth spectrum.



- CN-2400S SmartSequencer** - Same as above but with 20 amp capacity



CN-15MP 15 Amp MiniPort

- SmartSequencing™ Technology allows large or complex A/V systems to be safely powered on and off with the simple press of a button or key turn. • 15 amp capacity.
- Extreme Voltage Shutdown (EVS) safeguards from catastrophic under & over voltage conditions.

- CN-20MP 20 Amp MiniPort** - Same as CN-15MP but with 20 amp capacity



Note: Furman Contractor Series requires certification - Call BAI for details!

BAI Carries the Entire Furman Line - Call for Complete Listing!



Family Owned
Since 1977

The Personal
Monitor Experts



WIRELESS PERSONAL MONITORS

Any Spot AS-900 Wireless Personal Monitor Fixed Frequency

A great entry-level Wireless Personal Monitor. This system features an 80mW receiver output. The receiver also contains an RF and low battery indicator. The transmitter has L/R level display, stereo XLR/1/4" inputs and an headphone output with volume control. Single channel, fixed frequency unit, EB4 ear buds and single/dual rack kit included. NEW FREQUENCIES AVAILABLE! 3 Year Warranty



AS-900

Any Spot AS-1100 Wireless Personal Monitor

The AS-1100 packs an amazing punch. The transmitter has stereo XLR/1/4" inputs, headphone output, and LCD display, which displays the channel and input level. The Receiver has an LCD with channel, battery level, and RF/AF indicator. The AS-1100 is perfect for anyone looking for their first system or to upgrade to the next level. 120 selectable channels, EB4 ear buds and single/dual rack kit included. 3 Year Warranty



AS-1100

Any Spot AS-1400 Wireless Personal Monitor

The new AS-1400 is the latest addition to Galaxy Audio's highly acclaimed line of Wireless Personal Monitors, offering high end features and performance at a very affordable price. The transmitter features stereo XLR/1/4" inputs, headphone output with volume control, input level control, and LCD display for channel and input level. The Receiver features **Mixed Mono Mode** for your own personal mix, volume, and an LCD display with channel, battery level, and RF level. The AS-1400 is perfect for the working musician, House of Worship or any application requiring an affordable, reliable WPM system. 275 Selectable Channels, EB4 ear buds and single/dual rack kit included. 3 Year Warranty



AS-1400

HOT SPOT® PERSONAL MONITORS

HOT SPOT Compact Personal Monitor HS7

The HS7 features an 18 dB Stepped Attenuator Volume Control, 'built-ins' like mic stand mount, mic boom socket, Integrated handle, stand/wall bracket mounts (optional bracket). 2 Twist-lock/1/4" combo inputs wired in parallel, high impact ABS plastic, two 5" neodymium Ferro Fluid cooled drivers, 150Hz-18kHz, 16 ohm Impedance which means 4 HS7's is only a 4 ohm load. 200 watts cont. power, 94dB sensitivity/126 dB SPL, 3 Year Warranty.

Weight: 4.5 lbs, Dimensions: 7.75" x 11.75" x 6.75".



HS7

Powered HOT SPOT Compact PA System PA6BT

The Powered Hot Spot now includes Bluetooth® technology with its own volume control. The PA6BT also features a 170 watt power amplifier, two way speaker system; 155 watt NEOLITE 6.5" Woofer, 1.5" 60 watt Titanium Dome Tweeter, two XLR/ 1/4" inputs with XLR pass through, built in compressor, line input, line output, three band EQ, built in mic stand mount, mic boom socket, integrated handle, built in stand/wall bracket mounts (optional bracket). The PA6BT is great for any live sound application whether it's used as a front of house compact PA speaker or a personal monitor. Frequency Response (80HZ -18kHz), 3 Year Warranty.

Weight: 6.4 lbs, Dimensions: 7.75" x 11.75" x 6.75".

Built-in
Bluetooth®



PA6BT



Family Owned
Since 1977

The Personal
Monitor Experts



WIRELESS MICROPHONE SYSTEMS

EDX Dual Channel Wireless Microphone System

The EDX Series is a dual channel wireless system. The EDX features 2 internal antennas (1 for each receiver), 16 selectable channels on each receiver, and IR Sync the receiver to transmitter. The EDX has 2 discreet male XLR outputs and 1 combined 1/4" output on the back of the unit. The output is controlled by a volume control for each receiver, located on the front of the unit.

EDXR/HH38 Dual Handheld System
EDXR/HHBPS Handheld & Headset Mic
EDXR/38VV Dual Lavalier System

EDXR/38SS Dual Headset System
EDXR/HHBPV Handheld & Lavalier Mic
EDXR/38SV Headset & Lavalier System



PSE Wireless Microphone System

The PSE is a UHF diversity receiver with 16 selectable channels. The receiver features a volume control, channel display, and IR Sync. The PSE has an XLR and 1/4" output and squelch adjustment. Single/Dual rack mount included.

PSER/HH52 Handheld system
PSER/52LV Lavalier system

PSER/52HS Headset system



ANY SPOT HEADSET MICS

Galaxy Audio offers the best choice for an affordable headset microphone. The super lightweight design makes wearing the microphone more comfortable, even for long periods of time, without using excessive pressure to hold the microphone in place. The soft microphone stem allows for easy adjustment of the microphone's position as you wear the headset. These Headset microphones, work great with many available wireless transmitters. Only Galaxy Audio Headsets now come with 4 free detachable cables! Cable choices are (4) Galaxy Audio®/AKG® cables, (4) Shure® cables, (4) Audio-Technica® cables, (4) Sennheiser® cables or a MIXED Set with one of each brand, (1) Galaxy Audio®/AKG®, (1) Shure®, (1) Audio-Technica®, and (1) Sennheiser®.



ESM8 Single Ear

ESM8-OBG Omni Beige
ESM8-OBK Omni Black
ESM8-UBG Uni Beige
ESM8-UBK Uni Black

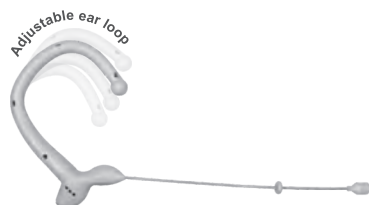

ESM3 Single Ear

ESM3-OBG Omni Beige
ESM3-OBK Omni Black

ONLY GALAXY
INCLUDES
4 FREE
EASY-REPLACE
CABLES WITH
EACH HEADSET
MICROPHONE



A \$280 Retail Value



HSM8 Dual Ear Hook

HSM8-OBG Omni Beige
HSM8-OBK Omni Black
HSM8-UBG Uni Beige
HSM8-UBK Uni Black



HSM3 Dual Ear

HSM3-OBG Omni Beige
HSM3-OBK Omni Black



Gator Cases is a well-known manufacturer of Audio Visual, Pro Audio and Musical bags & cases and a wide variety of Floor and Wall Mount Metal Rack Enclosures, Wood Studio & Media Racks, Portable Rack Systems and Rack Accessories.

SECTIONAL WALL MOUNT RACKS

- GRW2009508 - 9U, 21" Deep Sectional Wall Rack, Steel Door**
- GRW2009509 - 9U, 21" Deep Sectional Wall Rack, Glass Door**
- GRW2012508 - 12U, 21" Deep Sectional Wall Rack, Steel Door**
- GRW2012509 - 12U, 21" Deep Sectional Wall Rack, Glass Door**
- GRW2018508 - 18U, 21" Deep Sectional Wall Rack, Steel Door**
- GRW2018509 - 18U, 21" Deep Sectional Wall Rack, Glass Door**

- Hinged back double section welded frame construction
- 18 gauge SPCC cold rolled steel top and bottom
- 11 gauge drilled and tapped front and rear rack rails
- 1/2", 5/8", 3/4", 1"1 and 1 1/2" cable entry knockouts on top and bottom
- 18 gauge removable side panels w/spring latch
- Fan ready perforated top
- Rack U number printed on the rack rails



FIXED METAL WALL RACKS

- GRW1009508 - 9U 17" Deep Fixed Wall Rack, Steel Door**
- GRW1009509 - 9U 17" Deep Fixed Wall Rack, Glass Door**
- GRW1012508 - 12U 17" Deep Fixed Wall Rack, Steel Door**
- GRW1012509 - 12U 17" Deep Fixed Wall Rack, Glass Door**

- Reversible wall mounted hinged rack
- Hinged back double welded frame construction
- 18 gauge cold rolled steel top and bottom
- Rack U number printed on rack rails, includes 10/32 rack screws & same knock-outs as above
- Rear mounting section offers easier installation
- 18 gauge removable side panels w/spring latch
- 11 gauge drilled & tapped front & rear rack rails



FRAMEWORKS A/V STANDS

Gator Frameworks is a selection of high-quality a/v stands and accessories that are reasonably priced.

Included in the series are:

Guitar Stands

- GFW-GTRA-4000 - "A" Style Guitar Stands
- GFW-GTR-2000 - Double Guitar Stands
- GFW-GTR-SEAT - Guitar Seat/Stand Combo
- GFW-GTR-1000 - Single Guitar Stands
- GFW-GTR-3000 - Triple Guitar Stands

Amp Stands

- GFW-GTR-AMP - Combo Amp Stands

Keyboard Stands, Tables & Benches

- GFW-KEY-2000X - Deluxe 'X' Style Keyboard Stand
- GFW-KEY-5100X - 'X' Style Keyboard Stand w/Second Tier
- GFW-UTILITY-TBL - Heavy Duty Keyboard Table
- GFW-KEY-1000X - 'X' Style Keyboard Stand
- GFW-UTL-WS250 - Adjustable T-Stand Folding Workstation

Music Stands

- GFW-MUS-1000 - Standard Sheet Music Stand
- GFW-MUS-2000 - Tripod Style Sheet Music Stand

Tablet & A/V Stands

- GFW-UTL-TBLTMNT - iPad Tablet Tray w/Mic Stand Mount
- GFW-AV-LCD-1 - Standard Tripod LCD/LED Mount
- GFW-UTL-MEDIATRAY1 - Compact Adjustable Media Stand
- GFW-UTL-TBLTCLMP - iPod Tray w/Clamp Mount
- GFW-AV-LCD-2 - Deluxe LCD/LED Mount
- GFW-UTL-MEDIATRAY2 - Heavy Duty Adjustable Media Stand

Microphone Stands

- GFW-MIC-2110 - Deluxe Tripod Mic Stand w/Single Boom
- GFW-MIC-2020 - Tripod Mic Stand w/Telescope Boom
- GFW-MIC-1000 - Standard 10" Round Base Mic Stand
- GFW-MIC-1001 - Deluxe 10" Round Base Mic Stand
- GFW-MIC-0600 - Desktop Mic Stand w/Round Base
- GFW-MIC-2120 - Deluxe Tripod Mic Stand w/Telescoping Boom
- GFW-MIC-2010 - Tripod mic stand w/single Section Boom
- GFW-MIC-1200 - Standard 12" Round Base Mic Stand
- GFW-MIC-1201 - Deluxe 12" Round Base Mic Stand
- GFW-MIC-0601 - Desktop Mic Stand w/Twist Clutch

Speaker Stands

- GFW-SPK-2000 - Standard Aluminum Speaker Stand
- GFW-SPK-2000SET - GFW-SPK-2000 (pair) with Carry Bag
- GFW-SPK-WM100 - Wall Mount Speaker Stands (pair)
- GFW-SPK-3000 - Deluxe Aluminum Speaker Stand
- GFW-SPK-3000SET - GFW-SPK-3000 (pair) with Carry Bag
- GFW-SPK-SUB60 - Adjustable Sub Pole

ID Series Stands

- GFW-ID-MIC - ID Series Tripod Mic Stand with Boom
- GFW-ID-SPKR - ID Series Speaker Stand



NOTE! If you are not familiar with the ID Series Stands - Please Ask! They are Revolutionary!

Gator Frameworks also carries numerous other Stands and Accessories - Call for Catalog!

In addition to the above Commercial style rack cabinets, Gator also manufactures Floor Standing Cabinets, Wood Equipment Cabinets, Laptop and Projector cases, Flat Panel and Plasma flight cases and a wide variety of cases for numerous types of sound and video equipment.



Hosa Technology, Inc. is the leading supplier of analog and digital connectivity solutions to the musical instrument and professional audio industries. Since the company's inception in 1984, Hosa Technology's consumer-driven inventory has expanded to include a full line of audio, video, and computer products. Enthusiasts and professionals alike rely upon Hosa Technology to deliver world-class performance and value both on the stage and in the studio.

With over 1,200 products, from classic Hosa cables and adaptors to the tour-grade Edge series, Hosa's one-stop shop has options for every budget. Call BAI for a Full-Line Hosa Catalog.

ANALOG AUDIO



- Microphone Cables
- Microphone Adaptors
- Microphone Interfaces
- Instrument Cables
- Instrument Interfaces
- Footswitches
- Speaker Cables
- Speaker Adaptors
- Interconnect Cables
- Camcorder Mic Cables
- Snakes
- Stage Box Snakes
- Insert Cables
- Stereo Breakouts
- Y Cables
- Adaptors
- Patch Bays
- Patch Cables
- Audio Switchers
- Headphones
- Headphone Cables
- Headphone Adaptors
- Bulk Cable
- Connectors

DIGITAL AUDIO

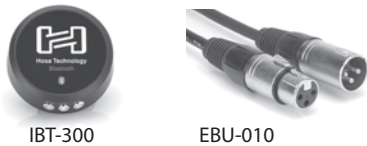

- Bluetooth Interfaces
- AES/EBU Cables
- AES/EBU Snakes
- Optical Cables
- Optical Adaptors
- S/PDIF Coax Cables
- S/PDIF Coax Interfaces

VIDEO

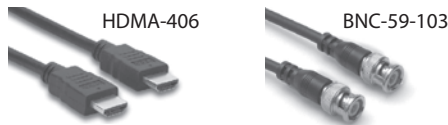

- HDMI Cables
- HDMI Adaptors
- VGA Cables
- VGA Adaptors
- Component Cables
- S-Video Cables
- S-Video Adaptors
- Composite AV Cables
- 75-ohm Coax Cables
- 75-ohm Coax Adaptors

DATA



- MIDI Cables
- MIDI Adaptors
- MIDI Interfaces
- Control & Sync Cables
- FireWire Cables
- FireWire Adaptors
- USB Cables
- USB Adaptors
- USB Hubs
- Network Cables
- DMX Cables
- DMX Adaptors

POWER



- Power Supplies
- Batteries
- Power Cords
- Power Extension Cords
- Power Distribution Cords
- Power Y Cables
- Power Adaptors

STANDS & RACKS

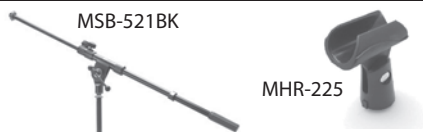

- Microphone Stands
- Microphone Clips
- Microphone Holders
- Stand Accessories
- Guitar Stands
- Keyboard Stands
- Speaker Stands
- Music Stands
- Racks

ACCESSORIES



- Windscreens
- Instrument Covers
- Organizers
- Cable Ties
- Console Tape
- Gaffer Tape
- Cleaners & Conditioners
- Cable Testers
- Console Lamps

IC Realtime is a Leading Supplier of Security Cameras, IP Cameras, DVR, and CCTV Equipment for Business and Home Surveillance.

Analog CCTV Cameras <ul style="list-style-type: none"> • Box CCD Cameras • Bullet Cameras • Discrete/Covert Cameras • Dome Cameras • License Plate Cameras • PTZ Cameras • Marine Cameras 	DVRS <ul style="list-style-type: none"> • Combo Series • Flex Series • Max Series • Specialty Recorders • HDAVS & Analog & IP 	HD AVS <ul style="list-style-type: none"> • HD-AVS 1080P Cameras • HD-AVS 1080P DVRs • HD-AVS 720P Cameras • HD-AVS 720P DVRs 	IP Systems <ul style="list-style-type: none"> • IP Cameras • IP Decoder • Network Video Recorder • Specialty IP Recorders • WIFI Network Recorders • NEMA I.C.E. Box
Camera Accessories <ul style="list-style-type: none"> • Mounts and Housings • Cables & Connectors 	System Accessories <ul style="list-style-type: none"> • Monitors • Power Supplies • Baluns & Transmission 	Intercom Systems <ul style="list-style-type: none"> • Indoor Touch Panels • Outdoor Camera Stations 	

Analog Cameras

ICR-150 - 600TVL Weatherproof Color IR Bullet Camera

- 3.6mm fixed lens/600 TV Lines
- IP55 Weatherproof Standard
- Water, Dust and Crush Resistant Glass Coating
- Built-in Weatherproof Audio Microphone
- Long range IR LED
- Top or Bottom Mount



ICR-200 : 700TVL Indoor/Outdoor Vandal Proof IR Dome Camera w/3.6mm Lens/Black

- 1/3" 960H High Sensitivity CCD/700 TV Lines
- Vandal Proof w/Flat front glass design
- IP-55 Waterproof Standard
- Up to 50 feet IR

ICR200W - Same as above in White



EL-1000B - 690TVL I-Sniper PIXIM DPS WideLux Vari-focal IP67 Bullet Camera

- 690TVL/960H Effective Pixel
- WDR (Wide Dynamic Range)
- Intelligent IR Image Compensation
- 2.8-12mm Vari-Focal Lens
- 2D/3D Digital Noise Reduction
- RS-485 Interface (Pelco D)



ICR-650VD-IR - 700TVL (Day) / 570TVL (Night) Indoor Vari-Focal Dome Camera

- 2.8-12mm Vari-focal Lens
- IP68; Dual switching power 12VDC/24VAC
- IR Distance up to 60'
- 0.1 Lux at F1.2(Color)/0.01 Lux (B&W)



DVRs

Flex Series has seen several hardware upgrades over its tenure in the IC Realtime lineup. The Flex series is a battle hardened, full sized (19" wide, 2U high) DVR capable of housing 8 HDDs internally. Available in 4,8,16 & 32 Channel Configurations.



The MAX series of DVRs is a compact digital video recorder available in 4, 8, and 16 channel. The latest generation of MAX series recorders will record and stream D1 resolution at 30 FPS on every input, giving it high-end features while maintaining a low price tag.



ATM & Specialty DVR's

DVR 56CL - is a 4 channel DVR with a built in 5.6" LCD screen. By adopting the 'All-in-One' design and having a small form factor (a bit shorter than a standard Shoe Box), the DVR56CL is well suited for installations where space is a premium. Standard installations for the DVR56CL include marine vessels, and more commonly inside ATM machines!



DVR-ATM4HS - similar to above but in an 8-channel configuration.

DVR-704MSG-V5 - 4 Channel Mobile Standalone HDAVR

- 4 HDAVR/Analog Video Inputs
- 2 Channel 1080P & 2 Channel 720P Realtime Recording
- 1 SATA HDD, 2 USB2.0
- Aviation Connections



BAI Carries the Entire IC Realtime Product Offering



Headquartered in Northridge, California, JBL Professional is the world's leading designer, manufacturer and marketer of professional loudspeakers for musician, contracting, tour, cinema and recording and broadcast applications. JBL Professional is part of the Harman International network of professional and consumer audio companies.

CONTROL SERIES CEILING SPEAKERS

Control 10 Series - installation-friendly features and value, delivering a level of sonic performance unmatched by comparably priced products. The Control 12C/T, Control 14C/T and Control 16C/T are ideal for applications where excellent sound quality is needed for medium-volume music playback and paging. Available in White or Black (-BK)

Control 12C/T - Power Capacity (at low-Z) - 40W Continuous Program/20W Continuous Pink Noise Transformer Taps - 15 W, 7.5 W, 3.8 W @ 70V and 100V (& 1.9 W @ 70V only)

Control 14C/T - Power Capacity (at low-Z) - 60W Continuous Program/30W Continuous Pink Noise Transformer Taps - 25 W, 12.5 W, 6.3 W @ 70V or 100V (plus 3.2 W @ 70V only)

Control 16C/T - Power Capacity (at low-Z) 100W Continuous Program/50W Continuous Pink Noise Transformer Taps - 30 W, 15 W, 7.5 W @ 70V or 100V (plus 3.8 W @ 70V only)

Control 24CT - compact in-ceiling speakers, providing full, high quality sound for background music and music-plus-paging systems. Available in White or Black (Control 24CT-BK) 70V taps - 30W, 15W, 7.5W, 3.7W

- Packaged with grille, backcan and tile rails
- Wide coverage allows fewer speakers
- Frequency Range - 80 Hz - 20 kHz
- Power Capacity - 80W Continuous Program Power

Control 26CT - is a powerhouse ceiling speaker containing a coaxially mounted 6.5" woofer and 3/4" titanium-coated tweeter, able to deliver maximum sound level over a wide coverage area. The Control 26CT includes a multi-tap transformer for a 70V or 100V line distribution system.

- Frequency Range - 75 Hz - 20 kHz
- Transformer Taps - 70V: 60W, 30W, 15W, & 7.5W
- Power Capacity - 150W Continuous Program Power

Control 26-DT - is a compact ceiling speaker assembly configured to install into standard ceiling backcans designed for 200 mm (8") drivers.

- Frequency Range - 70 Hz - 20 kHz
- Transformer Taps - 70V: 60W, 30W, 15W, & 7.5W
- Nominal Coverage Angle - 90°
- Fits standard backcans for 8" speakers

Control 19CST - In-Ceiling Subwoofer uses advanced proprietary technologies to produce powerful bass from a low profile in-ceiling design.

- Frequency Range 42 Hz - 200 Hz
- Power Capacity 200 W Continuous Program Power
- Transformer Taps 70 V: 75 W, 30 W, 15 W & 7.5 W
- Nominal Coverage Angle 180° conical coverage

Control Contractor 40 Series - premium, in-ceiling, specialty loudspeakers that combine outstanding pattern control and consistent coverage with superior sonic performance. Featuring JBL's proprietary conical Radiation Boundary Integrator® (RBI™) technology adapted from the groundbreaking VerTec® Series line array loudspeakers, the **Control 40 series includes six models:**

Control 47C/T - extended bass performance with 120° of coverage; allows fewer speakers to cover a large space.

Control 47LP - low-profile model for locations with limited above-ceiling clearance.

Control 47HC - high-ceiling model with narrow coverage.

Control 45C/T - the most compact RBI full-range model in the line-up.

Control 40 CS/T - a subwoofer with built-in passive crossover.

Control 42C - an ultra-compact, in-ceiling satellite speaker.



CONTROL SERIES SURFACE SPEAKERS

Control® 25T - is perhaps the most versatile of JBL Professional's Control Contractor Series indoor/outdoor loudspeakers.

- 5.25 in woofer, .75 in Titanium coated horn loaded tweeter
- Built-in InvisiBall® mounting hardware
- Readily paintable to match decor
- Frequency Range - 80 Hz to 15 kHz (-10 dB)
- Transformer Taps - 70V: 3.7W, 7.5W, 15W, 30 W
- Power Capacity - 150W Continuous Program Power

Control® 25AV - utilizes a deep cabinet, high power components and complex network to achieve extremely smooth high fidelity performance from a compact 2-way loudspeaker. Taps - 70V: 60W, 30W, 15W, 7.5W

- Video shielded for use near video monitors
- Stainless steel grill for harsh environments
- Frequency Range - 70 Hz - 23 kHz (-10 dB)
- Power Capacity - 200W Continuous Program Power

Control® 28T-60 - largest of JBL's Control Contractor Series indoor/outdoor loudspeakers.

- 8" woofer & 1" Titanium coated horn loaded tweeter
- Transformer Taps - 70V: 7.5W, 15W, 30W, 60W
- Frequency Range - 55Hz to 15kHz (-10 dB)
- Power Capacity - 175 W Continuous Program Power



Note: BAI carries the full line of JBL products - Don't see it? - Call!



CBT (CONSTANT BEAMWIDTH TECHNOLOGY™) SERIES LOUDSPEAKERS

JBL® CBT Series Line Array Columns with Constant Beamwidth Technology breaks new ground in performance, versatility, and affordability. Designed for venues that would typically use larger point-and-shoot speakers, the CBT models incorporate technical advancements that allow them to vastly outperform competitive systems, with a level of user-friendliness that virtually eliminates the challenges of delivering great sound. Includes SonicGuard™ overload protection.

CBT 50LA-1 - Constant Beamwidth Technology™ line Array Column Loudspeaker w/Eight 50 mm (2 in) Drivers
 • Built-in 70V/100V transformer, W/8Ω Bypass • Switchable voicing for music or voice applications

CBT 100LA-1 - Constant Beamwidth Technology™ Line Array Column Loudspeaker w/Sixteen 50 mm (2 in) Drivers
 • Vertical pattern coverage switchable 40° or 15° • Built-in 70V/100V transformer, W/8Ω Bypass

CBT 70J-1 - Constant Beamwidth Technology™ Line Array Column Loudspeaker w/16 x 1" tweeters & 4 x 5" woofers
 • Vertical pattern coverage switchable 45° or 25° • Built-in 70V/100V transformer, W/8Ω Bypass

CBT 70JE-1 - Purpose-Designed Extension for CBT 70J Line Array Column Speaker (shown at bottom of image to right)
 • When attached to the CBT 70J it provides extended bass response, pattern control & increased sound output

CBT 200LA-1 - 200 cm Tall Constant Beamwidth Technology™ Line Array Column Speaker w/32 - 2" full range drivers

CBT 1000 - Constant Beamwidth Technology™ Adjustable Coverage Line Array Column w/6 - 6.5" & 24 - 1" drivers



EON™ PORTABLE PRODUCTS

EON ONE - Compact All-in-One Linear-Array P.A. System with 6-Channel Mixer - 10" Woofer & 6 - 2" Drivers (No image)

EON206P - Packaged PA System with Detachable Powered 6-Channel Mixer - 160W (2X80W)
 • Max SPL 113dB • 6 inputs (2 Mono Mic/Line, 2 x Stereo)

EON208P - Packaged 8" 2-Way PA with Powered 8-Channel Mixer and Bluetooth® - 300W (2X150W)
 • Max SPL 121dB • 1-4: XLR/1/4" combo connectors, 5-6: 1/4" balanced TRS jacks & 1 pair RCA jacks
 7-8: one pair of 1/4" balanced TRS jacks (stereo), and a 3.5mm stereo jack

EON610/EON612/EON615 are 1000W Peak (700W LF+300W HF), 500W Continuous (350W LF+150W HF)

EON610 - 10" Two-Way Multipurpose Self-Powered Sound Reinforcement
 • Max SPL Output - 124 dB • Freq. Range (-10 dB) 52 Hz - 20 kHz

EON612 - 12" Two-Way Multipurpose Self-Powered Sound Reinforcement
 • Max SPL Output 126 dB • Freq. Range (-10 dB) 48 Hz - 20 kHz

EON615 - 15" Two-Way Multipurpose Self-Powered Sound Reinforcement
 • Max SPL Output 127 dB • Freq. Range (-10 dB) 39 Hz - 20 kHz

EON618S - 18" Self-Powered 1000W Subwoofer
 • Max SPL Output 134dB • Frequency Range (-10dB): 31Hz - 150Hz • M20 Pole Cup



AWC SERIES ALL-WEATHER LOUDSPEAKER PRODUCTS

The AWC All Weather Compact models incorporate co-axial drivers for high output, consistent pattern control, extraordinary speech clarity, and extended frequency response from very compact enclosures. Models include minimally audible overload protection. Weather-resistant IP56 rating.

AWC62 - All-Weather Compact 2-Way Coaxial Loudspeaker with 6.5" LF
 • 110° x 110° broadband pattern control • 175 Watt power handling (120W 70V Transformer)

AWC82 - All-Weather Compact 2-Way Coaxial Loudspeaker with 8" LF
 • 120° x 120° broadband pattern control • 250 Watt power handling (200W 70V Transformer)

AWC129 - All-Weather Compact 2-Way Coaxial Loudspeaker with 12" LF
 • Consistent 90° x 90° broadband pattern control • 400 Watt power handling (200W 70V Transformer)

AWC159 - All-Weather Compact 2-Way Coaxial Loudspeaker with 15" LF
 • 90° x 90° broadband pattern control • 500 W (2000 W peak) (300W 70V Transformer)

AW266 - High Power 2-Way All Weather Loudspeaker with 1 x 12" LF (Life Safety Version - LS)
 • 60° x 60° Coverage • 500 W (2000 W peak) (400W 70V Transformer)

AW295 - High Power 2-Way All Weather Loudspeaker with 1 x 12" LF & Rotatable Horn
 • 90° x 50° Coverage • 500 W (2000 W peak) (400W 70V Transformer)



Also available - **AWC15LF, AW295-LS, AW526, AW526-LS, AW566, AW566-LS & AW595**



CS SERIES MIXER AMPLIFIERS & POWER AMPLIFIERS

JBL® CSMA Series of Mixer-Amplifiers are a professional tool with a sleek industrial look that is designed and built for commercial sound applications. Utilizing Crown's DriveCore technology enables significantly reduced size and weight – all mixer/amps are highly efficient, fanless and just 1U rack space high. There are both single channel and two channel models with four or eight mixer channels, respectively

CSMA 180/1120

- 4 inputs with 1 output of 80W or 120W
- Fanless, space-saving 1U design
- Supports 70V and 100V
- Euro-block mic/line i/o connectors
- Bass and Treble each output
- Configurable output routing
- Remote v/c using JBL CSR-V module w/Ethernet cable
- Priority muting



CSMA 240/280/2120

- All the same features as above but has 8 inputs with 2 outputs of 40W ,80W, 120-watts of power



JBL® Commercial Series Amplifiers (CSA) efficient performance of Crown's DriveCore™ Technology sets new standards in commercial power amplifier technology. Supporting 70V and 100V installations out of the box, CS amps include RJ45 connectors for use with JBL CSR-V in-wall volume controls. 100 to 240 VAC, 50/60 Hz.



- CSA 140Z/180Z/1120Z/ CSA 240Z/280Z/2120Z** - 1 or 2 output channels with 40W, 80W, 120W per channel
- Built-in 70V and 100V
- Fanless, space-saving 1U design
- Sleep mode disable function

- CSA 1300Z/2300Z** - 1 or 2 channels X 300W output; built-in 70V/100V • Other features as above



CSA-2120 - professional-grade power amp built for commercial & installed sound applications. The amp is a 2X120W model providing simple analog front-end processing with a switch-mode universal power supply. **Available in 70/100v version as the CST-2120. (not pictured.)**

CS SERIES MIXERS

JBL® Commercial Series Mixers (CSM) deliver unsurpassed quality in commercial sound. All mixers feature 4 or 8 inputs with 1 or 2 channel outputs; a fanless, space-saving 1U design with configurable output routing (2 channel models only). Independent base/treble controls, Euro-block mic/line I/O connectors, and unbalanced RCA inputs for consumer connections. All models support JBL CSR-V wall controller & feature priority muting.

- CSM14/CSM28** - Commercial Mixers - 1 input and 4 output and 2 input and 8 output respectively.



CSM-21 offers fixed I/O, pre-configured architecture, full stereo or mono operation, flexible routing and control of multiple audio sources, simple front-panel configuration and control without the need for a computer, compatibility with the CSR wall controllers, compatibility with the CSPM paging microphones, and optional duplication of audio channels to another device via a Cat5 cable.



CSM-32 offers same features as the CSM-21 but with these features:

- 3 Stereo Inputs, 1 Mic Input & 1 Line Input for Priority Audio
- 2 Stereo Output with Dedicated Subwoofer Output
- 1 Mono Output for Music-On-Hold System



VMA SERIES MIXER/AMPS

JBL VMA Series is a cost-effective line of Mixer/Amplifiers for 4/8 & 70/100V, designed for commercial integrators. 1-channel Mixer/Amp models - **VMA160/1120/1240** - 60 watt/120watt & 240watt. Rack mount hardware included.

- 5 inputs/1 output
- Independent bass & treble
- Page chime & priority muting



2-channel Mixer/Amp models - **VMA260/2120** - 2X60W & 2X120W

- 8 inputs w/2 outputs
- All other features of single channel models are included.



CS SERIES SPEAKERS

JBL® Commercial Series Ceiling Speakers provide excellent performance for paging and background music applications. High sensitivity across the product line provides maximum sound level, even at low tap settings.

CSS8004 - 4" speaker with 90 dB sensitivity and a 5-Watt multi tap transformer. The speaker's triple-voltage transformer provides versatility by allowing use on 100V, 70V, or 25V distributed speaker lines.



CSS8008 - 8" speaker with 96 dB sensitivity and a 5-Watt multi tap transformer.



CSS8018 - a high-powered 8" speaker with 97 dB sensitivity and a 10-Watt multi tap transformer. (not pictured)

CSS-1S/T - a versatile, compact 2-way loudspeaker designed for use on 100V or 70V distributed speaker lines, or in 8 ohm direct mode. The 5.25" low frequency loudspeaker and 3/4" polycarbonate dome tweeter reproduce full-range sound quality for foreground or background music and are voiced for maximum speech clarity and intelligibility.





The World's Finest Transformers

For over 40 years, Jensen Transformers Inc. has set the benchmark for delivering the highest quality transformers, with the widest frequency response, least distortion, lowest phase deviation, best common-mode noise rejection and maximum signal handling.

Pro Audio Isolators

PI-XX - single channel line input isolator designed to eliminate noise in professional balanced audio systems by isolating the input of the connected device.

- Eliminates hum & buzz caused by ground loops
- Delivers exceptionally low distortion down to 20 Hz

PI-2XX - Same as above in a 2-channel version

PO-2XX - Line Output - Two channel ground isolator for high output professional line level signals where long output cables may be required.

PB-2XX - Universal Isolator - Two channel ground isolator may be used at the beginning, middle or end of a signal path. Ideally suited for long cable runs for large scale system integration, broadcast stations and recording studios.

PO-XX - Line Output - Single channel ground isolator for high output professional line level signal where long output cable may be required.

MI-XX - Mic Input Isolator - Single channel ground isolator and RFI suppressor for low impedance (150 to 200 Ω nominal) balanced microphone signals to eliminate noise and ground loops.

SUB-2XX - Sub Woofer - Dual input isolator with extended low frequency response delivers full bass signal without compromise. Up to +24 dB signal handling at 20 Hz.

Pro Audio DI Boxes

DB-2RM-WP - Wall-mount Direct Box - Two channel passive multi-media DI converts unbalanced -10 dB consumer level signals to balanced. Variable level control, mono-sum and ground lift. Fits single gang electrical box with Decora® plate.

DB-2PX - Instrument Direct Box - Two channel isolator converts Hi-Z instrument signals to a balanced mic level to interface with PA and recording consoles. Comes standard with 1/4" TRS inputs and XLR-M outputs.

Pro Audio Interface/Splitters

MS-8N2 - Mic Splitter - Eight channel 2-way passive mic splitter with one isolated and one direct output per channel. Features dual Faraday shields and mu-metal can to eliminate RF. Configurable phantom circuitry. Nema box ready for easy installation.

MS-8N3 - Same as above but 8-channel 3-way passive mic splitter.

MS-2XX - passive 2-channel mic splitter that lets you take a microphone signal and send it to two consoles at the same time.

PC-2XR - Pro to Consumer - Two channel isolator converts +4 dB professional balanced signals down to -10 dB for use with consumer audio devices such as laptops or video recorders. Comes with XLR-F inputs and RCA outputs.

SP-2SX - Speaker to Line Converter - Two channel isolator converts speaker level signals to +4 dBu balanced line level for distributed audio systems. Adjustable output via DIP switch. Comes with Speakon inputs and XLR outputs.

CI-RJ2R - Audio to CAT-5 Converter - two channel isolator sends -10 dB consumer level audio over CAT-5/6 cable for easy integration with network wiring. Passive design features send and receive modules for each end.



BAI carries the entire range of Jensen Transformer products...Call for a complete listing.

Enterprise AV™ Over IP

Enterprise AV over IP solutions create an infinitely expandable HDMI over IP system that can be scaled to fit any installation.

KD-IP1080Tx



Enterprise AV over IP with POE (TX) Transmitter with Redundant Power Connection, supports HDMI Pass-through

KD-IP1080Rx



Enterprise AV over IP with POE (RX) Receiver with Redundant Power Connection

HDBaseT/HDMI Extenders

KD-X422POA

Power over HDBaseT/HDMI via Single CAT5e/6 (Tx + Rx Set) Extenders with Audio De-Embedding, HDR10, HDCP2.2, 4K



KD-X422WP

Power over HDBaseT/HDMI via Single CAT5e/6 (Wallplate Tx + Rx Set) Extenders with HDR10, HDCP2.2, 4K



KD-X222

HDBaseT/HDMI via Single CAT5e/6 (Tx + Rx Set) Extenders with HDR, HDCP2.2, 4K



KD-X222PO

Power over HDBaseT/HDMI via Single CAT5e/6 (Tx + Rx Set) Extenders with HDR, HDCP2.2, 4K



HDBaseT/HDMI via CAT5e/6 Matrix Switchers

Compass Control® Inside: Key Digital's Compass Control® control system is built-in, replacing external master controller

KD-Pro6x6CC



6 to 6 HDBaseT/HDMI via Single CAT5e/6 Matrix Switcher with built-in Compass Control® system, supports HDR, HDCP2.2, 4K. Includes 3 KD-XSWRx Receiver Extenders.

KD-Pro8x8CC



8 to 8 HDBaseT/HDMI via Single CAT5e/6 Matrix Switcher with built-in Compass Control® system, supports HDR, HDCP2.2, 4K. Includes 4 KD-XSWRx Receiver Extenders.

Digital Signage Processors

KD-MLV4x2

4 to 2 MultiView Seamless Matrix Switcher, supports 4K, 6 MultiView Modes



KD-VW4x4Pro

4 to 4 Video Wall Processor, supports Seamless Matrix Switching, 8 Video Wall Modes



HDMI Matrix Switchers

KD-4x4CSA

4 to 4 HDMI Matrix Switcher with Audio De-embedding, supports HDR, HDCP2.2, 4K



KD-8x8CSA

8 to 8 HDMI Matrix Switcher with Audio De-embedding, supports HDR, HDCP2.2, 4K



HDMI Switchers

KD-Pro2x1

2 to 1 HDMI Switcher with Audio De-embedding, supports HDR10, HDCP2.2, 4K



KD-Pro4x1

4 to 1 HDMI Switcher with Audio De-embedding, supports HDR10, HDCP2.2, 4K



KD-S2x1

Ultra-slim 2 to 1 HDMI Switcher, supports HDR10, HDCP2.2, 4K



KD-S4x1

Ultra-slim 4 to 1 HDMI Switcher, supports HDR10, HDCP2.2, 4K



HDMI Distribution Amplifiers

KD-DA1x2

1 to 2 HDMI Distribution Amplifier, supports HDR10, HDCP2.2, 4K



KD-DA1x4

1 to 4 HDMI Distribution Amplifier, supports HDR10, HDCP2.2, 4K



KD-DA1x8

1 to 8 HDMI Distribution Amplifier, supports HDR10, HDCP2.2, 4K



KLIK

KLIK lets users stream content from laptops, smartphones and tablets to any projector or display without wires! Meetings are more productive when presenters don't have to worry about cables, connectors, adapters and configuration hassles. Make wireless presentations, easy, fast and affordable with KLIK!

KLIK is Your Wireless Presentation Connector!



Only KLIK Boks lets you choose how users can make wireless presentations through its fully configurable access modes:

ZERO-App Mode – Start using the KLIK Boks immediately with Windows, Mac, iOS and Android, without dongles, adapters or the installation of an app. Only KLIK lets you accommodate users that don't or can't install an app on their device.

KLIK Knkt Apps – Want more security and control? Install the free Knkt app and get the benefit of security password support and on-screen annotation and whiteboard features (Win/Mac).

Conference Mode – The ultimate in control that's ideal for classrooms or busy meeting rooms with a need for multiple presenters to cycle through quickly. In Conference Mode, a Moderator controls who's up next, with the bonus of remote screen preview.

Technical Specifications	
Processor	500MHz MIPS24Kc Highly Integrated System-on-a-Chip
Input / Output Connections	HDMI, HD15 VGA, Stereo RCA Audio Outputs, Optical Digital S/PDIF Audio Output, RJ-45 Ethernet Port, USB2.0 Type-A, 5.5mm DC Power Jack
Video Resolution	HDMI (1.3): NTSC, PAL, 480p, 576p, 720p-50Hz, 720p-60Hz, 1080i-50Hz, 1080i-60Hz, 1080p-50Hz, 1080p-60Hz VGA: 800x600, 1024x768, 1280x800, 1280x1024, 1366x768
Audio Outputs	Analog: 24-bit, 44.1kHz with Integrated DAC Digital: IEC-60958, LPCM, ADPCM, FLAC, AAC, WAV and OGG Vorbis
Controls	Power/Standby Button, Mode Button (Side), Reset Button (Underside)
LED Indicator	Blue: Solid (Power On), Slow Flashing (Standby Mode)
Power	5 Volts DC, 1A (5W)
Dimensions	Size (L x W x H): 88mm, 148mm, 30mm Weight: 55g
Certifications	FCC Part 15, CE, RoHS, UL (Power Adapter)
Network Specifications	
Protocols	IEEE 802.11 b/g/n 2.4GHz/5GHz Wireless IEEE 802.3 10/100MB Wired TCP/IP, SNMP
IP Configuration	Automatic IP via DHCP (Default), Static IP via Manual Setting
Security	WPA/WPA2 IEEE802.11i, AES 256-bit Encryption
Supported Operating Systems	
Windows	Windows 7/8/8.1/10 (KLIK Knkt), 8+ (Project to Wireless Display)
Mac	Mac OSX 10.9+ (KLIK Knkt), 10+ (AirPlay)
iOS	iOS 8+ (KLIK Knkt), iOS 7+ (AirPlay)
Android	Android 5+ (KLIK Knkt), Android 4.2+ (Miracast)
Streaming Protocols	Miracast, AirPlay, DLNA Digital Media Renderer
Warranty	
Term	2 Years, Repair or Replacement



Liberty AV Solutions has evolved from being one of the world's premier suppliers of wire and cable into a solutions-based company known for its wide ranging product offering and stellar customer service. We continue to lead the industry with our standard & breakthrough products of bulk & premade cable, connectors, plates and tools, but also offer power management and rack enclosures, plus an entire line of digital devices when Intelix became part of the Liberty family in 2011.

WITH THE COMBINATION OF PRO AV PRODUCTS & OUR EXTENSIVE TOP-NOTCH LIBERTY EDGE SERVICES... WE CAN'T BE BEAT!

Extension

DL-HD70, DL-HDE100

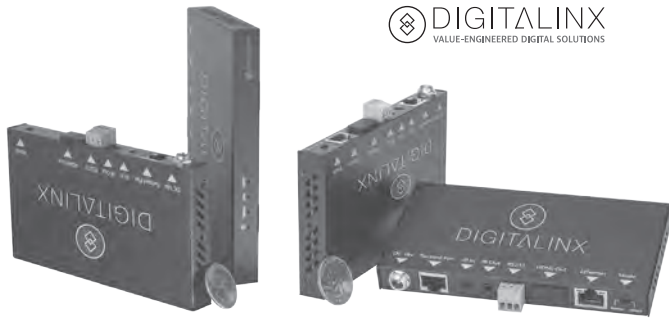

DigitalLinX is a rock solid line of simple yet affordable HDMI extenders. Complete HDMI Extender Sets w/ RS232, IR and Ethernet. Slim design, can hide and mount easily behind displays and above projectors.

Key Features

- HDMI transmission up to 230 feet (70m) or 330 feet (100M)
- 1080p, 4Kx2K (UHD) & 3D compatible
- CEC supported
- Built-in surge protection
- Diagnostic LEDs
- HDCP 2.2 compliant
- Bidirectional Wideband IR and RS232 passthrough
- Flexible power design (use power supply at TX or RX)
- Locking power connector (power supply included)

HDMI Plenum Cables

PF-HDM-M-XXX



Premium active optical HDMI cables support 4K @ 60Hz video signals with 4:2:0 chroma subsampling, from 10 meters to 100 meters.

Key Features

- HDMI "A" male to male connectivity
- Polymer Optical Fiber (POF) for better flexibility
- Ultra-Small diameter cable with reduced sized HDMI heads
- Draws power from pin 18 of the source/display HDMI port
- HDMI High Speed 10.2Gbps 4K@30Hz 3D all Audio formats
- Supports 4K@60Hz with 4:2:0 Chroma Sampling
- Does not support Ethernet or Audio Return
- Lengths: 10, 15, 20, 23, and 30 meters
- NEC/CEC rated CMP-OF Plenum, RoHS-2 Compliant

Universal HDMI Adapter Ring

DL-AR and DL-ADR

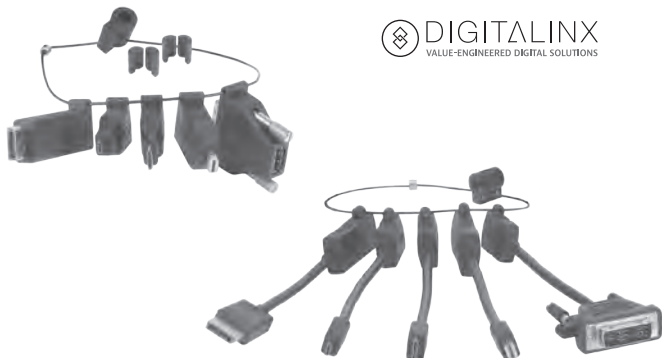

Slimmer, Sleeker new design, shallow depth two-position eyelets, dongles and adapter versions available.

Key Features

- Displayport plug male to hdmi® jack female
- Mini displayport plug male to hdmi® jack female
- Micro Hdmi® d plug male to hdmi® jack female
- Dvi-d plug male to hdmi® jack female
- Displayport adapters support audio
- Faux ferrite & wire loop – attach to hdmi® cable
- (2) sizes of foam rubber spacers, standard & micro cable
- Adapt various mobile content devices to hdmi®
- Interface laptops, macs, ipad® & smartphones to hdmi®

Liberty AV Solutions has evolved from being one of the world's premier suppliers of wire and cable into a solutions-based company known for its wide ranging product offering and stellar customer service. We continue to lead the industry with our standard & breakthrough products of bulk & premade cable, connectors, plates and tools, but also offer power management and rack enclosures, plus an entire line of digital devices when Intelix became part of the Liberty family in 2011.

WITH THE COMBINATION OF PRO AV PRODUCTS & OUR EXTENSIVE TOP-NOTCH LIBERTY EDGE SERVICES... WE CAN'T BE BEAT!

Small Conference Spaces

**DL-AS21C, DL-AS31-2H1V,
DL-AS31-2H1DP, DL-AS31-1H1DP1V**



Key Features

The DigitalLinx DL-S21C is a 2x1 auto switcher that is ideal for small conference rooms and huddle rooms. Connect a CEC enable display for an instant automated solution, just simply connect any source device to the DL-AS21C and the unit turns the display on! Once video signal is not present for 3 minutes the DL-AS21C turns the display off. Simple and easy automated solution. Conceal underneath a conference table and connect to your tabletop input pockets for an easy, clean and concealed design.

The DigitalLinx slim line HDMI switchers are ideal for small to medium size conference or huddle rooms or small residential applications. Conceal underneath a conference table and connect to your tabletop input pockets for an easy, clean and concealed design. Very affordable price points.

AVoverIP

IPLinx



Key Features

The Intelix IPEX2001 / 2002 Video over IP encoder and decoder system allows up to 1080p video signals to be distributed over a local area network and connects easily to off the shelf Level 2+/3 managed gigabit Ethernet switches. Combine with the IPEXCB control interface to control system via third party or use the Liberty control / preview APP. Great for schools, small to large businesses or corporate offices that require a simple and easy to use digital signage solution throughout the facility.

HDBT Matrix Switchers

INT-44/66/88HDX



Key Features

The new Intelix HDX series matrix switchers support 4K sources and displays with HDCP 2.2 support and comes in configurations of 4x4, 6x6 and 8x8. With HDBaseT PoH outputs on every output channel you can extend HDMI up to 100m as well as power a compatible HDBaseT receiver eliminating the need for bulky power adapters.

LIGHTRONICS

COMPLETE LIGHTING CONTROL SYSTEMS - Whether you're designing a new system or retrofitting an older system, Lightronics and BAI are here to assist you. Give us a call to help design your lighting space to perfectly suit your needs. We have professionals at our disposal that can lead the way from concept to finished production with the guidance you deserve.

UNITY ARCHITECTURAL SYSTEMS



AR Series - Wall Mount Dimmer

- 6 or 12 Channels
- 2400W per Channel
- Single or Three Phase
- DMX Input with Softpatch
- 100 Scene Memory
- Calendar Clock / Event Scheduler
- "Snapshot" Recording of Scenes
- UL-508 Compliant



AC1109 Remote Station
8 Scene and OFF Function



AC2116 Remote Station
16 Scene and OFF Function



AK1005 Remote Station
5 Scene Control



AK1003 Remote Station
3 Scene Control



AK1002 Remote Station
2 Scene Control



AF2104 Remote Station
4 Scene Manual Control



AF3107 Remote Station
6 Scene w/ Master Fader

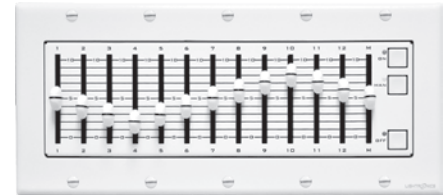

AF5113 Remote Station
12 Scene w/ Master Fader

UNITY Architectural Control

Protect your Main Theatrical Lighting Console with our 16 Preset Recall System. Record your presets and turn the main console OFF.



SR Series

- DMX512 Pile-On Operation
- 16 Scenes w/ Fade Times to 99 Minutes
- Multiple Remote Station Control
- Show Mode Station Lockout via DMX
- Scene Grouping - Mutually Exclusive
- Last Scene Recall
- 3 Configurable Contact Closures
- Optional Emergency On Contact Closure



SC810W Controller

- Self Programming DMX Fader Preset Station
- Independent control of 512 DMX channels
- Store and recall 18 scenes
- User defined fade times from 0 – 55 seconds
- Programmable fixed DMX output value
- Station lockout when live DMX signal is present
- Record from local setting or DMX snapshot
- Available in desktop or wall mount units

LIGHTRONICS

COMPLETE LIGHTING CONTROL SYSTEMS - Whether you're designing a new system or retrofitting an older system, Lightronics and BAI are here to assist you. Give us a call to help design your lighting space to perfectly suit your needs. We have professionals at our disposal that can lead the way from concept to finished production with the guidance you deserve.

UNITY ARCHITECTURAL SYSTEMS

UNITY Architectural Ballast Dimmer Drivers



AB Series

- 3 or 6 Relay/Dimmer Ballast Channels
- 2400 Watts Each
- DMX Input
- Softpatching per Channel
- 9 Contact Closure Inputs
- Unity Architectural Remote Station Port
- Stores 100 Programmable Scenes
- Available as:
 - Switched Hot Relay Only
 - Switched Hot Relay / 0-10VDC ballast driver
 - Switched Hot Relay / Dimmed Hot ballast driver
- "ON" and "OFF" Thresholds - Each Channel

AS SERIES PORTABLE DIMMERS



AS42L / D
4 Channels @ 1200W / 4800W Total



AS40L / D
4 Channels @ 600 Watts

- DMX512 or LMX128
- Relay Mode Switchable
- 8 Built In Chases

LIGHTING CONSOLES



TL2448
- 48 Channels
- 36 Chases
- 600 Scenes
- Moving Light Control
- DMX512 & LMX128 Control
- **Optional Wireless DMX**



TL5024
- 24 Channels
- Softpatching
- 192 Scenes & Cue List
- Programmable Chases
- DMX512 & LMX128 Control
- **Optional Wireless DMX**

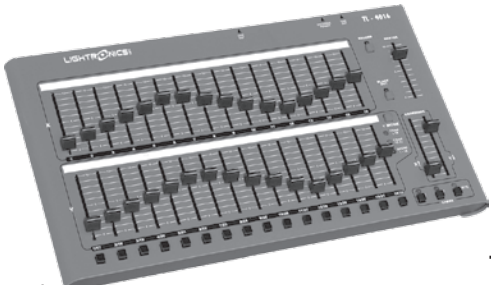

TL4016
- 32 Channels
- 2 Programmable Chases
- 8 / 16 Programmable Scenes
- DMX512 Option

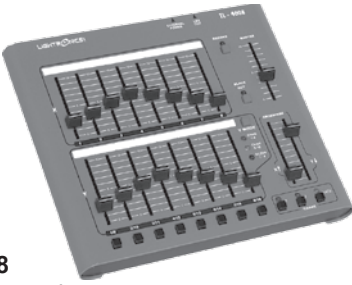

TL4008
- 16 Channels
- 2 Programmable Chases
- 8 / 16 Programmable Scenes
- DMX512 Option

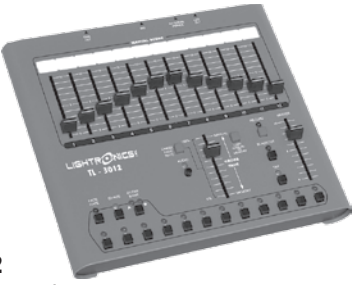

TL3012
- 12 Channels
- 2 Scene Banks
- 12 Chases
- DMX512 Option

LIGHTRONICS

COMPLETE LIGHTING CONTROL SYSTEMS - Whether you're designing a new system or retrofitting an older system, Lightronics and BAI are here to assist you. Give us a call to help design your lighting space to perfectly suit your needs. We have professionals at our disposal that can lead the way from concept to finished production with the guidance you deserve.

LIGHTING FIXTURES

FXLE1232W Warm White

- 120 Watt LED array
- LED color temp: 3200K
- HQ Optical system
- 19°, 26°, 36°, or 50° beam spread
- FX slot and B size gobo holder



FXLE1260W Daylight

- 120 Watt LED array
- LED color temp: 5500K
- HQ Optical system
- 19°, 26°, 36°, or 50° beam spread
- FX slot and B size gobo holder



FXLD1218FRP5I

- LED colors: R,G,B,A,W
- # of control channels: 5 or 9
- Beam Spread: 45°
- DMX I/O: 3 & 5 pin
- Refresh rate: >400 Hz



FXLD618FRP2I

- LED color temps:
WW 3200K CW 6000K
- # of control channels: 1,2,3,4 or 5
- Beam Spread: 45°
- DMX I/O: 3 & 5 pin
- Refresh rate: >400 Hz



FXLD2512B5I6

- LED colors: R,G,B,A,W,UV
- # of control channels: 5 or 9
- Beam Spread: 60°
- DMX I/O: 3 pin
- Refresh rate: >400 Hz



FXLD157FRP6I

- LED Colors: R,G,B,A,W,UV
- # of control channels: 6 or 10
- Beam Spread: 25°
- DMX I/O: 3 pin
- Refresh rate: >3000 Hz



FXLD127FRP5I

- LED Colors: R,G,B,A,W
- # of control channels: 5 or 9
- Beam Spread: 25°
- DMX I/O : 3 pin
- Refresh rate: >3000 Hz



LISTEN

TECHNOLOGIES

Listen Technologies brings power and clarity to the sounds that enrich people's lives—with solutions that overcome the challenges of noise, distance, clashing conversations, and hearing loss to deliver precise and personalized audio in any setting or environment. This includes: Assistive Listening Solutions; Classroom Audio Amplification Systems and Conference Solutions.

Assistive Listening

LS-55-072 Listen iDSP Prime Level III Stationary RF System (72 MHz)

- (1) LT-800-072-01 Stationary RF Transmitter
- (1) LA-326 Universal Rack Mounting Kit
- (4) LA-401 Universal Ear Speaker
- (1) LPT-A107-B Dual RCA to Dual RCA Cable 6.6 ft. (2 m)
- (1) LA-304 Assistive Listening Notification Signage Kit
- (1) LA-122 Universal Antenna Kit
- (4) LR-4200-072 Intelligent DSP RF Receivers
- (2) LA-430 Intelligent Earphone/Neck Loop
- (1) LA-381-01 Intelligent 12-Unit Charge Tray



LP-50-072 Advanced Intelligent DSP RF Receiver 6-Pack (72 MHz)

- (6) LR-5200-072-P1 Intelligent DSP RF Receiver Package 1
- (1) LA-381-01 Intelligent 12-Unit Charge Tray



LP-40-072 Intelligent DSP RF Receiver 6-Pack (72 MHz)

- (6) LR-4200-072-P1 Intelligent DSP RF Receiver Package 1
- (1) LA-381-01 Intelligent 12-Unit Charge Tray



LS-92-01 ListenIR iDSP Level III System

- (1) LT-84-01 ListenIR Transmitter/Radiator Combo
- (4) LA-430 Intelligent Ear Phone/Neck Loop Lanyard
- (1) LA-422 USB to Micro USB Cable
- (1) LA-382 Intelligent Cable Management Unit
- (1) LA-904 Listen Dispensing Log Book
- (4) LT-4200-IR Intelligent DSP IR Receiver
- (4) LA-401 Universal Ear Speaker
- (1) LA-381-01 Intelligent 12-Unit Charge Tray
- (1) LA-901 Listen Disinfecting Wipes (75 Ct)

LS-PL-11 10-Channel ListenWiFi Personal Listening System - lets venues like fitness centers, sports bars, airports, and waiting rooms provide their customers with unique and positive sound experiences, building customer loyalty and retention. The LS-PL-11 broadcasts audio from up to 10 televisions or other audio sources using digital WiFi transmission. The sound is delivered to any WiFi enabled device with audio streaming capability like a smartphone or tablet with the WiFi Personal Listening App using a separate WiFi network. **Also available in a 20-Channel version - LS-PL-21.**



MLD7 MultiLoop™ Driver is a part of the new "benchmark range" for professional audio Hearing Loop systems. In the past, a Hearing Loop phased array systems used to require two separate loop drivers and a 90° Phase Shifter which would take up valuable rack space. **Also available - MLD9 - higher power!**



ListenPoint Classroom Audio

ListenPoint is a classroom amplification system that allows students to hear clearly and learn better. It has been engineered to improve speech intelligibility, comprehension, and retention. ListenPoint's unique integrated features deliver a learning experience no other soundfield system can offer and includes:

- Integrated assistive listening for students with hearing loss to comply with national and local laws
- Virtual field trips allow students to go anywhere through Skype
- Integrated AV/Control allows ListenPoint to work seamlessly with other AV equipment
- Scalable solutions that add more functionality over time to grow with the needs of the classroom
- Easy installation and maintenance

LPT-F1-01 Basic Soundfield Frame - easy way to deliver scalable audio structure for multiple classrooms. The frame includes two (2) input C2 ListenPoint Standard Control Unit and the R12 Powered Room Module. As you scale and grow it can accept up to two (2) M1 microphones while delivering 60 Watts RMS speaker power.



LPT-S3-01 Basic Soundfield System - the perfect choice for building a precise Soundfield infrastructure in a school. This system is a complete soundfield system minus the M1 microphone. You can do several classrooms at a lower cost and then purchase the required number of microphones as needed. This system offers two (2) direct inputs and one (1) output on the control unit, a room module that delivers 60 Watts of power and (4) four speakers.

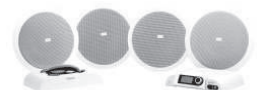

Listen Technologies offers numerous other Soundfield systems to fit most applications. Call us for more information. Listen Technologies also offers Several Conferencing Systems including Confidea Wired and Wireless G3, the D-Cerno System and the uniCOS Multimedia Conferencing System. Call for details.

LOUROE ELECTRONICS™ a successful California Corporation, specializes in manufacturing Audio Monitoring Technology. Louroe is a key supplier for the Security Industry; their Audio Systems are widely used in the CCTV market. LOUROE's most asked for product is the ASK-4® Systems (Kits). This well-known Single Zone Monitoring System still performs as a revolutionary contribution to the Security Industry. In addition to the Single Zone Audio Monitoring System, LOUROE provides systems for 2, 4, 8, 12, and 16 monitoring zones. All ASK Kits come with single or dual RCA cables for hook-up and power supplies.

AUDIO MONITORING KITS

One-Way Listen Kits

ASK-4 KIT #101 Audio Monitoring Kit

A complete single zone audio monitoring system, designed for audio monitoring and interfacing with a VCR or DVR. The desk top base unit has a 3" speaker for monitoring live audio as well as playback. Built-in mute switch enhances audio monitoring. The low impedance electret condenser microphone can easily pick up normal sounds approximately 15' away or within a 30' diameter circle.

Kit Contains:

- Verifact Model A Microphone
- Model APR-1 Desk Top Base Station
- Power Supply
- Cable for connection



ASK-4 KIT #300 Audio Monitoring Kit

Single zone audio monitoring system designed for direct connection to a DVR, VCR, or computer sound card. Model IF-1 Interface Adapter receives the wiring from the microphone, supplies power to the microphone and drives the audio signals into the audio input of the recording device. Kit includes an RCA cable for connecting to a DVR or VCR, and a 3.5mm cable for connection to a computer sound card. It also contains a variable gain adjust to prevent overdriving the sound card.

Kit Contains:

- Verifact Model A Microphone
- IF-1 Interface Adapter
- Power Supply



ASK-4 KIT #401 Audio Monitoring Kit

Single zone audio monitoring system with two Model A microphones for extended zone coverage.

Kit contains:

- 2 - Verifact Model A Microphones
- 1 - Model APR-1 Single Zone Base Station
- 1 - Model RN-2 Microphone Mixer
- Power Supply



Two-Way Talk/Listen Kits

ASK-4 KIT #501 Audio Monitoring Kit

Complete single zone audio monitoring system with two-way listen and talkback. Remote unit contains an electret condenser, low impedance microphone and a 2 1/2" speaker, all within one housing. Desk top base unit produces live audio with a 3" speaker and has input/output ports to recorder. Talkback from base unit to remote speaker/microphone is accomplished by pressing and holding down a switch while speaking into a built-in microphone. Person at the remote speaker/microphone can listen and talkback hands free.

Kit contains:

- Model TLM-W Speaker/Microphone
- Model AP-1TB Desk Top Base Station
- Model AD-3 24VDC Power Supply
- Power Supply & Cable for connection



MICROPHONES

All Verifact microphones are omni-directional, low impedance, electret condenser mics w/built-in preamp and produce line level outputs.

Verifact Model A - designed for ceiling or wall mounting.

Verifact Model B - designed for high ceiling applications.

Verifact Model C - is mounted to a small PC board by way of two lead wires 5" in length and is designed for small or unusual housings and custom requirements.

Verifact Model D - mounted to the back of a single gang S/S face plate. Available in vandal resistant - Model D-V

Verifact Model E - housed inside a single-gang weather resistant Bell Box®.

Verifact Model K - designed for areas with excessive background noise or where the ambient sound level is high.



AUDIO BASE STATIONS

Model AP-1TB is a single zone non-alarming audio monitoring base station with listen and talkback. As a system (with a Louroe speaker/microphone), it provides live audio with a built-in 3" speaker and a built-in microphone for talkback to the remote area. Model AP-1TB is designed to interface with a DVR or VCR.

Note: Audio base stations are also available in 2,4,8,12 & 16 zone/channel version. There are also 'listen only' base stations as well as a series of alarming base stations that are sound or switch-closure activated.



Lowell.™

Distributed Audio, Power & Rack Solutions



Recessed Ceiling Speaker

ES-4T (2 per box)

- 4" 25W dual cone driver
- 16W transformer
- Steel back-can with reversible mounting dogs
- Press-fit grille with scrim and pull-tool
- Tile support rails and C-ring
- Removable (four-pin) Phoenix-style connector with two terminals for input to speaker and two parallel terminals for output to next speaker in string.



Recessed Ceiling Speaker

RPAK-810-72 (2 per box)

- 8" 15W dual cone drivers
- Wired 70/25V transformers
- 12.875" dia. grilles
- 10" dia. x 4"D steel enclosures
- 23.75"L tile bridges



OS-50-TW

OS-50-TB

Indoor/Protected Outdoor Speaker

OS-50-TW or OS-50-TB (1 per box)

- 5.25" woofer w/rubber surround, 0.5" PEI tweeter
- Transformer with direct 8ohm or distributed 25V, 70V or 100V tap positions
- Plastic housing with weather-resistant terminal cover
- Fine mesh aluminum grille
- Adjustable U-shaped aluminum bracket
- White or black

NOTE: 100W and 150W speakers also available.

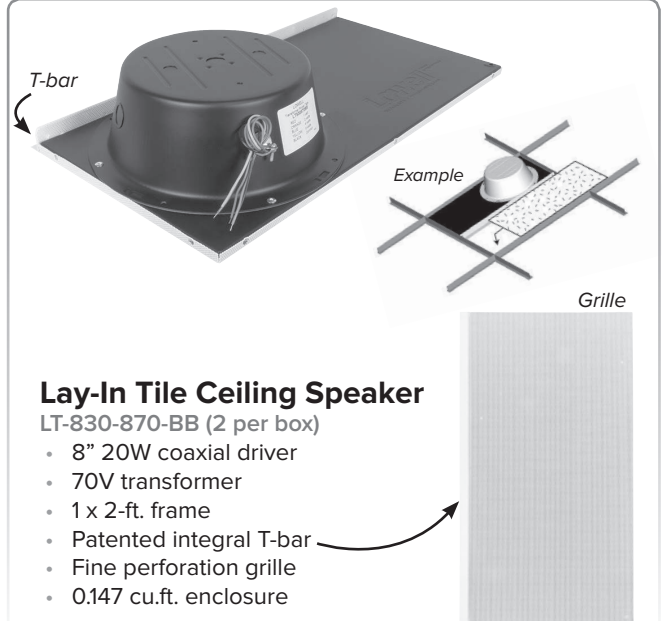

Lay-In Tile Ceiling Speaker

LT-830-870-BB (2 per box)

- 8" 20W coaxial driver
- 70V transformer
- 1 x 2-ft. frame
- Patented integral T-bar
- Fine perforation grille
- 0.147 cu.ft. enclosure

NOTE: 2'x2' models also available



MA30



MA60
MA125
MA250

Amplifiers

MA Series

4ohm, 8ohm, 25V and 70V speaker outputs (rackmount brackets included)

- **MA30:** 30W RMS
Three input channels
- **MA60:** 60W RMS, Five input channels
- **MA125:** 125W RMS, Five input channels
- **MA250:** 250W RMS, Five input channels



Stereo Tuner

AMFM2

- 19" x 1.75" x 9.5"
- 10AM/10FM station presets
- 14 day memory retention
- Auto station search
- 12 VDC power connection
- F-style adapter
- 2-ft. cable
(RCA stereo to RCA stereo)



Advanced Surge Suppressor

ACSP-1502-RPC (remote power control)

- 1.75" x 6" x 9"
- Patented plate rotates 90° for front or side access to two 15A NEMA outlets
- Suppresses line to neutral w/no ground contamination
- TCR technology defeats surges up to 72,000 amps
- Surge suppression (UL 1449-4 Listed)
- 6-ft. detachable IEC cord
- Includes universal mounting brackets



Power Panel

ACR-159-S

- 1.75" x 19" x 9"
- Nine 15A NEMA outlets
- One front outlet
- Eight rear outlets
- Front rocker switch controls all outlets (on/off)
- Power rating: 120VAC, 60Hz, 15A
- Surge suppression up to 30,000A
- 9-ft. attached cord



Power Strips

- 15A NEMA outlets
- Surge suppression (UL 1449-3 Listed)
- 12-ft. attached cord
- **ACS-1512:** 32"L chassis with 12 outlets
- **ACS-1524:** 60"L chassis with 24 outlets

NOTE: 20A AC power strips also available!

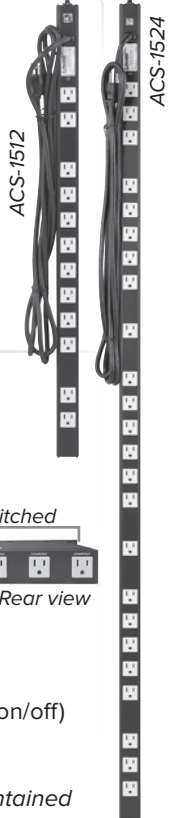

Front view

Power Panel

ACR-1509-S

- 1.75" x 19" x 9"
- Nine 15A NEMA outlets w/ 9-ft. attached cord
- One front outlet (unswitched/always on)
- Eight rear outlets (3 switched, 5 unswitched)
- Front rocker switch controls switched outlets (on/off)
- Power rating: 120VAC, 60Hz, 15A
- Surge suppression up to 30,000A

NOTE: Great for DSP Blue Tooth, etc. where maintained power is required

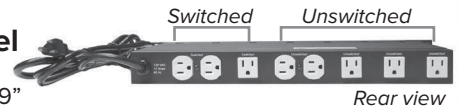

Rear view

On-off System Reboot w/Remote Power Control (RPC)

RPC-20-SCD-RJ

- 7.5" x 3.25" x 2.75"
- Two 20A NEMA outlets
- Power Rating: 20A, 125VAC
- Surge suppression up to 20,000A
- 6-ft. attached cord with NEMA 5-20P plug
- RJ45 connector
- Activation via dry contact or logic signal

NOTE: also available with NEMA 5-15P plug/15A outlets

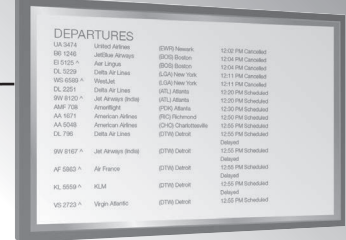

One example application: Screen reboot.

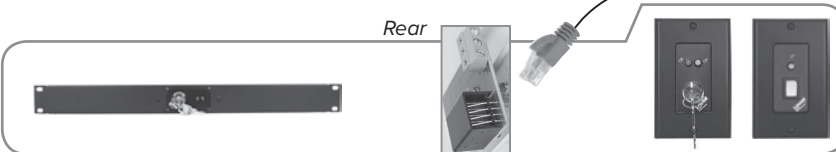

Switch installation can be up to 3 miles from RPC with 24-ga. wire.



MSM2
Allows multiple switches

RPS Series w/1U rackmount panel

- SPST switch
- Momentary (2 status LED) OR maintained (1 status LED)
- Rocker switch OR key switch
- RJ45 and Phoenix style connectors

RPS Series w/wall plate

- SPST switch
- Momentary (2 status LED) OR maintained (1 status LED)
- Rocker switch OR key switch
- 1-gang decorator style wall plate (black)
- RJ45 and Phoenix style connectors

Additional 15A, 20A & 30A, UL/ETL Power by LOWELL!

19" EIA Panels

Rackmount panels with AC power include options such as sequential switching, remote power control, surge suppression, over/under voltage protection and lighting

Power Strips

Rackmount power strips with single or multiple circuits and outlets in 12" to 70" chassis, corded or hardwired, optional surge suppression, remote power control (RPC)

Lowell.™

Distributed Audio, Power & Rack Solutions

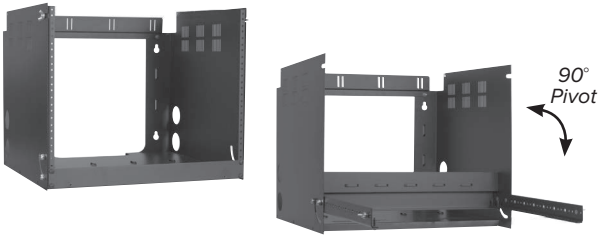

Pivot Frame Wall-Mount Rack

PFR Series (19.30"W)

- Hinged panel mounting frame pivots down 90°
- One-pair fixed position mounting rails tapped 10-32
- 30-40 lbs. load capacity (depending on rack size)
- Sizes 4Ux6", 8Ux6", 4Ux12", 8Ux12", 8Ux18" (shown)

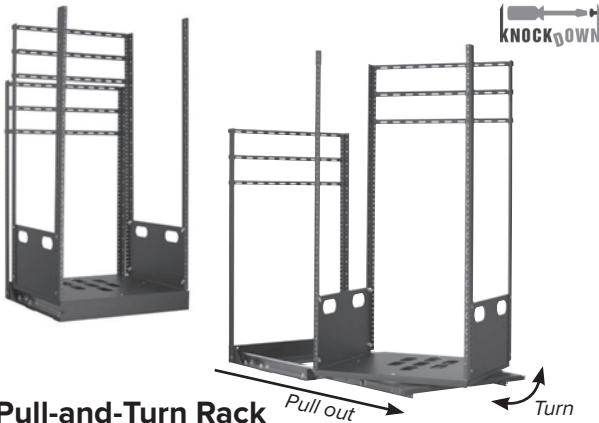

Pull-and-Turn Rack

LPTR Series (19.13"W)

- For easy access to equipment
- Rotates and locks securely at 60° or 90°
- 6 lacing bars
- 125 or 250 lbs. load capacity (depends on rack size)
- Available in 10U, 12U, 14U, 16U, 21U (shown) & 24U
- Lower freight costs with knockdown assembly



Swing Gate Wall-Mount Rack

SGR Series (20.03"W)

- One fully open side
- Gate swings open for extraordinary access
- 150 lbs. load capacity
- Available in 12U & 20U
- Two-piece assembly required

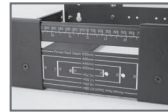

Selectable depth
(14"-21")



LXR Series
Similar slim frame design as LVR but with fixed 21" or 26" depths.

Slim Frame Vari-Rack™

LVR Series (19.21"W)

- Variable depth (any depth between 14"-21" or 21"-28")
- Internal mount corner post rails can be cut for clean look in-field height adjustment
- 400 lbs. load capacity
- Available in 8U (shown), 14U, 22U, 30U, 38U & 44U
- Lower freight costs with knockdown assembly



Horizontal Mount



Vertical Mount

Versatile Wall-Mount Rack

VR Series (19.17"W)

- Mounts to wall or desk, vertically or horizontally
- Accommodates equipment of just about any depth
- Use two together for four-point mounting
- 200 lbs. load capacity
- Available in 2U, 3U (shown) & 4U



Flat-ship, Wall-Mount Shelf

FS18-16 (18.22"W)

- Steel wall-mount shelf ships flat, folds out to service position, no assembly required
- Keyhole mounting slots on 16" stud centers
- Cutouts for cable drop-down
- 100 lbs. load capacity
- Available 14", 16" & 20" depths
- Lower freight costs with knockdown

Mic Connector Wall Plate

WP1 Series

- Stainless steel
- 1 or 2 female connectors (Neutrik® NC3FDL)
- Countersunk mounting holes
- Mounting hardware
- For standard gang-size E.O. box

NOTE: Male connectors also available



Rack Utility Light

RL-1a

- LED light (350 Lumens)
- Shatter resistant lens
- Dual hanging hooks and magnet
- 6 ft. 16/3 SJTW cord with 5-15 plug
- Single 11A grounded outlet in handle



Blank Rack Panel

SEP Series

- 18-ga. steel with flange
- **SEP-1** – 19"W x 1.75"H (1U)
- **SEP-2** – 19"W x 3.5"H (2U)
- Other sizes available



Vented Rack Panel

SVP Series

- 18-ga. steel with flange
- **SVP-1** – 19"W x 1.75"H (1U)
- **SVP-2** – 19"W x 3.5"H (2U)
- Other sizes available



Rack Utility Shelf

US-210

- 16-ga. steel
- 19"W x 10"D x 2U
- 50 lbs. load capacity
- Other sizes available



Cable Management

CMBS Series

- 19"W, slotted steel bars
- Straight or offset
- Stackable versatility
- **CMBS** – straight
- **CMBS-2** – 2" offset
- **CMBS-4** – 4" offset
- **CMBS-6** – 6" offset

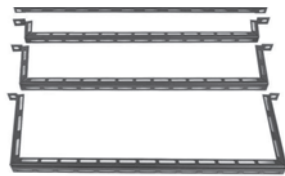

CMFW Series

- 19"W steel flat wire
- Non-abrasive rounded edge
- Straight or offset
- Stackable versatility



CMFW – straight
CMFW-2 – 1.75" offset
CMFW-4 – 4" offset

150W Volume Control

150LVCS-DSB

- 150W STEREO
- 3dB step attenuation
- 25/70/100V speaker line
- Black/stainless steel decorator style 2-gang wall plate (shown)
- Also available in 2-gang stainless steel



200W Volume Control

200LVC

- 200W MONO
- 3dB step attenuation
- 70/100V speaker line
- Stainless steel standard 2-gang wall plate
- Other colors / styles available, including rackmount.



NOTE: Ideal for 70V zone amp applications

100W Volume Control

10015LVC-DB

- 100W MONO
- 1.5dB step attenuation
- 25/70/100V speaker line
- Black decorator style wall plate
- Other colors / styles available, including rackmount.



NOTE: 25W & 50W also available

100W Volume Control (Key)

KL100-DW

- 100W MONO
- 3dB step attenuation
- 25/70/100V speaker line
- Key-switch for security
- White decorator style wall plate
- Other colors / styles available, including rackmount.



Potentiometer

10KLVC-DW

- 10kohm resistance
- Line level
- VCA control or audio circuit
- White decorator style wall plate
- Other colors / styles available, including rackmount.



Surface-Mount Boxes

P1X Series

- 20-gauge steel
- 1-gang and 2-gang
- U-clips
- Knockouts (0.5 in.)
- Holes conform to standard/decorator wall plate centers

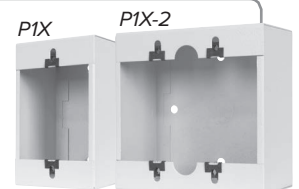



Martin value through knowledge and partnership.

Martin is all about fresh ideas, built on a solid basis of experience and an unparalleled range of dynamic lighting solutions. That is why Martin is the lighting supplier of choice for lighting designers, rental houses, and installers across the architectural, commercial and entertainment worlds.

RUSH MOVING HEADS

RUSH MH 1 Profile Plus P/N: 90280050 - This super bright LED profile moving head is even brighter than its predecessor RUSH MH 1 Profile with 50% more output. Efficient optics with an increased beam angle from 13 degrees to 16 degrees punches out a variety of effects and colors from two gobo wheels and two color wheels. For added versatility and effect, it also houses an electronic dimmer and strobe, iris and 3-facet prism and an improved cooling system for quieter operation.



RUSH MH 2 Wash P/N: 90280020 - Compact yet powerful, this fast and agile LED wash light moving head features RGBW color mixing. Unique wash beam effects are possible with auto trig shows and music triggered sound activation.



RUSH MH 3 Beam P/N: 90280010 - The RUSH MH 3 Beam is a powerful beam moving head that blasts an intense and narrow long-throw beam for spectacular mid-air looks and effects. It houses a fixed gobo wheel and color wheel with a multitude of effects possible from a dimmer, strobe effect, 8-facet prism and focus.



RUSH MH 4 Beam P/N: 90280030 - This compact beam moving head for smaller venues blasts an intense and narrow beam for spectacular mid-air looks and effects. It houses a fixed gobo wheel and color wheel with a multitude of effects possible from a dimmer and strobe, 6-facet prism and focus.



RUSH MH 5 Profile P/N: 90280040 - This compact and bright LED profile moving head with efficient optics punches out a variety of effects and colors. With two color wheels, two gobo wheels and rotating prism the MH 5 Profile offers full effect in a super compact housing, making it perfect for DJs, bands, clubs, bars, cruise ships and installations where small footprint and low weight is critical.



RUSH STATIC LIGHTS

RUSH Gobo Projector 1 P/N: 90480060 - The RUSH Gobo Projector 1 is ideal for applications that require a compact fixture for easy LED gobo projection. Ideal for clubs, bars, restaurants and shopping malls, this silent gobo projector provides easy adjustment of focus. Speed and direction is controlled by easy-touch buttons, and the magnetic gobo holder makes it easy to change gobos in seconds.



RUSH PAR 2 CT Zoom P/N: 90280060 - The RUSH PAR 2 CT Zoom is a bright single-lens LED PAR Can with fully premixed white color temperatures. With twelve 10W WW/CW (warm white and cold white) LEDs and a 10° to 60° motorized zoom, the RUSH PAR 2 CT Zoom is ideal for multiple applications, ranging from cabaret clubs and theatre through to conferences and exhibitions. It offers full electronic dimming and variable strobe effects and is controlled via DMX or a stand-alone function.



RUSH PAR 2 RGBW Zoom P/N: 90480040 - The RUSH PAR 2 RGBW Zoom is a bright single-lens LED PAR Can with fully premixed color from 12 RGBW LEDs and a spectacular 10 – 60 ° zoom. It offers electronic dimming and strobe and comes with a flexible bracket for floor or truss mounting.



RUSH PAR 1 RGBW P/N: 90480000 - The RUSH PAR 1 RGBW is a bright LED PAR Can with premixed RGBW color mixing. It offers electronic dimming & strobe and comes with a flexible bracket for floor or truss mounting.



RUSH Pin 1 CW P/N: 90480010 - This bright white-LED pin spot comes with two beam options for greater flexibility of coverage. Totally silent with an easy-to-adjust bracket, it works as the ideal mirror ball spot light or decorative table spot.



RUSH EFFECT LIGHTS

RUSH Strobe 1 5x5 P/N: 90480020 - This white strobe/blinder is a 5 x 5 LED matrix panel with individually-controllable LEDs. Controllable via multiple DMX options or sound activated, it includes preprogrammed effect, letter and number macros for easy-to-produce graphics and messaging. Panels link via an integrated horizontal and vertical locking mechanism.



RUSH Multibeam 2 P/N: 90480030 - The RUSH Multibeam 2 is a versatile effect light featuring 2 moveable LED bars each with 5 individually controllable narrow beams for powerful mid-air effects. It punches out 10 intense and narrow long-throw beams and features electronic dimming and strobe effect.



RUSH Wizard P/N: 90480070 - The RUSH Wizard is the iconic Martin Wizard Extreme re-energized: lighter, brighter, more compact and even more energy-efficient. This music triggered and DMX-Controllable "full-house" effect light, features extraordinary bright and magical effects.



BAI carries the entire Martin range of products - Don't see it? Call us!



BAI Distributors is proud to be full line distributors for the following Milestone AV Technologies manufacturers:



Numark®

Numark is obsessed with designing equipment that meets the individual needs of every DJ. That's why the sound of Numark has been present in mixes, scratches, breaks, and beats for more than 40 years.

MIXERS

C1 is a three-channel rack mixer for clubs, bars, and mobile DJs. Everything a club or mobile DJ needs is built in, with none of the confusing bells and whistles found in more expensive mixers.

- Three-channel rack DJ mixer
- Five-band EQ
- Outputs: Master & Record (RCA), Headphone (1/4" stereo)
- Inputs: two phono/line switchable (RCA), four line (RCA), mic

C3 is a versatile mixer with five channels plus a DJ mic input with EQ. Thanks to its wide range of inputs, you can connect all of your gear with just this mixer. Combine turntables, CD players, samplers and more.

- Five-channel rack DJ mixer
- Outputs: Balanced (XLR), Master (RCA), Record (RCA), Zone (RCA), Headphone (1/4" stereo)
- Inputs: three phono (RCA), 10 line (RCA), three mic (1/4")

X5 is a two-channel, 24-bit, high-resolution mixer with high-end analog-to-digital and digital-to-analog circuitry and powerful look-ahead limiters at the master, booth, and headphone outputs to deliver virtually lossless, clip-proof audio performance.

- Each channel offers EQ/Kills, gain, Transform
- Master (1/4" pair, balanced), Booth (RCA, pair), S/PDIF optical and coaxial digital outputs
- Slope and reverse controls on crossfader and line faders
- Complete range of beat-synced effects and filters

iM9 is a 4-Channel DJ Mixer with Effects has a built-in dedicated three-band EQ controls for custom shaping the music anytime on any mix. Create on-the-fly remixes and stunning song transitions by engaging iM9's high-quality, beat synced effects.

- Beatkeeper™ BPM detection
- Dedicated XLR mic input with Gain & EQ
- Crossfader with channel assign switches
- Complete range of beat-synced effects and filters

HDMIX has been specifically designed for mobile DJs and club owners who need a compact, portable system that sets up and packs away at a moment's notice. HDMIX lets you load in and out in one shot. Just pack HDMIX and a pair of powered speakers and you can leave the pickup truck at home.

- Professional DJ mixer with CD and expandable playback options
- Plays CDs, MP3-CDs, and MP3-DVDs
- Two mic, three line, and two phono inputs
- Text search, letter-pick scrolling, and on-board playlist creation
- 80GB hard drive
- Two USB ports
- XLR master and RCA zone outputs

iDJ3 is a complete DJ system that works with the music on your Mac, PC or iPod™. Connects to your computer so you can mix your favorite tracks plus you can dock your iPod™ or iPhone™ to play tracks or record your mix. iDJ3 gives you the classic two-turntables-and-a-mixer setup. iDJ3 also has all the inputs and outputs you'll need for your headphones, speakers, and a mic

- I/O capable for headphones, speakers and mic
- Scratch, mix, loop and much more
- Full Color LCD
- Create and integrate seamless loops on each deck
- Beatkeeper™ technology enables you to beat-match visually

COMPUTER DJ/VJ

V7 is the turntable for today's DJ. V7 delivers outstanding feel and unprecedented power in a single-platter digital DJ controller. V7 is based around the acclaimed adjustable torque, motorized-platter design from Numark's NS7 and delivers a host of professional features including real vinyl and a slipmat that analog turntablists will love, plus turntable control at ten times the resolution of standard MIDI, mouse-less library navigation, and Strip Search virtual-needle drop. V7's link function enables you to combine two V7s with your choice of any mixer and your Mac or PC for a completely customizable, totally seamless performance environment.

- Direct-drive, motorized turntable platter
- Strip Search virtual needle-drop control
- Industry-first handoff between two DJs using two different computers for up to four virtual decks
- Includes Serato ITCH software W/Serato Scratch LIVE libraries
- Complete effects controls for audio manipulation

NDX800 is high-performance control for DJs who blend different kinds of music sources. Whether your music is on CDs, MP3 CDs, USB flash drives, or your computer, you can play and manipulate it with NDX800. This digital deck has the feel and layout you're used to, with a twist of Numark innovation.

- CD/MP3/USB player with USB-MIDI computer interface
- Play from CDs, MP3 CDs, USB flash drives, and control software
- Adjust pitch ±6, 12, 25, and 100%, in half steps (semitones), or bend with pitch buttons
- Smooth, fast, reliable, slot-loading drive
- Adjustable start and stop time

MIXDECK is a complete system for every DJ who blends different kinds of music sources. Whether your music is on CDs, MP3 CDs, USB flash drives, iPod, your computer, or even other analog players, you can mix and perform with it all using MIXDECK. This performance station has the traditional two-decks-and-a-mixer layout you're used to, but that's where time-honored DJ tradition meets Numark innovation.

- Studio-quality computer interface
- Slide BPM ±6, 12, 25, and 100% or bend with pitch buttons
- EQ/rotary kills, replaceable crossfader & complete iPod control

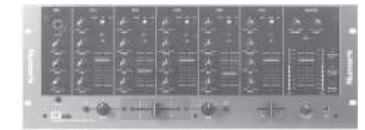



OMNI^{PRO} SERIES

HIGH QUALITY SOLUTIONS DESIGNED WITH THE INSTALLER IN MIND

The OmniPro series is OmniMount's professional line of TV wall mounts. The series spans a wide range of panel sizes (from 26" all the way up to 90") while maintaining a condensed 9 SKU lineup (3 fixed, 3 tilt and 4 full motion). Quality mounts built to last, designed for secure installation, and backed by a brand you can trust.

	MODEL	FITS	SUPPORTS	FUNCTION	VESA	PROFILE		MODEL	FITS	SUPPORTS	FUNCTION	VESA	PROFILE	
MEDIUM	CI80F 	 37-55" TVs	 80 lbs (36,3 kg)		 Universal & VESA 100x100 to 400x400	 1.0" (2,5 cm)		EXTRA LARGE	CI175T 	 37-90" TVs	 175 lbs (79,4 kg)	 Up to +15°	 Universal & VESA 100x100 to 600x400	 2.7" (6,9 cm)
LARGE	CI120F 	 37-75" TVs	 120 lbs (54,4 kg)		 Universal & VESA 200x200 to 600x400	 1.0" (2,5 cm)		MEDIUM	CI60FM 	 37-55" TVs	 60 lbs (27,2 kg)	 Tilts up to +15°; Pans & swivels	 Universal & VESA 100x100 to 400x400	 2.6-14.3" (6,7- 36,2 cm)
EXTRA LARGE	CI175F 	 37-90" TVs	 175 lbs (79,4 kg)		 Universal & VESA 100x100 to 600x400	 1.7" (4,4 cm)		LARGE	CI100FM 	 37-60" TVs	 100 lbs (45,3 kg)	 Tilts up to +15°; Pans & swivels	 Universal & VESA 100x100 to 400x400	 3.0-18.3" (7,6- 46,6 cm)
MEDIUM	CI80T 	 37-55" TVs	 80 lbs (36,3 kg)	 Up to +10°	 Universal & VESA 200x200 to 400x400	 1.6" (4,0 cm)		LARGE	CI125FM 	 37-80" TVs	 125 lbs (56,7 kg)	 Tilts +15° to -1°; Pans & levels	 VESA 200x200 to 600x400	 3.8-19" (9,7- 48,3 cm)
LARGE	CI120T 	 37-75" TVs	 120 lbs (54,4 kg)	 Up to +10°	 Universal & VESA 200x200 to 600x400	 1.6" (4,0 cm)								



RACK SYSTEMS

ENCLOSED RACKS AND ACCESSORIES

OmniMount rack systems come fully assembled with rack accessories.

- 16-gauge steel and powder-coated finish
- Protective box and frame allow for easy accessibility using left or right hinges
- 23" wide enclosure with full access to components
- 5 mm tempered glass front door with metal lockable latch - back door also locks with metal latch
- Removable side panels for easy servicing
- Leveling feet on all 4 corners
- Accepts front or rear-mounted components
- Fully enclosed cooling system with top and bottom ventilation
- Includes pre-installed cooling fans on top and grounded 3-prong AC plug
- UL and cUL approved fan



RE12W

RE12W

Wall mounted rack; supports up to 120 lbs (54,4 kg)
(fans not included)



RE18

RE18

(1) 18-space rack; supports up to 500 lbs (226,8 kg)
(3) 2U-space shelves; each supports up to 50 lbs (22,7 kg)
(3) 2U-space solid blanks



RE27

RE27

(1) 27-space rack; supports up to 750 lbs (340,2 kg)
(5) 2U-space shelves; each supports up to 50 lbs (22,7 kg)
(5) 2U-space solid blanks



RE42

RE42

(1) 42-space rack; supports up to 1100 lbs (500 kg)
(3) 5U-space shelves; each supports up to 100 lbs (45,4 kg)
(7) 2U-space shelves; each supports up to 50 lbs (22,7 kg)
(10) 2U-space solid blanks

RE2UBLANK

Add on for the RE18, RE27 and RE42 for a clean appearance

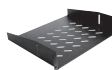

RE2USHELF

RE2USHELF

Add on for the RE18, RE27 and RE42 for managing additional components
Shelf supports up to 50 lbs (22,7 kg)



RE5USHELF

RE5USHELF

Add on for the RE18, RE27 and RE42 for managing additional components
Shelf supports up to 100 lbs (45,4 kg)



OMNI MOUNT®

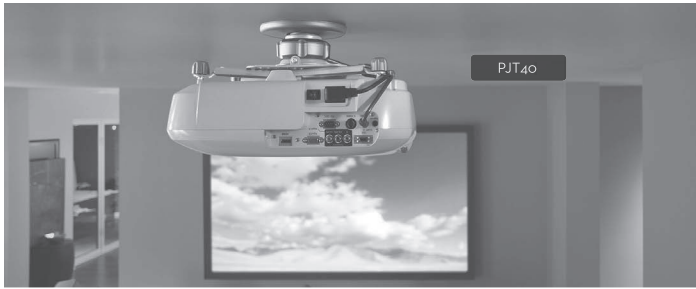

PROJECTOR MOUNTS



PJT40

Fits most small to large projectors up to 40 lbs (18,1 kg)
 Legs adjustable from 5" to 19.8"
 Pitch: +/-15°, Roll: +/-15°, Yaw: +/-180°
 Includes ceiling plate



3NI-PJT / PRO-PJT

Fits most small to large projectors up to 40 lbs (18,1 kg)
 Legs adjustable from 5" to 19.8"
 Pitch: +/-15°, Roll: +/-15°, Yaw: +/-180°
 Includes ceiling plate

CEILING MOUNTS

	MODEL	FITS	SUPPORTS	FUNCTION	VESA
MEDIUM	DCM250	 Fits Most 32-65" TVs	 Supports 250 lbs (113,4 kg)	 Double Tilt Up to 25° in 5° increments	 VESA 200x100 to 600x400
MEDIUM	SCM125	 Fits Most 32-65" TVs	 Supports 125 lbs (56,7 kg)	 Tilt Up to 25° in 5° increments	 VESA 200x100 to 600x400



ASK ABOUT THE OMNIMOUNT LINE OF WALL FURNITURE

SPEAKER STANDS AND MOUNTS



5.0 W/C

5.0 W/C

Fits most Bookshelf speakers up to 5 lbs (2,3 kg)
 Suitable for all-weather use



10.0 W/C

10.0 W/C

Fits most Bookshelf speakers up to 10 lbs (4,5 kg)
 Suitable for all-weather use



15.0 W/C

15.0 W/C

Fits most Satellite speakers up to 15 lbs (6,8 kg)
 Suitable for all-weather use



25.0 W/C

25.0 W/C

Fits most Satellite speakers up to 25 lbs (11,3 kg)
 Suitable for all-weather use



AB1

Fits most micro satellite speakers up to 2.5 lbs (1,1 kg)
 Mount on wall or ceiling
 Suitable for all-weather use



AB2

Fits most medium bookshelf speakers up to 8 lbs (3,6 kg)
 Mount on wall or ceiling
 Suitable for all-weather use



OCSBA

Supports sound bars up to 30 lbs (13,6 kg)
 Easily attaches a sound bar below a TV mount
 Works with most brands or styles of TV mount (fixed, tilt, full motion, interactive)
 Improves audio quality, especially when used with full motion TV mounts

Speaker Stands & Mounts available in Black

On-Stage®

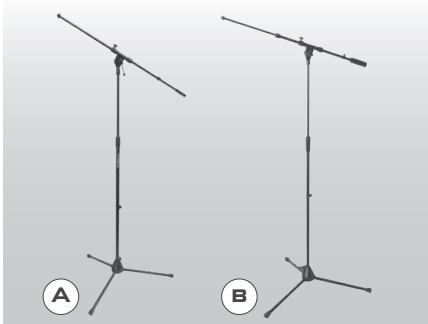

A) MS7701B

Euro Boom Microphone Stand

Our best selling stand! This Euro Boom boasts a hybrid sheet metal and composite leg housing, making it virtually unbreakable. With a removable boom arm and its ability to fold flat, this stand is a must for every member of the band.

Height Adj.: 32-62". Boom Length: 30".

B) MS9701TB+

Pro Tele-Boom Microphone Stand

Pro-level stand feature all-metal parts, thicker tubing and premium threads. An ergonomic center clutch grip, coupled with an anti-rotating device on the lower shaft, makes for easy one-hand height adjustments.

Height Adj.: 36-64". Boom Length Adj.: 19-30"

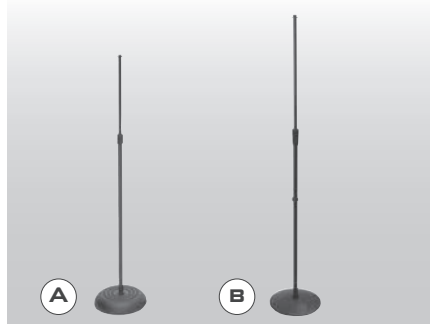

A) MS7201

Round Base Microphone Stand

An industry standard! The 7 lb. sand-cast base is sturdy enough for road abuse yet light enough to carry. This black powder coated stand features a diecast zinc clutch.

Height Adj.: 33-60". Base Diameter/Weight: 10"/7 lbs.

B) MS9210

Heavy Duty Round Base Mic Stand

This pro level round base stand features a low profile sand cast base that ensures stability while maintaining a minimal footprint on stage. M20 Heavy coarse threading on the lower shaft makes assembly faster and extends thread-wear compared to older threaded designs.

Height Adj.: 36-65". Base Diameter/Weight: 10"/6 lbs.

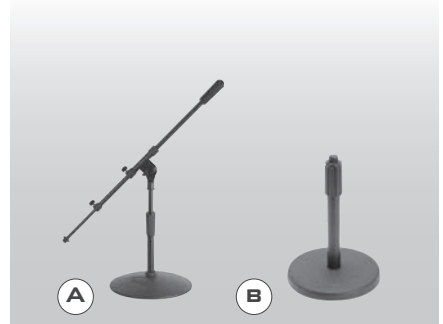

A) MS9409

Pro Kick Drum Mic Stands

Comprised entirely of powder-coated aluminum alloy, these pro stands provide both durability and flexibility. The teleboom features a removable counterweight for dual mic functionality.

Height Adj.: 9-13". Base Diameter/Weight: 10"/6 lbs.

Boom Length Adj.: 21.5-36". Threading: 5/8"-27 for mic clips and accessory parts; M20 threading at base.

B) DS7200B

Ideal for broadcast, boardroom, conference, and press use—anywhere portable tabletop miking is needed. They also work great for miking guitar cabs.

Height Adj.: 9-13". Base Diameter/Weight: 6 1/2 lbs.



A) MSA7040TB

19-32" Teleboom Arm

B) MSA9030-13B

13" Black Gooseneck



A) MY100: Wired Rubber Mic Clip

B) MY110: Wireless Rubber Mic Clip

C) TMO8-B: Flange Mount

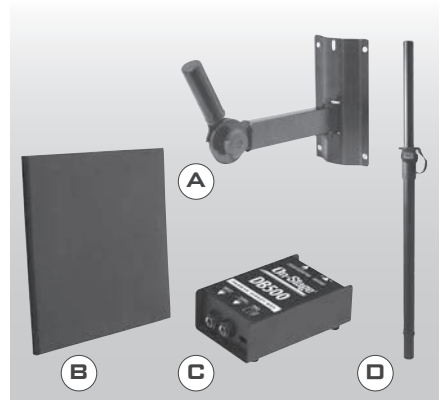

A) SS7322B

Wall Mount Speaker Bracket

Distance from wall: 12.5". Weight Capacity: 80 lbs.

Tilt Angle Adjustment: 90°-30°.

Swivel Angle Adjustment: ±30°. Construction: Steel

B) AP3500

Acoustical Wall Treatment

Dimensions: 2' x 2' x 1". Material: High density, class A fire rated acoustical fiberglass

C) DB500

Passive DI Box

Single channel, passive direct box. Input Resistance: 50K

Frequency Response: 10-40k

D) SS7745

Adjustable Subwoofer Shaft

Length Adj.: 36"-60". Weight Capacity: 80 lbs.

Construction: Steel



SSP7950 | 10634

All-Aluminum Speaker Stand Pack

(2) Tripod Speaker Stands

· Reversible 1-3/8" or 1 1/2" upper shaft

· Weight Capacity: 120 lbs.

· Stand Height Adj.: 44-80"

(1) Speaker Stand Bag



UTC2200

Utility Cart

The UTC2200 is practically a necessity for musicians on the move. Weighing a mere 28.7 pounds, it holds up to 485 pounds of equipment and is easily adjustable to whatever size gear you're hauling. Folds flat for storage.

Compact Size: (w) 18" x (l) 28 1/2" x (h) 10 1/2"

Extended Size: (w) 18" x (l) 42 1/2" x (h) 31"



SHORT THROW AND ULTRA SHORT THROW PROJECTORS

X316ST - 3400 ANSI Short Throw

- XGA resolution 20,000:1 contrast, HDMI input
- Crestron RoomView® – RJ45 control & monitoring



W316ST - 3600 ANSI Short Throw

- WXGA resolution 20,000:1 contrast, HDMI input
- Crestron RoomView® – RJ45 control & monitoring



X305ST - 3000 ANSI Short Throw

- Native XGA - 60" image from under 3' away
- Shadow-free images on interactive whiteboards



W303ST - 3000 ANSI Short Throw (Not shown)

- WXGA resolution, 18,000:1 contrast, HDMI/VGA
- Text, images & video are sharp and easy to read



W305ST - 3200 ANSI Short Throw

- WXGA resolution, 18,000:1 contrast, HDMI/VGA
- Widescreen 3D projection in the smallest of rooms



EH200ST - 3000 ANSI Short Throw

- WXGA resolution, 20,000:1 contrast, 2XHDMI, MHL
- Full HD 1080p image quality



EH415ST - 3500 ANSI Short Throw

- 1080p resolution, 15,000:1 resolution, 2XHDMI
- Full 3D for captivating immersive presentations



EH319UST - 3500 ANSI Ultra Short Throw

- 1080p resolution, 18,000:1 contrast, 2XHDMI
- Crestron RoomView® – RJ45 control & monitoring



EH319USTi - 3500 ANSI Ultra Short Throw (Not shown)

- 1080p resolution, 18,000:1 contrast, 2XHDMI
- TouchBeam finger touch interactive



EH320UST - 4000 ANSI Ultra Short Throw

- 1080p resolution, 20,000:1 contrast, 2XHDMI
- Crestron RoomView® – RJ45 control & monitoring



EH320USTi - 4000 ANSI Ultra Short Throw (Not shown)

- 1080p resolution, 20,000:1 contrast, 2XHDMI
- TouchBeam finger touch interactive



W319UST - 3300 ANSI Ultra Short Throw

- WXGA resolution, 18,000:1 contrast, 2XHDMI/VGA
- Large shadow-free images from a short distance



W319USTir - 3300 ANSI Ultra Short Throw with IR Pen Interactive Technology (Not shown)

- WXGA resolution, 18,000:1 contrast, 2XHDMI/VGA
- Users can work simultaneously on the screen



W320UST - 4000 ANSI Ultra Short Throw

- WXGA resolution, 20,000:1 contrast, 2XHDMI/VGA
- 100" image from less than 24 inches away



SINGLE LAMP PROFESSIONAL PROJECTORS

EH504 - 5000 ANSI Full HD 1080p Resolution with Vertical Lens Shift & 1.6x Zoom

- Ultimate Control - Crestron, Extron, AMX, PJ-Link and Telnet LAN commands



W515 - 6000 ANSI WXGA, 10,000:1 with Vertical/Horizontal keystone & lens shift & 1.8 zoom

- 4 corner Geometric Correction for easy installation of basic stacking solutions or on uneven walls



W515T - 6000 ANSI WXGA, 10,000:1 with Vertical/Horizontal keystone & lens shift & 1.8 zoom

- 4 corner Geometric Correction for easy installation of basic stacking solutions or on uneven walls



EH515 - 5500 ANSI 1080p, 10,000:1 with Vertical/Horizontal keystone & lens shift & 1.8 zoom

- 1x Display port, 2xHDMI + MHL, 2xVGA, 1x VGA out, Composite Video, S-Video, 3x Audio-In



WU515 - 6000 ANSI WUXGA 10,000:1 w/Vertical/Horizontal keystone & lens shift & 1.8 zoom

- 1x Display port, 2xHDMI + MHL, 2xVGA, 1x VGA out, Composite Video, S-Video, 3x Audio-In



Note: Both EH515 & WU515 available with HDBase T connectivity as **EH515T** and **WU515T**

BAI Carries the entire range of Optoma projectors; if you don't see what you require, please call us.



FLAT PANEL MOUNTING SYSTEMS

Peerless SmartMount™, the sleekest looking mount on the market with a superior level of functionality and versatility. The outstanding aesthetics and airy design enhance the screen and give a contemporary artistic touch to any environment. Peerless offers a wide variety of mounts for flat panels from 10" to 102" in fixed style, tilt and articulating.

Style	Screen Size		Model Chart				
	10" - 29"	22" - 40"	13" - 37"	32" - 60"	37" - 75"	39" - 80"	46" - 90"
Fixed	SF630	SF632	N/A	SF640	SF650	SF660	SF670
Tilt	ST630	ST632	ST635	ST640	ST650	ST660	ST670

• Also available - **SF680** & **ST680** for 60" to 95" Panels

Articulating	10" - 29"	22" - 40"	32" - 50"	37"-55"	40" - 75"
		SA730P	SA740P	SA746PU	SA752PU



SA740P

Note: All mounts are Black finish - Suffix (S) - Silver
Suffix 'P' denotes standard model -does not come with security hardware.

PLA Series - Articulating Wall Mounts

Offer the best view in the room with ability to swing, tilt or articulate the most popular sizes of plasma and LCD screens. Self-lubricating bushings enable the arms to smoothly extend, while adjustable tilt and pivot position the screen to the optimal viewing angle.

- PLA50 - 37" - 80" Flat Panel Mount. Adapter Plate sold separately
- PLA50 UNL(P) - 37" - 80" Universal Flat Panel Mount
- PLA60 - 37" - 95" Flat Panel Mount. Adapter Plate sold separately
- PLA60UNL(P) - 37" - 95" Universal Flat Panel Mount

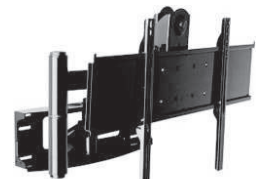

PLB 1 - Dedicated Dual Flat Screen Mount

These mounts are designed to safely support two flat screen monitors, back to back, from a ceiling structure. Each screen tilts independently, and the entire unit can be rotated 360° for best viewing position. Requires two PLP adaptor plates, ADD, AEC or EXT model extension column and DCS or DCT model ceiling plate, sold separately.



PLCM Series - Straight Column Ceiling Mount for 32" to 65" Panels

The Straight Column Ceiling Mount offers a straight column from the ceiling attachment point to the flat panel screen. The straight column ceiling mount is ideal for sports facilities, airports, lobbies or retail environments. It delivers 20° of adjustable tilt and 360° of swivel. This mount ships complete with 2.5' fixed length extension column and theft resistant security fasteners.



LCC Series - LCD Ceiling Mount with VESA 75/100 Adapter Plate

The slim design of the LCD Ceiling Mount offers the ideal low profile mounting solution and enhances the professional look of 13" to 29" LCD screens. The slender adjustable extension column minimizes the mount's appearance while maximizing the screen's presence in any room. Models with the optional cable management covers offer a sleek, stylized veneer that conceals cords and augments the mount's overall aesthetic.

- LCC-18 (C)(CS)(S) - 18" - 30" Adjustable Length
- LCC-36 (C)(CS)(S) - 36" - 48" Adjustable Length
- Standard Color - Black (S)-Silver (CS)-Cord Management



MISCELLANEOUS MOUNTING SYSTEMS

SmartMount XT™ series of flat-panel TV mounts in articulating, tilt and flat styles achieves expert professional mounting in a fraction of the time. The line of pre-assembled, one-piece mounts that can be affixed to walls by a single professional installer or integrator now provides post-installation height adjustments on flat, tilt mount, and articulating and improved cable housing on articulating mounts to render a clean finish. Available in sizes to accommodate 32" to 70" flat panels. Both the tilt and articulating models carry the One-Touch™ tilt feature, enabling correction of viewing angles by +15/-5 degrees without using tools. An improved hinge on the tilt mount eliminates the need for ratchet handle adjusting. Displays on articulating mounts can be rotated to a landscape or portrait orientation; those on flat and tilt mounts can be adjusted vertically by up to an inch and horizontally, up to 13 inches. This allows post-installation leveling and shifting, without having to remove the display.

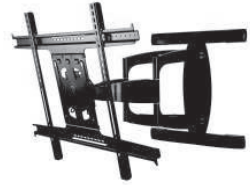

FPZ-600 - Flat Panel Floor Stand for 32"-60" LCD and Plasma Screens

Perfect for conference rooms, lobbies or convention centers, the FPZ-600 Flat Panel Display Stand provides a safe and secure solution for displaying digital content in public areas. Its versatile functionality and solid engineering enable you to display a single screen, two screens back to back or even four screens (requires additional accessory) in either landscape or portrait orientations. The integrated security fasteners lock the screens in place, virtually eliminating theft. Internal cord management hides your display a clean, professional look.



Also available as **FPZ-670** for 50" - 71" panels.

- VESA 100/200x100/200x200 compatible
- Easy switch from portrait to landscape orientation
- Supports non-VESA screens with additional PLP screen adapter plate (sold separately)
- Fits single or back-to-back 32"-60" flat panel screens (up to four with additional parts)
- Integrated cable management
- Hook-on design for simple installation

SR560 Series Flat Panel TV Cart for 32" - 60" Flat Panel Screens

The new SmartMount® line of Flat Panel TV Carts offer the most complete mobile solutions for any application. These versatile presentation carts allow you to hold meetings with A/V support or simply to display information. Their full line of accessories enable each cart to be fully tailored to meet your specific requirements.

- Incremental tilt of -2°, 0° and +5° for desired view angle
- 4" swivel casters ensure safe and easy maneuverability
- Adjustable metal (**SR560M**) or tinted glass (**SR560G**) shelf for A/V components and accessories
- Vertical adjustment feature
- UL Listed



PLP-UNL Universal Adapter Bracket for 32" - 65" Flat Panel Screens

The Universal Adapter Bracket offers unparalleled compatibility with medium to large sized plasma and LCD flat panel screens 32" to 65". The heavy duty reinforced plate and brackets hold up to 200 lbs and quickly and easily attach to most Peerless flat panel mounts. Includes Sorted-For-You™ fastener pack with all necessary hardware. Available in black or silver.



PRSS Projector Mount for projectors up to 50 pounds

offers one of the fastest and easiest installation available in the market, allowing for independent pitch, roll & swivel alignment with two easily accessible adjustment points. Just set the mount to the desired position and secure it in place. It will hold its position even during projector maintenance. With its discreet, low-profile design the projector mount is perfect for flush mounting applications. Available in black, white and silver.



PRG-UNV Series Projector Mounts

PRG Precision Gear Projector Mount is changing the way image alignment is done. The patent-pending precision gear design provides exact tilt and roll image positioning with a simple turn of a knob. Once the installer sets the precision gear to the desired position it stays securely in place. It will not shift during projector maintenance, bulb replacement, and will not loosen or change alignment due to vibration, accidental bumping etc. Available in black, white & silver.



PJF2 Projector Mount with Spider® Universal Adapter Plate

For Multimedia projectors up to 50 pounds. The mount features a ceiling plate, ball & socket design, multidirectional positioning (roll, pitch and yaw) for proper image alignment & pre-installed security hardware at every connection point.



CMJ455 Lightweight Suspended Ceiling Plate

The CMJ455 Lightweight Suspended Ceiling Plate for Projector Mounts consists of an 8"x 24" filler tray and a 15.75"(400mm) x 24"(610mm) ceiling tray suspended by four tie wires from the true ceiling above. (CMJ455 does not include hanger brackets)



Peerless-AV™ DIGITAL SIGNAGE MOUNTING SYSTEMS

Peerless Mounts for Digital Signage

Excellence in Digital Signage starts with outstanding content and screen placement. Peerless brand mounting solutions have been deployed in thousands of locations all over the globe. Integrators, installers and network administrators have trusted Peerless Mounts for quality, durability and ease of installation for years. From standard products to custom designed specialty mounts, Peerless leads the way in Digital Signage with aesthetics, logistics and creative, high quality solutions.

VIDEO WALL SYSTEMS

DS-VW665 is for 40" to 65" displays and includes innovative features that simplify the installation process, such as custom wall spacers and 8 points of tool-less micro adjustment. These unique features provide seamless display alignment of small or large video wall configurations while ensuring each mount is positioned for the specific display being used.

Also available in this series are:

- DS-VW655-2X2 - 46"- 55" Displays
- DS-VW650 - 40"-50" Ultra-thin Displays
- DS-VW765-LAND - 40"-65" Displays - Full Service Video Wall - Land Aspect
- DS-VW765-POR - 42"-65" Displays - Full Service Video Wall - Portrait Aspect
- DS-C560-2X2/DS-C560-1X3 - Portable Video Wall Carts - 1X3 or 2X2 Configuration - 46"-60" Displays
- DS-C555-3X3 - Portable SmartMount® 3x3 Video Wall Cart - 46"-55" Displays
- DS-VWT955-2X2 - Video Wall Ceiling Mount for 2 x 2 Configurations - 40"-55" Displays
- DST965 - Back-to-Back 20° Fixed Tilt Ceiling Mount w/Media Player Storage - 40"-65" Displays



KIOSK ENCLOSURES

Make a statement with Peerless' sleek digital signage kiosk enclosure. Peerless kiosk enclosures are sure to make an impact with its audience. Whether it's advertising, a digital directory, or wayfinding, this solution is an ideal fit for hospitals and more. Available in models to support 40", 46" & 55" displays, with and without antimicrobial finishes. Most models are designed for ultra-thin displays.

- KL540-AB - Landscape Kiosk Enclosure w/Antimicrobial Finish - Black Finish fits most 40" Displays
- KL540-AW - Same as above with White Finish
- KL546-AB - Landscape Kiosk Enclosure w/Antimicrobial Finish - Black Finish fits most 46" Displays
- KL546-WH - Same as above with White Finish
- KP555-AB - Portrait Kiosk Enclosure with Antimicrobial Finish - Black Finish fits most 55" Displays
- KP555-AW - Same as above with White Finish
- KL540-S - Landscape Kiosk Enclosure - Fits most 40" Ultra-thin LCD Displays**
- KL546-S - Landscape Kiosk Enclosure - Fits most 46" Ultra-thin LCD Displays**
- KP555-S - Portrait Kiosk Enclosure - Fits most 55" Ultra-thin LCD Displays**

** Special Order - wide range of colors and accessories available



WIRELESS MULTIMEDIA

HDS-WHDI100 PeerAir™ Wireless HD Multimedia System - Wireless content streaming and gaming with plug-and-play setup, zero latency, and the ability to stream Full HD 1080p and all 3D content formats. A wired pass-through feature sends content to a nearby HDTV, and a wireless receiver able to receive wirelessly streamed content up to 100ft away. This is the only system that provides the ability to expand wireless connectivity with an available Transmitter accessory.

Peerless-AV® PeerAir™ Pro Multi-Display System - When running cables is not an option, stream HD content wirelessly with the PeerAir™ Pro Wireless AV Multi-Display System. With four inputs and the ability to multicast to up to six displays, this wireless workhorse streams Full HD 1080p and passive 3D signals up to 210ft (64m) to an HDTV, projector or any other display. For new installations and retrofits alike, this kit is a time-saving tool for professional AV integrators in both commercial and residential applications.

- HDS300 - Signal transfer to a single HDTV
- HDS300-2 - Signal transfer to 2 - HDTV's
- HDS300-3 - Signal transfer to 3 - HDTV's
- HDS300-4 - Signal transfer to 4 - HDTV's
- HDS300-5 - Signal transfer to 5 - HDTV's
- HDS300-6 - Signal transfer to 6 - HDTV's



Peerless Does Custom!

Haven't found the perfect mount to fit your application? **PEERLESS DOES CUSTOM** - and have been doing so for many years. Call **BAI** with your requirements and let us get you a quote.

PHILIPS

Signage Solutions

It's a world where we are constantly seeking the next WOW, and you've just found it. A stunning Philips display does not just offer an eye-catching way to send marketing messages or show attention grabbing video – it also gives you the opportunity to lower your Total Cost of Ownership and at the same time dramatically increasing sales. With some of the lowest energy consumption of any display in their respective class, the Philips range of displays brings you 24/7 reliability coupled with cutting edge energy saving technologies. We have products for all segments of the market.

DIGITAL SIGNAGE

70EL Series - Enhance your business with the 70EL series displays from Philips. Boasting 16GB of internal memory, a slim bezel of just 6.5mm, and an integrated content management system, it's a digital signage solution that makes conducting your business easier.

- **BDL4270EL** - 42" Edge IPS, 500nit, Portrait and Landscape, 24/7 Duty Cycle
- **BDL4970EL** - 49" Edge IPS, 500nit, Portrait and Landscape, 24/7 Duty Cycle
- **BDL5570EL** - 55" Edge IPS, 500nit, Portrait and Landscape, 24/7 Duty Cycle



V Series - The 24/7 V-Line from Philips features High Bright panels, capable of standing up to even the most demanding of environments. Plus with narrow bezels and integrated memory (90VL Series), your message shines.

- **BDL4290VL** - 42" IPS Panel 700nit, Portrait and Landscape, 24/7 Duty Cycle
- **BDL4780VH** - 47" IPS Panel 2000nit, Portrait and Landscape, 24/7 Duty Cycle
- **BDL4990VL** - 49" IPS Panel 700nit, Portrait and Landscape, 24/7 Duty Cycle
- **BDL5590VL** - 55" IPS Panel 700nit, Portrait and Landscape, 24/7 Duty Cycle



Q Line Series - Deliver startlingly clear images in a more eco-friendly way with the Q-Line displays. High on performance and reliability, yet low on power consumption, it's ideal for projects where no compromise is accepted. Available in sizes 32", 43", 48", 55" & 65". 350nit

- **BDL3230QL** - 32" IPS, 16/7 Duty Cycle
- **BDL4335QL** - 43" IPS, 16/7 Duty Cycle
- **BDL4835QL** - 48" IPS, 16/7 Duty Cycle
- **BDL5535QL** - 55" IPS, 16/7 Duty Cycle
- **BDL4330QL** - 43" IPS, 16/7 Duty Cycle
- **BDL4830QL** - 48" IPS, 16/7 Duty Cycle
- **BDL5530QL** - 55" IPS, 16/7 Duty Cycle
- **BDL3000Q** - 65" MVA, 16/7 Duty Cycle

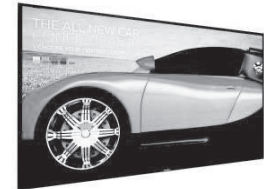

D-Line: Android Powered Displays - Next Generation Signage - Amaze your customers with this Android powered display. With integrated WiFi and designed to run android apps, it's the next evolution in signage solutions. All D-Line panels are 450nit, except the 32", which is 400nit.

- **32BDL4050D** - 32" IPS, 24/7 Duty Cycle
- **49BDL4050D** - 49" IPS, 24/7 Duty Cycle
- **65BDL4050D** - 65" IPS, 24/7 Duty Cycle
- **43BDL4050D** - 43" IPS, 24/7 Duty Cycle
- **55BDL4050D** - 55" IPS, 24/7 Duty Cycle



T-Line: Multi-Touch - Bring interactivity to your business with multi-touch displays from Philips. Our touch displays are HID compliant, meaning all you have to do is plug it in and you've got touch enabled. Simple as that. Available in 10", 32", 42", 43", 49", 55", 65" and 84" sizes.

- **10BDL3051T** - 10.1", 300nit, 16/7 Duty Cycle
- **BDL4270TT** - 42" IPS, 24/7 Duty Cycle
- **BDL4970TT** - 49" IPS, 24/7 Duty Cycle
- **55BDL4051T** - 55" IPS, 24/7 Duty Cycle
- **BDL6520TT** - 65" IPS, 24/7 Duty Cycle
- **BDL8470TT** - 84" IPS, 16/7 Duty Cycle
- **BDL3260TT** - 32" IPS, 24/7 Duty Cycle
- **43BDL4051T** - 43" IPS, 24/7 Duty Cycle
- **BDL5570TT** - 55" IPS, 24/7 Duty Cycle
- **65BDL3010T** - 65" IPS, 16/7 Duty Cycle
- **75BDL3010T** - 75" IPS, 16/7 Duty Cycle



X-Line: Video Walls - Create a memorable message with a video wall. Perfect for anywhere you want to wow your audience. With bezels as thin as 3.5mm A-A and ease of installations features like a color calibration tool, it's the next generation in digital signage.

- **BDL4988XL** - 49" IPS, 24/7 Duty Cycle
- **BDL5588XL** - 55" IPS, 24/7 Duty Cycle
- **BDL5588XH** - 49" IPS, 24/7 Duty Cycle



BAI Carries the entire line of Philips Commercial Displays - Call for a complete list.



Founded in 1995, PreSonus® Audio Electronics, Inc., is a leading designer and manufacturer of audio recording and live-sound software, hardware, and related accessories. PreSonus's software, microphone preamps, signal processors, digital audio interfaces, digital mixers, control surfaces, studio monitors, loudspeakers, and other products are used worldwide for recording, sound reinforcement, broadcast, sound design, and Internet audio.

StudioLive Series III Digital Mixers

StudioLive® 32 - digital console/recorder is by far the most powerful mixer in its class. The result of nine years of R&D, our third-generation StudioLive mixer is fully recallable, with 33 touch-sensitive, motorized faders and 33 recallable XMAX preamps. Yet despite its extensive features, the StudioLive 32 actually improves upon PreSonus®' legendary ease of use while letting you customize its workflow and operations to fit the way you work. The coveted StudioLive sound is better than ever, including all-new Fat Channel processing, re-engineered from the ground up, and vintage-style EQs and compressors. Add built-in AVB networking, onboard multitrack Capture™ recording to SD Card, and a complete suite of software, and you have a mixing and recording powerhouse that's equally formidable in live and studio applications.



StudioLive® 16 - This third-generation StudioLive mixer is fully recallable, with 17 touch-sensitive, motorized faders and 17 recallable XMAX preamps. Yet despite its extensive features, the StudioLive 16 actually improves upon PreSonus®' legendary ease of use while letting you customize its workflow and operations. The StudioLive sound is better than ever, including all-new Fat Channel processing, re-engineered from the ground up, and vintage-style EQs and compressors. Add built-in AVB networking, onboard multitrack Capture™ recording to SD Card, and a complete suite of software, and you have a mixing and recording powerhouse that's equally formidable in live and studio applications.



StudioLive AR Series Mixers

StudioLive® AR8 USB 8-channel hybrid mixers make it simple to mix and record live shows, studio productions, band rehearsals, podcasts, and much more. This is a musician's mixer: lightweight, versatile, feature-rich, and packed with analog connections and digital tools, yet easy to learn and use. Mix with PreSonus®' famous Class A preamps and three-band EQ. Create multitrack recordings and fly in backing tracks with a 24-bit, 96 kHz, USB 2.0 digital audio interface. Record and playback in stereo with the integrated SD™ digital recorder. Stream program music wirelessly, using onboard Bluetooth®. Compact and road-ready, StudioLive AR mixers provide a superior all-in-one solution for mixing and recording your performances.

- 2 mono & 2 stereo channels, each with Level knob, Pan, Mute & PFL solo
- 1 stereo Super Channel (Ch. 7/8)
- 1 monitor bus with PFL solo
- 1 stereo effects return with Level knob, Dedicated monitor sends, Effects bypass footswitch jack
- 1 stereo effects bus
- 4 balanced mic inputs



StudioLive® AR12 14-channel hybrid performance and recording mixer has all the same great features as the StudioLive® AR8 but in a 14-channel platform with 8 balanced mic inputs.

- 4 mono & 4 stereo channels, each with 60 mm level faders, Pan, Mute, & PFL solo
- 1 stereo Super Channel (Ch. 13/14)
- 2 monitor buses with PFL solo
- 1 stereo effects bus
- 1 stereo effects return with 60 mm master fader, Dedicated monitor sends & Effects bypass footswitch jack



StudioLive® AR16 18-channel hybrid performance and recording mixer has all the same features as the other AR mixers but with 18-channels including 12 balanced mic inputs.

- 8 mono & 4 stereo channels, each with 60 mm level faders, Pan, Mute & PFL solo
- 1 stereo Super Channel (Ch. 17/18)
- 2 monitor buses with PFL solo
- 1 stereo effects bus
- 1 stereo effects return with 60 mm master fader, Dedicated monitor sends & Effects bypass footswitch jack



AIR Loudspeakers

AIR10 2-Way Active Sound-Reinforcement Loudspeakers - Each type of power amplifier has advantages and disadvantages. By employing different amplifier types for each driver, AIR10 loudspeakers use the respective strengths of Class D and Class A/B amplifiers to provide optimal response throughout the speaker's frequency range. A 500W (continuous), Class D amplifier powers the 10-inch low-frequency driver, providing efficient, clean low end when you need it. A 200W (continuous), Class AB amplifier powers the 1-inch high-frequency driver, delivering a natural sounding, "AIR-y" high end. The combination can deliver up to 121 dB SPL of sweet, clear sound between 66 Hz and 20 kHz.

- Easy-to-use DSP performance presets including DJ for music playback, FOH - normal front-of-house, Enhance - for enhanced low end, Monitor for floor wedge placement and Speech - where speech intelligibility is critical.
- Additional presets and controls include a 35mm pole socket with 7.5° downward tilt feature, wall-mount bracket points and M10 rigging points.

The AIR Series of loudspeakers also include the **AIR12**, which is a 12" version that includes a 12" woofer with a 2.5" voice coil and a 1.35" high-frequency compression driver and the **AIR15**, a 15" version that includes a 15" woofer with a 2.5" voice coil and a 1.35" high-frequency compression driver.

Also in the series are 2 incredible subwoofers including the **AIR15s**, a 1200 watt 15" subwoofer with a 3" voice coil and 2 combo XLR-1/4" line inputs and 2 XLR direct outputs. For those that need just a little more low-end the **AIR18s** finishes off the series with a 18" woofer and 3" voice coil. Both subwoofers have the 1200 watts of power and full DSP control.

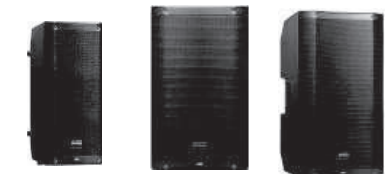

AIR10 AIR12 AIR15



AIR15s AIR18s

PROJECTORS & FLAT PANELS

BAI Distributors offers our dealers the ability to purchase A/V Projectors & Flat Panel Displays from numerous manufacturers. We have a direct relationship with BenQ, Digital Projection, InFocus, LG, Optoma, Peerless AV and Philips; but have the capability to purchase from most other manufacturers at competitive pricing. Call BAI for your next display requirement.

Some of the manufacturers we have access to are:

BARCO

Canon

CHRISTIE[®]

HITACHI

 **LG**

 **Optoma**

SHARP

TOSHIBA

BenQ

CASIO[®]

DIGITAL / **PROJECTION**

InFocus

NEC

Panasonic[®]

SONY[®]

ViewSonic[®]



The Quam-Nichols Company was established in 1930. Living in the shadow of the Great Depression, our namesake in founders shared a sense of determination and optimism; but along with that came expertise. Together, these men and their complementary skills formed the basis of the Quam-Nichols Company. For over seventy-five years, Quam has been based in Chicago, and we remain successful. Our original guiding principles of Legendary Reliability, Superior Customer Service and Outstanding Value are enhanced by another critical factor — **it is made in Chicago, by Chicagoans!**

LOUDSPEAKER ASSEMBLIES

The Quam 'C' Series is a complete loudspeaker assembly with an 8" O.D., full range loudspeaker, multiple transformer options and 22 gauge steel baffle. • Baffle Finish: White baked epoxy hybrid.

Models:

- C5/B70/W** - 8" O.D. speaker, 5 oz magnet, 4W-70V transformer, round screw-through baffle
- C5/BU/W** - 8" O.D. speaker, 5 oz magnet, 5W-25/70V transformer, round screw-through baffle
- C10X/B70/WS** - 8" O.D. speaker, 10 oz magnet, 4W-70V transformer, round studded baffle
- C10X/BU/WS** - 8" O.D. speaker, 10 oz magnet, 25/70V transformer, round studded baffle
- C5/BU/W/VC** - 8" O.D. speaker, 5 oz magnet, round screw-through baffle, 5W-25/70V xfmr w/VC
- C5/B70/W/VC** - 8" O.D. speaker, 5 oz magnet, round screw-through baffle, 5W-70V xfmr w/VC
- C10X/BU/WS/VC** - 8" O.D. speaker, 10 oz magnet, round studded baffle, 5W-25/70V xfmr w/VC
- C10X/B70/WS/VC** - 8" O.D. speaker, 10 oz magnet, round studded baffle, 5W-70V xfmr w/VC

SYSTEM 12, SYSTEM12/VC, SYSTEM12/25RS, SYSTEM12/70RS are complete loudspeaker assemblies with an 8" O.D., full range loudspeaker, multiple transformer options, perforated steel baffle, and integral molded fiber enclosure. Transformer Options: 5W-25/70.7V pigtail, 5W-25/70.7V pigtail with V/C, 4W-25V rotary select or 4W-70.7V rotary select. White or black baked epoxy hybrid.

Surface Mount Speaker Systems:

SYSTEM 1 is a complete loudspeaker assembly with an 8" O.D., full range loudspeaker, 5Watt 25/70.7V pigtail transformer, 22 gauge steel baffle & 16 gauge square steel enclosure. Baffle and Enclosure Finish: White baked epoxy hybrid. Order **SYSTEM 1VP** for vandal proof.

SYSTEM 2 is a complete loudspeaker assembly with an 8" O.D., full range loudspeaker, 5Watt 25/70.7V pigtail transformer, 22 gauge steel baffle and 16 gauge slanted steel enclosure. Baffle and Enclosure Finish: White baked epoxy hybrid. Order **System 2VP** for vandal proof.

Beam Mount Speaker Systems:

BB2 is a complete beam mount loudspeaker assembly with an 8" O.D., full range loudspeaker, transformer, perforated 22 gauge white steel baffle, 16 gauge steel back box and two (2) beam clamps. Transformer Options: 5W-25/70.7V pigtail or 4W-70.7V rotary select.



C10X/BU/WS



C10X/BU/WS



SYSTEM 12



SYSTEM 1



SYSTEM 2



BB2

LOUDSPEAKERS - INDIVIDUAL & MOUNTING ACCESSORIES

The Quam '**8C**' Series of loudspeakers are 8" O.D., 8 Ohm loudspeaker with concentric mount hard fiber HF cone. The finish is a black baked epoxy hybrid.

Raw Speakers:

- 8C5PAX/TBL25B** - 8" O.D. speaker, 5 ounce magnet, 4W-25V transformer
- 8C5PAX/TBL70B** - 8" O.D. speaker, 5 ounce magnet, 4W-70V transformer
- 8C5PAX/TBLUB** - 8" O.D. speaker, 5 ounce magnet, 5W-25/70V transformer
- 8C10PAX/TBL25B** - 8" O.D. speaker, 10 ounce magnet, 4W-25V transformer
- 8C10PAX/TBL70B** - 8" O.D. speaker, 10 ounce magnet, 4W-70V transformer
- 8C10PAX/TBLUB** - 8" O.D. speaker, 10 ounce magnet, 5W-25/70V transformer



**8C5PAXB
FRONT & REAR**



Flush Mount Backboxes:

- ERD-8** - Back Box Enclosure UL LISTED UUMW Round,275CID, welded tie off straps
- ERD8U** - Back Box Enclosure UL LISTED UUMW Round,275CID, snap in tie off straps
- ES-8** - Back Box Enclosure Square, 3.75" Deep **ES8-6** - Same as ES-8 but 6" deep



ERD-8

Tile Bridges:

- SSB-2** - Loudspeaker Support Bridge for 8" O.D. speaker
- SSB-3** - Combo torsion/ screw/ stud Support Bridge for 8" O.D. speaker



SSB-2



Rane Corporation was purchased by InMusic Brands in late 2016. The products are being reconfigured and it is anticipated that they will become available again in the Fall of 2017.

BAI Distributors will contact our dealers when it is available again.

We appreciate your patience.

RF VENUE

RF Venue was co-founded in late 2009 by Chris Regan and Bob Crowley as an incubator project within Bob's R&D company Soundwave Research Laboratories of Ashland, MA. After a period of R&D, beta testing, and market research, in 2011 the company began marketing a range of patented wireless products that fall into three categories: Antennas (transmitting and capturing signals), Distribution (moving those signals around), and Software (visualizing the RF spectrum using a combination of hardware and software).

ANTENNAS

Diversity Fin - Our most versatile antenna, The Diversity Fin reduces signal dropouts and completely eliminates multi-path interference on any UHF wireless microphone system. It gives better performance than paired "paddle" type LPDAs in half the space, and significantly speeds setup and take-down with its folding design.

CP Beam- The CP Beam antenna provides high gain for wireless mics and IEMs in a lightweight, portable package. Unlike other bulky helical antennas requiring heavy flight cases, the CP Beam is quickly deployed and stowed—fitting in a 2RU rack drawer and weighing just 2.5 lbs while delivering 9dB of gain.

RF Spotlight - The RF Spotlight is a low profile floor pad antenna which enables wireless mics and IEMs in the most crowded RF environments. Perfect on stages, in hotel breakout rooms, at conventions, or in church sanctuaries, the Spotlight is effective where multiple wireless systems are inter-operating across facilities and open channels are limited.

2.4 GHz CP Beam - This lightweight, miniaturized version of the UHF CP Beam is specially designed for maximum gain in the 2.4 GHz band. Well-suited for use with Line 6® digital microphones and wireless intercoms, the 2.4 GHz CP Beam is equally at home extending Wi-Fi networks or for long range wireless network access. With 14 dB of gain, it can significantly increase useable range.

CX-22 - The CX-22 Antenna is an unobtrusive, near field antenna system designed to work with UHF wireless microphones. It attaches easily to any standard 2' x 2' ceiling tile with the included hardware kit and blends easily into any boardroom, classroom, or other drop-ceiling environment.



DISTRIBUTION

DISTRO4 - With Cascade - DISTRO4 provides RF and DC power to 4 wireless microphone systems of any brand, allowing you to split 2 incoming antenna signals across multiple receivers.

OPTIX - The OPTIX™ fiber optic remote antenna system represents a new era in RF distribution for any brand wireless audio system or distributed antenna installation. OPTIX systems substantially reduces material and labor costs by eliminating the need for expensive and lossy coaxial cables.

RF Explorer RackPRO - The RF Venue RF Explorer RackPRO is a 1RU hardware tool for spectrum analysis and frequency coordination. Designed for the needs of audio professionals.

COMBINE4 - COMBINE4 joins four IEM signals into a single RF output for dramatic improvement in signal quality.

2x1SPLIT - Passive splitter/combiner



RHC R.M.R. AUDIO

ProCo
DEFINING
PROFESSIONAL

RHC's professional line of customizable audio, video, data, communications and fiber-optic interfacing solutions. With product lines such as Evolution high-end signal transfer cable; TradeTools industrial strength device boxes; RoadMaster heavy-duty touring snakes and PlateWorks standard and custom wall plates designed through Design Vision, ProCo truly defines what it means to be professional.

<http://www.procosound.com>



RAPCOHORIZON

RHC's line of audio solutions, RapcoHorizon products are tailored to the entire retail music industry to meet the demands of both live sound and studio recording.

www.rapcohorizon.com

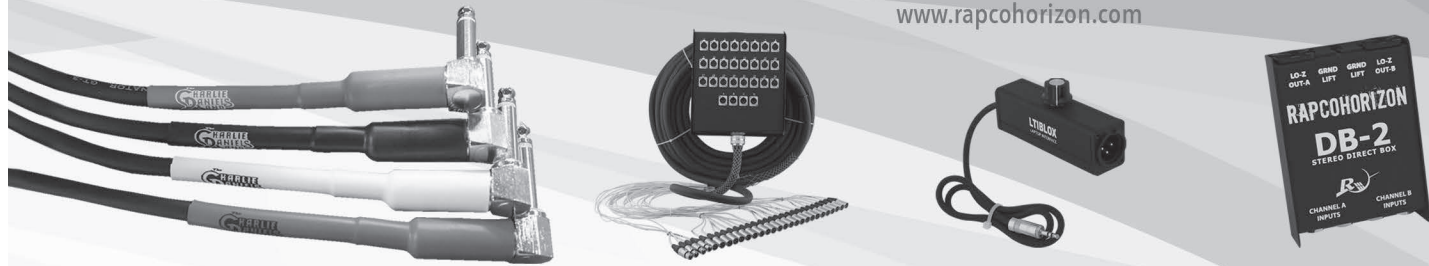

Road Hog TOURING CABLES

Touring cables uniquely designed for touring performers. Engineered "Road Ready and Tour Tough," RoadHog cables utilize the most rugged construction. Trusted on tour with acts such as Foreigner, Fall Out Boy, Papa Roach and Breaking Benjamin.



StageMASTER

Stagemaster is a line of cables and snakes designed to be quiet, durable and dependable while at the same time very affordable. Each cable and snake uses RHC connectors and wire.



ROLLS

Rolls Corporation is an innovative audio electronics manufacturer specializing in interface accessories, mixers, amplifiers, signal processors and signal sources.

MIXERS

MX410 The MX410 is a four channel, microphone mixer w/ balanced XLR I/O.
 • Four balanced XLR Inputs • Two balanced XLR Outputs • Switchable Output Level
 • Switchable Phantom Power • Level controls • 3.5mm Headphone Output



RM65b HexMix one of Rolls most popular mixers - rack-mountable with a console-type mixer in mind.
 • Monitor/FX Send • Bass/Treble Controls • XLR Inputs w/trim
 • FX Send • XLR & 1/4" inputs • Monitor Sends



RM67 Mic/Source Mixer mixes 3 microphones with up to 4 stereo signals.
 • Balanced Inputs • Individual Phantom Power • Remote Volume Jack
 • Clip Indicator • Bass/Treble Controls • FX Loop for Mic Inputs



RM82 Mic/Line Mixer mixes 8 XLR or 1/4" inputs to a single 1/4" TRS output.
 • Phantom Power • Tone Control each Channel • Mic or Line output level



RM64 4 Zone Mixer combines two paging microphones with up to 4 line level inputs.
 • Each Input Selectable to any of 4 zones out • Auto Ducking
 • Switchable Automatic Talkover • Phantom Power



RM68 Zone Wolf 2 Mixer mixes 3 mic inputs with 3 stereo sources and sends them in any combination to 2 separate zones.
 • 2-Zones/6 Assignable RCA Inputs • Bass & Treble Control each Zone
 • Talkover on Mic 1 to Assigned Zone • 1/4" TRS Outputs



RM69 MixMate 3 is a six channel, single rack space, electronic audio mixer with two microphone inputs and four stereo line inputs.
 • 4 Stereo Inputs, 4 RCA & 1- Front Panel Stereo 3.5mm • Stereo RCA and XLR Outputs



MA66 2 Zone Mixer with a 20 watt per Zone power amplifier built in.
 • Two XLR Mic Inputs w/switchable phantom power • 4 RCA & 1 front panel 3.5mm input
 • RCA Outputs



AMPLIFIERS

RA163 is an 8-channel mono, or 4-channel stereo distribution amplifier designed for the contractor/install market. The XLR outputs are designed to drive high-level balanced lines.



MA251 is a compact class D stereo amplifier with a 4-channel stereo mixer built in. It has 5 watts per channel @ 4 Ohms • XLR input, 2 RCA inputs & 3.5mm input • Small size and low heat class D design



RA235 35WX2 Power Amp
 • 1/4" & RCA Inputs • Protected Output • Spring type Output Terminals



RA200 100WX2 Power Amp
RA2100 70V Power Amp/ 200W RMS @ 70V
RA170 70V Power Amp/ 70W RMS @ 70V

RA200

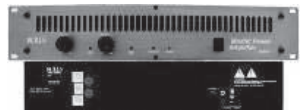

MA2152 Mixer Amp 200W @ 70V
MA2355 Mixer Amp 35W @ 8 Ohms

MA2152



AM/FM TUNERS

RS81B AM/FM Quartz PLL Synthesized Tuner

• 30 Presets • RDS Display • Headphone & XLR Outs



RTS

CONFERENCE LINE INTERCOMMUNICATIONS

The TW Intercom System is a high performance conference-line intercommunications system that features over 25 different components and accessories to allow an almost infinite variety of system configurations.

The system operates in full duplex mode: simultaneous talk and listen, to and from each user station. While a minimum of two user stations and a power supply are required for communications, up to 75 user stations can be employed.

The refined Phase III circuitry permits 12-volt power operation, low-cost multi-channel selection, dry line capability, two-, three-, or four-wire line formats, a ten mile operating range, and balanced line operation. Also, a series of versatile options are available to meet virtually any special requirements.

MRT-327 USER STATION

This modular package, 2-channel station features call signaling and remote talk-off: It can be used in a portable or permanent application, as a headset or speaker station.



MCE-325 PROGRAMMABLE USER STATION

This modular package station features user programming, 2 or 4-channel operation, headset or speaker operation, call signaling, 4-wire mode, IFB and more.



MCS-325 MODULAR SPEAKER

This unique low profile loudspeaker serves as a matching package to the MRT327 and MCE325 User Stations. It can also be used with any other user station or as a program audio monitor.



WM-300L WALL MOUNT USER STATION

This 2-channel, headset user station fits into a 2-gang electrical box, or it can be installed in a desk top as a low profile console mount station.



WMS-300L WALL MOUNT SPEAKER STATION

Designed to fit into a standard 4-gang electrical box, this station augments headset/ handset operation with a loud-speaker for monitoring the line.



Also available - **CM-300L** Console Mount Station, **RM-325** 2-Channel User Station & **SPK-300L** Portable Desktop Station.

SAP-612 SOURCE ASSIGN PANEL

The multiple switch assembly assigns any one of 6 intercom channels and/or 2 program audio channels to 12 separate intercom 2-channel user stations. Also available SAP1626 12-channel.



DSI-2008 DUAL DIGITAL HYBRID

DSI 2008 Dual Digital Hybrid interfaces two (2), 2-wire intercom lines to two(2), 4-wire intercom lines. Features advanced DSP to achieve automatic nulling of the 2-wire lines. Each hybrid features convenient peak-reading level meters to quickly match the levels between the lines being interfaced.



SSA-324 SYSTEM INTERFACE

Features two channels of 2-wire to 4-wire conversion or one channel of 2-wire to 2-wire conversion. Optional circuitry allows for carrier signal conversion and relay contacts.



PS20 POWER SUPPLY

PS-20 features two (2) channels of communication where both channels are wet, meaning there is power on each channel (RTS 2-channel mode). In RTS 4-channel mode, the audio signals and DC exist on the same wire. The PS-20 can also be switched into Clear-Com mode.



BP-325 BELT PACK USER STATION

This new generation two channel unit features user programmable operational functions. It is a stereo/ mono unit with program input and call light.



BP-319/351 BELT PACK USER STATION

These lightweight user stations provide 1 & 2 channels respectively and feature call signaling and microphone kill capacities.



TW5W SPLITTER

A completely passive 1x5 connector splitter assembly.



BAI Carries the entire RTS line except for Digital Matrices. Call for full list of products!

RTS

RADIOCOM® PROFESSIONAL WIRELESS INTERCOM

RTS intercoms are found in the vast majority of television stations and production trucks in the United States, behind the scenes at Broadway plays, on the sidelines of pro, college & high school football games, in nuclear power plants and countless other mission critical applications worldwide.

BTR-240

BTR-240 is a digital, multi-channel, wireless intercom system offering reliable and secure, full-duplex communications supporting up to eight (8) wireless TR-240 belt packs and an almost unlimited number of half-duplex belt packs. Operating in the 2.4GHz frequency band, the BTR-240 system uses the widely adopted IEEE 802.11 technology and is approved for license-free use in most countries. The system also incorporates the intelligence called ClearScan, which automatically selects the optimal RF (Radio Frequency) channel for communication.



BTR-24

The Telex® RadioCom™ **BTR-24** and **TR-24** series intercom is a full-duplex wireless intercom system that offers a complete stand alone solution for 2 to 10 users and an unlimited number of listen-only users. The Telex® RadioCom™ BTR-24 system operates utilizing the license-free 2.4GHz IEEE 802.11b "WiFi" standard. The BTR-24 system incorporates the option of three selectable audio channels at each TR-24 belt pack and the base station automatically scans and selects the best RF channel. The BTR-24 also includes rackmount hardware and has a 3-Year Warranty.



BTR-800

BTR-800 UHF Wireless Intercom offers a list of standard features that is unparalleled in the industry and will change the way wireless intercom is done forever. Features like full UHF operation, two intercom channel access from each belt pack, stage announce output with relay closure, wireless talk around (ISO), Enhanced ClearScan™, talk/listen headset station at the base, graphical user interface and much more.



BTR-80N

BTR-80N has most of the features of a BTR-800 but in a narrow band configuration.

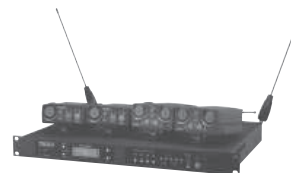

BTR-700

BTR-700 is a single channel UHF frequency agile wireless intercom system with Enhanced ClearScan™, talk/listen headset station at the base, easy-to-use graphical user interface, Intelligent Power Control™, combination tone code/RF noise squelch and DSP digital audio processing, and much more. Each base station supports up to four full time transmit, full duplex communication belt packs. The BTR-700 is fully compatible with Telex, RTS and Clear-Com hardwired communications systems right out of the box.



BTR-300

BTR-300 is the first wireless intercom system to be designed specifically with DTV band allocations in mind. Improved front-end filtering allows the BTR-300 to be used in RF environments where other wireless intercoms simply can't function. The single channel, fixed crystal intercom base station supports up to four full time transmit, full duplex belt packs (TR-300). Four base stations can be used together in one location to support up to 16 belt packs in simultaneous operation. This is a great choice when budget is the primary concern, but you cannot do without high quality RF performance.



ROAMEO Cellular DECT-based Wireless Intercom System - an easy to use system based on a wireless keypad in the form of a belt pack. The system provides high quality audio and caters to a large number of simultaneous users across a wide coverage area. The capacity can be increased by adding wireless belt packs and associated access points.



BAI Carries the full range of RTS Wired and Wireless Intercom Products. *

* with the exception of Digital Matrix products

RTS

AUDIOCOM PROFESSIONAL WIRED INTERCOM

RTS professional intercom systems are used by the discerning professional that wants only the best for their sports team, stage production, auditorium communication, or military exercise. RTS wired and wireless intercom systems provide the user with exacting quality that exceeds most users specifications. RTS intercom systems are compatible with other major suppliers of wired and wireless communication systems. Once your customer uses an RTS system, they won't ever want to switch!

Audiocom Wired System Components

- MS-2002** 2-channel user/main station with built-in power supply and speaker
- MS-4002** 4-channel user/main station with built-in power supply
- EMS-4001** 4-channel expansion station with built-in power supply
- US-2002** Microprocessor controlled 2-channel User/Main Station. Power supply required
- ES-4000A** Microprocessor controlled 4-channel Expansion Station. Requires US2000A
- PS-2001L** 2-channel Power Supply
- PS-4001** 4-channel Power Supply
- SPS-2001** 2-channel Power Supply w/built-in Speaker



User Stations/Remote Speaker Stations

- BP-1002** 1-channel Portable Beltpack
- BP-2002** 2-channel Portable Beltpack
- IFB-1000** 1-channel Listen-only IFB Beltpack
- SS-1002** 1-channel Speaker Station - Flush Mount
- SS-1002** 1-channel Speaker Station Desktop/Portable
- SS-1002 S** 1-channel Speaker Station - Top Handle
- SS-2002** 2-channel Speaker Station - Flush Mount
- SS-2002 P** 2-channel Speaker Station Desktop/Portable
- SS-2002 S** 2-channel Speaker Station - Top Handle
- WM-1000** 1-channel Wall Mount Headset Station
- WM-2000** 2-channel Wall Mount Headset Station
- SPK-2000** Powered Loudspeaker



HEADSETS

Lightweight

- PH-88 Single-Sided Headset with Flexible Dynamic Boom Mic
- PH-88R Single Sided (RTS)
- PH-88E Single Sided with Coil Cord
- PH-44 Dual-Sided Headset with Flexible Dynamic Boom Mic
- PH-44R Dual Sided (RTS)

Full Cushion-Medium Weight Headsets

- PH-1 Single-Sided Headset with Flexible Dynamic Boom Mic
- PH-2 Dual-Sided Headset with Flexible Dynamic Boom Mic
- PH-3 Dual-Sided Headset with Flexible Dynamic Boom Mic
- HR-1 HR-1 Single-Sided Headset with Flexible Dynamic Boom Mic
- HR-2 HR-2 Dual-Sided Headset with Flexible Dynamic Boom Mic
- PH-16 - Dual-Sided Headset with 24dB NRR, Flexible Dynamic Boom Mic

Monitor Headsets

- HR-1 PT Single-Sided Headset with Flexible Dynamic Boom Mic - Pigtailed
- HR-2 PT Medium-Weight, Dual-Sided, Listen-Only Headphone - Pigtailed
- PH-36 Lightweight, Dual-Sided Mono Headphone
- HFY-91 Under-the-Chin Style Headphone with 2000Ω Impedance



PH-88

PH-44

PH-1

PH-2



HR-1

HR-2

PH-36

HFY-91

SAMSON®

Samson is a world leader in developing innovative audio products for professionals and consumers. Samson products are sold in over 140 countries and are used and trusted by musicians, broadcasters, fitness professionals, podcasters and more. Key products include wireless audio systems, portable PAs, USB microphones, mixers, accessories and more.

PORTABLE PA

Expedition XP106w

Rechargeable Portable PA with *Bluetooth*®

- Compact, all-in-one PA for small venues with 75-100 people
- Use for presentations requiring multiple audio sources, solo artist in a coffee shop (no AC required)
- Internal rechargeable battery for 20 hours of continuous use
- 4 input channels for dual mic, instrument and mobile device
- Includes Stage XPD Handheld USB Digital Wireless System
- *Bluetooth* connectivity to wirelessly stream music



WIRELESS

AirLine 88 AH8 Headset

Frequency-Agile UHF Wireless System

AH8 Micro Headset Transmitter

- Double-ear design, no belt-pack or cable required
- Moisture resistant coating design
- Rechargeable lithium ion battery
- Stainless steel microphone boom

CR88 Wireless Receiver

- True diversity design minimizes dropouts
- Up to 16 systems can be operated simultaneously
- Infrared set links the receiver and transmitter channels



MICRO HEADSETS

SE10

Earset Microphone with Miniature Condenser Capsule

- Outstanding audio quality for presentation, fitness and other vocal applications
- 3mm mic capsule with omnidirectional pickup pattern
- Easily adjusts to fit left or right ear, retaining band holds mic in place
- Moisture resistant coating
- Detachable cable



SPEECHLINE

The world's first digital wireless microphone exclusively for speech. Automatic Frequency Management to find free frequencies. No need for manual fine tuning.

WIRELESS

SL Handheld Set: Handheld transmitter with MME 865 condenser capsule, stationary receiver

SL Headmic Set: SL Headmic 1, bodypack transmitter, stationary receiver

SL Lavalier Set: MKE 1 condenser lavalier, bodypack transmitter, stationary receiver

SL TS 153 GN-L Set DW: SL Tablestand 153-S DW, MEG 14-40-L-II B gooseneck microphone, stationary receiver

SL TS 133 GN Set DW: SL Tablestand 133-S DW, MEG 14-40 B gooseneck microphone, stationary receiver

FEATURES

- Automatic frequency and interference management
- Speech optimized gain automatics
- License free 1.9 GHz frequency range
- Secure 256 bit AES encryption
- Remote control via Ethernet
- Advanced power management and Li-Ion rechargeables
- Up to 20 channels per range



WIRED

MEG 14-40 B / MEG 14-40-LB: German-made quality 16" gooseneck. Light ring (L-version) indicates when the speaker is active. Features KE10 cardioid capsule. MEG 14-40 B features a standard XLR 3 connector. The MEG 14-40-L B features an XLR 5 connector to power the light ring.

MEB 114: Desktop microphone optimized for speech. Switchable version (MEB 114-S) available.

MEB 102 / MEB 104: Boundary layer microphone. MEB 102 – omnidirectional, MEB 104 – cardioid

MAT 133: Rugged mic stand for XLR-3 gooseneck mics. Switchable version (MAT 133-S) available.

MAT 153-S: Mic stand for XLR-5 gooseneck microphones with a lighting ring.

MZH 3015: A metal 6" gooseneck for use with the ME 34, ME 35 and ME 36 microphone heads. The rugged, matte black gooseneck is fitted with a balanced, floating XLR-3 output, enabling the mic to be powered from 12-48 V phantom power.

MZH 3042: Similar in features as the MZH 3015 but with a 'dual flex' 16" gooseneck

ME 34/35/36: Capsules for use with MZH series goosenecks. ME 34 (Cardioid), ME 35 (Supercardioid), ME 36 (Mini-Shotgun) – all available in white, black or gray finish.



EVOLUTION WIRED

Whether music is your passion (our evolution 600/800 series), or your profession (evolution 900), we have the right instrument or vocal mic for you!

e602-II: dynamic cardioid instrument mic (kick/floor tom)

e604: dynamic cardioid instrument mic (tom/snare)

e608: dynamic supercardioid instrument mic (brass/percussion)

e835: industry leading dynamic cardioid vocal mic

e865: condenser supercardioid vocal mic

e609s: dynamic supercardioid instrument mic (electric guitar)

e904: dynamic cardioid instrument mic (tom/snare)

e914: condenser cardioid instrument mic (acoustic guitar, spot mic, overheads)

e935: dynamic cardioid vocal mic

e965: flagship multi-pattern (cardioid/supercardioid) condenser vocal mic



EVOLUTION G3 WIRELESS SYSTEMS

evolution wireless 100 Series G3 is your entrance to the professional league of wireless sound transmission. It features ease of use, wide switching bandwidth, robust construction, true diversity receivers and, like all evolution wireless, is made in the USA.

ew100-ENG-G3: SKP100 plug-on transmitter, ME2 clip-on mic w/SK100 bodypack & EK100 portable receiver

ew112G3: ME 2 clip-on mic (omni-directional) w/SK100 bodypack transmitter & EM100 receiver

ew112-pG3: SK100 portable transmitter, ME2 clip-on omni mic, EK100 portable receiver

ew122G3: ME 4 clip-on mic (cardioid directional) w/SK100 bodypack transmitter & EM100 receiver

ew135G3: SKM100-835 handheld cardioid transmitter w/EM100 receiver, MZQ1 mic clamp

ew135-pG3: SKM100-835 handheld cardioid mic, w/EK100 portable receiver

ew145G3: SKM100-845 handheld supercardioid transmitter w/EM100 receiver, MZQ 1 mic clamp

ew152G3: ME 3-ew directional headset mic w/ SK100 bodypack transmitter & EM100 receiver

ew165G3: SKM100-865 supercardioid handheld transmitter w/EM100 receiver, MZQ 1 mic clamp

ew172G3: SK100 bodypack transmitter w/EM100 receiver & CI 1 guitar cable

ew300IEMG3: EK300 IEM stereo bodypack receiver, IE4 in-ear headphones & SR300 IEM stereo transmitter

FEATURES

- Infrared interface for sync of transmitters
- Increased audio fidelity
- Up to 20 compatible frequency banks with 12 presets each.
- More control options (menu)



ew112G3



ew135G3

evolution wireless 300 Series G3 comes with even more advanced features – such as the selectable mute function on the hand-held transmitters, integration with WSM software and our industry-leading in-ear monitor systems.

ew312G3: SK300 bodypack transmitter w/ME2 clip-on omni mic, EM300 receiver & GA3 rack mount

ew322G3: SK300 bodypack transmitter w/ME4 clip-on cardioid mic, EM300 receiver & GA3 rack mount

ew335G3: SKM300-835 handheld cardioid transmitter w/EM300 receiver, GA3 rack mount & MZQ1 mic clamp

ew345G3: SKM300-845 handheld supercardioid transmitter w/EM300 receiver, GA3 rack mount & MZQ1 mic clamp

ew352G3: SK300 bodypack transmitter w/ EM300 receiver, GA3 rack mount & ME3-ew headset mic

ew365G3: SKM300-865 handheld supercardioid transmitter w/EM300 receiver, GA3 rack mount & MZQ1 mic clamp

FEATURES

- Infrared interface for sync of transmitters
- Up to 20 compatible frequency banks with 24 presets each
- Ethernet port for connecting to Wireless Systems Manager
- 2 AA batteries for more than 8 hours of use



ew312G3



ew335G3

evolution wireless 500 Series G3 is the top of the line in our evolution wireless series and features superlative technical components, WSM software access and our 900-series capsules. Call BAI Distributors today to learn more about the ew 500 G3 professional series.

EVOLUTION WIRELESS D1

evolution wireless D1 combines digital innovation with the brilliance of evolution capsules. D1 is user friendly, reliable and gives you the exceptional sound quality that you expect from Sennheiser.

ew D1-835S, ew D1-845S: Vocal-Set, with choice of e835 cardioid or e845 supercardioid capsule

ew D1-CL1: Instrument Set with CL1 cable and lightweight bodypack transmitter

ew D1-ME3: Headmic Set with ME 3-II headmic for live stage use

ew D1-ME2: Lavalier Set with ME 2 lavalier microphone

FEATURES

- Up to 15 compatible channels (under optimal conditions) in license-free 2.4 GHz band
- Automatic frequency management
- Prevents interference: Intelligent channel back-up allows co-existence with Wi-Fi & Bluetooth
- Audio effects: equalizer, de-esser, automatic gain control
- iOS & Android app for remote control and monitoring of the system



XS WIRELESS 1

XS Wireless 1 is an easy-to-use, all-in-one wireless series that allows singers, presenters and instrumentalists to operate up to 10 systems simultaneously.

XSW 1-825, XSW 1-835: Vocal-Set, with choice of e825 cardioid or e835 cardioid capsule

XSW 1-CL1: Instrument Set with CL1 cable and lightweight bodypack transmitter

XSW 1-ME3: Headmic Set with ME 3-II headmic for live stage use

XSW 1-ME2: Lavalier Set with ME 2 lavalier microphone

XSW 1-908: Brass Set with e908 flexible gooseneck microphone

FEATURES

- Plastic receiver housing
- Built-in antennas
- Switching diversity reception
- 8 banks of 10 channels (up to 10 systems)
- Icon-based indicators



XS WIRELESS 2

XS Wireless 2 is an easy-to-use, all-in-one wireless series that allows the user more features and greater control with the ability to operate up to 12 systems simultaneously.

XSW 2-835, XSW 1-865: Vocal-Set, with choice of e835 cardioid or e865 super-cardioid condenser capsule

XSW 2-CL1: Instrument Set with CL1 cable and lightweight bodypack transmitter

XSW 2-ME3: Headmic Set with ME 3-II headmic for live stage use

XSW 2-ME2: Lavalier Set with ME 2 lavalier microphone

FEATURES

- Metal receiver housing
- External, detachable antennas
- True diversity reception
- 8 banks of 12 channels (up to 12 systems)
- Detailed display with user tuning (960 frequencies)
- Rack ears included in delivery



ADN WIRED & WIRELESS

ADN C1 (chairperson unit), **ADN D1** (delegate unit) – both available in wired and wireless versions (**ADN-W C1**, **ADN-W D1** wireless variants). Wireless variants feature 128-bit encryption and over 20 hours of operating time. The series features a full range of detachable gooseneck microphones in a variety of patterns and lengths as well as a full range of charging solutions, batteries and control units (**ADN CU1** and **ADN PS**).



TEAMCONNECT

Remote conferencing is made easy with Sennheiser's TeamConnect system. Choose from an assortment of compatible SpeechLine wired product components or select the tailor-made MEB 114-S TC.

Central Unit CU 1 and Combox CB 1:

The Central Unit and Communication Box provide several mic/line inputs and outputs. Auto-mixing, various filters and a powerful Acoustic Echo Canceling provide excellent audio performance.

MEB 114-S TC: Designed specifically for use with TeamConnect, the MEB 114-S TC is a desktop microphone that is ideal for group conferences.

SL 52 A: Loudspeaker optimized for speech intelligibility with integrated DSP.

FEATURES

- All components from one source, manufactured in Sennheiser quality. It reliably works.
- Easy device integration via Combox. Simply plug in any PC, tablet or mobile phone to connect.
- Ideal solution for small and mid-size meeting rooms with up to 16 participants.



TEAMCONNECT WIRELESS

TeamConnect Wireless is a go anywhere, wireless audio conferencing solution, which makes it possible for any user in virtually any room environment to set up and host a professional-sounding conference for up to 24 people.

TC-W Set Case: TeamConnect Wireless set with charging case, (1) master, (3) satellite, (4) BA 100 batteries, jack cable, USB cable, microfiber cloth

TC-W Set Tray: TeamConnect Wireless Kit with charging tray, (1) master, (3) satellites, (4) batteries, charging tray, power pack, USB cable and jack cable

TC-W Set Tray M: TeamConnect wireless set with charging tray, (1) master, (1) satellite, (2) batteries, charging strip, power supply, USB cable and cable harness

FEATURES

- Meeting solution for up to 24 participants
- Connect with any device (BYOD) - smartphone, tablet or PC
- Wireless connectivity via Bluetooth, USB or 3.5mm jack audio cable
- Supports multiple simultaneous audio channels, so additional callers can be added with ease



TEAMCONNECT CEILING

TeamConnect Ceiling is a combination of a ceiling microphone (SL Ceiling Mic) featuring the latest beamforming technology and a TeamConnect Central Unit with DSP for echo cancellation and auto mixing.

SL Ceiling Mic: uses the latest beamforming technology to focus automatically on the speaker regardless of the position. The microphone consists of 29 omnidirectional microphone capsules that guarantee best speech intelligibility during telephone and online meetings. Integrable into any infrastructure, the discreet metal casing adds unobtrusively into any conference room and can be installed in place of a ceiling tile, suspended or surface mounted.

FEATURES

- Beamforming array ceiling microphone consisting of 29 omnidirectional microphone capsules
- Coverage area of up to 60 square meters and extendable with additional ceiling mics with an external DSP
- Highly directive ceiling microphone offers best speech intelligibility by automatically identifying the position of the current speaker within the room

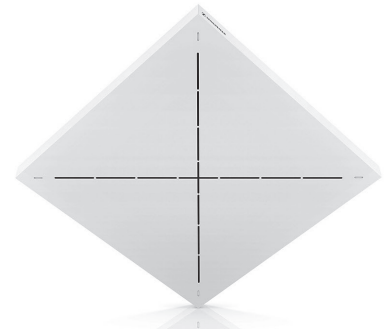

SHURE®

LEGENDARY
PERFORMANCE™



BLX WIRELESS

THE IDEAL ENTRY-LEVEL WIRELESS MICROPHONE SYSTEM FOR SMALL VENUES, BLX OFFERS PROFESSIONAL QUALITY SOUND WITH SIMPLE SETUP AND AN INTUITIVE INTERFACE.



Lavalier Systems

BLX14/CVL
BLX14R/W85
BLX14R/W93

Hand-Held Systems

BLX24/PG58
BLX24/SM58
BLX24/B58

Dual Systems

BLX288/PG58
BLX188/CVL
BLX1288/CVL
BLX1288/P31



BLX-R WIRELESS

BLX-R OFFERS THE SAME PROFESSIONAL QUALITY SOUND WITH SIMPLE SETUP AND AN INTUITIVE INTERFACE, BUT INCLUDES A RACKMOUNT RECEIVER, EXTERNAL REMOVABLE ANTENNAS, RACK MOUNT HARDWARE AND FRONT MOUNT ANTENNA KIT. THE BLX-R IS THE PERFECT STEP-UP FROM THE BLX ALLOWING THE USE OF ANTENNA DISTRIBUTION.



Lavalier Systems

BLX14R/W85
BLX14R/W93

Hand-Held Systems

BLX24R/SM58
BLX24R/B58

Headworn Systems

BLX14R/MX53
BLX14R/SM35

SHURE®

LEGENDARY
PERFORMANCE™

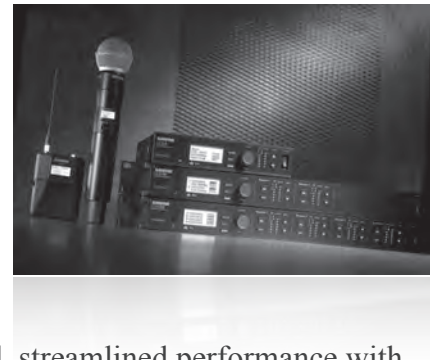

QLX-D AND ULX-D WIRELESS

QLX-D and ULX-D Digital Wireless Systems deliver defined, streamlined performance with transparent 24-bit digital audio. Combining professional features with simplified setup and operation, QLX-D and ULX-D offers outstanding wireless functionality for demanding live sound events and installations.

Scalable, intelligent hardware delivers the best performing digital wireless available, with a wide selection of trusted Shure microphones to choose from. Unmatched spectrum efficiency enables a dramatic increase in the number of simultaneous active transmitters on one TV channel, with rock solid signal over the entire range.

Both QLX-D and ULX-D are compatible with Shure rechargeable battery technology, saving time, money and

QLX-D



QLX-D1

QLX-D2



QLX-D4



SBC-200
Battery Charger

ULX-D



ULX-D1

ULX-D2



ULXD4Q
Quad Receiver

SHURE SB900 RECHARGEABLE BATTERY SYSTEM
Get a handle on your battery workflow.

BATTERY LIFE DISPLAY
8:30
Custom Display as HMM Format
Accuracy within 1 minute

BATTERY RUN TIME IN HOURS
QLX-D: 10 HRS
ULX-D: 11 HRS

CHARGING OPTIONS
SBC200 Dual Docking Station
Charges SB900 Rechargeable Batteries with Rechargeable Indicator of Use.
Line 4 SB900s with 6x2 Power Source

RAPID CHARGING
1 HOUR = 50%
3 HOURS = 100%
BATTERY LIFE ACCURACY within 1 minute
LITHIUM-ION CHEMISTRY
Consistent output
BATTERY STABILITY
No Memory Effect
Recharge & Charge
Recharge & Charge
Recharge & Charge

NETWORKED RACK CHARGING
AXT500 with SBC-AX Networkable Rack Charging Station
100% accuracy
100% accuracy
100% accuracy

SHURE



MICROFLEX® MICROPHONES

Combining sleek, low profile aesthetics and a complete selection of microphones and mounting options, Microflex microphones include the highest standard of quality and efficiency for installed audio applications.

Get the exact fit for your professional installation; knowing it's backed by the superior sound quality, reliability, and durability you only get from Shure.

Gooseneck Mics



Boundary Mics



Overhead Mics



CALL YOUR BAI REP TODAY FOR CONFIGURATIONS, COLORS AND POLAR PATTERNS OF THE MICROFLEX SERIES

**CommShield®
technology improves
RF Resistance.**



All Microflex® models offer CommShield Technology, which guards against unwanted radio interference from consumer wireless devices such as cell phones and PDA's. Shure engaged their development teams to redesign Microflex microphones to be highly resistant to radio frequency interference such as might be experienced with GSM cell phone technology and to implement design techniques such as multilayer circuit boards, improved grounding techniques, tighter enclosures for improved shielding, and improved microphone cable and audio connectors. The combination of improved techniques is utilized to deliver Microflex microphones that are highly resistant to intense nearby radio signals.

SHURE®

LEGENDARY
PERFORMANCE™



WIRED MICROPHONES



SM48



SM57



SM-58



SM-58S

CENTRAVERSE ECONOMICAL INSTALL MICS



CVG

GOOSENECK

12" & 18"



CVB

GOOSENECK

BASE



CVO

OVERHEAD



CVB

BOUNDARY

CALL YOUR BAI REP TODAY FOR CONFIGURATIONS
AND AVAILABILITY.

SONY®

FOR PROFESSIONALS

RECORDERS

PCMD100 Portable High Resolution Audio Recorder

The PCM-D100 is a high resolution recorder with two-position (X-Y or Wide) stereo microphones, 32 GB of internal flash memory and a SD-XC Card slot. Recording formats include linear PCM (at 192, 176.4, 96, 88.2, 48 and 44.1kHz); DSD (2.8224 MHz) and MP3 (320 and 128 kbps). Additional playback support is provided for FLAC, WMA and AAC files.



MIXERS

DMXP01 Portable Digital Mixer

The DMX-P01 digital mixer is a lightweight and portable field mixer developed for electronic news gathering (ENG) and electronic field production (EFP). The unit has 32-bit, full digital sound processing and its unique Scene store - recall feature enables users to instantly recall up to ten different mixer user-snapshots.



SHOTGUN MICS

ECM-VG1

The ECM-VG1 is a short shotgun, electret condenser-type microphone, which delivers excellent sound performance in field and studio production applications at an affordable price. The ECM-VG1 is well-suited for use with compact camcorders or attached to a boom pole. This microphone requires 48 volt phantom power and connects using a supplied XLR cable.



ECM-CG50BP

The ECM-CG50BP is a short shotgun electret condenser microphone with a super-cardioid directional response ideally suited for capturing medium range sound sources. The ECM-CG50BP is best-suited for use with camcorders such as the Sony HVR-HD1000 or HXR-MC2000. It's supplied with a shock-mounted cold-shoe mic holder, furry windscreen and short non-detachable cable including a 1/8" stereo mini plug.



WIRED LAVALIER MICS

ECMFT5B Back Electret Condenser Lavalier Microphone - with 9.8 ft cable and XLR connector. The ECM-FT5B omni-directional lavalier microphone has a flat shaped durable metal body that can easily be concealed under clothing or used with a mic tie clip. Omni-directional lavalier condenser microphone with AA battery power supply and XLR connector.



ECM166BMP Electret Condenser Lavalier Microphone - Uni-directional lavalier condenser microphone with BMP style plug



HEADPHONES

MDR-7520 - high-quality studio headphone for critical listening pro applications, including studio and broadcast monitoring.

MDR-7502 Headphone features gold connectors, an oxygen-free cord, high quality sound reproduction at an affordable price.

MDR-7506 is a large diaphragm foldable headphone designed for professional studio and live/broadcast applications.

MDR-7510 is a high-quality studio headphone for demanding pro applications, including studio and broadcast monitoring

MDR-7550 is a high quality in-ear monitoring headphone (IEM) for live stage use.



Established in 1972, based in Miami, Florida, Sound Barrier is an international manufacturer of professional audio equipment. Comprised of a team of designers and engineers, Sound Barrier has long been a staple of the international audio community. We pride ourselves on our products quality and our reliability. What sets us apart is our superior customer service. We understand our company's livelihood depends on our customers and many customers rely on our products for their livelihood. We strive to provide support as quickly and as efficiently possible.

Line Array • Loudspeakers • Processors & Distros • Microphones • Mixers • Cables • Cases • Truss & Stage • Raw Components

PRO AUDIO



The CORE series is the evolution of the active line array system. The state of the art integrated Class D amplifier designed for the CORE series active cabinets sets a new industry benchmark in audio performance, efficiency and flexibility. The class D amplifiers were specifically designed to power not only the active loudspeaker that it is built-into but it is specifically designed to drive its corresponding passive cabinet.

CORE102P Passive 2 x 10" Line Array Module
CORE102A Active 2 x 10" Line Array Module.
CORE10218SP Passive 18" Sub-bass System
CORE10218SA Active 18" Sub-bass System

CORE82P Passive 2 x 8" Line Array Module
CORE82A Active 2 x 8" Line Array Module.
CORE8218SP Passive 18" Sub-bass System
CORE8218SA Active 18" Sub-bass System



The Sound Barrier iQ Series consists of surface mounted, 6.5", 8" and 10" two-way loudspeaker systems, suitable for a wide variety of foreground and background sound reinforcement applications. The iQ series offers integrators and installers a premium quality installed sound solution where performance, coverage, and aesthetics are all important. Ease-of-installation and high weather resistance (IP-56), the iQ series provides a versatile and reliable project solution.



iQ6.5 6.5", 240W Full Range, Waterproof Loudspeaker
iQ8 8", 600W Full Range, Waterproof Loudspeaker
iQ10 10", 720W Full Range, Waterproof Loudspeaker



The Nexone series is the next level of high performance Loudspeakers Systems featuring 4 two way cabinets with Mylar Diaphragm Compression Drivers and 3 High power subwoofers systems. This series offers optimal performance and clarity that is ideal for any venue large or small. Highly efficient and true professional grade power and performance makes the NEXONE series an audio spectacle you have to hear to believe.

NX8 8" Passive, 600W, Full Range Loudspeaker
NX10 10" Passive, 800W, Full Range Loudspeaker
NX12 12" Passive, 1400W, Full Range Loudspeaker
NX15 15" Passive, 1600W, Full Range Loudspeaker
NX210S Dual 10" Passive, 1600W, Sub-bass System
NX215S Dual 15" Passive, 3200W, Sub-bass System
NX118S 18" Passive, 2000W, Sub-bass System



With their powerful, reliable performance, the PCS series amps have become the choice of many sound companies world wide. The PCS series easily handles 2-ohm loads and its rugged construction is ideal for touring. All PCS series amplifiers are heavy duty Class H amplifiers and provide superior power output, incredible efficiency, and produce chest shattering lows.

PCS1000 2 Channel 900 Watt Class H Amplifier
PCS1500 2 Channel 1400 Watt Class H Amplifier
PCS2500 2 Channel 2300 Watt Class H Amplifier
PCS3400 2 Channel 2900 Watt Class H Amplifier
PCS4000 2 Channel 3800 Watt Class H Amplifier
PCS5000 2 Channel 4400 Watt Class H Amplifier
PCS6000 2 Channel 5600 Watt Class H Amplifier
PCS8000 2 Channel 7200 Watt Class TD Amplifier

TRUSS & STAGE

Whether its live performances, theaters, festivals, night clubs, permanent installations, mobile applications or trade show's our full line of trussing, staging systems and accessories has evolved to include more products to suit the needs of just about any event or venue. All our systems bear the prestigious TUV certification so you can be assured that all our products can be relied upon for safety and strength.

DECO TRUSS BEAMS
DECO TRUSS ACCESSORIES
DECO TRUSS KITS
LIGHT DUTY SQUARE TRUSS BEAMS
HEAVY DUTY SQUARE TRUSS BEAMS
CIRCLE TRUSS
BOX TRUSS ACCESSORIES
TRIANGLE TRUSS BEAMS
TRIANGLE TRUSS ACCESSORIES
FOLDING TRUSS

FLAT TRUSS
FLAT TRUSS ACCESSORIES
TRUSS HARDWARE & ACCESSORIES
TRUSS SAFETY
TRUSS CLAMPS
ROOF STRUCTURES
SPEAKER TRUSS TOWERS
SPEAKER SCAFFOLD TOWER
SCAFFOLD WORK STRUCTURES
STAGE

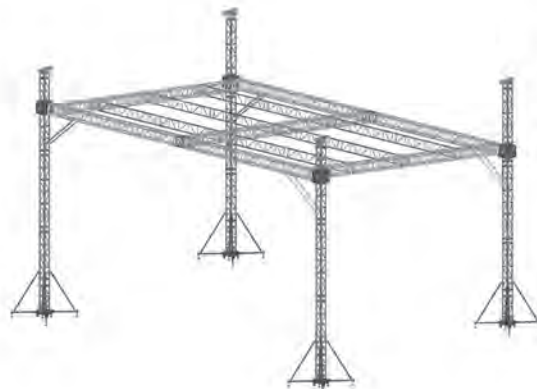



MIXING CONSOLES

Si Performer - drawing on the combined heritage of legendary Soundcraft quality and the powerful and intuitive Vi Series digital live sound mixers, the Si Performer brings unparalleled mix power and performance to small format digital live sound mixers. Sitting where a plethora of gear once was, the Si Performer delivers the equivalent of 448 rack units of DSP including sophisticated 4-band fully parametric EQ, full dynamics processing, a comprehensive range of output options, totally flexible routing and, as with all Soundcraft consoles, an unmatched range of options to fully integrate the Si Performer into an existing system or become the centre of a thriving new installation.

Si Performer 1

- 16 local recallable mic pre amps & 8 stereo inputs
- An additional 128x96 input/output paths
- Automated faders
- 2-ViSi Connect™ option card slots
- Built-in automated lighting controller
- Four Stereo Lexicon FX processors

Si Performer 2

- Same features as above but with 24 local recallable mic pre amps and 8 stereo inputs

Si Performer 3

- Same features as Si Performer 1 but with 32 local recallable mic pre amps and 8 stereo inputs

Si Expression exploits some of the newest DSP, component technology and manufacturing techniques to deliver our most powerful cost effective digital console ever! Each console in the range is identical in its feature set so your only choice is how many faders and local mic amps you want. With a range covering the super portable 19" rack mount Expression 1 to the mighty Si Expression 3 with its 30+2 faders and 32 mic/line inputs there is a model to meet all needs.

- Si Expression 1 features 16 recallable mic pre amps (24 on Si Expression 2 and 32 on Si Expression 3)
- Color touch screen interface
- Soundcraft FaderGlow™
- Stereo Lexicon Effects engines
- Pre/Post selection per input per bus
- GEQ on every bus
- Delay on inputs and outputs

Ui Series Mixers feature cross-platform compatibility with iOS, Android, Windows, Mac OS, and Linux devices, and can use up to 10 control devices simultaneously. In addition, the **Ui12** and **Ui16** each feature built-in HARMAN signal processing from dbx, DigiTech and Lexicon, including dbx AFS2, DigiTech Amp Modeling, and more. Both models feature fully recallable and remote-controlled mic gain and phantom power, along with 4-band parametric EQ, high-pass filter, compressor, de-esser and noise gate on input channels.

Ui 12 12-input Remote-Controlled Digital Mixer

- 4-XLR combo mic/line inputs & 4-XLR mic inputs
- Stereo RCA line input
- 2 channels of Hi-Z/instrument inputs
- 2-balanced XLR Aux outputs
- 2-channel USB media player

Ui 16 16-input Remote-Controlled Digital Mixer

Same features as Ui 12 but with 8-XLR combo mic/line inputs along with 4 balanced XLR Aux outputs

Ui24R 24-channel Digital Mixer/USB Multi-Track Recorder with Wireless Control

- Built-in dual-band Wi-Fi
- 24 simultaneous inputs
- Control from iOS, Android, Windows, Mac OS & Linux
- Dual-path, redundant multi-track recording of all 24 inputs to USB drive and connected Mac/PC
- 31-band graphic EQ, noise gate, compressor, and dbx® AFS2 Automatic Feedback Suppression on all outputs

GB2 featuring 4 group busses configured as 2 stereo subgroups and an integral 6 x 2 matrix. Great for installed-sound & A/V applications that do not require the functionality provided by the GB4 or GB8. Available in frame sizes of 16, 24 and 32 mono inputs, each with 2 stereo inputs as standard. Each input features the high-performance GB30 Mic Pre and GB30 Equalizer designs of the GB4 and GB8, along with 6 Aux buses.

- Channel direct out with pre/post switch (switch on rear)
- 16, 24 and 32 mono input channel versions
- 2 Stereo Inputs, 6 Aux Outputs & 2 Matrix Outputs
- 4 Group busses, configured as 2 Stereo Sub Groups
- Internal Power Supply
- GB30 Mic Preamps and GB30 EQ on Mono Inputs
- Stereo Mix and Mono Sum Outputs
- 4-band EQ with sweep mids

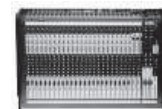

MULTI-PURPOSE CONSOLES

EPM™ Series are quality built with an easy to understand control surface uncluttered by unnecessary facilities, with new technologies and ideas in a cost-effective range. Surface mount technology is used throughout, using close-tolerance components for high accuracy and repeatable settings for EQ and gain controls. **Models include EPM6, EPM8 and EPM12.**

- 6, 8 & 12 mono input channel sizes, each w/2 stereo ins
- Precision GB30 mic pre-amps
- Multi-point signal channel status monitoring
- True, professional +48V phantom power
- 2 Aux sends -switchable pre or post-fade
- 3-band EQ with swept mid frequency
- Smooth 60mm faders on all inputs and masters
- Professional insert points for external processing

EFX™ Series combines all the features of the popular Soundcraft EPM™ mixer with a built-in 24-bit, digital Lexicon® effects processor, expanding the Soundcraft low-cost, multipurpose compact range.

- **EFX8** - 8+2 and **EFX12** - 12+2 channel frame sizes
- XLR-type and ¼" Connections
- 3-band EQ with a swept mid on mono inputs
- Ten-segment LED output metering
- Tap Tempo and FX setting store function
- RCA stereo playback inputs and record outputs
- TRS insert sockets and inserts on all mono inputs
- Easily rack mountable (optional)

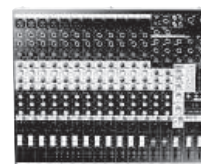

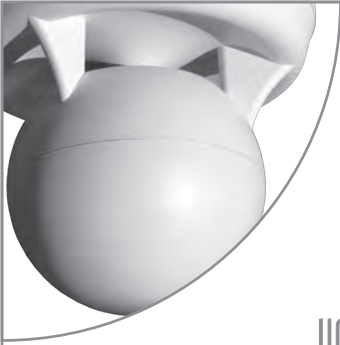

SOUNDSPHERE®

L O U D S P E A K E R S

I10B



Clear, crisp voice announcements and background music housed in a lightweight, easy to mount speaker.

Ideal for supermarkets & retail stores, factories, warehouses, courtrooms, classrooms & other educational facilities, stadium or arena concourses, gift shops & rest rooms, airports & transportation centers, office building reception areas, restaurants, casinos, shopping center common areas and food courts.

I10 Page



High-intelligibility voice paging in noisy environments housed in a lightweight, easy to mount speaker.

Ideal for factories, warehouses, fire houses, airports, train stations, cruise terminals and correctional institutions.

Q-6



High-fidelity foreground/background music and clear paging in a lightweight, easy to mount speaker.

Suitable for outdoor applications in any climate. Ideal for health clubs, sports bars, restaurants (indoor and outdoor), shopping malls and retail stores.

Q-8



High-power, high-fidelity foreground/background music and clear paging in single or distributed speaker systems.

A single Q-8 provides a cost effective, high performance system in small school gymnasiums or multipurpose rooms. Also ideal in restaurants, bars, nightclubs, hotel atria, houses of worship, factories, shopping malls and airports.

Q-12A



High power, high fidelity foreground music and clear paging in single, multiple or distributed speaker systems.

Ideal for gymnasiums, ice rinks, houses of worship, swim centers, transportation terminals, factories with high ambient noise levels, open public areas, bars and nightclubs.

Q-15



High-power, high-fidelity foreground music with enhanced low frequency response and high-SPL capability in single or multiple speaker systems

Ideal for gymnasiums, ice rinks, houses of worship, swim centers, open public areas, bars and nightclubs.

Q-SB2



Sub-bass supplement unit for use in Q-12A systems where extended low frequency performance is required. Q-12 combo systems that include a Q-SB2 create a single source of high-fidelity, intelligible sound with deep, extended bass.

SOUNDTUBE®

E N T E R T A I N M E N T

No other speaker company takes the same approach to developing technology, bringing innovation to market and celebrating creativity in everything it does. Because of that, SoundTube continues to introduce products no other speaker company can match. SoundTube speakers have evolved over the years, from the first actual tubes to today's sleek products covering open-ceiling, in-ceiling, surface-mount, outdoor and sound-focusing applications.

Pendant Speakers

RSi series RS-EZ series HPI series

For open, spacious buildings with high ceilings, SoundTube has built the RSi, HPI and RS-EZ series of hanging speakers. Whether your installation is a cathedral or an exclusive boutique, our pendant speakers will deliver high-fidelity music and clearly intelligible paging from an aesthetically pleasing design.

If your installation requires a mix of hanging speakers and in-ceiling or surface-mount models, you can rest assured that sound quality will stay the same throughout your facility, as SoundTube speakers are designed to match one another with the same timbre and tone.

Along with fantastic sound and great looks, your SoundTube speakers come with peace of mind. All pendant speakers are compliant with CE, WEEE, and RoHS regulations. Additionally, all RSi and HPI speakers are UL-listed.



Surface-Mount Speakers

SM series



If you need big sound from your outdoor light pole or soft music in your café, SoundTube's SM series delivers crystal-clear audio from an inconspicuous surface-mounted location. Whether attached to a ceiling, wall or pole, SM speakers will deliver high-fidelity music and clearly intelligible announcements. Featuring simple, secure mounting mechanisms, the SM series is designed for easy, versatile installation. SoundTube has now introduced the new SM-EZ line of surface-mount speakers which provides an economical solution for integrators needing both indoor and outdoor capable surface-mount speakers.

SoundTube also offers the SM500i-II-WX, SM590i-II-WX, SM890i-WX, SM52-EZ-WX and SM82-EZ-II-WX which features WX Weather Guard technology. WX Weather Guard technology utilizes a dual layer hydrophobic material inside the speaker grille to keep water from the drivers and internal electronics in even the most extreme weather conditions. IP65 rating on SM-EZ models and IP44 rating on SMi models. All SM speakers are compliant with CE, WEEE, and RoHS regulations.

Outdoor Speakers

XT series

SoundTube never accepted the conventional "wisdom" that the quality of outdoor audio isn't important. As a result, SoundTube's XT speakers have set a new standard for performance in outdoor music and paging, such as in theme parks, sports venues, public areas, transit stations, hotel grounds and restaurant patios. SoundTube's new fully weatherproof, outdoor line array provides long throw with high intelligibility. The XT-Spyke features a sealed enclosure with aluminum grille and weatherproof mounting bracket; connections are made via a Neutrik speakON weatherproof input jack.

XT speakers include anti-theft brackets that sink deep into the ground, making them highly unlikely to "disappear" overnight. The XT550 and XT850 are made with industrial-strength enclosures that will last decades in even the worst conditions, maintaining their good looks after years of abuse from children, lawn equipment, chemicals and inclement weather.



In-Ceiling Speakers

CMi series CM-EZ series CM-BGM series



Designed for the most demanding in-ceiling applications, SoundTube's CM series speakers are engineered for both paging and background or foreground music. The CMi speakers' heavy-duty components and high-power-handling capabilities make them versatile for music and intelligible paging. Higher power through robust woofers produces a richer bass response while BroadBeam tweeters distribute high frequencies over a wider area. CM-EZ's offer crystal-clear PA announcements at an economical price. Engineered specifically for background music applications where additional low end response is needed, CM-BGM speakers provide integrators reduced amplification costs with high efficiency. Both the CM-EZ and CM-BGM speakers are offered with shallow backcans with a mounting depth of only 3.75" when ceiling height is minimal.

The result is powerful sound for both music and paging. Whether your restaurant needs louder music in the bar area or your office needs clearer PA announcements, the CM series has an in-ceiling speaker to meet your needs. All CM speakers are compliant with CE, WEEE, and RoHS regulations. Additionally, all CM speakers are UL-listed.

IP Addressable Speakers

IP series

The SoundTube STNet system is an IP-addressable speaker system with proprietary 40 watts PoE (Power over Ethernet) to each of its speakers. The system includes a rack mountable 16-port switch, rack mountable power supply, and in-ceiling and surface-mount PoE-powered speakers. In addition to the 16 Ethernet ports, the STNet-switch includes two gigabit ports to connect control DSP's and Dante™ enabled input devices and is also used for linking additional switches. Also, a WAN port is provided for integration with an outside network. An outside network is the gateway for email status reporting and STNet system setup.

In addition to the standard IP-addressable speakers, SoundTube now also offers IPD4 speakers which allow you power up to three passive CM-BGM speakers with one IPD4 networked speaker. Each IPD4 speaker allows for connection of one or two audio signals, and then distributes an amplified signal to each satellite speaker. Satellite speakers may be set up to receive either of the two signals, allowing you to set up either one or two zones from one networked speaker.

Using the Dante standard as its backbone, the system allows each SoundTube speaker on the network to be powered, controlled and receive the digital audio signal via its Ethernet cable. Set up and equalization can be done individually or as a group. Each speaker can receive different audio signals and is continuously monitored by the system to provide report-back status to the main control point. Any failure in the speaker will immediately trigger an alarm. The STNet-switch and speakers are compatible with all other Dante-enabled control systems. All CM-BGM speakers are compliant with CE, WEEE, and RoHS regulations. Additionally, all CM-BGM speakers are UL-listed.





The Special Projects heavy-duty performance series headsets and wireless systems are designed for the active professional. They offer hands-free communication allowing complete freedom of movement. Applications include live performances, aerobics instruction, entertainment, television reporting and others. Special Projects is a division of Ansr Audio.

SP-H20 Waterproof Headworn Mic is designed for use in any application where water is present. It features a user-replaceable cable to prevent any down time. No need to replace the headset, just put on a new cable! The SP-H20 has been laboratory tested to be dust-proof and water-proof!

SP-746 Waterproof Headworn Mic is a rugged and dependable mic that has been designed specifically for the demanding environment of the fitness and amusement industries or anywhere all those other mics give it up. Has all the features of the SP-H20, except with an attached cable. (Must specify connector.)

EVO True Wireless Transmitter Recharging, water resistant, 16 channels and a patented revolutionary new design completely eliminates the bodypack transmitter. The SP-EVO combines the small transmitter with the headset - placing the electronics comfortable behind the ear, not hanging off the back of the headband. The Sp-EVO headworn mic is paired with either the reliable Auto Scan 16 channel receiver, the GX-Lite 4.8lb portable PA system or the SP-GX mid size portable PA system.

Evo True Fitness Wireless System - Rechargeable, water resistant, sixteen channels and a patented revolutionary new design that completely eliminates the bodypack transmitter! Water resistant microphone element and transmitter - you won't sweat this out!

- No bodypack, no cables - just real, reliable wireless
- Flexible microphone boom
- Frequency agile - 16 FCC-safe UHF channels
- Noise-canceling mic element

Fitness Pack - SP-256-H20

Specifically designed for fitness studios, the industry standard SP-H20 fitness microphone has now been combined with the Special Projects SP-25 Auto Scan receiver and 16 channel body pack transmitter, making setup easier and more reliable than ever before. Most instructors have to deal with headset cables going bad. Usually the headset is out of service while it's repaired or replaced. The SP-H20 allows the user to quickly and easily snap a new cable on in seconds - simply line up the arrows, click it in and go. Don't forget the SP-H20 is completely water and sweatproof. Lab tested to withstand total submersion in water, a little sweat will not stop the mic.

Group.X Evo - With the development of the Evo True Wireless fitness system, we thought we'd also revamp our Group.X portable systems to offer complete, real portable systems for Evo users. Using an iPod or other MP3 player? The Group.X Evo includes an external line in and a USB input. The Group.X Evo combines the freedom of the Evo with the versatility of a portable PA.

Features:

- Built-in 16 channel UHF receiver
- Optional 2nd UHF receiver for dual use
- Powerful 120W digital amplifier
- 10" woofer, 1" high frequency driver
- Anti-shock CD/MP3 player, USB and SD input
- Rechargeable battery (8 hours)

Group.X Evo Lite - Perfect for smaller group exercise, the Group.X Evo Lite delivers high quality sound in a super-lightweight system. Evo wireless system built-in! Teaching in multiple locations? At only 4.8 pounds, the Group.X Evo Lite carries easily in the supplied case with shoulder strap. No other portable delivers this much power for it's weight.

Features:

- 40 Watts of portable power
- 5.25" Full Range Speaker
- Up to 8 hours operating time
- Built-in 16 channel wireless system



AMPLIFIERS/MIXER AMPLIFIERS

P60FACD 60W Amplifier w/AM/FM Tuner & MP3-Ready CD Player

- 4 zoned 70 or 25V speaker outputs
- 4 XLR MIC connectors
- Auxiliary 200mV input.
- "Music-On-Hold" output
- FM digital tuner and 8 function CD player
- 600 Ohms telephone paging input
- 70 Volt or 8 Ohm speaker outputs
- UL & CSA listed



PL200M 5X4 Multi-Source/Multi-Zone 160 Watt Matrix Distribution P.A. Amplifier

- Telephone Paging Function
- Mic 1 VOX Priority Page Feature
- Separate Gain, Bass, Treble into 4 Speaker Zones & Volume for each Zone
- 40W RMS per Zone/160W Total Output
- Distribute up to 5 Sources



PL260A Seven Zone 260 Watt Commercial Amplifier

- 260 Watt RMS
- Pre Amp input/Booster output
- 5 XLR Mic ins w/Phantom Power & 3 Aux ins
- Seven 25/70V Outputs with selector switch
- Music on Hold feature



PMM60A 60W/ PMM120A 120W Public Address Mixer Power Amplifier

- 60 Watt RMS or 120 Watt RMS
- 6 MIC Inputs/4 XLR connections
- 1 Telephone (100mV/600 Ohm)
- 3 Aux Inputs (200mV/50k Ohm)
- AC 120V, 50/60Hz
- Treble/Bass Control
- Master Volume Control
- UL & CSA listed
- 50-15kHz
- "Music-On-Hold" feature
- 4/8/16 Ohms & 25/70V Line Outputs



PBM30 30W RMS Contractor Series P.A. Amplifier

- 2 mic inputs (terminal strip)
- Audio mute function
- Auto summing stereo AUX input
- Aux input
- Bass & treble tone controls
- "Music-On-Hold" output w/separate level control
- Front panel level controls
- Outputs 70/25V & 4/8/16 ohm



P30FA 30W P.A. Amplifier with 30 Preset Digital Tuner

- Digital 30 station preset FM/AM tuner
- 4/8 Ohms or 70/25V output
- Mic1 selectable priority paging
- Telephone paging input and Music-on-hold output



SPEAKER PRODUCTS

SP6MAT 6.5" 70/25V Commercial ABS Plastic Back Can Speaker

- pre-assembled with back can and mounted transformer.
- features a quick-flip 70 or 25 Volt selector switch
- Easy select transformer wattage dial - choice of 8 or 9 individual wattage tap settings
- Flame-retardant ABS unit also comes with insulated wires
- Attached metal safety loop and easy-mount tabs for securing the unit



SP30PT 70/25V / 8 Ohm Hanging Pendant Speaker

- Woofer: 5" polypropylene with rubber surround/Tweeter: 1/2" Mylar
- Wattage: 30 Watts/RMS 60 watts max.
- Includes hanging apparatus (may differ from one shown)
- Dimensions: 8.25" w x 5.5" h/5 pounds
- Also available in black: SP30PTB



SP4AWE All-Weather Elite Series 4" Speakers

- Woofer 4" Mica / Polypropylene Cone/Tweeter .75" Silk Dome Tweeter
- Frequency 75Hz - 20kHz
- Dimensions 9.5" H x 6" L x 6.5" D
- Sensitivity 84 dB 1 w/1m
- Impedance 8 Ohm
- Sold in pairs
- Wattage 25 Watts RMS / 40 Watts Max.
- Also available in White - SP4AWEW • Available in 70V - SP4AWET (Black) & SP4AWETW (White)



SPG86TC 8" 70/25V Modern Grille In-Ceiling with Volume Control Knob

- 70/25V transformer with colored leads
- Dog-ear mounting clamps
- Available without volume control knob as SPG86T
- Modern style mesh steel grille
- Lifetime Warranty
- Available in 6" version as SPG66TC W/No V/C SP66T



G86TG 8" 70/25V Classic Grille In-Ceiling Speaker

- Classic style white steel grille
- G86TCG features volume control knob centered on grille
- 70/25V transformer with colored leads



BAI Carries the entire product offering from Speco Technologies including all Audio and CCTV Equipment!



Switchcraft® Pro Audio

Switchcraft Pro Audio & Broadcast division's line of interconnects & accessories meet the needs of every audio and video application with the highest quality signal routing and patching products. With over sixty years as the worldwide premium manufacturer of **American-made** professional interconnect solutions, why trust your production to anybody else?

Audio, Video, Data Connectors



Extensive line of audio, video and data connectors used to create cable assemblies, custom I/O panels and wall plates for A/V, pro audio, broadcast, mobile production and post production installations.

- XLR Connectors
- EH Series Modular Patch Connectors (Audio, Video, Data)
- High Power Connector (HPC) Series
- Mini XLR Connectors
- Cable Mount BNC Connectors – up to 24 GHz
- DIN 1.0/2.3 Connectors

Jacks and Plugs



High quality 1/4 inch commercial, 1/4 inch long frame, 3.5mm (1/8 inch mini), RCA and Bantam/TT jacks and plugs for musical instruments, audio patching and other pro audio gear.

- 1/4" Jacks & Plugs
- 3.5mm Jacks & Plugs
- Bantam (TT) Plugs
- RCA Series Jacks and Plugs

Direct Boxes, Splitters, I/O Panels and Adapters



Ultra high-quality peripherals for providing super-quiet and professional inserts, extracts, and inline adjustments to various signal routes.

- Stereo A/V Direct Boxes
- Passive / Active Instrument DI Boxes
- Adapter and Single MIC Splitter Boxes
- I/O Rack Panels & Dual ISO Mic Splitters
- Wall Plates
- AudioStix® In-line Adapters

Audio, Video, Data Patchbays



Audio, video and data patching solutions designed to seamlessly integrate into any pro audio, broadcast, or live sound application.

- EZ Norm TT / Bantam Patchbays
- Mini / Micro Video Patchbays including 24 GHz
- AES Digital Audio Patchbays
- Standard Size High Definition Patchbays
- 1/4" and DIN 1.0/2.3 Feed-Thru Patchbays
- Punchdown Accessories

Cable Assemblies and Patch Cords



Audio and video patchcords, snakes, DB25 breakout cable and video patchbay accessories.

- TT/Bantam Audio Patchcords
- 1/4" Audio Patchcords
- Micro / Midsize / Standard Video Patchcords
- Multi-channel Audio Snakes
- DB25 Breakout Cables
- Dual TT/Bantam Patchcords

Guitar Products



High end 1/4" jacks, plugs and switches for guitars and musical instruments.

- 1/4" Guitar Plugs
- 1/4" Guitar End Pin Jacks
- 1/4" Open Frame Jacks
- Selector Switches and Knobs



Connect with **BAI** for full-line information and pricing. 888-224-3446 | baionline.com



TAF aluminum trussing, accessories and other products are mostly used in entertainment industry, exhibitions, corporate events and most recently we entered also fields of building constructions, architectural designs, advertisement market and sport events market. Our products can be found under many various labels such as stage truss or staging truss, lighting truss, light truss, DJ truss, exhibition truss etc.

Truss Lines

Quicklock Line is defined by the quick-lock connection system. The greatest advantage of this type of connection lies in fast and easy assembly of the trusses while maintaining high level of strength and durability. This trussing system, also known as spigoted truss, represents the widest range of TAF aluminium trussing products in one connection type. Their application is almost limitless from small lighting truss design to large scale roof systems. This line is available in numerous different versions including a single straight pipe, a dual pipe, triangle, box and rectangular.

Quicklock Line Profiles:

- **Straight Tube**

FT21 - Small quick-lock single tube 35x2mm (ca. 1.4x0.08inch). Great for decorative purposes, carrying minimal load.

FT31 - Standard quick-lock single tube 50x2mm (ca. 2x0.08inch).

- **Ladder Truss - Double Tube**

FT22 - Small quick-lock ladder truss 220mm (9").

FT32 - Standard quick-lock ladder truss 290mm (12").

HT32 - Standard heavy quick-lock ladder truss 290mm (11.417inch)

FT42 - Large quick-lock ladder truss 400mm (16").

HT42 - Large heavy quick-lock ladder truss 400mm (16").

- **Triangle Truss**

FT23 - Small quick-lock triangle truss 220mm (9").

FT33 - Standard quick-lock triangle truss 290mm (12").

HT33 - Standard heavy quick-lock triangle truss 290mm (12")

FT43 - Large quick-lock triangle truss 400mm(16")

HT42 - Large heavy quick-lock triangle truss 400mm (16")

- **Box Truss**

FT14 - Small light duty deco quick-lock box truss 100mm (4"). Good for small decorations and as a design item for promotion purposes and small displays.

FT24 - Small quick-lock box truss 220mm (9").

FT34 - Standard quick-lock box truss 290mm (12").

HT34 - Standard heavy quick-lock box truss 290mm (12")

FT44 - Large quick-lock box truss 400mm (16")

HT44 - Large heavy quick-lock box truss 400mm (16").

TT54 - Heavy duty quick-lock box truss 520mm (20.5"). Used in large structures with high loading capacity.

- **Rectangular Truss**

FTR4030 - Rectangular large heavy truss 290x400mm (12"x16"). Good for carrying higher loads in larger structures.

TT74 - Extremely large heavy duty quick-lock truss 520x760mm (20.5x30"). The largest quick-lock trussing line for high loads. Commonly used in extreme size & high loading capacity structures.

All Quicklock trussing comes in a variety of lengths and formats including straight segments, corner segments in various angles, round segments, box segments, 'T' junctions, 2-Way, 3-Way & 4-Way segments and many more configurations.

- **Bolted Truss - TAF bolted truss includes three types of bolted trussing lines - light duty, medium duty and heavy duty. The connection is made by bolting 2 aluminium plates together in all four corners of the trussing segments.**

Bolted Truss Profiles:

FTB-L - Light Duty bolted truss - 30.5x30.5cm (12x12inch)

FTB-M - Medium Duty bolted truss - 52x52cm (20.5x20.5inch)

FTB-H - Heavy Duty bolted truss - 52x77.5cm (20.5x30.5inch)

- **Fork Truss - Fork truss system is defined by the connection of the trussing segments by forks. There is always a female set of fork connectors on one side of the truss and a male set on the other so the segments can be put together easily & secured by special fork truss pin.**

TAF also manufactures Towers & Tower Lifters, Roofs, Stages, Barriers, Furniture, Exhibits and numerous other products. Call BAI for more information.

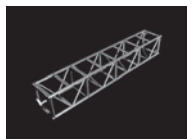
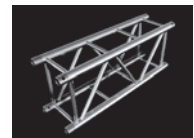

TASCAM

From Front of House to House of Worship and Boardroom to Backstage - Only TASCAM delivers the depth of product, technical innovation and legendary reliability you need to make every project a success and maintain your hard-earned reputation.

DIGITAL MEMORY RECORDERS

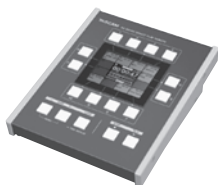

RC-SS150 controller

- Twelve flash play buttons trigger recordings on the SS-R250N or SS-CDR250N
- Play and pause buttons
- Color LCD with brightness control
- Color display shows file name, time count, level meter, and other operational info
- Eight pages of sounds can be stored, for a total of 96 available tracks
- Buttons designed for minimal clicking noise
- Power supplied from the SS-R250N/CDR250N unit
- Connects via RS-232C

SS-R250N solid-state recorder

SS-CDR250N solid-state/CD recorder

- Stereo recording up to 96kHz/24-bit
- Records to dual SDXC cards or USB flash drive
- Mic level inputs & Unbalanced and balanced analog I/O
- Control via Ethernet, RS-232C, Parallel
- Free iOS/Android App for remote control
- Compressor and limiter on input
- Optional IF-DA2 Dante audio I/O
- Record direct to CDR or dub to CD (SS-CDR250N only)



IF-DA2 Dante card

- Optional Dante interface card for SS-R250N & CDR250N
- 2-in and 2-out
- Works at 44.1k, 48k, 96k sampling frequencies at 16/24 bit
- RJ-45 connection to Dante network
- Works with Dante Controller for configuration, monitor control, and routing to other devices
- One of the lowest - if not THE lowest - priced Dante equipped recording solutions in the world

MEDIA PLAYERS AND RECORDERS



BD-01U Industrial Grade Blu-ray/DVD/CD Player

- Play Blu-ray, DVD, CD, WAV, MP3, WMA and other audio formats
- RS-232C serial control connector
- Ethernet / LAN for remote control via a Network
- HDMI high-definition audio/video output
- XLR balanced audio outputs & RCA unbalanced audio outputs
- Coaxial/optical digital outputs (Compatible with SPDIF/Dolby/DTS digital audio)
- Panel lock & On Screen Display On/Off function
- Capable of playing JPEG slideshows and AVCHD via DVD or the USB terminal

CD-A580 CD/Cassette Player / Media Recorder

Cassette deck

- One-way IC Logic transport control enables recording and playback
- Dub from CDs
- Dub from USB flash drive and recording from LINE Inputs
- +/-10% pitch control

CD Player

- Playback of audio CDs, CD-RW discs and data CDs (MP3 files) supported
- Various repeat playback modes, including Single, All and Program

USB flash drive recorder/player

- Recording as MP3 files possible from CD, cassette and line input sources
- MP3 file playback

MULTICHANNEL AND HIGH-RESOLUTION MASTER RECORDERS



DA-6400 64 Channel Multitrack Recorder

- Supports recording/playback of 64 channels at 48kHz/24-bit or 32 channels at 96kHz/24-bit PCM
- 2.5-inch SSD recording media with excellent vibration and environmental resistance as well as maintenance-free operation.
- Includes TASCAM SSD - designed with custom controller parts and thoroughly tested using DA-6400 units
- Hot swappable AK-CC25 case loads into front-loaded storage bay with USB 3 I/O port for transfer to DAW computer
- AK-CC25 with TASCAM 240GB SSD drive included with unit
- Hi-visibility Color LCD (320x120 pixels)
- BWF support for storing time information with files
- Two I/O slots for optional audio interface cards

DA-3000 High Resolution Master Recorder

- Stereo recording to SDHC card or CF card
- PCM recording format: BWF (44.1/48/88.2/96/176.4/192kHz, 16/24bit)
- DSD recording format: DSDIFF/DSF (2.8/5.6MHz)
- SD card slot (supports 4 to 32GB SDHC cards)
- CF card slot (supports UDMA)
- WAV file playback
- Cascade function enables simultaneous operation of multiple units
- Recording 2 mono files from stereo input is possible

TASCAM®

RECORDERS

CD-RW900MKII CD Recorder

- Analog/Digital XLR Inputs and Outputs
- External Control via RS-232C & Parallel Control
- Pitch Control +/-16%
- Independent input level controls



CD-RW901MKII - Same features as above but also includes:

- Sync trim function
- Selectable COPY ID and Call function
- Automatic track division with trim function
- XLR analog balanced ins/outs & XLR digital I/O



SD-20M Single-rackspace SD card recorder with XLR mic inputs

- Compatible with SD, SDHC and SDXC
- Tempo change function
- Four-track recorder capable of simultaneously recording from both the mic inputs and line inputs
- MP3 format for making long recordings
- XLR/TSR combo microphone inputs on front panel



CLOCK GENERATORS

CG-2000 Video sync/master clock generator - With redundancy of both the power supply and the video/audio clock, as well as many other functions that meet the strict demands of broadcasting and post production, the CG-2000 is at the top of its class.

- Numerous output connectors, including (12) word clock outputs, enabling the use in large-scale video/audio synchronization systems
- Word clock performance up to 192 kHz



CG-1000 Master clock generator - based on a high-precision OCXO – Oven Controlled Crystal Oscillator – with jitter management and glitch-free relocking for the best clock precision available.



CD/DVD PLAYERS

CD-200iL CD Player with iPod Dock w/Unbalanced Output

- Dock connector for Apple iPod
- Repeat All and Repeat Single
- CD TEXT and ID3 tag support
- Continue, Random and Program play modes
- ±12% pitch control
- Plays audio CDs, MP3 CDs & WAV file CDs



CD-200 CD Player - Same features as above w/o iPod Dock capability



CD-200BT CD Player/Bluetooth Receiver

- Up to eight Bluetooth® transmission devices can be paired
- Supports CD text and ID3 tags
- Four playback modes (continuous, shuffle, program and single)



CD-200SB SD/USB/CD Player

- Dubbing from CD to memory storages
- CD Text & ID3/WMA/AAC tag display
- Direct access to 10 user defined folders
- Four playback modes: continuous, shuffle, single and program



CD-240 Network Audio/CD Player

- Direct File Playback using DLNA
- COAXIAL RCA (S/PDIF) digital output
- 100BASE-T Ethernet connection
- Internet Radio Support
- OPTICAL TOS (S/PDIF) digital output
- Control from Free iPhone or Android app



CD-500B Single Rack Space CD Player with Balanced Outs

- XLR AES/EBU output
- RS-232C and Parallel control
- Optical & Coaxial S/PDIF digital outputs
- All, single, random, A/B & 99-track program play



CD500 - Same features as the CD-500B but in an unbalanced version.



RC-20 Direct Play Remote brings instant playback through flash start to the CD-500 or CD-500B – the only CD players available with flash start capability. A set of 20 pushbuttons on the remote play the first 20 tracks on a CD when plugged into the remote jack on the CD-500 or 500B. The simple-to-use remote includes space to label each track to help locate the target material. A Stop/Load button is also available for preloading tracks and stopping playback.



RC-SS20 is a remote control for the SS-CDR200, SS-R200, HS-8 & HD-R1 solid-state recorders. A panel of 20 illuminated buttons provides instant access to tracks on TASCAM recorders. The RC-SS20 supports the Flash Play mode on the SS-CDR200, SS-R200 and HS-8, so effects and announcements can be preloaded for instant playback. An "End Of Message" indicator shows when the end of the track is approaching.



BAI carries the entire Tascam product line. If you don't see it - call us!

BAI Distributors is proud to be a distributor for



This includes products from the following



Meeting rooms just became a lot easier to design, install & operate!



SMP Series "Show-Me" System

Table-top collaboration for multiple devices

- VGA & HDMI source inputs
- Extended HDMI output
- Built-in display on/off & volume control
- System connects with a single twisted pair cable

SM Series "Show-Me" System

Table insert collaboration for multiple devices

- VGA, HDMI & DisplayPort source inputs
- HDMI output
- Built-in display on/off control
- System connects with a 3.5mm cable



TechLogix makes audio-visual installations *grandma simple*.

- Complete **boardroom & meeting room systems** that install in 15 minutes.
- **System controllers** that are simple enough for any user to understand.
- Complete **classroom systems** that install in 30 minutes.
- Electronics for sending **HDMI over fiber** optic cabling.
- **Rack-mount power supplies** that clean up rack wiring.
- **AV over IP systems** designed for AV professionals.
- **Splitters, extenders & switchers** for 4K HDMI.



TELEX

Telex is one of the leading manufacturers of wired and wireless communications products in the world. As one of the leading innovators of wireless technology for over fifty years, Telex continually strives to have the absolute latest technology at the most cost-conscious pricing in the industry. Telex wireless systems have repeatedly led the industry in innovation and design excellence.

FMR-500 FREQUENCY AGILE UHF WIRELESS SYSTEMS

Key Features:

- Optimized channel frequencies allow up to 14 systems to operate simultaneously by combining channels from the low and high bands, or up to 10 within one band
- 1122-Channel Frequency Agile system with ClearScan™ auto channel selection allows quick Setup, transmitter matching, and new channel selection if RF conditions change
- Handheld transmitter includes Electro-Voice® N/DYM® 767a dynamic microphone element or RE410 Condenser element
- Digital Posi-Phase™ Diversity receiver technology provides clear, drop-out free audio.
- Front panel Battery Level, RF and audio meters with XLR Balanced Mic or Adjustable Line Level output plus 1/4" Unbalanced line output on back panel
- Rack mount hardware included
- Three year warranty



Applications:

Fixed Install, Rentals, Professional Small to Medium Installs 1 -14 systems

SOUNDMATE PERSONAL LISTENING SYSTEMS

The **SM-2 System** includes one ST-300 base transmitter, (4) SR-50 receivers, (4) SEB-1 earbuds, and a SoundMate™ wall plaque.

The **SMP-2 Portable Listening System** includes one PST-16 portable transmitter, one SCHS-745 headworn mic, six SR-50 single frequency receivers, six HED-2 dual earbuds, 14-AA alkaline batteries and system briefcase.



System Components:

ST-300 Base Transmitter - features 17 user selectable frequencies controlled by a front mount selector knob, a headphone jack with adjustable level for input signal monitoring & a peak reading LED display for visual input monitoring. On the back of the unit are a balanced XLR-3F input with selectable mic, line and 70 volt input options, as well as an unbalanced 4" input. Also features an input attenuator and hi/low RF power switch.



PST-170 Belt Pack Transmitter - may be set to any one of 17 channels, and operates on frequencies in the 72-76MHz band. It is lightweight, battery operated and includes a small electret lapel microphone for convenient portable use. The PST-170 has two audio input jacks. The Auxiliary input is designed to allow audio devices such as teacher's aids or tape players. The second jack is normally used for microphones and is located on the top panel.



SR-400 17 Channel Receiver - is the perfect solution to multiple transmitter hearing assistance systems. The SR-400 features an advanced digital PLL synthesizer to tune all 17 narrow band frequencies available in the 72-76 MHz band. The receiver also includes a special high frequency contour filter and boost switch to increase the intelligibility of the audio signal. The receiver also features automatic power off when the earphone is unplugged.



SR-50 Single Channel Receiver - provides clear reception and the simplicity of a single fixed channel. This economical receiver features an ergonomic raised volume control knob and recessed headphone jack. Two AA batteries give up to 30 hours of continuous battery life.



Digital Mixers with DSP

MM-700F Digital Matrix Mixer



- Matrix controls 4 LINE inputs and 2 MIC/LINE level inputs
- 4 output channels for zoning
- Each output channel features 64 DSP preset selections
- 2 MIC/LINE inputs have 1st and 2nd priority levels
- Pair with optional WP-700-AM wall remotes via CAT-5 cable for remote source selection and volume control
- Pair with 4 channel DA series digital amplifiers

M-864D Digital Stereo Mixer

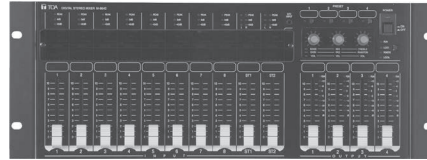

- 4U rack mountable Digital stereo mixer
- 8 monaural Mic/Line input channels and 2 stereo input channels (7 sources)
- 6 output channels including 4 bus assignable monaural output channels and 1 stereo recording output channel
- DSP: Automatic Resonance Control (ARC), Feed-back Suppressor function (FBS), Automatic stereo input mute function (AUTO MUTE or Ducker), and Parametric Equalizer

M-9000M2 Modular Digital Matrix Mixer



- Flexible modular design - up to 8 mic/line inputs and 8 outputs with mixer and paging matrix
- Extensive DSP functions included in user-friendly GUI
- Any of the 30 EQ presets appropriate to the TOA speakers used may be selected for each output
- Up to 16 flush-mount remote panels connectable
- Programmed operating system - 32 scene memories and 32 paging memories
- Fully customizable with TOA modules

Digital Mixer Amplifiers

A-5006 / A-5012 Power Amplifiers with DSP



- 1U-half size compact and simple hardware for easy setting
- Hi-/Low-Z speaker connection
- 60W (A-5006) and 120W (A-5012) models
- 2 x mic/line inputs with mute
- Intuitive GUI software for sound optimization
- DSP: Automatic Priority Mute Function; High Pass Filter for Each Input; Parametric EQ; Speaker EQ Library; 10 points filter for Output EQ (PEQ, HPF, LPF = Selectable)
- Remote master volume control
- Pair with optional rack mounting brackets: MB-15-BK, MB-15B-J, YA-706

MA-725F Matrix/Amplifier with DSP



- 4 stereo-summing line inputs with matrix routing to 4 amplifier outputs
- Each line input has input level adjustment and assignable restriction setting for each output to prevent routing selection
- 2 priority MIC/LINE inputs with different priority level for paging or other pre-recorded source which can override the selected line input on assigned output channels
- Each output channel equipped with 250W Class-D amplifier at 70V/100V output voltage selectable with independent DSP preset selection and 50Hz HPF for the protection of connected speakers

BG-2240D Class D Mixer/Amplifier



- 240W output @ 70V
- Dual balanced priority mic/line inputs
- Dual unbalanced line inputs for BGM sources
- Assignable 2nd zone/MOH output
- Front panel bass & treble controls
- Remote volume control port
- Assignable mute function
- Module option slot (accepts any of a range of compatible 900 Series input & special function modules)
- Pair with BA-Series amps; bracket: MB-1000; volume control cover: YA-920

Digital Amplifiers

AV-20D / AV-60S Power Amplifier



- Micro Class D amplifier for use in meeting/board rooms & signage applications
- UL 2043-rated for plenum installation
- Energy Star certified
- AV-20D: 20W x 2 @ 4 Ohms / 40W @ 8 Ohms in Bridge Mode
- AV-60S: 1 x 60W @ 4 Ohms / 70V
- Clip Limiter prevents distortion from overload
- Base tone and treble control
- Remote volume control

DA Series Multi-channel Digital Amplifiers



- The DA Series amplifiers are ideal for multi-zone distributed speaker systems and professional sound applications. Engineered with Class D technology, the DA Series operate at 85 percent efficiency & consume almost 1/3 less power than conventional analog amps.
- Single rack space
 - Switching power supply
 - Each channel equipped with independent power
 - DA-250D (2x250W@4Ω)
 - DA-250DH (2x250W@70V)
 - DA-250F (4X250W@4Ω)
 - DA-250FH (4X250W@70V)

High-Powered DA Series Multi-channel Digital Amplifiers



- The DA Series amplifiers are ideal for multi-zone distributed speaker systems and professional sound applications. Engineered with Class D technology, the DA Series operate at 85 percent efficiency & consume almost 1/3 less power than conventional analog amps.
- Dual rack space
 - Switching power supply
 - Each channel equipped with independent power
 - DA-500F-HL (4X500W@70V or 8Ω)
 - DA-500F (4X550W@4)

Mixers

M-243 6-Channel Stereo Mixer



- 2 mono mic/line inputs, each with compressor and high pass filter
- 4 stereo inputs with RCA and 1/4" phone plug connectors
- Stereo output with separate paralleled record outputs
- 2 mono outputs, switchable to stereo sum
- Auto-priority of mono over stereo inputs for paging/BGM applications

M-900MK2 8 Input Mixer/Preamplifier



- Accepts 900 Series modules for ultimate flexibility (8 input ports) [mixer frame only]
- Bass and treble controls with bypass switch
- High-pass filter for speech-only applications
- Remote control of master volume
- Indicators for signal presence, clip protect and power
- Two mute buses for multiple muting priorities

900 Series Modules



TOA 900 Series Modules give you the power to configure custom systems fast! The modules are available in three categories:

- Microphone Input
- Line Input
- Special Function
- New modules
 - SP-11N SIP Module for VOIP phone paging
 - NM-01 Noise Masking Module

Mixer/Amplifiers

BG-235 / BG-260 Power Amplifier



- 35 and 60 W versions
- 3 inputs
- MOH output
- 2-channel broadcast with booster amplifier
- Pair with booster amplifier BA-235 (35W) or BA-260 (60W)

BG-2035 / BG-2060 / BG-2120 Modular Mixer/Amplifier



- 35, 60 and 120 Watt models
- Compact five channel mixer/amplifier
- 25V, 70V, and 4 Ohm outputs
- Single 900 Series module slot
- Mic/AUX/PGM/telephone page inputs
- Music-on-hold output
- Auto mute with sense control

A-706 / A-712 / A-724 9 Channel 60 / 120 / 240 Watt Mixer Amplifier



- Ideal for BGM, FGM paging systems
- 6 Mic/Line inputs, 2 Aux inputs
- Auto Mute Priority function
- 25V, 70.7V & 4 Ohm outputs
- Individual Channel & Master volume
- Phoenix Connectors
- 9 Channel integrated amp
- Bass/Treble tone controls
- Remote master volume
- Remote AC turn-on w/ delay

A-2240 Mixer Power Amplifier



- Cost effective and durable 240W mixer power amplifier
- User friendly front panel allows easy operation
- 2 electronically balanced microphone inputs, 2 AUX inputs and recording output
- Phantom power at MIC 1
- Wide tone-control adjustment range of +/-10 dB for both bass and treble
- 100V / 70V line or 4 speaker outputs
- Auto-mute function for voice-activated paging through mic or telephone inputs
- Booster amplifier for additional power

A-903MK2, A-906MK2, A-912MK 28-Channel Integrated Amplifiers



- Three models available in 30, 60 and 120 Watts (main frame only)
- All models accept 900 Series modules for ultimate flexibility (8 input ports)
- Two mute buses for multiple muting priorities
- Bass and treble controls with bypass switch plus high-pass filter for speech only applications
- Remote control of master volume.
- Jacks for processor insertion and integrated or separate mixer/amp operation
- Indicators for signal presence, clip protect and power

A-9000 Series Digital Matrix Mixer/Amplifiers



The TOA 9000M2 Series Digital Matrix Mixer/Amplifiers combines a modular matrix mixer, digital signal processor (DSP) & single or dual 70V amps in a compact, 2RU package. Single/Dual Channel models are easily configured to include up to 8 Mic/Line inputs & 8 outputs.

- A-9060DHM2 (2x60W)
- A-9120DHM2 (2x120W)
- A-9060SM2 (1x60W)
- A-9120SM2 (1x120W)
- A-9240SHM2 (1x240W)

Pair with ZM Series Wall Controllers and SS-9001 Speaker Selector

Interior Design Speakers

H-1 EX and H-2 EX Speakers



- Sleek, Stylish Appearance
- Built-In 70.7/100 V Matching Transformer
- H-1 EX: cylinder-shaped flush-mount 2-way speaker with 90° adjustable mounting angle: 90W continuous program @ 4 Ohms
- H2-EX: dome-shaped surface-mount 2-way speaker with 360° adjustability parallel to mounting surface
- Weather-Proof Version Available, Model H-2WP

H-3 EX Wide-Dispersion Speakers



- Architectural-friendly appearance
- Dispersion: 140° horizontal and 70° vertical
- High Power Handling - 150 W
- Two-Way, Sealed Enclosure w/ High-Quality Components
- Built-in 70.7/100V Matching Transformer (30 W max.)
- Weather-proof version available Model H-3WD

PE-304/604BU/WU Pendant Speaker (UL1480 UUMW rated)



- 30W and 60W versions
- Directly attached 5m (16.4ft) hanging wire allows speaker to be suspended from high ceilings
- Driven on both high impedance (100V, 70V, and 25V) and low impedance (8 Ohm) lines
- Certified to UL 1480 UUMW standards
- Using supplied GRIPPLE® hangers will facilitate the speaker mounting height adjustment

Ceiling Speakers

F Series - Wide-Dispersion Ceiling Speakers



TOA F Series Ceiling Speakers are ideal for music and paging applications such as audio/visual, business music or retail sound systems. The lineup consists of six models with features and price points to suit premium-to-economy applications; all built with 25/70.7 multi-tap transfers, low impedance mode (8/16 Ohms), and integral metal back-can and safety cable. Key benefits include smooth off-axis coverage, ease of installation, and competitive pricing. Models include:

- F-122CU2 - 5" FULL-RANGE, 30 W
- F-2352CU2 - 5" CO-AXIAL, 30 W
- F-2852CU2 - 6.5" CO-AXIAL, 60 W
- F-2322CU2 - 5" FULL-RANGE, 30 W
- F-1522SC - 4" FULL-RANGE, 6 W
- F-2352SC - 5" CO-AXIAL, 6 W

PC-580RU/RVU Ceiling Mount Speakers



- 8" in-ceiling speaker for high quality applications
- 25V & 70V transformer taps up to 5W
- Unique "monocoque" design provides better structural integrity
- High-performance, cost effective ceiling speaker for use in mass notification systems, voice evacuation, emergency paging and everyday paging and background music
- Meets UL 1480 UUMW (Fire alarm signaling) and UL 2043 (use in air handling spaces when using the HY-BC580U back can)
- Optional Tile rail, Q-HY-TB2
- Optional Tile bridge, LBS8-R1-AM

Spring Loaded Ceiling Speakers



- Spring clamp mechanism for easy installation
- 3W, 70V with easy tap setting
- PC-648R
 - 5" cone-type
- PC-2369
 - 6" double cone-type
 - Metallic construction

Horn Speakers

CS Series Wide-Range Paging Speakers



- CS-64/CS-64U* (6W)
- Wide-range paging speaker for voice paging, background music and tone signaling distribution
 - Exponential horn improves directivity characteristics and ensure uniform and clear sound dispersion
 - Weatherproof polyurethane resin paint and impact-proof lightweight ABS resin enclosure
 - Stainless steel hardware protects the speaker from corrosion
 - *UL 1460 UEAY listed



- CS-154/CS-154U*
CS-304/CS-304U*
- Wide-range paging speaker for voice paging, background music and tone signaling distribution
 - Constant directivity horn improves directivity characteristics and ensure uniform and clear sound dispersion
 - High sensitivity: up to 98 dB (1W/1m)IP65 certified weatherproof construction
 - Weatherproof polyurethane resin paint and impact-proof lightweight ABS resin enclosure
 - Stainless steel hardware protects the speaker from corrosion
 - *UL 1480 UEAY listed

SC Series Paging Horn Speakers



- Paging Horn Speakers for voice paging and tone signaling distribution
- Weather-Resistant to withstand demanding environmental conditions
- Double Re-Entrant Horn with Compression Driver
- High Sensitivity Up To 113 dB
- Built-in 25V/70.7V Transformer ("T" Models)
- Models:
 - SC-610: 10W, 8 Ω
 - SC-610T: 10W, w/Transformer
 - SC-615: 15W, 8 Ω
 - SC-615T: 15W, w/Transformer
 - SC-630: 30W, 8 Ω
 - SC-630TU: 30W, w/Transformer (UL listed)
 - SC-651: 50W, 16 Ω

Wall Mount Box Speakers

BS-678 Public Address Speaker



- Stylish, compact and unobtrusive design
- Quick and easy installation, which saves time on setting-up
- Horizontal / vertical installation
- A push-type input terminal allows easy cable connections and bridge wiring
- Ideally suited for BGM and announcements

BS-1030 Music/Paging Speakers

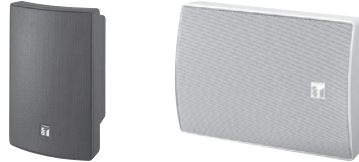

- 2-Way bass reflex speaker
- Cost-effective high power PA box speaker
- Low impedance (8Ω) or high impedance (100V/70V) selectable by rotary switch
- Splashproof construction in compliance with IPX4
- Available in black or white

F Series - Wide-Dispersion Speakers



- Indoor/Outdoor Speaker for music/voice
- 2-Way Bass reflex design
- 4", 5" & 8" Models
- 90W, 150W & 180W Models
- 15W, 30W & 60W @ 70.7V
- Wall/Ceiling Bracket included

Array Speakers

HX-5 Variable Dispersion Speaker



- Adjustable Dispersion Angle of 15°, 30°, 45° & 60°
- High Power 600W Continuous
- Horizontal Coverage 100° Fixed
- Frequency response: 70Hz to 20kHz
- Sensitivity 99dB
- Black or White & weather-proof (WP) versions available
- Optional 70V transformer
- Pair with FB-120B/W 12" Subwoofer

Subwoofers



- FB-120B/W (black pictured)
- Compact 12" subwoofer
- Extremely wide frequency range
- For floor-, wall-, corner- or ceiling-mount
- 600W continuous program @ 8 Ohms
- FB-150B/W (white pictured)
- Bass-reflex enclosure
- High-compliance 15" low-frequency speaker
- Screw-terminal & Speakon™ connectors
- Power handling 600W Continuous Program @ 8 Ohms

HX-7 Variable Dispersion Speaker



- 4 cell configuration each incorporating:
 - (2) 5 1/2" Low-frequency drivers
 - (1) Center-mounting, waveguide-loaded 1" compression driver
- Sync-Drive™ technology built-in
- Flexible vertical angle adjustment between 0° and 45° (60° w/optional adapter)
- 750W Continuous Program @ 8 Ohms
- Frequency response: 75Hz to 20kHz
- 100dB sensitivity (1W @ 1m)
- Black or White & weather-proof (WP) versions
- Pair with FB-150B/W 15" Subwoofer

Type H Line Array Speakers



- Clear sound & excellent directionality
- Adjustable sound coverage
- SR-H2S (curved) Short-throw 90°Hx20°V
- SR-H2L (straight) Long-throw 90°Hx0°V
- SR-H3S (curved) Short-throw 90°Hx20°V
- SR-H3L (straight) Long-throw 90°Hx0°V
- Optional 70V Transformer (MT-S0301)

HA-1010 Long Range Slim Array Speaker



- Long Range Slim Array Speaker
- 90° horizontal x 15° vertical wide directivity
- High-frequency array horn speaker
- Multiple horn speakers positioned in an array
- Long-range sound coverage further than conventional horn speakers
- Narrowly focused vertical directivity that allows excessive volume to be controlled at closer proximity

HX-7 Variable Dispersion Speaker Mounting Options

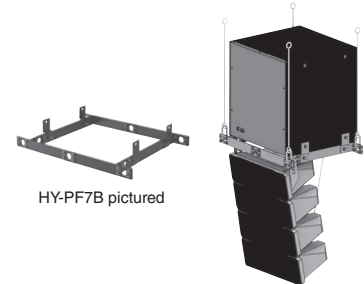

- Indoor and outdoor versions
- Available in black or white:
 - Rigging Frame
 - Ceiling Bracket
 - T-Bracket
 - Stand Bracket
 - Wall-Mount Bracket

Microphones

AM-1 Real-time Steering Array Microphone System



- Detects sound source location and steers its beam angle automatically to focus on sound source
- Dedicated user-friendly GUI is available as a free app for iPad™ or firmware for PC browsing
- Set area of acceptance
- Available in black or white
- Ceiling and surface mounting options available
- Parameter settings with ability to create presets:
 - Mute ON/OFF operation
 - Output gain level adjustment
 - Duration (Time monitoring of sound source footprint)
 - Disabling of MUTE switch function on the microphone
 - Tracking range (Horizontal angle and distance), sensitivity, speed
 - Gain compensation ON/OFF
 - Distance adjustment threshold

PM-660U Desk Mount Paging Microphone



- Cardioid dynamic
- PTT bar with locking lever
- Elegant integral stand design
- Extra switch contact for mute or relay control

Wireless Systems

Trantec Wireless Microphone Systems



Trantec S4 Series UHF Professional Wireless Microphone System:

- Plug and play wireless systems
- Fully synthesized PLL quartz tuning technology
- A single AA battery gives up to 10 hours of quality performance with a range of up to 100 meters
- S4.04: Four selectable frequencies
 - Receiver LED's show AF peak level, RF level & diversity channel A or B
 - Professional metal enclosure
- S4.10: Up to 10 simultaneous channels
 - Diversity operation with detachable antenna
 - Professional metal enclosure
 - 19" rack mount option for one or two receivers



Trantec S5.3 Series UHF Professional Wireless Microphone System:

- High quality audio and RF dynamics
- True diversity operation
- Multi-channel capability, enabling up to 12 channels to operate simultaneously
- AA cell battery operation, providing over 10 hours of continuous use
- All metal construction
- Supplied control software

5000 Series Wireless Microphone System



5000 Series UHF Wireless Microphone Systems

- 64 tunable frequencies (up to 16 simultaneously)
- Options include:
 - WT-5800/5805/5810 Diversity UHF Tuners
 - WM-5325 Body-pack Transmitter (mic optional: YP-M5300 Omni-directional or YP-M5310 Uni-directional lapel mic, WH-4000H headset, WH-4000A aerobics headset or Q-EM77 ear-worn headset mic)
 - WM-5225 Hand-held Condenser Mic Transmitter
 - WM-5265 Hand-held Dynamic Mic Transmitter
 - WM-5270 Hand-Held Dynamic Mic Transmitter
- Single AA battery (charger optional) for up to 10 hours of continuous operation.

IR-700 Series Wireless Microphone System



IR-700 Series Wireless Microphone System uses infrared transmission, eliminating the problems associated with RF (VHF/UHF) type systems. The system has an optional 4-way distributor, to be used with no fear of interference or loss of privacy. Employs a PLL synthesized system, allowing either of 2 frequencies to be set.

Components include:

- IR-702T - 2-Channel IR Tuner
- IR-200M Hand-Held IR Mic Transmitter
- IR-300M Body-Pack Mic w/External Mic Input
- IR-720T Tuner (can receive signals from any two IR transmitters)
- IR-500R, IR-510R, IR-520R - IR remote receivers
- IR-200BT Rechargeable Batteries
- IR-200BC Charging Station

IR-802 Infrared Wireless Classroom System



TOA's educational IR-802PA microphone system offers uniform classroom-wide sound quality with a single wide-dispersion speaker which provides ample 100 m² coverage. Quick & easy installation requiring just one CAT-5 cable.

IR Classroom System, includes:

- IR-802T IR Tuner/Mixer
- IR-820SP IR Powered Speaker
- IR-310M Teacher's IR Pendant Mic
- IR-310-BC Charger
- IR-200-BT NIMH Batteries

TS-800/TS-900 Series Wireless Conferencing Systems



- Wireless Delegate and Chairperson Stations
- TS-800 Infrared Conference System: External Control Communication Specifications
- TS-910 Conference System: External Control Communication Specifications
- Secure, wireless infrared communication assures freedom from eavesdropping and interference
- Up to 96 Chairperson/Delegate stations each powered with rechargeable lithium-ion battery (ten hour operation) or AC power supply
- Convenient voting function (Yes, No, Abstain) (TS-900)
- Simultaneous translation channel (TS-900)
- External source inputs and PA/record outputs



Tripp Lite offers a diverse selection of connectivity, cabling, mounting and power protection solutions to complete any A/V or digital signage application. This is a small sampling of more than 3,500 quality products to power, protect, manage, house, cool, connect and mount your equipment. Founded in 1922, Tripp Lite has a reputation for quality products, competitive pricing and superior customer service.

UPS SYSTEMS

Choose from more than 250 models to protect against power problems and provide battery backup.

- Line-interactive UPS systems feature automatic voltage regulation (AVR)
- On-line UPS systems have true on-line protection with pure sine wave output for the best protection available
- Up to 3-year limited warranty
- Up to \$250,000 Ultimate Lifetime Insurance (Valid in U.S., Canada and Puerto Rico only)

UP TO \$250,000
ULTIMATE
Lifetime Insurance



Desktop/Tower Line-Interactive 120V UPS Systems	
AVR750U	750VA/450W, 12 Outlets, USB Port, Tel/DSL Protection
OMNI900LCD	900VA/475W, 8 Outlets, LCD, USB Port
SMART1000LCD	1000VA/500W, 8 Outlets, LCD, USB Port, Tel/DSL/Coaxial Protection
OMNIVS1500XL	1500VA/940W, 8 Outlets, USB Port, Tel/DSL/Ethernet Protection, Expandable Runtime

SmartPro® Rack/Tower Line-Interactive Sine Wave 120V UPS Systems	
SMART1000RM1U	1kVA/800W, 6 Outlets, Network Card Option, 1U
SMART2200CRMXL	2.2kVA/1.9kW, 8 Outlets, Expandable Runtime, Network Card Option, 4U
SmartOnline® Rack/Tower Double-Conversion 120V UPS System	
SU1500RTL2UA	1.5kVA/1.2kW, 6 Outlets, Expandable Runtime, Network Card Option, 2U

RACKS

Choose from more than 120 rack enclosures and open frame racks to organize 19" equipment.

- Wall-mount racks from 2U to 26U
- Floor-standing racks from 12U to 58U

SRW6U	6U Switch-Depth Wall-Mount Rack Enclosure
SRW12US	12U Switch-Depth Wall-Mount Rack Enclosure, Hinged Back
SR12UB	12U Mid-Depth Floor-Standing Rack Enclosure

SR18UB	18U Mid-Depth Floor-Standing Rack Enclosure
SR42UB	42U Standard-Depth Floor-Standing Rack Enclosure

Custom Racks Available!



SURGE PROTECTORS

Choose from more than 150 models to protect equipment from power surges and line noise.

- Lifetime limited warranty
- Up to \$500,000 Ultimate Lifetime Insurance (Valid in U.S., Canada and Puerto Rico only)

UP TO \$500,000
ULTIMATE
Lifetime Insurance



Protect It!® Surge Protectors	
TLP606SSTELB	6 Outlets, Tel/Modem Protection, 1440 Joules, 6 ft. Cord
TLP808	8 Outlets, 1440 Joules, 8 ft. Cord
Eco-Surge™ Surge Protector with 7 Power-Saving Outlets	
AV10IRG	10 Outlets, Coaxial and Tel/Ethernet Protection, 6480 Joules, 8 ft. Cord

Isobar® Premium Surge Protectors	
ISOBAR6ULTRA	6 Outlets, 3330 Joules, 6 ft. Cord
IBAR12-20ULTRA	12 Outlets, 3840 Joules, 15 ft. Cord, 20A, 1U Rack Mount
Isobar Professional A/V Power Conditioning Center	
AV3500PC	8 Outlets, Coaxial and Tel/Modem Protection, 5700 Joules, 10 ft. Cord, LCD

DISPLAY MOUNTS

Choose from more than 40 mounts for flat-panel displays from 10" to 100".

- All models are VESA® compliant and include mounting hardware

DWM3770X	Swivel/Tilt Wall Mount, 37" to 70"
DWM60100XX	Swivel/Tilt Wall Mount, 60" to 100"
DWT60100XX	Tilt Wall Mount, 60" to 100"
DWF4585X	Fixed Wall Mount, 45" to 85"

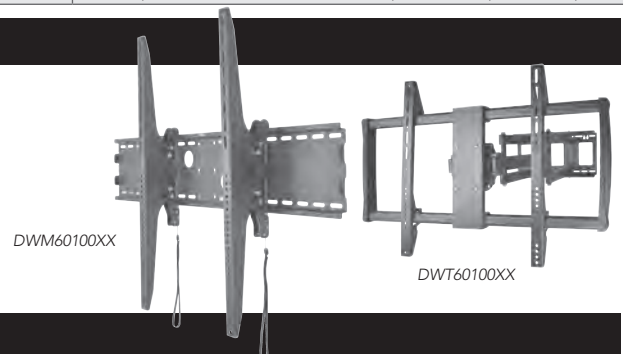

A/V EXTENDERS

Choose from more than 100 A/V extenders to connect high-resolution video sources and displays.

- Options for DisplayPort™, HDMI®, DVI, VGA, serial and component video

B122-000	HDMI In-Line Signal Booster/Extender, 1920 x 1200
B126-1A1	HDMI over Cat5/6 Active Extender Kit, 1080p
B202-150	USB over Cat5/6 Extender Kit
B130-101A-2	VGA + Audio over Cat5/6 Extender Kit with EDID, Local VGA Output, 1920 x 1440
B130-101-2	VGA over Cat5/6 Extender Kit with EDID, Local VGA Output, 1920 x 1440



UPS | PDUs | RACKS | COOLING | KVMs | USB/AC CHARGING | CABLES & CONNECTIVITY

All trademarks are the property of their respective owners. Tripp Lite has a policy of continuous improvement. Specifications are subject to change without notice.



REDEFINING CAMERA CONTROL

Vaddio is the premier global manufacturer of PTZ cameras, specialty camera control systems and professional USB peripherals for the audiovisual, videoconference and broadcast marketplaces.

We make robotic camera technology easy to use - and even easier to install.

High Definition PTZ Cameras

HD pan/tilt/zoom cameras - ideal for broadcast, audiovisual and videoconferencing environments.

Vaddio PowerVIEW HD-22 (999-6960-000) - equipped with a multi-element 22x optical glass auto-focus zoom lens providing up to a 66-degree field-of-view for a wide range of telephoto or wide-angle options. An impressive 128x wide dynamic range covers both light & dark contrast areas and a Color Capture light system produces vivid color images without color saturation or filtering.



Vaddio PowerVIEW HD-30 (999-6970-000) - comes equipped with a multi-element 22x optical glass auto-focus zoom lens that provides up to a 66-degree field-of-view for a wide range of telephoto or wide-angle shot options. The HD-30 has a robust 30x optical power zoom, capable of capturing the most detailed video images regardless of room size.

Vaddio ClearVIEW HD-20SE (999-6980-000) - HD PTZ Camera combines the best features and functions of the HD-18, HD-19 and HD-20 PTZ cameras. This new PTZ camera features an advanced Image Signal Processor (ISP) and encompasses the innovation of the HD-18, the low light capability of the HD-19 and the Full HD performance of the HD-20 ClearVIEW Camera line. Available in Black or White.



Vaddio DomeVIEW 70 Flush Mount Camera System (999-9000-070) - integrated camera mounting system designed for indoor security applications. The 7.3-inch (18.54cm) flush mount dome enclosure is outfitted with the internal brackets to support the Sony EVI-D70 pan/tilt/zoom camera and Vaddio's EZCamera Cabling System enabling the use of Cat. 5 cabling for video, power and control. The Domes are formed from optical grade polycarbonate and are available in clear (standard) or smoked tint (optional).



DomeVIEW HD Indoor Flush Dome Enclosure for Vaddio RoboSHOT and HD-Series PTZ Cameras (998-9000-200) - provide integrators with a secure camera housing designed to protect the PTZ camera against damage that can be caused when cameras are exposed to the elements and vandalism. The clear and smoked optically correct domes provide for distortion-free viewing that allows the camera operator to position the camera anywhere within its pan/tilt range.



RoboSHOT 20 UHD (999-9950-000) - an Ultra HD (4K) PTZ camera with pristine color reproduction, outstanding low light performance, and unrivaled video performance. Enterprise class features including IP streaming and network control via web interface, this camera is designed for use in UHD or HD environments like higher education, corporate broadcast and houses of worship.



RoboSHOT 12 HD-SDI (999-9933-000) - RoboSHOT 12 HD-SDI with simultaneous HD-SDI and HDMI digital video outputs and Full HD IP streaming.



RoboSHOT 30 HD-SDI (999-9933-000) - RoboSHOT 30 HD-SDI with simultaneous HD-SDI and HDMI digital video outputs and Full HD IP streaming.

ProductionVIEW Mixer Systems

ProductionVIEW HD MV (999-5625-000) - Camera Control Console with multiviewer capabilities, digital I/O, HD, RGBHV and SD video mixing, transitions, lower screen graphics and automated control functionality. With the TeleTouch touch screen, all live video feeds can be selected and up to 12 thumbnail presets can be created, recalled and stored by simply touching the monitor.



ProductionVIEW HD-SDI MV (999-5655-000) - Camera control console with HD-SDI/SDI video switching/mixing, built-in multiviewer, lower screen graphics & automated control functionality. New Multi-View Input Screens allow user to select between screen layouts that display four, five or six inputs.



ProductionVIEW HD (999-5600-000) - Camera Control Console with HD, RGBHV & SD video mixing, transitions, lower screen graphics and automated control functionality.

Available with SDI capabilities as the ProductionVIEW HD-SDI (999-5650-000)
BAI Carries the entire Vaddio line of products. Please call for more information!





With years of music entertainment business experience, VocoPro provides products for professionals & amateurs alike. Included are wireless mic systems, self contained vocal systems, Multi-Format players, mixers, amplifiers, speakers, and accessories. Call BAI for a full listing and prices of the wide variety of VocoPro products.

UHF WIRELESS MICROPHONE SYSTEMS

Digital-1 - Digital Wireless Microphone with Mic-On-Chip Technology - entirely digital wireless microphone system that utilizes mic-on-chip technology to package the audio for transmission, which produces crystal clear sound while delivering extreme value. It operates in the future-proof 900 MHz frequency band which is far outside the TV broadcast station and is the primary cause for wireless microphone interference. Unlike most of the digital wireless mic sets on the market using 2.4GHz band, the 900MHz provides superior range and does not conflict with Wi-Fi networks.



UDH-PLAY 4 - FOUR CHANNEL UHF Headset & Lapel Wireless Microphone Package with Mic-on-chip Technology

- Includes 4 Bodyback Transmitters with 4 Headset mics and 4 Lapel mics.
- Operates in the 900 MHz Band
- All-in-one wireless Mic-On-IC™ has a pre-amp, compressor, and expander onboard
- Plug and Play design requires no microphone syncing set-up
- Fits standard sized 19" Rack Cases



Also available in an 2-Channel version as the UDH-DUAL-B & 8-Channel Version - UDH-PLAY 8

UDH-CHOIR 4 - Four Channel UHF Handheld Wireless Microphone Package with Mic-on-chip Technology
Same features as above but in a Handheld version. Available in 8-Channel version as the **UDH-CHOIR 8**



UDH-4-ULTRA - Four Channel UHF System with Handheld Microphones, Bodypacks, and Instrument Cables Mic-on-Chip Technology

- Four Channel Receiver Allows Users To Mix And Match Between Handheld Microphones and Bodypacks
- Includes: 4 Handheld Microphones & 4 Bodypack Transmitters with Headsets & Lavalier Mics
- Includes: 4 Bodypack Patch Cables To Enable Instruments To Go Wireless
- New Mic-On-Chip Wireless Technology For Clean And Stable Audio Across the 200ft. Range

Also available in an 8-Channel version as the UDH-8-ULTRA



Digital-Play-8 - EIGHT CHANNEL UHF Headset & Label Wireless Microphone Package with Mic-on-chip Technology

- Eight Wireless Bodypacks with Headsets and Lapel Mics - Each Channel Has Dedicated XLR Output & Volume Control
- 24-Bit Digital Technology Delivers a Clean, Professional Quality Signal
- Individual Digital Microphone IDs Eliminates Channel Cross-Talk

Also available in a 12 and 16-Channel version as the Digital-Play-12 & Digital-Play-16



Digital-Acapella-8 - Eight Channel 24BIT DIGITAL Wireless Handheld Microphone System with Mic-On-Chip Technology All same features as Hybrid-Play systems but in a Handheld version.

Also available in a 12 and 16-Channel version as the **Digital-Acapella-12 and Digital-Acapella-16**



UHF-3200 - UHF-Dual Channel Wireless Microphone System

- Individual volume controls
- 2 - 1/4" unbalanced mic outputs & 1 - 1/4" mixed output
- 2 wireless handheld mics included
- Low battery indicator (LED) on mics



UHF-5800 - Professional 4-Channel UHF Wireless Microphone System

- 4 Handheld mics included
- 4 individual XLR Mic Outputs & 1 - 1/4" Mixed Output
- Individual volume controls
- 4 independent Field-replaceable Modules



UHF-5900 - UHF PLL Wireless Mic System with Frequency Scan

- Includes Four UHF Wireless Microphones
- Four XLR Independent Channel Audio Outputs
- Frequency Scan
- 150+ Wireless Frequencies To Choose From



UHF-5805 - Professional Rechargeable 4-Channel UHF Wireless Microphone System

- 4 individual XLR Mic Outputs and 1 1/4" Mixed Output
- 4 independent Field-replaceable Modules
- 4 Handheld mics included
- Individual Volume controls



UHF-8800 - Professional 8 Channel UHF Wireless Microphone System

- 8 XLR Microphone Outputs w/8 Handheld mics included
- 8 Independent Field-Replaceable Modules
- Individual Volume & Squelch Controls
- Aluminum Carrying Case Included



UHF-8900 - 8 Channel UHF PLL Wireless Handheld Mic System with Frequency Scan

- 8 UHF PLL Wireless Microphones
- 8 Balanced XLR Outputs & 2-1/4" Unbalanced Mixed Outs
- Frequency Scan-Finds Interference-free Channels
- Bodypack Mics Available - Sold Separately

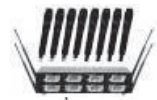

UHF-18 Single Channel UHF Wireless Mic System - Ever find yourself thinking "if only I had one more wireless mic," or wanting to add a wireless mic to a non-wireless system? Now you can, thanks to the UHF-18 from VocoPro.

- Can Be Used as a Plug-In Device or Independently
- UHF Antenna Connects Securely with BNC Plug





Silent PA SYSTEMS

SilentPA-SOLO -16CH UHF Wireless Audio Broadcast System (Stationary Transmitter with 1-bodypack receiver) - Have you ever tried to use a PA system in a place with strict sound restrictions? Or want to do a voice presentation to a group of people in a place with loud background noise? Or offer those that might have hearing problems hear the presentation more clearly? Now you can speak or perform to an unlimited number of people and be heard loud and clear, without disturbing others, with VocoPro's new wireless audio broadcast system, the SilentPA™.

- Bodypack Receiver Has Two Dedicated Audio Outputs
- Stationary Transmitter Equipped with Mixing Function to Combine Microphone And Music Signals
- Bodypack Transmitter/Receiver Powered by two (2x) AA, Alkaline OR rechargeable, Batteries
- Internal Recharge Circuit Allows Simultaneous Operation and Charging of Rechargeable Batteries on both Bodypack Transmitter & Receiver

Also available with 4 beltpack receivers as the SilentPA-PRACTICE and with 10 beltpack receivers as the SilentPA-Seminar10



SilentPA-PORTABLE -16CH UHF Wireless Audio Broadcast System (Bodypack Transmitter with one bodypack receiver) - this system is similar to the SilentPA-SOLO, except it includes a portable transmitter rather than a fixed receiver for more portability. Can fulfill all the same functions as the other system but allows for ease of movement and can be used as a tour system or portable interpretation system.

- Includes SILENT-PA-TX and one SILENT-PA-RX (Does not include headphones)
- Bodypack Transmitter/Receiver Powered by two (2x) regular AA or rechargeable batteries

Also available with 10 bodypack receivers as the SilentPA-Tour10.



KARAOKE SYSTEMS

TabletOke-II - Digital Karaoke Mixer with Wireless Mics and Bluetooth Receiver

- Two Wireless Microphones Operate in The License-Free 2.4GHz Band For Reliable Transmission
- New Vocal Eliminator Function to Reduce Vocals on Non-Karaoke Tracks
- MPX Function Removes Vocals on Songs With Multi Audio Tracks
- LED Display Shows Volume And Microphone Effect Levels
- Use Your Tablet or Smart Device as the Display Monitor for Karaoke Lyrics



TabletOke-2MC - Digital Karaoke Mixer with Wireless Mics and Professional Tablet Stand

- Same as above but includes a professional tablet/mic stand



SmartTVOke - Karaoke Mixer with Digital Input and Wireless Microphones - If you own a smart TV, it likely has karaoke capability. It could be a dedicated karaoke app like Karaoke Channel™, or Red Karaoke™, or even choose from thousands of karaoke tracks on YouTube. You're just one step way from hosting a great karaoke party and that's VocoPro's new SmartTVOke! It's the quick solution to incorporate karaoke into your speaker set up at home. Simply connect the SmartTVOke in between your TV and stereo system and you're ready to rock on for hours of karaoke fun.



VHF WIRELESS MICROPHONE SYSTEMS

VHF-4000 - Professional Quad VHF Wireless Handheld Microphone System

- Each Mic has Independent Volume Control
- Mics Use 2-AA Batteries
- 4 Balanced XLR Outputs & 1- 1/4" Mixed Output
- Optional Headset Bodypacks Available



VHF-4005 - Professional Quad VHF Wireless Microphone System w/Rechargeable Handheld Mics

- Each Mic has Independent Volume Control
- Mics Use 2-AA Rechargeable Batteries - Included
- 4 Balanced XLR Outputs & 1- 1/4" Mixed Output
- Includes 2 Dual Microphone Charging Docks
- Optional Headset Bodypacks Available



RECORDERS & PLAYERS

SDR-4000 Dual Digital USB/SD Audio Recorder

- Records 192 kbps audio files directly to SD card or USB drive via line in jacks or XLR jacks
- Compatible with SD/SDHC cards and USB drives up to 32GB • Individual record level controls with LED's
- Dual recorder design allows for independent recording/playback on each side



DVX-668K - Multi-Format USB/DVD/CD+G Player

- Multi-format disc player reads DVD, CD, CD+G, Mp3, HDCD, and VCD
- USB Flash Drive playback
- 5.1 channel digital surround sound
- 2 - 1/4" Mic input channels w/individual VC's
- Full-function remote control



WEST PENN WIRE



AV, SECURITY & NETWORKING SOLUTIONS

Since 1971

West Penn Wire designs and manufactures wires, cables, harnesses and related products for small, mid-size and Fortune 500 companies worldwide, as well as for higher education, healthcare and government organizations, and houses of worship.

Our design, engineering and manufacturing excellence enable customers to obtain solutions that meet the most demanding requirements for audio, video, security and networking applications.

PRODUCTS



NETWORKING PRODUCTS

- Networking Cables
 - Cat5E, Cat6, Cat6A
 - Optical Fibers
- Networking Connectors & Accessories
- 25 year Networking Warranty
- Fiber Optic Connectors & Accessories



PRO AUDIO/VIDEO PRODUCTS

- Digital Video Cables
 - HDBaseT - Cat6 F/UTP and Cat6A F/UTP
 - IPBaseT - Cat6A UTP
 - HD-SDI Coaxial Cables
- Digital Video Connectors & Accessories
- Pro Audio Cables
 - Line Level Audio Cables
 - Wireless Mic Audio Cables
 - Speaker Cables



SECURITY PRODUCTS

- Fire Alarm Cables
- IP CCTV Cables
 - Cat5E, Cat6, Optical Fibers
- Access Control Cables
- Security Cable Connectors & Accessories

WI-FI PRODUCTS

Hearing HotSpot™ is an innovative, new listening technology that allows any venue to stream real-time audio via Wi-Fi from TVs, music sources or live programs directly to an individual's personal smartphone or tablet.



HHS 108 BAI Includes an eight-channel Wi-Fi server and a single, wireless access point — together capable of streaming eight channels of real-time audio directly to smart phones and tablets through the free Hearing HotSpot app. Turns your Android or iOS hand-held device into a wireless receiver. Serves as its own SSID and can serve up to 250 connected users. Covers up to 70,000 square feet, depending upon placement and construction materials. System activation and venue information required for system start-up. Custom configurations are available. No subscription or license fees. Three-year activation fee required.



DIGITAL PRODUCTS

Digi-Wave™ 300 Series is a portable, digital communication technology featuring full-duplex capability. Now supports up to four simultaneous talkers in two-way mode and up to six simultaneous talkers in intercom mode.

- Sleek, lightweight design · Accommodates multiple listeners/multiple speakers · 2.4 GHz operation – legal for use in most countries · Patented, interference-reduction technology for seamless, secure operation · Rechargeable — full day on a single charge · Multiple accessories available · Fulfills ADA/DDA accessibility requirements

DWS COM 6 300 — Digi-Wave™ Wireless Intercom System

System Includes: (6) DLT 300 transceivers, (6) MIC 044 2P headset microphones, (1) CCS 030 DW heavy-duty system carry case, (1) CCS 044 GR silicone skin, (6) CCS 044 BK silicone skins



FM PRODUCTS

The **PPA T45 transmitter** features multiple digital audio input options, and an OLED display with easy-to-manage menu navigation. Features three powerful microprocessors and the same high-quality audio and RF performance you've come to expect from Williams Sound. Ideal for large venues where superior coverage is essential. ADA compliant.

PPA 458 PRO — PPA® Pro FM Assistive Listening System

System Includes: (1) PPA T45 transmitter, (4) PPA R38 receivers, (2) NKL 001 neckloops, (4) EAR 022 surround earphones, (1) ANT 025 whip antenna, (1) TFP 048 power supply, (1) WLC 004 main power cord (U.S.), (1) WCA 013 RCA audio cable, (4) BAT 001-2 AA alkaline batteries, (1) IDP 008 wall plaque, (1) ANT 005 coaxial antenna, (1) RPK 005 rack panel kit.



PPA 457 PRO — PPA® Pro FM Assistive Listening System

System Includes: (1) PPA T45 transmitter, (4) PPA R37 receivers, (2) NKL 001 neckloops, (4) EAR 013 single mini earbuds, (1) ANT 025 whip antenna, (1) TFP 048 power supply, (1) WLC 004 main power cord (U.S.), (1) WCA 013 RCA audio cable, (4) BAT 001-2 AA alkaline batteries, (1) IDP 008 wall plaque, (1) ANT 005 coaxial antenna, (1) RPK 005 rack panel kit.

FM ADA KIT 1 — Large-area Value Kit

Includes: (1) PPA T27 transmitter, (2) PPA R37 receivers, (2) BAT 001-2 AA alkaline batteries, (2) EAR 013 single mini earbuds, (2) NKL 001 neckloops, (1) IDP 008 ADA wall plaque, (1) ANT 021 antenna, (1) TFP 036 power supply.

LOOP PRODUCTS

Induction loop drivers for any size space. Call for configuration and free design services. Integration required.

INFRARED PRODUCTS

WIR SYS 7522 PRO — Mid-Range Infrared

System Includes: (1) WIR TX75 PRO infrared transmitter, (3) WIR RX22-4 four-channel selectable, infrared receivers, (3) HED 021 folding headphones, (2) NKL 001 neckloops, (3) BAT 001-2 AA alkaline batteries, (1) IDP 008 ADA wall plaque, (1) BKT 024 wall/ceiling mounting bracket, (1) TFP 046 international power supply with WLC 004 AC line cord (U.S.)



WIR SYS 1 — SoundPlus® Pro Courtroom System

Includes: (1) MOD 232 modulator (with TFP 016 110VAC/24VAC power supply) (1) **New!** WIR TX9 DC emitter (with TFP 053 U.S. DC power supply) — available in black or white, (1) BKT 024 wall/ceiling mount, (4) WIR RX22-4 receivers, (4) HED 021 headphones, (2) NKL 001 neckloops, (1) RPK 005 rack mount kit, (8) BAT 001 AA alkaline batteries, (1) IDP 008 ADA wall plaque.

For the past forty years Xantech has been associated with many of the control innovations that made the audio/video entertainment revolution possible, earning it a place at the forefront of the A/V industry.

LCD/CFL Proof IR Rx Kits

All kits have a standard range of up to 80 feet; works with LED, LCD & plasma TV's & CFL lighting and works with all types of cable boxes, satellite boxes, remote controls & TVs

DL85K - LCD/CFL Proof Dinky Link IR Receiver Kit

Includes: 1-DL85 IR receiver; 1-Model 789-44 connecting block; 1-12VDC regulated power supply; 4-Blink-IR™ Designer emitters; 1-Trim kit to match white, silver and black AV components

HL85K - LCD/CFL Hidden Link (HL85BK, HL85SK & HL85WK)

Includes: 1-HL85 IR receiver; 1-Model 789-44 connecting block; 1-12VDC regulated power supply; 4-Blink-IR™ Designer emitters

ML85K - LCD/CFL Proof Micro Link IR Receiver

Includes: 1-ML85 IR receiver; 1-Model 789-44 connecting block; 1-12VDC regulated power supply; 4-Blink-IR™ Designer emitters; 1-Trim kit with white, black, and brass bezels



IR Emitters

- 282D Standard High Output Designer Emitter - Available in Single, 5 Pack & 10 Pack
- 282TPD Designer Emitter With Twin Plug
- 283D Visible Designer Emitter - Available in Single, 5 Pack & 10 Pack
- 283DMW Visible Designer Emitter With Mini Wire
- 283DPRO Professional Designer Visible Emitter
- 283DPROKIT Professional Visible Emitter Kit
- 283TPD Visible Designer Emitter With Twin Plug
- 284D Dual Designer Emitter - Available in Single, 5 Pack & 10 Pack
- 286D Dual Visible Designer Emitter - Available in Single, 5 Pack & 10 Pack
- 28DES Designer Emitter Shield Cover
- 38020 J-Box IR Blaster

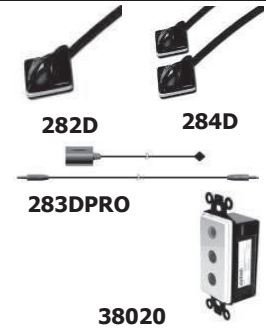

Connecting Blocks

- 78944 One Zone Four Source Connecting Block
- 78944CB5P One Zone Four Source Connecting Block Five Pack
- 78944DI Ivory Single Zone In-Wall Decora Style Connecting Block
- 78944DW White Single Zone In-Wall Decora Style Connecting Block
- 78944PSRP One Zone Four Source Connecting Block Including Power supply
- 79000 Multiple Emitter Connecting Block
- 79144 One Zone Ten Source Amplified Connecting Block
- 79210 Phantom Power Module for IR Receives
- 79310 Serial Control Combiner
- 79410 3.5mm stereo mini plug Interface Module
- 79450 RCA-type phone plug Interface Module
- 79520 Four Zone Ten Source Amplified Connecting Block
- 79620 Six Zone Connecting Block/Expander
- CB12 One Zone One Source Connecting Block
- CB18 "The Strip-IR" Parallel Connecting Block
- CB20 One Zone Two Source Connecting Block
- CB60 One Zone Six Source Quick Connect Connecting Block
- XLIP200 IP-IR Connecting Block
- XLIP232 IP-RS232 Connecting Block
- ZC21 Two Zone Connecting Block

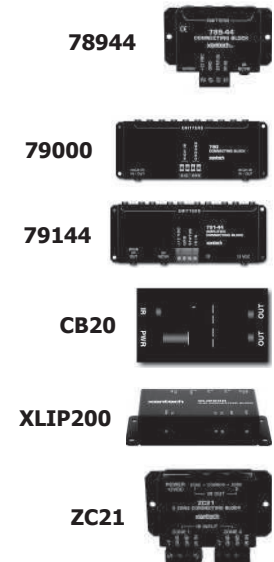

Power Supplies

- 781ERGPS Regulated Power Supply - Comes Single or in 5 Packs or 10 Packs
- 782ERGPS High Current Regulated Power Supply



BAI Sells the entire range of Xantech Products! Call for a Complete Listing.

HOW TO ORDER:

Call us Toll Free at **1-888-224-3446** Or Call (352) 732-7009 Monday – Friday: 8:00 AM – 5:00 PM EST. Fax Orders to (352) 732-1616. You may also Order Online through: sales@baionline.com or via our Online Dealer Store at www.baionline.com (password required). Prices quoted are cash/terms prices. Any other form of payment will be at a different cost. BAI reserves the right to refuse any order. Minimum order is \$25.00. Orders placed for less than the minimum will be assessed a \$7.50 Handling Charge. Buyer must have a current annual resale certificate on file with BAI Distributors, Inc. prior to shipment. All order cancellations must be made in writing. No 'verbal' cancellations will be considered valid. Non-stock or special order items that are in transit may not be cancelled under any circumstance. Any associated factory restock fees will be passed along to the customer. It is the dealer's responsibility to review all order confirmations for accuracy. Failure to do so might cause shipping and/or pricing errors to occur that will become the dealer's responsibility.

BAI is a wholesale only distributor and does not sell to the end user.

TERMS:

All invoices are payable in U.S. Dollars. Terms of sale are C.O.D., C.I.A. Bank Transfer or Net 30 terms (pending approval of completed credit application.) Payment on account must be received within the terms given. Without prejudice to all or any other rights and remedies of the Company, any delinquent account could be changed to C.O.D. status until account is current. BAI reserves the right to not ship orders to delinquent accounts. All BAI customers agree and hereby unconditionally and irrevocably, jointly and severally guarantee to BAI, the full, prompt and complete payment of any and all indebtedness to BAI. The customer understands and agrees that any product purchased from BAI remains the property of BAI until said time that the customer pays in full for said product. If default occurs, BAI has the right to re-claim said property with any means available and at the cost of the customer or may choose to proceed with collection activity which might include legal action.

Default: Any account that becomes past due will be charged a finance charge at the maximum rate permitted by law, currently 1.5% per month. If default in payment occurs and account is turned over for collection, customer agrees to pay all costs of collection to include reasonable attorney's fees and any other fees and charges including collection fees. A service charge, currently \$40.00 will be charged on any check(s) returned due to NSF (non-sufficient funds), or for any other reason. Any account having one check returned NSF may be shipped CIA or COD – Certified Check or Money Order Only for any future orders placed through BAI Distributors, Inc.

Pricing: The Price(s) quoted and viewed on our web site may be based on prices in effect at the time of quoting and/or viewing, and therefore may not be the same as the price(s) on your order if placed at a different time. It is the responsibility of the buyer to confirm price(s) at the time the order is placed. Pricing does not include shipping, handling and insurance. All prices quoted and/or viewed on our dealer store are based on Net 30 or COD terms; any other method of payment might be a different price.

FREIGHT: All orders are shipped FOB Ocala, Florida for in-stock items. Non-stock items will be FOB shipping point. If product must be brought into BAI warehouses before shipping, freight will be FOB factory plus shipping to your location. Any delivery dates given by the Company indicate estimated delivery times and shall not amount to any contractual obligation to deliver at the time stated. BAI Distributors, Inc. does not accept liability for direct or consequential loss/damage arising from any delays in delivery. BAI Distributors, Inc. will not be liable for expedited freight due to factory delays. All shipping, billing or pricing errors must be reported to BAI within 7 days of receipt of shipment; NO EXCEPTIONS.

Loss Or Damage In Transit: BAI Distributors, Inc. will carefully pack and inspect all orders before shipment. However, our responsibility ends when the respective carrier issues its receipt of the shipment from us. All claims are the responsibility of the consignee; BAI Distributors, Inc. will not file claims on consignee's behalf. We recommend that you promptly open the carton(s) and inspect the shipment upon its delivery to you. If any product is missing or damaged, make notations to that effect on both the carrier's and your copies of the freight bill and delivery receipt. If you discover damages after delivery, immediately report the damage to the carrier and request an inspection. The length of time allowed to report concealed loss or damage varies in different sections of the country and with different carriers, but in many instances it is less than 15 days after delivery. Published carrier rules should be read carefully. The carton and packing materials, as well as the damaged products should be held for inspection. You will also be required to file a written claim with the carrier within three (3) months of the date of delivery. BAI Distributors, Inc. will not accept return of merchandise damaged in transit.

RETURN POLICY: A return merchandise authorization (RMA) number must be obtained from our customer service team prior to return. This number must be marked on all documents related to the return, as well as clearly visible on the outside of any package(s) being returned. All material must be returned within thirty (30) days after authorization is received. Products must be new, unaltered, in original cartons and in re-saleable condition. Return freight is to be prepaid by the customer, unless otherwise authorized in advance. Product must be standard catalog items. Merchandise that is custom ordered, non-standard, or obsolete is not returnable for credit. Credit will be issued at the price(s) originally invoiced or at the current selling price and will be given in the form of a Credit Memo and not cash. All returns are subject to inspection of quality and count. No credit will be authorized or implied until BAI Distributors, Inc. or the manufacturer performs an evaluation. The invoice value of the product to be returned must be no less than \$50.00 to qualify for an accommodation return. Refused shipments will be charged a 25% restock fee plus all applicable shipping charges. A refused shipment will cause the customer to lose account terms with BAI Distributors Inc. **Sale of closeout and special order items is final; NO EXCEPTIONS.**
Flat Panel Displays, Duplication Equipment, Projectors, Bulbs or Screens may not be returned for any reason.

Warranty: All manufacturers' warranties apply. BAI Distributors, Inc. will provide advance replacements for out of carton failures for 30 days from date of shipment if inventory is available. After thirty (30) days, customer must return units to respective factory for necessary repairs or replacement. BAI Distributors, Inc. accepts no responsibility for factory warranties or repairs after thirty (30) days.

2312 N.E. 29TH AVENUE
OCALA, FL 34470

PRESORTED
STANDARD
U.S. POSTAGE
PAID
OCALA, FL
PERMIT #100

TOLL FREE: 1 (888) 224-3446

LOCAL: (352) 732-7009

FAX: (352) 732-1616

WWW.BAIONLINE.COM



AND MANY MORE!