



BACKER STANDARD PRODUCTS

INTELLIGENT HEATING & CONTROL

WELCOME TO BACKER BHV AB

- OUR RESOURCES SOLVE YOUR HEATING DEMANDS -

Our value added heating products together with our measurement and control devices offer our customers complete solutions. Bring us an idea or a problem and we will guide you to an optimal resolution. Our engineers will not only present answers, but they are able to take charge of the entire product development and testing process by utilizing our advanced technical tools and lab facilities. Our extensive experience and competence as well as our reliable quality and service guarantees your success. Our ambition is to not only be a supplier, but your preferred partner.

Together we can make it happen!



Stock-kept articles can be sent from
Backer within 24 h after order

EXAMPLES OF CUSTOMIZED SOLUTIONS

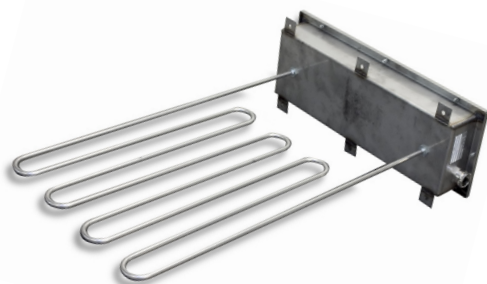
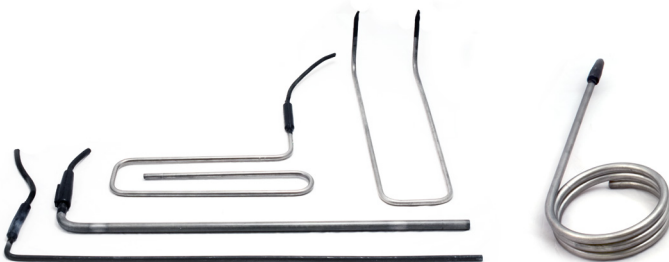
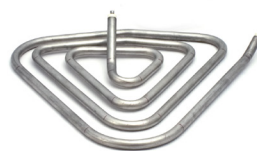
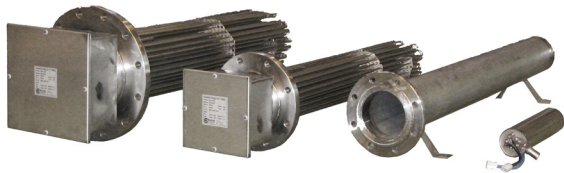

CONTENTS

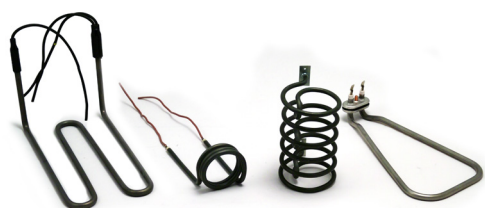

Tubular heating elements..... 6
 Defrosting elements..... 10
 PTC Elements..... 11
 Bending examples..... 12
 Fixing devices and connectors..... 13



Liquid heating..... 17
 Water -, oil -, and hydraulic heating..... 18
 Accessories 20
 Immersion heaters..... 21
 Cast-in elements..... 23
 Barrel heaters..... 24
 Flow through heaters..... 29

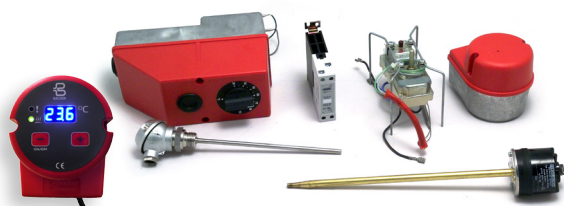

Temperature control/measurement
 and terminal boxes..... 30
 Terminal boxes..... 31
 Thermostats/thermal cut-offs..... 32
 Regulators and sensors..... 36



Contact - and tool heating..... 39
 Cartridge heaters..... 40
 Nozzle elements..... 58
 Ring - and band elements..... 60
 Foil elements 61
 Compressor and crank case heaters..... 63



Radiant - and air heating..... 65
 IR-elements. 66
 Cabinet heaters..... 84
 Elements in aluminium profiles..... 86
 PTC-heating elements..... 89

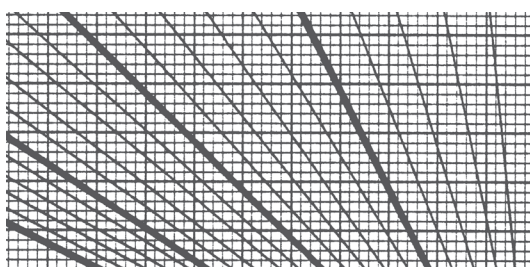

Technical information 89

TUBULAR HEATING ELEMENTS

The following heating elements are kept in stock, semi-finished, in small quantities for quick deliveries. See the following pages for examples of possible ways to design the heating

element, fixing devices and connections. Elements with other dimensions, power, voltage, etc, are produced according to customer specification.

Type 6N 4,5									
TYPE	ARTICLE NO.	TUBE Ø	MATERIAL	VOLTAGE V	POWER W	LENGTH	SURFACE LOAD	COLD PART	
6N4,5	2040 595 001	6.4	EN 1.4828	230	250	400	4.44	60	
6N4,5	2040 595 005	6.4	EN 1.4828	230	1000	1230	4.48	60	
6N4,5	2040 595 006	6.4	EN 1.4828	230	1500	1780	4.50	60	

Type 9NL									
TYPE	ARTICLE NO.	TUBE Ø	MATERIAL	VOLTAGE V	POWER W	LENGTH	SURFACE LOAD	COLD PART	
9NL	2040 558 201	8.5	EN 1.4541	230	75	900	0.40	100	
9NL	2040 558 206	8.5	EN 1.4541	230	125	2000	0.26	100	
9NL	2040 558 205	8.5	EN 1.4541	230	175	2500	0.29	100	

Type 9NL									
TYPE	ARTICLE NO.	TUBE Ø	MATERIAL	VOLTAGE V	POWER W	LENGTH	SURFACE LOAD	COLD PART	
9NF	2040 558 301	8.5	EN 1.4541	230	1000	2930	1.37	100	
9NF	2040 558 302	8.5	EN 1.4541	230	1000	3430	1.16	100	
9NF	2040 558 303	8.5	EN 1.4541	400	1000	2930	1.37	100	
9NF	2040 558 304	8.5	EN 1.4541	400	1000	3430	1.16	100	
9NF	2040 558 305	8.5	EN 1.4541	440	1000	2930	1.37	100	
9NF	2040 558 306	8.5	EN 1.4541	440	1000	3430	1.16	100	

CONT. TUBULAR HEATING ELEMENTS

Type 9ND 6

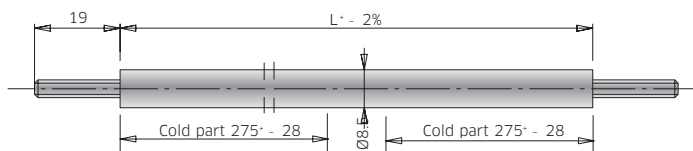

TYPE	ARTICLE NO.	TUBE Ø	MATERIAL	VOLTAGE V	POWER W	LENGTH	SURFACE LOAD	COLD PART
9ND6	2040 634 401	8.5	EN 1.4404	230	1000	1160	6.14	275
9ND6	2040 634 402	8.5	EN 1.4404	230	1500	1450	6.24	275
9ND6	2040 634 403	8.5	EN 1.4404	230	2000	1750	6.24	275
9ND6	2040 634 404	8.5	EN 1.4404	230	2500	2040	6.29	275
9ND6	2040 634 405	8.5	EN 1.4404	230	3000	2340	6.28	275
9ND6	2040 634 413	8.5	EN 1.4404	230	4000	2930	6.30	275
9ND6	2040 634 406	8.5	EN 1.4404	230	4500	3220	6.31	275
9ND6	2040 634 407	8.5	EN 1.4404	400	1000	1160	6.14	275
9ND6	2040 634 408	8.5	EN 1.4404	400	1500	1450	6.24	275
9ND6	2040 634 409	8.5	EN 1.4404	400	2000	1750	6.24	275
9ND6	2040 634 410	8.5	EN 1.4404	400	2500	2040	6.29	275
9ND6	2040 634 411	8.5	EN 1.4404	400	3000	2340	6.28	275
9ND6	2040 634 414	8.5	EN 1.4404	400	4000	2930	6.30	275
9ND6	2040 634 412	8.5	EN 1.4404	400	4500	3220	6.31	275

Type 9N 2,3

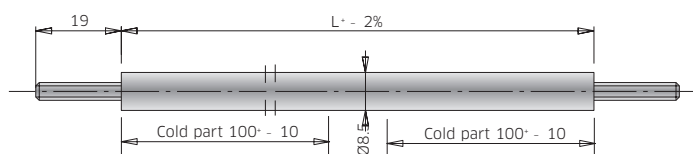

TYPE	ARTICLE NO.	TUBE Ø	MATERIAL	VOLTAGE V	POWER W	LENGTH	SURFACE LOAD	COLD PART
9N2,3	2040 558 432	8.5	EN 1.4404	230	330	760	2.21	100
9N2,3	2040 558 401	8.5	EN 1.4404	230	500	900	2.68	100
9N2,3	2040 558 402	8.5	EN 1.4404	230	670	1210	2.49	100
9N2,3	2040 558 403	8.5	EN 1.4404	230	1000	1600	2.68	100
9N2,3	2040 558 404	8.5	EN 1.4404	230	1330	2000	2.77	100
9N2,3	2040 558 405	8.5	EN 1.4404	230	1500	2250	2.74	100
9N2,3	2040 558 406	8.5	EN 1.4404	230	1670	2500	2.72	100
9N2,3	2040 558 407	8.5	EN 1.4404	230	1800	2765	2.63	100
9N2,3	2040 558 408	8.5	EN 1.4404	230	2000	2950	2.72	100
9N2,3	2040 558 425	8.5	EN 1.4404	230	2330	3200	2.91	100
9N2,3	2040 558 428	8.5	EN 1.4404	230	2500	3665	2.70	100
9N2,3	2040 558 433	8.5	EN 1.4404	400	330	760	2.21	100
9N2,3	2040 558 417	8.5	EN 1.4404	400	500	900	2.68	100
9N2,3	2040 558 418	8.5	EN 1.4404	400	670	1210	2.49	100
9N2,3	2040 558 419	8.5	EN 1.4404	400	1000	1600	2.68	100
9N2,3	2040 558 420	8.5	EN 1.4404	400	1330	2000	2.77	100
9N2,3	2040 558 421	8.5	EN 1.4404	400	1500	2250	2.74	100
9N2,3	2040 558 422	8.5	EN 1.4404	400	1670	2500	2.72	100
9N2,3	2040 558 423	8.5	EN 1.4404	400	1800	2765	2.63	100
9N2,3	2040 558 424	8.5	EN 1.4404	400	2000	2950	2.72	100
9N2,3	2040 558 427	8.5	EN 1.4404	400	2330	3200	2.91	100
9N2,3	2040 558 409	8.5	EN 1.4404	290	500	900	2.68	100
9N2,3	2040 558 410	8.5	EN 1.4404	290	670	1210	2.49	100
9N2,3	2040 558 411	8.5	EN 1.4404	290	1000	1600	2.68	100
9N2,3	2040 558 412	8.5	EN 1.4404	290	1330	2000	2.77	100
9N2,3	2040 558 413	8.5	EN 1.4404	290	1500	2250	2.74	100
9N2,3	2040 558 414	8.5	EN 1.4404	290	1670	2500	2.44	100
9N2,3	2040 558 415	8.5	EN 1.4404	290	1800	2765	2.45	100
9N2,3	2040 558 416	8.5	EN 1.4404	290	2000	2950	2.50	100
9N2,3	2040 558 426	8.5	EN 1.4404	290	2330	3200	2.91	100

CONT. TUBULAR HEATING ELEMENTS

Type 9N 3,5

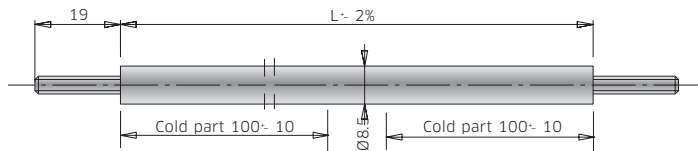

TYPE	ARTICLE NO.	TUBE Ø	MATERIAL	VOLTAGE V	POWER W	LENGTH	SURFACE LOAD	COLD PART
9N3,5	2040 558 501	8.5	EN 1.4404	230	500	705	3.71	100
9N3,5	2040 558 502	8.5	EN 1.4404	230	1000	1210	3.71	100
9N3,5	2040 558 503	8.5	EN 1.4404	230	1330	1540	3.72	100
9N3,5	2040 558 504	8.5	EN 1.4404	230	1500	1700	3.75	100
9N3,5	2040 558 505	8.5	EN 1.4404	230	1670	1880	3.72	100
9N3,5	2040 558 506	8.5	EN 1.4404	230	2000	2220	3.71	100
9N3,5	2040 558 507	8.5	EN 1.4404	230	2500	2725	3.71	100
9N3,5	2040 558 508	8.5	EN 1.4404	230	3000	3230	3.71	100
9N3,5	2040 558 509	8.5	EN 1.4404	400	500	705	3.71	100
9N3,5	2040 558 510	8.5	EN 1.4404	400	1000	1210	3.71	100
9N3,5	2040 558 511	8.5	EN 1.4404	400	1330	1540	3.72	100
9N3,5	2040 558 512	8.5	EN 1.4404	400	1500	1700	3.75	100
9N3,5	2040 558 513	8.5	EN 1.4404	400	1670	1880	3.72	100
9N3,5	2040 558 514	8.5	EN 1.4404	400	2000	2220	3.71	100
9N3,5	2040 558 515	8.5	EN 1.4404	400	2500	2725	3.71	100
9N3,5	2040 558 516	8.5	EN 1.4404	400	3000	3230	3.71	100

Type 9N 5,5

TYPE	ARTICLE NO.	TUBE Ø	MATERIAL	VOLTAGE V	POWER W	LENGTH	SURFACE LOAD	COLD PART
9N5,5	2040 558 601	8.5	EN 1.4828	230	500	525	5.76	100
9N5,5	2040 558 602	8.5	EN 1.4828	230	1000	850	5.76	100
9N5,5	2040 558 603	8.5	EN 1.4828	230	1500	1175	5.76	100
9N5,5	2040 558 604	8.5	EN 1.4828	230	1670	1300	5.69	100
9N5,5	2040 558 605	8.5	EN 1.4828	230	2000	1500	5.76	100
9N5,5	2040 558 606	8.5	EN 1.4828	230	3000	2125	5.84	100
9N5,5	2040 558 615	8.5	EN 1.4828	230	4000	2785	5.80	100
9N5,5	2040 558 607	8.5	EN 1.4828	230	4500	3100	5.81	100
9N5,5	2040 558 609	8.5	EN 1.4828	400	1000	850	5.76	100
9N5,5	2040 558 610	8.5	EN 1.4828	400	1500	1175	5.76	100
9N5,5	2040 558 611	8.5	EN 1.4828	400	1670	1300	5.69	100
9N5,5	2040 558 612	8.5	EN 1.4828	400	2000	1500	5.76	100
9N5,5	2040 558 613	8.5	EN 1.4828	400	3000	2125	5.84	100
9N5,5	2040 558 616	8.5	EN 1.4828	400	4000	2785	5.80	100
9N5,5	2040 558 614	8.5	EN 1.4828	400	4500	3100	5.81	100

CONT. TUBULAR HEATING ELEMENTS

Type 14RV								
TYPE	ARTICLE NO.	TUBE Ø	MATERIAL	VOLTAGE V	POWER W	LENGTH	SURFACE LOAD	COLD PART
14RV	2040 558 915	14.0	EN 1.4541	230	400	158	10.34	35
14RV	2040 558 916	14.0	EN 1.4541	230	550	208	7.23	35
14RV	2040 558 901	14.0	EN 1.4541	230	325	258	3.32	35
14RV	2040 558 908	14.0	EN 1.4541	230	650	258	6.63	35
14RV	2040 558 902	14.0	EN 1.4541	230	400	308	3.33	35
14RV	2040 558 909	14.0	EN 1.4541	230	800	308	6.67	35
14RV	2040 558 903	14.0	EN 1.4541	230	450	358	3.17	35
14RV	2040 558 910	14.0	EN 1.4541	230	900	358	6.34	35
14RV	2040 558 904	14.0	EN 1.4541	230	500	408	3.05	35
14RV	2040 558 911	14.0	EN 1.4541	230	1000	408	6.10	35
14RV	2040 558 905	14.0	EN 1.4541	230	600	458	3.23	35
14RV	2040 558 912	14.0	EN 1.4541	230	1200	458	6.45	35
14RV	2040 558 906	14.0	EN 1.4541	230	650	508	3.13	35
14RV	2040 558 913	14.0	EN 1.4541	230	1300	508	6.25	35
14RV	2040 558 907	14.0	EN 1.4541	230	800	608	3.18	35
14RV	2040 558 914	14.0	EN 1.4541	230	1600	608	6.35	35

Type 14 NF								
TYPE	ARTICLE NO.	TUBE Ø	MATERIAL	VOLTAGE V	POWER W	LENGTH	SURFACE LOAD	COLD PART
14NF	2040 558 801	14.0	EN 1.4404	230	650	430	4.62	110
14NF	2040 558 802	14.0	EN 1.4404	230	750	530	4.06	110
14NF	2040 558 803	14.0	EN 1.4404	230	1000	630	4.37	110
14NF	2040 558 804	14.0	EN 1.4404	230	1000	730	3.67	110
14NF	2040 558 805	14.0	EN 1.4404	230	1250	980	3.27	110
14NF	2040 558 807	14.0	EN 1.4404	230	2000	1480	3.32	110
14NF	2040 558 808	14.0	EN 1.4404	230	2000	1680	2.90	110
14NF	2040 558 809	14.0	EN 1.4404	230	2000	1830	2.65	110
14NF	2040 558 810	14.0	EN 1.4404	230	2000	1930	2.50	110
14NF	2040 558 811	14.0	EN 1.4404	230	2500	2180	2.75	110
14NF	2040 558 812	14.0	EN 1.4404	230	2500	2330	2.56	110
14NF	2040 558 813	14.0	EN 1.4404	230	2500	2580	2.30	110
14NF	2040 558 814	14.0	EN 1.4404	400	650	430	4.62	110
14NF	2040 558 815	14.0	EN 1.4404	400	750	530	4.06	110
14NF	2040 558 816	14.0	EN 1.4404	400	1000	630	4.37	110
14NF	2040 558 817	14.0	EN 1.4404	400	1000	730	3.67	110
14NF	2040 558 818	14.0	EN 1.4404	400	1250	980	3.27	110
14NF	2040 558 820	14.0	EN 1.4404	400	2000	1480	3.32	110
14NF	2040 558 821	14.0	EN 1.4404	400	2000	1680	2.90	110
14NF	2040 558 822	14.0	EN 1.4404	400	2000	1830	2.65	110
14NF	2040 558 823	14.0	EN 1.4404	400	2000	1930	2.50	110
14NF	2040 558 824	14.0	EN 1.4404	400	2500	2180	2.75	110
14NF	2040 558 825	14.0	EN 1.4404	400	2500	2330	2.56	110
14NF	2040 558 826	14.0	EN 1.4404	400	2500	2580	2.30	110
14NF	2040 558 827	14.0	EN 1.4404	400	3000	2830	2.51	110
14NF	2040 558 828	14.0	EN 1.4404	440	650	430	4.62	110
14NF	2040 558 829	14.0	EN 1.4404	440	750	530	4.06	110
14NF	2040 558 830	14.0	EN 1.4404	440	1000	630	4.37	110
14NF	2040 558 831	14.0	EN 1.4404	440	1000	730	3.67	110
14NF	2040 558 832	14.0	EN 1.4404	440	1250	980	3.27	110
14NF	2040 558 834	14.0	EN 1.4404	440	2000	1480	3.32	110
14NF	2040 558 835	14.0	EN 1.4404	440	2000	1680	2.90	110

TUBULAR HEATING ELEMENT FOR DEFROSTING

Examples of applications: Freezing - and cooling equipment, compressors, outdoor use, etc.

Below defrosting elements are kept in stock, semi-finished. Defrosting elements are produced in many designs according to customer specifications.

Defrosting elements type TP

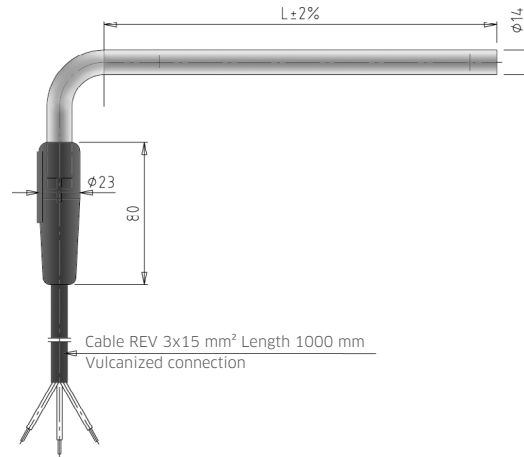

TYPE	POWER W	VOLTAGE V	INSERTION LENGTH mm	ARTICLE NO.
TP 350	650	230	350	2540 619401
TP 450	750	230	450	2540 619402
TP 550	1000	230	550	2540 619403
TP 650	1000	230	650	2540 619404
TP 900	1250	230	900	2540 619405
TP 1400	2000	230	1400	2540 619 407
TP 1600	2000	230	1600	2540 619 408
TP 1750	2000	230	1750	2540 619 409
TP 1850	2000	230	1850	2540 619 410
TP 2100	2500	230	2100	2540 619 411
TP 2250	2500	230	2250	2540 619 412
TP 2500	2500	230	2500	2540 619 413
TP 350	650	400	350	2540 484 701
TP 450	750	400	450	2540 484 702
TP 550	1000	400	550	2540 484 703
TP 650	1000	400	650	2540 484 704
TP 900	1250	400	900	2540 484 705
TP 1400	2000	400	1400	2540 484 707
TP 1600	2000	400	1600	2540 484 708
TP 1750	2000	400	1750	2540 484 709
TP 1850	2000	400	1850	2540 484 710
TP 2100	2500	400	2100	2540 484 711
TP 2250	2500	400	2250	2540 484 712
TP 2500	2500	400	2500	2540 484 713
TP 2750	3000	400	2750	2540 484 714
TP 350	650	440	350	2540 619 501
TP 450	750	440	450	2540 619 502
TP 550	1000	440	550	2540 619 503
TP 650	1000	440	650	2540 619 504
TP 900	1250	440	900	2540 619 505
TP 1400	2000	440	1400	2540 619 507
TP 1600	2000	440	1600	2540 619 508

PTC HEATING ELEMENT 12 MM

Examples of applications: Radiators, towel dryers, evaporation of condensed water, defrosting

The element automatically adjusts its power consumption until it reaches the pre-set desired temperature (curie temp). Thanks to it's self-regulating properties there is no need for overheating protection and temperatureregulation and the same element can be used both for air- and water heating without any risk of overheating.

Tube in EN 1.4404 or EN 1.4301
 Ø 12 mm
 Vulcanized connection with cable 4000 mm
 Voltage: 110-240 V
 Temperature: 50-180°C

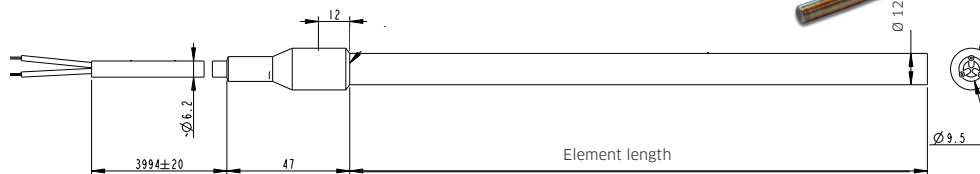

POWER 0°C WATER/AIR 110 V	POWER 0°C WATER/AIR 230V	ELEMENT LENGTH	ARTICLE NO.
100W/15W	140W/15W	121 mm	2550 885 103
160W/20W	30W/20W	171 mm	2550 885 102
205W/25W	330W/25W	221 mm	2550 885 101

In addition to above standard range, unique PTC elements can be produced, e.g. with nipple and cable. Contact us for more information.



EX. OF WAYS TO DESIGN TUBULAR HEATING ELEMENTS

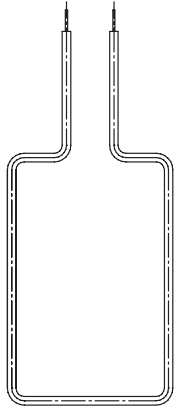

A

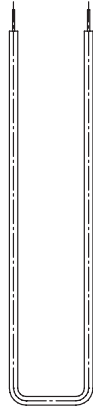

B

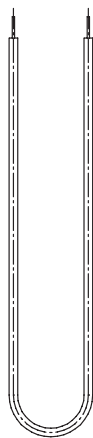

C

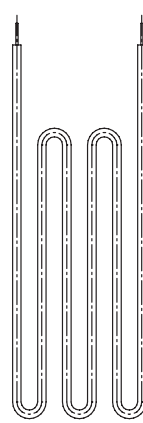

D

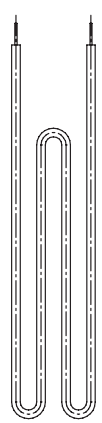

E

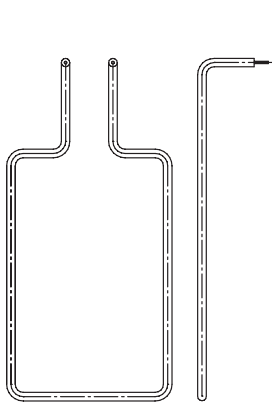

F

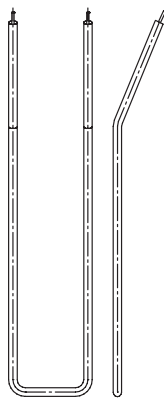

G

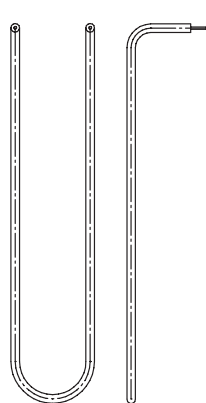

H

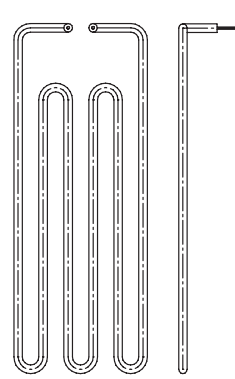

I

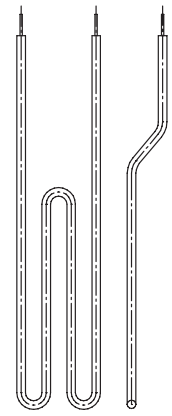

J

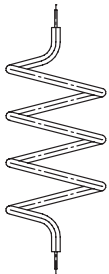

K

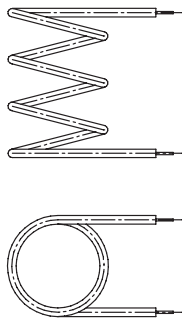

L

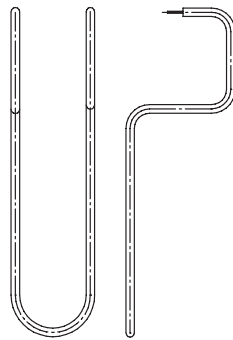

M

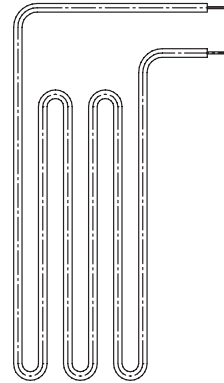

N

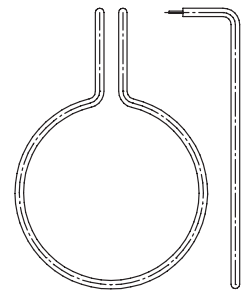

O



P



Q

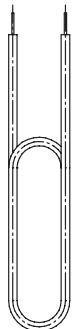

R

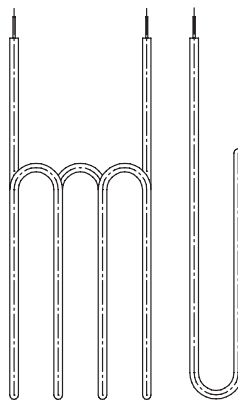

S

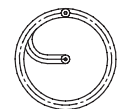

T

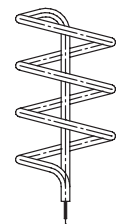

FIXING AND CONNECTING DEVICES

When selecting connecting and fixing devices it is often important to bear in mind the size of the series. In this section we include the most frequent alternatives, which also can be considered as standard.

Cost savings can often be made if elements are fitted with connecting and fixing devices during manufacture. We can also supply special flanges and alternative methods of fixing, completely according to your requirements.

WIRING TYPES

The heating elements may be supplied with connecting wiring which is normally spot welded to the terminal bolts. Uninsulated as well as insulated wiring is available. Uninsulated wiring can be fitted with insulative tubing. The joint between the wiring and the terminal bolt can also be fitted with insulative tubing if required.

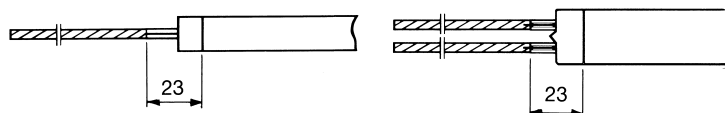

Wiring material	Insulation material	Max. operating temperature (°C)
Copper	-	180
Copper	Silicone	180
Copper	Fiberglass/silicone	180
Nickel	-	400
Nickel	Ceramic bushings	400
Nickel	Fiberglass/silicone	200

VULCANIZED/PLASTIC MOLDED CONNECTION

The heating elements may be vulcanized or molded with plastic together with rubber cable. The temperature of the element ends should not exceed 60°C. This design is suitable for instance at defrosting of refrigerators.

Vulcanized connections

Plastic molded connections

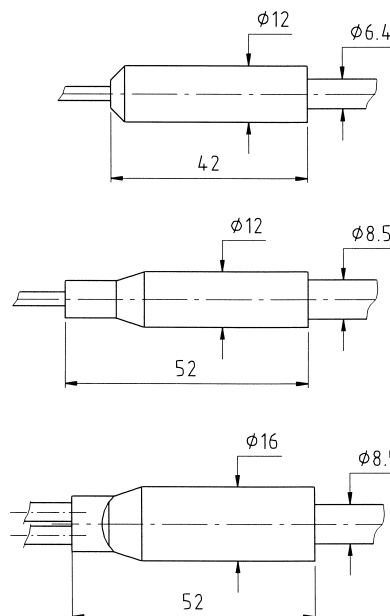
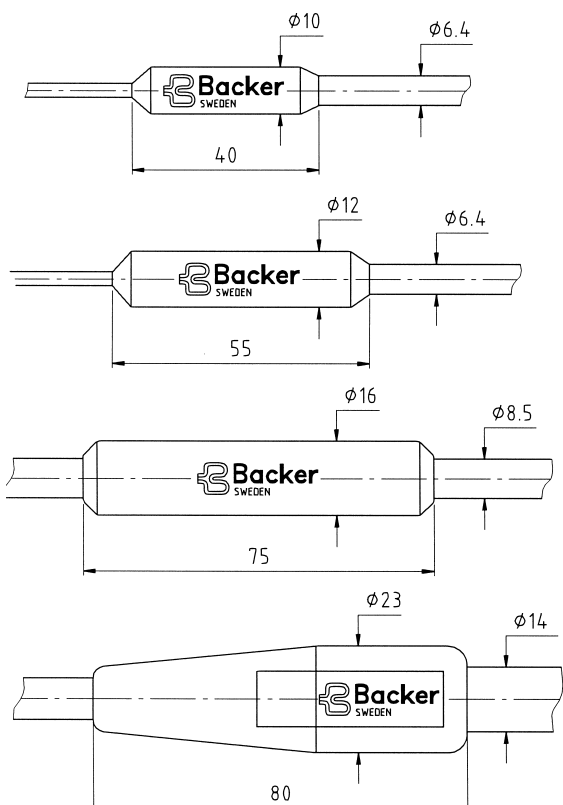

FIXING PLATE PRESSED ON TO THE ELEMENT

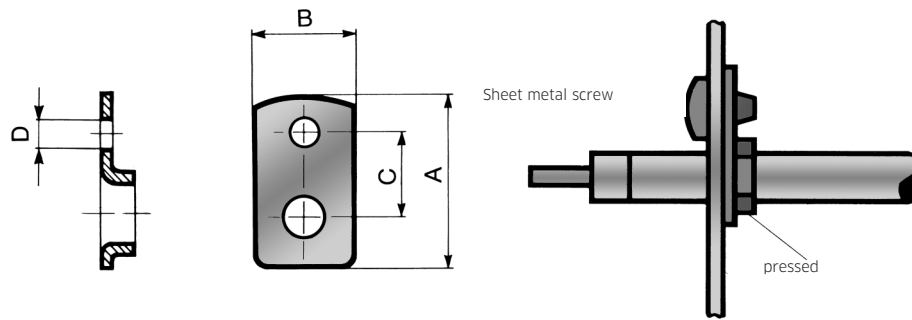

ARTICLE NO.	MATERIAL	A	B	C	D	INTENDED FOR ELEMENT TYPES		
						064	085	140
1140 544 004	steel	25	12	15	3.3	X		
1140 560 401	steel	20	12	9	3.7	X		
1140 519 104	steell	36	15	20	M4		X	
1140 519 105	steel	36	15	20	3.2		X	
1140 563 201	steel	24	15	11	4.2		X	
1140 563 202	steel	24	15	11	3.7		X	
1140 563 203	steel	24	15	11	2.8		X	
1140 458 701	steel	35	20	19	6.0			X
1140 458 703	EN 1.4301	35	20	19	6.0			X

NIPPLE - PRESSED ON TO THE ELEMENT

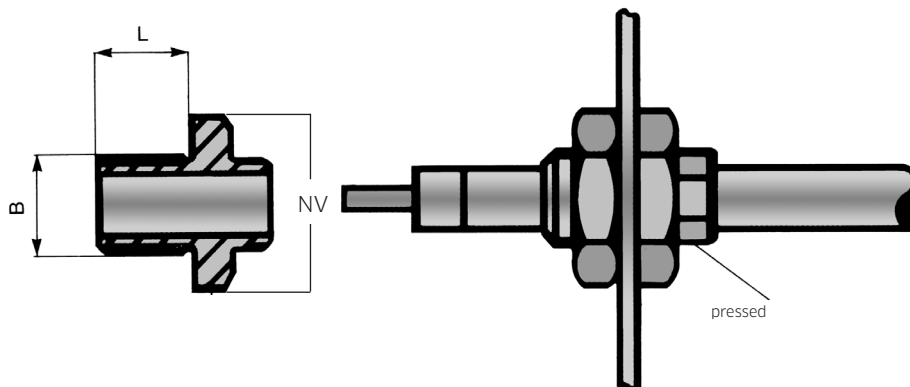

ARTICLE NO.	MATERIAL	THREAD B	THREAD LÄNGD L	NV	INTENDED FOR ELEMENT TYPE		
					064	085	140
1140 580 001	AISI 1213	M 10 x 1	10	16	X		
1140 580 002	AISI 303	M 10 x 1	10	15	X		
1140 580 003	AISI 1213	M 10 x 1	12	16	X		
1140 720 501	C 36000	M 12 x 1	17	17		X	
1140 723 401	AISI 1213	M 14 x 1.5	15	19		X	
1140 723 403	AISI 1213	M 14 x 1.5	25	19		X	
1140 723 404	AISI 1213	M 14 x 1.5	30	19		X	
1140 723 405	AISI 1213	M 14 x 1.5	40	19		X	
1140 723 408	AISI 303	M 14 x 1.5	15	19		X	
1140 723 421	AISI 1213	M 14 x 1.5	10	19		X	
1140 716 701	AISI 1213	M 24 x 1.5	15	Ø 32			X
1140 549 602	AISI 1213	Pr 18.6	15	24			X
1140 549 603	SS 2382	Pr 18.6	15	24			X
1140 597 501	AISI 1213	Pr 22.5	10	24			X

NIPPLE - SOLDERED TO THE ELEMENT

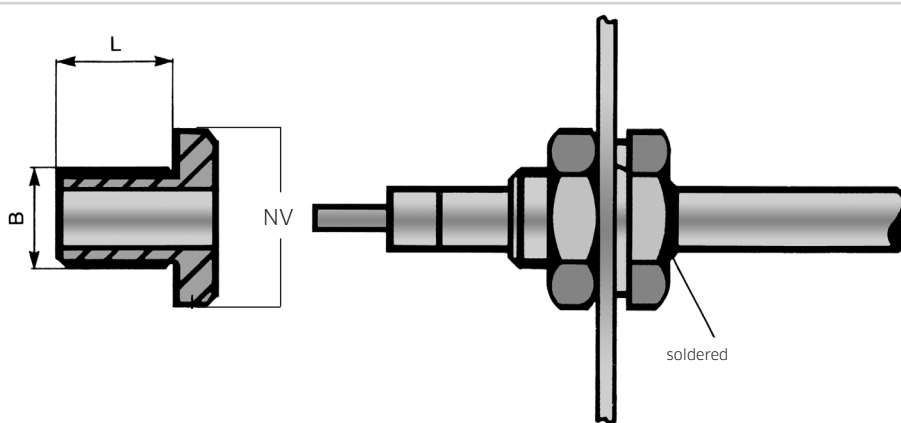

ARTICLE NO.	MATERIAL	THREAD B	THREAD LENGTH L	NV	INTENDED FOR ELEMENT TYPE		
					064	085	140
1140 519 801	C 36000	M 10 x 1	12	17	X		
1140 519 803	AISI 303	M 10 x 1	12	17	X		
1140 536 002	C 36000	M 12 x 1.5	16	18	X		
1140 536 003	AISI 303	M 12 x 1.5	12	17	X		
1140 722 801	C 36000	M 12 x 1	20	17		X	
1140 723 202	SS 1912	M 14 x 1.5	15	19		X	
1140 723 206	SS 1912	M 14 x 1.5	40	19		X	
1140 723 208	AISI 303	M 14 x 1.5	12	19		X	
1140 723 209	AISI 303	M 14 x 1.5	15	19		X	
1140 723 210	AISI 303	M 14 x 1.5	20	19		X	
1140 723 211	AISI 303	M 14 x 1.5	25	19		X	
1140 723 213	AISI 303	M 14 x 1.5	40	19		X	
1140 723 217	C 36000	M 14 x 1.5	12	19		X	
1140 723 218	C 36000	M 14 x 1.5	15	19		X	
1140 723 219	C 36000	M 14 x 1.5	20	19		X	
1140 723 220	C 36000	M 14 x 1.5	25	19		X	
1140 723 221	C 36000	M 14 x 1.5	30	19		X	
1140 723 222	C 36000	M 14 x 1.5	40	19		X	
1140 574 102	C 36000	M 14 x 1.5	10	Ø 18	X		
1140 544 901	C 36000	Pr 18.6	15	26			X
1140 544 903	AISI 303	Pr 18.6	15	27			X
1140 711 501	SS 1912	Pr 18.6	17	Ø 31			X
1140 550 301	C 36000	G1/2"	15	26			X
1140 550 302	AISI 303	G1/2"	15	26			X

ELEMENT HEAD - PIPE THREAD, SOLDERED ELEMENTS

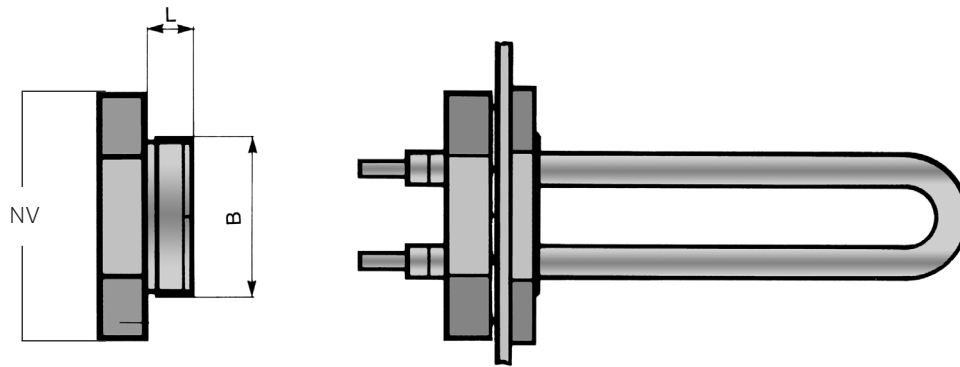

ARTICLE NO.	MATERIAL	THREAD B LENGTH L	THREAD	NV
1140 629 605	C 36000	1"	13	41
1140 514 901	C 36000	1 1/4"	13	57
1140 536 503	AISI 316	1 1/2"	16	57
1140 536 504	SAE 1044/1045	1 1/2"	16	57
1140 679 001	C 36000	1 1/2"	18	57
1140 547 101	C 36000	2"	14	74
1140 667 603	SAE 1044/1045	2"	19	74
1140 667 605	AISI 303	2"	14	74
1140 667 602	AISI 303	2"	19	74
1140 428 501	C 36000	2 1/2"	16	74

FLANGE - SOLDERED ELEMENTS

Over and above our standard, we can solder tubular heating elements to special flanges, nipples or plugs supplied either by ourselves or our clients. Such soldering would be carried out for instance according to this sketch.

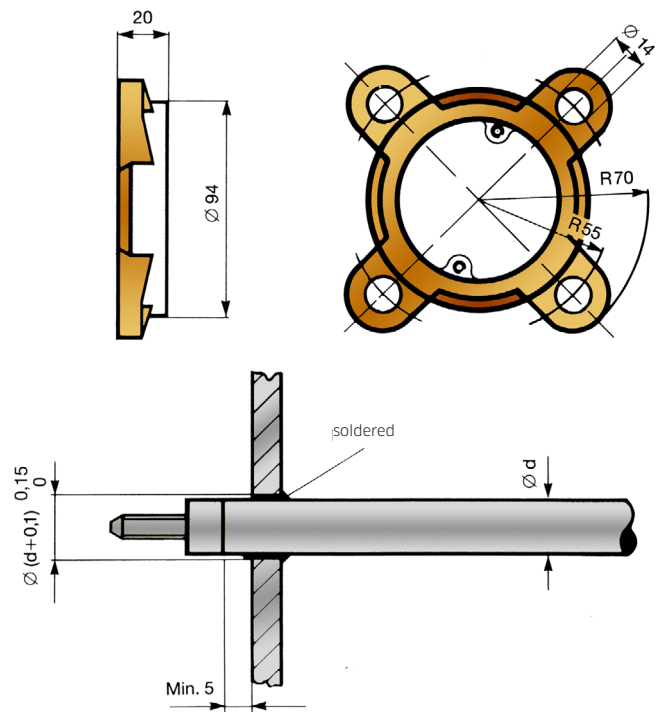

ARTICLE NO.	MATERIAL
1130 360 001	C 36000

LIQUID HEATING

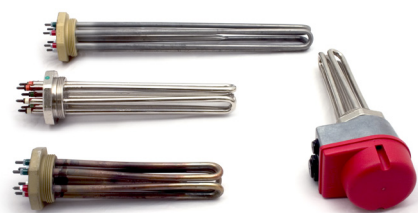

Water heating..... 18
 Oil heating..... 19
 Hydraulic oil heating..... 19



Accessories..... 20

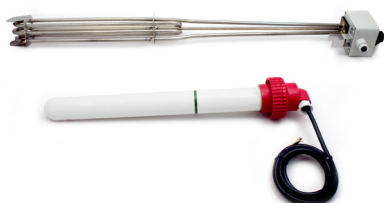

Immersion heaters..... 21



Cast-in elements..... 23



Barrel heaters..... 24



Flow through heaters..... 29

SCREW PLUG IMMERSION HEATERS FOR WATER HEATING

TUBULAR ELEMENTS IN COPPER

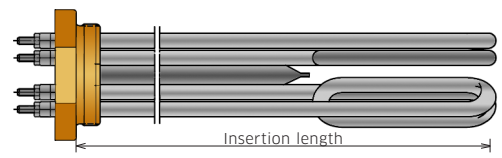
<p>Tubular elements in copper C 12200 Protective tubing with inner diam. 10.6 mm for thermostat and/or thermal cut-off. Brass plug.</p>	
--	--

Brass plug G 11/4"

TYPE	POWER W	VOLTAGE V	INSERTION LENGTH MM	ARTICLE NO.
IU20	1x500+ 2x750	230	215	2530 607 301

Brass plug G 2"

TYPE	POWER W	VOLTAGE V	INSERTION LENGTH MM	ARTICLE NO.	TYPE	POWER W	VOLTAGE V	INSERTION LENGTH MM	ARTICLE NO.
IU31	1500	230/400	180	2520 341 001	IU311	9000	230/400	390	2520 341 009
IU33	2250	230/400	230	2520 341 002	IU312	10500	230/400	860	2520 341 010
IU34	3000	230/400	280	2520 341 003	IU313	12000	230/400	985	2520 341 011
IU36	4500	230/400	390	2520 341 005	IU314	13500	230/400	1085	2520 341 012
IU39	6000	230/400	390	2520 341 007	IU315	15000	3 x 400	1235	2520 341 013
IU310	7500	230/400	390	2520 341 008	IU611	9000	230/400	400	2520 539 302

TUBULAR ELEMENTS IN STAINLESS STEEL WITH BRASS HEAD

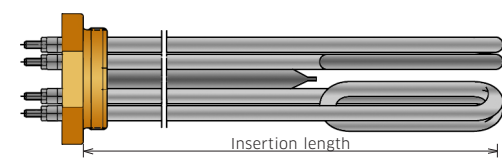
<p>Tubular element in stainless acidproof steel EN 1.4404. Protective tubing with inner diam. 10.6 mm for thermostat and/or thermal cut-off. Brass head.</p>	
--	--

Brass plug G 1" (without protective tubing)

TYPE	POWER W	VOLTAGE V	INSERTION LENGTH MM	ARTICLE NO.	TYPE	POWER W	VOLTAGE V	INSERTION LENGTH MM	ARTICLE NO.
IU21	1x250+1x750	230	320	3020 398 001	IU23	1x725+1x1225	230	450	3020 398 003
IU22	1x500+1x1000	230	355	3020 398 002	IU24	1x1250+1x1750	230	475	3020 398 004

Brass plug G 11/4"

TYPE	POWER W	VOLTAGE V	INSERTION LENGTH MM	ARTICLE NO.	TYPE	POWER W	VOLTAGE V	INSERTION LENGTH MM	ARTICLE NO.
IU25	1x500+1x500	230	160	3020 398 101	IU27	1x670+1x1330	230	255	3020 398 103
IU26	1x500+1x1000	230	255	3020 398 102	IU29	1x1000+1x2000	230	380	3020 398 104

Brass plug G 2"

TYPE	POWER W	VOLTAGE V	INSERTION LENGTH MM	ARTICLE NO.	TYPE	POWER W	VOLTAGE V	INSERTION LENGTH MM	ARTICLE NO.
IU31R	1500	230/400	180	2520 391 501	IU3R	12000	3x400	755	2520 387 504
IU3R	2000	230/400	260	2520 391 502	IU3R	15000	3x400	900	2520 387 505
IU34R	3000	230/400	280	2520 548 001	IU315R	15000	3x400	1235	2530 397 706
IU36R	4500	230/400	390	2520 548 002	IU3R	20000	3x400	900	2520 387 506
IU39R	6000	230/400	390	2520 548 003	IU3R	23300	3x400	900	2520 387 507
IU311R	9000	3x400	390	2520 548 004	IU611R	9000	230/400	400	2520 539 303
IU3R	9000	3x400	755	2520 548 005					

TUBULAR ELEMENTS IN STAINLESS STEEL WITH STAINLESS STEEL PLUG

Tubular element in stainless steel EN 1.4404
 Protective tubing with inner diam 10.6 mm
 for thermostat and/or thermal cut-off.
 Plug G 2" in stainless steel EN 1.4305.

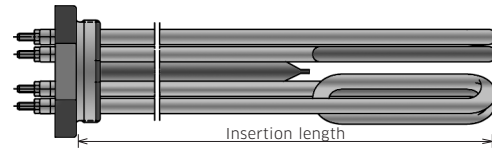

Stainless steel plug G2"

TYPE	POWER W	VOLTAGE V	INSERTION LENGTH MM	ARTICLE NO.	TYPE	POWER W	VOLTAGE V	INSERTION LENGTH MM	ARTICLE NO.
IU34S	3000	230/400	280	2520 391 601	IU39S	6000	230/400	540	2520 391 602

SCREW PLUG IMMERSION HEATERS FOR OIL HEATING

TUBULAR ELEMENTS IN STAINLESS STEEL WITH BRASS PLUG

Tubular elements in stainless acidproof steel EN 1.4404.
 Protective tubing with inner diam 10.6 mm for thermostat and/or thermal cut-off.
 Brass plug G 2"

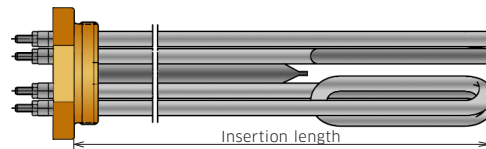

Surface load approx 2.7 W/cm²

TYPE	POWER W	VOLTAGE V	INSERTION LENGTH MM	ARTICLE NO.	TYPE	POWER W	VOLTAGE V	INSERTION LENGTH MM	ARTICLE NO.
OE31	1000	230/400	270	2530 341 405	OE36	4500	230/400	815	2530 341 403
OE33	2000	230/400	435	2530 341 401	OE39	6000	230/400	1085	2530 341 404
OE34	3000	230/400	555	2530 341 402					

SCREW PLUG IMMERSION HEATERS FOR HYDRAULIC OIL HEATING

TUBULAR ELEMENT IN STAINLESS STEEL WITH BRASS HEAD

Tubular elements in stainless acidproof steel EN 1.4404.
 Protective tubing with inner diam 10,6 mm for thermostat and/or thermal cut-off.
 Brass plug G 2"

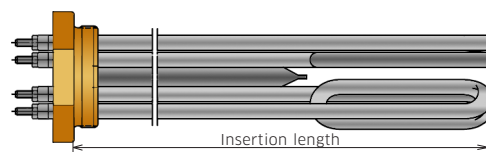



Surface load approx 0.9 W/cm²

TYPE	POWER W	VOLTAGE V	INSERTION LENGTH MM	ARTICLE NO.	TYPE	POWER W	VOLTAGE V	INSERTION LENGTH MM	ARTICLE NO.
OE311	330	230/400	270	2530 490 205	OE361	1500	230/400	815	2530 490 203
OE331	670	230/400	435	2530 490 201	OE391	2000	230/400	1085	2530 490 204
OE341	1000	230/400	555	2530 490 202					

ACCESSORIES FOR IMMERSION HEATERS

Nut in brass.		
DIMENSION	ARTICLE NO.	
1 ¼"	1140 485 403	
1 ½"	1140 485 404	
2"	1140 485 405	

Extension sleeve for G 2" immersion heaters		
LENGTH MM	ARTICLE NO.	
50	1130 692 801	
100	1130 692 802	
150	1130 692 803	
200	1130 692 804	

Reduction nipple		
DIMENSION	ARTICLE NO.	
1 ½"-1 ¼"	1160 135 701	

Socket key for G 2" immersion heaters		
DIMENSION	ARTICLE NO.	
2"	1160 143 201	

Gasket		
DIMENSION	MATERIAL	ARTICLE NO.
1 ¼"	Copper	1140 408 702
1 ½"	Copper	1140 408 703
2"	Copper	1140 408 704
1 ¼"	Fibre	1140 577 704
2"	Fibre	1140 577 706

OVER THE SIDE IMMERSION HEATERS

Examples of applications:

Chemical baths, baths for deacidification, batghs for degreasing etc.

Available in:

Protection class IP55

Teflon coating can be added.

Connection: cable

Over the side immersion heaters can also be produced after customer specification

Submersible oil heater

Material: Stainless steel EN 1.4301/SS 23333

Surface load: 0.9 W/cm

Connection: 4m cable, 3x1.0mm

Safety: CE-marked acc. to LVD, 2006/95/CE

Hysteresis: 11°C

Others: Heater complete with thermostat



POWER W	VOLTAGE V	CUTTING TEMP.°C	DIMENSION L X B X Ø MM	ARTICLE NO.
250	230	40	225 x 74 x 67	6150 432 301
500	230	40	325 x 74 x 67	6150 432 302
1000	230	40	525 x 74 x 67	6150 432 303
250	230	20	225 x 74 x 67	6150 432 304
500	230	20	325 x 74 x 67	6150 432 305
1000	230	20	525 x 74 x 67	6150 432 306
250	24	20	225 x 74 x 67	6150 432 307
250	24	40	225 x 74 x 67	6150 432 308

Tubular heating element in stainless steel EN 1.4404.

Cold part 400 mm.

Thermostat 30-90°C.

1500 mm connection cable.



POWER W	VOLTAGE V	INSERTION LENGTH MM	ARTICLE NO.
1500	230	800	3060 191 501

Tube in steel. Cold part 150 mm.

Diameter 80/42.5 mm

2000 mm connection cable.



POWER W	VOLTAGE V	INSERTION LENGTH MM	ARTICLE NO.	POWER W	VOLTAGE V	INSERTION LENGTH MM	ARTICLE NO.
1000	230	600	3081 806 010	2500	3x400	800	3081 808 040
1500	230	600	3081 806 028	3250	400	1000	3081 801 011
1500	400	600	3081 806 036	3250	3x400	1000	3081 801 029
1500	230	800	3081 808 016	4000	400	1200	3081 801 219
2500	230	800	3081 808 024	4000	3x400	1200	3081 801 227
2500	400	800	3081 808 032				

Tube in stainless steel EN 1.4404. Cold part 150mm.

Diameter 80/42.5 mm.

2000 mm connection cable.



POWER W	VOLTAGE V	INSERTION LENGTH MM	ARTICLE NO.	POWER W	VOLTAGE V	INSERTION LENGTH MM	ARTICLE NO.
1000	230	600	3081 806 218	2500	3x400	800	3081 808 248
1500	230	600	3081 806 226	3250	400	1000	3081 801 045
1500	400	600	3081 806 234	3250	3x400	1000	3081 801 052
1500	230	800	3081 808 214	4000	400	1200	3081 801 243
2500	230	800	3081 808 222	4000	3x400	1200	3081 801 250
2500	400	800	3081 808 230				

CONT. OVER THE SIDE IMMERSION HEATERS

Tube in titanium. Cold part 150 mm.
Diameter 80/40 mm
2000 mm connection cable.



POWER W	VOLTAGE V	INSERTION LENGTH MM	ARTICLE NO.	POWER W	VOLTAGE V	INSERTION LENGTH MM	ARTICLE NO.
1000	230	600	3081 806 416	2500	3x400	800	3081 808 446
1500	230	600	3081 806 424	3250	400	1000	3081 801 078
1500	400	600	3081 806 432	3250	3x400	1000	3081 801 086
1500	230	800	3081 808 412	4000	400	1200	3081 801 276
2500	230	800	3081 808 420	4000	3x400	1200	3081 801 284
2500	400	800	3081 808 438				

Tube in glass. Cold part 150 mm. Diameter 80/44 mm.
2000 mm connection cable.



POWER W	VOLTAGE V	INSERTION LENGTH MM	ARTICLE NO.	POWER W	VOLTAGE V	INSERTION LENGTH MM	ARTICLE NO.
1000	230	600	3080 806 110	2500	400	800	3080 808 132
1500	230	600	3080 806 128	2500	3x400	800	3080 808 140
1500	400	600	3080 806 136	3250	400	1000	3080 801 111
1500	230	800	3080 808 116	3250	3x400	1000	3080 801 129
2500	230	800	3080 808 124				

Tube in porcelain. Cold part 150 mm.
Diameter 80/45 mm.
2000 mm connection cable.



POWER W	VOLTAGE V	INSERTION LENGTH MM	ARTICLE NO.	POWER W	VOLTAGE V	INSERTION LENGTH MM	ARTICLE NO.
1000	230	600	3080 806 011	2500	3x400	800	3080 808 041
1500	230	600	3080 806 029	3250	400	1000	3080 801 012
1500	400	600	3080 806 037	3250	3x400	1000	3080 801 020
1500	230	800	3080 808 017	4000	400	1200	3080 801 210
2500	230	800	3080 808 025	4000	3x400	1200	3080 801 228
2500	400	800	3080 808 033				

CAST-IN TUBULAR HEATING ELEMENTS

Application area:
Indirect liquid heating, heating tables, oil heating, etc.
Assembly: Fixing to the object

HEATING SHIELD

The heating shield consists of a \varnothing 6.4 mm tubular element of stainless steel casted in silumin. The shield is positioned outside the tank and heats the liquid indirectly. As the heating is not in direct contact with the liquid it cannot be exposed to limescale or corrosion attacks.

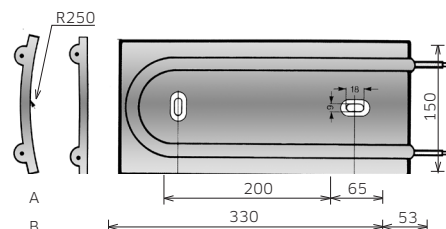

TYPE	POWER W	VOLTAGE V	ARTICLE NO.	TYPE	POWER W	VOLTAGE V	ARTICLE NO.
A = Bent	1000	230	2520 295 301	B = Flat	1000	230	2520 340 101
A = Bent	1000	400	2520 295 303	B = Flat	1000	400	2520 340 102

HEATING PLATE

The heating plate consists of a \varnothing 8.5 mm tubular element cast in silumin.

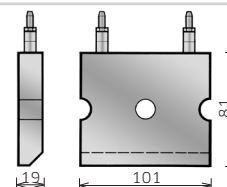

TYPE	POWER W	VOLTAGE V	ARTICLE NO.
Heating plate	480	230	2530 396 901

HEAT TRANSFER CEMENT

Heat transfer cement. Odourless, can be mixed with water.
No danger of fire.
0.8 kg is enough for 3 heating shields.



TYPE	WEIGHT KG	ARTICLE NO.	TYPE	WEIGHT KG	ARTICLE NO.
Can	0.8	1160 123 801	Can	6.5	1160 123 802

DRUM & IBC HEATERS

Backer Drum and IBC heaters are specifically designed to heat viscous products and thereby facilitate emptying containers. They are also very effective for keeping heat and to avoid freezing. Ideal for heating water, oils, diesel, resin, petroleum jelly, wax e.g. lanolin, fats, butter e.g. butter oil, syrup, sugar and other industrial liquids or foods that must have a uniform temperature or viscosity.

The heaters are available with housings made of steel plate, silicone rubber, polyester and fiberglass fabric. They are also offered with different enclosure classes and are compatible with both digital or mechanical temperature control, depending on the purpose of use.

Can also be manufactured according to customer specifications.

DRUM HEATER 30-110°C WITH CASING OF STEEL PLATE



POWER W	VOLTAGE V	CONTAINER L	ARTICLE NO.	POWER W	VOLTAGE V	CONTAINER L	ARTICLE NO.
1000	230	200	3056 800 113	2000	230	200	3056 800 139
1500	230	200	3056 800 121				

DRUM HEATER 0-120°C WITH CASING OF SILICONE RUBBER



POWER W	VOLTAGE V	CONTAINER L	ARTICLE NO.	POWER W	VOLTAGE V	CONTAINER L	ARTICLE NO.
1500	230	200	3051190701	800	230	200	3051190901
1000	230	200	3051190702	500	230	50-60	3051191001
1000	230	150	3051190801	300	230	25-30	3051191101

DRUM HEATER 0-90°C WITH CASING OF POLYESTER



POWER W	VOLTAGE V	CONTAINER L	ARTICLE NO.	POWER W	VOLTAGE V	CONTAINER L	ARTICLE NO.
1200	230	200	3051191201	400	110	105	3051191403
1200	110	200	3051191203	300	230	50-60	3051191501
530	230	200	3051191301	300	110	50-60	3051191503
530	110	200	3051191303	225	230	25-30	3051191601
400	230	105	3051191401	225	110	25-30	3051191603

DRUM HEATER 0-200°C WITH CASING OF GLASS FIBER FABRIC



POWER W	VOLTAGE V	CONTAINER L	ARTICLE NO.	POWER W	VOLTAGE V	CONTAINER L	ARTICLE NO.
1200	230	200	3051191701	700	230	105	3051191801
1200	110	200	3051191703	440	230	50	3051191901
1500	230	200	3051191702	380	230	25	3051192001

CONT. DRUM & IBC HEATERS

DRUM HEATER 0-120°C FOR FOOD & PHARMACEUTICALS

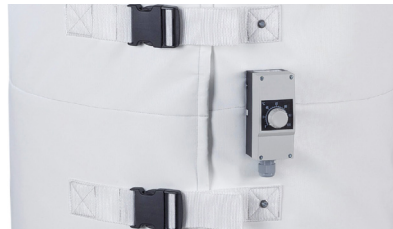

POWER W	VOLTAGE V	CONTAINER L	ARTICLE NO.
1200	230	200	3051192101

IBC HEATER 0-90°C WITH CASING OF POLYESTER



POWER W	VOLTAGE V	SIZE MM	ARTICLE NO.	POWER W	VOLTAGE V	SIZE MM	ARTICLE NO.
2x1000	230	4400-1000	3051192301	1300	230	4400-1000	3051192501
2x1000	110	4400-1000	3051192303	1300	110	4400-1000	3051192503
3x1000	230	4400-1000	3051192401				

BASE HEATER IN SILICONE FOR IBC CONTAINERS



POWER W	VOLTAGE V	SIZE MM	ARTICLE NO.
2700	230	1035x851	3051393701

BASE HEATER IN ALUMINIUM FOIL FOR IBC CONTAINERS



POWER W	VOLTAGE V	SIZE MM	ARTICLE NO.
1080	230	1095x895	3051393802
1080	230	1095x895	3051393803
1400	230	1095x895	3051393801

ACCESSORIES DRUM & IBC HEATERS

<p>Base drum heater 50-300°C</p> 	<p>Nylon insulation cover for 200L drums</p> 	<p>Nylon insulation cover for IBC containers</p> 
<p>DIMENSION MM</p> <p>W/V</p> <p>ARTICLE NO.</p>	<p>DIMENSION</p> <p>ARTICLE NO.</p>	<p>DIMENSION</p> <p>ARTICLE NO.</p>
<p>Ø555x105</p> <p>1800W/230V</p> <p>3051192702</p>	<p>Other sizes on demand</p> <p>3051192201</p>	<p>Stand. size for 1000L cont.</p> <p>3051393402</p>
<p>Base drum heater 0-120°C</p> 	<p>PVC protection cover for IBC containers</p> 	<p>Cordura top protection for IBC containers</p> 
<p>DIMENSION MM</p> <p>W/V</p> <p>ARTICLE NO.</p>	<p>DIMENSION</p> <p>ARTICLE NO.</p>	<p>DIMENSION</p> <p>ARTICLE NO.</p>
<p>Ø550x105</p> <p>900W/230V</p> <p>3051192701</p>	<p>Stand. size for 1000L cont.</p> <p>3051192602</p>	<p>Stand. size for 1000L cont.</p> <p>3051192601</p>
<p>Nylon insulation cover for IBC containers</p> 	<p>Cordura insulation cover for IBC containers</p> 	
<p>DIMENSION</p> <p>ARTICLE NO.</p>	<p>DIMENSION MM</p> <p>ARTICLE NO.</p>	
<p>Stand. size for 1000L cont.</p> <p>3051393501</p>	<p>4400x1000</p> <p>3051393401</p>	

TUBES FOR FLOW-THROUGH HEATERS

Application:
Water heating, oil heating, etc.

SUITED FOR IMMERSION HEATER WITH G 2" CONNECTION

Elements in stainless steel EN 1.4404 max. 5 bar. Connection G 3/4" for in - and outlet.
Cell rubber insulation for mounting on tubes.
Thickness 10 mm.

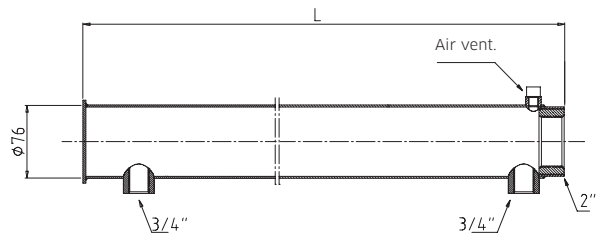

LENGTH MM	ARTICLE NO.	INSULATION FOR FLOW-THROUGH TUBE	ARTICLE NO.
320	3050 308 301	3050 308 301	1150 420 501
465	3050 308 302	3050 308 302	1150 420 502
585	3050 308 303	3050 308 303	1150 420 503
850	3050 308 304	3050 308 304	1150 420 504
965	3050 308 305	3050 308 305	1150 420 505



TEMP.CONTROL/-MEASUREMENT AND TERMINAL BOXES



Terminal boxes..... 31

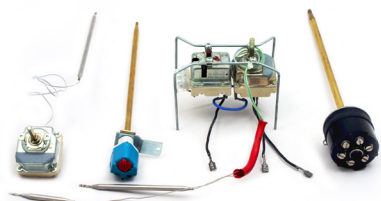

Thermostats/thermal cut-offs..... 33



Control devices, regulators
and sensors..... 36
Backer temperature control unit - BCU 36
Solid state relays 37
Temperature sensors 37

TERMINAL BOXES

For mounting on our standard or special manufactured immersion heaters for liquid heating.

The terminal boxes can be delivered empty or with thermostat and/or thermal cut-offs.

TERMINAL BOXES

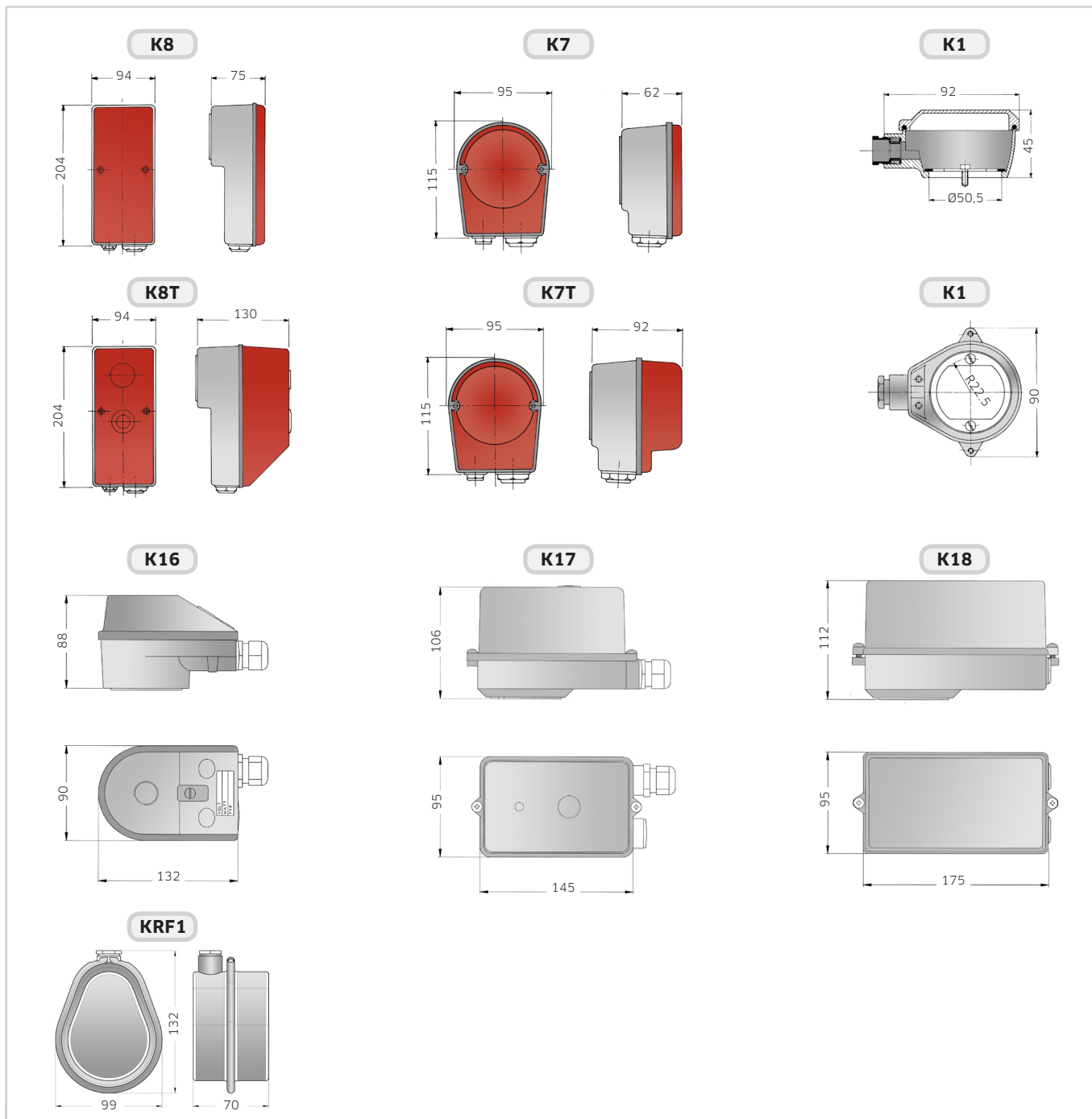

TYPE	DESIGNED FOR	ARTICLE NO.
K1	1¼"-1½"	1130 397 201
K7	1¼"-2"	1130 541 001
K7T	1¼"-2"	1130 541 101
K8	2"	1125 001 003
K8T	2"	1125 001 002
K16	2"	1120 548 202
K17	2"	1120 548 301
K18	2"	1120 548 502
KRF1	2"	3019 900 349

TERMINAL BOXES WITH THERMOSTAT AND/OR THERMAL CUT-OFFS

		K11/K12		K13			
TYPE	DESIGNED FOR	THERMOSTAT	BREAKING CAPACITY A/V	THERMAL CUT-OFF PART	BREAKING-CAPACITY A/V	ARTICLE NO.	
K11A	2"	2-pole 30-90°C	16/400	3-pole 110°C	20/400	1120 332 701	
K12A	2"	1-pole 30-90°C	16/400	3-pole 110°C	20/400	1120 332 801	
K13A	2"	-	-	3-pole 110°C	20/400	1120 332 901	
K13A	2"	-	-	3-pole 65°C	20/400	1120 332 905	
K15A	2"	2-pole 0-50°C	16/400	3-pole 65°C	20/400	1120 391 801	

<p>If mounting on 2" plugs assembly kit 1150710301 shall be used.</p>		<p>K31A</p>					
TYPE	DESIGNED FOR	BREAKING CAPACITY A/V	THERMOSTAT PART	THERMAL CUT-OFF PART	ARTICLE NO.		
K31A	1 ½"-2"	20/400	3-pole 25-85°C	3-pole 110°C	1150 666		
Assembly kit	2"				1150 710 301		

<p>Terminal box with electronic controller. User-friendly with push buttons for desired setpoint and hysteresis.</p> <p>LED display for monitoring setpoints, process value and setup. K7E fits our element heads from 1¼" to 2½".</p> <p>K7E is designed to operate stand-alone or with other external control systems.</p>		<p>K7E</p>					
TYPE	SUPPLY VOLTAGE	POWER RANGE OF HEATING UNITS USED	MEASUREMENT RANGE	SETPOINT RANGE	ARTICLE NO.		
K7E	230 VAC +N or 3x400 VAC +N	From 1000 W to 12000 W is adjustable 1- 10°C	-45°C - 195°C	5°C - 90°C	1151409701		

STEERING BASKETS FOR TERMINAL BOX K17 AND K18

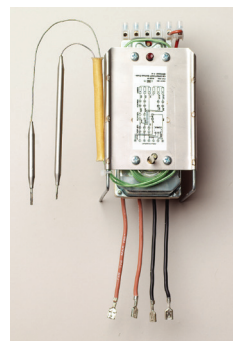
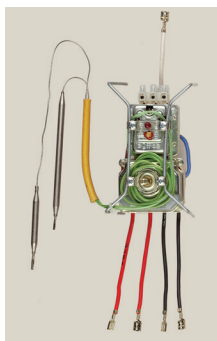
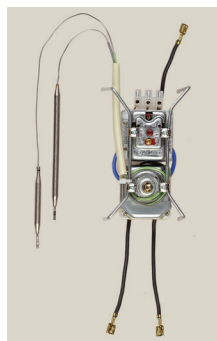

TYPE	DESIGNED THERMOSTAT FOR	BREAKING CAPACITY A/V	THERMAL CUT-OFF	BREAKING CAPACITY A/V	ARTICLE NO.
S17A	K17 2-pole 30-90°C	16/400	3-pole 110°C	20/400	1130 685 401
S17D	K17 -		3-pole 110°C	20/400	1130 710 201
S17B	K17 2-pole 0-50°C	16/400	3-pole 65°C	20/400	1130 685 402
S17C	K17 4-pole 30-90°C	16/400	3-pole 110°C	20/400	1130 685 801
S18A	K18 4-pole 30-90°C	16/400	3-pole 110°C	20/400	1120 550 701

Contactor and time relay

TERMINAL BOX AND PROTECTION TUBES

Plastic terminal box and protection tube designed to be used for separate mounting of stick thermostat type TSDH/TSDO

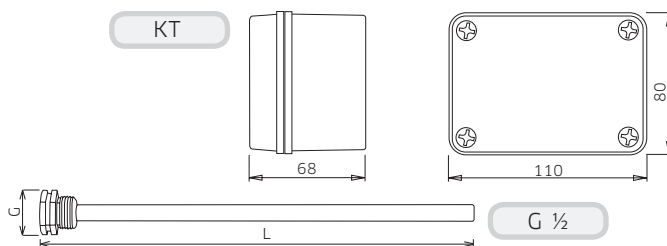

TYPE	LENGTH MM	THREAD	ARTICLE NO.
KT			1140 839 001
G1/2	140	1/2"	1160 052 501
G1/2	280	1/2"	1160 052 502

THERMOSTATS

Rod type T-sprooved 120°C, breaking capacity 20A/240V

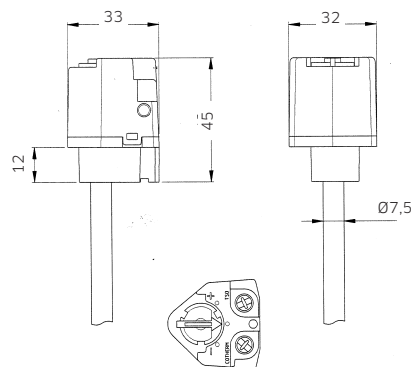

TYPE	FUNCTION	CONTROL AREA °C	ROD LENGTH	ARTICLE NO.
TSDH 0702	Breaking 1-pole	10-90	180	1160 156 701
TSDO 1103	Breaking 1-pole	3-55	270	1160 156 702
TSDH 1104	Breaking 1-pole	38-90	270	1160 156 703
TSDH 1103	Breaking 1-pole	58-110	270	1160 156 704
TSDH 1102	Breaking 1-pole	98-150	270	1160 156 705
TSDH 1106	Breaking 1-pole	130-182	270	1160 156 706

Capillary tube design T-approved 150°C, breaking capacity 16A/400V

	A mm	B mm	C mm	D mm	D bulb Ø mm	L Bulb length mm	K Capillary tube
1-pole	28	18	51.5	35	4	240	370
2-pole	53.5	19	50	46	6	130	400
3-pole	53.5	19	50	46	6	240	420
4-pole	53.5	23	50	60	6	130	800
2-pole 0-50°C	53.5	19	50	46	4	240	370

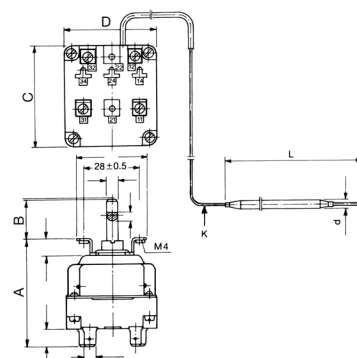

TYPE	FUNCTION	CONTROL-AREA °C	ARTICLE NO.
EGO	Breaking 1-pole	30-90	1160 127 401
EGO	Breaking 2-pole	30-90	1160 119 201
EGO	Switching 3-pole	30-90	1160 047 501
EGO	Breaking 4-pole	30-90	1160 210 401
EGO	Breaking 2-pole	0-50	1160 160 501

Capillary tube design T-approved 120°C.
Breaking capacity 16A/240V

Bulb diameter d mm	Bulb length L mm	Capillary tube length K mm
6	92	1150
8	150	1000

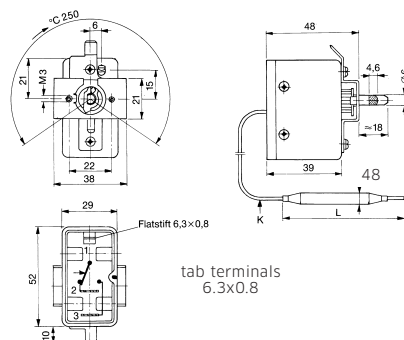

TYPE	FUNCTION	CONTROL AREA °C	ARTICLE NO.
Jumo	Switching 1-pole	0-200	1160 156 301
Jumo	Switching 2-pole	20-500	1160 156 303

THERMAL CUT-OFF

Rod type T-approved 100°C.
Breaking capacity 40A/400V

Rod diameter d mm	Rod length L mm
9	270
9	270

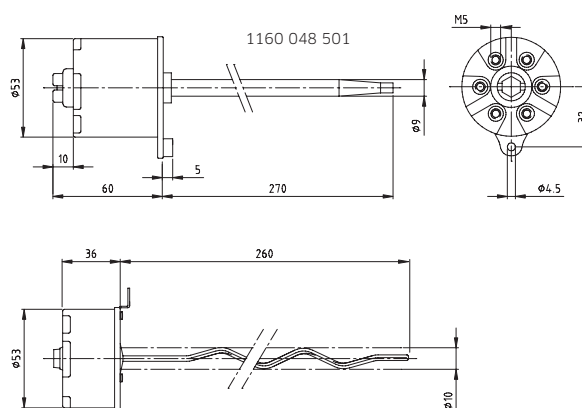

TYPE	FUNCTION	BREAKING TEMP °C	RESETTING	ARTICLE NO.
Stibel	Breaking 3-pole	110 +0-15	Manual	1160 048 501
Stibel	Breaking 3-pole	140 +0-30	Manual	1160 048 601

CONT. THERMOSTATS

Capillary tube design T-approval 125°C,
Breaking capacity 20A/400V

Bulb diameter d mm	Bulb length L mm	Capillary tube length K mm
6	75	540
4	230	420

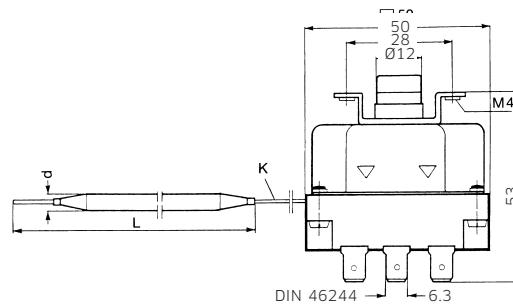

TYPE	FUNCTION	BREAKING TEMP °C	RESETTING	ARTICLE NO.
EGO	Breaking 3-pole	110 +0-8	Manual	1160 119 301
EGO	Breaking 3-pole	65 +0-6	Manual	1160 160 601

Capillary tube design T-approval 120°C, Breaking capacity 10A/400V

Bulb diameter d mm	Bulb length L mm	Capillary tube length K mm
6	92	1150
8	150	1000

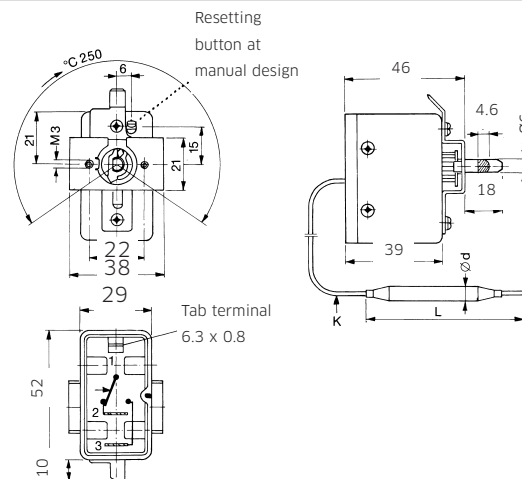

TYPE	FUNCTION	BREAKING TEMP °C	RESETTING	ARTICLE NO.
JUMO	Switching 1-pole	0-200	Manual	1160 156 302
JUMO	Switching 1-pole	20-500	Manual	1160 156 304

REGULATORS AND SENSORS

iTRON 32

Display for actual or set value.

1 entrance free programmable for e.g. Pt100 temperature sensor or thermo element

2 exits, relay and 0/5V for solid state relay

Autotune, front frame 48x24 mm



dTRON 316

2 displays for actual or set value

1 entrance free programmable for e.g. Pt100 temperature sensor or thermo element, eg. "K" or "J".

5 exits, 3 relays and 2 0/12V for solid state relays

Autotune, front frame 48x48 mm

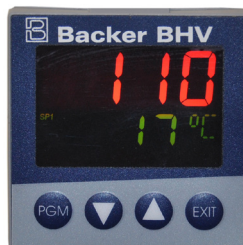

TYPE

iTRON 32

dTRON 316

ARTICLE NO.

3000 382 105

3000 345 761

BACKER TEMPERATURE CONTROL UNIT - BCU

Complete and universal temperature control for smooth temperature control and high precision. Control box provided with Backer PID regulator, internal fuses, switches and inputs and outputs for supply and load. The effect is controlled by the internal solid state relay.

Advantages

- Plug and Play for accurate heat control
- Flexible device for several functions
- Stable and robust construction
- Ease to use

Applications

- Lab environment
- Tests and experiments
- Basic process control



MAX OP. TEMP.	MAX LOAD	CONNECTION	DIMENSIONS	SENSORS	ARTICLE NO.
1300°C	10A vid 230V	supplied with 2.5m grounded power cord and separate male connector for temperature sensor type K	W170 x H95 x D235mm	The control box is designed for sensor type K with standard connectors	6150870401

SOLID STATE RELAYS



For DIN-socket (not TYA 432-45)

TYPE	TECHNICAL INFO	L x W x T	ARTICLE NO.
TYA 432-45/25	25A, 265V	59 x 45 x 29	3000 367 632
TYA 432-45/50	50A, 530V	59 x 45 x 32	3000 367 633
TYA 432-100/30	30A, 265V with integr. heat sink	103/80 x 23 x 103	3000 367 634
TYA 432-100/30	30A, 660V with integr. heat sink	103/80 x 23 x 103	3000 418 274
TYA 432-100/45	45A, 660V with integr. heat sink	103/80 x 23 x 103	3000 367 636
GTS-25/480-0	25A, 480V with integr. heat sink	122/100 x 24 x 107	3050 646 501
GTS-40/480-0	40A, 480V with integr. heat sink	122/100 x 35 x 142	3050 646 502
GTS-50/480-0	50A, 480V with integr. heat sink	122/100 x 60 x 142	3050 646 503
GTS-60/480-0	60A, 480V with integr. heat sink	122/100 x 80 x 142	3050 646 504
GTS-75/480-0	75A, 480V with integr. heat sink	122/100 x 127 x 142	3050 646 505
GTS-90/480-0	90A, 480V with integr. heat sink	122/100 x 127 x 142	3050 646 506
GTS-120/480-0	120A, 480V with integr. heat sink	122/100 x 127 x 142	3050 646 507
GTZ-24/400-0-0	3x25A, 400V with integr. heat sink	88/80 x 127 x 150	3050 596 301
GTZ-25/480-0-0	3x25A, 480V with integr. heat sink	88/88 x 127 x 150	3050 596 302
GTZ-40/480-0-0	3x40A, 480V with integr. heat sink	158/100 x 127 x 150	3050 596 303
GTZ-55/480-0-0	3x55A, 480V with integr. heat sink	158/100 x 127 x 150	3050 596 304
GTF-25/480-0-0-0-0	25A, 480V with integr. heat sink	137/104 x 60 x 143	3050 968 401
GTF-40/480-0-0-0-0	40A, 480V with integr. heat sink	137/104 x 60 x 143	3050 968 402
GTF-50/480-0-0-0-0	50A, 480V with integr. heat sink	137/104 x 60 x 143	3050 968 403
GTF-60/480-0-0-0-0	60A, 480V with integr. heat sink	148/104 x 80 x 143	3050 968 404
GTF-75/480-0-0-0-0	75A, 480V with integr. heat sink	154/104 x 127 x 144	3050 968 405
GTF-90/480-0-0-0-0	90A, 480V with integr. heat sink	154/104 x 127 x 144	3050 968 406
GTF-120/480-0-0-0-0	120A, 480V with integr. heat sink	154/104 x 127 x 144	3050 968 407
GTF-150/480-0-0-0-0	150A, 480V with integr. heat sink	302 x 109/84 x 158	3050 968 408
GTF-200/480-0-0-0-0	200A, 480V with integr. heat sink	302 x 109/84 x 158	3050 968 409
GTF-250/480-0-0-0-0	250A, 480V with integr. heat sink	302 x 109/84 x 158	3050 968 410

TEMPERATURE SENSORS

Resistive sensors type Pt 100 for measuring of temperatures up to 600°C.

Thermo couple type J and K for measuring of temperatures up to 800 respectively 1150°C.

Typical application areas are ovens , climate-, cooling- and heating devices.

Pt 100 sensor for temperature measurement in gases and liquids

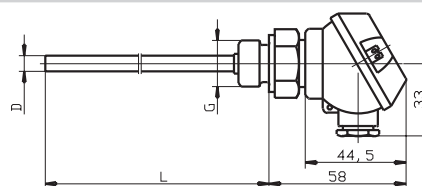

TYPE	DIA x L, TEMP	G	ARTICLE NO.
Pt 100 form J	6 x 50 mm, 400 °C	1/2"	3000 055 692
Pt 100 form J	6 x 100 mm, 400 °C	1/2"	3000 055 693
Pt 100 form J	6 x 200 mm, 400 °C	1/2"	3000 315 945

Protection tube for Pt 100 sensor and thermo couple			
TYPE	DIA x L	G	ARTICLE NO.
Protection tube	8/6.5 x 50 mm	1/2"	3000 407 130
Protection tube	8/6.5 x 100 mm	1/2"	3000 323 363
Protection tube	8/6.5 x 200 mm	1/2"	3000 407 129

Pt 100 cable sensor		
TYPE	DIA x L, TEMP	ARTICLE NO.
Pt 100	6 x 50 mm, 200°C, cable= 1.5 m	3000 407 307
Pt 100	6 x 50 mm, 200°C, cable= 3.5 m	3000 408 687

Pt 100 screwing sensor		
TYPE	DIA x L, TEMP	ARTICLE NO.
Pt 100	M6 x 8 mm, 260°C, cable=2.5m	3050 038 001
Pt 100	M8 x 25 mm, 300°C, cable=2.5 m	3000 055 732

Pt 100 mantle sensor. Bendable with vibration resistant measuring device.		
TYPE	DIA x L, TEMP	ARTICLE NO.
Pt 100 mantle	3 x 200 mm, 600°C, cable= 2.5 m	3000 068 244
Pt 100 mantle	3 x 300 mm, 600°C, cable= 2.5 m	3000 055 764
Pt 100 mantle	3 x 500 mm, 600°C, cable= 2.5 m	3000 068 248

Termo couple. Bendable mantle sensor with vibration resistant measuring device.		
TYPE	DIA x L, TEMP	ARTICLE NO.
Fe-CuNi type L	1,5 x 100 mm, 800°C, cable= 2.5 m	3000 056 809
Fe-CuNi type L	3 x 100 mm, 800°C, cable= 2.5 m	3000 056 809
Fe-CuNi type L	3 x 200 mm, 800°C, cable= 2.5 m	3000 068 433
NiCr-Ni type K	3 x 100 mm, 1150°C, cable= 2.5 m	3000 056 813
NiCr-Ni type K	3 x 200 mm, 1150°C, cable= 2.5 m	3000 068 441

Insert sensor with bayonet connection and protection tube in stainless steel. Typical application area is injection moulding machines.		
TYPE	DIA x L, TEMP	ARTICLE NO.
Pt 100	6 x 20-175 mm, 260°C, cable= 2.5 m	3000 055 798
Pt 100	8 x 20-175 mm, 350°C, cable= 2.5 m	3000 055 797
Fe-CuNi type L	6 x 20-175 mm, 400°C, cable= 2.5 m	3000 055 784
Fe-CuNi type L	8 x 20-175 mm, 400°C, cable= 2.5 m	3000 055 785

CONTACT- AND TOOL HEATING

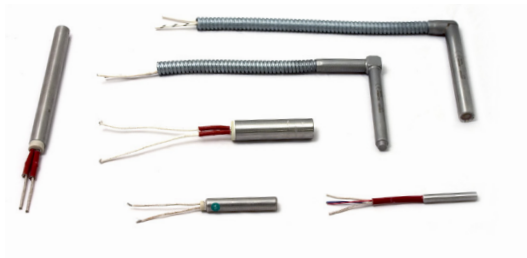

Cartridge heaters.....	40
Cartridge heaters type UTX	40
Cartridge heaters type UTC.....	44
Connections and special designs.....	47
Water proof sealing.....	53
Mounting manual.....	55



Nozzle elements.....	58
----------------------	----



Ring - and band elements.....	60
-------------------------------	----

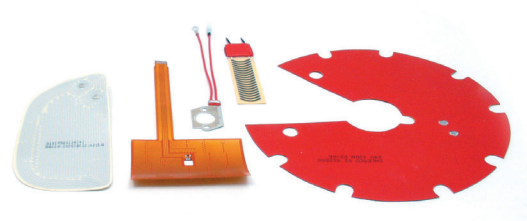

Heating foil elements.....	61
----------------------------	----



Compressor and crank case heaters.....	63
--	----

CARTRIDGE HEATERS UTX

Cartridge heaters can, to a limited space, give very high power. Thanks to the design the heat is quickly distributed over the whole surface mantle of the element. The element fulfill high demands of impact resistance and vibration security. Fields of application are primarily tool heating within e.g. plastic -, rubber -, wood -, and paper industry, foundries, medicin technical and laboratorial heating of liquids. Types: surface mantle material in stainless steel EN 1.4541. The element is fitted with 300 mm nickle wires, insulated with teflon- and fibreglass. Cold part at connection end 10 mm and

at bottom end 5 mm. Reamed holes a smallest tolerance H7 are required.

Surface load over 20 W/cm² is requires individual adjustment. Designed for connection to rated voltage 230 V. Surface load up to 60 W/cm². Design according to articles as shown below. The cartridges can also be fitted with connections as described (on following pages). Alternatively they can be be manufactured acc. to customer specification.

Surface mantle in stainless steel EN 1.4541, rated voltage 230V. Connection 300 mm fibreglass insulated nickle wire. Standard range.

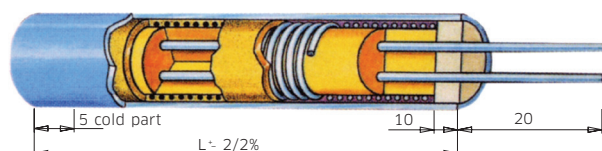

DIA X L	POWER W	SURF. LOAD W/CM ²	VOLTAGE V	ARTICLE NO.	DIA X L	POWER W	SURF. LOAD W/CM ²	VOLTAGE V	ARTICLE NO.
6.5x25	75	25	230	3060 250 075	6.5x160	150	5	230	3061 600 150
6.5x25	100	33	230	3060 250 100	6.5x160	200	7	230	3061 600 200
6.5x25	150	50	230	3060 250 150	6.5x160	300	10	230	3061 600 300
6.5x25	175	58	230	3060 250 175	6.5x160	350	12	230	3061 600 350
6.5x40	100	18	230	3060 400 100	6.5x160	400	14	230	3061 600 400
6.5x40	125	22	230	3060 400 125	6.5x160	500	17	230	3061 600 500
6.5x40	150	27	230	3060 400 150	8x40	125	18	230	3080 400 125
6.5x40	175	31	230	3060 400 175	8x40	150	21	230	3080 400 150
6.5x40	200	36	230	3060 400 200	8x40	200	28	230	3080 400 200
6.5x40	250	44	230	3060 400 250	8x50	125	13	230	3080 500 125
6.5x50	125	17	230	3060 500 125	8x50	150	16	230	3080 500 150
6.5x50	150	20	230	3060 500 150	8x50	200	22	230	3080 500 200
6.5x50	175	24	230	3060 500 175	8x50	250	27	230	3080 500 250
6.5x50	200	27	230	3060 500 200	8x60	125	11	230	3080 600 125
6.5x50	250	34	230	3060 500 250	8x60	150	13	230	3080 600 150
6.5x60	125	13	230	3060 600 125	8x60	200	17	230	3080 600 200
6.5x60	150	16	230	3060 600 150	8x60	250	21	230	3080 600 250
6.5x60	175	19	230	3060 600 175	8x60	300	25	230	3080 600 300
6.5x60	200	21	230	3060 600 200	8x60	400	34	230	3080 600 400
6.5x60	250	26	230	3060 600 250	8x80	150	9	230	3080 800 150
6.5x60	300	32	230	3060 600 300	8x80	175	11	230	3080 800 175
6.5x80	125	9	230	3060 800 125	8x80	200	12	230	3080 800 200
6.5x80	175	13	230	3060 800 175	8x80	250	15	230	3080 800 250
6.5x80	200	15	230	3060 800 200	8x80	300	18	230	3080 800 300
6.5x80	250	19	230	3060 800 250	8x80	400	24	230	3080 800 400
6.5x80	300	22	230	3060 800 300	8x100	175	8	230	3081 000 175
6.5x100	125	7	230	3061 000 125	8x100	200	9	230	3081 000 200
6.5x100	150	9	230	3061 000 150	8x100	250	12	230	3081 000 250
6.5x100	200	12	230	3061 000 200	8x100	300	14	230	3081 000 300
6.5x100	250	15	230	3061 000 250	8x100	400	19	230	3081 000 400
6.5x100	300	17	230	3061 000 300	8x130	175	6	230	3081 300 175
6.5x100	350	20	230	3061 000 350	8x130	200	7	230	3081 300 200
6.5x100	400	23	230	3061 000 400	8x130	250	9	230	3081 300 250
6.5x130	125	7	230	3061 300 125	8x130	300	10	230	3081 300 300
6.5x130	150	8	230	3061 300 150	8x130	400	14	230	3081 300 400
6.5x130	200	9	230	3061 300 200	8x160	200	6	230	3081 600 200
6.5x130	250	11	230	3061 300 250					
6.5x130	300	13	230	3061 300 300					
6.5x130	350	15	230	3061 300 350					
6.5x130	400	17	230	3061 300 400					

CONT. CARTRIDGE HEATERS UTX

DIA X L	POWER W	SURF.LOAD W/CM ²	VOLTAGE V	ARTICLE NO.	DIA X L	POWER W	SURF.LOAD W/CM ²	VOLTAGE V	ARTICLE NO.
8x160	250	7	230	3081 600 250	10x200	500	9	230	3102 000 500
8x160	300	8	230	3081 600 300	10x200	600	10	230	3102 000 600
8x160	400	11	230	3081 600 400	10x200	800	14	230	3102 000 800
8x160	500	14	230	3081 600 500	10x200	1000	18	230	3102 001 000
8x160	600	17	230	3081 600 600					
					12.5x40	125	13	230	3120 400 125
10x25	75	16	230	3100 250 075	12.5x40	160	16	230	3120 400 160
10x25	100	21	230	3100 250 100	12.5x40	200	20	230	3120 400 200
10x25	150	32	230	3100 250 150	12.5x40	250	25	230	3120 400 250
10x25	200	43	230	3100 250 200	12.5x40	300	30	230	3120 400 300
					12.5x40	350	35	230	3120 400 350
10x40	100	12	230	3100 400 100	12.5x40	400	40	230	3120 400 400
10x40	125	15	230	3100 400 125	12.5x40	500	50	230	3120 400 500
10x40	150	18	230	3100 400 150					
10x40	200	24	230	3100 400 200	12.5x50	160	12	230	3120 500 160
10x40	250	30	230	3100 400 250	12.5x50	200	15	230	3120 500 200
10x40	300	37	230	3100 400 300	12.5x50	250	18	230	3120 500 250
					12.5x50	300	22	230	3120 500 300
10x50	125	11	230	3100 500 125	12.5x50	350	25	230	3120 500 350
10x50	150	13	230	3100 500 150	12.5x50	400	29	230	3120 500 400
10x50	200	18	230	3100 500 200	12.5x50	500	36	230	3120 500 500
10x50	250	22	230	3100 500 250	12.5x50	600	44	230	3120 500 600
10x50	300	26	230	3100 500 300					
10x50	400	36	230	3100 500 400	12.5x60	125	7	230	3120 600 125
					12.5x60	160	9	230	3120 600 160
10x60	125	9	230	3100 600 125	12.5x60	200	12	230	3120 600 200
10x60	150	11	230	3100 600 150	12.5x60	250	15	230	3120 600 250
10x60	200	14	230	3100 600 200	12.5x60	300	17	230	3120 600 300
10x60	250	18	230	3100 600 250	12.5x60	350	20	230	3120 600 350
10x60	300	21	230	3100 600 300	12.5x60	400	23	230	3120 600 400
10x60	400	28	230	3100 600 400	12.5x60	500	29	230	3120 600 500
					12.5x60	600	35	230	3120 600 600
10x80	150	7	230	3100 800 150					
10x80	200	10	230	3100 800 200	12.5x80	125	5	230	3120 800 125
10x80	250	12	230	3100 800 250	12.5x80	160	6	230	3120 800 160
10x80	300	15	230	3100 800 300	12.5x80	200	8	230	3120 800 200
10x80	400	20	230	3100 800 400	12.5x80	250	10	230	3120 800 250
10x80	500	25	230	3100 800 500	12.5x80	300	12	230	3120 800 300
					12.5x80	350	14	230	3120 800 350
10x100	200	8	230	3101 000 200	12.5x80	400	16	230	3120 800 400
10x100	250	9	230	3101 000 250	12.5x80	500	20	230	3120 800 500
10x100	300	11	230	3101 000 300	12.5x80	600	24	230	3120 800 600
10x100	350	13	230	3101 000 350	12.5x80	750	30	230	3120 800 750
10x100	400	15	230	3101 000 400					
10x100	500	19	230	3101 000 500	12.5x100	160	5	230	3121 000 160
10x100	600	23	230	3101 000 600	12.5x100	200	6	230	3121 000 200
					12.5x100	250	8	230	3121 000 250
10x130	250	7	230	3101 300 250	12.5x100	300	9	230	3121 000 300
10x130	300	8	230	3101 300 300	12.5x100	400	12	230	3121 000 400
10x130	400	11	230	3101 300 400	12.5x100	500	15	230	3121 000 500
10x130	500	14	230	3101 300 500	12.5x100	600	18	230	3121 000 600
10x130	600	17	230	3101 300 600	12.5x100	800	25	230	3121 000 800
10x130	800	22	230	3101 300 800	12.5x100	1000	31	230	3121 001 000
10x160	300	7	230	3101 600 300	12.5x130	250	6	230	3121 300 250
10x160	400	9	230	3101 600 400	12.5x130	300	7	230	3121 300 300
10x160	500	11	230	3101 600 500	12.5x130	400	9	230	3121 300 400
10x160	600	13	230	3101 600 600	12.5x130	500	11	230	3121 300 500
10x160	800	18	230	3101 600 800	12.5x130	600	14	230	3121 300 600
					12.5x130	800	18	230	3121 300 800
10x200	400	7	230	3102 000 400	12.5x130	1000	22	230	3121 301 000
					12.5x160	400	7	230	3121 600 400

CONT. CARTRIDGE HEATERS UTX

DIA X L	POWER W	SURF.LOAD W/CM ²	VOLTAGE V	ARTICLE NO.	DIA X L	POWER W	SURF.LOAD W/CM ²	VOLTAGE V	ARTICLE NO.
12.5x160	500	8	230	3121 600 500	16x100	400	10	230	3161 000 400
12.5x160	600	10	230	3121 600 600	16x100	500	12	230	3161 000 500
12.5x160	800	13	230	3121 600 800	16x100	600	15	230	3161 000 600
12.5x160	1000	17	230	3121 601 000	16x100	800	20	230	3161 000 800
12.5x160	1200	20	230	3121 601 200	16x100	1000	25	230	3161 001 000
					16x100	1200	30	230	3161 001 200
12.5x200	300	4	230	3122 000 300					
12.5x200	500	7	230	3122 000 500	16x130	400	7	230	3161 300 400
12.5x200	600	8	230	3122 000 600	16x130	500	9	230	3161 300 500
12.5x200	800	11	230	3122 000 800	16x130	600	11	230	3161 300 600
12.5x200	1000	14	230	3122 001 000	16x130	800	14	230	3161 300 800
12.5x200	1200	17	230	3122 001 200	16x130	1000	18	230	3161 301 000
12.5x200	1500	21	230	3122 001 500	16x130	1200	22	230	3161 301 200
12.5x250	500	5	230	3122 500 500	16x160	400	6	230	3161 600 400
12.5x250	800	9	230	3122 500 800	16x160	500	7	230	3161 600 500
12.5x250	1000	11	230	3122 501 000	16x160	600	8	230	3161 600 600
12.5x250	1250	14	230	3122 501 250	16x160	800	11	230	3161 600 800
12.5x250	1500	17	230	3122 501 500	16x160	1000	14	230	3161 601 000
12.5x250	2000	22	230	3122 502 000	16x160	1300	19	230	3161 601 300
					16x160	1600	23	230	3161 601 600
12.5x300	500	5	230	3123 000 500					
12.5x300	800	7	230	3123 000 800	16x200	500	6	230	3162 000 500
12.5x300	1000	9	230	3123 001 000	16x200	800	9	230	3162 000 800
12.5x300	1250	11	230	3123 001 250	16x200	1000	11	230	3162 001 000
12.5x300	1500	14	230	3123 001 500	16x200	1250	14	230	3162 001 250
12.5x300	2000	18	230	3123 002 000	16x200	1500	17	230	3162 001 500
					16x200	2000	22	230	3162 002 000
16x40	160	13	230	3160 400 160					
16x40	200	16	230	3160 400 200	16x250	500	4	230	3162 500 500
16x40	250	20	230	3160 400 250	16x250	800	7	230	3162 500 800
16x40	300	24	230	3160 400 300	16x250	1000	9	230	3162 501 000
16x40	400	32	230	3160 400 400	16x250	1300	11	230	3162 501 300
16x40	500	40	230	3160 400 500	16x250	1600	14	230	3162 501 600
					16x250	2000	17	230	3162 502 000
16x50	160	9	230	3160 500 160					
16x50	200	11	230	3160 500 200	16x300	500	4	230	3163 000 500
16x50	250	14	230	3160 500 250	16x300	800	6	230	3163 000 800
16x50	300	17	230	3160 500 300	16x300	1000	7	230	3163 001 000
16x50	400	23	230	3160 500 400	16x300	1300	9	230	3163 001 300
16x50	500	28	230	3160 500 500	16x300	1500	11	230	3163 001 500
16x50	600	30	230	3160 500 600	16x300	1800	13	230	3163 001 800
					16x300	2000	14	230	3163 002 000
16x60	160	8	230	3160 600 160	16x300	2500	18	230	3163 002 500
16x60	200	10	230	3160 600 200					
16x60	250	12	230	3160 600 250	16x350	750	5	230	3163 500 750
16x60	300	15	230	3160 600 300	16x350	1000	6	230	3163 501 000
16x60	400	20	230	3160 600 400	16x350	1300	8	230	3163 501 300
16x60	500	24	230	3160 600 500	16x350	1600	10	230	3163 501 600
16x60	600	30	230	3160 600 600	16x350	2000	12	230	3163 502 000
					16x350	2500	15	230	3163 502 500
16x80	250	8	230	3160 800 250					
16x80	300	10	230	3160 800 300	16x400	1000	5	230	3164 001 000
16x80	400	13	230	3160 800 400	16x400	1300	7	230	3164 001 300
16x80	500	16	230	3160 800 500	16x400	1600	8	230	3164 001 600
16x80	600	20	230	3160 800 600	16x400	2000	10	230	3164 002 000
16x80	800	26	230	3160 800 800	16x400	2500	13	230	3164 002 500
16x80	1000	33	230	3160 801 000					
					20x60	200	8	230	3200 600 200
16x100	300	7	230	3161 000 300	20x60	300	12	230	3200 600 300
					20x60	500	20	230	3200 600 500
					20x60	600	24	230	3200 600 600
					20x60	800	32	230	3200 600 800
					20x80	300	8	230	3200 800 300

CONT. CARTRIDGE HEATERS UTX

DIA X L	POWER W	SURF.LOAD W/CM ²	VOLTAGE V	ARTICLE NO.	DIA X L	POWER W	SURF.LOAD W/CM ²	VOLTAGE V	ARTICLE NO.
20x80	400	11	230	3200 800 400	20x450	2500	9	230	3204 502 500
20x80	500	14	230	3200 800 500	20x450	3000	11	230	3204 503 000
20x80	600	16	230	3200 800 600	20x450	3500	13	230	3204 503 500
20x80	800	22	230	3200 800 800	20x450	4000	15	230	3204 504 000
20x80	1000	27	230	3200 801 000					
20x80	1250	34	230	3200 801 250	20x500	2000	7	230	3205 002 000
					20x500	3000	10	230	3205 003 000
20x100	400	8	230	3201 000 400	20x500	4000	14	230	3205 004 000
20x100	600	12	230	3201 000 600	20x500	5000	17	230	3205 005 000
20x100	800	16	230	3201 000 800					
20x100	1000	20	230	3201 001 000					
20x100	1300	27	230	3201 001 300					
20x100	1600	32	230	3201 001 600					
20x130	400	6	230	3201 300 400					
20x130	500	7	230	3201 300 500					
20x130	600	9	230	3201 300 600					
20x130	800	12	230	3201 300 800					
20x130	1000	15	230	3201 301 000					
20x130	1500	22	230	3201 301 500					
20x130	2000	30	230	3201 302 000					
20x160	500	6	230	3201 600 500					
20x160	800	9	230	3201 600 800					
20x160	1000	12	230	3201 601 000					
20x160	1500	18	230	3201 601 500					
20x160	2000	23	230	3201 602 000					
20x200	800	7	230	3202 000 800					
20x200	1000	9	230	3202 001 000					
20x200	1300	12	230	3202 001 300					
20x200	1600	15	230	3202 001 600					
20x200	2000	18	230	3202 002 000					
20x200	2500	23	230	3202 002 500					
20x250	800	6	230	3202 500 800					
20x250	1000	7	230	3202 501 000					
20x250	1500	11	230	3202 501 500					
20x250	2000	14	230	3202 502 000					
20x250	2500	18	230	3202 502 500					
20x300	1000	6	230	3203 001 000					
20x300	1500	9	230	3203 001 500					
20x300	2000	12	230	3203 002 000					
20x300	2500	15	230	3203 002 500					
20x350	1500	7	230	3203 501 500					
20x350	2000	10	230	3203 502 000					
20x350	2500	12	230	3203 502 500					
20x350	3000	15	230	3203 503 000					
20x350	3500	17	230	3203 503 500					
20x400	1500	6	230	3204 001 500					
20x400	2000	9	230	3204 002 000					
20x400	2500	11	230	3204 002 500					
20x400	3000	13	230	3204 003 000					
20x400	3500	15	230	3204 003 500					
20x400	4000	17	230	3204 004 000					
20x450	2000	8	230	3204 502 000					

CARTRIDGE HEATERS UTC

Design: Surface mantle in stainless steel EN 1.4541. The element is fitted with thermo elements Fe-CuNi type J and 1000 mm teflon and fibreglass insulated nickle wires.
Reamed holes with smallest tolerance H7 are required. At surface load over 20W/cm² individual adjustment is required. Designed for connection to rated voltage 230V. Surface load up to 60 W/cm².

Design acc. to following articles as fitted below.
All elements on following pages can be furnished with thermo elements. The cartridges can also be furnished with connections described later in this section. Alternatively they can be manufactured acc. to customer specification.

Element UTC type 2 with built-in thermo element Fe-CuNi type J. Surface mantle in stainless steel EN 1.4541, rated voltage 230V. Connection 1000 mm fiberglass insulated nickle wire. Standard range.



DIA X L	POWER W	SURF. LOAD W/CM ²	VOLTAGE V	ARTICLE NO.	DIA X L	POWER W	SURF. LOAD W/CM ²	VOLTAGE V	ARTICLE NO.
6.5x40	125	22	230	3060 400 126	8x160	300	8	230	3081 600 301
6.5x40	150	27	230	3060 400 151	8x160	400	11	230	3081 600 401
6.5x40	175	31	230	3060 400 176	8x160	500	14	230	3081 600 501
6.5x40	200	36	230	3060 400 201					
6.5x50	150	20	230	3060 500 151	10x40	150	18	230	3100 400 151
6.5x50	175	24	230	3060 500 176	10x40	200	24	230	3100 400 201
6.5x50	200	27	230	3060 500 201	10x40	250	30	230	3100 400 251
6.5x50	250	34	230	3060 500 251					
6.5x60	200	21	230	3060 600 201	10x50	200	18	230	3100 500 201
6.5x60	250	26	230	3060 600 251	10x50	250	22	230	3100 500 251
6.5x60	300	32	230	3060 600 301	10x50	300	26	230	3100 500 301
6.5x80	200	15	230	3060 800 201	10x60	250	18	230	3100 600 251
6.5x80	250	19	230	3060 800 251	10x60	300	21	230	3100 600 301
6.5x80	300	22	230	3060 800 301	10x60	400	28	230	3100 600 401
6.5x100	250	15	230	3061 000 251	10x80	250	12	230	3100 800 251
6.5x100	300	17	230	3061 000 301	10x80	300	15	230	3100 800 301
6.5x100	400	23	230	3061 000 401	10x80	400	20	230	3100 800 401
8x40	150	21	230	3080 400 151	10x100	300	11	230	3101 000 301
8x40	200	28	230	3080 400 201	10x100	400	15	230	3101 000 401
					10x100	500	19	230	3101 000 501
8x50	150	16	230	3080 500 151					
8x50	200	22	230	3080 500 201	10x130	300	8	230	3101 300 301
8x50	250	27	230	3080 500 251	10x130	400	11	230	3101 300 401
					10x130	500	14	230	3101 300 501
8x60	200	17	230	3080 600 201					
8x60	250	21	230	3080 600 251	10x160	400	9	230	3101 600 401
8x60	300	25	230	3080 600 301	10x160	600	13	230	3101 600 601
8x80	200	12	230	3080 800 201					
8x80	250	15	230	3080 800 251	12.5x40	200	20	230	3120 400 201
8x80	300	18	230	3080 800 301	12.5x40	250	25	230	3120 400 251
8x80	400	24	230	3080 800 401					
					12.5x50	300	22	230	3120 500 301
8x100	200	9	230	3081 000 201	12.5x50	400	29	230	3120 500 401
8x100	250	12	230	3081 000 251					
8x100	300	14	230	3081 000 301	12.5x60	300	17	230	3120 600 301
8x100	400	19	230	3081 000 401	12.5x60	400	23	230	3120 600 401
8x130	250	9	230	3081 300 251	12.5x80	400	16	230	3120 800 401
8x130	300	10	230	3081 300 301	12.5x80	500	20	230	3120 800 501
8x130	400	14	230	3081 300 401					
					12.5x100	500	15	230	3121 000 501
					12.5x130	600	14	230	3121 300 601

CONT. CARTRIDGE HEATERS UTC

DIA X L	POWER W	RUF.LOAD W/CM ²	VOLTAGE V	ARTICLE NO.	DIA X L	POWER W	RUF.LOAD W/CM ²	VOLTAGE V	ARTICLE NO.
12.5x160	800	13	230	3121600801	12.5x250	1250	14	230	3122501251
12.5x200	1000	14	230	3122001001	12.5x300	1500	14	230	3123001501

CARTRIDGE HEATERS UTC WITH BUILT-IN THERMOCOUPLE

All UTC heaters can be manufactured with built-in thermocouple.

The thermocouple joint can be positioned as follows:

UTC TYPE 1

Grounded in a special bottom plate. Guarantees excellent reading of temperature and quick response. Generally used in injection systems for plastic materials.

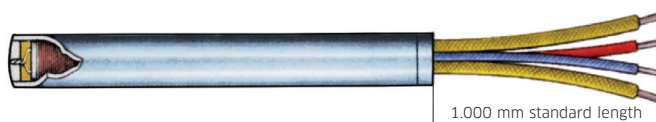

UTC TYPE 2

Insulated in proximity to the bottom plate. Suitable for avoiding disturbances to sensitive equipment.

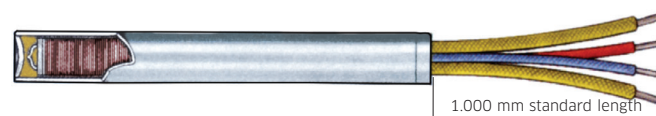

UTC TYPE 3

In contact with metal sheath within a 12 mm cold part, located at the center of the heater. Guarantees excellent reading of temperature and rapid response. Cannot be manufactured with diameters less than 10 mm.

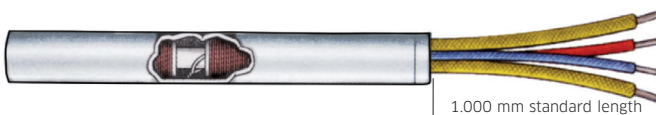

UTC TYPE 4

Insulated at the center of the heater. Makes it possible to evaluate the heater temperature and heat exchange in order to optimize the heater from energy point of view.



CODE	POSITIVE	COLOR	NEGATIVE	COLOR	TEMPERATURE AREA
J	Iron	Red	Constantan	Blue	-20 - +750°C
K	Chromel*	Red	Alumel*	Green	-20 - +1250°C

IMPORTANT INFORMATION FOR SAFE USING OF UTC TYPE 1, 2, 3 AND 4

As shown in the drawings of UTC heaters type 1 and 2, the sensitive joint of the thermocouple is located on the tip of the heater and therefore in an area that is relatively colder than the body of the heater. If the heater, though introduced into a system equipped with automatic temperature control, is powered at rated voltage, there will be a drastic overheating of the cartridge body. The greater the density in W/cm^2 of the heater, the greater the overheating will be. The reason for this is that the time which elapses before the generated heat reaches the thermocouple joint by thermal conduction is sometimes sufficient to the irreversibly damage the heater.

A. Example of turning on heaters with built-in TC 1-type thermocouple in the open air with temperature controlled by means of thermoregulator:

Set the thermoregulator. the lower the temperature, the higher the watt density of the heater. For instance, with a TC 1 cartridge with dimension 10 x 100 mm, 500 W, surface load 19 W/cm^2 : set the thermoregulator at 80°C. Then set it up to 180°C, then another 100°C, then another 100°C, and so on until the required temperature is reached.

Please note that if the thermoregulator was set to the final temperature directly, for instance 500°C, before the thermocouple joint reached the intervention temperature, the central body of the heater would reach temperatures over 1000°C and the heater would be destroyed.

B. Example of turning on heaters with built-in TC1-type thermocouple, inserted in a metal ground with temperature controlled by means of a thermoregulator:

1. If the metal ground is small and the heater has a density above 10 W/cm^2 , follow the instructions for elements in open air.
2. If the metal ground is large and the hole is reamed to tolerance H7, the thermoregulator can be set to working temperature directly.

For UTC type 3 heaters, there is no need of special precautions as the thermocouple is positioned between two heating areas and by this is quicker influenced by the heat radiation from the element. A pre-heating case is however always advisable.

If the temperature control equipment has a soft-start effect, all of the above precautions can be considerably reduced. It is always recommended to run test cycles.

CARTRIDGE HEATERS UTX AND UTC DIFFERENT CONNECTIONS AND SPECIAL DESIGNS

S 1. FLEXIBLE CABLES

Suitable when a highly flexible cable also near the element head is required. Note that with this solution, the temperature of the cartridge connection end may not exceed 260°C.

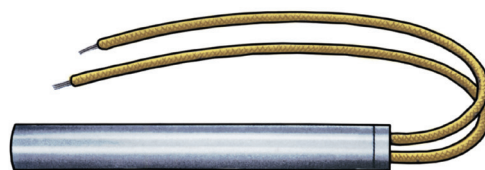

S 2. CABLES INSIDE PROTECTIVE TUBE

The cables are protected by a flexible tube of galvanized steel in the standard version. On demand a stainless protective tube is also offered. Advisable to protect the cables from being smashed, grazed or torn.

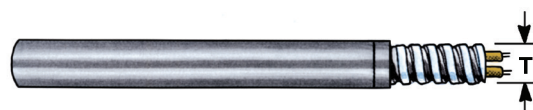

Diam. of the protective tube						
Element Ø	6.5-1/4"	8	10-3/8"	12-1/2"	16-5/8"	20-3/4"
T	6.7	7.5	8.5	10.5	12.5	13

S 3. FLEXIBLE METAL BRAID

The cables are protected by a flexible metal braid in galvanized steel. On demand we also offer stainless protective braid. Advisable for protection of the cables against damages but with maximal preserved flexibility.



S 4. SOLID NICKEL WIRES

The elements can be fitted with solid nickel wires, naked or insulated with a silicone hose, glass armoured silicone, teflon or ceramic bushings. Useful when the input wires, by mechanical needs or assembly purposes, need to be particularly rigid.



S 5. INSULATED CABLES FOR HIGH TEMPERATURES

The elements can be fitted with nickel wires insulated with ceramic beads (A) or ceramic fibres (B). One of these solutions is demanded when the cables are exposed to a temperature continuously over 260°C.

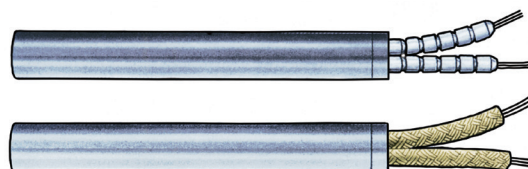

S 6. CORRUGATED, FLEXIBLE TUBE WITH CONTINUOUS WALL

The cables are protected by a corrugated, flexible and completely tight protective tube in stainless steel welded to the cartridge sheath. This solution is indispensable when the cables must go through areas with liquids, corrosive gases, etc.



S 7. SEALED HEATERS

All cartridge heaters can be produced completely sealed. Due to the high level of hygroscopicity of the insulating ceramic material, the heaters can easily absorb atmospheric humidity and thus decrease their electrical installation. Though this drawback can be remedied with a short period of pre-heating, the cartridges must be sealed to avoid humidity absorption. This is done by resins or silicone when the head temperature is below 260°C; or with the patented SC-sealing when the temperature is over 260°C. Sealing is indispensable when the cartridge head might be exposed to washing, oil leakage, corrosive gases, etc.

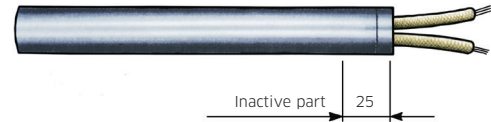

S 8. CABLE OUTLET AT RIGHT ANGLE

The cables are protected by a flexible protective tube in galvanized steel.

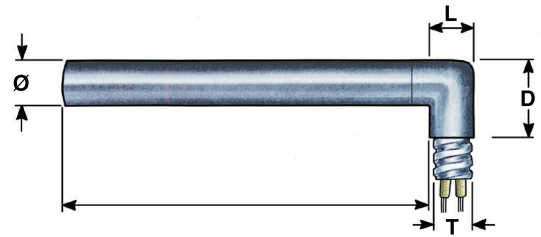

S 9. CABLE OUTLET AT RIGHT ANGLE

The cables are protected by a flexible metal braid in galvanized steel.

Angular head dimensions						
Ø	6.5-1/4"	8-5/16"	10-3/8"	12.5-1/2"	16-5/8"	20-3/4"
L	7.5	8	10	12.5	16	20
D	18	20	23	27	30	36
Dimensions of tube or flexible braid						
T	6.7	7.5	8.5	10.5	12.5	13

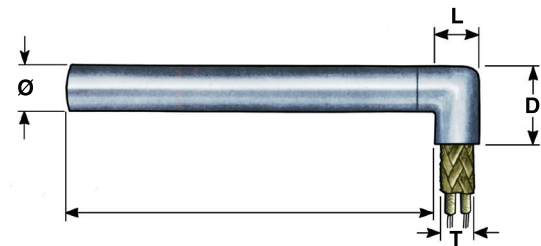

S 10. CABLE OUTLET AT RIGHT ANGLE

Flexible cables coming out of the tube directly from bilateral opening in a 90° angle. Particularly suitable for very small spaces.

Ø	6.5-1/4"	8-5/16"	10-3/8"	12.5-1/2"	16-5/8"	20-3/4"
L	8	8	10	12	14	16



S 11. CABLE OUTLET AT RIGHT ANGLE

Connection with 90° bend in copper.

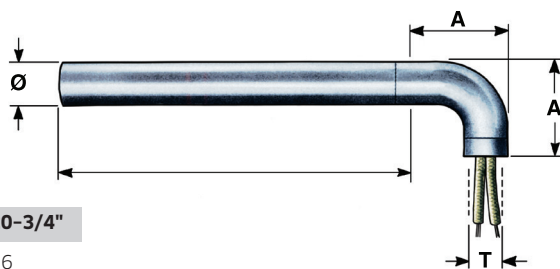

Ø	6.5-1/4"	8-5/16"	10-3/8"	12.5-1/2"	16-5/8"	20-3/4"
A	20	21.5	23	26	34	36
T	6.7	7.5	8.5	10.5	12.5	13

S 12. CABLE OUTLET - CURVED COLD PARTS

Element with curved cold part. Recommended to use in 90° outlets into high temperature environments and for incorporations in fusions. On request, the hot and cold part of the element can be manufactured with any length. Input cables can have S8 or S9 protection - see above.

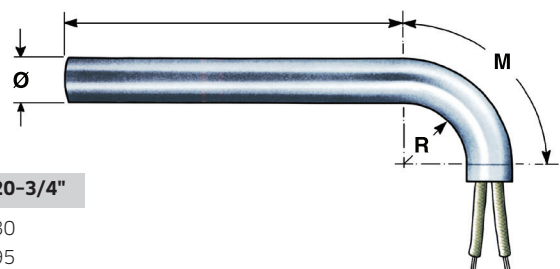

Ø	6.5-1/4"	8-5/16"	10-3/8"	12.5-1/2"	16-5/8"	20-3/4"
R	12	12	13	20	25	30
M	50	60	60	70	80	95

S 13. THREADED PINS

Heaters with diameter 12.5 mm or more can be furnished with threaded pins, nuts and washers for electrical connection. This solution is useful when parallel coupling of two or several elements near one another is necessary.



S 14. TAB TERMINALS

Heaters with a diameter of 14 mm or more can be furnished with tab terminals, built solidly into the cartridge head.

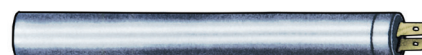

S 15. FLANGE

All heaters can be supplied with a stainless steel flange.

Ø	DIMENSIONS STANDARD FLANGES				
	D	C	H	S	
6.5-1/4"	8-5/16"	25	19	3.5	2
10-3/8"	12.5-1/2"				
6.5-1/4"	8-5/16"	35	28	4.5	2
10-3/8"	12.5-1/2"				
16-5/8"	20-3/4"				

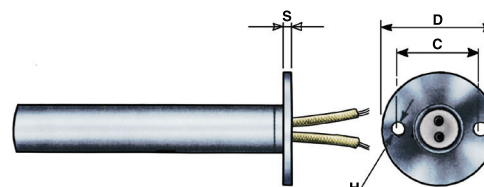

S 16. SINGLE SMALL RIGHT ANGLE FLANGE

S 17. DOUBLE SMALL RIGHT ANGLE FLANGE

Dimensions of small flanges						
Ø	6.5-1/4"	8-5/16"	10-3/8"	12.5-1/2"	16-5/8"	20-3/4"
A	10	11	13	15	18	22
B	6	7	9	10	13	15
C	8.7	10	13	15.8	18	23
D	3.2	3.2	4.2	5.3	5.4	6.2
H	6	7	9	11	13.5	16.6
L	5.7	6	6.6	6.8	10.3	12
S	1	1	1	1	1.5	2

S 18, S 19, S 20. HEATERS WITH ELECTRICAL INPUTS AT BOTH ENDS

Elements with electrical input at both ends

S 18. With smooth nickel pins

S 19. With threaded pins and nuts for electrical connections

S 20. With flexible cables

S 21, S 22. WELDED NIPPLE

The elements can be fitted with threaded fittings in stainless steel as indicated in the table below or acc. to particular specification. Particularly suitable for liquid heating.

Standard stainless steel threaded fittings:												
ELEMENT DIAMETER												
MM	6.5	8	10	12.5	16	20	inch	1/4"	3/8"	1/2"	5/8"	3/4"
A	11	13	15	17	20	25		11	15	17	20	25
B	4	4.5	5	5.5	6	7		4	5	5.5	6	7
C	12	14	17	19	24	30		12	17	19	24	30
Thread	10x1	12x1.5	14x1.5	16x1.5	20x1.5	27x1.5		1/8"	1/4"	3/8"	1/2"	3/4"

S 23. DOUBLE THREADED NIPPLE

Fittings with double stainless steel thread:

ELEMENT DIAMETER												
MM	6.5	8	10	12.5	16	20	inch	1/4"	3/8"	1/2"	5/8"	3/4"
A1	7	8.5	10	11.5	14	18		7	10	11.5	14	18
B	4	4.5	5	5.5	6	7		4	5	5.5	6	7

S 24. EXPLOSION PROOF DESIGN PER CENELEC STANDARDS

The elements can be mounted on commercial boxes, approved for dangerous environments acc. to standard: EExd, IIC, T5 and IP65.

NOTE! The assembled element is not certified.

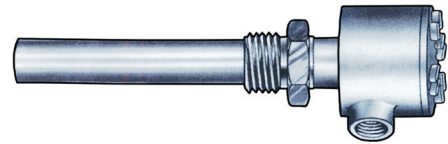

S 25. CABLE CLAMP

The elements can be built with a threaded crown that facilitates extraction from the mounting position. The threaded crown can be welded onto either of the ends of the heater.



S 26. CONNECTION CABLE WITH TENSILE UNLOADING

The elements can be built with a multi-polar input cable and connections protected from tears and external agents by a water-proof cable clamp.

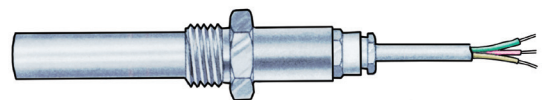

S 27. WATER-PROOF HEAD PROTECTION

In particular suitable when exposed to pouring water, for example in de-icing of industrial cooling equipments and evaporators.



S 28. BUILT-IN THERMOSTAT

Heaters with built-in thermostat are an ideal solution when an extremely compact systems for heating and temperature control is demanded. They are especially suitable for liquid heating, in particular if effective control against exceeding maximum temperatures is demanded. The thermostat has a pre-adjusted, non-adjustable colibration.



S 29. CONTACTS FOR SLIDING SUPPLY

Suitable for heating of rotating cylinders.



S 30. TEFLON END BUSHING

The heaters can be furnished with head bushings in teflon instead of ceramic material. The teflon bushing offers a moderate protection from humidity and excellent protection against mechanical shocks.

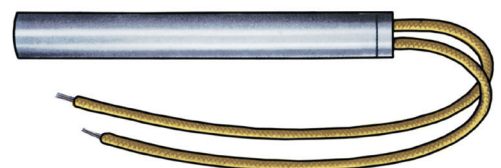

S 31. DIFFERENTIATED TEMPERATURE- OR NON-HEATING SECTIONS

The heaters can be produced with differentiated wattage density heating sections and with cold sections.

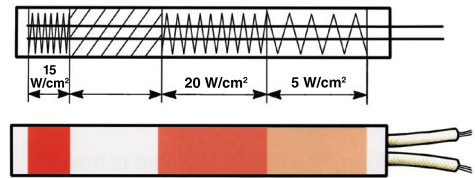

S 32. INDIVIDUAL TEMPERATURE CONTROL AREAS

The heaters can be furnished with individual temperature control areas that allow diversified temperature control on pre-determined parts of the heating system.

These parts can have a constant or varying power and length, with internal or external thermocouplers.

By order, please specify exact dimension, length, power and voltage as well as the position for the temperature control and thermocouplers.

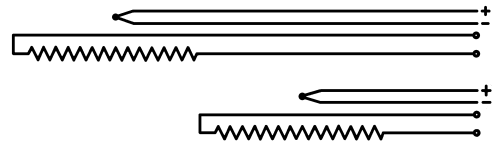

WATER-PROOF SEALING TYPE SC 400

The magnesium oxide used in the cartridge heaters is an excellent electrical insulator and a good heat conductor. It has however a high hygroscopic level, implying that a non-occluding elements tend to lose their insulation and sometimes drop to values so low that during power-up they could cause the safety devices to intervene. In worst case the elements can be irreversibly damaged by short circuit.

If the element end does not exceed 260°C, the sealing can be done by resins or silicone. In cases where higher temperature resistance or bigger safety margins are required other solutions are required, we offer the SC 400 solution. It is a completely water-proof sealing, irreversible, unorganic and resistant to high pressures and continuous high temperatures, up to 400°C.

The sealing does not undergo the aging process and is resistant to water, acids atmospheric agents and it does not char.

SC 400 is an unorganic compound, fused to the heater head by a controlled cycle process, thus forming a cohesive seal adherent to the metal surfaces on a molecular level.

SC 400 protects the inner components completely from pollutants and oxidation, meaning a striking increase of the element life time.

The use of SC 400 is totally necessary in cases where high level of safety and reliability are needed, like in electric medical equipment, manual tools, aeronautics-, space-, nuclear- surgical- or military appliances.

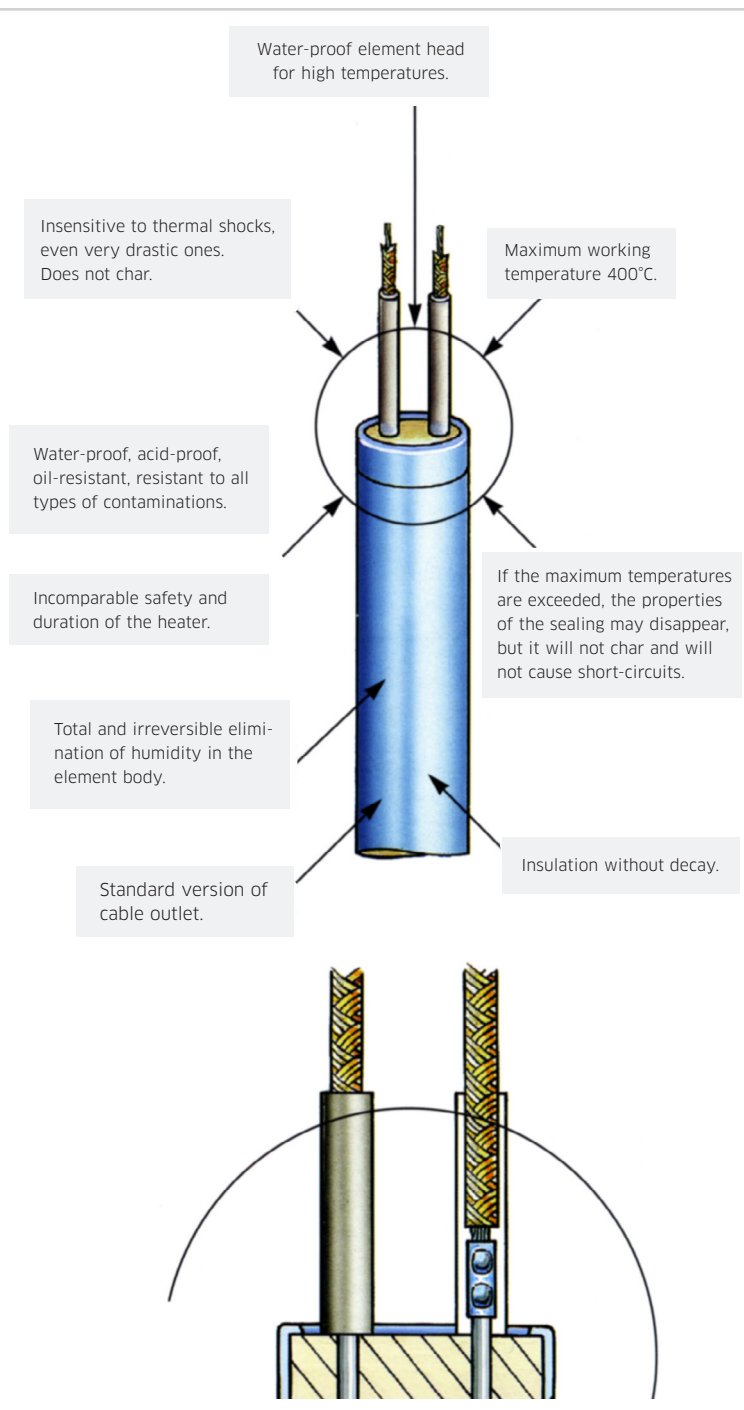

HIGH TEMPERATURE RESISTANT ASSEMBLY OIL NEVER SEEZ

Properties:

- Facilitates the mounting
- Prevents stuck burning of the element
- Keeps its properties up to 1100°C it can however arise harmful substances when heated over 700°C.

- Content 113 g



TYPE	ARTICLE NO.
Assembly oil	1160 099 401

HIGH TEMPERATURE RESISTANT ASSEMBLY PASTE LUBRI-HOT

Properties:

- Improves the contact between the hole wall and the surface of the heater.
- Favors heat transfer, thus increases the life time of the heater.
- Eliminates corrosive effects caused by high temperatures.
- Maintains its properties up to 1200°C.

The paste can also be used for any kind of lubrication at high temperatures, even in extremely harsh environments and in the handling operations within the chemical -, and enamelling industry, foundries and steam valves, locking nuts in turbines, ovens and furnaces.

Content: 50 g



TYPE	ARTICLE NO.
Assembly paste	3050 027 501

HIGH PENETRATION LUBRICATING SPRAY EXTRACTOR

Properties:

- Facilitates extraction of used heaters.
- Excellent penetration ability that reaches deeply, also when small tolerances between hole and element.
- Dissolves oxides and transforms them to a lubricating film that facilitates extraction of the element with minimal traction effort.
- Leaves the inner wall of the assembly hole intact, allowing the new element to be inserted directly.

The spray can also be used to loosen rusty and corroded mechanisms, dissolve grease, tar, glue and markings or clean and lubricate movable parts and counteract start problems in very humid climate areas.

The spray does not react with metals, neither with most plastics.

Content: 200 ml with CO₂ operating gas.



TYPE	ARTICLE NO.
Deassembly spray	3050 028 001

TECHNICAL INFORMATION - RECOMMENDATIONS FOR INSTALLATION

- Distribute the required load over the highest possible number of heaters in order to reduce the density in W/cm² of each heater.
- Insert the cartridges in bored holes. Clearance as possible. Clearance between heater and hole reduces heat transmission, increases cartridge temperature, intensifies the oxidation process, increases energy consumption and considerably decreases heater life.
- If the heaters are mounted on moving parts of the machine, make sure the cables are well anchored a few centimeters upstream from the heater outlet to prevent movement that could result in break-downs. Even though small movements are generally acceptable, there is always a high risk of breakage. It is advisable to make a few extra turns of the cable upstream of the outlet to prolong its life. If the application requires continuous movements, it is indispensable to communicate the width and type of motion. In many cases an intermediate box is very useful for transferring motion to an additional cable that can easily be replaced.
- If there is a significant number of vibrations, it is advisable to use an intermediate connection box as described above.
- Protect cables and cartridge head, especially if not sealed, against contamination from oils, liquids, sprays, corrosive gases, splashes of water. With repeated hot/cold cycles, the cartridge absorbs any substance that comes into contact with the insulating material. Most substances char and produce short circuits. The only sealant that ensures total protection is SC400.
- If the cables remain in areas with a constant temperature above 250 °C, it is indispensable to use one of the following solutions:
 - Flexible nickel cables insulated with ceramic fiber or ceramic beads.
 - Rigid nickel conductors, not insulated alternatively insulated with a sheath of ceramic fiber or ceramic beads.
 - Extend cold zone of heater enough to bring the cables out of the high temperature area.
- Prevent the cartridge head, and, consequently the cables, from entering the hole. The heat of the metal ground could damage the insulating material and the sealant.
- Avoid using self-sticking tape near cartridge head. The adhesive of certain types of tape could enter the head, char and produce short circuits. If taping is unavoidable, use silicone-base adhesives.
- At high temperatures, it is always advisable to thermally insulate the heated parts. The following positive effects are obtained by insulation:
 - Energy consumption is lowered with up to 40%.
 - Less powerful and consequently longer lasting elements can be used.
 - Higher temperatures are reached in a shorter time.

Standard tolerances

Diameter: The tolerance is indicated in correspondence to the various diameters listed in the catalogue.

Length: ≤ 100 mm ±2 mm
 >100 mm ±2 %

Power: +5 % -10 %

Resistance: +10 % -5 %

Resistance changes as the temperature varies. At ambient temperature, resistance is approximately 5 % lower than that of working temperature.

Straightness: For lengths up to 300 mm:

0.1 mm/150 mm.

For lengths >300 mm:

$L^2 \times 4$

1.000.000

L= length of heater in mm.

In any case, given the flexibility of the heater, the straightness can hardly represent a problem upon being inserted into the heater, even if the hole is very precise.

Tolerances stricter than standard can be accepted after agreement.

TECHNICAL INFORMATION - RECOMMENDATIONS FOR INSTALLATION

- To improve heat conductivity and ease the extraction of the element, use the compound LUBRIHOT. Avoid polluting the element head with the paste as this can cause electricity leakage or short circuits.
- Place the external thermocouples no further than 10 mm from the cartridge and, if possible, in the centre area. This warning is extremely important when the heater has a high watt density.
- To achieve increased life time of the element, the use of proportional microprocessor thermoregulators is essential.
- Oxidation of the heaters and the hole in which they are inserted, produced by many hours of work at high temperatures, can make it difficult to extract the burnt element. Try first to loosen the element with the spray EXTRACTOR. Then drill a hole with a bit 2 to 3 tenths smaller than the nominal diameter of the heater. Remove the element, then use a boring machine to rebore the hole, if necessary, use an iron rod and a hammer as well.
- If used correctly, the heaters have a very long life. To obtain maximum performance it is important to supply an accurate specification of the element demand and the operation conditions.

HEATING OF LIQUIDS

The compactness and high surface load of the cartridge heaters offer excellent solutions for heating liquids.

General recommendations:

- Place the element as far away as possible from the walls of the container, allowing best possible circulation of the liquid by convection.
- Make sure that the liquid level is always at least 20 mm above the element.
- Avoid too frequent ON/OFF cycles, (use a proportional thermoregulator).
- Make sure there are no deposits of incrustation, lime deposits, substances etc. on the heater surface.
- To avoid emptying the container when a worn out element shall be replaced, it is recommended to use our supplementary sheaths .
- If there is a risk of the liquid overflowing, steam, high ambient humidity, contamination etc, sealed elements should be used.
- As far as possible, never exceed recommended surface loads, according to table beside.

Recommended surface loads for different material. At forced circulation the density can be slightly increased. A lower density than indicated will increase the heater life time.

Material	Max temp °C	Max W/cm ²
Water	100	30
Asphalt, tar and other thick substances	95	1.5
	150	1.2
	200	1.0
	250	0.8
Petrol - photogen	150	3.5
Freon	150	0.5
Ethylene glycol	150	4.5
Molasses	40	0.7
Melt metal	260-500	4.0
Heavy oil	90	1.5
Heat conducting oil	400	3.5
SAE 30 motor oil	120	3.0
Vegetable oil	200	4.5
Salt bath	500	4.5
Caustic soda, NaOH 10 %	90	4.0
Caustic soda, NaOH 75 %	70	2.3
Acid solutions	70	6.0
Alcalic solutions	100	6.0
Decreasing solutions	130	3.5

TECHNICAL INFORMATION - RECOMMENDATION WHEN MOUNTING

Temperature taken on by sheath at various wattage densities

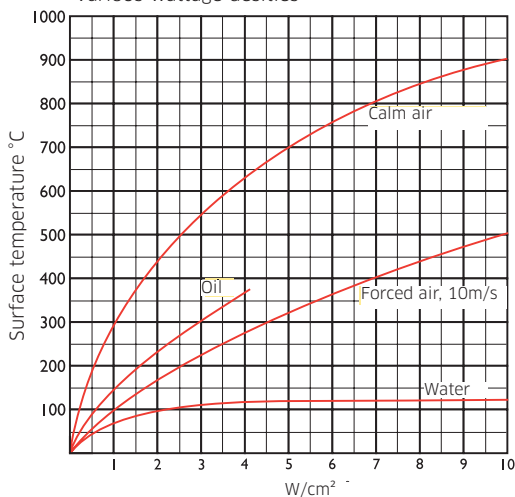

Maximum density on the heaters, used in high temperature environments

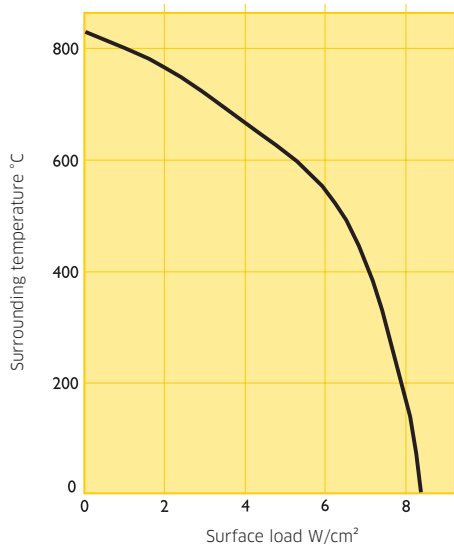

W/cm ²	Working temperature							
	100°C	200°C	300°C	400°C	500°C	600°C	700°C	800°C
2								1.30
3								0.35
4							1.00	0.15
5					2.00	1.50	0.60	0.080
6		2.00	1.75	1.30	1.50	0.70	0.30	0.040
7	2.00	1.75	1.50	1.20	1.30	0.55	0.20	0.035
8	1.75	1.50	1.30	1.00	1.00	0.45	0.15	0.030
9	1.50	1.25	1.00	0.70	0.60	0.35	0.10	0.025
10	1.00	0.75	0.70	0.60	0.50	0.25	0.085	0.020
12	0.65	0.60	0.55	0.50	0.35	0.20	0.065	0.015
15	0.55	0.50	0.50	0.40	0.30	0.15	0.050	0.010
18	0.50	0.45	0.40	0.35	0.20	0.10	0.040	
20	0.40	0.35	0.35	0.30	0.15	0.075	0.030	
25	0.30	0.25	0.25	0.20	0.10	0.050	0.025	
30	0.25	0.20	0.18	0.10	0.085	0.045	0.020	
35	0.22	0.17	0.15	0.080	0.075	0.040	0.015	
40	0.20	0.15	0.10	0.070	0.050	0.035		
50	0.15	0.12	0.085	0.065	0.045	0.030		
60	0.13	0.10	0.075	0.060	0.040	0.025		
70	0.10	0.080	0.060	0.050	0.035	0.020		
80								

For aluminium and brass, choose the clearance in the column corresponding to the temperature immediately superior that of the working temperature (+100°C)

The clearance is obtained by the difference between the hole diameter and the real diameter of the cartridge.

Example: hole diameter 12.6 mm

nominal diameter of cartridge 12.5 mm

12.6 mm - 12.42 mm (12.5 - 0.08 max catalog tolerance)

= 0.18 mm (max admissible clearance)

For optimum working conditions, energy saving and longer life time of the heater, it is advisable to bore holes with a tolerance of H7.

NOZZLE ELEMENTS

Nozzle elements are produced with high precision and with high surface loading to meet the high demands of quick and safe heating. During the manufacturing process the element is subject to very high pressure to reach high insulation resistance, good heat

transmission without internal voids in the element and a very smooth surface for optional and uniform heat transmission from the total surface of the element. The element is absolutely tight to avoid that for instance melted plastic, oil or gas can leak in.

Sheath of brass with 45 axial connection. The element is furnished with 1000 mm cable and earth connection protected by a housing of metal braid. Designed for connection to nominal voltage 230V. Surface load 4.5 W/cm². Tensional stability 2 kV.

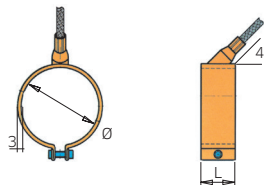

DIA	DIA X L	POWER W	VOLTAGE V	ARTICLE NO.	DIA	DIA X L	POWER W	VOLTAGE V	ARTICLE NO.
25	25 x 20	80	230	3002 520 080	55	55 x 20	155	230	3005 520 155
	25 x 30	100	230	3002 530 100		55 x 25	190	230	3005 525 190
30	30 x 20	100	230	3003 020 100	55	55 x 30	230	230	3005 530 230
	30 x 25	105	230	3003 025 105		55 x 35	270	230	3005 535 270
30	30 x 30	125	230	3003 030 125	55	55 x 40	310	230	3005 540 310
	30 x 35	145	230	3003 035 145		55 x 50	385	230	3005 550 385
30	30 x 40	165	230	3003 040 170	60	60 x 20	165	230	3006 020 165
	35 x 20	110	230	3003 520 110		60 x 25	210	230	3006 025 210
35	35 x 25	120	230	3003 525 120	60	60 x 30	250	230	3006 030 250
	35 x 30	145	230	3003 530 145		60 x 35	295	230	3006 035 295
35	35 x 35	170	230	3003 535 170	60	60 x 40	335	230	3006 040 335
	35 x 40	195	230	3003 540 195		60 x 50	420	230	3006 050 420
35	35 x 45	220	230	3003 545 220	60	60 x 60	505	230	3006 060 505
	38 x 20	110	230	3003 820 110		65	65 x 20	180	230
38	38 x 25	140	230	3003 825 140	65		65 x 25	225	230
	38 x 30	165	230	3003 830 165		65 x 30	275	230	3006 530 275
38	38 x 35	200	230	3003 835 200	65	65 x 35	320	230	3006 535 320
	38 x 38	215	230	3003 838 215		65 x 40	365	230	3006 540 365
38	38 x 40	220	230	3003 840 220	65	65 x 50	455	230	3006 550 455
	38 x 45	250	230	3003 845 250		65 x 60	550	230	3006 550 550
38	38 x 50	300	230	3003 850 300	70	70 x 20	195	230	3007 020 195
	40 x 20	110	230	3004 020 110		70 x 25	245	230	3007 025 245
40	40 x 25	140	230	3004 025 140	70	70 x 30	295	230	3007 030 295
	40 x 30	165	230	3004 030 165		70 x 35	345	230	3007 035 345
40	40 x 35	195	230	3004 035 195	70	70 x 40	395	230	3007 040 395
	40 x 40	225	230	3004 040 225		70 x 50	490	230	3007 050 490
40	40 x 45	250	230	3004 045 250	70	70 x 60	590	230	3007 060 590
	42 x 20	120	230	3004 220 120		75	75 x 20	210	230
42	42 x 25	145	230	3004 225 145	75		75 x 25	260	230
	42 x 30	175	230	3004 230 175		75 x 30	315	230	3007 530 315
42	42 x 35	205	230	3004 235 205	75	75 x 35	370	230	3007 535 370
	42 x 40	235	230	3004 240 235		75 x 40	420	230	3007 540 420
45	45 x 20	130	230	3004 520 130	75	75 x 50	525	230	3007 550 525
	45 x 25	155	230	3004 525 155		75 x 60	635	230	3007 560 635
45	45 x 30	190	230	3004 530 190	80	80 x 20	225	230	3008 020 225
	45 x 35	220	230	3004 535 220		80 x 25	280	230	3008 025 280
45	45 x 40	250	230	3004 540 250	80	80 x 30	335	230	3008 030 335
	45 x 45	285	230	3004 545 285		80 x 35	395	230	3008 035 395
45	45 x 50	315	230	3004 550 315	80	80 x 40	450	230	3008 040 450
	45 x 55	345	230	3004 555 345		80 x 50	565	230	3008 050 565
48	48 x 20	135	230	3004 820 135	85	80 x 60	675	230	3008 060 675
	48 x 30	200	230	3004 830 200		85 x 20	240	230	3008 520 240
48	48 x 50	380	230	3004 850 380	85	85 x 25	300	230	3008 525 300
	50 x 20	140	230	3005 020 140		85 x 30	360	230	3008 530 360
50	50 x 25	175	230	3005 025 175	85	85 x 35	420	230	3008 535 420
	50 x 30	210	230	3005 030 210		85 x 40	480	230	3008 540 480
50	50 x 35	245	230	3005 035 245	85	85 x 50	600	230	3008 550 600
	50 x 40	280	230	3005 040 280		85 x 60	720	230	3008 560 720
50	50 x 50	350	230	3005 050 350					
	50 x 60	420	230	3005 060 420					

CONT. NOZZLE ELEMENTS

DIA	DIA X L	POWER W	VOLTAGE V	ARTICLE NO.	DIA	DIA X L	POWER W	VOLTAGE V	ARTICLE NO.
90	90 x 20	250	230	3009 020 250	95	95 x 40	535	230	3009 540 535
	90 x 25	315	230	3009 025 315		95 x 50	670	230	3009 550 670
	90 x 30	380	230	3009 030 380		95 x 60	800	230	3009 560 800
	90 x 35	445	230	3009 035 445	100	100 x 20	280	230	3010 020 280
	90 x 40	505	230	3009 040 505		100 x 25	350	230	3010 025 350
	90 x 50	635	230	3009 050 635		100 x 30	420	230	3010 030 420
	90 x 60	760	230	3009 060 760		100 x 35	490	230	3010 035 490
95	95 x 20	265	230	3009 520 265		100 x 40	560	230	3010 040 560
	95 x 25	335	230	3009 525 335		100 x 50	700	230	3010 050 700
	95 x 30	400	230	3009 530 400		100 x 60	840	230	3010 060 840
	95 x 35	465	230	3009 535 465					

NOZZLE ELEMENTS- SPECIAL DESIGN

Sheath in stainless steel for very corrosive environments like injection moulding of details in PVC plastic, which also allows a higher temperature and surface loading 7 W/cm². Thermo sensor type J for temperature regulation. Alternative connections see beside.

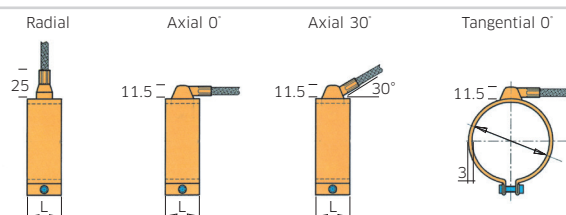

NOZZLE ELEMENTS- ASSEMBLY INSTRUCTIONS

Socket head cap wrench 4 mm is used. It is very important that the nozzle element is assembled tightly to avoid any internal voids between the element and for instance the nozzle of an injection moulder. After the first heating the nozzle element must be after-stretched.

Bending of the connection cable close to the element should be avoided. Remaining plastic material at element surface can be removed by heating to melting point. Avoid blows at the element and take good care when removing plastic.

RING- AND BAND ELEMENTS

We produce ring- and band elements according to customer specification.

Examples of application areas:

Injection moulding machines-extruders, containers, tanks, moulds, tools, etc.

Design:

Micanite with plate casing
Ceramics with plate casing
According to customer specification

Examples of connection options:

Terminal box
Cabinet inlet
Nickel wire
Tab terminal
Screw and nut, etc.

Contact us for further info/order form or order.

Band element in micanite with sheet metal casing

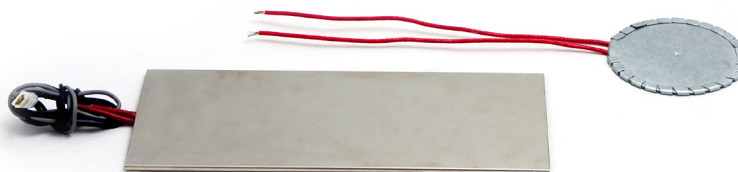

Ring element in ceramics with sheet metal casing

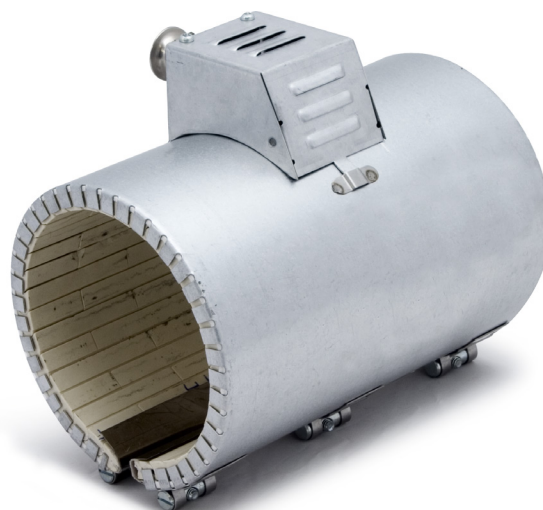

Ring element in micanite with sheet metal casing



HEATING FOIL ELEMENTS

Backer has a range of foil elements in stock for direct delivery. The elements have a certain resistance and give different powers depending on connected voltage according tables below. The ele-

ments can be used directly in your application or to be tested for an appropriate dimension or quality before order of a special designed heater.

SILICONE

Silicone rubber is a flexible material with good heat resistance, max 200°C.
Silicone rubber has a high resistance towards many chemicals.
One side of the foil element is furnished with an adhesive substance.
Connection cables length 200mm.

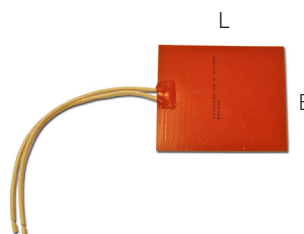

SILICONE				12V Power W	24V Power W	48V Power W	110V Power W	230V Power W	400V Power W	ARTICLE NO.
B mm	L mm	AREA CM ²	RESISTANCE OHM							
25	50	12.5	56.9	2.5	10	40				SI102985-00
50	50	25	28.8	5	20	80				SI102987-00
50	100	50	14.4	10	40	160				SI102989-00
95	100	100	151			15	80	350		SI102991-00
95	200	200	75.5			30	160	700		SI102993-00
95	200	200	331				36	160	483	SI102995-00
190	200	400	37.8			61	320	1399		SI102997-00
190	300	600	110				110	480	1454	SI103001-00
ø 70		38	19.2	7.5	30	120				SI103005-00
ø 150		177	16.5		35	139	733			SI103009-00
ø 200		314	211.6				57	250	756	SI103011-00

POLYIMIDE

Polyimide is a thin semi-transparent material with good electrical insulation ability. It is also resistant towards a great number of acids and bases. It can be used in environments with temperatures from -271°C to 220°C.
One side of the foil element is furnished with an adhesive substance.
Connection cables length 200mm

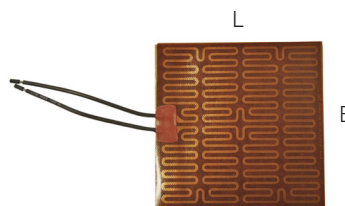

POLYIMIDE				1.5V Power W	3V Power W	4.5V Power W	6V Power W	9V Power W	12V Power W	24V Power W	48V Power W	ARTICLE NO.
B mm	L mm	AREA CM ²	RESISTANCE OHM									
25	50	12.5	1.9	1.2	4.7	10.7	19					PI102831-00
50	50	25	3.6	0.6	2.5	5.6	10	22	40			PI102833-00
50	100	50	1.8	1.3	5	11.3	20	45	80			PI102835-00
100	100	100	3.6		2.5	5.6	10	22	40	160		PI102837-00
100	200	200	1.8		5.0	11.3	20	45	80	320		PI102839-00
195	200	400	3.6				10	22	40	160	640	PI102841-00
195	300	600	2.4				15	33	60	240	960	PI102843-00

MICANITE

Foil heating element between micarite plates.
 Heat resistance max 400°C
 Connection cables length 200mm

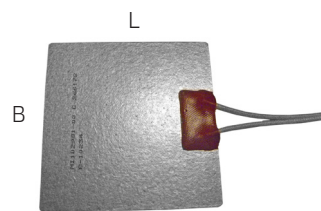

MICANITE				12V	24V	48V	110V	230V	400V	ARTICLE NO.
L mm	B mm OHM	AREA CM ²	RESISTANCE	Power W	Power W	Power W	Power W	Power W	Power W	
100	100	100	353			6.5	34	150	453	MI102981-00
180	200	400	400			26	137	599	1814	MI102983-00

COMPRESSOR AND CRANK CASE HEATERS

Standard range of heating products for crank cases of compressors to heat pumps, etc. The main purpose is to avoid starts with cold

oil in the crank case and as a result prolong the life time of the compressor. The heaters can also be customized.

Crankcase heater with a shell of aluminium and a constant power. Voltage 220-240 V.

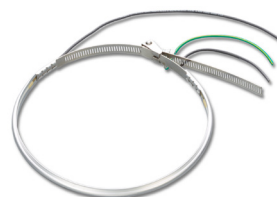

DIAMETER MM	DIA. MIN-MAX MM	POWER W	ARTICLE NO.
139	124-178	40	3840 028 001
168	165-200	40	3840 028 010
186	172-226	70	3840 028 017
233	227-281	90	3840 028 024
273	248-302	70	3840 028 027
273	275-330	120	3840 028 035
334	319-373	140	3840 028 040

A self-regulating heating cable with operating temperature 65°C furnished with a connection cable and an UV-resistant bundle band for fixing around the crank case of the compressor.



VOLTAGE V	POWER AT 10°C W	LENGTH V-CABLE MM	LENGTH BUNDLE BAND MM	LENGTH CONNECTION CABLE MM	ARTICLE NO.
230	12	300	550	1000	6150 410 201

Compressor heater in silicone rubber that can manage a surrounding temperature from -50 °C to 200 °C. The heaters are furnished with a feather for fixing around the crankcase of the compressor.

For better fixing and better contact we recommend the use of our stainless steel bundle band.



VOLTAGE V	POWER W	LENGTH H-CABLE MM	LENGTH BUNDLE BAND MM	LENGTH CONNECTION CABLE MM	ARTICLE NO.
230	45	640	14	1000	3050 810 001
230	45	490	14	1000	3050 810 101

Stainless steel bundle band for mounting of compressor heater.



MATERIAL	LENGTH MM	WIDTH MM	ARTICLE NO.
EN 1.4301	838	4.6	1150 810 201

CONT. COMPRESSOR HEATERS

Backer is a leading producer of compressor heaters and develop products in aluminium and polymer according to the latest know technologies.

With manufacturers of compressors and heat pumps as well as other big volume users in mind, Backer offer a big standard range of compressor heaters. In close cooperation with our customers we also produce tailor made solutions.

Example of designs:

Please contact us for more information and prices.

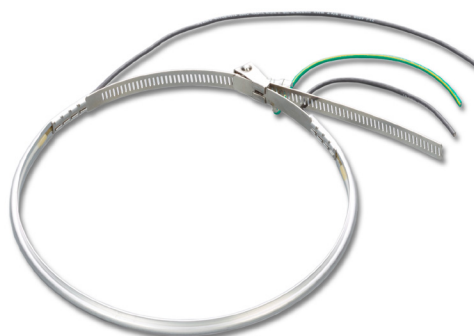
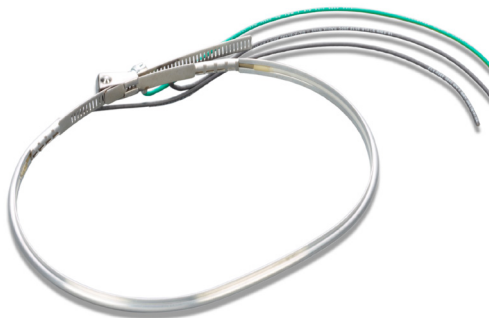

RADIANT- AND AIR HEATING



IR-elements.....	66
IR-elements in ceramics.....	66
IR-elements in quartz glass.....	73
IR-elementd in quartz glass and volfram.....	76
IR-heaters.....	77
IR-reflectors.....	80
IR-heating panel.....	81
Special designs and accessories/connections.....	82



Anti-condensation heaters.....	84
Accessories.....	85



Elements in aluminium profile.....	86
------------------------------------	----



PTC heating elements.....	88
---------------------------	----

IR ELEMENTS

Examples of application areas:

Plastic moulding, sterilization, gluing, screen printing, drying of varnish and printing, heating at animal breeding, etc.

Material:

Ceramics, quartz glass, quartz glass with halogen.
Operating temperature: 150-2400°C

CERAMICS

IR-elements in ceramics type LFFE incl. lock - and spring washer.					 				
TYPE	L X W mm	POWER W	VOLTAGE V	ARTICLE NO.	TYPE	L X W mm	POWER W	VOLTAGE V	ARTICLE NO.
LFFE	245x95	750	230	3054 400 750	LFFE	245x95	1200	230	3054 401 200
LFFE	245x95	1000	230	3054 401 000	LFFE	245x95	1400	230	3054 401 400
Type LFFE with built-in thermo element NiCr-Hi type K.									
TYPE	L X W mm	POWER W	VOLTAGE V	ARTICLE NO.	TYPE	L X W mm	POWER W	VOLTAGE V	ARTICLE NO.
LFFE-K	245x95	750	230	3054 400 751	LFFE-K	245x95	1200	230	3054 401 201
LFFE-K	245x95	1000	230	3054 401 001	LFFE-K	245x95	1400	230	3054 401 401
Type LFFE with built-in thermo element Fe-CuNi type J.									
TYPE	L X W mm	POWER W	VOLTAGE V	ARTICLE NO.	TYPE	L X W mm	POWER W	VOLTAGE V	ARTICLE NO.
LFFE-J	245x95	750	230	3054 400 752	LFFE-J	245x95	1200	230	3054 401 202
LFFE-J	245x95	1000	230	3054 401 002	LFFE-J	245x95	1400	230	3054 401 402
IR-elements in ceramics type LFTE incl. lock - and spring washer.					 				
TYPE	L X W mm	POWER W	VOLTAGE V	ARTICLE NO.	TYPE	L X W mm	POWER W	VOLTAGE V	ARTICLE NO.
LFTE	245x110	750	230	3054 410 750	LFTE	245x110	1200	230	3054 411 200
LFTE	245x110	1000	230	3054 411 000	LFTE	245x110	1400	230	3054 411 400
Type LFTE with built-in thermo element type K.									
TYPE	L X W mm	POWER W	VOLTAGE V	ARTICLE NO.	TYPE	L X W mm	POWER W	VOLTAGE V	ARTICLE NO.
LFTE-K	245x110	750	230	3054 410 751	LFTE-K	245x110	1200	230	3054 411 201
LFTE-K	245x110	1000	230	3054 411 001	LFTE-K	245x110	1400	230	3054 411 401
Ditto, type LFTE with built-in thermo element type J.									
TYPE	L X W mm	POWER W	VOLTAGE V	ARTICLE NO.	TYPE	L X W mm	POWER W	VOLTAGE V	ARTICLE NO.
LFTE-J	245x110	750	230	3054 410 752	LFTE-J	245x110	1200	230	3054 411 202
LFTE-J	245x110	1000	230	3054 411 002	LFTE-J	245x110	1400	230	3054 411 402

CONT. IR-ELEMENTS, CERAMICS

IR-elements in ceramics type FFE incl. lock - and spring washer.

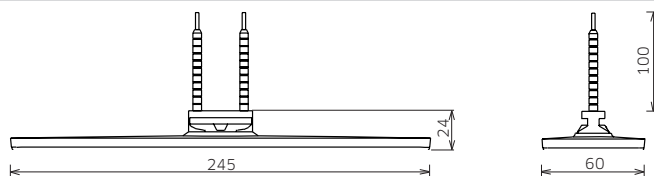

TYPE	L X W mm	POWER W	VOLTAGE V	ARTICLE NO.	TYPE	L X W mm	POWER W	VOLTAGE V	ARTICLE NO.
FFE	245x60	150	230	3054 190 150	FFE	245x60	500	230	3054 190 500
FFE	245x60	250	230	3054 190 250	FFE	245x60	650	230	3054 190 650
FFE	245x60	300	230	3054 190 300	FFE	245x60	750	230	3054 190 750
FFE	245x60	350	230	3054 190 350	FFE	245x60	800	230	3054 190 800
FFE	245x60	400	230	3054 190 400	FFE	245x60	1000	230	3054 191 000

Type FFE with built-in thermo element NiCr-Ni type K.

TYPE	L X W mm	POWER W	VOLTAGE V	ARTICLE NO.	TYPE	L X W mm	POWER W	VOLTAGE V	ARTICLE NO.
FFE-K	245x60	150	230	3054 190 151	FFE-K	245x60	500	230	3054 190 501
FFE-K	245x60	250	230	3054 190 251	FFE-K	245x60	650	230	3054 190 651
FFE-K	245x60	300	230	3054 190 301	FFE-K	245x60	750	230	3054 190 751
FFE-K	245x60	350	230	3054 190 351	FFE-K	245x60	800	230	3054 190 801
FFE-K	245x60	400	230	3054 190 401	FFE-K	245x60	1000	230	3054 191 001

Type FFE with built-in thermo element FeCu-Ni type J.

TYPE	L X W mm	POWER W	VOLTAGE V	ARTICLE NO.	TYPE	L X W mm	POWER W	VOLTAGE V	ARTICLE NO.
FFE-J	245x60	150	230	3054 190 152	FFE-J	245x60	500	230	3054 190 502
FFE-J	245x60	250	230	3054 190 252	FFE-J	245x60	650	230	3054 190 652
FFE-J	245x60	300	230	3054 190 302	FFE-J	245x60	750	230	3054 190 752
FFE-J	245x60	350	230	3054 190 352	FFE-J	245x60	800	230	3054 190 802
FFE-J	245x60	400	230	3054 190 402	FFE-J	245x60	1000	230	3054 191 002

IR-elements in ceramics type FFES incl. lock - and spring washer.

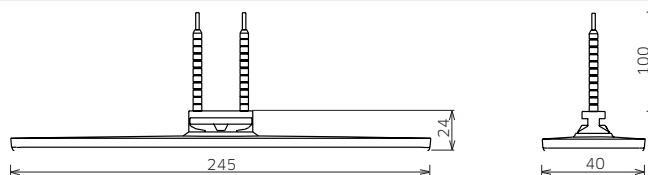

TYPE	L X W mm	POWER W	VOLTAGE V	ARTICLE NO.	TYPE	L X W mm	POWER W	VOLTAGE V	ARTICLE NO.
FFES	245x40	150	230	3054 180 150	FFES	245x40	400	230	3054 180 400
FFES	245x40	250	230	3054 180 250	FFES	245x40	500	230	3054 180 500
FFES	245x40	300	230	3054 180 300	FFES	245x40	650	230	3054 180 650
FFES	245x40	350	230	3054 180 350					

IR-elements in ceramics type FFEH incl. lock - and spring washer.

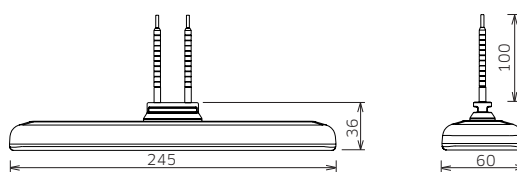

TYPE	L X W mm	POWER W	VOLTAGE V	ARTICLE NO.	TYPE	L X W mm	POWER W	VOLTAGE V	ARTICLE NO.
FFEH	245x60	150	230	3054 590 150	FFEH	245x60	500	230	3054 590 500
FFEH	245x60	250	230	3054 590 250	FFEH	245x60	650	230	3054 590 650
FFEH	245x60	300	230	3054 590 300	FFEH	245x60	750	230	3054 590 750
FFEH	245x60	350	230	3054 590 350	FFEH	245x60	800	230	3054 590 800
FFEH	245x60	400	230	3054 590 400					

CONT. IR-ELEMENTS, CERAMICS

Type FFEH with built-in thermo element NiCr-Ni type K.

TYPE	L X W mm	POWER W	VOLTAGE V	ARTICLE NO.	TYPE	L X W mm	POWER W	VOLTAGE V	ARTICLE NO.
FFEH-K	245x60	150	230	3054 590 151	FFEH-K	245x60	500	230	3054 590 501
FFEH-K	245x60	250	230	3054 590 251	FFEH-K	245x60	650	230	3054 590 651
FFEH-K	245x60	300	230	3054 590 301	FFEH-K	245x60	750	230	3054 590 751
FFEH-K	245x60	350	230	3054 590 351	FFEH-K	245x60	800	230	3054 590 801
FFEH-K	245x60	400	230	3054 590 401					

Type FFEH with built-in thermo element FeCu-Ni type J.

TYPE	L X W mm	POWER W	VOLTAGE V	ARTICLE NO.	TYPE	L X W mm	POWER W	VOLTAGE V	ARTICLE NO.
FFEH-J	245x60	150	230	3054 590 152	FFEH-J	245x60	500	230	3054 590 502
FFEH-J	245x60	250	230	3054 590 252	FFEH-J	245x60	650	230	3054 590 652
FFEH-J	245x60	300	230	3054 590 302	FFEH-J	245x60	750	230	3054 590 752
FFEH-J	245x60	350	230	3054 590 352	FFEH-J	245x60	800	230	3054 590 802
FFEH-J	245x60	400	230	3054 590 402					

IR-elements in ceramics type FTE incl. lock - and spring washer.

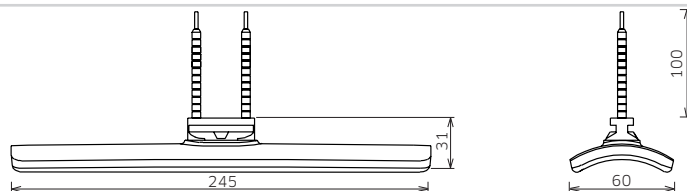

TYPE	L X W mm	POWER W	VOLTAGE V	ARTICLE NO.	TYPE	L X W mm	POWER W	VOLTAGE V	ARTICLE NO.
FTE	245x60	150	230	3054 110 150	FTE	245x60	500	230	3054 110 500
FTE	245x60	250	230	3054 110 250	FTE	245x60	650	230	3054 110 650
FTE	245x60	300	230	3054 110 300	FTE	245x60	750	230	3054 110 750
FTE	245x60	350	230	3054 110 350	FTE	245x60	800	230	3054 110 800
FTE	245x60	400	230	3054 110 400	FTE	245x60	1000	230	3054 111 000

Ditto, type FTE with built-in thermo element NiCr-Ni type K.

TYPE	L X W mm	POWER W	VOLTAGE V	ARTICLE NO.	TYPE	L X W mm	POWER W	VOLTAGE V	ARTICLE NO.
FTE-K	245x60	150	230	3054 110 151	FTE-K	245x60	500	230	3054 110 501
FTE-K	245x60	250	230	3054 110 251	FTE-K	245x60	650	230	3054 110 651
FTE-K	245x60	300	230	3054 110 301	FTE-K	245x60	750	230	3054 110 751
FTE-K	245x60	350	230	3054 110 351	FTE-K	245x60	800	230	3054 110 801
FTE-K	245x60	400	230	3054 110 401	FTE-K	245x60	1000	230	3054 111 001

Ditto, type FTE with built-in thermo element FeCu-Ni type J.

TYPE	L X W mm	POWER W	VOLTAGE V	ARTICLE NO.	TYPE	L X W mm	POWER W	VOLTAGE V	ARTICLE NO.
FTE-J	245x60	150	230	3054 110 152	FTE-J	245x60	500	230	3054 110 502
FTE-J	245x60	250	230	3054 110 252	FTE-J	245x60	650	230	3054 110 652
FTE-J	245x60	300	230	3054 110 302	FTE-J	245x60	750	230	3054 110 752
FTE-J	245x60	350	230	3054 110 352	FTE-J	245x60	800	230	3054 110 802
FTE-J	245x60	400	230	3054 110 402	FTE-J	245x60	1000	230	3054 111 002

CONT. IR-ELEMENTS, CERAMICS

IR-elements in ceramics type HFE incl. lock and spring washer.



TYPE	L X W mm	POWER W	VOLTAGE V	ARTICLE NO.	TYPE	L X W mm	POWER W	VOLTAGE V	ARTICLE NO.
HFE	122x60	125	230	305 4140 125	HFE	122x60	325	230	305 4140 325
HFE	122x60	150	230	305 4140 150	HFE	122x60	400	230	305 4140 400
HFE	122x60	200	230	305 4140 200	HFE	122x60	500	230	305 4140 500
HFE	122x60	250	230	305 4140 250					

Ditto, type HFE with built-in thermo element NiCr-Ni type K.

TYPE	L X W mm	POWER W	VOLTAGE V	ARTICLE NO.	TYPE	L X W mm	POWER W	VOLTAGE V	ARTICLE NO.
HFE-K	122x60	125	230	3054 140 126	HFE-K	122x60	325	230	3054 140 326
HFE-K	122x60	150	230	3054 140 151	HFE-K	122x60	400	230	3054 140 401
HFE-K	122x60	200	230	3054 140 201	HFE-K	122x60	500	230	3054 140 501
HFE-K	122x60	250	230	3054 140 251					

Type HFE with built-in thermo element FeCu-Ni type J.

TYPE	L X W mm	POWER W	VOLTAGE V	ARTICLE NO.	TYPE	L X W mm	POWER W	VOLTAGE V	ARTICLE NO.
HFE-J	122x60	125	230	3054 140 127	HFE-J	122x60	325	230	3054 140 327
HFE-J	122x60	150	230	3054 140 152	HFE-J	122x60	400	230	3054 140 402
HFE-J	122x60	200	230	3054 140 202	HFE-J	122x60	500	230	3054 140 502
HFE-J	122x60	250	230	3054 140 252					

IR-elements in ceramics type HFEH incl. lock - and spring washer.

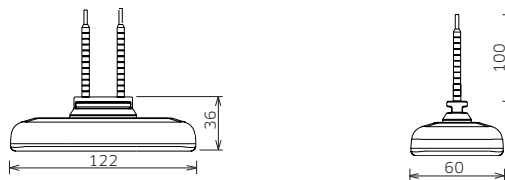

TYPE	L X W mm	POWER W	VOLTAGE V	ARTICLE NO.	TYPE	L X W mm	POWER W	VOLTAGE V	ARTICLE NO.
HFEH	122x60	125	230	3054 540 125	HFEH	122x60	250	230	3054 540 250
HFEH	122x60	150	230	3054 540 150	HFEH	122x60	325	230	3054 540 325
HFEH	122x60	200	230	3054 540 200	HFEH	122x60	400	230	3054 540 400

Type HFEH with built-in thermo element NiCr-Ni type K.

TYPE	L X W mm	POWER W	VOLTAGE V	ARTICLE NO.	TYPE	L X W mm	POWER W	VOLTAGE V	ARTICLE NO.
HFEH-K	122x60	125	230	3054 540 126	HFEH-K	122x60	250	230	3054 540 251
HFEH-K	122x60	150	230	3054 540 151	HFEH-K	122x60	325	230	3054 540 326
HFEH-K	122x60	200	230	3054 540 201	HFEH-K	122x60	400	230	3054 540 401

Type HFEH with built-in thermo element FeCu-Ni type J.

TYPE	L X W mm	POWER W	VOLTAGE V	ARTICLE NO.	TYPE	L X W mm	POWER W	VOLTAGE V	ARTICLE NO.
HFEH-J	122x60	125	230	3054 540 127	HFEH-J	122x60	250	230	3054 540 252
HFEH-J	122x60	150	230	3054 540 152	HFEH-J	122x60	325	230	3054 540 327
HFEH-J	122x60	200	230	3054 540 202	HFEH-J	122x60	400	230	3054 540 402

CONT. IR-ELEMENTS, CERAMICS

IR-elements in ceramics type HTE incl. lock - and spring washer.

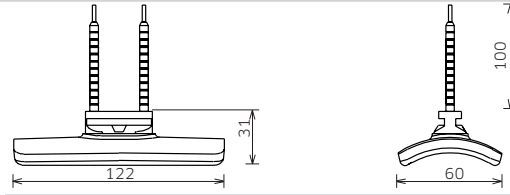

TYPE	L X W mm	POWER W	VOLTAGE V	ARTICLE NO.	TYPE	L X W mm	POWER W	VOLTAGE V	ARTICLE NO.
HTE	122x60	125	230	3054 120 125	HTE	122x60	325	230	3054 120 325
HTE	122x60	150	230	3054 120 150	HTE	122x60	400	230	3054 120 400
HTE	122x60	200	230	3054 120 200	HTE	122x60	500	230	3054 120 500
HTE	122x60	250	230	3054 120 250					

Type HTE with built-in thermo element NiCr-Ni type K.

TYPE	L X W mm	POWER W	VOLTAGE V	ARTICLE NO.	TYPE	L X W mm	POWER W	VOLTAGE V	ARTICLE NO.
HTE-K	122x60	125	230	3054 120 126	HTE-K	122x60	325	230	3054 120 326
HTE-K	122x60	150	230	3054 120 151	HTE-K	122x60	400	230	3054 120 401
HTE-K	122x60	200	230	3054 120 201	HTE-K	122x60	500	230	3054 120 501
HTE-K	122x60	250	230	3054 120 251					

Type HTE with built-in thermo element FeCu-Ni type J.

TYPE	L X W mm	POWER W	VOLTAGE V	ARTICLE NO.	TYPE	L X W mm	POWER W	VOLTAGE V	ARTICLE NO.
HTE-J	122x60	125	230	3054 120 127	HTE-J	122x60	325	230	3054 120 327
HTE-J	122x60	150	230	3054 120 152	HTE-J	122x60	400	230	3054 120 402
HTE-J	122x60	200	230	3054 120 202	HTE-J	122x60	500	230	3054 120 502
HTE-J	122x60	250	230	3054 120 252					

IR-elements in ceramics type QFE incl. lock - and spring washer.

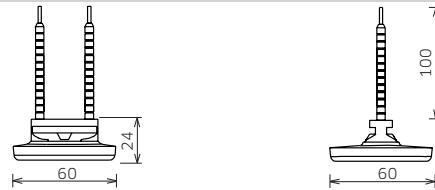

TYPE	L X W mm	POWER W	VOLTAGE V	ARTICLE NO.	TYPE	L X W mm	POWER W	VOLTAGE V	ARTICLE NO.
QFE	60x60	125	230	3054 350 125	QFE	60x60	250	230	3054 350 250

IR-elements in ceramics type QTE incl. lock - and spring washer.

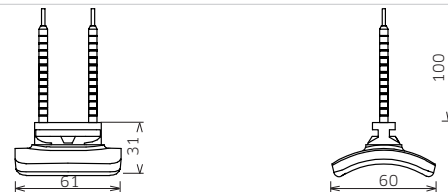

TYPE	L X W mm	POWER W	VOLTAGE V	ARTICLE NO.	TYPE	L X W mm	POWER W	VOLTAGE V	ARTICLE NO.
QTE	61x60	125	230	3054 150 125	QTE	61x60	250	230	3054 150 250

CONT. IR-ELEMENTS, CERAMICS

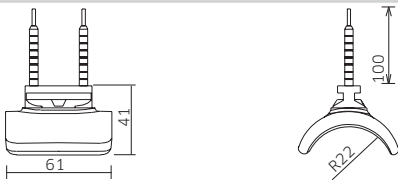
IR-elements in ceramics type QCE incl. lock - and spring washer.									
TYPE	L X W mm	POWER W	VOLTAGE V	ARTICLE NO.	TYPE	L X W mm	POWER W	VOLTAGE V	ARTICLE NO.
QCE	61x60	150	230	3054 360 150	QCE	61x60	250	230	3054 360 250

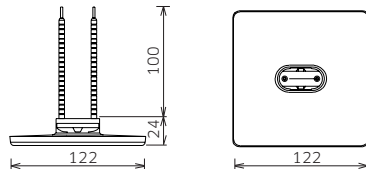
IR-elements in ceramics type SFSE incl. lock - and spring washer.									
TYPE	L X W mm	POWER W	VOLTAGE V	ARTICLE NO.	TYPE	L X W mm	POWER W	VOLTAGE V	ARTICLE NO.
SFSE	122x122	150	230	3054 130 150	SFSE	122x122	400	230	3054 130 400
SFSE	122x122	250	230	3054 130 250	SFSE	122x122	500	230	3054 130 500
SFSE	122x122	300	230	3054 130 300	SFSE	122x122	650	230	3054 130 650
SFSE	122x122	350	230	3054 130 350	SFSE	122x122	750	230	3054 130 750

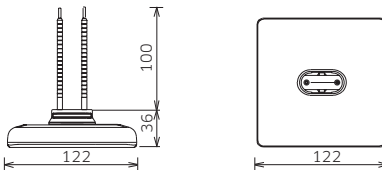
IR-elements in ceramics type SFEH incl. lock - and spring washer.									
TYPE	L X W mm	POWER W	VOLTAGE V	ARTICLE NO.	TYPE	L X W mm	POWER W	VOLTAGE V	ARTICLE NO.
SFEH	122x122	250	230	3054 530 250	SFEH	122x122	500	230	3054 530 500
SFEH	122x122	300	230	3054 530 300	SFEH	122x122	650	230	3054 530 650
SFEH	122x122	350	230	3054 530 350	SFEH	122x122	750	230	3054 530 750
SFEH	122x122	400	230	3054 530 400	SFEH	122x122	800	230	3054 530 800

CONT. IR-ELEMENTS, CERAMICS

IR-lamp in ceramics type ESE.

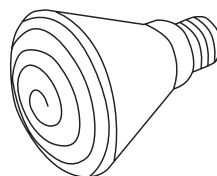

TYPE	DIA X L mm	POWER W	VOLTAGE V	ARTICLE NO.	TYPE	DIA X L mm	POWER W	VOLTAGE V	ARTICLE NO.
ESES	80x110	60	230	3054 160 060	ESEL	95x140	250	230	3054 160 250
ESES	80x110	100	230	3054 160 100	ESEXL	145x140	500	230	3054 160 500
ESEL	95x140	150	230	3054 160 150					

Reflector adapted to IR-lamp type ESE.

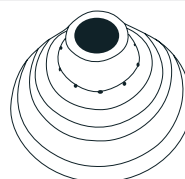

TYPE	DIA X L mm	VOLTAGE V	ARTICLE NO.
ESE	210x117	230	3005 020 308

E27 lamp holder in ceramics adapted for IR-lamp type ESE.

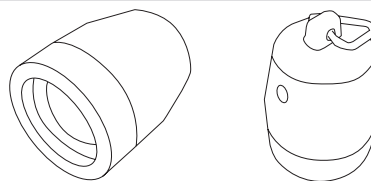

TYPE	DIA X L mm	VOLTAGE V	ARTICLE NO.
ESE	53x74	230	3016 120 201

QUARTZ GLASS

IR-elements in quartz glass type FQE with 2 pcs M5x30 mm.

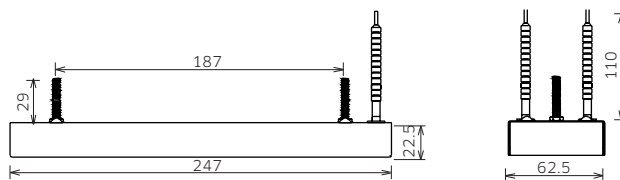

TYPE	L X W mm	POWER W	VOLTAGE V	ARTICLE NO.	TYPE	L X W mm	POWER W	VOLTAGE V	ARTICLE NO.
FQE	247x62.5	250	230	3054 220 250	FQE	247x62.5	500	230	3054 220 500
FQE	247x62.5	300	230	3054 220 300	FQE	247x62.5	650	230	3054 220 650
FQE	247x62.5	350	230	3054 220 350	FQE	247x62.5	750	230	3054 220 750
FQE	247x62.5	400	230	3054 220 400	FQE	247x62.5	1000	230	3054 221 000

IR-elements in quartz glass type FQEG with gilt reflector and 2 pcs. M5x30 mm.

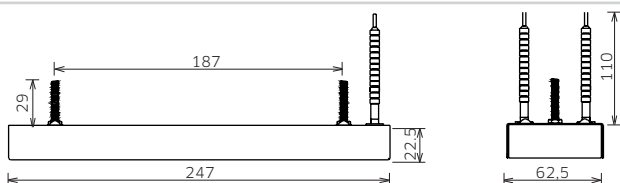

TYPE	L X W mm	POWER W	VOLTAGE V	ARTICLE NO.	TYPE	L X W mm	POWER W	VOLTAGE V	ARTICLE NO.
FQEG	247x62.5	250	230	3054 250 250	FQEG	247x62.5	500	230	3054 250 500
FQEG	247x62.5	300	230	3054 250 300	FQEG	247x62.5	650	230	3054 250 650
FQEG	247x62.5	350	230	3054 250 350	FQEG	247x62.5	750	230	3054 250 750
FQEG	247x62.5	400	230	3054 250 400	FQEG	247x62.5	1000	230	3054 251 000

IR-elements in quartz glass type PFQE incl. lock - and spring washer.

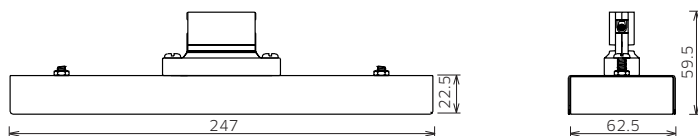

TYPE	L X W mm	POWER W	VOLTAGE V	ARTICLE NO.	TYPE	L X W mm	POWER W	VOLTAGE V	ARTICLE NO.
PFQE	247x62.5	250	230	3054 230 250	PFQE	247x62.5	500	230	3054 230 500
PFQE	247x62.5	300	230	3054 230 300	PFQE	247x62.5	650	230	3054 230 650
PFQE	247x62.5	350	230	3054 230 350	PFQE	247x62.5	750	230	3054 230 750
PFQE	247x62.5	400	230	3054 230 400	PFQE	247x62.5	1000	230	3054 231 000

CONT. IR-ELEMENTS, QUARTZ GLASS

IR-elements in quartz glass type HQE with 2 pcs. M5x30 mm.									
TYPE	L X W mm	POWER W	VOLTAGE V	ARTICLE NO.	TYPE	L X W mm	POWER W	VOLTAGE V	ARTICLE NO.
HQE	123.5x62.5	125	230	3054 210 125	HQE	123.5x62.5	325	230	3054 210 325
HQE	123.5x62.5	150	230	3054 210 150	HQE	123.5x62.5	400	230	3054 210 400
HQE	123.5x62.5	200	230	3054 210 200	HQE	123.5x62.5	500	230	3054 210 500
HQE	123.5x62.5	250	230	3054 210 250					

IR-elements in quartz glass type PHQE incl. lock - and spring washer.									
TYPE	L X W mm	POWER W	VOLTAGE V	ARTICLE NO.	TYPE	L X W mm	POWER W	VOLTAGE V	ARTICLE NO.
PHQE	123.5x62.5	125	230	3054 270 125	PHQE	123.5x62.5	250	230	3054 270 250
PHQE	123.5x62.5	150	230	3054 270 150	PHQE	123.5x62.5	325	230	3054 270 325
PHQE	123.5x62.5	200	230	3054 270 200	PHQE	123.5x62.5	500	230	3054 270 500

IR-elements in quartz glass type QQE with 2 pcs. M5x30 mm.									
TYPE	L X W mm	POWER W	VOLTAGE V	ARTICLE NO.	TYPE	L X W mm	POWER W	VOLTAGE V	ARTICLE NO.
QQE	62.5x62.5	125	230	3054 240 125	QQE	62.5x62.6	250	230	3054 240 250

IR-elements in quartz glass type SQE with 2 pcs M5x30 mm.									
TYPE	L X W mm	POWER W	VOLTAGE V	ARTICLE NO.	TYPE	L X W mm	POWER W	VOLTAGE V	ARTICLE NO.
SQE	123.5x123.5	150	230	3054 260 150	SQE	123.5x123.5	500	230	3054 260 500
SQE	123.5x123.5	250	230	3054 260 250	SQE	123.5x123.5	650	230	3054 260 650
SQE	123.5x123.5	300	230	3054 260 300	SQE	123.5x123.5	750	230	3054 260 750
SQE	123.5x123.5	350	230	3054 260 350	SQE	123.5x123.5	1000	230	3054 261 000
SQE	123.5x123.5	400	230	3054 260 400					

CONT. IR-ELEMENTS, QUARTZ GLASS

IR-elements in quartz glass type STQH 100.

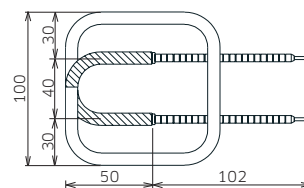

TYPE	L X W X DIA mm	POWER W	VOLTAGE V	ARTICLE NO.
STQH	100x100x8	150	230	3220 202 150
STQH	100x100x8	200	230	3220 202 200

TYPE	L X W X DIA mm	POWER W	VOLTAGE V	ARTICLE NO.
STQH	100x100x8	250	230	3220 202 250
STQH	100x100x8	400	230	3220 202 400

IR-elements in quartz glass type STQH 112.

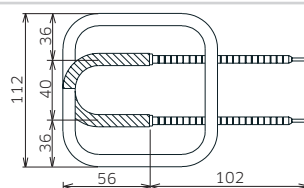

TYPE	L X W X DIA mm	POWER W	VOLTAGE V	ARTICLE NO.
STQH	112x112x8	150	230	3040 401 150
STQH	112x112x8	200	230	3040 401 200

TYPE	L X W X DIA mm	POWER W	VOLTAGE V	ARTICLE NO.
STQH	112x112x8	250	230	3040 401 250
STQH	112x112x8	400	230	3040 401 400

IR-elements in quartz glass type STQH 140.

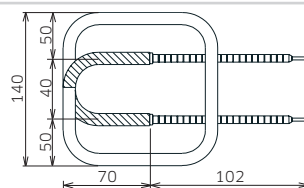

TYPE	L X W X DIA mm	POWER W	VOLTAGE V	ARTICLE NO.
STQH	140x140x8	150	230	3230 402 150
STQH	140x140x8	200	230	3230 402 200
STQH	140x140x8	250	230	3230 402 250

TYPE	L X W X DIA mm	POWER W	VOLTAGE V	ARTICLE NO.
STQH	140x140x8	400	230	3230 402 400
STQH	140x140x8	500	230	3230 402 500
STQH	140x140x8	650	230	3230 402 650

IR-elements in quartz glass type STQH 150.

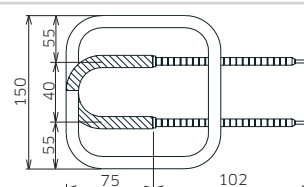

TYPE	L X W X DIA mm	POWER W	VOLTAGE V	ARTICLE NO.
STQH	150x150x8	150	230	3130 600 150
STQH	150x150x8	200	230	3130 600 200
STQH	150x150x8	250	230	3130 600 250

TYPE	L X W X DIA mm	POWER W	VOLTAGE V	ARTICLE NO.
STQH	150x150x8	400	230	3130 600 400
STQH	150x150x8	500	230	3130 600 500
STQH	150x150x8	650	230	3130 600 650

QUARTZ GLASS AND VOLFRAM

IR-elements type QTS in quartz glass and volfram filled with nitrogen and furnished with R7s connections.
Wire temperature max 1450°C, wave length approx. 1.6 micron. Ditto, type QHS filled with halogen gas.
Max 2520°C, approx. 1 micron.

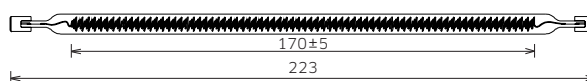

TYPE	DIA X L mm	POWER W	VOLTAGE V	ARTICLE NO.
QTS	10x223	750	240	3054 280 750
QHS	10x223	750	240	3054 290 750

TYPE	DIA X L mm	POWER W	VOLTAGE V	ARTICLE NO.
QHS	10x223	1000	480	3054 301 000

IR-elements type QTM in quartz glass and volfram filled with nitrogen and furnished with R7s connections.
Wire temperature max 1450°C, wave length approx. 1.6 micron. Ditto, typw QHM filled with halogen gas.
Max 2410°C, some 1 micron.

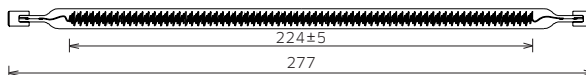

TYPE	DIA X L mm	POWER W	VOLTAGE V	ARTICLE NO.
QTM	10x277	1000	240	3054 281 000

TYPE	DIA X L mm	POWER W	VOLTAGE V	ARTICLE NO.
QHM	10x277	1000	240	3054 291 000

IR-elements type QTL in quartz glass and volfram filled with nitrogen and furnished with R7s connections.
Wire temperature max 1500°C, wave length approx. 1.6 micron. Ditto, typ QHL filled with halogen gas.
Max 2390°C, approx. 1 micron

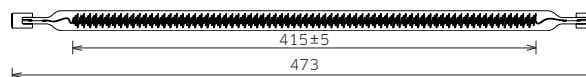

TYPE	DIA X L mm	POWER W	VOLTAGE V	ARTICLE NO.
QTL	10x473	1500	240	3054 281 500
QTL	10x473	1750	240	3054 281 750

TYPE	DIA X L mm	POWER W	VOLTAGE V	ARTICLE NO.
QTL	10x473	2000	240	3054 282 000
QHL	10x473	2000	240	3054 292 000

IR-elements in quartz glass and halogen with connection cables length 135 mm. Type QTRH has reflecting coating.

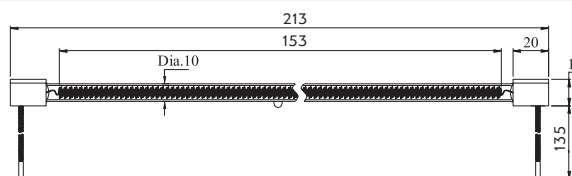

TYPE	DIA X L mm	POWER W	VOLTAGE V	ARTICLE NO.
QTHS	10x118	300	240	3050 384 801
QTHM	10x213	700	240	3050 129 701

TYPE	DIA X L mm	POWER W	VOLTAGE V	ARTICLE NO.
QTRH	10x213	700	240	3050 129 801

IR-reflector type QTRS with R7s holder adapted for element type QTS and QHS.

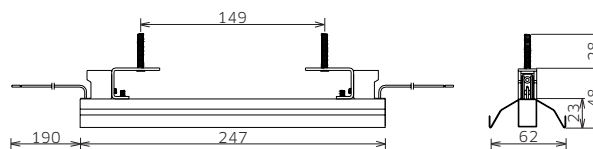

TYPE	L X W mm	ARTICLE NO.
QTRS	247x62	3054 280 751

CONT. IR-ELEMENTS, QUARTZ GLASS AND VOLFRAM, IR-HEATERS

<p>IR-reflector type QTMR with R7s holder adapted for element type QTM/QHM.</p>			
TYPE	L X W mm	ARTICLE NO.	
QTMR	301x62	3054 281 001	

<p>IR-reflector type QTLR with R7s holder adapted for element type QTL/QHL.</p>			
TYPE	L X W mm	ARTICLE NO.	
QTLR	497x62	3054 281 501	

IR-HEATERS

<p>IR heater Fast IR 305 with 2000mm connection cable, protected with a 1500mm flexible metal hose. IR elements type QTM alt. QHM are not included.</p>				
TYPE	L X W mm	POWER W	VOLTAGE V	ARTICLE NO.
Fast IR 305	305x305	4x1000	230/400	3050 129 901
Fast IR 305	305x305	5x1000	230/400	3050 130 001

<p>IR heater Fast IR 505 with 2000mm connection cable, protected with a 1500mm flexible metal hose. IR elements type QTL alt. QHL are not included.</p>				
TYPE	L X W mm	POWER W	VOLTAGE V	ARTICLE NO.
Fast IR 505	500x500	6x2000	230/400	3050 130 101
Fast IR 505	500x500	7x2000	230/400	3050 130 201

<p>IR-heater type PAS without elements in ceramics or quartz glass. Flexible protective hose in galvanized steel length 1500 mm and connection cables length 1750 mm included.</p>					
TYPE	W X H X L mm	ARTICLE NO.	TYPE	W X H X L mm	ARTICLE NO.
PAS 1	94x76x258	3050 068 701	PAS 4	94x76x1008	3050 069 001
PAS 2	94x76x508	3050 068 801	PAS 5	94x76x1258	3050 069 101
PAS 3	94x76x758	3050 068 901			

CONT. IR-HEATERS

IR-heaters type PAS with IR-elements in ceramics type FTE. Flexible protective hose in galvanized steel length 1500 mm and connection cables length 1750 mm included.

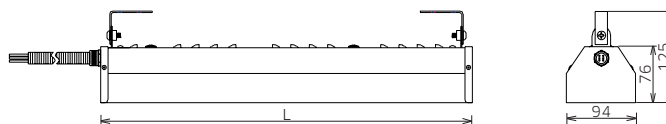

TYPE	W X H X L mm	POWER W	VOLTAGE V	ARTICLE NO.	TYPE	W X H X L mm	POWER W	VOLTAGE V	ARTICLE NO.
PAS 1	94x76x258	1x150	230	3050 067 701	PAS 3	94x76x758	3x400	230	3050 067 905
PAS 1	94x76x258	1x250	230	3050 067 702	PAS 3	94x76x758	3x500	230	3050 067 906
PAS 1	94x76x258	1x300	230	3050 067 703	PAS 3	94x76x758	3x650	230	3050 067 907
PAS 1	94x76x258	1x350	230	3050 067 704	PAS 4	94x76x1008	4x150	230	3050 068 001
PAS 1	94x76x258	1x400	230	3050 067 705	PAS 4	94x76x1008	4x250	230	3050 068 002
PAS 1	94x76x258	1x500	230	3050 067 706	PAS 4	94x76x1008	4x300	230	3050 068 003
PAS 1	94x76x258	1x650	230	3050 067 707	PAS 4	94x76x1008	4x350	230	3050 068 004
PAS 2	94x76x508	2x150	230	3050 067 801	PAS 4	94x76x1008	4x400	230	3050 068 005
PAS 2	94x76x508	2x250	230	3050 067 802	PAS 4	94x76x1008	4x500	230	3050 068 006
PAS 2	94x76x508	2x300	230	3050 067 803	PAS 4	94x76x1008	4x650	230	3050 068 007
PAS 2	94x76x508	2x350	230	3050 067 804	PAS 5	94x76x1258	5x150	230	3050 068 101
PAS 2	94x76x508	2x400	230	3050 067 805	PAS 5	94x76x1258	5x250	230	3050 068 102
PAS 2	94x76x508	2x500	230	3050 067 806	PAS 5	94x76x1258	5x300	230	3050 068 103
PAS 2	94x76x508	2x650	230	3050 067 807	PAS 5	94x76x1258	5x350	230	3050 068 104
PAS 3	94x76x758	3x150	230	3050 067 901	PAS 5	94x76x1258	5x400	230	3050 068 105
PAS 3	94x76x758	3x250	230	3050 067 902	PAS 5	94x76x1258	5x500	230	3050 068 106
PAS 3	94x76x758	3x300	230	3050 067 903	PAS 5	94x76x1258	5x650	230	3050 068 107
PAS 3	94x76x758	3x350	230	3050 067 904					

IR-heaters type PAS ditto, with built-in thermo element NiCr-Ni type K in one of the elements.

TYPE	W X H X L mm	POWER W	VOLTAGE V	ARTICLE NO.	TYPE	W X H X L mm	POWER W	VOLTAGE V	ARTICLE NO.
PAS 1	94x76x258	1x150	230	3050 068 201	PAS 3	94x76x758	3x400	230	3050 068 405
PAS 1	94x76x258	1x250	230	3050 068 202	PAS 3	94x76x758	3x500	230	3050 068 406
PAS 1	94x76x258	1x300	230	3050 068 203	PAS 3	94x76x758	3x650	230	3050 068 407
PAS 1	94x76x258	1x350	230	3050 068 204	PAS 4	94x76x1008	4x150	230	3050 068 501
PAS 1	94x76x258	1x400	230	3050 068 205	PAS 4	94x76x1008	4x250	230	3050 068 502
PAS 1	94x76x258	1x500	230	3050 068 206	PAS 4	94x76x1008	4x300	230	3050 068 503
PAS 1	94x76x258	1x650	230	3050 068 207	PAS 4	94x76x1008	4x350	230	3050 068 504
PAS 2	94x76x508	2x150	230	3050 068 301	PAS 4	94x76x1008	4x400	230	3050 068 505
PAS 2	94x76x508	2x250	230	3050 068 302	PAS 4	94x76x1008	4x500	230	3050 068 506
PAS 2	94x76x508	2x300	230	3050 068 303	PAS 4	94x76x1008	4x650	230	3050 068 507
PAS 2	94x76x508	2x350	230	3050 068 304	PAS 5	94x76x1258	5x150	230	3050 068 601
PAS 2	94x76x508	2x400	230	3050 068 305	PAS 5	94x76x1258	5x250	230	3050 068 602
PAS 2	94x76x508	2x500	230	3050 068 306	PAS 5	94x76x1258	5x300	230	3050 068 603
PAS 2	94x76x508	2x650	230	3050 068 307	PAS 5	94x76x1258	5x350	230	3050 068 604
PAS 3	94x76x758	3x150	230	3050 068 401	PAS 5	94x76x1258	5x400	230	3050 068 605
PAS 3	94x76x758	3x250	230	3050 068 402	PAS 5	94x76x1258	5x500	230	3050 068 606
PAS 3	94x76x758	3x300	230	3050 068 403	PAS 5	94x76x1258	5x650	230	3050 068 607
PAS 3	94x76x758	3x350	230	3050 068 404					

CONT. IR-HEATERS

IR-heaters type PAS with IR-elements in ceramics type FTELN. Insulated for position out-door under roof, red-varnished and with connection cable length 1400 mm

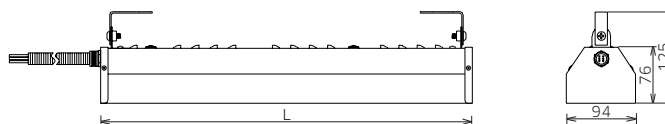

TYPE	W X H X L mm	POWER W	VOLTAGE V	ARTICLE NO.	TYPE	W X H X L mm	POWER W	VOLTAGE V	ARTICLE NO.
PAS 1R	94x76x258	1x650	230	3050 135 106	PAS 4R	94x76x1008	4x650	230	3050 135 406
PAS 2R	94x76x508	2x650	230	3050 135 206	PAS 5R	94x76x1258	5x650	230	3050 135 506
PAS 3R	94x76x758	3x650	230	3050 135 306					

IR-REFLECTORS

IR-reflector type RAS with 300 mm connection cables without element.



TYPE	W X H X L mm	VOLTAGE V	ARTICLE NO.	TYPE	W X H X L mm	POWER W	VOLTAGE V	ARTICLE NO.
RAS 1	100x63x254	230	3050 018 101	RAS 4	100x63x1004	230	230	3050 018 401
RAS 2	100x63x504	230	3050 018 201	RAS 5	100x63x1254	230	230	3050 018 501
RAS 3	100x63x754	230	3050 018 301					

CONT. IR-HEATERS, REFLECTORS

IR-reflector type RAS with IR-element in ceramics type FTE and 300 mm connection cables.



TYPE	W X H X L mm	POWER W	VOLTAGE V	ARTICLE NO.	TYP	W X H X L mm	POWER W	VOLTAGE V	ARTICLE NO.
RAS 1	100x63x254	1x150	230	3050 070 201	RAS 3	100x63x754	3x500	230	3050 070 406
RAS 1	100x63x254	1x250	230	3050 070 202	RAS 3	100x63x754	3x650	230	3050 070 407
RAS 1	100x63x254	1x300	230	3050 070 203	RAS 3	100x63x754	3x750	230	3050 070 408
RAS 1	100x63x254	1x350	230	3050 070 204	RAS 3	100x63x754	3x1000	230	3050 070 409
RAS 1	100x63x254	1x400	230	3050 070 205	RAS 4	100x63x1004	4x150	230	3050 070 501
RAS 1	100x63x254	1x500	230	3050 070 206	RAS 4	100x63x1004	4x250	230	3050 070 502
RAS 1	100x63x254	1x650	230	3050 070 207	RAS 4	100x63x1004	4x300	230	3050 070 503
RAS 1	100x63x254	1x750	230	3050 070 208	RAS 4	100x63x1004	4x350	230	3050 070 504
RAS 1	100x63x254	1x1000	230	3050 070 209	RAS 4	100x63x1004	4x400	230	3050 070 505
RAS 2	100x63x504	2x150	230	3050 070 301	RAS 4	100x63x1004	4x500	230	3050 070 506
RAS 2	100x63x504	2x250	230	3050 070 302	RAS 4	100x63x1004	4x650	230	3050 070 507
RAS 2	100x63x504	2x300	230	3050 070 303	RAS 4	100x63x1004	4x750	230	3050 070 508
RAS 2	100x63x504	2x350	230	3050 070 304	RAS 4	100x63x1004	4x1000	230	3050 070 509
RAS 2	100x63x504	2x400	230	3050 070 305	RAS 5	100x63x1254	5x150	230	3050 070 601
RAS 2	100x63x504	2x500	230	3050 070 306	RAS 5	100x63x1254	5x250	230	3050 070 602
RAS 2	100x63x504	2x650	230	3050 070 307	RAS 5	100x63x1254	5x300	230	3050 070 603
RAS 2	100x63x504	2x750	230	3050 070 308	RAS 5	100x63x1254	5x350	230	3050 070 604
RAS 2	100x63x504	2x1000	230	3050 070 309	RAS 5	100x63x1254	5x400	230	3050 070 605
RAS 3	100x63x754	3x150	230	3050 070 401	RAS 5	100x63x1254	5x500	230	3050 070 606
RAS 3	100x63x754	3x250	230	3050 070 402	RAS 5	100x63x1254	5x650	230	3050 070 607
RAS 3	100x63x754	3x300	230	3050 070 403	RAS 5	100x63x1254	5x750	230	3050 070 608
RAS 3	100x63x754	3x350	230	3050 070 404	RAS 5	100x63x1254	5x1000	230	3050 070 609
RAS 3	100x63x754	3x400	230	3050 070 405					

IR-reflector type RAS with IR-element in ceramics type FTE, 300 mm connection cables and built-in thermo element NiCr-Ni type K, in one of the elements.



TYPE	W X H X L mm	POWER W	VOLTAGE V	ARTICLE NO.	TYPE	W X H X L mm	POWER W	VOLTAGE V	ARTICLE NO.
RAS 1	100x63x254	1x150	230	3050 070 701	RAS 3	100x63x754	3x500	230	3050 070 906
RAS 1	100x63x254	1x250	230	3050 070 702	RAS 3	100x63x754	3x650	230	3050 070 907
RAS 1	100x63x254	1x300	230	3050 070 703	RAS 3	100x63x754	3x750	230	3050 070 908
RAS 1	100x63x254	1x350	230	3050 070 704	RAS 3	100x63x754	3x1000	230	3050 070 909
RAS 1	100x63x254	1x400	230	3050 070 705	RAS 4	100x63x1004	4x150	230	3050 071 001
RAS 1	100x63x254	1x500	230	3050 070 706	RAS 4	100x63x1004	4x250	230	3050 071 002
RAS 1	100x63x254	1x650	230	3050 070 707	RAS 4	100x63x1004	4x300	230	3050 071 003
RAS 1	100x63x254	1x750	230	3050 070 708	RAS 4	100x63x1004	4x350	230	3050 071 004
RAS 1	100x63x254	1x1000	230	3050 070 709	RAS 4	100x63x1004	4x400	230	3050 071 005
RAS 2	100x63x504	2x150	230	3050 070 801	RAS 4	100x63x1004	4x500	230	3050 071 006
RAS 2	100x63x504	2x250	230	3050 070 802	RAS 4	100x63x1004	4x650	230	3050 071 007
RAS 2	100x63x504	2x300	230	3050 070 803	RAS 4	100x63x1004	4x750	230	3050 071 008
RAS 2	100x63x504	2x350	230	3050 070 804	RAS 4	100x63x1004	4x1000	230	3050 071 009
RAS 2	100x63x504	2x400	230	3050 070 805	RAS 5	100x63x1254	5x150	230	3050 071 101
RAS 2	100x63x504	2x500	230	3050 070 806	RAS 5	100x63x1254	5x250	230	3050 071 102
RAS 2	100x63x504	2x650	230	3050 070 807	RAS 5	100x63x1254	5x300	230	3050 071 103
RAS 2	100x63x504	2x750	230	3050 070 808	RAS 5	100x63x1254	5x350	230	3050 071 104
RAS 2	100x63x504	2x1000	230	3050 070 809	RAS 5	100x63x1254	5x400	230	3050 071 105
RAS 3	100x63x754	3x150	230	3050 070 901	RAS 5	100x63x1254	5x500	230	3050 071 106
RAS 3	100x63x754	3x250	230	3050 070 902	RAS 5	100x63x1254	5x650	230	3050 071 107
RAS 3	100x63x754	3x300	230	3050 070 903	RAS 5	100x63x1254	5x750	230	3050 071 108
RAS 3	100x63x754	3x350	230	3050 070 904	RAS 5	100x63x1254	5x1000	230	3050 071 109
RAS 3	100x63x754	3x400	230	3050 070 905					

IR-HEATING PANEL

IR-heating panels with elements in ceramics or quartz glass. Customer adapted design to be mounted in for instance in a thermo forming machine with or without control equipment.



SPECIAL DESIGN AND ACCESSORIES/CONNECTIONS

Cable type NPC 2.5 mm² 14 A 320°C.

TYPE	ARTICLE NO.
100 m coil	3072 218 121
per m	3050 079 001

Cable type NPC 1.0 mm² 7A 320°C.

TYPE	ARTICLE NO.
100 m coil	3072 227 501
per m	3050 078 901

Terminal block 2P in ceramics with screw connections.

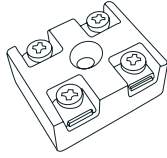

TYPE	L X W X H mm	ARTICLE NO.
2P	40x32x20	3005 020 301

Terminal block 3P in ceramics with screw connections.

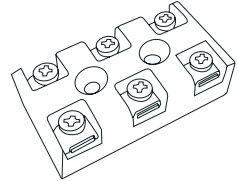

TYPE	L X W X H mm	ARTICLE NO.
3P	62x32x20	3005 020 306

Terminal block 2P in ceramics without screw connections.

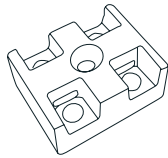

TYPE	L X W X H mm	ARTICLE NO.
2P	40x32x20	3005 020 302

Terminal block 3P in ceramics without screw connections.

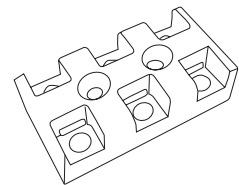

TYPE	L X W X H mm	ARTICLE NO.
3P	62x32x20	3005 020 307

Coupling rail in stainless steel.

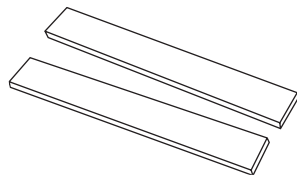

L X W X H mm	ARTICLE NO.
1000x8x2	3005 020 305

V-clamps.

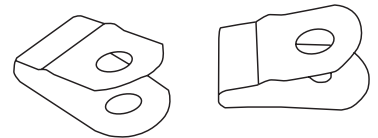

ARTICLE NO.
3006 020 301

CONT. SPECIAL DESIGN AND ACCESSORIES/CONNECTIONS

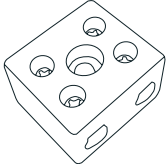
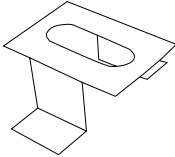
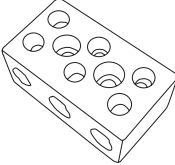
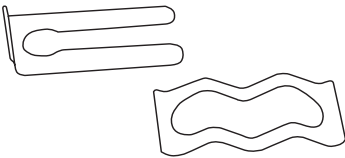
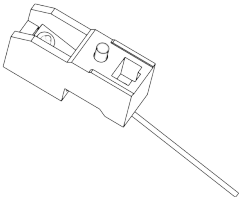
<p>Terminal block TB2C in ceramics. 16 mm²</p>		<p>Socket for element in ceramics.</p>									
<table border="1"> <thead> <tr> <th>TYPE</th> <th>L X W B X H mm</th> <th>ARTICLE NO.</th> </tr> </thead> <tbody> <tr> <td>TB2C</td> <td>35x31x23</td> <td>3005 020 303</td> </tr> </tbody> </table>		TYPE	L X W B X H mm	ARTICLE NO.	TB2C	35x31x23	3005 020 303	<table border="1"> <thead> <tr> <th>ARTICLE NO.</th> </tr> </thead> <tbody> <tr> <td>3009 010 301</td> </tr> </tbody> </table>		ARTICLE NO.	3009 010 301
TYPE	L X W B X H mm	ARTICLE NO.									
TB2C	35x31x23	3005 020 303									
ARTICLE NO.											
3009 010 301											
<p>Terminal block TB3C in ceramics. 16 mm²</p>		<p>Lock - and spring washer</p>									
<table border="1"> <thead> <tr> <th>TYPE</th> <th>L X W X H mm</th> <th>ARTICLE NO.</th> </tr> </thead> <tbody> <tr> <td>TB3C</td> <td>51x31x23</td> <td>3005 020 304</td> </tr> </tbody> </table>		TYPE	L X W X H mm	ARTICLE NO.	TB3C	51x31x23	3005 020 304	<table border="1"> <thead> <tr> <th>ARTICLE NO.</th> </tr> </thead> <tbody> <tr> <td>3050 138 001</td> </tr> </tbody> </table>		ARTICLE NO.	3050 138 001
TYPE	L X W X H mm	ARTICLE NO.									
TB3C	51x31x23	3005 020 304									
ARTICLE NO.											
3050 138 001											
<p>R7s clips i ceramics with 190 mm wiring</p>		<p>FOR AN ADDITIONAL CHARGE WE OFFER:</p> <ul style="list-style-type: none"> • Extra length of connection with ceramic bushings. • Other voltage than standard 230V. • Ceramic elements in yellow. 									
<table border="1"> <thead> <tr> <th>TYPE</th> <th>ARTICLE NO.</th> </tr> </thead> <tbody> <tr> <td>R7s</td> <td>3050 234 701</td> </tr> </tbody> </table>		TYPE	ARTICLE NO.	R7s	3050 234 701						
TYPE	ARTICLE NO.										
R7s	3050 234 701										

ANTI-CONDENSATION HEATERS

Example of application areas:
Cabinets, electric plants, information tables.
Design: Anodized aluminium, neutral or black.

Protection class IP55.
Connection: Cable

Voltage: Heating unit: 230VAC, Fan: 24VDC
Mounting: DIN socket
Material: Anodized aluminium
Protection class: IP20

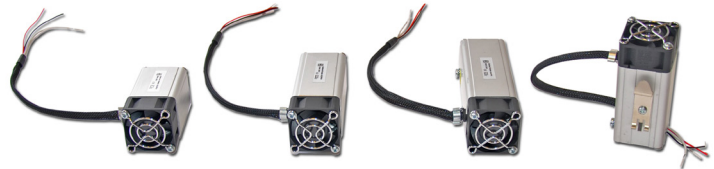





TYPE	POWER AT 10°C	L X W X H mm	ARTICLE NO.
ACHF01	200	126.5x41x41	2550 645 901
ACHF01	120	102x41x41	2550 645 902
ACHF01	80	78.5x41x41	2550 645 903

Cabinet heater in black anodized aluminium with cable.



TYPE	L X W X H mm	POWER W	VOLTAGE V	ARTICLE NO.
PTC	75x72x57	15	12-48	3060 505 005
PTC	75x72x57	15	110-240	3060 505 013
Thermostat	145x72x57	75	240	3060 505 021
PTC	100x116x33	20	12-48	3060 505 039
PTC	100x116x33	20	110-240	3060 505 047
PTC	100x116x33	20	220-440	3060 505 054
PTC	250x116x33	40	12-48	3060 505 062
PTC	250x116x33	40	110-240	3060 505 070
PTC	250x116x33	40	220-440	3060 505 088
Thermostat	250x116x33	100	230	3060 505 096
Thermostat	250x116x33	160	230	3060 505 104

ACCESSORIES FOR ANTI-CONDENSATION HEATERS

<p>Thermostat type KTO/KTS For DIN socket Max load 10A AC 250V Temperature area 0-60°C</p>													
<table border="1"> <thead> <tr> <th data-bbox="113 421 288 483">TYPE</th> <th data-bbox="292 421 895 483">FUNCTION</th> <th data-bbox="898 421 1270 483">REGULATION AREA °C</th> <th data-bbox="1273 421 1477 483">ARTICLE NO.</th> </tr> </thead> <tbody> <tr> <td data-bbox="113 488 288 510">KTO</td> <td data-bbox="292 488 895 510">Breaking (NC) 1-pole</td> <td data-bbox="898 488 1270 510">0-60</td> <td data-bbox="1273 488 1477 510">3000 032 011</td> </tr> <tr> <td data-bbox="113 515 288 537">KTS</td> <td data-bbox="292 515 895 537">Closing (NO) 1-pole</td> <td data-bbox="898 515 1270 537">0-60</td> <td data-bbox="1273 515 1477 537">3000 032 010</td> </tr> </tbody> </table>	TYPE	FUNCTION	REGULATION AREA °C	ARTICLE NO.	KTO	Breaking (NC) 1-pole	0-60	3000 032 011	KTS	Closing (NO) 1-pole	0-60	3000 032 010	
TYPE	FUNCTION	REGULATION AREA °C	ARTICLE NO.										
KTO	Breaking (NC) 1-pole	0-60	3000 032 011										
KTS	Closing (NO) 1-pole	0-60	3000 032 010										
<p>Electronic thermostat Termonic with a high level of accuracy. Max load 10A AC 250V Changing relay contact Adjustable hysteresis 1-10°K including sensor of type NTC (permits cabling up to 50m) For DIN socket.</p>													
<table border="1"> <thead> <tr> <th data-bbox="113 801 288 864">TYPE</th> <th data-bbox="292 801 895 864">FUNCTION</th> <th data-bbox="898 801 1270 864">REGULATION AREA °C</th> <th data-bbox="1273 801 1477 864">ARTICLE NO.</th> </tr> </thead> <tbody> <tr> <td data-bbox="113 869 288 891">Termonic</td> <td data-bbox="292 869 895 891">Changing 1-pole</td> <td data-bbox="898 869 1270 891">-15 till +95</td> <td data-bbox="1273 869 1477 891">3000 026 090</td> </tr> </tbody> </table>	TYPE	FUNCTION	REGULATION AREA °C	ARTICLE NO.	Termonic	Changing 1-pole	-15 till +95	3000 026 090					
TYPE	FUNCTION	REGULATION AREA °C	ARTICLE NO.										
Termonic	Changing 1-pole	-15 till +95	3000 026 090										
<p>Hygrostat type MFR012 Simple model with changing relay contact Max load 5A AC 230V For DIN socket.</p>													
<table border="1"> <thead> <tr> <th data-bbox="113 1160 288 1223">TYPE</th> <th data-bbox="292 1160 895 1223">FUNCTION</th> <th data-bbox="898 1160 1270 1223">REGULATION AREA °C</th> <th data-bbox="1273 1160 1477 1223">ARTICLE NO.</th> </tr> </thead> <tbody> <tr> <td data-bbox="113 1227 288 1249">MFR012</td> <td data-bbox="292 1227 895 1249">Changing 1-pole</td> <td data-bbox="898 1227 1270 1249">35-95</td> <td data-bbox="1273 1227 1477 1249">3000 032 038</td> </tr> </tbody> </table>	TYPE	FUNCTION	REGULATION AREA °C	ARTICLE NO.	MFR012	Changing 1-pole	35-95	3000 032 038					
TYPE	FUNCTION	REGULATION AREA °C	ARTICLE NO.										
MFR012	Changing 1-pole	35-95	3000 032 038										
<p>Combined electronic thermo/hygrostat type ETF012 Regulation area 0-60°C 50-90%RH Max load 8A AC 240V For DIN socket</p>													
<table border="1"> <thead> <tr> <th data-bbox="113 1518 288 1581">TYPE</th> <th data-bbox="292 1518 895 1581">FUNCTION</th> <th data-bbox="898 1518 1270 1581">REGULATION AREA °C</th> <th data-bbox="1273 1518 1477 1581">ARTICLE NO.</th> </tr> </thead> <tbody> <tr> <td data-bbox="113 1585 288 1608">ETF012</td> <td data-bbox="292 1585 895 1608">Changing 1-pole</td> <td data-bbox="898 1585 1270 1608">0-60</td> <td data-bbox="1273 1585 1477 1608">3000 031 984</td> </tr> </tbody> </table>	TYPE	FUNCTION	REGULATION AREA °C	ARTICLE NO.	ETF012	Changing 1-pole	0-60	3000 031 984					
TYPE	FUNCTION	REGULATION AREA °C	ARTICLE NO.										
ETF012	Changing 1-pole	0-60	3000 031 984										
<p>Current supply MDR-20-24 Power pack for DIN socket Input voltage 100-240VAC Output voltage 24VDC max 1A adjustable between 21.6-26.4VDC For DIN socket</p>													
<table border="1"> <thead> <tr> <th data-bbox="113 1877 288 1939">TYPE</th> <th data-bbox="292 1877 1270 1939">ARTICLE NO.</th> </tr> </thead> <tbody> <tr> <td data-bbox="113 1944 288 1966">MDR-20-24</td> <td data-bbox="292 1944 1270 1966">3050 843 601</td> </tr> </tbody> </table>	TYPE	ARTICLE NO.	MDR-20-24	3050 843 601									
TYPE	ARTICLE NO.												
MDR-20-24	3050 843 601												

HEATING ELEMENTS IN ALUMINIUM PROFILE

Example of application areas: Radiators, frost protection, etc.
Types of heating: Radiation, convection.

Design: One alt. two powers/profile, one alt. two side connection.
The elements can be produced according to customer specification in other dimensions and with other powers.

Type I 100

TYPE	LENGTH mm	POWER W	VOLTAGE V	ARTICLE NO.	TYPE	LENGTH mm	POWER W	VOLTAGE V	ARTICLE NO.
I 100	425	500	230	2550 134 401	I 100	850	1000	230	2550 134 402

Type I 100

TYPE	LENGTH mm	POWER W	VOLTAGE V	ARTICLE NO.	TYPE	LENGTH mm	POWER W	VOLTAGE V	ARTICLE NO.
I 100	425	250	230	2550 134 501	I 100	850	500	230	2550 134 502

CONT. HEATING ELEMENTS IN ALUMINIUM PROFILE

Type X

Var.	A	B
01	700	83
02	350	83

TYPE	LENGTH mm	POWER W	VOLTAGE V	ARTICLE NO.	TYPE	LENGTH mm	POWER W	VOLTAGE V	ARTICLE NO.
X	350	500	230	2550 134 601	X	700	1000	230	2550 134 602

Type X

TYPE	LENGTH mm	POWER W	VOLTAGE V	ARTICLE NO.
X	680	1000/500	230	2550 134 701

PTC-HEATING ELEMENTS

Our standard PTC-heaters are constructed for heating of forced air and can be built into several heating devices and systems.

The PTC technology offers many advantages compared to conventional resistant heating elements, for instance the self-regulating automatic temperature control gives an increased security and eliminates the need of further thermal cut-off.

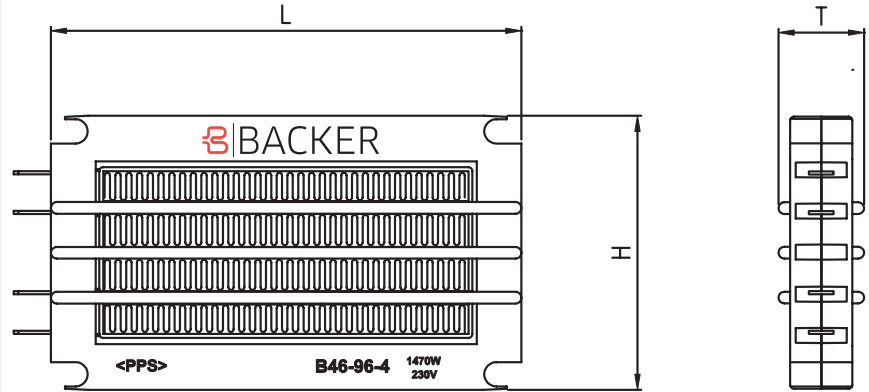

TYPE	NOM VOLTAGE	NOMINAL POWER	DIMENSION LxHxT mm	ARTICLE NO.
B34-96-3	230 VAC	820W±10% @ 48m ³ /h, 25°C	120x53x22	3050 230 901
B46-96-3	230 VAC	840W±10% @ 48m ³ /h,25°C	120.5x70.5x22	3050 231 001
B46-96-4	230 VAC	1100W±10% @ 72m ³ /h,25°C	120.5x70.5x22	3050 231 101
B46-96-4	110 VAC	1100W±10% @ 72m ³ /h,25°C	120.5x70.5x22	3050 231 102
B46-148-3	230 VAC	1250W±10% @ 72m ³ /h,25°C	173x70.5x22	3050 231 201
B46-148-4	230 VAC	1900W±10% @ 110m ³ /h,25°C	173x70.5x22	3050 231 301

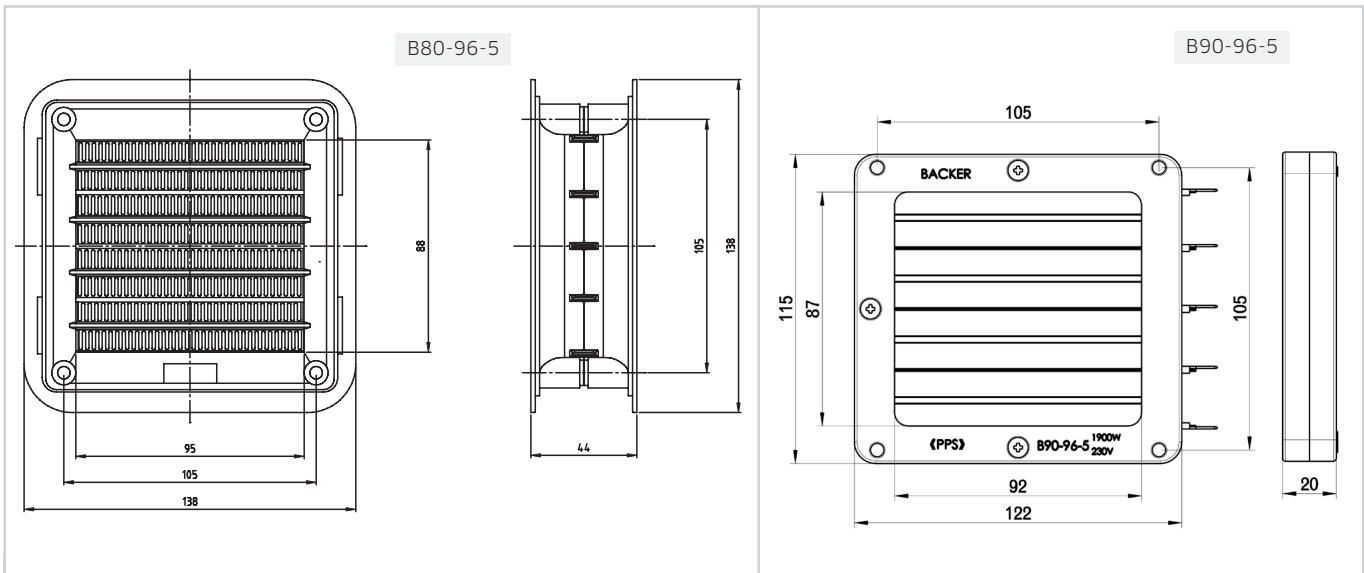

TYPE	NOMINAL VOLTAGE	VAC NOMINAL POWER	DIMENSION LXHXHT mm	ARTICLE NO.
B80-96-5	230	1900W±10% @ 96m ³ /h, 25°C	See drawing	3050 231 401
B90-96-5	230	1900W±10% @ 96m ³ /h, 25°C	See drawing	3050 863 101

CALCULATION DOCUMENTATION & TECHNICAL INFORMATION

In this chapter we have accumulated both general and specific technical information for Backer's tubular elements. Here you will find tables, formulas, diagrams and check-lists for the design work.

Guide.....	90
Thermology/science of electricity	92
Charts	96
Base for calculation	100
Tables	102
Design check list	106

GUIDE

Guide

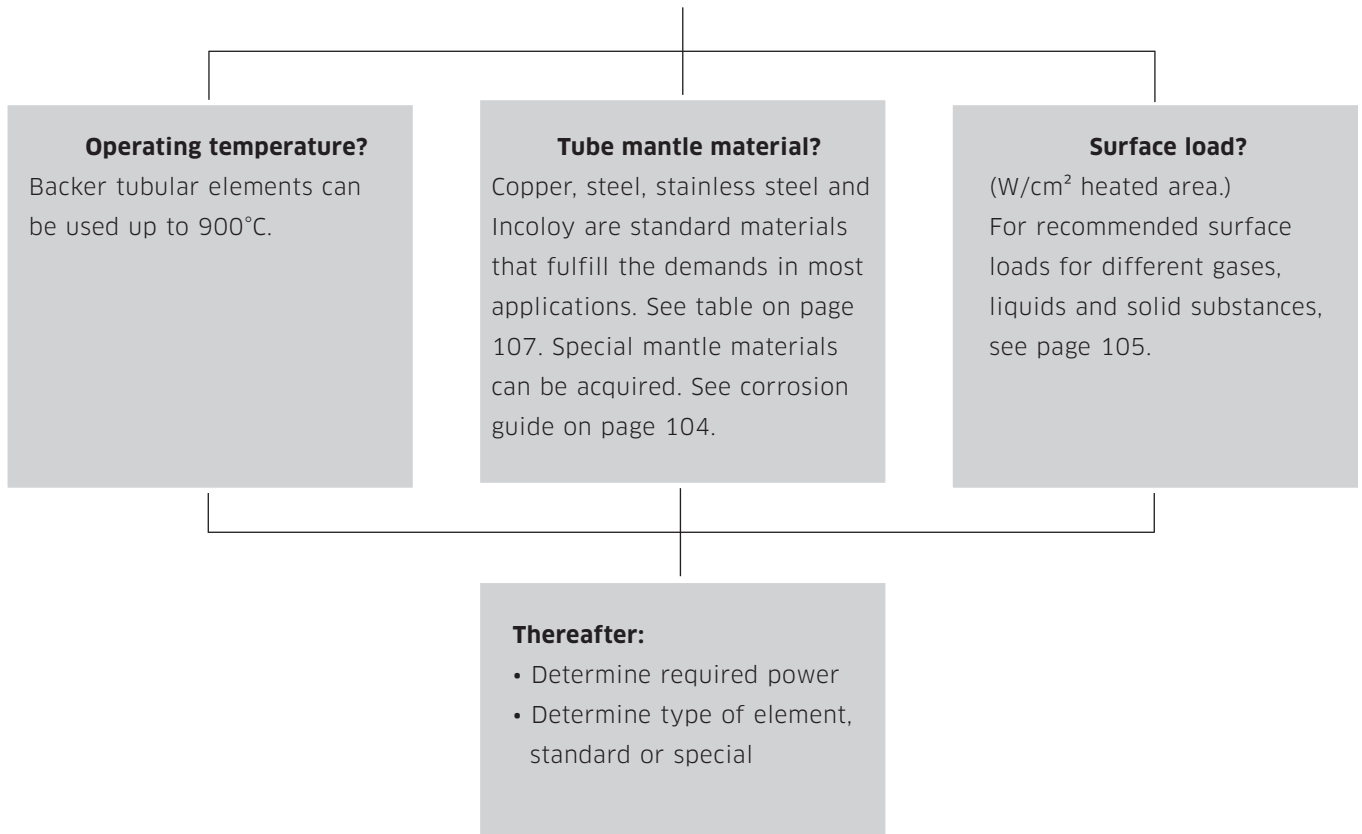

TO DETERMINE THE POWER DEMAND USE ONE OF THE FOLLOWING FORMULAS:

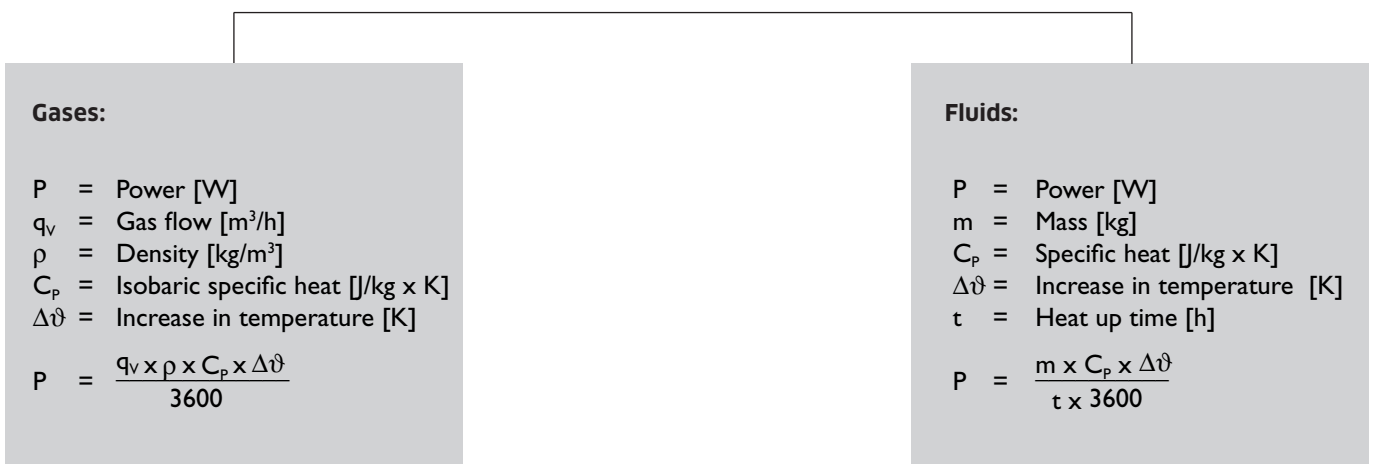

For highest efficiency and quickest heating-up time, use heaters immersed into the medium or process.

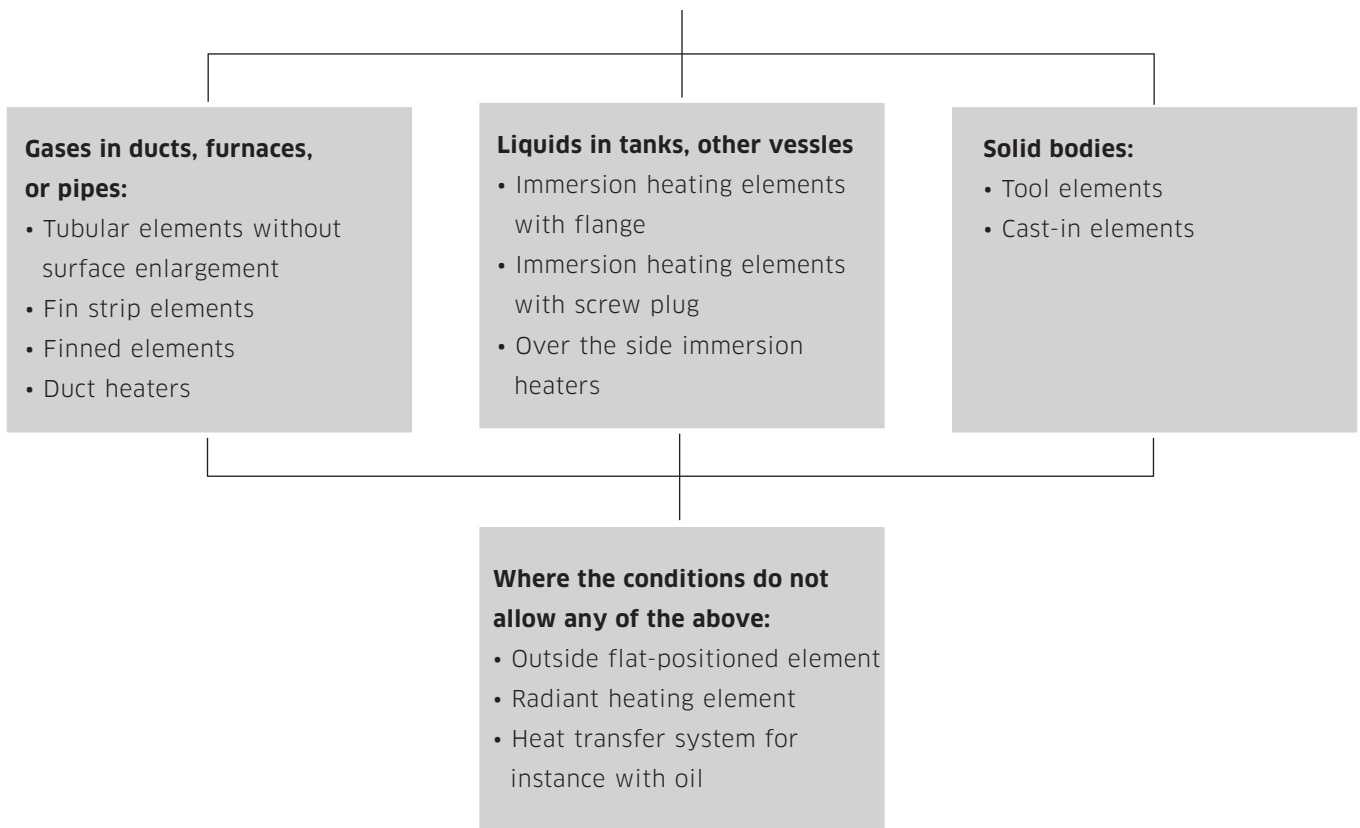

CRITERIAS AND CONSIDERATIONS AT DIMENSIONING

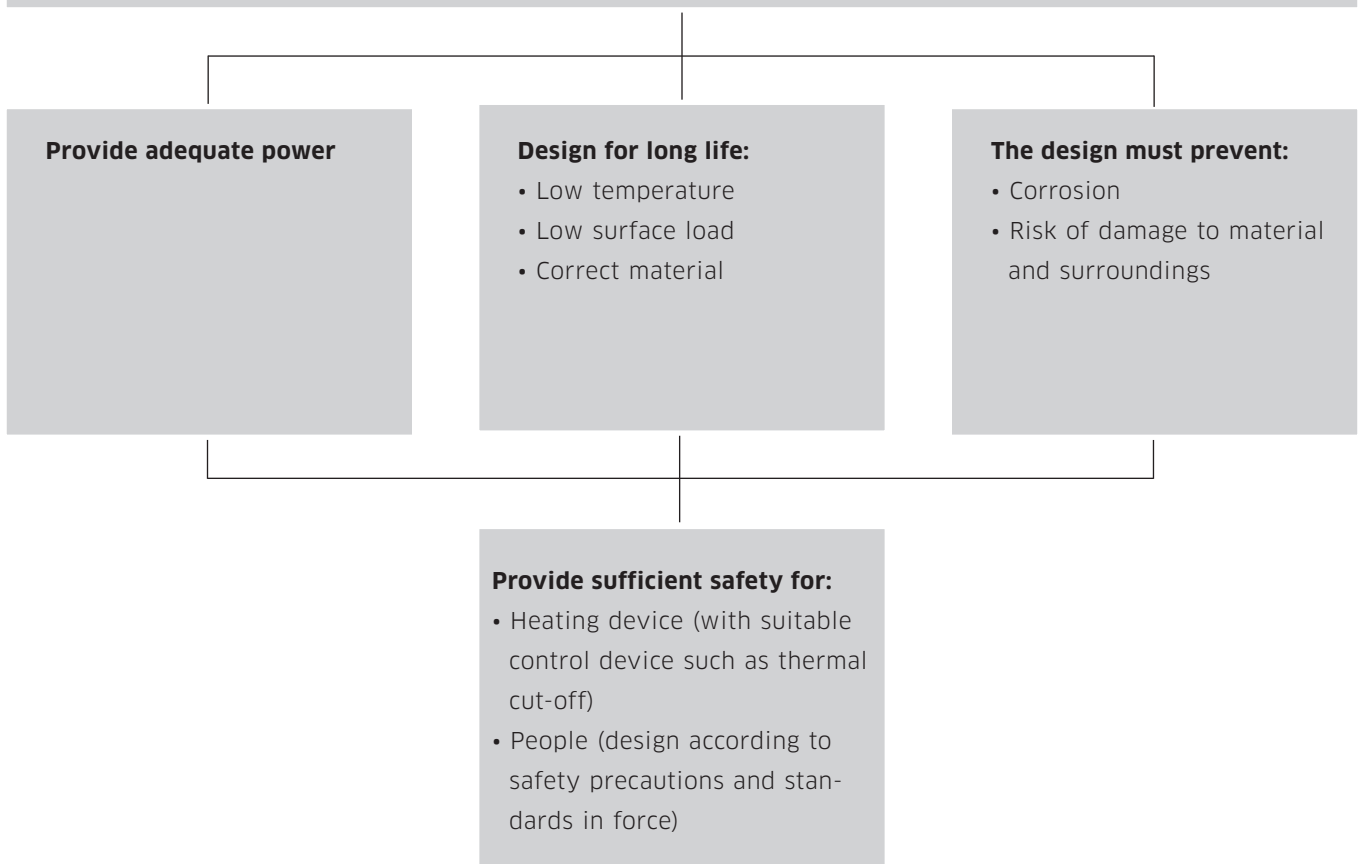

THERMINOLOGY

Thermology

In nature, energy is found in many different forms that can be transformed between each other. One of these is mechanical work. Heat is another, which can come up from chemical energy at combustion, from mechanical work or from electrical energy. The transformation from electrical energy to heat is the objective of electroheat technology. In other segments of electro technology, when electrical energy is transformed into mechanical work, heat is normally produced in a greater or smaller extent. This heat dissipates to the surroundings and is mostly regarded as an energy loss. All forms of energy is normally measured in J or Ws, which is the unit for energy.

Thermal parameters.

Specific heat: c_p . The c_p for a body is the number of J per kilogram of the body that is required to raise its temperature 1K.

$$\Delta\vartheta = \text{temperature rise}$$

$$Q = m \times c_p \times \Delta\vartheta$$

Melting heat: The melting heat of a substance is the energy required to transform it from solid to liquid state. The unit for melting heat is J/kg.

Vaporization heat: The vaporization heat of a liquid is the energy required to transform it from liquid to vapour state at constant pressure and temperature. The unit for vaporization heat is J/kg.

Heat transfer

Heat can be transferred mainly in three different ways: by convection, conduction or radiation.

Convection most commonly applies where liquids are in circulation or gases are flowing, transferring heat from one place to another.

The heat flow P (W) transferred by convection to a liquid or a gas from a heat source such as a radiator can be calculated by

$$P = \alpha \times A \times (\vartheta_1 - \vartheta_2)$$

where

- α = heat transfer coefficient in W/m²K
- A = area of the heat dissipating surface in m²
- ϑ_1 = temperature of the heat emitting medium in °C
- ϑ_2 = temperature of the heat absorbing medium in °C

The heat transfer coefficient depends on whether the gas or the liquid is flowing freely, i.e. it flows as a result of the difference in temperature between different places in the medium, or as a result of applied mechanical force such as a pump or a fan.

The flow of gases or liquids by force is found mainly in pipe or duct systems. The heat transfer coefficient can be calculated from empiric formulae. Flowing air that is heated by heating elements obtains this heat by forced convection. The sheath temperature of the element can be determined using the graphs 1 and 2 for this kind of heat transfer.

For the elements closest to the duct walls, heat radiation from these elements should also be considered. This radiated heat can raise the wall temperature quite a lot and must always be taken into consideration when dimensioning the insulation etc. The inner elements only "see" other elements with the same temperature and therefore the net radiation is zero.

The power required to heat a flow of air can be calculated by

$$P = \frac{\rho \times c_p \times q_v \times (\vartheta_2 - \vartheta_1)}{3600}$$

where

- ρ = air density in kg/m³
- c_p = isobaric specific heat for air in J/kgK
- q_v = air flow in m³/h
- ϑ_1 = initial temperature of the air in °C
- ϑ_2 = final temperature of the air in °C

The values for ρ and q_v are at same temperature. The value for c_p is at mean temperature $\frac{(\vartheta_1 + \vartheta_2)}{2}$

As a general rule, $\rho \times c_p$ can be put equal to 1200 to which must be added heat losses. This general rule applies at 20°C. At higher temperatures $\rho \times c_p > 1200$.

CONT. THERMINOLOGY

Heat is *conducted* in a solid medium by the vibration of molecules. These vibrations are transferred from molecule to molecule. The heat flow P transferred by conduction from one side of a hotplate to another can be calculated by

$$P = \frac{\lambda \times A \times (\vartheta_1 - \vartheta_2)}{\delta}$$

where

λ = thermal conductivity in W/mK

A = area of the hotplate in m^2

δ = thickness of the hotplate in m

ϑ_1 and ϑ_2 = temperature of the hotplate on each side in $^{\circ}C$

Heat *radiation* is a heat transfer process between bodies without the aid of heat transfer by a surrounding medium.

According to Stefan Boltzmann's law of radiation the following expression for heat transfer between two absolutely black parallell surfaces of equal size apply:

$$Q_{12} = C_s \times A \times (\Theta_1^4 - \Theta_2^4)$$

where

C_s = black body radiation constant: $5,77 \times 10^{-8} \text{ W/m}^2\text{K}^4$

A = area of the surfaces absorbing or emitting the heat in m^2

Θ_1 and Θ_2 = absolute temperatures of the bodies in K, i.e. temperatures in $^{\circ}C + 273^{\circ}C$

Bodies that are not totally black emit and absorb less radiated energy than black bodies, at the same temperature.

For such bodies with parallell surfaces of equal size and at short distance from each other, the C_s value must be replaced by

$$C_{12} = \frac{C_s}{\frac{1}{\varepsilon_1} + \frac{1}{\varepsilon_2} - 1}$$

When a larger surface A_2 completely surrounds a surface A_1 , e.g. a heating element in a room, C_s is replaced by

$$C_{12} = \frac{C_s}{\frac{1}{\varepsilon_1} + \left[\frac{1}{\varepsilon_2} - 1 \right] \frac{A_1}{A_2}}$$

For element in free air, heat is transferred both by free convection and by radiation.

The element temperature can be determined from graph 3 for elements at different ambient temperatures.

ε = absorption/emission coefficient.

Calculation of required electrical power

The amount of heat that must be transferred to a medium which is to be heated can be calculated by

$$Q = m \times c_p \times (\vartheta_1 - \vartheta_2)$$

where

m = weight of the medium in kg

c_p = specific heat for the medium in J/kgK

ϑ_1 = initial temperature in $^{\circ}C$

ϑ_2 = final temperature in $^{\circ}C$

If h = desired heating time in hours, the required power is

$$P = \frac{m \times c_p \times (\vartheta_2 - \vartheta_1)}{h \times 3600}$$

To this must be added 5–20 % to compensate for heat losses which depend on the heat insulation of the appliance.

Electrical parameters

U = voltage in V

R = resistance in Ω

I = current in A

P = power in W

Q = energy in J

A heating appliance with a resistance $R \Omega$ at a current I A requires an amount of energy per s defined as the rated power of the appliance:

$$P = R \times I^2 = \frac{U^2}{R}$$

During the time t (in sec) the energy consumption of the appliance is

$$Q = P \times t$$

The resistance of a conductor wire is calculated by

$$R = \rho \times \frac{4 \times L}{\pi \times D^2}$$

where

L = wire length in m

D = wire diameter in mm

ρ = specific resistance, resistivity, for the wire in $\Omega\text{mm}^2/\text{m}$

CONT. THERMINOLOGY

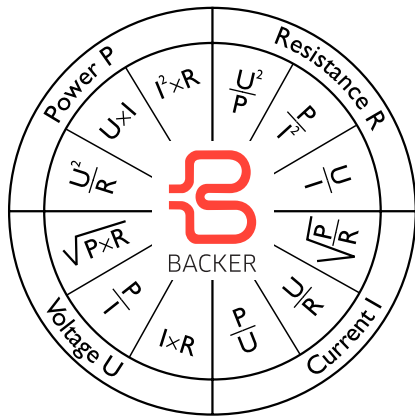

Designation	Parameter	Symbol	Name
P	Power	W	Watt
U	Voltage	V	Volt
I	Current	A	Ampere
R	Resistance		Ohm

In a 3-phase system
 U = Main voltage
 I = Main ampere

U_v = Phase voltage
 I_v = Current in phase

$$P = \sqrt{3}UI = 3U_v I_v$$

(cos φ of resistance = 1)

Connection in series

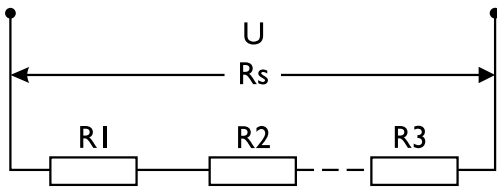

$$R_s = R_1 + R_2 + \dots + R_n$$

Connection in parallel

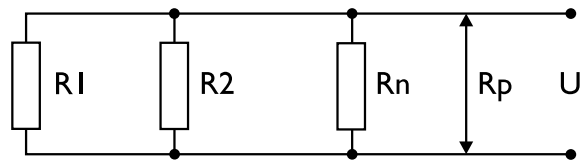

$$\frac{1}{R_p} = \frac{1}{R_1} + \frac{1}{R_2} + \dots + \frac{1}{R_n} \quad R_p = \frac{R_1 \times R_2}{R_1 + R_2} \text{ (2 elements)}$$

Connection of equal resistances				
	Connection in series	Connection in parallel	Example of 2 resistances 52.9 U=230 V	
			Connection in series	Connection in parallel
Resistance	$R_s = n R_1$	$R_p = \frac{R_1}{n}$	$R_s = 2 \times 52.9 = 105.8$	$R_p = \frac{52.9}{2} = 26.45$
Power	$P_s = \frac{U^2}{n R_1}$	$P_p = \frac{U^2 n}{R_1}$	$P_s = \frac{230^2}{2 \times 52.9} = 500 \text{ W}$	$P_p = \frac{230^2 \times 2}{52.9} = 500 \text{ W}$
Relationship	$\frac{P_s}{P_p} = \frac{1}{n^2}$	$P_r = n^2 P_s$	250 W resistance 1000 W resistance	
$P_p = 2^2 \times P_s = 4 \times P_s$				

Power at different voltages

E.g. 400 V instead of 230 V

$$P_1 = \frac{U_1^2}{R_1} \quad P_2 = \frac{U_2^2}{R_1} ; \frac{P_1}{P_2} = \frac{U_1^2}{U_2^2} \quad P_2 = \frac{U_2^2}{U_1^2} \times P_1 \quad P_2 = \frac{400^2}{230^2} \times P_1 = 3 \times P_1$$

CONT. THERMINOLOGY

Star and delta connections with 3-phase systems. Phases equally loaded

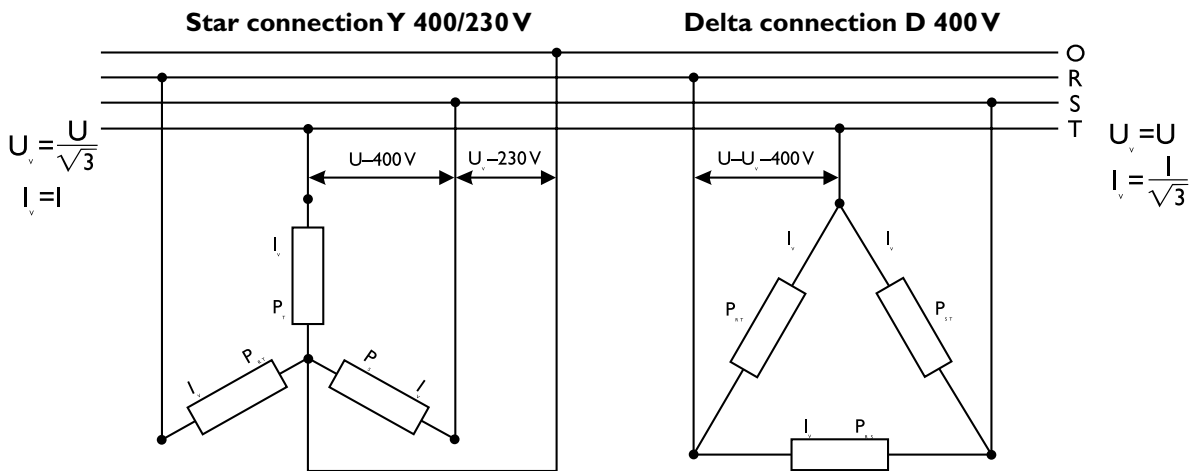

$$P_R = P_S = P_T = \frac{U_V^2}{R}$$

$$P_Y = P_R + P_S + P_T$$

$$P_Y = \frac{3U_V^2}{R} = \frac{U^2}{R}$$

$$P_Y = U_V I = \sqrt{3} UI (\cos \varphi = 1)$$

$$I_V = \frac{1}{3U_V} P_Y$$

$$I_V (A) = 1,52 \times P_Y (kW)$$

$$P_{RS} = P_{ST} = P_{TR} = \frac{U^2}{R}$$

$$P_D = P_{RS} + P_{ST} + P_{TR}$$

$$P_D = \frac{3U^2}{R}$$

$$P_D = 3U I_V = \sqrt{3} UI (\cos \varphi = 1)$$

$$I_V = \frac{1}{3U} P_D$$

$$I_V (A) = 0,88 \times P_D (kW)$$

$$P_D = 3 \times P_Y$$

$$I = \frac{1}{\sqrt{3} U} P (\cos \varphi = 1)$$

$$I (A) = 1,52 P (kW)$$

Effekt	Motstånd Ω		
	230 V	400 V	500 V
100	529,0	1600,0	2500,0
133	397,7	1203,0	1879,7
167	316,8	958,1	1497,0
200	264,5	800,0	1250,0
250	211,6	640,0	1000,0
333	158,9	480,5	750,8
350	151,1	457,1	714,3
500	105,8	320,0	500,0
667	79,3	239,9	374,8
750	70,5	213,3	333,3
1000	52,9	160,0	250,0
1250	42,3	128,0	200,0
1330	39,8	120,3	187,5
1500	35,3	106,7	166,7
1667	31,7	96,0	150,0
2000	26,5	80,0	125,0
2500	21,2	64,0	100,0
3000	17,6	53,3	83,3
3333	15,9	48,0	75,0
4000	13,2	40,0	62,5
4500	11,8	35,6	55,6
5000	10,6	32,0	50,0

Power with different connections of two or three identical resistances. The power for one resistance at 230 equals 1. The figure in brackets is the corresponding effect connected to 400 V.

Important! Check to ensure that none of the resistances is overloaded when making these different connections.

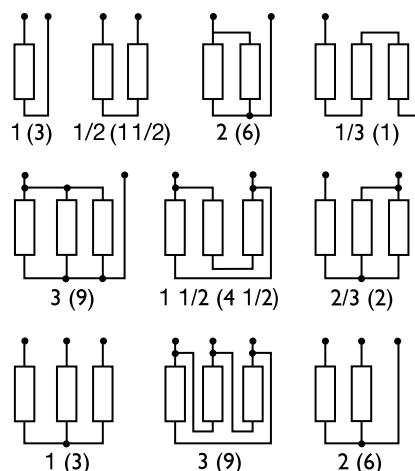

CHARTS

Air Heating

Example:

Calculate the surface temperature of the element for air input at 100°C and air output at 300°C.

The rate of air flow is 10 m/s.

The surface load of the tubular element is 2.6 W/cm².

The mean temperature will be $\frac{300 + 100}{2} = 200^\circ\text{C}$.

From graph no. 1 we obtain $\alpha = 129 \text{ W/m}^2 \text{ K}$ for a mean temperature of 200°C and a rate of air flow of 10 m/s.

Then turn to the axis for surface load on graph no. 2. The

surface load was 2.6 W/cm². Trace the graph upwards to $\alpha = 129 \text{ W/m}^2 \text{ K}$. Then go horizontally towards the graph for the increase in air temperature 200°C.

Now go to the graph for a mean air temperature of 200°C and then horizontally to the axis for element temperature.

From this you will be able to read the surface temperature of the element, 420°C

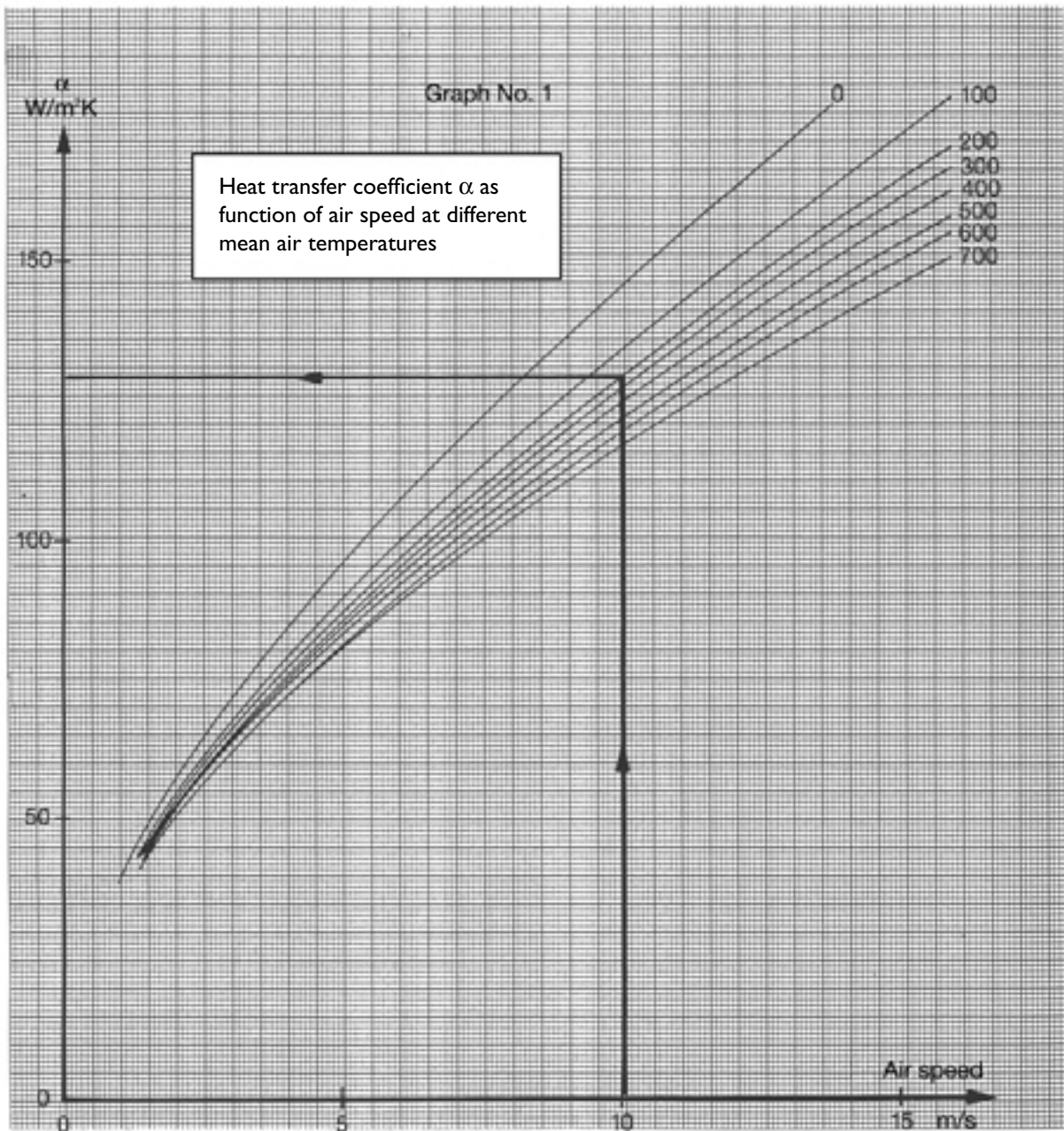

CONT. CHARTS

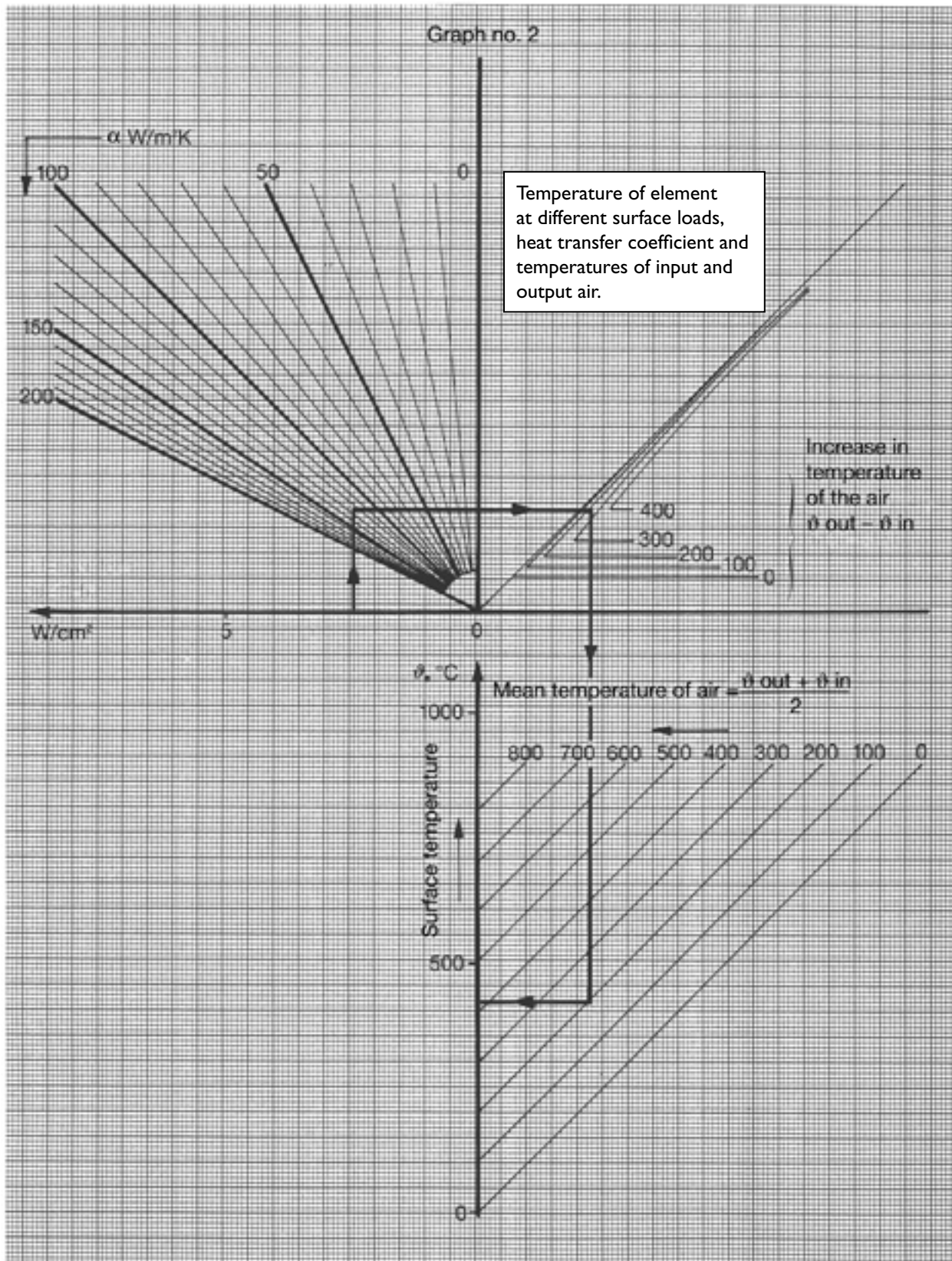

CONT. CHARTS

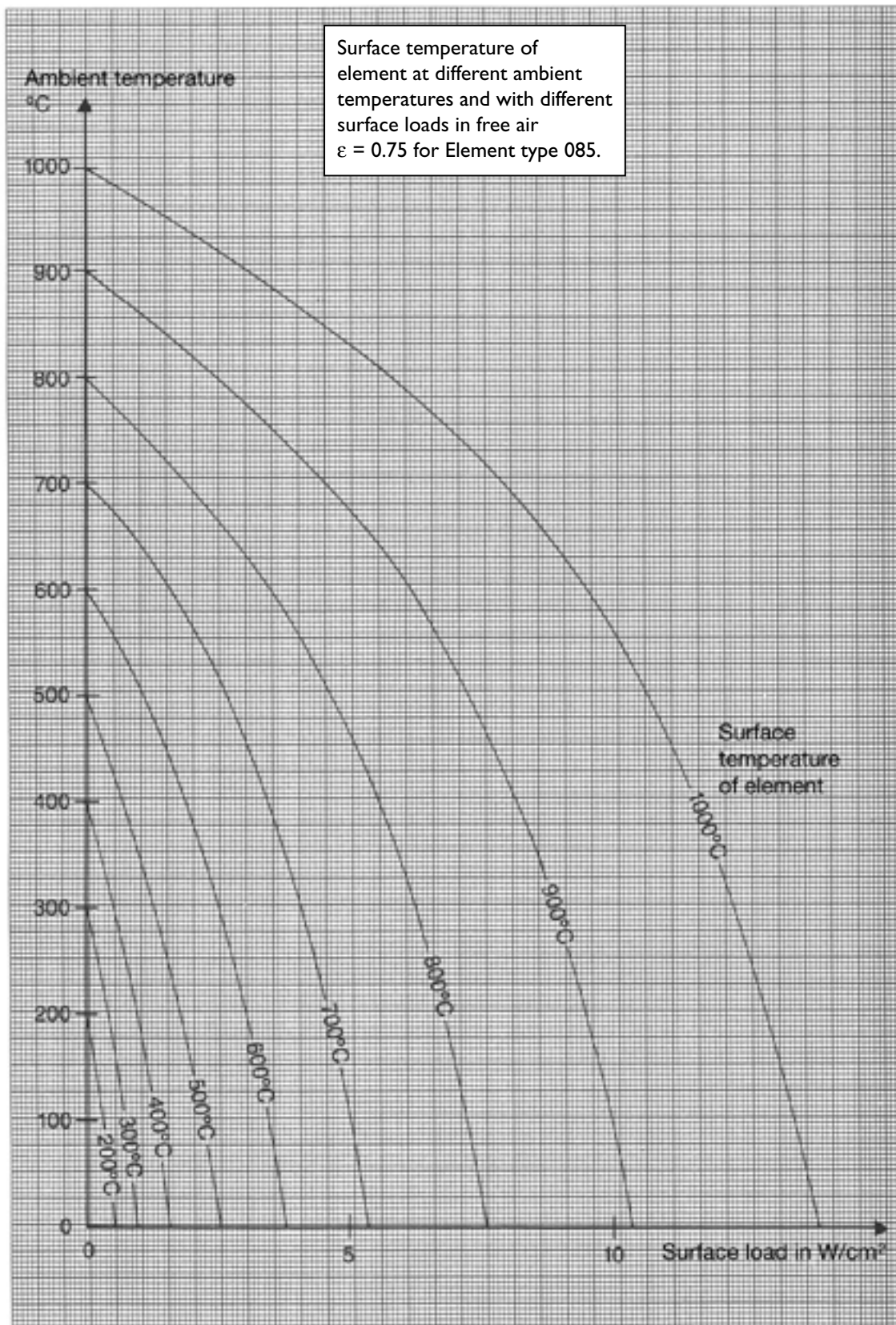

CONT. CHARTS

Loss of power from oven wall in an ambient temperature of 20°C.

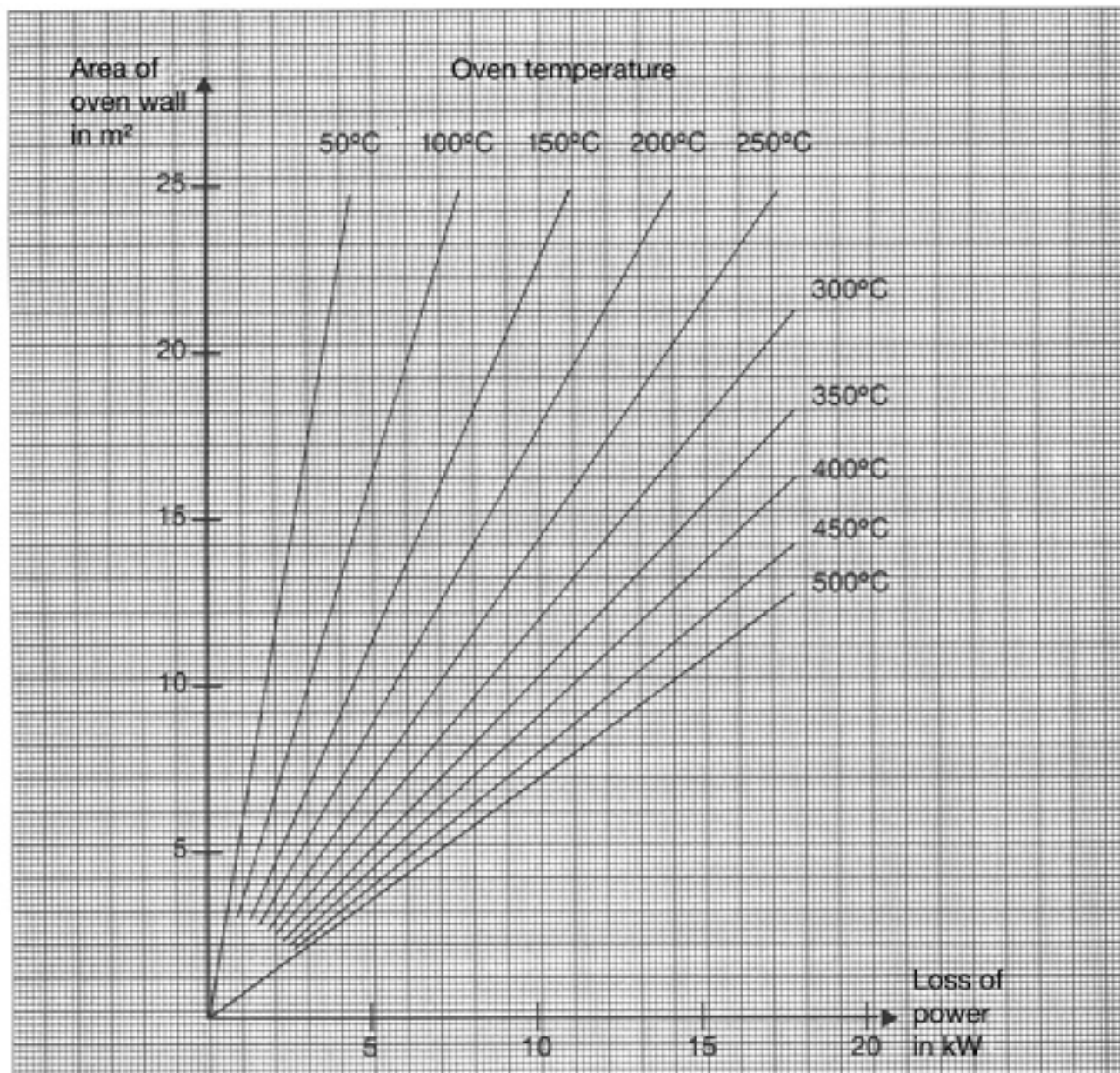

CONT. BASE FOR CALCULATION

Heating water in a tank

An open tank filled with water is to be heated to a temperature of 70°C in one hour and after that be kept at this temperature.
The tank is made of 5 mm stainless steel and the dimensions

are (L x B x H) 2 m x 1 m x 1 m. The tank is insulated with 50 mm mineral wool.
The tank is not fitted with a lid. The ambient temperature is 20°C and the relative humidity is 40 %.

A. Power required for heating

Density of steel: $\rho = 7840 \text{ kg/m}^3$

Weight of tank: $(3 \cdot 2 \cdot 1 + 2 \cdot 1 \cdot 1) \cdot 5 \cdot 10^{-3} \cdot 7840 = 314 \text{ kg}$

Weight of water: $2 \cdot 10^3 \text{ kg}$

Specific heat of steel: $c_{p, st} = 0.46 \text{ kJ/kg K}$

Specific heat of water: $c_{p, W} = 4.18 \text{ kJ/kg K}$

$$P_A = \frac{(314 \cdot 0.46 + 2 \cdot 10^3 \cdot 4.18) \cdot (70 - 20)}{3600} = 118.1 \text{ kW}$$

B. Heat losses from vertical wall of tank

$A = 2(2 \cdot 1 + 1 \cdot 1) = 6 \text{ m}^2$

$P_B = 1 \text{ kW}$

(see diagram page 10:28)

C. Heat loss from surface of water

$A = 1 \cdot 2 = 2 \text{ m}^2$

$F = 4.5 \text{ kW/m}^2$

$P_C = 2 \cdot 4.5 = 9 \text{ kW}$

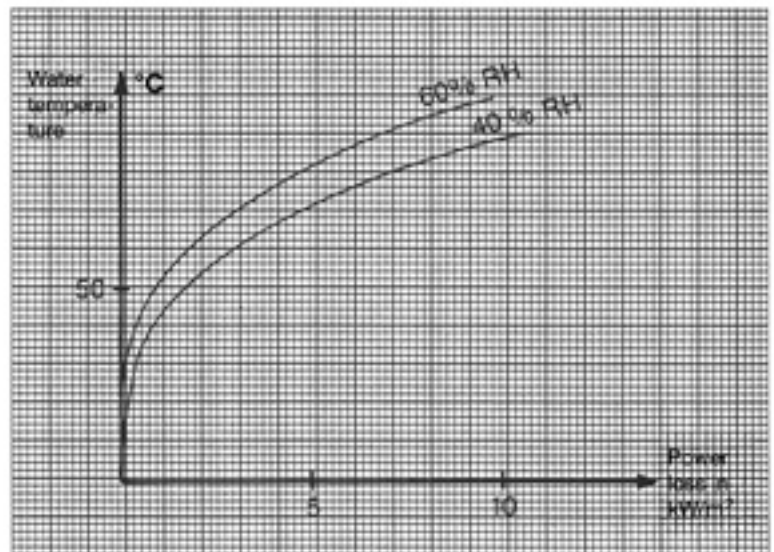

During heating one should allow for a loss of 2/3 of the losses of B and C above, i.e. $2/3 \times 10 = 6.7 \text{ kW}$.

The total power required, inclusive of an additional 10 % as a safety margin, will be:

$$P = 1.1 \cdot (118.1 + 6.7) = 137.3 = 140 \text{ kW}$$

CONT. BASE FOR CALCULATION

Pressure Pascal, Pa 1 Pa = 1 N/m

Pa	kp/cm	lbf/in ²	mmHg	mmvp
1	10.2 · 10 ⁻⁶	0.145 · 10 ³	7.5 · 10 ⁻³	1.0120 · 10
98.07 · 10 ³	1	14.22	735.6	1.10
6.89 · 10 ³	70.3 · 10 ³	1	51.7	697.3
133	1.36 · 10 ⁻³	19.3 · 10 ⁻³	1	13.46
9.807	1 · 10 ⁻²	1.43 · 10 ⁻³	74.3 · 10 ⁻³	1

Power Watt, W

W, Nm/s	kpm/s	kcal/h	hk	ft · ibf/s
1	0.102	0.86	1.36 · 10 ⁻³	0.738
9.81	1	8.43	13.3 · 10 ⁻³	7.233
1.16	0.119	1	1.58 · 10 ⁻³	0.858
735.5	75	632	1	542.5
1.356	0.138	1.166	1.84 · 10 ⁻³	1

Energy Joule, J

J, Ws, Nm	Wh	cal	ft · lbf
1	0.278 · 10 ⁻³	0.239	0.738
3.6 · 10 ⁻³	1	860	2.66 · 10 ⁻³
4.19	1.16 · 10 ⁻³	1	3.088
1.356	0.377 · 10 ⁻³	0.324	1

Temperature Kelvin, K

Magnitude	Kelvin scale K	Centigrade scale C	Fahrenheit scale F
Related temperatures	0	-273.15	-459.67
	255.37	-17.78	0
	273.15	0	32
	373.15	100	212
Related temperature-differences	1	1	1.8
	0.55556 =5/9	0.5556 =5/9	1

Conversion
°C ↔ °F
t_C = 5/9 (t_F-32)
t_F = 9/5 t_C+32

The electrochemical chain of potential

The electrochemical chain of potential shown in the table gives the electrochemical potentials of the principle metals with their relevant chemical symbols and also according to the magnitude of their normal potentials which arise when each of the metals is immersed in a normal aqueous solution (1n) of its salt.

The valency of the metal ions of each solution is indicated by a corresponding number of dots after the chemical symbol. The metals listed above hydrogen (H) in the table are termed electropositive, those listed below H are termed electronegative.

If two metals are placed together in a galvanic element the further the two metals are from each other in the chain of potential the greater will be their electromotive force. Electromotive forces can be calculated using the formula e.g. Cu/Ni gives + 0.34 - (-0.23) = 0.57V.

Metals	Process that determines potential (oxidation)	Normal potential
Magnesium	Mg → Mg ^{··}	-2.34
Aluminium	Al → Al ^{···}	-1.70
Beryllium	Be → Be ^{··}	-1.69
Manganese	Mn → Mn ^{··}	-1.10
Zinc	Zn → Zn ^{··}	-0.76
Chrome	Cr → Cr ^{··}	-0.60
Iron	Fe → Fe ^{··}	-0.44
Cadmium	Cd → Cd ^{··}	-0.44
Nickel	Ni → Ni ^{··}	-0.23
Tin	Sn → Sn ^{··}	-0.14
Lead	Pb → Pb ^{··}	-0.13
Hydrogen	H → H [·]	0
Copper	Cu → Cu ^{··}	+0.34
Silver	Ag → Ag [·]	+0.80
Mercury	Hg ₂ → 2Hg ^{··}	+0.80
Gold	Au → Au [·]	+1.5

TABLES

Physical properties

	Temperature °C	Density kg/m ³	Specific heat kJ/kg K	Thermal conductivity W/m K	Melting point °C
Gases					
Ammonia	0/100	0.771	2.056/2.219	0.022/0.033	
Carbon dioxide	0/200	1.951	0.816/1.001	0.015/0.030	
Carbon monoxide	0/200	1.234	1.038/1.055	0.023/0.037	
Nitrogen	0/200	1.234	1.038/1.047	0.024/0.037	
Air	0/200	1.276	1.005/1.022	0.024/0.039	
Oxygen	0/200	1.410	0.909/0.963	0.024/0.039	
Sulphur dioxide	0/200	2.888	0.586/0.712	0.0086/0.019	
Hydrogen	0/200	0.089	14.05/14.41	0.171/0.249	
Liquids					
Ethanol	18	791	2.39	0.17	-115
Fuel oil class I	15	860	2.36	0.285	
Paraffin	20	800	0.50	0.145	
Glycerine	20	1260	2.36	0.285	-18
Glycol	20	1120	2.4		
Hydraulic oil	XX	XX	XX		
Methanol	20	790	2.50	0.21	
Olive oil	20	920	1.65	0.17	
Paraffin	20	710	0.71	0.242	
Lubricating oil	30	900-930	2.09	0.13-0.14	
Coal tar	15-90	1100-1260	1.42		
Turpentine	18	840	1.75	0.15	10
Trichlorethylene	20	1480	0.96	0.15	
Water	18	999	4.18	0.60	
Metals					
Babits	20	10000	0.16		
Lead	20	11340	0.13	34.6	327
Bronze	20	8670	0.34	26.0	1000
Cast iron	20	7000-7800	0.54	55-64	1200
Incoloy 800	20	8030	0.50	14.0	1357
Copper	20	8950	0.42	388.0	1083
Brass	20	8100-8600	0.38	110-150	925
Stainless steel	20	7840	0.46	15.0	1440
Silumin	20	2700	0.90	160.0	570
Steel	20	7850	0.50	65.8	1516
Other solid substances					
ABS	20	1100-1220	1.46	0.19	
Acrylic	20	1100-1180	1.42	0.14	
Asbestos	0	470-700	0.81	0.15-0.23	
Asphalt	20	1100-1500	2.09	0.7	120
Bakelite	20	1400	1.60	0.23	
Cement/concrete	20	1800-2500	0.88	0.8-1.4	
Beeswax	20	965	65		
Oak (air dried)	20	690-1030	2.38	0.1-0.46	
Fat	20	920-940	2.09		
Glass	20	2400-2900	0.71-0.83	0.9	
Graphite (pure)	20	1800-2350	0.75-1.25	1.46	3000
Pine (air dried)	20	350-600	2.72	0.1-0.46	
Gravel (dry)	20	1800-2100	3.34	0.34	
Rubber (pure)	20	900-1000	1.42-2.1	0.23	125
Resin	20	1030-1340			70200
Ice	0	920	1.92	2.25	0
Marble	20	2500-2800	0.83	2.1-3.5	
Nylon	20	1070-1150	1.26-2.09	0.24	
Paper	20	700-1200	1.88	0.19 (0.13)	
Paraffin wax	20	900	2.88	0.28 (0.24)	54
Polyethylene	20	910-960	2.26	0.33	
Polyimide	20	1440	1.31-1.30	0.36-0.98	
Polycarbonate	20	1180-1250	1.26	0.20	
Polypropylene	20	880-910	1.93	0.25	
Polystyrene	20	1060	1.34	0.05-0.14	
Polyester	20	1060-1470	0.84-1.46	0.57-0.72	
Porcelain	20	2150-2360	1.09	1.05 (1.52)	1550
Sand (dry)	20	1410-1600	0.80	0.32	
Steatit	20	2590	0.84	2.94	
Brick	20	1400-2000	0.83-1.09	0.41	1580-2200

CONT. TABLES

General physical constants for elements in solid form

M = Atomic weight; ρ = Density at 18°C, kg/m³; λ = Thermal conductivity at 18°C, W/mK

c_p = Specific heat at 20–100°C, J/kgK; ϑ_{SM} = Melting point in °C; ϑ_{KP} = Boiling point at 1 bar, °C

Q_{KP} = Vaporization heat at ϑ_{KP} kJ/kg; Q_{SM} = Melting point, kJ/kg; ρ_e = Resistivity at 20°C, Ωm

$$\beta = \frac{\rho - \rho_0}{(\vartheta - \vartheta_0)\rho_0} = \text{Temperature coefficient of the resistivity}$$

$$e_0 = \text{Volta-effect at } 0^\circ\text{C, } \mu\text{V}; e_{100} = \text{Volta-effect at } 100^\circ\text{C, } \mu\text{V}$$

$$e_\vartheta = \text{Volta-effect at } \vartheta^\circ\text{C} = e_0 + \frac{\vartheta}{100}(e_{100} - e_0) \mu\text{V}$$

No	Name	Atomic no	Period	Group	M	ρ	Symbol	λ	c _p	ϑ _{sm}	Q _{sm}	ϑ _{kp}	Q _{kp}	Volta-effect		Resistivity		
														e ₀	e ₁₀₀	10 ⁵ e	10 ² β	
1	Aluminium.....	13	3	3	26.97	2700	Al	218	890	658	388	2500	11500	-1.6	-2.1	2.72	4	
2	Antimony.....	51	5	15	121.76	6680	Sb	19	210	630.5	164	1635	1250	+21	+25	39.8	5.4	
3	Arsenic.....	33	4	15	74.91	5720	As	-	325	-500	-	615	1700	-	-	37.6	3.89	
4	Barium.....	56	6	2	137.36	3780	Ba	-	300	-710	-	1640	1350	-	-	57.5	-	
5	Beryllium.....	4	2	2	9.01	1840	Be	168	1800	1280	1400	3000	24800	-	-	6.3	0.42	
6	Lead.....	82	6	14	207.21	11340	Pb	35	125	327	24.8	1750	920	-1.2	-1.4	20.7	4.2	
7	Boron.....	5	2	13	10.82	2500	B	-	1300	2300	-	2550	-	-	-	-	-	
8	Cerium.....	58	6	3	140.13	6800	Ce	-	170	775	-	1400	-	-	-	74.0	-	
9	Cesium.....	55	6	1	132.91	1873	Cs	-	210	28.5	16.3	690	500	-	-	20.8	4.4	
10	Phosphor, yellow.....	15	3	15	30.98	1830	P	-	790	44	22	280.5	1650	-	-	-	-	
11	Gallium.....	31	4	13	69.72	5903	Ga	128	330	30	79	2064	540	-	-	43.9	4.0	
12	Germanium.....	32	4	13	72.60	5460	Ge	-	290	958	-	-	-	+301.3	+373.6	-	-	
13	Gold.....	79	6	11	197.2	19300	Au	300	130	1063	84	2960	2280	+1.7	+2.2	2.21	4.0	
14	Hafnium.....	72	6	4	178.6	13300	Hf	-	-	2230	-	>3200	-	-	-	32	-	
15	Indium.....	49	5	13	114.76	7250	In	-	210	155	-	1450	-	+1.2	+1.2	9.1	4.7	
16	Iridium.....	77	6	9	193.1	22420	Ir	59	135	2454	120	>4800	3900	+1.2	0.9	5.3	4.1	
17	Iodine.....	53	5	17	126.92	4950	I	-	220	113.5	120	184.35	100	-	-	-	-	
18	Iron (amorph).....	26	4	8	55.85	7860	Fe	84	460	1530	270	2500	6400	+15.0	+10.3	9.9	6.6	
19	Cadmium.....	48	5	12	112.41	8640	Cd	100	330	320.9	54	765	1000	±0.0	+2.0	7.25	4.2	
20	Calcium.....	20	4	2	40.08	1540	Ca	600	630	850	328	1487	4200	-9.4	-12.5	4.5	3.3	
21	Potassium.....	19	4	1	39.096	870	K	134	750	63.5	60	776	2050	-12.5	-16.5	6.9	5.8	
22	Cilikon.....	14	3	14	28.06	2330	Si	-	750	1420	-	2600	14000	-	-	-	-	
23	Cobalt.....	27	4	9	58.94	8800	Co	70	420	1492	260	3185	6500	-18.6	-26.6	6.8	6.6	
24	Carbon, diamond.....	6	2	14	12.01	3510	C	165	490	3500	17000	4200	-	-	-	-		
	Carbon, graphite.....	6	2	14	12.01	2220	C	160	690	3500	17000	4200	50000	-	-	-	-	
	Carbon, amorphous.....	6	2	14	12.01	1900	C	2	840	3500	17000	4200	-	-	-	-3500	-0.5	
25	Copper.....	29	4	11	63.54	8918	Cu	395	385	1083	205	2595	4650	+1.7	+2.2	1.7241	3.93	
26	Chrome.....	24	4	6	52.01	7100	Cr	43	440	1920	315	2327	6150	-	-	2.8	-	
27	Mercury.....	80	6	12	200.61	13550	Hg	10.3	140	38.9	11.5	357	287	-3.2	-4.9	95.4	0.99	
28	Lanthanum.....	57	6	3	138.92	6150	La	-	170	885	-	1800	-	-	-	59.8	-	
29	Lithium.....	3	2	1	6.94	534	Li	70	3400	179	140	1372	21300	+13.2	+21.8	9.1	4.4	
30	Magnesium.....	12	3	2	24.32	1734	Mg	171	1000	650	200	1097	5650	-1.3	-1.5	4.3	4.1	
31	Manganese.....	25	4	7	54.93	7200	Mn	-	500	1260	260	2152	4200	-	-	5.0	-	
32	Molybdenum.....	42	5	6	95.95	10200	Mo	138	260	2620	290	4800	7100	+4.7	+8.0	4.72	4.7	
33	Sodium.....	11	3	1	23.00	970	Na	140	1250	97.5	115	877	4200	-5.4	-4.4	4.6	5.5	
34	Nickel.....	28	4	10	58.69	8900	Ni	88	450	1452	300	3075	6200	-17.8	-21.6	7.35	6.7	
35	Niobium.....	41	5	5	92.91	8550	Nb	-	270	1950	-	-	-	-	-	-	-	
36	Osmium.....	76	6	8	190.2	22480	Os	-	130	2500	145	5300	-	-	-	9.45	4	
37	Palladium.....	46	5	10	106.7	12160	Pd	67	250	1555	160	2200	3950	-6.7	-9.5	10.75	3.8	
38	Platinum.....	78	6	10	195.23	21450	Pt	71	130	1773	100	4300	2500	-4.4	-7.3	10.5	3.92	
39	Renium.....	75	6	7	186.31	20530	Re	-	135	3170	-	-	-	-	-	-	-	
40	Rhodium.....	45	5	9	102.91	12100	Rh	89	240	1966	215	>2500	-	+1.0	+0.8	5.0	4.4	
41	Rubidium.....	37	5	1	85.48	1520	Rb	-	350	38.5	25.5	713	8400	-1.5	-7.7	12.6	5.2	
42	Ruthenium.....	44	5	8	101.7	12200	Ru	-	250	2500	-	>2700	-	-	-	14.5	-	
43	Selenium (amorph).....	34	4	16	78.96	4800	Se	-	375	217.4	64.5	690	1100	-	-	-	-	
44	Silver.....	47	5	11	107.88	10500	Ag	420	230	960.5	105	2170	2150	+1.3	+2.0	1.58	4.1	
45	Strontium.....	38	5	2	87.63	2500	Sr	-	670	577	-	1360	-	-	-	32.4	3.83	
46	Sulphur, amorph.....	16	3	16	32.07	-	S	0.19	-	-120	-	-	-	-	-	-	-	-
	Sulphur, monochloride.....	16	3	16	32.07	1960	S	-	735	119.0	46	-	-	-	-	-	-	-
	Sulphur, rhombic.....	16	3	16	32.07	2070	S	0.29	720	112.8	39	444.6	290	-	-	-	-	-
47	Thallium.....	81	6	13	204.39	11850	Tl	51	125	303	17	1457	800	+0.5	±0	17.5	5.2	
48	Tantalum.....	73	5	5	180.88	16600	Ta	55	140	3027	-	5300	-	-5.0	-6.7	14.7	3.5	
49	Tellurium.....	52	5	16	127.61	6250	Te	-	210	452	30	1300	670	+330	+330	200000	-	
50	Tin.....	50	5	14	118.70	7300	Sn	65	210	231.9	59	2430	2600	-0.7	-1.1	11.3	4.6	
														-1.5	-1.5			
51	Titanium.....	22	4	4	47.90	4500	Ti	-	460	1727	-	3000	-	-	-	90.2	-	
52	Thorium.....	90	7	4	232.12	11200	Th	-	125	1840	-	>3000	-	-	-	40.1	2.1	
53	Uranium.....	92	7	6	238.07	18700	U	-	125	1690	-	-	-	-	-	-	-	-
54	Vanadium.....	23	4	5	50.95	5866	V	-	500	1715	-	3000	-	-	-	-	-	-
55	Bismuth.....	83	6	15	209.00	9800	Bi	10	120	271.3	59	1560	840	-110	-95	118	4.5	
														-54	-59			
55	Wolfram.....	74	6	6	183.92	19300	W	170	135	3370	250	5900	4800	+0.4	+3.6	5.32	4.8	
57	Zinc.....	30	4	12	65.38	7140	Zn	113	390	419.5	112	907	1800	+0.4	+0.8	5.95	4.2	
														+2.2	+3.6			
58	Zirconium.....	40	5	4	91.22	6400	Zr	-	275	1857	-	2900	-	-	-	45	-	

Reproduced from Ingenjörshandboken (The Engineer's handbook).
The Basic Technical Sciences, Nordisk Rotogravyrs Förlag/Norstedts
1965. Reproduced with necessary permission.

CONT. TABLES

Corrosion guide

The effects of corrosion have been graded in the table as follows:

- 0: Rate of corrosion <0.1 mm per year
Material used is resistant to corrosion.
- 1: Rate of corrosion 0.1–1.0 mm per year.
Material not resistant to corrosion but usable in certain cases.
- 2: Rate of corrosion >1.0 mm per year.
Excessive corrosion. Material not usable.

P: Risk for pitting and crevice corrosion.

S: Risk for stress corrosion.

Please note that the figures in the corrosion table can change considerably in if concentrations and temperatures are increased. The mixing of different substances can result in the resistance to corrosion being reduced. This applies above all to solutions containing chlorides.

Substance	Conc.%	Temp.°C	SS2337	SS2348	SS2562	I 800
1 Acetone		20-K	0	0	0	0
2 Aluminium chloride.....	5	50	P2 ^S	P2 ^S	P0 ^S	P0 ^S
3 Aluminium sulphate neutr. low Fe	10	20-K	0 2	0 1	0	0
4 Ammonium hydrate solution.....		20-K	0	0	0	0
5 Ammonium bicarbonate		20-K	0	0	0	0
6 Ammonium chloride.....	5	20-K	P0 ^S	P0 ^S	P0 ^S	P0
7 Ammonium nitrate.....	saturated	20-K	1	0	0	0
8 Ammonium persulphate	10	20	0	0	0	0
9 Ammonium sulphate.....	all concentrations	20-K	0	0	0	0
10 Benzene		20-K	0	0	0	0
11 Blood (meat juices).....		20	0	0	0	0
12 Lead acetate.....	20	20-K	0	0	0	0
13 Borax.....	saturated	20-K	0	0	0	0
14 Boric acid	saturated	20-K	0	0	0	0
15 Citric acid.....	5	20-K	0	0	0	0
16 Ether.....		20	0	0	0	0
17 Ethyl alcohol	all concentrations	20	0	0	0	0
18 Carboic acid.....	all concentrations	20-K	0 1	0	0	0
19 Formaldehyde.....	all concentrations	20	0	0	0	0
20 Phosphoric acid.....	<35, 50	80, K	0 2	0 2	—	0
21 Photographic developer		20	0	0	0	0
22 Fruit juices.....		20-K	0	0	0	0
23 Furfurol, vapour		vapour	0	0	0	0
24 Gallic acid	saturated	20-K	0	0	0	0
25 Tannic acid.....	50	20-K	0	0	0	0
26 Glycerine	all concentrations	20	0	0	0	0
27 Iron chloride (III).....	5	20	P2 ^S	P2 ^S	P2 ^S	P2 ^S
28 Iron nitrate (III).....	5	20	0	0	0	0
29 Iron sulphate (II, III)	5	20-K	0	0	0	0
30 Coffee.....		K	0	0	0	0
31 Calcium chloride.....	5	20-K	P0 ^S	P0 ^S	P0 ^S	P0 ^S
32 Potassium chromate	25	20-K	0	0	0	0
33 Potassium cyanide		20	0	0	0	0
34 Potassium chloride.....	saturated	20-K	P0 P1	P0	P0	P0
35 Potassium nitrate.....	saturated	20-K	0	0	0	0
36 Potassium permanganate	5	20-K	0	0	0	0
37 Potassium sulphate.....	5	20-K	0	0	0	0
38 Chlorine (hydrous).....		20	P2	P2	P1	P2
39 Chloroform.....		20-K	P0 P0 ^S	P0 P0 ^S	P0 P0 ^S	P0 P0 ^S

CONT. TABLES

Substance	Conc. %	Temp. °C	SS2337	SS2348	SS2562	I 800
40 Carbene tetrachloride	100	20-K	0	0	0	0
41 Copper cyanide.....	saturated	20-K	0	0	0	0
42 Copper nitrate.....	10	20-K	0	0	0	0
43 Copper sulphate.....	10	20-K	0	0	0	0
44 Chromic acid.....	10	20-K	0 2	0 2	0 2	0 2
45 Magnesium chloride.....	2.5	20	P0	P0	P0	P0
46 Magnesium sulphate.....	saturated	20-K	0	0	0	0
47 Manganese chloride.....	10	20-K	P0 ^S	P0 ^S	P0 ^S	P0 ^S
48 Lactic acid.....	5	20-K	0	0	0	0
49 Formic acid.....	5	20	0	0	0	0
50 Sodium bisulphate.....	10	20-50	0	0	0	0
51 Sodium bisulphate.....	10	20-K	0 1	0	0	0
52 Sodium citrate.....	saturated	20	0	0	0	0
53 Sodium hydroxide.....	20	20-K	0	0	0	0
54 Sodium carbonate.....	25	20-K	0	0	0	0
56 Sodium nitrate.....	saturated	20-K	0	0	0	0
57 Sodium nitrite.....	saturated	20-K	0	0	0	0
58 Sodium peroxide.....	10	20-K	0	0	0	0
59 Sodium sulphate.....	saturated	20-K	0	0	0	0
60 Sodium sulphite.....	5	20-K	0	0	0	0
61 Sodium thiosulphate.....	25	20-K	0	0	0	0
In presence of Cl.....	25	20-K	P0 ^S	P0 ^S	P0 ^S	P0 ^S
62 Nickel chloride.....	saturated	20	P0	P0	P0	P0
63 Nickel sulphate.....	saturated	20-K	0	0	0	0
64 Oxalic acid.....	5	20-K	0 2	0 1	0 1	0 1
65 Pyrogalllic acid.....	all concentrations	20-K	0	0	0	0
66 Nitric acid.....	<40	20-K	0	0	0	0
67 Hydrochloric acid.....	1	60	2	2	P1	2
68 Silvernitrate.....	5	20-K	0	0	0	0
69 Butyric acid.....		20-K	0 1	0	0	0
70 Stearic acid.....		130	0	0	0	0
71 Sulphuric acid.....	1	20-100	0 2	0 1	0 1	0 1
.....	20	20-100	2	0 2	0 2	0 2
.....	60	20-70	2	2	0 2	0 2
72 Stannic chloride.....	5	20	P2	P1	P1	P1
73 Trichlorethylene.....		20-K	0	0	0	0
74 Tartaric acid.....	10	20-K	0	0	0	0
75 Hydrogen peroxide.....	30	20	0	0	0	0
76 Zinc chloride.....	5-20	20-K	P0 P1 ^S	P0 P0 ^S	P0 P0 ^S	P0 P0 ^S
77 Zinc sulphate.....	saturated	20-K	0 1	0	0	0
78 Acetic acid.....	80	20-K	0 1	0	0	0
79 Malic acid.....	10		0	0	0	0

DESIGN CHECK LIST

- Calculate the power required
- Suitable surface load..... 107
- Decide increase in heat dissipation surface 107
- Choice of type of element..... 108
- Choice of mantle material 108
- Choice of cold parts 109
- Calculation of total length of element..... 109
- Bending 110
- Choice of fixing devices and
connections 13

Maximum recommended surface loads when heating different substances and media

Substance	Surface effect in W/cm ²			
	Temp °C	Steel	Stainless steel	Copper
Still air	50	1.7	6	
Still air	450		4	
air 3 m/s.....	200	1.5	5	
air 6 m/s.....	260	2.5	7	
air 10 m/s.....	200	3.5	10	
air 10 m/s.....	300	1.5	8	
air 10 m/s.....	450		4	
Alkaline solutions	100		6	
Thin oil.....	50		6	
Thin oil solutions.....	200		4	
Thin oil solutions.....	350		2	
Vegetable oil.....	200		4	
Heat transfer oil	200		5	
Heat transfer oil	300		2	
Tar	150		1	
Still water	100		10	10
Flowing water.....	80		15	15
Metallic surfaces for contact heating ...400	2			
Metallic surfaces for contact heating ...600		5		
Solid castings in aluminium.....	300	12	12	

The following types of tubular elements are produced

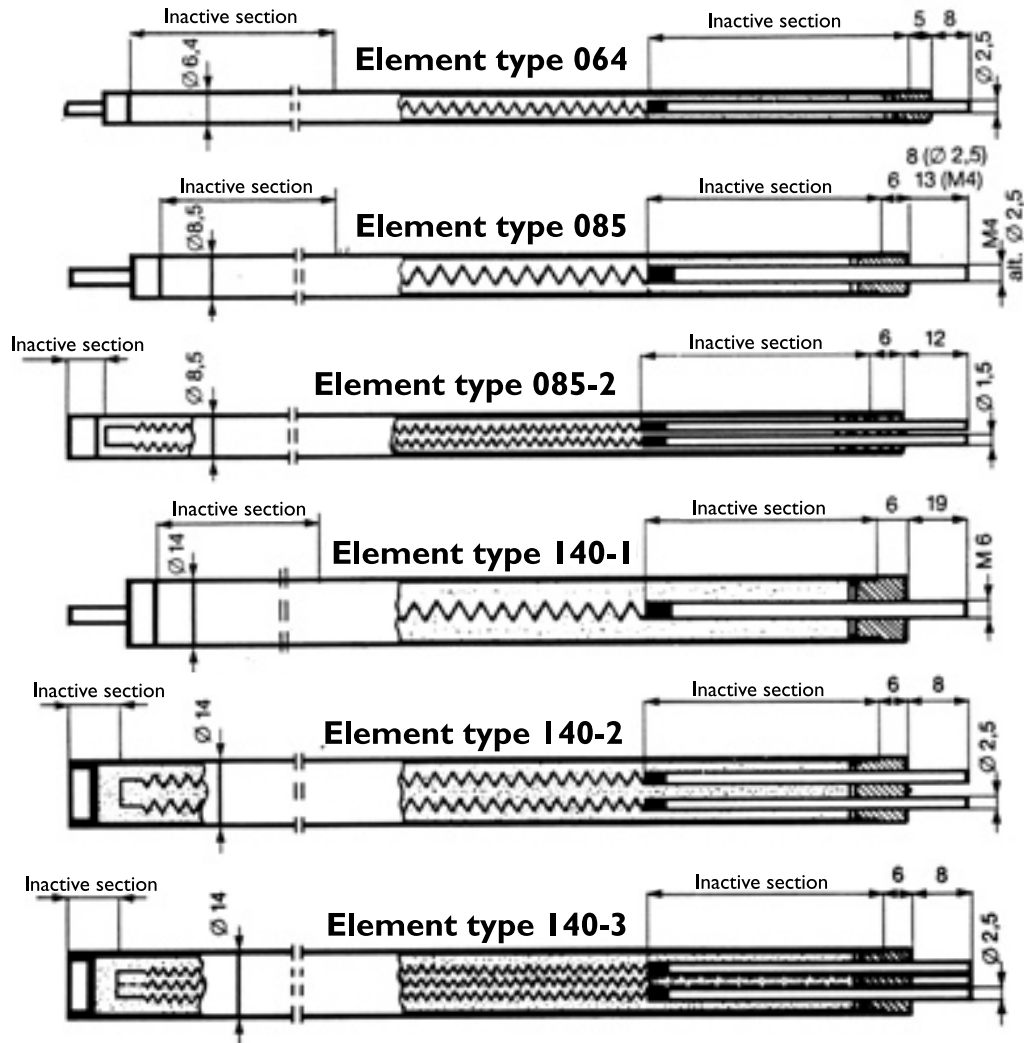

We can supply these different types of elements in the following sheath materials:

Material	Swedish standard	AISI	WERK-stoff	Max. temp*	064	085	I40
Steel.....		-	-	400	X	X	X
Stainless steel	SS2333	304	1.4301	750	X		
Stainless steel	SS2337	321	1.4541	750			X
Acid proof steel	SS2348	316L	1.4404	700	X	X	X
Copper.....	SS5015	C12200	-	250		X	X
Nickel/bronze.....	SS5667	C70600	-	275		X	
SMO254.....	SS2378	UNS S31254	-	400	X	X	X
Incoloy 800		-	1.4876	800	X	X	X
Incoloy 825		-	2.4858	450	X	X	X
R323		(302B)	1.4828S	900	X	X	
Titan		-	-				X

* Max. temp refers to the sheath temperature of the element.

Standard cold part - and max/min element lengths other cold part lengths on request

All tubular elements must be produced with an inactive part in both ends.

Tubular Element Type	Cold part length in mm																	Element length					
	30	35	45	60	70	85	100	110	130	145	175	190	200	205	235	245	275	325	375	425	475	Min.	Max.
064 Terminal pin Ø 2,5 mm Qual. SS 1914		•	•	•	•	•	•	•	•	•	•	•	•	•		•	•	•				250	3400
085 Terminal pin Ø 2,5 mm Qual. SS 1914		•	•	•	•	•	•	•	•	•	•	•	•	•		•	•	•	•	•	•	210	6400
Alt. M 4 Qual. SS 1914	•		•	•	•		•			•	•	•		•	•		•	•	•		•	210	6400
085-2 Terminal pin Ø 1,5 mm Qual. SS 1914		•	•	•			•		•	•	•	•										350	3600
140-1 Terminal pin M 6 Qual. SS 1914			•			•			•			•					•			•		160	6400
140-2 Terminal pin Ø 2,5 mm Kval. SS 1914		•	•	•	•	•	•	•	•	•	•	•	•	•		•	•	•	•	•	•	160	4200
140-3 Terminal pin Ø 2,5 mm Qual. SS 1914		•	•	•	•	•	•	•	•	•	•	•	•	•		•						220	4200

Through other companies within the Backer group we can offer a wide range of other dimensions. Please contact us for more info!

Surface load

Among other factors the functional life of an element depends on the surface load of the element. You will find recommendations for surface loads for different kind of heating purposes on page 107.

Surface load is calculated as follows:

$$Y = \frac{P}{LXM} \quad L = \frac{P}{MXY}$$

Y = Surface load in W/cm²

L = Active length of the element in cm

P = Output in W

M = Element type 064: 2.01 cm²/cm

Element type 085: 2.67 cm²/cm

Element type 140: 4.40 cm²/cm

Total length of element

The total length of the element is obtained by adding L to the total length of the inactive section.

Ohms/metre

In certain cases ohms/metre can be a limiting factor. The following limits apply:

Type of element	064	085	085-2	140-1	140-2	140-3	Min. 6 Ω/ mL	Max. 6 Ω/ mL
		3	14	3	8	8		
		1300	700	1300	1200	1000		

P = Power in W

U = Voltage in V

L = Active length of element in m

$$\text{Ohms/metre} = \frac{U^2}{P \times L}$$

Bending instructions

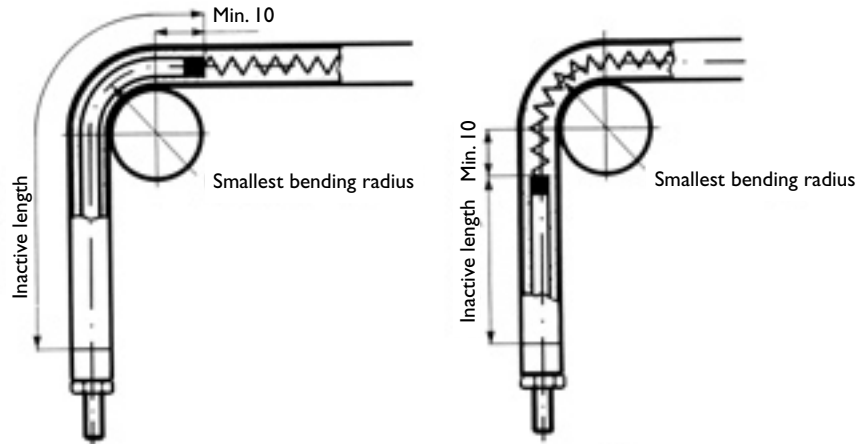

In cold state Backer's elements can easily be bent to a small radius. This simplifies the work of design. The requirement for space in different electrical appliances can be reduced

to a minimum. Terminal pins must always be least 10 mm from the extremity of a bend (see diagram).

Smallest bending radius of different sheath materials.

Type of tubular element	Copper C12200	Steel Grade D	Stainless steel EN 1.4301	Stainless steel EN 1.4404	Stainless steel EN 1.4828	Stainless steel Incoloy 800	Stainless steel Incoloy 825	Stainless steel UNS S31254	S/Titanium 20
064	10	-	10	10	10	11,5	17,5	12,5	-
085	12,5	12,5	12,5	12,5	11	15	18	15	-
140	25	25	25	25	25	30	30	30	35

When figuring an element drawing, c-c measures apply.

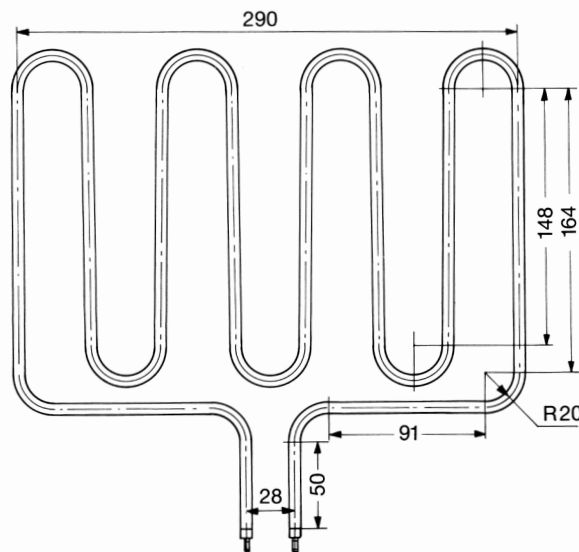

SALES CONDITIONS

1. General

These conditions of sale and delivery are applicable on deliveries of products, plants and components manufactured, delivered and/or erected by Backer BHV AB (the "Supplier"). Such products, plants and components are hereinafter jointly referred to as the "Products". These conditions apply as a complement to the parties' separate contract or any other corresponding written agreement, such as for example offers and orders preceding the delivery (the "Agreement"). The applicable Orgalime General Conditions shall be stated in the Agreement. If applicable Orgalime General Conditions are not indicated in the Agreement, Orgalime SC 06 (or any subsequent conditions that replace Orgalime SC 06) shall apply between the parties. However, Appendix 1 to Orgalime SC 06 shall never apply between the parties unless otherwise specifically set forth in the Agreement. In the event the provisions of these conditions of sale and delivery, the Agreement and applicable Orgalime General Conditions should be in conflict the documents shall take precedence in the order listed below.

- 1.The Agreement
- 2.These conditions of sale and delivery
- 3.Applicable Orgalime General Conditions (including supplementary conditions)

Any deviation from the above mentioned documents shall be approved in writing by the Supplier in order to form part of the parties' agreement. This means inter alia that the purchaser's conditions of purchase are applicable between the parties only after the Supplier's written approval.

2. Prices

All prices indicated in the Agreement are exclusive of value added tax and packaging costs.

3. Packaging

The purchaser shall pay compensation for packaging in accordance with the Supplier's at each time valid price list. The purchaser shall at its own risk and expense return standard pallets and collars to the Supplier within two months from receipt. The purchaser shall receive compensation for such standard pallets and collars in accordance with the Supplier's at any time current price list. The Supplier does not accept any other packaging in return.

4. Conditions of delivery

Unless otherwise stated in the Agreement the Products are delivered Ex Works the Supplier's factory in accordance with the valid Incoterms at any time.

5. Payment and invoicing

Unless otherwise stated in the Agreement, the purchase price shall be paid no later than thirty (30) days from the delivery date. The Supplier has the right to request payment in advance of the purchase price or that the purchaser provides other corresponding security, such as for example documentary letter of credit, before delivery of the Products, irrespective of the reason therefor.

6. Retention of title

The Products shall remain the property of the Supplier until full payment of any of the Supplier's claims out of or in connection with the Agreement has been made. However, until full payment of any of the Supplier's claims out of or in connection with the Agreement has been made the purchaser shall be entitled to process and resell

the Products in the ordinary course of business in accordance with the following provisions. Any processing of the Products shall be conducted on behalf of the Supplier as manufacturer and the Supplier shall acquire the ownership in any such newly manufactured products ("Newly Manufactured Products") in whole or, if the Newly Manufactured Products comprise products of different owners; pro rata in accordance with the value of the processed products. The purchaser herewith (in advance) assigns any current and future claims against its customers resulting from or in connection with the resale of the Products or resale of Newly Manufactured Products (in case of co-ownership of the Newly Manufactured Products; pro rata) to the Supplier as security. The Supplier herewith authorizes the purchaser to collect such assigned claims on behalf of the Supplier. The Supplier may at any time revoke said authorization. The stipulations set forth above shall apply to the extent that such retention of title is valid under the applicable law.

7. Deviations

The following shall only apply when Orgalime SC 06 or Orgalime S 2012 (or any subsequent conditions that replace said conditions) is applicable between the parties: The purchaser must accept a deviation in the quantity of delivered Products (excess or short delivery) by maximum ten (10) per cent of the ordered quantity and must make full payment of the purchase price. In case of excess delivery the purchaser is also obligated to pay for the surplus Products.

8. Samples, tools and equipment

All samples and tools as well as equipment furnished by the Supplier for the manufacture of the Products remain the sole property of the Supplier.

9. Documentation

To the extent available, the Supplier will provide product information regarding the delivered Products. Other documentation and assembly instructions are offered separately at the Purchaser's request.

10. Complaints and liability for defects

The Supplier's liability for defects follows from the applicable Orgalime General Conditions, except as set out below in this clause 10. The Supplier assumes no liability for defects as regards layout and design of the Products unless expressly stated in the Agreement. Each Product is marked with a serial number indicating the date of manufacture. The Supplier's liability for defects expires after a period of 52 weeks calculated from the date of manufacture of the Product in question. The mentioned time limitation shall apply irrespective of whether the Product or parts of the Product has/have been repaired or replaced during this period. The purchaser is liable for all costs in connection with reparations or replacements of the Products or parts of the Products. All transportation of defect Products or defect parts of the Products to and from the Supplier shall be at the purchaser's risk and expense.

11. Third party claims

If the Supplier incurs liability towards a third party that has purchased the Products from the purchaser or from downstream distributors, the purchaser shall indemnify, defend and hold the Supplier harmless against any and all such claims.



BACKER

Backer BHV AB
280 10 Sösdala, Sweden
Tel: +46 451 - 661 00
info@backer.se

www.backer.eu

EVERYDAY · EVERYWHERE